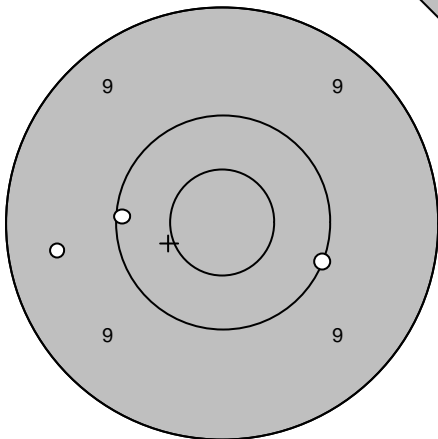
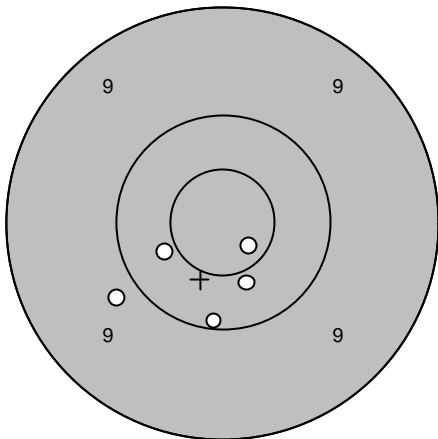
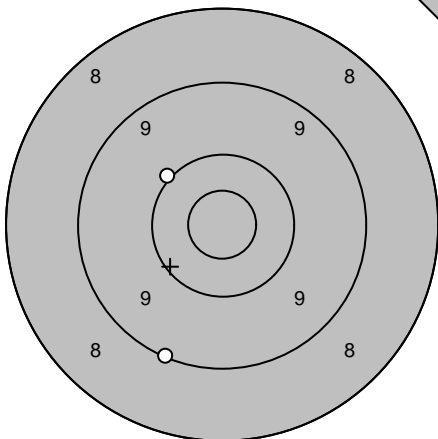
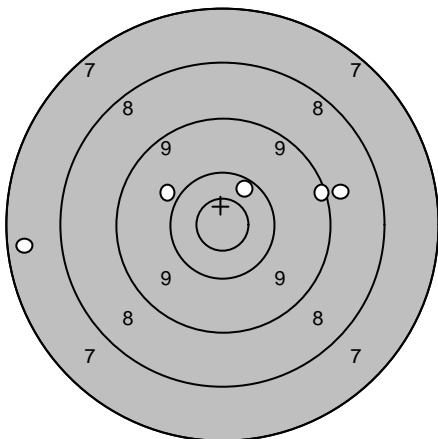
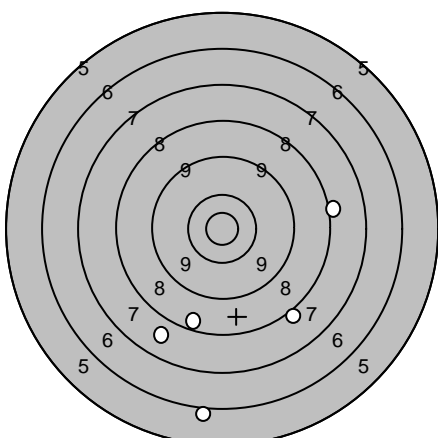
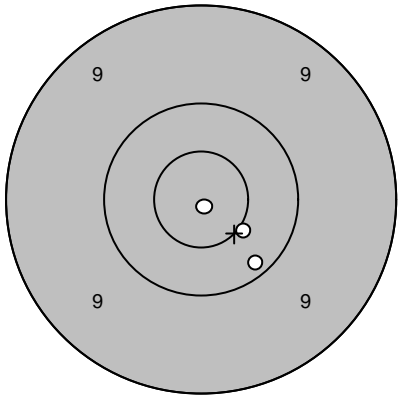
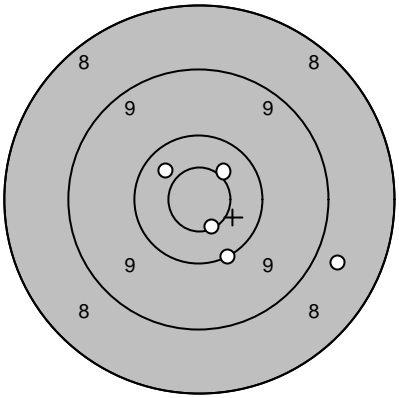
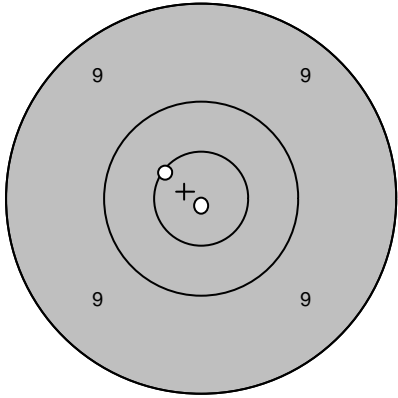
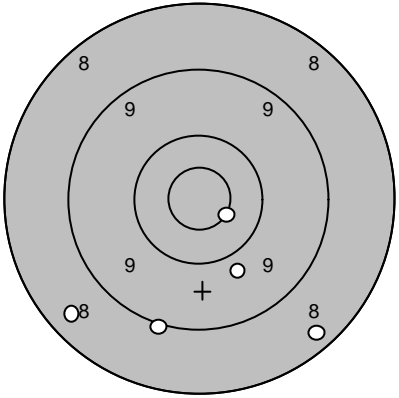
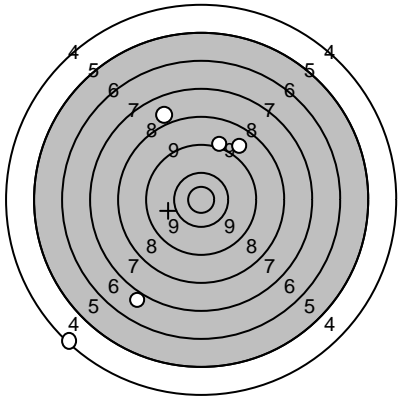
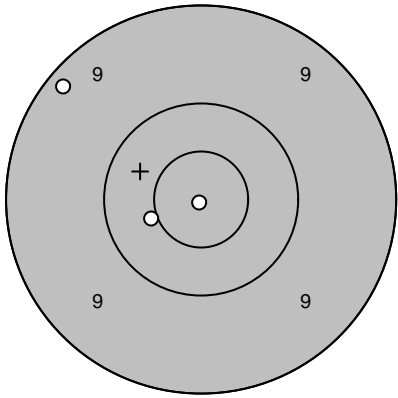
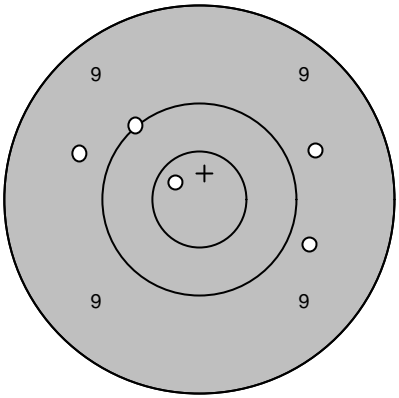
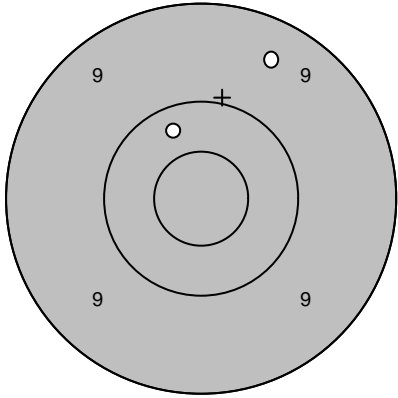
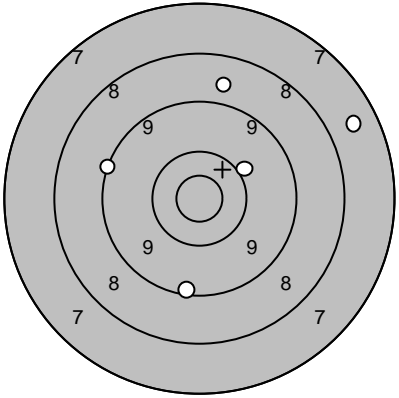
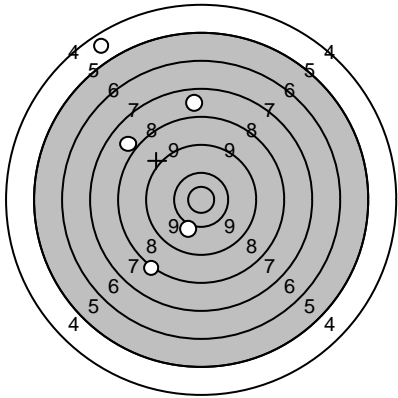
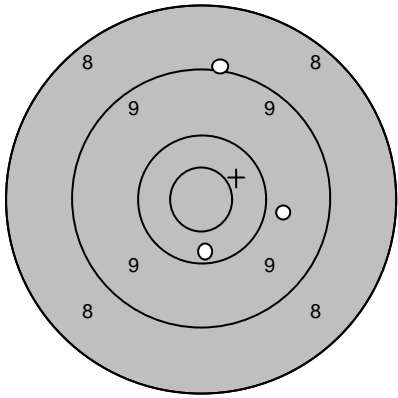
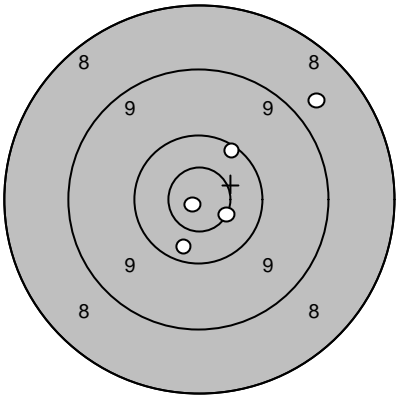
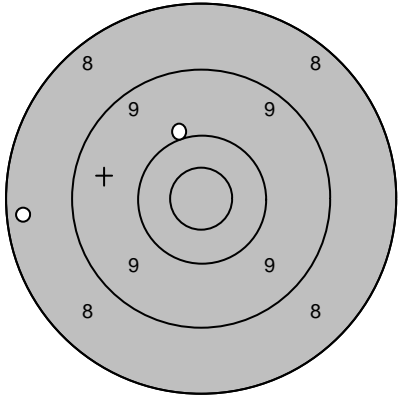
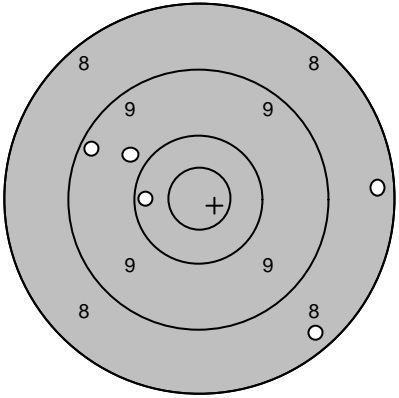
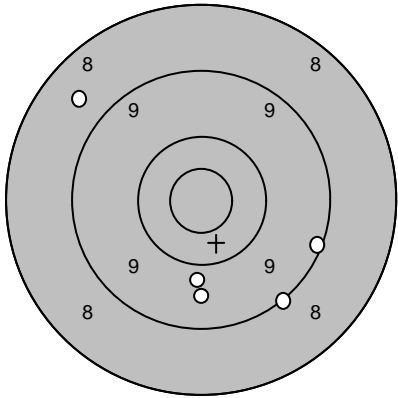
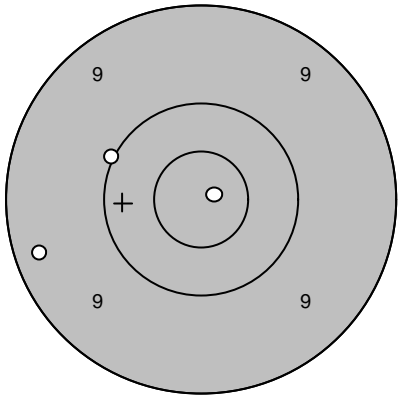
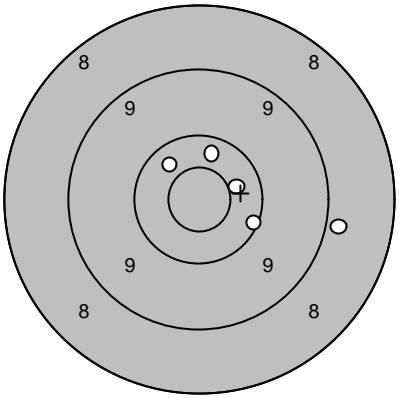
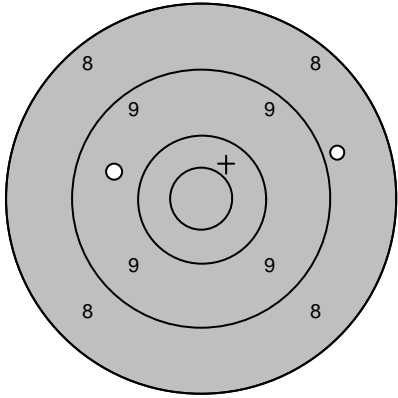
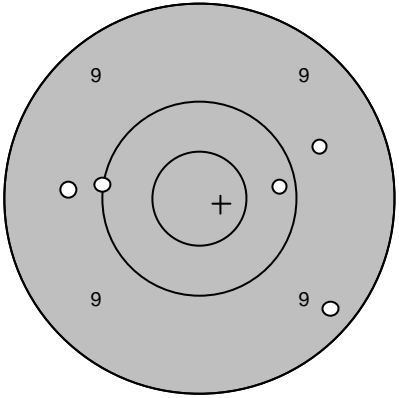
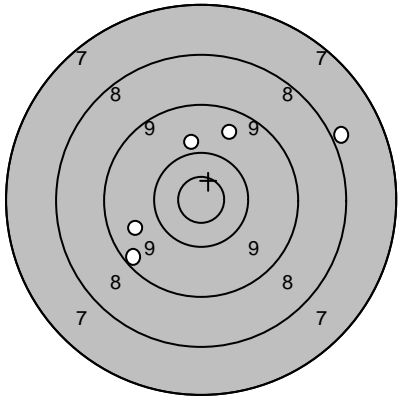

Skjutlag 1	Tavla 1	Jan-Erik Karlsson		
Ramselefors		Ramselefors		
2005-07-10		Tavelträffen B 2005 Final		Ramselefors Skytteförening
Prov 	1: 10,0 →	Serie 1 	1: 9,8 ↙	
	2: 10,1 ←		2: 10,7* ↘	
	3: 9,5 ←		3: 10,1 ↓	
			4: 10,4 ↓	
			5: 10,4 ↙	
	Serie 29,0		Serie 49,0	
	Totalt 280,0		Totalt 329,0	
Prov 	1: 10,0 ↖	Serie 2 	1: 9,2 →	
	2: 9,1 ↓		2: 7,4 ←	
				3: 8,8 →
			4: 9,9 ↙	
			5: 10,3 ↗	
	Serie 19,0		Serie 43,0	
	Totalt 329,0		Totalt 372,0	
Serie 3 	1: 8,5 ↓			
	2: 7,8 ↙			
	3: 8,0 ↘			
	4: 6,0 ↓			
	5: 8,0 →			
	Serie 37,0			
	Totalt 409,0			

Skjutlag 1	Tavla 2	Dan-Ivan Karlsson	
Ramselefors	Ramselefors		
2005-07-10	Tavelträffen B 2005 Final	Ramselefors Skytteförening	
Prov		1: 10,2 ↘ 2: 10,9* ↘ 3: 10,5* ↘	Serie 1 
			1: 10,4 ↗ 2: 10,1 ↘ 3: 8,7 ↘ 4: 10,6* ↘ 5: 10,5* ↗
		Serie 30,0	Serie 48,0
		Totalt 279,0	Totalt 327,0
Prov		1: 10,6* ↗ 2: 10,9* ↘	Serie 2 
			1: 10,6* ↘ 2: 9,8 ↘ 3: 9,0 ↘ 4: 8,4 ↘ 5: 8,4 ↘
		Serie 20,0	Serie 44,0
		Totalt 327,0	Totalt 371,0
Serie 3		1: 7,0 ↘ 2: 7,9 ↗ 3: 8,9 ↗ 4: 9,1 ↗ 5: 4,4 ↘	
		Serie 35,0	
		Totalt 406,0	

Skjutlag 1	Tavla 3	Kjell Marklund	
Ramselefors		S 3	
2005-07-10		Tavelträffen B 2005 Final	Ramselefors Skytteförening
Prov 	1: 10,5* ←	Serie 1 	1: 9,7 ←
	2: 10,9* ↓		2: 9,8 →
	3: 9,2 ↖		3: 9,8 →
			4: 10,7* ↗
			5: 10,0 ↗
	Serie 29,0		Serie 47,0
	Totalt 279,0		Totalt 326,0
Prov 	1: 10,3 ↗	Serie 2 	1: 8,7 ↑
	2: 9,4 ↗		2: 9,1 ←
			3: 9,2 ↓
			4: 7,6 ↗
			5: 10,0 ↗
	Serie 19,0		Serie 43,0
	Totalt 326,0		Totalt 369,0
Serie 3 	1: 4,7 ↖		
	2: 8,2 ↓		
	3: 10,1 ↓		
	4: 7,8 ↑		
	5: 8,0 ↖		
	Serie 37,0		
	Totalt 406,0		

Skjutlag 1	Tavla 5	Gunnar Iversen	
Ramselefors		S 3	
2005-07-10		Tavelträffen B 2005 Final	Ramselefors Skytteförening
Prov 	1: 10,3 ↓	Serie 1 	1: 10,3 ↓
	2: 9,8 →		2: 8,7 ↗
	3: 9,0 ↑		3: 10,2 ↗
			4: 10,6* →
			5: 10,9* ↙
	Serie 28,0		Serie 48,0
	Totalt 275,0		Totalt 323,0
Prov 	1: 8,3 ←	Serie 2 	1: 9,3 ←
	2: 10,0 ↑		2: 8,4 ↓
			3: 9,8 ↗
			4: 8,4 →
			5: 10,3 ←
	Serie 18,0		Serie 44,0
	Totalt 323,0		Totalt 367,0
Serie 3 	1: 9,1 ↘		
	2: 8,7 ↗		
	3: 9,2 →		
	4: 9,9 ↓		
	5: 9,6 ↓		
	Serie 44,0		
	Totalt 411,0		

Skjutlag	Tavla	Bror Rantakyrö	
1	6		
Ramselefors	Övertorneå		
2005-07-10	Tavelträffen B 2005 Final	Ramselefors Skytteförening	
Prov 	1: 10,0 ←	Serie 1 	1: 10,2 ↘
	2: 9,3 ←		2: 10,4 ↗
	3: 10,9* →		3: 8,9 →
	4: 10,4 ↑		4: 10,4 ↑
	5: 10,5* →		5: 10,5* →
	Serie 29,0		Serie 48,0
	Totalt 271,0		Totalt 319,0
Prov 	1: 8,9 →	Serie 2 	1: 9,7 ←
	2: 9,7 ←		2: 10,2 →
			3: 10,0 ←
			4: 9,7 →
			5: 9,3 ↘
	Serie 17,0		Serie 47,0
	Totalt 319,0		Totalt 366,0
Serie 3 	1: 9,9 ↑		
	2: 9,6 ↑		
	3: 8,0 →		
	4: 9,3 ↙		
	5: 9,7 ←		
	Serie 44,0		
	Totalt 410,0		

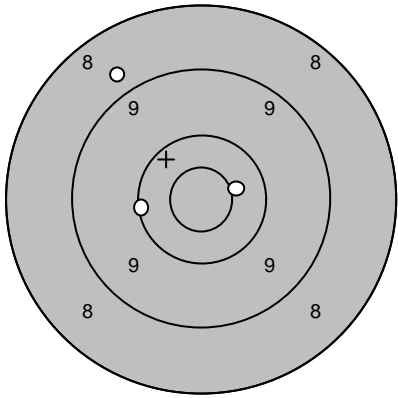
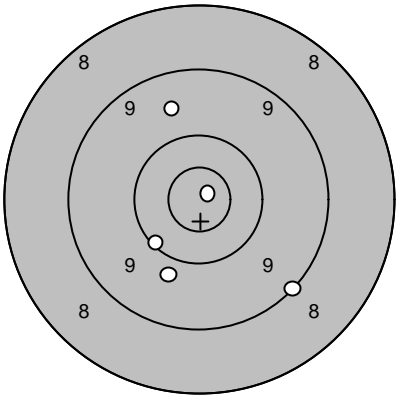
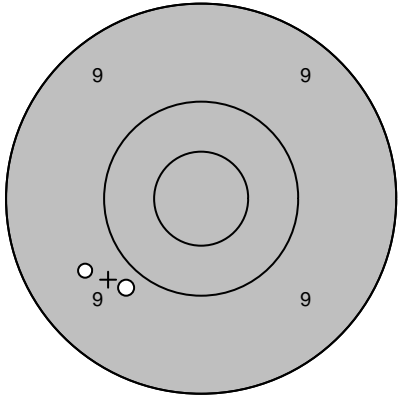
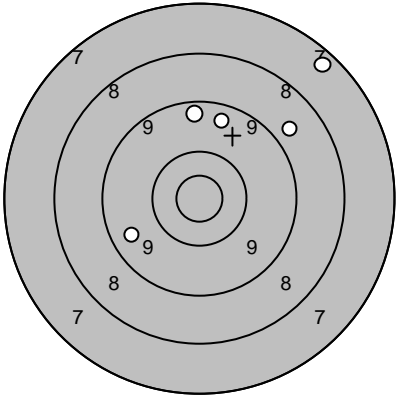
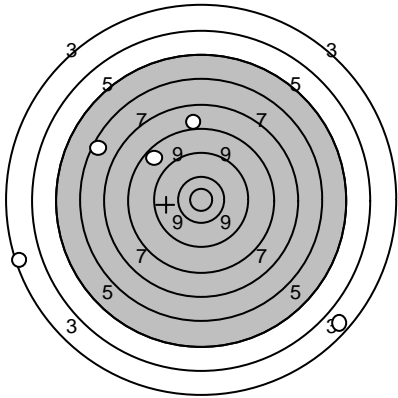
Skjutlag 1	Tavla 7	Håkan Engman	
Ramselefors		Lindesberg	
2005-07-10		Tavelträffen B 2005 Final	Ramselefors Skytteförening
Prov		1: 10,1 ← 2: 10,5* → 3: 8,8 ↖	Serie 1 
		Serie 28,0 Totalt 265,0	1: 10,1 ↙ 2: 9,8 ↓ 3: 10,9* ↗ 4: 9,1 ↘ 5: 9,6 ↑
			Serie 47,0 Totalt 312,0
Prov		1: 9,9 ↙ 2: 9,6 ↙	Serie 2 
		Serie 18,0 Totalt 312,0	1: 9,6 ↙ 2: 7,4 ↗ 3: 8,8 ↗ 4: 9,4 ↑ 5: 9,5 ↑
			Serie 42,0 Totalt 354,0
Serie 3		1: 3,5 ← 2: 8,1 ↑ 3: 6,6 ↖ 4: 8,7 ↗ 5: 3,7 ↘	
		Serie 28,0 Totalt 382,0	

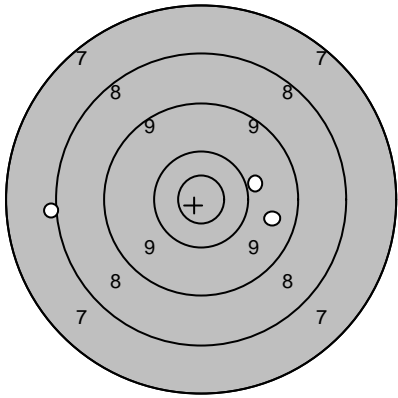
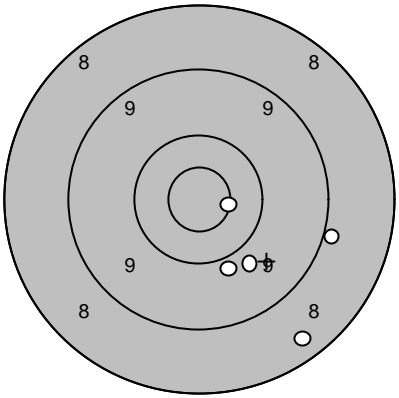
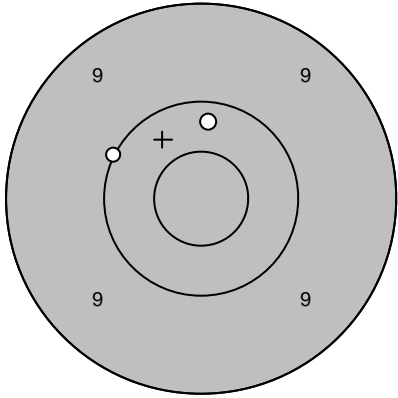
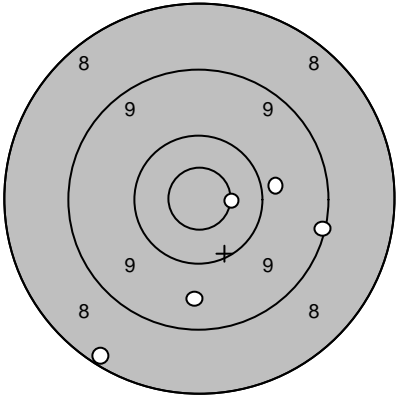
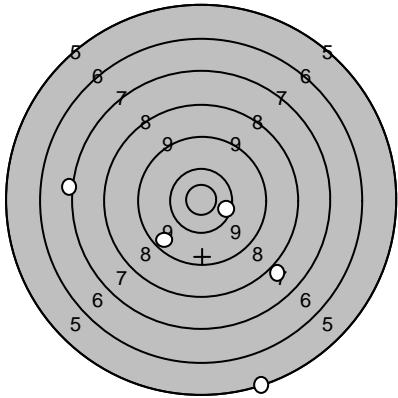
Skjutlag 1	Tavla 9	Curt Linerud	
Ramselefors		I 20	
2005-07-10		Tavelträffen B 2005 Final	Ramselefors Skytteförening
Prov		1: 8,1 ← 2: 10,0 → 3: 9,6 →	Serie 1 
		Serie 27,0 Totalt 263,0	1: 10,6* → 2: 8,4 ↙ 3: 9,9 ↙ 4: 9,0 ↘ 5: 9,8 ↙
			Serie 45,0 Totalt 308,0
Prov		1: 10,0 ↙ 2: 10,3 ↑	Serie 2 
		Serie 20,0 Totalt 308,0	1: 9,1 → 2: 9,5 ↓ 3: 10,6* → 4: 8,2 ↙ 5: 9,9 →
			Serie 45,0 Totalt 353,0
Serie 3		1: 9,5 ↙ 2: 10,4 → 3: 5,2 ↙ 4: 7,2 ← 5: 8,0 ↙	
		Serie 39,0 Totalt 392,0	

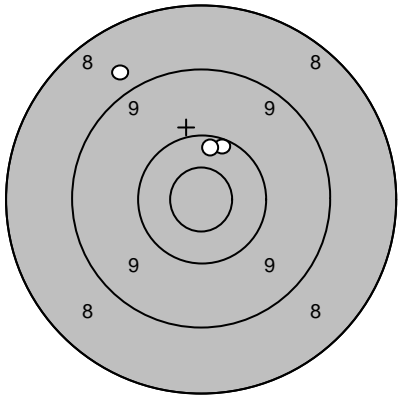
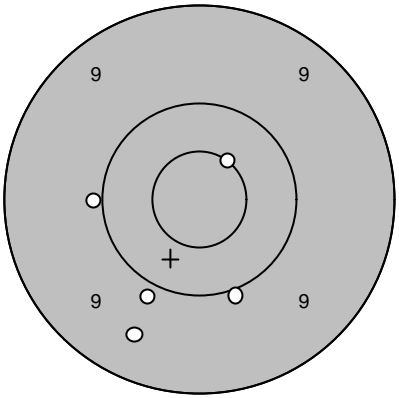
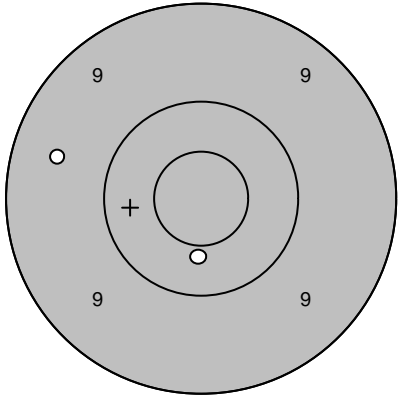
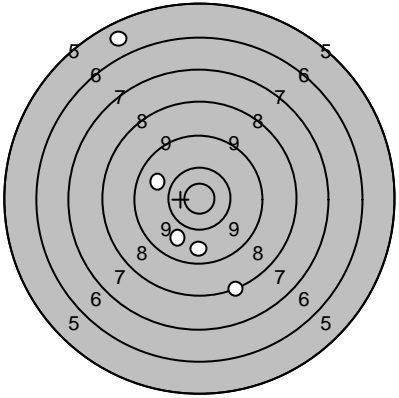
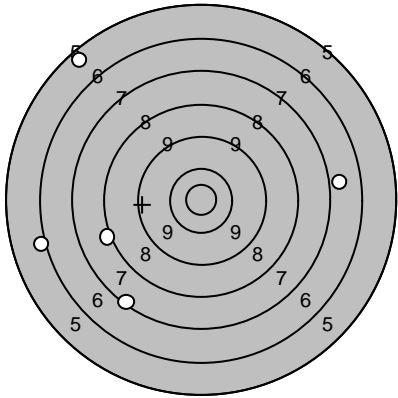
Skjutlag 1	Tavla 10	Dennis Sundqvist	
Ramselefors		Piteå	
2005-07-10		Tavelträffen B 2005 Final	Ramselefors Skytteförening
Prov		1: 8,8 ↖ 2: 10,2 ↑ 3: 10,3 ↑	Serie 1 
		Serie 28,0 Totalt 262,0	1: 10,0 ← 2: 9,9 ↓ 3: 10,0 ↓ 4: 10,5* ↗ 5: 9,5 ↓
			Serie 48,0 Totalt 310,0
Prov		1: 9,5 ← 2: 10,4 ↓	Serie 2 
		Serie 19,0 Totalt 310,0	1: 9,8 ← 2: 5,7 ↗ 3: 8,2 ↓ 4: 9,7 ↓ 5: 9,8 ↓
			Serie 40,0 Totalt 350,0
Serie 3		1: 6,1 ← 2: 7,3 ↓ 3: 5,5 ↖ 4: 8,1 ← 5: 6,9 →	
		Serie 32,0 Totalt 382,0	

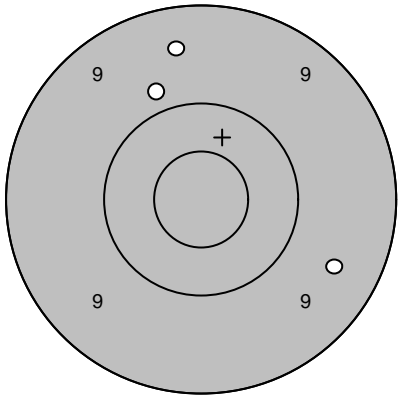
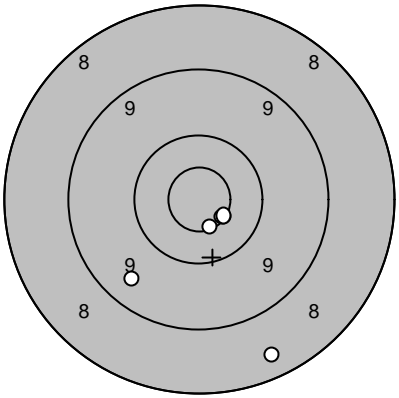
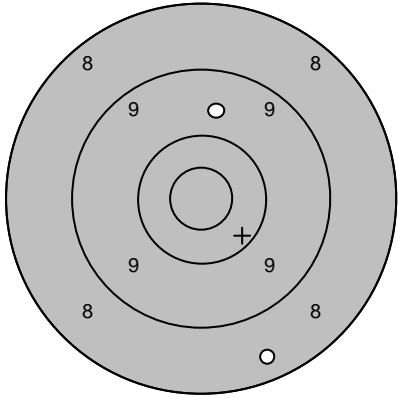
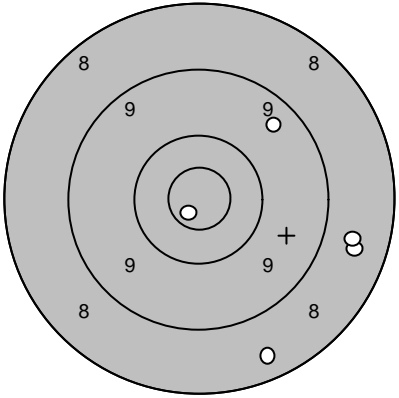
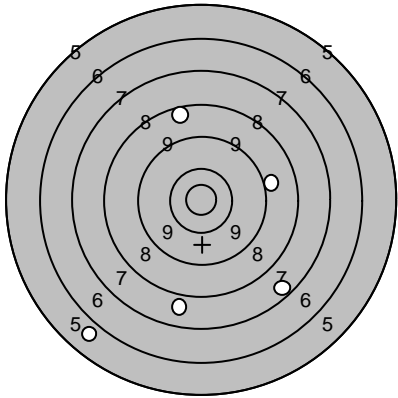
Skjutlag 1	Tavla 11	Martin Olofsson	
Ramselefors		Vännäs	
2005-07-10		Tavelträffen B 2005 Final	Ramselefors Skytteförening
Prov		1: 9,8 ↗ 2: 9,5 ↑ 3: 9,5 →	Serie 1 
		Serie 27,0 Totalt 262,0	1: 10,6* ↘ 2: 10,6* ↘ 3: 10,6* ↘ 4: 9,5 ↘ 5: 8,5 ↘
			Serie 47,0 Totalt 309,0
Prov		1: 9,7 ↑ 2: 8,4 ↘	Serie 2 
		Serie 17,0 Totalt 309,0	1: 9,5 ↗ 2: 10,8* ↘ 3: 8,5 ↘ 4: 8,6 → 5: 8,6 →
			Serie 43,0 Totalt 352,0
Serie 3		1: 8,5 ↑ 2: 7,6 ↘ 3: 5,8 ↘ 4: 7,9 ↘ 5: 9,0 →	
		Serie 36,0 Totalt 388,0	

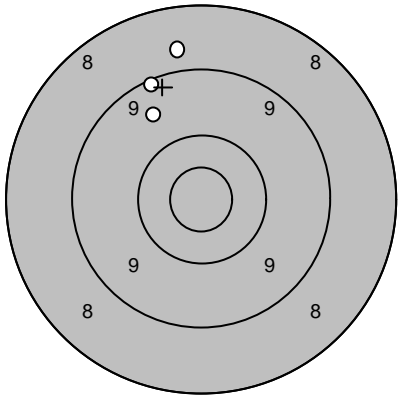
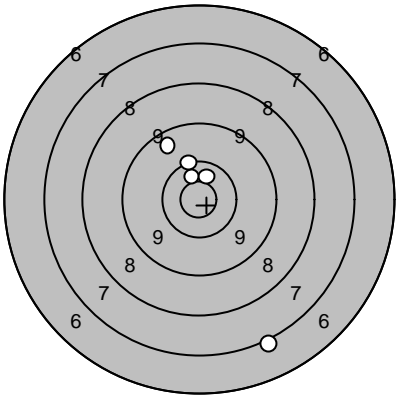
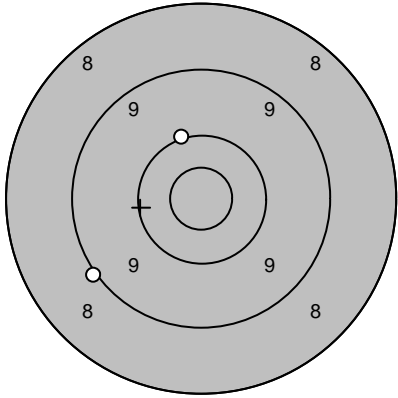
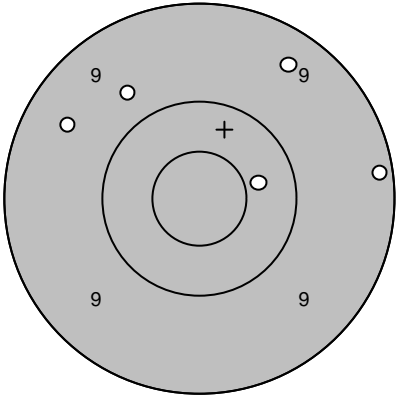
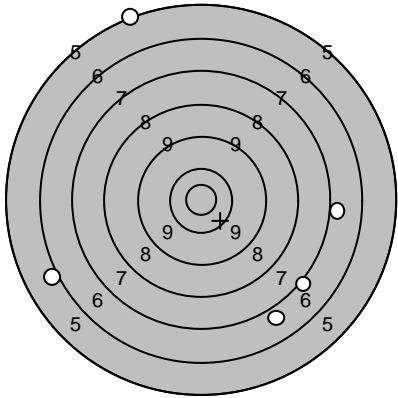
Skjutlag	Tavla	Roland Nilsson		
1	12			
Ramselefors	Piteå			
2005-07-10	Tavelträffen B 2005 Final	Ramselefors Skytteförening		
Prov		1: 9,2 ↖ 2: 8,8 ↑ 3: 9,6 ↖	Serie 1 	1: 10,5* ↗ 2: 10,6* ↗ 3: 9,6 ↗ 4: 10,2 ↗ 5: 7,1 ↘
		Serie 26,0	Serie 46,0	
		Totalt 261,0	Totalt 307,0	
Prov		1: 9,0 ↙ 2: 10,1 ↑	Serie 2 	1: 9,5 ↖ 2: 9,4 ↗ 3: 9,2 → 4: 9,7 ↗ 5: 10,4 →
		Serie 19,0	Serie 46,0	
		Totalt 307,0	Totalt 353,0	
Serie 3		1: 5,2 ↗ 2: 7,0 → 3: 6,9 ↘ 4: 7,1 ↘ 5: 6,1 ↖		
		Serie 31,0		
		Totalt 384,0		

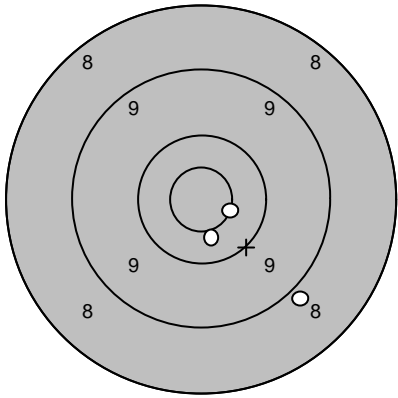
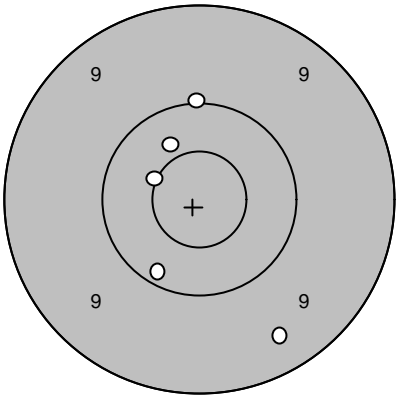
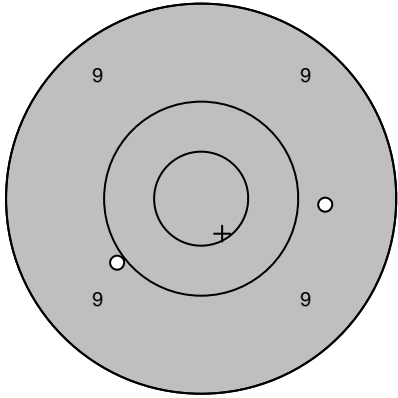
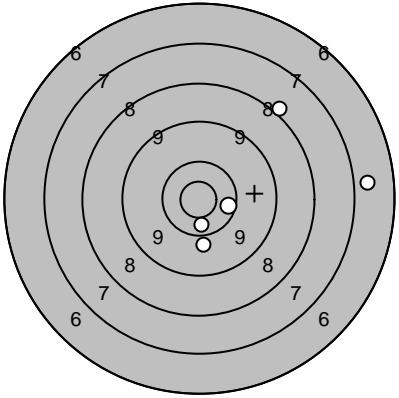
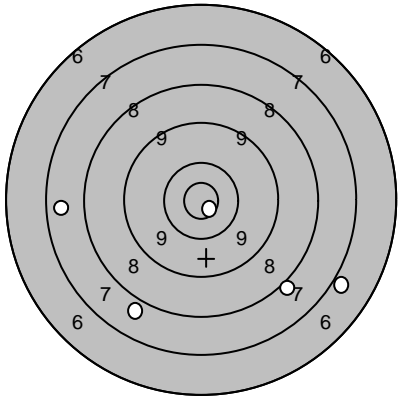
Skjutlag 1	Tavla 13	Linda Bergman	
Ramselefors		Ununge	
2005-07-10		Tavelträffen B 2005 Final	Ramselefors Skytteförening
Prov		1: 10,5* ↓ 2: 10,6* → 3: 8,9 ↓	Serie 1 
		Serie 28,0 Totalt 277,0	1: 10,0 ↑ 2: 10,2 ↓ 3: 10,4 ↗ 4: 10,5* ← 5: 9,4 ↓
			Serie 49,0 Totalt 326,0
Prov		1: 10,0 ↙ 2: 9,8 →	Serie 2 
		Serie 19,0 Totalt 326,0	1: 10,4 → 2: 10,5* ↓ 3: 10,0 ↓ 4: 8,1 ↗ 5: 6,8 →
			Serie 44,0 Totalt 370,0
Serie 3		1: 7,6 ← 2: 7,0 → 3: 10,9* ↓ 4: 8,0 ↓ 5: 7,9 ↓	
		Serie 39,0 Totalt 409,0	

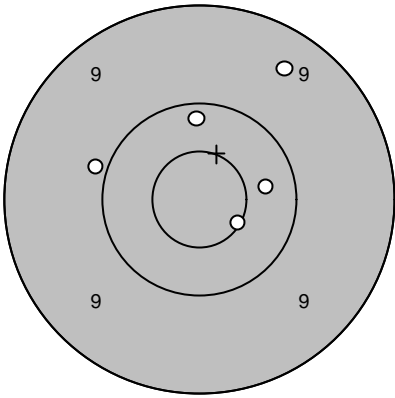
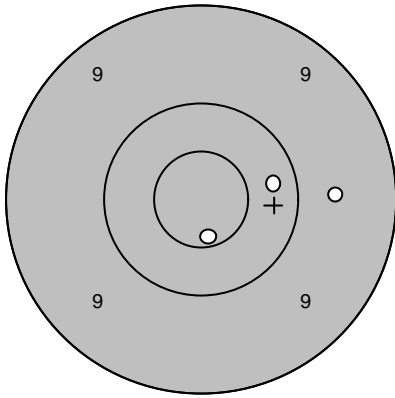
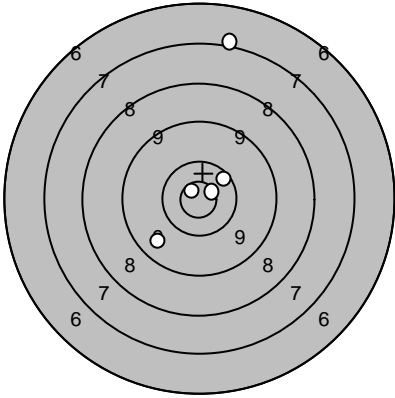
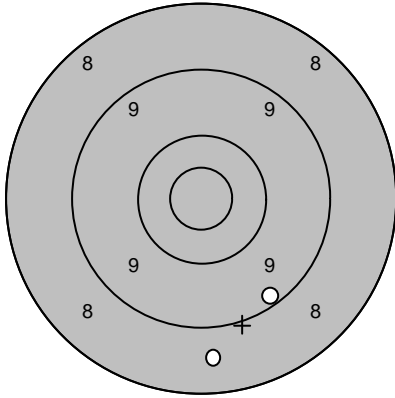
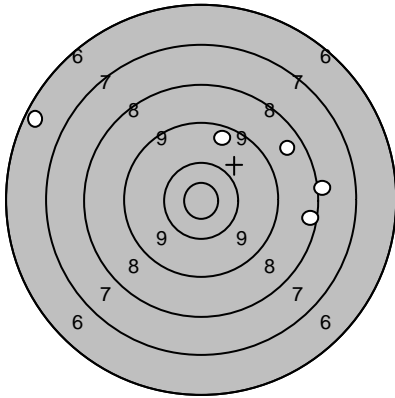
Skjutlag	Tavla			
1	14	Johan Nilsson		
Ramselefors	Ramselefors			
2005-07-10	Tavelträffen B 2005 Final	Ramselefors Skytteförening		
Prov		1: 9,7 → 2: 10,6* ↓ 3: 10,3 →	Serie 1 	1: 10,6* ↘ 2: 9,9 ← 3: 10,2 ↑ 4: 10,3 → 5: 9,4 ↗
				
		Serie 29,0		Serie 48,0
		Totalt 273,0		Totalt 321,0
Prov		1: 9,2 ↘ 2: 8,6 ↓	Serie 2 	1: 9,6 ↙ 2: 10,4 ↗ 3: 10,9* ↖ 4: 10,8* ↗ 5: 7,1 ↑
				
		Serie 17,0		Serie 46,0
		Totalt 321,0		Totalt 367,0
Serie 3		1: 6,5 ↖ 2: 8,3 → 3: 8,6 ↗ 4: 9,5 ↑ 5: 8,0 →		
				
		Serie 39,0		
		Totalt 406,0		

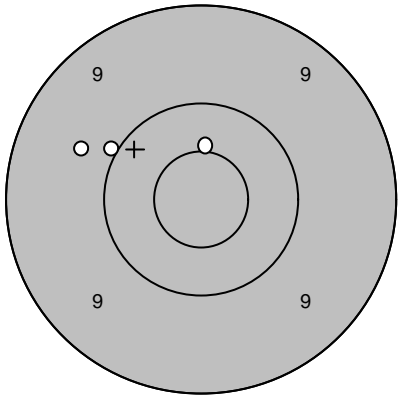
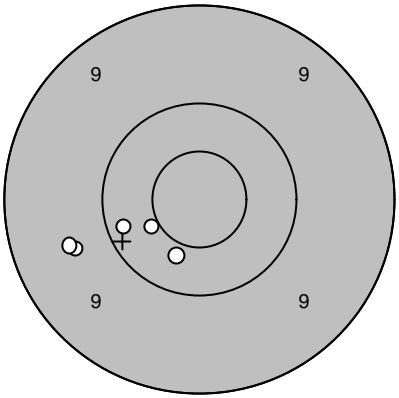
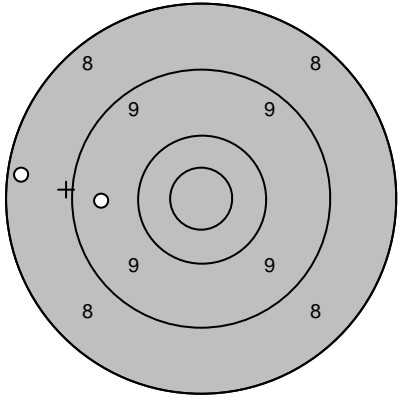
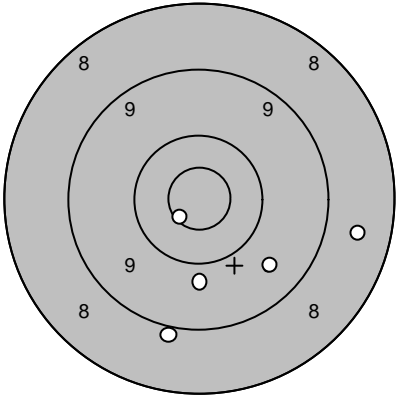
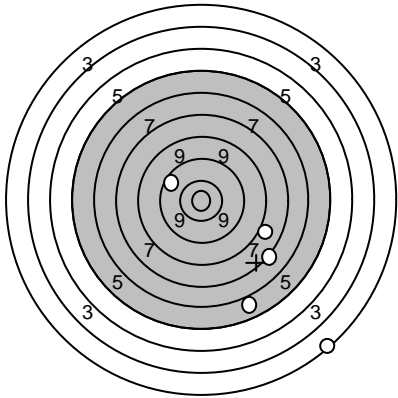
Skjutlag	Tavla	Rune Utterström	
1	15		
Ramselefors	Ale		
2005-07-10	Tavelträffen B 2005 Final	Ramselefors Skytteförening	
Prov		1: 10,5* ↑ 2: 9,7 ← 3: 10,0 ←	Serie 1 
		Serie 29,0 Totalt 267,0	1: 9,7 ← 2: 10,2 ← 3: 10,5* ← 4: 10,4 ↓ 5: 9,6 ←
			Serie 48,0 Totalt 315,0
Prov		1: 9,5 ← 2: 8,3 ←	Serie 2 
		Serie 17,0 Totalt 315,0	1: 10,7* ← 2: 9,6 ↘ 3: 8,9 ↓ 4: 9,8 ↓ 5: 8,6 →
			Serie 44,0 Totalt 359,0
Serie 3		1: 2,5 ↓ 2: 8,0 → 3: 6,0 ↓ 4: 7,2 ↓ 5: 9,8 ↗	
		Serie 32,0 Totalt 391,0	

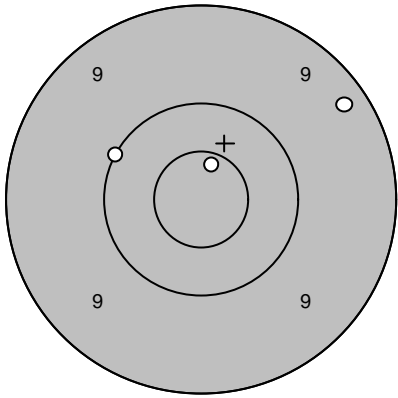
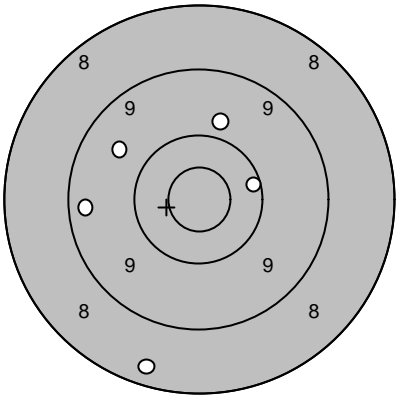
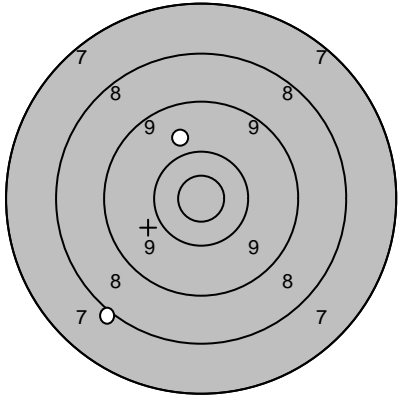
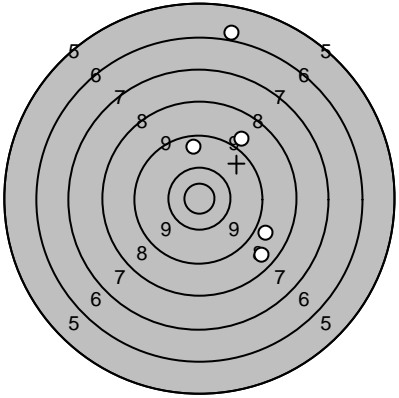
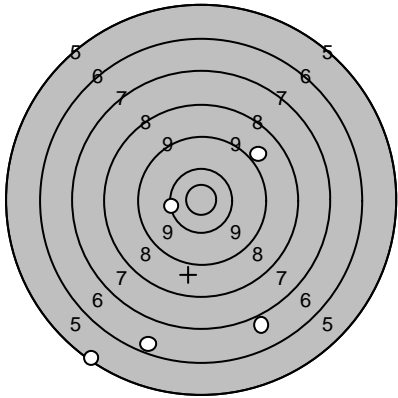
Skjutlag	Tavla			
1	16	Ivar Larsson		
Ramselefors	Närkes-Kil			
2005-07-10	Tavelträffen B 2005 Final	Ramselefors Skytteförening		
Prov		1: 9,3 ↗ 2: 10,7* ↑ 3: 10,0 ↖	Serie 1 	1: 10,2 → 2: 9,8 ↑ 3: 9,3 ← 4: 9,7 ↖ 5: 8,4 ↓
		Serie 29,0	Serie 45,0	
		Totalt 261,0	Totalt 306,0	
Prov		1: 9,8 ↑ 2: 8,1 ↘	Serie 2 	1: 9,0 ↗ 2: 8,9 ↘ 3: 6,0 ↑ 4: 9,6 ↑ 5: 8,6 ↘
		Serie 17,0	Serie 40,0	
		Totalt 306,0	Totalt 346,0	
Serie 3		1: 6,9 ↓ 2: 9,0 ↗ 3: 6,5 ↓ 4: 5,3 ↘ 5: 10,3 ←		
		Serie 36,0		
		Totalt 382,0		

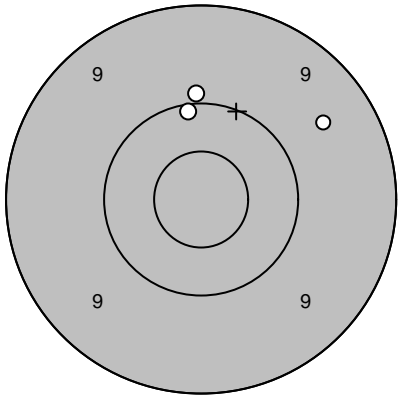
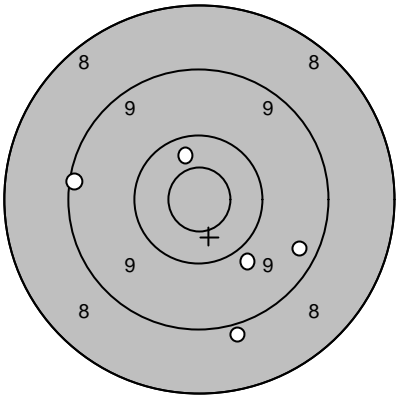
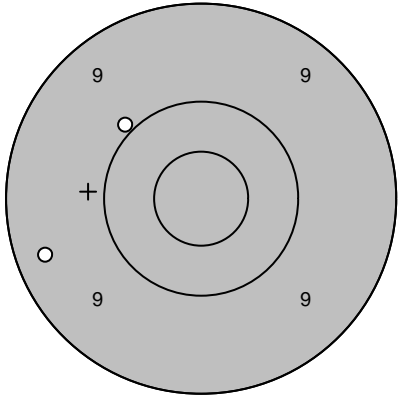
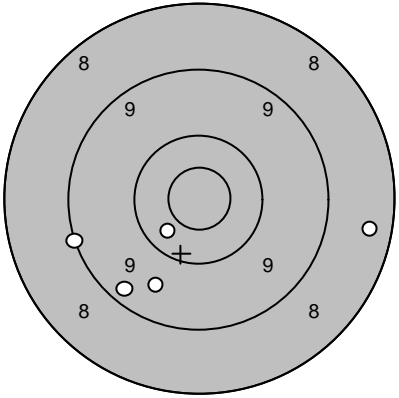
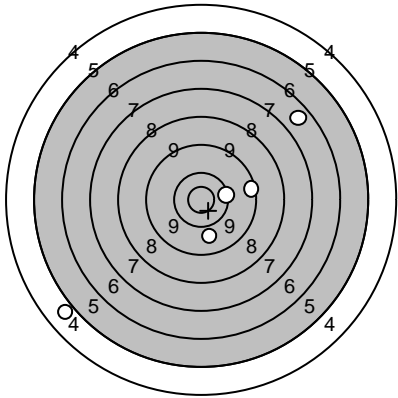
Skjutlag 1	Tavla 17	Mattias Lundström	
Ramselefors	Flarken		
2005-07-10	Tavelträffen B 2005 Final	Ramselefors Skytteförening	
Prov		1: 10,1 ↑ 2: 9,6 ↗ 3: 10,0 ↑	Serie 1 
			1: 10,4 ↑ 2: 9,9 ↓ 3: 9,2 ← 4: 9,4 ↘ 5: 8,9 ↓
		Serie 29,0	Serie 45,0
		Totalt 259,0	Totalt 304,0
Prov		1: 10,0 ↖ 2: 9,3 ←	Serie 2 
			1: 9,6 ↓ 2: 10,4 ↓ 3: 9,3 ↓ 4: 9,1 ← 5: 8,4 →
		Serie 19,0	Serie 45,0
		Totalt 304,0	Totalt 349,0
Serie 3		1: 6,7 ↗ 2: 10,3 → 3: 9,9 ↓ 4: 5,0 ↙ 5: 9,4 →	
		Serie 39,0	
		Totalt 388,0	

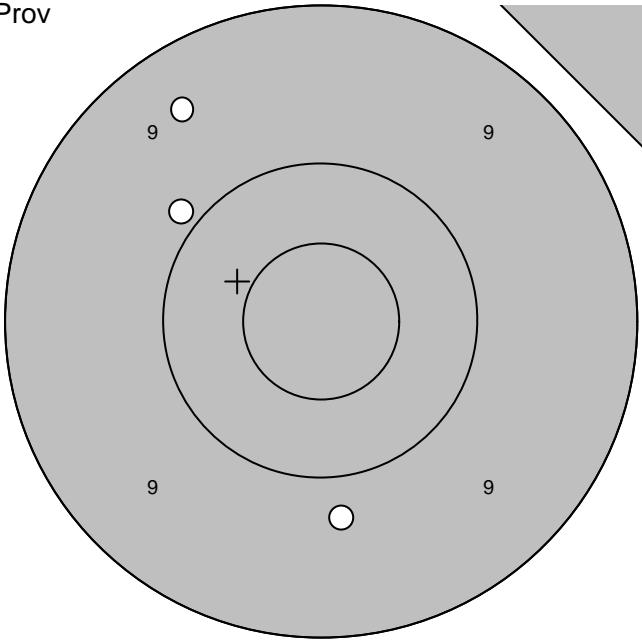
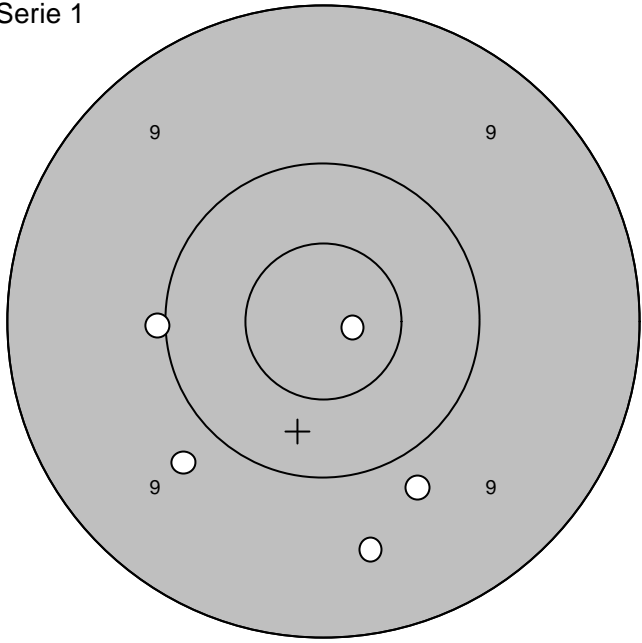
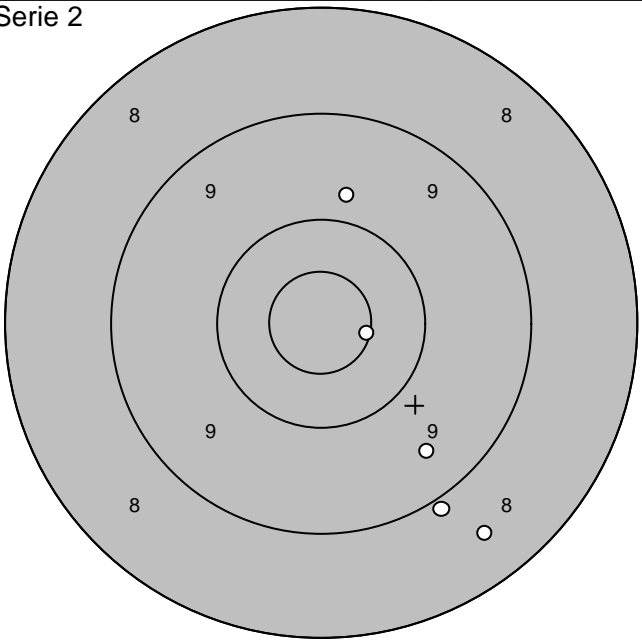
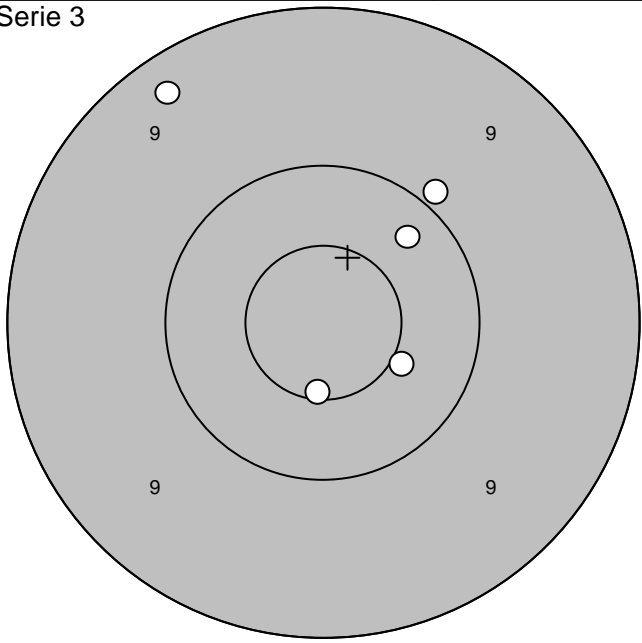
Skjutlag	Tavla	Per Östling	
1	20		
Ramselefors	F 21		
2005-07-10	Tavelträffen B 2005 Final	Ramselefors Skytteförening	
Prov	Serie 1		
			
1: 9,9 ↗	Serie 27,0	1:10,0 ←	Serie 47,0
2: 9,4 ↗		2:10,8* →	
3: 9,8 ↓	Totalt 283,0	3: 9,6 ↓	Totalt 330,0
		4: 9,8 ↙	
		5: 9,8 ↓	
Serie 2		Serie 3	
			
1: 9,8 ↑	Serie 44,0	1: 9,9 ↗	Serie 48,0
2:10,6* →		2: 9,3 ↗	
3: 8,9 ↓	Totalt 374,0	3:10,5* →	Totalt 422,0
4: 8,5 ↓		4:10,6* ↓	
5: 9,4 ↓		5:10,3 ↗	

Skjutlag 1	Tavla 21	Hugo Håkansson	
Ramselefors		Östersund	
2005-07-10		Tavelträffen B 2005 Final	Ramselefors Skytteförening
Prov		Serie 1	
1: 8,6 ↑	Serie 27,0	1: 9,4 ↓	Serie 47,0
2: 10,3 ↖		2: 9,2 ↘	
3: 9,5 ←	Totalt 280,0	3: 9,5 ↘	Totalt 327,0
		4: 10,5* →	
		5: 10,4 ↑	
Serie 2		Serie 3	
1: 10,1 ↗	Serie 46,0	1: 9,9 ←	Serie 48,0
2: 10,7* ↘		2: 10,3 ←	
3: 9,4 ↘	Totalt 373,0	3: 10,7* ↘	Totalt 421,0
4: 7,1 ↑		4: 9,1 ↓	
5: 10,8* →		5: 10,6* →	

Skjutlag 1	Tavla 22	Rolf Åström	
Ramselefors		Brattby	
2005-07-10		Tavelträffen B 2005 Final	Ramselefors Skytteförening
Prov		Serie 1	
1: 8,9 ↖ 2: 10,3 ↘ 3: 9,5 →		Serie 27,0 Totalt 278,0	1: 9,5 ↗ 2: 9,9 ↗ 3: 9,4 → 4: 8,9 ↘ 5: 7,8 ↘
		Serie 42,0 Totalt 320,0	
Serie 2		Serie 3	
1: 9,7 ↓ 2: 9,6 ← 3: 8,9 ↘ 4: 9,2 ↓ 5: 9,4 ↘		Serie 44,0 Totalt 364,0	1: 9,8 ↘ 2: 9,6 ↗ 3: 8,5 ↗ 4: 9,0 ↓ 5: 10,9* →
		Serie 45,0 Totalt 409,0	

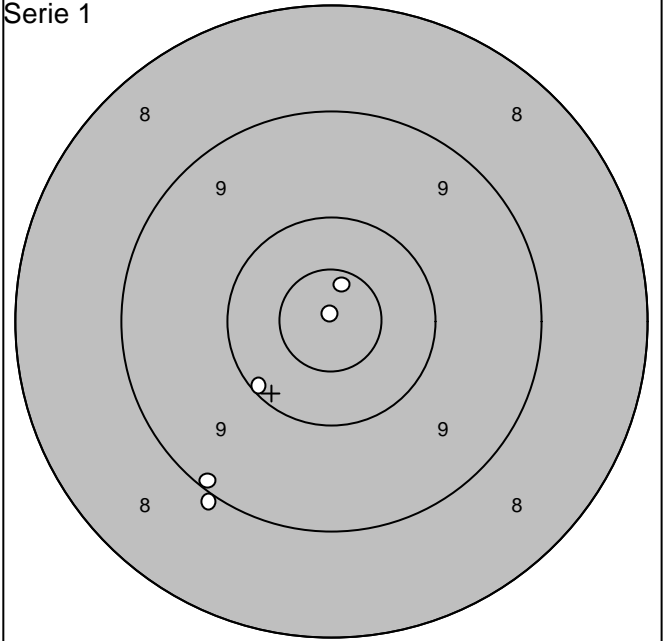
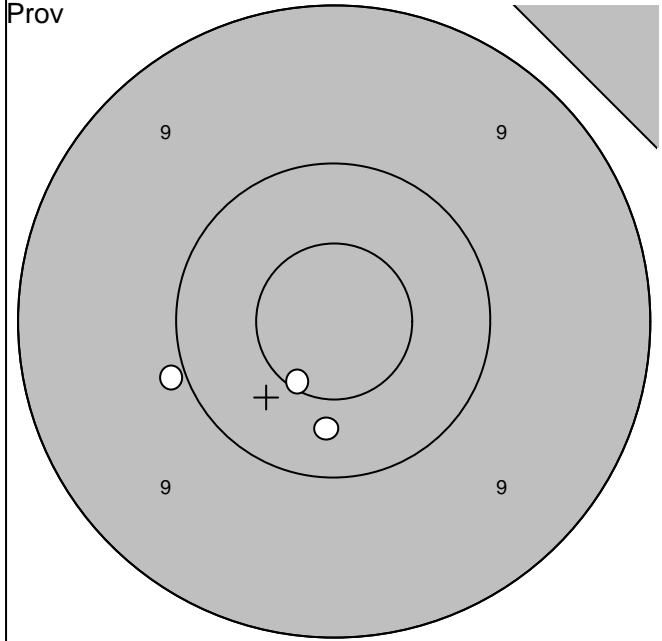

1:10,3 ↓		Serie	29,0
2: 9,9 ←		Totalt	274,0
3:10,6* ↓			

1:10,7* ↑		Serie	48,0
2: 9,1 ↙		Totalt	322,0
3:10,1 ↙			
4: 9,0 ↙			
5:10,9* ↑			

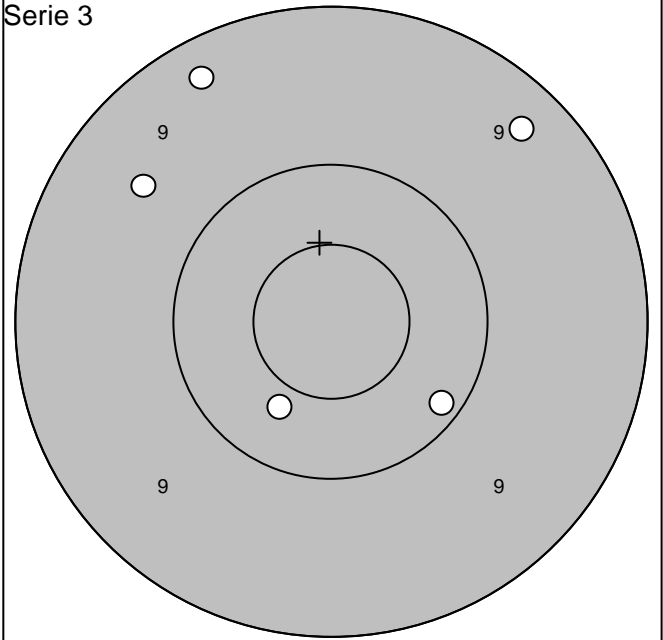
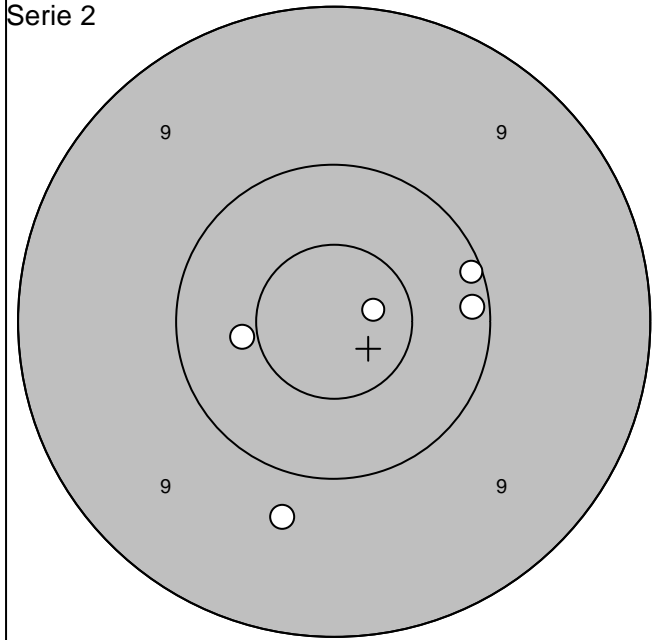

1:10,4 ←		Serie	49,0
2:10,1 →		Totalt	371,0
3:10,2 →			
4:10,8* →			
5: 9,8 ↓			

1: 9,3 ↑		Serie	47,0
2: 9,6 ↑		Totalt	418,0
3:10,2 ↘			
4:10,4 ↙			
5: 9,3 ↗			

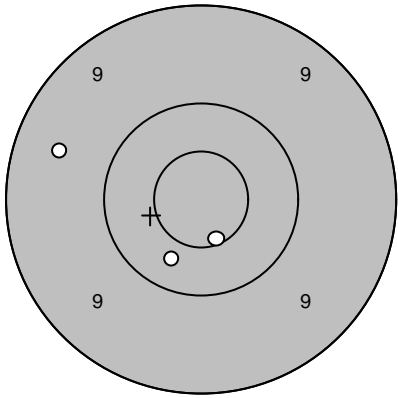
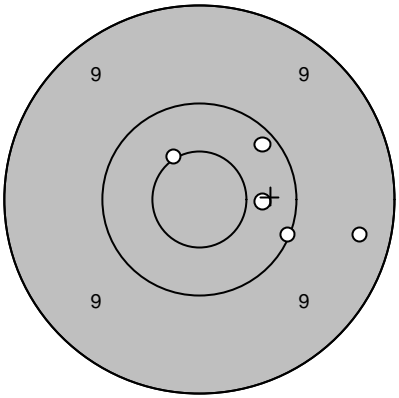
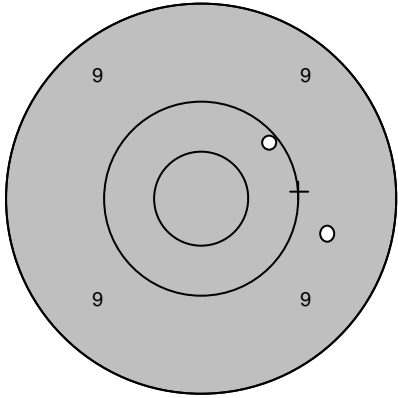
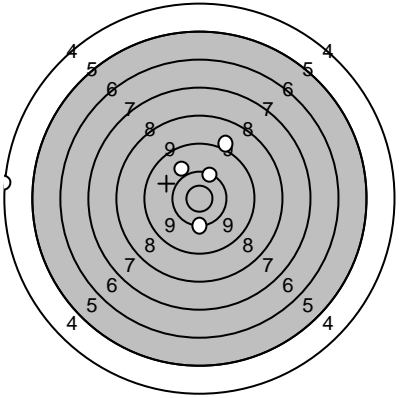
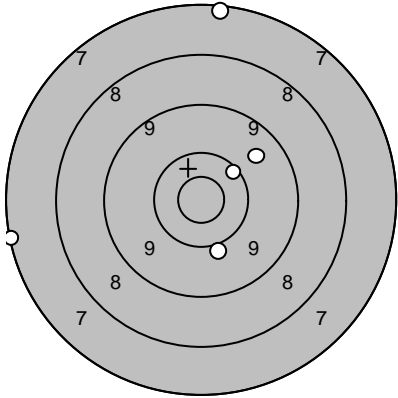
Skjutlag 2	Tavla 1	David Karlsson		
Ramselefors		Bastuträsk		
2005-07-10		Tavelträffen B 2005 Final	Ramselefors Skytteförening	
Prov		1: 10,6* ↓ 2: 9,5 ← 3: 10,3 ↓	Serie 1 	1: 10,5* ↗ 2: 10,2 ↗ 3: 9,4 → 4: 10,4 → 5: 10,1 ↘
		Serie 29,0	Serie 49,0	
		Totalt 284,0	Totalt 333,0	
Prov		1: 10,1 ↗ 2: 9,7 →	Serie 2 	1: 10,3 ↗ 2: 10,3 ↓ 3: 10,0 ↗ 4: 9,1 ↗ 5: 4,3 ←
		Serie 19,0	Serie 43,0	
		Totalt 333,0	Totalt 376,0	
Serie 3		1: 10,3 ↗ 2: 7,2 ↑ 3: 9,7 ↗ 4: 10,0 ↓ 5: 7,2 ←		
		Serie 43,0		
		Totalt 419,0		

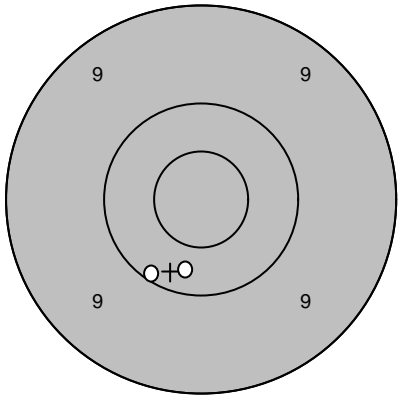
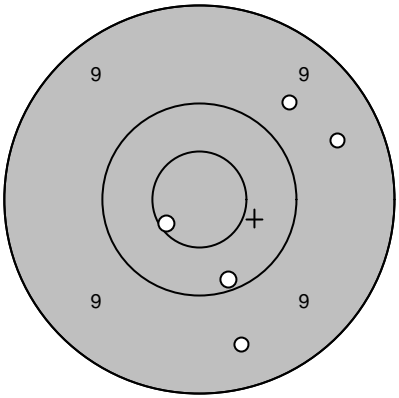
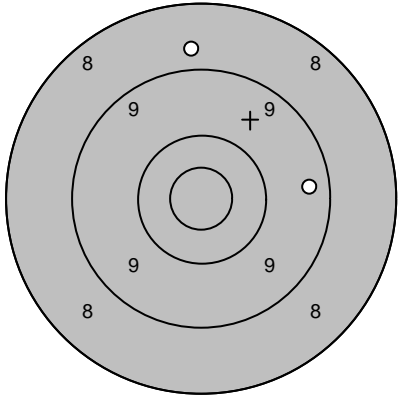
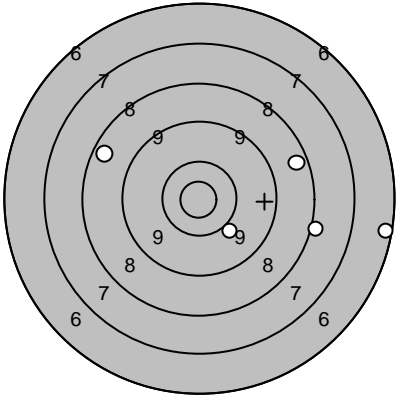
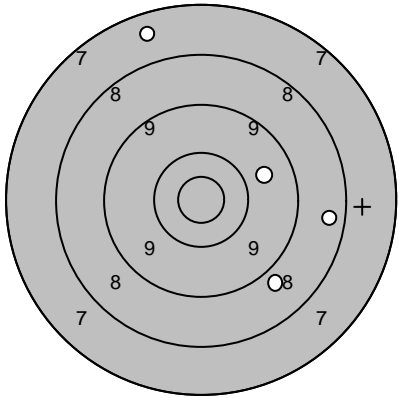
Skjutlag	Tavla	Ronnie Pettersson	
2	2		
Ramselefors	Loos		
2005-07-10	Tavelträffen B 2005 Final	Ramselefors Skytteförening	
Prov 	1: 10,1 ↙ 2: 10,3 ↓	Serie 1 	1: 9,5 ↓ 2: 10,2 ↓ 3: 10,6* ↙ 4: 9,7 ↗ 5: 9,5 →
	Serie 20,0 Totalt 282,0		Serie 47,0 Totalt 329,0
Prov 	1: 9,4 → 2: 8,8 ↑	Serie 2 	1: 8,1 → 2: 8,5 ↙ 3: 8,5 → 4: 10,0 ↓ 5: 6,3 →
	Serie 17,0 Totalt 329,0		Serie 40,0 Totalt 369,0
Serie 3 	1: 0,0 → 2: 8,8 ↓ 3: 8,5 → 4: 7,6 ↑ 5: 9,7 →		
	Serie 32,0 Totalt 401,0		

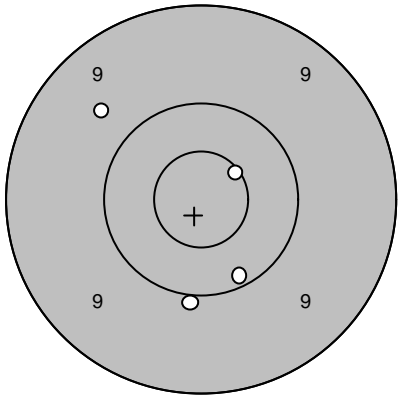
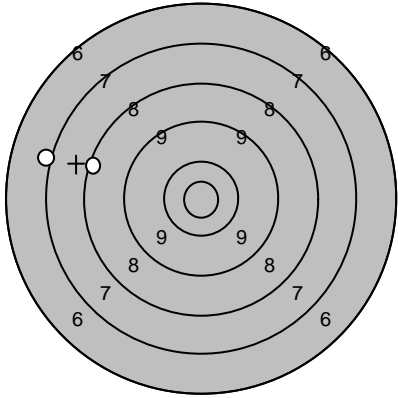
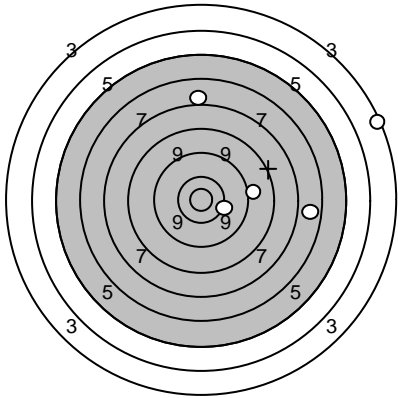
Skjutlag 2	Tavla 3	Claes Gustafsson	
Ramselefors		Hofors	
2005-07-10		Tavelträffen B 2005 Final	Ramselefors Skytteförening
Prov		1: 10,2 ↘ 2: 9,7 ↖ 3: 10,6* ↗ 4: 10,0 ↓	Serie 1
			1: 9,6 → 2: 9,4 ↓ 3: 9,9 ↓ 4: 10,3 ↓ 5: 10,1 ↓
		Serie 39,0	Serie 47,0
		Totalt 280,0	Totalt 327,0
Prov		1: 8,3 ← 2: 7,1 ←	Serie 2
			1: 10,2 ↓ 2: 10,0 ↘ 3: 10,4 ↓ 4: 10,1 ↑ 5: 10,0 ↗
		Serie 15,0	Serie 50,0
		Totalt 327,0	Totalt 377,0
Serie 3		1: 3,4 ↗ 2: 10,3 → 3: 7,1 ↑ 4: 9,1 → 5: 6,8 →	
		Serie 35,0	
		Totalt 412,0	

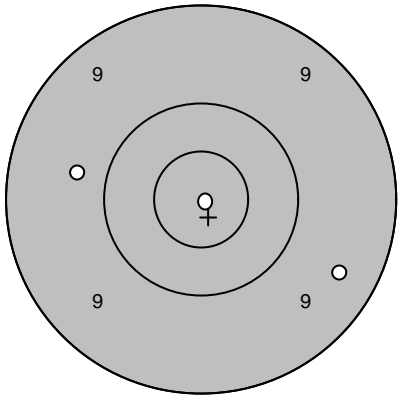
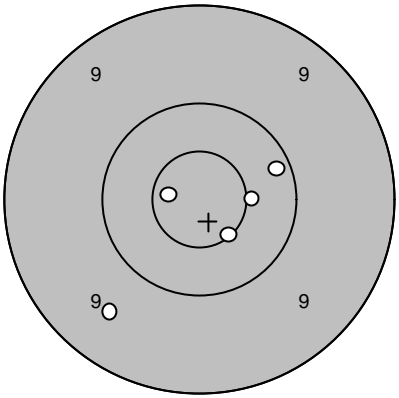
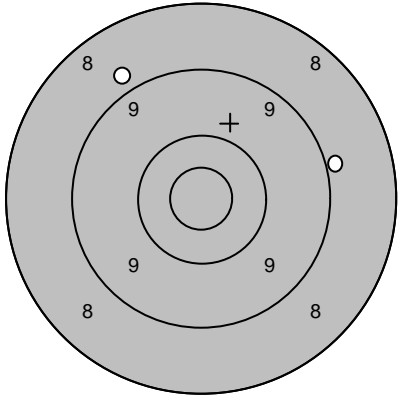
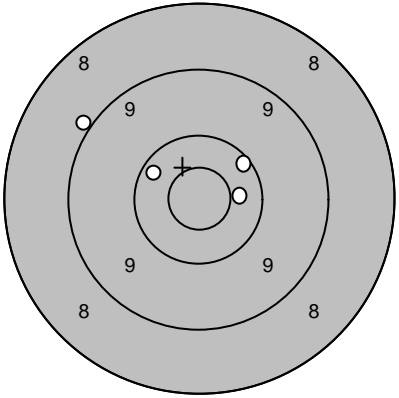
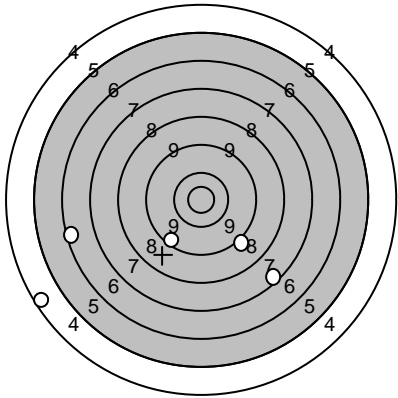
Skjutlag 2	Tavla 4	Jarmo Marjala	
Ramselefors		I 21 / T3	
2005-07-10		Tavelträffen B 2005 Final	Ramselefors Skytteförening
Prov		1: 9,7 ← 2: 10,9* ↘ 3: 9,4 ↘	Serie 1 
		Serie 28,0 Totalt 280,0	1: 10,5* → 2: 10,6* ↘ 3: 9,6 ↘ 4: 10,7* ← 5: 10,2 →
			Serie 49,0 Totalt 329,0
Prov		1: 8,9 → 2: 8,8 ↗	Serie 2 
		Serie 16,0 Totalt 329,0	1: 10,3 ← 2: 10,5* → 3: 10,2 ↗ 4: 9,0 ↖
			Serie 39,0 Totalt 368,0
Serie 3		1: 9,1 ↘ 2: 4,6 ← 3: 6,4 ← 4: 7,5 ↘ 5: 9,4 ↘	
		Serie 35,0 Totalt 403,0	

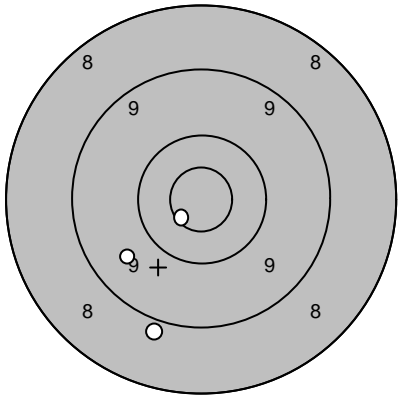
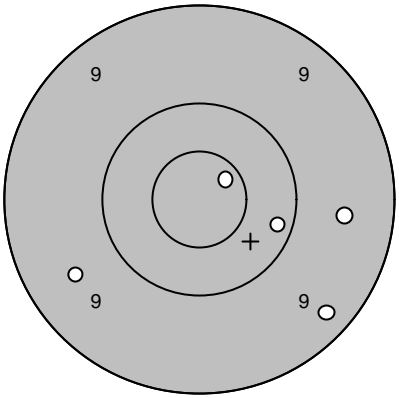
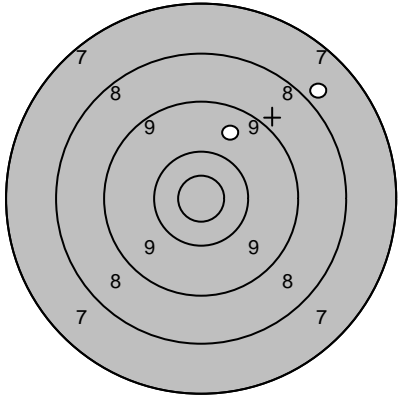
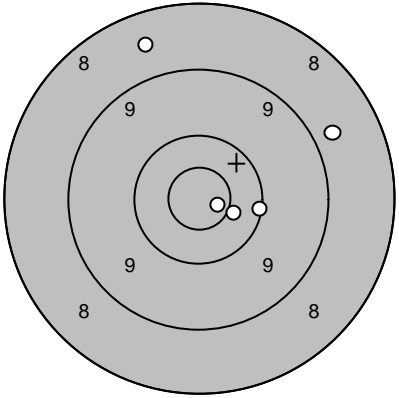
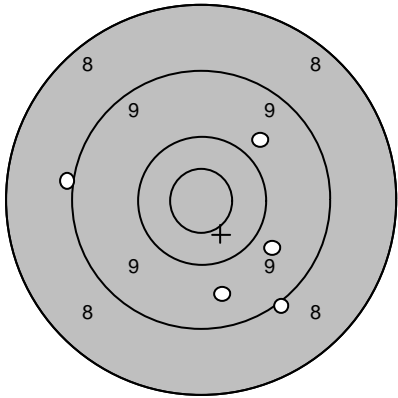
Skjutlag 2	Tavla 5	Helena Arvidsson	
Ramselefors		Bälgviken	
2005-07-10		Tavelträffen B 2005 Final	Ramselefors Skytteförening
Prov 	1: 8,9 ↙	Serie 1 	1: 9,6 ↙
	2: 10,7* ↙		2: 9,3 ↘
	3: 9,6 ↙		3: 10,7* ↗
			4: 9,5 →
			5: 10,2 ↘
	Serie 27,0		Serie 47,0
	Totalt 276,0		Totalt 323,0
Prov 	1: 9,7 ↗	Serie 2 	1: 10,5* ➤
	2: 7,9 ↗		2: 8,6 ↑
			3: 10,1 ➤
			4: 10,8* ➤
			5: 8,8 ↗
	Serie 16,0		Serie 46,0
	Totalt 323,0		Totalt 369,0
Serie 3 	1: 9,8 ↗		
	2: 9,0 ←		
	3: 9,8 ➤		
	4: 9,0 ↘		
	5: 9,6 ↓		
	Serie 45,0		
	Totalt 414,0		

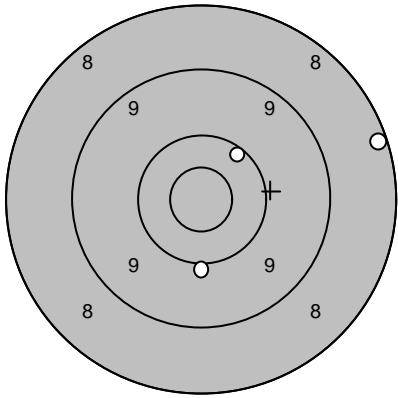
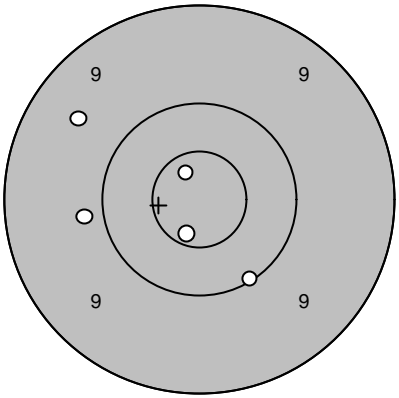
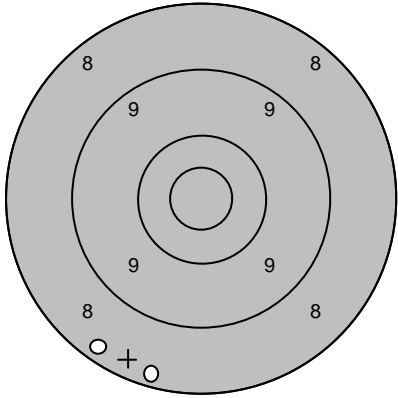
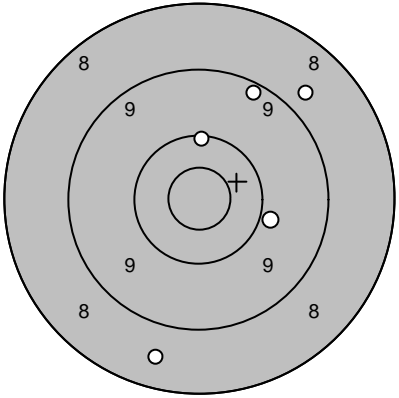
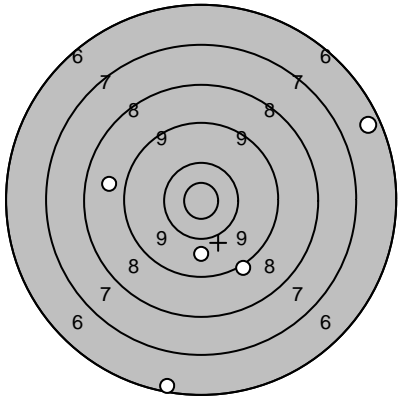
Skjutlag 2	Tavla 7	Carina Norling	
Ramselefors		Söderala	
2005-07-10		Tavelträffen B 2005 Final	Ramselefors Skytteförening
Prov 	1: 10,2 ↗	Serie 1 	1: 9,9 ←
	2: 10,0 ↓		2: 10,1 ↓
	3: 8,2 →		3: 10,7* ↗
			4: 9,6 ↖
			5: 10,7* ↓
	Serie 28,0		Serie 48,0
	Totalt 276,0		Totalt 324,0
Prov 	1: 8,3 ↓	Serie 2 	1: 8,8 ↗
	2: 8,3 ↓		2: 10,2 ↑
			3: 9,3 ↗
			4: 9,9 →
			5: 8,6 ↓
	Serie 16,0		Serie 44,0
	Totalt 324,0		Totalt 368,0
Serie 3 	1: 6,3 ↓		
	2: 6,5 →		
	3: 9,8 ↓		
	4: 9,1 ↓		
	5: 8,8 ←		
	Serie 38,0		
	Totalt 406,0		

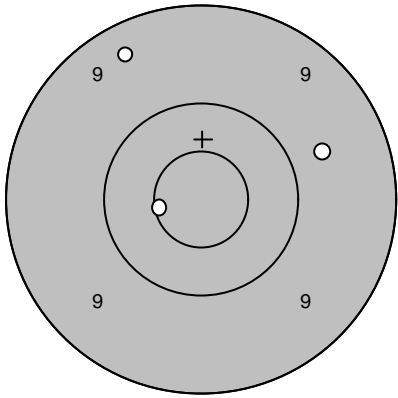
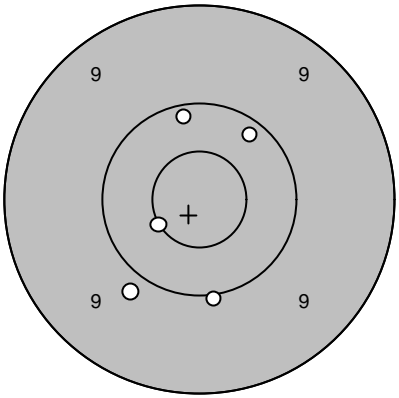
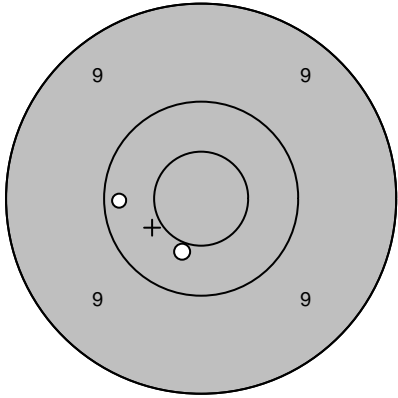
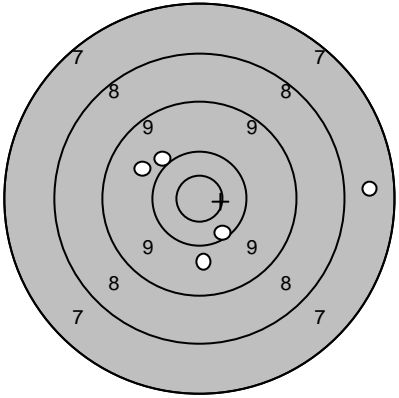
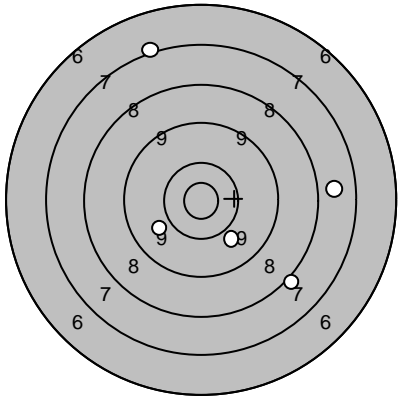
Skjutlag 2	Tavla 8	Robert Lindström	
Ramselefors		Skultuna	
2005-07-10		Tavelträffen B 2005 Final	Ramselefors Skytteförening
Prov 	1: 9,7 →	Serie 1 	1: 9,9 ↙
	2: 9,4 ↗		2: 10,0 ↓
	3: 10,6* ←		3: 10,2 ↗
			4: 10,2 ↑
			5: 10,5* ↙
	Serie 28,0		Serie 49,0
	Totalt 275,0		Totalt 324,0
Prov 	1: 10,2 ←	Serie 2 	1: 10,0 ↗
	2: 10,5* ↓		2: 10,3 ↓
			3: 9,8 ↗
			4: 9,8 ↓
			5: 7,6 →
	Serie 20,0		Serie 45,0
	Totalt 324,0		Totalt 369,0
Serie 3 	1: 7,7 →		
	2: 7,1 ↗		
	3: 8,1 ↓		
	4: 9,9 ↓		
	5: 9,9 ↙		
	Serie 40,0		
	Totalt 409,0		

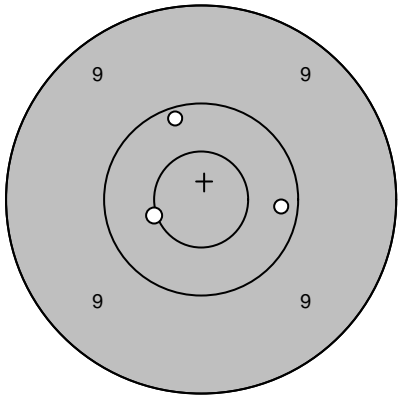
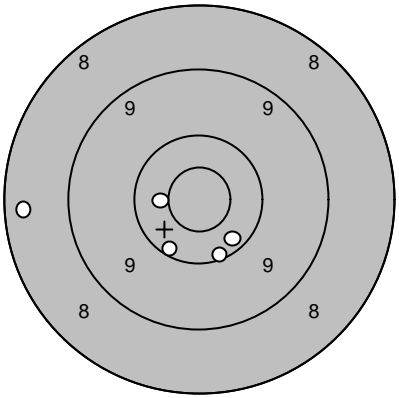
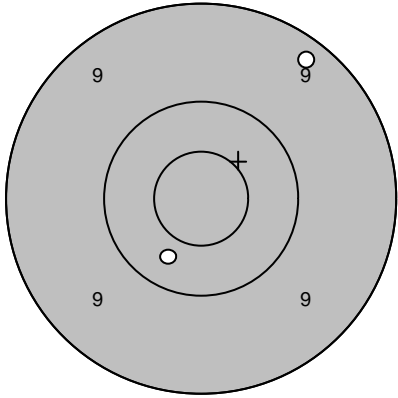
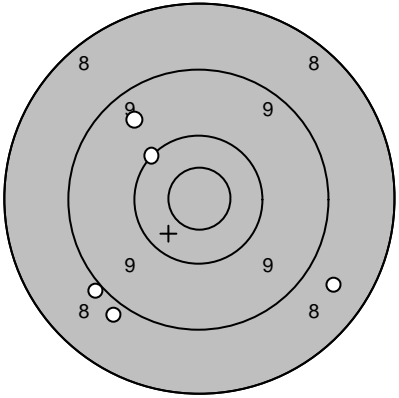
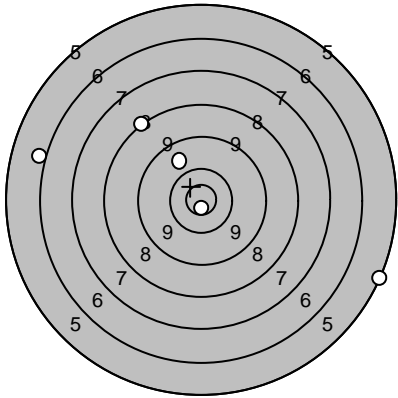
Skjutlag 2	Tavla 9	Krister Pettersson	
Ramselefors		Bastuträsk	
2005-07-10		Tavelträffen B 2005 Final	Ramselefors Skytteförening
Prov		1: 10,2 ↗ 2: 10,2 → 3: 10,5* ←	Serie 1 
		Serie 30,0 Totalt 274,0	1: 10,2 ↘ 2: 8,4 ← 3: 10,2 ↘ 4: 10,3 ↘ 5: 10,5* ←
			Serie 48,0 Totalt 322,0
Prov		1: 10,3 ↘ 2: 9,3 ↗	Serie 2 
		Serie 19,0 Totalt 322,0	1: 9,5 ↗ 2: 8,6 ↘ 3: 10,1 ↗ 4: 8,9 ↘ 5: 9,0 ←
			Serie 44,0 Totalt 366,0
Serie 3		1: 5,3 → 2: 6,1 ← 3: 9,8 ↗ 4: 8,2 ↗ 5: 10,9* ↓	
		Serie 38,0 Totalt 404,0	

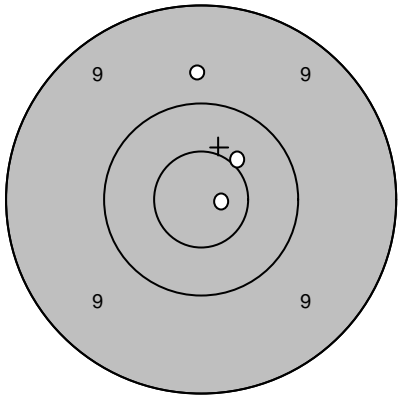
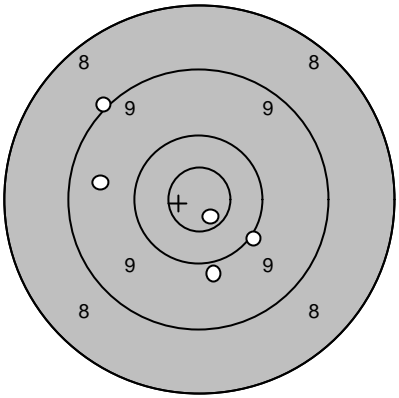
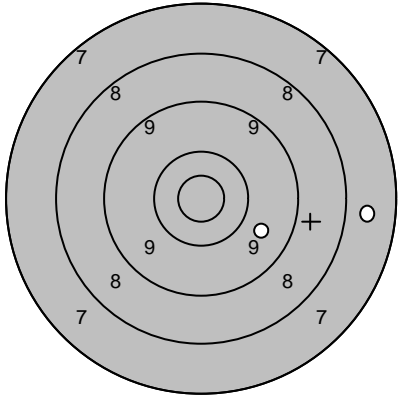
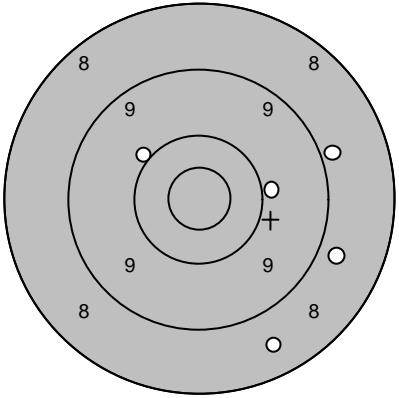
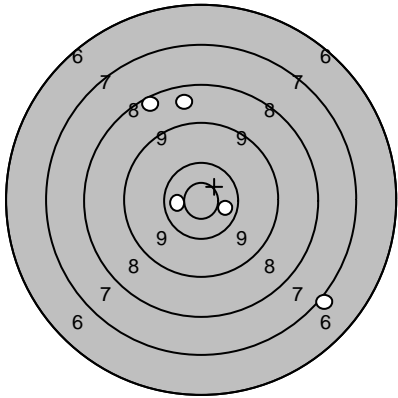
Skjutlag	Tavla	Daniel Zakrisson		
2	10			
Ramselefors	Ramselefors			
2005-07-10	Tavelträffen B 2005 Final	Ramselefors Skytteförening		
Prov		1: 10,8* → 2: 10,5* ↗ 3: 9,7 ↑	Serie 1 	1: 9,0 ↗ 2: 9,6 ← 3: 9,9 ↓ 4: 10,8* ↓ 5: 10,1 ↓
	Serie 29,0 Totalt 273,0		Serie 47,0 Totalt 320,0	
Prov		1: 7,7 → 2: 9,7 →	Serie 2 	1: 10,0 → 2: 8,8 → 3: 8,9 → 4: 10,0 ↗ 5: 8,6 ↓
	Serie 16,0 Totalt 320,0		Serie 44,0 Totalt 364,0	
Serie 3		1: 10,5* → 2: 8,4 ↗ 3: 10,6* ← 4: 7,1 ↓ 5: 8,6 ↑		
	Serie 43,0 Totalt 407,0			

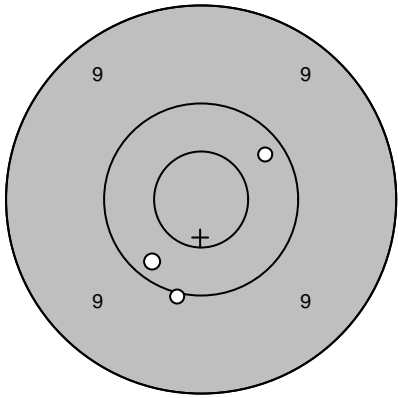
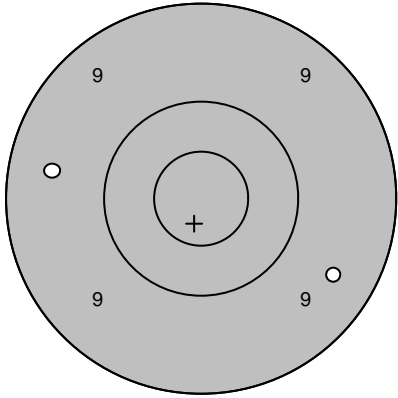
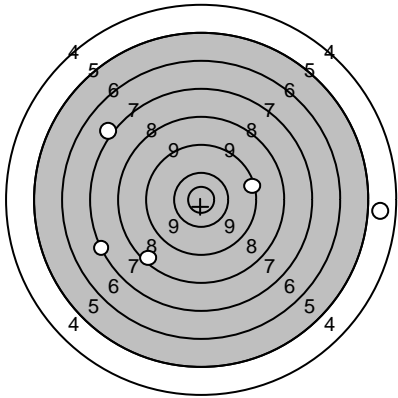
Skjutlag 2	Tavla 11	Rickard Edin	
Ramselefors		Ale	
2005-07-10		Tavelträffen B 2005 Final	Ramselefors Skytteförening
Prov		1: 10,0 ↓ 2: 10,2 ↙ 3: 10,2 ↗	Serie 1 1: 10,9* ↖ 2: 9,1 ↗ 3: 10,3 → 4: 10,4 → 5: 10,7* ↓
		Serie 30,0 Totalt 271,0	Serie 49,0 Totalt 320,0
Prov		1: 9,5 → 2: 9,5 ←	Serie 2 1: 9,0 ← 2: 8,8 ↗ 3: 6,9 ← 4: 9,6 ↖ 5: 9,0 →
		Serie 18,0 Totalt 320,0	Serie 41,0 Totalt 361,0
Serie 3		1: 7,1 ↖ 2: 4,8 → 3: 9,3 → 4: 7,3 ← 5: 8,5 ↙	
		Serie 35,0 Totalt 396,0	

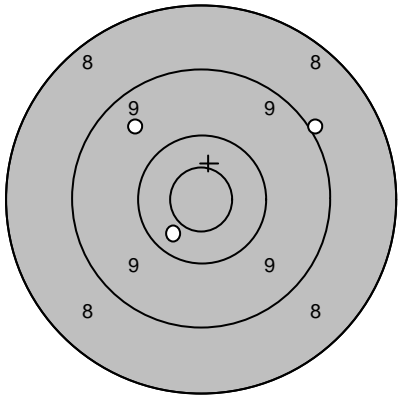
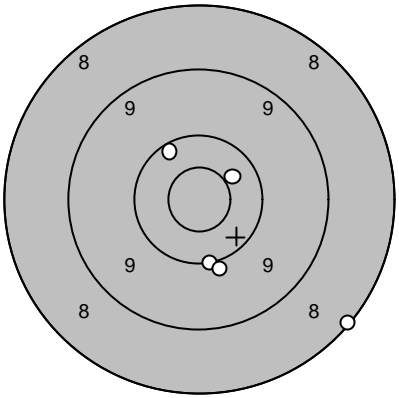
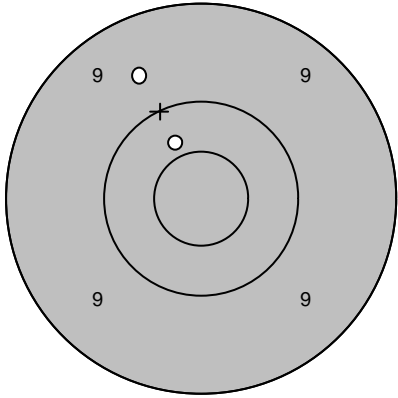
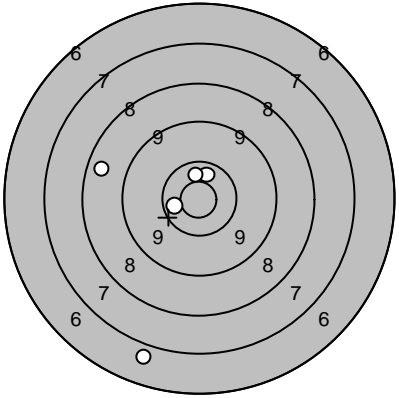
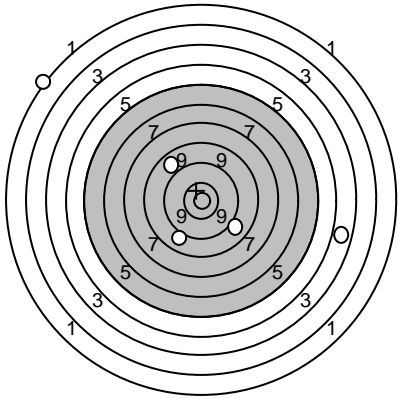
Skjutlag	Tavla	Ingemar Långström	
2	12		
Ramselefors	Ramselefors		
2005-07-10	Tavelträffen B 2005 Final	Ramselefors Skytteförening	
Prov 	1: 9,0 ↗	Serie 1 	1: 10,1 ↓
	2: 10,4 ↙		2: 10,0 ↓
	3: 9,6 ↖		3: 10,2 ↗
			4: 10,4 ↗
			5: 8,1 ↓
	Serie 28,0		Serie 48,0
	Totalt 270,0		Totalt 318,0
Prov 	1: 9,6 ↖	Serie 2 	1: 10,5* ↑
	2: 10,4 ↖		2: 8,6 ←
			3: 10,5* ←
			4: 6,9 ↓
			5: 10,6* ↑
	Serie 19,0		Serie 44,0
	Totalt 318,0		Totalt 362,0
Serie 3 	1: 9,1 ↓		
	2: 1,3 ↗		
	3: 4,0 →		
4: 9,1 ↙			
5: 9,0 ↗			
	Serie 32,0		
	Totalt 394,0		

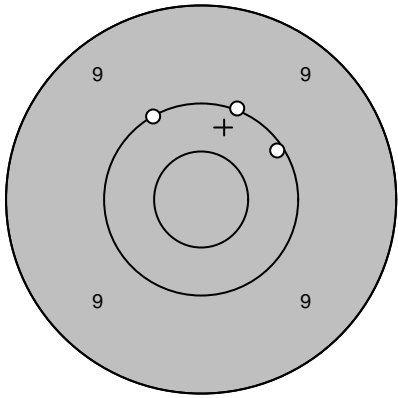
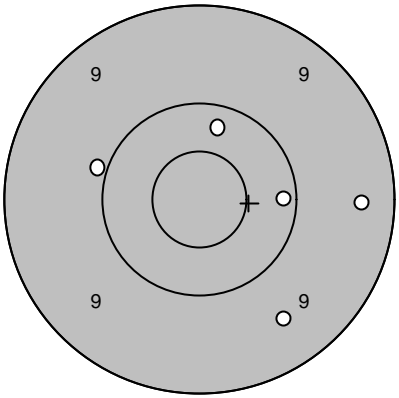
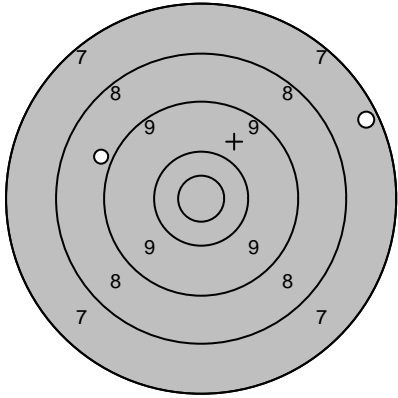
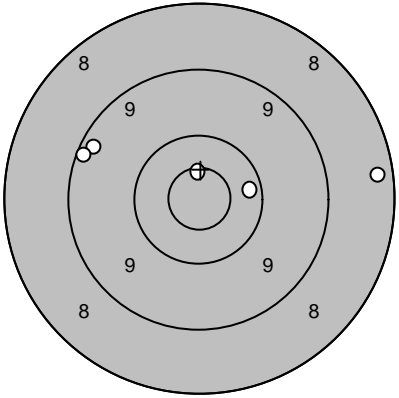
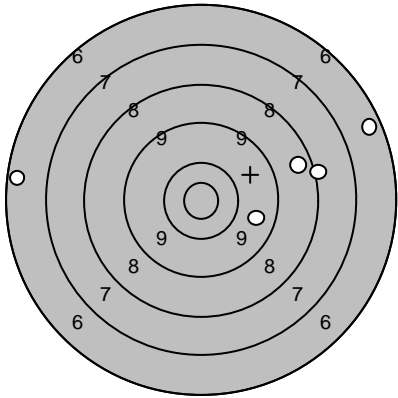
Skjutlag 2	Tavla 13	Lennart Jacobsson	
Ramselefors	Ramselefors		
2005-07-10	Tavelträffen B 2005 Final	Ramselefors Skytteförening	
Prov		1: 10,1 → 2: 10,1 ↖ 3: 10,0 ↑	Serie 1 
			1: 10,2 → 2: 9,5 ↘ 3: 10,3 ↑ 4: 9,9 ← 5: 9,4 →
		Serie 30,0	Serie 47,0
		Totalt 268,0	Totalt 315,0
Prov		1: 7,4 → 2: 8,9 ←	Serie 2 
			1: 10,3 → 2: 8,3 → 3: 10,7* ↑ 4: 9,3 ← 5: 9,2 ←
		Serie 15,0	Serie 46,0
		Totalt 315,0	Totalt 361,0
Serie 3		1: 8,5 → 2: 6,4 ← 3: 6,5 → 4: 8,1 → 5: 9,7 →	
		Serie 37,0	
		Totalt 398,0	

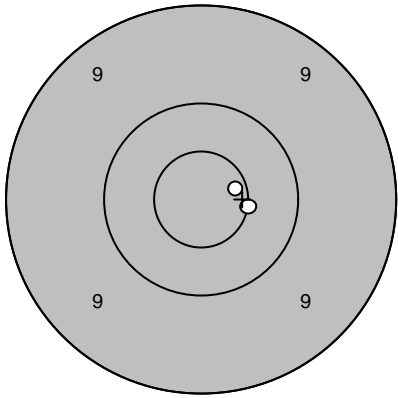
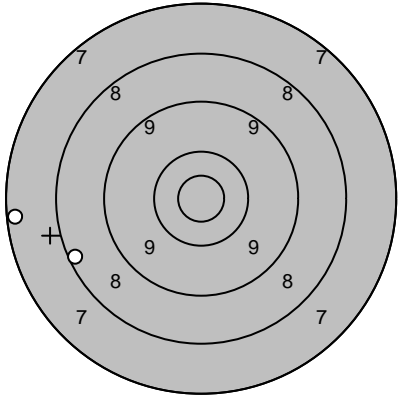
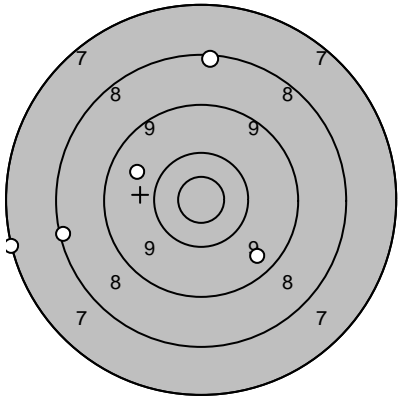
Skjutlag 2	Tavla 14	Johan Zakrisson	
Ramselefors		Ramselefors	
2005-07-10		Tavelträffen B 2005 Final	Ramselefors Skytteförening
Prov		1: 10,5* → 2: 10,7* →	Serie 1 1: 8,6 ↑ 2: 10,0 ↑ 3: 10,5* ↖ 4: 9,4 ↓ 5: 10,7* ←
		Serie 20,0 Totalt 268,0	Serie 47,0 Totalt 315,0
Prov		1: 7,3 ← 2: 8,3 ←	Serie 2 1: 8,4 ← 2: 9,8 ↗ 3: 10,2 ↖ 4: 7,2 ← 5: 8,9 ↗
		Serie 15,0 Totalt 315,0	Serie 42,0 Totalt 357,0
Serie 3		1: 8,2 ↑ 2: 9,5 ↘ 3: 7,1 ← 4: 8,2 ← 5: 9,7 ↖	
		Serie 41,0 Totalt 398,0	

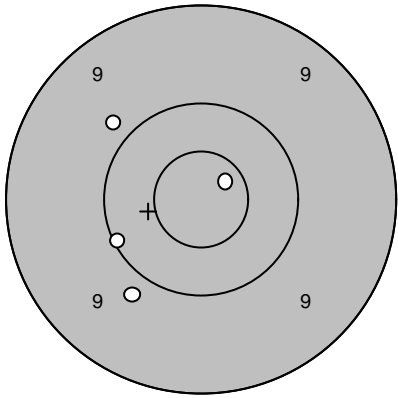
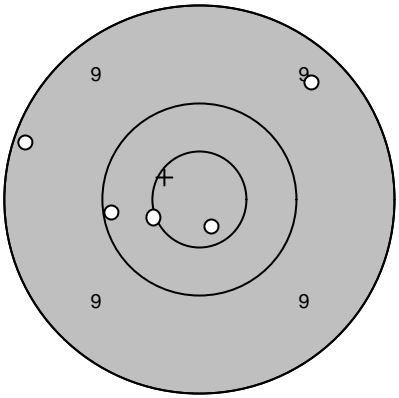
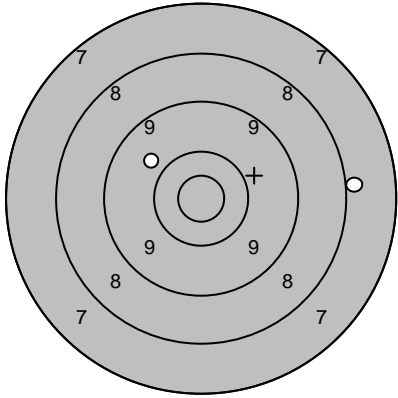
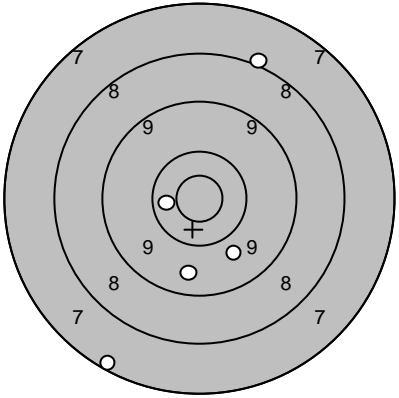
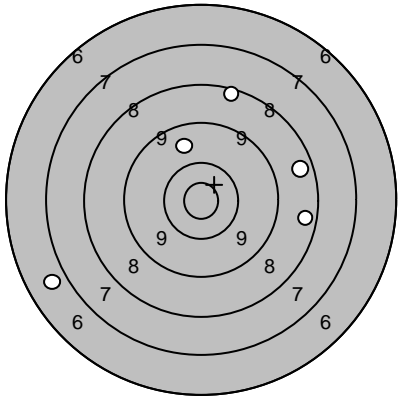
Skjutlag 2	Tavla 15	Alf Edin		
Ramselefors		Ale		
2005-07-10		Tavelträffen B 2005 Final	Ramselefors Skytteförening	
Prov		1: 9,8 ↙ 2: 9,8 ↖ 3: 10,7* ↗ 4: 10,1 ↖	Serie 1 	1: 10,5* ↖ 2: 9,2 ↖ 3: 10,1 ↖ 4: 9,4 ↗ 5: 10,7* ↘
		Serie 38,0	Serie 48,0	
		Totalt 266,0	Totalt 314,0	
Prov		1: 8,0 → 2: 9,8 ↖	Serie 2 	1: 8,1 ↗ 2: 9,8 ↘ 3: 7,3 ↘ 4: 9,6 ↘ 5: 10,5* ↖
		Serie 17,0	Serie 43,0	
		Totalt 314,0	Totalt 357,0	
Serie 3		1: 9,7 ↗ 2: 8,5 → 3: 8,3 ↗ 4: 8,5 → 5: 6,8 ↖		
		Serie 39,0		
		Totalt 396,0		

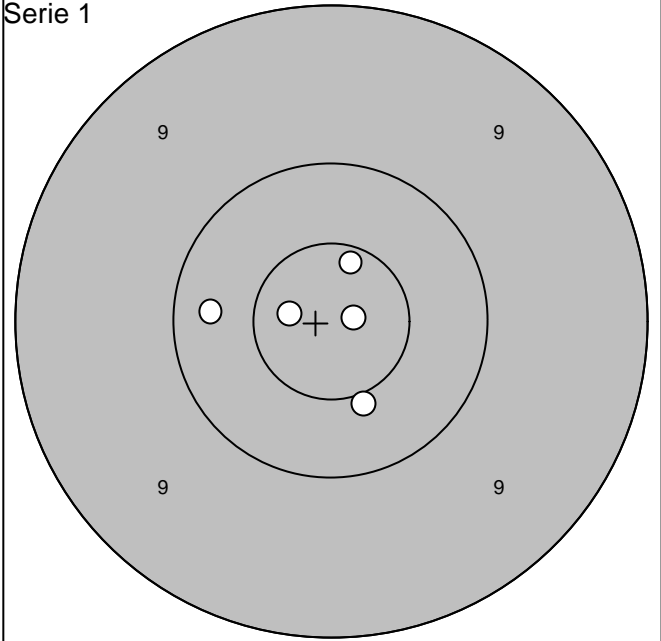
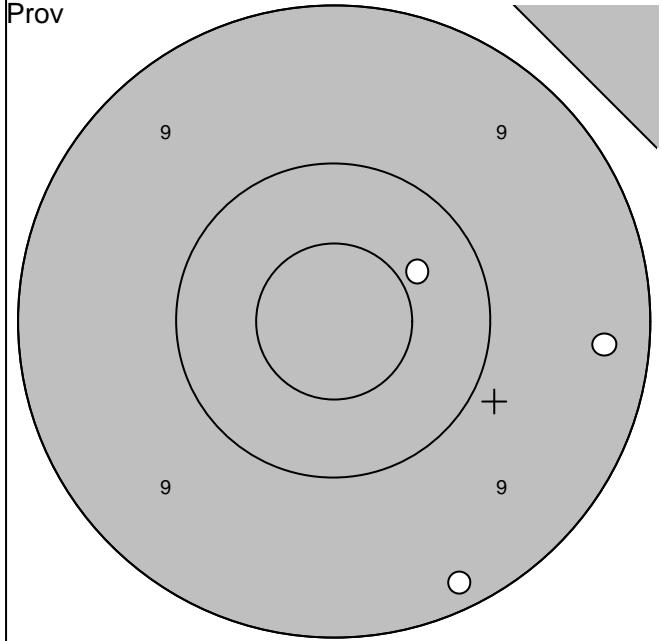

1:10,4 ↗		Serie	28,0		
2: 9,3 →		Totalt	293,0		
3: 9,2 ↓					

1:10,5* ↓		Serie	50,0		
2:10,9* →		Totalt	343,0		
3:10,3 ←					
4:10,8* ←					
5:10,6* ↑					

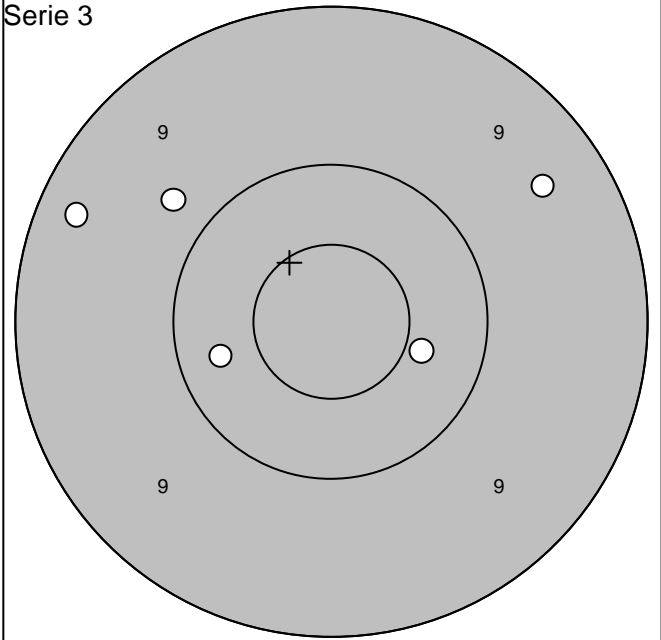
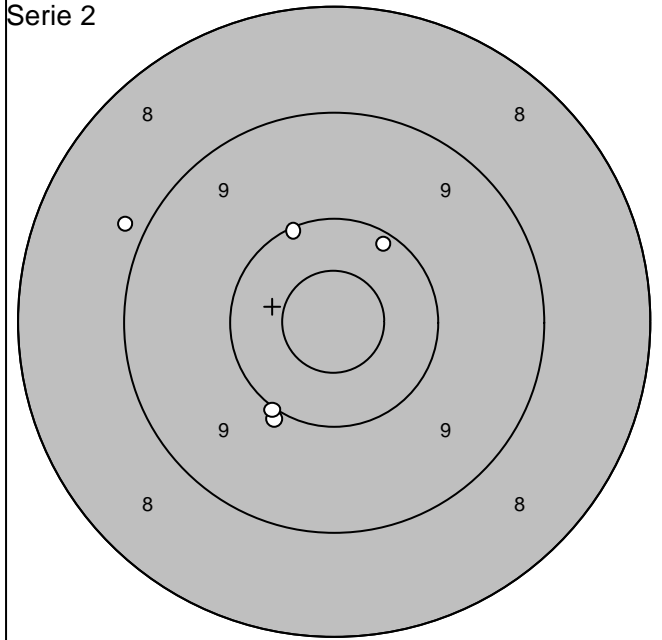

1: 8,9 ←		Serie	48,0		
2:10,1 ↑		Totalt	391,0		
3:10,2 ↗					
4:10,0 ↓					
5:10,0 ↓					

1: 9,3 ↖		Serie	47,0		
2: 9,8 ↗		Totalt	438,0		
3:10,4 →					
4: 9,4 ↗					
5:10,3 ←					

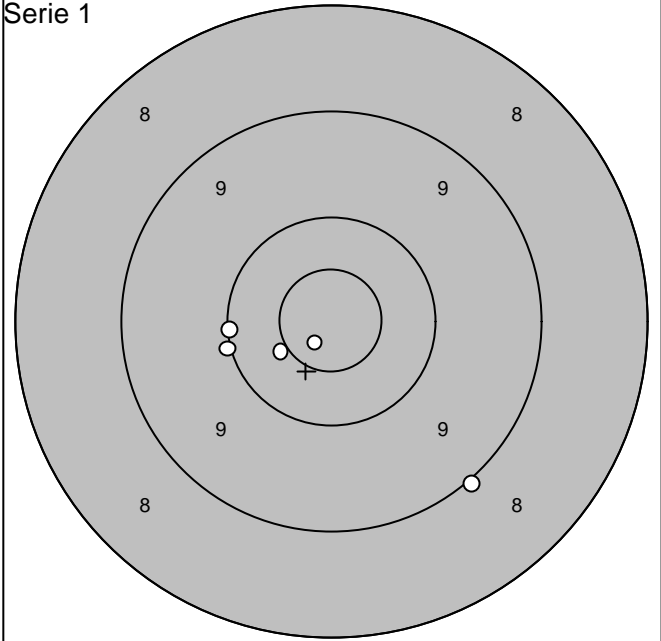
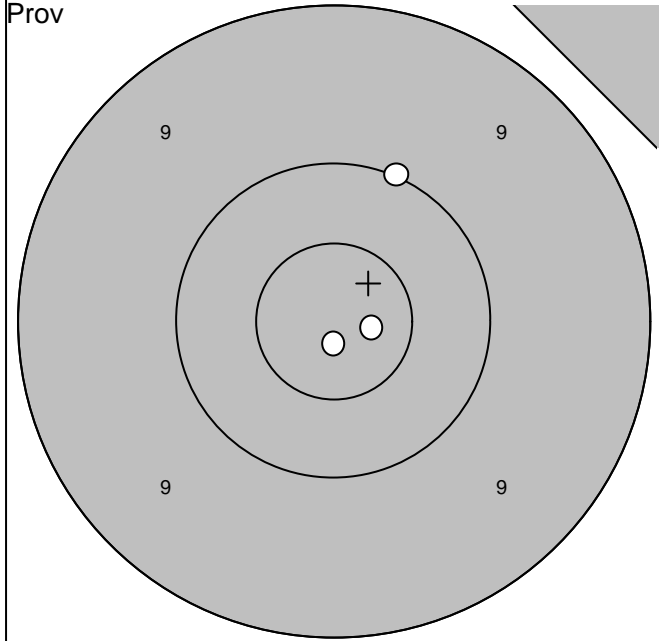

1:10,8* →		
2:10,0 ↗		
3:10,9* ↓		
Serie	30,0	
Totalt	291,0	

1: 9,0 ↘		
2:10,8* ↙		
3:10,1 ←		
4:10,0 ←		
5:10,5* ↙		
Serie	49,0	
Totalt	340,0	

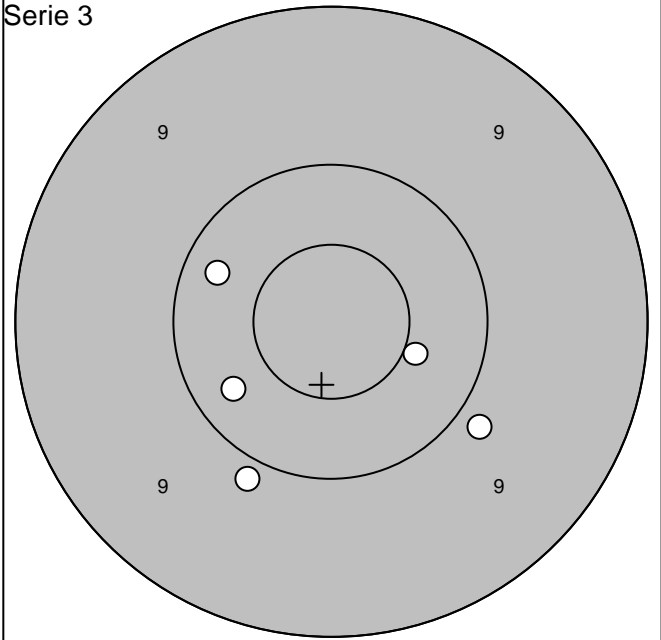
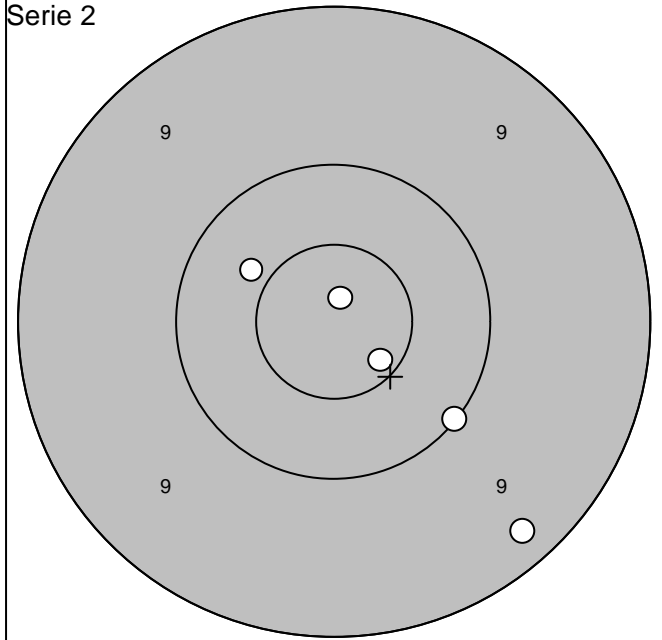

1:10,4 ↗		
2: 9,3 ↘		
3:10,0 ↘		
4:10,9* ↗		
5:10,6* ↘		
Serie	49,0	
Totalt	389,0	

1:10,3 ↙		
2:10,3 ↖		
3: 9,9 ↘		
4: 9,9 ↘		
5:10,5* ↘		
Serie	48,0	
Totalt	437,0	

Skjutlag	Tavla	Christer Burvall
2	20	

Ramselefors	Bastuträsk		
-------------	------------	--	--

2005-07-10	Tavelträffen B 2005 Final	Ramselefors Skytteförening
------------	---------------------------	----------------------------

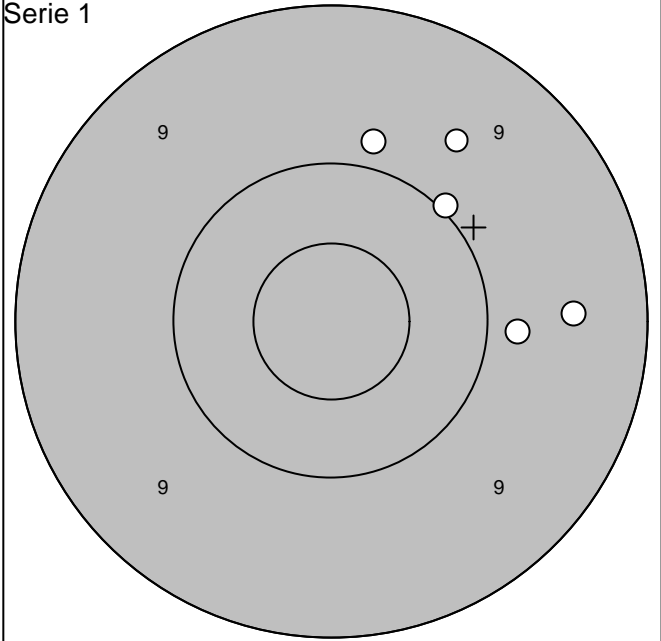
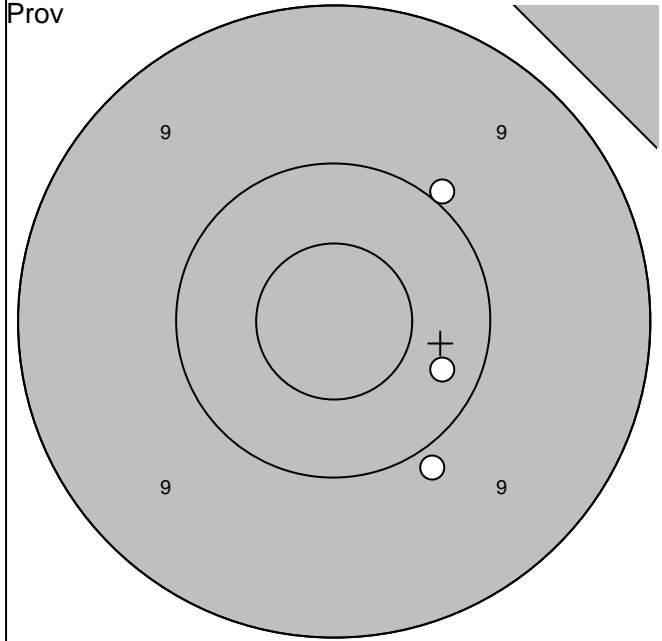

1: 9,9 ↘	Serie 29,0
2: 10,3 ↘	
3: 10,0 ↗	Totalt 286,0

1: 9,6 ↗	Serie 46,0
2: 9,5 →	
3: 9,9 ↑	Totalt 332,0
4: 10,0 ↗	
5: 9,8 →	

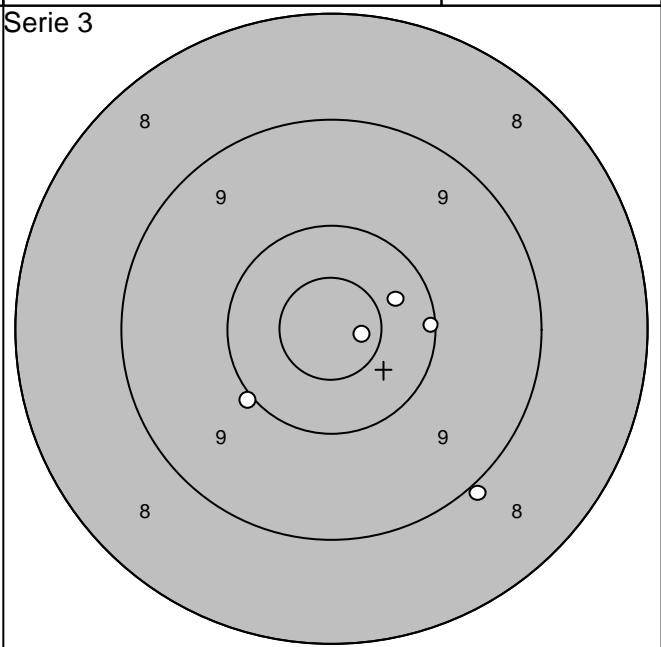
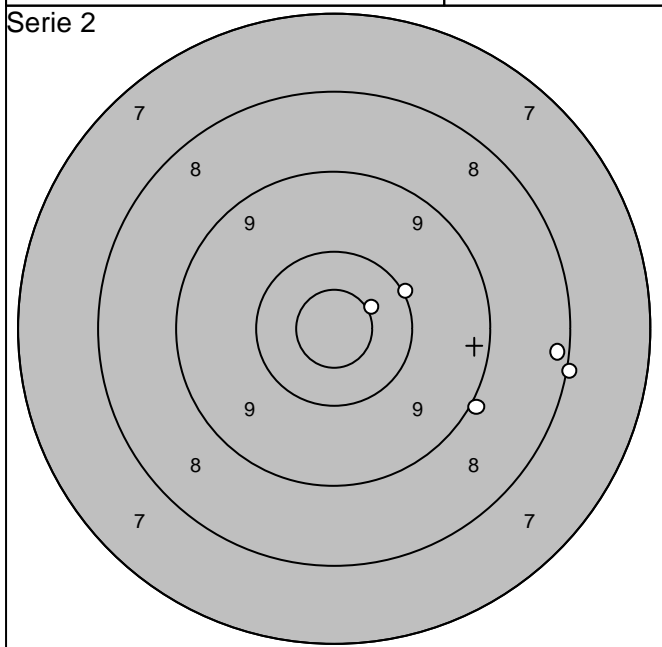

1: 9,0 ↘	Serie 45,0
2: 8,0 →	
3: 10,0 ↗	Totalt 377,0
4: 8,2 →	
5: 10,5* ↗	

1: 10,7* →	Serie 48,0
2: 10,1 →	
3: 10,4 →	Totalt 425,0
4: 8,9 ↘	
5: 10,0 ↙	

Skjutlag 2	Tavla 21	Daniel Wallberg
----------------------	--------------------	------------------------

Ramselefors	Loos		
-------------	------	--	--

2005-07-10	Tavelträffen B 2005 Final	Ramselefors Skytteförening
------------	---------------------------	----------------------------

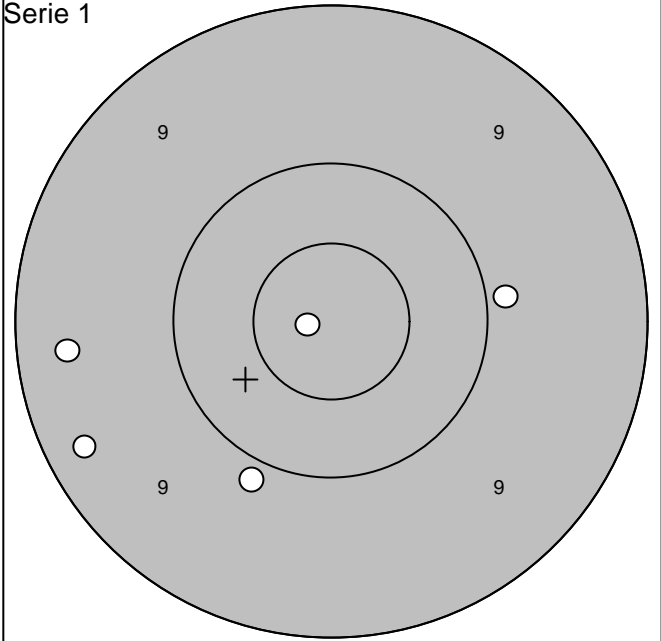
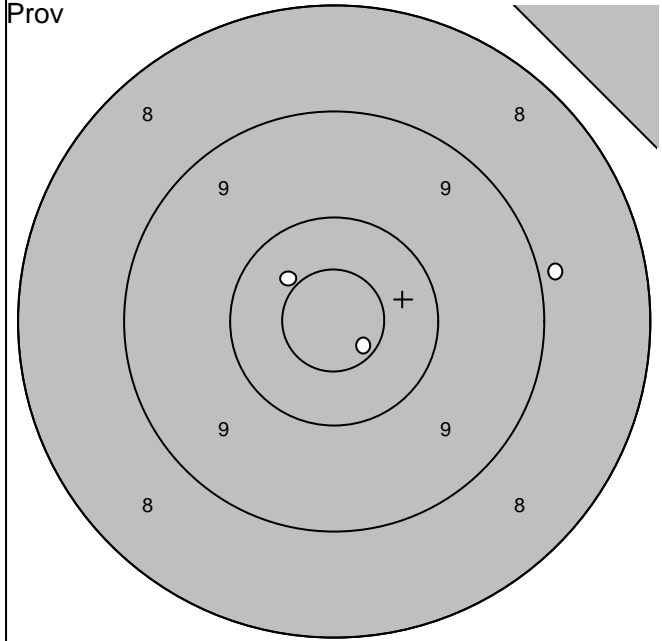

1: 8,9 →	Serie 28,0
2: 10,7* ↘	
3: 10,4 ↗	Totalt 285,0

1: 9,9 →	Serie 46,0
2: 9,9 ↘	
3: 9,4 ←	Totalt 331,0
4: 9,3 ↙	
5: 10,9* ←	

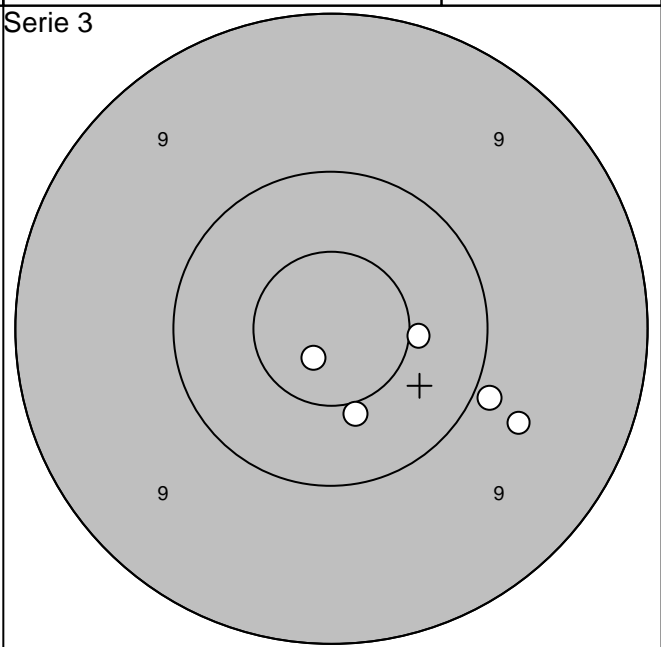
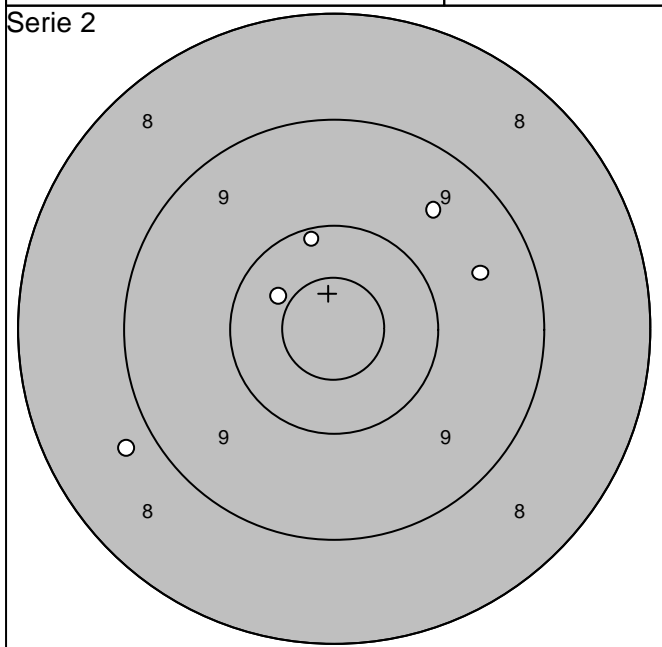

1: 9,6 ↗	Serie 46,0
2: 10,4 ↖	
3: 9,5 →	Totalt 377,0
4: 10,1 ↑	
5: 8,8 ←	

1: 10,5* ↘	Serie 48,0
2: 10,5* →	
3: 9,9 →	Totalt 425,0
4: 9,7 ↘	
5: 10,8* ↙	

Skjutlag 2	Tavla 23	Petter Ivarsson	
Ramselefors		Loos	
2005-07-10		Tavelträffen B 2005 Final	Ramselefors Skytteförening
Prov		Serie 1	
1: 7,8 ↘ 2: 8,9 ← 3:10,0 ←	Serie 25,0 Totalt 273,0	1: 9,6 ↘ 2: 9,3 ↗ 3:10,9* ↘ 4: 9,2 ← 5: 9,5 ↘	Serie 46,0 Totalt 319,0
Serie 2		Serie 3	
1: 9,7 ↓ 2: 9,4 → 3: 9,7 → 4: 9,9 ← 5:10,2 ↗	Serie 46,0 Totalt 365,0	1: 8,6 ↘ 2: 9,6 ← 3: 8,6 ↘ 4: 9,4 ↗ 5: 9,0 ↘	Serie 43,0 Totalt 408,0
www.AC-Skytte.com			

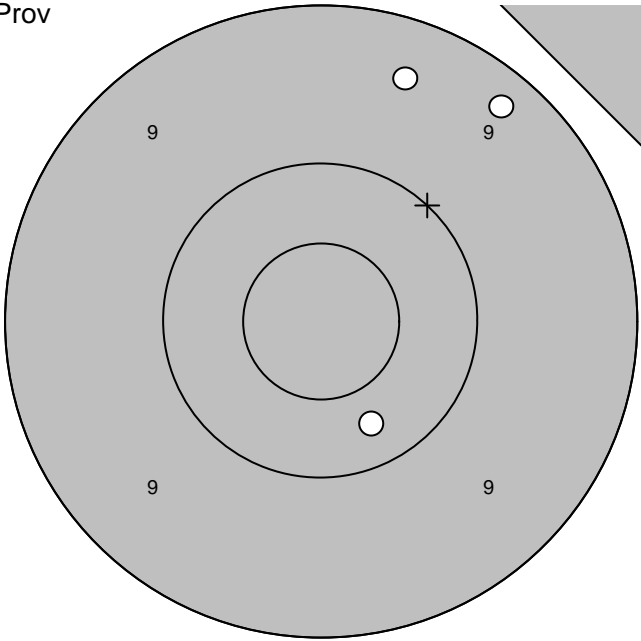
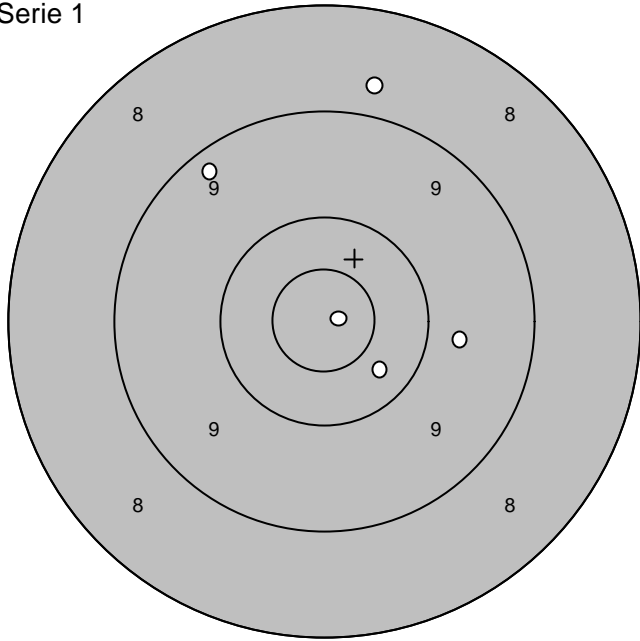
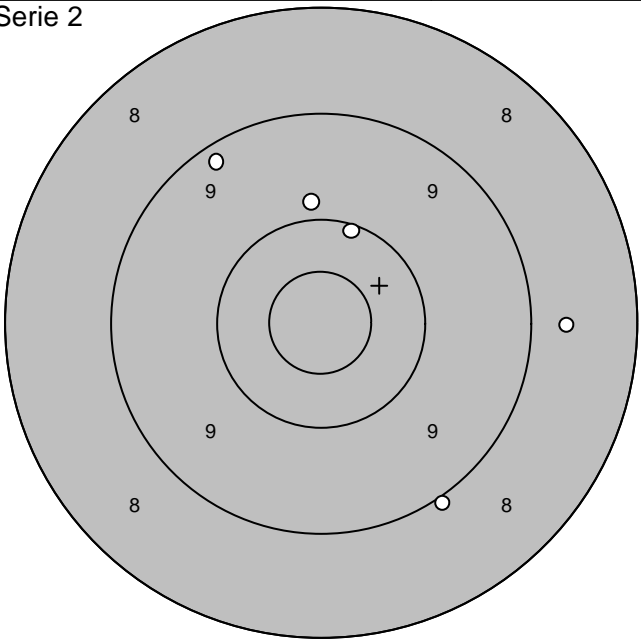
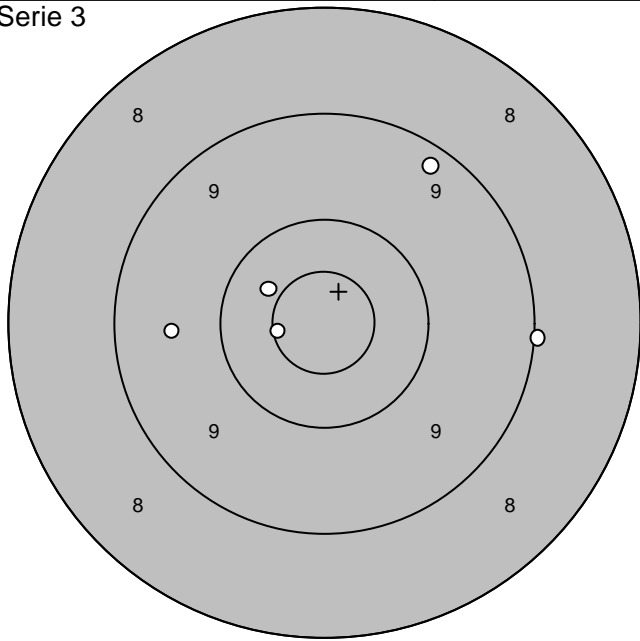
Skjutlag 2	Tavla 24	Elina Högström	
Ramselefors		Ramselefors	
2005-07-10		Tavelträffen B 2005 Final	Ramselefors Skytteförening
Prov		Serie 1	
			
1: 9,3 ↗ 2: 9,4 ↗ 3:10,3 ↘		Serie 28,0 Totalt 269,0	1: 8,7 ↑ 2: 9,2 ↗ 3: 9,7 → 4:10,9* → 5:10,3 ↘
			Serie 46,0 Totalt 315,0
Serie 2		Serie 3	
			
1:10,1 ↑ 2: 8,7 → 3: 9,2 ↗ 4: 9,9 ↑ 5: 9,0 ↘		Serie 45,0 Totalt 360,0	1: 9,6 ← 2: 9,0 → 3: 9,2 ↗ 4:10,4 ↖ 5:10,6* ←
			Serie 47,0 Totalt 407,0
www.AC-Skytte.com			

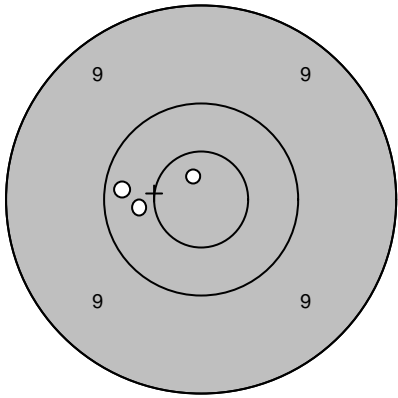
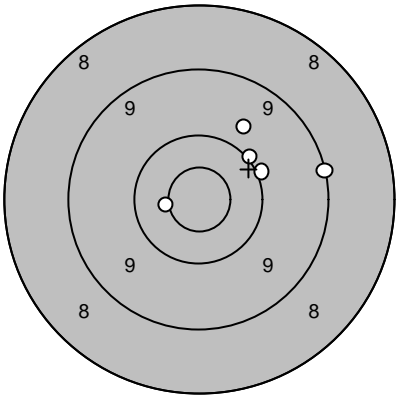
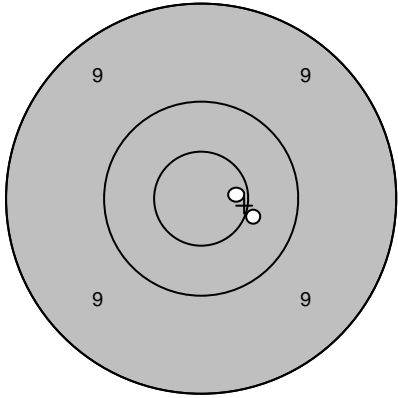
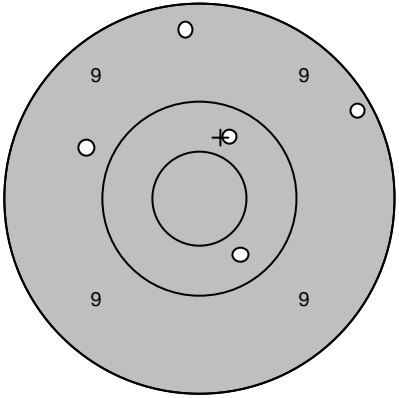
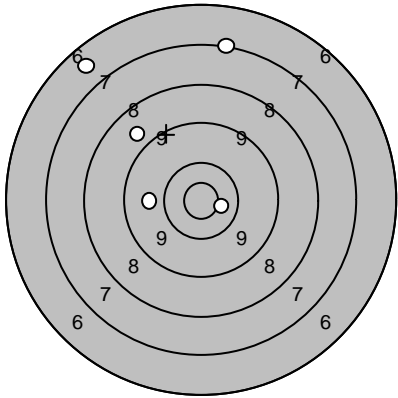
Skjutlag 3	Tavla 1	Petter Eriksson		
Ramselefors		Moälven-Modo		
2005-07-10		Tavelträffen B 2005 Final	Ramselefors Skytteförening	
Prov		1: 10,8* ↗ 2: 10,2 ← 3: 10,4 ←	Serie 1 	1: 10,6* ← 2: 10,0 ↗ 3: 9,8 ↗ 4: 10,1 ↗ 5: 9,1 →
		Serie 30,0	Serie 48,0	
		Totalt 290,0	Totalt 338,0	
Prov		1: 10,5* → 2: 10,7* →	Serie 2 	1: 10,3 ↘ 2: 10,3 ↗ 3: 9,2 ↗ 4: 9,8 ← 5: 9,3 ↑
		Serie 20,0	Serie 47,0	
		Totalt 338,0	Totalt 385,0	
Serie 3		1: 8,8 ↖ 2: 9,8 ← 3: 10,6* → 4: 7,2 ↑ 5: 6,7 ↖		
		Serie 40,0		
		Totalt 425,0		

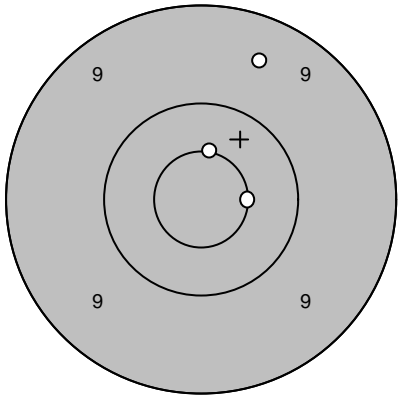
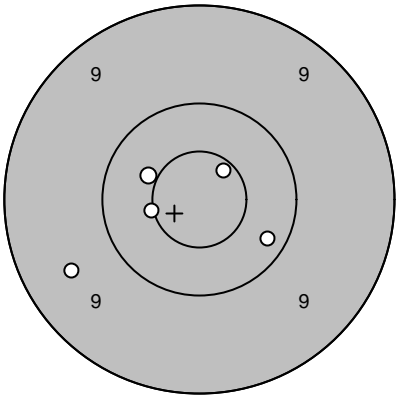
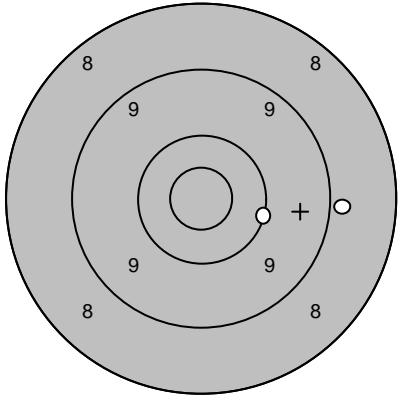
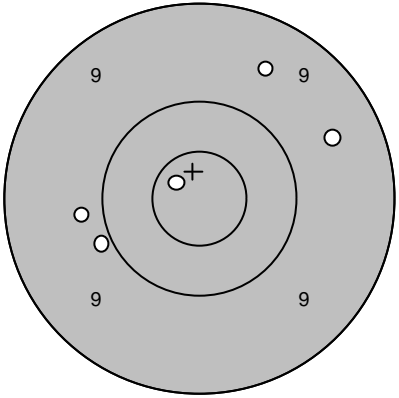
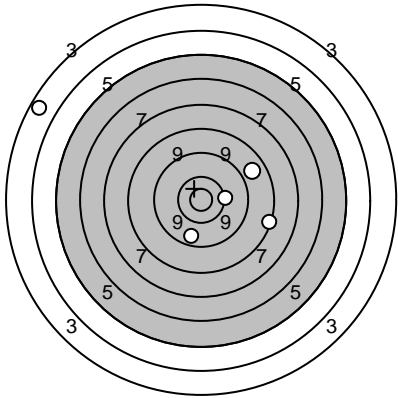
Skjutlag 3	Tavla 2	Stefan Håkansson	
Ramselefors		Östersund	
2005-07-10		Tavelträffen B 2005 Final	Ramselefors Skytteförening
Prov		1: 9,5 ↗ 2: 10,5* ↑ 3: 10,6* →	Serie 1 
		Serie 29,0	Serie 49,0
		Totalt 289,0	Totalt 338,0
Prov		1: 8,9 → 2: 10,1 →	Serie 2 
		Serie 18,0	Serie 46,0
		Totalt 338,0	Totalt 384,0
Serie 3		1: 3,7 ↖ 2: 10,3 → 3: 9,8 ↓ 4: 8,9 ↗ 5: 8,4 →	
		Serie 38,0	
		Totalt 422,0	

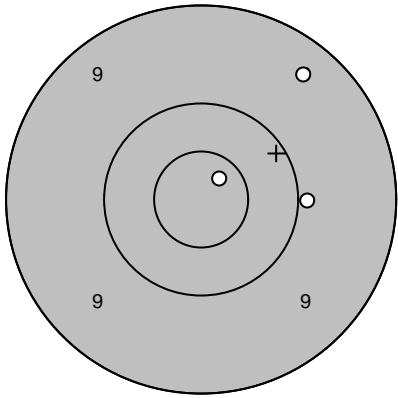
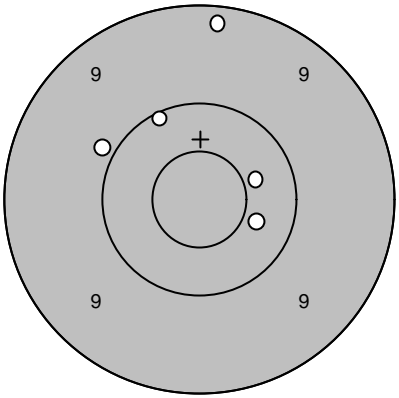
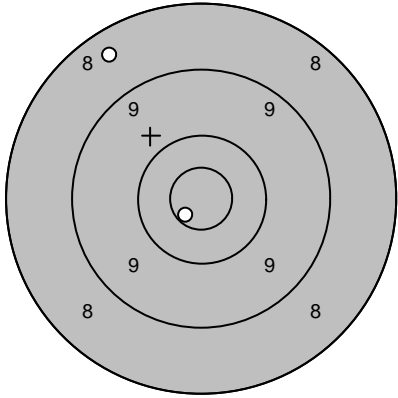
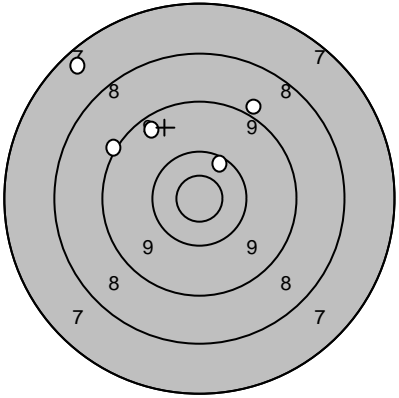
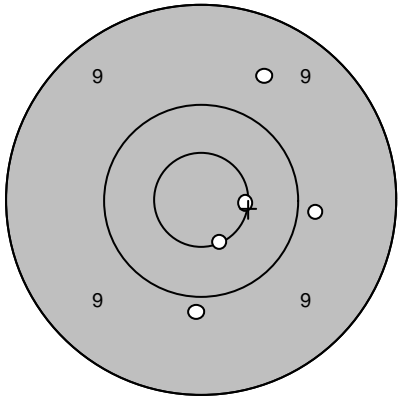
Skjutlag	Tavla	Mikael Olofsson	
3	3		
Ramselefors	Moälven-Modo		
2005-07-10	Tavelträffen B 2005 Final	Ramselefors Skytteförening	
Prov 	1: 9,4 ↗	Serie 1 	1: 9,2 ↑
	2: 9,9 →		2: 10,4 ➤
	3: 10,8* ↗		3: 10,4 ➤
			4: 10,1 ↑
			5: 9,9 ↖
	Serie 28,0		Serie 48,0
	Totalt 288,0		Totalt 336,0
Prov 	1: 8,5 ↖	Serie 2 	1: 7,5 ↖
	2: 10,7* ↙		2: 8,9 ↗
			3: 9,1 ↖
			4: 10,3 ↗
			5: 9,4 ↗
	Serie 18,0		Serie 43,0
	Totalt 336,0		Totalt 379,0
Serie 3 	1: 9,9 →		
	2: 10,6* →		
	3: 10,6* ↓		
	4: 9,9 ↓		
	5: 9,6 ↗		
	Serie 47,0		
	Totalt 426,0		

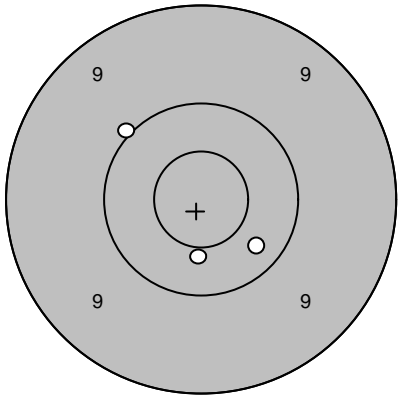
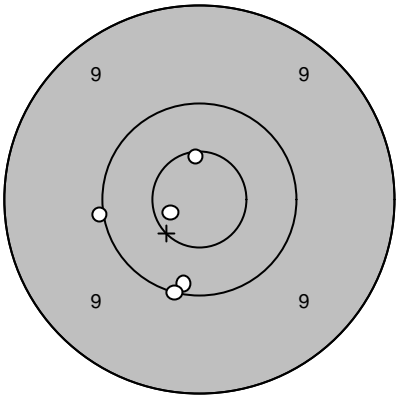
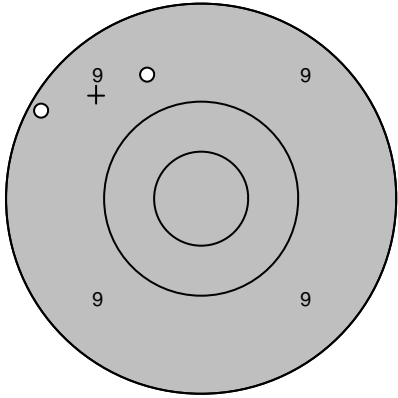
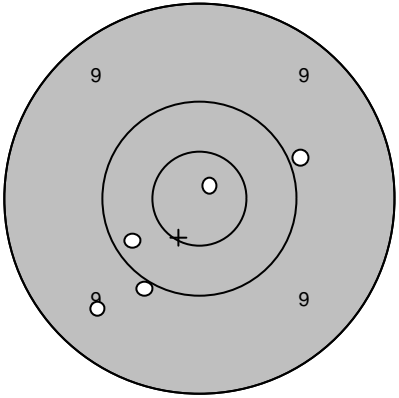
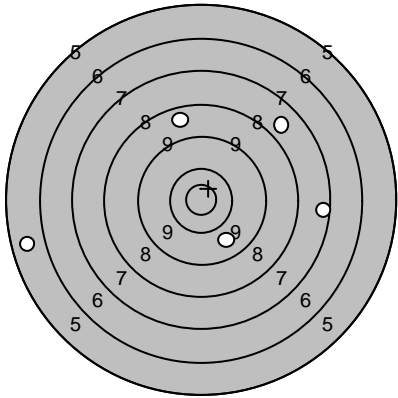
Skjutlag	Tavla	Stefan Lundqvist	
3	4		
Ramselefors	Ununge		
2005-07-10	Tavelträffen B 2005 Final	Ramselefors Skytteförening	
Prov 	1: 10,3 ↘ 2: 10,0 ↗ 3: 10,4 ↓	Serie 1 	1: 10,0 ← 2: 10,2 ↓ 3: 10,1 ↓ 4: 10,6* ↑ 5: 10,7* ←
	Serie 30,0 Totalt 288,0		Serie 50,0 Totalt 338,0
Prov 	1: 9,7 ↗ 2: 9,2 ↖	Serie 2 	1: 9,9 → 2: 10,2 ← 3: 10,9* ↗ 4: 9,5 ↓ 5: 10,0 ↓
	Serie 18,0 Totalt 338,0		Serie 48,0 Totalt 386,0
Serie 3 	1: 7,8 ↗ 2: 9,8 ↓ 3: 7,4 → 4: 8,7 ↑ 5: 5,7 ←		
	Serie 36,0 Totalt 422,0		

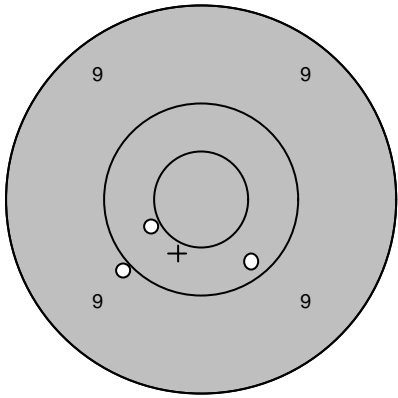
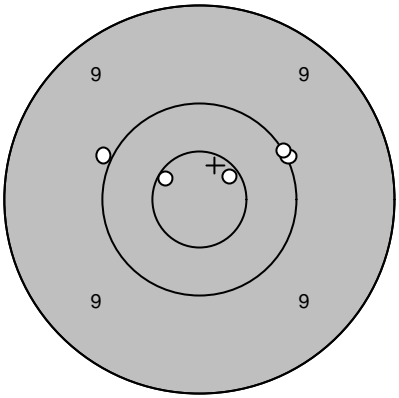
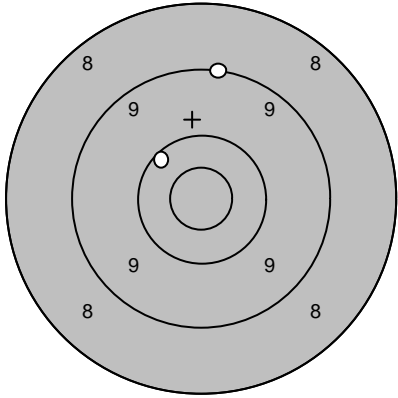
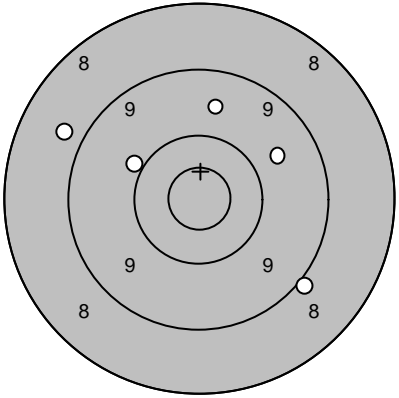
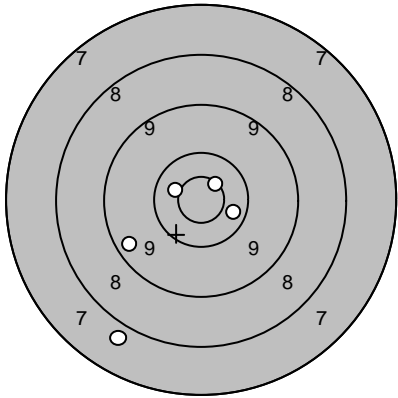
Skjutlag 3	Tavla 5	Jane Jönsson	
Ramselefors		Skurup	
2005-07-10		Tavelträffen B 2005 Final	Ramselefors Skytteförening
Prov 	1: 10,5* ↙	Serie 1 	1: 10,6* ↖
	2: 10,0 ↙		2: 10,0 ↗
	3: 10,2 ↘		3: 10,0 ↗
			4: 10,6* ↗
			5: 10,0 ↖
	Serie 30,0		Serie 50,0
	Totalt 288,0		Totalt 338,0
Prov 	1: 10,2 ↖	Serie 2 	1: 9,6 ↑
	2: 9,1 ↑		2: 8,8 ↖
			3: 9,9 ↖
			4: 9,0 ↘
			5: 9,7 ↗
	Serie 19,0		Serie 44,0
	Totalt 338,0		Totalt 382,0
Serie 3 	1: 7,8 ↙		
	2: 10,7* ↗		
3: 9,4 ↙			
4: 10,6* ↖			
5: 10,4 ➔			
	Serie 46,0		
	Totalt 428,0		

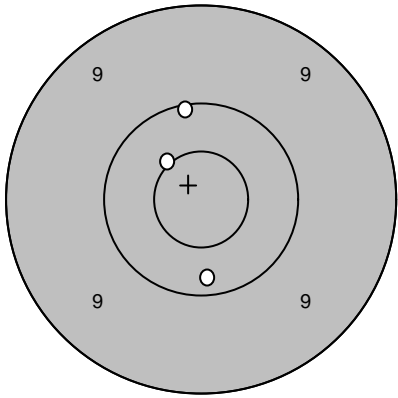
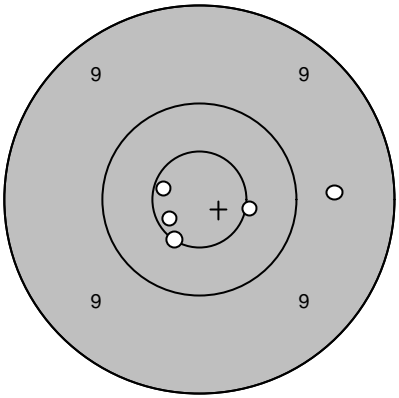
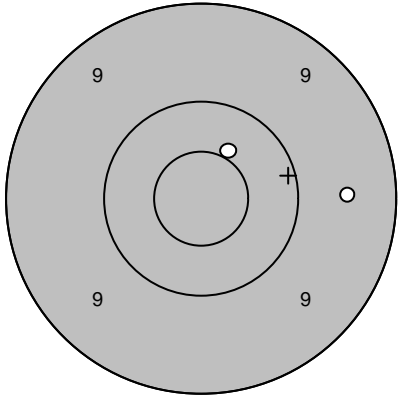
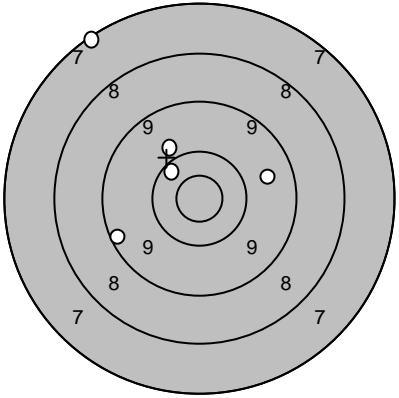
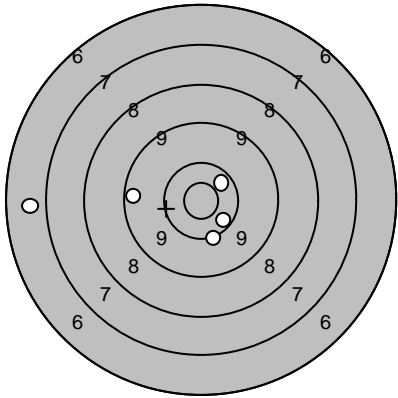
Skjutlag 3	Tavla 6	Bengt Jansson	
Ramselefors		Söderala	
2005-07-10		Tavelträffen B 2005 Final	Ramselefors Skytteförening
Prov		1: 10,5* ↖ 2: 10,1 ↑ 3: 10,2 ↓	Serie 1 
			1: 10,7* ↙ 2: 10,5* → 3: 9,7 → 4: 10,6* ↘ 5: 10,7* ↖
		Serie 30,0	Serie 49,0
		Totalt 287,0	Totalt 336,0
Prov		1: 10,5* ↗ 2: 9,5 →	Serie 2 
			1: 9,9 ↖ 2: 9,7 → 3: 10,3 ↗ 4: 7,2 ↗ 5: 9,3 ↖
		Serie 19,0	Serie 44,0
		Totalt 336,0	Totalt 380,0
Serie 3		1: 10,1 ↓ 2: 10,5* ↗ 3: 10,4 ↘ 4: 9,4 ← 5: 6,8 ←	
		Serie 45,0	
		Totalt 425,0	

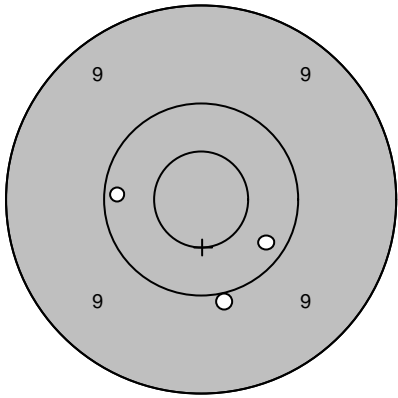
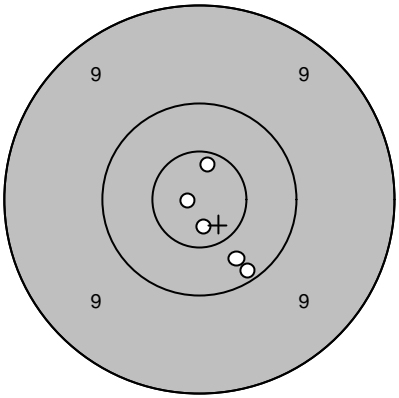
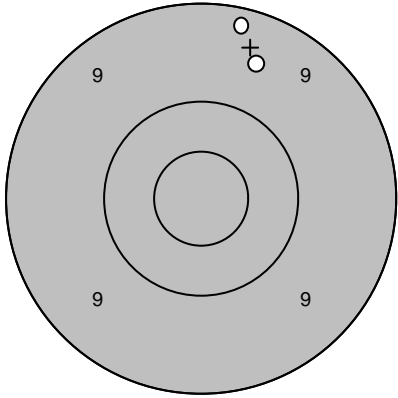
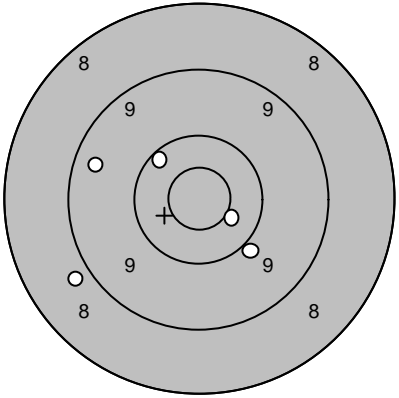
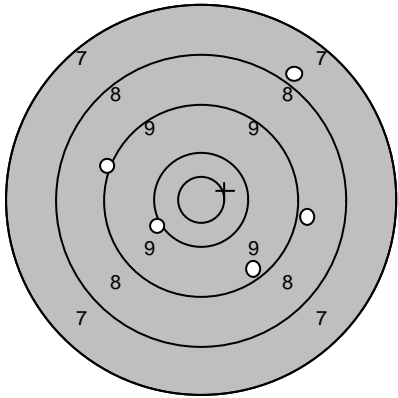
Skjutlag 3	Tavla 7	Maria Falck	
Ramselefors		Moälven-Modo	
2005-07-10		Tavelträffen B 2005 Final	Ramselefors Skytteförening
Prov		1: 10,0 ↓ 2: 10,2 ← 3: 10,2 ↘	Serie 1 
			1: 10,9* ← 2: 10,8* ↓ 3: 10,2 ↘ 4: 10,7* ↑ 5: 10,3 ↘
		Serie 30,0	Serie 50,0
		Totalt 287,0	Totalt 337,0
Prov		1: 9,2 ↑ 2: 9,5 ↑	Serie 2 
			1: 10,5* ↘ 2: 10,2 ↗ 3: 9,9 ↘ 4: 8,8 ← 5: 9,4 ↖
		Serie 18,0	Serie 46,0
		Totalt 337,0	Totalt 383,0
Serie 3		1: 9,3 ↘ 2: 8,9 → 3: 9,1 ← 4: 10,1 ↙ 5: 7,9 ↗	
		Serie 43,0	
		Totalt 426,0	

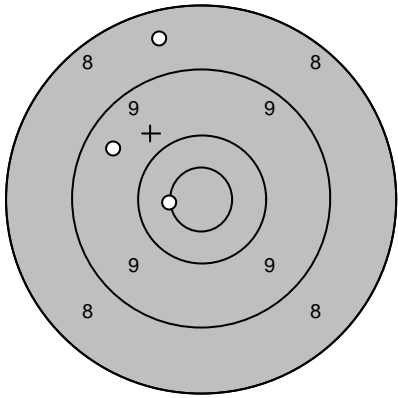
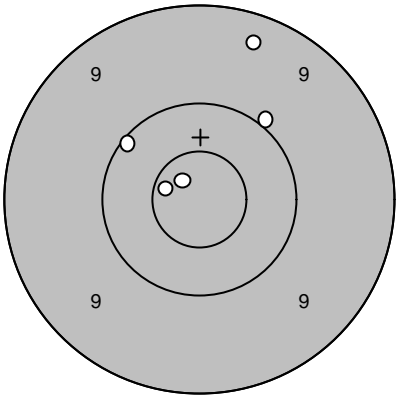
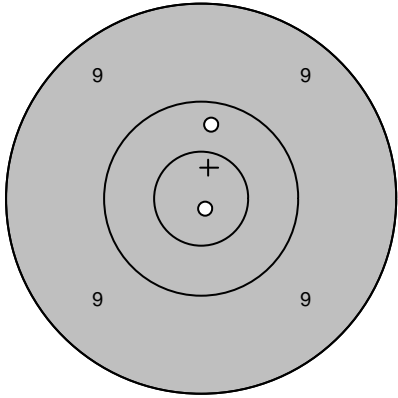
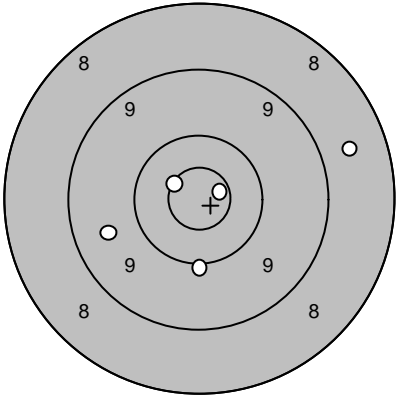
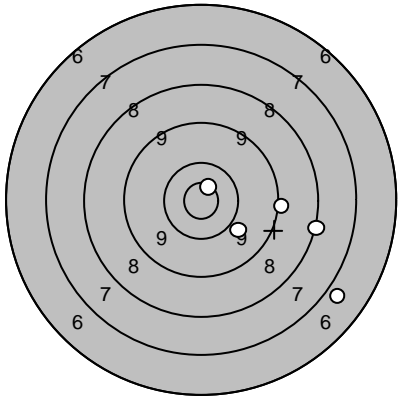
Skjutlag 3	Tavla 8	Lars-Göran Lundqvist	
Ramselefors		Ununge	
2005-07-10		Tavelträffen B 2005 Final	Ramselefors Skytteförening
Prov		1: 8,5 ↑ 2: 10,6* ← 3: 9,5 ↙	Serie 1 
		Serie 27,0 Totalt 286,0	1: 9,3 ↑ 2: 10,7* ← 3: 10,8* ↙ 4: 10,0 ↗ 5: 10,1 ↖
			Serie 49,0 Totalt 335,0
Prov		1: 10,9* ↓ 2: 10,3 ↑	Serie 2 
		Serie 20,0 Totalt 335,0	1: 8,7 → 2: 10,7* → 3: 10,6* ↖ 4: 9,6 ← 5: 10,0 ↓
			Serie 47,0 Totalt 382,0
Serie 3		1: 10,8* ↗ 2: 9,9 ↓ 3: 9,1 → 4: 8,1 → 5: 6,9 ↘	
		Serie 42,0 Totalt 424,0	

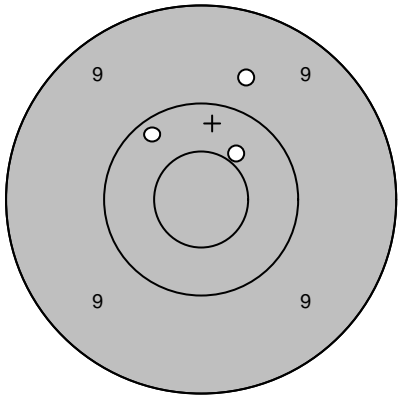
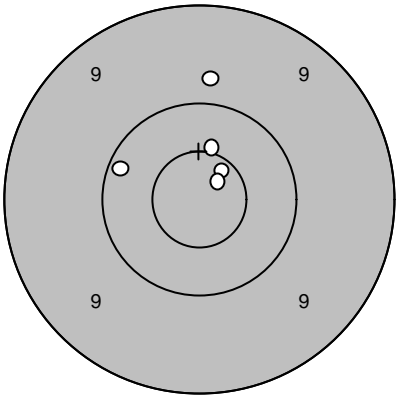
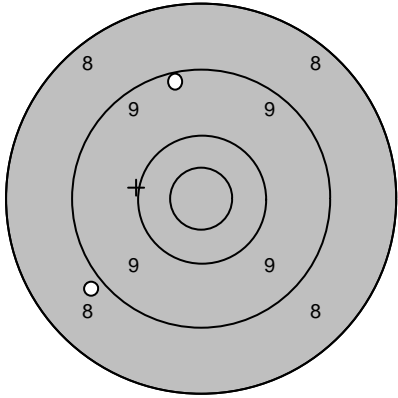
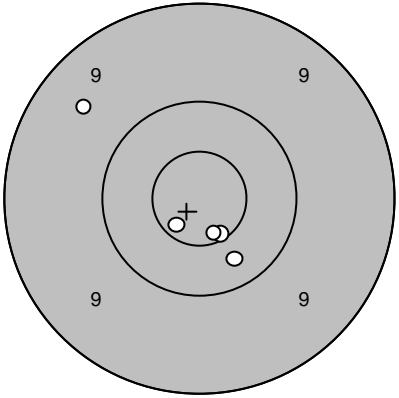
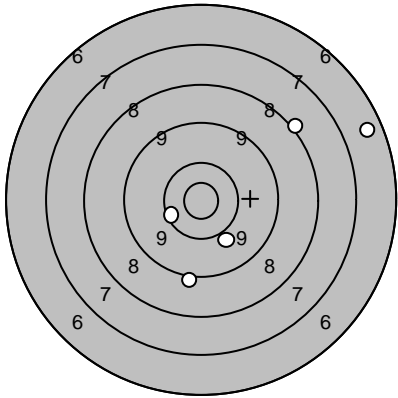
Skjutlag 3	Tavla 9	Magnus Lindkvist	
Ramselefors		Umeå	
2005-07-10		Tavelträffen B 2005 Final	Ramselefors Skytteförening
Prov 	1: 10,2 ↖	Serie 1 	1: 9,8 ↑
	2: 9,7 ↑		2: 10,2 ↖
	3: 10,4 ↗		3: 10,5* ↑
			4: 10,7* ↗
			5: 10,8* ↗
	Serie 29,0		Serie 49,0
	Totalt 284,0		Totalt 333,0
Prov 	1: 9,2 ↑	Serie 2 	1: 10,7* ↙
	2: 8,9 ↙		2: 9,5 ↗
			3: 10,3 ↙
			4: 10,6* ↙
			5: 10,7* ↙
	Serie 17,0		Serie 49,0
	Totalt 333,0		Totalt 382,0
Serie 3 	1: 9,1 ↓		
	2: 10,0 ↓		
	3: 6,5 →		
	4: 10,3 ↙		
	5: 8,1 ↗		
	Serie 43,0		
	Totalt 425,0		

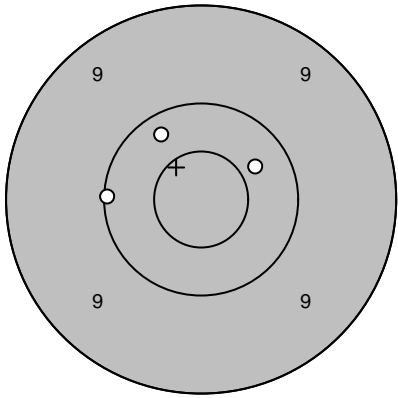
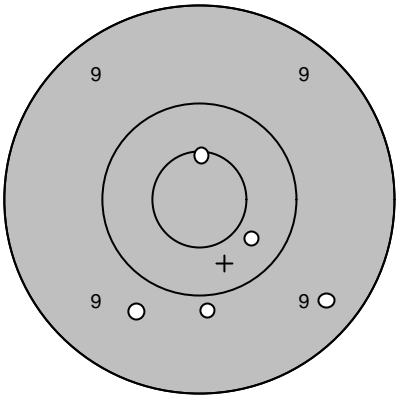
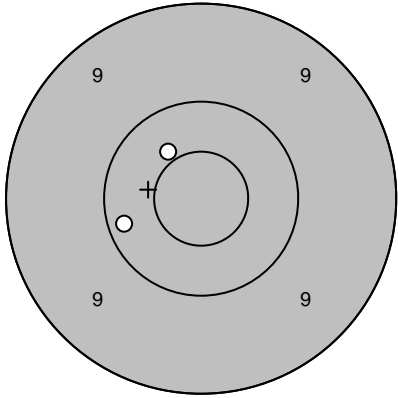
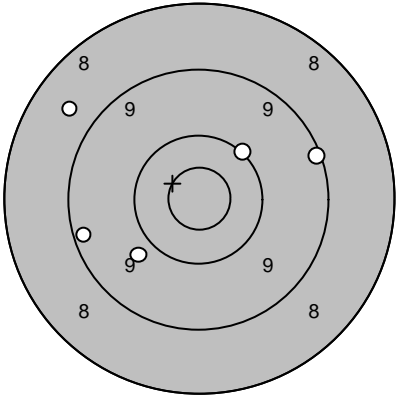
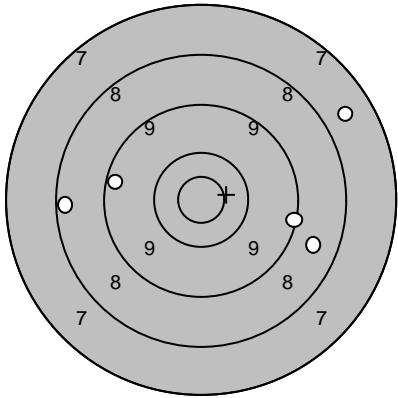
Skjutlag 3	Tavla 10	Helena Jansson	
Ramselefors		Söderala	
2005-07-10		Tavelträffen B 2005 Final	Ramselefors Skytteförening
Prov		1: 10,1 ← 2: 10,3 ↖ 3: 10,4 ↗	Serie 1 
			1: 10,4 ↘ 2: 10,6* ↑ 3: 9,9 ↓ 4: 9,4 ↘ 5: 9,7 ↙
		Serie 30,0	Serie 47,0
		Totalt 283,0	Totalt 330,0
Prov		1: 10,4 ↖ 2: 10,2 ←	Serie 2 
			1: 9,8 ↙ 2: 9,2 → 3: 9,2 ← 4: 8,7 ↖ 5: 10,1 ↗
		Serie 20,0	Serie 45,0
		Totalt 330,0	Totalt 375,0
Serie 3		1: 9,2 → 2: 7,7 ↗ 3: 8,3 ← 4: 9,3 ← 5: 8,7 →	
		Serie 41,0	
		Totalt 416,0	

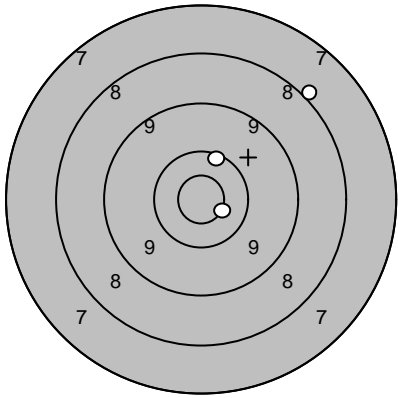
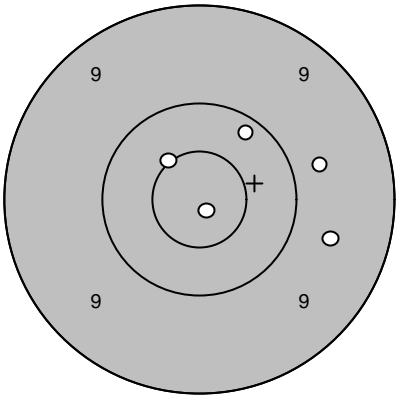
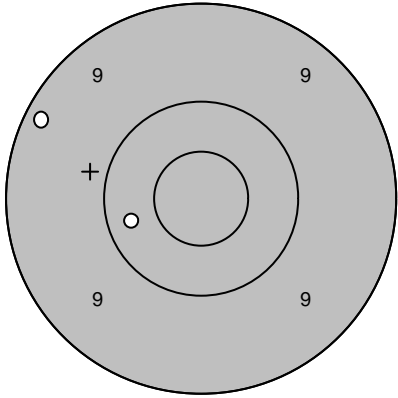
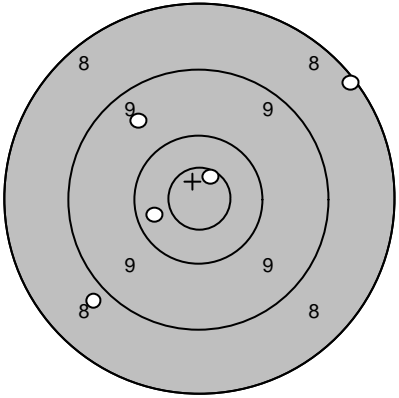
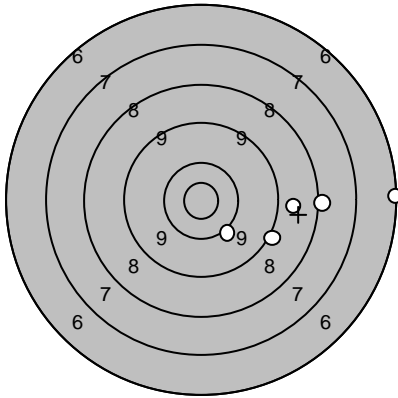
Skjutlag 3	Tavla 11	Ulf Ohlsson	
Ramselefors		Umeå	
2005-07-10		Tavelträffen B 2005 Final	Ramselefors Skytteförening
Prov		1: 10,2 ↗ 2: 8,0 ↗ 3: 10,6* →	Serie 1 
		Serie 28,0 Totalt 282,0	1: 10,5* ↗ 2: 10,9* ↘ 3: 9,8 → 4: 9,6 → 5: 10,2 ↗ Serie 48,0 Totalt 330,0
Prov		1: 10,3 ← 2: 9,2 ↖	Serie 2 
		Serie 19,0 Totalt 330,0	1: 10,7* ↗ 2: 8,2 ↗ 3: 8,8 ↘ 4: 10,4 ← 5: 9,6 ↗ Serie 45,0 Totalt 375,0
Serie 3		1: 6,2 → 2: 8,1 → 3: 10,1 ↘ 4: 9,1 → 5: 8,8 →	
		Serie 41,0 Totalt 416,0	

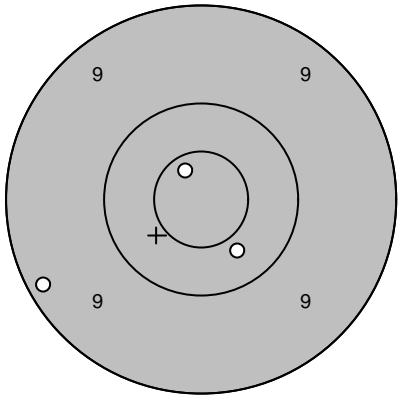
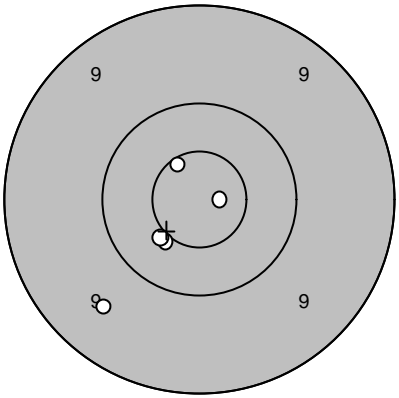
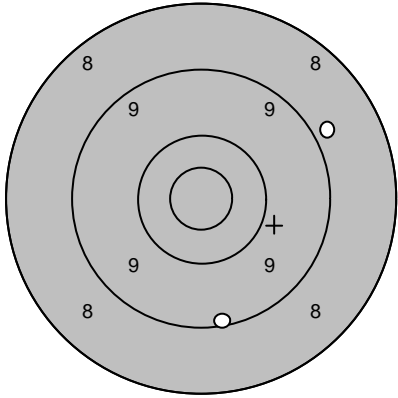
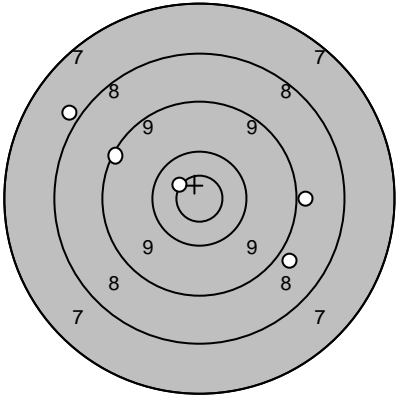
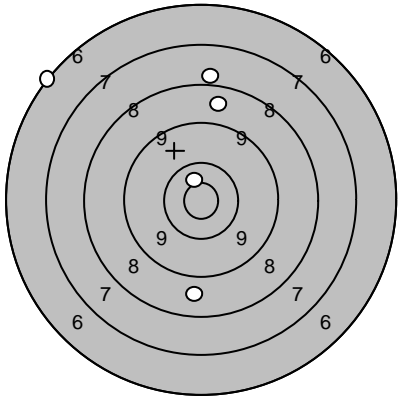
Skjutlag 3	Tavla 12	Peter Lavér		
Ramselefors		Söderala		
2005-07-10		Tavelträffen B 2005 Final	Ramselefors Skytteförening	
Prov		1: 10,7* ↖ 2: 10,4 ↓ 3: 9,2 ↙	Serie 1 	1: 10,5* ↙ 2: 9,6 ↙ 3: 10,5* ↙ 4: 10,6* ↖ 5: 10,8* →
		Serie 29,0		Serie 49,0
		Totalt 281,0		Totalt 330,0
Prov		1: 8,9 ↗ 2: 9,2 ↓	Serie 2 	1: 10,6* ↖ 2: 9,0 → 3: 9,2 ↖ 4: 7,9 ↖ 5: 8,9 ↘
		Serie 17,0		Serie 43,0
		Totalt 330,0		Totalt 373,0
Serie 3		1: 8,8 ↓ 2: 6,1 ↖ 3: 8,7 ↑ 4: 10,6* ↑ 5: 8,0 ↑		
		Serie 40,0		
		Totalt 413,0		

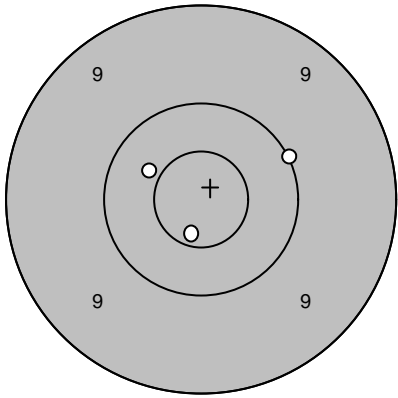
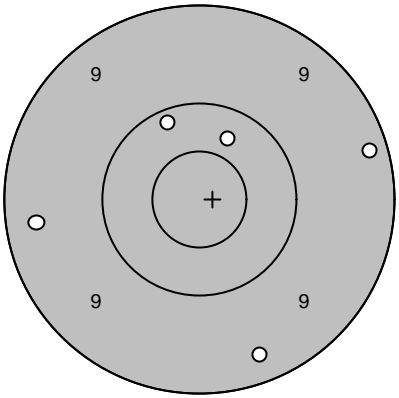
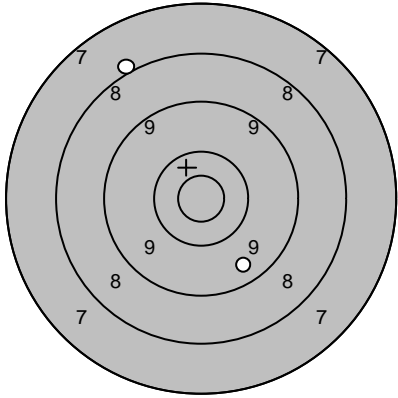
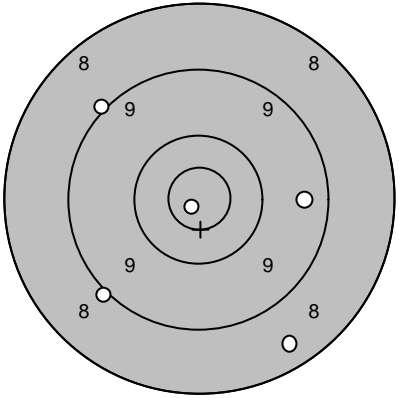
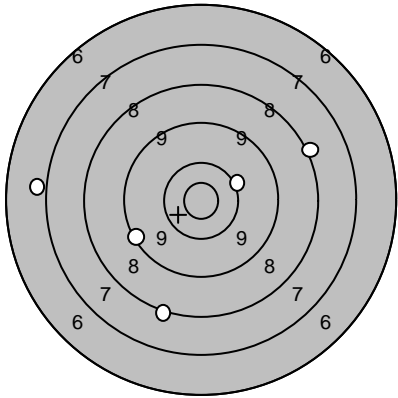
Skjutlag 3	Tavla 13	Jan-Olof Lampinen		
Ramselefors	S 3			
2005-07-10	Tavelträffen B 2005 Final	Ramselefors Skytteförening		
Prov		1: 10,4 ↖ 2: 10,0 ↗ 3: 10,7* ↓	Serie 1 	1: 9,2 → 2: 9,4 ← 3: 10,2 ↑ 4: 10,4 ↗ 5: 9,3 ↓
	Serie 30,0 Totalt 280,0		Serie 47,0 Totalt 327,0	
Prov		1: 8,0 ↖ 2: 9,5 ↓	Serie 2 	1: 9,0 ↖ 2: 8,5 ↓ 3: 9,0 ↗ 4: 10,9* ↖ 5: 9,5 →
	Serie 17,0 Totalt 327,0		Serie 45,0 Totalt 372,0	
Serie 3		1: 8,1 ↗ 2: 8,1 ↓ 3: 10,1 ↗ 4: 7,0 ← 5: 9,3 ↖		
	Serie 42,0 Totalt 414,0			

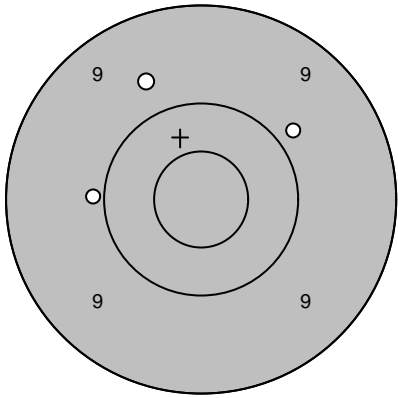
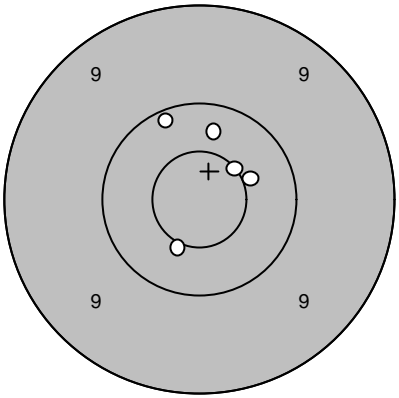
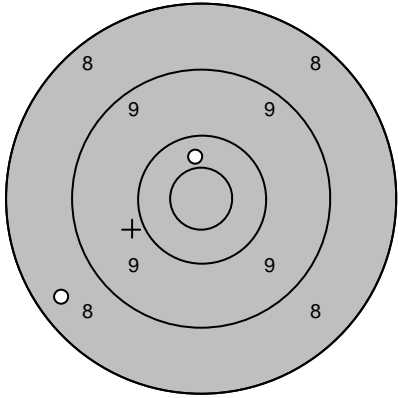
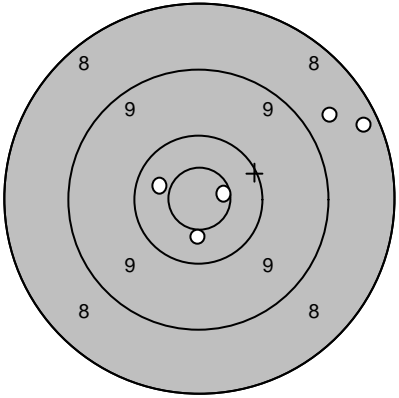
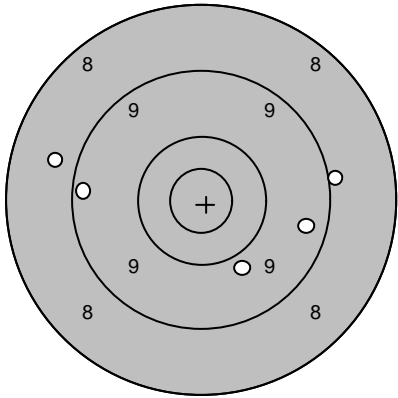
Skjutlag 3	Tavla 14	Urban Åberg		
Ramselefors		Madesjö-Nybro		
2005-07-10		Tavelträffen B 2005 Final	Ramselefors Skytteförening	
Prov		1: 9,9 ↗ 2: 9,9 ← 3: 9,7 ↖	Serie 1 	1: 10,3 ↗ 2: 10,5* ↓ 3: 10,2 ↖ 4: 10,6* ↗ 5: 10,5* →
		Serie 27,0	Serie 50,0	
		Totalt 280,0	Totalt 330,0	
Prov		1: 10,4 ↗ 2: 8,5 ↙	Serie 2 	1: 8,7 ↗ 2: 10,7* → 3: 8,3 ↗ 4: 10,5* ↓ 5: 10,4 ←
		Serie 18,0	Serie 46,0	
		Totalt 330,0	Totalt 376,0	
Serie 3		1: 9,0 → 2: 9,3 ← 3: 9,9 ↓ 4: 8,7 ← 5: 9,4 →		
		Serie 44,0		
		Totalt 420,0		

Skjutlag 3	Tavla 15	Anton Lindfors	
Ramselefors		I 19	
2005-07-10		Tavelträffen B 2005 Final	Ramselefors Skytteförening
Prov		1: 10,4 → 2: 10,4 ← 3: 10,8* ↗	Serie 1
			1: 10,6* ↓ 2: 10,7* ↘ 3: 9,7 → 4: 9,7 ↗ 5: 10,2 ↗
		Serie 30,0	Serie 48,0
		Totalt 280,0	Totalt 328,0
Prov		1: 9,4 ↗ 2: 8,7 ←	Serie 2
			1: 9,5 → 2: 10,1 ↘ 3: 9,7 ↗ 4: 10,2 ← 5: 9,8 ↗
		Serie 17,0	Serie 47,0
		Totalt 328,0	Totalt 375,0
Serie 3		1: 7,6 ↖ 2: 7,8 ↖ 3: 9,7 → 4: 8,4 ← 5: 9,8 ↓	
		Serie 40,0	
		Totalt 415,0	

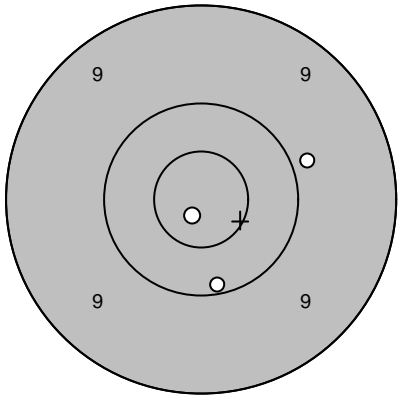
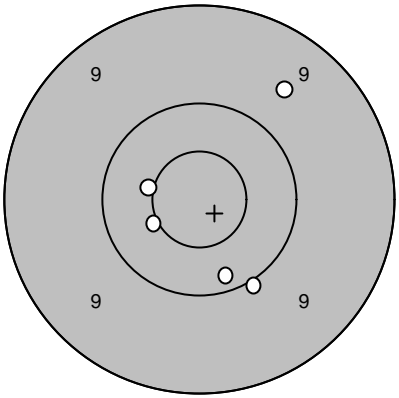
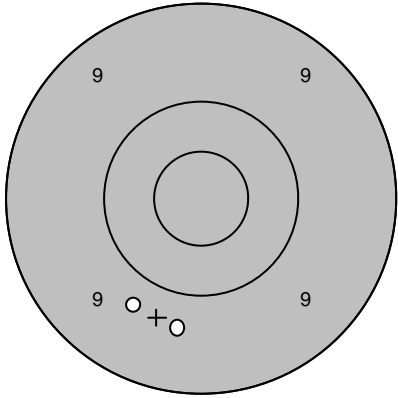
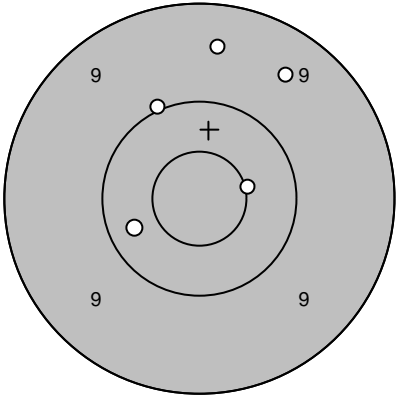
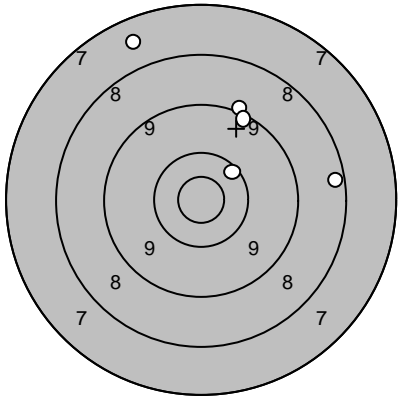
Skjutlag	Tavla	Peder Vahlberg		
3	16			
Ramselefors	Ramselefors			
2005-07-10	Tavelträffen B 2005 Final	Ramselefors Skytteförening		
Prov		1: 10,8* ↙ 2: 10,2 ↓ 3: 9,9 →	Serie 1 	1: 9,6 ↗ 2: 10,0 ↓ 3: 10,5* ← 4: 10,5* ← 5: 10,2 ↓
	Serie 29,0 Totalt 280,0		Serie 49,0 Totalt 329,0	
Prov		1: 9,7 ↙ 2: 9,7 ↓	Serie 2 	1: 9,5 ↑ 2: 9,5 ↗ 3: 10,0 ↗ 4: 10,5* → 5: 10,3 ←
	Serie 18,0 Totalt 329,0		Serie 48,0 Totalt 377,0	
Serie 3		1: 9,1 ↗ 2: 8,3 → 3: 9,2 ↗ 4: 7,6 ↖ 5: 10,3 ↗		
	Serie 43,0 Totalt 420,0			

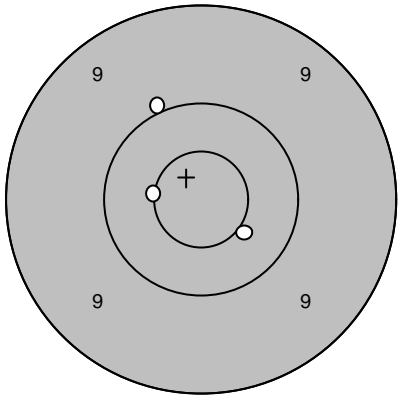
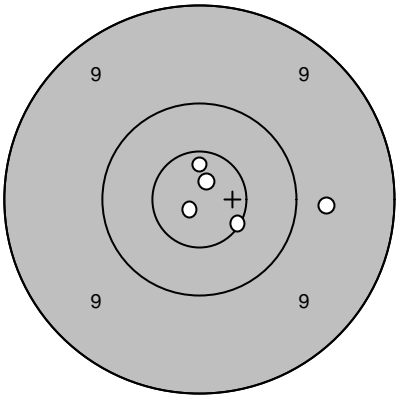
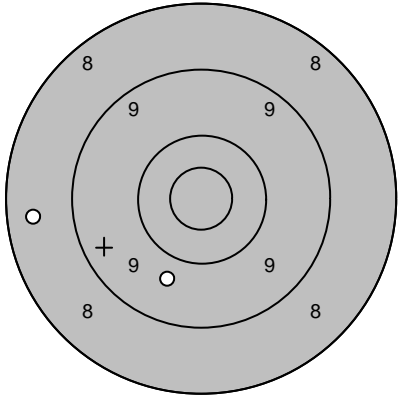
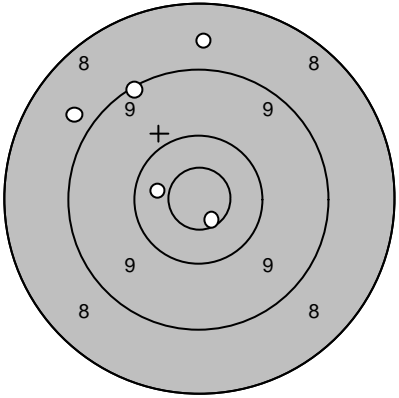
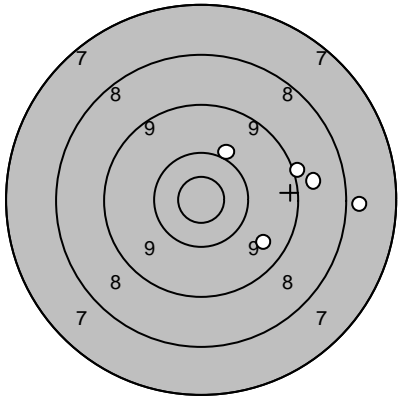
Skjutlag	Tavla	Linda Gustavsson	
3	17		
Ramselefors	Moälven-Modo		
2005-07-10	Tavelträffen B 2005 Final	Ramselefors Skytteförening	
Prov		1: 10,0 ↗ 2: 10,5* ← 3: 10,5* ↘	Serie 1 1: 10,7* ↑ 2: 10,6* ↘ 3: 9,7 → 4: 10,9* ↙ 5: 10,8* ↗
			
		Serie 30,0	Serie 49,0
		Totalt 279,0	Totalt 328,0
Prov		1: 8,5 ← 2: 9,8 ↙	Serie 2 1: 8,7 ↑ 2: 10,7* ↘ 3: 9,1 ↗ 4: 8,8 ↗ 5: 10,4 ←
			
		Serie 17,0	Serie 45,0
		Totalt 328,0	Totalt 373,0
Serie 3		1: 10,0 ↗ 2: 7,9 → 3: 9,6 ↘ 4: 9,1 → 5: 8,8 →	
			
		Serie 43,0	
		Totalt 416,0	

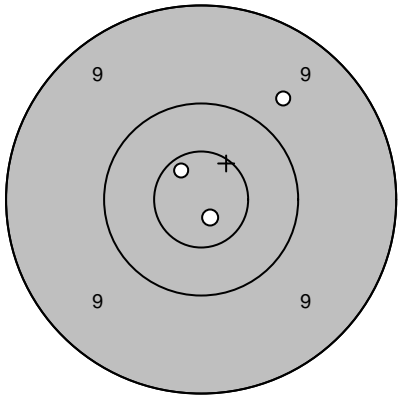
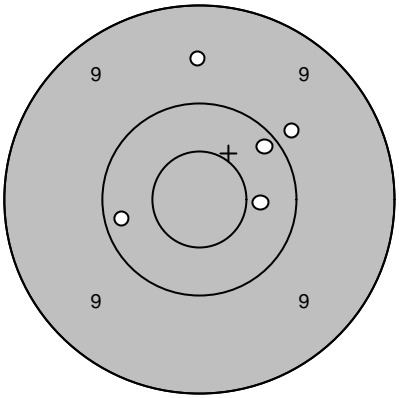
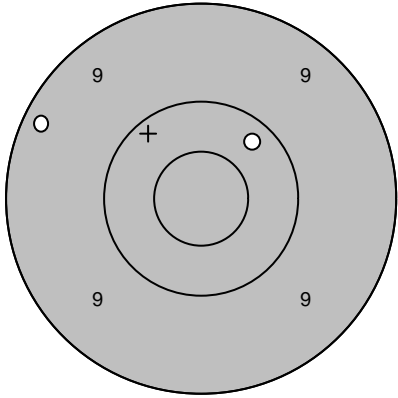
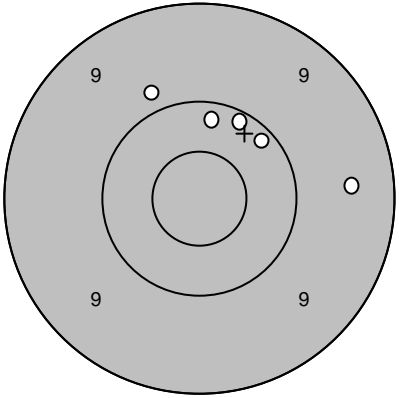
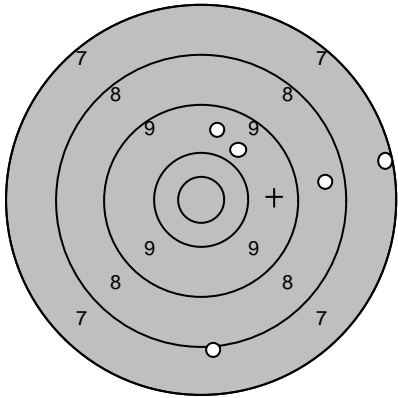
Skjutlag	Tavla	Patrik Lindfors	
3	19		
Ramselefors	I 19		
2005-07-10	Tavelträffen B 2005 Final	Ramselefors Skytteförening	
Prov 	1: 10,8* ↓	Serie 1 	1: 9,9 ↗
	2: 10,7* ↖		2: 10,2 ←
	3: 9,7 ↗		3: 9,6 ↑
			4: 10,4 →
			5: 10,2 ↗
	Serie 29,0		Serie 48,0
	Totalt 278,0		Totalt 326,0
Prov 	1: 10,3 ↗	Serie 2 	1: 10,2 ↗
	2: 9,2 ←		2: 9,5 →
			3: 10,2 ↑
			4: 9,9 ↖
			5: 10,1 ↗
	Serie 19,0		Serie 48,0
	Totalt 326,0		Totalt 374,0
Serie 3 	1: 8,0 ↓		
	2: 9,9 ↗		
	3: 7,3 →		
	4: 9,6 ↑		
	5: 8,6 →		
	Serie 41,0		
	Totalt 415,0		

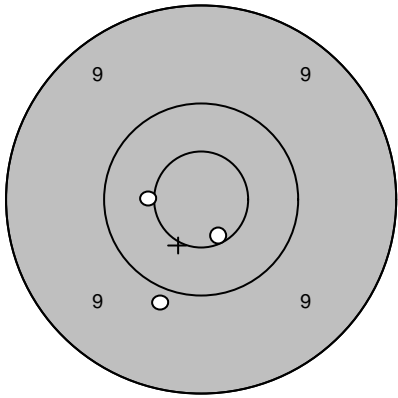
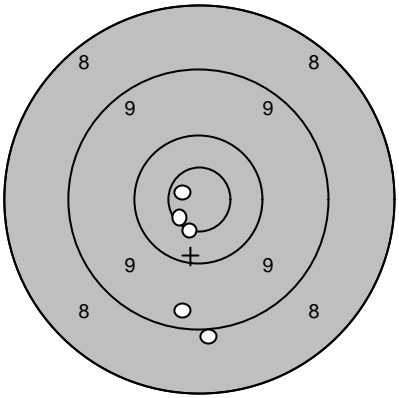
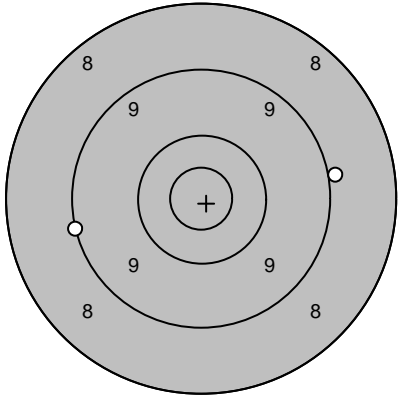
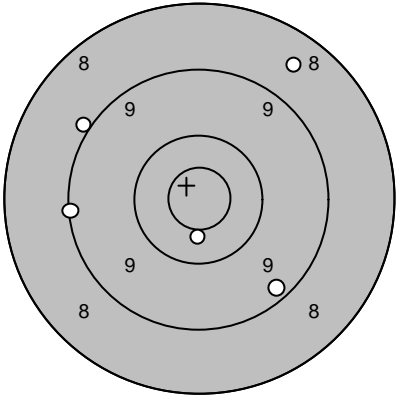
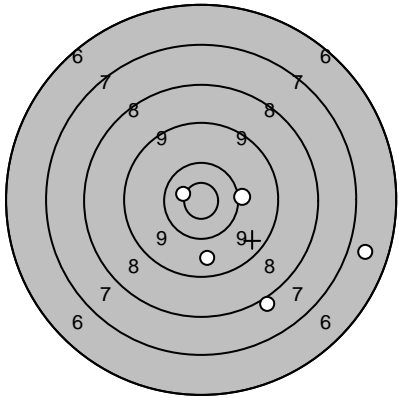
Skjutlag	Tavla	Sören Olsson		
3	20			
Ramselefors	Umeå			
2005-07-10	Tavelträffen B 2005 Final	Ramselefors Skytteförening		
Prov		1: 10,5* ← 2: 9,9 ↓ 3: 10,6* ↓	Serie 1 	1: 10,8* ← 2: 9,4 ↓ 3: 10,7* ↙ 4: 9,0 ↓ 5: 10,6* ↓
		Serie 29,0		Serie 48,0
		Totalt 277,0		Totalt 325,0
Prov		1: 9,0 → 2: 9,1 ←	Serie 2 	1: 9,1 ← 2: 9,0 ↖ 3: 10,5* ↓ 4: 9,3 ↓ 5: 8,6 ↗
		Serie 18,0		Serie 45,0
		Totalt 325,0		Totalt 370,0
Serie 3		1: 9,7 ↓ 2: 6,8 → 3: 8,0 ↓ 4: 10,1 → 5: 10,7* ←		
		Serie 43,0		
		Totalt 413,0		

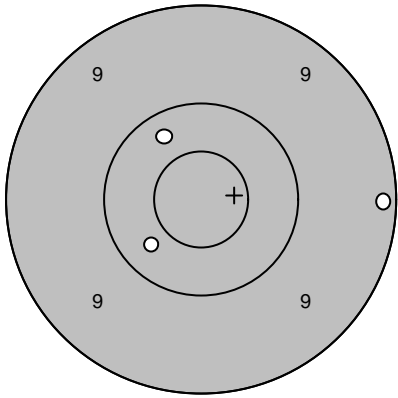
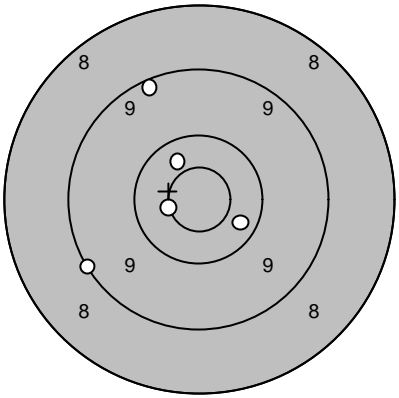
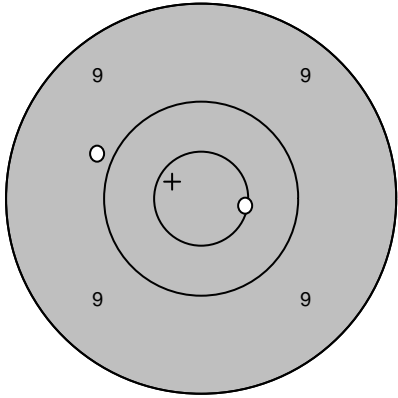
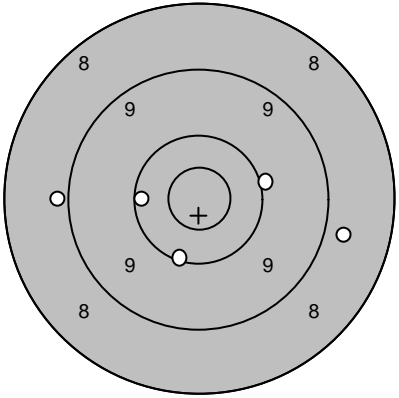
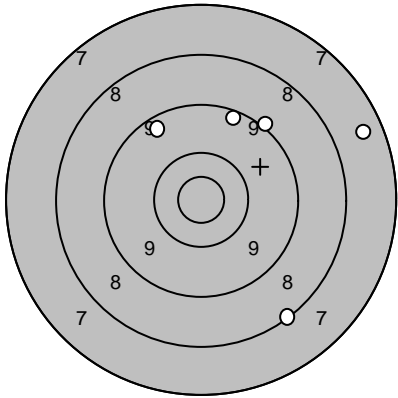
Skjutlag	Tavla	Donald Johansson	
3	21		
Ramselefors	Ale		
2005-07-10	Tavelträffen B 2005 Final	Ramselefors Skytteförening	
Prov		1: 9,2 → 2: 10,3 ↙ 3: 10,3 ↖	Serie 1 
			1: 10,6* ← 2: 9,1 ← 3: 9,2 ↗ 4: 10,3 ↘ 5: 10,4 ↗
		Serie 29,0	Serie 48,0
		Totalt 277,0	Totalt 325,0
Prov		1: 9,9 ← 2: 10,6* →	Serie 2 
			1: 10,1 ↓ 2: 8,8 → 3: 10,0 → 4: 8,9 ← 5: 10,2 ←
		Serie 19,0	Serie 46,0
		Totalt 325,0	Totalt 371,0
Serie 3		1: 9,3 ↗ 2: 9,4 ↖ 3: 7,5 → 4: 9,1 ↗ 5: 8,1 ↓	
		Serie 42,0	
		Totalt 413,0	

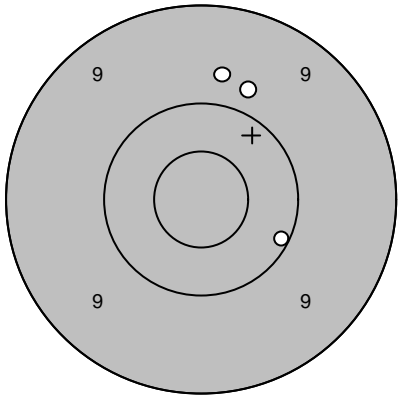
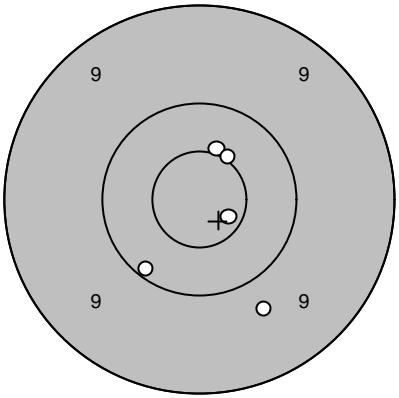
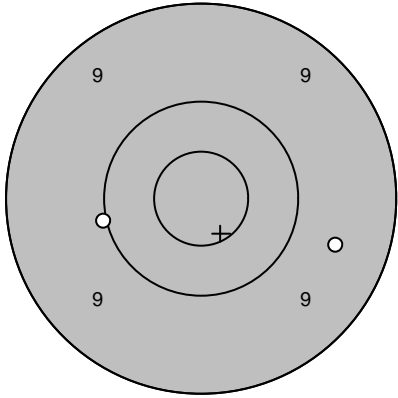
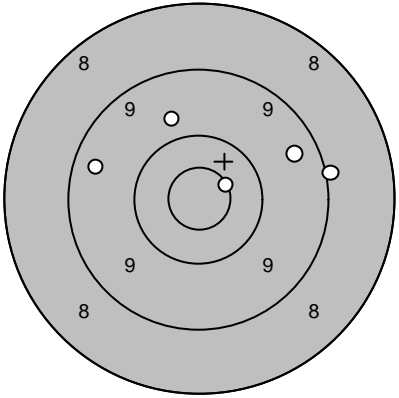
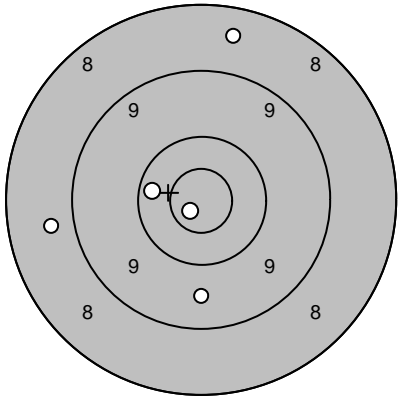
Skjutlag	Tavla	Harry Östling		
3	22			
Ramselefors	F 21			
2005-07-10	Tavelträffen B 2005 Final	Ramselefors Skytteförening		
Prov		1: 10,1 → 2: 9,7 ↑ 3: 9,8 ↑	Serie 1 	1: 10,5* ↑ 2: 10,7* → 3: 10,1 ↙ 4: 10,5* ↗ 5: 9,7 ↓
		Serie 28,0	Serie 49,0	
		Totalt 277,0	Totalt 326,0	
Prov		1: 9,6 → 2: 10,0 ←	Serie 2 	1: 9,5 → 2: 9,4 ← 3: 10,6* ↗ 4: 9,0 → 5: 9,8 ↑
		Serie 19,0	Serie 46,0	
		Totalt 326,0	Totalt 372,0	
Serie 3		1: 10,3 ← 2: 8,7 ← 3: 8,5 ↑ 4: 10,8* ↙ 5: 9,6 ↓		
		Serie 45,0		
		Totalt 417,0		

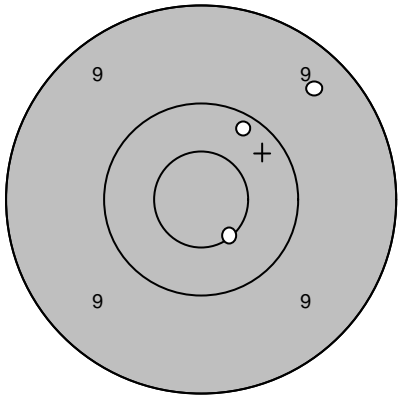
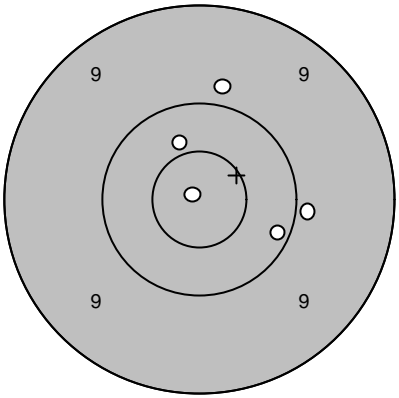
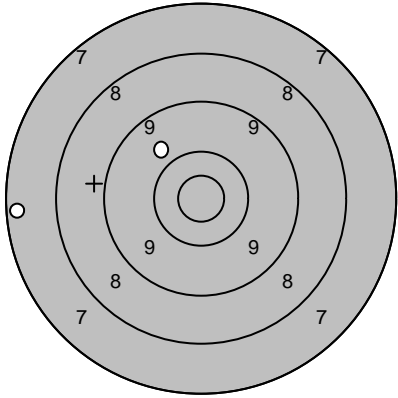
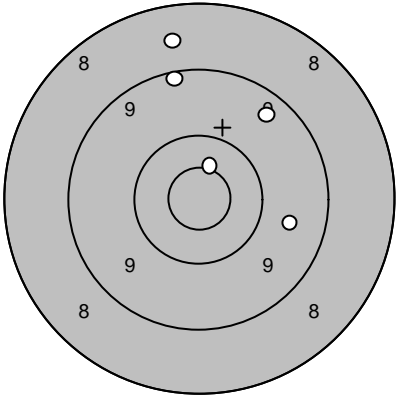
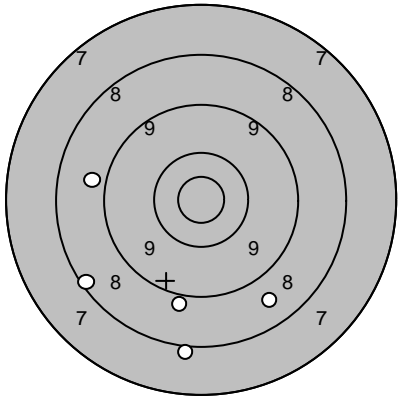
Skjutlag 3	Tavla 23	Gustav Lövgren		
Ramselefors		Niemisel		
2005-07-10		Tavelträffen B 2005 Final	Ramselefors Skytteförening	
Prov		1: 10,6* ↘ 2: 10,2 ↗ 3: 9,4 ↗	Serie 1 	1: 10,4 ↗ 2: 9,9 → 3: 10,2 ↘ 4: 10,9* ↗ 5: 9,9 ↗
		Serie 29,0	Serie 48,0	
		Totalt 276,0	Totalt 324,0	
Prov		1: 9,8 ↖ 2: 7,4 ←	Serie 2 	1: 9,4 ↗ 2: 8,6 ↗ 3: 10,6* ↗ 4: 9,2 ↗ 5: 9,6 →
		Serie 16,0	Serie 45,0	
		Totalt 324,0	Totalt 369,0	
Serie 3		1: 9,0 ↓ 2: 8,0 ↓ 3: 8,9 ← 4: 8,3 ↙ 5: 8,7 ↘		
		Serie 41,0		
		Totalt 410,0		