

Skjutlag <b>1</b>	Tavla <b>1</b>	<b>Petter Ivarsson</b>	
----------------------	-------------------	------------------------	--

Ramselefors	Loos		
-------------	------	--	--

2005-07-10	Tavelträffen B 2005	Ramselefors Skytteförening	
------------	---------------------	----------------------------	--

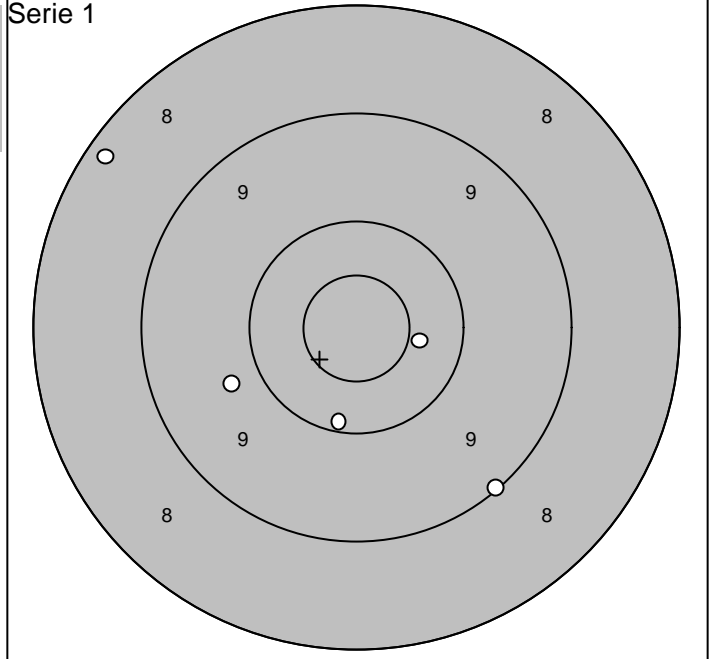
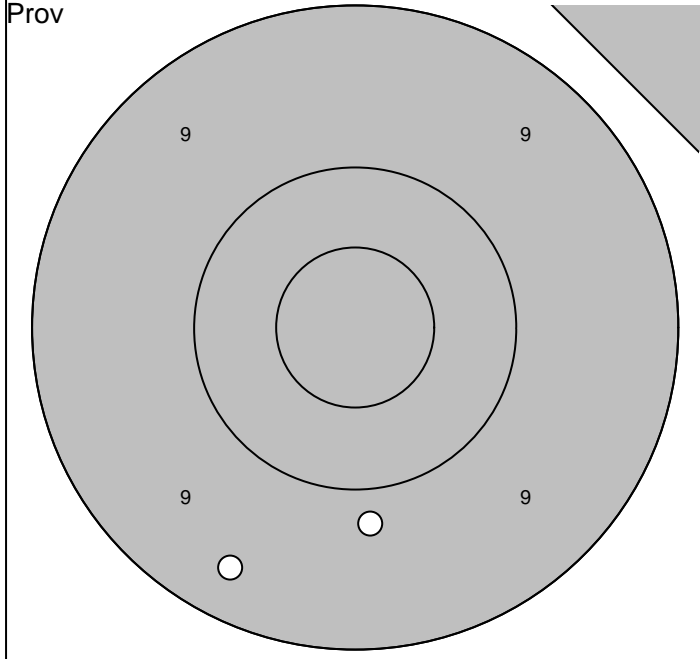

1: 0,0 →	Serie	18,0
2: 0,0 →		
3: 9,4 ↘	Totalt	0,0
4: 9,8 ↓		

1: 9,1 ↘	Serie	46,0
2: 9,8 ←		
3: 10,1 ↘	Totalt	46,0
4: 8,2 ↗		
5: 10,4 →		

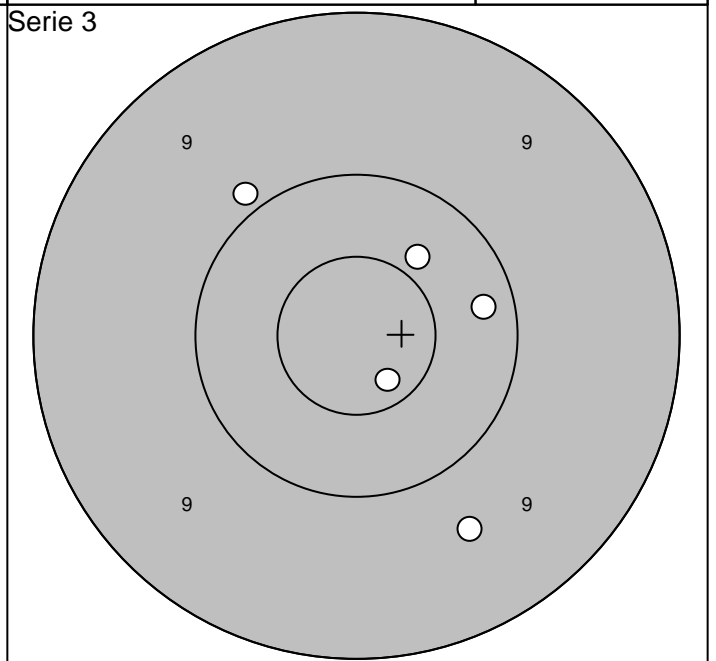
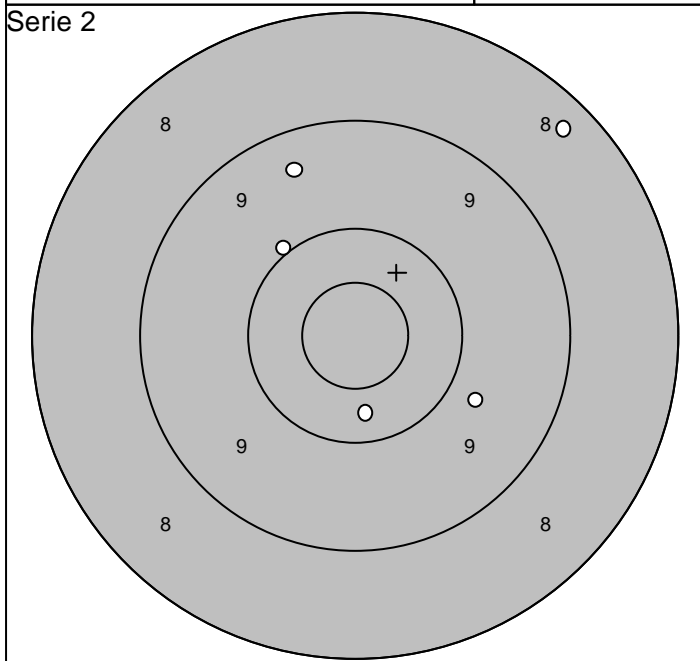

1: 9,8 ↘	Serie	46,0
2: 9,4 ↗		
3: 10,0 ↗	Totalt	92,0
4: 10,3 ↓		
5: 8,3 ↗		

1: 10,4 ↗	Serie	48,0
2: 10,2 →		
3: 10,7* ↘	Totalt	140,0
4: 9,9 ↗		
5: 9,6 ↘		

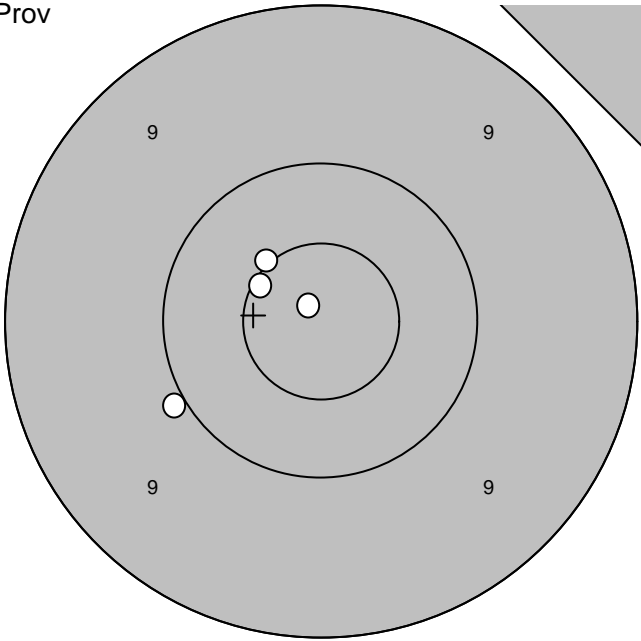
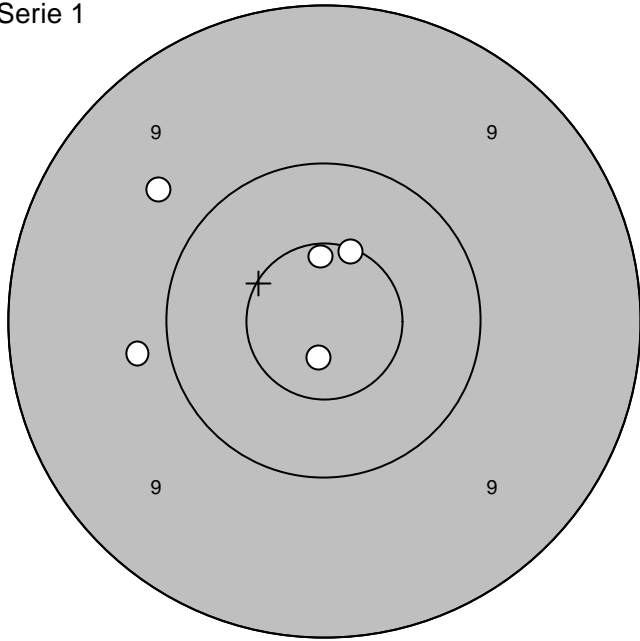
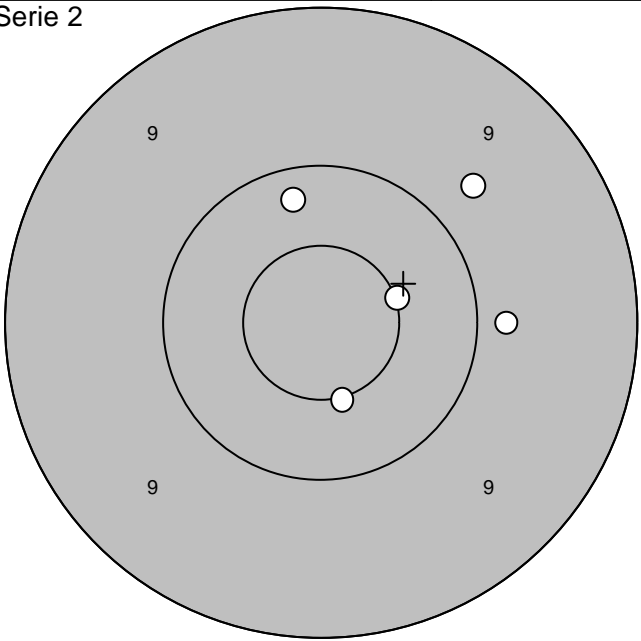
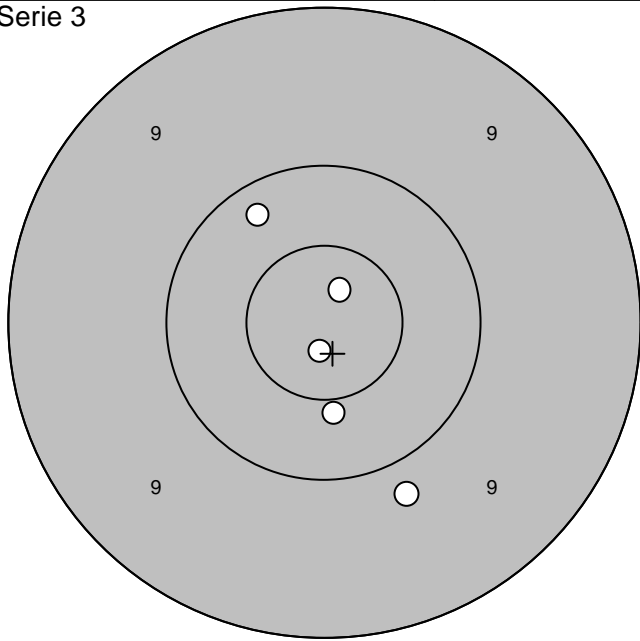
Skjutlag <b>1</b>	Tavla <b>2</b>	<b>Peter Ericson</b>	
Ramselefors		Loos	
2005-07-10		Tavelträffen B 2005	Ramselefors Skytteförening
Prov		Serie 1	
			
1:10,6* ↖		Serie 40,0	1: 9,8 ←
2:10,9* ↗			2: 9,7 ↖
3:10,5* ↗		Totalt 0,0	3:10,6* ↗
4:10,0 ←			4:10,6* ↑
			5:10,8* ↓
		Serie 48,0	Serie 48,0
		Totalt 96,0	Totalt 48,0
Serie 2		Serie 3	
			
1:10,5* →		Serie 48,0	1:10,8* ↗
2:10,2 ↑			2:10,5* ↓
3: 9,9 →		Totalt 96,0	3:10,2 ↗
4:10,5* ↓			4:10,8* ↓
5: 9,7 ↗			5: 9,8 ↘
		Serie 49,0	Serie 49,0
		Totalt 145,0	Totalt 145,0

Skjutlag <b>1</b>	Tavla <b>4</b>	<b>Elina Högström</b>	
Ramselefors		Ramselefors	
2005-07-10		Tavelträffen B 2005	Ramselefors Skytteförening
Prov		Serie 1	
1: 9,2 ↖	Serie 32,0	1: 9,3 →	Serie 46,0
2: 7,6 ↑		2: 10,5* ←	
3: 8,7 ↗	Totalt 0,0	3: 10,5* ↓	Totalt 46,0
4: 8,9 ←		4: 9,8 ↖	
Serie 2		Serie 3	
1: 9,1 ↗	Serie 44,0	1: 7,9 ↑	Serie 45,0
2: 9,0 ↗		2: 9,2 ↑	
3: 8,8 →	Totalt 90,0	3: 10,5* ↗	Totalt 135,0
4: 9,4 ↓		4: 9,5 →	
5: 9,6 ↓		5: 10,0 ↖	

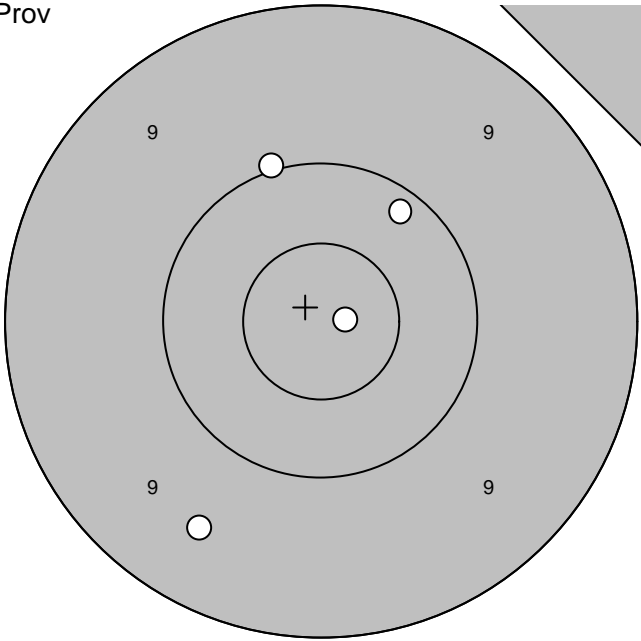
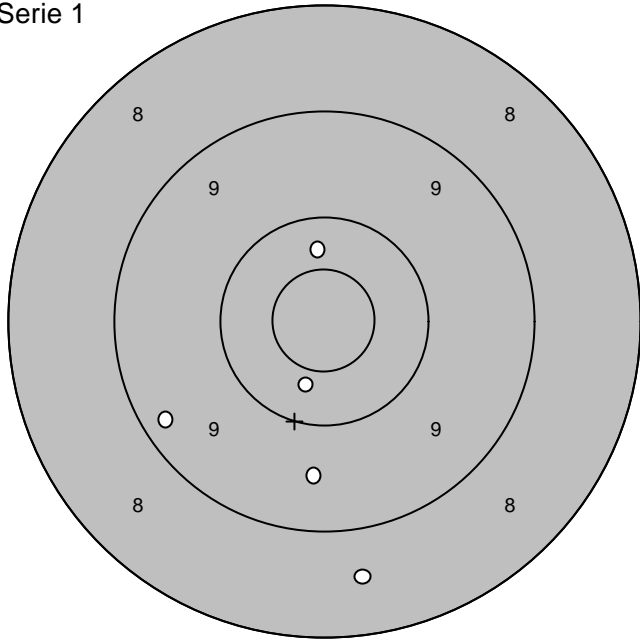
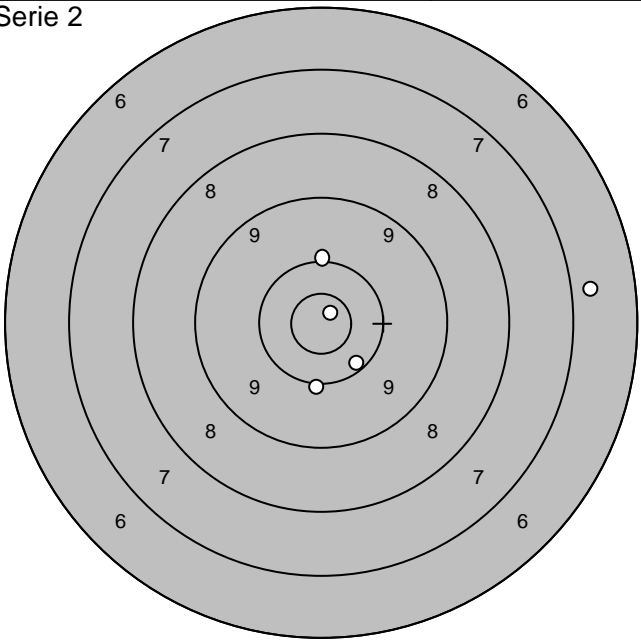
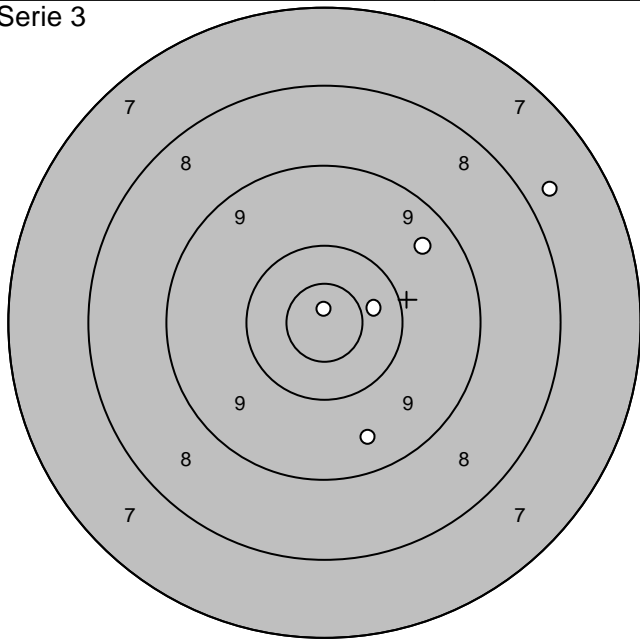
Skjutlag	Tavla	<b>Peter Lundqvist</b>	
<b>1</b>	<b>5</b>		
Ramselefors	Ununge		
2005-07-10	Tavelträffen B 2005	Ramselefors Skytteförening	
Prov	Serie 1		
			
1:10,0 ↑	Serie 39,0	1:10,4 ↑	Serie 46,0
2:10,2 ↗		2: 9,3 ↙	
3: 9,5 ↘	Totalt 0,0	3: 9,6 ↓	Totalt 46,0
4:10,9* →		4:10,4 ↘	
		5: 8,6 ↓	
Serie 2		Serie 3	
			
1:10,1 ↑	Serie 46,0	1: 9,5 ↓	Serie 45,0
2:10,2 ↘		2:10,4 →	
3: 6,8 →	Totalt 92,0	3: 9,5 ↗	Totalt 137,0
4:10,9* ↗		4: 7,7 ↗	
5:10,1 ↓		5:10,9* ↑	

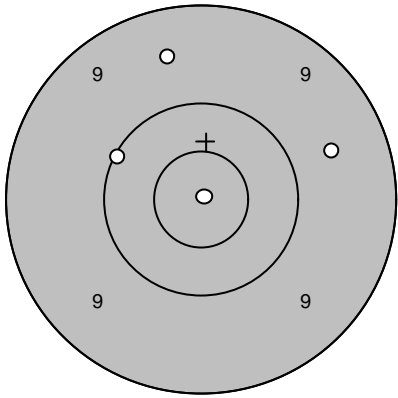
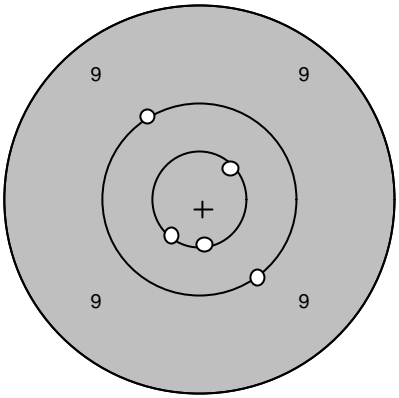
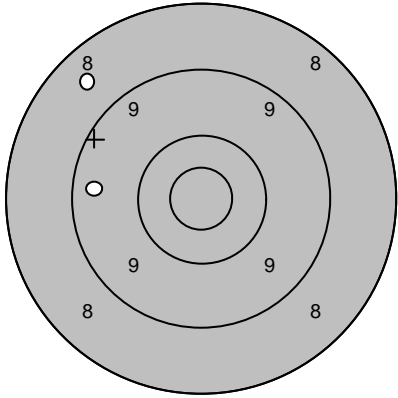
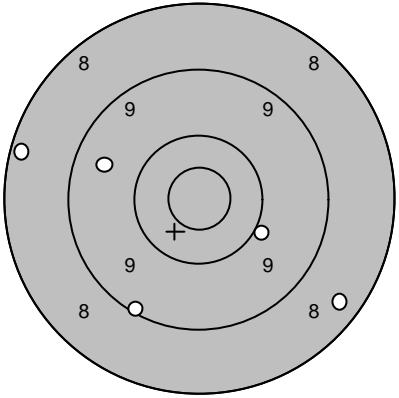
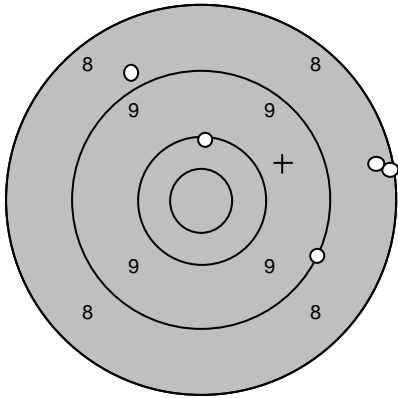
Skjutlag	Tavla	<b>Claes Gustafsson</b>	
<b>1</b>	<b>6</b>		
Ramselefors	Hofors		
2005-07-10	Tavelträffen B 2005	Ramselefors Skytteförening	
Prov		1: 9,5 ↗ 2: 10,1 ↖ 3: 9,6 → 4: 10,9* ↗	Serie 1 
		Serie 38,0 Totalt 0,0	1: 10,0 ↗ 2: 10,0 ↘ 3: 10,6* ↗ 4: 10,6* ↓ 5: 10,6* ↘
			Serie 50,0 Totalt 50,0
Prov		1: 8,6 ↖ 2: 9,4 ←	Serie 2 
		Serie 17,0 Totalt 50,0	1: 8,3 ← 2: 9,5 ↖ 3: 8,4 ↘ 4: 9,1 ↘ 5: 10,0 ↘
			Serie 44,0 Totalt 94,0
Serie 3		1: 8,1 → 2: 8,3 → 3: 10,2 ↑ 4: 8,9 ↖ 5: 9,1 ↘	
		Serie 43,0 Totalt 137,0	

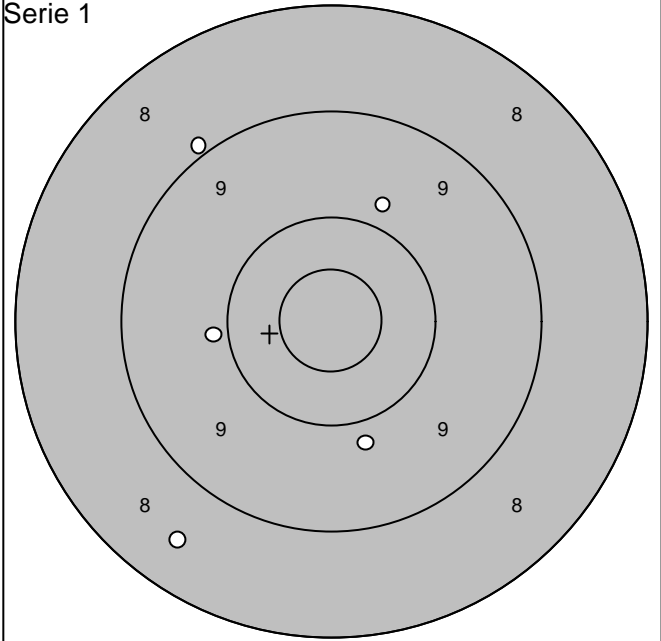
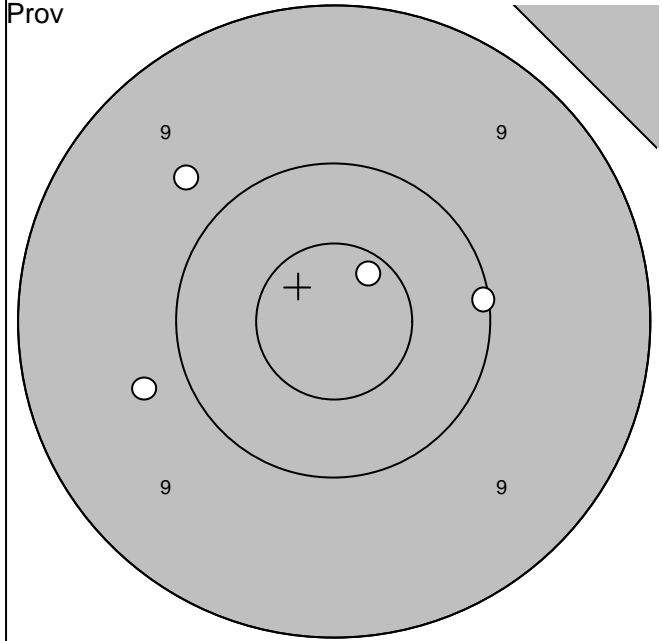

1: 9,7 ↖	Serie	38,0	
2: 9,8 ←		0,0	
3: 10,1 →	Totalt	0,0	
4: 10,7* ↗			

1: 9,9 ←	Serie	44,0	
2: 9,0 ↗		44,0	
3: 8,5 ↘	Totalt	44,0	
4: 9,8 ↓			
5: 9,8 ↗			

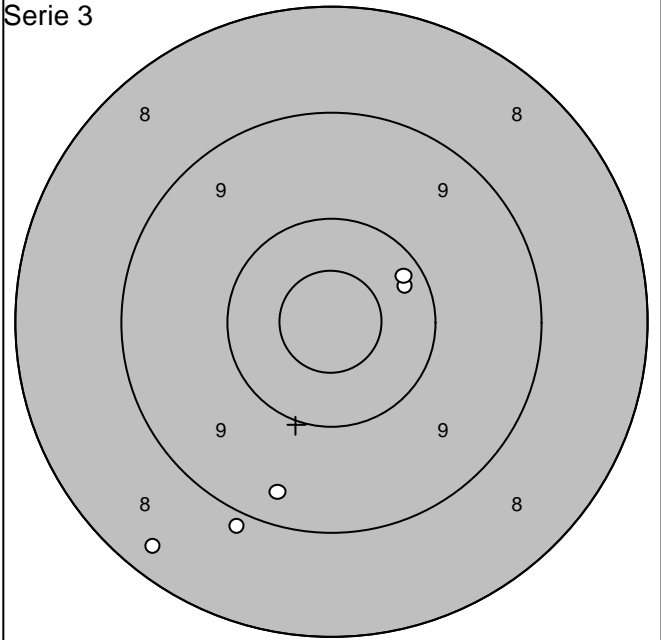
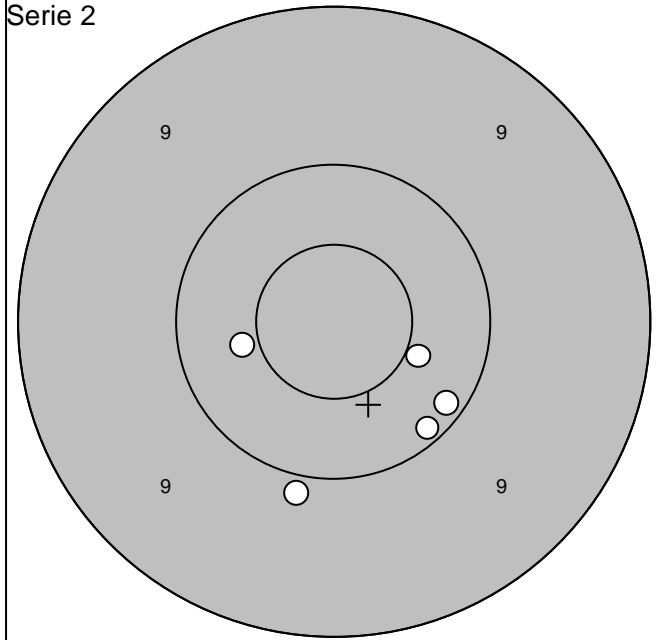

1: 10,4 ←	Serie	49,0	
2: 10,1 ↓		93,0	
3: 9,9 ↓	Totalt	93,0	
4: 10,2 ↓			
5: 10,5* →			

1: 10,3 ↗	Serie	45,0	
2: 10,2 ↗		138,0	
3: 8,9 ↓	Totalt	138,0	
4: 8,3 ↘			
5: 9,3 ↓			

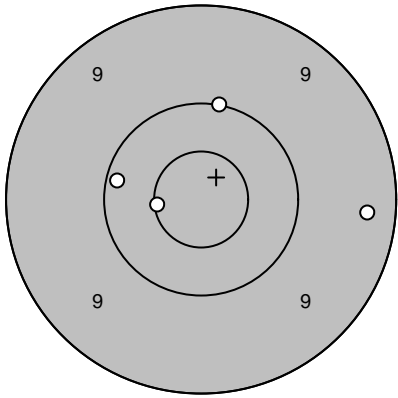
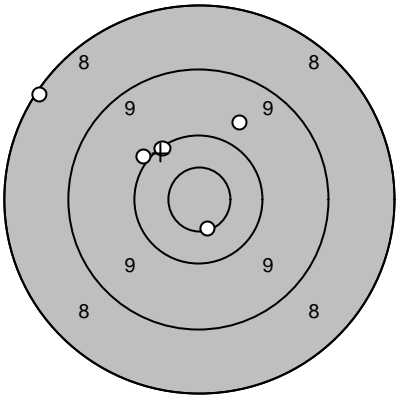
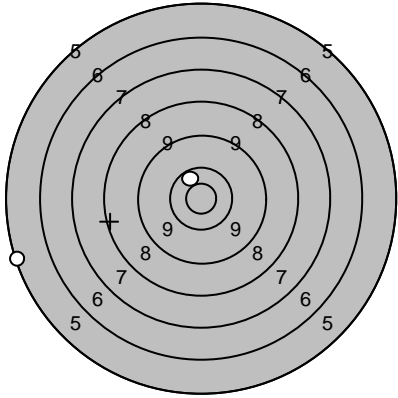
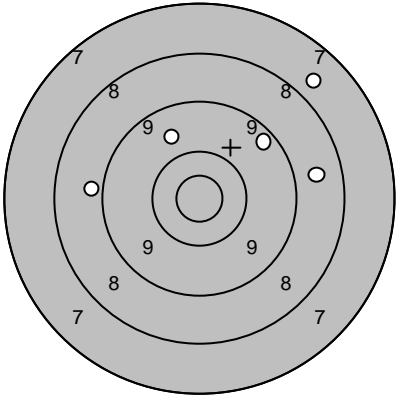
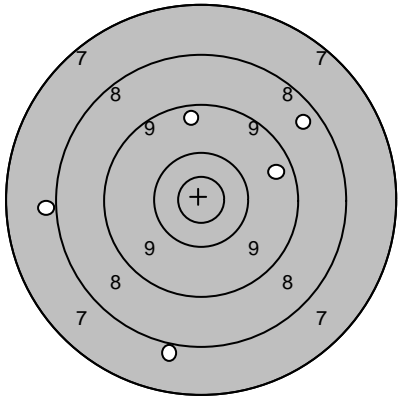
Skjutlag <b>1</b>	Tavla <b>9</b>	<b>Daniel Zakrisson</b>	
Ramselefors	Ramselefors		
2005-07-10	Tavelträffen B 2005	Ramselefors Skytteförening	
Prov		1: 10,1 ↑ 2: 10,6* ← 3: 10,2 ← 4: 9,3 →	Serie 1 
			1: 10,1 ↗ 2: 8,2 ↖ 3: 10,0 ↗ 4: 10,6* ↓ 5: 9,7 ↗
		Serie 39,0	Serie 47,0
		Totalt 0,0	Totalt 47,0
Prov		1: 10,5* ↖ 2: 5,3 ←	Serie 2 
			1: 9,4 ↗ 2: 8,9 ← 3: 8,7 → 4: 9,7 ↖ 5: 7,7 ↗
		Serie 15,0	Serie 41,0
		Totalt 47,0	Totalt 88,0
Serie 3		1: 8,5 ↗ 2: 8,0 ← 3: 9,4 ↑ 4: 7,9 ↓ 5: 9,5 →	
		Serie 41,0	
		Totalt 129,0	

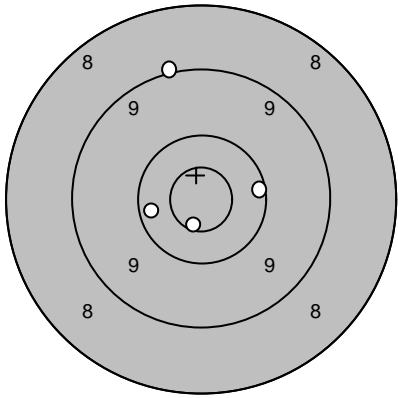
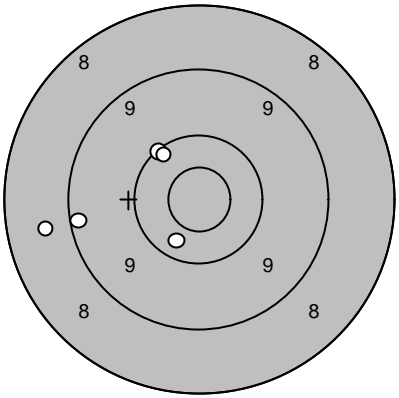
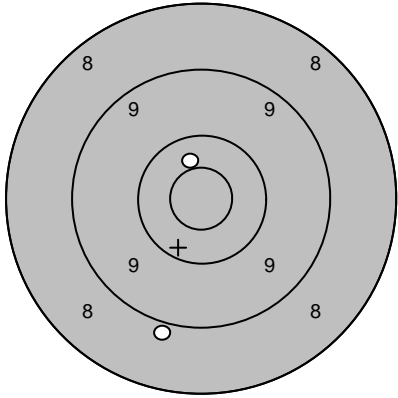
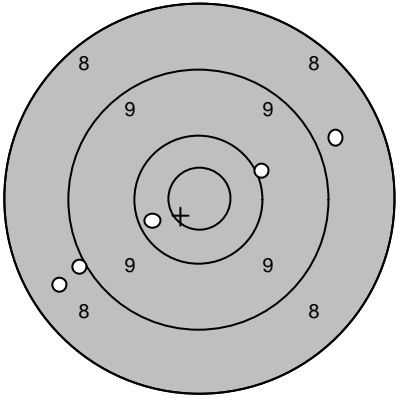
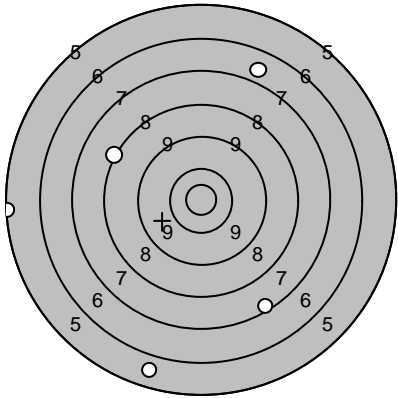
Skjutlag <b>1</b>	Tavla <b>10</b>	<b>Sven Magnusson</b>		
Ramselefors		Liden		
2005-07-10		Tavelträffen B 2005	Ramselefors Skytteförening	
Prov		1: 10,7* ↓ 2: 10,3 ← 3: 9,0 ↑ 4: 10,2 →	Serie 1 	1: 10,1 ↖ 2: 8,7 ← 3: 9,2 ← 4: 10,2 ↖ 5: 10,4 ↓
		Serie 39,0	Serie 47,0	
		Totalt 0,0	Totalt 47,0	
Prov		1: 8,9 ↓ 2: 10,5* ↑	Serie 2 	1: 8,6 ← 2: 8,8 → 3: 10,0 → 4: 9,0 ← 5: 10,3 ←
		Serie 18,0	Serie 45,0	
		Totalt 47,0	Totalt 92,0	
Serie 3		1: 5,8 ↓ 2: 5,2 ← 3: 6,8 ↑ 4: 8,2 ← 5: 7,4 ↓		
		Serie 31,0		
		Totalt 123,0		

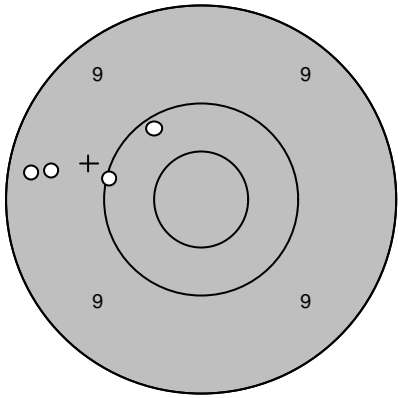
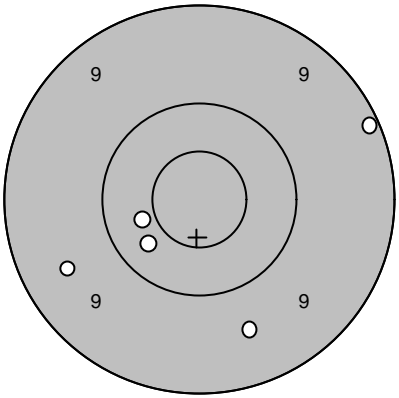
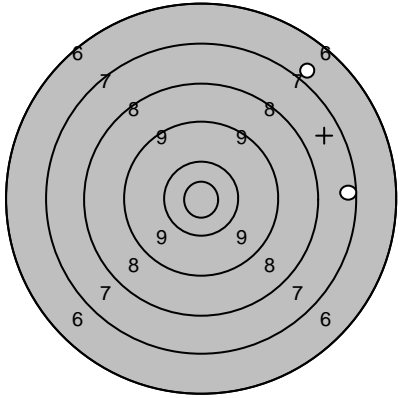
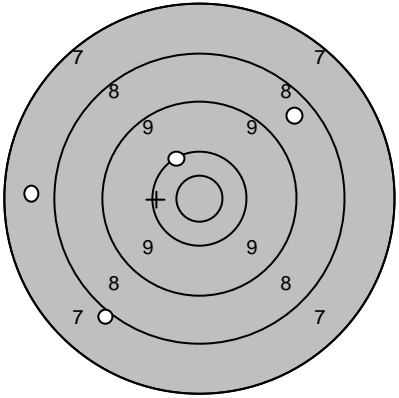
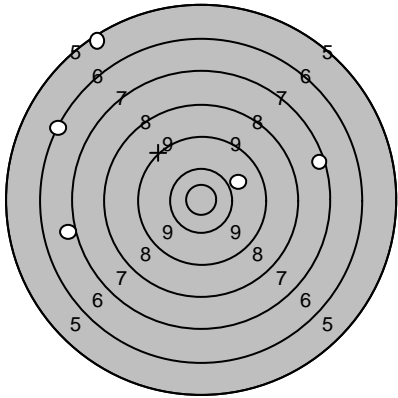

Skjutlag	Tavla	<b>Fredrik Wikström</b>	
<b>1</b>	<b>11</b>		
Ramselefors	Umeå		
2005-07-10	Tavelträffen B 2005	Ramselefors Skytteförening	
Prov 	1: 10,1 ←	Serie 1 	1: 9,1 →
	2: 10,2 ↗		2: 10,4 ←
	3: 9,3 ←		3: 9,6 ↓
	4: 9,5 ←		4: 9,5 ←
			5: 10,4 ↙
	Serie 38,0		Serie 47,0
	Totalt 0,0		Totalt 47,0
Prov 	1: 6,9 ↗	Serie 2 	1: 7,7 ←
	2: 7,4 →		2: 8,5 ↗
			3: 8,0 ↙
			4: 10,2 ↗
	Serie 13,0		Serie 33,0
	Totalt 47,0		Totalt 80,0
Serie 3 	1: 9,9 →		
	2: 5,4 ↖		
	3: 7,4 →		
	4: 6,3 ←		
	5: 7,0 ←		
	Serie 34,0		
	Totalt 114,0		

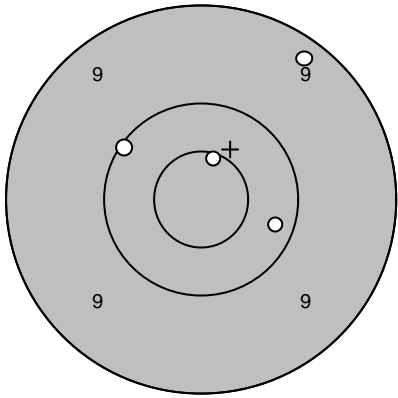
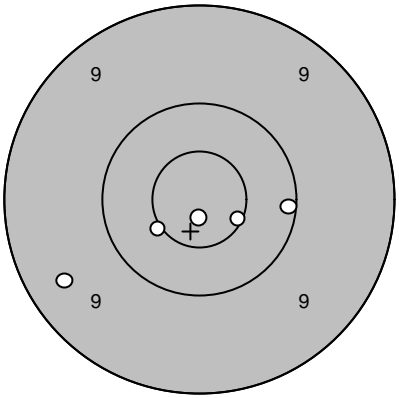
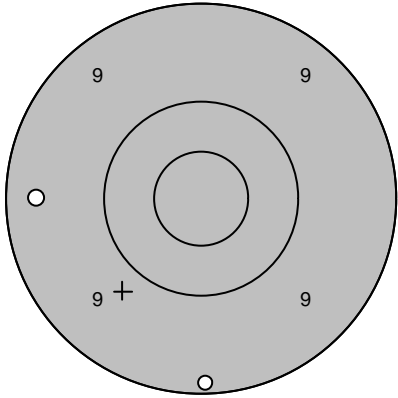
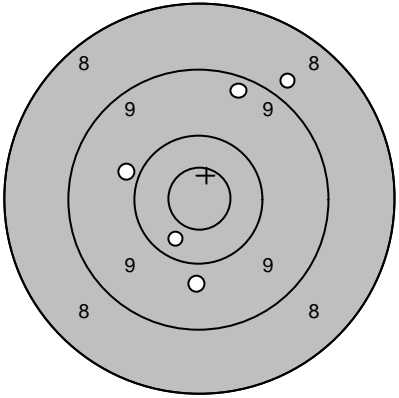
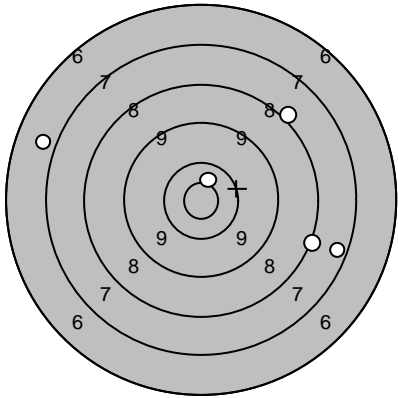
Skjutlag	Tavla	<b>Jarmo Marjala</b>	
<b>1</b>	<b>12</b>		
Ramselefors	I 21 / T3		
2005-07-10	Tavelträffen B 2005	Ramselefors Skytteförening	
Prov		1: 10,6* ↗ 2: 10,1 ↖ 3: 9,3 ↗ 4: 10,2 ➔	Serie 1 
		Serie 39,0 Totalt 0,0	1: 10,5* ↖ 2: 9,4 ↖ 3: 10,8* ↓ 4: 10,6* ➔ 5: 10,1 ➔
			Serie 49,0 Totalt 49,0
Prov		1: 9,4 ← 2: 9,2 ↓	Serie 2 
		Serie 18,0 Totalt 49,0	1: 8,8 ↗ 2: 10,4 ↖ 3: 9,8 ↓ 4: 9,9 ← 5: 9,3 ↗
			Serie 45,0 Totalt 94,0
Serie 3		1: 8,1 ↗ 2: 6,9 ← 3: 8,1 ➔ 4: 7,5 ➔ 5: 10,6* ↗	
		Serie 39,0 Totalt 133,0	

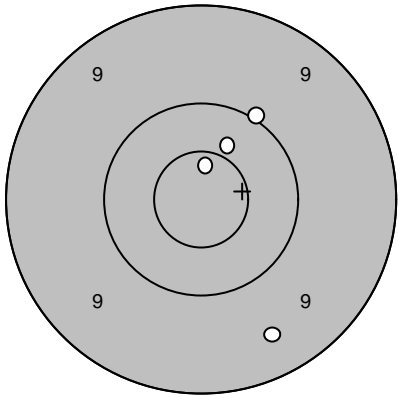
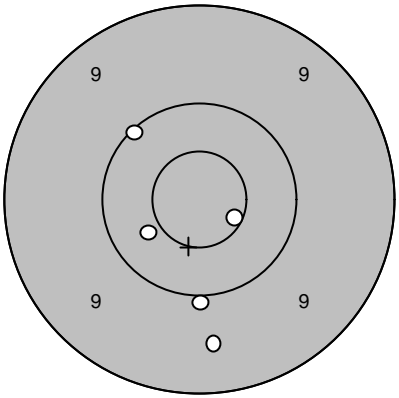
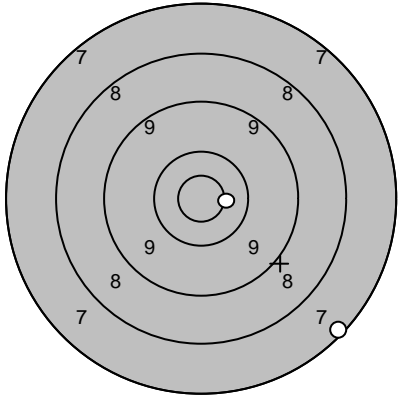
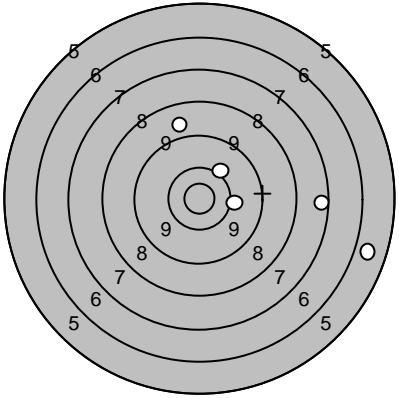
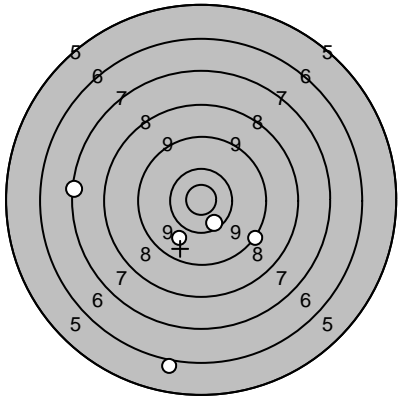
Skjutlag	Tavla			
<b>1</b>	<b>13</b>	<b>Lennart Jacobsson</b>		
Ramselefors	Ramselefors			
2005-07-10	Tavelträffen B 2005	Ramselefors Skytteförening		
Prov		1: 10,4 ↗ 2: 10,7* ↑ 3: 9,5 ↓ 4: 10,0 ↗	Serie 1 	1: 9,5 ↓ 2: 10,1 ↗ 3: 10,4 ↙ 4: 10,0 ↓ 5: 10,6* ↘
	Serie 39,0		Serie 49,0	
	Totalt 0,0		Totalt 49,0	
Prov		1: 7,2 ↘ 2: 10,6* →	Serie 2 	1: 10,1 ↗ 2: 5,8 → 3: 10,1 → 4: 7,5 → 5: 8,9 ↑
	Serie 17,0		Serie 40,0	
	Totalt 49,0		Totalt 89,0	
Serie 3		1: 6,0 ↓ 2: 7,3 ← 3: 9,2 → 4: 9,9 ↓ 5: 10,4 ↓		
	Serie 41,0			
	Totalt 130,0			

Skjutlag <b>1</b>	Tavla <b>16</b>	<b>Jonas Gyllenäs</b>	
Ramselefors		Piteå	
2005-07-10		Tavelträffen B 2005	Ramselefors Skytteförening
Prov		Serie 1	
1: 9,3 ↑ 2: 10,2 ↓ 3: 7,2 ↗ 4: 7,7 ↘	Serie 33,0  Totalt 0,0	1: 10,1 → 2: 9,5 ↑ 3: 9,6 ← 4: 8,7 ↙ 5: 10,6* ↑	Serie 46,0  Totalt 46,0
Serie 2		Serie 3	
1: 8,7 ↗ 2: 8,3 ↗ 3: 10,4 ↗ 4: 8,9 ↗ 5: 8,2 ←	Serie 42,0  Totalt 88,0	1: 10,7* ↗ 2: 9,8 → 3: 10,0 ← 4: 10,7* ↙ 5: 10,2 ↗	Serie 49,0  Totalt 137,0

Skjutlag <b>1</b>	Tavla <b>18</b>	<b>Rolf Åström</b>	
Ramselefors		Brattby	
2005-07-10		Tavelträffen B 2005	Ramselefors Skytteförening
Prov		Serie 1	
1: 9,0 ← 2: 9,2 ↓ 3: 8,2 ↓ 4: 10,4 →		Serie 36,0 Totalt 0,0	Serie 44,0 Totalt 44,0
Serie 2		Serie 3	
1: 10,1 ↗ 2: 9,5 ← 3: 10,6* ↗ 4: 9,5 ↗ 5: 8,7 →		Serie 46,0 Totalt 90,0	Serie 46,0 Totalt 136,0

Skjutlag <b>1</b>	Tavla <b>19</b>	<b>Per Östling</b>	
Ramselefors		F 21	
2005-07-10		Tavelträffen B 2005	Ramselefors Skytteförening
Prov		Serie 1	
1: 8,5 ↑ 2: 10,4 ← 3: 10,1 ↙ 4: 10,8* →	Serie 38,0  Totalt 0,0	1: 9,3 ↖ 2: 9,1 ← 3: 9,2 ↗ 4: 9,7 ← 5: 9,9 →	Serie 45,0  Totalt 45,0
Serie 2		Serie 3	
1: 10,0 → 2: 9,5 ↗ 3: 10,1 ↗ 4: 9,7 ← 5: 10,5* ↘	Serie 48,0  Totalt 93,0	1: 9,6 ↖ 2: 10,3 ← 3: 10,2 ← 4: 10,7* ↓ 5: 10,4 ↗	Serie 49,0  Totalt 142,0
www.AC-Skytte.com			

Skjutlag <b>1</b>	Tavla <b>20</b>	<b>Hugo Håkansson</b>	
Ramselefors		Östersund	
2005-07-10		Tavelträffen B 2005	Ramselefors Skytteförening
Prov		Serie 1	
1: 9,6 ↗ 2: 8,9 ↘		Serie 17,0 Totalt 0,0	1: 9,1 ↗ 2: 10,5* ↖ 3: 10,0 ↘ 4: 9,0 ↘ 5: 10,0 ← Serie 48,0 Totalt 48,0
Serie 2		Serie 3	
1: 8,8 ← 2: 10,4 ↑ 3: 8,3 ↖ 4: 9,5 ↖ 5: 9,7 ↘		Serie 44,0 Totalt 92,0	1: 9,0 ↑ 2: 10,5* → 3: 10,8* ↘ 4: 10,4 ↘ 5: 8,9 ↘ Serie 47,0 Totalt 139,0
www.AC-Skytte.com			

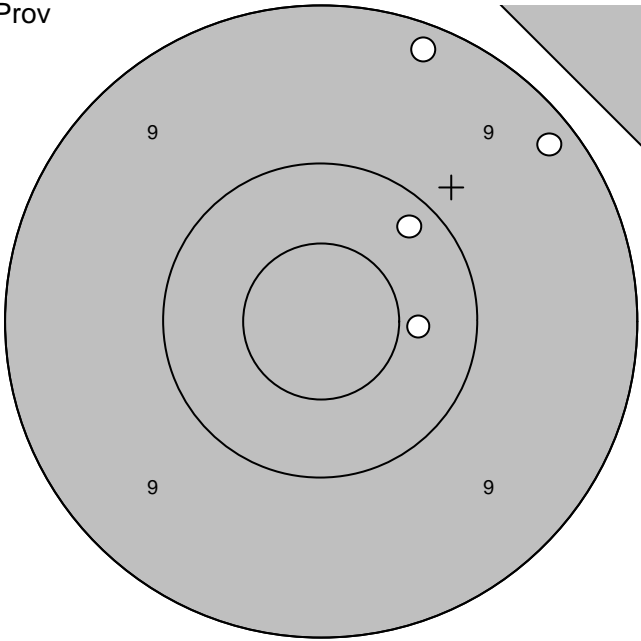
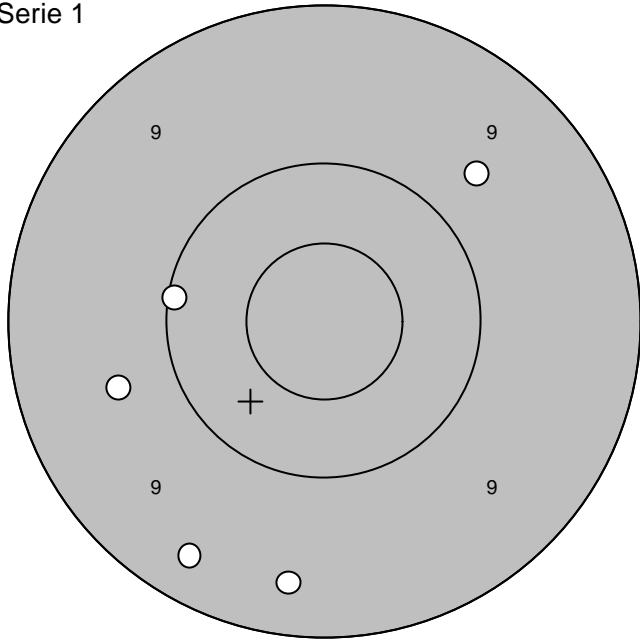
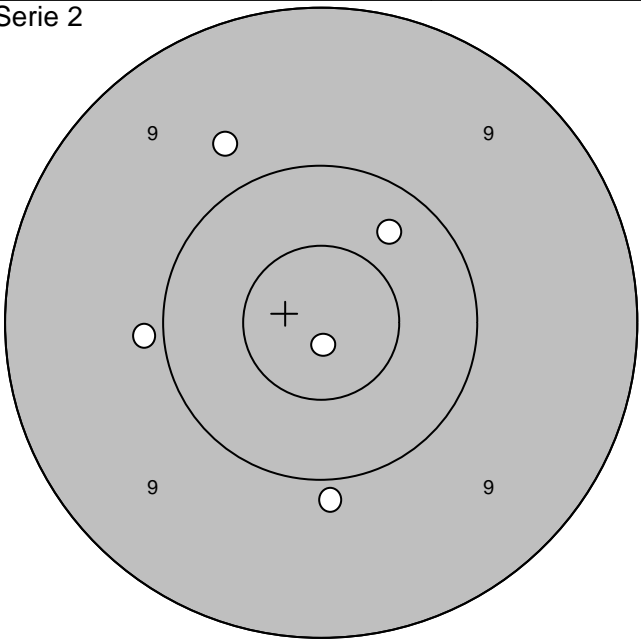
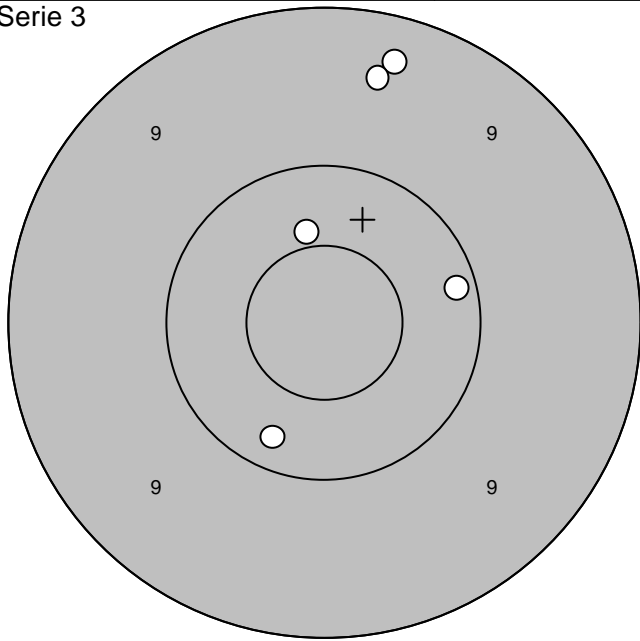
Skjutlag <b>1</b>	Tavla <b>21</b>	<b>Marlene Forsell</b>	
Ramselefors	Ramselefors		
2005-07-10	Tavelträffen B 2005	Ramselefors Skytteförening	
Prov		Serie 1	
			
1: 9,2 ↗	Serie 38,0	1: 9,7 ↗	Serie 46,0
2: 10,2 ↗		2: 9,3 ↘	
3: 9,2 ↗	Totalt 0,0	3: 10,1 ←	Totalt 46,0
4: 10,4 →		4: 9,4 ↘	
		5: 9,7 ←	
Serie 2		Serie 3	
			
1: 9,9 ↓	Serie 47,0	1: 10,4 ↑	Serie 48,0
2: 9,9 ←		2: 9,3 ↑	
3: 10,3 ↗	Totalt 93,0	3: 10,2 ↘	Totalt 141,0
4: 9,8 ↖		4: 9,4 ↑	
5: 10,9* ↓		5: 10,2 →	



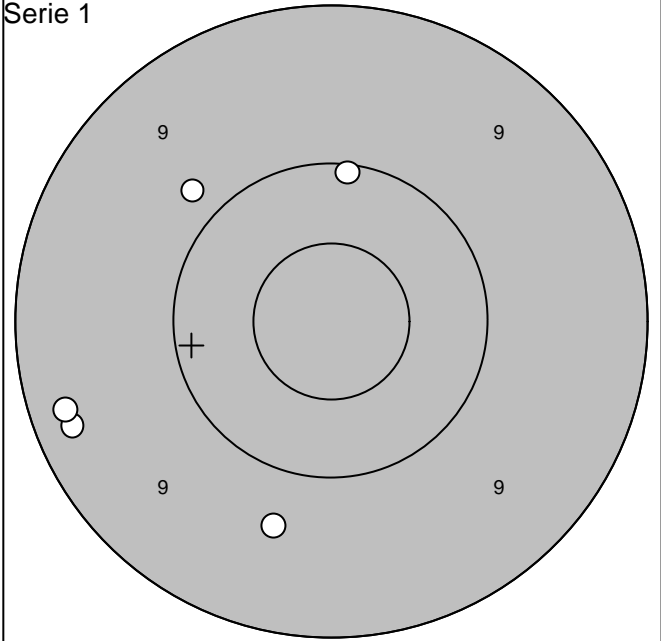
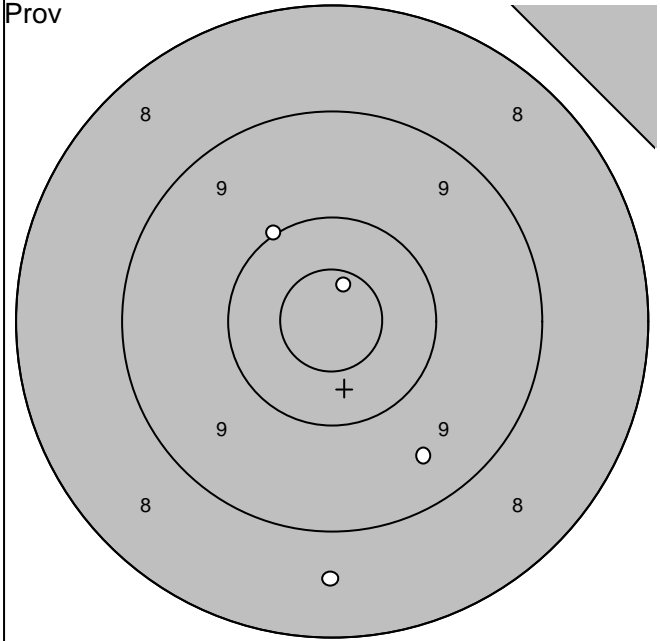

1: 9,5 ↘
2: 10,0 ↗
3: 8,6 ↘
4: 10,7* ↗

Serie	37,0
Totalt	0,0

1: 9,3 ←
2: 10,1 ↑
3: 9,8 ↖
4: 9,3 ←
5: 9,7 ↘

Serie	46,0
Totalt	46,0

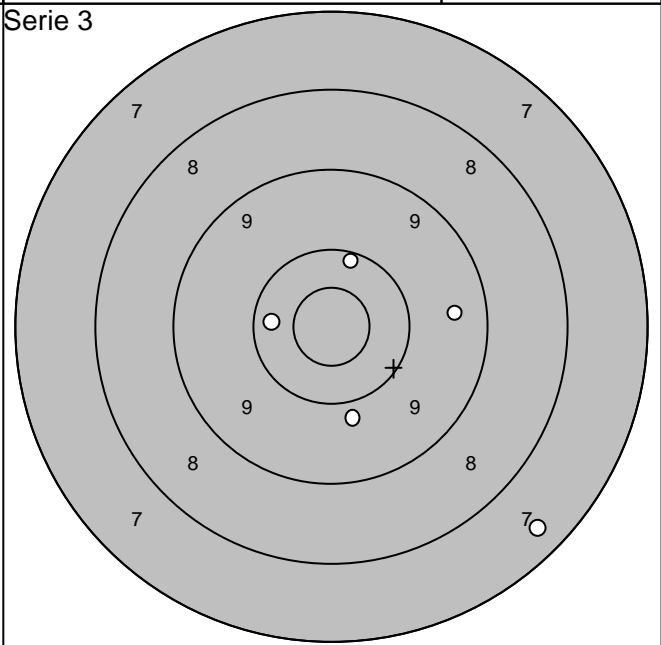
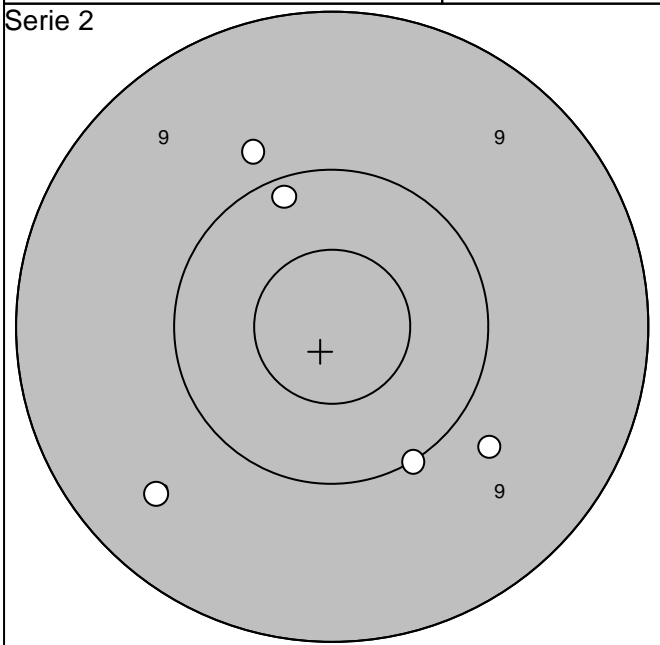

1: 9,8 ↗
2: 9,5 ↘
3: 9,8 ↘
4: 10,2 ↗
5: 10,0 ↘

Serie	47,0
Totalt	93,0

1: 9,9 ↘
2: 9,5 →
3: 10,3 ←
4: 7,4 ↘
5: 10,2 ↗

Serie	45,0
Totalt	138,0

Skjutlag <b>2</b>	Tavla <b>1</b>	<b>Daniel Wallberg</b>
----------------------	-------------------	------------------------

Ramselefors	Loos		
-------------	------	--	--

2005-07-10	Tavelträffen B 2005	Ramselefors Skytteförening
------------	---------------------	----------------------------

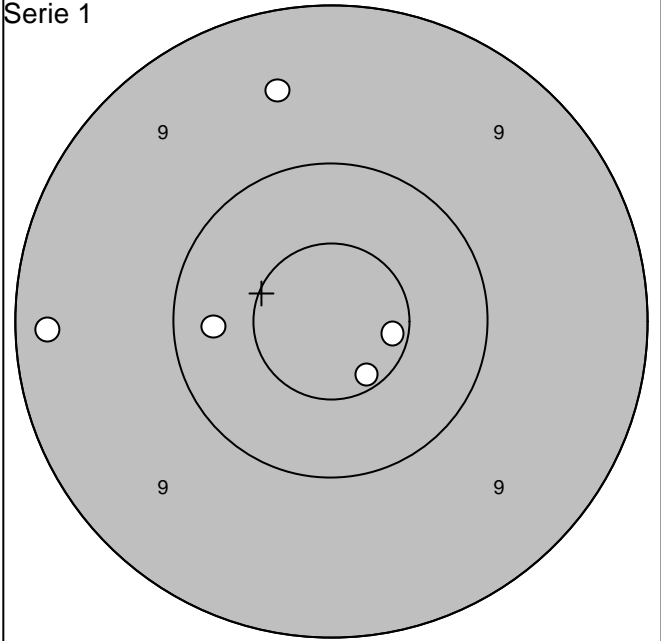
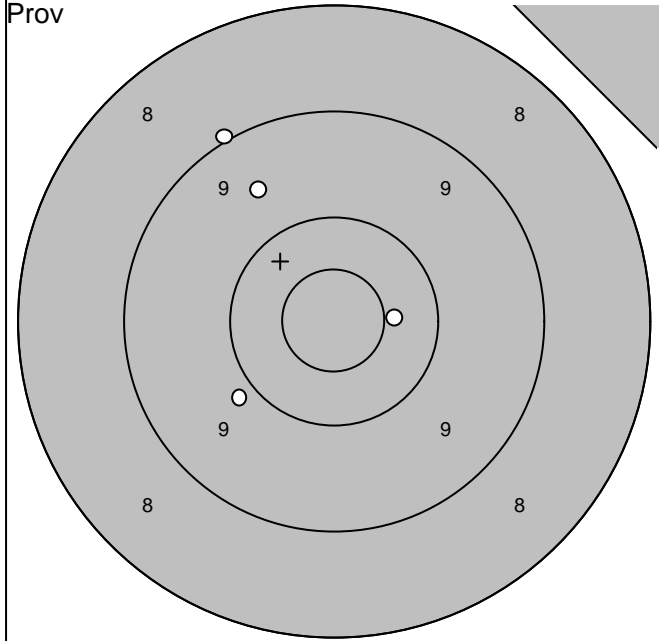

1: 9,0 ↗	Serie	37,0
2: 10,5* →		
3: 9,6 ↗	Totalt	0,0
4: 9,9 ↙		

1: 10,6* →	Serie	48,0
2: 9,2 ←		
3: 9,5 ↗	Totalt	48,0
4: 10,6* ↘		
5: 10,3 ←		

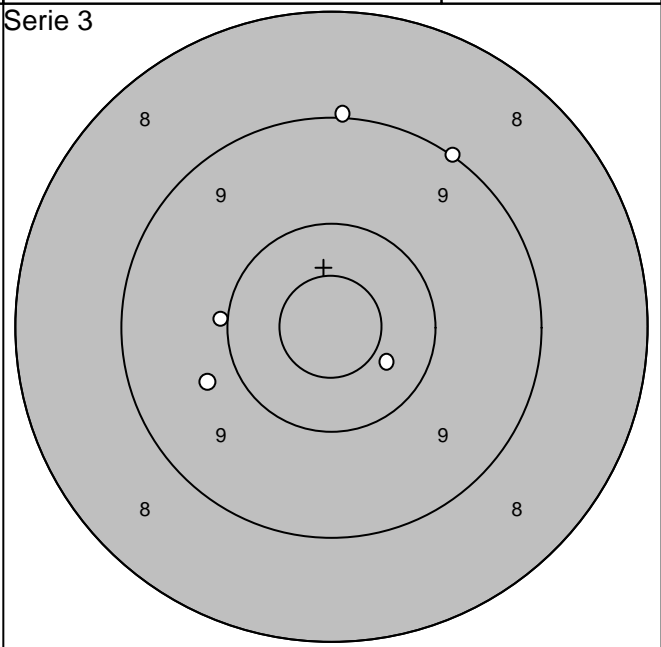
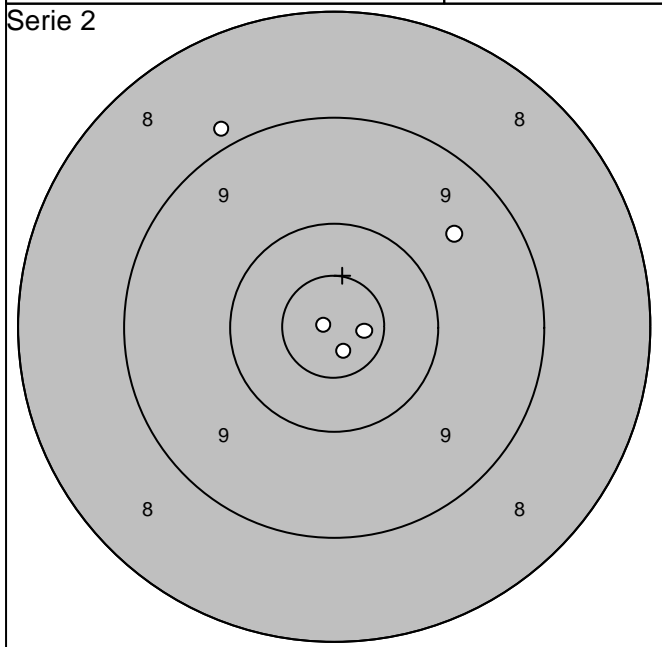

1: 9,6 ↗	Serie	47,0
2: 10,8* ↘		
3: 10,9* ←	Totalt	95,0
4: 8,9 ↗		
5: 10,7* →		

1: 10,4 ↘	Serie	47,0
2: 10,0 ←		
3: 9,0 ↗	Totalt	142,0
4: 9,8 ←		
5: 9,0 ↑		

Skjutlag <b>2</b>	Tavla <b>2</b>	<b>Jennie Ericsson</b>	
----------------------	-------------------	------------------------	--

Ramselefors	Loos		
-------------	------	--	--

2005-07-10	Tavelträffen B 2005	Ramselefors Skytteförening	
------------	---------------------	----------------------------	--

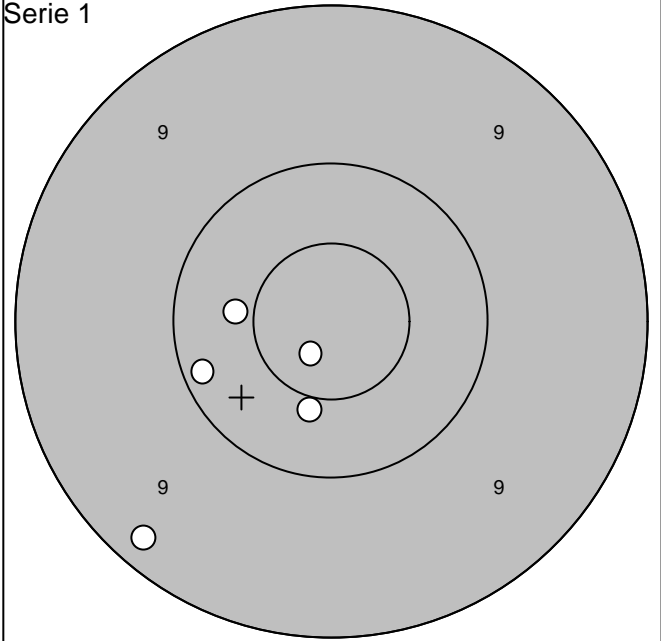
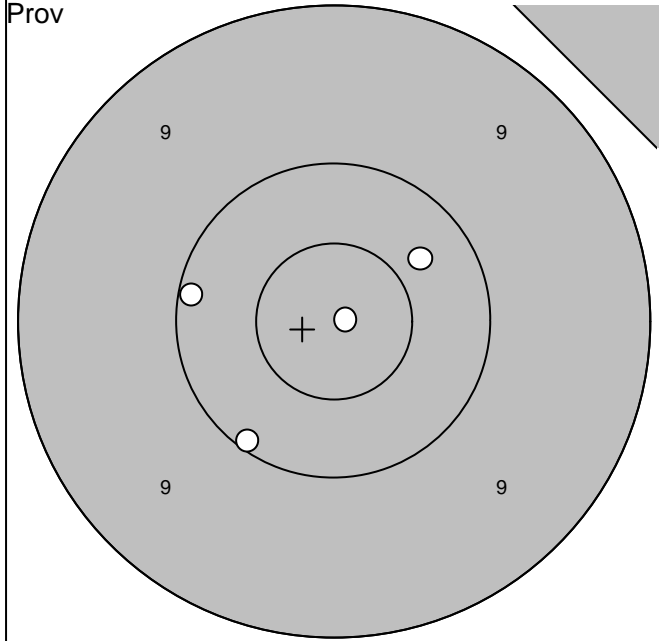

1:10,4 ↗	Serie	40,0
2:10,1 ←		
3:10,1 ↘	Totalt	0,0
4:10,9* →		

1: 9,2 ↘	Serie	49,0
2:10,8* ↘		
3:10,4 ←	Totalt	49,0
4:10,2 ←		
5:10,4 ↓		

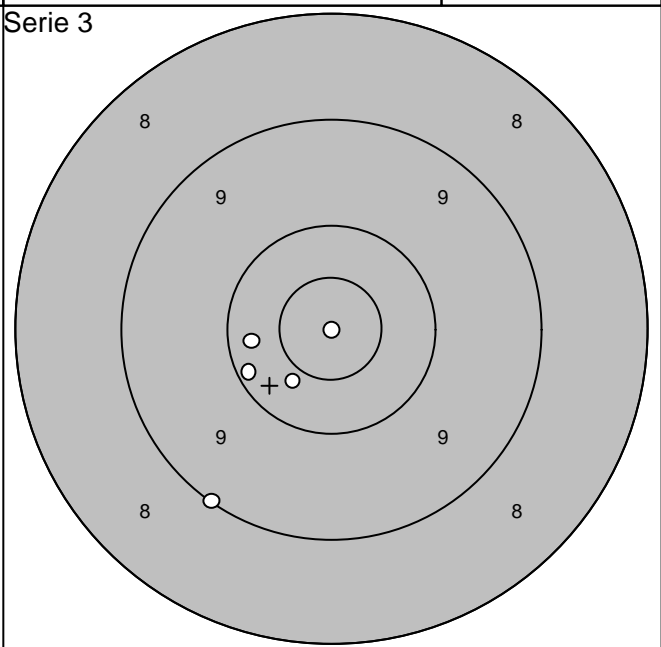
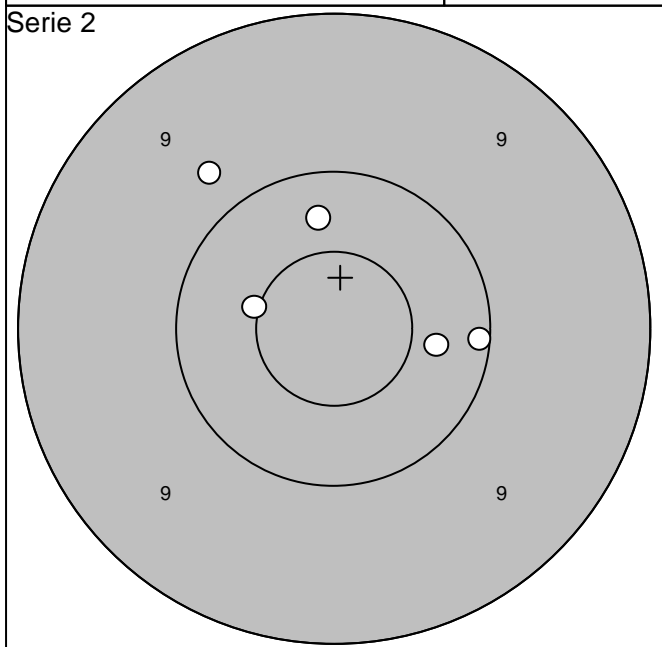

1: 9,8 ↗	Serie	49,0
2:10,5* ←		
3:10,3 ↑	Totalt	98,0
4:10,4 →		
5:10,1 →		

1:10,9* ↘	Serie	49,0
2: 9,0 ↘		
3:10,4 ↘	Totalt	147,0
4:10,3 ←		
5:10,2 ←		

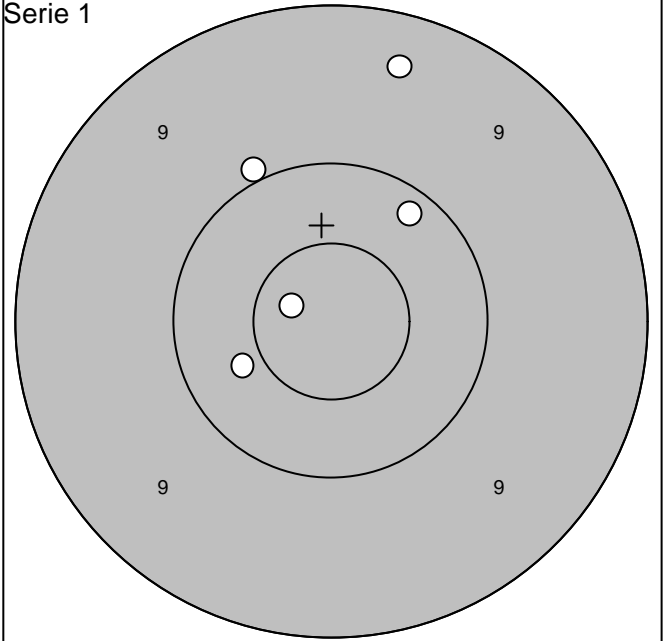
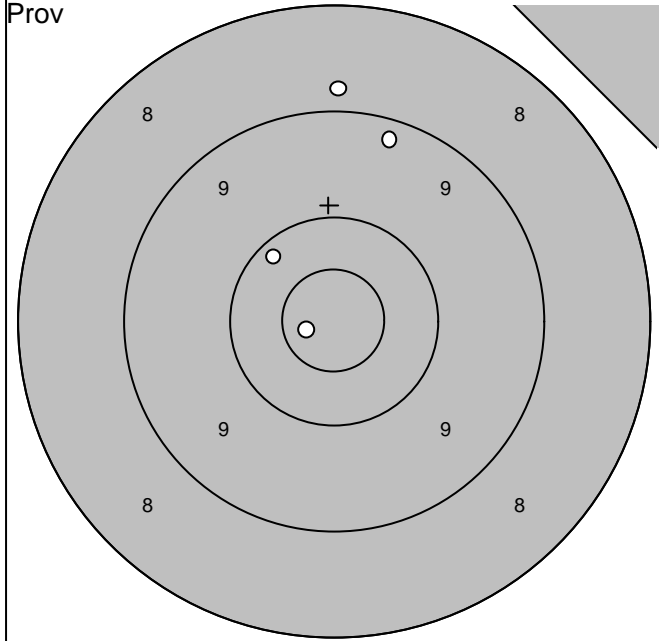

1: 9,2 ↑		Serie	37,0
2: 8,8 ↑		Totalt	0,0
3: 10,2 ↖			
4: 10,8* ←			

1: 9,4 ↑		Serie	49,0
2: 10,8* ←		Totalt	49,0
3: 10,4 ↙			
4: 10,0 ↖			
5: 10,2 ↗			

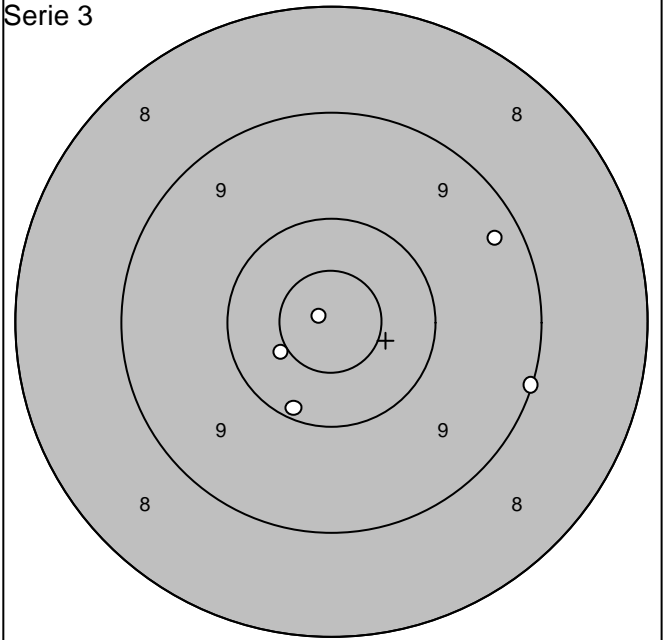
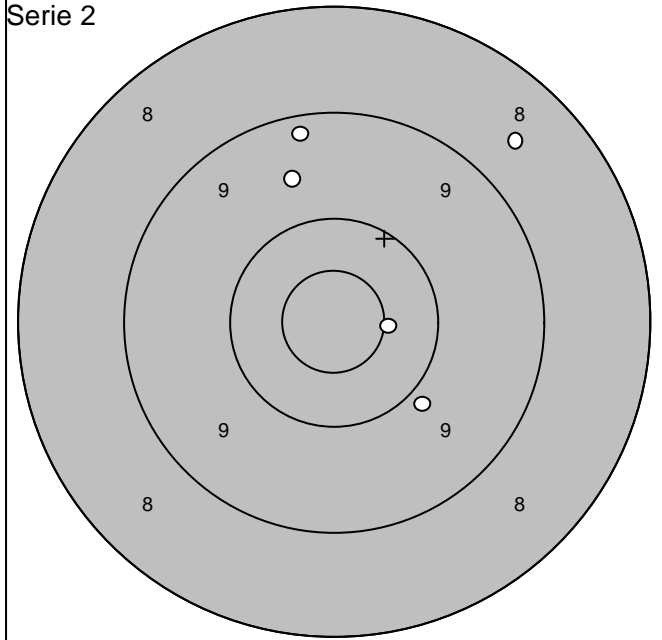

1: 9,6 ↑		Serie	45,0
2: 9,2 ↑		Totalt	94,0
3: 8,6 ↗			
4: 10,5* →			
5: 9,9 ↘			

1: 9,0 →		Serie	48,0
2: 9,3 ↗		Totalt	142,0
3: 10,9* ←			
4: 10,1 ↘			
5: 10,5* ↙			

Skjutlag **2** Tavla **4** **Linda Lidman**

Ramselefors Piteå

2005-07-10 Tavelträffen B 2005 Ramselefors Skytteförening

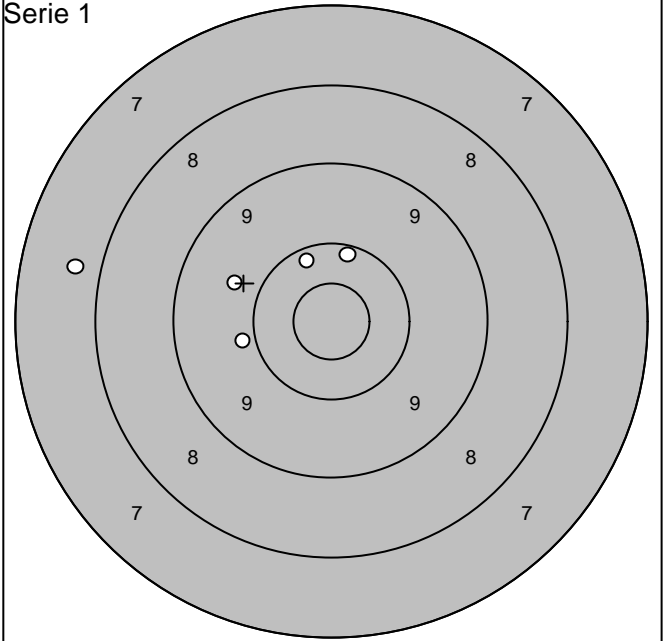
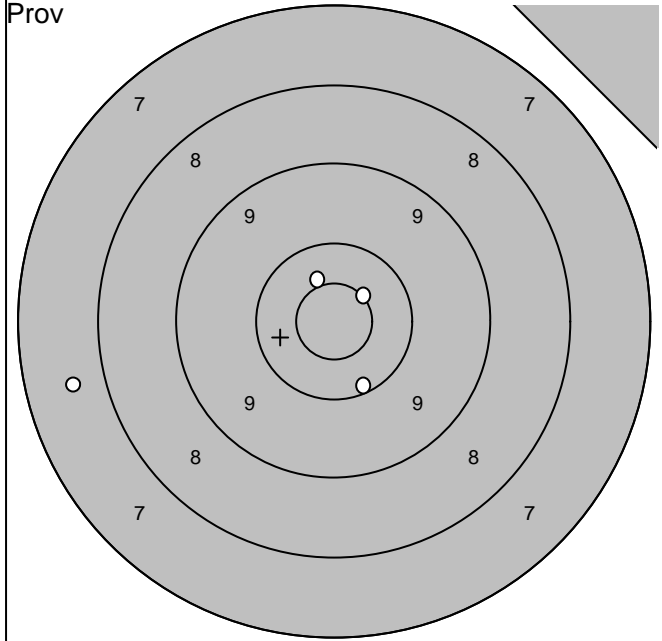

1:10,2 ↓  
 2: 7,7 ←  
 3:10,5\* ↑  
 4:10,6\* ↗

Serie 37,0  
 Totalt 0,0

1: 9,8 ↖  
 2: 7,8 ←  
 3: 9,9 ←  
 4:10,2 ↑  
 5:10,2 ↑

Serie 45,0  
 Totalt 45,0

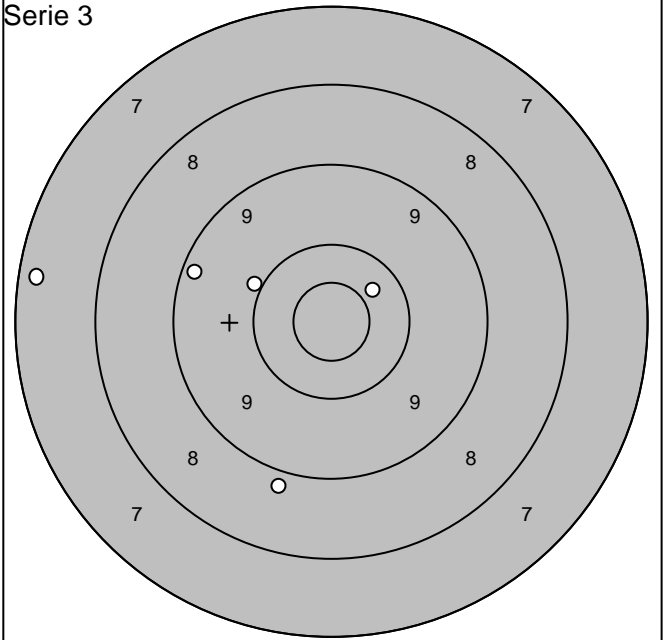
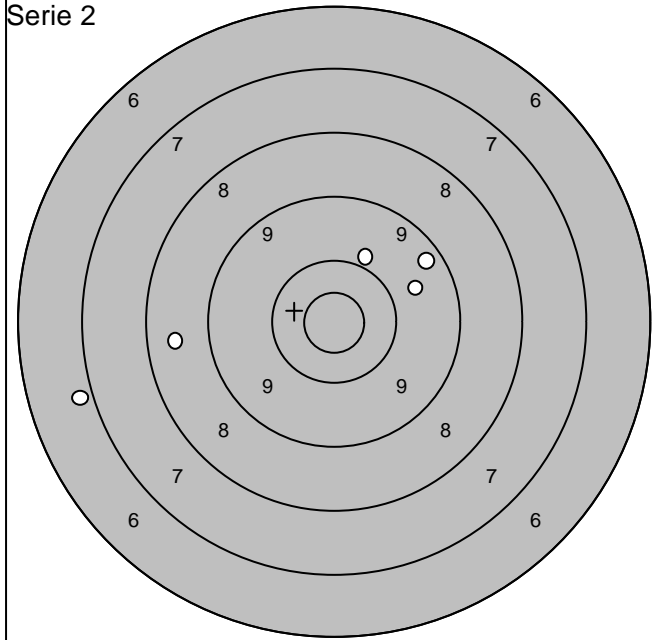

1: 9,7 ↗  
 2: 8,6 ←  
 3: 9,3 ↗  
 4: 6,9 ←  
 5: 9,9 ↑

Serie 41,0  
 Totalt 86,0

1:10,4 ↗  
 2:10,0 ↖  
 3: 8,9 ↓  
 4: 9,2 ↖  
 5: 7,3 ←

Serie 44,0  
 Totalt 130,0

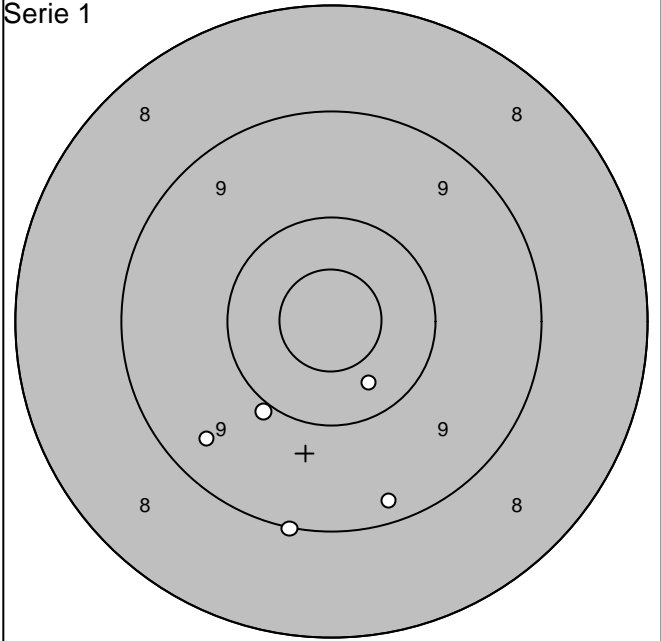
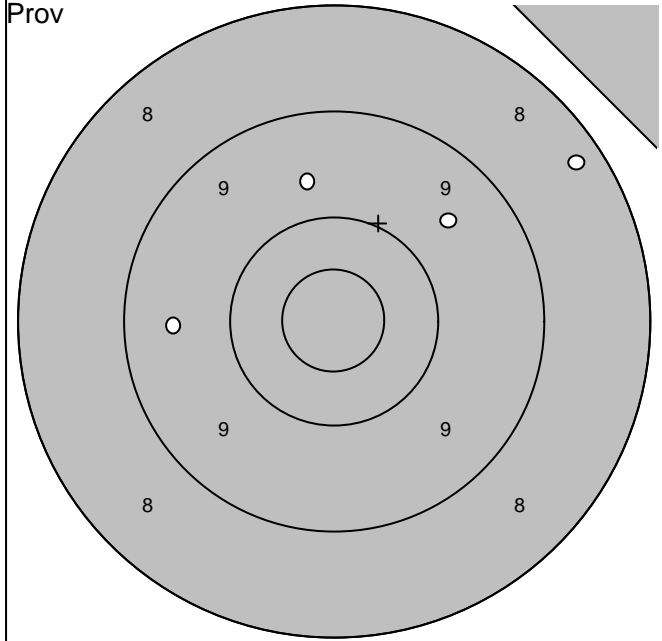

1: 9,7 ↑					
2: 8,3 ↗					
3: 9,5 ←					
4: 9,6 ↗					
Serie	35,0				
Totalt	0,0				

1: 9,2 ↓					
2: 10,0 ↙					
3: 10,3 ↘					
4: 9,4 ↙					
5: 9,0 ↓					
Serie	47,0				
Totalt	47,0				

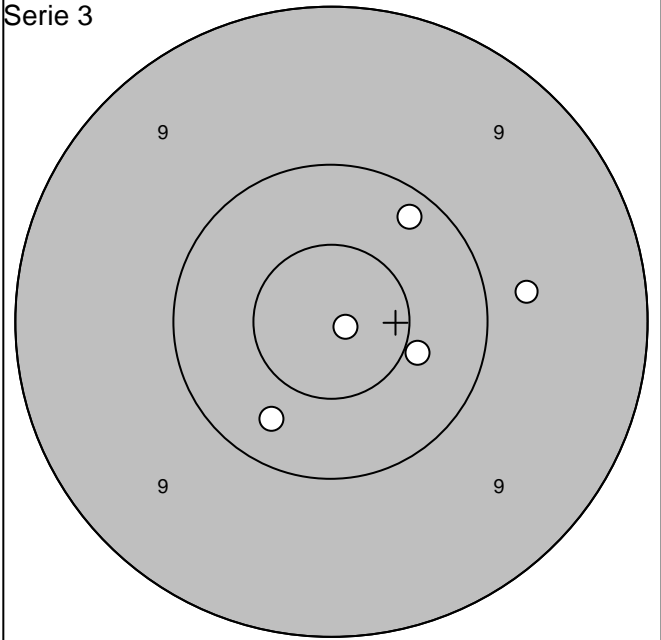
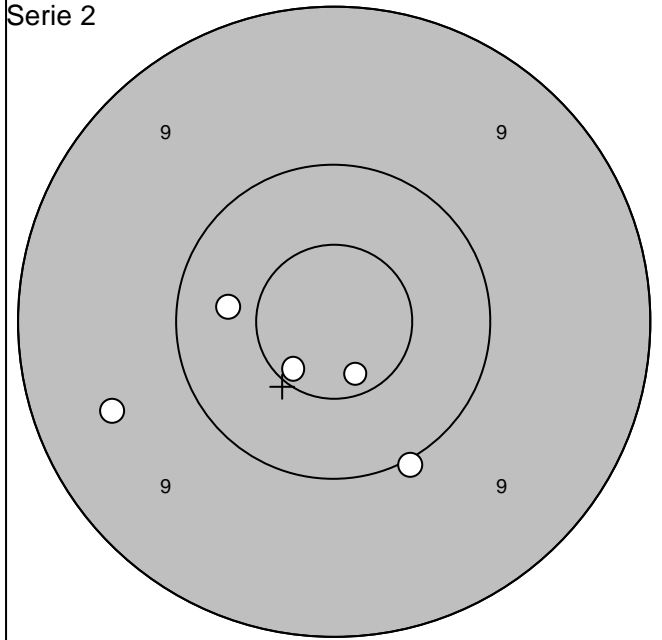

1: 10,0 ↓					
2: 10,7* ↓					
3: 10,4 ←					
4: 10,6* ↙					
5: 9,5 ←					
Serie	49,0				
Totalt	96,0				

1: 9,8 →					
2: 10,2 ↗					
3: 10,4 →					
4: 10,3 ↙					
5: 10,9* →					
Serie	49,0				
Totalt	145,0				

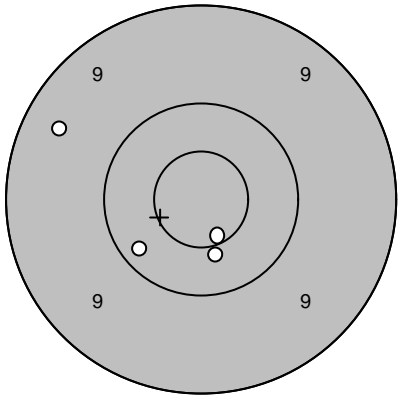
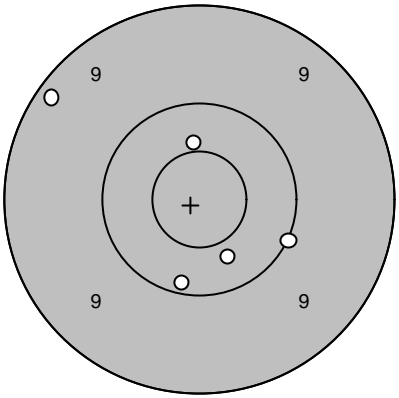
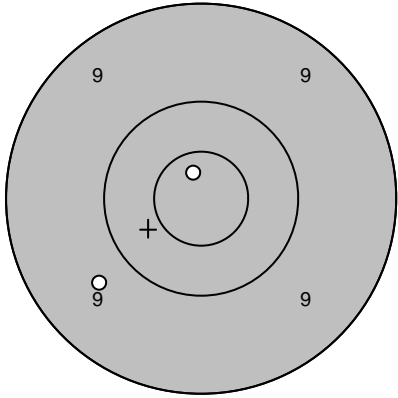
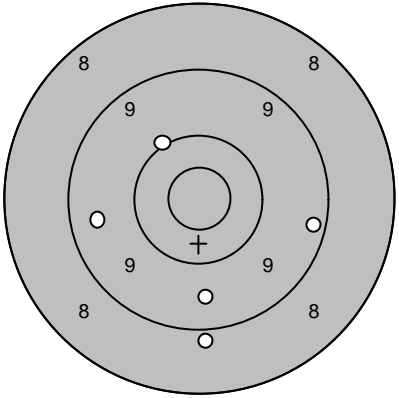
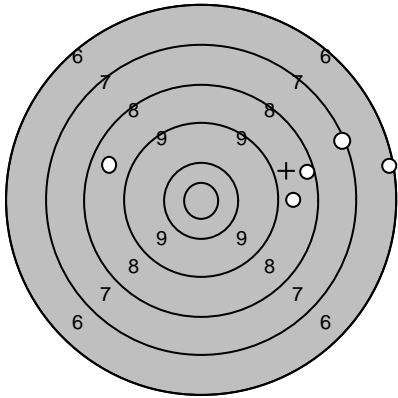

Skjutlag <b>2</b>	Tavla <b>9</b>	<b>Robert Lindström</b>		
Ramselefors		Skultuna		
2005-07-10		Tavelträffen B 2005	Ramselefors Skytteförening	
Prov		1: 9,4 ↖ 2: 10,2 ↙ 3: 10,6* ↓ 4: 10,5* ↓	Serie 1 	1: 10,0 ↘ 2: 10,4 ↓ 3: 10,2 ↓ 4: 10,5* ↑ 5: 9,2 ↗
		Serie 39,0	Serie 49,0	
		Totalt 0,0	Totalt 49,0	
Prov		1: 10,8* ↑ 2: 9,7 ↙	Serie 2 	1: 10,0 ↗ 2: 8,9 ↓ 3: 9,6 ↓ 4: 9,5 ← 5: 9,3 →
		Serie 19,0	Serie 45,0	
		Totalt 49,0	Totalt 94,0	
Serie 3		1: 8,7 ↖ 2: 8,8 → 3: 6,3 → 4: 7,3 ↗ 5: 8,4 →		
		Serie 37,0		
		Totalt 131,0		



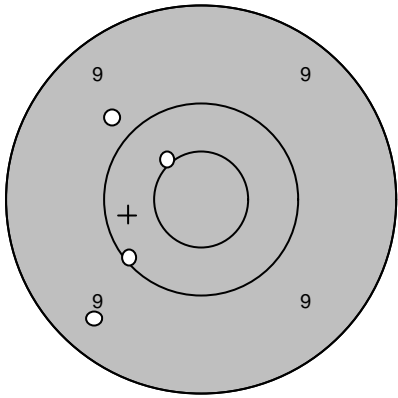
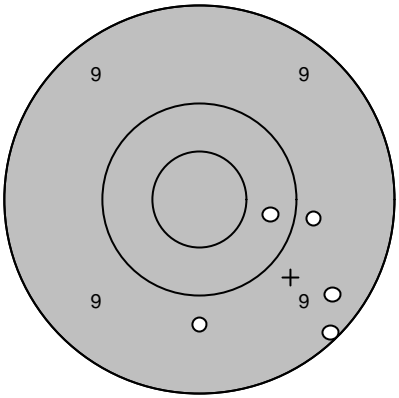
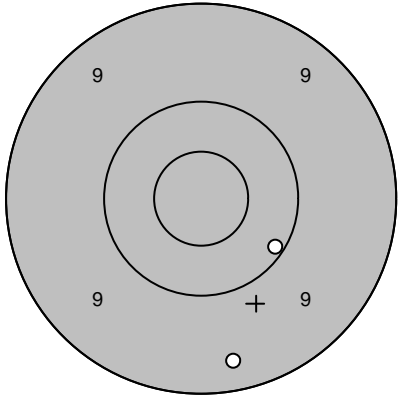
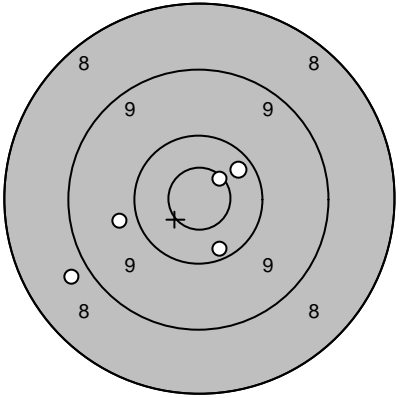
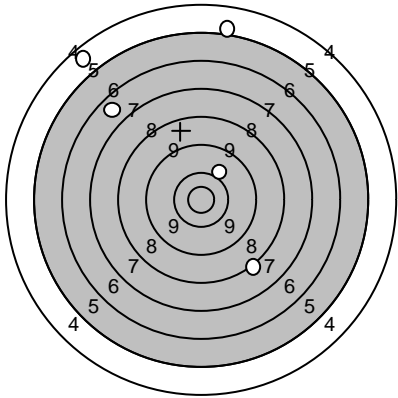

Skjutlag	Tavla	Ingemar Långström		
2	12			
Ramselefors	Ramselefors			
2005-07-10	Tavelträffen B 2005	Ramselefors Skytteförening		
Prov		1: 9,8 ↖ 2: 10,5* ↖ 3: 10,1 ↙ 4: 9,4 ↙	Serie 1 	1: 9,8 → 2: 9,4 ↘ 3: 9,8 ↓ 4: 9,1 ↘ 5: 10,3 →
	Serie 38,0		Serie 46,0	
	Totalt 0,0		Totalt 46,0	
Prov		1: 9,3 ↓ 2: 10,1 →	Serie 2 	1: 10,3 ↗ 2: 9,8 ← 3: 10,2 ↓ 4: 10,6* ↗ 5: 8,8 ←
	Serie 19,0		Serie 47,0	
	Totalt 46,0		Totalt 93,0	
Serie 3		1: 4,7 ↖ 2: 10,0 ↗ 3: 5,1 ↑ 4: 6,7 ↖ 5: 8,2 ↓		
	Serie 33,0			
	Totalt 126,0			

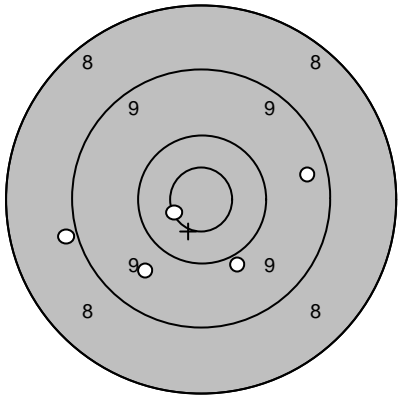
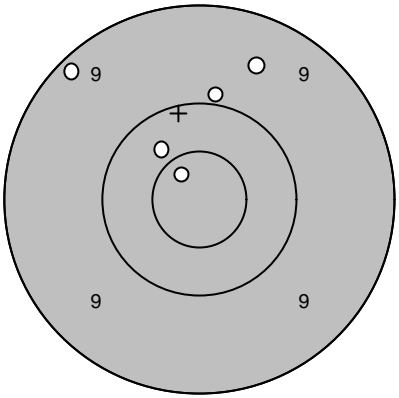
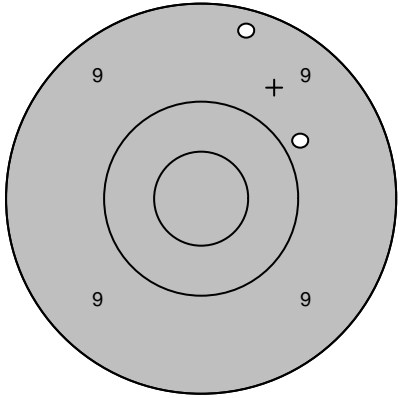
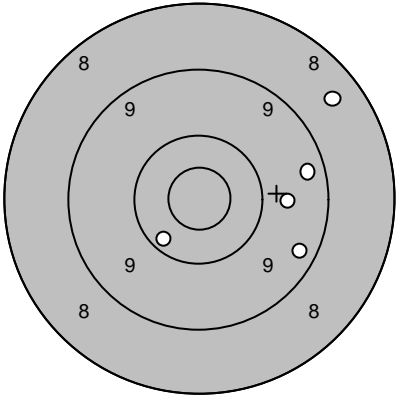
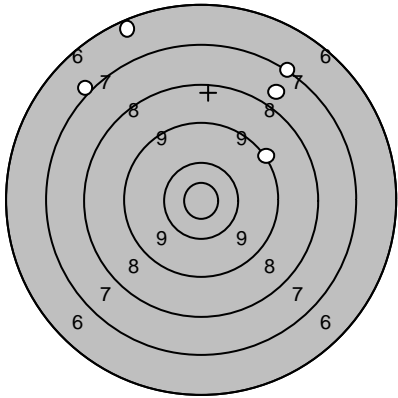
Skjutlag <b>2</b>	Tavla <b>15</b>	<b>Johan Nilsson</b>		
Ramselefors		Ramselefors		
2005-07-10		Tavelträffen B 2005	Ramselefors Skytteförening	
Prov		1: 10,6* ↙ 2: 9,4 → 3: 9,9 ↓ 4: 9,7 ↙ 5: 8,9 ←	Serie 1 	1: 9,6 ↗ 2: 10,7* ↖ 3: 10,4 ↖ 4: 10,0 ↑ 5: 9,2 ↖
		Serie 45,0	Serie 48,0	
		Totalt 0,0	Totalt 48,0	
Prov		1: 9,3 ↑ 2: 9,9 ↗	Serie 2 	1: 8,5 ↗ 2: 10,3 ↙ 3: 9,3 ↘ 4: 9,7 → 5: 9,4 →
		Serie 18,0	Serie 45,0	
		Totalt 48,0	Totalt 93,0	
Serie 3		1: 6,4 ↖ 2: 9,1 ↗ 3: 7,2 ↗ 4: 7,1 ↖ 5: 7,8 ↗		
		Serie 36,0		
		Totalt 129,0		

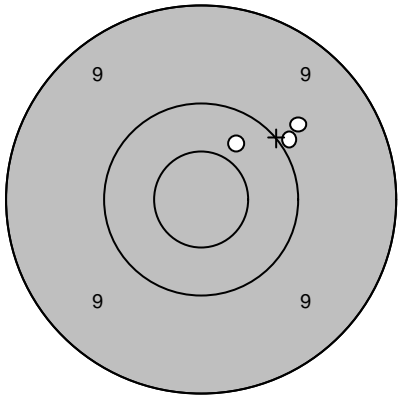
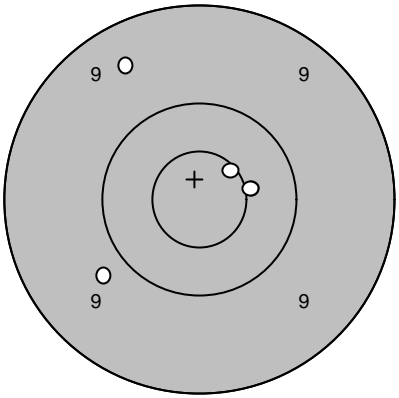
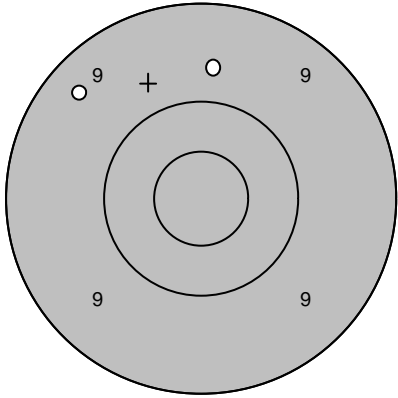
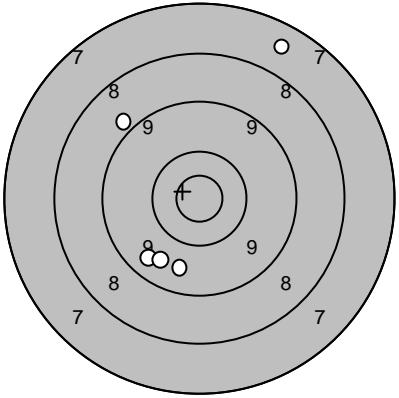
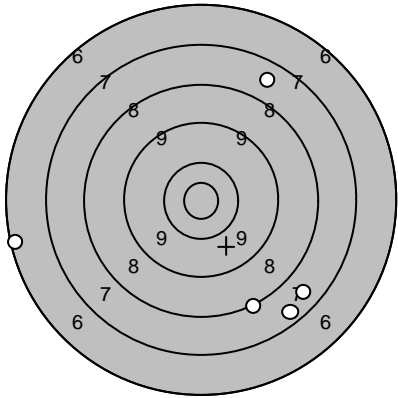
Skjutlag	Tavla	<b>Rune Utterström</b>	
<b>2</b>	<b>16</b>		
Ramselefors	Ale		
2005-07-10	Tavelträffen B 2005	Ramselefors Skytteförening	
Prov		1: 9,9 ↗ 2: 10,4 ↗ 3: 9,8 ↗	Serie 1 
		Serie 28,0 Totalt 0,0	1: 9,5 ↖ 2: 10,5* → 3: 10,5* → 4: 10,6* ↗ 5: 9,8 ↖
			Serie 48,0 Totalt 48,0
Prov		1: 9,7 ↑ 2: 9,4 ↖	Serie 2 
		Serie 18,0 Totalt 48,0	1: 7,6 ↗ 2: 9,5 ↖ 3: 9,7 ↘ 4: 9,6 ↘ 5: 8,9 ↖
			Serie 42,0 Totalt 90,0
Serie 3		1: 7,7 ↘ 2: 8,1 ↘ 3: 7,7 ↗ 4: 7,5 ↘ 5: 6,3 ←	
		Serie 35,0 Totalt 125,0	

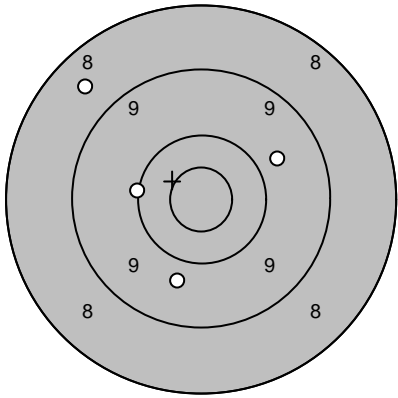
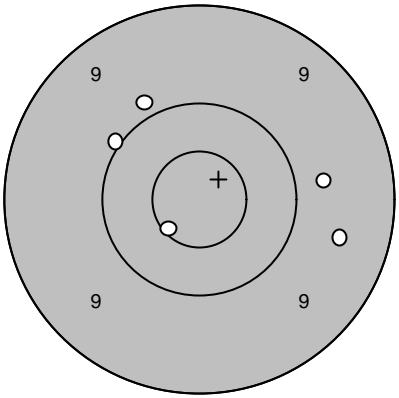
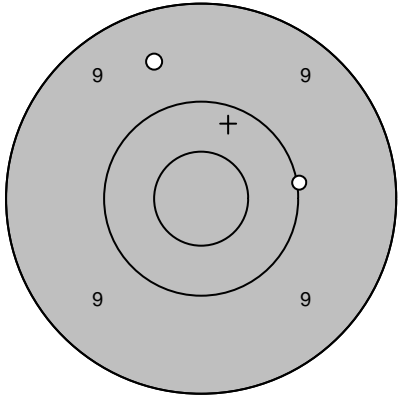
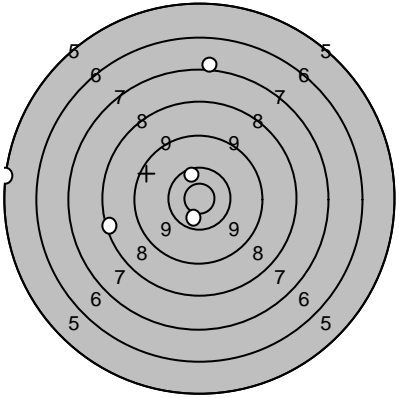
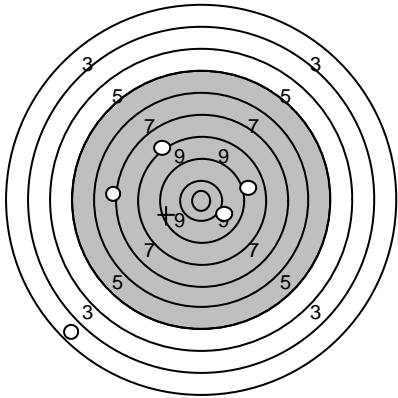
Skjutlag <b>2</b>	Tavla <b>17</b>	<b>Mattias Lundström</b>			
Ramselefors		Flarken			
2005-07-10		Tavelträffen B 2005		Ramselefors Skytteförening	
Prov		1: 8,6 ↖ 2: 10,1 ← 3: 9,8 ↓ 4: 9,7 →	Serie 1		1: 10,0 ↖ 2: 10,6* ↙ 3: 9,9 ↗ 4: 9,5 → 5: 9,7 →
		Serie 36,0		Serie 47,0	
		Totalt 0,0		Totalt 47,0	
Prov		1: 10,0 → 2: 9,6 ↗	Serie 2		1: 7,1 ↑ 2: 10,6* ↓ 3: 10,5* ↑ 4: 5,3 ← 5: 8,3 ←
		Serie 19,0		Serie 40,0	
		Totalt 47,0		Totalt 87,0	
Serie 3		1: 8,3 ↗ 2: 10,1 → 3: 9,1 → 4: 7,3 ← 5: 2,8 ↙			
		Serie 36,0			
		Totalt 123,0			

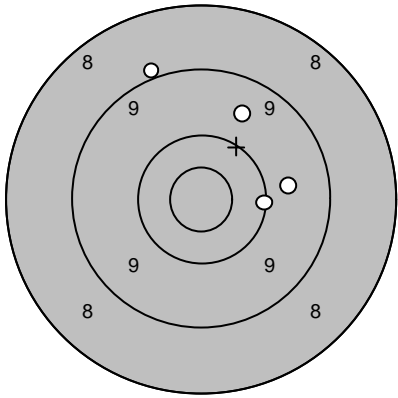
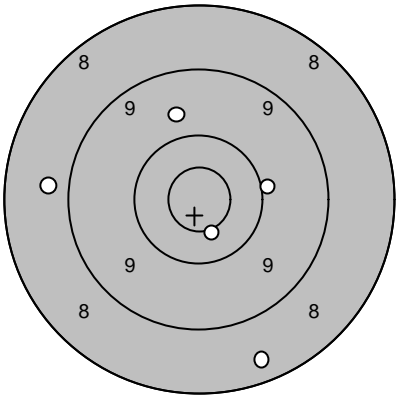
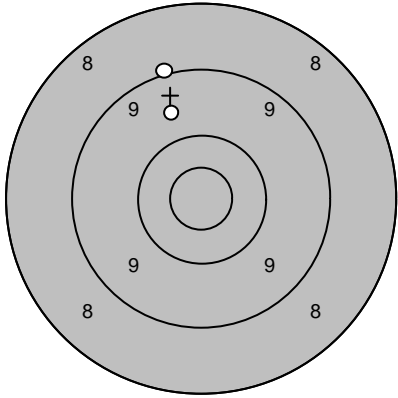
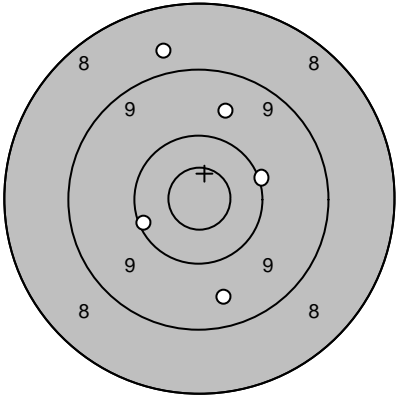
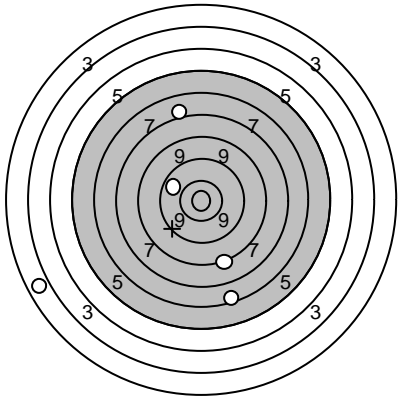
Skjutlag <b>2</b>	Tavla <b>18</b>	<b>Ivar Larsson</b>		
Ramselefors		Närkes-Kil		
2005-07-10		Tavelträffen B 2005		Ramselefors Skytteförening
Prov 	1: 10,1 →	Serie 1 	1: 9,7 ↑	
	2: 9,7 →		2: 10,0 →	
	3: 9,0 ↗		3: 8,8 ←	
	4: 9,6 ↗		4: 10,5* ↓	
			5: 8,4 ↓	
	Serie 37,0		Serie 45,0	
	Totalt 0,0		Totalt 45,0	
Prov 	1: 9,0 ↗	Serie 2 	1: 8,8 ↑	
	2: 9,7 ↗		2: 9,7 ↑	
			3: 10,1 →	
			4: 9,5 ↓	
			5: 10,2 ←	
	Serie 18,0		Serie 46,0	
	Totalt 45,0		Totalt 91,0	
Serie 3 	1: 8,3 ↓			
	2: 2,9 ←			
	3: 6,6 ↓			
	4: 9,9 ←			
	5: 7,2 ↑			
	Serie 32,0			
	Totalt 123,0			

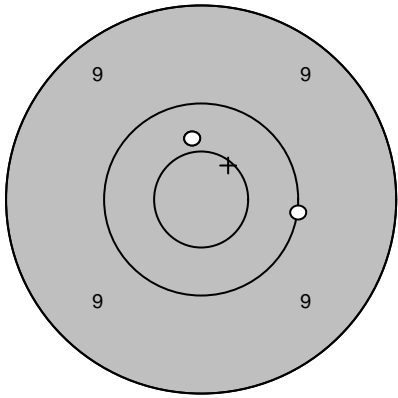
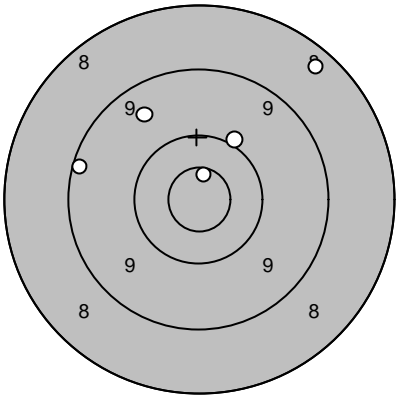
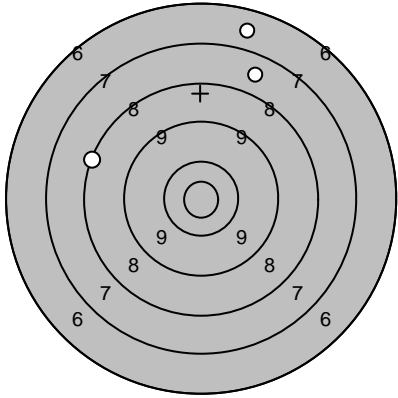
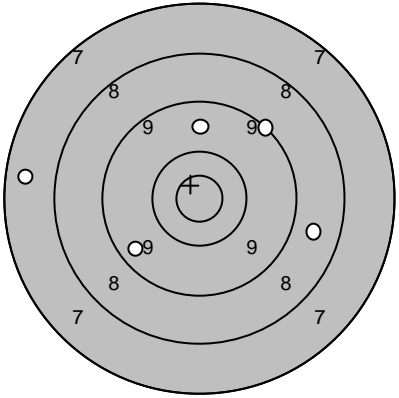
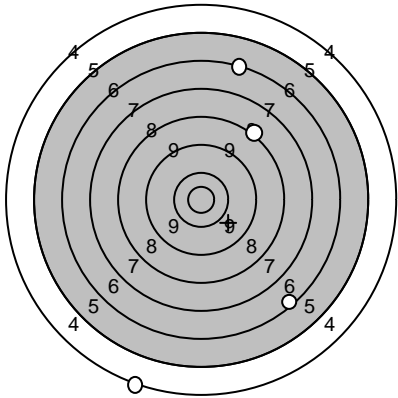
Skjutlag	Tavla	<b>Erhard Höglander</b>	
<b>2</b>	<b>20</b>		
Ramselefors	Rundvik		
2005-07-10	Tavelträffen B 2005	Ramselefors Skytteförening	
Prov 	1: 10,0 →	Serie 1 	1: 8,4 ↗
	2: 10,4 ↑		2: 10,0 ↗
	3: 10,4 ↑		3: 9,2 ←
			4: 9,6 ↗
			5: 10,7* ↑
	Serie 30,0		Serie 46,0
	Totalt 0,0		Totalt 46,0
Prov 	1: 7,7 ↗	Serie 2 	1: 9,6 ↑
	2: 6,7 ↑		2: 7,6 ←
	3: 8,2 ←		3: 8,7 →
			4: 9,5 ↙
			5: 9,1 ↗
	Serie 21,0		Serie 42,0
	Totalt 46,0		Totalt 88,0
Serie 3 	1: 8,2 ↗		
	2: 6,3 ↑		
	3: 6,4 ↘		
	4: 4,2 ↓		
	Serie 24,0		
	Totalt 112,0		

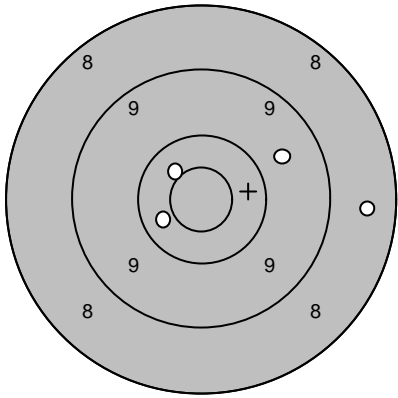
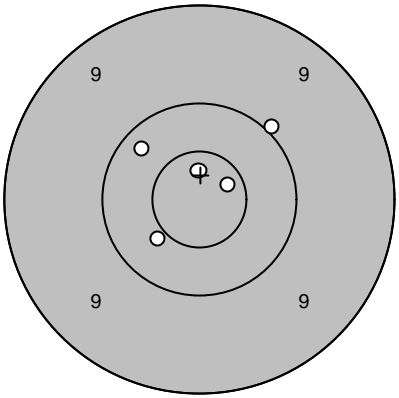
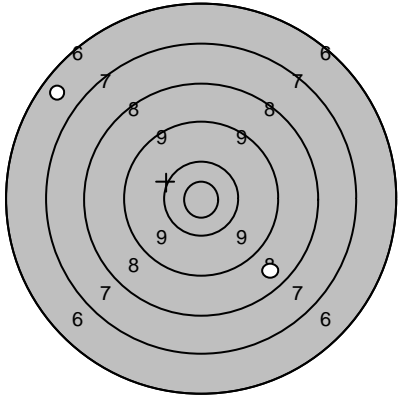
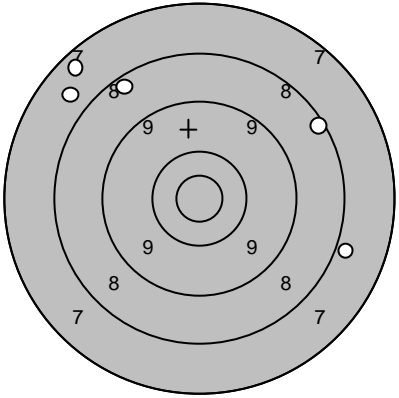
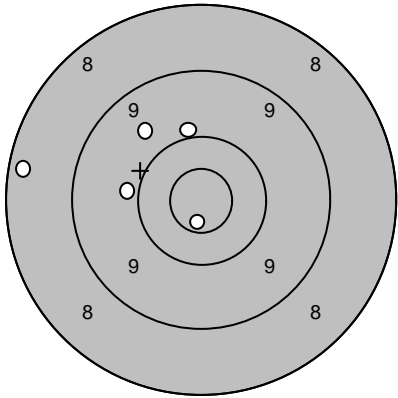
Skjutlag <b>2</b>	Tavla <b>21</b>	<b>Linda Bergman</b>		
Ramselefors		Ununge		
2005-07-10		Tavelträffen B 2005	Ramselefors Skytteförening	
Prov		1: 10,4 ↙ 2: 10,5* ↖ 3: 8,5 → 4: 9,7 ↗	Serie 1 	1: 10,0 ↗ 2: 10,7* ↗ 3: 10,5* ↙ 4: 10,7* ↑ 5: 10,2 ↖
		Serie 37,0	Serie 50,0	
		Totalt 0,0	Totalt 50,0	
Prov		1: 8,6 ↘ 2: 6,6 ↗	Serie 2 	1: 7,8 ↖ 2: 7,5 ↗ 3: 8,4 ↗ 4: 8,3 ↗ 5: 7,9 →
		Serie 14,0	Serie 37,0	
		Totalt 50,0	Totalt 87,0	
Serie 3		1: 10,7* ↓ 2: 9,7 ↗ 3: 8,3 ← 4: 9,9 ← 5: 10,0 ↑		
		Serie 46,0		
		Totalt 133,0		

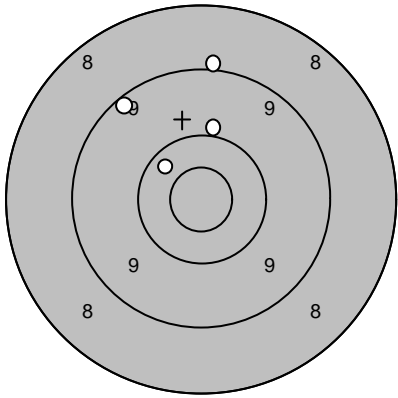
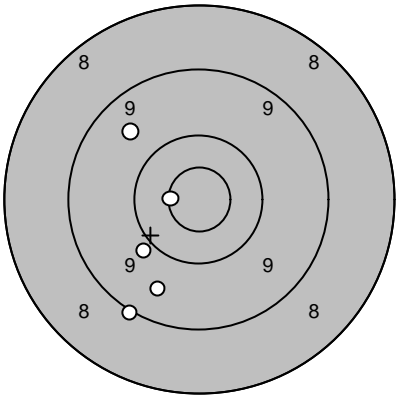
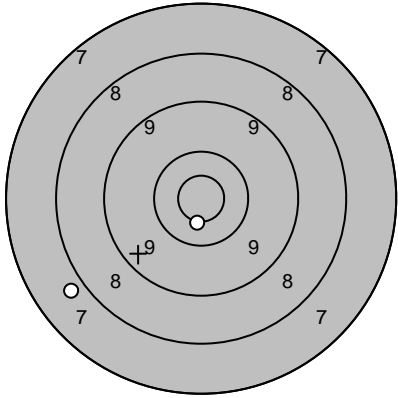
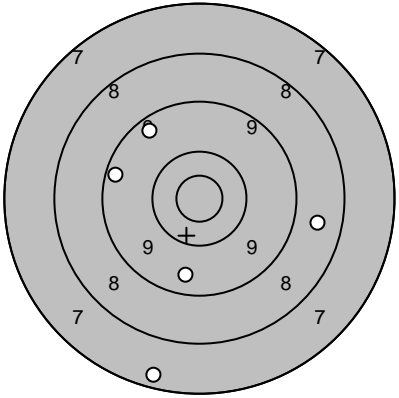
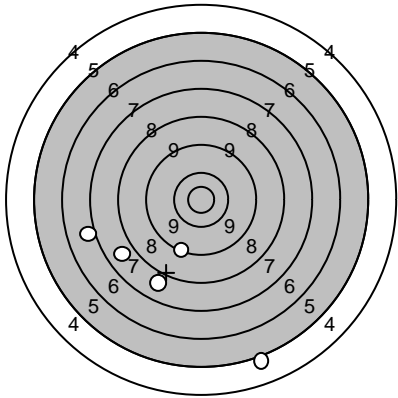

Skjutlag <b>2</b>	Tavla <b>22</b>	<b>Torvald Andersson</b>	
Ramselefors		Ununge	
2005-07-10		Tavelträffen B 2005	Ramselefors Skytteförening
Prov		1: 10,0 ↑ 2: 9,0 ↑ 3: 10,4 ↖ 4: 9,2 ↖	Serie 1  1: 9,9 ↙ 2: 9,6 ↖ 3: 9,6 ↓ 4: 10,6* ← 5: 9,0 ↓
		Serie 38,0	Serie 46,0
		Totalt 0,0	Totalt 46,0
Prov		1: 7,9 ↙ 2: 10,6* ↓	Serie 2  1: 8,6 → 2: 9,4 ↗ 3: 7,4 ↓ 4: 9,5 ↓ 5: 9,3 ←
		Serie 17,0	Serie 42,0
		Totalt 46,0	Totalt 88,0
Serie 3		1: 9,3 ↓ 2: 7,8 ↙ 3: 7,0 ← 4: 5,1 ↓ 5: 7,9 ↓	
		Serie 35,0	
		Totalt 123,0	

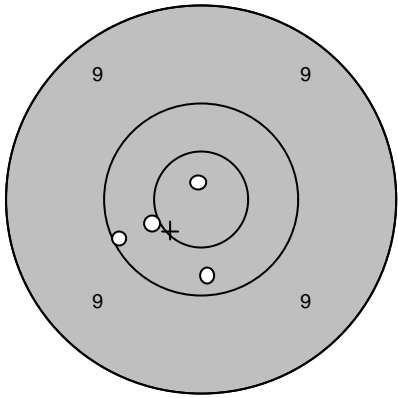
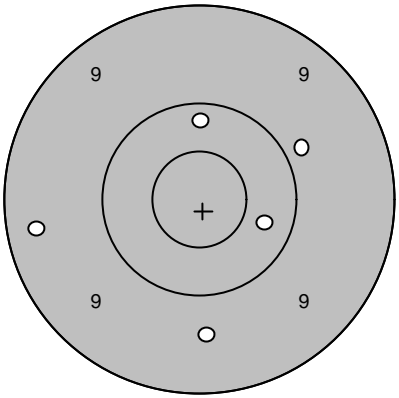
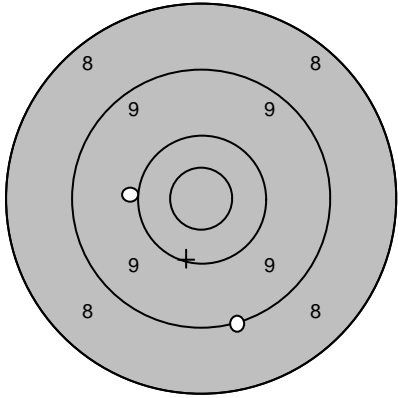
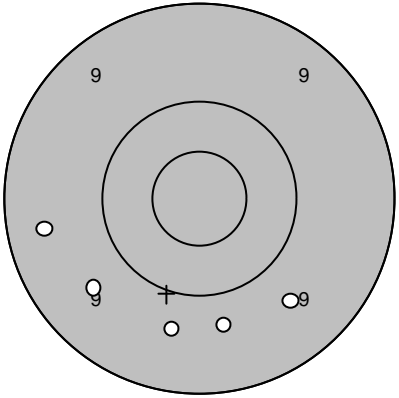
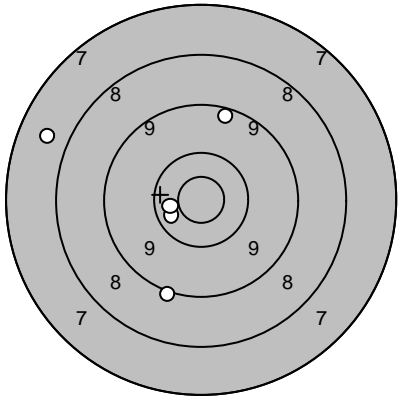
Skjutlag <b>2</b>	Tavla <b>23</b>	<b>Lars-Göran Lundqvist</b>		
Ramselefors		Ununge		
2005-07-10		Tavelträffen B 2005	Ramselefors Skytteförening	
Prov		1: 10,1 ↙ 2: 10,5* ↙ 3: 10,2 ↓ 4: 10,9* ↑	Serie 1 	1: 9,9 ↗ 2: 10,2 ↑ 3: 10,3 → 4: 9,7 ↓ 5: 9,4 ←
		Serie 40,0	Serie 47,0	
		Totalt 0,0	Totalt 47,0	
Prov		1: 9,1 ↓ 2: 10,0 ←	Serie 2 	1: 9,6 ↘ 2: 9,6 ↙ 3: 9,7 ↓ 4: 9,4 ← 5: 9,7 ↓
		Serie 19,0	Serie 45,0	
		Totalt 47,0	Totalt 92,0	
Serie 3		1: 9,3 ↑ 2: 10,4 ↙ 3: 7,7 ↙ 4: 10,5* ← 5: 9,1 ↓		
		Serie 45,0		
		Totalt 137,0		

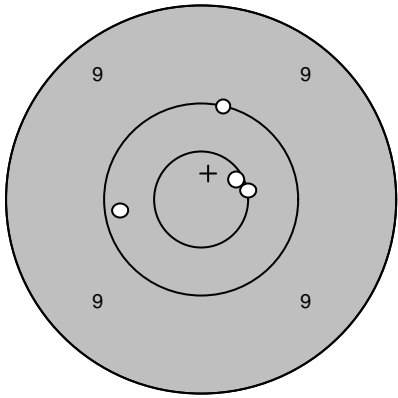
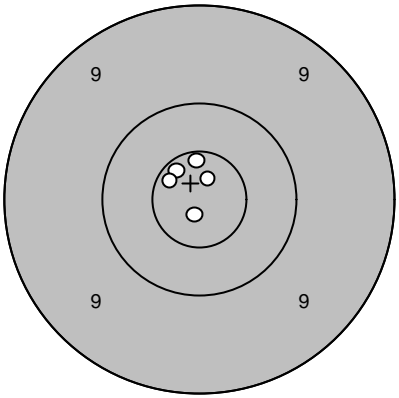
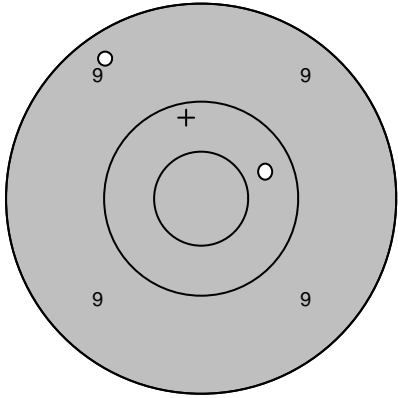
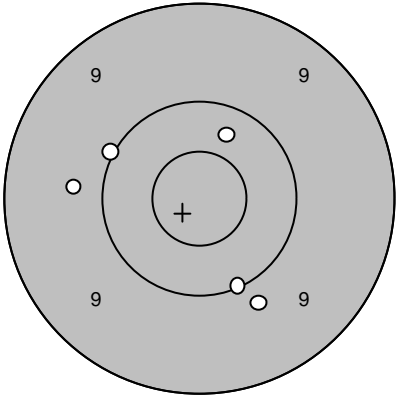
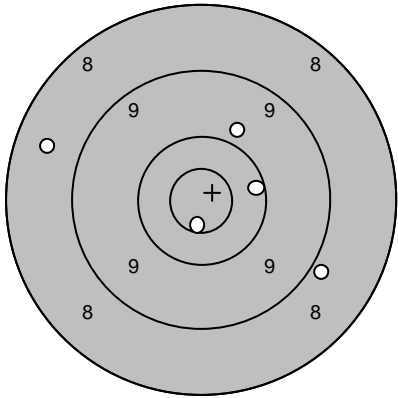
Skjutlag	Tavla	<b>Stefan Lundqvist</b>	
<b>2</b>	<b>24</b>		
Ramselefors	Ununge		
2005-07-10	Tavelträffen B 2005	Ramselefors Skytteförening	
Prov 	1: 10,5* →	Serie 1 	1: 10,8* ↗
	2: 10,6* →		2: 10,7* ↖
	3: 10,1 ↑		3: 10,6* ↑
	4: 10,2 ←		4: 10,7* ↖
			5: 10,9* ↓
	Serie 40,0		Serie 50,0
	Totalt 0,0		Totalt 50,0
Prov 	1: 9,3 ↖	Serie 2 	1: 10,0 ↖
	2: 10,3 →		2: 10,3 ↑
			3: 9,8 ↓
			4: 9,8 ←
			5: 10,1 ↓
	Serie 19,0		Serie 48,0
	Totalt 50,0		Totalt 98,0
Serie 3 	1: 10,7* ↓		
	2: 10,2 →		
	3: 8,9 ↘		
	4: 9,9 ↑		
	5: 8,6 ←		
	Serie 45,0		
	Totalt 143,0		

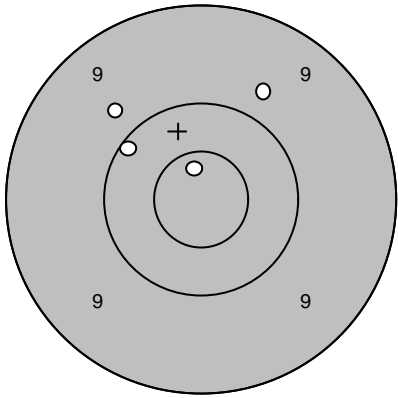
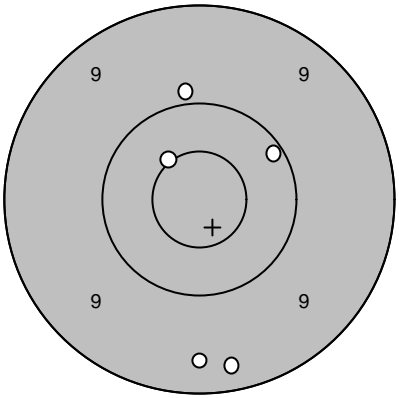
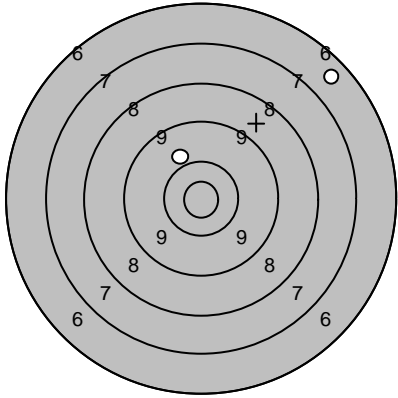
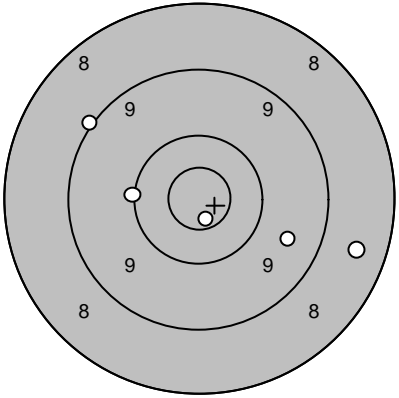
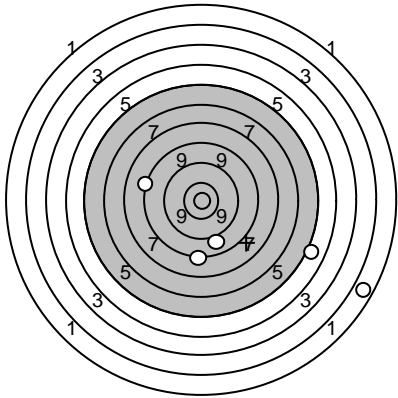
Skjutlag <b>3</b>	Tavla <b>1</b>	<b>Johnny Wallberg</b>		
Ramselefors	Loos			
2005-07-10	Tavelträffen B 2005	Ramselefors Skytteförening		
Prov		1: 10,7* ↑ 2: 10,1 ↖ 3: 9,8 ↗ 4: 9,8 ↖	Serie 1 	1: 10,5* ↖ 2: 9,4 ↓ 3: 9,3 ↓ 4: 10,1 ↗ 5: 9,9 ↑
	Serie 38,0		Serie 47,0	
	Totalt 0,0		Totalt 47,0	
Prov		1: 6,6 ↗ 2: 10,0 ↖	Serie 2 	1: 8,5 → 2: 10,1 ← 3: 10,7* ↓ 4: 9,0 ↗ 5: 9,6 ↘
	Serie 16,0		Serie 46,0	
	Totalt 47,0		Totalt 93,0	
Serie 3		1: 8,4 ↓ 2: 1,9 → 3: 5,1 → 4: 8,4 ← 5: 9,1 ↓		
	Serie 31,0			
	Totalt 124,0			

Skjutlag <b>3</b>	Tavla <b>2</b>	<b>Tony Ericson</b>	
Ramselefors		Loos	
2005-07-10		Tavelträffen B 2005	Ramselefors Skytteförening
Prov		1: 10,2 ← 2: 10,2 → 3: 10,2 ↗ 4: 9,6 ↑	Serie 1
			1: 9,8 → 2: 10,4 → 3: 9,6 → 4: 9,7 → 5: 10,5* ↗
		Serie 39,0	Serie 47,0
		Totalt 0,0	Totalt 47,0
Prov		1: 7,5 ↙ 2: 7,4 ↙	Serie 2
			1: 10,2 ↓ 2: 10,6* ← 3: 8,6 → 4: 10,7* ↓ 5: 6,7 →
		Serie 14,0	Serie 44,0
		Totalt 47,0	Totalt 91,0
Serie 3		1: 7,1 ↙ 2: 5,2 ↓ 3: 4,9 ↗ 4: 9,7 ↑ 5: 3,0 ↘	
		Serie 28,0	
		Totalt 119,0	

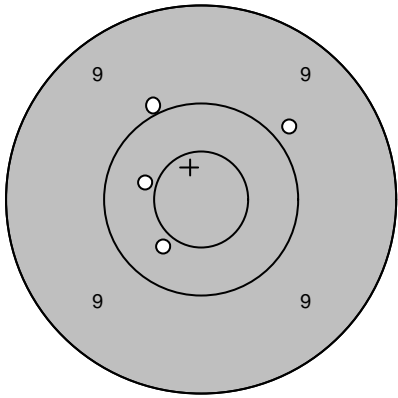
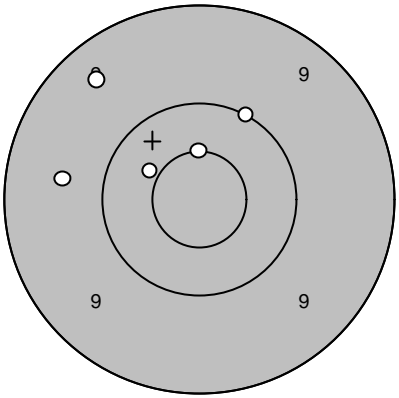
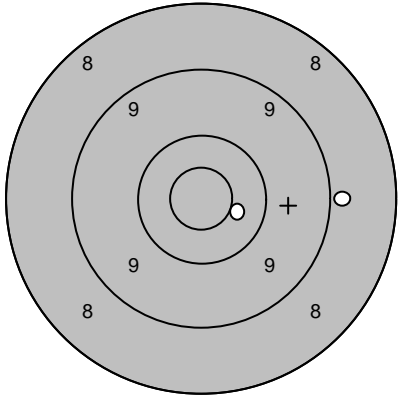
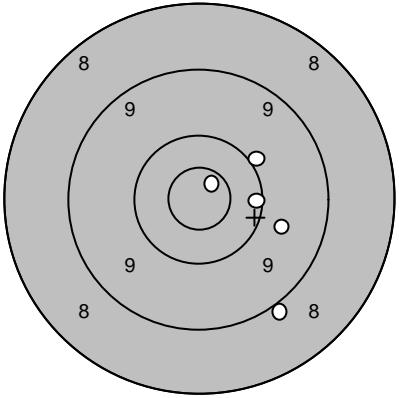
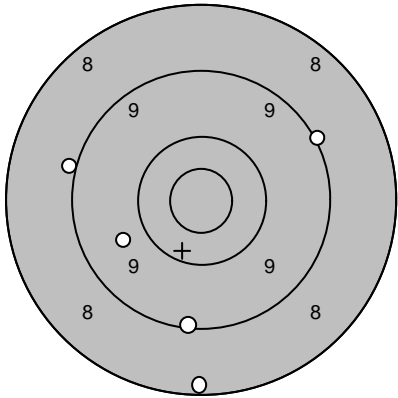
Skjutlag <b>3</b>	Tavla <b>3</b>	<b>Ronnie Pettersson</b>		
Ramselefors		Loos		
2005-07-10		Tavelträffen B 2005	Ramselefors Skytteförening	
Prov		1: 9,9 ↗ 2: 10,0 ↖ 3: 10,4 ← 4: 10,4 ↘	Serie 1 	1: 10,5* ↑ 2: 10,5* ↖ 3: 10,1 ↗ 4: 9,4 ↗ 5: 9,6 ←
		Serie 39,0	Serie 48,0	
		Totalt 0,0	Totalt 48,0	
Prov		1: 10,5* ➔ 2: 8,9 ➔	Serie 2 	1: 9,8 ➔ 2: 10,0 ↗ 3: 10,2 ➔ 4: 9,0 ↘ 5: 10,8* ↗
		Serie 18,0	Serie 48,0	
		Totalt 48,0	Totalt 96,0	
Serie 3		1: 9,7 ← 2: 8,2 ↓ 3: 9,0 ← 4: 9,1 ↗ 5: 9,1 ↓		
		Serie 44,0		
		Totalt 140,0		

Skjutlag

Tavla

3

8

Erik Sigfridsson

Ramselefors

Ramselefors

2005-07-10

Tavelträffen B 2005

Ramselefors Skytteförening

Prov

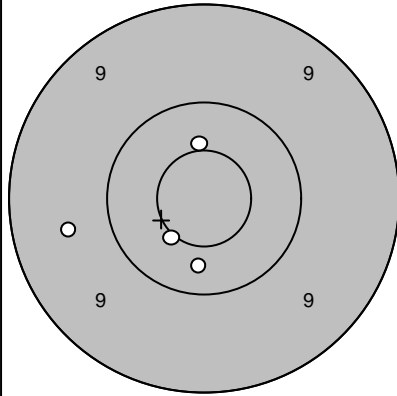

1: 10,5\* ↙  
 2: 10,3 ↓  
 3: 9,6 ←  
 4: 10,5\* ↑

Serie 1

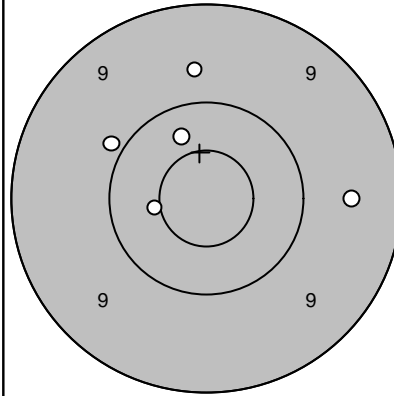

1: 9,9 ↖  
 2: 9,7 ↑  
 3: 10,5\* ←  
 4: 9,6 →  
 5: 10,4 ↗

Serie 39,0

Totalt 0,0

Serie 47,0

Totalt 47,0

Prov

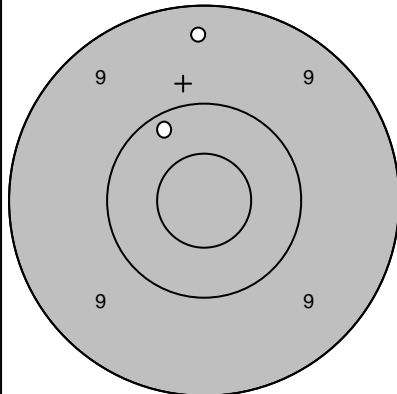

1: 9,3 ↑  
 2: 10,2 ↖

Serie 2

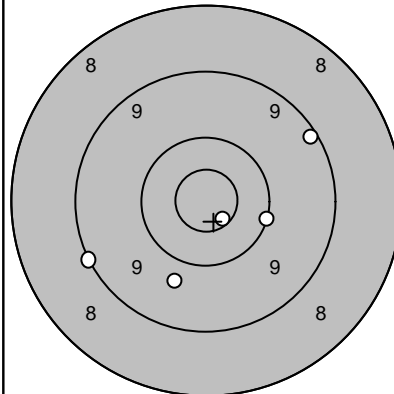

1: 9,8 ↓  
 2: 10,7\* ↓  
 3: 10,1 →  
 4: 9,1 ←  
 5: 9,2 ↗

Serie 19,0

Totalt 47,0

Serie 47,0

Totalt 94,0

Serie 3

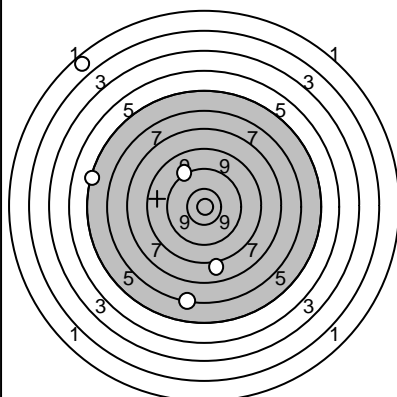

1: 8,2 ↓  
 2: 6,4 ↓  
 3: 1,8 ↗  
 4: 5,5 ←  
 5: 9,4 ↗

Serie 29,0

Totalt 123,0

www.AC-Skytte.com

http://www.megalink.no

MLRemotelSSF 300m

11:33 - 10.07.2005





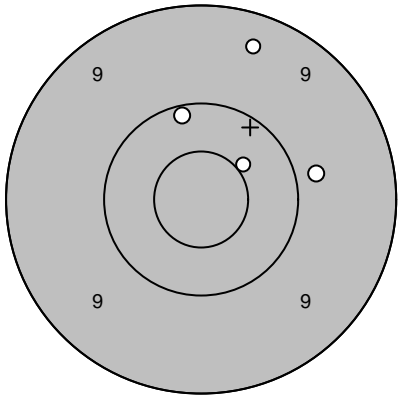
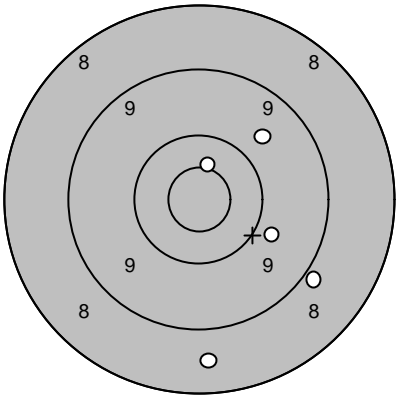
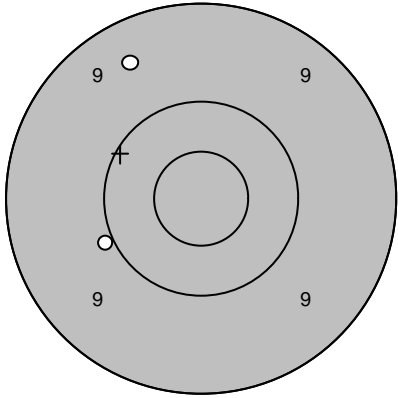
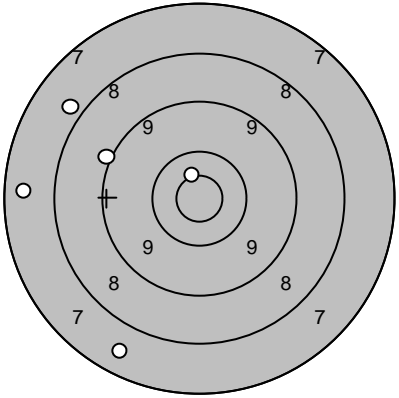
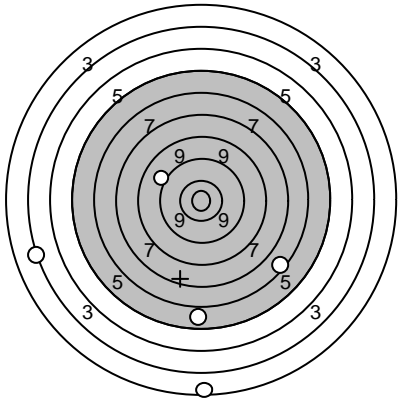

Skjutlag	Tavla	<b>Bengt Heder</b>		
<b>3</b>	<b>12</b>			
Ramselefors	Evertsberg			
2005-07-10	Tavelträffen B 2005	Ramselefors Skytteförening		
Prov		1: 10,5* ↗ 2: 9,4 ↑ 3: 9,8 → 4: 10,2 ↑	Serie 1 	1: 8,9 ↘ 2: 9,7 ↗ 3: 9,8 ↘ 4: 8,6 ↓ 5: 10,5* ↑
		Serie 38,0		Serie 44,0
		Totalt 0,0		Totalt 44,0
Prov		1: 10,0 ← 2: 9,5 ↗	Serie 2 	1: 7,6 ↘ 2: 7,5 ← 3: 7,9 ↗ 4: 9,0 ← 5: 10,6* ↑
		Serie 19,0		Serie 40,0
		Totalt 44,0		Totalt 84,0
Serie 3		1: 3,4 ← 2: 6,0 ↓ 3: 9,3 ↗ 4: 6,6 ↘ 5: 2,6 ↓		
		Serie 26,0		
		Totalt 110,0		

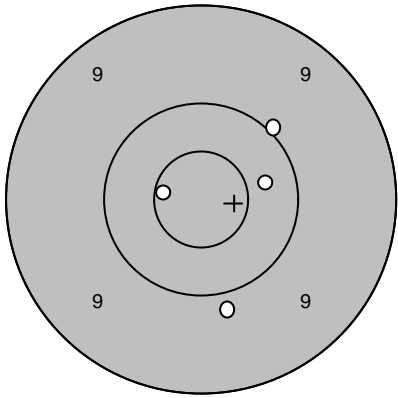
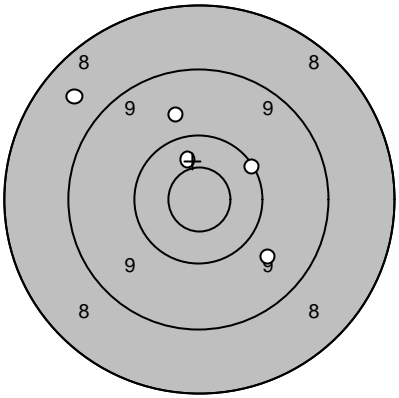
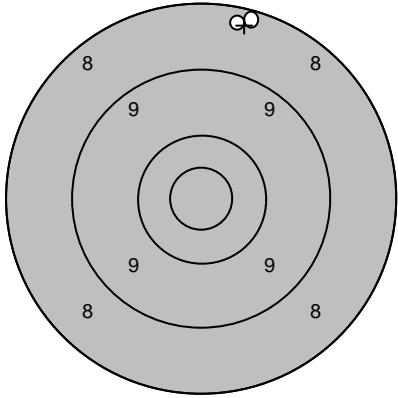
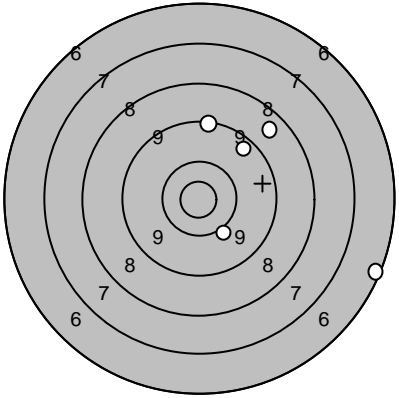
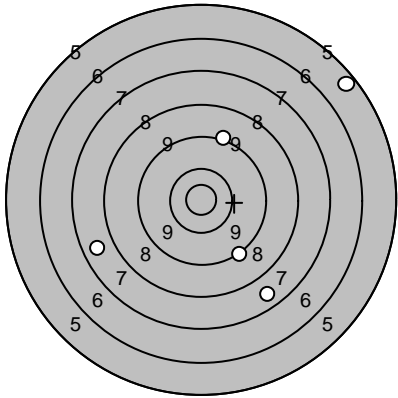
Skjutlag <b>3</b>	Tavla <b>13</b>	<b>Torgny Lindfors</b>		
Ramselefors	I 19			
2005-07-10	Tavelträffen B 2005	Ramselefors Skytteförening		
Prov		1: 9,9 ↓ 2: 10,4 → 3: 10,6* ← 4: 10,0 ↗	Serie 1 	1: 9,7 ↑ 2: 8,6 ↖ 3: 10,4 ↑ 4: 10,1 ↗ 5: 9,7 ↓
		Serie 39,0	Serie 46,0	
		Totalt 0,0	Totalt 46,0	
Prov		1: 8,3 ↑ 2: 8,2 ↑	Serie 2 	1: 9,2 ↑ 2: 10,1 ↓ 3: 8,6 ↗ 4: 9,4 ↗ 5: 6,3 →
		Serie 16,0	Serie 42,0	
		Totalt 46,0	Totalt 88,0	
Serie 3		1: 7,7 ↓ 2: 7,7 ← 3: 9,2 ↓ 4: 5,5 ↗ 5: 9,2 ↑		
		Serie 37,0		
		Totalt 125,0		

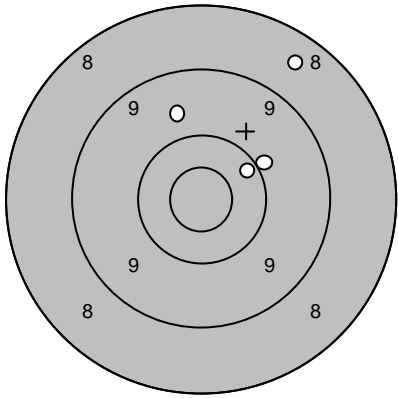
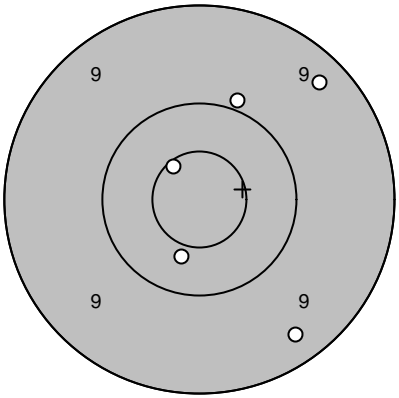
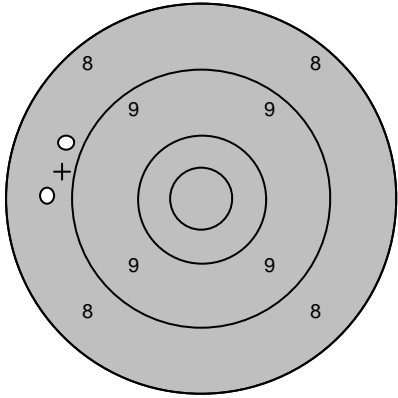
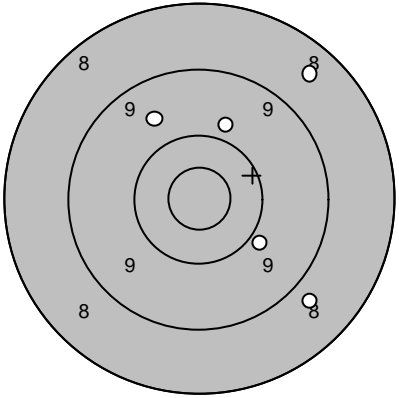
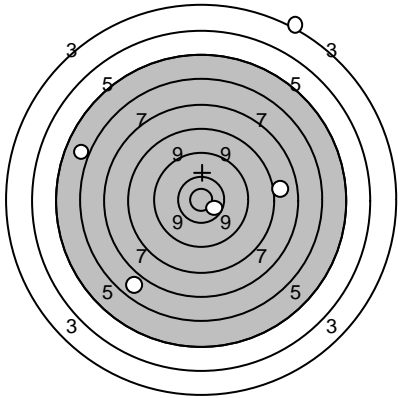

Skjutlag <b>3</b>	Tavla <b>15</b>	<b>Håkan Engman</b>		
Ramselefors		Lindesberg		
2005-07-10		Tavelträffen B 2005	Ramselefors Skytteförening	
Prov		1: 10,0 → 2: 8,5 ↗ 3: 10,2 → 4: 9,7 ↗	Serie 1 	1: 10,4 ↓ 2: 10,0 ↗ 3: 9,3 ↗ 4: 10,6* ↗ 5: 9,3 ↓
		Serie 37,0	Serie 48,0	
		Totalt 0,0	Totalt 48,0	
Prov		1: 8,7 ← 2: 8,8 ←	Serie 2 	1: 9,9 ↘ 2: 8,5 ↗ 3: 8,8 ↘ 4: 9,7 ↗ 5: 9,9 ↗
		Serie 16,0	Serie 43,0	
		Totalt 48,0	Totalt 91,0	
Serie 3		1: 8,0 → 2: 6,9 ↘ 3: 3,2 ↗ 4: 6,1 ← 5: 10,7* ↘		
		Serie 33,0		
		Totalt 124,0		

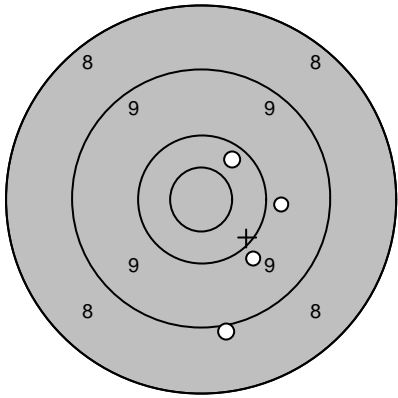
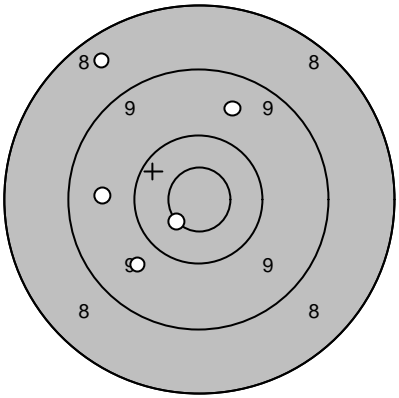
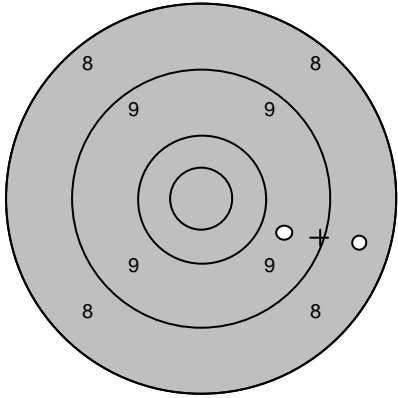
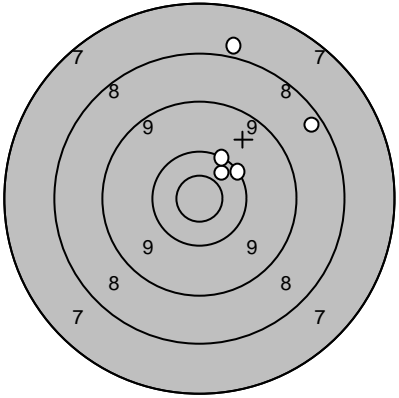
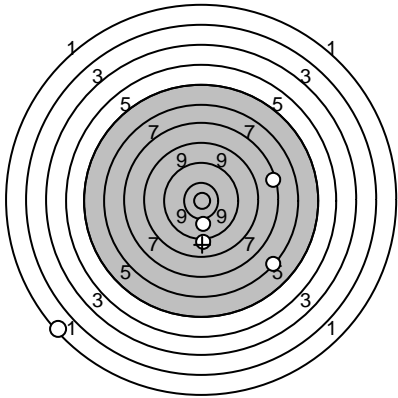
Skjutlag	Tavla	<b>Dennis Sundqvist</b>		
<b>3</b>	<b>16</b>			
Ramselefors	Piteå			
2005-07-10	Tavelträffen B 2005	Ramselefors Skytteförening		
Prov		1: 10,3 ↗ 2: 9,9 → 3: 9,0 ↓ 4: 9,9 ↘	Serie 1 	1: 8,5 ↖ 2: 9,7 ↙ 3: 9,6 ↗ 4: 10,6* ↙ 5: 9,6 ←
		Serie 37,0	Serie 45,0	
		Totalt 0,0	Totalt 45,0	
Prov		1: 8,6 → 2: 9,7 →	Serie 2 	1: 10,4 ↗ 2: 7,9 ↑ 3: 8,4 ↗ 4: 10,2 ↑ 5: 10,1 ↗
		Serie 17,0	Serie 45,0	
		Totalt 45,0	Totalt 90,0	
Serie 3		1: 10,1 ↓ 2: 1,6 ↙ 3: 6,5 ↘ 4: 7,5 → 5: 9,3 ↓		
		Serie 33,0		
		Totalt 123,0		

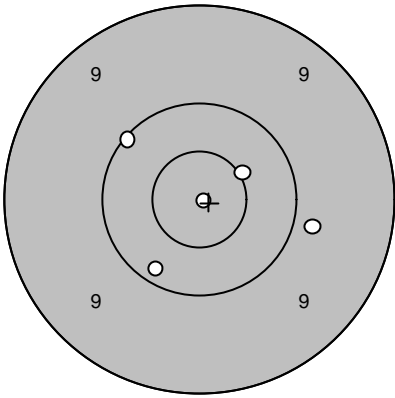
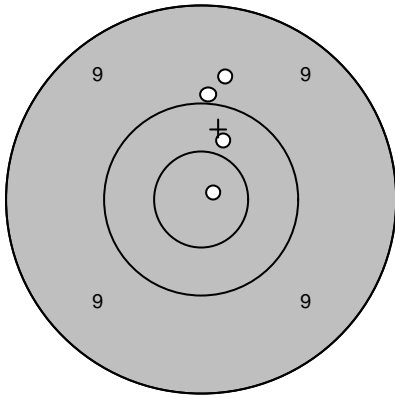
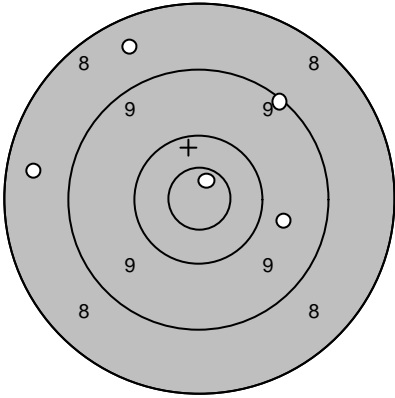
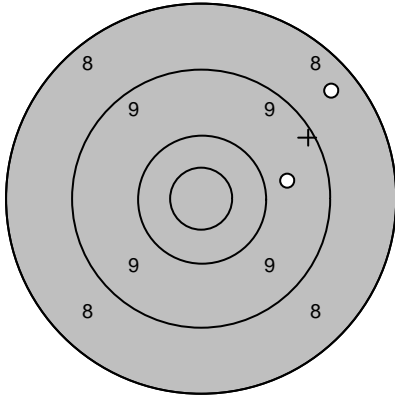
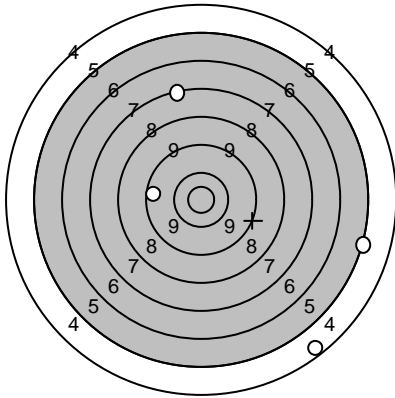
Skjutlag	Tavla	<b>Roland Nilsson</b>	
<b>3</b>	<b>17</b>		
Ramselefors	Piteå		
2005-07-10	Tavelträffen B 2005	Ramselefors Skytteförening	
Prov		1: 10,4 ↗ 2: 10,9* ↗ 3: 9,8 ↑ 4: 10,0 ↑	Serie 1  1: 10,2 ↘ 2: 9,8 → 3: 10,5* ↗ 4: 10,1 ↗ 5: 10,9* →
		Serie 39,0 Totalt 0,0	Serie 49,0 Totalt 49,0
Prov		1: 8,5 ↗ 2: 9,7 →	Serie 2  1: 8,5 ↗ 2: 9,1 ↗ 3: 8,5 ← 4: 10,8* ↑ 5: 9,7 →
		Serie 17,0 Totalt 49,0	Serie 44,0 Totalt 93,0
Serie 3		1: 7,3 ↑ 2: 4,6 ↘ 3: 5,2 → 4: 9,5 ←	
		Serie 25,0 Totalt 118,0	

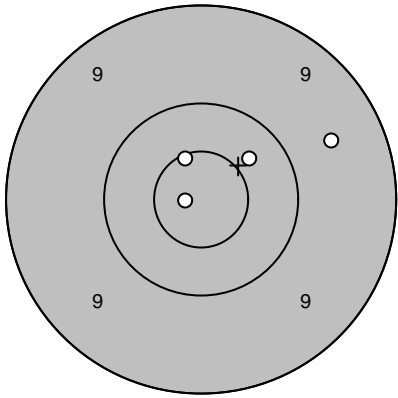
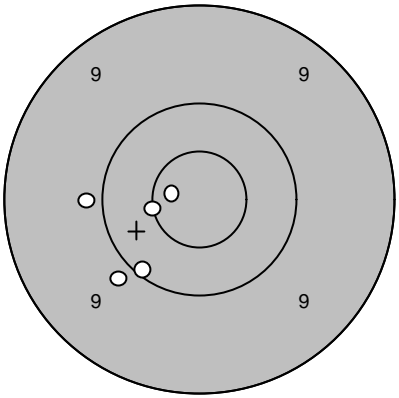
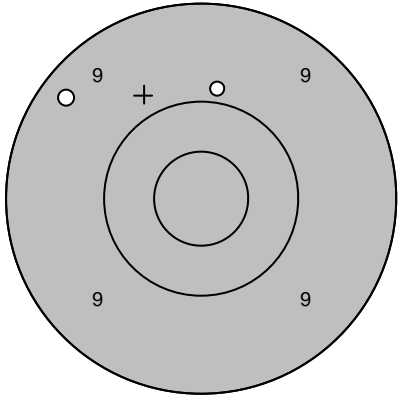
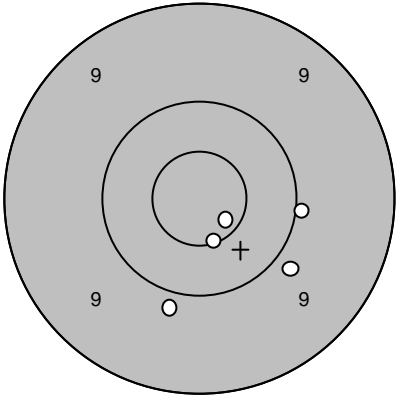
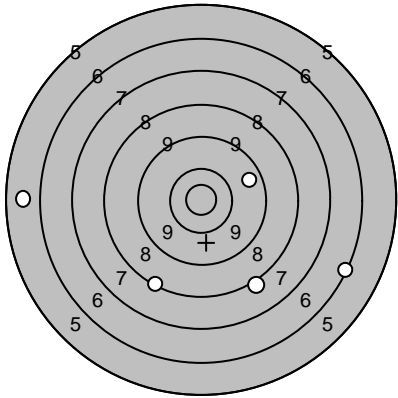
Skjutlag <b>3</b>	Tavla <b>19</b>	<b>Gunnar Iversen</b>	
Ramselefors		S 3	
2005-07-10		Tavelträffen B 2005	Ramselefors Skytteförening
Prov		1: 9,6 → 2: 10,4 ↗ 3: 10,9* ← 4: 10,6* ↖	Serie 1 
		Serie 39,0 Totalt 0,0	1: 10,1 ↘ 2: 10,6* ← 3: 10,7* ← 4: 9,9 ← 5: 9,9 ↘
			Serie 48,0 Totalt 48,0
Prov		1: 9,3 ↖ 2: 9,9 ↑	Serie 2 
		Serie 18,0 Totalt 48,0	1: 10,6* ↘ 2: 9,9 ↘ 3: 10,7* ↘ 4: 9,9 ↘ 5: 10,0 →
			Serie 48,0 Totalt 96,0
Serie 3		1: 9,6 → 2: 5,8 ← 3: 6,3 → 4: 8,1 ↘ 5: 8,3 ↘	
		Serie 36,0 Totalt 132,0	

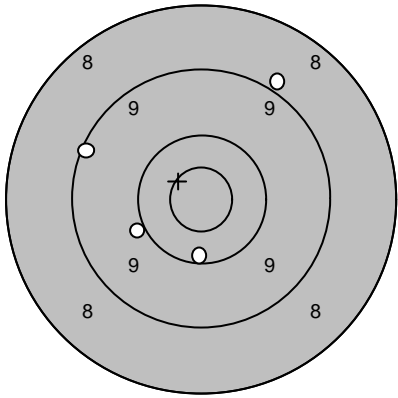
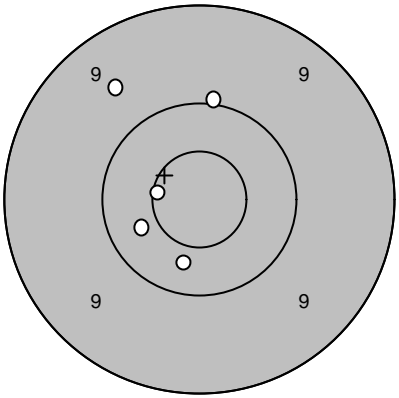
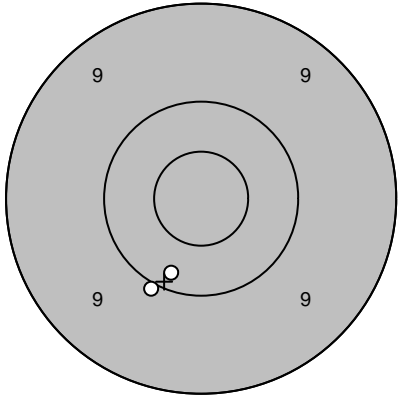
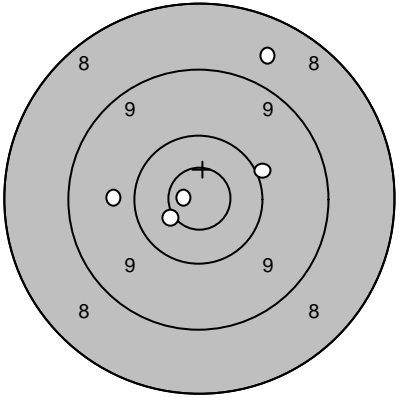
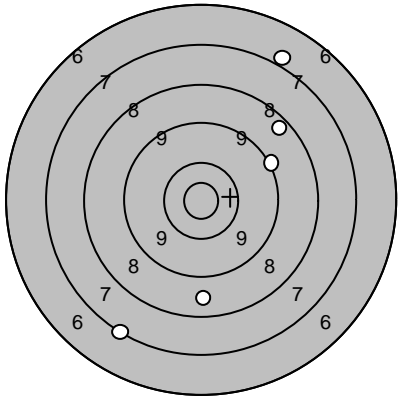

Skjutlag	Tavla	<b>Kjell Marklund</b>		
<b>3</b>	<b>20</b>			
Ramselefors	S 3			
2005-07-10	Tavelträffen B 2005	Ramselefors Skytteförening		
Prov		1: 8,9 ↗ 2: 10,0 ← 3: 10,2 ↓ 4: 9,2 ←	Serie 1 	1: 10,6* ← 2: 10,0 ↑ 3: 9,6 ↗ 4: 10,4 ← 5: 10,4 ↓
		Serie 37,0	Serie 49,0	
		Totalt 0,0	Totalt 49,0	
Prov		1: 10,0 ↓ 2: 10,2 ↓	Serie 2 	1: 9,8 ← 2: 10,9* ← 3: 10,6* ← 4: 8,6 ↑ 5: 10,0 →
		Serie 20,0	Serie 47,0	
		Totalt 49,0	Totalt 96,0	
Serie 3		1: 7,0 ↗ 2: 8,4 ↗ 3: 9,1 → 4: 8,7 ↓ 5: 7,2 ↓		
		Serie 39,0		
		Totalt 135,0		

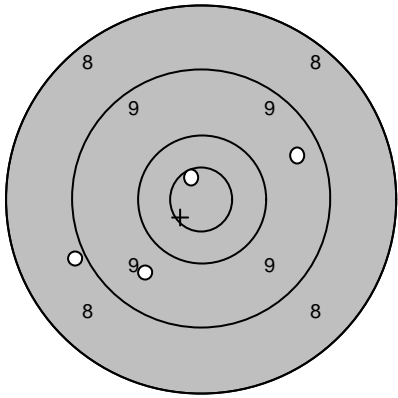
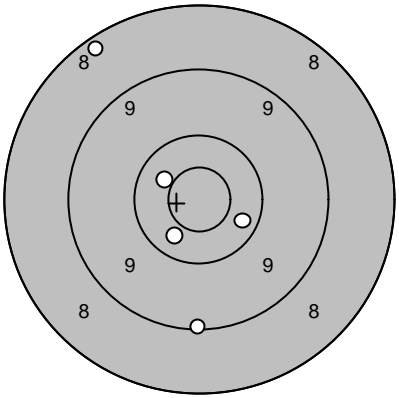
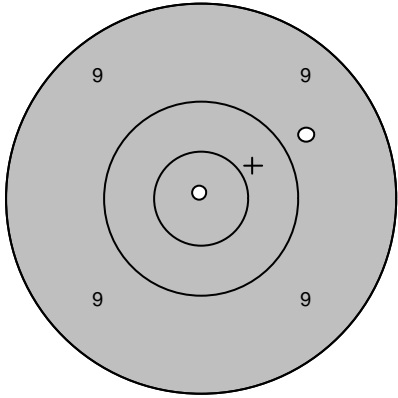
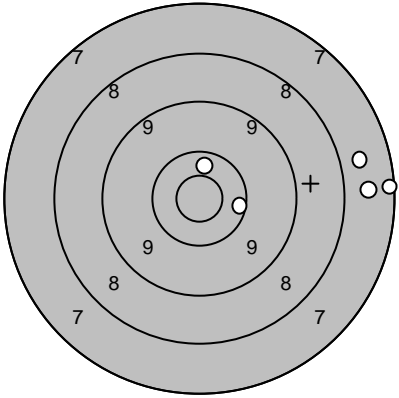
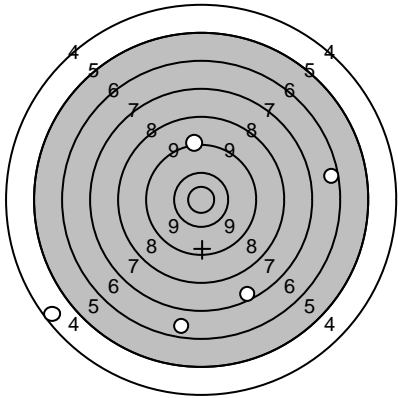
Skjutlag	Tavla	<b>Martin Olofsson</b>	
<b>3</b>	<b>21</b>		
Ramselefors	Vännäs		
2005-07-10	Tavelträffen B 2005	Ramselefors Skytteförening	
Prov 	1: 9,7 ↙	Serie 1 	1: 8,3 ↗
	2: 8,9 ↙		2: 10,5* ↖
	3: 9,5 →		3: 10,3 ↘
	4: 10,7* ↗		4: 9,1 ↓
			5: 10,4 ↘
	Serie 36,0		Serie 47,0
	Totalt 0,0		Totalt 47,0
Prov 	1: 10,9* ↗	Serie 2 	1: 7,7 →
	2: 9,8 ↗		2: 10,4 ↑
			3: 7,8 →
			4: 10,3 →
			5: 7,2 →
	Serie 19,0		Serie 41,0
	Totalt 47,0		Totalt 88,0
Serie 3 	1: 6,5 →		
	2: 9,2 ↑		
	3: 4,5 ↙		
	4: 7,5 ↓		
	5: 6,7 ↓		
	Serie 32,0		
	Totalt 120,0		

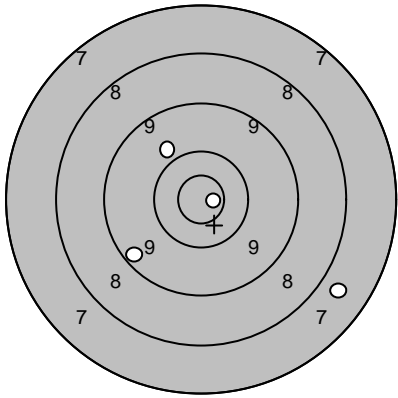
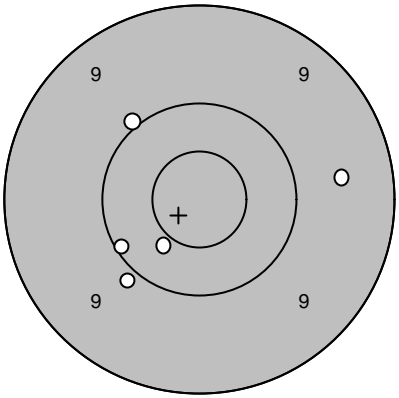
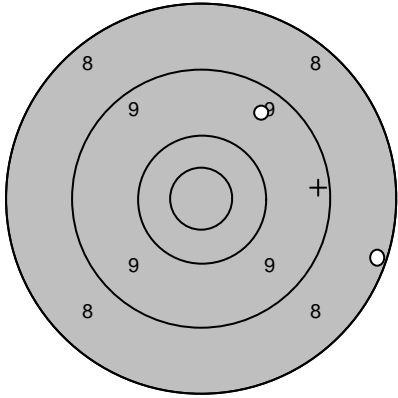
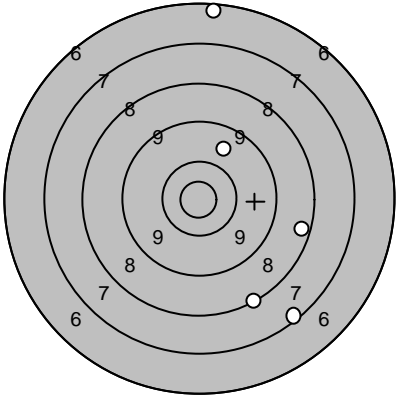
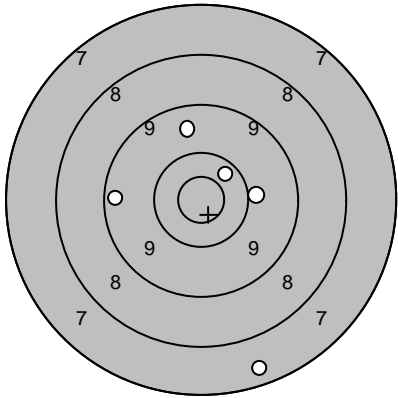
Skjutlag <b>3</b>	Tavla <b>22</b>	<b>Bror Rantakyrö</b>	
Ramselefors		Övertorneå	
2005-07-10		Tavelträffen B 2005	Ramselefors Skytteförening
Prov		1: 10,9* → 2: 7,7 → 3: 9,3 ↙ 4: 9,9 ↗	Serie 1 
		Serie 35,0 Totalt 0,0	1: 10,4 ↙ 2: 10,0 ↖ 3: 10,1 ↙ 4: 9,9 ↙ 5: 9,6 →
			Serie 48,0 Totalt 48,0
Prov		1: 9,5 ↗ 2: 8,2 →	Serie 2 
		Serie 17,0 Totalt 48,0	1: 7,3 ↘ 2: 6,3 ↑ 3: 9,7 ↗ 4: 8,4 → 5: 8,2 ↘
			Serie 38,0 Totalt 86,0
Serie 3		1: 7,5 ↓ 2: 9,4 ← 3: 10,0 → 4: 9,6 ↑ 5: 10,4 ↗	
		Serie 45,0 Totalt 131,0	

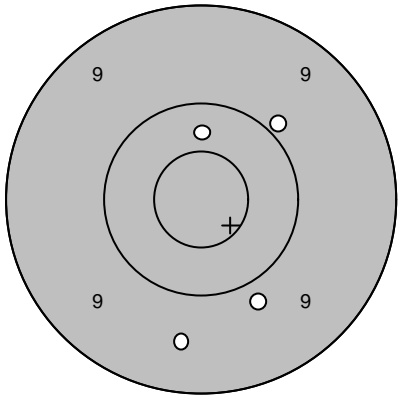
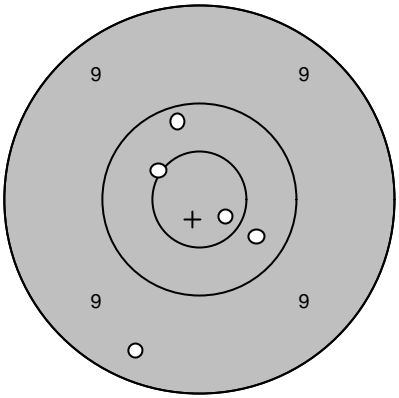
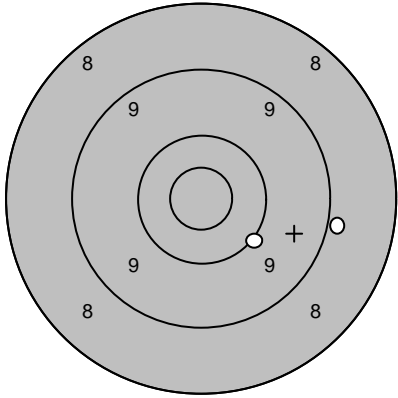
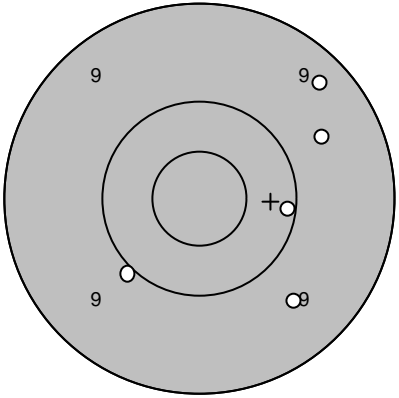
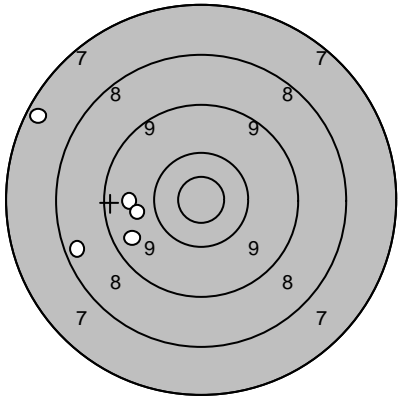
Skjutlag	Tavla	<b>Jan-Erik Karlsson</b>	
<b>3</b>	<b>23</b>		
Ramselefors	Ramselefors		
2005-07-10	Tavelträffen B 2005	Ramselefors Skytteförening	
Prov 	1: 9,8 ↘	Serie 1 	1: 10,7* ↘
	2: 9,9 ↗		2: 10,3 ↘
	3: 10,4 ↑		3: 10,2 ↗
	4: 9,6 ↘		4: 10,5* ↗
	5: 9,4 ↘		
	Serie 37,0		Serie 49,0
	Totalt 0,0		Totalt 49,0
Prov 	1: 8,9 →	Serie 2 	1: 9,3 ↗
	2: 10,0 ↘		2: 9,6 ↗
			3: 9,6 ↘
			4: 10,0 ↘
	5: 10,1 →		
	Serie 18,0		Serie 47,0
	Totalt 49,0		Totalt 96,0
Serie 3 	1: 9,6 ←		
	2: 9,5 ↙		
	3: 9,8 ←		
	4: 8,4 ↙		
	5: 7,4 ↙		
	Serie 42,0		
	Totalt 138,0		

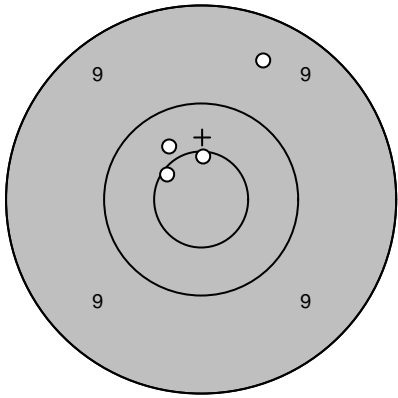
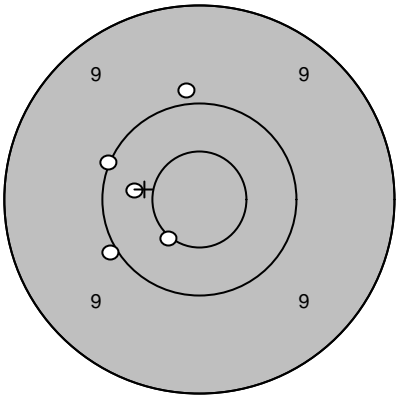
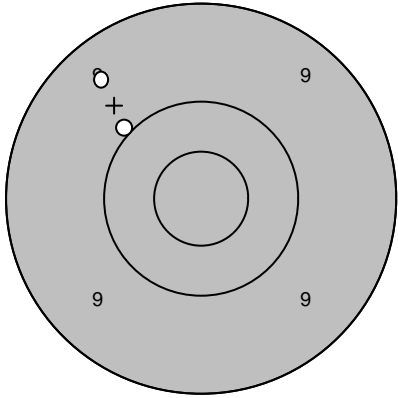
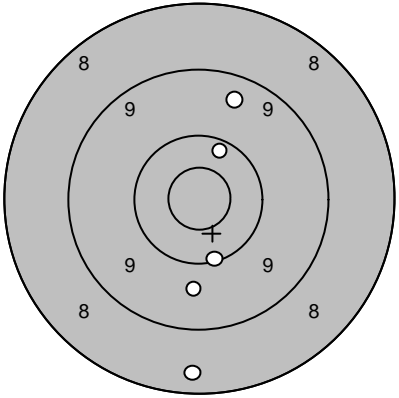
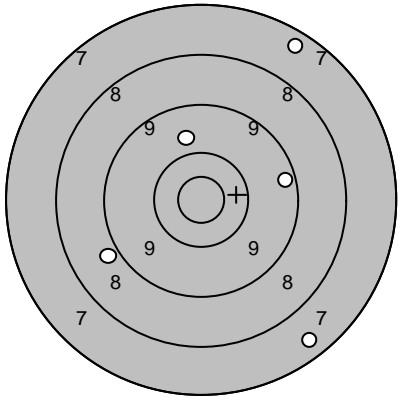
Skjutlag	Tavla	<b>Dan-Ivan Karlsson</b>	
<b>3</b>	<b>24</b>		
Ramselefors	Ramselefors		
2005-07-10	Tavelträffen B 2005	Ramselefors Skytteförening	
Prov 	1: 10,4 ↗	Serie 1 	1: 10,5* ↘
	2: 10,6* ↖		2: 10,0 ↙
	3: 9,5 ↗		3: 9,9 ↗
	4: 10,6* ↗		4: 10,0 ↖
			5: 10,4 ↖
	Serie 39,0		Serie 49,0
	Totalt 0,0		Totalt 49,0
Prov 	1: 10,0 ↖	Serie 2 	1: 9,5 ↗
	2: 9,4 ↗		2: 10,3 ↗
			3: 10,1 ↘
			4: 9,7 ↘
			5: 8,4 ↘
	Serie 19,0		Serie 46,0
	Totalt 49,0		Totalt 95,0
Serie 3 	1: 7,4 ↗		
	2: 8,9 ↙		
	3: 7,5 ↘		
	4: 9,3 →		
	5: 9,8 ↗		
	Serie 40,0		
	Totalt 135,0		

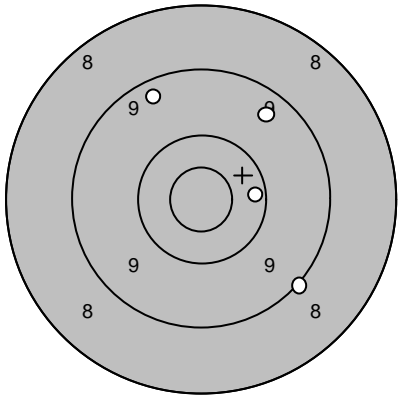
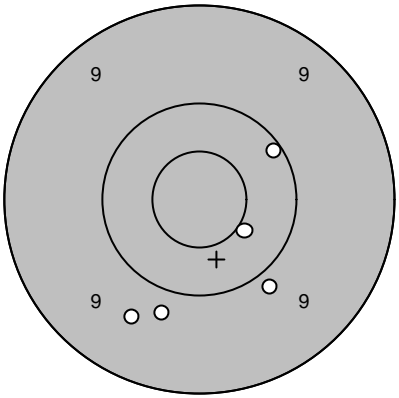
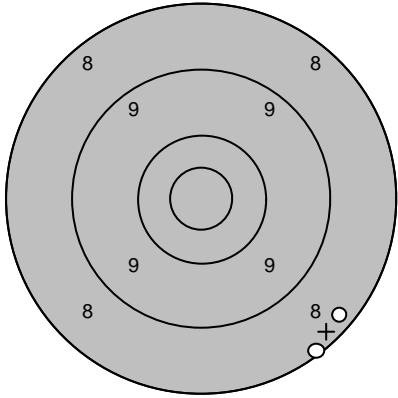
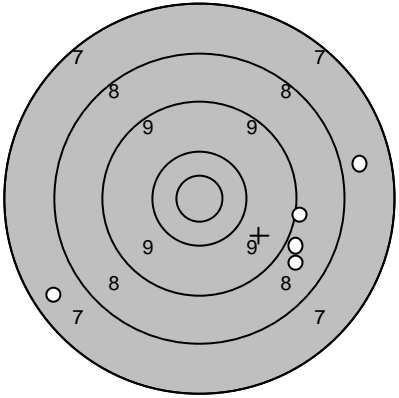
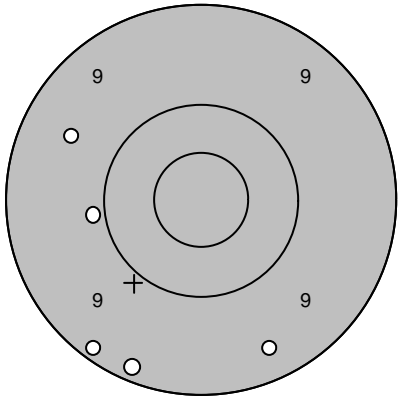
Skjutlag <b>4</b>	Tavla <b>1</b>	<b>Fredrik Ågren</b>	
Ramselefors		I 19	
2005-07-10		Tavelträffen B 2005	Ramselefors Skytteförening
Prov		1: 9,3 ↖ 2: 9,4 ↗ 3: 9,1 ↘ 4: 10,2 →	Serie 1 
		Serie 37,0 Totalt 0,0	1: 10,5* ↘ 2: 10,1 ↗ 3: 9,7 ↘ 4: 9,8 ↘ 5: 9,9 ↘
			Serie 47,0 Totalt 47,0
Prov		1: 8,3 ↘ 2: 8,2 ↘	Serie 2 
		Serie 16,0 Totalt 47,0	1: 7,8 → 2: 9,0 → 3: 8,8 ↘ 4: 8,9 ↘ 5: 7,6 ↙
			Serie 39,0 Totalt 86,0
Serie 3		1: 9,4 ↘ 2: 9,6 ↖ 3: 9,2 ↘ 4: 9,2 ↘ 5: 9,9 ←	
		Serie 45,0 Totalt 131,0	

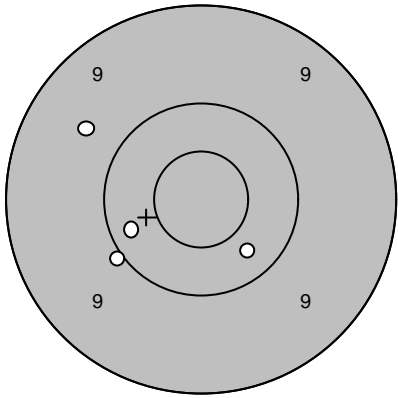
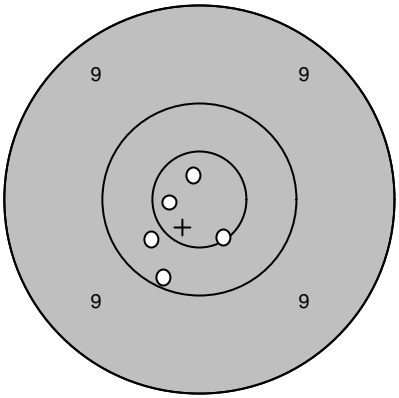
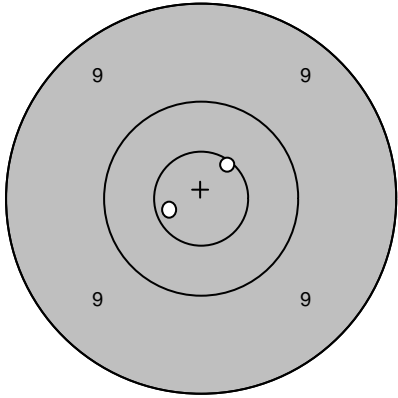
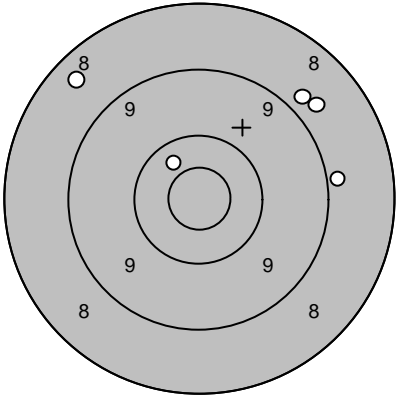
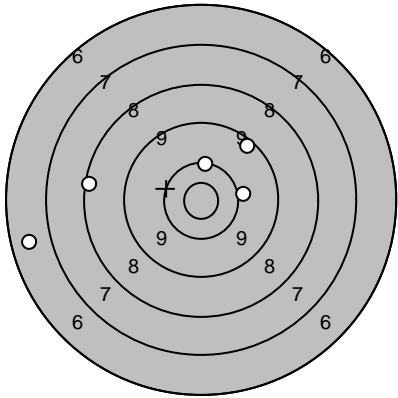
Skjutlag <b>4</b>	Tavla <b>2</b>	<b>Anton Lindfors</b>	
Ramselefors		I 19	
2005-07-10		Tavelträffen B 2005	Ramselefors Skytteförening
Prov		1: 10,0 ↙ 2: 10,3 ← 3: 9,7 ↖ 4: 10,3 ↘	Serie 1 
		Serie 39,0 Totalt 0,0	1: 10,2 ↓ 2: 10,4 ← 3: 10,7* ← 4: 10,6* ↓ 5: 10,8* ↑
			Serie 50,0 Totalt 50,0
Prov		1: 10,6* ↗ 2: 10,7* ←	Serie 2 
		Serie 20,0 Totalt 50,0	1: 8,9 → 2: 8,5 ↗ 3: 8,8 ↗ 4: 10,4 ↗ 5: 8,8 ↗
			Serie 42,0 Totalt 92,0
Serie 3		1: 6,7 ← 2: 10,2 ↑ 3: 8,3 ← 4: 9,4 ↗ 5: 10,1 →	
		Serie 43,0 Totalt 135,0	

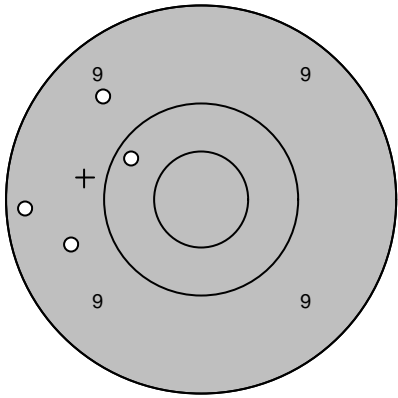
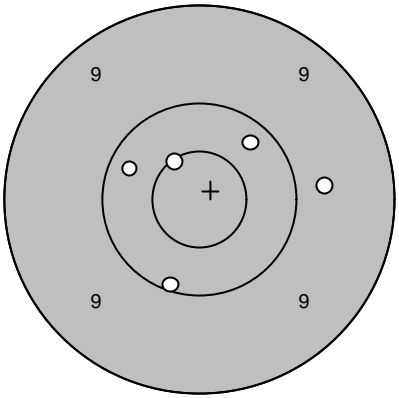
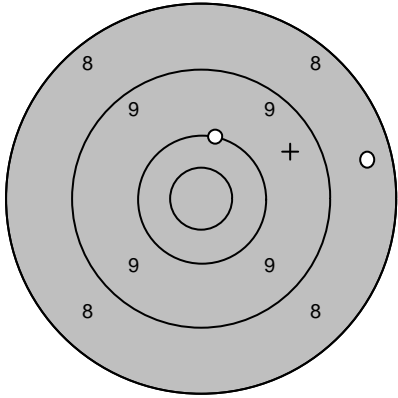
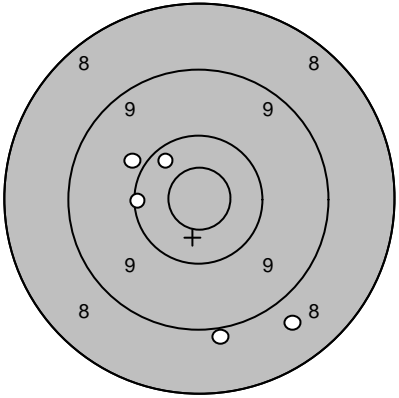
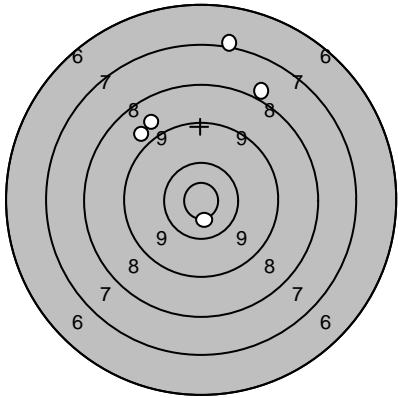
Skjutlag <b>4</b>	Tavla <b>3</b>	<b>Patrik Lindfors</b>		
Ramselefors		I 19		
2005-07-10		Tavelträffen B 2005		Ramselefors Skytteförening
Prov 	1: 9,6 ←	Serie 1 	1: 10,1 ↓	
	2: 9,2 ←		2: 10,3 ←	
	3: 10,2 ↖		3: 10,6* ↗	
	4: 9,6 ↗		4: 10,3 ↗	
			5: 9,7 →	
	Serie 37,0		Serie 49,0	
	Totalt 0,0		Totalt 49,0	
Prov 	1: 10,1 ↑	Serie 2 	1: 8,7 ↓	
	2: 8,5 →		2: 10,3 ↗	
			3: 10,1 ←	
			4: 9,9 ↖	
			5: 8,9 ↓	
	Serie 18,0		Serie 45,0	
	Totalt 49,0		Totalt 94,0	
Serie 3 	1: 8,8 ↖			
	2: 8,0 ↗			
	3: 7,1 ↑			
	4: 10,6* ↓			
	5: 8,9 ↖			
	Serie 41,0			
	Totalt 135,0			

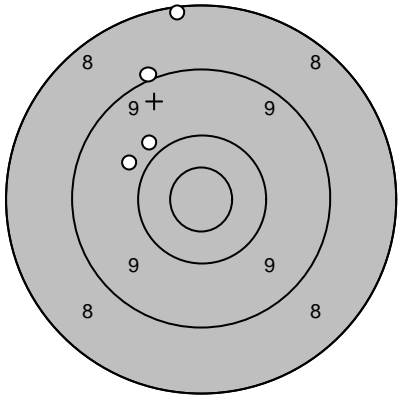
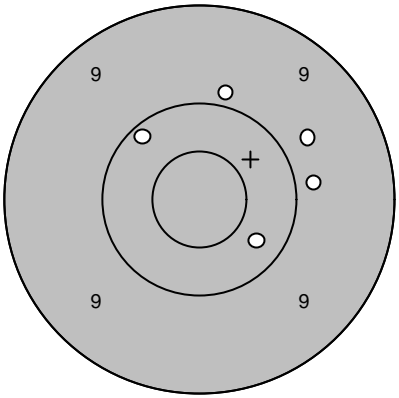
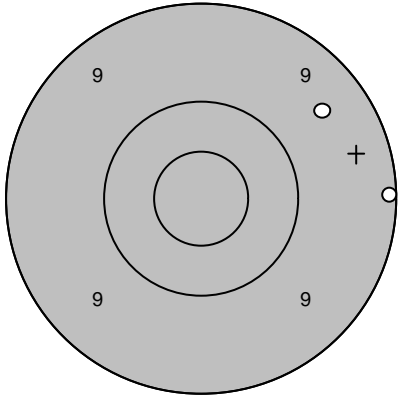
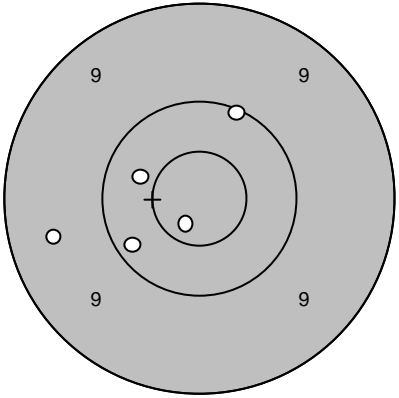
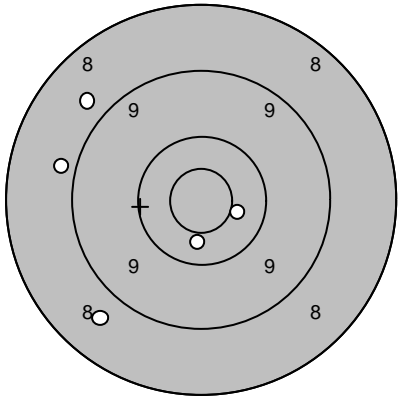

Skjutlag <b>4</b>	Tavla <b>4</b>	<b>Jane Jönsson</b>	
Ramselefors		Skurup	
2005-07-10		Tavelträffen B 2005	Ramselefors Skytteförening
Prov		1: 8,2 ↑ 2: 9,0 ↗ 3: 9,8 ↖ 4: 9,9 ↗	Serie 1 
		Serie 35,0 Totalt 0,0	1: 9,9 → 2: 10,3 ↘ 3: 10,2 ↖ 4: 9,9 ↑ 5: 9,8 ↗
			Serie 47,0 Totalt 47,0
Prov		1: 9,1 → 2: 9,5 ↗	Serie 2 
		Serie 18,0 Totalt 47,0	1: 10,4 ← 2: 9,5 ← 3: 10,7* ↓ 4: 10,1 ↑ 5: 10,2 ←
			Serie 49,0 Totalt 96,0
Serie 3		1: 10,4 ↓ 2: 8,7 ↘ 3: 10,5* → 4: 8,8 ↖ 5: 8,9 ←	
		Serie 44,0 Totalt 140,0	

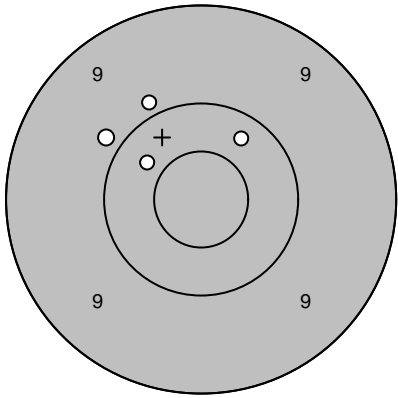
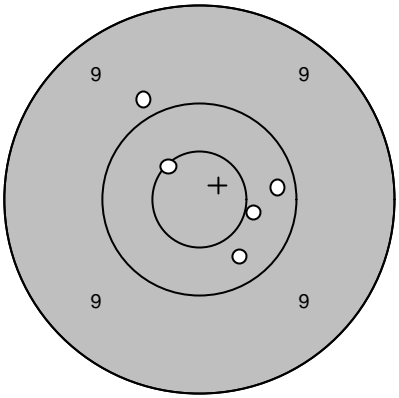
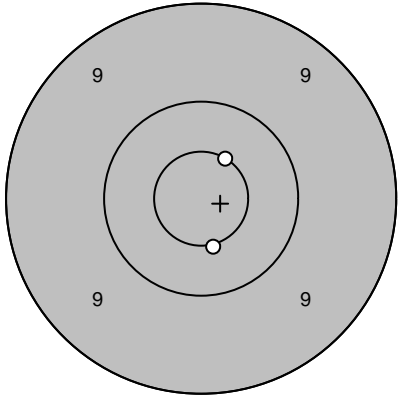
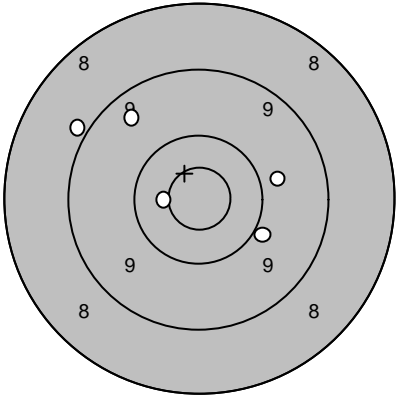
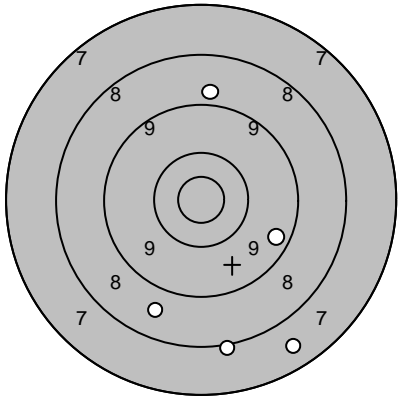
Skjutlag <b>4</b>	Tavla <b>5</b>	<b>Liselott Danielsson</b>	
Ramselefors		Värnamo	
2005-07-10		Tavelträffen B 2005	Ramselefors Skytteförening
Prov		1: 10,4 ↙ 2: 10,3 ↗ 3: 9,9 ↗ 4: 9,9 ↙	Serie 1 
		Serie 38,0 Totalt 0,0	1: 10,5* → 2: 10,2 → 3: 10,6* ↗ 4: 9,9 ↗ 5: 10,3 ↘
			Serie 49,0 Totalt 49,0
Prov		1: 10,6* ↗ 2: 10,5* ↘	Serie 2 
		Serie 20,0 Totalt 49,0	1: 9,5 ↗ 2: 8,9 ↗ 3: 9,9 ↘ 4: 10,5* ← 5: 9,8 →
			Serie 45,0 Totalt 94,0
Serie 3		1: 7,6 ↘ 2: 8,0 ↘ 3: 8,7 ↘ 4: 8,9 ↑ 5: 9,4 →	
		Serie 40,0 Totalt 134,0	

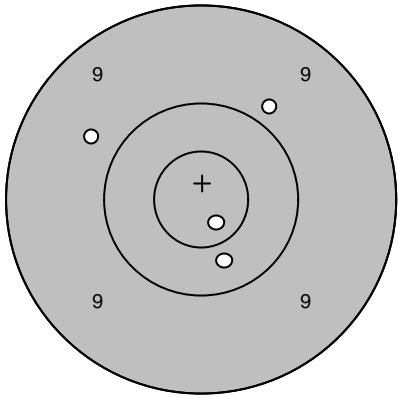
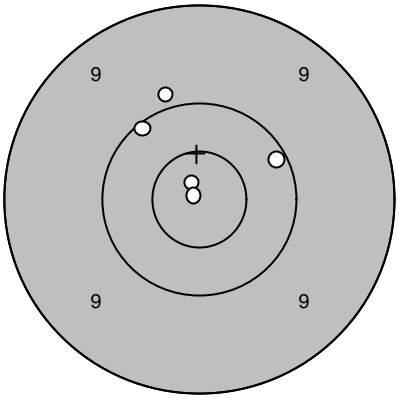
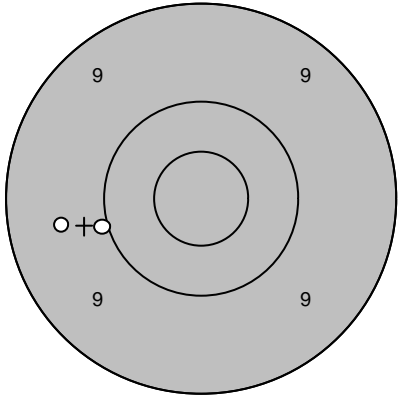
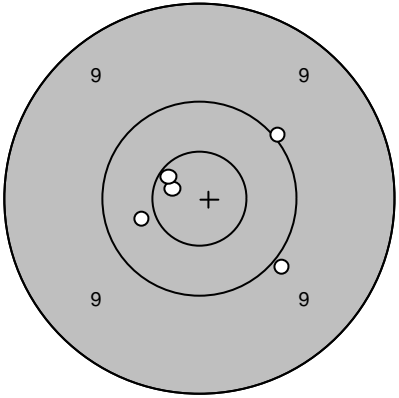
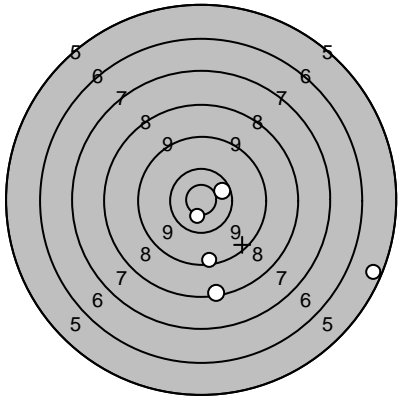
Skjutlag <b>4</b>	Tavla <b>6</b>	<b>Helena Jansson</b>		
Ramselefors		Söderala		
2005-07-10		Tavelträffen B 2005	Ramselefors Skytteförening	
Prov		1: 10,4 ↓ 2: 9,9 ↗ 3: 9,8 ↖ 4: 10,7* ↓	Serie 1 	1: 10,1 ↗ 2: 9,9 ↗ 3: 10,9* ↗ 4: 10,9* ↖ 5: 10,1 ↗
		Serie 38,0	Serie 49,0	
		Totalt 0,0	Totalt 49,0	
Prov		1: 9,6 ← 2: 10,0 ←	Serie 2 	1: 10,8* ← 2: 10,7* ↗ 3: 9,9 ↓ 4: 10,0 ↗ 5: 10,4 ←
		Serie 19,0	Serie 49,0	
		Totalt 49,0	Totalt 98,0	
Serie 3		1: 10,5* ↗ 2: 8,3 ↓ 3: 5,5 → 4: 10,7* ↓ 5: 9,3 ↓		
		Serie 42,0		
		Totalt 140,0		

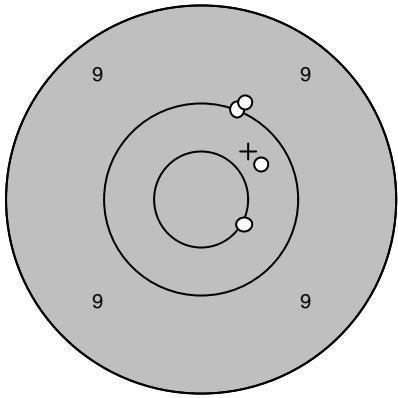
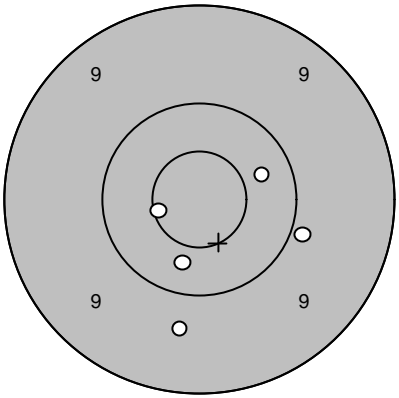
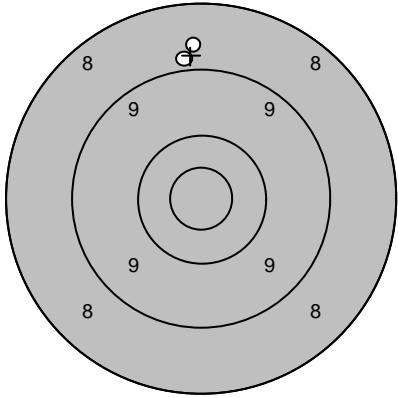
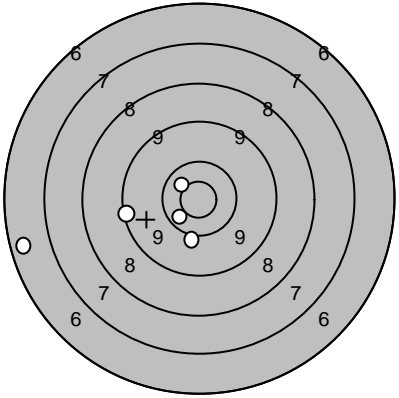
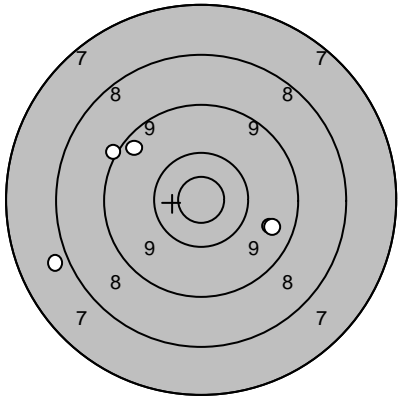
Skjutlag <b>4</b>	Tavla <b>7</b>	<b>Peter Lavér</b>	
Ramselefors		Söderala	
2005-07-10		Tavelträffen B 2005	Ramselefors Skytteförening
Prov		1: 10,0 ↗ 2: 10,5* → 3: 10,0 ↗ 4: 10,3 →	Serie 1 
		Serie 40,0 Totalt 0,0	1: 9,9 → 2: 10,4 → 3: 10,4 ↓ 4: 9,7 ↓ 5: 10,6* ←
			Serie 48,0 Totalt 48,0
Prov		1: 8,7 ↗ 2: 8,9 ↗	Serie 2 
		Serie 16,0 Totalt 48,0	1: 10,5* ↖ 2: 10,1 ↓ 3: 10,6* ↗ 4: 6,5 ← 5: 9,3 ←
			Serie 45,0 Totalt 93,0
Serie 3		1: 7,9 ↖ 2: 9,6 → 3: 9,6 → 4: 9,1 ↗ 5: 9,4 ↗	
		Serie 43,0 Totalt 136,0	

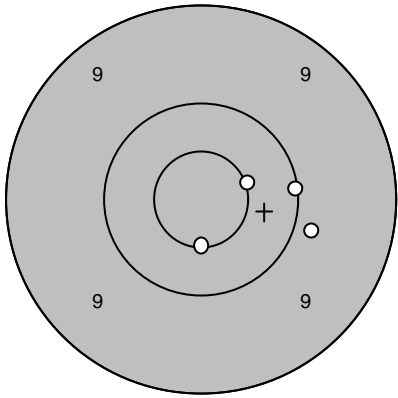
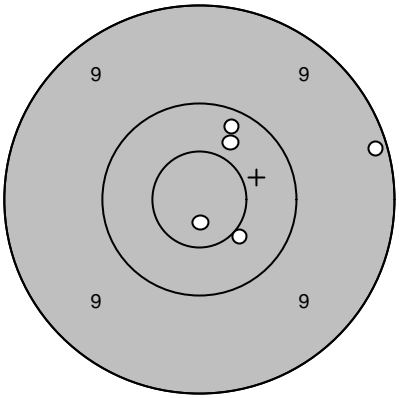
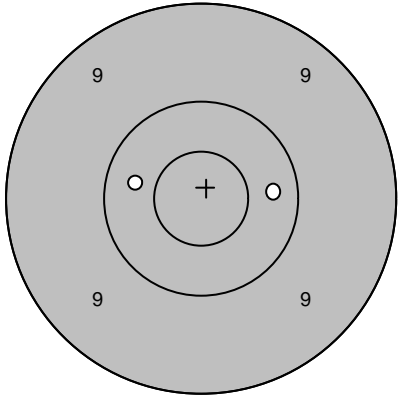
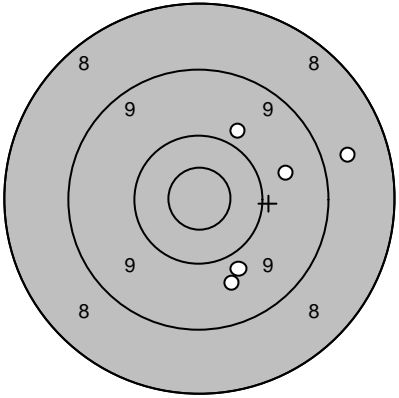
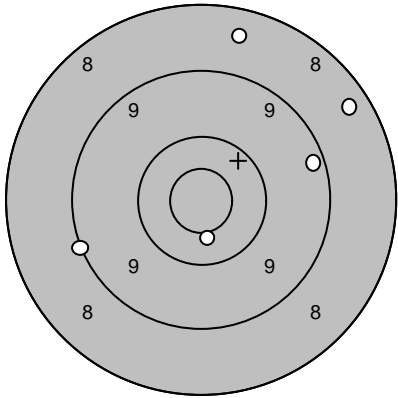
Skjutlag <b>4</b>	Tavla <b>8</b>	<b>Urban Åberg</b>	
Ramselefors		Madesjö-Nybro	
2005-07-10		Tavelträffen B 2005	Ramselefors Skytteförening
Prov 	1: 10,1 →	Serie 1 	1: 10,4 ↗
	2: 10,6* ↓		2: 9,2 →
	3: 10,5* →		3: 10,2 ↗
	4: 9,9 →		4: 10,5* ↘
			5: 10,8* ↓
	Serie 39,0		Serie 49,0
	Totalt 0,0		Totalt 49,0
Prov 	1: 10,3 ←	Serie 2 	1: 9,9 ↗
	2: 10,3 →		2: 9,7 →
			3: 9,8 ↘
			4: 8,7 →
			5: 9,7 ↓
	Serie 20,0		Serie 44,0
	Totalt 49,0		Totalt 93,0
Serie 3 	1: 9,1 ←		
	2: 8,5 ↑		
	3: 9,3 →		
	4: 10,5* ↓		
	5: 8,4 ↗		
	Serie 44,0		
	Totalt 137,0		

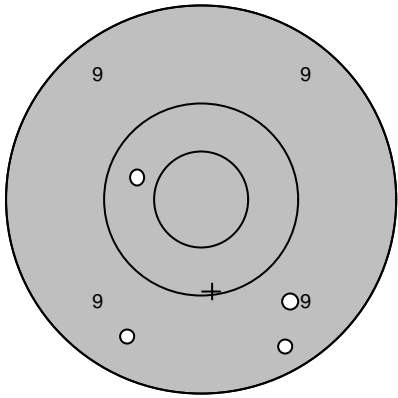
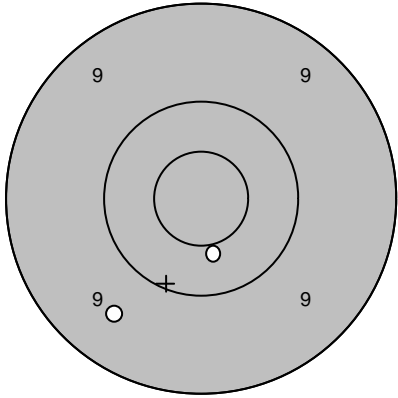
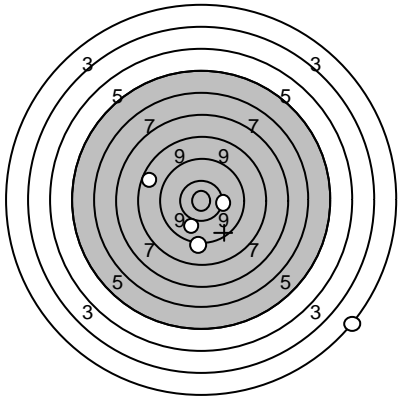

Skjutlag <b>4</b>	Tavla <b>10</b>	<b>Sören Olsson</b>		
Ramselefors		Umeå		
2005-07-10		Tavelträffen B 2005		Ramselefors Skytteförening
Prov		1: 9,3 ↘ 2: 9,6 ↘ 3: 10,3 ↗ 4: 9,4 ↘	Serie 1	1: 9,9 ↗ 2: 10,6* ↗ 3: 10,9* ↗ 4: 10,3 ↗ 5: 10,0 ↖
		Serie 37,0		Serie 49,0
		Totalt 0,0		Totalt 49,0
Prov		1: 9,6 ↘ 2: 10,5* ↘	Serie 2	1: 8,0 ↗ 2: 10,1 ↖ 3: 9,6 ↗ 4: 8,8 → 5: 10,0 ↓
		Serie 19,0		Serie 45,0
		Totalt 49,0		Totalt 94,0
Serie 3		1: 9,3 ↓ 2: 8,8 ↖ 3: 2,3 ↘ 4: 10,3 → 5: 10,1 ↘		
		Serie 39,0		
		Totalt 133,0		

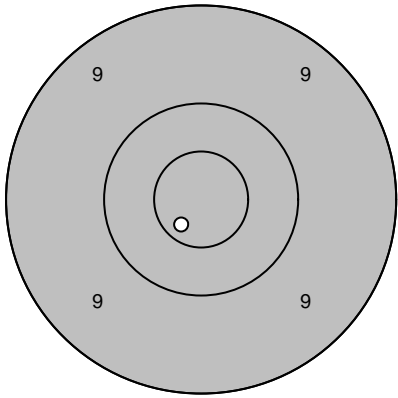
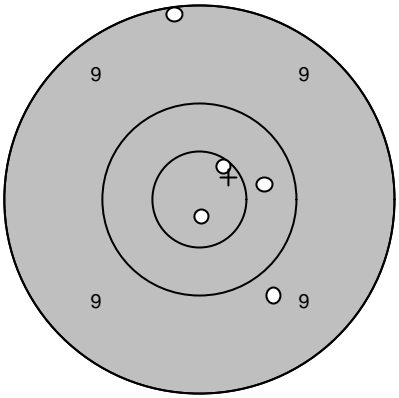
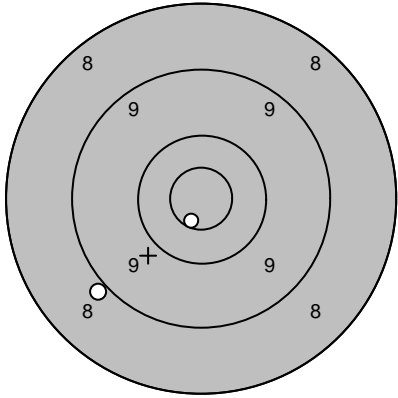
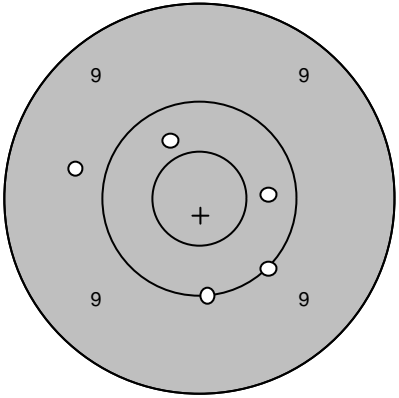
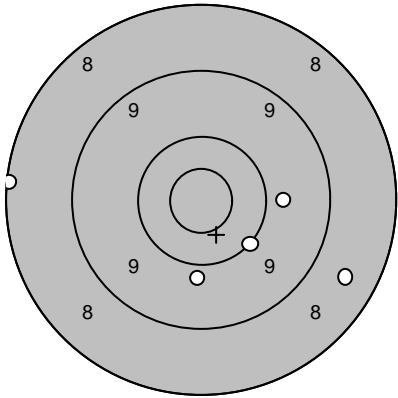
Skjutlag <b>4</b>	Tavla <b>11</b>	<b>Stefan Håkansson</b>		
Ramselefors		Östersund		
2005-07-10		Tavelträffen B 2005		Ramselefors Skytteförening
Prov 	1: 10,7* ↙		Serie 1 	1: 10,3 →
				2: 9,1 ↑
				3: 9,8 ↘
				4: 10,6* ↗
				5: 10,8* ↓
		Serie 10,0	Serie 48,0	
		Totalt 0,0	Totalt 48,0	
Prov 	1: 8,9 ↙		Serie 2 	1: 10,3 →
	2: 10,7* ↘			2: 10,4 ↗
				3: 10,0 ↘
				4: 10,0 ↓
				5: 9,7 ←
		Serie 18,0	Serie 49,0	
		Totalt 48,0	Totalt 97,0	
Serie 3 	1: 9,9 ↓			
	2: 9,8 →			
				3: 8,1 ←
				4: 8,6 →
				5: 10,1 ↘
		Serie 44,0		
		Totalt 141,0		

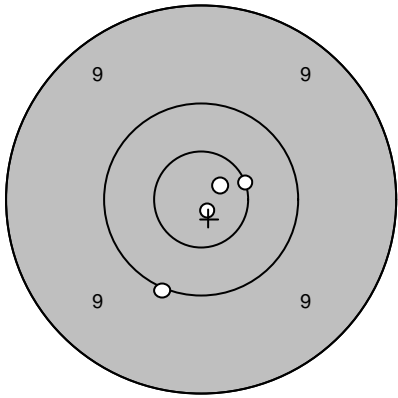
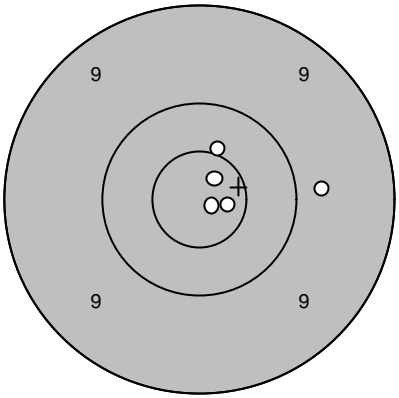
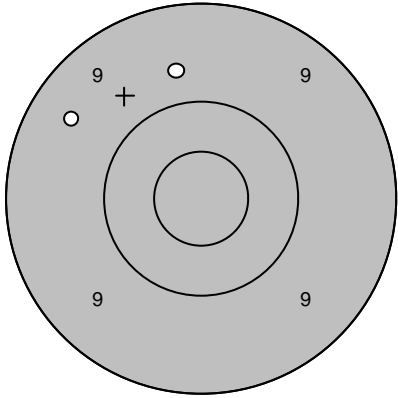
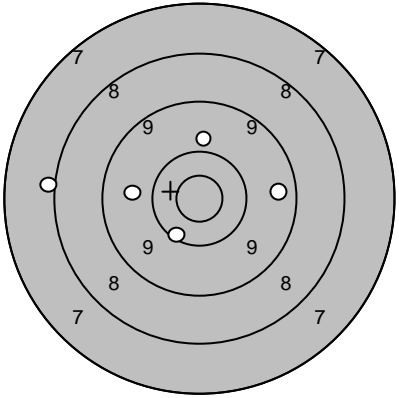
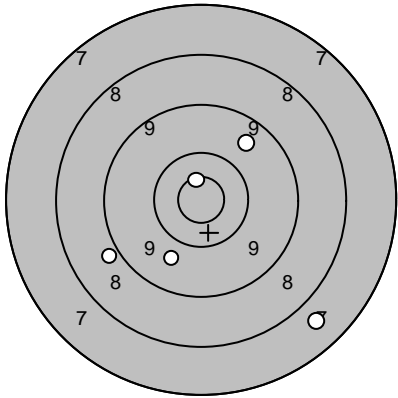

Skjutlag <b>4</b>	Tavla <b>12</b>	<b>Maria Falck</b>		
Ramselefors		Moälven-Modo		
2005-07-10		Tavelträffen B 2005	Ramselefors Skytteförening	
Prov		1: 10,0 ↙ 2: 10,9* ↘ 3: 10,6* → 4: 10,8* ↗	Serie 1 	1: 10,7* → 2: 9,8 → 3: 10,9* ↘ 4: 10,5* ↑ 5: 10,8* ↗
		Serie 40,0	Serie 49,0	
		Totalt 0,0	Totalt 49,0	
Prov		1: 9,5 ↖ 2: 9,7 ↑	Serie 2 	1: 10,2 ↘ 2: 9,8 ← 3: 8,1 ← 4: 9,9 ↑ 5: 9,5 →
		Serie 18,0	Serie 45,0	
		Totalt 49,0	Totalt 94,0	
Serie 3		1: 8,9 ↖ 2: 10,7* ↑ 3: 9,8 ↘ 4: 9,6 ↗ 5: 7,7 ↘		
		Serie 43,0		
		Totalt 137,0		

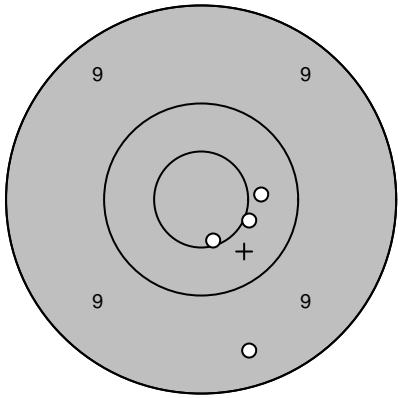
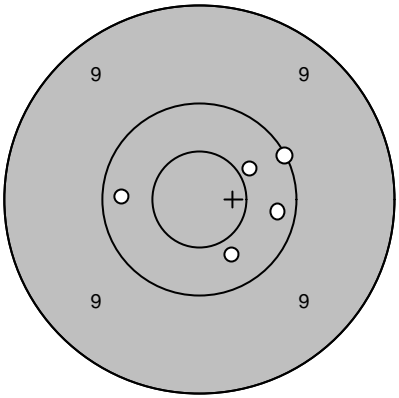
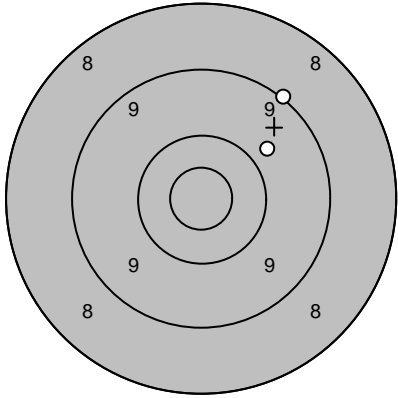
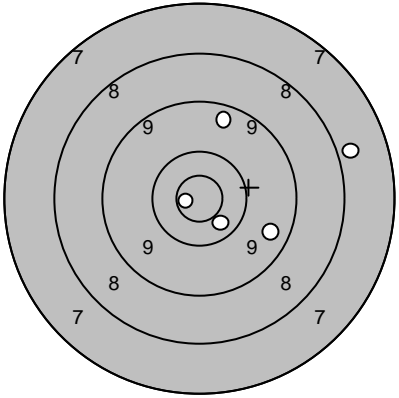
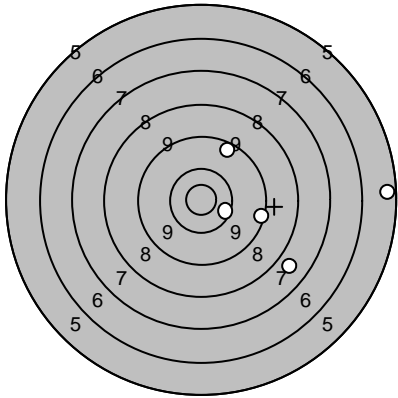
Skjutlag <b>4</b>	Tavla <b>13</b>	<b>Linda Gustavsson</b>		
Ramselefors		Moälven-Modo		
2005-07-10		Tavelträffen B 2005		Ramselefors Skytteförening
Prov 	1: 10,5* →	Serie 1 	1: 10,2 →	
	2: 9,4 ↓		2: 10,4 ↗	
	3: 10,6* ↓		3: 10,1 ↗	
	4: 10,4 →		4: 10,3 ←	
			5: 10,4 ↓	
	Serie 39,0		Serie 50,0	
	Totalt 0,0		Totalt 50,0	
Prov 	1: 9,1 ↗	Serie 2 	1: 7,9 →	
	2: 9,8 ↗		2: 9,5 →	
			3: 10,5* ↓	
			4: 9,4 ↑	
			5: 10,8* ←	
	Serie 18,0		Serie 45,0	
	Totalt 50,0		Totalt 95,0	
Serie 3 	1: 5,5 →			
	2: 7,8 ↓			
	3: 9,5 ↑			
	4: 10,4 →			
	5: 9,3 →			
	Serie 40,0			
	Totalt 135,0			

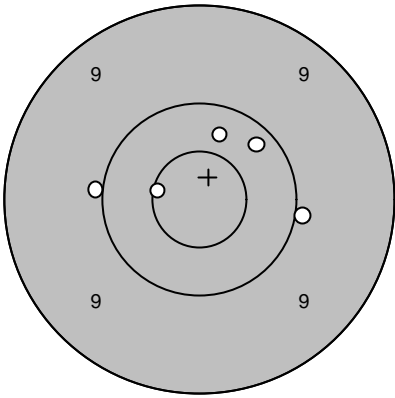
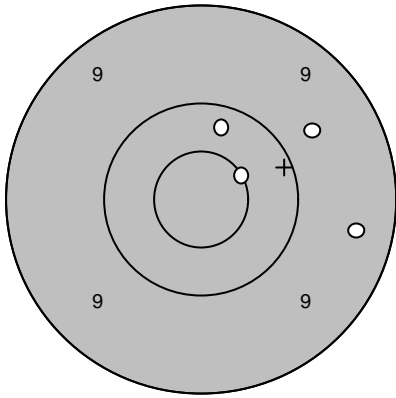
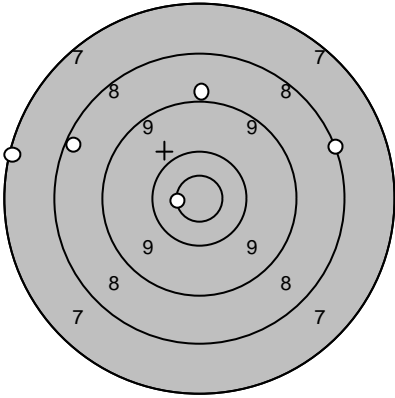
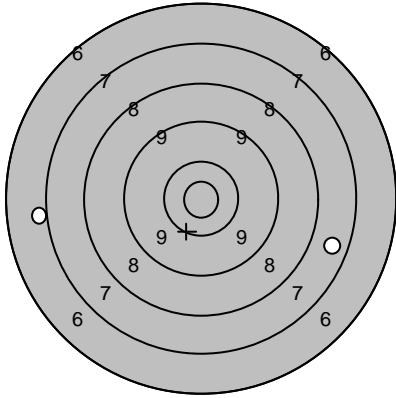
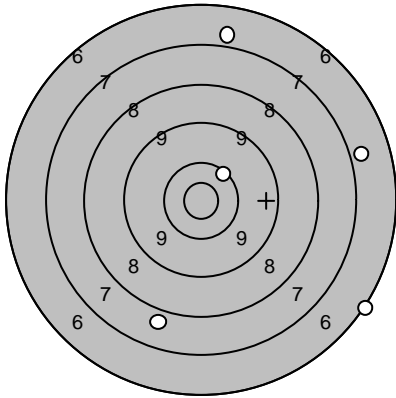
Skjutlag	Tavla	Alf Edin	
4	17		
Ramselefors	Ale		
2005-07-10	Tavelträffen B 2005	Ramselefors Skytteförening	
Prov		1: 10,3 ↗ 2: 9,7 ↗ 3: 10,6* ↗ 4: 9,4 →	Serie 1 
			1: 10,3 ↗ 2: 10,2 ↗ 3: 10,6* ← 4: 10,0 → 5: 10,0 ←
		Serie 38,0	Serie 50,0
		Totalt 0,0	Totalt 50,0
Prov		1: 7,6 → 2: 7,0 ←	Serie 2 
			1: 8,1 → 2: 7,2 ← 3: 8,3 ↖ 4: 10,7* ← 5: 8,9 ↑
		Serie 14,0	Serie 41,0
		Totalt 50,0	Totalt 91,0
Serie 3		1: 7,9 ↓ 2: 6,9 → 3: 6,9 ↑ 4: 6,2 → 5: 10,3 ↗	
			
		Serie 35,0	
		Totalt 126,0	

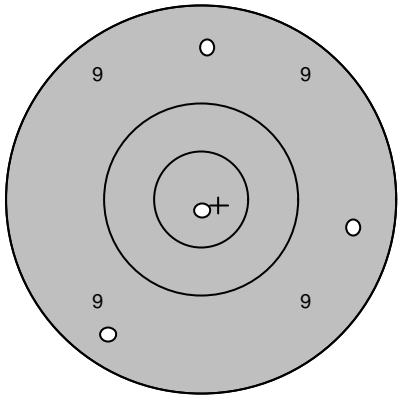
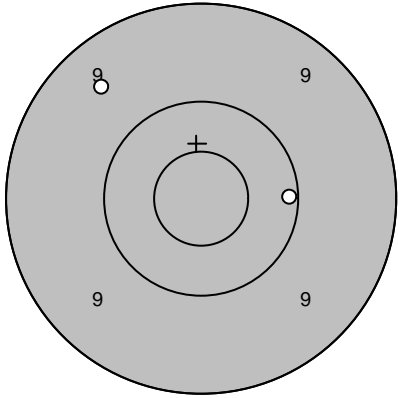
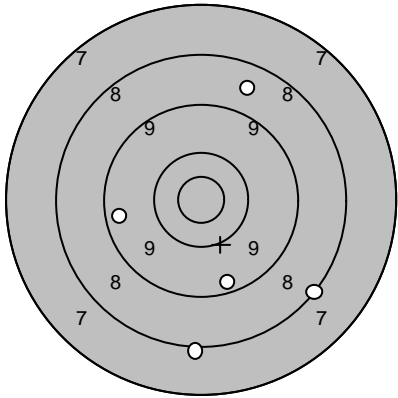
Skjutlag <b>4</b>	Tavla <b>18</b>	<b>Emil Johansson</b>		
Ramselefors		Ale		
2005-07-10		Tavelträffen B 2005		Ramselefors Skytteförening
Prov		1: 9,5 → 2: 9,4 ↙ 3: 10,9* ↓ 4: 9,5 ↑	Serie 1	1: 10,6* ↖ 2: 10,5* ↗ 3: 10,4 → 4: 9,9 → 5: 10,2 ↓
		Serie 37,0		Serie 49,0
		Totalt 0,0		Totalt 49,0
Prov		1: 9,5 ↖ 2: 10,1 →	Serie 2	1: 9,9 ↑ 2: 7,1 → 3: 9,5 ↙ 4: 9,5 ← 5: 10,1 ↘
		Serie 19,0		Serie 44,0
		Totalt 49,0		Totalt 93,0
Serie 3		1: 8,6 ↑ 2: 8,0 ↓ 3: 9,4 ← 4: 9,4 ↓ 5: 8,1 ↘		
		Serie 42,0		
		Totalt 135,0		

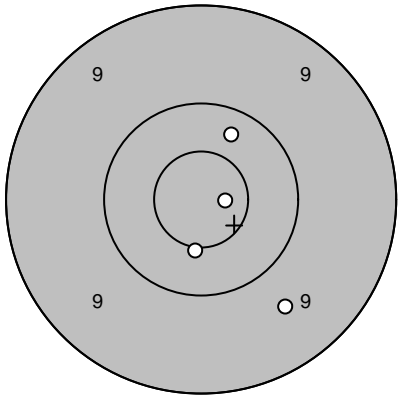
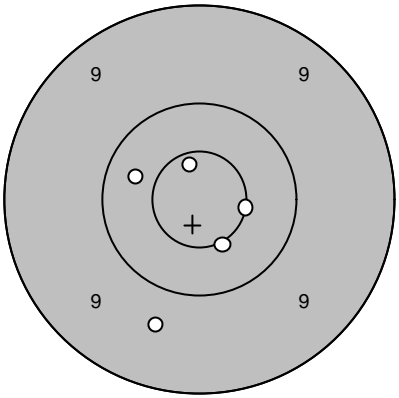
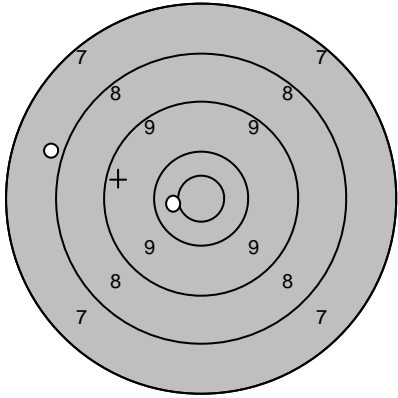
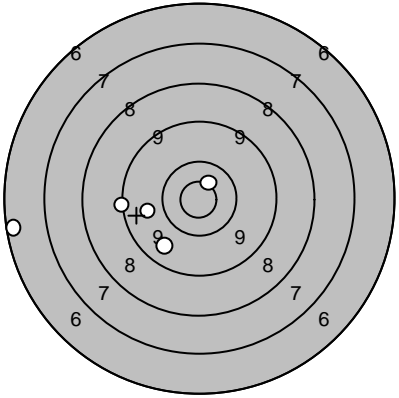
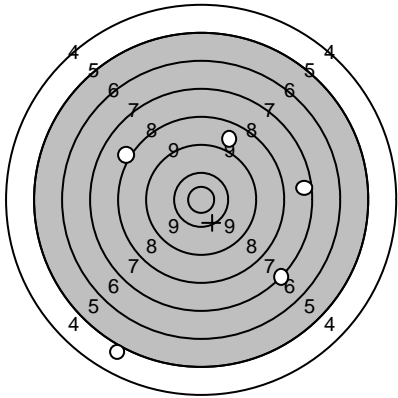
Skjutlag <b>4</b>	Tavla <b>19</b>	<b>Rickard Edin</b>		
Ramselefors		Ale		
2005-07-10		Tavelträffen B 2005	Ramselefors Skytteförening	
Prov		1: 10,5* ↓ 2: 10,3 ↗ 3: 10,8* → 4: 9,6 ↘	Serie 1 	1: 10,7* ↑ 2: 9,7 ↓ 3: 10,6* → 4: 10,3 ← 5: 10,5* ↘
		Serie 39,0	Serie 49,0	
		Totalt 0,0	Totalt 49,0	
Prov		1: 10,5* ← 2: 7,9 ←	Serie 2 	1: 6,4 ← 2: 9,8 ← 3: 9,2 ← 4: 10,7* ↗ 5: 9,7 ↘
		Serie 17,0	Serie 43,0	
		Totalt 49,0	Totalt 92,0	
Serie 3		1: 7,3 ↘ 2: 8,1 ↖ 3: 8,8 ↗ 4: 7,5 → 5: 5,0 ↙		
		Serie 35,0		
		Totalt 127,0		

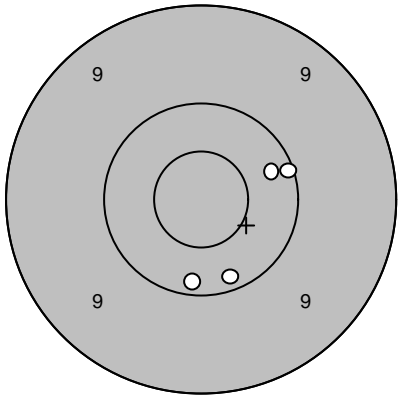
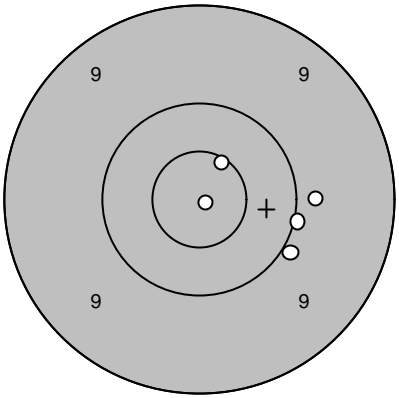
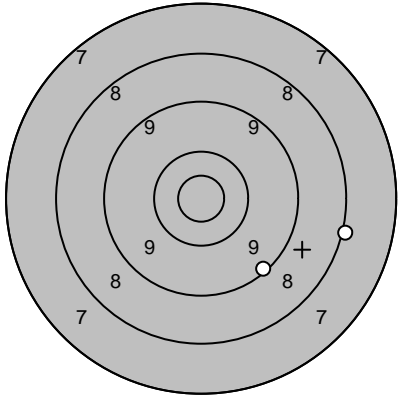
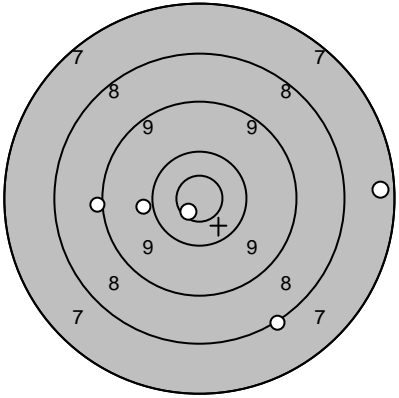
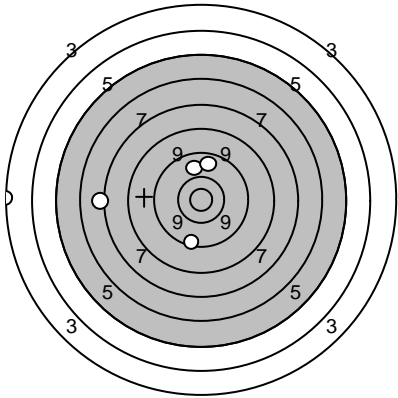
Skjutlag <b>4</b>	Tavla <b>20</b>	<b>Krister Pettersson</b>	
Ramselefors		Bastuträsk	
2005-07-10		Tavelträffen B 2005	Ramselefors Skytteförening
Prov		1: 10,2 ↓ 2: 10,2 ↓ 3: 10,1 → 4: 10,3 →	Serie 1 
		Serie 40,0 Totalt 0,0	1: 9,8 → 2: 10,0 ↘ 3: 10,6* ↗ 4: 10,0 → 5: 10,9* ↘
			Serie 49,0 Totalt 49,0
Prov		1: 8,1 → 2: 9,2 ↓	Serie 2 
		Serie 17,0 Totalt 49,0	1: 7,4 → 2: 8,1 ↓ 3: 9,0 ← 4: 10,0 ← 5: 10,8* ↘
			Serie 44,0 Totalt 93,0
Serie 3		1: 10,0 ↑ 2: 9,8 ↑ 3: 3,3 ← 4: 7,2 ← 5: 9,5 ↓	
		Serie 38,0 Totalt 131,0	

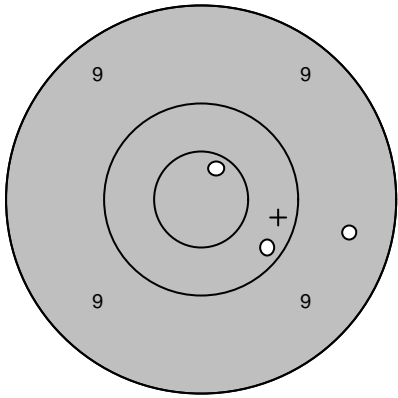
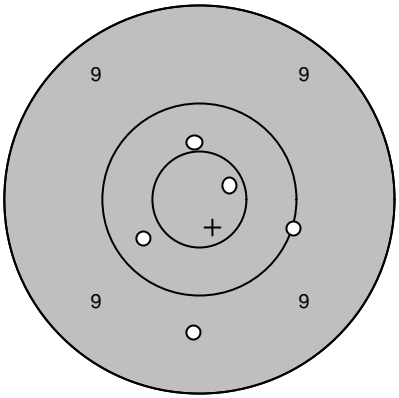
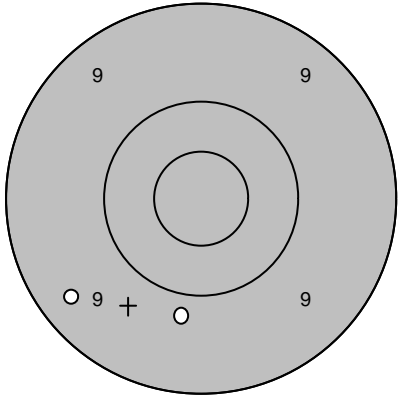
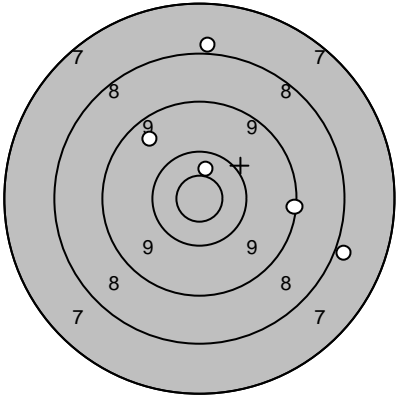
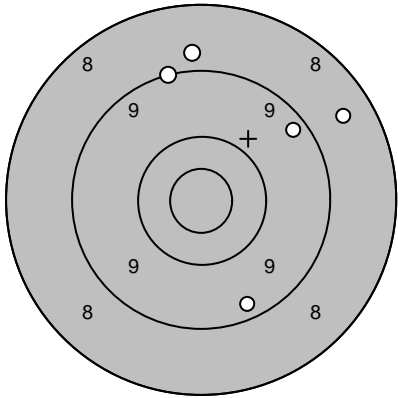
Skjutlag <b>4</b>	Tavla <b>21</b>	<b>David Karlsson</b>	
Ramselefors		Bastuträsk	
2005-07-10		Tavelträffen B 2005	Ramselefors Skytteförening
Prov		1: 10,7* ↗ 2: 10,2 ↘ 3: 9,5 →	Serie 1 
		Serie 29,0 Totalt 0,0	1: 10,3 ↙ 2: 10,5* ↑ 3: 10,0 → 4: 10,7* ↗ 5: 9,7 ↓
			Serie 49,0 Totalt 49,0
Prov		1: 9,8 ↓ 2: 9,4 ↙	Serie 2 
		Serie 18,0 Totalt 49,0	1: 8,0 → 2: 10,5* ↑ 3: 8,0 ↑ 4: 9,2 → 5: 9,5 ↗
			Serie 44,0 Totalt 93,0
Serie 3		1: 9,3 ↗ 2: 9,1 ↑ 3: 9,3 ↓ 4: 8,5 ↗ 5: 8,8 ↑	
		Serie 43,0 Totalt 136,0	

Skjutlag	Tavla	
<b>4</b>	<b>22</b>	

Ramselefors		
-------------	--	--

2005-07-10	Tavelträffen B 2005	Ramselefors Skytteförening
------------	---------------------	----------------------------

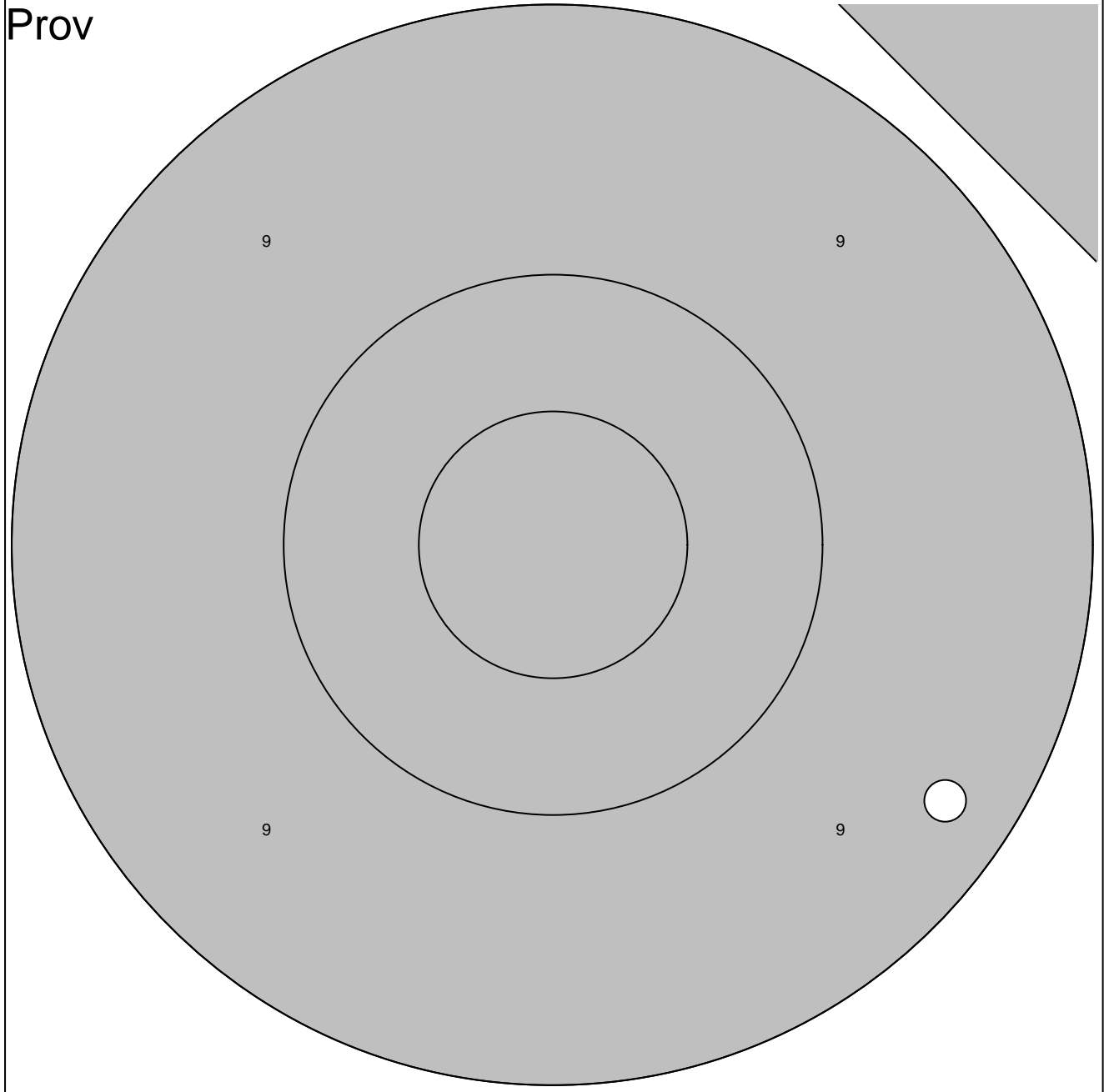

<b>1: 9,3</b> ↘	<b>Serie</b> 9,0
	<b>Totalt</b> 0,0

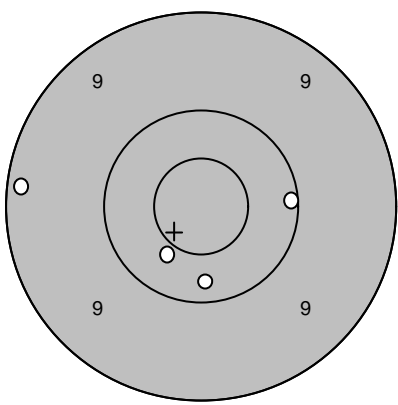
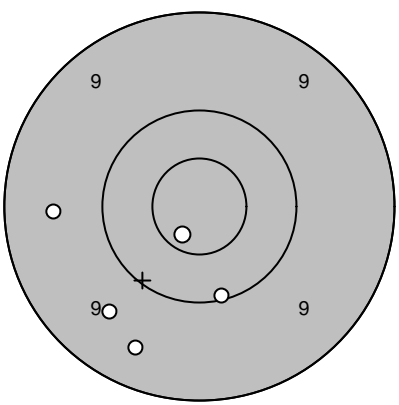
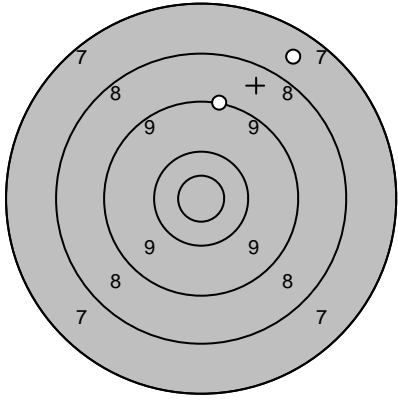
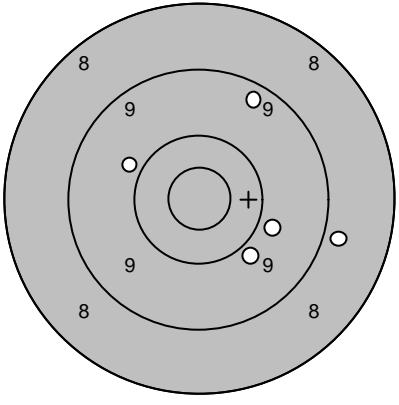
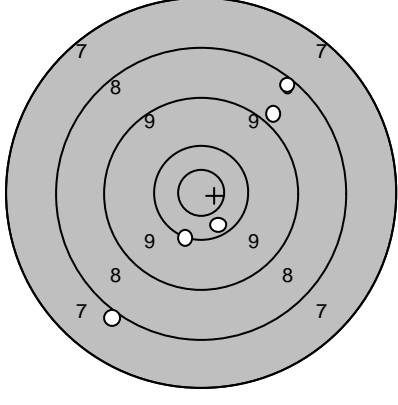

Skjutlag	Tavla	<b>Helena Arvidsson</b>	
<b>4</b>	<b>24</b>		
Ramselefors	Bälgviken		
2005-07-10	Tavelträffen B 2005	Ramselefors Skytteförening	
Prov 	1: 10,4 ↘ 2: 9,2 ← 3: 10,1 → 4: 10,3 ↓	Serie 1 	1: 9,6 ↘ 2: 9,4 ↘ 3: 10,1 ↓ 4: 9,6 ← 5: 10,7* ↘
	Serie 39,0		Serie 47,0
	Totalt 0,0		Totalt 47,0
Prov 	1: 9,1 ↑ 2: 7,7 ↗	Serie 2 	1: 8,9 → 2: 9,9 ↖ 3: 9,9 ↓ 4: 9,4 ↗ 5: 9,9 →
	Serie 16,0		Serie 44,0
	Totalt 47,0		Totalt 91,0
Serie 3 	1: 10,4 ↘ 2: 8,9 ↗ 3: 10,1 ↓ 4: 8,3 ↗ 5: 8,0 ↘		
	Serie 44,0		
	Totalt 135,0		

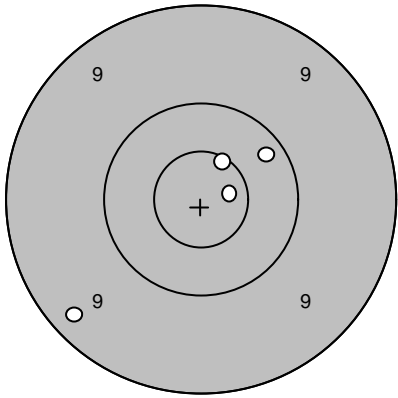
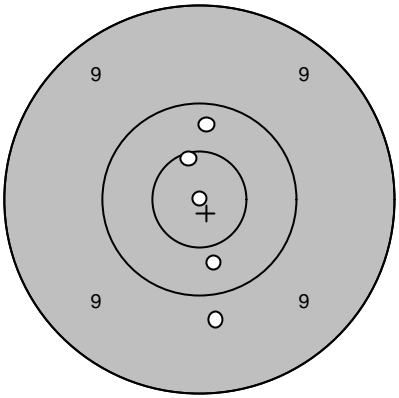
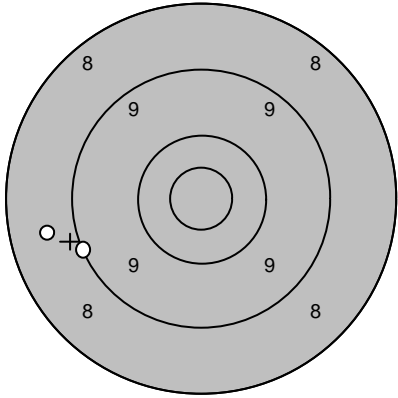
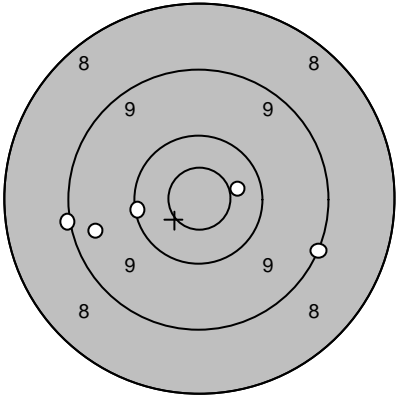
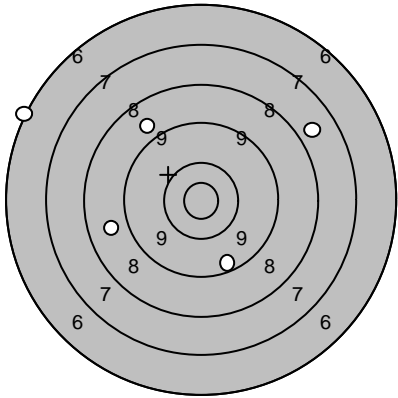
Skjutlag	Tavla	<b>Peder Vahlberg</b>	
<b>5</b>	<b>1</b>		
Ramselefors	Ramselefors		
2005-07-10	Tavelträffen B 2005	Ramselefors Skytteförening	
Prov		1: 9,3 ↙ 2: 10,6* ↗ 3: 10,7* → 4: 10,2 ↗	Serie 1 
			1: 10,4 ↓ 2: 10,6* ↑ 3: 10,9* ↗ 4: 10,3 ↑ 5: 9,8 ↓
		Serie 39,0	Serie 49,0
		Totalt 0,0	Totalt 49,0
Prov		1: 8,7 ← 2: 9,1 ←	Serie 2 
			1: 10,1 ← 2: 9,0 ← 3: 9,1 → 4: 10,5* → 5: 9,4 ←
		Serie 17,0	Serie 47,0
		Totalt 49,0	Totalt 96,0
Serie 3		1: 6,2 ↖ 2: 8,7 ← 3: 9,4 ↓ 4: 8,8 ↗ 5: 7,8 ↗	
		Serie 38,0	
		Totalt 134,0	

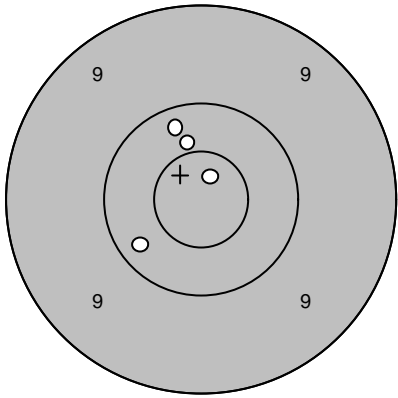
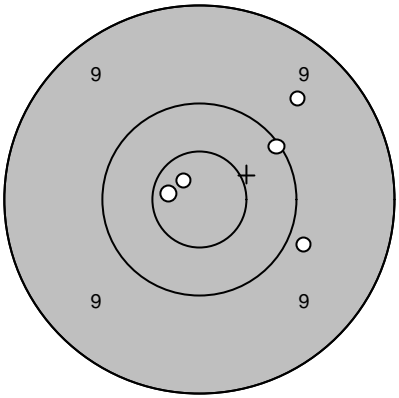
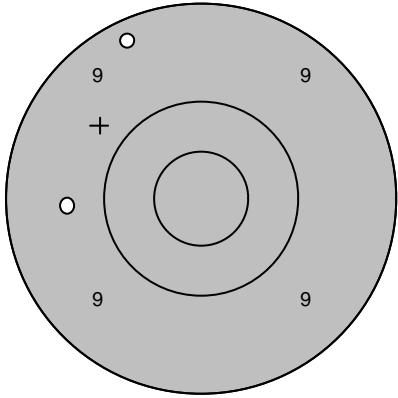
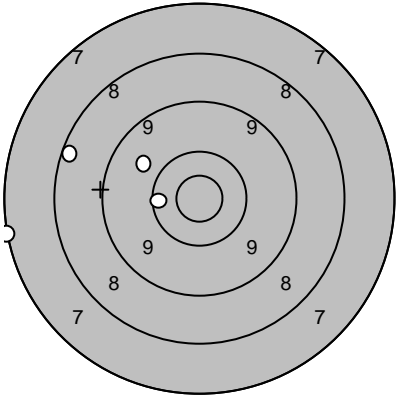
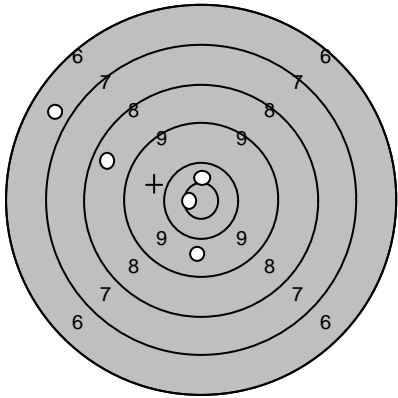
Skjutlag <b>5</b>	Tavla <b>2</b>	<b>Lars Sandström</b>		
Ramselefors	Ramselefors			
2005-07-10	Tavelträffen B 2005	Ramselefors Skytteförening		
Prov		1: 10,4 ↑ 2: 10,8* ↑ 3: 10,3 ↑ 4: 10,3 ↙	Serie 1 	1: 10,7* ← 2: 9,9 ↘ 3: 9,6 ↗ 4: 10,8* ↖ 5: 10,1 ↗
	Serie 40,0		Serie 48,0	
	Totalt 0,0		Totalt 48,0	
Prov		1: 9,3 ↖ 2: 9,7 ←	Serie 2 	1: 8,3 ← 2: 10,3 ← 3: 9,8 ↖ 4: 7,1 ←
	Serie 18,0		Serie 34,0	
	Totalt 48,0		Totalt 82,0	
Serie 3		1: 6,8 ↖ 2: 10,6* ↑ 3: 10,9* ← 4: 8,6 ↖ 5: 9,8 ↓		
	Serie 43,0			
	Totalt 125,0			

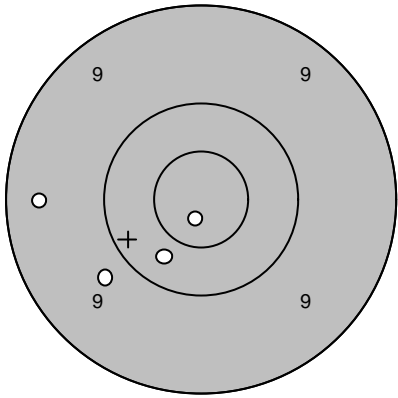
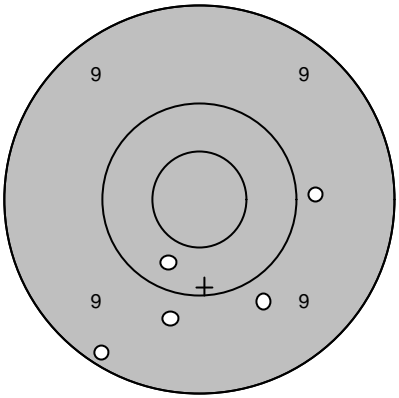
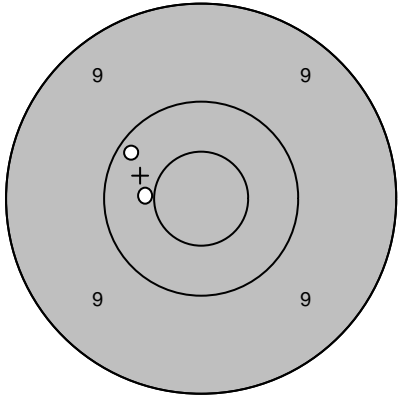
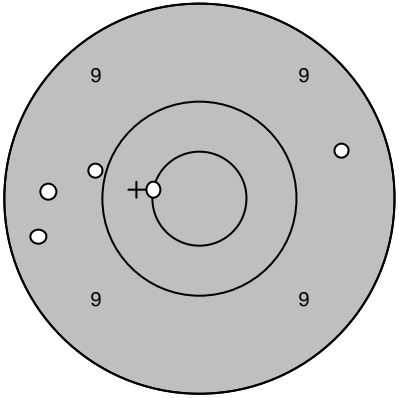
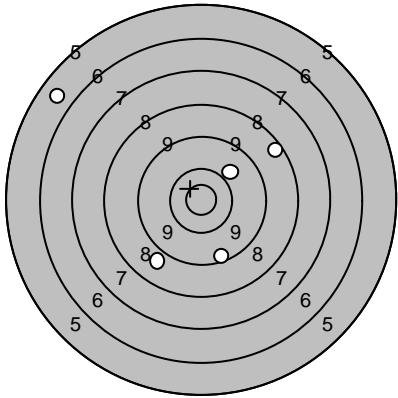
Skjutlag	Tavla	<b>Donald Johansson</b>	
<b>5</b>	<b>3</b>		
Ramselefors	Ale		
2005-07-10	Tavelträffen B 2005	Ramselefors Skytteförening	
Prov 	1: 10,3 ↘ 2: 9,8 ↙ 3: 9,4 ← 4: 10,8* ↘	Serie 1 	1: 9,8 ↓ 2: 9,8 → 3: 9,8 ↘ 4: 10,3 ↘ 5: 9,2 ↘
	Serie 38,0 Totalt 0,0		Serie 46,0 Totalt 46,0
Prov 	1: 10,5* ← 2: 10,2 ↗	Serie 2 	1: 10,6* ← 2: 9,5 ← 3: 9,9 ← 4: 9,5 → 5: 9,4 ←
	Serie 20,0 Totalt 46,0		Serie 46,0 Totalt 92,0
Serie 3 	1: 10,0 ↗ 2: 5,8 ↙ 3: 9,4 ↓ 4: 8,5 ↗ 5: 8,9 ↘		
	Serie 40,0 Totalt 132,0		

Skjutlag	Tavla	Andreas Edin	
5	4		
Ramselefors		Ale	
2005-07-10		Tavelträffen B 2005	Ramselefors Skytteförening
Prov		1: 10,3 ↗ 2: 10,2 ← 3: 10,8* → 4: 9,8 ↘	Serie 1
		Serie 39,0 Totalt 0,0	1: 9,7 ← 2: 10,6* ← 3: 10,5* ← 4: 10,4 ← 5: 9,3 ↘
			Serie 48,0 Totalt 48,0
Prov		1: 10,4 ↓ 2: 10,3 ←	Serie 2
		Serie 20,0 Totalt 48,0	1: 10,3 ↗ 2: 9,1 ↖ 3: 10,1 ↑ 4: 10,2 ↑ 5: 10,5* ↖
			Serie 49,0 Totalt 97,0
Serie 3		1: 5,3 ↗ 2: 9,6 ↘ 3: 8,4 ← 4: 8,7 ↓ 5: 8,0 ↗	
		Serie 38,0 Totalt 135,0	

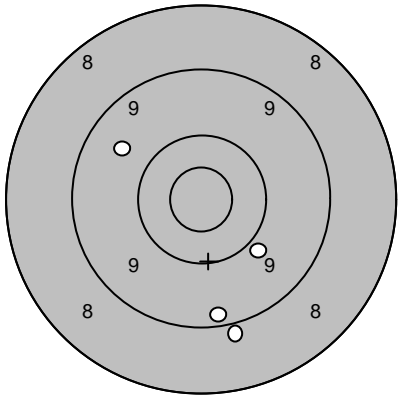
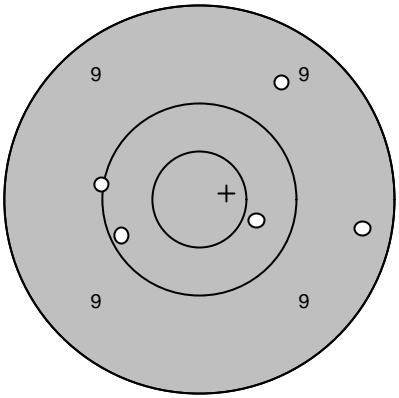
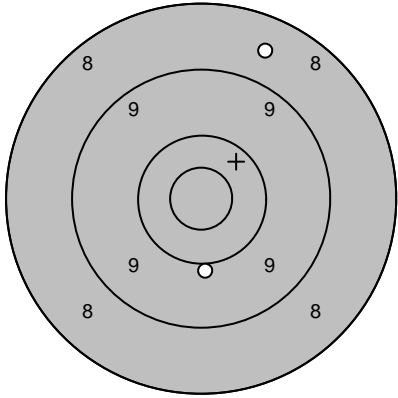
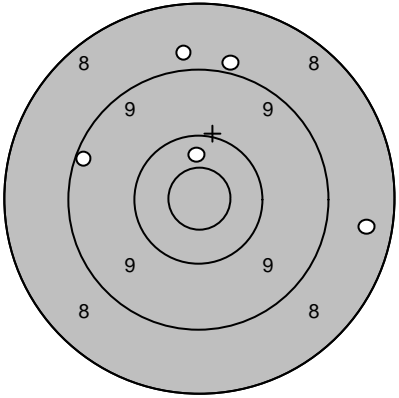
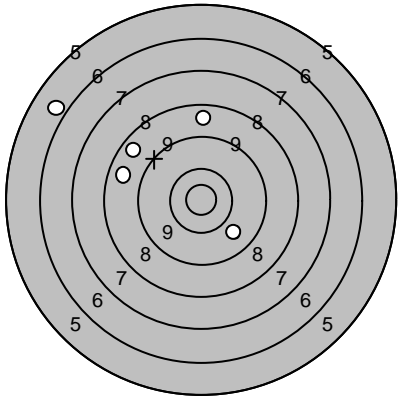
Skjutlag	Tavla	<b>Johnny Vadebo</b>	
<b>5</b>	<b>5</b>		
Ramselefors	Helsingborg		
2005-07-10	Tavelträffen B 2005	Ramselefors Skytteförening	
Prov		1: 9,9 ↘ 2: 9,3 ↓ 3: 9,0 ↓ 4: 9,6 ↗	Serie 1 
		Serie 36,0 Totalt 0,0	1: 9,6 ↗ 2: 10,4 → 3: 9,3 → 4: 10,0 ← 5: 10,2 ←
			Serie 48,0 Totalt 48,0
Prov		1: 8,6 ↗ 2: 10,0 ↓	Serie 2 
		Serie 18,0 Totalt 48,0	1: 9,2 ← 2: 8,5 → 3: 8,9 ↑ 4: 10,4 ↑ 5: 8,8 ↑
			Serie 43,0 Totalt 91,0
Serie 3		1: 6,0 ↗ 2: 8,6 ↗ 3: 8,7 ← 4: 8,7 ↑ 5: 9,8 ↘	
		Serie 39,0 Totalt 130,0	

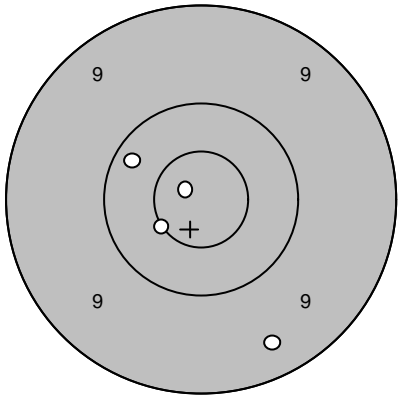
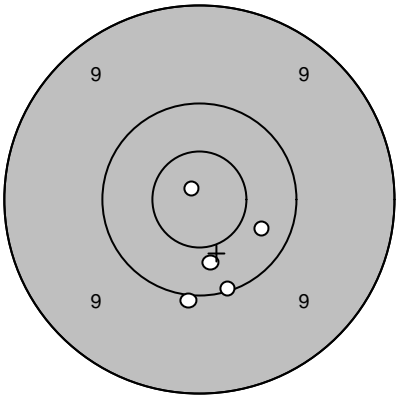
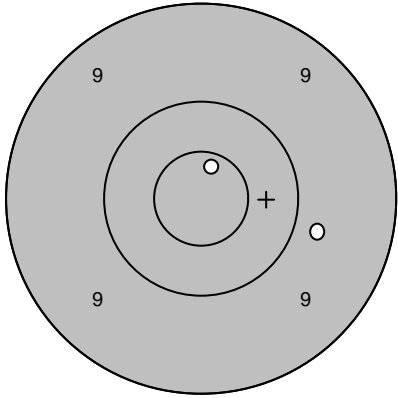
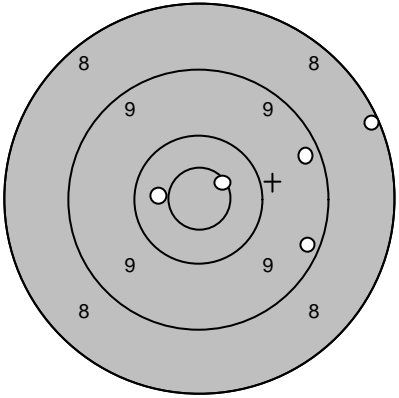
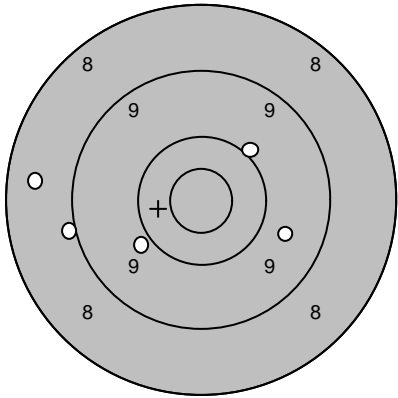
Skjutlag	Tavla	<b>Bengt Jansson</b>		
<b>5</b>	<b>6</b>			
Ramselefors	Söderala			
2005-07-10	Tavelträffen B 2005	Ramselefors Skytteförening		
Prov		1: 10,2 ↖ 2: 10,5* ↙ 3: 9,4 ↓ 4: 10,8* ↗	Serie 1 	1: 10,3 ↘ 2: 10,1 ↓ 3: 10,9* ↗ 4: 10,4 ↓ 5: 10,0 ↓
	Serie 39,0 Totalt 0,0		Serie 50,0 Totalt 50,0	
Prov		1: 10,7* ↗ 2: 9,8 →	Serie 2 	1: 10,6* ↗ 2: 8,2 → 3: 9,3 → 4: 10,5* ← 5: 9,3 →
	Serie 19,0 Totalt 50,0		Serie 46,0 Totalt 96,0	
Serie 3		1: 9,0 ← 2: 9,9 ↙ 3: 10,0 ↗ 4: 9,7 → 5: 8,5 ←		
	Serie 45,0 Totalt 141,0			

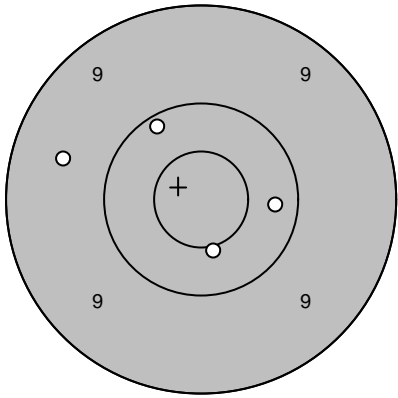
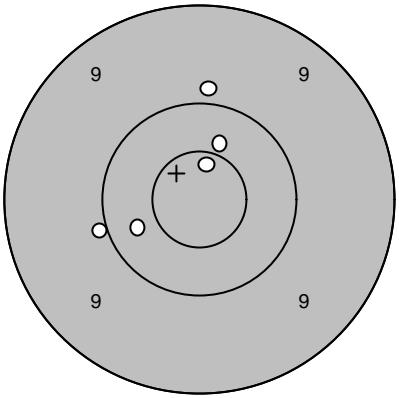
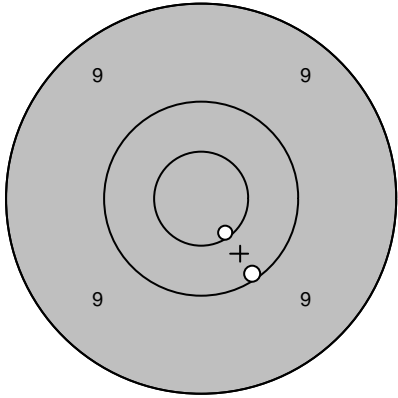
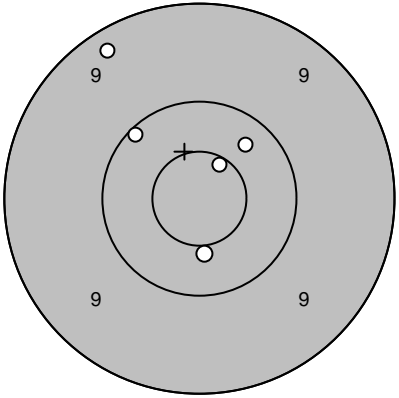
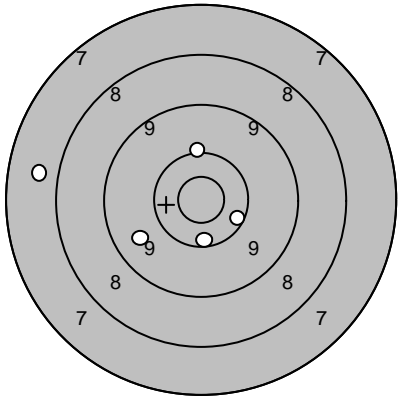
Skjutlag	Tavla	<b>Mikael Olofsson</b>	
<b>5</b>	<b>7</b>		
Ramselefors	Moälven-Modo		
2005-07-10	Tavelträffen B 2005	Ramselefors Skytteförening	
Prov 	1: 10,2 ↗ 2: 9,6 ← 3: 10,5* ↓ 4: 10,3 →	Serie 1 	1: 9,9 ↑ 2: 10,4 ↑ 3: 10,0 ← 4: 10,3 ← 5: 10,7* ↑
	Serie 39,0 Totalt 0,0		Serie 49,0 Totalt 49,0
Prov 	1: 10,6* ↓ 2: 10,1 ↓	Serie 2 	1: 9,3 ↖ 2: 10,5* ↓ 3: 10,3 ↗ 4: 10,1 ↖ 5: 10,6* ↗
	Serie 20,0 Totalt 49,0		Serie 49,0 Totalt 98,0
Serie 3 	1: 9,7 ← 2: 10,3 → 3: 10,3 ↓ 4: 7,8 ← 5: 10,1 ↑		
	Serie 46,0 Totalt 144,0		

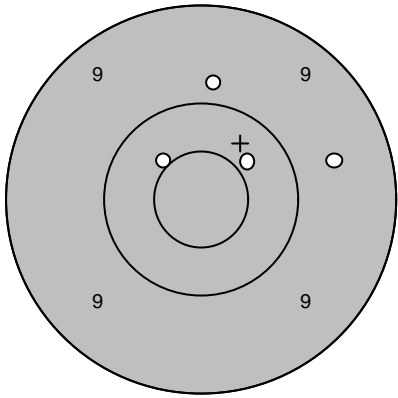
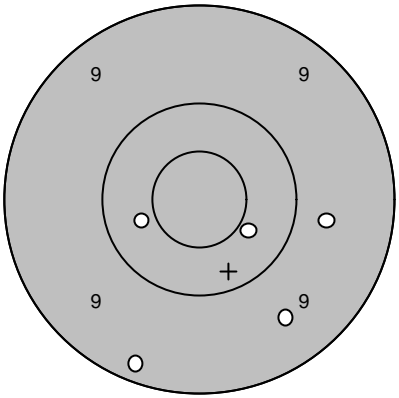
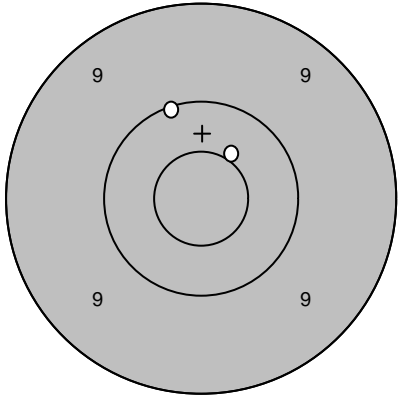
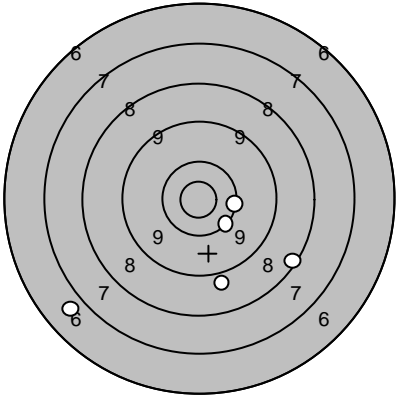
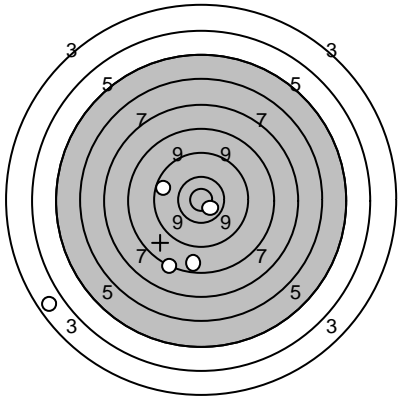

Skjutlag	Tavla	<b>Mats Kallin</b>		
<b>5</b>	<b>8</b>			
Ramselefors	Moälven-Modo			
2005-07-10	Tavelträffen B 2005	Ramselefors Skytteförening		
Prov		1: 10,4 ↗ 2: 9,6 → 3: 10,5* ↖ 4: 9,8 ↑	Serie 1 	1: 9,7 → 2: 10,4 ↘ 3: 9,5 ↘ 4: 9,2 ↓ 5: 10,4 ←
		Serie 38,0		Serie 47,0
		Totalt 0,0		Totalt 47,0
Prov		1: 10,5* ↗ 2: 10,1 ↑	Serie 2 	1: 10,2 → 2: 8,3 ↘ 3: 6,9 ↖ 4: 8,9 ↓ 5: 10,2 ↘
		Serie 20,0		Serie 42,0
		Totalt 47,0		Totalt 89,0
Serie 3		1: 3,8 ↙ 2: 10,8* ↘ 3: 9,7 ↖ 4: 8,7 ↓ 5: 8,3 ↘		
		Serie 38,0		
		Totalt 127,0		

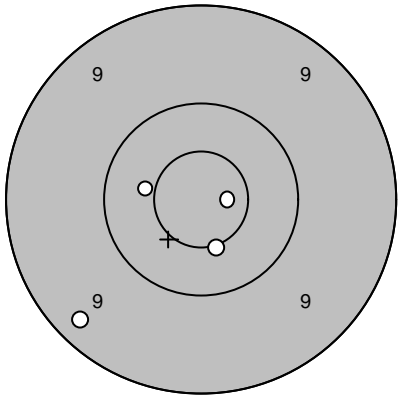
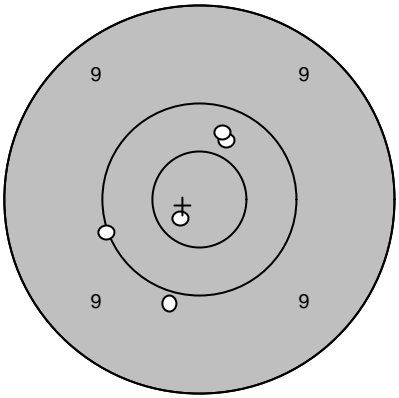
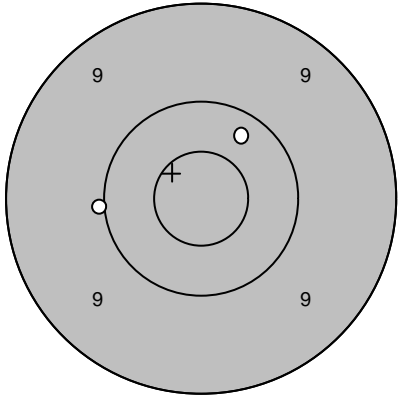
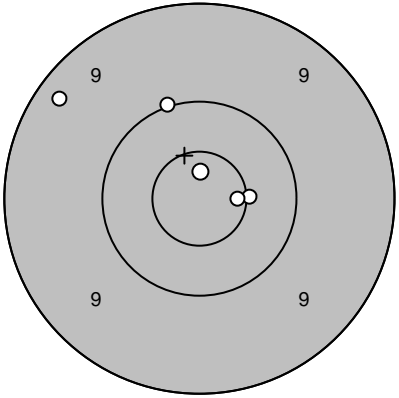
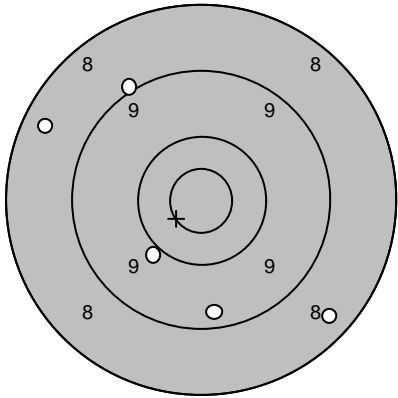
Skjutlag	Tavla	<b>Petter Eriksson</b>	
<b>5</b>	<b>9</b>		
Ramselefors	Moälven-Modo		
2005-07-10	Tavelträffen B 2005	Ramselefors Skytteförening	
Prov 	1: 9,3 ↙ 2: 10,4 ← 3: 10,8* → 4: 10,5* ↓	Serie 1 	1: 10,4 ↗ 2: 10,8* ↙ 3: 10,3 ↗ 4: 9,9 ↓ 5: 10,0 ←
	Serie 39,0 Totalt 0,0		Serie 49,0 Totalt 49,0
Prov 	1: 10,3 ↗ 2: 10,0 ←	Serie 2 	1: 9,3 ↖ 2: 10,8* ↑ 3: 10,5* → 4: 10,0 ↑ 5: 10,6* →
	Serie 20,0 Totalt 49,0		Serie 49,0 Totalt 98,0
Serie 3 	1: 10,0 ↙ 2: 8,4 ↖ 3: 9,4 ↓ 4: 8,4 ↘ 5: 9,0 ↗		
	Serie 44,0 Totalt 142,0		

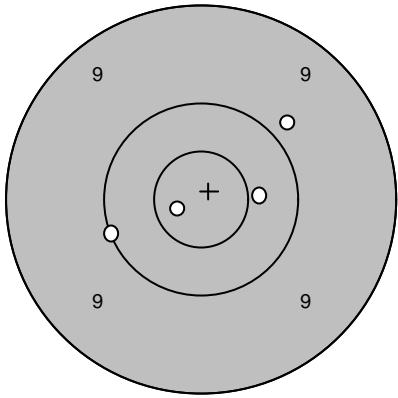
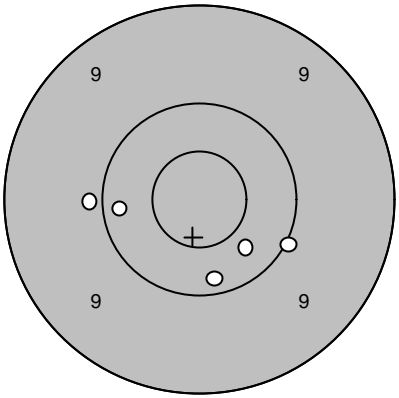
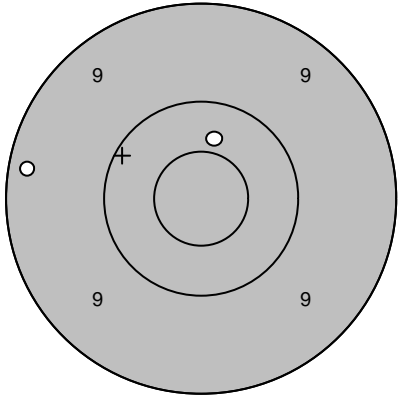
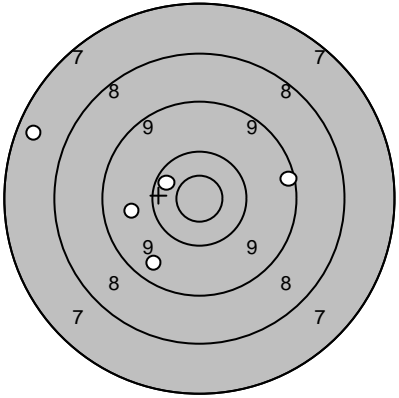
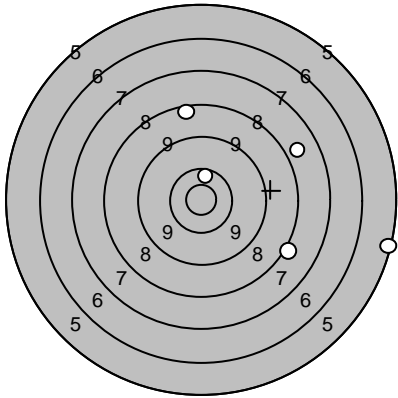
Skjutlag	Tavla	<b>Harry Östling</b>		
<b>5</b>	<b>10</b>			
Ramselefors	F 21			
2005-07-10	Tavelträffen B 2005	Ramselefors Skytteförening		
Prov		1: 10,4 → 2: 9,9 ↗ 3: 10,0 ← 4: 10,8* ←	Serie 1 	1: 9,9 ← 2: 10,2 ← 3: 10,4 ↘ 4: 10,0 ↘ 5: 10,2 ↓
		Serie 39,0		Serie 49,0
		Totalt 0,0		Totalt 49,0
Prov		1: 9,2 ← 2: 10,4 ↑	Serie 2 	1: 9,3 → 2: 7,5 ← 3: 10,4 ↖ 4: 9,5 ↘ 5: 9,7 ←
		Serie 19,0		Serie 44,0
		Totalt 49,0		Totalt 93,0
Serie 3		1: 10,4 ↑ 2: 8,4 ↑ 3: 5,3 → 4: 7,9 ↗ 5: 8,1 ↘		
		Serie 38,0		
		Totalt 131,0		

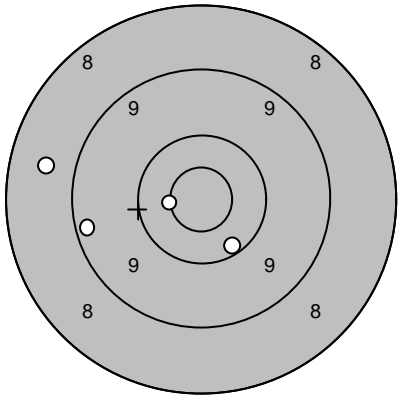
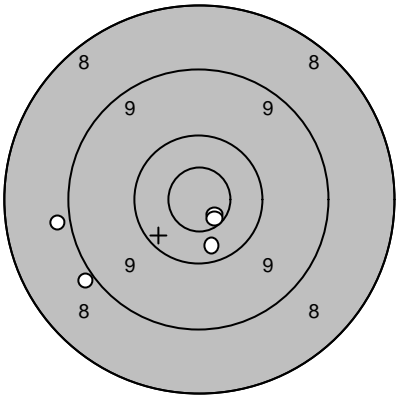
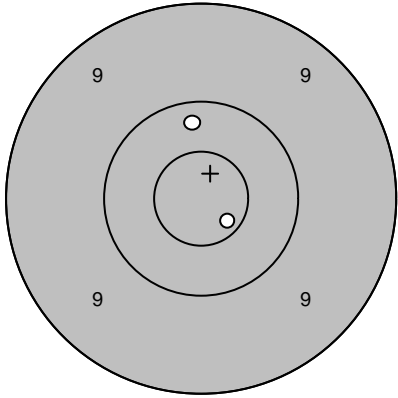
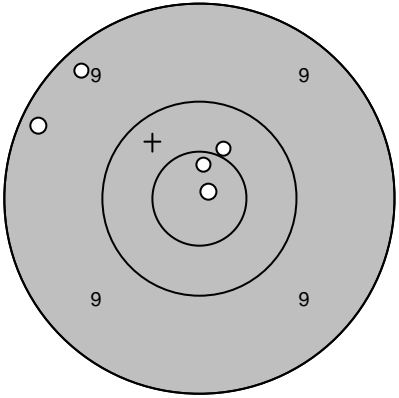
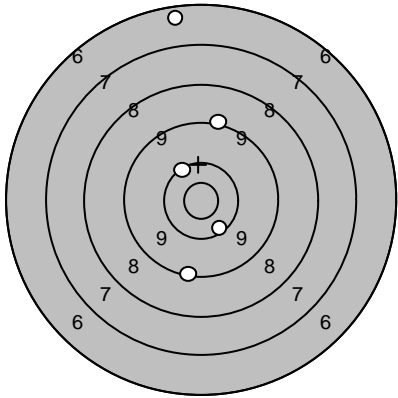
Skjutlag	Tavla	<b>Jan-Olof Lampinen</b>	
<b>5</b>	<b>11</b>		
Ramselefors	S 3		
2005-07-10	Tavelträffen B 2005	Ramselefors Skytteförening	
Prov		1: 8,7 ←	Serie 1
		2: 9,3 ←	
3: 10,6* ←	1: 8,9 ↙		
4: 10,2 ↘		2: 10,7* ↘	
		3: 10,7* ↘	
		4: 8,9 ←	
		5: 10,3 ↘	
	Serie 37,0	Serie 46,0	
	Totalt 0,0	Totalt 46,0	
Prov		1: 10,3 ↑	Serie 2
		2: 10,7* ↘	
	1: 9,3 ↖		
		2: 10,9* ↗	
		3: 10,5* ↗	
		4: 9,2 ↖	
		5: 10,7* ↑	
	Serie 20,0	Serie 48,0	
	Totalt 46,0	Totalt 94,0	
Serie 3		1: 9,1 ↑	
		2: 6,5 ↑	
	3: 9,2 ↓		
	4: 10,3 ↓		
	5: 10,3 ↗		
	Serie 44,0		
	Totalt 138,0		

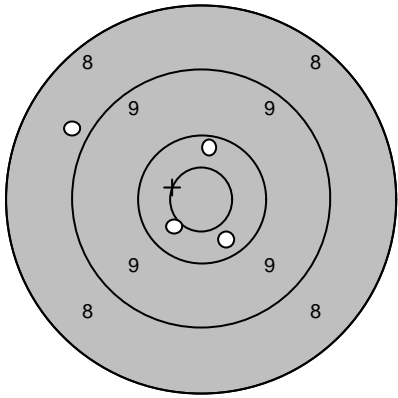
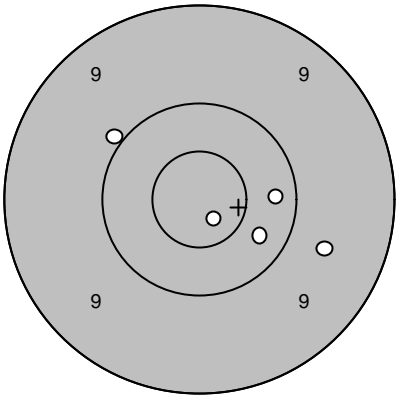
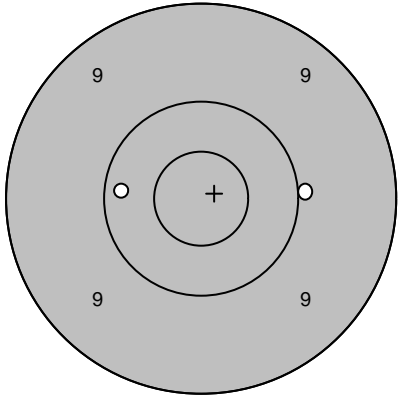
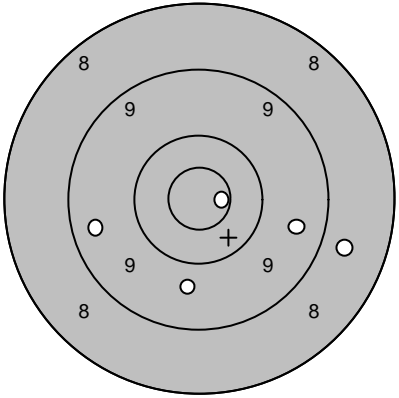
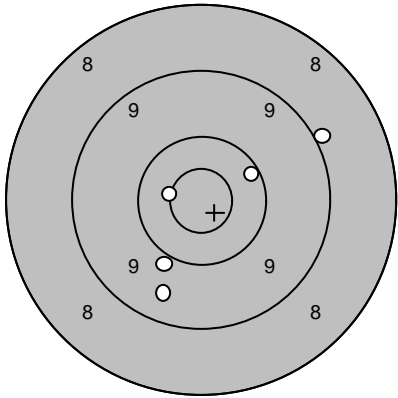
Skjutlag <b>5</b>	Tavla <b>12</b>	<b>Magnus Lindkvist</b>	
Ramselefors	Umeå		
2005-07-10	Tavelträffen B 2005	Ramselefors Skytteförening	
Prov		1: 8,8 ↙ 2: 10,3 ↑ 3: 10,3 ↓ 4: 10,5* ↘	Serie 1 
			1: 10,0 ↗ 2: 10,3 → 3: 9,7 ↘ 4: 10,8* ↘ 5: 10,3 ↘
		Serie 38,0	Serie 49,0
		Totalt 0,0	Totalt 49,0
Prov		1: 10,0 → 2: 10,2 ←	Serie 2 
			1: 10,7* → 2: 9,7 ↓ 3: 9,5 → 4: 8,7 → 5: 9,4 ←
		Serie 20,0	Serie 45,0
		Totalt 49,0	Totalt 94,0
Serie 3		1: 9,5 ↓ 2: 10,0 ↓ 3: 10,6* ← 4: 10,2 → 5: 9,0 →	
		Serie 48,0	
		Totalt 142,0	

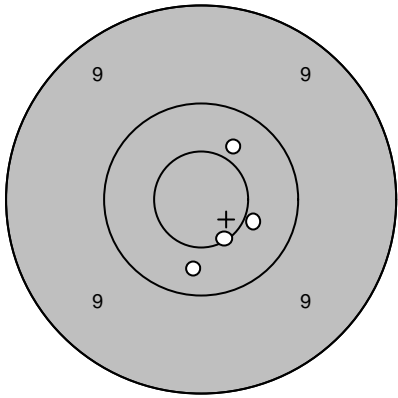
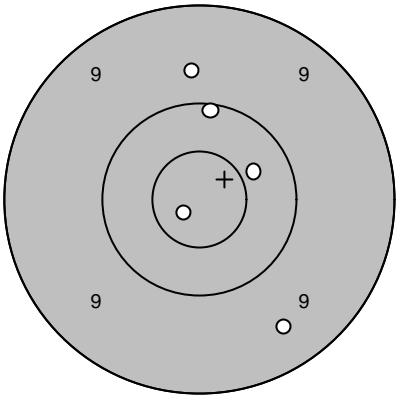
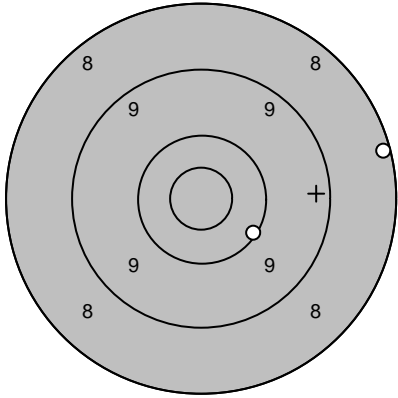
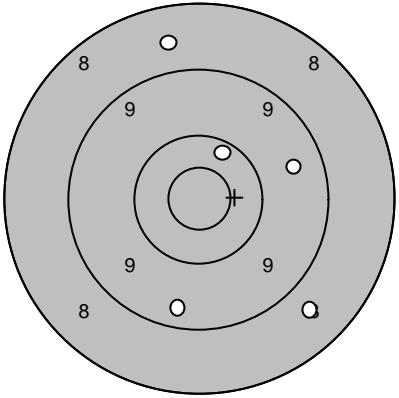
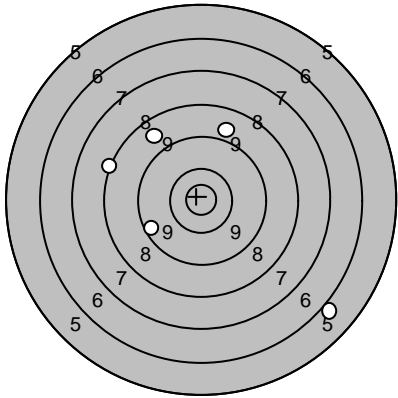
Skjutlag	Tavla	<b>Lars Möllsten</b>		
<b>5</b>	<b>13</b>			
Ramselefors	Umeå			
2005-07-10	Tavelträffen B 2005	Ramselefors Skytteförening		
Prov		1: 10,4 ↗ 2: 10,3 ↓ 3: 10,6* ↓ 4: 10,5* →	Serie 1 	1: 10,4 ↗ 2: 9,5 ↓ 3: 10,1 ↑ 4: 9,7 ↑ 5: 10,8* ↙
		Serie 40,0		Serie 48,0
		Totalt 0,0		Totalt 48,0
Prov		1: 8,2 → 2: 10,1 →	Serie 2 	1: 10,3 ↗ 2: 9,4 ↓ 3: 8,6 ↑ 4: 9,6 → 5: 8,7 ↓
		Serie 18,0		Serie 44,0
		Totalt 48,0		Totalt 92,0
Serie 3		1: 8,9 ↑ 2: 6,0 ↓ 3: 8,8 ↗ 4: 8,2 ↖ 5: 9,5 ↙		
		Serie 39,0		
		Totalt 131,0		

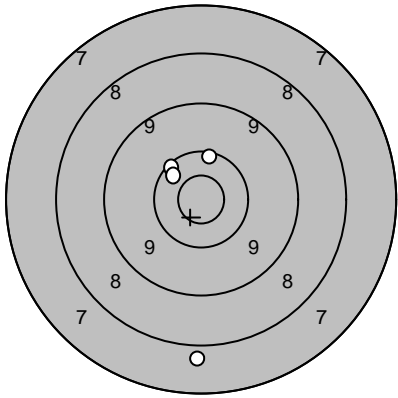
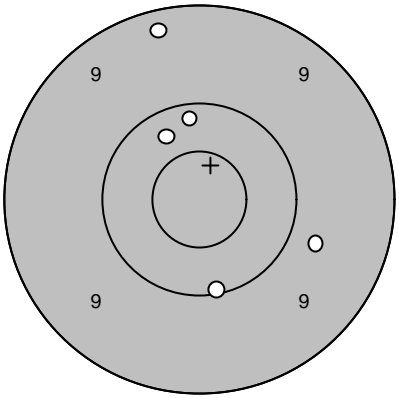
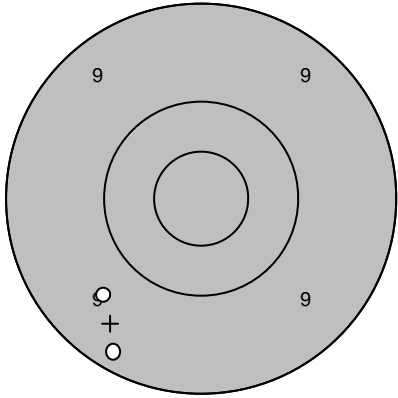
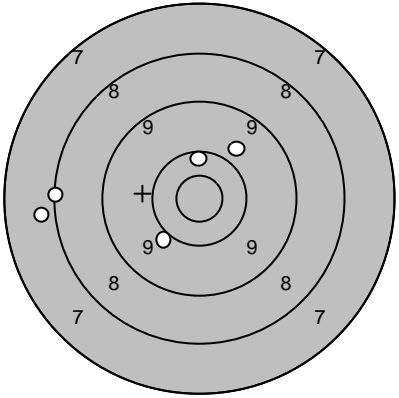
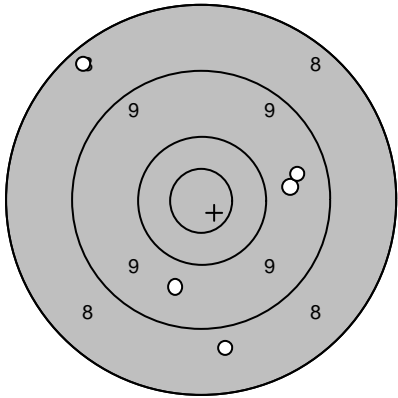
Skjutlag	Tavla	<b>Gustav Lövgren</b>		
<b>5</b>	<b>15</b>			
Ramselefors	Niemisel			
2005-07-10	Tavelträffen B 2005	Ramselefors Skytteförening		
Prov		1: 7,9 ↓ 2: 10,2 ↗ 3: 10,4 ↖ 4: 10,2 ↑	Serie 1 	1: 10,2 ↑ 2: 9,3 ↑ 3: 9,8 → 4: 10,3 ↗ 5: 10,1 ↓
		Serie 37,0	Serie 48,0	
		Totalt 0,0	Totalt 48,0	
Prov		1: 9,2 ↘ 2: 9,6 ↘	Serie 2 	1: 10,0 ↙ 2: 10,3 ↑ 3: 7,9 ← 4: 8,2 ← 5: 9,9 ↗
		Serie 18,0	Serie 44,0	
		Totalt 48,0	Totalt 92,0	
Serie 3		1: 8,8 ↓ 2: 9,7 → 3: 9,6 → 4: 8,3 ↖ 5: 9,7 ↓		
		Serie 43,0		
		Totalt 135,0		

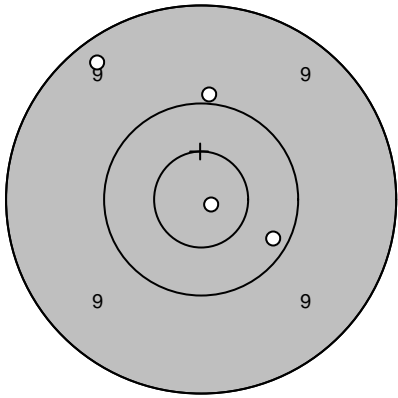
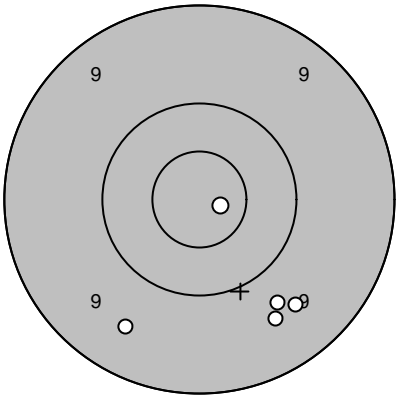
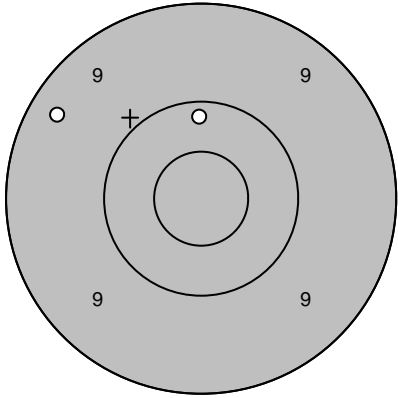
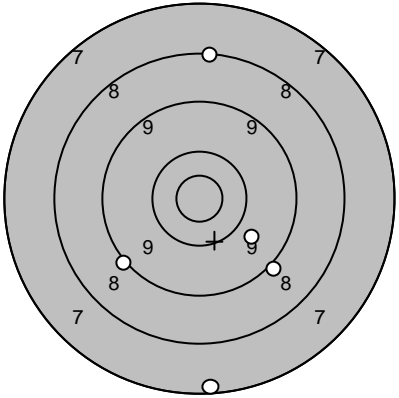
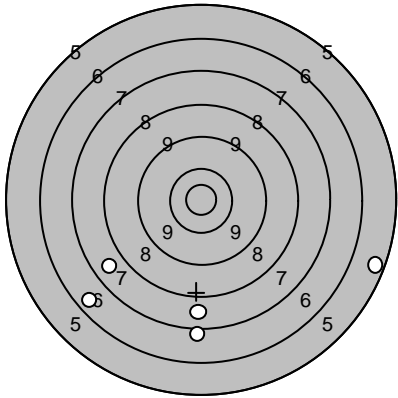
Skjutlag	Tavla	<b>Sture Grahn</b>		
<b>5</b>	<b>19</b>			
Ramselefors	Piteå			
2005-07-10	Tavelträffen B 2005	Ramselefors Skytteförening		
Prov		1: 9,3 ↖ 2: 10,9* → 3: 10,0 ↑ 4: 10,2 →	Serie 1 	1: 9,6 ↘ 2: 9,5 ↘ 3: 10,8* → 4: 9,6 ↘ 5: 9,7 ↘
		Serie 39,0	Serie 46,0	
		Totalt 0,0	Totalt 46,0	
Prov		1: 10,2 ↑ 2: 9,3 ↖	Serie 2 	1: 9,1 ↙ 2: 8,2 ↑ 3: 9,0 ↘ 4: 7,3 ↓ 5: 9,8 ↘
		Serie 19,0	Serie 42,0	
		Totalt 46,0	Totalt 88,0	
Serie 3		1: 7,8 ↙ 2: 5,5 → 3: 7,1 ↓ 4: 6,6 ↙ 5: 7,8 ↓		
		Serie 32,0		
		Totalt 120,0		

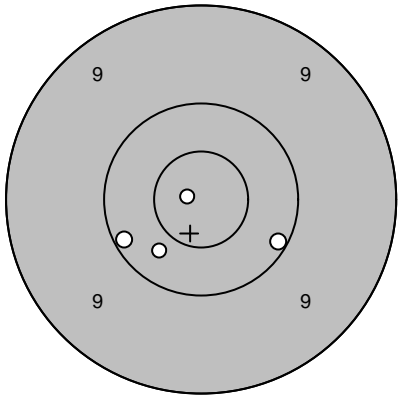
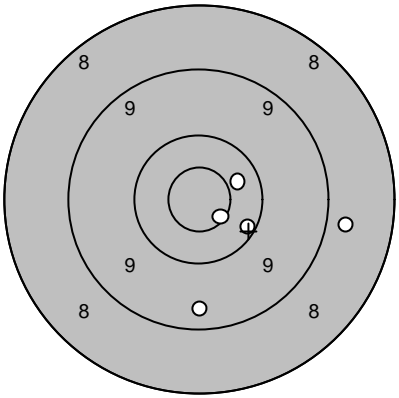
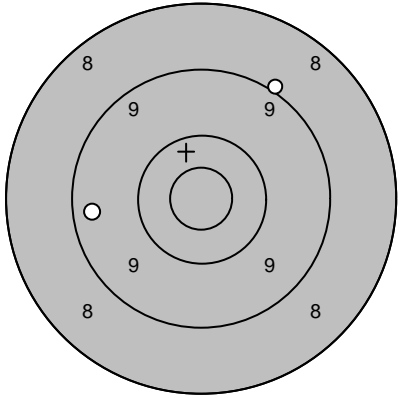
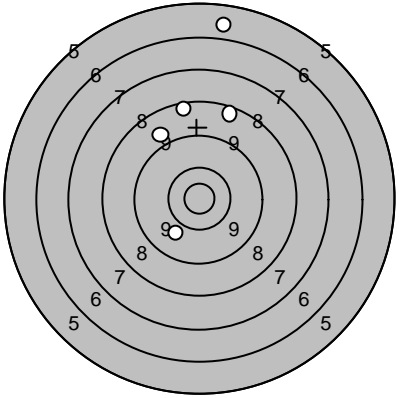
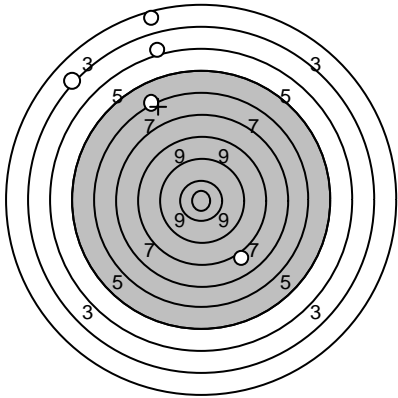

Skjutlag	Tavla	Anders Carlqvist	
5	23		
Ramselefors	Skyllberg		
2005-07-10	Tavelträffen B 2005	Ramselefors Skytteförening	
Prov 	1: 10,9* ←	Serie 1 	1: 10,4 →
	2: 10,1 →		2: 8,8 →
	3: 10,1 ←		3: 9,4 ↓
	4: 10,4 ↙		4: 10,2 ↘
			5: 10,6* ↘
	Serie 40,0		Serie 47,0
	Totalt 0,0		Totalt 47,0
Prov 	1: 9,0 ↗	Serie 2 	1: 8,4 ↑
	2: 9,4 ←		2: 9,9 ↙
			3: 8,9 ↗
			4: 8,4 ↑
			5: 5,9 ↑
	Serie 18,0		Serie 38,0
	Totalt 47,0		Totalt 85,0
Serie 3 	1: 6,3 ↗		
	2: 2,7 ↑		
	3: 3,3 ↗		
	4: 8,1 ↘		
	5: 4,1 ↑		
	Serie 23,0		
	Totalt 108,0		

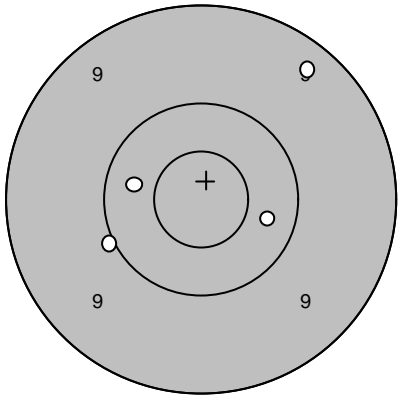
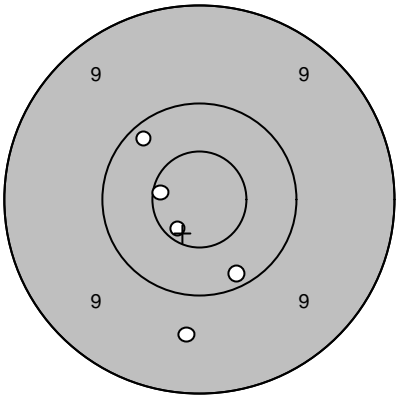
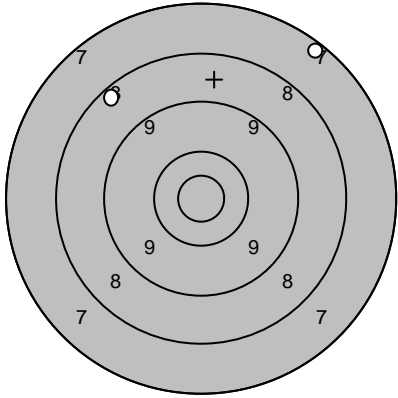
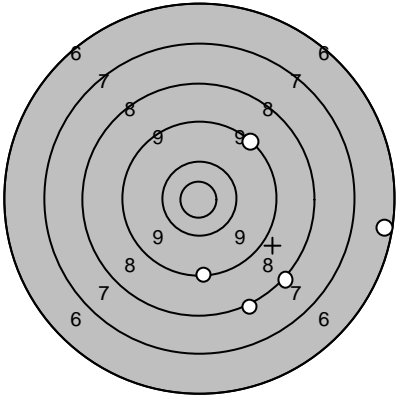
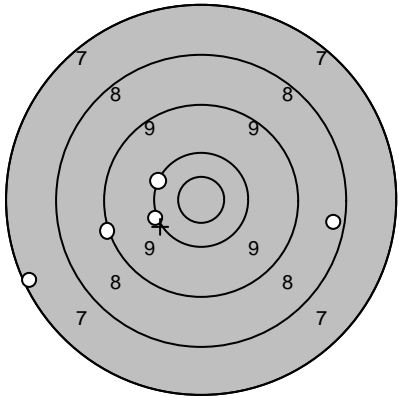
Skjutlag	Tavla	<b>Hampus Stenlund</b>		
<b>5</b>	<b>24</b>			
Ramselefors	A 4			
2005-07-10	Tavelträffen B 2005	Ramselefors Skytteförening		
Prov		1: 10,3 → 2: 9,3 ↗ 3: 10,0 ← 4: 10,3 ←	Serie 1 	1: 10,7* ↘ 2: 10,2 ↗ 3: 10,2 ↘ 4: 10,6* ← 5: 9,7 ↓
		Serie 39,0	Serie 49,0	
		Totalt 0,0	Totalt 49,0	
Prov		1: 8,4 ↖ 2: 7,3 ↗	Serie 2 	1: 6,4 → 2: 9,2 ↓ 3: 8,1 ↘ 4: 8,1 ↘ 5: 9,2 ↗
		Serie 15,0	Serie 40,0	
		Totalt 49,0	Totalt 89,0	
Serie 3		1: 10,2 ↖ 2: 9,1 ← 3: 8,4 → 4: 7,3 ← 5: 10,1 ←		
		Serie 44,0		
		Totalt 133,0		