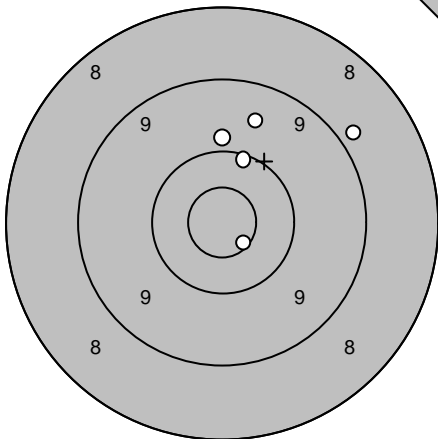
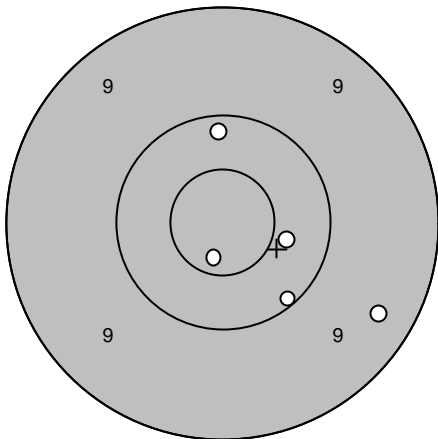
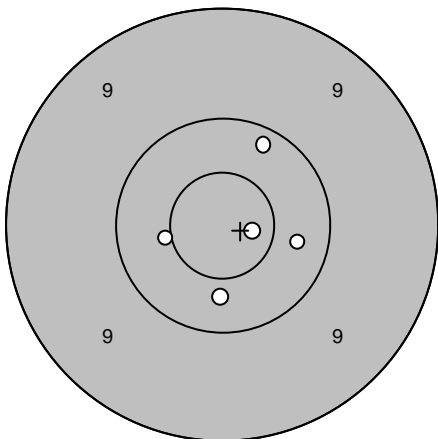
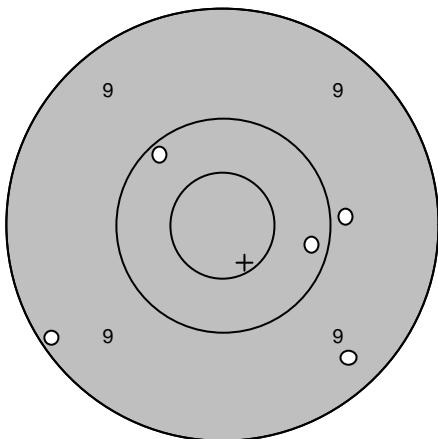
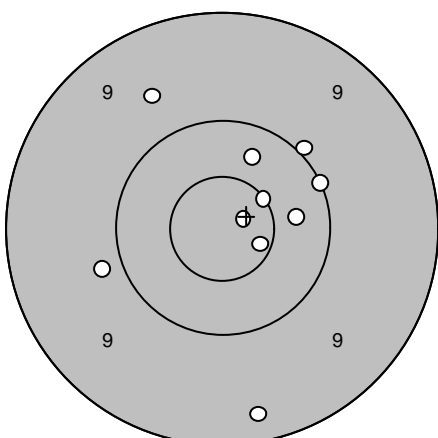
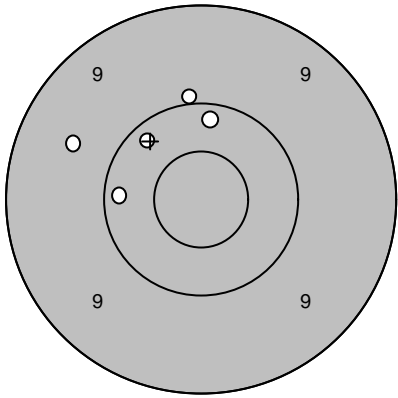
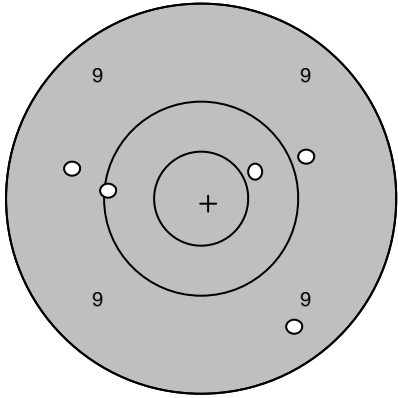
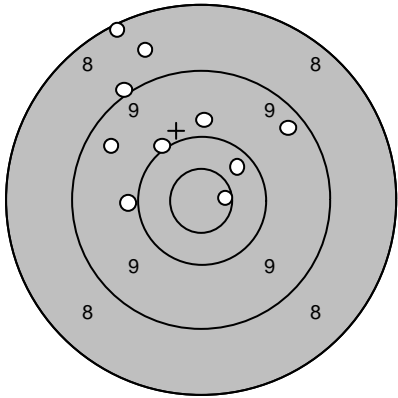
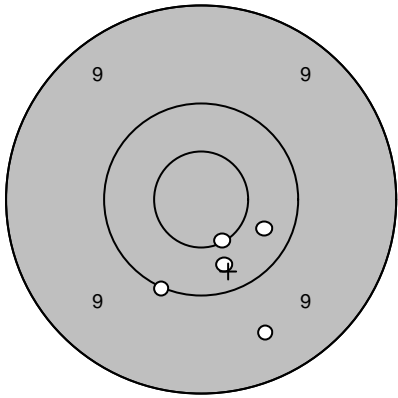
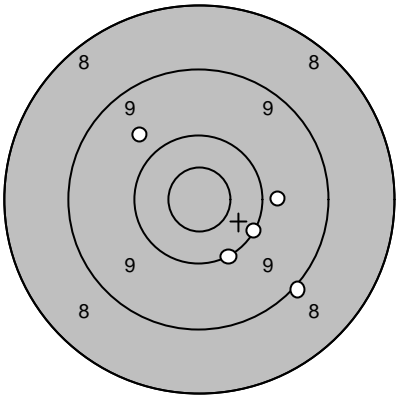
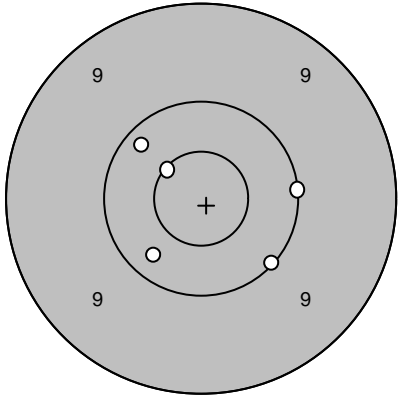
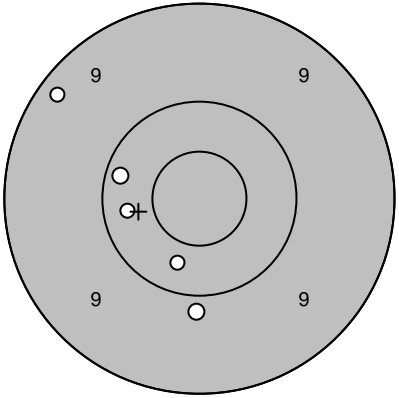
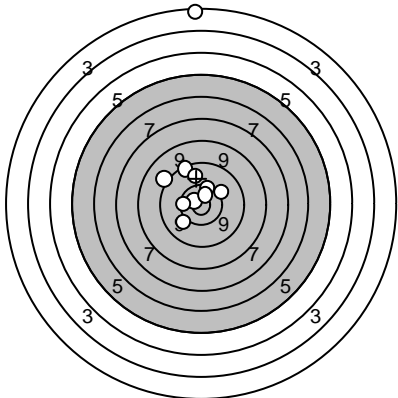
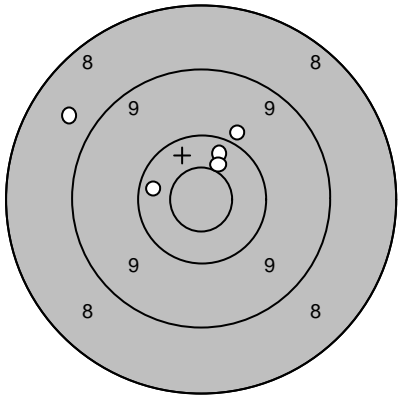
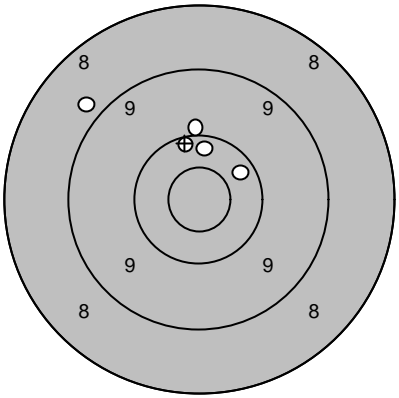
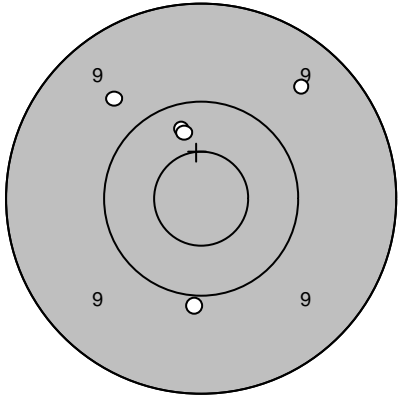
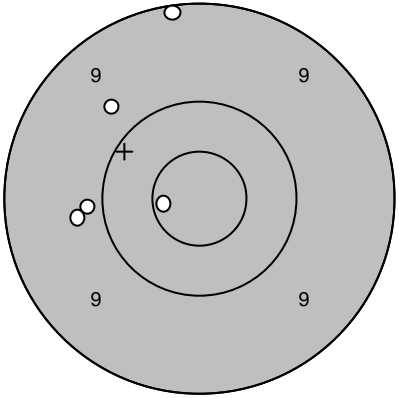
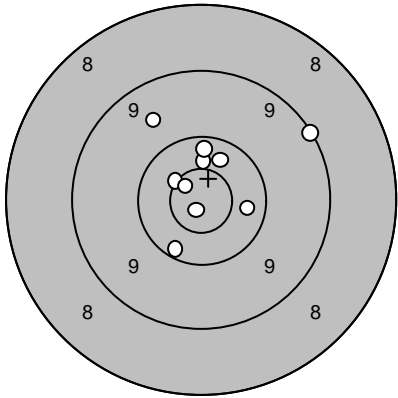
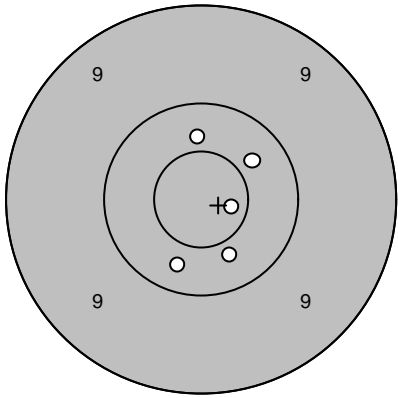
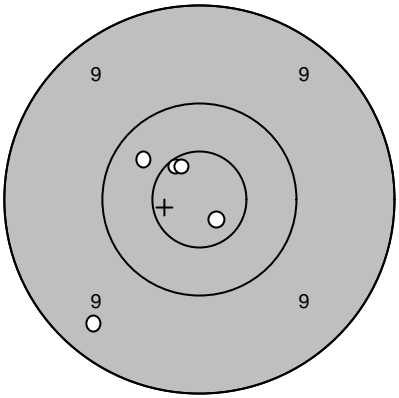
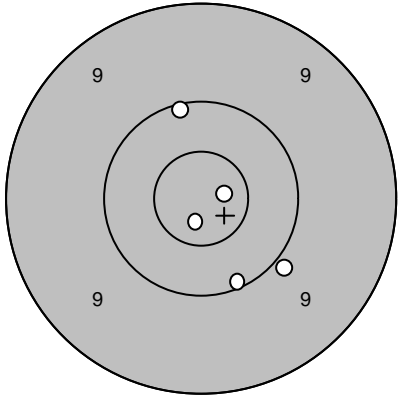
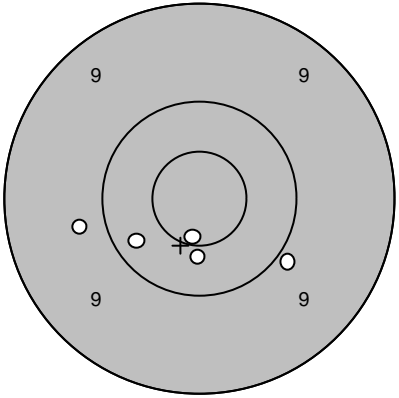
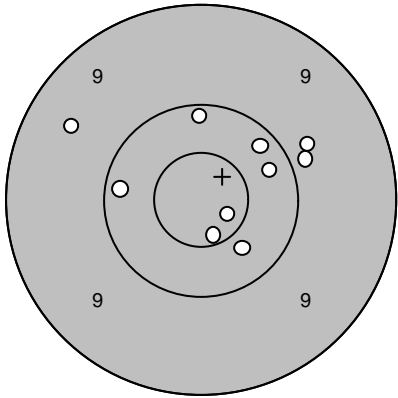

Skjutlag 1	Tavla 1	Peder Vahlberg	
Ramselefors	Ramselefors		
2005-07-09	Tavelträffen A 2005	Ramselefors Skytteförening	
Prov		1: 10,7* ↘ 2: 10,2 ↑ 3: 9,6 ↑ 4: 9,9 ↑ 5: 8,9 ↗	Serie 1 
	Serie 49,3 Totalt 0,0	1: 10,7* ↓ 2: 10,2 ↑ 3: 10,4 → 4: 9,4 ↘ 5: 10,1 ↓	Serie 50,8 Totalt 50,8
Serie 2		1: 10,7* → 2: 10,4 ↓ 3: 10,2 ↑ 4: 10,5* ← 5: 10,3 →	Serie 3 
	Serie 52,1 Totalt 102,9	1: 9,9 → 2: 10,2 → 3: 10,2 ↗ 4: 9,1 ← 5: 9,3 ↓	Serie 48,7 Totalt 151,6
Extratävling		1: 10,3 → 2: 10,0 ↗ 3: 9,7 ↖ 4: 9,9 ← 5: 10,0 ↗ 6: 10,8* ↗ 7: 9,3 ↓ 8: 10,3 ↑ 9: 10,7* → 10: 10,6* ↗	
	Serie 101,6 Totalt 253,2		

Skjutlag 1	Tavla 2	Lars Sandström	
Ramselefors	Ramselefors		
2005-07-09	Tavelträffen A 2005	Ramselefors Skytteförening	
Prov		Serie 1 1: 10,2 ← 2: 9,6 ↙ 3: 10,0 ↑ 4: 10,2 ↖ 5: 10,2 ↑	Serie 1 1: 10,3 ↑ 2: 9,5 ↘ 3: 9,7 ↘ 4: 10,1 ↓ 5: 10,7* ←
	Serie 50,2 Totalt 0,0	Serie 50,3 Totalt 50,3	
Serie 2		Serie 3 1: 10,4 → 2: 9,4 ↓ 3: 10,1 ← 4: 9,9 → 5: 9,7 ←	Serie 3 1: 8,4 ↗ 2: 10,1 ↓ 3: 9,4 ↑ 4: 9,9 ↖ 5: 10,2 ↗
	Serie 49,5 Totalt 99,8	Serie 48,0 Totalt 147,8	
Extratävling		1: 8,6 ↑ 2: 9,0 ↖ 3: 10,0 ↖ 4: 8,2 ↖ 5: 9,9 ↑ 6: 9,5 ↖ 7: 10,7* → 8: 9,3 ↗ 9: 10,0 ← 10: 10,3 ↗	
	Serie 95,5 Totalt 243,3		

Skjutlag 1	Tavla 3	Donald Johansson	
Ramselefors		Ale	
2005-07-09		Tavelträffen A 2005	Ramselefors Skytteförening
Prov		1: 10,3 ↓ 2: 10,3 → 3: 10,6* ↓ 4: 10,0 ↓ 5: 9,5 ↓	Serie 1 
		Serie 50,7 Totalt 0,0	1: 9,7 ↗ 2: 9,9 → 3: 10,1 ↓ 4: 10,1 ↓ 5: 9,0 ↓
		Serie 51,3 Totalt 100,1	Serie 48,8 Totalt 48,8
Serie 2		1: 10,3 ↙ 2: 10,1 ↓ 3: 10,2 ↗ 4: 10,1 → 5: 10,6* ↗	Serie 3 
		Serie 50,0 Totalt 150,1	1: 10,3 ← 2: 9,3 ↗ 3: 9,9 ↓ 4: 10,2 ← 5: 10,3 ↓
Extratävling		1: 10,5* ↗ 2: 2,5 ↑ 3: 10,9* ↖ 4: 10,2 ↗ 5: 10,9* ↗ 6: 9,6 ↗ 7: 10,2 ↓ 8: 10,5* ← 9: 9,3 ↗ 10: 10,0 ↑	
		Serie 94,6 Totalt 244,7	

Skjutlag 1	Tavla 5	Johnny Vadebo	
Ramselefors		Helsingborg	
2005-07-09		Tavelträffen A 2005	Ramselefors Skytteförening
Prov 	1: 10,3 ↗ 2: 10,3 ← 3: 9,9 ↗ 4: 8,7 ← 5: 10,5* ↗	Serie 1 	1: 8,8 ↖ 2: 10,3 ↗ 3: 10,0 ↑ 4: 10,2 ↑ 5: 10,3 ↑
	Serie 49,7		Serie 49,6
	Totalt 0,0		Totalt 49,6
Serie 2 	1: 9,5 ↗ 2: 10,3 ↑ 3: 9,7 ↗ 4: 10,3 ↑ 5: 9,9 ↓	Serie 3 	1: 9,1 ↑ 2: 9,7 ↖ 3: 10,7* ← 4: 9,9 ← 5: 9,8 ←
	Serie 49,7		Serie 49,2
	Totalt 99,3		Totalt 148,5
Extratävling 	1: 10,9* ↓ 2: 10,5* ↑ 3: 10,4 → 4: 10,6* ↖ 5: 10,8* ↖ 6: 9,6 ↖ 7: 10,4 ↗ 8: 9,1 ↗ 9: 10,3 ↑ 10: 10,2 ↓		
	Serie 102,8		
	Totalt 251,3		

Skjutlag	Tavla	Bengt Jansson		
1	6			
Ramselefors	Söderala			
2005-07-09	Tavelträffen A 2005	Ramselefors Skytteförening		
Prov		1: 10,4 ↗ 2: 10,4 ↓ 3: 10,7* → 4: 10,4 ↑ 5: 10,3 ↓	Serie 1 	1: 10,3 ↖ 2: 10,6* ↗ 3: 10,8* ↓ 4: 10,7* ↗ 5: 9,4 ↙
		Serie 52,2	Serie 51,8	
		Totalt 0,0	Totalt 51,8	
Serie 2		1: 10,1 ↑ 2: 10,8* → 3: 9,9 ↓ 4: 10,8* ↓ 5: 10,1 ↓	Serie 3 	1: 9,8 ← 2: 10,6* ↓ 3: 10,3 ↙ 4: 10,4 ↓ 5: 9,9 ↘
		Serie 51,7	Serie 51,0	
		Totalt 103,5	Totalt 154,5	
Extratävling		1: 10,2 ← 2: 10,7* → 3: 9,5 ↖ 4: 10,7* ↓ 5: 10,3 → 6: 10,2 ↗ 7: 9,9 → 8: 10,2 ↑ 9: 10,4 ↓ 10: 9,8 →		
		Serie 101,9		
		Totalt 256,4		

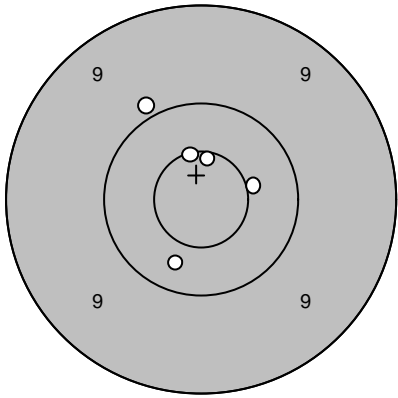
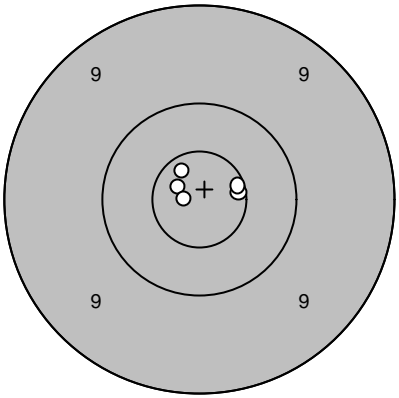
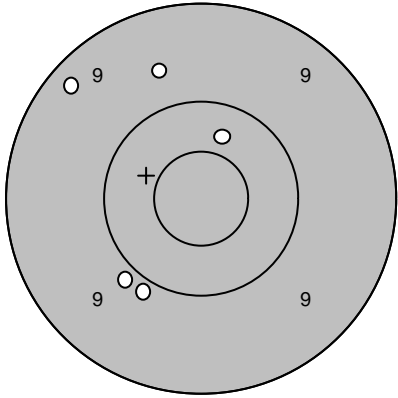
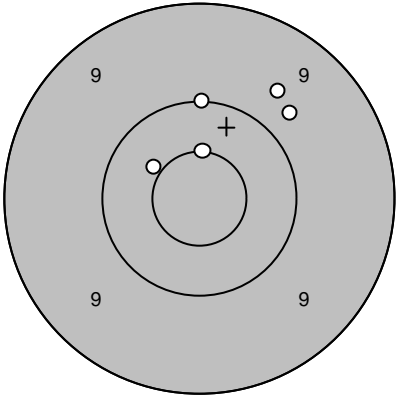
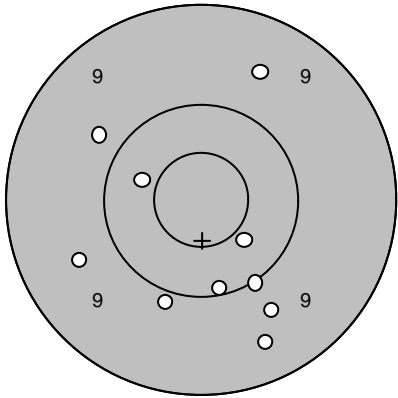
Skjutlag 1	Tavla 7	Mikael Olofsson		
Ramselefors		Moälven-Modo		
2005-07-09		Tavelträffen A 2005	Ramselefors Skytteförening	
Prov		1: 10,5* → 2: 9,9 ↖ 3: 10,6* ↑ 4: 10,6* ↑ 5: 10,3 ↓	Serie 1 	1: 10,7* ↖ 2: 10,8* ↖ 3: 10,6* → 4: 10,6* → 5: 10,9* ←
		Serie 51,9	Serie 53,6	
		Totalt 0,0	Totalt 53,6	
Serie 2		1: 9,3 ↖ 2: 9,7 ↑ 3: 9,9 ↓ 4: 10,4 ↑ 5: 9,9 ↓	Serie 3 	1: 10,5* ↑ 2: 10,5* ↖ 3: 10,0 ↑ 4: 9,8 ↗ 5: 9,7 ↗
		Serie 49,2	Serie 50,5	
		Totalt 102,8	Totalt 153,3	
Extratävling		1: 9,4 ↓ 2: 9,9 ↓ 3: 9,8 ↖ 4: 9,6 ↑ 5: 9,7 ← 6: 10,4 ← 7: 10,4 ↓ 8: 9,7 ↓ 9: 10,1 ↓ 10: 10,0 ↓		
		Serie 99,0		
		Totalt 252,3		

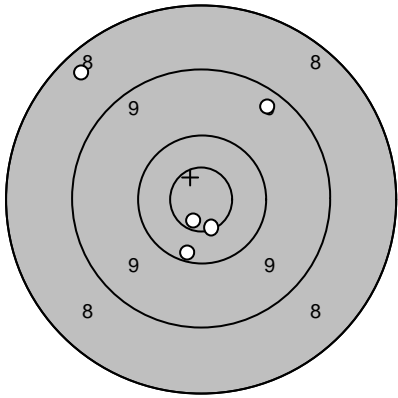
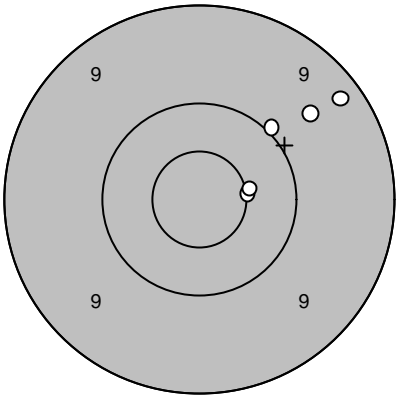
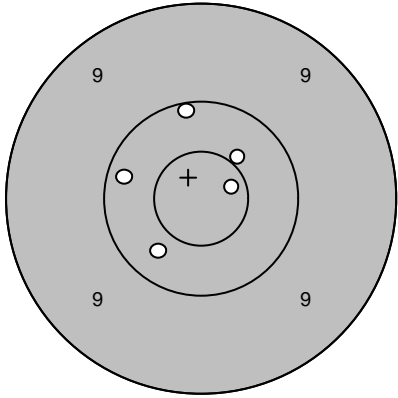
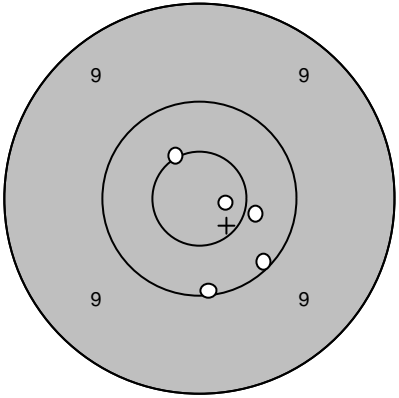
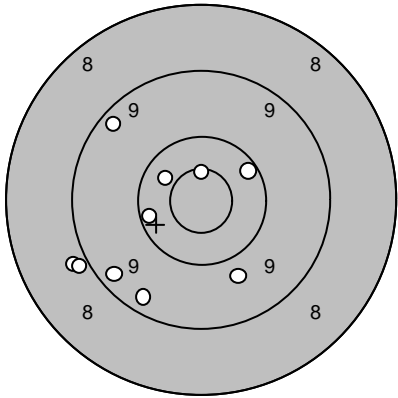
Skjutlag 1	Tavla 8	Mats Kallin	
Ramselefors		Moälven-Modo	
2005-07-09		Tavelträffen A 2005	Ramselefors Skytteförening
Prov 	1: 10,2 ↓	Serie 1 	1: 10,0 ↗
	2: 10,7* ↓		2: 9,6 ↗
	3: 10,6* ↓		3: 10,5* →
	4: 8,4 ↖		4: 10,5* →
	5: 9,3 ↗		5: 9,3 ↗
	Serie 49,2		Serie 49,9
	Totalt 0,0		Totalt 49,9
Serie 2 	1: 10,1 ↑	Serie 3 	1: 10,5* ↗
	2: 10,3 ↓		2: 10,1 ↓
	3: 10,5* ↗		3: 10,8* →
	4: 10,7* →		4: 10,1 ↓
	5: 10,2 ↖		5: 10,4 →
	Serie 51,8		Serie 51,9
	Totalt 101,7		Totalt 153,6
Extratävling 	1: 9,8 ↓		
	2: 8,9 ↖		
	3: 10,2 ↗		
	4: 10,4 ↖		
	5: 9,3 ↖		
	6: 9,3 ↓		
	7: 9,3 ↖		
	8: 10,6* ↑		
	9: 9,0 ↖		
	10: 10,2 ↖		
	Serie 97,0		
	Totalt 250,6		

Skjutlag	Tavla	Petter Eriksson	
1	9		
Ramselefors	Moälven-Modo		
2005-07-09	Tavelträffen A 2005	Ramselefors Skytteförening	
Prov		Serie 1	
	1: 10,6* ↖ 2: 10,5* ↖ 3: 10,3 ↑ 4: 9,8 ↖ 5: 10,8* ↗		1: 10,1 ↗ 2: 10,1 ↘ 3: 10,7* ↘ 4: 10,9* ← 5: 10,5* ↘
	Serie 52,0 Totalt 0,0		Serie 52,3 Totalt 52,3
Serie 2		Serie 3	
	1: 9,9 ↘ 2: 10,6* ↗ 3: 10,7* ↖ 4: 10,1 ↗ 5: 9,7 ←		1: 10,3 ↖ 2: 10,5* ↘ 3: 10,0 ↘ 4: 10,1 ↘ 5: 10,2 ←
	Serie 51,0 Totalt 103,3		Serie 51,1 Totalt 154,4
Extratävling			
	1: 10,9* ↓ 2: 10,5* → 3: 10,8* ↘ 4: 10,4 → 5: 9,5 → 6: 10,8* → 7: 9,7 → 8: 10,2 → 9: 10,6* ← 10: 9,7 ↓		
	Serie 103,1 Totalt 257,5		

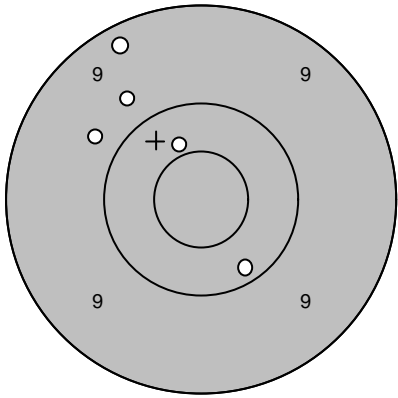
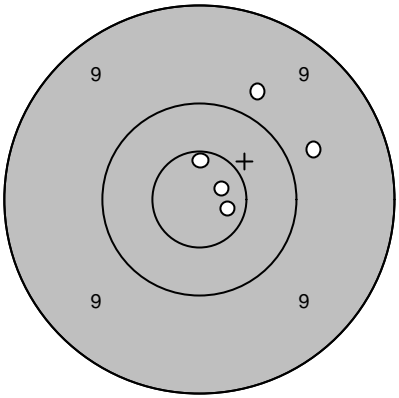
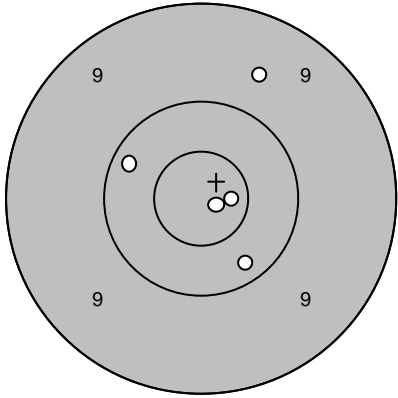
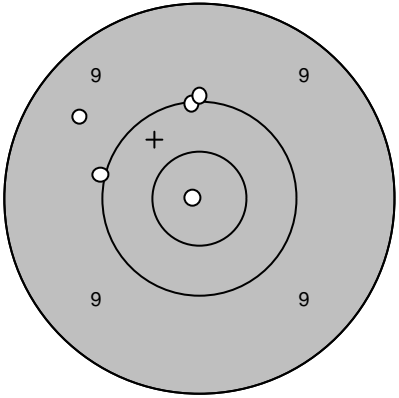
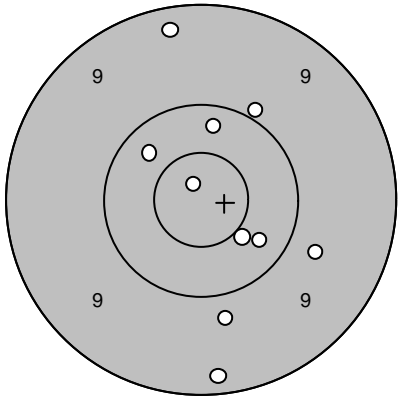
Skjutlag 1	Tavla 10	Harry Östling	
Ramselefors	F 21		
2005-07-09	Tavelträffen A 2005	Ramselefors Skytteförening	
Prov		1: 10,4 ↗ 2: 9,3 ↗ 3: 9,8 ↗ 4: 9,8 ↗ 5: 10,2 ↘ Serie 49,5 Totalt 0,0	Serie 1 
			1: 10,6* ↑ 2: 9,8 ↗ 3: 10,7* → 4: 9,8 → 5: 10,8* → Serie 51,7 Totalt 51,7
Serie 2		1: 9,6 ↗ 2: 10,7* → 3: 10,2 ↗ 4: 10,9* → 5: 10,2 ↘ Serie 51,6 Totalt 103,3	Serie 3 
			1: 10,1 ↑ 2: 10,9* ← 3: 10,0 ↑ 4: 10,0 ← 5: 9,6 ↖ Serie 50,6 Totalt 153,9
Extratävling		1: 9,3 ↑ 2: 9,7 → 3: 10,3 ↘ 4: 9,2 ↓ 5: 9,8 ↓ 6: 10,9* ↗ 7: 10,0 ↗ 8: 10,3 ↑ 9: 10,5* ↘ 10: 10,3 ↗ Serie 100,3 Totalt 254,2	

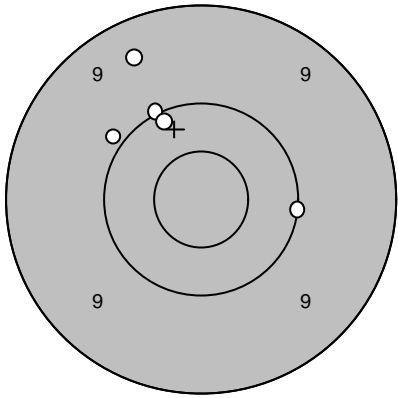
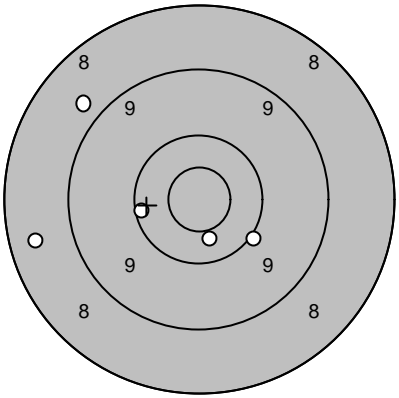
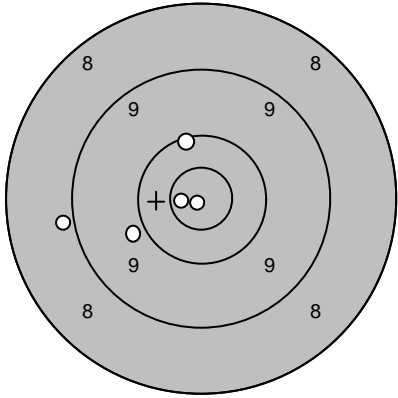
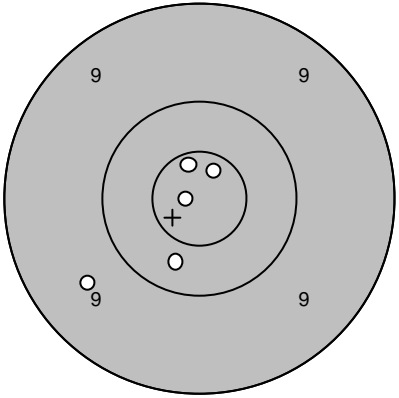
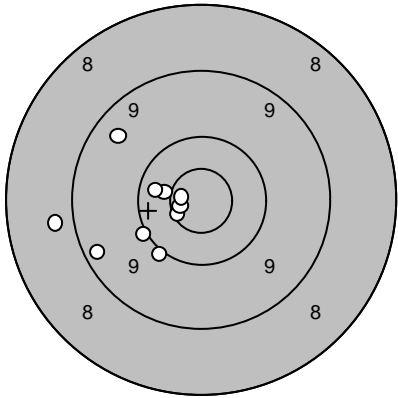
Skjutlag 1	Tavla 11	Jan-Olof Lampinen	
Ramselefors		S 3	
2005-07-09		Tavelträffen A 2005	Ramselefors Skytteförening
Prov		1: 9,4 ↗ 2: 9,9 ↗ 3: 10,0 ↗ 4: 10,2 ↗ 5: 10,0 →	Serie 1 
			1: 8,8 ↖ 2: 10,2 ← 3: 10,5* ↓ 4: 10,0 ↘ 5: 8,5 ←
		Serie 49,5	Serie 48,0
		Totalt 0,0	Totalt 48,0
Serie 2		1: 10,2 ↑ 2: 8,9 ← 3: 10,9* ↙ 4: 10,8* ← 5: 9,9 ↙	Serie 3 
			1: 10,7* ↗ 2: 9,6 ↙ 3: 10,9* ← 4: 10,7* ↑ 5: 10,3 ↓
		Serie 50,7	Serie 52,2
		Totalt 98,7	Totalt 150,9
Extratävling		1: 9,5 ↖ 2: 10,7* ↙ 3: 10,7* ↙ 4: 8,8 ← 5: 10,5* ↙ 6: 10,8* ↙ 7: 10,0 ↘ 8: 9,3 ← 9: 10,1 ↙ 10: 10,4 ←	
		Serie 100,8	
		Totalt 251,7	

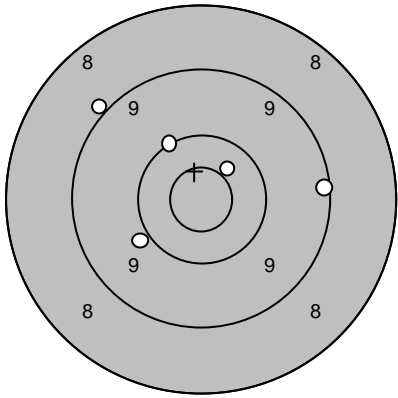
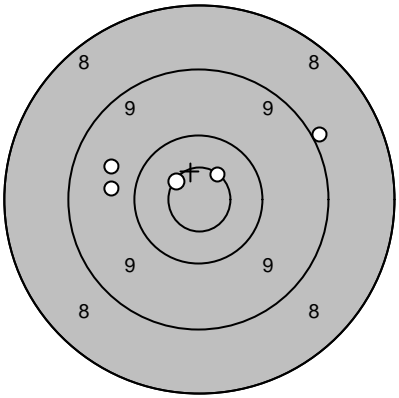
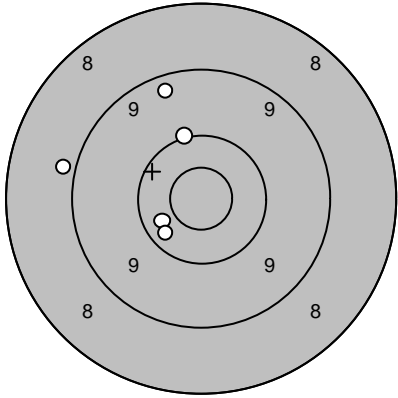
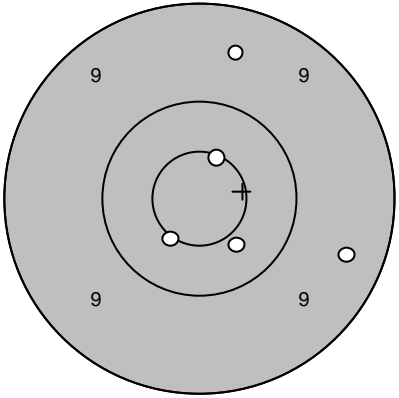
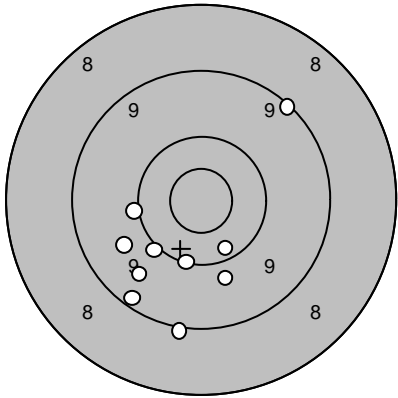
Skjutlag	Tavla	Magnus Lindkvist	
1	12		
Ramselefors	Umeå		
2005-07-09	Tavelträffen A 2005	Ramselefors Skytteförening	
Prov 	1: 9,0 ↖	Serie 1 	1: 10,6* ↗
	2: 10,5* ↗		2: 9,7 ↖
	3: 10,1 ↖		3: 9,7 ↖
	4: 9,9 ↖		4: 9,0 ↗
	5: 9,2 →		5: 10,6* ↖
	Serie 48,7		Serie 49,6
	Totalt 0,0		Totalt 49,6
Serie 2 	1: 9,3 ↗	Serie 3 	1: 9,5 ↗
	2: 8,9 ↖		2: 10,6* ↗
	3: 10,4 ↖		3: 10,4 ↘
	4: 10,1 ↗		4: 10,5* ↘
	5: 10,3 ↖		5: 9,4 →
	Serie 49,0		Serie 50,4
	Totalt 98,6		Totalt 149,0
Extratävling 	1: 9,1 ↗		
	2: 10,1 ↓		
	3: 9,0 ↓		
	4: 9,2 ↓		
	5: 10,0 ↓		
	6: 9,7 ↖		
	7: 9,6 ↖		
	8: 9,8 ↓		
	9: 10,0 ↖		
	10: 10,3 ↓		
	Serie 96,8		
	Totalt 245,8		

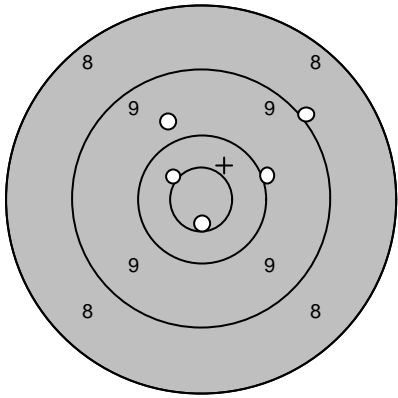
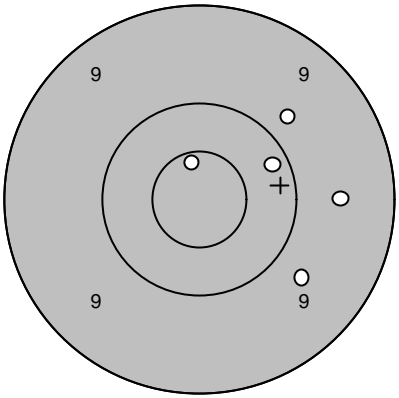
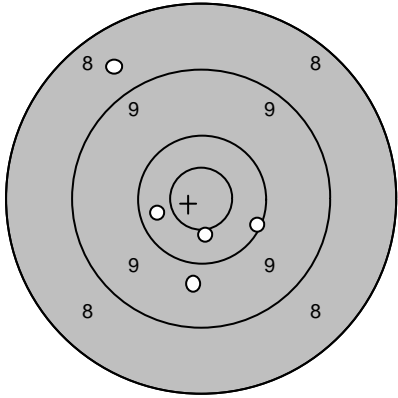
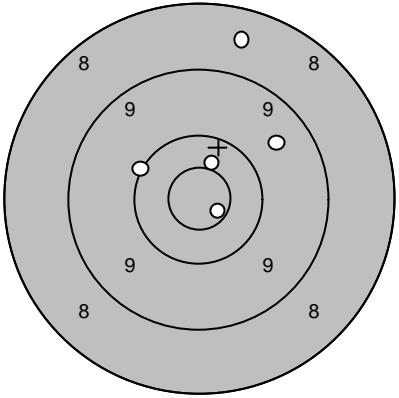
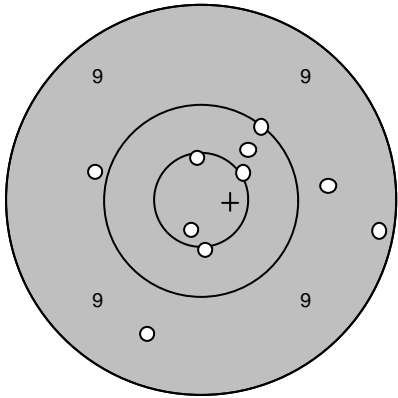
Skjutlag 1	Tavla 15	Gustav Lövgren	
Ramselefors		Niemisel	
2005-07-09		Tavelträffen A 2005	Ramselefors Skytteförening
Prov		1: 9,0 ↗ 2: 9,8 ↗ 3: 10,5* ↖ 4: 10,7* ↓ 5: 10,0 →	Serie 1  1: 9,8 ↗ 2: 9,7 ↘ 3: 9,6 → 4: 10,2 ↗ 5: 10,7* ↑
		Serie 50,0	Serie 50,0
		Totalt 0,0	Totalt 50,0
Serie 2		1: 8,7 ↖ 2: 9,8 ↓ 3: 10,1 → 4: 10,4 ← 5: 10,5* ↓	Serie 3  1: 10,5* ↑ 2: 9,6 ↗ 3: 10,7* ↘ 4: 8,6 ↑ 5: 10,1 ↖
		Serie 49,5	Serie 49,5
		Totalt 99,5	Totalt 149,0
Extratävling		1: 10,7* ↓ 2: 9,2 → 3: 10,3 ↗ 4: 10,6* ↑ 5: 10,1 ↗ 6: 9,7 → 7: 9,9 ← 8: 10,5* ↗ 9: 10,5* ↓ 10: 9,6 ↓	
		Serie 101,1	
		Totalt 250,1	

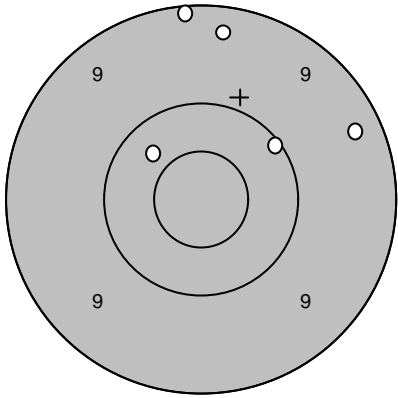
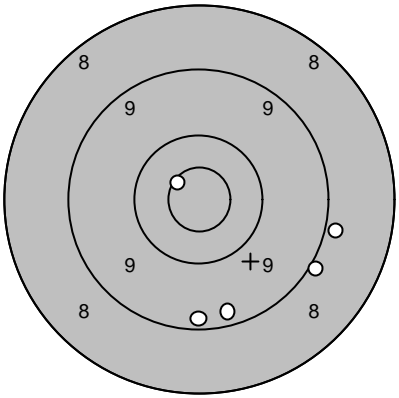
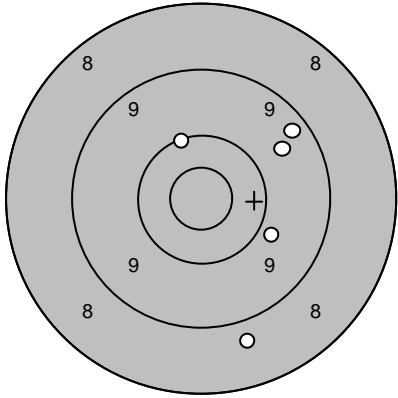
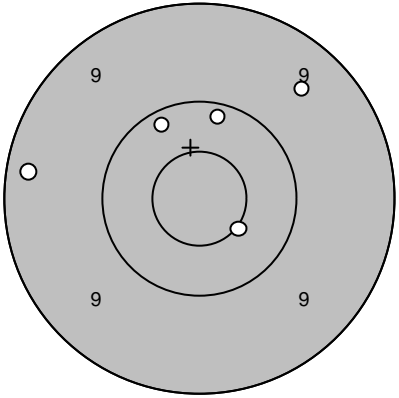
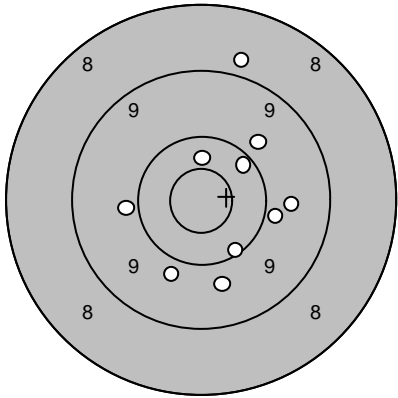
Skjutlag 1	Tavla 22	Lennart Jacobsson	
Ramselefors	Ramselefors		
2005-07-09	Tavelträffen A 2005	Ramselefors Skytteförening	
Prov		1: 9,1 ↑ 2: 10,4 ↖ 3: 9,3 ↑ 4: 9,3 → 5: 10,1 ↗ Serie 48,2 Totalt 0,0	Serie 1 
			1: 10,7* ↖ 2: 9,2 ↓ 3: 9,3 ↓ 4: 8,9 ↘ 5: 9,0 ↘ Serie 47,1 Totalt 47,1
Serie 2		1: 8,8 ↓ 2: 9,9 → 3: 9,6 ↗ 4: 10,1 ↑ 5: 9,3 ↗ Serie 47,7 Totalt 94,8	Serie 3 
			1: 9,3 ← 2: 10,5* ↘ 3: 10,2 ↑ 4: 10,2 ↑ 5: 9,5 ↗ Serie 49,7 Totalt 144,5
Extratävling		1: 9,7 → 2: 8,8 ↑ 3: 9,8 ↗ 4: 10,2 ↓ 5: 9,8 ↓ 6: 9,9 → 7: 9,9 ← 8: 10,2 ↗ 9: 10,4 ↑ 10: 9,7 ↓ Serie 98,4 Totalt 242,9	

Skjutlag	Tavla	<h1>Anders Carlqvist</h1>
1	23	

Ramselefors	Skyllberg		
-------------	-----------	--	--

2005-07-09	Tavelträffen A 2005	Ramselefors Skytteförening
------------	---------------------	----------------------------

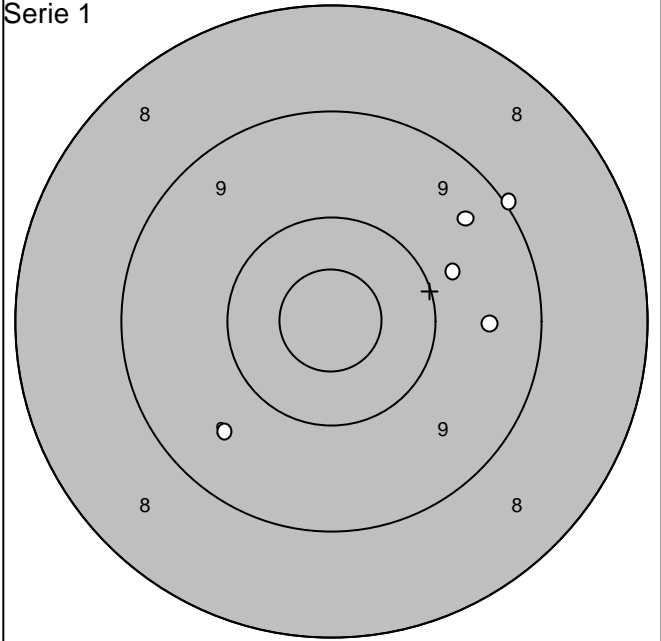
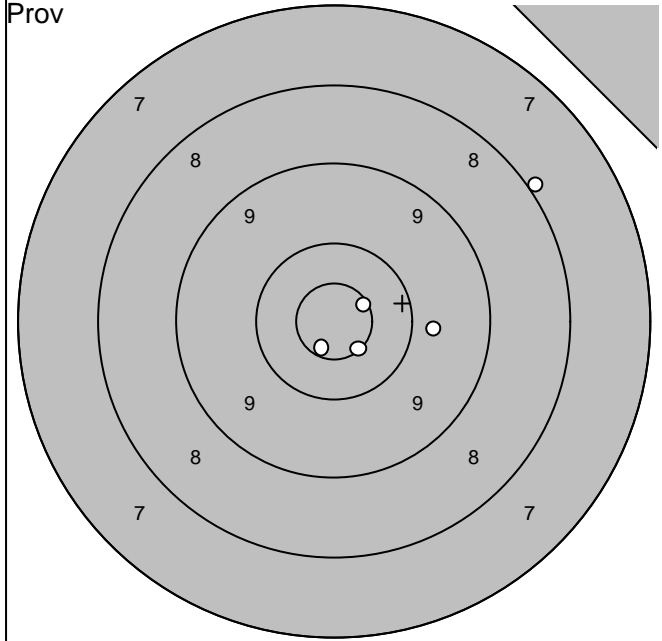

1: 8,0 ↗	Serie	49,7
2: 9,8 →		
3: 10,6* ↘	Totalt	0,0
4: 10,6* ↗		
5: 10,7* ↘		

1: 9,0 ↗	Serie	47,3
2: 9,4 ↗		
3: 9,5 →	Totalt	47,3
4: 9,8 ↗		
5: 9,6 ↙		

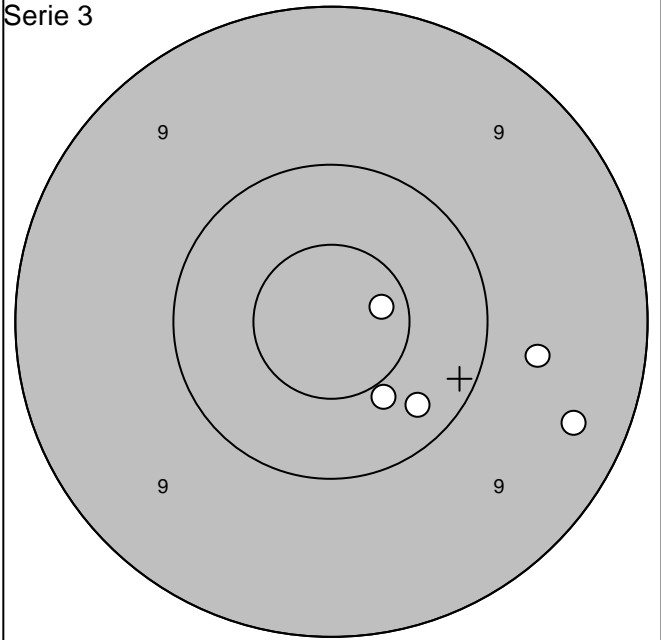
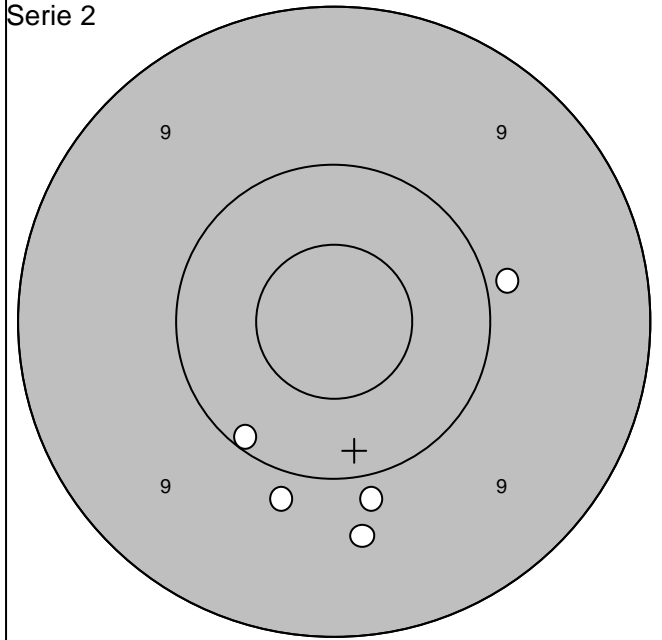

1: 9,9 →	Serie	49,5
2: 10,1 ↘		
3: 9,9 ↘	Totalt	96,8
4: 9,7 ↘		
5: 9,9 ↘		

1: 9,7 →	Serie	50,5
2: 10,7* →		
3: 10,4 ↘	Totalt	147,3
4: 9,4 →		
5: 10,3 ↘		

www.AC-Skytte.com

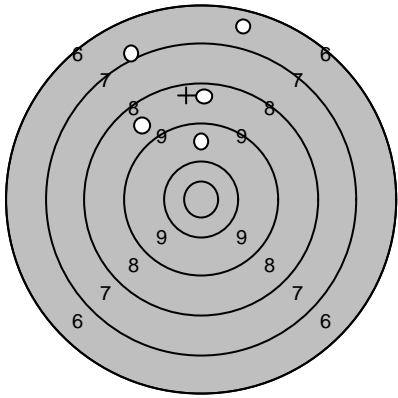
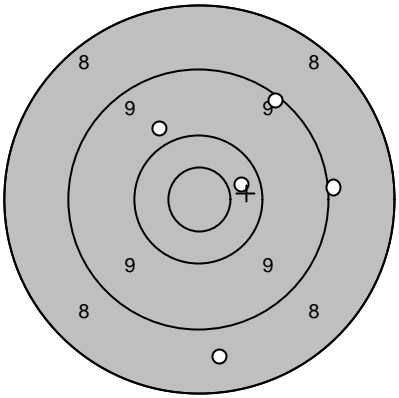
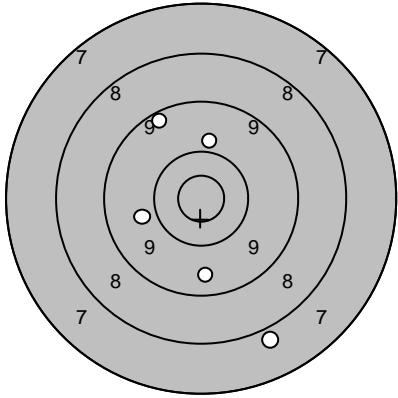
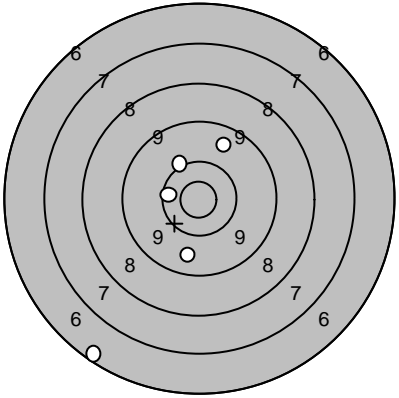
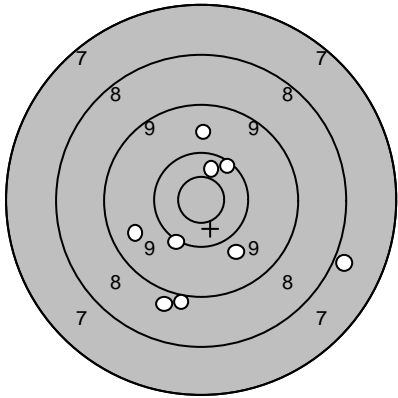
Skjutlag	Tavla	Hampus Stenlund		
1	24			
Ramselefors	A 4			
2005-07-09	Tavelträffen A 2005	Ramselefors Skytteförening		
Prov		1: 8,8 ↖ 2: 9,7 ↑ 3: 8,5 ↑ 4: 6,6 ↑ 5: 7,0 ↖	Serie 1 	1: 8,7 ↓ 2: 9,0 → 3: 9,2 ↗ 4: 10,4 → 5: 9,8 ↖
		Serie 40,6	Serie 47,1	
		Totalt 0,0	Totalt 47,1	
Serie 2		1: 9,3 ↖ 2: 9,9 ↑ 3: 7,9 ↓ 4: 9,5 ↓ 5: 9,9 ←	Serie 3 	1: 10,1 ↖ 2: 9,7 ↓ 3: 6,4 ↙ 4: 9,7 ↗ 5: 10,4 ←
		Serie 46,5	Serie 46,3	
		Totalt 93,6	Totalt 139,9	
Extratävling		1: 10,2 ↗ 2: 9,8 ↓ 3: 8,9 ↓ 4: 9,6 ← 5: 7,9 → 6: 9,0 ↓ 7: 10,1 ↙ 8: 9,7 ↑ 9: 10,4 ↗		
		Serie 85,6		
		Totalt 225,5		

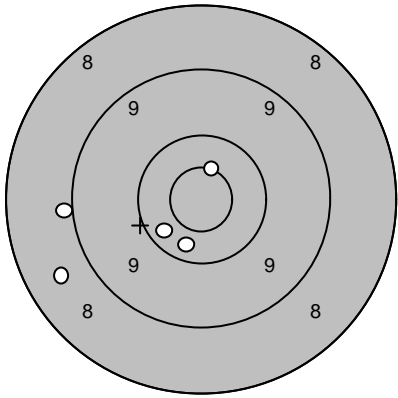
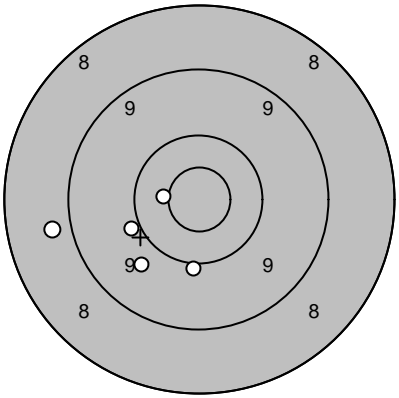
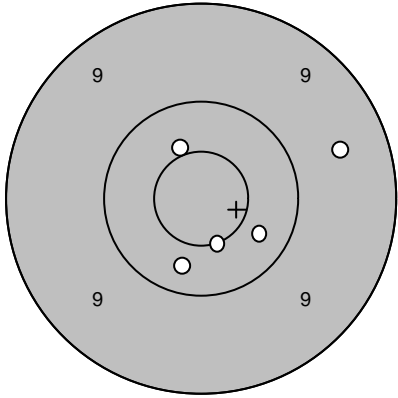
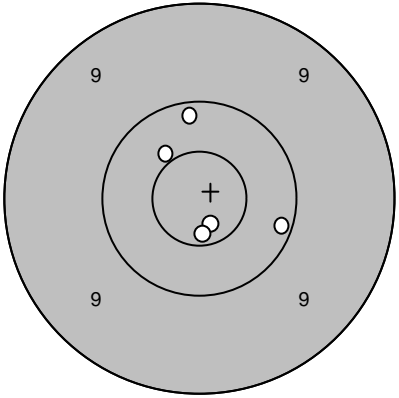
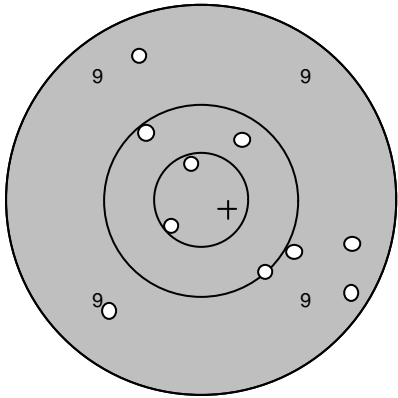
Skjutlag 2	Tavla 1	Fredrik Ågren	
Ramselefors		I 19	
2005-07-09		Tavelträffen A 2005	Ramselefors Skytteförening
Prov		1: 9,0 ← 2: 8,6 ← 3: 10,3 ← 4: 10,3 ↓ 5: 10,6* ↑	Serie 1 
		Serie 47,0 Totalt 0,0	1: 9,9 ← 2: 10,0 ↓ 3: 8,8 ← 4: 10,5* ← 5: 9,7 ↓
			Serie 46,0 Totalt 46,0
Serie 2		1: 10,5* ↑ 2: 10,5* ↓ 3: 10,3 → 4: 9,5 → 5: 10,3 ↓	Serie 3 
		Serie 49,0 Totalt 95,0	1: 10,5* ↗ 2: 10,8* ↓ 3: 10,2 ↑ 4: 10,7* ↓ 5: 10,1 →
			Serie 50,0 Totalt 145,0
Extratävling		1: 9,4 ↑ 2: 10,1 ↓ 3: 10,6* ↑ 4: 9,2 ↓ 5: 9,4 → 6: 9,6 ↓ 7: 10,2 ↑ 8: 10,6* ← 9: 10,3 ↑ 10: 9,9 ↓	
		Serie 95,0 Totalt 240,0	

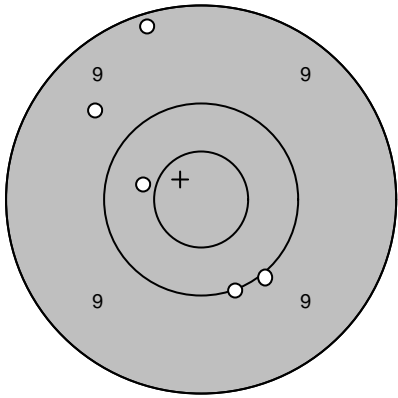
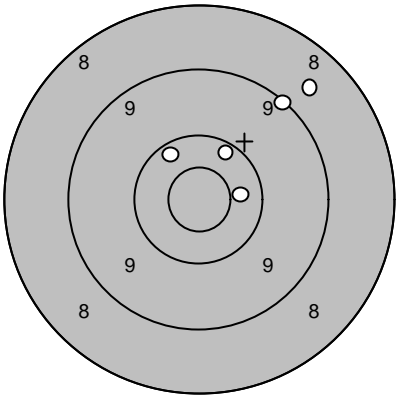
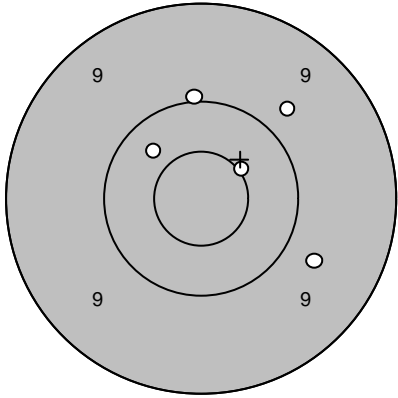
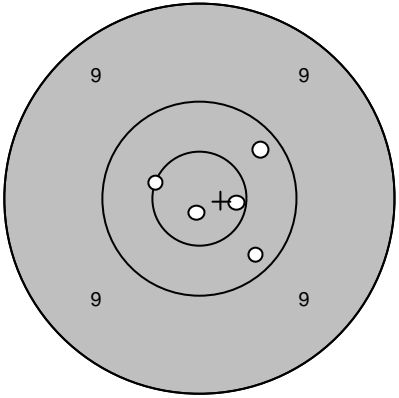
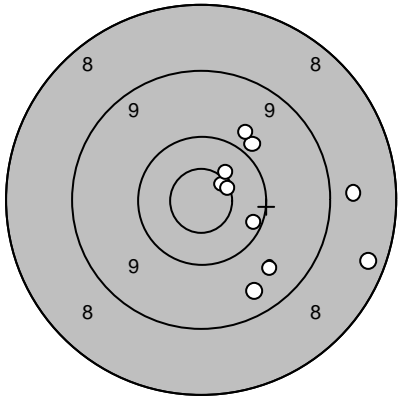
Skjutlag 2	Tavla 2	Anton Lindfors		
Ramselefors	I 19			
2005-07-09	Tavelträffen A 2005	Ramselefors Skytteförening		
Prov		1: 10,0 ↘ 2: 10,0 ↓ 3: 9,2 ↗ 4: 10,4 ← 5: 9,6 ↗	Serie 1 	1: 10,4 → 2: 10,3 ↗ 3: 10,3 ↖ 4: 9,1 ↗ 5: 8,7 ↗
	Serie 48,0		Serie 47,0	
	Totalt 0,0		Totalt 47,0	
Serie 2		1: 10,0 ↑ 2: 9,7 → 3: 10,5* ↗ 4: 9,8 ↗ 5: 10,3 ↖	Serie 3 	1: 10,6* ← 2: 10,7* → 3: 10,2 ↓ 4: 10,2 ↗ 5: 10,9* ↓
	Serie 48,0		Serie 50,0	
	Totalt 95,0		Totalt 145,0	
Extratävling		1: 9,9 ↗ 2: 10,7* ↗ 3: 9,6 ↓ 4: 9,5 ↓ 5: 10,2 → 6: 10,5* ↗ 7: 8,7 → 8: 9,8 ↗ 9: 8,3 → 10: 10,6* ↗		
	Serie 92,0			
	Totalt 237,0			

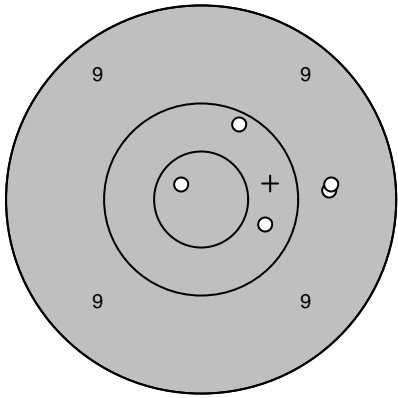
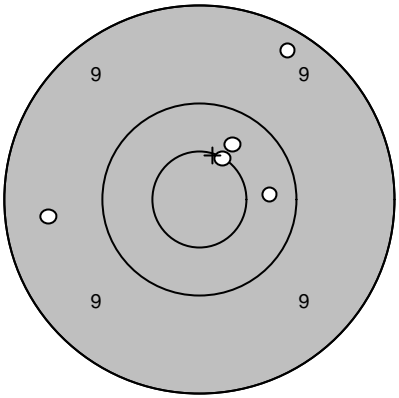
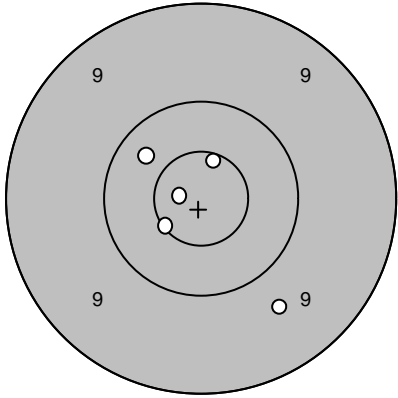
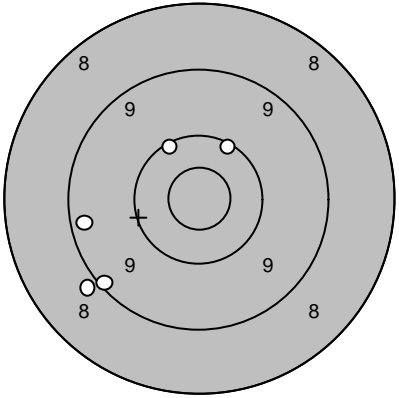
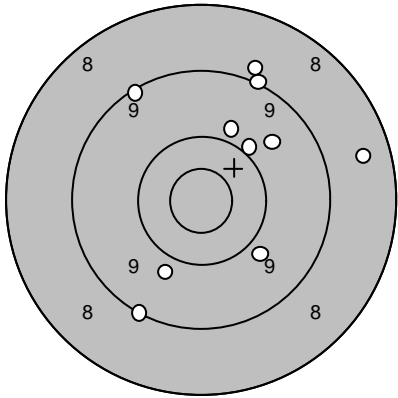
Skjutlag 2	Tavla 3	Patrik Lindfors			
Ramselefors	I 19				
2005-07-09	Tavelträffen A 2005	Ramselefors Skytteförening			
Prov		1: 9,7 → 2: 9,7 → 3: 10,3 → 4: 10,2 ↗ 5: 10,8* ↖	Serie 1		1: 9,3 ↗ 2: 10,4 ↗ 3: 10,6* ↗ 4: 10,3 → 5: 9,5 ←
		Serie 48,0		Serie 48,0	
		Totalt 0,0		Totalt 48,0	
Serie 2		1: 10,8* ← 2: 9,7 ↓ 3: 10,6* ← 4: 10,3 ↖ 5: 10,6* ↗	Serie 3		1: 9,3 ← 2: 10,2 ↗ 3: 10,2 ↗ 4: 8,9 ↙ 5: 9,1 ↙
		Serie 49,0		Serie 46,0	
		Totalt 97,0		Totalt 143,0	
Extratävling		1: 9,9 ↗ 2: 9,7 ↗ 3: 9,1 ↗ 4: 8,9 ↗ 5: 10,0 ↗ 6: 9,2 ↖ 7: 9,9 ↘ 8: 9,9 ↓ 9: 9,1 ↓ 10: 8,5 →			
		Serie 89,0			
		Totalt 232,0			

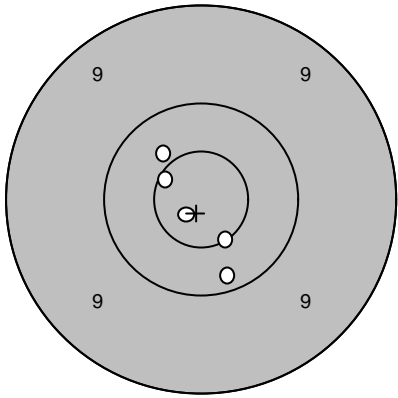
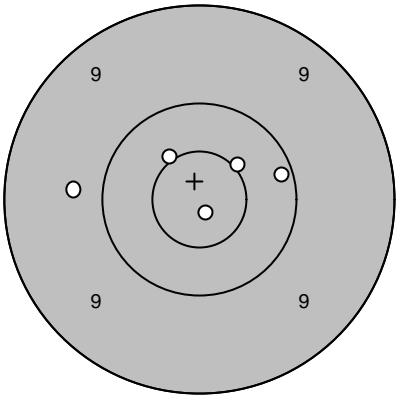
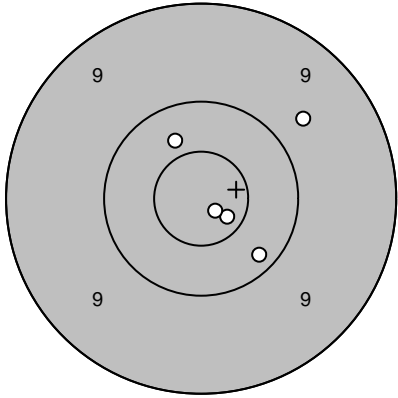
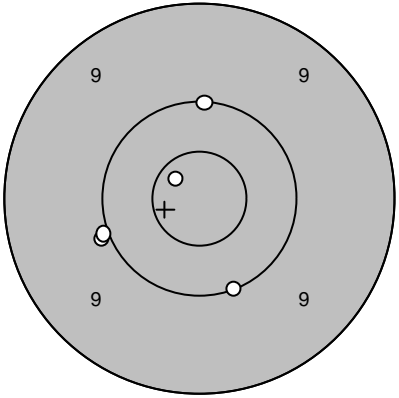
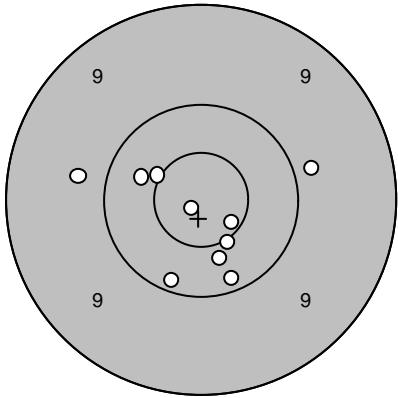
Skjutlag 2	Tavla 4	Jane Jönsson		
Ramselefors		Skurup		
2005-07-09		Tavelträffen A 2005		Ramselefors Skytteförening
Prov 	1: 10,4 ↖	Serie 1 	1: 10,2 →	
	2: 10,6* ↖		2: 10,5* ↖	
	3: 10,2 ↓		3: 9,8 ←	
	4: 10,8* ↙		4: 10,9* ↓	
	5: 10,6* ↓		5: 10,5* ↗	
	Serie 50,0		Serie 49,0	
	Totalt 0,0		Totalt 49,0	
Serie 2 	1: 10,4 ↖	Serie 3 	1: 10,0 ←	
	2: 10,7* ↘		2: 10,1 ↓	
	3: 9,7 ↗		3: 10,0 ←	
	4: 10,2 ↓		4: 10,1 ↑	
	5: 10,8* ↓		5: 10,7* ↖	
	Serie 49,0		Serie 50,0	
	Totalt 98,0		Totalt 148,0	
Extratävling 	1: 10,4 ←			
	2: 10,7* ↓			
	3: 9,9 →			
	4: 10,5* ↖			
	5: 10,2 ↓			
	6: 9,8 ←			
	7: 10,9* ↙			
	8: 10,4 ↓			
	9: 10,5* ↓			
	10: 10,2 ↓			
	Serie 98,0			
	Totalt 246,0			

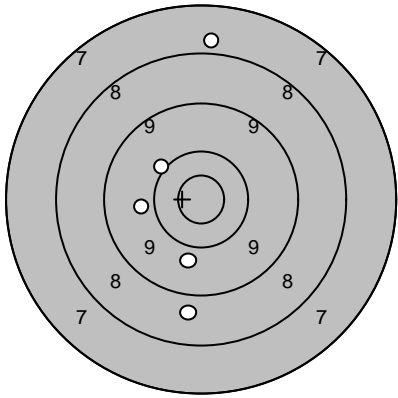
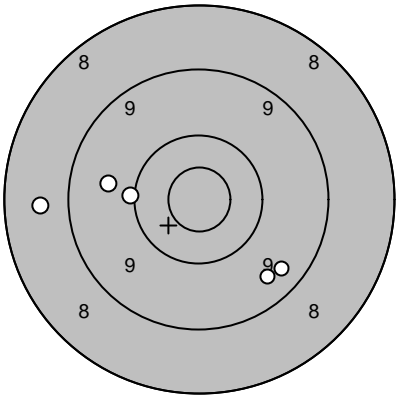
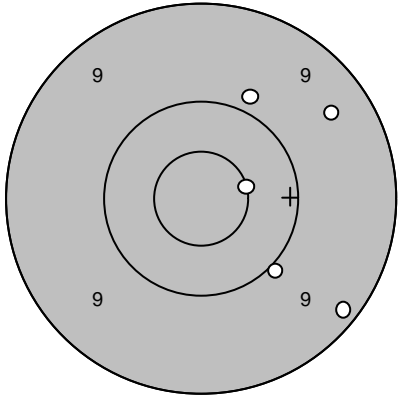
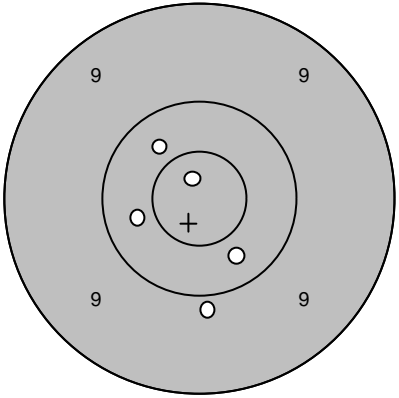
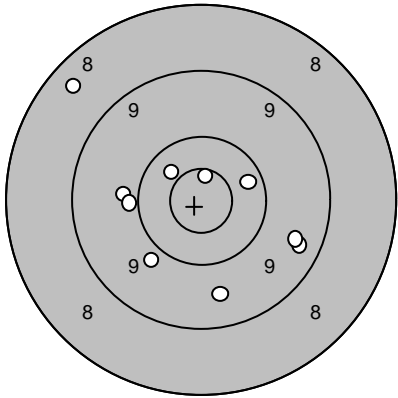
Skjutlag 2	Tavla 5	Liselott Danielsson	
Ramselefors		Värnamo	
2005-07-09		Tavelträffen A 2005	Ramselefors Skytteförening
Prov		1: 7,9 ↑ 2: 9,9 ← 3: 10,1 ↖ 4: 8,8 ↓ 5: 9,8 ↓	Serie 1 
		Serie 43,0 Totalt 0,0	1: 10,0 ← 2: 8,7 ← 3: 9,7 ← 4: 9,5 ↓ 5: 9,4 ↓
			Serie 45,0 Totalt 45,0
Serie 2		1: 10,6* → 2: 9,4 ↗ 3: 9,2 ↘ 4: 9,9 ↑ 5: 10,0 ↓	Serie 3 
		Serie 47,0 Totalt 92,0	1: 10,3 ↓ 2: 10,8* ↑ 3: 9,9 ↓ 4: 10,4 ↗ 5: 10,4 ←
			Serie 49,0 Totalt 141,0
Extratävling		1: 9,6 ↓ 2: 9,4 → 3: 10,5* ↖ 4: 10,3 ↗ 5: 9,5 → 6: 9,9 ↓ 7: 10,7* ↑ 8: 8,4 ↗ 9: 9,9 ← 10: 10,0 ←	
		Serie 93,0 Totalt 234,0	

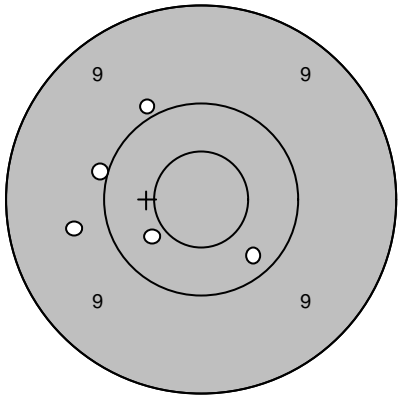
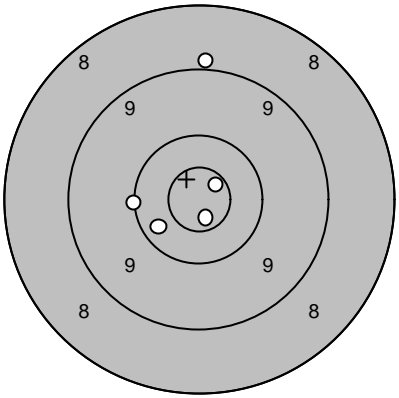
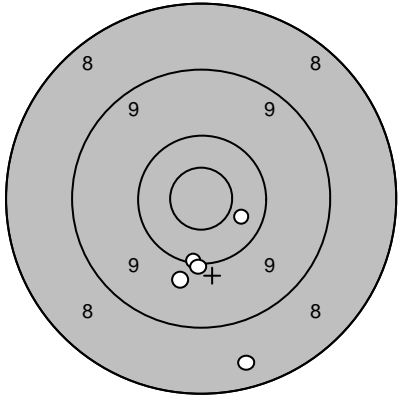
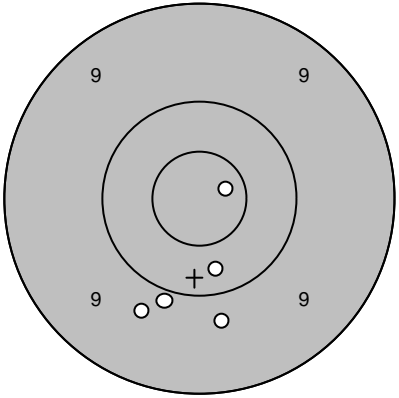
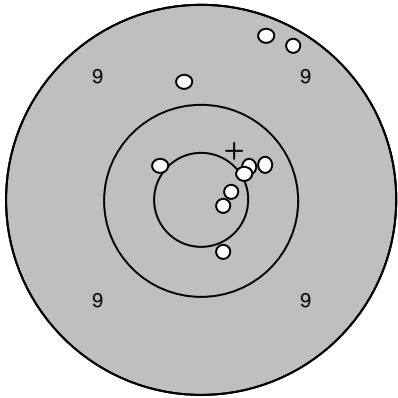
Skjutlag 2	Tavla 6	Helena Jansson		
Ramselefors	Söderala			
2005-07-09	Tavelträffen A 2005	Ramselefors Skytteförening		
Prov		1: 9,9 ↗ 2: 10,0 ← 3: 10,3 ↓ 4: 10,4 ↙ 5: 9,7 ←	Serie 1 	1: 10,7* ↗ 2: 10,3 ↙ 3: 10,1 ← 4: 10,8* ↓ 5: 9,0 ↑
	Serie 48,0		Serie 49,0	
	Totalt 0,0		Totalt 49,0	
Serie 2		1: 10,4 → 2: 9,8 ↓ 3: 10,1 ↓ 4: 8,5 ↓ 5: 10,0 ↓	Serie 3 	1: 10,3 ↓ 2: 9,9 ↓ 3: 9,8 ↓ 4: 9,7 ↙ 5: 10,7* →
	Serie 47,0		Serie 47,0	
	Totalt 96,0		Totalt 143,0	
Extratävling		1: 9,2 ↗ 2: 10,4 ↗ 3: 10,5* ↙ 4: 10,5* ↗ 5: 9,8 ↑ 6: 10,5* ↓ 7: 10,8* → 8: 9,2 ↑ 9: 10,7* → 10: 10,3 ↗		
	Serie 97,0			
	Totalt 240,0			

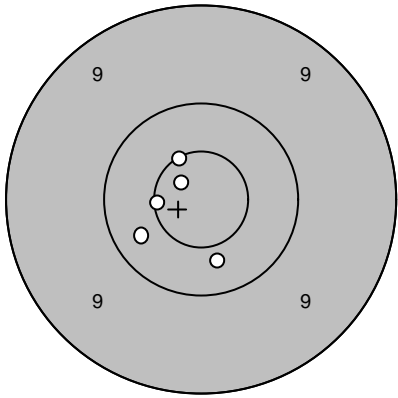
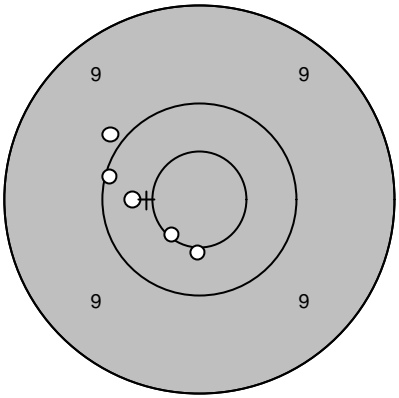
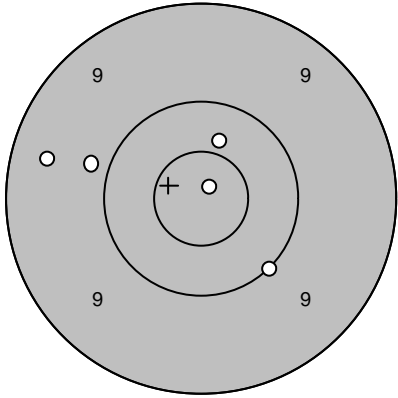
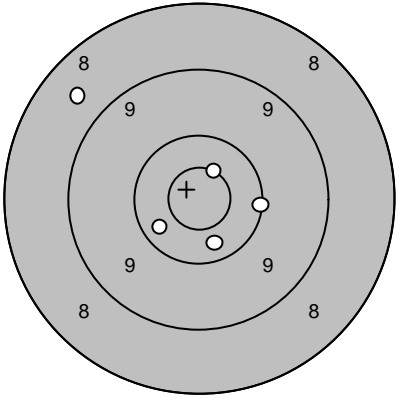
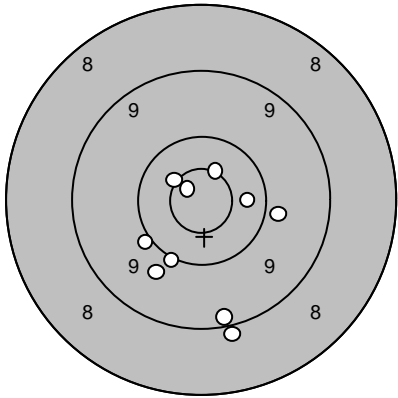
Skjutlag 2	Tavla 7	Peter Lavér	
Ramselefors		Söderala	
2005-07-09		Tavelträffen A 2005	Ramselefors Skytteförening
Prov		1: 10,3 ↙ 2: 10,4 ↓ 3: 10,8* ↖ 4: 10,6* ↗ 5: 10,6* ←	Serie 1 
		Serie 50,0 Totalt 0,0	1: 10,4 ← 2: 9,9 ↖ 3: 10,1 ← 4: 10,5* ↓ 5: 10,6* ↙
			Serie 49,0 Totalt 49,0
Serie 2		1: 10,0 ↘ 2: 9,4 ← 3: 10,4 ↗ 4: 10,9* ↗ 5: 9,9 ←	Serie 3 
		Serie 48,0 Totalt 97,0	1: 8,6 ↖ 2: 10,4 ↓ 3: 10,1 → 4: 10,3 ↙ 5: 10,6* ↗
			Serie 48,0 Totalt 145,0
Extratävling		1: 9,8 ↙ 2: 9,0 ↓ 3: 10,8* ↖ 4: 9,9 → 5: 10,6* ↗ 6: 10,6* ↖ 7: 10,4 → 8: 10,1 ↓ 9: 10,0 ← 10: 9,2 ↓	
		Serie 96,0 Totalt 241,0	

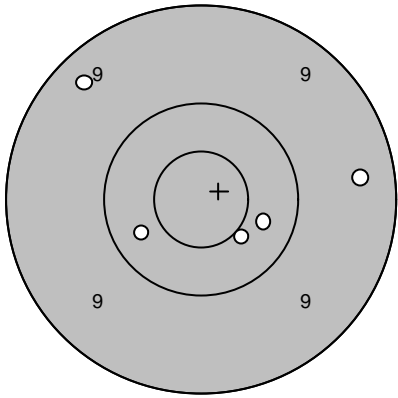
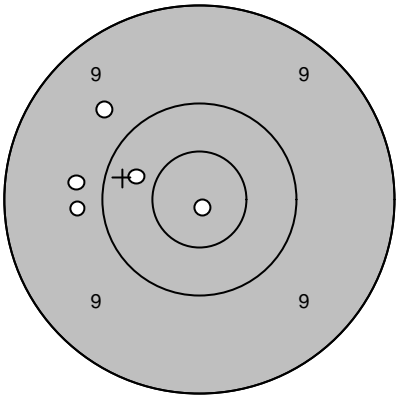
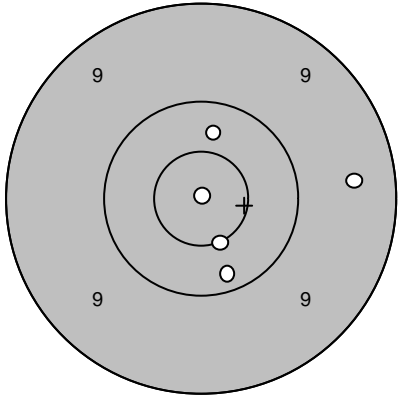
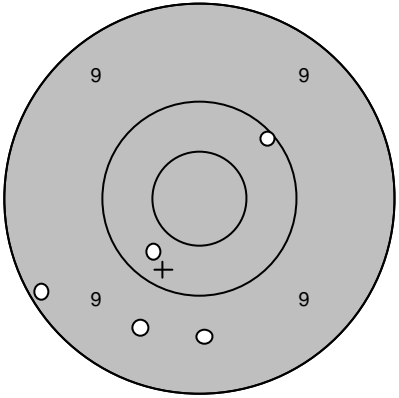
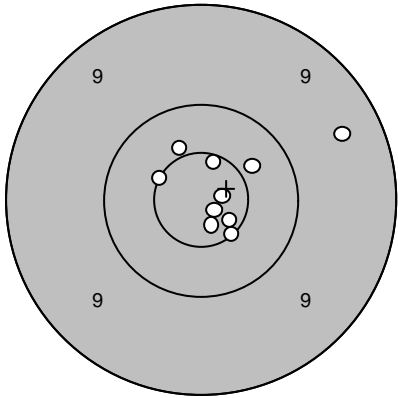
Skjutlag 2	Tavla 8	Urban Åberg		
Ramselefors		Madesjö-Nybro		
2005-07-09		Tavelträffen A 2005	Ramselefors Skytteförening	
Prov		1: 10,5* ↘ 2: 9,4 → 3: 10,4 → 4: 10,3 ← 5: 9,4 ↗	Serie 1 	1: 9,8 ← 2: 9,8 ← 3: 10,4 ← 4: 9,7 ↗ 5: 10,9* ↓
		Serie 48,0	Serie 47,0	
		Totalt 0,0	Totalt 47,0	
Serie 2		1: 10,2 ↓ 2: 9,5 → 3: 10,9* ↗ 4: 10,4 ↑ 5: 10,5* ↓	Serie 3 	1: 9,2 ← 2: 10,3 ↘ 3: 10,1 ↗ 4: 9,6 ↓ 5: 9,6 ↓
		Serie 49,0	Serie 47,0	
		Totalt 96,0	Totalt 143,0	
Extratävling		1: 10,6* ↗ 2: 10,8* → 3: 10,4 ↗ 4: 10,6* ↘ 5: 10,6* ← 6: 10,7* ↘ 7: 9,4 ↗ 8: 10,8* ↓ 9: 10,5* ↗ 10: 10,9* ↓		
		Serie 99,0		
		Totalt 242,0		

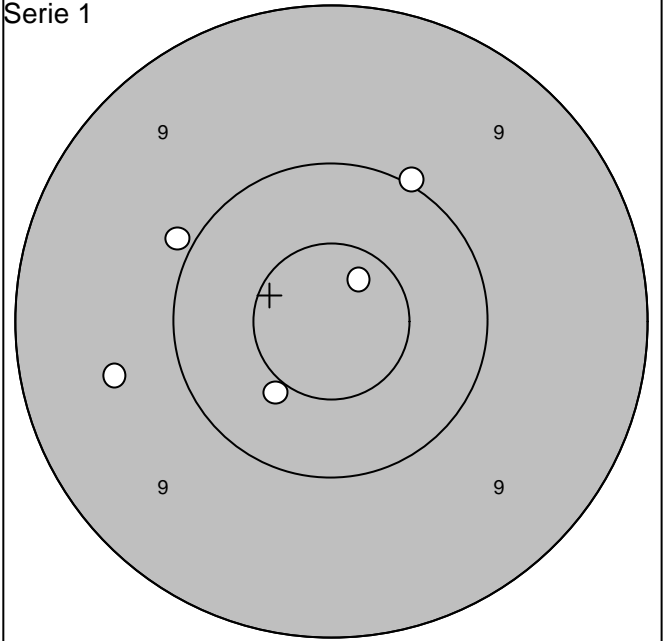
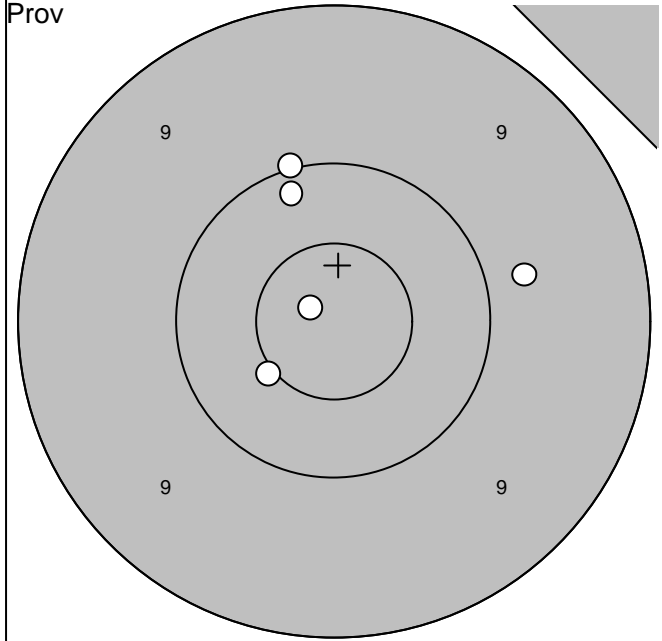

1:10,0 ↗		Serie	49,0
2:10,2 ↗		Totalt	0,0
3: 9,8 →			
4:10,5* ↙			
5:10,9* ↖			

1: 9,6 ↖		Serie	48,0
2:10,7* ↗		Totalt	48,0
3: 9,9 ↖			
4:10,0 ↗			
5:10,5* ↙			

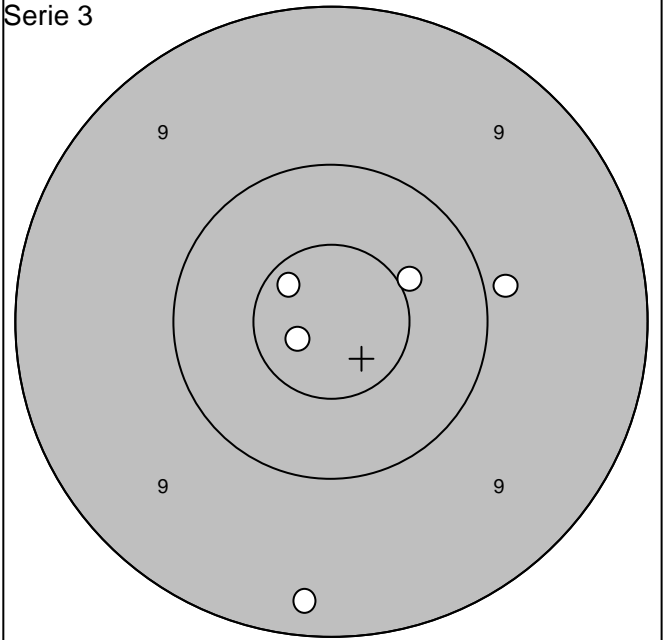
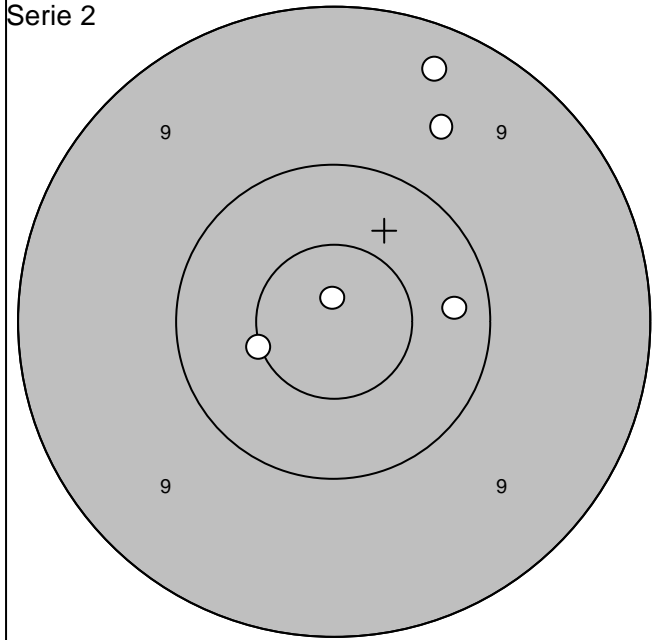

1: 9,3 ↗		Serie	48,0
2:10,3 →		Totalt	96,0
3:10,9* ↗			
4: 9,6 ↗			
5:10,5* ↖			

1:10,5* ↗		Serie	48,0
2: 9,3 ↓		Totalt	144,0
3:10,7* ↖			
4:10,8* ↖			
5: 9,9 →			

Skjutlag 2	Tavla 11	Stefan Håkansson	
Ramselefors		Östersund	
2005-07-09		Tavelträffen A 2005	Ramselefors Skytteförening
Prov		Serie 1 1: 10,9* ↓ 2: 9,8 ↗ 3: 10,4 ↓ 4: 10,7* ↓ 5: 10,3 ←	 1: 10,2 ← 2: 9,6 ← 3: 10,8* ↘ 4: 10,5* ← 5: 10,4 ↓
		Serie 49,0	Serie 49,0
		Totalt 0,0	Totalt 49,0
Serie 2		Serie 3 1: 10,7* ↓ 2: 10,3 → 3: 9,7 ↓ 4: 10,4 → 5: 10,1 ↘	 1: 10,8* ↑ 2: 10,5* ↑ 3: 10,1 ↖ 4: 10,6* ↓ 5: 10,3 ↗
		Serie 49,0	Serie 50,0
		Totalt 98,0	Totalt 148,0
Extratävling		1: 10,2 ↖ 2: 9,8 → 3: 10,9* ↑ 4: 10,2 ↖ 5: 9,4 ↓ 6: 10,0 ↓ 7: 10,5* → 8: 10,7* ↑ 9: 10,4 ↗ 10: 10,4 ↗	
		Serie 98,0	
		Totalt 246,0	

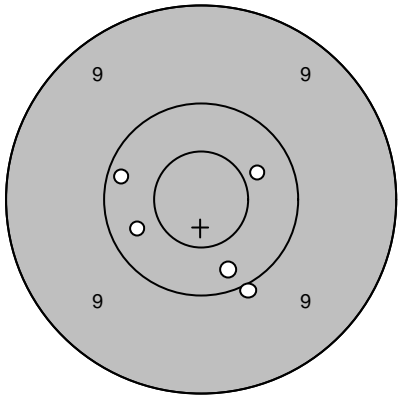
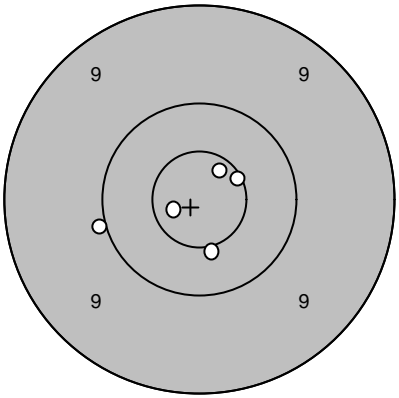
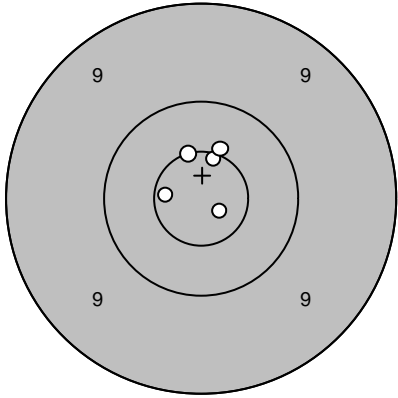
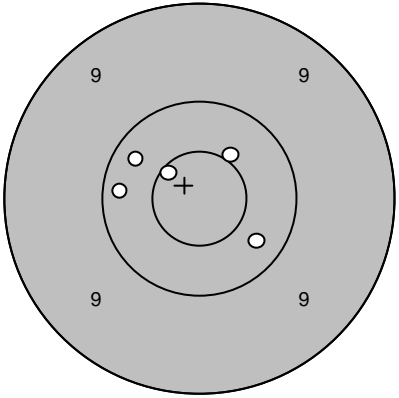
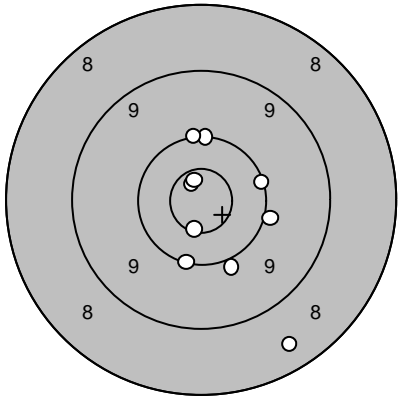
Skjutlag 2	Tavla 12	Maria Falck	
Ramselefors		Moälven-Modo	
2005-07-09		Tavelträffen A 2005	Ramselefors Skytteförening
Prov		1: 10,3 ← 2: 10,3 ↓ 3: 10,0 ↓ 4: 10,4 → 5: 10,2 ←	Serie 1 
		Serie 50,0 Totalt 0,0	1: 10,0 ← 2: 10,7* ↗ 3: 10,8* ← 4: 10,5* ↓ 5: 10,6* →
		Serie 50,0 Totalt 50,0	Serie 50,0 Totalt 50,0
Serie 2		1: 10,6* ↗ 2: 10,8* ↘ 3: 10,5* ↗ 4: 10,7* ← 5: 10,6* ↗	Serie 3 
		Serie 50,0 Totalt 100,0	1: 10,2 ← 2: 10,5* ↗ 3: 10,6* ↗ 4: 10,3 ↗ 5: 10,3 ↓
		Serie 50,0 Totalt 150,0	
Extratävling		1: 10,8* ↗ 2: 10,1 ↑ 3: 10,8* ↗ 4: 9,9 ↓ 5: 10,1 ↓ 6: 10,6* ↓ 7: 10,1 ↑ 8: 8,5 ↓ 9: 10,0 → 10: 10,1 →	
		Serie 97,0 Totalt 247,0	

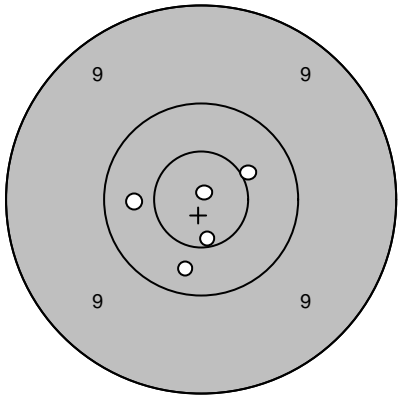
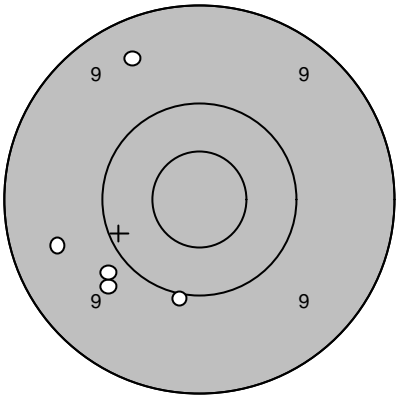
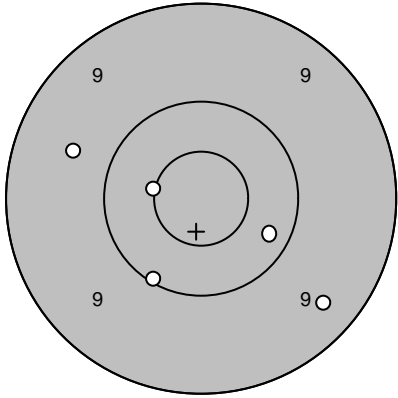
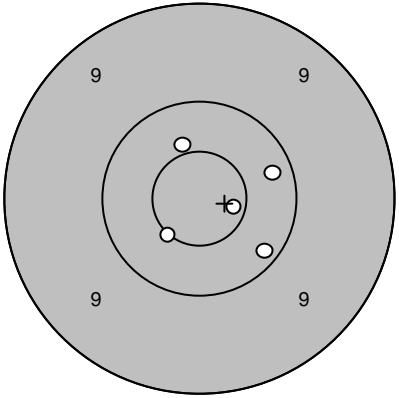
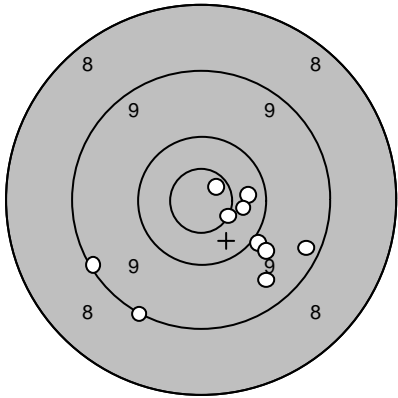
Skjutlag 2	Tavla 13	Linda Gustavsson	
Ramselefors		Moälven-Modo	
2005-07-09		Tavelträffen A 2005	Ramselefors Skytteförening
Prov		1: 10,6* ↓ 2: 10,5* ↗ 3: 10,4 ← 4: 10,3 ↓ 5: 10,9* ↗	Serie 1 
		Serie 50,0 Totalt 0,0	1: 9,7 ↙ 2: 9,5 ← 3: 9,5 ↗ 4: 10,0 ↓ 5: 9,8 ↙
			Serie 46,0 Totalt 46,0
Serie 2		1: 10,1 ↙ 2: 9,4 ↘ 3: 10,3 ↘ 4: 10,5* ← 5: 9,6 ↙	Serie 3 
		Serie 48,0 Totalt 94,0	1: 10,7* → 2: 10,2 → 3: 10,5* ↗ 4: 10,2 ↘ 5: 10,5* ↙
			Serie 50,0 Totalt 144,0
Extratävling		1: 10,6* → 2: 10,4 → 3: 10,0 ↘ 4: 9,1 ↙ 5: 9,1 ↙ 6: 10,8* ↗ 7: 9,3 → 8: 10,4 → 9: 9,8 ↘ 10: 9,5 ↘	
		Serie 95,0 Totalt 239,0	

Skjutlag	Tavla	Alf Edin	
2	17		

Ramselefors	Ale		
-------------	-----	--	--

2005-07-09	Tavelträffen A 2005	Ramselefors Skytteförening	
------------	---------------------	----------------------------	--

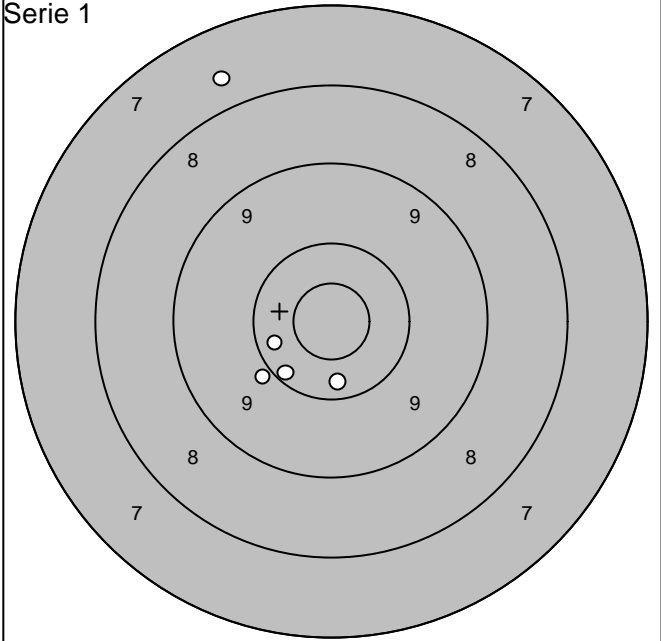
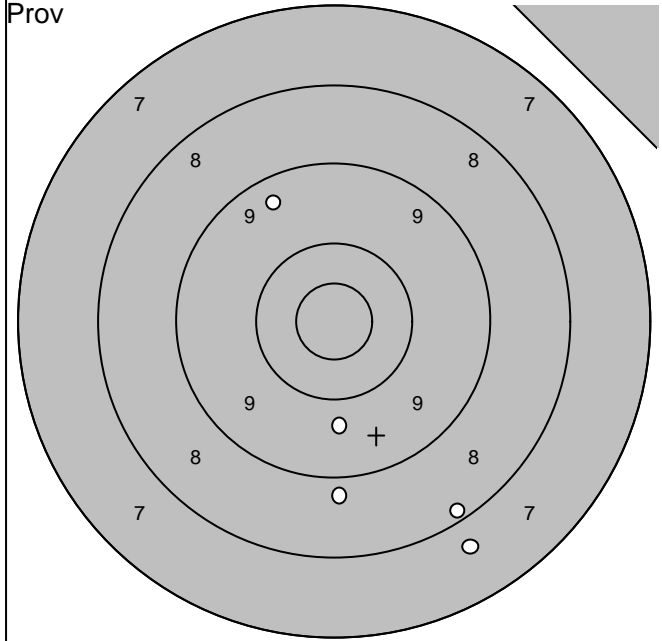

1: 7,7	↘
2: 8,8	↓
3: 9,4	↗
4: 9,7	↓
5: 8,2	↘

Serie	41,0
Totalt	0,0

1: 7,7	↖
2: 10,3	↓
3: 10,2	↙
4: 10,3	←
5: 9,9	↙

Serie	46,0
Totalt	46,0

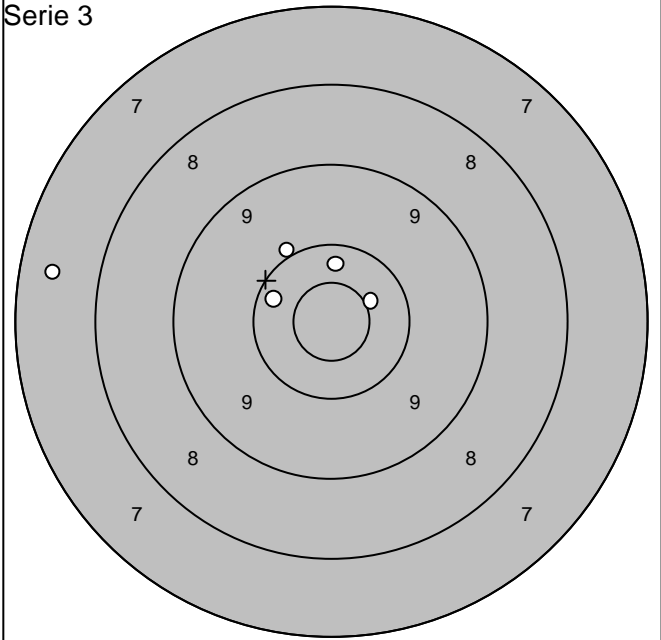
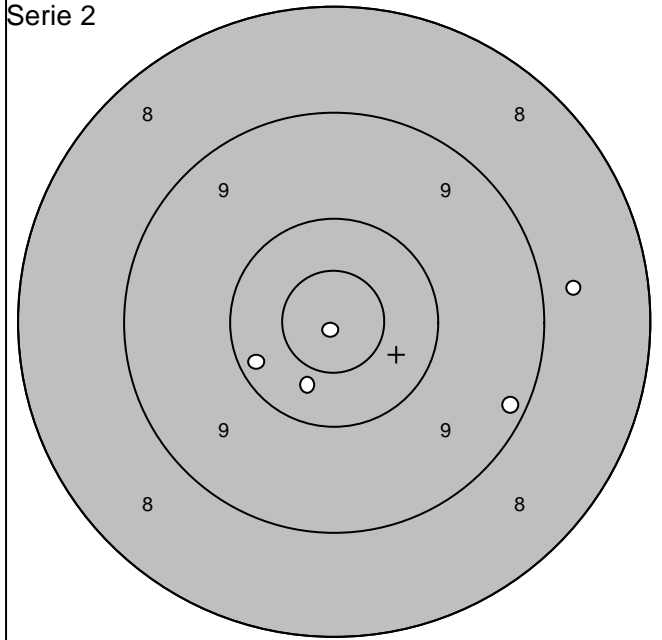

1: 10,4	↘
2: 8,7	→
3: 9,2	↘
4: 10,2	←
5: 10,9*	↘

Serie	47,0
Totalt	93,0

1: 7,5	←
2: 10,5*	↗
3: 10,3	←
4: 10,3	↑
5: 10,0	↖

Serie	47,0
Totalt	140,0

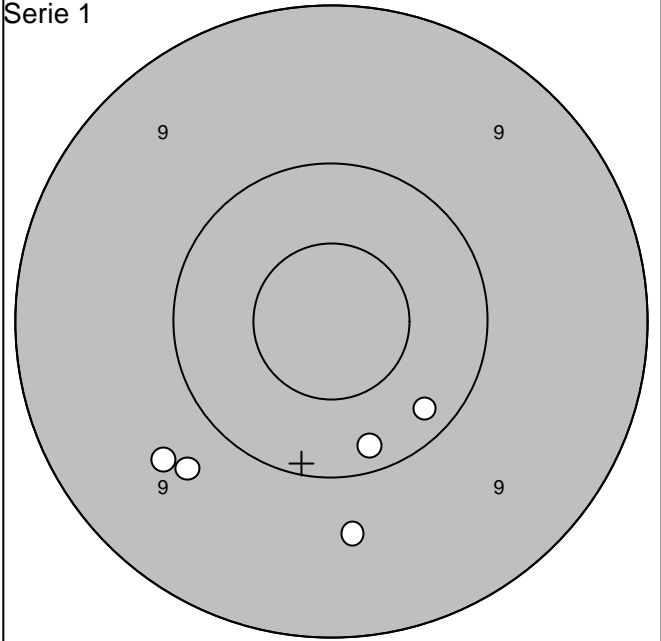
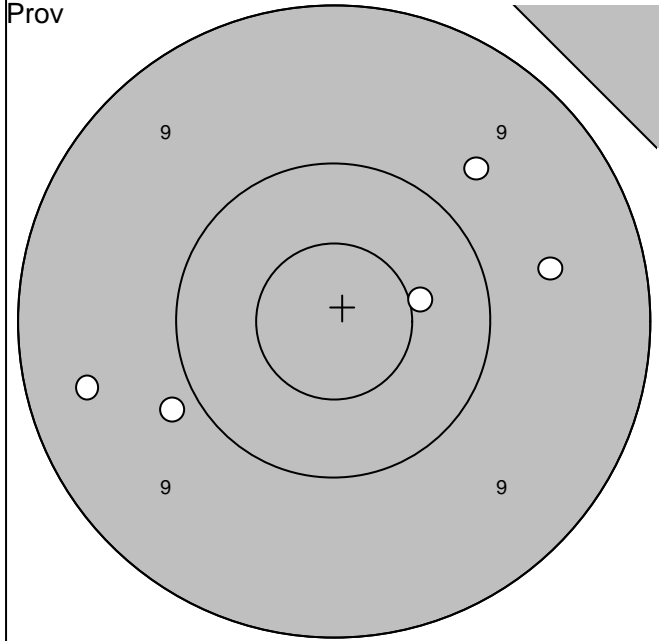

1: 9,7 ↗	Serie	46,0
2: 9,6 →		
3:10,5* →	Totalt	0,0
4: 9,4 ←		
5: 9,9 ↙		

1: 9,7 ↘	Serie	47,0
2: 9,7 ↙		
3:10,2 ↘	Totalt	47,0
4:10,2 ↓		
5: 9,7 ↓		

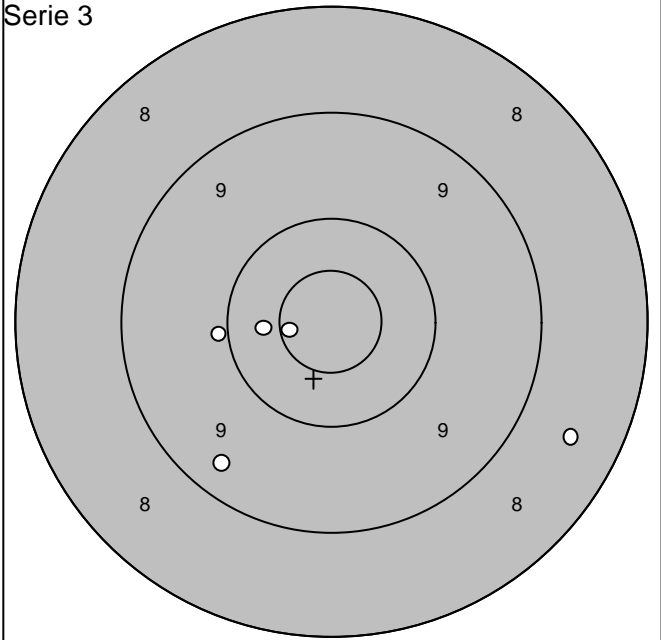
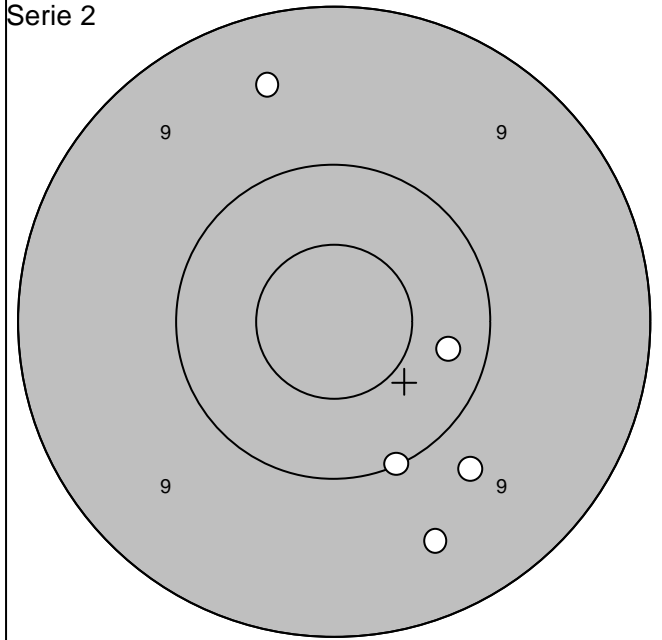

1: 9,5 ↑	Serie	47,0
2: 9,8 ↘		
3:10,3 →	Totalt	94,0
4:10,0 ↓		
5: 9,5 ↓		

1:10,4 ←	Serie	47,0
2:10,0 ←		
3:10,6* ←	Totalt	141,0
4: 9,3 ↙		
5: 8,5 ↘		

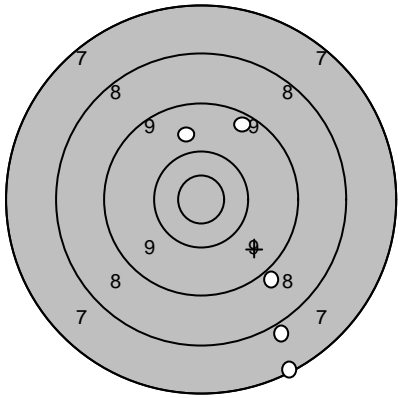
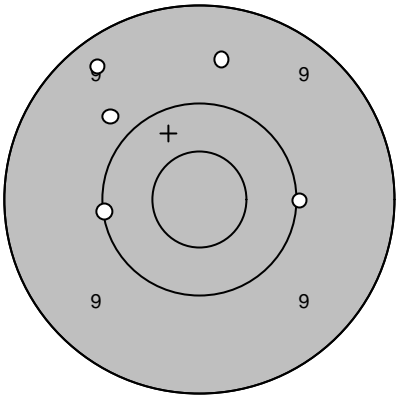
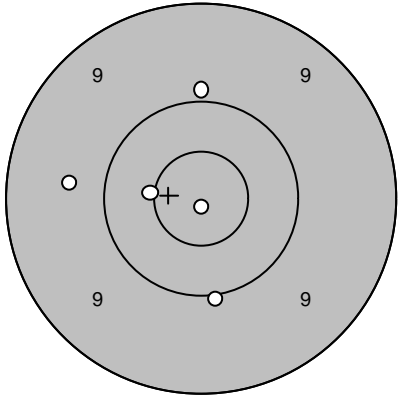
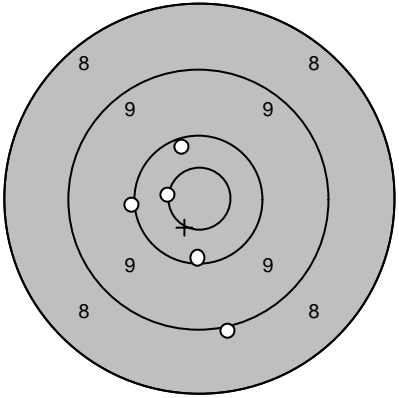
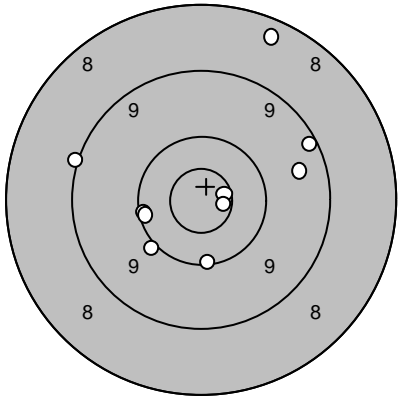
Skjutlag 2	Tavla 19	Rickard Edin	
Ramselefors		Ale	
2005-07-09		Tavelträffen A 2005	Ramselefors Skytteförening
Prov 	1: 7,9 ↘ 2: 7,2 ↘ 3: 8,9 ↘ 4: 9,8 ↑ 5: 9,4 ↗	Serie 1 	1: 10,1 ← 2: 9,3 ↗ 3: 9,8 ↗ 4: 9,6 ↑ 5: 10,0 →
	Serie 40,0		Serie 47,0
	Totalt 0,0		Totalt 47,0
Serie 2 	1: 9,9 ↑ 2: 10,5* ← 3: 9,7 ← 4: 10,0 ↓ 5: 10,9* ↓	Serie 3 	1: 10,2 ↗ 2: 10,2 ↓ 3: 10,6* ← 4: 9,0 ↓ 5: 10,0 ←
	Serie 48,0		Serie 49,0
	Totalt 95,0		Totalt 144,0
Extratävling 	1: 10,0 ↙ 2: 9,2 → 3: 10,2 ← 4: 10,2 ← 5: 9,1 ← 6: 10,7* → 7: 10,7* → 8: 10,1 ↓ 9: 9,5 → 10: 8,4 ↗		
	Serie 95,0		
	Totalt 239,0		

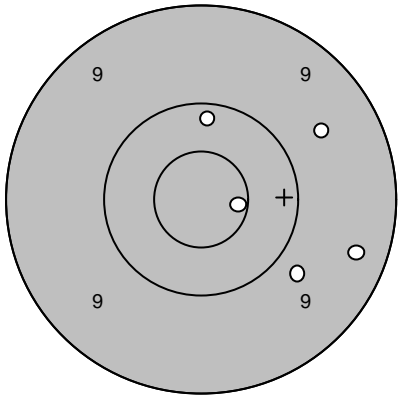
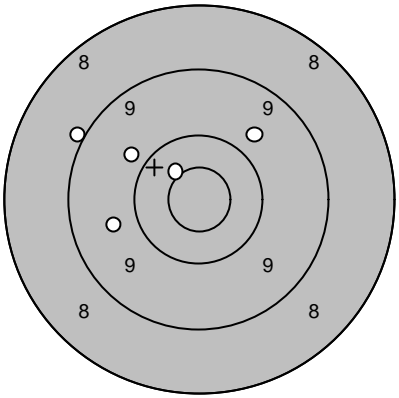
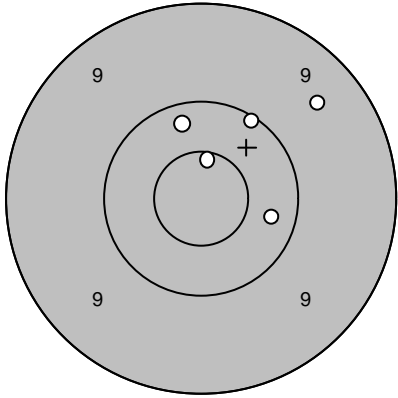
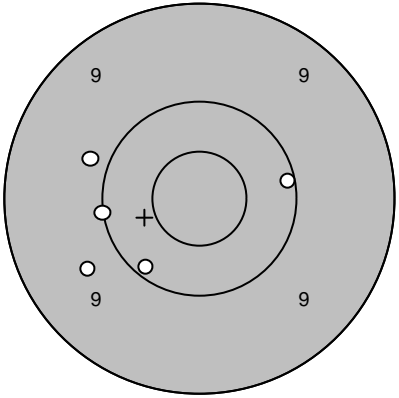
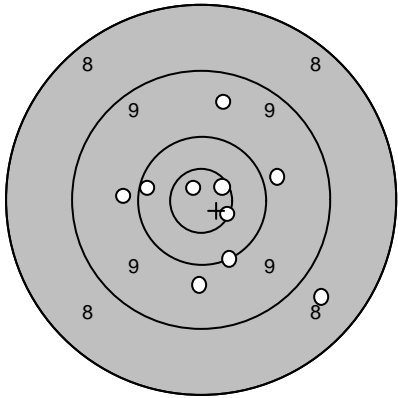
Skjutlag 2	Tavla 20	Krister Pettersson	
Ramselefors		Bastuträsk	
2005-07-09		Tavelträffen A 2005	Ramselefors Skytteförening
Prov		1: 9,4 → 2: 9,8 ↘ 3: 9,6 ↗ 4: 10,6* → 5: 10,2 ↑	Serie 1 
		Serie 47,0 Totalt 0,0	1: 9,7 ← 2: 9,8 ↖ 3: 9,8 ↗ 4: 9,0 ← 5: 10,5* ↗
			Serie 46,0 Totalt 46,0
Serie 2		1: 9,5 ↗ 2: 10,6* ↑ 3: 10,2 ↑ 4: 10,1 ↗ 5: 10,3 →	Serie 3 
		Serie 49,0 Totalt 95,0	1: 9,7 ← 2: 10,1 → 3: 9,9 ← 4: 10,0 ← 5: 10,2 ↘
			Serie 48,0 Totalt 143,0
Extratävling		1: 9,9 → 2: 10,6* → 3: 10,7* ↗ 4: 10,2 ← 5: 10,9* ↗ 6: 9,5 ↑ 7: 9,9 ← 8: 10,1 ↓ 9: 8,7 ↓ 10: 9,8 ↓	
		Serie 94,0 Totalt 237,0	

Skjutlag 2	Tavla 21	David Karlsson
----------------------	--------------------	-----------------------

Ramselefors	Bastuträsk	
-------------	------------	--

2005-07-09	Tavelträffen A 2005	Ramselefors Skytteförening
------------	---------------------	----------------------------

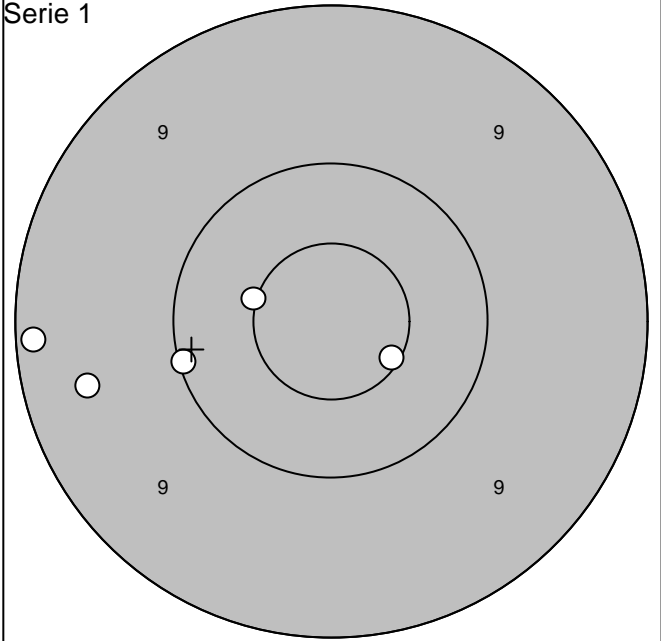
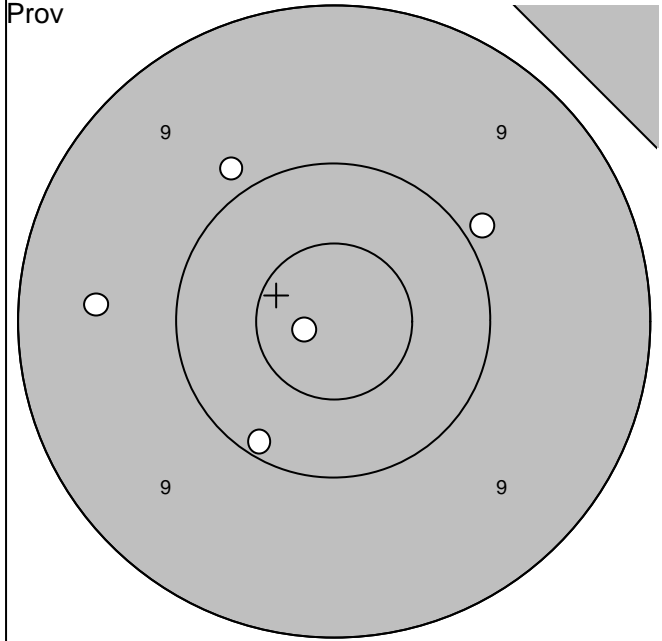

1: 9,9 ↗	Serie 47,0
2: 9,5 ←	
3: 9,9 ↘	Totalt 0,0
4: 10,1 ↘	
5: 10,8* ←	

1: 9,4 ←	Serie 48,0
2: 10,5* ←	
3: 9,2 ←	Totalt 48,0
4: 10,6* ↘	
5: 10,1 ←	

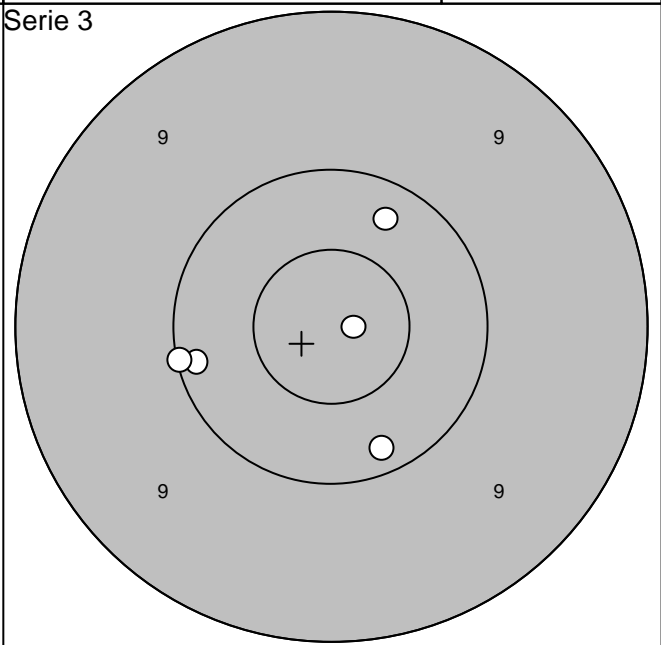
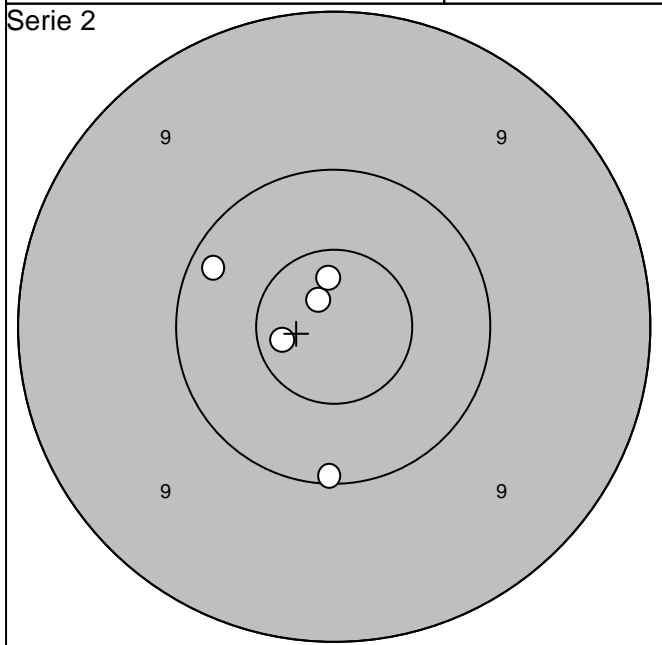

1: 10,8* ↗	Serie 50,0
2: 10,1 ↘	
3: 10,7* ←	Totalt 98,0
4: 10,7* ↑	
5: 10,2 ↖	

1: 10,2 ←	Serie 50,0
2: 10,1 ←	
3: 10,3 ↗	Totalt 148,0
4: 10,2 ↘	
5: 10,9* →	

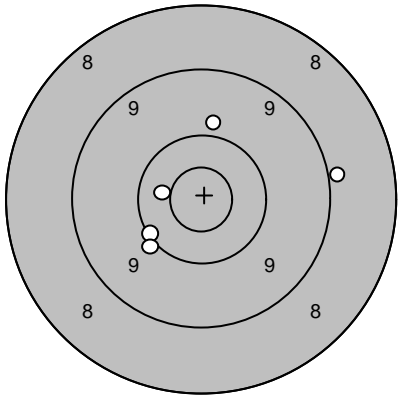
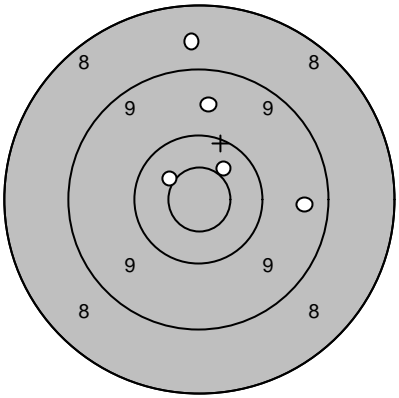
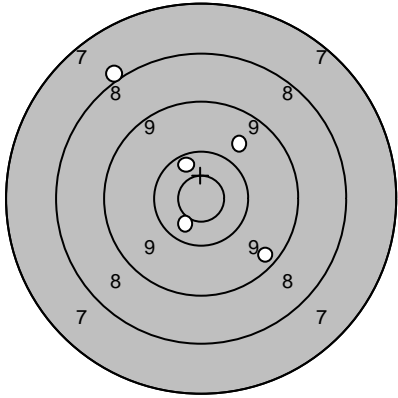
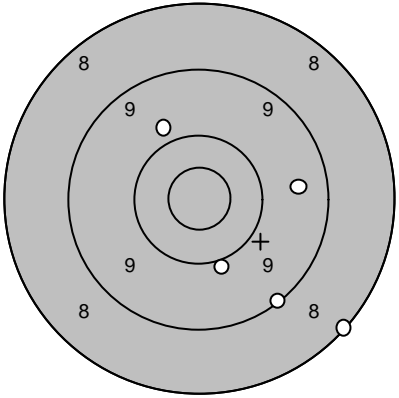
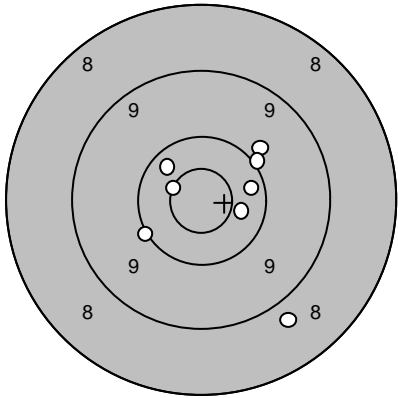
Skjutlag 3	Tavla 1	Johnny Wallberg	
Ramselefors	Loos		
2005-07-09	Tavelträffen A 2005	Ramselefors Skytteförening	
Prov		1: 10,1 ↙ 2: 10,0 ↙ 3: 9,9 ↑ 4: 10,5* ← 5: 9,0 →	Serie 1 
			1: 9,5 → 2: 9,6 ↑ 3: 10,5* ↗ 4: 10,5* ↖ 5: 8,7 ↑
		Serie 48,0	Serie 46,0
		Totalt 0,0	Totalt 46,0
Serie 2		1: 9,7 ↗ 2: 8,0 ↗ 3: 9,4 ↘ 4: 10,5* ↙ 5: 10,4 ↗	Serie 3 
			1: 9,9 ↗ 2: 9,5 → 3: 10,0 ↘ 4: 8,1 ↘ 5: 9,1 ↘
		Serie 46,0	Serie 45,0
		Totalt 92,0	Totalt 137,0
Extratävling		1: 10,4 → 2: 10,3 → 3: 9,9 ↗ 4: 10,6* ← 5: 8,8 ↘ 6: 10,4 ↗ 7: 10,0 ↗ 8: 10,1 ←	
		Serie 77,0	
		Totalt 214,0	

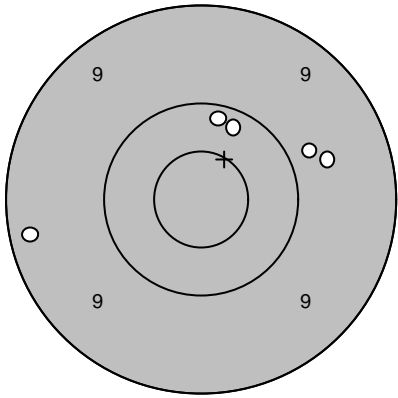
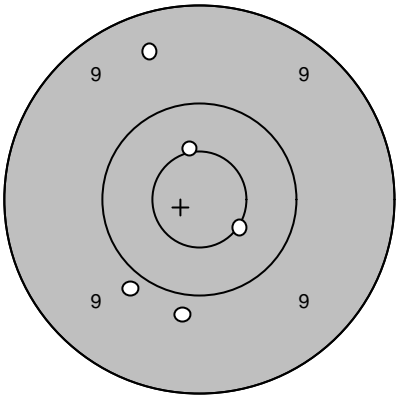
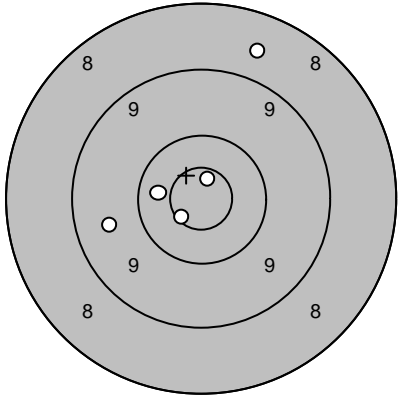
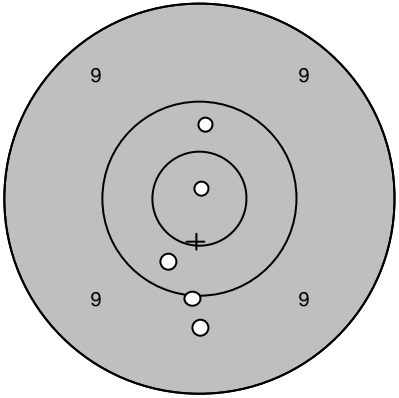
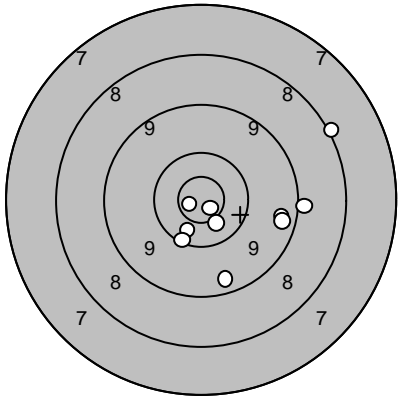
Skjutlag 3	Tavla 2	Tony Ericson	
Ramselefors	Loos		
2005-07-09	Tavelträffen A 2005	Ramselefors Skytteförening	
Prov		1: 9,3 ← 2: 9,8 → 3: 10,2 ↑ 4: 9,7 → 5: 10,2 ↑	Serie 1 
			1: 10,5* ↘ 2: 9,9 ↙ 3: 10,5* ↑ 4: 9,4 ↑ 5: 9,8 ↓
		Serie 47,0	Serie 47,0
		Totalt 0,0	Totalt 47,0
Serie 2		1: 9,6 ← 2: 10,7* ↙ 3: 10,4 ← 4: 8,7 ↑ 5: 10,8* ↑	Serie 3 
			1: 10,3 ↘ 2: 10,0 ↓ 3: 9,7 ↓ 4: 10,3 ↑ 5: 10,9* ↑
		Serie 47,0	Serie 49,0
		Totalt 94,0	Totalt 143,0
Extratävling		1: 9,4 ↓ 2: 9,0 → 3: 10,9* ↘ 4: 10,9* ← 5: 9,4 → 6: 10,4 ↘ 7: 10,5* ↘ 8: 8,1 → 9: 10,2 ↘ 10: 9,4 →	
		Serie 94,0	
		Totalt 237,0	

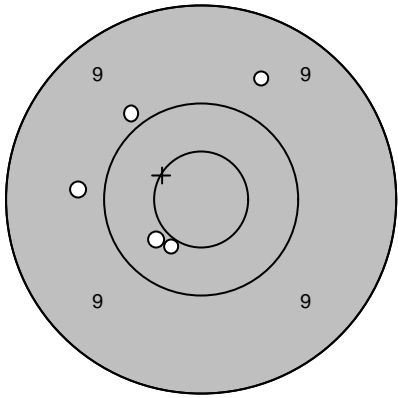
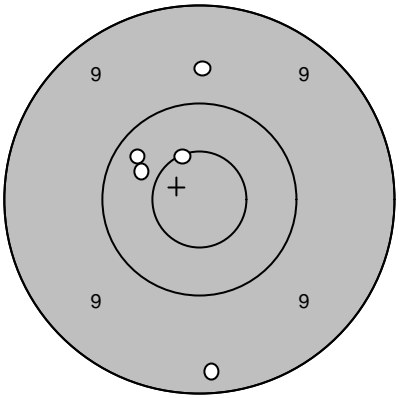
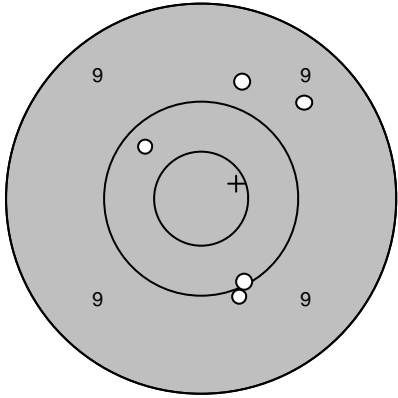
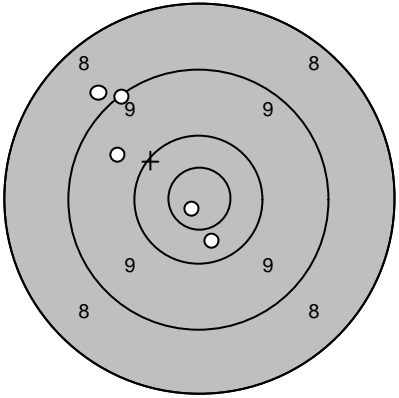
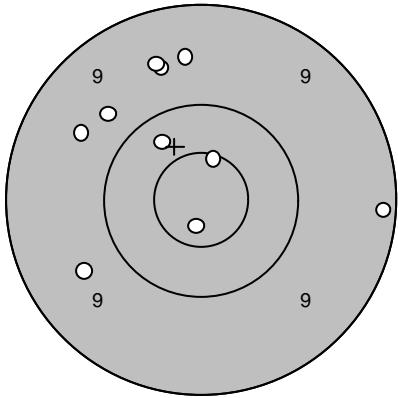
Skjutlag 3	Tavla 3	Ronnie Pettersson		
Ramselefors	Loos			
2005-07-09	Tavelträffen A 2005	Ramselefors Skytteförening		
Prov		1: 9,9 ↖ 2: 9,8 ← 3: 10,5* ↓ 4: 9,7 ↗ 5: 10,4 ↙	Serie 1 	1: 10,6* ↗ 2: 10,4 ← 3: 9,7 ↑ 4: 10,3 ↖ 5: 9,3 ↓
	Serie 47,0		Serie 48,0	
	Totalt 0,0		Totalt 48,0	
Serie 2		1: 10,1 ↓ 2: 10,0 ↓ 3: 9,8 ↑ 4: 10,3 ↖ 5: 9,6 ↗	Serie 3 	1: 10,4 ↓ 2: 9,7 ↖ 3: 8,8 ↗ 4: 9,1 ↗ 5: 10,9* ↙
	Serie 48,0		Serie 46,0	
	Totalt 96,0		Totalt 142,0	
Extratävling		1: 10,8* ↓ 2: 9,6 ↑ 3: 9,2 → 4: 9,7 ↖ 5: 9,6 ↗ 6: 9,6 ↖ 7: 10,6* ↑ 8: 10,3 ↗ 9: 9,6 ↖ 10: 9,6 ↑		
	Serie 93,0			
	Totalt 235,0			

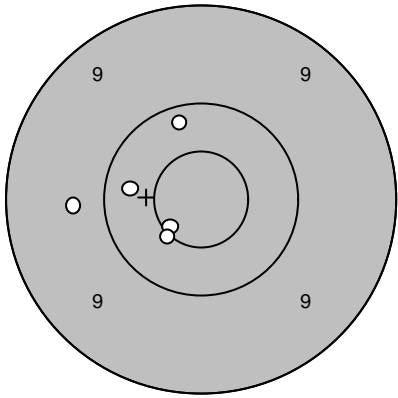
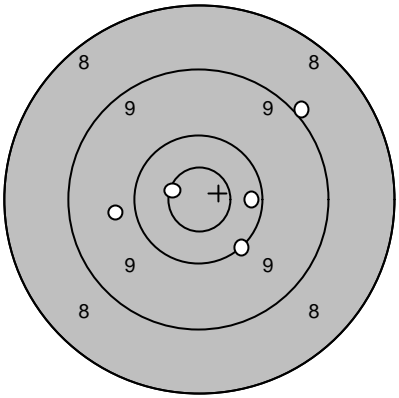
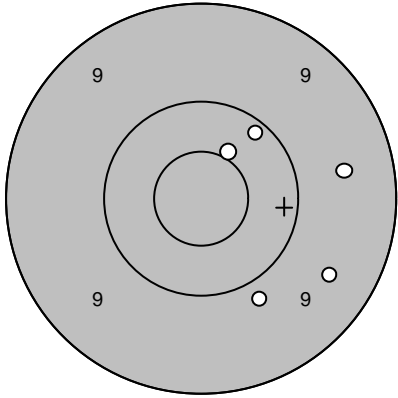
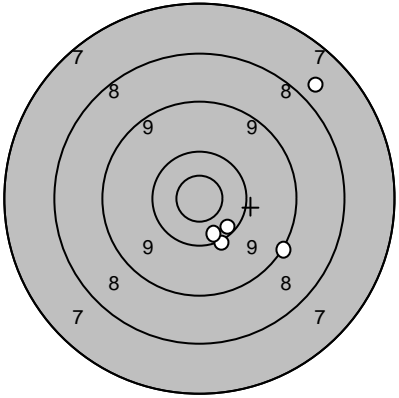
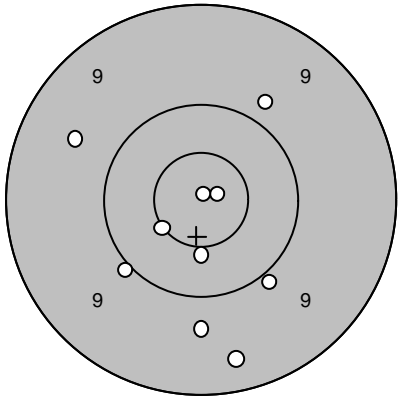
Skjutlag 3	Tavla 8	Erik Sigfridsson	
Ramselefors		Ramselefors	
2005-07-09		Tavelträffen A 2005	Ramselefors Skytteförening
Prov		1: 10,6* ↙ 2: 10,5* ↙ 3: 10,2 ↗ 4: 10,3 ← 5: 9,7 ←	Serie 1 
		Serie 49,0 Totalt 0,0	1: 9,8 ← 2: 9,0 ↗ 3: 10,1 ↘ 4: 10,7* ← 5: 10,3 →
			Serie 48,0 Totalt 48,0
Serie 2		1: 9,9 ↘ 2: 10,5* ↗ 3: 10,2 ↗ 4: 9,5 → 5: 9,5 →	Serie 3 
		Serie 47,0 Totalt 95,0	1: 10,1 ↘ 2: 7,8 ↗ 3: 10,3 ↘ 4: 9,1 ↘ 5: 10,3 ↘
			Serie 46,0 Totalt 141,0
Extratävling		1: 9,6 ↙ 2: 9,7 ↓ 3: 9,4 ↓ 4: 10,0 ↙ 5: 10,5* ↓ 6: 10,5* ↙ 7: 10,9* ↗ 8: 10,9* ↗ 9: 9,8 ↗ 10: 9,9 ↘	
		Serie 95,0 Totalt 236,0	

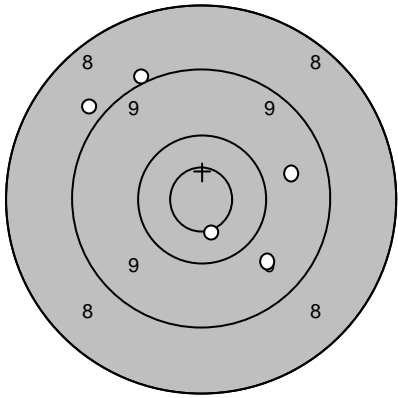
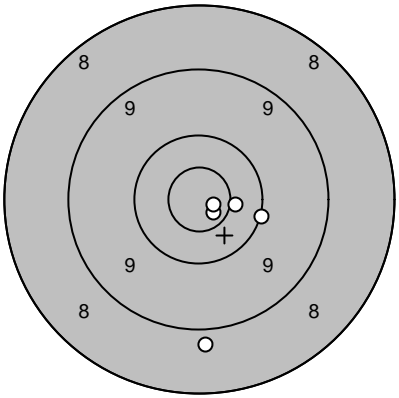
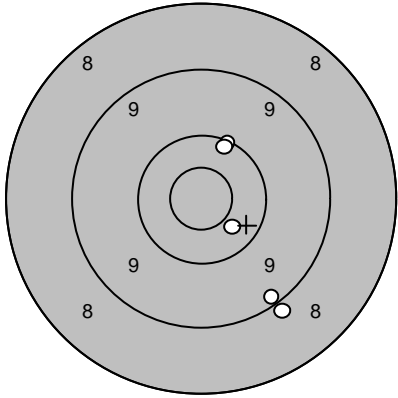
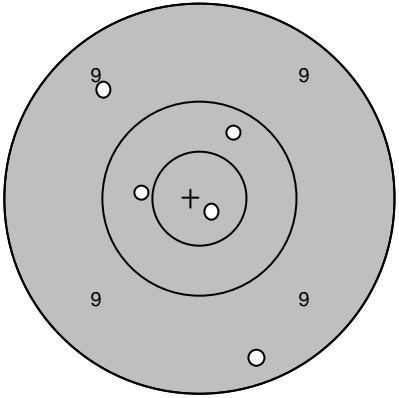
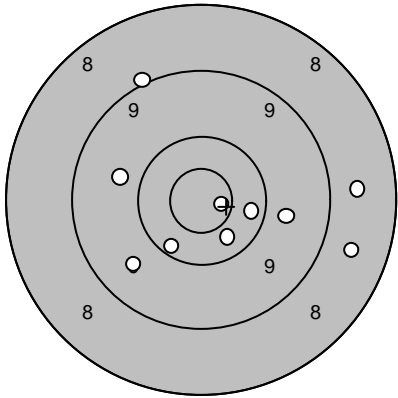
Skjutlag 3	Tavla 9	Johan Zakrisson	
Ramselefors		Ramselefors	
2005-07-09		Tavelträffen A 2005	Ramselefors Skytteförening
Prov		1: 8,8 ↖ 2: 9,0 ↗ 3: 9,6 → 4: 10,5* ↓ 5: 9,7 ↓	Serie 1 
		Serie 45,0 Totalt 0,0	1: 10,8* ↓ 2: 10,5* → 3: 10,1 → 4: 10,8* ↗ 5: 8,8 ↓
			Serie 48,0 Totalt 48,0
Serie 2		1: 10,1 ↗ 2: 10,2 ↗ 3: 10,4 ↘ 4: 9,2 ↘ 5: 9,0 ↘	Serie 3 
		Serie 48,0 Totalt 96,0	1: 9,6 ↖ 2: 10,3 ↗ 3: 10,4 ← 4: 9,3 ↓ 5: 10,8* ↘
			Serie 48,0 Totalt 144,0
Extratävling		1: 9,8 ↖ 2: 9,6 ↖ 3: 8,7 → 4: 10,4 ↓ 5: 8,6 → 6: 10,2 ↖ 7: 9,8 → 8: 10,3 → 9: 9,0 ↗ 10: 10,8* →	
		Serie 92,0 Totalt 236,0	

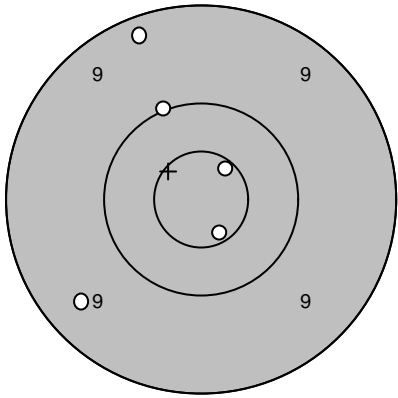
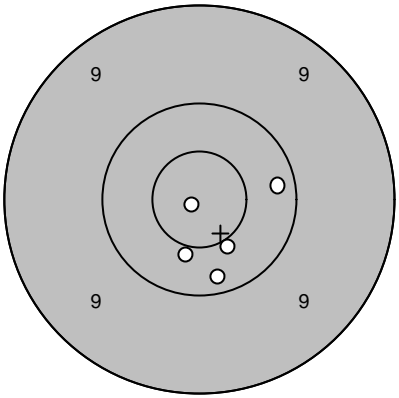
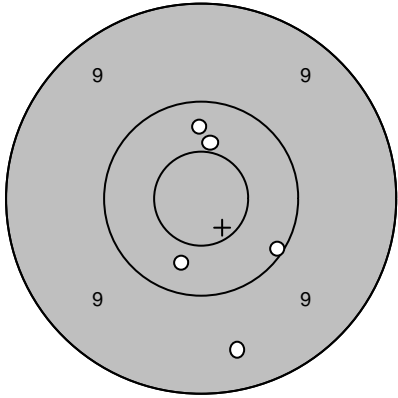
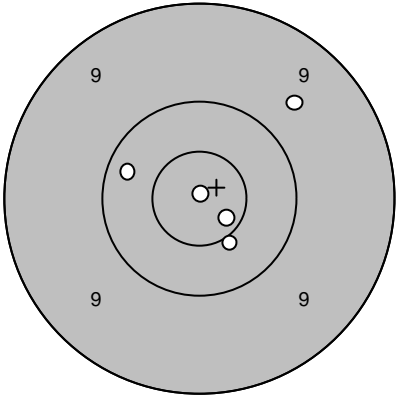
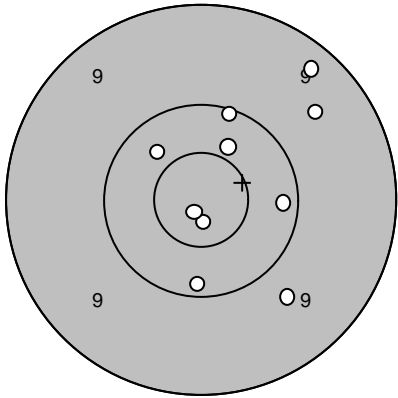
Skjutlag 3	Tavla 11	Nils Ström	
Ramselefors		Övertorneå	
2005-07-09		Tavelträffen A 2005	Ramselefors Skytteförening
Prov 	1: 9,2 ↖ 2: 10,0 ↖ 3: 10,6* ↘ 4: 10,6* ↗ 5: 9,4 ↙	Serie 1 	1: 10,9* ↙ 2: 10,5* ↘ 3: 10,2 → 4: 10,5* ↘ 5: 10,2 ↘
	Serie 48,0		Serie 50,0
	Totalt 0,0		Totalt 50,0
Serie 2 	1: 10,3 ↑ 2: 10,5* ↑ 3: 10,1 → 4: 10,3 ↓ 5: 9,5 ↓	Serie 3 	1: 10,3 ↙ 2: 10,7* ↘ 3: 9,7 ↗ 4: 10,9* ↑ 5: 10,5* ↘
	Serie 49,0		Serie 49,0
	Totalt 99,0		Totalt 148,0
Extratävling 	1: 10,4 ↖ 2: 10,8* ↓ 3: 9,7 ↘ 4: 10,2 ↓ 5: 10,9* ↘ 6: 10,1 ↑ 7: 9,6 ↗ 8: 10,2 → 9: 10,4 ↑ 10: 9,3 ↗		
	Serie 97,0		
	Totalt 245,0		

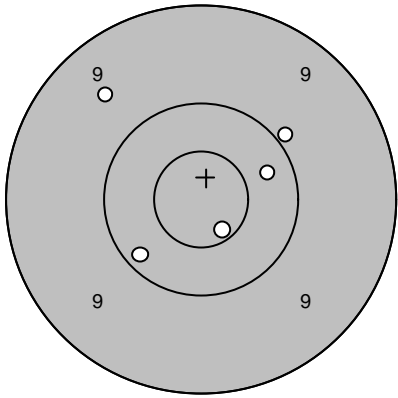
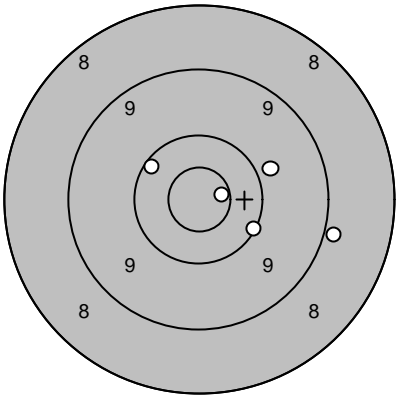
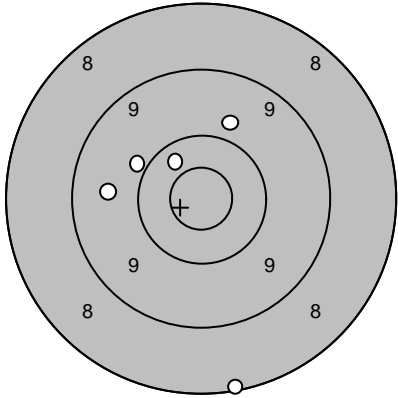
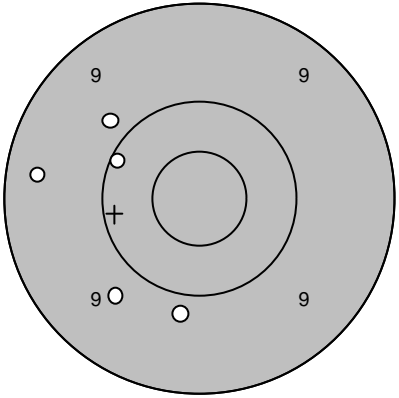
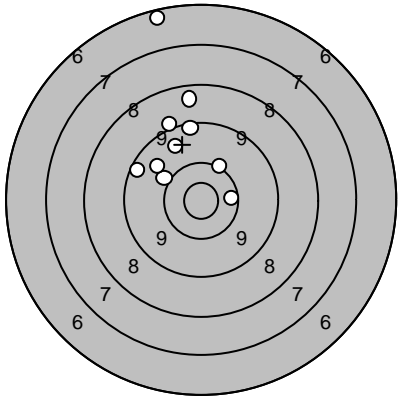
Skjutlag 3	Tavla 12	Bengt Heder	
Ramselefors		Evertsberg	
2005-07-09		Tavelträffen A 2005	Ramselefors Skytteförening
Prov 	1: 9,6 ↖ 2: 10,0 ↗ 3: 10,2 ↙ 4: 10,7* ↘ 5: 10,3 →	Serie 1 	1: 10,2 ↖ 2: 10,7* → 3: 9,9 ↗ 4: 8,9 → 5: 10,1 ↘
	Serie 49,0		Serie 47,0
	Totalt 0,0		Totalt 47,0
Serie 2 	1: 10,0 ↖ 2: 9,7 ← 3: 8,1 ↘ 4: 9,8 ↗ 5: 10,4 ↗	Serie 3 	1: 9,4 ← 2: 9,8 ↗ 3: 9,8 ↘ 4: 9,7 ↙ 5: 10,1 ↖
	Serie 46,0		Serie 46,0
	Totalt 93,0		Totalt 139,0
Extratävling 	1: 10,1 ↖ 2: 9,3 ↑ 3: 10,4 → 4: 8,6 ↑ 5: 9,4 ↖ 6: 6,4 ↑ 7: 9,7 ↖ 8: 10,2 ↗ 9: 9,6 ↗ 10: 9,0 ↗		
	Serie 89,0		
	Totalt 228,0		

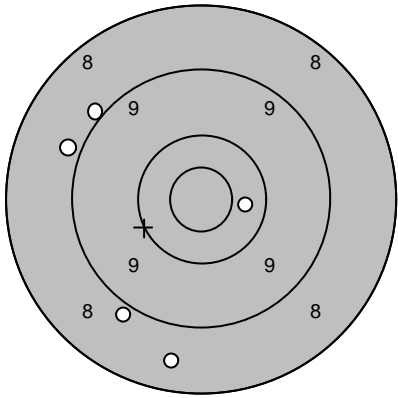
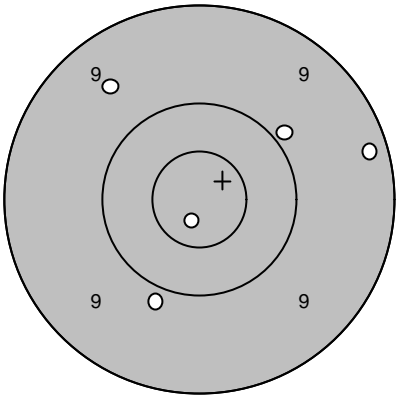
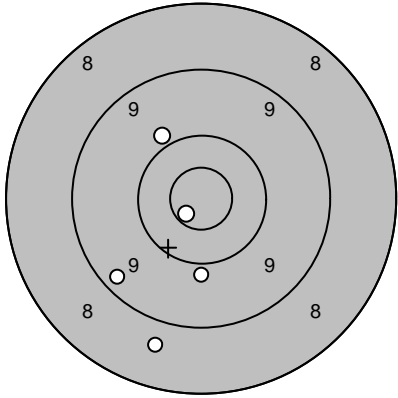
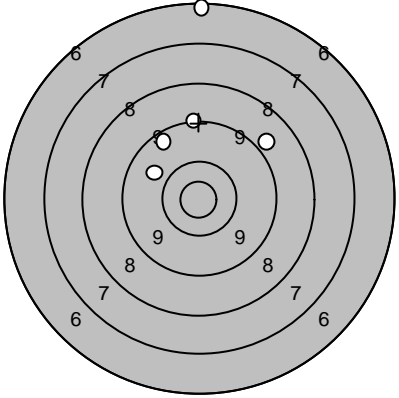
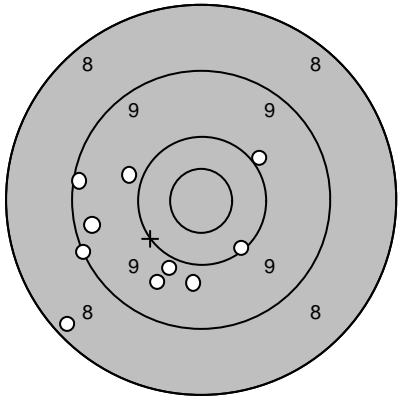
Skjutlag 3	Tavla 13	Torgny Lindfors	
Ramselefors	I 19		
2005-07-09	Tavelträffen A 2005	Ramselefors Skytteförening	
Prov		1: 10,4 → 2: 8,9 ↓ 3: 8,6 ↓ 4: 9,0 ↗ 5: 8,9 ↖	Serie 1 
			1: 9,9 ↗ 2: 9,2 → 3: 10,8* ↓ 4: 9,6 ↗ 5: 9,9 ↓
		Serie 43,0	Serie 46,0
		Totalt 0,0	Totalt 46,0
Serie 2		1: 9,3 ↙ 2: 10,8* ↙ 3: 8,7 ↓ 4: 9,9 ↗ 5: 9,9 ↓	Serie 3 
			1: 6,3 ↑ 2: 8,9 ↗ 3: 9,2 ↑ 4: 9,5 ↗ 5: 9,9 ↖
		Serie 45,0	Serie 41,0
		Totalt 91,0	Totalt 132,0
Extratävling		1: 9,4 ← 2: 8,3 ↙ 3: 10,1 ↘ 4: 9,2 ← 5: 9,1 ← 6: 9,9 ↓ 7: 9,7 ↓ 8: 9,9 ← 9: 9,8 ↓ 10: 10,0 ↗	
		Serie 91,0	
		Totalt 223,0	

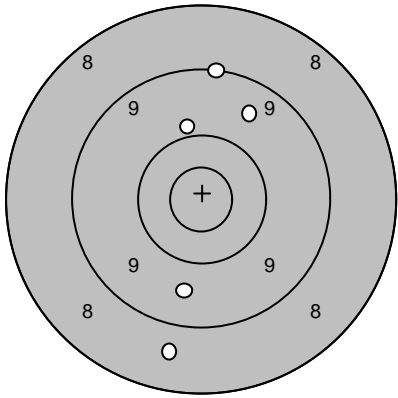
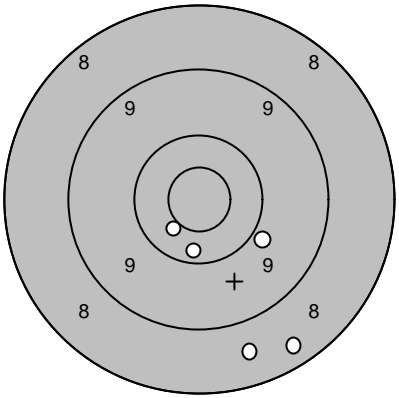
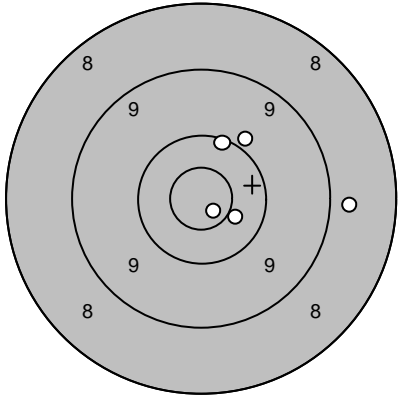
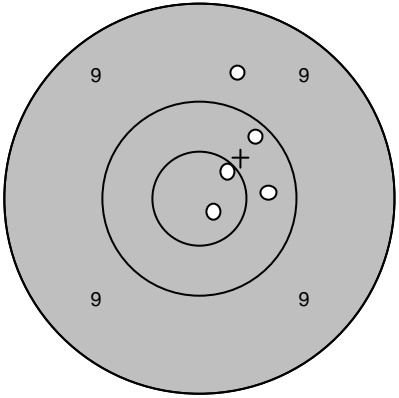
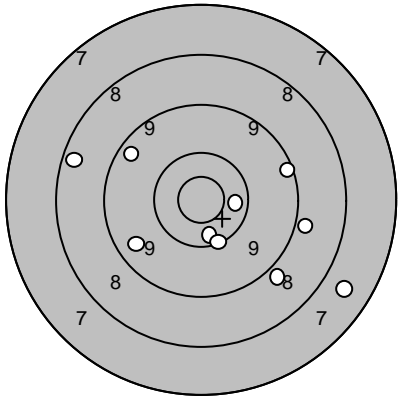
Skjutlag 3	Tavla 14	Curt Linerud		
Ramselefors		I 20		
2005-07-09		Tavelträffen A 2005	Ramselefors Skytteförening	
Prov		1: 9,6 ↗ 2: 9,7 ↓ 3: 9,1 ↑ 4: 10,0 ↑ 5: 8,7 ↓	Serie 1 	1: 10,3 ↓ 2: 8,6 ↓ 3: 8,4 ↓ 4: 10,5* ↘ 5: 9,9 ↘
		Serie 45,0	Serie 45,0	
		Totalt 0,0	Totalt 45,0	
Serie 2		1: 10,2 ↑ 2: 10,5* → 3: 10,8* ↘ 4: 8,8 → 5: 9,9 ↑	Serie 3 	1: 9,7 ↑ 2: 10,2 ↗ 3: 10,6* ↗ 4: 10,8* ↘ 5: 10,3 →
		Serie 47,0	Serie 49,0	
		Totalt 92,0	Totalt 141,0	
Extratävling		1: 8,4 ← 2: 9,4 ↗ 3: 9,5 ↙ 4: 10,4 ↓ 5: 10,4 → 6: 10,2 ↓ 7: 9,2 → 8: 8,9 ↘ 9: 7,7 ↘ 10: 8,9 →		
		Serie 88,0		
		Totalt 229,0		

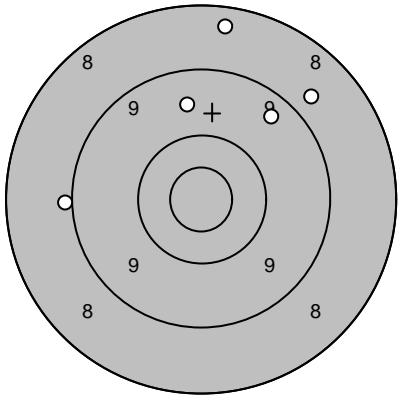
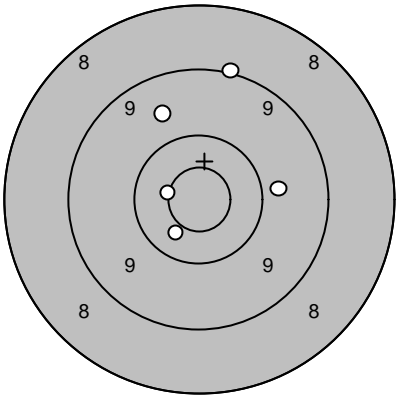
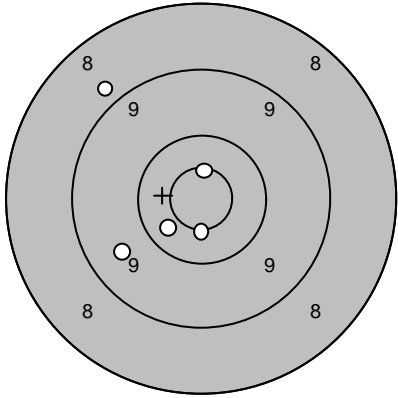
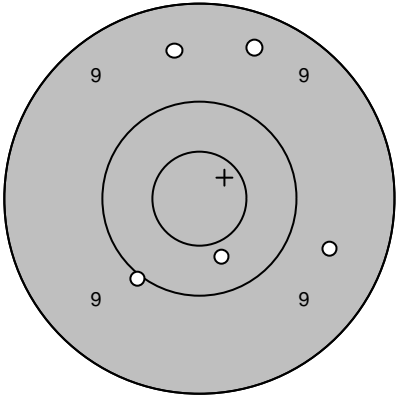
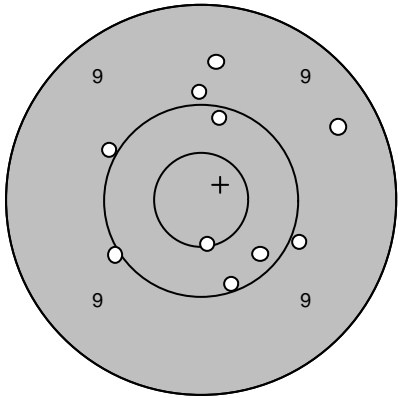
Skjutlag 3	Tavla 15	Håkan Engman	
Ramselefors	Lindesberg		
2005-07-09	Tavelträffen A 2005	Ramselefors Skytteförening	
Prov		1: 9,4 ↗ 2: 8,8 ↗ 3: 8,4 ↑ 4: 9,6 ↑ 5: 9,0 ←	Serie 1 
			1: 9,9 → 2: 10,6* ← 3: 9,1 ↑ 4: 9,7 ↗ 5: 10,5* ↘
		Serie 43,0	Serie 47,0
		Totalt 0,0	Totalt 47,0
Serie 2		1: 9,6 ↙ 2: 10,6* ↓ 3: 8,8 ↗ 4: 10,4 ↙ 5: 10,7* ↑	Serie 3 
			1: 10,0 ↘ 2: 9,6 → 3: 9,5 ↑ 4: 9,4 ↗ 5: 10,4 ↓
		Serie 47,0	Serie 47,0
		Totalt 94,0	Totalt 141,0
Extratävling		1: 10,0 ↙ 2: 10,6* ↓ 3: 9,9 → 4: 10,0 ↗ 5: 10,2 ↑ 6: 9,9 ↑ 7: 10,2 ↘ 8: 9,4 → 9: 9,6 ↑ 10: 10,1 ↓	
		Serie 96,0	
		Totalt 237,0	

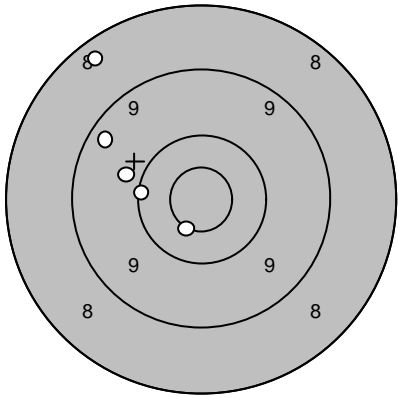
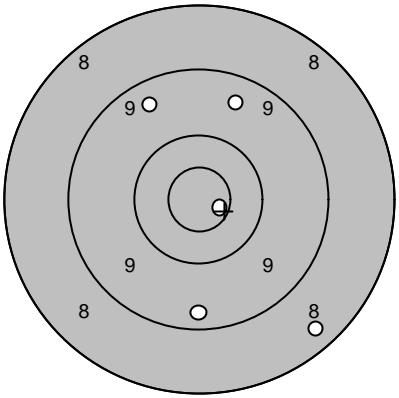
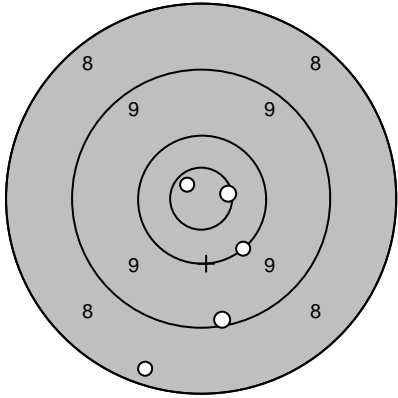
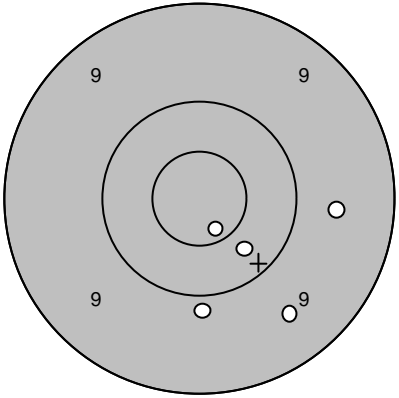
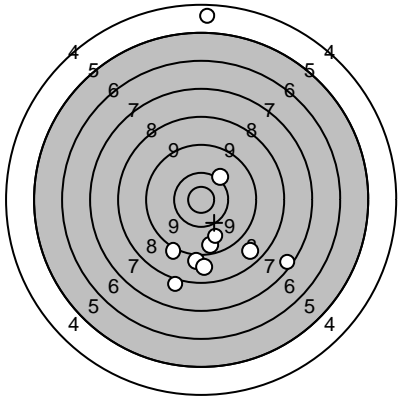
Skjutlag 3	Tavla 16	Dennis Sundqvist	
Ramselefors	Piteå		
2005-07-09	Tavelträffen A 2005	Ramselefors Skytteförening	
Prov		1: 8,4 ↗ 2: 10,2 ← 3: 9,9 ↗ 4: 9,4 ↗ 5: 10,6* ↓	Serie 1 
	Serie 46,0 Totalt 0,0	1: 9,5 ↗ 2: 9,5 ↗ 3: 8,4 ↓ 4: 10,7* ↘ 5: 9,3 ↓	Serie 45,0 Totalt 45,0
Serie 2		1: 10,6* → 2: 8,3 ↓ 3: 10,1 ↓ 4: 9,2 ↓ 5: 10,8* ↗	Serie 3 
	Serie 47,0 Totalt 92,0	1: 10,7* ↓ 2: 9,6 → 3: 9,5 ↓ 4: 10,3 ↓ 5: 9,9 ↓	Serie 47,0 Totalt 139,0
Extratävling		1: 9,6 ↓ 2: 10,2 ↗ 3: 7,5 ↘ 4: 9,1 ↓ 5: 4,6 ↑ 6: 8,1 ↓ 7: 8,7 ↘ 8: 9,9 ↓ 9: 9,2 ↓ 10: 8,8 ↓	
	Serie 81,0 Totalt 220,0		

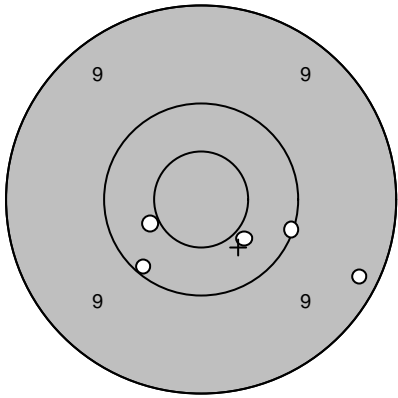
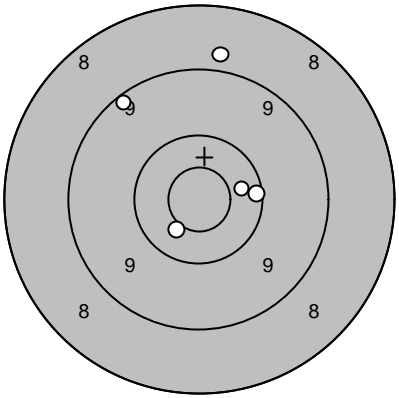
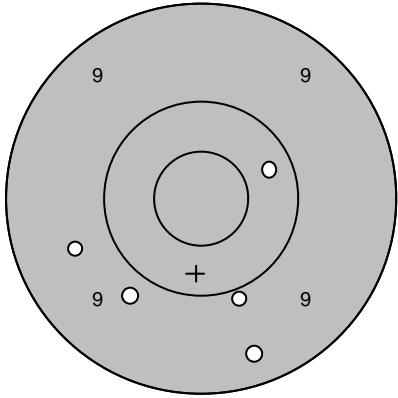
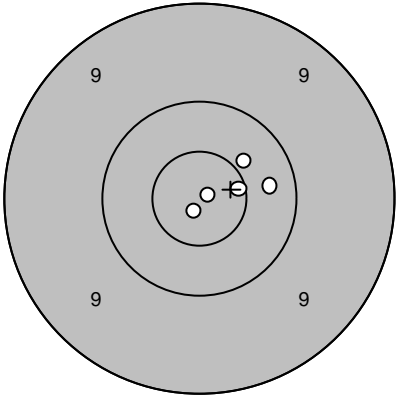
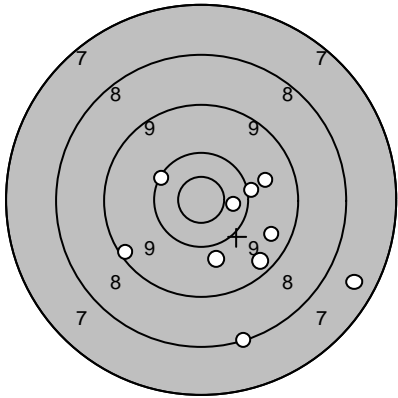
Skjutlag 3	Tavla 17	Roland Nilsson		
Ramselefors	Piteå			
2005-07-09	Tavelträffen A 2005	Ramselefors Skytteförening		
Prov		1: 10,5* ↙ 2: 10,1 ↙ 3: 9,2 → 4: 10,1 → 5: 10,4 ↘	Serie 1 	1: 9,2 ↖ 2: 8,8 ↑ 3: 10,2 → 4: 10,4 → 5: 10,5* ↘
	Serie 49,0		Serie 47,0	
	Totalt 0,0		Totalt 47,0	
Serie 2		1: 10,3 → 2: 9,4 ↓ 3: 9,9 ↓ 4: 9,8 ↓ 5: 9,7 ←	Serie 3 	1: 10,4 ↗ 2: 10,3 → 3: 10,6* → 4: 10,9* → 5: 10,9* ↓
	Serie 46,0		Serie 50,0	
	Totalt 93,0		Totalt 143,0	
Extratävling		1: 9,2 ↙ 2: 8,1 ↓ 3: 9,4 ↘ 4: 9,9 ↓ 5: 9,5 → 6: 10,1 → 7: 10,2 ↗ 8: 9,7 → 9: 10,4 → 10: 7,6 →		
	Serie 90,0			
	Totalt 233,0			

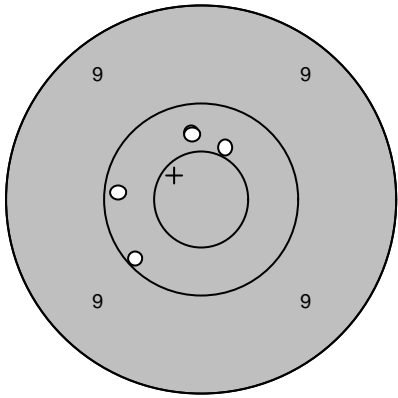
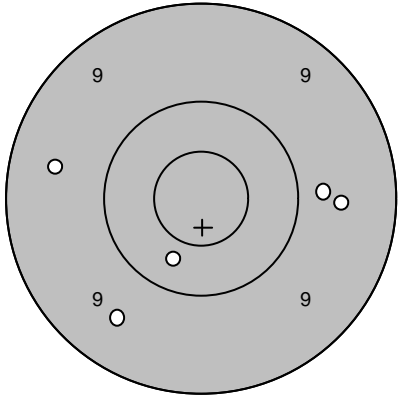
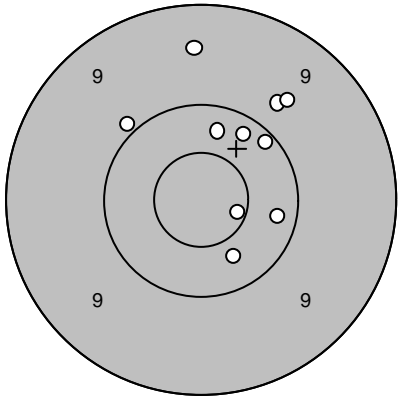
Skjutlag 3	Tavla 18	Gillis Engman		
Ramselefors		Rundvik (Endast lördag)		
2005-07-09		Tavelträffen A 2005	Ramselefors Skytteförening	
Prov		1: 10,4 ↑ 2: 10,5* ↗ 3: 10,2 ← 4: 10,4 ↑ 5: 10,1 ↘	Serie 1	1: 9,4 ↖ 2: 10,8* ↙ 3: 10,8* ↘ 4: 10,2 ↗ 5: 10,6* ↗
		Serie 50,0	Serie 49,0	
		Totalt 0,0	Totalt 49,0	
Serie 2		1: 9,5 ← 2: 10,4 ↘ 3: 9,6 → 4: 9,5 ↘ 5: 9,8 →	Serie 3	1: 10,6* ↑ 2: 9,3 ↘ 3: 9,4 ↘ 4: 9,8 ↑ 5: 10,7* ↘
		Serie 46,0	Serie 47,0	
		Totalt 95,0	Totalt 142,0	
Extratävling		1: 10,3 ↑ 2: 10,4 ↘ 3: 10,2 → 4: 10,1 ↗ 5: 10,6* → 6: 9,8 ↗ 7: 9,5 ↑ 8: 10,2 ↗ 9: 9,7 ↗ 10: 9,9 ↖		
		Serie 96,0		
		Totalt 238,0		

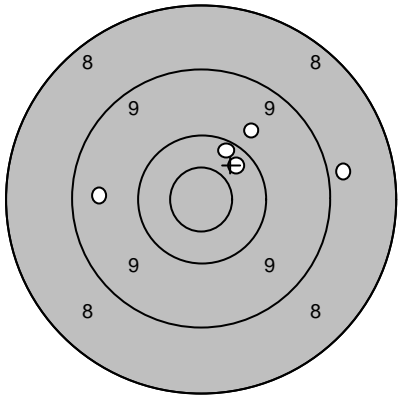
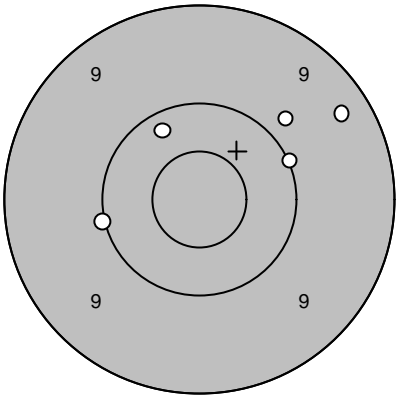
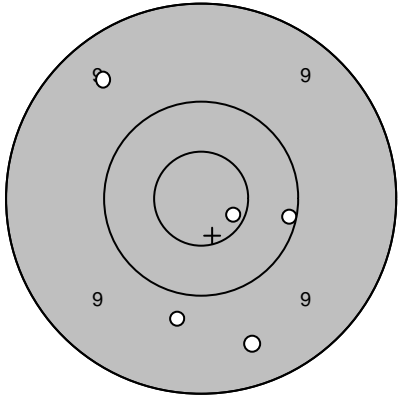
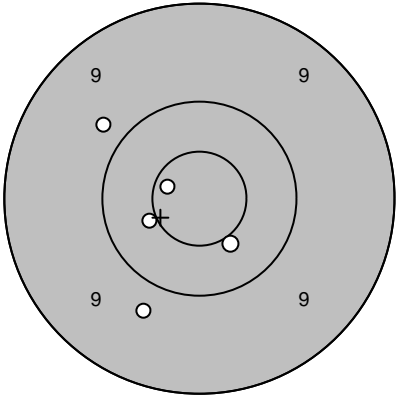
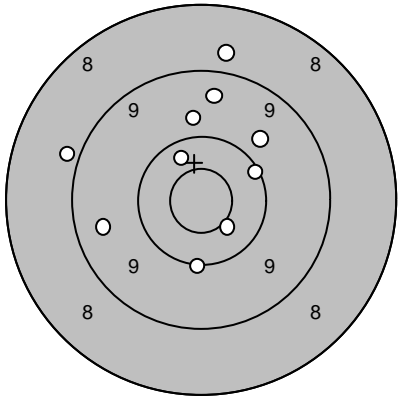
Skjutlag 3	Tavla 19	Gunnar Iversen	
Ramselefors		S 3	
2005-07-09		Tavelträffen A 2005	Ramselefors Skytteförening
Prov		1: 9,8 ↗ 2: 10,3 ↗ 3: 8,9 → 4: 10,2 ↑ 5: 9,5 ←	Serie 1  1: 9,3 ↗ 2: 10,0 ← 3: 9,8 ↗ 4: 10,2 ↑ 5: 10,0 →
		Serie 46,0	Serie 48,0
		Totalt 0,0	Totalt 48,0
Serie 2		1: 9,5 ↓ 2: 10,1 → 3: 9,5 ↗ 4: 9,8 ↓ 5: 10,7* →	Serie 3  1: 10,5* ← 2: 9,8 ↓ 3: 9,8 ↗ 4: 10,5* ↓ 5: 10,7* ←
		Serie 47,0	Serie 48,0
		Totalt 95,0	Totalt 143,0
Extratävling		1: 10,1 ↓ 2: 10,5* ↓ 3: 9,8 ↗ 4: 10,1 → 5: 8,8 ↑ 6: 9,5 ↑ 7: 8,9 ← 8: 9,5 ← 9: 9,8 ↑ 10: 10,4 ↗	
		Serie 92,0	
		Totalt 235,0	

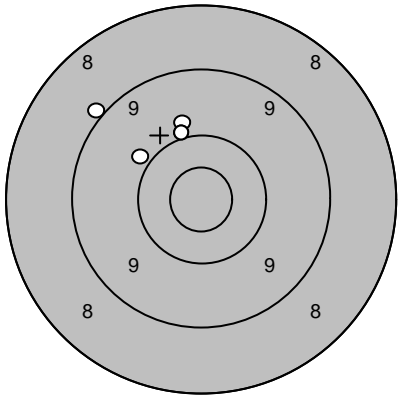
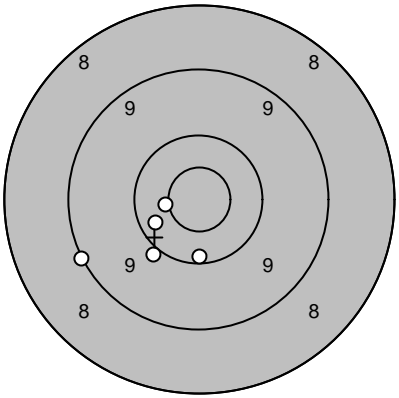
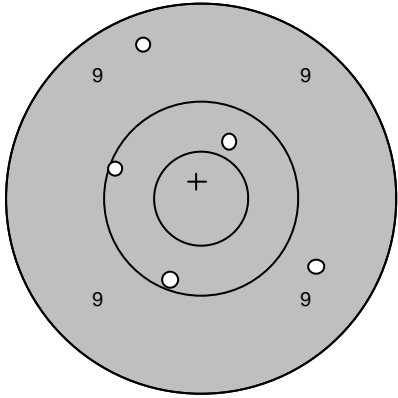
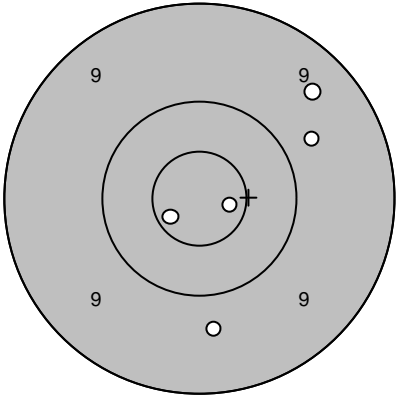
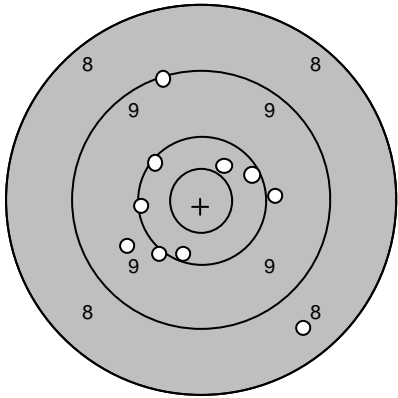
Skjutlag	Tavla	Kjell Marklund	
3	20		
Ramselefors	S 3		
2005-07-09	Tavelträffen A 2005	Ramselefors Skytteförening	
Prov		1: 9,9 ↖ 2: 9,9 ↑ 3: 10,0 ↑ 4: 10,0 ↑ 5: 9,0 ↖	Serie 1 
			1: 10,6* ← 2: 10,2 ↓ 3: 10,3 ← 4: 9,1 ← 5: 10,0 ↘
		Serie 47,0	Serie 49,0
		Totalt 0,0	Totalt 49,0
Serie 2		1: 10,1 ← 2: 10,4 ↑ 3: 10,1 ↓ 4: 9,7 → 5: 9,4 ↑	Serie 3 
			1: 10,7* ← 2: 9,4 ↗ 3: 10,7* → 4: 9,7 ↗ 5: 9,7 ↓
		Serie 48,0	Serie 47,0
		Totalt 97,0	Totalt 144,0
Extratävling		1: 10,2 ↓ 2: 9,1 ↑ 3: 10,2 ← 4: 9,7 ← 5: 8,6 ↓ 6: 9,9 → 7: 10,2 ↗ 8: 10,4 ↗ 9: 10,0 ↓ 10: 10,2 ↖	
		Serie 95,0	
		Totalt 239,0	

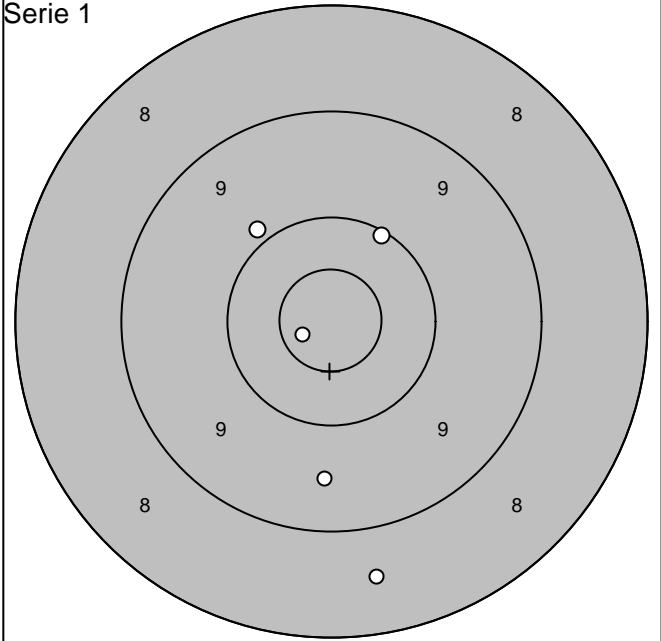
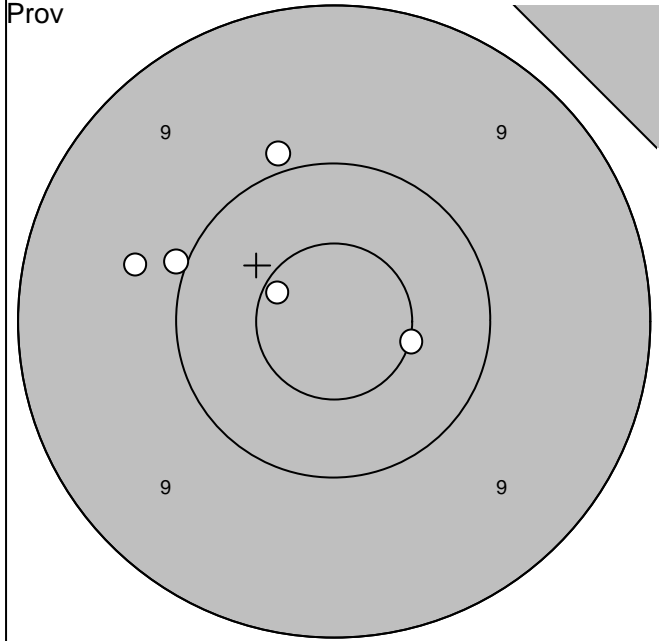

1:10,0 ↖		Serie	48,0		
2:10,6* ↖		Totalt	0,0		
3: 9,9 ↗					
4: 9,7 ↖					
5:10,5* ➔					

1: 9,9 ↗		Serie	46,0		
2:10,7* ↙		Totalt	46,0		
3: 9,5 ↓					
4: 8,6 ↓					
5:10,1 ↗					

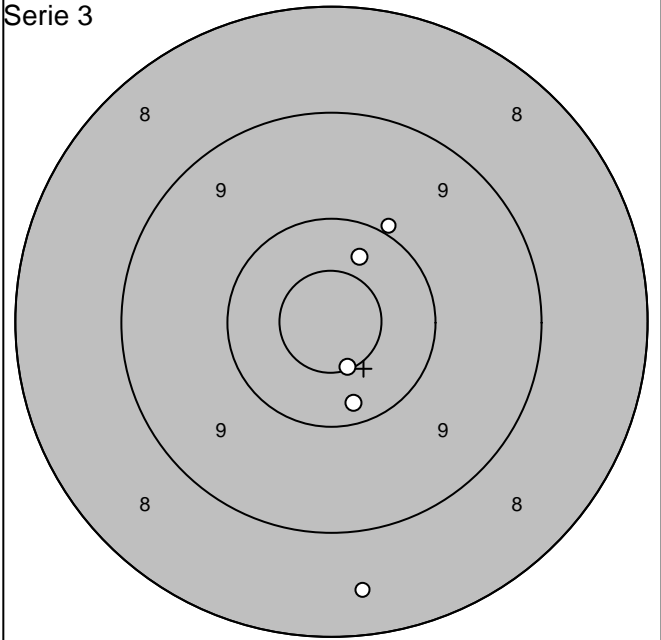
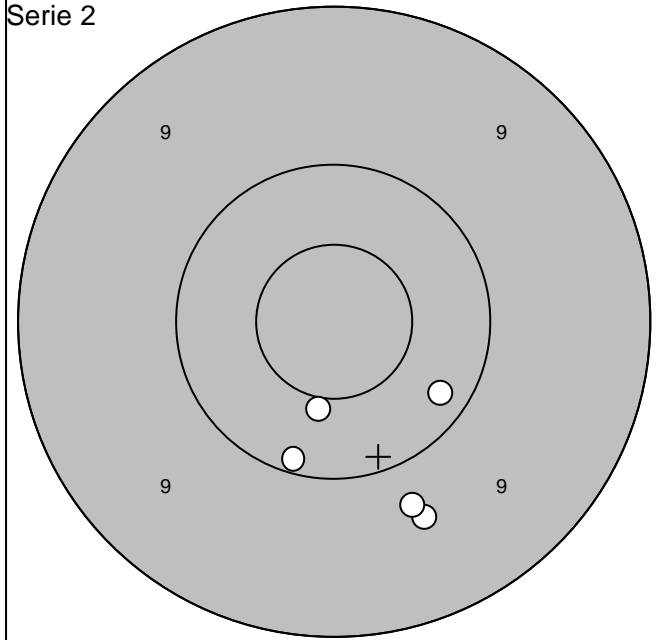

1:10,1 ↓		Serie	48,0		
2: 9,7 ↓		Totalt	94,0		
3: 9,8 ↓					
4:10,5* ↓					
5:10,2 ↘					

1:10,4 ↗		Serie	48,0		
2:10,6* ↓		Totalt	142,0		
3:10,2 ↓					
4: 8,5 ↓					
5:10,0 ↗					

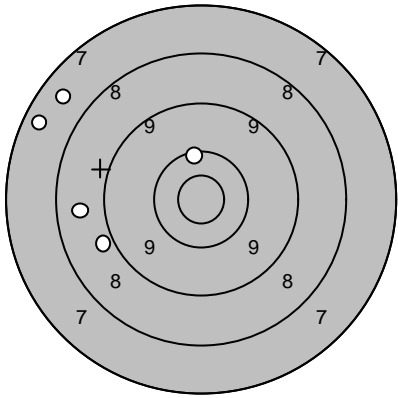
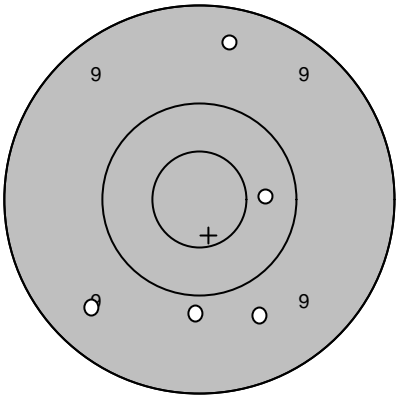
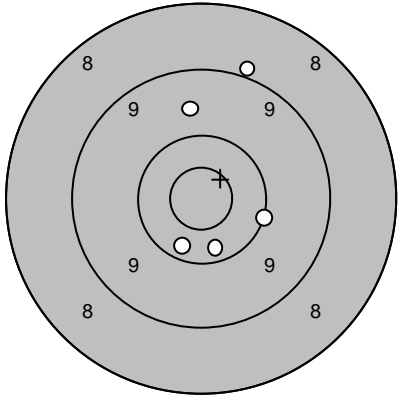
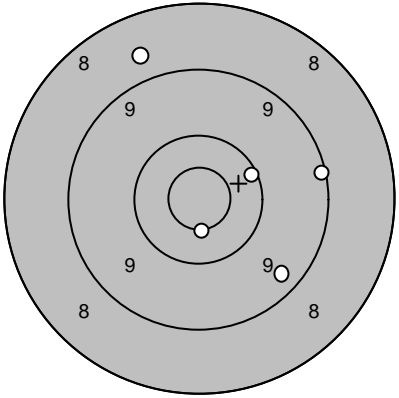
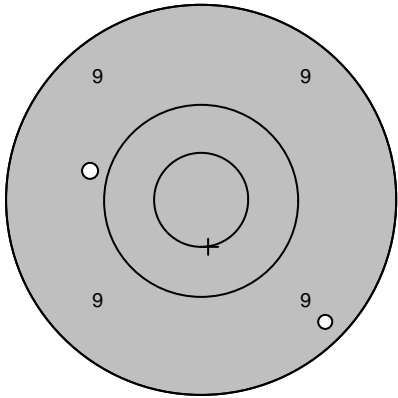
Skjutlag 3	Tavla 22	Bror Rantakyrö	
Ramselefors		Övertorneå	
2005-07-09		Tavelträffen A 2005	Ramselefors Skytteförening
Prov		1: 8,9 ← 2: 10,2 ↑ 3: 7,4 ← 4: 7,6 ↗ 5: 8,6 ←	Serie 1 
		Serie 40,0 Totalt 0,0	1: 9,4 ↑ 2: 9,9 ↓ 3: 9,5 ↙ 4: 9,7 ↓ 5: 10,4 →
			Serie 46,0 Totalt 46,0
Serie 2		1: 9,7 ↑ 2: 10,3 ↓ 3: 9,0 ↑ 4: 10,3 ↓ 5: 10,1 →	Serie 3 
		Serie 48,0 Totalt 94,0	1: 10,6* ↓ 2: 8,7 ↑ 3: 10,2 ↗ 4: 9,2 → 5: 9,4 ↓
			Serie 46,0 Totalt 140,0
Extratävling		1: 9,9 ← 2: 9,3 ↓	
		Serie 18,0 Totalt 158,0	

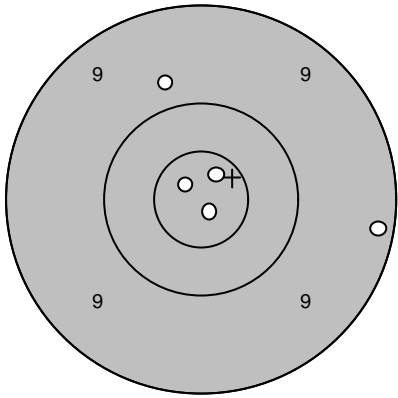
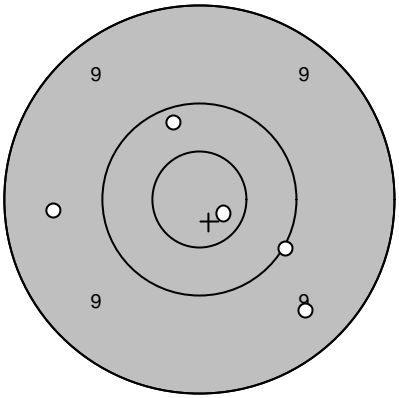
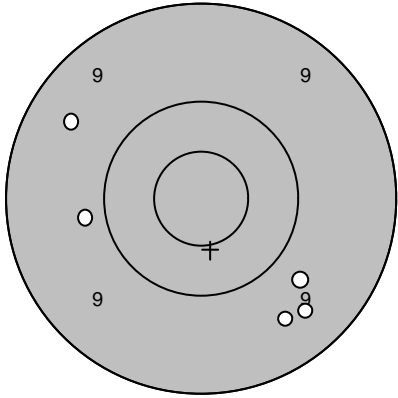
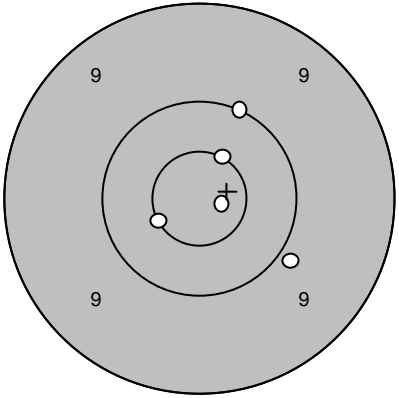
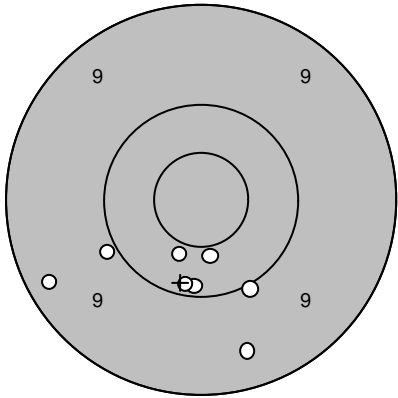
Skjutlag 3	Tavla 23	Jan-Erik Karlsson		
Ramselefors	Ramselefors			
2005-07-09	Tavelträffen A 2005	Ramselefors Skytteförening		
Prov		1: 9,2 → 2: 9,8 ↗ 3: 10,8* ↗ 4: 10,9* ↘ 5: 10,7* ↗	Serie 1 	1: 9,6 ← 2: 10,2 ↗ 3: 10,0 ↘ 4: 10,7* ↘ 5: 9,5 ↘
	Serie 48,0		Serie 48,0	
	Totalt 0,0		Totalt 48,0	
Serie 2		1: 9,8 ← 2: 9,5 ↗ 3: 9,5 ↘ 4: 9,5 ↘ 5: 9,7 ↘	Serie 3 	1: 10,6* ← 2: 10,8* → 3: 10,0 ↗ 4: 9,9 ↘ 5: 10,5* ↗
	Serie 45,0		Serie 49,0	
	Totalt 93,0		Totalt 142,0	
Extratävling		1: 10,4 ↓ 2: 10,2 ↓ 3: 9,9 ← 4: 10,5* ↓ 5: 10,2 ↓ 6: 9,3 ← 7: 9,4 ↓ 8: 10,0 ↓		
	Serie 77,0			
	Totalt 219,0			

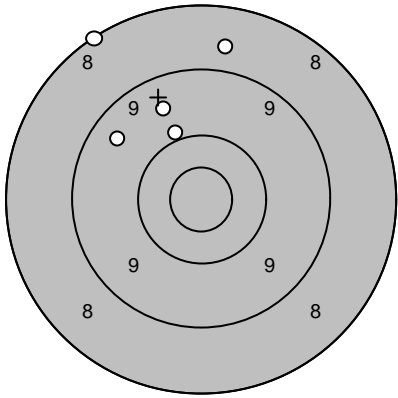
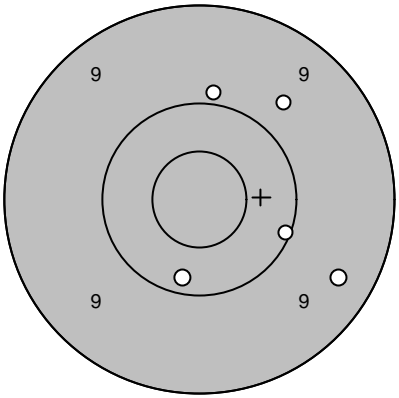
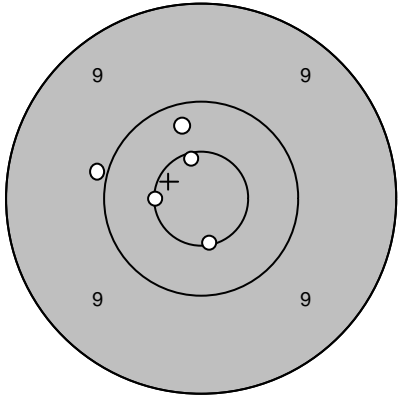
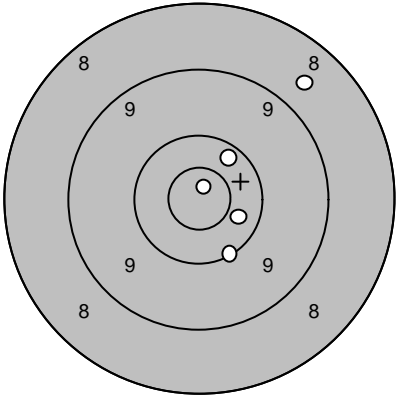
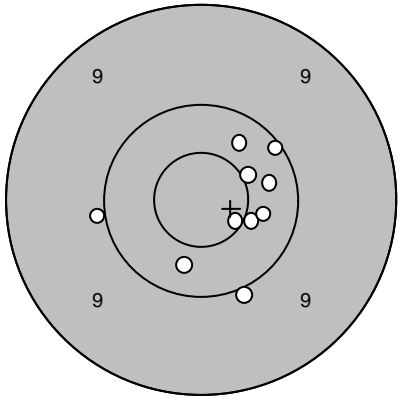
Skjutlag	Tavla	Dan-Ivan Karlsson	
3	24		
Ramselefors	Ramselefors		
2005-07-09	Tavelträffen A 2005	Ramselefors Skytteförening	
Prov 	1: 8,7 ↗	Serie 1 	1: 9,9 ↗
	2: 9,5 ↖		2: 10,2 ↓
	3: 8,1 ↗		3: 9,4 ↘
	4: 10,0 ↗		4: 9,7 ↗
	5: 9,6 ↗		5: 10,1 ↘
	Serie 44,0		Serie 47,0
	Totalt 0,0		Totalt 47,0
Serie 2 	1: 9,9 ←	Serie 3 	1: 10,4 ↘
	2: 10,6* ↓		2: 10,9* ↗
	3: 10,3 ↗		3: 10,3 ↗
	4: 10,6* ←		4: 8,7 ↗
	5: 10,6* ↗		5: 10,1 ↓
	Serie 49,0		Serie 48,0
	Totalt 96,0		Totalt 144,0
Extratävling 	1: 10,0 ↓		
	2: 10,5* →		
3: 10,3 →			
4: 10,0 ←			
5: 10,3 ↗			
6: 10,4 →			
7: 10,1 ↗			
8: 10,6* ↘			
9: 10,4 ↓			
10: 10,5* ↗			
	Serie 100,0		
	Totalt 244,0		

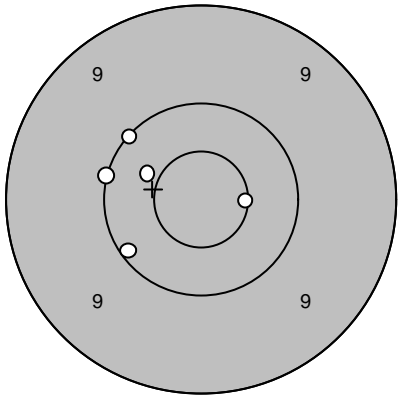
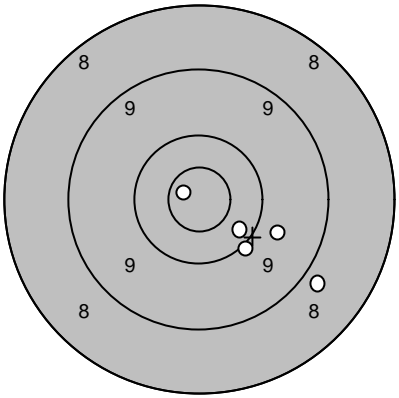
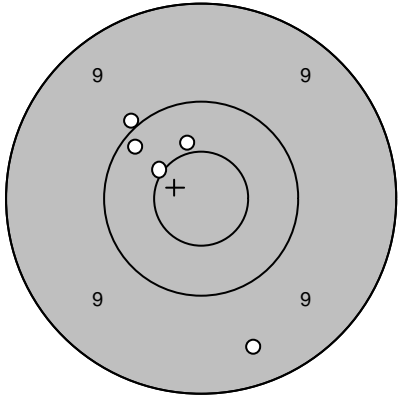
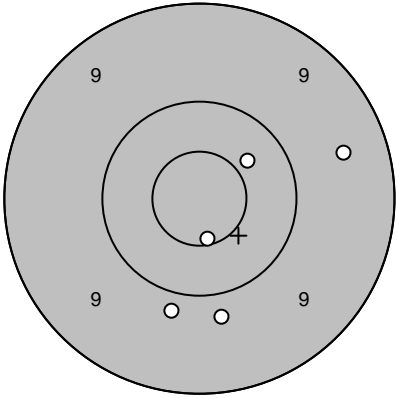
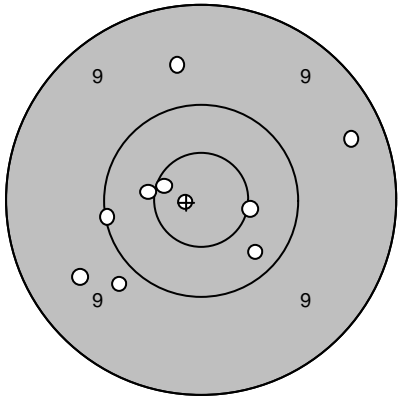
Skjutlag 4	Tavla 1	Daniel Wallberg		
Ramselefors		Loos		
2005-07-09		Tavelträffen A 2005	Ramselefors Skytteförening	
Prov		1: 10,4 ← 2: 10,0 ← 3: 10,6* → 4: 10,1 ↗ 5: 10,1 ↙	Serie 1 	1: 8,9 ↘ 2: 10,3 ↘ 3: 10,0 ↘ 4: 10,8* ↗ 5: 9,8 ↘
		Serie 51,2	Serie 49,8	
		Totalt 0,0	Totalt 49,8	
Serie 2		1: 10,2 ↗ 2: 9,4 ↓ 3: 10,0 ↗ 4: 10,5* ↗ 5: 10,4 ↗	Serie 3 	1: 10,4 ↗ 2: 9,8 ↓ 3: 10,6* ↓ 4: 9,5 → 5: 9,9 ↓
		Serie 50,5	Serie 50,2	
		Totalt 100,3	Totalt 150,5	
Extratävling		1: 10,9* ← 2: 10,1 ← 3: 9,4 → 4: 10,3 ↓ 5: 10,5* → 6: 10,6* ↗ 7: 9,8 ↙ 8: 9,6 ↙ 9: 10,5* ← 10: 9,6 ↗		
		Serie 101,3		
		Totalt 251,8		

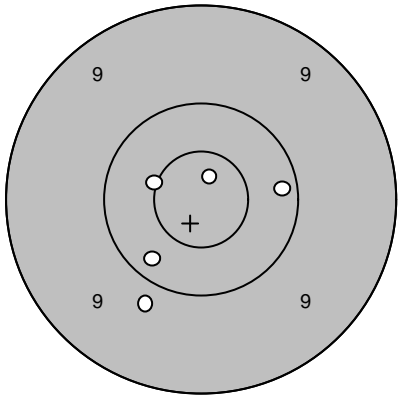
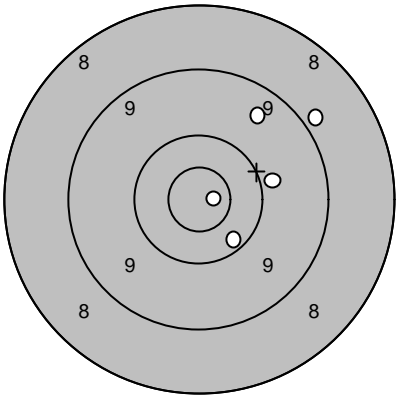
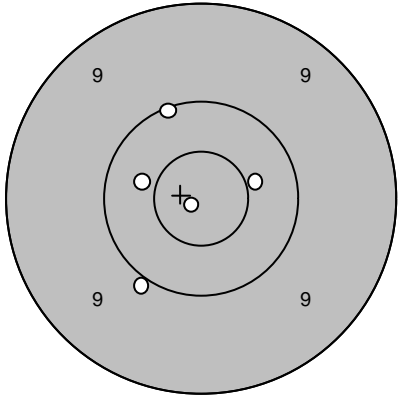
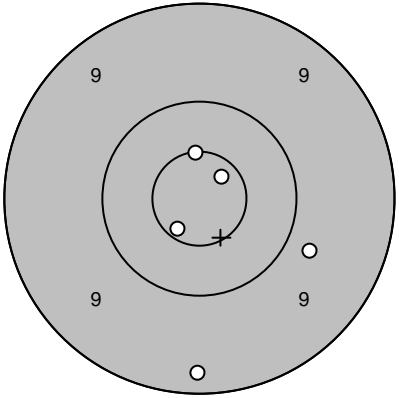
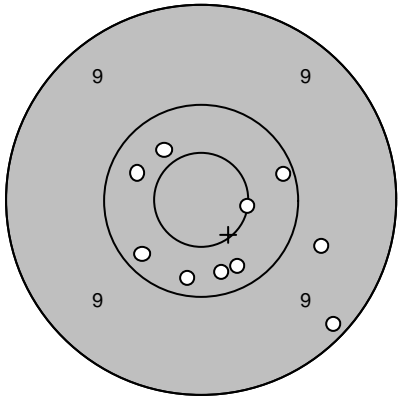
Skjutlag 4	Tavla 2	Jennie Ericsson	
Ramselefors	Loos		
2005-07-09	Tavelträffen A 2005	Ramselefors Skytteförening	
Prov		Serie 1 1: 10,5* ← 2: 10,2 ↙ 3: 9,8 ↘ 4: 10,8* ↑ 5: 10,2 →	Serie 1 
			1: 9,9 → 2: 8,9 ↗ 3: 9,5 ↗ 4: 10,9* → 5: 10,3 ↘
		Serie 51,5	Serie 49,5
		Totalt 0,0	Totalt 49,5
Serie 2		1: 10,1 ↗ 2: 10,9* ↙ 3: 10,5* → 4: 10,4 ↙ 5: 10,0 ↘	Serie 3 
			1: 10,6* ↑ 2: 10,7* ↘ 3: 9,8 → 4: 10,7* ↗ 5: 9,3 ↓
		Serie 51,9	Serie 51,1
		Totalt 101,4	Totalt 152,5
Extratävling		1: 10,2 → 2: 10,3 ↘ 3: 10,2 ↘ 4: 9,7 → 5: 10,3 ↘ 6: 10,3 ↗ 7: 10,4 ↗ 8: 10,2 ↙ 9: 10,6* → 10: 9,2 ↘	
		Serie 101,4	
		Totalt 253,9	

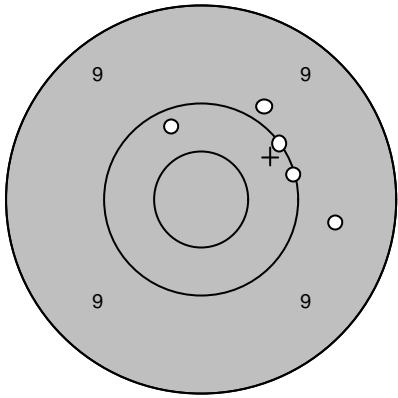
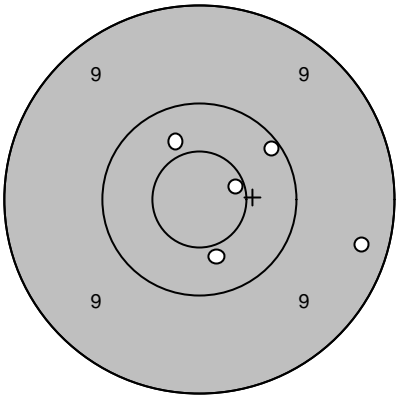
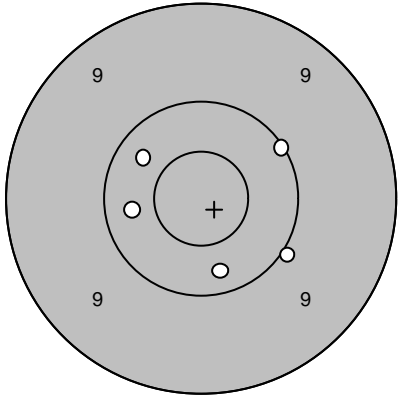
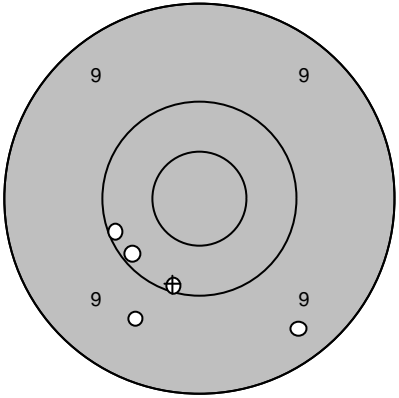
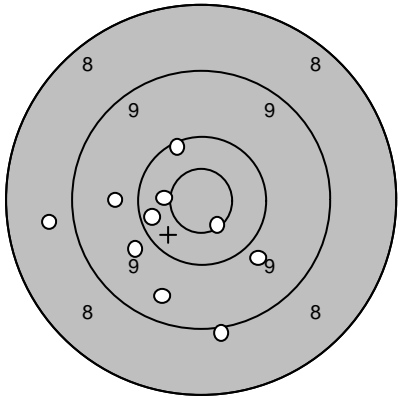
Skjutlag 4	Tavla 3	Amanda Nilsson		
Ramselefors	Loos			
2005-07-09	Tavelträffen A 2005	Ramselefors Skytteförening		
Prov		1: 9,6 → 2: 10,1 → 3: 10,1 ↗ 4: 9,9 ↗ 5: 10,2 ↖	Serie 1 	1: 10,4 ↓ 2: 10,1 ↗ 3: 10,6* → 4: 9,3 → 5: 10,4 ↖
	Serie 49,9		Serie 50,8	
	Totalt 0,0		Totalt 50,8	
Serie 2		1: 10,1 ↗ 2: 10,0 → 3: 10,3 ← 4: 10,3 ↗ 5: 10,3 ↓	Serie 3 	1: 9,7 ↓ 2: 10,1 ← 3: 9,4 ↓ 4: 10,1 ↓ 5: 10,2 ↖
	Serie 51,0		Serie 49,5	
	Totalt 101,8		Totalt 151,3	
Extratävling		1: 10,2 ↖ 2: 9,8 ↓ 3: 10,6* ↓ 4: 10,3 ← 5: 10,5* ← 6: 8,7 ← 7: 9,8 ← 8: 9,0 ↓ 9: 9,5 ↓ 10: 9,8 ↖		
	Serie 98,2			
	Totalt 249,5			

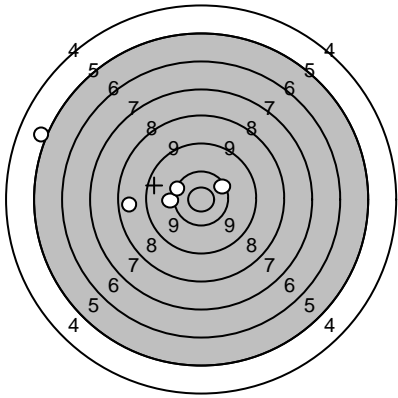
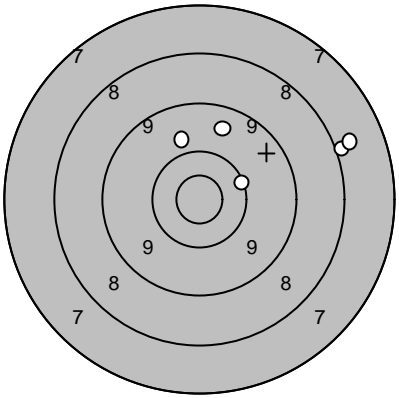
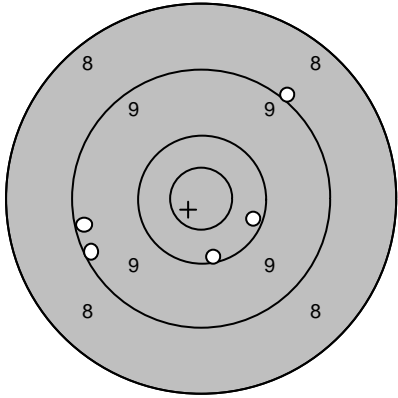
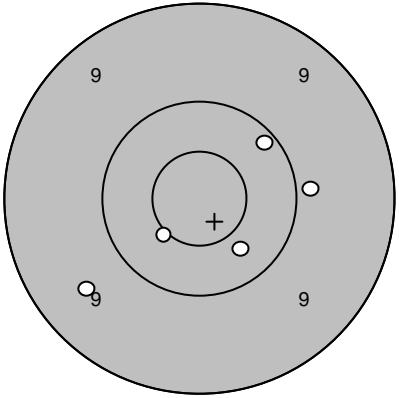
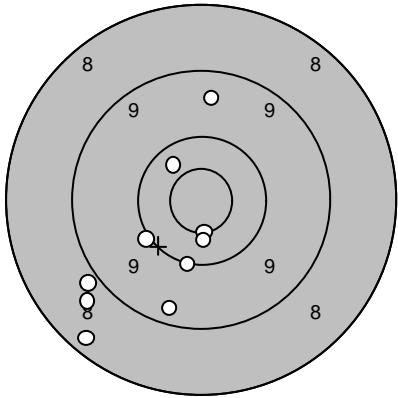
Skjutlag 4	Tavla 4	Linda Lidman	
Ramselefors		Piteå	
2005-07-09		Tavelträffen A 2005	Ramselefors Skytteförening
Prov		1: 8,7 ← 2: 10,1 ← 3: 10,3 → 4: 5,1 ← 5: 10,4 ←	Serie 1  1: 8,0 → 2: 10,2 → 3: 7,8 → 4: 9,6 ↑ 5: 9,9 ↑
		Serie 44,6	Serie 45,5
		Totalt 0,0	Totalt 45,5
Serie 2		1: 10,2 ↓ 2: 9,2 ← 3: 10,2 → 4: 9,0 ↗ 5: 9,2 ←	Serie 3  1: 10,5* ↙ 2: 10,2 ↗ 3: 9,9 → 4: 9,6 ↙ 5: 10,4 ↓
		Serie 47,8	Serie 50,6
		Totalt 93,3	Totalt 143,9
Extratävling		1: 9,5 ↑ 2: 10,4 ↖ 3: 10,0 ← 4: 9,3 ↓ 5: 10,1 ↓ 6: 8,9 ← 7: 10,6* ↓ 8: 8,7 ← 9: 10,5* ↓ 10: 8,3 ↙	
		Serie 96,3	
		Totalt 240,2	

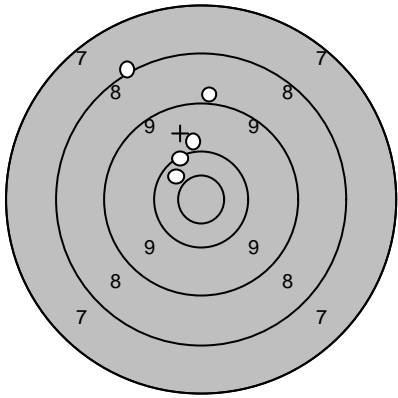
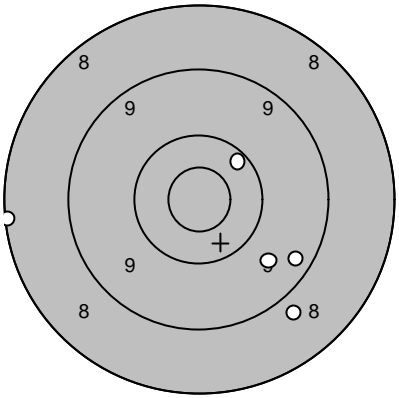
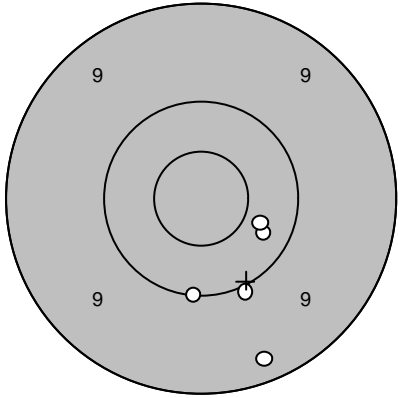
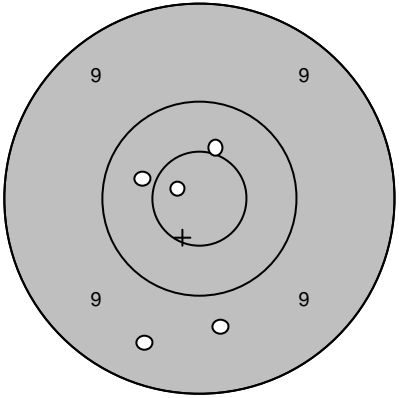
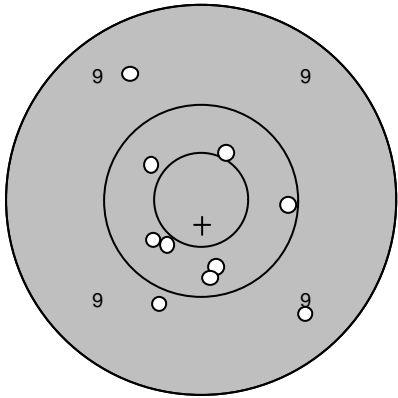
Skjutlag 4	Tavla 5	Christer Burvall		
Ramselefors		Bastuträsk		
2005-07-09		Tavelträffen A 2005	Ramselefors Skytteförening	
Prov		1: 9,0 ↑ 2: 8,1 ↗ 3: 10,4 ↖ 4: 10,2 ↗ 5: 9,9 ↑	Serie 1 	1: 9,4 ↘ 2: 10,3 ↗ 3: 8,1 ← 4: 8,8 ↘ 5: 9,7 ↘
		Serie 47,6	Serie 46,3	
		Totalt 0,0	Totalt 46,3	
Serie 2		1: 10,3 → 2: 10,1 ↓ 3: 10,4 → 4: 10,0 ↓ 5: 9,3 ↓	Serie 3 	1: 10,5* ↑ 2: 10,8* ← 3: 9,7 ↓ 4: 9,5 ↓ 5: 10,4 ←
		Serie 50,1	Serie 50,9	
		Totalt 96,4	Totalt 147,3	
Extratävling		1: 9,5 ↘ 2: 10,1 → 3: 10,4 ↖ 4: 9,6 ↗ 5: 10,5* ↘ 6: 10,5* ↗ 7: 10,3 ↓ 8: 9,9 ↓ 9: 10,4 ↖ 10: 10,2 ↓		
		Serie 101,4		
		Totalt 248,7		

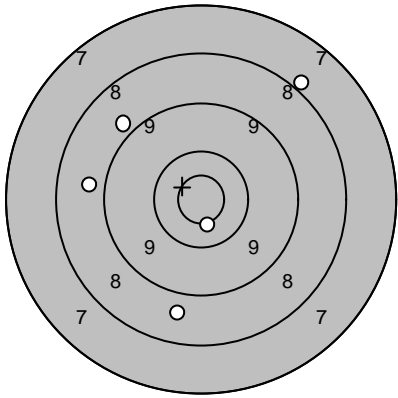
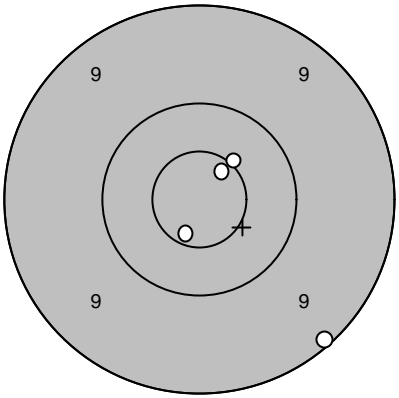
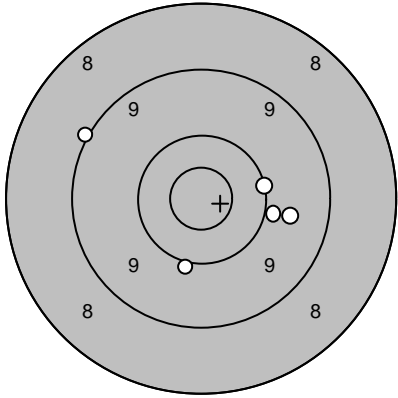
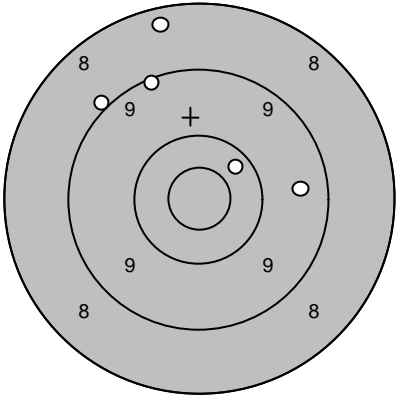
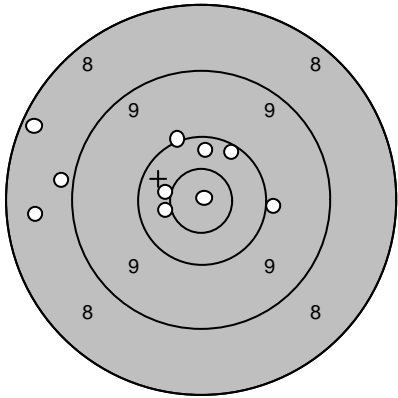
Skjutlag 4	Tavla 6	Andreas Halfvars	
Ramselefors		Hofors	
2005-07-09		Tavelträffen A 2005	Ramselefors Skytteförening
Prov 	1: 8,9 ↖ 2: 10,6* ↓ 3: 8,8 ↓ 4: 8,8 ← 5: 8,0 ↗	Serie 1 	1: 10,5* ↗ 2: 10,7* ↗ 3: 10,7* ↓ 4: 9,1 ↓
	Serie 45,1		Serie 41,0
	Totalt 0,0		Totalt 41,0
Serie 2 	1: 10,1 → 2: 9,7 → 3: 10,0 ↓ 4: 9,9 → 5: 9,0 ↖	Serie 3 	1: 9,0 ↖ 2: 8,4 ↑ 3: 9,2 ↑ 4: 10,3 ↗ 5: 9,5 →
	Serie 48,7		Serie 46,4
	Totalt 89,7		Totalt 136,1
Extratävling 	1: 8,5 ← 2: 10,3 ↑ 3: 10,1 ↗ 4: 10,5* ← 5: 10,0 → 6: 10,2 ↗ 7: 8,9 ← 8: 10,5* ← 9: 10,9* ↗ 10: 8,3 ↖		
	Serie 98,2		
	Totalt 234,3		

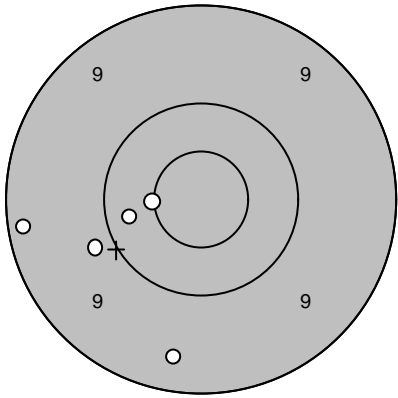
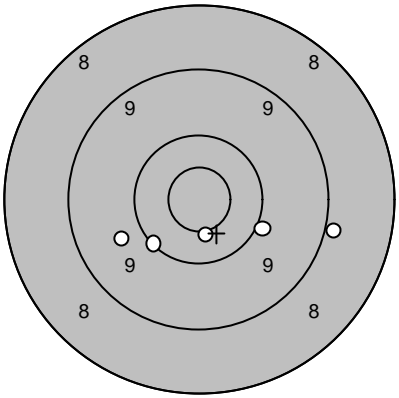
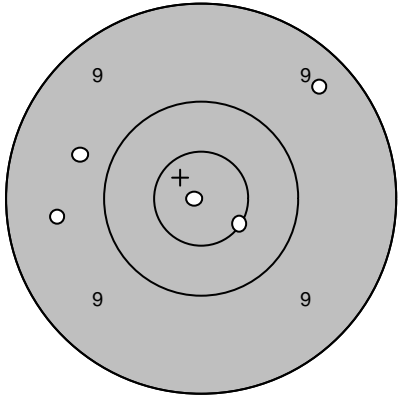
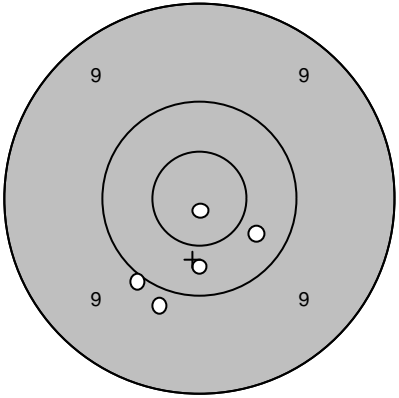
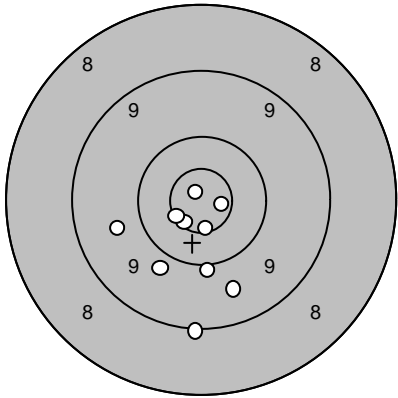
Skjutlag 4	Tavla 9	Robert Lindström	
Ramselefors		Skultuna	
2005-07-09		Tavelträffen A 2005	Ramselefors Skytteförening
Prov 	1: 9,2 ←	Serie 1 	1: 10,1 ↙
	2: 9,4 ↓		2: 10,0 →
	3: 9,8 ←		3: 9,7 ←
	4: 10,3 ←		4: 10,5* ↓
	5: 10,5* ←		5: 9,0 →
	Serie 49,2		Serie 49,3
	Totalt 0,0		Totalt 49,3
Serie 2 	1: 9,7 ←	Serie 3 	1: 10,0 ↙
	2: 9,4 ↗		2: 10,3 ↓
	3: 10,6* →		3: 9,9 ↓
	4: 10,9* ←		4: 10,9* ↓
	5: 9,6 ←		5: 10,3 ↘
	Serie 50,2		Serie 51,4
	Totalt 99,5		Totalt 150,9
Extratävling 	1: 9,1 ↓		
	2: 9,7 ←		
	3: 9,6 ↓		
	4: 10,0 ↓		
	5: 10,6* ↓		
	6: 9,9 ↓		
	7: 10,7* ↙		
	8: 10,6* ←		
	9: 10,8* →		
	10: 10,9* ↗		
	Serie 101,9		
	Totalt 252,8		

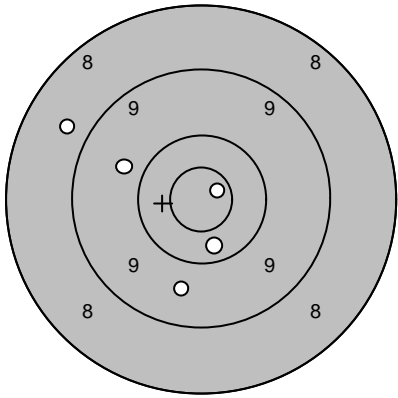
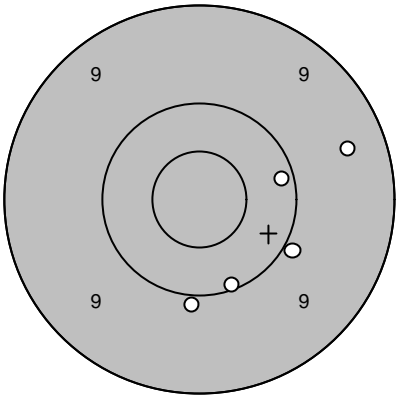
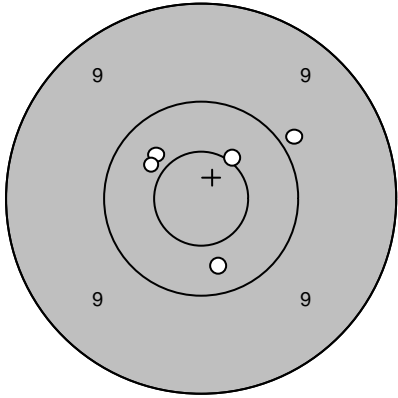
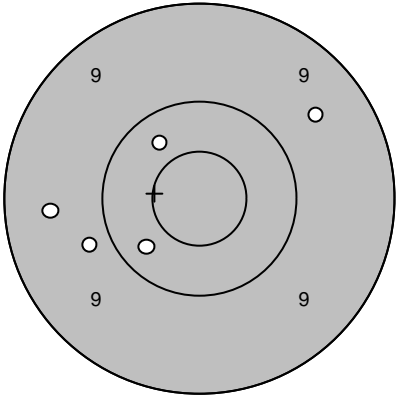
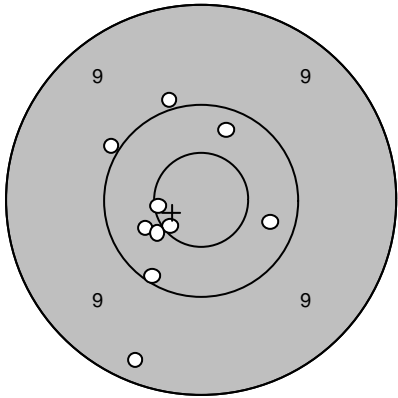
Skjutlag 4	Tavla 10	Carina Norling	
Ramselefors		Söderala	
2005-07-09		Tavelträffen A 2005	Ramselefors Skytteförening
Prov		1: 8,7 ↖ 2: 9,8 ↖ 3: 10,8* → 4: 10,3 ↓ 5: 9,7 ↓	Serie 1 
		Serie 49,3 Totalt 0,0	1: 9,4 → 2: 10,0 ↘ 3: 10,0 ↓ 4: 10,1 ↓ 5: 10,2 →
			Serie 49,7 Totalt 49,7
Serie 2		1: 10,4 ↖ 2: 9,9 → 3: 10,5* ↗ 4: 10,3 ↓ 5: 10,4 ↖	Serie 3 
		Serie 51,5 Totalt 101,2	1: 9,6 ↗ 2: 9,5 ← 3: 10,3 ↙ 4: 10,3 ↗ 5: 9,8 ←
			Serie 49,5 Totalt 150,7
Extratävling		1: 10,6* ↙ 2: 10,6* ← 3: 10,0 ↖ 4: 10,3 ↗ 5: 10,4 ← 6: 9,3 ↓ 7: 10,5* ↙ 8: 10,0 ↗ 9: 10,1 ↙ 10: 10,3 →	
		Serie 102,1 Totalt 252,8	

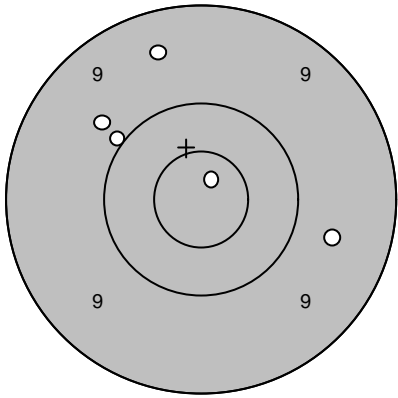
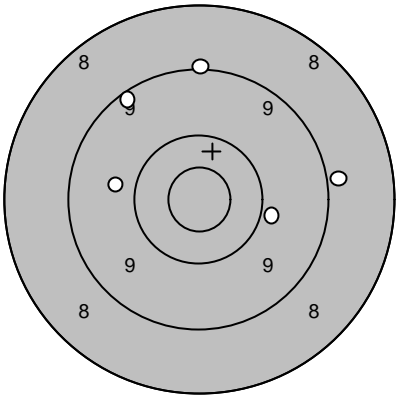
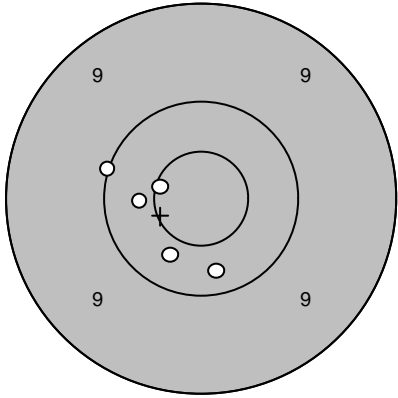
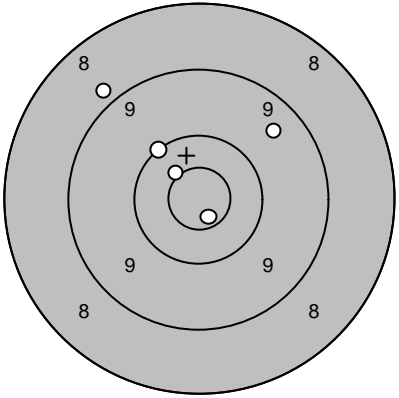
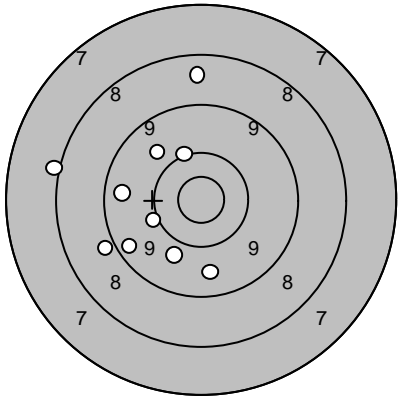
Skjutlag 4	Tavla 11	Lars Eliasson	
Ramselefors		Ramselefors	
2005-07-09		Tavelträffen A 2005	Ramselefors Skytteförening
Prov		1: 9,5 ↗ 2: 10,0 ↗ 3: 9,6 → 4: 9,8 ↗ 5: 10,8* ↗	Serie 1 
		Serie 49,7 Totalt 0,0	1: 8,9 → 2: 9,0 ↑ 3: 9,2 ↗ 4: 9,8 ← 5: 9,9 →
			Serie 46,8 Totalt 46,8
Serie 2		1: 10,6* ← 2: 10,4 ← 3: 10,0 ↗ 4: 10,3 ↓ 5: 10,4 ↓	Serie 3 
		Serie 51,7 Totalt 98,5	1: 9,5 ↗ 2: 10,1 ↗ 3: 8,9 ↗ 4: 10,8* ↓ 5: 10,5* ↗
			Serie 49,8 Totalt 148,3
Extratävling		1: 8,6 ↑ 2: 8,9 ← 3: 10,1 ← 4: 9,5 ← 5: 8,0 ← 6: 10,1 ↗ 7: 9,9 ↓ 8: 9,4 ← 9: 9,6 ↓ 10: 9,8 ↗	
		Serie 93,9 Totalt 242,2	

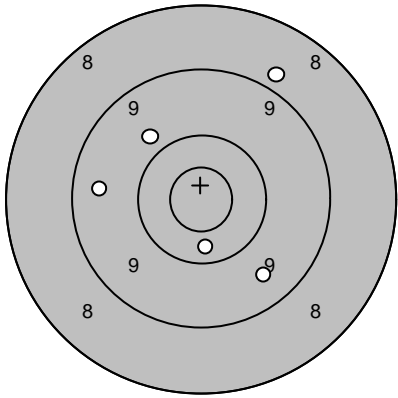
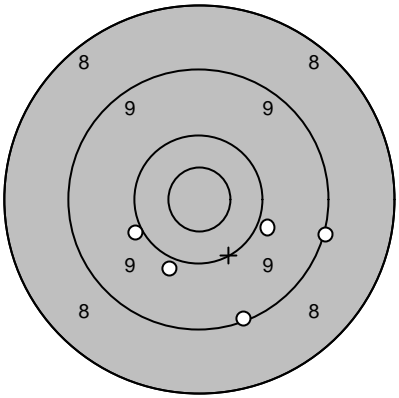
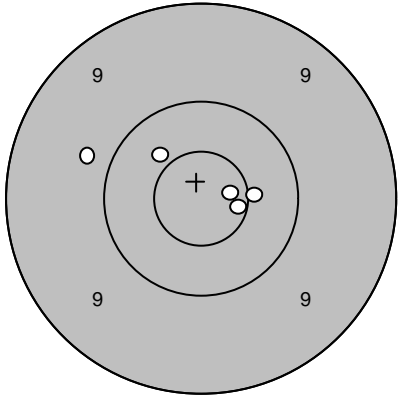
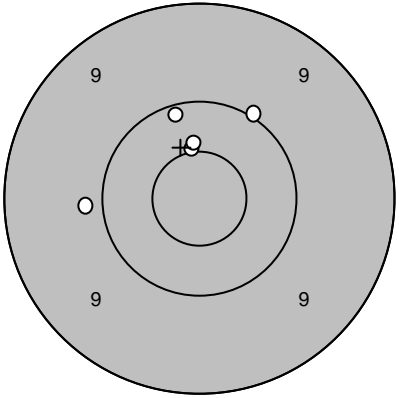
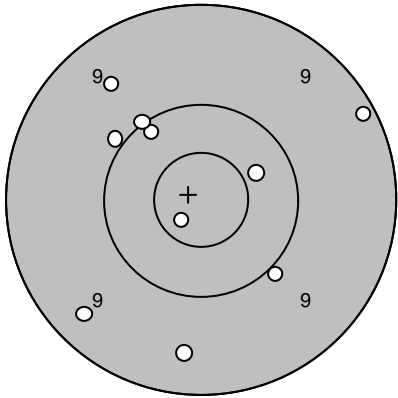
Skjutlag 4	Tavla 12	Ingemar Långström	
Ramselefors		Ramselefors	
2005-07-09		Tavelträffen A 2005	Ramselefors Skytteförening
Prov		1: 9,8 ↗ 2: 9,5 ← 3: 8,8 ↗ 4: 10,3 ↓ 5: 9,6 ↓	Serie 1 
		Serie 48,0 Totalt 0,0	1: 9,9 → 2: 9,9 ↓ 3: 9,1 → 4: 10,0 ← 5: 9,1 ↓
			Serie 48,0 Totalt 48,0
Serie 2		1: 10,7* → 2: 10,5* → 3: 9,8 ↗ 4: 10,4 ↗ 5: 10,6* →	Serie 3 
		Serie 52,0 Totalt 100,0	1: 10,0 ↗ 2: 10,5* ↑ 3: 10,2 ↑ 4: 9,9 ← 5: 10,5* ↑
			Serie 51,1 Totalt 151,1
Extratävling		1: 9,5 ↗ 2: 9,5 ↓ 3: 10,2 ↗ 4: 10,0 ↗ 5: 10,4 → 6: 10,0 ↗ 7: 10,0 ↓ 8: 9,4 ↓ 9: 10,7* ↓ 10: 9,2 →	
		Serie 98,9 Totalt 250,0	

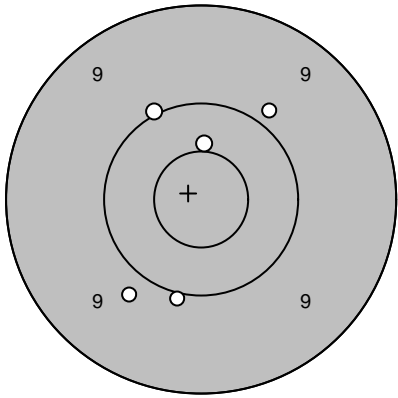
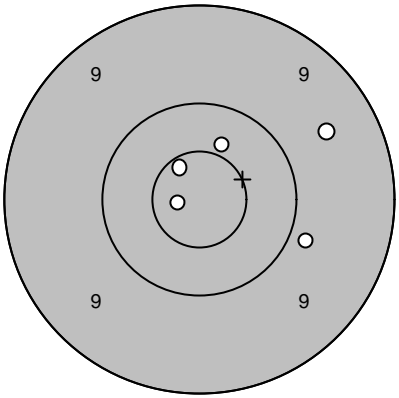
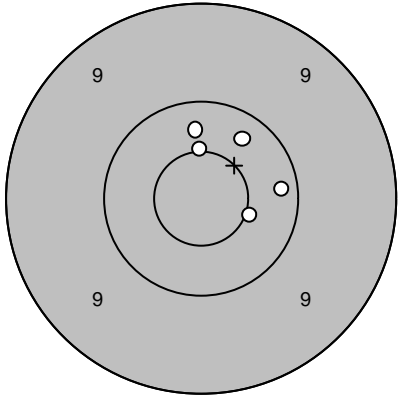
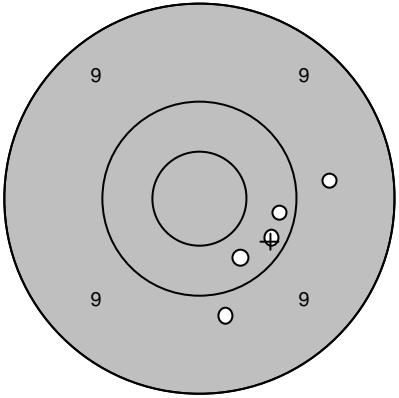
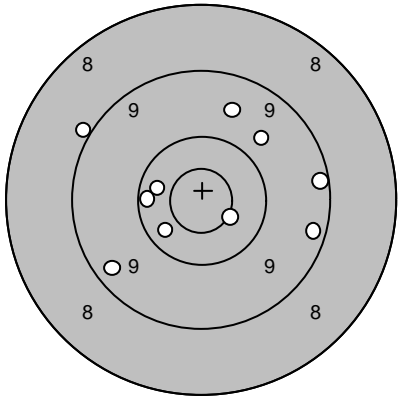
Skjutlag 4	Tavla 13	Stefan Thorin (endast lördag)	
Ramselefors	Umeå		
2005-07-09	Tavelträffen A 2005	Ramselefors Skytteförening	
Prov		1: 9,8 ↙ 2: 10,0 ↓ 3: 10,5* ↑ 4: 10,0 ↖ 5: 9,9 ↗	Serie 1 
	Serie 50,2 Totalt 0,0	1: 10,8* ← 2: 9,9 → 3: 10,7* ↖ 4: 9,6 ↗ 5: 10,4 ↗	Serie 51,4 Totalt 51,4
Serie 2		1: 10,3 ↗ 2: 10,5* → 3: 10,3 ↑ 4: 10,5* ↑ 5: 10,2 →	Serie 3 
	Serie 51,8 Totalt 103,2	1: 9,8 ↓ 2: 10,2 ↘ 3: 9,7 → 4: 10,3 ↘ 5: 10,2 →	Serie 50,2 Totalt 153,4
Extratävling		1: 9,2 → 2: 9,6 ↑ 3: 9,3 → 4: 10,4 ← 5: 10,3 ← 6: 9,0 ↖ 7: 10,4 ↙ 8: 10,6* → 9: 9,4 ↙ 10: 9,7 ↗	
	Serie 97,9 Totalt 251,3		

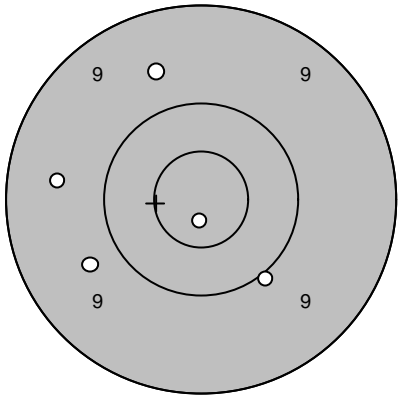
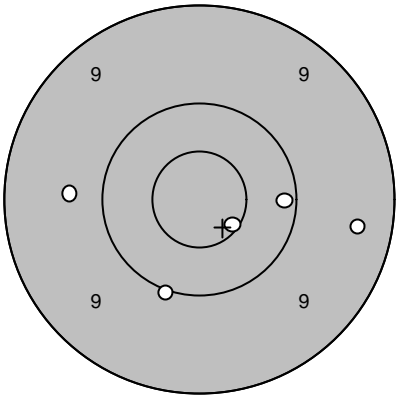
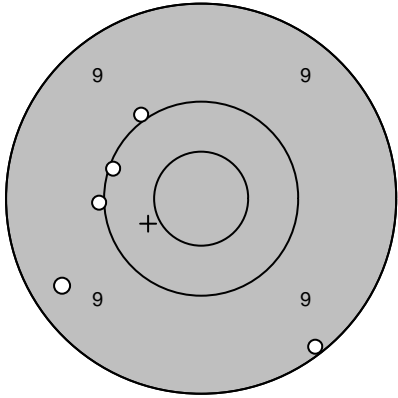
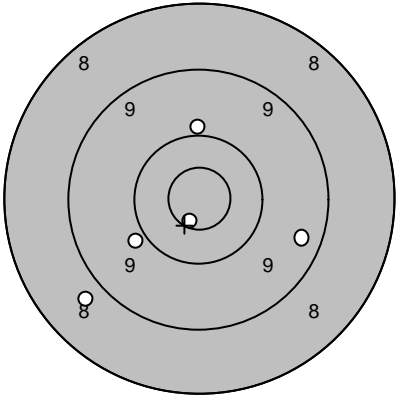
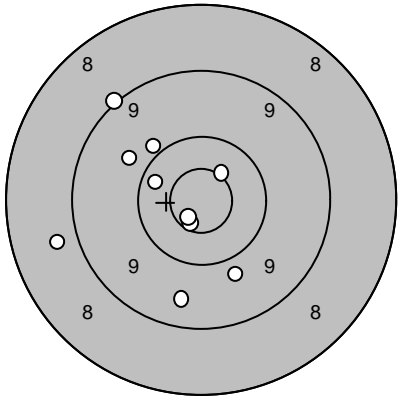
Skjutlag	Tavla	Rune Utterström	
4	16		
Ramselefors	Ale		
2005-07-09	Tavelträffen A 2005	Ramselefors Skytteförening	
Prov		1: 9,7 ↙ 2: 10,8* ↓ 3: 9,7 ↗ 4: 9,6 ← 5: 10,0 ↓	Serie 1 
			1: 10,6* ↘ 2: 9,4 → 3: 10,0 ↓ 4: 10,2 → 5: 9,7 ←
		Serie 49,8	Serie 49,9
		Totalt 0,0	Totalt 49,9
Serie 2		1: 9,1 ↘ 2: 10,1 ↗ 3: 10,0 ↗ 4: 9,4 ← 5: 10,0 ←	Serie 3 
			1: 9,4 → 2: 9,9 ← 3: 8,8 ↙ 4: 10,0 ↑ 5: 10,7* ↓
		Serie 48,6	Serie 48,8
		Totalt 98,5	Totalt 147,3
Extratävling		1: 9,8 ↘ 2: 9,1 ↗ 3: 10,6* ↗ 4: 10,3 ← 5: 10,0 ↗ 6: 8,8 ← 7: 10,7* ↓ 8: 9,5 ↓ 9: 10,7* ↓ 10: 9,8 ↖	
		Serie 99,3	
		Totalt 246,6	

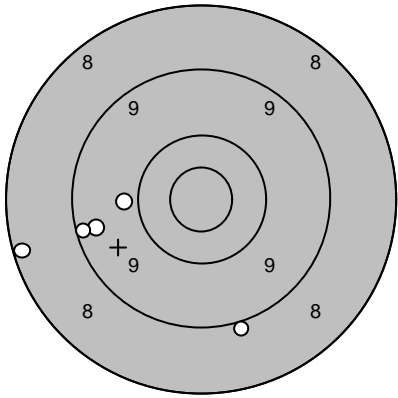
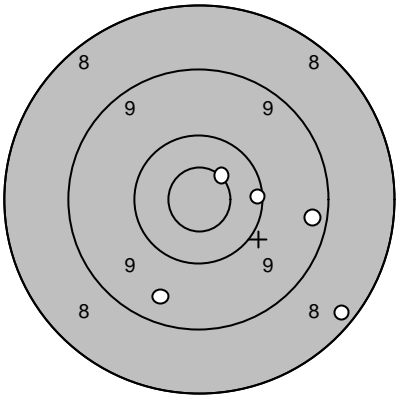
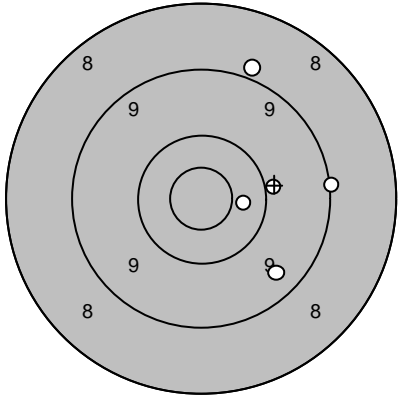
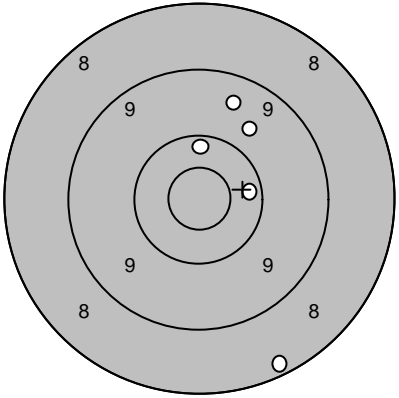
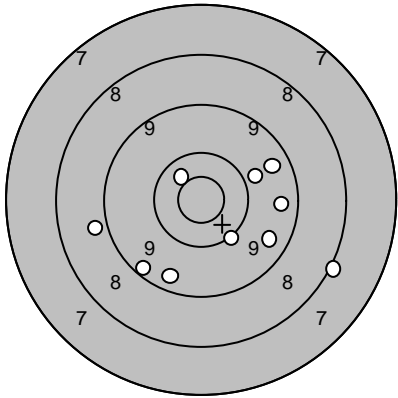
Skjutlag 4	Tavla 18	Ivar Larsson	
Ramselefors		Närkes-Kil	
2005-07-09		Tavelträffen A 2005	Ramselefors Skytteförening
Prov		1: 8,2 ← 2: 9,0 ↓ 3: 9,9 ← 4: 9,4 ← 5: 9,2 ←	Serie 1  1: 10,6* ↗ 2: 8,3 ↘ 3: 9,3 → 4: 9,5 ↓ 5: 10,2 →
		Serie 45,7	Serie 47,9
		Totalt 0,0	Totalt 47,9
Serie 2		1: 9,5 ↘ 2: 8,9 ↑ 3: 10,4 → 4: 10,0 → 5: 9,1 →	Serie 3  1: 9,5 ↑ 2: 10,3 ↑ 3: 9,8 ↗ 4: 10,3 → 5: 8,3 ↓
		Serie 47,9	Serie 48,2
		Totalt 95,8	Totalt 144,0
Extratävling		1: 10,5* ↗ 2: 9,5 → 3: 9,5 → 4: 9,5 ↓ 5: 8,1 → 6: 9,9 → 7: 8,9 ← 8: 9,5 → 9: 10,1 ↓ 10: 9,3 ↘	
		Serie 94,8	
		Totalt 238,8	

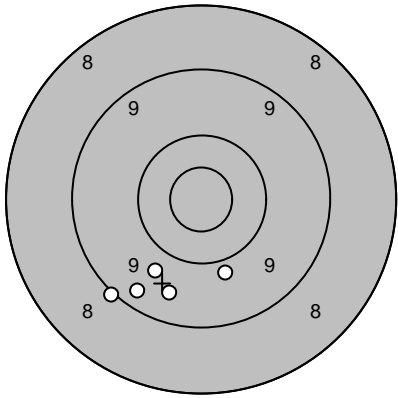
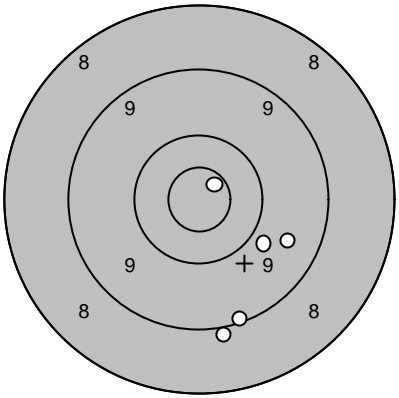
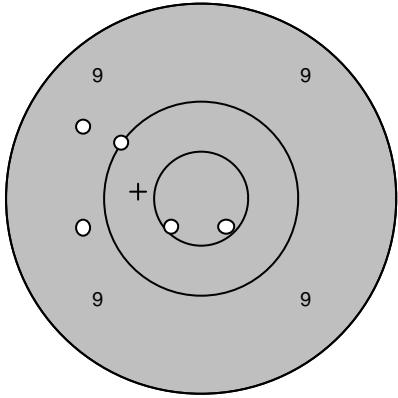
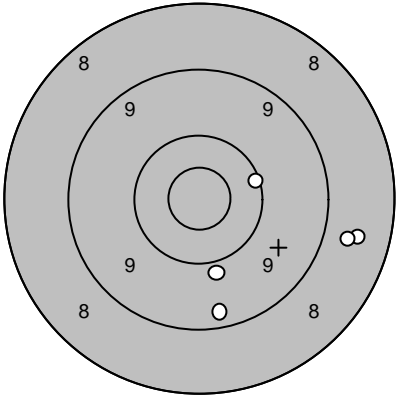
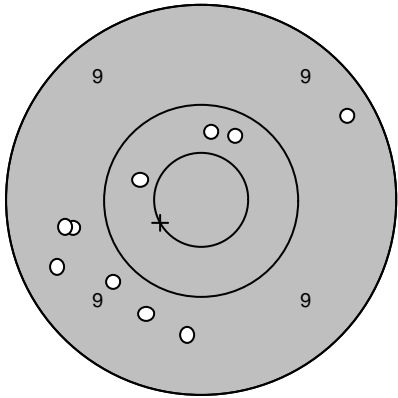
Skjutlag 4	Tavla 19	Sture Grahn	
Ramselefors		Piteå	
2005-07-09		Tavelträffen A 2005	Ramselefors Skytteförening
Prov		1: 9,1 ↙ 2: 9,4 ↙ 3: 9,5 ↙ 4: 9,9 ↙ 5: 9,8 ↙ Serie 47,7 Totalt 0,0	Serie 1  1: 9,9 ↘ 2: 9,0 ↓ 3: 9,6 ↘ 4: 9,1 ↓ 5: 10,8* ↗ Serie 48,4 Totalt 48,4
Serie 2		1: 10,0 ↖ 2: 9,8 ← 3: 10,6* ↙ 4: 10,6* ↘ 5: 9,6 ↖ Serie 50,6 Totalt 99,0	Serie 3  1: 8,6 → 2: 8,7 → 3: 9,9 ↓ 4: 9,3 ↓ 5: 10,2 → Serie 46,7 Totalt 145,7
Extratävling		1: 9,7 ← 2: 9,4 ← 3: 10,3 ↗ 4: 10,4 ← 5: 9,3 ↗ 6: 10,3 ↗ 7: 9,6 ↓ 8: 9,8 ↙ 9: 9,7 ↙ 10: 9,6 ← Serie 98,1 Totalt 243,8	

Skjutlag	Tavla	Erhard Högländer	
4	20		

Ramselefors	Rundvik		
-------------	---------	--	--

2005-07-09	Tavelträffen A 2005	Ramselefors Skytteförening	
------------	---------------------	----------------------------	--

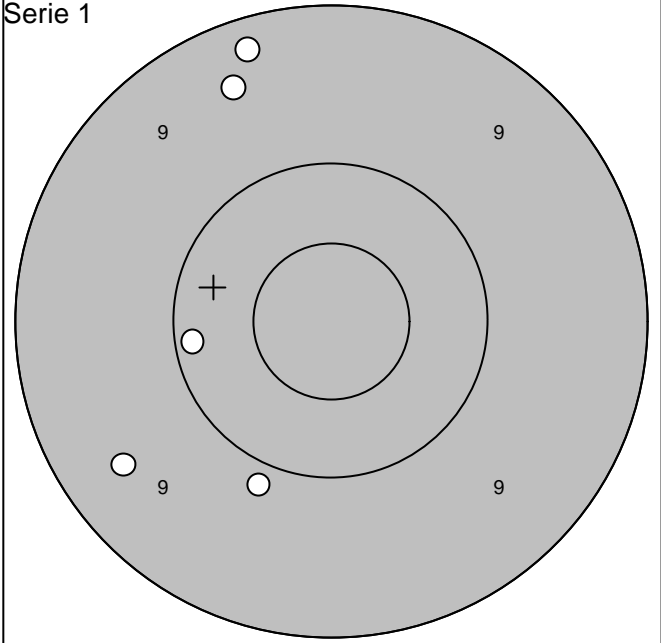
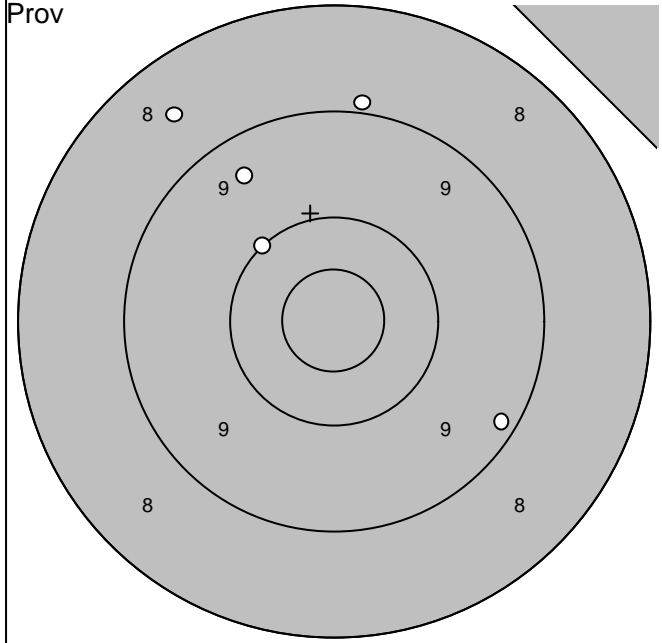

1: 8,6	↗
2: 9,2	↘
3:10,0	↗
4: 9,4	↗
5: 8,9	↑

Serie	46,1
Totalt	0,0

1: 9,2	↗
2: 9,4	↗
3:10,1	←
4: 9,9	↘
5: 9,4	↙

Serie	48,0
Totalt	48,0

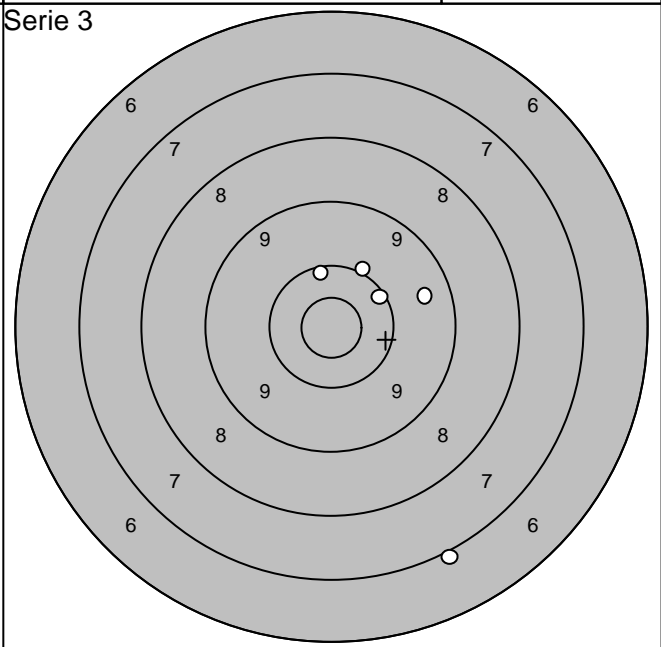
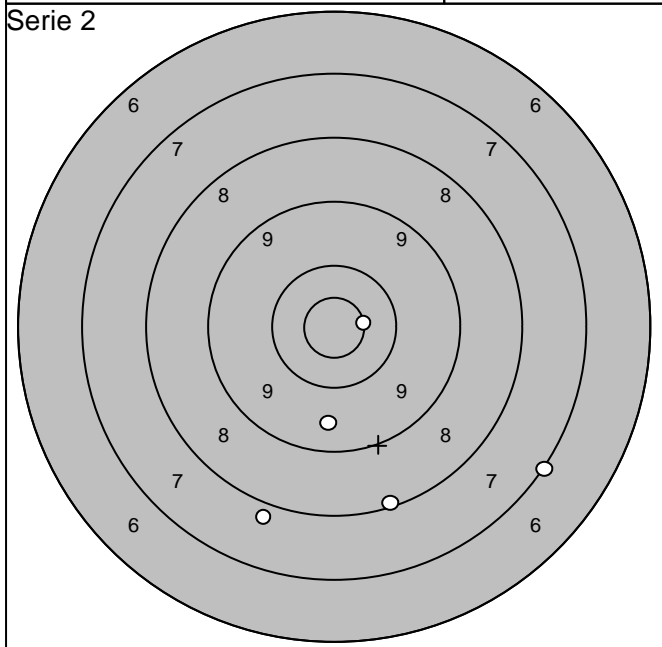

1: 7,9	↘
2:10,6*	→
3: 9,6	↘
4: 7,1	↘
5: 8,2	↘

Serie	43,4
Totalt	91,4

1: 7,0	↘
2:10,2	↑
3:10,0	↗
4: 9,5	→
5:10,2	↗

Serie	46,9
Totalt	138,3

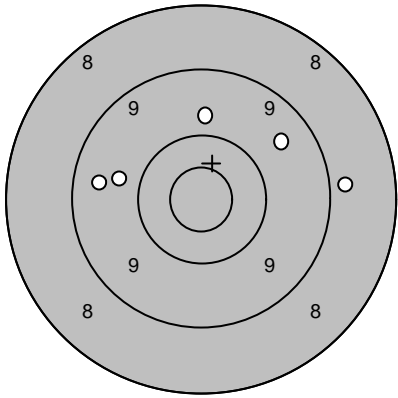
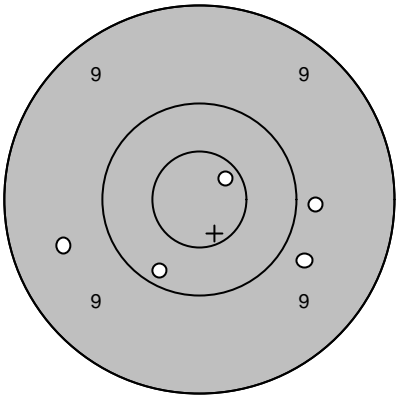
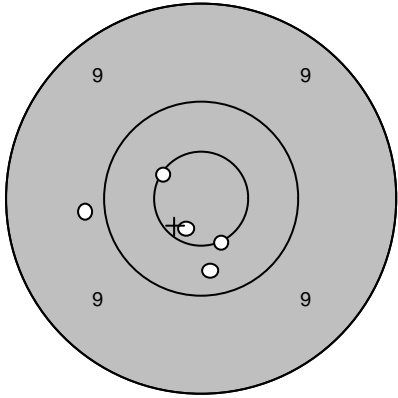
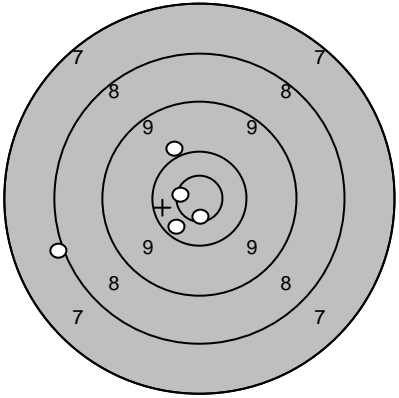
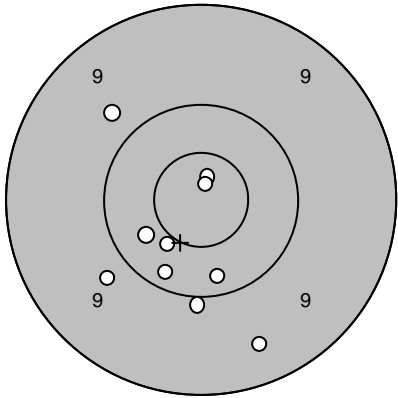
Skjutlag 4	Tavla 21	Linda Bergman	
Ramselefors	Ununge		
2005-07-09	Tavelträffen A 2005	Ramselefors Skytteförening	
Prov		1: 9,5 ← 2: 9,8 ← 3: 9,8 ↑ 4: 8,9 → 5: 9,6 ↗	Serie 1 
	Serie 47,6 Totalt 0,0	1: 10,7* ↗ 2: 9,8 → 3: 9,8 ↘ 4: 9,6 ← 5: 10,2 ↙	Serie 50,1 Totalt 50,1
Serie 2		1: 10,6* ↖ 2: 10,7* ↙ 3: 10,3 ↓ 4: 9,8 ← 5: 10,5* ↙	Serie 3 
	Serie 51,9 Totalt 102,0	1: 10,7* ← 2: 8,1 ← 3: 10,4 ↙ 4: 10,0 ↑ 5: 10,7* ↓	Serie 49,9 Totalt 151,9
Extratävling		1: 10,4 ↖ 2: 10,2 ↙ 3: 9,8 ↖ 4: 10,2 ↓ 5: 10,5* ↖ 6: 10,0 ↓ 7: 10,8* ↑ 8: 9,5 ↙ 9: 9,8 ↖ 10: 10,9* ↑	
	Serie 102,1 Totalt 254,0		

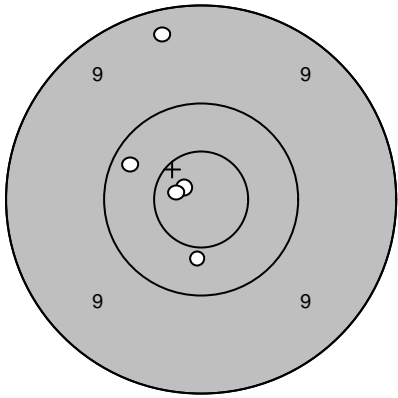
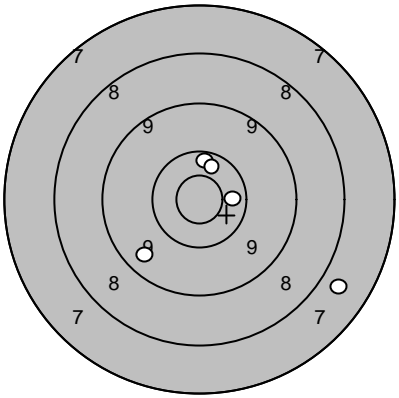
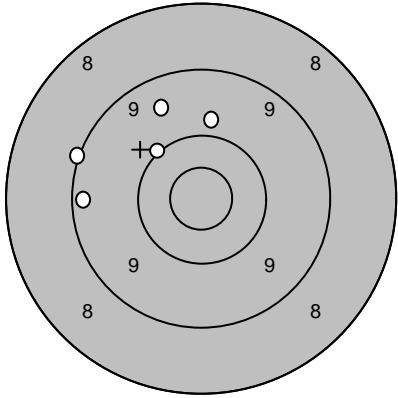
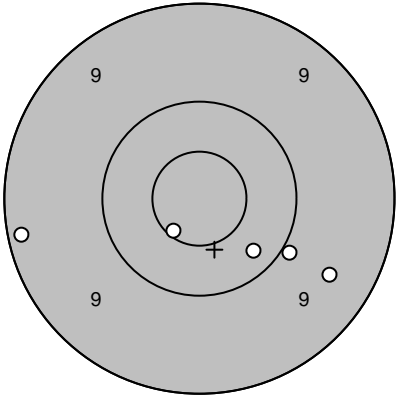
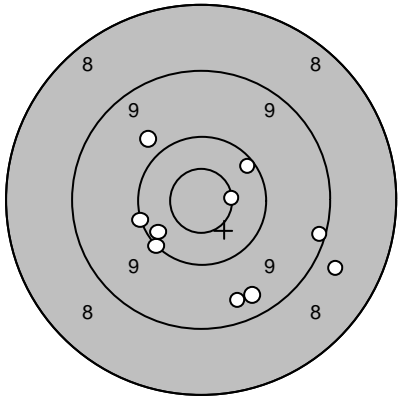
Skjutlag 4	Tavla 22	Torvald Andersson	
Ramselefors		Ununge	
2005-07-09		Tavelträffen A 2005	Ramselefors Skytteförening
Prov		1: 10,4 ↓ 2: 10,8* ↗ 3: 10,2 ↗ 4: 10,8* ← 5: 9,3 ↑	Serie 1 
		Serie 1: 10,3 ↑ 2: 7,8 ↘ 3: 10,4 → 4: 10,4 ↑ 5: 9,5 ↘	
		Serie 51,5	Serie 48,4
		Totalt 0,0	Totalt 48,4
Serie 2		1: 9,9 ↑ 2: 10,1 ↗ 3: 9,6 ↗ 4: 9,3 ← 5: 9,1 ←	Serie 3 
		Serie 2: 10,0 ↘ 2: 10,6* ↘ 3: 9,2 ← 4: 10,3 ↘ 5: 9,5 ↘	
		Serie 48,0	Serie 49,6
		Totalt 96,4	Totalt 146,0
Extratävling		1: 9,4 ↓ 2: 8,8 → 3: 9,8 ↗ 4: 9,5 ↓ 5: 9,2 → 6: 10,2 ↗ 7: 10,6* → 8: 10,1 ↘ 9: 10,1 ← 10: 10,3 ↘	
		Serie 98,0	
		Totalt 244,0	

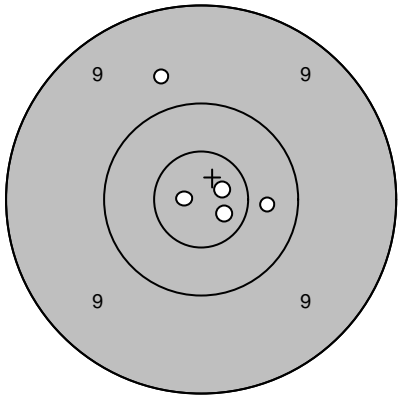
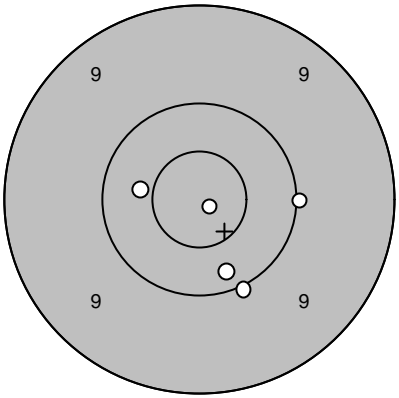
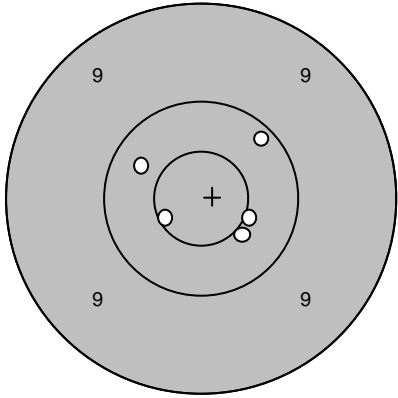
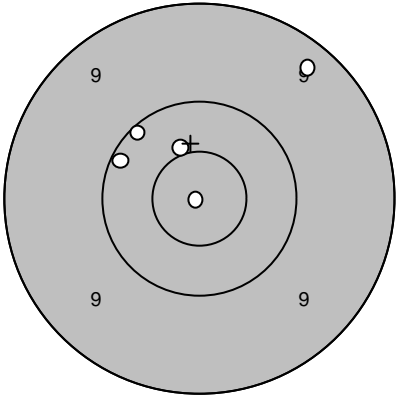
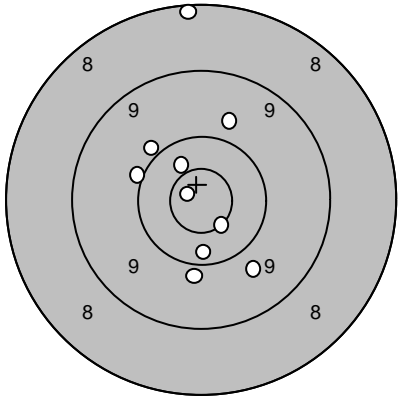
Skjutlag 4	Tavla 23	Lars-Göran Lundqvist		
Ramselefors		Ununge		
2005-07-09		Tavelträffen A 2005	Ramselefors Skytteförening	
Prov		1: 10,9* ← 2: 10,3 → 3: 10,8* → 4: 9,7 ↑ 5: 10,8* ↓	Serie 1 	1: 10,0 → 2: 10,0 ↓ 3: 10,2 ↓ 4: 10,4 ← 5: 10,9* ↓
		Serie 52,5	Serie 51,5	
		Totalt 0,0	Totalt 51,5	
Serie 2		1: 10,5* → 2: 10,3 ↖ 3: 10,2 ↗ 4: 10,5* ↓ 5: 10,6* ↙	Serie 3 	1: 9,3 ↗ 2: 10,9* ← 3: 10,5* ↑ 4: 10,1 ↖ 5: 10,1 ↗
		Serie 52,1	Serie 50,9	
		Totalt 103,6	Totalt 154,5	
Extratävling		1: 8,2 ↑ 2: 10,0 ↗ 3: 9,9 ↓ 4: 10,8* ↖ 5: 9,8 ↓ 6: 10,0 ↖ 7: 9,8 ↑ 8: 10,3 ↓ 9: 10,6* ↓ 10: 10,5* ↗		
		Serie 99,9		
		Totalt 254,4		

Skjutlag 4	Tavla 24	Stefan Lundqvist
----------------------	--------------------	-------------------------

Ramselefors	Ununge		
-------------	--------	--	--

2005-07-09	Tavelträffen A 2005	Ramselefors Skytteförening
------------	---------------------	----------------------------

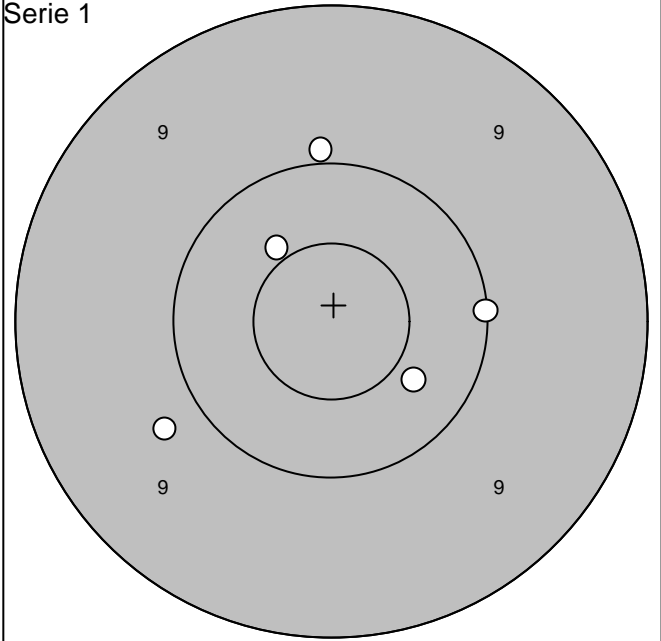
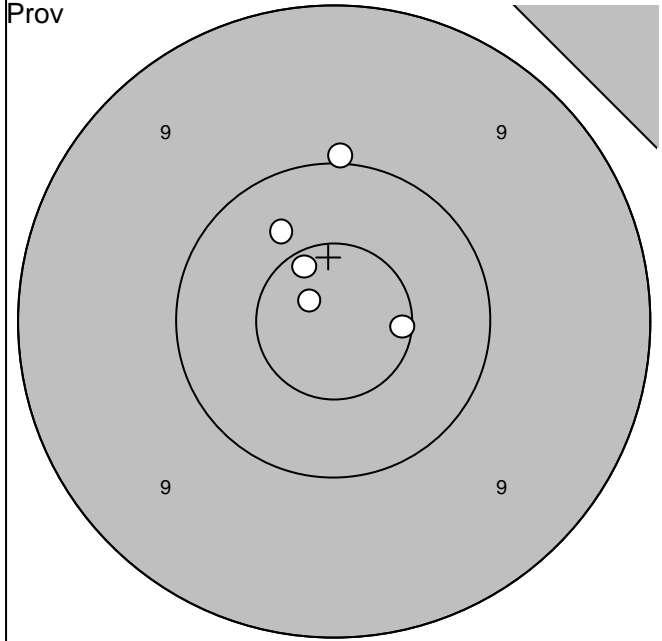

1:10,0 ↑	Serie	52,4
2:10,8* ↗		
3:10,6* →	Totalt	0,0
4:10,4 ↗		
5:10,6* ↗		

1:10,4 ↘	Serie	50,7
2: 9,9 ↑		
3:10,1 →	Totalt	50,7
4:10,5* ↗		
5: 9,8 ↙		

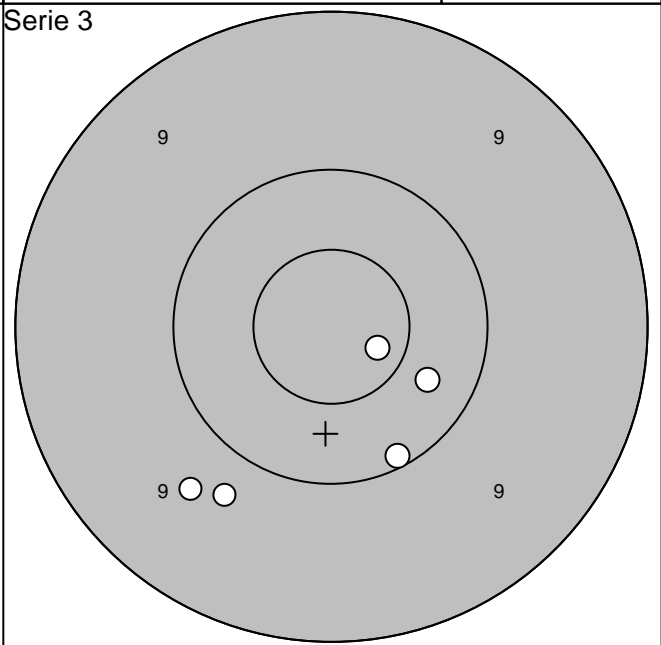
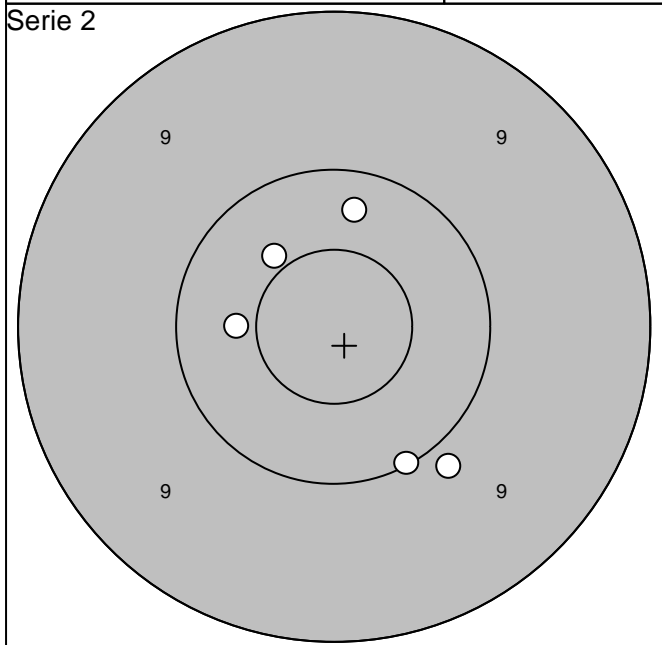

1:10,4 ←	Serie	51,1
2:10,4 ↗		
3: 9,9 ↘	Totalt	101,8
4:10,3 ↑		
5:10,1 ↘		

1:10,3 ↘	Serie	50,6
2: 9,7 ↙		
3:10,7* →	Totalt	152,4
4:10,1 ↘		
5: 9,8 ↙		

www.AC-Skytte.com

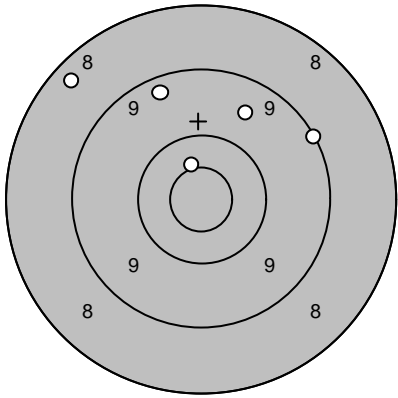
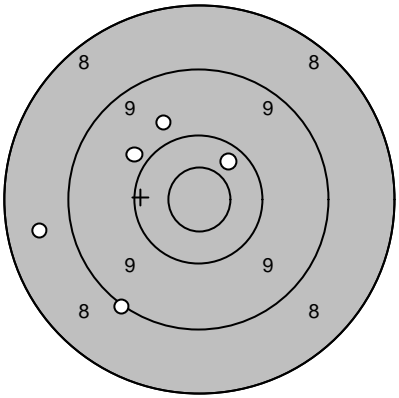
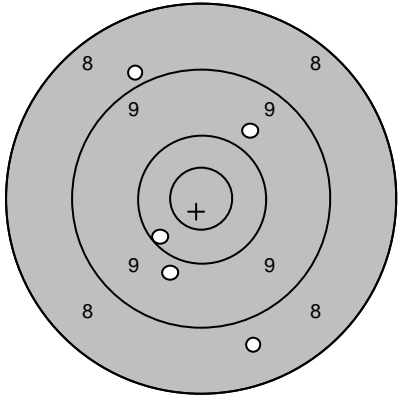
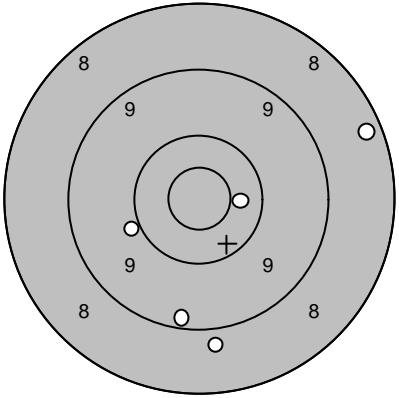
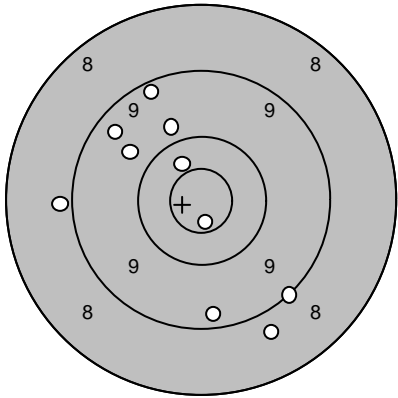
Skjutlag 5	Tavla 1	Petter Ivarsson	
Ramselefors	Loos		
2005-07-09	Tavelträffen A 2005	Ramselefors Skytteförening	
Prov		1: 8,4 ↖ 2: 9,3 ↗ 3: 9,1 → 4: 10,5* ↗ 5: 9,6 ↗	Serie 1 
	Serie 46,9 Totalt 0,0	1: 8,6 ← 2: 9,1 ↘ 3: 9,9 ↖ 4: 9,8 ↗ 5: 10,3 ↗	Serie 47,7 Totalt 47,7
Serie 2		1: 8,9 ↖ 2: 9,8 ↗ 3: 8,7 ↘ 4: 9,9 ↘ 5: 10,2 ↙	Serie 3 
	Serie 47,5 Totalt 95,2	1: 9,9 ← 2: 9,2 ↓ 3: 8,8 ↓ 4: 8,3 → 5: 10,4 →	Serie 46,6 Totalt 141,8
Extratävling		1: 10,7* ↓ 2: 8,8 ↓ 3: 9,1 ↘ 4: 9,2 ↗ 5: 9,3 ↓ 6: 10,5* ↗ 7: 9,4 ↗ 8: 9,9 ↗ 9: 8,9 ← 10: 9,8 ↖	
	Serie 95,6 Totalt 237,4		

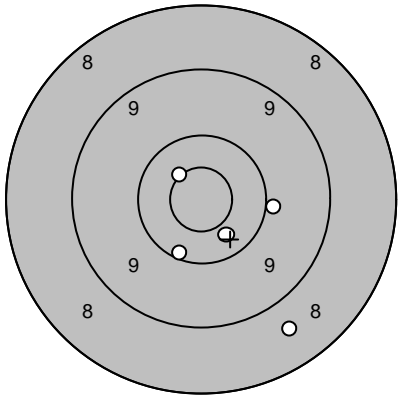
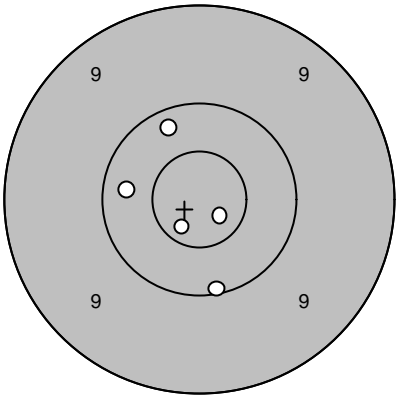
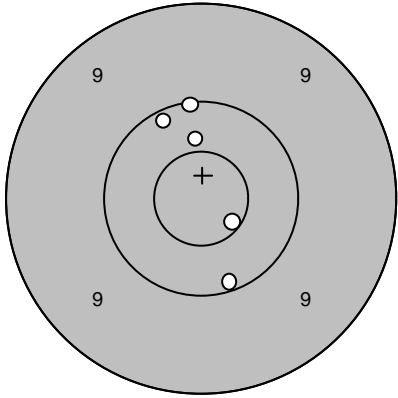
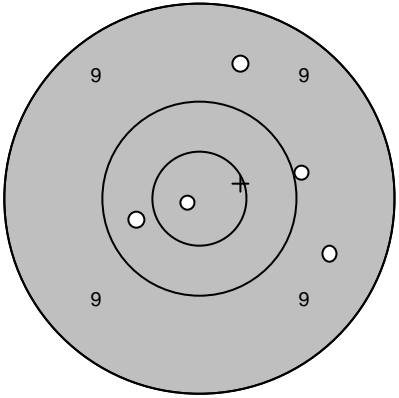
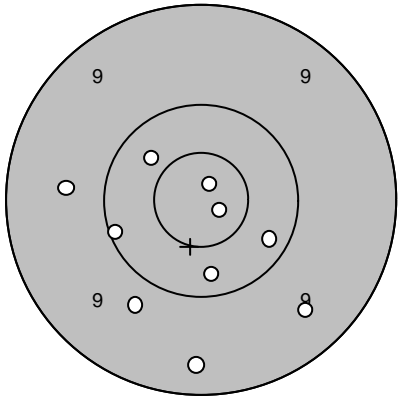
Skjutlag	Tavla	Peter Ericson		
5	2			
Ramselefors	Loos			
2005-07-09	Tavelträffen A 2005	Ramselefors Skytteförening		
Prov		1: 10,6* ↖ 2: 10,0 → 3: 10,2 ↓ 4: 10,4 ↓ 5: 8,7 ↓	Serie 1 	1: 10,2 ↖ 2: 10,3 ← 3: 10,7* ↓ 4: 10,8* ↘ 5: 10,1 ↓
		Serie 49,9	Serie 52,1	
		Totalt 0,0	Totalt 52,1	
Serie 2		1: 10,1 ↑ 2: 10,6* ↘ 3: 10,4 ↑ 4: 10,2 ↖ 5: 10,1 ↓	Serie 3 	1: 9,6 ↖ 2: 10,0 → 3: 9,6 ↘ 4: 10,9* ← 5: 10,4 ←
		Serie 51,4	Serie 50,5	
		Totalt 103,5	Totalt 154,0	
Extratävling		1: 10,4 ↖ 2: 9,6 ← 3: 9,8 ↓ 4: 10,9* ↖ 5: 10,8* ↘ 6: 10,1 ← 7: 10,2 ↘ 8: 9,3 ↓ 9: 9,5 ↘ 10: 10,3 ↓		
		Serie 100,9		
		Totalt 254,9		

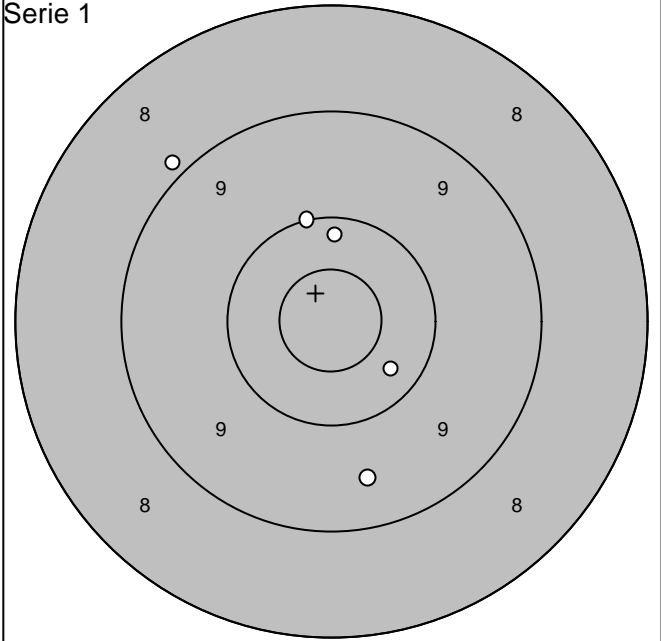
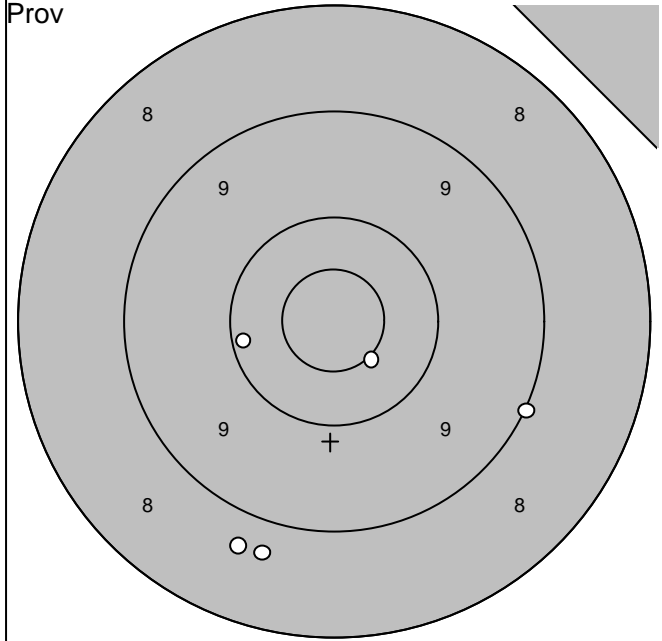

1:10,5* ↘	Serie	47,0	
2: 9,0 →			
3: 8,7 ↓	Totalt	0,0	
4: 8,7 ↓			
5:10,1 ←			

1:10,1 ↑	Serie	49,0	
2:10,2 ↑			
3: 9,5 ↓	Totalt	49,0	
4: 8,9 ↗			
5:10,3 ↘			

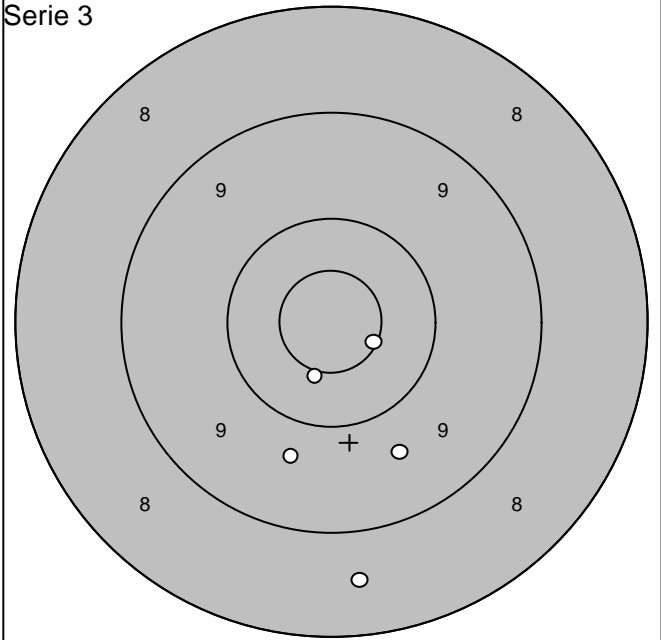
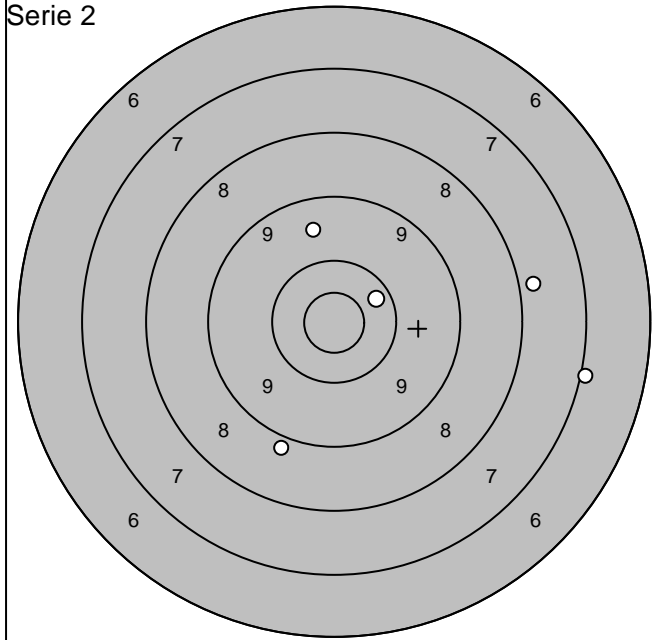

1: 7,9 →	Serie	43,7	
2: 9,6 ↑			
3: 8,9 ↓	Totalt	92,7	
4:10,3 ↗			
5: 7,0 →			

1:10,5* ↓	Serie	49,0	
2: 9,7 ↓			
3: 8,6 ↓	Totalt	141,7	
4: 9,6 ↓			
5:10,6* ↘			

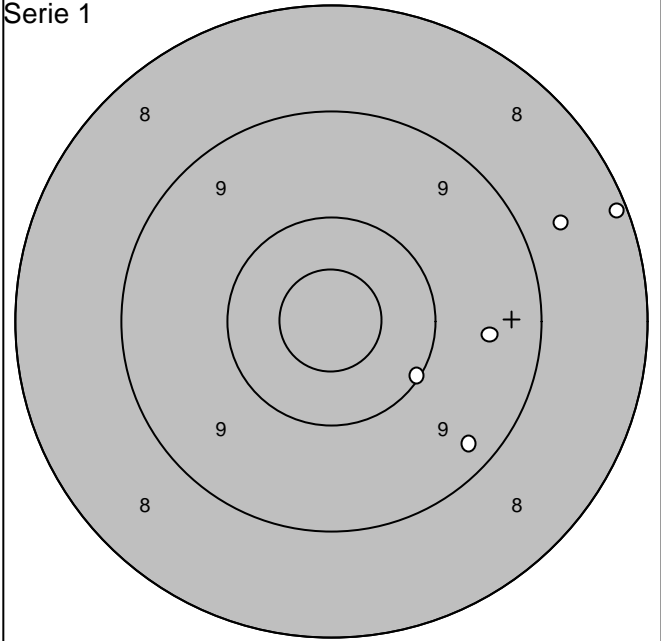
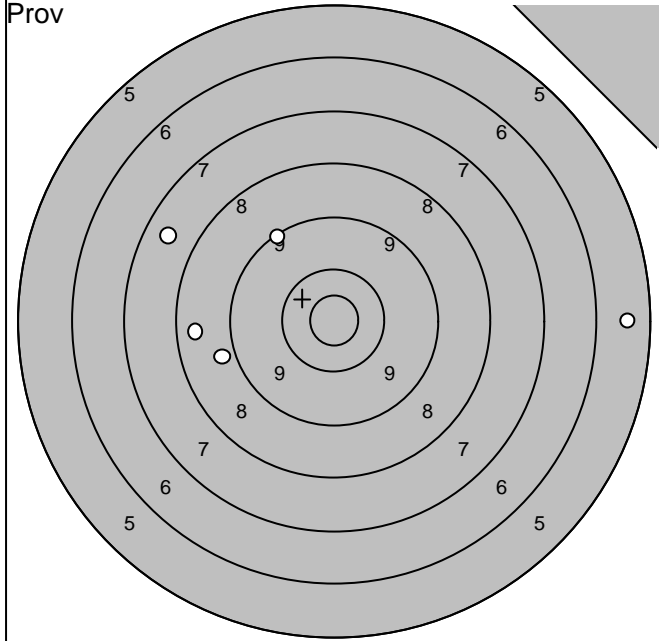

1: 8,9 ←		Serie	39,8		
2: 7,6 ↖		Totalt	0,0		
3: 8,5 ←					
4: 5,6 →					
5: 9,2 ↗					

1: 9,5 →		Serie	45,7		
2: 8,7 →		Totalt	45,7		
3: 9,3 ↘					
4: 8,1 →					
5: 10,1 ↘					

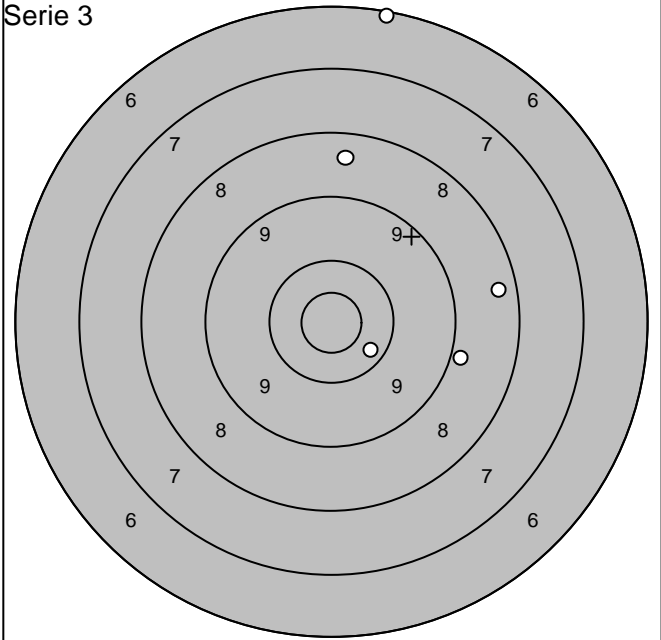
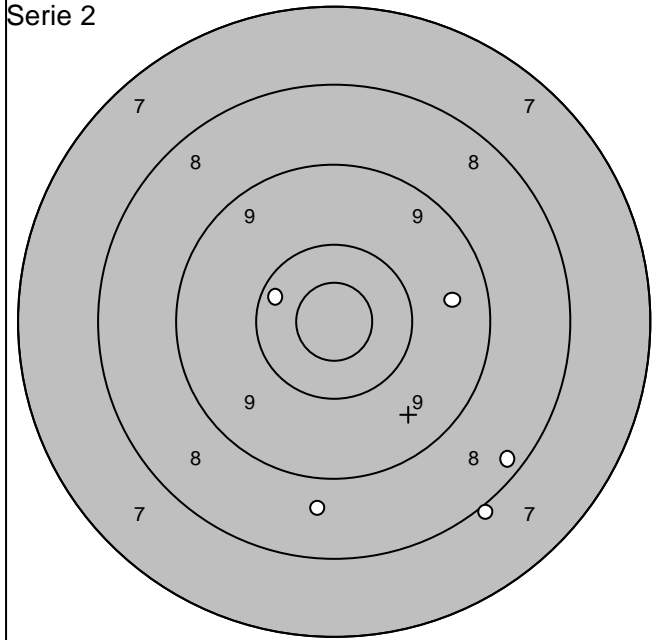

1: 9,5 →		Serie	44,8		
2: 8,3 ↘		Totalt	90,5		
3: 8,0 ↘					
4: 10,3 ↖					
5: 8,7 ↓					

1: 6,2 ↑		Serie	42,3		
2: 10,3 ↘		Totalt	132,8		
3: 8,4 →					
4: 8,9 →					
5: 8,5 ↑					

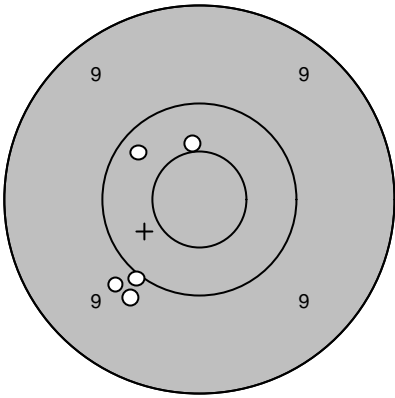
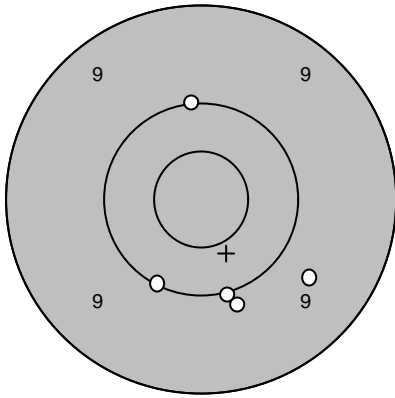
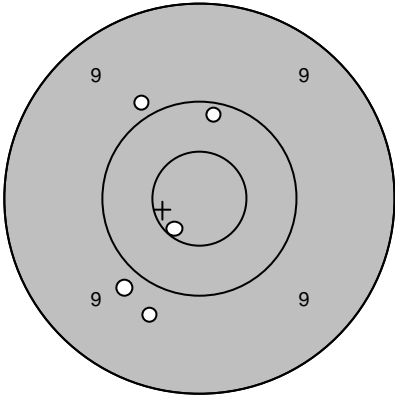
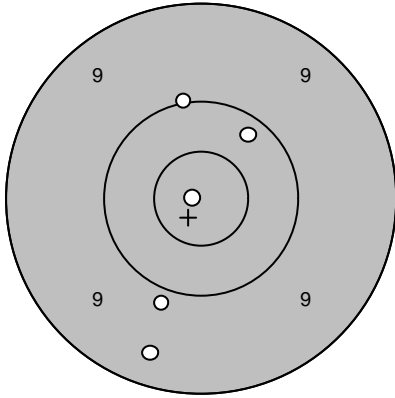
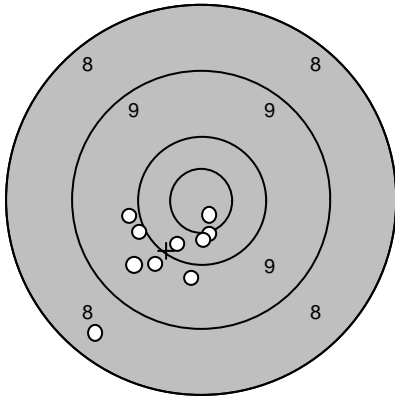
Skjutlag	Tavla	Claes Gustafsson	
5	6		
Ramselefors	Hofors		
2005-07-09	Tavelträffen A 2005	Ramselefors Skytteförening	
Prov		1: 9,7 ↘ 2: 10,0 ↓ 3: 10,0 ↑ 4: 9,9 ↓ 5: 10,1 ↘	Serie 1  1: 10,5* ↑ 2: 10,3 ↖ 3: 10,0 ↘ 4: 9,8 ↘ 5: 9,8 ↘
		Serie 49,7 Totalt 0,0	Serie 50,4 Totalt 50,4
Serie 2		1: 10,2 ↗ 2: 10,9* ← 3: 10,0 ↑ 4: 9,9 ↓ 5: 9,4 ↓	Serie 3  1: 9,9 ↖ 2: 10,2 ↑ 3: 10,6* ↘ 4: 9,7 ↓ 5: 9,9 ↘
		Serie 50,4 Totalt 100,8	Serie 50,3 Totalt 151,1
Extratävling		1: 9,9 ↓ 2: 10,5* ↓ 3: 9,9 ↘ 4: 10,3 ↘ 5: 9,7 ↘ 6: 8,5 ↘ 7: 10,8* ↘ 8: 10,0 ← 9: 10,0 ← 10: 10,5* ↓	
		Serie 100,1 Totalt 251,2	

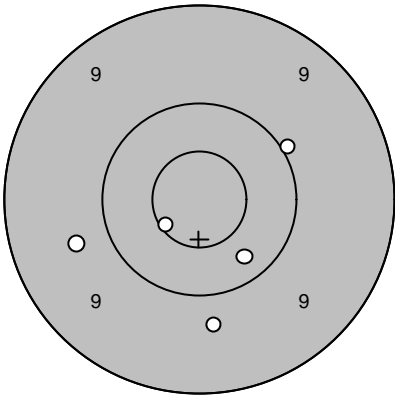
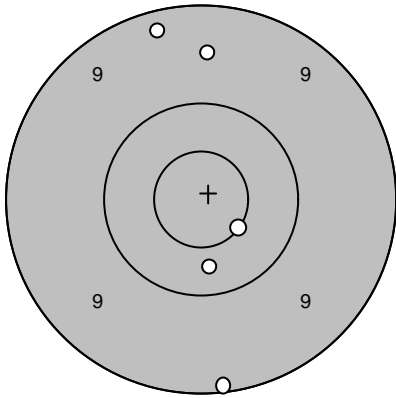
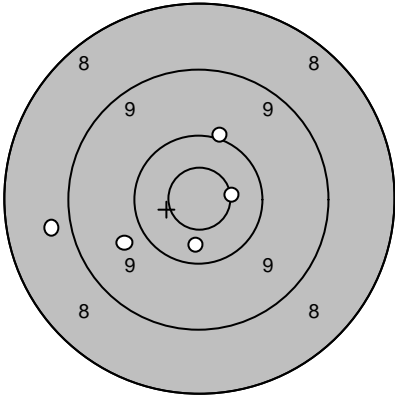
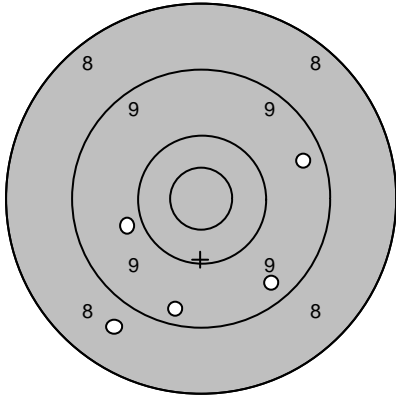
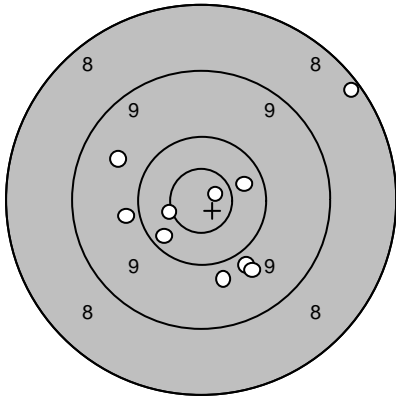
Skjutlag	Tavla	Tomas Wexell	
5	7		
Ramselefors	Loos		
2005-07-09	Tavelträffen A 2005	Ramselefors Skytteförening	
Prov		1: 9,5 ↑ 2: 9,3 ↑ 3: 9,1 ↓ 4: 10,3 ↓ 5: 10,6* ↘	Serie 1 
			1: 10,6* ↙ 2: 10,0 ↗ 3: 10,3 ↘ 4: 9,7 ↓ 5: 9,7 ←
		Serie 48,8	Serie 50,3
		Totalt 0,0	Totalt 50,3
Serie 2		1: 9,4 ↘ 2: 9,4 → 3: 9,9 ← 4: 9,4 ↓ 5: 8,7 ↘	Serie 3 
			1: 10,6* → 2: 10,0 ↑ 3: 9,8 ← 4: 8,8 ← 5: 10,4 ↓
		Serie 46,8	Serie 49,6
		Totalt 97,1	Totalt 146,7
Extratävling		1: 10,8* → 2: 9,7 ↙ 3: 9,9 ← 4: 10,5* ← 5: 10,4 → 6: 9,9 ↓ 7: 10,3 ↙ 8: 9,8 ↓ 9: 9,8 ↓ 10: 8,2 ↗	
			
		Serie 99,3	
		Totalt 246,0	

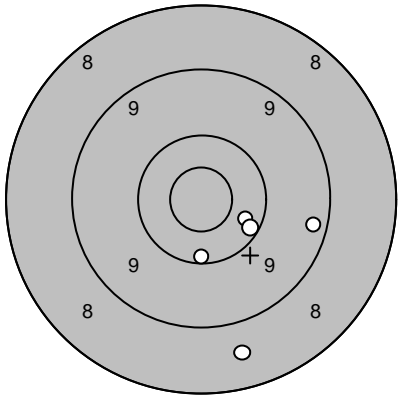
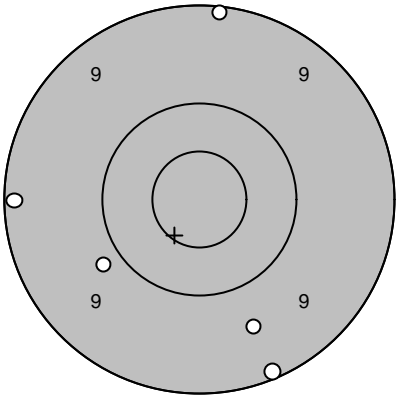
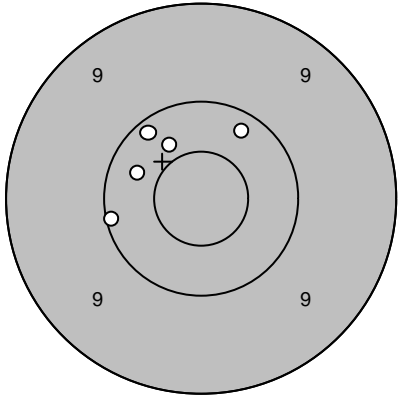
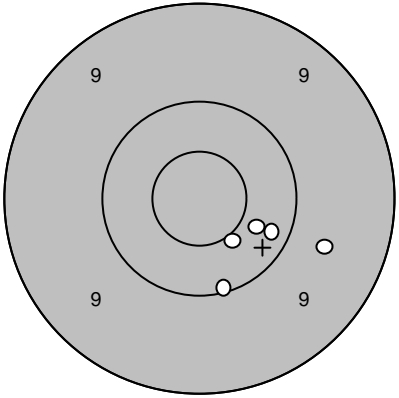
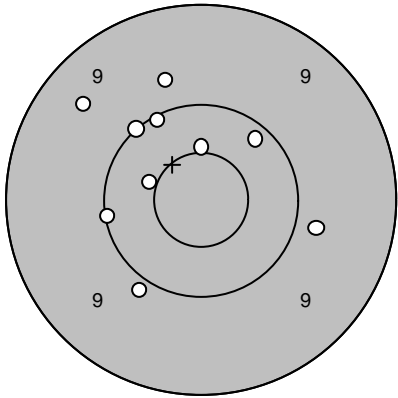
Skjutlag 5	Tavla 9	Daniel Zakrisson	
Ramselefors		Ramselefors	
2005-07-09		Tavelträffen A 2005	Ramselefors Skytteförening
Prov 	1: 10,3 → 2: 10,2 ↓ 3: 8,6 ↓ 4: 10,2 → 5: 9,3 →	Serie 1 	1: 9,1 ↑ 2: 9,2 ← 3: 9,6 ↓ 4: 9,9 ↙ 5: 9,1 ↓
	Serie 48,6		Serie 46,9
	Totalt 0,0		Totalt 46,9
Serie 2 	1: 10,3 ← 2: 10,1 ← 3: 10,2 ↗ 4: 10,2 ↗ 5: 10,4 ↗	Serie 3 	1: 10,4 → 2: 10,1 ↓ 3: 10,2 → 4: 10,5* ↓ 5: 9,7 →
	Serie 51,2		Serie 50,9
	Totalt 98,1		Totalt 149,0
Extratävling 	1: 9,8 → 2: 10,1 ← 3: 10,1 ↗ 4: 9,5 ↗ 5: 10,5* ↑ 6: 10,0 ↗ 7: 9,9 ↓ 8: 10,2 ↗ 9: 9,8 ↑ 10: 10,5* ←		
	Serie 100,4		
	Totalt 249,4		

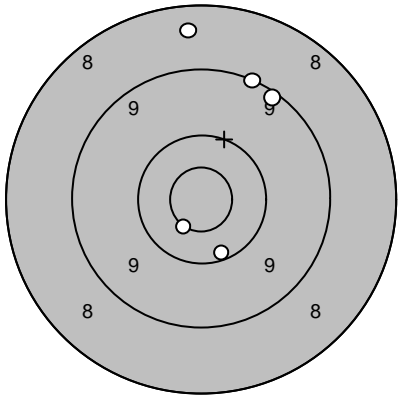
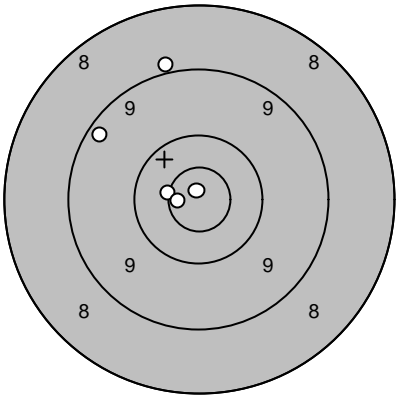
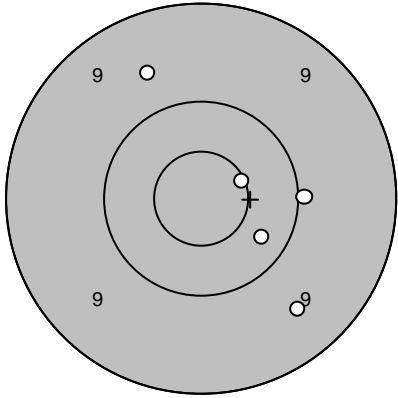
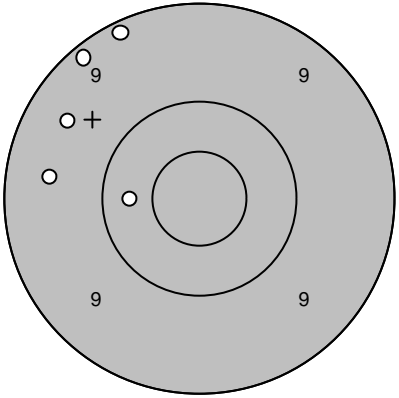
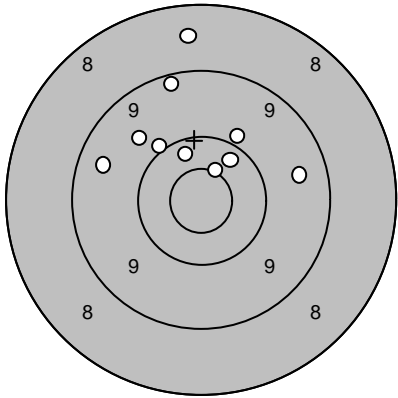
Skjutlag	Tavla	Sven Magnusson	
5	10		
Ramselefors	Liden		
2005-07-09	Tavelträffen A 2005	Ramselefors Skytteförening	
Prov		1: 8,5 ↑ 2: 9,2 ↗ 3: 9,1 ↗ 4: 10,6* ↘ 5: 10,2 ↓ Serie 47,6 Totalt 0,0	Serie 1  1: 10,6* ← 2: 9,0 ↑ 3: 10,7* ← 4: 9,3 ↖ 5: 10,9* ↑ Serie 50,5 Totalt 50,5
Serie 2		1: 10,3 ↘ 2: 10,0 → 3: 9,6 ↗ 4: 9,5 ↘ 5: 10,6* → Serie 50,0 Totalt 100,5	Serie 3  1: 9,5 ← 2: 9,5 ↖ 3: 10,3 ← 4: 9,2 ↗ 5: 9,2 ↗ Serie 47,7 Totalt 148,2
Extratävling		1: 9,5 → 2: 9,2 ↑ 3: 8,6 ↑ 4: 10,6* ↗ 5: 10,0 ↖ 6: 9,5 ← 7: 9,7 ↗ 8: 9,9 ↗ 9: 10,3 ↑ 10: 10,3 ↗ Serie 97,6 Totalt 245,8	

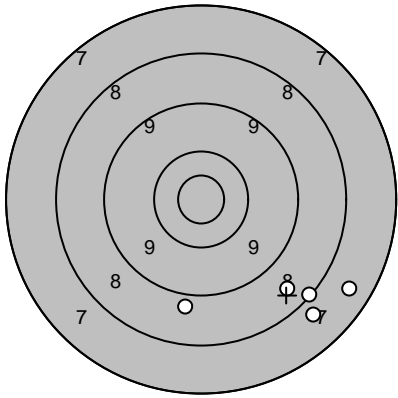
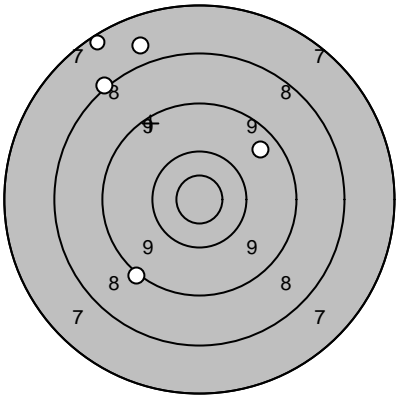
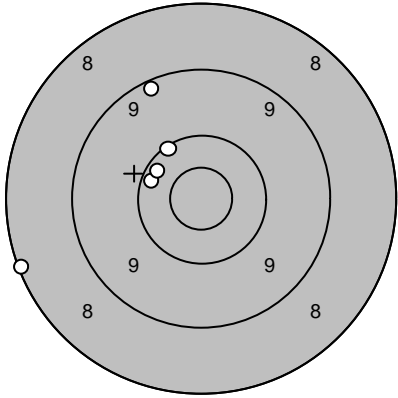
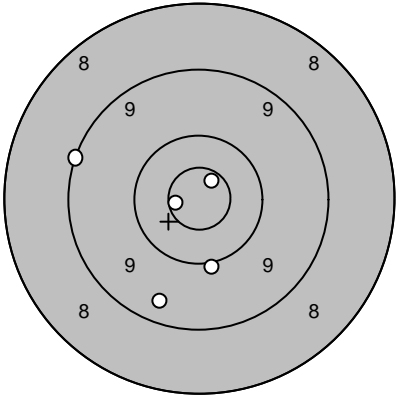
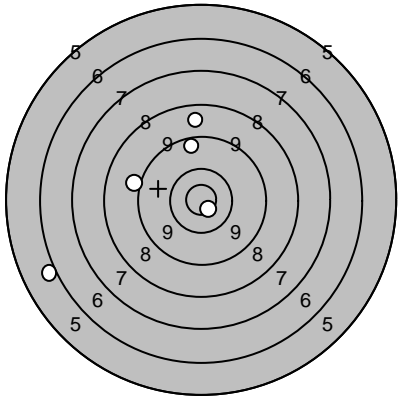
Skjutlag 5	Tavla 11	Fredrik Wikström	
Ramselefors	Umeå		
2005-07-09	Tavelträffen A 2005	Ramselefors Skytteförening	
Prov		1: 8,6 ↘ 2: 7,6 → 3: 8,2 ↘ 4: 7,8 ↘ 5: 8,9 ↓	Serie 1 
			1: 7,8 ↗ 2: 9,1 ↘ 3: 7,3 ↗ 4: 9,5 ↗ 5: 8,1 ↗
		Serie 41,1	Serie 41,8
		Totalt 0,0	Totalt 41,8
Serie 2		1: 9,2 ↗ 2: 10,3 ↗ 3: 10,2 ↗ 4: 10,3 ↗ 5: 8,1 ↖	Serie 3 
			1: 10,7* ↗ 2: 9,4 ↓ 3: 9,1 ↖ 4: 10,0 ↓ 5: 10,7* ↖
		Serie 48,1	Serie 49,9
		Totalt 89,9	Totalt 139,8
Extratävling		1: 10,9* ↘ 2: 8,7 ↑ 3: 9,5 ↑ 4: 6,0 ↖ 5: 9,1 ↖	
		Serie 44,2	
		Totalt 184,0	

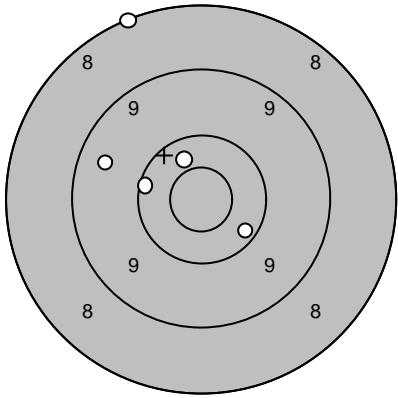
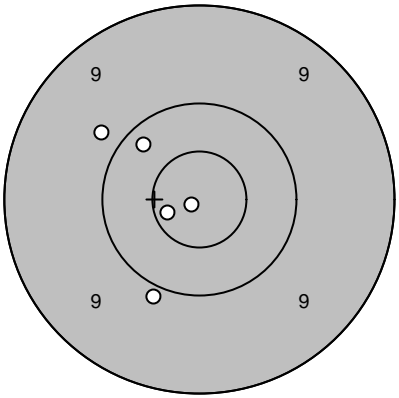
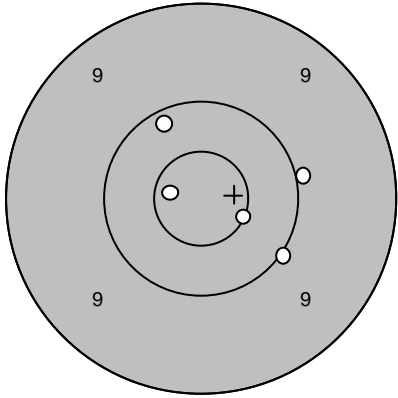
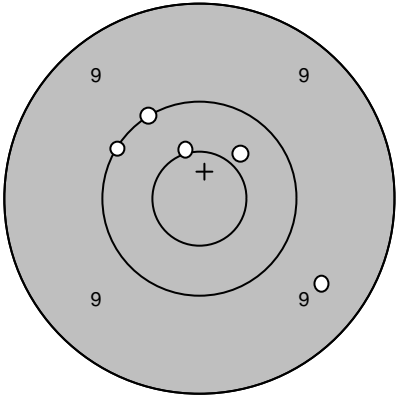
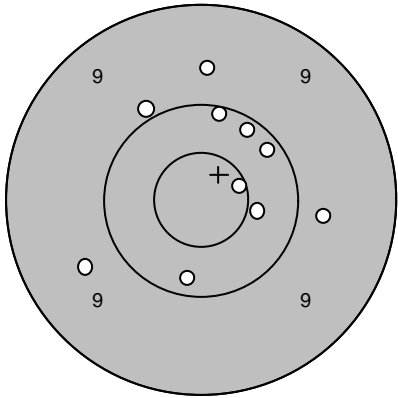
Skjutlag	Tavla	Jarmo Marjala	
5	12		
Ramselefors	I 21 / T3		
2005-07-09	Tavelträffen A 2005	Ramselefors Skytteförening	
Prov		1: 8,1 ↗ 2: 9,5 ↖ 3: 10,2 ↖ 4: 10,4 ↗ 5: 10,2 ↘	Serie 1 
		1: 9,8 ↖ 2: 10,3 ↖ 3: 10,9* ↙ 4: 10,7* ↙ 5: 9,9 ↘	
		Serie 48,4	Serie 51,6
		Totalt 0,0	Totalt 51,6
Serie 2		1: 10,6* → 2: 10,0 → 3: 10,2 ↗ 4: 10,7* ↖ 5: 10,0 ↘	Serie 3 
		1: 10,0 ↖ 2: 10,5* ↗ 3: 10,4 ↗ 4: 10,1 ↖ 5: 9,5 ↘	
		Serie 51,5	Serie 50,5
		Totalt 103,1	Totalt 153,6
Extratävling		1: 10,1 ↗ 2: 9,8 → 3: 10,2 ↗ 4: 9,9 ↖ 5: 10,2 ↗ 6: 9,7 ↖ 7: 10,2 ↘ 8: 9,7 ↗ 9: 10,6* → 10: 10,5* →	
		Serie 100,9	
		Totalt 254,5	

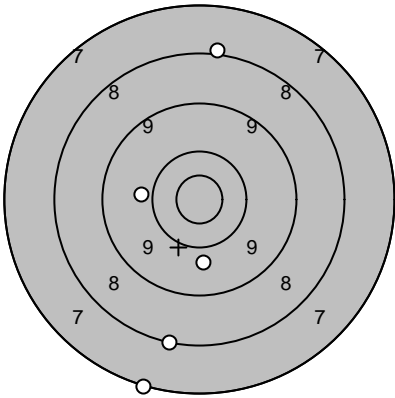
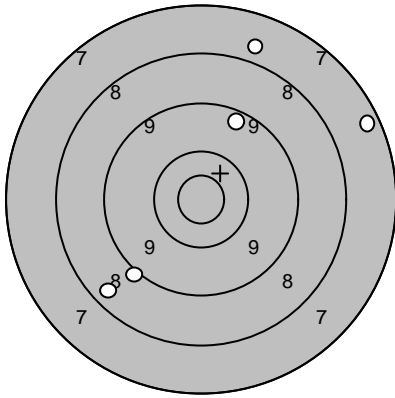
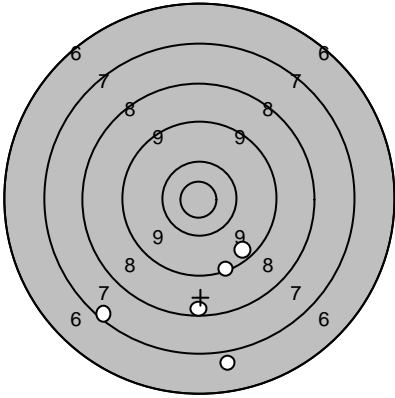
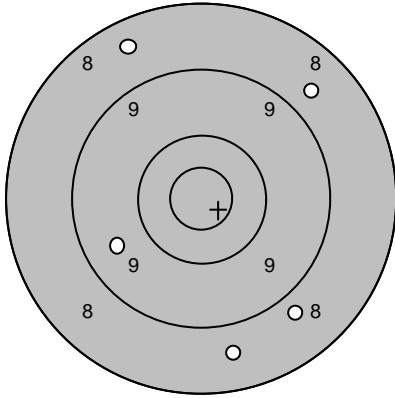
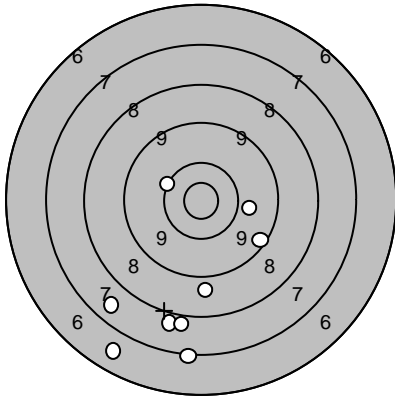
Skjutlag	Tavla	Jonas Gyllenäs		
5	16			
Ramselefors	Piteå			
2005-07-09	Tavelträffen A 2005	Ramselefors Skytteförening		
Prov		1: 7,4 → 2: 7,8 ↑ 3: 9,4 ↑ 4: 9,1 ↓ 5: 8,5 ↓	Serie 1 	1: 8,1 ↑ 2: 9,9 ← 3: 8,1 ↓ 4: 7,1 ↓ 5: 9,8 ↓
		Serie 42,2 Totalt 0,0		Serie 43,0 Totalt 43,0
Serie 2		1: 8,5 ↖ 2: 8,7 ↗ 3: 9,6 ← 4: 8,8 ↓ 5: 8,7 ↓	Serie 3 	1: 7,4 ↙ 2: 9,2 ↓ 3: 9,5 ↘ 4: 6,9 ↓ 5: 8,4 ↓
		Serie 44,3 Totalt 87,3		Serie 41,4 Totalt 128,7
Extratävling		1: 8,9 ↓ 2: 0,0 ↓ 3: 9,3 → 4: 7,2 ↓ 5: 7,6 ↓ 6: 9,9 → 7: 7,9 ↓ 8: 8,0 ↓ 9: 10,2 ↖ 10: 6,7 ↓		
		Serie 75,7 Totalt 204,4		

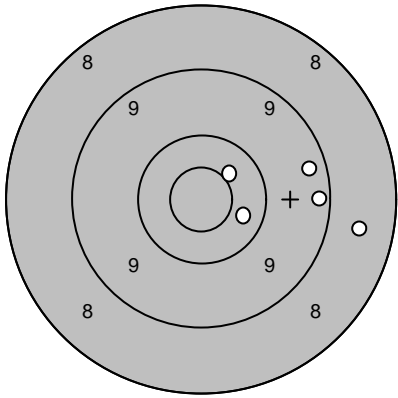
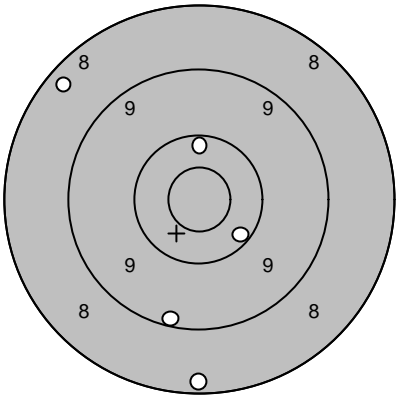
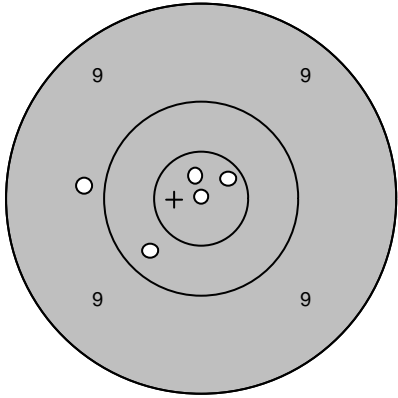
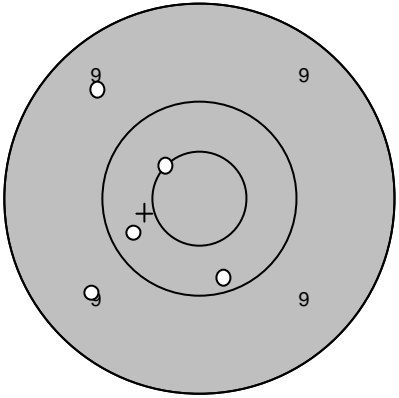
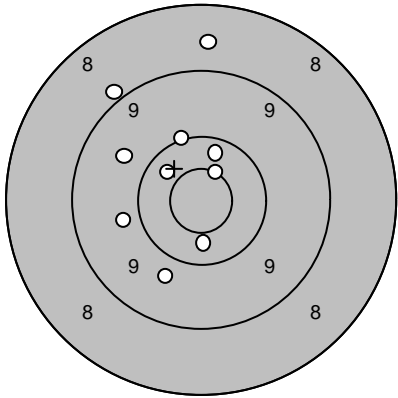
Skjutlag 5	Tavla 17	Jörgen Åström	
Ramselefors		Brattby	
2005-07-09		Tavelträffen A 2005	Ramselefors Skytteförening
Prov 	1: 8,6 → 2: 9,4 → 3: 10,5* ↗ 4: 9,3 → 5: 10,4 →	Serie 1 	1: 8,4 ↖ 2: 10,3 ↑ 3: 10,2 ↘ 4: 9,2 ↓ 5: 8,3 ↓
	Serie 48,2		Serie 46,4
	Totalt 0,0		Totalt 46,4
Serie 2 	1: 9,8 ← 2: 10,7* ↗ 3: 10,9* ↑ 4: 10,8* ↑ 5: 10,3 ↙	Serie 3 	1: 10,6* ↖ 2: 9,6 ↙ 3: 10,3 ← 4: 9,5 ↗ 5: 10,2 ↓
	Serie 52,5		Serie 50,2
	Totalt 98,9		Totalt 149,1
Extratävling 	1: 9,0 ↖ 2: 8,7 ↑ 3: 9,7 ↖ 4: 9,8 ← 5: 10,4 ↖ 6: 10,1 ↑ 7: 10,4 ↓ 8: 9,8 ↓ 9: 10,3 ↑ 10: 10,6* ↗		
	Serie 98,8		
	Totalt 247,9		

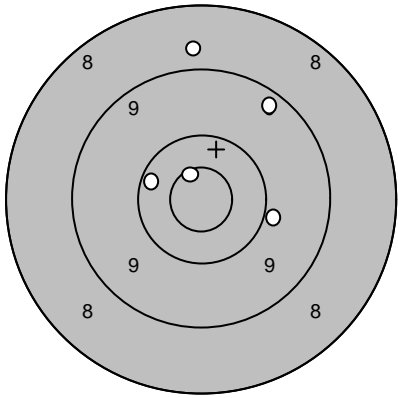
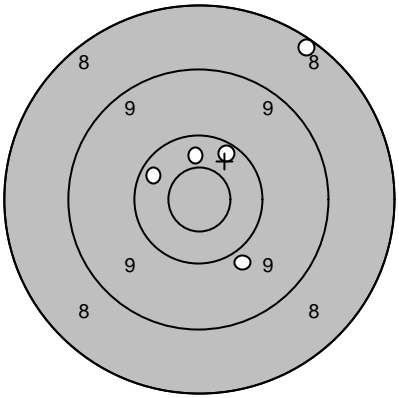
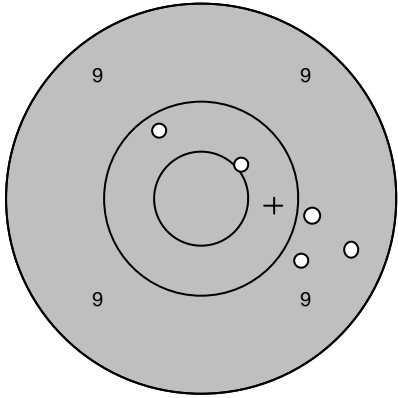
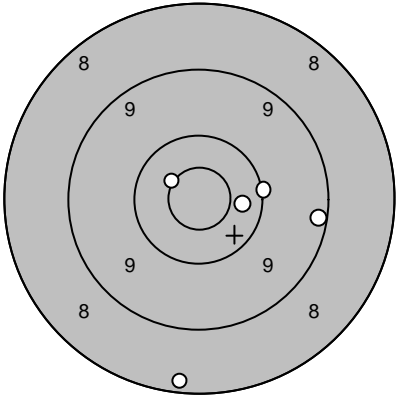
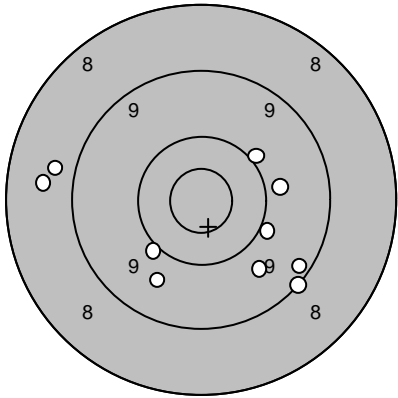
Skjutlag	Tavla	Per Östling	
5	19		
Ramselefors	F 21		
2005-07-09	Tavelträffen A 2005	Ramselefors Skytteförening	
Prov		1: 8,8 ↗ 2: 9,9 → 3: 10,7* ↗ 4: 9,3 ↗ 5: 10,3 ←	Serie 1 
			1: 8,2 ↗ 2: 10,3 ↖ 3: 10,3 ↗ 4: 9,9 ↘ 5: 10,4 ↑
		Serie 49,0	Serie 49,1
		Totalt 0,0	Totalt 49,1
Serie 2		1: 9,9 → 2: 10,5* ↗ 3: 9,8 ↘ 4: 9,4 → 5: 10,2 ↗	Serie 3 
			1: 8,3 ↓ 2: 10,6* ↖ 3: 10,1 → 4: 10,4 → 5: 9,2 →
		Serie 49,8	Serie 48,6
		Totalt 98,9	Totalt 147,5
Extratävling		1: 8,6 ← 2: 9,1 ↘ 3: 10,0 ↗ 4: 10,0 ↘ 5: 9,9 → 6: 10,0 → 7: 8,8 ← 8: 9,3 ↘ 9: 9,7 ↘ 10: 9,7 ↘	
		Serie 95,1	
		Totalt 242,6	

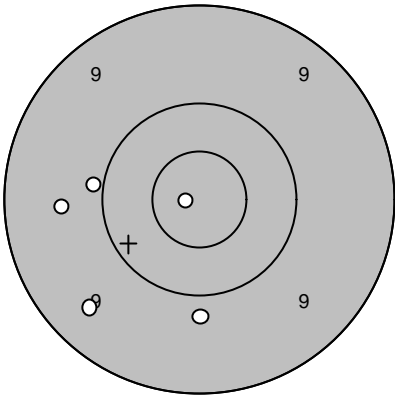
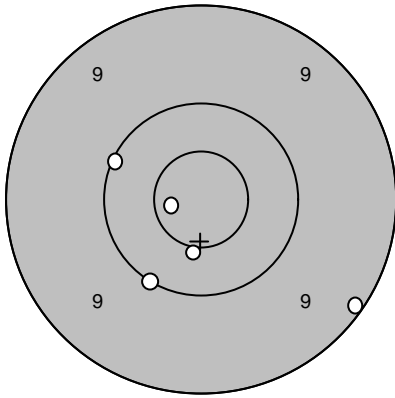
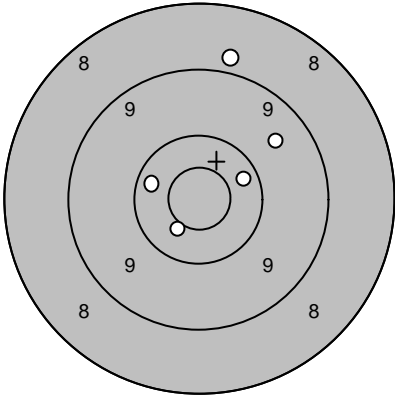
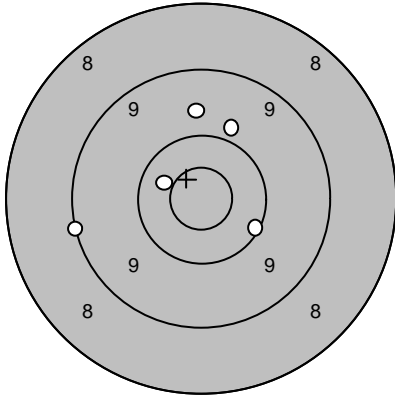
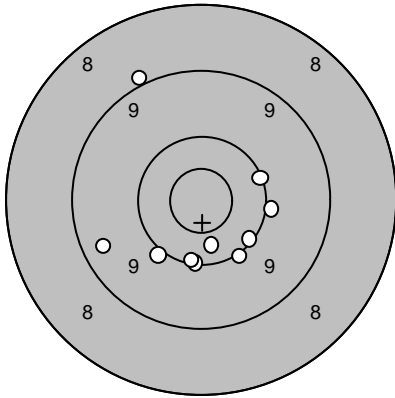
Skjutlag	Tavla	Hugo Håkansson	
5	20		
Ramselefors	Östersund		
2005-07-09	Tavelträffen A 2005	Ramselefors Skytteförening	
Prov		1: 10,5* ↓ 2: 9,1 → 3: 10,1 ↖ 4: 10,7* ← 5: 10,0 ↙	Serie 1  1: 10,9* ← 2: 9,8 ↓ 3: 9,6 ← 4: 9,5 ↙ 5: 10,0 ←
		Serie 50,4 Totalt 0,0	Serie 49,8 Totalt 49,8
Serie 2		1: 9,9 ↗ 2: 10,1 → 3: 10,5* ← 4: 9,7 ↑ 5: 9,1 ←	Serie 3  1: 8,9 ↑ 2: 10,5* ↙ 3: 9,6 ↗ 4: 10,3 ← 5: 10,3 ↗
		Serie 49,3 Totalt 99,1	Serie 49,6 Totalt 148,7
Extratävling		1: 9,0 ↗ 2: 10,0 ↓ 3: 10,1 ↓ 4: 10,4 ↓ 5: 10,0 → 6: 10,1 ↘ 7: 10,1 → 8: 10,2 ↓ 9: 9,4 ← 10: 10,0 ↙	
		Serie 99,3 Totalt 248,0	

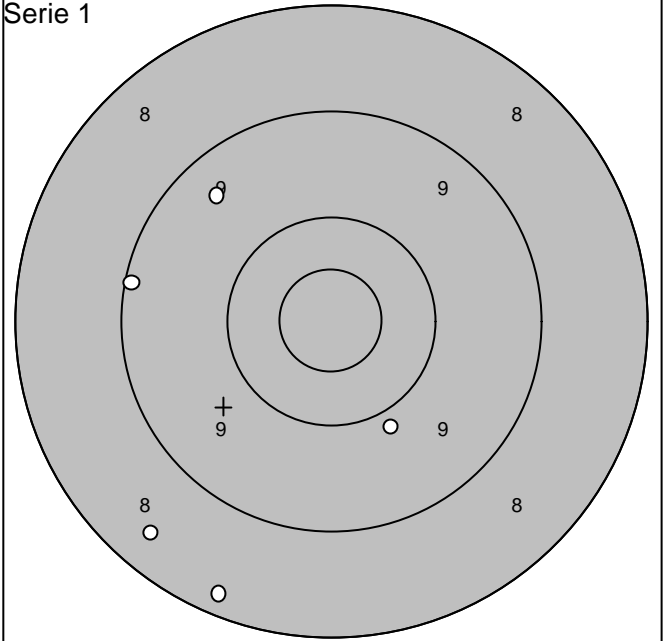
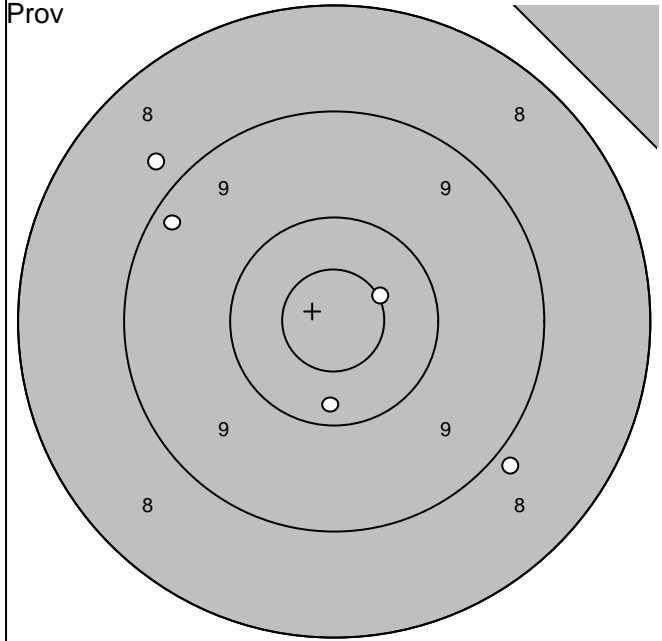

1:10,5* ↗	Serie	47,6	
2: 8,8 ↗		Totalt	
3: 9,2 ↖			
4: 8,9 ↘			
5:10,2 ↓			

1: 9,4 ↖	Serie	45,0	
2: 9,9 ↘		Totalt	
3: 8,2 ↘			
4: 9,1 ←			
5: 8,4 ↙			

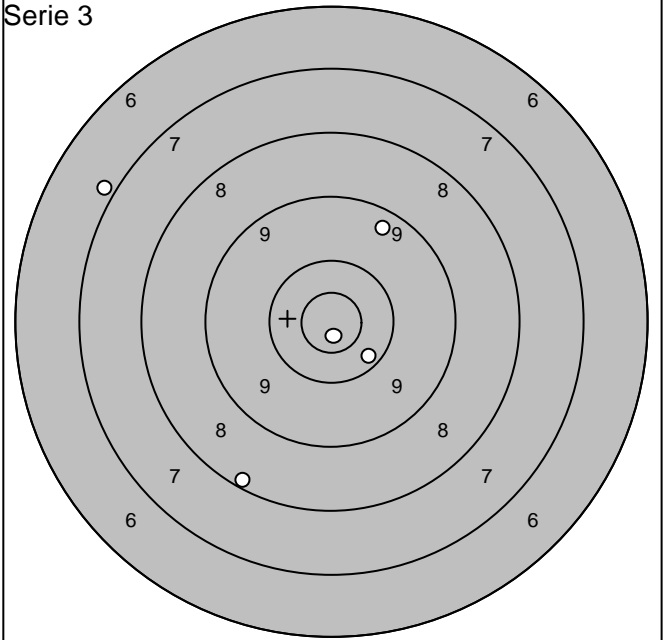
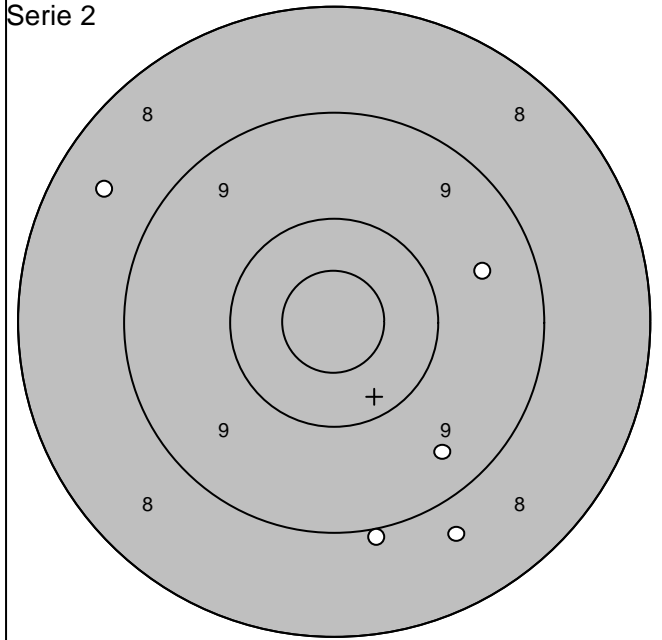

1: 9,4 ↘	Serie	45,1	
2: 9,0 ↓		Totalt	
3: 8,7 ↘			
4: 9,5 ↗			
5: 8,5 ↖			

1: 6,9 ↖	Serie	45,6	
2:10,3 ↘		Totalt	
3: 8,2 ↘			
4:10,8* ↓			
5: 9,4 ↗			