

1:	10.4	←
2:	9.8	→
3:	10.0	↘
<hr/>		
Serie	29 (0x)	
Total	218 (0x)	

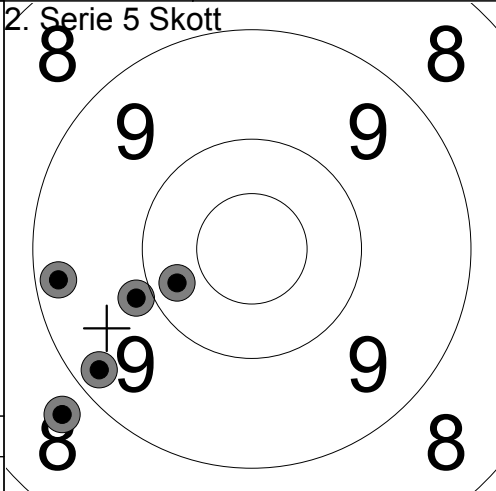

1:	10.3	←
2:	9.2	←
3:	8.7	↘
4:	9.9	←
5:	9.3	↘
<hr/>		
Serie	45 (0x)	
Total	263 (0x)	

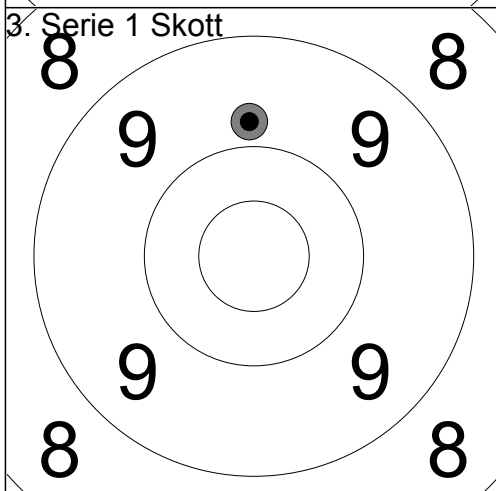

1:	9.8	↑
<hr/>		
Serie	9 (0x)	
Total	272 (0x)	

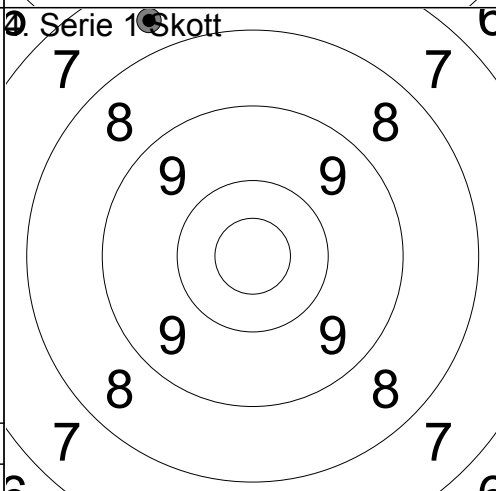

1:	7.6	↖
<hr/>		
Serie	7 (0x)	
Total	279 (0x)	

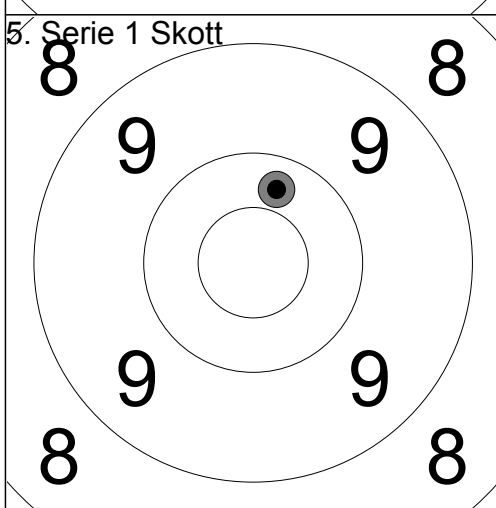

1:	10.3	↑
<hr/>		
Serie	10 (0x)	
Total	289 (0x)	

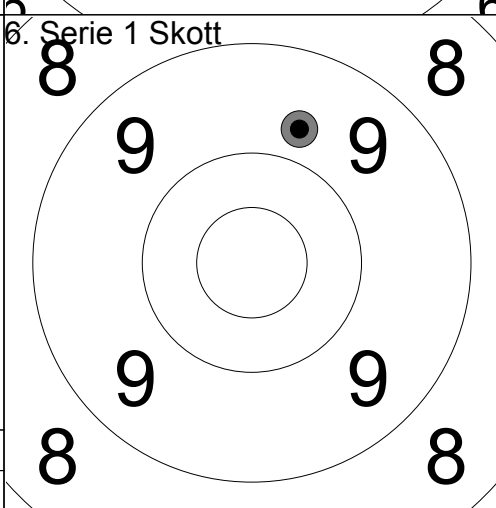

1:	9.7	↑
<hr/>		
Serie	9 (0x)	
Total	298 (0x)	

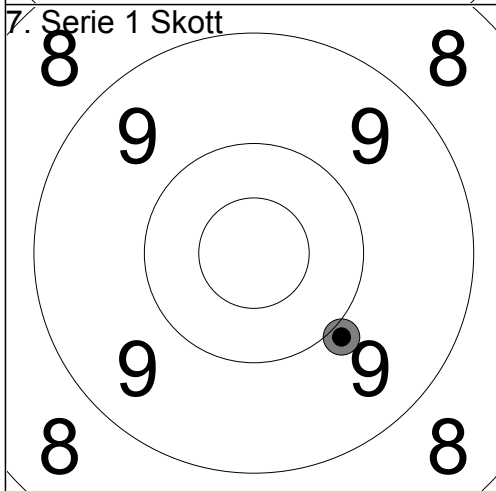

1:	9.9	↘
<hr/>		
Serie	9 (0x)	
Total	307 (0x)	

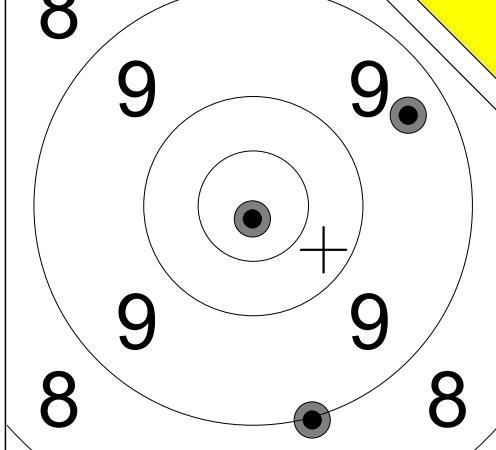

1:	9.0	↓
2:	9.4	↗
3:	10.8x	↓

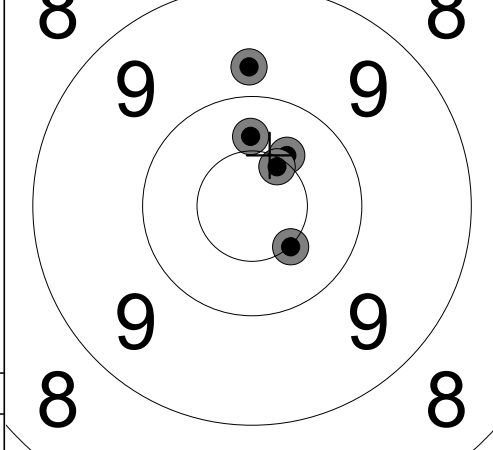

1:	10.4	↑
2:	10.4x	↗
3:	10.6x	↗
4:	10.5x	↘
5:	9.8	↑

Serie	28 ( 1x)
Total	236 ( 0x)

Serie	49 ( 3x)
Total	285 ( 3x)

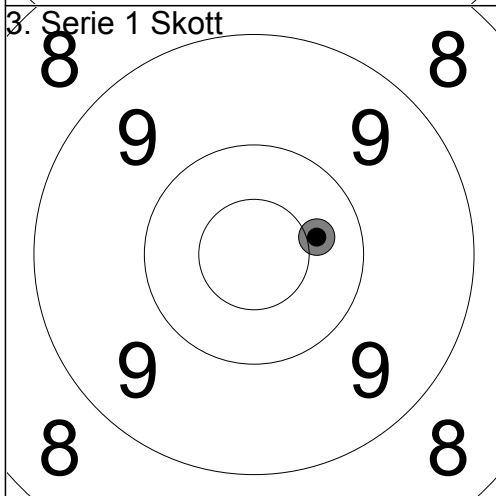

1:	10.4	↗
----	------	---

Serie	10 ( 0x)
Total	295 ( 3x)

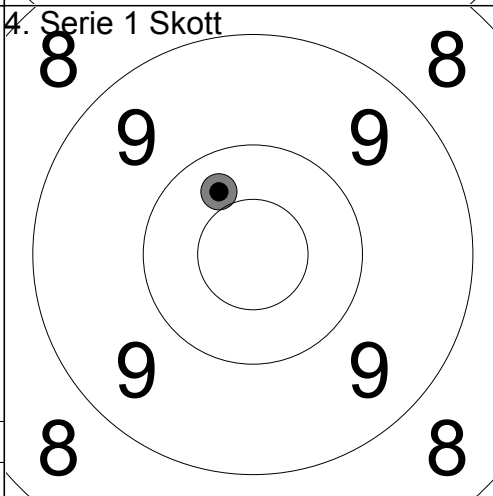

1:	10.4	↖
----	------	---

Serie	10 ( 0x)
Total	305 ( 3x)

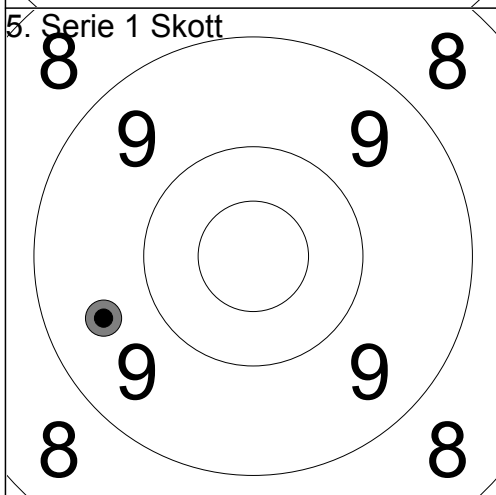

1:	9.6	↖
----	-----	---

Serie	9 ( 0x)
Total	314 ( 3x)

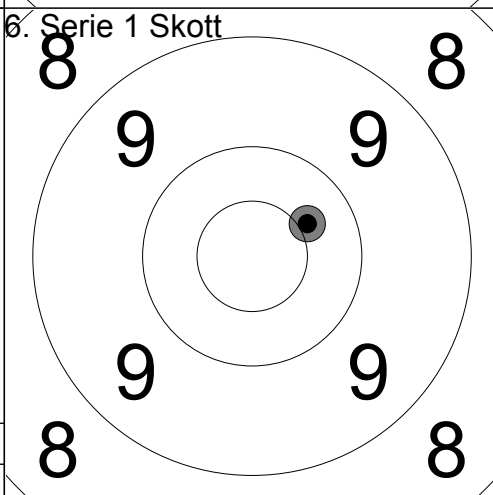

1:	10.4	↗
----	------	---

Serie	10 ( 0x)
Total	324 ( 3x)

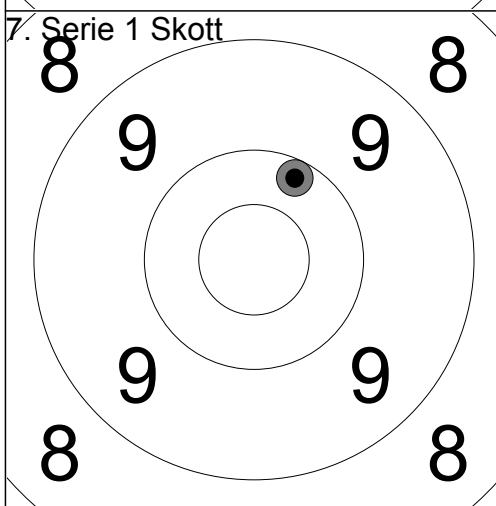

1:	10.2	↗
----	------	---

Serie	10 ( 0x)
Total	334 ( 3x)

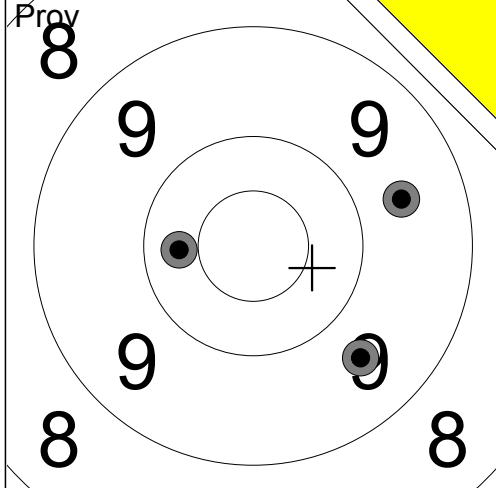

1:	9.6	↘
2:	9.6	→
3:	10.3	←

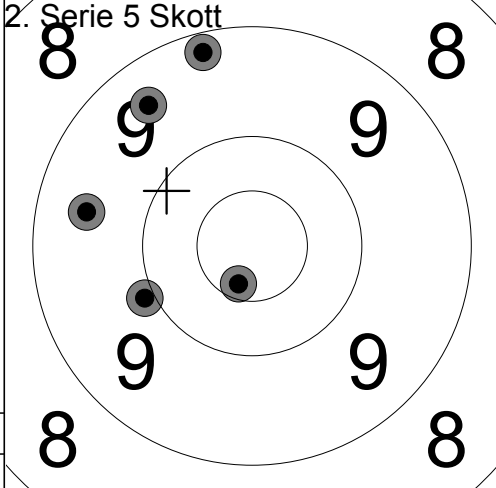

1:	9.9	←
2:	9.5	←
3:	9.2	↑
4:	9.4	↗
5:	10.6x	↘

Serie	28 ( 0x)
Total	229 ( 0x)

Serie	46 ( 1x)
Total	275 ( 1x)

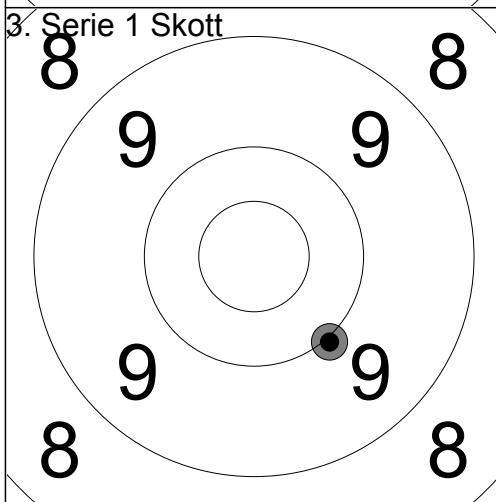

1:	10.0	↘
----	------	---

Serie	10 ( 0x)
Total	285 ( 1x)

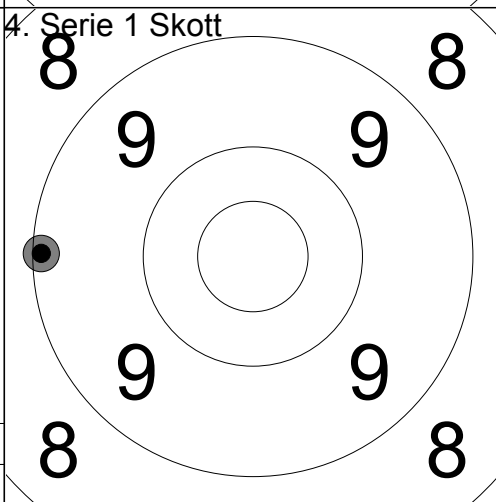

1:	9.1	←
----	-----	---

Serie	9 ( 0x)
Total	294 ( 1x)

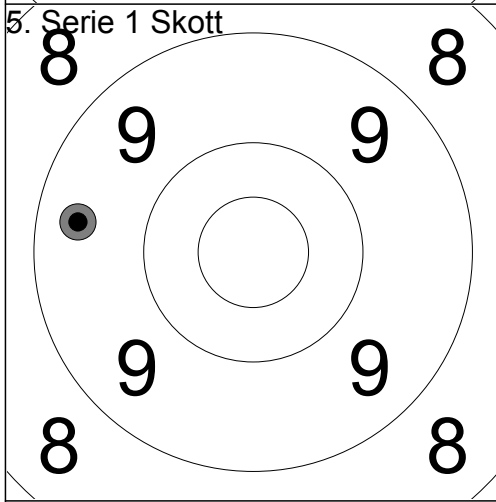

1:	9.4	←
----	-----	---

Serie	9 ( 0x)
Total	303 ( 1x)

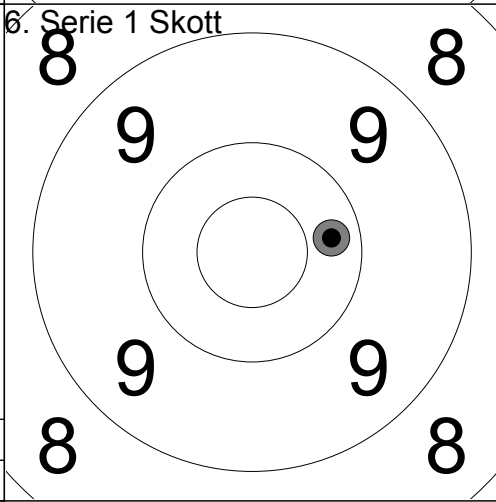

1:	10.3	→
----	------	---

Serie	10 ( 0x)
Total	313 ( 1x)

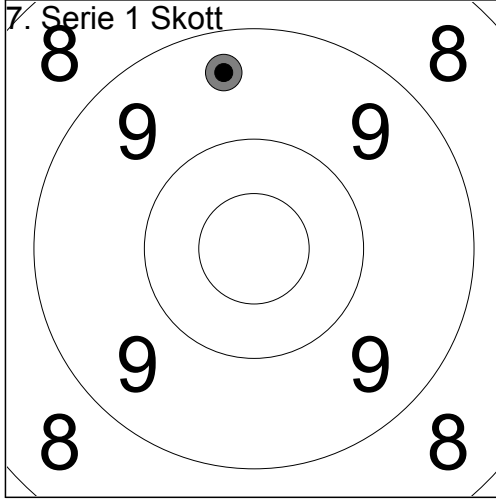

1:	9.4	↑
----	-----	---

Serie	9 ( 0x)
Total	322 ( 1x)

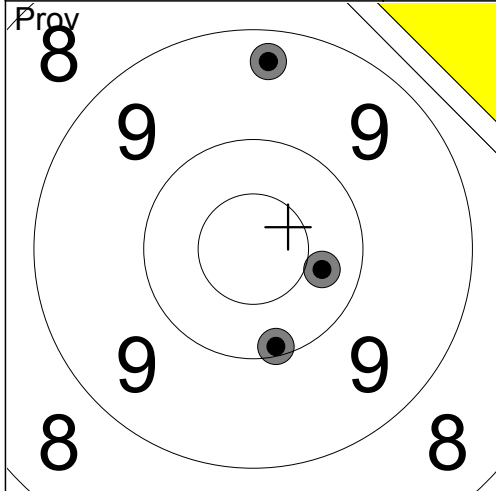

1: 9.3 ↑

2: 10.3 →

3: 10.1 ↓

Serie	29 ( 0x)
Total	236 ( 0x)

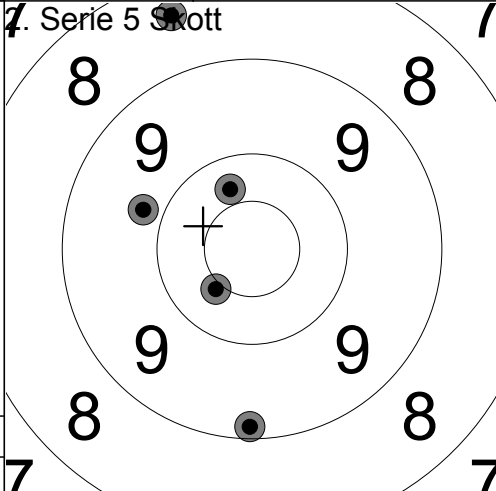

1: 9.8 ←

2: 10.3 ↑

3: 8.4 ↑

4: 10.4x ↙

5: 9.2 ↓

Serie	46 ( 1x)
Total	282 ( 1x)

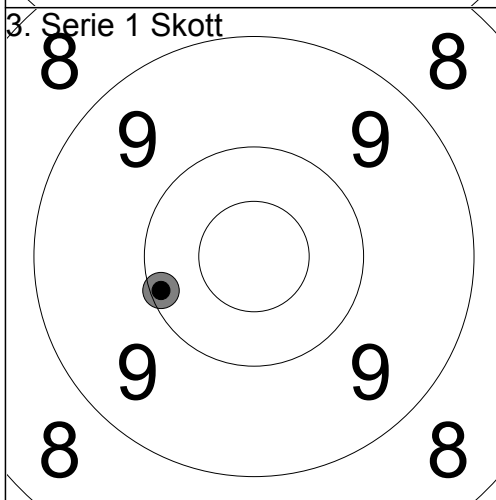

1: 10.1 ←

Serie	10 ( 0x)
Total	292 ( 1x)

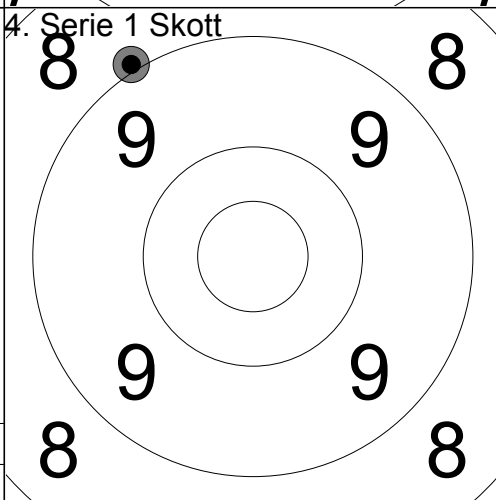

1: 9.0 ↗

Serie	9 ( 0x)
Total	301 ( 1x)

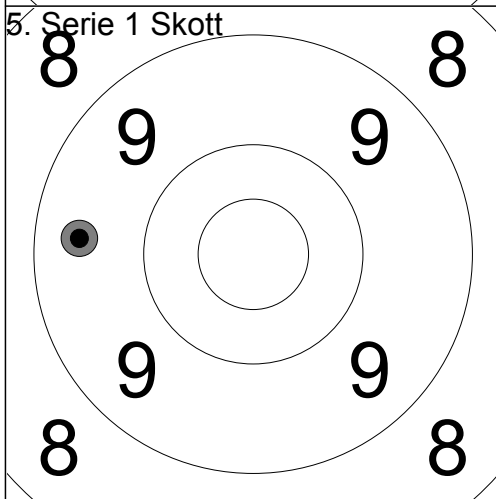

1: 9.4 ←

Serie	9 ( 0x)
Total	310 ( 1x)

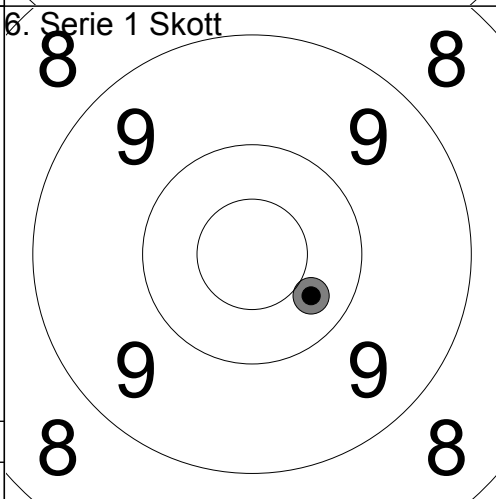

1: 10.3 →

Serie	10 ( 0x)
Total	320 ( 1x)

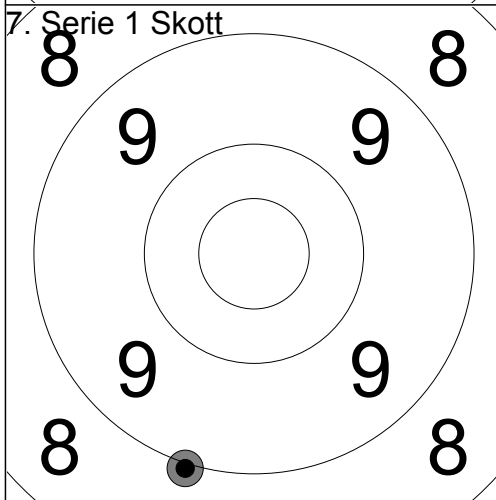

1: 9.0 ↓

Serie	9 ( 0x)
Total	329 ( 1x)

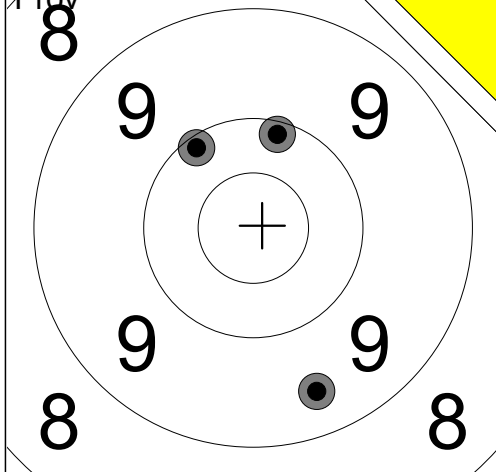

1:	9.4	↘
2:	10.1	↗
3:	10.1	↗
<hr/>		
Serie	29 ( 0x)	
Total	224 ( 0x)	

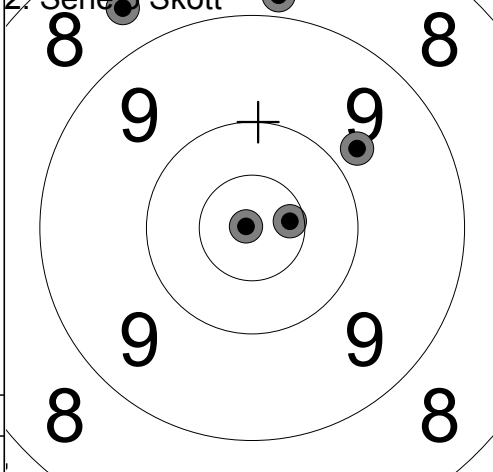

1:	10.9x	↖
2:	10.6x	→
3:	8.8	↗
4:	8.6	↗
5:	9.8	↗
<hr/>		
Serie	45 ( 2x)	
Total	269 ( 2x)	

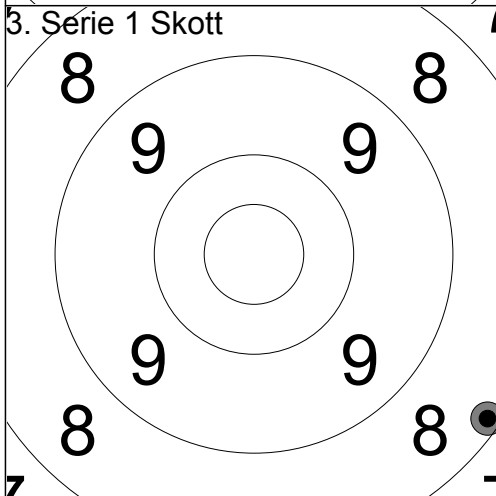

1:	8.2	↘
<hr/>		
Serie	8 ( 0x)	
Total	277 ( 2x)	

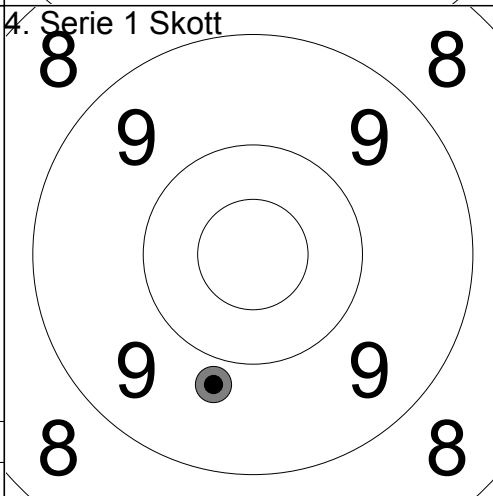

1:	9.8	↘
<hr/>		
Serie	9 ( 0x)	
Total	286 ( 2x)	

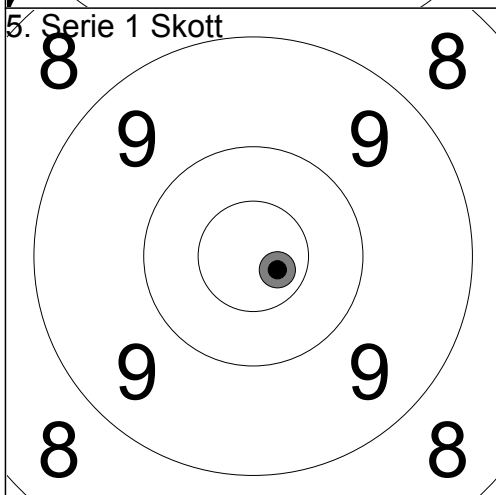

1:	10.7x	↘
<hr/>		
Serie	10 ( 1x)	
Total	296 ( 3x)	

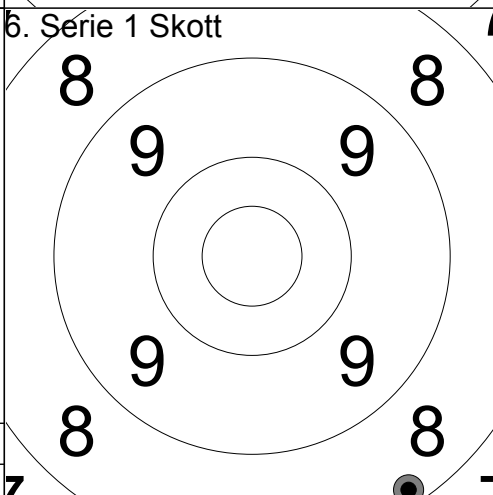

1:	8.2	↘
<hr/>		
Serie	8 ( 0x)	
Total	304 ( 3x)	

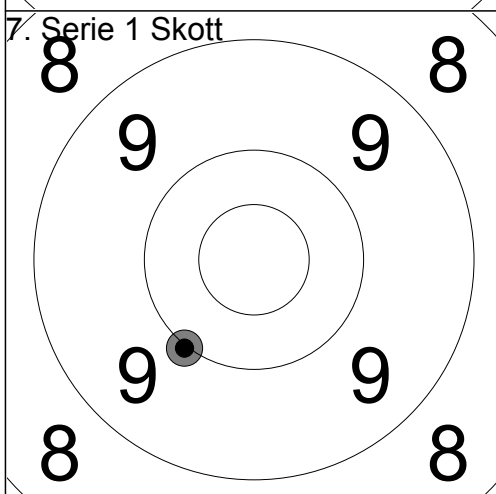

1:	10.0	↘
<hr/>		
Serie	10 ( 0x)	
Total	314 ( 3x)	

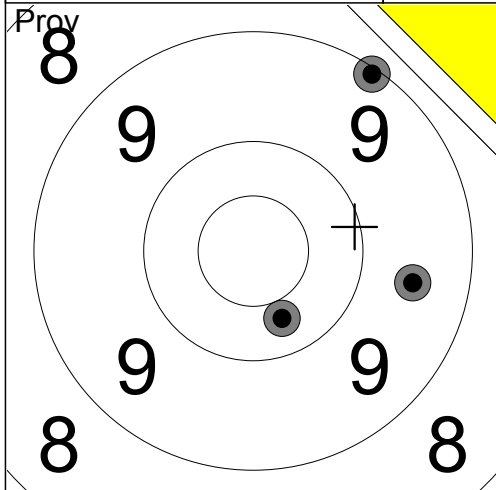

1:	9.6	→
2:	10.3	↓
3:	9.1	↗
Serie 28 ( 0x)		
Total 224 ( 0x)		

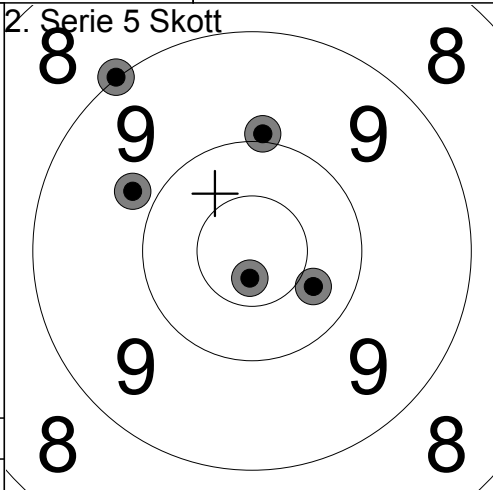

1:	10.7x	↓
2:	9.0	↗
3:	10.4	↓
4:	9.8	↗
5:	10.0	↑
Serie 48 ( 1x)		
Total 272 ( 1x)		

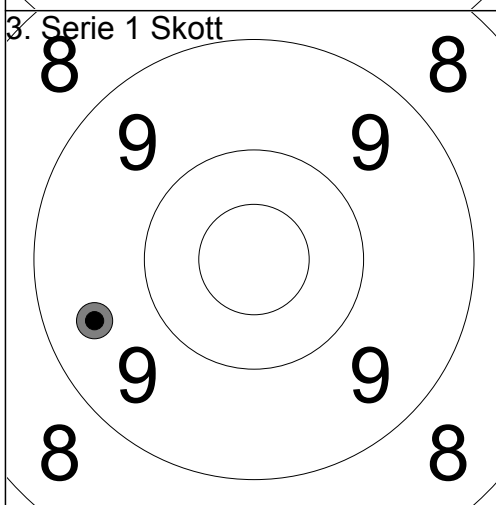

1:	9.5	←
Serie 9 ( 0x)		
Total 281 ( 1x)		

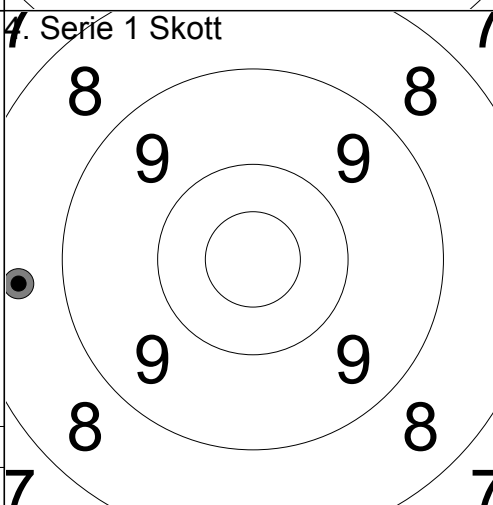

1:	8.6	←
Serie 8 ( 0x)		
Total 289 ( 1x)		

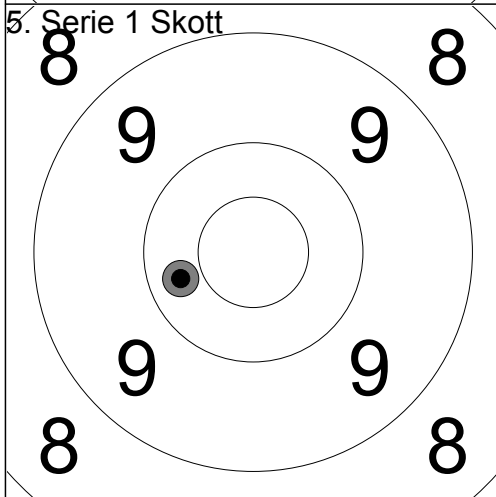

1:	10.3	←
Serie 10 ( 0x)		
Total 299 ( 1x)		

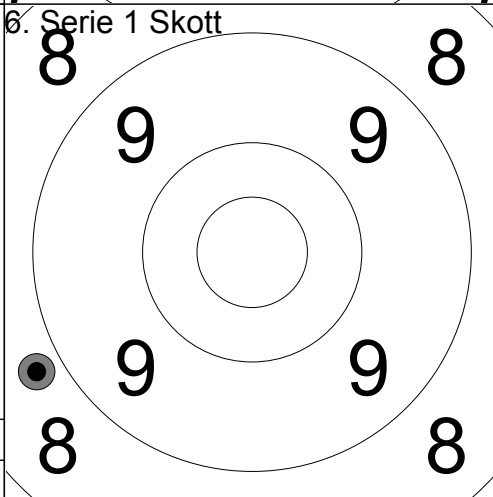

1:	8.8	←
Serie 8 ( 0x)		
Total 307 ( 1x)		

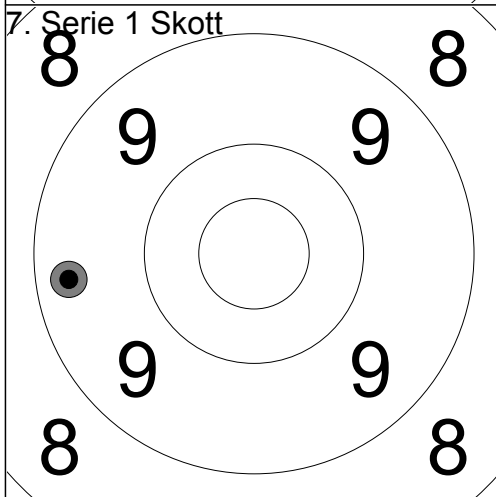

1:	9.3	←
Serie 9 ( 0x)		
Total 316 ( 1x)		

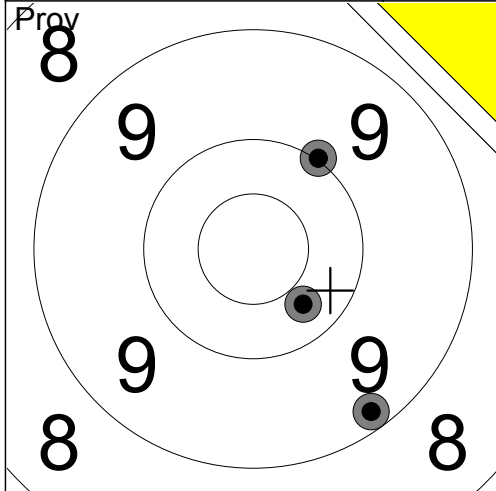

1:	10.0	↗
2:	10.3	↘
3:	9.2	↘
<hr/>		
Serie	29 ( 0x)	
Total	243 ( 0x)	

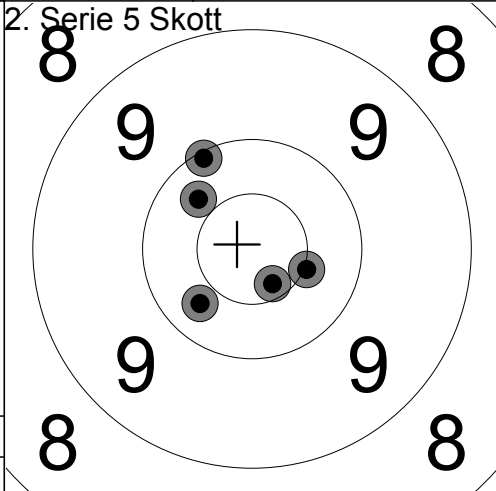

1:	10.1	↗
2:	10.3	↘
3:	10.5x	↘
4:	10.6x	↘
5:	10.3	↗
<hr/>		
Serie	50 ( 2x)	
Total	293 ( 2x)	

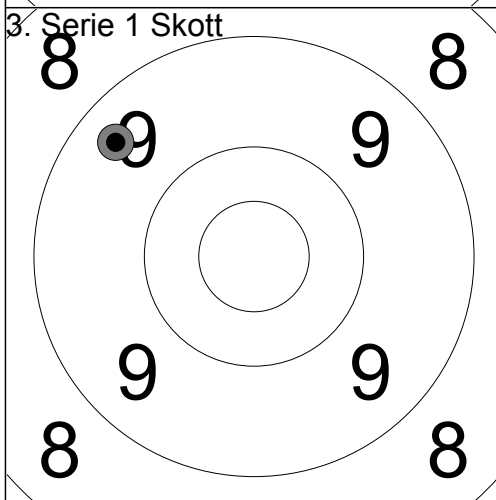

1:	9.4	↖
<hr/>		
Serie	9 ( 0x)	
Total	302 ( 2x)	

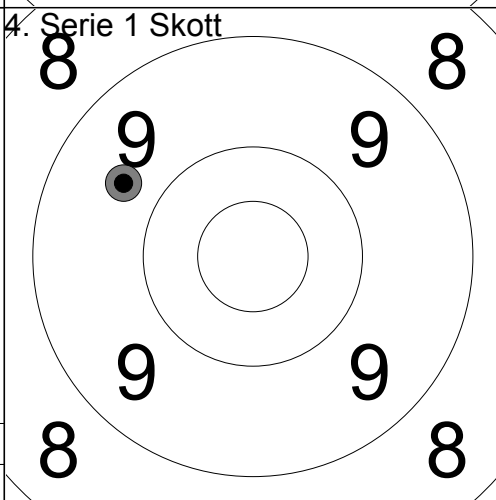

1:	9.7	↖
<hr/>		
Serie	9 ( 0x)	
Total	311 ( 2x)	

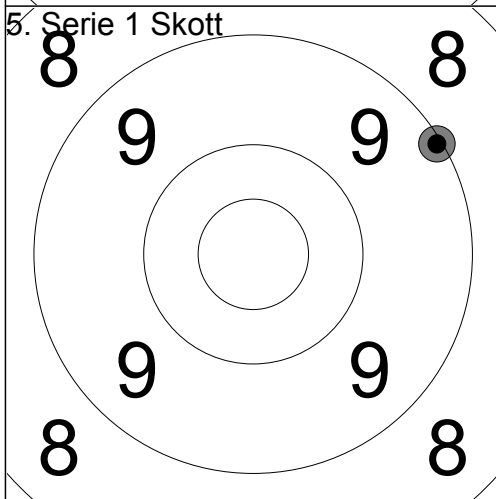

1:	9.1	↗
<hr/>		
Serie	9 ( 0x)	
Total	320 ( 2x)	

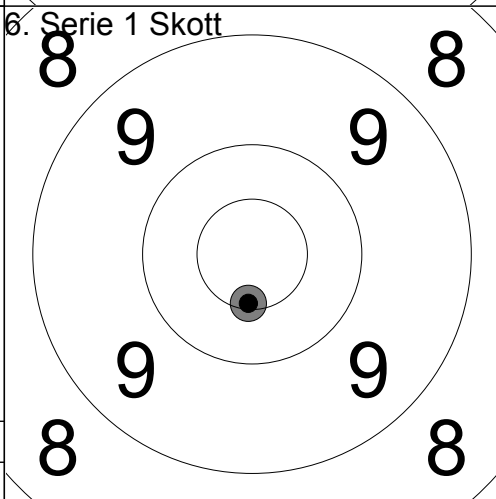

1:	10.5x	↘
<hr/>		
Serie	10 ( 1x)	
Total	330 ( 3x)	

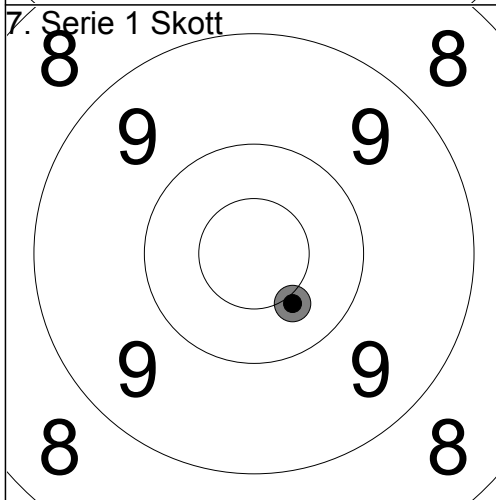

1:	10.4x	↘
<hr/>		
Serie	10 ( 1x)	
Total	340 ( 4x)	

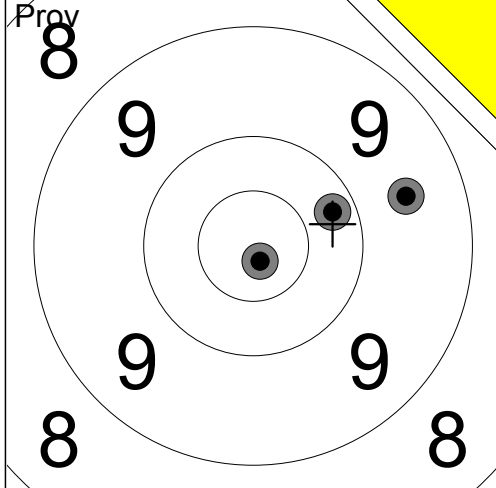

1:	9.6	→
2:	10.2	→
3:	10.8x	↓

Serie	29 ( 1x)
Total	240 ( 0x)

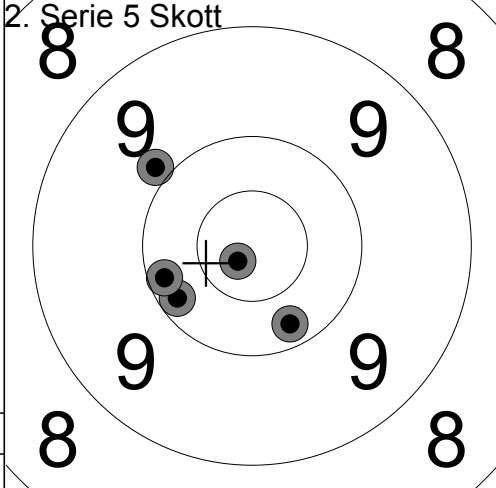

1:	9.9	↖
2:	10.2	↙
3:	10.2	↓
4:	10.8x	↙
5:	10.2	↖

Serie	49 ( 1x)
Total	289 ( 1x)

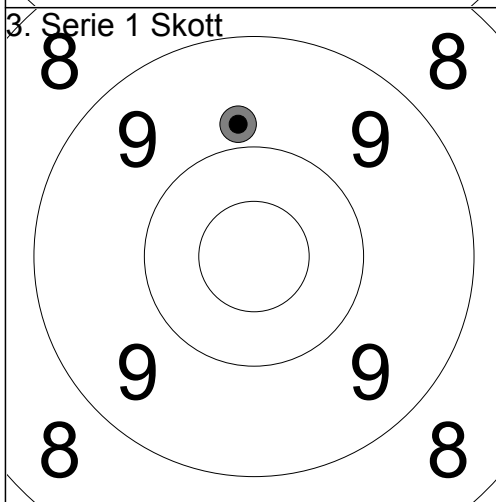

1:	9.8	↑
----	-----	---

Serie	9 ( 0x)
Total	298 ( 1x)

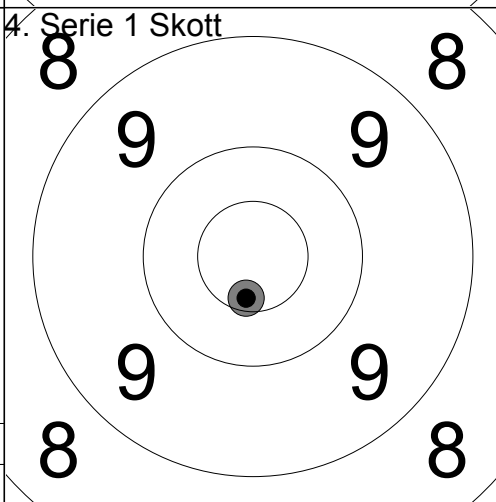

1:	10.6x	↓
----	-------	---

Serie	10 ( 1x)
Total	308 ( 2x)

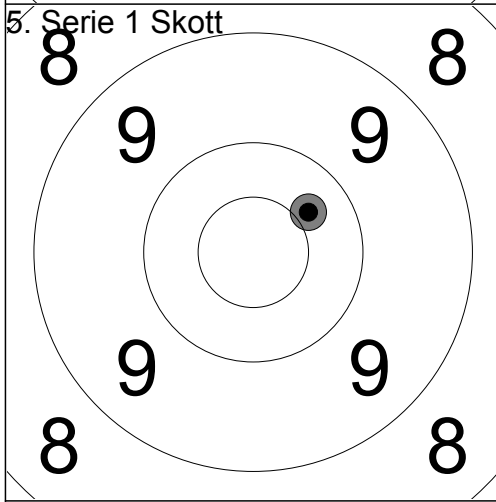

1:	10.4	↗
----	------	---

Serie	10 ( 0x)
Total	318 ( 2x)

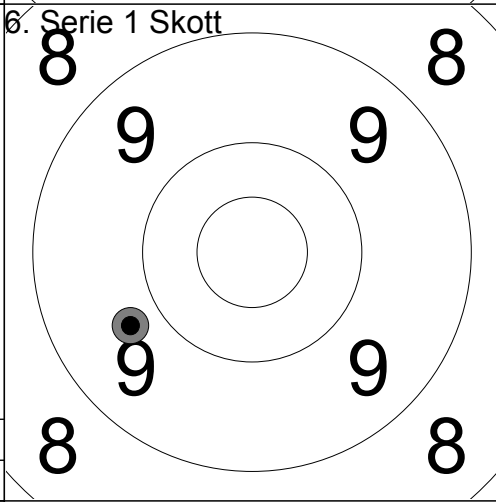

1:	9.7	↖
----	-----	---

Serie	9 ( 0x)
Total	327 ( 2x)

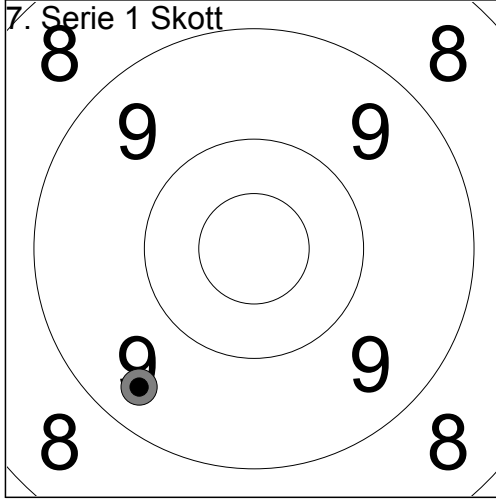

1:	9.4	↙
----	-----	---

Serie	9 ( 0x)
Total	336 ( 2x)



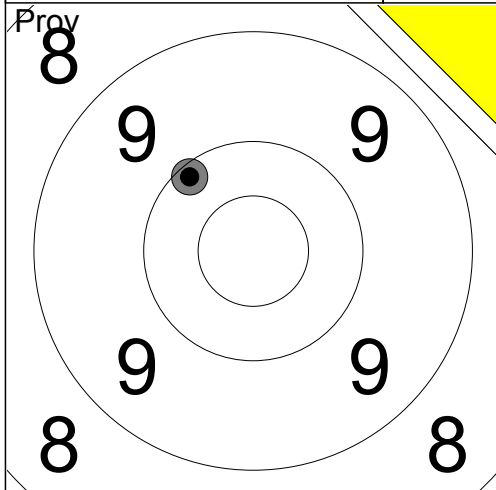

1: 10.1 ↖

Serie	10 ( 0x)
Total	232 ( 0x)

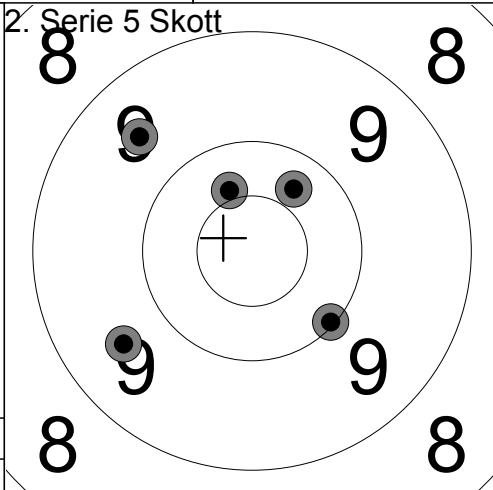

1: 9.6 ↙  
2: 10.4 ↗  
3: 10.3 ↗  
4: 9.6 ↗  
5: 10.1 ↘

Serie	48 ( 0x)
Total	280 ( 0x)

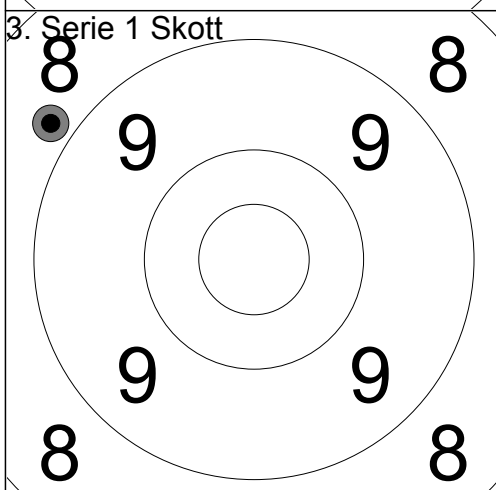

1: 8.8 ↙

Serie	8 ( 0x)
Total	288 ( 0x)

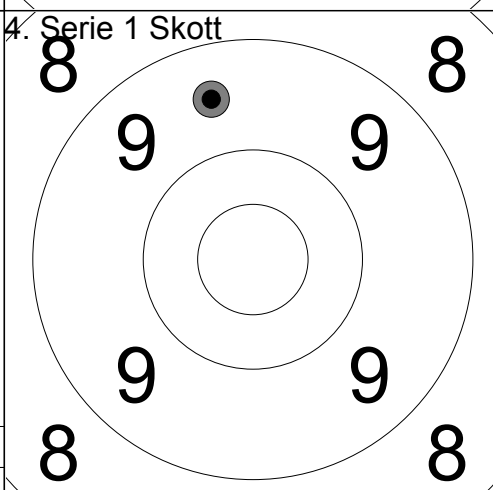

1: 9.5 ↗

Serie	9 ( 0x)
Total	297 ( 0x)

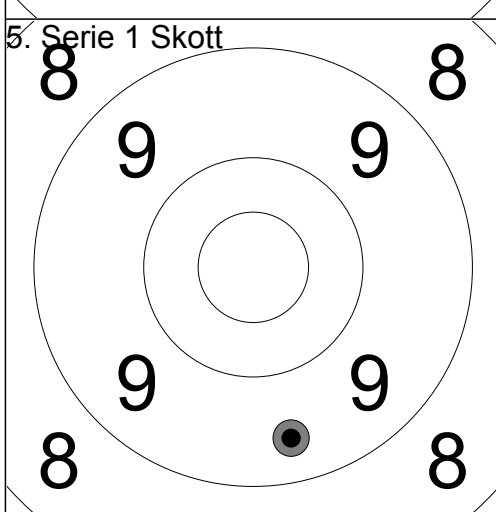

1: 9.4 ↓

Serie	9 ( 0x)
Total	306 ( 0x)

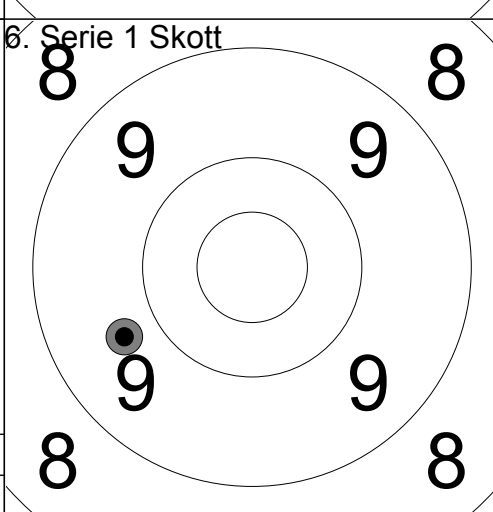

1: 9.7 ↙

Serie	9 ( 0x)
Total	315 ( 0x)

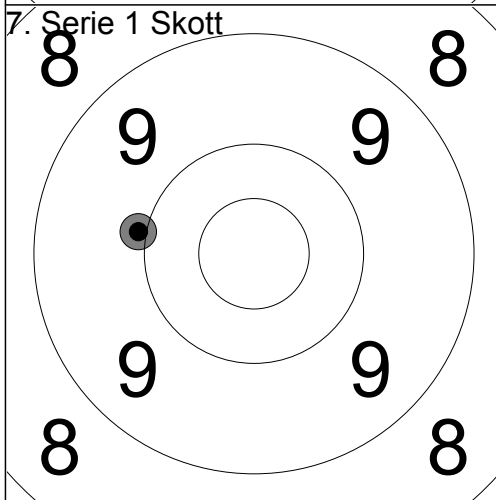

1: 10.0 ←

Serie	10 ( 0x)
Total	325 ( 0x)

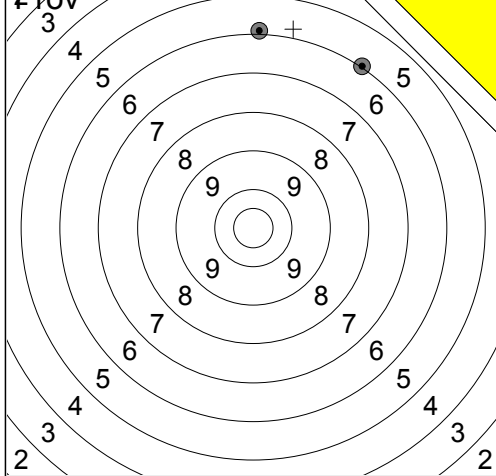

1: 4.9 ↑  
 2: 5.9 ↑  
 3: 6.0 ↗

Serie	15 (0x)
Total	193 (0x)

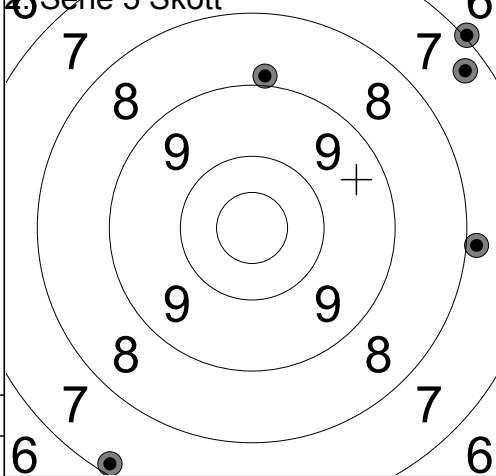

1: 7.9 →  
 2: 7.3 ↗  
 3: 7.0 ↗  
 4: 8.9 ↑  
 5: 7.2 ↓

Serie	36 (0x)
Total	229 (0x)

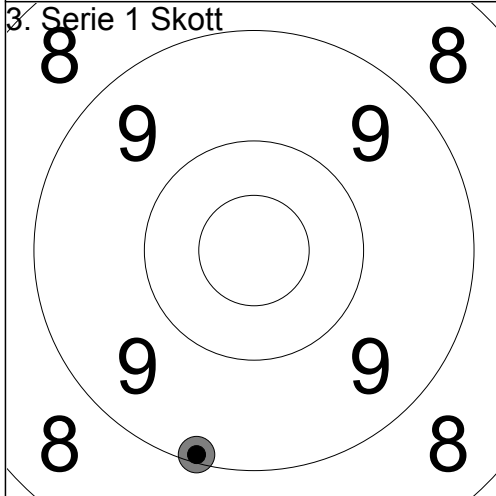

1: 9.1 ↓

Serie	9 (0x)
Total	238 (0x)

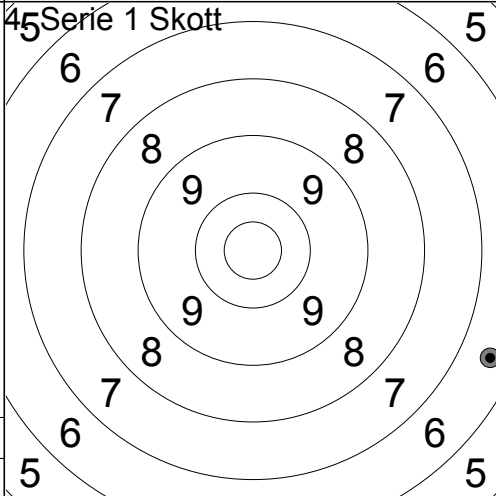

1: 6.5 →

Serie	6 (0x)
Total	244 (0x)

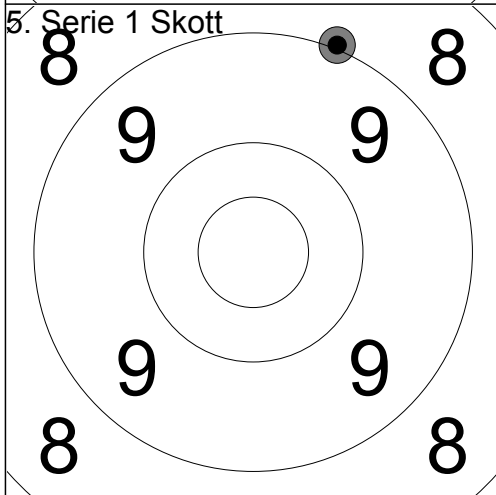

1: 9.0 ↑

Serie	9 (0x)
Total	253 (0x)

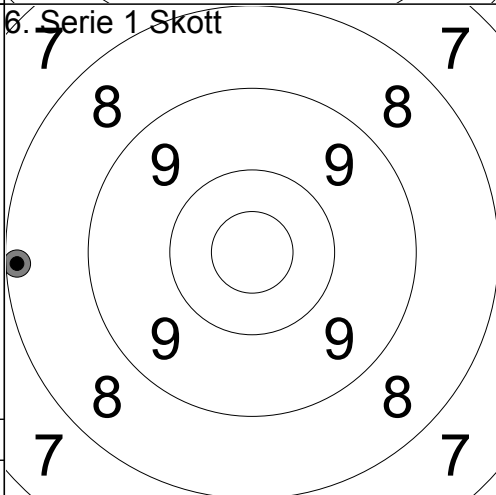

1: 8.2 ←

Serie	8 (0x)
Total	261 (0x)

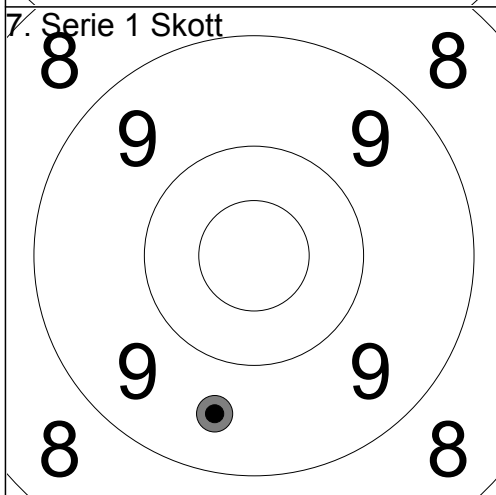

1: 9.6 ↓

Serie	9 (0x)
Total	270 (0x)

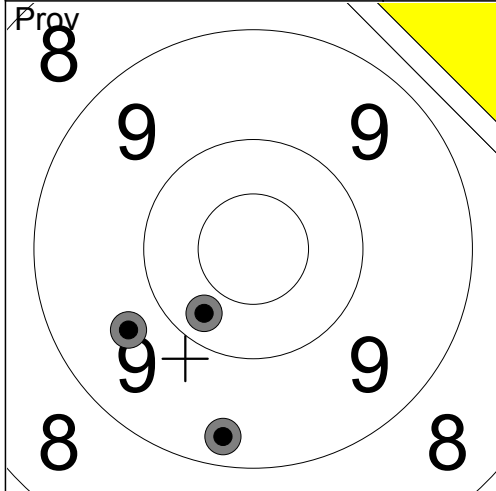

1:	9.3	↓
2:	10.3	↓
3:	9.7	↙
<hr/>		
Serie	28 ( 0x)	
Total	232 ( 0x)	

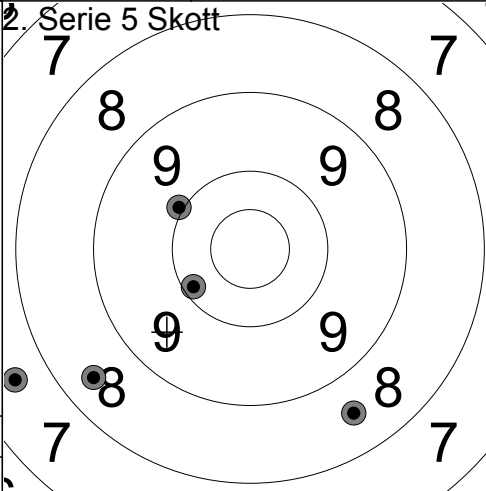

1:	7.6	↙
2:	10.0	↖
3:	8.5	↓
4:	10.1	↙
5:	8.4	↙
<hr/>		
Serie	43 ( 0x)	
Total	275 ( 0x)	

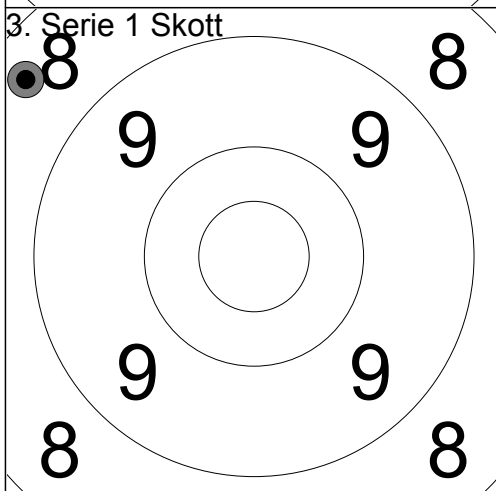

1:	8.4	↖
<hr/>		
Serie	8 ( 0x)	
Total	283 ( 0x)	

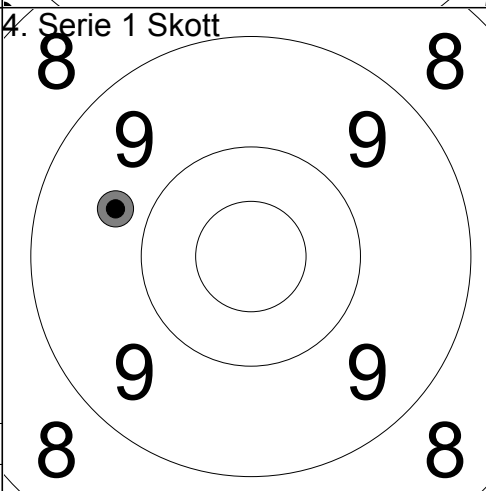

1:	9.7	↖
<hr/>		
Serie	9 ( 0x)	
Total	292 ( 0x)	

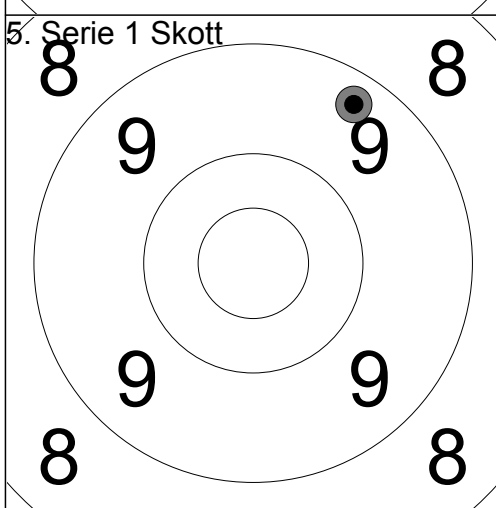

1:	9.3	↗
<hr/>		
Serie	9 ( 0x)	
Total	301 ( 0x)	

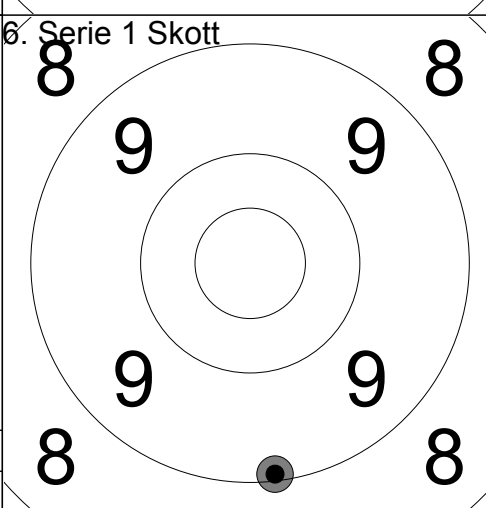

1:	9.1	↓
<hr/>		
Serie	9 ( 0x)	
Total	310 ( 0x)	

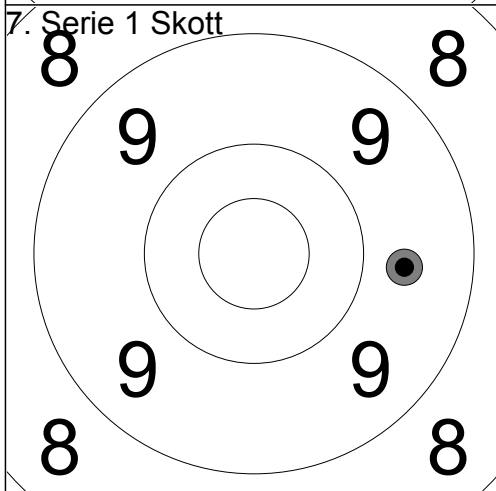

1:	9.7	→
<hr/>		
Serie	9 ( 0x)	
Total	319 ( 0x)	

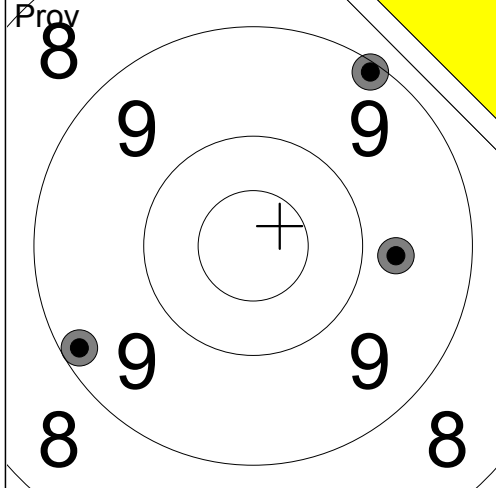

1:	9.7	→
2:	9.2	←
3:	9.1	↗

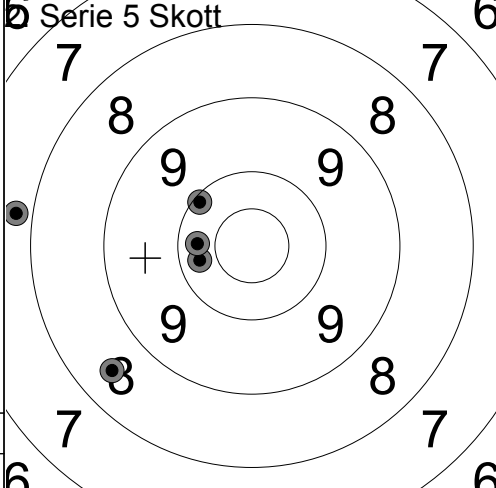

1:	10.3	←
2:	7.8	←
3:	10.1	↗
4:	10.3	←
5:	8.5	↙

Serie	27 (0x)
Total	219 (0x)

Serie	45 (0x)
Total	264 (0x)

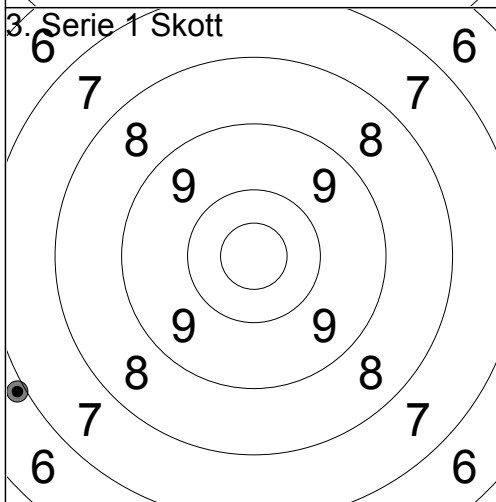

1:	6.9	←
----	-----	---

Serie	6 (0x)
Total	270 (0x)

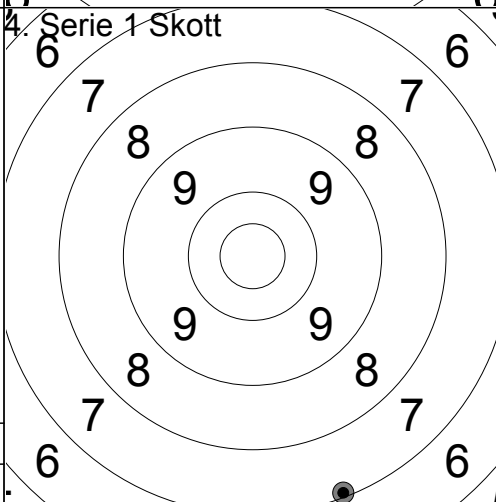

1:	7.1	↘
----	-----	---

Serie	7 (0x)
Total	277 (0x)

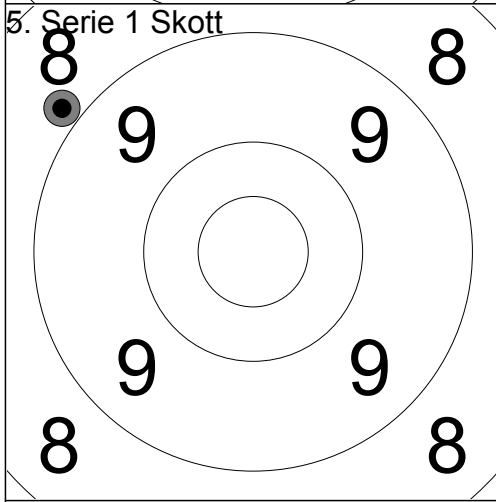

1:	8.9	↖
----	-----	---

Serie	8 (0x)
Total	285 (0x)

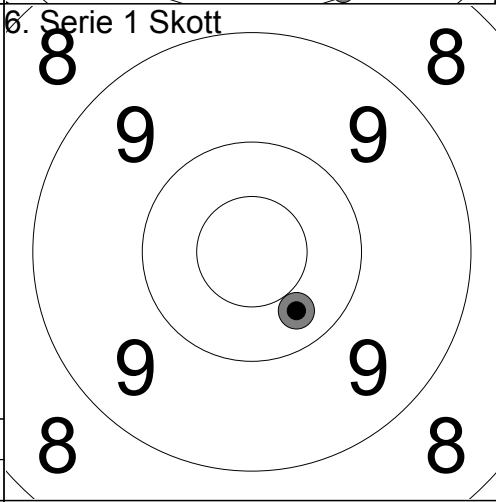

1:	10.3	↘
----	------	---

Serie	10 (0x)
Total	295 (0x)

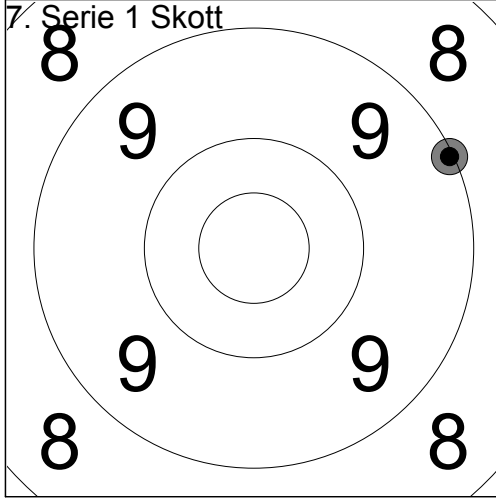

1:	9.1	↗
----	-----	---

Serie	9 (0x)
Total	304 (0x)

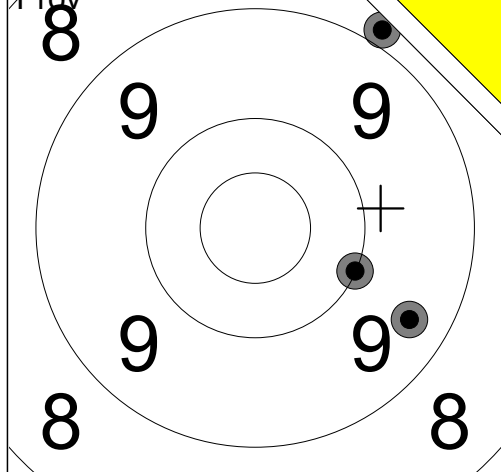

1:	8.9	↗
2:	10.0	→
3:	9.4	↘
<hr/>		
Serie	27 ( 0x)	
Total	222 ( 0x)	

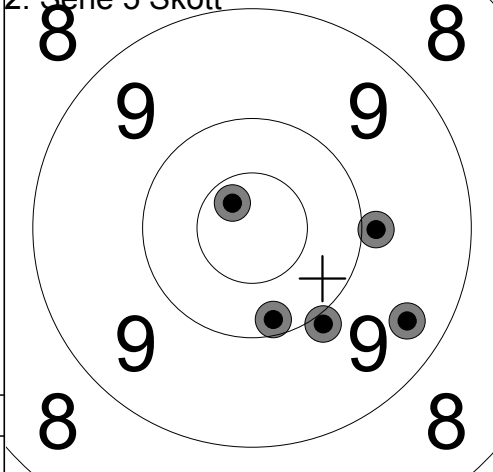

1:	10.7x	↗
2:	9.4	→
3:	9.9	↘
4:	10.2	↘
5:	9.9	→
<hr/>		
Serie	47 ( 1x)	
Total	269 ( 1x)	

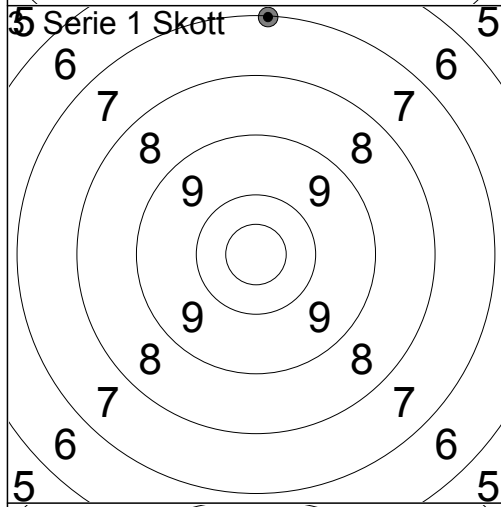

1:	7.1	↑
<hr/>		
Serie	7 ( 0x)	
Total	276 ( 1x)	

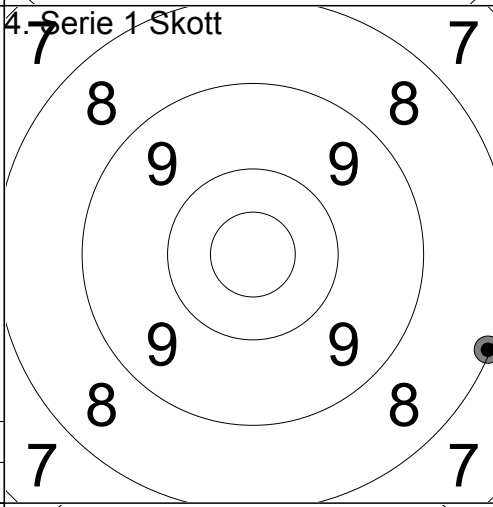

1:	8.1	→
<hr/>		
Serie	8 ( 0x)	
Total	284 ( 1x)	

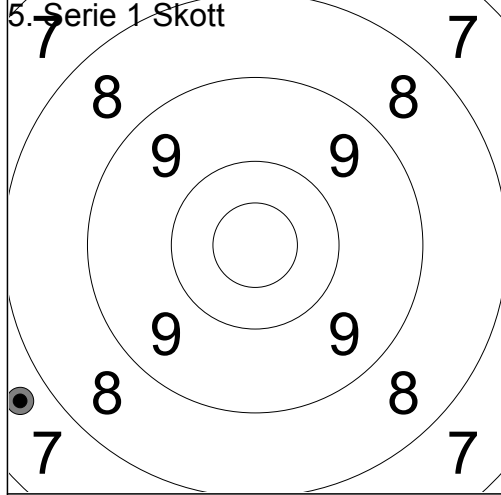

1:	7.7	↙
<hr/>		
Serie	7 ( 0x)	
Total	291 ( 1x)	

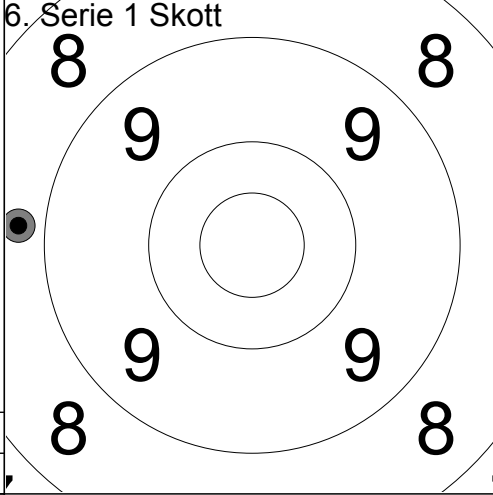

1:	8.8	←
<hr/>		
Serie	8 ( 0x)	
Total	299 ( 1x)	

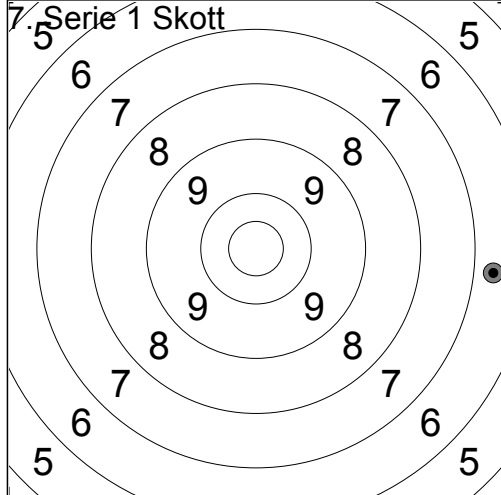

1:	6.7	→
<hr/>		
Serie	6 ( 0x)	
Total	305 ( 1x)	

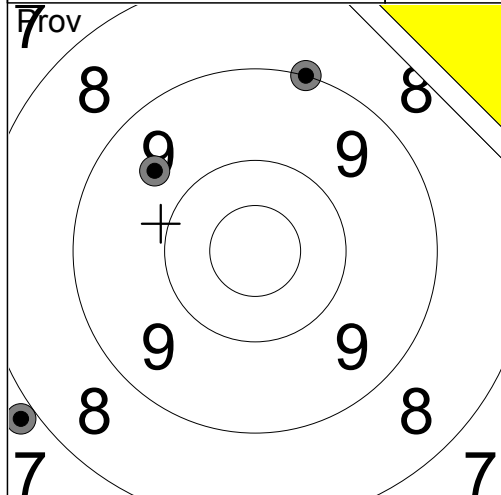

1:	9.0	↑
2:	9.6	↖
3:	7.9	↙
Serie 25 (0x)		
Total 217 (0x)		

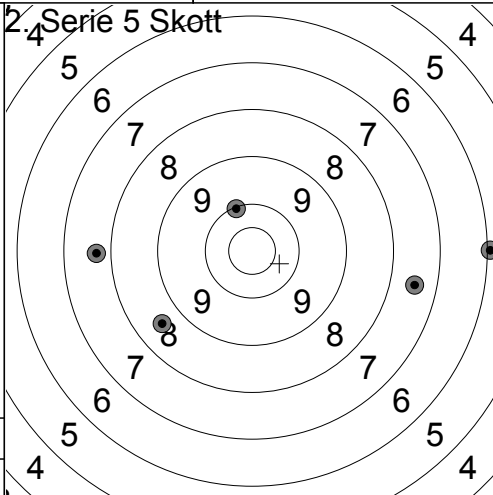

1:	7.7	←
2:	10.1	↑
3:	6.0	→
4:	8.6	↙
5:	7.5	→
Serie 38 (0x)		
Total 255 (0x)		

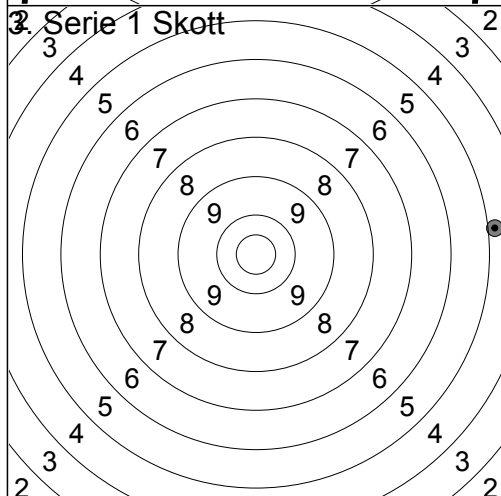

1:	4.9	→
Serie 4 (0x)		
Total 259 (0x)		

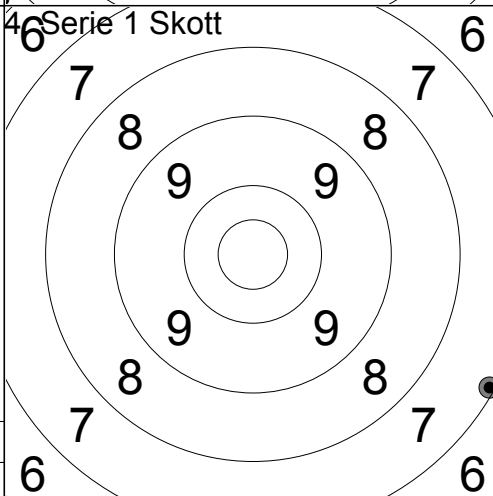

1:	7.1	↘
Serie 7 (0x)		
Total 266 (0x)		

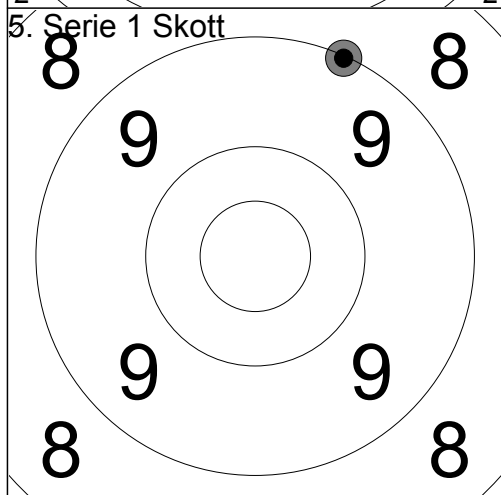

1:	9.1	↑
Serie 9 (0x)		
Total 275 (0x)		

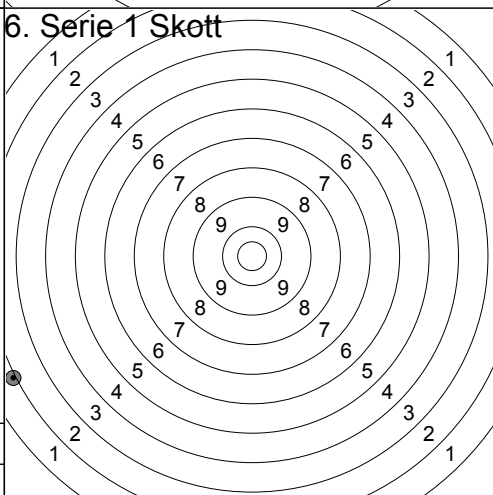

1:	1.9	←
Serie 1 (0x)		
Total 276 (0x)		

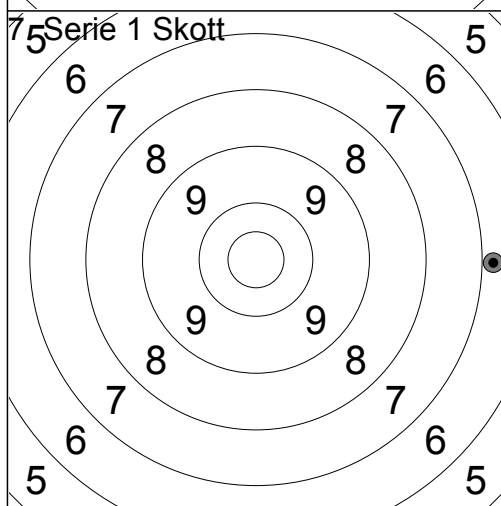

1:	6.8	→
Serie 6 (0x)		
Total 282 (0x)		

--	--	--

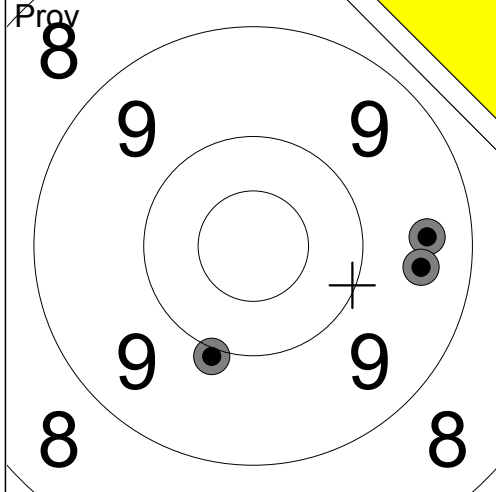

1:	10.0	↓
2:	9.4	→
3:	9.5	→

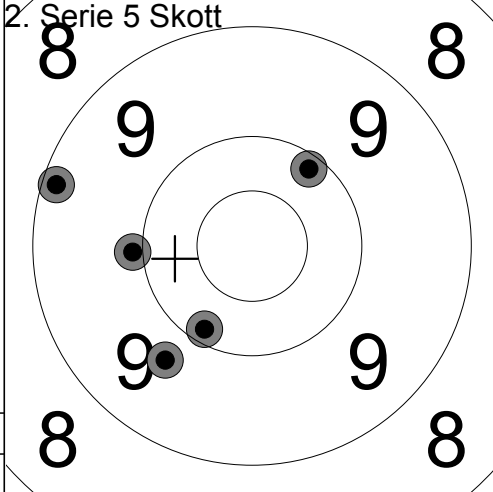

1:	9.2	←
2:	10.1	↗
3:	10.1	↓
4:	9.7	↙
5:	9.9	←

Serie	28 ( 0x)
Total	231 ( 0x)

Serie	47 ( 0x)
Total	278 ( 0x)

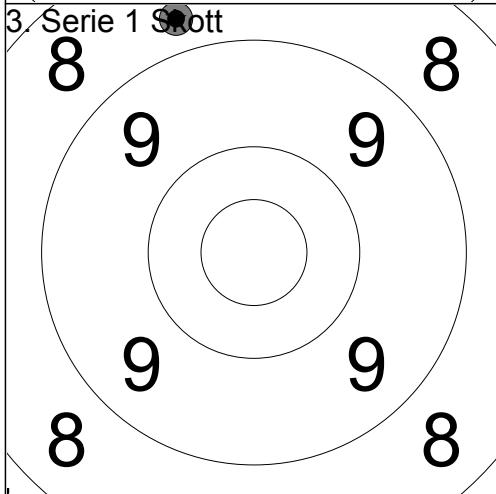

1:	8.7	↖
----	-----	---

Serie	8 ( 0x)
Total	286 ( 0x)

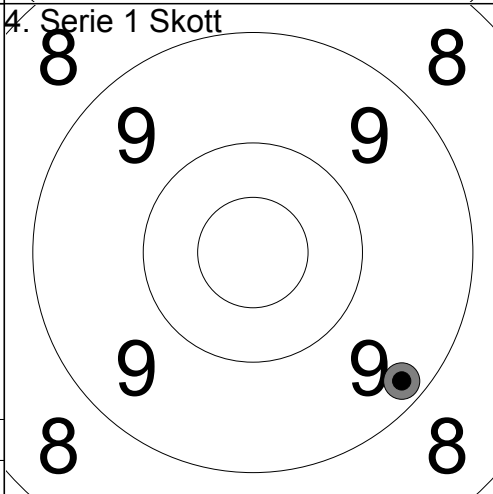

1:	9.2	↘
----	-----	---

Serie	9 ( 0x)
Total	295 ( 0x)

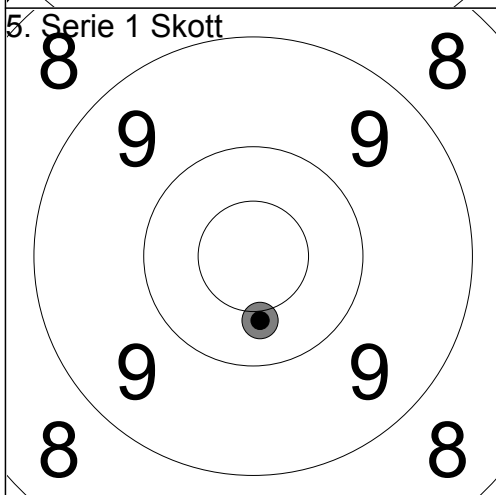

1:	10.4	↓
----	------	---

Serie	10 ( 0x)
Total	305 ( 0x)

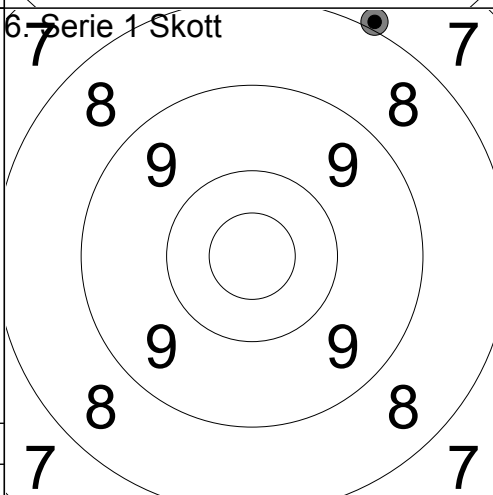

1:	7.9	↗
----	-----	---

Serie	7 ( 0x)
Total	312 ( 0x)

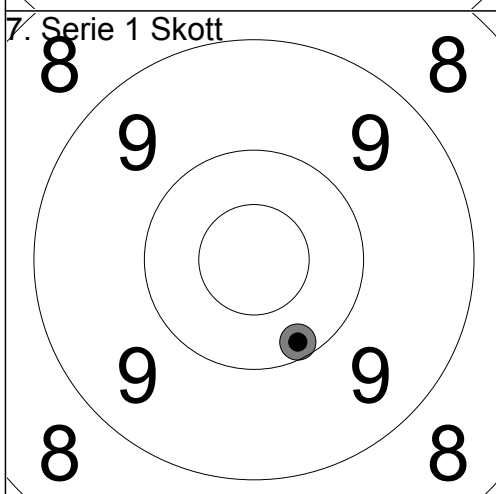

1:	10.2	↓
----	------	---

Serie	10 ( 0x)
Total	322 ( 0x)

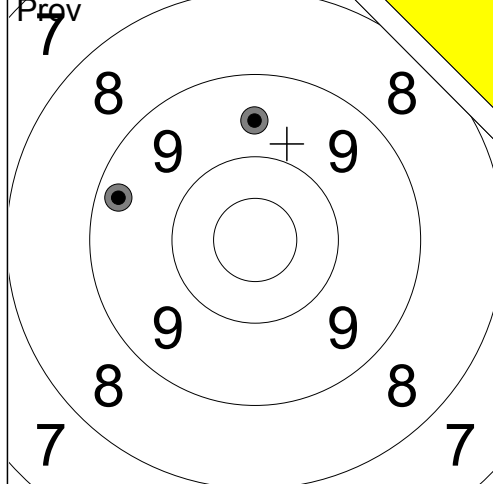

1:	7.8	→
2:	9.6	↑
3:	9.3	←
Serie 25 (0x)		
Total 231 (0x)		

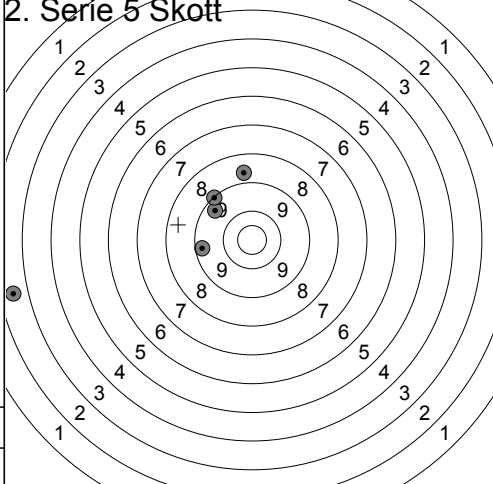

1:	8.7	↑
2:	2.5	←
3:	9.4	↗
4:	9.3	←
5:	9.1	↗
Serie 37 (0x)		
Total 268 (0x)		

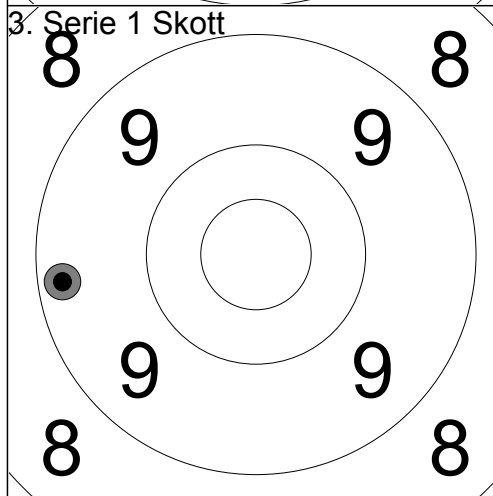

1:	9.2	←
Serie 9 (0x)		
Total 277 (0x)		

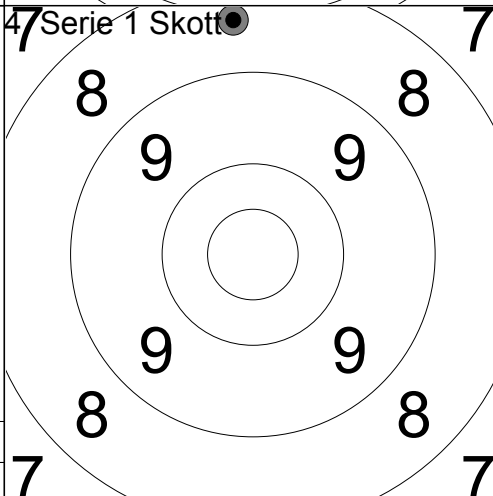

1:	8.4	↑
Serie 8 (0x)		
Total 285 (0x)		

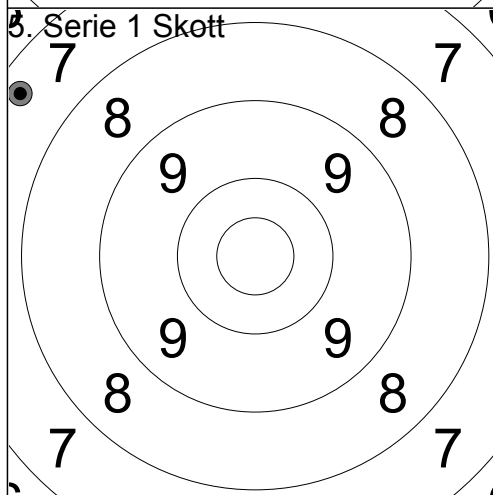

1:	7.4	↖
Serie 7 (0x)		
Total 292 (0x)		

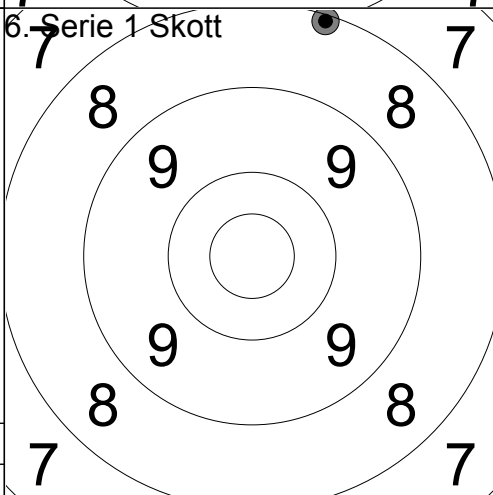

1:	8.1	↑
Serie 8 (0x)		
Total 300 (0x)		

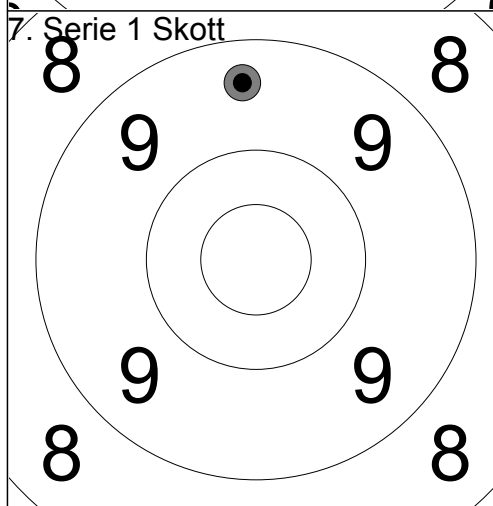

1:	9.4	↑
Serie 9 (0x)		
Total 309 (0x)		

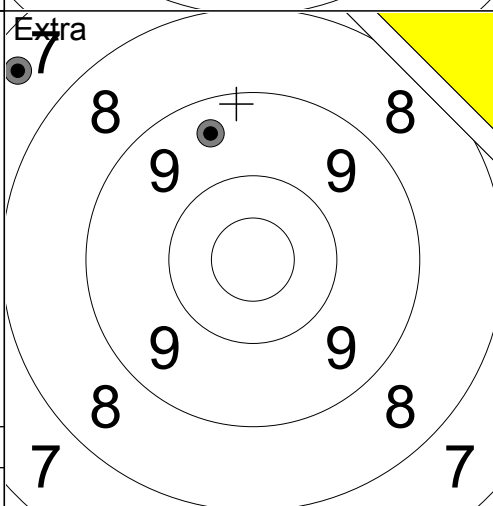

1:	7.8	↗
2:	7.4	↖
3:	9.4	↑
Serie 23 (0x)		
Total 309 (0x)		



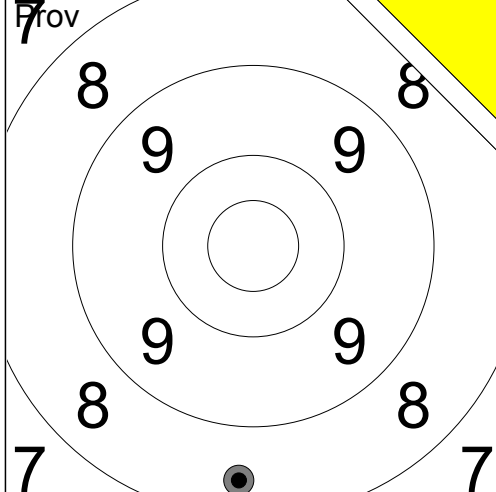

1: 8.4 ↓

Serie	8 ( 0x)
Total	223 ( 0x)

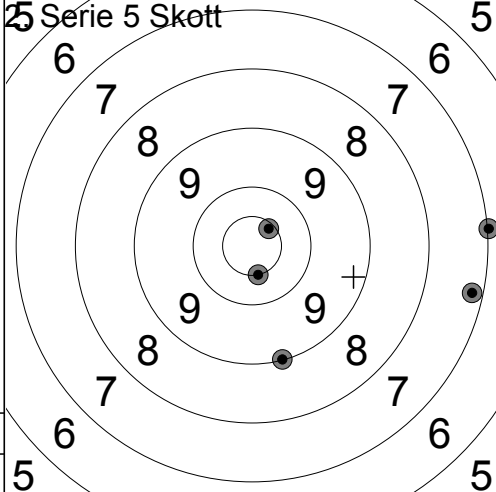

1: 10.6x ↗  
2: 7.0 →  
3: 7.2 →  
4: 10.5x ↓  
5: 9.0 ↓

Serie	43 ( 2x)
Total	266 ( 2x)

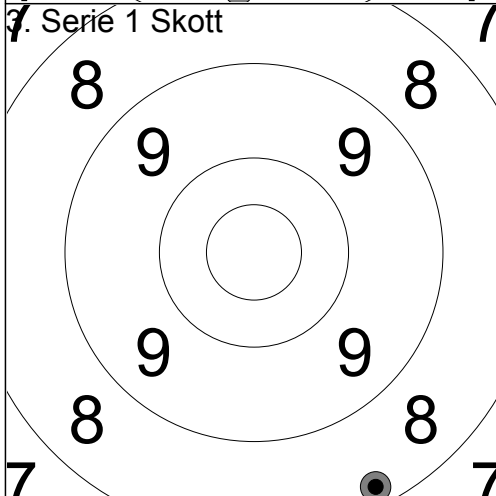

1: 8.2 ↓

Serie	8 ( 0x)
Total	274 ( 2x)

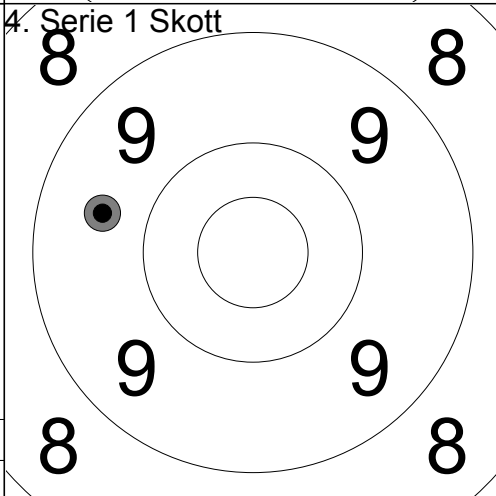

1: 9.6 ←

Serie	9 ( 0x)
Total	283 ( 2x)

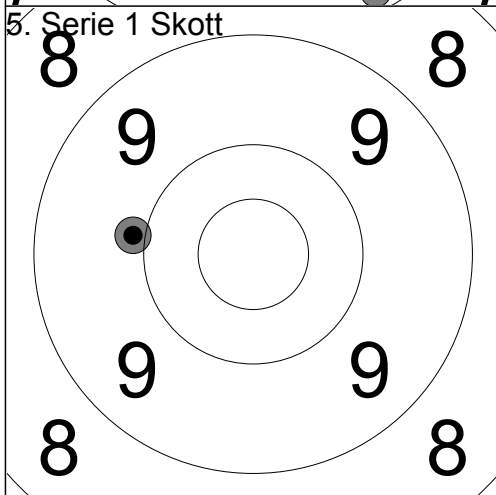

1: 9.9 ←

Serie	9 ( 0x)
Total	292 ( 2x)

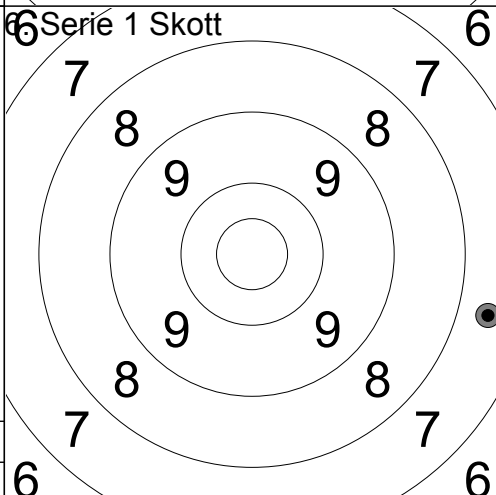

1: 7.6 →

Serie	7 ( 0x)
Total	299 ( 2x)

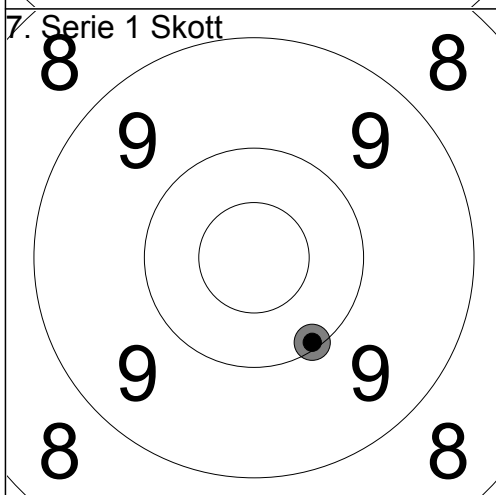

1: 10.1 ↓

Serie	10 ( 0x)
Total	309 ( 2x)

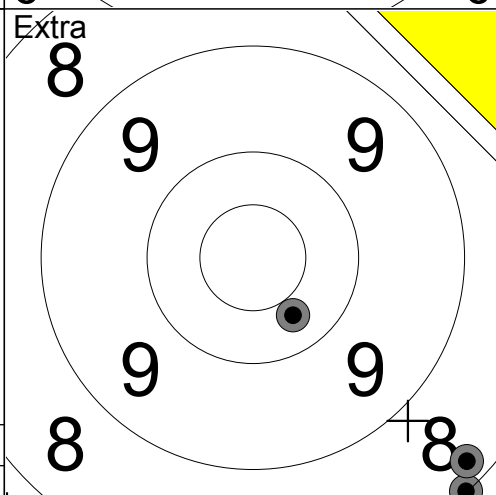

1: 10.3 ↓  
2: 8.0 ↓  
3: 8.2 ↓

Serie	26 ( 0x)
Total	309 ( 2x)

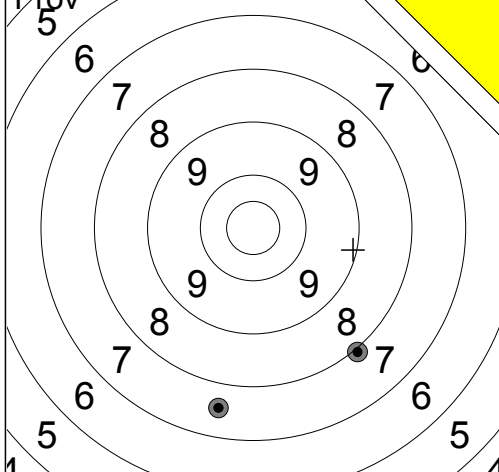

1:	4.8	↗
2:	8.0	↘
3:	7.6	↓
Serie 19 (0x)		
Total 176 (0x)		

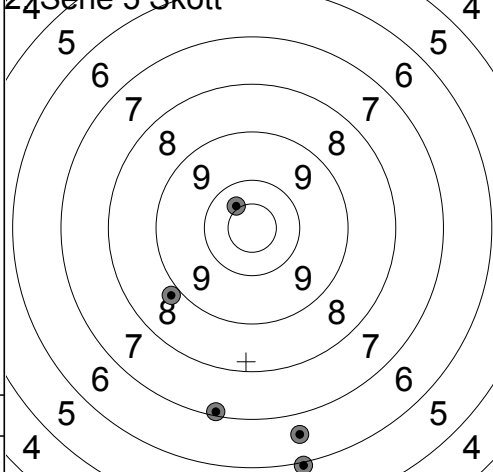

1:	8.8	↖
2:	5.9	↓
3:	10.4x	↗
4:	7.1	↓
5:	6.6	↓
Serie 36 (1x)		
Total 212 (1x)		

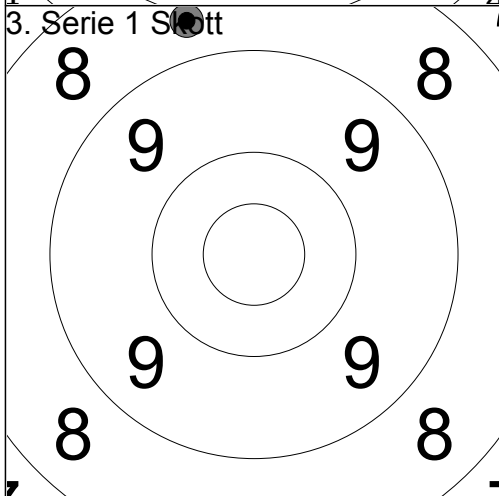

1:	8.6	↗
Serie 8 (0x)		
Total 220 (1x)		

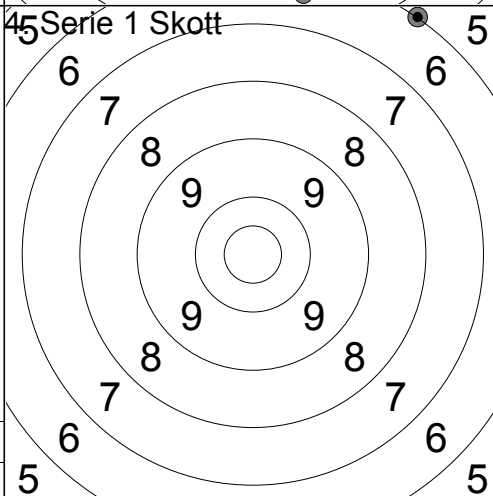

1:	6.0	↗
Serie 6 (0x)		
Total 226 (1x)		

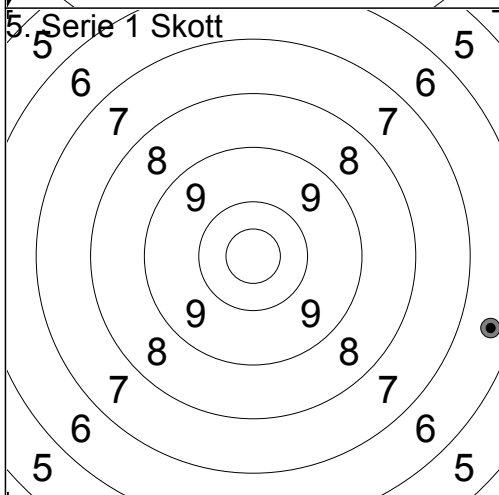

1:	6.5	→
Serie 6 (0x)		
Total 232 (1x)		

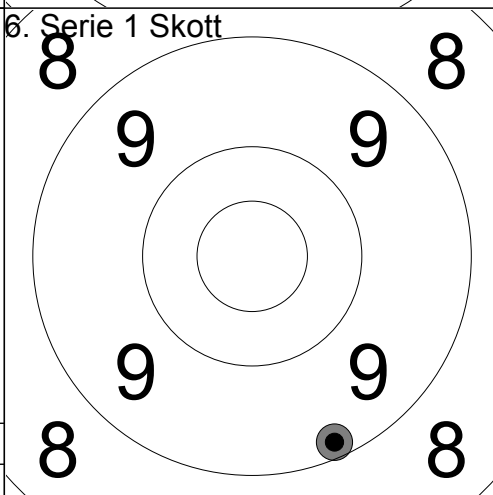

1:	9.2	↓
Serie 9 (0x)		
Total 241 (1x)		

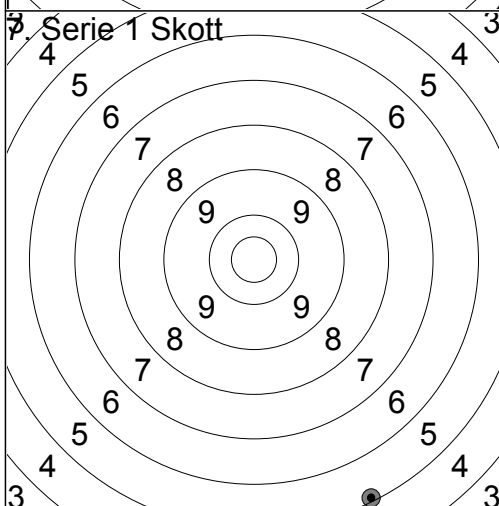

1:	5.1	↓
Serie 5 (0x)		
Total 246 (1x)		

