

1:	7.1	↓
2:	8.2	↓
3:	8.2	←
4:	6.7	↙
5:	8.7	↘
Serie		37 (0x)
Total		0 (0x)

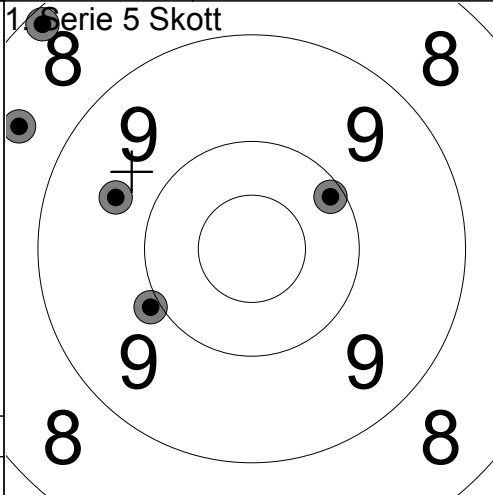

1:	8.2	↗
2:	8.6	↖
3:	9.7	↖
4:	10.1	↗
5:	9.9	↖
Serie		44 (0x)
Total		44 (0x)

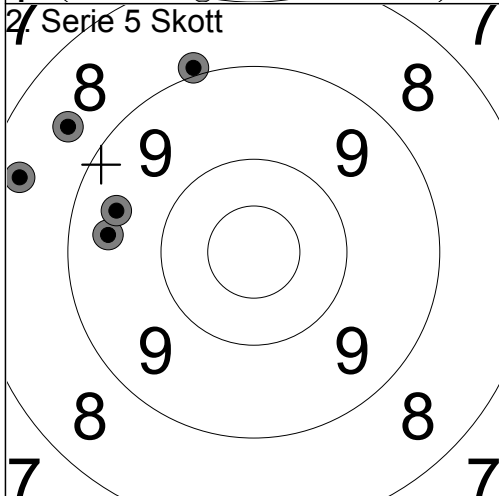

1:	8.6	↖
2:	8.4	←
3:	8.9	↗
4:	9.4	←
5:	9.5	↖
Serie		42 (0x)
Total		86 (0x)

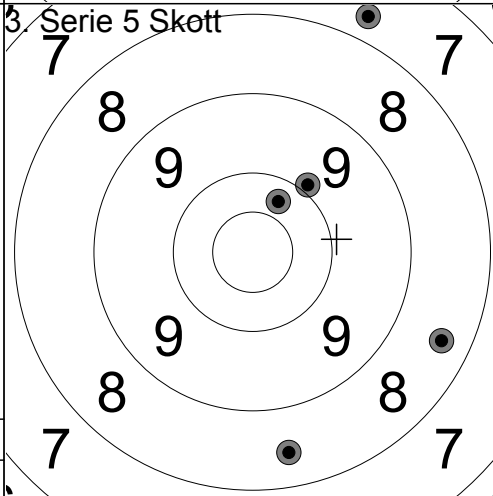

1:	7.7	↗
2:	10.3	↗
3:	9.9	↗
4:	8.4	→
5:	8.5	↓
Serie		42 (0x)
Total		128 (0x)

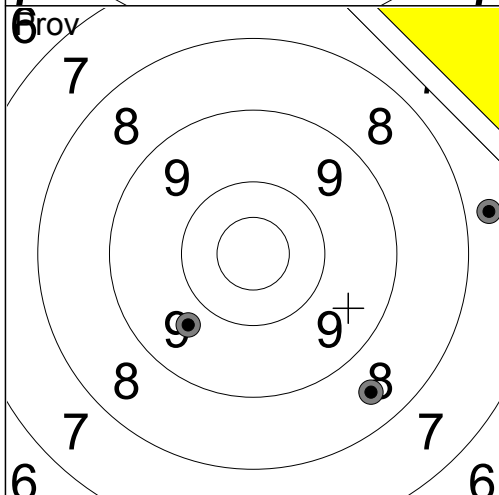

1:	7.7	→
2:	8.5	↘
3:	9.7	↘
Serie		24 (0x)
Total		128 (0x)

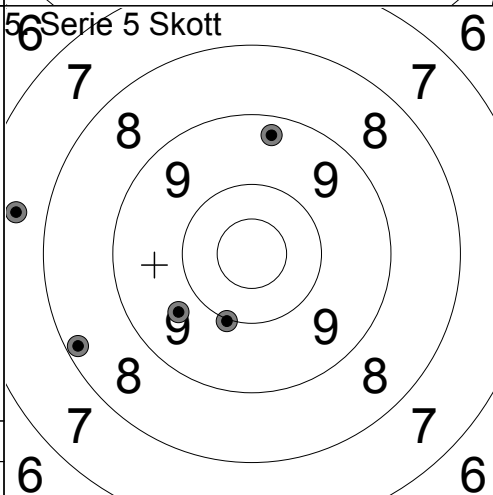

1:	9.3	↗
2:	8.2	←
3:	7.6	←
4:	9.7	↙
5:	10.0	↓
Serie		43 (0x)
Total		171 (0x)

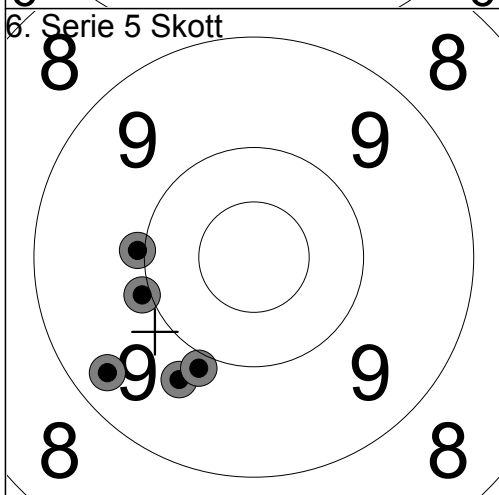

1:	9.7	↘
2:	10.0	←
3:	9.3	↙
4:	9.9	↘
5:	10.0	←
Serie		47 (0x)
Total		218 (0x)

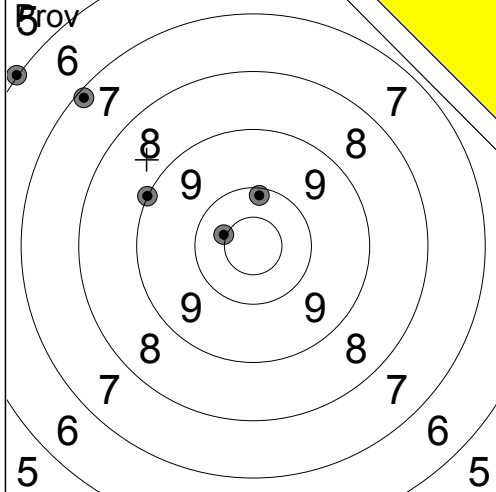

1:	6.0	↖
2:	7.2	↗
3:	10.4x	↖
4:	9.0	↗
5:	10.1	↑
<hr/>		
Serie	42 (1x)	
Total	0 (0x)	

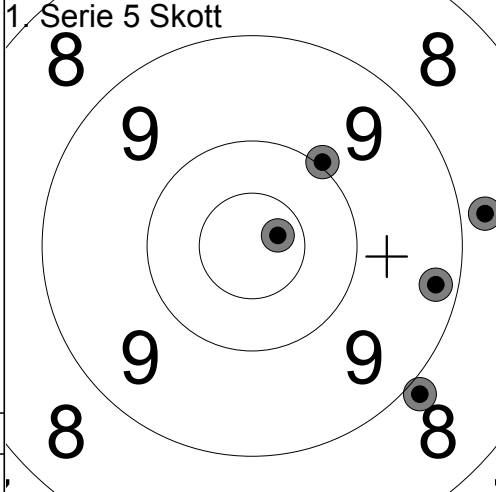

1:	10.7x	↗
2:	9.2	→
3:	10.0	↗
4:	8.9	↘
5:	8.8	→
<hr/>		
Serie	45 (1x)	
Total	45 (1x)	

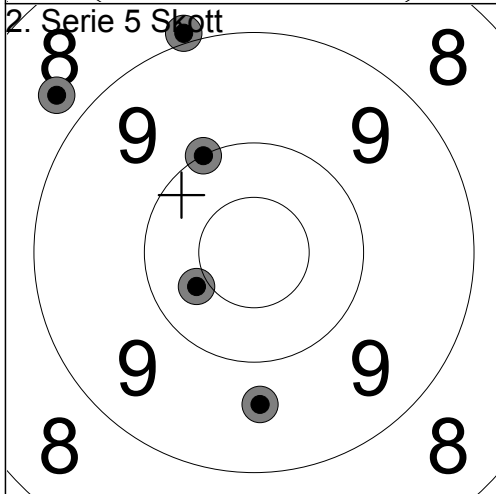

1:	10.0	↖
2:	8.9	↗
3:	8.7	↖
4:	10.4	↙
5:	9.6	↘
<hr/>		
Serie	45 (0x)	
Total	90 (1x)	

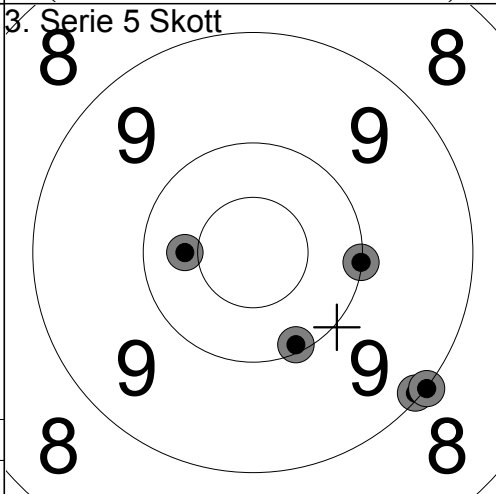

1:	9.1	↘
2:	10.1	↘
3:	9.0	↘
4:	10.0	→
5:	10.4	←
<hr/>		
Serie	48 (0x)	
Total	138 (1x)	

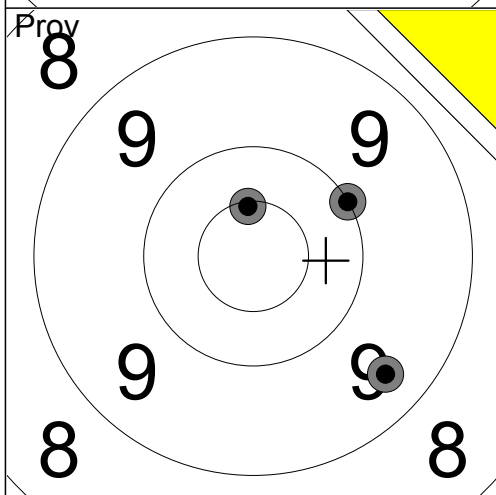

1:	9.4	↘
2:	10.5x	↑
3:	10.0	↗
<hr/>		
Serie	29 (1x)	
Total	138 (1x)	

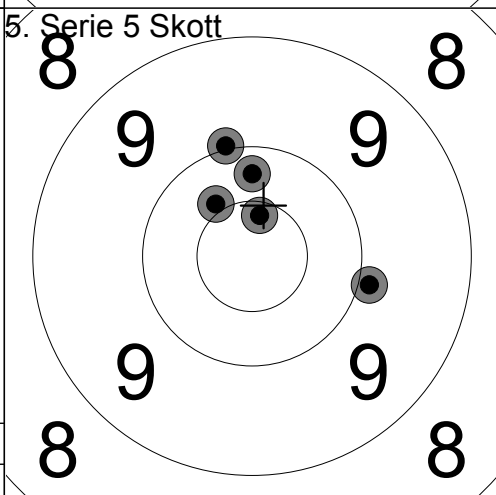

1:	10.6x	↑
2:	10.3	↑
3:	9.9	→
4:	10.0	↑
5:	10.4	↗
<hr/>		
Serie	49 (1x)	
Total	187 (2x)	

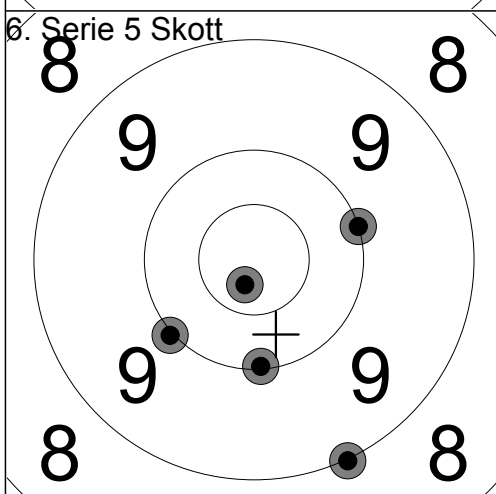

1:	10.1	↓
2:	10.0	→
3:	10.0	↙
4:	10.7x	↘
5:	9.0	↘
<hr/>		
Serie	49 (1x)	
Total	236 (3x)	

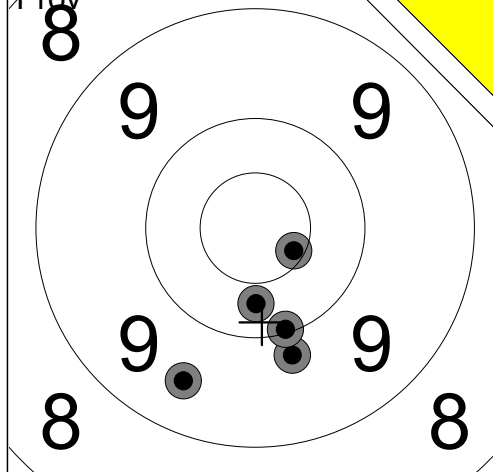

1:	9.8	↓
2:	10.6x	→
3:	10.3	↓
4:	9.5	↓
5:	10.1	↓
Serie		48 (1x)
Total		0 (0x)

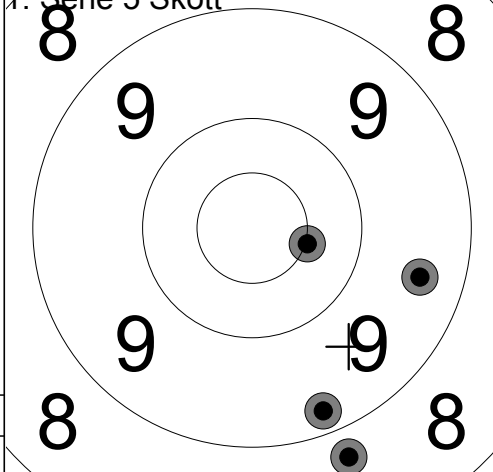

1:	0.0	
2:	9.2	↓
3:	8.8	↓
4:	9.4	→
5:	10.5x	→
Serie		36 (1x)
Total		36 (1x)

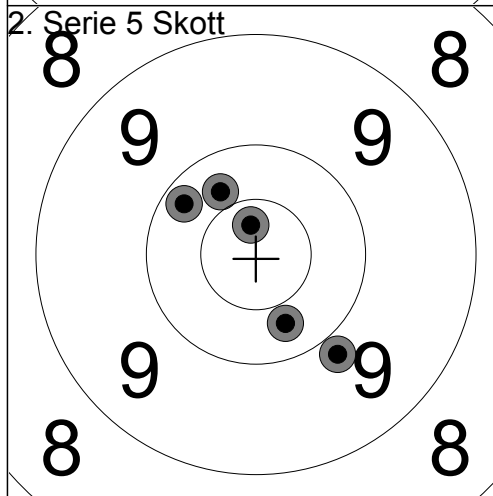

1:	10.3	↓
2:	9.9	↓
3:	10.2	↗
4:	10.7x	↗
5:	10.3	↗
Serie		49 (1x)
Total		85 (2x)

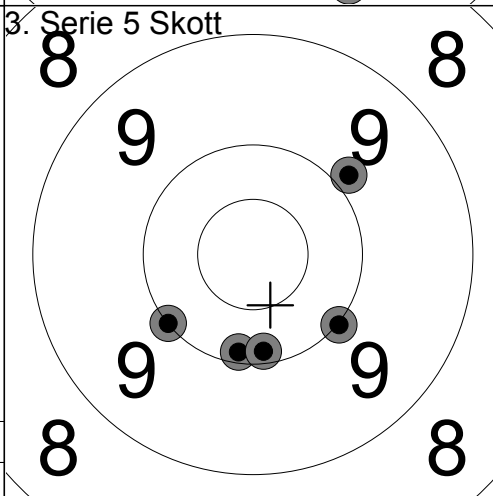

1:	10.0	↙
2:	10.1	↓
3:	9.9	↗
4:	10.0	↓
5:	10.1	↓
Serie		49 (0x)
Total		134 (2x)

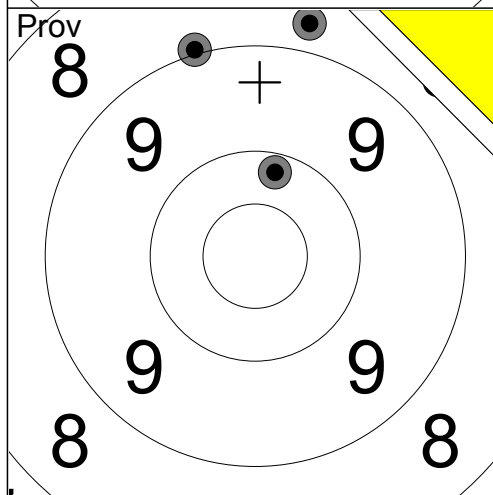

1:	10.2	↑
2:	9.0	↑
3:	8.7	↑
Serie		27 (0x)
Total		134 (2x)

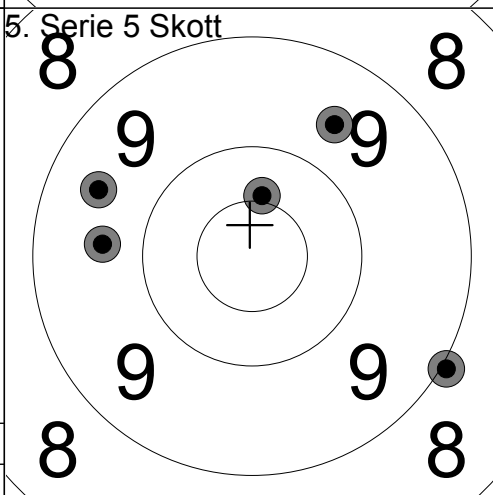

1:	10.4x	↑
2:	9.7	←
3:	9.5	↖
4:	9.0	↘
5:	9.6	↗
Serie		46 (1x)
Total		180 (3x)

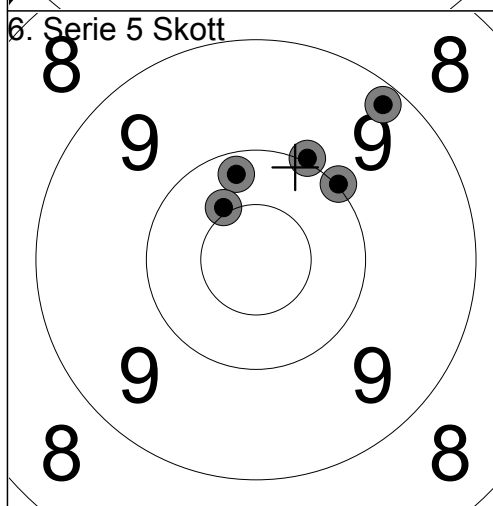

1:	10.0	↗
2:	10.2	↑
3:	10.0	↗
4:	10.4x	↖
5:	9.2	↗
Serie		49 (1x)
Total		229 (4x)

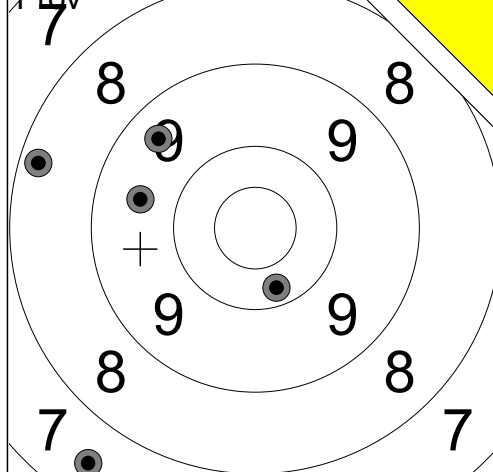

1:	9.6	←
2:	10.2	↓
3:	9.4	↗
4:	7.5	↘
5:	8.3	←

Serie	43 (0x)
Total	0 (0x)

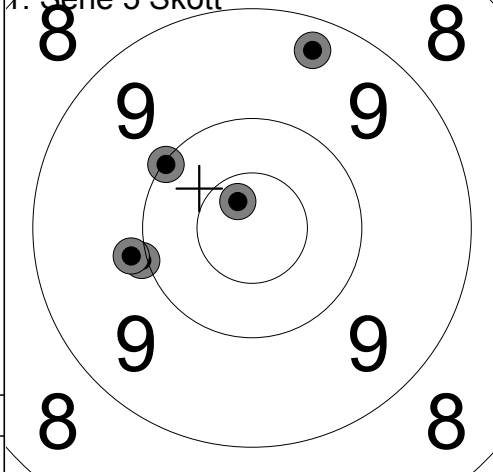

1:	10.0	↖
2:	9.3	↑
3:	10.0	←
4:	9.9	←
5:	10.7x	↗

Serie	48 (1x)
Total	48 (1x)

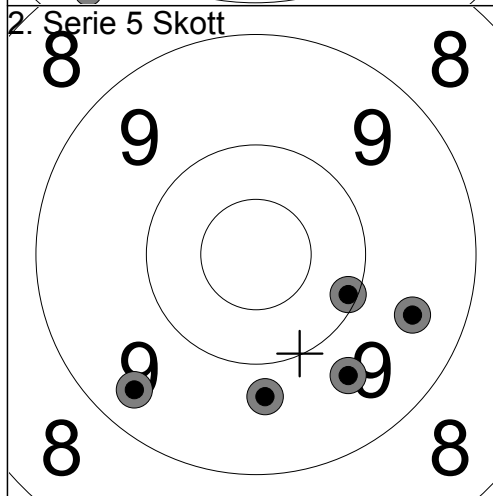

1:	10.1	→
2:	9.5	→
3:	9.6	↘
4:	9.7	↓
5:	9.4	↙

Serie	46 (0x)
Total	94 (1x)

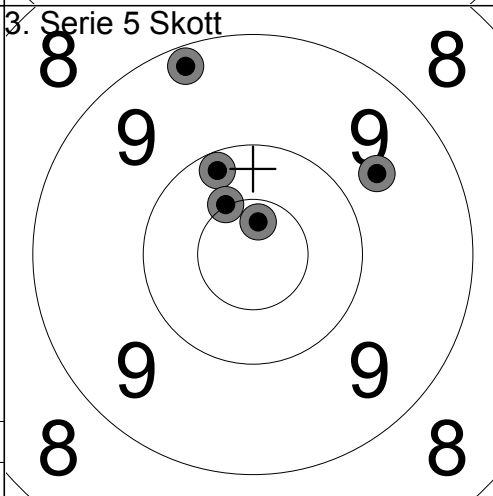

1:	10.2	↖
2:	10.5x	↖
3:	9.2	↖
4:	10.7x	↑
5:	9.7	↗

Serie	48 (2x)
Total	142 (3x)

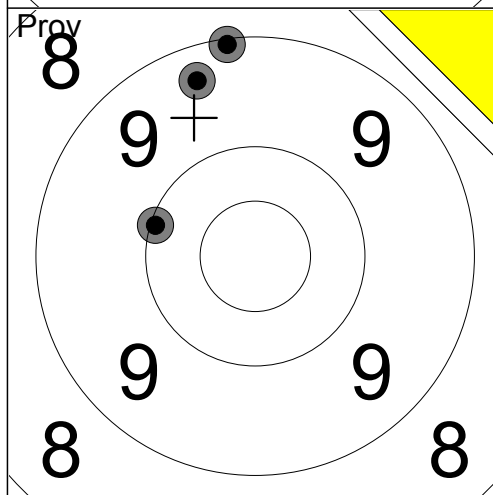

1:	9.1	↑
2:	9.3	↑
3:	10.1	←

Serie	28 (0x)
Total	142 (3x)

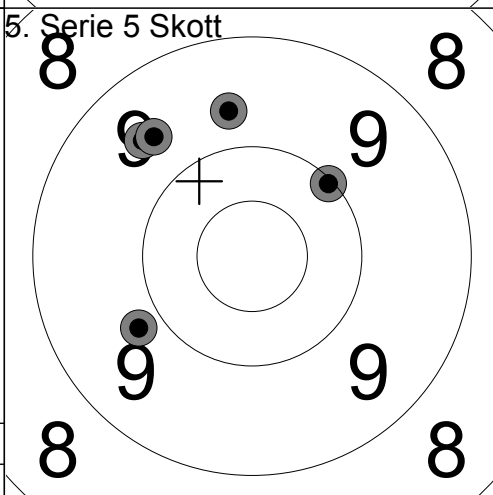

1:	10.1	↗
2:	9.7	↑
3:	9.6	↖
4:	9.8	↙
5:	9.6	↖

Serie	46 (0x)
Total	188 (3x)

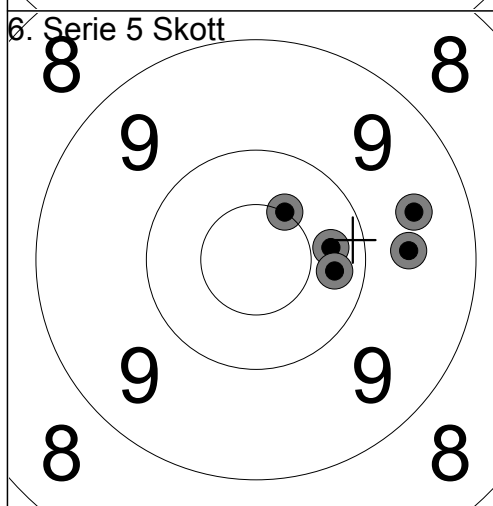

1:	10.3	→
2:	10.3	→
3:	9.6	→
4:	9.5	→
5:	10.5x	↗

Serie	48 (1x)
Total	236 (4x)

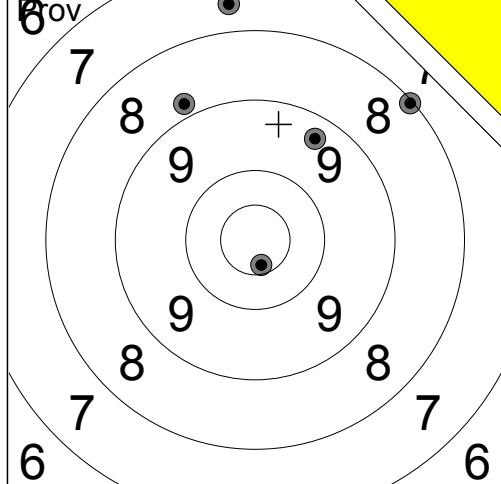

1:	7.6	↑
2:	8.8	↗
3:	9.4	↗
4:	10.6x	↓
5:	8.1	↗

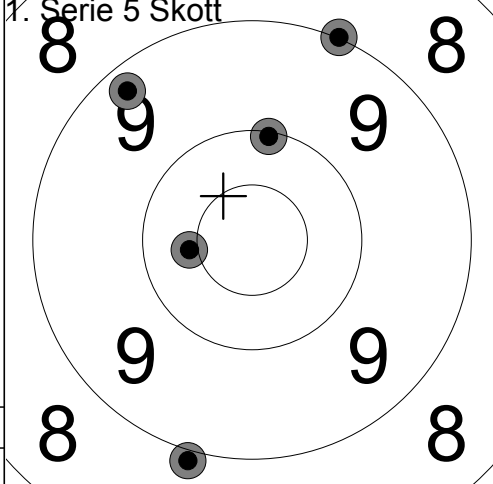

1:	9.0	↗
2:	10.1	↑
3:	10.4x	←
4:	9.3	↗
5:	8.9	↓

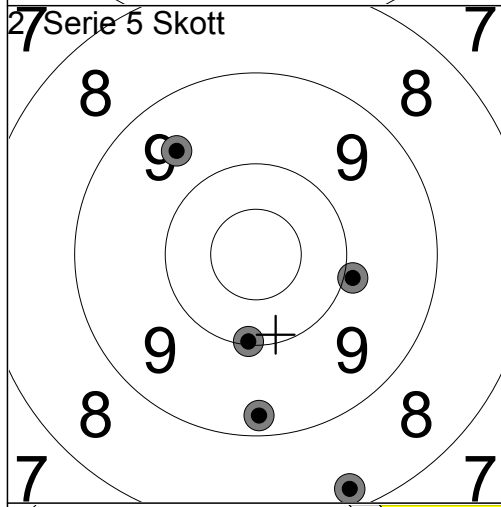

1:	10.1	↓
2:	8.3	↓
3:	9.3	↓
4:	9.6	↗
5:	9.9	→

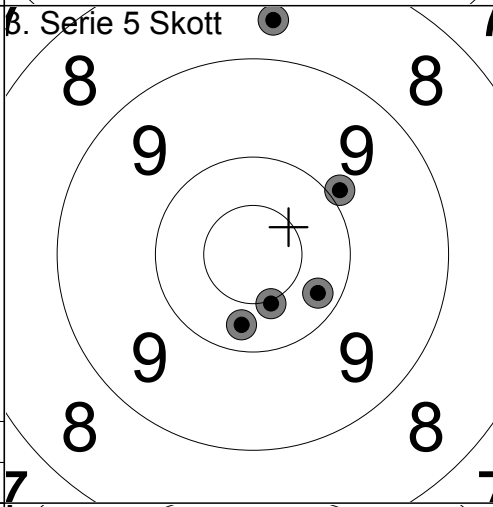

1:	10.5x	↓
2:	10.2	→
3:	8.6	↑
4:	10.3	↓
5:	9.9	↗

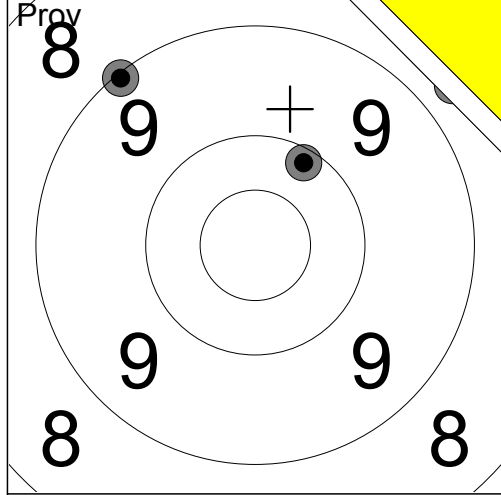

1:	8.7	↗
2:	9.1	↗
3:	10.1	↑

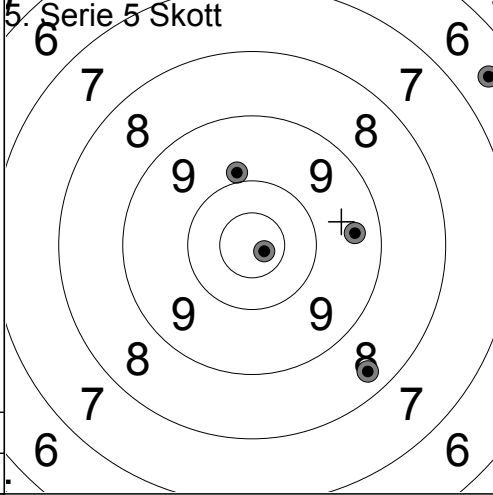

1:	8.4	↓
2:	9.4	→
3:	9.9	↑
4:	10.8x	→
5:	6.5	↗

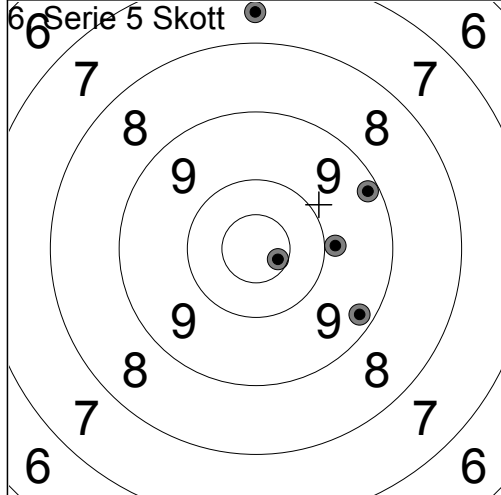

1:	7.6	↑
2:	9.9	→
3:	9.2	↗
4:	10.6x	↓
5:	9.2	↓

Serie	42 (1x)
Total	138 (2x)

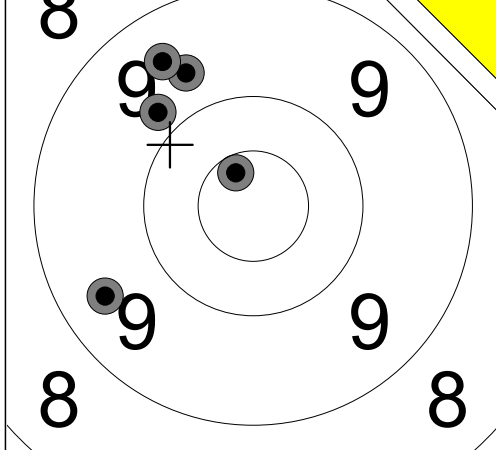

1:	9.7	↗
2:	9.5	↗
3:	9.8	↗
4:	9.4	↖
5:	10.6x	↗
Serie		46 (1x)
Total		0 (0x)

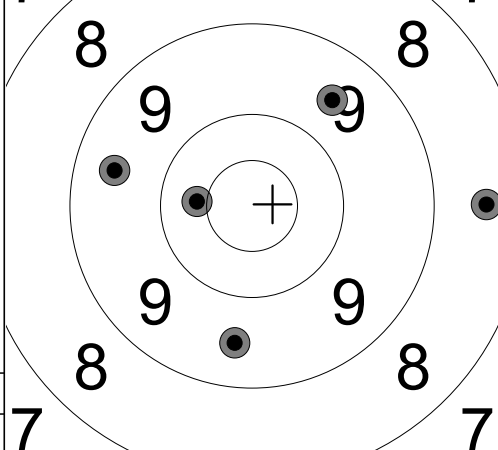

1:	8.5	→
2:	10.4	←
3:	9.5	↓
4:	9.5	←
5:	9.6	↗
Serie		45 (0x)
Total		45 (0x)

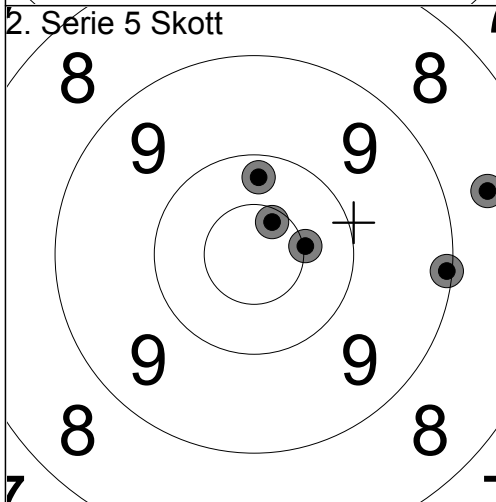

1:	10.2	↑
2:	8.6	→
3:	10.5x	→
4:	10.6x	↗
5:	9.1	→
Serie		47 (2x)
Total		92 (2x)

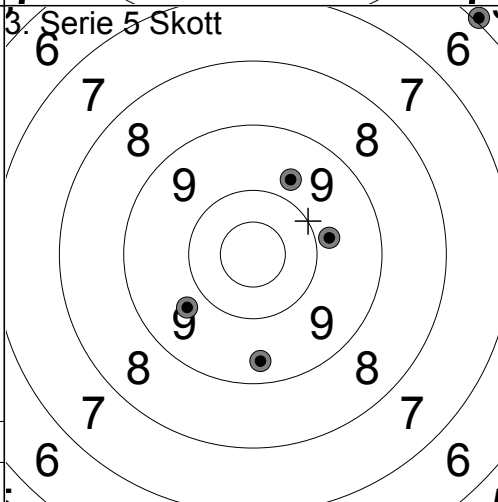

1:	9.7	↖
2:	9.4	↓
3:	9.8	→
4:	6.0	↗
5:	9.7	↗
Serie		42 (0x)
Total		134 (2x)

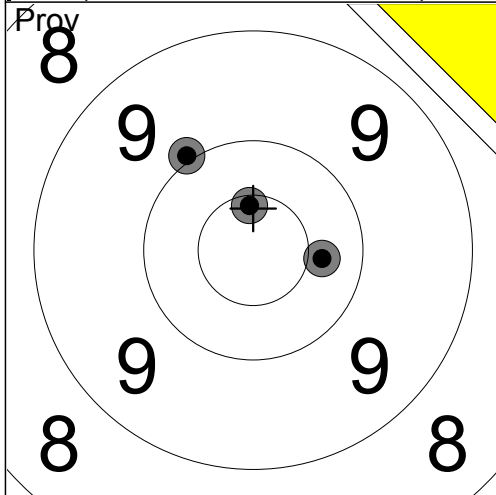

1:	10.0	↖
2:	10.4	→
3:	10.6x	↑
Serie		30 (1x)
Total		134 (2x)

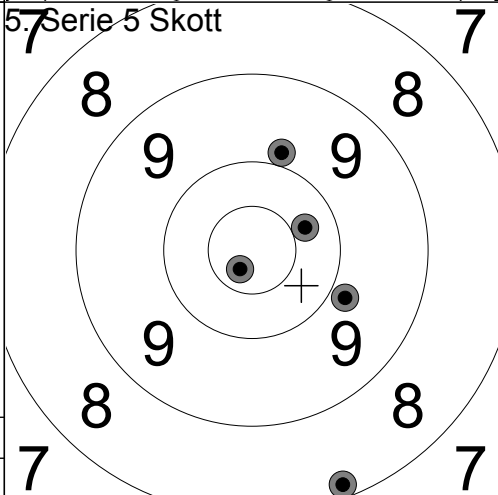

1:	10.3	↗
2:	8.2	↓
3:	9.9	↑
4:	10.7x	↖
5:	9.8	↘
Serie		46 (1x)
Total		180 (3x)

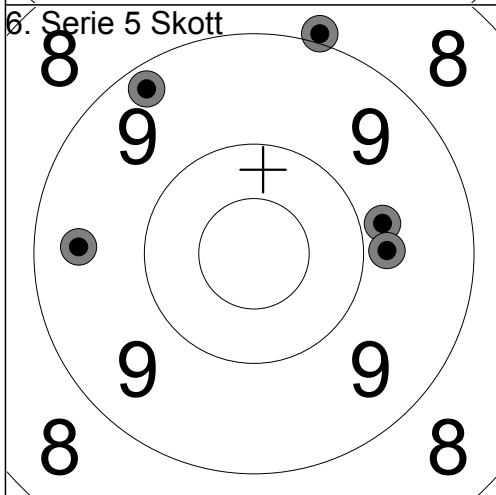

1:	9.8	→
2:	9.4	←
3:	9.2	↗
4:	9.8	→
5:	8.9	↗
Serie		44 (0x)
Total		224 (3x)

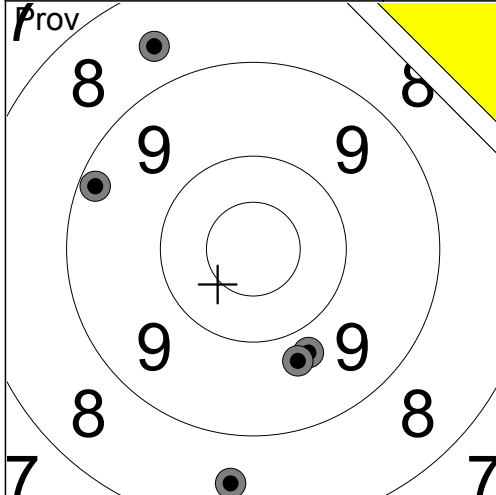

1:	8.6	↗
2:	9.2	↖
3:	9.8	↘
4:	8.5	↙
5:	9.7	↘
Serie		43 (0x)
Total		0 (0x)

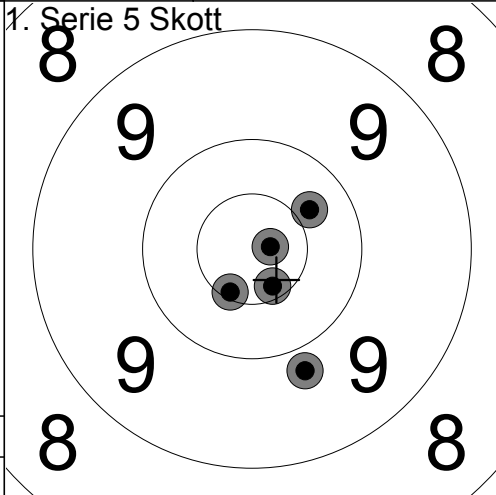

1:	10.4	↗
2:	10.6x	↘
3:	10.5x	↘
4:	10.8x	→
5:	9.8	↘
Serie		49 (3x)
Total		49 (3x)

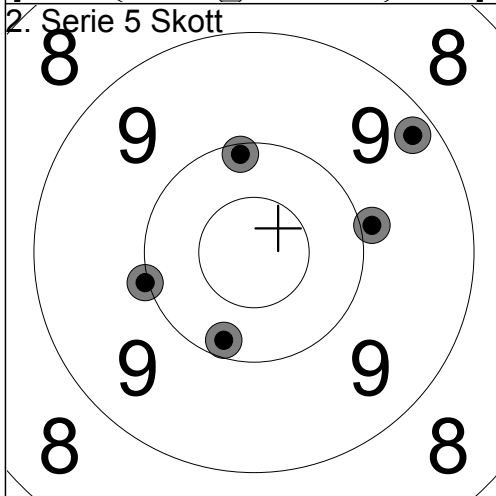

1:	9.2	↗
2:	10.0	←
3:	9.9	→
4:	10.2	↘
5:	10.1	↑
Serie		48 (0x)
Total		97 (3x)

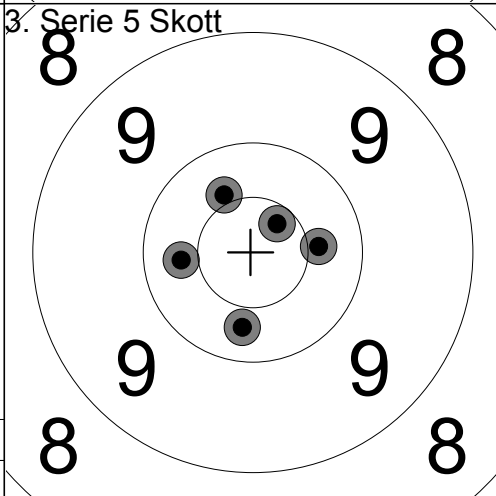

1:	10.4	↗
2:	10.6x	↗
3:	10.3	←
4:	10.4	→
5:	10.3	↘
Serie		50 (1x)
Total		147 (4x)

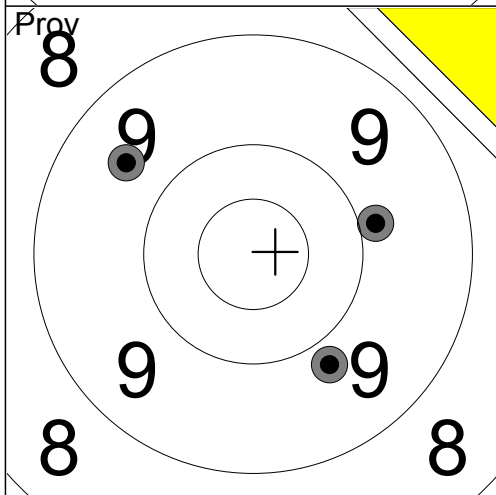

1:	9.6	↗
2:	9.8	↘
3:	9.9	→
Serie		27 (0x)
Total		147 (4x)

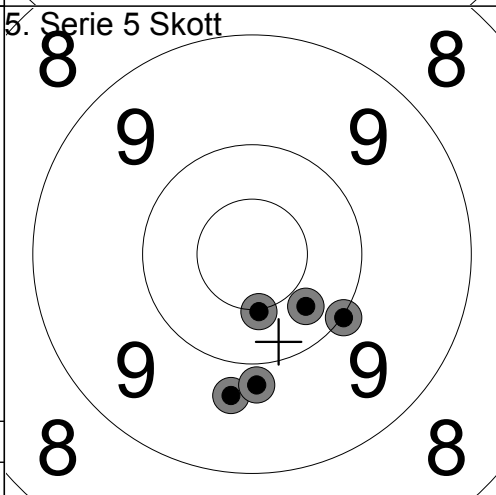

1:	10.0	↘
2:	9.7	↘
3:	10.3	↘
4:	10.5x	↘
5:	9.8	↘
Serie		48 (1x)
Total		195 (5x)

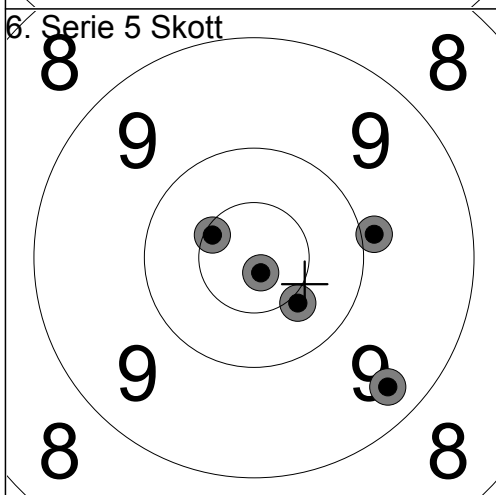

1:	10.4x	↘
2:	10.8x	↘
3:	10.6x	↗
4:	9.9	→
5:	9.3	↘
Serie		48 (3x)
Total		243 (8x)

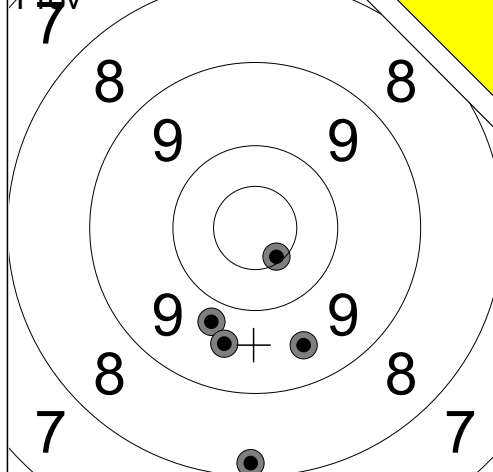

1:	10.5x	↘
2:	8.2	↓
3:	9.8	↘
4:	9.5	↘
5:	9.6	↓
Serie		45 (1x)
Total		0 (0x)

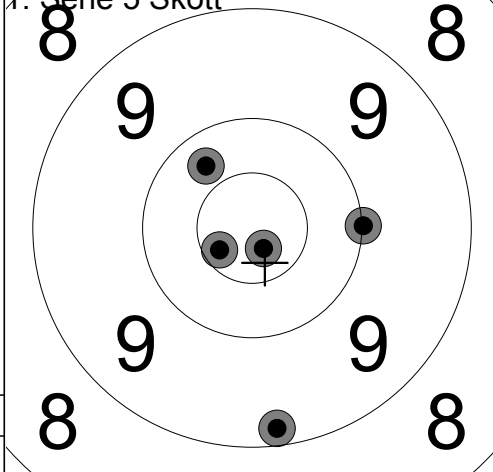

1:	10.3	↗
2:	10.6x	↙
3:	9.2	↓
4:	10.8x	↘
5:	10.0	→
Serie		49 (2x)
Total		49 (2x)

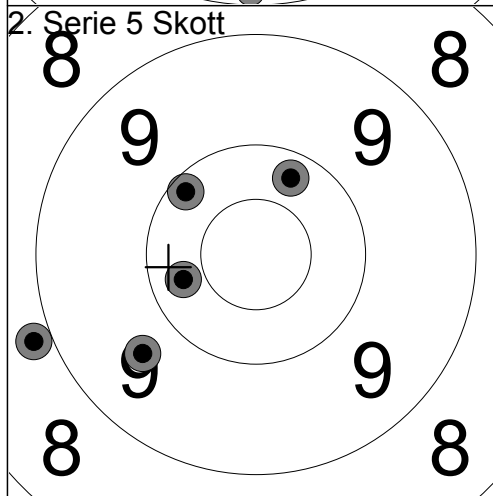

1:	8.9	↙
2:	10.3	↙
3:	10.2	↗
4:	10.2	↘
5:	9.7	↙
Serie		47 (0x)
Total		96 (2x)

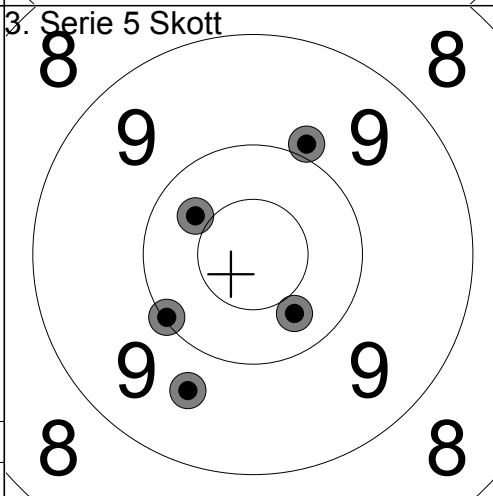

1:	9.9	↗
2:	10.3	↘
3:	9.7	↘
4:	10.1	↙
5:	10.4	↖
Serie		48 (0x)
Total		144 (2x)

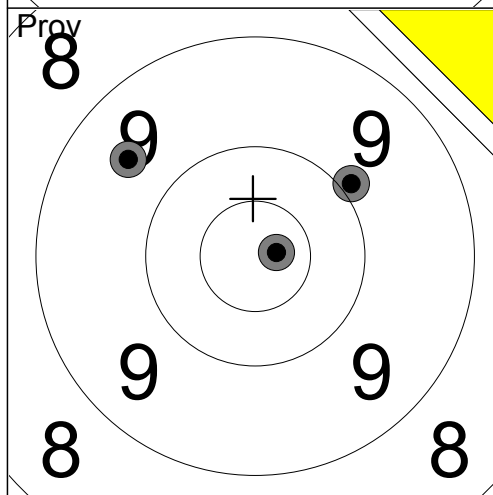

1:	9.6	↖
2:	9.9	↗
3:	10.8x	→
Serie		28 (1x)
Total		144 (2x)

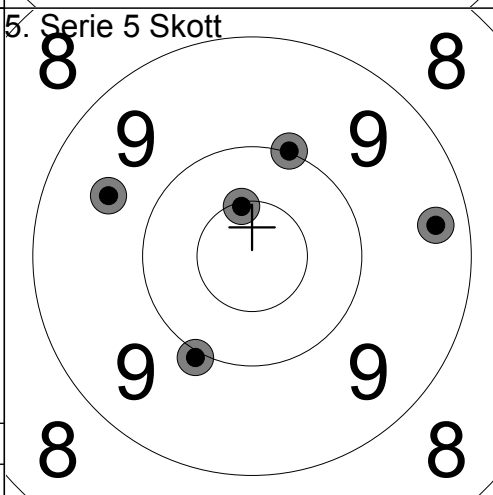

1:	10.0	↗
2:	9.6	↙
3:	9.3	→
4:	10.0	↘
5:	10.5x	↗
Serie		48 (1x)
Total		192 (3x)

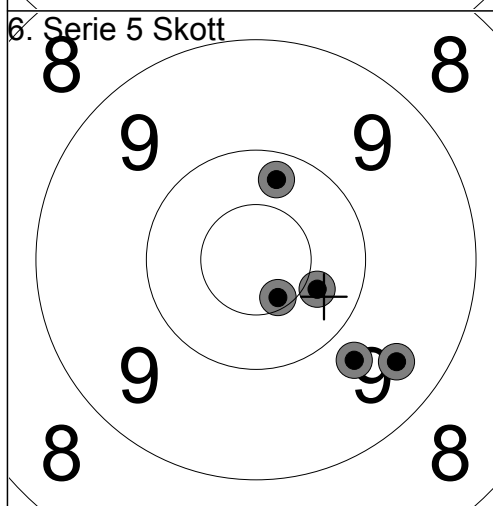

1:	10.4	↘
2:	9.8	↘
3:	10.3	↗
4:	9.5	↘
5:	10.6x	↘
Serie		48 (1x)
Total		240 (4x)

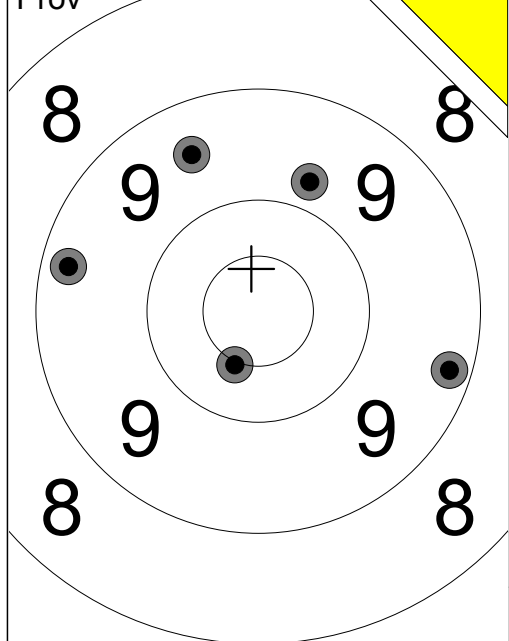

1:	9.5	↖
2:	10.5x	↓
3:	9.3	←
4:	9.8	↗
5:	9.2	→
Serie 46 (1x)		
Total 0 (0x)		

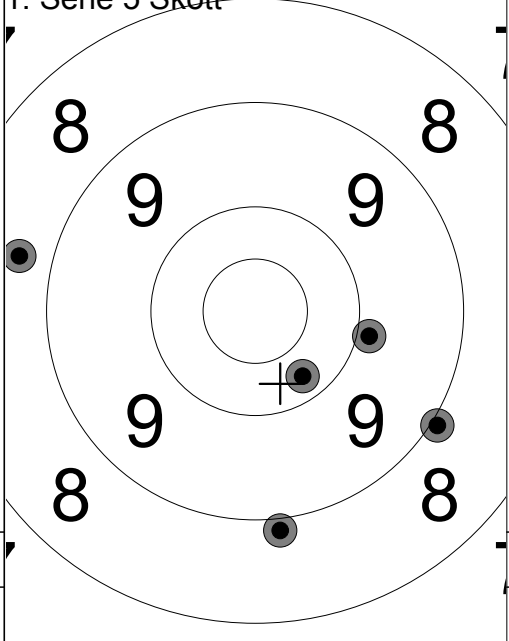

1:	8.7	↖
2:	8.9	↓
3:	9.9	→
4:	10.2	↘
5:	9.0	↘
Serie 44 (0x)		
Total 44 (0x)		

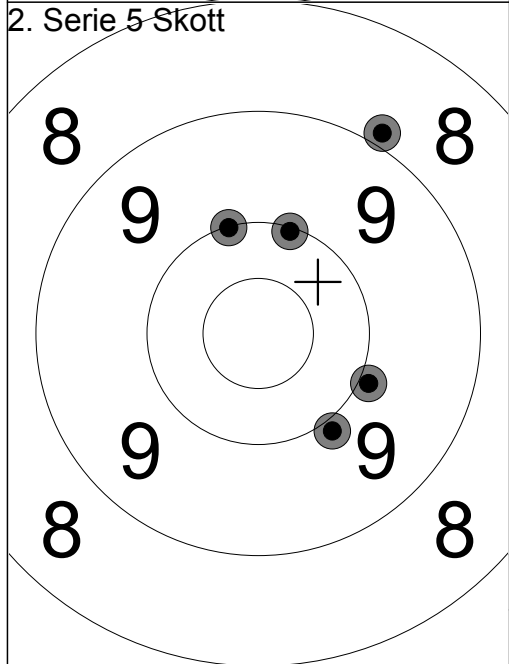

1:	10.0	↖
2:	8.9	↗
3:	9.9	→
4:	10.1	↖
5:	9.9	↘
Serie 46 (0x)		
Total 90 (0x)		

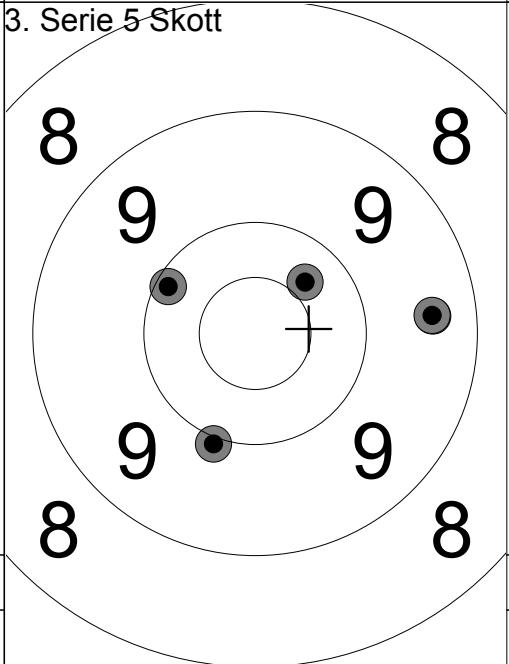

1:	10.4	↗
2:	10.1	↖
3:	9.4	→
4:	9.4	→
5:	10.0	↘
Serie 48 (0x)		
Total 138 (0x)		

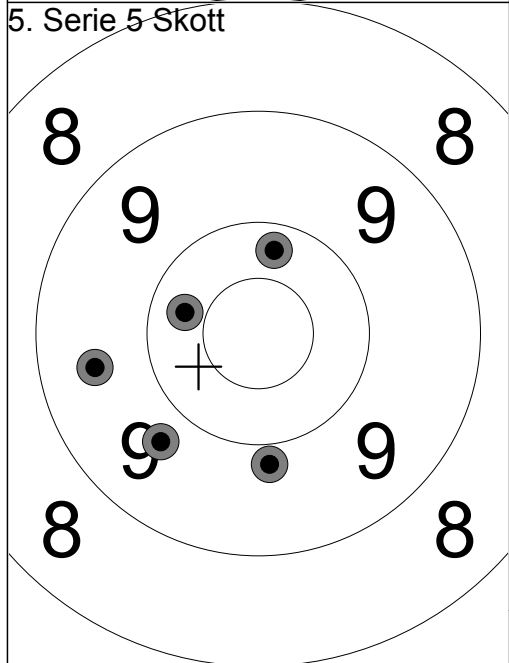

1:	9.7	↘
2:	9.8	↓
3:	10.2	↖
4:	9.5	←
5:	10.3	↖
Serie 47 (0x)		
Total 185 (0x)		

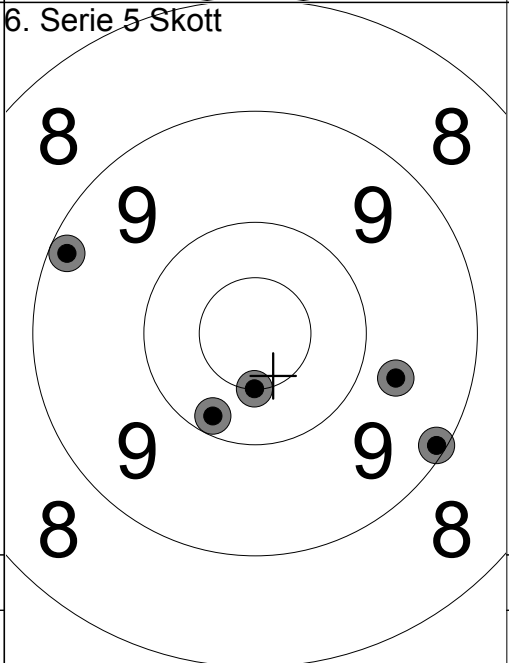

1:	9.2	↖
2:	9.7	→
3:	9.1	↘
4:	10.5x	↓
5:	10.2	↘
Serie 47 (1x)		
Total 232 (1x)		

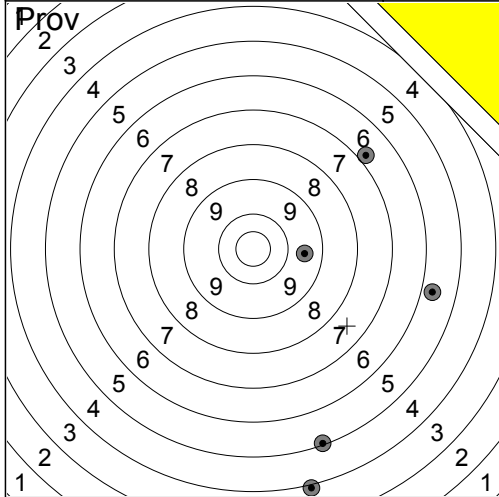

1:	6.8	↗
2:	9.5	→
3:	5.7	→
4:	3.9	↓
5:	5.1	↓
Serie		28 (0x)
Total		0 (0x)

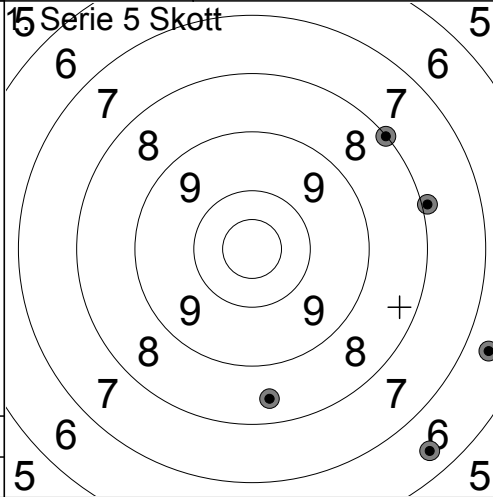

1:	6.4	↘
2:	6.6	→
3:	8.5	↓
4:	7.9	→
5:	8.0	↗
Serie		35 (0x)
Total		35 (0x)

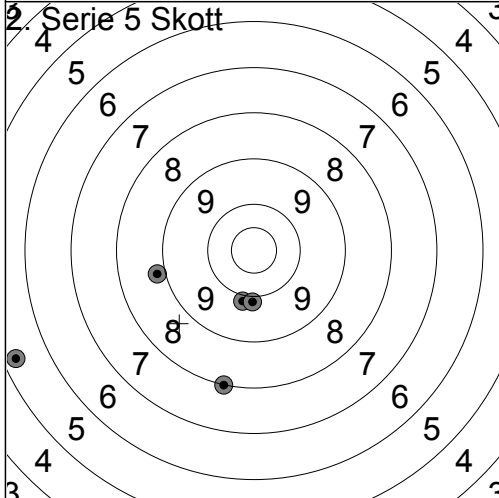

1:	9.9	↓
2:	5.3	←
3:	8.0	↓
4:	8.8	←
5:	9.9	↓
Serie		39 (0x)
Total		74 (0x)

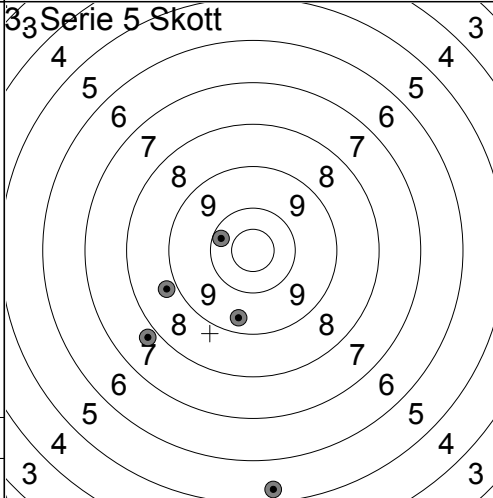

1:	5.3	↓
2:	7.8	←
3:	9.4	↓
4:	8.8	←
5:	10.2	←
Serie		39 (0x)
Total		113 (0x)

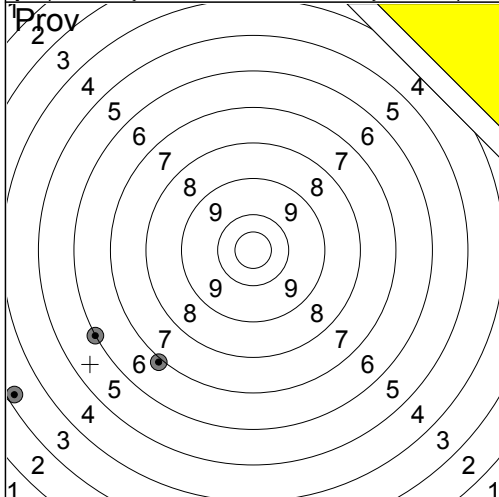

1:	6.0	←
2:	3.2	←
3:	6.9	↘
Serie		15 (0x)
Total		113 (0x)

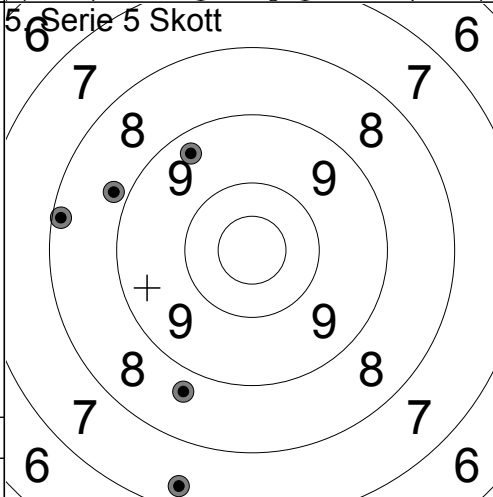

1:	9.3	↗
2:	8.2	←
3:	7.4	↓
4:	8.7	↓
5:	8.8	←
Serie		40 (0x)
Total		153 (0x)

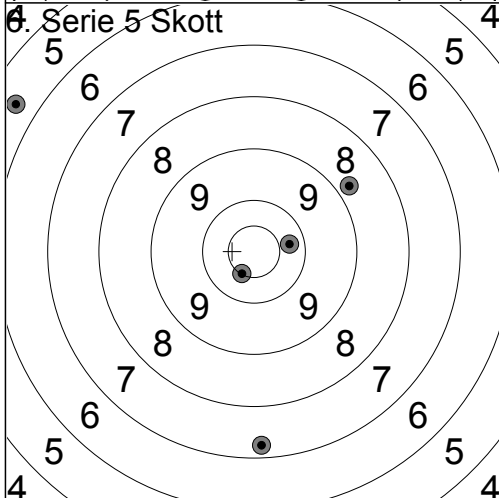

1:	7.3	↓
2:	10.5x	↓
3:	8.8	↗
4:	10.3	→
5:	5.6	↖
Serie		40 (1x)
Total		193 (1x)

--	--	--

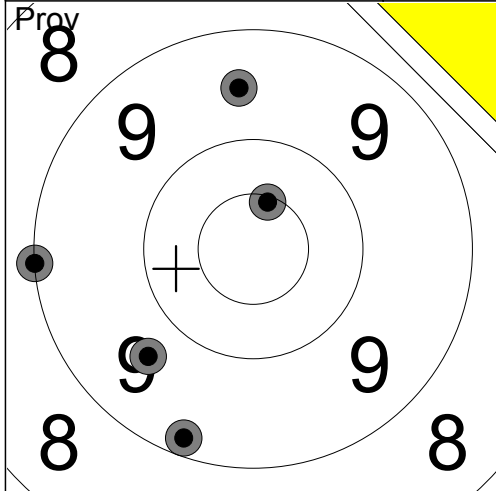

1:	9.7	↙
2:	9.6	↑
3:	10.5x	↑
4:	9.0	←
5:	9.2	↘
Serie 46 (1x)		
Total 0 (0x)		

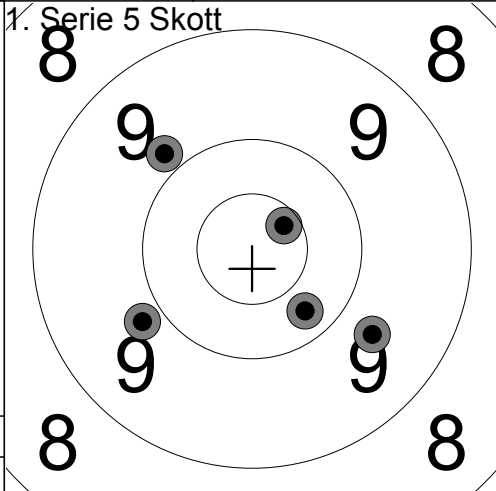

1:	9.9	↗
2:	9.8	↖
3:	9.7	↘
4:	10.6x	↗
5:	10.3	↘
Serie 47 (1x)		
Total 47 (1x)		

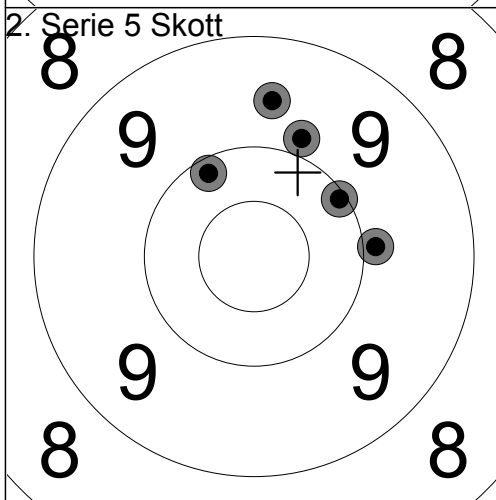

1:	10.1	↗
2:	9.9	↑
3:	9.6	↑
4:	9.9	→
5:	10.2	↗
Serie 47 (0x)		
Total 94 (1x)		

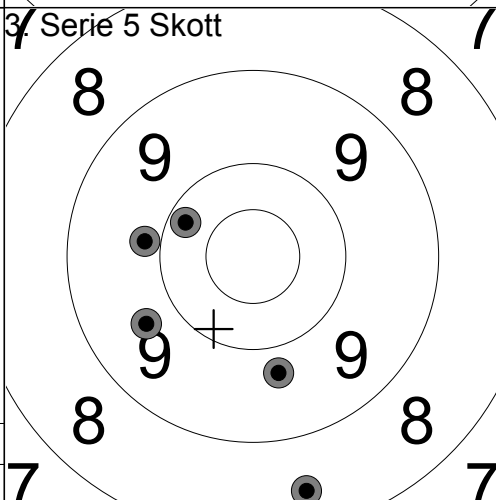

1:	10.2	↖
2:	9.9	←
3:	9.7	↖
4:	8.4	↘
5:	9.7	↘
Serie 45 (0x)		
Total 139 (1x)		

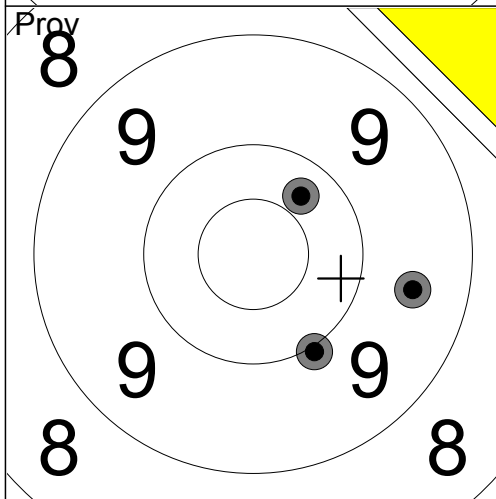

1:	10.0	↘
2:	10.3	↗
3:	9.5	→
Serie 29 (0x)		
Total 139 (1x)		

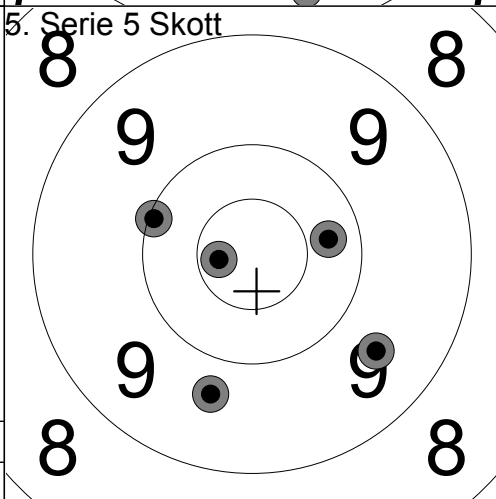

1:	9.6	↘
2:	10.3	→
3:	10.1	↖
4:	10.7x	←
5:	9.7	↘
Serie 48 (1x)		
Total 187 (2x)		

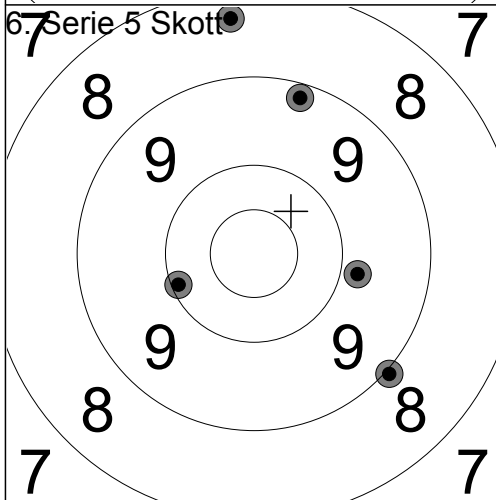

1:	10.1	←
2:	8.4	↑
3:	9.0	↘
4:	9.8	→
5:	9.2	↑
Serie 45 (0x)		
Total 232 (2x)		

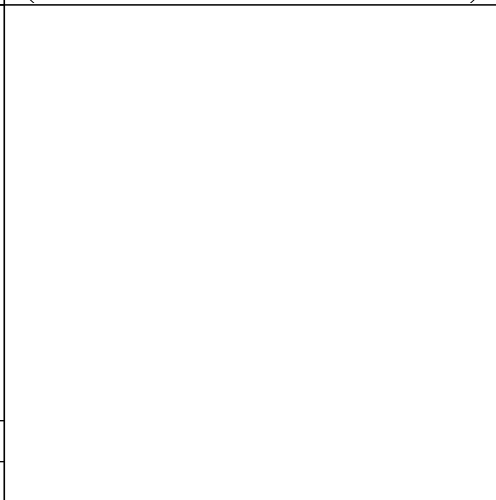

1:	9.9	↗
2:	9.8	↖
3:	9.7	↘
4:	10.6x	↗
5:	10.3	↘
Serie 47 (1x)		
Total 47 (1x)		

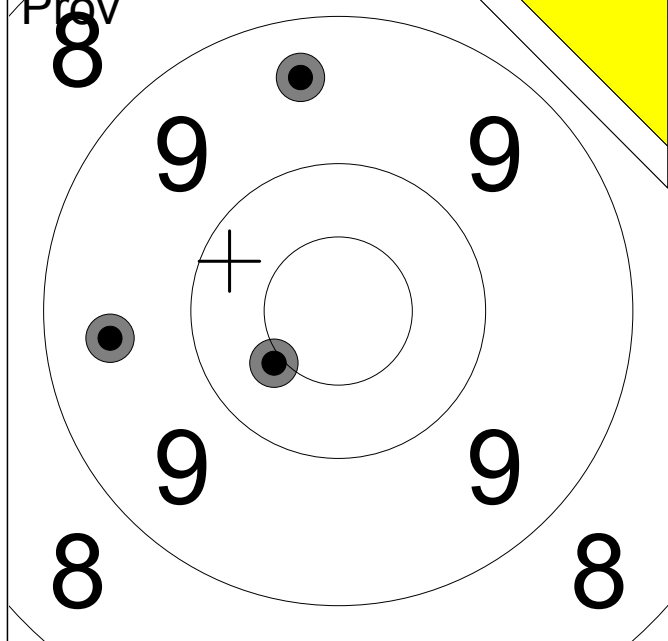

1:	9.4	↑
2:	9.5	←
3:	10.4x	↙
Serie		28 (1x)
Total		0 (0x)

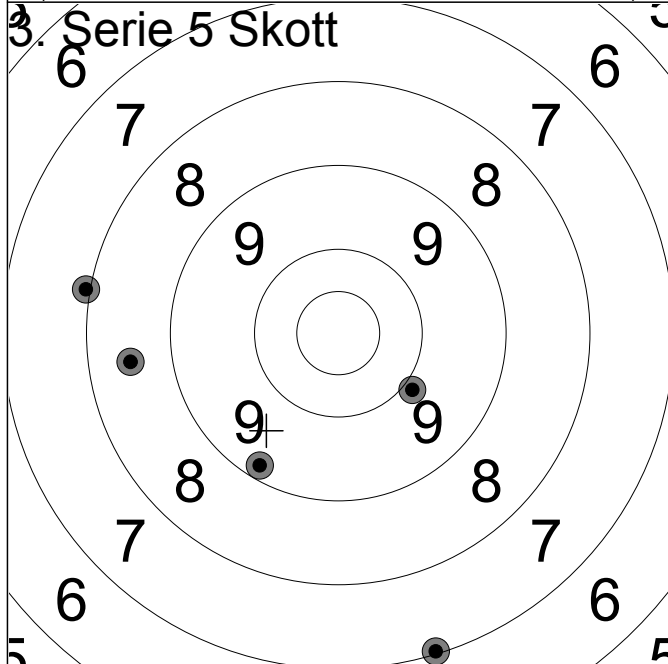

1:	9.9	↘
2:	7.1	↘
3:	9.2	↘
4:	8.0	←
5:	8.5	←
Serie		41 (0x)
Total		41 (0x)

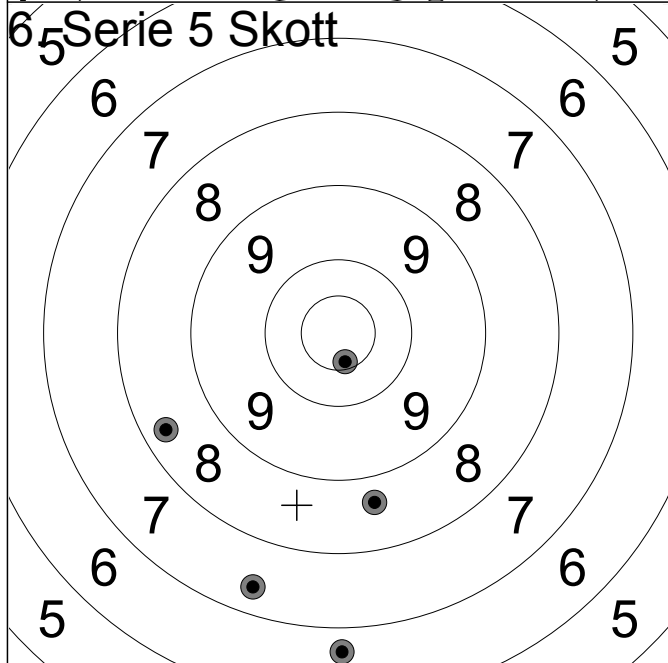

1:	10.6x	↓
2:	8.3	↙
3:	7.4	↘
4:	8.7	↘
5:	6.7	↓
Serie		39 (1x)
Total		80 (1x)

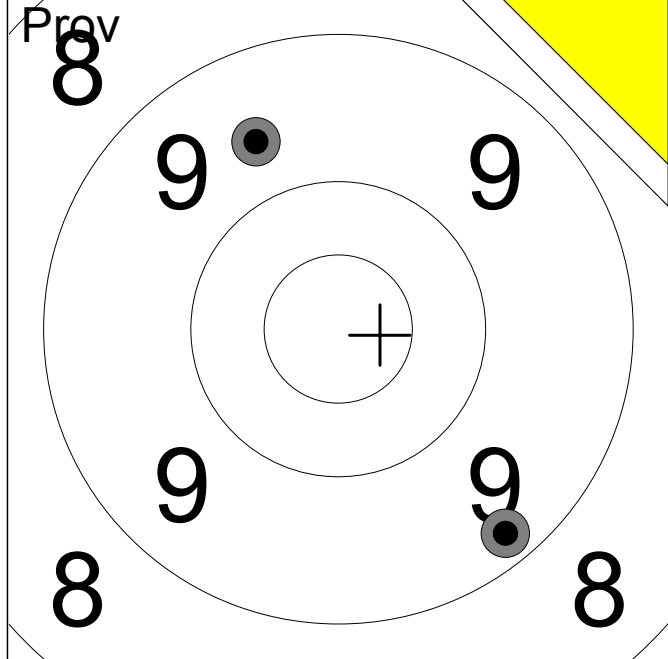

	1:	9.2	↘
	2:	9.6	↗
Serie			18 (0x)
Total			0 (0x)

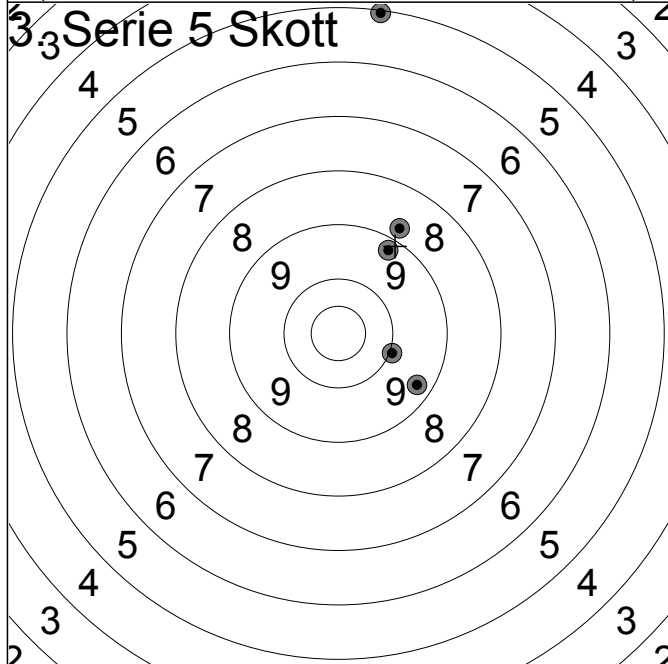

	1:	8.8	↗
	2:	9.3	↘
	3:	10.0	→
	4:	9.2	↗
	5:	5.1	↑
Serie			41 (0x)
Total			41 (0x)

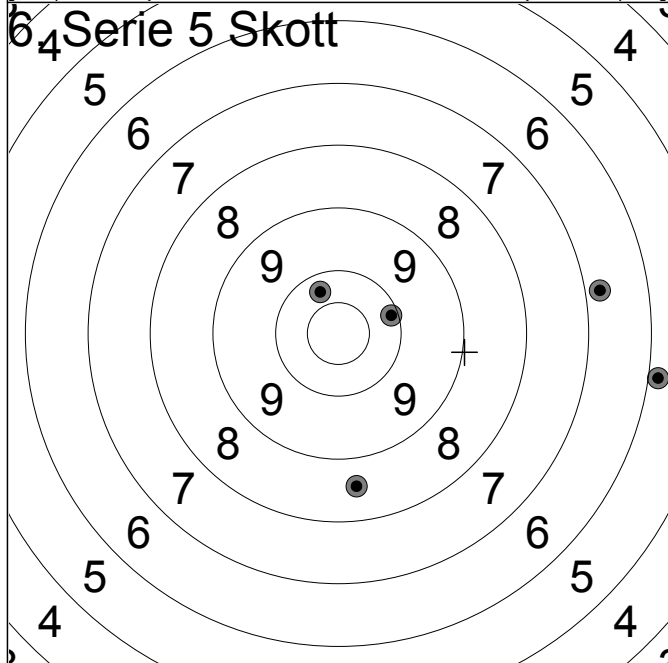

	1:	10.3	↑
	2:	10.1	→
	3:	8.6	↘
	4:	5.9	→
	5:	6.8	→
Serie			39 (0x)
Total			80 (0x)

Skjutlag
2

Tavla
9

Ramselefors

17.08.2024

Förbundsmästerskap 2024

Ramselefors SKF

Prov

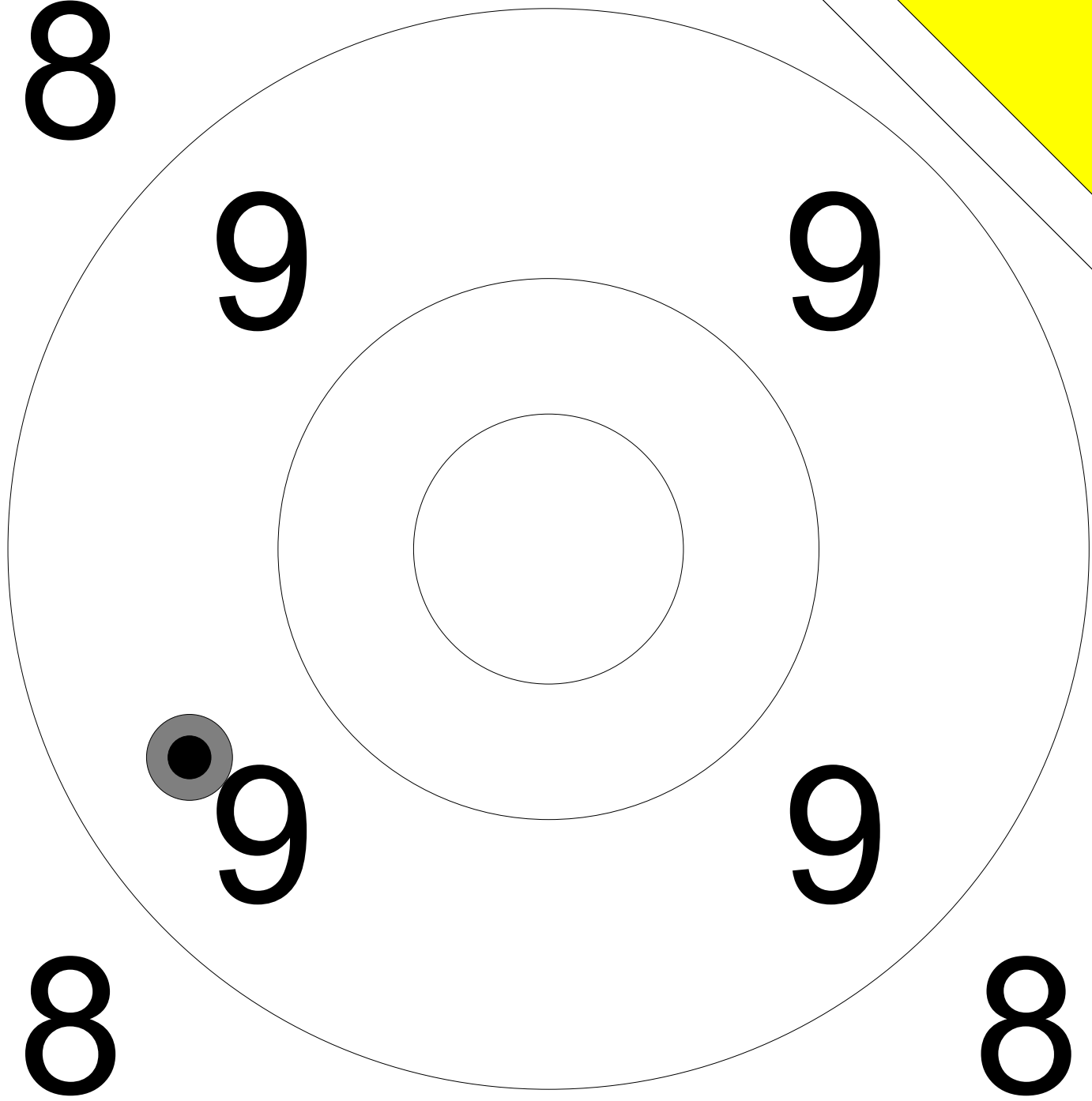

1: 9.5



Serie 9 (0x)

Total 0 (0x)

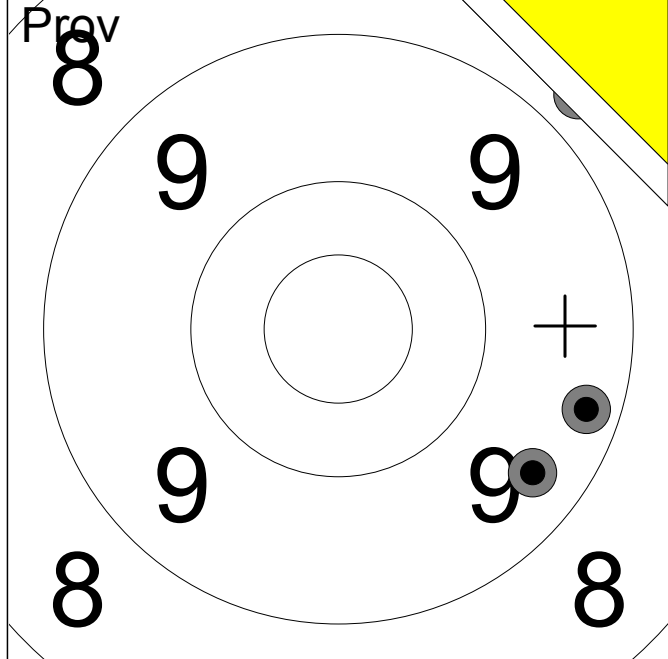

1:	9.4	↘
2:	9.3	→
3:	8.8	↗
Serie		26 (0x)
Total		0 (0x)

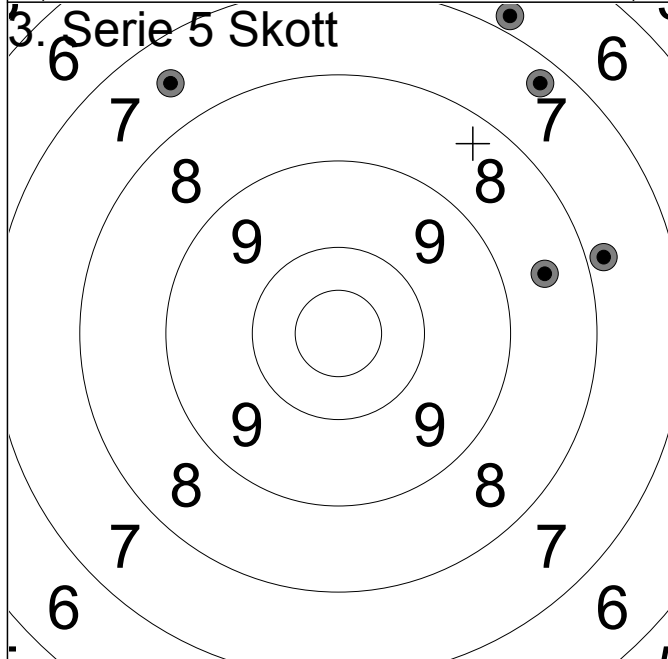

1:	6.8	↗
2:	8.5	→
3:	7.3	↗
4:	7.5	↗
5:	7.8	→
Serie		35 (0x)
Total		35 (0x)

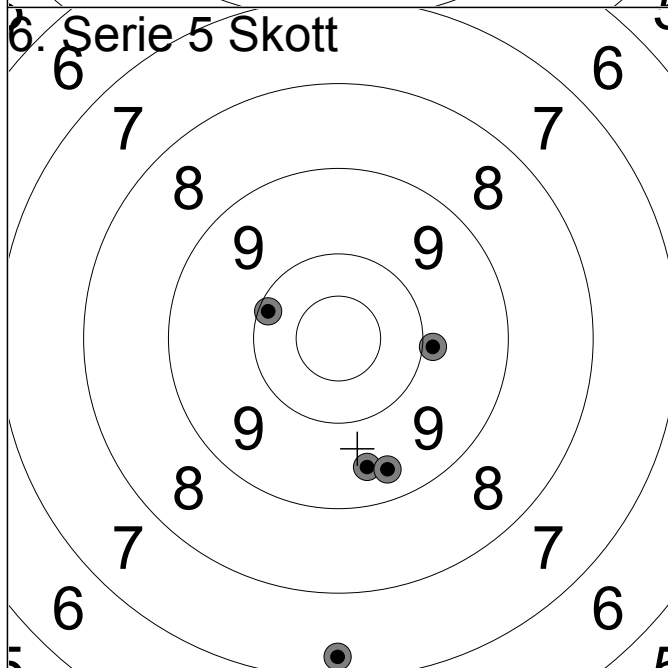

1:	10.1	↖
2:	7.3	↓
3:	9.9	→
4:	9.5	↓
5:	9.4	↓
Serie		44 (0x)
Total		79 (0x)

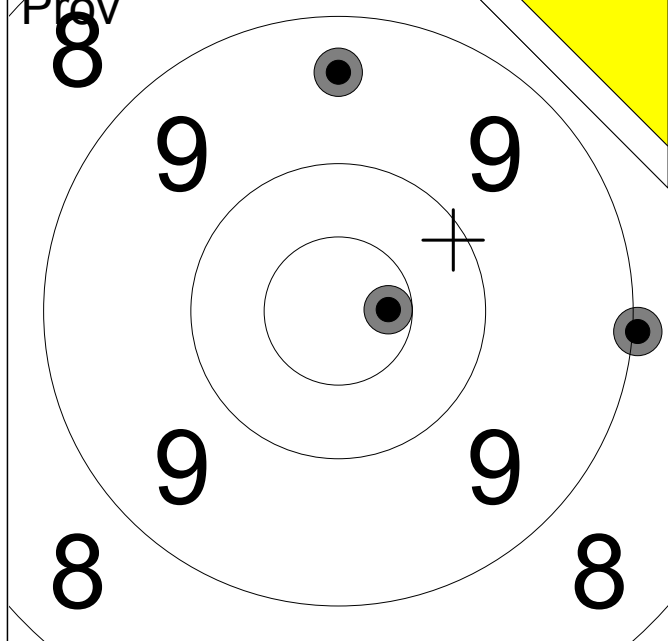

1:	9.4	↑
2:	10.6x	→
3:	9.0	→
Serie		28 (1x)
Total		0 (0x)

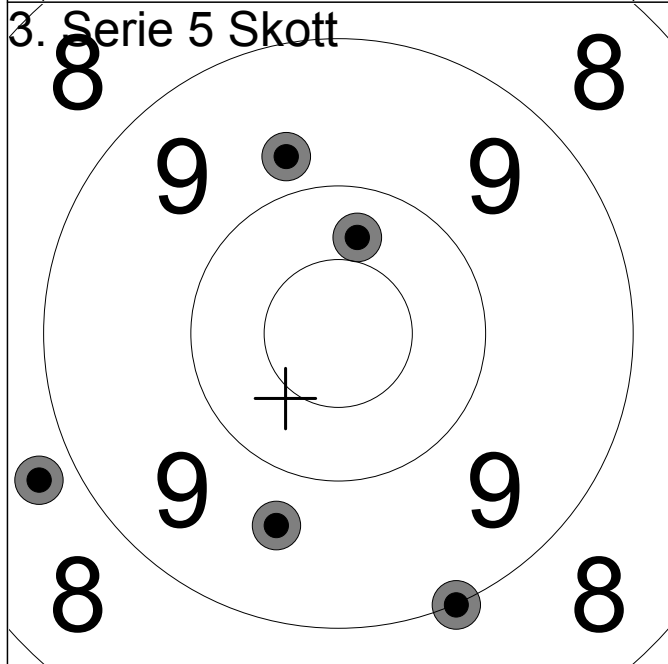

1:	9.0	↓
2:	10.3	↑
3:	8.8	↙
4:	9.8	↑
5:	9.7	↓
Serie		45 (0x)
Total		45 (0x)

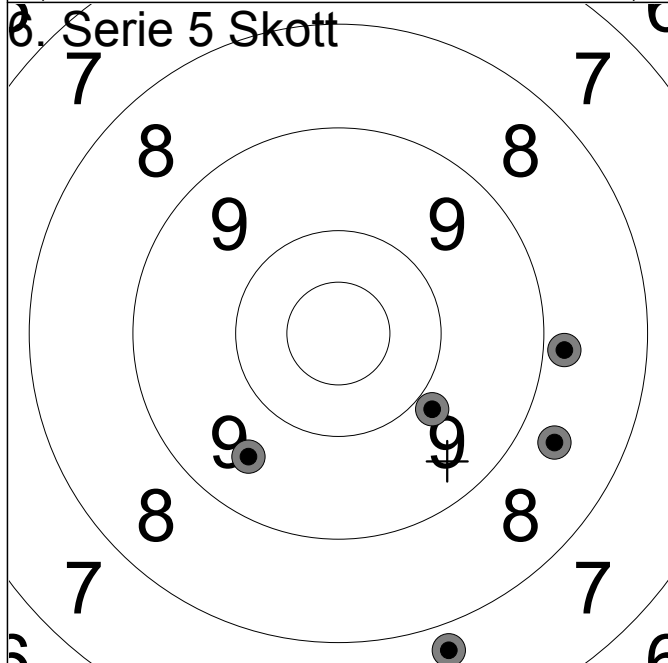

1:	9.9	↘
2:	8.8	→
3:	9.5	↙
4:	7.8	↓
5:	8.7	↘
Serie		41 (0x)
Total		86 (0x)

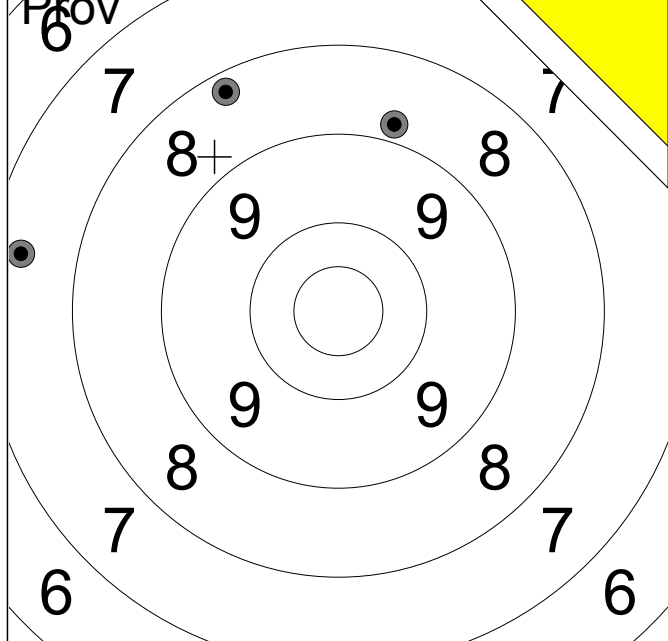

	1:	8.8	↑
	2:	8.2	↑
	3:	7.4	←
<hr/>			
Serie			23 (0x)
Total			0 (0x)

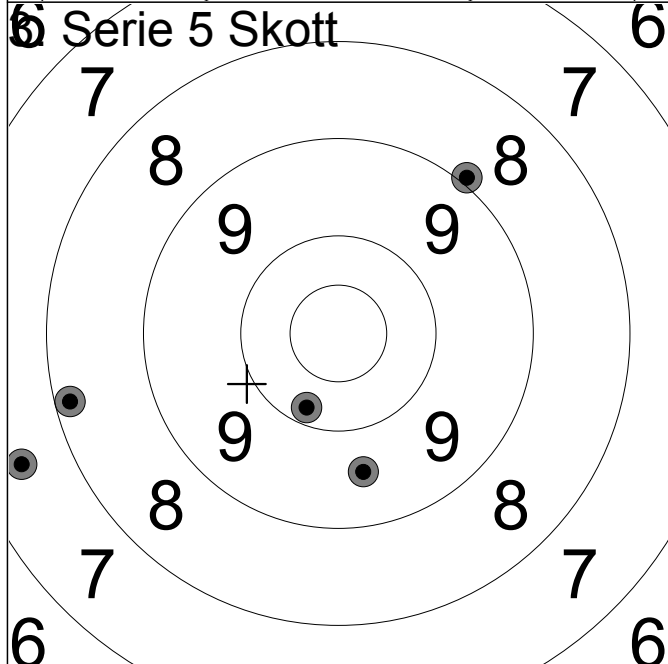

	1:	7.5	←
	2:	8.2	←
	3:	9.0	↗
	4:	10.2	↓
	5:	9.6	↓
<hr/>			
Serie			43 (0x)
Total			43 (0x)

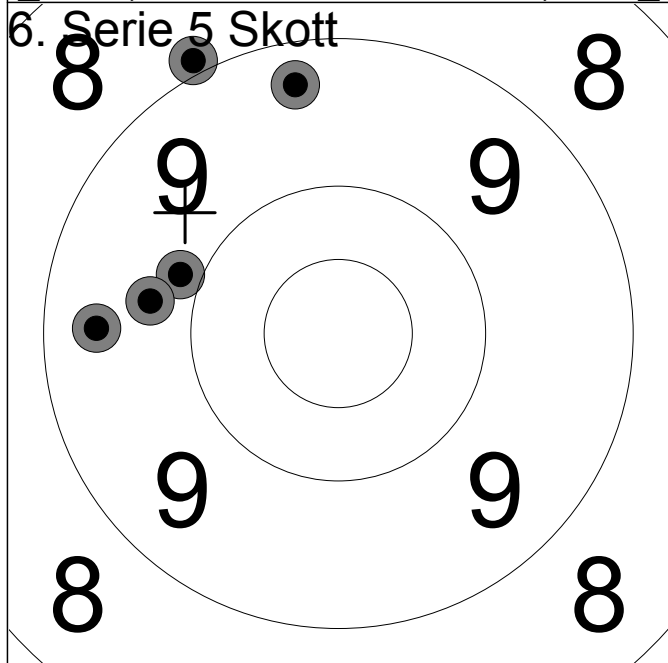

	1:	9.3	↑
	2:	9.9	←
	3:	9.4	←
	4:	9.7	←
	5:	8.9	↗
<hr/>			
Serie			44 (0x)
Total			87 (0x)

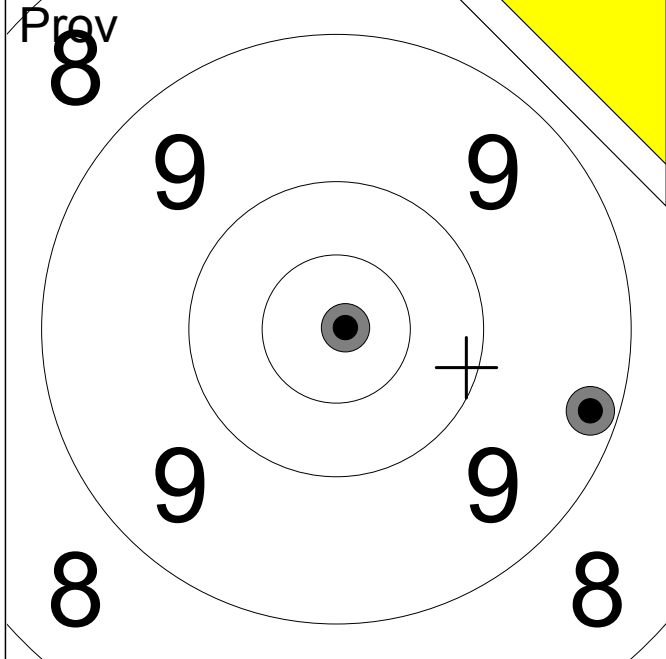

1:	9.2	→
2:	10.9x	→
<hr/>		
Serie	19 (1x)	
Total	0 (0x)	

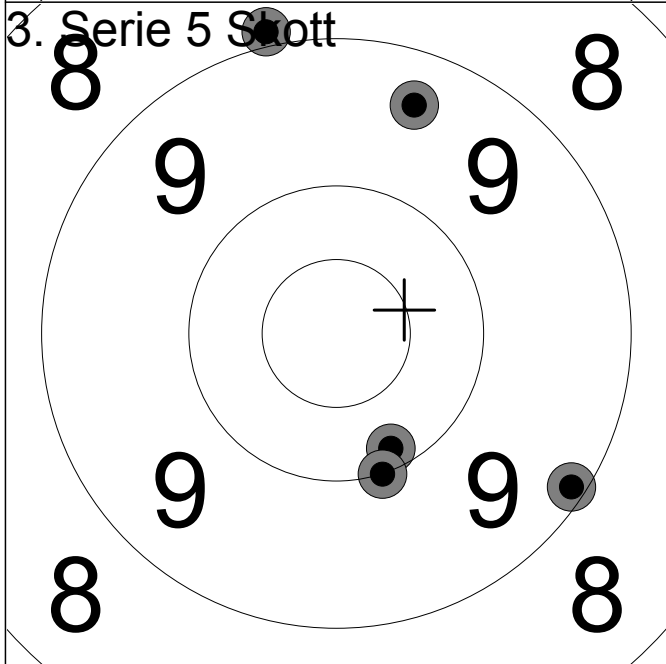

1:	8.9	↑
2:	9.4	↑
3:	10.2	↓
4:	9.1	↓
5:	10.0	↓
<hr/>		
Serie	46 (0x)	
Total	46 (0x)	

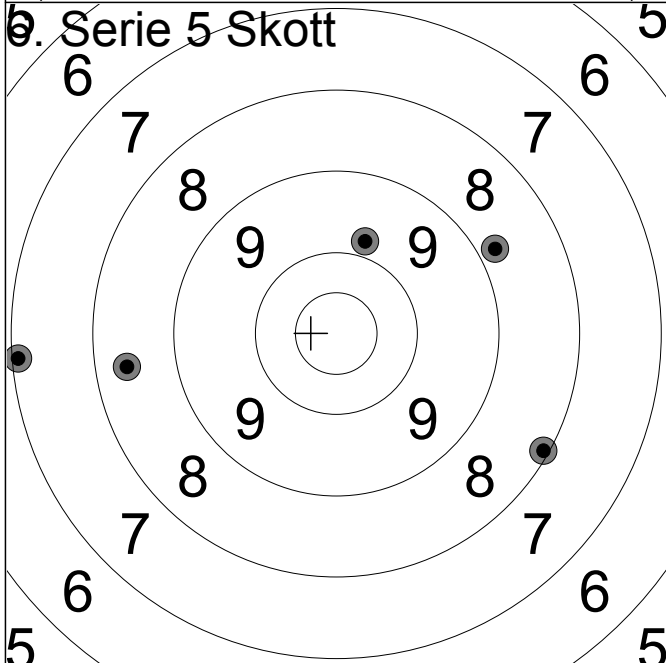

1:	9.8	↑
2:	8.4	←
3:	7.1	←
4:	8.8	→
5:	8.1	→
<hr/>		
Serie	40 (0x)	
Total	86 (0x)	

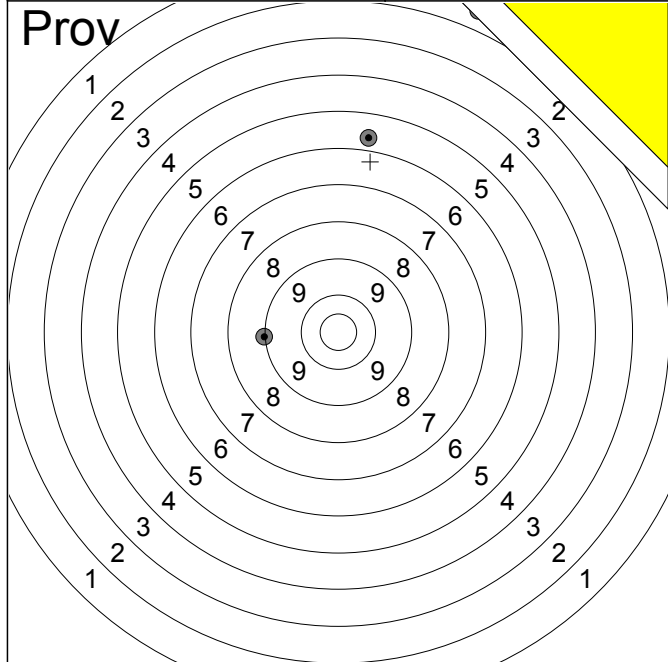

	1:	1.5	↗
	2:	5.7	↑
	3:	9.0	←
Serie			15 (0x)
Total			0 (0x)

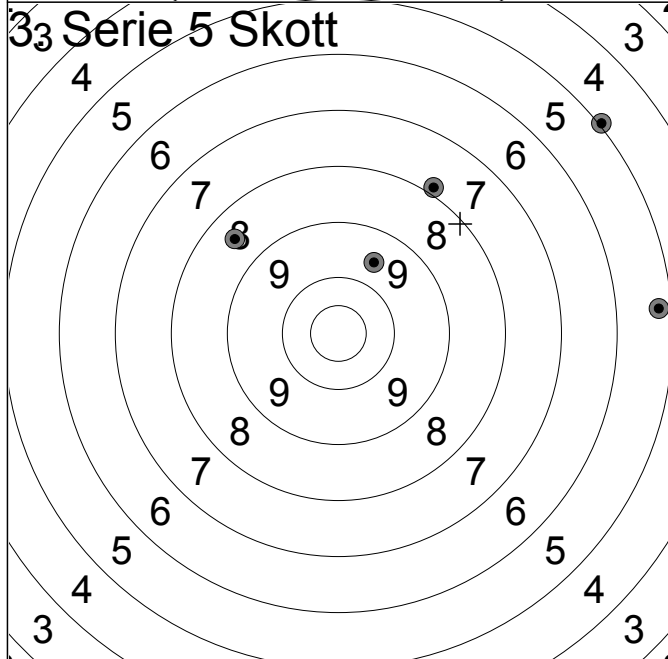

	1:	8.5	↖
	2:	5.0	↗
	3:	9.6	↑
	4:	7.9	↑
	5:	5.3	→
Serie			34 (0x)
Total			34 (0x)

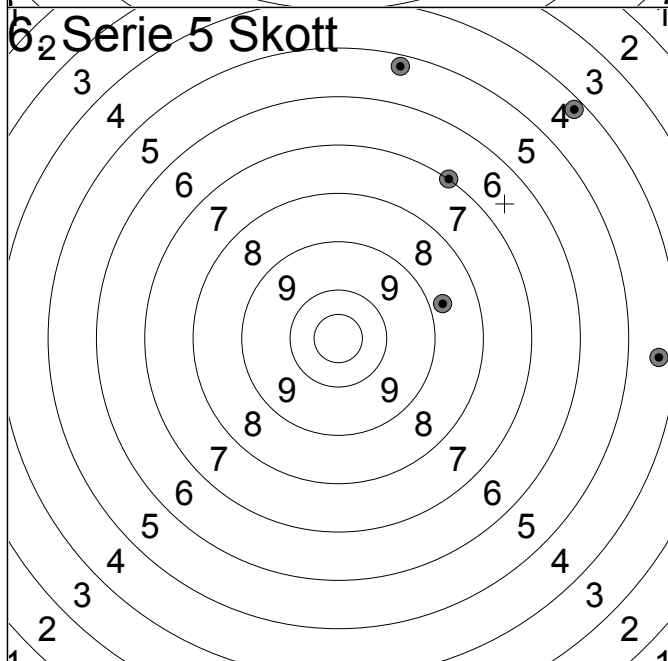

	1:	7.0	↗
	2:	8.8	→
	3:	5.3	↑
	4:	4.4	→
	5:	4.2	↗
Serie			28 (0x)
Total			62 (0x)