

Prov 	1: 7.5 ↓ 2: 9.9 ↓ 3: 9.7 ↗ 4: 9.5 ↗ 5: 8.4 ↓ 6: 8.4 ↓ 7: 10.1 ↓ 8: 8.0 ↓ 9: 9.1 ↓ 10: 10.7x ↖ Serie 87 (1x) Total 177 (0x)	Prov 	11: 9.6 ↗ 12: 9.6 ↘ 13: 9.0 ↓ 14: 9.6 ↗ 15: 9.4 ↓ Serie 45 (0x) Total 177 (0x)
----------	---	----------	--

1. Serie 10 Skott 	1: 8.5 ↘ 2: 8.7 ↗ 3: 10.5x ↖ 4: 9.1 ← 5: 10.1 ← Serie 45 (1x) Total 222 (1x)	1. Serie 10 Skott 	6: 9.4 ↓ 7: 8.8 ← 8: 9.0 ← 9: 9.8 ← 10: 8.8 ↗ Serie 43 (0x) Total 265 (1x)
-----------------------	--	-----------------------	--

2. Serie 1 Skott 	1: 10.7x → 2: 10.1 ↙ 3: 10.2 ↖ 4: 10.3 → 5: 7.7 ↗ Serie 47 (1x) Total 312 (2x)		
----------------------	--	--	--

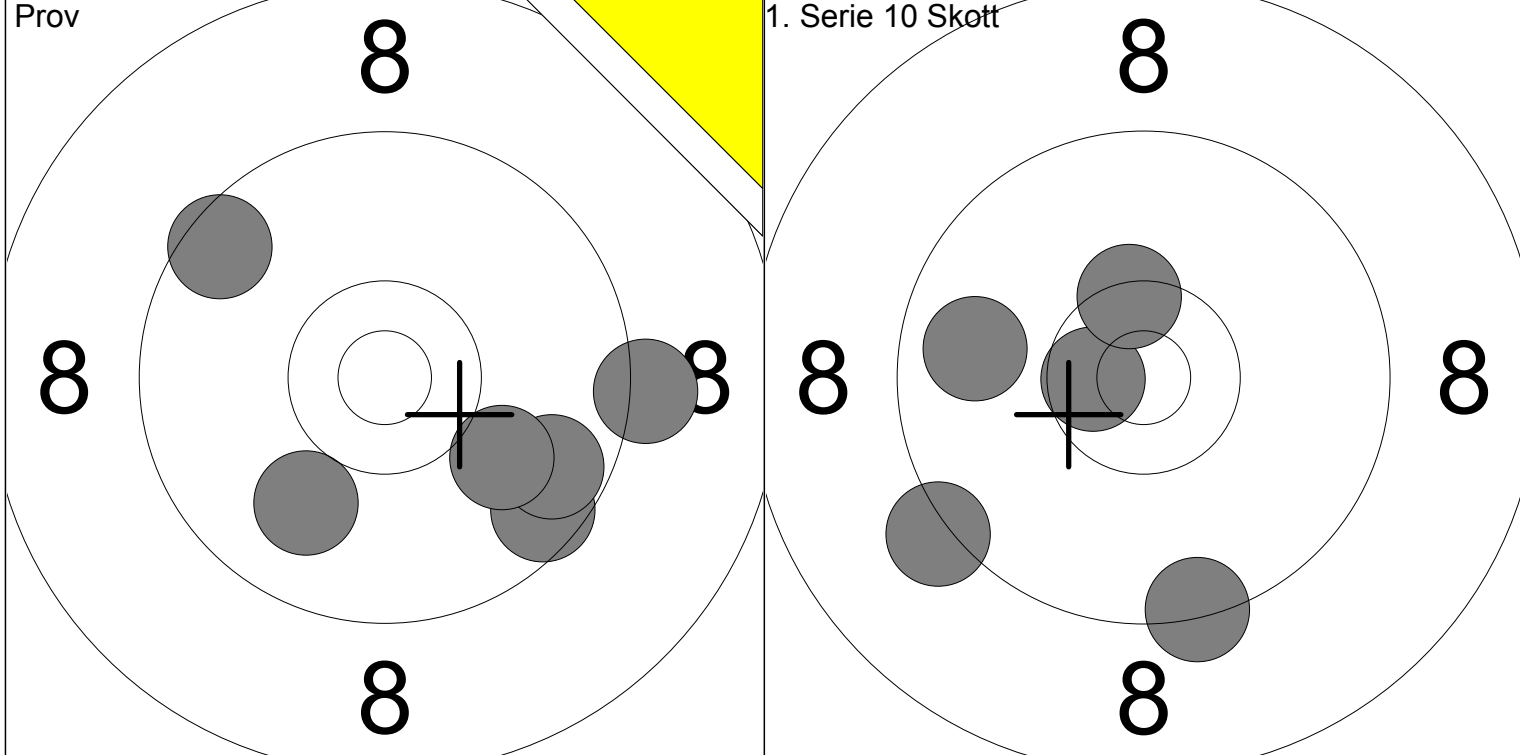

1: 9.6 ↘	6: 10.0 ↙	Serie 56 (0x)	1: 10.6x ←	Serie 47 (2x)
2: 9.7 ↘			2: 9.8 ←	
3: 10.0 ↘			3: 10.4x ↑	
4: 9.2 →		Total 187 (0x)	4: 9.4 ↓	
5: 9.5 ↗			5: 9.2 ↘	Total 234 (2x)

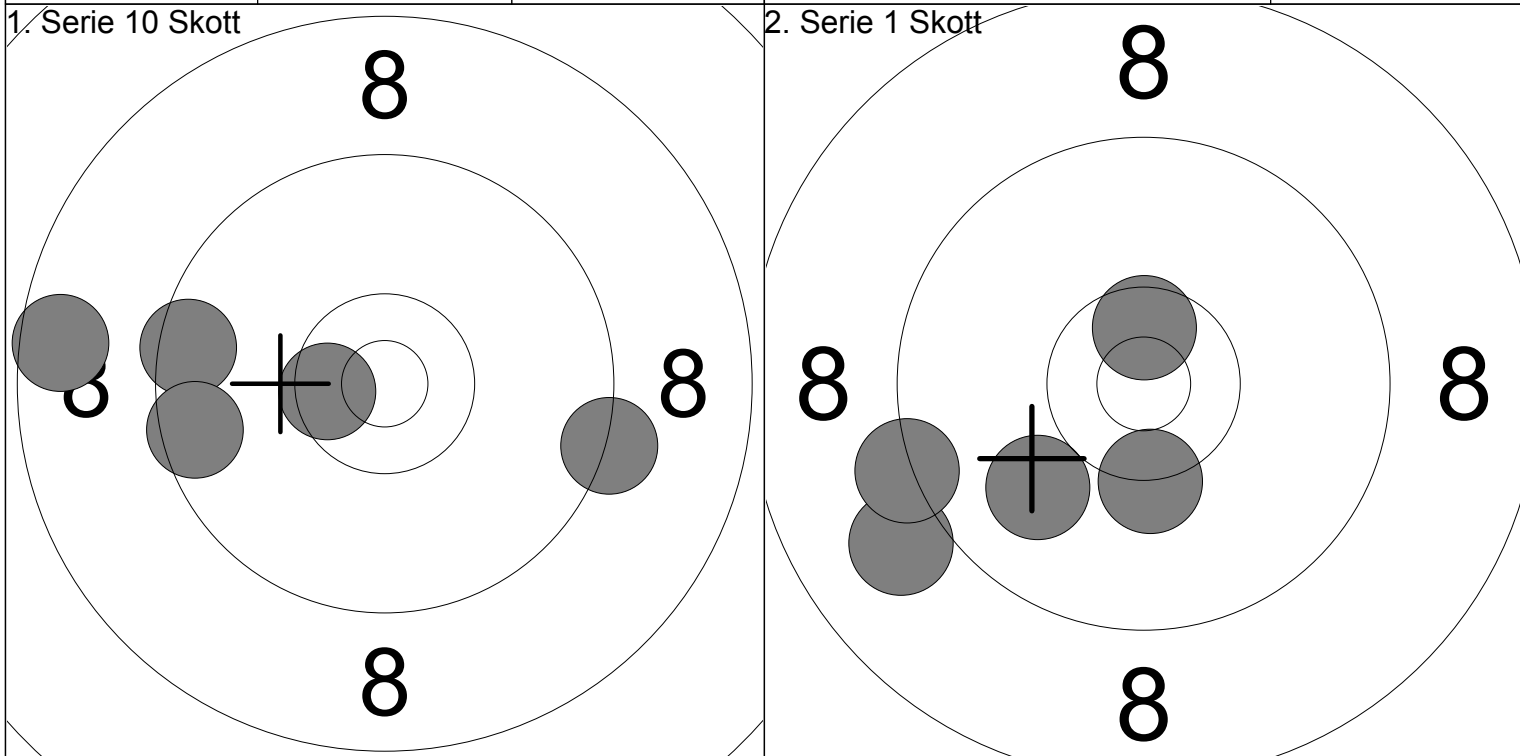

6: 9.5 ←	7: 9.5 ←	Serie 45 (1x)	1: 10.6x ↑	Serie 48 (2x)
8: 8.6 ←			2: 9.0 ←	
9: 9.3 →			3: 9.3 ←	
10: 10.5x ←		Total 279 (3x)	4: 10.0 ↘	
			5: 10.3x ↓	Total 327 (5x)

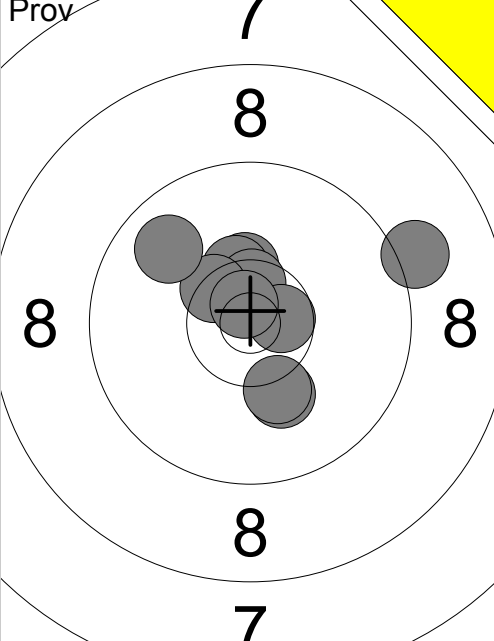
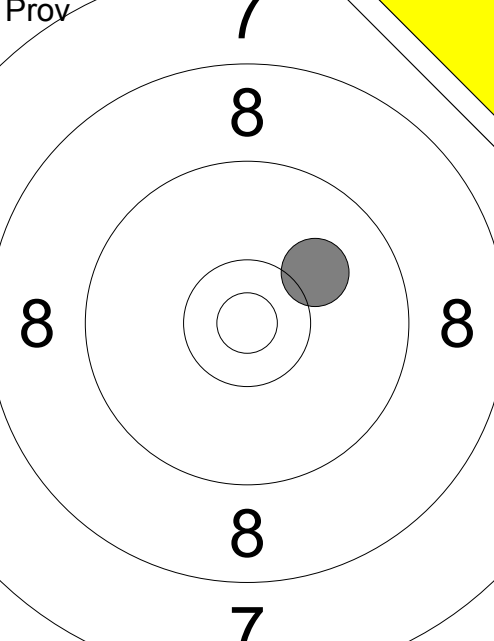
Prov 	1: 9.1 → 2: 10.4x ↑ 3: 10.4x ↑ 4: 10.5x ↑ 5: 10.2 ↓ 6: 10.2 ↓ 7: 10.6x → 8: 10.4x ↖ 9: 10.7x ↑ 10: 9.8 ↖ Serie 98 (6x) Total 187 (0x)	Prov  11: 10.1 ↗ Serie 10 (0x) Total 187 (0x)
--	--	--

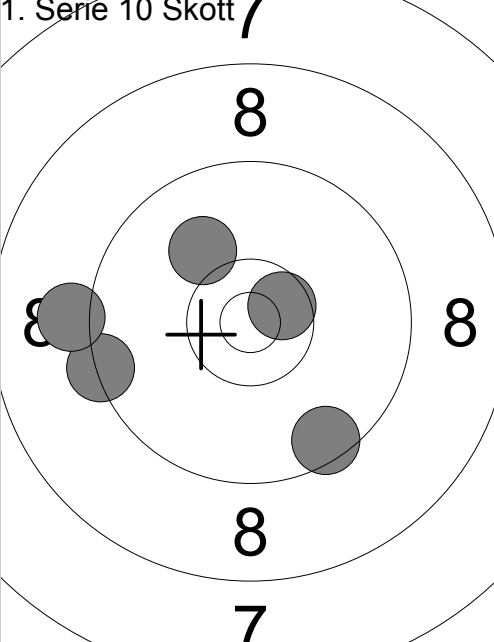
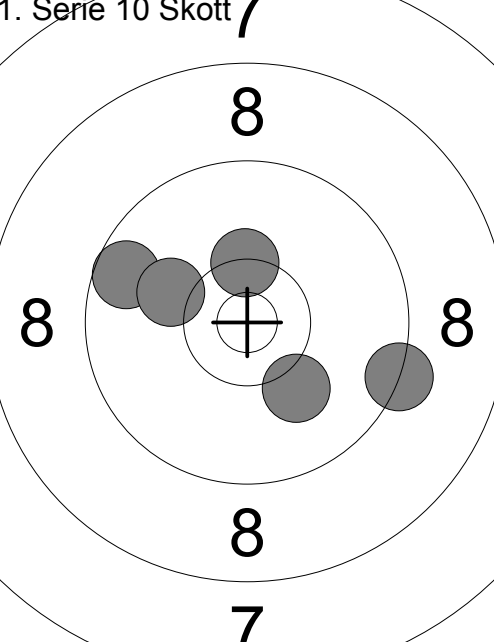
1. Serie 10 Skott 	1: 10.1 ↖ 2: 9.5 ↓ 3: 9.4 ← 4: 9.1 ← 5: 10.6x → Serie 47 (1x) Total 234 (1x)	1. Serie 10 Skott  6: 10.1 ↓ 7: 9.6 ↖ 8: 10.1 ↖ 9: 9.3 → 10: 10.3x ↑ Serie 48 (1x) Total 282 (2x)
--	--	---

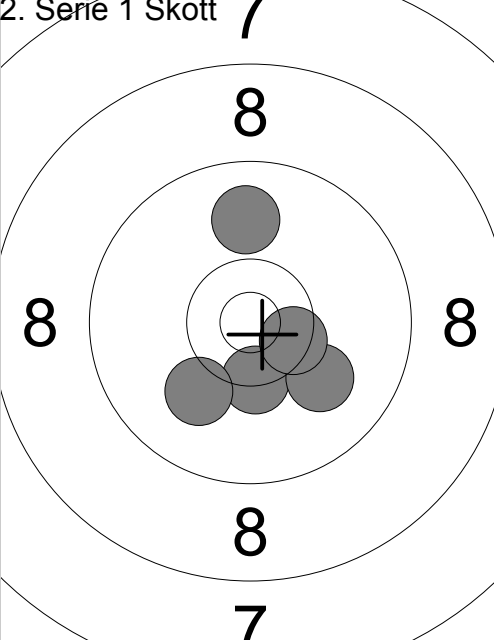
2. Serie 1 Skott 	1: 9.9 ↑ 2: 10.4x ↓ 3: 10.1 ↖ 4: 10.0 ↓ 5: 10.5x → Serie 49 (2x) Total 331 (4x)	
--	---	--

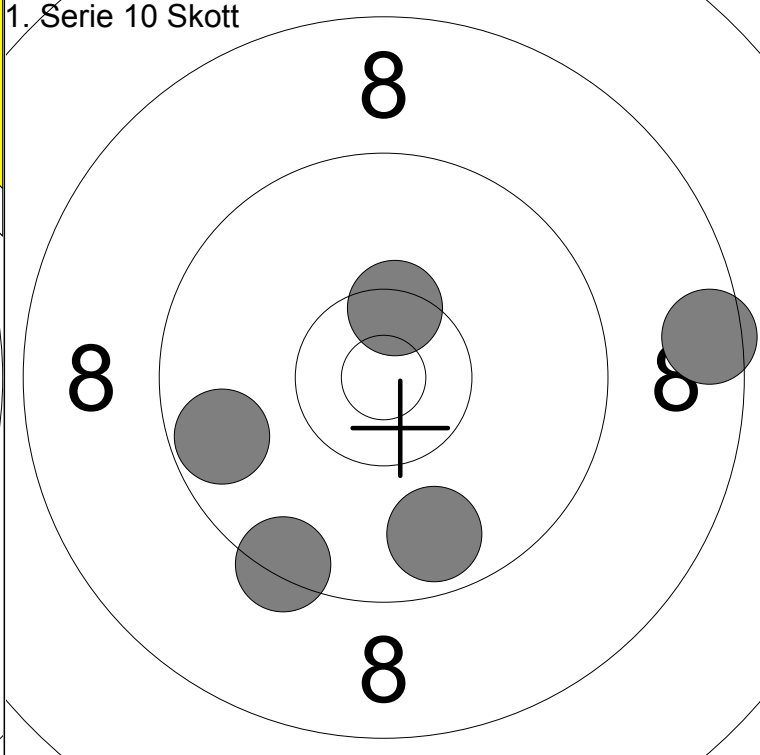
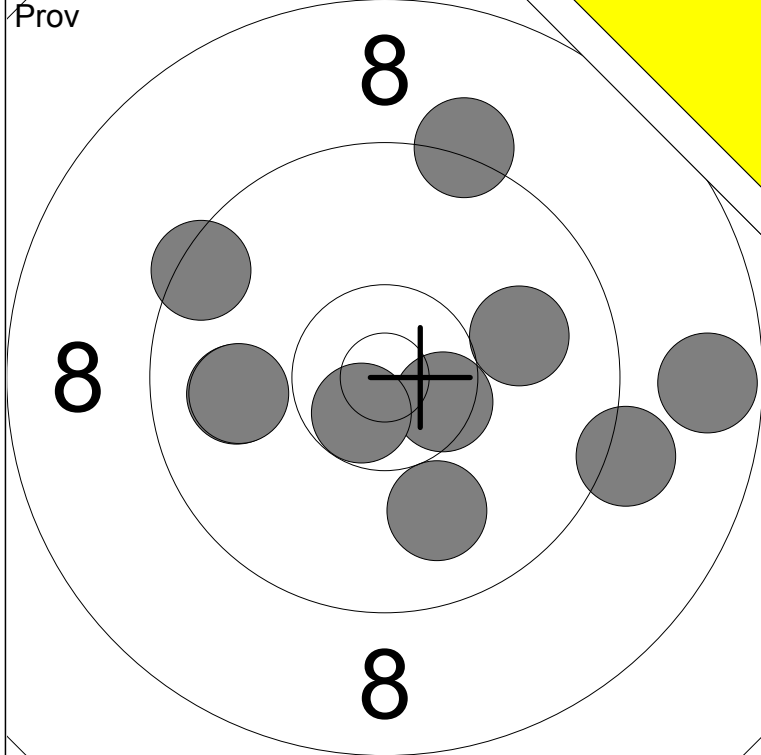

1: 8.7 →	6: 10.0 →	Serie	92 (2x)
2: 9.2 →	7: 10.7x ↘		
3: 9.9 ←	8: 9.5 ↗	Total	184 (0x)
4: 9.2 ↗	9: 9.9 ←		
5: 10.5x →	10: 9.9 ↘		

1: 9.7 ←	Serie	45 (1x)
2: 9.4 ↘		
3: 8.5 →	Total	229 (1x)
4: 9.7 ↘		
5: 10.4x ↗		

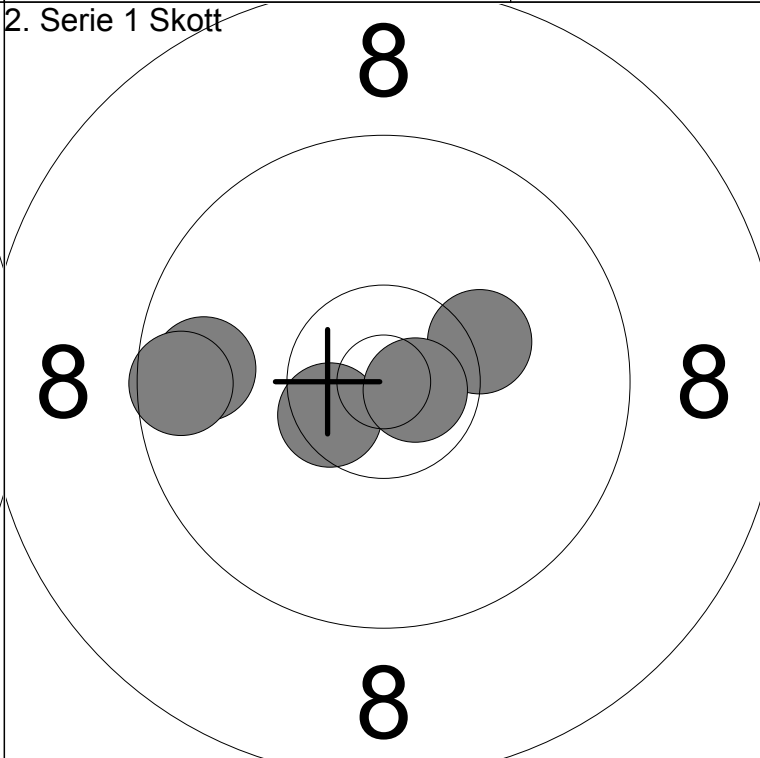
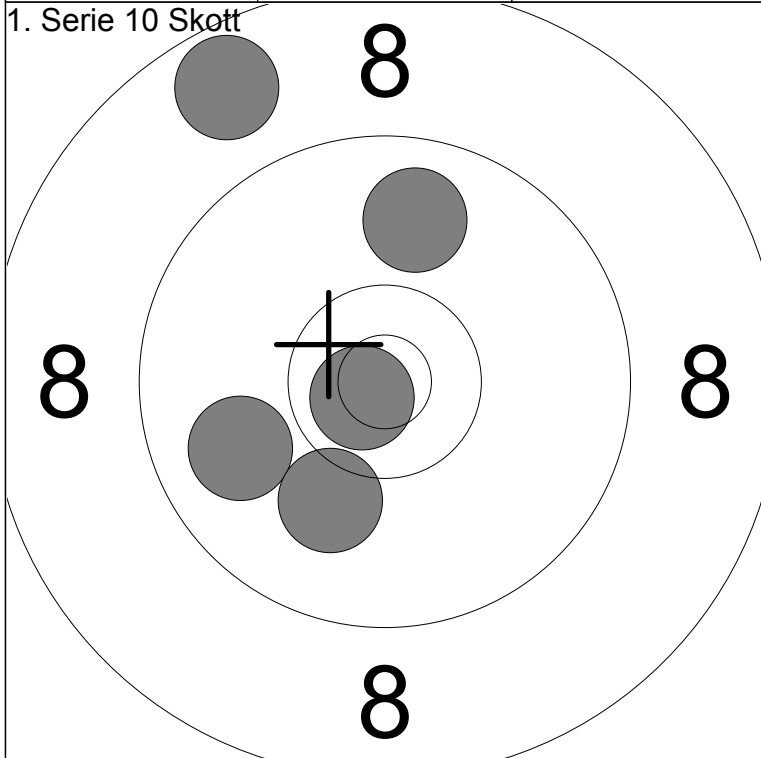

6: 8.7 ↖	Serie	46 (1x)
7: 10.8x ↙		
8: 9.8 ↗	Total	275 (2x)
9: 9.9 ←		
10: 10.1 ↘		

1: 9.7 ←	Serie	48 (2x)
2: 9.6 ←		
3: 10.3 →	Total	323 (4x)
4: 10.5x ↙		
5: 10.7x →		

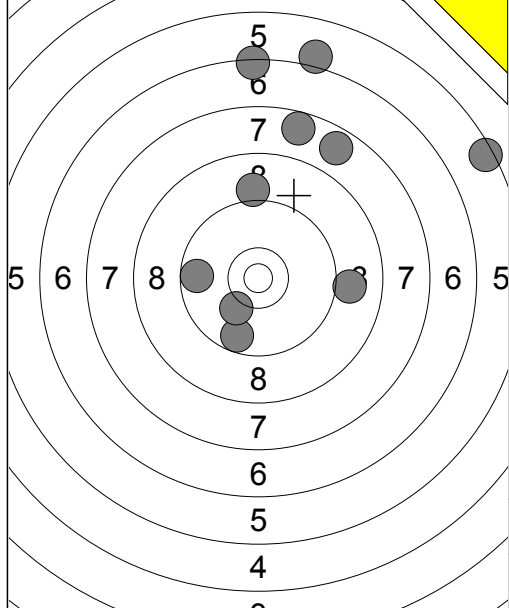

1:	9.7	↓
2:	5.5	↗
3:	6.4	↑
4:	7.7	↗
5:	7.7	↑
6:	10.2	↓
7:	6.1	↑
8:	9.1	↑
9:	9.6	←
10:	9.0	→
Serie		77 (0x)
Total		161 (0x)

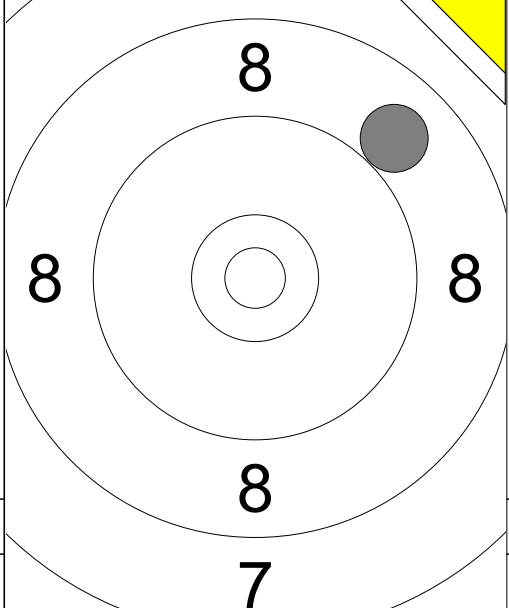

11:	8.9	↗
Serie		8 (0x)
Total		161 (0x)

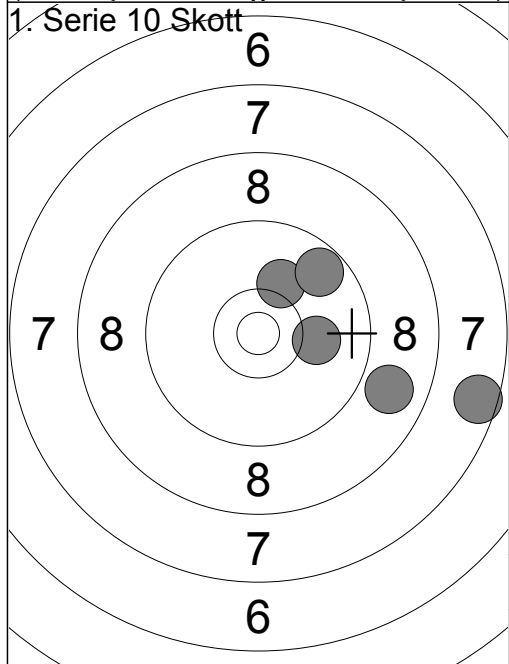

1:	10.1	↗
2:	9.7	↗
3:	7.6	→
4:	8.9	→
5:	10.1	→
Serie		44 (0x)
Total		205 (0x)

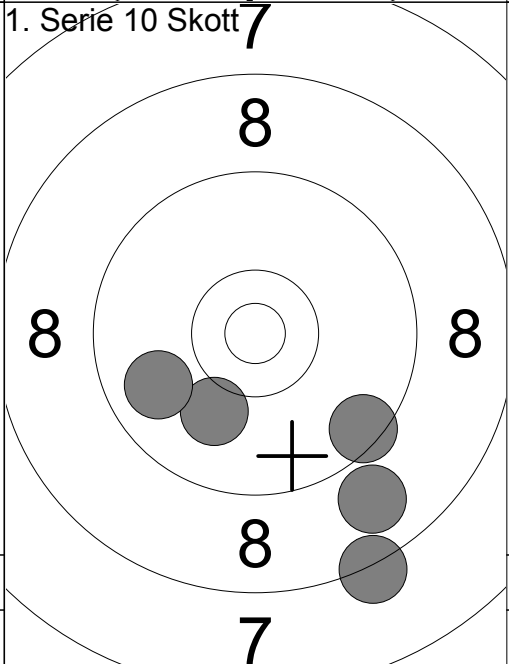

6:	10.1	↓
7:	9.8	←
8:	9.5	↓
9:	8.3	↓
10:	8.9	↓
Serie		44 (0x)
Total		249 (0x)

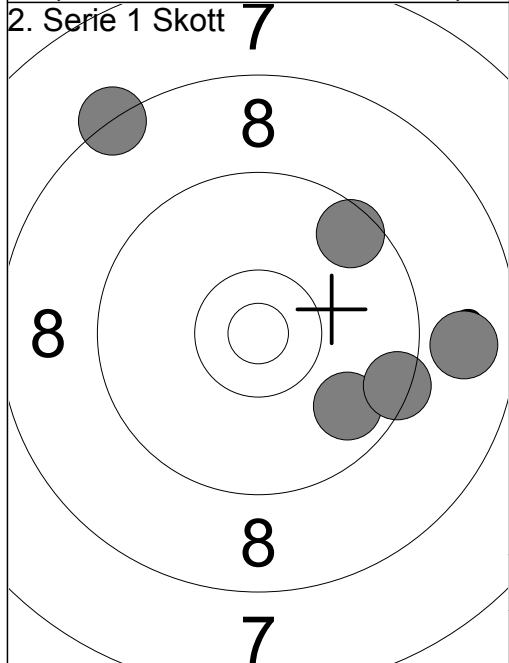

1:	8.3	↖
2:	9.6	↗
3:	9.8	↘
4:	9.4	→
5:	8.8	→
Serie		43 (0x)
Total		292 (0x)

Serie		8 (0x)
Total		161 (0x)

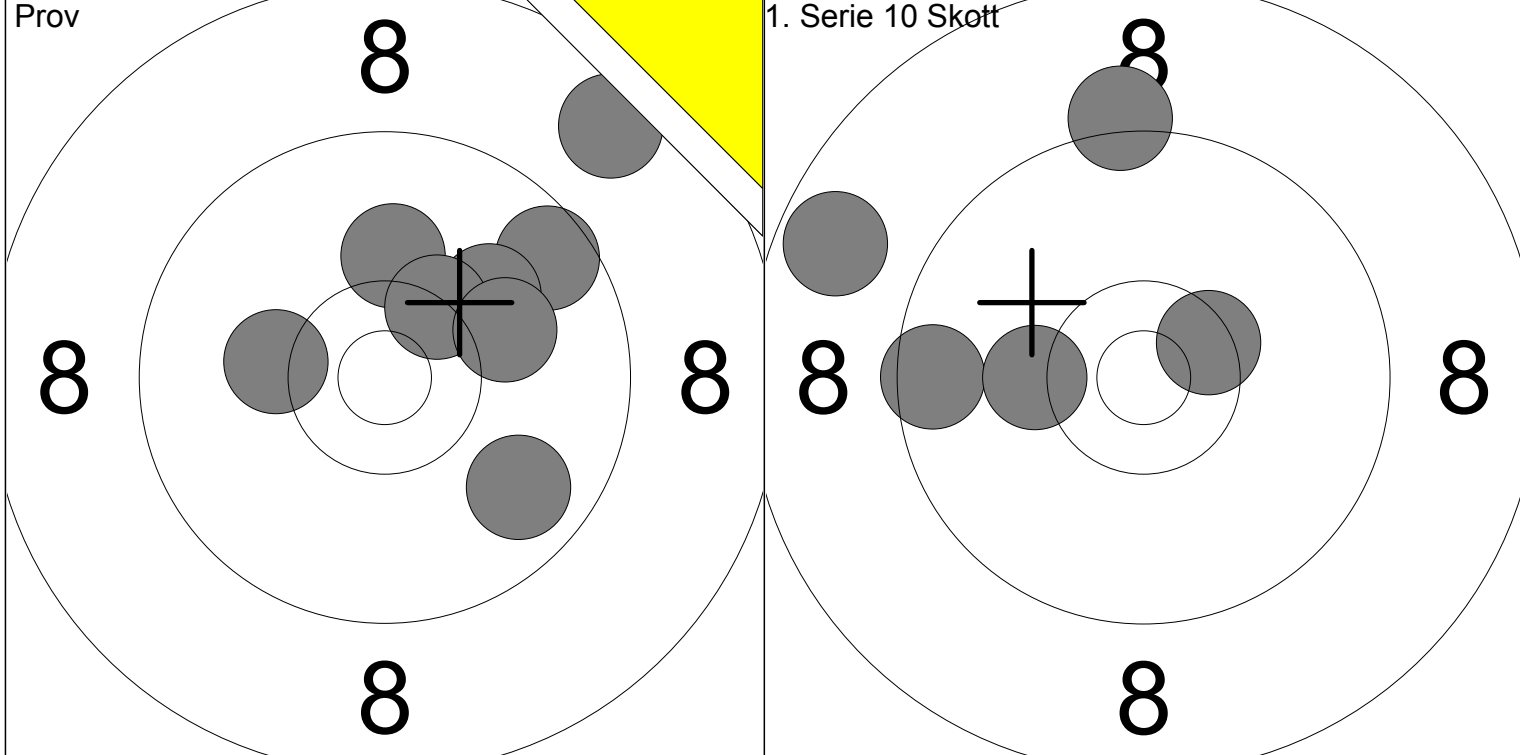

1: 9.6 ↗	6: 8.7 ↗			1: 10.5x ↗			
2: 10.1 ↑	7: 9.8 ↘	Serie	76 (1x)	2: 9.5 ←	Serie	46 (1x)	
3: 10.2 ←	8: 10.1 →		Total	192 (0x)		3: 10.2 ←	Total
4: 10.1 ↗				4: 8.7 ↖			
5: 10.4x ↗				5: 9.2 ↑			

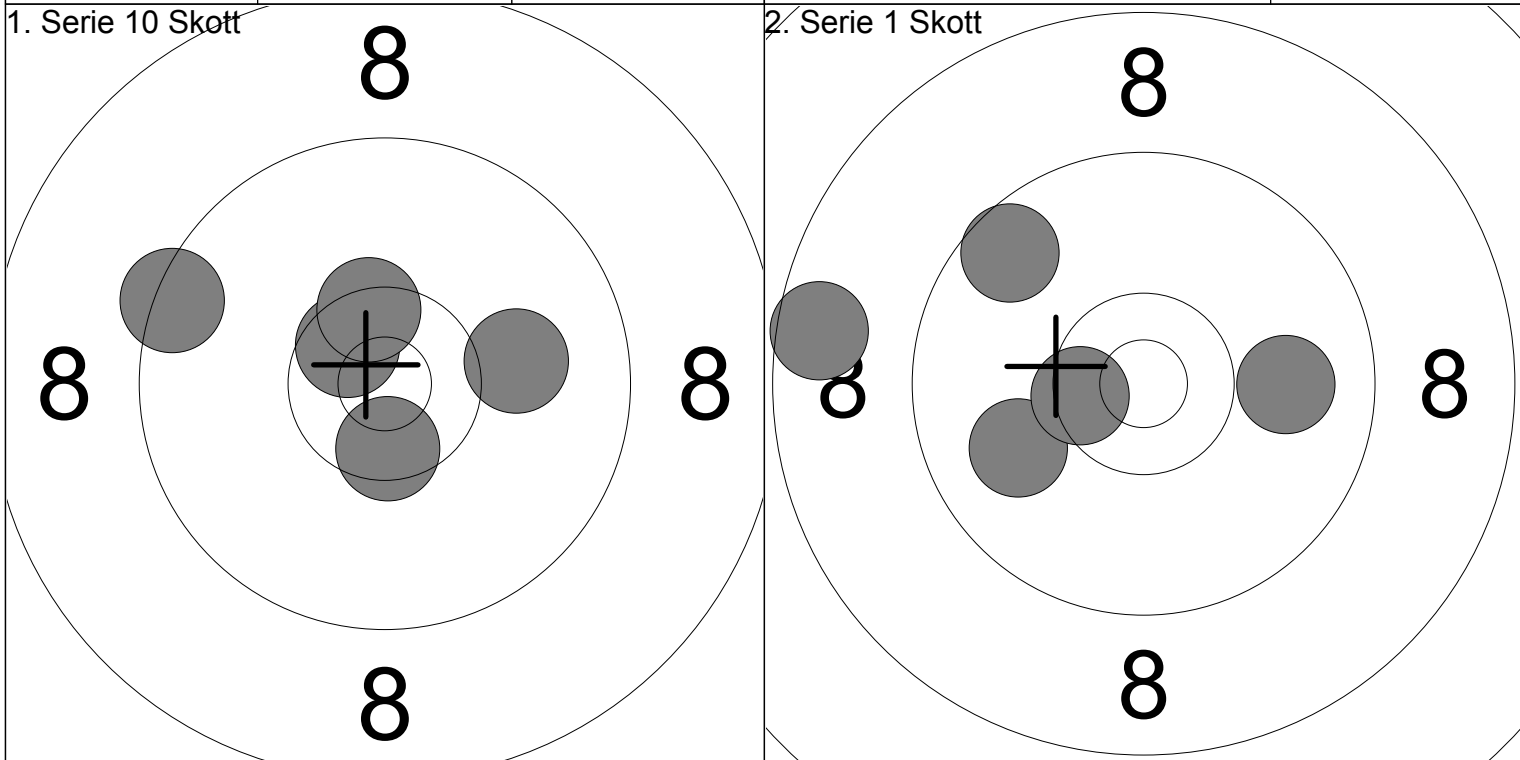

6: 9.4 ←				1: 9.6 ↗			
7: 10.6x ↗		Serie	49 (3x)	2: 8.6 ←	Serie	45 (1x)	
8: 10.4x ↑			Total	287 (4x)		3: 9.9 ←	Total
9: 10.5x ↓				4: 9.9 →			
10: 10.1 →				5: 10.5x ←			

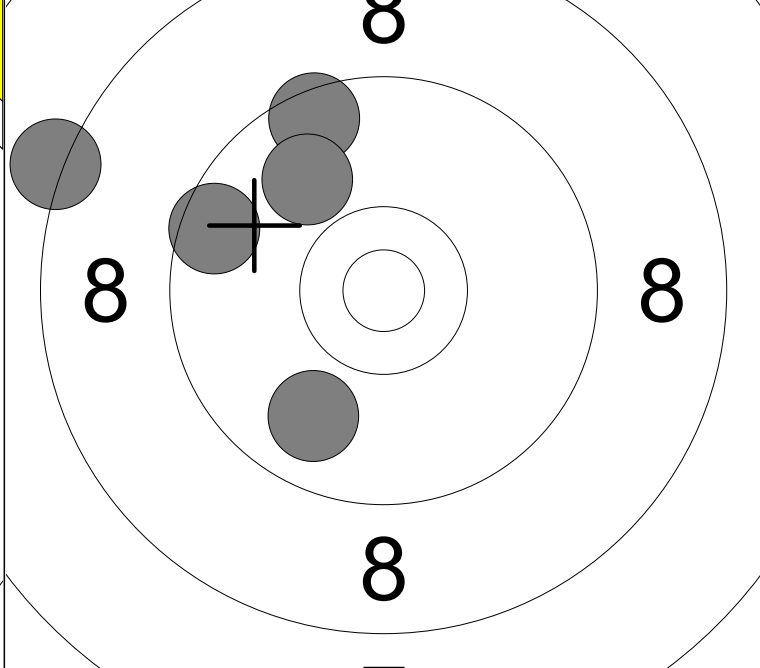
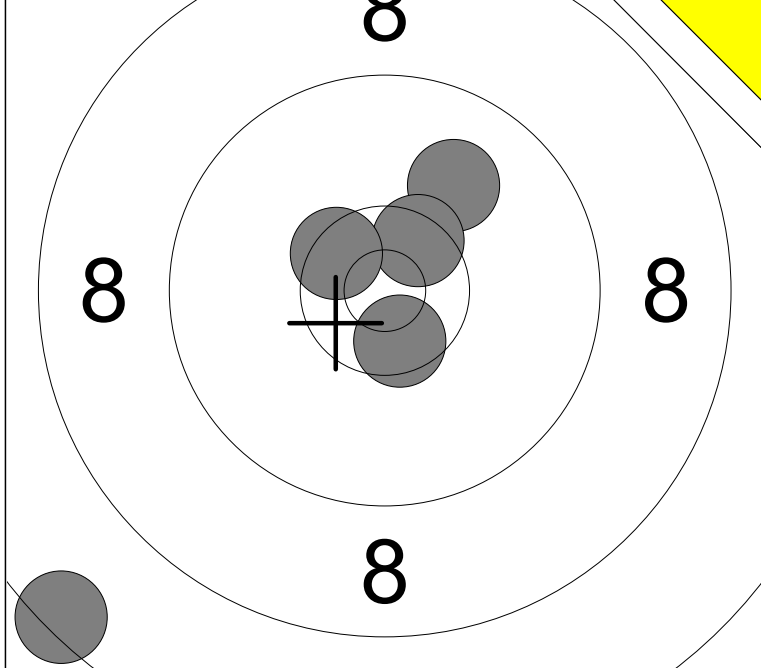

1:	10.0	↗
2:	10.5x	↗
3:	10.5x	↘
4:	10.5x	↖
5:	7.4	↙

Serie	47 (3x)
Total	178 (0x)

1:	9.6	↖
2:	9.8	↘
3:	9.5	↗
4:	8.2	↖
5:	9.9	↗

Serie	44 (0x)
Total	222 (0x)

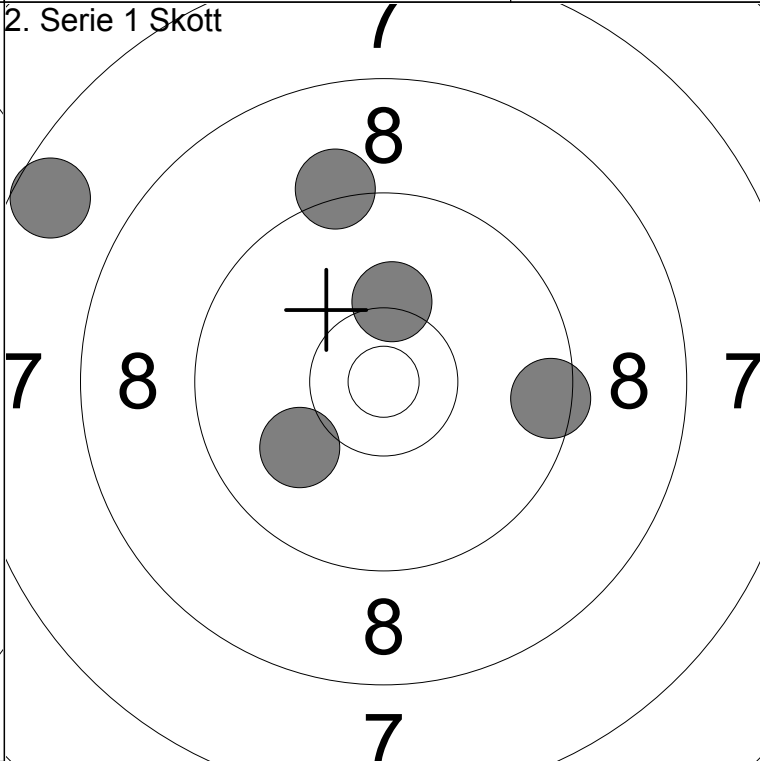
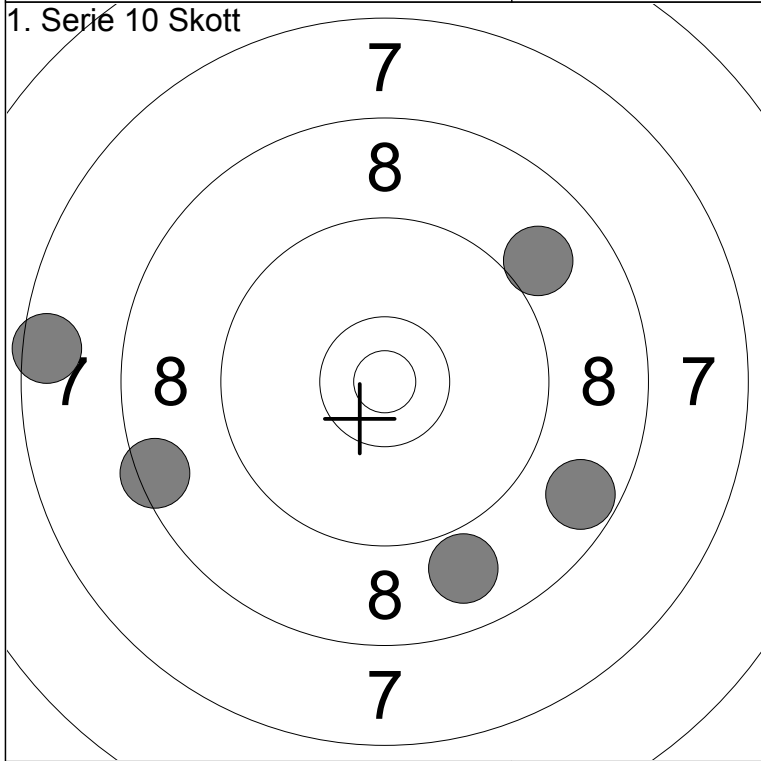

6:	7.5	↖
7:	8.7	↘
8:	8.5	↖
9:	8.9	↘
10:	9.0	↗

Serie	40 (0x)
Total	262 (0x)

1:	9.5	→
2:	7.6	↖
3:	9.2	↗
4:	10.2	↗
5:	10.0	↙

Serie	45 (0x)
Total	307 (0x)

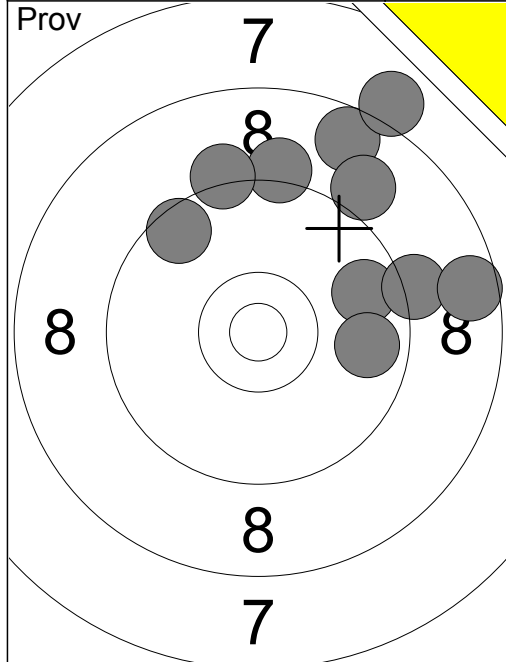

1:	8.6	↗
2:	8.1	↗
3:	9.2	↑
4:	9.6	↖
5:	9.7	→
6:	9.2	↑
7:	9.0	↗
8:	9.8	→
9:	9.2	→
10:	8.6	→

Serie	87 (0x)
Total	181 (0x)

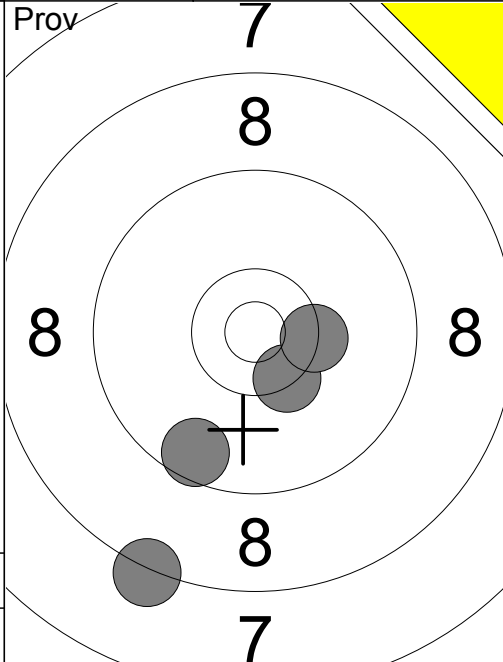

11:	10.4x	↘
12:	9.6	↘
13:	10.3x	→
14:	8.3	↘

Serie	37 (2x)
Total	181 (0x)

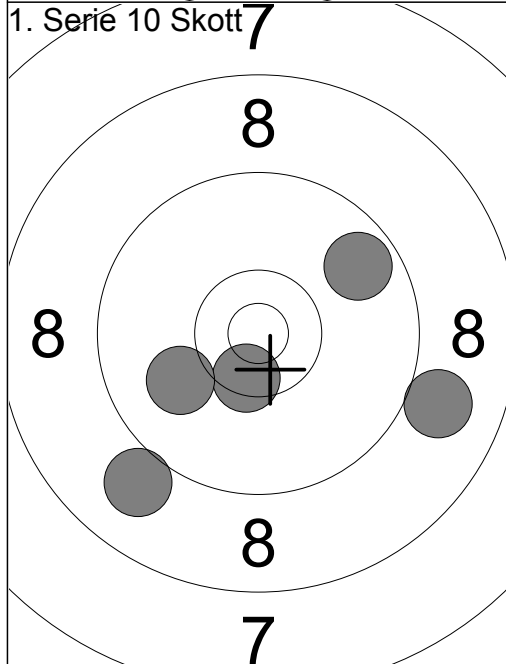

1:	10.5x	↘
2:	9.0	↘
3:	9.0	→
4:	10.0	↙
5:	9.7	↗

Serie	47 (1x)
Total	228 (1x)

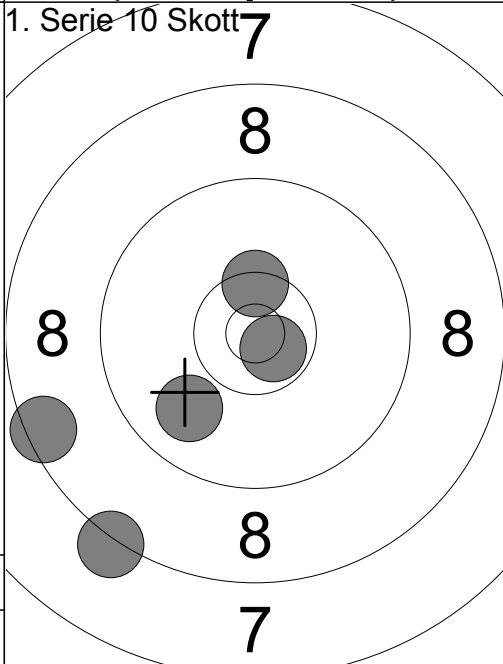

6:	9.9	↘
7:	8.5	↙
8:	8.2	↘
9:	10.4x	↑
10:	10.7x	↘

Serie	45 (2x)
Total	273 (3x)

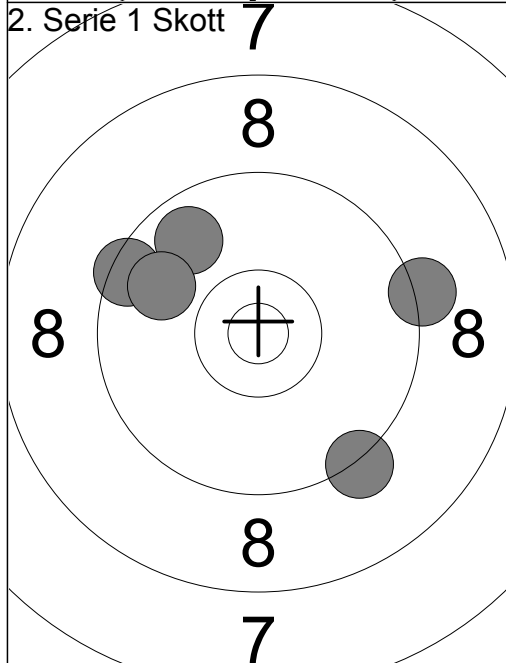

1:	9.5	↙
2:	9.2	→
3:	9.8	↗
4:	9.8	↗
5:	9.3	↘

Serie	45 (0x)
Total	318 (3x)

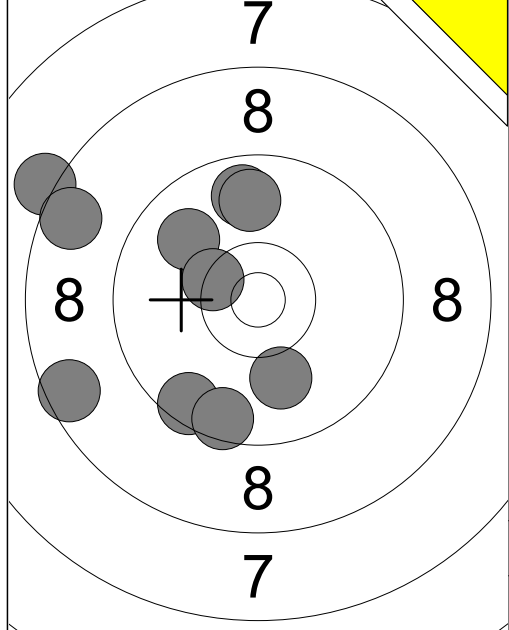

1:	9.7	↑
2:	9.5	↓
3:	9.9	↗
4:	8.2	↖
5:	8.6	←
6:	10.0	↓
7:	9.5	↓
8:	8.6	↖
9:	9.8	↑
10:	10.4x	↖
Serie		89 (1x)
Total		152 (0x)

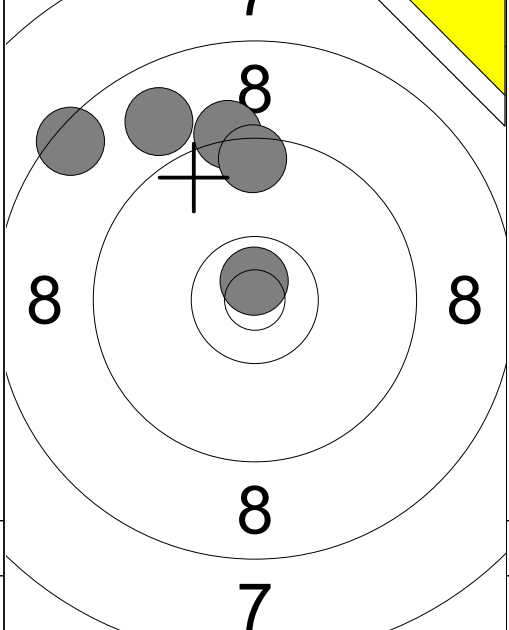

11:	8.9	↖
12:	8.5	↖
13:	10.8x	↑
14:	9.2	↑
15:	9.5	↑
Serie		44 (1x)
Total		152 (0x)

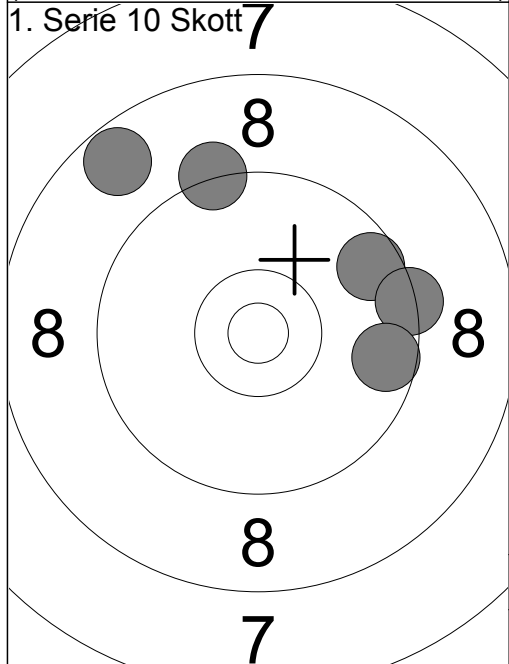

1:	9.6	↗
2:	9.4	→
3:	9.3	↑
4:	9.6	→
5:	8.7	↗
Serie		44 (0x)
Total		196 (0x)

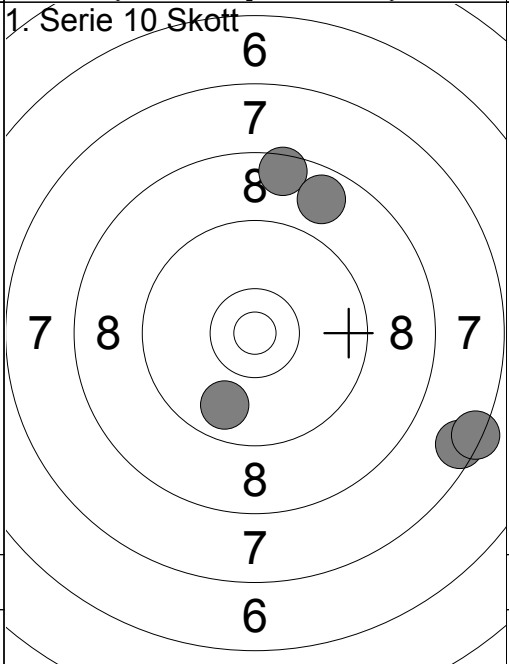

6:	8.5	↑
7:	9.8	↓
8:	8.8	↗
9:	7.5	→
10:	7.4	→
Serie		39 (0x)
Total		235 (0x)

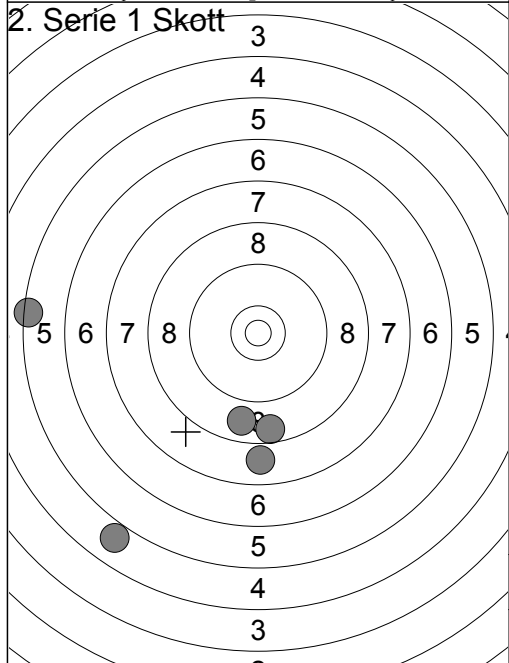

1:	4.9	↘
2:	5.4	←
3:	7.9	↓
4:	8.8	↓
5:	8.6	↓
Serie		32 (0x)
Total		267 (0x)

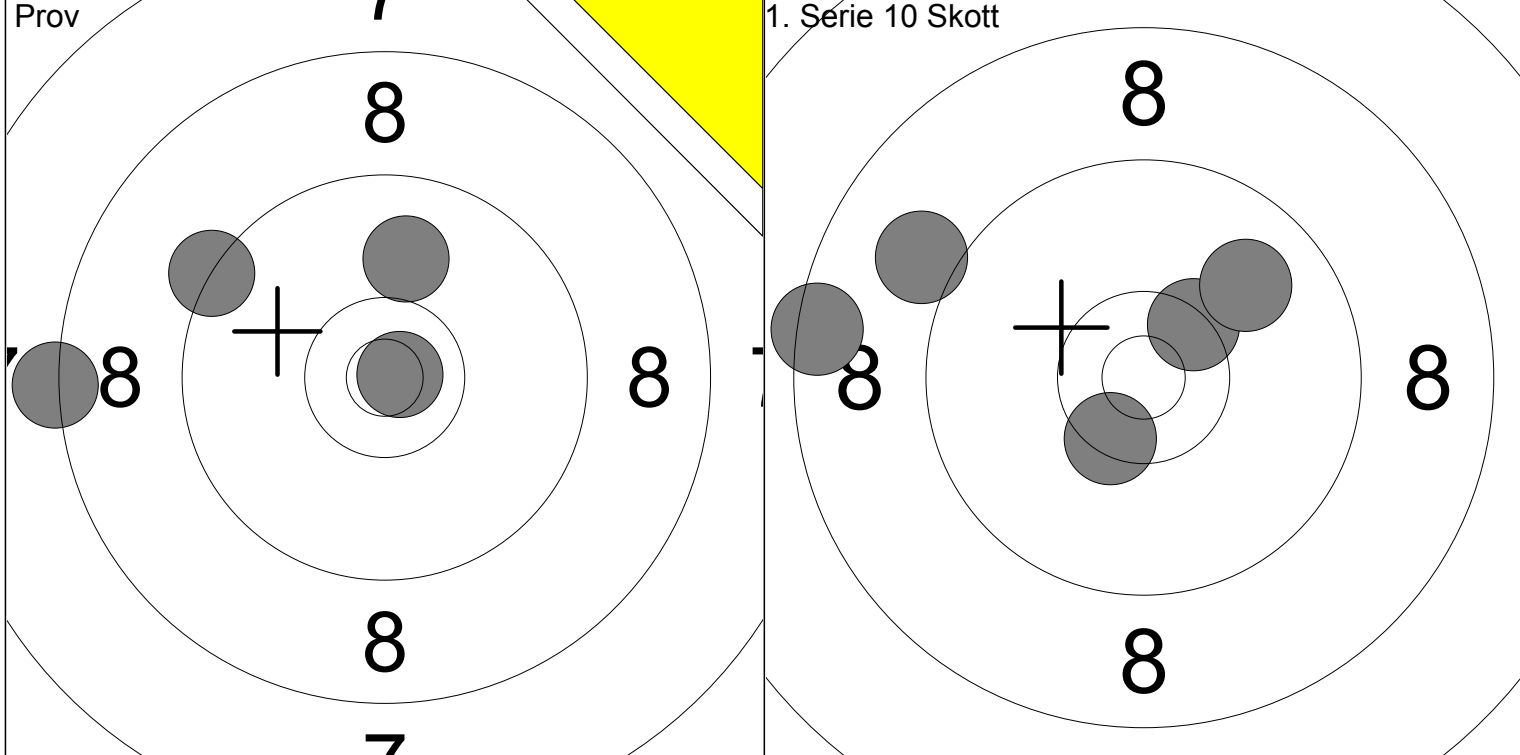

1: 10.0 ↑ 2: 10.8x → 3: 8.3 ← 4: 9.3 ↖	Serie 37 (1x) Total 181 (0x)	1: 9.0 ↖ 2: 10.4x ↘ 3: 8.4 ← 4: 10.4x ↗ 5: 9.9 ↗	Serie 46 (2x) Total 227 (2x)
---	---------------------------------------	--	---------------------------------------

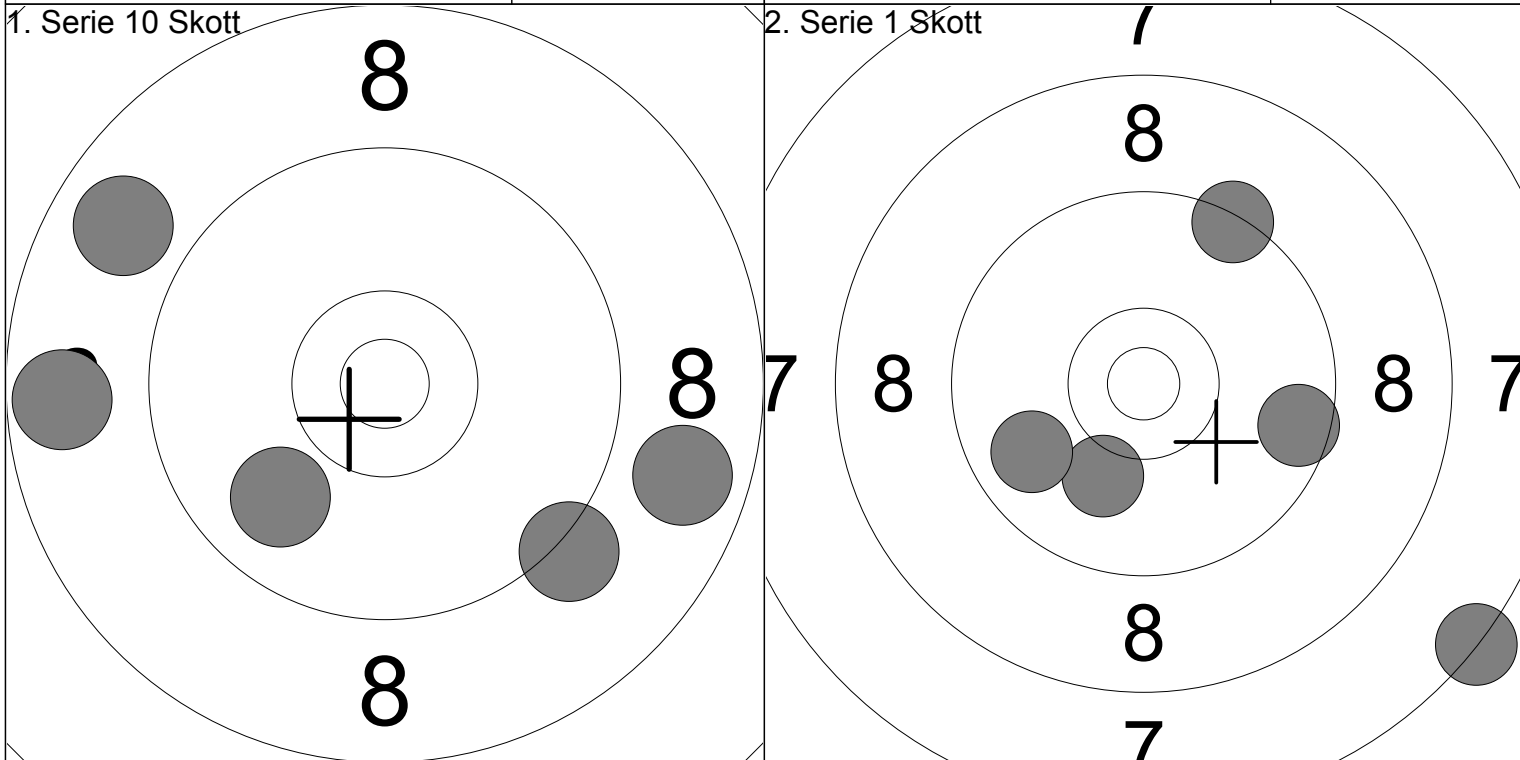

6: 8.8 → 7: 9.2 ↘ 8: 9.9 ↙ 9: 8.7 ← 10: 8.8 ↖	Serie 42 (0x) Total 269 (2x)	1: 7.3 ↘ 2: 9.6 → 3: 10.1 ↘ 4: 9.4 ↗ 5: 9.8 ↖	Serie 44 (0x) Total 313 (2x)
---	---------------------------------------	---	---------------------------------------

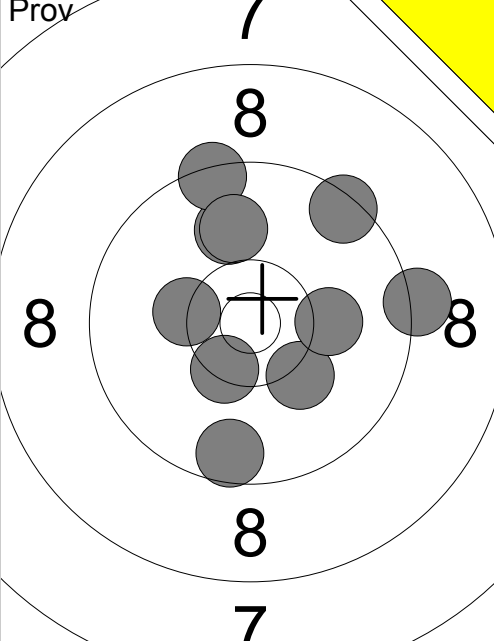
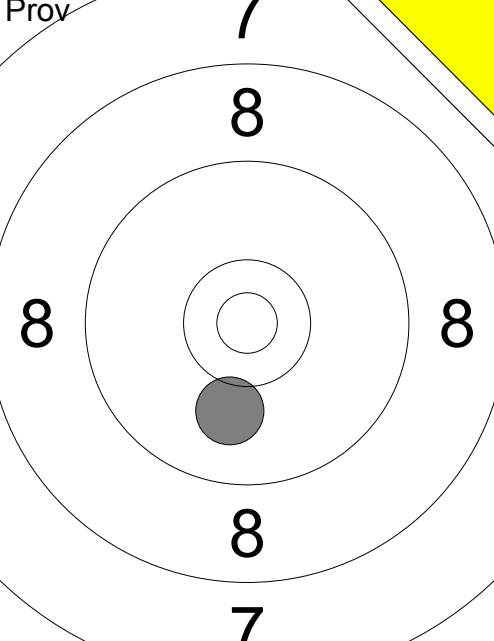
Prov 	1: 9.2 → 2: 10.0 ↑ 3: 9.4 ↑ 4: 9.6 ↓ 5: 10.2 ↓ 6: 10.3 ← 7: 9.4 ↗ 8: 10.0 ↑ 9: 10.1 → 10: 10.4x ↓	Prov 	11: 10.0 ↓
Serie 96 (1x)		Serie 10 (0x)	
Total 182 (0x)		Total 182 (0x)	

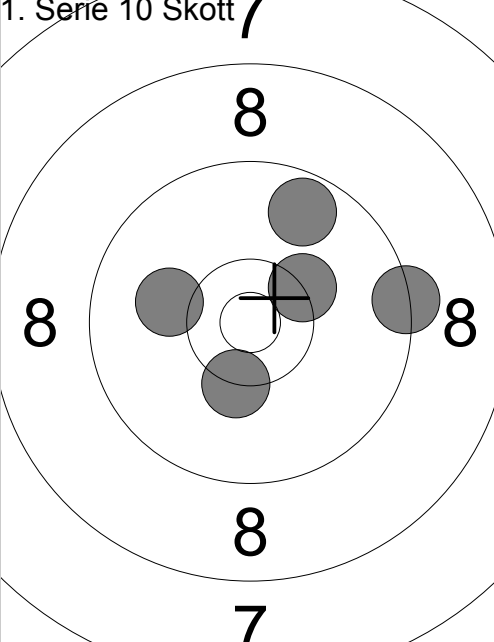
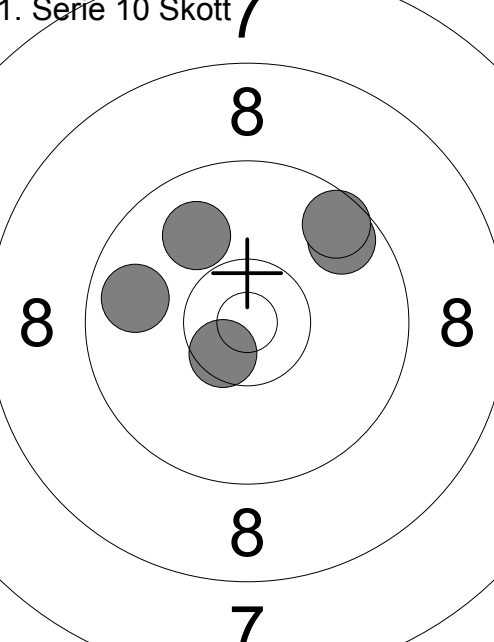
1. Serie 10 Skott 	1: 10.1 ← 2: 10.3x ↓ 3: 9.7 ↑ 4: 9.3 → 5: 10.3x ↗	1. Serie 10 Skott 	6: 10.5x ↓ 7: 9.7 ↗ 8: 9.9 ↑ 9: 9.8 ← 10: 9.6 ↗
Serie 48 (2x)		Serie 46 (1x)	
Total 230 (2x)		Total 276 (3x)	

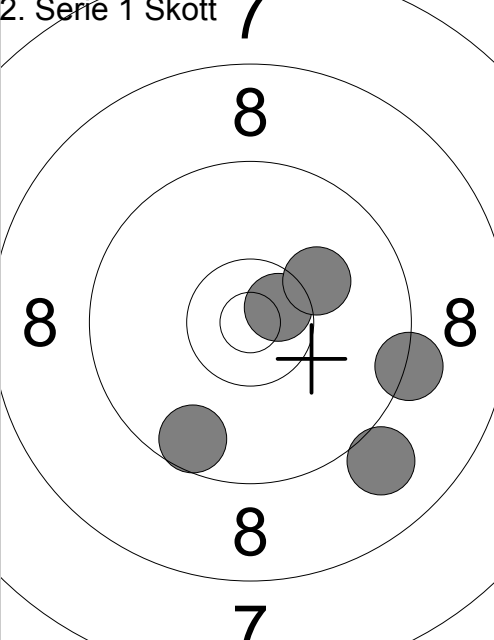
2. Serie 1 Skott 	1: 9.3 → 2: 9.0 ↓ 3: 9.6 ↓ 4: 10.6x ↗ 5: 10.1 ↗		
Serie 47 (1x)			
Total 323 (4x)			

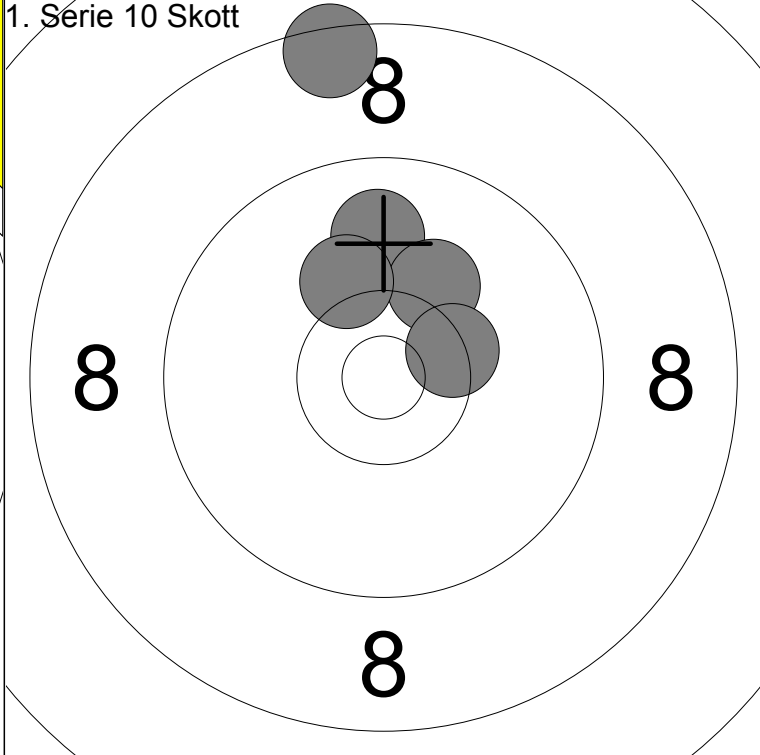
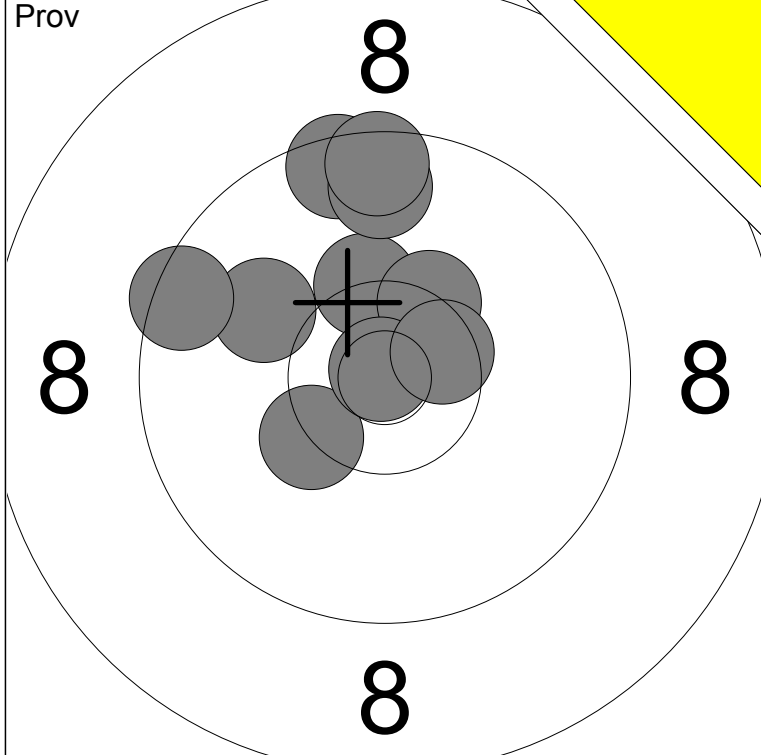

1: 10.3x ↑	6: 10.0 ↙	Serie	96 (5x)
2: 9.5 ↑	7: 10.5x →		
3: 10.3x ↙	8: 9.7 ↑	Total	167 (0x)
4: 10.4x ↗	9: 9.5 ↙		
5: 10.9x ↖	10: 9.5 ↑		

1: 8.5 ↑	Serie	47 (1x)
2: 9.9 ↑		
3: 10.2 ↗	Total	214 (1x)
4: 10.2 ↑		
5: 10.4x →		

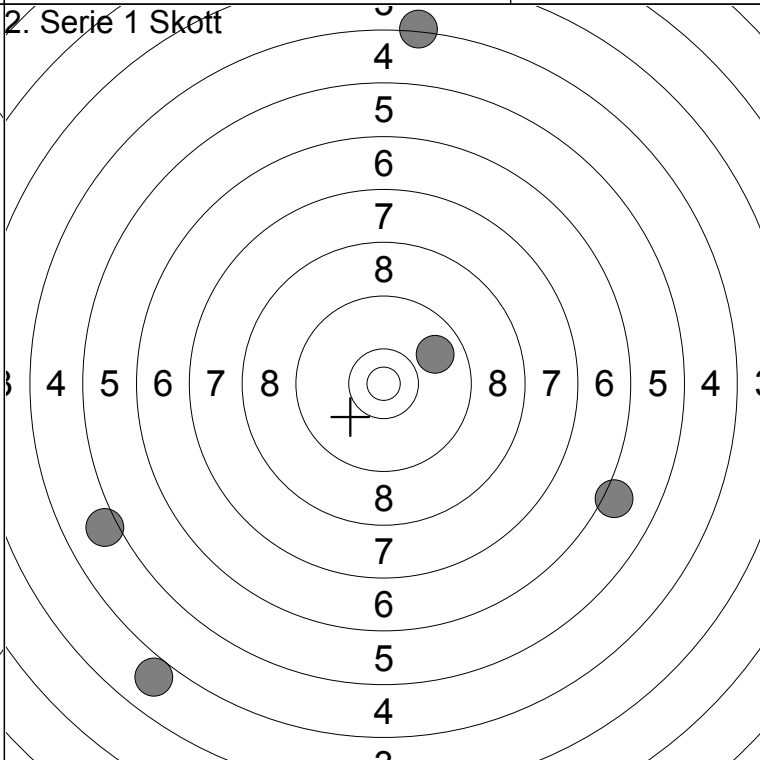
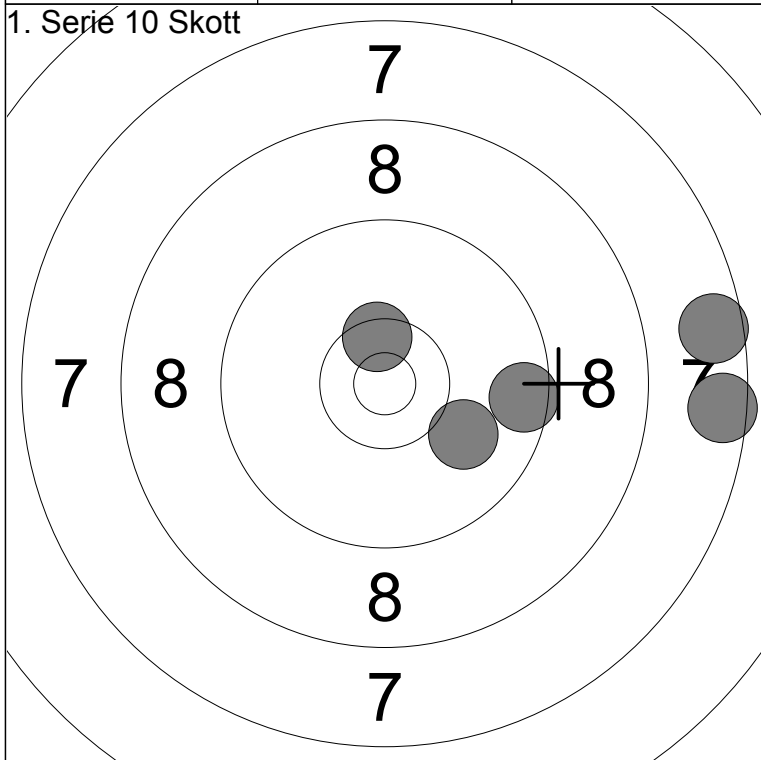

6: 9.5 →	Serie	43 (1x)
7: 10.5x ↑		
8: 7.5 →	Total	257 (2x)
9: 7.6 →		
10: 10.0 ↘		

1: 4.3 ↑	Serie	27 (0x)
2: 3.9 ↘		
3: 9.8 →	Total	284 (2x)
4: 5.1 ↙		
5: 6.1 →		

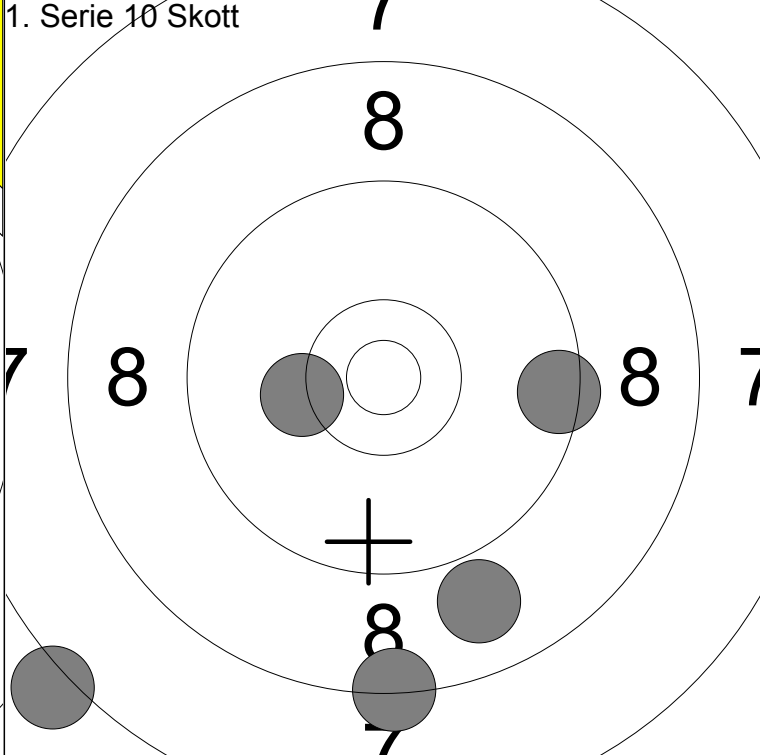
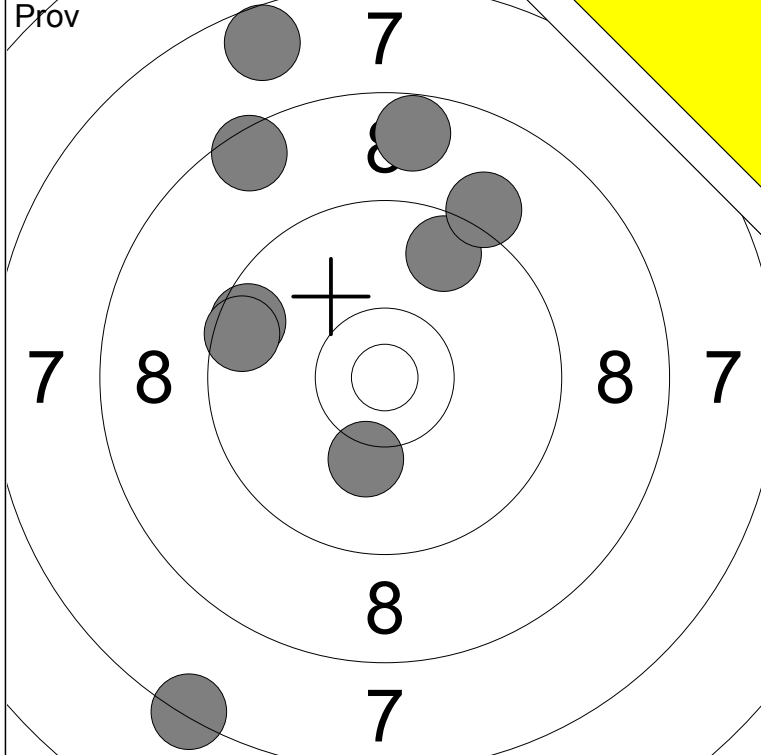

1: 9.7 ↗	6: 9.1 ↗	Serie	76 (0x)
2: 9.6 ↖	7: 7.3 ↘		
3: 8.5 ↗	8: 10.2 ↘	Total	153 (0x)
4: 9.6 ↖	9: 7.6 ↗		
5: 8.7 ↗			

1: 8.3 ↓	Serie	42 (0x)
2: 8.9 ↓		
3: 10.2 ←	Total	195 (0x)
4: 7.1 ↖		
5: 9.5 →		

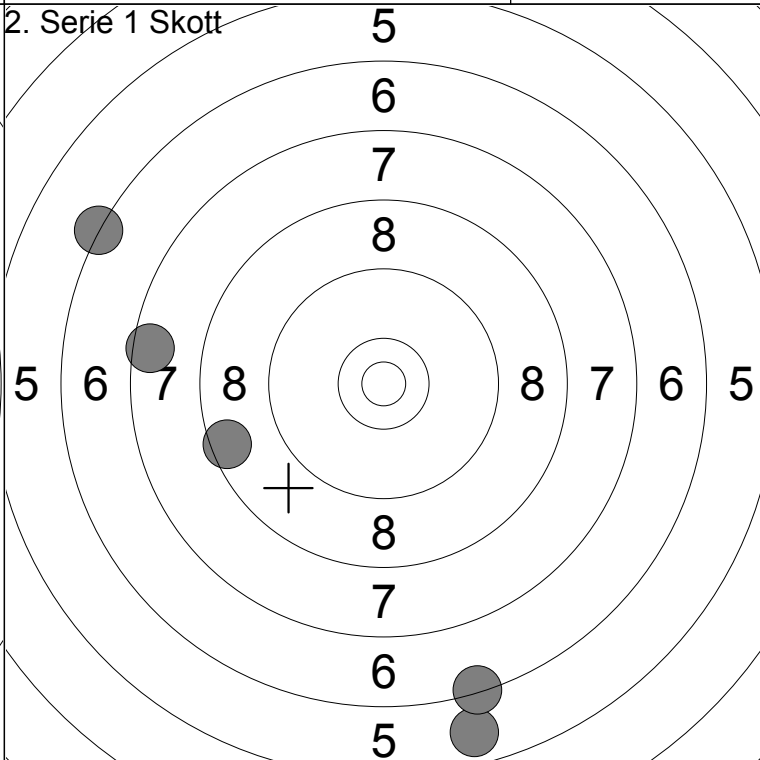
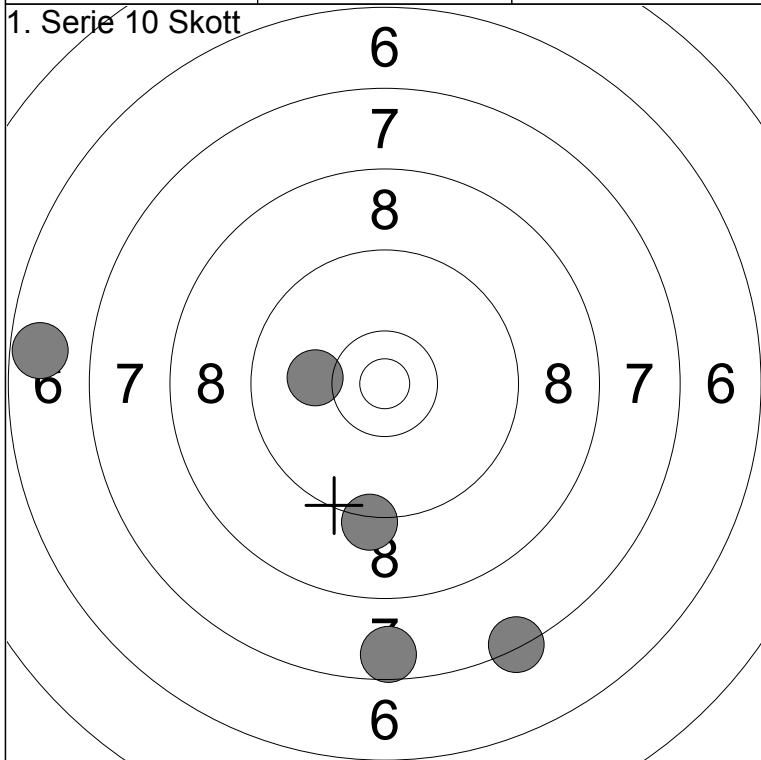

6: 6.7 ←	Serie	39 (0x)
7: 7.3 ↓		
8: 7.6 ↓	Total	234 (0x)
9: 9.2 ↓		
10: 10.1 ←		

1: 5.8 ↓	Serie	32 (0x)
2: 6.3 ↓		
3: 8.5 ←	Total	266 (0x)
4: 6.3 ↗		
5: 7.6 ←		

Skjutlag
4

Tavla
8

Stefan Thorin

Ramselefors

Umeå

Vb

20.08.2023

Förbundmästerskap KH 2023

Ramselefors SKF

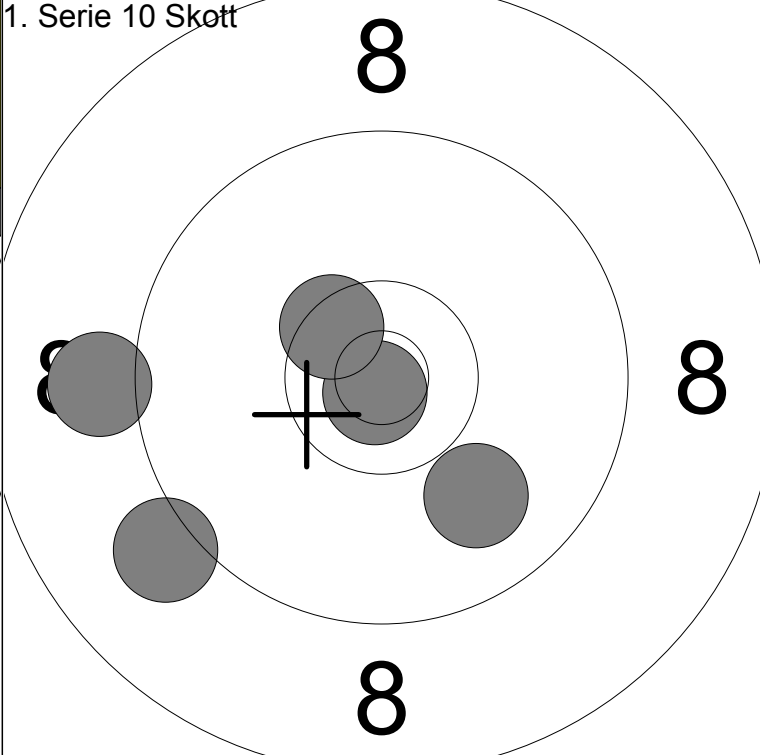
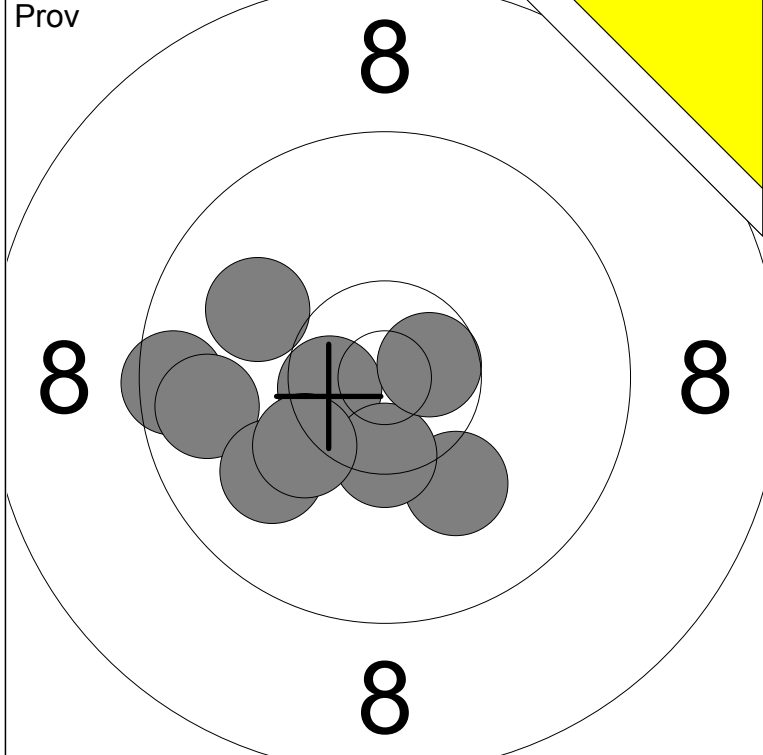

1: 10.1 ↘	6: 9.7 ←	Serie 88 (3x)
2: 9.5 ←	7: 10.0 ↘	
3: 10.0 ↗	8: 10.6x →	Total 177 (0x)
4: 10.6x ←	9: 10.2 ↘	
5: 10.4x ↓		

1: 9.1 ↘	Serie 47 (2x)
2: 9.1 ←	
3: 10.8x ↘	Total 224 (2x)
4: 9.9 ↘	
5: 10.5x ↗	

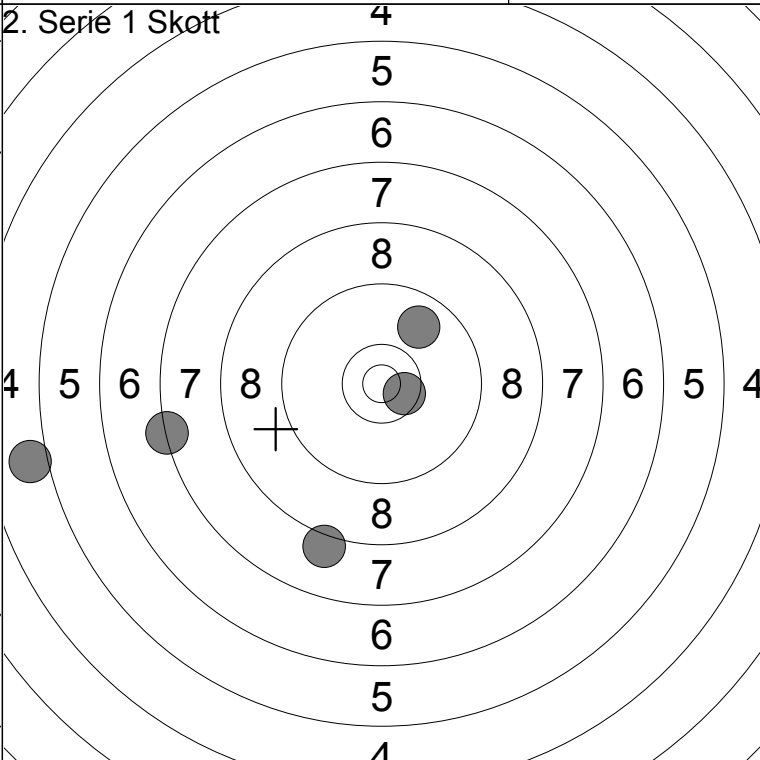
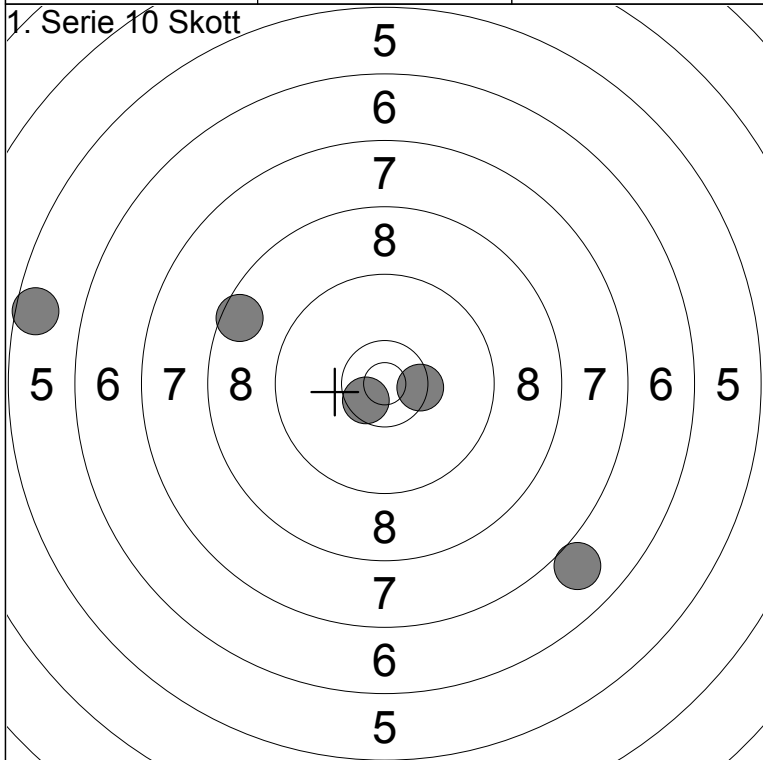

6: 7.0 ↘	Serie 40 (2x)
7: 10.4x →	
8: 5.6 ←	Total 264 (4x)
9: 8.6 ↗	
10: 10.6x ↘	

1: 7.3 ←	Serie 39 (1x)
2: 10.5x →	
3: 9.8 ↗	Total 303 (5x)
4: 5.0 ←	
5: 8.1 ↓	

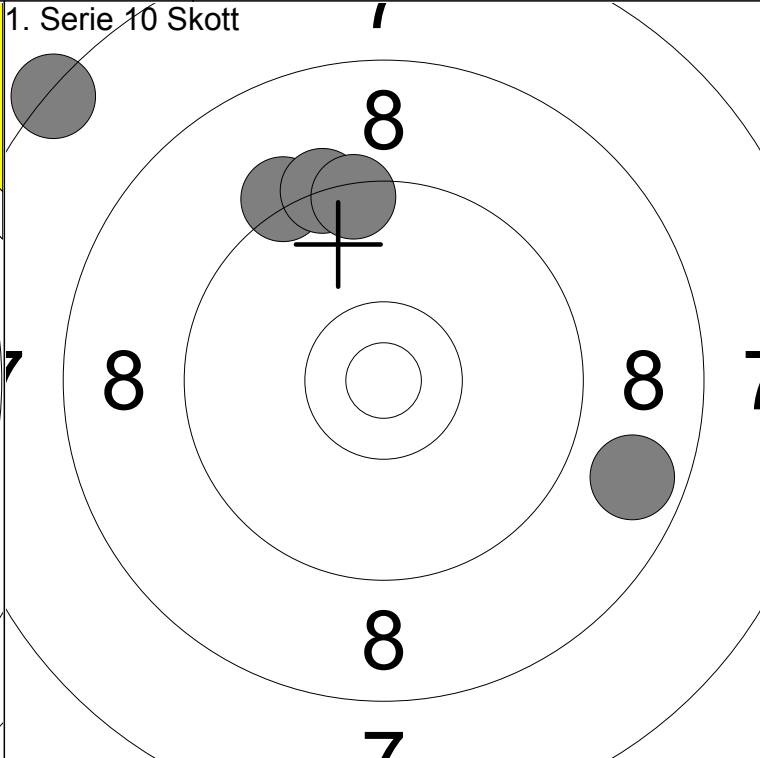
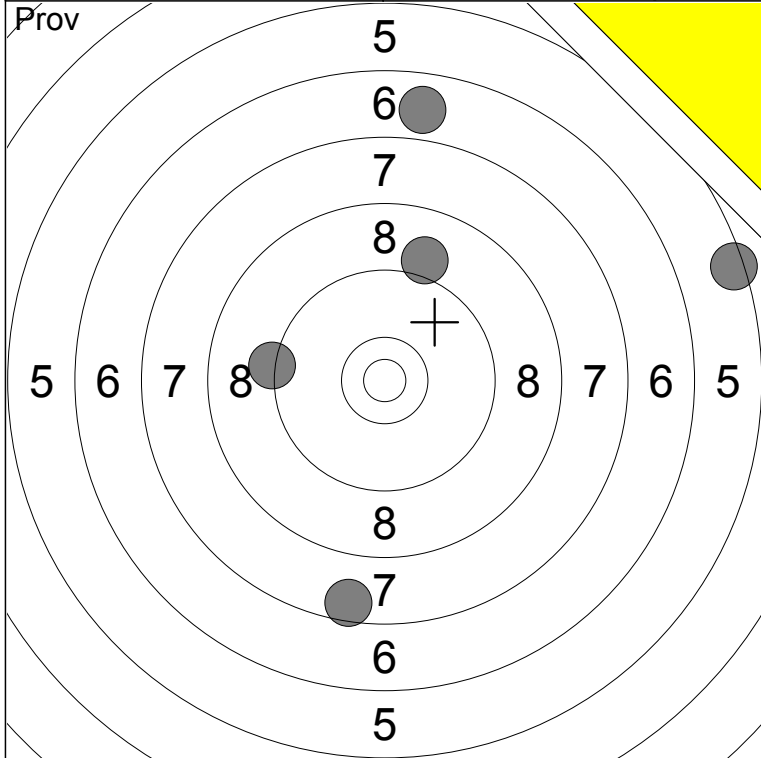

1:	7.6	↓
2:	6.8	↑
3:	9.1	↑
4:	9.2	←
5:	5.4	→

Serie	36 (0x)
Total	161 (0x)

1:	9.2	↗
2:	7.3	↗
3:	9.3	↑
4:	9.4	↑
5:	8.7	↘

Serie	42 (0x)
Total	203 (0x)

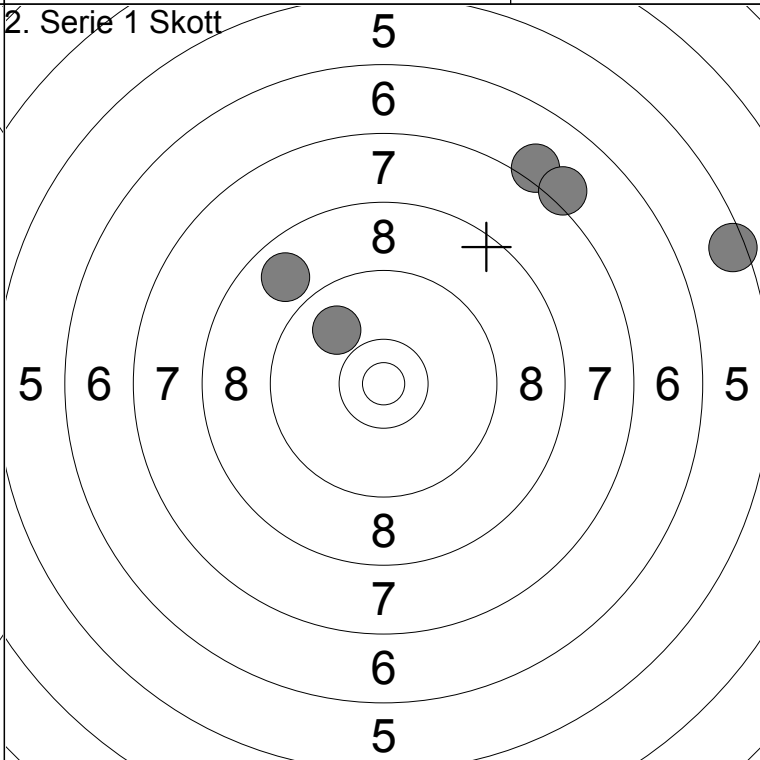
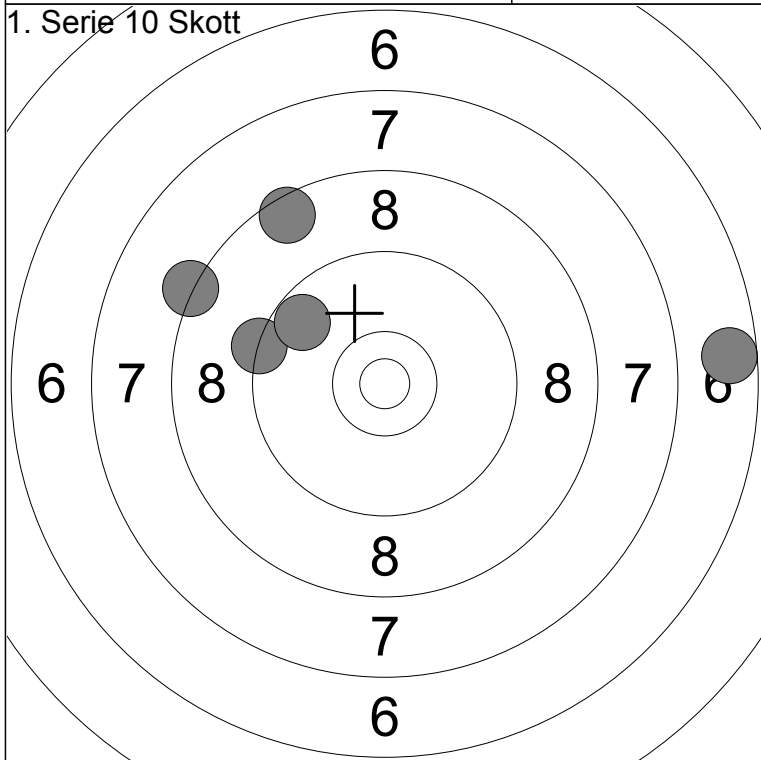

6:	8.3	↖
7:	9.3	↖
8:	8.5	↗
9:	9.7	↗
10:	6.6	→

Serie	40 (0x)
Total	243 (0x)

1:	8.8	↖
2:	7.1	↗
3:	5.5	→
4:	9.9	↖
5:	7.1	↗

Serie	36 (0x)
Total	279 (0x)