

1:	10.3	↘
2:	10.1	↘
3:	10.0	↘
4:	9.4	↘
5:	10.5x	↘
Serie		49 (1x)
Total		0 (0x)

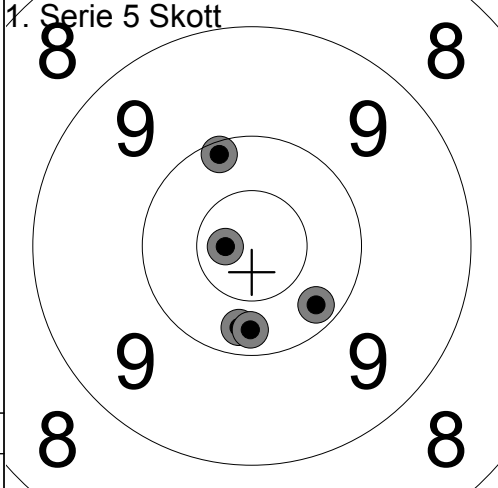

1:	10.3	↓
2:	10.1	↑
3:	10.2	↘
4:	10.2	↓
5:	10.7x	←
Serie		50 (1x)
Total		50 (1x)

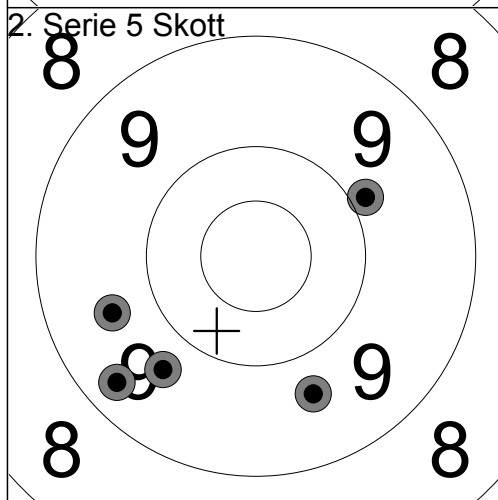

1:	9.9	→
2:	9.3	↘
3:	9.7	↘
4:	9.6	←
5:	9.7	↘
Serie		45 (0x)
Total		95 (1x)

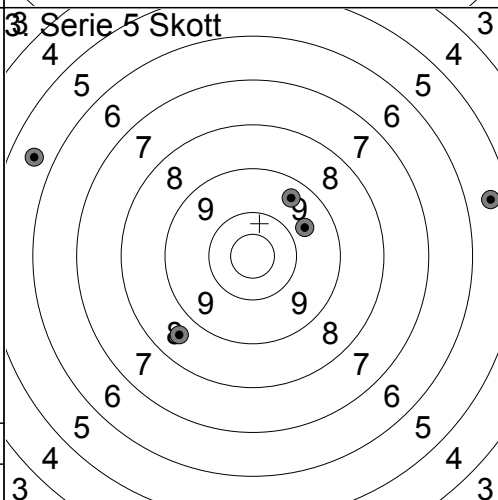

1:	5.6	←
2:	5.5	→
3:	9.7	→
4:	9.5	↗
5:	8.6	↘
Serie		36 (0x)
Total		131 (1x)

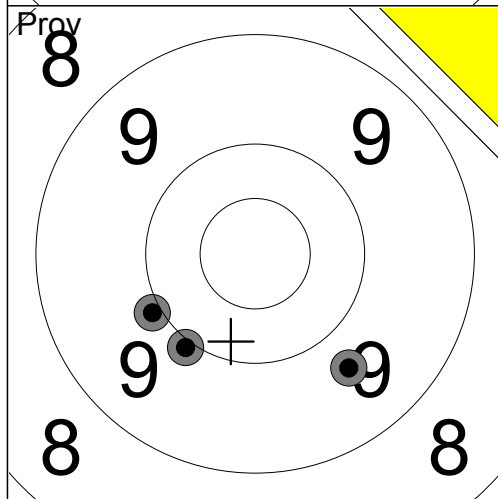

1:	10.0	↘
2:	10.0	←
3:	9.7	↘
Serie		29 (0x)
Total		131 (1x)

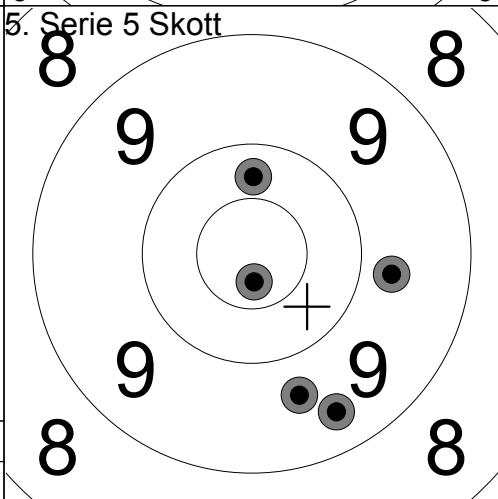

1:	10.3	↑
2:	9.7	↓
3:	9.7	→
4:	10.7x	↓
5:	9.4	↘
Serie		47 (1x)
Total		178 (2x)

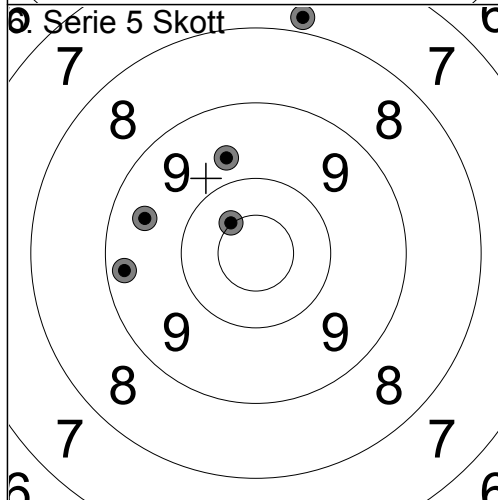

1:	9.7	↑
2:	9.5	←
3:	9.3	←
4:	10.5x	↗
5:	7.8	↑
Serie		44 (1x)
Total		222 (3x)

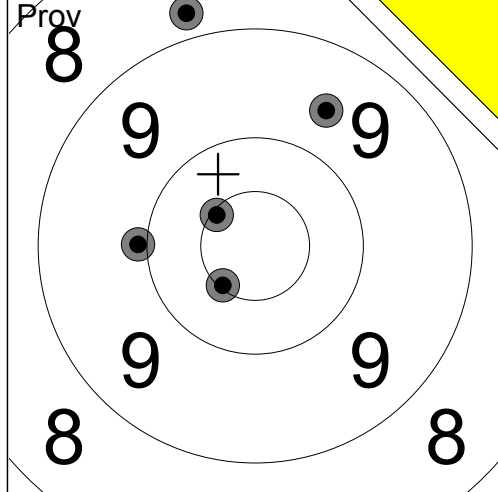

1:	8.8	↑
2:	10.5x	↖
3:	9.9	←
4:	9.6	↑
5:	10.5x	↙
Serie		46 (2x)
Total		0 (0x)

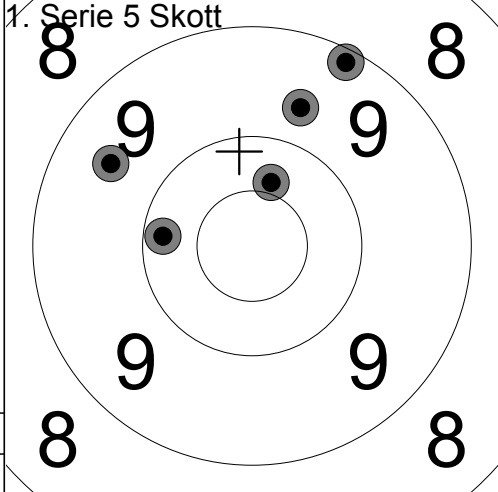

1:	9.5	↖
2:	9.2	↑
3:	9.7	↑
4:	10.2	←
5:	10.4	↑
Serie		47 (0x)
Total		47 (0x)

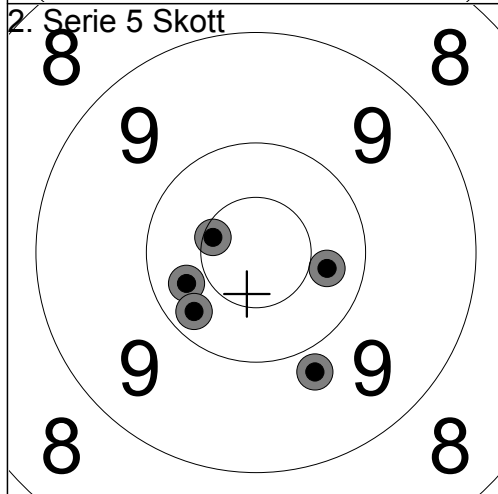

1:	9.8	↘
2:	10.6x	←
3:	10.3	→
4:	10.3	←
5:	10.2	↙
Serie		49 (1x)
Total		96 (1x)

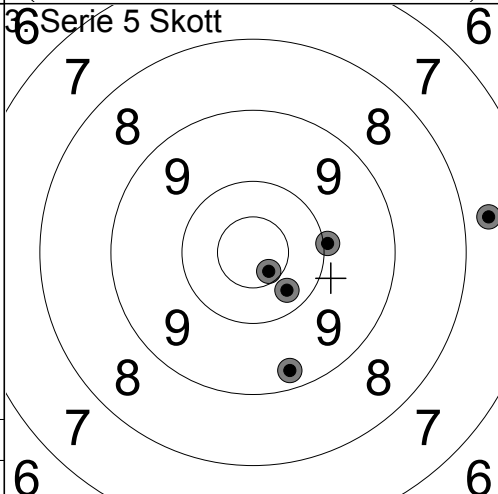

1:	10.6x	↘
2:	10.0	→
3:	7.7	→
4:	9.3	↘
5:	10.3	↘
Serie		46 (1x)
Total		142 (2x)

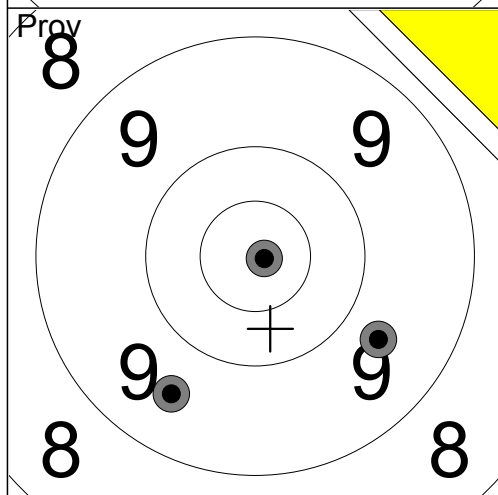

1:	9.7	→
2:	10.9x	→
3:	9.6	↘
Serie		28 (1x)
Total		142 (2x)

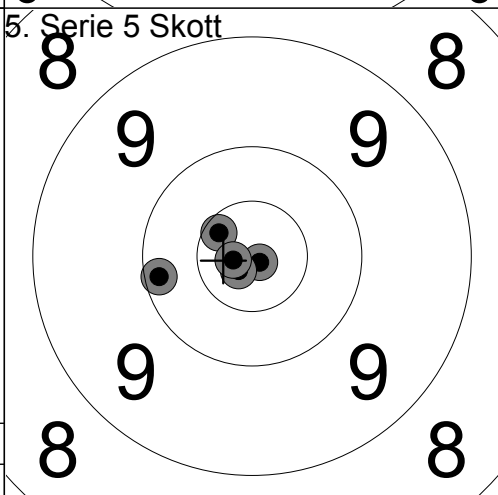

1:	10.9x	↘
2:	10.6x	↖
3:	10.8x	↘
4:	10.1	←
5:	10.8x	←
Serie		50 (4x)
Total		192 (6x)

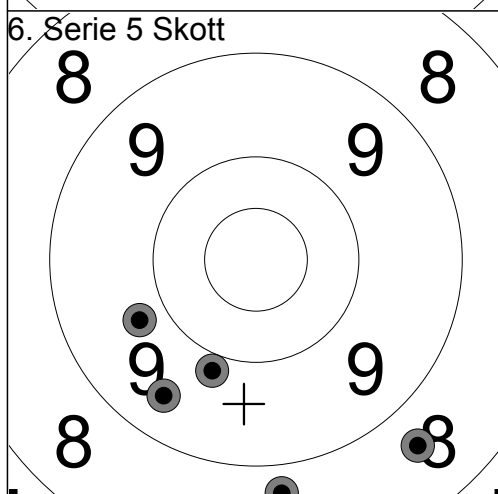

1:	9.9	↘
2:	8.8	↘
3:	9.4	↘
4:	8.6	↘
5:	9.8	←
Serie		43 (0x)
Total		235 (6x)

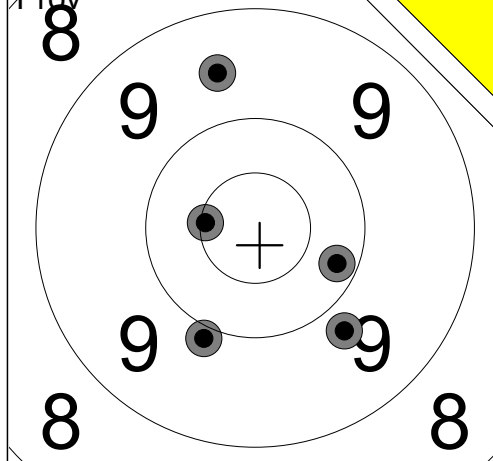

1:	10.2	→
2:	9.9	↓
3:	9.8	↓
4:	10.5x	←
5:	9.6	↑
Serie 47 (1x)		
Total 0 (0x)		

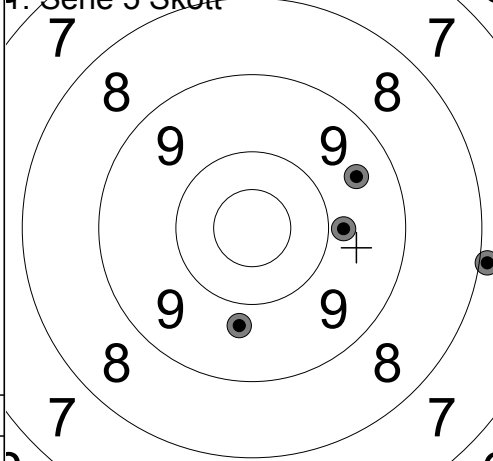

1:	9.8	↓
2:	7.9	→
3:	9.5	→
4:	9.8	→
5:	0.0	
Serie 34 (0x)		
Total 34 (0x)		

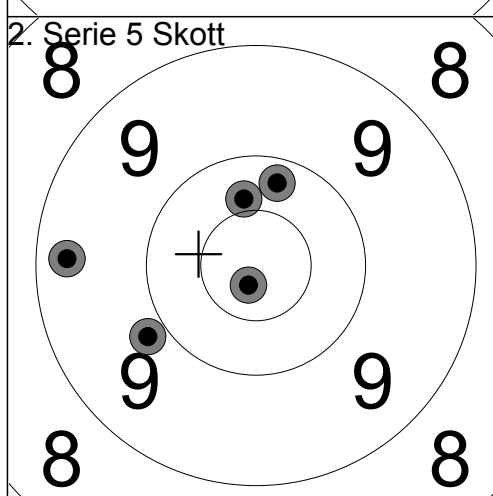

1:	9.3	←
2:	9.9	←
3:	10.2	↑
4:	10.8x	↓
5:	10.4	↑
Serie 48 (1x)		
Total 82 (1x)		

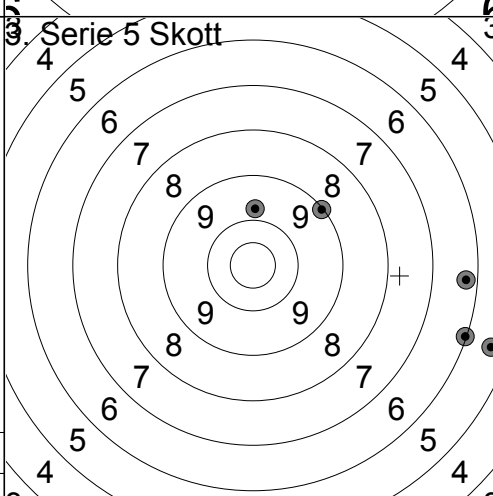

1:	9.1	↗
2:	6.0	→
3:	6.3	→
4:	5.4	→
5:	9.8	↑
Serie 35 (0x)		
Total 117 (1x)		

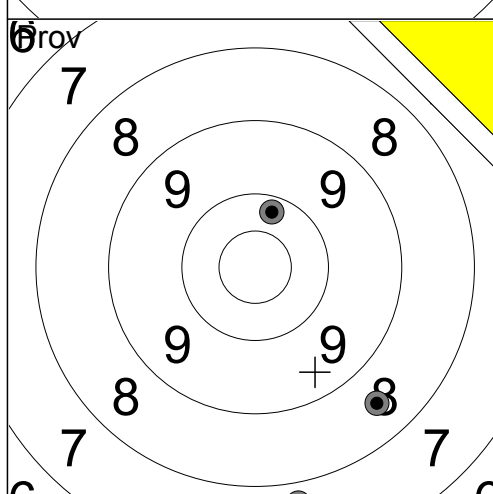

1:	8.5	↘
2:	7.8	↓
3:	10.2	↑
Serie 25 (0x)		
Total 117 (1x)		

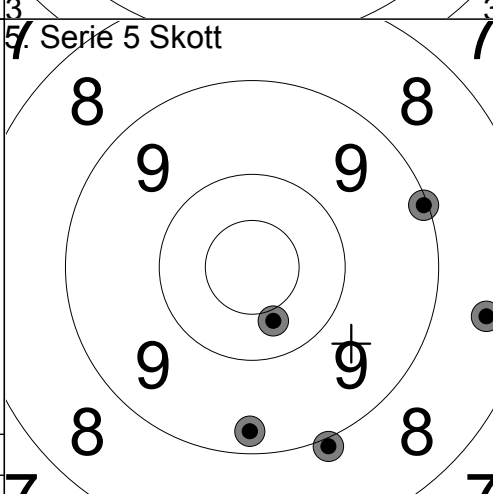

1:	8.5	→
2:	9.3	↓
3:	10.4	↓
4:	8.9	↓
5:	9.1	→
Serie 44 (0x)		
Total 161 (1x)		

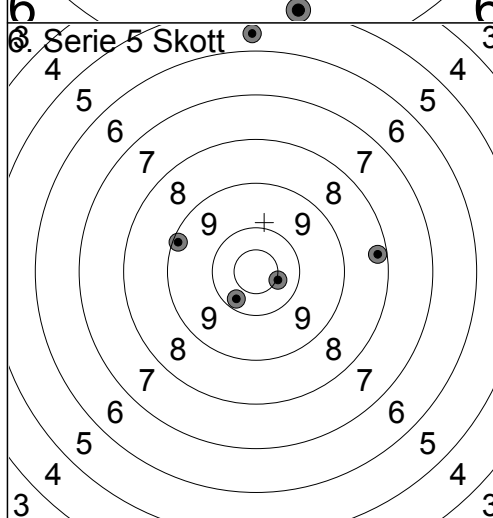

1:	5.6	↑
2:	9.1	←
3:	8.2	→
4:	10.5x	→
5:	10.3	↘
Serie 42 (1x)		
Total 203 (2x)		

Total 161 (1x)		
-----------------	--	--

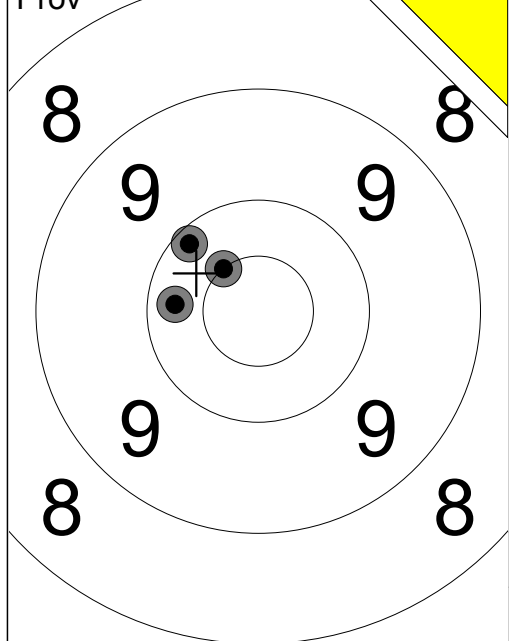

1:	10.3	↙
2:	10.5x	↗
3:	10.1	↗
Serie 30 (1x)		
Total 0 (0x)		

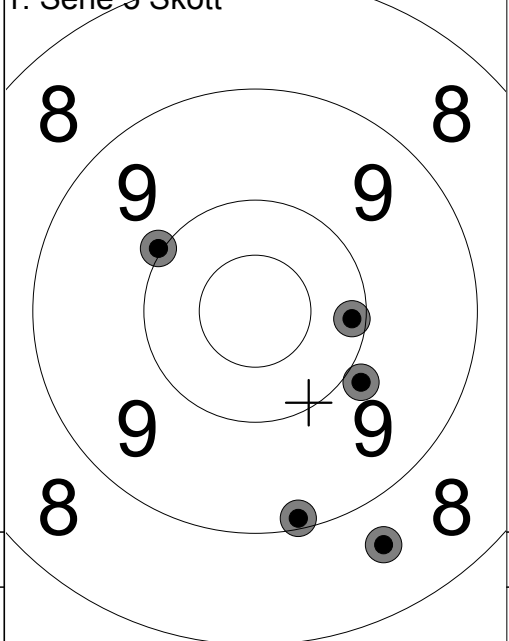

1:	8.6	↘
2:	9.9	↘
3:	9.1	↘
4:	10.0	↗
5:	10.1	→
Serie 46 (0x)		
Total 46 (0x)		

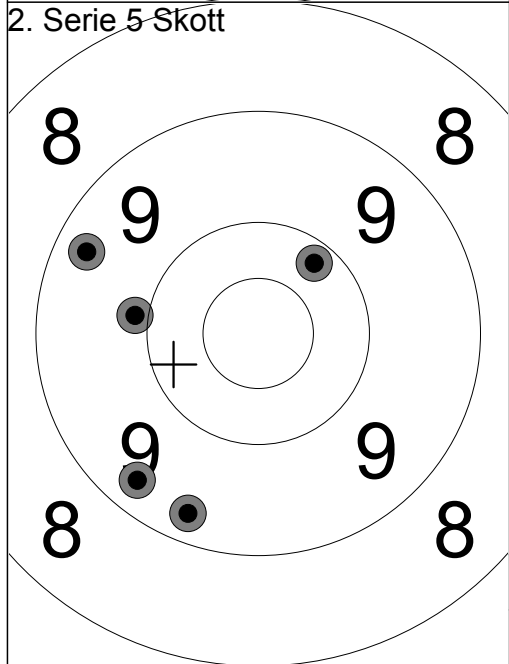

1:	10.2	↗
2:	9.3	↙
3:	9.3	↘
4:	9.9	↙
5:	9.3	↘
Serie 46 (0x)		
Total 92 (0x)		

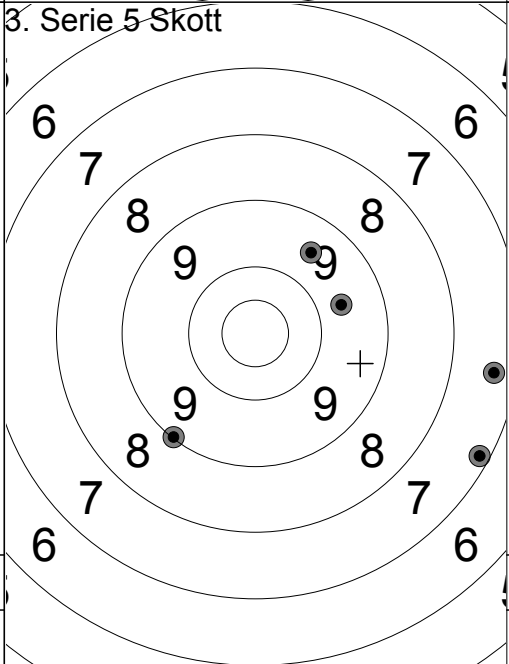

1:	9.0	↘
2:	7.4	→
3:	7.2	↘
4:	9.5	↗
5:	9.7	→
Serie 41 (0x)		
Total 133 (0x)		

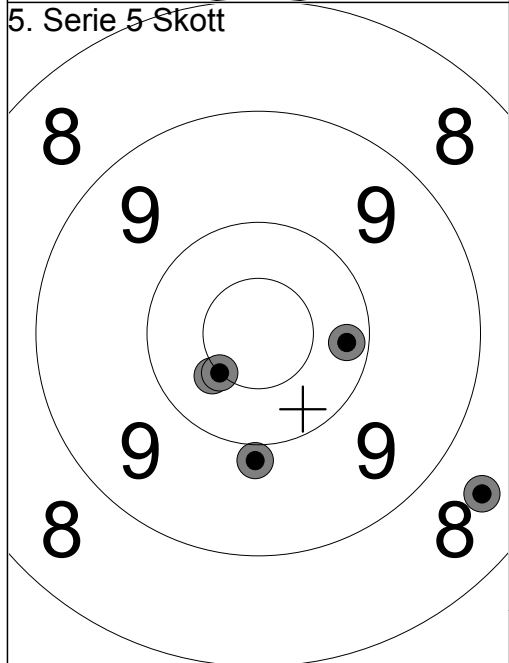

1:	10.4x	↘
2:	10.2	→
3:	8.5	↘
4:	10.5x	↘
5:	9.9	↘
Serie 47 (2x)		
Total 180 (2x)		

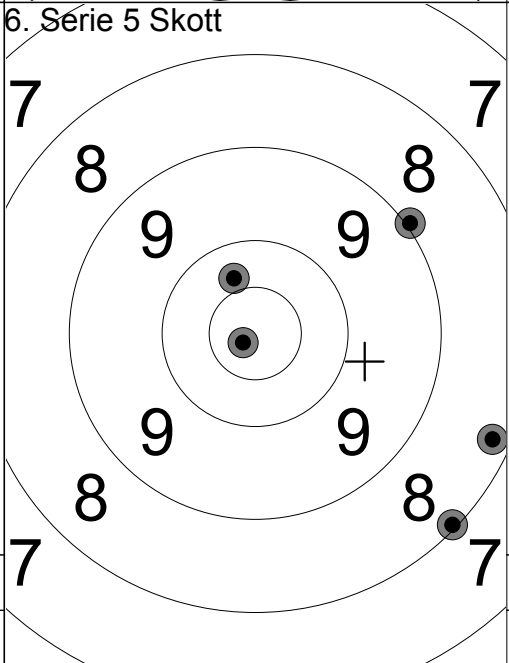

1:	8.1	↘
2:	10.8x	↘
3:	10.4	↗
4:	8.2	↘
5:	9.0	↗
Serie 45 (1x)		
Total 225 (3x)		

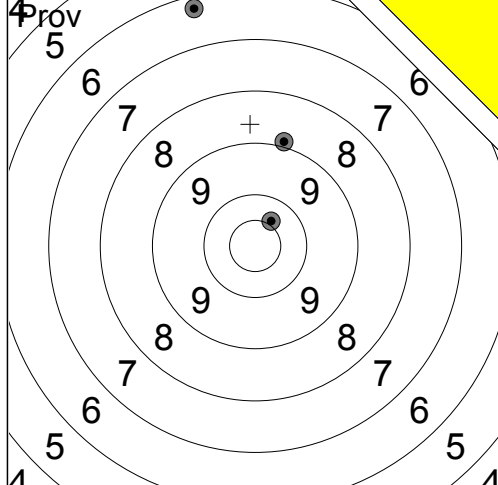

1:	8.9	↑
2:	10.4x	↗
3:	6.3	↑
Serie	24 (1x)	
Total	0 (0x)	

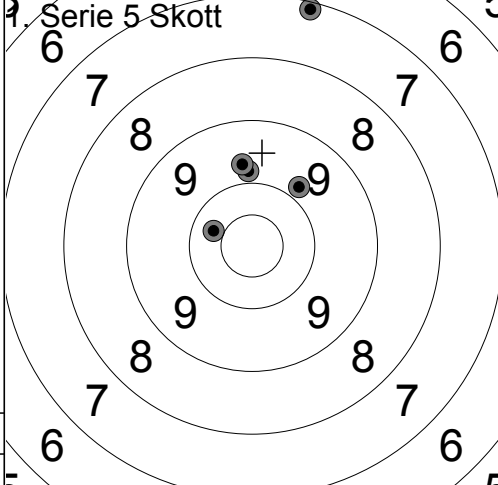

1:	10.3	←
2:	9.8	↑
3:	9.8	↗
4:	7.1	↑
5:	9.7	↑
Serie	44 (0x)	
Total	44 (0x)	

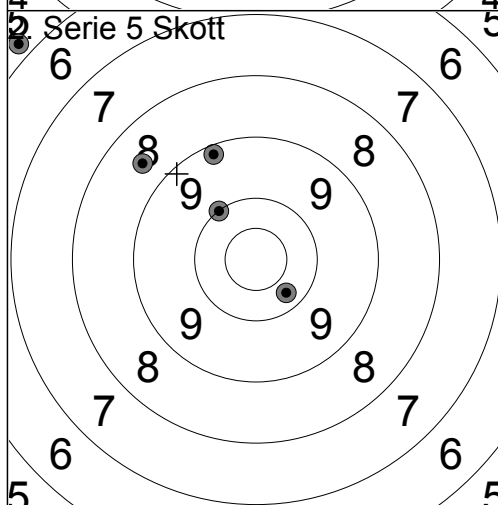

1:	10.3	↘
2:	8.6	↗
3:	10.0	↗
4:	9.2	↗
5:	5.8	↗
Serie	42 (0x)	
Total	86 (0x)	

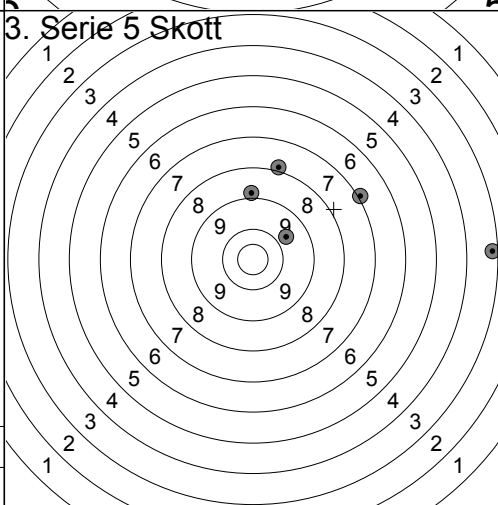

1:	8.9	↑
2:	9.7	↗
3:	7.0	↗
4:	3.2	→
5:	7.9	↑
Serie	34 (0x)	
Total	120 (0x)	

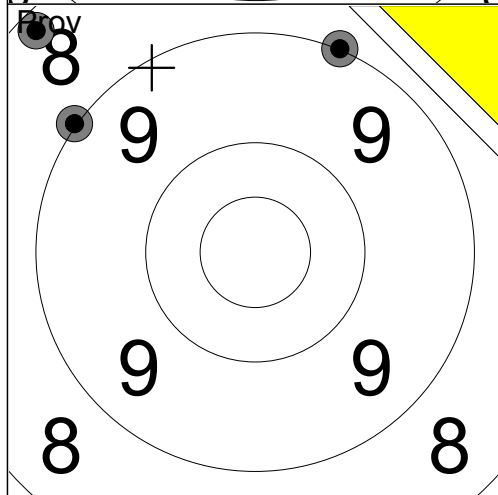

1:	8.2	↗
2:	9.0	↑
3:	9.0	←
Serie	26 (0x)	
Total	120 (0x)	

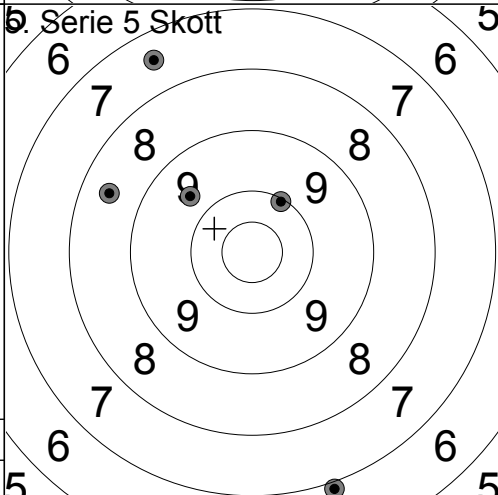

1:	9.7	↗
2:	7.5	↑
3:	8.5	←
4:	6.9	↘
5:	10.1	↗
Serie	40 (0x)	
Total	160 (0x)	

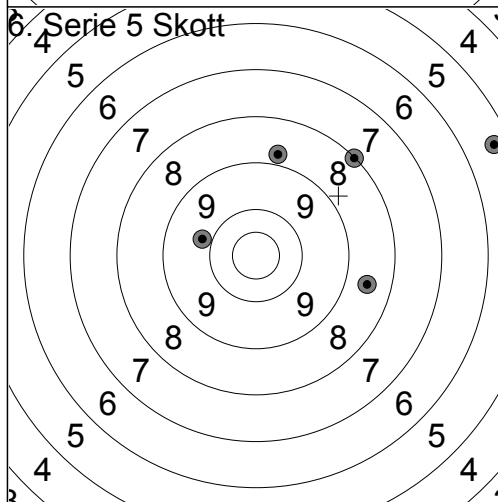

1:	5.4	→
2:	8.8	↑
3:	9.8	←
4:	8.1	↗
5:	8.6	→
Serie	38 (0x)	
Total	198 (0x)	

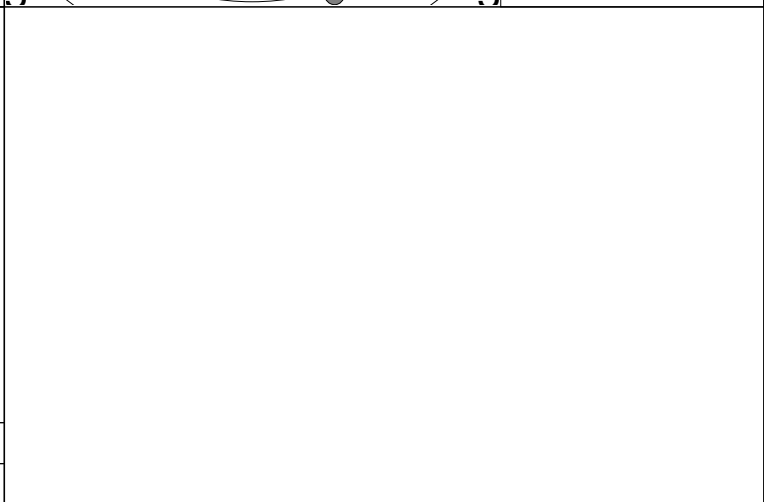

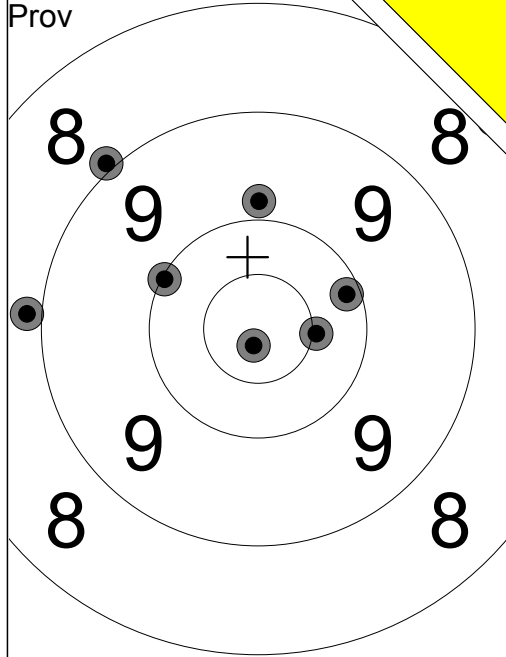

1:	10.1	→
2:	10.8x	↓
3:	9.0	↖
4:	10.0	↖
5:	10.4x	→
6:	8.1	↗
7:	9.9	↑
8:	8.9	←
Serie		74 (2x)
Total		0 (0x)

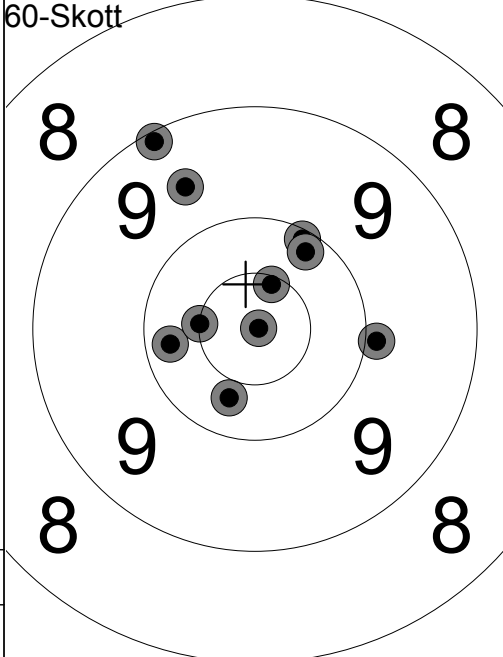

1:	9.1	↖
2:	10.2	←
3:	9.9	→
4:	10.9x	→
5:	10.1	↗
6:	9.6	↖
7:	10.6x	↗
8:	10.2	↗
9:	10.3	↓
10:	10.5x	←
Serie		97 (3x)
Total		97 (3x)

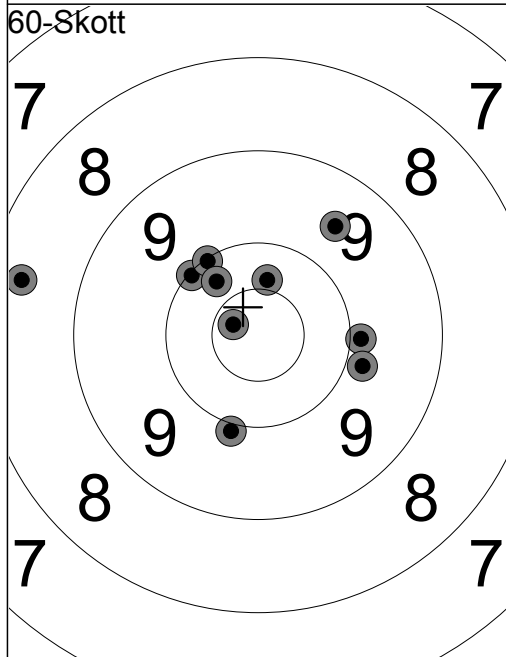

11:	9.6	↗
12:	9.9	↓
13:	10.1	↖
14:	8.4	←
15:	9.9	→
16:	9.9	→
17:	10.0	↗
18:	10.3	↗
19:	10.7x	↖
20:	10.4	↑
Serie		94 (1x)
Total		191 (4x)

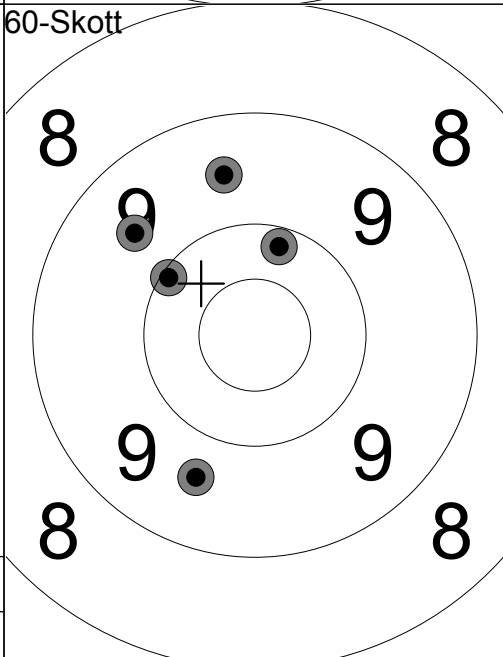

21:	9.6	↑
22:	10.1	↖
23:	10.2	↑
24:	9.6	↓
25:	9.6	↖
Serie		47 (0x)
Total		238 (4x)

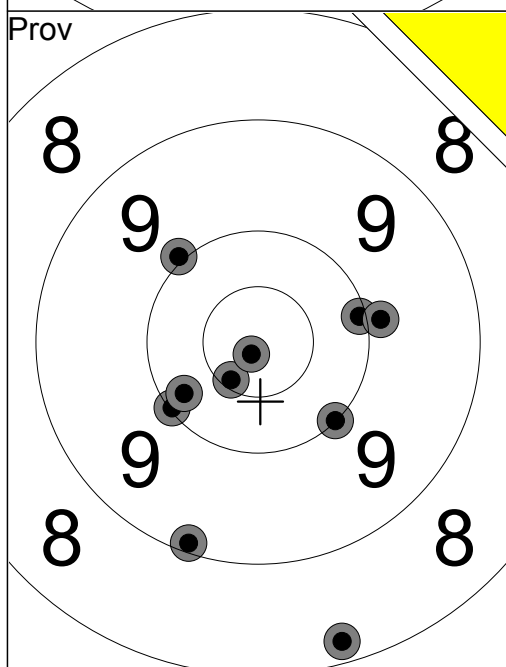

1:	10.6x	↙
2:	10.0	↙
3:	10.1	→
4:	9.1	↓
5:	10.0	↖
6:	8.2	↓
7:	10.2	↖
8:	9.9	→
9:	10.0	↓
10:	10.8x	↙
Serie		96 (2x)
Total		238 (4x)

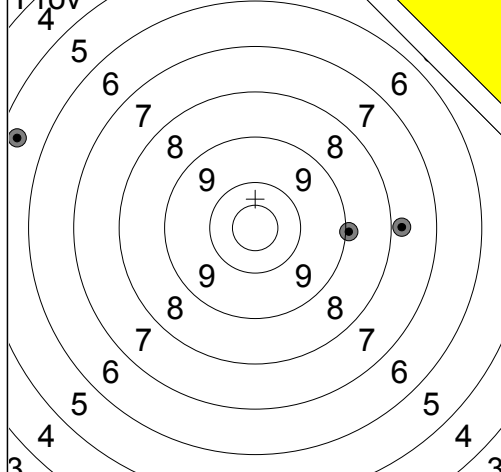

1:	9.0	→
2:	5.4	←
3:	7.8	→
Serie 21 (0x)		
Total 222 (0x)		

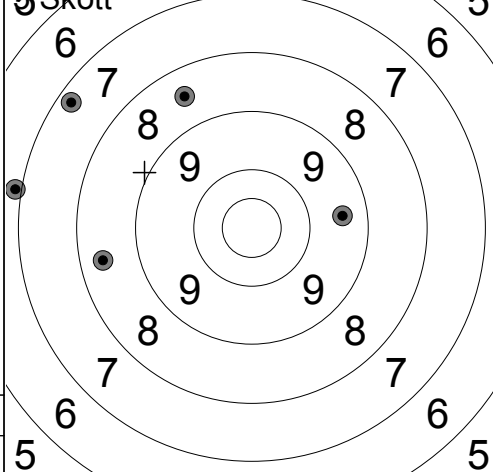

1:	8.5	↗
2:	8.4	←
3:	9.5	→
4:	7.3	↖
5:	6.9	←
Serie 38 (0x)		
Total 260 (0x)		

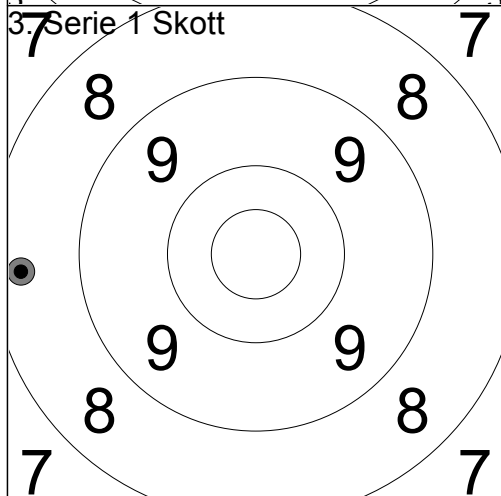

1:	8.4	←
Serie 8 (0x)		
Total 268 (0x)		

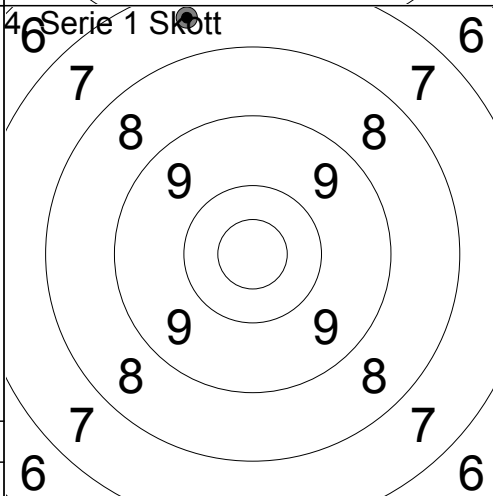

1:	7.5	↗
Serie 7 (0x)		
Total 275 (0x)		

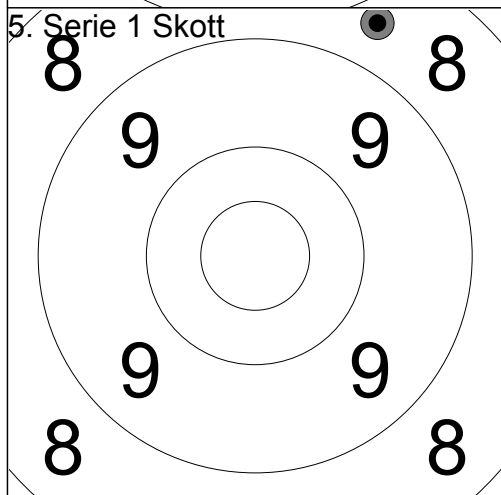

1:	8.6	↗
Serie 8 (0x)		
Total 283 (0x)		

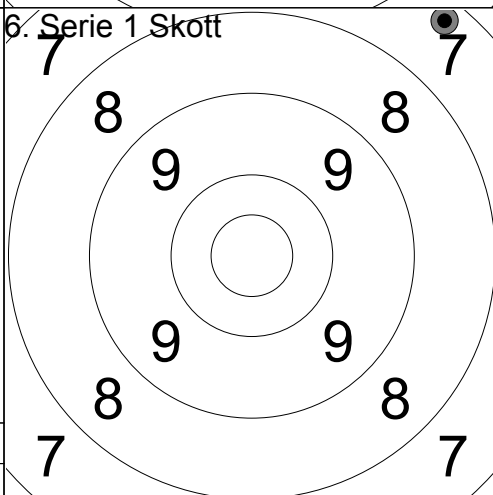

1:	7.3	↗
Serie 7 (0x)		
Total 290 (0x)		

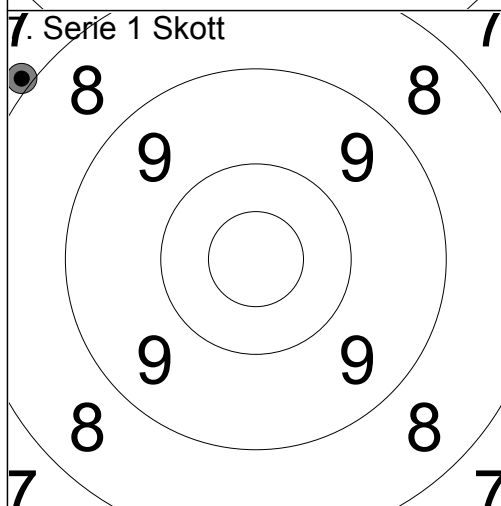

1:	7.9	↖
Serie 7 (0x)		
Total 297 (0x)		

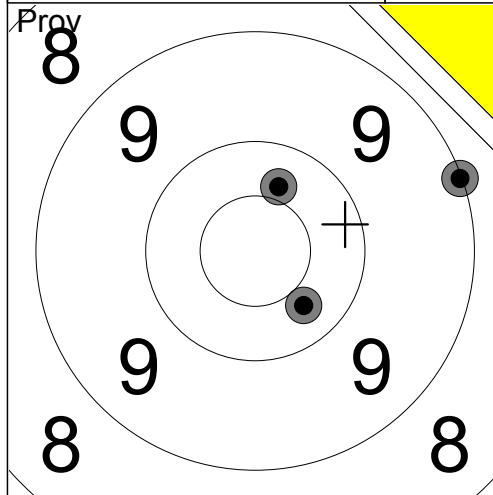

1:	10.4	↑
2:	9.1	→
3:	10.3	↓
Serie 29 (0x)		
Total 235 (0x)		

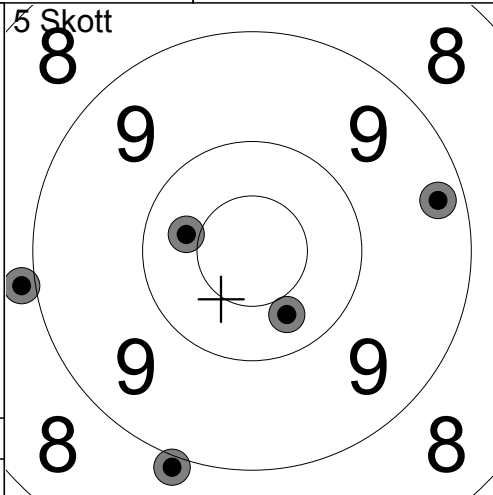

1:	9.3	→
2:	10.4	←
3:	8.9	←
4:	10.3	↓
5:	8.9	↓
Serie 45 (0x)		
Total 280 (0x)		

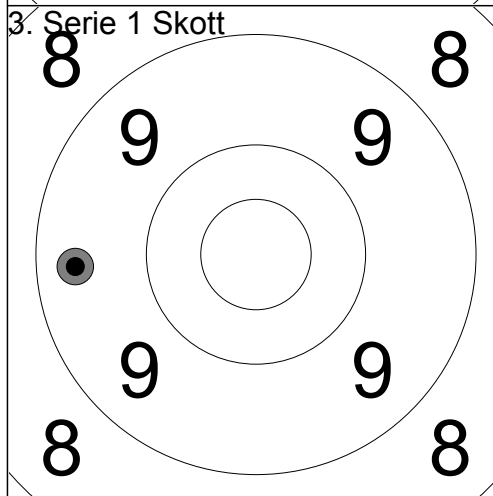

1:	9.4	←
Serie 9 (0x)		
Total 289 (0x)		

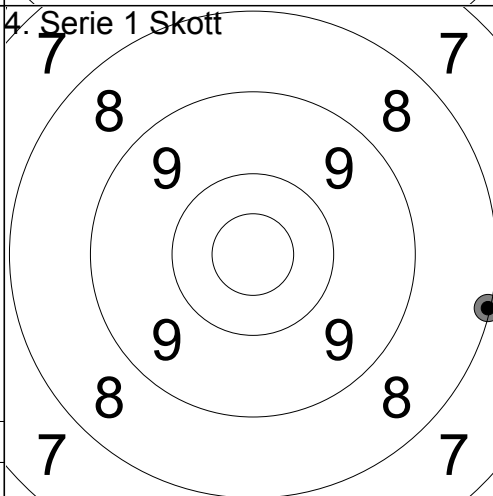

1:	8.1	→
Serie 8 (0x)		
Total 297 (0x)		

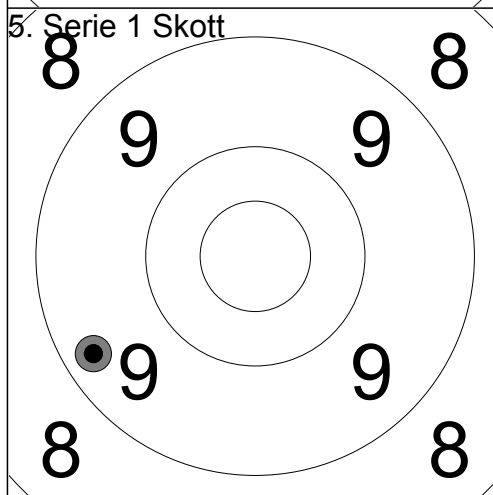

1:	9.3	←
Serie 9 (0x)		
Total 306 (0x)		

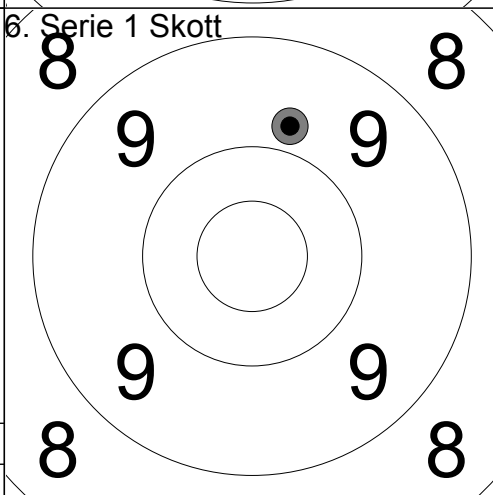

1:	9.8	↑
Serie 9 (0x)		
Total 315 (0x)		

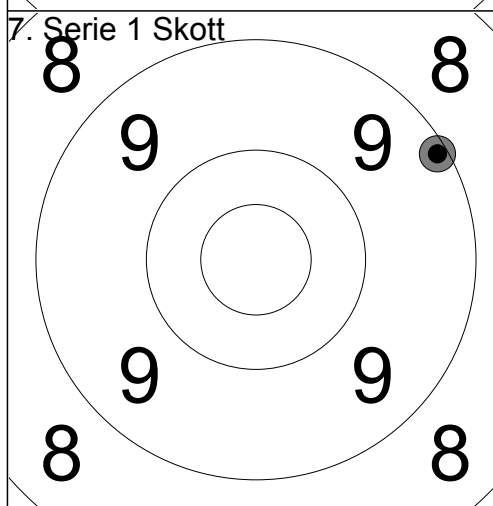

1:	9.1	→
Serie 9 (0x)		
Total 324 (0x)		

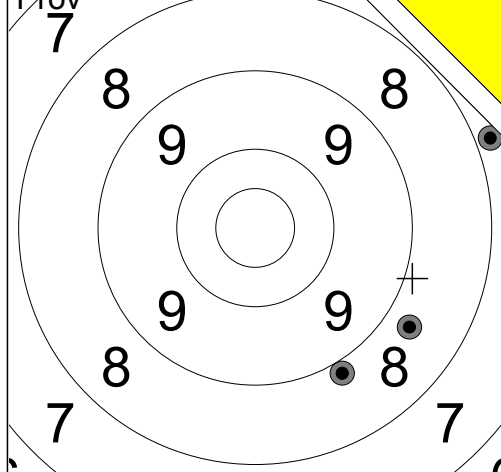

1:	7.8	→
2:	8.9	↘
3:	8.7	↘
Serie 23 (0x)		
Total 203 (0x)		

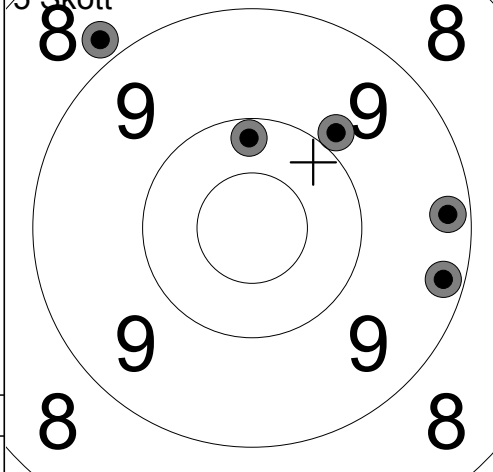

1:	10.2	↑
2:	9.9	↗
3:	9.2	→
4:	8.8	↗
5:	9.2	→
Serie 45 (0x)		
Total 248 (0x)		

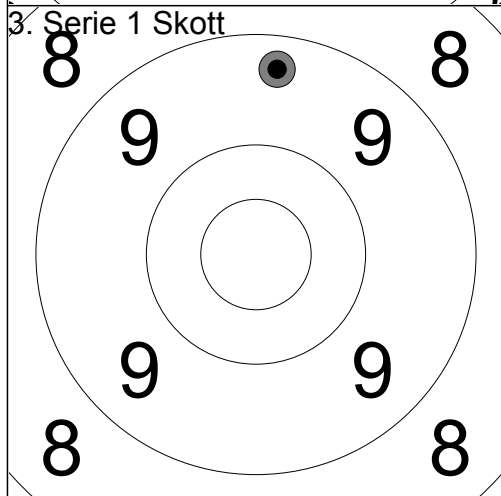

1:	9.3	↑
Serie 9 (0x)		
Total 257 (0x)		

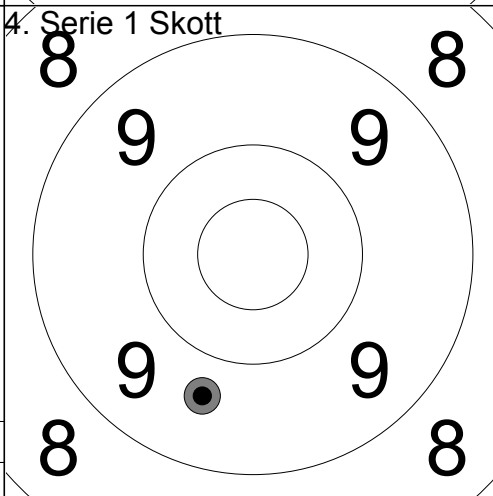

1:	9.7	↘
Serie 9 (0x)		
Total 266 (0x)		

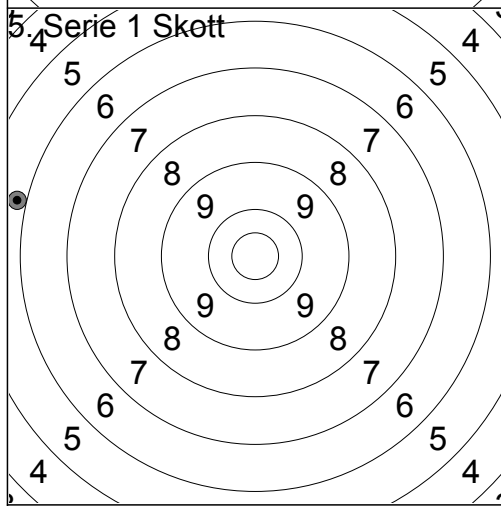

1:	5.8	←
Serie 5 (0x)		
Total 271 (0x)		

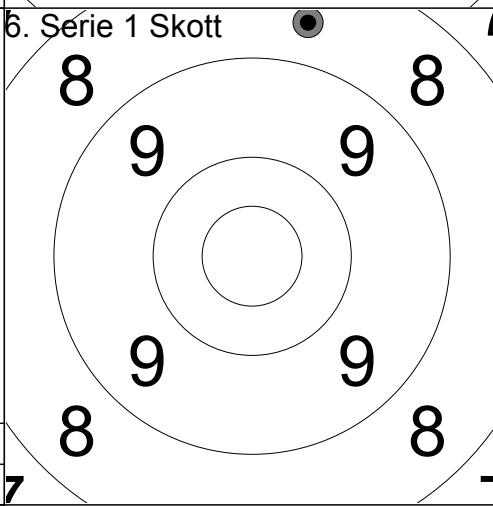

1:	8.6	↑
Serie 8 (0x)		
Total 279 (0x)		

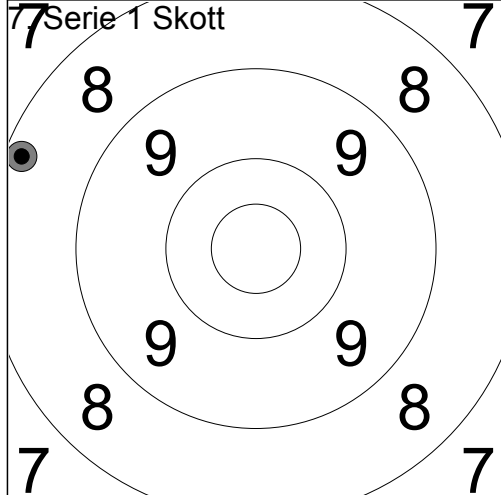

1:	8.2	←
Serie 8 (0x)		
Total 287 (0x)		

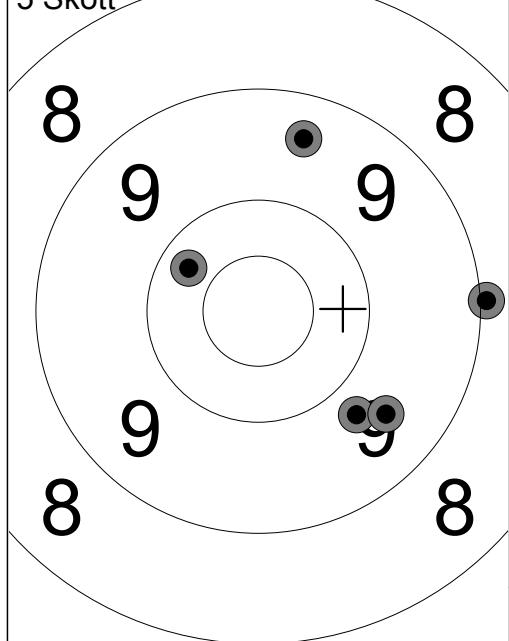

1:	9.7	↘
2:	9.0	→
3:	10.3	↗
4:	9.6	↘
5:	9.4	↗
<hr/>		
Serie	46	(0x)
Total	271	(0x)

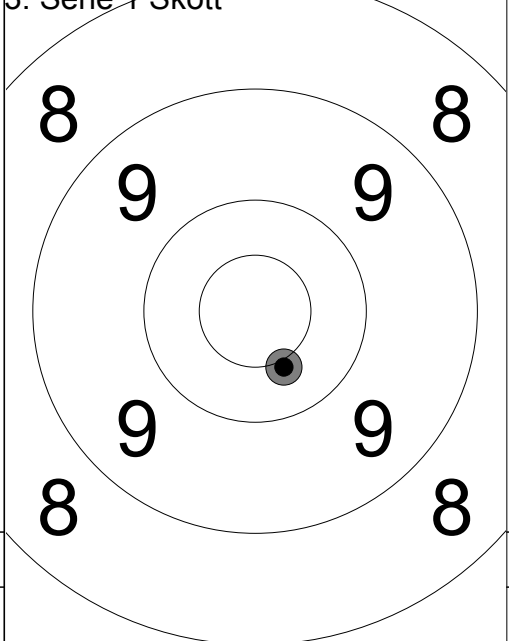

1:	10.4x	↘
<hr/>		
Serie	10	(1x)
Total	281	(1x)

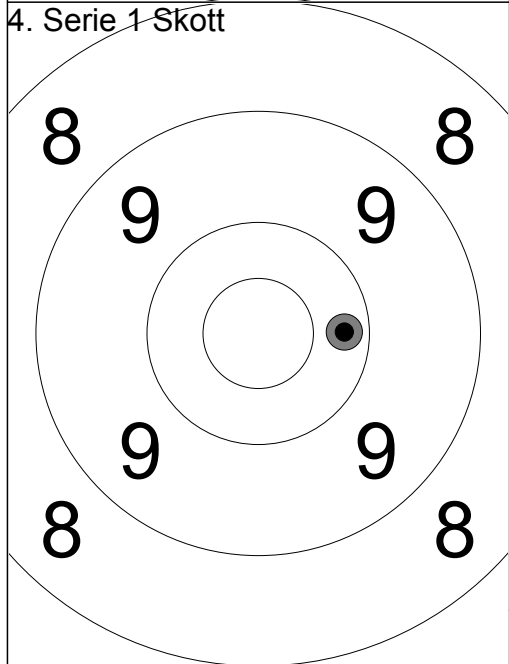

1:	10.2	→
<hr/>		
Serie	10	(0x)
Total	291	(1x)

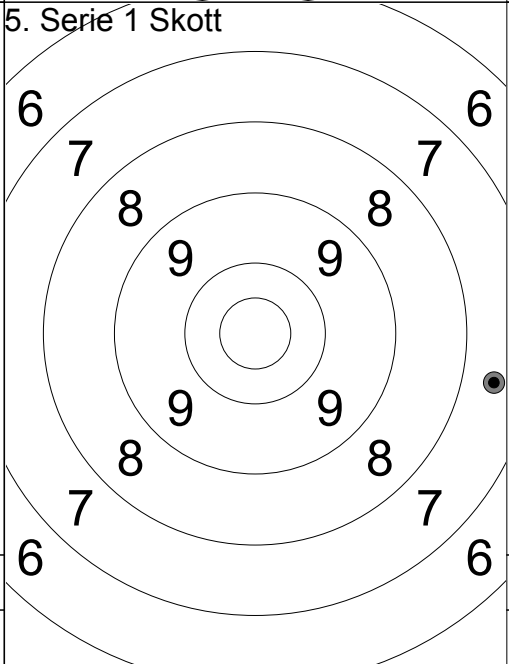

1:	7.6	→
<hr/>		
Serie	7	(0x)
Total	298	(1x)

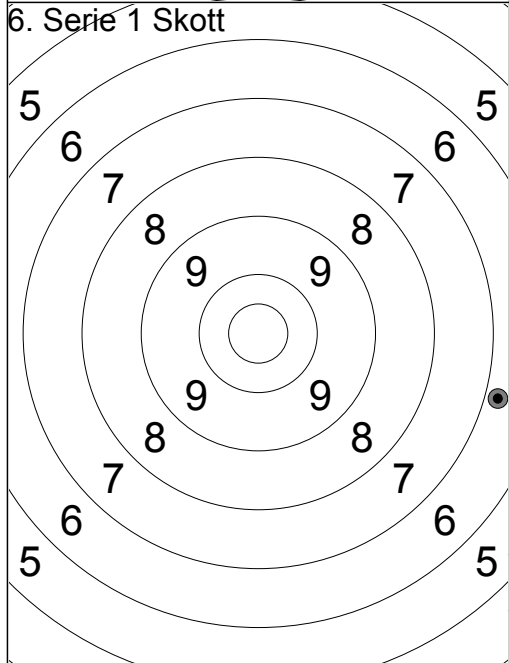

1:	6.8	→
<hr/>		
Serie	6	(0x)
Total	304	(1x)

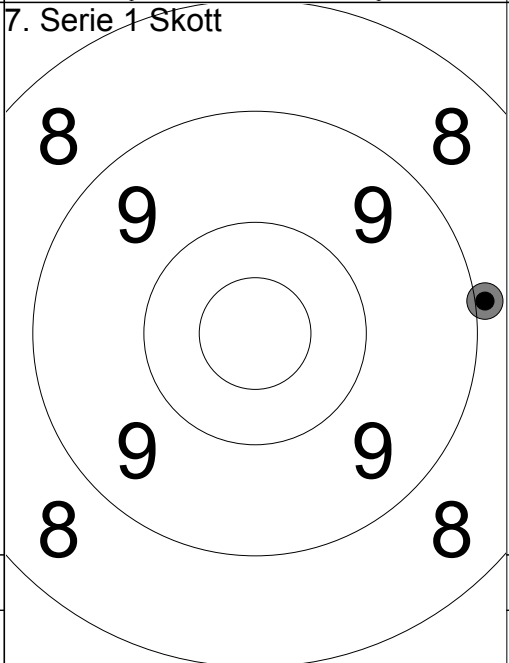

1:	8.9	→
<hr/>		
Serie	8	(0x)
Total	312	(1x)

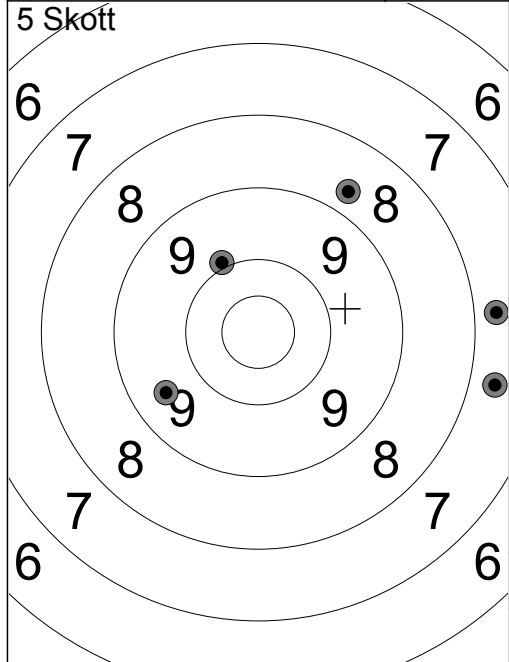

1:	9.9	↖
2:	7.7	→
3:	9.5	↙
4:	8.7	↗
5:	7.7	→
Serie 40 (0x)		
Total 238 (0x)		

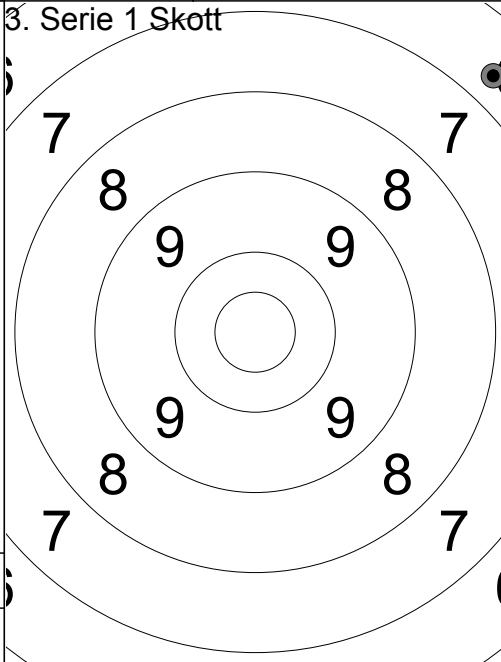

1:	6.7	↗
Serie 6 (0x)		
Total 244 (0x)		

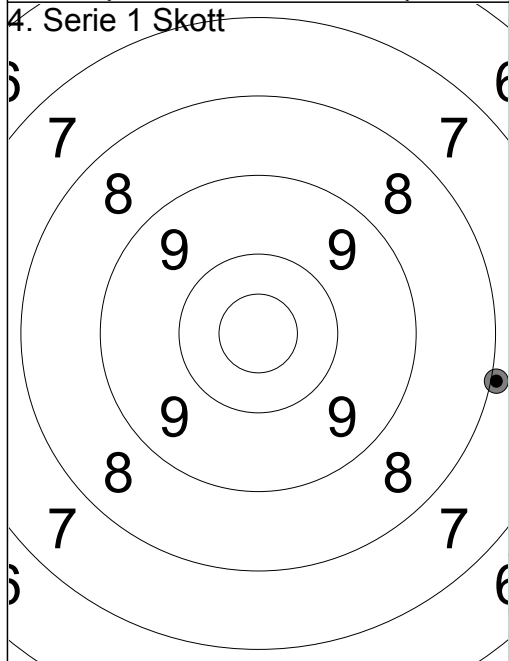

1:	8.0	→
Serie 8 (0x)		
Total 252 (0x)		

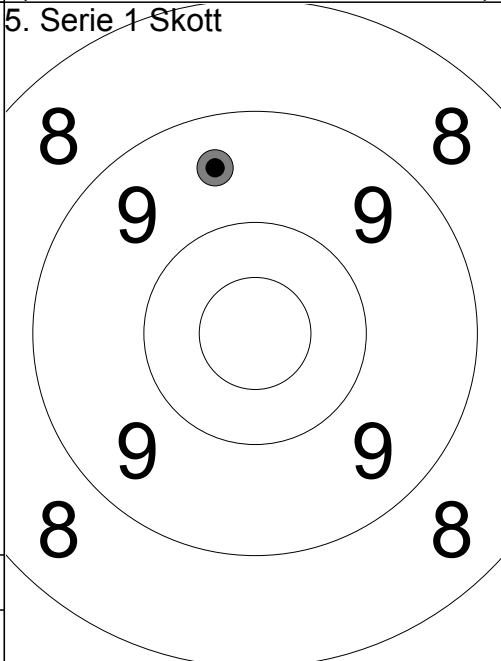

1:	9.5	↖
Serie 9 (0x)		
Total 261 (0x)		

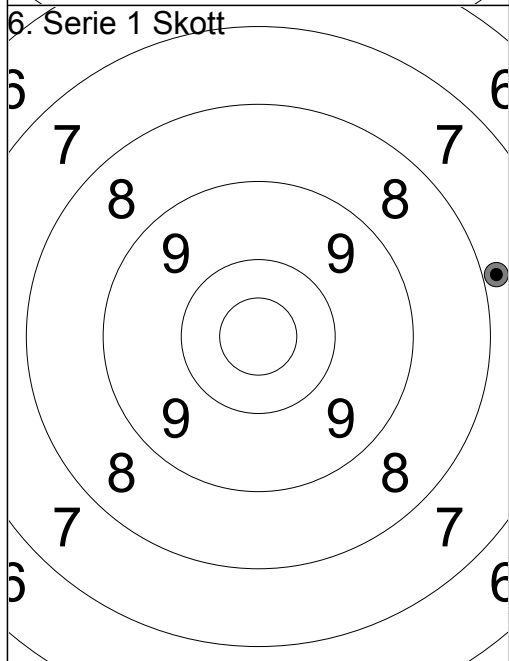

1:	7.9	→
Serie 7 (0x)		
Total 268 (0x)		

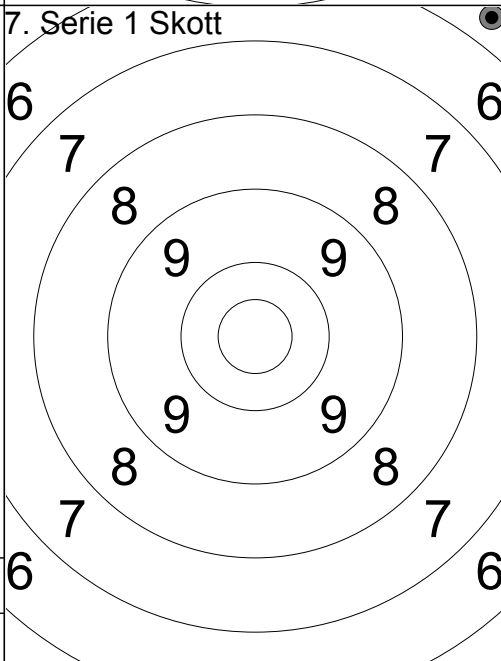

1:	5.7	↗
Serie 5 (0x)		
Total 273 (0x)		