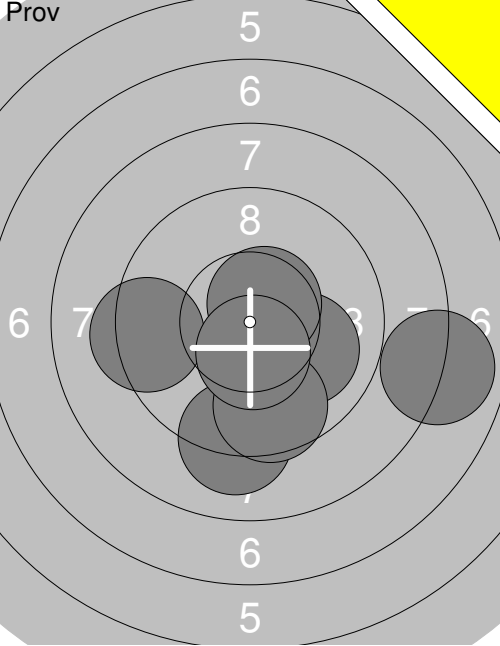
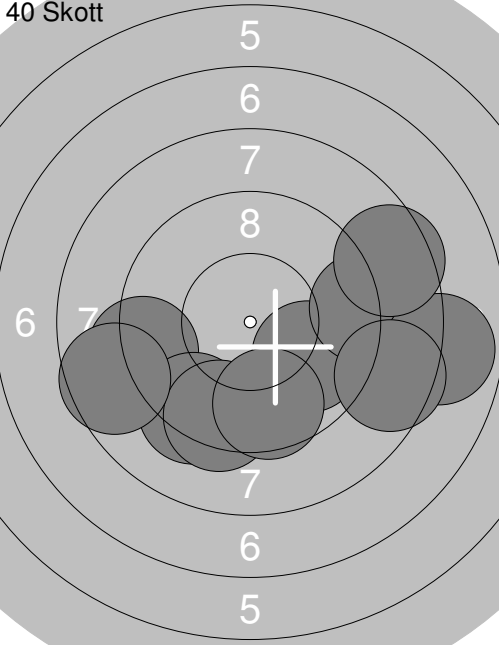
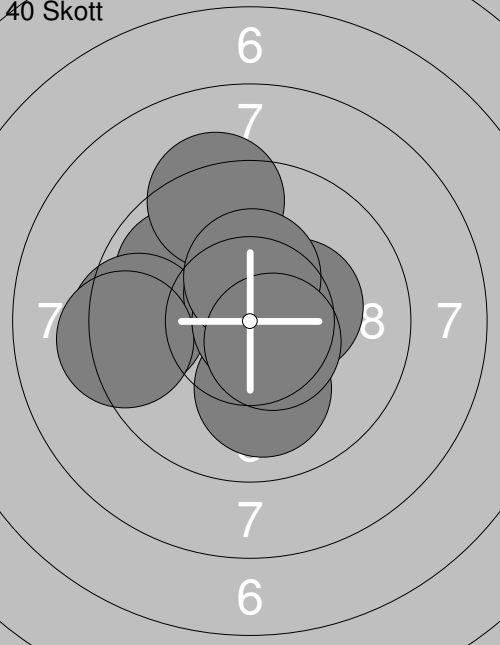
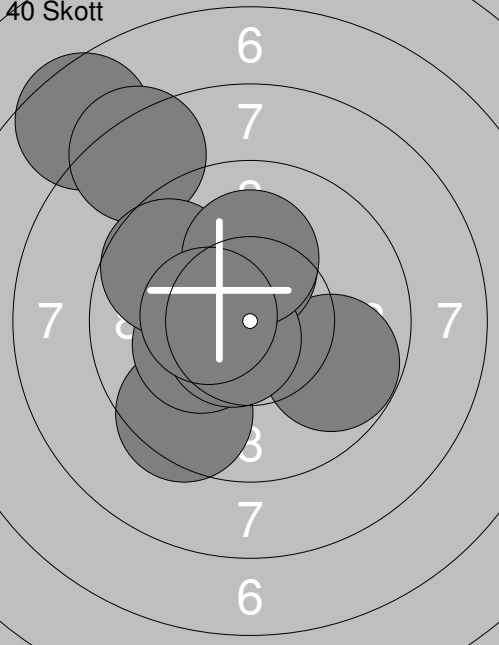
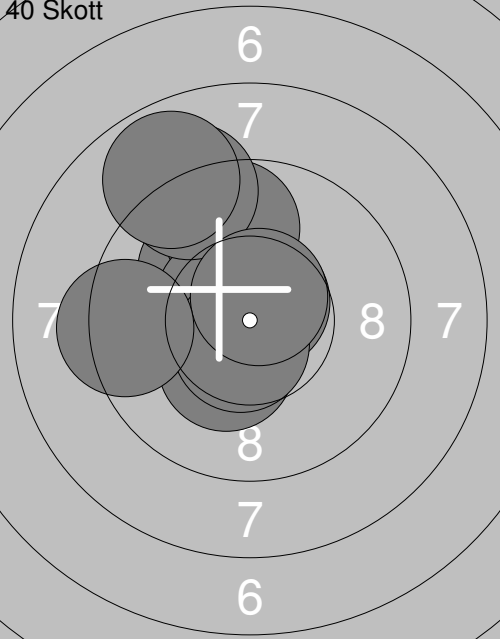
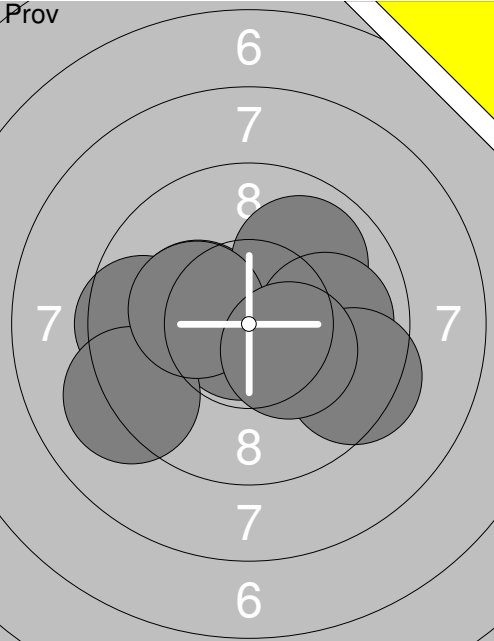
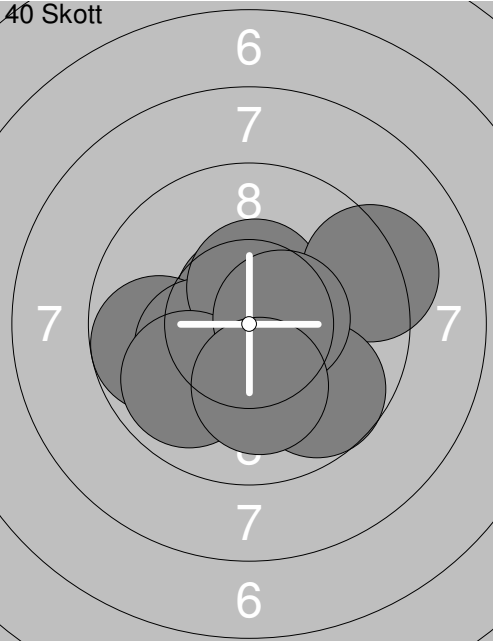
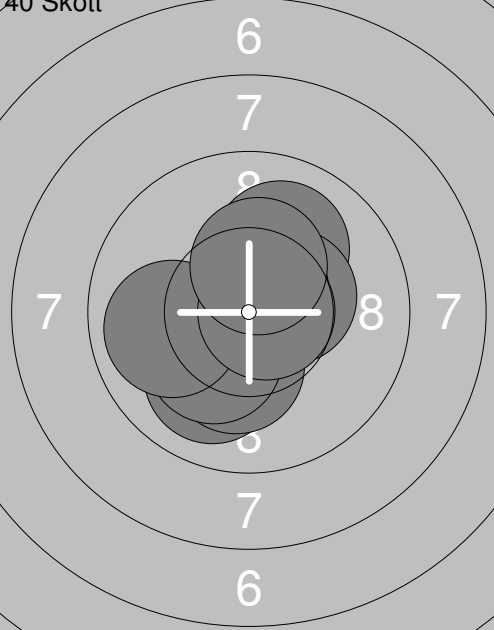
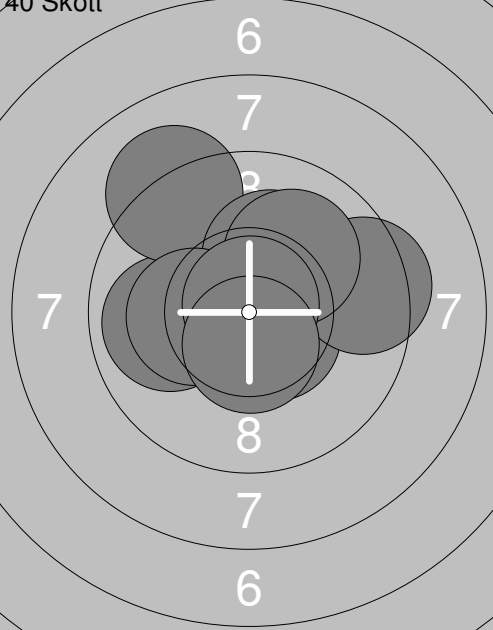
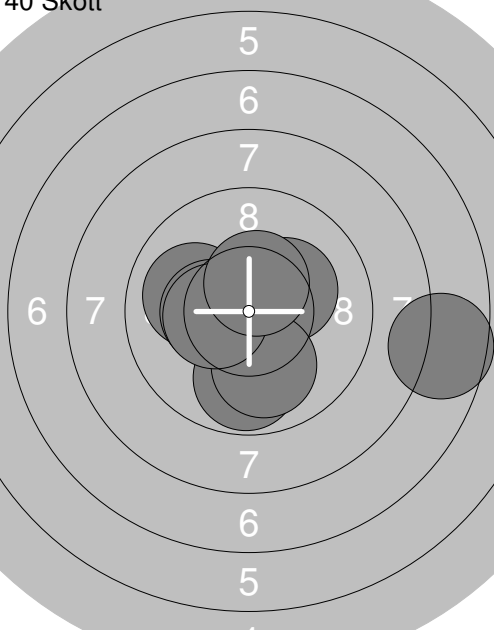
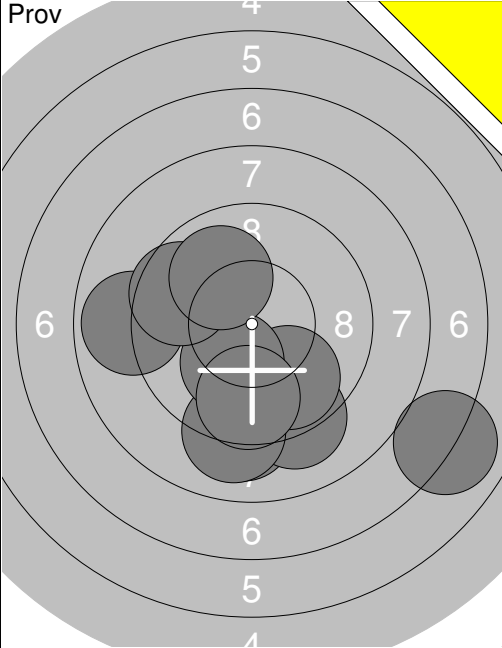
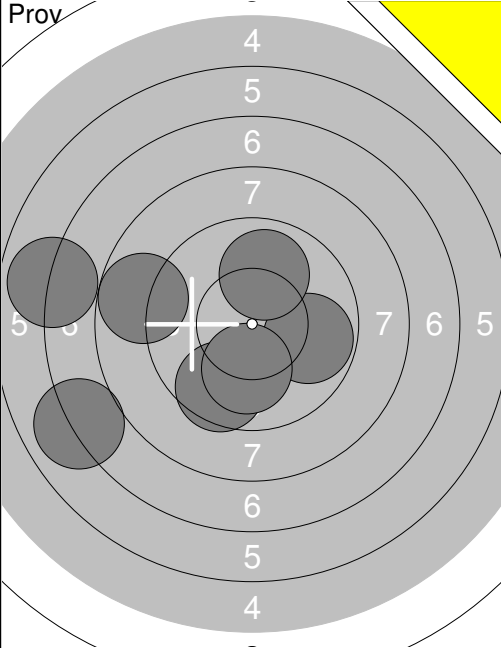
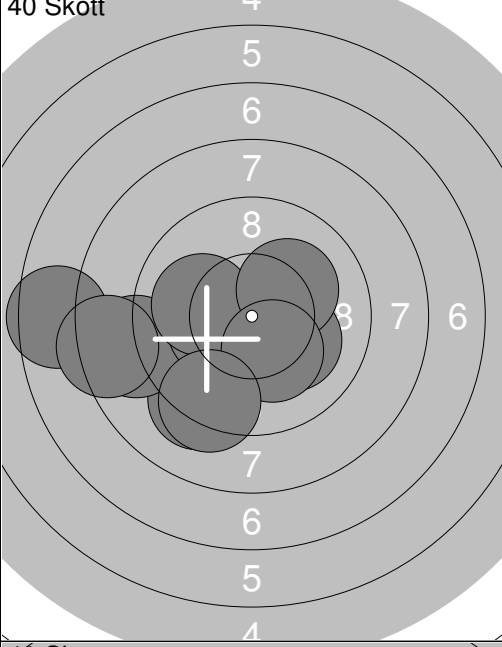
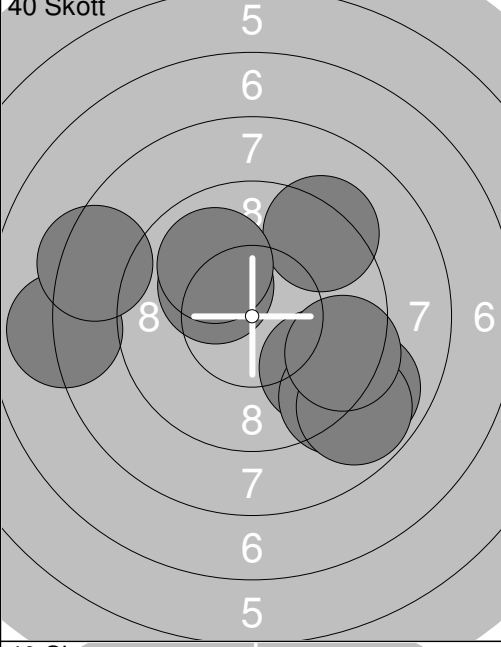
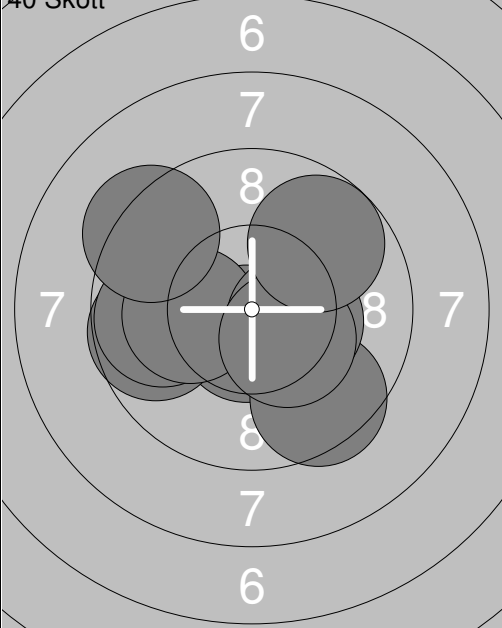
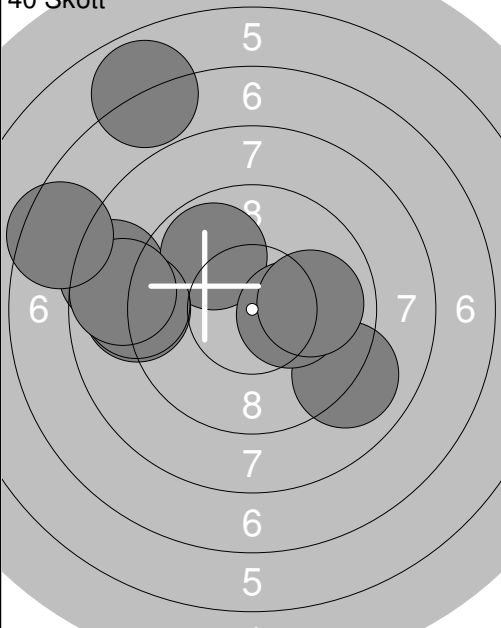
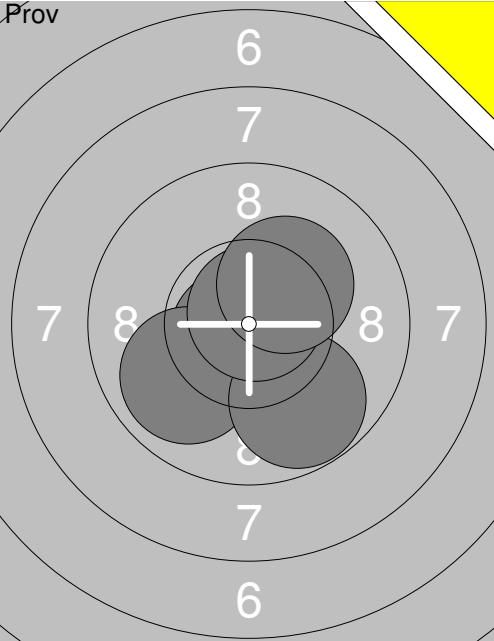
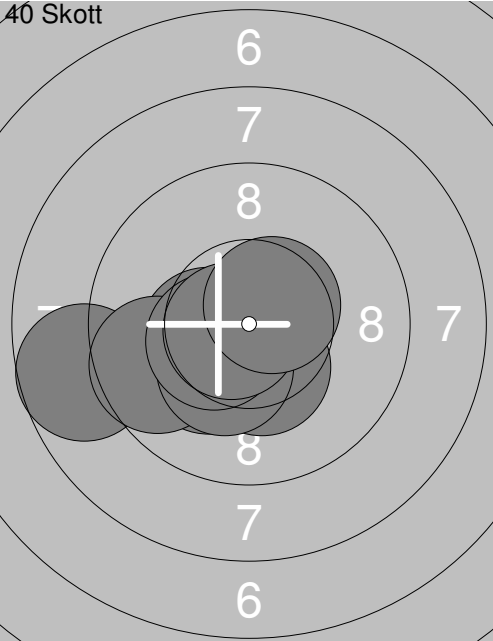
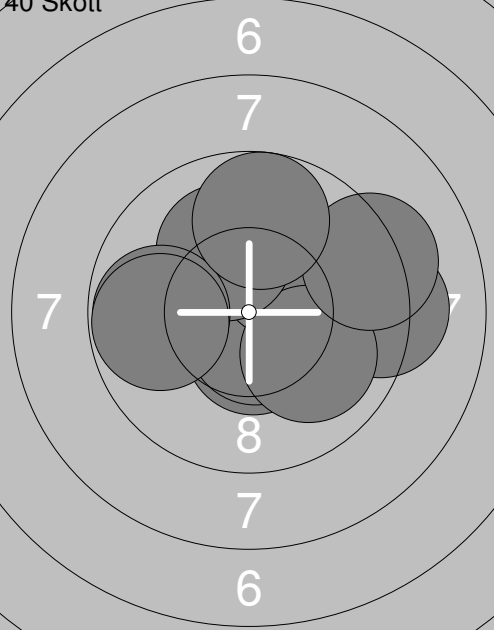
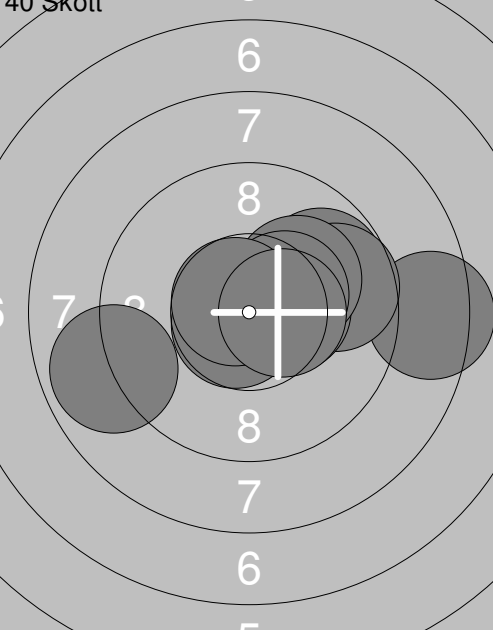
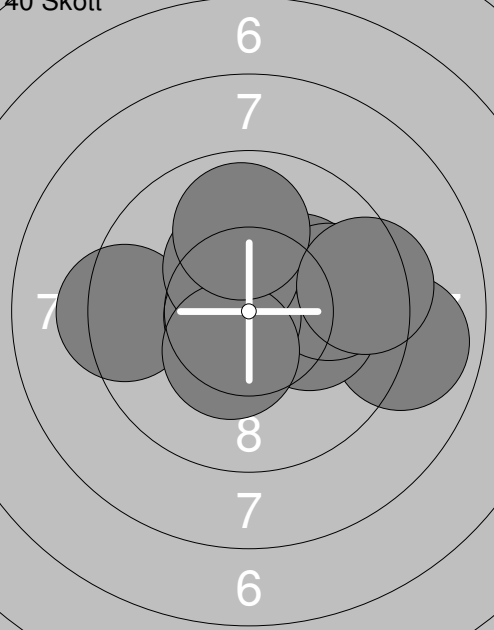

Skjutlag	Tavla	Vincent Stridsson	
S	Gällivare Skf	L17s	No
04.02.2023	Skyttiaden 2023 Region	Umeå skytteallians	
Prov		1: 9.1 ↓ 2: 7.9 → 3: 10.0 → 4: 9.6 ↓ 5: 9.3 ← 6: 10.6x ↗ 7: 10.5x ↓	40 Skott  1: 9.9 ↘ 2: 9.1 → 3: 7.9 → 4: 8.5 → 5: 8.5 ↗ 6: 9.2 ← 7: 9.3 ↓ 8: 9.4 ↓ 9: 8.6 ← 10: 9.6 ↓
	Serie 67.0	Serie 90.0	
	Total 0.0	Total 90.0	
40 Skott		11: 9.9 ↖ 12: 9.5 ← 13: 10.6x ↗ 14: 10.1 ↓ 15: 9.3 ← 16: 10.8x → 17: 9.3 ↑ 18: 10.3x → 19: 10.4x ↗ 20: 10.6x ↘	40 Skott  21: 9.5 ↘ 22: 7.6 ↖ 23: 9.8 → 24: 8.3 ↖ 25: 10.2x ↘ 26: 10.2x ↗ 27: 10.6x ↘ 28: 9.7 ↖ 29: 10.1 ↑ 30: 10.4x ↘
	Serie 100.8	Serie 96.4	
	Total 190.8	Total 287.2	
40 Skott		31: 10.7x ↗ 32: 10.1 ↖ 33: 10.3x ↘ 34: 9.7 ↑ 35: 10.5x ↘ 36: 10.6x ↘ 37: 9.1 ↖ 38: 10.6x ↗ 39: 8.9 ↖ 40: 9.3 ←	
	Serie 99.8		
	Total 387.0		

Skjutlag 1	Tavla 12	Nicolle Nygren	
S		Umeå Skf	L17s Vb
04.02.2023		Skyttiaden 2023 Region	Umeå skytteallians
Prov		1: 10.3x↖ 2: 9.6 ← 3: 10.8x↙ 4: 10.7x➤ 5: 9.9 ↗ 6: 10.0➔ 7: 9.2 ↙ 8: 10.2x↖ 9: 9.4 ➤ 10: 10.3x↘ Serie 100.4 Total 0.0	40 Skott  1: 10.7x↗ 2: 10.7x↗ 3: 9.7 ← 4: 10.3x↖ 5: 10.5x↗ 6: 9.2 ➔ 7: 9.9 ↙ 8: 9.7 ↘ 9: 10.5x➤ 10: 10.1 ↓ Serie 101.3 Total 101.3
40 Skott		11: 10.0 ↗ 12: 10.6x↗ 13: 10.0 ↘ 14: 10.4x➤ 15: 10.2x↘ 16: 10.6x↗ 17: 10.2x↘ 18: 9.9 ← 19: 10.7x➤ 20: 10.3x↗ Serie 102.9 Total 204.2	40 Skott  21: 10.7x↘ 22: 10.5x↘ 23: 9.4 ➔ 24: 9.9 ← 25: 9.1 ↗ 26: 10.2x↗ 27: 10.0 ↗ 28: 10.2x↖ 29: 10.9x↗ 30: 10.5x↘ Serie 101.4 Total 305.6
40 Skott		31: 10.7x↖ 32: 10.0↖ 33: 7.6 ➔ 34: 10.7x↙ 35: 10.3x↖ 36: 9.8 ↓ 37: 10.2x➤ 38: 10.0 ↓ 39: 10.4x↖ 40: 10.5x↗ Serie 100.2 Total 405.8	

Skjutlag	Tavla	Olle Grindborg																																																																								
S	Fältjägarna Skf	L17s	Jä																																																																							
04.02.2023	Skyttiaden 2023 Region	Umeå skytteallians																																																																								
Prov	 <table border="1"> <tr><td>1:</td><td>9.1</td><td>↓</td></tr> <tr><td>2:</td><td>9.2</td><td>↓</td></tr> <tr><td>3:</td><td>9.8</td><td>↓</td></tr> <tr><td>4:</td><td>8.9</td><td>←</td></tr> <tr><td>5:</td><td>9.1</td><td>↓</td></tr> <tr><td>6:</td><td>10.2x</td><td>↘</td></tr> <tr><td>7:</td><td>9.7</td><td>↓</td></tr> <tr><td>8:</td><td>9.6</td><td>←</td></tr> <tr><td>9:</td><td>10.0</td><td>↗</td></tr> <tr><td>10:</td><td>7.0</td><td>↘</td></tr> <tr><td>Serie</td><td>92.6</td><td></td></tr> <tr><td>Total</td><td>0.0</td><td></td></tr> </table>	1:	9.1	↓	2:	9.2	↓	3:	9.8	↓	4:	8.9	←	5:	9.1	↓	6:	10.2x	↘	7:	9.7	↓	8:	9.6	←	9:	10.0	↗	10:	7.0	↘	Serie	92.6		Total	0.0		 <table border="1"> <tr><td>11:</td><td>6.9</td><td>←</td></tr> <tr><td>12:</td><td>9.8</td><td>→</td></tr> <tr><td>13:</td><td>7.0</td><td>↙</td></tr> <tr><td>14:</td><td>9.6</td><td>↘</td></tr> <tr><td>15:</td><td>9.9</td><td>↑</td></tr> <tr><td>16:</td><td>8.7</td><td>←</td></tr> <tr><td>17:</td><td>10.1</td><td>↓</td></tr> <tr><td>Serie</td><td>62.0</td><td></td></tr> <tr><td>Total</td><td>0.0</td><td></td></tr> </table>	11:	6.9	←	12:	9.8	→	13:	7.0	↙	14:	9.6	↘	15:	9.9	↑	16:	8.7	←	17:	10.1	↓	Serie	62.0		Total	0.0										
1:	9.1	↓																																																																								
2:	9.2	↓																																																																								
3:	9.8	↓																																																																								
4:	8.9	←																																																																								
5:	9.1	↓																																																																								
6:	10.2x	↘																																																																								
7:	9.7	↓																																																																								
8:	9.6	←																																																																								
9:	10.0	↗																																																																								
10:	7.0	↘																																																																								
Serie	92.6																																																																									
Total	0.0																																																																									
11:	6.9	←																																																																								
12:	9.8	→																																																																								
13:	7.0	↙																																																																								
14:	9.6	↘																																																																								
15:	9.9	↑																																																																								
16:	8.7	←																																																																								
17:	10.1	↓																																																																								
Serie	62.0																																																																									
Total	0.0																																																																									
40 Skott	 <table border="1"> <tr><td>1:</td><td>9.2</td><td>↘</td></tr> <tr><td>2:</td><td>8.8</td><td>←</td></tr> <tr><td>3:</td><td>10.3x</td><td>↙</td></tr> <tr><td>4:</td><td>10.1</td><td>↘</td></tr> <tr><td>5:</td><td>10.1</td><td>←</td></tr> <tr><td>6:</td><td>10.2x</td><td>↗</td></tr> <tr><td>7:</td><td>10.2x</td><td>↘</td></tr> <tr><td>8:</td><td>7.5</td><td>←</td></tr> <tr><td>9:</td><td>8.4</td><td>←</td></tr> <tr><td>10:</td><td>9.3</td><td>↘</td></tr> <tr><td>Serie</td><td>94.1</td><td></td></tr> <tr><td>Total</td><td>94.1</td><td></td></tr> </table>	1:	9.2	↘	2:	8.8	←	3:	10.3x	↙	4:	10.1	↘	5:	10.1	←	6:	10.2x	↗	7:	10.2x	↘	8:	7.5	←	9:	8.4	←	10:	9.3	↘	Serie	94.1		Total	94.1		 <table border="1"> <tr><td>11:</td><td>9.3</td><td>↗</td></tr> <tr><td>12:</td><td>9.7</td><td>↘</td></tr> <tr><td>13:</td><td>8.9</td><td>↘</td></tr> <tr><td>14:</td><td>8.0</td><td>←</td></tr> <tr><td>15:</td><td>9.1</td><td>↘</td></tr> <tr><td>16:</td><td>8.8</td><td>↘</td></tr> <tr><td>17:</td><td>10.2x</td><td>↙</td></tr> <tr><td>18:</td><td>9.4</td><td>↘</td></tr> <tr><td>19:</td><td>10.0</td><td>↗</td></tr> <tr><td>20:</td><td>8.4</td><td>←</td></tr> <tr><td>Serie</td><td>91.8</td><td></td></tr> <tr><td>Total</td><td>185.9</td><td></td></tr> </table>	11:	9.3	↗	12:	9.7	↘	13:	8.9	↘	14:	8.0	←	15:	9.1	↘	16:	8.8	↘	17:	10.2x	↙	18:	9.4	↘	19:	10.0	↗	20:	8.4	←	Serie	91.8		Total	185.9	
1:	9.2	↘																																																																								
2:	8.8	←																																																																								
3:	10.3x	↙																																																																								
4:	10.1	↘																																																																								
5:	10.1	←																																																																								
6:	10.2x	↗																																																																								
7:	10.2x	↘																																																																								
8:	7.5	←																																																																								
9:	8.4	←																																																																								
10:	9.3	↘																																																																								
Serie	94.1																																																																									
Total	94.1																																																																									
11:	9.3	↗																																																																								
12:	9.7	↘																																																																								
13:	8.9	↘																																																																								
14:	8.0	←																																																																								
15:	9.1	↘																																																																								
16:	8.8	↘																																																																								
17:	10.2x	↙																																																																								
18:	9.4	↘																																																																								
19:	10.0	↗																																																																								
20:	8.4	←																																																																								
Serie	91.8																																																																									
Total	185.9																																																																									
40 Skott	 <table border="1"> <tr><td>21:</td><td>10.6x</td><td>↘</td></tr> <tr><td>22:</td><td>9.5</td><td>↘</td></tr> <tr><td>23:</td><td>10.4x</td><td>↘</td></tr> <tr><td>24:</td><td>9.7</td><td>←</td></tr> <tr><td>25:</td><td>9.8</td><td>←</td></tr> <tr><td>26:</td><td>10.1</td><td>←</td></tr> <tr><td>27:</td><td>9.3</td><td>↙</td></tr> <tr><td>28:</td><td>10.4x</td><td>↘</td></tr> <tr><td>29:</td><td>10.3x</td><td>↘</td></tr> <tr><td>30:</td><td>9.8</td><td>↗</td></tr> <tr><td>Serie</td><td>99.9</td><td></td></tr> <tr><td>Total</td><td>285.8</td><td></td></tr> </table>	21:	10.6x	↘	22:	9.5	↘	23:	10.4x	↘	24:	9.7	←	25:	9.8	←	26:	10.1	←	27:	9.3	↙	28:	10.4x	↘	29:	10.3x	↘	30:	9.8	↗	Serie	99.9		Total	285.8		 <table border="1"> <tr><td>31:</td><td>8.5</td><td>←</td></tr> <tr><td>32:</td><td>9.9</td><td>↗</td></tr> <tr><td>33:</td><td>9.0</td><td>↘</td></tr> <tr><td>34:</td><td>9.0</td><td>←</td></tr> <tr><td>35:</td><td>10.3x</td><td>↘</td></tr> <tr><td>36:</td><td>10.0</td><td>→</td></tr> <tr><td>37:</td><td>6.9</td><td>↗</td></tr> <tr><td>38:</td><td>9.0</td><td>←</td></tr> <tr><td>39:</td><td>8.8</td><td>←</td></tr> <tr><td>40:</td><td>7.5</td><td>←</td></tr> <tr><td>Serie</td><td>88.9</td><td></td></tr> <tr><td>Total</td><td>374.7</td><td></td></tr> </table>	31:	8.5	←	32:	9.9	↗	33:	9.0	↘	34:	9.0	←	35:	10.3x	↘	36:	10.0	→	37:	6.9	↗	38:	9.0	←	39:	8.8	←	40:	7.5	←	Serie	88.9		Total	374.7	
21:	10.6x	↘																																																																								
22:	9.5	↘																																																																								
23:	10.4x	↘																																																																								
24:	9.7	←																																																																								
25:	9.8	←																																																																								
26:	10.1	←																																																																								
27:	9.3	↙																																																																								
28:	10.4x	↘																																																																								
29:	10.3x	↘																																																																								
30:	9.8	↗																																																																								
Serie	99.9																																																																									
Total	285.8																																																																									
31:	8.5	←																																																																								
32:	9.9	↗																																																																								
33:	9.0	↘																																																																								
34:	9.0	←																																																																								
35:	10.3x	↘																																																																								
36:	10.0	→																																																																								
37:	6.9	↗																																																																								
38:	9.0	←																																																																								
39:	8.8	←																																																																								
40:	7.5	←																																																																								
Serie	88.9																																																																									
Total	374.7																																																																									

Skjuttag	Tavla	Martin Blombäck			
1	14	Piteå Skf	L17s No		
04.02.2023	Skyttiaden 2023 Region	Umeå skytteallians			
Prov		1: 8.4 ← 2: 8.8 ↓ 3: 7.7 ↓ 5: 9.6 ↗ 6: 9.3 ← 7: 9.7 ← 8: 8.5 ↓ 9: 8.5 ↓ 10: 5.7 ↖	Prov		11: 7.8 → 13: 9.7 ↗ 14: 10.0 ↗ 15: 7.6 ← 16: 10.0 ↑ 17: 10.6 ↘
	Serie 76.2		Serie 55.7		
	Total 0.0		Total 0.0		
40 Skott		1: 9.9 ↗ 2: 9.4 → 3: 7.7 ↓ 4: 6.6 ← 5: 8.6 ↖ 6: 7.9 ↓ 7: 9.1 → 8: 9.7 ↓ 9: 9.3 ↓ 10: 6.7 ←	40 Skott		11: 8.7 ← 12: 9.4 ← 13: 8.2 ← 14: 10.0 ← 15: 7.2 → 16: 9.6 ↓ 17: 9.6 → 18: 8.4 → 19: 10.1 ↗ 20: 8.7 →
	Serie 84.9		Serie 89.9		
	Total 84.9		Total 174.8		
40 Skott		21: 7.2 ↘ 22: 8.4 ↓ 23: 10.8 ↘ 24: 8.8 ↗ 25: 7.8 → 26: 9.7 ↖ 27: 10.0 → 28: 6.2 → 29: 10.0 → 30: 7.4 →	40 Skott		31: 8.2 → 32: 9.8 → 33: 9.0 → 34: 9.9 ↗ 35: 7.8 ← 36: 9.1 ← 37: 10.2 ↘ 38: 9.0 ↑ 39: 8.8 ↗ 40: 9.0 ←
	Serie 86.3		Serie 90.8		
	Total 261.1		Total 351.9		

Skjuttag 1	Tavla 15	Helena Dreyer		
S		Umeå Skf	L17s Vb	
04.02.2023		Skyttiaden 2023 Region	Umeå skytteallians	
Prov		1: 10.7x ↘ 2: 9.9 ↙ 3: 9.8 ↘ 4: 10.8x ↗ 5: 10.3x ↗	40 Skott 	1: 10.8x ↗ 2: 10.4x ↘ 3: 8.7 ↙ 4: 10.2x ↘ 5: 9.6 ↙ 6: 10.4x ↘ 7: 10.3x ↘ 8: 10.4x ↘ 9: 10.7x ↘ 10: 10.6x ↗
		Serie 51.5	Serie 102.1	
		Total 0.0	Total 102.1	
40 Skott		11: 10.5x ↘ 12: 10.6x ↘ 13: 10.2x ↗ 14: 9.2 → 15: 10.0 ↘ 16: 10.1 ↗ 17: 9.2 → 18: 9.8 ↙ 19: 9.8 ↙ 20: 9.7 ↗	40 Skott 	21: 10.7x ↘ 22: 8.4 → 23: 9.8 ↗ 24: 8.9 ↙ 25: 9.7 → 26: 10.4x → 27: 10.1 ↗ 28: 10.4x ↗ 29: 10.7x ↘ 30: 10.5x →
		Serie 99.1	Serie 99.6	
		Total 201.2	Total 300.8	
40 Skott		31: 8.9 → 32: 10.2x → 33: 9.3 ↙ 34: 10.2x ↗ 35: 9.9 → 36: 10.7x ↘ 37: 10.3x ↘ 38: 10.4x ↘ 39: 9.9 ↗ 40: 9.4 →		
		Serie 99.2		
		Total 400.0		

Skjutlag	Tavla	Emma Eriksson	
S	Ramselefors Skf	L21s	Vb
04.02.2023	Skyttiaden 2023 Region	Umeå skytteallians	
Prov		Prov	
	1: 9.6 ← 2: 10.1 ← 3: 9.2 → 4: 10.6x ↓ 5: 10.4x ← 6: 9.6 ← 7: 8.6 ← 8: 9.7 ← 9: 7.7 ← 10: 10.3x ↓		11: 9.8 → 12: 9.8 → 13: 10.2x ↗ 14: 10.0 ↓ 15: 10.4x ↘
	Serie 95.8 Total 0.0		Serie 50.2 Total 0.0
40 Skott		40 Skott	
	1: 8.4 ← 2: 10.4x ↗ 3: 9.6 ↓ 4: 10.6x ↓ 5: 10.3x ↘ 6: 9.5 ← 7: 10.4x ↗ 8: 10.9x → 9: 10.3x ↘ 10: 10.4x ↗		11: 8.5 ← 12: 9.9 → 13: 9.5 ← 14: 10.4x ← 15: 9.1 ↖ 16: 9.6 ↖ 17: 10.4x ↗ 18: 10.5x ↗ 19: 9.0 ↖ 20: 9.8 →
	Serie 100.8 Total 100.8		Serie 96.7 Total 197.5
40 Skott		40 Skott	
	21: 9.4 ← 22: 9.3 ↗ 23: 10.4x → 24: 9.8 ↗ 25: 10.3x ↘ 26: 10.8x ↗ 27: 10.1 ↓ 28: 9.6 ↓ 29: 9.7 → 30: 9.9 ↓		31: 10.4x ↘ 32: 9.6 → 33: 10.0 → 34: 9.4 ← 35: 9.8 ↗ 36: 9.4 ↑ 37: 10.7x ↗ 38: 9.9 ↑ 39: 10.1 ← 40: 9.9 ↓
	Serie 99.3 Total 296.8		Serie 99.2 Total 396.0

<p>Prov</p>	<p>1: 10.6x↘ 2: 10.2x↘ 3: 10.1 ↘ 4: 9.5 ↘ 5: 9.8 ↘ 6: 9.4 ↘ 7: 9.9 ↘ 8: 10.1→ 9: 9.2 ↗ 10: 9.5 →</p> <p>Serie 98.3 Total 0.0</p>	<p>Prov</p>	<p>11: 10.1 ↗ 12: 10.3x↘ 13: 10.1 → 14: 10.1 ↗ 15: 9.0 ↗ 16: 10.1→ 17: 8.5 ↖ 18: 10.2x↗</p> <p>Serie 78.4 Total 0.0</p>
<p>40 Skott</p>	<p>1: 9.6 → 2: 10.5x↘ 3: 9.2 ↘ 4: 10.3x↗ 5: 10.4x↗ 6: 10.4x↗ 7: 9.7 ↗ 8: 10.3x↗ 9: 10.5x↘ 10: 10.3x↗</p> <p>Serie 101.2 Total 101.2</p>	<p>40 Skott</p>	<p>11: 10.8x↘ 12: 9.6 ↖ 13: 9.8 ↘ 14: 10.2x↗ 15: 10.2x↘ 16: 10.0 ↗ 17: 9.8 ↖ 18: 10.1 ↘ 19: 9.5 ↘ 20: 10.3x↗</p> <p>Serie 100.3 Total 201.5</p>
<p>40 Skott</p>	<p>21: 10.0 ↘ 22: 10.7x↖ 23: 9.8 ↘ 24: 10.3x↗ 25: 10.4x↗ 26: 10.1 ↘ 27: 9.6 ↘ 28: 10.7x↖ 29: 10.6x↖ 30: 10.5x↖</p> <p>Serie 102.7 Total 304.2</p>	<p>40 Skott</p>	<p>31: 9.9 ↘ 32: 10.6x↗ 33: 10.5x↘ 34: 10.8x↗ 35: 9.9 ↖ 36: 10.1 ↘ 37: 9.6 → 38: 10.4x↘ 39: 10.6x↖ 40: 10.3x↘</p> <p>Serie 102.7 Total 406.9</p>

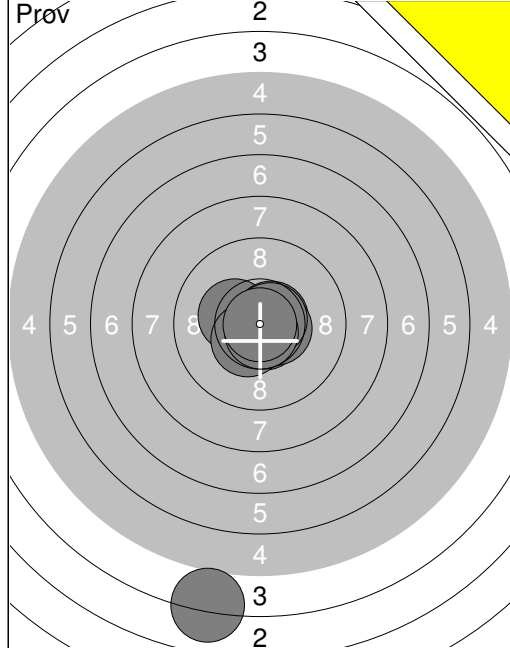

1:	10.3x
2:	4.0 ↓
3:	10.7x↓
4:	10.6x↗
5:	10.8x→
6:	10.6x→
7:	10.5x↘
8:	10.7x↗
9:	10.7x↓
10:	10.9x↓
Serie	99.8
Total	0.0

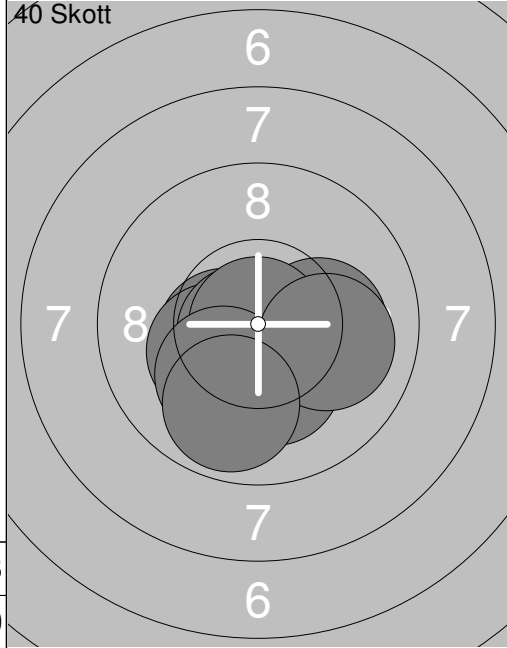

1:	10.2x→
2:	10.5x↘
3:	10.3x↘
4:	10.2x↓
5:	10.7x↓
6:	10.7x↘
7:	10.9x↓
8:	10.1 ↓
9:	10.0→
10:	9.9 ↓
Serie	103.5
Total	103.5

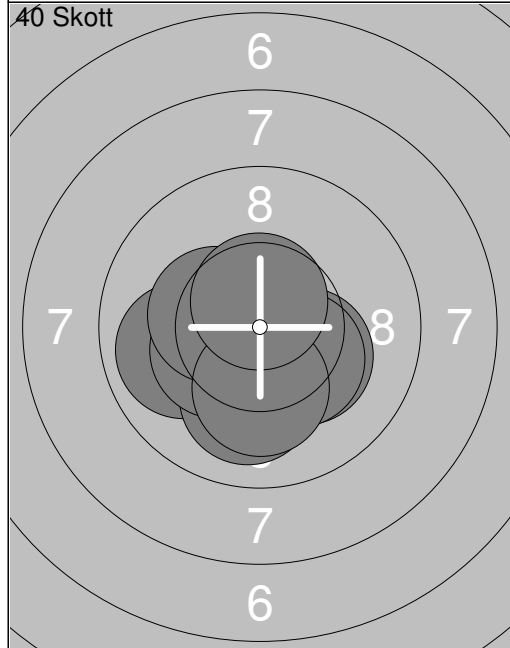

11:	10.3x↘
12:	9.9 ←
13:	10.8x↓
14:	10.3x↓
15:	10.0 ↓
16:	10.3x↘
17:	10.3x↘
18:	10.4x↘
19:	10.2x↓
20:	10.6x↑
Serie	103.1
Total	206.6

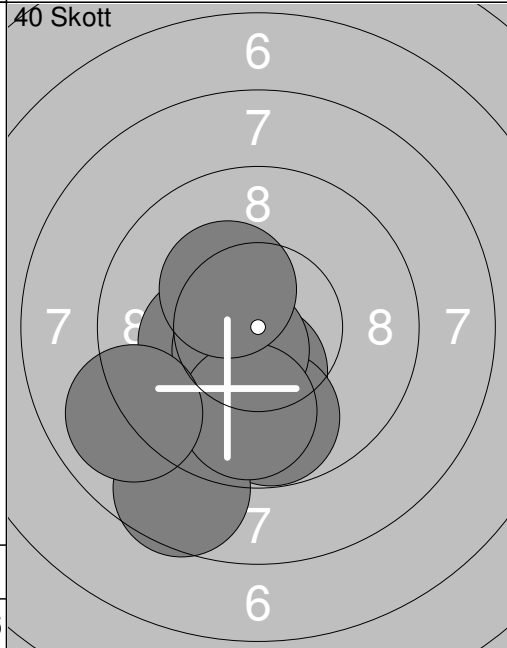

21:	10.3x↘
22:	10.4x↓
23:	9.9 ↓
24:	9.8 ↓
25:	9.5 ↓
26:	8.6 ↓
27:	10.6x↘
28:	9.8 ↓
29:	9.0 ←
30:	10.3x↘
Serie	98.2
Total	304.8

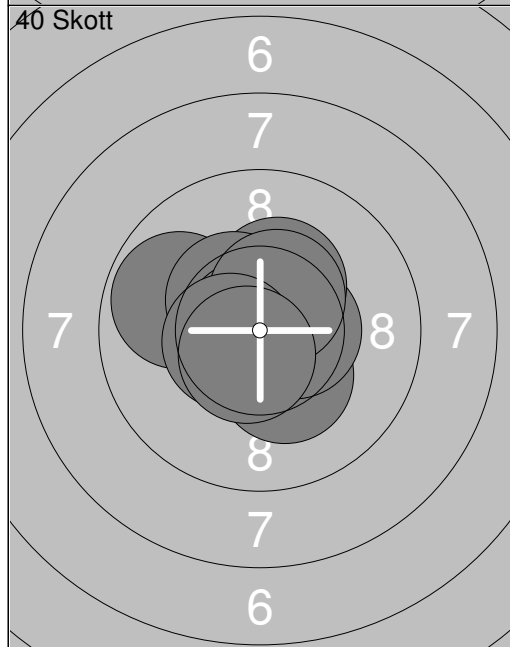

31:	9.8 ←
32:	10.3x↓
33:	10.5x→
34:	10.3x↗
35:	10.4x↘
36:	10.8x↘
37:	10.6x↓
38:	10.5x↗
39:	10.5x↘
40:	10.6x↓
Serie	104.3
Total	409.1

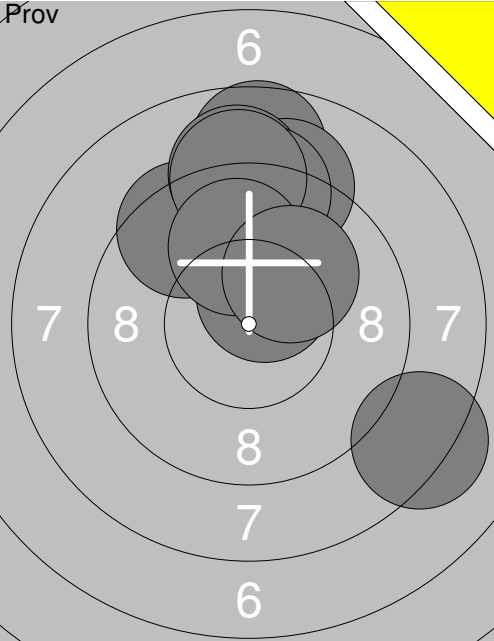
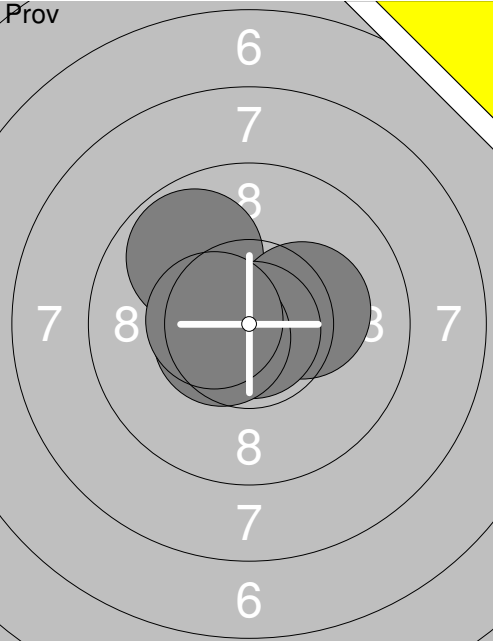
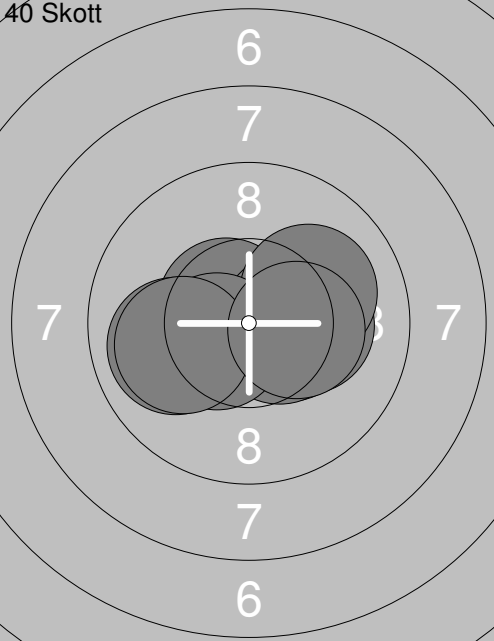
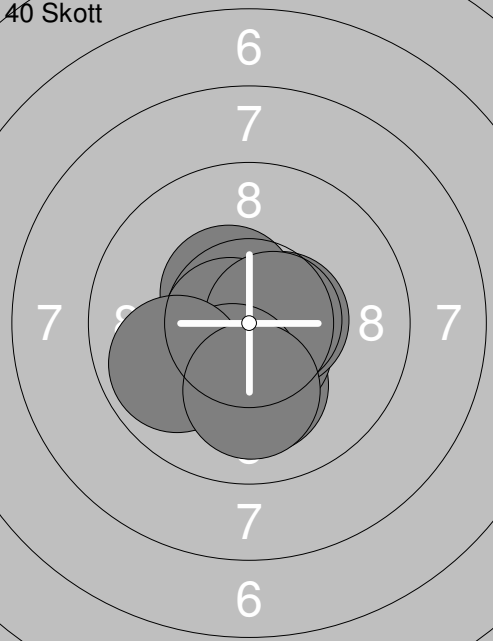
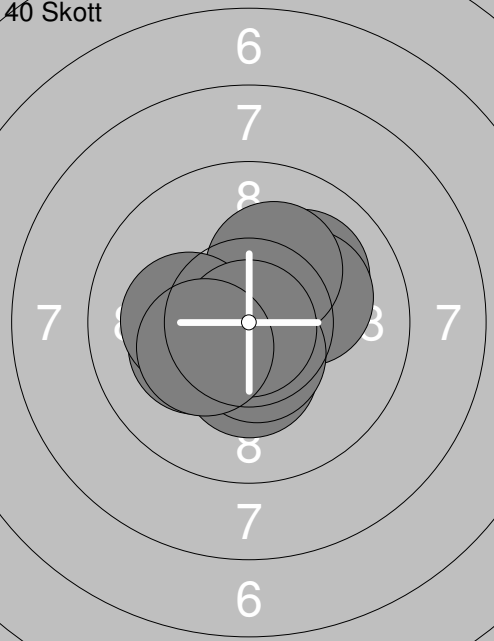
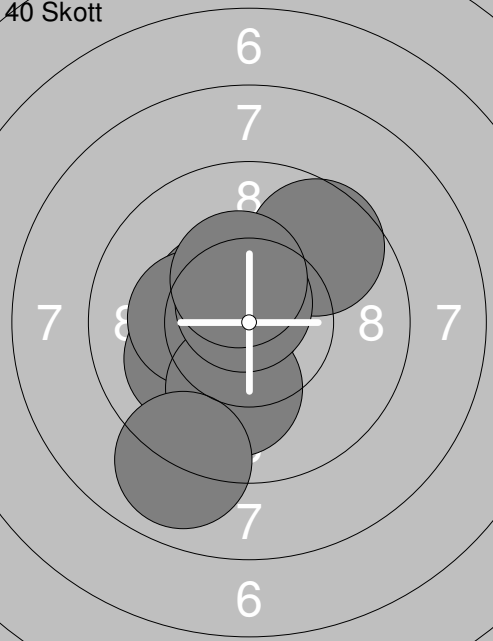
Skjutlag	Tavla	Tove Hallin		
S	Gideå Skf	L13	Vn	
04.02.2023	Skyttiaden 2023 Region	Umeå skytteallians		
Prov		1: 9.5 ↗ 2: 8.7 ↑ 3: 9.1 ↑ 4: 8.2 ↘ 5: 9.0 ↑ 6: 9.2 ↑ 7: 9.0 ↑ 8: 10.5x↗ 9: 9.9 ↑ 10: 10.1 ↗		11: 9.8 ↗ 12: 10.2x↗ 13: 10.9x↘ 14: 10.6x↘ 15: 10.5x↘
	Serie 93.2		Serie 52.0	
	Total 0.0		Total 0.0	
40 Skott		1: 10.6x↘ 2: 9.9 ← 3: 10.2x↗ 4: 10.4x↗ 5: 10.4x↗ 6: 10.5x↗ 7: 10.1 ↗ 8: 10.5x↘ 9: 10.0 ← 10: 10.3x↗		11: 10.1 ↓ 12: 10.6x↘ 13: 10.5x↗ 14: 10.5x↘ 15: 10.5x↘ 16: 10.7x↘ 17: 10.6x↗ 18: 10.3x↘ 19: 9.9 ← 20: 10.1 ↓
	Serie 102.9		Serie 103.8	
	Total 102.9		Total 206.7	
40 Skott		21: 10.3x↘ 22: 10.1 ↗ 23: 10.2x↗ 24: 10.2x↘ 25: 10.2x↗ 26: 10.8x↘ 27: 10.5x↘ 28: 10.2x↘ 29: 10.9x↘ 30: 10.3x↘		31: 10.1 ↘ 32: 10.7x↘ 33: 10.4x↘ 34: 10.5x↘ 35: 10.3x↘ 36: 10.1 ↓ 37: 9.0 ↓ 38: 9.6 ↗ 39: 10.7x↗ 40: 10.4x↗
	Serie 103.7		Serie 101.8	
	Total 310.4		Total 412.2	

Skjuttlag	Tavla	Tilde Hedlind	
1	24	Kyrkås Skf	L13 Jä
04.02.2023	Skyttiaden 2023 Region	Umeå skytteallians	
Prov		Prov	
	1: 9.5 ↘ 2: 10.1 ↓ 3: 10.5x↘ 4: 10.2x↘ 5: 10.2x← 6: 10.7x↓ 7: 10.5x➤ 8: 10.1← 9: 10.9x↘ 10: 10.4x↗		11: 10.0 ↖ 12: 10.8x↘ 13: 10.3x↘ 14: 10.1 ↖ 15: 10.6x➤ 16: 10.6x↘ 17: 10.8x➤
	Serie 103.1 Total 0.0		Serie 73.2 Total 0.0
40 Skott		40 Skott	
	1: 10.1 ↖ 2: 10.5x↘ 3: 10.9x← 4: 10.7x↓ 5: 10.8x↘ 6: 10.7x↘ 7: 10.5x↘ 8: 10.4x↘ 9: 10.6x↘ 10: 10.6x↗		11: 10.6x↘ 12: 10.9x↓ 13: 10.3x↘ 14: 10.0 ↖ 15: 10.8x↘ 16: 10.8x↘ 17: 10.6x➤ 18: 10.5x↗ 19: 10.9x← 20: 10.4x➤
	Serie 105.8 Total 105.8		Serie 105.8 Total 211.6
40 Skott		40 Skott	
	21: 10.5x↗ 22: 10.2x➤ 23: 10.3x↗ 24: 10.6x↘ 25: 10.4x↗ 26: 10.5x↗ 27: 10.3x➤ 28: 10.5x↘ 29: 10.6x↘ 30: 10.7x↗		31: 10.5x↘ 32: 10.7x↘ 33: 10.3x➤ 34: 10.4x↘ 35: 10.9x➤ 36: 10.5x↓ 37: 9.9 ↓ 38: 10.8x↘ 39: 10.3x↘ 40: 10.7x↘
	Serie 104.6 Total 316.2		Serie 105.0 Total 421.2

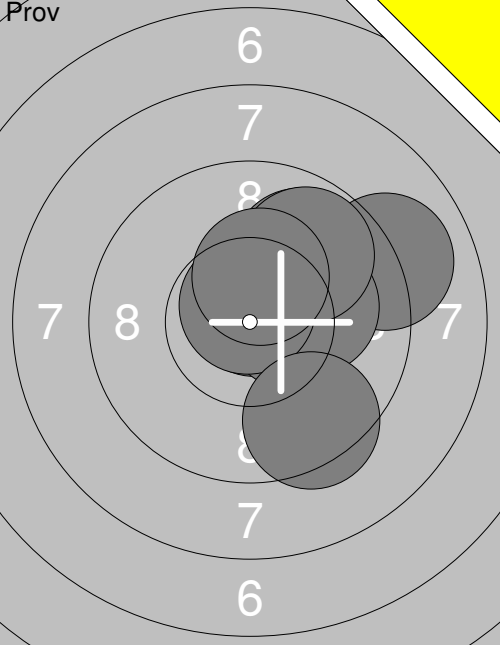
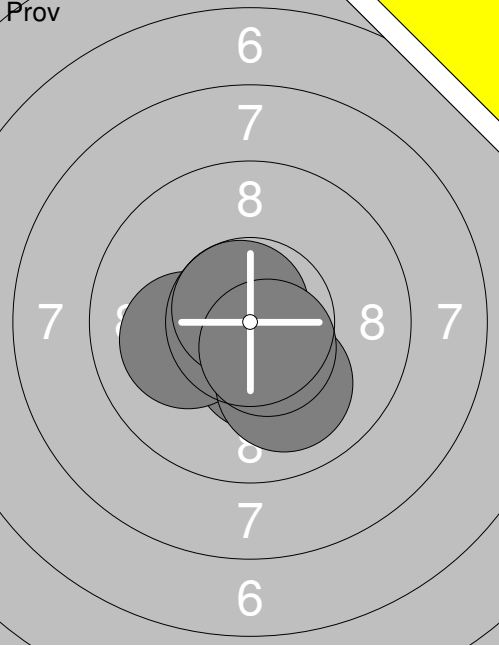
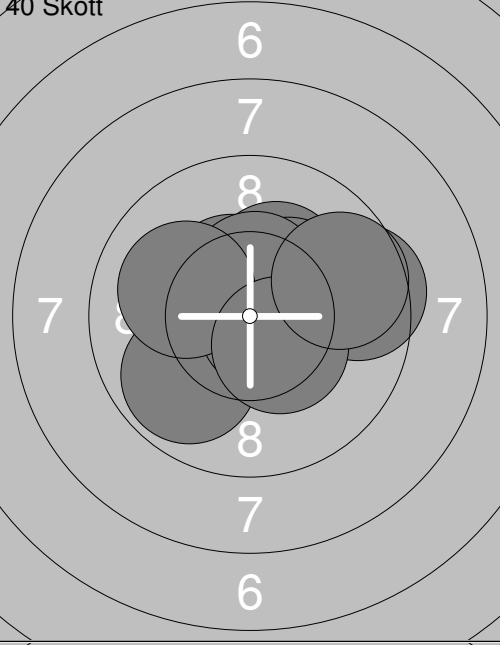
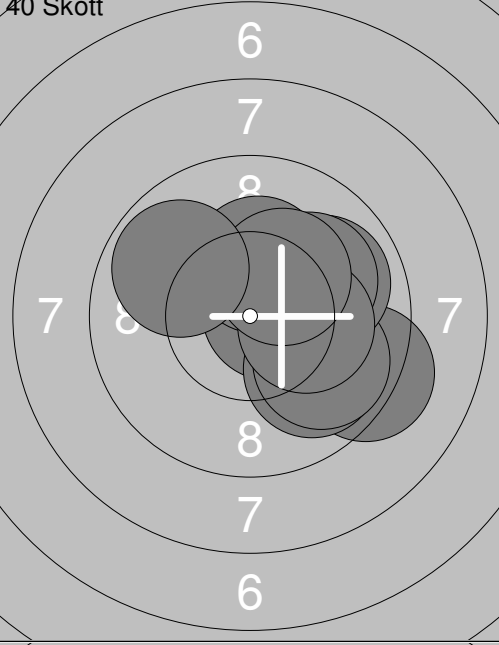
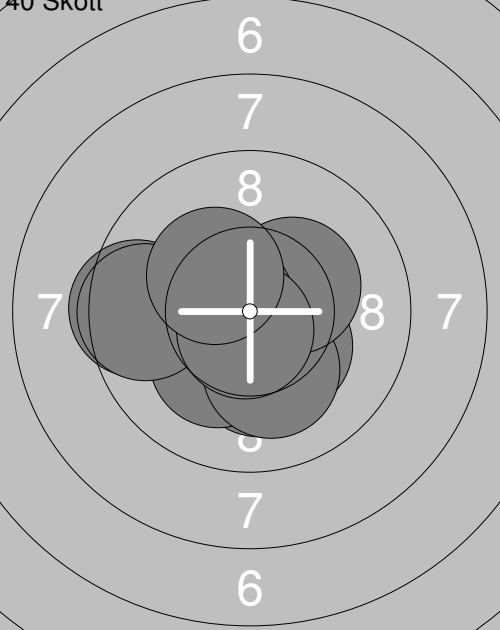
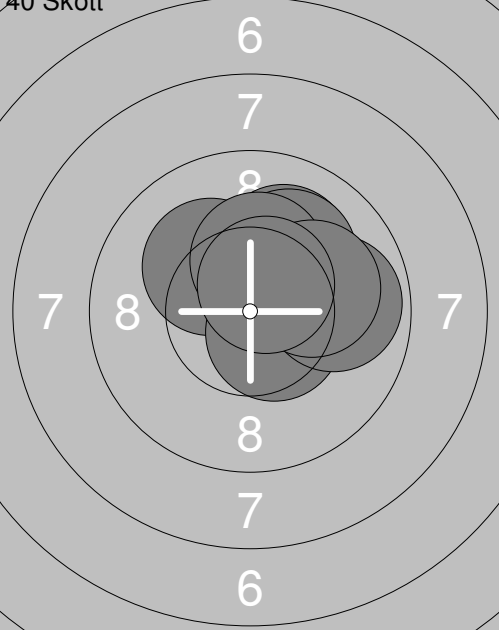
Skjutlag	Tavla	Adrian Bergström Larsson	
1	25	Överkalix Skf	No
S		Överkalix Skf	L13
04.02.2023	Skyttiaden 2023 Region	Umeå skytteallians	
	1: 10.8x↗ 2: 9.0 → 3: 10.5x↗ 4: 10.4x→ 5: 9.9 ↗ 6: 10.1 → 7: 9.8 ↗ 8: 10.7x↗ 9: 10.3x↗ 10: 9.4 ↓		11: 10.4x↘ 12: 10.1 ← 13: 10.0 ↓ 14: 10.7x↘ 15: 10.5x↘
	Serie 100.9		Serie 51.7
	Total 0.0		Total 0.0
	1: 9.5 → 2: 10.3x↗ 3: 10.5x↘ 4: 9.8 ↘ 5: 10.3x↗ 6: 10.7x→ 7: 10.5x↗ 8: 10.0 ← 9: 10.4x↘ 10: 9.7 →		11: 10.7x→ 12: 9.3 ↘ 13: 9.9 ↓ 14: 10.3x↗ 15: 9.9 ↘ 16: 9.9 → 17: 10.1 ↗ 18: 10.2x→ 19: 10.3x↗ 20: 9.8 ↘
	Serie 101.7		Serie 100.4
	Total 101.7		Total 202.1
	21: 10.2x↘ 22: 10.3x↘ 23: 10.2x↘ 24: 9.5 ← 25: 10.1 ↓ 26: 10.3x↗ 27: 10.6x↘ 28: 9.6 ← 29: 10.7x↘ 30: 10.3x↘		31: 10.5x↗ 32: 10.5x→ 33: 10.2x↘ 34: 10.1 ↗ 35: 10.5x↘ 36: 9.9 → 37: 10.1 ↗ 38: 10.3x↗ 39: 10.1 → 40: 10.6x↗
	Serie 101.8		Serie 102.8
	Total 303.9		Total 406.7

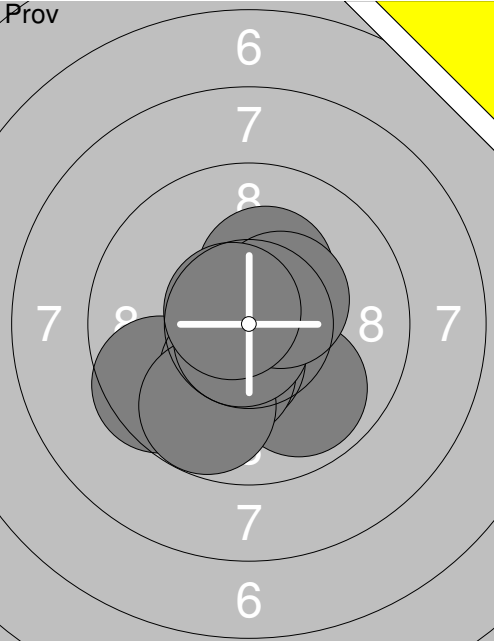
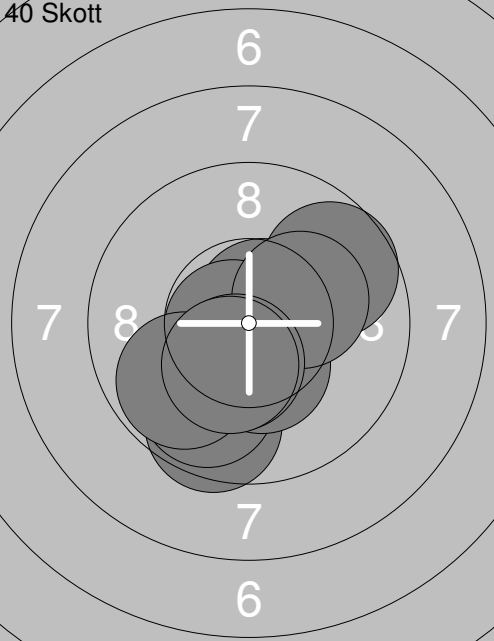
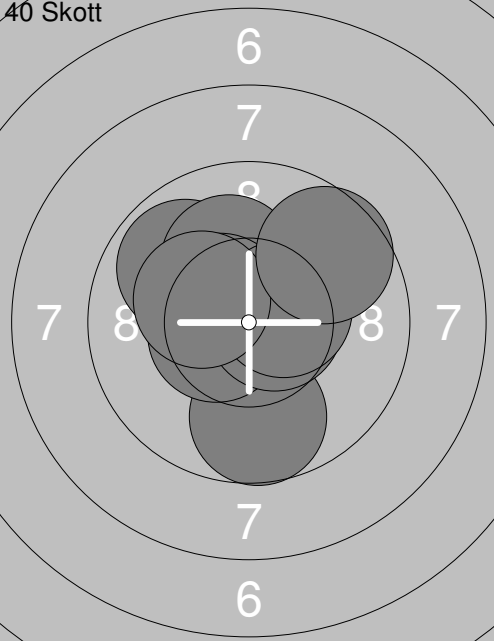
Skjutlag	Tavla	Frank Blomqvist	
S	Fältjägarna Skf	L13	Jä
04.02.2023	Skyttiaden 2023 Region	Umeå skytteallians	
Prov		1: 9.6 ↙ 3: 10.3x↗ 4: 9.9 ↘ 5: 10.5x↘ 6: 10.3x↘ 7: 9.8 ↘ 8: 10.7x↘ 9: 10.4x↗ 10: 10.7x↘	Prov
		Serie 92.2	11: 10.2x↘
		Total 0.0	Serie 10.2
			Total 0.0
40 Skott		1: 9.6 ↘ 2: 9.8 ↘ 3: 10.7x↗ 4: 10.7x↘ 5: 9.8 ↘ 6: 9.7 ↗ 7: 10.4x↘ 8: 10.2x↗ 9: 10.4x↘ 10: 10.4x↘	40 Skott
		Serie 101.7	11: 10.8x↘
		Total 101.7	12: 10.8x↗
			13: 10.5x↗
			14: 10.7x↘
			15: 10.0 ↗
			16: 10.8x➤
			17: 9.7 ↗
			18: 10.8x➤
			19: 9.4 ↗
			20: 10.0 ↗
		Serie 103.5	
		Total 205.2	
40 Skott		21: 9.9 ↙ 22: 10.1 ↗ 23: 10.5x↘ 24: 9.7 ↘ 25: 10.6x➤ 26: 10.5x↘ 27: 10.6x➤ 28: 10.5x➤ 29: 10.3x↘ 30: 9.6 ↗	40 Skott
		Serie 102.3	31: 10.6x↘
		Total 307.5	32: 10.6x↘
			33: 9.6 ←
			34: 10.5x↘
			35: 10.7x↘
			36: 9.7 ←
			37: 9.7 ↘
			38: 10.2x↘
			39: 10.8x➤
			40: 9.5 ←
		Serie 101.9	
		Total 409.4	

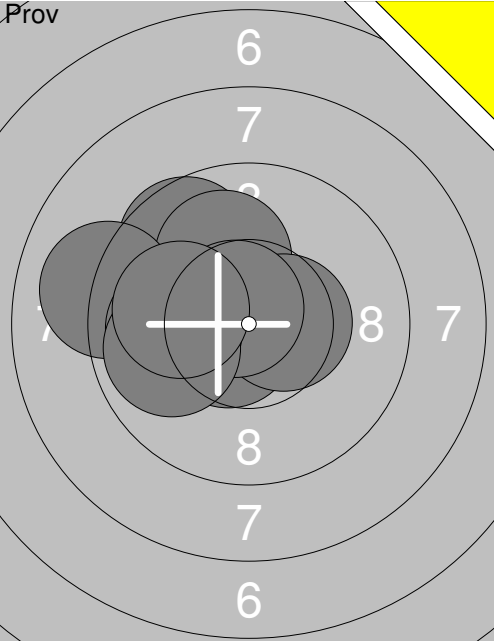
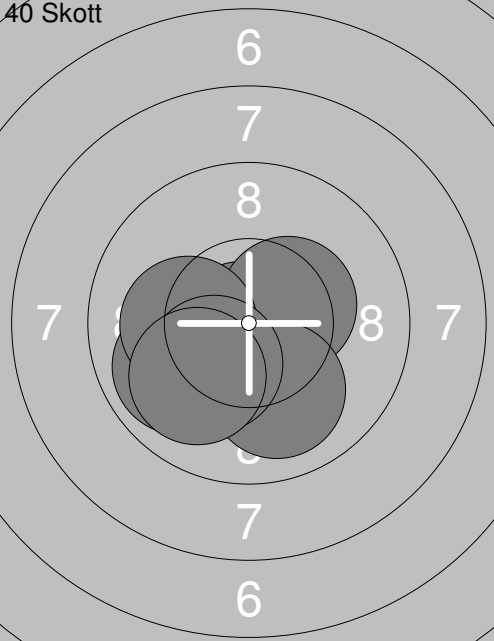
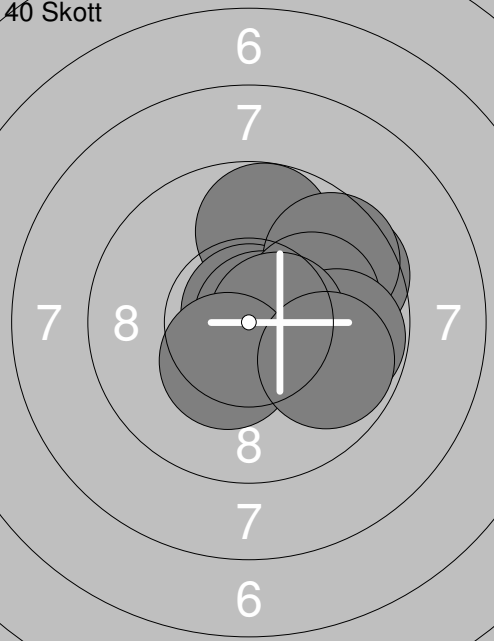
Skjuttlag	Tavla	Ellen Segerstedt	
1	28	Luleå Spssk	L13 No
04.02.2023	Skyttiaden 2023 Region	Umeå skytteallians	
Prov		1: 9.6 ↗ 2: 10.0 ↗ 3: 10.2x ↗ 4: 10.6x ↗ 5: 10.5x → 6: 9.1 ← 7: 10.7x ↗ 8: 10.0 ← 9: 9.9 ← 10: 10.0 ← Serie 100.6 Total 0.0	11: 10.1 ↑ 12: 10.6x → 13: 10.4x ↘ 14: 10.5x ↘ 15: 9.4 ← 16: 10.2x ↗ Serie 61.2 Total 0.0
40 Skott		1: 10.8x ↘ 2: 9.9 ← 3: 10.4x ↘ 4: 10.3x ↘ 5: 10.6x ↘ 6: 10.4x → 7: 10.0 ↓ 8: 10.2x ← 9: 10.3x ↘ 10: 10.0 ↘ Serie 102.9 Total 102.9	11: 9.8 ↓ 12: 10.1 → 13: 10.4x ↘ 14: 10.2x ↘ 15: 10.3x → 16: 9.9 → 17: 9.6 ↓ 18: 9.9 ↗ 19: 10.3x ↘ 20: 10.2x ↘ Serie 100.7 Total 203.6
40 Skott		21: 9.8 ↑ 22: 9.6 → 23: 10.8x ↑ 24: 9.6 → 25: 10.8x → 26: 10.1 → 27: 9.8 → 28: 10.6x → 29: 10.4x ↘ 30: 9.8 → Serie 101.3 Total 304.9	31: 9.8 ↗ 32: 10.5x → 33: 10.6x → 34: 9.3 → 35: 8.5 ↓ 36: 9.4 ↓ 37: 10.5x → 38: 10.6x ↘ 39: 10.7x → 40: 10.3x ↑ Serie 100.2 Total 405.1

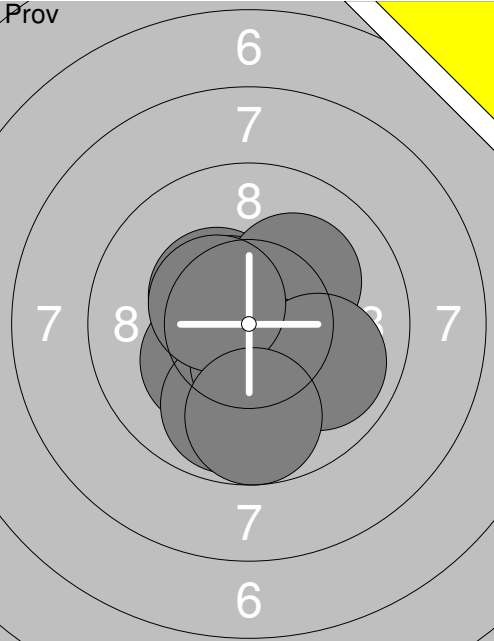
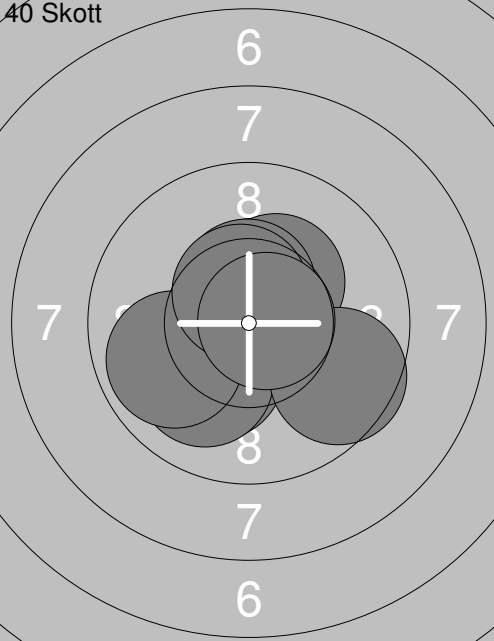
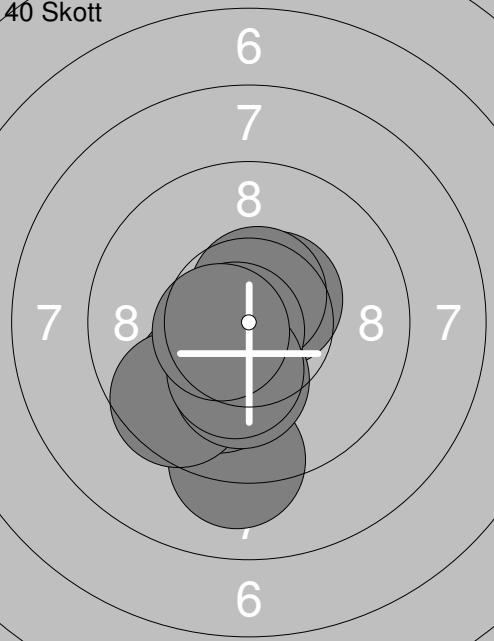
Skjutlag	Tavla	Alvin Persson	
S	Överkalix Skf	L13	No
04.02.2023	Skyttiaden 2023 Region	Umeå skytteallians	
Prov		1: 10.4x↘ 2: 10.2x↘ 3: 10.6x↘ 4: 10.4x↗ 5: 10.2x↗ 6: 9.9 ↓ 7: 10.4x↓ 8: 9.9 ↘ 9: 10.5x↘ 10: 9.7 ↓ Serie 102.2 Total 0.0	11: 10.6x↓ 12: 10.2x↘ 13: 9.9 ↓ 14: 10.2x↓ 15: 9.8 ↙ 16: 10.5x↘ 17: 10.4x↓ 18: 10.2x↑ 19: 9.8 ↓ 20: 10.5x↘ Serie 101.9 Total 204.9
40 Skott		11: 10.6x↓ 12: 10.2x↘ 13: 9.9 ↓ 14: 10.2x↓ 15: 9.8 ↙ 16: 10.5x↘ 17: 10.4x↓ 18: 10.2x↑ 19: 9.8 ↓ 20: 10.5x↘ Serie 101.9 Total 204.9	21: 9.1 ↓ 22: 10.5x↗ 23: 10.0 ↓ 24: 10.6x↑ 25: 10.1 ↓ 26: 9.6 ↙ 27: 10.2x↓ 28: 10.7x↘ 29: 10.3x↓ 30: 10.6x↘ Serie 101.7 Total 306.6
40 Skott		21: 9.1 ↓ 22: 10.5x↗ 23: 10.0 ↓ 24: 10.6x↑ 25: 10.1 ↓ 26: 9.6 ↙ 27: 10.2x↓ 28: 10.7x↘ 29: 10.3x↓ 30: 10.6x↘ Serie 101.7 Total 306.6	31: 10.3x↘ 32: 10.0 → 33: 10.1 ↙ 34: 10.8x→ 35: 10.1 ↗ 36: 10.5x↘ 37: 10.0 ↘ 38: 10.5x↘ 39: 10.7x↑ 40: 9.7 ↓ Serie 102.7 Total 409.3

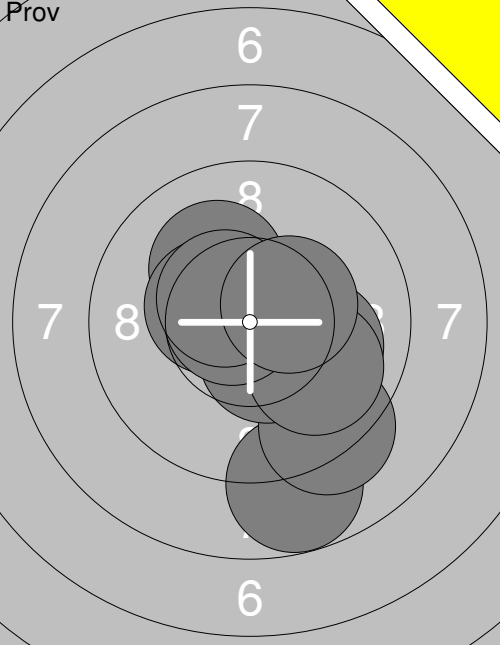
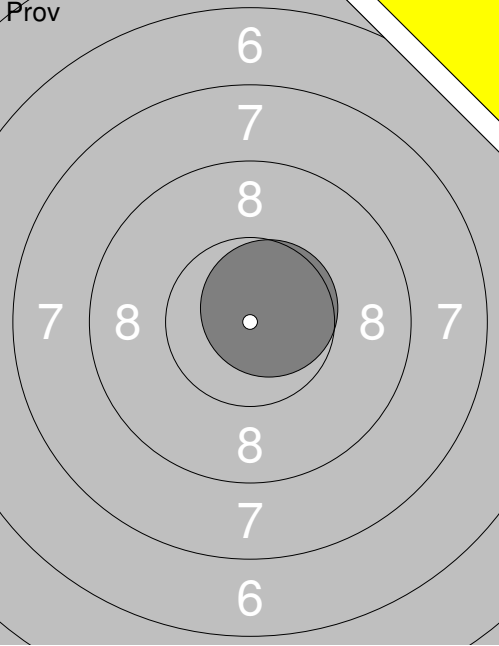
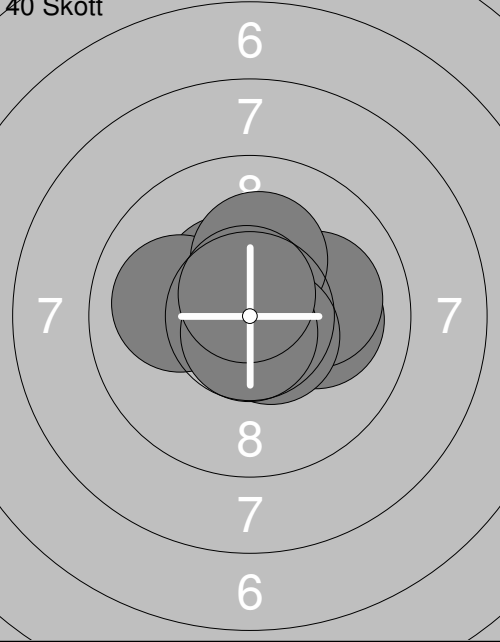
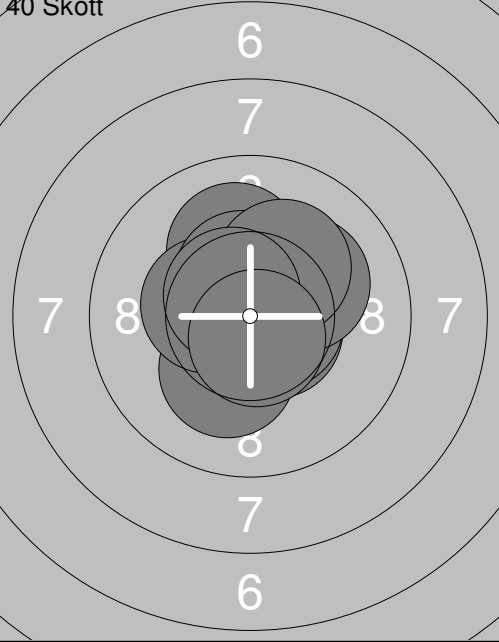
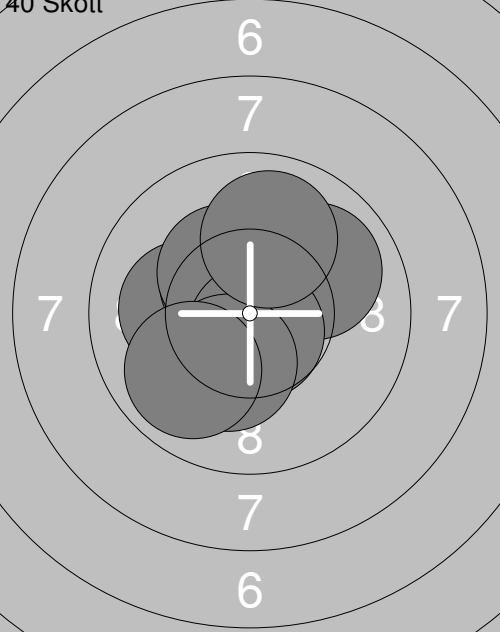
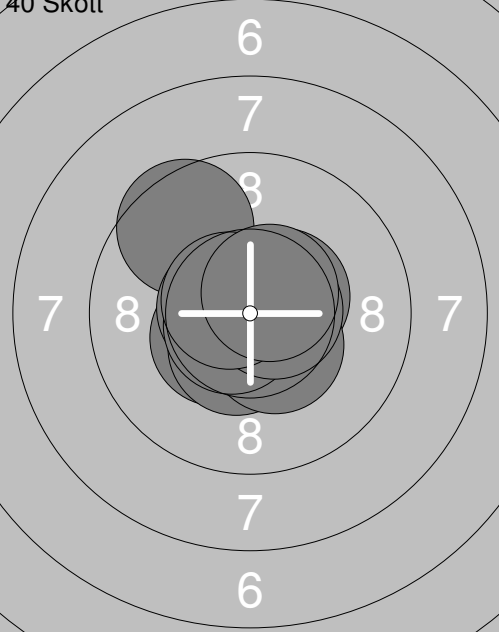

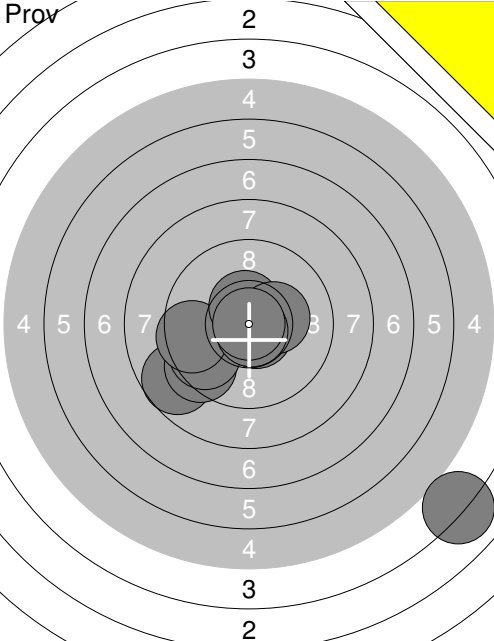
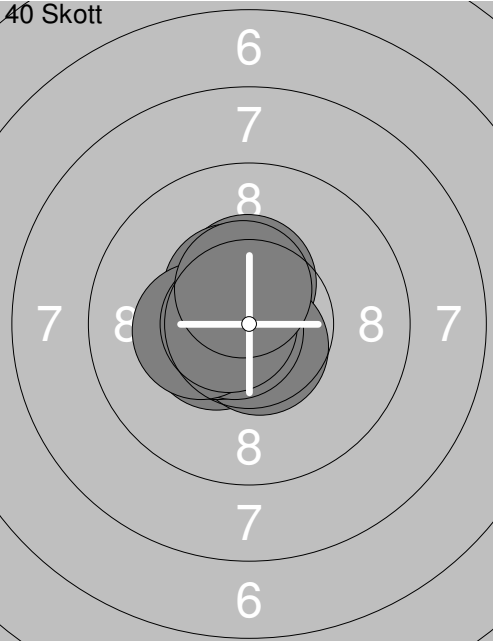
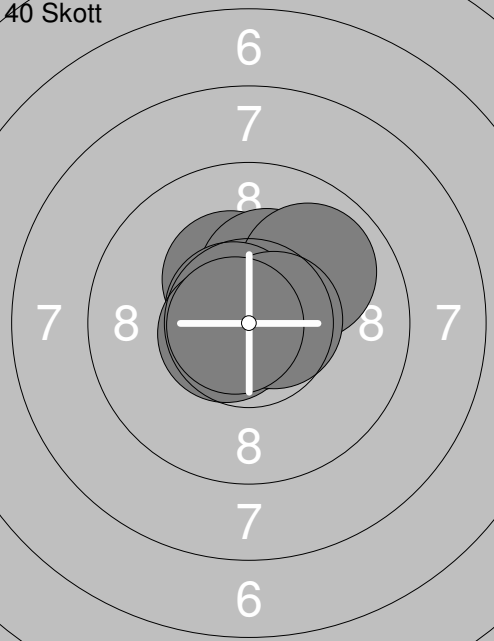
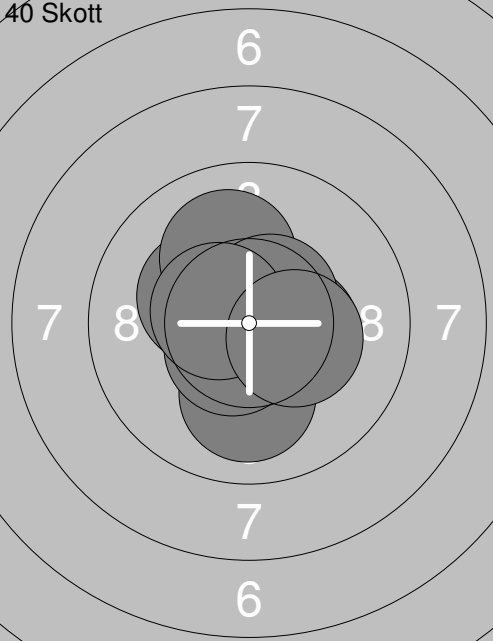
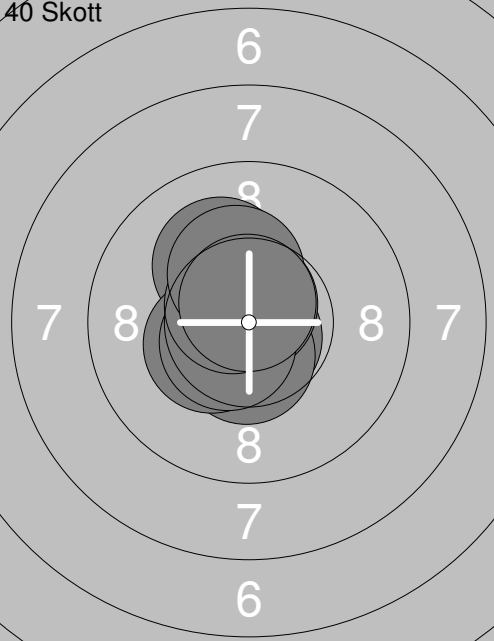
Skjuttlag	Tavla	Saga Lundmark	
1	31	Piteå Skf	No
04.02.2023	Skyttiaden 2023 Region	Umeå skytteallians	
Prov		Prov	
	1: 8.8 ↓ 2: 9.3 ↓ 3: 10.0 → 4: 10.5x↓ 5: 9.9 ↘ 6: 10.1 ↗ 7: 10.4x↖ 8: 10.7x↖ 9: 10.5x↖ 10: 10.4x↗		11: 10.7x↗
	Serie 100.6		Serie 10.7
	Total 0.0		Total 0.0
40 Skott		40 Skott	
	1: 10.7x↖ 2: 10.9x→ 3: 10.1 → 4: 10.5x↖ 5: 10.0 ← 6: 10.1 → 7: 10.2x↑ 8: 10.6x↘ 9: 10.7x↓ 10: 10.7x↑		11: 10.6x↘ 12: 10.6x→ 13: 10.2x↓ 14: 10.2x↗ 15: 10.1 ↑ 16: 10.4x↖ 17: 10.5x↑ 18: 10.2x↗ 19: 10.6x↖ 20: 10.6x↓
	Serie 104.5		Serie 104.0
	Total 104.5		Total 208.5
40 Skott		40 Skott	
	21: 10.1 ← 22: 10.4x↖ 23: 10.5x↖ 24: 10.7x↑ 25: 10.0 ↗ 26: 10.3x↖ 27: 10.7x↓ 28: 10.3x↓ 29: 9.9 ↓ 30: 10.0 ↑		31: 10.5x↗ 32: 10.4x↖ 33: 9.6 ↖ 34: 10.5x↓ 35: 10.6x↖ 36: 10.4x↘ 37: 10.7x↖ 38: 10.6x→ 39: 10.6x↖ 40: 10.6x↗
	Serie 102.9		Serie 104.5
	Total 311.4		Total 415.9

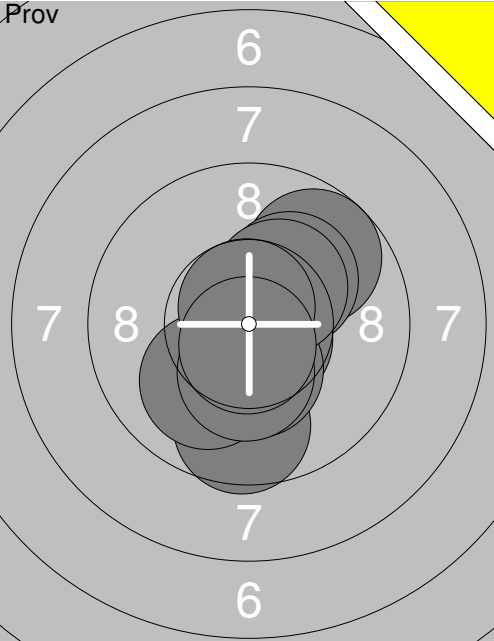
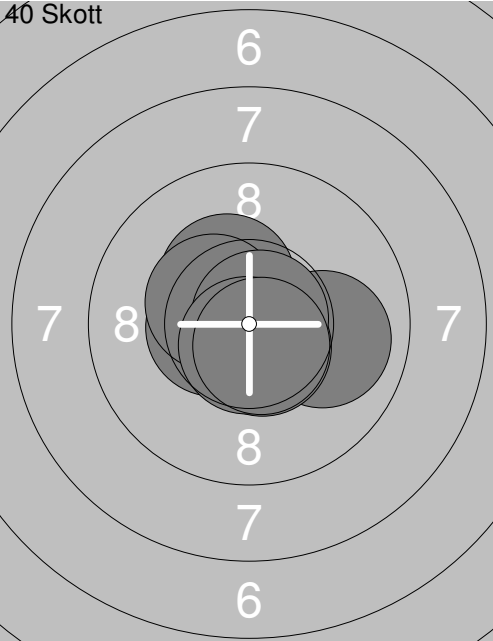
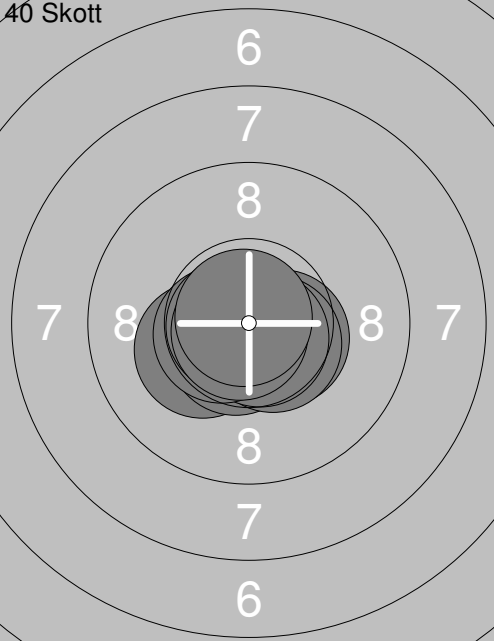
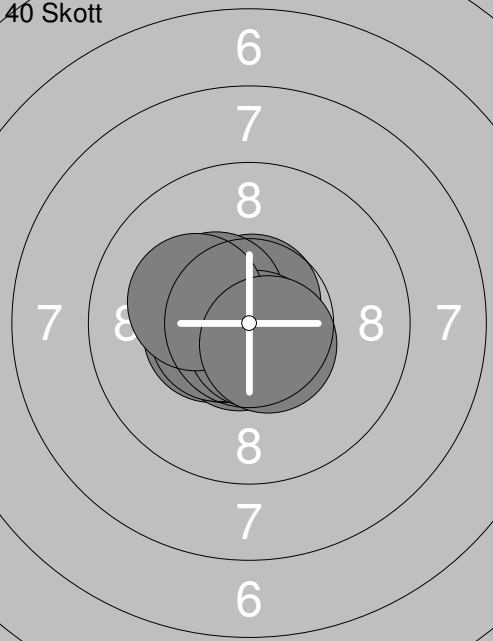
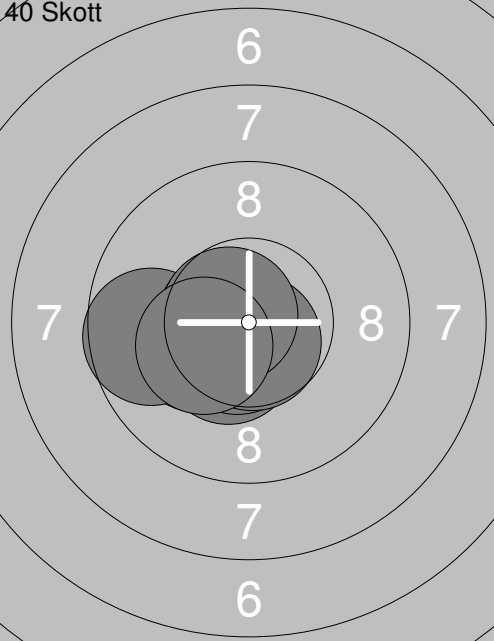
Skjutlag 1	Tavla 32	Hannah Hemå	
S		Fältjägarna Skf	L15 Jä
04.02.2023		Skyttiaden 2023 Region	Umeå skytteallians
Prov		1: 8.7 ↙ 2: 9.4 ↙ 3: 9.6 ↙ 4: 9.5 ← 5: 4.0 ↘ 6: 10.7x↘ 7: 10.5x↗ 8: 10.3x→ 9: 10.8x↓ 10: 10.9x↘ Serie 94.4 Total 0.0	40 Skott  1: 10.5x↘ 2: 10.4x↗ 3: 10.6x↘ 4: 10.6x↓ 5: 10.5x↘ 6: 10.7x↘ 7: 10.5x↗ 8: 10.3x↘ 9: 10.7x↘ 10: 10.5x↗ Serie 105.3 Total 105.3
40 Skott		11: 10.6x↗ 12: 10.9x→ 13: 10.3x↗ 14: 10.3x↗ 15: 10.8x↗ 16: 9.9 ↗ 17: 10.7x↘ 18: 10.6x↘ 19: 10.6x→ 20: 10.8x↘ Serie 105.5 Total 210.8	40 Skott  21: 10.8x↘ 22: 10.3x↘ 23: 10.7x↘ 24: 10.0 ↓ 25: 10.1 ↑ 26: 10.4x→ 27: 10.6x↗ 28: 10.6x↘ 29: 10.5x↘ 30: 10.3x→ Serie 104.3 Total 315.1
40 Skott		31: 10.8x↓ 32: 10.8x↘ 33: 10.5x↓ 34: 10.1 ↖ 35: 10.7x↗ 36: 10.4x↘ 37: 10.6x↘ 38: 10.6x↘ 39: 10.3x↗ 40: 10.7x↗ Serie 105.5 Total 420.6	

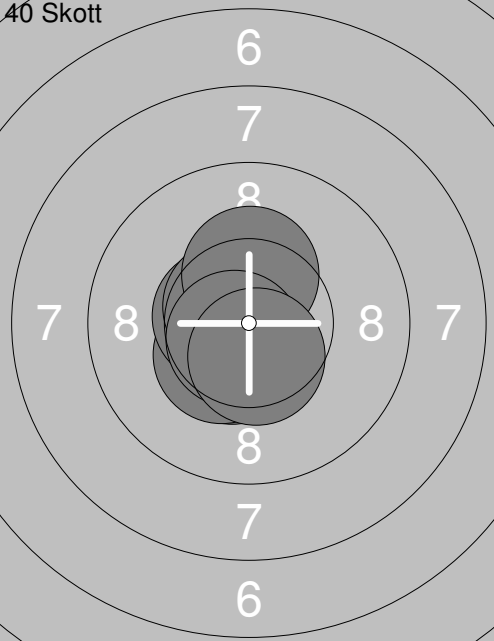
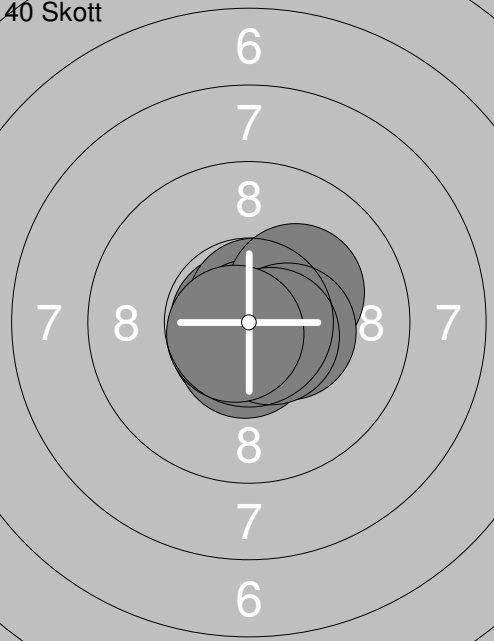
Skjutlag 1	Tavla 33	Filip Hansson	
S	Vännäs Skf	L15	Vb
04.02.2023	Skyttiaden 2023 Region	Umeå skytteallians	
	1: 9.7 ↗ 2: 10.2 ↗ 3: 10.7 ↘ 4: 9.6 ↓ 5: 10.4 ↘ 6: 10.0 ↘ 7: 10.3 ↘ 8: 10.3 ↗ 9: 10.7 ↗ 10: 10.7 ↘ Serie 102.6 Total 0.0		1: 10.7 ↘ 2: 10.0 → 3: 10.6 ↘ 4: 10.5 ← 5: 10.7 ↗ 6: 10.3 ↗ 7: 10.4 ← 8: 10.8 ↗ 9: 10.7 ↘ 10: 10.6 ↘ Serie 105.3 Total 105.3
	11: 10.5 ↘ 12: 10.3 ← 13: 10.7 ↘ 14: 10.6 ↘ 15: 10.5 ↘ 16: 10.7 ↘ 17: 10.6 ← 18: 10.8 ← 19: 10.8 ↘ 20: 10.9 ↘ Serie 106.4 Total 211.7		21: 10.5 ← 22: 10.8 ↘ 23: 10.7 ↘ 24: 10.6 ← 25: 10.5 ← 26: 10.7 ↗ 27: 10.4 ← 28: 10.7 ↘ 29: 10.2 ← 30: 10.6 ↘ Serie 105.7 Total 317.4
	31: 10.4 ↘ 32: 10.8 ↘ 33: 10.2 ← 34: 9.7 ← 35: 10.8 ← 36: 10.6 ↘ 37: 10.6 ← 38: 10.7 ↘ 39: 10.7 ← 40: 10.3 ← Serie 104.8 Total 422.2		

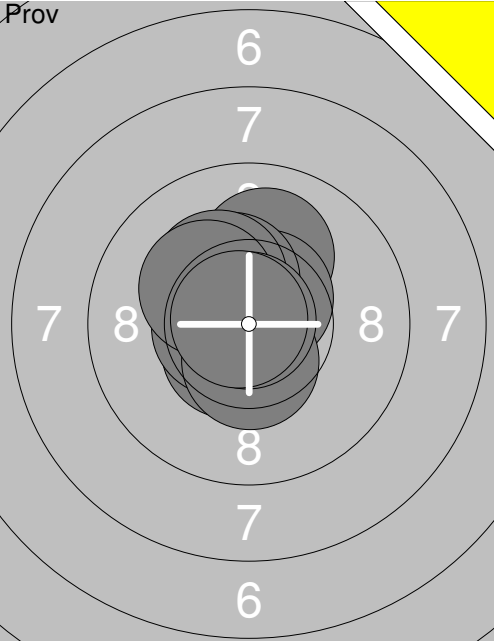
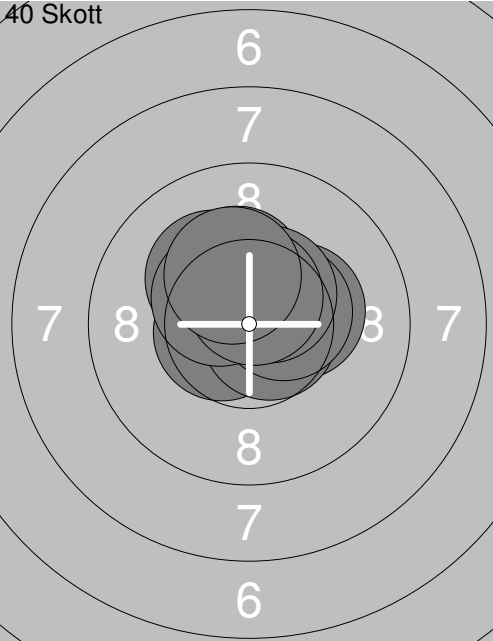
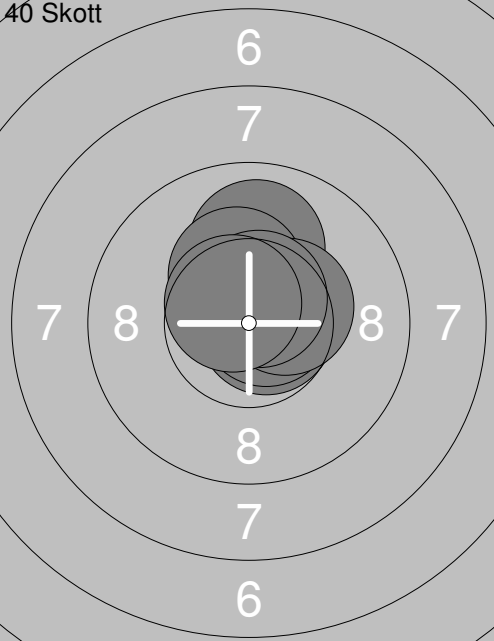
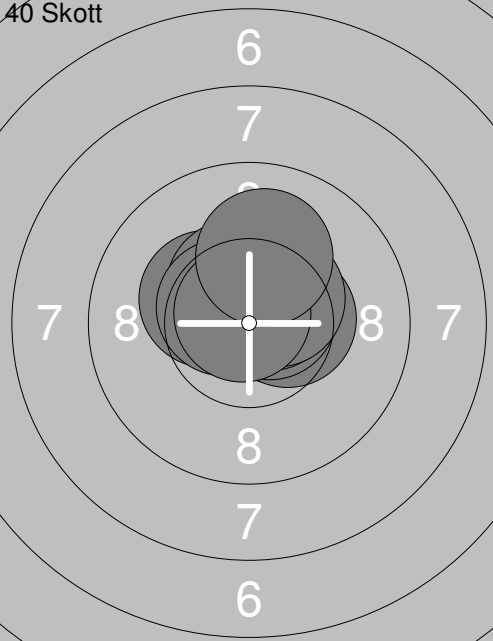
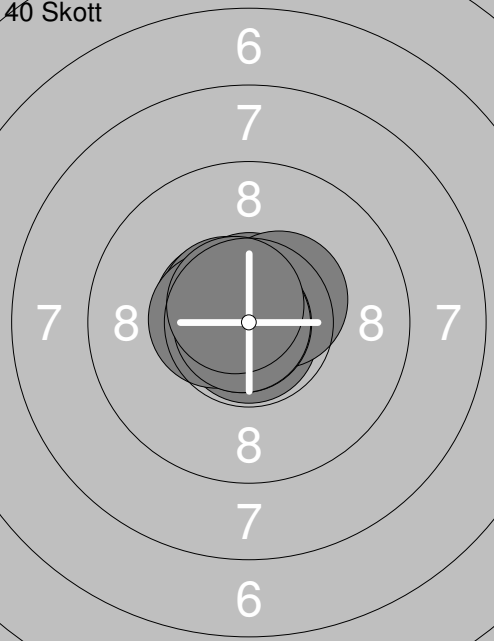
Skjutlag	Tavla	Emil Arntsen	
S	Kyrkås Skf	L15	Jä
04.02.2023	Skyttiaden 2023 Region	Umeå skytteallians	
Prov		1: 10.6x 2: 10.6x 3: 10.7x 4: 10.5x 5: 10.6x 6: 10.4x 7: 10.4x 8: 10.4x 9: 10.3x 10: 10.9x Serie 105.4 Total 0.0	11: 10.8x 12: 10.5x 13: 10.5x 14: 10.4x 15: 10.4x 16: 10.5x 17: 10.3x 18: 10.9x 19: 10.8x 20: 10.7x Serie 105.7 Total 211.6
40 Skott		11: 10.8x 12: 10.5x 13: 10.8x 14: 10.4x 15: 10.6x 16: 10.7x 17: 10.6x 18: 10.3x 19: 10.7x 20: 10.5x Serie 105.9 Total 105.9	21: 10.7x 22: 10.8x 23: 10.8x 24: 10.7x 25: 10.9x 26: 10.2x 27: 10.6x 28: 10.4x 29: 10.6x 30: 10.7x Serie 106.4 Total 318.0
40 Skott		31: 10.4x 32: 10.3x 33: 10.6x 34: 10.6x 35: 10.4x 36: 10.4x 37: 10.8x 38: 10.8x 39: 10.5x 40: 10.9x Serie 105.7 Total 423.7	

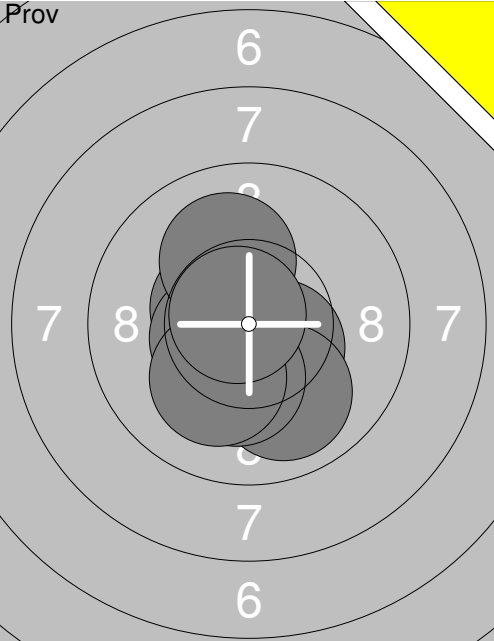
Skjutlag 1	Tavla 35	Rasmus Lindgren		
S	Umeå Skf	L15	Vb	
04.02.2023	Skyttiaden 2023 Region	Umeå skytteallians		
Prov		1: 10.5x ↘ 2: 10.6x ↗ 3: 10.0 ↑ 4: 10.6x ↗ 5: 10.3x ↘ 6: 10.5x ↓ 7: 10.2x ↘ 8: 10.2x ↘ 9: 10.9x ↗ 10: 10.8x ↗ Serie 104.6 Total 0.0	40 Skott	 1: 10.6x ↗ 2: 10.3x ↗ 3: 10.7x ↗ 4: 10.5x ↗ 5: 10.3x ↗ 6: 10.2x ↘ 7: 10.4x ↘ 8: 10.5x ↗ 9: 10.6x ↗ 10: 10.3x ↘ Serie 104.4 Total 104.4
40 Skott		11: 10.5x ↗ 12: 10.8x ↗ 13: 10.7x ↗ 14: 10.7x ↗ 15: 10.0 ↑ 16: 10.7x ↗ 17: 10.3x ↗ 18: 10.4x ↗ 19: 10.6x ↗ 20: 10.6x ↘ Serie 105.3 Total 209.7	40 Skott	 21: 10.5x ↗ 22: 10.4x ↗ 23: 10.6x ↗ 24: 10.6x ↗ 25: 10.3x ↗ 26: 10.5x ↗ 27: 10.5x ↗ 28: 10.6x ↗ 29: 10.8x ↘ 30: 10.1 ↑ Serie 104.9 Total 314.6
40 Skott		31: 10.6x ↗ 32: 10.7x ↗ 33: 10.8x ↗ 34: 10.8x ↓ 35: 10.6x ↗ 36: 10.5x ↗ 37: 10.9x ↗ 38: 10.5x ↗ 39: 10.9x ↗ 40: 10.7x ↘ Serie 107.0 Total 421.6		

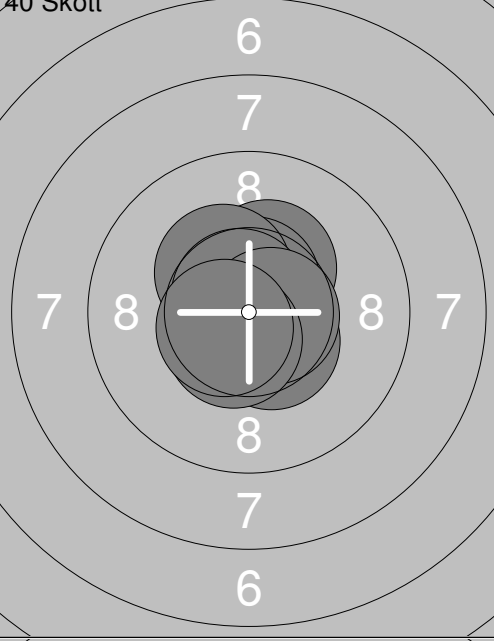
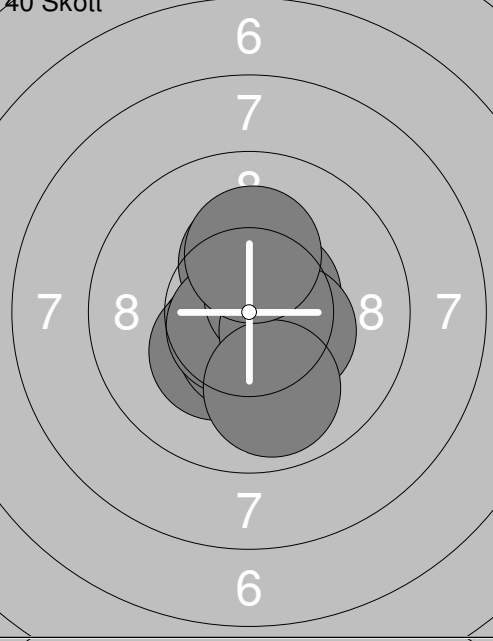
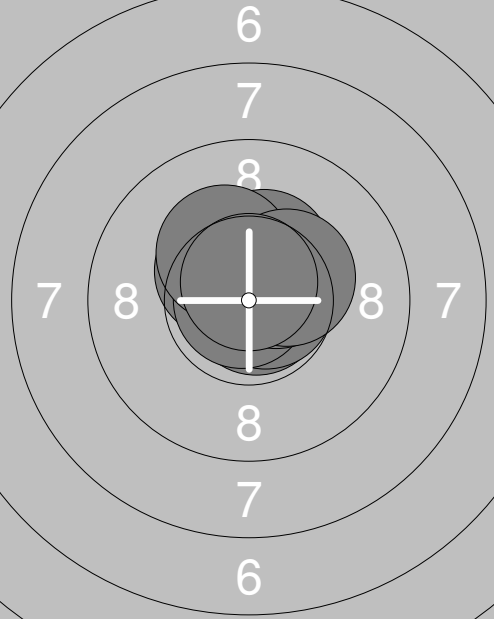
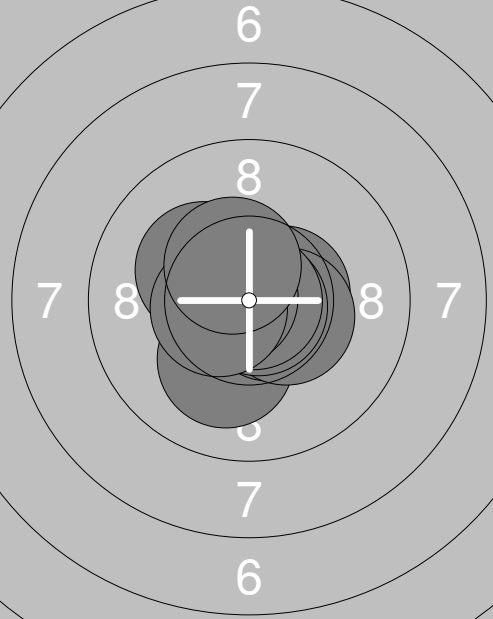
Skjutlag	Tavla	Axel Hedendahl			
1	36	Kyrkås Skf	L15	Jä	
04.02.2023	Skyttiaden 2023 Region	Umeå skytteallians			
Prov 	1: 10.5x↘	Prov 	11: 10.7x↗		
	2: 10.7x↘		12: 10.8x↘		
	3: 10.5x↘		13: 10.8x↗		
	4: 10.4x↓				
	5: 10.0 ↓				
	6: 10.2x↓				
	7: 10.5x↘				
	8: 10.1 ↓				
	9: 10.1 ↗				
	10: 10.8x↘				
	Serie 103.8		Serie 32.3		
	Total 0.0		Total 0.0		
40 Skott 	1: 10.7x↗	40 Skott 	11: 10.9x↘		
	2: 10.3x↗		12: 10.4x↘		
	3: 10.6x↗		13: 10.3x↘		
	4: 10.7x↘		14: 10.5x↓		
	5: 10.3x↘		15: 10.3x↗		
	6: 10.5x↘		16: 10.7x↘		
	7: 10.7x↗		17: 10.6x↗		
	8: 10.7x➡		18: 10.4x↘		
	9: 10.5x↘		19: 9.9 ↓		
	10: 10.6x↘		20: 10.2x↗		
	Serie 105.6		Serie 104.2		
	Total 105.6		Total 209.8		
40 Skott 	21: 10.8x↘	40 Skott 	31: 10.1 ↓		
	22: 10.4x↘		32: 10.6x↘		
	23: 10.7x➡		33: 10.5x➡		
	24: 10.7x↗		34: 10.4x➡		
	25: 10.9x↘		35: 10.2x↘		
	26: 10.4x↗		36: 10.8x↘		
	27: 10.5x↗		37: 10.9x➡		
	28: 10.3x↘		38: 10.7x↘		
	29: 10.4x↗		39: 10.5x↘		
	30: 10.7x↗		40: 10.5x↘		
	Serie 105.8		Serie 105.2		
	Total 315.6		Total 420.8		

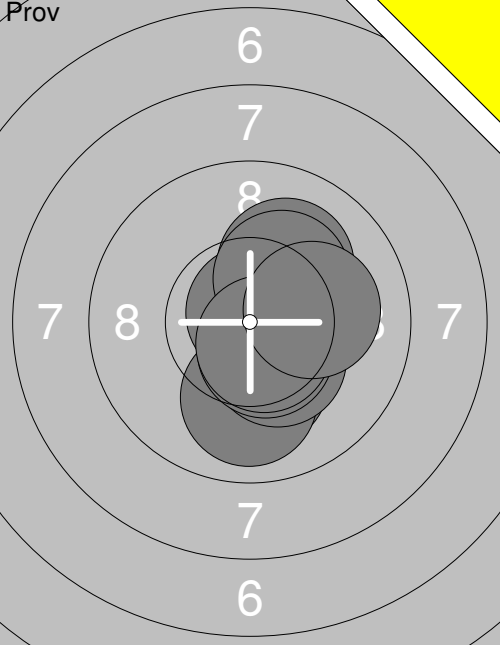
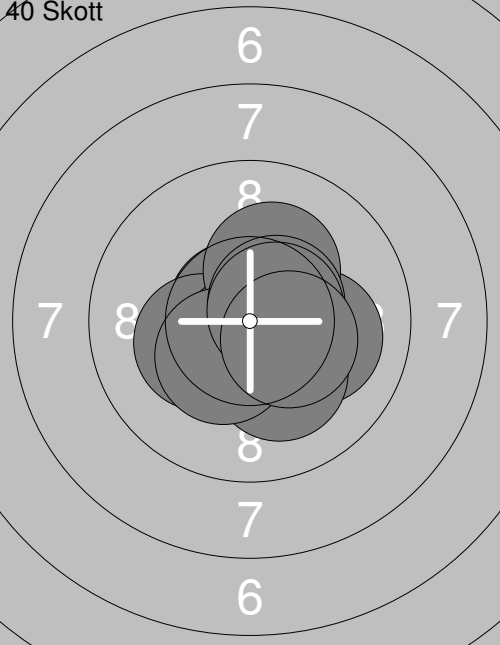
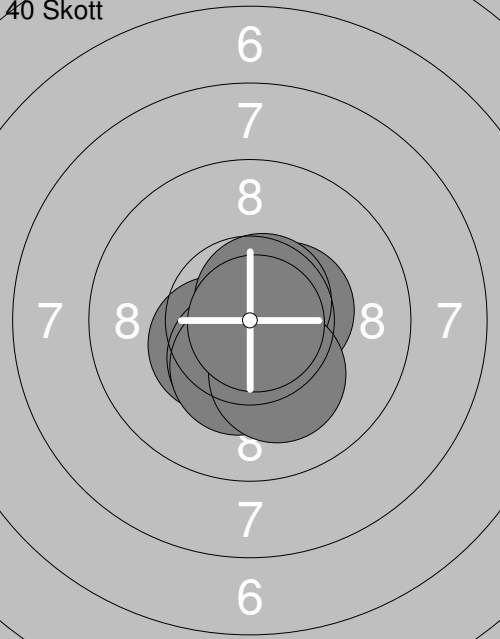
Skjutlag	Tavla	Elias Molin	
1	37	Fältjägarna Skf	L15
S			Jä
04.02.2023	Skyttiaden 2023 Region	Umeå skytteallians	
Prov		1: 10.2x↓ 2: 10.0 ↓ 3: 10.5x↘ 4: 10.1 ↗ 5: 10.4x↘ 6: 10.5x↓ 7: 10.8x↗ 8: 10.3x↗ 9: 10.6x↓ 10: 10.1 →	11: 10.7x↓ 12: 10.5x↓
		Serie 103.5	Serie 21.2
		Total 0.0	Total 0.0
40 Skott		1: 10.7x↘ 2: 10.3x↘ 3: 10.7x↓ 4: 10.1 → 5: 10.2x↓ 6: 10.2x↗ 7: 10.4x↘ 8: 10.5x↗ 9: 10.6x↗ 10: 10.4x↘	11: 10.6x↘ 12: 10.2x↘ 13: 10.8x↘ 14: 10.6x↘ 15: 10.8x↘ 16: 10.3x↗ 17: 10.7x↘ 18: 10.5x↘ 19: 10.7x↓ 20: 10.7x↗
		Serie 104.1	Serie 105.9
		Total 104.1	Total 210.0
40 Skott		21: 10.7x↓ 22: 10.5x↓ 23: 10.4x↘ 24: 10.6x↘ 25: 10.4x↓ 26: 10.5x↘ 27: 10.7x↗ 28: 10.3x↓ 29: 10.2x↓ 30: 10.9x↘	31: 10.6x↓ 32: 10.7x↓ 33: 10.8x↓ 34: 10.2x↘ 35: 10.5x↘ 36: 8.9 ↓ 37: 10.1 ↓ 38: 10.2x↗ 39: 10.6x↗ 40: 10.6x↓
		Serie 105.2	Serie 103.2
		Total 315.2	Total 418.4

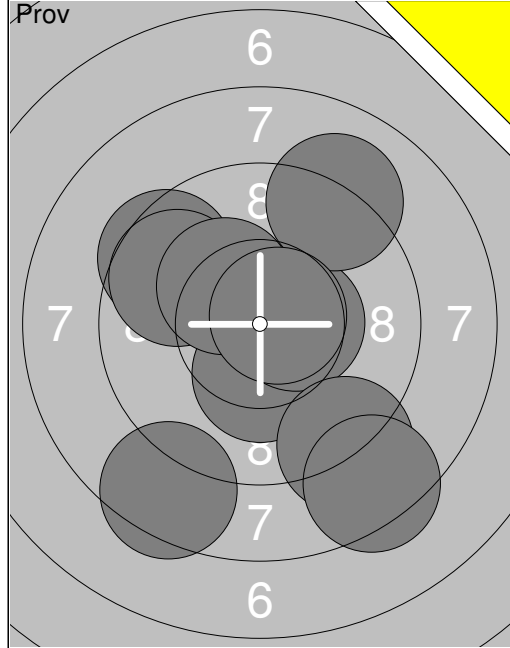

1:	10.3x↓
2:	9.5 ↖
3:	9.7 ↖
4:	10.3x↖
5:	10.5x→
6:	9.1 ↗
7:	9.0 ↓
8:	10.7x↗
9:	8.4 ↓
10:	8.5 ↓
Serie	96.0
Total	0.0

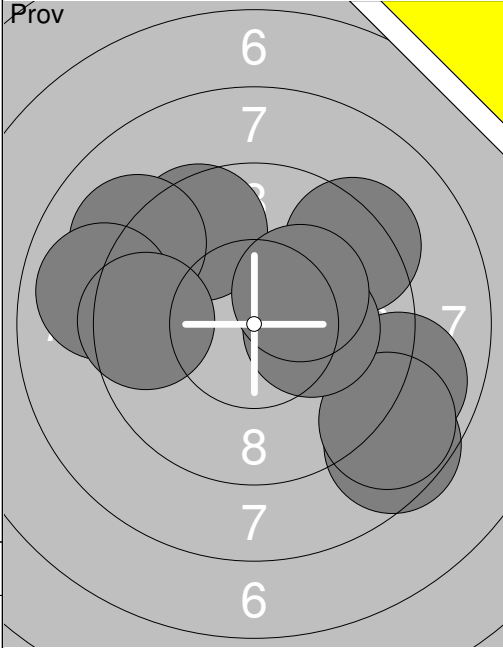

11:	8.9 →
12:	9.3 ↗
13:	9.6 ↗
14:	9.1 ↖
15:	8.6 ↓
16:	8.8 ↓
17:	10.2x→
18:	10.2x↗
19:	9.0 ←
20:	9.5 ←
Serie	93.2
Total	0.0

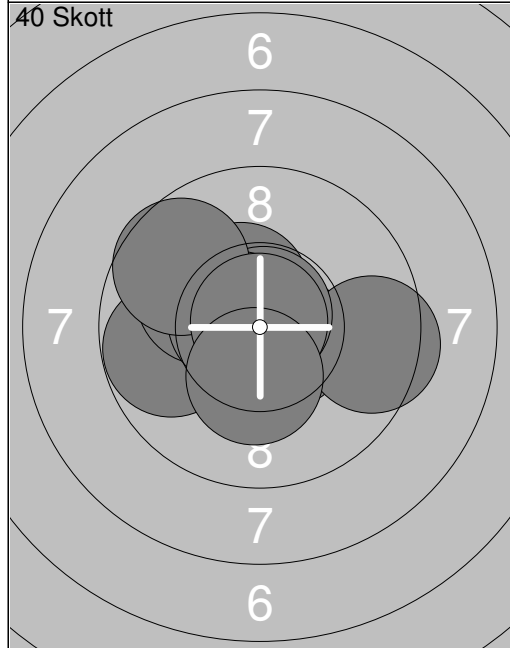

1:	9.8 ←
2:	10.1 ↖
3:	10.6x↖
4:	10.4x↖
5:	9.5 →
6:	10.8x↗
7:	10.6x↖
8:	9.7 ↖
9:	10.9x↗
10:	10.3x↓
Serie	102.7
Total	102.7

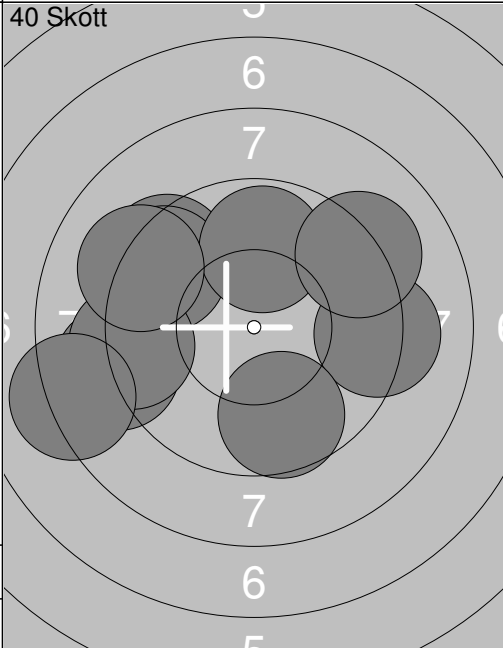

11:	9.4 ↖
12:	8.9 ←
13:	9.4 ↖
14:	9.2 ←
15:	9.8 ↑
16:	9.2 →
17:	8.2 ←
18:	9.7 ↓
19:	9.1 ↖
20:	9.2 ↗
Serie	92.1
Total	194.8

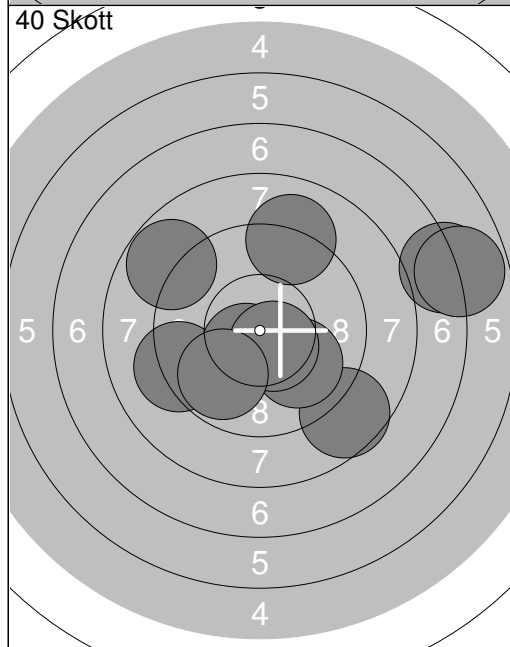

21:	9.2 ←
22:	10.5x↓
23:	8.8 ↖
24:	8.6 ↓
25:	10.0 ↓
26:	9.1 ↗
27:	7.1 →
28:	10.5x↓
29:	6.8 →
30:	9.8 ↓
Serie	90.4
Total	285.2

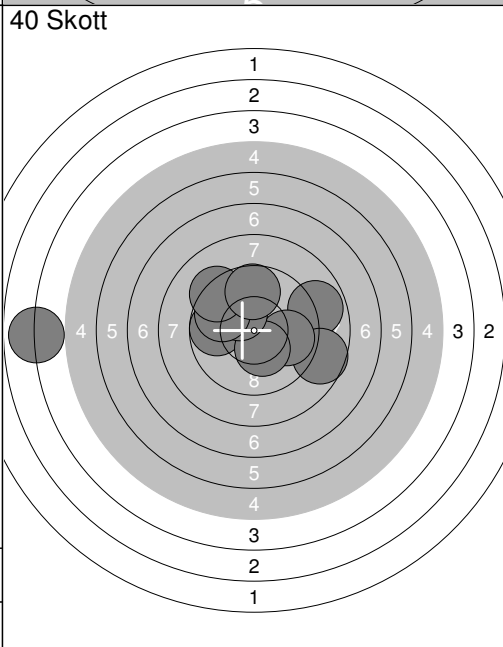

31:	3.9 ←
32:	8.9 →
33:	8.7 →
34:	9.8 ←
35:	9.9 →
36:	10.3x↓
37:	10.2x↖
38:	9.8 ↖
39:	9.3 ↖
40:	9.7 ↑
Serie	90.5
Total	375.7

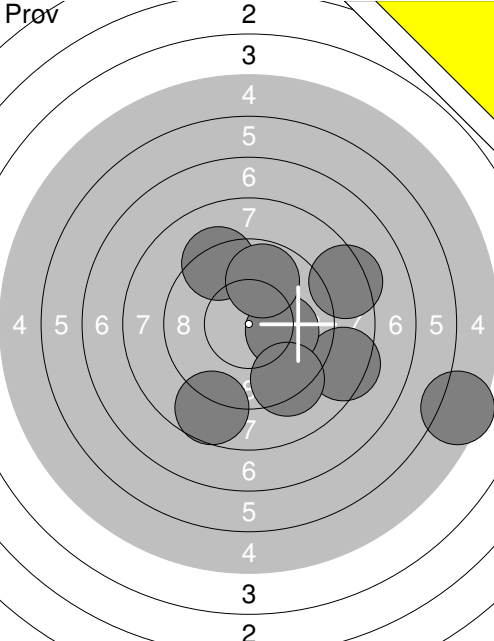
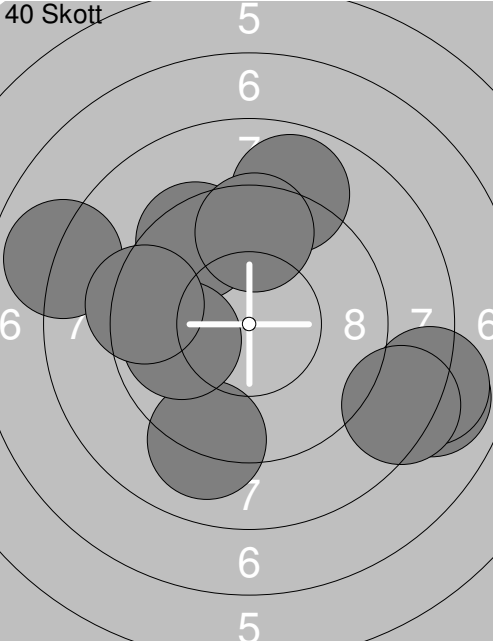
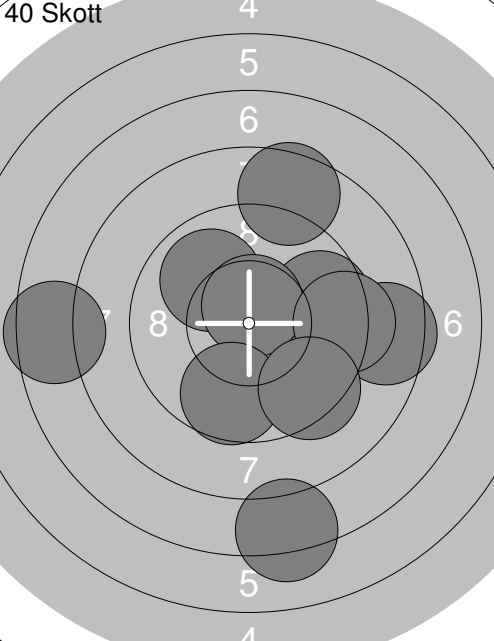
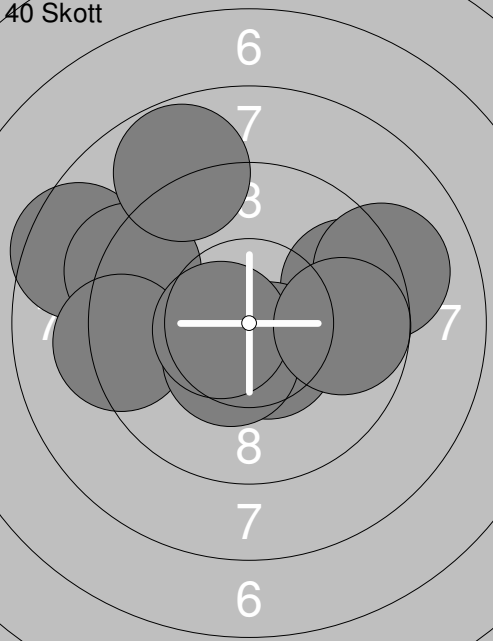
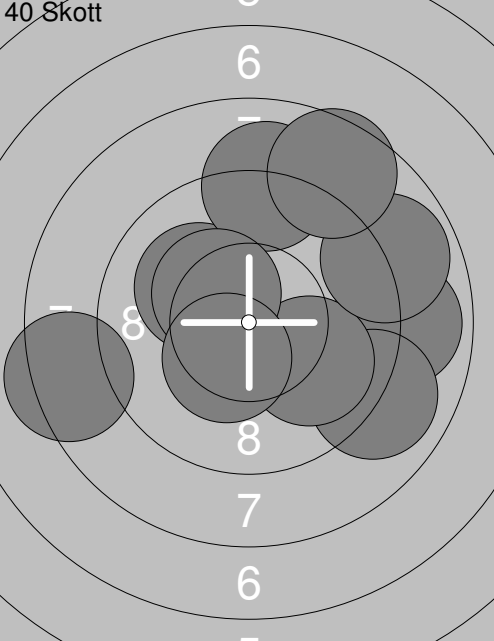
Skjutlag	Tavla	Johan Utsi Hæggrud	
2	3	Gällivare Skf	L13s No
04.02.2023	Skyttiaden 2023 Region	Umeå skytteallians	
Pröv 	1: 8.4 → 2: 8.7 ↓ 3: 8.4 → 4: 5.4 → 5: 9.3 ↗ 6: 10.1 → 7: 9.8 ↑ 8: 9.3 ↓	40 Skott 	1: 8.0 → 2: 8.9 ↑ 3: 8.1 → 4: 9.1 ↓ 5: 8.0 ← 6: 9.5 ↗ 7: 9.9 ← 8: 8.4 → 9: 9.3 ← 10: 9.6 ↑
	Serie 69.4		Serie 88.8
	Total 0.0		Total 88.8
40 Skott 	11: 9.7 → 12: 9.9 ↗ 13: 10.6x↑ 14: 8.5 → 15: 7.2 ↓ 16: 9.7 ↓ 17: 7.5 ← 18: 8.6 ↑ 19: 9.3 → 20: 9.4 ↓	40 Skott 	21: 9.6 → 22: 8.5 ← 23: 9.3 ← 24: 10.5x↓ 25: 8.8 ↗ 26: 9.3 ← 27: 10.4x↓ 28: 10.6x← 29: 9.1 → 30: 9.7 →
	Serie 90.4		Serie 95.8
	Total 179.2		Total 275.0
40 Skott 	31: 8.9 → 32: 9.0 → 33: 10.0 → 34: 10.1 ↗ 35: 8.9 → 36: 9.1 ↑ 37: 10.3x↘ 38: 8.4 ← 39: 10.4x↓ 40: 8.6 ↗		
	Serie 93.7		
	Total 368.7		

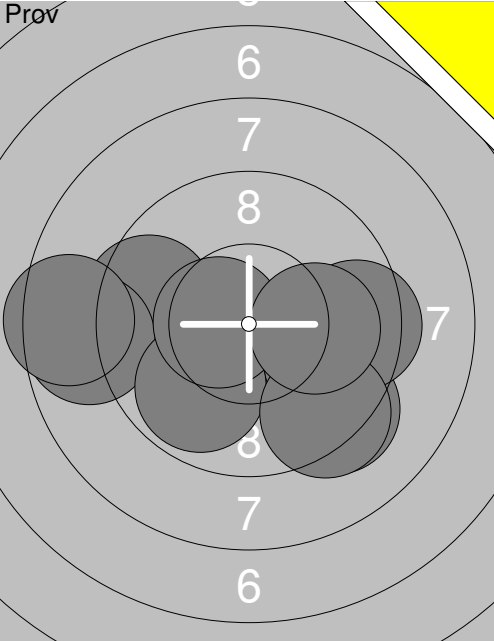
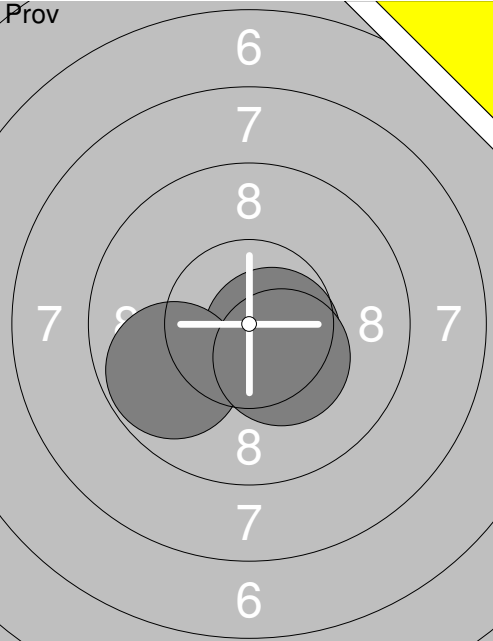
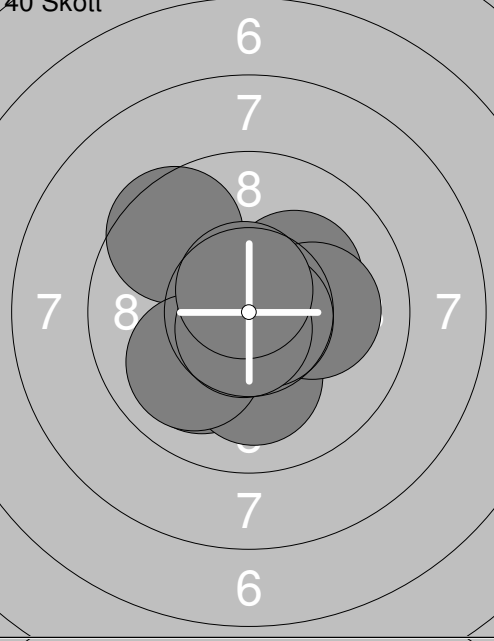
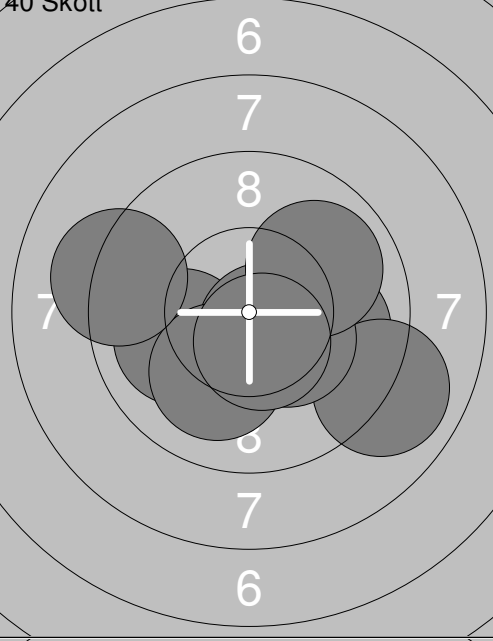
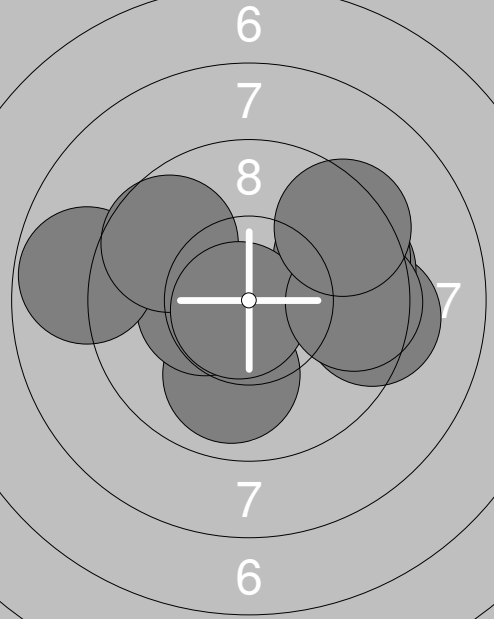
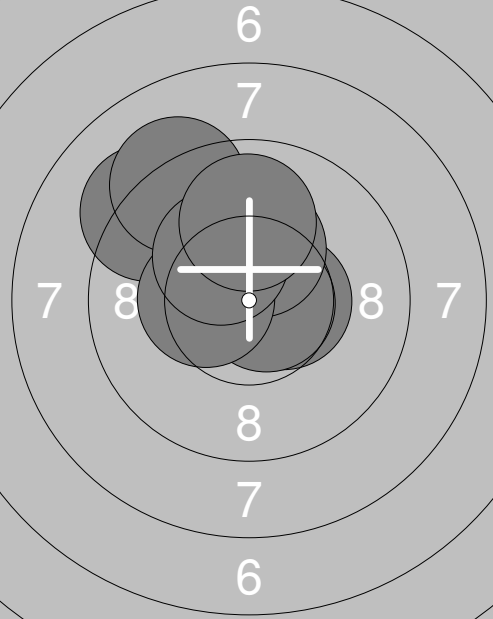
Skjutlag	Tavla	Vilda Stridsson	
2	5	Gällivare Skf	L15s No
04.02.2023	Skyttiaden 2023 Region	Umeå skytteallians	
Prov 	1: 9.5 ←	Prov 	11: 10.6x↘
	2: 8.8 ←		12: 9.8 ↙
	3: 8.5 ←		13: 10.3x↘
	4: 9.7 →		
	5: 9.3 ↘		
	6: 9.9 ↘		
	7: 10.5x←		
	8: 9.5 →		
	9: 9.3 ↘		
	10: 10.0 →		
	Serie 95.0		Serie 30.7
	Total 0.0		Total 0.0
40 Skott 	1: 10.0 ↘	40 Skott 	11: 10.0 ←
	2: 10.3x↓		12: 10.1 →
	3: 10.2x↗		13: 10.0 →
	4: 9.6 ↖		14: 9.0 ↘
	5: 10.1 ↓		15: 10.6x↘
	6: 10.1 →		16: 10.3x↘
	7: 10.0 ↘		17: 10.1 ↓
	8: 10.7x↘		18: 9.2 ←
	9: 10.7x↓		19: 9.9 ↗
	10: 10.7x↑		20: 10.5x↓
	Serie 102.4		Serie 99.7
	Total 102.4		Total 202.1
40 Skott 	21: 10.0 ↓	40 Skott 	31: 10.2x↖
	22: 9.3 →		32: 10.5x→
	23: 9.6 →		33: 9.2 ↖
	24: 9.6 ↗		34: 10.3x↖
	25: 10.4x←		35: 10.7x→
	26: 8.8 ←		36: 9.2 ↖
	27: 9.7 ↖		37: 10.3x↑
	28: 10.8x↘		38: 10.4x←
	29: 9.6 →		39: 10.3x↖
	30: 9.4 ↗		40: 9.9 ↑
	Serie 97.2		Serie 101.0
	Total 299.3		Total 400.3

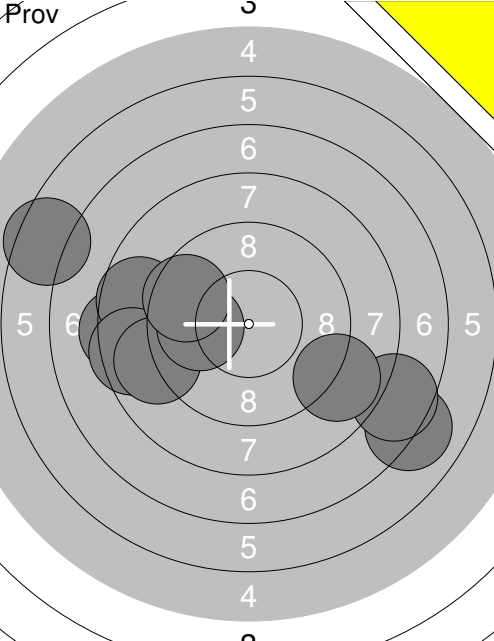
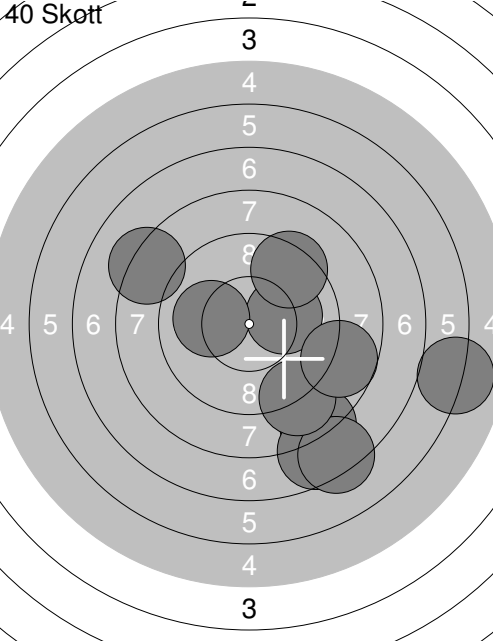
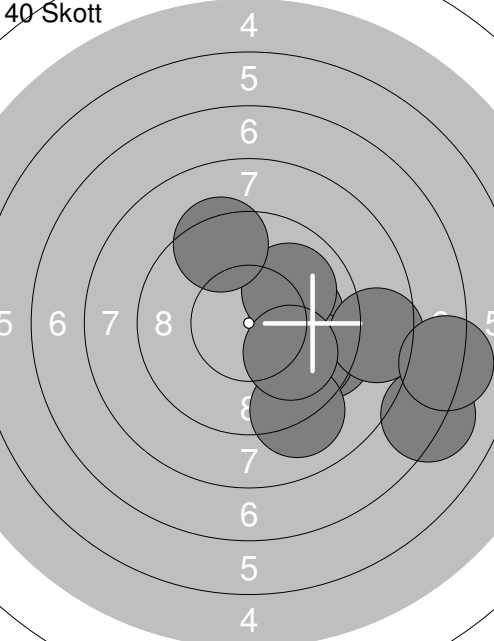
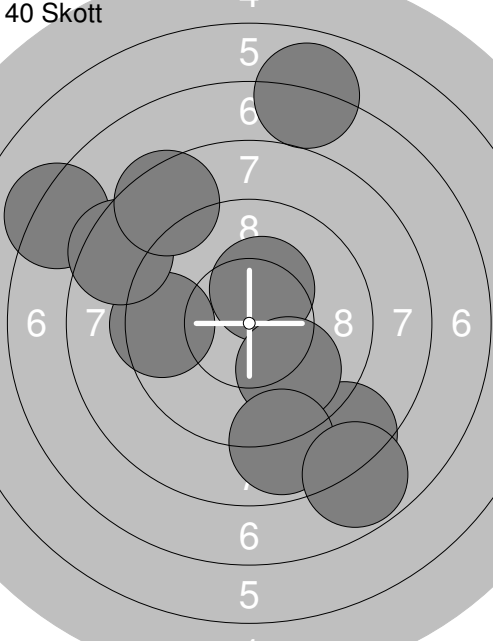
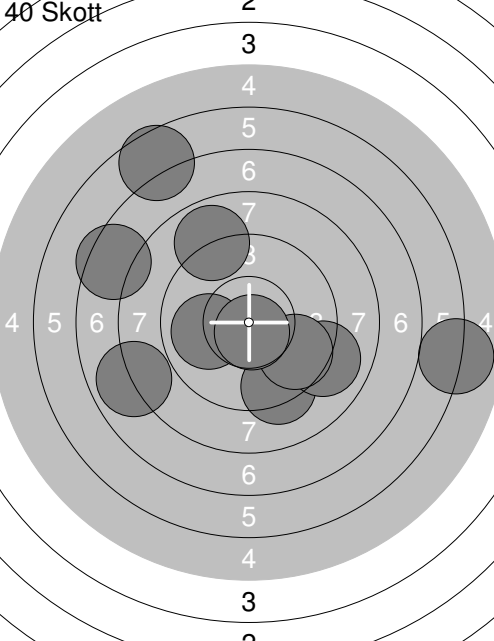
Skjutlag 2	Tavla 6	Hannah Hemå	
S		Fältjägarna Skf	L15s Jä
04.02.2023		Skyttiaden 2023 Region	Umeå skytteallians
Prov		1: 8.3 ← 2: 8.7 ← 3: 7.0 ↘ 4: 8.5 ← 5: 6.5 ↖ 6: 8.9 ← 7: 7.6 ↘ 8: 9.9 ← 9: 8.8 ↘ 10: 9.6 ↖ Serie 83.8 Total 0.0	40 Skott  1: 10.1 → 2: 8.1 ↘ 3: 7.6 ↘ 4: 8.2 ↖ 5: 10.1 ← 6: 7.3 ↘ 7: 6.0 → 8: 9.4 ↗ 9: 8.9 ↘ 10: 8.7 ↘ Serie 84.4 Total 84.4
40 Skott		11: 7.2 ↘ 12: 9.4 → 13: 10.0 → 14: 9.7 ↘ 15: 8.5 → 16: 7.2 → 17: 9.1 ↘ 18: 10.0 ↗ 19: 10.0 ↘ 20: 9.4 ↗ Serie 90.5 Total 174.9	40 Skott  21: 9.5 ← 22: 7.2 ↖ 23: 8.5 ↘ 24: 7.0 ↗ 25: 8.5 ↖ 26: 10.3x ↗ 27: 9.9 ↘ 28: 8.5 ↗ 29: 8.9 ↘ 30: 7.8 ↘ Serie 86.1 Total 261.0
40 Skott		31: 10.0 ← 32: 9.3 ↘ 33: 9.0 ↘ 34: 8.9 ↗ 35: 7.4 ↖ 36: 9.7 ↘ 37: 7.9 ← 38: 10.7x ↘ 39: 6.6 ↗ 40: 6.0 → Serie 85.5 Total 346.5	

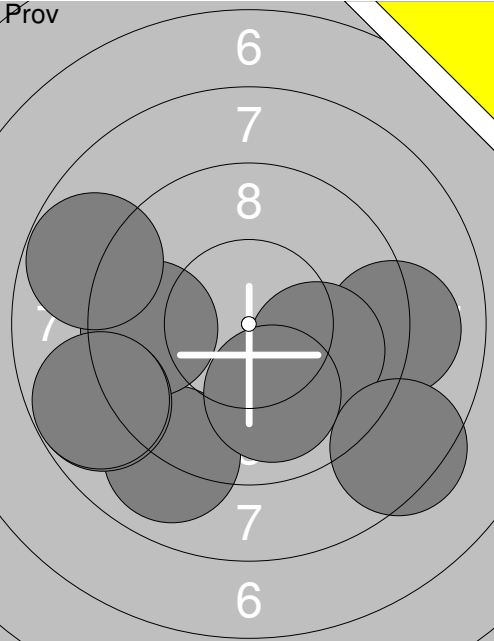
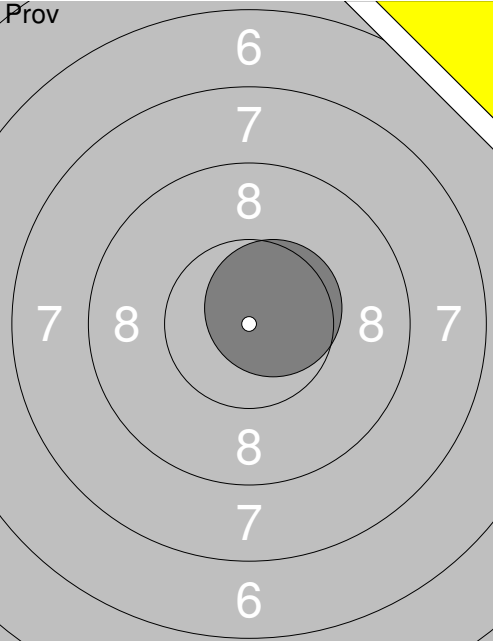
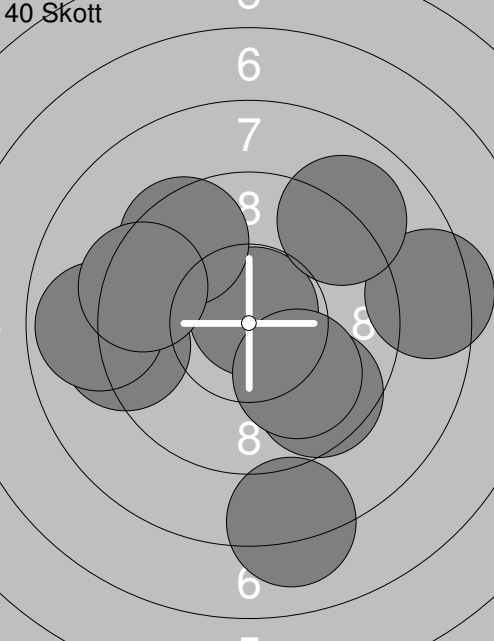
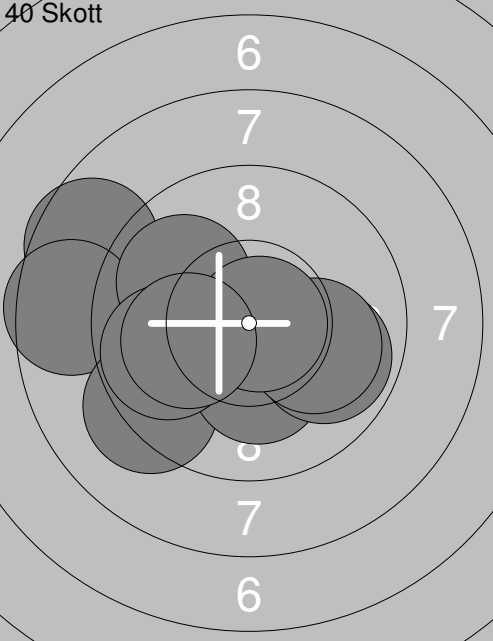
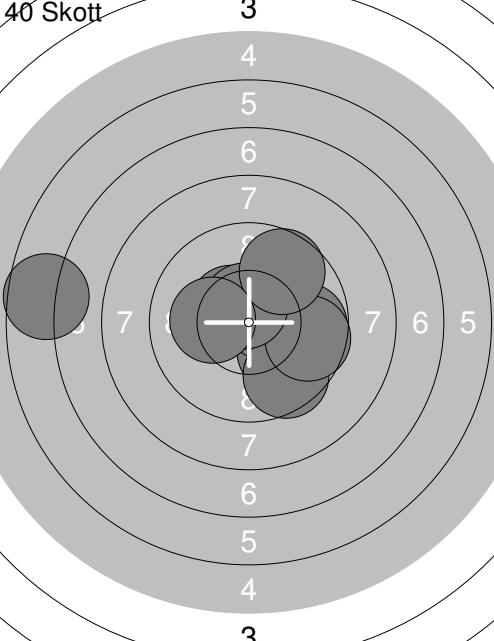
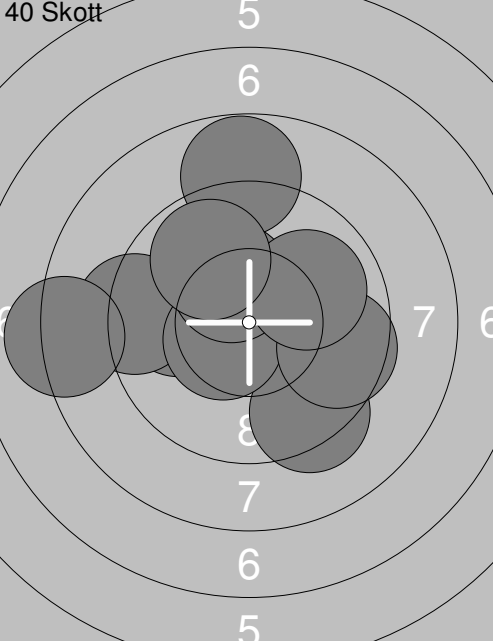
Skjuttag	Tavla	Jacob Hedman	
S	Umeå Skf	L15s	Vb
04.02.2023	Skyttiaden 2023 Region	Umeå skytteallians	
Prov		1: 9.0 ↘ 2: 9.6 ← 3: 8.8 ← 5: 8.8 ← 6: 9.1 → 7: 8.8 ← 8: 10.0 → 9: 8.4 ↘ 10: 10.0 ↘ Serie 82.5 Total 0.0	11: 10.6x↗ 
40 Skott		1: 10.8x↗ 2: 9.2 ← 3: 8.9 ← 4: 9.6 ↘ 5: 8.4 → 6: 9.0 ↗ 7: 9.5 ↗ 8: 10.0 ↘ 9: 8.1 ↘ 10: 9.4 ← Serie 92.9 Total 92.9	
40 Skott		21: 10.1 ↘ 22: 10.6x→ 23: 9.8 → 24: 9.6 ↘ 25: 10.5x↘ 26: 9.7 → 27: 10.6x↗ 28: 9.7 ↗ 29: 10.2x← 30: 6.7 ← Serie 97.5 Total 287.5	
			31: 9.9 ← 32: 9.2 ← 33: 9.3 ↘ 34: 10.5x↘ 35: 8.8 ↑ 36: 9.6 → 37: 10.3x↗ 38: 10.0 ↗ 39: 9.9 ↗ 40: 8.2 ← Serie 95.7 Total 383.2

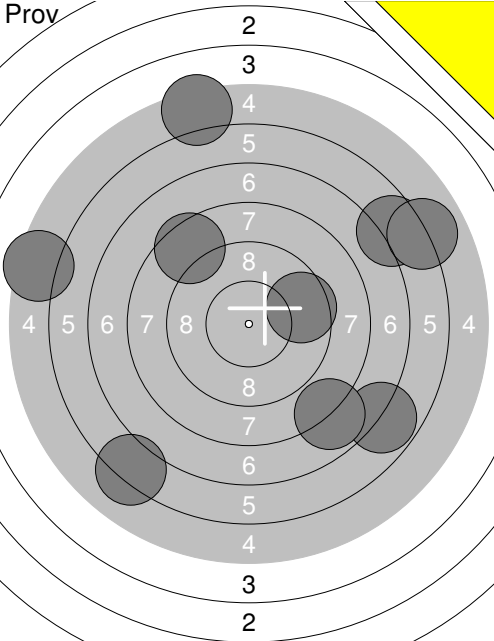
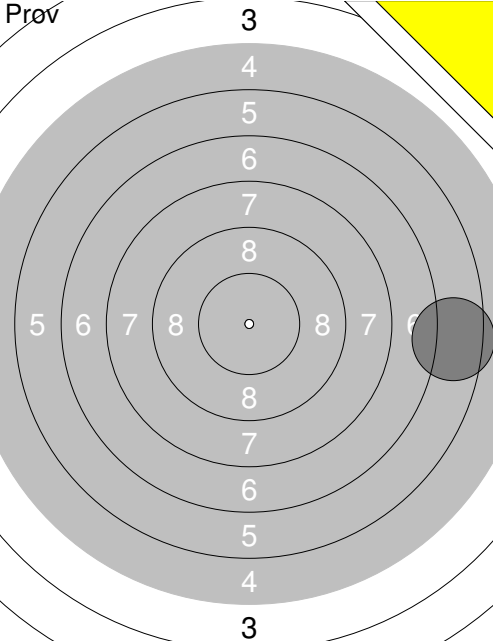
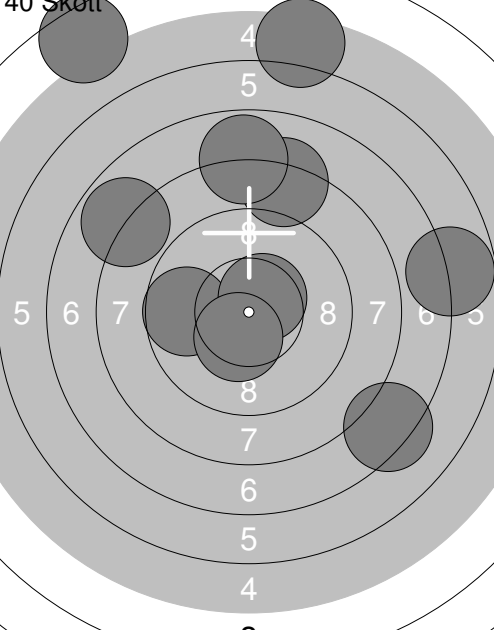
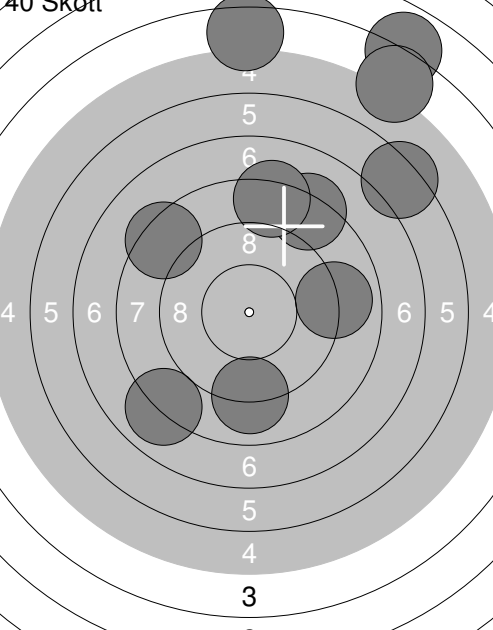
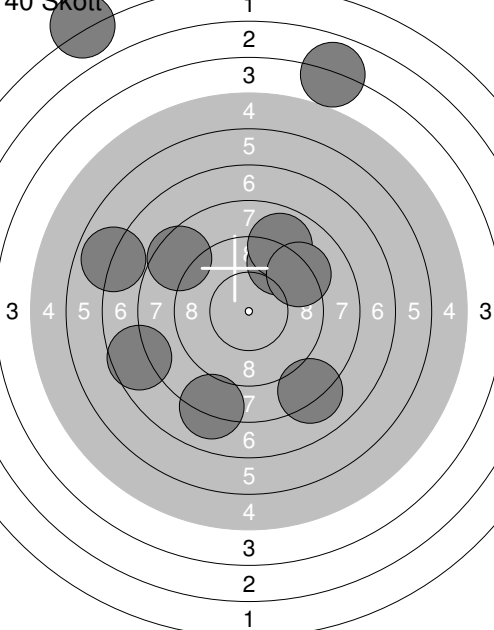
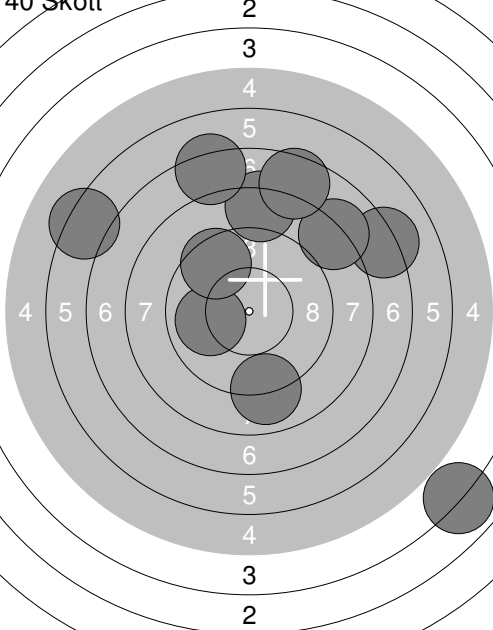
Skjuttag	Tavla	Jonathan Fordal	
2	8		
S		Kubikborg Uskf	L15s Vn
04.02.2023	Skyttiaden 2023 Region	Umeå skytteallians	
Prov		1: 5.4 ← 2: 6.6 ↗ 3: 6.0 ↗ 4: 9.5 → 6: 6.2 ↘ 7: 8.5 ↖ 8: 6.8 ↘ 9: 5.3 ↑ 10: 7.9 ↘	Prov  11: 6.5 →
	Serie 62.2		Serie 6.5
	Total 0.0		Total 0.0
40 Skott		1: 5.4 ↑ 2: 8.2 ↑ 3: 7.9 ↖ 4: 7.9 ↑ 5: 9.7 ← 6: 10.5x ↗ 7: 10.4x ↘ 8: 6.8 → 9: 4.5 ↖ 10: 7.3 ↘	40 Skott  11: 3.9 ↗ 12: 4.4 ↑ 13: 8.4 ↖ 14: 8.0 ↘ 15: 8.3 ↗ 16: 8.3 ↑ 17: 4.7 ↗ 18: 9.0 ↓ 19: 9.0 → 20: 6.3 ↗
	Serie 78.6		Serie 70.3
	Total 78.6		Total 148.9
40 Skott		21: 1.7 ↖ 22: 8.1 ↘ 23: 9.4 ↗ 24: 8.1 ↘ 25: 8.9 ↗ 26: 6.9 ← 27: 9.2 ↗ 28: 3.9 ↑ 29: 8.5 ↖ 30: 7.6 ←	40 Skott  31: 7.2 ↗ 32: 8.3 ↑ 33: 9.0 ↓ 34: 8.1 ↗ 35: 7.5 ↑ 36: 10.0 ← 37: 7.3 ↑ 38: 6.3 ↖ 39: 9.5 ↖ 40: 3.9 ↘
	Serie 72.3		Serie 77.1
	Total 221.2		Total 298.3

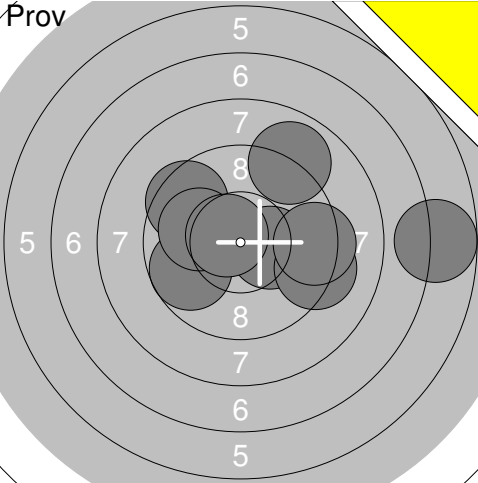
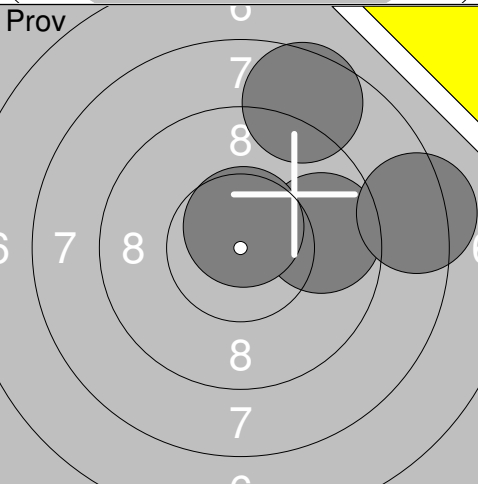
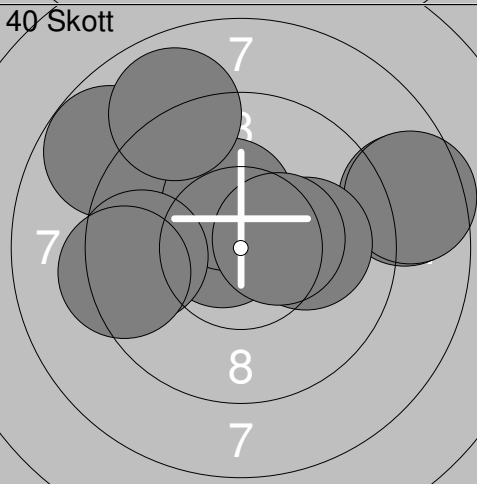
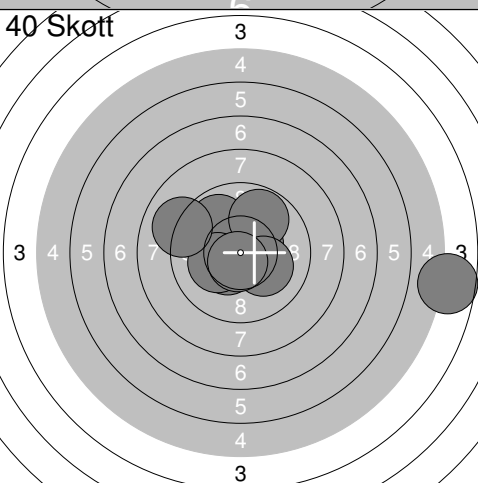
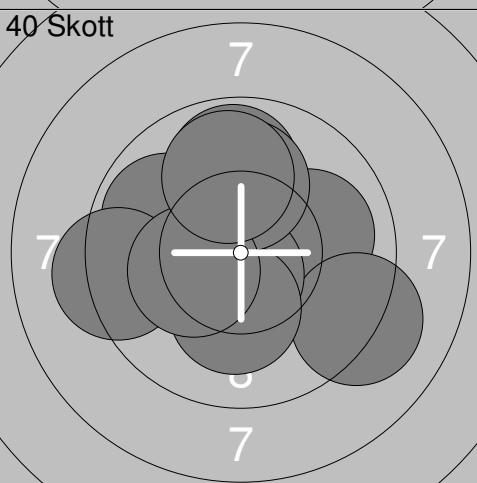
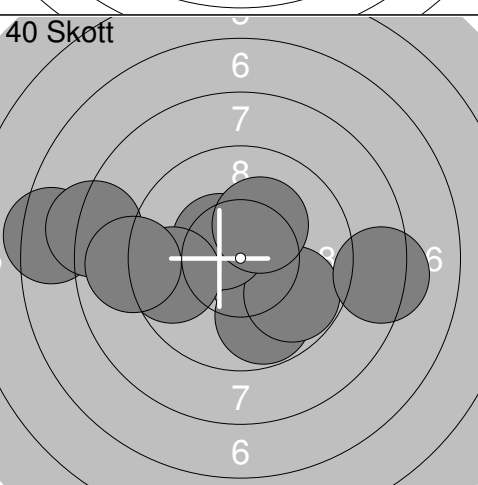
Skjutlag	Tavla	Elsa Martinsson		
2	9			
S		Hammerdal Skf	L15s	Jä
04.02.2023		Skyttiaden 2023 Region		Umeå skytteallians
Prov			1: 6.7 → 2: 10.3x → 4: 9.2 → 5: 8.9 ↗ 6: 9.5 ↗ 7: 9.7 ← 8: 10.0 ← 9: 10.6x ↗ 10: 9.3 →	11: 9.8 → 12: 8.9 → 13: 8.6 → 14: 9.5 ↘ 15: 10.8x ↗ 16: 10.2x ← 17: 9.5 → 18: 9.6 ↗ 19: 8.9 ↗ 20: 10.6x ↘
		Serie 84.2	Serie 96.4	
		Total 0.0	Total 0.0	
Prov			40 Skott 	1: 8.6 → 2: 10.7x ← 3: 8.6 → 4: 10.1 → 5: 8.8 ↗ 6: 10.3x ↗ 7: 8.9 ↗ 8: 9.6 ← 9: 9.3 ← 10: 10.4x →
		Serie 37.2	Serie 95.3	
		Total 0.0	Total 95.3	
40 Skott			40 Skott 	21: 10.0 → 22: 9.1 → 23: 10.6x ↓ 24: 10.2x ↓ 25: 9.8 ↑ 26: 9.9 ← 27: 10.0 ↑ 28: 9.3 ← 29: 10.3x ← 30: 9.9 ↑
		Serie 96.0	Serie 99.1	
		Total 191.3	Total 290.4	
40 Skott				
		Serie 93.2		
		Total 383.6		

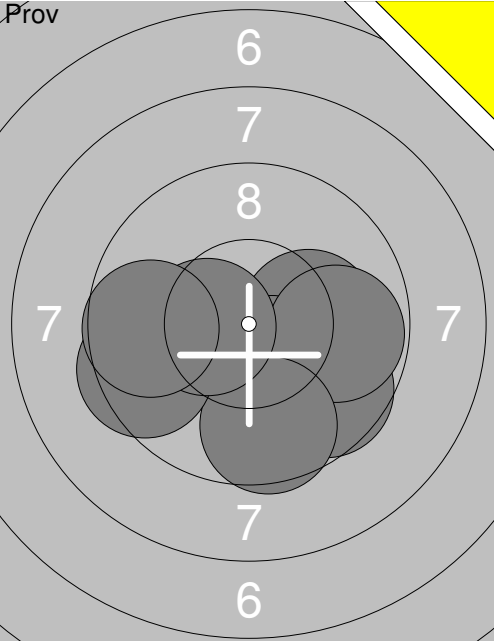
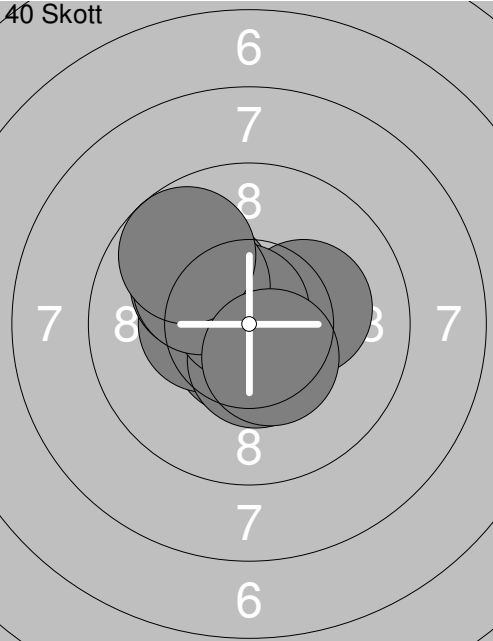
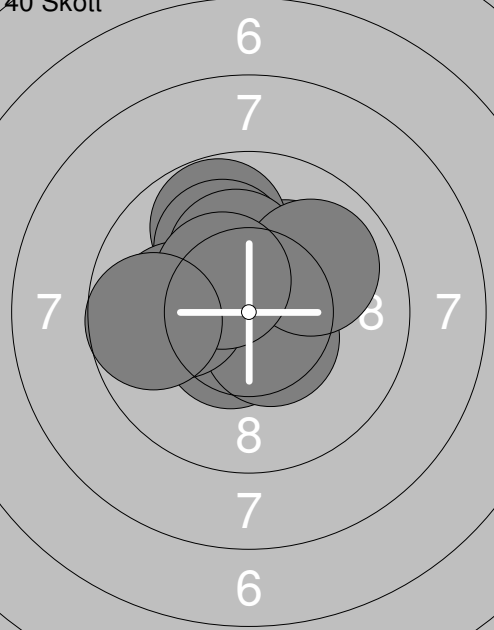
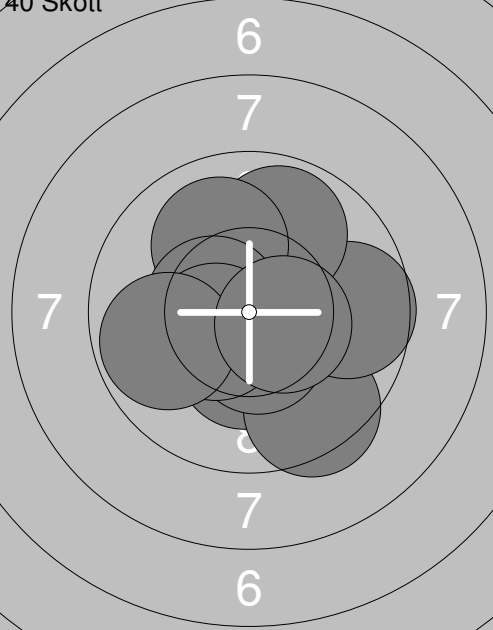
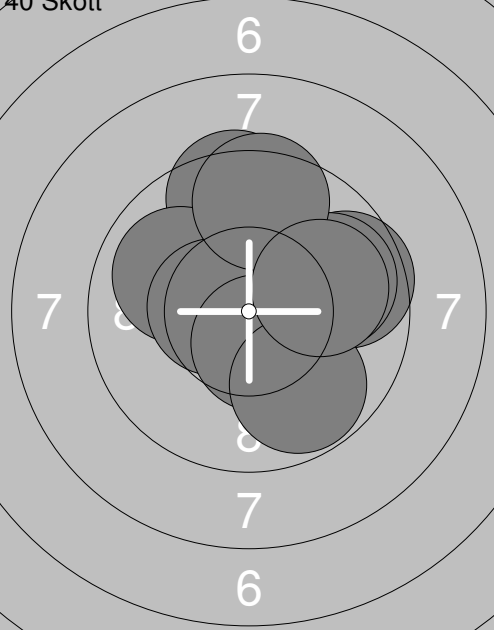
Skjutlag 2	Tavla 10	Caroline Rannebo Eklund					
S		Gällivare Skf		L15s	No		
04.02.2023		Skyttiaden 2023 Region		Umeå skytteallians			
		1: 10.5x↘ 2: 9.6 ↘ 3: 10.2x➤ 4: 10.3x↘ 5: 10.3x↘ 6: 9.8 ➤ 7: 9.6 ↘ 8: 9.5 ↙ 9: 10.4x↙ 10: 9.7 ↙ Serie 99.9 Total 0.0				1: 10.2x➤ 2: 10.6x↘ 3: 10.4x↙ 4: 10.5x↘ 5: 10.1 ↙ 6: 10.2x↙ 7: 10.8x↙ 8: 10.2x↙ 9: 9.7 ↙ 10: 10.4x↘ Serie 103.1 Total 103.1	
		11: 10.2x↗ 12: 10.5x↘ 13: 9.8 ↗ 14: 10.5x↘ 15: 10.0 ↗ 16: 10.2x↗ 17: 10.0↙ 18: 10.0 ➤ 19: 10.4x↙ 20: 9.7 ↙ Serie 101.3 Total 204.4				21: 10.3x↘ 22: 9.5 ↘ 23: 10.5x↘ 24: 9.7 ➤ 25: 9.9 ↗ 26: 10.0 ↗ 27: 10.5x↙ 28: 10.4x↙ 29: 9.8 ↙ 30: 10.5x➤ Serie 101.1 Total 305.5	
		31: 9.6 ➤ 32: 10.3x↗ 33: 9.5 ↗ 34: 9.9 ↙ 35: 10.5x↙ 36: 9.8 ➤ 37: 10.5x↘ 38: 9.5 ↗ 39: 9.8 ↘ 40: 10.0 ➤ Serie 99.4 Total 404.9					

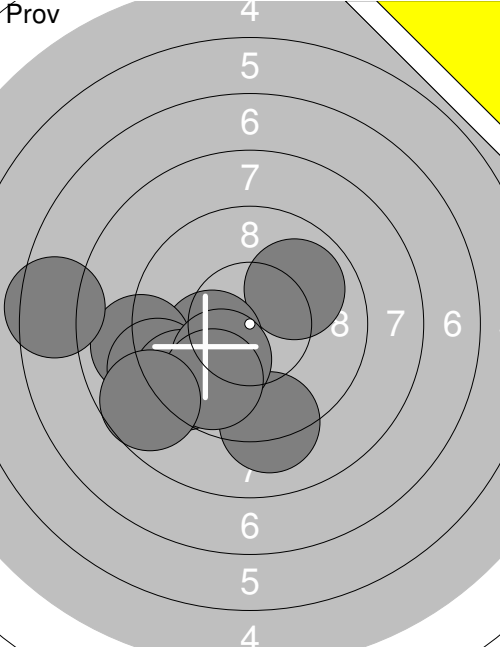
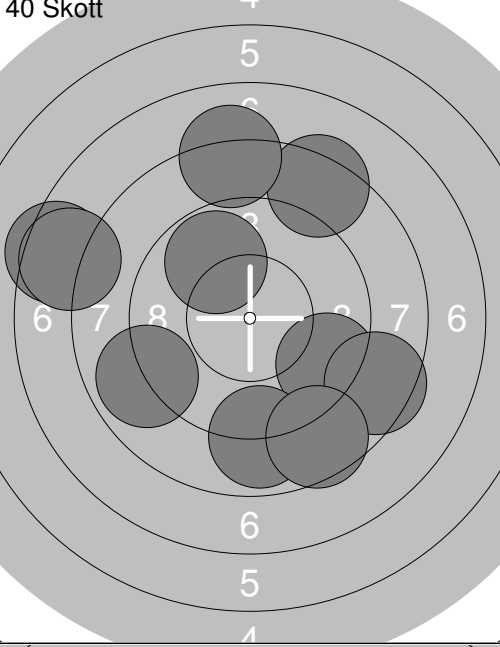
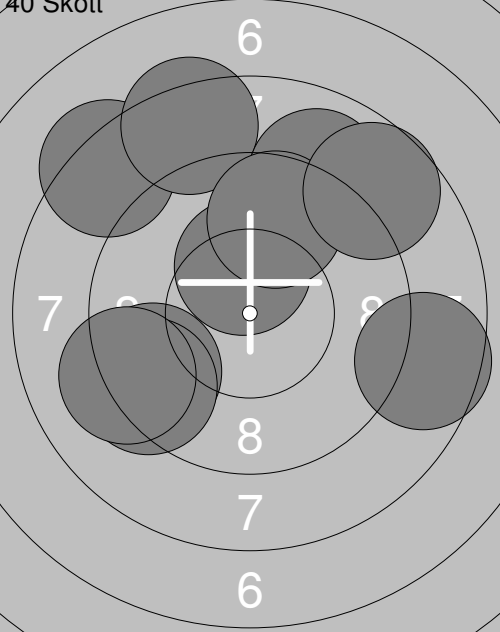
Skjutlag	Tavla	Gisela Grönblad Anders	
2	11	Fältjägarna Skf	L15s Jä
04.02.2023	Skyttiaden 2023 Region	Umeå skytteallians	
Prov		1: 9.9 ↗ 2: 10.2 ✕ 3: 9.0 ← 4: 9.1 ← 5: 9.2 ↓ 6: 9.4 ↙ 7: 10.1 ↓ 8: 9.8 ↓ 9: 8.7 ↙ 10: 7.5 ← Serie 92.9 Total 0.0	11: 8.3 ↓ 12: 10.5 ↗ 13: 7.6 → 14: 9.8 ↖ 15: 9.2 ↗ Serie 45.4 Total 0.0
40 Skott		1: 8.4 ↗ 2: 9.4 ↘ 3: 8.9 ↓ 4: 8.5 ↘ 5: 8.6 ↓ 6: 9.8 ↗ 7: 8.9 ← 8: 7.4 ← 9: 7.7 ← 10: 8.1 ↑ Serie 85.7 Total 85.7	11: 9.2 ↗ 12: 10.2 ✕ 13: 8.6 ← 14: 10.4 ✕ 15: 10.2 ✕ 16: 9.1 ↗ 17: 9.1 → 18: 7.8 ↖ 19: 8.1 ↗ 20: 9.5 ↖ Serie 92.2 Total 177.9
40 Skott		21: 8.3 ↖ 22: 8.4 ↗ 23: 10.3 ✕ 24: 9.5 ← 25: 9.0 ↗ 26: 9.3 ← 27: 9.2 ← 28: 9.7 ↗ 29: 8.6 → 30: 8.7 ↗ Serie 91.0 Total 268.9	31: 9.9 ↖ 32: 8.4 ← 33: 9.1 ↓ 34: 9.9 ↑ 35: 8.4 ← 36: 9.6 ↑ 37: 9.7 ↓ 38: 8.7 → 39: 9.1 ← 40: 7.5 ↑ Serie 90.3 Total 359.2

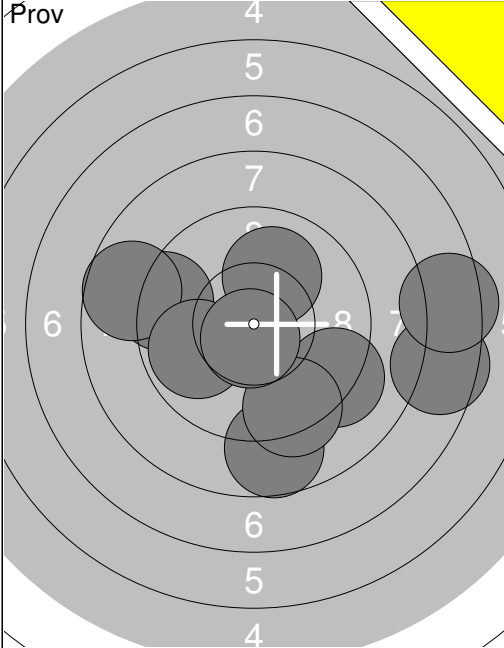
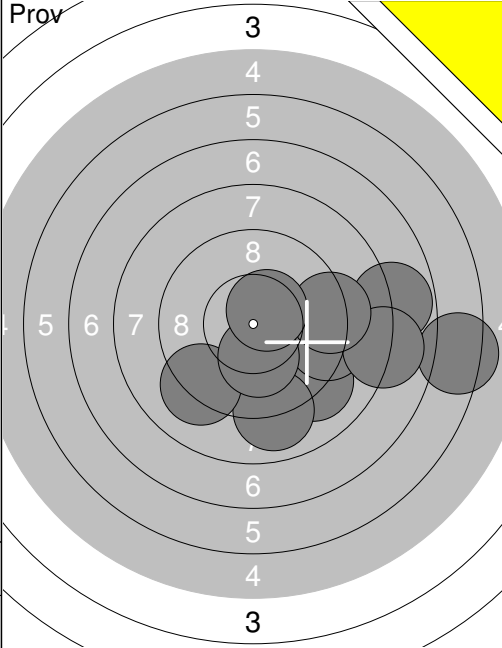
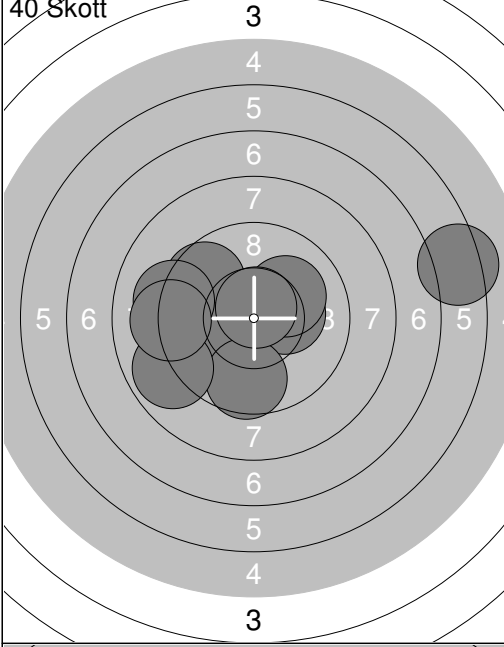
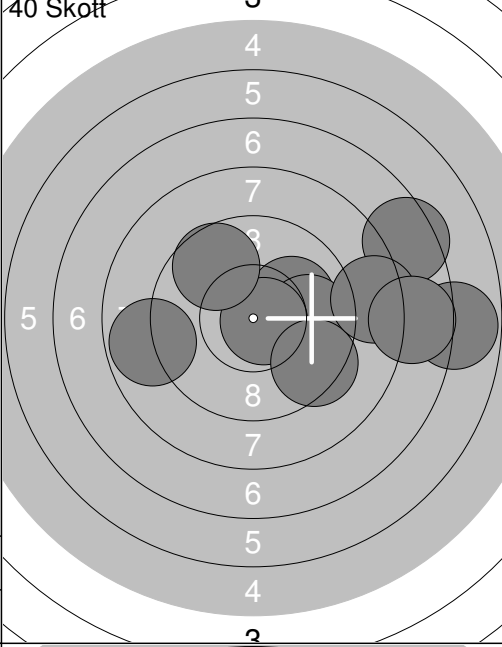
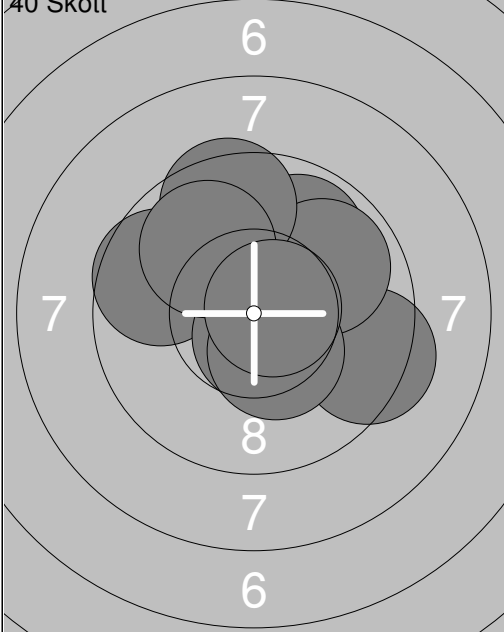
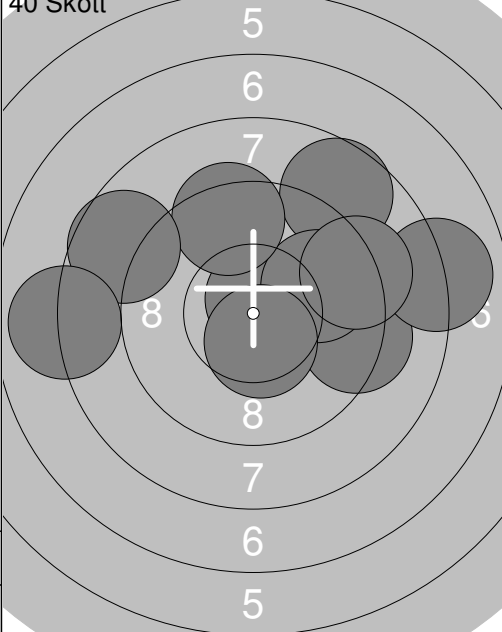
Skjutlag	Tavla	Gabiella Nilsson Rova	
2	12		
S	Gällivare Skf	L15s	No
04.02.2023	Skyttiaden 2023 Region	Umeå skytteallians	
Prov		Prov	
	1: 8.7 ↓ 2: 10.0 ↗ 3: 9.3 ← 4: 8.7 ← 5: 7.5 → 6: 9.9 ← 7: 7.4 → 8: 9.2 ↘ 9: 9.3 ↓ 10: 10.7x↓		11: 6.4 → 12: 9.1 ↘ 13: 7.8 → 14: 9.3 → 15: 8.0 → 16: 9.0 ↓ 17: 9.2 → 18: 9.2 ↘ 19: 10.2x↓ 20: 10.5x↗
	Serie 90.7 Total 0.0		Serie 88.7 Total 0.0
40 Skott		40 Skott	
	1: 9.6 ↖ 2: 10.3x→ 3: 9.6 ← 4: 9.6 ↓ 5: 8.9 ↖ 6: 10.1 ↗ 7: 9.2 ← 8: 6.3 → 9: 10.7x↗ 10: 9.1 ←		11: 10.1 ↗ 12: 9.8 → 13: 10.7x→ 14: 9.4 ↘ 15: 9.7 ↗ 16: 7.4 ↗ 17: 8.8 ← 18: 6.8 → 19: 8.4 → 20: 7.7 →
	Serie 93.4 Total 93.4		Serie 88.8 Total 182.2
40 Skott		40 Skott	
	21: 9.6 ↖ 22: 10.2x↗ 23: 9.9 ↗ 24: 9.4 → 25: 9.9 ↗ 26: 10.6x↓ 27: 9.5 ↑ 28: 10.4x↓ 29: 9.9 ↗ 30: 10.7x→		31: 10.7x↗ 32: 8.7 ↗ 33: 9.3 → 34: 9.8 → 35: 8.0 → 36: 9.2 → 37: 9.4 ↑ 38: 8.6 ↖ 39: 10.5x↓ 40: 8.0 ←
	Serie 100.1 Total 282.3		Serie 92.2 Total 374.5

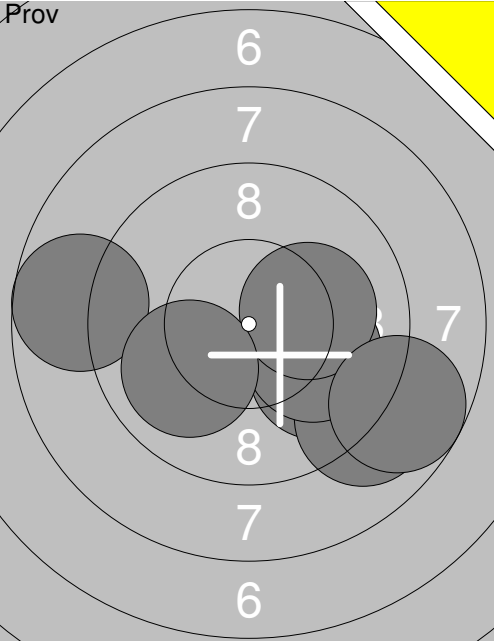
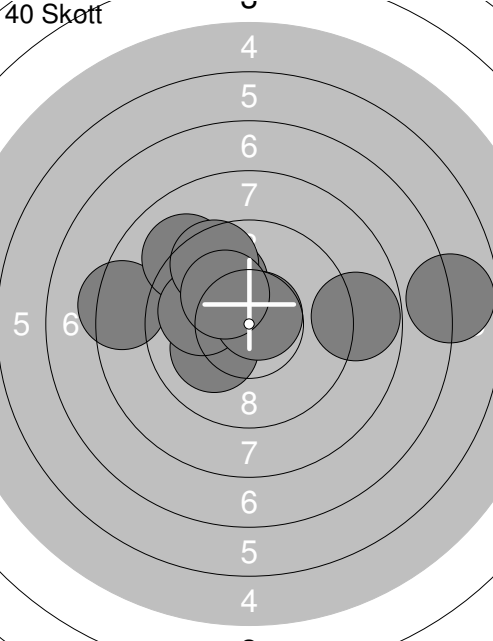
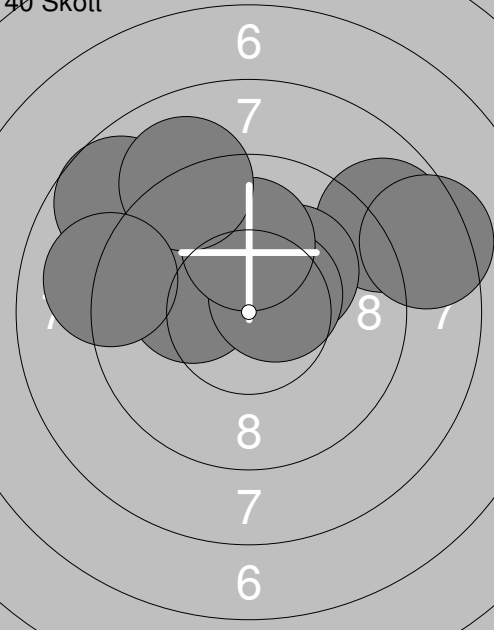
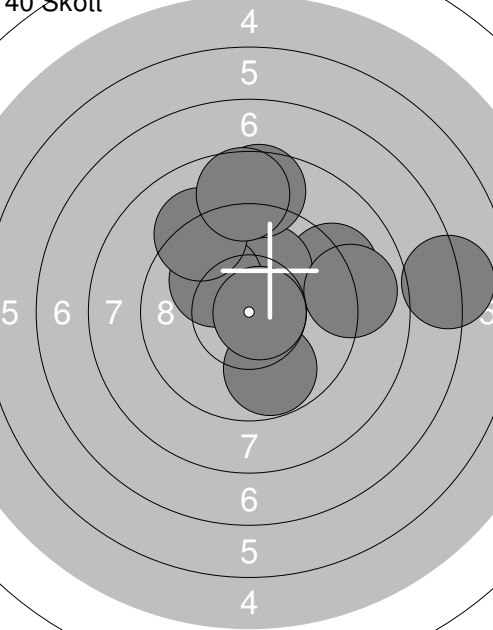
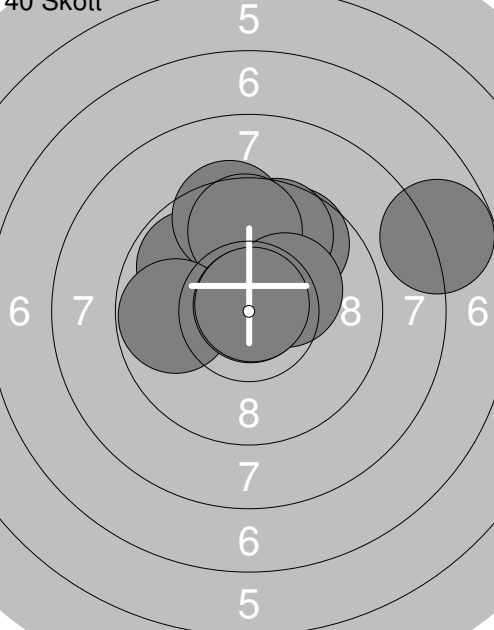
Skjutlag	Tavla	Casper Danielsson	
S	Fältjägarna Skf	L15s	Jä
04.02.2023	Skyttiaden 2023 Region	Umeå skytteallians	
Prov		40 Skott	
	1: 8.7 ← 2: 9.9 ↘ 3: 9.0 ↘ 4: 10.0 ↘ 5: 10.2x→ 6: 10.0↙ 7: 8.8 ↘		1: 8.8 → 2: 10.1↙ 3: 9.9 ↗ 4: 8.4 ← 5: 6.9 → 6: 9.1 ↗ 7: 10.0← 8: 9.6 ↗ 9: 10.7x↗ 10: 10.2x↘
	Serie 66.6		Serie 93.7
	Total 0.0		Total 93.7
40 Skott		40 Skott	
	11: 8.8 ↗ 12: 9.4 ↙ 13: 10.2x↗ 14: 10.2x↙ 15: 8.7 ↙ 16: 8.4 → 17: 10.5x↗ 18: 10.0 ↑ 19: 9.0 ↙ 20: 9.1 ←		21: 9.8 ↓ 22: 9.2 ↗ 23: 10.1 ↑ 24: 9.0 → 25: 8.6 ↑ 26: 10.1↙ 27: 9.2 ↙ 28: 8.7 ↑ 29: 10.7x→ 30: 7.1 →
	Serie 94.3		Serie 92.5
	Total 188.0		Total 280.5
40 Skott			
	31: 9.8 ↙ 32: 9.7 ↗ 33: 7.8 → 34: 9.7 ↗ 35: 9.4 ↑ 36: 9.7 ↑ 37: 9.8 ← 38: 10.9x↗ 39: 10.3x↗ 40: 10.8x↗		
	Serie 97.9		
	Total 378.4		

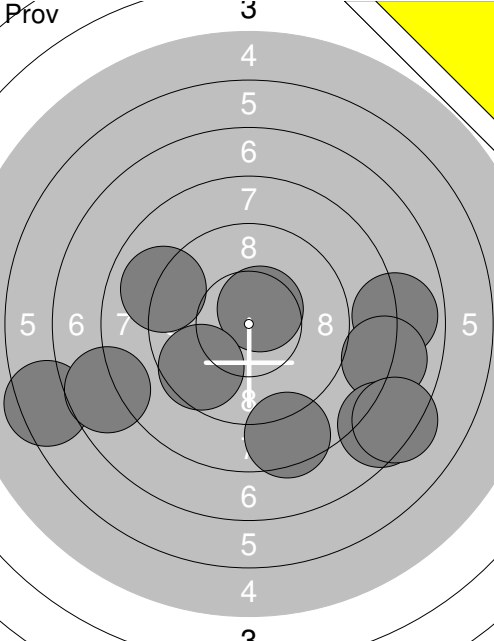
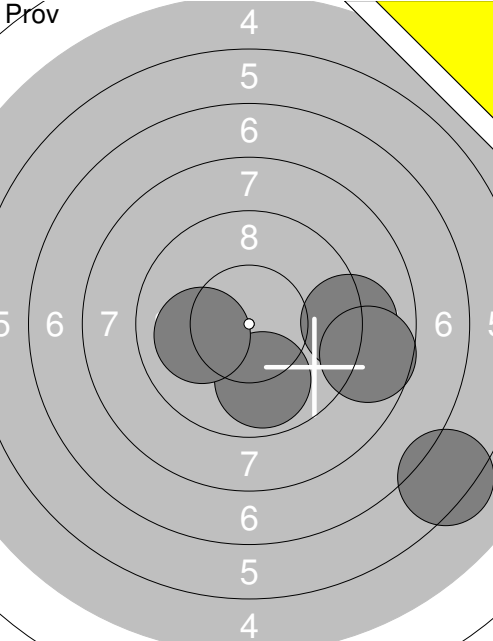
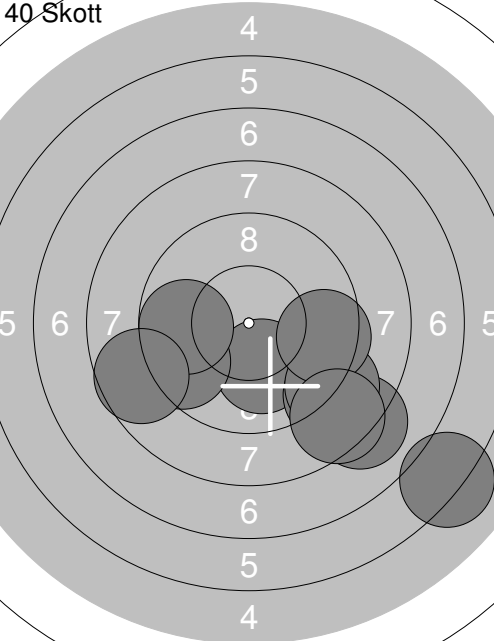
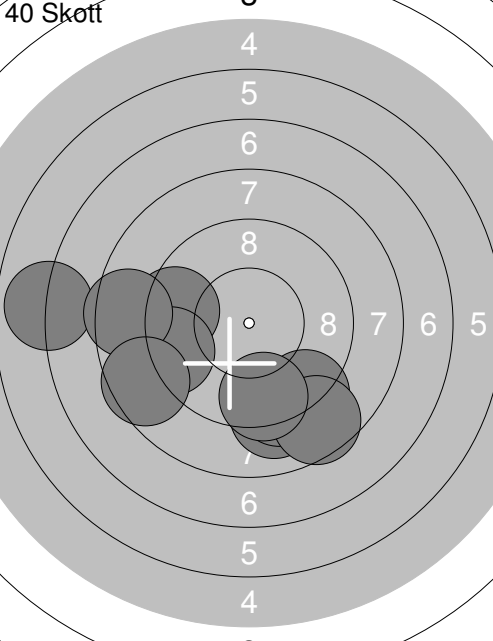
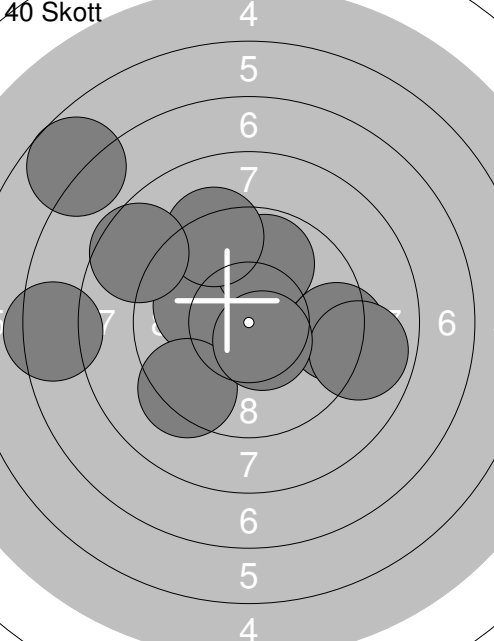
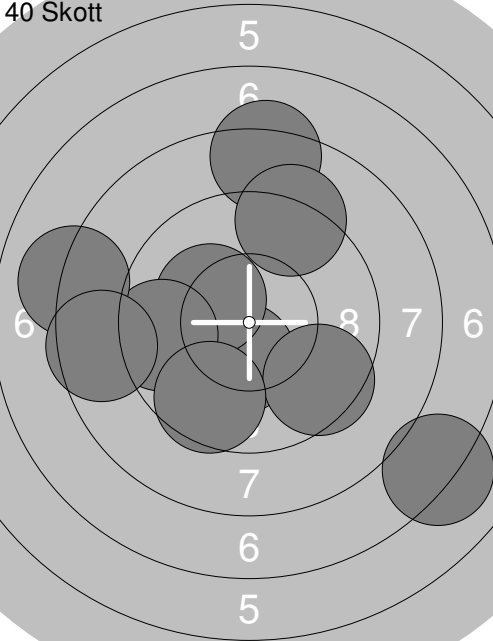
Skjutlag	Tavla	Saga Lundmark	
2	14		
S	Piteå Skf	L15s	No
04.02.2023	Skyttiaden 2023 Region	Umeå skytteallians	
Pröv		Pröv	
	1: 6.4 ← 2: 7.9 → 3: 8.5 ↓ 4: 10.6x↗ 5: 9.0 ← 6: 9.6 ← 7: 8.0 → 8: 7.7 ← 9: 7.5 ↓ 10: 7.3 ↓ Serie 82.5 Total 0.0		11: 9.1 → 12: 9.9 ↓ 13: 6.3 ↘ 14: 8.7 → 15: 10.0 ← Serie 44.0 Total 0.0
40 Skott		40 Skott	
	1: 10.1 ↓ 2: 8.1 ↓ 3: 8.9 ↓ 4: 9.5 ← 5: 9.8 ← 6: 8.7 ← 7: 6.2 ↓ 8: 9.0 ↓ 9: 9.5 → 10: 8.5 ↓ Serie 88.3 Total 88.3		11: 9.1 ↓ 12: 9.4 ← 13: 9.3 ← 14: 9.3 ↓ 15: 9.1 ↓ 16: 6.9 ← 17: 8.5 ← 18: 8.6 ↓ 19: 8.6 ← 20: 9.5 ↓ Serie 88.3 Total 176.6
40 Skott		40 Skott	
	21: 10.1 ← 22: 9.3 ↓ 23: 9.9 ↑ 24: 6.7 ↖ 25: 9.3 → 26: 7.4 ← 27: 9.3 ↑ 28: 8.6 ↖ 29: 8.9 → 30: 10.5x↘ Serie 90.0 Total 266.6		31: 8.3 ↑ 32: 9.2 ↗ 33: 10.4x↘ 34: 10.2x↖ 35: 9.5 ← 36: 8.1 ← 37: 9.5 ↓ 38: 7.1 ↓ 39: 9.6 ↓ 40: 8.6 ← Serie 90.5 Total 357.1

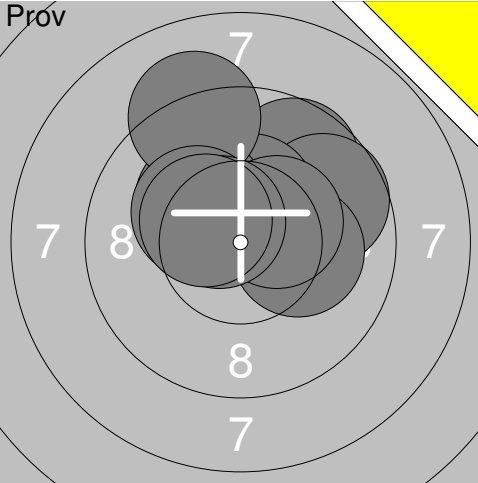
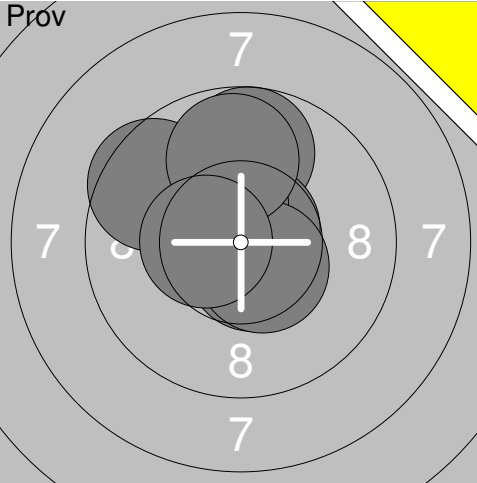
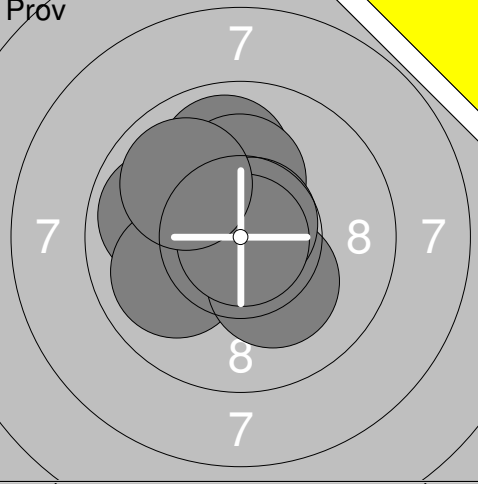
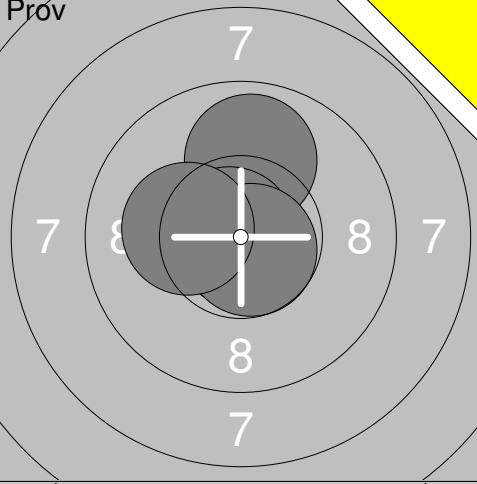
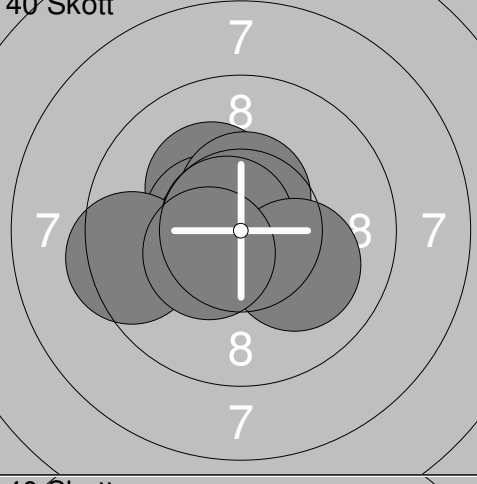
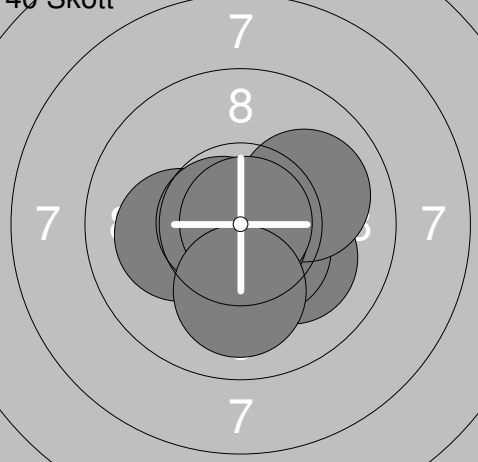
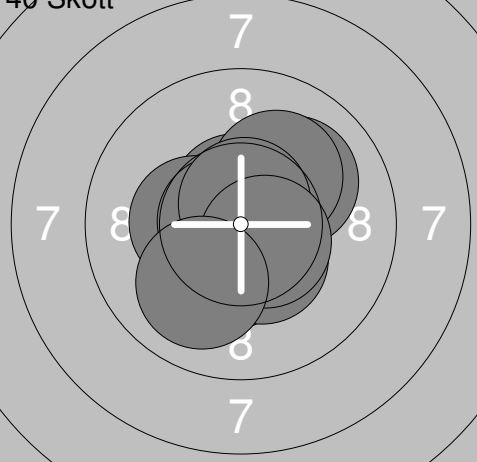

Skjutlag	Tavla	Elias Molin	
S	Fältjägarna Skf	L15s	Jä
04.02.2023	Skyttiaden 2023 Region	Umeå skytteallians	
Prov		1: 7.6 ↗ 2: 7.9 ↖ 3: 7.6 ↗ 4: 6.7 ↓ 5: 7.7 ↖ 6: 9.8 ↓ 7: 9.3 ↓ 8: 6.6 ↖ 9: 7.8 ↘ 10: 9.1 ↖ Serie 80.1 Total 0.0	11: 9.4 ← 12: 7.7 ← 13: 9.1 ← 14: 6.3 ↗ 15: 4.9 ↖ 16: 8.9 ↗ 17: 9.4 ↗ 18: 10.0 ↖ 19: 8.9 ← 20: 8.5 ↓ 21: 8.7 ↗ Serie 82.4 Total 169.9
40 Skott		1: 8.4 ↖ 2: 7.3 ↗ 3: 9.5 ↗ 4: 7.8 ↗ 5: 10.0 → 6: 7.1 ← 7: 10.3 ↘ 8: 8.0 ← 9: 9.1 ↓ 10: 10.0 ↗ Serie 87.5 Total 87.5	11: 9.3 ↓ 12: 9.1 ↗ 13: 8.5 ↗ 14: 5.9 ← 15: 8.5 ← 16: 8.3 ↘ 17: 8.0 ← 18: 4.8 ← 19: 8.1 ↘ 20: 8.3 ↗ Serie 78.8 Total 335.8
40 Skott		21: 9.8 ↖ 22: 7.7 ↓ 23: 9.7 ↘ 24: 8.0 ↗ 25: 10.1 ↖ 26: 9.3 ← 27: 10.6 ↘ 28: 8.6 ↗ 29: 6.5 ↖ 30: 6.8 ↖ Serie 87.1 Total 257.0	31: 9.3 ↓ 32: 9.1 ↗ 33: 8.5 ↗ 34: 5.9 ← 35: 8.5 ← 36: 8.3 ↘ 37: 8.0 ← 38: 4.8 ← 39: 8.1 ↘ 40: 8.3 ↗ Serie 78.8 Total 335.8

Prov 	1: 9.7 ↙ 2: 9.5 ↙ 3: 10.3x↓ 4: 10.7x↙ 5: 10.9x↓ 6: 10.7x↙ 7: 10.4x➤ 8: 10.9x↗ 9: 10.2x↙ 10: 10.6x↓ Serie 103.9 Total 0.0	Prov 	11: 10.5x↙ 12: 10.5x↗ 13: 10.6x➤ 14: 10.6x➤ 15: 10.6x↙ 16: 10.8x↙ 17: 10.5x➤ 18: 10.5x↓ 19: 10.7x➤ 20: 10.6x↓ Serie 105.9 Total 0.0
40 Skott 	1: 10.5x↙ 2: 10.6x↗ 3: 10.3x↙ 4: 10.7x↓ 5: 10.1↙ 6: 10.6x↙ 7: 10.6x↗ 8: 10.2x↙ 9: 9.9↙ 10: 10.5x↓ Serie 104.0 Total 104.0	40 Skott 	11: 10.6x➤ 12: 10.4x↓ 13: 10.3x↓ 14: 10.5x➤ 15: 10.4x↓ 16: 10.7x↙ 17: 10.9x➤ 18: 10.5x➤ 19: 10.6x↓ 20: 10.8x↙ Serie 105.7 Total 209.7
40 Skott 	21: 10.5x↓ 22: 10.7x↓ 23: 10.7x↗ 24: 10.5x↙ 25: 10.4x↓ 26: 10.6x↗ 27: 10.6x↓ 28: 10.7x↓ 29: 10.6x↓ 30: 10.8x↓ Serie 106.1 Total 315.8	40 Skott 	31: 10.7x↓ 32: 10.5x↓ 33: 10.3x↓ 34: 10.5x↙ 35: 10.7x↓ 36: 10.7x↙ 37: 10.0↗ 38: 10.6x↗ 39: 10.4x➤ 40: 10.4x➤ Serie 104.8 Total 420.6

Skjutlag	Tavla	Felicia Perkiö			
2	22	Umeå Skf	L11 Vb		
04.02.2023	Skyttiaden 2023 Region	Umeå skytteallians			
Prov		1: 9.7 ↗ 2: 9.7 → 3: 10.2x → 4: 10.4x ↑ 5: 10.2x ↗ 6: 10.4x → 7: 9.2 ↗ 8: 10.2x ↗ 9: 10.6x ↗ 10: 10.4x ↗ Serie 101.0 Total 0.0	Prov		11: 9.7 ↑ 12: 10.8x ↓ 14: 10.7x ↗ 15: 10.4x ↗ 16: 10.6x ↓ 17: 9.5 ↗ 18: 10.5x ↓ 19: 9.8 ↑ 20: 10.5x ← Serie 92.5 Total 0.0
Prov		21: 9.9 ↑ 22: 10.6x ↗ 23: 9.9 ← 24: 10.0 ← 25: 10.5x ↗ 26: 10.2x ↑ 27: 10.2x ↓ 28: 10.7x ↗ 29: 10.9x ↓ 30: 9.9 ↗ Serie 102.8 Total 0.0	Prov		31: 10.9x ↓ 32: 9.9 ↑ 33: 10.8x ← 34: 10.7x ↓ 35: 10.2x ← Serie 52.5 Total 0.0
40 Skott		1: 10.6x ← 2: 10.4x ↗ 3: 10.9x ← 4: 10.1 ↗ 5: 10.3x ↓ 6: 10.4x → 7: 10.4x ↗ 8: 10.2x ↗ 9: 10.4x ↗ 10: 10.4x ↗ Serie 104.1 Total 104.1	40 Skott		11: 10.6x ← 12: 10.3x ↗ 13: 10.5x ← 14: 10.6x ← 15: 10.7x ↑ 16: 10.5x ↑ 17: 9.4 ← 18: 10.7x ↗ 19: 10.1 ↘ 20: 10.4x ↘ Serie 103.8 Total 207.9
40 Skott		21: 10.6x → 22: 10.1 ↓ 23: 10.5x ↓ 24: 10.5x ↓ 25: 10.1 ← 26: 10.0 → 27: 10.8x ↓ 28: 10.7x ← 29: 10.9x → 30: 10.0 ↓ Serie 104.2 Total 312.1	40 Skott		31: 10.6x ↑ 32: 10.4x ↓ 33: 10.3x ← 34: 10.0 ↗ 35: 10.1 ↗ 36: 10.7x ← 37: 10.4x ↓ 38: 10.7x ↑ 39: 10.5x ↘ 40: 10.0 ↘ Serie 103.7 Total 415.8

Skjutlag	Tavla	Lucas Bjurström Ring	
2	23	Kubikenborg Uskf	L11 Vn
04.02.2023	Skyttiaden 2023 Region	Umeå skytteallians	
Prov		1: 9.7 ↑ 2: 10.6x ↑ 3: 10.7x ↑ 4: 10.5x ← 5: 9.5 ↗ 7: 9.7 ↗ 8: 9.8 ↑ 9: 10.9x ↗ 10: 10.0 ↑	11: 10.5x ↓ 12: 10.5x ↘ 13: 10.4x ↗ 14: 10.2x ↑ 15: 10.2x ↘ 16: 10.4x ← 17: 10.0 ↗ 18: 10.3x ↑ 19: 9.8 ↑ 20: 10.1 →
		Serie 91.4	Serie 102.4
		Total 0.0	Total 0.0
Prov		21: 10.1 ↑	40 Skott
		Serie 10.1	1: 10.4x ↑ 2: 9.4 ↑ 3: 10.3x → 4: 10.7x ↘ 5: 8.8 ← 6: 10.0 ← 7: 10.5x ↗ 8: 9.4 ↑ 9: 10.2x ↑ 10: 10.5x ↑
		Total 0.0	Serie 100.2
			Total 100.2
40 Skott		11: 10.6x ↑ 12: 10.3x ↓ 13: 10.9x ← 14: 10.0 ↓ 15: 9.8 ↗ 16: 10.2x ↗ 17: 10.9x ↗ 18: 10.9x ↓ 19: 10.9x ↘ 20: 10.5x →	40 Skott
		Serie 105.0	21: 10.6x ← 22: 10.1 ↑ 23: 10.0 ↗ 24: 10.8x ↗ 25: 10.3x ↗ 26: 10.7x ↓ 27: 10.4x ↑ 28: 9.9 ↑ 29: 10.2x ↓ 30: 9.4 ↘
		Total 205.2	Serie 102.4
			Total 307.6
40 Skott		31: 10.2x → 32: 9.7 ↑ 33: 10.6x ↑ 34: 10.1 ↑ 35: 10.8x ↘ 36: 9.3 ↗ 37: 10.5x → 38: 10.3x → 39: 10.0 ← 40: 10.7x ↘	
		Serie 102.2	
		Total 409.8	

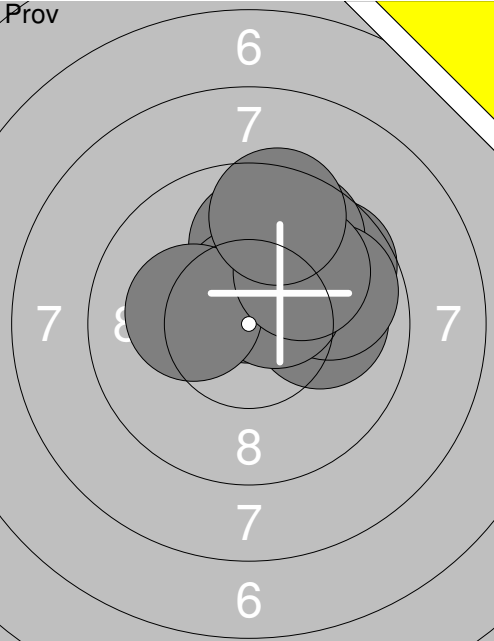
Skjutlag	Tavla	Stella Medin	
S		Kyrkås Skf	L11 Jä
04.02.2023	Skyttiaden 2023 Region	Umeå skytteallians	
Prov		1: 9.6 ← 2: 9.6 ← 3: 10.0 ↘ 4: 10.5x ↘ 5: 10.4x ↘ 6: 9.9 ← 7: 10.8x ↗ 8: 10.6x → 9: 10.8x ← 10: 10.6x ↗	11: 10.6x ↑ 12: 10.1 → 13: 10.6x → 14: 10.5x ↘ 15: 10.3x ↑ 16: 10.5x ← 17: 10.6x → 18: 10.7x ←
		Serie 102.8	Serie 83.9
		Total 0.0	Total 0.0
40 Skott		1: 10.3x ↘ 2: 10.7x ↗ 3: 10.8x ↓ 4: 10.3x → 5: 10.1 → 6: 10.8x ↗ 7: 9.5 ↓ 8: 10.3x ↘ 9: 10.4x ↘ 10: 10.4x →	11: 9.8 ↖ 12: 10.7x ↘ 13: 10.1 ↖ 14: 10.9x ↘ 15: 10.5x → 16: 10.7x ↘ 17: 10.5x ↘ 18: 10.5x ↓ 19: 10.2x ↘ 20: 10.1 ↓
		Serie 103.6	Serie 104.0
		Total 103.6	Total 207.6
40 Skott		21: 10.4x ↘ 22: 10.6x ↘ 23: 10.4x ↘ 24: 10.2x ← 25: 10.7x → 26: 10.4x ↑ 27: 10.5x ↗ 28: 10.5x ↑ 29: 10.4x ↘ 30: 10.2x ←	31: 10.3x ↗ 32: 9.5 → 33: 10.3x ↘ 34: 10.7x ↘ 35: 10.5x ↘ 36: 10.5x ↘ 37: 10.5x → 38: 10.6x ↘ 39: 10.6x → 40: 9.9 →
		Serie 104.3	Serie 103.4
		Total 311.9	Total 415.3

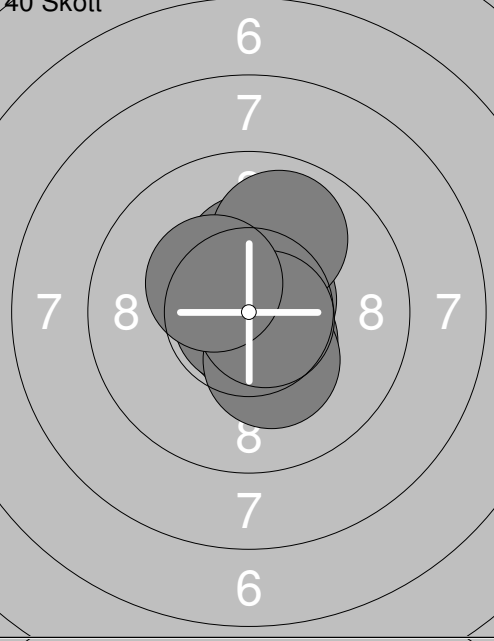
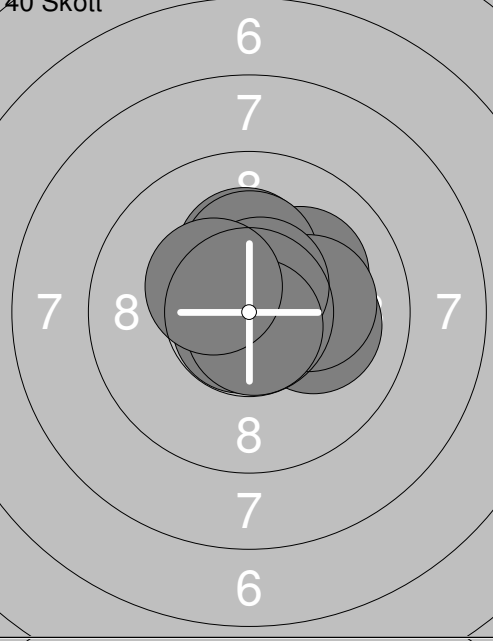
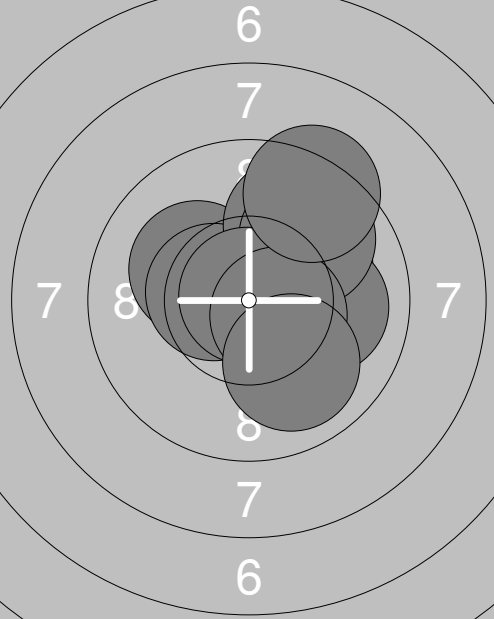
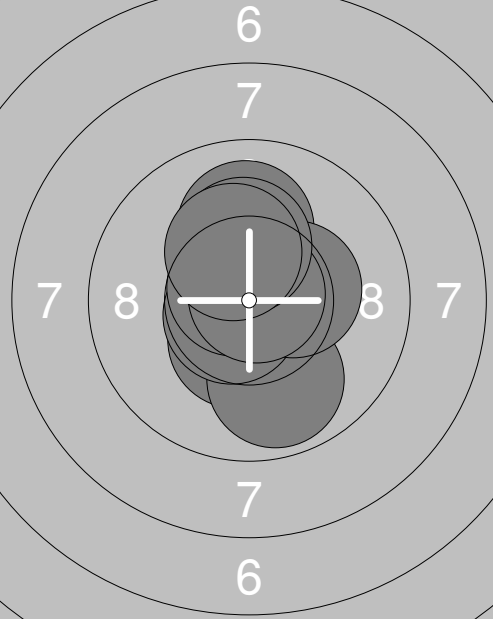

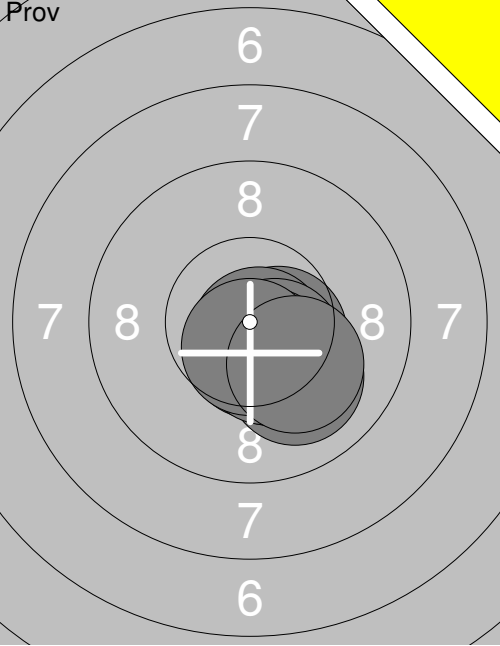
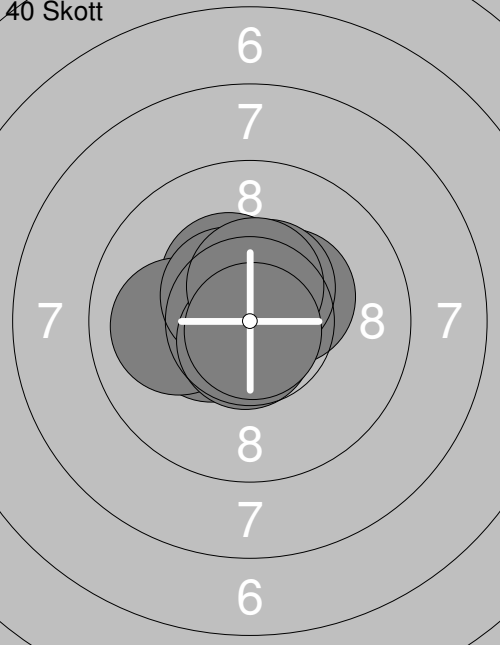
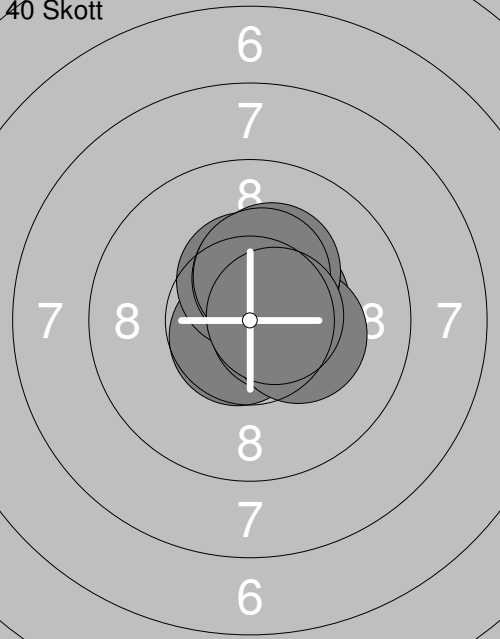
Skjutlag	Tavla	Inka Martikainen			
2	25	Gällivare Skf	L11	No	
04.02.2023	Skyttiaden 2023 Region	Umeå skytteallians			
	1: 9.9 ↑		11: 10.3x↑		
	2: 9.7 ↗		12: 10.7x↓		
	3: 9.7 ↗				
	4: 10.0 →				
	5: 9.8 ↗				
	6: 10.6x↑				
	7: 10.5x↗				
	8: 10.2x↖				
	9: 10.0 ↗				
	10: 9.5 ↑				
	Serie 99.9		Serie 21.0		
	Total 0.0		Total 0.0		
	1: 10.8x↓		11: 10.8x↗		
	2: 10.7x↗		12: 10.1 ↗		
	3: 10.5x↑		13: 10.8x↓		
	4: 10.3x↑		14: 10.1 →		
	5: 10.5x↓		15: 10.2x↑		
	6: 9.9 ↑		16: 10.3x↑		
	7: 10.8x↖		17: 10.2x→		
	8: 10.3x↓		18: 10.6x↑		
	9: 10.7x→		19: 10.7x↓		
	10: 10.4x↖		20: 10.4x↖		
	Serie 104.9		Serie 104.2		
	Total 104.9		Total 209.1		
	21: 10.1 ↗		31: 10.0 ↑		
	22: 10.0 →		32: 10.4x↓		
	23: 10.2x↖		33: 9.9 ↓		
	24: 10.5x↖		34: 10.7x↖		
	25: 9.8 ↗		35: 10.6x↑		
	26: 9.8 ↗		36: 10.7x↖		
	27: 10.9x↑		37: 10.4x→		
	28: 10.5x→		38: 10.8x↗		
	29: 10.0 ↓		39: 10.2x↑		
	30: 9.3 ↑		40: 10.3x↑		
	Serie 101.1		Serie 104.0		
	Total 310.2		Total 414.2		

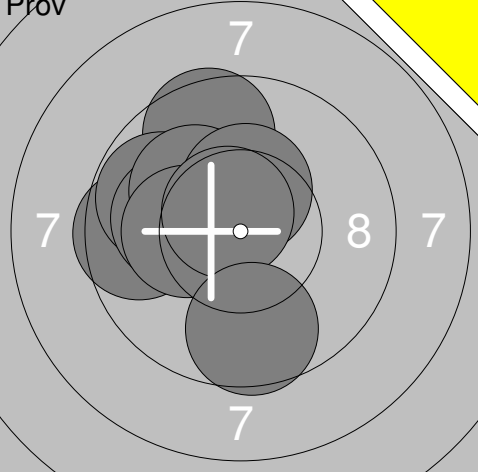
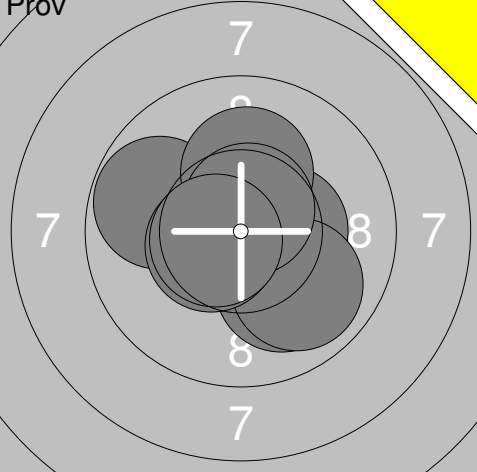
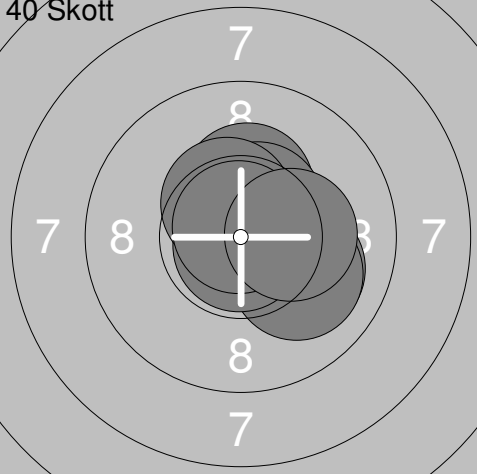
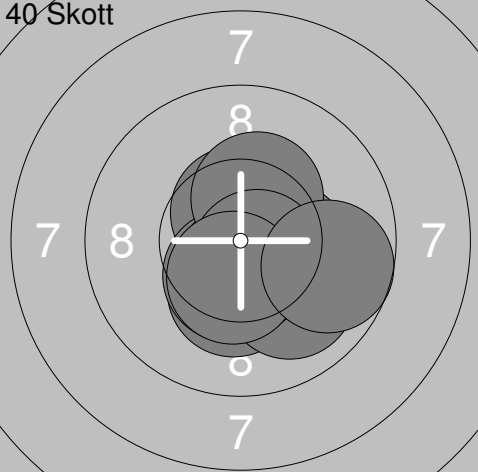
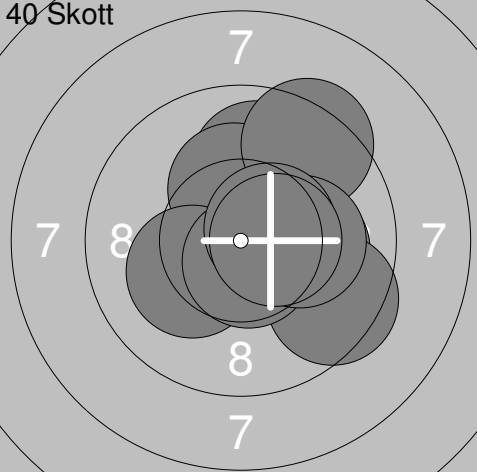
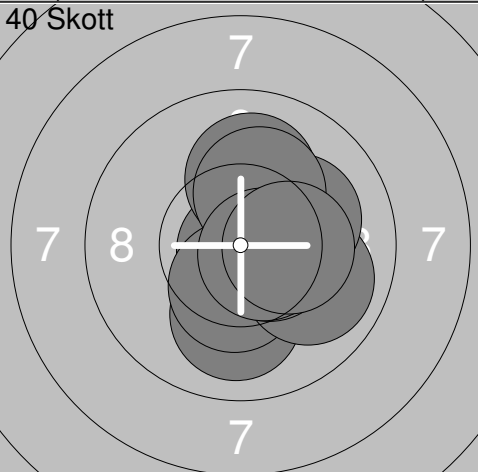
Skjuttlag	Tavla	Dennis Alenius	
2	26	Ramselefors Skf	L11 Vb
04.02.2023	Skyttiaden 2023 Region	Umeå skytteallians	
Prov		1: 10.3x↘ 2: 10.0 ↘ 3: 10.4x↘ 4: 10.5x➤ 5: 10.7x↘ 6: 10.6x↓ 7: 10.5x↘ 8: 10.5x↘ 9: 10.6x↓ 10: 10.1 ↘ Serie 104.2 Total 0.0	11: 10.8x↘ 12: 10.6x↗ Serie 21.4 Total 0.0
40 Skott		1: 10.4x↙ 2: 10.4x↗ 3: 10.0↙ 4: 10.9x↙ 5: 10.5x↗ 6: 10.4x➤ 7: 10.5x↗ 8: 10.7x↓ 9: 10.5x↗ 10: 10.8x↓ Serie 105.1 Total 105.1	11: 10.5x↙ 12: 10.7x↙ 13: 10.4x↓ 14: 10.4x➤ 15: 10.3x➤ 16: 10.5x➤ 17: 10.4x↙ 18: 10.6x↘ 19: 10.6x↗ 20: 10.9x↙ Serie 105.3 Total 210.4
40 Skott		21: 10.5x➤ 22: 10.7x↙ 23: 10.4x↗ 24: 10.4x↗ 25: 10.6x➤ 26: 10.3x➤ 27: 10.3x↗ 28: 10.2x↗ 29: 10.4x↗ 30: 10.6x➤ Serie 104.4 Total 314.8	31: 10.5x➤ 32: 10.6x↗ 33: 10.5x➤ 34: 10.5x↙ 35: 10.6x↗ 36: 10.5x➤ 37: 10.7x➤ 38: 10.6x↘ 39: 10.3x↓ 40: 10.5x➤ Serie 105.3 Total 420.1

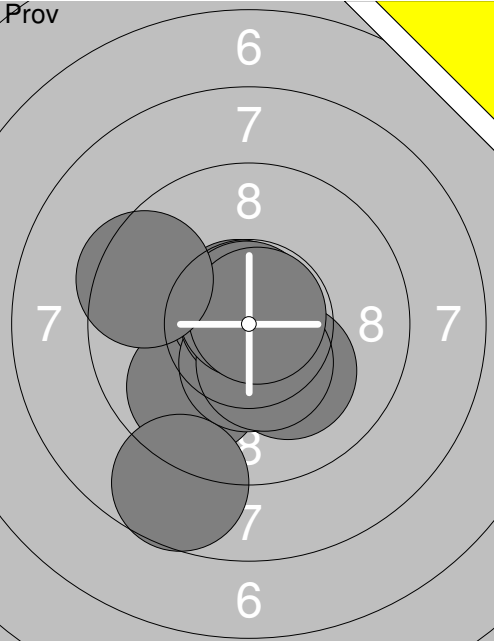
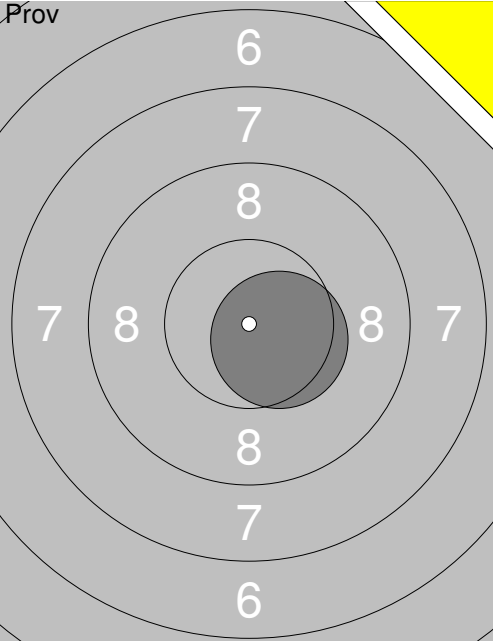
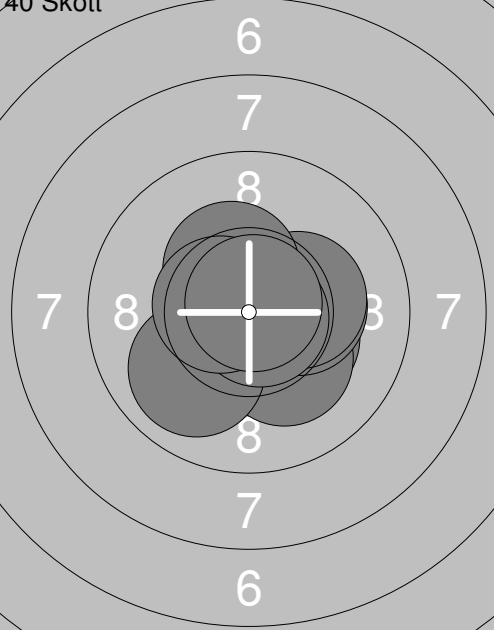
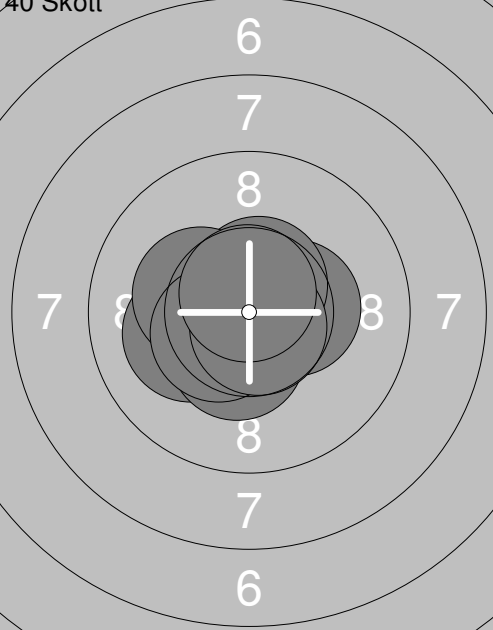
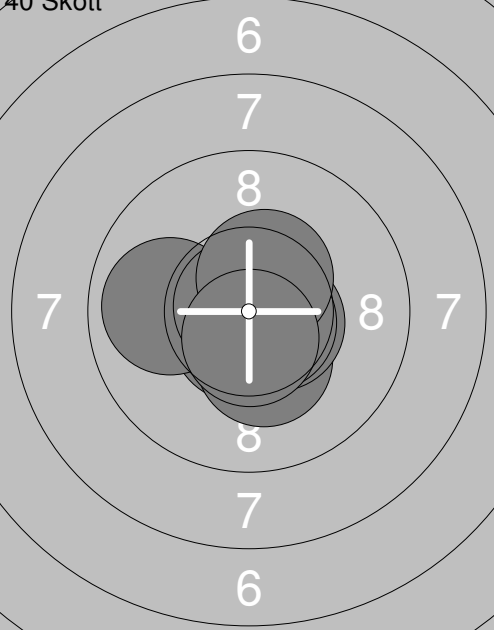
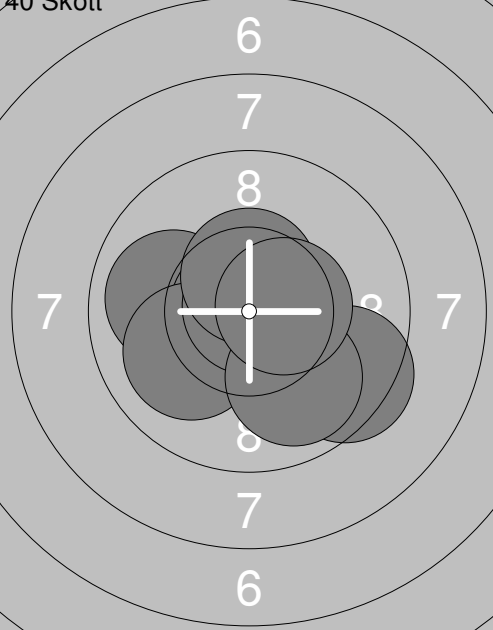

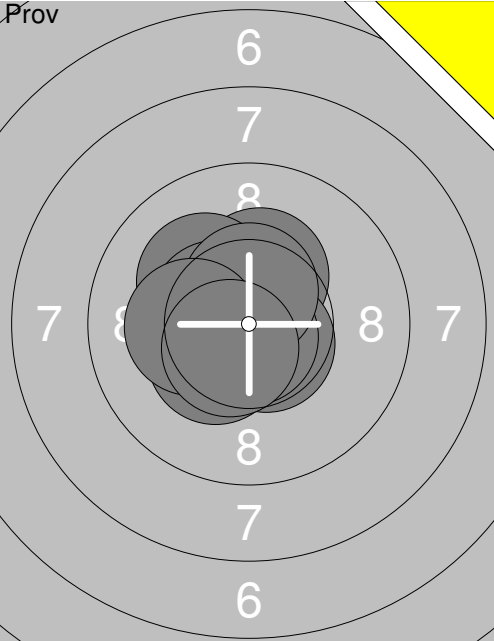
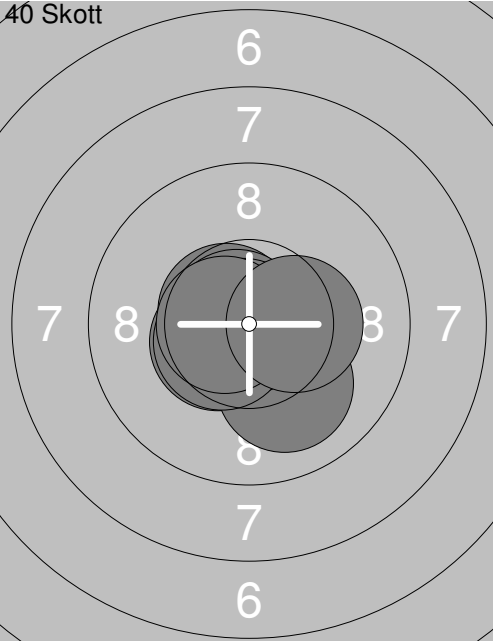
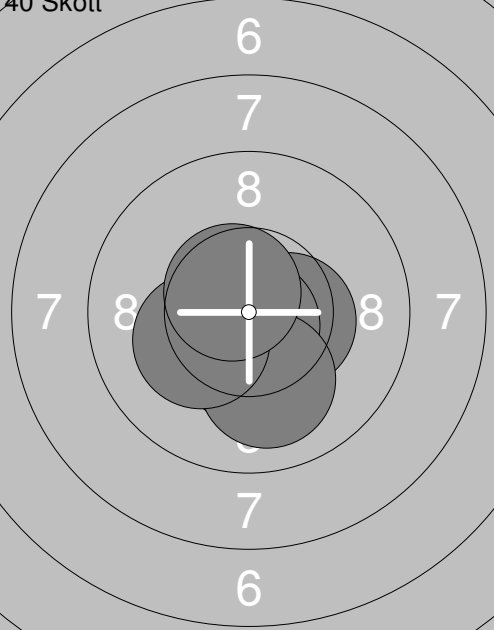
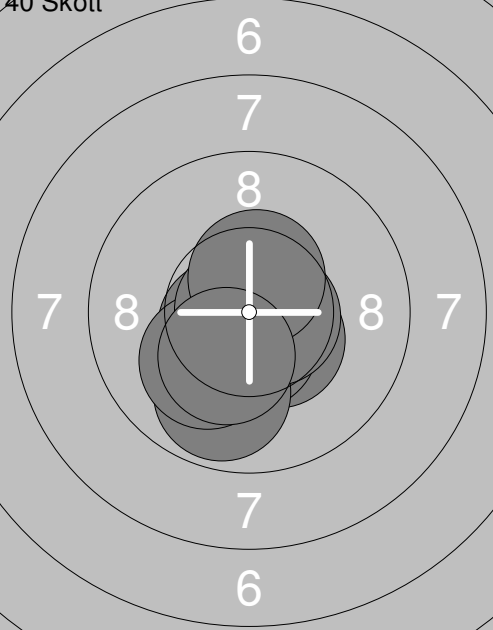
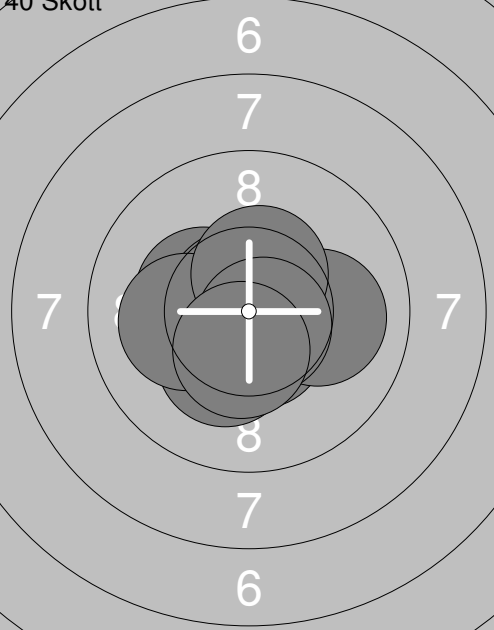
Prov 	1: 9.6 ↗ 2: 9.6 ← 3: 9.8 ↗ 4: 10.3x ↗ 5: 10.1 ← 6: 10.1 ↗ 7: 10.2x ← 8: 10.4x ↑ 9: 10.6x ↗ 10: 9.6 ↓ <hr/> Serie 100.3 Total 0.0	Prov 	11: 10.5x ← 12: 9.8 ← 13: 10.0 ↘ 14: 10.4x → 16: 10.2x ↑ 17: 9.9 ↘ 18: 10.6x ↑ 19: 10.5x ← 20: 10.6x ← <hr/> Serie 92.5 Total 0.0
Prov 	21: 10.5x ↗ <hr/> Serie 10.5 Total 0.0	40 Skott 	1: 10.6x → 2: 10.1 ↘ 3: 10.7x ↑ 4: 10.0 ↘ 5: 10.3x ↑ 6: 10.5x ↗ 7: 10.8x ↓ 8: 10.5x ↑ 9: 10.8x ↑ 10: 10.3x → <hr/> Serie 104.6 Total 104.6
40 Skott 	11: 10.6x ↑ 12: 10.3x ↓ 13: 10.0 ↘ 14: 10.5x ↓ 15: 10.6x ↓ 16: 10.4x → 17: 10.3x ↑ 18: 10.6x ↘ 19: 10.4x ↓ 20: 9.7 → <hr/> Serie 103.4 Total 208.0	40 Skott 	21: 9.9 ↑ 22: 10.1 → 23: 10.2x ↑ 24: 9.4 ↗ 25: 10.2x ← 26: 9.5 ↘ 27: 10.6x ↓ 28: 10.2x → 29: 10.5x → 30: 10.5x → <hr/> Serie 101.1 Total 309.1
40 Skott 	31: 10.9x ↓ 32: 10.0 ↓ 33: 10.4x ↓ 34: 9.9 ↘ 35: 10.1 → 36: 10.1 ↑ 37: 10.2x ↑ 38: 10.5x ↘ 39: 10.6x ↘ 40: 10.3x → <hr/> Serie 103.0 Total 412.1		

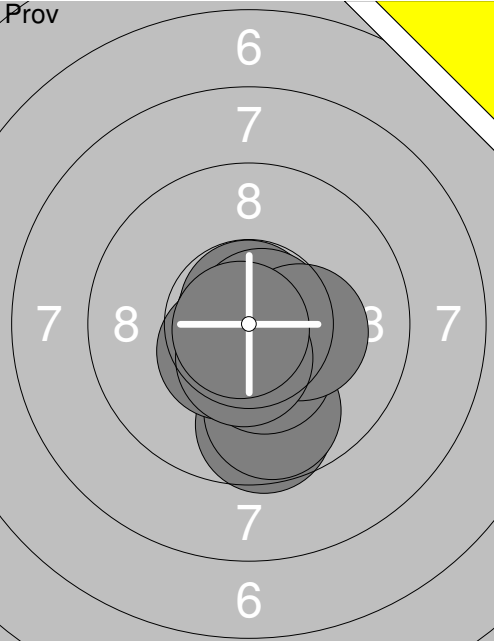
Skjutlag	Tavla	Melvin Berndt Nääs			
S		Fältjägarerna Skf	L11	Jä	
04.02.2023		Skyttiaden 2023 Region	Umeå skytteallians		
Prov		1: 9.9 ↙ 2: 8.7 ↓ 3: 10.7↗ 4: 10.1 ↘ 5: 10.4x↓ 6: 10.8x↑ 7: 10.4x↘ 8: 10.8x↑ 9: 10.8x↗ 10: 9.5 ↖	Prov		11: 10.5x↘
		Serie 102.1			Serie 10.5
		Total 0.0			Total 0.0
40 Skott		1: 10.3x↘ 2: 10.2x↘ 3: 10.3x→ 4: 10.3x→ 5: 10.7x← 6: 10.0 ↙ 7: 10.8x↘ 8: 10.4x↗ 9: 10.6x← 10: 10.8x↑	40 Skott		11: 10.1↖ 12: 10.4x→ 13: 10.6x↑ 14: 10.9x↗ 15: 10.5x↓ 16: 10.3x← 17: 10.4x↓ 18: 10.5x← 19: 10.7x↘ 20: 10.7x↑
		Serie 104.4			Serie 105.1
		Total 104.4			Total 209.5
40 Skott		21: 10.8x↓ 22: 10.6x↓ 23: 10.3x↓ 24: 10.6x→ 25: 9.9 ↖ 26: 10.8x→ 27: 10.7x↘ 28: 10.8x← 29: 10.5x↑ 30: 10.6x↓	40 Skott		31: 10.7x→ 32: 9.5 ↘ 33: 10.5x← 34: 10.0↖ 35: 10.8x← 36: 10.0↙ 37: 10.9x↑ 38: 10.5x↑ 39: 9.9 ↘ 40: 10.5x→
		Serie 105.6			Serie 103.3
		Total 315.1			Total 418.4

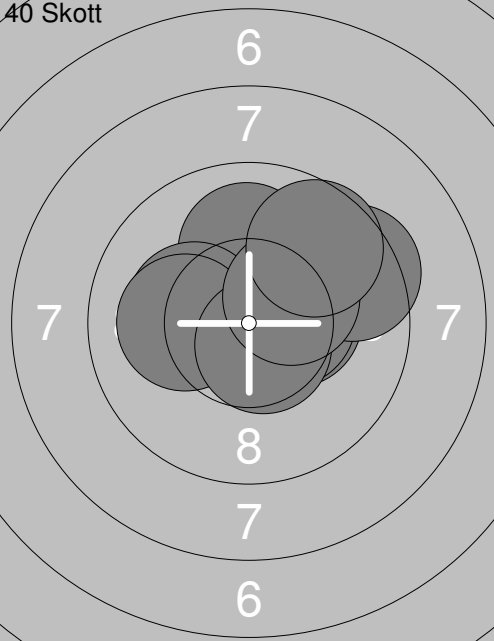
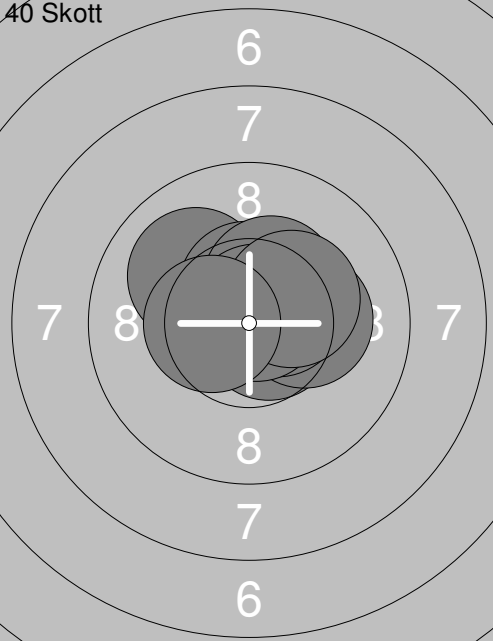
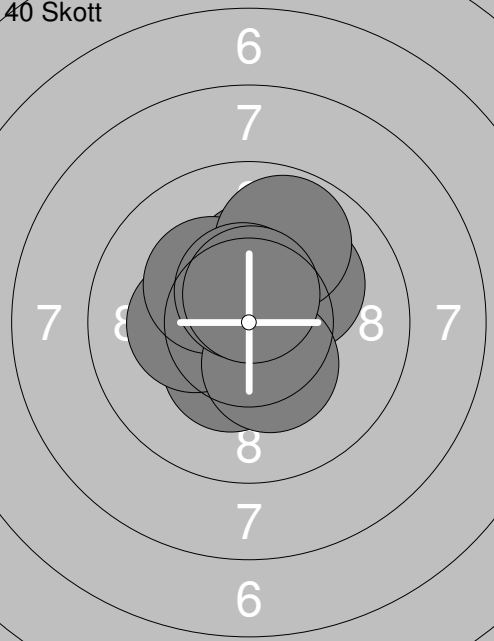
Skjutlag	Tavla	Vinston Åkerlund	
2	29	Gällivare Skf	No
S		L11	No
04.02.2023	Skyttiaden 2023 Region	Umeå skytteallians	
Prov		40 Skott	
	1: 10.3x↗ 2: 10.2x↘ 3: 10.6x↘ 4: 10.5x↘ 5: 10.6x↘ 6: 10.8x↓ 7: 10.5x↑ 8: 10.3x↘ 9: 10.2x← 10: 10.5x↘ Serie 104.5 Total 0.0		1: 10.5x↘ 2: 10.6x↘ 3: 10.7x↘ 4: 10.7x↘ 5: 10.8x↘ 6: 10.0 ↓ 7: 10.9x↘ 8: 10.5x↘ 9: 10.6x← 10: 10.4x> Serie 105.7 Total 105.7
40 Skott		40 Skott	
	11: 10.6x↘ 12: 10.3x↘ 13: 10.4x↓ 14: 10.8x↘ 15: 10.4x> 16: 10.8x↓ 17: 10.4x↘ 18: 10.0 ↓ 19: 10.2x↘ 20: 10.6x↘ Serie 104.5 Total 210.2		21: 10.4x↘ 22: 10.6x↓ 23: 10.9x> 24: 10.6x↘ 25: 9.8 ↓ 26: 10.1 ↓ 27: 10.9x↘ 28: 10.6x> 29: 10.5x↑ 30: 10.3x↘ Serie 104.7 Total 314.9
40 Skott			
	31: 10.6x↘ 32: 10.3x↘ 33: 10.3x↘ 34: 10.6x↓ 35: 10.7x↘ 36: 10.1← 37: 10.1→ 38: 10.5x↑ 39: 10.7x↘ 40: 10.4x↓ Serie 104.3 Total 419.2		

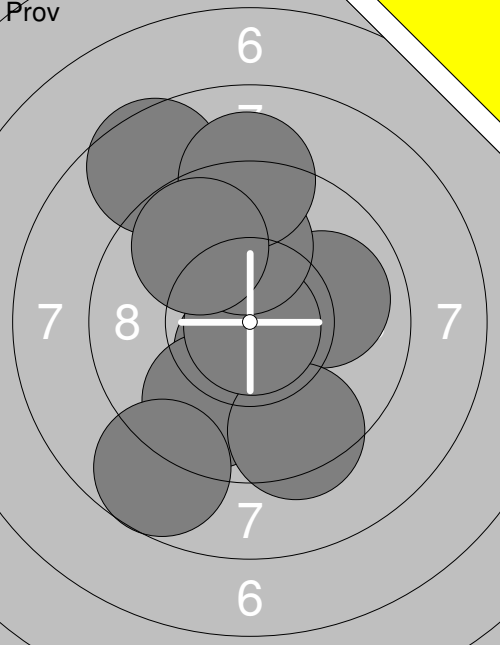
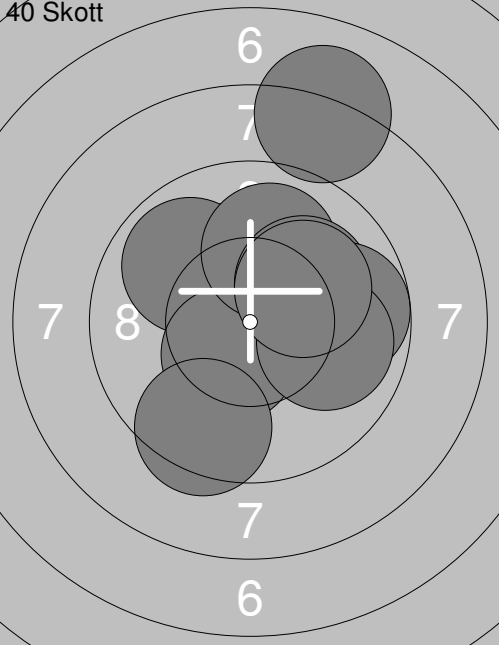
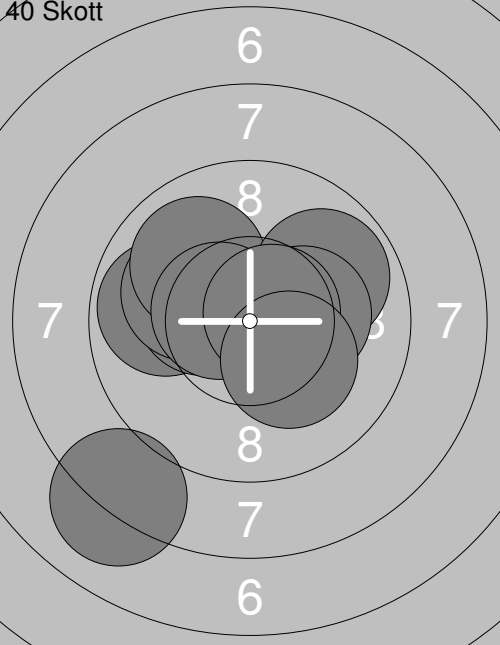
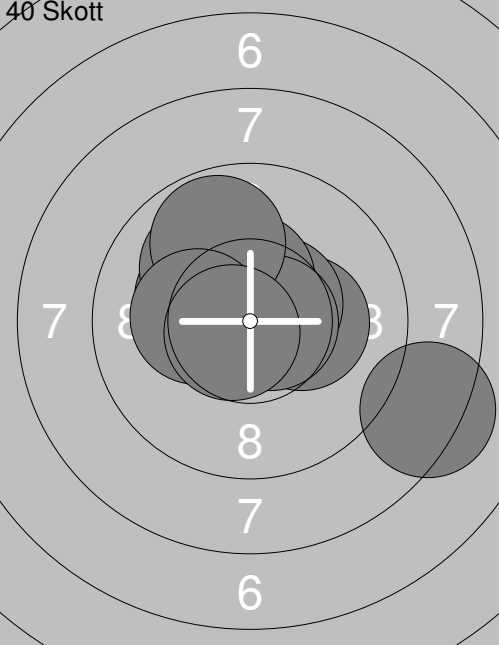
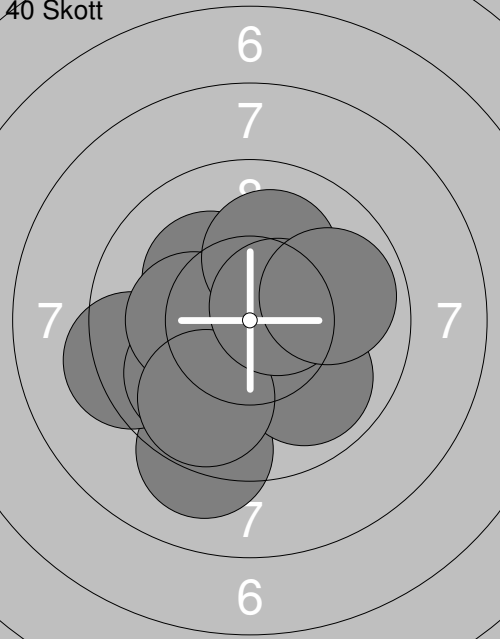
Skjutlag 2	Tavla 30	Ylva Lundstedt					
S		Ramselefors Skf		L11	Vb		
04.02.2023		Skyttiaden 2023 Region		Umeå skytteallians			
		1: 9.6 ↓ 2: 9.8 ↓ 3: 10.9 ↗ 4: 10.7x↑ 5: 10.4x↓ 6: 10.5x↘ 7: 10.8x↗ 8: 10.3x→ 9: 10.5x↓ 10: 10.8x↘ Serie 104.3 Total 0.0				1: 10.4x→ 2: 10.5x↗ 3: 10.3x→ 4: 10.8x↓ 5: 10.1 ↓ 6: 10.1 → 7: 10.4x↓ 8: 10.5x→ 9: 10.9x↓ 10: 10.7x↑ Serie 104.7 Total 104.7	
		11: 10.9x↗ 12: 10.0 ↑ 13: 10.4x→ 14: 10.2x↗ 15: 10.1← 16: 10.4x→ 17: 9.4 ↗ 18: 10.6x↓ 19: 10.3x↗ 20: 9.7 ↗ Serie 102.0 Total 206.7				21: 10.8x↗ 22: 10.7x→ 23: 10.2x→ 24: 10.0 ↗ 25: 10.5x↗ 26: 10.5x↑ 27: 10.4x↗ 28: 10.8x↗ 29: 10.3x↗ 30: 10.5x↗ Serie 104.7 Total 311.4	
		31: 10.4x↓ 32: 10.2x↗ 33: 10.3x↑ 34: 10.8x↗ 35: 10.2x← 36: 10.3x↗ 37: 10.3x↓ 38: 9.8 ↗ 39: 10.5x↑ 40: 10.6x↑ Serie 103.4 Total 414.8					

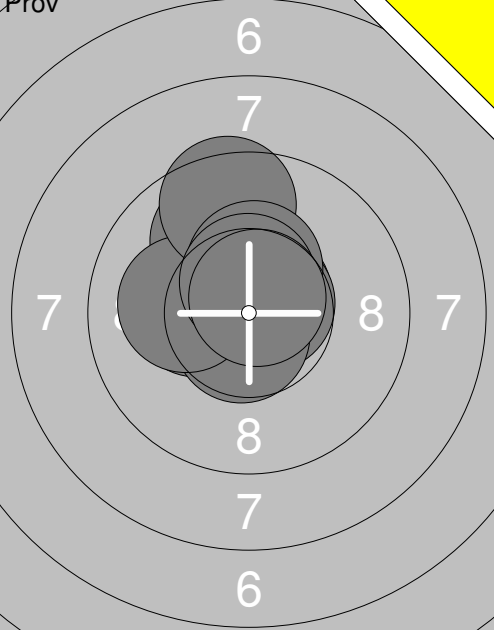
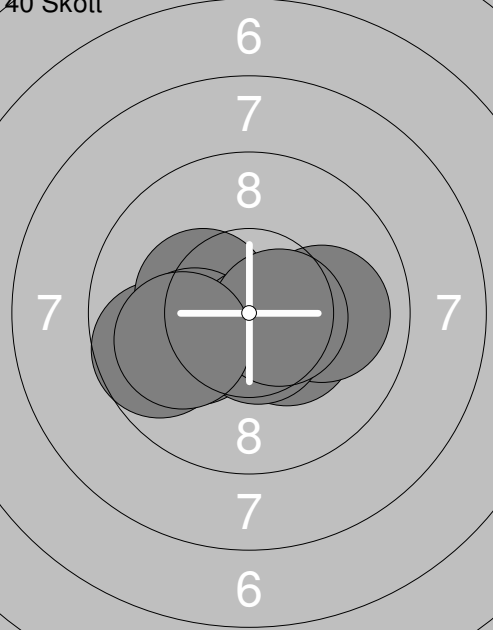
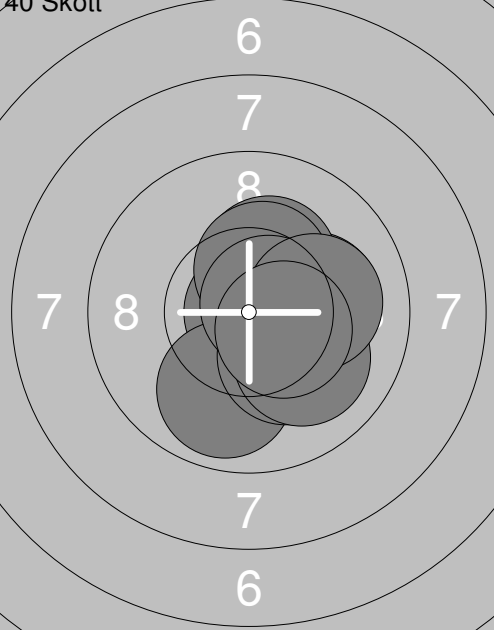
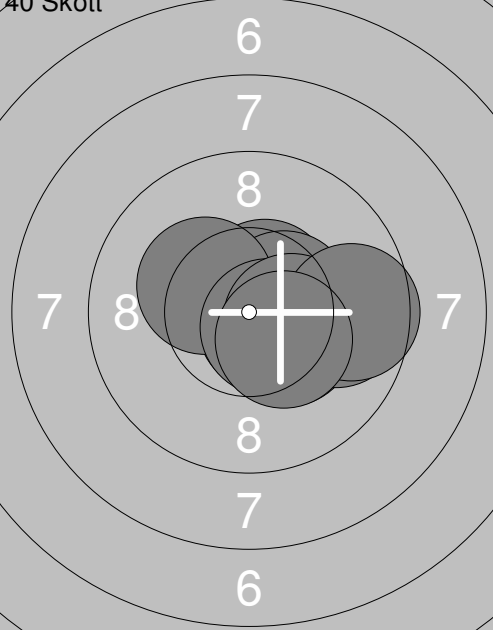
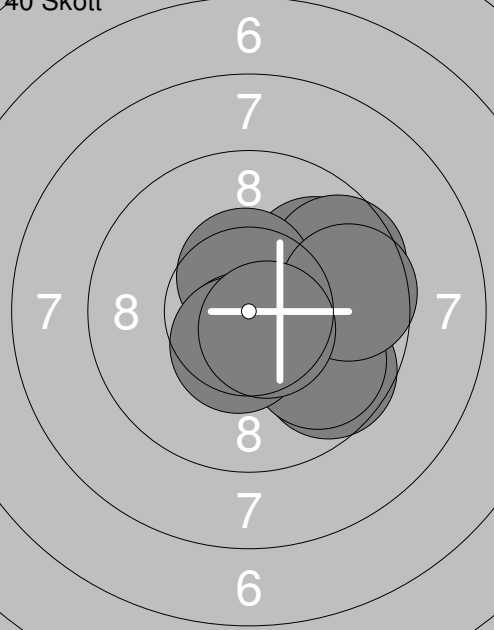
Skjutlag	Tavla	Nour Öfverdahl		
S		Gideå Skf	L11	Vn
04.02.2023		Skyttiaden 2023 Region	Umeå skytteallians	
	1: 10.6x ↘		1: 10.2x ↗	
	2: 9.8 ↓		2: 9.9 ↖	
	3: 10.0 →		3: 10.5x ↘	
	4: 9.4 ↓		4: 10.0 ↑	
	5: 10.9x ↘		5: 9.4 ↓	
	6: 8.6 ↗		6: 10.1 ↗	
	7: 10.0 ↑		7: 8.1 ↑	
	8: 9.1 ↑		8: 9.7 →	
	9: 9.8 ↖		9: 9.9 →	
	10: 8.7 ↓		10: 10.1 ↗	
	Serie 96.9		Serie 97.9	
	Total 0.0		Total 97.9	
	11: 9.8 ←		21: 10.3x →	
	12: 10.3x ↘		22: 10.5x ↗	
	13: 10.1 ↖		23: 10.3x ↘	
	14: 8.1 ↓		24: 10.0 ↖	
	15: 10.0 ↖		25: 10.4x ↑	
	16: 10.5x ↘		26: 8.3 →	
	17: 9.9 ↗		27: 10.7x →	
	18: 10.3x →		28: 9.8 ↑	
	19: 10.6x →		29: 10.3x ↘	
	20: 10.2x ↘		30: 10.7x ↘	
	Serie 99.8		Serie 101.3	
	Total 197.7		Total 299.0	
	31: 9.2 ↓			
	32: 9.3 ←			
	33: 9.9 ↘			
	34: 10.2x ↘			
	35: 9.9 ↘			
	36: 10.2x ↘			
	37: 10.1 ↑			
	38: 9.8 ↓			
	39: 10.5x →			
	40: 9.9 →			
	Serie 99.0			
	Total 398.0			

<p>Prov</p> 	<p>40 Skott</p> 	<p>1: 10.7x ↗</p> <p>2: 10.3x ↖</p> <p>3: 9.9 ↗</p> <p>4: 10.7x ↗</p> <p>5: 10.7x ↘</p> <p>6: 10.1 ↖</p> <p>7: 9.5 ↗</p> <p>8: 10.4x ↗</p> <p>9: 10.5x ↗</p> <p>10: 10.7x ↗</p> <hr/> <p>Serie 103.5</p> <p>Total 0.0</p>
<p>40 Skott</p> 	<p>40 Skott</p> 	<p>11: 10.9x ➤</p> <p>12: 10.1 ➔</p> <p>13: 10.3x ↗</p> <p>14: 9.9 ↘</p> <p>15: 10.2x ↘</p> <p>16: 10.4x ↗</p> <p>17: 10.0 ↘</p> <p>18: 10.7x ↗</p> <p>19: 10.1 ➔</p> <p>20: 10.4x ↘</p> <hr/> <p>Serie 103.0</p> <p>Total 205.7</p>
<p>40 Skott</p> 	<p>40 Skott</p> 	<p>21: 10.7x ↘</p> <p>22: 10.6x ↗</p> <p>23: 10.4x ↘</p> <p>24: 9.8 ➔</p> <p>25: 10.5x ↗</p> <p>26: 10.3x ↖</p> <p>27: 10.6x ↘</p> <p>28: 10.4x ➤</p> <p>29: 9.6 ➔</p> <p>30: 10.4x ↘</p> <hr/> <p>Serie 103.3</p> <p>Total 309.0</p>
<p>40 Skott</p>	<p>40 Skott</p>	<p>31: 9.9 ↗</p> <p>32: 9.6 ↗</p> <p>33: 10.5x ↗</p> <p>34: 10.6x ↘</p> <p>35: 9.7 ↘</p> <p>36: 10.1 ➤</p> <p>37: 9.8 ↘</p> <p>38: 9.6 ➔</p> <p>39: 10.5x ↘</p> <p>40: 10.6x ↘</p> <hr/> <p>Serie 100.9</p> <p>Total 409.9</p>

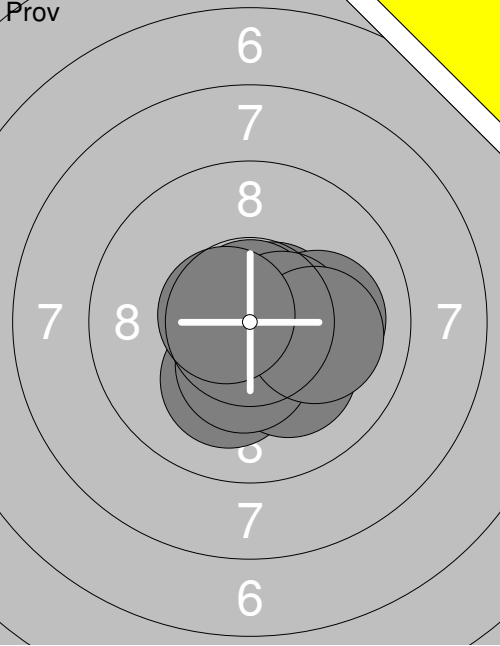
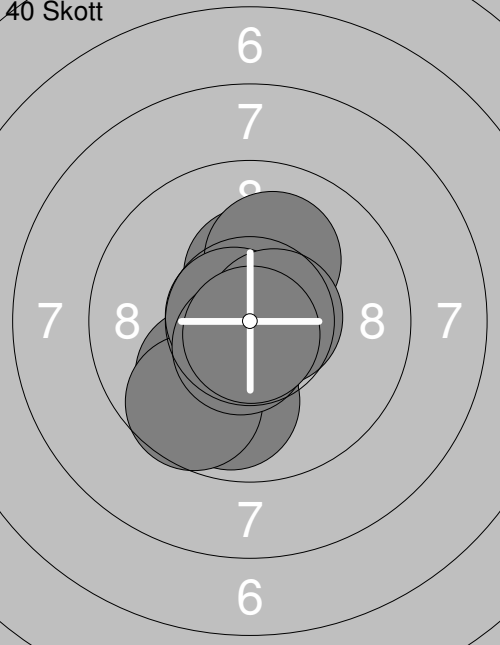
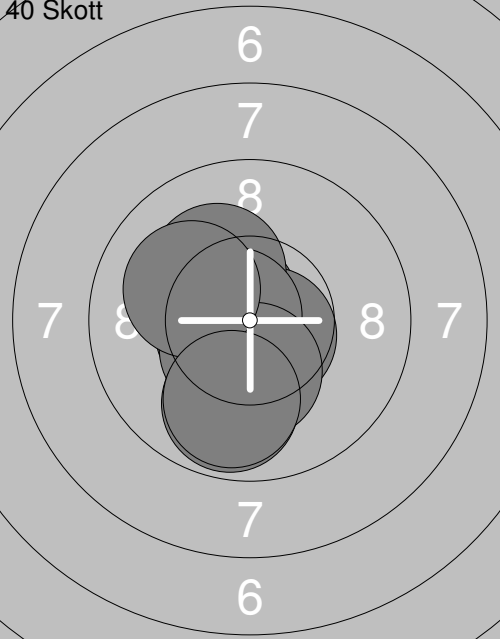
Skjutlag	Tavla	Inez Persson	
S	Överkalix Skf	L11	No
04.02.2023	Skyttiaden 2023 Region	Umeå skytteallians	
Prov		1: 10.6x↗ 2: 10.8x↑ 3: 10.8x↓ 4: 10.2x↓ 5: 10.1→ 6: 10.2x↘ 7: 10.5x→ 8: 10.4x↓ 9: 10.1→ 10: 10.6x↖	Prov
		Serie 104.3	11: 10.5x↓
		Total 0.0	Serie 10.5
			Total 0.0
40 Skott		1: 10.2x↓ 2: 9.9 ↓ 3: 10.0 ↙ 4: 10.3x↑ 5: 9.7 ↓ 6: 10.1 ↑ 7: 10.7x↖ 8: 10.6x↓ 9: 10.6x→ 10: 10.8x↓	40 Skott
		Serie 102.9	11: 10.8x↖
		Total 102.9	12: 10.6x↖
			13: 10.5x↗
			14: 10.6x↓
			15: 10.4x↓
			16: 10.1→
			17: 10.4x↓
			18: 10.4x↖
			19: 10.8x↓
			20: 10.7x↓
		Serie 105.3	
		Total 208.2	
40 Skott		21: 10.6x↖ 22: 10.6x↖ 23: 10.6x↖ 24: 10.2x↖ 25: 10.5x↓ 26: 10.7x↖ 27: 9.8 ↓ 28: 10.3x↓ 29: 10.1↖ 30: 9.9 ↓	40 Skott
		Serie 103.3	31: 10.4x↓
		Total 311.5	32: 10.8x↓
			33: 10.6x↘
			34: 10.4x↓
			35: 10.2x↑
			36: 10.6x↓
			37: 10.4x↖
			38: 10.2x↓
			39: 10.2x↓
			40: 10.5x↓
		Serie 104.3	
		Total 415.8	

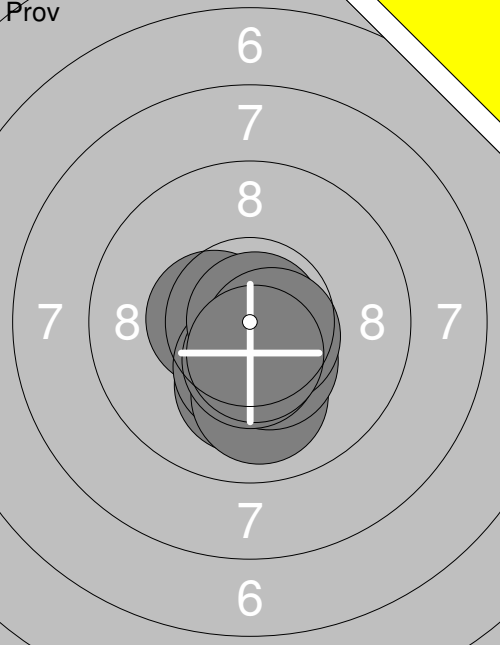
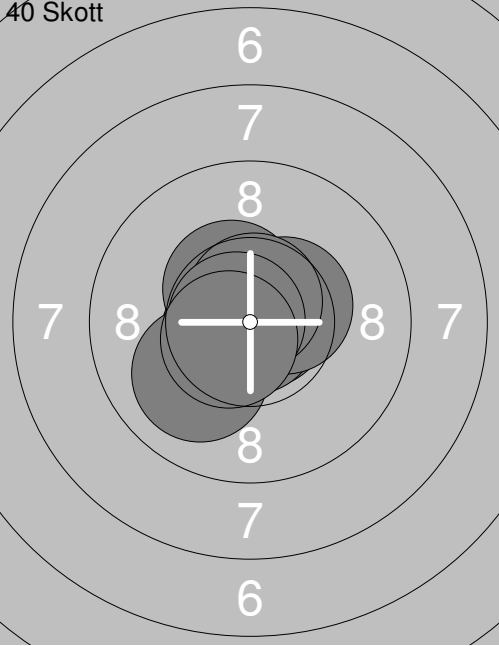
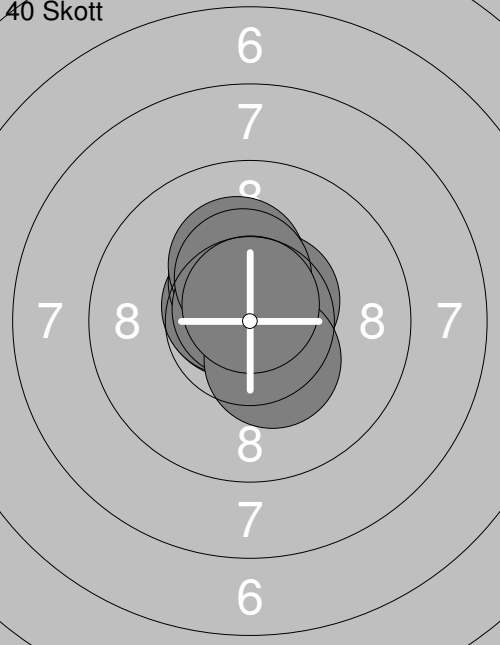
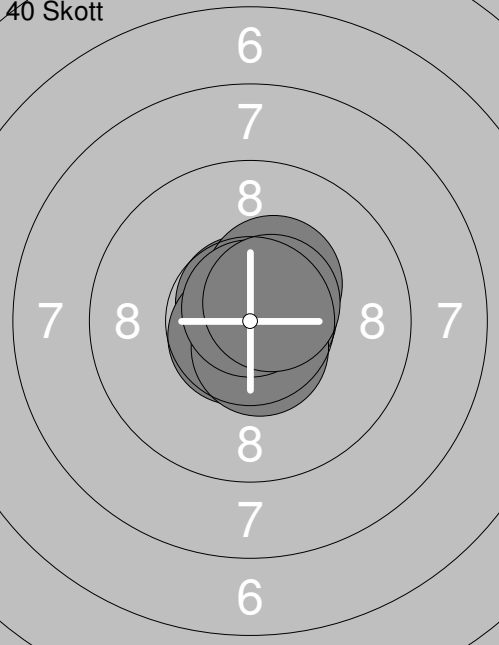
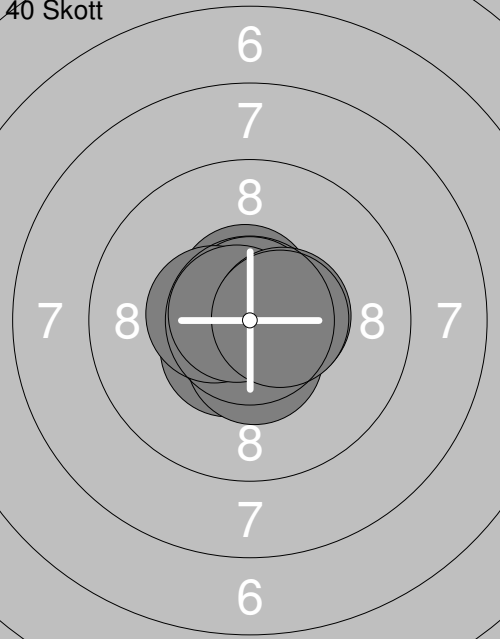
Skjutlag	Tavla	Milly Burström	
2	34	Bjurholm-Balsjö Skf	L11 Vb
04.02.2023	Skyttiaden 2023 Region	Umeå skytteallians	
Prov		1: 10.1 ↓ 2: 10.5 ✕ 3: 10.4 ✕ 4: 10.0 ↓ 5: 10.6 ✕ 6: 10.4 ✕ 7: 10.5 ✕ 8: 10.9 ✕ 9: 10.6 ✕ 10: 10.5 ✕ Serie 104.5 Total 0.0	40 Skott  1: 10.6 ✕ 2: 10.0 ↓ 3: 10.5 ✕ 4: 10.8 ✕ 5: 10.9 ✕ 6: 10.9 ✕ 7: 10.5 ✕ 8: 10.7 ✕ 9: 10.8 ✕ 10: 10.6 ✕ Serie 106.3 Total 106.3
40 Skott		11: 10.4 ✕ 12: 10.6 ✕ 13: 10.7 ✕ 14: 10.6 ✕ 15: 10.4 ✕ 16: 10.2 ✕ 17: 10.8 ✕ 18: 10.4 ✕ 19: 10.4 ✕ 20: 10.7 ✕ Serie 105.2 Total 211.5	40 Skott  21: 10.8 ✕ 22: 10.7 ✕ 23: 10.7 ✕ 24: 10.9 ✕ 25: 10.9 ✕ 26: 10.4 ✕ 27: 10.7 ✕ 28: 10.6 ✕ 29: 10.8 ✕ 30: 10.6 ✕ Serie 107.1 Total 318.6
40 Skott		31: 10.6 ✕ 32: 10.8 ✕ 33: 10.9 ✕ 34: 10.5 ✕ 35: 10.5 ✕ 36: 10.5 ✕ 37: 10.5 ✕ 38: 10.8 ✕ 39: 10.5 ✕ 40: 10.5 ✕ Serie 106.1 Total 424.7	

	1: 8.2 ↗		11: 9.8 ↑
	2: 9.6 ↖		12: 9.9 ↙
	3: 9.0 ↗		13: 9.3 ↘
4: 8.3 ↗	4: 8.3 ↗	14: 9.2 ↗	14: 9.2 ↗
5: 8.9 ↑	5: 8.9 ↑	15: 10.8x ↙	15: 10.8x ↙
6: 9.4 ↖	6: 9.4 ↖	16: 9.9 ↙	16: 9.9 ↙
7: 10.0 ↗	7: 10.0 ↗	17: 10.7x ↙	17: 10.7x ↙
8: 10.0 ↗	8: 10.0 ↗	18: 10.2x →	18: 10.2x →
9: 10.4x ↘	9: 10.4x ↘	19: 10.6x →	19: 10.6x →
10: 10.4x ↑	10: 10.4x ↑	20: 10.2x ↘	20: 10.2x ↘
Serie 94.2	Serie 94.2	Serie 100.6	Serie 100.6
Total 0.0	Total 0.0	Total 0.0	Total 0.0

	1: 10.4x ↙		11: 10.8x →
	2: 10.6x ↘		12: 9.0 ↙
	3: 9.7 ↘		13: 10.0 ↙
4: 10.5x ↙	4: 10.5x ↙	14: 9.2 ↖	14: 9.2 ↖
5: 10.8x ↙	5: 10.8x ↙	15: 9.0 ↖	15: 9.0 ↖
6: 9.6 ↖	6: 9.6 ↖	16: 9.9 ↖	16: 9.9 ↖
7: 10.1 ↖	7: 10.1 ↖	17: 10.3x ↙	17: 10.3x ↙
8: 9.2 ↑	8: 9.2 ↑	18: 9.5 ↖	18: 9.5 ↖
9: 9.6 ↑	9: 9.6 ↑	19: 9.3 ↖	19: 9.3 ↖
10: 9.8 ↖	10: 9.8 ↖	20: 10.0 ↗	20: 10.0 ↗
Serie 100.3	Serie 100.3	Serie 97.0	Serie 97.0
Total 100.3	Total 100.3	Total 197.3	Total 197.3

	21: 8.9 ↙		31: 8.5 ↑
	22: 10.2x ↑		32: 9.3 ↖
	23: 10.0 ↙		33: 8.9 ↖
24: 10.0 ↖	24: 10.0 ↖	34: 9.1 ↖	34: 9.1 ↖
25: 9.3 ↗	25: 9.3 ↗	35: 10.1 ↖	35: 10.1 ↖
26: 7.5 ↖	26: 7.5 ↖	36: 10.1 ↙	36: 10.1 ↙
27: 10.7x →	27: 10.7x →	37: 10.7x ↑	37: 10.7x ↑
28: 9.9 ↑	28: 9.9 ↑	38: 10.4x ↖	38: 10.4x ↖
29: 10.6x ↘	29: 10.6x ↘	39: 9.9 ↖	39: 9.9 ↖
30: 9.2 ↖	30: 9.2 ↖	40: 8.7 ↖	40: 8.7 ↖
Serie 96.3	Serie 96.3	Serie 95.7	Serie 95.7
Total 293.6	Total 293.6	Total 389.3	Total 389.3

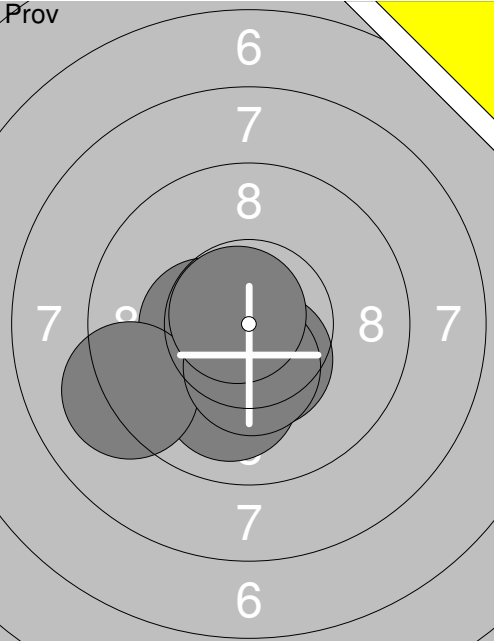
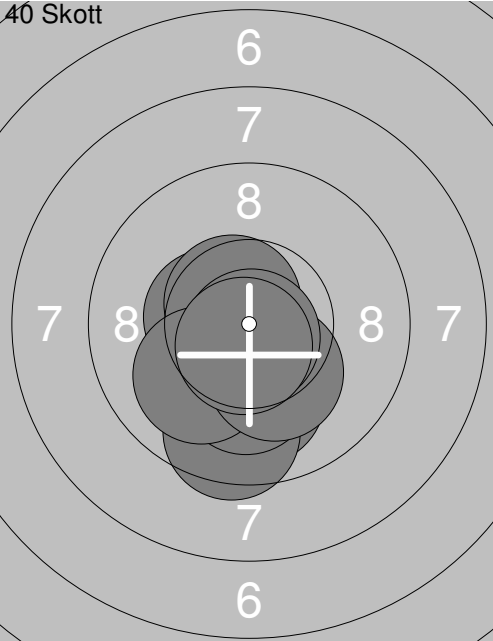
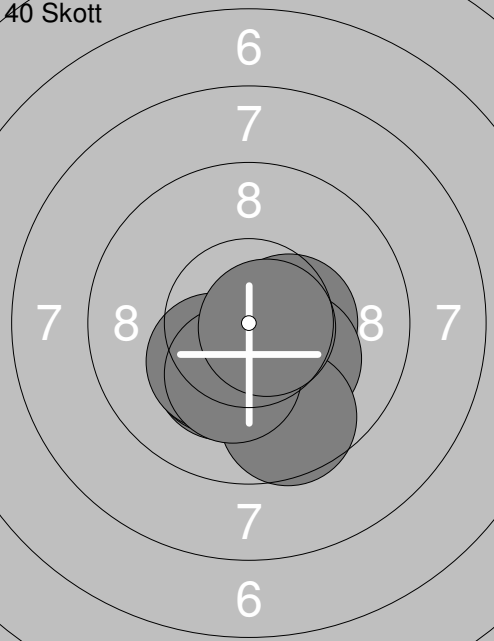
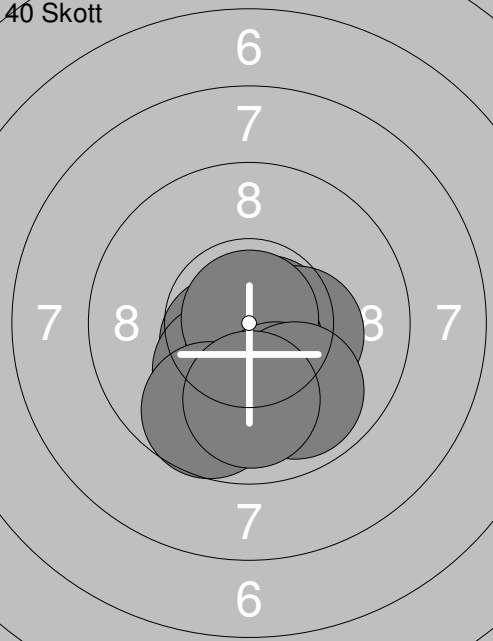
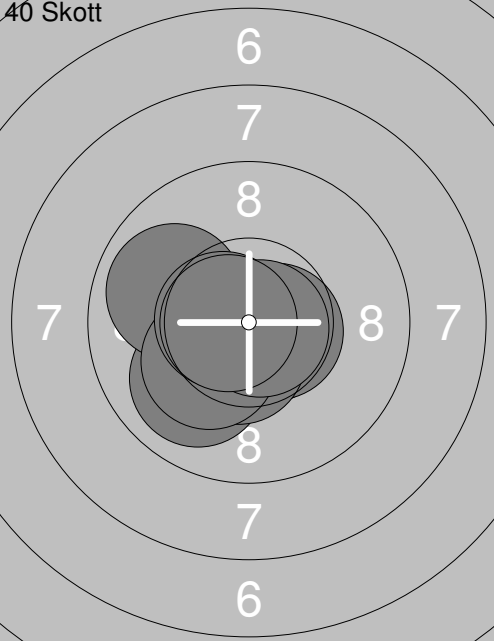
Skjutlag 2	Tavla 36	Moa Olofsson	
S		Överkalix Skf	L11 No
04.02.2023	Skyttiaden 2023 Region	Umeå skytteallians	
Prov		40 Skott	
	1: 10.4✕ 2: 10.0 ↓ 3: 10.4✕↓ 4: 9.2 ↙ 5: 10.4✕↓ 6: 10.8✕	1: 10.0 ↓ 2: 9.5 ↓ 3: 10.1 ↓ 4: 10.6✕↓ 5: 10.5✕ 6: 10.6✕↘ 7: 10.0 ↙ 8: 10.2✕↓ 9: 10.8✕↓ 10: 10.7✕↓	
	Serie 61.2		Serie 103.0
	Total 0.0		Total 103.0
40 Skott		40 Skott	
	11: 10.2✕↓ 12: 10.3✕↓ 13: 10.4✕↓ 14: 10.4✕→ 15: 10.4✕↓ 16: 10.2✕↘ 17: 10.3✕↓ 18: 9.6 ↓ 19: 10.2✕↓ 20: 10.7✕→	21: 10.6✕↘ 22: 10.7✕→ 23: 10.3✕→ 24: 10.2✕↓ 25: 10.6✕↓ 26: 10.9✕↑ 27: 10.0 ↓ 28: 9.9 ↓ 29: 9.7 ↓ 30: 10.0 ↓	
	Serie 102.7		Serie 102.9
	Total 205.7		Total 308.6
40 Skott			
	31: 10.0 ↓ 32: 10.7✕↘ 33: 9.9 ↙ 34: 10.6✕→ 35: 10.5✕↓ 36: 10.5✕↓ 37: 10.2✕↓ 38: 10.6✕↘ 39: 10.8✕↘ 40: 10.7✕↘		
	Serie 104.5		
	Total 413.1		

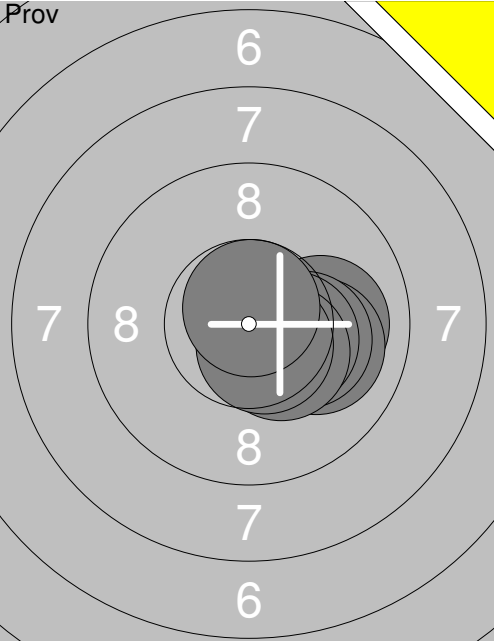
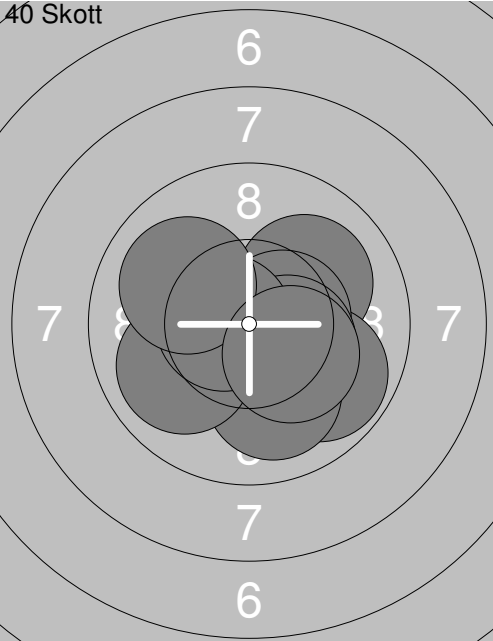
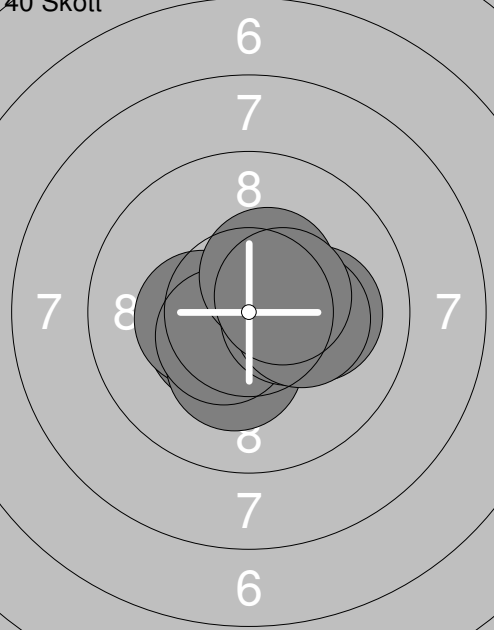
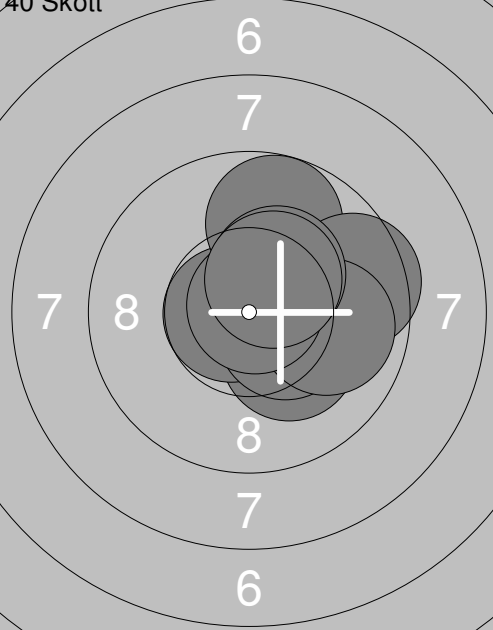
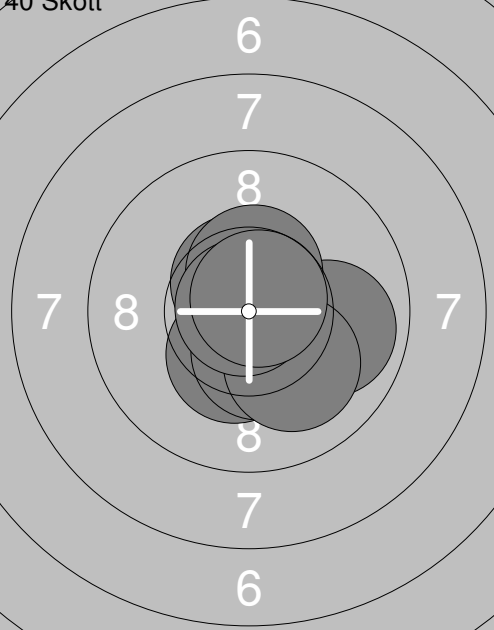
Skjutlag	Tavla	Alexander Lindahl			
2	37	Vännäs Skf	L11	Vb	
04.02.2023	Skyttiaden 2023 Region	Umeå skytteallians			
Prov 	1: 10.0 → 2: 10.0 → 3: 10.2x → 4: 10.4x → 5: 10.4x ↘ 6: 10.6x ↘ 7: 10.7x ↗ Serie 72.3 Total 0.0	40 Skott 	1: 10.6x ↘ 2: 10.1 ↗ 3: 9.8 ↘ 4: 10.5x → 5: 10.0 ↓ 6: 9.9 ↙ 7: 10.4x ↘ 8: 10.6x ← 9: 10.0 ↖ 10: 10.3x ↘ Serie 102.2 Total 102.2		
40 Skott 	11: 10.4x ↘ 12: 10.4x ↘ 13: 10.3x ← 14: 10.3x ↘ 15: 10.1 → 16: 10.5x ↘ 17: 10.4x ↗ 18: 10.4x → 19: 10.3x → 20: 10.5x ↗ Serie 103.6 Total 205.8	40 Skott 	21: 10.2x ↘ 22: 10.7x ← 23: 9.7 ↑ 24: 10.6x → 25: 9.5 → 26: 10.4x ↘ 27: 9.9 → 28: 10.3x ↗ 29: 10.8x ↗ 30: 10.4x ↗ Serie 102.5 Total 308.3		
40 Skott 	31: 10.4x ↘ 32: 9.9 → 33: 10.5x ↘ 34: 10.4x ↘ 35: 10.4x ↘ 36: 10.1 ↓ 37: 10.6x ↗ 38: 10.5x ↗ 39: 10.9x ↘ 40: 10.7x ↗ Serie 104.4 Total 412.7				