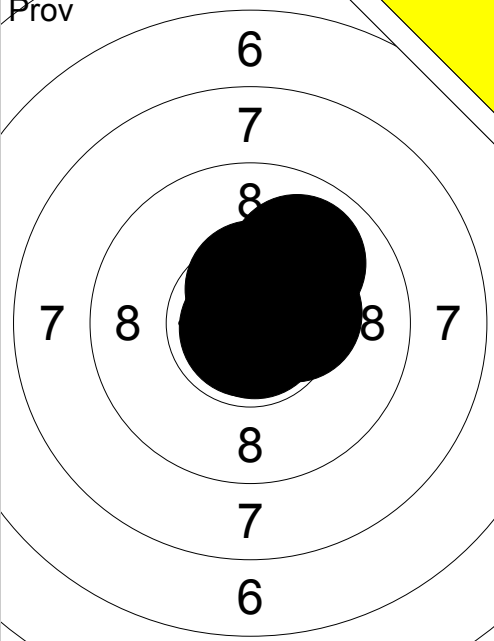
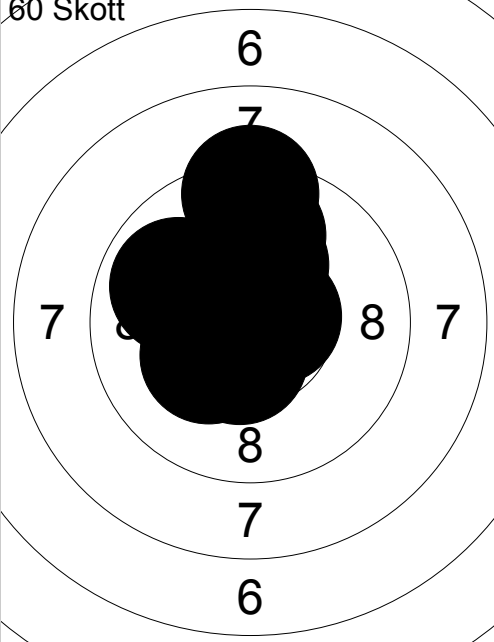
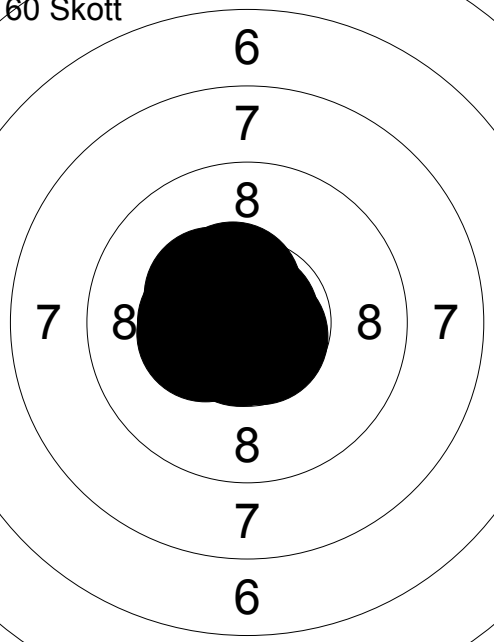

<p>Prov</p>	<p>60 Skott</p>	<table style="width:100%; border-collapse: collapse;"> <tr><td>1:</td><td>10.3x →</td><td>1:</td><td>9.8 →</td></tr> <tr><td>2:</td><td>10.6x ↘</td><td>2:</td><td>10.6x ←</td></tr> <tr><td>3:</td><td>10.3x ↗</td><td>3:</td><td>10.3x ↑</td></tr> <tr><td>4:</td><td>10.8x ←</td><td>4:</td><td>10.1 ↓</td></tr> <tr><td>5:</td><td>10.0 →</td><td>5:</td><td>10.1 →</td></tr> <tr><td>6:</td><td>10.2x ←</td><td>6:</td><td>10.8x ←</td></tr> <tr><td>7:</td><td>10.1 ↓</td><td>7:</td><td>10.2x ↗</td></tr> <tr><td>8:</td><td>10.3x ←</td><td>8:</td><td>9.7 →</td></tr> <tr><td>9:</td><td>10.0 ↗</td><td>9:</td><td>10.8x ↗</td></tr> <tr><td>10:</td><td>10.8x ←</td><td>10:</td><td>10.1 →</td></tr> <tr><td colspan="2">Serie 100 (7x)</td><td colspan="2">Serie 98 (5x)</td></tr> <tr><td colspan="2">Total 0 (0x)</td><td colspan="2">Total 98 (5x)</td></tr> </table>	1:	10.3x →	1:	9.8 →	2:	10.6x ↘	2:	10.6x ←	3:	10.3x ↗	3:	10.3x ↑	4:	10.8x ←	4:	10.1 ↓	5:	10.0 →	5:	10.1 →	6:	10.2x ←	6:	10.8x ←	7:	10.1 ↓	7:	10.2x ↗	8:	10.3x ←	8:	9.7 →	9:	10.0 ↗	9:	10.8x ↗	10:	10.8x ←	10:	10.1 →	Serie 100 (7x)		Serie 98 (5x)		Total 0 (0x)		Total 98 (5x)	
1:	10.3x →	1:	9.8 →																																															
2:	10.6x ↘	2:	10.6x ←																																															
3:	10.3x ↗	3:	10.3x ↑																																															
4:	10.8x ←	4:	10.1 ↓																																															
5:	10.0 →	5:	10.1 →																																															
6:	10.2x ←	6:	10.8x ←																																															
7:	10.1 ↓	7:	10.2x ↗																																															
8:	10.3x ←	8:	9.7 →																																															
9:	10.0 ↗	9:	10.8x ↗																																															
10:	10.8x ←	10:	10.1 →																																															
Serie 100 (7x)		Serie 98 (5x)																																																
Total 0 (0x)		Total 98 (5x)																																																

<p>60 Skott</p>	<p>60 Skott</p>	<table style="width:100%; border-collapse: collapse;"> <tr><td>11:</td><td>10.4x →</td><td>21:</td><td>10.8x ↘</td></tr> <tr><td>12:</td><td>10.6x ↓</td><td>22:</td><td>10.0 ←</td></tr> <tr><td>13:</td><td>10.2x →</td><td>23:</td><td>10.4x →</td></tr> <tr><td>14:</td><td>10.0 ←</td><td>24:</td><td>10.4x →</td></tr> <tr><td>15:</td><td>10.4x ↑</td><td>25:</td><td>10.1 ↓</td></tr> <tr><td>16:</td><td>10.1 ←</td><td>26:</td><td>10.1 ↓</td></tr> <tr><td>17:</td><td>10.7x ↘</td><td>27:</td><td>9.7 →</td></tr> <tr><td>18:</td><td>10.3x ↗</td><td>28:</td><td>9.9 →</td></tr> <tr><td>19:</td><td>10.3x ↗</td><td>29:</td><td>10.3x →</td></tr> <tr><td>20:</td><td>9.8 →</td><td>30:</td><td>10.3x ↗</td></tr> <tr><td colspan="2">Serie 99 (7x)</td><td colspan="2">Serie 98 (5x)</td></tr> <tr><td colspan="2">Total 197 (12x)</td><td colspan="2">Total 295 (17x)</td></tr> </table>	11:	10.4x →	21:	10.8x ↘	12:	10.6x ↓	22:	10.0 ←	13:	10.2x →	23:	10.4x →	14:	10.0 ←	24:	10.4x →	15:	10.4x ↑	25:	10.1 ↓	16:	10.1 ←	26:	10.1 ↓	17:	10.7x ↘	27:	9.7 →	18:	10.3x ↗	28:	9.9 →	19:	10.3x ↗	29:	10.3x →	20:	9.8 →	30:	10.3x ↗	Serie 99 (7x)		Serie 98 (5x)		Total 197 (12x)		Total 295 (17x)	
11:	10.4x →	21:	10.8x ↘																																															
12:	10.6x ↓	22:	10.0 ←																																															
13:	10.2x →	23:	10.4x →																																															
14:	10.0 ←	24:	10.4x →																																															
15:	10.4x ↑	25:	10.1 ↓																																															
16:	10.1 ←	26:	10.1 ↓																																															
17:	10.7x ↘	27:	9.7 →																																															
18:	10.3x ↗	28:	9.9 →																																															
19:	10.3x ↗	29:	10.3x →																																															
20:	9.8 →	30:	10.3x ↗																																															
Serie 99 (7x)		Serie 98 (5x)																																																
Total 197 (12x)		Total 295 (17x)																																																

<p>60 Skott</p>	<table style="width:100%; border-collapse: collapse;"> <tr><td>31:</td><td>10.3x ↗</td></tr> <tr><td>32:</td><td>10.3x ↓</td></tr> <tr><td>33:</td><td>10.1 ↓</td></tr> <tr><td>34:</td><td>10.4x ↓</td></tr> <tr><td>35:</td><td>10.4x →</td></tr> <tr><td>36:</td><td>9.9 ←</td></tr> <tr><td>37:</td><td>10.7x ←</td></tr> <tr><td>38:</td><td>9.2 ↑</td></tr> <tr><td>39:</td><td>10.8x ↓</td></tr> <tr><td>40:</td><td>10.7x ↓</td></tr> <tr><td colspan="2">Serie 98 (7x)</td></tr> <tr><td colspan="2">Total 393 (24x)</td></tr> </table>	31:	10.3x ↗	32:	10.3x ↓	33:	10.1 ↓	34:	10.4x ↓	35:	10.4x →	36:	9.9 ←	37:	10.7x ←	38:	9.2 ↑	39:	10.8x ↓	40:	10.7x ↓	Serie 98 (7x)		Total 393 (24x)		
31:	10.3x ↗																									
32:	10.3x ↓																									
33:	10.1 ↓																									
34:	10.4x ↓																									
35:	10.4x →																									
36:	9.9 ←																									
37:	10.7x ←																									
38:	9.2 ↑																									
39:	10.8x ↓																									
40:	10.7x ↓																									
Serie 98 (7x)																										
Total 393 (24x)																										

Prov 	1: 10.0 ↗ 2: 10.4x → 3: 10.8x ↓ 4: 10.9x ↓ 5: 10.5x → 6: 10.5x ↑	60 Skott 	1: 10.4x ↓ 2: 10.3x ↙ 3: 10.2x ↓ 4: 10.2x ← 5: 10.8x ↖ 6: 10.1 ↑ 7: 10.7x → 8: 10.7x ↙ 9: 9.7 ↑ 10: 10.9x ↓
	Serie 60 (5x)		Serie 99 (8x)
	Total 0 (0x)		Total 99 (8x)

60 Skott 	11: 10.2x ↑ 12: 10.3x ↑ 13: 10.3x ↖ 14: 9.8 ↑ 15: 9.9 ↖ 16: 9.3 ↑ 17: 10.3x ↙ 18: 10.6x → 19: 10.8x ↖ 20: 10.5x ↓	60 Skott 	21: 10.4x ← 22: 10.4x ↖ 23: 10.4x ← 24: 10.7x ↓ 25: 10.5x ↖ 26: 10.4x ↖ 27: 10.9x ↗ 28: 10.6x ← 29: 10.8x ← 30: 10.7x ↓
	Serie 97 (7x)		Serie 100 (10x)
	Total 196 (15x)		Total 296 (25x)

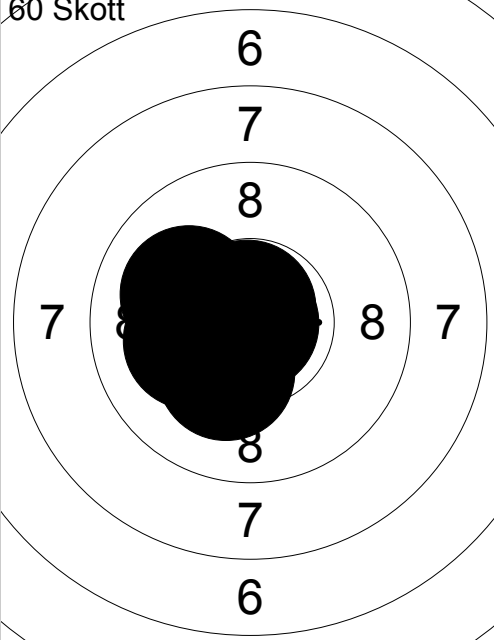
60 Skott 	31: 10.3x ↙ 32: 10.2x ↓ 33: 10.2x ← 34: 10.1 ↖ 35: 10.5x ↙ 36: 10.6x ← 37: 10.9x ↓ 38: 10.5x ↙ 39: 10.8x ↖ 40: 10.6x ↙		
	Serie 100 (9x)		
	Total 396 (34x)		

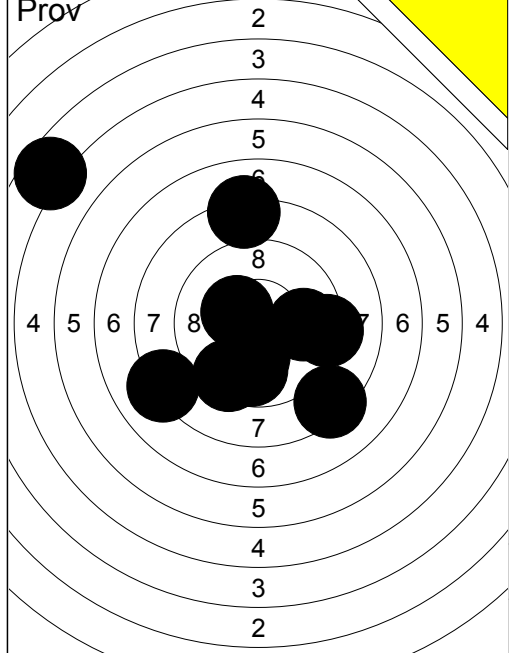

1:	9.8	→
2:	8.1	↙
3:	9.2	→
4:	8.3	↘
5:	9.8	↓
6:	9.4	↙
7:	8.2	↑
8:	10.3x	↖
9:	10.1	↓
10:	4.6	↖
Serie		84 (1x)
Total		0 (0x)

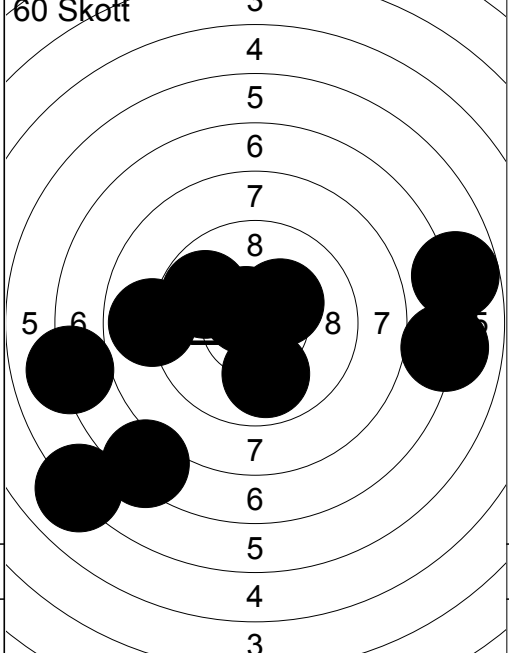

1:	9.9	↓
2:	7.3	↙
3:	8.8	←
4:	7.0	←
5:	10.6x	↖
6:	9.8	↖
7:	6.0	↙
8:	10.3x	↗
9:	6.7	→
10:	7.0	→
Serie		79 (2x)
Total		79 (2x)

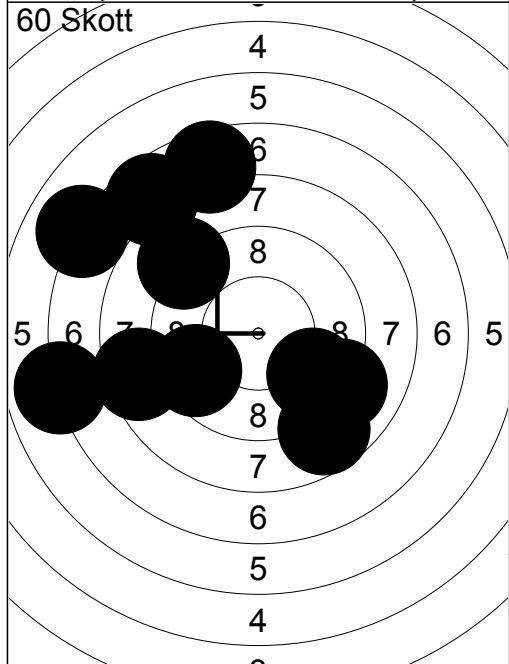

11:	7.6	↑
12:	7.6	↑
13:	7.0	↖
14:	9.5	↙
15:	9.6	↘
16:	8.7	↘
17:	8.9	↗
18:	6.9	←
19:	9.0	↘
20:	8.5	←
Serie		78 (0x)
Total		157 (2x)

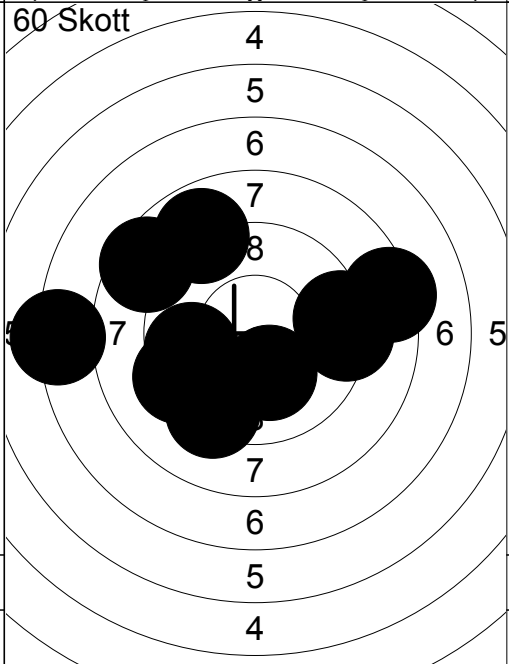

21:	8.8	↖
22:	9.3	→
23:	9.7	←
24:	8.5	↖
25:	7.2	←
26:	8.3	→
27:	9.3	←
28:	9.3	↓
29:	9.2	→
30:	10.2x	↓
Serie		86 (1x)
Total		243 (3x)

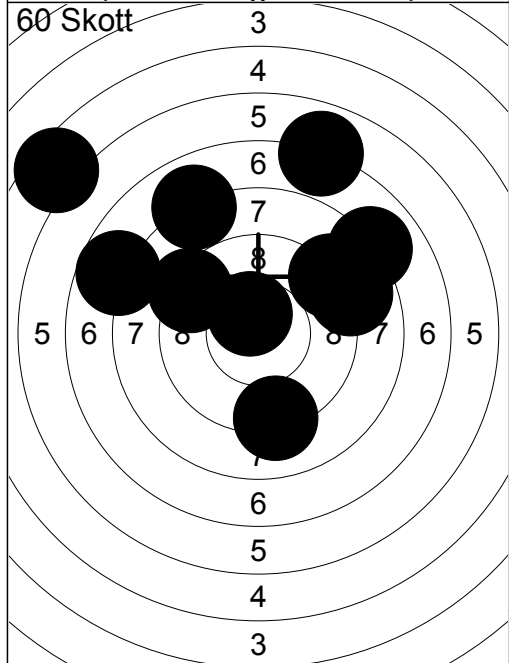

31:	10.5x	↖
32:	6.9	↑
33:	8.0	↗
34:	7.7	↖
35:	7.9	↑
36:	5.4	↖
37:	8.8	→
38:	9.0	↗
39:	9.2	↖
40:	9.1	↓
Serie		78 (1x)
Total		321 (4x)

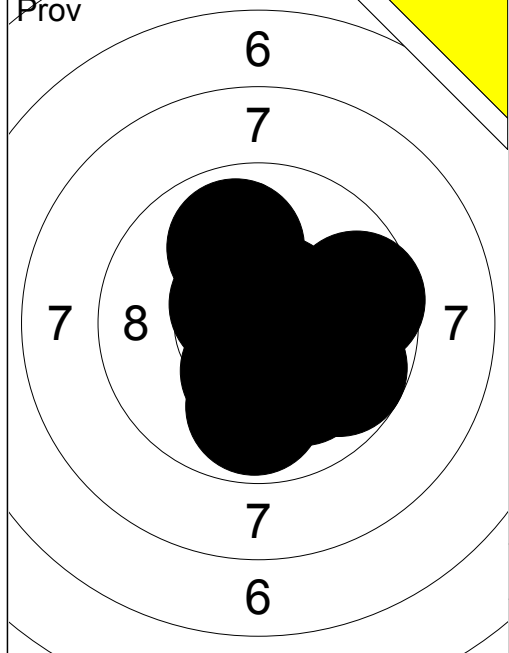

1:	9.9	↓
2:	10.1	↓
3:	10.2x	↓
4:	10.7x	↑
5:	10.6x	↖
6:	10.6x	↗
7:	9.6	→
8:	10.3x	↓
9:	9.9	↑
10:	9.7	→
Serie	96	(5x)
Total	0	(0x)

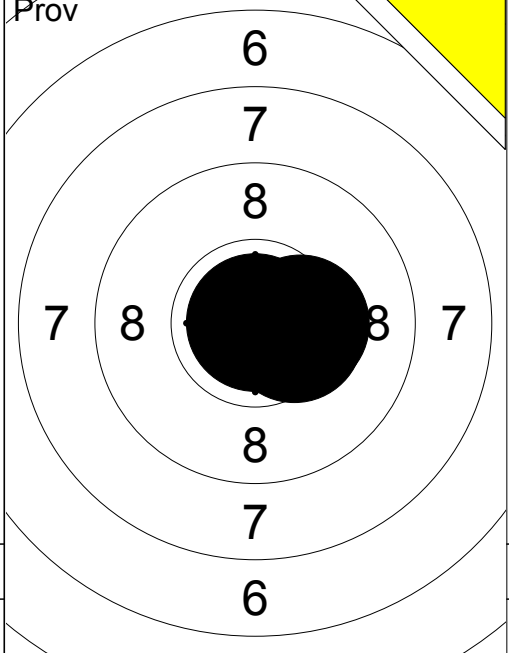

11:	10.4x	→
12:	10.9x	↑
13:	10.4x	→
Serie	30	(3x)
Total	0	(0x)

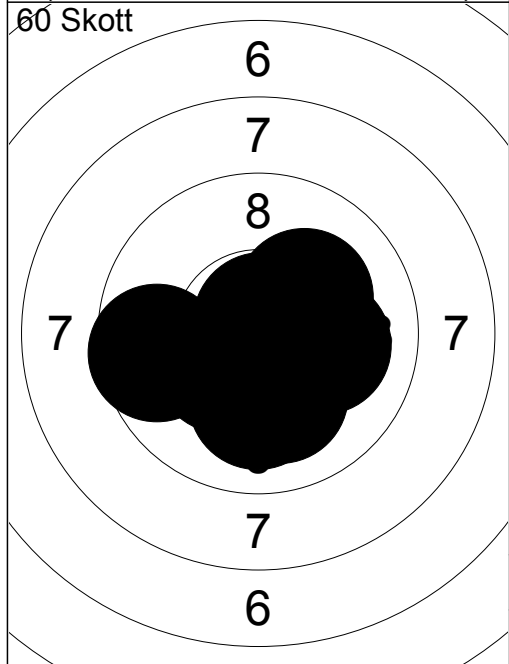

1:	10.1	→
2:	10.2x	↗
3:	10.3x	↖
4:	10.7x	↓
5:	10.5x	↓
6:	10.8x	↑
7:	10.1	↓
8:	10.7x	↓
9:	10.1	↓
10:	9.6	←
Serie	99	(6x)
Total	99	(6x)

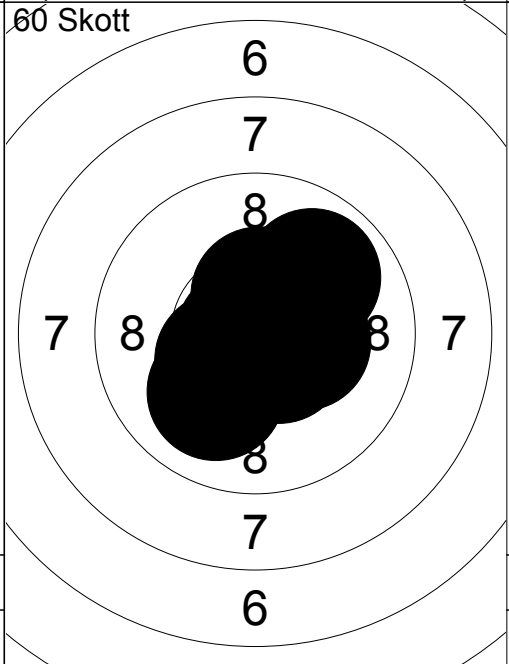

11:	10.2x	↗
12:	9.9	↗
13:	10.8x	↖
14:	10.5x	↘
15:	10.3x	→
16:	10.6x	↘
17:	10.4x	↑
18:	10.4x	↖
19:	10.6x	→
20:	10.0	↘
Serie	99	(8x)
Total	198	(14x)

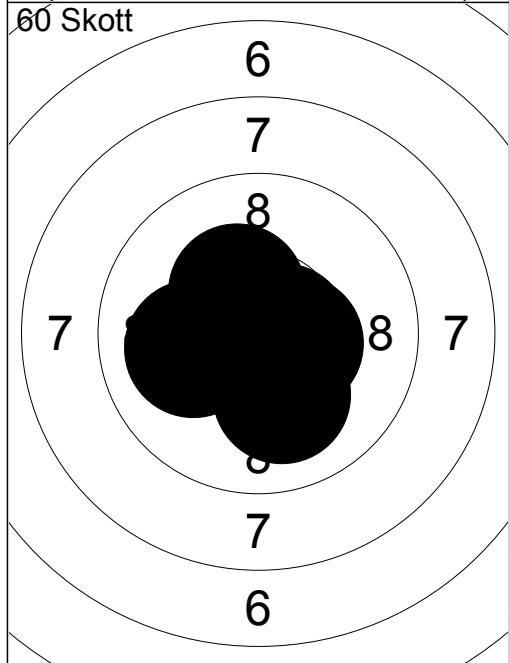

21:	10.8x	↖
22:	10.5x	→
23:	10.5x	↓
24:	10.6x	↘
25:	10.1	↓
26:	10.3x	↑
27:	10.5x	→
28:	10.6x	→
29:	10.1	←
30:	10.4x	↖
Serie	100	(8x)
Total	298	(22x)

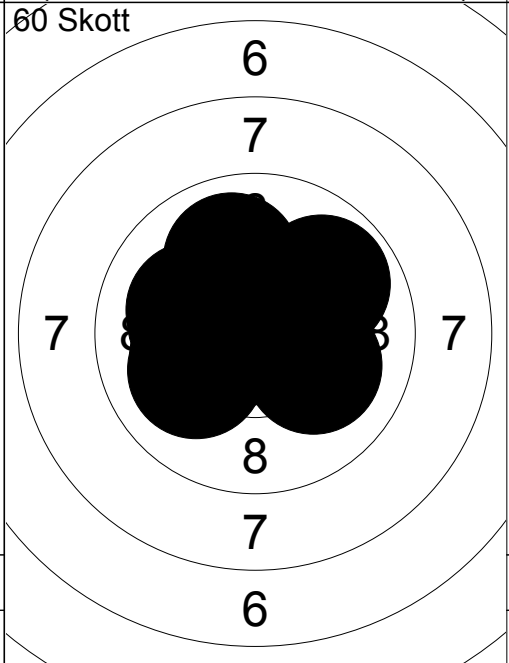

31:	10.0	↖
32:	9.9	↗
33:	10.1	↘
34:	10.6x	↗
35:	10.7x	↖
36:	10.1	←
37:	10.0	↑
38:	10.2x	↖
39:	10.2x	↖
40:	10.6x	↑
Serie	99	(5x)
Total	397	(27x)

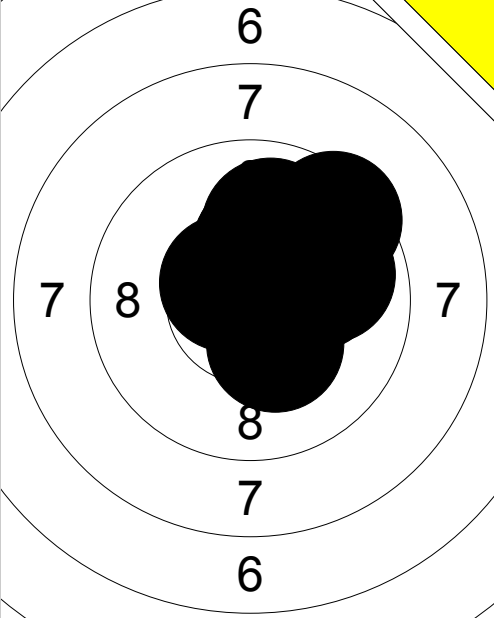
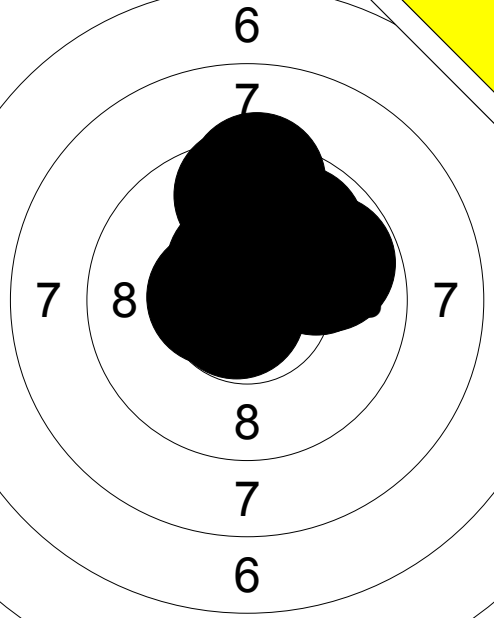
Prov 	1: 10.2x ↑ 2: 9.9 → 3: 10.6x → 4: 9.4 ↗ 5: 10.1 → 6: 10.6x ↖ 7: 10.0 ↑ 8: 10.6x ↑ 9: 10.3x ↑ 10: 10.3x ↓ <hr/> Serie 98 (6x) Total 0 (0x)	Prov 	11: 9.9 → 12: 9.4 ↑ 13: 9.6 ↑ 14: 10.1 ↑ 15: 9.8 → 16: 10.5x ↖ 17: 9.9 ↗ 18: 10.8x ↙ 19: 10.5x ← <hr/> Serie 85 (3x) Total 0 (0x)
--	--	--	---

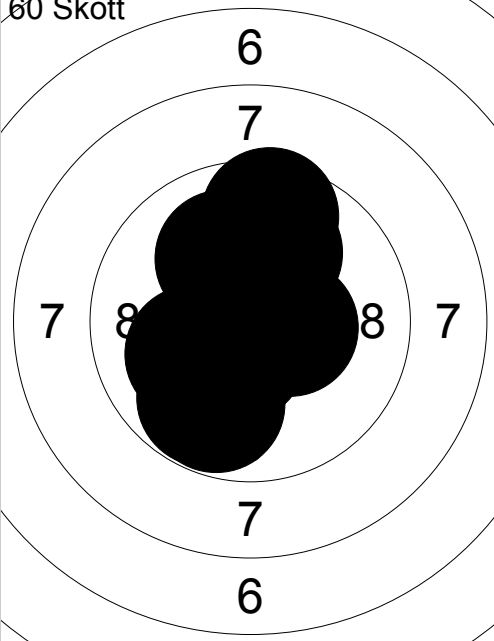
60 Skott 	1: 9.8 ↓ 2: 10.5x ↓ 3: 10.1 ↙ 4: 10.8x ↙ 5: 10.0 ↑ 6: 10.8x ↓ 7: 10.4x → 8: 10.1 ↖ 9: 9.5 ↑ 10: 9.8 ↓ <hr/> Serie 97 (4x) Total 97 (4x)	60 Skott 	11: 10.8x ↓ 12: 10.5x ↙ 13: 10.4x ↖ 14: 9.1 ↓ 15: 10.3x ↙ 16: 10.7x → 17: 8.9 ↓ 18: 9.7 ← 19: 10.5x → 20: 10.0 ↓ <hr/> Serie 96 (6x) Total 193 (10x)
---	--	---	---

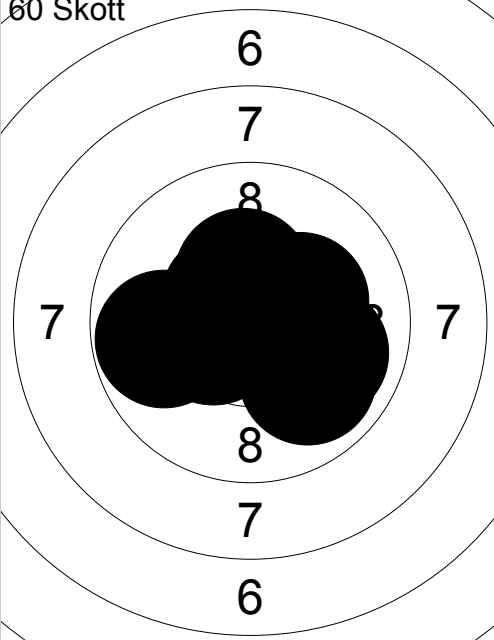
60 Skott 	21: 10.7x → 22: 10.2x → 23: 10.5x ↖ 24: 10.8x ↑ 25: 10.0 → 26: 9.8 ← 27: 10.4x ↙ 28: 10.3x ↑ 29: 10.4x → 30: 9.9 ↓ <hr/> Serie 98 (7x) Total 291 (17x)	60 Skott 	31: 10.3x ↓ 32: 10.6x ↑ 33: 10.1 → 34: 10.2x → 35: 10.6x → 36: 10.5x ↓ 37: 10.0 ↓ 38: 10.2x ↑ 39: 9.7 ↗ 40: 10.4x ↖ <hr/> Serie 99 (7x) Total 390 (24x)
--	---	--	--

Pröv 	Pröv 	11: 10.1 ↓ 12: 10.6x ← 13: 10.6x ↖ 14: 10.6x ↑
1: 8.6 → 2: 9.0 → 3: 10.7x ← 4: 10.1 ↓ 5: 9.4 → 6: 10.1 ↓ 7: 9.9 ↓ 8: 10.3x → 9: 9.9 ↓ 10: 10.0 →	1: 8.6 → 2: 9.0 → 3: 10.7x ← 4: 10.1 ↓ 5: 9.4 → 6: 10.1 ↓ 7: 9.9 ↓ 8: 10.3x → 9: 9.9 ↓ 10: 10.0 →	Serie 94 (2x) Total 0 (0x)

60 Skott 	60 Skott 	11: 10.4x ↓ 12: 9.8 ↖ 13: 10.3x ↖ 14: 10.5x ← 15: 10.1 ↖ 16: 10.8x ↑ 17: 10.7x ↓ 18: 10.7x ↖ 19: 10.2x ↖ 20: 10.9x ←
1: 10.3x ↖ 2: 9.8 ↖ 3: 10.8x ↑ 4: 10.6x ↗ 5: 9.5 ↗ 6: 10.0 ↖ 7: 10.2x ← 8: 10.5x ↗ 9: 10.6x ↖ 10: 10.0 ↑	1: 10.3x ↖ 2: 9.8 ↖ 3: 10.8x ↑ 4: 10.6x ↗ 5: 9.5 ↗ 6: 10.0 ↖ 7: 10.2x ← 8: 10.5x ↗ 9: 10.6x ↖ 10: 10.0 ↑	Serie 98 (6x) Total 98 (6x)

60 Skott 	60 Skott 	31: 10.3x ↑ 32: 10.6x → 33: 10.2x ↑ 34: 10.5x ← 35: 10.3x ← 36: 10.4x ↖ 37: 10.3x ← 38: 10.2x ↖ 39: 9.9 ↖ 40: 9.8 ↑
21: 10.5x ↗ 22: 10.5x → 23: 10.1 ↓ 24: 10.6x ↓ 25: 9.8 ↖ 26: 10.2x ← 27: 10.4x ↑ 28: 10.5x ↖ 29: 10.6x ↑ 30: 10.2x ←	21: 10.5x ↗ 22: 10.5x → 23: 10.1 ↓ 24: 10.6x ↓ 25: 9.8 ↖ 26: 10.2x ← 27: 10.4x ↑ 28: 10.5x ↖ 29: 10.6x ↑ 30: 10.2x ←	Serie 99 (8x) Total 296 (22x)

<p>Prov</p>	<p>60 Skott</p>	<table style="width:100%; border-collapse: collapse;"> <tr><td>1:</td><td>10.1</td><td>→</td></tr> <tr><td>2:</td><td>10.3x</td><td>←</td></tr> <tr><td>3:</td><td>10.3x</td><td>↗</td></tr> <tr><td>4:</td><td>10.0</td><td>←</td></tr> <tr><td>5:</td><td>10.2x</td><td>↓</td></tr> <tr><td>6:</td><td>10.3x</td><td>→</td></tr> <tr><td>7:</td><td>10.5x</td><td>↓</td></tr> <tr><td>8:</td><td>10.6x</td><td>↓</td></tr> <tr><td>9:</td><td>10.2x</td><td>↓</td></tr> <tr><td>10:</td><td>10.3x</td><td>↗</td></tr> <tr><td colspan="3">Serie 100 (8x)</td></tr> <tr><td colspan="3">Total 0 (0x)</td></tr> </table>	1:	10.1	→	2:	10.3x	←	3:	10.3x	↗	4:	10.0	←	5:	10.2x	↓	6:	10.3x	→	7:	10.5x	↓	8:	10.6x	↓	9:	10.2x	↓	10:	10.3x	↗	Serie 100 (8x)			Total 0 (0x)		
1:	10.1	→																																				
2:	10.3x	←																																				
3:	10.3x	↗																																				
4:	10.0	←																																				
5:	10.2x	↓																																				
6:	10.3x	→																																				
7:	10.5x	↓																																				
8:	10.6x	↓																																				
9:	10.2x	↓																																				
10:	10.3x	↗																																				
Serie 100 (8x)																																						
Total 0 (0x)																																						
<table style="width:100%; border-collapse: collapse;"> <tr><td>1:</td><td>10.3x</td><td>↗</td></tr> <tr><td>2:</td><td>10.1</td><td>↓</td></tr> <tr><td>3:</td><td>10.8x</td><td>↖</td></tr> <tr><td>4:</td><td>10.2x</td><td>↓</td></tr> <tr><td>5:</td><td>10.5x</td><td>↖</td></tr> <tr><td>6:</td><td>10.3x</td><td>↗</td></tr> <tr><td>7:</td><td>9.5</td><td>→</td></tr> <tr><td>8:</td><td>10.6x</td><td>↗</td></tr> <tr><td>9:</td><td>10.2x</td><td>↗</td></tr> <tr><td>10:</td><td>10.7x</td><td>↖</td></tr> <tr><td colspan="3">Serie 99 (8x)</td></tr> <tr><td colspan="3">Total 99 (8x)</td></tr> </table>	1:	10.3x	↗	2:	10.1	↓	3:	10.8x	↖	4:	10.2x	↓	5:	10.5x	↖	6:	10.3x	↗	7:	9.5	→	8:	10.6x	↗	9:	10.2x	↗	10:	10.7x	↖	Serie 99 (8x)			Total 99 (8x)				
1:	10.3x	↗																																				
2:	10.1	↓																																				
3:	10.8x	↖																																				
4:	10.2x	↓																																				
5:	10.5x	↖																																				
6:	10.3x	↗																																				
7:	9.5	→																																				
8:	10.6x	↗																																				
9:	10.2x	↗																																				
10:	10.7x	↖																																				
Serie 99 (8x)																																						
Total 99 (8x)																																						

<p>60 Skott</p>	<p>60 Skott</p>	<table style="width:100%; border-collapse: collapse;"> <tr><td>11:</td><td>10.5x</td><td>→</td></tr> <tr><td>12:</td><td>10.6x</td><td>→</td></tr> <tr><td>13:</td><td>10.4x</td><td>↗</td></tr> <tr><td>14:</td><td>10.2x</td><td>↓</td></tr> <tr><td>15:</td><td>10.6x</td><td>↖</td></tr> <tr><td>16:</td><td>10.8x</td><td>↓</td></tr> <tr><td>17:</td><td>10.2x</td><td>↓</td></tr> <tr><td>18:</td><td>10.6x</td><td>→</td></tr> <tr><td>19:</td><td>10.6x</td><td>↖</td></tr> <tr><td>20:</td><td>10.4x</td><td>↖</td></tr> <tr><td colspan="3">Serie 100 (10x)</td></tr> <tr><td colspan="3">Total 199 (18x)</td></tr> </table>	11:	10.5x	→	12:	10.6x	→	13:	10.4x	↗	14:	10.2x	↓	15:	10.6x	↖	16:	10.8x	↓	17:	10.2x	↓	18:	10.6x	→	19:	10.6x	↖	20:	10.4x	↖	Serie 100 (10x)			Total 199 (18x)		
11:	10.5x	→																																				
12:	10.6x	→																																				
13:	10.4x	↗																																				
14:	10.2x	↓																																				
15:	10.6x	↖																																				
16:	10.8x	↓																																				
17:	10.2x	↓																																				
18:	10.6x	→																																				
19:	10.6x	↖																																				
20:	10.4x	↖																																				
Serie 100 (10x)																																						
Total 199 (18x)																																						
<table style="width:100%; border-collapse: collapse;"> <tr><td>21:</td><td>10.2x</td><td>↓</td></tr> <tr><td>22:</td><td>10.6x</td><td>↓</td></tr> <tr><td>23:</td><td>10.7x</td><td>→</td></tr> <tr><td>24:</td><td>10.4x</td><td>↘</td></tr> <tr><td>25:</td><td>10.7x</td><td>↖</td></tr> <tr><td>26:</td><td>10.2x</td><td>↖</td></tr> <tr><td>27:</td><td>10.6x</td><td>↓</td></tr> <tr><td>28:</td><td>10.8x</td><td>↓</td></tr> <tr><td>29:</td><td>10.4x</td><td>↖</td></tr> <tr><td>30:</td><td>10.5x</td><td>→</td></tr> <tr><td colspan="3">Serie 100 (10x)</td></tr> <tr><td colspan="3">Total 299 (28x)</td></tr> </table>	21:	10.2x	↓	22:	10.6x	↓	23:	10.7x	→	24:	10.4x	↘	25:	10.7x	↖	26:	10.2x	↖	27:	10.6x	↓	28:	10.8x	↓	29:	10.4x	↖	30:	10.5x	→	Serie 100 (10x)			Total 299 (28x)				
21:	10.2x	↓																																				
22:	10.6x	↓																																				
23:	10.7x	→																																				
24:	10.4x	↘																																				
25:	10.7x	↖																																				
26:	10.2x	↖																																				
27:	10.6x	↓																																				
28:	10.8x	↓																																				
29:	10.4x	↖																																				
30:	10.5x	→																																				
Serie 100 (10x)																																						
Total 299 (28x)																																						

<p>60 Skott</p>	<table style="width:100%; border-collapse: collapse;"> <tr><td>31:</td><td>10.2x</td><td>↖</td></tr> <tr><td>32:</td><td>10.2x</td><td>↗</td></tr> <tr><td>33:</td><td>10.6x</td><td>↓</td></tr> <tr><td>34:</td><td>10.7x</td><td>→</td></tr> <tr><td>35:</td><td>10.1</td><td>→</td></tr> <tr><td>36:</td><td>10.6x</td><td>→</td></tr> <tr><td>37:</td><td>10.4x</td><td>↖</td></tr> <tr><td>38:</td><td>10.5x</td><td>↖</td></tr> <tr><td>39:</td><td>10.6x</td><td>↖</td></tr> <tr><td>40:</td><td>10.6x</td><td>↗</td></tr> <tr><td colspan="3">Serie 100 (9x)</td></tr> <tr><td colspan="3">Total 399 (37x)</td></tr> </table>	31:	10.2x	↖	32:	10.2x	↗	33:	10.6x	↓	34:	10.7x	→	35:	10.1	→	36:	10.6x	→	37:	10.4x	↖	38:	10.5x	↖	39:	10.6x	↖	40:	10.6x	↗	Serie 100 (9x)			Total 399 (37x)			
31:	10.2x	↖																																				
32:	10.2x	↗																																				
33:	10.6x	↓																																				
34:	10.7x	→																																				
35:	10.1	→																																				
36:	10.6x	→																																				
37:	10.4x	↖																																				
38:	10.5x	↖																																				
39:	10.6x	↖																																				
40:	10.6x	↗																																				
Serie 100 (9x)																																						
Total 399 (37x)																																						

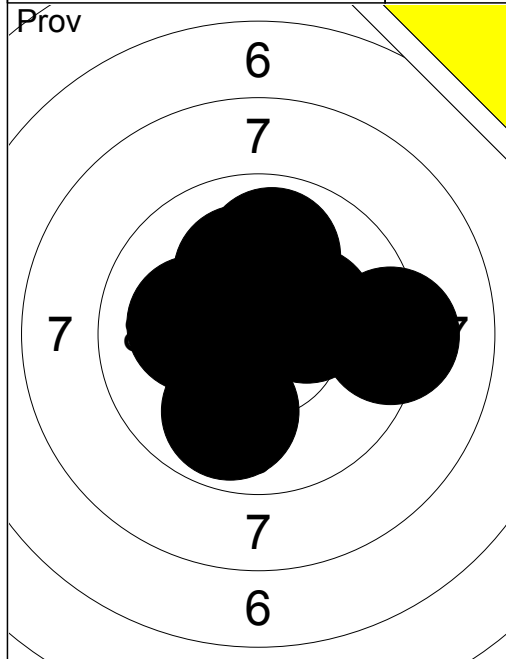

1:	9.9	↓
2:	10.3x	→
3:	9.2	→
4:	9.9	↑
5:	10.1	←
6:	10.1	↑
Serie 57 (1x)		
Total 0 (0x)		

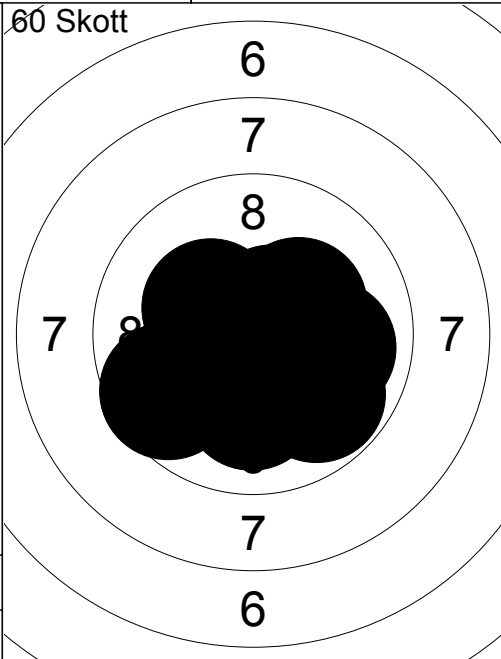

1:	10.1	↓
2:	10.6x	↗
3:	10.3x	↖
4:	10.0	→
5:	10.3x	↗
6:	10.5x	→
7:	9.6	↖
8:	9.8	↓
9:	10.3x	→
10:	10.7x	→
Serie 98 (6x)		
Total 98 (6x)		

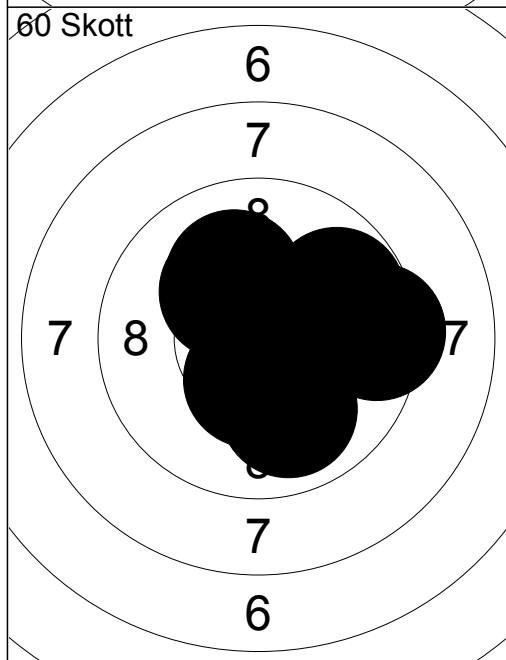

11:	9.8	→
12:	10.4x	↓
13:	10.2x	↖
14:	10.4x	→
15:	10.4x	→
16:	9.9	↓
17:	10.1	↑
18:	10.5x	↓
19:	10.1	→
20:	9.4	→
Serie 97 (5x)		
Total 195 (11x)		

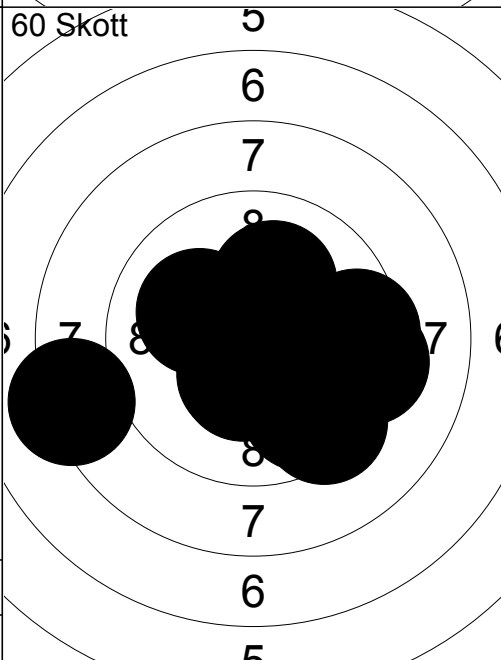

21:	9.3	→
22:	10.1	↖
23:	10.4x	↓
24:	9.7	↓
25:	8.2	↖
26:	10.1	↑
27:	10.4x	↓
28:	9.5	→
29:	10.3x	→
30:	9.4	↓
Serie 94 (3x)		
Total 289 (14x)		

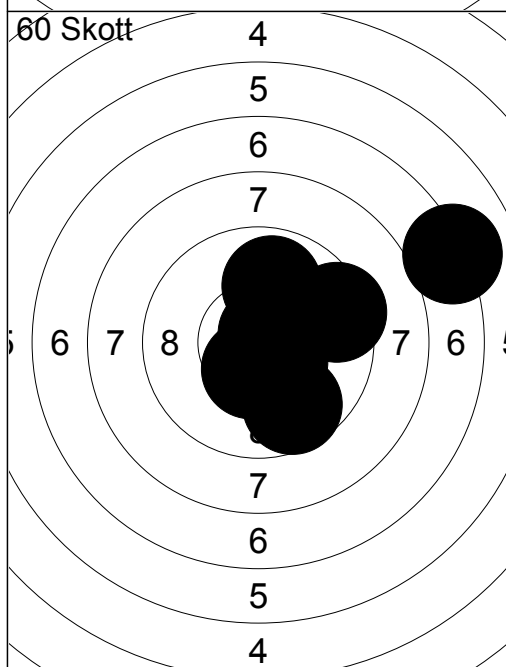

31:	9.4	→
32:	10.1	↑
33:	10.4x	↘
34:	10.7x	↗
35:	10.1	↑
36:	9.9	↑
37:	9.7	↓
38:	10.5x	→
39:	7.1	→
40:	10.4x	↓
Serie 94 (4x)		
Total 383 (18x)		

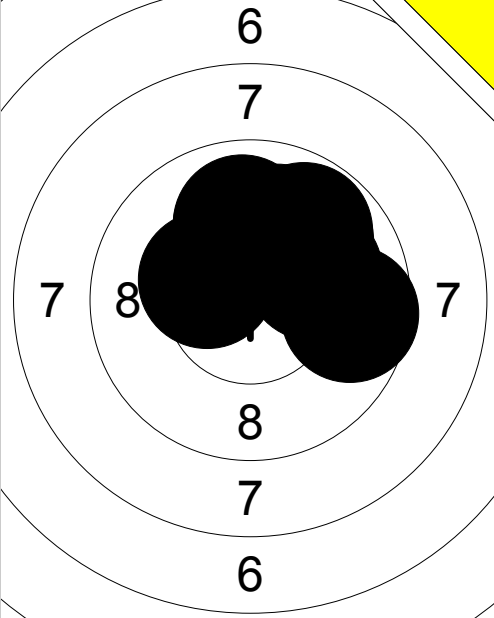
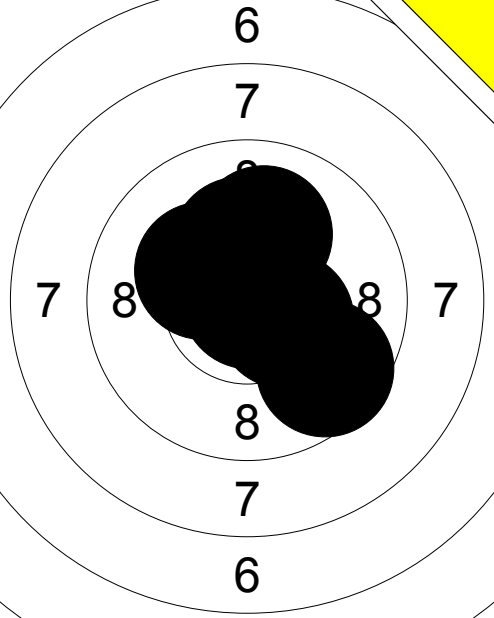
Prov 	1: 9.9 ↑ 2: 10.0 ↑ 3: 10.0 → 4: 10.1 ↑ 5: 9.8 ↗ 6: 10.0 ↑ 7: 10.3x ↙ 8: 9.9 ↗ 9: 10.0 ↑ 10: 9.6 → Serie 96 (1x) Total 0 (0x)	Prov 	11: 9.6 ↘ 12: 10.9x → 13: 10.1 ↑ 14: 10.4x ↘ 15: 10.3x ↙ 16: 10.7x ↑ 17: 10.2x ↑ Serie 69 (5x) Total 0 (0x)
--	---	--	---

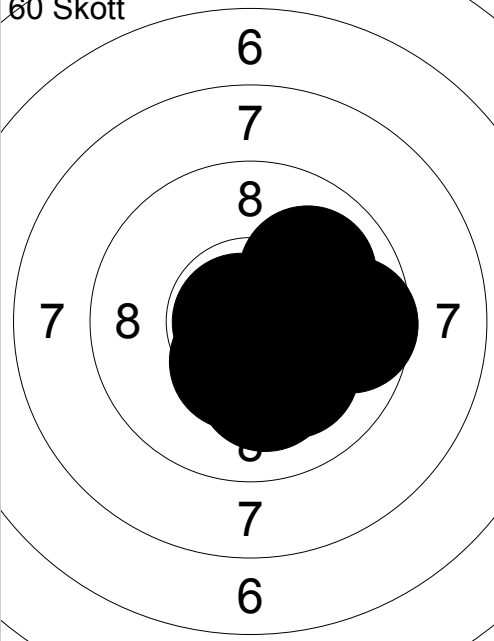
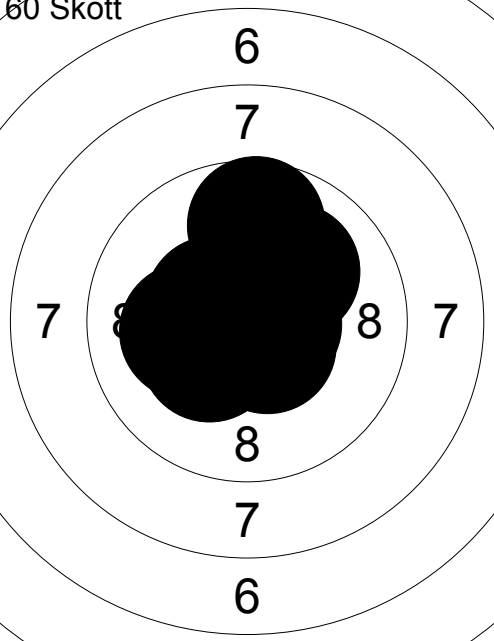
60 Skott 	1: 10.1 ↓ 2: 10.6x ↘ 3: 10.1 ↓ 4: 10.4x ↓ 5: 10.0 ↗ 6: 10.8x ← 7: 10.4x ↓ 8: 10.1 → 9: 9.7 → 10: 10.6x ↓ Serie 99 (5x) Total 99 (5x)	60 Skott 	11: 10.1 ↗ 12: 10.3x ↙ 13: 10.6x ↖ 14: 10.5x ↘ 15: 9.7 ↑ 16: 10.2x ← 17: 10.2x ← 18: 10.5x ↙ 19: 10.7x ↑ 20: 10.6x → Serie 99 (8x) Total 198 (13x)
---	---	---	---

60 Skott 	21: 10.2x ↗ 22: 10.1 ↑ 23: 10.7x ↑ 24: 10.4x ↘ 25: 10.4x ↙ 26: 10.2x ↓ 27: 9.3 ↙ 28: 10.2x ↙ 29: 10.4x ↗ 30: 10.2x ↖ Serie 99 (8x) Total 297 (21x)	60 Skott 	31: 10.3x ↑ 32: 10.2x → 33: 10.2x ↖ 34: 10.2x ↑ 35: 10.7x ↑ 36: 10.4x ← 37: 9.9 ↓ 38: 10.0 ↗ 39: 10.2x ↓ 40: 10.3x ↗ Serie 99 (8x) Total 396 (29x)
--	---	--	---

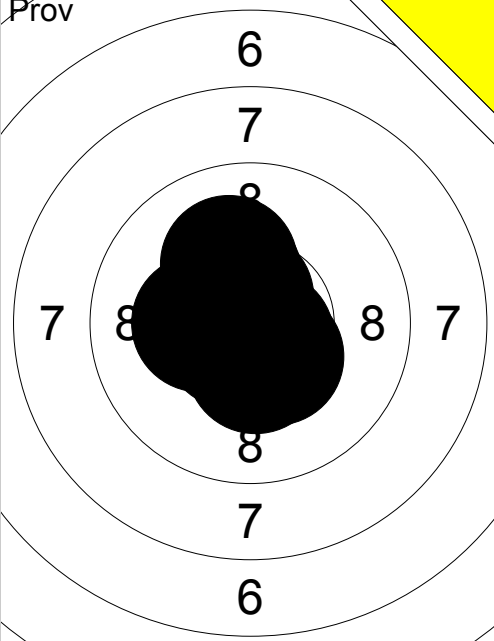
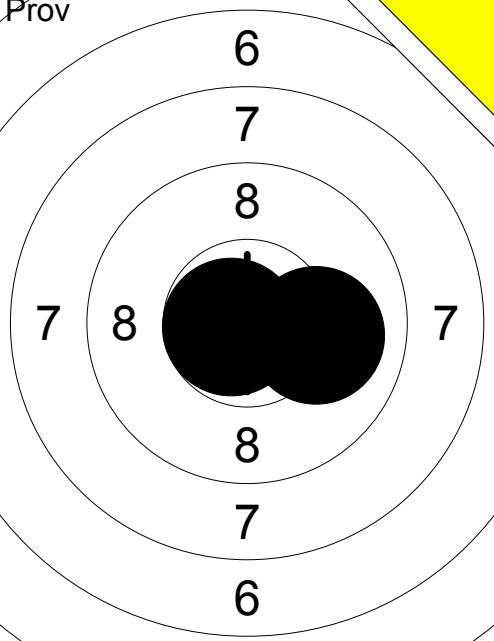
Prov 	1: 10.3x ← 2: 10.3x ↑ 3: 10.5x ↖ 4: 10.1 ↑ 5: 10.6x ↑ 6: 10.7x ↗ 7: 10.7x ↘ 8: 10.6x ↙ 9: 10.4x ↘ 10: 10.4x ↓ Serie 100 (9x) Total 0 (0x)	Prov 	11: 10.0 → 12: 10.7x ← Serie 20 (1x) Total 0 (0x)
--	--	--	--

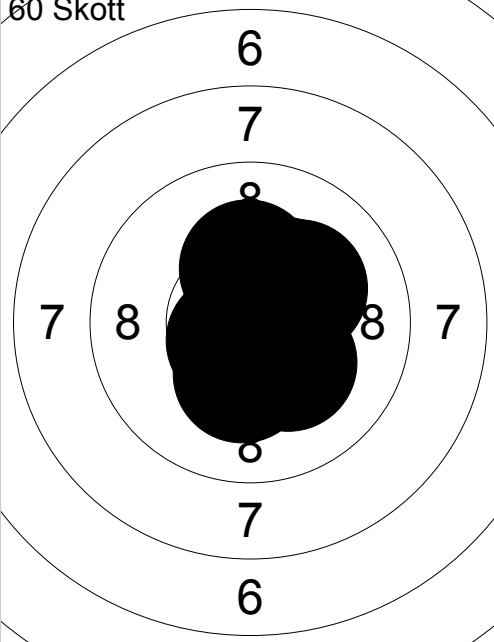
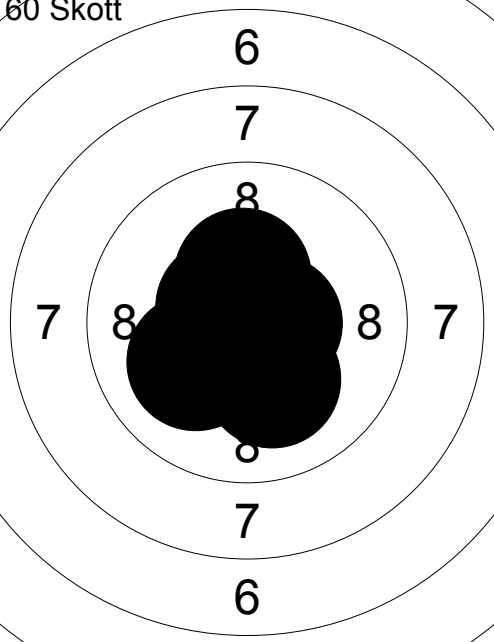
60 Skott 	1: 10.2x ↑ 2: 10.3x ↑ 3: 10.8x → 4: 10.3x ↗ 5: 10.7x → 6: 10.2x ↗ 7: 10.9x ↓ 8: 10.6x ↙ 9: 10.2x ↘ 10: 10.3x ↓ Serie 100 (10x) Total 100 (10x)	60 Skott 	11: 10.5x ↓ 12: 10.6x ↖ 13: 10.1 ↙ 14: 10.1 ↓ 15: 10.9x ↙ 16: 10.4x ↑ 17: 10.5x ↙ 18: 10.7x ↓ 19: 10.6x → 20: 10.8x ↗ Serie 100 (8x) Total 200 (18x)
---	---	---	--

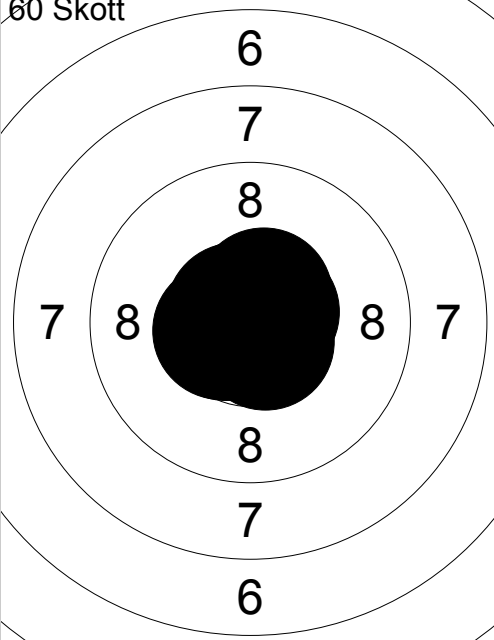
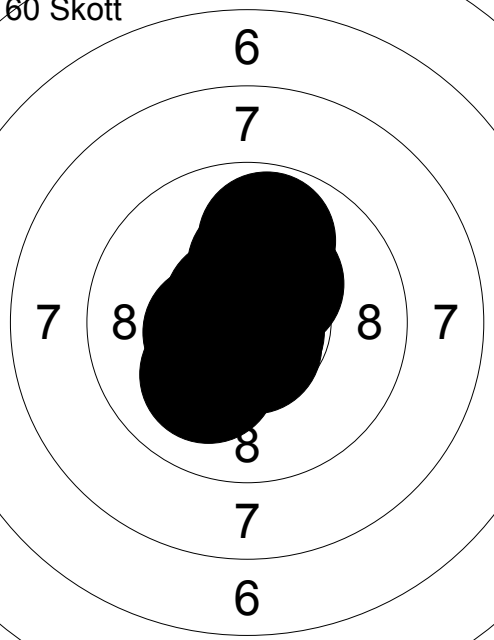
60 Skott 	21: 10.8x → 22: 10.6x ← 23: 10.6x ↗ 24: 10.6x ↘ 25: 10.6x ← 26: 10.7x → 27: 10.7x ↖ 28: 10.8x ← 29: 10.8x ↓ 30: 10.8x ↗ Serie 100 (10x) Total 300 (28x)	60 Skott 	31: 10.7x ↙ 32: 10.8x ↘ 33: 10.5x ← 34: 10.6x ↙ 35: 9.9 ↑ 36: 10.1 ↙ 37: 10.3x ↗ 38: 10.2x ↑ 39: 10.7x ↖ 40: 10.6x ↓ Serie 99 (8x) Total 399 (36x)
--	--	--	--

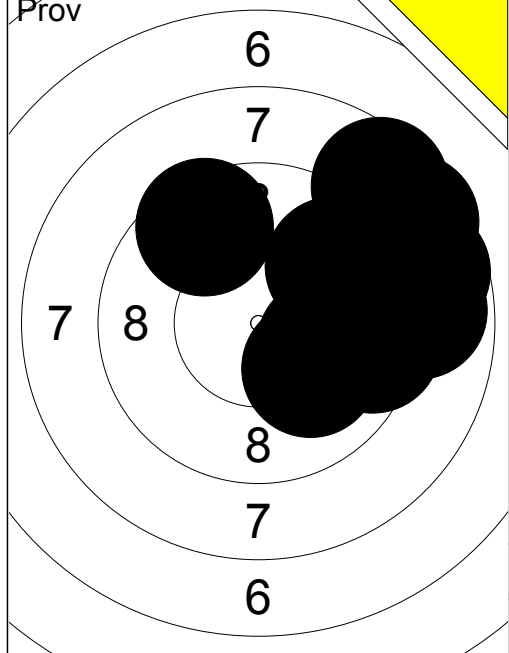

1:	9.7	↗
2:	10.0	↘
3:	8.7	→
4:	10.0	→
5:	9.4	→
6:	8.8	→
7:	8.5	↗
8:	9.0	→
9:	8.6	↗
10:	9.5	↖
Serie	88	(0x)
Total	0	(0x)

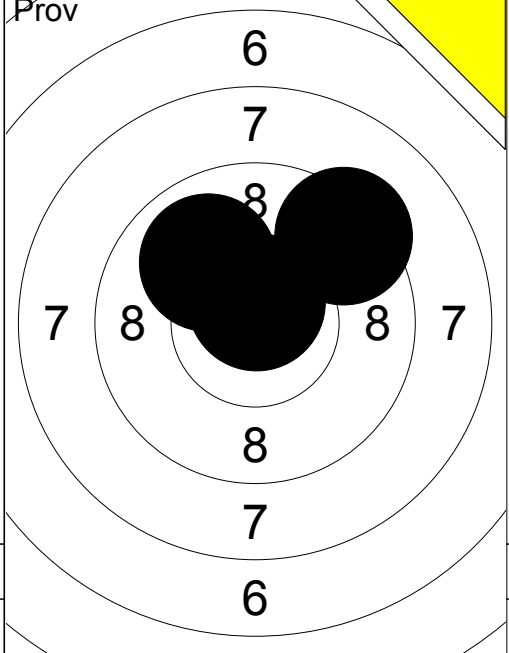

11:	9.3	↗
12:	10.7x	↑
13:	9.9	↖
Serie	28	(1x)
Total	0	(0x)

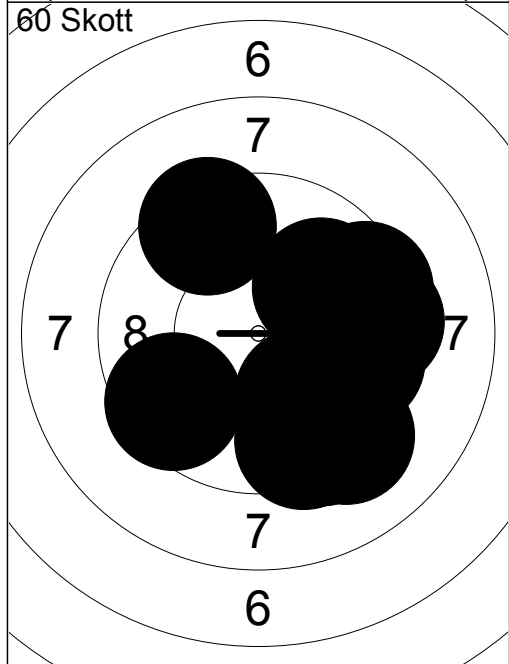

1:	9.4	↘
2:	9.6	→
3:	9.5	↙
4:	9.4	→
5:	9.4	→
6:	9.9	↗
7:	9.9	↘
8:	9.4	↗
9:	9.2	↘
10:	9.4	↘
Serie	90	(0x)
Total	90	(0x)

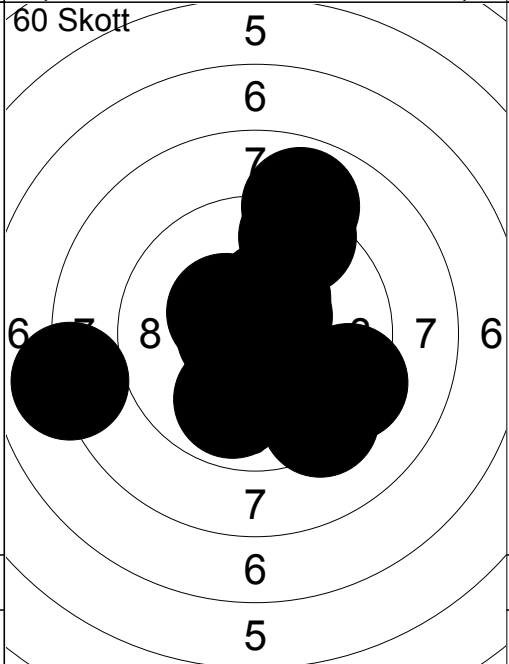

11:	9.3	↗
12:	10.6x	↗
13:	9.3	→
14:	10.4x	↖
15:	10.4x	↗
16:	9.9	↘
17:	9.3	↘
18:	8.0	←
19:	8.9	↗
20:	10.6x	←
Serie	92	(4x)
Total	182	(4x)

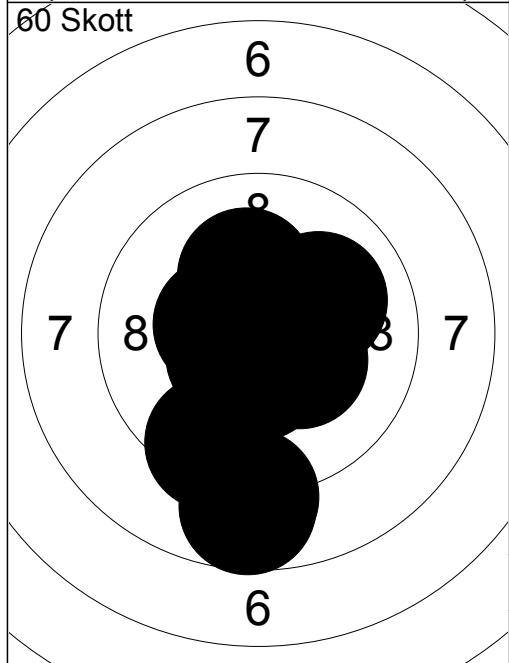

21:	8.8	↘
22:	10.5x	←
23:	10.5x	↑
24:	10.4x	↘
25:	8.7	↘
26:	10.5x	↖
27:	10.2x	↑
28:	10.3x	→
29:	9.4	↘
30:	10.0	↗
Serie	95	(6x)
Total	277	(10x)

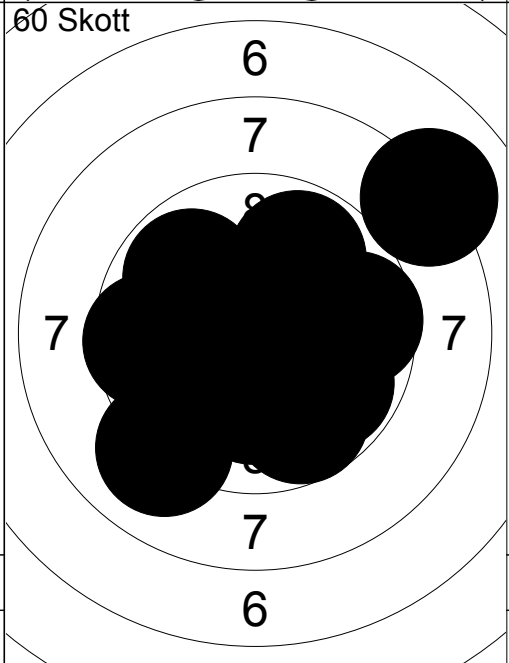

31:	10.6x	→
32:	8.1	↗
33:	9.7	↘
34:	9.8	↘
35:	10.1	↘
36:	9.8	↗
37:	9.6	→
38:	9.8	↖
39:	9.0	↘
40:	9.6	←
Serie	91	(1x)
Total	368	(11x)

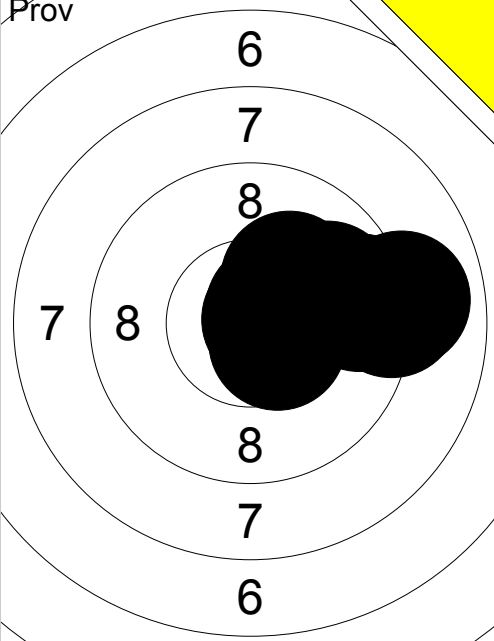
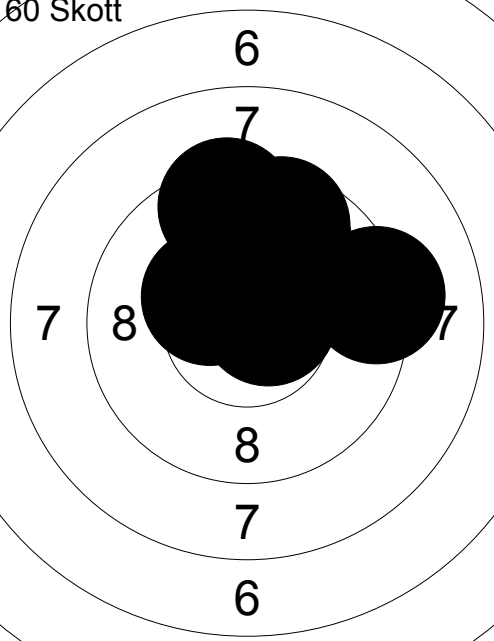
Prov 	1: 10.6x → 2: 10.2x ↗ 3: 8.9 → 4: 10.1 ↗ 5: 9.5 → 6: 9.1 → 7: 10.7x → 8: 10.5x ↘ 9: 9.9 ↗ Serie 85 (4x) Total 0 (0x)	60 Skott  1: 10.4x ↖ 2: 9.8 ↑ 3: 9.4 ↑ 4: 10.7x → 5: 10.1 ↑ 6: 9.2 → 7: 10.6x ↑ 8: 10.3x ↗ 9: 10.3x ↗ 10: 9.6 ↑ Serie 96 (5x) Total 96 (5x)
--	--	---

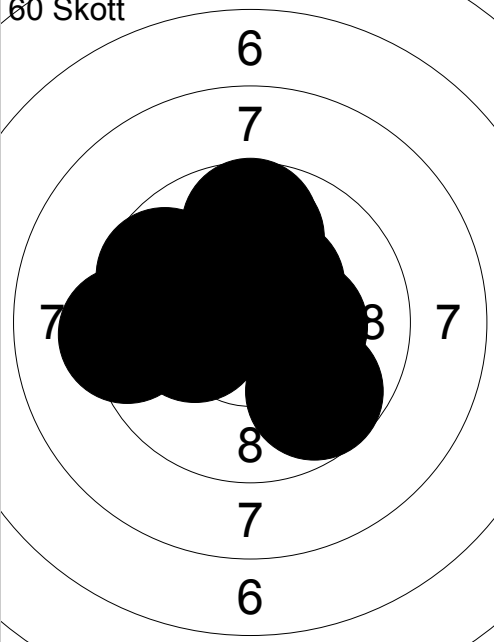
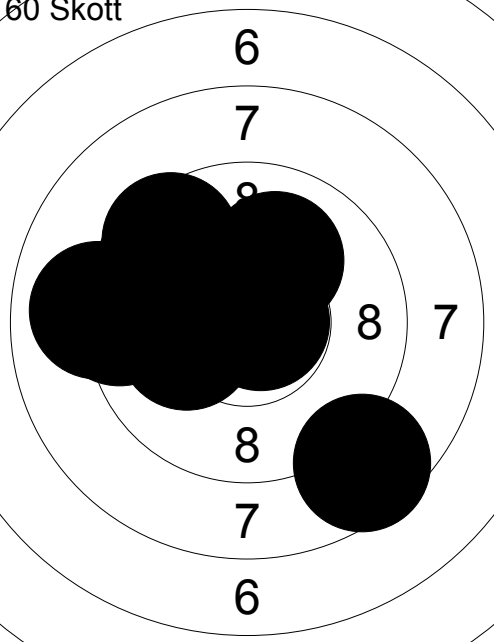
60 Skott 	11: 10.7x ↖ 12: 9.8 ↑ 13: 9.7 ↘ 14: 10.2x ← 15: 10.3x → 16: 10.4x ← 17: 9.7 ↑ 18: 9.3 ← 19: 9.7 ↖ 20: 10.4x ↗ Serie 95 (5x) Total 191 (10x)	60 Skott  21: 10.2x ← 22: 9.7 ↖ 23: 10.1 ↗ 24: 9.5 ↖ 25: 10.8x → 26: 9.3 ← 27: 9.0 ← 28: 8.6 ↘ 29: 10.1 ← 30: 10.6x ↑ Serie 94 (3x) Total 285 (13x)
---	--	--

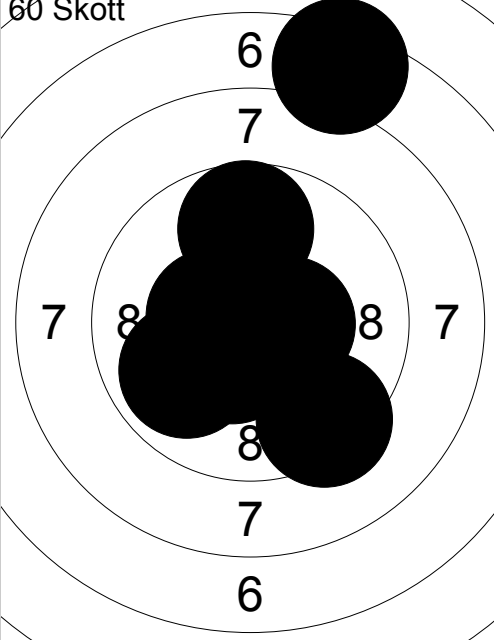
60 Skott 	31: 10.8x ↘ 32: 10.5x ← 33: 9.9 ↖ 34: 9.3 ↘ 35: 10.5x ← 36: 9.7 ↑ 37: 10.5x → 38: 7.4 ↑ 39: 10.5x ↘ 40: 10.8x ← Serie 94 (6x) Total 379 (19x)	
--	--	--

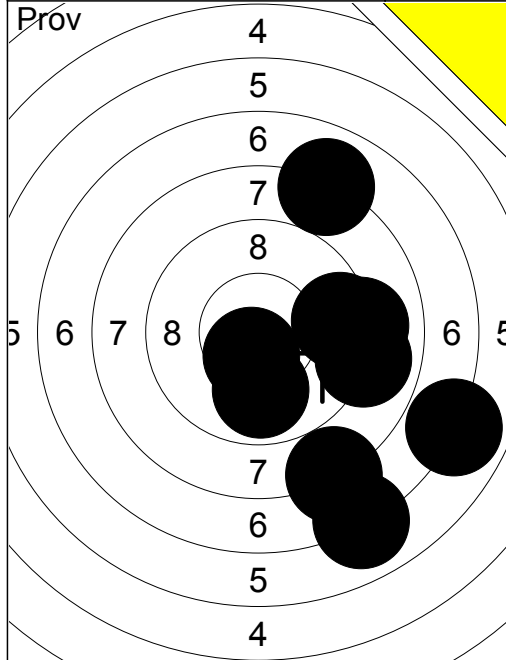

1:	6.9	→
2:	10.5x	↓
3:	7.0	↓
4:	8.9	→
5:	9.1	→
6:	7.9	↓
7:	9.4	→
8:	8.0	↑
9:	9.9	↓
10:	9.0	→
Serie		82 (1x)
Total		0 (0x)

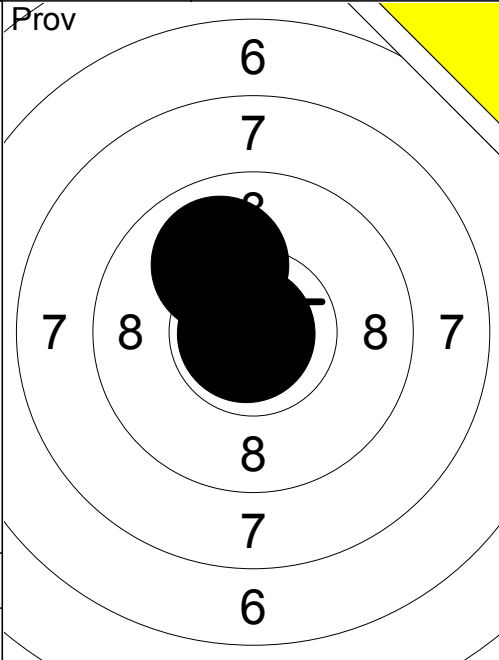

11:	10.9x	←
12:	10.0	↑
Serie		20 (1x)
Total		0 (0x)

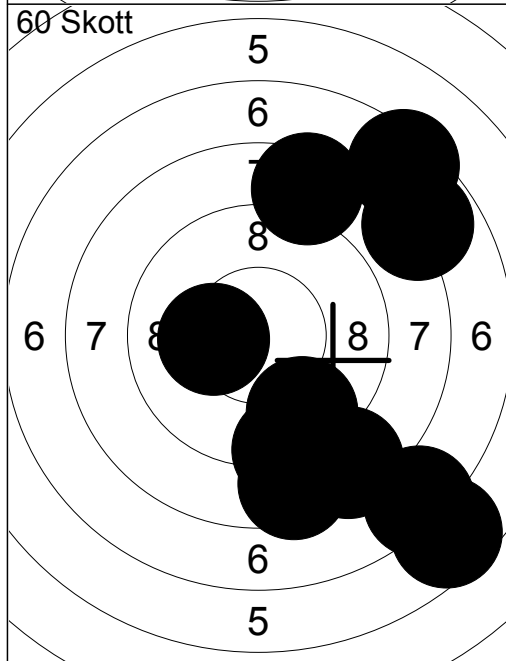

1:	7.2	↓
2:	9.5	↓
3:	6.6	↓
4:	7.8	↗
5:	10.2x	←
6:	8.4	↓
7:	8.5	↑
8:	7.4	↗
9:	9.0	↓
10:	8.5	↓
Serie		79 (1x)
Total		79 (1x)

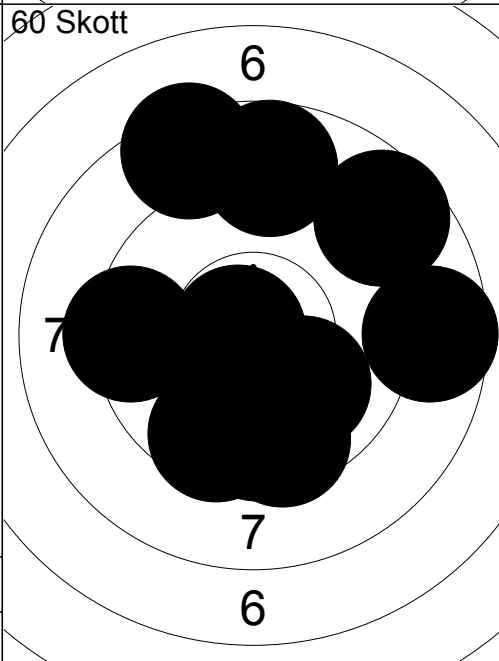

11:	10.0	↓
12:	9.3	←
13:	9.7	↓
14:	8.7	↑
15:	10.7x	←
16:	9.5	↓
17:	8.7	↗
18:	8.6	→
19:	9.6	↓
20:	8.4	↑
Serie		88 (1x)
Total		167 (2x)

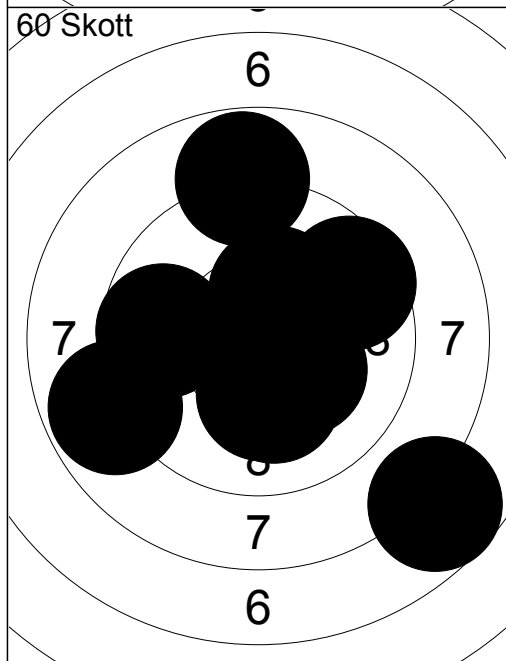

21:	9.7	←
22:	8.8	↑
23:	10.4x	↓
24:	8.8	←
25:	10.3x	↑
26:	7.7	↓
27:	10.3x	↓
28:	10.2x	↓
29:	10.2x	↓
30:	9.5	↗
Serie		91 (5x)
Total		258 (7x)

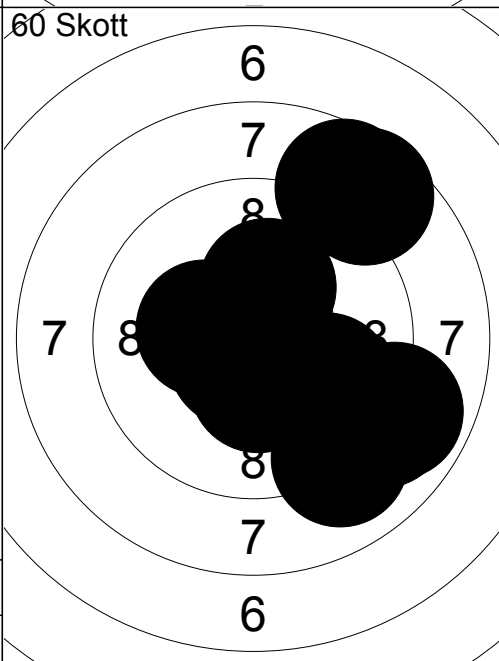

31:	10.6x	↙
32:	10.3x	↑
33:	10.3x	↓
34:	10.3x	←
35:	9.8	↓
36:	9.0	↓
37:	9.0	↓
38:	8.6	↗
39:	8.7	↗
40:	8.9	↘
Serie		91 (4x)
Total		349 (11x)

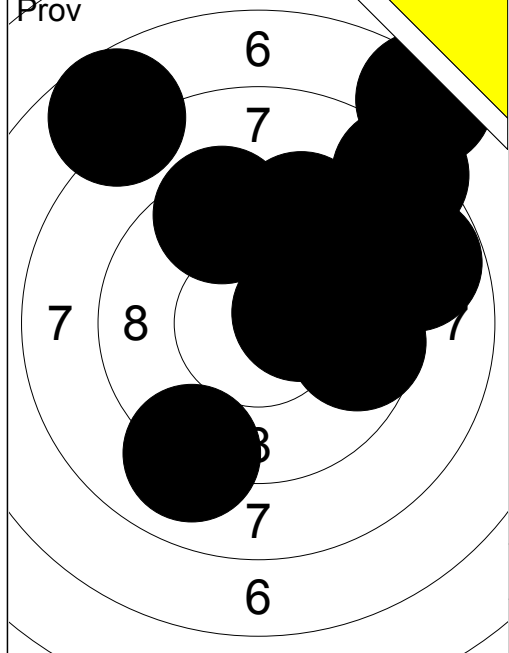

1:	9.7	→
2:	8.3	↗
3:	9.6	→
4:	9.5	↑
5:	10.4x	→
6:	8.8	→
7:	7.3	↗
8:	9.0	↓
9:	9.5	↑
10:	7.7	↖
Serie	85	(1x)
Total	0	(0x)

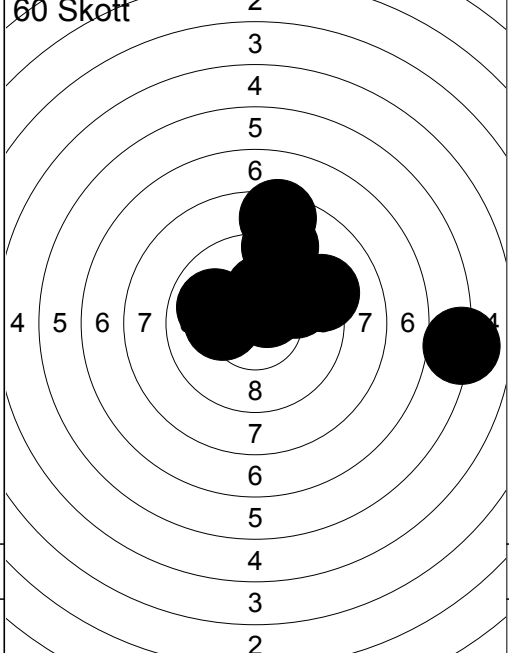

1:	10.2x	↑
2:	10.1	↗
3:	10.2x	←
4:	9.2	→
5:	8.4	↑
6:	9.9	↖
7:	9.9	↗
8:	10.5x	↗
9:	9.1	↑
10:	6.1	→
Serie	90	(3x)
Total	90	(3x)

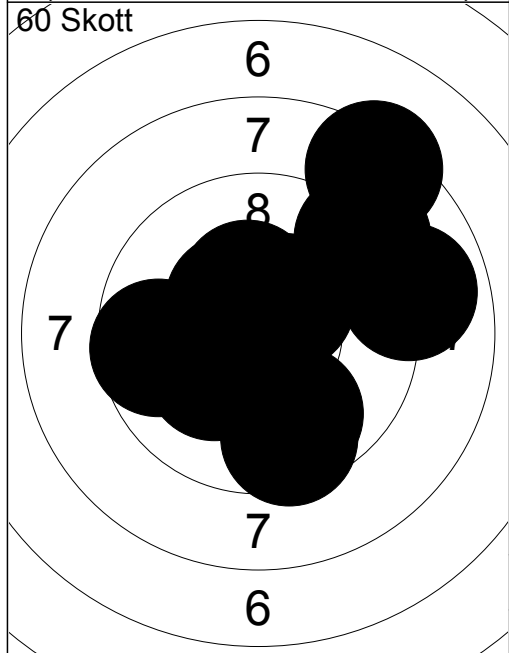

11:	10.4x	↗
12:	10.4x	↖
13:	8.9	→
14:	10.3x	↑
15:	9.6	←
16:	8.3	↗
17:	9.5	↓
18:	10.2x	↖
19:	9.8	↓
20:	9.1	↗
Serie	92	(4x)
Total	182	(7x)

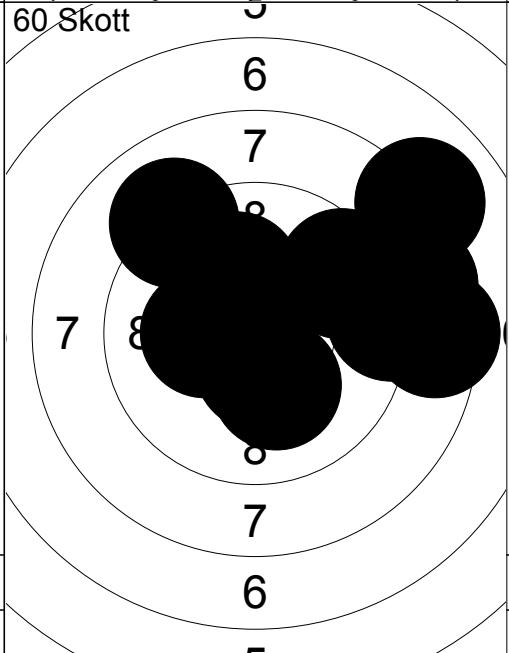

21:	10.5x	↓
22:	9.0	↖
23:	10.3x	←
24:	9.5	↗
25:	9.1	→
26:	8.5	→
27:	8.7	→
28:	8.0	↗
29:	10.2x	↓
30:	10.1	↑
Serie	91	(3x)
Total	273	(10x)

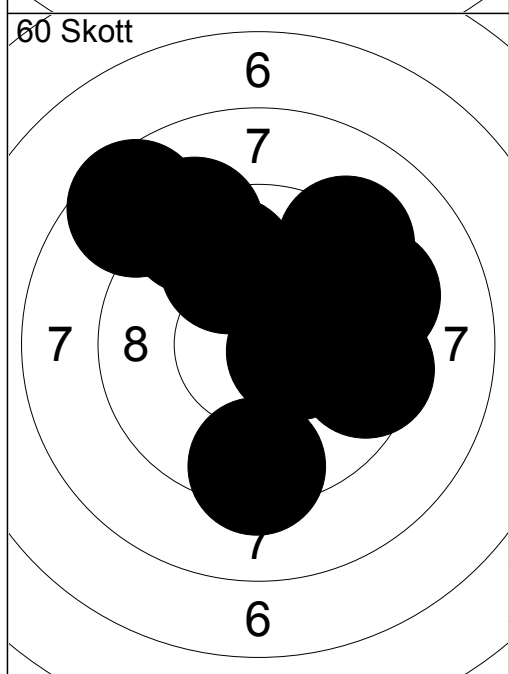

31:	9.4	↓
32:	9.8	↑
33:	9.5	→
34:	9.7	→
35:	10.2x	↑
36:	9.3	→
37:	9.2	↗
38:	10.5x	→
39:	9.2	↗
40:	8.6	↖
Serie	91	(2x)
Total	364	(12x)

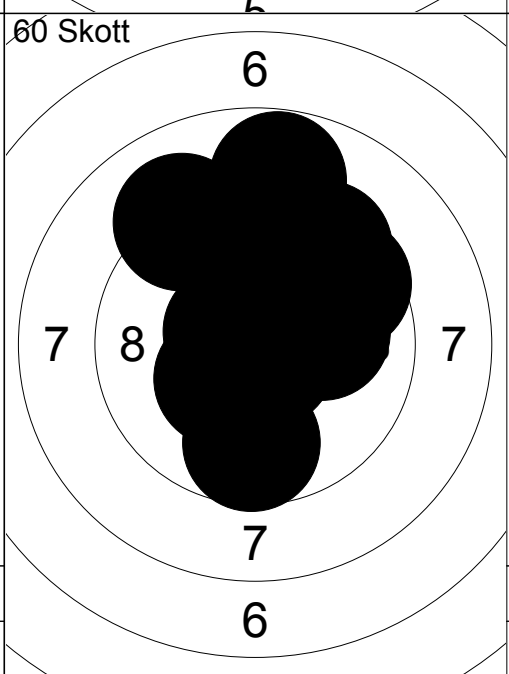

41:	10.6x	↖
42:	9.1	↖
43:	9.6	↗
44:	10.3x	↖
45:	10.7x	↓
46:	8.8	↑
47:	9.4	↗
48:	10.5x	↑
49:	9.7	↓
50:	10.1	→
Serie	94	(4x)
Total	458	(16x)

Prov 	Prov 	11: 10.5x ↘ 12: 10.5x ↙ 13: 10.9x ↑ 14: 10.6x ← 15: 10.5x ↗ 16: 10.4x ↘ 17: 10.6x ↙ 18: 10.7x ↗
1: 9.2 ← 2: 10.5x → 3: 10.3x ↓ 4: 10.5x ↓ 5: 10.5x ↓ 6: 10.1 ↓ 7: 10.5x ↗ 8: 10.7x ↓ 9: 10.5x ← 10: 10.6x ↗	Serie 99 (8x) Total 0 (0x)	Serie 80 (8x) Total 0 (0x)

60 Skott 	60 Skott 	11: 10.7x ↙ 12: 10.7x ↙ 13: 10.5x → 14: 10.5x ↗ 15: 10.6x ↖ 16: 10.5x ↑ 17: 10.4x → 18: 10.5x ↓ 19: 10.6x → 20: 10.6x →
1: 10.4x ↗ 2: 10.2x ↗ 3: 10.4x ↙ 4: 10.4x ↑ 5: 10.2x ↑ 6: 10.6x → 7: 10.8x ↓ 8: 10.6x ↙ 9: 10.8x ↗ 10: 10.6x ↓	Serie 100 (10x) Total 100 (10x)	Serie 100 (10x) Total 200 (20x)

60 Skott 	60 Skott 	31: 10.9x ↘ 32: 10.7x → 33: 10.6x ↑ 34: 10.7x ↑ 35: 10.8x ↓ 36: 10.5x ↗ 37: 10.7x ↖ 38: 10.8x → 39: 10.6x ↖ 40: 10.6x ↙
21: 10.5x → 22: 10.4x ↗ 23: 10.2x → 24: 10.4x ↓ 25: 10.4x ↓ 26: 10.6x ↓ 27: 10.6x ← 28: 10.6x ↗ 29: 10.9x ↗ 30: 10.5x ←	Serie 100 (10x) Total 300 (30x)	Serie 100 (10x) Total 400 (40x)

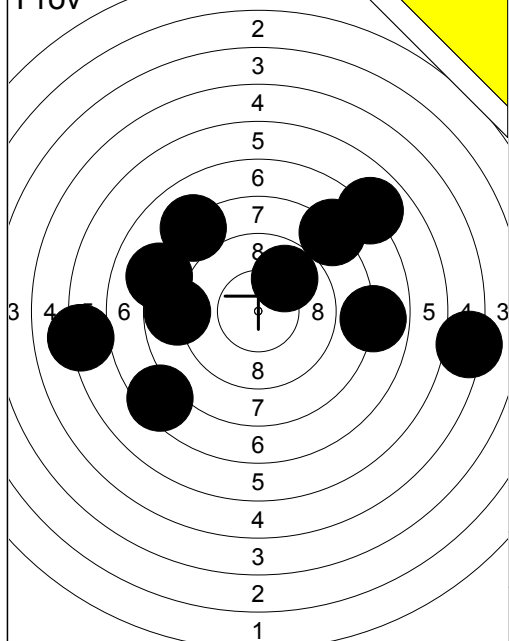

1:	7.4	↙
2:	8.8	←
3:	8.1	↙
4:	6.1	←
5:	8.1	↗
6:	5.2	→
7:	8.0	↗
8:	7.9	→
9:	6.9	↗
10:	9.8	↗
Serie		72 (0x)
Total		0 (0x)

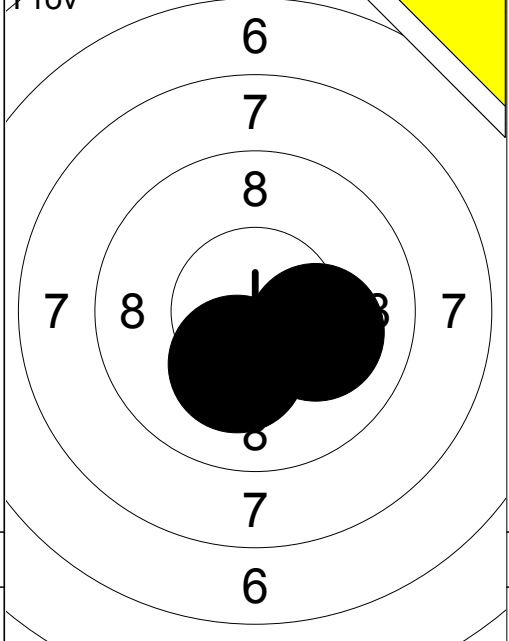

11:	10.2x	↘
12:	10.1	→
Serie		20 (1x)
Total		0 (0x)

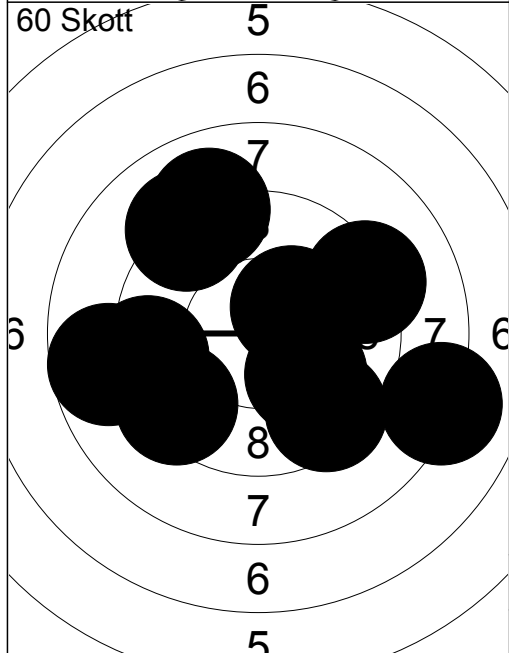

13:	9.2	↗
14:	9.3	←
15:	8.1	→
16:	10.0	↘
17:	9.4	↙
18:	9.4	↘
19:	9.0	↗
20:	10.3x	↗
21:	9.1	↗
22:	8.7	←
Serie		90 (1x)
Total		90 (1x)

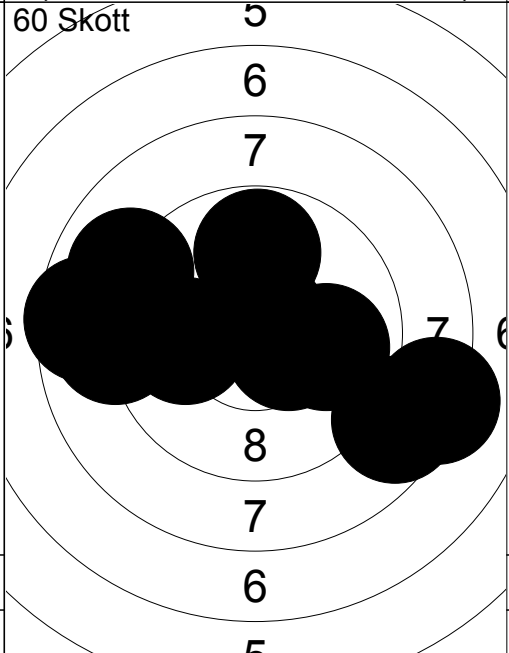

11:	9.0	←
12:	9.0	↙
13:	9.8	↑
14:	10.4x	→
15:	9.9	→
16:	10.0	←
17:	10.7x	↗
18:	8.2	→
19:	8.6	←
20:	8.6	↘
Serie		90 (2x)
Total		180 (3x)

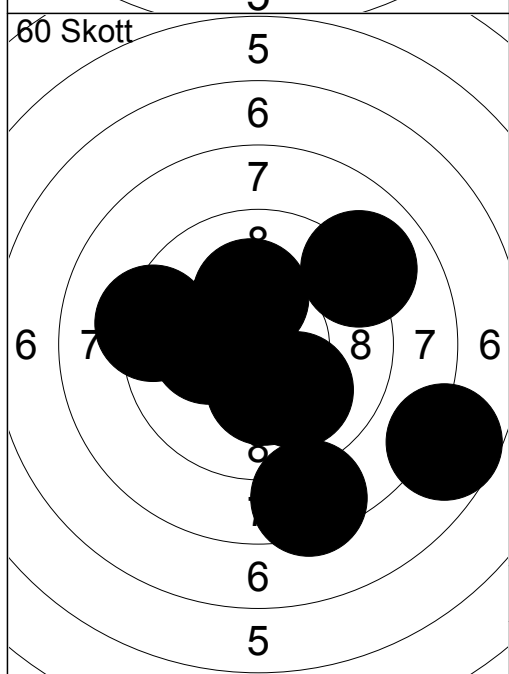

21:	9.0	↗
22:	10.0	↘
23:	10.6x	←
24:	10.2x	←
25:	10.4x	↖
26:	10.3x	↘
27:	10.2x	↗
28:	9.3	←
29:	7.7	→
30:	8.4	↘
Serie		93 (5x)
Total		273 (8x)

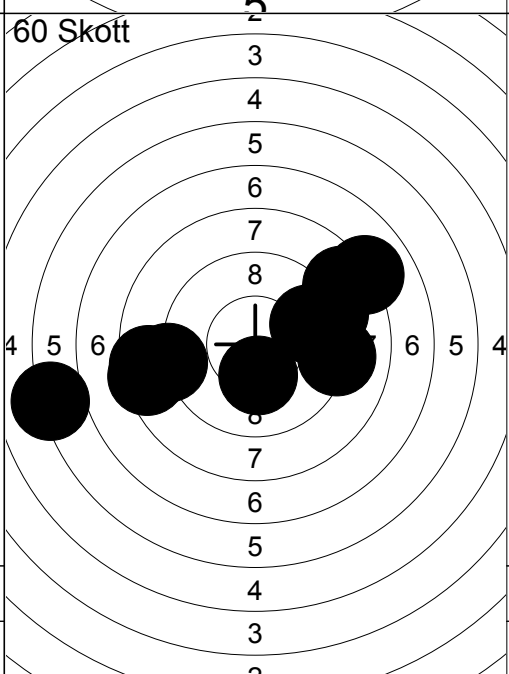

31:	9.1	→
32:	8.0	↗
33:	8.6	↗
34:	9.6	→
35:	8.5	←
36:	9.1	↗
37:	6.1	←
38:	8.9	←
39:	10.2x	↘
40:	8.4	←
Serie		83 (1x)
Total		356 (9x)

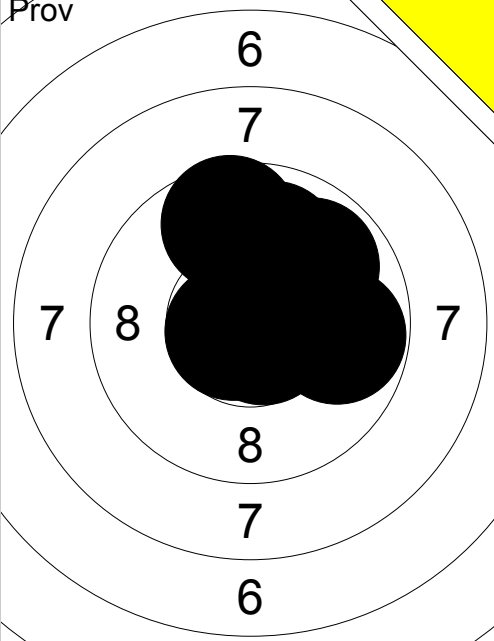
<p>Pröv</p>  <p style="text-align: center;">6 7 8 7 8 7 6</p>	<p>1: 9.9 ↗ 2: 9.8 → 3: 9.9 ↑ 4: 9.6 ↑ 5: 10.7x ↘ 6: 10.8x ↘ 7: 10.7x ↙ 8: 10.8x ↗</p> <p>Serie 76 (4x) Total 0 (0x)</p>	<p>60 Skott</p>  <p style="text-align: center;">6 7 8 7 8 7 6</p> <p>1: 10.4x ↙ 2: 10.2x ↘ 3: 10.7x ↙ 4: 10.8x → 5: 10.4x ↘ 6: 10.5x ↑ 7: 10.5x ↘ 8: 10.6x ↑ 9: 10.5x ↙ 10: 10.4x ↘</p> <p>Serie 100 (10x) Total 100 (10x)</p>
---	--	--

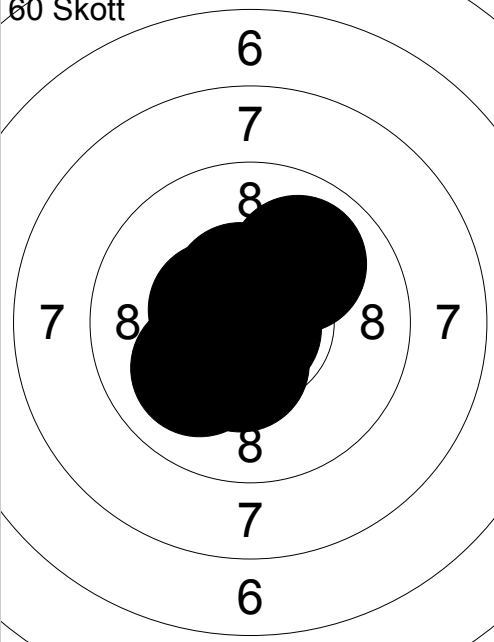
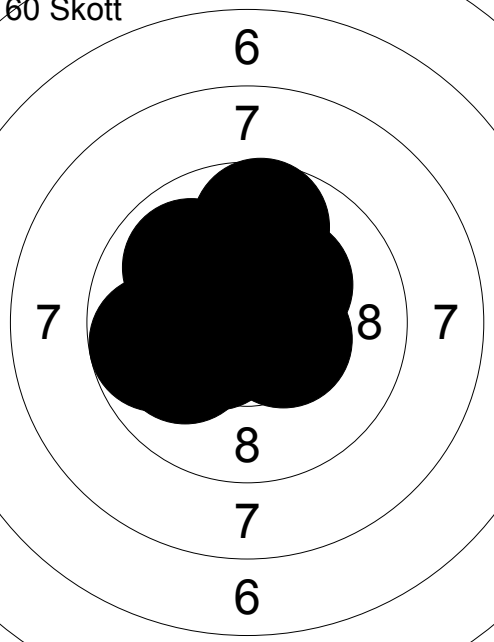
<p>60 Skott</p>  <p style="text-align: center;">6 7 8 7 8 7 6</p>	<p>11: 10.5x ↙ 12: 10.9x ↘ 13: 10.5x ↑ 14: 10.2x ↙ 15: 10.5x ↘ 16: 10.1 ↙ 17: 10.5x ↙ 18: 10.0 ↗ 19: 10.4x ↘ 20: 10.7x ↙</p> <p>Serie 100 (8x) Total 200 (18x)</p>	<p>60 Skott</p>  <p style="text-align: center;">6 7 8 7 8 7 6</p> <p>21: 9.8 ← 22: 10.0 ← 23: 10.5x ↖ 24: 10.5x ↙ 25: 10.3x ↗ 26: 10.4x ↑ 27: 9.7 ↑ 28: 9.9 ↖ 29: 10.4x ↑ 30: 10.4x →</p> <p>Serie 97 (6x) Total 297 (24x)</p>
--	--	---

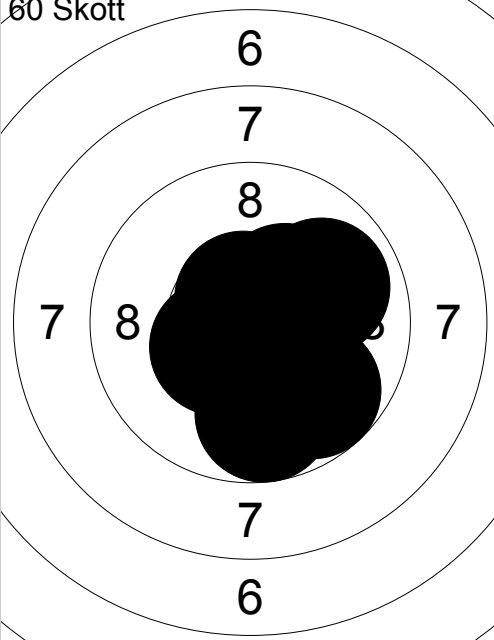
<p>60 Skott</p>  <p style="text-align: center;">6 7 8 7 8 7 6</p>	<p>31: 9.9 ↗ 32: 10.5x ↘ 33: 10.5x → 34: 10.5x ↘ 35: 9.8 ↘ 36: 10.6x ↑ 37: 10.3x ↗ 38: 9.7 ↘ 39: 10.4x ↙ 40: 10.5x ↘</p> <p>Serie 97 (7x) Total 394 (31x)</p>	
---	---	--

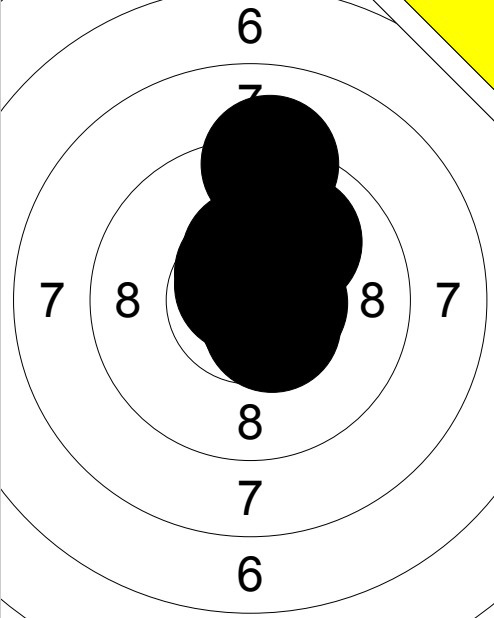
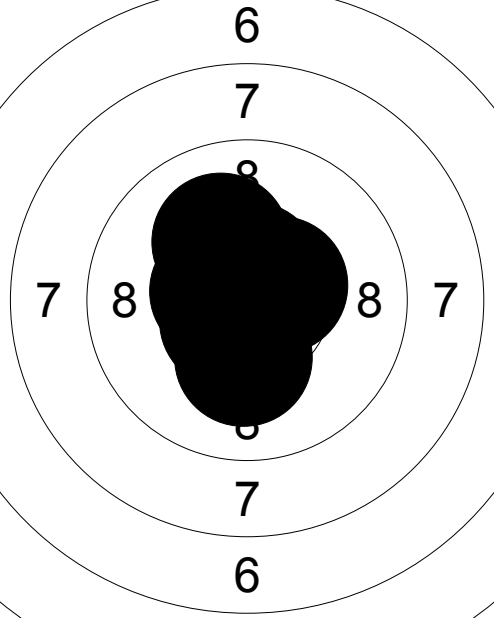
Prov 	1: 9.1 ↑ 2: 10.4x ↑ 3: 10.6x ↑ 4: 10.0 ↗ 5: 10.5x ↑ 6: 10.7x ↑ 7: 10.5x ↘ 8: 10.6x → 9: 10.7x ↘ <hr/> Serie 89 (7x) Total 0 (0x)	60 Skott 	1: 10.6x ↑ 2: 10.6x ↑ 3: 10.8x ↓ 4: 10.2x ↓ 5: 10.1 ↑ 6: 10.6x ↙ 7: 10.5x ↗ 8: 10.6x ↖ 9: 10.7x ↖ 10: 10.6x ↑ <hr/> Serie 100 (9x) Total 100 (9x)
--	--	--	--

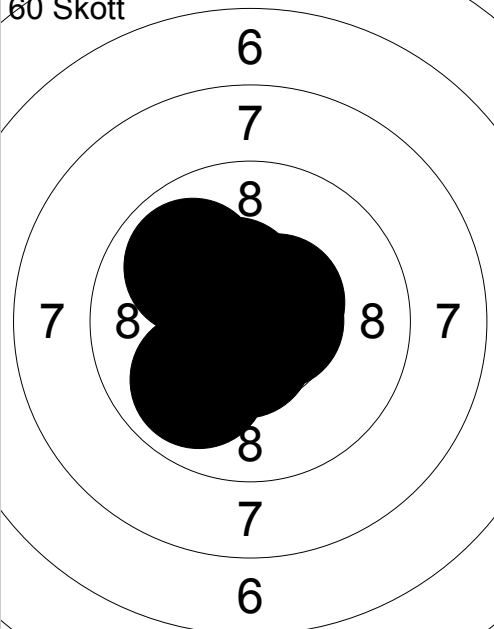
60 Skott 	11: 9.9 ↖ 12: 10.4x ↑ 13: 10.7x ↑ 14: 10.6x ↙ 15: 10.7x ↖ 16: 9.9 ↙ 17: 10.6x → 18: 10.5x ↗ 19: 10.6x ↓ 20: 10.8x ↖ <hr/> Serie 98 (8x) Total 198 (17x)	60 Skott 	21: 10.9x ↗ 22: 10.8x → 23: 10.7x ↖ 24: 10.6x ↖ 25: 10.3x ↙ 26: 10.8x ↑ 27: 10.7x ↓ 28: 10.5x → 29: 10.5x ↓ 30: 10.3x ↘ <hr/> Serie 100 (10x) Total 298 (27x)
---	---	---	--

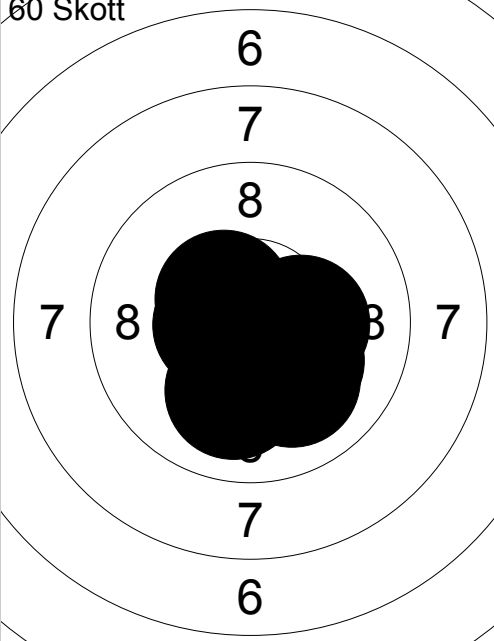
60 Skott 	31: 10.0 ↓ 32: 10.3x → 33: 10.2x ↘ 34: 10.6x ↖ 35: 10.4x ↓ 36: 10.2x ↓ 37: 10.0 ↓ 38: 10.5x ↖ 39: 10.7x ↓ 40: 10.7x ↖ <hr/> Serie 100 (8x) Total 398 (35x)		
--	--	--	--

<p>Prov</p>	<p>60 Skott</p>	<p>1: 10.2x →</p> <p>2: 10.1 ↑</p> <p>3: 10.1 ↗</p> <p>4: 10.5x ←</p> <p>5: 10.6x ↙</p> <p>6: 10.2x ↗</p> <p>7: 10.6x ←</p> <p>8: 10.6x ↑</p> <p>9: 10.8x ←</p> <p>10: 10.4x ↑</p> <p>Serie 100 (8x)</p> <p>Total 0 (0x)</p>	<p>1: 10.6x ↗</p> <p>2: 10.7x ↑</p> <p>3: 10.4x ↑</p> <p>4: 10.6x →</p> <p>5: 10.1 ↓</p> <p>6: 10.5x ↘</p> <p>7: 10.5x ↓</p> <p>8: 10.0 →</p> <p>9: 10.8x ←</p> <p>10: 10.4x →</p> <p>Serie 100 (8x)</p> <p>Total 100 (8x)</p>
-------------	-----------------	--	--

<p>60 Skott</p>	<p>60 Skott</p>	<p>11: 10.7x ↘</p> <p>12: 10.0 ↓</p> <p>13: 10.2x ↓</p> <p>14: 10.6x ↘</p> <p>15: 10.5x ↓</p> <p>16: 10.1 ↓</p> <p>17: 10.7x ←</p> <p>18: 10.5x ↓</p> <p>19: 10.0 ←</p> <p>20: 10.2x ↓</p> <p>Serie 100 (7x)</p> <p>Total 200 (15x)</p>	<p>21: 10.8x ↗</p> <p>22: 10.6x ↙</p> <p>23: 10.6x ↙</p> <p>24: 10.5x ↙</p> <p>25: 10.3x ←</p> <p>26: 10.4x ←</p> <p>27: 10.6x ↓</p> <p>28: 10.3x ↙</p> <p>29: 10.4x ←</p> <p>30: 10.6x ←</p> <p>Serie 100 (10x)</p> <p>Total 300 (25x)</p>
-----------------	-----------------	---	---

<p>60 Skott</p>	<p>60 Skott</p>	<p>31: 9.8 ←</p> <p>32: 10.6x ←</p> <p>33: 10.4x ←</p> <p>34: 10.6x ↙</p> <p>35: 10.3x ↙</p> <p>36: 10.2x ←</p> <p>37: 10.3x ←</p> <p>38: 10.6x ↙</p> <p>39: 10.0 ←</p> <p>40: 10.7x ↓</p> <p>Serie 99 (8x)</p> <p>Total 399 (33x)</p>	
-----------------	-----------------	--	--

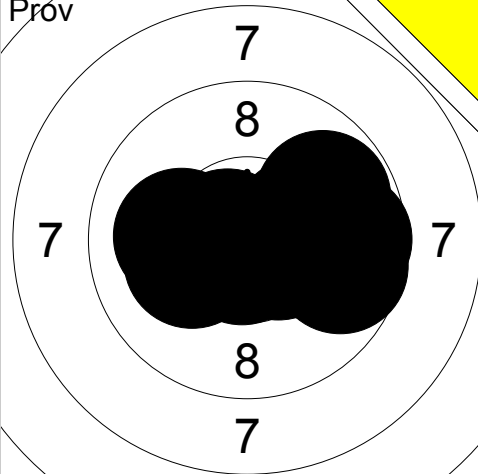
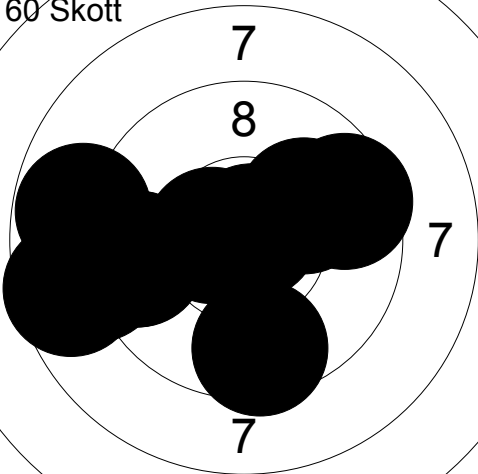
Pröv 	1: 10.7x ↓ 2: 9.7 → 3: 10.5x → 4: 9.7 → 5: 9.8 ↗ 6: 10.1 ← 7: 10.2x → 8: 10.7x ← 9: 10.2x ← 10: 10.0 →	60 Skott 	1: 8.9 ← 2: 10.0 ↗ 3: 8.6 ← 4: 9.5 → 5: 9.5 ↓ 6: 10.5x ← 7: 9.5 ← 8: 9.5 ← 9: 8.8 ← 10: 10.8x ↗
Serie 101.6		Serie 95.6	
Total 0.0		Total 95.6	

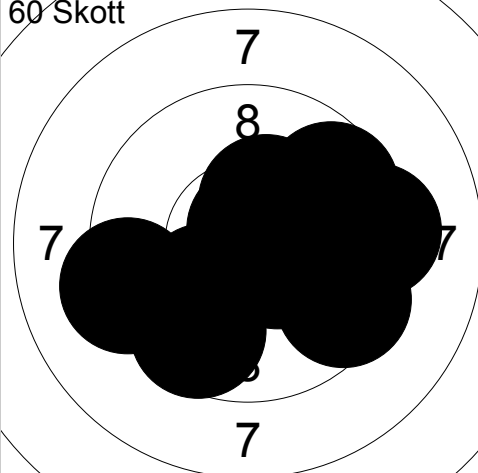
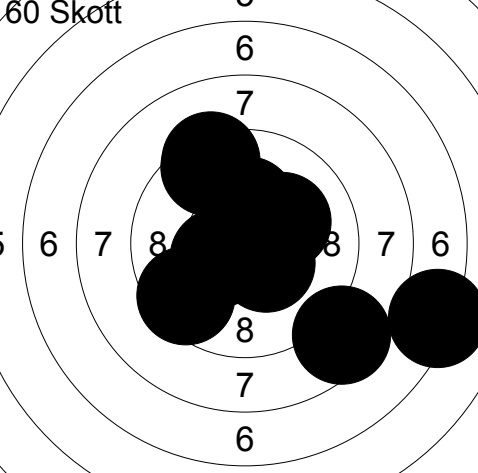
60 Skott 	11: 10.1 ↓ 12: 9.6 ↓ 13: 10.7x ↑ 14: 10.4x ↑ 15: 9.6 ↗ 16: 9.3 ← 17: 10.0 → 18: 9.3 → 19: 10.5x ↓ 20: 9.5 ↓	60 Skott 	21: 9.4 ↑ 22: 9.3 ↑ 23: 9.5 ← 24: 10.4x ↓ 25: 7.1 → 26: 8.5 ↓ 27: 10.2x ↗ 28: 10.3x ↑ 29: 10.8x ← 30: 10.4x ←
Serie 99.0		Serie 95.9	
Total 194.6		Total 290.5	

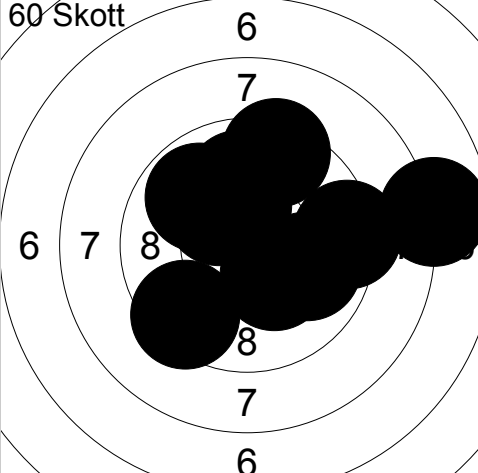
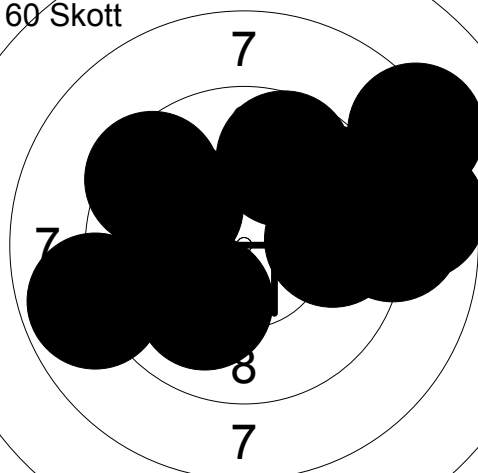
60 Skott 	31: 9.3 → 32: 9.4 ↓ 33: 9.9 ↑ 34: 7.8 → 35: 10.2x ↗ 36: 9.3 ↑ 37: 10.3x ↓ 38: 10.3x ↑ 39: 9.8 ↗ 40: 9.9 ↓	60 Skott 	41: 9.6 ↗ 42: 9.9 ↖ 43: 8.8 ← 44: 9.0 → 45: 9.8 → 46: 9.5 ↖ 47: 10.0 ↓ 48: 9.7 ↑ 49: 8.2 ↗ 50: 8.6 →
Serie 96.2		Serie 93.1	
Total 386.7		Total 479.8	

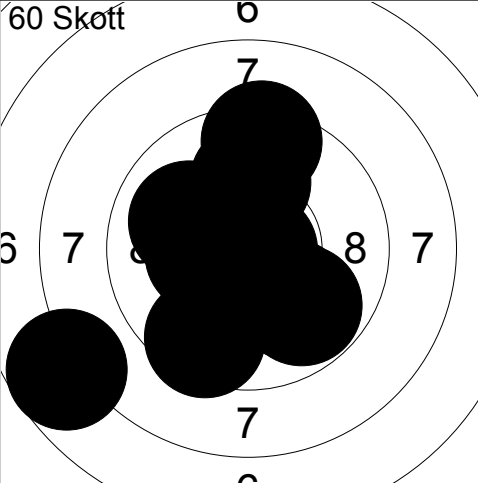
60 Skott 	51: 7.7 ← 52: 9.5 ↓ 53: 9.3 ↑ 54: 10.3x ← 55: 10.0 ↓ 56: 10.3x ← 57: 9.8 ↓ 58: 10.0 ↑ 59: 10.0 ↖ 60: 10.8x →		
Serie 97.7			
Total 577.5			

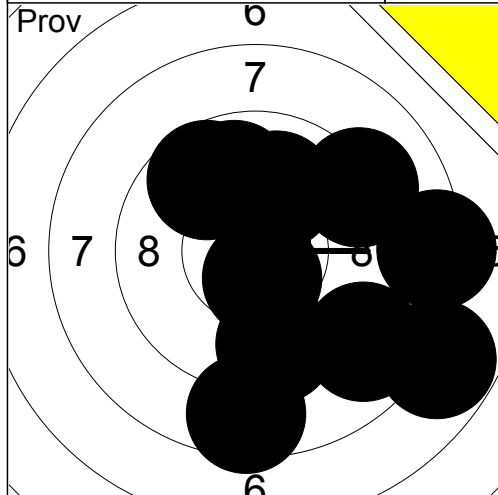

1:	8.5	↓
2:	7.8	↘
3:	9.5	↓
4:	9.1	↗
5:	10.0	↑
6:	9.7	↗
7:	9.8	↑
8:	8.8	↘
9:	8.2	→
10:	10.5x	↓
Serie		91.9
Total		0.0

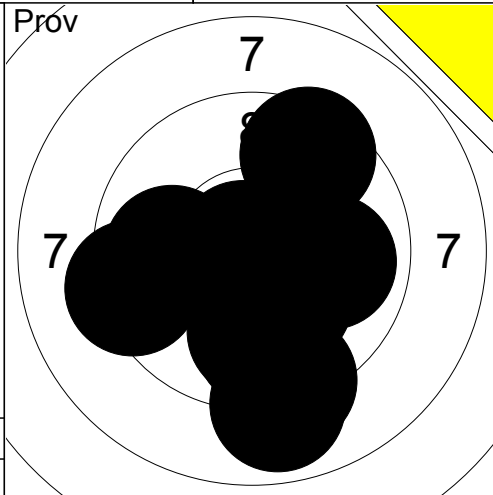

11:	9.5	↗
12:	10.8x	←
13:	8.9	↓
14:	10.2x	↘
15:	9.3	←
16:	9.2	↓
17:	9.9	←
18:	9.9	↓
19:	9.9	→
20:	9.7	↓
Serie		97.3
Total		0.0

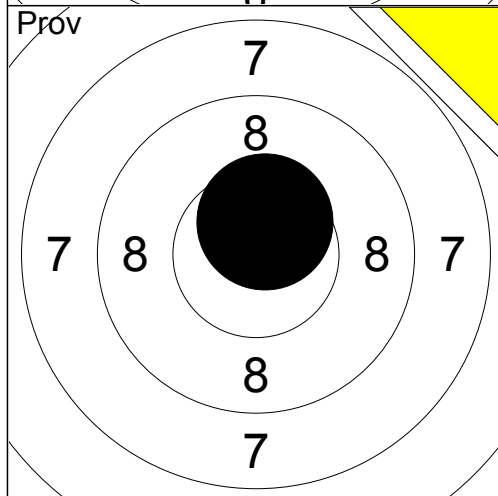

21:	10.5x	↑
Serie		10.5
Total		0.0

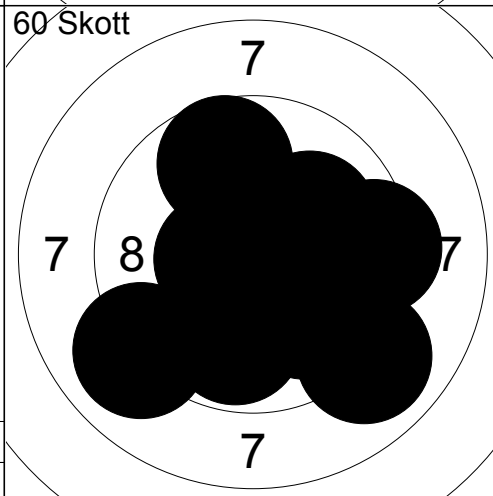

1:	9.0	↘
2:	9.8	↓
3:	9.0	↙
4:	9.3	→
5:	10.1	↗
6:	9.9	↘
7:	9.9	↘
8:	9.7	↑
9:	10.5x	←
10:	10.2x	↘
Serie		97.4
Total		97.4

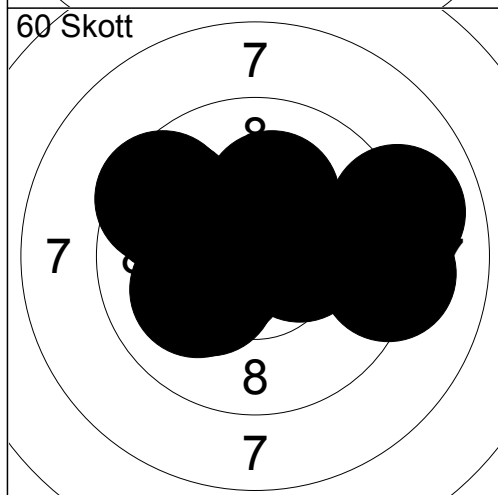

11:	9.2	→
12:	10.4x	→
13:	9.5	↗
14:	10.2x	↑
15:	9.0	→
16:	10.1	←
17:	10.2x	←
18:	9.7	↗
19:	10.5x	←
20:	10.7x	↗
Serie		99.5
Total		196.9

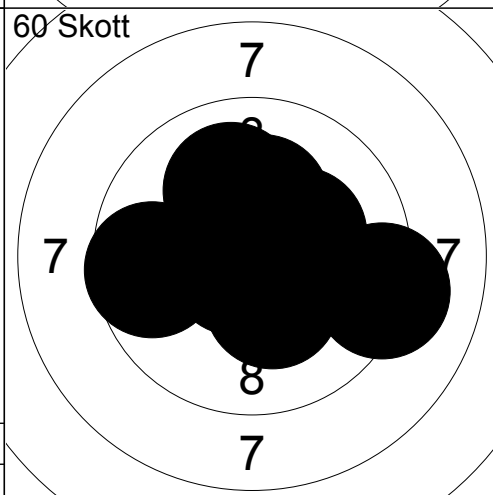

21:	10.5x	→
22:	10.0	↑
23:	10.3x	↑
24:	10.3x	↗
25:	10.6x	↓
26:	9.2	→
27:	9.6	←
28:	10.2x	↑
29:	10.7x	←
30:	10.3x	↓
Serie		101.7
Total		298.6

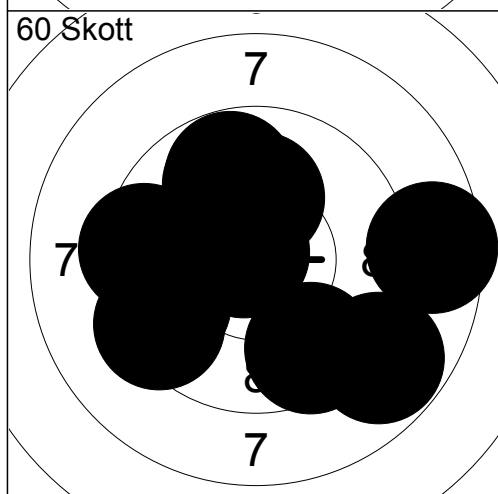

31:	8.8	↘
32:	9.4	←
33:	10.8x	↗
34:	10.1	↑
35:	9.4	←
36:	9.6	←
37:	9.8	↑
38:	9.5	↘
39:	8.5	→
40:	9.9	↑
Serie		95.8
Total		394.4

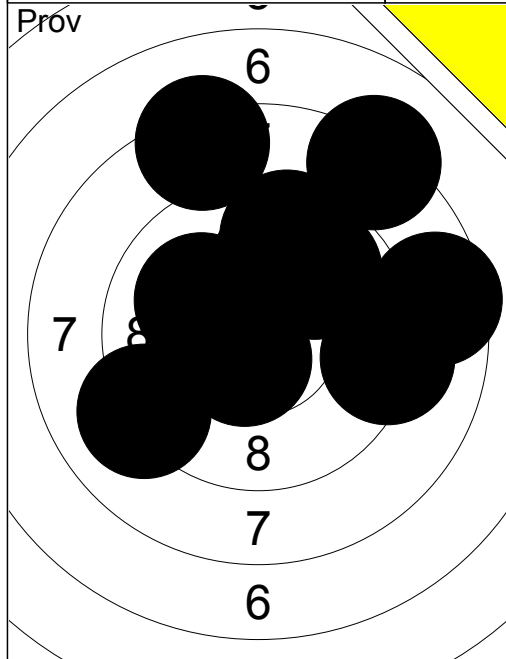

1:	8.3	↑
2:	9.6	↑
3:	9.9	↑
4:	9.8	↗
5:	8.5	→
6:	10.6x	↙
7:	9.2	→
8:	10.1	↖
9:	8.2	↑
10:	9.1	↙
Serie		93.3
Total		0.0

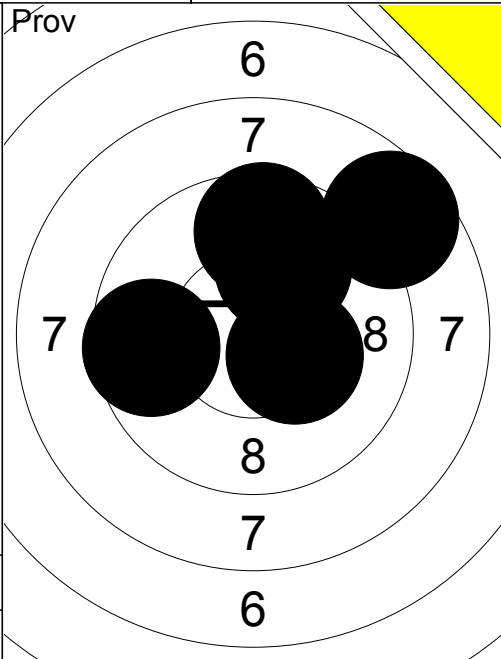

11:	9.6	↑
12:	8.6	↗
13:	10.0	↑
14:	9.6	←
15:	10.3x	↘
Serie		48.1
Total		0.0

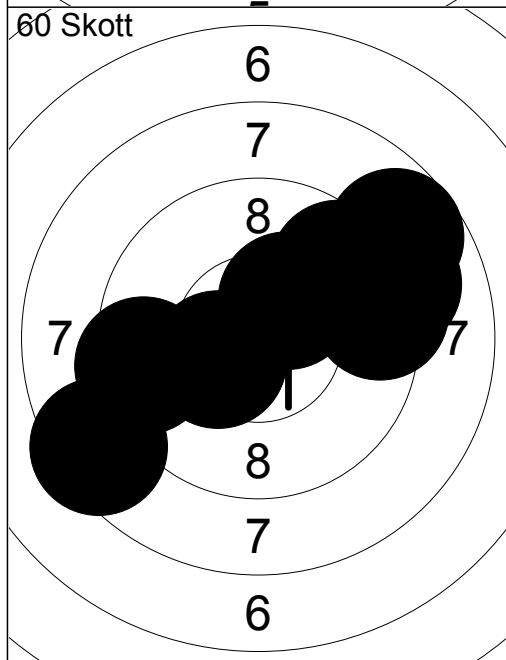

1:	9.3	→
2:	8.7	↗
3:	9.0	→
4:	9.0	↗
5:	9.5	↗
6:	9.6	↗
7:	10.3x	↗
8:	10.4x	↙
9:	8.4	↙
10:	9.4	←
Serie		93.6
Total		93.6

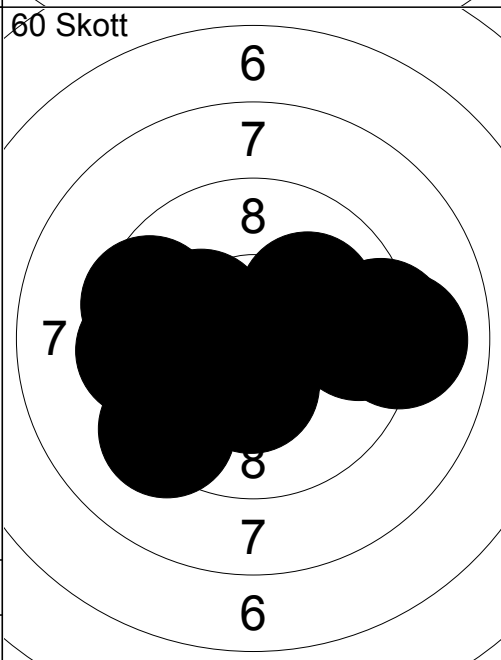

11:	10.3x	↙
12:	10.2x	↙
13:	9.0	→
14:	9.6	→
15:	9.3	→
16:	10.1	↗
17:	9.5	←
18:	9.3	→
19:	9.3	↙
20:	9.5	←
Serie		96.1
Total		189.7

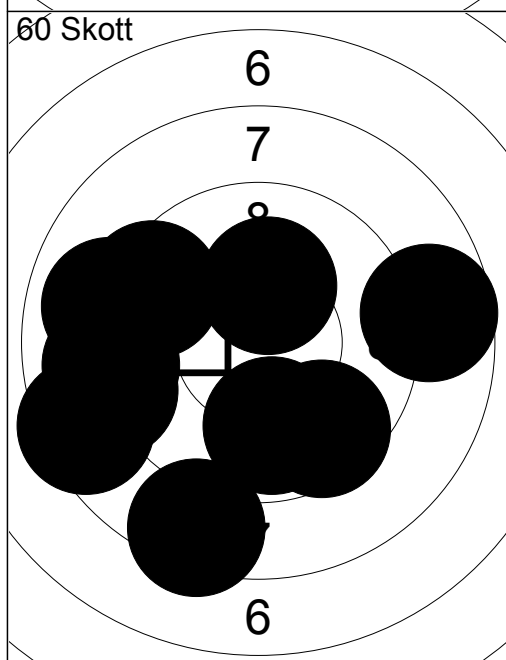

21:	9.5	↘
22:	9.8	↘
23:	9.0	←
24:	9.4	↖
25:	8.4	↘
26:	8.4	←
27:	8.9	←
28:	8.9	←
29:	10.2x	↑
30:	8.7	→
Serie		91.2
Total		280.9

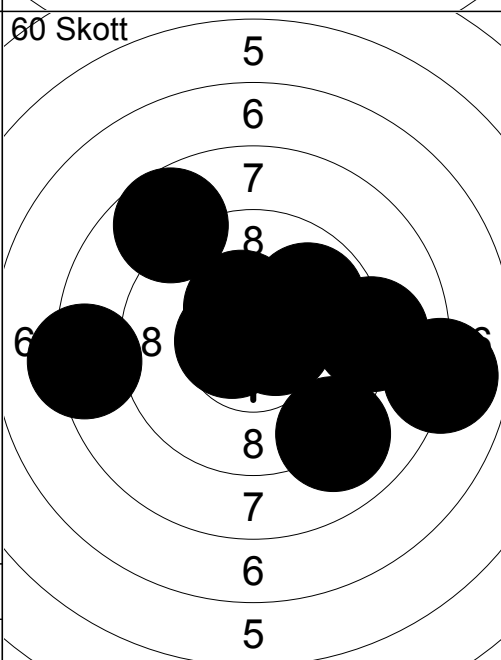

31:	10.4x	↑
32:	10.6x	→
33:	9.0	↘
34:	8.0	→
35:	10.6x	↗
36:	8.3	←
37:	10.6x	←
38:	8.7	↖
39:	9.9	↗
40:	9.1	→
Serie		95.2
Total		376.1

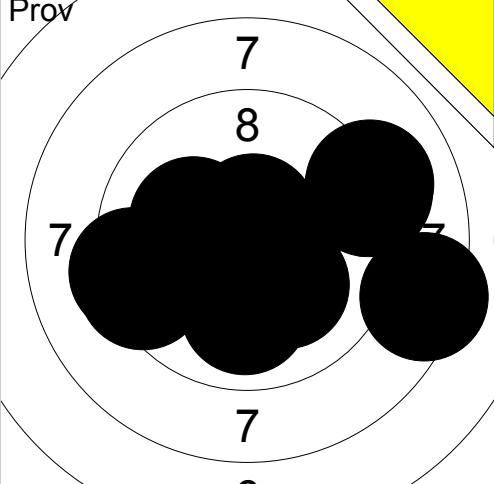
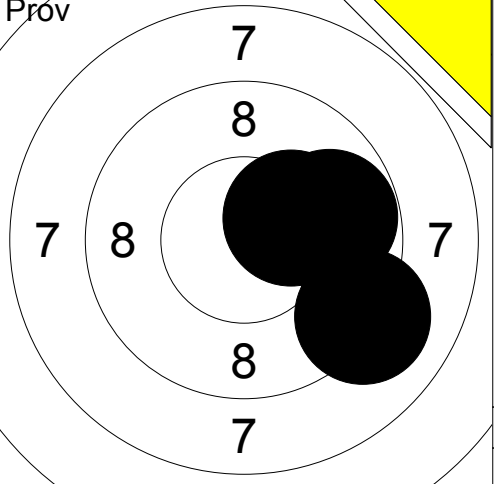
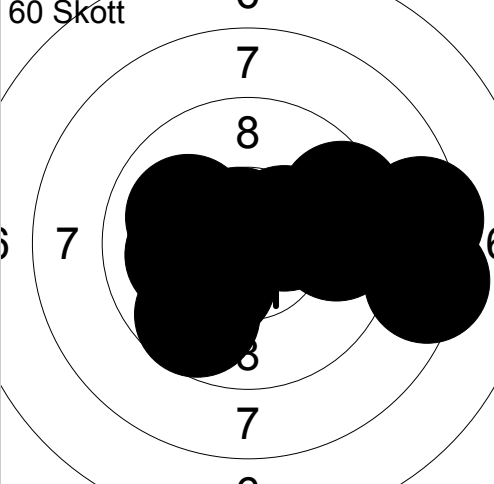
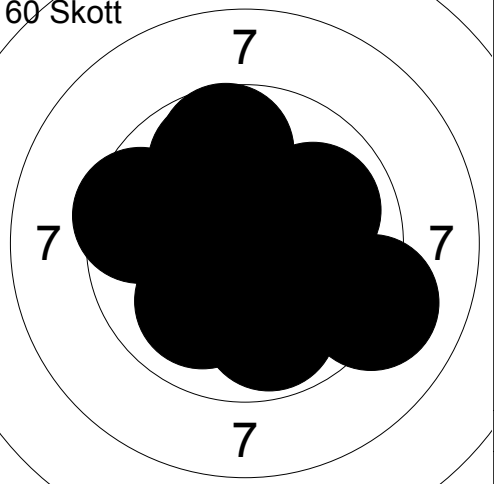
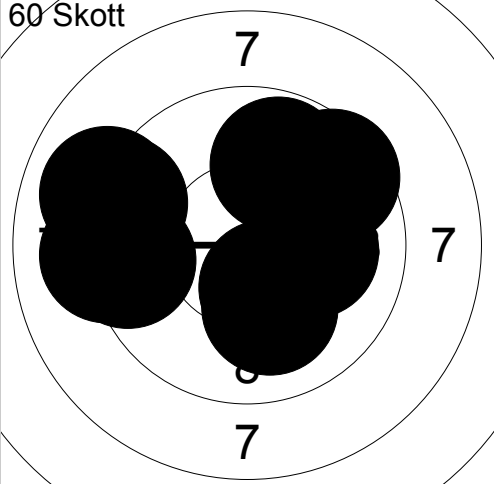
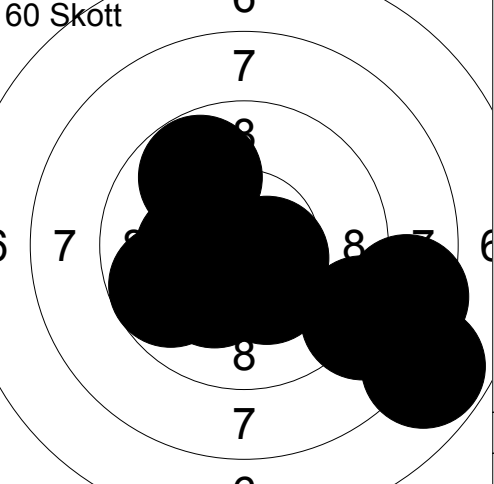
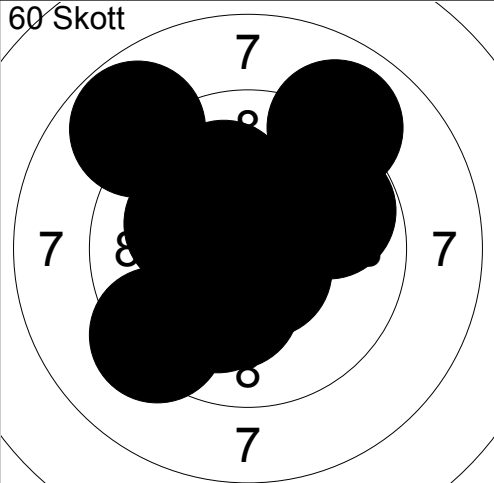
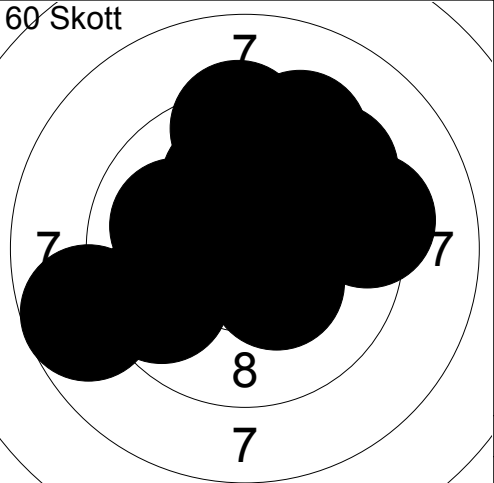
Prov 	1: 10.2x ← 2: 8.4 → 3: 9.4 ← 4: 10.0 ↓ 5: 9.3 ← 6: 10.5x ← 7: 9.1 → 8: 10.1 ↘ 9: 9.1 → 10: 10.6x ↑ <hr/> Serie 96.7 Total 0.0	Prov 	11: 9.8 → 12: 10.3x ↗ 13: 9.1 ↘ <hr/> Serie 29.2 Total 0.0
60 Skott 	1: 10.0 ← 2: 10.4x → 3: 9.7 ↘ 4: 8.3 → 5: 8.4 → 6: 10.7x ↗ 7: 10.1 ← 8: 10.2x ↘ 9: 9.7 → 10: 9.5 → <hr/> Serie 97.0 Total 97.0	60 Skott 	11: 9.8 ↑ 12: 9.1 → 13: 10.0 → 14: 9.7 ↘ 15: 9.5 ← 16: 10.0 ↘ 17: 10.2x ↑ 18: 9.7 ↑ 19: 9.9 ↘ 20: 10.5x ↗ <hr/> Serie 98.4 Total 195.4
60 Skott 	21: 9.1 ← 22: 9.8 ↑ 23: 10.3x ↘ 24: 9.4 ← 25: 9.0 ← 26: 9.2 ← 27: 9.5 ↗ 28: 9.8 ↗ 29: 10.1 → 30: 10.1 ↓ <hr/> Serie 96.3 Total 291.7	60 Skott 	31: 9.8 ↗ 32: 10.3x ← 33: 9.7 ← 34: 7.8 ↘ 35: 8.9 ↘ 36: 8.5 → 37: 10.2x ↘ 38: 10.6x ↘ 39: 10.3x ↘ 40: 10.4x ↘ <hr/> Serie 96.5 Total 388.2
60 Skott 	41: 10.1 ← 42: 9.3 ↘ 43: 10.5x ↗ 44: 10.1 ↗ 45: 9.0 ↗ 46: 10.6x ↘ 47: 9.8 → 48: 10.1 ↘ 49: 10.2x ↘ 50: 8.8 ↗ <hr/> Serie 98.5 Total 486.7	60 Skott 	51: 9.4 ↑ 52: 9.7 ← 53: 9.3 ↗ 54: 9.3 → 55: 10.3x ↘ 56: 10.1 ↑ 57: 8.7 ← 58: 10.7x ↘ 59: 9.4 ↗ 60: 10.0 ← <hr/> Serie 96.9 Total 583.6

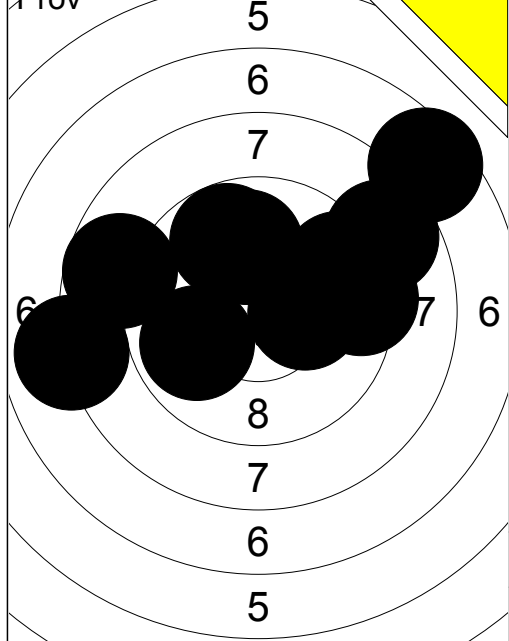

1:	9.9	↙
2:	9.9	↑
3:	10.2x	→
4:	8.7	↗
5:	7.5	↗
6:	9.5	↗
7:	8.7	↖
8:	8.0	↖
9:	9.3	→
10:	9.8	↑
Serie		91.5
Total		0.0

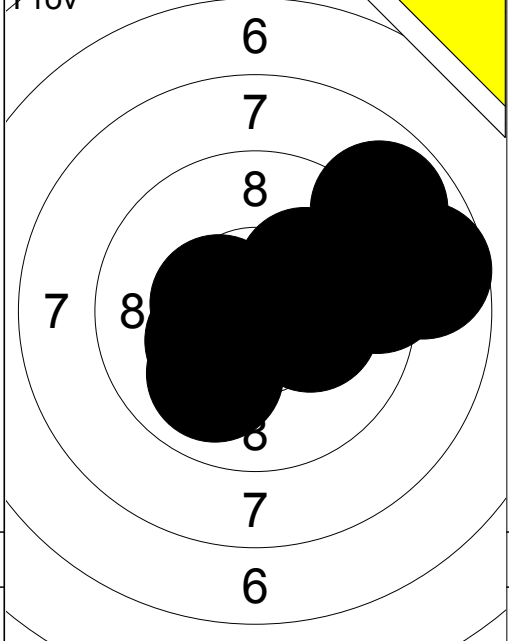

11:	9.3	→
12:	10.0	↘
13:	10.3x	↙
14:	10.2x	→
15:	8.9	↗
16:	8.7	→
17:	10.5x	↖
18:	10.2x	↗
Serie		78.1
Total		0.0

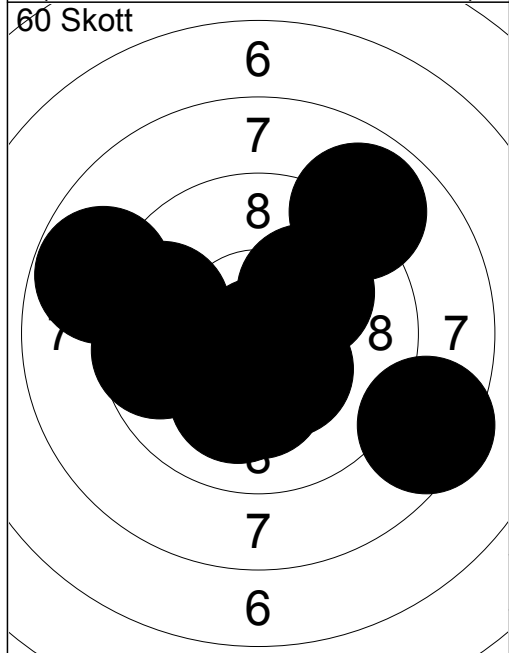

1:	10.8x	↘
2:	10.2x	↘
3:	8.9	↗
4:	9.6	↖
5:	9.6	↖
6:	10.4x	↘
7:	8.8	↖
8:	10.1	↘
9:	8.4	↗
10:	10.1	↗
Serie		96.9
Total		96.9

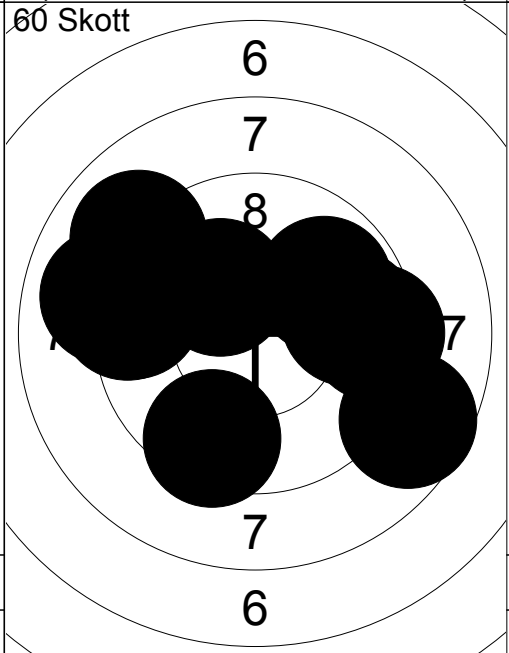

11:	9.4	→
12:	9.5	↘
13:	10.2x	↖
14:	9.9	↗
15:	8.7	↘
16:	9.3	↖
17:	9.3	↖
18:	9.0	↖
19:	9.0	↗
20:	9.7	→
Serie		94.0
Total		190.9

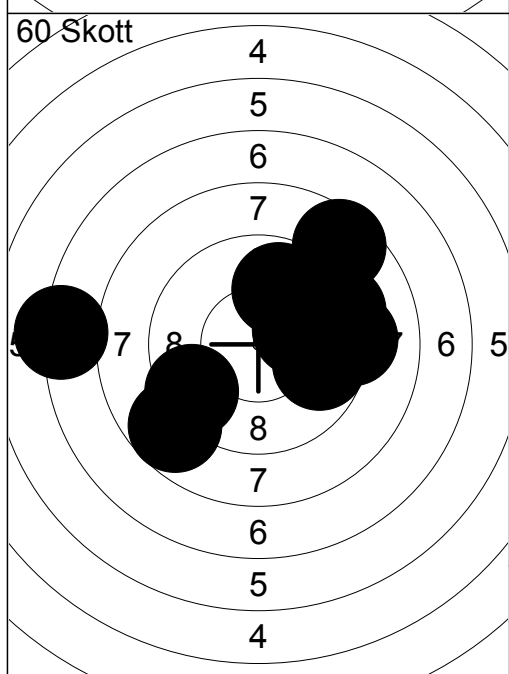

21:	9.5	→
22:	9.4	↖
23:	9.7	→
24:	9.3	→
25:	10.1	→
26:	8.7	↖
27:	7.2	↖
28:	8.5	↗
29:	9.2	→
30:	9.8	↑
Serie		91.4
Total		282.3

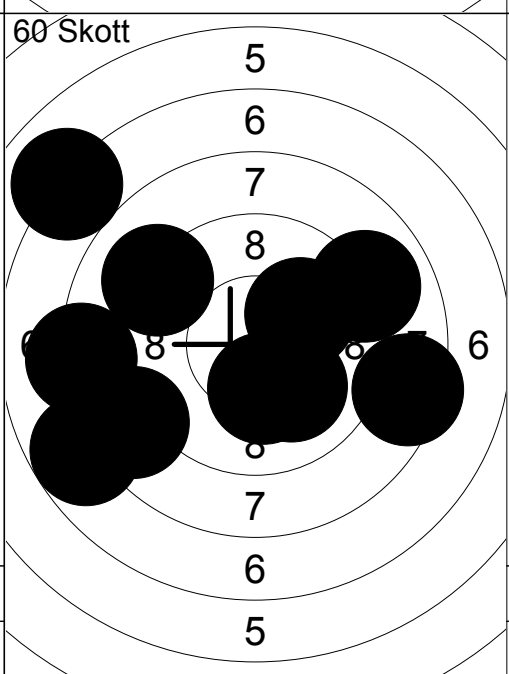

31:	7.0	↖
32:	9.1	↖
33:	7.8	↖
34:	9.0	↗
35:	8.1	↖
36:	10.2x	↘
37:	8.6	↖
38:	10.1	↘
39:	10.1	↗
40:	8.4	→
Serie		88.4
Total		370.7

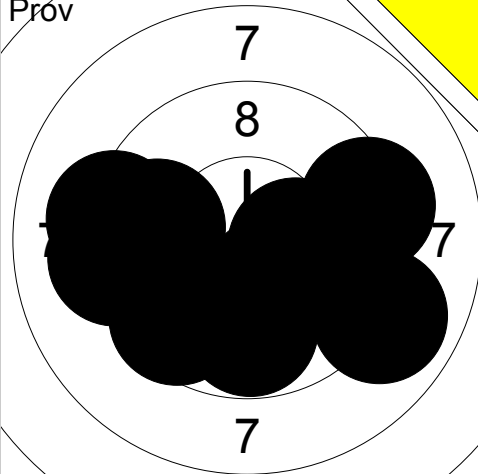
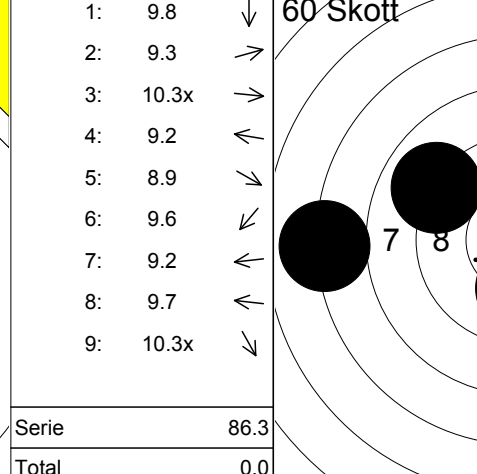
<p>Pröv</p> 	<p>60 Skott</p> 	<table style="width:100%; border-collapse: collapse;"> <tr><td>1:</td><td>9.8</td><td>↓</td></tr> <tr><td>2:</td><td>9.3</td><td>→</td></tr> <tr><td>3:</td><td>10.3x</td><td>→</td></tr> <tr><td>4:</td><td>9.2</td><td>←</td></tr> <tr><td>5:</td><td>8.9</td><td>↓</td></tr> <tr><td>6:</td><td>9.6</td><td>↓</td></tr> <tr><td>7:</td><td>9.2</td><td>←</td></tr> <tr><td>8:</td><td>9.7</td><td>←</td></tr> <tr><td>9:</td><td>10.3x</td><td>↓</td></tr> <tr><td colspan="2">Serie</td><td>86.3</td></tr> <tr><td colspan="2">Total</td><td>0.0</td></tr> </table>	1:	9.8	↓	2:	9.3	→	3:	10.3x	→	4:	9.2	←	5:	8.9	↓	6:	9.6	↓	7:	9.2	←	8:	9.7	←	9:	10.3x	↓	Serie		86.3	Total		0.0			
1:	9.8	↓																																				
2:	9.3	→																																				
3:	10.3x	→																																				
4:	9.2	←																																				
5:	8.9	↓																																				
6:	9.6	↓																																				
7:	9.2	←																																				
8:	9.7	←																																				
9:	10.3x	↓																																				
Serie		86.3																																				
Total		0.0																																				
		<table style="width:100%; border-collapse: collapse;"> <tr><td>1:</td><td>8.8</td><td>↘</td></tr> <tr><td>2:</td><td>7.0</td><td>←</td></tr> <tr><td>3:</td><td>8.3</td><td>↓</td></tr> <tr><td>4:</td><td>9.0</td><td>↗</td></tr> <tr><td>5:</td><td>9.6</td><td>↑</td></tr> <tr><td>6:</td><td>6.7</td><td>↓</td></tr> <tr><td>7:</td><td>10.1</td><td>↗</td></tr> <tr><td>8:</td><td>10.0</td><td>↓</td></tr> <tr><td>9:</td><td>9.9</td><td>↑</td></tr> <tr><td>10:</td><td>9.9</td><td>↓</td></tr> <tr><td colspan="2">Serie</td><td>89.3</td></tr> <tr><td colspan="2">Total</td><td>89.3</td></tr> </table>	1:	8.8	↘	2:	7.0	←	3:	8.3	↓	4:	9.0	↗	5:	9.6	↑	6:	6.7	↓	7:	10.1	↗	8:	10.0	↓	9:	9.9	↑	10:	9.9	↓	Serie		89.3	Total		89.3
1:	8.8	↘																																				
2:	7.0	←																																				
3:	8.3	↓																																				
4:	9.0	↗																																				
5:	9.6	↑																																				
6:	6.7	↓																																				
7:	10.1	↗																																				
8:	10.0	↓																																				
9:	9.9	↑																																				
10:	9.9	↓																																				
Serie		89.3																																				
Total		89.3																																				

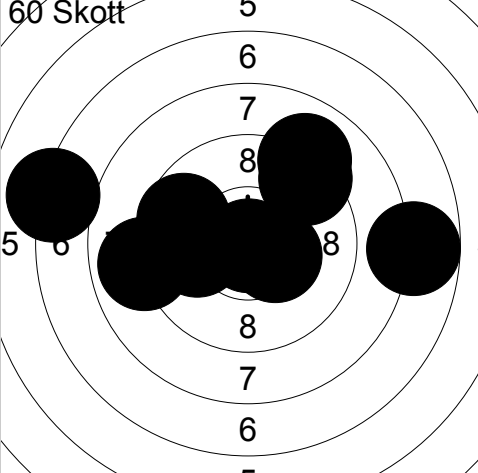
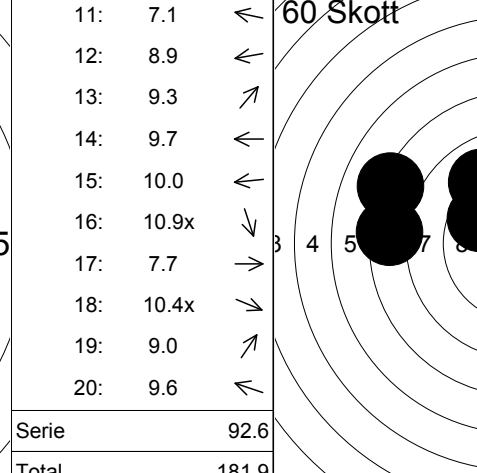
<p>60 Skott</p> 	<p>60 Skott</p> 	<table style="width:100%; border-collapse: collapse;"> <tr><td>11:</td><td>7.1</td><td>←</td></tr> <tr><td>12:</td><td>8.9</td><td>←</td></tr> <tr><td>13:</td><td>9.3</td><td>↗</td></tr> <tr><td>14:</td><td>9.7</td><td>←</td></tr> <tr><td>15:</td><td>10.0</td><td>←</td></tr> <tr><td>16:</td><td>10.9x</td><td>↓</td></tr> <tr><td>17:</td><td>7.7</td><td>→</td></tr> <tr><td>18:</td><td>10.4x</td><td>↗</td></tr> <tr><td>19:</td><td>9.0</td><td>↗</td></tr> <tr><td>20:</td><td>9.6</td><td>←</td></tr> <tr><td colspan="2">Serie</td><td>92.6</td></tr> <tr><td colspan="2">Total</td><td>181.9</td></tr> </table>	11:	7.1	←	12:	8.9	←	13:	9.3	↗	14:	9.7	←	15:	10.0	←	16:	10.9x	↓	17:	7.7	→	18:	10.4x	↗	19:	9.0	↗	20:	9.6	←	Serie		92.6	Total		181.9
11:	7.1	←																																				
12:	8.9	←																																				
13:	9.3	↗																																				
14:	9.7	←																																				
15:	10.0	←																																				
16:	10.9x	↓																																				
17:	7.7	→																																				
18:	10.4x	↗																																				
19:	9.0	↗																																				
20:	9.6	←																																				
Serie		92.6																																				
Total		181.9																																				
		<table style="width:100%; border-collapse: collapse;"> <tr><td>21:</td><td>9.0</td><td>↗</td></tr> <tr><td>22:</td><td>9.3</td><td>→</td></tr> <tr><td>23:</td><td>9.6</td><td>←</td></tr> <tr><td>24:</td><td>6.7</td><td>↗</td></tr> <tr><td>25:</td><td>10.3x</td><td>↗</td></tr> <tr><td>26:</td><td>7.4</td><td>←</td></tr> <tr><td>27:</td><td>7.1</td><td>←</td></tr> <tr><td>28:</td><td>10.9x</td><td>↑</td></tr> <tr><td>29:</td><td>8.9</td><td>→</td></tr> <tr><td>30:</td><td>4.3</td><td>↘</td></tr> <tr><td colspan="2">Serie</td><td>83.5</td></tr> <tr><td colspan="2">Total</td><td>265.4</td></tr> </table>	21:	9.0	↗	22:	9.3	→	23:	9.6	←	24:	6.7	↗	25:	10.3x	↗	26:	7.4	←	27:	7.1	←	28:	10.9x	↑	29:	8.9	→	30:	4.3	↘	Serie		83.5	Total		265.4
21:	9.0	↗																																				
22:	9.3	→																																				
23:	9.6	←																																				
24:	6.7	↗																																				
25:	10.3x	↗																																				
26:	7.4	←																																				
27:	7.1	←																																				
28:	10.9x	↑																																				
29:	8.9	→																																				
30:	4.3	↘																																				
Serie		83.5																																				
Total		265.4																																				

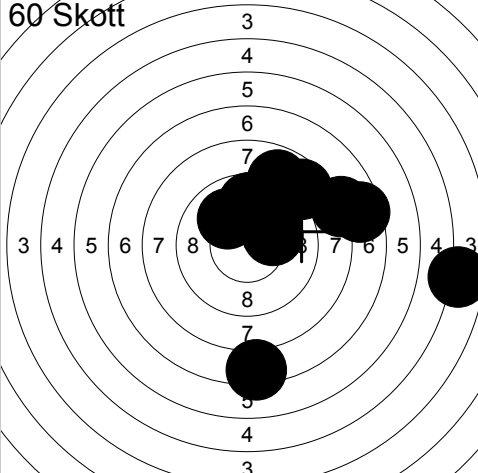
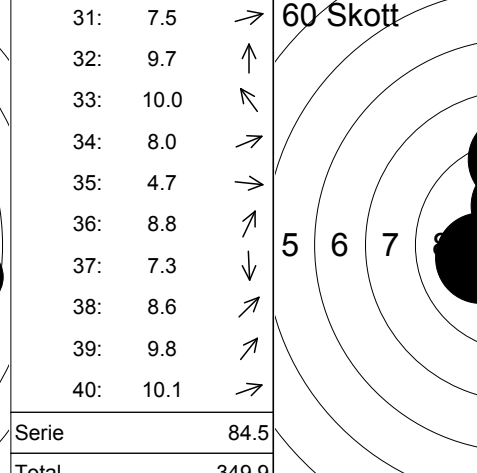
<p>60 Skott</p> 	<p>60 Skott</p> 	<table style="width:100%; border-collapse: collapse;"> <tr><td>31:</td><td>7.5</td><td>→</td></tr> <tr><td>32:</td><td>9.7</td><td>↑</td></tr> <tr><td>33:</td><td>10.0</td><td>↗</td></tr> <tr><td>34:</td><td>8.0</td><td>↗</td></tr> <tr><td>35:</td><td>4.7</td><td>→</td></tr> <tr><td>36:</td><td>8.8</td><td>↑</td></tr> <tr><td>37:</td><td>7.3</td><td>↓</td></tr> <tr><td>38:</td><td>8.6</td><td>↗</td></tr> <tr><td>39:</td><td>9.8</td><td>↗</td></tr> <tr><td>40:</td><td>10.1</td><td>→</td></tr> <tr><td colspan="2">Serie</td><td>84.5</td></tr> <tr><td colspan="2">Total</td><td>349.9</td></tr> </table>	31:	7.5	→	32:	9.7	↑	33:	10.0	↗	34:	8.0	↗	35:	4.7	→	36:	8.8	↑	37:	7.3	↓	38:	8.6	↗	39:	9.8	↗	40:	10.1	→	Serie		84.5	Total		349.9
31:	7.5	→																																				
32:	9.7	↑																																				
33:	10.0	↗																																				
34:	8.0	↗																																				
35:	4.7	→																																				
36:	8.8	↑																																				
37:	7.3	↓																																				
38:	8.6	↗																																				
39:	9.8	↗																																				
40:	10.1	→																																				
Serie		84.5																																				
Total		349.9																																				
		<table style="width:100%; border-collapse: collapse;"> <tr><td>41:</td><td>8.0</td><td>↗</td></tr> <tr><td>42:</td><td>9.2</td><td>↑</td></tr> <tr><td>43:</td><td>7.8</td><td>↗</td></tr> <tr><td>44:</td><td>9.9</td><td>↑</td></tr> <tr><td>45:</td><td>10.2x</td><td>↑</td></tr> <tr><td>46:</td><td>7.0</td><td>→</td></tr> <tr><td>47:</td><td>8.8</td><td>↘</td></tr> <tr><td>48:</td><td>8.6</td><td>↑</td></tr> <tr><td>49:</td><td>9.1</td><td>→</td></tr> <tr><td>50:</td><td>10.1</td><td>←</td></tr> <tr><td colspan="2">Serie</td><td>88.7</td></tr> <tr><td colspan="2">Total</td><td>438.6</td></tr> </table>	41:	8.0	↗	42:	9.2	↑	43:	7.8	↗	44:	9.9	↑	45:	10.2x	↑	46:	7.0	→	47:	8.8	↘	48:	8.6	↑	49:	9.1	→	50:	10.1	←	Serie		88.7	Total		438.6
41:	8.0	↗																																				
42:	9.2	↑																																				
43:	7.8	↗																																				
44:	9.9	↑																																				
45:	10.2x	↑																																				
46:	7.0	→																																				
47:	8.8	↘																																				
48:	8.6	↑																																				
49:	9.1	→																																				
50:	10.1	←																																				
Serie		88.7																																				
Total		438.6																																				

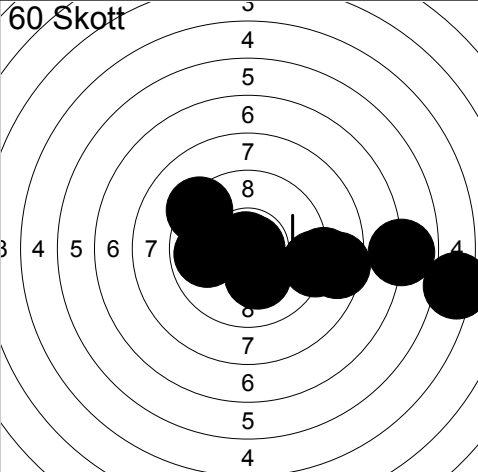
<p>60 Skott</p> 	<table style="width:100%; border-collapse: collapse;"> <tr><td>51:</td><td>8.5</td><td>→</td></tr> <tr><td>52:</td><td>9.3</td><td>↗</td></tr> <tr><td>53:</td><td>9.1</td><td>→</td></tr> <tr><td>54:</td><td>10.2x</td><td>↓</td></tr> <tr><td>55:</td><td>6.8</td><td>→</td></tr> <tr><td>56:</td><td>9.9</td><td>←</td></tr> <tr><td>57:</td><td>10.8x</td><td>↗</td></tr> <tr><td>58:</td><td>5.3</td><td>→</td></tr> <tr><td>59:</td><td>8.9</td><td>→</td></tr> <tr><td>60:</td><td>10.8x</td><td>→</td></tr> <tr><td colspan="2">Serie</td><td>89.6</td></tr> <tr><td colspan="2">Total</td><td>528.2</td></tr> </table>	51:	8.5	→	52:	9.3	↗	53:	9.1	→	54:	10.2x	↓	55:	6.8	→	56:	9.9	←	57:	10.8x	↗	58:	5.3	→	59:	8.9	→	60:	10.8x	→	Serie		89.6	Total		528.2	
51:	8.5	→																																				
52:	9.3	↗																																				
53:	9.1	→																																				
54:	10.2x	↓																																				
55:	6.8	→																																				
56:	9.9	←																																				
57:	10.8x	↗																																				
58:	5.3	→																																				
59:	8.9	→																																				
60:	10.8x	→																																				
Serie		89.6																																				
Total		528.2																																				

Pröv			
	1: 9.6 ↓ 2: 9.7 ↓ 3: 10.4x ↓ 4: 10.1 ↓ 5: 10.4x → 6: 10.4x ← 7: 10.8x ← 8: 9.6 ↓ 9: 10.4x ↓ 10: 10.3x →		11: 10.2x ↓ 12: 9.6 → 13: 10.0 ↑ 14: 10.0 → 15: 10.2x ← 16: 9.6 ← 17: 10.5x →
	Serie 101.7		Serie 70.1
	Total 0.0		Total 0.0

60 Skott			
	1: 10.2x ↖ 2: 9.8 ← 3: 10.6x → 4: 10.4x ↓ 5: 9.7 ↗ 6: 10.5x ↓ 7: 10.6x ↓ 8: 10.0 ← 9: 10.4x ↓ 10: 10.4x ↓		11: 10.5x ↙ 12: 10.2x ↙ 13: 9.9 ↗ 14: 10.4x ↗ 15: 10.4x → 16: 10.7x ↙ 17: 10.2x ↗ 18: 10.2x ↘ 19: 10.7x ↙ 20: 10.5x ↖
	Serie 102.6		Serie 103.7
	Total 102.6		Total 206.3

60 Skott			
	21: 10.7x → 22: 10.3x ↗ 23: 9.7 ← 24: 10.4x ↑ 25: 10.0 ← 26: 10.8x ↓ 27: 10.0 ↓ 28: 10.4x ↖ 29: 10.0 ↓ 30: 10.8x ↓		31: 10.1 ↘ 32: 10.1 ↙ 33: 10.1 ↘ 34: 10.6x ↑ 35: 9.6 ↗ 36: 10.2x ↗ 37: 10.7x ↑ 38: 9.9 ↗ 39: 10.1 ↘ 40: 10.3x ↗
	Serie 103.1		Serie 101.7
	Total 309.4		Total 411.1

60 Skott			
	41: 10.2x ← 42: 10.7x ← 43: 10.4x ← 44: 10.0 ↗ 45: 9.8 ↗ 46: 10.7x ↙ 47: 10.5x ↗ 48: 10.1 ↘ 49: 9.9 → 50: 9.8 ←		51: 10.7x ← 52: 10.2x ↘ 53: 10.5x → 54: 10.4x ↙ 55: 10.0 → 56: 9.9 → 57: 9.9 ↓ 58: 10.2x ↑ 59: 10.5x ↙ 60: 10.6x ↙
	Serie 102.1		Serie 102.9
	Total 513.2		Total 616.1

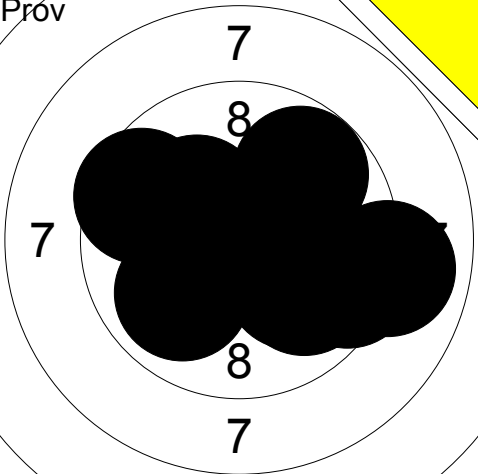
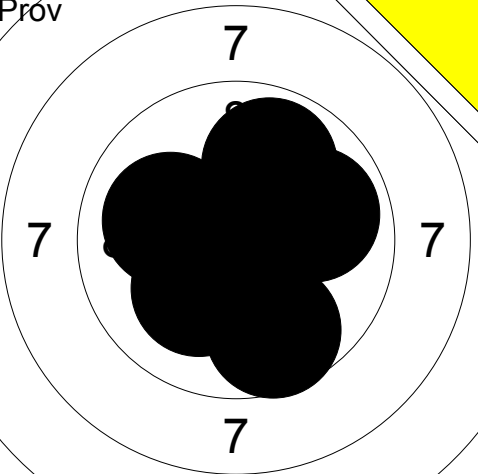
<p>Pröv</p> 	<p>1: 9.0 →</p> <p>2: 9.8 ↗</p> <p>3: 9.5 ←</p> <p>4: 10.0 ↓</p> <p>5: 10.2x ↗</p> <p>6: 9.4 →</p> <p>7: 9.9 ↓</p> <p>8: 9.9 ↓</p> <p>9: 9.8 →</p> <p>10: 10.6x ←</p>	<p>Pröv</p> 	<p>11: 10.0 ←</p> <p>12: 10.7x ↓</p> <p>13: 10.1 ↙</p> <p>14: 9.7 ↓</p> <p>15: 9.9 ↗</p> <p>16: 9.9 →</p>
Serie 98.1		Serie 60.3	
Total 0.0		Total 0.0	

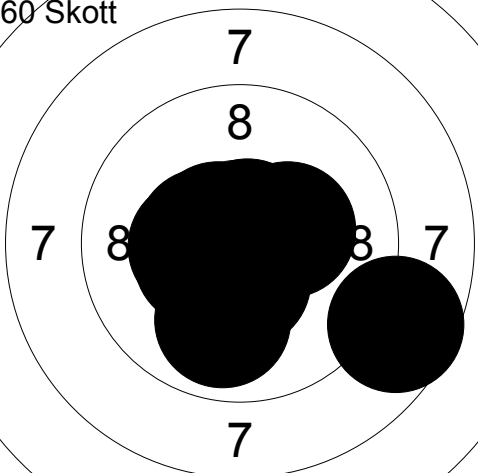
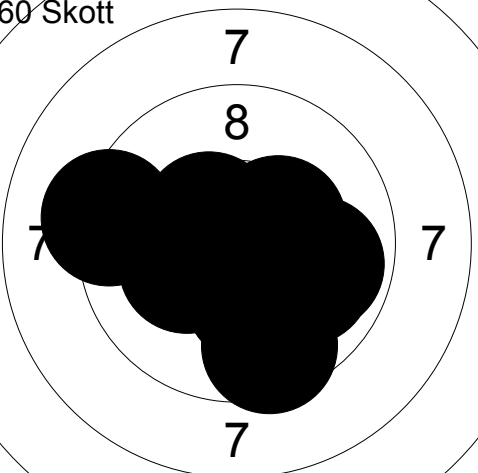
<p>60 Skott</p> 	<p>1: 10.5x ↓</p> <p>2: 10.3x →</p> <p>3: 10.5x ←</p> <p>4: 10.7x ↗</p> <p>5: 10.8x ←</p> <p>6: 8.6 →</p> <p>7: 9.9 ↓</p> <p>8: 10.6x ↗</p> <p>9: 10.4x ←</p> <p>10: 10.4x ←</p>	<p>60 Skott</p> 	<p>11: 9.2 ←</p> <p>12: 10.3x →</p> <p>13: 10.7x ↘</p> <p>14: 9.9 →</p> <p>15: 10.3x ←</p> <p>16: 10.5x ↗</p> <p>17: 9.9 →</p> <p>18: 10.2x ↓</p> <p>19: 9.5 ↓</p> <p>20: 10.2x ←</p>
Serie 102.7		Serie 100.7	
Total 102.7		Total 203.4	

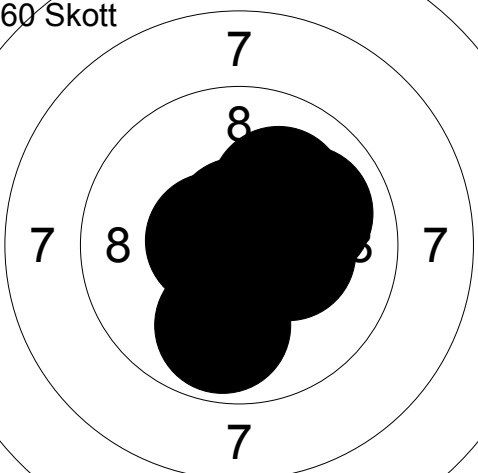
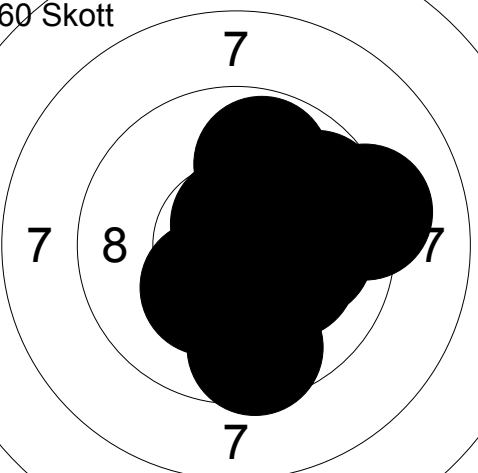
<p>60 Skott</p> 	<p>21: 9.9 ↓</p> <p>22: 10.6x ←</p> <p>23: 10.3x →</p> <p>24: 10.1 ↗</p> <p>25: 10.8x ←</p> <p>26: 10.3x →</p> <p>27: 10.0 →</p> <p>28: 10.7x ↓</p> <p>29: 10.7x ↑</p> <p>30: 10.1 ↗</p>	<p>60 Skott</p> 	<p>31: 9.8 ↗</p> <p>32: 9.7 →</p> <p>33: 10.7x ↓</p> <p>34: 10.2x ↘</p> <p>35: 10.0 →</p> <p>36: 9.2 →</p> <p>37: 10.5x ↘</p> <p>38: 10.3x ↙</p> <p>39: 10.7x ↑</p> <p>40: 9.6 ↓</p>
Serie 103.5		Serie 100.7	
Total 306.9		Total 407.6	

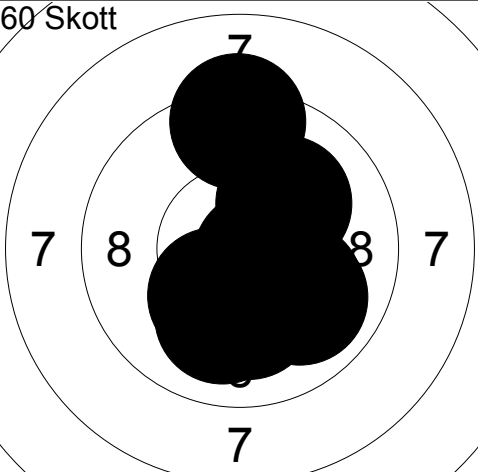
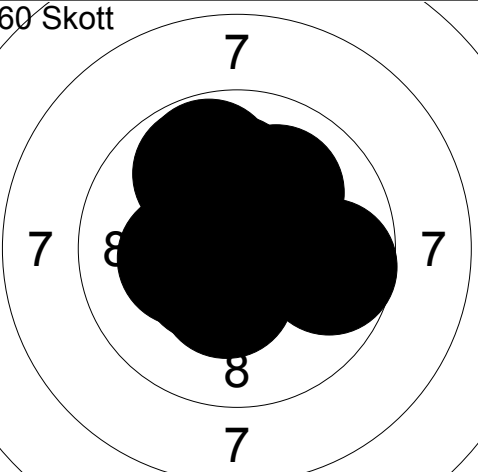
<p>60 Skott</p> 	<p>41: 10.0 ↘</p> <p>42: 9.3 ↑</p> <p>43: 10.2x ↓</p> <p>44: 10.3x ↓</p> <p>45: 10.1 ↗</p> <p>46: 9.9 ↘</p> <p>47: 10.0 ↓</p> <p>48: 10.3x ↓</p> <p>49: 10.6x →</p> <p>50: 10.1 ↓</p>	<p>60 Skott</p> 	<p>51: 9.8 ↗</p> <p>52: 9.8 ↗</p> <p>53: 10.4x ↓</p> <p>54: 9.7 →</p> <p>55: 10.3x ↗</p> <p>56: 10.1 ↑</p> <p>57: 10.0 ↗</p> <p>58: 10.4x ↙</p> <p>59: 10.3x ←</p> <p>60: 10.4x ←</p>
Serie 100.8		Serie 101.2	
Total 508.4		Total 609.6	

<p>Pröv</p>	<p>1: 9.1 ↓ 2: 9.0 ← 3: 10.6x ← 4: 9.4 ↓ 5: 9.2 ↓ 6: 10.4x ← 7: 10.6x ↓ 8: 9.5 ↓ 9: 9.6 ↓ 10: 8.7 ←</p> <p>Serie 96.1 Total 0.0</p>	<p>Pröv</p>	<p>11: 10.2x ↗ 12: 9.9 ↓</p> <p>Serie 20.1 Total 0.0</p>
-------------	--	-------------	---

<p>60 Skott</p>	<p>1: 9.5 ↗ 2: 9.6 ← 3: 9.5 → 4: 10.5x ↗ 5: 9.7 ← 6: 10.6x ↓ 7: 10.4x → 8: 10.3x ↑ 9: 10.1 → 10: 10.3x ↗</p> <p>Serie 100.5 Total 100.5</p>	<p>60 Skott</p>	<p>11: 10.5x ↖ 12: 10.0 → 13: 10.9x ↑ 14: 10.4x ↓ 15: 10.1 → 16: 10.4x ↑ 17: 9.9 → 18: 10.7x ← 19: 10.2x ↑ 20: 10.1 ←</p> <p>Serie 103.2 Total 203.7</p>
-----------------	--	-----------------	---

<p>60 Skott</p>	<p>21: 10.4x → 22: 10.7x ↓ 23: 10.4x ← 24: 10.2x ↓ 25: 10.2x ↓ 26: 10.0 ↑ 27: 10.5x ↗ 28: 9.4 → 29: 9.6 ← 30: 9.9 ←</p> <p>Serie 101.3 Total 305.0</p>	<p>60 Skott</p>	<p>31: 9.9 ↑ 32: 9.4 ↑ 33: 10.3x ↓ 34: 8.9 ← 35: 10.7x ↑ 36: 9.6 → 37: 10.8x ↓ 38: 10.1 ↓ 39: 10.0 ↗ 40: 10.3x →</p> <p>Serie 100.0 Total 405.0</p>
-----------------	---	-----------------	--

<p>60 Skott</p>	<p>41: 10.6x ← 42: 9.8 ↓ 43: 9.3 ← 44: 10.6x ↓ 45: 9.4 ← 46: 10.3x ← 47: 8.8 → 48: 10.7x → 49: 10.2x ↓ 50: 9.4 ←</p> <p>Serie 99.1 Total 504.1</p>	<p>60 Skott</p>	<p>51: 10.0 ↓ 52: 10.1 ↗ 53: 10.2x ↗ 54: 10.0 ← 55: 7.4 → 56: 10.3x ↖ 57: 9.9 ↓ 58: 10.2x ↑ 59: 9.2 → 60: 10.2x ←</p> <p>Serie 97.5 Total 601.6</p>
-----------------	---	-----------------	--

Pröv	Pröv																																																								
		<table style="width:100%; border-collapse: collapse;"> <tr><td>1:</td><td>10.0</td><td>↖</td></tr> <tr><td>2:</td><td>10.0</td><td>↗</td></tr> <tr><td>3:</td><td>9.5</td><td>↖</td></tr> <tr><td>4:</td><td>8.6</td><td>↗</td></tr> <tr><td>5:</td><td>10.7x</td><td>↗</td></tr> <tr><td>6:</td><td>10.6x</td><td>↘</td></tr> <tr><td>7:</td><td>10.2x</td><td>↘</td></tr> <tr><td>8:</td><td>10.1</td><td>↖</td></tr> <tr><td>9:</td><td>10.7x</td><td>↘</td></tr> <tr><td>10:</td><td>10.2x</td><td>↗</td></tr> </table>	1:	10.0	↖	2:	10.0	↗	3:	9.5	↖	4:	8.6	↗	5:	10.7x	↗	6:	10.6x	↘	7:	10.2x	↘	8:	10.1	↖	9:	10.7x	↘	10:	10.2x	↗	<table style="width:100%; border-collapse: collapse;"> <tr><td>11:</td><td>10.3x</td><td>↗</td></tr> <tr><td>12:</td><td>10.3x</td><td>↘</td></tr> <tr><td>13:</td><td>10.5x</td><td>↖</td></tr> <tr><td>14:</td><td>10.5x</td><td>↗</td></tr> <tr><td>15:</td><td>10.8x</td><td>↘</td></tr> <tr><td>16:</td><td>10.4x</td><td>↖</td></tr> <tr><td>17:</td><td>10.5x</td><td>↗</td></tr> <tr><td>18:</td><td>10.4x</td><td>↖</td></tr> </table>	11:	10.3x	↗	12:	10.3x	↘	13:	10.5x	↖	14:	10.5x	↗	15:	10.8x	↘	16:	10.4x	↖	17:	10.5x	↗	18:	10.4x	↖
1:	10.0	↖																																																							
2:	10.0	↗																																																							
3:	9.5	↖																																																							
4:	8.6	↗																																																							
5:	10.7x	↗																																																							
6:	10.6x	↘																																																							
7:	10.2x	↘																																																							
8:	10.1	↖																																																							
9:	10.7x	↘																																																							
10:	10.2x	↗																																																							
11:	10.3x	↗																																																							
12:	10.3x	↘																																																							
13:	10.5x	↖																																																							
14:	10.5x	↗																																																							
15:	10.8x	↘																																																							
16:	10.4x	↖																																																							
17:	10.5x	↗																																																							
18:	10.4x	↖																																																							
Serie		100.6	Serie	83.7																																																					
Total		0.0	Total	0.0																																																					

60 Skott	60 Skott																																																														
		<table style="width:100%; border-collapse: collapse;"> <tr><td>1:</td><td>10.3x</td><td>↗</td></tr> <tr><td>2:</td><td>10.0</td><td>↖</td></tr> <tr><td>3:</td><td>10.6x</td><td>↘</td></tr> <tr><td>4:</td><td>10.0</td><td>↗</td></tr> <tr><td>5:</td><td>10.8x</td><td>↘</td></tr> <tr><td>6:</td><td>10.3x</td><td>↗</td></tr> <tr><td>7:</td><td>10.6x</td><td>↘</td></tr> <tr><td>8:</td><td>10.4x</td><td>↗</td></tr> <tr><td>9:</td><td>10.6x</td><td>↖</td></tr> <tr><td>10:</td><td>10.4x</td><td>↖</td></tr> </table>	1:	10.3x	↗	2:	10.0	↖	3:	10.6x	↘	4:	10.0	↗	5:	10.8x	↘	6:	10.3x	↗	7:	10.6x	↘	8:	10.4x	↗	9:	10.6x	↖	10:	10.4x	↖	<table style="width:100%; border-collapse: collapse;"> <tr><td>11:</td><td>10.4x</td><td>↖</td></tr> <tr><td>12:</td><td>8.9</td><td>↗</td></tr> <tr><td>13:</td><td>9.3</td><td>↖</td></tr> <tr><td>14:</td><td>10.6x</td><td>↖</td></tr> <tr><td>15:</td><td>10.0</td><td>↖</td></tr> <tr><td>16:</td><td>10.3x</td><td>↗</td></tr> <tr><td>17:</td><td>10.6x</td><td>↗</td></tr> <tr><td>18:</td><td>10.4x</td><td>↗</td></tr> <tr><td>19:</td><td>9.7</td><td>↖</td></tr> <tr><td>20:</td><td>10.4x</td><td>↘</td></tr> </table>	11:	10.4x	↖	12:	8.9	↗	13:	9.3	↖	14:	10.6x	↖	15:	10.0	↖	16:	10.3x	↗	17:	10.6x	↗	18:	10.4x	↗	19:	9.7	↖	20:	10.4x	↘
1:	10.3x	↗																																																													
2:	10.0	↖																																																													
3:	10.6x	↘																																																													
4:	10.0	↗																																																													
5:	10.8x	↘																																																													
6:	10.3x	↗																																																													
7:	10.6x	↘																																																													
8:	10.4x	↗																																																													
9:	10.6x	↖																																																													
10:	10.4x	↖																																																													
11:	10.4x	↖																																																													
12:	8.9	↗																																																													
13:	9.3	↖																																																													
14:	10.6x	↖																																																													
15:	10.0	↖																																																													
16:	10.3x	↗																																																													
17:	10.6x	↗																																																													
18:	10.4x	↗																																																													
19:	9.7	↖																																																													
20:	10.4x	↘																																																													
Serie		104.0	Serie	100.6																																																											
Total		104.0	Total	204.6																																																											

60 Skott	60 Skott																																																														
		<table style="width:100%; border-collapse: collapse;"> <tr><td>21:</td><td>10.1</td><td>↗</td></tr> <tr><td>22:</td><td>10.4x</td><td>↗</td></tr> <tr><td>23:</td><td>10.3x</td><td>↘</td></tr> <tr><td>24:</td><td>10.6x</td><td>↗</td></tr> <tr><td>25:</td><td>10.3x</td><td>↗</td></tr> <tr><td>26:</td><td>10.4x</td><td>↗</td></tr> <tr><td>27:</td><td>10.2x</td><td>↗</td></tr> <tr><td>28:</td><td>10.5x</td><td>↗</td></tr> <tr><td>29:</td><td>10.6x</td><td>↗</td></tr> <tr><td>30:</td><td>9.8</td><td>↘</td></tr> </table>	21:	10.1	↗	22:	10.4x	↗	23:	10.3x	↘	24:	10.6x	↗	25:	10.3x	↗	26:	10.4x	↗	27:	10.2x	↗	28:	10.5x	↗	29:	10.6x	↗	30:	9.8	↘	<table style="width:100%; border-collapse: collapse;"> <tr><td>31:</td><td>10.2x</td><td>↘</td></tr> <tr><td>32:</td><td>10.4x</td><td>↖</td></tr> <tr><td>33:</td><td>10.5x</td><td>↗</td></tr> <tr><td>34:</td><td>10.6x</td><td>↖</td></tr> <tr><td>35:</td><td>10.4x</td><td>↖</td></tr> <tr><td>36:</td><td>9.9</td><td>↖</td></tr> <tr><td>37:</td><td>10.2x</td><td>↗</td></tr> <tr><td>38:</td><td>9.7</td><td>↘</td></tr> <tr><td>39:</td><td>10.6x</td><td>↖</td></tr> <tr><td>40:</td><td>10.7x</td><td>↗</td></tr> </table>	31:	10.2x	↘	32:	10.4x	↖	33:	10.5x	↗	34:	10.6x	↖	35:	10.4x	↖	36:	9.9	↖	37:	10.2x	↗	38:	9.7	↘	39:	10.6x	↖	40:	10.7x	↗
21:	10.1	↗																																																													
22:	10.4x	↗																																																													
23:	10.3x	↘																																																													
24:	10.6x	↗																																																													
25:	10.3x	↗																																																													
26:	10.4x	↗																																																													
27:	10.2x	↗																																																													
28:	10.5x	↗																																																													
29:	10.6x	↗																																																													
30:	9.8	↘																																																													
31:	10.2x	↘																																																													
32:	10.4x	↖																																																													
33:	10.5x	↗																																																													
34:	10.6x	↖																																																													
35:	10.4x	↖																																																													
36:	9.9	↖																																																													
37:	10.2x	↗																																																													
38:	9.7	↘																																																													
39:	10.6x	↖																																																													
40:	10.7x	↗																																																													
Serie		103.2	Serie	103.2																																																											
Total		307.8	Total	411.0																																																											

60 Skott	60 Skott																																																														
		<table style="width:100%; border-collapse: collapse;"> <tr><td>41:</td><td>10.1</td><td>↗</td></tr> <tr><td>42:</td><td>9.8</td><td>↘</td></tr> <tr><td>43:</td><td>10.7x</td><td>↘</td></tr> <tr><td>44:</td><td>10.4x</td><td>↗</td></tr> <tr><td>45:</td><td>10.3x</td><td>↖</td></tr> <tr><td>46:</td><td>10.3x</td><td>↘</td></tr> <tr><td>47:</td><td>9.9</td><td>↗</td></tr> <tr><td>48:</td><td>10.9x</td><td>↖</td></tr> <tr><td>49:</td><td>10.2x</td><td>↗</td></tr> <tr><td>50:</td><td>10.4x</td><td>↖</td></tr> </table>	41:	10.1	↗	42:	9.8	↘	43:	10.7x	↘	44:	10.4x	↗	45:	10.3x	↖	46:	10.3x	↘	47:	9.9	↗	48:	10.9x	↖	49:	10.2x	↗	50:	10.4x	↖	<table style="width:100%; border-collapse: collapse;"> <tr><td>51:</td><td>10.6x</td><td>↘</td></tr> <tr><td>52:</td><td>10.0</td><td>↖</td></tr> <tr><td>53:</td><td>10.5x</td><td>↖</td></tr> <tr><td>54:</td><td>10.8x</td><td>↗</td></tr> <tr><td>55:</td><td>10.3x</td><td>↗</td></tr> <tr><td>56:</td><td>10.4x</td><td>↖</td></tr> <tr><td>57:</td><td>10.6x</td><td>↗</td></tr> <tr><td>58:</td><td>9.8</td><td>↖</td></tr> <tr><td>59:</td><td>10.7x</td><td>↘</td></tr> <tr><td>60:</td><td>10.2x</td><td>↘</td></tr> </table>	51:	10.6x	↘	52:	10.0	↖	53:	10.5x	↖	54:	10.8x	↗	55:	10.3x	↗	56:	10.4x	↖	57:	10.6x	↗	58:	9.8	↖	59:	10.7x	↘	60:	10.2x	↘
41:	10.1	↗																																																													
42:	9.8	↘																																																													
43:	10.7x	↘																																																													
44:	10.4x	↗																																																													
45:	10.3x	↖																																																													
46:	10.3x	↘																																																													
47:	9.9	↗																																																													
48:	10.9x	↖																																																													
49:	10.2x	↗																																																													
50:	10.4x	↖																																																													
51:	10.6x	↘																																																													
52:	10.0	↖																																																													
53:	10.5x	↖																																																													
54:	10.8x	↗																																																													
55:	10.3x	↗																																																													
56:	10.4x	↖																																																													
57:	10.6x	↗																																																													
58:	9.8	↖																																																													
59:	10.7x	↘																																																													
60:	10.2x	↘																																																													
Serie		103.0	Serie	103.9																																																											
Total		514.0	Total	617.9																																																											

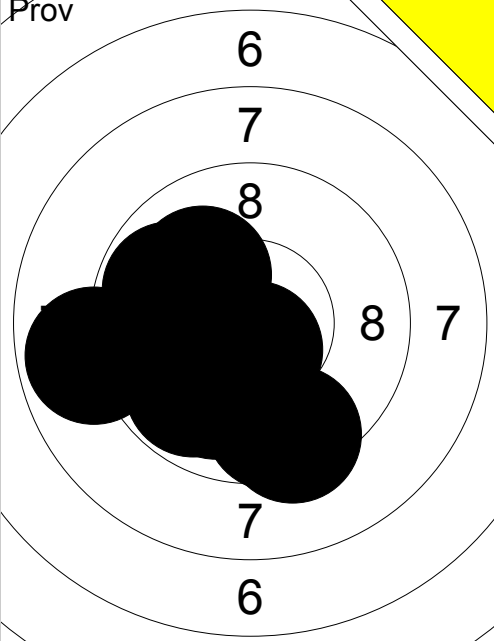
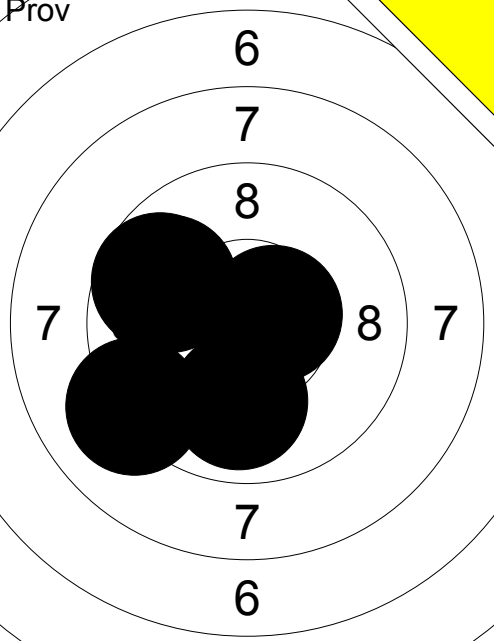
Prov 	1: 10.1 ↙ 2: 9.4 ↓ 3: 8.9 ← 4: 9.8 ↖ 5: 10.3x↖ 6: 10.1 ↗ 7: 10.6x↓ 8: 9.6 ↓ 9: 9.8 ↙ 10: 10.0 ↓ <hr/> Serie 94 (2x) Total 0 (0x)	Prov 	11: 9.1 ↙ 12: 9.9 ↓ 13: 10.6x→ 14: 9.8 ↖ 15: 9.7 ↖ <hr/> Serie 46 (1x) Total 0 (0x)
--	---	--	---

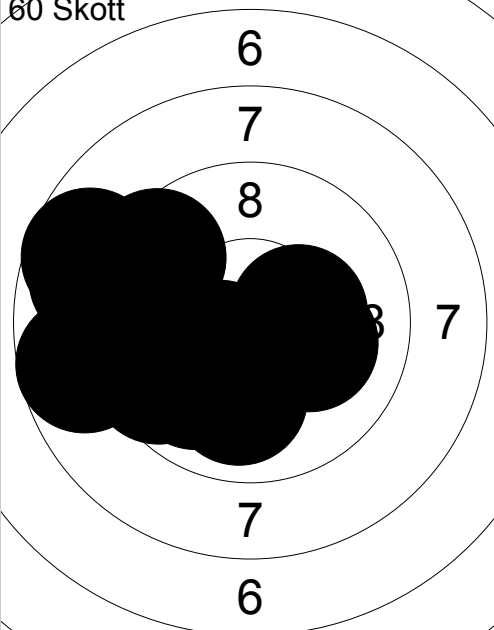
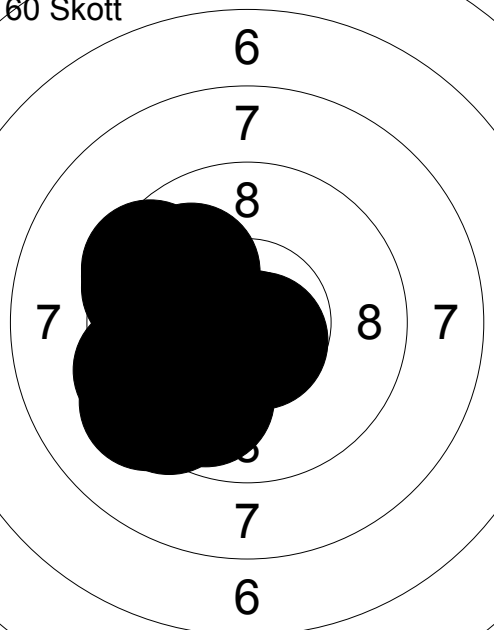
60 Skott 	1: 9.6 ↖ 2: 10.1 → 3: 10.0 ↓ 4: 9.9 ↙ 5: 8.9 ↖ 6: 8.7 ↖ 7: 10.4x↙ 8: 10.3x→ 9: 8.7 ↖ 10: 9.5 ↖ <hr/> Serie 91 (2x) Total 91 (2x)	60 Skott 	11: 10.7x↓ 12: 9.3 ↖ 13: 9.5 ↖ 14: 9.5 ↙ 15: 9.6 ↖ 16: 9.5 ↖ 17: 10.7x↓ 18: 9.4 ↖ 19: 9.8 ↙ 20: 10.0 ↖ <hr/> Serie 93 (2x) Total 184 (4x)
---	---	---	--

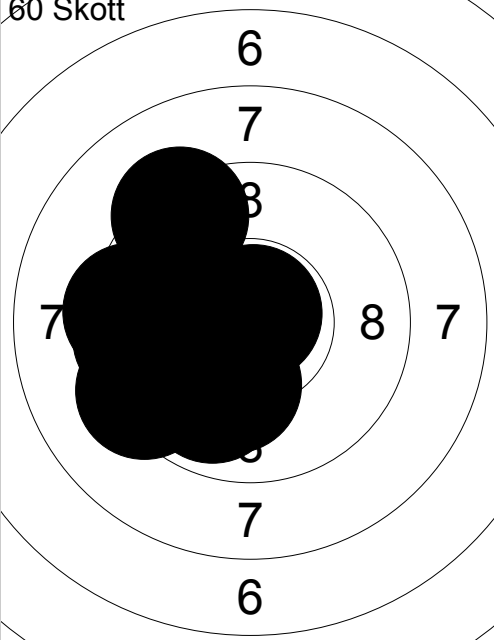
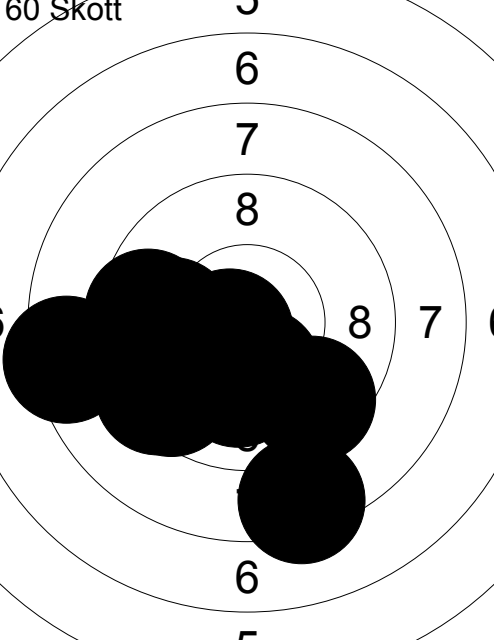
60 Skott 	21: 10.1 ↓ 22: 9.3 ↖ 23: 10.6x↙ 24: 9.4 ↖ 25: 9.9 ↖ 26: 9.9 ↖ 27: 9.3 ↗ 28: 9.9 ↙ 29: 10.8x↗ 30: 9.5 ↖ <hr/> Serie 93 (2x) Total 277 (6x)	60 Skott 	31: 10.1 ↓ 32: 9.9 ↖ 33: 9.5 ↓ 34: 9.4 ↙ 35: 8.3 ↖ 36: 9.5 ↙ 37: 10.2x↓ 38: 10.7x↙ 39: 9.5 ↖ 40: 8.3 ↓ <hr/> Serie 91 (2x) Total 368 (8x)
--	--	--	--

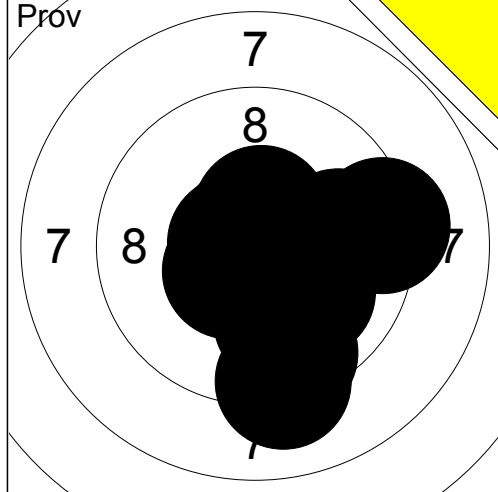

1:	9.1	↓
2:	10.0	↓
3:	10.5x	↙
4:	9.2	→
5:	10.5x	↑
6:	9.9	↓
7:	9.8	→
8:	10.7x	←
9:	10.6x	↓
10:	9.5	↓
Serie		95 (4x)
Total		0 (0x)

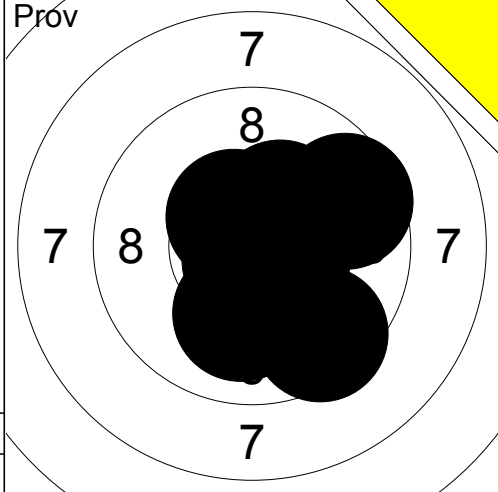

11:	10.2x	↓
12:	10.8x	↓
13:	9.5	↓
14:	10.3x	↗
15:	10.5x	↓
16:	10.5x	↗
17:	10.5x	→
18:	10.3x	↓
19:	10.0	↓
20:	9.6	↗
Serie		98 (7x)
Total		0 (0x)

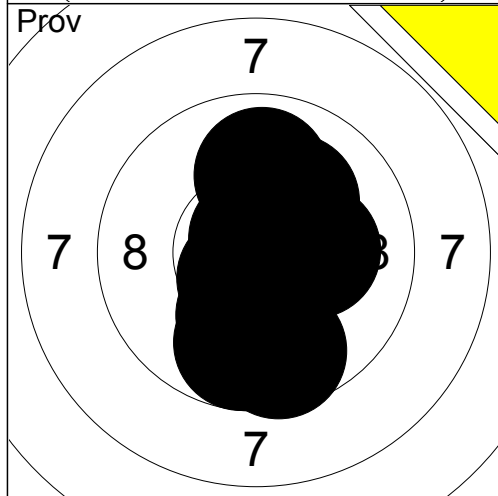

21:	9.6	↓
22:	9.7	↓
23:	10.2x	→
24:	10.8x	↑
25:	10.6x	↓
26:	10.1	↓
27:	10.1	↗
28:	9.9	↑
29:	10.5x	↗
Serie		87 (4x)
Total		0 (0x)

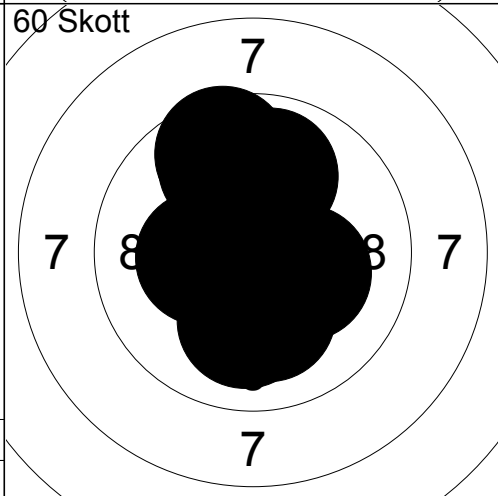

1:	10.0	↓
2:	10.2x	→
3:	9.6	↑
4:	9.9	↑
5:	10.1	↓
6:	10.6x	↑
7:	10.3x	←
8:	9.8	↑
9:	10.5x	↑
10:	10.4x	↘
Serie		97 (5x)
Total		97 (5x)

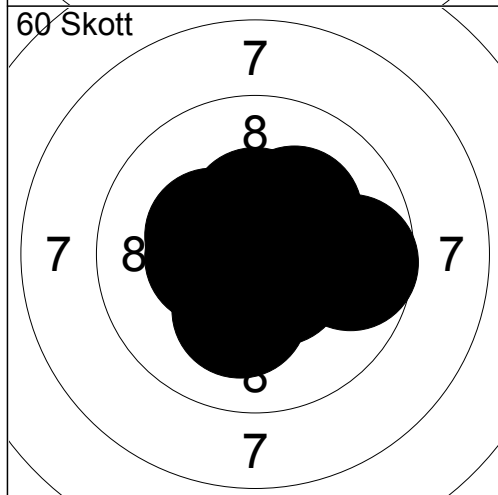

11:	10.3x	←
12:	10.4x	↑
13:	10.2x	↓
14:	9.7	→
15:	10.5x	↘
16:	10.7x	↘
17:	10.4x	←
18:	10.4x	←
19:	10.2x	↗
20:	10.5x	↓
Serie		99 (9x)
Total		196 (14x)

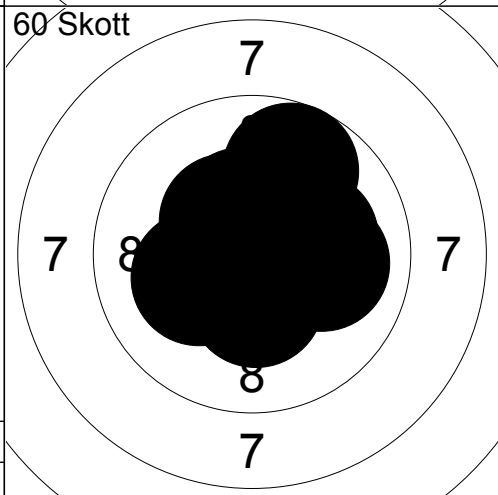

21:	10.0	→
22:	10.3x	↑
23:	10.4x	↑
24:	9.7	↗
25:	10.4x	↗
26:	10.1	→
27:	10.5x	←
28:	10.7x	↓
29:	10.2x	←
30:	10.3x	↓
Serie		99 (7x)
Total		295 (21x)

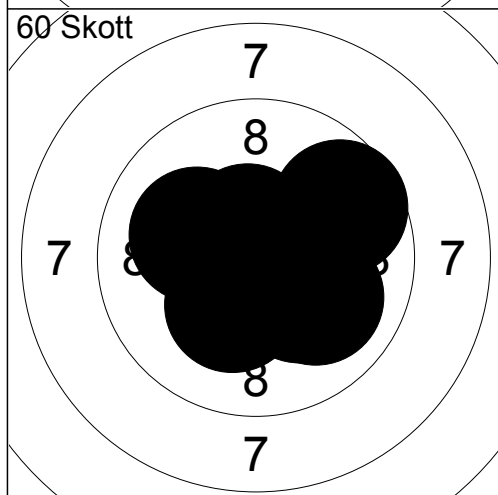

31:	10.3x	↓
32:	10.0	↘
33:	10.6x	↓
34:	10.6x	↑
35:	10.5x	↘
36:	9.7	↗
37:	10.6x	↗
38:	10.6x	↓
39:	10.2x	↓
40:	10.1	←
Serie		99 (7x)
Total		394 (28x)

Prov 	1: 8.2 ↑ 2: 8.6 ↑ 3: 7.9 ↑ 4: 8.9 ↑ 5: 9.3 ↑ 6: 9.2 ↑ 7: 10.2x ↑ 8: 9.9 ↑ 9: 10.0 ↘ 10: 10.2x ↗ Serie 88 (2x) Total 0 (0x)	Prov 	11: 10.7x → 12: 10.6x → 13: 9.9 ↙ 14: 10.4x ↑ 15: 10.3x ↗ 16: 10.7x ↖ Serie 59 (5x) Total 0 (0x)
----------	---	----------	---

60 Skott 	1: 10.3x ↑ 2: 10.7x ↙ 3: 10.8x ↓ 4: 10.3x ↙ 5: 10.6x ↓ 6: 10.3x ↗ 7: 10.2x ↑ 8: 10.8x ↖ 9: 9.9 ← 10: 10.7x ↙ Serie 99 (9x) Total 99 (9x)		11: 10.6x → 12: 9.4 ↑ 13: 10.7x ↖ 14: 9.9 ↙ 15: 10.5x ↑ 16: 10.3x ↑ 17: 10.2x ↑ 18: 9.8 ↙ 19: 10.1 ↑ 20: 10.3x → Serie 97 (6x) Total 196 (15x)
--------------	---	--	---

60 Skott 	21: 10.9x ↑ 22: 10.3x → 23: 10.1 ↓ 24: 9.9 ↑ 25: 9.8 ↑ 26: 10.3x ↑ 27: 10.1 ↖ 28: 9.9 ↑ 29: 10.5x ↖ 30: 10.1 ↖ Serie 97 (4x) Total 293 (19x)		31: 10.3x ↑ 32: 10.3x ↑ 33: 10.3x ↑ 34: 10.2x ↑ 35: 9.7 ↑ 36: 10.1 ↖ 37: 9.9 ↗ 38: 10.2x ↙ 39: 10.2x ↖ 40: 10.7x ← Serie 98 (7x) Total 391 (26x)
--------------	---	--	---

Pröv 	1: 9.9 → 2: 10.1 → 3: 10.5x ↓ 4: 10.6x → 5: 10.4x ↓ 6: 10.3x → 7: 10.5x ↓ 8: 10.4x ↖ 9: 10.6x ↖ 10: 10.1 ↑ Serie 99 (7x) Total 0 (0x)	Pröv 	11: 10.3x ↗ 12: 10.5x ← 13: 10.3x ↘ 14: 10.5x → Serie 40 (4x) Total 0 (0x)
----------	--	----------	---

60 Skott 	1: 10.7x → 2: 10.6x ← 3: 10.8x ↖ 4: 10.3x ← 5: 9.8 ↑ 6: 10.7x ↖ 7: 10.6x ↓ 8: 10.7x ↖ 9: 10.7x ↓ 10: 10.4x ↓ Serie 99 (9x) Total 99 (9x)	60 Skott 	11: 10.4x ↗ 12: 10.8x ↗ 13: 10.7x ↓ 14: 10.1 → 15: 10.3x ↘ 16: 10.3x ↓ 17: 10.6x ← 18: 10.3x ↑ 19: 10.2x ↑ 20: 10.1 ↑ Serie 100 (8x) Total 199 (17x)
--------------	---	--------------	---

60 Skott 	21: 10.4x → 22: 10.7x → 23: 10.2x ↘ 24: 10.6x ↖ 25: 10.7x ↓ 26: 10.7x ↖ 27: 10.6x ↘ 28: 10.7x → 29: 10.6x → 30: 10.6x ← Serie 100 (10x) Total 299 (27x)	60 Skott 	31: 10.7x ← 32: 10.6x ↖ 33: 10.8x ↗ 34: 10.6x ↘ 35: 10.5x → 36: 10.6x ↖ 37: 10.9x ↓ 38: 10.8x ← 39: 10.9x ↘ 40: 10.3x ↓ Serie 100 (10x) Total 399 (37x)
--------------	--	--------------	--

Pröv 	Pröv 	11: 9.9 ↗ 12: 9.7 ↑ 13: 10.4x → Serie 28 (1x) Total 0 (0x)
1: 10.4x ↑ 2: 10.6x ↘ 3: 10.3x ↘ 4: 10.5x ← 5: 10.3x ↘ 6: 10.2x ↘ 7: 10.8x → 8: 10.7x → 9: 10.4x ↑ 10: 9.8 → Serie 99 (9x) Total 0 (0x)	1: 10.5x ↘ 2: 10.5x ↓ 3: 10.4x ↘ 4: 10.8x ← 5: 10.7x ↓ 6: 10.5x → 7: 10.7x ↘ 8: 10.6x ↘ 9: 9.3 ↗ 10: 10.7x ← Serie 99 (9x) Total 99 (9x)	11: 10.1 ↘ 12: 10.0 ← 13: 10.4x ↑ 14: 10.7x ↑ 15: 10.8x ↘ 16: 10.2x ↘ 17: 10.4x ↘ 18: 10.5x → 19: 10.1 ↓ 20: 10.3x ↓ Serie 100 (7x) Total 199 (16x)

60 Skott 	60 Skott 	21: 10.8x ↓ 22: 10.4x ← 23: 10.8x ↑ 24: 10.4x ← 25: 9.6 ↓ 26: 10.9x ↓ 27: 10.2x ← 28: 10.1 ← 29: 10.4x ← 30: 10.0 → Serie 99 (7x) Total 298 (23x)
1: 10.5x ↘ 2: 10.5x ↓ 3: 10.4x ↘ 4: 10.8x ← 5: 10.7x ↓ 6: 10.5x → 7: 10.7x ↘ 8: 10.6x ↘ 9: 9.3 ↗ 10: 10.7x ← Serie 99 (9x) Total 99 (9x)	11: 10.0 ↘ 12: 10.4x ↑ 13: 10.7x ↑ 14: 10.8x ↘ 15: 10.2x ↘ 16: 10.4x ↘ 17: 10.5x → 18: 10.1 ↓ 19: 10.3x ↓ Serie 100 (7x) Total 199 (16x)	31: 10.0 ← 32: 10.7x ↑ 33: 10.2x ↘ 34: 10.4x → 35: 10.2x → 36: 10.2x → 37: 10.4x ↓ 38: 10.5x ← 39: 10.3x ← 40: 10.6x ↘ Serie 100 (9x) Total 398 (32x)

60 Skott 	60 Skott 	31: 10.0 ← 32: 10.7x ↑ 33: 10.2x ↘ 34: 10.4x → 35: 10.2x → 36: 10.2x → 37: 10.4x ↓ 38: 10.5x ← 39: 10.3x ← 40: 10.6x ↘ Serie 100 (9x) Total 398 (32x)
21: 10.8x ↓ 22: 10.4x ← 23: 10.8x ↑ 24: 10.4x ← 25: 9.6 ↓ 26: 10.9x ↓ 27: 10.2x ← 28: 10.1 ← 29: 10.4x ← 30: 10.0 → Serie 99 (7x) Total 298 (23x)	1: 10.5x ↘ 2: 10.5x ↓ 3: 10.4x ↘ 4: 10.8x ← 5: 10.7x ↓ 6: 10.5x → 7: 10.7x ↘ 8: 10.6x ↘ 9: 9.3 ↗ 10: 10.7x ← Serie 99 (9x) Total 99 (9x)	11: 10.1 ↘ 12: 10.0 ← 13: 10.4x ↑ 14: 10.7x ↑ 15: 10.8x ↘ 16: 10.2x ↘ 17: 10.4x ↘ 18: 10.5x → 19: 10.1 ↓ 20: 10.3x ↓ Serie 100 (7x) Total 199 (16x)

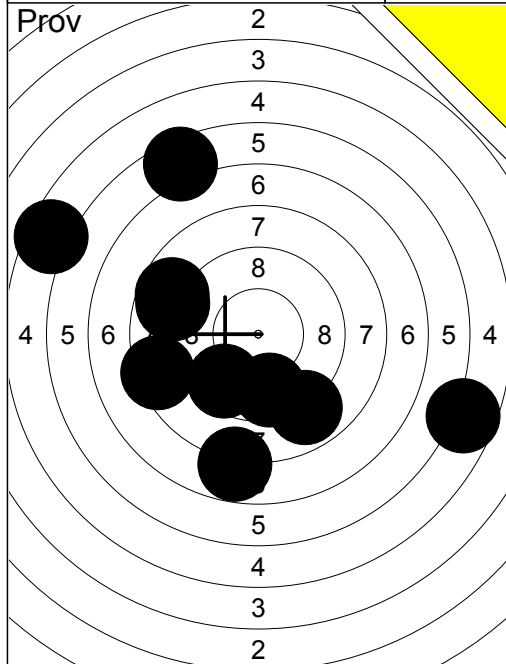

1:	6.5	↗
2:	8.8	↖
3:	5.4	↖
4:	8.7	↖
5:	8.4	↖
6:	9.5	↙
7:	7.8	↓
8:	5.6	→
9:	8.8	↙
10:	9.6	↓
Serie		73 (0x)
Total		0 (0x)

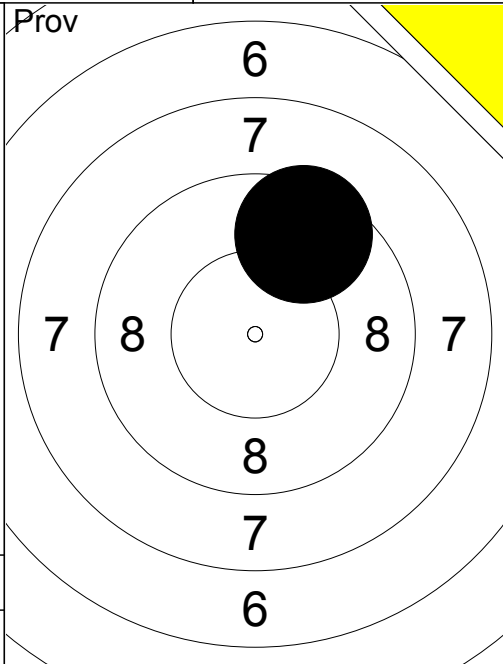

11:	9.5	↗
Serie		9 (0x)
Total		0 (0x)

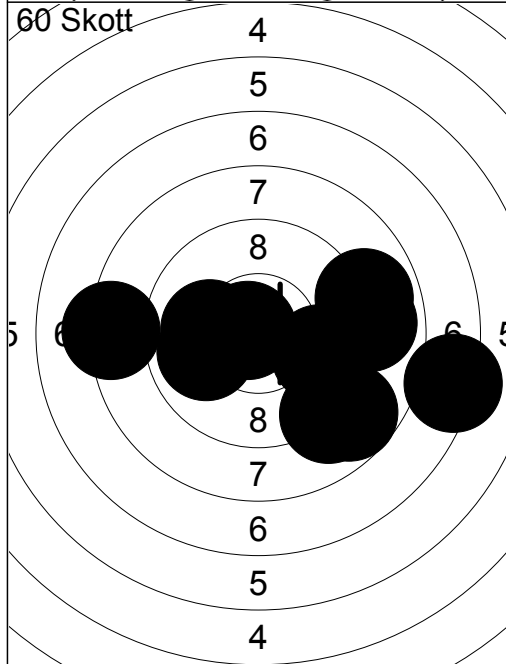

1:	8.7	↙
2:	8.9	→
3:	8.9	→
4:	9.0	↙
5:	10.1	←
6:	7.2	→
7:	9.7	→
8:	9.9	←
9:	10.7x	←
10:	8.2	←
Serie		86 (1x)
Total		86 (1x)

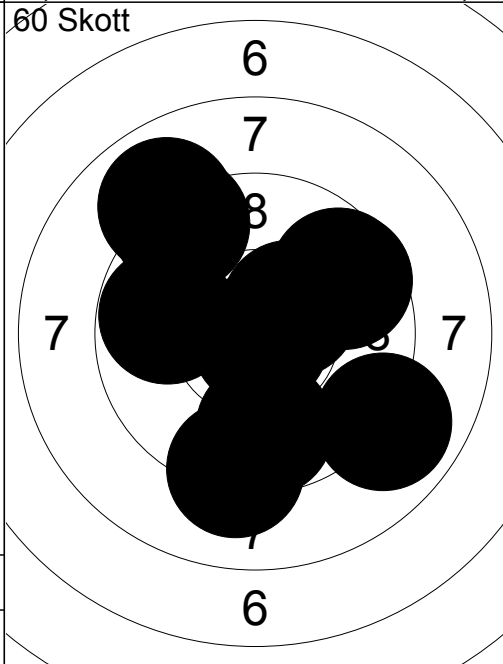

11:	9.7	↓
12:	9.6	↗
13:	8.9	↙
14:	9.8	←
15:	9.2	↓
16:	10.8x	↙
17:	8.9	↗
18:	9.6	↗
19:	9.2	↗
20:	10.4x	↗
Serie		90 (2x)
Total		176 (3x)

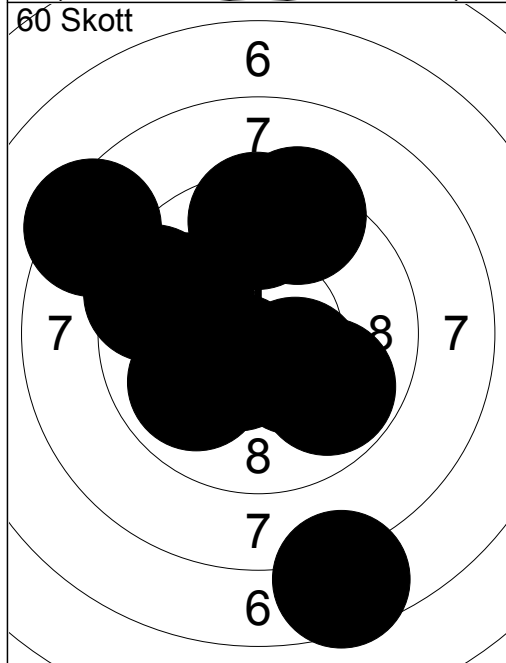

21:	9.5	←
22:	9.9	↙
23:	9.5	↑
24:	9.3	↑
25:	9.9	↖
26:	7.5	↙
27:	9.8	↙
28:	8.4	↖
29:	10.3x	↙
30:	10.5x	↙
Serie		89 (2x)
Total		265 (5x)

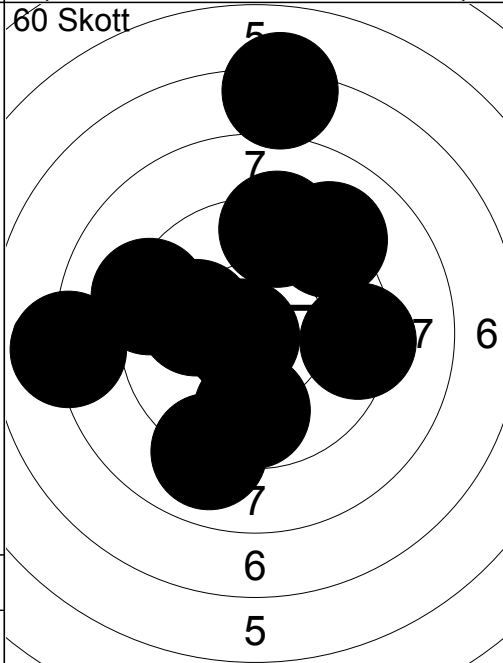

31:	9.3	→
32:	10.7x	←
33:	9.8	↓
34:	9.2	←
35:	10.0	←
36:	8.0	←
37:	7.2	↑
38:	9.0	↙
39:	9.1	↗
40:	9.3	↑
Serie		89 (1x)
Total		354 (6x)

Prov 	1: 10.0 ↗ 2: 9.8 ↗ 3: 10.8x ↘ 4: 10.7x → 5: 10.7x ↓ Serie 49 (3x) Total 0 (0x)	60 Skott 	1: 10.2x ↓ 2: 10.8x → 3: 10.2x ↘ 4: 10.2x ↘ 5: 10.6x ↙ 6: 10.1 ↓ 7: 10.2x ↓ 8: 10.8x ↗ 9: 9.9 ↓ 10: 10.2x ↙ Serie 99 (8x) Total 99 (8x)
--	--	--	--

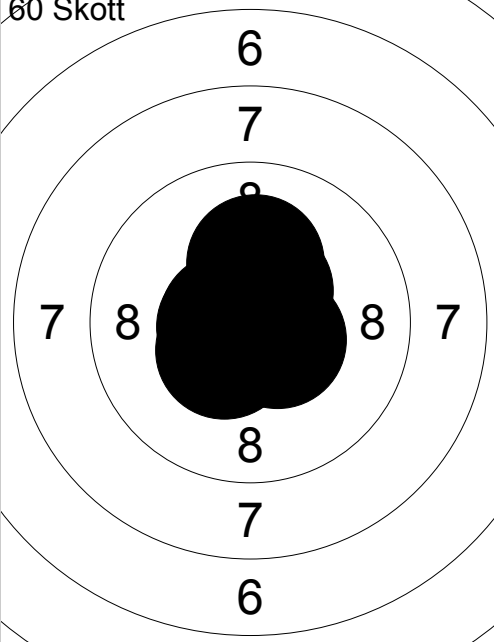
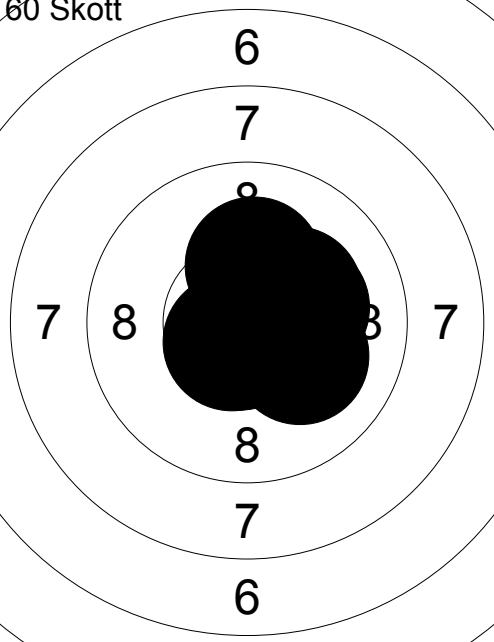
60 Skott 	11: 10.6x ↙ 12: 10.7x ↙ 13: 10.5x ↘ 14: 10.6x ↗ 15: 10.7x ↓ 16: 10.8x → 17: 10.2x ↑ 18: 10.9x ↓ 19: 10.5x ↙ 20: 10.5x ↗ Serie 100 (10x) Total 199 (18x)	60 Skott 	21: 10.6x ↙ 22: 10.2x → 23: 10.9x → 24: 10.2x ↑ 25: 10.2x ↗ 26: 10.1 ↘ 27: 10.3x → 28: 10.7x ↓ 29: 10.6x ↘ 30: 10.8x ↓ Serie 100 (9x) Total 299 (27x)
---	--	---	---

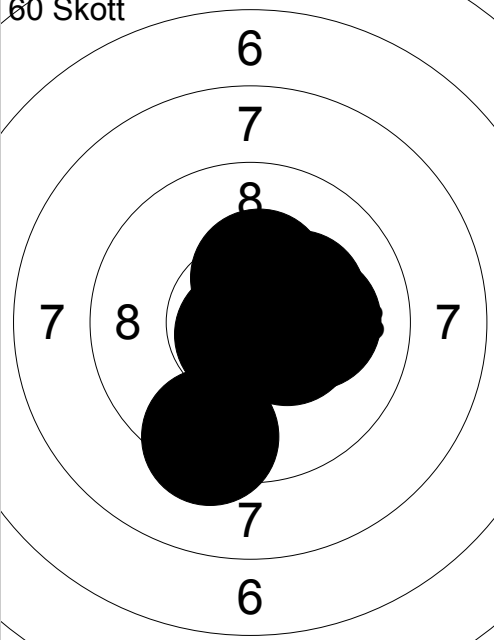
60 Skott 	31: 10.4x ↑ 32: 10.6x → 33: 10.4x → 34: 9.4 ↓ 35: 10.4x → 36: 10.8x ↙ 37: 10.3x ↗ 38: 10.4x → 39: 10.1 → 40: 10.5x → Serie 99 (8x) Total 398 (35x)		
--	--	--	--

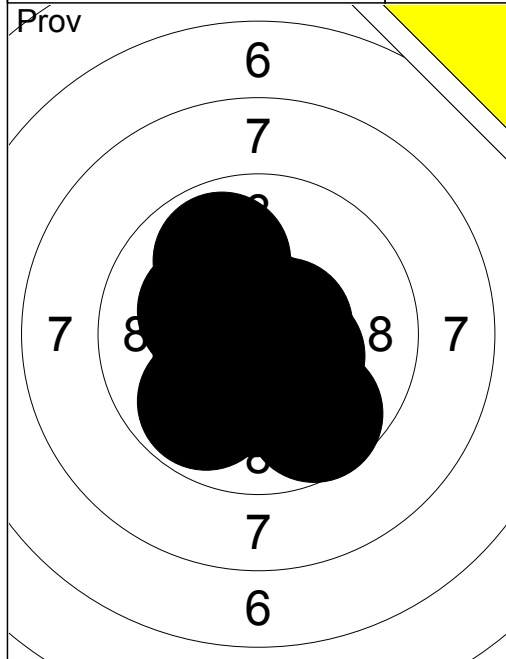

1:	10.6x ↙
2:	9.7 ↘
3:	10.4x ↘
4:	9.9 ↗
5:	10.2x ↓
6:	10.6x →
7:	9.8 ↙
8:	10.4x ↙
9:	10.2x ↖
10:	10.8x ↘
Serie	97 (7x)
Total	0 (0x)

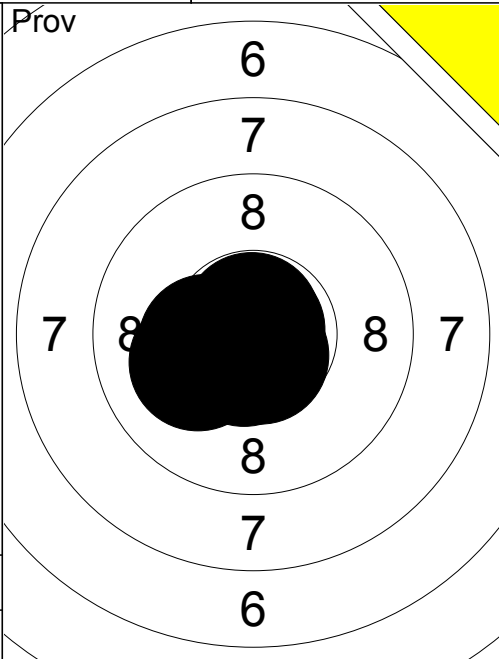

11:	10.7x ↓
12:	10.1 ↙
13:	10.9x ↗
14:	10.7x ↙
15:	10.3x ↙
16:	10.8x ↗
17:	10.6x ↘
Serie	70 (6x)
Total	0 (0x)

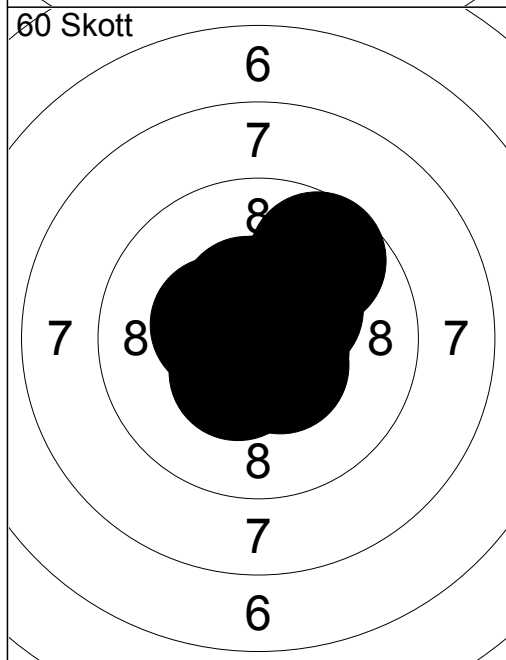

1:	10.4x ↙
2:	10.5x ↘
3:	10.3x ↗
4:	10.4x ↖
5:	10.6x ↘
6:	10.5x ↑
7:	10.6x ↗
8:	10.5x ↑
9:	10.4x ↗
10:	9.7 ↗
Serie	99 (9x)
Total	99 (9x)

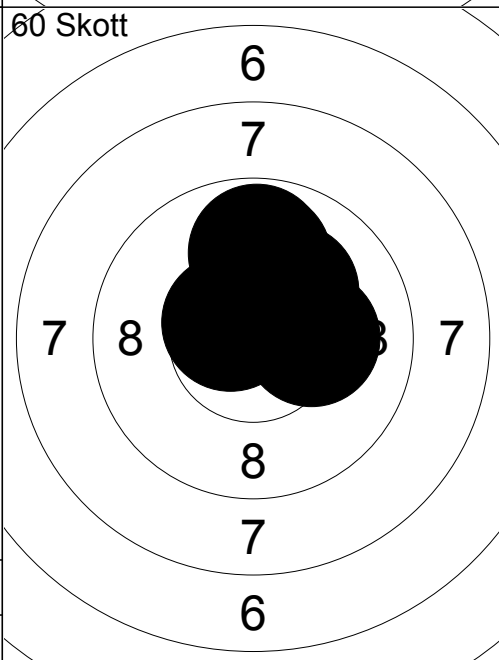

11:	10.6x ↑
12:	9.8 ↑
13:	10.2x ↗
14:	10.4x →
15:	10.6x ↗
16:	9.9 ↑
17:	10.6x ↗
18:	10.4x ↗
19:	10.2x →
20:	10.6x ↖
Serie	98 (8x)
Total	197 (17x)

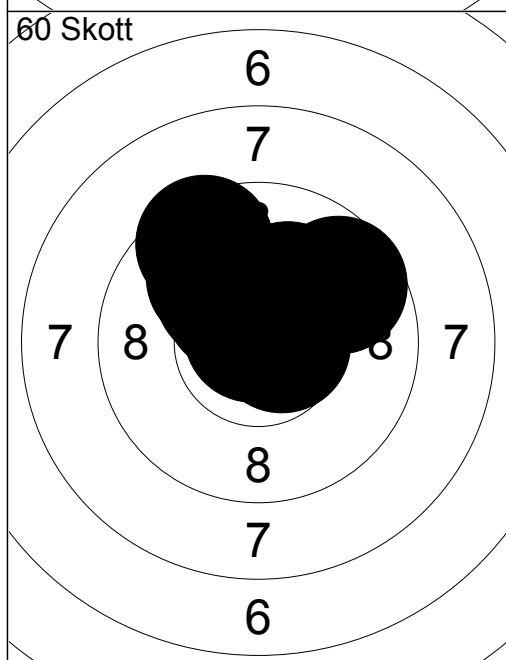

21:	10.8x ↖
22:	10.6x →
23:	10.2x ↗
24:	10.7x ↗
25:	9.7 ↗
26:	9.5 ↗
27:	9.9 ↗
28:	10.5x ↑
29:	10.3x ↖
30:	10.2x ↖
Serie	97 (7x)
Total	294 (24x)

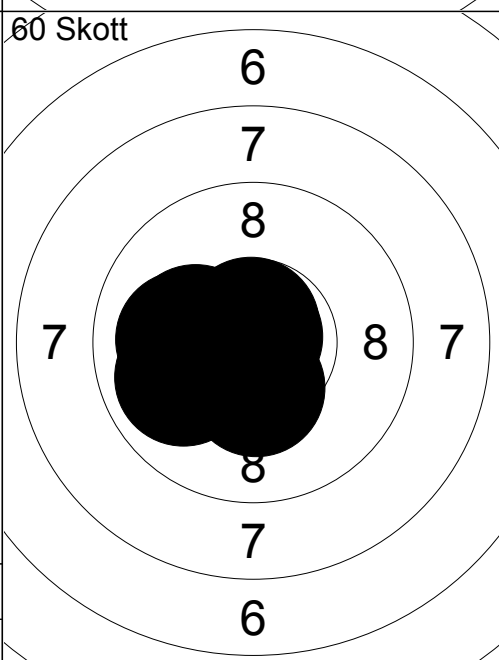

31:	10.4x ↙
32:	10.4x ↙
33:	10.4x ↙
34:	10.7x ↘
35:	10.2x ↙
36:	10.7x ↑
37:	9.9 ↙
38:	10.4x ↓
39:	10.9x ↑
40:	10.0 ←
Serie	99 (8x)
Total	393 (32x)

Prov

1:	10.5x →
2:	8.5 ↗
3:	8.2 ←
4:	8.6 ↗
5:	2.0 ↓
6:	6.2 ←
7:	2.4 ↗
8:	0.0 →
9:	5.2 ↗
10:	3.9 ←
Serie	52 (1x)
Total	0 (0x)

Prov

11:	9.1 →
Serie	9 (0x)
Total	0 (0x)

60 Skott

1:	3.0 ←
2:	2.8 ↙
3:	9.2 ←
4:	9.6 ↗
5:	8.1 ←
6:	6.4 →
7:	0.0 ←
8:	4.0 →
9:	7.7 ↓
10:	8.9 ↓
Serie	56 (0x)
Total	56 (0x)

60 Skott

11:	4.6 ↘
12:	8.1 →
13:	0.0 ←
14:	0.0 →
15:	8.4 →
16:	0.0 ↓
17:	6.4 ↓
18:	6.4 ↓
19:	1.2 ←
20:	4.9 ↓
Serie	37 (0x)
Total	93 (0x)

60 Skott

21:	0.0 ↓
22:	0.0 ←
23:	5.9 ←
24:	7.5 ↓
25:	2.5 ↓
26:	7.7 ↗
27:	6.6 ↑
28:	3.3 ←
29:	0.0 →
30:	6.7 ←
Serie	36 (0x)
Total	129 (0x)

60 Skott

31:	0.0 →
32:	2.6 ↓
33:	4.7 ↗
34:	1.4 ↗
35:	6.3 ↘
36:	2.8 →
37:	5.2 ↖
38:	6.8 →
39:	1.8 ←
40:	4.1 ←
Serie	31 (0x)
Total	160 (0x)

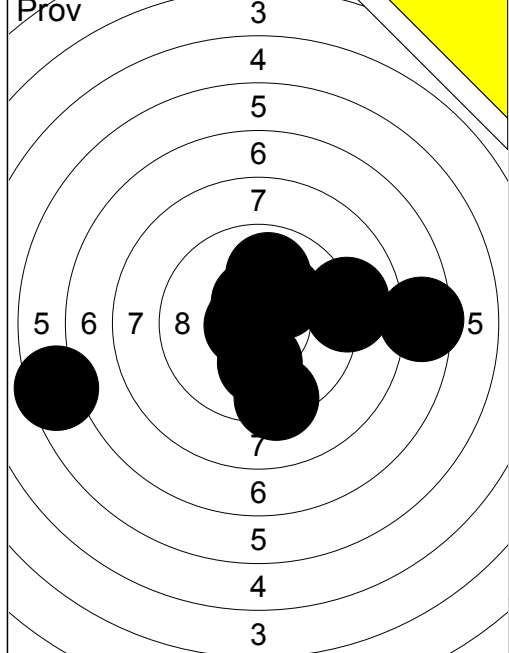

1:	9.9	↑
2:	9.3	↓
3:	7.5	→
4:	9.0	→
5:	10.2x	↗
6:	6.5	←
7:	10.7x	←
8:	10.1	↓
9:	9.0	→
10:	10.5x	↑
Serie		89 (3x)
Total		0 (0x)

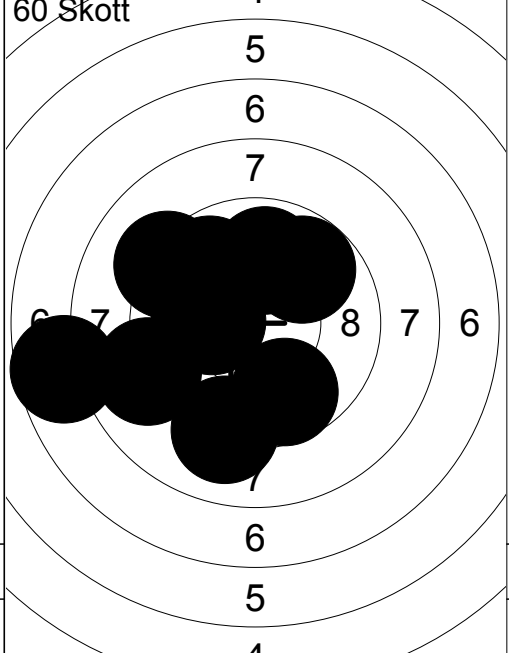

1:	10.0	↖
2:	9.8	↗
3:	9.2	↖
4:	9.8	↖
5:	9.1	↓
6:	7.7	←
7:	9.7	↓
8:	9.0	←
9:	10.2x	←
10:	9.9	↑
Serie		90 (1x)
Total		90 (1x)

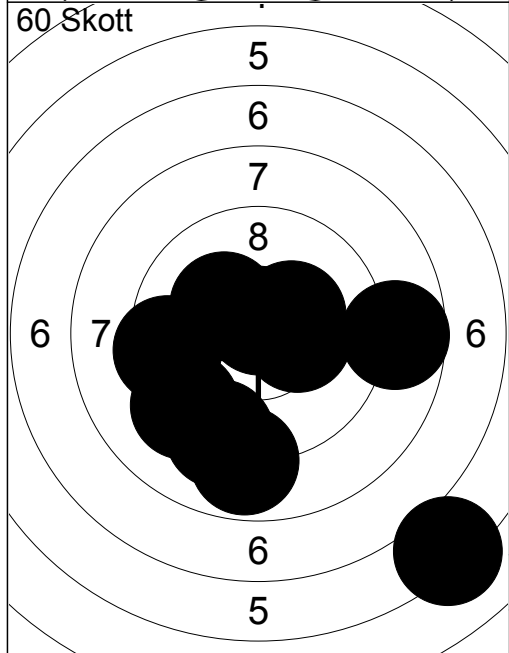

11:	8.7	→
12:	10.3x	→
13:	9.4	←
14:	9.2	↖
15:	6.2	↘
16:	9.2	↓
17:	10.7x	↑
18:	10.2x	↖
19:	8.8	↓
20:	10.3x	↗
Serie		89 (4x)
Total		179 (5x)

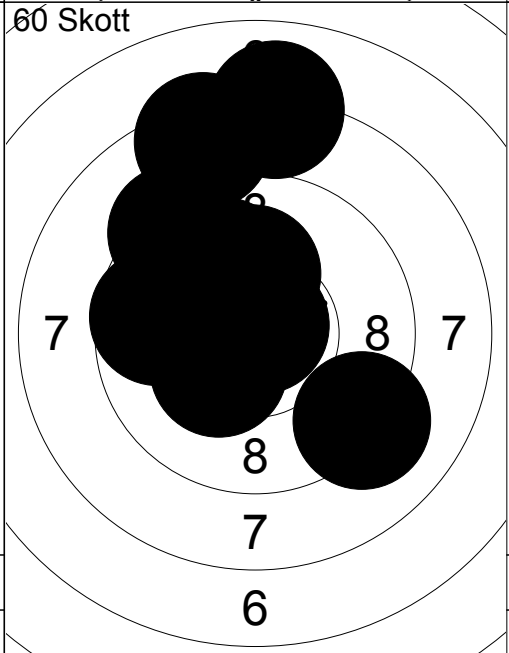

21:	10.0	↖
22:	8.3	↑
23:	9.2	↘
24:	8.0	↑
25:	9.3	↖
26:	10.3x	↑
27:	9.7	←
28:	10.8x	↗
29:	10.3x	↘
30:	10.2x	↑
Serie		93 (4x)
Total		272 (9x)

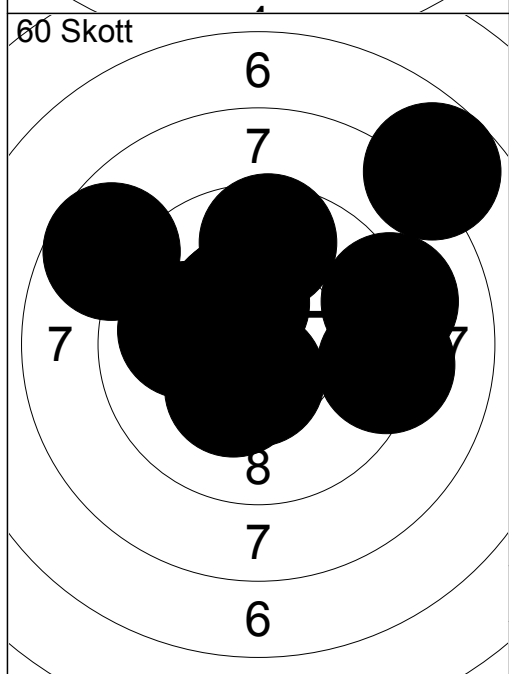

31:	9.6	↑
32:	10.3x	↘
33:	10.4x	↖
34:	9.1	→
35:	9.3	→
36:	8.7	↖
37:	10.5x	↓
38:	10.0	←
39:	10.4x	↖
40:	7.7	↗
Serie		92 (4x)
Total		364 (13x)

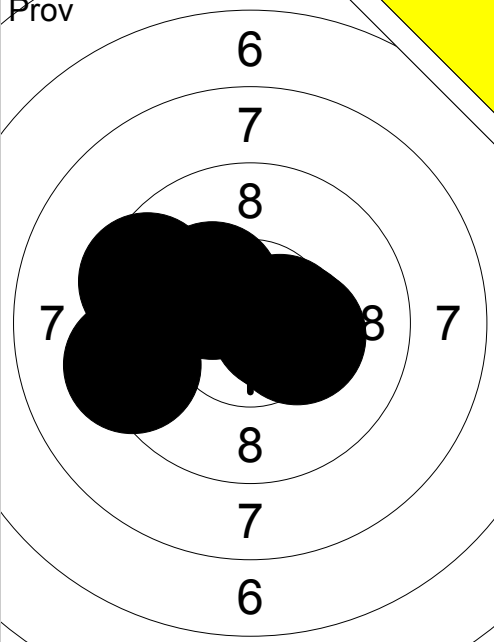
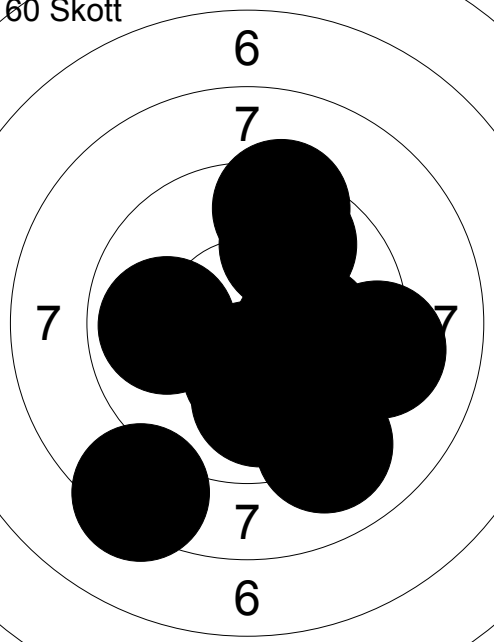
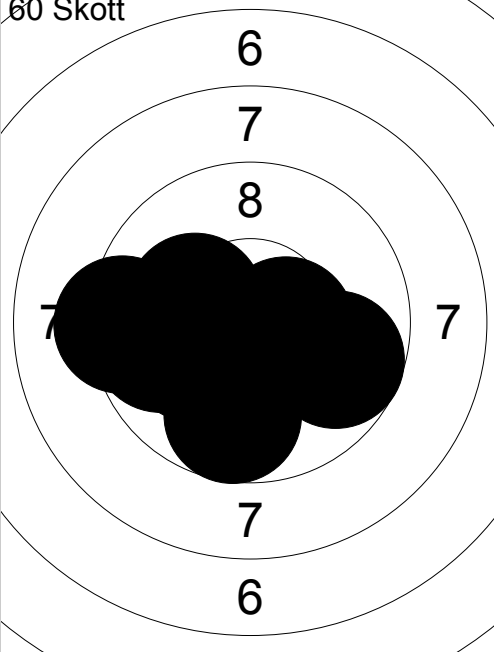
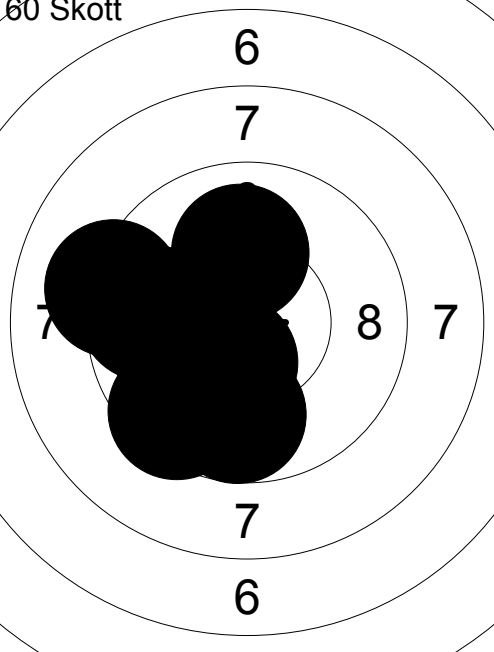
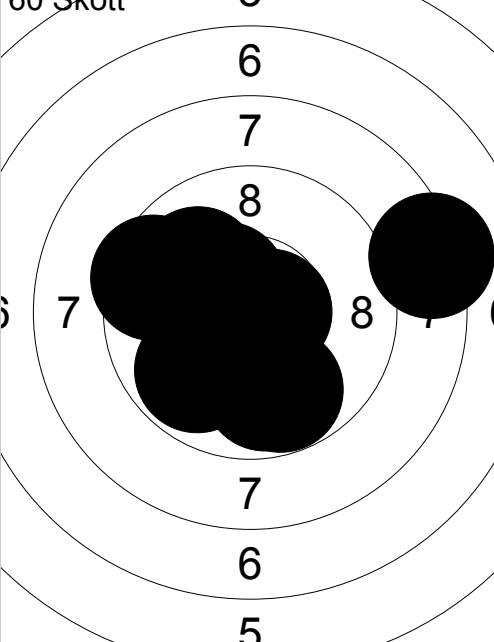
Ramselefors	Ramselefors	Funk	Vb
06.11.2022	Vindelnskyttet 2022	Ramselefors SKF	
Prov 	1: 9.5 ↖ 2: 9.3 ← 3: 10.3x ↖ 4: 10.4x → 5: 10.6x → 6: 10.3x → Serie 58 (4x) Total 0 (0x)	60 Skott 	1: 9.1 ↘ 2: 9.9 ← 3: 10.2x → 4: 9.8 ↗ 5: 9.4 ↗ 6: 10.2x → 7: 10.3x ↓ 8: 9.2 → 9: 10.0 ↓ 10: 8.3 ↘ Serie 93 (3x) Total 93 (3x)
60 Skott 	11: 10.6x ↙ 12: 10.5x → 13: 10.1 ← 14: 10.1 ← 15: 9.7 ↓ 16: 10.3x ← 17: 10.2x ↙ 18: 9.7 ← 19: 9.3 ← 20: 9.7 → Serie 96 (4x) Total 189 (7x)	60 Skott 	21: 10.1 ← 22: 10.0 ↑ 23: 10.0 ← 24: 9.7 ↓ 25: 10.3x ← 26: 10.1 ← 27: 9.1 ← 28: 10.4x ↓ 29: 9.6 ← 30: 9.5 ↘ Serie 96 (2x) Total 285 (9x)
60 Skott 	31: 10.7x → 32: 10.0 ↖ 33: 10.7x ↓ 34: 9.8 ↓ 35: 9.5 ← 36: 10.3x ← 37: 8.2 → 38: 10.4x ↖ 39: 9.8 ↓ 40: 9.8 ↘ Serie 94 (4x) Total 379 (13x)		

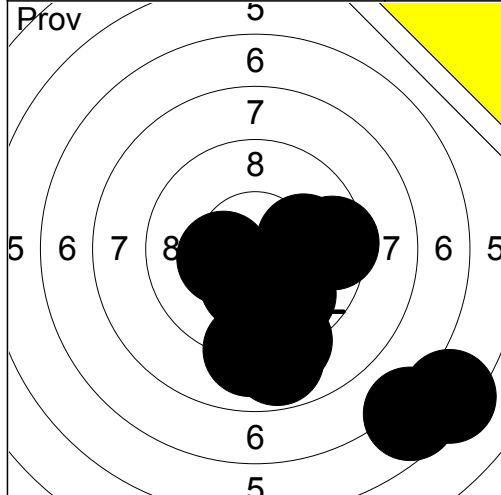

1:	9.9	↘
2:	6.6	↘
3:	8.8	↘
4:	10.0	→
5:	6.3	↘
6:	10.3x	↘
7:	9.1	↘
8:	9.0	↓
9:	10.3x	←
10:	9.5	→

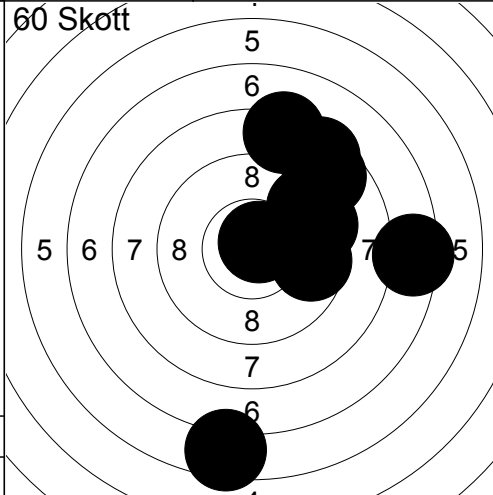

1:	9.4	↗
2:	10.7x	↗
3:	6.5	↓
4:	10.1	→
5:	8.7	↗
6:	9.4	→
7:	8.4	↗
8:	8.3	↑
9:	7.4	→
10:	9.6	→

Serie	86 (2x)
Total	0 (0x)

Serie	84 (1x)
Total	84 (1x)

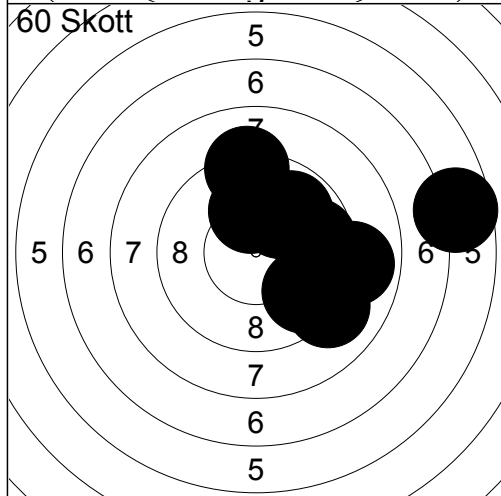

11:	6.6	→
12:	9.6	↘
13:	9.1	↘
14:	8.9	→
15:	9.9	↗
16:	10.0	↗
17:	10.1	↑
18:	9.8	↗
19:	9.2	↑
20:	9.7	→

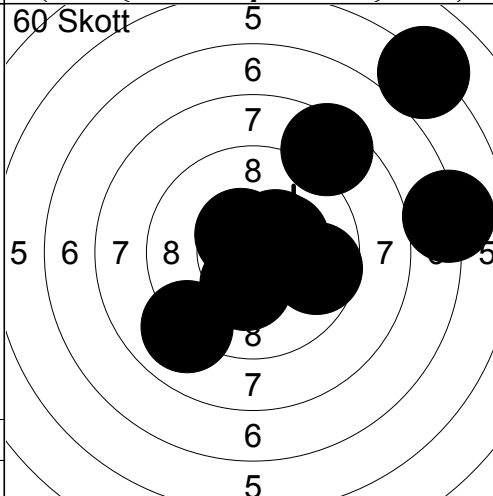

21:	6.1	↗
22:	9.0	↘
23:	9.7	→
24:	10.3x	→
25:	7.0	→
26:	10.6x	↗
27:	10.5x	↗
28:	8.5	↗
29:	10.3x	↓
30:	10.4x	↗

Serie	88 (0x)
Total	172 (1x)

Serie	89 (5x)
Total	261 (6x)

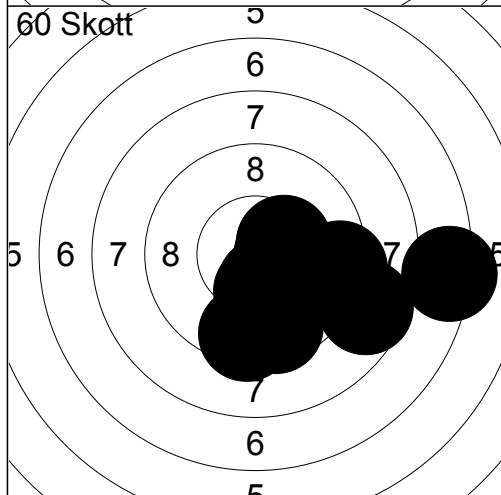

31:	10.4x	→
32:	7.3	→
33:	9.5	↘
34:	10.4x	↘
35:	10.4x	→
36:	10.0	↘
37:	10.2x	↘
38:	9.3	→
39:	9.4	↘
40:	8.6	↘

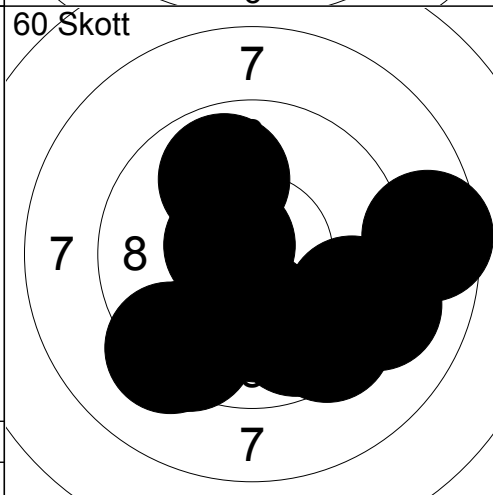

41:	9.4	↘
42:	10.1	↓
43:	8.5	→
44:	9.4	↘
45:	10.6x	←
46:	9.9	↑
47:	9.8	↘
48:	9.1	→
49:	9.3	↘
50:	9.4	↘

Serie	92 (4x)
Total	353 (10x)

Serie	91 (1x)
Total	444 (11x)

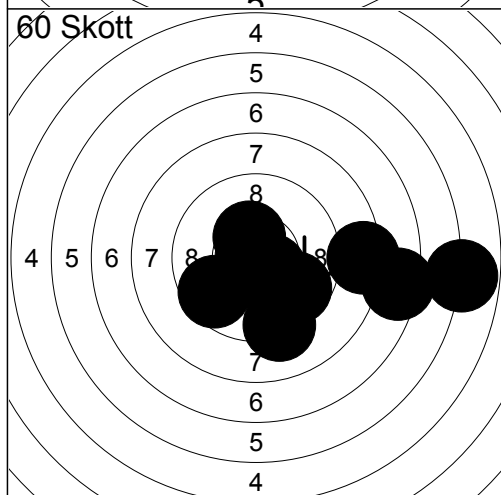

51:	7.4	→
52:	10.5x	↘
53:	9.6	↖
54:	5.8	→
55:	10.4x	↗
56:	10.8x	↖
57:	8.3	→
58:	10.3x	↘
59:	9.7	↘
60:	9.2	↘

Serie	87 (4x)
Total	531 (15x)

Pröv 	1: 9.3 ← 2: 9.3 ↗ 3: 10.3x ← 4: 10.1 ← 5: 9.9 ↗ 6: 9.4 ↗ 7: 10.3x ↗ 8: 9.6 ↗ 9: 10.0 ← 10: 10.0 ↗	Pröv 	11: 10.2x ↗ 12: 10.0 ↗ 13: 10.6x ↙ 14: 10.3x → 15: 10.6x ↗ 16: 9.6 ← 17: 9.9 ← 18: 10.7x ↙ 19: 10.4x ↙ 20: 10.5x ↗
	Serie 95 (2x)		Serie 98 (7x)
	Total 0 (0x)		Total 0 (0x)

Pröv 	21: 10.7x ← 22: 10.2x ↙ 23: 10.1 ↙ 24: 10.6x ↙ 25: 10.1 ↘ 26: 10.6x ↗ 27: 10.3x ↘ 28: 10.6x ↗ 29: 10.5x ↘ 30: 10.5x ↙	Pröv 	31: 10.6x ← 32: 10.0 ↓ 33: 10.4x ↙ 34: 10.6x ↗ 35: 10.3x ↘ 36: 10.7x → 37: 10.3x ↘ 38: 10.8x ↗ 39: 10.7x ↗ 40: 10.8x ↗
	Serie 100 (8x)		Serie 100 (9x)
	Total 0 (0x)		Total 0 (0x)

Pröv 	41: 10.1 → 42: 10.7x ← 43: 10.4x ↗ 44: 10.8x ↘	60 Skott 	1: 9.8 ← 2: 9.9 ↗ 3: 10.3x ↘ 4: 9.7 ↘ 5: 10.2x ↘ 6: 10.2x ↗ 7: 10.4x ↗ 8: 10.4x → 9: 10.8x ← 10: 10.4x ←
	Serie 40 (3x)		Serie 97 (7x)
	Total 0 (0x)		Total 97 (7x)

60 Skott 	11: 10.2x → 12: 9.7 ↘ 13: 10.1 ↘ 14: 10.4x ↙ 15: 10.6x ↘ 16: 10.5x ↘ 17: 10.3x ↘ 18: 10.1 ↘ 19: 10.5x ↘ 20: 10.6x →	60 Skott 	21: 10.8x ↘ 22: 10.0 → 23: 10.2x ↗ 24: 10.9x → 25: 10.5x ↘ 26: 10.4x → 27: 10.5x → 28: 10.0 ↓ 29: 10.4x → 30: 10.1 →
	Serie 99 (7x)		Serie 100 (7x)
	Total 196 (14x)		Total 296 (21x)

60 Skott 	31: 10.1 ← 32: 10.2x → 33: 10.9x ↗ 34: 10.1 ↘ 35: 10.4x ↘ 36: 10.5x ↘ 37: 10.5x ↗ 38: 10.2x ↗ 39: 9.3 ← 40: 10.0 →		
	Serie 99 (6x)		
	Total 395 (27x)		

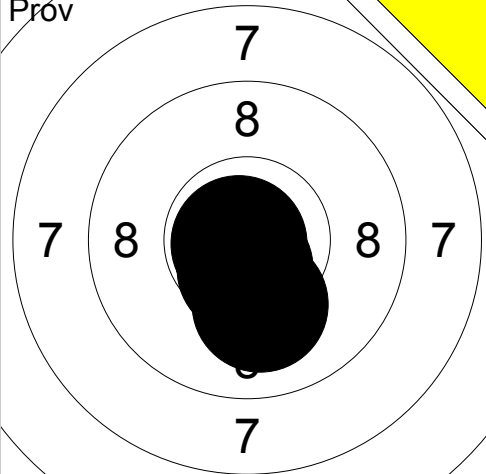
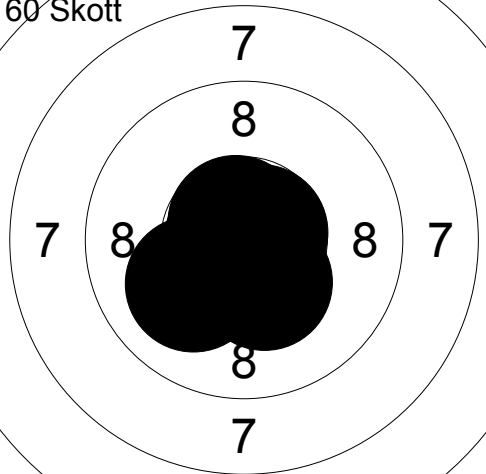
Pröv 	1: 10.1 ↓ 2: 10.8x ← 3: 10.6x ↓ Serie 30 (2x) Total 0 (0x)	60 Skott 	1: 10.7x ↓ 2: 10.3x ↓ 3: 10.8x ← 4: 10.9x ↑ 5: 10.9x ↓ 6: 10.8x ↓ 7: 10.7x → 8: 10.9x ← 9: 10.1 ← 10: 10.7x ↑ Serie 100 (9x) Total 100 (9x)
--	--	--	--

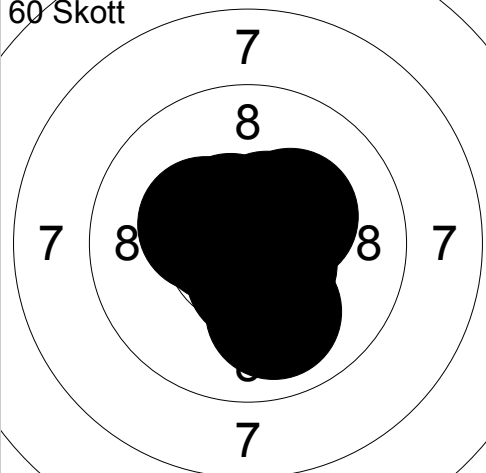
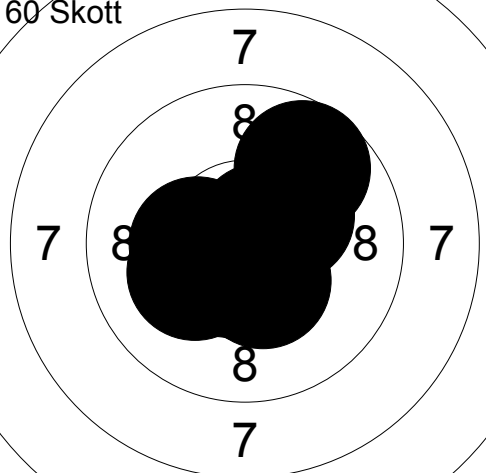
60 Skott 	11: 10.3x ← 12: 10.6x ↓ 13: 10.7x ↑ 14: 10.6x ← 15: 10.7x ↑ 16: 10.6x ↑ 17: 10.5x → 18: 10.3x → 19: 10.5x ↓ 20: 10.0 ↓ Serie 100 (9x) Total 200 (18x)	60 Skott 	21: 10.2x ← 22: 10.4x ← 23: 10.7x → 24: 10.4x ↓ 25: 10.3x ← 26: 10.5x ↓ 27: 10.5x ↓ 28: 10.3x → 29: 10.8x ↓ 30: 9.7 ↑ Serie 99 (9x) Total 299 (27x)
---	--	---	--

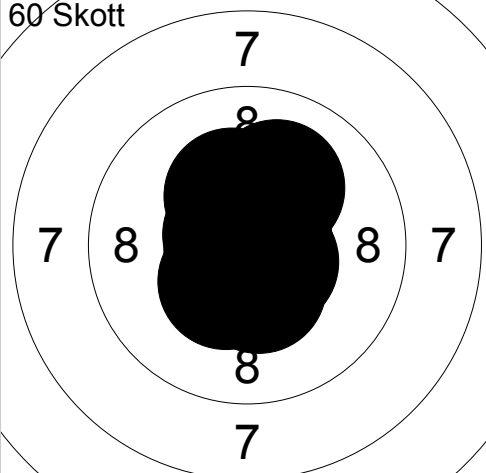
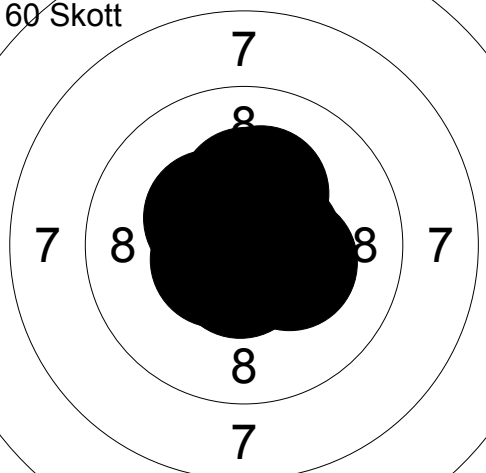
60 Skott 	31: 10.1 ↑ 32: 10.5x ↑ 33: 10.7x ← 34: 10.3x ↑ 35: 10.7x → 36: 10.4x ↓ 37: 10.6x ↓ 38: 10.7x ↑ 39: 10.4x ↓ 40: 10.8x ↓ Serie 100 (9x) Total 399 (36x)	60 Skott 	41: 10.2x ↑ 42: 10.8x ↑ 43: 10.4x ↖ 44: 10.6x ← 45: 10.6x → 46: 10.3x → 47: 10.6x ↓ 48: 10.3x ↑ 49: 10.6x ↖ 50: 10.7x ← Serie 100 (10x) Total 499 (46x)
--	--	--	--

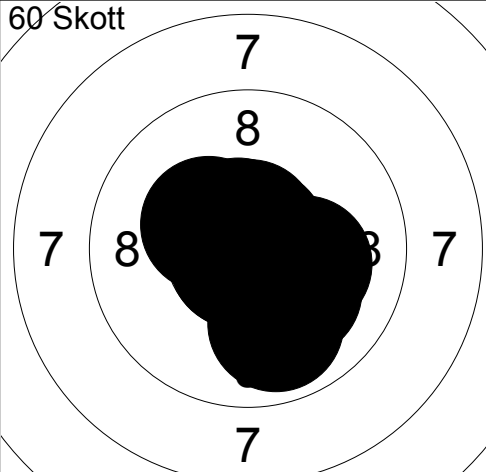
60 Skott 	51: 10.6x ↑ 52: 10.1 ↓ 53: 10.7x ↑ 54: 10.6x ↓ 55: 10.2x → 56: 10.3x ↖ 57: 9.9 ↓ 58: 10.7x ↖ 59: 10.7x ↑ 60: 10.8x ↖ Serie 99 (8x) Total 598 (54x)		
--	---	--	--