

Skjuttag 1	Tavla 6	Stefan Thorin	
S		Umeå Skf	
05.11.2022		Umeå skytteallians	
Extraskottet 2022			
Prov		1: 10.0 ↗ 2: 10.4x → 3: 10.4x → 4: 10.4x ↗ 5: 7.5 → 6: 9.6 ← 7: 10.0 ← 8: 10.0 ↑ 9: 8.7 ← 10: 10.6x ↓ Serie 97.6 Total 0.0	60 Skott
			 1: 10.6x ↖ 2: 10.3 → 3: 9.6 ← 4: 9.7 ↓ 5: 9.5 ↓ 6: 10.6x ↓ 7: 9.9 ↓ 8: 9.9 ↖ 9: 9.7 ↑ 10: 10.0 ↖ Serie 99.8 Total 99.8
60 Skott		11: 10.1 ↓ 12: 10.4x ↗ 13: 9.7 ← 14: 9.0 ↖ 15: 9.4 ↗ 16: 10.1 ↖ 17: 9.7 ↓ 18: 9.5 ← 19: 10.3x ↗ 20: 10.0 ← Serie 98.2 Total 198.0	60 Skott
			 21: 10.7x ↓ 22: 10.1 ← 23: 9.3 ↗ 24: 9.6 ↗ 25: 10.8x ↗ 26: 10.0 ↓ 27: 10.1 ↖ 28: 8.9 ← 29: 10.1 ↖ 30: 10.0 ← Serie 99.6 Total 297.6
60 Skott		31: 9.4 ↗ 32: 10.1 → 33: 10.2 → 34: 10.1 ↗ 35: 9.3 ← 36: 9.5 ↗ 37: 10.4x ← 38: 9.3 → 39: 9.8 ← 40: 10.0 → Serie 98.1 Total 395.7	60 Skott
			 41: 10.1 ↖ 42: 10.1 ← 43: 9.3 → 44: 9.4 ↑ 45: 9.6 ↗ 46: 9.7 ↓ 47: 10.8x ↗ 48: 10.1 ↓ 49: 9.9 → 50: 10.2 ↖ Serie 99.2 Total 494.9
60 Skott		51: 10.7x → 52: 9.9 ↓ 53: 9.8 ↓ 54: 10.4x ↗ 55: 10.4x → 56: 9.9 ↓ 57: 10.8x ↗ 58: 9.9 → 59: 10.9x → 60: 10.1 ↖ Serie 102.8 Total 597.7	

	<table style="width:100%; border-collapse: collapse;"> <tr><td>1:</td><td>5.4</td><td>↑</td></tr> <tr><td>2:</td><td>9.5</td><td>↙</td></tr> <tr><td>3:</td><td>7.5</td><td>←</td></tr> <tr><td>4:</td><td>9.2</td><td>←</td></tr> <tr><td>5:</td><td>9.8</td><td>↗</td></tr> <tr><td>6:</td><td>9.5</td><td>↖</td></tr> <tr><td>7:</td><td>8.8</td><td>↘</td></tr> <tr><td>8:</td><td>9.6</td><td>↘</td></tr> <tr><td>9:</td><td>9.0</td><td>↘</td></tr> <tr><td>10:</td><td>9.5</td><td>↓</td></tr> <tr><td colspan="2">Serie</td><td>87.8</td></tr> <tr><td colspan="2">Total</td><td>0.0</td></tr> </table>	1:	5.4	↑	2:	9.5	↙	3:	7.5	←	4:	9.2	←	5:	9.8	↗	6:	9.5	↖	7:	8.8	↘	8:	9.6	↘	9:	9.0	↘	10:	9.5	↓	Serie		87.8	Total		0.0		<table style="width:100%; border-collapse: collapse;"> <tr><td>11:</td><td>10.5x</td><td>↓</td></tr> <tr><td>12:</td><td>10.7x</td><td>→</td></tr> <tr><td>13:</td><td>10.1</td><td>←</td></tr> <tr><td>14:</td><td>10.3x</td><td>↗</td></tr> <tr><td>15:</td><td>10.4x</td><td>↘</td></tr> <tr><td colspan="2">Serie</td><td>52.0</td></tr> <tr><td colspan="2">Total</td><td>0.0</td></tr> </table>	11:	10.5x	↓	12:	10.7x	→	13:	10.1	←	14:	10.3x	↗	15:	10.4x	↘	Serie		52.0	Total		0.0															
1:	5.4	↑																																																																									
2:	9.5	↙																																																																									
3:	7.5	←																																																																									
4:	9.2	←																																																																									
5:	9.8	↗																																																																									
6:	9.5	↖																																																																									
7:	8.8	↘																																																																									
8:	9.6	↘																																																																									
9:	9.0	↘																																																																									
10:	9.5	↓																																																																									
Serie		87.8																																																																									
Total		0.0																																																																									
11:	10.5x	↓																																																																									
12:	10.7x	→																																																																									
13:	10.1	←																																																																									
14:	10.3x	↗																																																																									
15:	10.4x	↘																																																																									
Serie		52.0																																																																									
Total		0.0																																																																									
	<table style="width:100%; border-collapse: collapse;"> <tr><td>1:</td><td>9.8</td><td>↘</td></tr> <tr><td>2:</td><td>9.6</td><td>↘</td></tr> <tr><td>3:</td><td>10.4x</td><td>→</td></tr> <tr><td>4:</td><td>10.3x</td><td>↑</td></tr> <tr><td>5:</td><td>10.2</td><td>↗</td></tr> <tr><td>6:</td><td>10.6x</td><td>↗</td></tr> <tr><td>7:</td><td>10.2</td><td>↘</td></tr> <tr><td>8:</td><td>9.4</td><td>←</td></tr> <tr><td>9:</td><td>10.4x</td><td>←</td></tr> <tr><td>10:</td><td>10.5x</td><td>↘</td></tr> <tr><td colspan="2">Serie</td><td>101.4</td></tr> <tr><td colspan="2">Total</td><td>101.4</td></tr> </table>	1:	9.8	↘	2:	9.6	↘	3:	10.4x	→	4:	10.3x	↑	5:	10.2	↗	6:	10.6x	↗	7:	10.2	↘	8:	9.4	←	9:	10.4x	←	10:	10.5x	↘	Serie		101.4	Total		101.4		<table style="width:100%; border-collapse: collapse;"> <tr><td>11:</td><td>10.1</td><td>↑</td></tr> <tr><td>12:</td><td>10.1</td><td>←</td></tr> <tr><td>13:</td><td>10.3x</td><td>↗</td></tr> <tr><td>14:</td><td>10.3</td><td>↑</td></tr> <tr><td>15:</td><td>10.0</td><td>↗</td></tr> <tr><td>16:</td><td>9.9</td><td>↓</td></tr> <tr><td>17:</td><td>8.9</td><td>↓</td></tr> <tr><td>18:</td><td>10.6x</td><td>↑</td></tr> <tr><td>19:</td><td>10.1</td><td>↘</td></tr> <tr><td>20:</td><td>9.6</td><td>↗</td></tr> <tr><td colspan="2">Serie</td><td>99.9</td></tr> <tr><td colspan="2">Total</td><td>201.3</td></tr> </table>	11:	10.1	↑	12:	10.1	←	13:	10.3x	↗	14:	10.3	↑	15:	10.0	↗	16:	9.9	↓	17:	8.9	↓	18:	10.6x	↑	19:	10.1	↘	20:	9.6	↗	Serie		99.9	Total		201.3
1:	9.8	↘																																																																									
2:	9.6	↘																																																																									
3:	10.4x	→																																																																									
4:	10.3x	↑																																																																									
5:	10.2	↗																																																																									
6:	10.6x	↗																																																																									
7:	10.2	↘																																																																									
8:	9.4	←																																																																									
9:	10.4x	←																																																																									
10:	10.5x	↘																																																																									
Serie		101.4																																																																									
Total		101.4																																																																									
11:	10.1	↑																																																																									
12:	10.1	←																																																																									
13:	10.3x	↗																																																																									
14:	10.3	↑																																																																									
15:	10.0	↗																																																																									
16:	9.9	↓																																																																									
17:	8.9	↓																																																																									
18:	10.6x	↑																																																																									
19:	10.1	↘																																																																									
20:	9.6	↗																																																																									
Serie		99.9																																																																									
Total		201.3																																																																									
	<table style="width:100%; border-collapse: collapse;"> <tr><td>21:</td><td>10.2</td><td>←</td></tr> <tr><td>22:</td><td>9.1</td><td>←</td></tr> <tr><td>23:</td><td>9.8</td><td>↗</td></tr> <tr><td>24:</td><td>10.4x</td><td>←</td></tr> <tr><td>25:</td><td>10.2</td><td>↘</td></tr> <tr><td>26:</td><td>10.3x</td><td>→</td></tr> <tr><td>27:</td><td>9.6</td><td>↗</td></tr> <tr><td>28:</td><td>9.9</td><td>↘</td></tr> <tr><td>29:</td><td>9.7</td><td>↘</td></tr> <tr><td>30:</td><td>10.0</td><td>←</td></tr> <tr><td colspan="2">Serie</td><td>99.2</td></tr> <tr><td colspan="2">Total</td><td>300.5</td></tr> </table>	21:	10.2	←	22:	9.1	←	23:	9.8	↗	24:	10.4x	←	25:	10.2	↘	26:	10.3x	→	27:	9.6	↗	28:	9.9	↘	29:	9.7	↘	30:	10.0	←	Serie		99.2	Total		300.5		<table style="width:100%; border-collapse: collapse;"> <tr><td>31:</td><td>8.9</td><td>↙</td></tr> <tr><td>32:</td><td>10.0</td><td>↗</td></tr> <tr><td>33:</td><td>10.4x</td><td>↙</td></tr> <tr><td>34:</td><td>8.8</td><td>↘</td></tr> <tr><td>35:</td><td>8.8</td><td>↘</td></tr> <tr><td>36:</td><td>10.1</td><td>↘</td></tr> <tr><td>37:</td><td>10.5x</td><td>↗</td></tr> <tr><td>38:</td><td>9.9</td><td>↘</td></tr> <tr><td>39:</td><td>9.6</td><td>↘</td></tr> <tr><td>40:</td><td>10.2</td><td>↘</td></tr> <tr><td colspan="2">Serie</td><td>97.2</td></tr> <tr><td colspan="2">Total</td><td>397.7</td></tr> </table>	31:	8.9	↙	32:	10.0	↗	33:	10.4x	↙	34:	8.8	↘	35:	8.8	↘	36:	10.1	↘	37:	10.5x	↗	38:	9.9	↘	39:	9.6	↘	40:	10.2	↘	Serie		97.2	Total		397.7
21:	10.2	←																																																																									
22:	9.1	←																																																																									
23:	9.8	↗																																																																									
24:	10.4x	←																																																																									
25:	10.2	↘																																																																									
26:	10.3x	→																																																																									
27:	9.6	↗																																																																									
28:	9.9	↘																																																																									
29:	9.7	↘																																																																									
30:	10.0	←																																																																									
Serie		99.2																																																																									
Total		300.5																																																																									
31:	8.9	↙																																																																									
32:	10.0	↗																																																																									
33:	10.4x	↙																																																																									
34:	8.8	↘																																																																									
35:	8.8	↘																																																																									
36:	10.1	↘																																																																									
37:	10.5x	↗																																																																									
38:	9.9	↘																																																																									
39:	9.6	↘																																																																									
40:	10.2	↘																																																																									
Serie		97.2																																																																									
Total		397.7																																																																									
	<table style="width:100%; border-collapse: collapse;"> <tr><td>41:</td><td>9.5</td><td>↘</td></tr> <tr><td>42:</td><td>9.8</td><td>→</td></tr> <tr><td>43:</td><td>10.2</td><td>↗</td></tr> <tr><td>44:</td><td>9.7</td><td>↗</td></tr> <tr><td>45:</td><td>10.7x</td><td>↗</td></tr> <tr><td>46:</td><td>10.1</td><td>→</td></tr> <tr><td>47:</td><td>10.1</td><td>↘</td></tr> <tr><td>48:</td><td>10.6x</td><td>↘</td></tr> <tr><td>49:</td><td>10.1</td><td>←</td></tr> <tr><td>50:</td><td>10.7x</td><td>↘</td></tr> <tr><td colspan="2">Serie</td><td>101.5</td></tr> <tr><td colspan="2">Total</td><td>499.2</td></tr> </table>	41:	9.5	↘	42:	9.8	→	43:	10.2	↗	44:	9.7	↗	45:	10.7x	↗	46:	10.1	→	47:	10.1	↘	48:	10.6x	↘	49:	10.1	←	50:	10.7x	↘	Serie		101.5	Total		499.2		<table style="width:100%; border-collapse: collapse;"> <tr><td>51:</td><td>10.4x</td><td>↘</td></tr> <tr><td>52:</td><td>10.8x</td><td>↗</td></tr> <tr><td>53:</td><td>9.3</td><td>↗</td></tr> <tr><td>54:</td><td>9.8</td><td>↗</td></tr> <tr><td>55:</td><td>10.5x</td><td>←</td></tr> <tr><td>56:</td><td>10.7x</td><td>↘</td></tr> <tr><td>57:</td><td>9.5</td><td>→</td></tr> <tr><td>58:</td><td>10.0</td><td>↘</td></tr> <tr><td>59:</td><td>10.1</td><td>↗</td></tr> <tr><td>60:</td><td>10.2</td><td>↘</td></tr> <tr><td colspan="2">Serie</td><td>101.3</td></tr> <tr><td colspan="2">Total</td><td>600.5</td></tr> </table>	51:	10.4x	↘	52:	10.8x	↗	53:	9.3	↗	54:	9.8	↗	55:	10.5x	←	56:	10.7x	↘	57:	9.5	→	58:	10.0	↘	59:	10.1	↗	60:	10.2	↘	Serie		101.3	Total		600.5
41:	9.5	↘																																																																									
42:	9.8	→																																																																									
43:	10.2	↗																																																																									
44:	9.7	↗																																																																									
45:	10.7x	↗																																																																									
46:	10.1	→																																																																									
47:	10.1	↘																																																																									
48:	10.6x	↘																																																																									
49:	10.1	←																																																																									
50:	10.7x	↘																																																																									
Serie		101.5																																																																									
Total		499.2																																																																									
51:	10.4x	↘																																																																									
52:	10.8x	↗																																																																									
53:	9.3	↗																																																																									
54:	9.8	↗																																																																									
55:	10.5x	←																																																																									
56:	10.7x	↘																																																																									
57:	9.5	→																																																																									
58:	10.0	↘																																																																									
59:	10.1	↗																																																																									
60:	10.2	↘																																																																									
Serie		101.3																																																																									
Total		600.5																																																																									

Skjutlag	Tavla	Håkan Lidman	
S	Rönnskärs Skf		
05.11.2022	Extraskottet 2022	Umeå skytteallians	
Pröv		1: 6.2 ↑ 2: 10.4x ↑ 3: 9.3 ↗ 4: 8.5 ↑ 5: 10.5x ↖ 6: 9.9 ↘ 7: 9.9 ↗ 8: 9.9 ↑ 9: 9.7 ↑ 10: 9.6 ↘ Serie 93.9 Total 0.0	Pröv 11: 10.0 ↑ 12: 9.6 → 13: 9.9 ↘ 14: 10.4x ↗ 15: 10.4x → 16: 8.8 ↖ 17: 10.7x ↑ 18: 10.2 ↘ 19: 9.7 ↘ 20: 10.7x ↙ Serie 100.4 Total 0.0
60 Skott		1: 9.8 ↓ 2: 9.1 ↓ 3: 9.8 ↓ 4: 10.0 → 5: 10.5x ↑ 6: 10.8x ← 7: 10.0 ↗ 8: 10.2 ↗ 9: 10.1 ↓ 10: 10.1 ↙ Serie 100.4 Total 100.4	60 Skott 11: 9.7 ↘ 12: 9.7 ← 13: 10.5x ↓ 14: 9.7 ↗ 15: 9.9 ↓ 16: 9.9 → 17: 10.1 ↘ 18: 9.0 → 19: 10.2 ↗ 20: 9.4 → Serie 98.1 Total 198.5
60 Skott		21: 10.1 → 22: 10.6x ↖ 23: 9.6 ↗ 24: 9.5 → 25: 9.8 → 26: 9.3 ↓ 27: 9.4 ↓ 28: 10.3 → 29: 10.2 ↑ 30: 10.1 ↗ Serie 98.9 Total 297.4	60 Skott 31: 10.7x ← 32: 9.9 ↖ 33: 9.1 ↘ 34: 10.3x ↘ 35: 9.4 ↗ 36: 10.0 ↗ 37: 10.2 ← 38: 10.6x ← 39: 9.9 ↗ 40: 10.0 ↗ Serie 100.1 Total 397.5
60 Skott		41: 9.8 ↖ 42: 9.9 ↑ 43: 9.2 → 44: 10.5x ↘ 45: 9.9 ← 46: 10.7x ↖ 47: 9.7 ↖ 48: 10.4x ↘ 49: 10.5x ← 50: 9.4 ↓ Serie 100.0 Total 497.5	60 Skott 51: 10.7x ← 52: 9.8 ← 53: 10.2 → 54: 10.2 ↘ 55: 9.5 ↘ 56: 10.1 ↑ 57: 9.2 → 58: 9.2 ↗ 59: 10.4x ↑ 60: 9.9 ↗ Serie 99.2 Total 596.7

Skjuttlag	Tavla	Emma Johansson	
S		Ramselefors Skf	
05.11.2022		Extraskottet 2022	Umeå skytteallians
Prov		1: 7.8 ↗ 2: 10.0 ← 3: 8.4 ↗ 4: 8.5 ↗ 5: 8.6 ↗ 6: 10.5x ↗ 7: 10.3x ← 8: 10.5x ↗ 9: 10.2 ↗ 10: 10.0 ↘ Serie 94.8 Total 0.0	Prov
			11: 10.1 ↗ Serie 10.1 Total 0.0
60 Skott		1: 10.2 ↘ 2: 10.3 ← 3: 9.7 ↘ 4: 10.3x ↗ 5: 10.0 ↘ 6: 10.4x ↗ 7: 10.2 ↗ 8: 10.5x ↗ 9: 9.7 → 10: 10.4x ← Serie 101.7 Total 101.7	60 Skott
			11: 9.4 → 12: 10.4x ↗ 13: 9.9 → 14: 10.2 ↗ 15: 10.4x ↗ 16: 9.8 ↘ 17: 9.4 ↘ 18: 9.8 ↘ 19: 10.3x ↗ 20: 10.9x ↗ Serie 100.5 Total 202.2
60 Skott		21: 9.4 → 22: 9.6 → 23: 10.2 ↗ 24: 9.9 ← 25: 10.8x ↘ 26: 10.1 ↘ 27: 9.9 ↘ 28: 10.6x ↘ 29: 9.3 ↗ 30: 9.9 ↘ Serie 99.7 Total 301.9	60 Skott
			31: 10.5x → 32: 10.1 ↗ 33: 10.7x ↘ 34: 9.7 ← 35: 10.6x ↗ 36: 9.4 ↗ 37: 10.9x ← 38: 10.2 → 39: 9.5 ↗ 40: 10.3 ↘ Serie 101.9 Total 403.8
60 Skott		41: 9.4 ↘ 42: 9.7 ↗ 43: 9.8 ↘ 44: 10.1 ↘ 45: 10.1 ↗ 46: 10.4x ↗ 47: 10.6x ↗ 48: 10.4x ↗ 49: 10.4x ↘ 50: 8.6 ↗ Serie 99.5 Total 503.3	60 Skott
			51: 10.2 ↗ 52: 10.6x ↘ 53: 9.8 ↗ 54: 10.0 ↗ 55: 9.8 ↗ 56: 9.8 ↘ 57: 10.3x ↘ 58: 10.0 ↗ 59: 10.0 ↗ 60: 10.5x ↗ Serie 101.0 Total 604.3

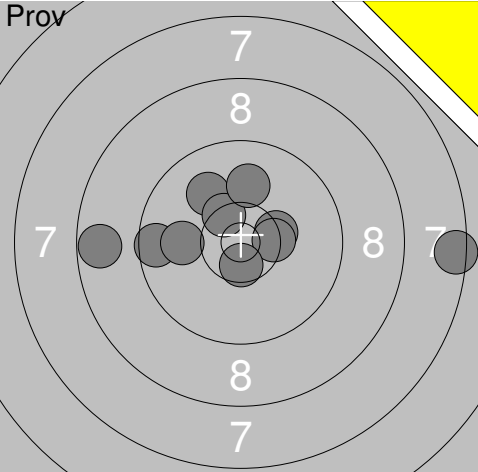
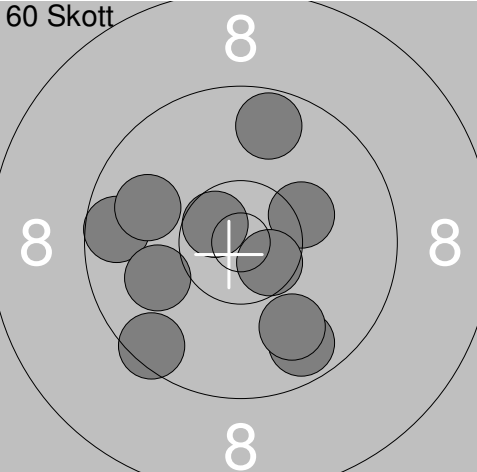
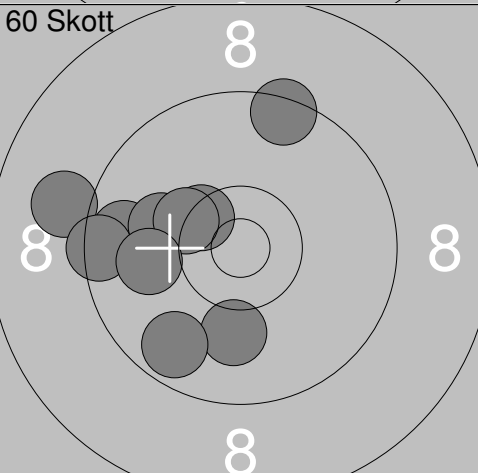
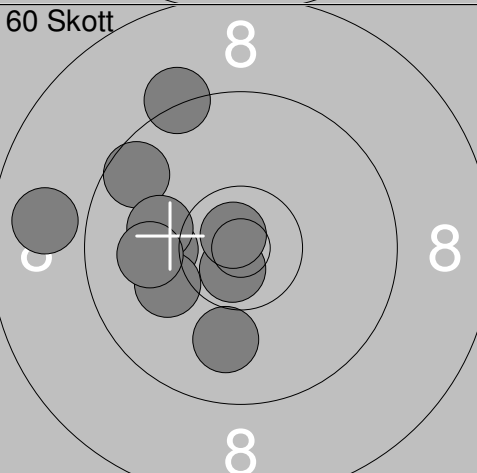
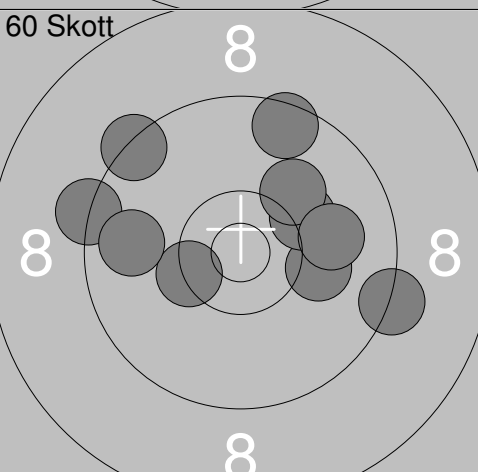
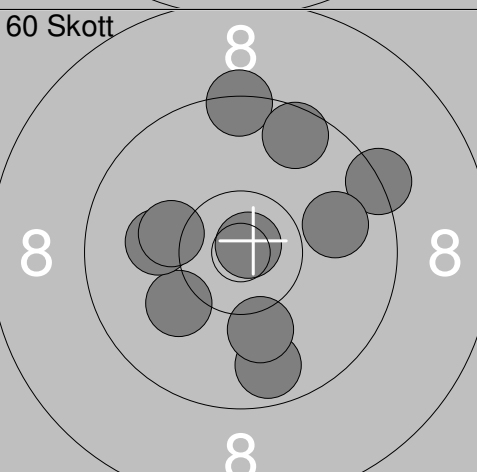
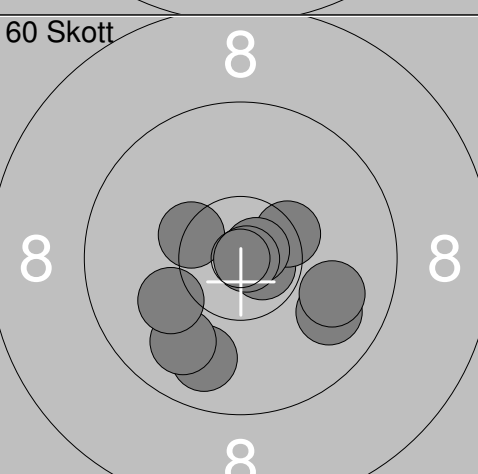
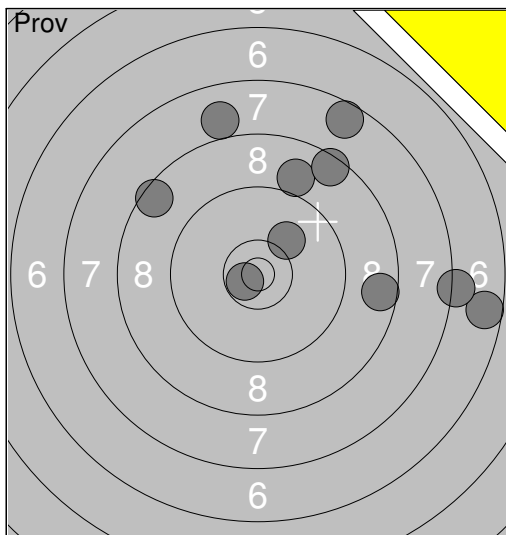

1:	6.6	→
2:	10.7x	↙
3:	9.0	↗
4:	10.1	↗
5:	8.6	→
6:	7.6	↗
7:	8.0	↗
8:	8.5	↗
9:	8.5	↗
10:	7.2	→
Serie		84.8
Total		604.3

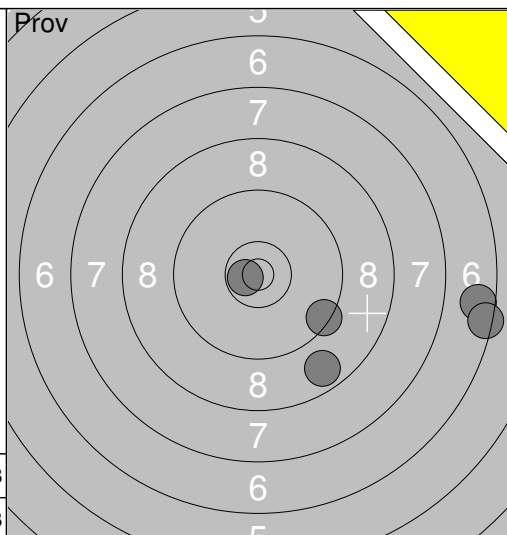

11:	6.6	→
12:	10.7x	↙
13:	6.4	→
14:	9.4	↘
15:	8.7	↘
Serie		41.8
Total		604.3

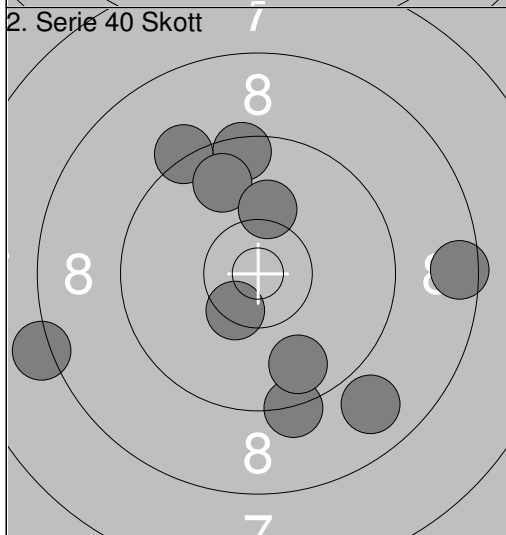

1:	9.3	↘
2:	8.5	→
3:	8.2	↙
4:	9.5	↗
5:	9.3	↗
6:	8.9	↘
7:	9.8	↗
8:	10.2	↗
9:	9.8	↘
10:	10.4x	↘
Serie		93.9
Total		698.2

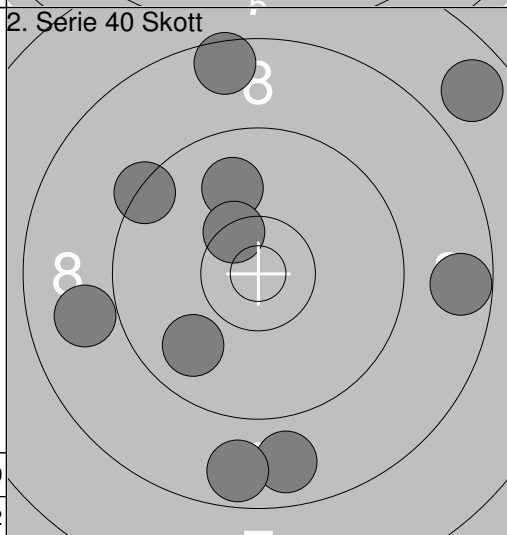

11:	8.8	↘
12:	9.9	↙
13:	9.9	↗
14:	10.4x	↗
15:	9.4	↗
16:	8.9	↙
17:	8.7	→
18:	7.8	↗
19:	8.6	↗
20:	8.7	↘
Serie		91.1
Total		789.3

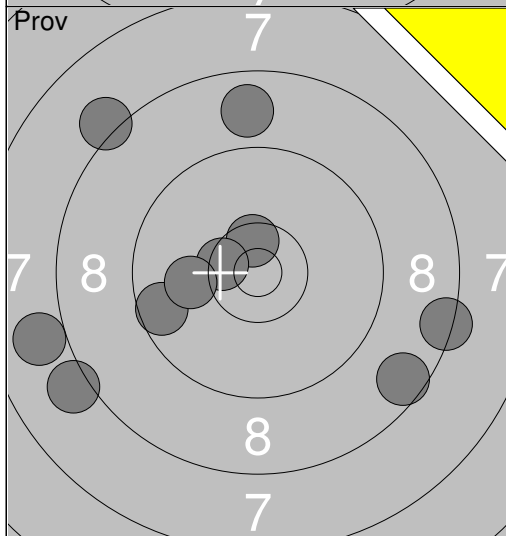

1:	8.4	→
2:	8.6	↘
3:	9.6	↙
4:	8.0	↙
5:	10.5x	↗
6:	8.1	↙
7:	10.5x	↙
8:	8.8	↗
9:	8.2	↗
10:	10.1	↙
Serie		90.8
Total		789.3

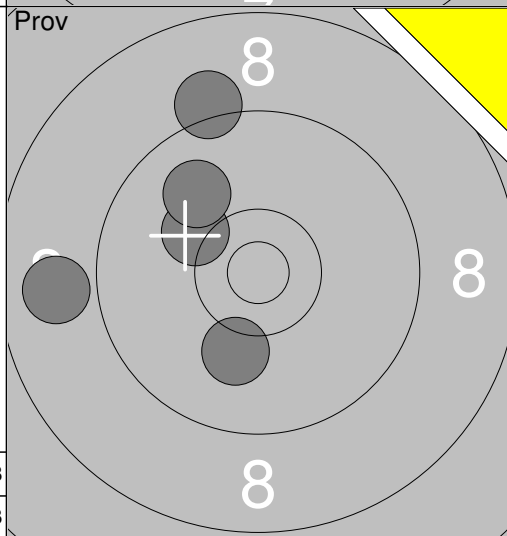

11:	10.2	↗
12:	9.9	↗
13:	9.2	↗
14:	10.1	↘
15:	8.9	↙
Serie		48.3
Total		789.3

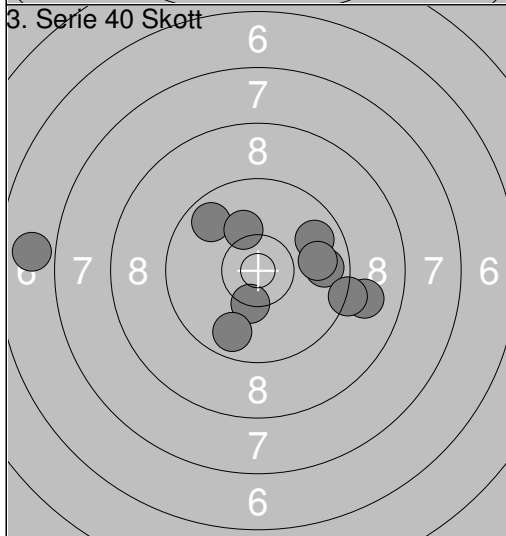

1:	9.0	→
2:	9.8	→
3:	10.3x	↘
4:	9.7	↗
5:	10.2	↗
6:	9.8	→
7:	9.3	→
8:	9.9	→
9:	9.8	↘
10:	6.9	↙
Serie		94.7
Total		884.0

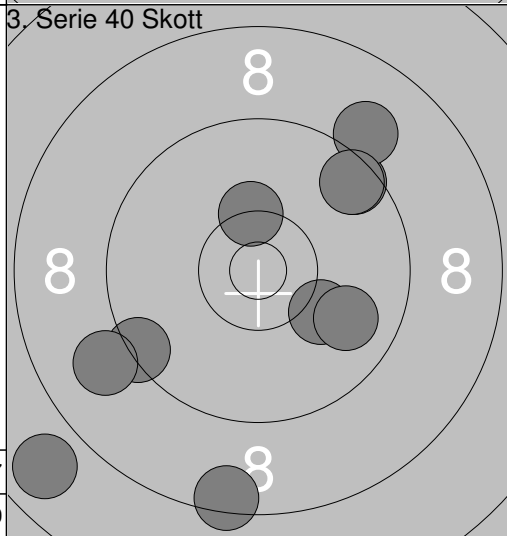

11:	8.5	↘
12:	9.4	↙
13:	7.8	↙
14:	10.3x	↗
15:	9.5	↗
16:	9.1	↗
17:	9.0	↙
18:	10.1	↘
19:	9.6	↗
20:	9.9	↘
Serie		93.2
Total		977.2

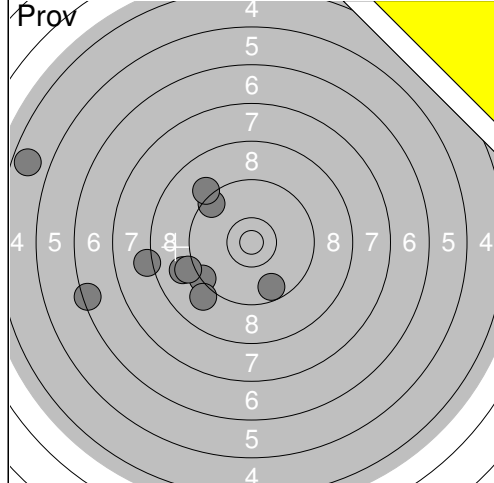

1:	4.7	↖
2:	9.3	↙
3:	8.2	↖
4:	6.4	↖
5:	9.0	↖
6:	9.0	↙
7:	9.7	↙
8:	9.1	↖
9:	9.5	↗
10:	9.2	↗
Serie		84.1
Total		0.0

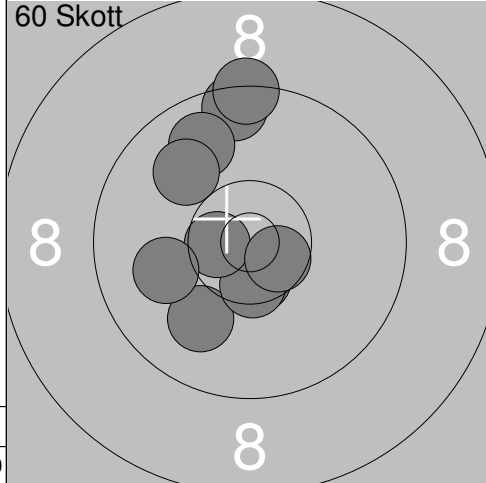

1:	9.5	↑
2:	9.8	↗
3:	10.5x	↘
4:	9.4	↑
5:	10.0	↙
6:	10.0	↗
7:	10.5x	↘
8:	10.6x	↖
9:	10.6x	↗
10:	10.0	↖
Serie		100.9
Total		100.9

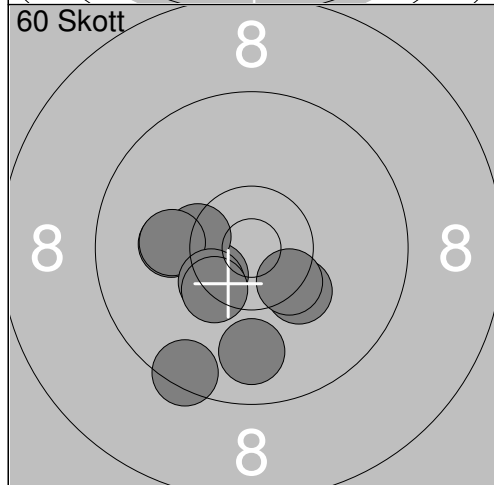

11:	9.9	↓
12:	9.5	↘
13:	10.3	↘
14:	10.5x	↖
15:	10.1	↖
16:	10.4x	↖
17:	10.1	↖
18:	10.4x	↖
19:	10.4x	↖
20:	10.4x	↘
Serie		102.0
Total		202.9

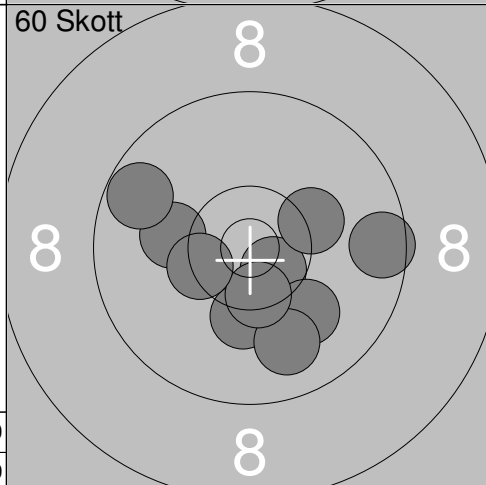

21:	10.6x	↘
22:	10.2	↓
23:	10.2	↗
24:	10.0	↘
25:	10.1	↖
26:	9.9	↘
27:	9.6	↗
28:	9.7	↗
29:	10.5x	↘
30:	10.4x	↖
Serie		101.2
Total		304.1

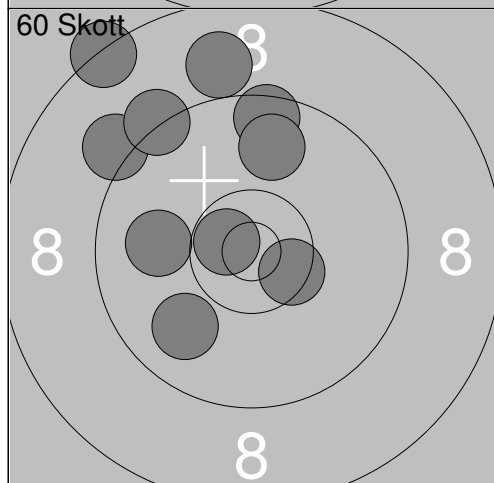

31:	9.9	↖
32:	10.5x	↗
33:	10.0	↖
34:	9.1	↗
35:	9.5	↑
36:	9.8	↑
37:	9.0	↑
38:	10.7x	↗
39:	9.3	↗
40:	8.3	↗
Serie		96.1
Total		400.2

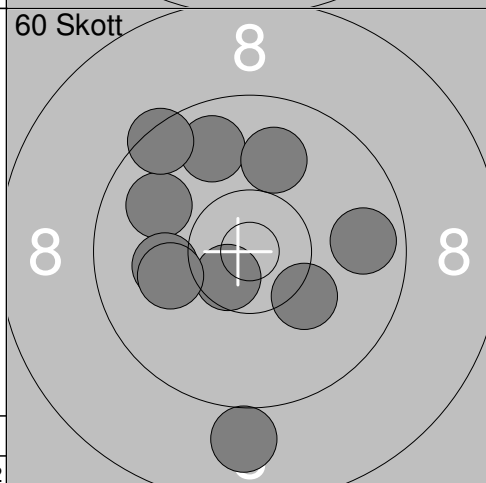

41:	9.9	↖
42:	10.2	↘
43:	9.8	↗
44:	9.5	↗
45:	9.0	↓
46:	10.6x	↖
47:	10.0	↑
48:	10.0	↖
49:	10.1	↖
50:	9.7	↗
Serie		98.8
Total		499.0

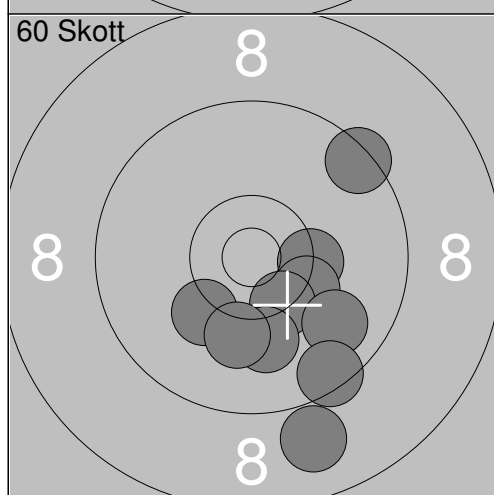

51:	10.3x	↗
52:	10.3	↘
53:	10.2	↘
54:	8.9	↘
55:	10.4x	↘
56:	10.1	↘
57:	9.4	↗
58:	9.8	↘
59:	10.1	↘
60:	9.5	↘
Serie		99.0
Total		598.0

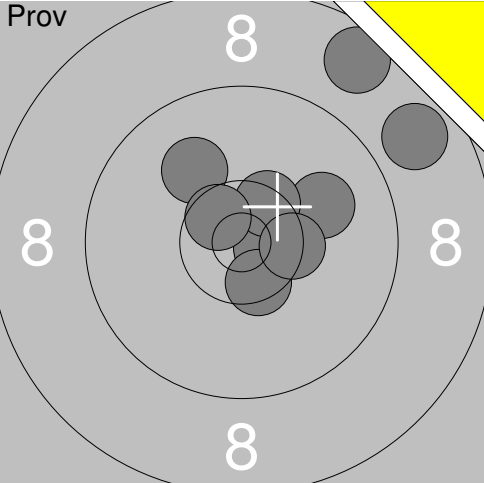
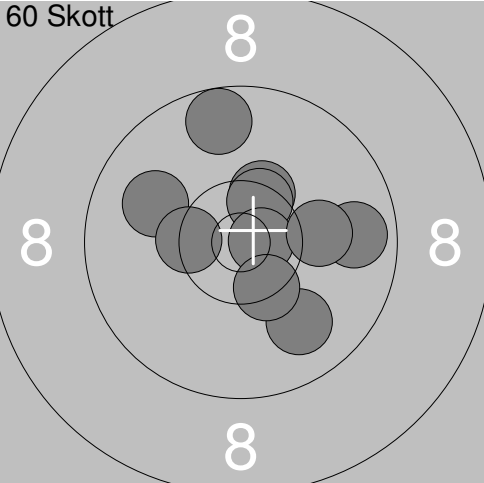
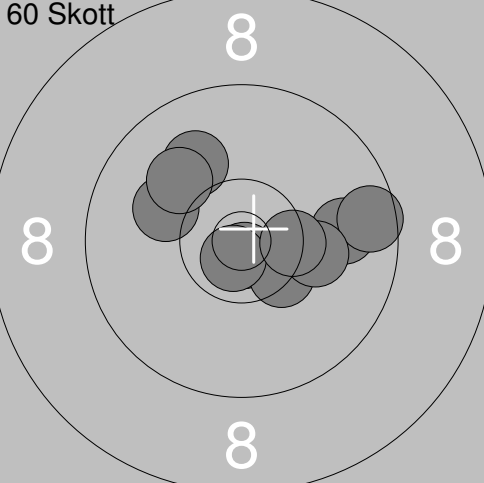
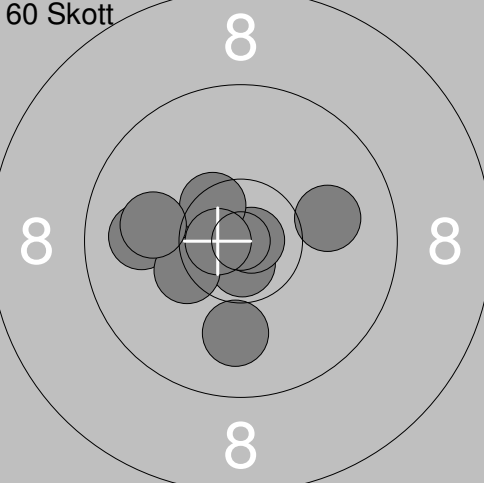
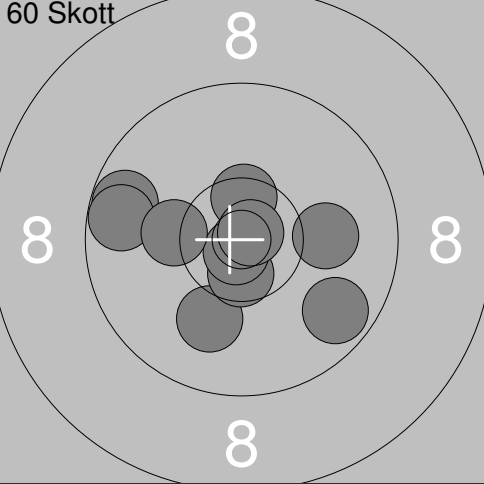
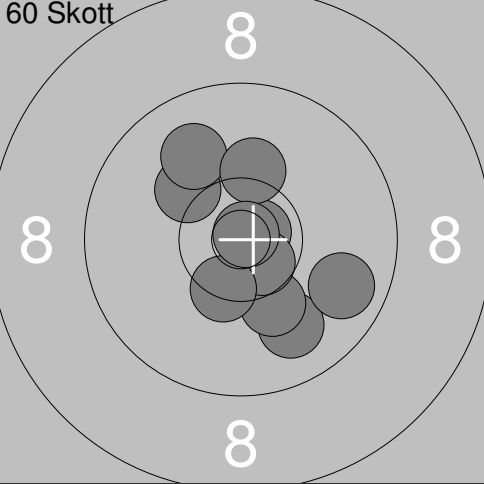
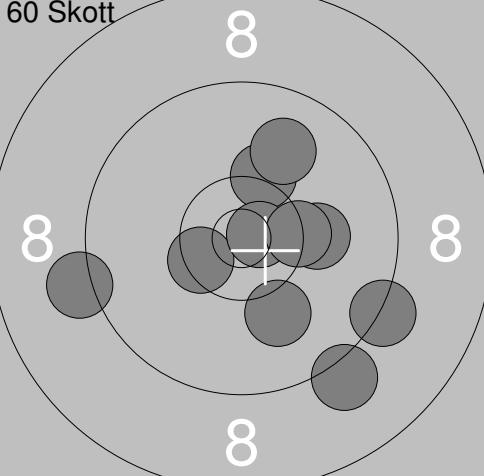
Skjuttlag 1	Tavla 14	Marlene Forsell Forsman			
S		Ramselefors Skf			
05.11.2022		Extraskottet 2022		Umeå skytteallians	
Prov		1: 8.7 ↗ 2: 10.0 → 3: 8.8 → 4: 10.0 ↗ 5: 10.7x → 6: 10.5x ↗ 7: 10.5x ↘ 8: 10.6x ↗ 9: 10.4x →	60 Skott		1: 10.0 ↖ 2: 9.9 ↘ 3: 10.4x ↗ 4: 10.5x ↗ 5: 9.7 ↗ 6: 9.8 → 7: 10.7x → 8: 10.1 → 9: 10.4x ↘ 10: 10.4x ←
		Serie 90.2		Serie 101.9	
		Total 0.0		Total 101.9	
60 Skott		11: 10.0 ↗ 12: 10.8x ↘ 13: 10.1 ↗ 14: 10.0 ↗ 15: 9.9 → 16: 10.4x ↘ 17: 9.6 → 18: 10.7x ↘ 19: 10.2 → 20: 10.4x →	60 Skott		21: 10.0 ↘ 22: 10.7x ↘ 23: 10.8x → 24: 10.4x ← 25: 9.9 ← 26: 10.5x ↗ 27: 10.3x ← 28: 10.7x ← 29: 10.0 ← 30: 10.0 →
		Serie 102.1		Serie 103.3	
		Total 204.0		Total 307.3	
60 Skott		31: 10.0 ↘ 32: 10.6x ↘ 33: 10.1 → 34: 10.8x ↘ 35: 10.5x ↗ 36: 9.7 ← 37: 10.8x ↗ 38: 9.7 ← 39: 10.2 ← 40: 9.7 ↘	60 Skott		41: 9.9 ↘ 42: 10.2 ↘ 43: 10.2 ↗ 44: 9.9 ↗ 45: 10.8x → 46: 10.6x ↘ 47: 9.8 ↘ 48: 10.4x ↘ 49: 10.2 ↗ 50: 10.9x ↗
		Serie 102.1		Serie 102.9	
		Total 409.4		Total 512.3	
60 Skott		51: 10.5x ← 52: 9.2 ← 53: 9.3 ↘ 54: 10.1 ↘ 55: 10.2 → 56: 10.3 ↗ 57: 9.1 ↘ 58: 10.8x → 59: 9.9 ↗ 60: 10.3x →			
		Serie 99.7			
		Total 612.0			