

1: 7.9 ↓	6: 10.3 ↗	Serie	93
2: 9.5 ↘	7: 10.3x ↙		
3: 10.5x →	8: 9.8 ↙	Total	196
4: 9.6 ↘	9: 10.5x →		
5: 9.0 ↓	10: 10.4x ↗		

1: 9.3 ↗	Serie	48
2: 10.5x ↘		
3: 9.3 ↙	Total	244
4: 10.1 ↙		
5: 10.2 ↘		

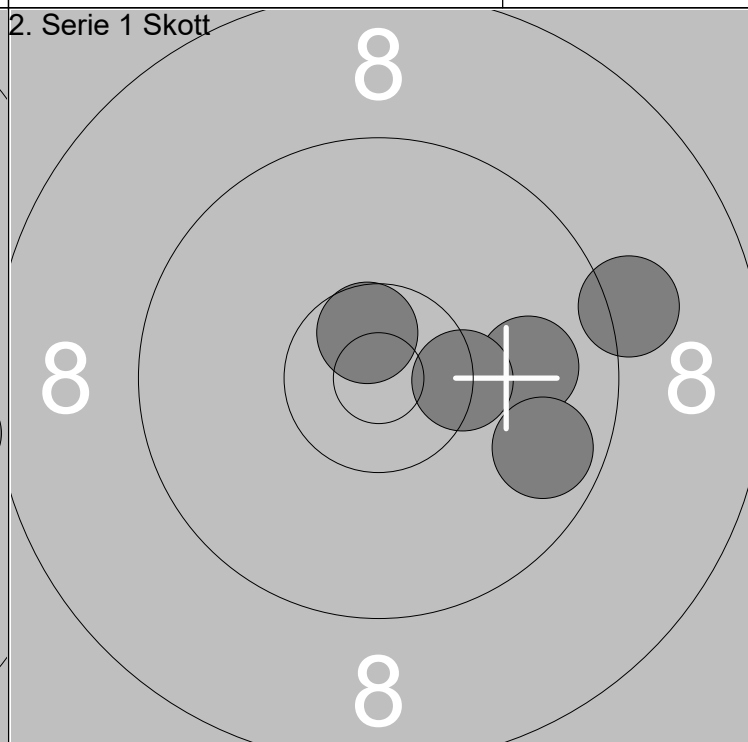
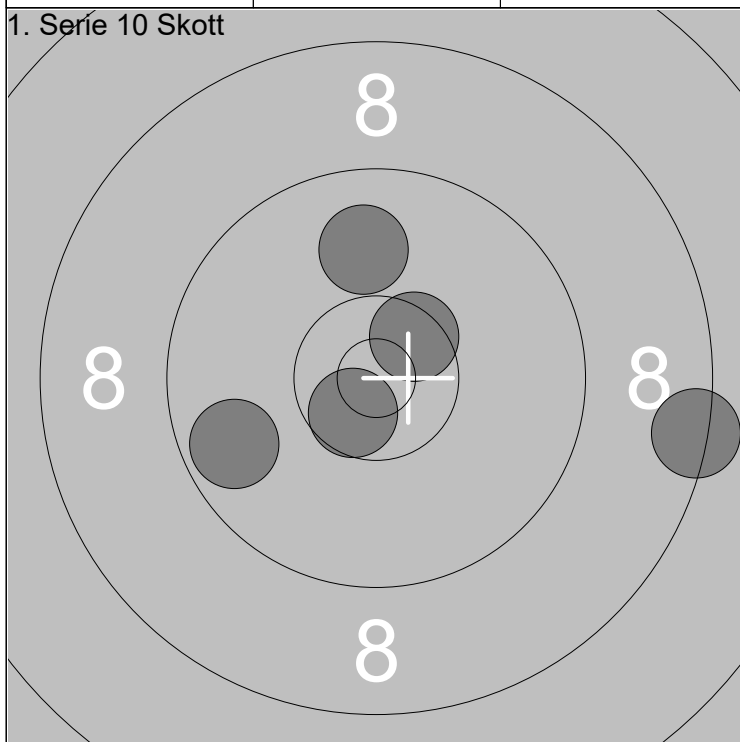

6: 9.9 ↑	Serie	46
7: 10.5x ↗		
8: 8.4 →	Total	290
9: 10.6x ↘		
10: 9.7 ↙		

1: 9.9 →	Serie	47
2: 9.2 →		
3: 10.6x ↗	Total	337
4: 10.4x →		
5: 9.7 ↘		

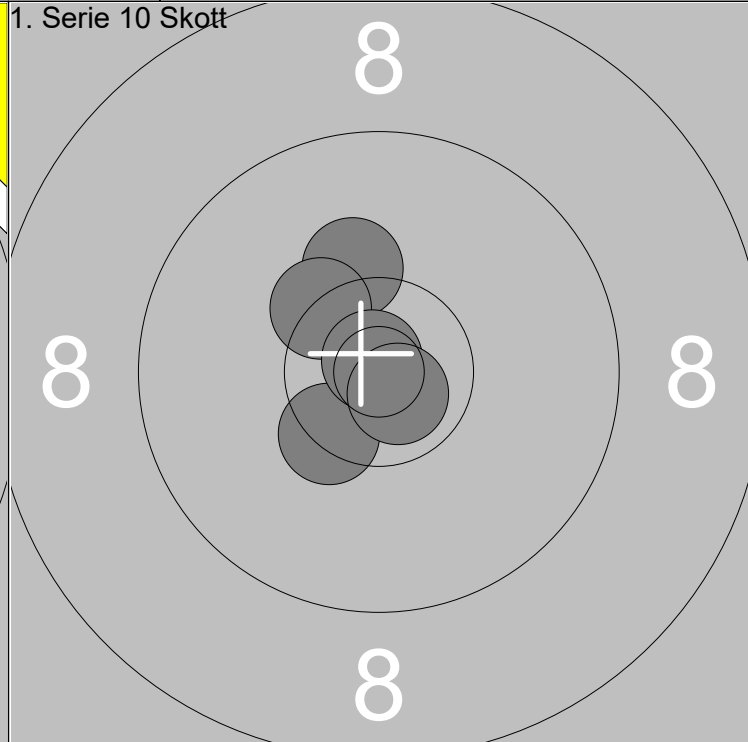
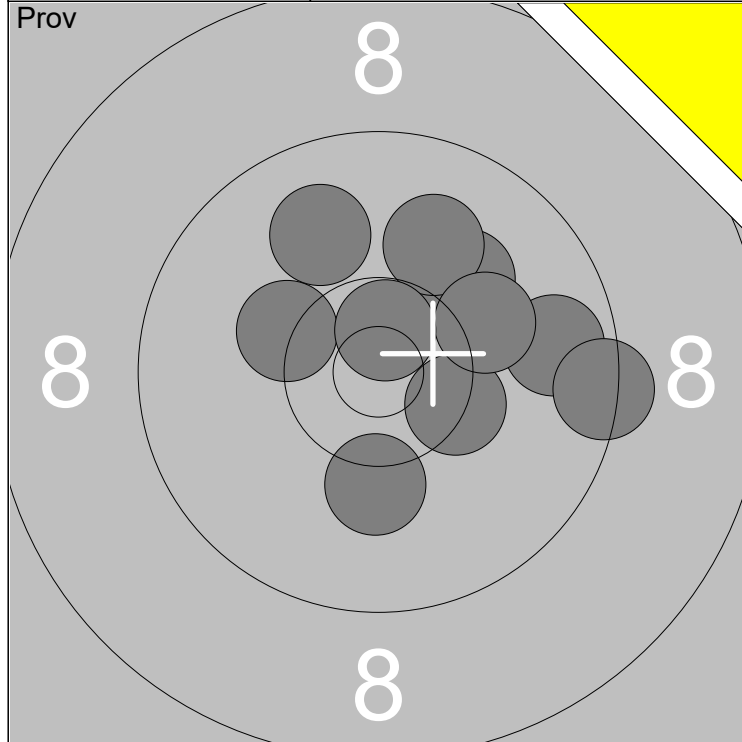

1: 9.7 →	6: 10.3 ↖	Serie	97
2: 10.1 ↗	7: 9.4 →		
3: 10.4x →	8: 9.9 ↗	Total	196
4: 10.0 ↗	9: 10.7x ↗		
5: 10.1 →	10: 10.2 ↓		

1: 10.2 ↗	Serie	50
2: 10.4x ↗		
3: 10.4x ↘	Total	246
4: 10.9x ↗		
5: 10.8x ↘		

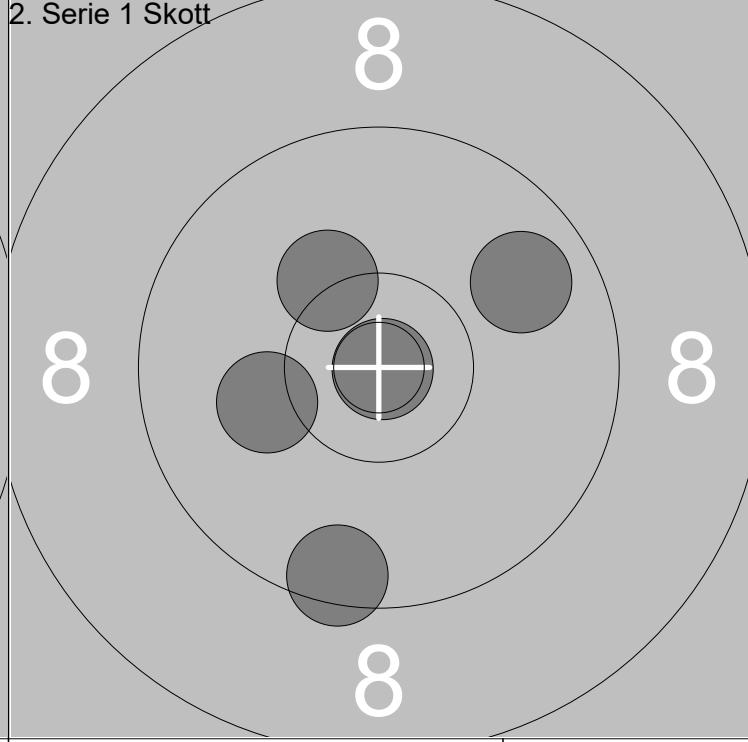
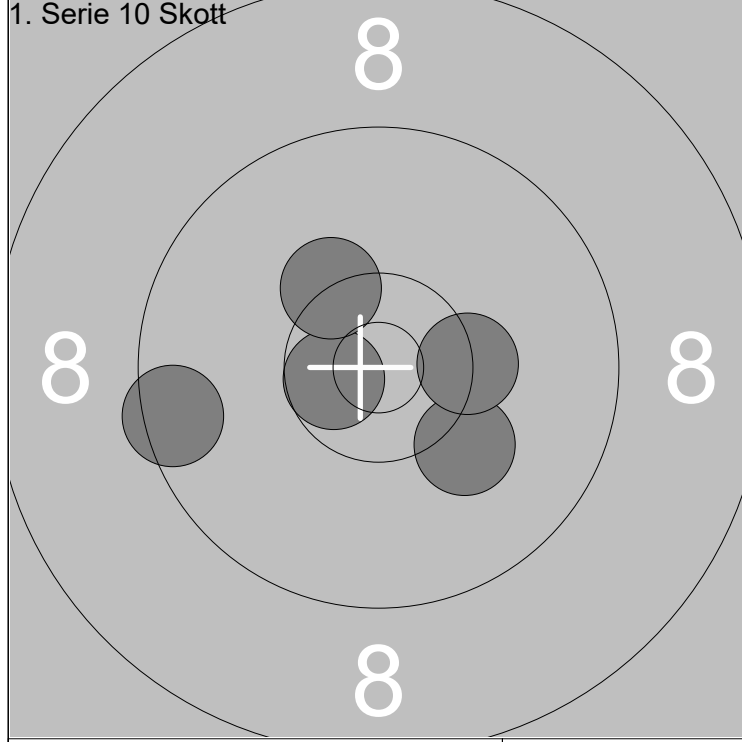

6: 10.6x ←	Serie	49
7: 9.5 ←		
8: 10.3x ↗	Total	295
9: 10.2 ↘		
10: 10.3x →		

1: 10.3 ↗	Serie	48
2: 9.8 ↗		
3: 10.1 ←	Total	343
4: 10.9x →		
5: 9.5 ↓		

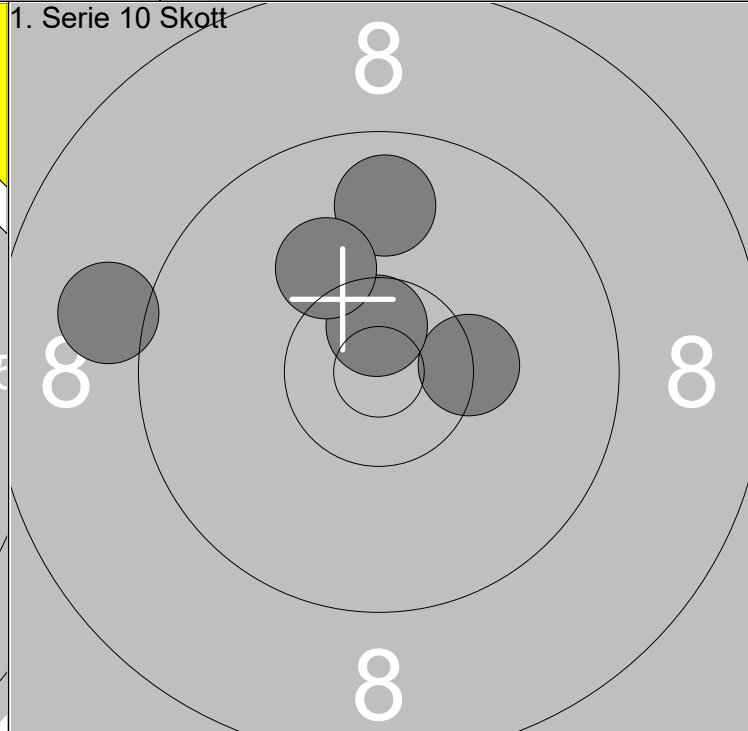

1: 5.8 ↓ 2: 9.5 ↓ 3: 8.9 ↓ 4: 10.7x ← 5: 9.4 ↓	6: 10.0 ↙ 7: 9.3 ↙ 8: 9.8 ← 9: 9.9 ↘ 10: 9.9 ↘	Serie 87 Total 194
--	--	-----------------------

1: 9.0 ← 2: 9.8 ↑ 3: 10.3x → 4: 10.6x ↑ 5: 10.2 ↖	Serie 48 Total 242
---	-----------------------

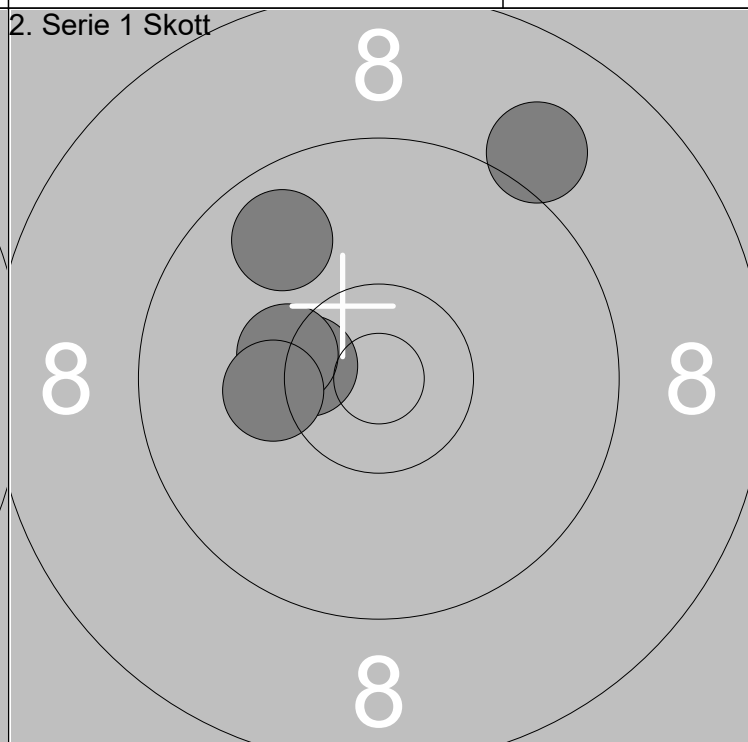
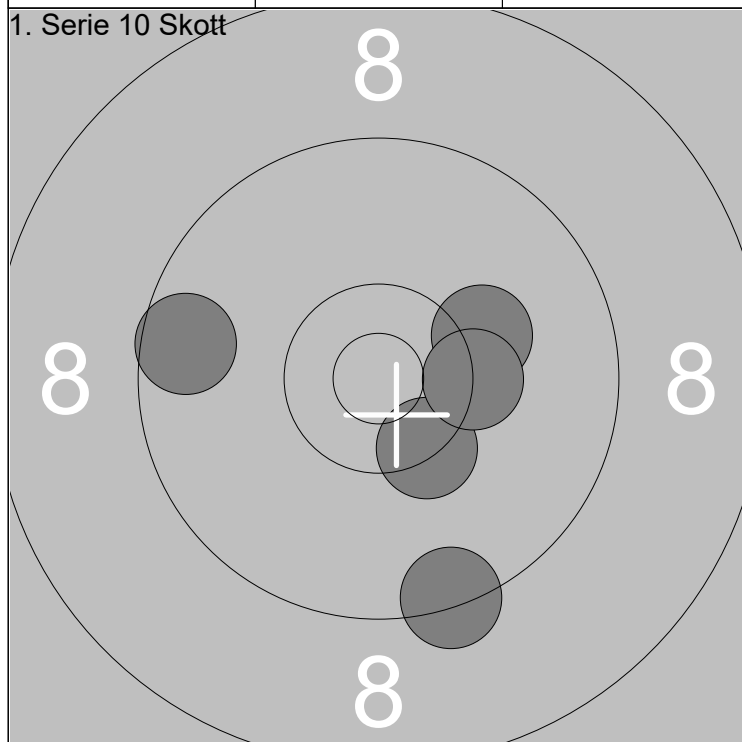

6: 10.2 → 7: 9.6 ← 8: 10.4x ↓ 9: 9.4 ↓ 10: 10.3x →	Serie 48 Total 290
--	-----------------------

1: 9.1 ↗ 2: 10.4x ← 3: 10.3x ← 4: 10.2 ← 5: 9.8 ↖	Serie 48 Total 338
---	-----------------------

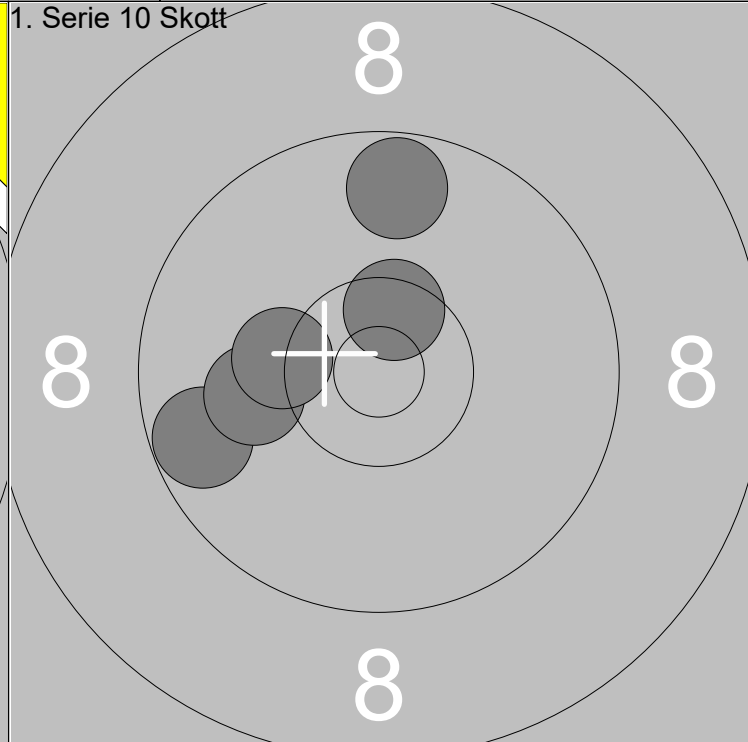
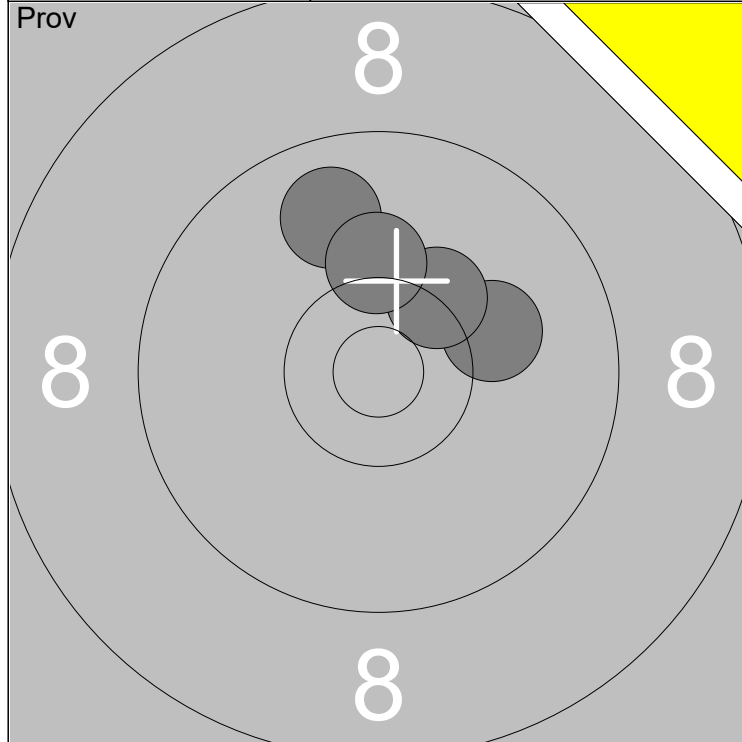

1: 10.1	→
2: 10.3x	↗
3: 9.8	↑
4: 10.2	↑

Serie	39
Total	191

1: 9.7	←
2: 10.5x	↑
3: 9.7	↑
4: 10.1	←
5: 10.3	←

Serie	48
Total	239

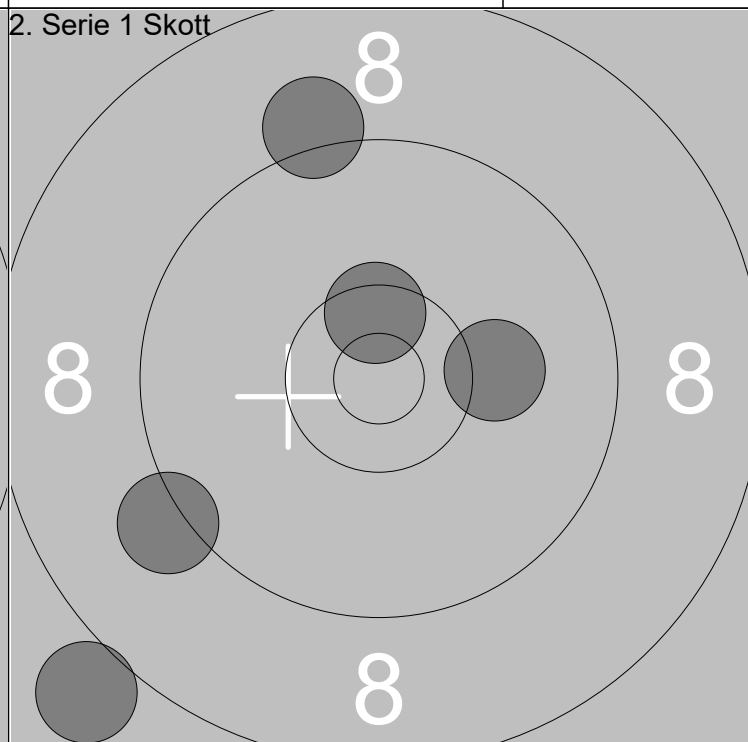
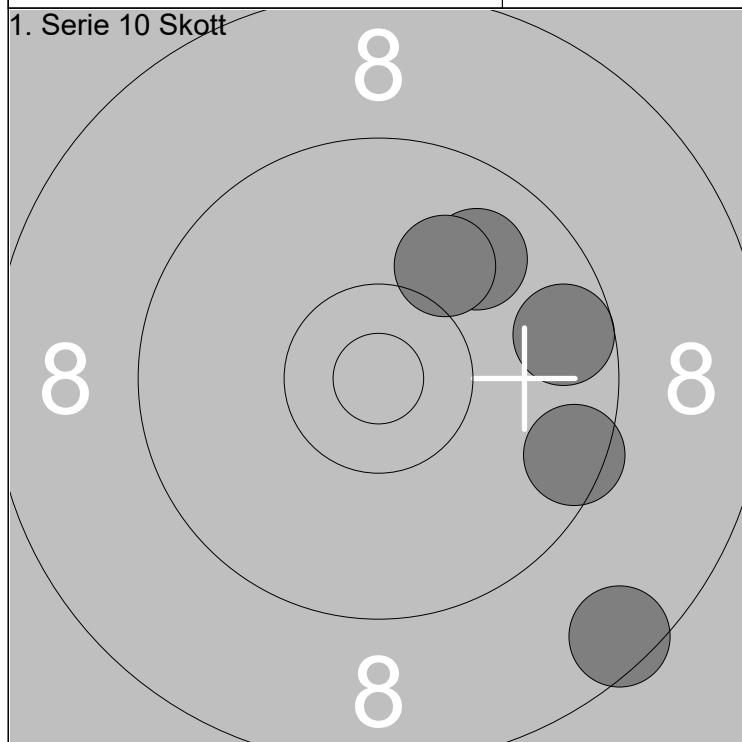

6: 8.5	↘
7: 9.6	→
8: 9.9	↗
9: 9.5	↘
10: 10.1	↗

Serie	45
Total	284

1: 9.2	↑
2: 10.5x	↑
3: 9.2	←
4: 10.1	→
5: 8.0	↘

Serie	46
Total	330

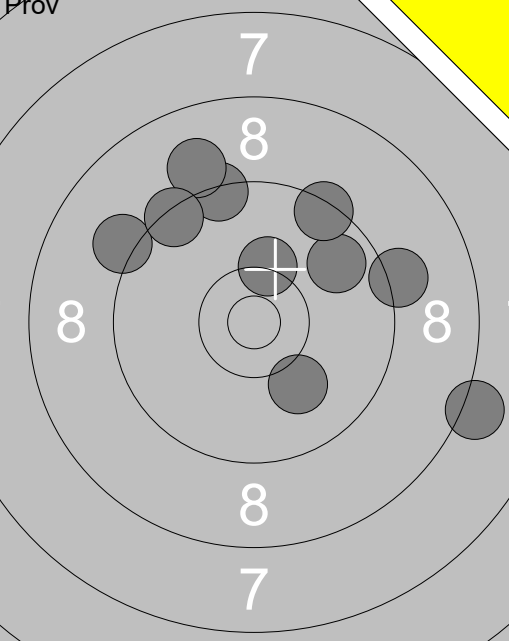
	<p>1: 9.2 →</p> <p>2: 10.3 ↑</p> <p>3: 10.1 ↓</p> <p>4: 9.8 ↗</p> <p>5: 9.4 ↑</p> <p>6: 9.0 ↑</p> <p>7: 8.2 →</p> <p>8: 9.1 ↖</p> <p>9: 9.4 ↗</p> <p>10: 9.4 ↖</p>	<p>11: 9.5 ↑</p> <p>12: 10.4x ↖</p>
Serie 91.0		Serie 19.0
Total 191.0		Total 191.0

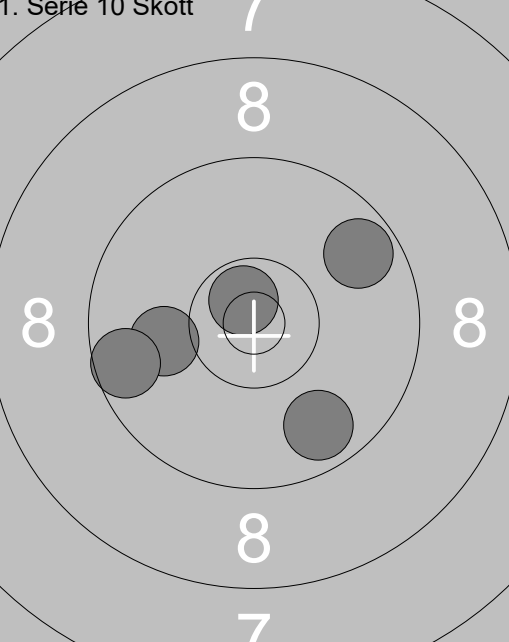
<p>1. Serie 10 Skott</p> 	<p>1: 10.7x ↖</p> <p>2: 9.7 ↗</p> <p>3: 9.7 ↓</p> <p>4: 10.0 ←</p> <p>5: 9.6 ←</p>	<p>1. Serie 10 Skott</p> <p>6: 10.4x ↖</p> <p>7: 8.9 ↓</p> <p>8: 8.2 →</p> <p>9: 10.4x →</p> <p>10: 9.8 ↑</p>
Serie 47.0		Serie 45.0
Total 238.0		Total 283.0

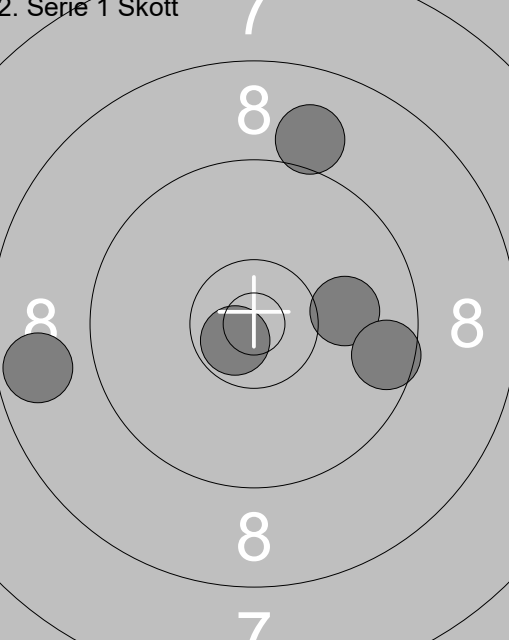
<p>2. Serie 1 Skott</p> 	<p>1: 10.0 →</p> <p>2: 10.7x ↖</p> <p>3: 8.7 ←</p> <p>4: 9.6 →</p> <p>5: 9.0 ↑</p>	
Serie 46.0		
Total 329.0		

Prov 	1: 9.4 ↗ 2: 9.2 ↗ 3: 9.7 ↘ 4: 10.0 ← 5: 10.5 ↘ 6: 10.5 ↘ 7: 8.2 ↗ 8: 9.0 ↗ 9: 9.8 ↗ 10: 10.1 → <hr/> Serie 93.0 Total 189.0	Prov 	11: 8.6 ↑ <hr/> Serie 8.0 Total 189.0
--	--	--	---

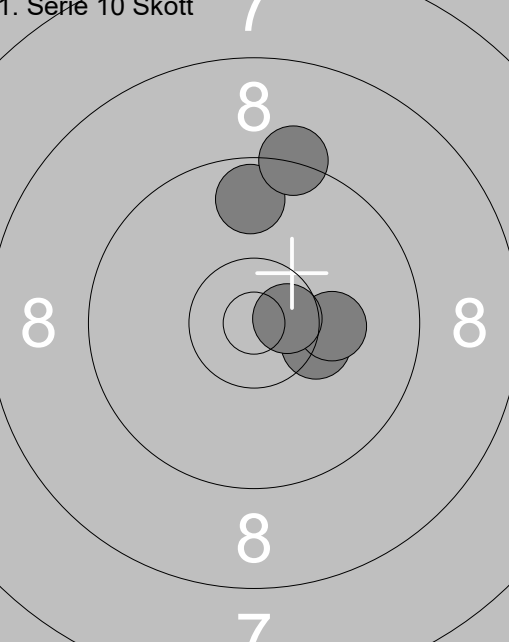
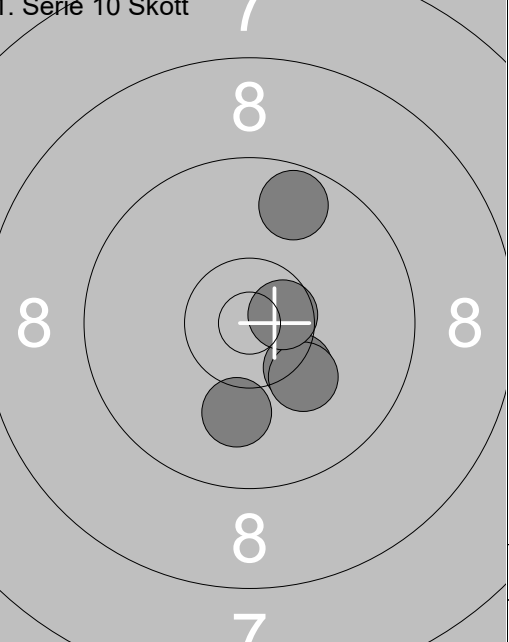
1. Serie 10 Skott 	1: 9.7 ↑ 2: 9.3 ↑ 3: 10.3x → 4: 10.2 → 5: 10.6x → <hr/> Serie 48.0 Total 237.0	1. Serie 10 Skott 	6: 10.3x ↘ 7: 10.1 ↓ 8: 10.2 ↘ 9: 9.7 ↑ 10: 10.6x → <hr/> Serie 49.0 Total 286.0
--	--	--	--

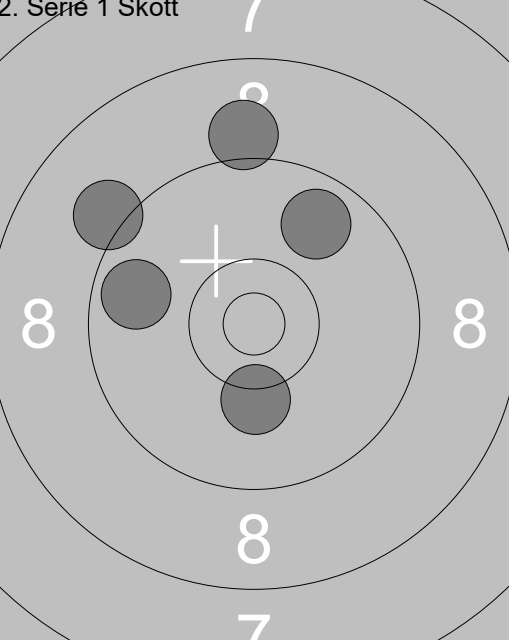
2. Serie 1 Skott 	1: 9.1 ↖ 2: 9.7 ← 3: 9.1 ↑ 4: 9.8 ↗ 5: 10.2 ↓ <hr/> Serie 46.0 Total 332.0		
--	--	--	--

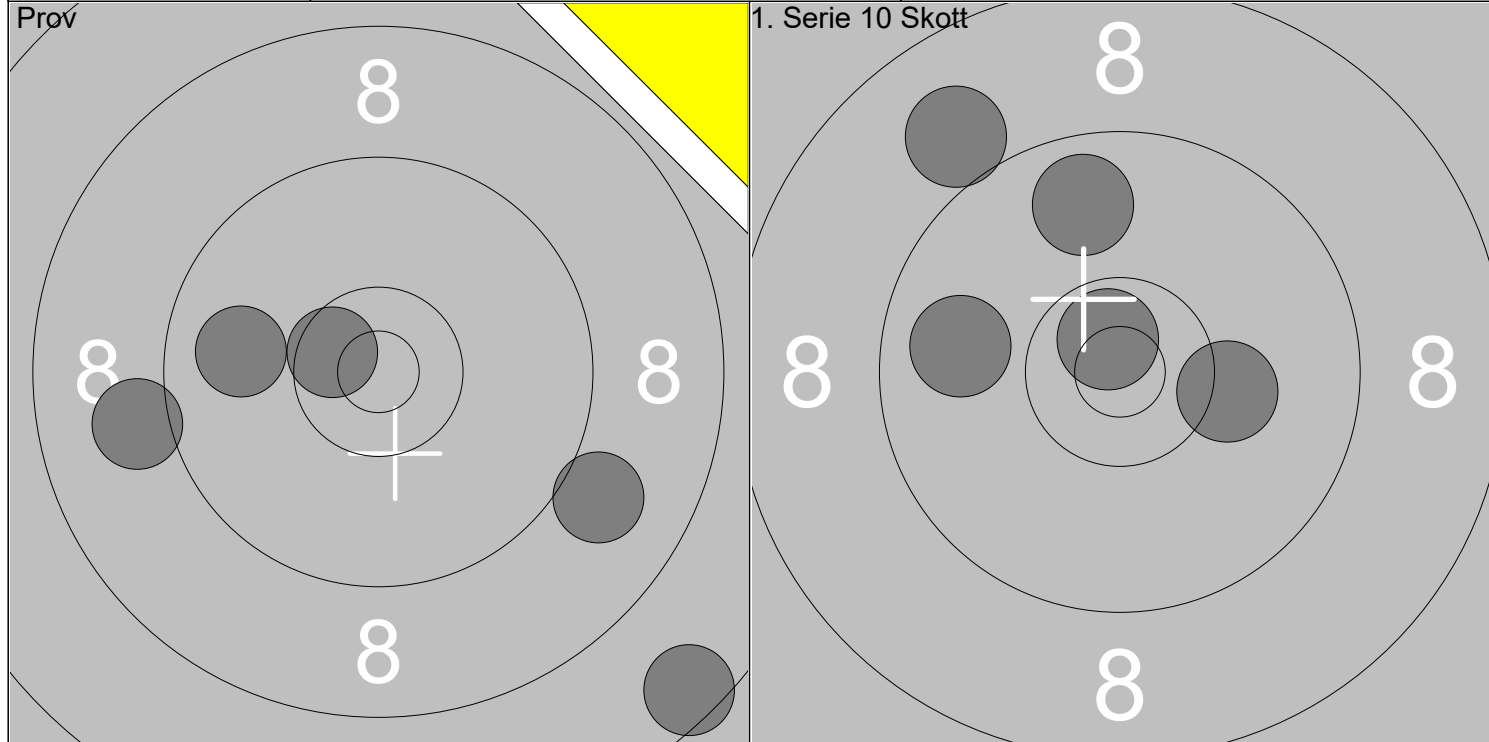

1: 7.5 ↘ 2: 9.0 ↘ 3: 10.6x ↗ 4: 9.9 ← 5: 9.1 ←	Serie	44	1: 9.8 ← 2: 10.7x ↗ 3: 9.0 ↗ 4: 10.2 → 5: 9.8 ↗	Serie	47
	Total	188		Total	235

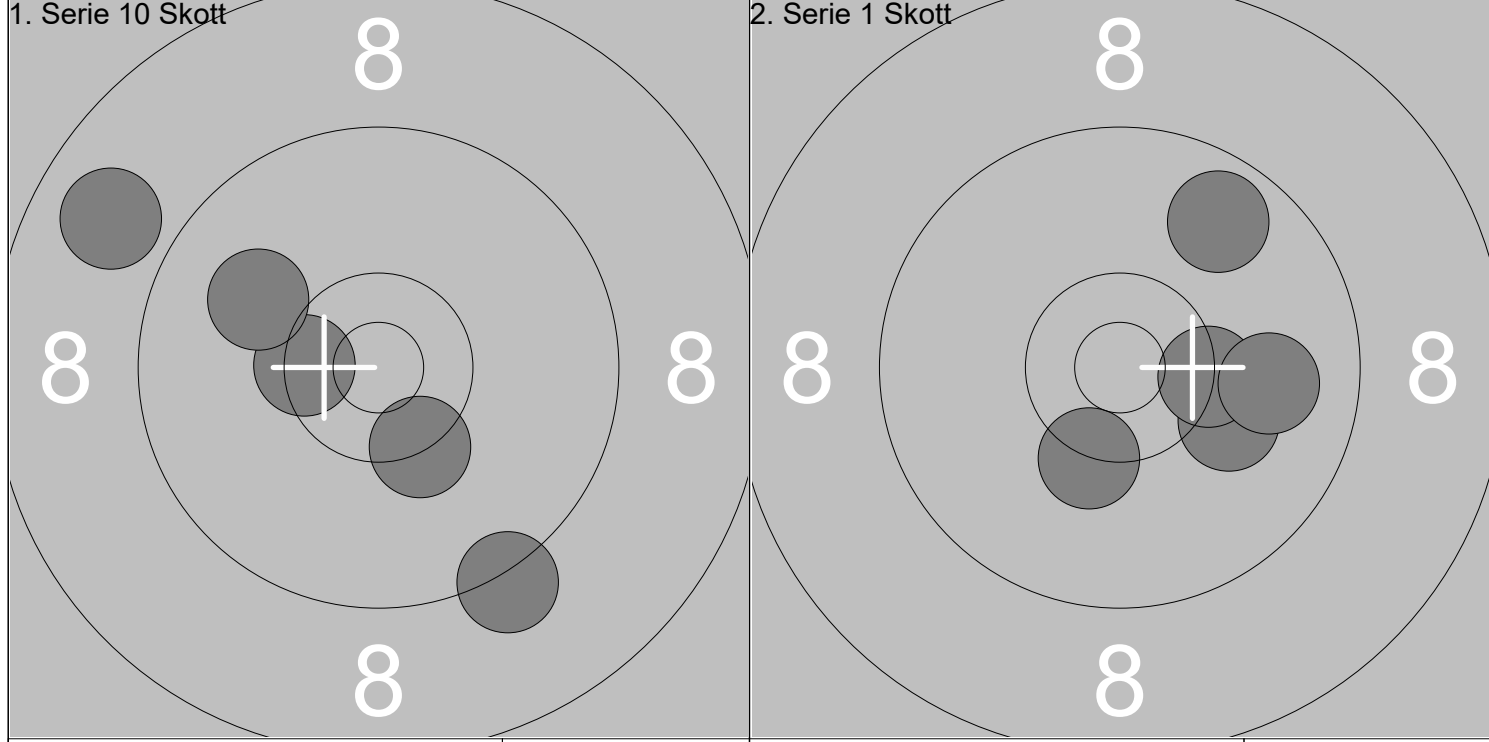

6: 10.4x ← 7: 10.0 ↗ 8: 10.3x ↘ 9: 9.2 ↘ 10: 8.8 ↗	Serie	47	1: 10.1 → 2: 9.7 ↗ 3: 10.3x → 4: 10.3x ↘ 5: 9.9 →	Serie	48
	Total	282		Total	330

	<p>1: 8.8 ↙</p> <p>2: 8.9 ↘</p> <p>3: 10.3x ↘</p> <p>4: 10.5x ↘</p> <p>5: 10.0 ↗</p> <p>6: 10.5x →</p> <p>7: 9.7 ←</p> <p>8: 10.4x ↙</p> <p>9: 10.1 →</p> <p>10: 10.1 ↖</p>		<p>11: 9.0 ←</p> <p>12: 9.0 ←</p> <p>13: 10.9x ↘</p> <p>14: 9.6 ←</p> <p>15: 10.7x ↘</p>
Serie 95.0		Serie 47.0	
Total 186.0		Total 186.0	

<p>1. Serie 10 Skott</p>	<p>1: 10.4x ↘</p> <p>2: 10.7x →</p> <p>3: 10.5x ↘</p> <p>4: 8.1 ←</p> <p>5: 10.2 →</p>	<p>1. Serie 10 Skott</p>	<p>6: 10.3x ↘</p> <p>7: 10.4x ↘</p> <p>8: 8.7 ←</p> <p>9: 8.6 →</p> <p>10: 8.8 ←</p>
Serie 48.0		Serie 44.0	
Total 234.0		Total 278.0	

<p>2. Serie 1 Skott</p>	<p>1: 9.1 ↙</p> <p>2: 10.1 ←</p> <p>3: 10.9x →</p> <p>4: 10.2 ←</p> <p>5: 8.0 ←</p>		
Serie 47.0			
Total 325.0			

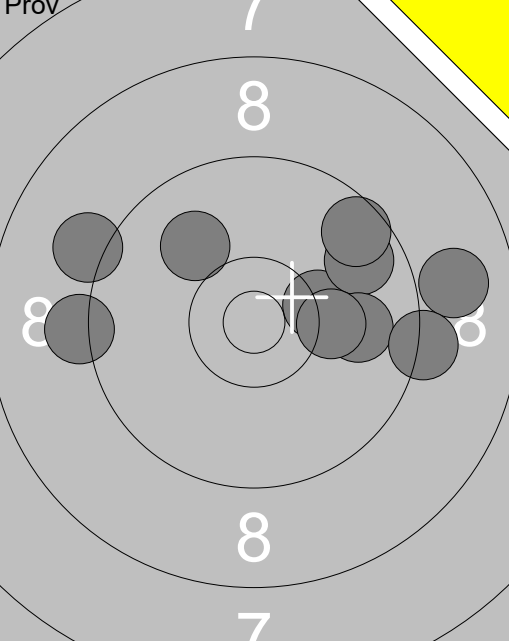

	<p>1: 10.3x ↗</p> <p>2: 8.9 →</p> <p>3: 9.7 ↗</p> <p>4: 10.0 ↖</p> <p>5: 9.9 →</p> <p>6: 9.2 →</p> <p>7: 9.6 ↗</p> <p>8: 10.2 →</p> <p>9: 9.1 ↖</p> <p>10: 9.2 ←</p>	<p>11: 10.4x ↗</p> <p>12: 10.3x ↖</p> <p>13: 10.3x ↗</p>
Serie 92.0		Serie 30.0
Total 185.0		Total 185.0

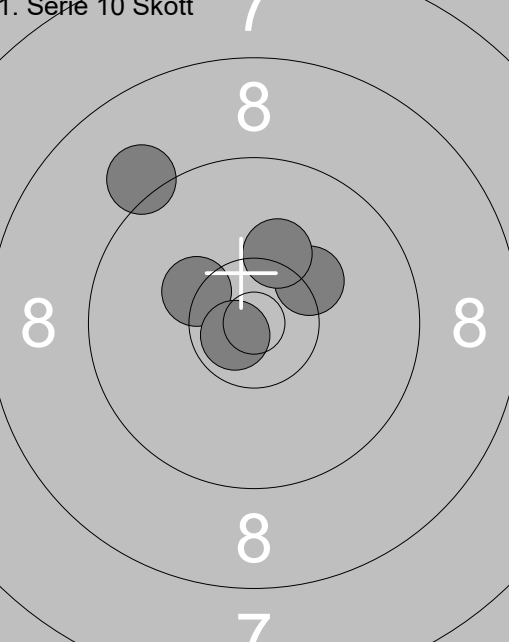
<p>1. Serie 10 Skott</p> 	<p>1: 9.1 ↖</p> <p>2: 10.3 ↗</p> <p>3: 10.3x ↖</p> <p>4: 10.2 ↗</p> <p>5: 10.7x ↖</p>	<p>6: 10.9x ↘</p> <p>7: 10.0 ↗</p> <p>8: 10.2 ↘</p> <p>9: 10.0 ←</p> <p>10: 9.9 ↖</p>
Serie 49.0		Serie 49.0
Total 234.0		Total 283.0

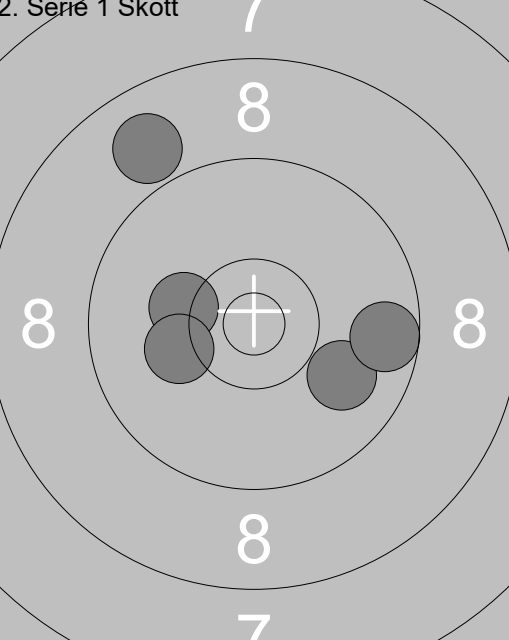
<p>2. Serie 1 Skott</p> 	<p>1: 10.2 ←</p> <p>2: 8.9 ↖</p> <p>3: 10.2 ←</p> <p>4: 9.9 →</p> <p>5: 9.6 →</p>	
Serie 46.0		
Total 329.0		

	1: 8.4 ↗ 2: 9.5 ↗ 3: 10.1 → 4: 10.1 ↘ 5: 9.5 → 6: 10.0 ↗ 7: 10.0 → 8: 9.5 ↖ 9: 8.7 ← 10: 8.7 ↖		11: 9.1 ↖ 12: 9.3 ← 13: 10.1 ↓ 14: 10.6 ✕ 15: 10.3 ✕
Serie 91.0		Serie 48.0	
Total 185.0		Total 185.0	

1. Serie 10 Skott 	1: 10.6 ✕ 2: 9.9 ↓ 3: 9.6 → 4: 9.6 → 5: 9.6 ↓	1. Serie 10 Skott 	6: 10.2 → 7: 9.8 → 8: 10.2 ← 9: 10.0 ↖ 10: 10.0 ↖
Serie 46.0		Serie 49.0	
Total 231.0		Total 280.0	

2. Serie 1 Skott 	1: 8.1 ↓ 2: 8.7 ← 3: 10.6 ✕ 4: 8.8 ↓ 5: 8.6 ↖		
Serie 42.0			
Total 322.0			

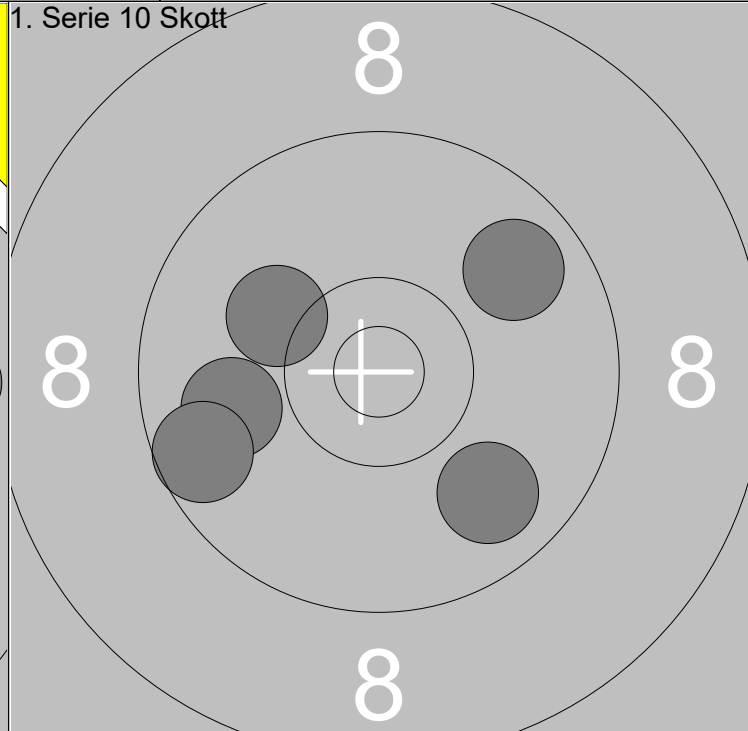
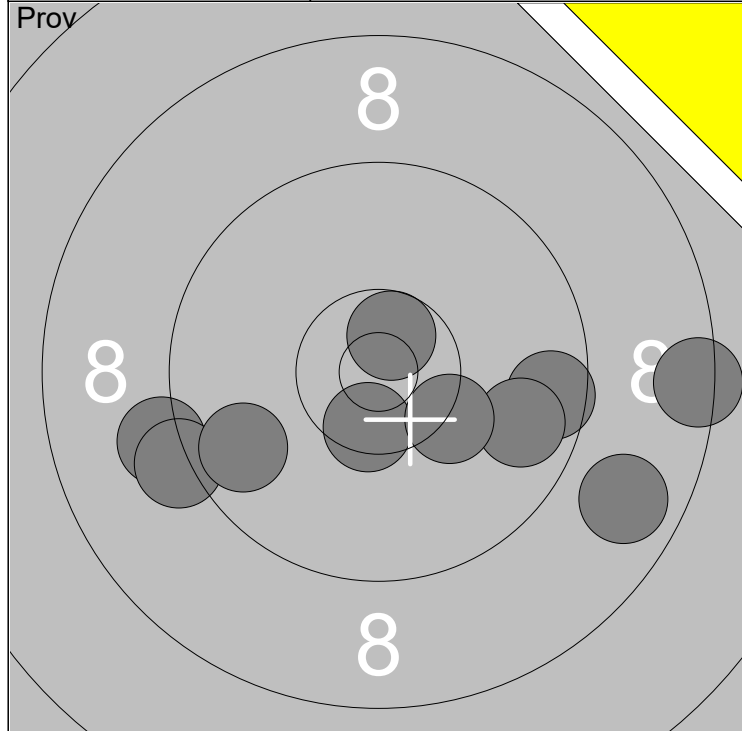

1: 8.4 →	6: 10.5x ↓	Serie	91
2: 8.8 ↘	7: 9.2 ←		
3: 9.6 →	8: 10.3 ↘	Total	183
4: 9.8 →	9: 9.2 ←		
5: 10.6x ↑	10: 9.7 ←		

1: 9.9 ←	Serie	46
2: 9.6 ←		
3: 9.8 ↗	Total	229
4: 10.2 ↖		
5: 9.8 ↘		

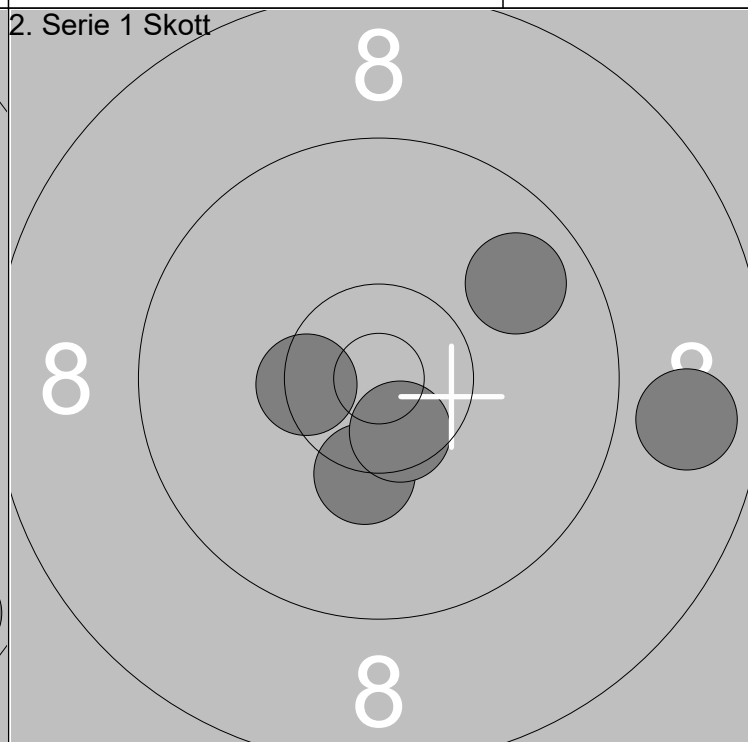
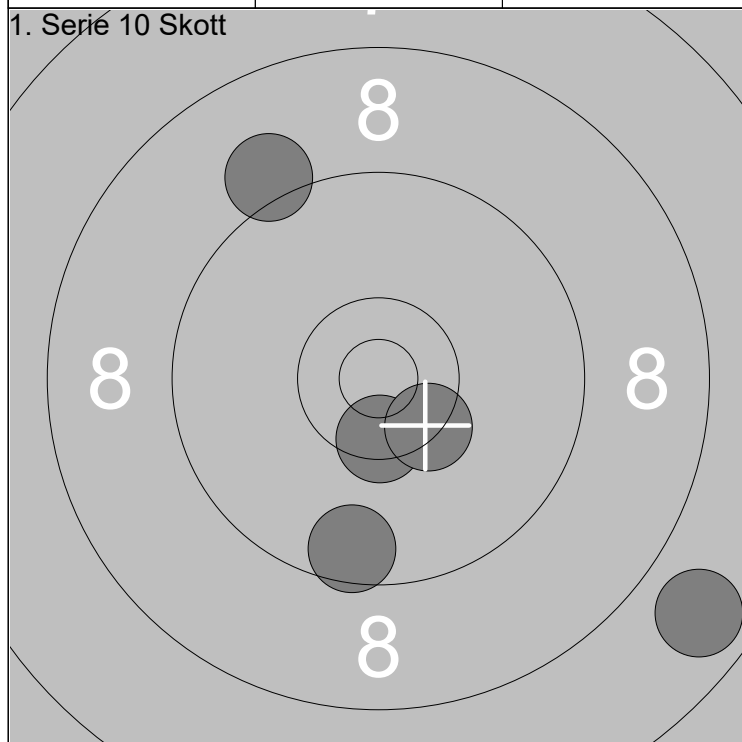

6: 7.8 ↘	Serie	45
7: 10.5x ↓		
8: 9.6 ↓	Total	274
9: 9.1 ↗		
10: 10.4x ↘		

1: 10.3x ↓	Serie	47
2: 9.8 ↗		
3: 8.8 →	Total	321
4: 10.6x ↓		
5: 10.5x ←		

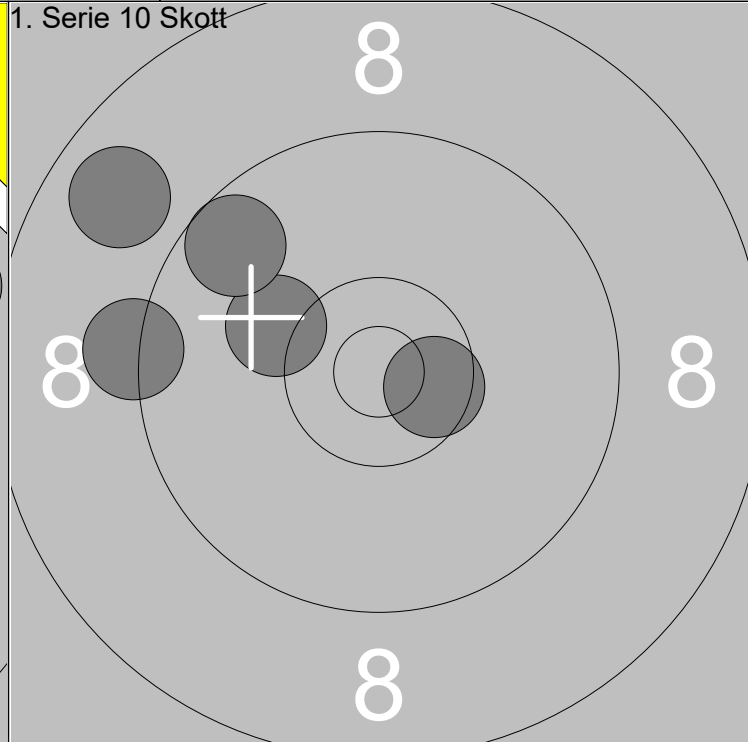
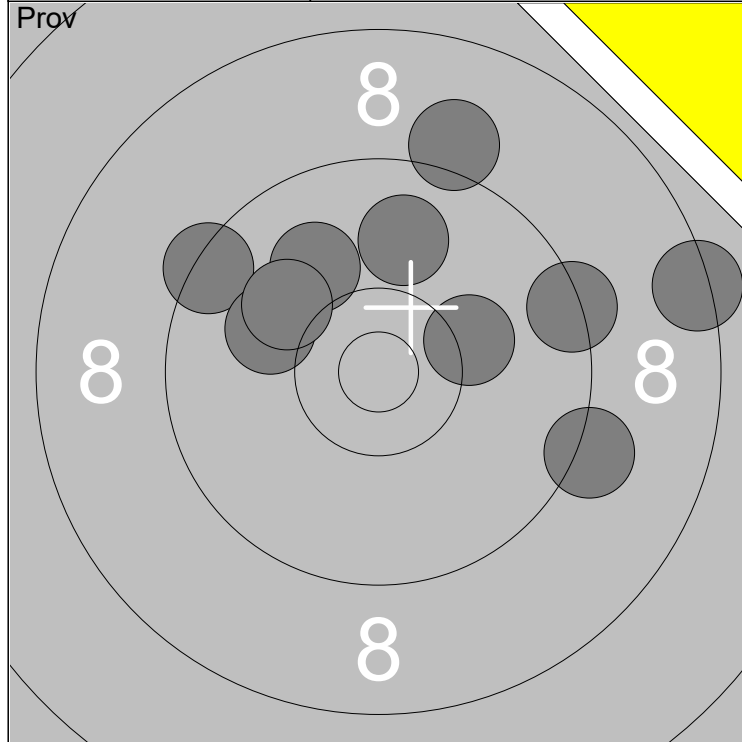

1: 9.9	↑	6: 9.4	↗	Serie	93
2: 9.1	↑	7: 10.0	↖		
3: 9.2	↘	8: 10.1	↗	Total	183
4: 9.4	→	9: 8.4	→		
5: 10.0	↖	10: 10.2	→		

1: 8.8	↗	Serie	46
2: 10.2	↖		
3: 9.6	↗	Total	229
4: 9.3	↖		
5: 10.6x	↘		

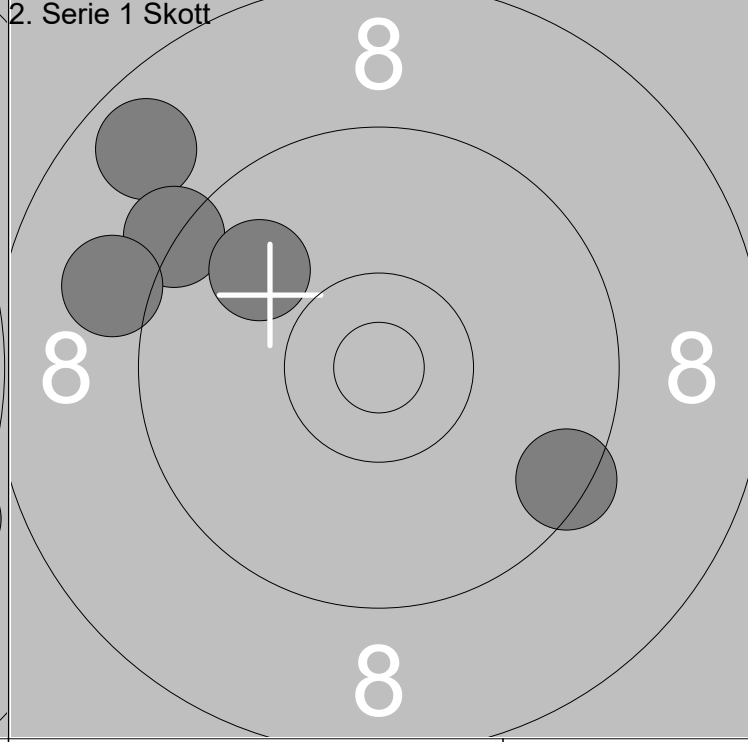
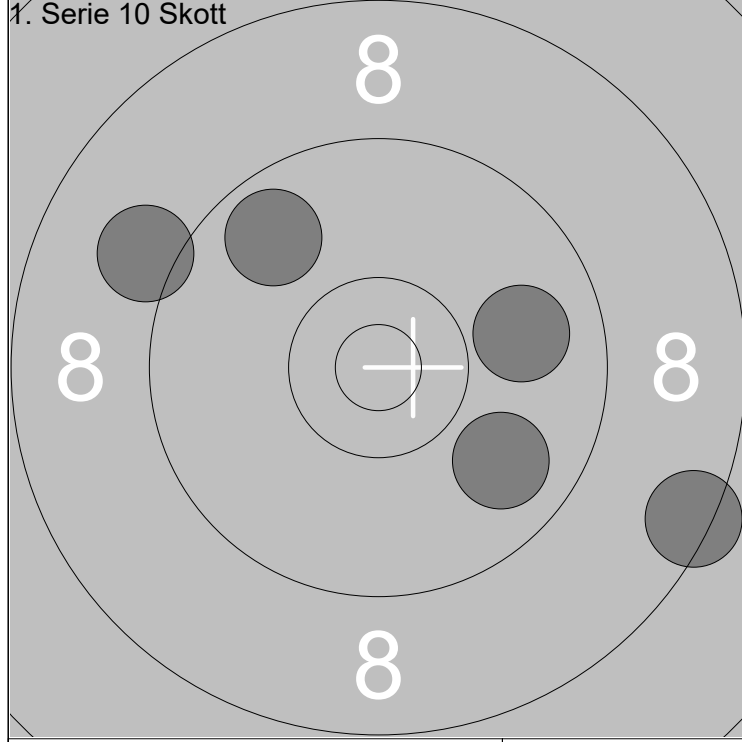

6: 9.7	↗	Serie	44
7: 8.4	↘		
8: 9.8	↘	Total	273
9: 9.9	→		
10: 9.1	↖		

1: 8.8	↗	Serie	44
2: 9.5	↘		
3: 9.3	↗	Total	317
4: 9.9	↗		
5: 9.0	↖		

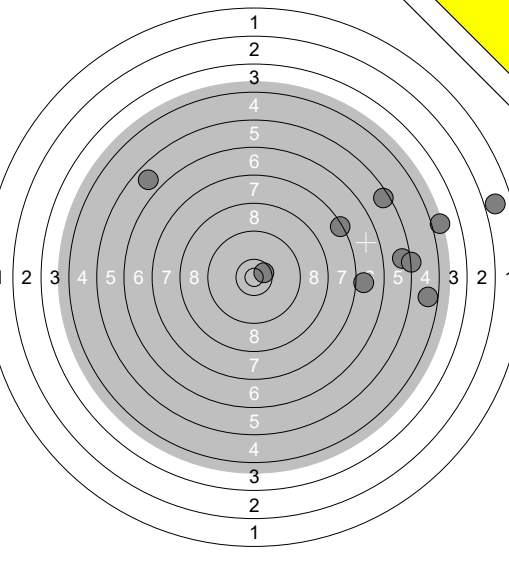
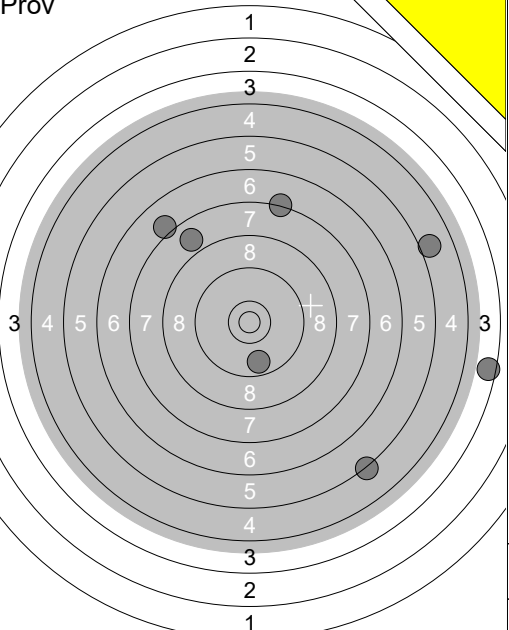
<p>Prov</p> 	<p>1: 5.6 →</p> <p>2: 7.0 →</p> <p>3: 7.4 ↗</p> <p>4: 5.3 →</p> <p>5: 4.0 →</p> <p>6: 5.5 ↗</p> <p>7: 1.9 →</p> <p>8: 4.7 →</p> <p>9: 10.6x ↗</p> <p>10: 5.8 ↖</p>	<p>Prov</p> 	<p>11: 7.1 ↖</p> <p>12: 7.9 ↖</p> <p>13: 9.7 ↓</p> <p>14: 3.5 →</p> <p>15: 5.3 ↓</p> <p>16: 5.0 →</p> <p>17: 7.3 ↑</p>
Serie 53.0		Serie 43.0	
Total 172.0		Total 172.0	

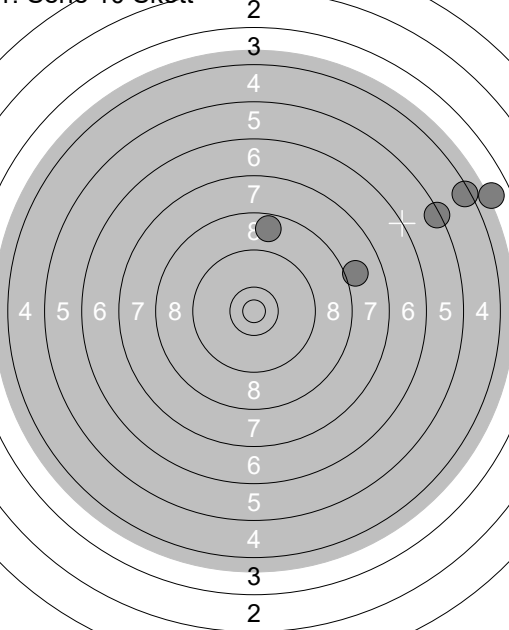
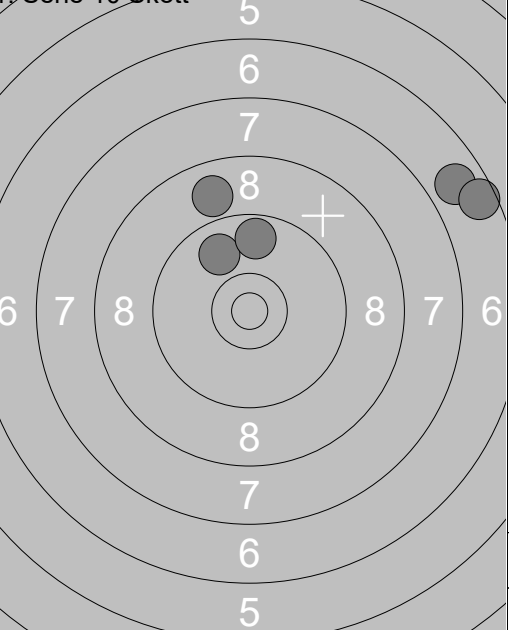
<p>1. Serie 10 Skott</p> 	<p>1: 8.0 →</p> <p>2: 4.4 ↗</p> <p>3: 8.7 ↑</p> <p>4: 3.8 ↗</p> <p>5: 5.4 ↗</p>	<p>1. Serie 10 Skott</p> 	<p>6: 9.9 ↖</p> <p>7: 6.8 ↗</p> <p>8: 6.6 ↗</p> <p>9: 9.7 ↑</p> <p>10: 8.9 ↖</p>
Serie 28.0		Serie 38.0	
Total 200.0		Total 238.0	

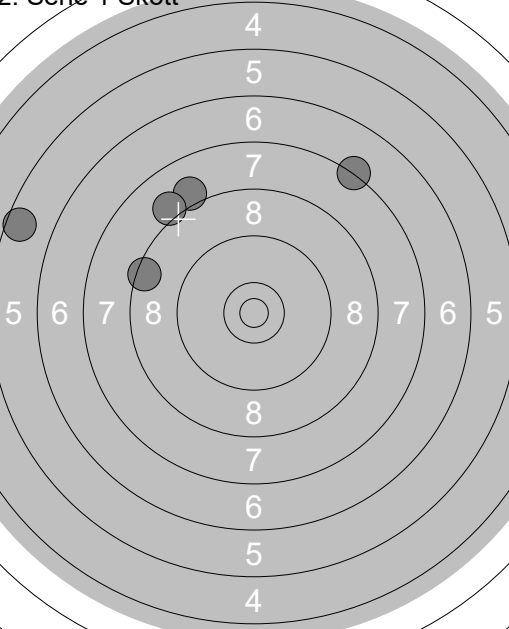
<p>2. Serie 1 Skott</p> 	<p>1: 5.6 ↖</p> <p>2: 8.1 ↖</p> <p>3: 8.5 ↖</p> <p>4: 7.3 ↗</p> <p>5: 8.1 ↖</p>		
Serie 36.0			
Total 274.0			

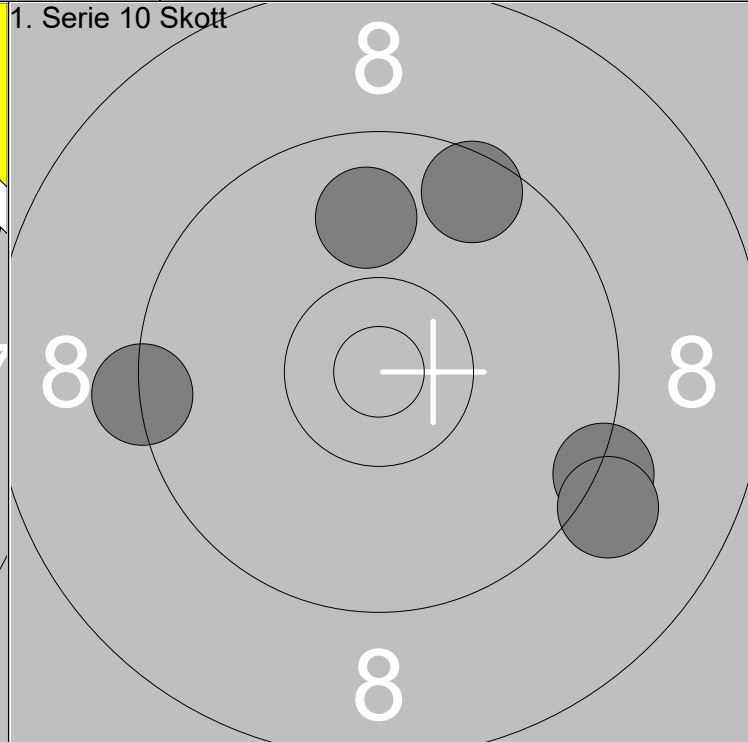
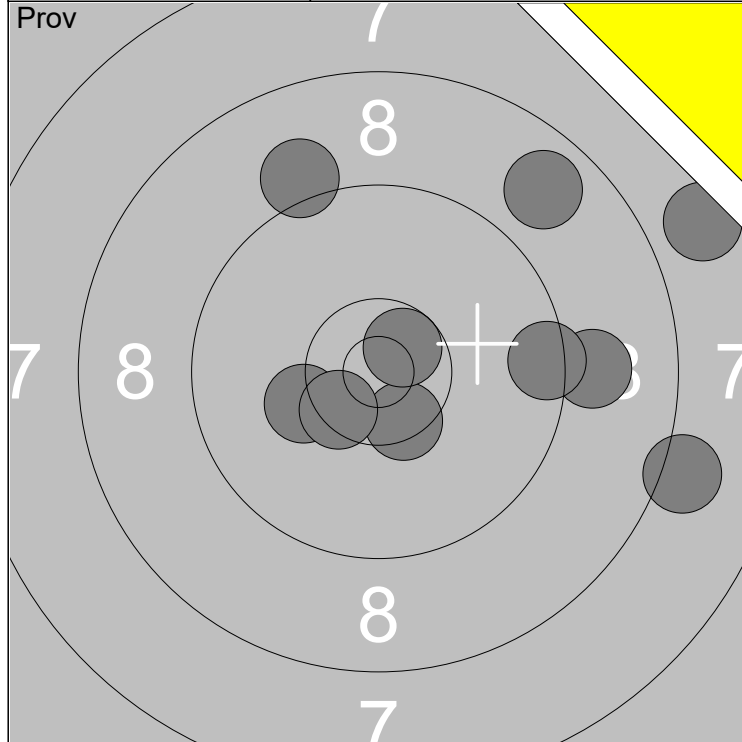

1: 9.1 →	6: 7.8 ↗	Serie	90
2: 8.1 →	7: 10.7x ↗		
3: 10.2 ←	8: 10.5x ↙	Total	162
4: 9.5 →	9: 8.8 ↗		
5: 10.5x ↓	10: 9.1 ↖		

1: 9.3 ←	Serie	45
2: 9.9 ↑		
3: 9.3 →	Total	207
4: 9.1 →		
5: 9.6 ↗		

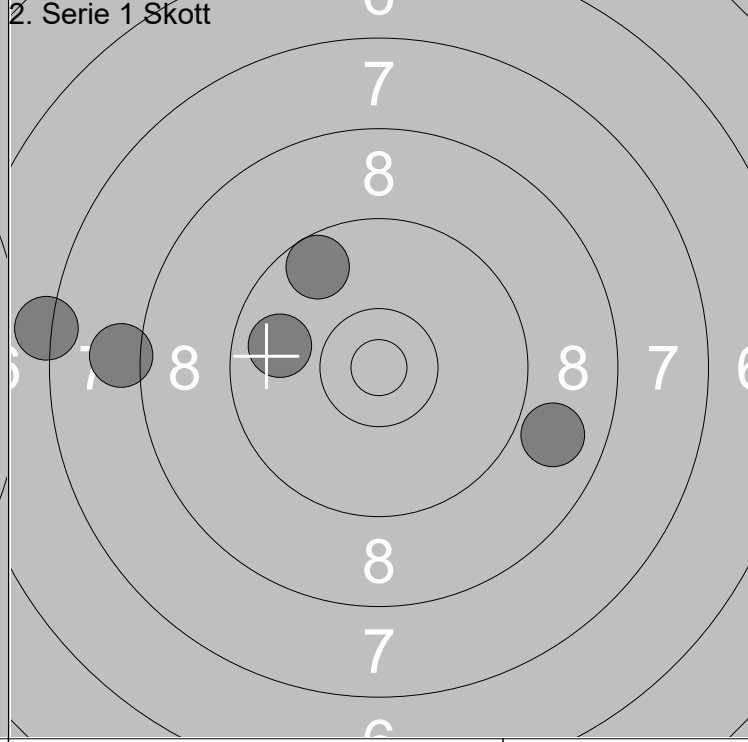
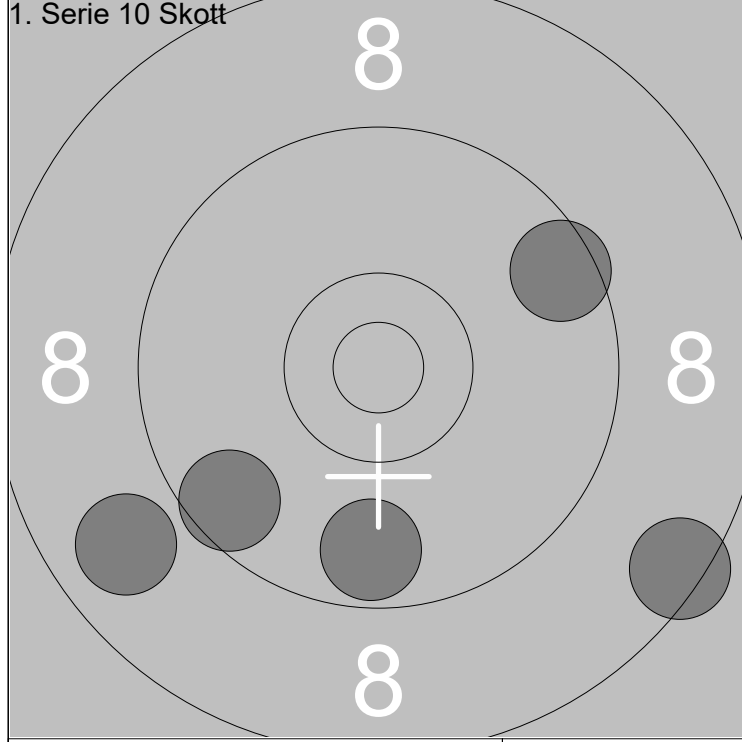

6: 9.6 ↙	Serie	43
7: 9.5 ↗		
8: 8.5 →	Total	250
9: 9.7 ↓		
10: 8.8 ↙		

1: 7.2 ←	Serie	41
2: 8.1 ←		
3: 9.6 ↗	Total	291
4: 8.9 →		
5: 9.8 ←		

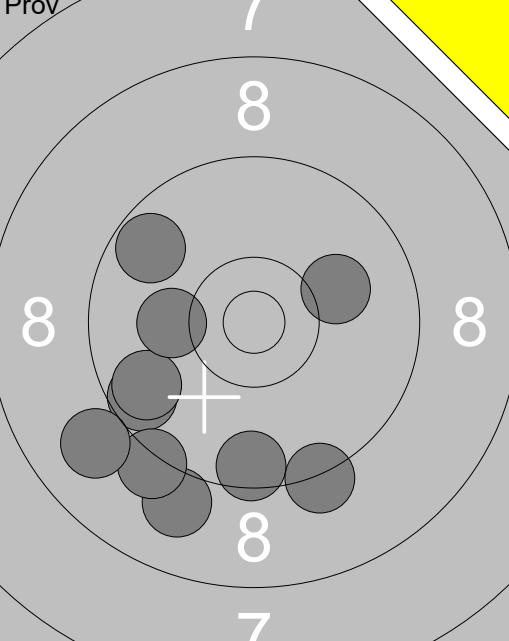
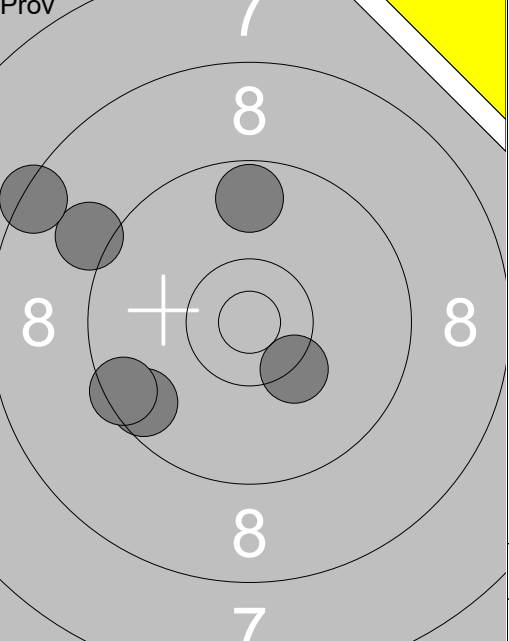
 <p style="text-align: center;">7 8 8 8 8 7</p>	<p>Prov</p> <p>1: 9.0 ↘ 2: 9.6 ↙ 3: 9.2 ↘ 4: 9.7 ↙ 5: 9.3 ↘ 6: 10.1 ← 7: 9.7 ↖ 8: 10.1 → 9: 9.5 ↘ 10: 9.0 ↙</p> <p>Serie 92.0 Total 192.0</p>	 <p style="text-align: center;">7 8 8 8 8 7</p>	<p>Prov</p> <p>11: 9.1 ↖ 12: 9.6 ↙ 13: 8.4 ↖ 14: 9.5 ↙ 15: 10.3x ↘ 16: 9.7 ↑</p> <p>Serie 54.0 Total 192.0</p>
---	---	---	--

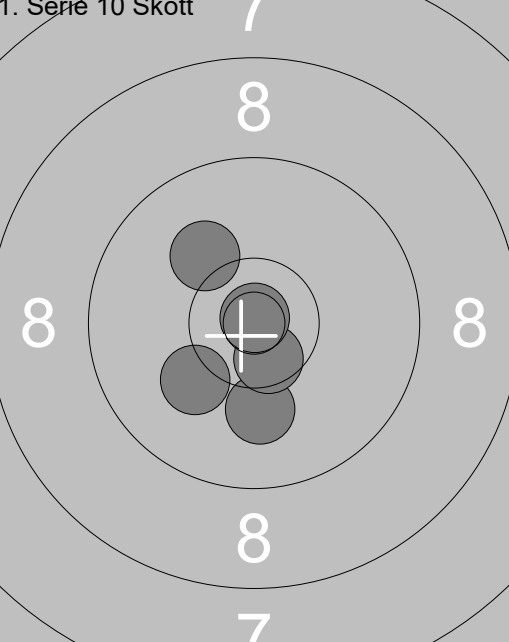
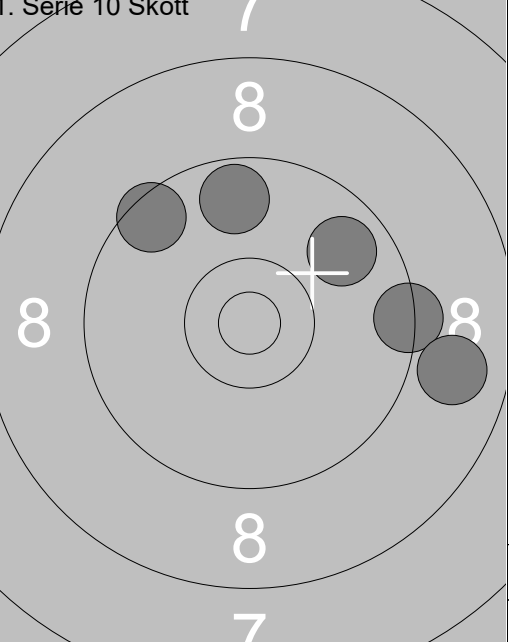
<p>1. Serie 10 Skott</p>  <p style="text-align: center;">7 8 8 8 8 7</p>	<p>1: 10.1 ↘ 2: 10.6x ↘ 3: 10.1 ↖ 4: 10.9x ↗ 5: 10.1 ↙</p> <p>Serie 50.0 Total 242.0</p>	<p>1. Serie 10 Skott</p>  <p style="text-align: center;">7 8 8 8 8 7</p>	<p>6: 9.7 ↑ 7: 9.5 ↖ 8: 9.4 → 9: 8.9 → 10: 9.8 ↗</p> <p>Serie 44.0 Total 286.0</p>
---	--	---	--

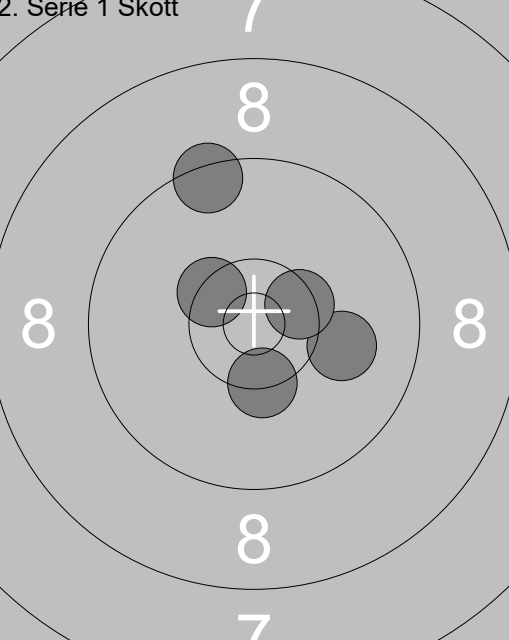
<p>2. Serie 1 Skott</p>  <p style="text-align: center;">7 8 8 8 7</p>	<p>1: 10.0 → 2: 9.4 ↑ 3: 10.4x ↖ 4: 10.5x ↗ 5: 10.4x ↘</p> <p>Serie 49.0 Total 335.0</p>		
---	--	--	--

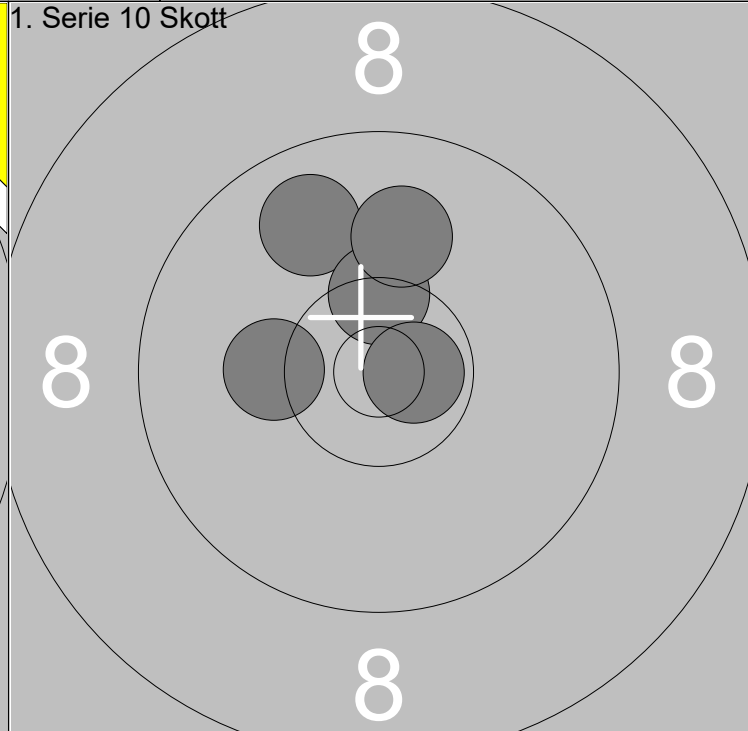
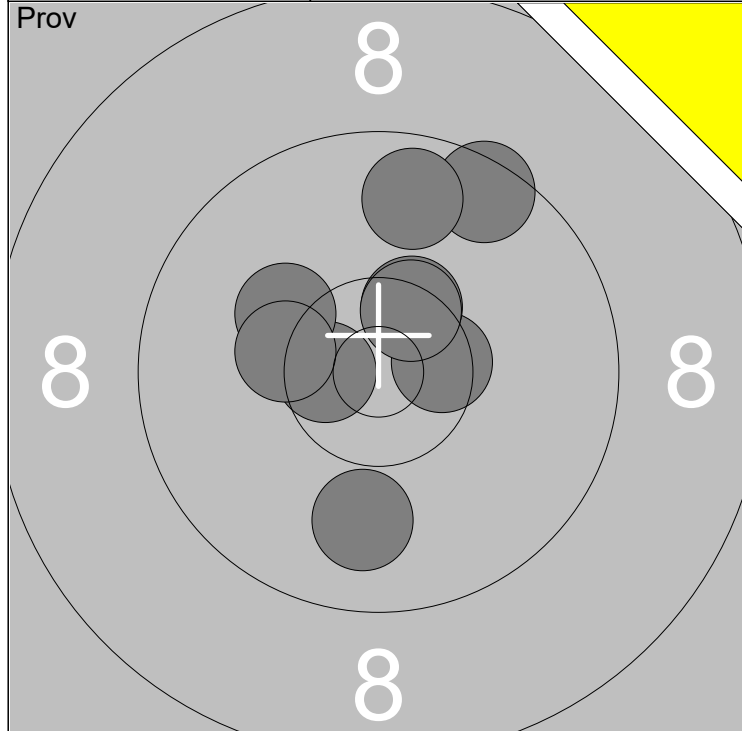

1: 10.5x →	6: 10.2 ↖	Serie	87
2: 10.6x ←	7: 10.3x ←		
3: 9.5 ↗	8: 10.5x ↗	Total	191
4: 9.7 ↑	9: 9.9 ↓		
5: 10.5x ↗			

1: 9.8 ↖	Serie	49
2: 10.4x ↑		
3: 10.2 ←	Total	240
4: 10.0 ↑		
5: 10.7x →		

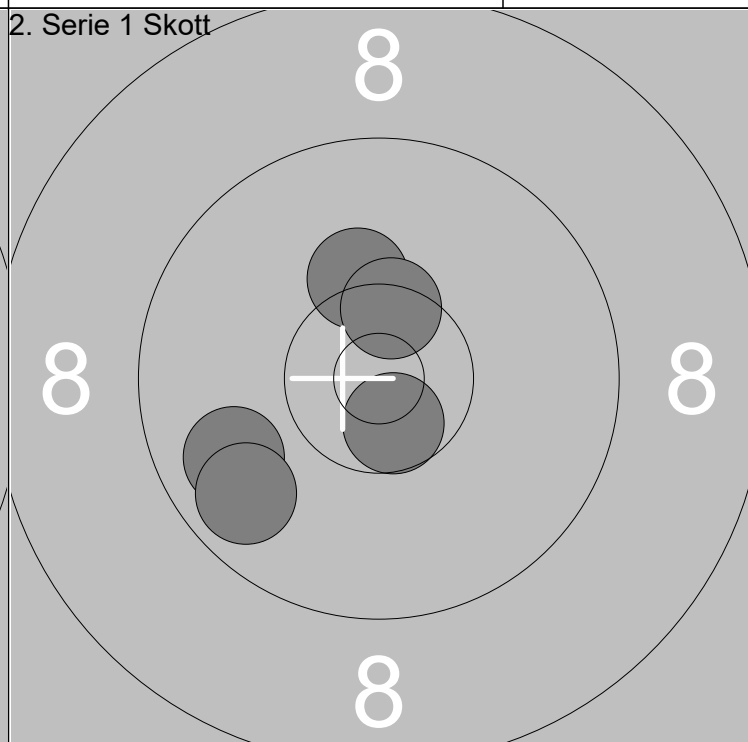
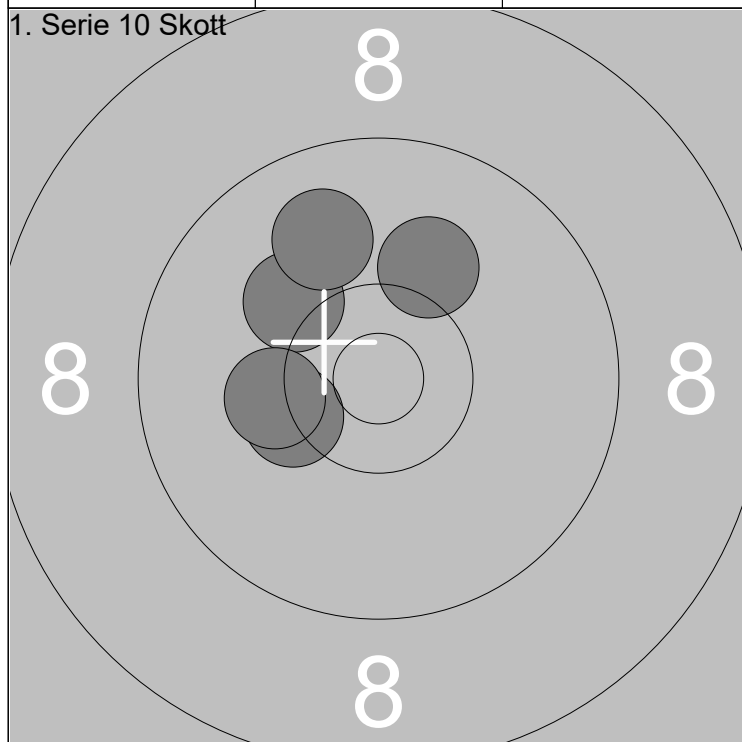

6: 10.2 ↖	Serie	49
7: 9.9 ↗		
8: 10.1 ↗	Total	289
9: 10.3x ←		
10: 10.2 ←		

1: 10.2 ↑	Serie	48
2: 9.8 ↙		
3: 10.5x ↑	Total	337
4: 10.6x ↓		
5: 9.7 ↙		



	<p>1: 9.2 ↙</p> <p>2: 10.5x↘</p> <p>3: 10.1 ↘</p> <p>4: 10.5x↓</p> <p>5: 8.6 ↗</p> <p>6: 9.6 ↑</p> <p>7: 9.2 ↑</p> <p>8: 9.0 ↘</p> <p>9: 9.4 ↗</p> <p>10: 9.8 ←</p>		<p>11: 9.9 ↑</p> <p>12: 9.5 ↙</p> <p>13: 10.4x↖</p>
Serie 92.0		Serie 28.0	
Total 185.0		Total 185.0	

<p>1. Serie 10 Skott</p>	<p>1: 8.9 ↖</p> <p>2: 9.9 ↙</p> <p>3: 10.6x↑</p> <p>4: 10.3x↖</p> <p>5: 10.7x↑</p>	<p>1. Serie 10 Skott</p>	<p>6: 10.0 ↗</p> <p>7: 10.0 ↗</p> <p>8: 10.4x↘</p> <p>9: 9.7 ↙</p> <p>10: 10.1 ↖</p>
Serie 47.0		Serie 49.0	
Total 232.0		Total 281.0	

<p>2. Serie 1 Skott</p>	<p>1: 10.0←</p> <p>2: 10.0→</p> <p>3: 9.8 ↗</p> <p>4: 9.7 ↗</p> <p>5: 10.2 ↘</p>		
Serie 48.0			
Total 329.0			

	<p>1: 6.9 ↙                  2: 9.7 ↙                  3: 8.6 ↑                  4: 9.3 ↙                  5: 8.7 →                  6: 9.2 →                  7: 8.2 →                  8: 9.0 ↘                  9: 9.4 ↗                  10: 9.8 ↘</p>		<p>11: 7.8 ↙                  12: 9.6 ↗                  13: 9.2 ↗                  14: 10.1 ←                  15: 9.2 ↘                  16: 9.2 ←</p>
Serie 84.0		Serie 53.0	
Total 178.0		Total 178.0	

<p>1. Serie 10 Skott</p>	<p>1: 8.8 →                  2: 10.2 ↑                  3: 8.5 ↘                  4: 8.4 ↘                  5: 10.1 ↘</p>	<p>1. Serie 10 Skott</p>	<p>6: 9.6 ←                  7: 6.4 ↘                  8: 10.4x→                  9: 9.7 ←                  10: 8.8 →</p>
Serie 44.0		Serie 42.0	
Total 222.0		Total 264.0	

<p>2. Serie 1 Skott</p>	<p>1: 9.2 ←                  2: 8.4 ↘                  3: 9.3 ↘                  4: 8.0 →                  5: 9.7 ↗</p>		
Serie 43.0			
Total 307.0			

Serie 80.0 Total 162.0	Serie 37.0 Total 162.0

1. Serie 10 Skott 	1. Serie 10 Skott 
Serie 45.0 Total 207.0	Serie 46.0 Total 253.0

2. Serie 1 Skott 	
Serie 46.0 Total 299.0	Serie 46.0 Total 299.0

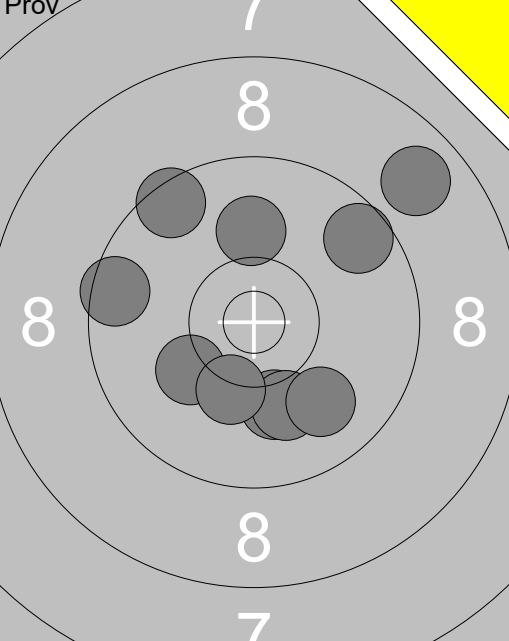
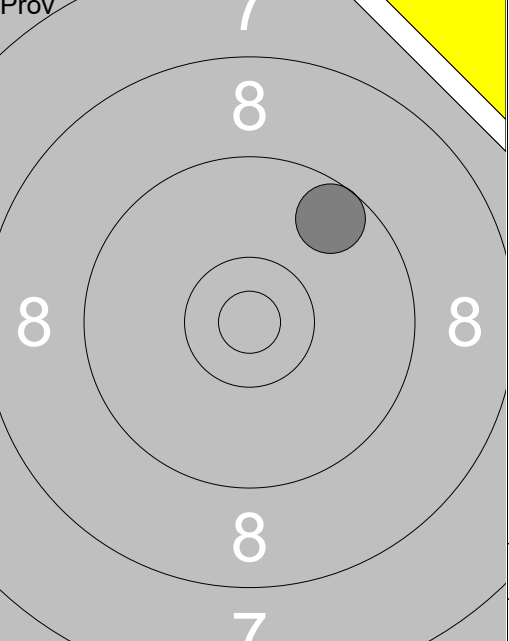
 <p>Prov</p>	<p>1: 8.8 ↗</p> <p>2: 9.5 ↗</p> <p>3: 9.5 ←</p> <p>4: 9.6 ↗</p> <p>5: 10.1 ↓</p> <p>6: 10.1 ↓</p> <p>7: 10.0 ↑</p> <p>8: 10.2 ↙</p> <p>9: 10.2 ↓</p> <p>10: 9.9 ↘</p>	 <p>Prov</p>	<p>11: 9.6 ↗</p>
Serie 94.0		Serie 9.0	
Total 194.0		Total 194.0	

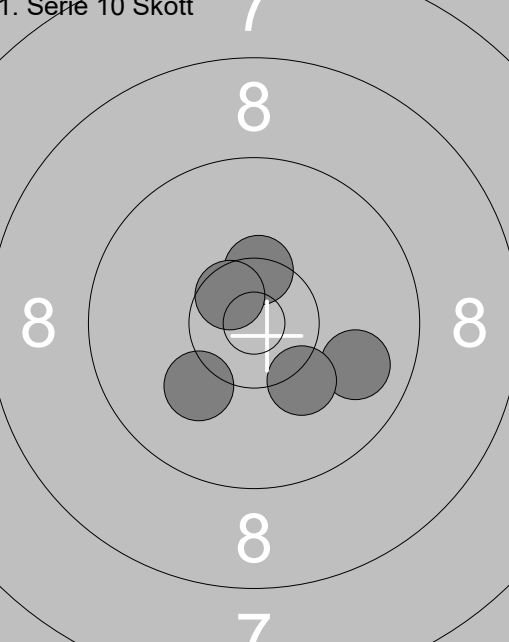
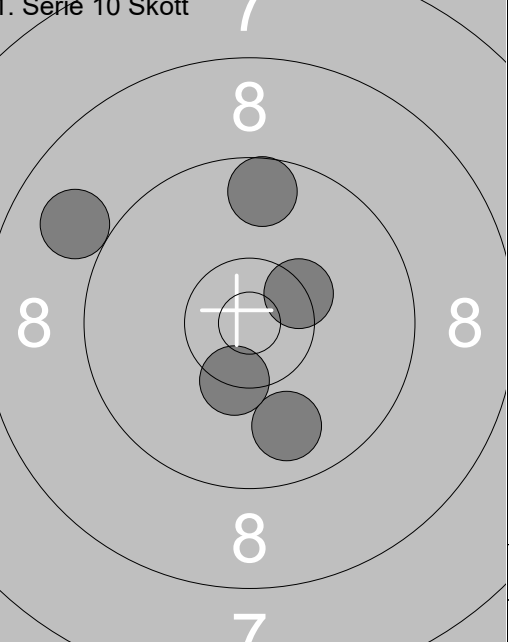
<p>1. Serie 10 Skott</p> 	<p>1: 10.4x↑</p> <p>2: 9.9 →</p> <p>3: 10.6x↘</p> <p>4: 10.2 ↓</p> <p>5: 10.1 ↙</p>	<p>1. Serie 10 Skott</p> 	<p>6: 10.4x↗</p> <p>7: 9.9 ↓</p> <p>8: 10.4x↓</p> <p>9: 9.6 ↑</p> <p>10: 9.0 ↙</p>
Serie 49.0		Serie 47.0	
Total 243.0		Total 290.0	

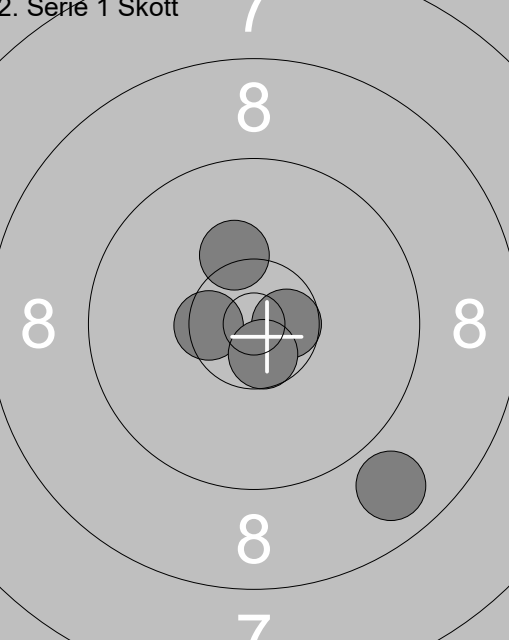
<p>2. Serie 1 Skott</p> 	<p>1: 10.6x→</p> <p>2: 8.8 ↘</p> <p>3: 10.2 ↑</p> <p>4: 10.5x←</p> <p>5: 10.6x↓</p>		
Serie 48.0			
Total 338.0			

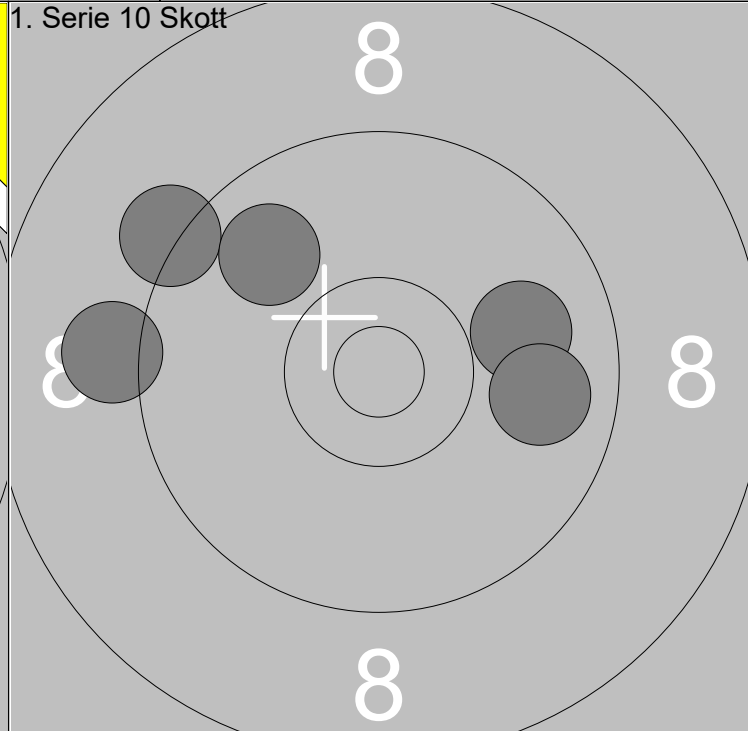
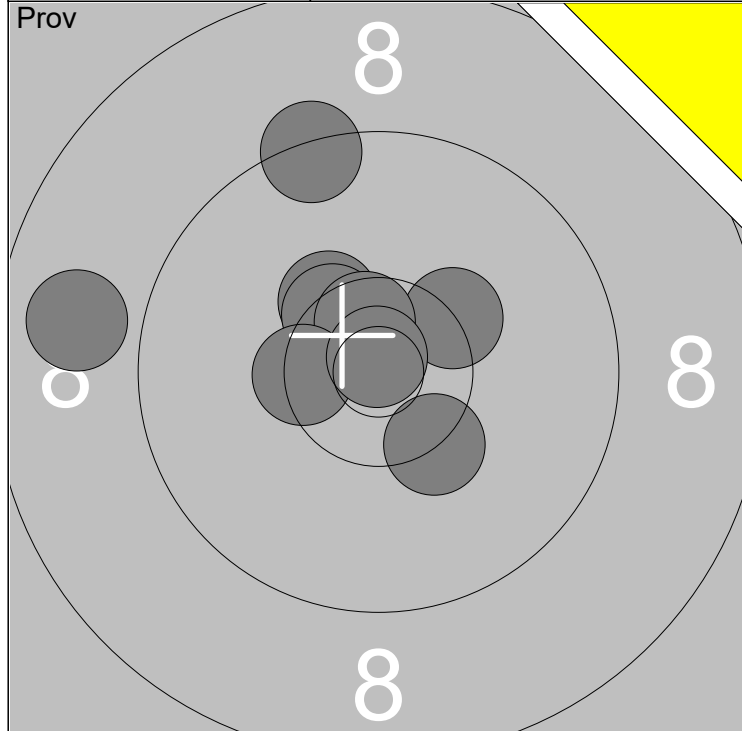

1: 8.8 ←	6: 9.4 ↗	Serie	87
2: 10.3x ↘	7: 10.6x ↗		
3: 10.4x ↗	8: 10.4x ←	Total	193
4: 10.4x ↗	9: 10.8x ↗		
5: 10.3x ↗			

1: 9.2 ↗	Serie	45
2: 9.9 →		
3: 9.1 ←	Total	238
4: 9.8 ↗		
5: 9.8 →		

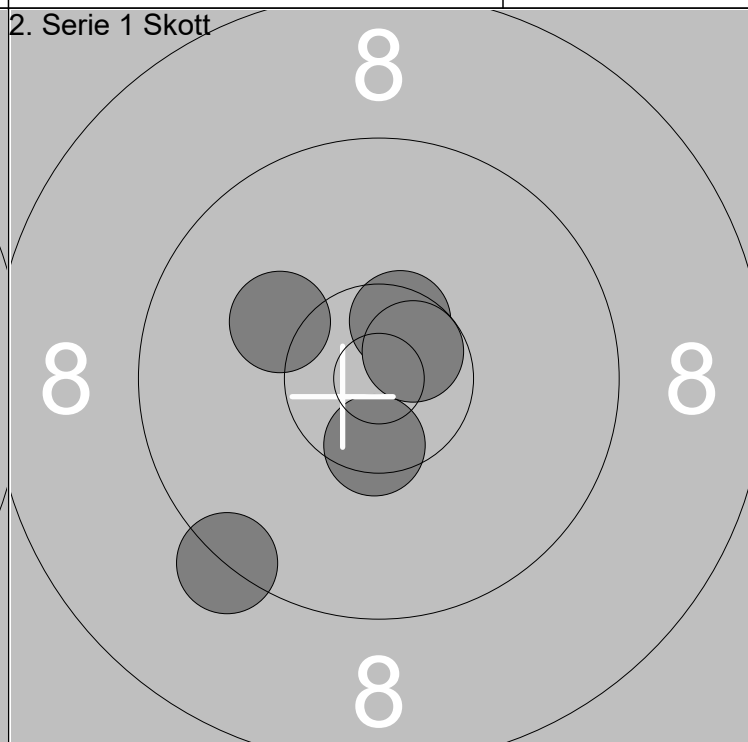
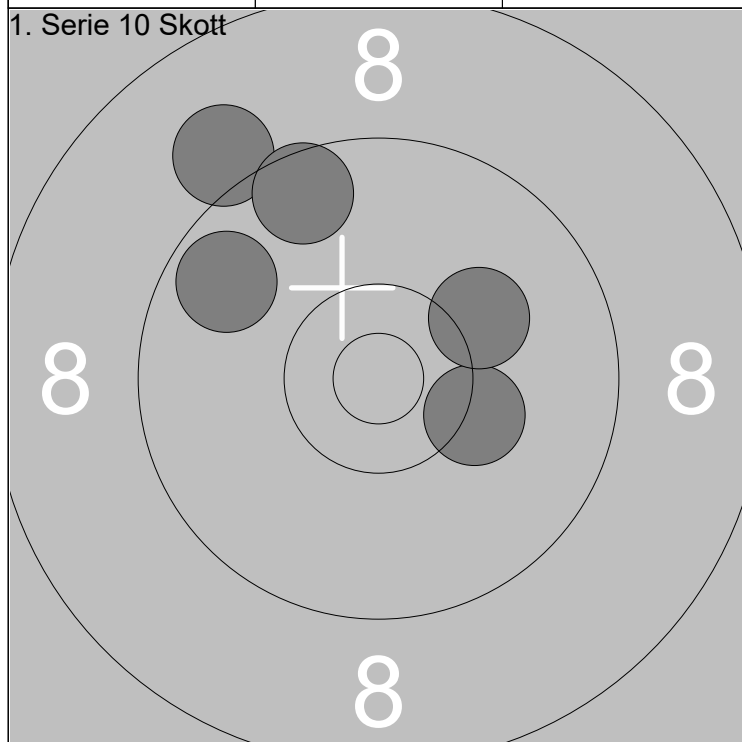

6: 9.7 ↗	Serie	47
7: 9.1 ↗		
8: 9.6 ↗	Total	285
9: 10.2 ↘		
10: 10.1 ↗		

1: 10.2 ↗	Serie	49
2: 9.3 ↘		
3: 10.5x ↘	Total	334
4: 10.5x ↗		
5: 10.7x ↗		

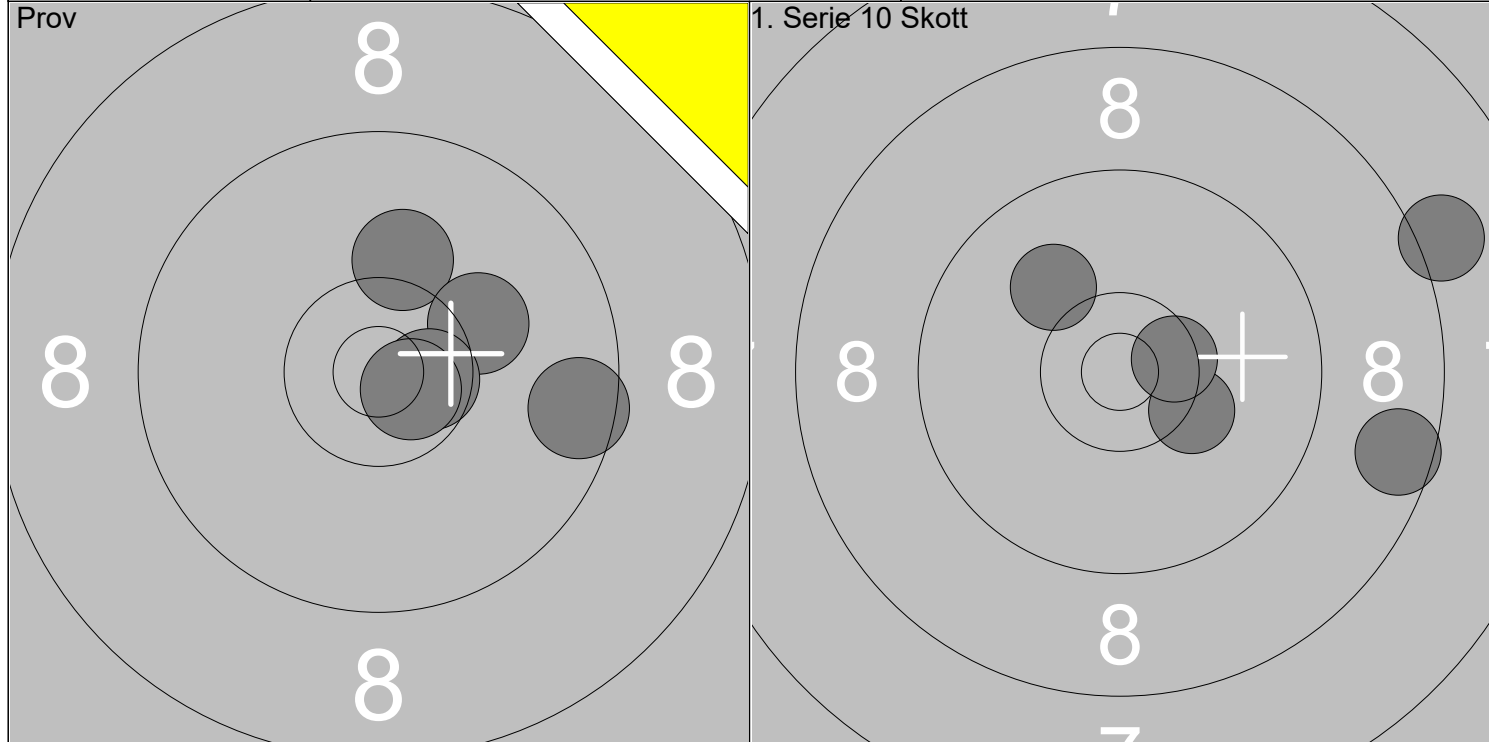

1:	10.2	↑
2:	9.6	→
3:	10.2	↗
4:	10.6x	→
5:	10.7x	↘

Serie	49
Total	193

1:	8.1	↗
2:	8.6	→
3:	10.1	↖
4:	10.3	↘
5:	10.5x	→

Serie	46
Total	239

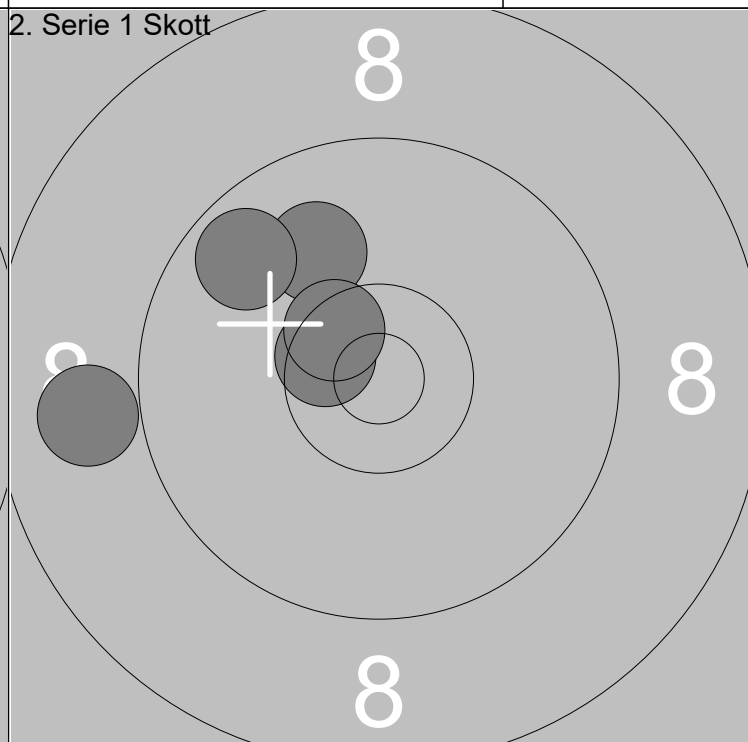
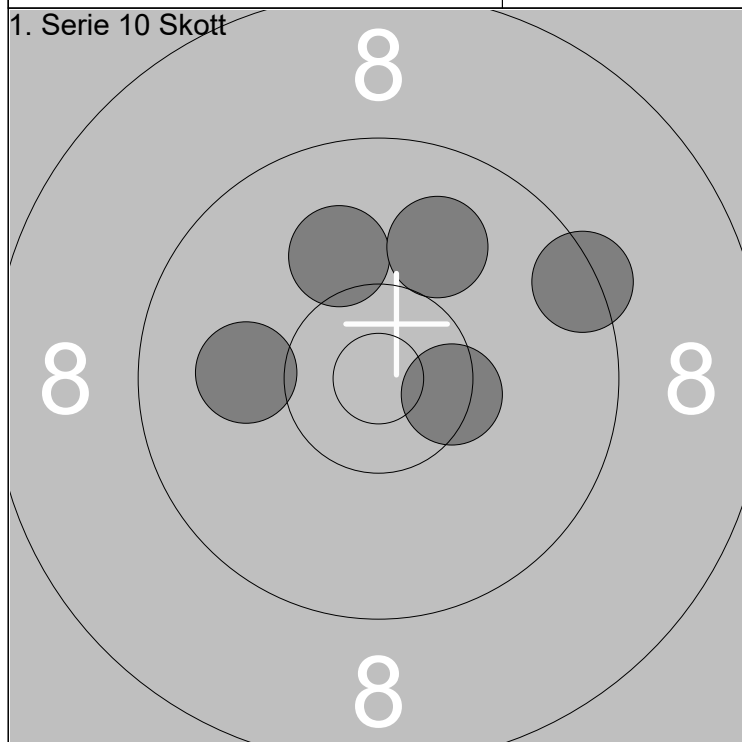

6:	10.4x	→
7:	10.0	←
8:	9.4	↗
9:	10.1	↑
10:	10.0	↑

Serie	49
Total	288

1:	10.5x	↖
2:	8.9	←
3:	10.0	↖
4:	10.5x	↖
5:	9.7	↖

Serie	47
Total	335

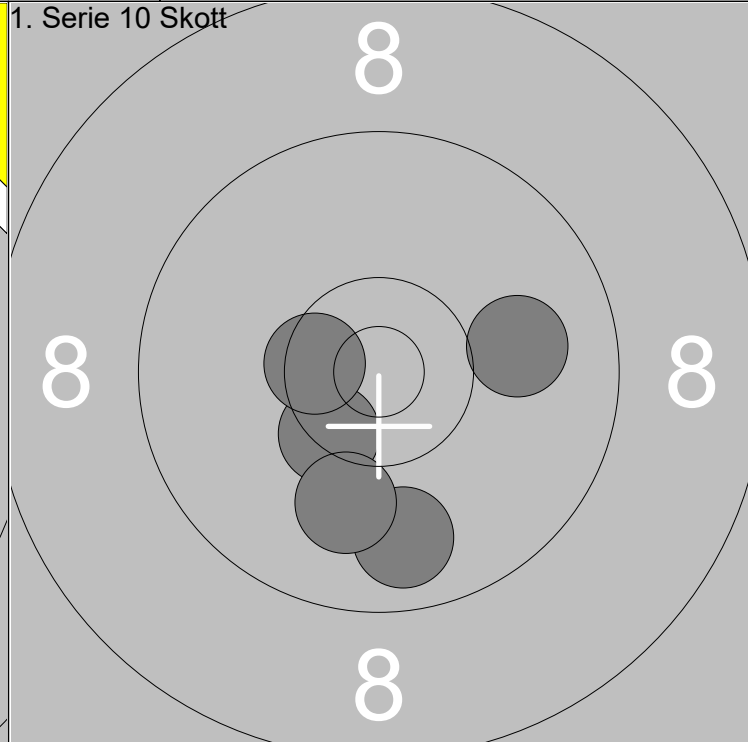
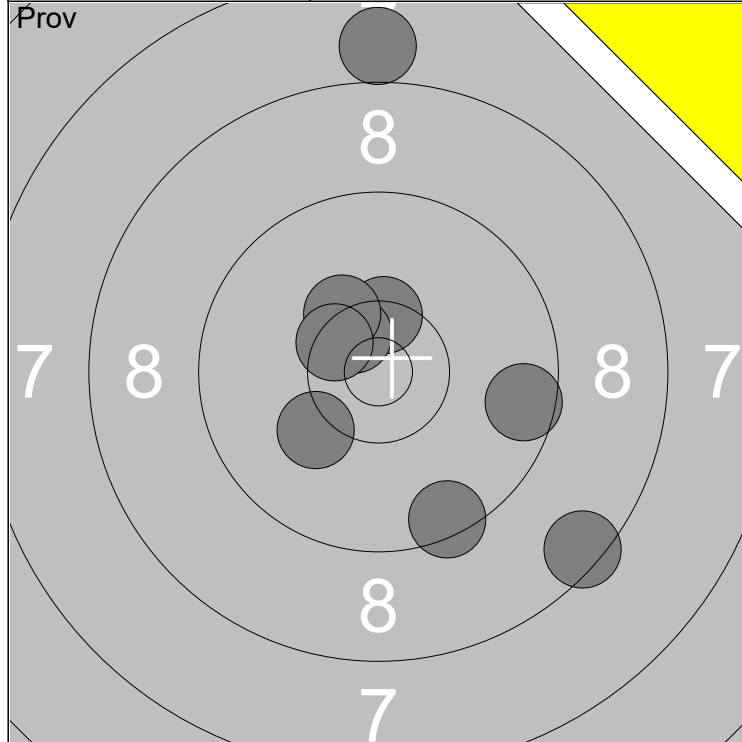

1: 8.0 ↑	6: 10.2 ↙	Serie	94
2: 10.5x ↗	7: 9.5 ↘		
3: 10.4x ↑	8: 8.5 ↘	Total	192
4: 10.5x ↗	9: 10.3x ↗		
5: 9.6 →	10: 10.5x ↗		

1: 9.8 ↓	Serie	49
2: 10.0 →		
3: 10.4x ↘	Total	241
4: 10.0 ↓		
5: 10.5x ←		

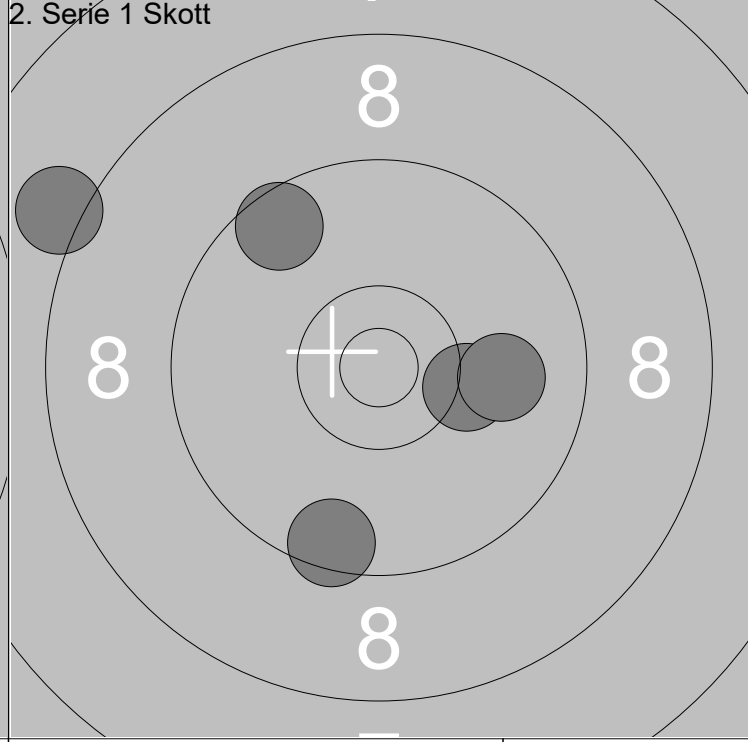
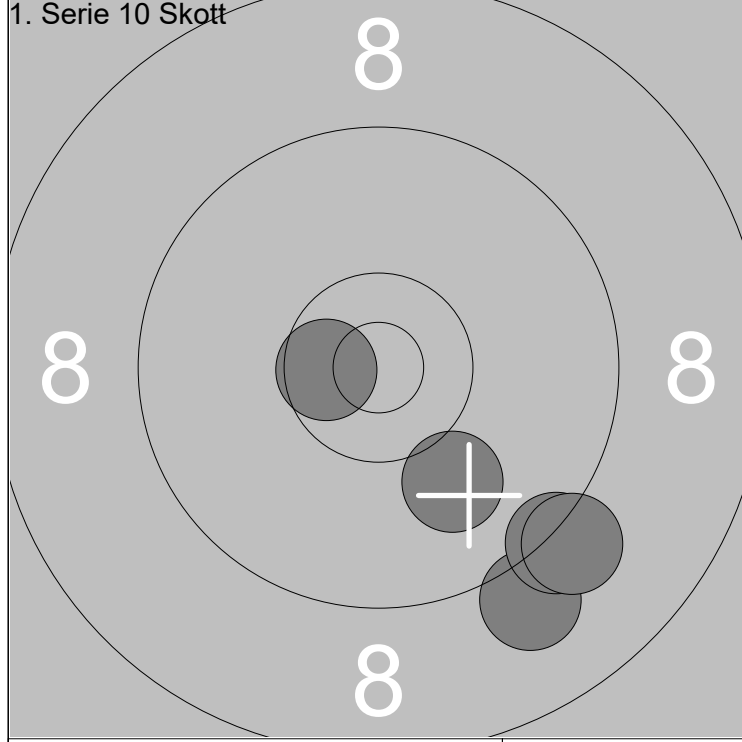

6: 9.0 ↘	Serie	47
7: 10.0 ↘		
8: 9.2 ↘	Total	288
9: 9.2 ↘		
10: 10.6x ←		

1: 8.1 ↗	Serie	46
2: 9.5 ↘		
3: 9.6 ↗	Total	334
4: 10.2 ↘		
5: 10.0 →		

	<p>1: 9.5 ←</p> <p>2: 8.0 ←</p> <p>3: 9.5 ↑</p> <p>4: 9.9 →</p> <p>5: 9.9 →</p> <p>7: 9.1 ↑</p> <p>8: 10.6x ↗</p> <p>9: 10.5x ↘</p> <p>10: 9.6 ↖</p>		<p>11: 10.8x ↗</p> <p>12: 10.3 ↖</p> <p>13: 10.3x ↘</p>
Serie 82.0		Serie 30.0	
Total 192.0		Total 192.0	

<p>1. Serie 10 Skott</p>	<p>1: 9.0 →</p> <p>2: 9.3 ↗</p> <p>3: 10.5x ↘</p> <p>4: 9.2 →</p> <p>5: 10.6x ↘</p>	<p>1. Serie 10 Skott</p>	<p>6: 10.1 →</p> <p>7: 9.8 →</p> <p>8: 10.8x ↘</p> <p>9: 10.1 →</p> <p>10: 10.7x ↗</p>
Serie 47.0		Serie 49.0	
Total 239.0		Total 288.0	

<p>2. Serie 1 Skott</p>	<p>1: 10.2 ↗</p> <p>2: 10.4x ↗</p> <p>3: 10.0 ↖</p> <p>4: 10.2 ↑</p> <p>5: 9.9 ↘</p>		
Serie 49.0			
Total 337.0			

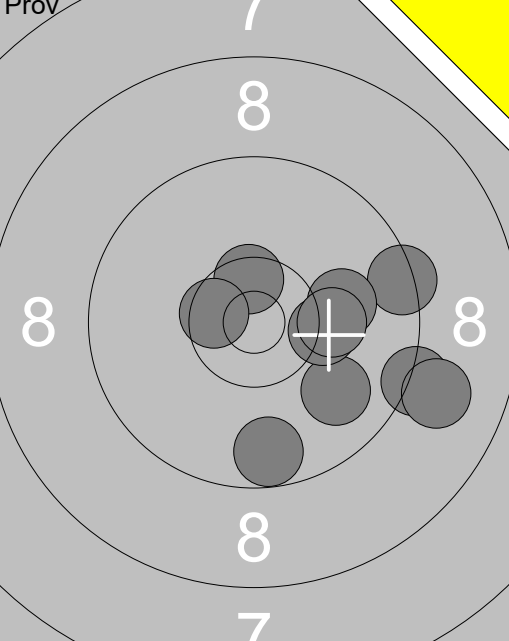
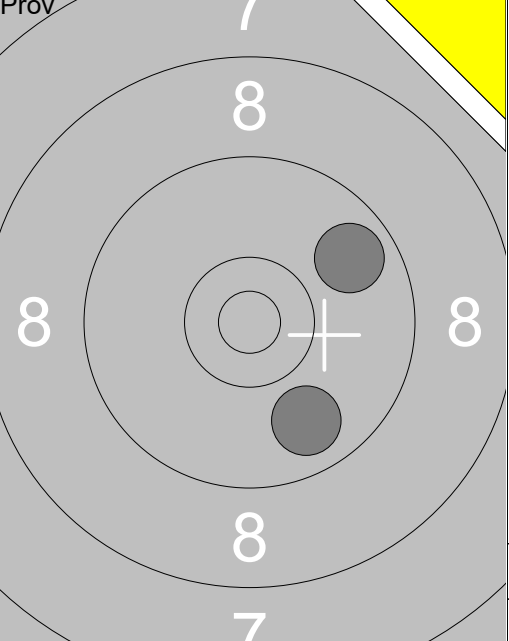

	<p>1: 9.9 ↘ 2: 9.4 → 3: 10.1 → 4: 9.2 → 5: 10.3 → 6: 9.0 → 7: 10.5x ↑ 8: 10.2 → 9: 10.5x ↙ 10: 9.6 ↓</p> <table border="1" style="width:100%; border-collapse: collapse;"> <tr><td>Serie</td><td style="text-align:right;">95.0</td></tr> <tr><td>Total</td><td style="text-align:right;">191.0</td></tr> </table>	Serie	95.0	Total	191.0		<p>11: 9.8 ↘ 12: 9.8 ↗</p> <table border="1" style="width:100%; border-collapse: collapse;"> <tr><td>Serie</td><td style="text-align:right;">18.0</td></tr> <tr><td>Total</td><td style="text-align:right;">191.0</td></tr> </table>	Serie	18.0	Total	191.0
Serie	95.0										
Total	191.0										
Serie	18.0										
Total	191.0										

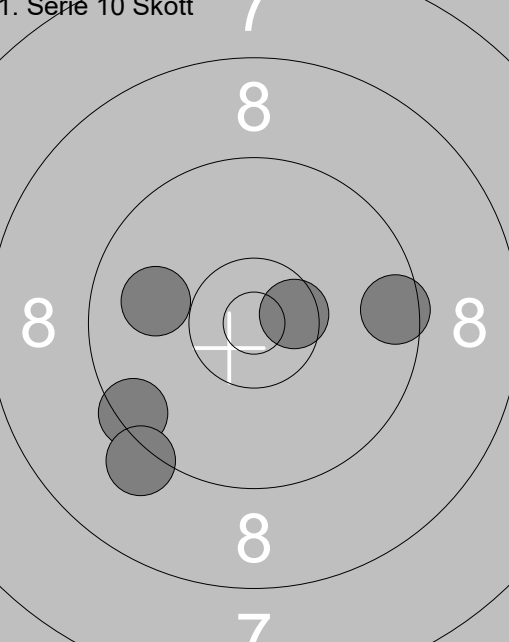
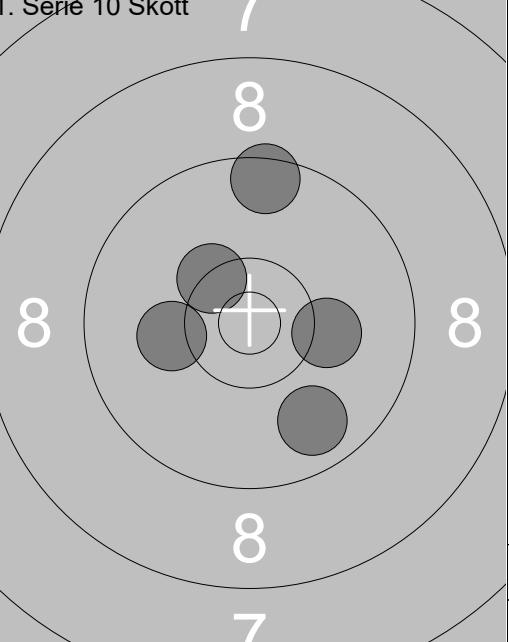
<p>1. Serie 10 Skott</p> 	<p>1: 9.9 ← 2: 10.5x → 3: 9.4 ← 4: 9.2 ↓ 5: 9.5 →</p> <table border="1" style="width:100%; border-collapse: collapse;"> <tr><td>Serie</td><td style="text-align:right;">46.0</td></tr> <tr><td>Total</td><td style="text-align:right;">237.0</td></tr> </table>	Serie	46.0	Total	237.0	<p>1. Serie 10 Skott</p> 	<p>6: 10.2 ← 7: 10.4x ↙ 8: 10.2 → 9: 9.8 ↓ 10: 9.5 ↑</p> <table border="1" style="width:100%; border-collapse: collapse;"> <tr><td>Serie</td><td style="text-align:right;">48.0</td></tr> <tr><td>Total</td><td style="text-align:right;">285.0</td></tr> </table>	Serie	48.0	Total	285.0
Serie	46.0										
Total	237.0										
Serie	48.0										
Total	285.0										

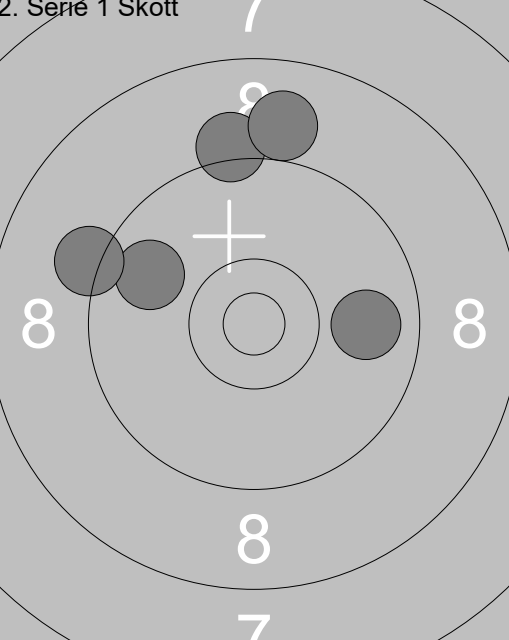
<p>2. Serie 1 Skott</p> 	<p>1: 9.8 ← 2: 9.8 → 3: 9.2 ← 4: 9.2 ↑ 5: 9.0 ↑</p> <table border="1" style="width:100%; border-collapse: collapse;"> <tr><td>Serie</td><td style="text-align:right;">45.0</td></tr> <tr><td>Total</td><td style="text-align:right;">330.0</td></tr> </table>	Serie	45.0	Total	330.0		
Serie	45.0						
Total	330.0						

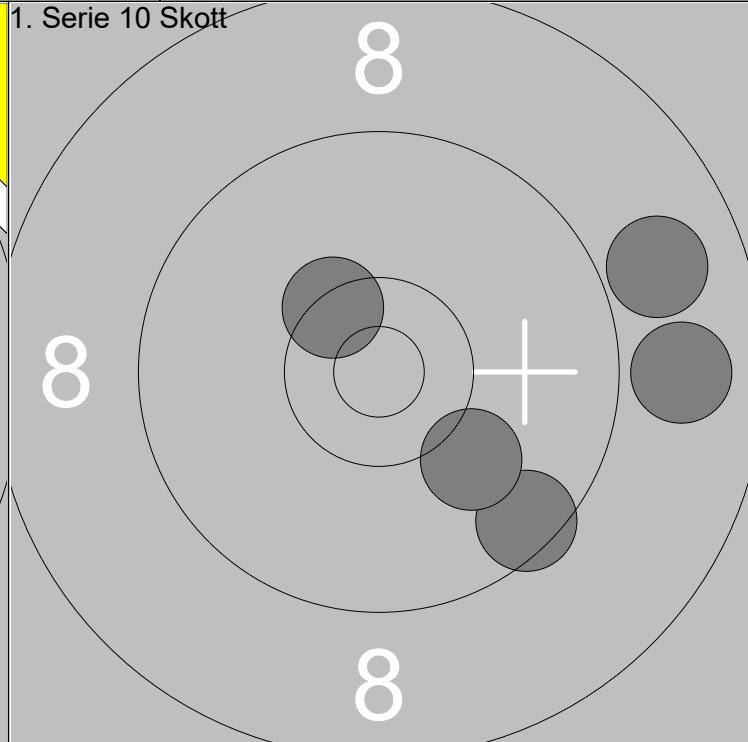
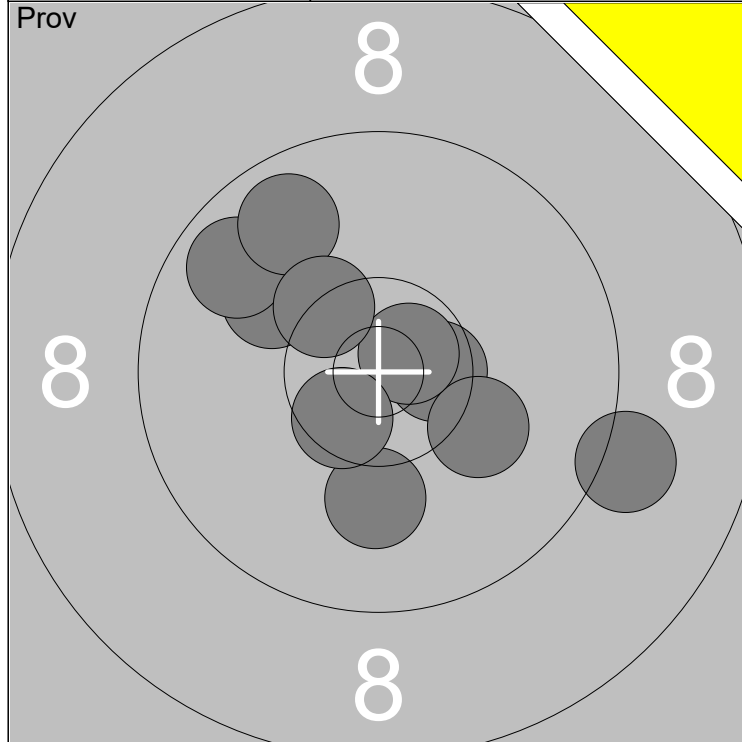

1: 10.1 ↗	6: 10.7x ↗	Serie	97
2: 9.7 ↗	7: 9.8 ↗		
3: 10.5x →	8: 10.1 ↓	Total	191
4: 10.2 ↘	9: 10.4x ↗		
5: 9.1 ↘	10: 10.5x ↘		

1: 8.9 →	Serie	45
2: 9.5 ↘		
3: 10.1 ↘	Total	236
4: 10.4x ↗		
5: 8.9 →		

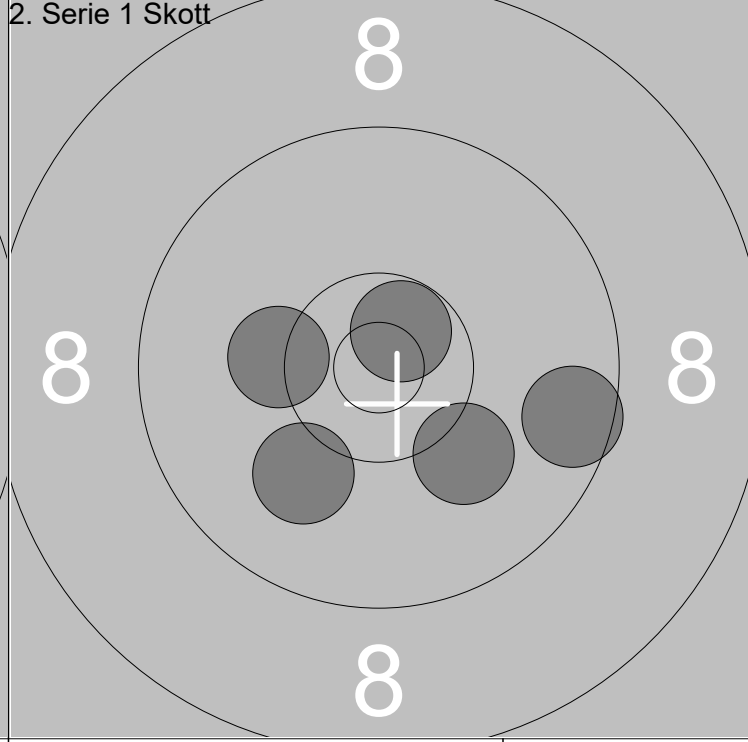
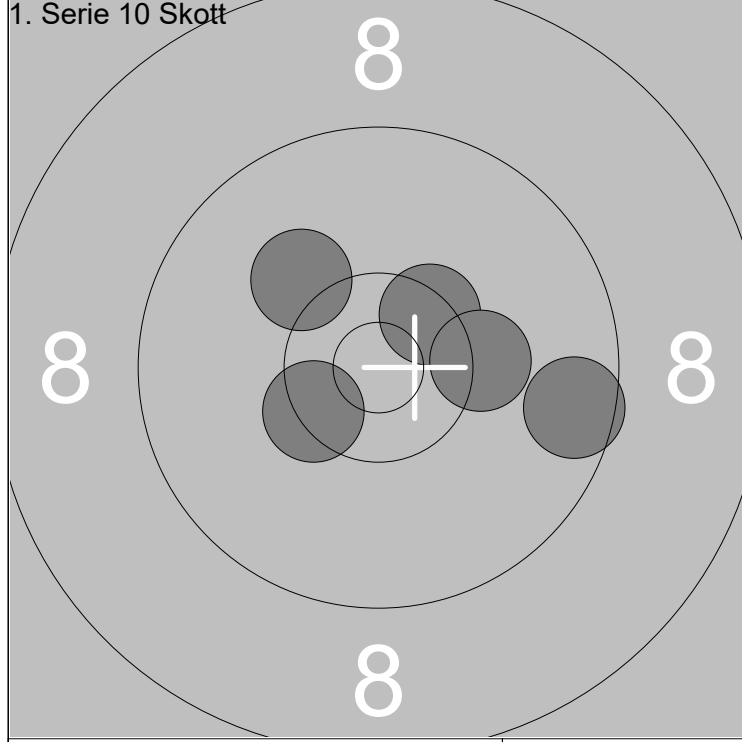

6: 10.4x ↙	Serie	49
7: 10.2 ↗		
8: 10.4x ↗	Total	285
9: 9.6 →		
10: 10.2 →		

1: 10.3 ←	Serie	49
2: 9.6 →		
3: 10.1 ↘	Total	334
4: 10.1 ↘		
5: 10.7x ↗		

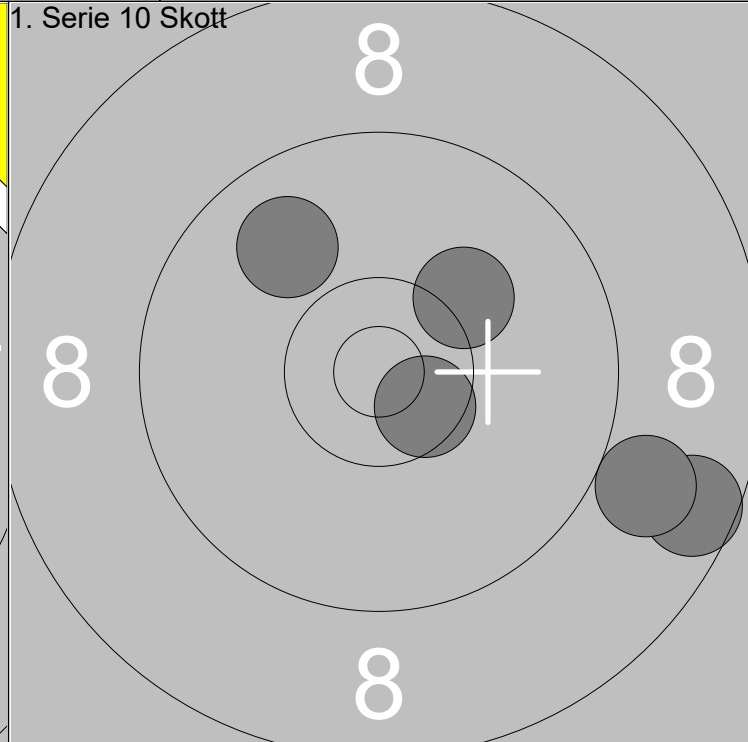
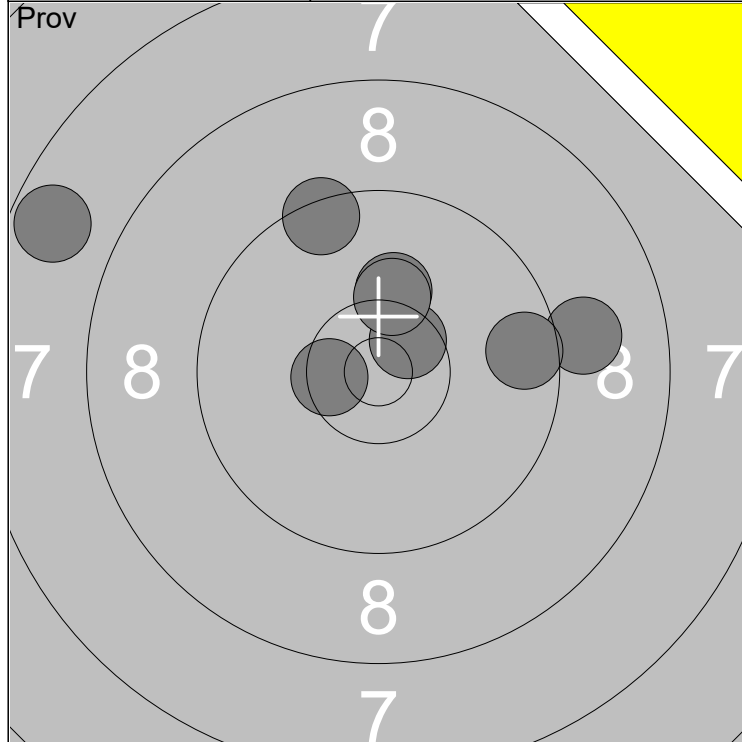

1: 7.7 ↙	6: 10.5x ←	Serie	74
2: 9.4 ↗	7: 10.6x ↗		
3: 10.2 ↑	8: 10.3 ↑	Total	191
4: 9.1 →			
5: 9.6 →			

1: 10.2 ↗	Serie	46
2: 10.6x ↘		
3: 9.9 ↗	Total	237
4: 8.6 ↘		
5: 9.0 ↘		

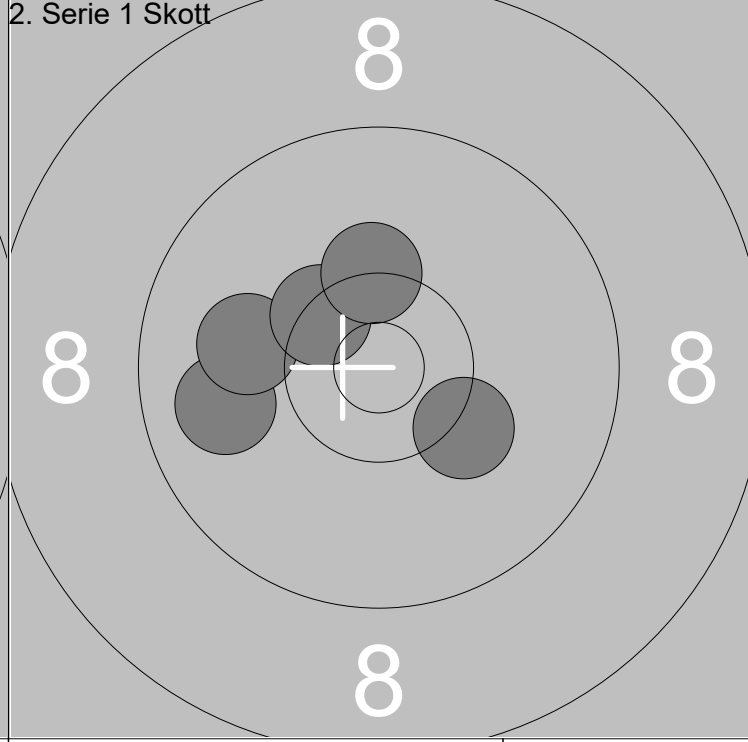
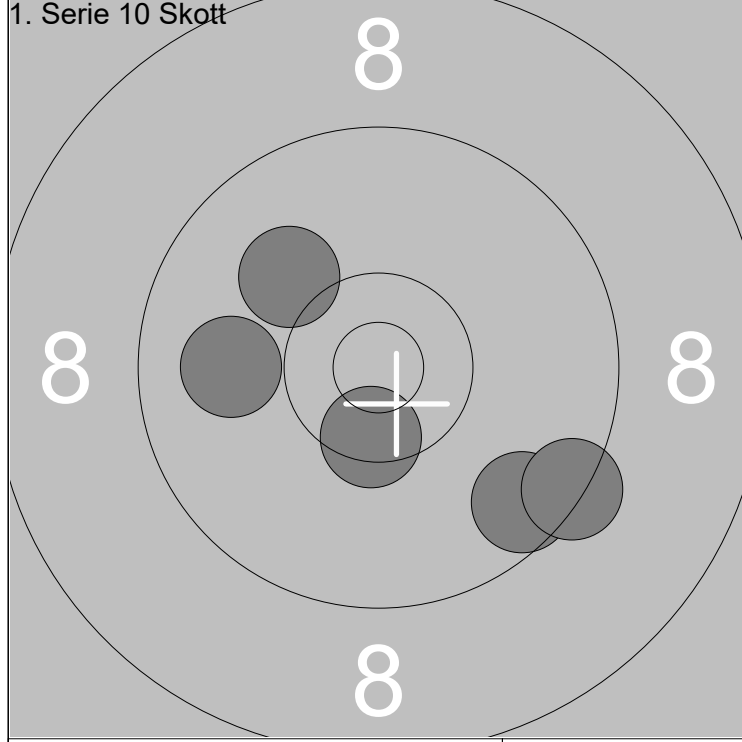

6: 10.5x ↓	Serie	47
7: 9.9 ←		
8: 10.1 ↗	Total	284
9: 9.6 ↘		
10: 9.4 ↘		

1: 10.2 ↘	Serie	49
2: 9.9 ←		
3: 10.0 ←	Total	333
4: 10.4x ↗		
5: 10.3x ↑		

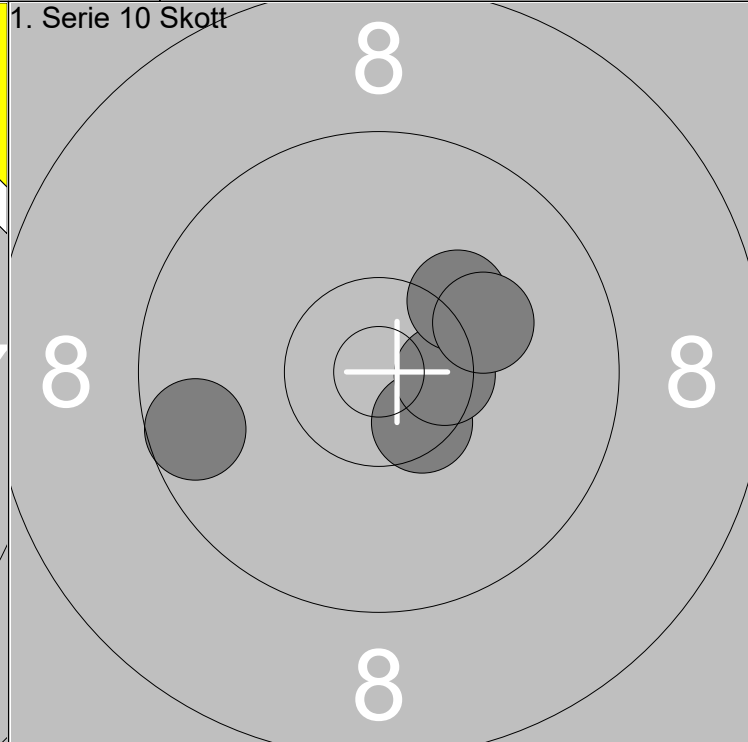
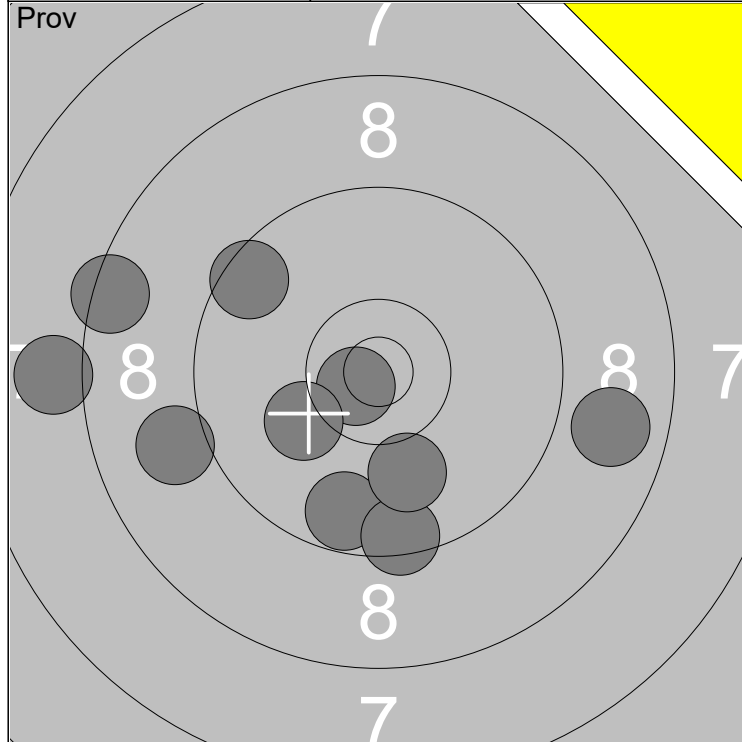

1: 8.5 ← 2: 8.0 ← 3: 9.0 ← 4: 10.7x ← 5: 9.5 ↖	6: 10.1 ↙ 7: 8.8 → 8: 9.7 ↓ 9: 9.5 ↓ 10: 10.0 ↓	Serie	90
		Total	190

1: 10.5x ↘ 2: 10.5x → 3: 9.6 ← 4: 10.2 ↗ 5: 10.2 ↗	Serie	49	
		Total	239

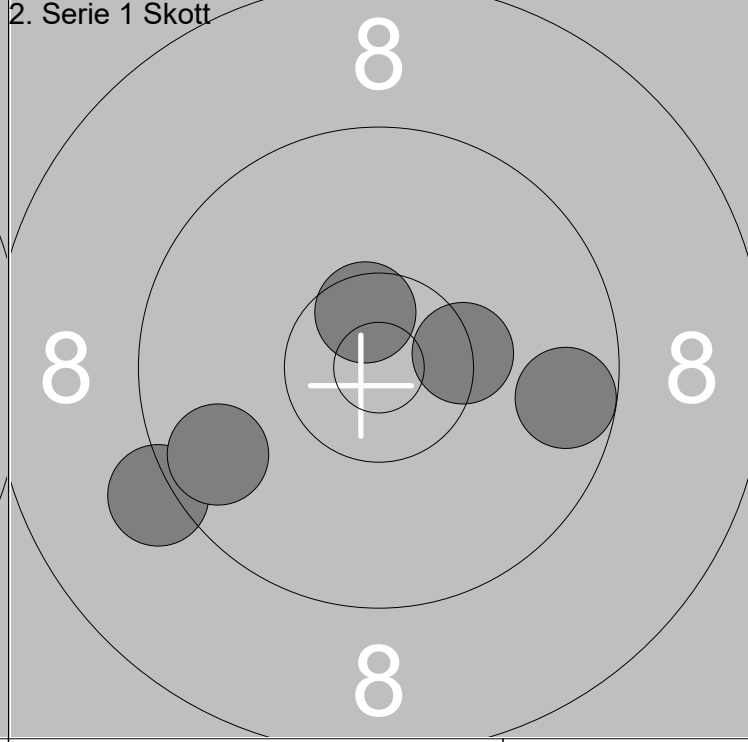
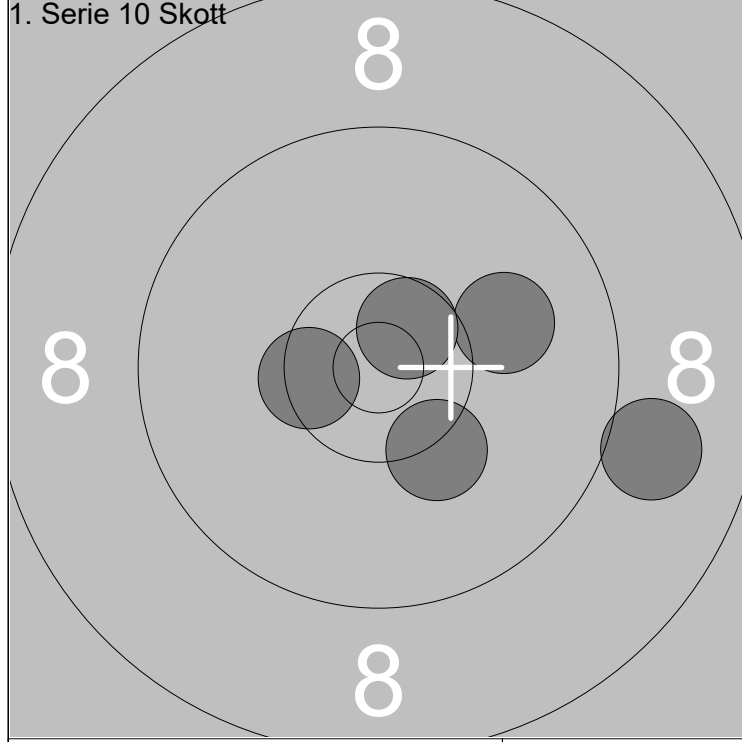

6: 10.0 → 7: 9.0 → 8: 10.3 ↓ 9: 10.5x ← 10: 10.6x ↗	Serie	49	
		Total	288

1: 10.4x → 2: 9.2 ← 3: 9.7 ← 4: 9.7 → 5: 10.6x ↑	Serie	47	
		Total	335

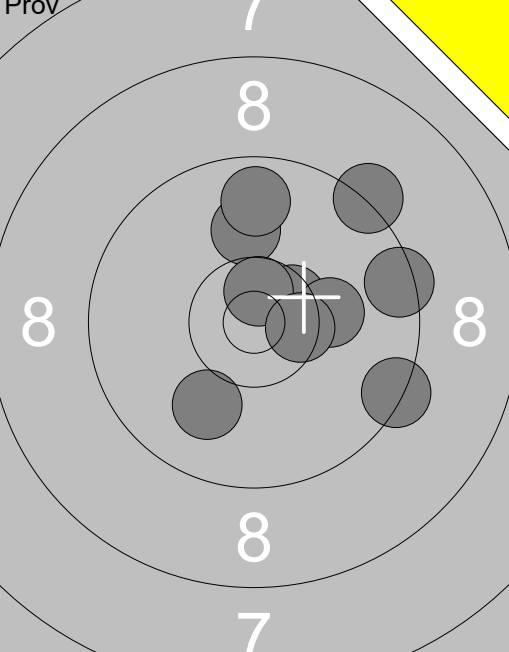
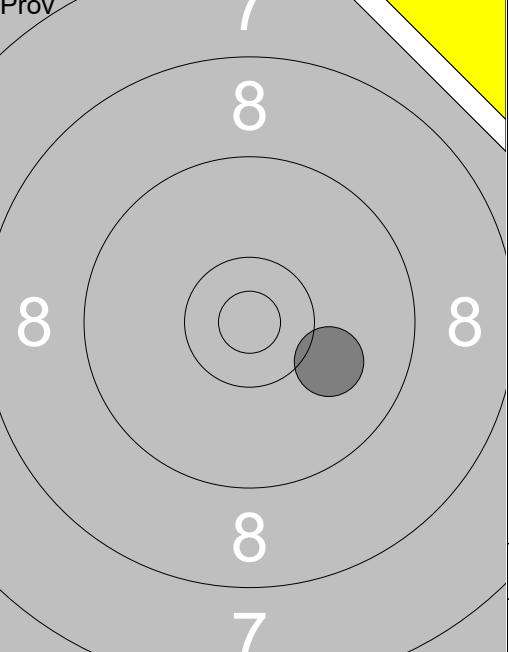
	<p>1: 9.3 ↗</p> <p>2: 10.0 ↑</p> <p>3: 9.4 →</p> <p>4: 9.4 →</p> <p>5: 10.5x ↗</p> <p>6: 10.2 →</p> <p>7: 10.0 ↓</p> <p>8: 10.6x ↑</p> <p>9: 9.7 ↑</p> <p>10: 10.5x →</p>		<p>11: 10.1 ↘</p>
Serie 96.0		Serie 10.0	
Total 187.0		Total 187.0	

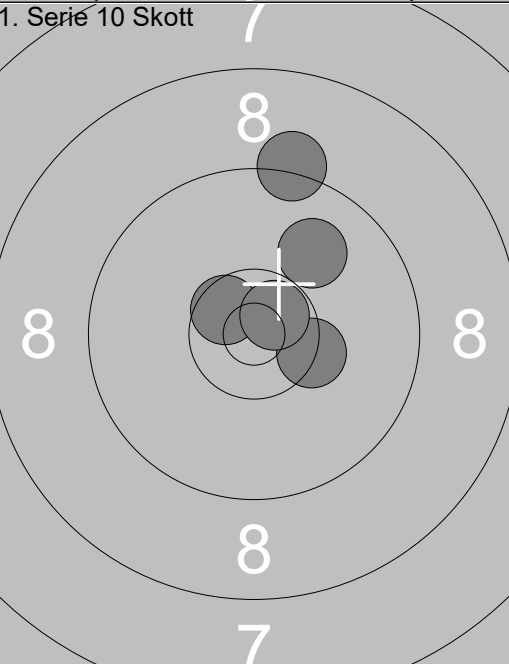
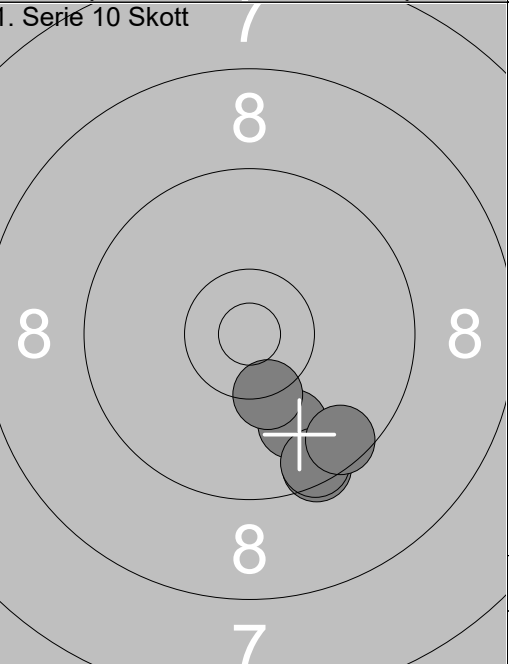
<p>1. Serie 10 Skott</p> 	<p>1: 9.2 ↑</p> <p>2: 10.6x ↘</p> <p>3: 10.3x →</p> <p>4: 10.0 ↗</p> <p>5: 10.7x ↗</p>		<p>6: 10.0 ↓</p> <p>7: 9.5 ↓</p> <p>8: 9.5 ↓</p> <p>9: 10.3x ↓</p> <p>10: 9.6 ↓</p>
Serie 49.0		Serie 47.0	
Total 236.0		Total 283.0	

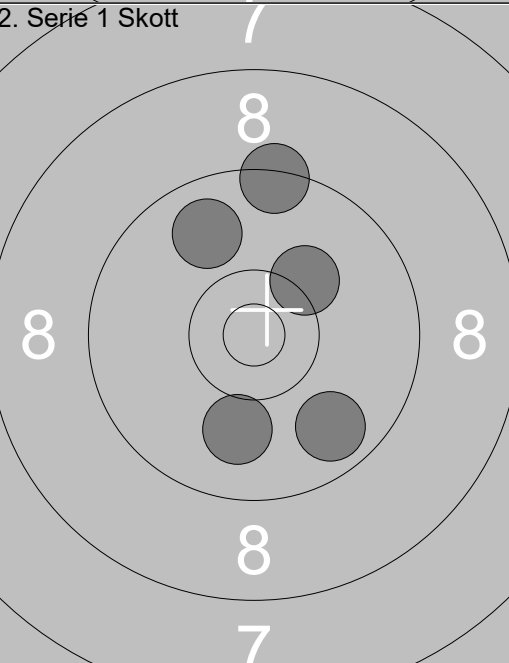
<p>2. Serie 1 Skott</p> 	<p>1: 9.8 ↓</p> <p>2: 9.4 ↑</p> <p>3: 10.2 ↗</p> <p>4: 10.0 ↓</p> <p>5: 9.8 ↑</p>		
Serie 47.0			
Total 330.0			

	<p>1: 9.4 ←</p> <p>2: 10.7x↑</p> <p>3: 9.8 ←</p> <p>4: 10.5x↑</p> <p>5: 9.5 →</p> <p>6: 10.4x↖</p> <p>7: 10.1 ↑</p> <p>8: 9.4 →</p> <p>9: 10.1 ↖</p> <p>10: 10.3x↘</p>		<p>11: 10.5x↖</p>
Serie 96.0		Serie 10.0	
Total 186.0		Total 186.0	

<p>1. Serie 10 Skott</p>	<p>1: 8.1 ↘</p> <p>2: 9.7 ↘</p> <p>3: 10.3x↖</p> <p>4: 10.6x←</p> <p>5: 10.2 ↘</p>		<p>6: 9.3 ↖</p> <p>7: 9.4 →</p> <p>8: 10.1 →</p> <p>9: 10.2 →</p> <p>10: 10.2 ↖</p>
Serie 47.0		Serie 48.0	
Total 233.0		Total 281.0	

<p>2. Serie 1 Skott</p>	<p>1: 10.7x↘</p> <p>2: 10.0 ←</p> <p>3: 9.5 ↘</p> <p>4: 10.2 →</p> <p>5: 9.8 ←</p>		
Serie 48.0			
Total 329.0			

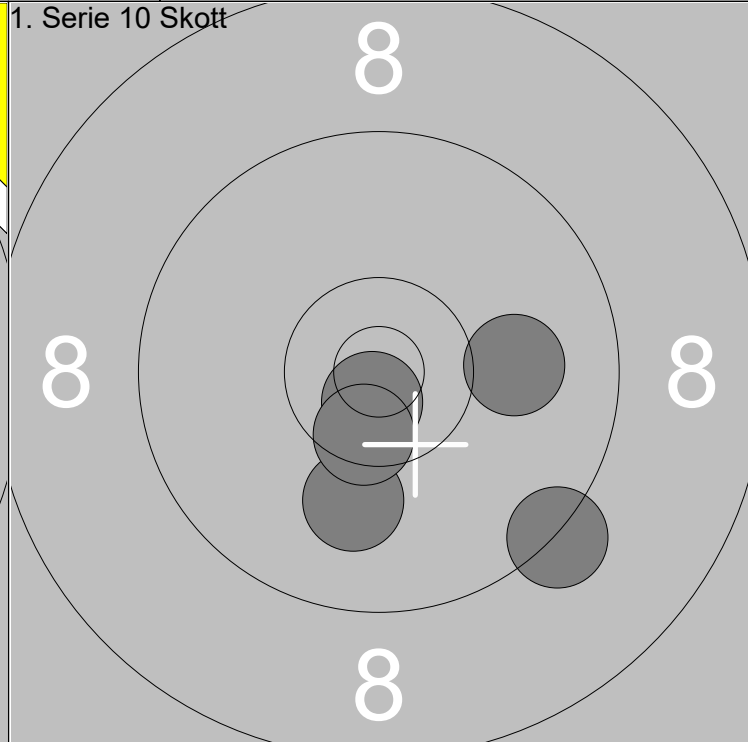
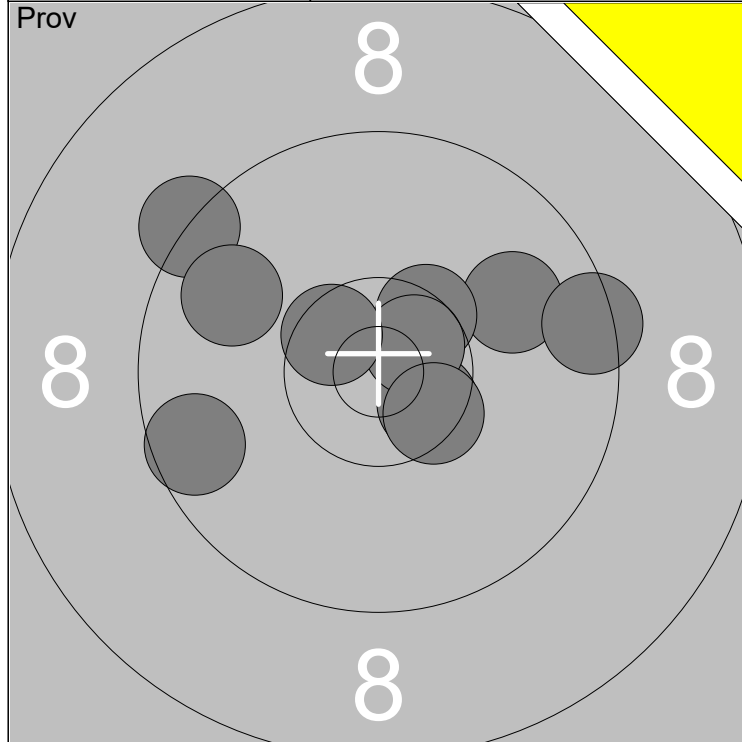

1: 9.3 ↖	6: 10.6x ↗	Serie	95
2: 9.9 ↗	7: 10.5x ↘		
3: 9.6 ↙	8: 9.4 ↘	Total	186
4: 10.4x ↗	9: 9.8 ↖		
5: 10.6x ↘	10: 10.5x ↖		

1: 10.1 ↓	Serie	49
2: 9.3 ↘		
3: 10.0 →	Total	235
4: 10.7x ↓		
5: 10.5x ↓		

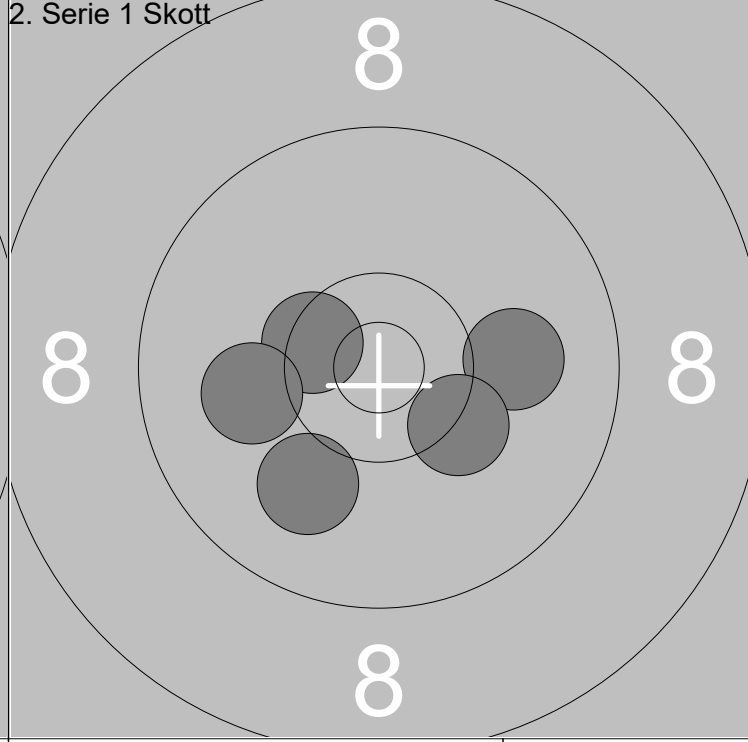
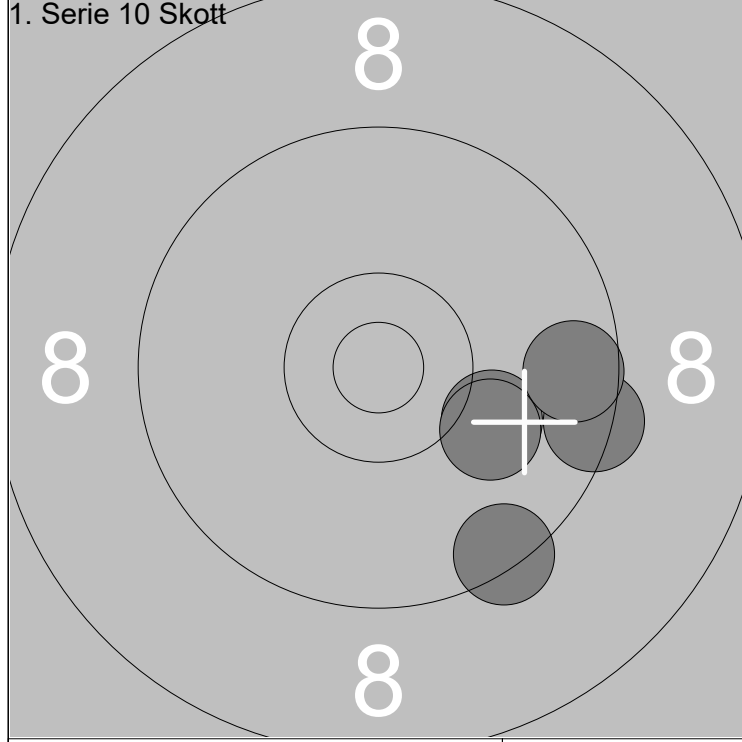

6: 10.1 ↘	Serie	47
7: 9.4 ↘		
8: 10.1 ↘	Total	282
9: 9.4 →		
10: 9.6 →		

1: 10.5x ↖	Serie	50
2: 10.0 ↘		
3: 10.0 →	Total	332
4: 10.3 ↘		
5: 10.1 ↖		

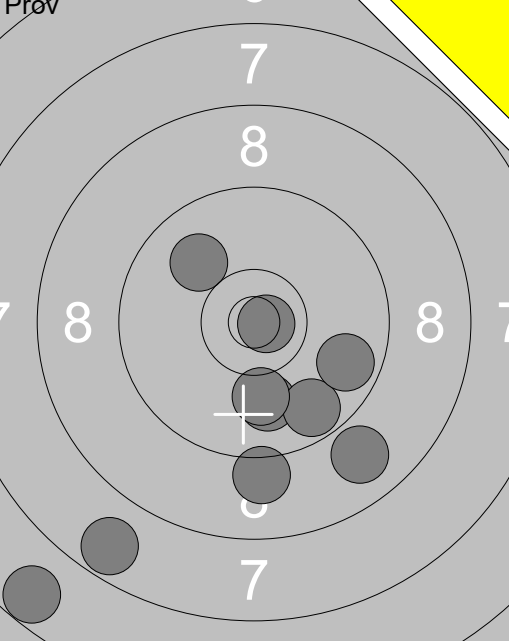
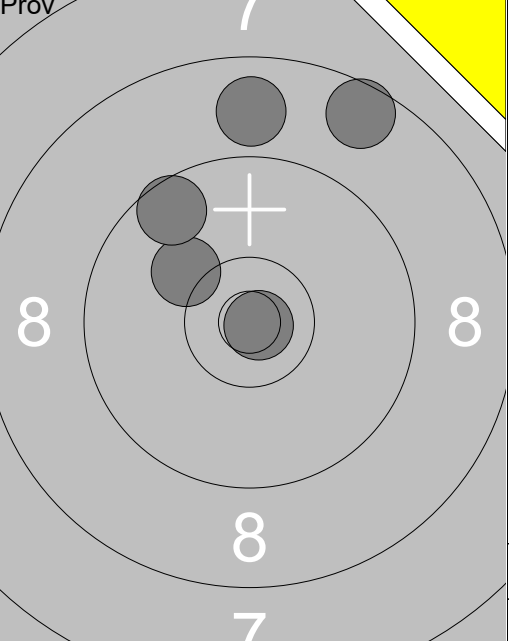
	<p>1: 7.7 ↘ 2: 6.7 ↘ 3: 8.9 ↘ 4: 10.0 ↓ 5: 9.1 ↓ 6: 9.7 ↘ 7: 10.0 ↗ 8: 9.7 → 9: 10.0 ↓ 10: 10.8x→</p> <p>Serie 88.0 Total 185.0</p>		<p>11: 10.1 ↖ 12: 8.8 ↑ 13: 8.6 ↗ 14: 9.6 ↖ 15: 10.9x→</p> <p>Serie 45.0 Total 185.0</p>
--	---	--	--

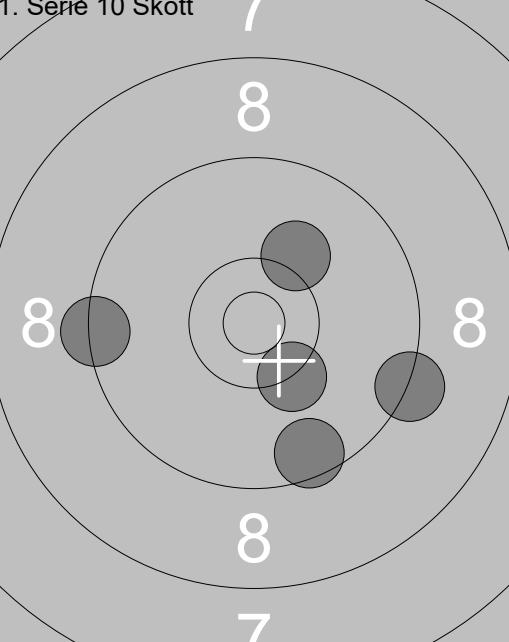
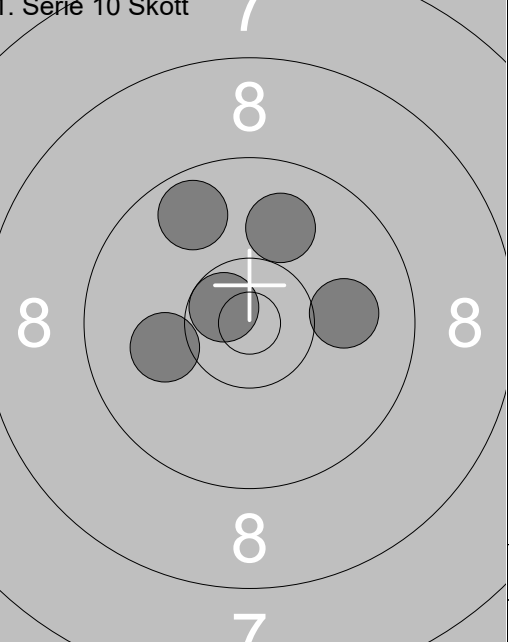
<p>1. Serie 10 Skott</p> 	<p>1: 9.3 → 2: 9.5 ↓ 3: 10.3x↘ 4: 9.4 ← 5: 10.2 ↗</p> <p>Serie 47.0 Total 232.0</p>	<p>1. Serie 10 Skott</p> 	<p>6: 10.0→ 7: 10.0 ↑ 8: 10.6x↖ 9: 9.7 ↖ 10: 10.1←</p> <p>Serie 49.0 Total 281.0</p>
--	---	--	--

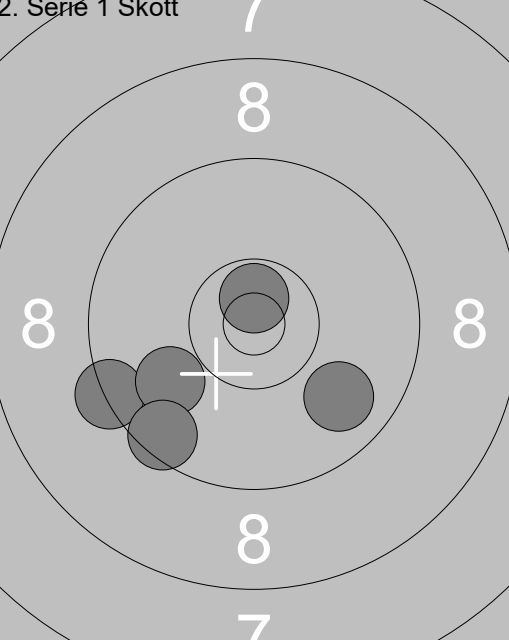
<p>2. Serie 1 Skott</p> 	<p>1: 10.7x↑ 2: 9.8 ↘ 3: 9.3 ← 4: 9.9 ← 5: 9.5 ↘</p> <p>Serie 46.0 Total 327.0</p>		
--	--	--	--



	<p>1: 8.4 ←</p> <p>2: 9.7 ←</p> <p>3: 9.7 ↗</p> <p>4: 9.4 ↗</p> <p>5: 10.6x↗</p> <p>6: 10.6x↗</p> <p>7: 10.7x↘</p> <p>8: 9.8 ←</p> <p>9: 10.3x←</p> <p>10: 9.0 ←</p>		<p>11: 10.0 →</p> <p>12: 8.9 ↘</p>
Serie 93.0		Serie 18.0	
Total 183.0		Total 183.0	

<p>1. Serie 10 Skott</p>	<p>1: 9.2 ↘</p> <p>2: 9.3 →</p> <p>3: 10.2 ↑</p> <p>4: 10.6x↘</p> <p>5: 10.4x↘</p>		<p>6: 9.5 ↗</p> <p>7: 10.3x↘</p> <p>8: 10.7x↘</p> <p>9: 10.6x↘</p> <p>10: 8.8 ↘</p>
Serie 48.0		Serie 47.0	
Total 231.0		Total 278.0	

<p>2. Serie 1 Skott</p>	<p>1: 10.7x←</p> <p>2: 9.9 ↓</p> <p>3: 9.6 ←</p> <p>4: 9.9 →</p> <p>5: 10.6x↗</p>		
Serie 47.0			
Total 325.0			

	<p>1: 9.1 ↓</p> <p>2: 10.3 ↗</p> <p>3: 10.6x→</p> <p>4: 9.2 →</p> <p>5: 9.4 ↓</p> <p>6: 10.2 ↗</p> <p>7: 9.9 ↑</p> <p>8: 9.6 ←</p> <p>9: 9.2 ↙</p> <p>10: 10.0 ↖</p>	<p>11: 10.2 ←</p> <p>12: 9.7 →</p> <p>13: 10.3x→</p>
Serie 94.0		Serie 29.0
Total 183.0		Total 183.0

<p>1. Serie 10 Skott</p>	<p>1: 8.3 ↓</p> <p>2: 8.7 ↓</p> <p>3: 7.9 →</p> <p>4: 10.8x→</p> <p>5: 10.8x↗</p>	<p>6: 8.7 ←</p> <p>7: 10.1 ↑</p> <p>8: 9.9 ↓</p> <p>9: 9.3 ↓</p> <p>10: 10.5x↘</p>
Serie 43.0		Serie 46.0
Total 226.0		Total 272.0

<p>2. Serie 1 Skott</p>	<p>1: 10.4x↘</p> <p>2: 10.4x↗</p> <p>3: 10.5x↗</p> <p>4: 7.3 →</p> <p>5: 8.8 →</p>	
Serie 45.0		
Total 317.0		

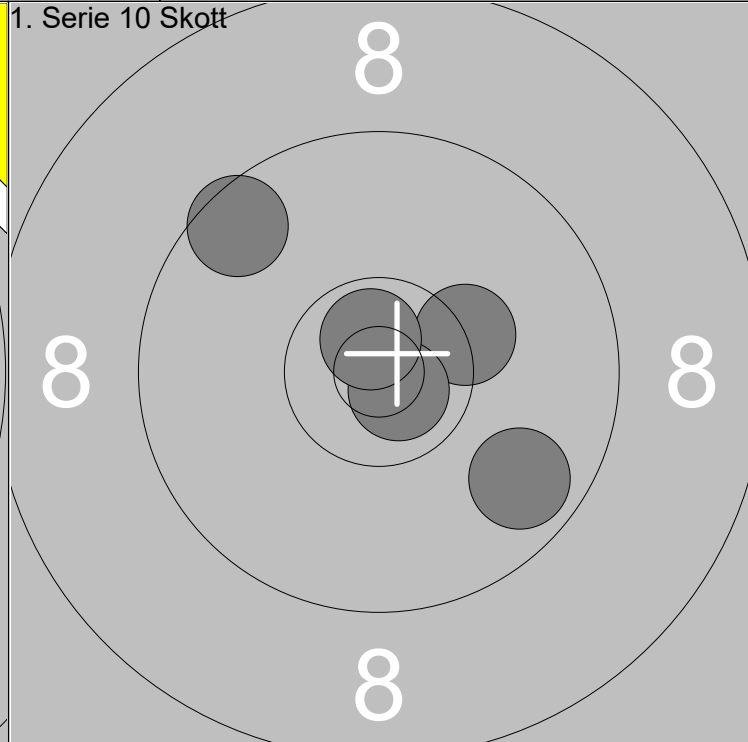
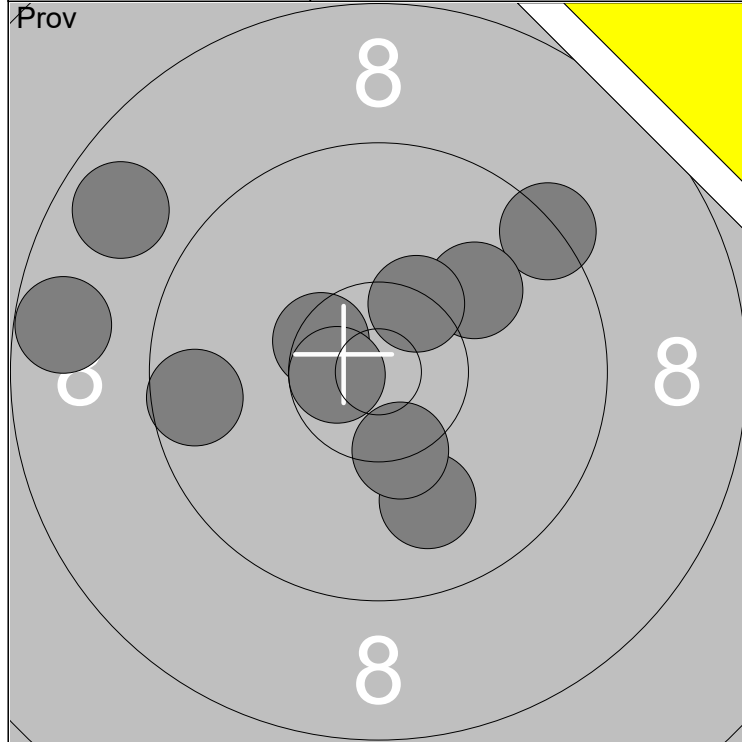

1: 8.7 ←	6: 9.4 ↗	Serie	94
2: 8.8 ↗	7: 10.0 ↗		
3: 10.5x ↖	8: 10.4x ↗	Total	180
4: 10.7x ←	9: 9.6 ←		
5: 10.0 ↓	10: 10.4x ↓		

1: 9.7 ↘	Serie	48
2: 10.3x ↗		
3: 9.6 ↖	Total	228
4: 10.8x ↘		
5: 10.7x ↗		

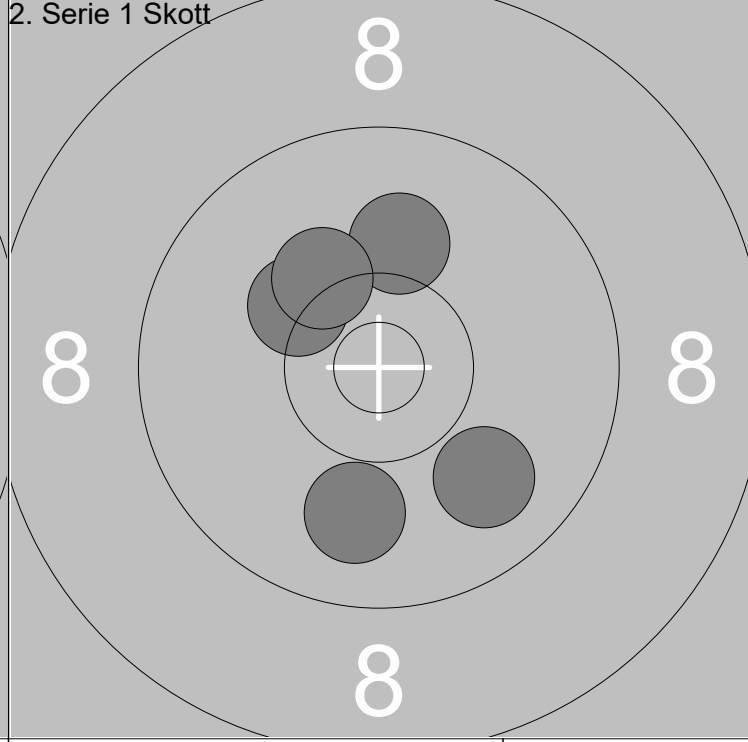
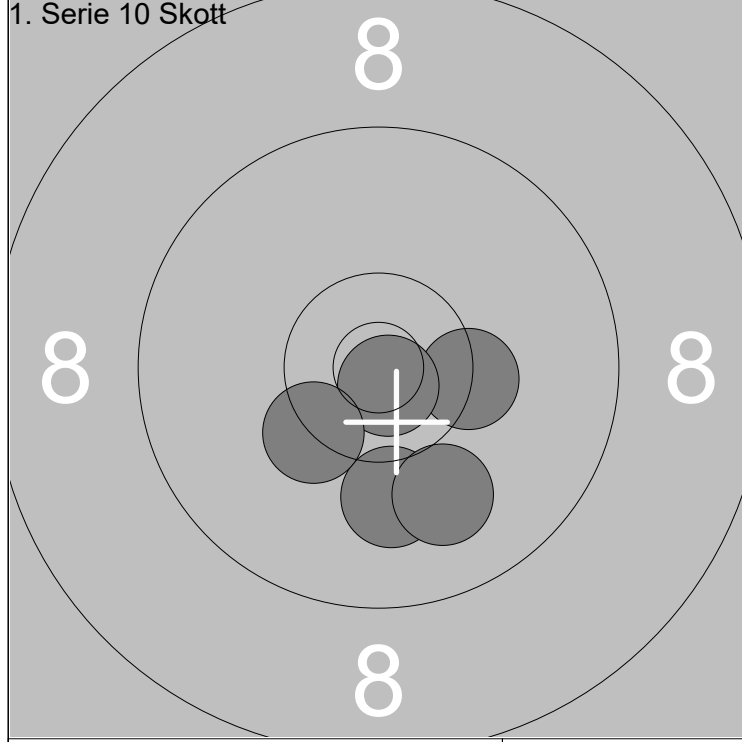

6: 10.3x →	Serie	50
7: 10.8x ↘		
8: 10.1 ↓	Total	278
9: 10.0 ↓		
10: 10.3x ↘		

1: 9.9 ↘	Serie	48
2: 9.9 ↓		
3: 10.2 ↖	Total	326
4: 10.1 ↗		
5: 10.2 ↖		

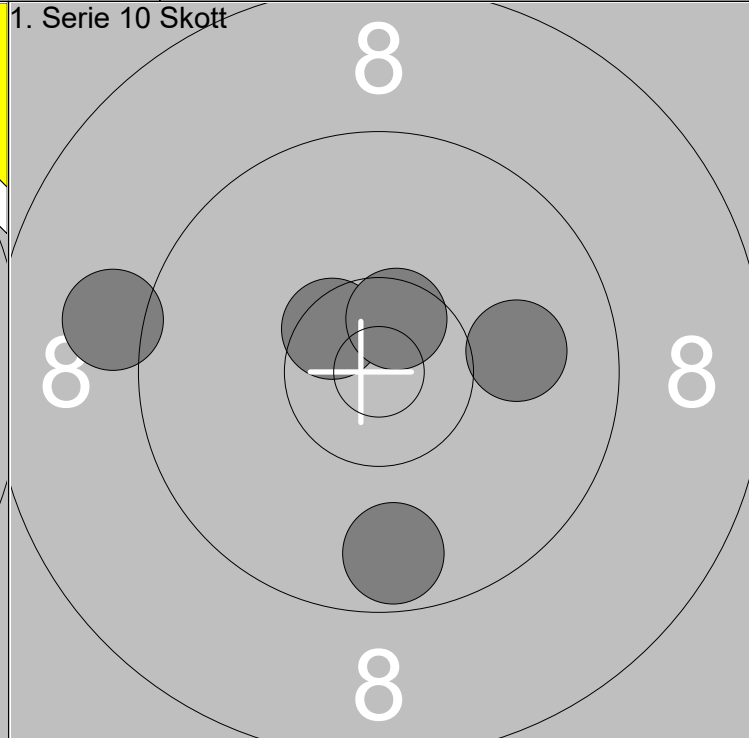
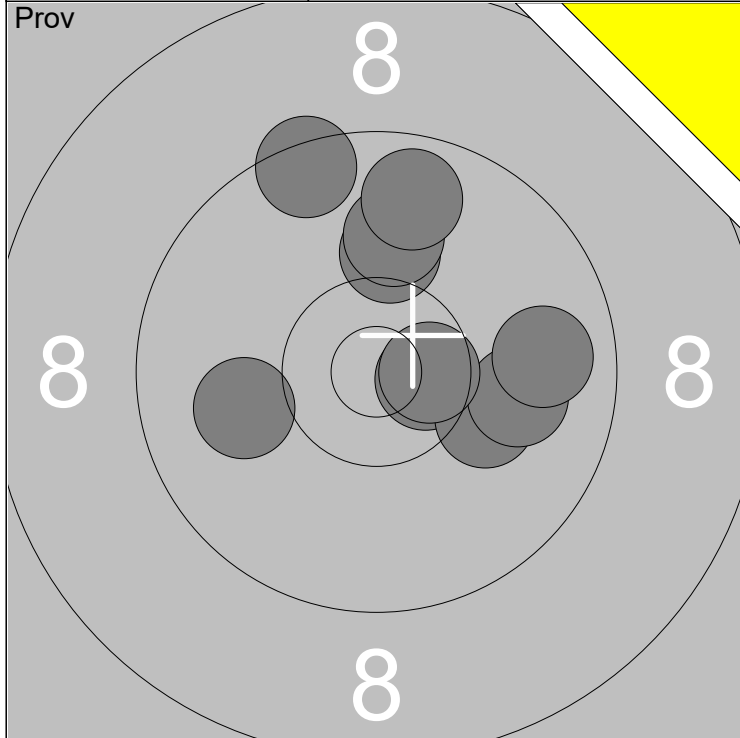

1: 10.6x →	6: 9.8 →	Serie	97
2: 10.1 ↑	7: 10.0 ←		
3: 10.1 →	8: 10.6x →	Total	186
4: 10.0 →	9: 10.0 ↑		
5: 9.5 ↑	10: 9.7 ↑		

1: 10.0 →	Serie	48
2: 10.5x ↖		
3: 10.6x ↑	Total	234
4: 9.7 ↓		
5: 9.1 ←		

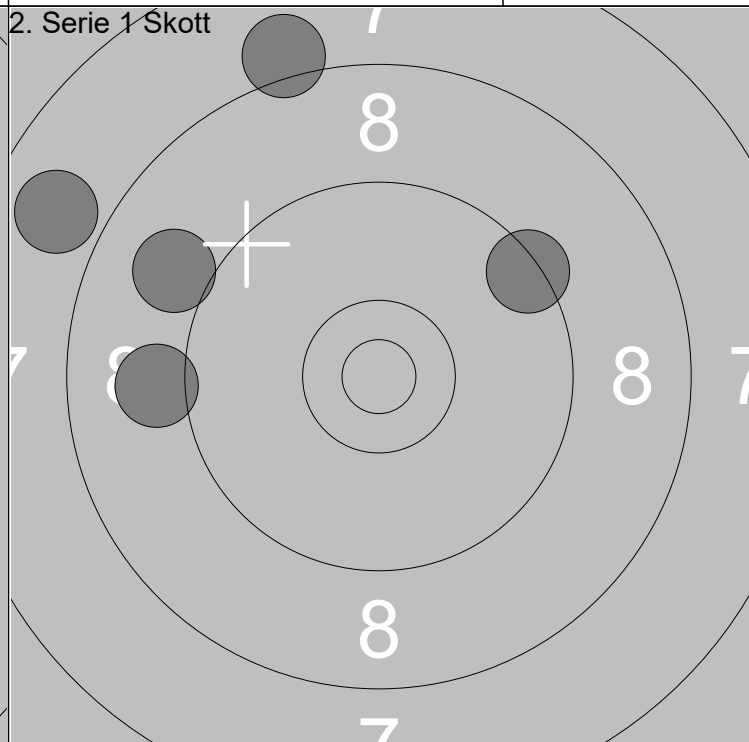
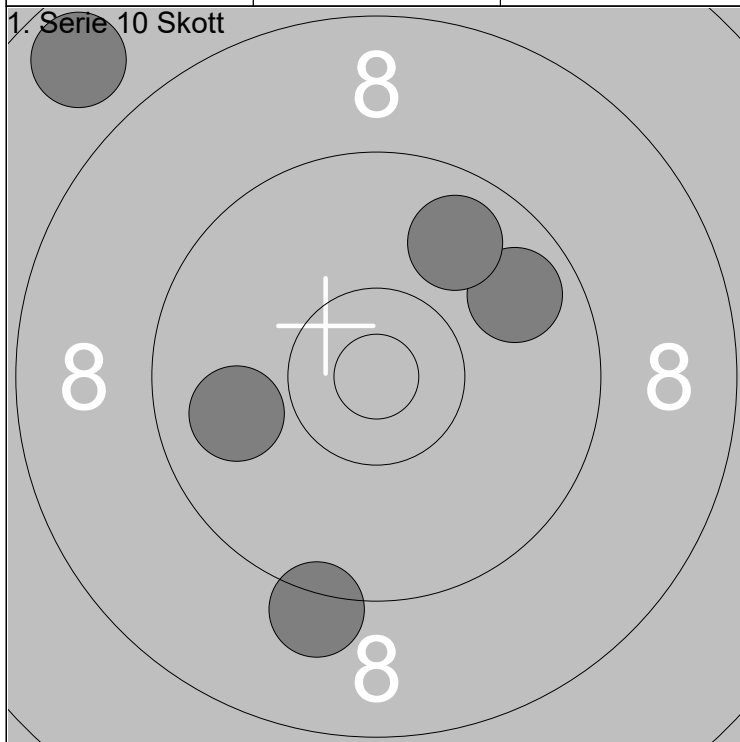

6: 9.8 ↗	Serie	43
7: 9.8 ↑		
8: 9.2 ↓	Total	277
9: 7.8 ↖		
10: 9.9 ←		

1: 7.9 ↖	Serie	42
2: 9.0 ↖		
3: 9.1 ←	Total	319
4: 8.1 ↑		
5: 9.4 ↗		

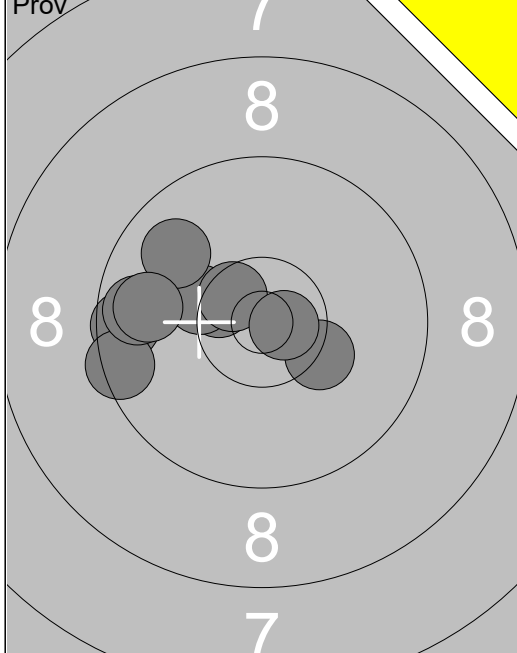

1:	10.3x	↘
2:	9.6	←
3:	10.5x	↘
4:	9.5	←
5:	10.3x	↘
6:	9.7	←
7:	10.6x	↘
8:	9.9	↗
9:	9.8	←
10:	10.7x	↘
Serie		95.0
Total		183.0

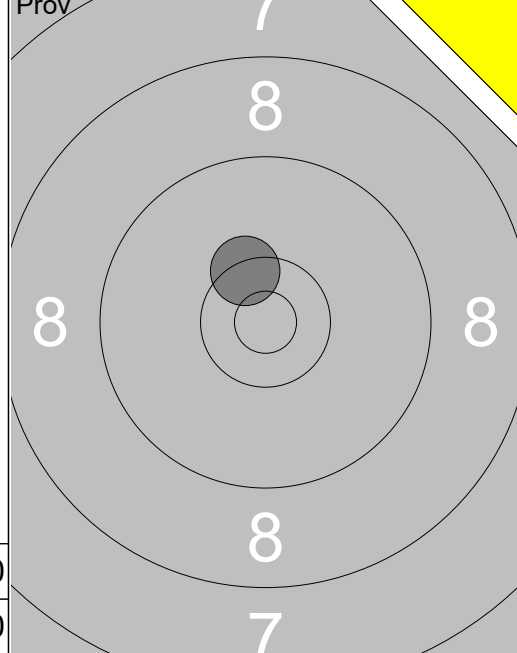

11:	10.4x	↘
Serie		10.0
Total		183.0

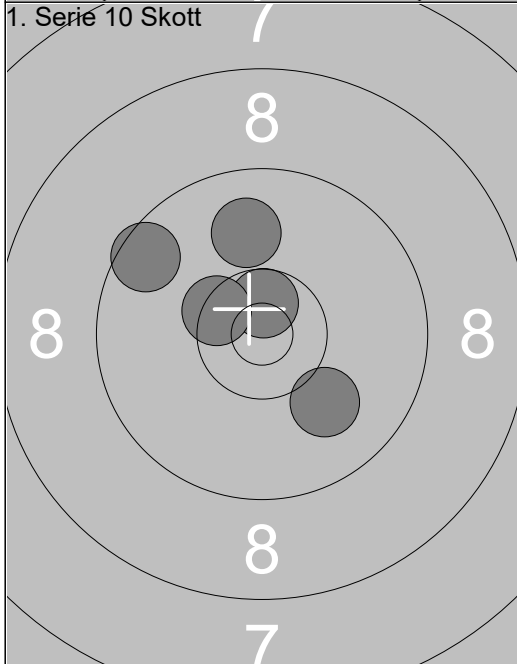

1:	10.6x	↑
2:	9.6	↖
3:	10.0	↘
4:	9.9	↑
5:	10.4x	↘
Serie		48.0
Total		231.0

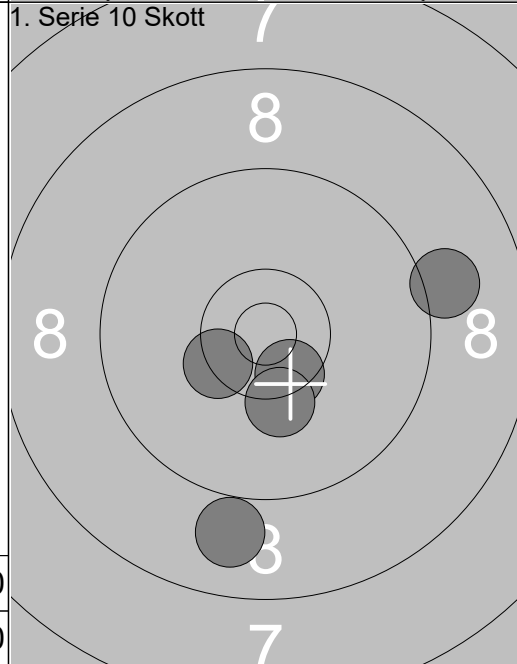

6:	8.9	↓
7:	9.1	→
8:	10.5x	↘
9:	10.4x	↘
10:	10.3	↓
Serie		47.0
Total		278.0

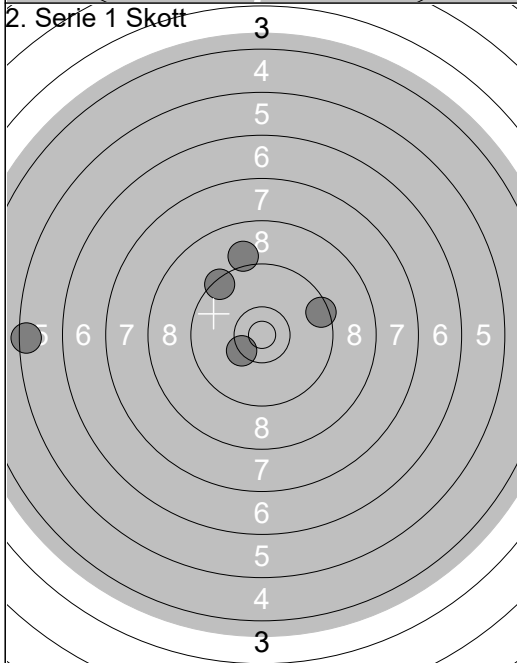

1:	9.5	→
2:	9.1	↑
3:	5.5	←
4:	10.3x	↘
5:	9.4	↖
Serie		42.0
Total		320.0

	<p>1: 10.0 →</p> <p>2: 10.5 ✕</p> <p>3: 9.9 ↓</p> <p>4: 9.9 ↓</p> <p>5: 9.8 →</p> <p>6: 9.4 ←</p> <p>7: 9.5 ←</p> <p>8: 10.6 ✕</p> <p>9: 10.4 ✕</p> <p>10: 10.6 ✕</p>	
Serie 95.0		Serie 10.0
Total 183.0		Total 183.0

<p>1. Serie 10 Skott</p>	<p>1: 10.2 ↖</p> <p>2: 10.8 ✕</p> <p>3: 9.7 →</p> <p>4: 10.2 ↓</p> <p>5: 10.6 ✕</p>	
Serie 49.0		Serie 44.0
Total 232.0		Total 276.0

<p>2. Serie 1 Skott</p>	<p>1: 8.6 ↑</p> <p>2: 10.0 ↗</p> <p>3: 9.0 →</p> <p>4: 9.2 ↖</p> <p>5: 9.5 →</p>	
Serie 45.0		
Total 321.0		

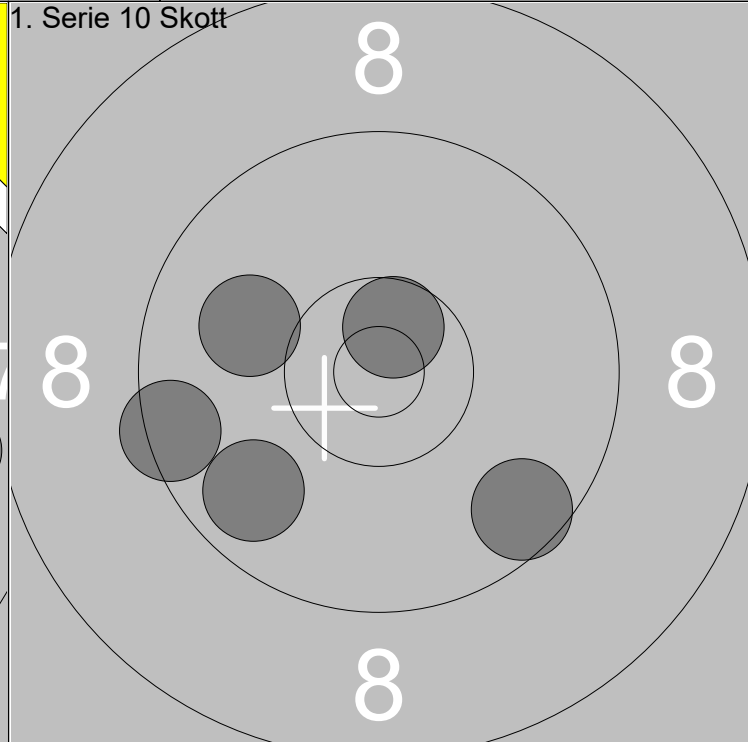
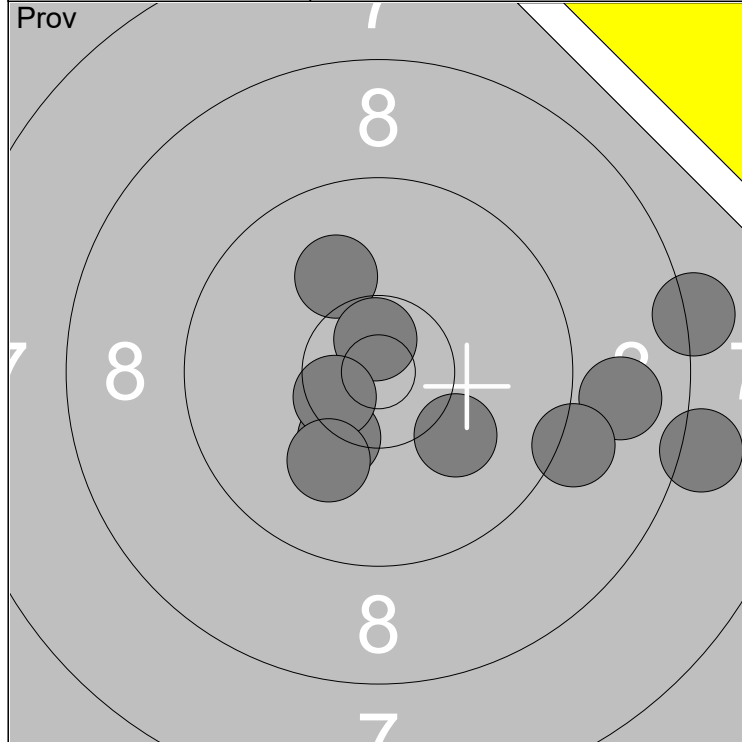

1: 8.2 →	6: 10.1 ↗	Serie	93
2: 8.1 →	7: 10.7x ↑		
3: 8.9 →	8: 10.5x ↙	Total	182
4: 10.3x ↘	9: 10.1 ↘		
5: 9.2 →	10: 10.1 ↘		

1: 9.6 ↘	Serie	47
2: 9.5 ←		
3: 9.8 ↙	Total	229
4: 10.6x ↑		
5: 10.0 ↖		

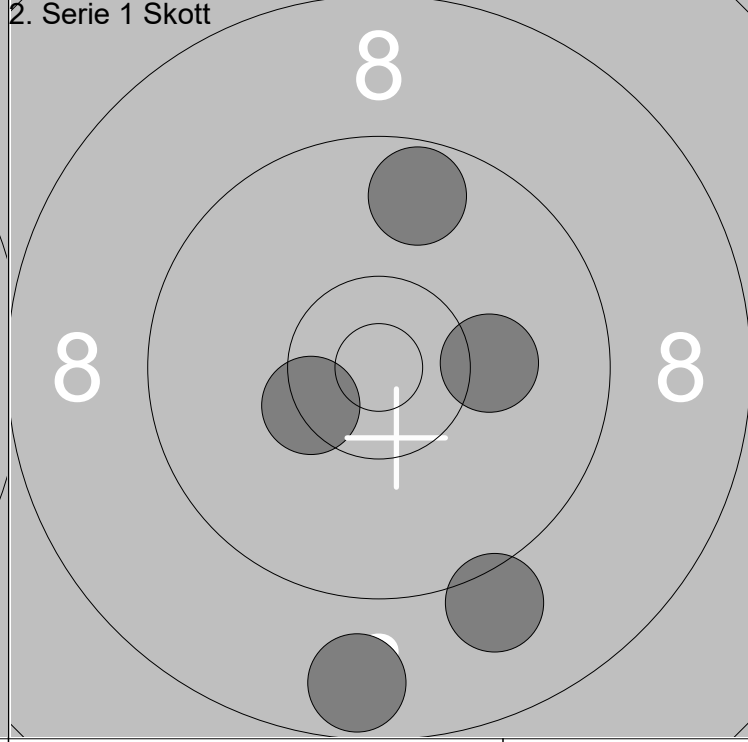
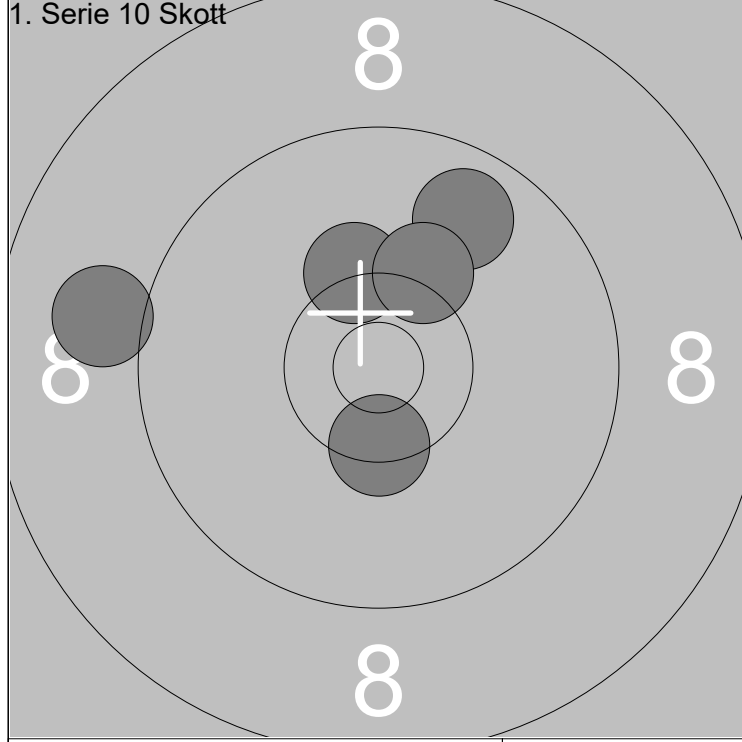

6: 9.8 ↗	Serie	48
7: 10.3 ↑		
8: 10.2 ↑	Total	277
9: 9.0 ←		
10: 10.4x ↓		

1: 10.2 →	Serie	46
2: 9.1 ↘		
3: 10.4x ↙	Total	323
4: 8.7 ↓		
5: 9.7 ↑		

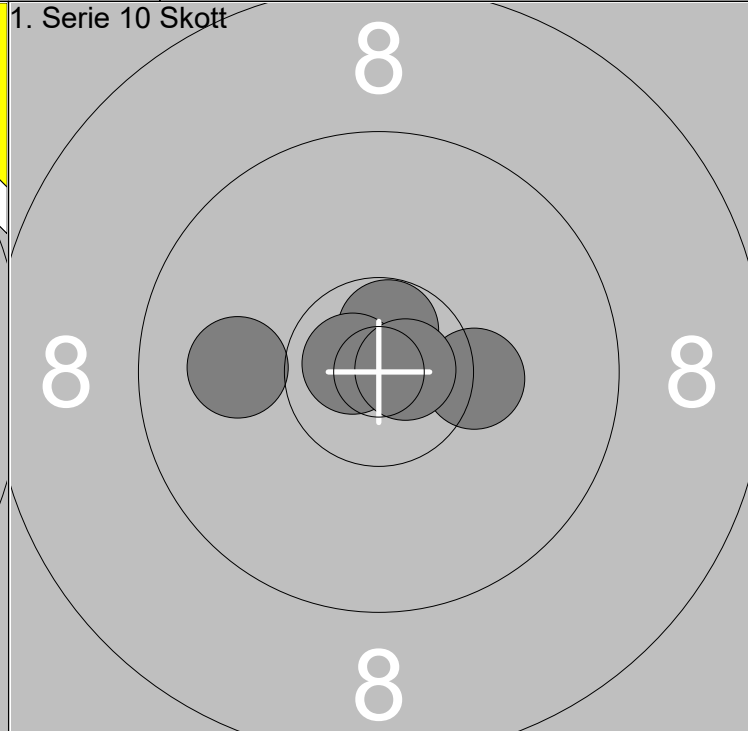
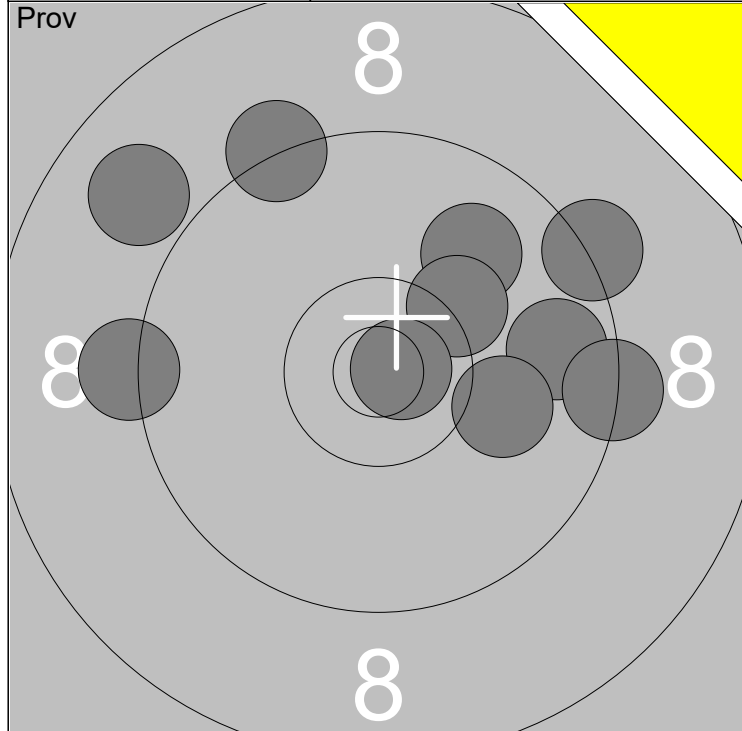

1: 9.3 ↖	6: 10.2 ↗	Serie	92
2: 9.9 ↗	7: 9.2 ←		
3: 9.7 →	8: 8.9 ↖	Total	181
4: 10.1 →	9: 10.8x →		
5: 9.3 →	10: 9.3 ↗		

1: 10.0 ←	Serie	50
2: 10.3x →		
3: 10.7x ↑	Total	231
4: 10.8x ←		
5: 10.8x →		

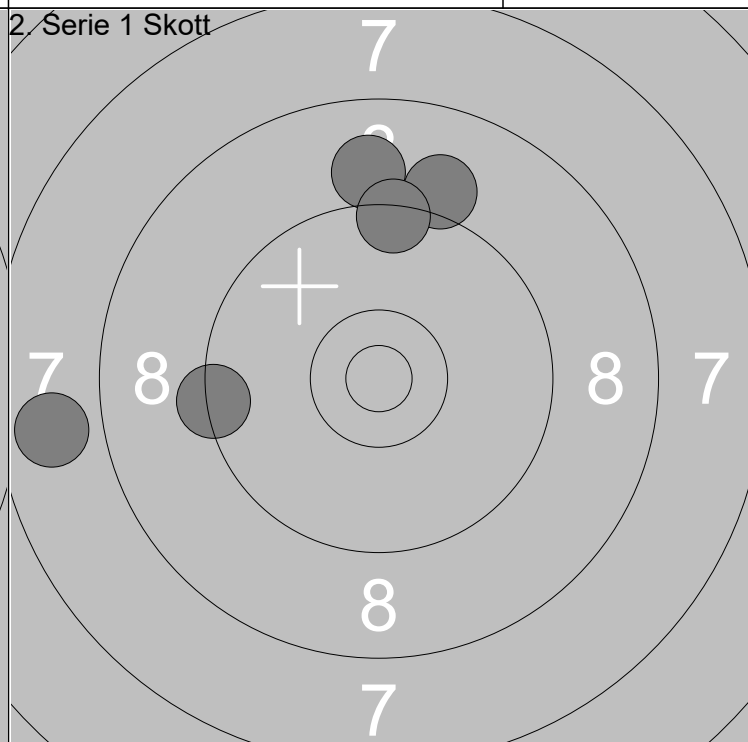
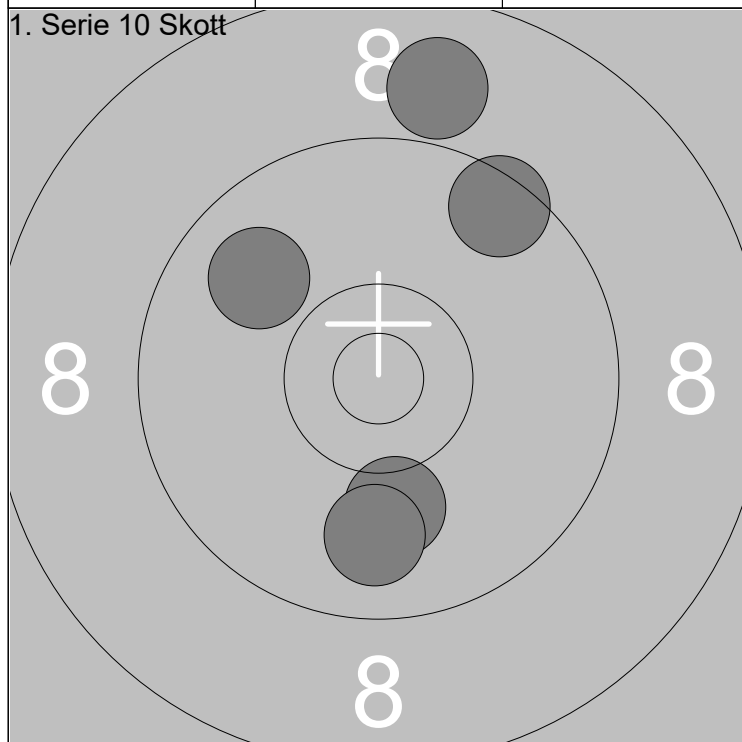

6: 10.1 ↓	Serie	45
7: 9.9 ↓		
8: 9.5 ↗	Total	276
9: 8.9 ↑		
10: 9.9 ↖		

1: 7.8 ←	Serie	43
2: 9.0 ↑		
3: 9.1 ↑	Total	319
4: 9.4 ←		
5: 9.4 ↑		



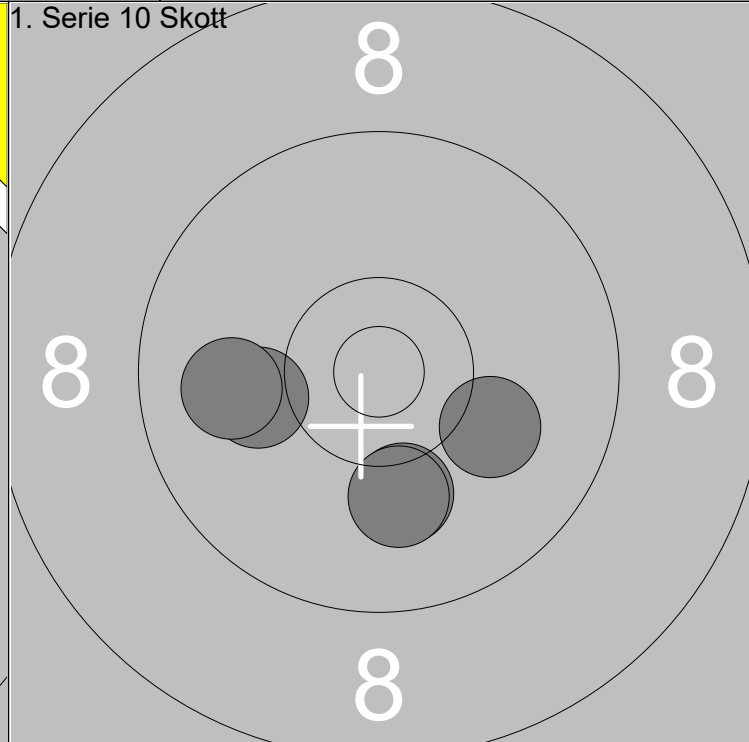
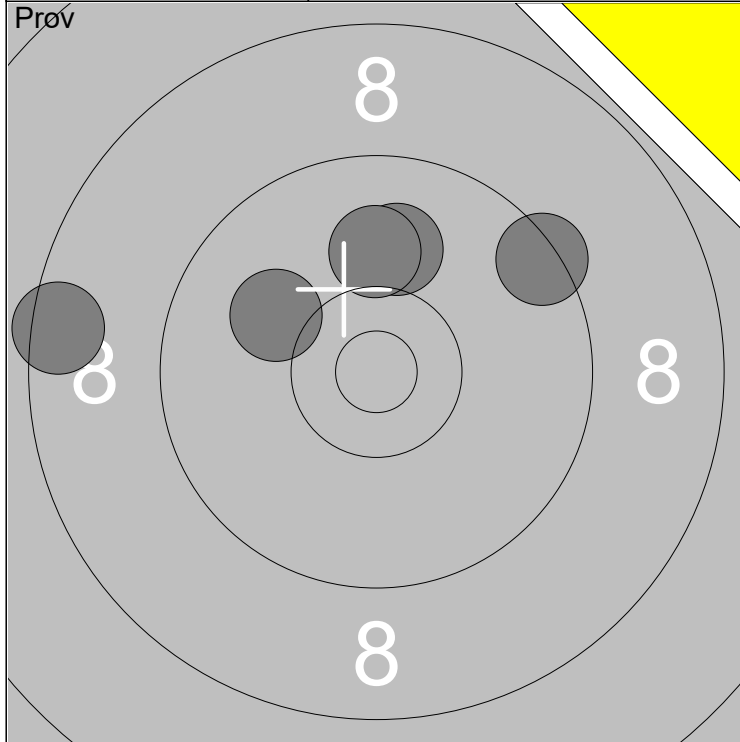

1: 8.5	←
2: 10.0	↑
3: 9.4	↗
4: 10.1	↖
5: 10.0	↑

Serie	47
Total	180

1: 10.1	↓
2: 10.1	↓
3: 10.1	↘
4: 10.1	←
5: 9.9	←

Serie	49
Total	229

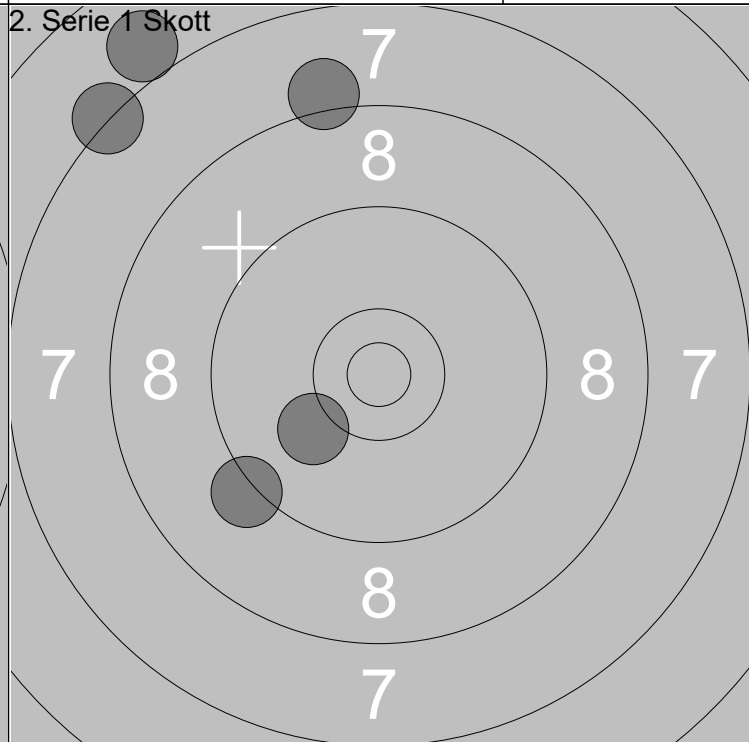
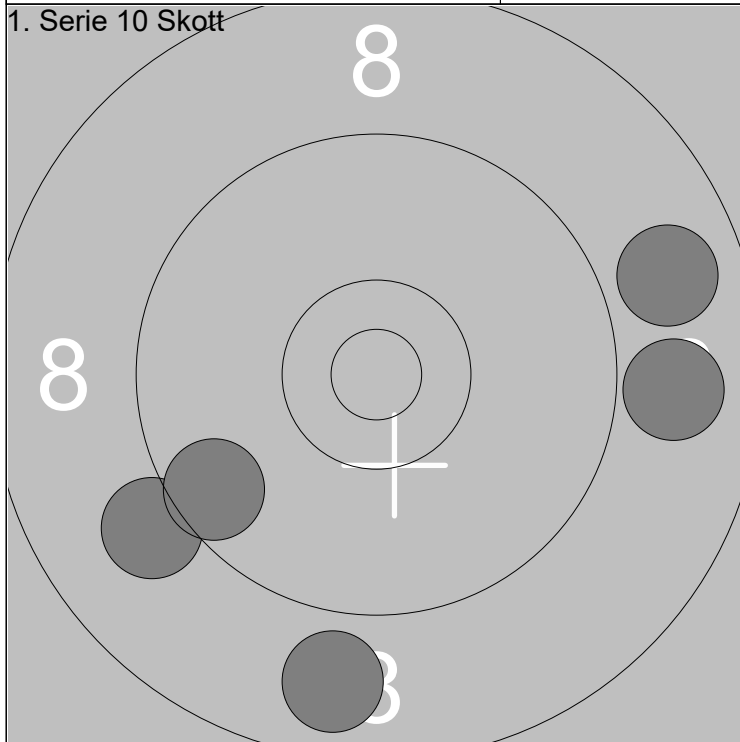

6: 9.1	↖
7: 9.6	↖
8: 8.8	↓
9: 8.9	→
10: 8.8	→

Serie	42
Total	271

1: 7.3	↖
2: 8.1	↑
3: 9.2	↖
4: 10.1	↖
5: 7.0	↖

Serie	41
Total	312

	<p>1: 9.5 ←</p> <p>2: 9.8 ↑</p> <p>3: 9.4 ←</p> <p>4: 10.1 ↗</p> <p>5: 10.2 →</p> <p>6: 10.5x ←</p> <p>7: 9.4 ↓</p> <p>8: 9.8 ←</p> <p>9: 9.8 ←</p> <p>10: 9.7 ↓</p>		<p>11: 10.0 ↙</p> <p>12: 9.3 ↓</p> <p>13: 8.8 ↓</p> <p>14: 10.3x ↓</p>
Serie 93.0		Serie 37.0	
Total 179.0		Total 179.0	

<p>1. Serie 10 Skott</p>	<p>1: 8.9 →</p> <p>2: 10.5x ↗</p> <p>3: 10.4x ↓</p> <p>4: 10.6x ↑</p> <p>5: 9.2 ↓</p>	<p>1. Serie 10 Skott</p>	<p>6: 8.6 ←</p> <p>7: 8.6 ↓</p> <p>8: 8.7 ↗</p> <p>9: 9.1 ↗</p> <p>10: 8.8 ↗</p>
Serie 47.0		Serie 41.0	
Total 226.0		Total 267.0	

<p>2. Serie 1 Skott</p>	<p>1: 9.7 →</p> <p>2: 7.6 →</p> <p>3: 9.0 ↗</p> <p>4: 9.1 ↓</p> <p>5: 7.0 ←</p>		
Serie 41.0			
Total 308.0			

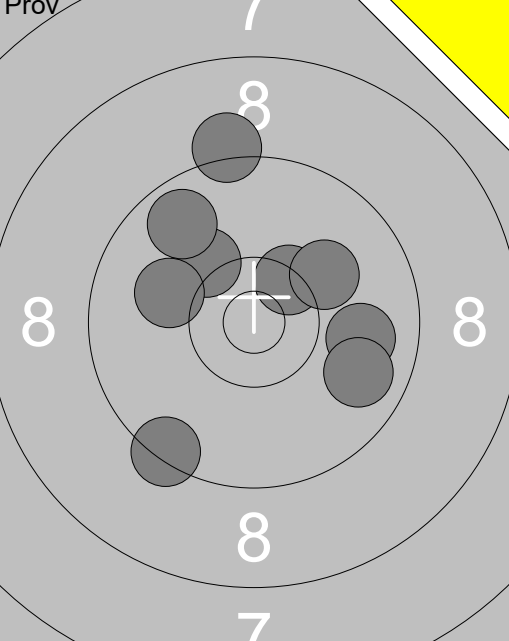
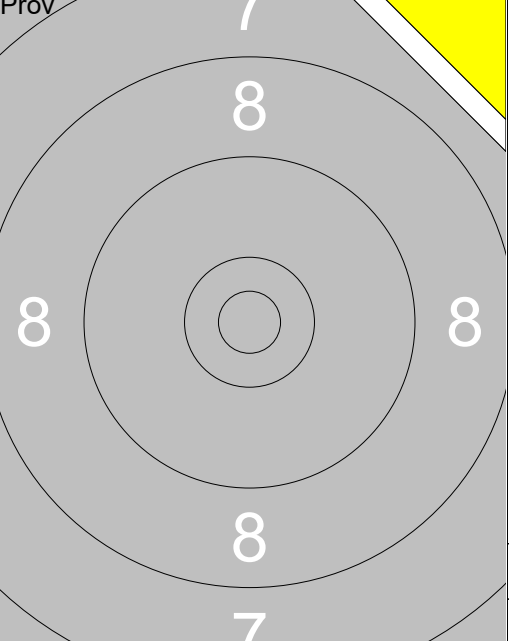
	<p>1: 10.2 ↖</p> <p>2: 9.9 →</p> <p>3: 9.8 ↘</p> <p>5: 9.7 ↖</p> <p>6: 10.4x ↗</p> <p>7: 9.2 ↑</p> <p>8: 10.1 ←</p> <p>9: 9.4 ↘</p> <p>10: 10.1 ↗</p>		
Serie 85.0		Serie 0.0	
Total 179.0		Total 179.0	

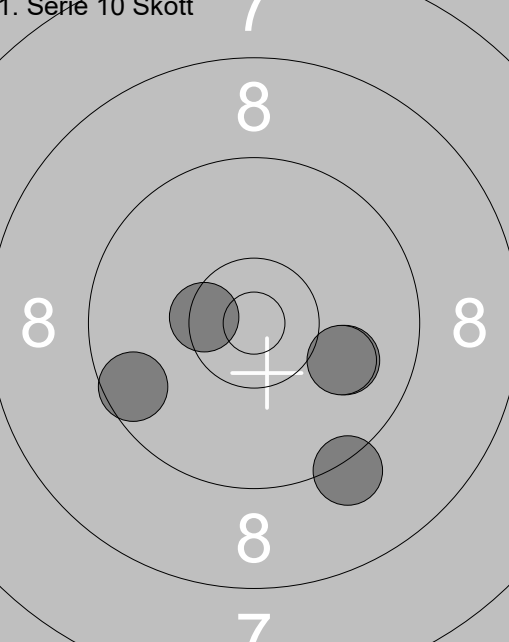
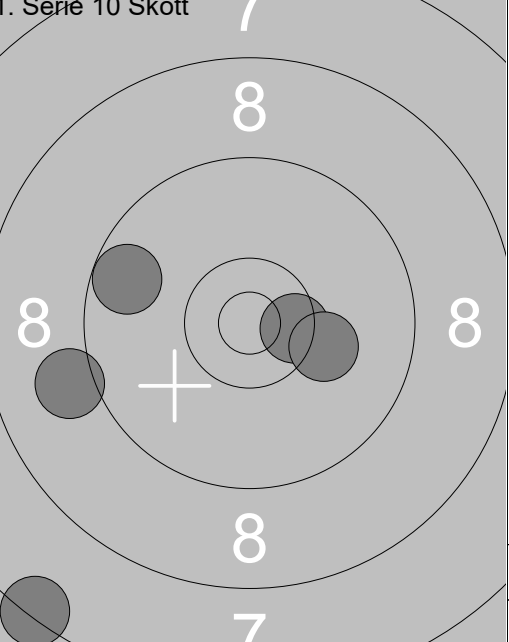
<p>1. Serie 10 Skott</p> 	<p>1: 10.0 →</p> <p>2: 10.4x ←</p> <p>3: 10.0 →</p> <p>4: 9.6 ←</p> <p>5: 9.2 ↘</p>	<p>1. Serie 10 Skott</p> 	
Serie 48.0		Serie 45.0	
Total 227.0		Total 272.0	

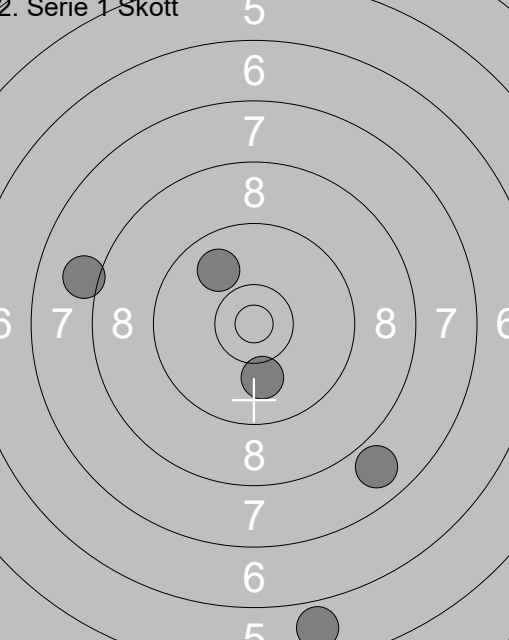
<p>2. Serie 1 Skott</p> 	<p>1: 8.1 ←</p> <p>2: 9.9 ↖</p> <p>3: 10.1 ↓</p> <p>4: 5.9 ↓</p> <p>5: 7.9 ↘</p>		
Serie 39.0			
Total 311.0			

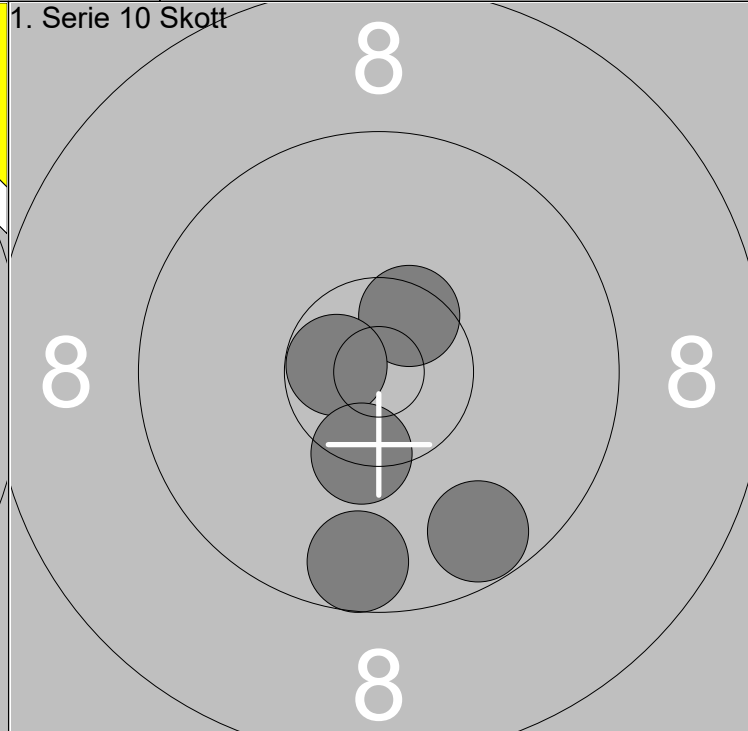
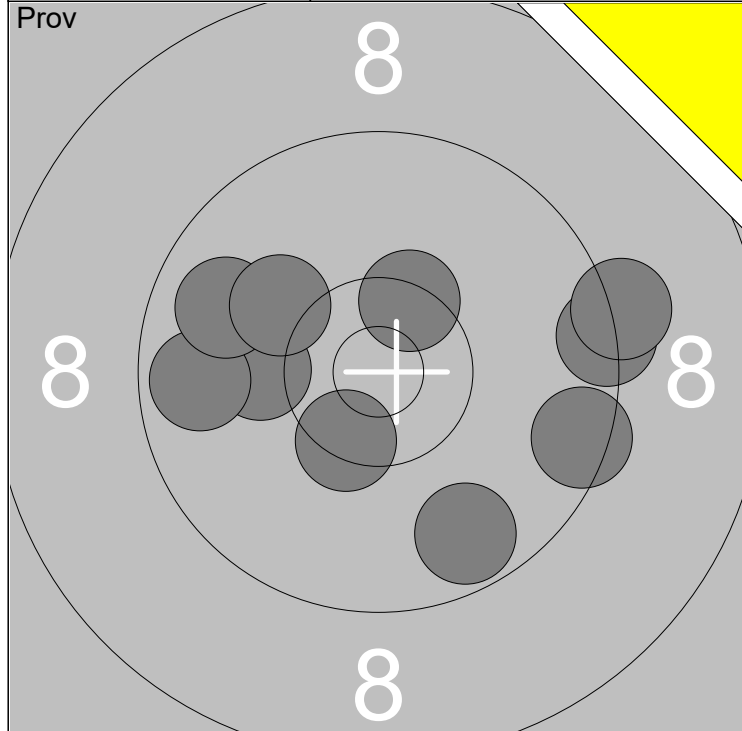

1: 10.1 ←	6: 9.2 →	Serie	94
2: 9.7 ←	7: 9.5 →		
3: 9.7 ↘	8: 10.4x ↗	Total	178
4: 9.4 →	9: 10.1 ↖		
5: 9.8 ↖	10: 10.4x ↘		

1: 9.6 ↓	Serie	48
2: 9.7 ↘		
3: 10.5x ↗	Total	226
4: 10.7x ←		
5: 10.4x ↘		

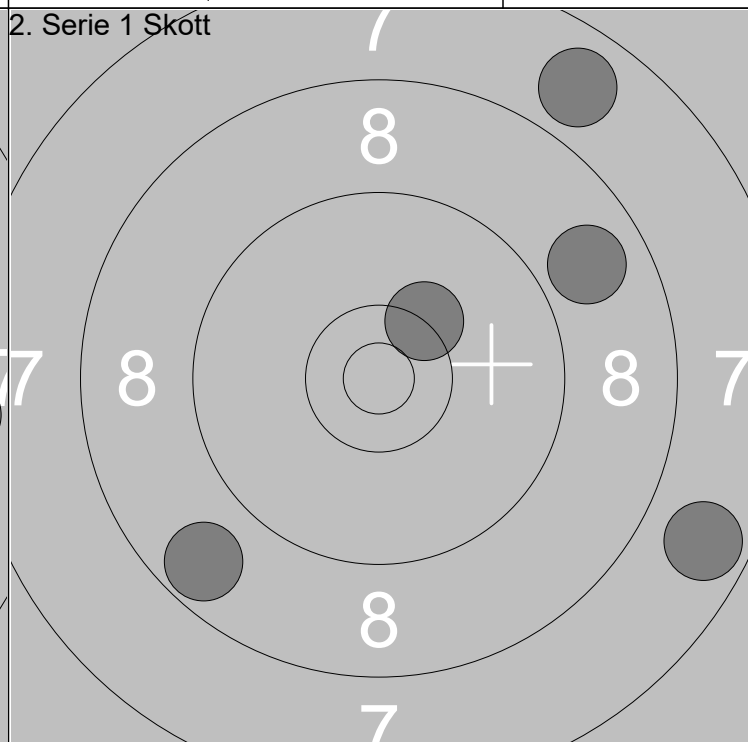
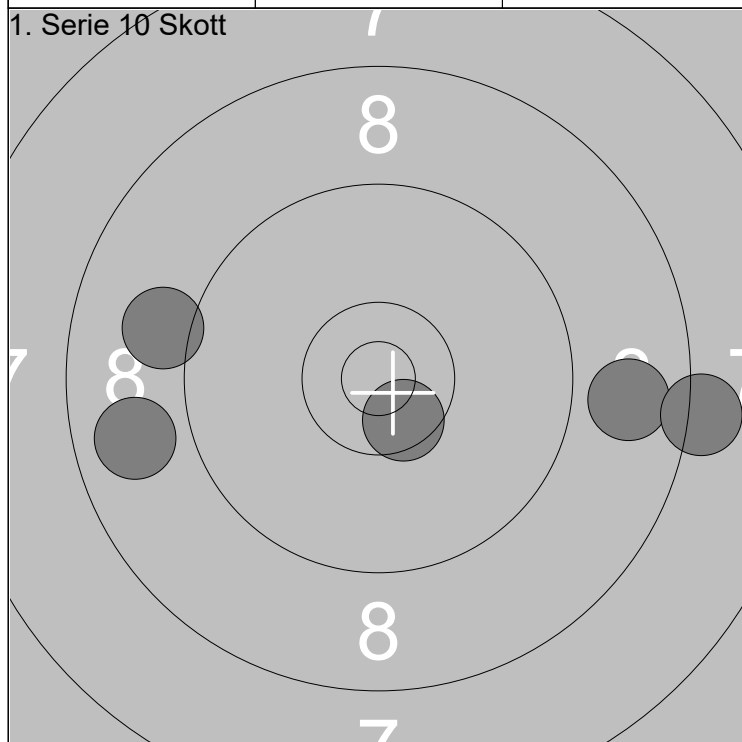

6: 8.8 ←	Serie	43
7: 9.1 ←		
8: 8.8 →	Total	269
9: 10.5x ↘		
10: 8.2 →		

1: 8.7 ↙	Serie	40
2: 8.8 ↗		
3: 10.3x ↗	Total	309
4: 7.8 ↗		
5: 7.7 ↘		

	<p>1: 10.4x➤</p> <p>2: 8.9 ➔</p> <p>3: 9.2 ➔</p> <p>4: 9.9 ↓</p> <p>5: 9.3 ↓</p> <p>6: 10.0 ↑</p> <p>7: 9.8 ↑</p> <p>8: 9.9 ←</p> <p>9: 9.9 ←</p> <p>10: 9.5 ↑</p>	<p>11: 10.7x➤</p> <p>12: 10.7x➤</p>
Serie 91.0	Serie 20.0	
Total 178.0	Total 178.0	

<p>1. Serie 10 Skott</p>	<p>1: 8.7 ➔</p> <p>2: 10.4x↗</p> <p>3: 9.3 ↗</p> <p>4: 9.9 ↖</p> <p>5: 10.2 ↑</p>	<p>6: 9.5 ←</p> <p>7: 8.5 ➔</p> <p>8: 10.6x↗</p> <p>9: 8.8 ➤</p> <p>10: 9.5 ↗</p>
Serie 46.0	Serie 44.0	
Total 224.0	Total 268.0	

<p>2. Serie 1 Skott</p>	<p>1: 9.8 ➔</p> <p>2: 9.0 ↑</p> <p>3: 6.4 ↖</p> <p>4: 8.2 ←</p> <p>5: 8.9 ➔</p>	
Serie 40.0		
Total 308.0		

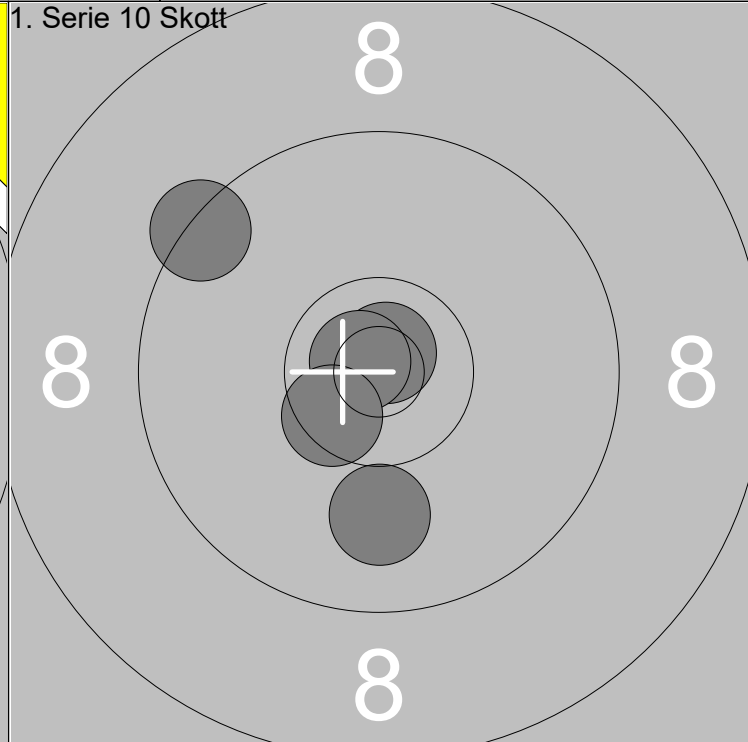
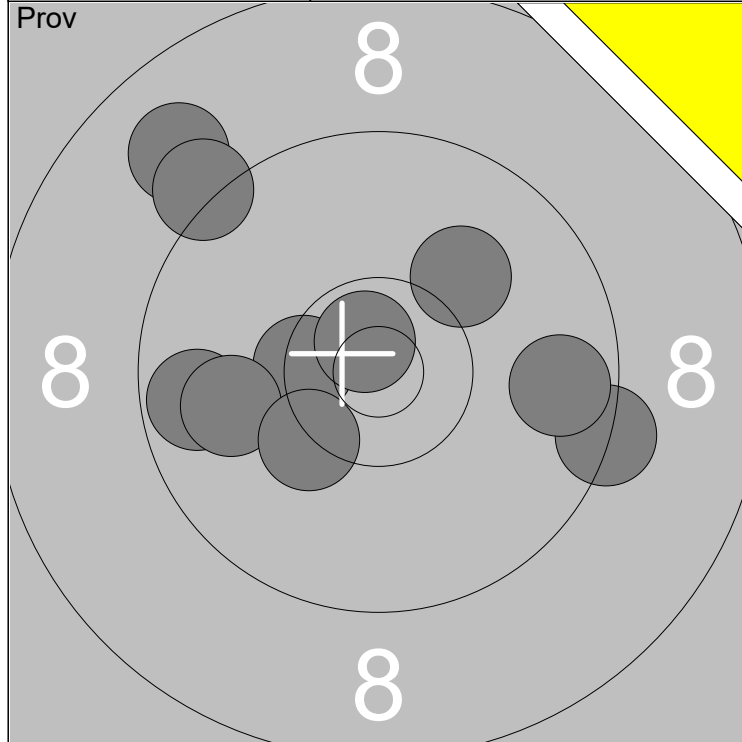

1: 8.9 ↗	6: 9.7 →	Serie	93
2: 10.4x ←	7: 9.7 ←		
3: 9.3 →	8: 9.9 ←	Total	176
4: 10.1 ↗	9: 9.2 ↖		
5: 10.7x ↗	10: 10.3 ↘		

1: 10.0 ↓	Serie	49
2: 10.8x ↗		
3: 9.4 ↖	Total	225
4: 10.8x ↖		
5: 10.5x ↘		

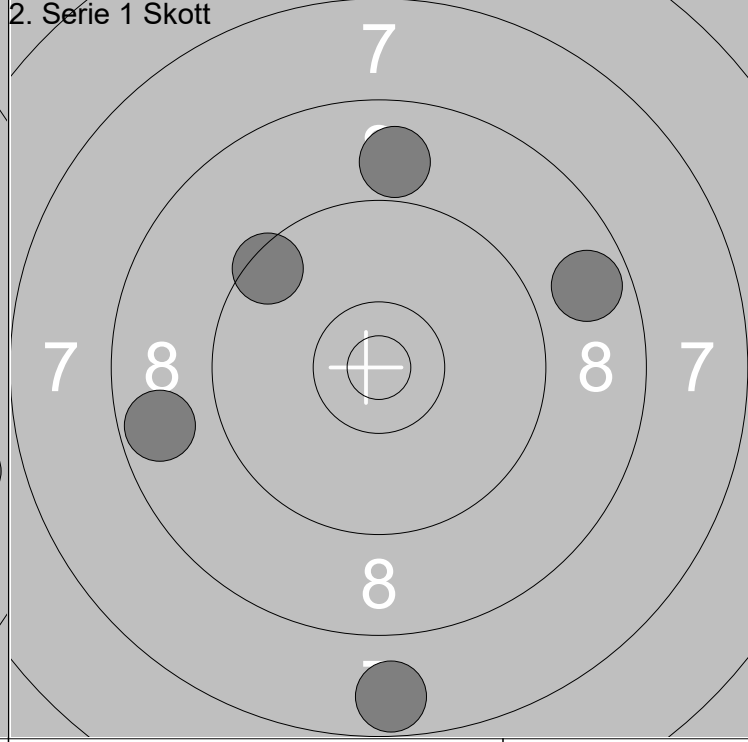
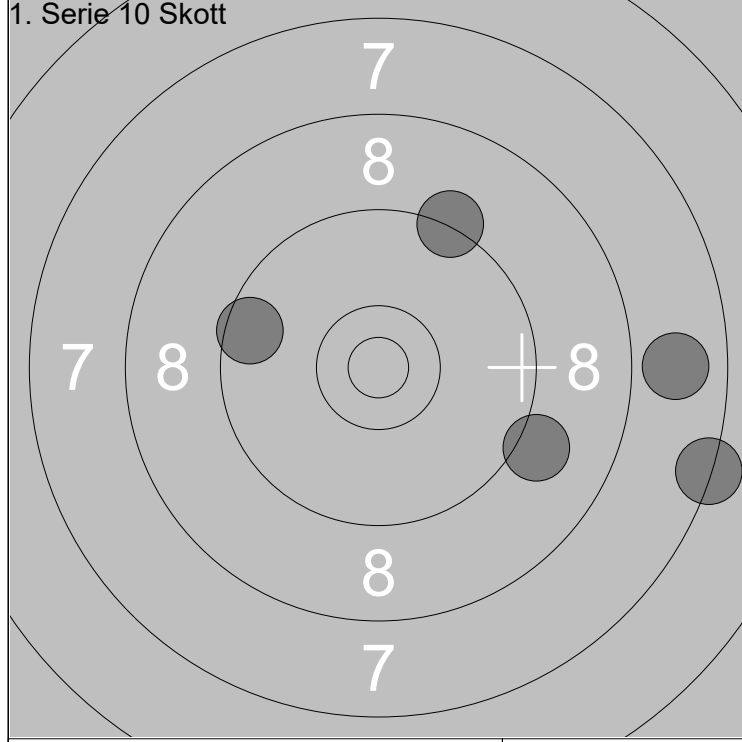

6: 9.3 ↗	Serie	41
7: 7.8 →		
8: 7.3 →	Total	266
9: 9.1 ↘		
10: 9.5 ←		

1: 8.9 ↗	Serie	40
2: 8.7 →		
3: 7.7 ↓	Total	306
4: 9.5 ↖		
5: 8.7 ←		

	1: 9.2 ↘ 2: 10.4 ↗ 3: 9.9 ↘ 4: 8.4 ↘ 5: 9.2 ↘ 6: 9.3 ↗ 7: 9.6 ← 8: 9.2 ← 9: 10.1 ↗ 10: 9.7 →		11: 10.5 ↗ 12: 10.8 ↗
Serie 91.0		Serie 20.0	
Total 172.0		Total 172.0	

1. Serie 10 Skott 	1: 9.8 ↘ 2: 10.1 ↗ 3: 9.9 ↗ 4: 9.5 ↘ 5: 10.3 ↗	1. Serie 10 Skott 	6: 9.4 ← 7: 7.4 → 8: 8.4 ↘ 9: 9.2 ← 10: 8.8 →
Serie 47.0		Serie 41.0	
Total 219.0		Total 260.0	

2. Serie 1 Skott 	1: 10.1 ↘ 2: 2.5 ↗ 3: 5.0 → 4: 7.7 ↗ 5: 4.7 ↘		
Serie 28.0			
Total 288.0			

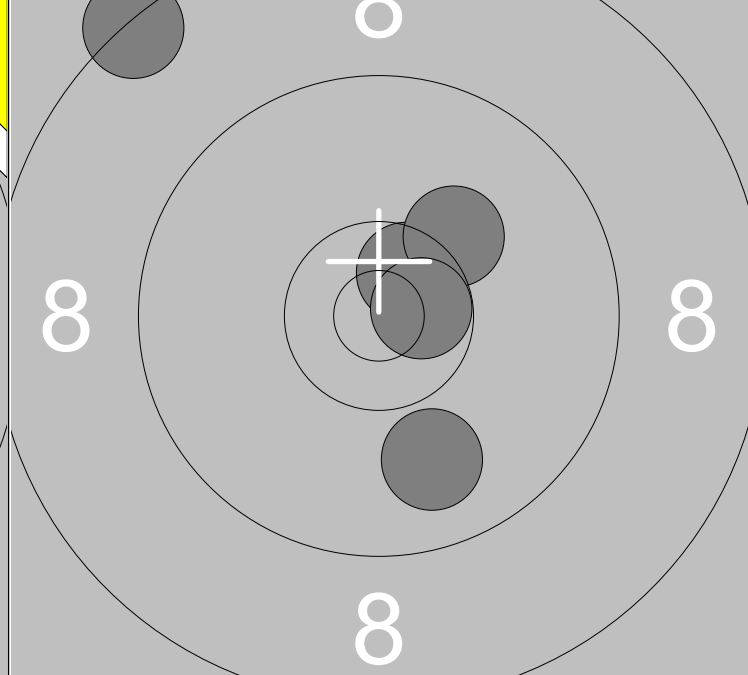
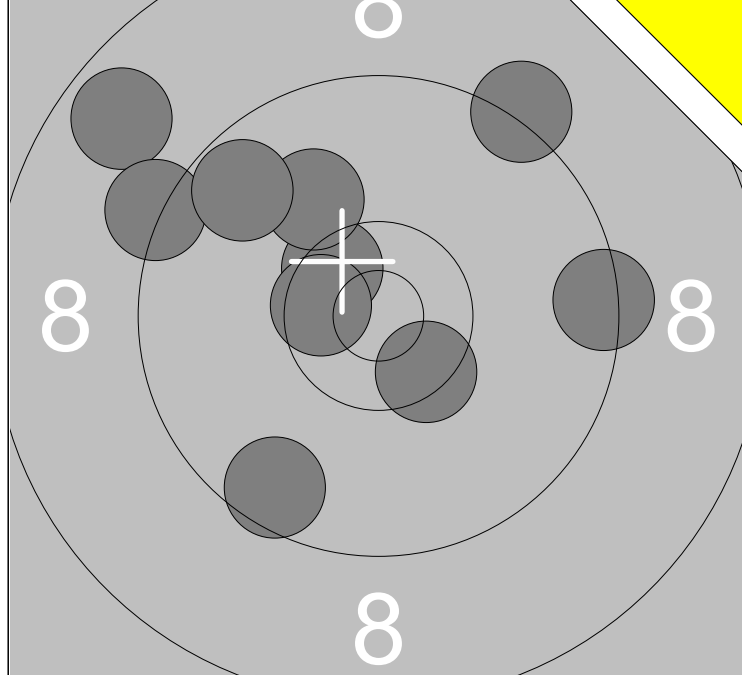

1: 10.5x ↗	6: 9.7 ↗	Serie	93
2: 10.0 ↗	7: 10.4x ↘		
3: 9.4 →	8: 9.2 ↗	Total	157
4: 8.7 ↗	9: 10.5x ↖		
5: 9.3 ↖	10: 9.6 ↘		

1: 10.6x ↗	Serie	47
2: 9.9 ↘		
3: 10.2 ↗	Total	204
4: 8.4 ↖		
5: 10.7x →		

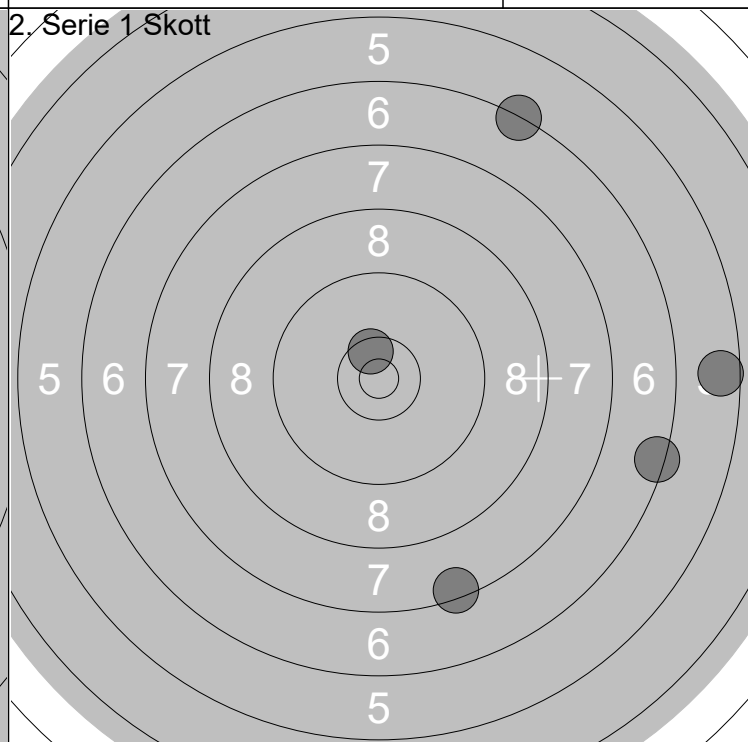
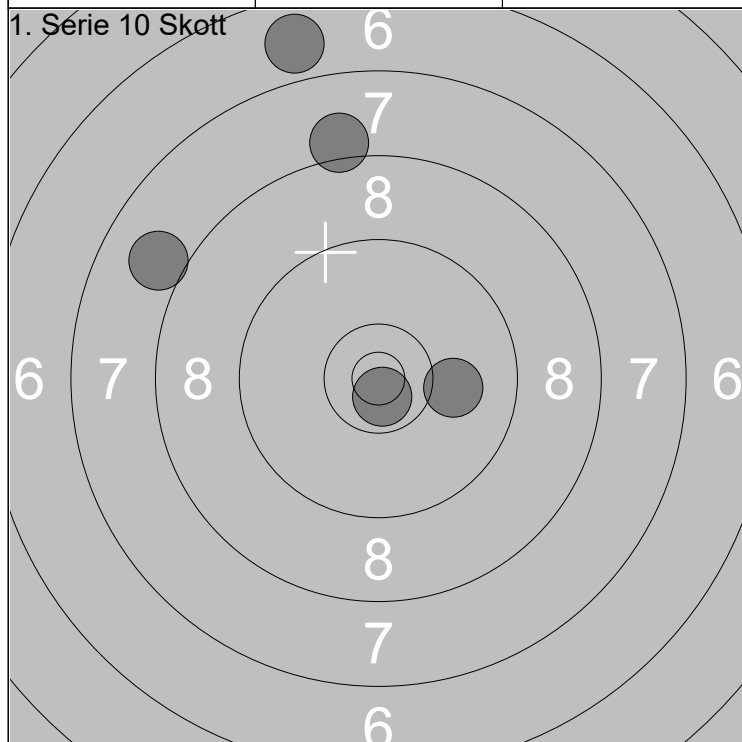

6: 6.9 ↗	Serie	42
7: 8.1 ↗		
8: 10.1 →	Total	246
9: 10.7x ↘		
10: 8.0 ↖		

1: 10.5x ↗	Serie	34
2: 6.3 ↗		
3: 5.6 →	Total	280
4: 6.4 →		
5: 7.4 ↘		



	<p>1: 10.7x ↙</p> <p>2: 9.7 ↘</p> <p>3: 9.6 →</p> <p>4: 8.8 ↓</p> <p>5: 9.6 ↓</p> <p>6: 9.7 ↓</p> <p>7: 8.9 →</p> <p>8: 9.2 ←</p> <p>9: 8.7 ←</p> <p>10: 10.0 ↗</p>		<p>11: 9.9 →</p> <p>12: 10.1 →</p>
Serie 89.0		Serie 19.0	
Total 176.0		Total 176.0	

<p>1. Serie 10 Skott</p>	<p>1: 9.5 ↘</p> <p>2: 9.9 ↗</p> <p>3: 9.9 ←</p> <p>4: 8.4 →</p> <p>5: 10.5x ↘</p>		<p>6: 9.2 ↙</p> <p>7: 8.2 ↙</p> <p>8: 6.4 ↙</p> <p>9: 10.1 ↙</p> <p>10: 6.2 →</p>
Serie 45.0		Serie 39.0	
Total 221.0		Total 260.0	

<p>2. Serie 1 Skott</p>	<p>1: 9.6 ↙</p> <p>2: 10.2 ↙</p> <p>3: 7.8 ↓</p> <p>4: 9.4 →</p> <p>5: 7.4 →</p>		
Serie 42.0			
Total 302.0			

	<p>1: 9.5 ←</p> <p>2: 9.7 ←</p> <p>3: 9.1 ↙</p> <p>4: 9.8 ←</p> <p>5: 9.1 ↙</p> <p>6: 10.6x →</p> <p>7: 10.0 ↙</p> <p>8: 10.6x ↓</p> <p>9: 9.8 ↓</p> <p>10: 8.6 →</p>	<p>11: 10.5x ↗</p> <p>12: 9.4 ←</p> <p>13: 10.4x ↗</p> <p>14: 10.6x ↗</p> <p>15: 8.9 ↓</p>
Serie 92.0		Serie 47.0
Total 190.0		Total 190.0

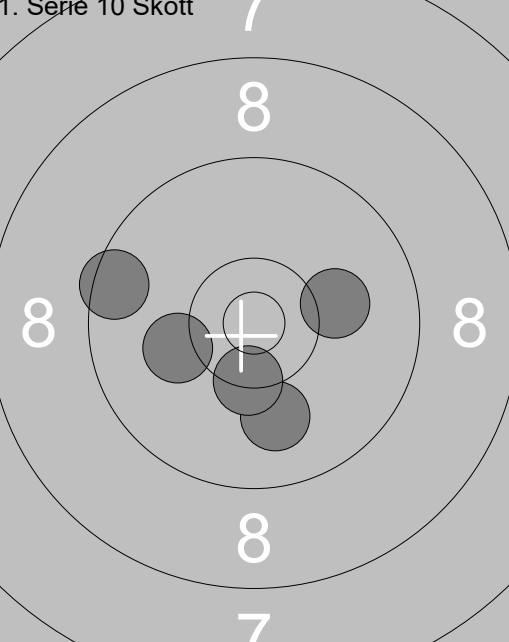
<p>1. Serie 10 Skott</p> 	<p>1: 9.5 ←</p> <p>2: 10.0 ↓</p> <p>3: 10.1 ←</p> <p>4: 10.1 →</p> <p>5: 10.4x ↓</p>	<p>6: 9.1 ↓</p> <p>7: 10.6x ↗</p> <p>8: 9.3 ↙</p> <p>9: 9.8 ↙</p> <p>10: 10.0 ↓</p>
Serie 49.0		Serie 47.0
Total 239.0		Total 286.0

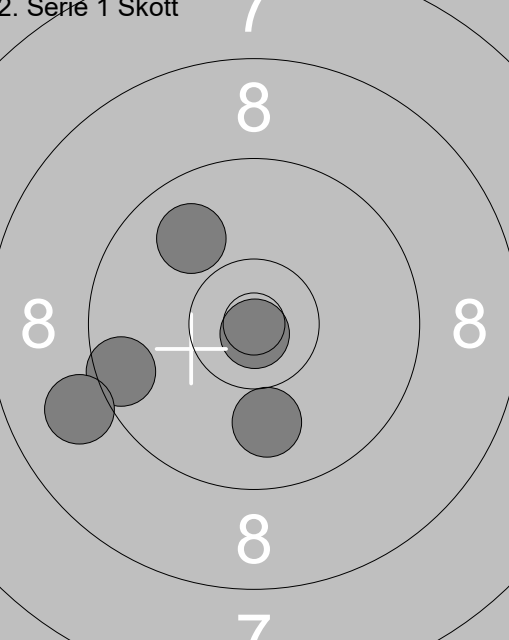
<p>2. Serie 1 Skott</p> 	<p>1: 10.9x ↓</p> <p>2: 9.9 ↗</p> <p>3: 9.5 ←</p> <p>4: 9.0 ←</p> <p>5: 10.0 ↓</p>	
Serie 47.0		
Total 333.0		

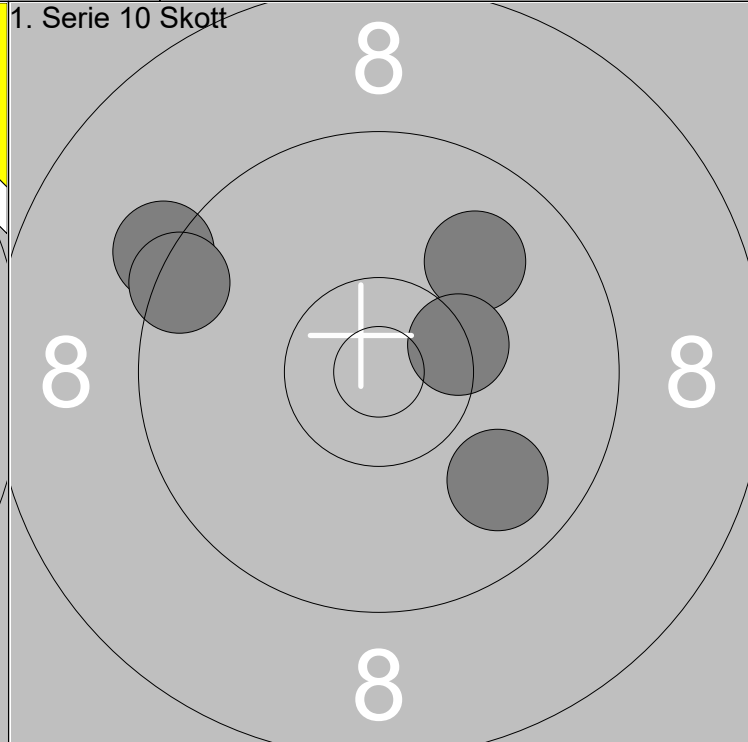
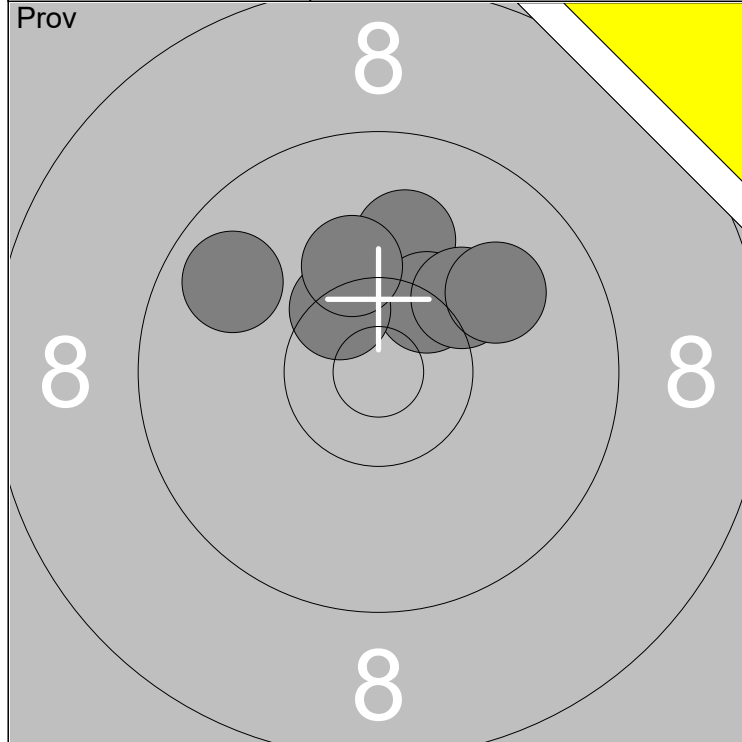

1: 10.0 ↑	6: 10.2 ↑	Serie	69
2: 10.4x ↗	7: 9.8 ↖		
3: 10.2 ↗		Total	190
4: 10.4x ↖			
5: 10.0 ↗			

1: 9.8 ↘	Serie	46
2: 9.3 ↖		
3: 9.9 ↗	Total	236
4: 10.4x →		
5: 9.4 ↖		

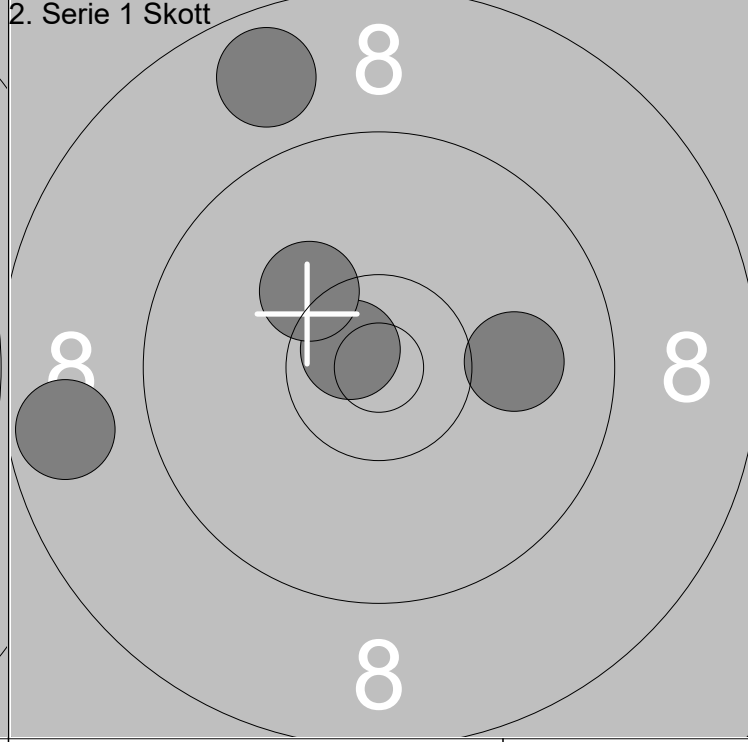

6: 7.6 ←	Serie	46
7: 10.4x ↘		
8: 10.7x ↘	Total	282
9: 9.6 ←		
10: 10.8x ↑		

1: 10.7x ↖	Serie	46
2: 10.0 →		
3: 8.7 ←	Total	328
4: 8.8 ↑		
5: 10.2 ↖		

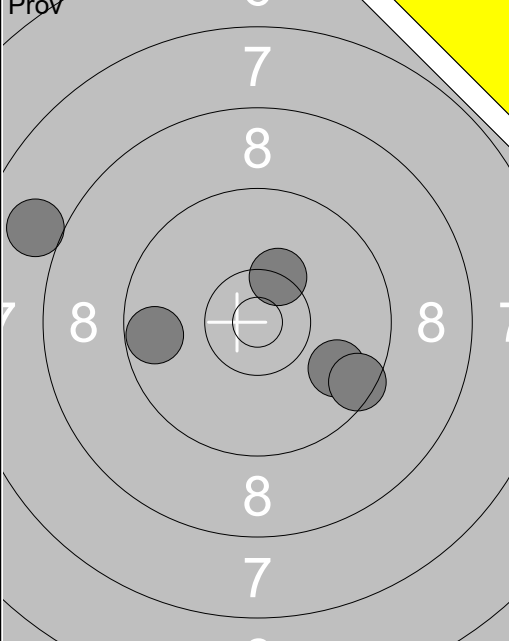
 <p style="text-align:center;">Prov</p>	<p>1: 10.2 →</p> <p>2: 9.1 →</p> <p>3: 9.5 ↓</p> <p>4: 10.0 →</p> <p>5: 9.6 ↓</p> <p>6: 9.3 ←</p> <p>7: 8.6 ←</p> <p>8: 9.8 ↑</p> <p>9: 9.0 ←</p> <p>10: 10.5x ↑</p>	 <p style="text-align:center;">Prov</p>	<p>11: 9.8 ↘</p> <p>12: 9.5 ↘</p> <p>13: 9.7 ←</p> <p>14: 10.3x ↗</p> <p>15: 8.0 ←</p>
Serie 92.0		Serie 45.0	
Total 188.0		Total 188.0	

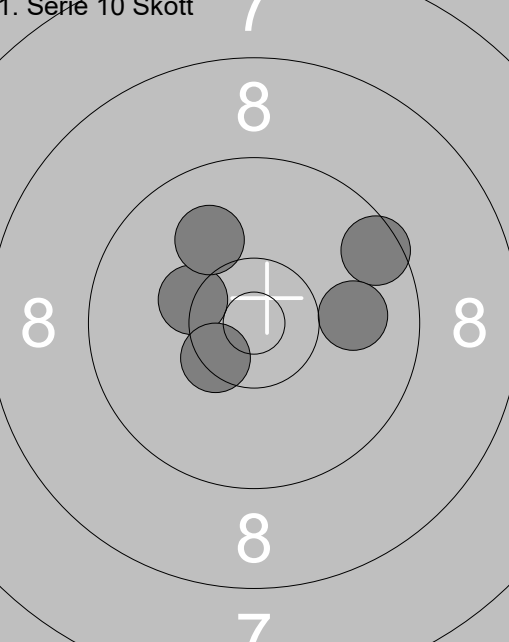
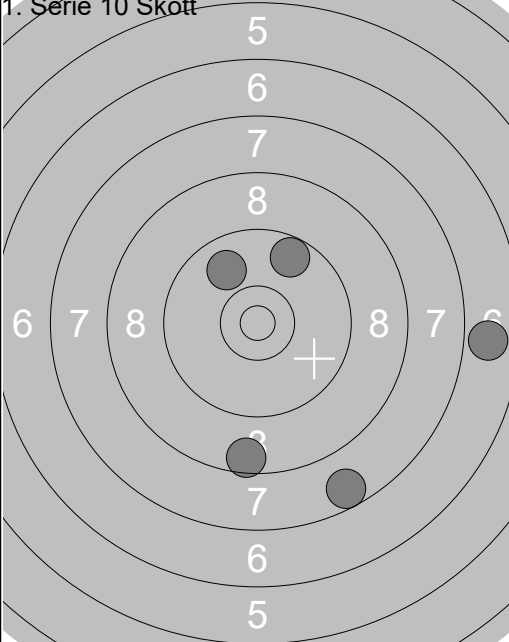
<p>1. Serie 10 Skott</p> 	<p>1: 9.5 ↗</p> <p>2: 10.0 →</p> <p>3: 10.3x ↘</p> <p>4: 10.4x ↘</p> <p>5: 10.0 ↖</p>	<p>1. Serie 10 Skott</p> 	<p>6: 9.9 ↖</p> <p>7: 9.7 ↗</p> <p>8: 7.6 ↓</p> <p>9: 6.9 →</p> <p>10: 8.6 ↓</p>
Serie 49.0		Serie 39.0	
Total 237.0		Total 276.0	

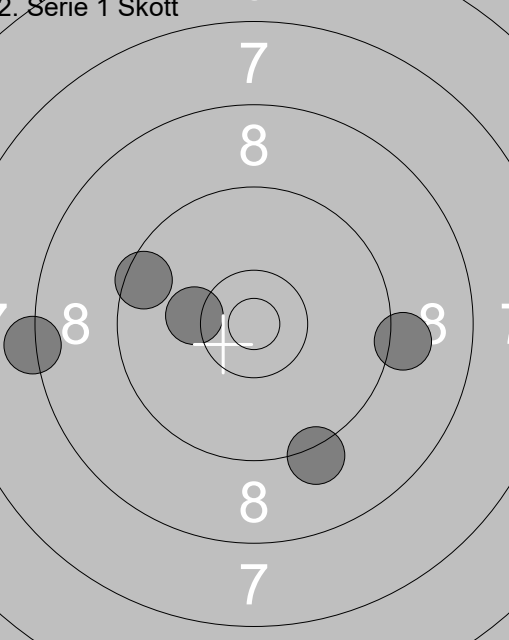
<p>2. Serie 1 Skott</p> 	<p>1: 8.3 ←</p> <p>2: 9.1 →</p> <p>3: 9.2 ↓</p> <p>4: 9.5 ←</p> <p>5: 10.2 ←</p>		
Serie 45.0			
Total 321.0			

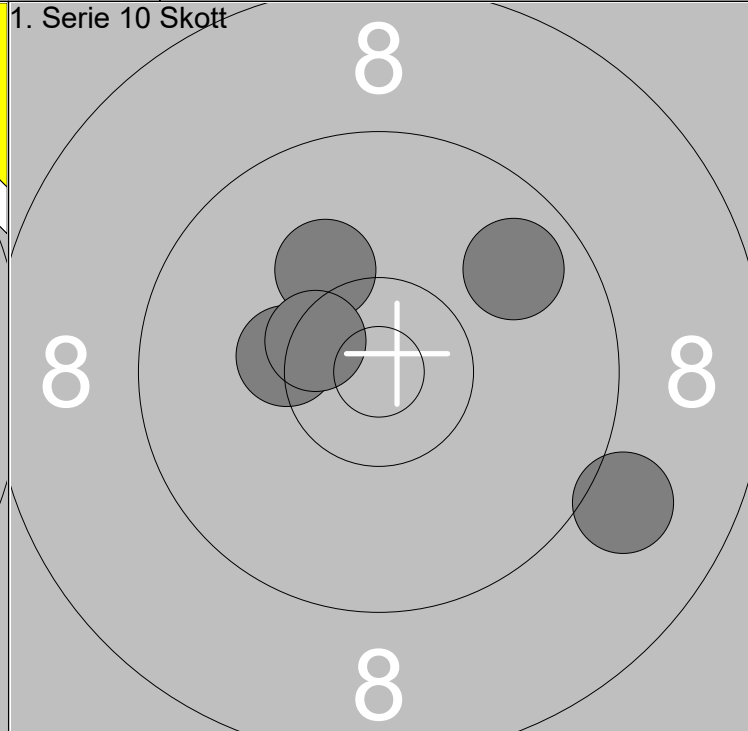
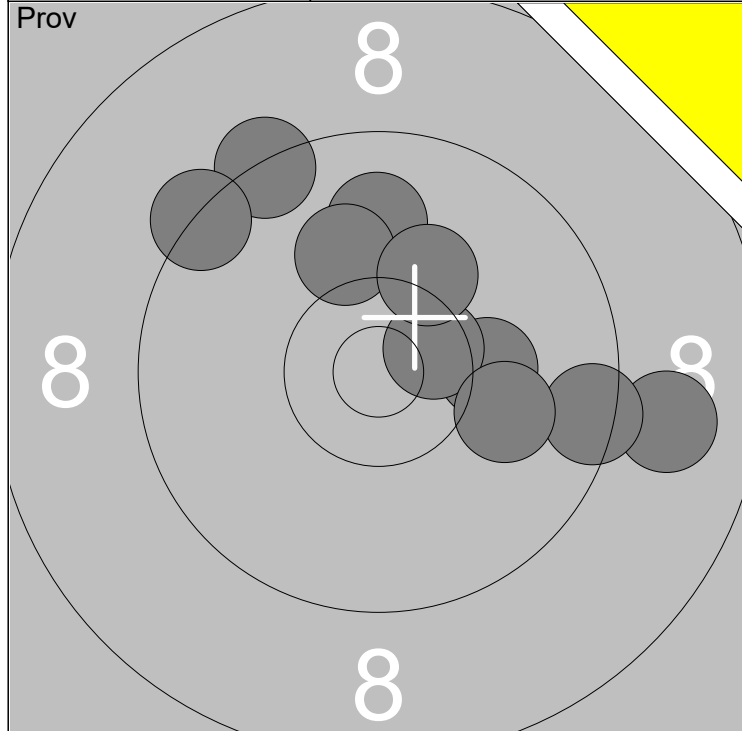

1: 9.9 ↑	6: 9.3 ↗	Serie	94
2: 8.9 →	7: 9.3 ↗		
3: 9.5 →	8: 10.1 ↗	Total	188
4: 10.2 →	9: 10.0 ↗		
5: 10.5x →	10: 10.2 ↗		

1: 9.0 →	Serie	48
2: 10.3x ←		
3: 9.8 ↗	Total	236
4: 10.2 ↗		
5: 10.5x ←		

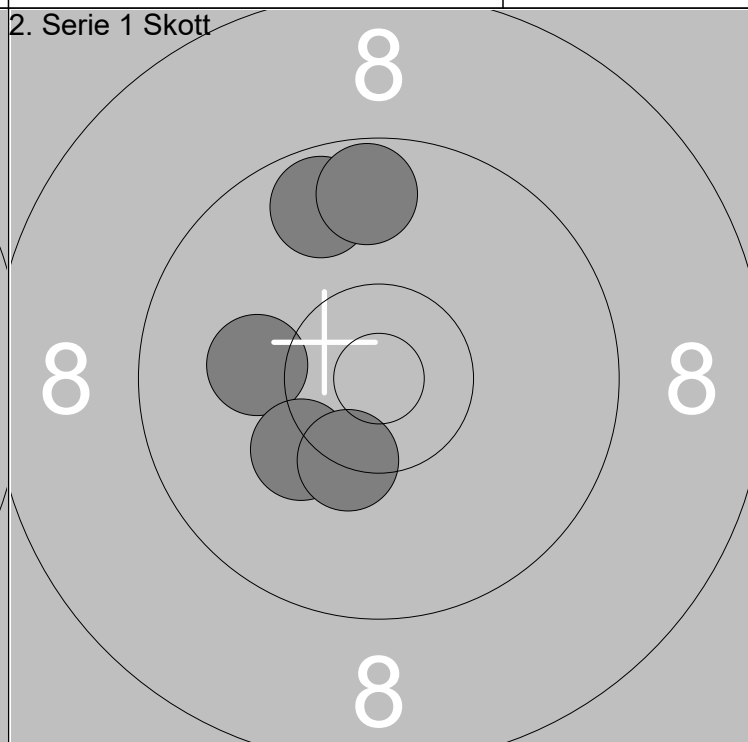
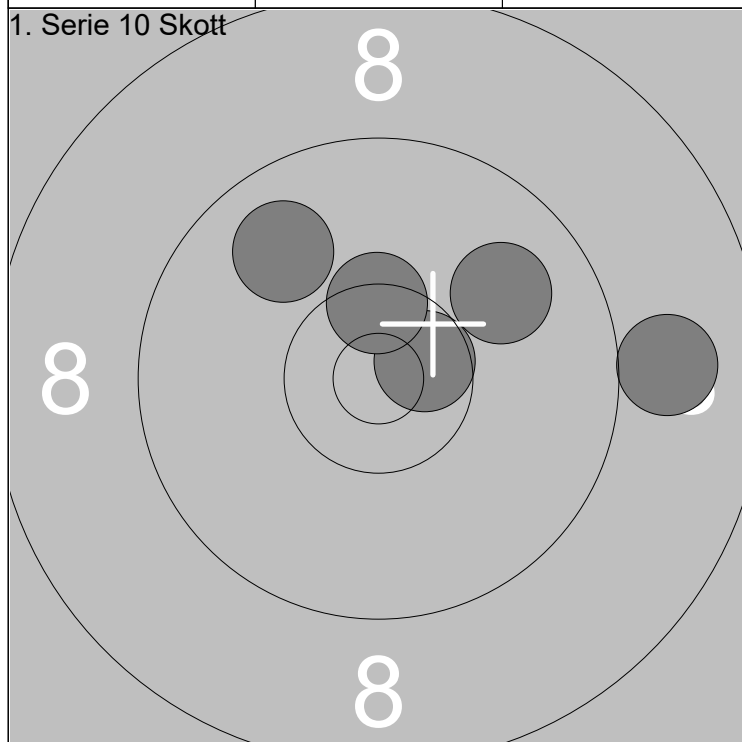

6: 10.6x →	Serie	47
7: 9.9 ↗		
8: 9.0 →	Total	283
9: 9.9 ↗		
10: 10.4x ↑		

1: 9.7 ↗	Serie	48
2: 10.1 ←		
3: 10.2 ↘	Total	331
4: 9.7 ↑		
5: 10.3x ↘		

	<p>1: 9.0 ←</p> <p>2: 9.6 ←</p> <p>3: 10.5x✓</p> <p>4: 9.9 →</p> <p>5: 9.9 →</p> <p>6: 9.7 →</p> <p>7: 9.7 ←</p> <p>8: 10.4x↘</p> <p>9: 9.6 ←</p> <p>10: 10.3x➤</p>		<p>11: 10.3x↘</p> <p>12: 10.1 ↗</p> <p>13: 9.3 ↖</p> <p>14: 10.2 ➤</p> <p>15: 10.7x↘</p>
Serie 93.0		Serie 49.0	
Total 184.0		Total 184.0	

<p>1. Serie 10 Skott</p>	<p>1: 8.2 ➤</p> <p>2: 9.9 ➤</p> <p>3: 10.7x↗</p> <p>4: 8.7 ➤</p> <p>5: 10.6x➤</p>	<p>1. Serie 10 Skott</p>	<p>6: 9.6 ➤</p> <p>7: 10.2 ➤</p> <p>8: 8.5 ➤</p> <p>9: 9.6 ↗</p> <p>10: 8.7 ➤</p>
Serie 45.0		Serie 44.0	
Total 229.0		Total 273.0	

<p>2. Serie 1 Skott</p>	<p>1: 8.2 ←</p> <p>2: 9.5 ↗</p> <p>3: 9.6 ←</p> <p>4: 10.6x➤</p> <p>5: 9.0 ↗</p>		
Serie 45.0			
Total 318.0			

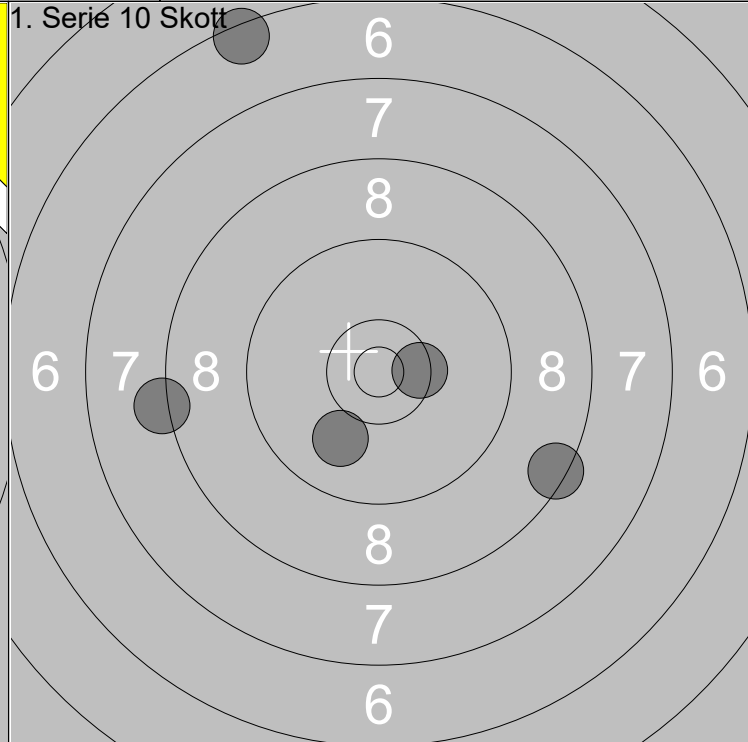
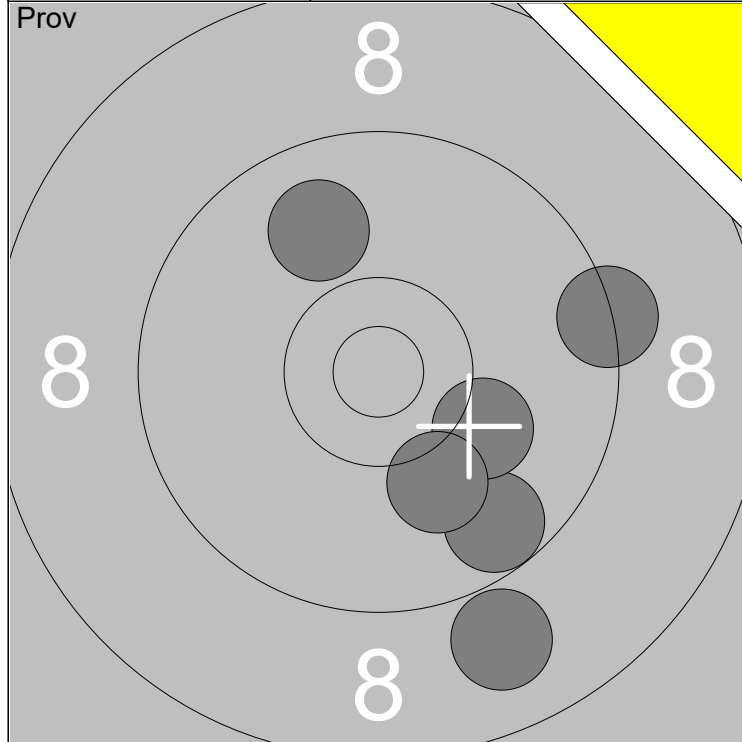

1: 9.9 ↗	6: 9.3 →		
2: 9.7 ↘		Serie	55
3: 10.1 ↘			
4: 10.1 ↘		Total	183
5: 8.9 ↘			

1: 10.4x →			
2: 8.2 ←		Serie	42
3: 10.0 ↘			
4: 8.4 ↗		Total	225
5: 6.4 ↖			

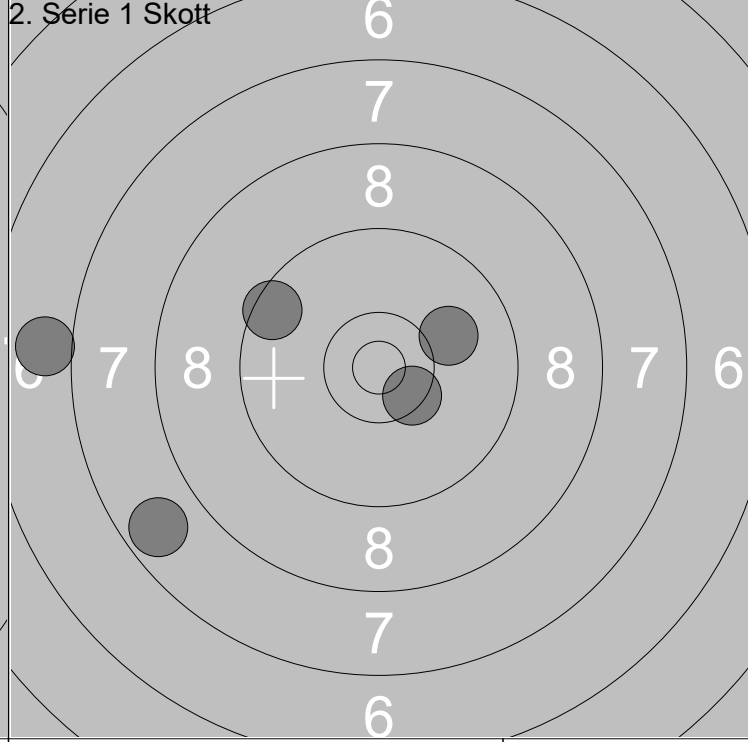
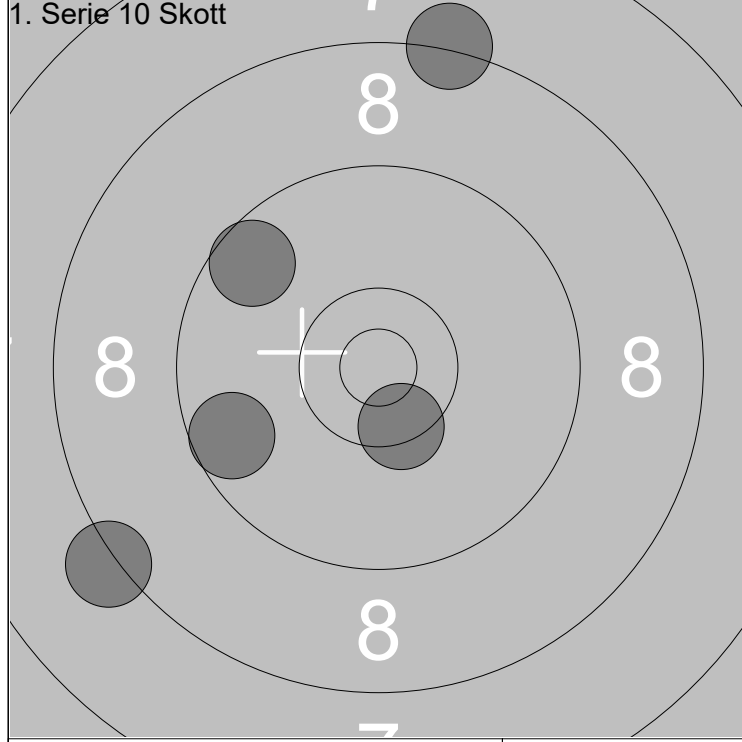

6: 8.3 ↑			
7: 9.6 ←		Serie	44
8: 8.2 ←			
9: 10.4x ↘		Total	269
10: 9.6 ↖			

1: 7.7 ↖			
2: 7.0 ←		Serie	43
3: 10.0 ↗			
4: 10.4x ↘		Total	312
5: 9.5 ↖			

<p>Pröv</p>	<p>1: 10.6x ➤</p> <p>2: 8.3 ➔</p> <p>3: 9.1 ➤</p> <p>4: 8.8 ➔</p> <p>5: 9.1 ↗</p> <p>6: 9.7 ➔</p> <p>7: 9.1 ➔</p> <p>8: 9.2 ↗</p> <p>9: 8.8 ↗</p> <p>10: 8.9 ↗</p>	<p>Pröv</p>	<p>11: 9.7 ↗</p> <p>12: 10.1 ↓</p> <p>13: 10.0 ➤</p> <p>14: 9.8 ➤</p> <p>15: 8.4 ➤</p>
Serie 87.0		Serie 46.0	
Total 180.0		Total 180.0	

<p>1. Serie 10 Skott</p>	<p>1: 9.4 ➔</p> <p>2: 9.1 ➤</p> <p>3: 7.4 ➤</p> <p>4: 9.5 ➔</p> <p>5: 10.3 ➔</p>	<p>1. Serie 10 Skott</p>	<p>6: 8.0 ➤</p> <p>7: 10.1 ➤</p> <p>8: 10.5x ➤</p> <p>9: 8.5 ➤</p> <p>10: 9.0 ➤</p>
Serie 44.0		Serie 45.0	
Total 224.0		Total 269.0	

<p>2. Serie 1 Skott</p>	<p>1: 10.1 ↙</p> <p>2: 8.5 ↙</p> <p>3: 8.7 ➤</p> <p>4: 8.7 ➤</p> <p>5: 9.7 ↗</p>		
Serie 43.0			
Total 312.0			



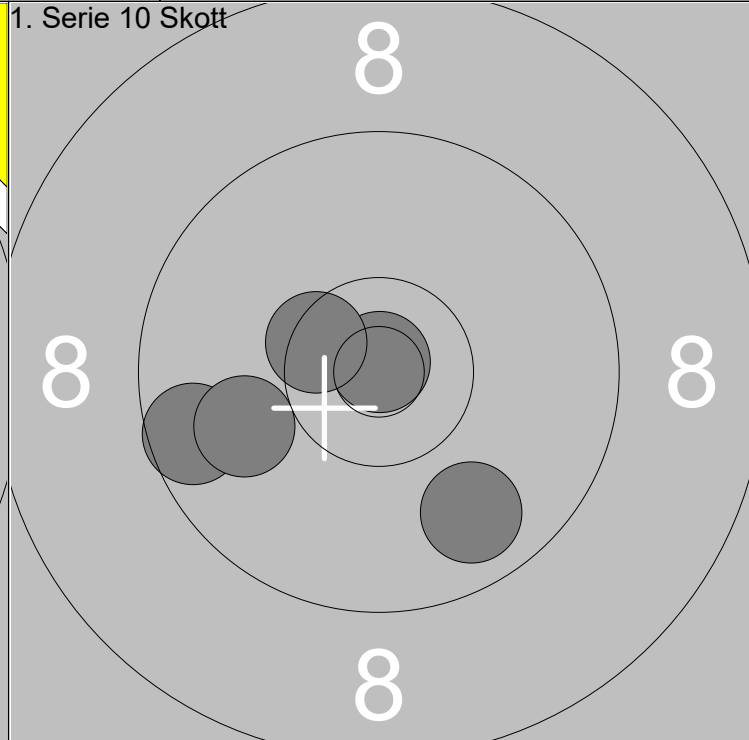
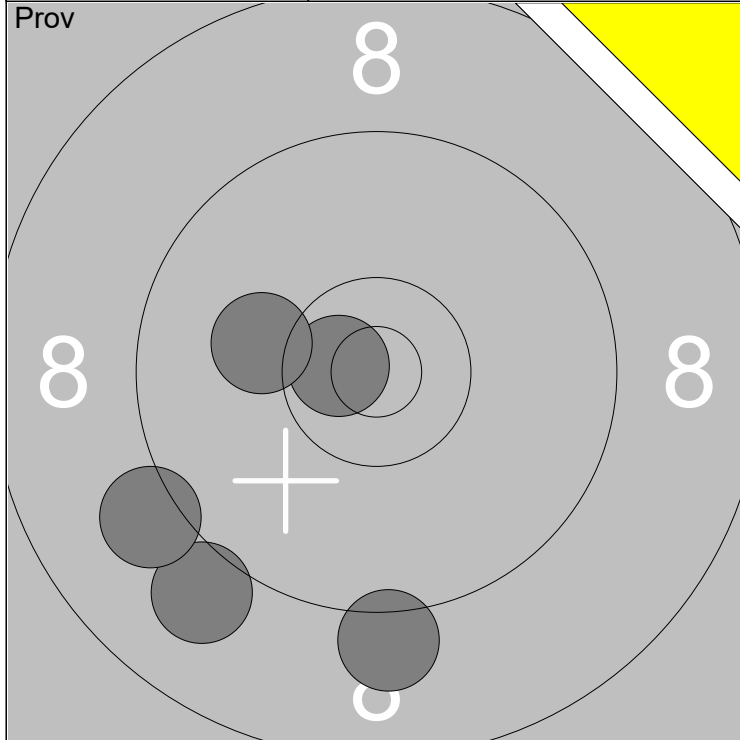

1: 9.1	↓
2: 10.7x	←
3: 9.0	↙
4: 9.1	←
5: 10.1	←

Serie	47
Total	178

1: 10.9x	↑
2: 9.6	←
3: 9.8	↙
4: 10.0	←
5: 10.5x	↙

Serie	48
Total	226

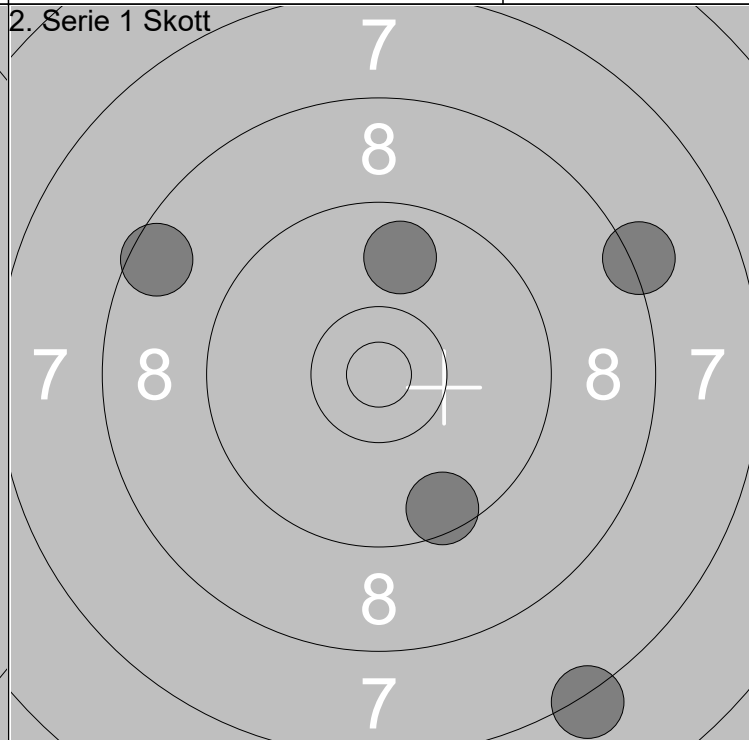
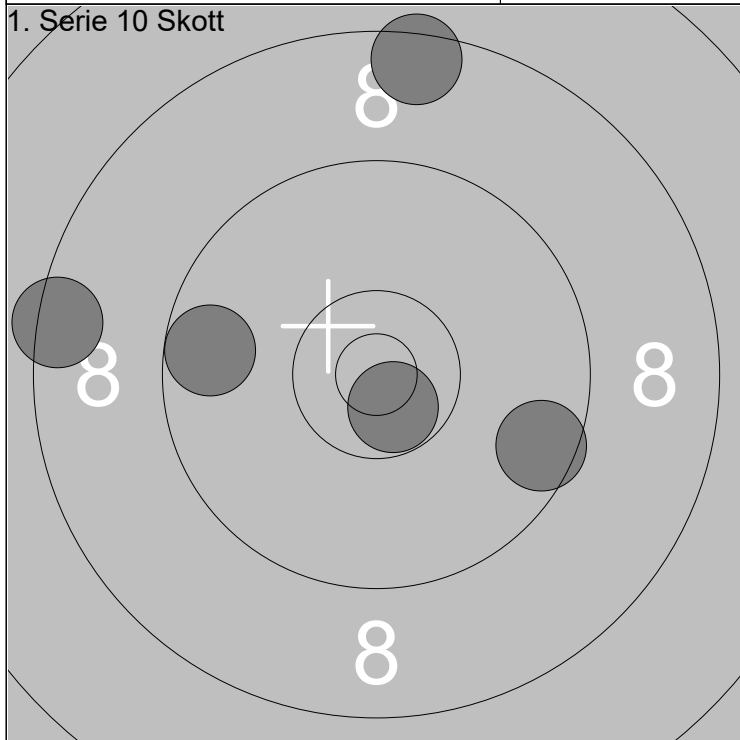

6: 9.7	←
7: 8.5	↑
8: 9.6	↘
9: 10.7x	↘
10: 8.5	←

Serie	44
Total	270

1: 9.5	↘
2: 8.6	↖
3: 9.8	↑
4: 8.2	↗
5: 7.2	↘

Serie	41
Total	311

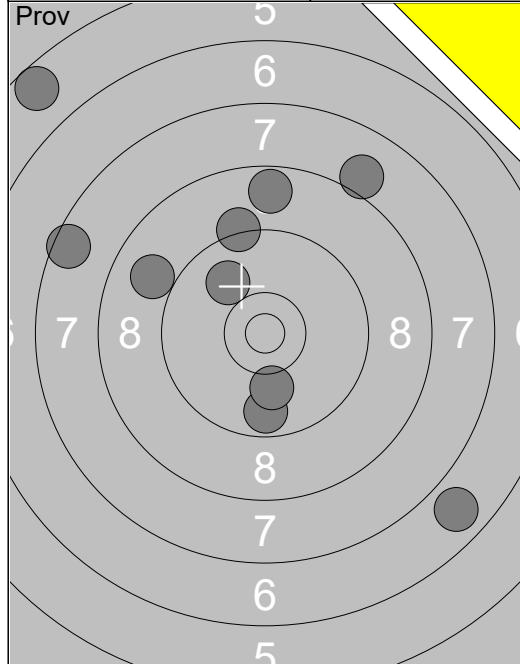

1:	10.0 ↖
2:	9.2 ↑
3:	9.7 ↓
4:	8.0 ↗
5:	8.7 ↑
6:	6.8 ↓
7:	10.1 ↓
8:	5.6 ↗
9:	8.9 ↖
10:	7.5 ↖
<b>Serie 80.0</b>	
<b>Total 172.0</b>	

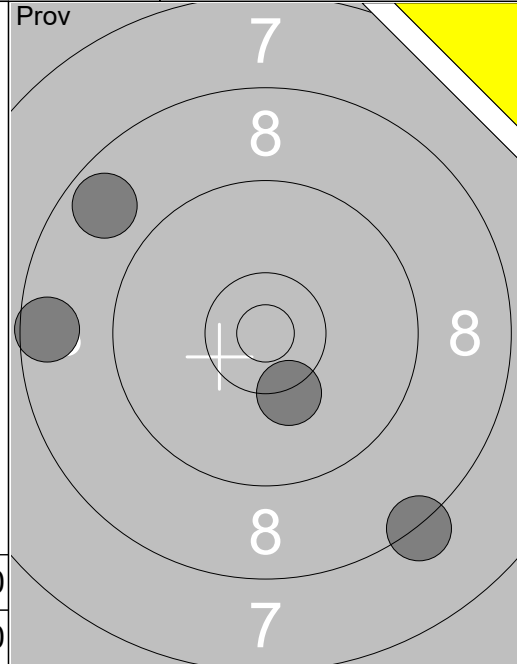

11:	8.7 ↖
12:	8.6 ←
13:	8.3 ↓
14:	10.3 ↓
<b>Serie 34.0</b>	
<b>Total 172.0</b>	

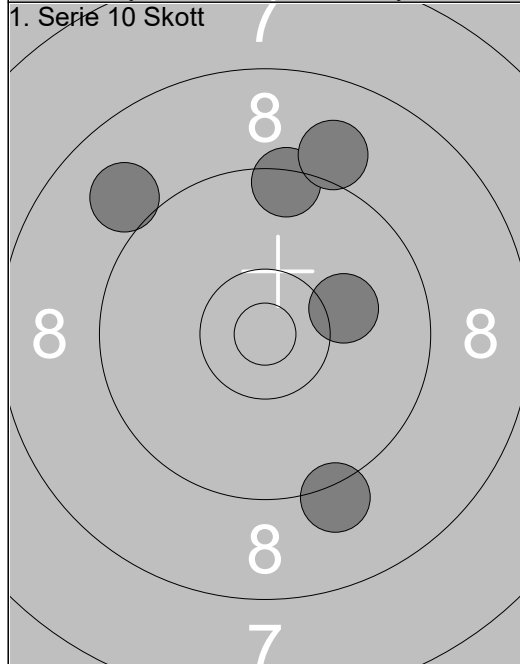

1:	10.1 →
2:	9.2 ↓
3:	9.4 ↑
4:	9.0 ↖
5:	9.0 ↑
<b>Serie 46.0</b>	
<b>Total 218.0</b>	

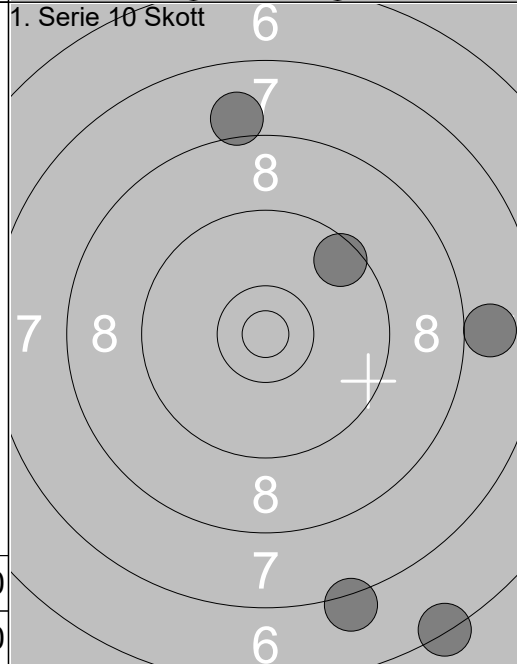

6:	8.1 ↑
7:	6.3 ↓
8:	8.0 →
9:	7.2 ↓
10:	9.5 ↗
<b>Serie 38.0</b>	
<b>Total 256.0</b>	

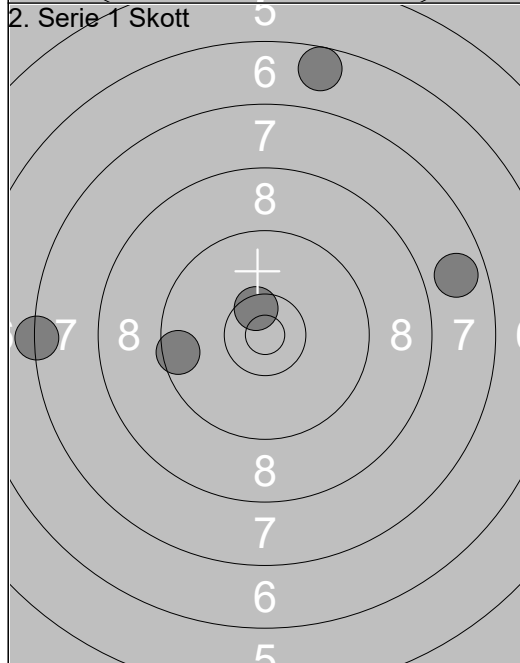

1:	9.5 ←
2:	7.3 ←
3:	7.8 →
4:	6.6 ↑
5:	10.5x ↖
<b>Serie 39.0</b>	
<b>Total 295.0</b>	