

1: 10.8x ↗	Serie	29
2: 9.6 ↙		
3: 10.4 →		
Total		196

1: 10.5x ↑	Serie	49
2: 10.0 →		
3: 9.7 ↙		
4: 10.0 ↘		
5: 10.4x ↓		
Total		245

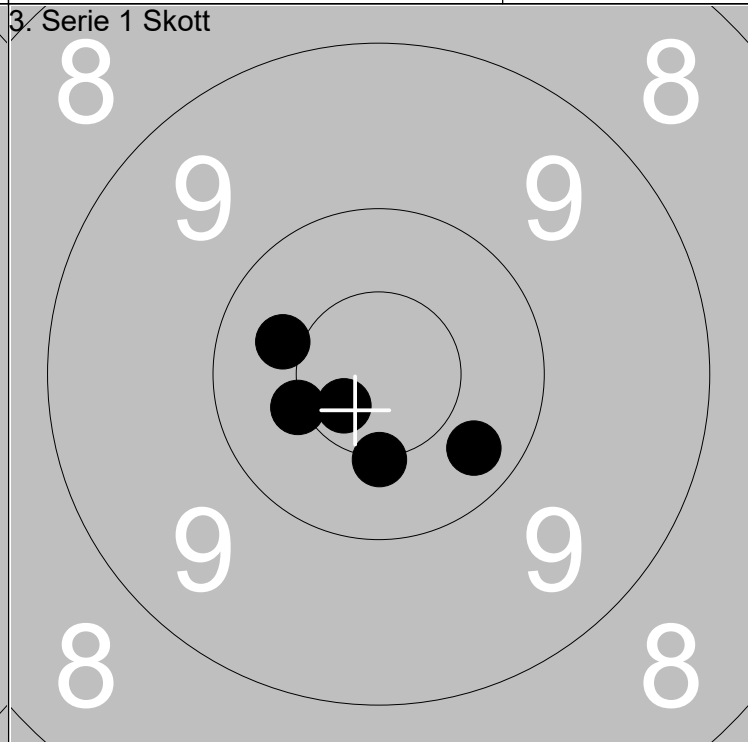
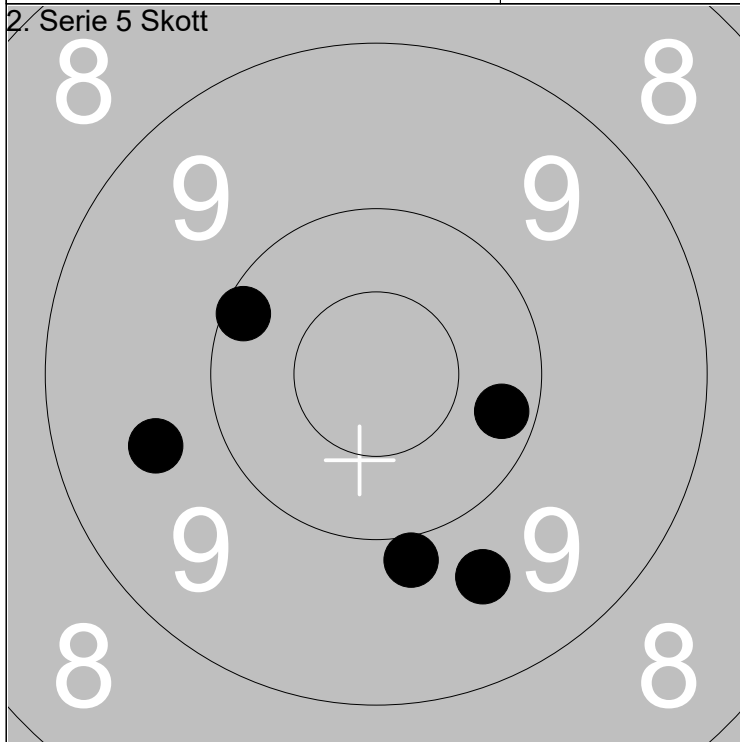

1: 10.2 →	Serie	47
2: 9.6 ↘		
3: 9.9 ↘		
4: 10.1 ↗		
5: 9.6 ←		
Total		292

1: 10.7x ↙	Serie	50
2: 10.4 ↙		
3: 10.3 ↘		
4: 10.5x ↙		
5: 10.5x ↓		
Total		342

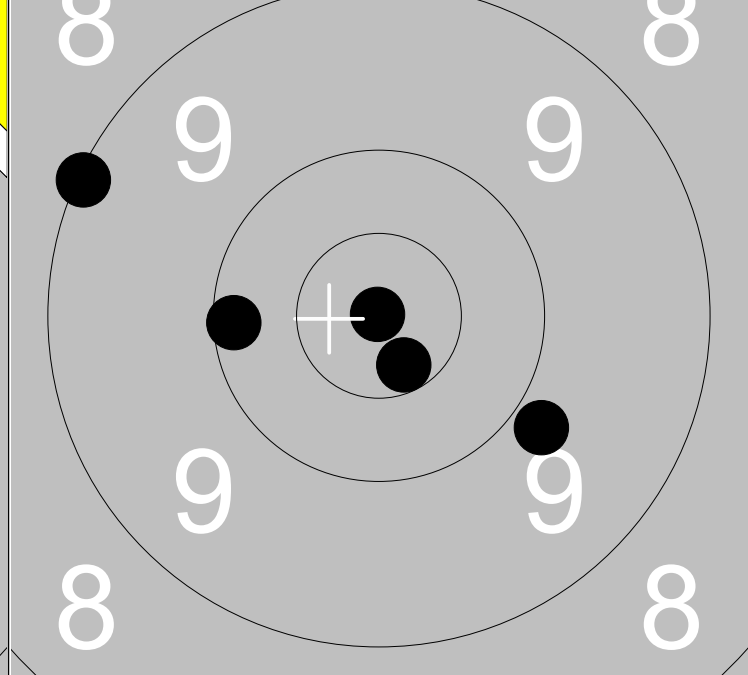
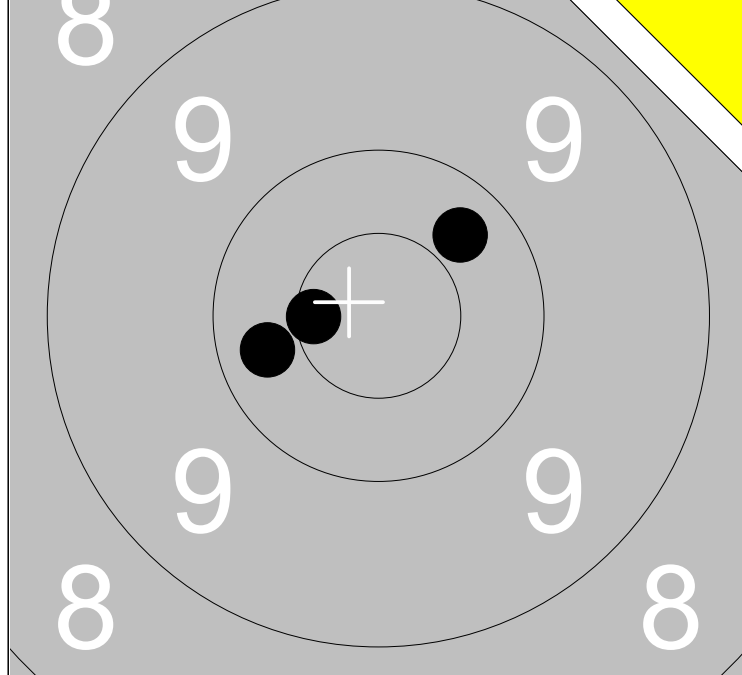

1: 10.3 ↗	Serie	30
2: 10.3 ←		
3: 10.6x ←		
Total		191

1: 10.9x ↗	Serie	48
2: 9.1 ↗		
3: 9.8 ↘		
4: 10.1 ←		
5: 10.6x ↘		
Total		239

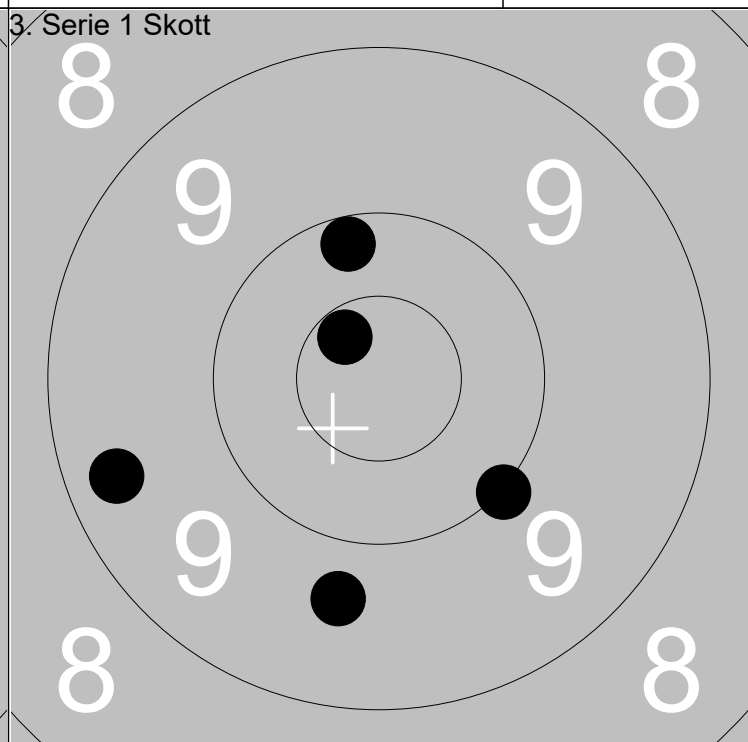
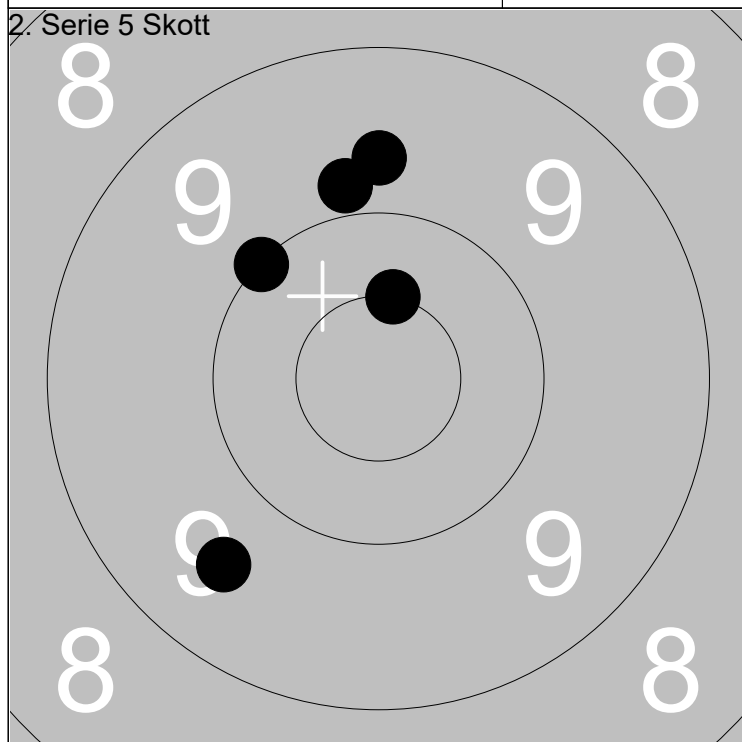

1: 9.7 ↑	Serie	47
2: 10.0 ↗		
3: 9.8 ↑		
4: 9.6 ↘		
5: 10.5x ↑		
Total		286

1: 10.0 ↘	Serie	48
2: 9.7 ↘		
3: 10.6x ↗		
4: 10.2 ↑		
5: 9.3 ←		
Total		334

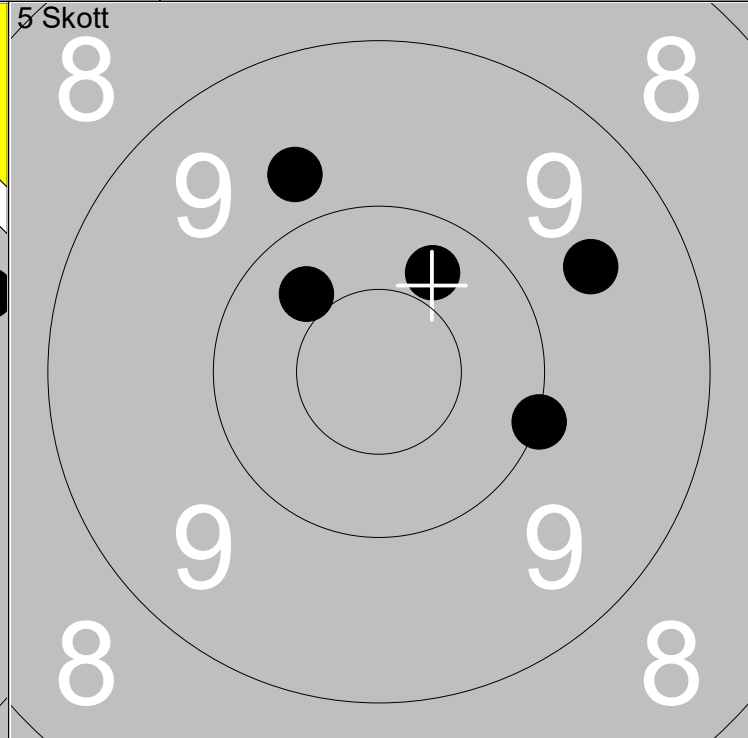
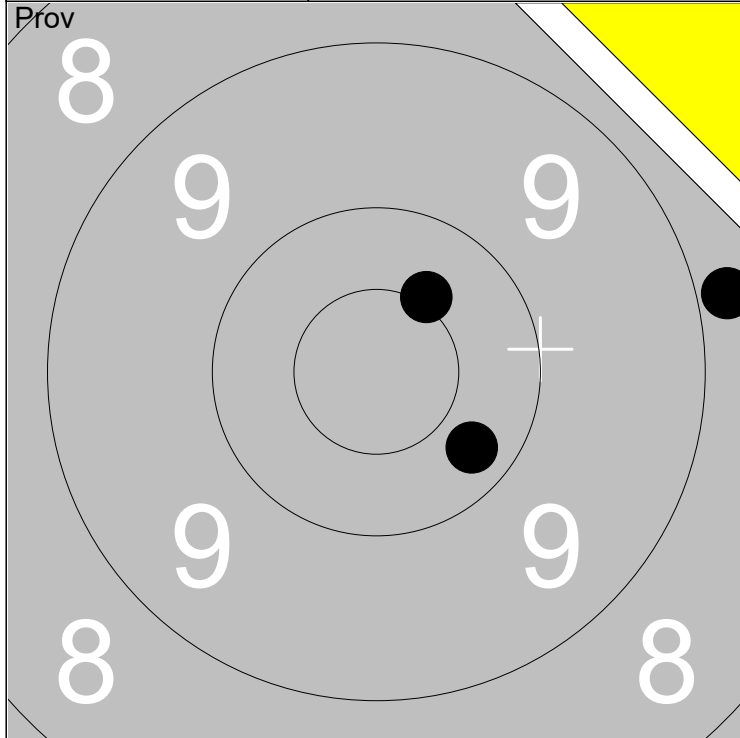

1: 10.4x ↗	Serie	28
2: 8.8 →		
3: 10.3 ↘		
Total		190

1: 9.7 ↖	Serie	48
2: 10.4 ↖		
3: 9.6 ↗		
4: 10.0 →		
5: 10.3 ↗		
Total		238

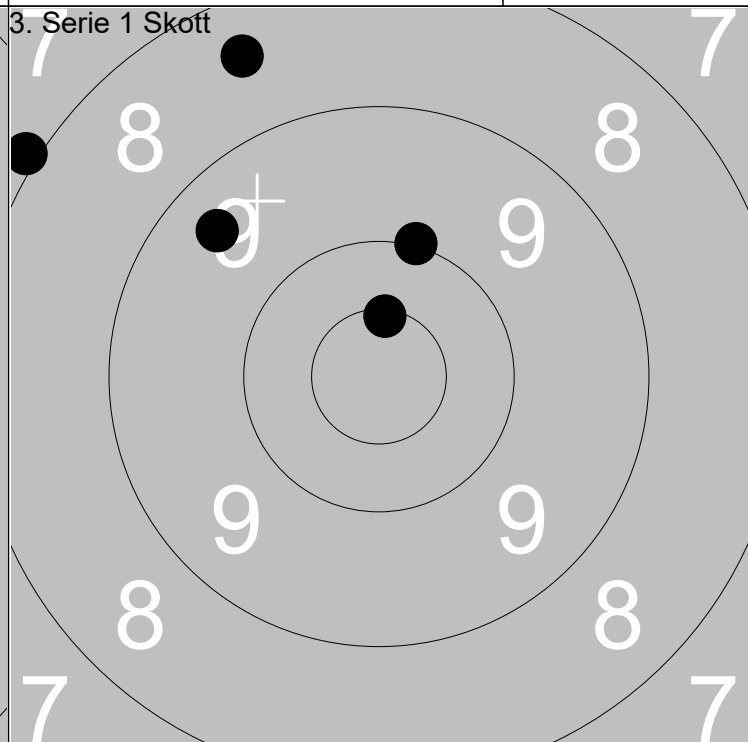
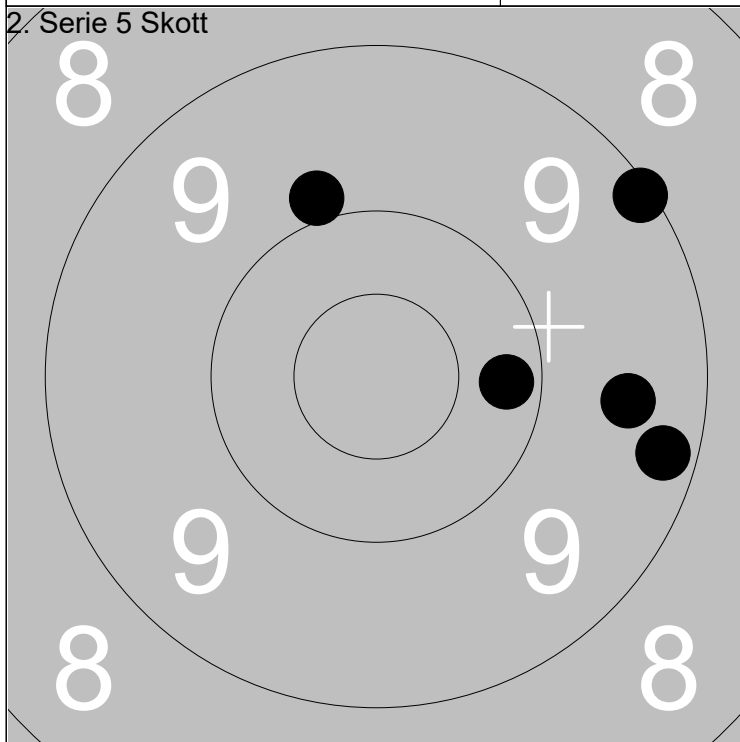

1: 9.2 →	Serie	46
2: 9.9 ↖		
3: 9.1 ↗		
4: 9.5 →		
5: 10.2 →		
Total		284

1: 9.4 ↖	Serie	44
2: 7.9 ↖		
3: 10.0 ↖		
4: 8.4 ↖		
5: 10.5x ↖		
Total		328

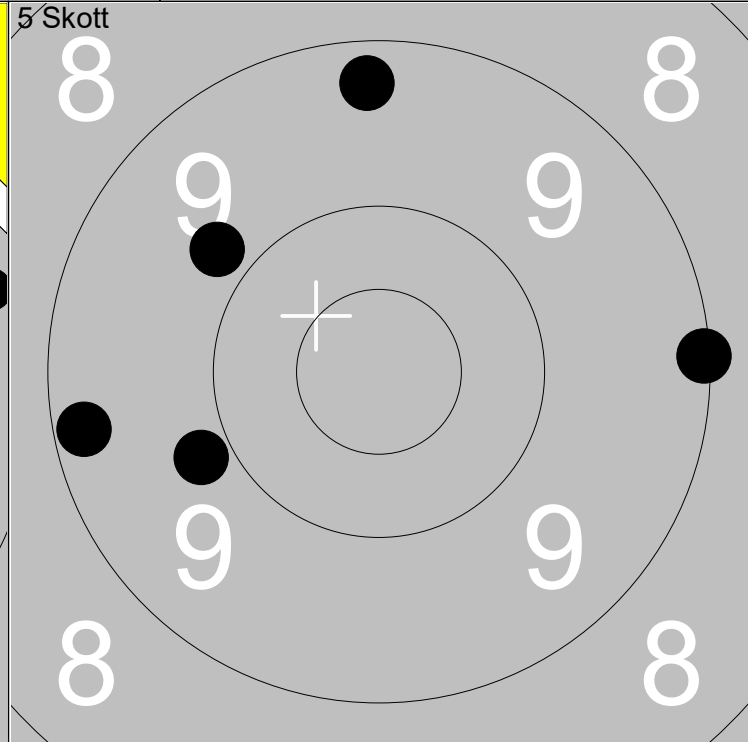
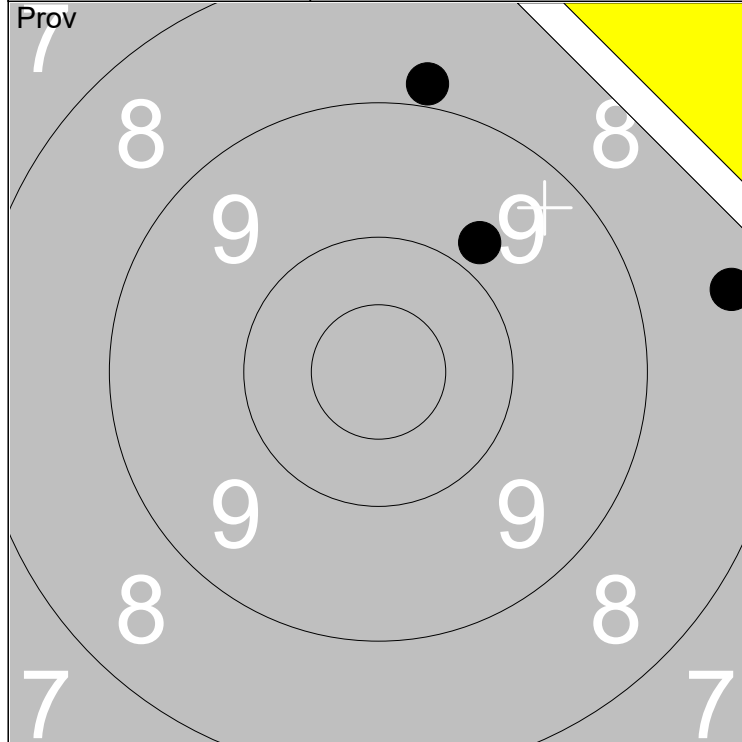

1:	9.8	↗
2:	8.9	↑
3:	8.3	→

Serie	25
Total	190

1:	9.1	→
2:	9.8	↖
3:	9.8	↙
4:	9.2	←
5:	9.3	↑

Serie	45
Total	235

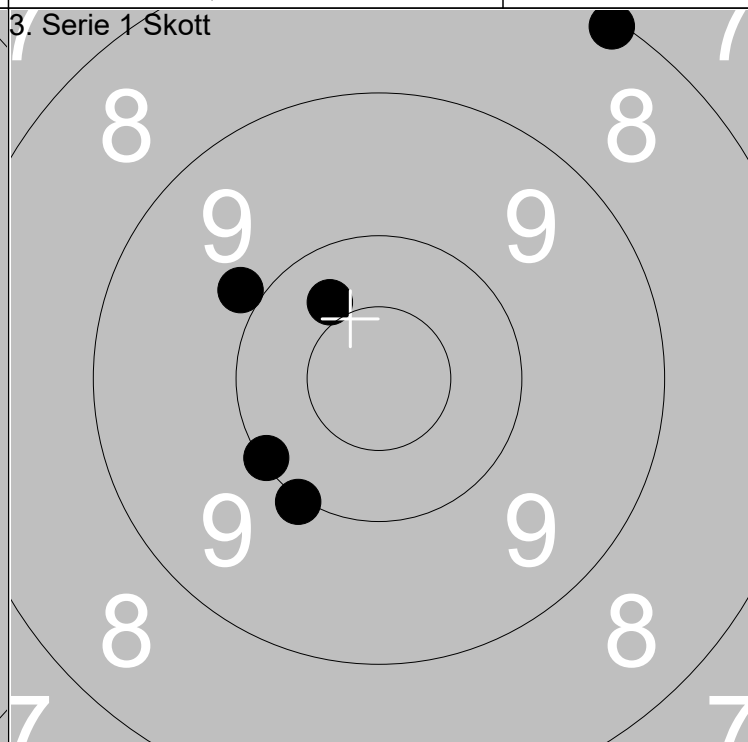
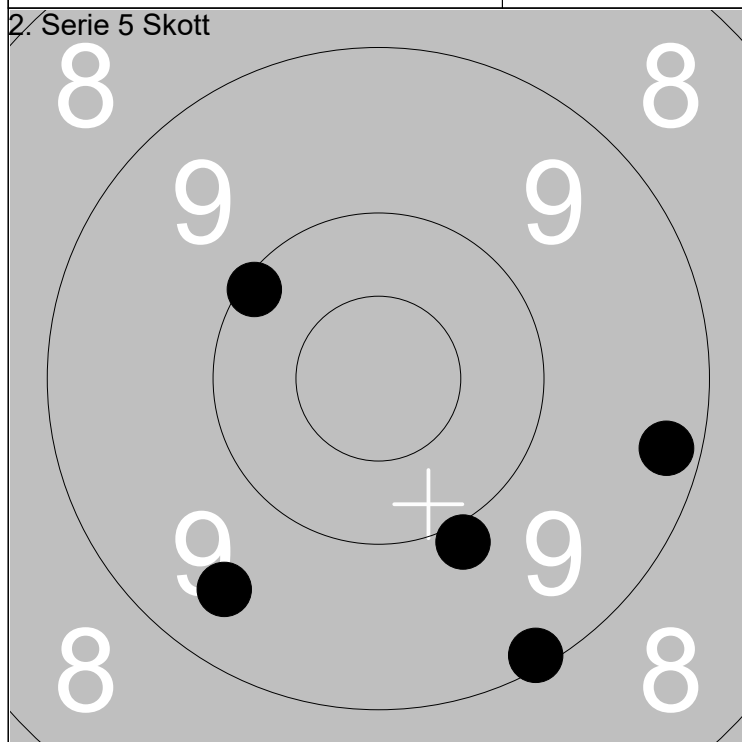

1:	9.1	↙
2:	9.2	→
3:	10.1	↗
4:	9.4	↙
5:	9.9	↙

Serie	46
Total	281

1:	10.0	↙
2:	10.4	↖
3:	8.1	↗
4:	10.1	↙
5:	9.9	↖

Serie	47
Total	328

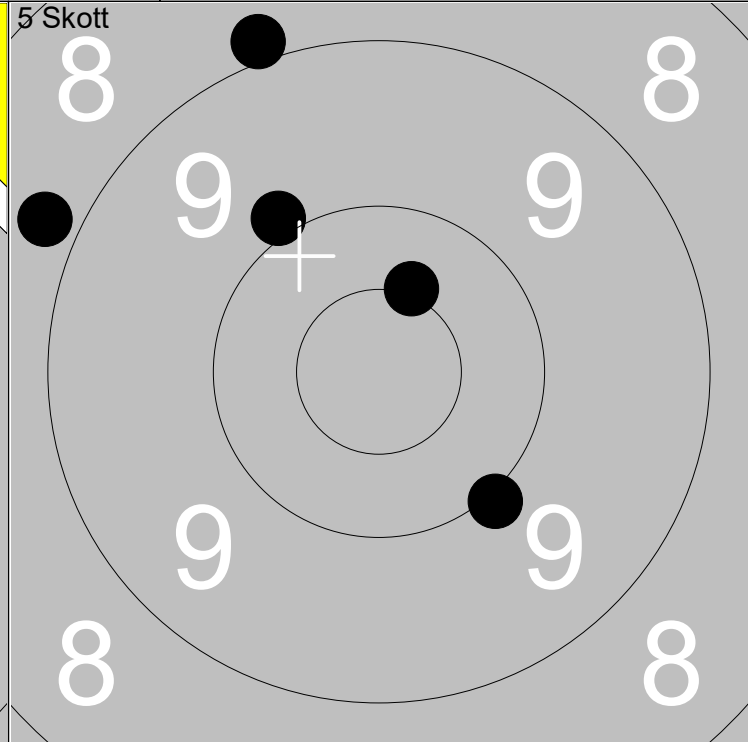
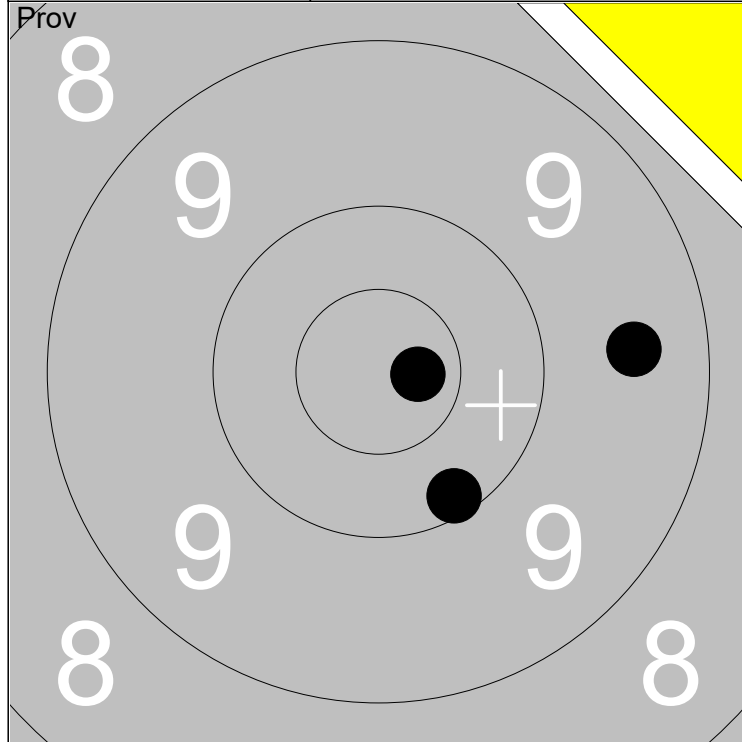

1: 9.5 →	Serie	29
2: 10.7x →		
3: 10.1 ↘		
Total		189

1: 8.9 ↖	Serie	45
2: 10.5x ↗		
3: 9.9 ↖		
4: 8.8 ↖		
5: 10.0 ↘		
Total		234

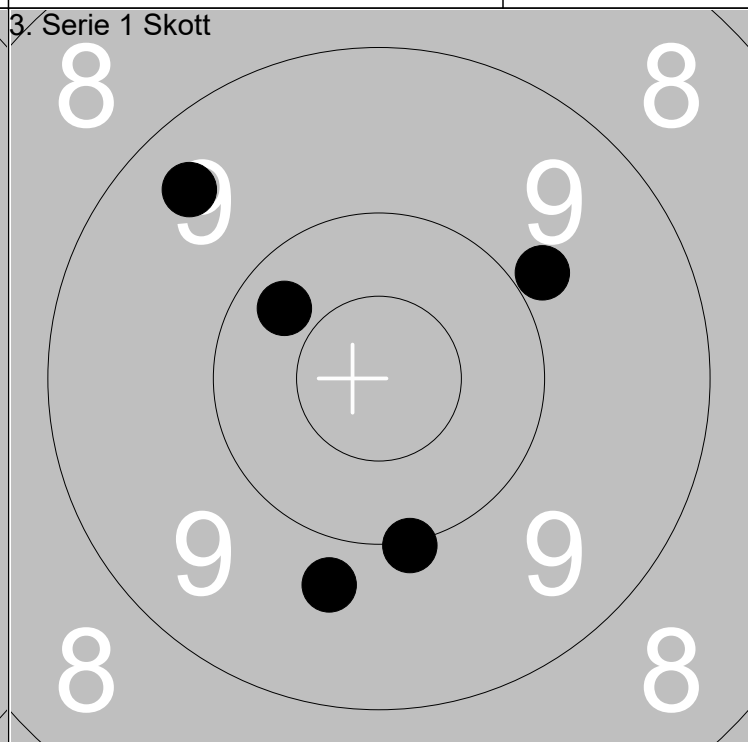
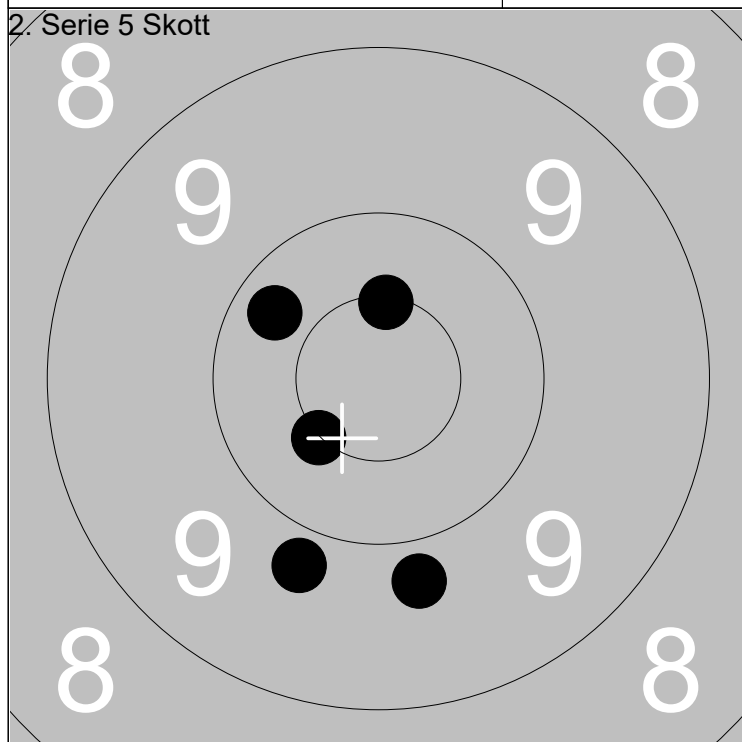

1: 10.3 ↖	Serie	48
2: 10.5x ↗		
3: 9.8 ↘		
4: 10.5x ↖		
5: 9.8 ↘		
Total		282

1: 9.4 ↖	Serie	47
2: 10.3 ↖		
3: 9.9 ↗		
4: 10.0 ↘		
5: 9.7 ↘		
Total		329

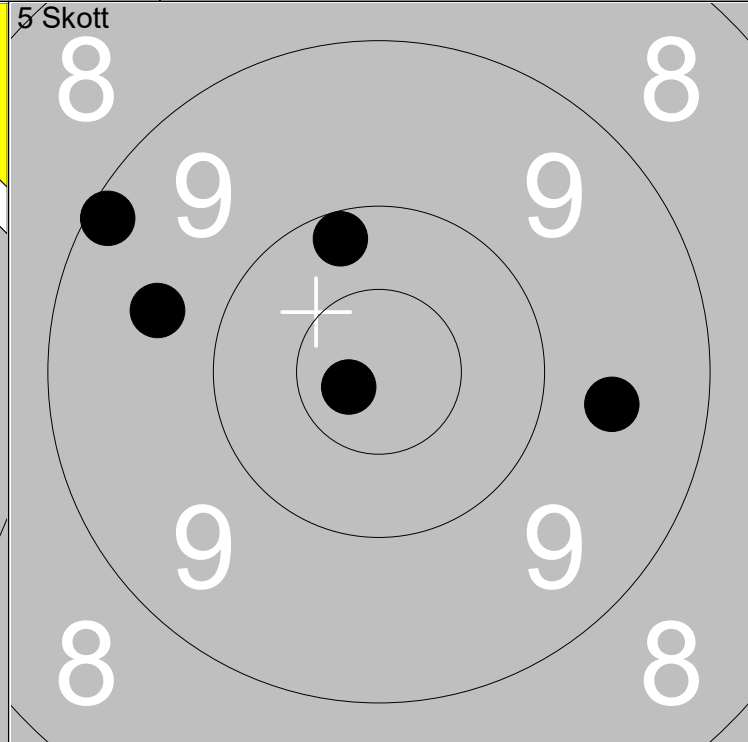
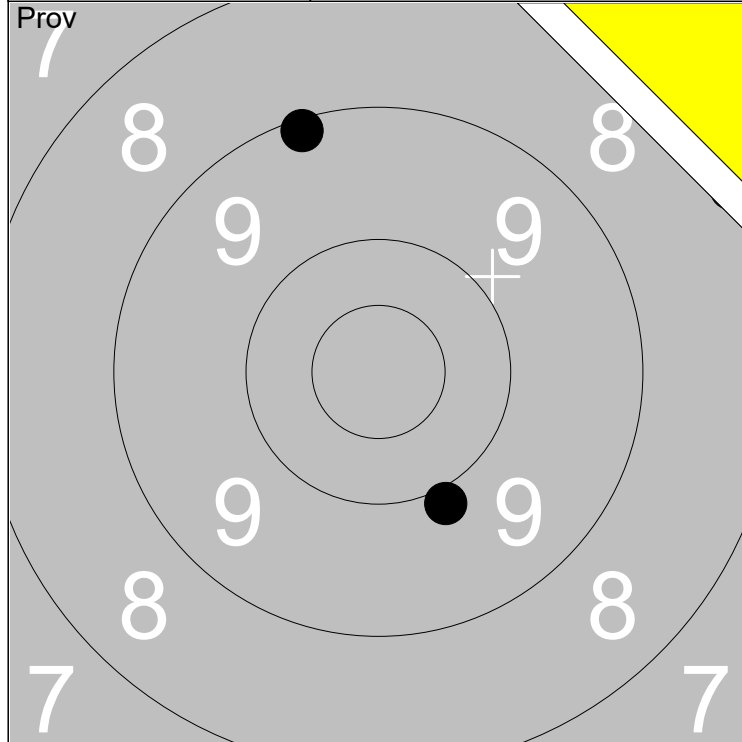

1: 8.0	↗
2: 9.1	↖
3: 9.9	↘

Serie	26
Total	185

1: 10.2	↖
2: 9.1	↖
3: 10.8x	↙
4: 9.6	↖
5: 9.6	↗

Serie	47
Total	232

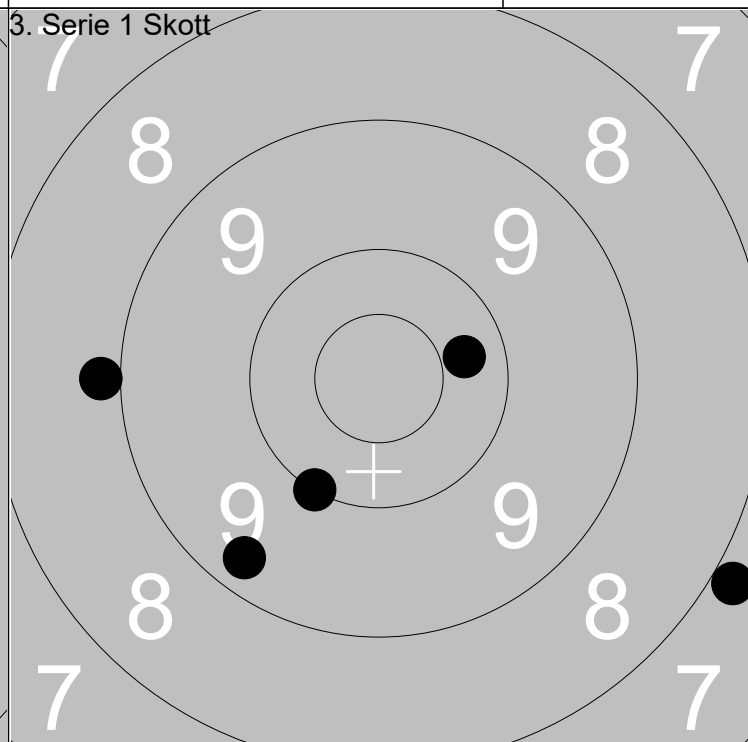
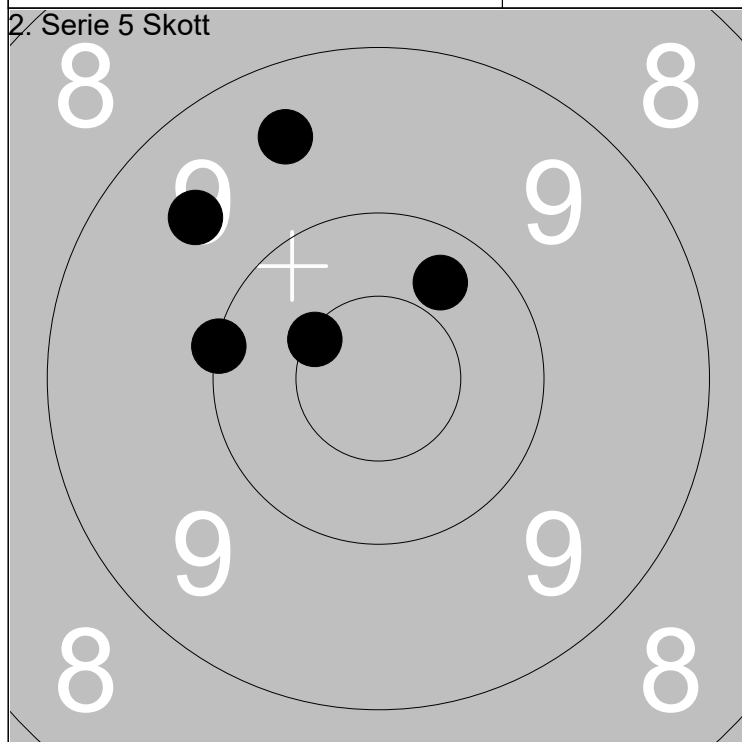

1: 9.6	↗
2: 10.0	↖
3: 9.5	↗
4: 10.5x	↖
5: 10.3	↗

Serie	48
Total	280

1: 9.3	↙
2: 8.9	←
3: 7.9	↘
4: 10.3	↗
5: 10.0	↙

Serie	44
Total	324

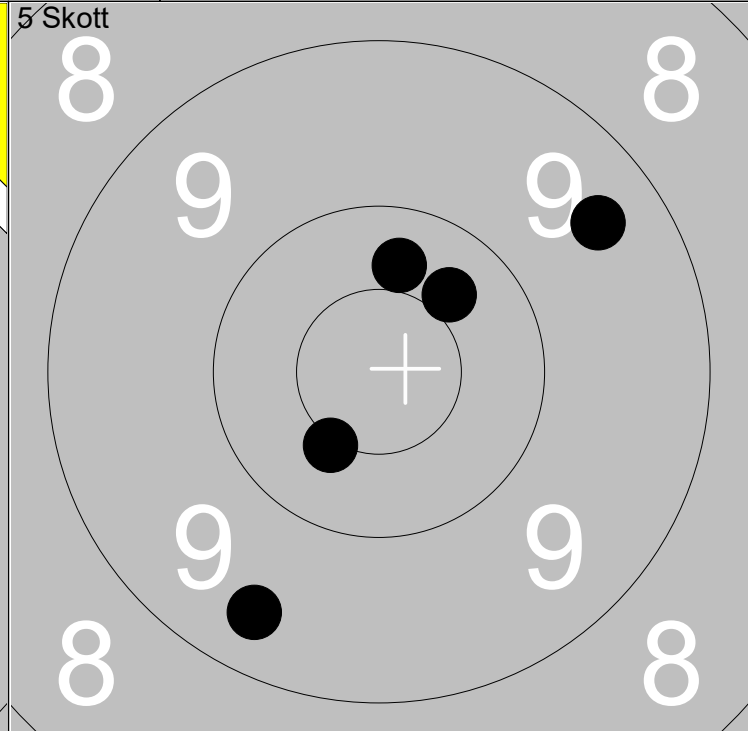
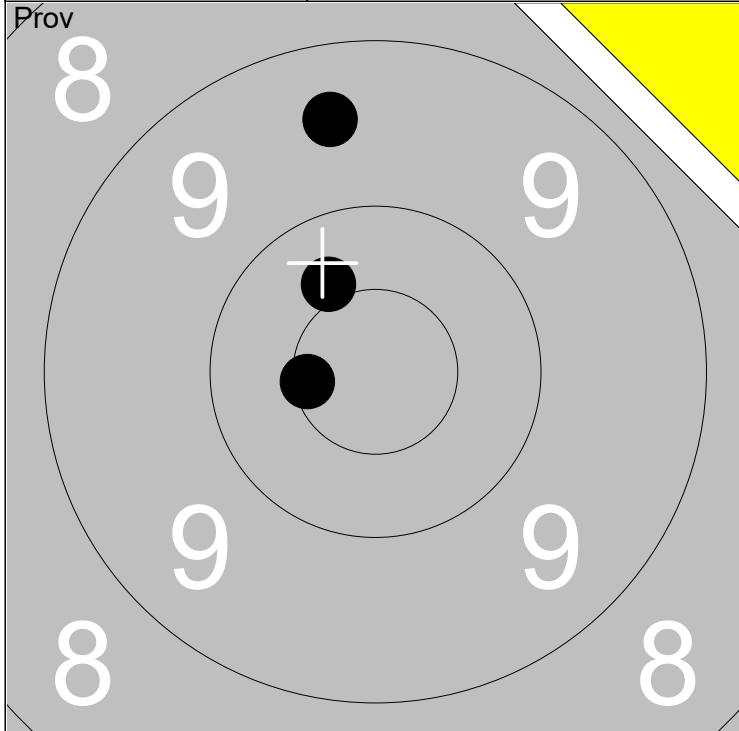

1: 9.5 ↑	Serie	29
2: 10.6x ←		
3: 10.4 ↑	Total 185	

1: 9.4 ↓	Serie	48
2: 9.4 ↗		
3: 10.5x ↓	Total 233	
4: 10.3 ↑		
5: 10.4 ↗		

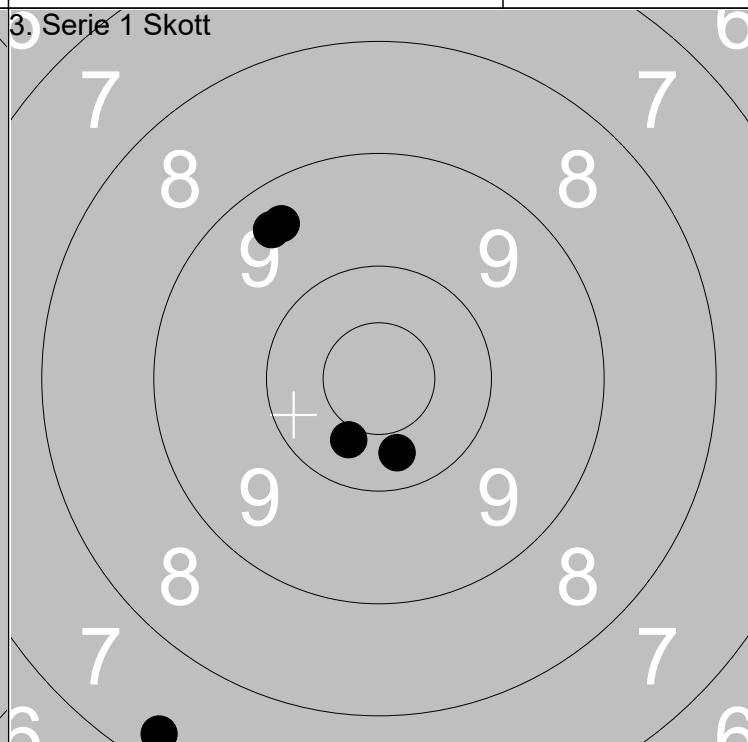
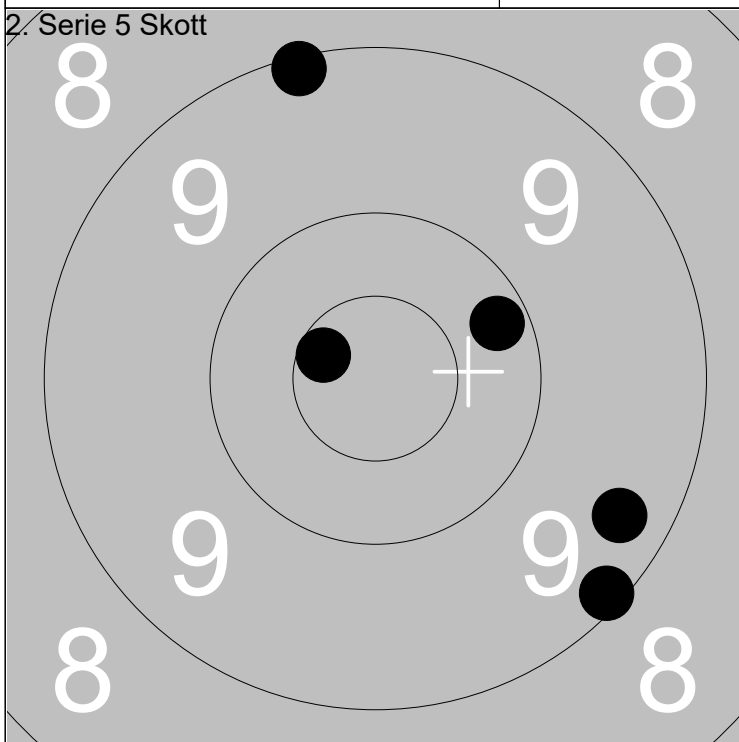

1: 10.2 ↗	Serie	47
2: 9.1 ↑		
3: 9.3 ↓	Total 280	
4: 9.1 ↓		
5: 10.6x ←		

1: 9.4 ↑	Serie	45
2: 9.4 ↑		
3: 7.3 ↓	Total 325	
4: 10.4 ↓		
5: 10.3 ↓		

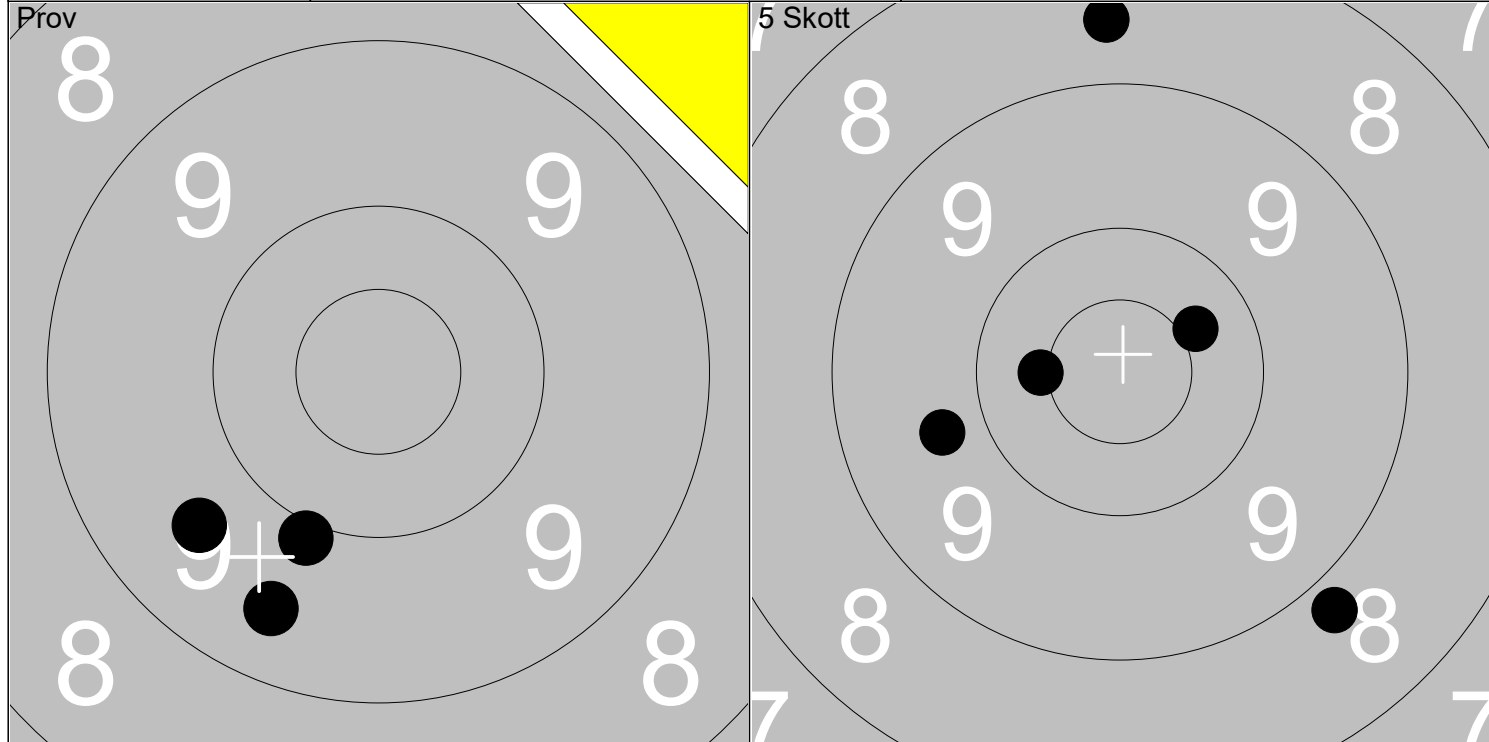

1: 9.5 ↘ 2: 9.6 ↘ 3: 9.9 ↘	Serie 27	1: 8.6 ↑ 2: 9.7 ← 3: 10.4x ← 4: 10.4 ↗ 5: 8.8 ↘	Serie 45
	Total 184		Total 229

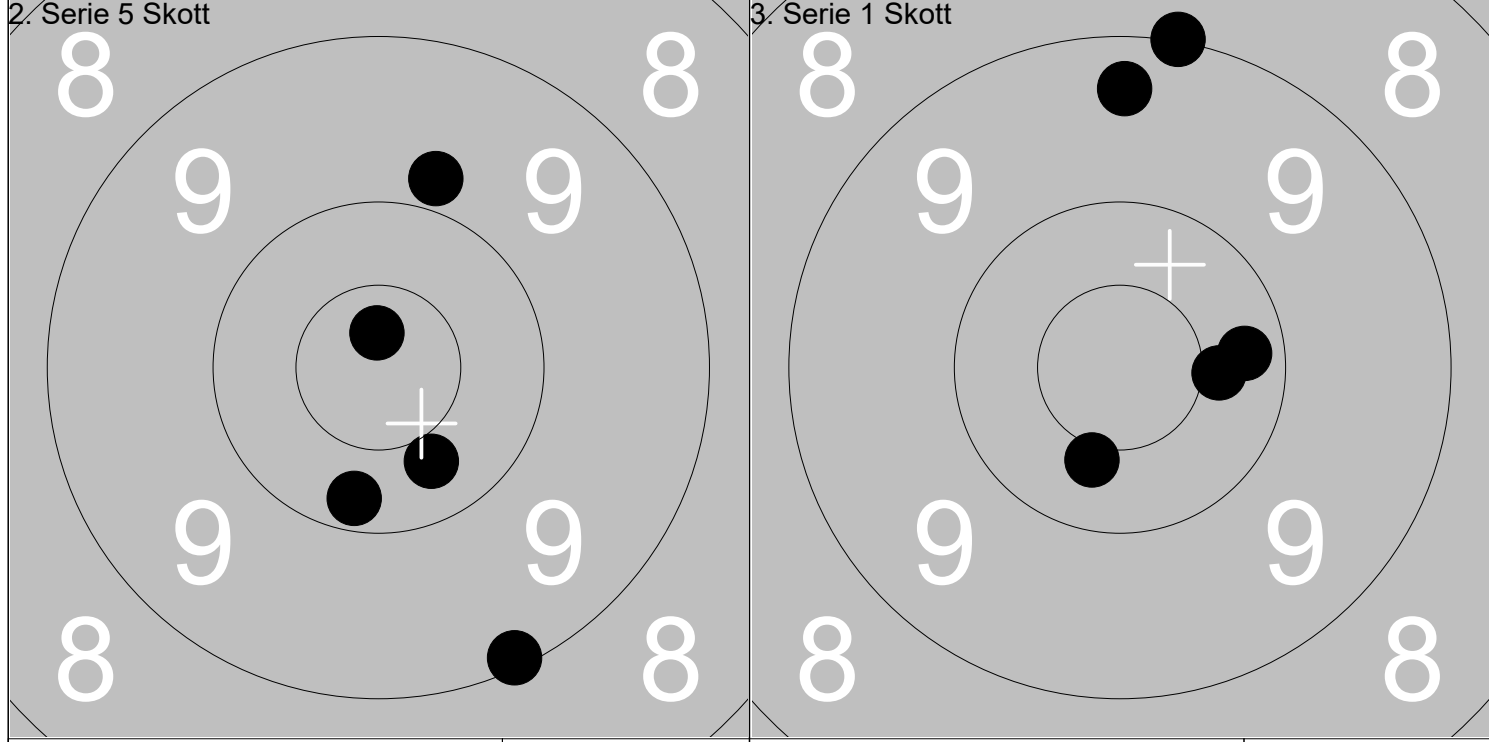

1: 9.8 ↑ 2: 10.8x ↑ 3: 10.3 ↘ 4: 10.2 ↘ 5: 9.1 ↘	Serie 48	1: 10.2 → 2: 9.0 ↑ 3: 10.4 → 4: 10.4 ↘ 5: 9.3 ↑	Serie 48
	Total 277		Total 325

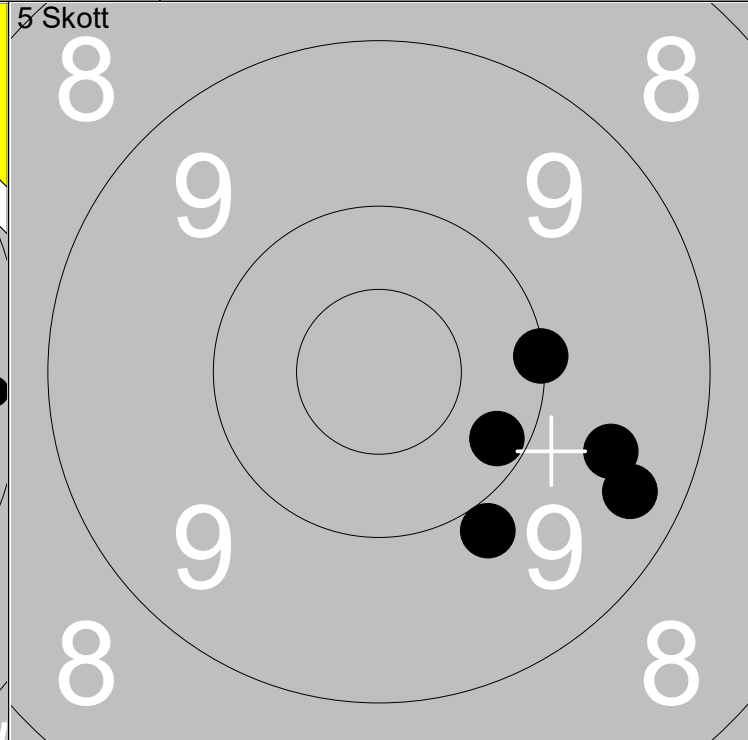
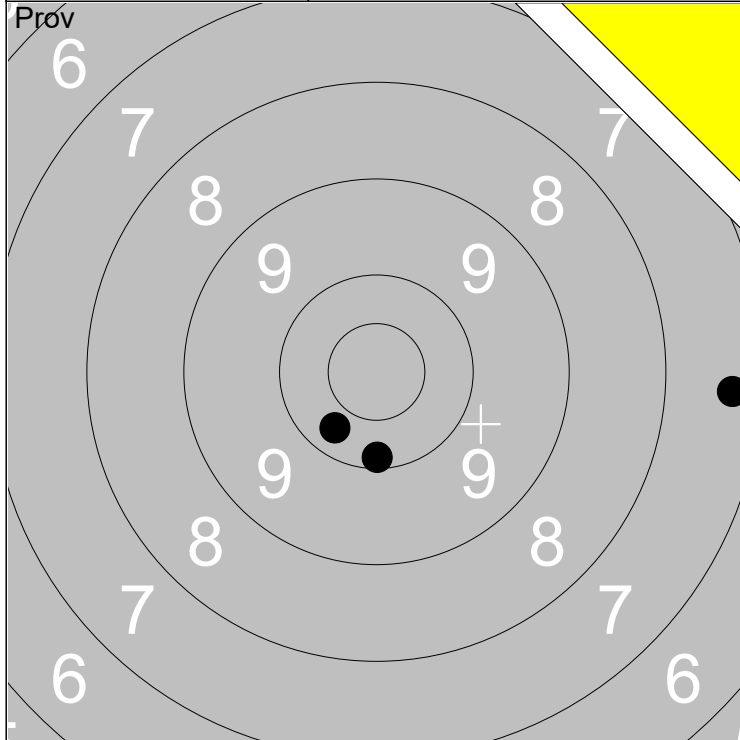

1: 7.3 →	Serie 27
2: 10.3 ↙	
3: 10.1 ↓	
Total 183	

1: 10.2 ↘	Serie 47
2: 9.9 ↙	
3: 9.4 ↘	
4: 9.5 →	
5: 10.0 →	
Total 230	

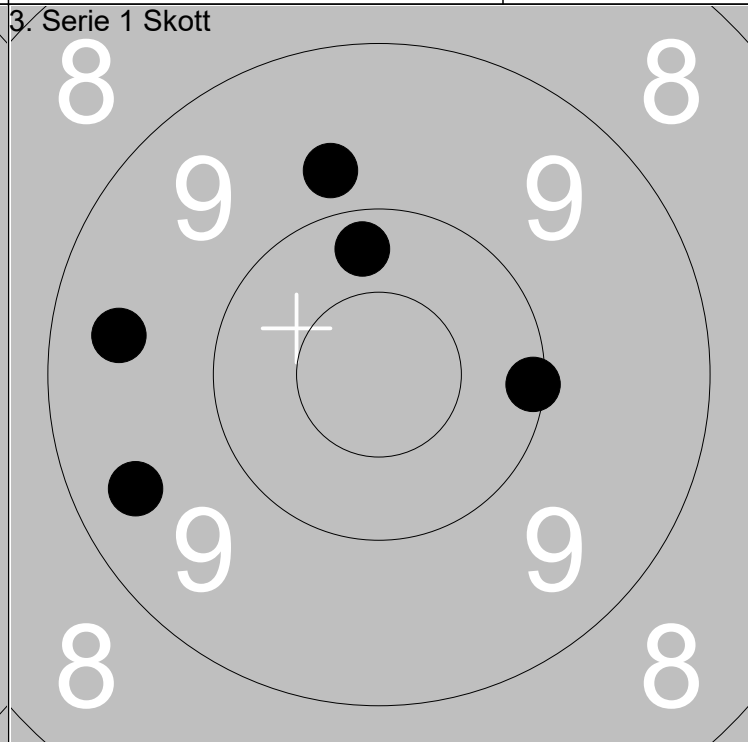
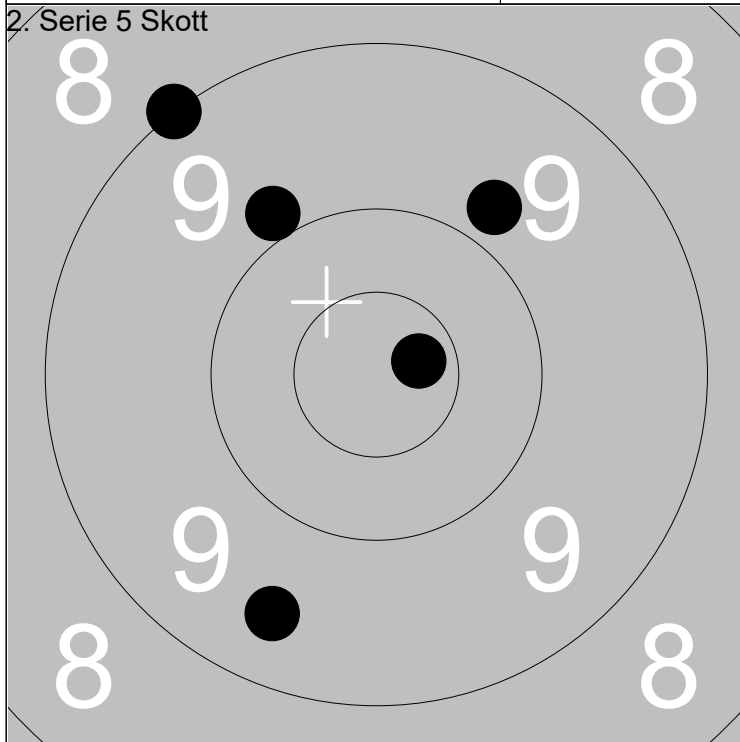

1: 9.5 ↙	Serie 46
2: 10.7x →	
3: 9.8 ↗	
4: 9.9 ↗	
5: 9.0 ↖	
Total 276	

1: 9.4 ↙	Serie 47
2: 9.4 ←	
3: 10.1 →	
4: 10.2 ↑	
5: 9.8 ↑	
Total 323	

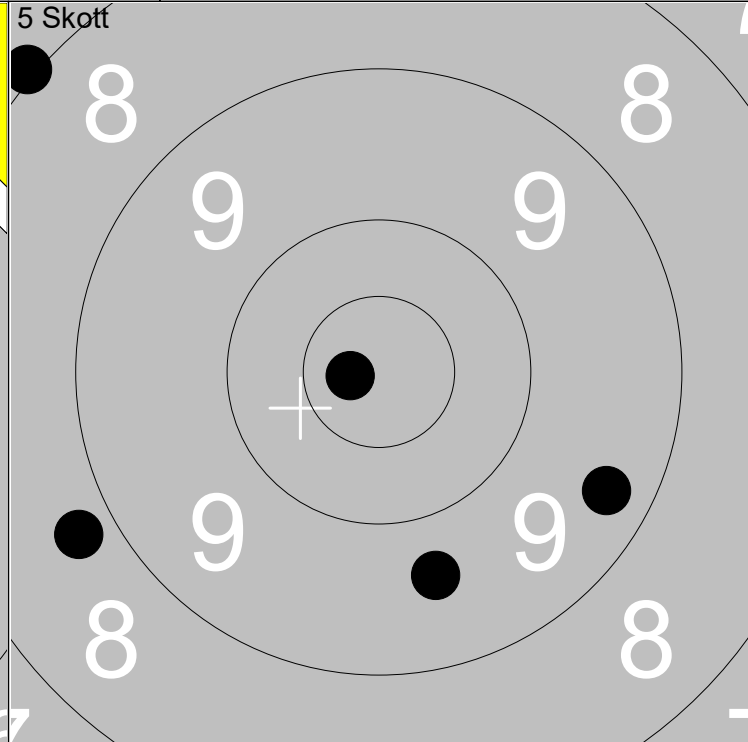
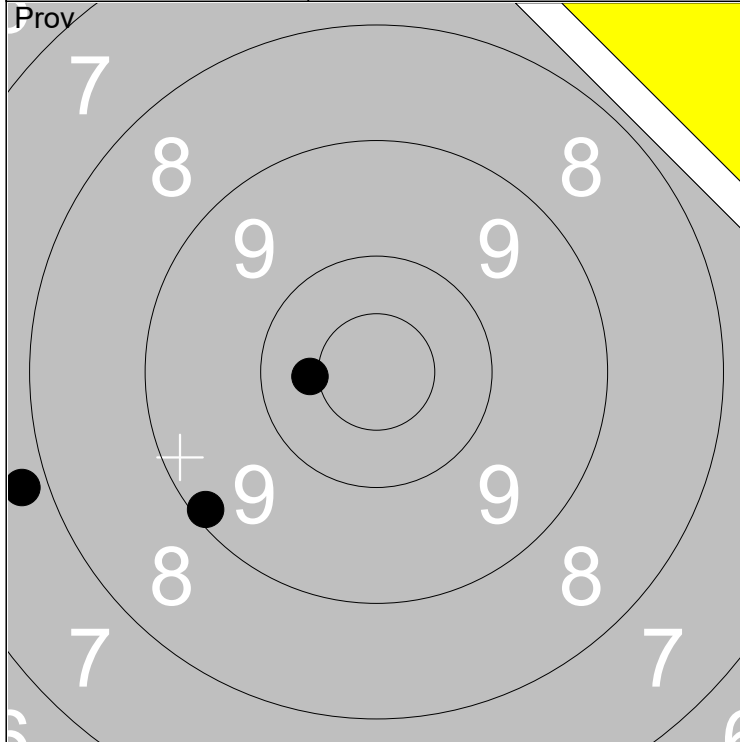

1: 9.1 ↙	Serie	26
2: 7.8 ←		
3: 10.4x ←		
Total		171

1: 8.8 ←	Serie	44
2: 8.0 ↗		
3: 9.6 ↓		
4: 10.8x ←		
5: 9.3 ↘		
Total		215

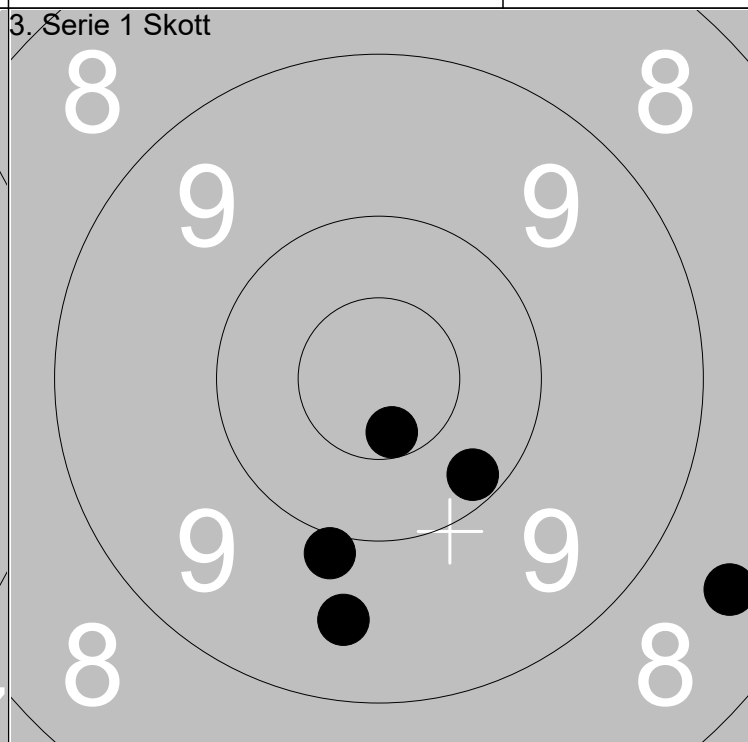
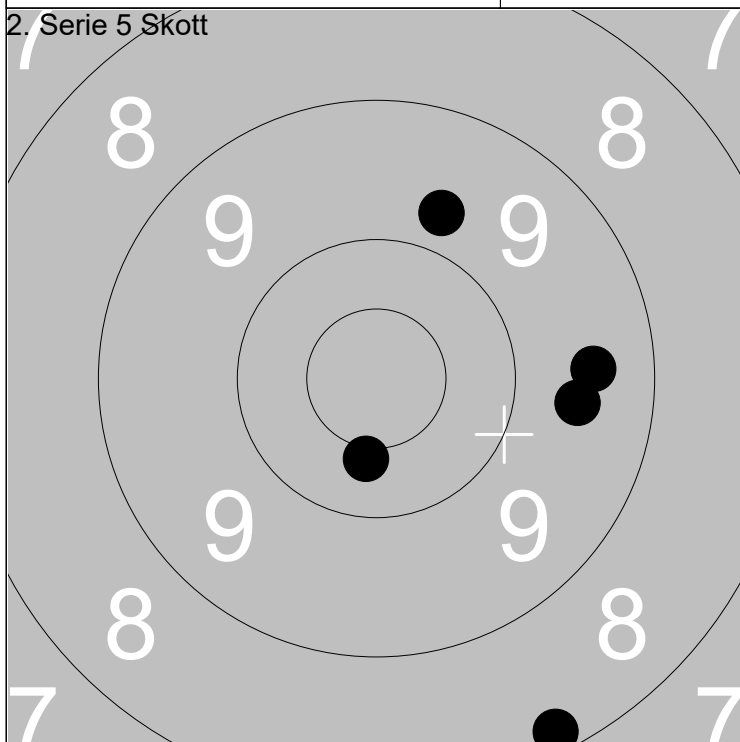

1: 8.2 ↓	Serie	45
2: 9.7 ↗		
3: 10.4x ↓		
4: 9.6 →		
5: 9.5 →		
Total		260

1: 9.9 ↓	Serie	46
2: 8.5 ↓		
3: 10.2 ↓		
4: 10.6x ↓		
5: 9.5 ↓		
Total		306

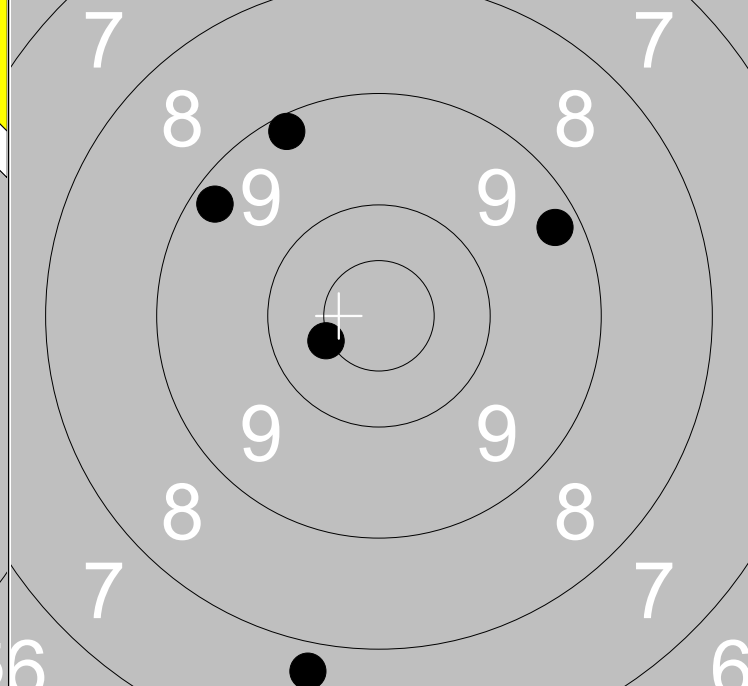
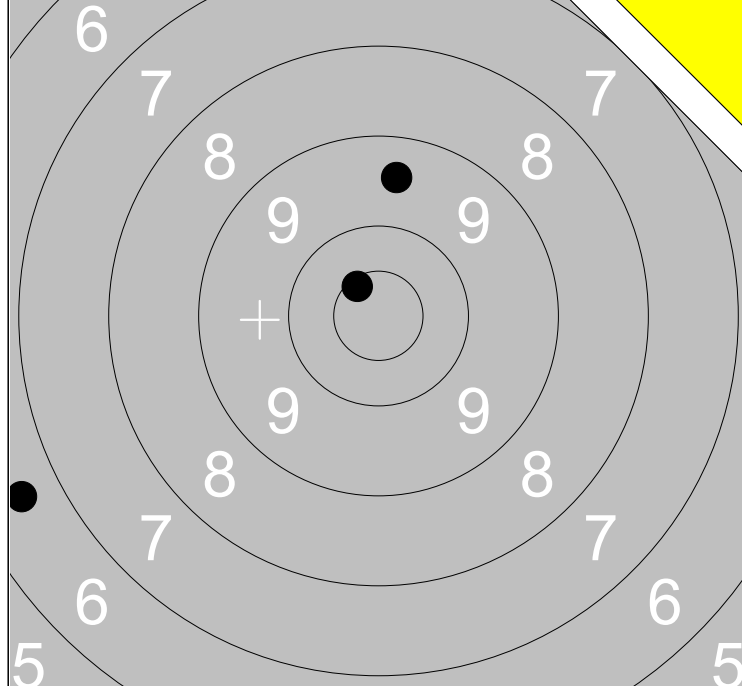

1: 9.5 ↑	Serie	25
2: 6.6 ↙		
3: 10.6x ↖		
Total		171

1: 9.2 ↖	Serie	44
2: 10.5x ↙		
3: 9.2 ↖		
4: 9.3 ↗		
5: 7.8 ↓		
Total		215

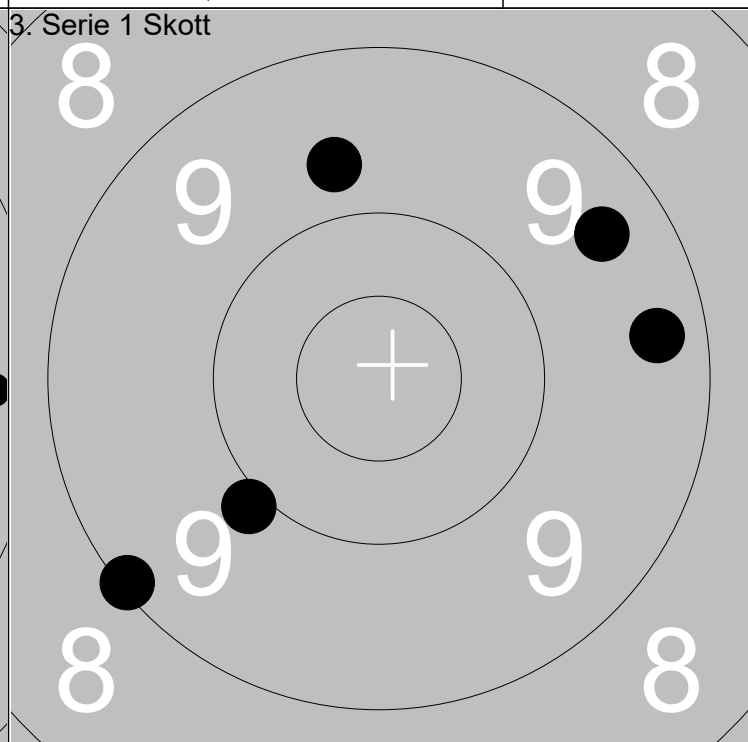
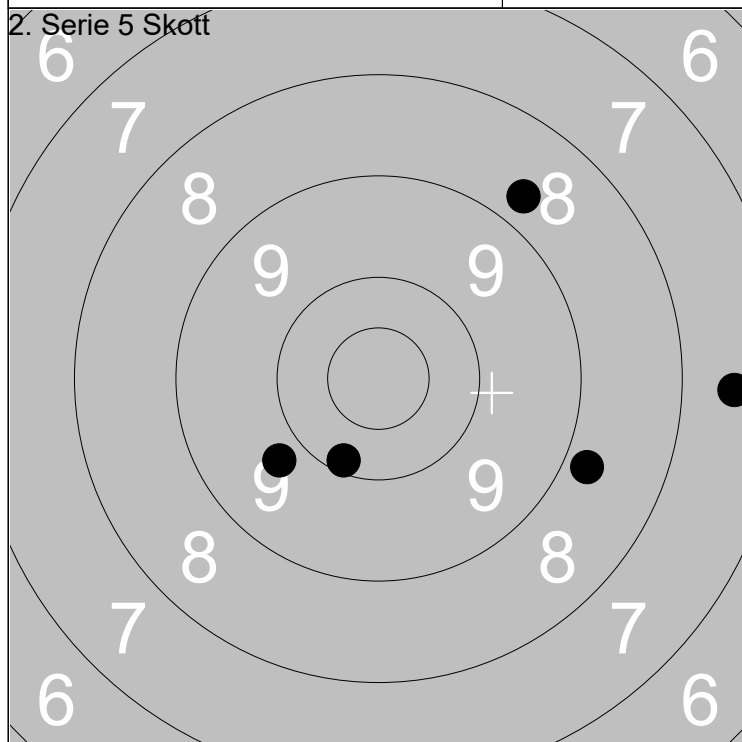

1: 8.7 ↗	Serie	42
2: 10.1 ↓		
3: 8.8 →		
4: 9.8 ↙		
5: 7.5 →		
Total		257

1: 9.7 ↑	Serie	45
2: 9.1 ↙		
3: 9.3 →		
4: 9.9 ↙		
5: 9.4 ↗		
Total		302

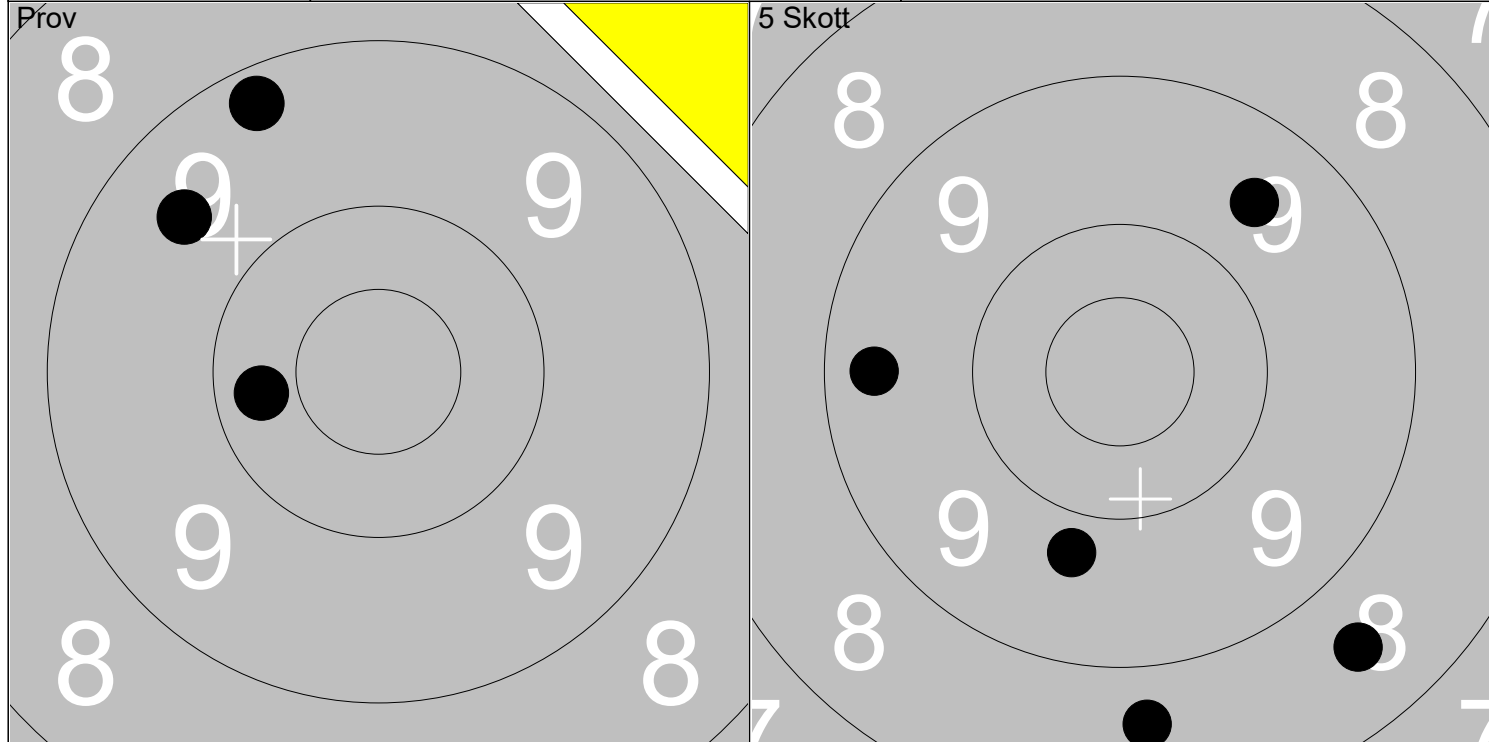

1: 9.2 ↗ 2: 10.3 ← 3: 9.5 ↖	Serie 28	1: 9.4 ← 2: 9.8 ↓ 3: 8.6 ↓ 4: 9.6 ↗ 5: 8.6 ↓	Serie 43
Total 192		Total 235	

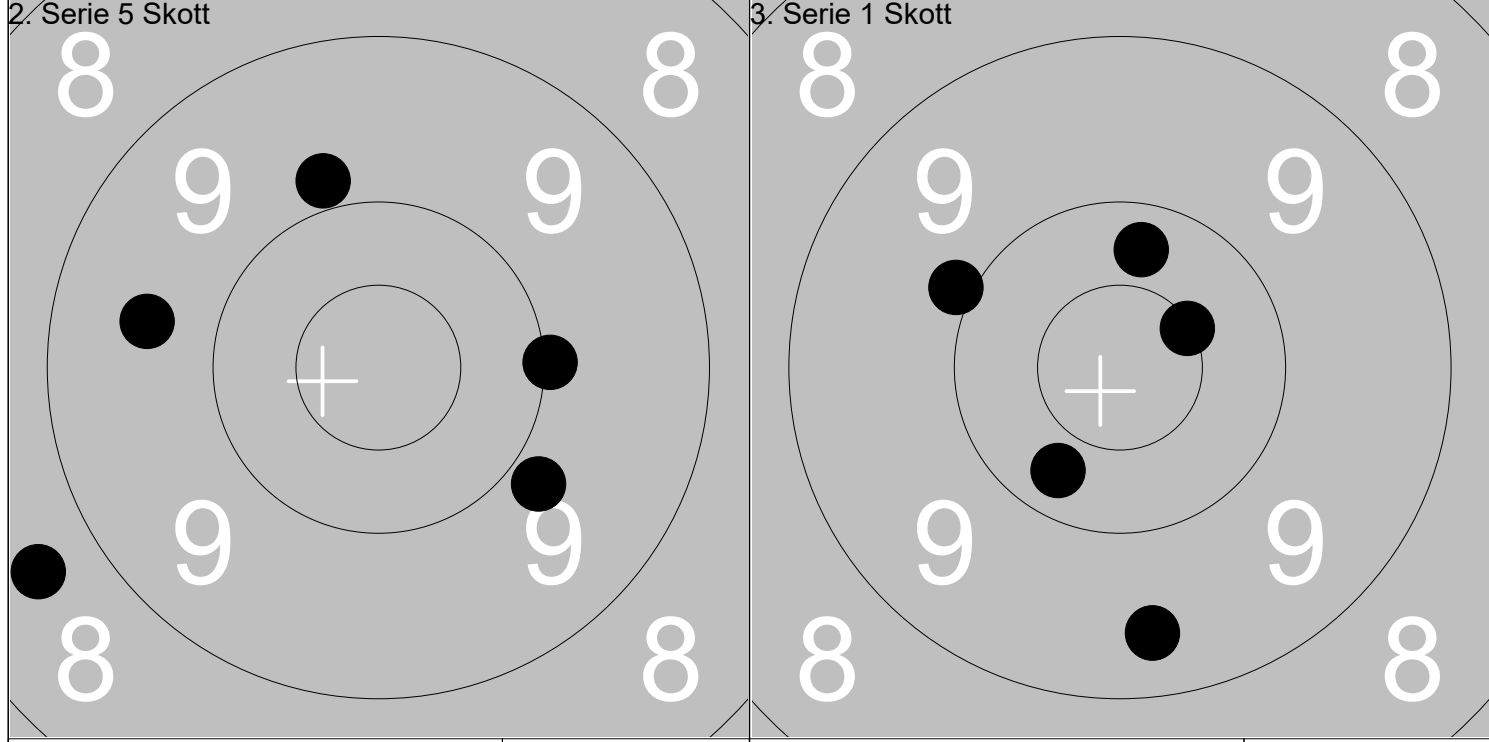

1: 8.6 ← 2: 9.8 ↓ 3: 9.9 ↗ 4: 10.0 → 5: 9.6 ←	Serie 45	1: 10.5x ↗	Serie 48
Total 280		Total 328	

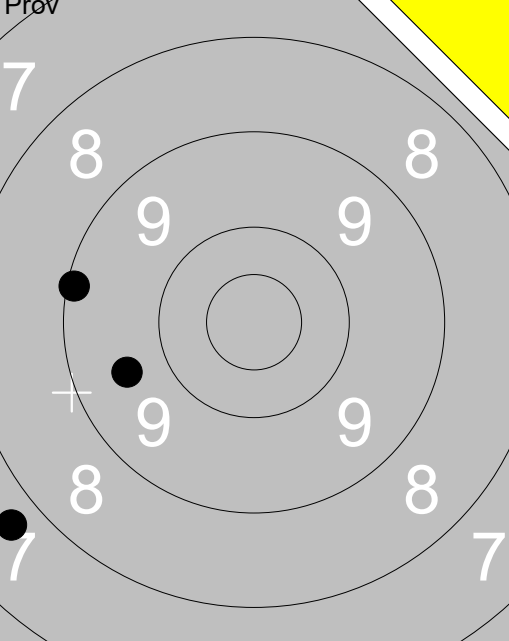
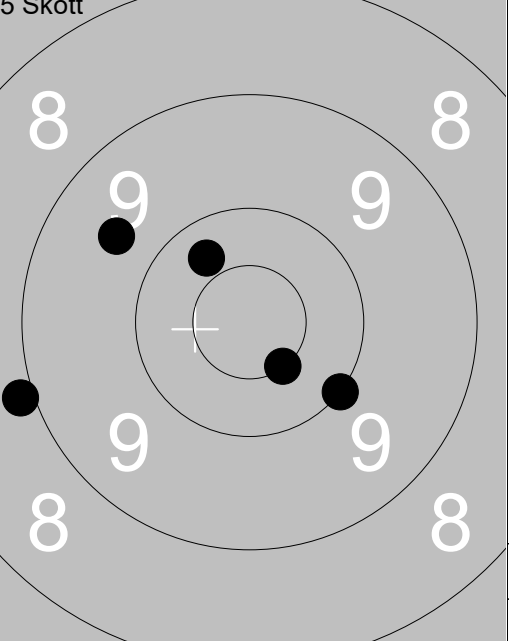
<p>Prøv</p> 	<p>1: 7.7 ↙ 2: 9.6 ← 3: 9.1 ←</p>	<p>5 Skott</p> 	<p>1: 10.3 ↗ 2: 8.9 ← 3: 10.5x↘ 4: 9.6 ↗ 5: 10.0 ↘</p>
Serie 25.0		Serie 47.0	
Total 191.0		Total 238.0	

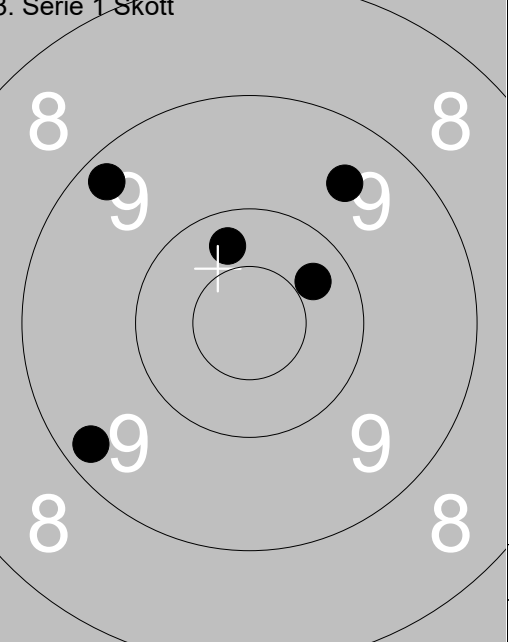
<p>2. Serie 5 Skott</p> 	<p>1: 9.3 ↙ 2: 10.8x↘ 3: 10.7x↘ 4: 10.2 ↓ 5: 10.0 ↑</p>	<p>3. Serie 1 Skott</p> 	<p>1: 9.5 ↗ 2: 9.3 ↗ 3: 10.3 ↗ 4: 10.3 ↑ 5: 9.3 ↙</p>
Serie 49.0		Serie 47.0	
Total 287.0		Total 334.0	

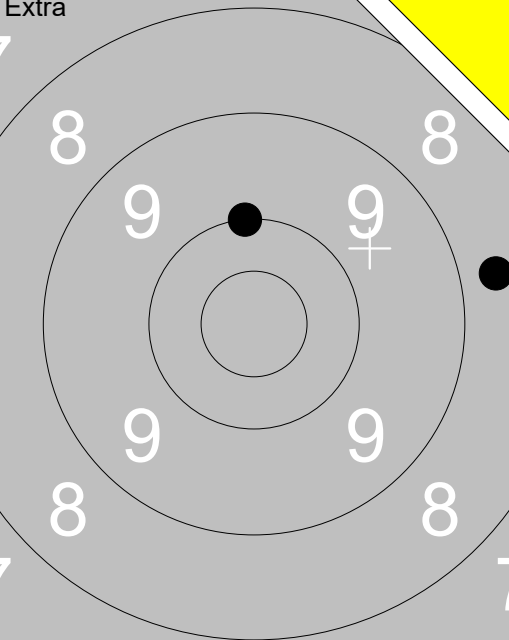
<p>Extra</p> 	<p>1: 10.0 ↑ 2: 8.7 →</p>		
Serie 18.0			
Total 334.0			

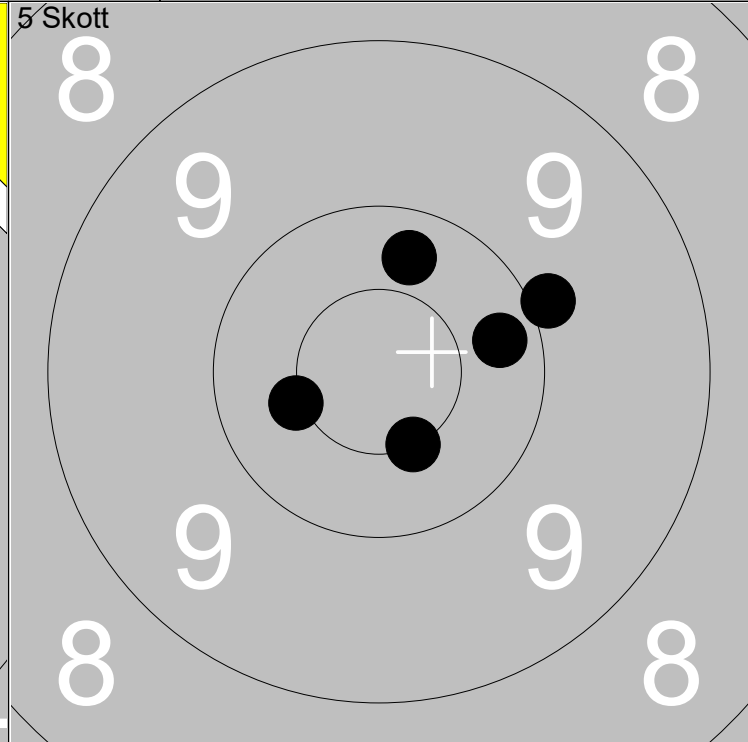
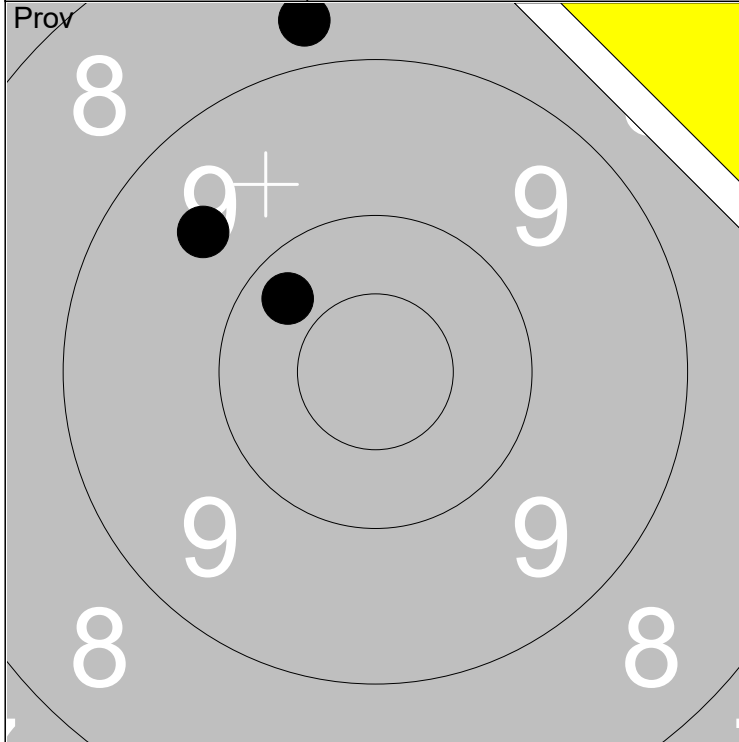

1: 8.7 ↗	Serie	27
2: 9.6 ↗		
3: 10.3 ↗		
Total		190

1: 10.5x ↘	Serie	49
2: 10.3 ↗		
3: 9.9 ↗		
4: 10.5x ↖		
5: 10.2 ↗		
Total		239

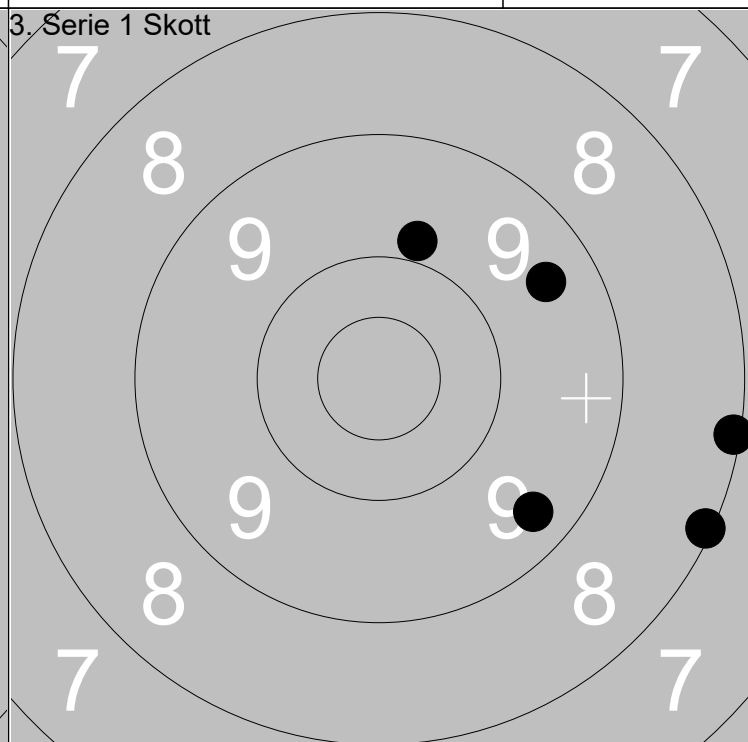
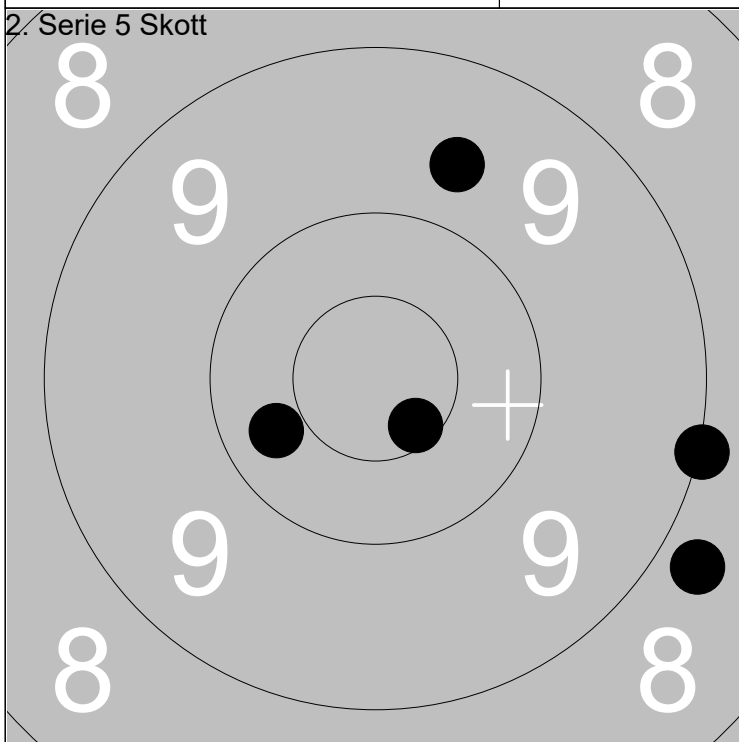

1: 8.8 ↘	Serie	46
2: 9.0 ↗		
3: 9.6 ↗		
4: 10.3 ↖		
5: 10.6x ↘		
Total		285

1: 9.4 ↘	Serie	43
2: 9.9 ↗		
3: 8.1 ↗		
4: 9.5 ↗		
5: 8.1 ↘		
Total		328

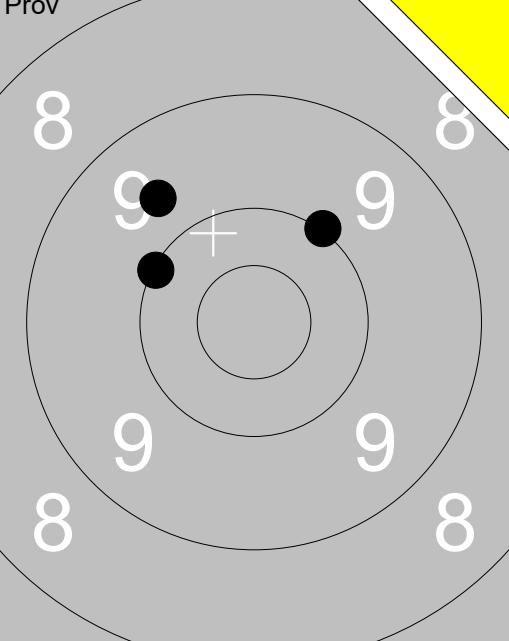
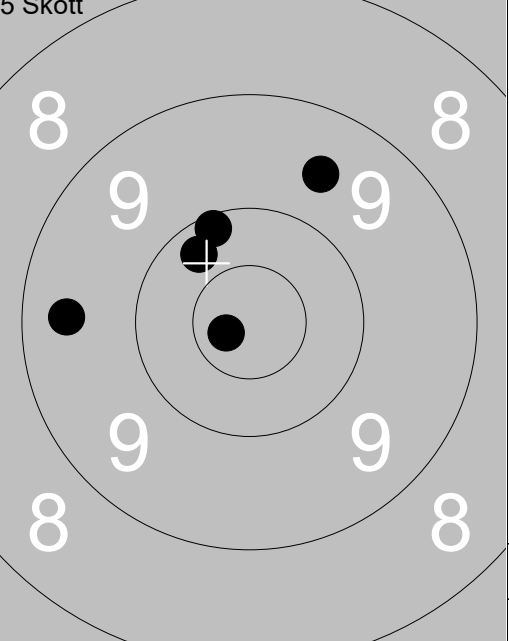
<p>Prov</p> 	<p>1: 10.0 ↙ 2: 10.0 ↗ 3: 9.7 ↙</p>	<p>5 Skott</p> 	<p>1: 10.1 ↗ 2: 10.7 ✖ 3: 9.4 ← 4: 10.3 ↙ 5: 9.6 ↗</p>
Serie 29.0		Serie 48.0	
Total 190.0		Total 238.0	

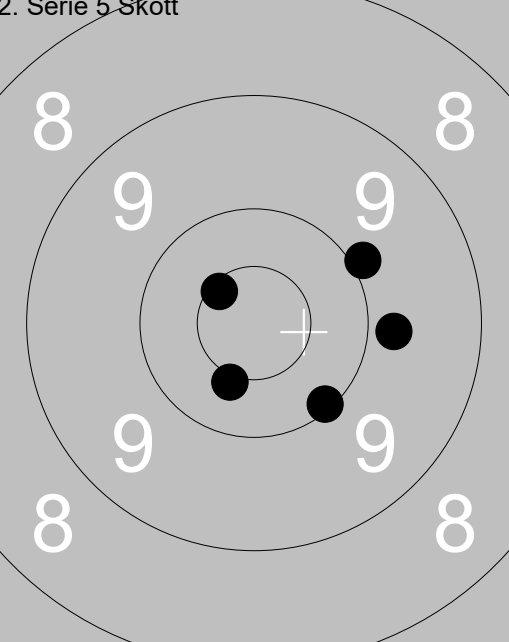
<p>2. Serie 5 Skott</p> 	<p>1: 10.6 ✖ 2: 10.4 ✖ 3: 9.8 → 4: 10.1 ↘ 5: 9.9 ↗</p>	<p>3. Serie 1 Skott</p> 	<p>1: 9.2 ← 2: 10.4 ✖ 3: 10.2 ↙ 4: 9.7 ↙ 5: 10.2 →</p>
Serie 48.0		Serie 48.0	
Total 286.0		Total 334.0	

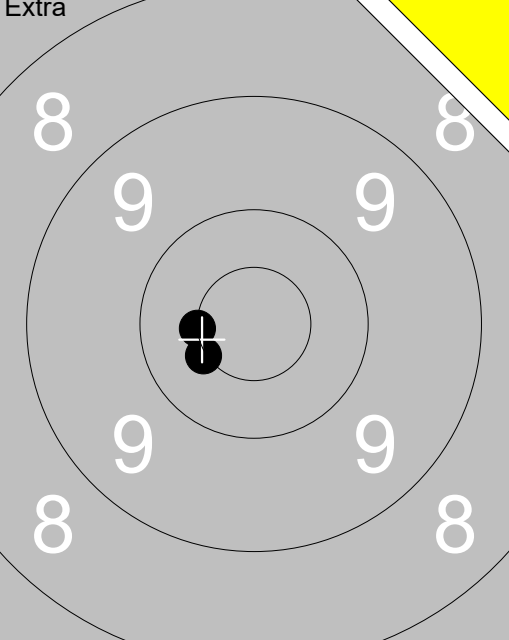
<p>Extra</p> 	<p>1: 10.5 ✖ 2: 10.5 ✖</p>		
Serie 20.0			
Total 334.0			

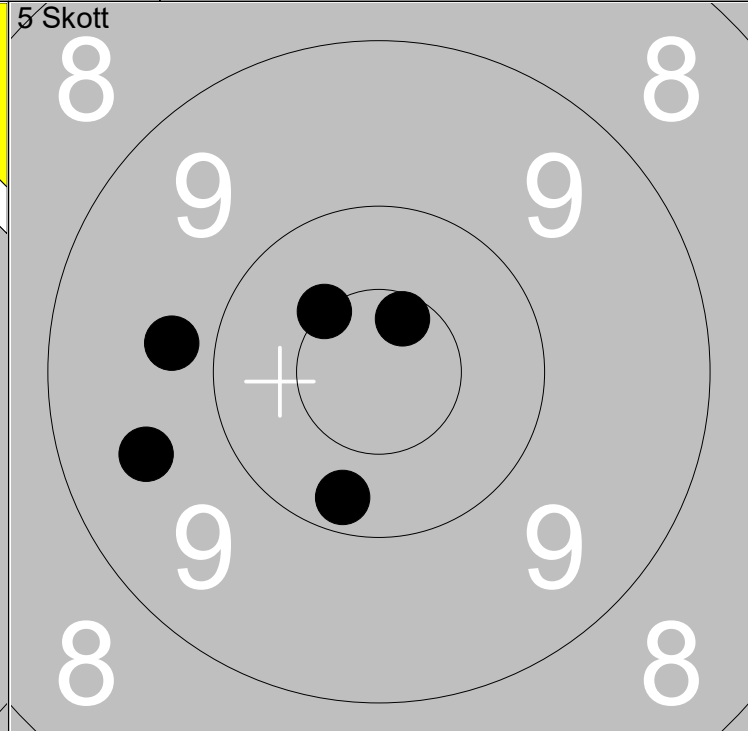
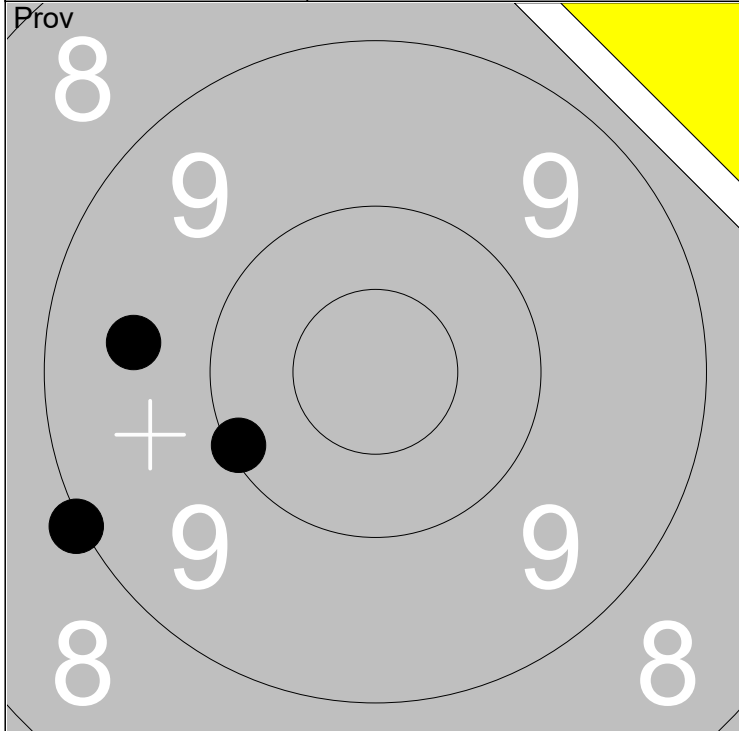

1: 10.1 ↙	Serie	28	
2: 9.6 ←			
3: 9.0 ↙			
Total		190	

1: 9.5 ↙	Serie	48	
2: 10.6x ↗			
3: 10.5x ↖			
4: 9.8 ←			
5: 10.2 ↘			
Total		238	

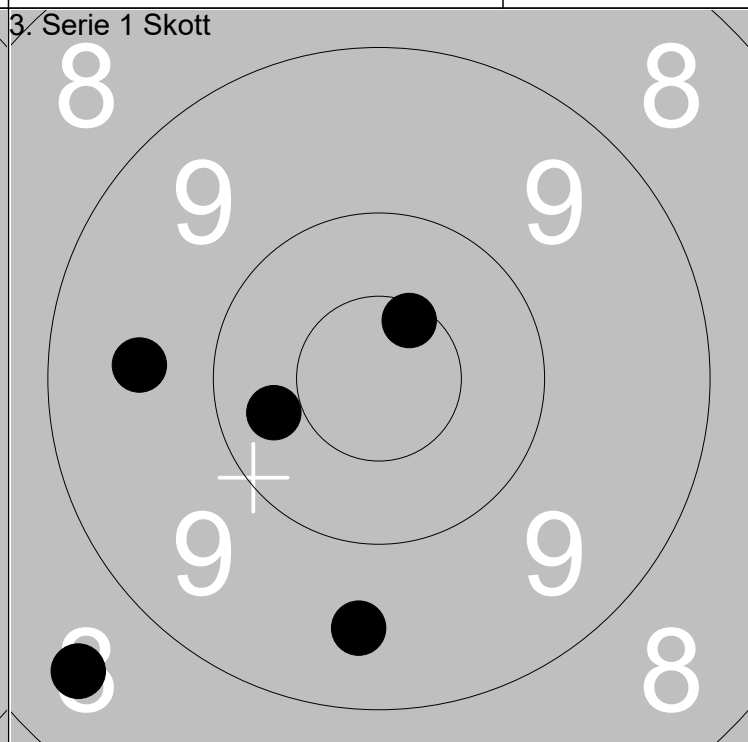
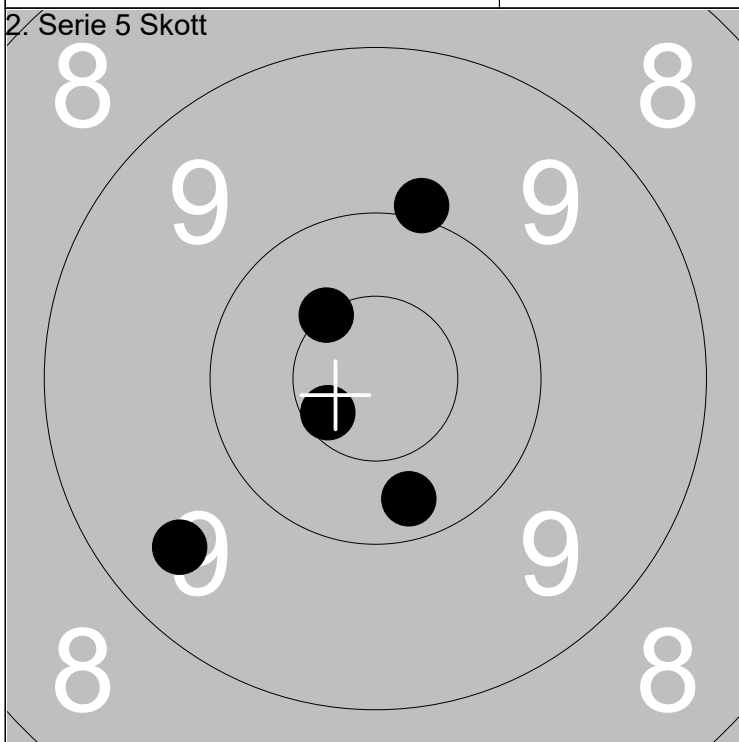

1: 10.6x ↙	Serie	48	
2: 9.9 ↗			
3: 10.2 ↘			
4: 10.5x ↖			
5: 9.5 ↙			
Total		286	

1: 9.5 ↘	Serie	46	
2: 9.6 ←			
3: 10.6x ↗			
4: 10.3 ←			
5: 8.5 ↙			
Total		332	

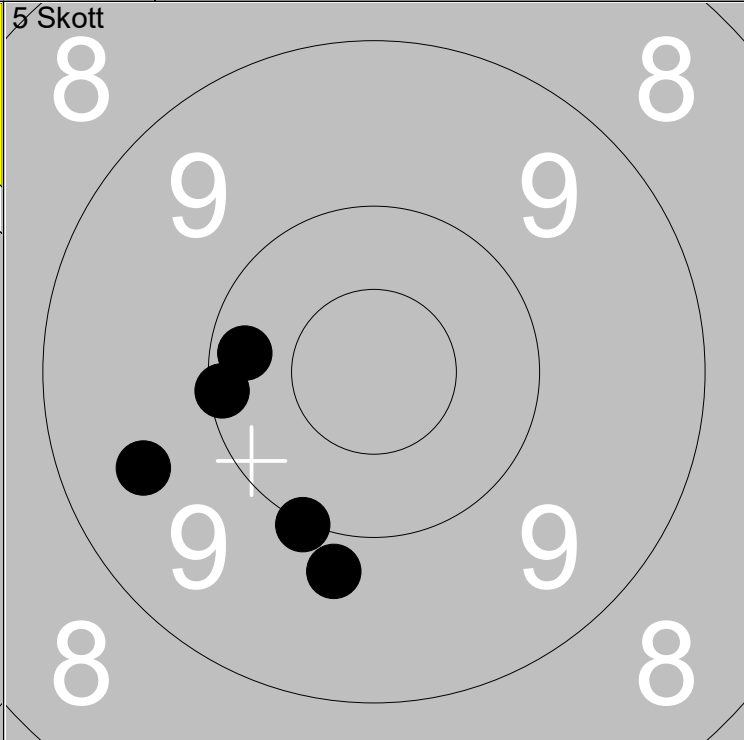
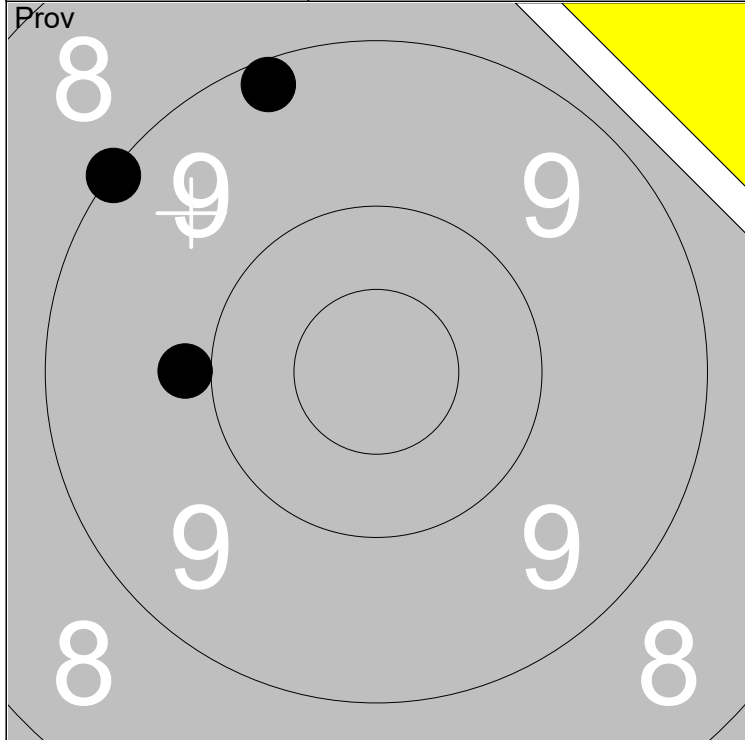

1: 9.2 ↗	Serie	27	
2: 9.9 ←			
3: 9.0 ↗			
Total		188	

1: 10.1 ←	Serie	48	
2: 9.5 ←			
3: 10.2 ←			
4: 10.0 ↘			
5: 9.8 ↘			
Total		236	

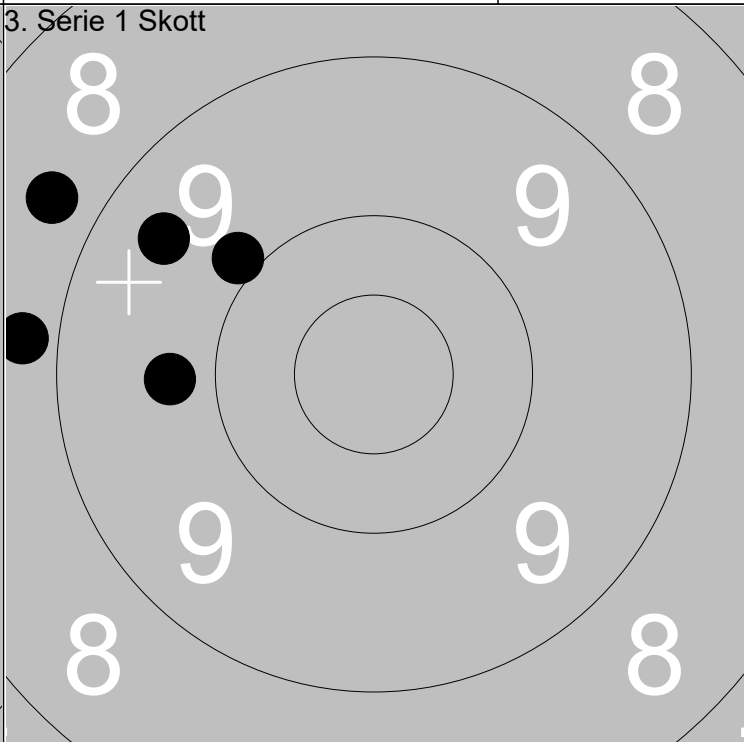
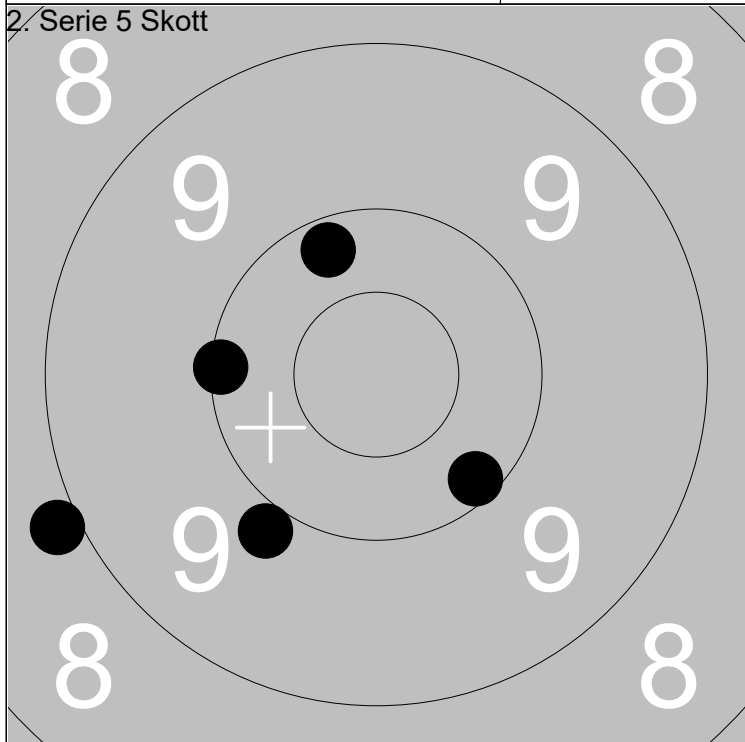

1: 10.2 ↗	Serie	47	
2: 10.1 ↘			
3: 8.9 ←			
4: 10.1 ←			
5: 9.9 ↘			
Total		283	

1: 9.5 ↗	Serie	43	
2: 8.7 ↗			
3: 9.9 ↗			
4: 8.8 ←			
5: 9.7 ←			
Total		326	

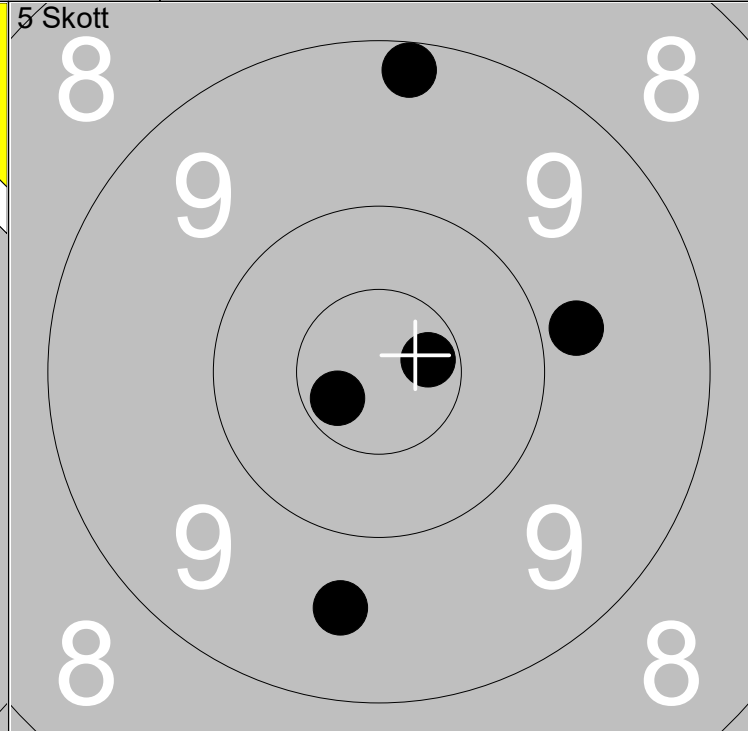
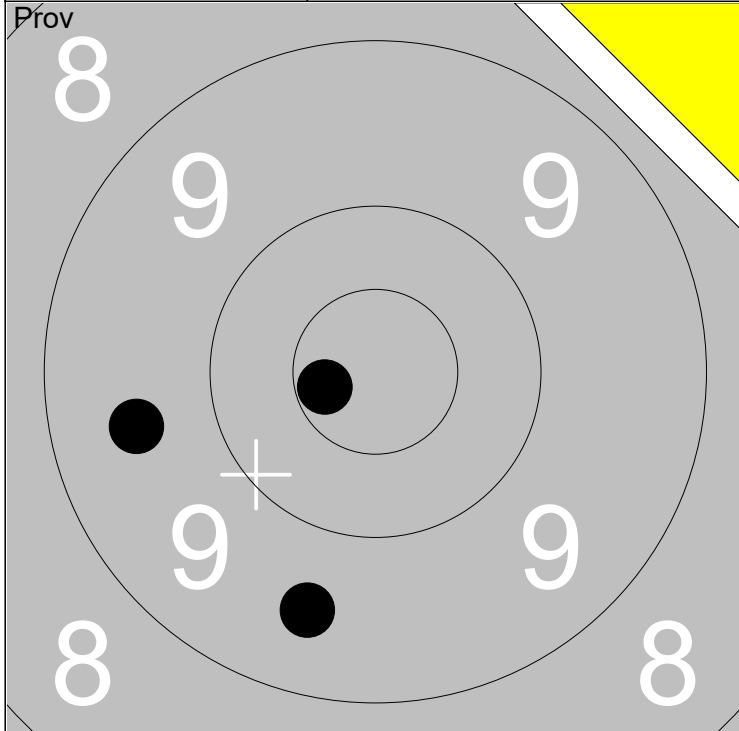

1: 9.5	←
2: 9.5	↓
3: 10.7x	←

Serie	28
Total	187

1: 9.2	↑
2: 10.7x	→
3: 9.6	↓
4: 10.7x	←
5: 9.8	→

Serie	47
Total	234

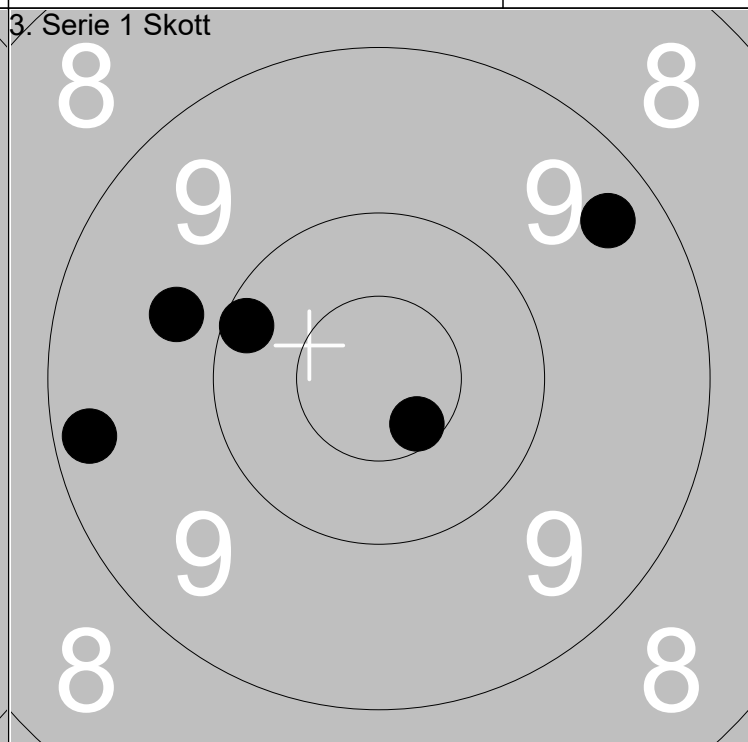
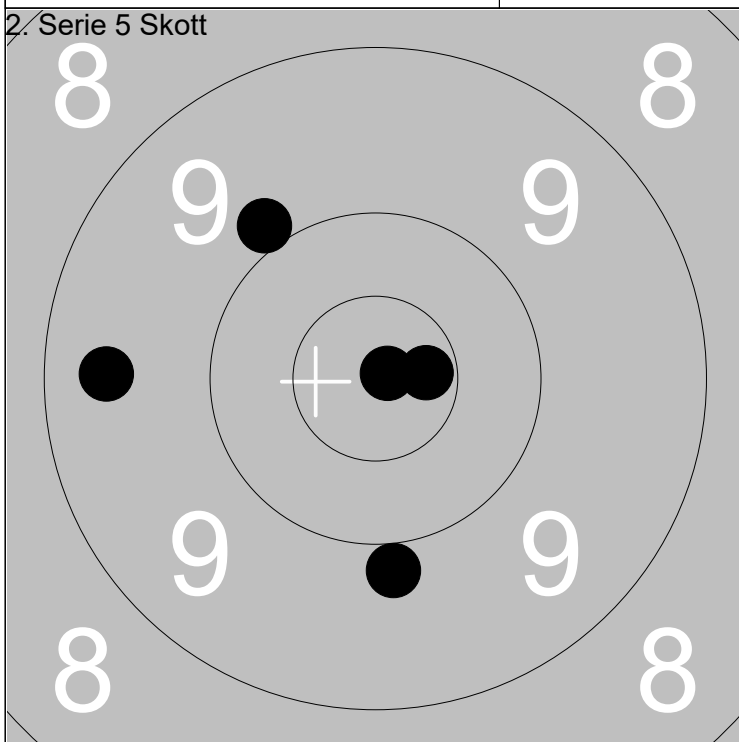

1: 10.9x	→
2: 10.7x	→
3: 9.9	↗
4: 9.9	↓
5: 9.4	←

Serie	47
Total	281

1: 9.7	←
2: 9.2	←
3: 9.3	↗
4: 10.6x	↘
5: 10.2	←

Serie	47
Total	328

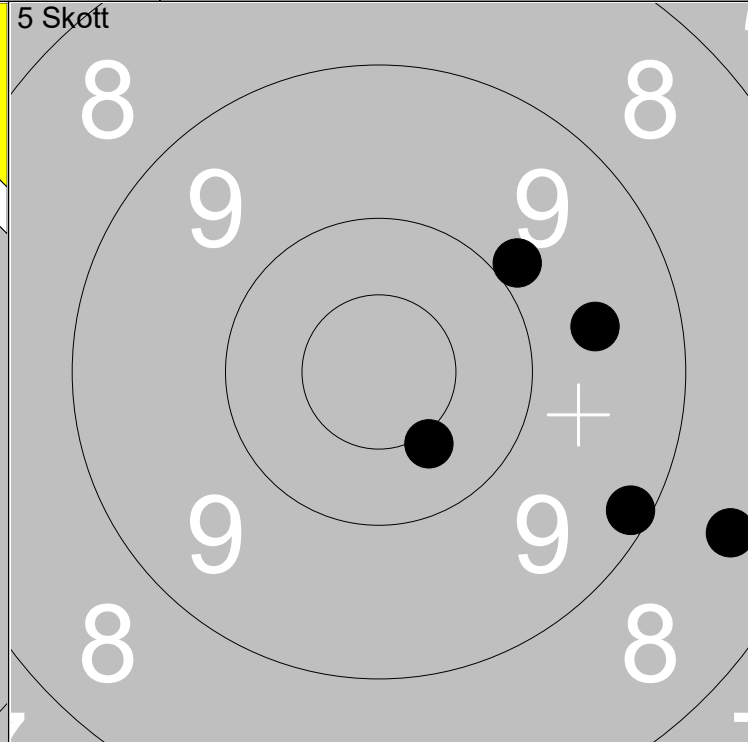
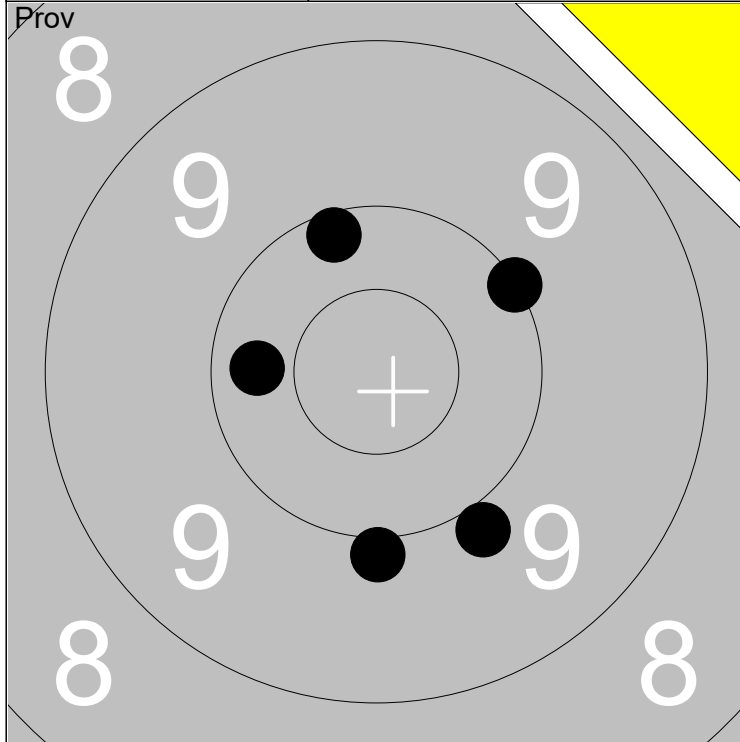

1: 10.2 ↑	Serie	48
2: 9.9 ↓		
3: 10.3 ←	Total	187
4: 10.0 ↗		
5: 9.9 ↓		

1: 8.5 →	Serie	45
2: 9.2 ↓		
3: 9.9 ↗	Total	232
4: 10.4x ↓		
5: 9.6 →		

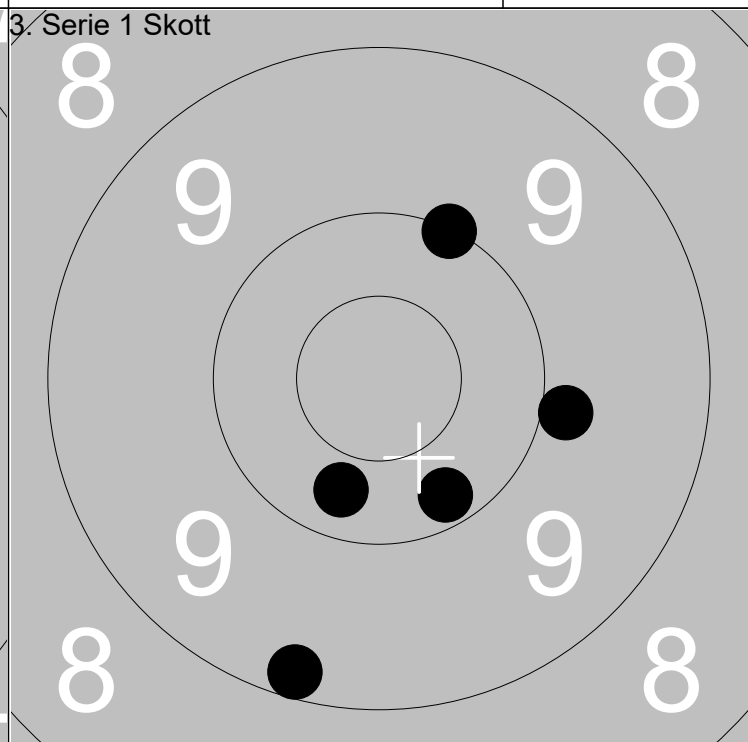
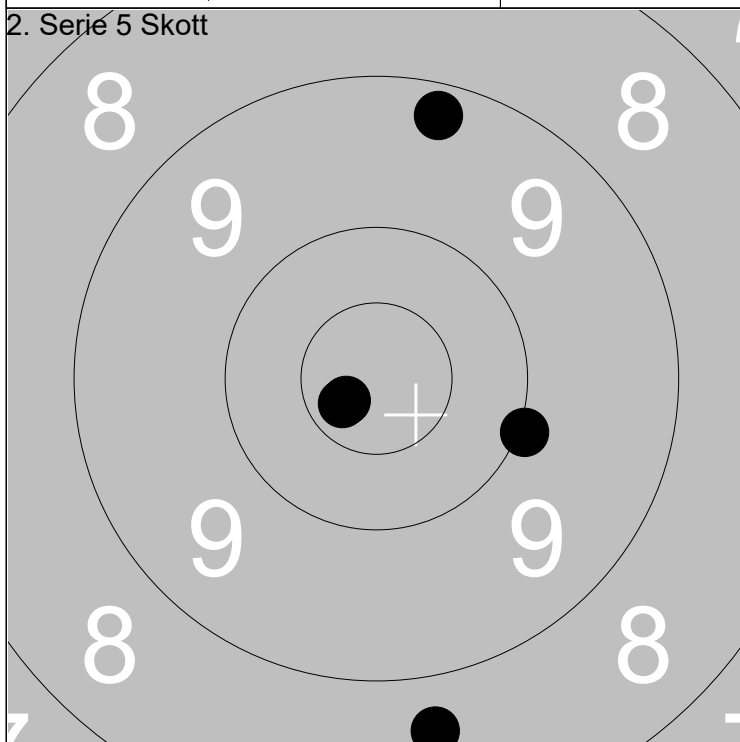

1: 10.7x ↙	Serie	47
2: 8.7 ↓		
3: 10.7x ↙	Total	279
4: 10.0 →		
5: 9.2 ↑		

1: 9.2 ↓	Serie	48
2: 10.2 ↓		
3: 10.0 ↗	Total	327
4: 10.3 ↓		
5: 9.9 →		

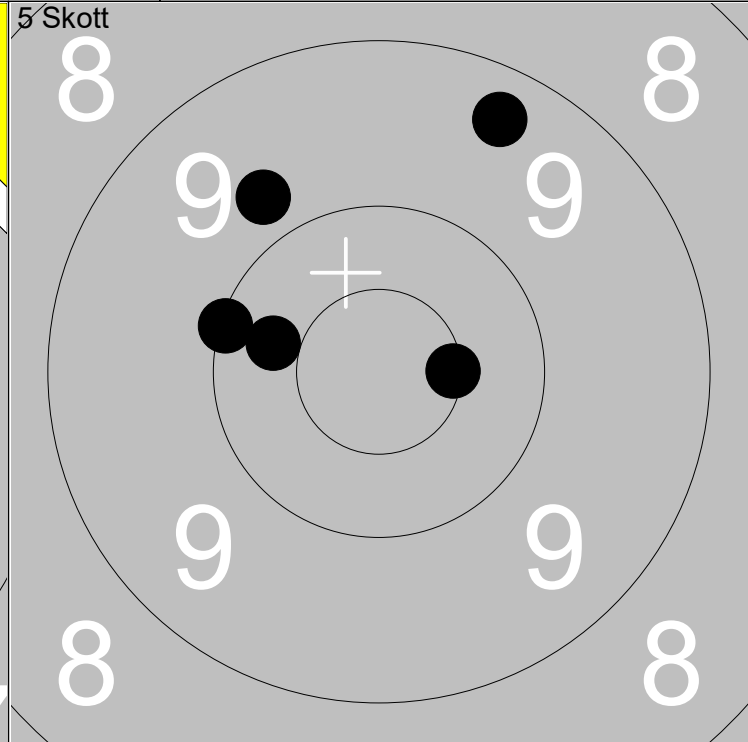
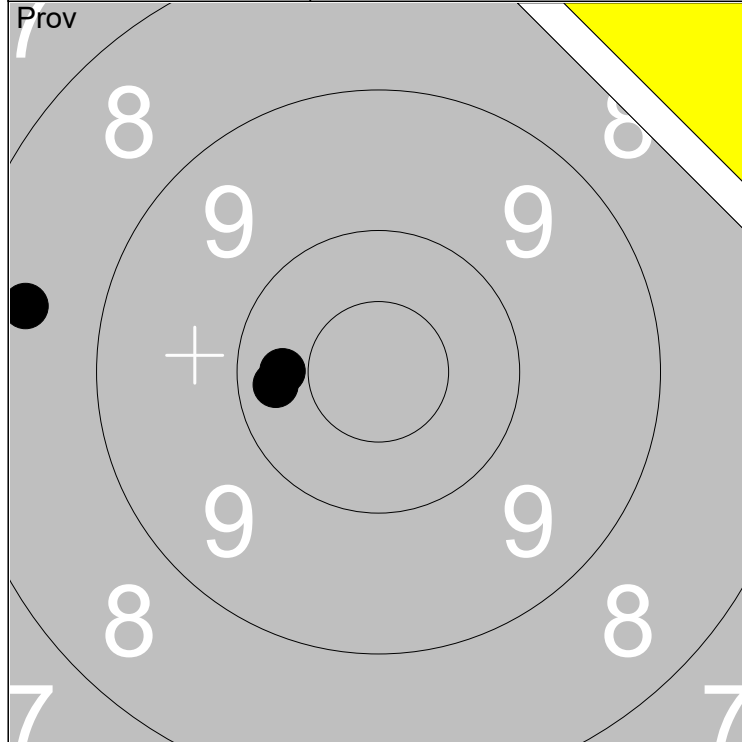

1: 8.5 ←	Serie	28
2: 10.3 ←		
3: 10.3 ←		
Total		184

1: 9.3 ↗	Serie	48
2: 10.1 ←		
3: 10.5x →		
4: 9.8 ↗		
5: 10.3 ←		
Total		232

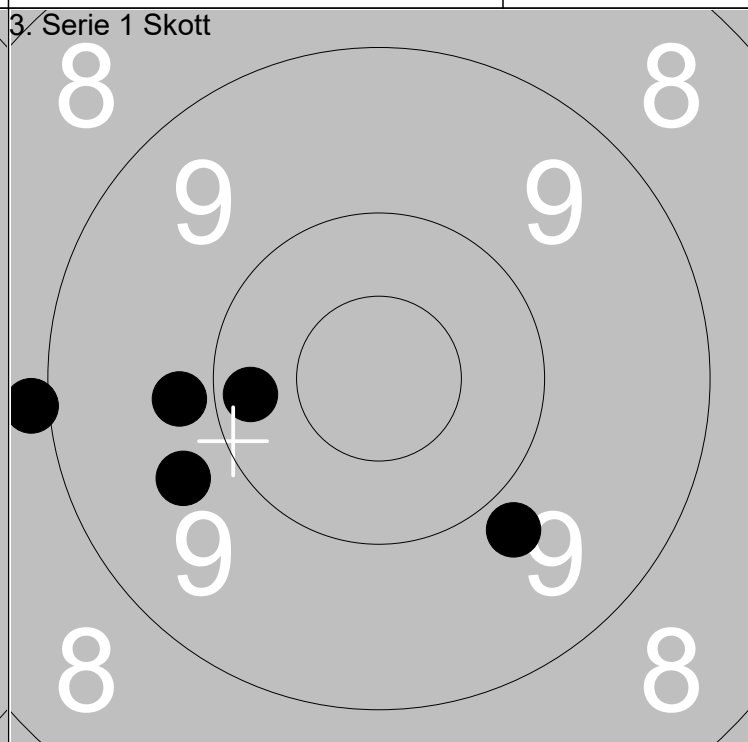
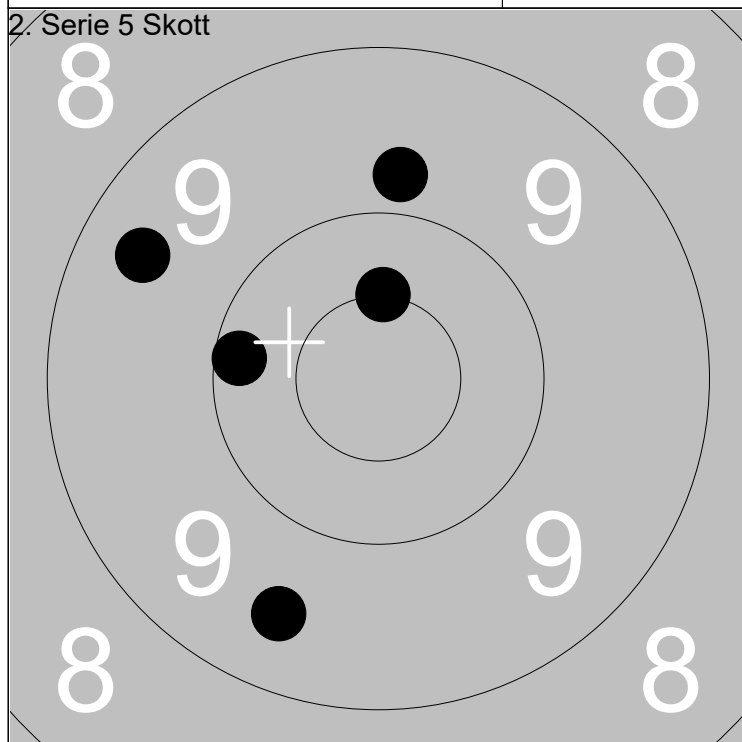

1: 9.4 ↖	Serie	47
2: 9.8 ↑		
3: 10.5x ↑		
4: 10.2 ←		
5: 9.5 ↘		
Total		279

1: 9.7 ←	Serie	45
2: 8.9 ←		
3: 9.8 ↘		
4: 10.2 ←		
5: 9.8 ←		
Total		324

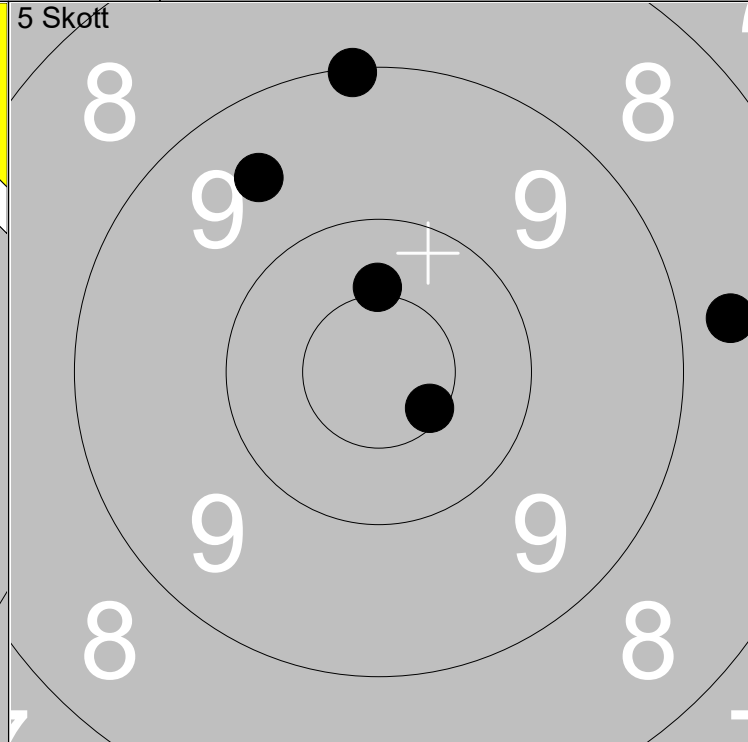
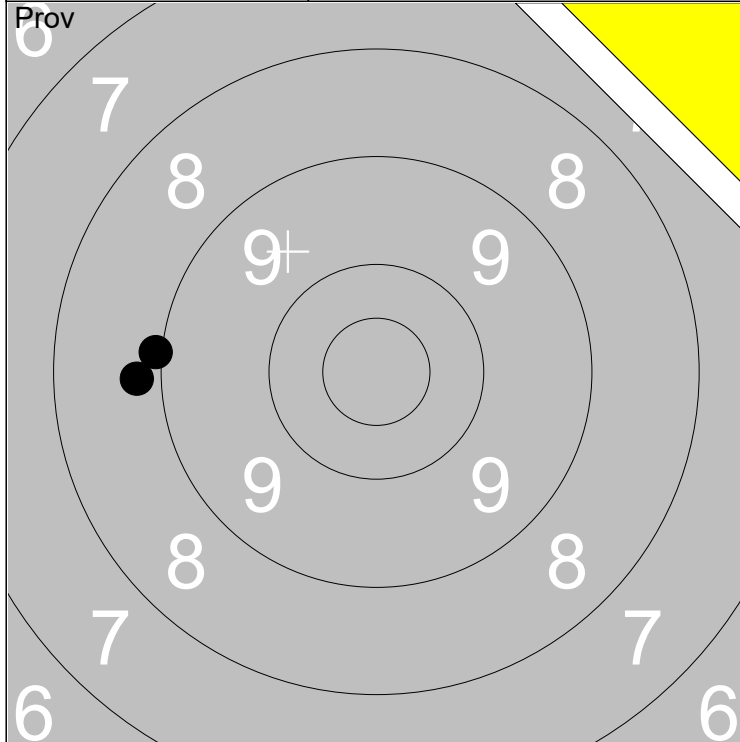

1: 7.3 ↗	Serie 24
2: 8.8 ←	
3: 9.0 ←	
Total 180	

1: 9.5 ↖	Serie 46
2: 8.7 →	
3: 9.1 ↑	
4: 10.4x ↑	
5: 10.6x ↘	
Total 226	

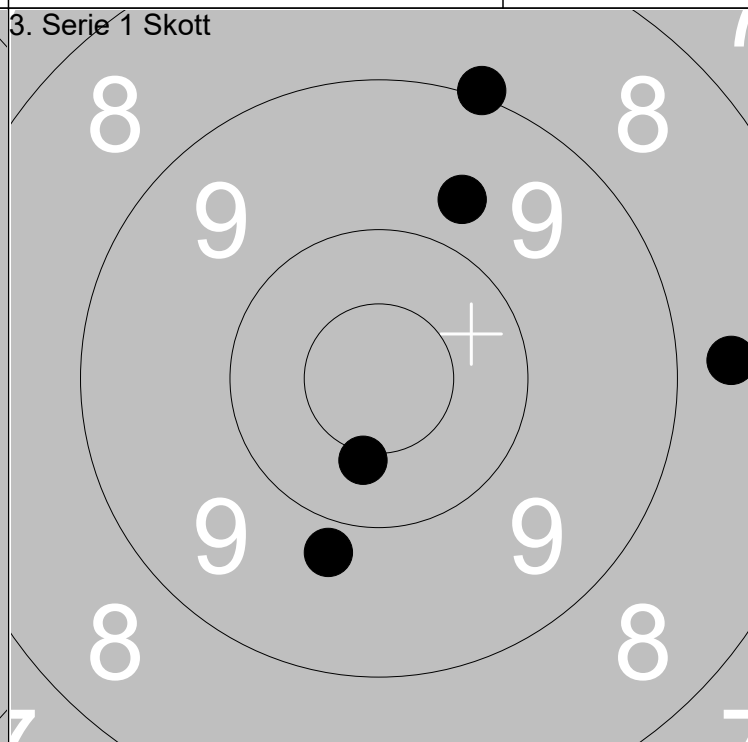
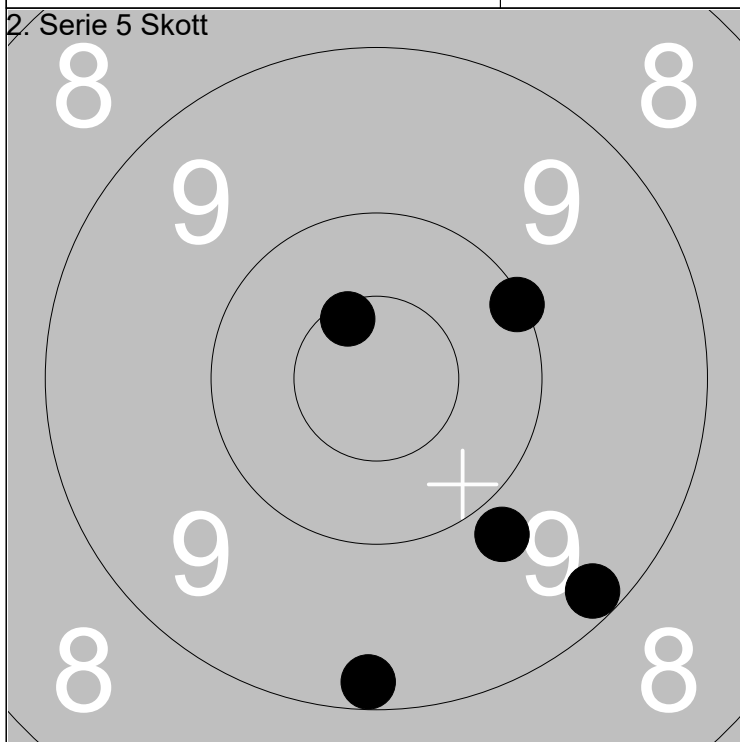

1: 10.6x ↗	Serie 47
2: 10.1 ↗	
3: 9.2 ↘	
4: 9.8 ↘	
5: 9.2 ↓	
Total 273	

1: 9.0 ↗	Serie 45
2: 10.4x ↓	
3: 8.7 →	
4: 9.7 ↗	
5: 9.8 ↓	
Total 318	

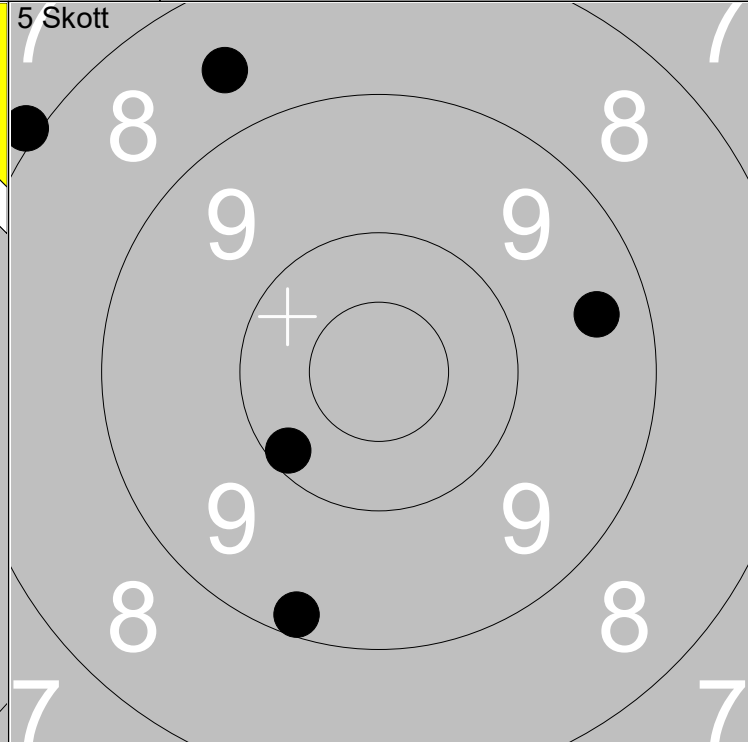
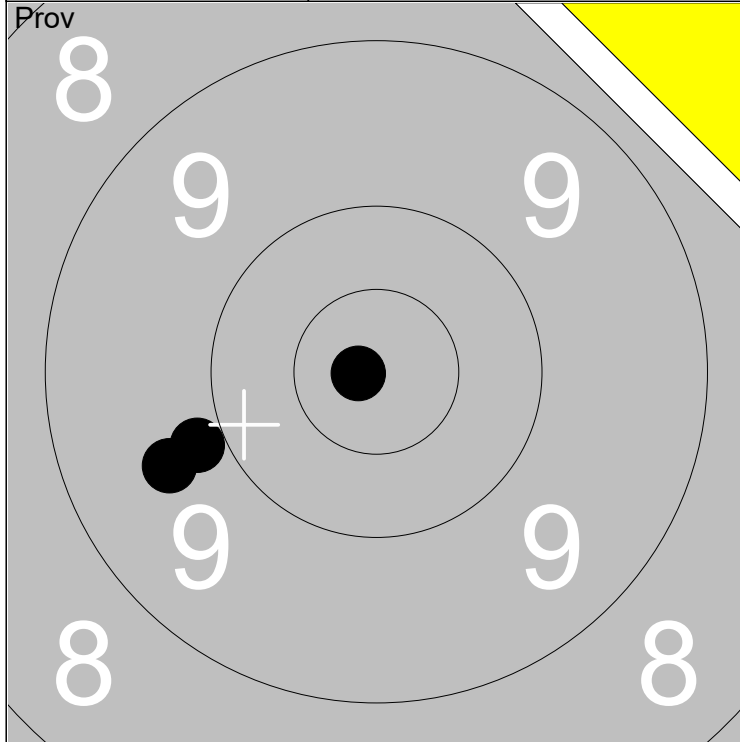

1: 10.8x ←	Serie	28
2: 9.7 ←		
3: 9.9 ←		
Total		178

1: 7.9 ↖	Serie	43
2: 9.2 ↓		
3: 9.4 →		
4: 8.6 ↗		
5: 10.2 ↙		
Total		221

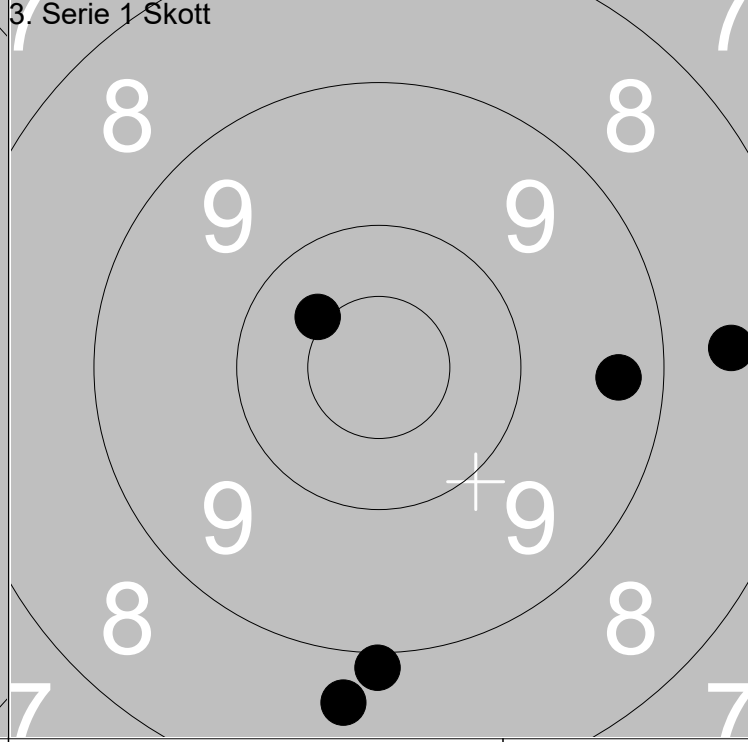
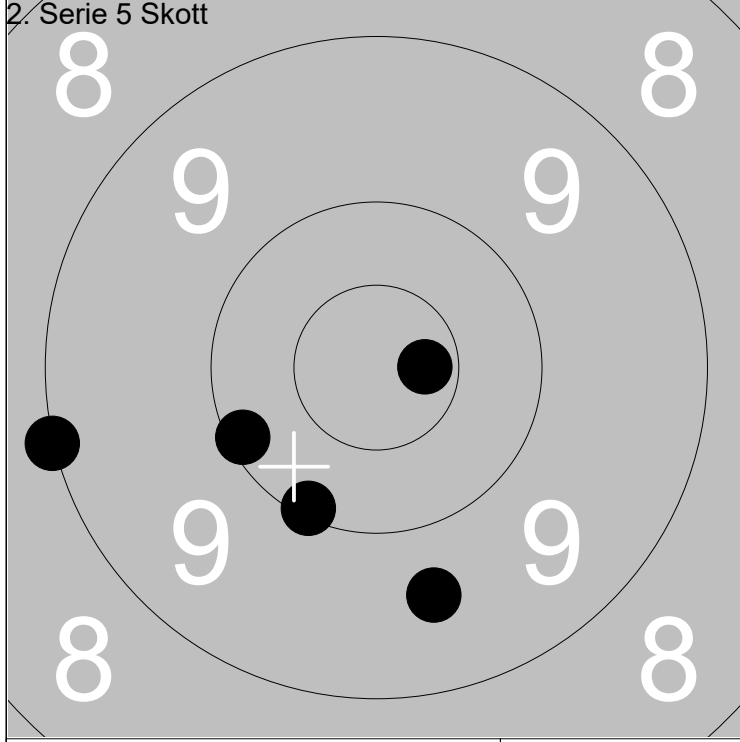

1: 10.1 ←	Serie	48
2: 9.6 ↓		
3: 10.7x →		
4: 9.0 ←		
5: 10.1 ↙		
Total		269

1: 8.7 ↓	Serie	43
2: 10.4x ↖		
3: 9.3 →		
4: 8.9 ↓		
5: 8.5 →		
Total		312

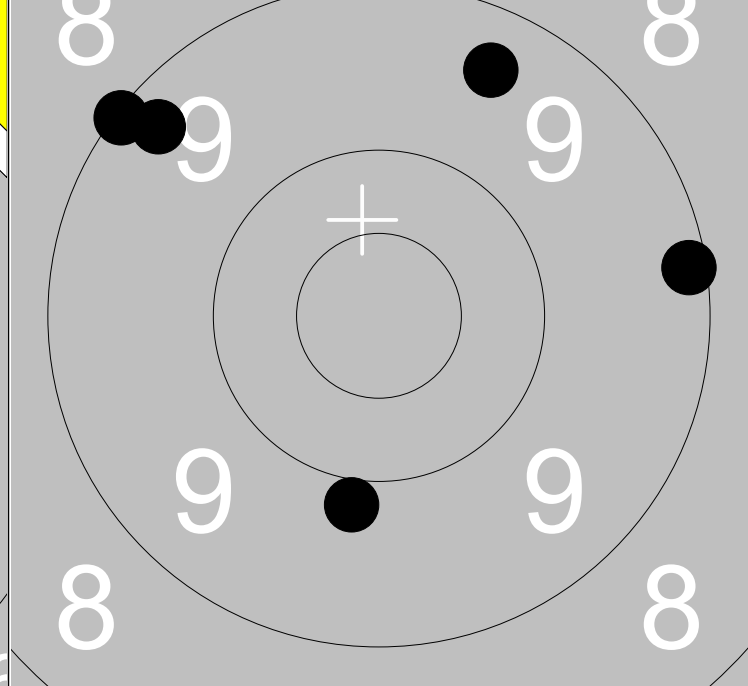
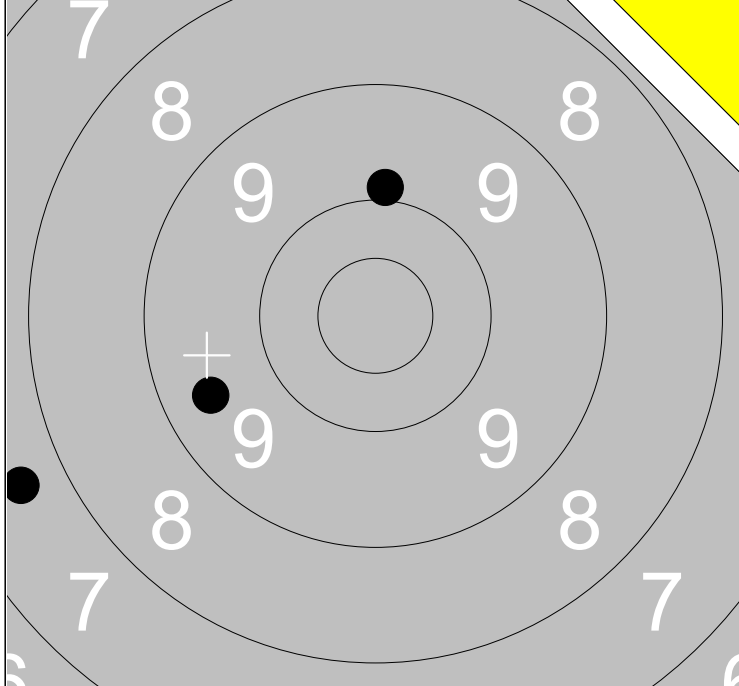

1:	9.9	↑			
2:	9.5	↙			
3:	7.6	↙			
			Serie	25	
			Total	164	

1:	9.1	↗			
2:	9.3	↗			
3:	9.9	↓			
4:	9.1	→			
5:	9.4	↑			
			Serie	45	
			Total	209	

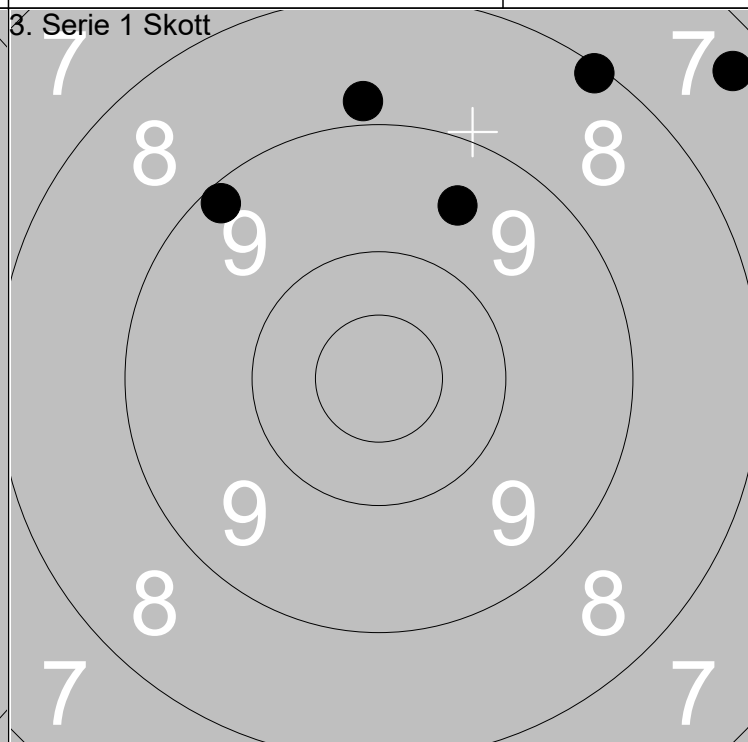
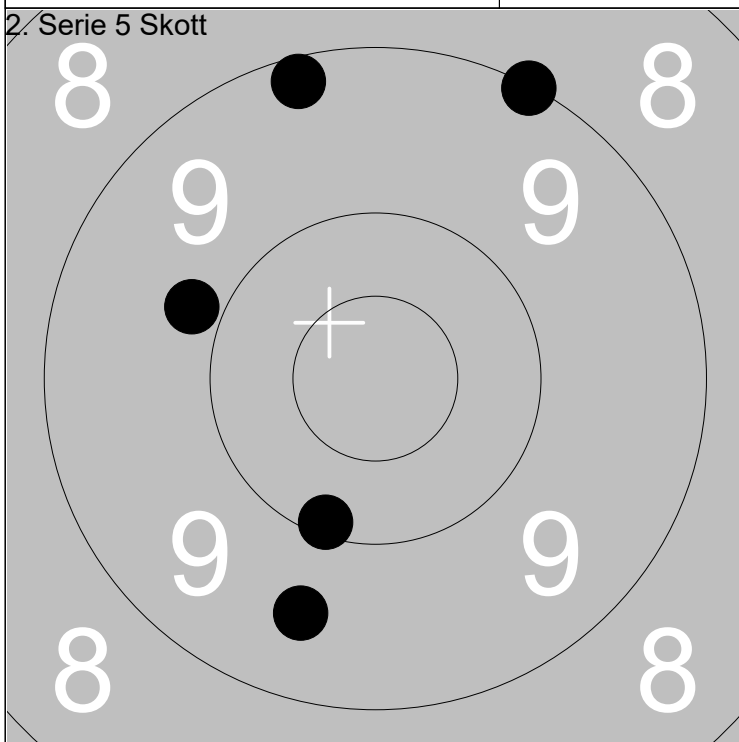

1:	9.0	↗			
2:	9.8	↖			
3:	9.2	↑			
4:	9.5	↓			
5:	10.1	↓			
			Serie	46	
			Total	255	

1:	7.3	↗			
2:	9.5	↑			
3:	8.1	↗			
4:	9.2	↖			
5:	8.8	↑			
			Serie	41	
			Total	296	

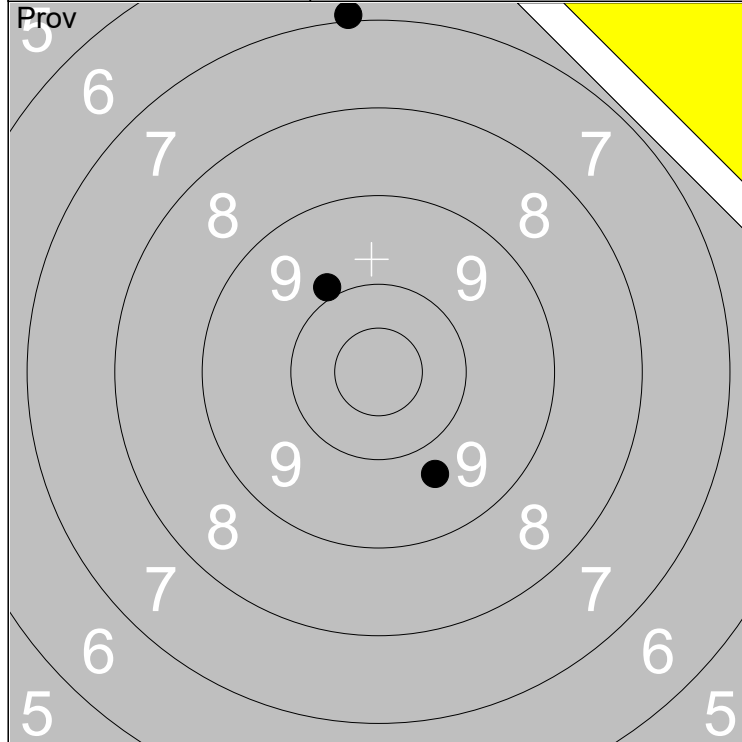

1: 9.7 ↘	Serie	25
2: 7.0 ↑		
3: 9.9 ↗		
Total		163

1: 8.2 ↑	Serie	43
2: 9.7 ↑		
3: 9.3 ↘		
Total		206

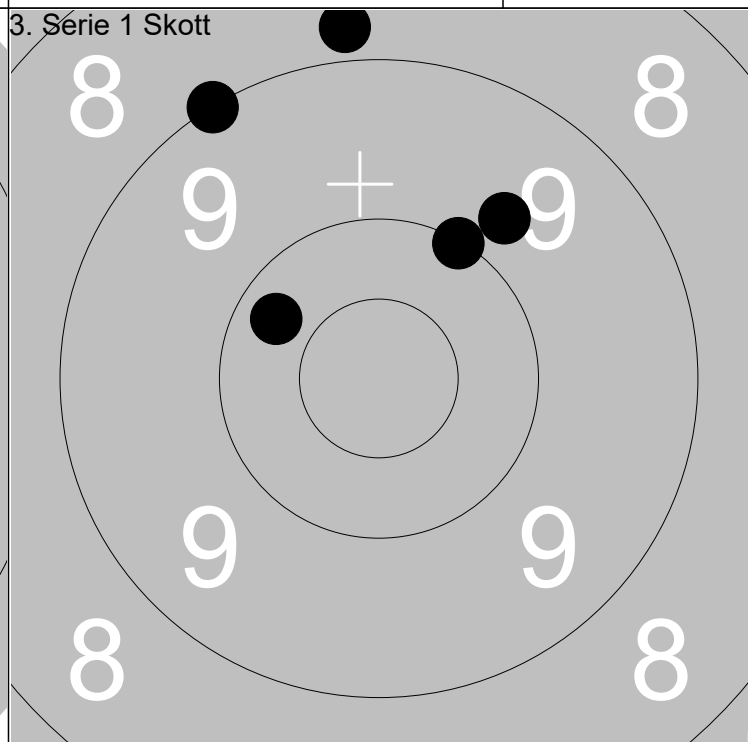
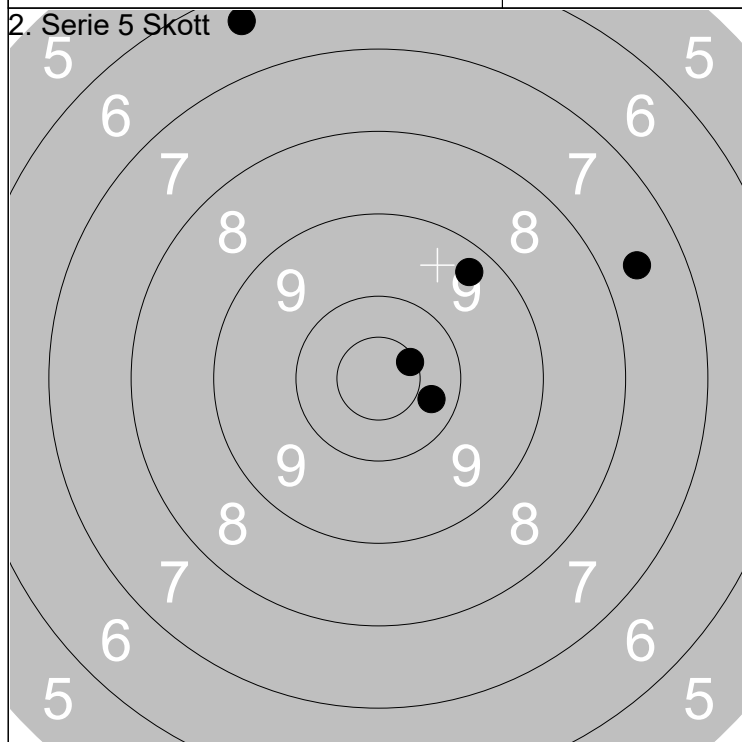

1: 9.3 ↗	Serie	42
2: 7.6 ↗		
3: 10.5x ↗		
Total		248

1: 10.0 ↗	Serie	46
2: 8.8 ↑		
3: 9.8 ↗		
Total		294

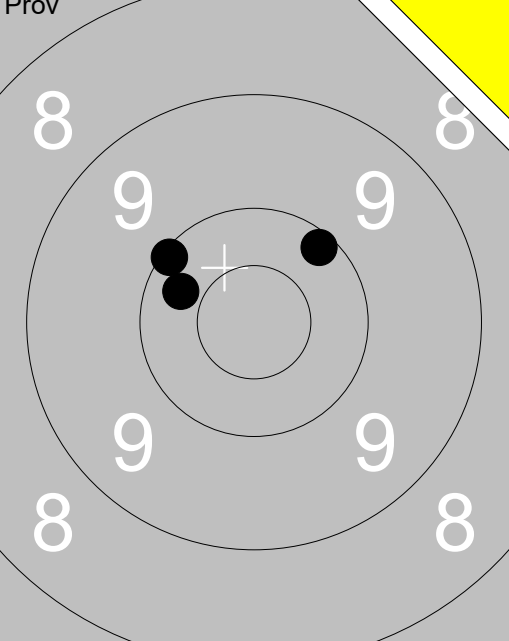
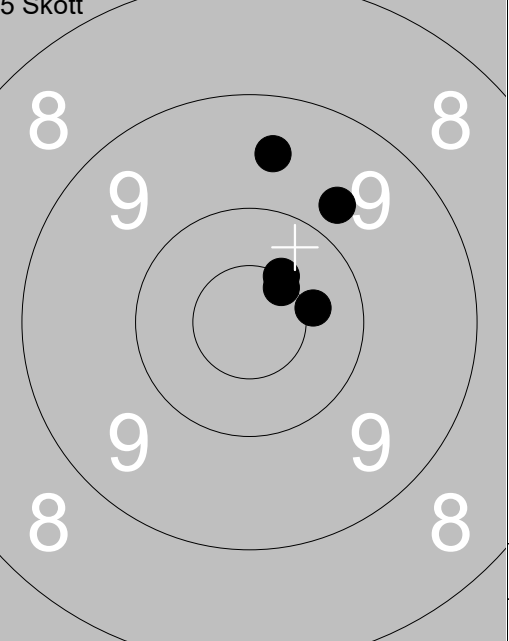
<p>Prov</p> 	<p>1: 10.1 ↗ 2: 10.1 ↖ 3: 10.3 ↙</p>	<p>5 Skott</p> 	<p>1: 9.5 ↑ 2: 9.7 ↗ 3: 10.5x ↗ 4: 10.6x ↗ 5: 10.4x ➤</p>
Serie 30.0		Serie 48.0	
Total 197.0		Total 245.0	

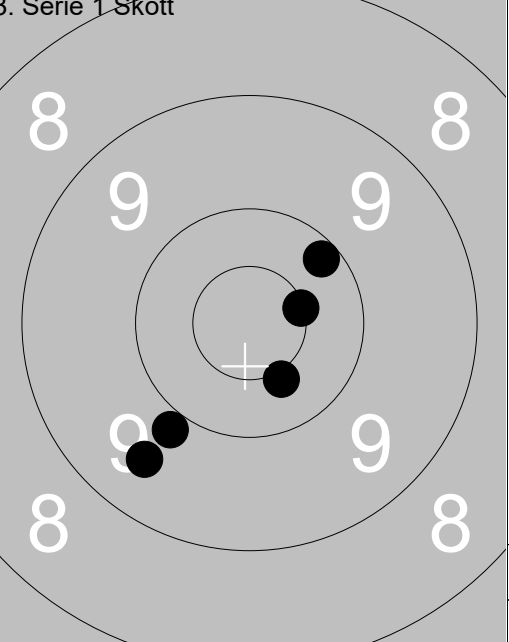
<p>2. Serie 5 Skott</p> 	<p>1: 10.3 ↓ 2: 10.8x ➤ 3: 10.6x ↗ 4: 10.8x ➤ 5: 10.4 ↓</p>	<p>3. Serie 1 Skott</p> 	<p>1: 9.9 ↙ 2: 10.2 ↗ 3: 9.5 ↙ 4: 10.4x ↘ 5: 10.5x ➤</p>
Serie 50.0		Serie 48.0	
Total 295.0		Total 343.0	

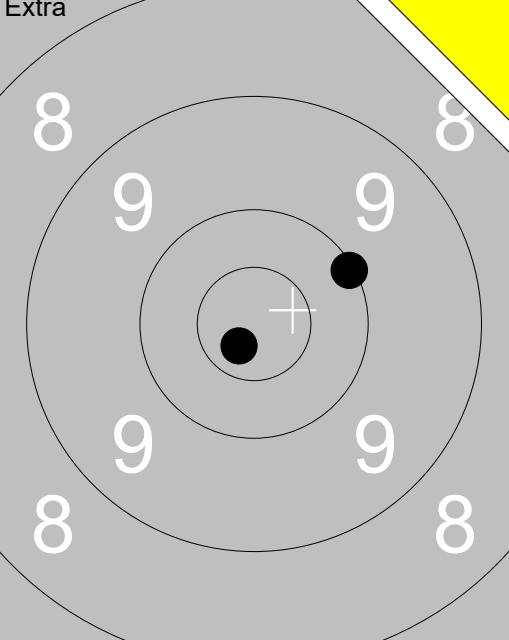
<p>Extra</p> 	<p>1: 10.1 ➤ 2: 10.7x ↘</p>		
Serie 20.0			
Total 343.0			

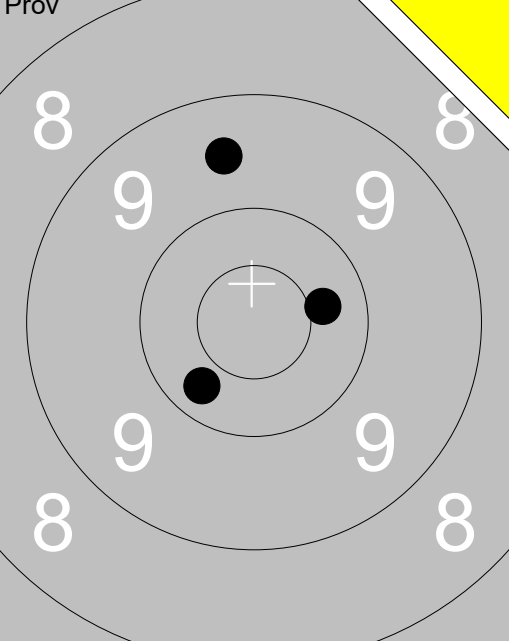
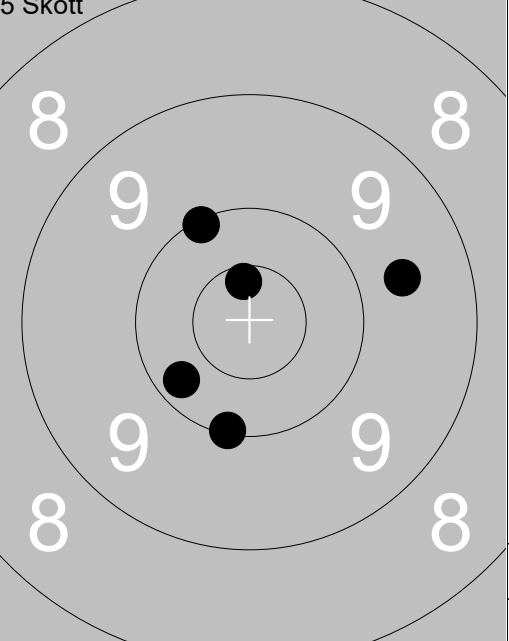
<p>Prov</p> 	<p>1: 10.3 ↙ 2: 10.4 → 3: 9.5 ↑</p>	<p>5 Skott</p> 	<p>1: 9.6 → 2: 10.1 ↓ 3: 10.1 ↖ 4: 10.6x ↗ 5: 10.2 ↙</p>
Serie 29.0		Serie 49.0	
Total 196.0		Total 245.0	

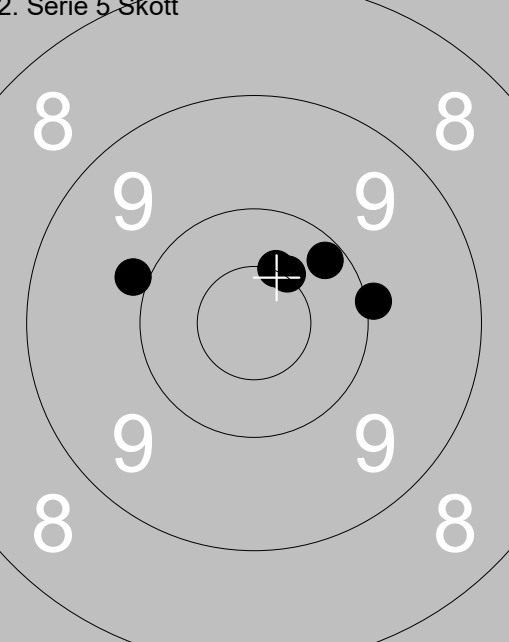
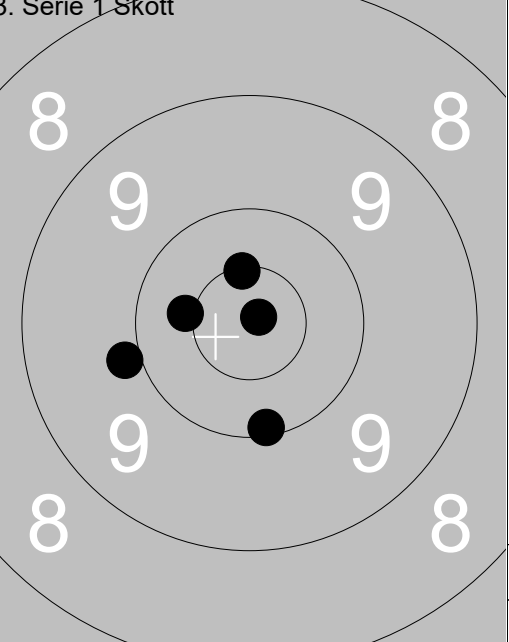
<p>2. Serie 5 Skott</p> 	<p>1: 9.9 ↖ 2: 10.5x ↗ 3: 10.5x ↗ 4: 10.2 ↗ 5: 10.0 →</p>	<p>3. Serie 1 Skott</p> 	<p>1: 10.1 ↓ 2: 10.5x ↗ 3: 10.9x ↗ 4: 10.4x ↗ 5: 9.9 ↖</p>
Serie 49.0		Serie 49.0	
Total 294.0		Total 343.0	

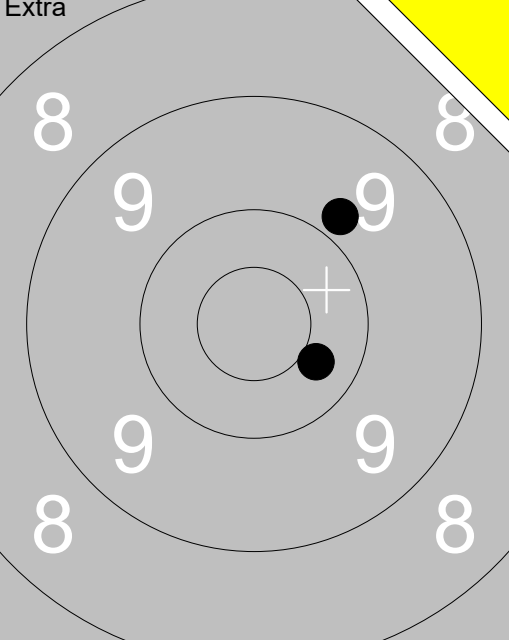
<p>Extra</p> 	<p>1: 10.4 ↘ 2: 9.8 ↗</p>		
Serie 19.0			
Total 343.0			

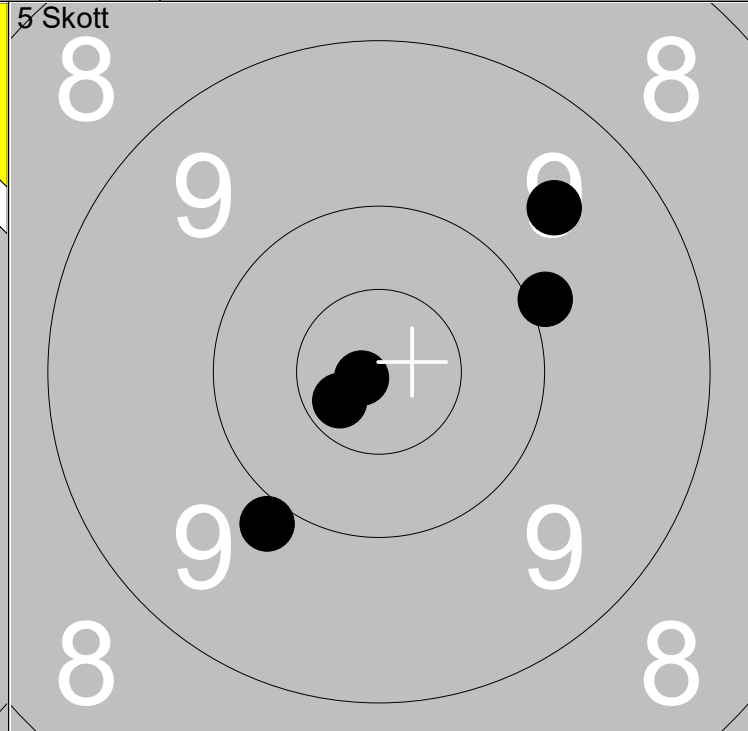
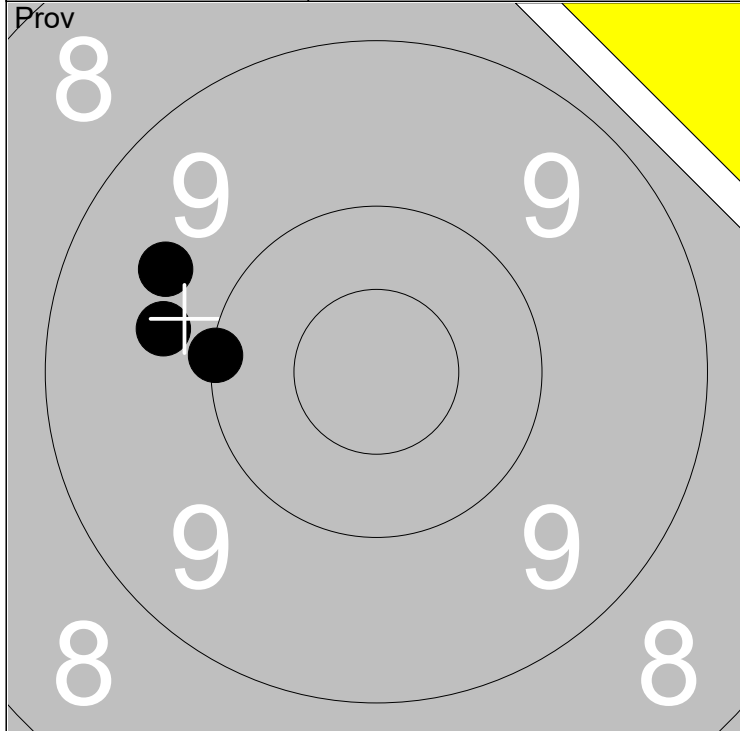

1: 10.0	←
2: 9.7	←
3: 9.6	↖

Serie	28
Total	194

1: 9.6	↗
2: 9.9	↘
3: 10.7x	↙
4: 9.9	↗
5: 10.8x	←

Serie	47
Total	241

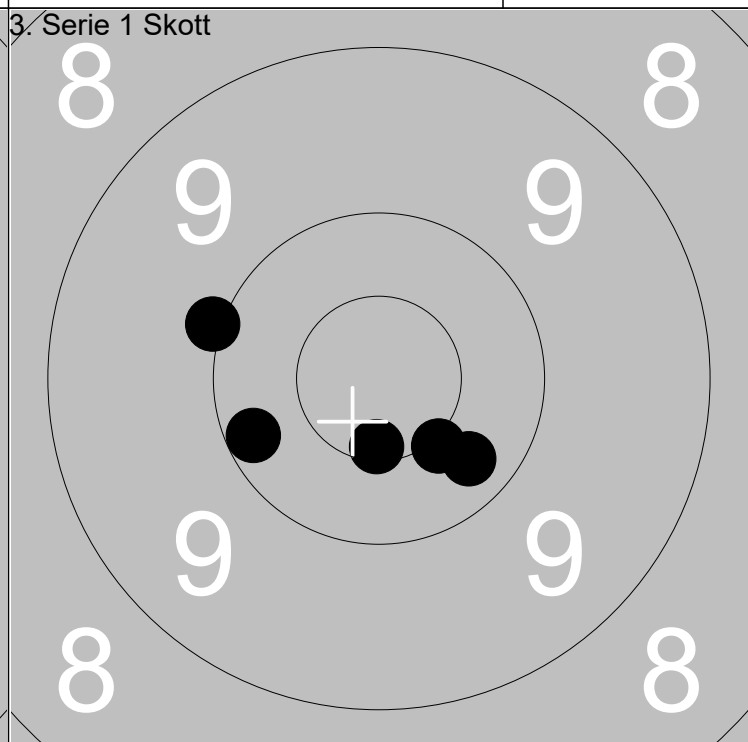
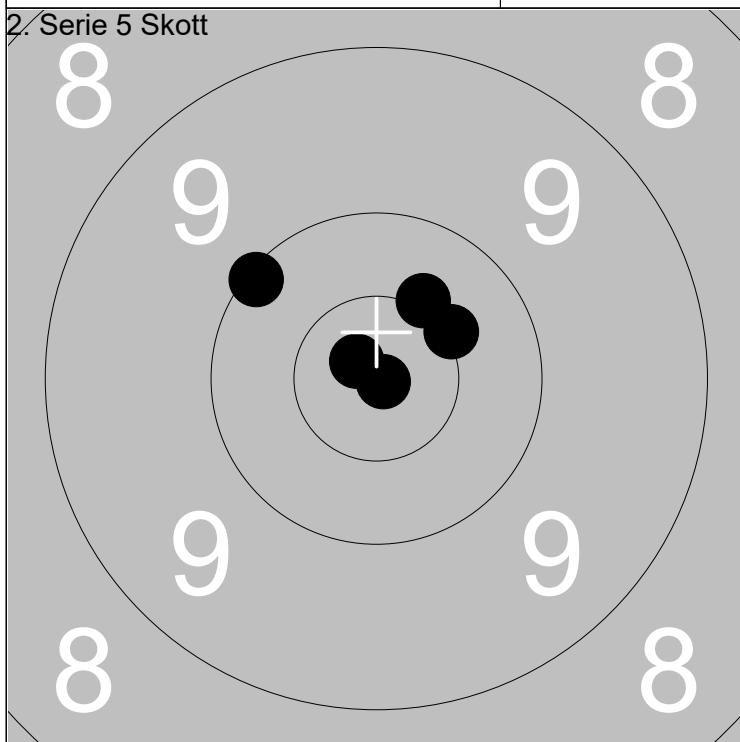

1: 10.4x	↗
2: 10.8x	↖
3: 10.9x	→
4: 10.1	↖
5: 10.5x	↗

Serie	50
Total	291

1: 10.6x	↓
2: 10.3	↘
3: 10.0	↖
4: 10.2	↙
5: 10.4x	↘

Serie	50
Total	341

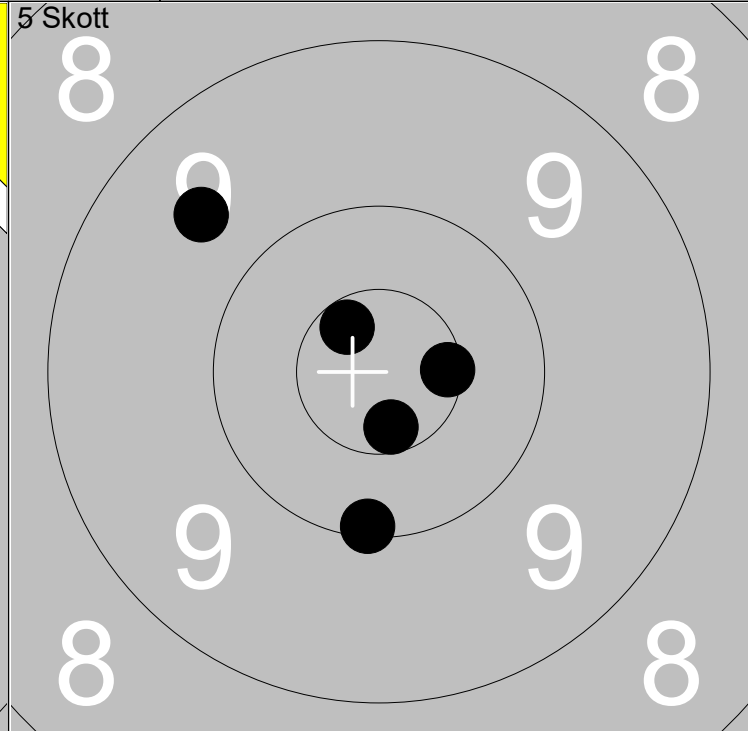
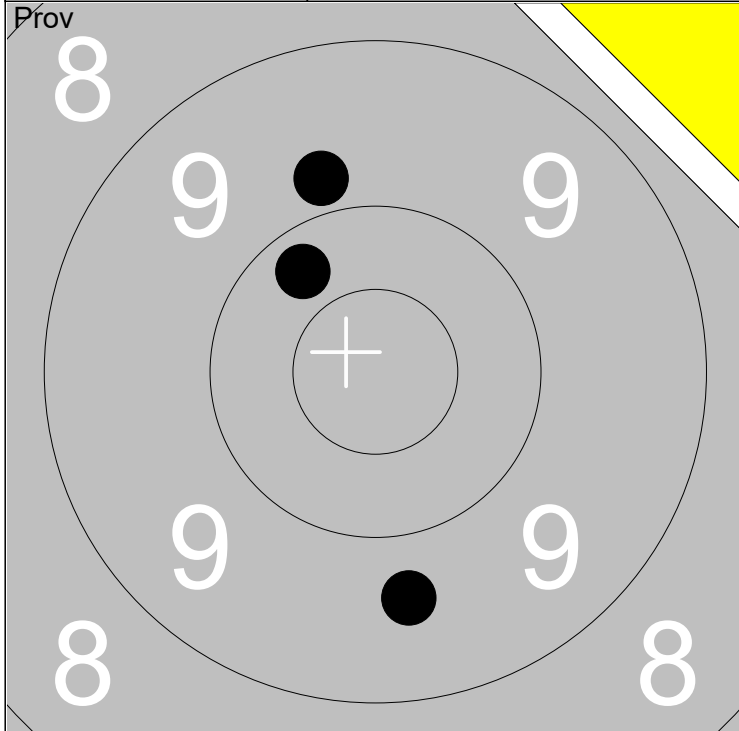

1: 10.3 ↗	Serie	28
2: 9.6 ↓		
3: 9.8 ↗		
Total		194

1: 9.6 ↗	Serie	49
2: 10.1 ↓		
3: 10.6x ↗		
Total		243

1: 9.6 ↗	Serie	49
2: 10.1 ↓		
3: 10.6x ↗		
Total		243

4: 10.6x →	Serie	49
5: 10.6x ↓		
Total		

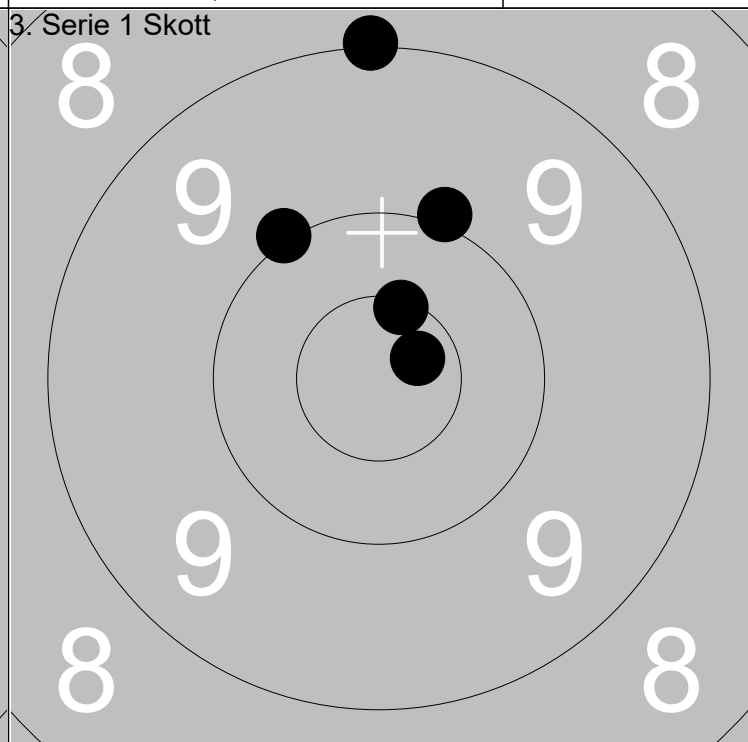
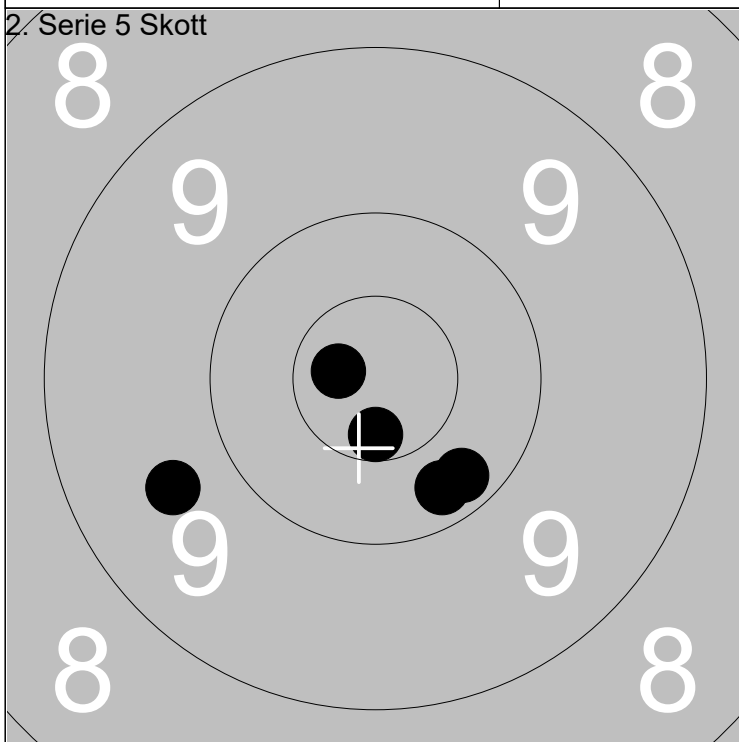

1: 10.7x ←	Serie	49
2: 9.6 ←		
3: 10.2 ↓		
Total		292

4: 10.6x ↓	Serie	49
5: 10.2 ↓		
Total		

1: 10.0 ↗	Serie	49
2: 10.7x ↗		
3: 9.0 ↑		
Total		341

4: 10.5x ↗	Serie	49
5: 10.0 ↖		
Total		

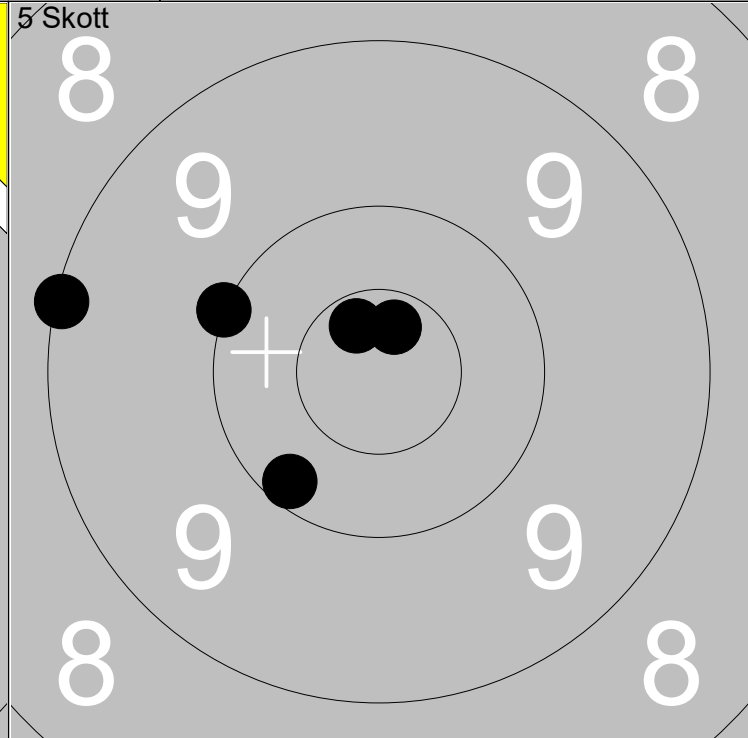
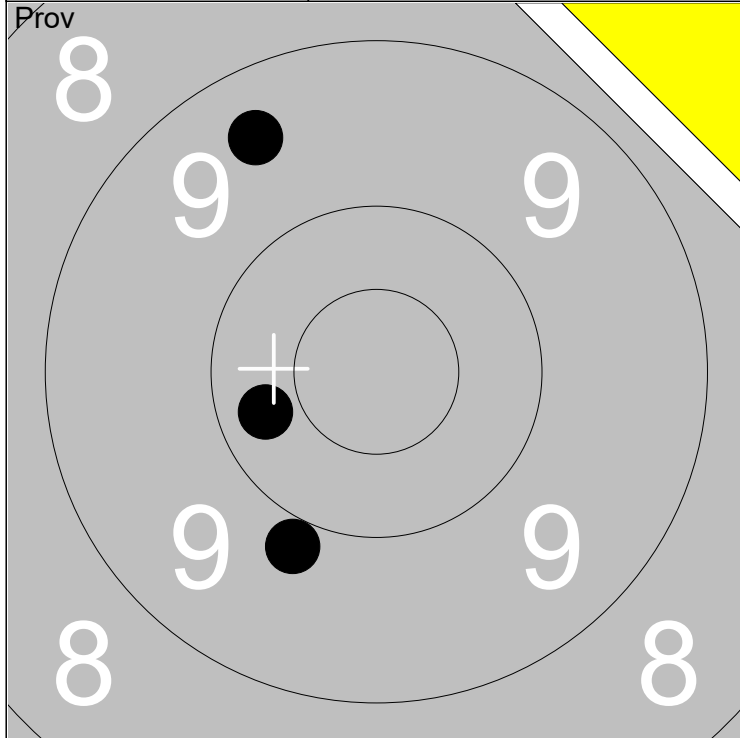

1: 9.4	↗
2: 10.3	↖
3: 9.9	↘

Serie	28
Total	194

1: 10.0	↖
2: 10.7x	↗
3: 9.1	↖
4: 10.2	↘
5: 10.7x	↗

Serie	49
Total	243

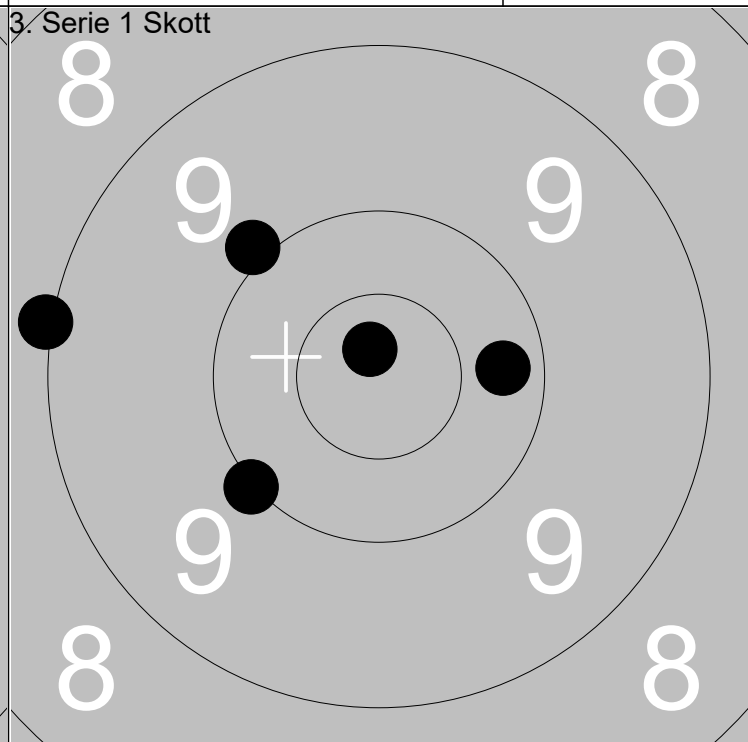
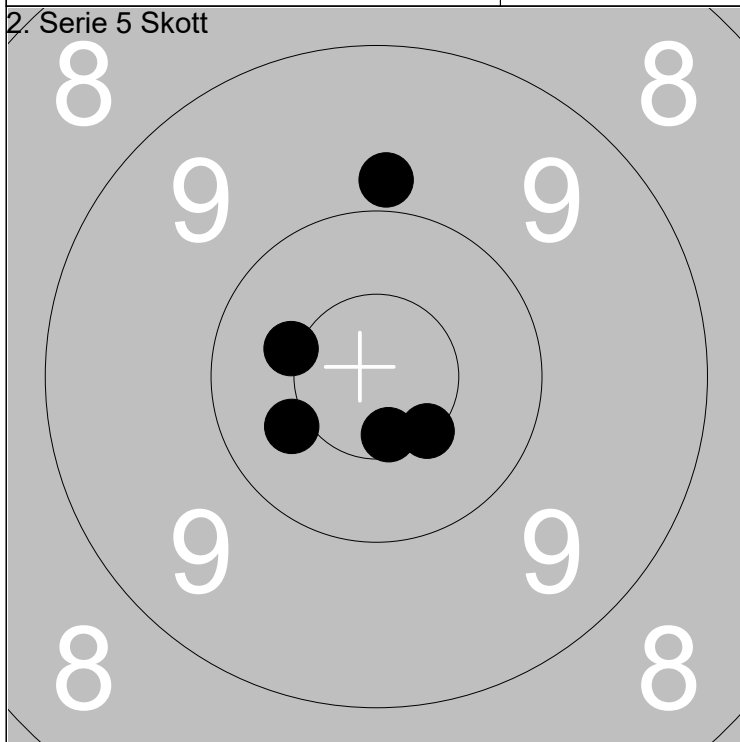

1: 9.8	↑
2: 10.4	↖
3: 10.4x	↖
4: 10.5x	↘
5: 10.6x	↘

Serie	49
Total	292

1: 10.8x	↗
2: 10.3	→
3: 9.0	↖
4: 9.9	↖
5: 10.0	↘

Serie	48
Total	340

Skjutlag

5

Tavla

6

Anna Eklöf

Ramselefors

Storfors

A

Vä

15.07.2022

Tavelträffen 2022

Ramselefors SKF

Pröv

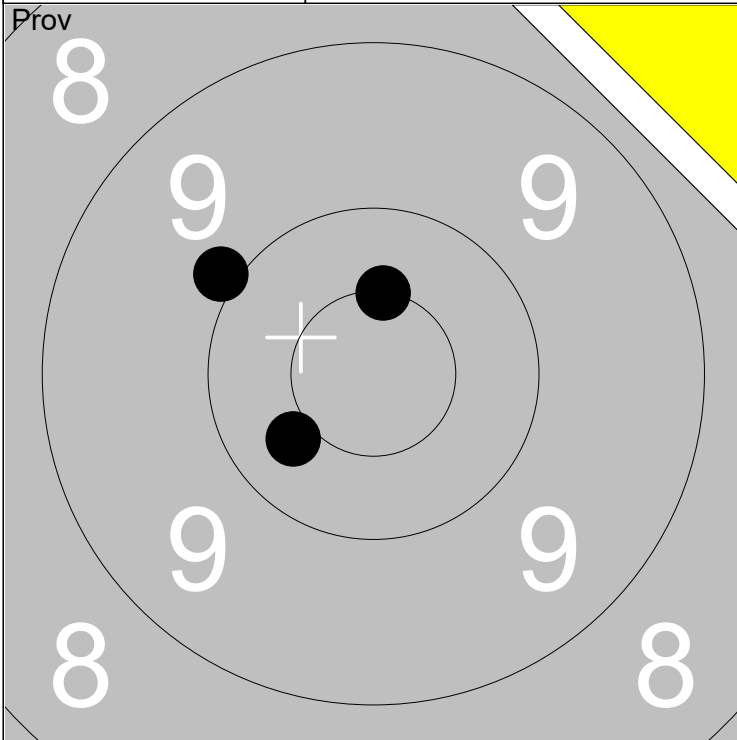

5 Skott

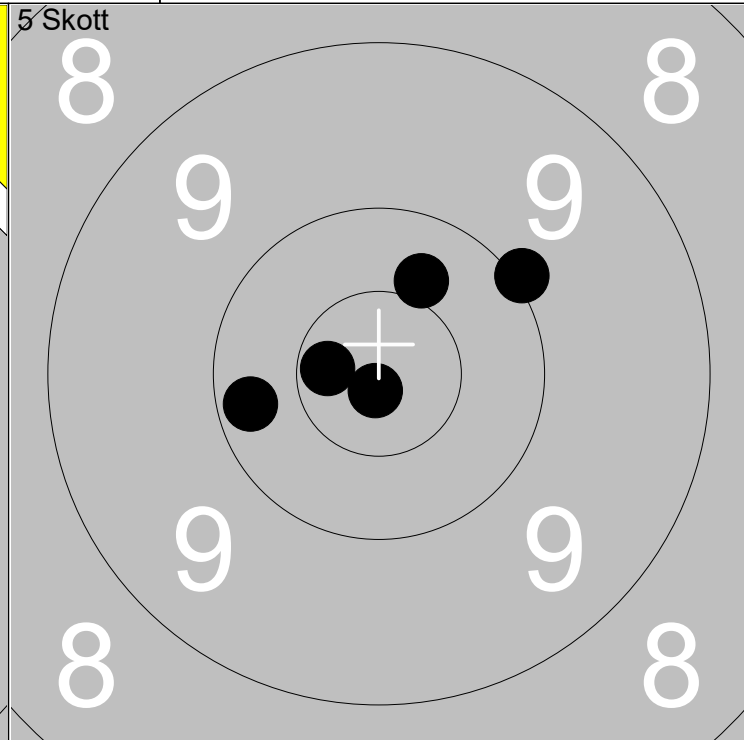

1: 9.9 ↖
 2: 10.5x ↑
 3: 10.4 ↙

Serie 29

Total 193

1: 10.2 ←
 2: 10.7x ←
 3: 10.4 ↗
 4: 10.0 ↘
 5: 10.9x ↓

Serie 50

Total 243

2. Serie 5 Skott

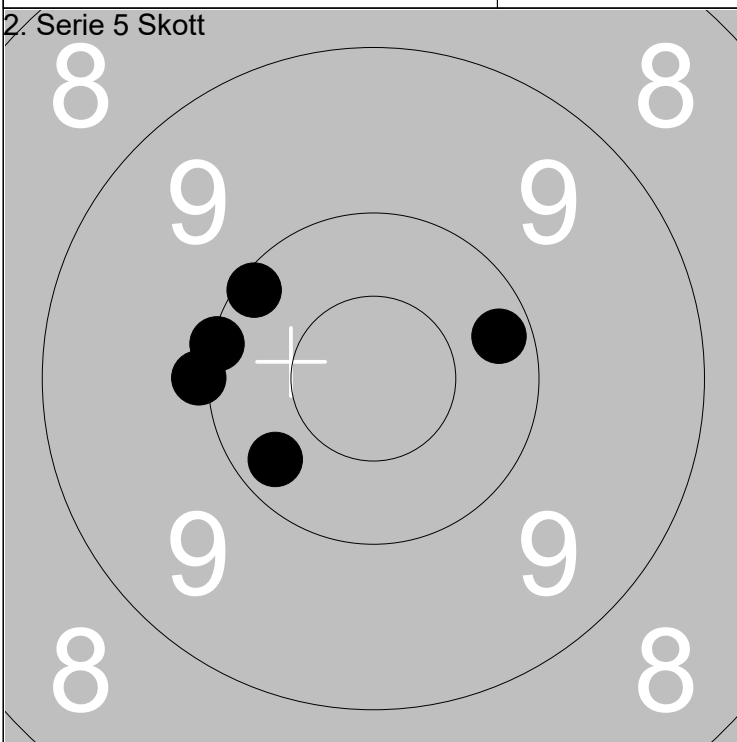

3. Serie 1 Skott

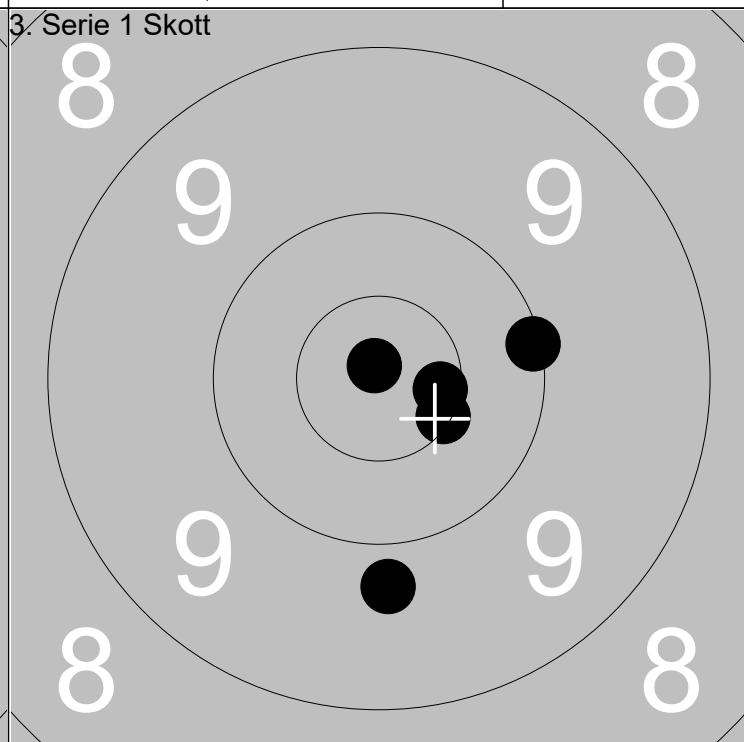

1: 10.1 ←
 2: 10.0 ←
 3: 10.1 ↖
 4: 10.2 ↙
 5: 10.2 →

Serie 50

Total 293

1: 10.9x ↗
 2: 10.1 →
 3: 10.6x →
 4: 10.5x ↘
 5: 9.8 ↓

Serie 49

Total 342

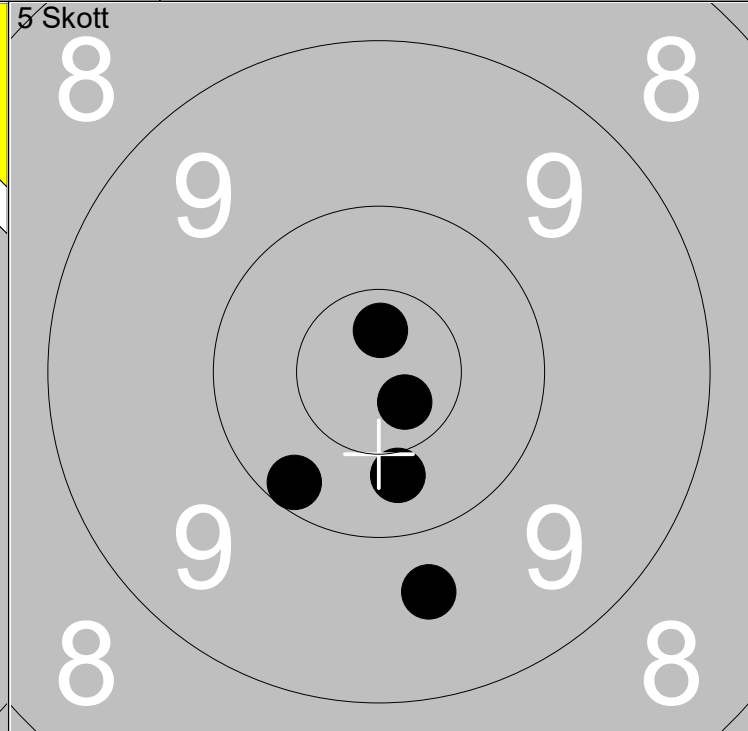
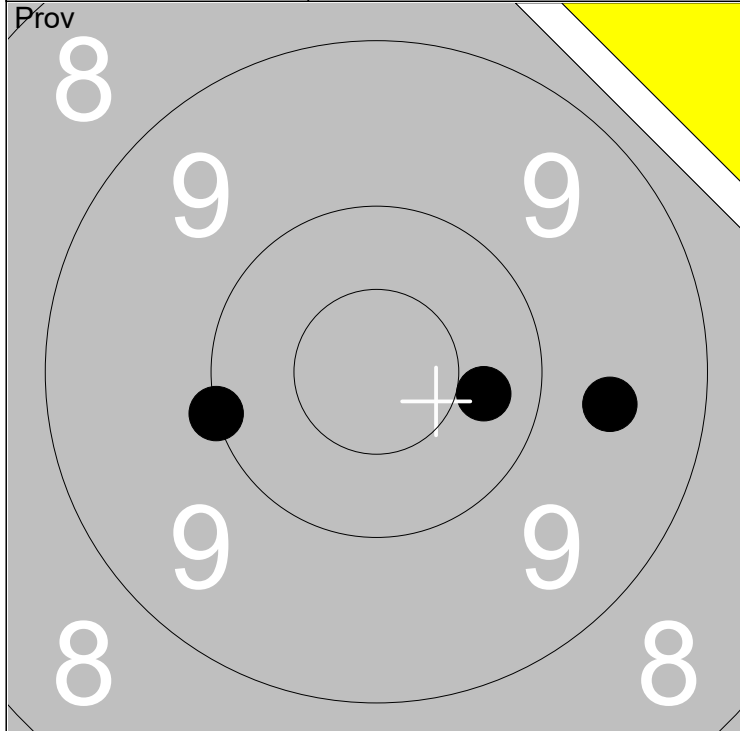

1: 10.0 ←	Serie	29
2: 10.3 →		
3: 9.6 →		
Total		192

1: 10.7x ↑	Serie	49
2: 10.7x ↘		
3: 9.7 ↓		
Total		241

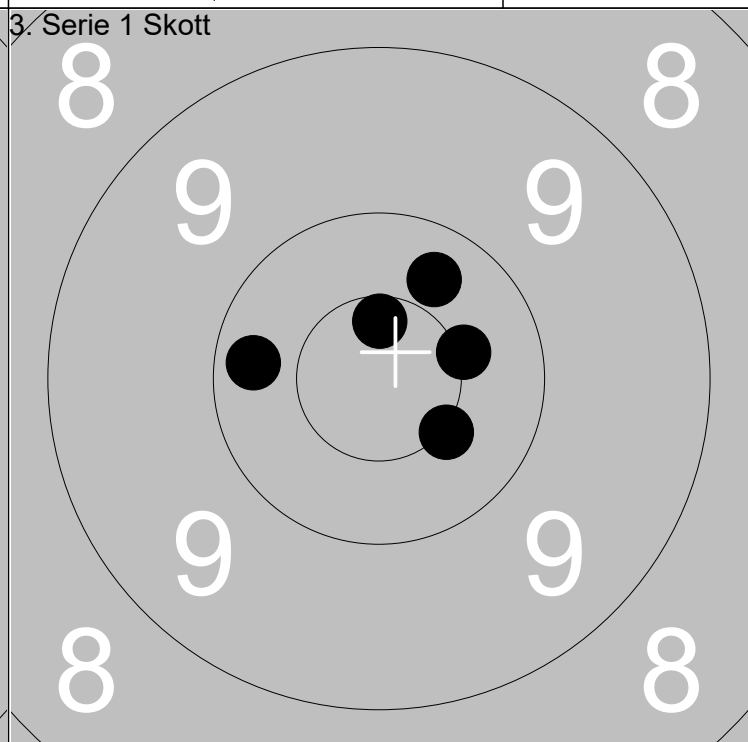
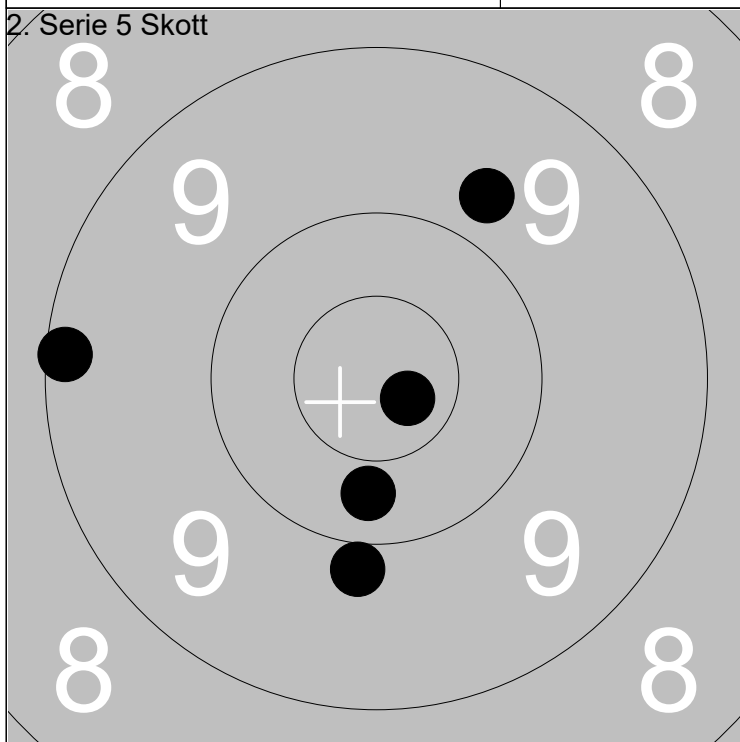

1: 9.7 ↗	Serie	47
2: 10.3 ↓		
3: 10.7x ↘		
Total		288

1: 10.3 ↗	Serie	50
2: 10.5x ↘		
3: 10.6x ↑		
Total		338

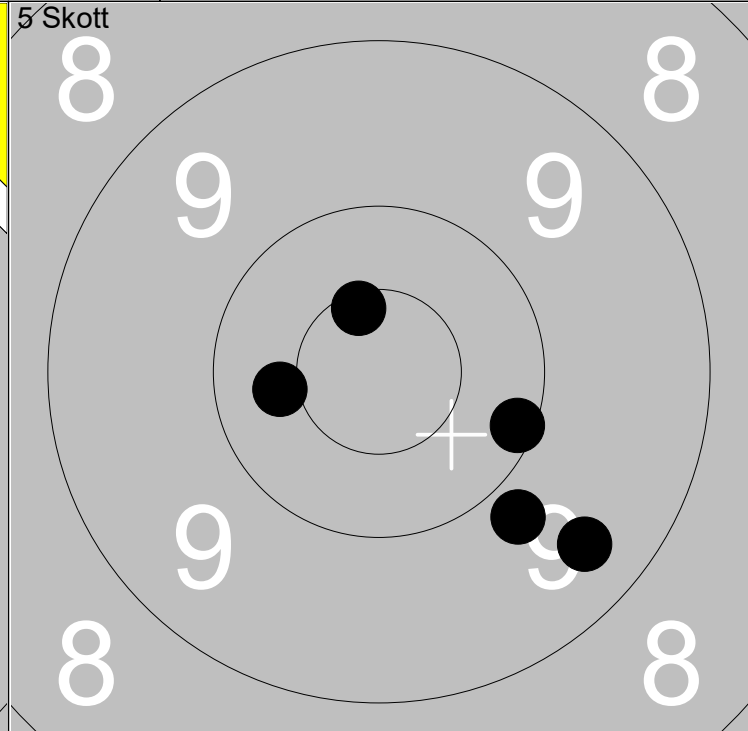
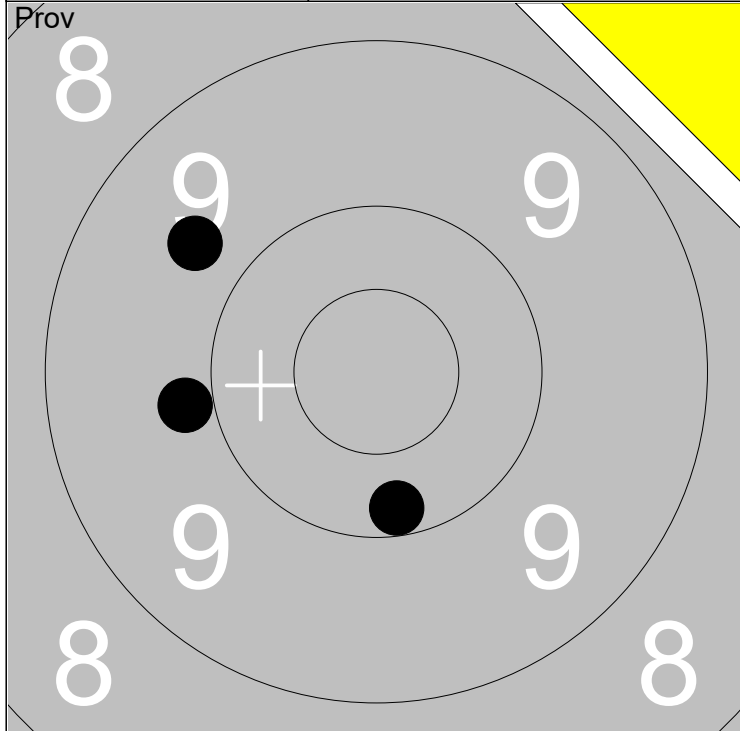

1: 9.9 ←		Serie	28	
2: 9.7 ↗			Total	191
3: 10.2 ↓				

1: 10.6x ↗		Serie	48	
2: 9.8 ↘			Total	239
3: 9.4 ↘				
4: 10.1 →				
5: 10.4 ←				

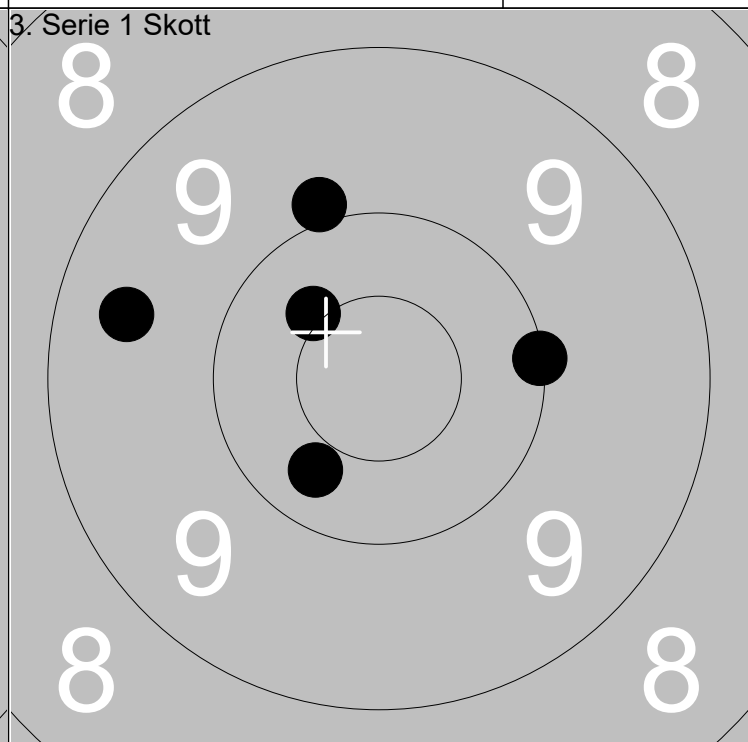
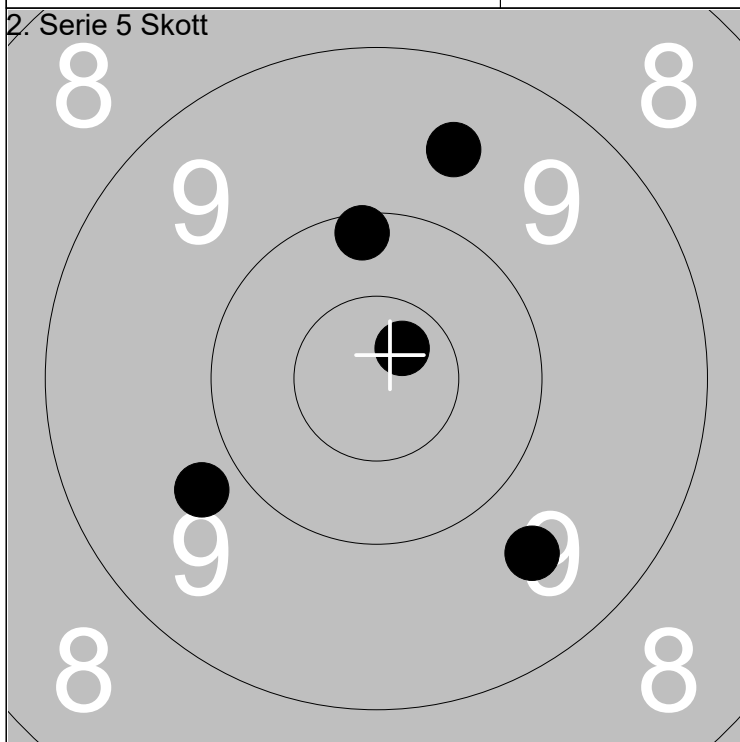

1: 9.6 ↗		Serie	47	
2: 10.1 ↗			Total	286
3: 10.7x ↗				
4: 9.8 ←				
5: 9.6 ↓				

1: 9.5 ←		Serie	48	
2: 9.9 ↗			Total	334
3: 10.3 ↘				
4: 10.0 →				
5: 10.4x ↗				

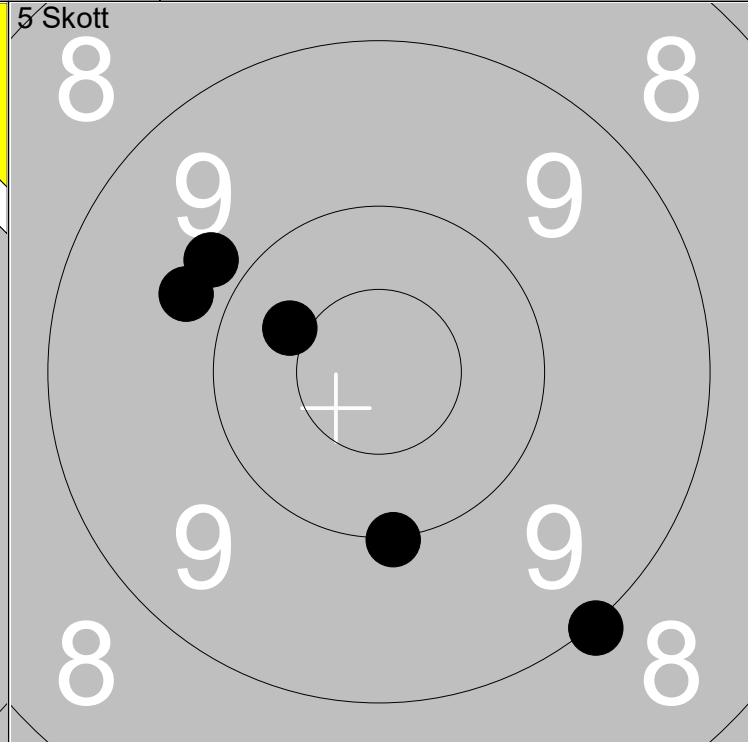
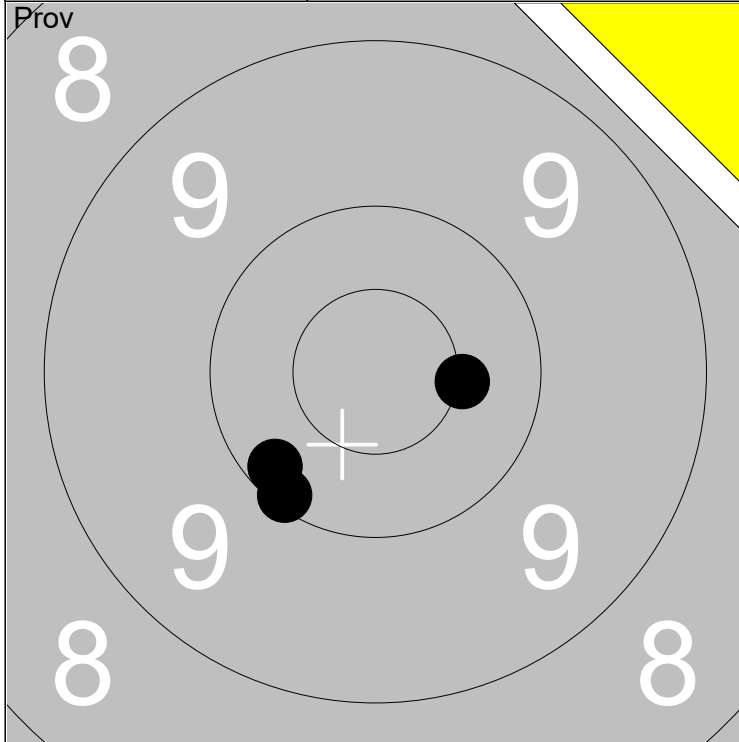

1: 10.5x →	Serie 30
2: 10.1 ↘	
3: 10.2 ↙	
Total 190	

1: 10.4 ↗	Serie 47
2: 9.8 ↗	
3: 9.8 ↗	
Total 237	
4: 10.0 ↓	
5: 9.0 ↘	

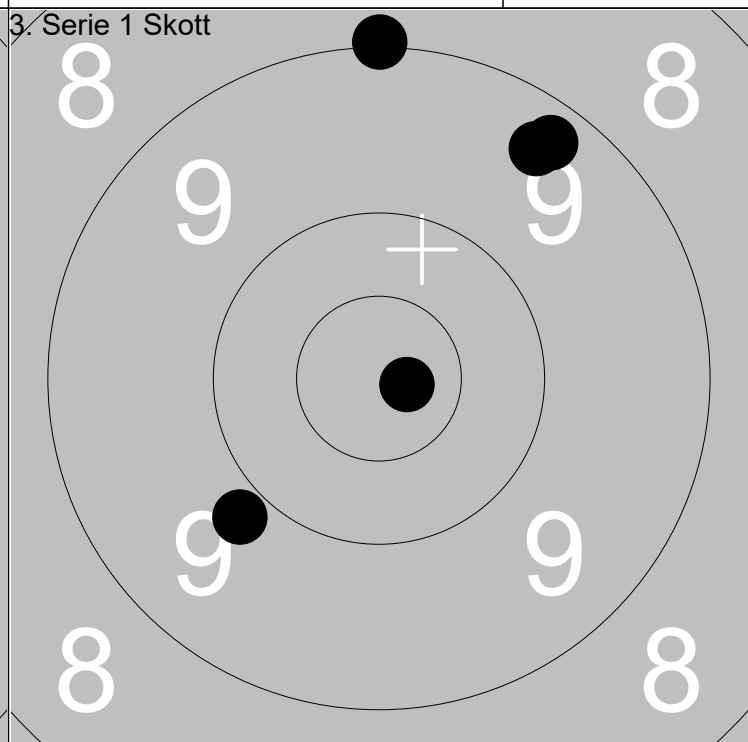
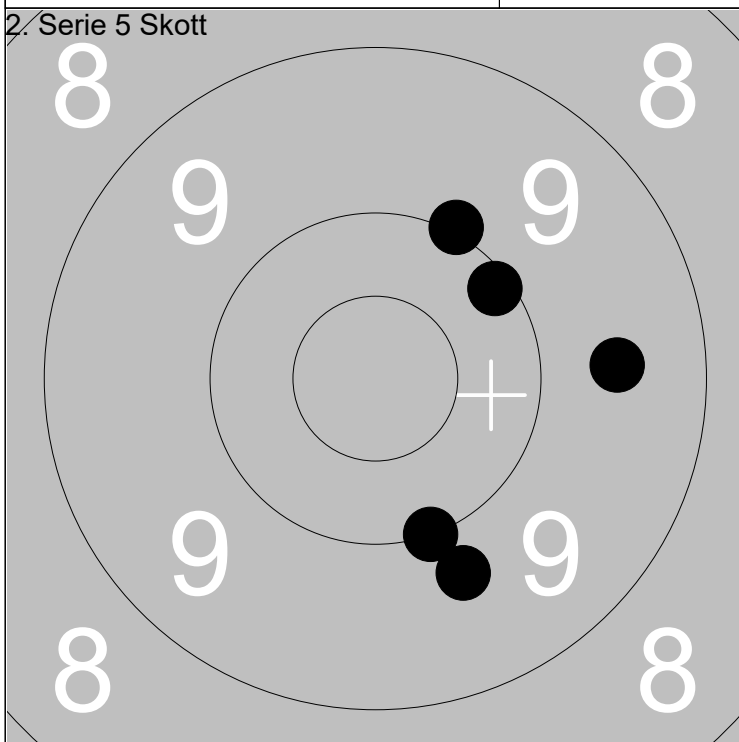

1: 10.0 ↗	Serie 48
2: 9.7 ↘	
3: 10.0 ↓	
4: 10.1 ↗	
5: 9.6 →	
Total 285	

1: 9.0 ↑	Serie 46
2: 9.3 ↗	
3: 9.8 ↙	
4: 9.3 ↗	
5: 10.8x →	
Total 331	

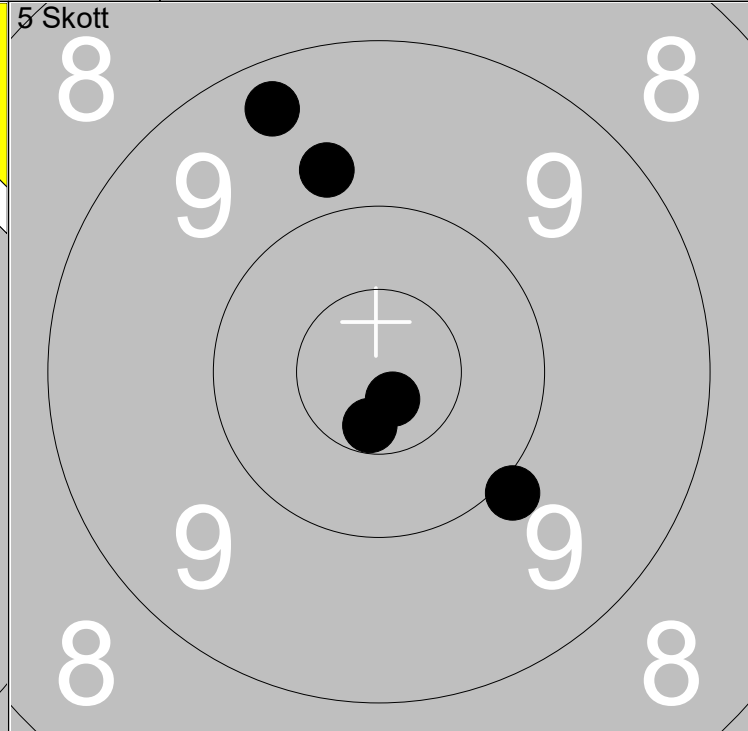
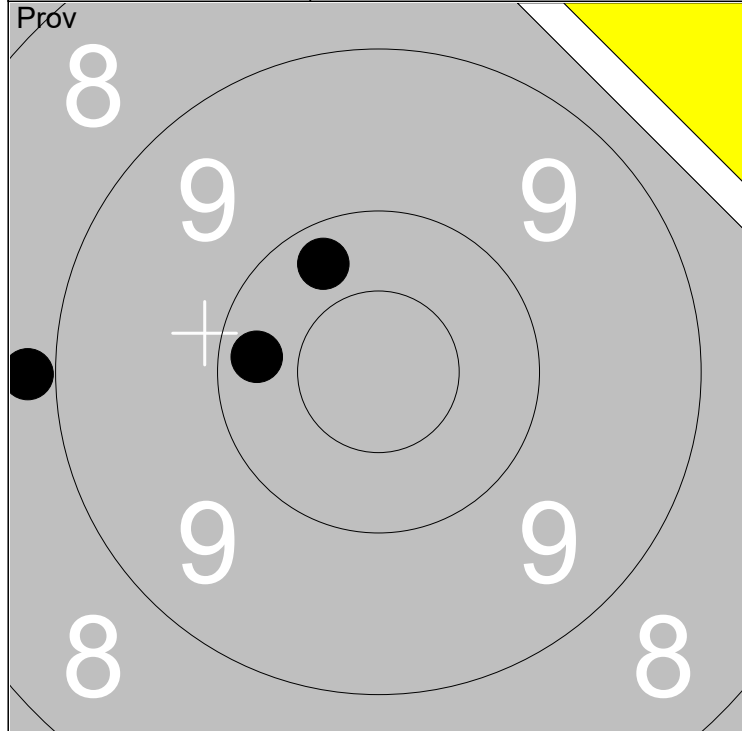

1: 10.3 ↗	Serie	28
2: 8.9 ←		
3: 10.2 ←		
Total		189

1: 10.8x ↘	Serie	47
2: 9.3 ↗		
3: 9.8 ↗		
4: 10.6x ↘		
5: 9.9 ↘		
Total		236

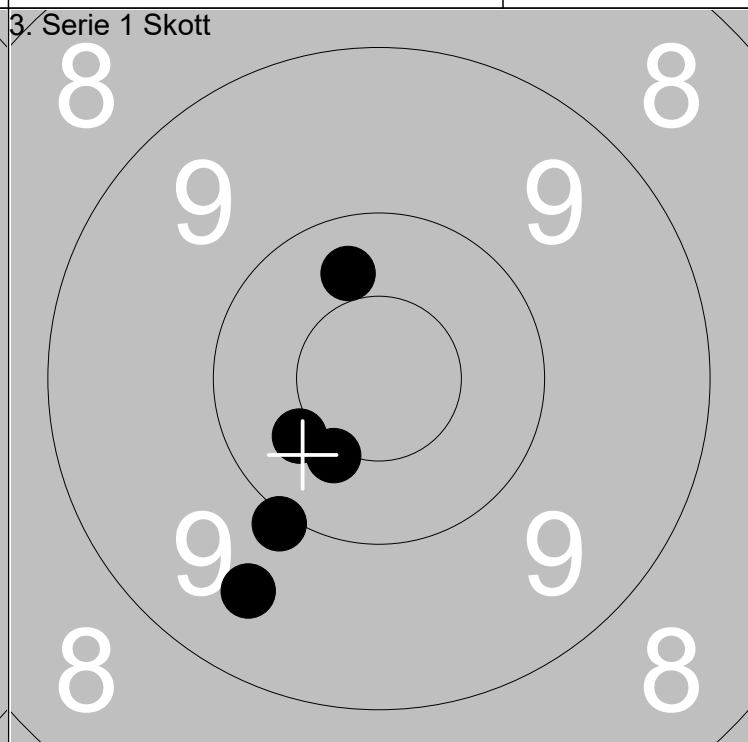
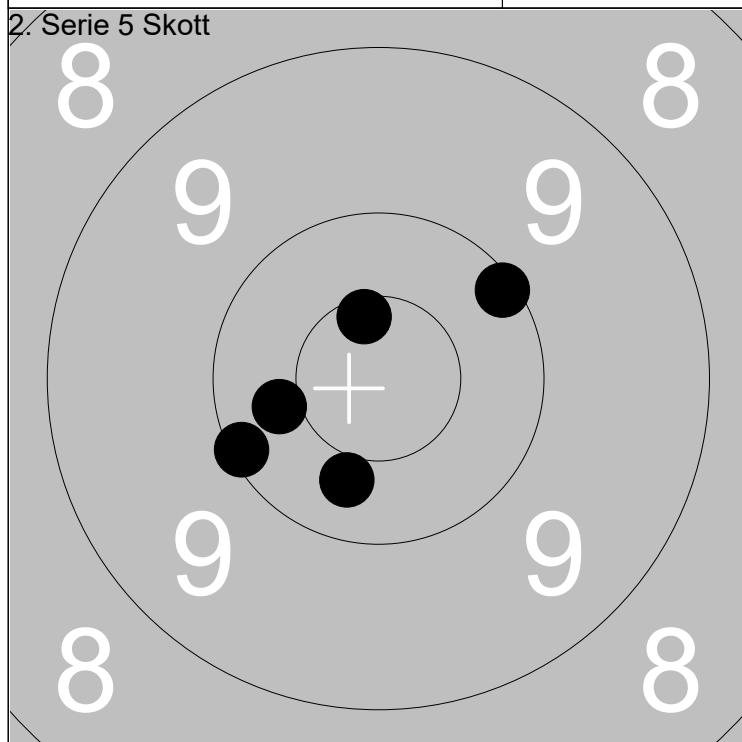

1: 10.1 ↗	Serie	50
2: 10.4 ↘		
3: 10.4 ←		
4: 10.1 ←		
5: 10.6x ↗		
Total		286

1: 9.5 ↘	Serie	49
2: 10.0 ↘		
3: 10.4 ←		
4: 10.3 ↗		
5: 10.5x ↘		
Total		335

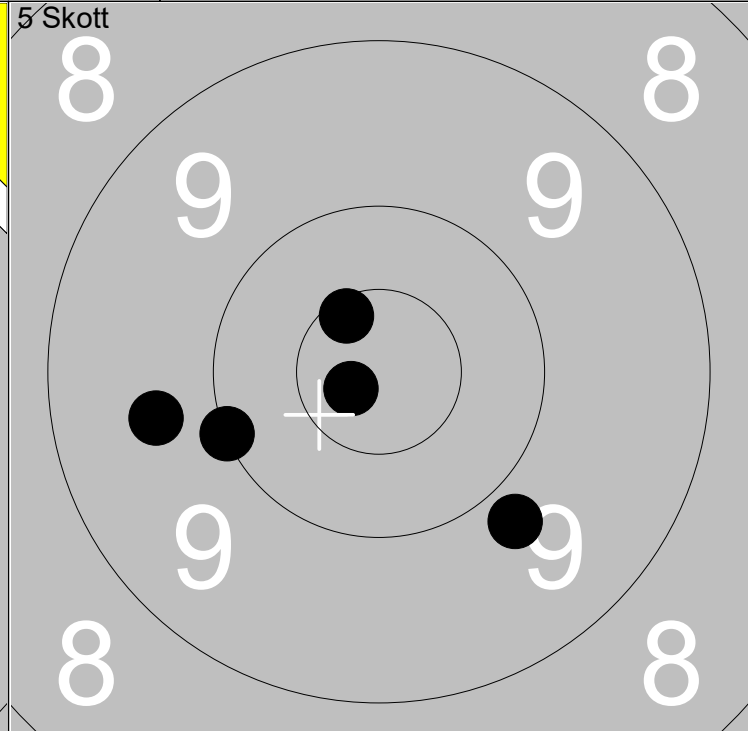
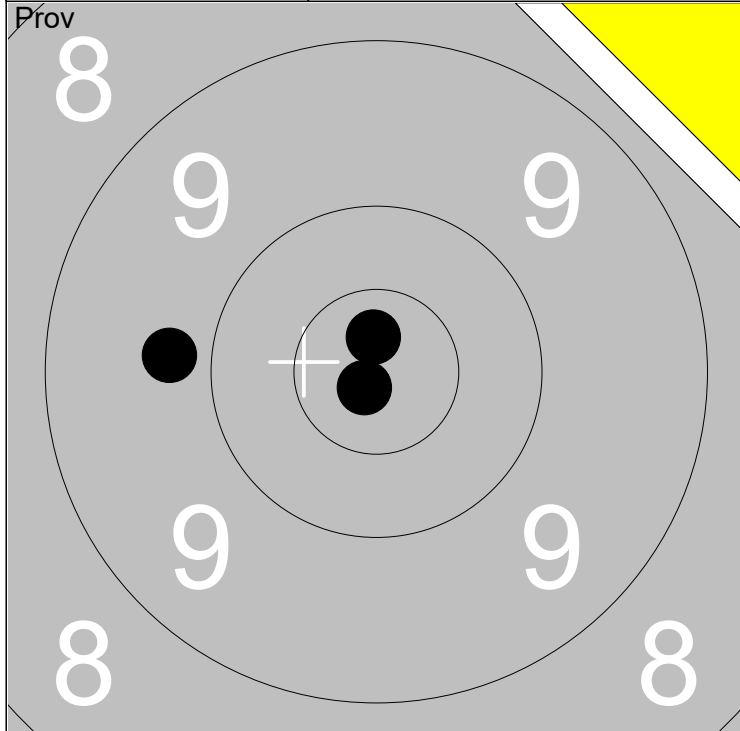

1: 10.8x ↘	Serie	29
2: 9.8 ←		
3: 10.8x ↑		
Total		189

1: 10.0 ←	Serie	48
2: 10.8x ↙		
3: 10.6x ↗		
4: 9.7 ←		
5: 9.8 ↘		
Total		237

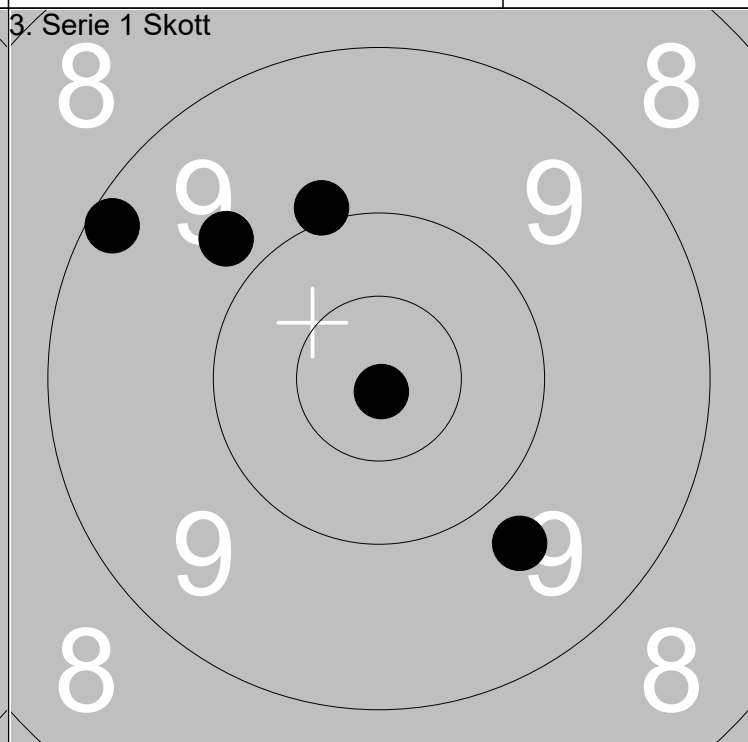
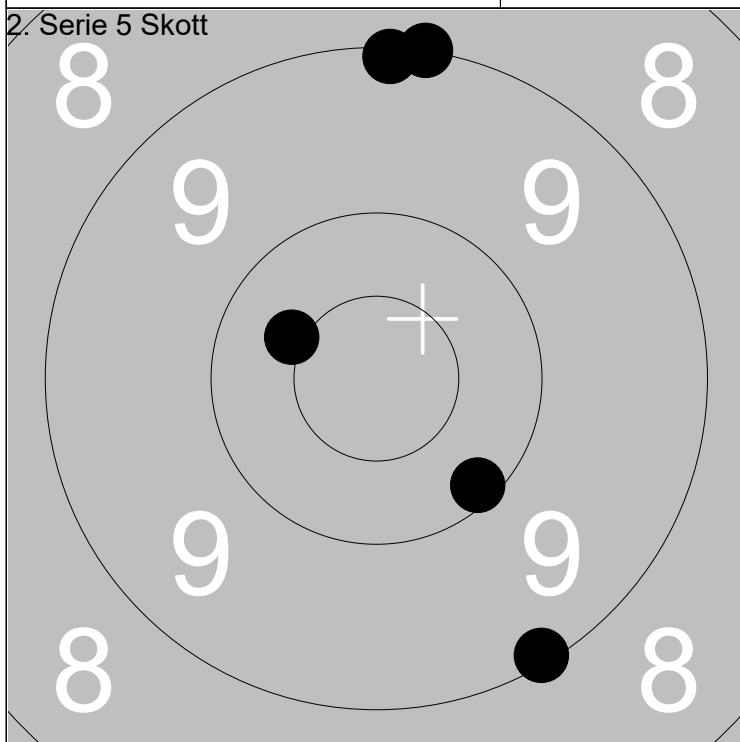

1: 10.1 ↘	Serie	47
2: 9.1 ↘		
3: 10.4x ↗		
4: 9.1 ↑		
5: 9.0 ↑		
Total		284

1: 9.8 ↗	Serie	46
2: 9.7 ↘		
3: 9.2 ↗		
4: 10.9x ↘		
5: 9.9 ↗		
Total		330

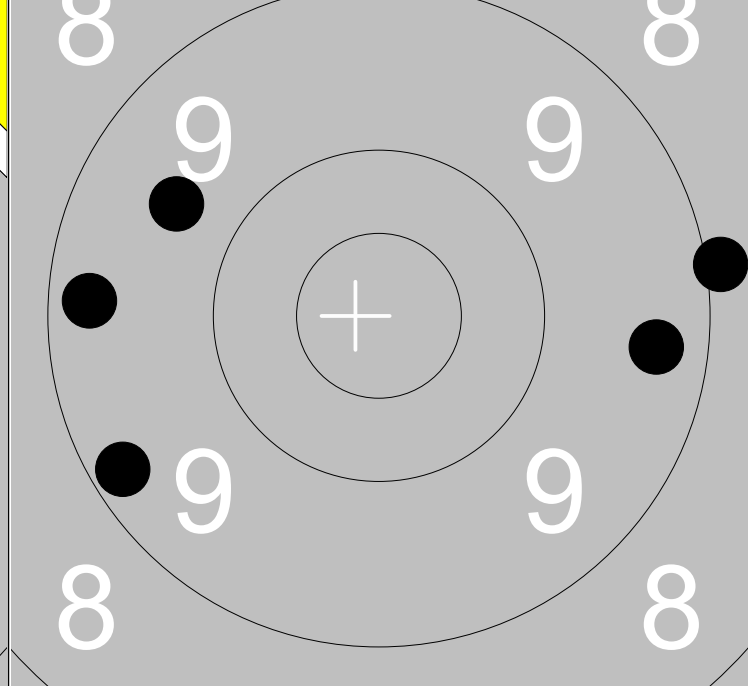
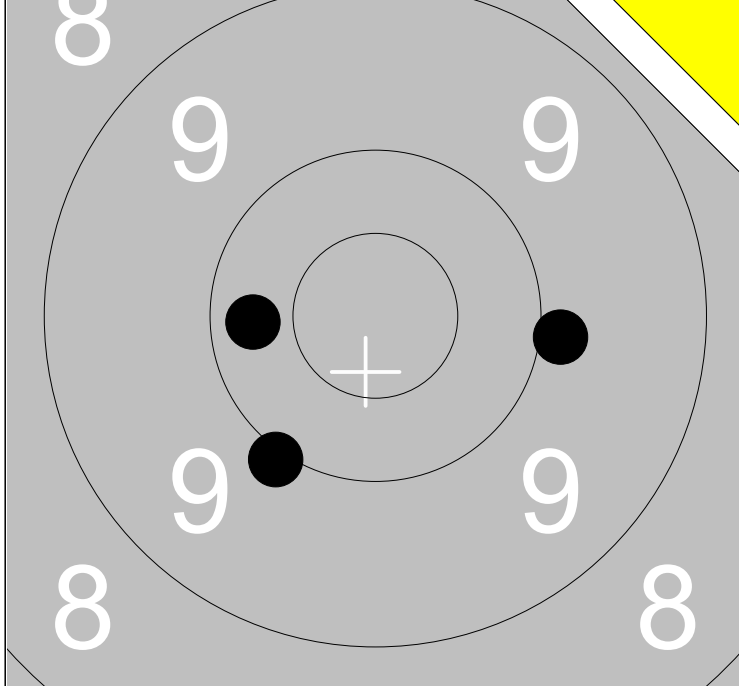

1: 9.9 →	Serie 29
2: 10.3 ←	
3: 10.0 ↙	
Total 194	

1: 9.6 ↗	Serie 44
2: 9.3 →	
3: 8.9 →	
4: 9.3 ←	
5: 9.2 ↙	
Total 238	

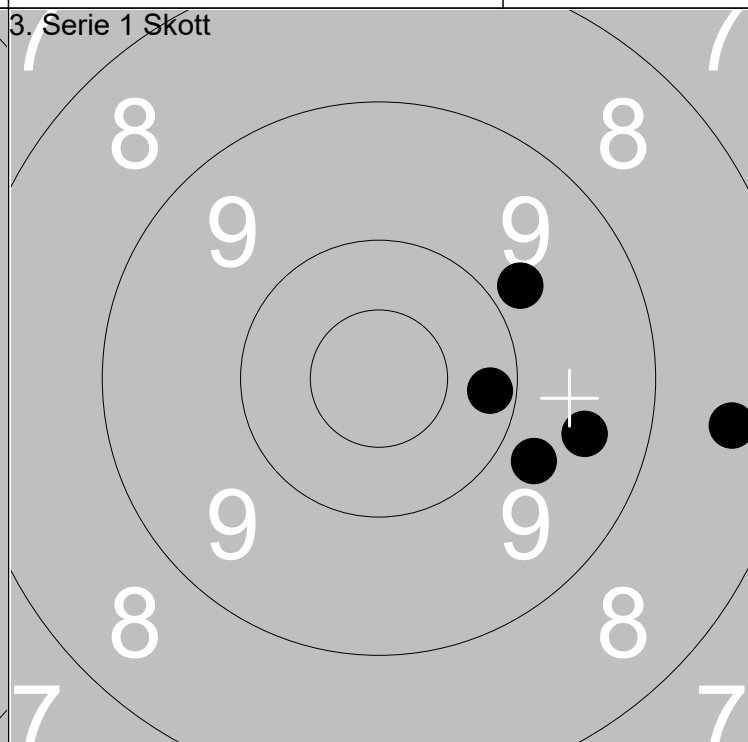
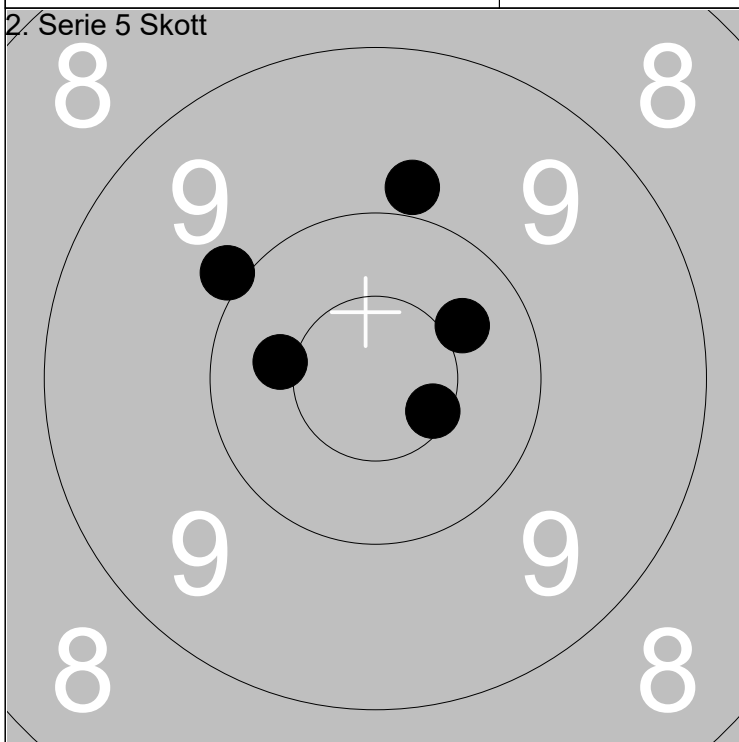

1: 10.4 ↗	Serie 48
2: 9.9 ↗	
3: 9.9 ↑	
4: 10.4 ←	
5: 10.6x ↘	
Total 286	

1: 9.8 →	Serie 45
2: 8.5 →	
3: 9.8 ↗	
4: 9.5 →	
5: 10.2 →	
Total 331	

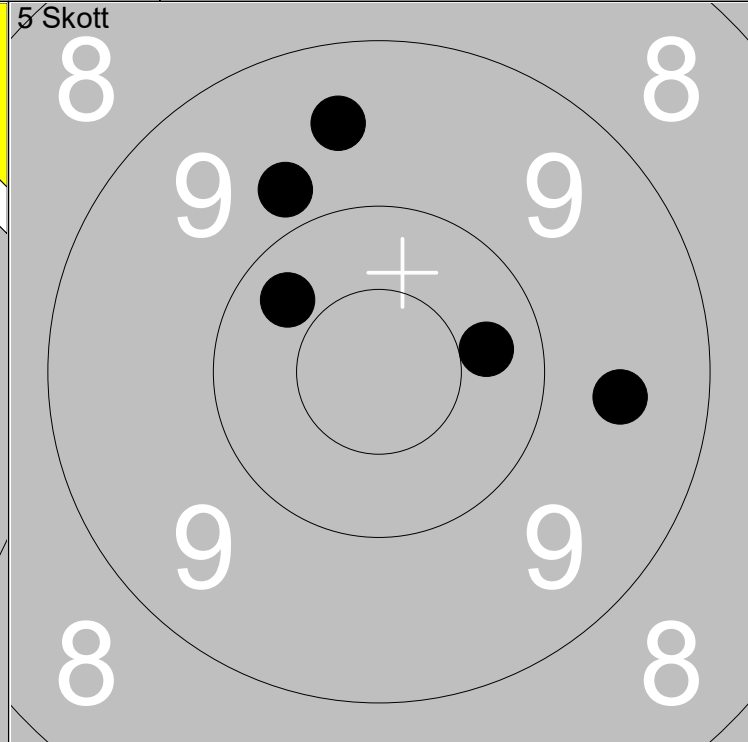
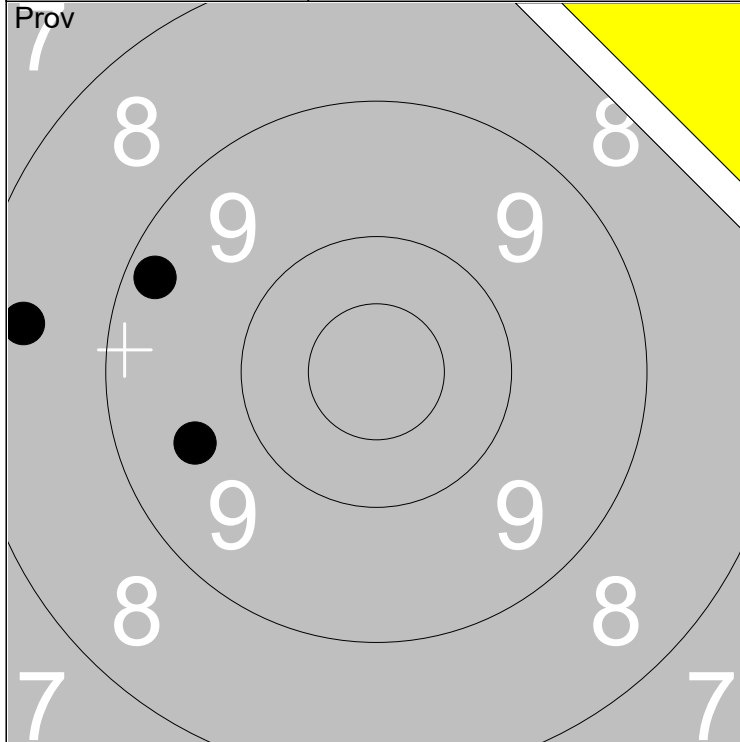

1: 9.6 ←		Serie	26
2: 8.4 ←			
3: 9.3 ↖			
Total		193	

1: 9.6 →		Serie	47
2: 10.3 ↗			
3: 9.5 ↑			
4: 9.8 ↗			
5: 10.3 →			
Total		240	

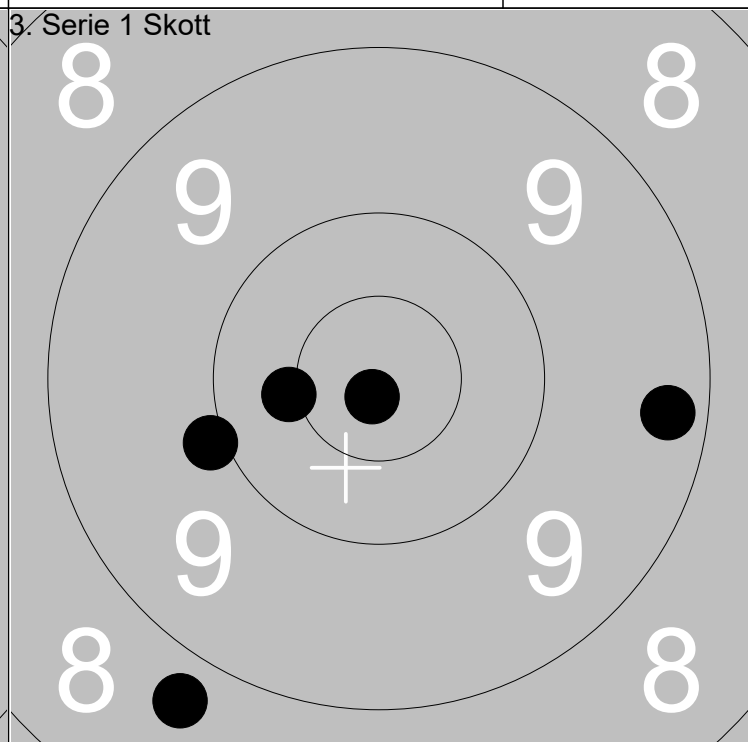
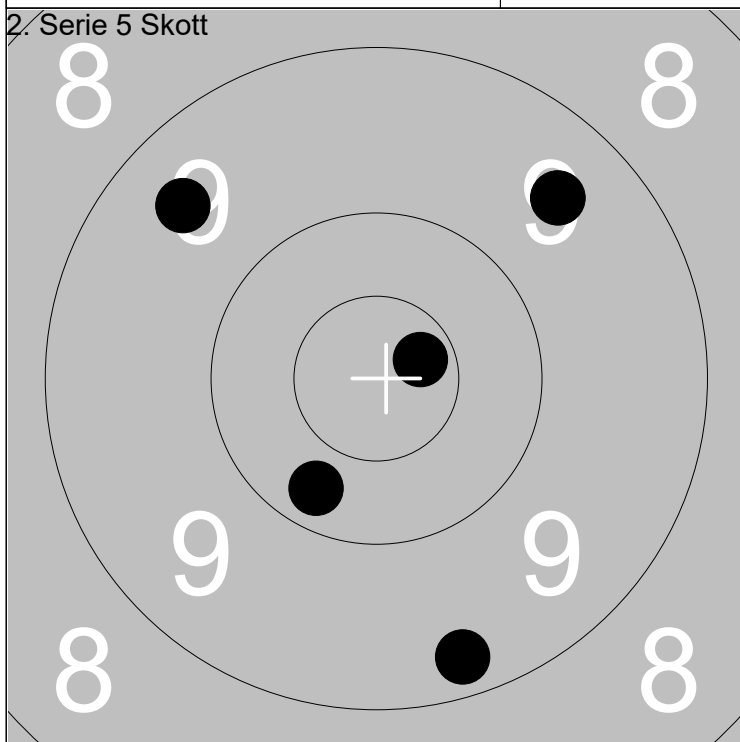

1: 9.5 ↗		Serie	47
2: 9.5 ↖			
3: 10.7x ↗			
4: 10.3 ↘			
5: 9.3 ↘			
Total		287	

1: 10.4x ←		Serie	46
2: 9.3 →			
3: 9.9 ←			
4: 10.8x ↘			
5: 8.7 ↘			
Total		333	

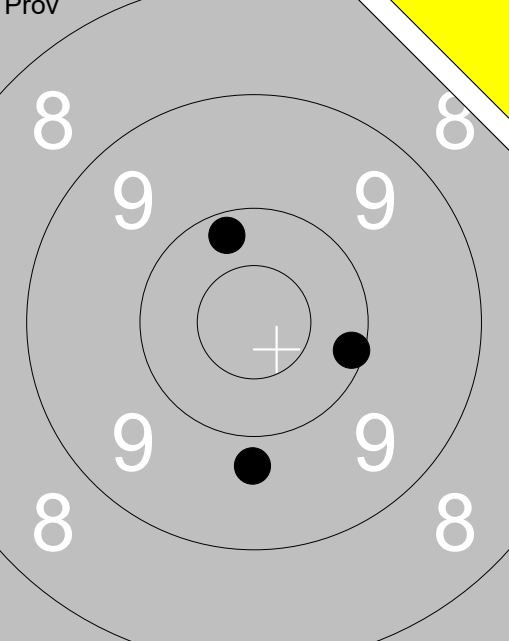
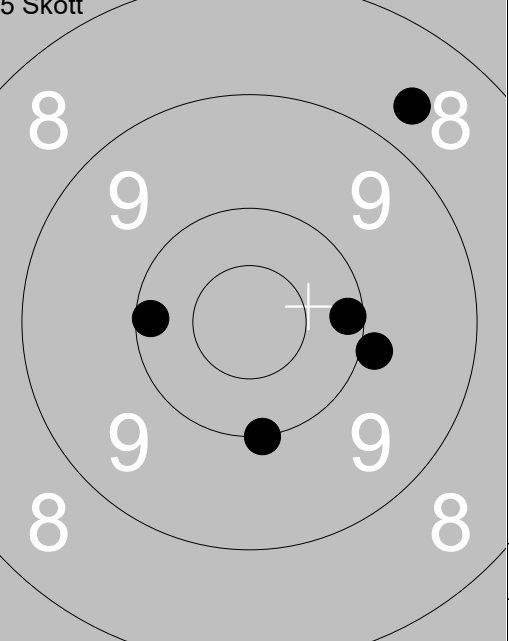
<p>Prov</p> 	<p>1: 9.8 ↓ 2: 10.1 → 3: 10.2 ↑</p>	<p>5 Skott</p> 	<p>1: 10.0 ↓ 2: 9.9 → 3: 8.7 ↗ 4: 10.1 → 5: 10.1 ←</p>
Serie 29.0		Serie 47.0	
Total 193.0		Total 240.0	

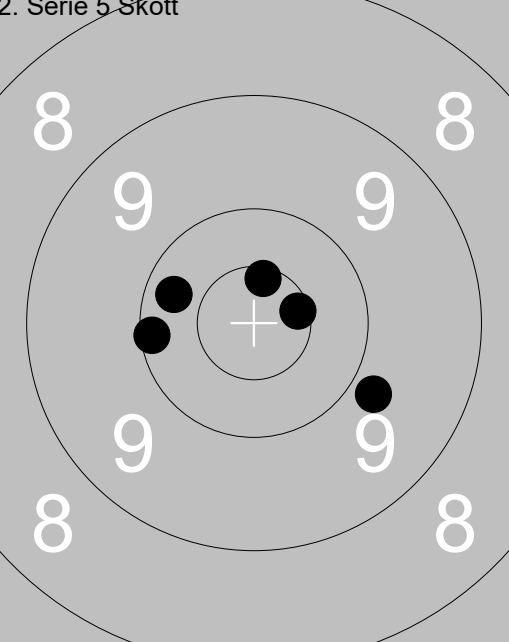
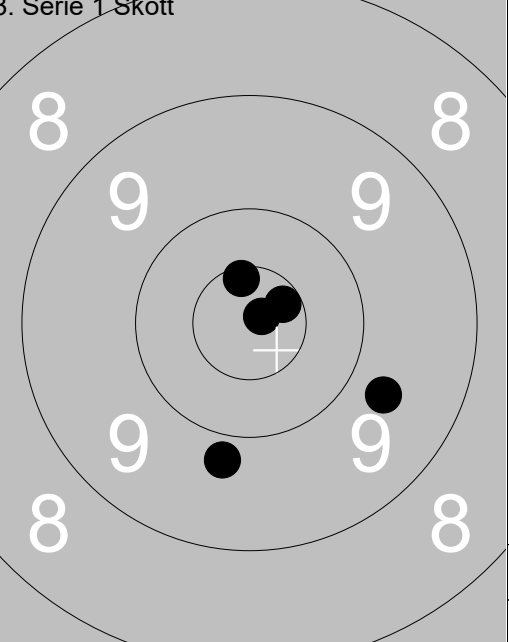
<p>2. Serie 5 Skott</p> 	<p>1: 10.3 ← 2: 10.6x → 3: 9.8 → 4: 10.1 ← 5: 10.6x ↑</p>	<p>3. Serie 1 Skott</p> 	<p>1: 10.6x ↗ 2: 9.7 → 3: 10.8x ↗ 4: 9.8 ↓ 5: 10.6x ↑</p>
Serie 49.0		Serie 48.0	
Total 289.0		Total 337.0	

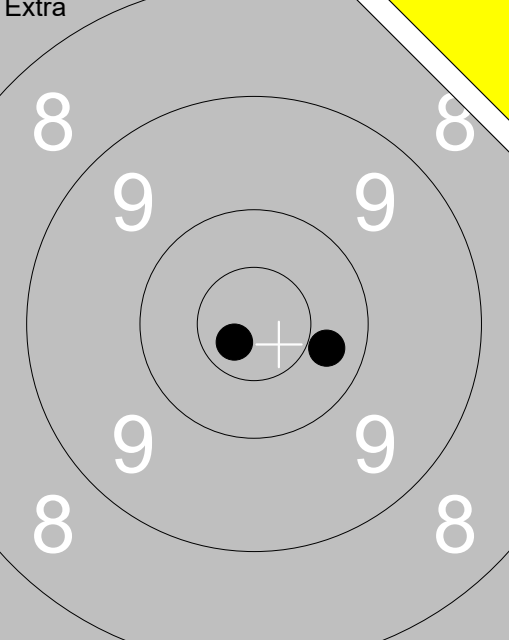
<p>Extra</p> 	<p>1: 10.7x ↘ 2: 10.3 →</p>		
Serie 20.0			
Total 337.0			

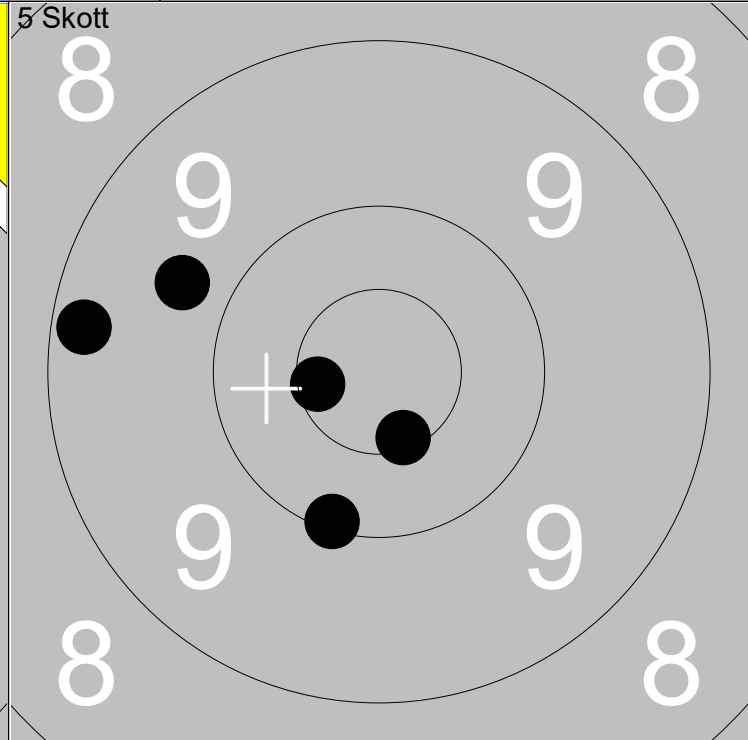
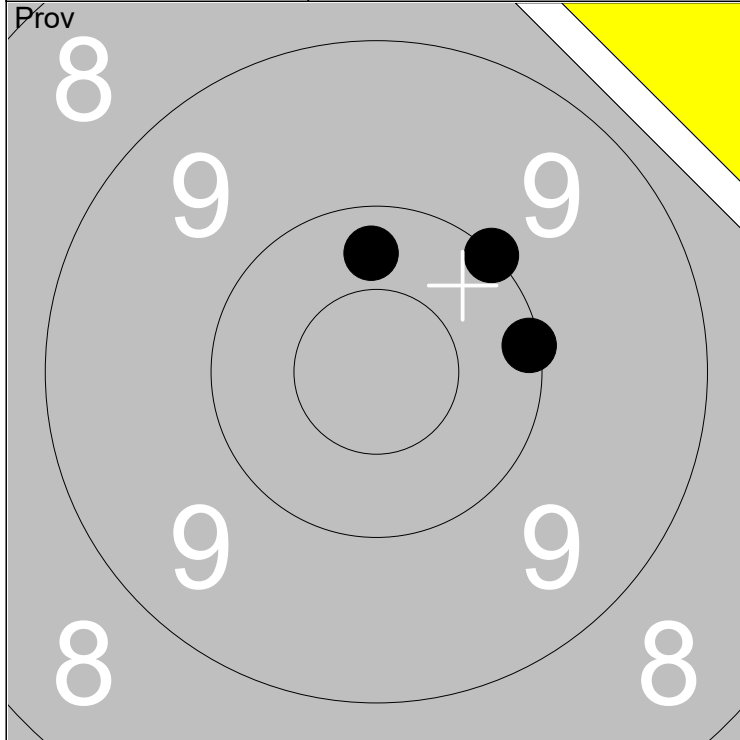

1: 10.1 →	Serie	30
2: 10.3 ↑		
3: 10.0 ↗		
Total		193

1: 10.6x ↓	Serie	48
2: 9.2 ←		
3: 10.1 ↓		
4: 9.7 ↖		
5: 10.6x ←		
Total		241

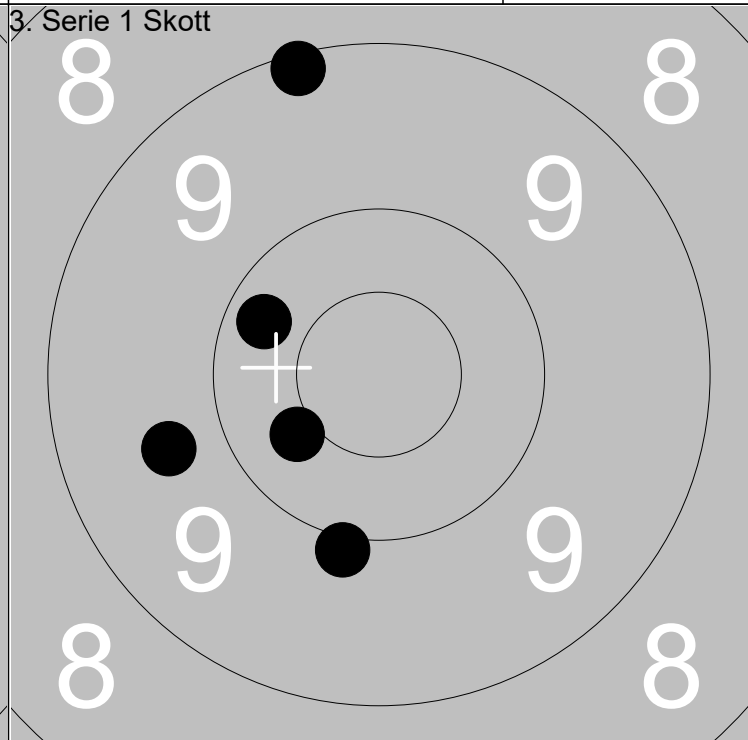
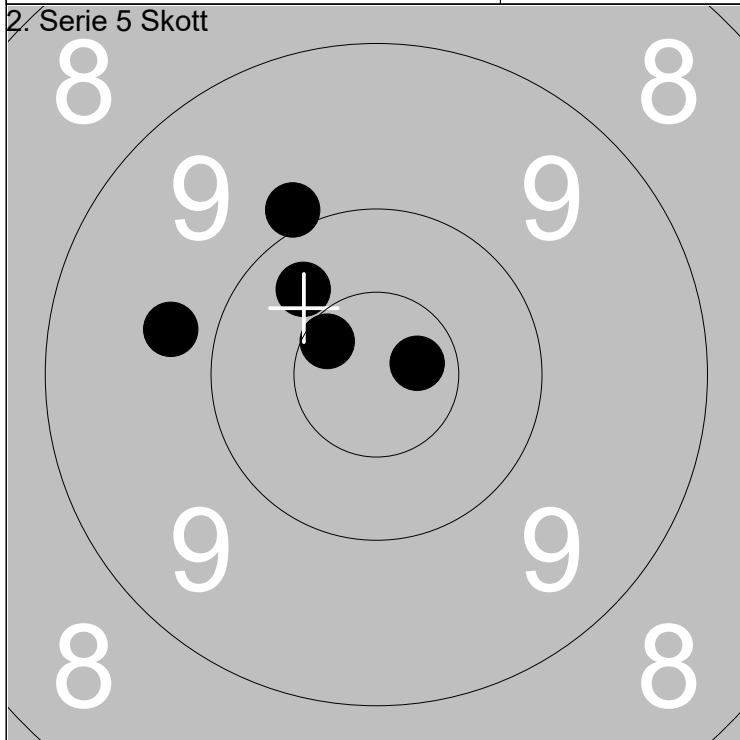

1: 9.9 ↗	Serie	48
2: 10.6x ↗		
3: 10.3 ↗		
4: 9.8 ←		
5: 10.7x →		
Total		289

1: 10.2 ↖	Serie	47
2: 10.4 ↙		
3: 9.7 ←		
4: 9.1 ↑		
5: 9.9 ↓		
Total		336

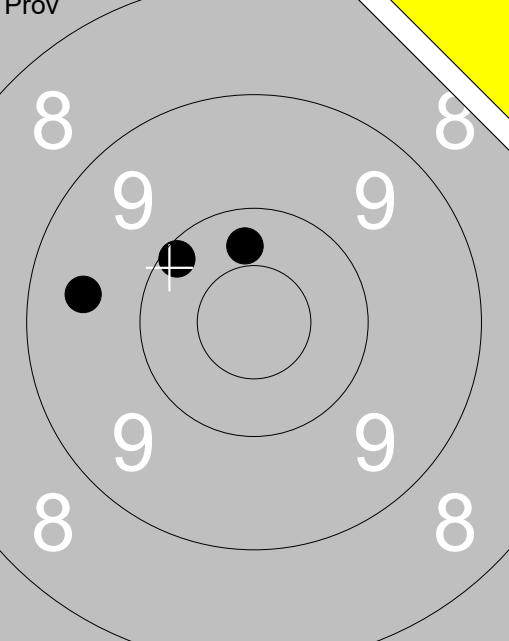
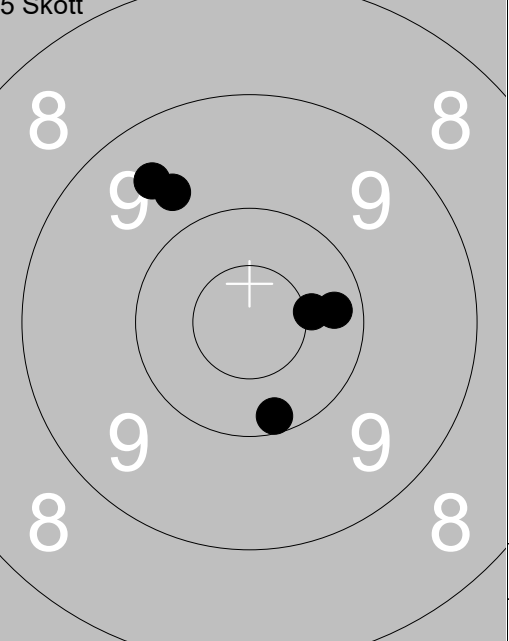
<p>Prov</p> 	<p>1: 10.1 ↖ 2: 9.5 ← 3: 10.3 ↑</p>	<p>5 Skott</p> 	<p>1: 10.3 → 2: 9.7 ↗ 3: 9.5 ↖ 4: 10.4x → 5: 10.2 ↓</p>
Serie 29.0		Serie 48.0	
Total 193.0		Total 241.0	

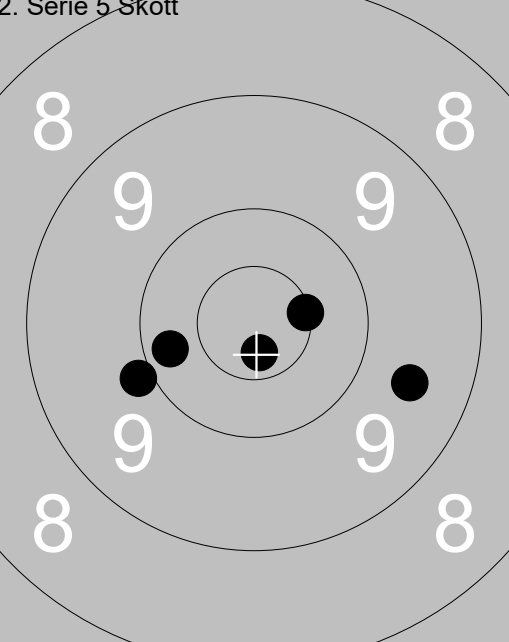
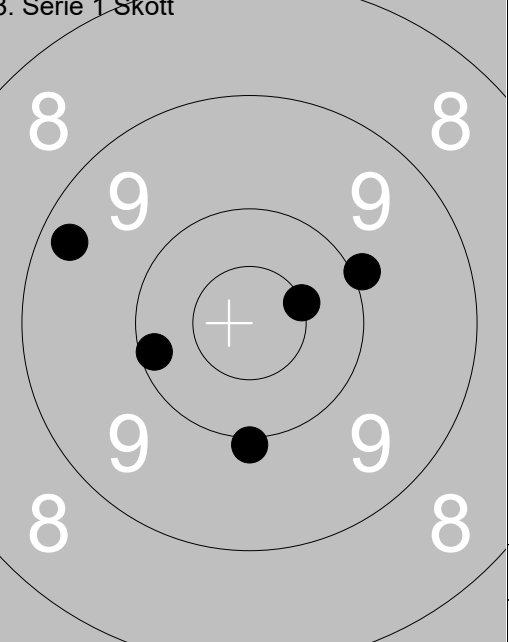
<p>2. Serie 5 Skott</p> 	<p>1: 9.6 → 2: 10.5x → 3: 9.9 ← 4: 10.7x ↓ 5: 10.2 ←</p>	<p>3. Serie 1 Skott</p> 	<p>1: 10.1 ← 2: 9.9 → 3: 10.5x → 4: 9.3 ← 5: 10.0 ↓</p>
Serie 48.0		Serie 48.0	
Total 289.0		Total 337.0	

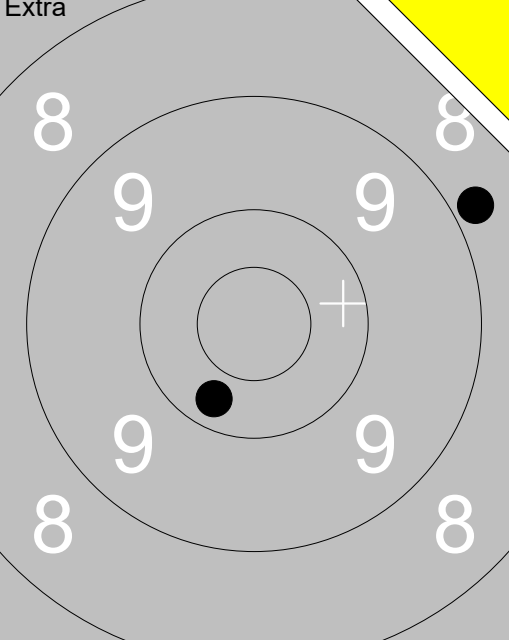
<p>Extra</p> 	<p>1: 10.3 ↓ 2: 8.8 →</p>		
Serie 18.0			
Total 337.0			

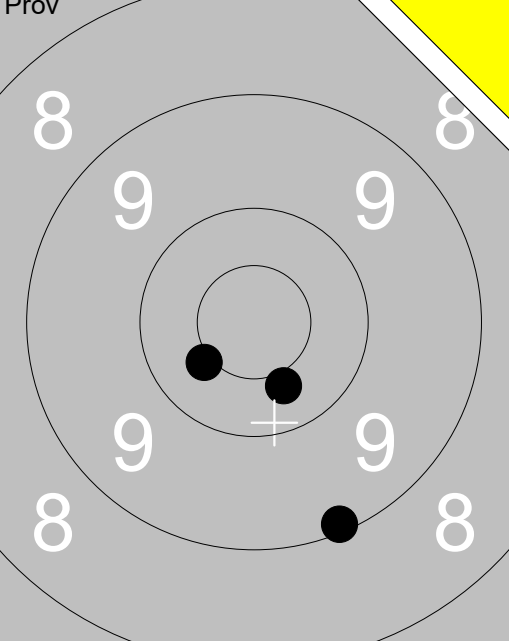
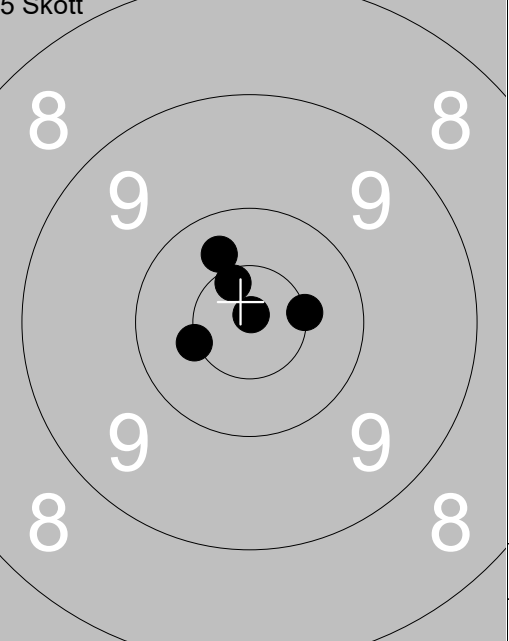
<p>Prov</p>  <p style="text-align: right;">Serie 29.0 Total 192.0</p>	<p>5 Skott</p>  <p style="text-align: right;">Serie 50.0 Total 242.0</p>
---	--

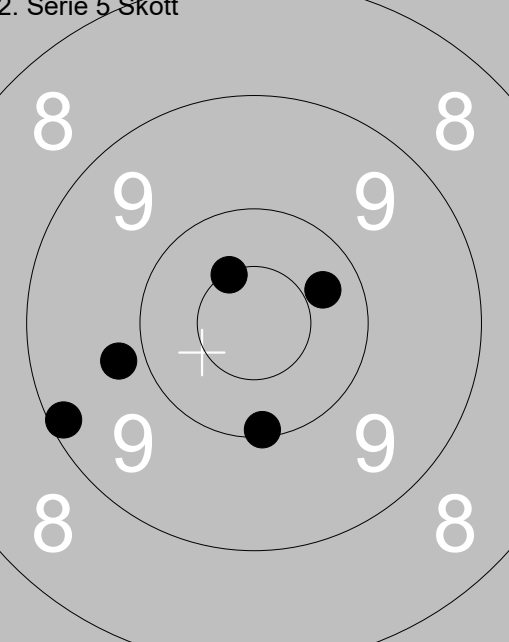
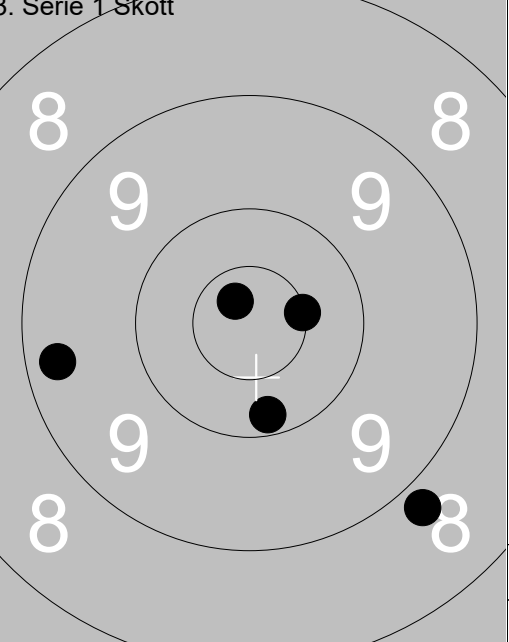
<p>2. Serie 5 Skott</p>  <p style="text-align: right;">Serie 48.0 Total 290.0</p>	<p>3. Serie 1 Skott</p>  <p style="text-align: right;">Serie 47.0 Total 337.0</p>
--	--

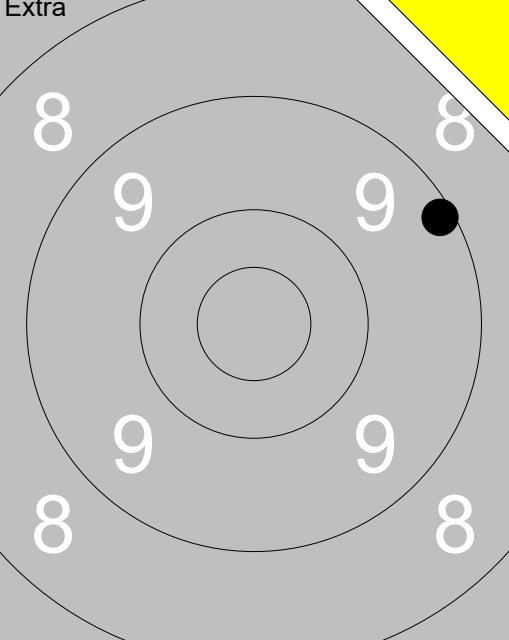
<p>Extra</p>  <p style="text-align: right;">Serie 9.0 Total 337.0</p>	
---	--

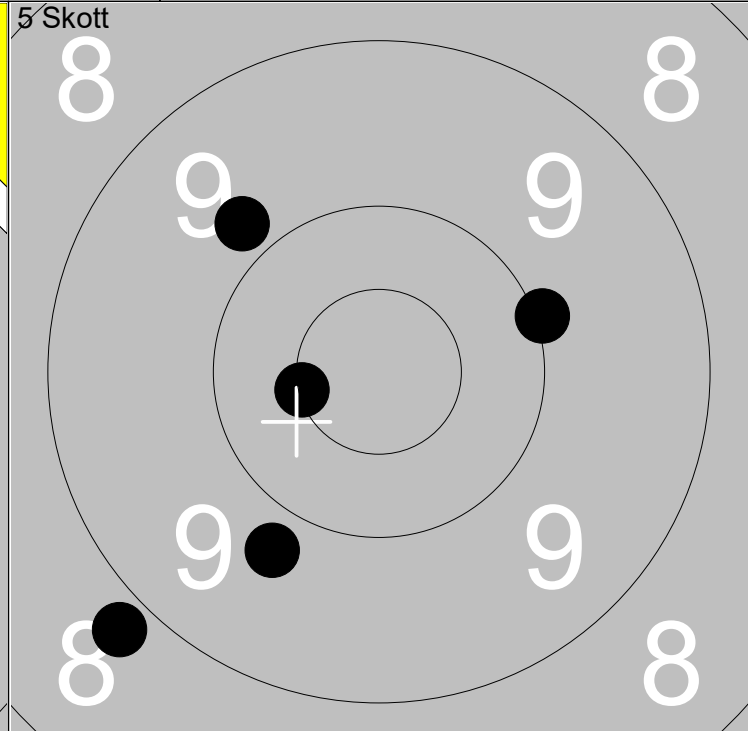
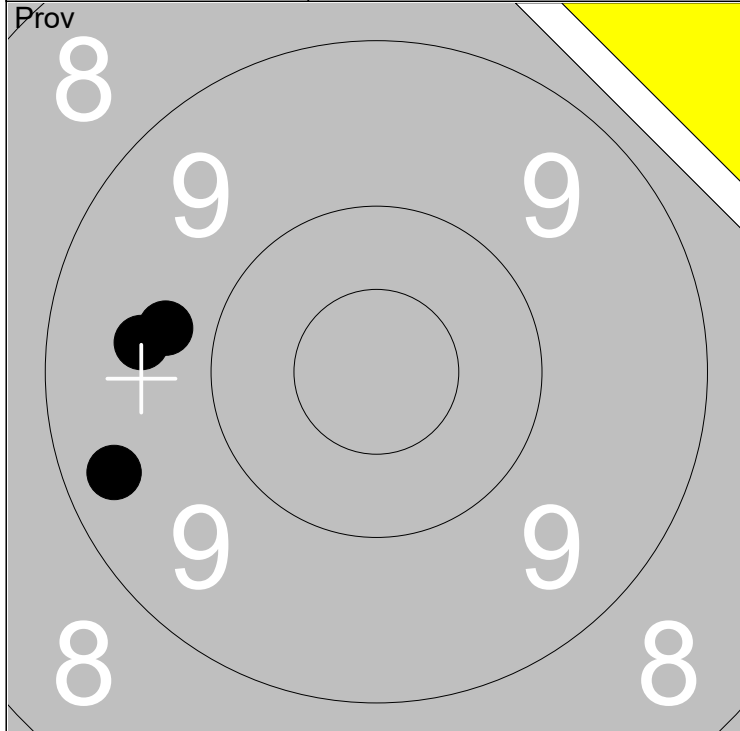

1: 9.7	←
2: 9.3	←
3: 9.6	←

Serie	27
Total	190

1: 10.5x	←
2: 9.8	↙
3: 9.8	↖
4: 10.0	→
5: 8.8	↙

Serie	46
Total	236

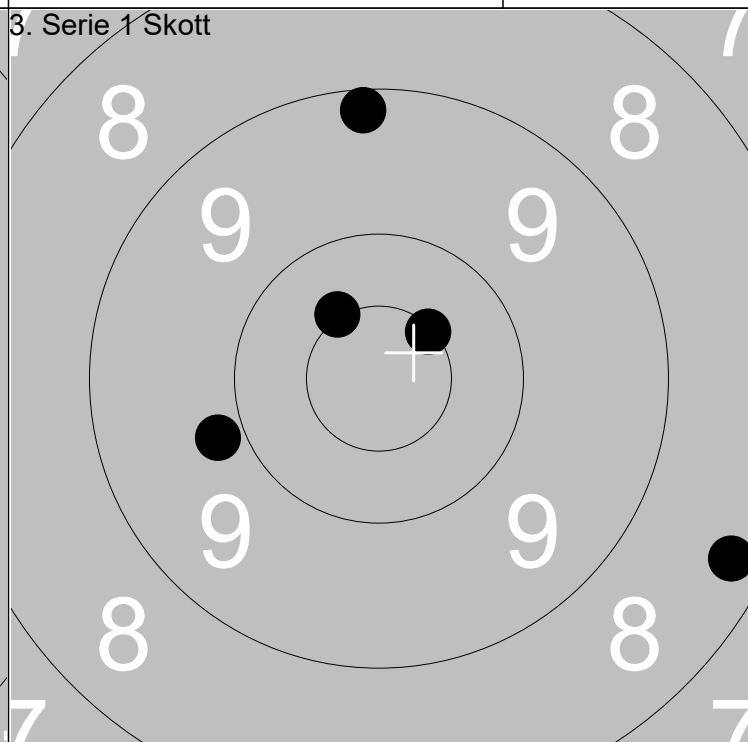
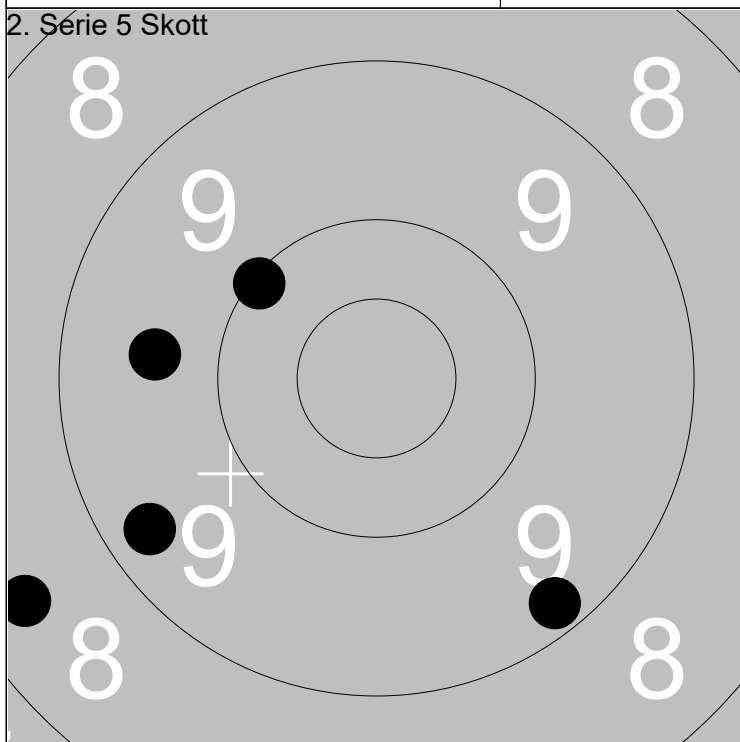

1: 9.3	←
2: 8.4	←
3: 10.1	↗
4: 9.2	↘
5: 9.6	←

Serie	45
Total	281

1: 9.8	←
2: 10.5x	↗
3: 8.3	→
4: 9.2	↑
5: 10.5x	↖

Serie	46
Total	327

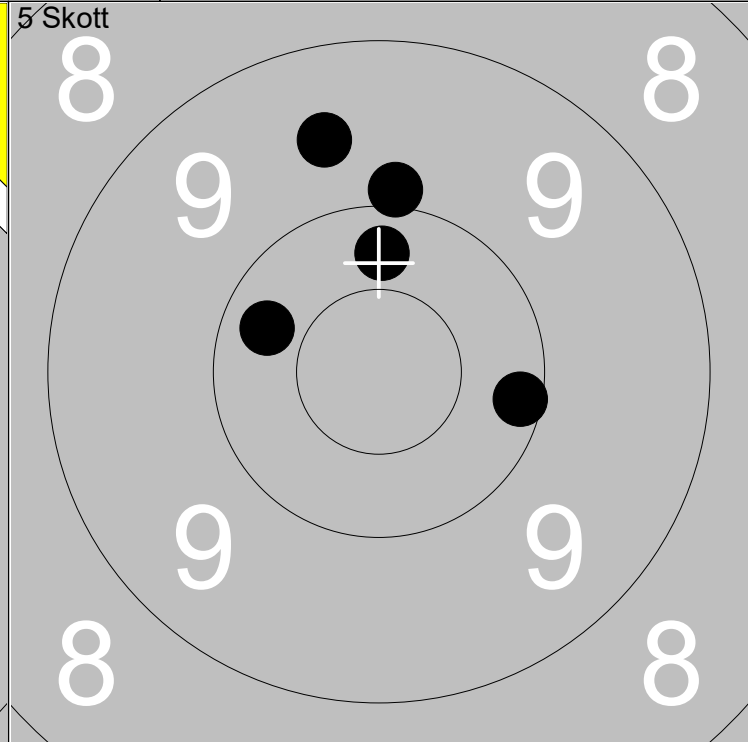
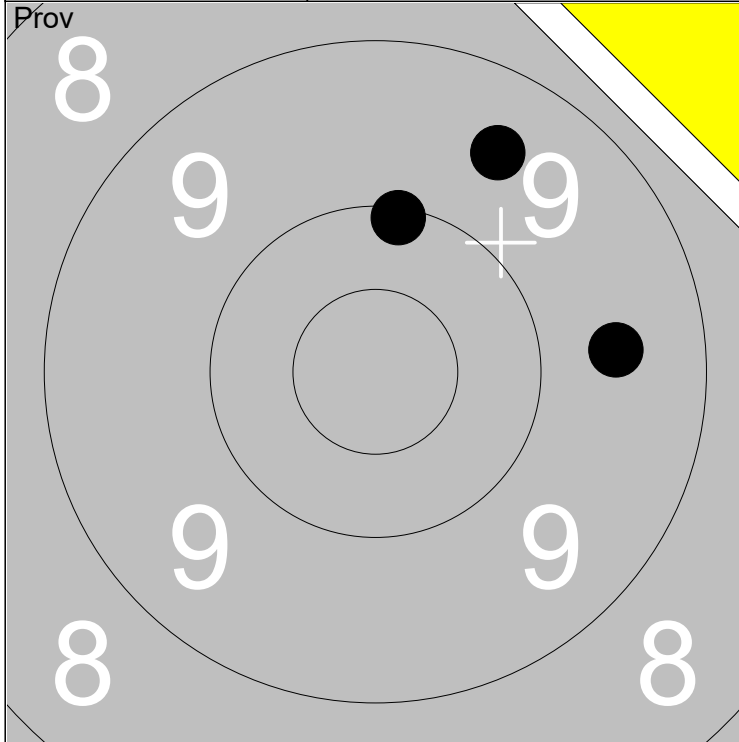

1: 9.6	→				
2: 9.5	↗				
3: 10.1	↑				
		Serie	28		
		Total	189		

1: 9.6	↑				
2: 9.9	↑				
3: 10.1	→				
4: 10.3	↖				
5: 10.3	↑				
		Serie	48		
		Total	237		

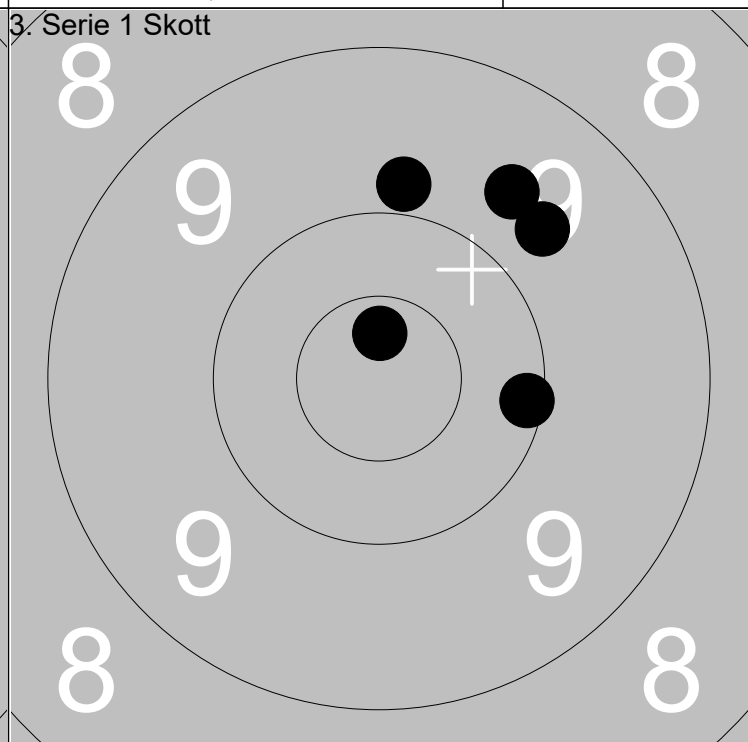
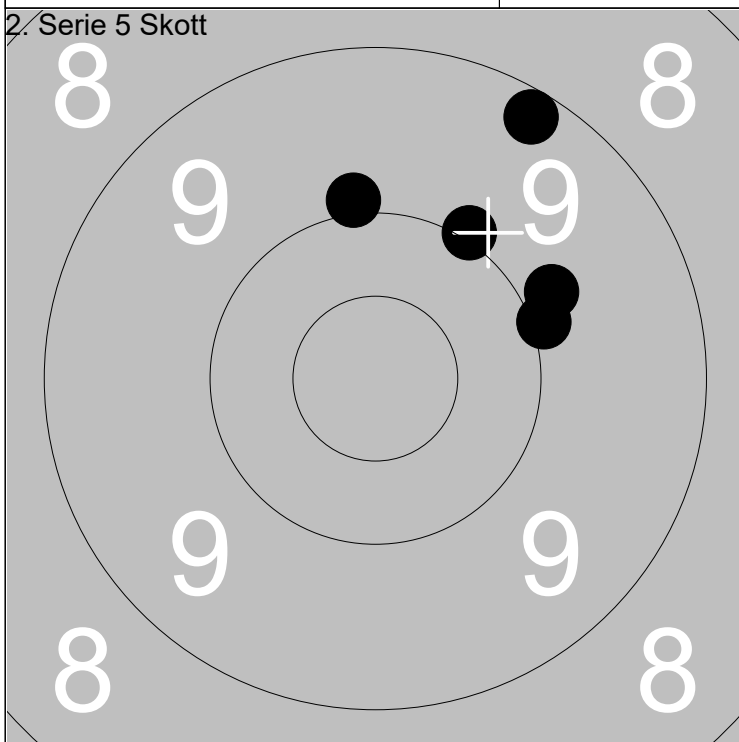

1: 9.2	↗				
2: 10.0	↗				
3: 9.9	↑				
4: 10.0	→				
5: 9.8	→				
		Serie	47		
		Total	284		

1: 9.7	↗				
2: 10.1	→				
3: 9.6	↗				
4: 9.8	↑				
5: 10.7x	↑				
		Serie	47		
		Total	331		

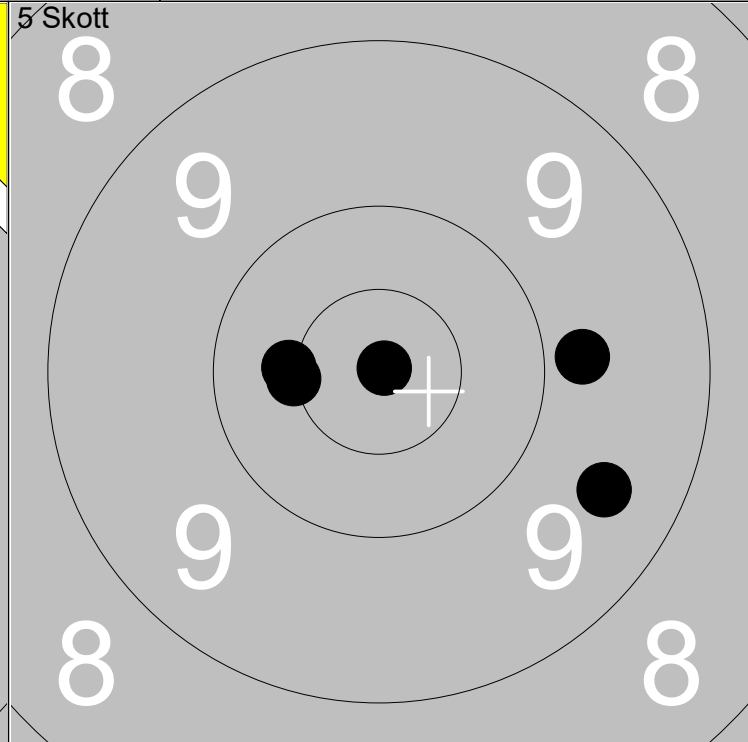
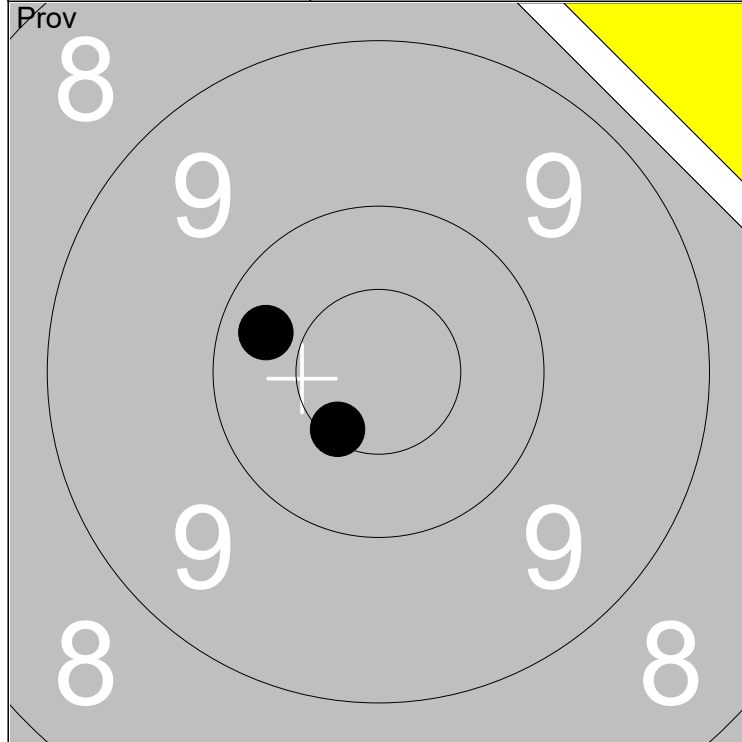

1: 10.3 ↙	Serie 20
2: 10.6x ↘	
Total 188	

1: 10.9x ↗	Serie 48
2: 9.8 →	
3: 10.4x ←	Total 236
4: 10.5x ←	
5: 9.5 ↘	

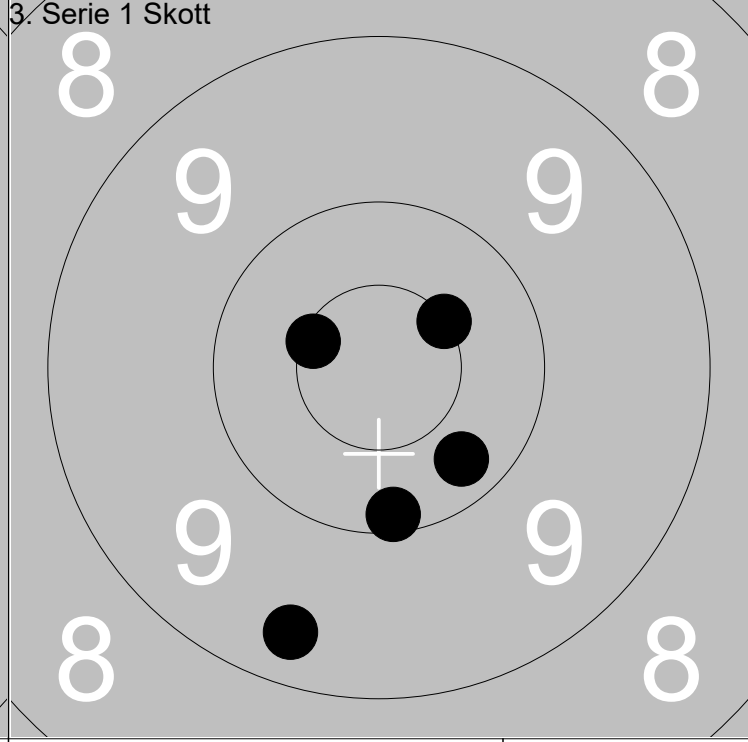
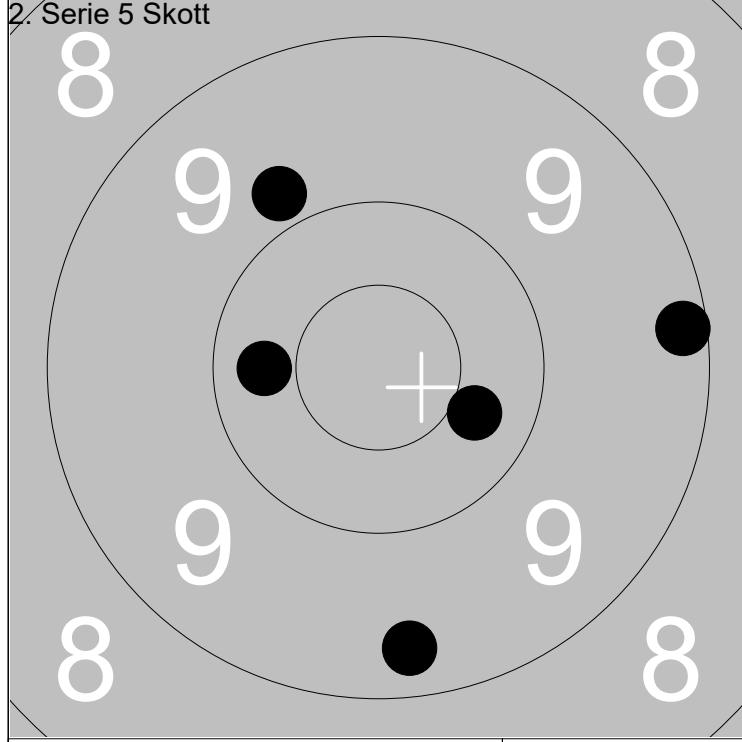

1: 9.8 ↗	Serie 47
2: 10.3 ←	
3: 10.4 →	Total 283
4: 9.3 ↓	
5: 9.2 →	

1: 9.3 ↓	Serie 49
2: 10.5x ↗	
3: 10.3 ↘	Total 332
4: 10.6x ←	
5: 10.1 ↓	

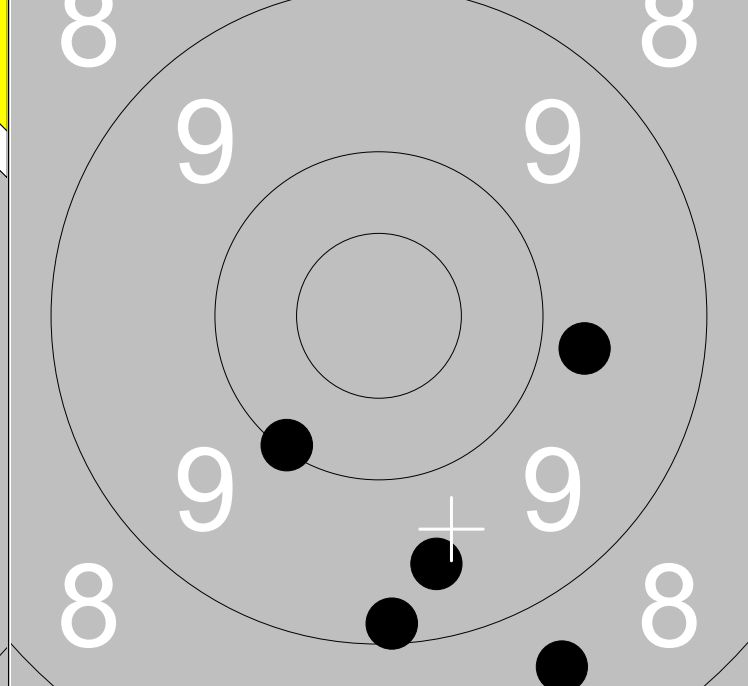
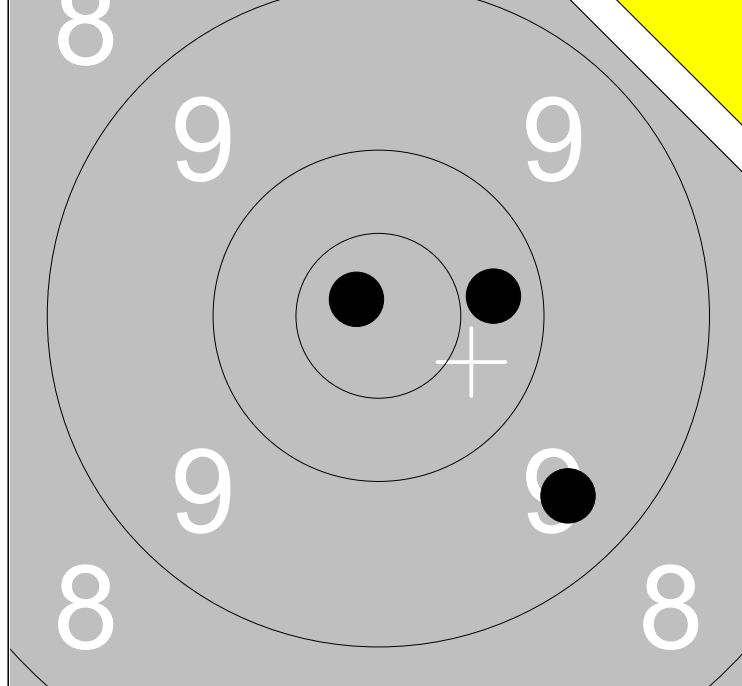

1: 10.8x ↗	Serie	29
2: 10.3 →		
3: 9.5 ↘		
Total		186

1: 9.5 ↓	Serie	45
2: 10.1 ↙		
3: 9.8 →		
4: 8.6 ↘		
5: 9.2 ↓		
Total		231

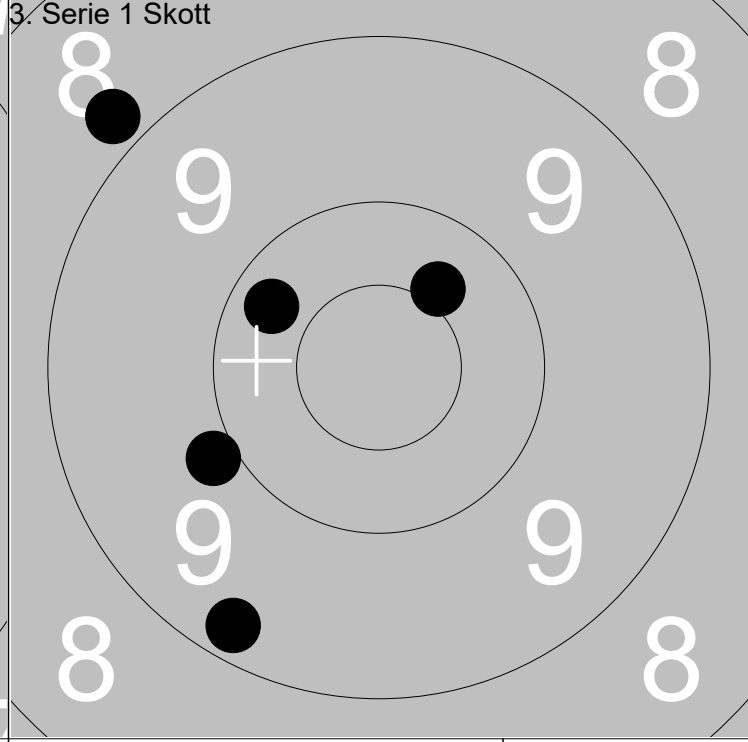
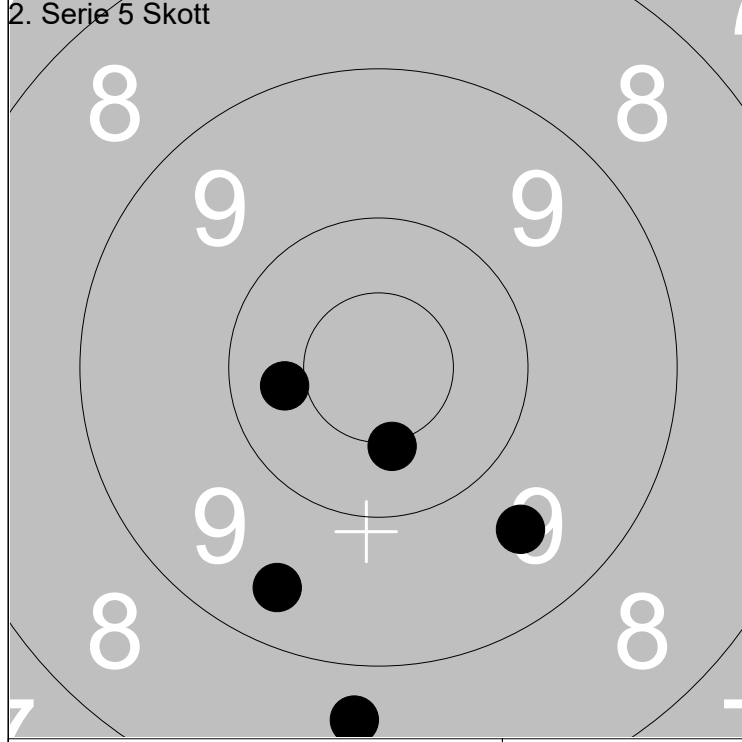

1: 10.5x ↓	Serie	46
2: 8.7 ↓		
3: 10.4 ←		
4: 9.6 ↘		
5: 9.4 ↙		
Total		277

1: 8.8 ↖	Serie	46
2: 10.4 ↗		
3: 9.9 ↙		
4: 10.3 ↖		
5: 9.2 ↘		
Total		323

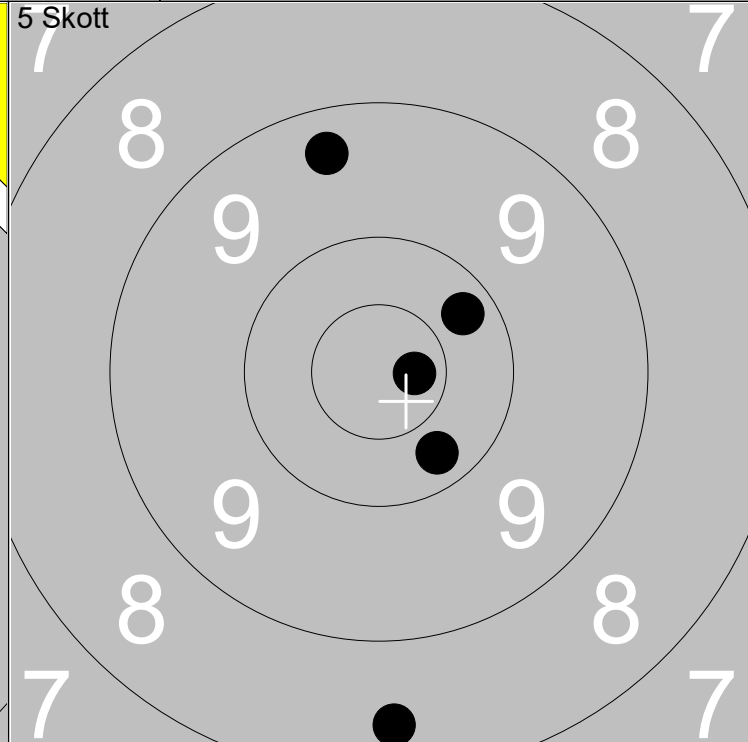
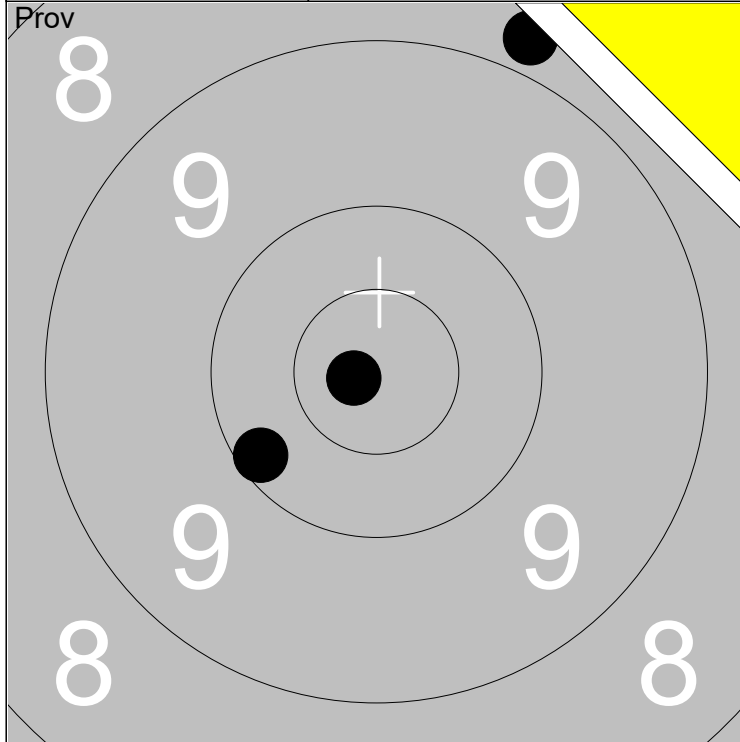

1: 10.2 ↙	Serie	28
2: 10.8x ←		
3: 8.8 ↗		
Total		184

1: 9.4 ↖	Serie	47
2: 10.2 ↗		
3: 10.7x →		
4: 10.3 ↘		
5: 8.4 ↓		
Total		231

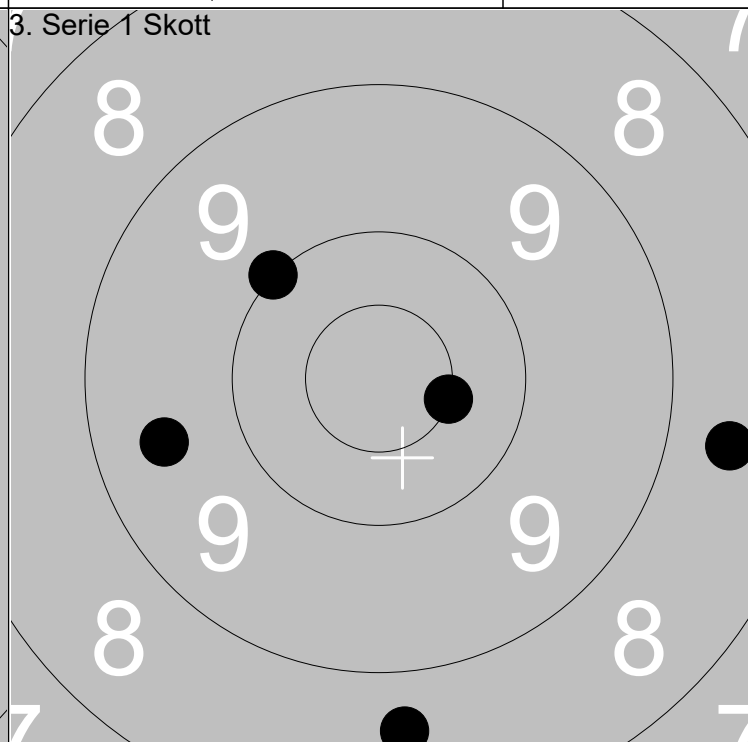
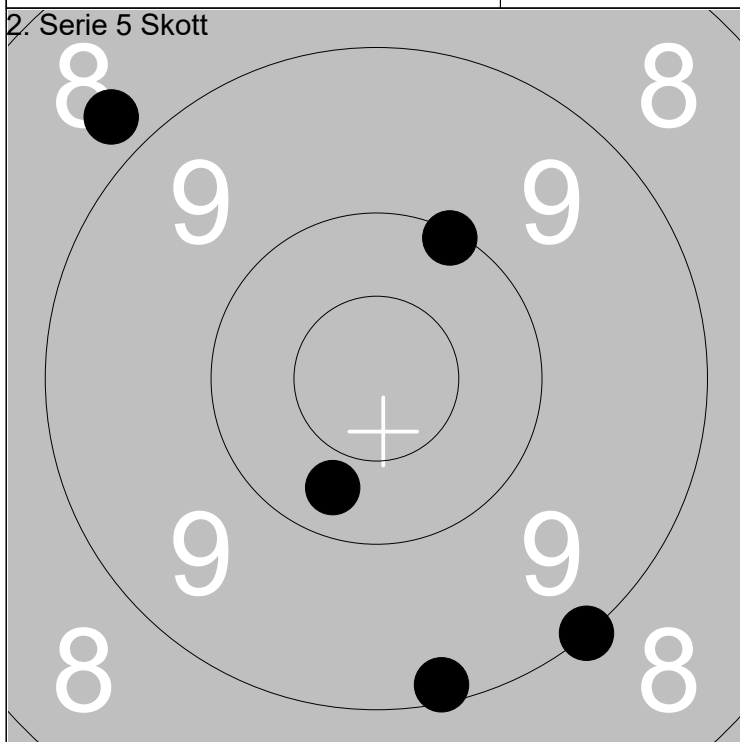

1: 10.1 ↗	Serie	46
2: 8.8 ↗		
3: 9.0 ↘		
4: 10.3 ↘		
5: 9.1 ↓		
Total		277

1: 8.6 →	Serie	45
2: 10.0 ↗		
3: 10.5x →		
4: 9.5 ←		
5: 8.6 ↓		
Total		322

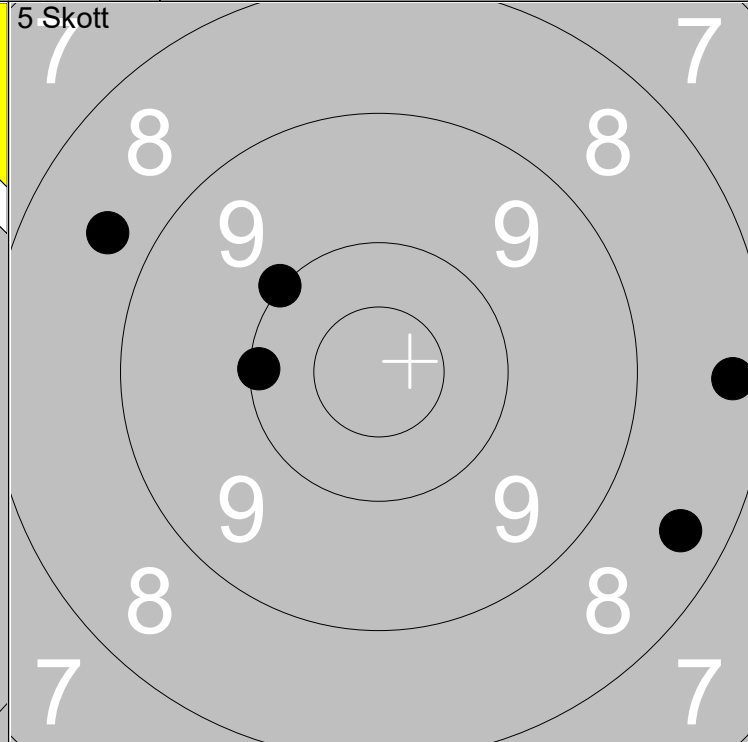
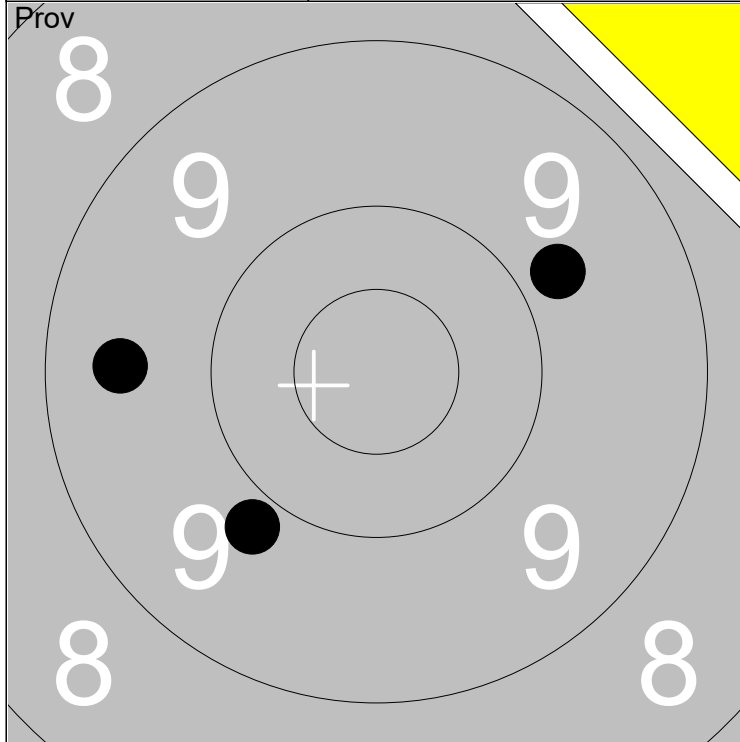

1: 9.8 ↙	Serie	27
2: 9.5 ←		
3: 9.8 ↗		
Total		183

1: 10.0 ↗	Serie	44
2: 8.4 ↘		
3: 8.3 →		
Total		227

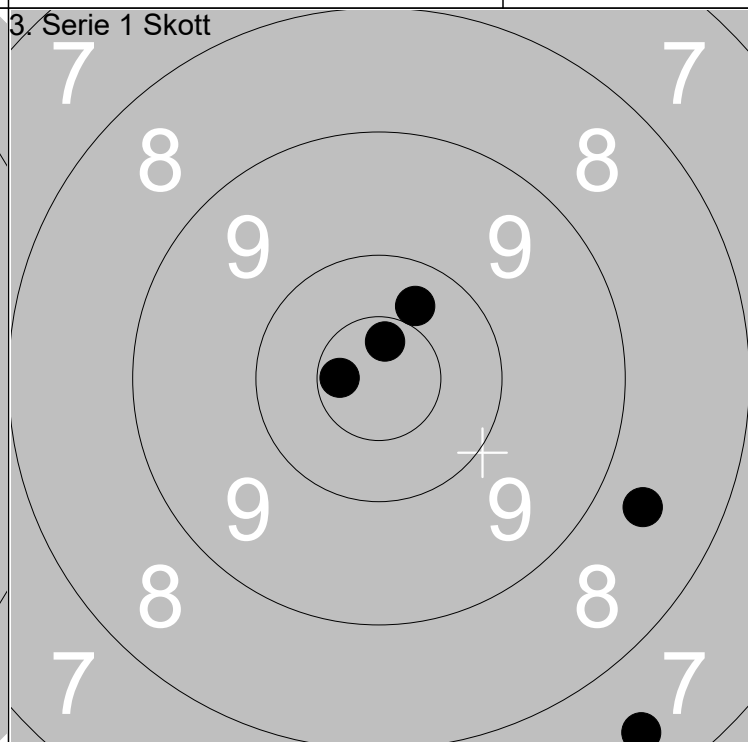
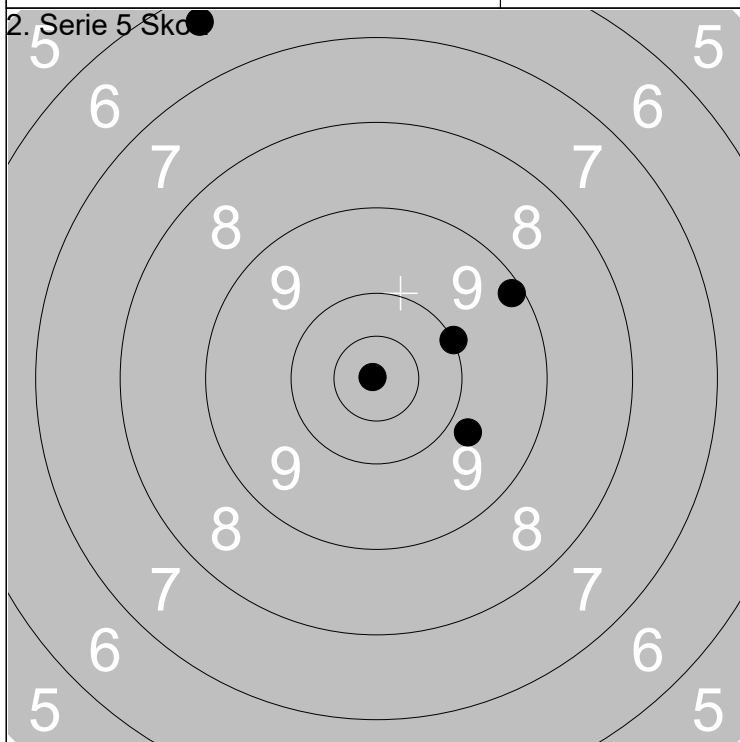

1: 10.9x ←	Serie	44
2: 10.0 ↗		
3: 9.8 ↘		
Total		271

1: 10.7x ←	Serie	45
2: 10.3 ↗		
3: 7.5 ↘		
Total		316

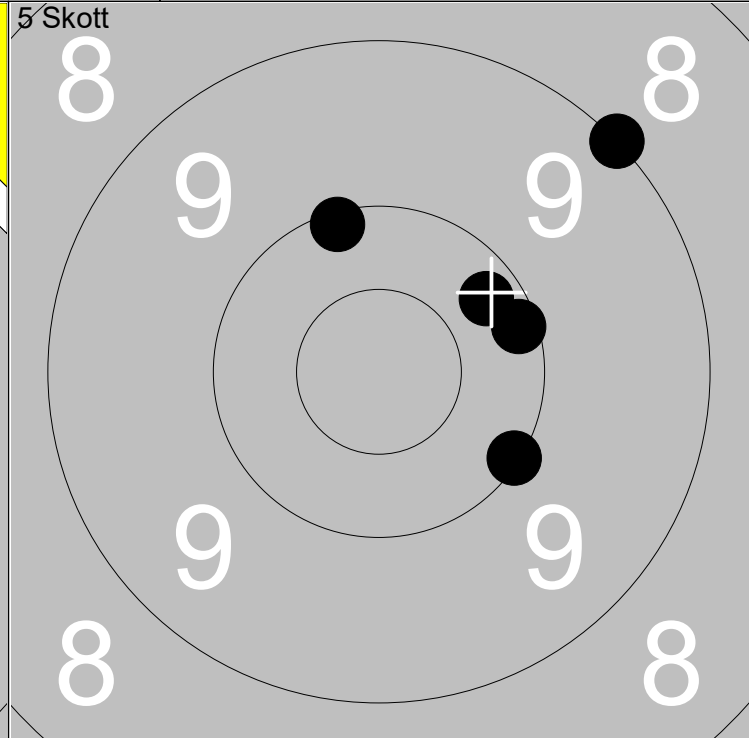
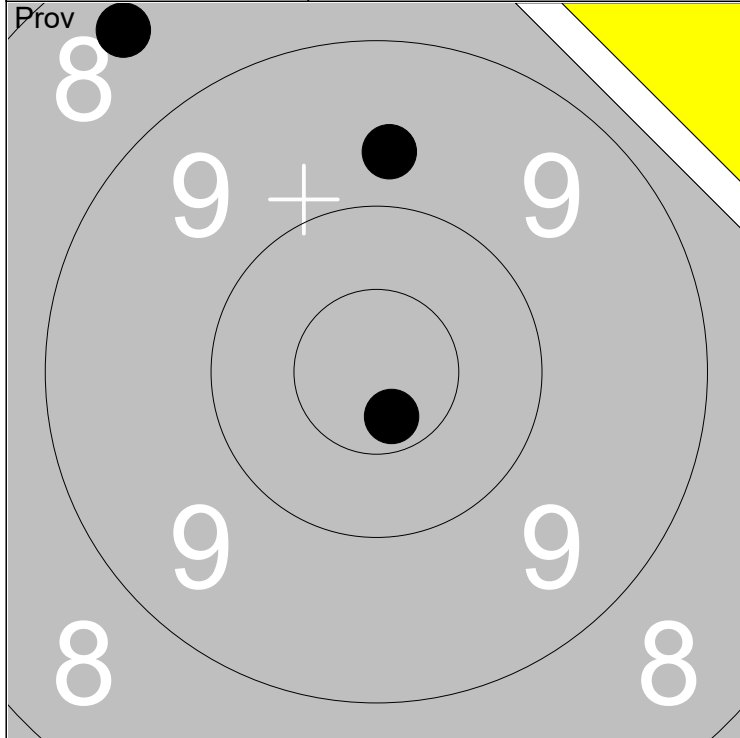

1: 10.7x ↓	
2: 8.5 ↗	Serie 27
3: 9.7 ↑	
Total 183	

1: 10.1 ↘	
2: 10.1 →	Serie 49
3: 9.0 ↗	
4: 10.2 ↗	
5: 10.1 ↑	
Total 232	

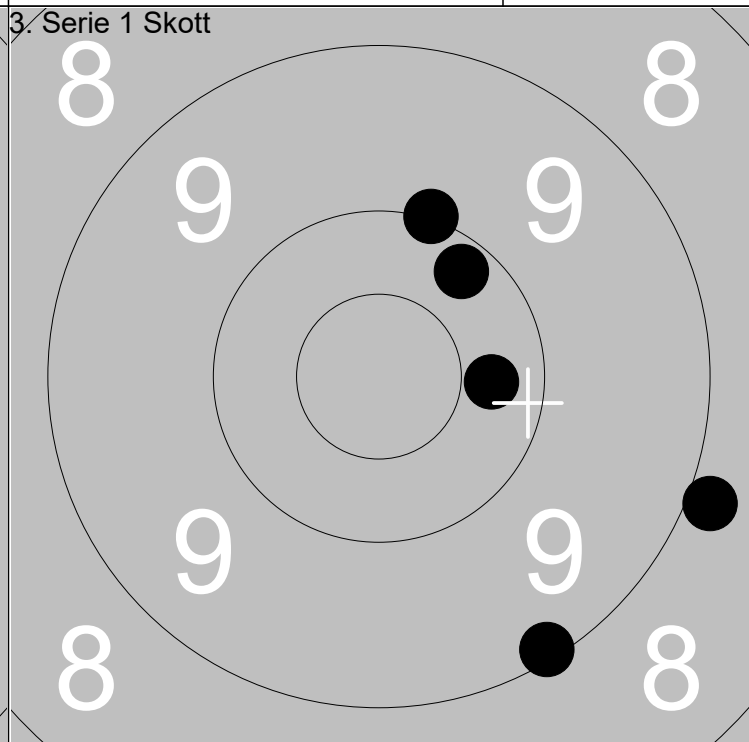
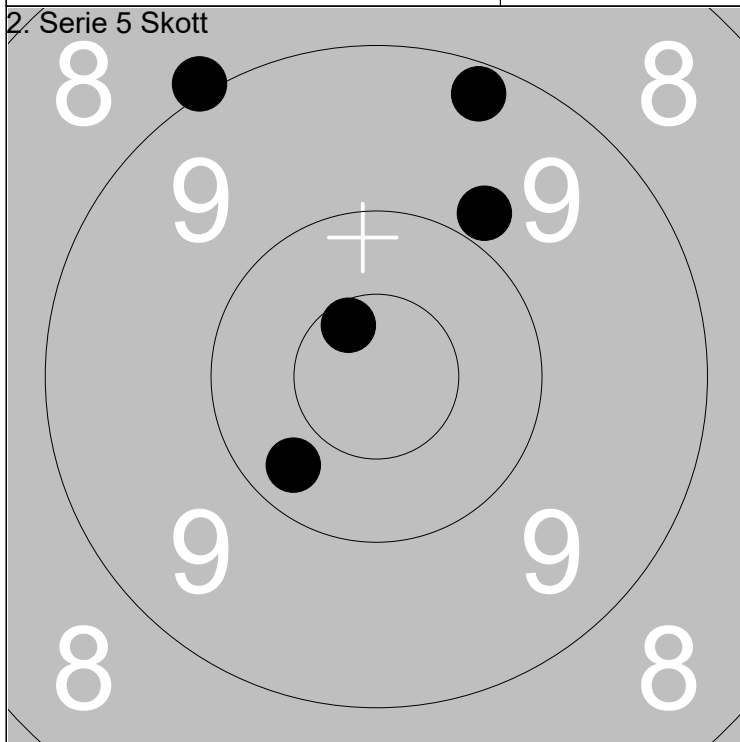

1: 9.8 ↗	
2: 10.3 ↙	Serie 47
3: 9.2 ↑	
4: 9.0 ↗	
5: 10.6x ↘	
Total 279	

1: 10.0 ↗	
2: 9.1 ↙	Serie 47
3: 8.9 →	
4: 10.3 →	
5: 10.2 ↗	
Total 326	