

1:	10.1	↖
2:	10.8x	↗
3:	9.2	↘
Serie		29.0
Total		243.0

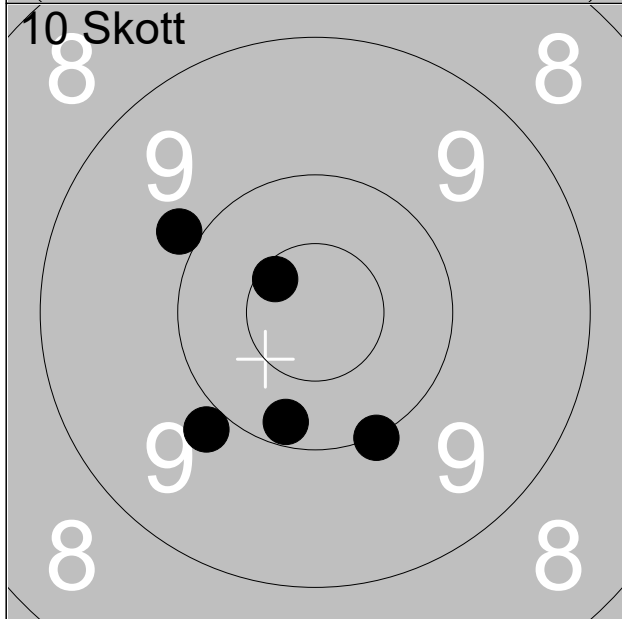

1:	9.9	↖
2:	10.2	↘
3:	9.9	↙
4:	10.0	↘
5:	10.6x	↗
Serie		48.0
Total		291.0

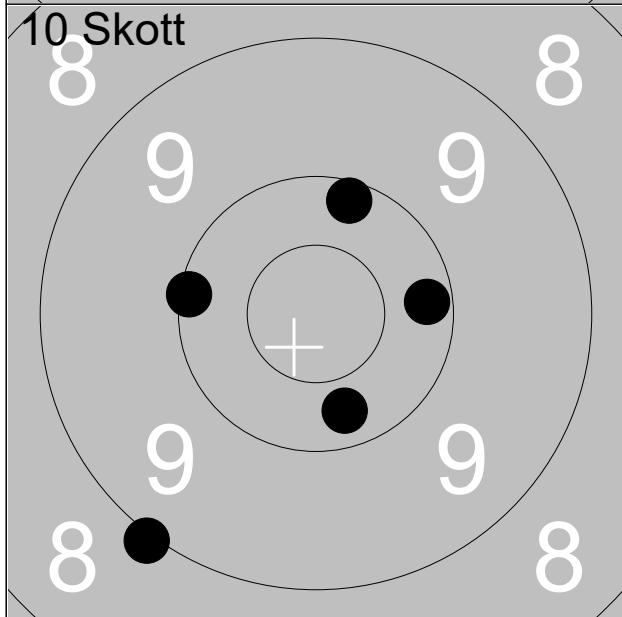

6:	10.2	↑
7:	10.1	←
8:	10.2	→
9:	10.3	↘
10:	9.0	↙
Serie		49.0
Total		340.0

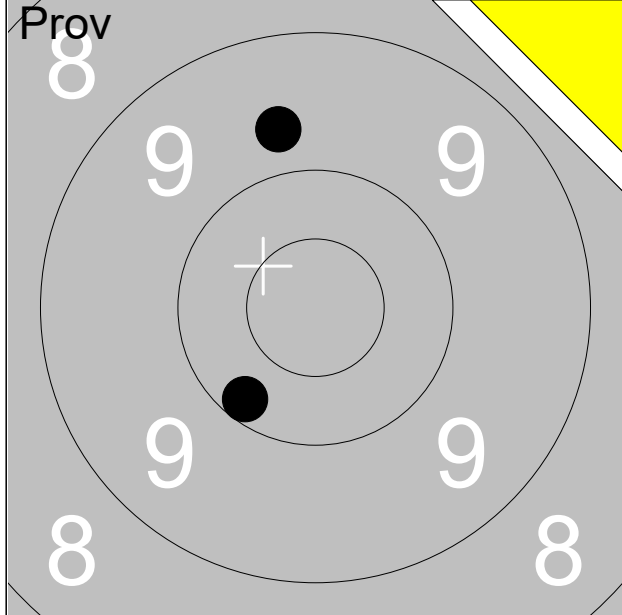

1:	9.7	↑
2:	10.2	↙
Serie		19.0
Total		236.0

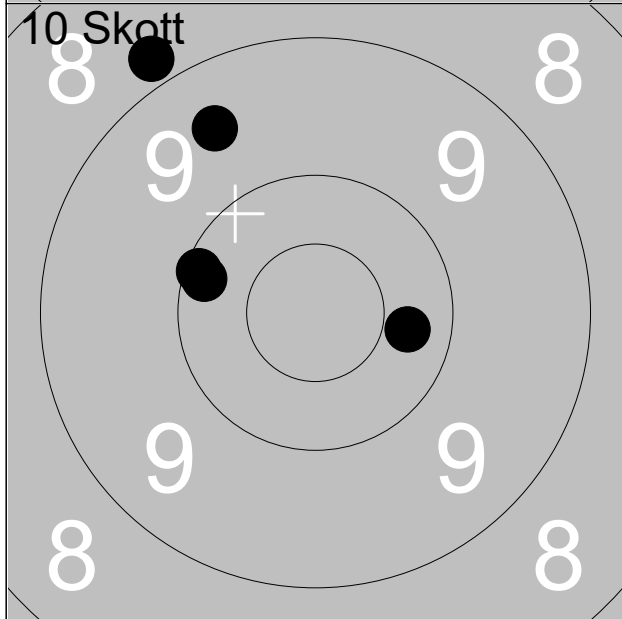

1:	8.8	↗
2:	10.2	↑
3:	10.1	↗
4:	9.5	↗
5:	10.3	↘
Serie		47.0
Total		283.0

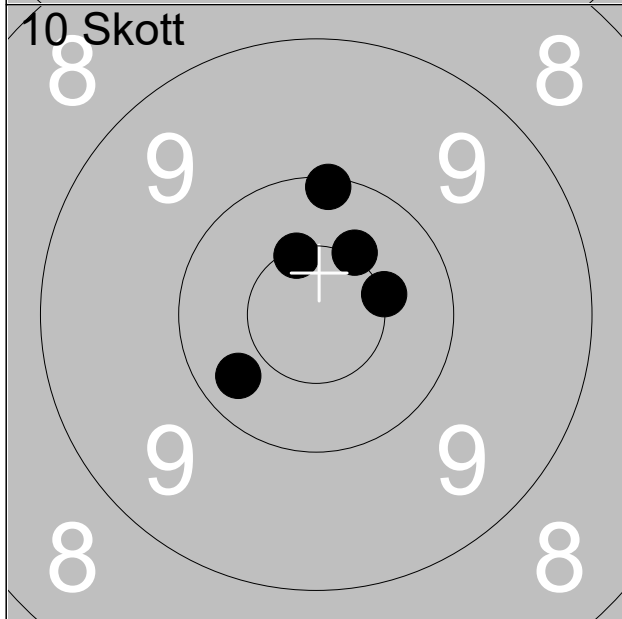

6:	10.5x	↑
7:	10.5x	↗
8:	10.1	↑
9:	10.3	↙
10:	10.5x	→
Serie		50.0
Total		333.0

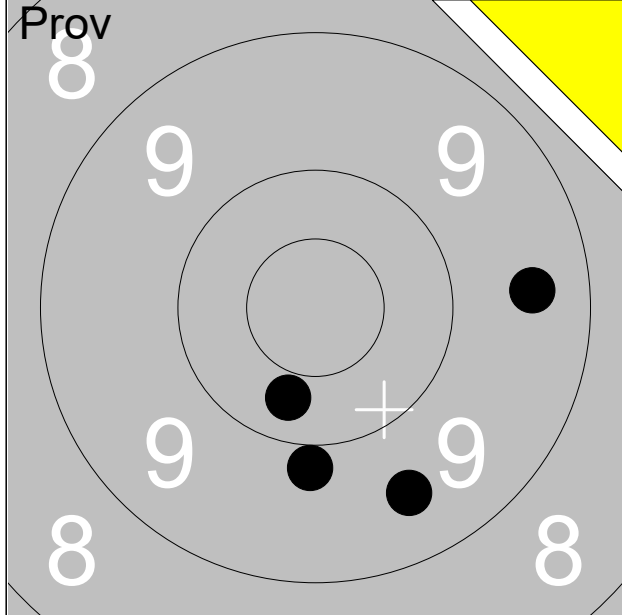

1:	9.4	→
2:	9.5	↘
3:	9.9	↘
4:	10.3	↘
Serie		37.0
Total		233.0

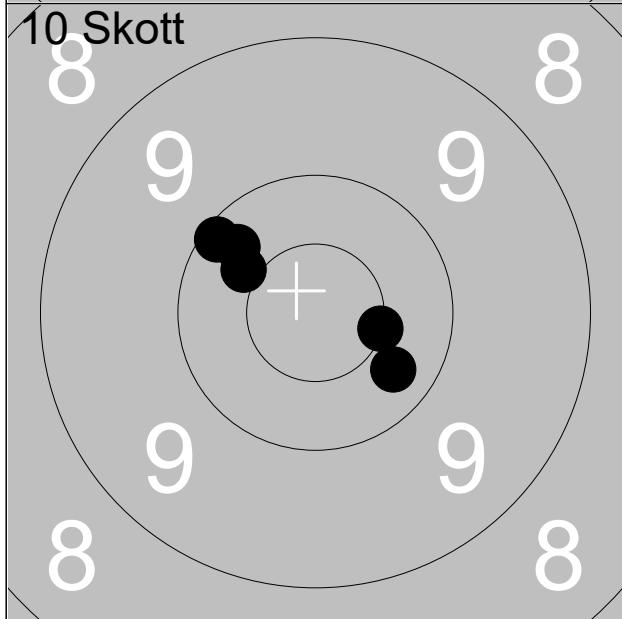

1:	10.4	↗
2:	10.3	↗
3:	10.3	↘
4:	10.5x	→
5:	10.1	↗
Serie		50.0
Total		283.0

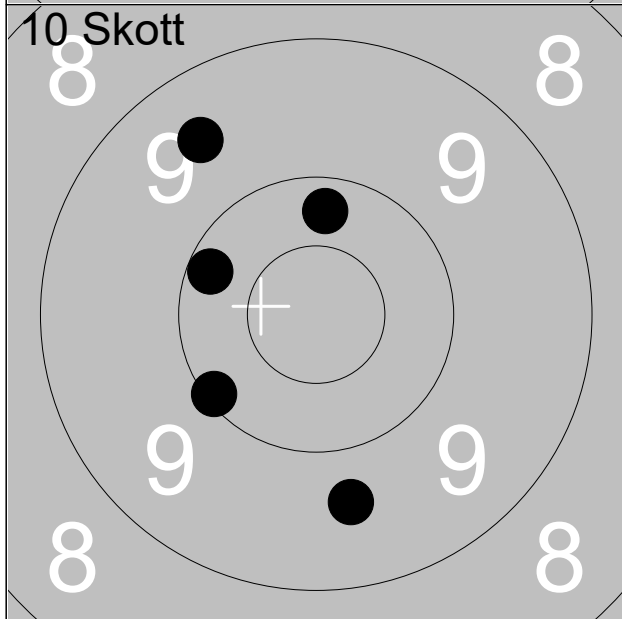

6:	10.1	↖
7:	9.5	↗
8:	9.6	↘
9:	10.2	↖
10:	10.3	↑
Serie		48.0
Total		331.0

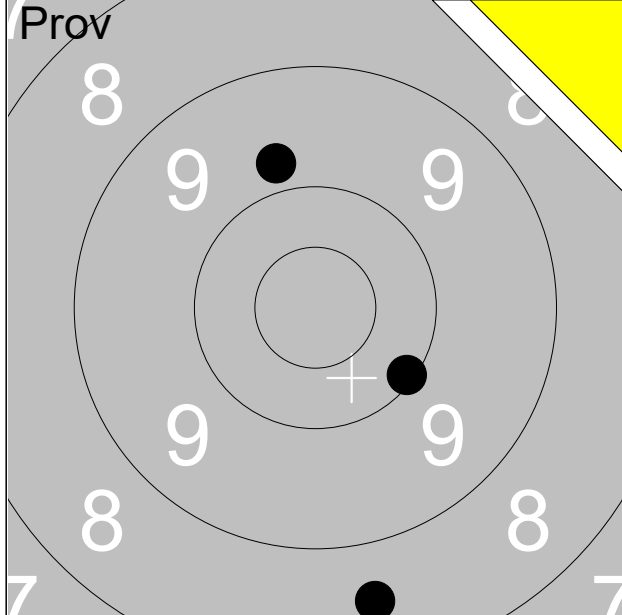

1:	8.5	↓
2:	9.8	↑
3:	10.1	↓
Serie		27.0
Total		233.0

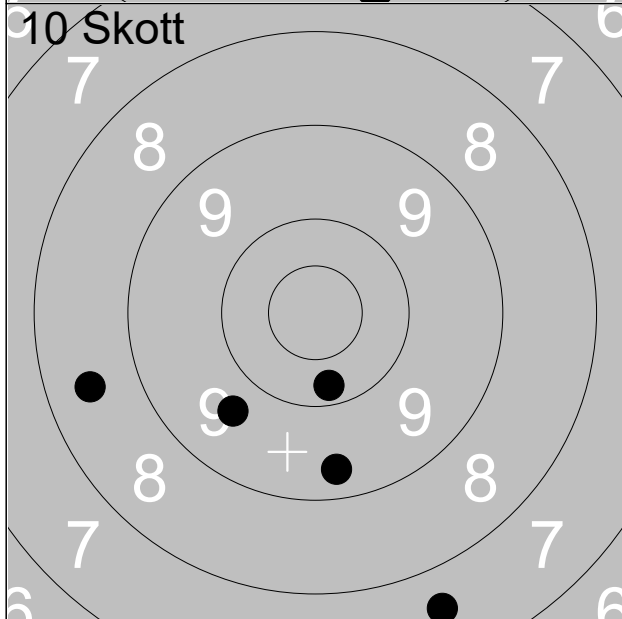

1:	9.3	↓
2:	10.2	↓
3:	9.7	↙
4:	8.5	←
5:	7.6	↓
Serie		43.0
Total		276.0

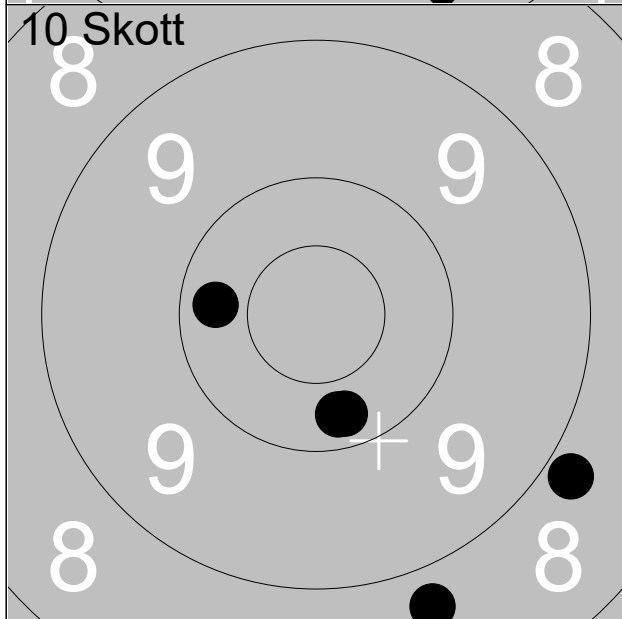

6:	10.3	↓
7:	8.7	↓
8:	8.8	↓
9:	10.3	←
10:	10.3	↓
Serie		46.0
Total		322.0

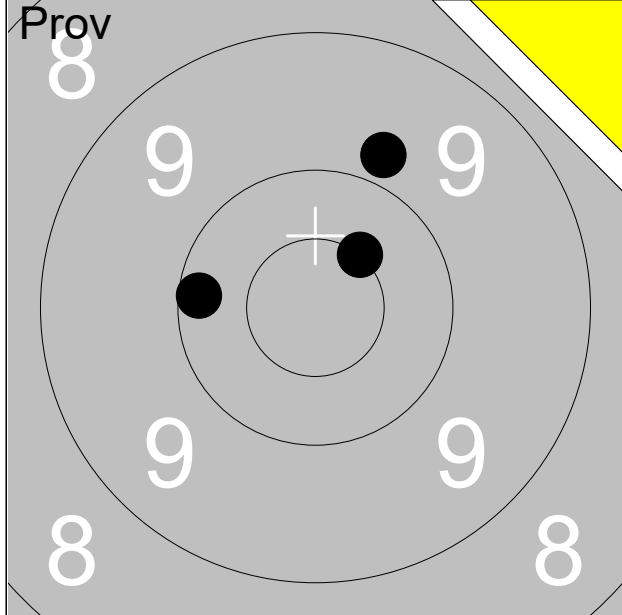

1:	10.2	←
2:	9.8	↑
3:	10.5x	↗
Serie		29.0
Total		228.0

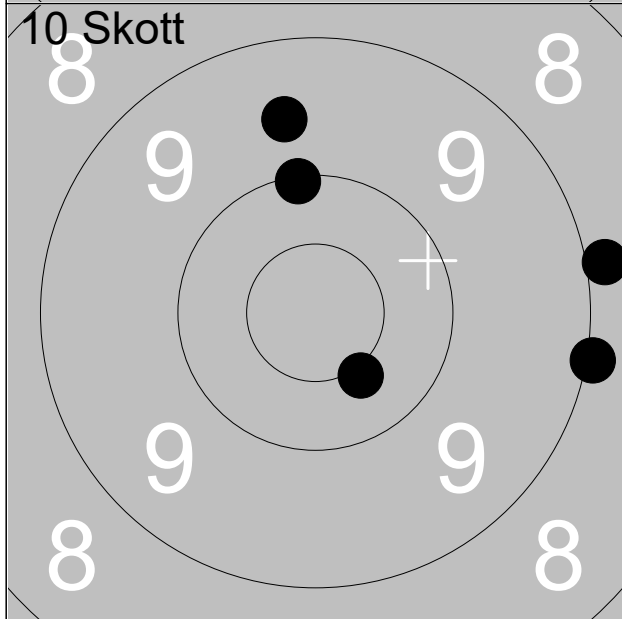

1:	9.6	↑
2:	8.9	→
3:	10.1	↑
4:	9.0	→
5:	10.4x	↘
Serie		46.0
Total		274.0

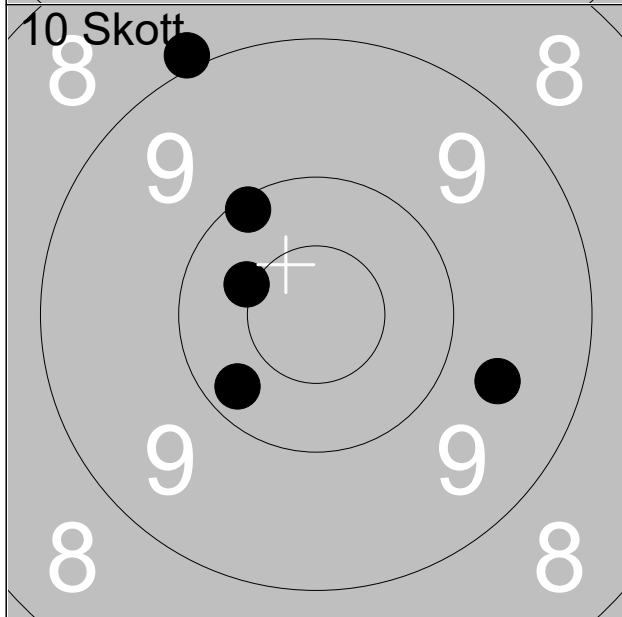

6:	10.1	↗
7:	9.6	→
8:	8.9	↑
9:	10.2	↖
10:	10.4x	↖
Serie		47.0
Total		321.0

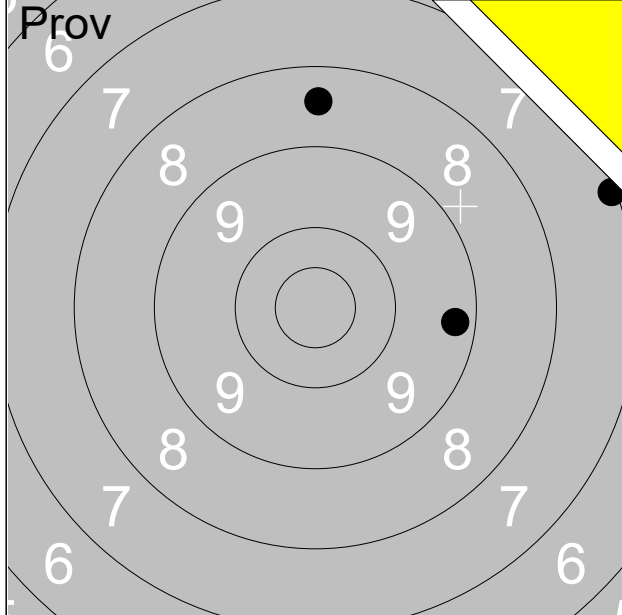

1:	9.3	→
2:	7.1	→
3:	8.5	↑
Serie		24.0
Total		214.0

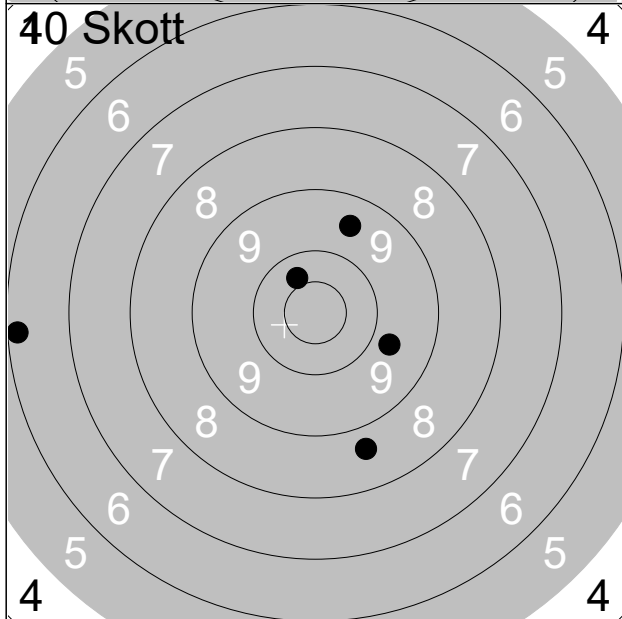

1:	6.2	←
2:	9.7	→
3:	8.7	↓
4:	10.4	↗
5:	9.5	↑
Serie		42.0
Total		256.0

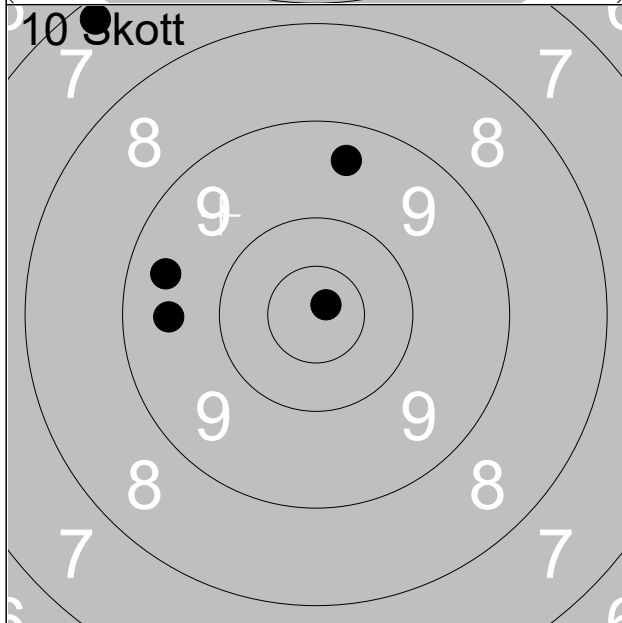

6:	7.2	↖
7:	10.8x	↗
8:	9.5	←
9:	9.4	↑
10:	9.4	←
Serie		44.0
Total		300.0

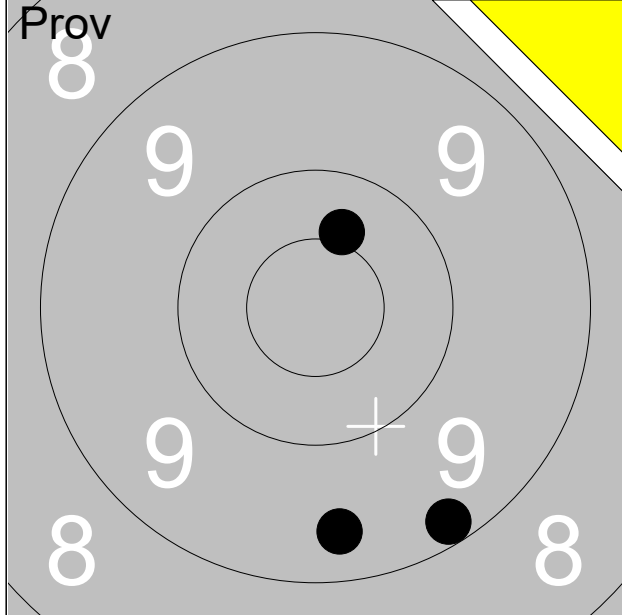

1:	9.4	↓
2:	10.4	↑
3:	9.2	↓
Serie		28.0
Total		238.0

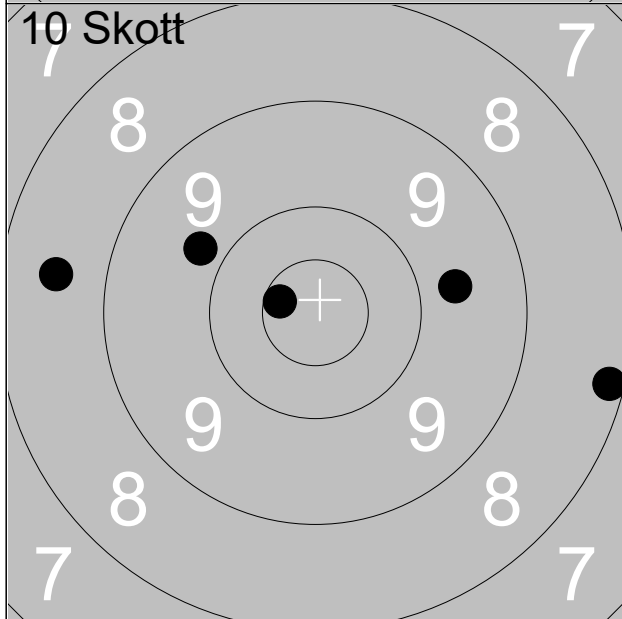

1:	8.2	→
2:	9.8	↑
3:	8.6	←
4:	10.6x	↑
5:	9.7	→
Serie		44.0
Total		282.0

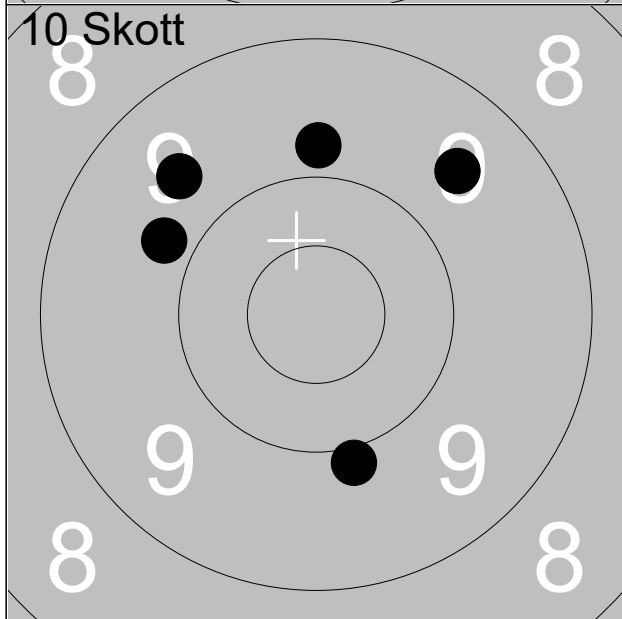

6:	9.9	↓
7:	9.6	↑
8:	9.8	←
9:	9.8	↑
10:	9.6	↗
Serie		45.0
Total		327.0

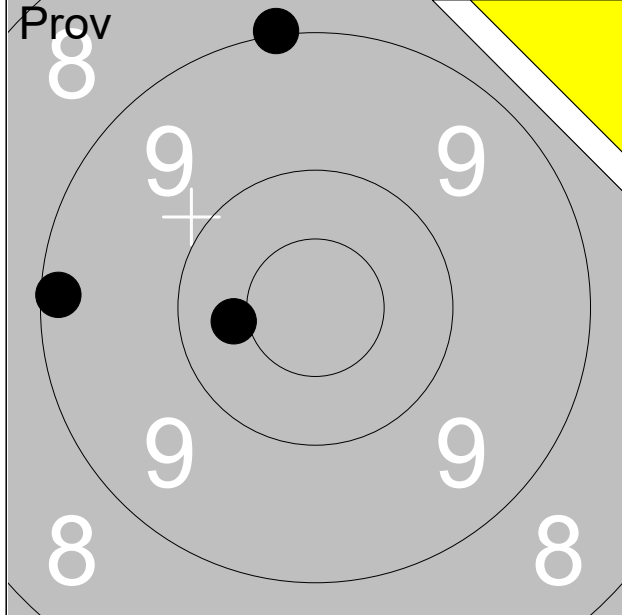

1:	9.0	↑
2:	10.4	←
3:	9.2	←
Serie		28.0
Total		238.0

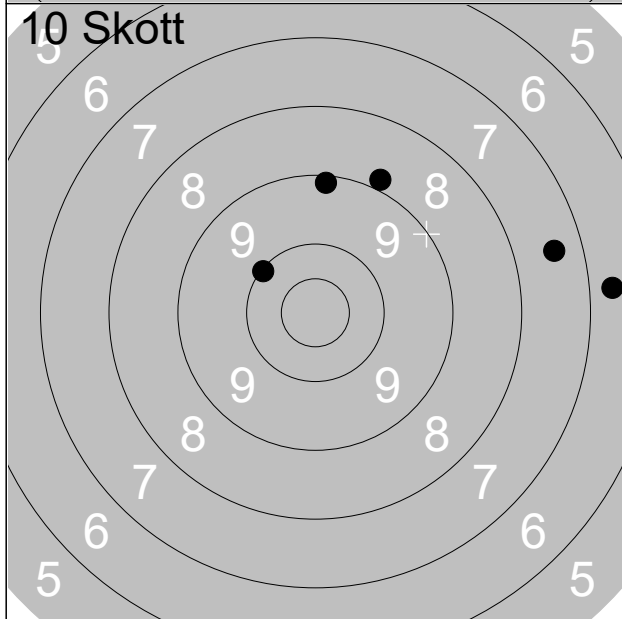

1:	10.1	↖
2:	7.4	→
3:	8.9	↗
4:	9.1	↑
5:	6.7	→
Serie		40.0
Total		278.0

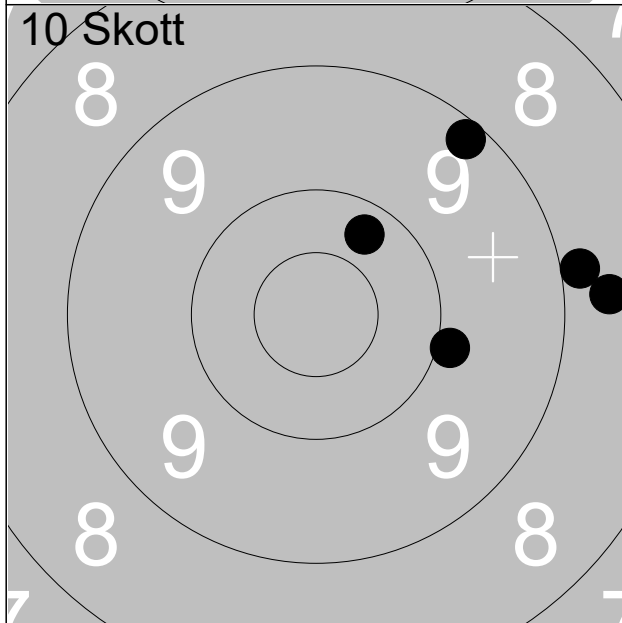

6:	8.9	→
7:	10.3	↗
8:	9.9	→
9:	8.7	→
10:	9.2	↗
Serie		44.0
Total		322.0

Skjutlag

Tavla

5

3

Urban Johansson

Ramselefors

F 21

Knä

No

13.07.2022

Björkskottet 2022

Ramselefors SKF

Prov

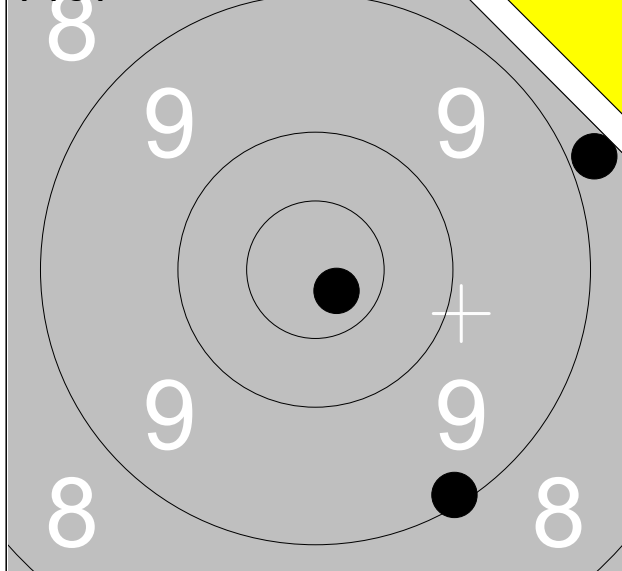

1: 10.8x

↘

2: 9.1

↘

3: 8.8

→

Serie

27.0

Total

236.0

10 Skott

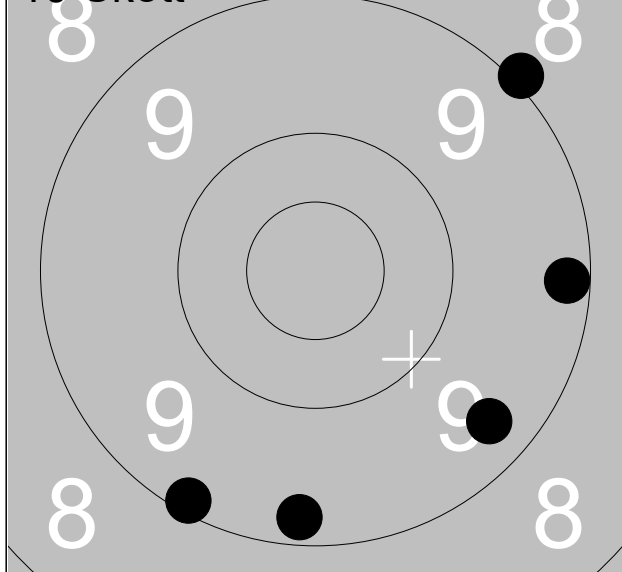

1: 9.4

↘

2: 9.0

↗

3: 9.1

↘

4: 9.2

↓

5: 9.2

→

Serie

45.0

Total

281.0

10 Skott

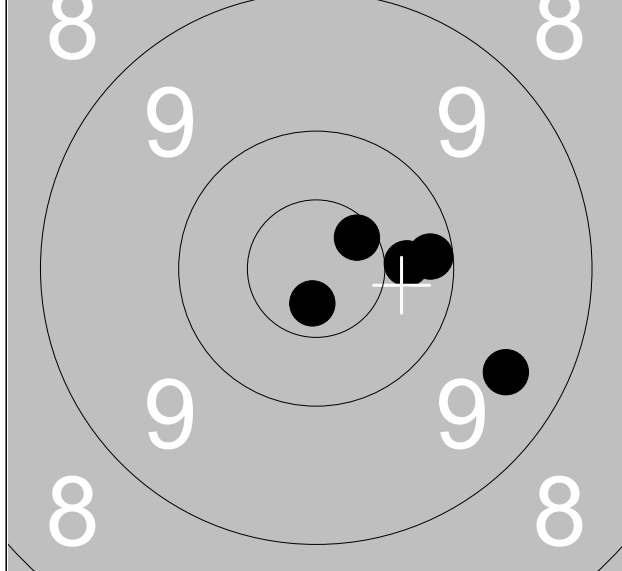

6: 10.3

→

7: 10.7x

↓

8: 10.6x

↗

9: 9.5

↘

10: 10.2

→

Serie

49.0

Total

330.0

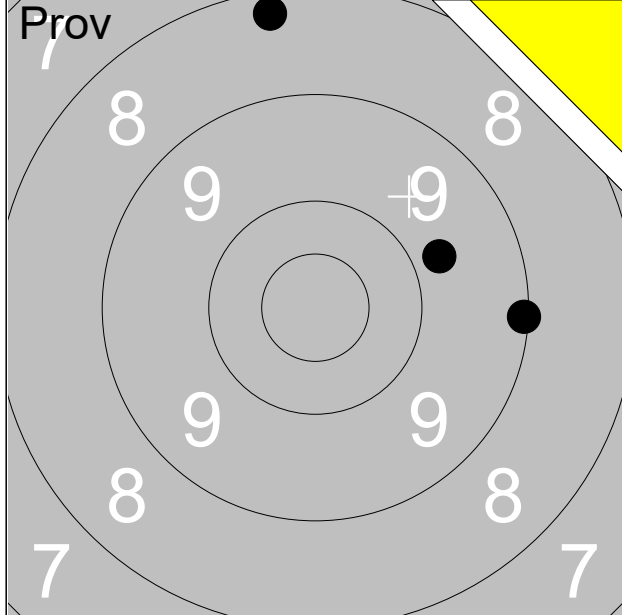

	1:	8.2			↑
	2:	9.8			→
	3:	9.1			→
Serie					26.0
Total					235.0

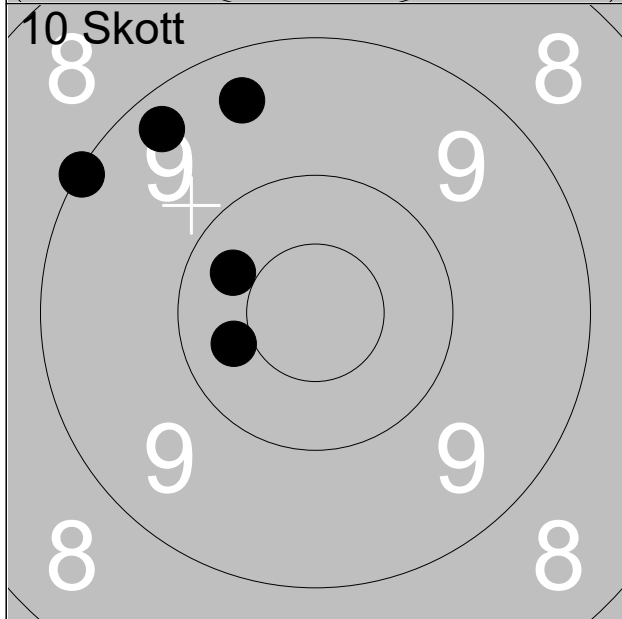

	1:	9.4			↑
	2:	9.3			↑
	3:	10.3			↑
	4:	10.4			←
	5:	9.1			↑
Serie					47.0
Total					282.0

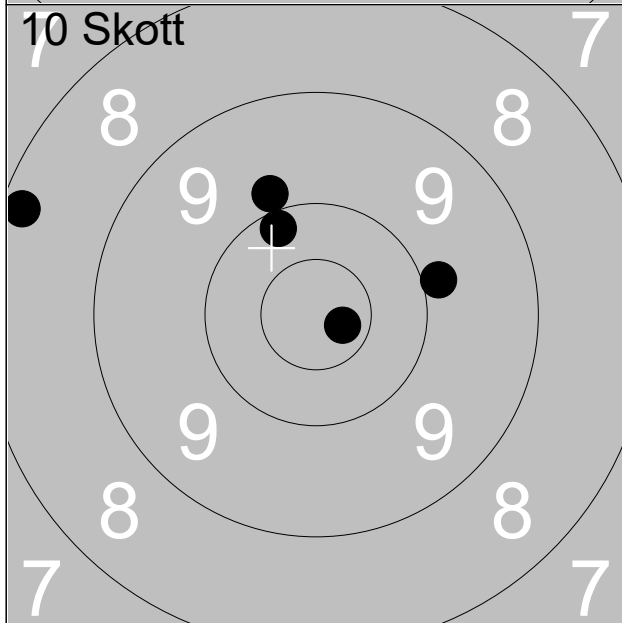

	6:	8.2			←
	7:	9.9			→
	8:	9.9			↑
	9:	10.7x			→
	10:	10.2			↑
Serie					46.0
Total					328.0

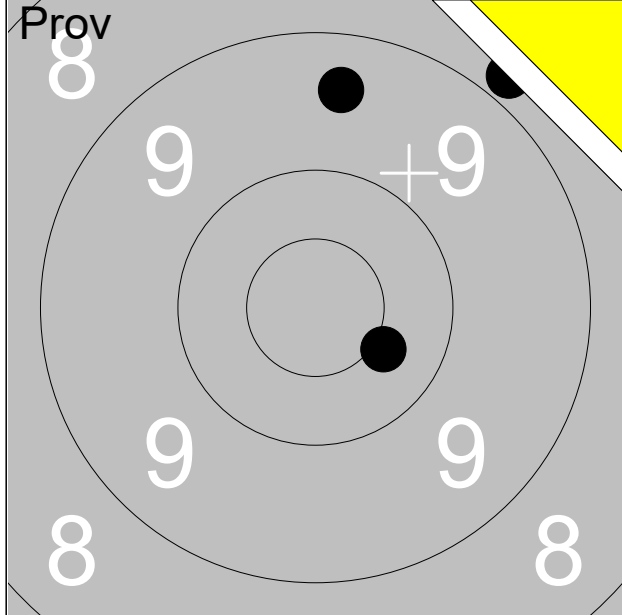

Prov	1:	9.4	↑
	2:	8.8	↗
	3:	10.4	↘
Serie		27.0	
Total		234.0	

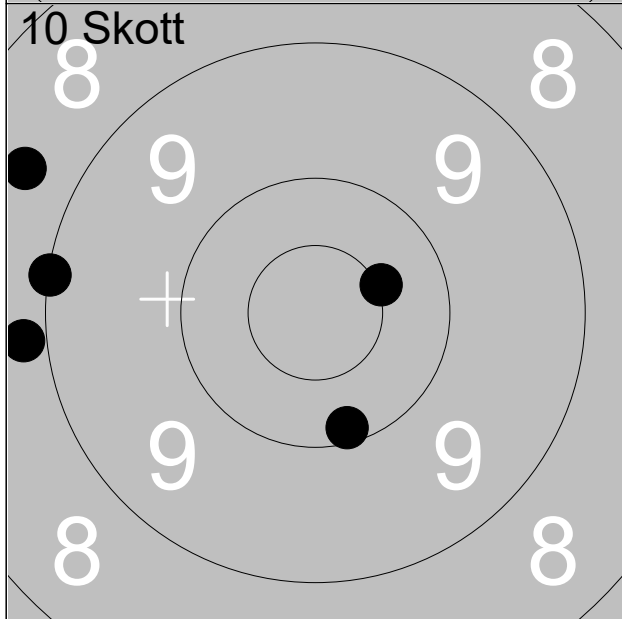

10 Skott	1:	8.9	←
	2:	9.0	←
	3:	8.6	↗
	4:	10.5x	→
	5:	10.1	↓
Serie		45.0	
Total		279.0	

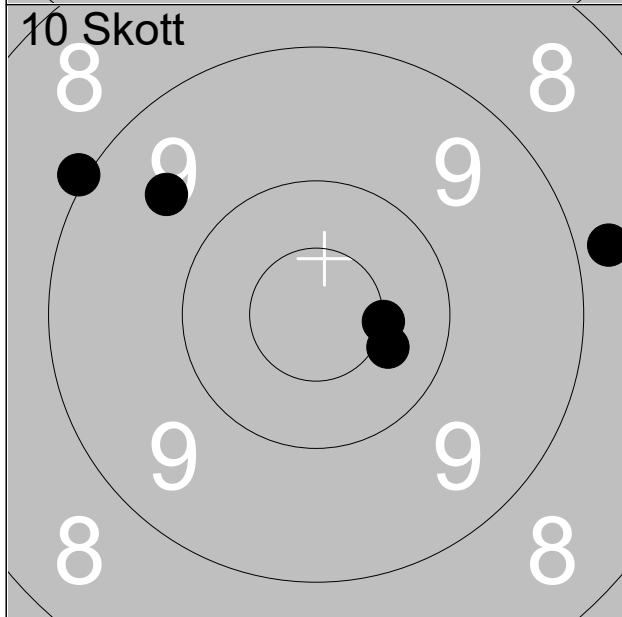

10 Skott	6:	10.4	→
	7:	8.8	→
	8:	9.6	↗
	9:	9.0	↗
	10:	10.5x	→
Serie		46.0	
Total		325.0	

Skjutlag

Tavla

5

6

Bengt Hansson

Ramselefors

Bromölla

Knä

Sk

13.07.2022

Björkskottet 2022

Ramselefors SKF

Prov

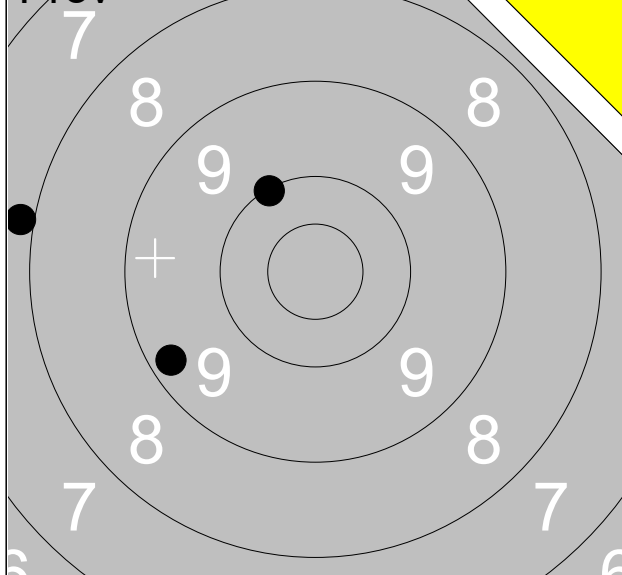

1: 10.0 ↗

2: 7.9 ←

3: 9.3 ↙

Serie

26.0

Total

233.0

10 Skott

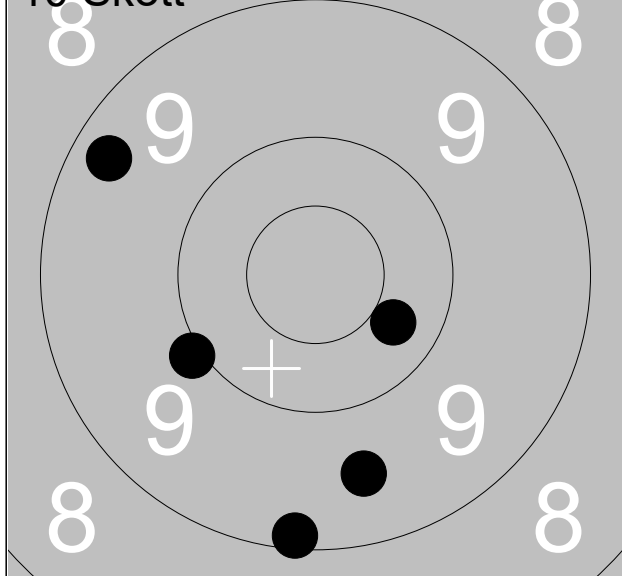

1: 10.3 ↘

2: 9.5 ↓

3: 9.3 ↗

4: 9.1 ↓

5: 10.0 ↙

Serie

47.0

Total

280.0

10 Skott

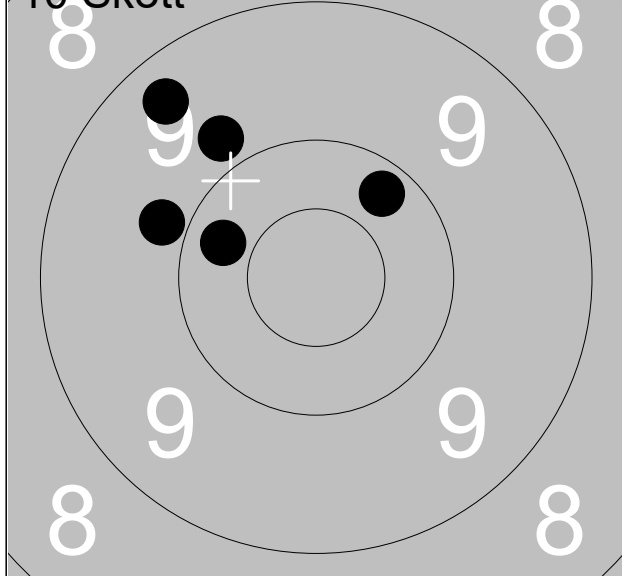

6: 9.8 ↗

7: 10.2 ↗

8: 9.3 ↗

9: 10.3 ↗

10: 9.8 ↗

Serie

47.0

Total

327.0

13.07.2022	Björkskottet 2022	Ramselefors SKF
------------	-------------------	-----------------

<p>Prov</p>	<table style="width:100%; border-collapse: collapse;"> <tr> <td style="width:10%;">1:</td> <td style="width:30%;">8.5</td> <td style="width:10%; text-align:right;">↗</td> </tr> <tr> <td>2:</td> <td>9.8</td> <td style="text-align:right;">↖</td> </tr> <tr> <td>3:</td> <td>9.7</td> <td style="text-align:right;">↖</td> </tr> </table>	1:	8.5	↗	2:	9.8	↖	3:	9.7	↖
1:	8.5	↗								
2:	9.8	↖								
3:	9.7	↖								
<table style="width:100%; border-collapse: collapse;"> <tr> <td style="width:10%;">Serie</td> <td style="width:80%;"></td> <td style="width:10%; text-align:right;">26.0</td> </tr> <tr> <td>Total</td> <td></td> <td style="text-align:right;">229.0</td> </tr> </table>		Serie		26.0	Total		229.0			
Serie		26.0								
Total		229.0								

<p>10 Skott</p>	<table style="width:100%; border-collapse: collapse;"> <tr> <td style="width:10%;">1:</td> <td style="width:30%;">6.2</td> <td style="width:10%; text-align:right;">↘</td> </tr> <tr> <td>2:</td> <td>7.8</td> <td style="text-align:right;">↙</td> </tr> <tr> <td>3:</td> <td>9.2</td> <td style="text-align:right;">↖</td> </tr> <tr> <td>4:</td> <td>8.2</td> <td style="text-align:right;">↗</td> </tr> <tr> <td>5:</td> <td>9.6</td> <td style="text-align:right;">↘</td> </tr> </table>	1:	6.2	↘	2:	7.8	↙	3:	9.2	↖	4:	8.2	↗	5:	9.6	↘
1:	6.2	↘														
2:	7.8	↙														
3:	9.2	↖														
4:	8.2	↗														
5:	9.6	↘														
<table style="width:100%; border-collapse: collapse;"> <tr> <td style="width:10%;">Serie</td> <td style="width:80%;"></td> <td style="width:10%; text-align:right;">39.0</td> </tr> <tr> <td>Total</td> <td></td> <td style="text-align:right;">268.0</td> </tr> </table>		Serie		39.0	Total		268.0									
Serie		39.0														
Total		268.0														

<p>10 Skott</p>	<table style="width:100%; border-collapse: collapse;"> <tr> <td style="width:10%;">6:</td> <td style="width:30%;">7.1</td> <td style="width:10%; text-align:right;">↘</td> </tr> <tr> <td>7:</td> <td>9.4</td> <td style="text-align:right;">↗</td> </tr> <tr> <td>8:</td> <td>9.6</td> <td style="text-align:right;">↙</td> </tr> <tr> <td>9:</td> <td>10.6x</td> <td style="text-align:right;">↙</td> </tr> <tr> <td>10:</td> <td>9.6</td> <td style="text-align:right;">↘</td> </tr> </table>	6:	7.1	↘	7:	9.4	↗	8:	9.6	↙	9:	10.6x	↙	10:	9.6	↘
6:	7.1	↘														
7:	9.4	↗														
8:	9.6	↙														
9:	10.6x	↙														
10:	9.6	↘														
<table style="width:100%; border-collapse: collapse;"> <tr> <td style="width:10%;">Serie</td> <td style="width:80%;"></td> <td style="width:10%; text-align:right;">44.0</td> </tr> <tr> <td>Total</td> <td></td> <td style="text-align:right;">312.0</td> </tr> </table>		Serie		44.0	Total		312.0									
Serie		44.0														
Total		312.0														

Skjutlag

Tavla

5

8

Bo Knoblauch

Ramselefors

Karlstad-Ulvsby

Knä

Vä

13.07.2022

Björkskottet 2022

Ramselefors SKF

Prov

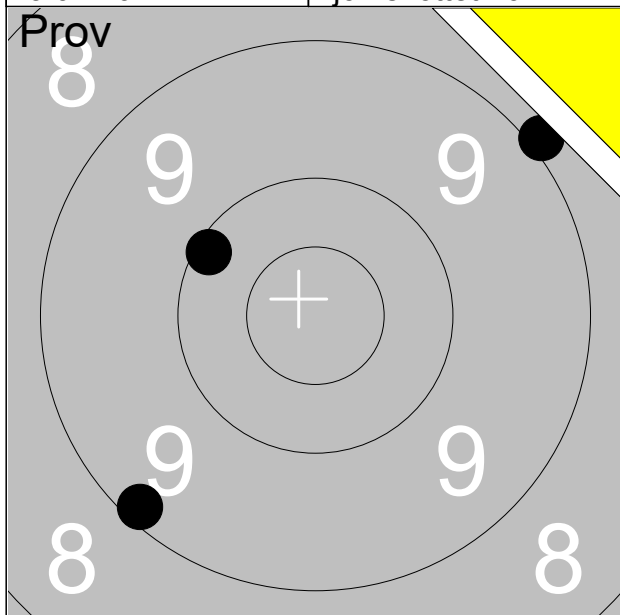

1: 9.1 ↙
 2: 8.9 ↗
 3: 10.1 ↘

Serie 27.0
 Total 229.0

10 Skott

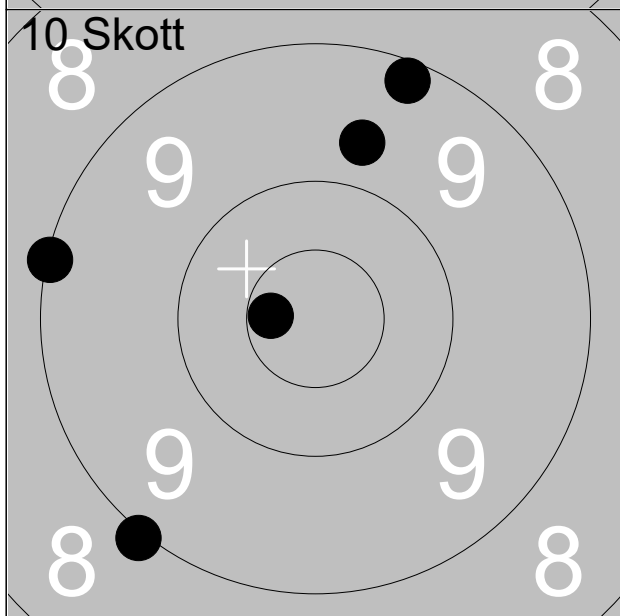

1: 9.2 ↗
 2: 10.7x ←
 3: 9.7 ↗
 4: 9.0 ↘
 5: 9.1 ←

Serie 46.0
 Total 275.0

10 Skott

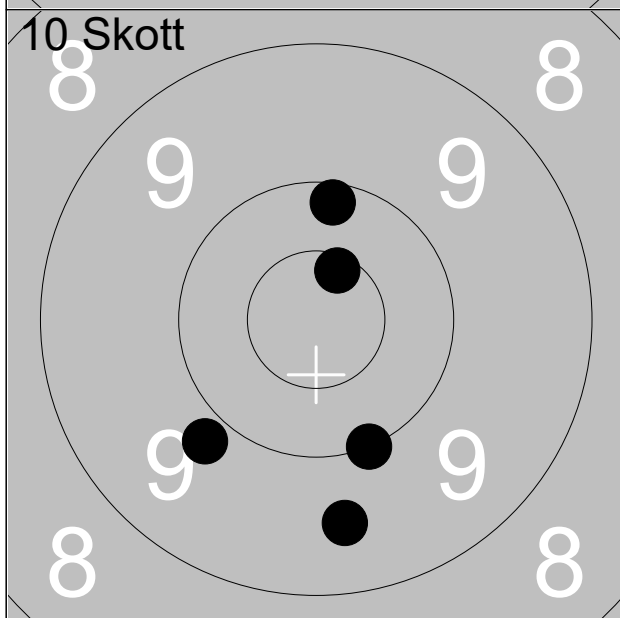

6: 10.6x ↗
 7: 10.2 ↗
 8: 9.5 ↓
 9: 9.8 ↘
 10: 10.0 ↓

Serie 48.0
 Total 323.0

Skjutlag

Tavla

5

9

Lars-Göran Lundqvist

Ramselefors

Ununge

Knä

St

13.07.2022

Björkskottet 2022

Ramselefors SKF

Prov

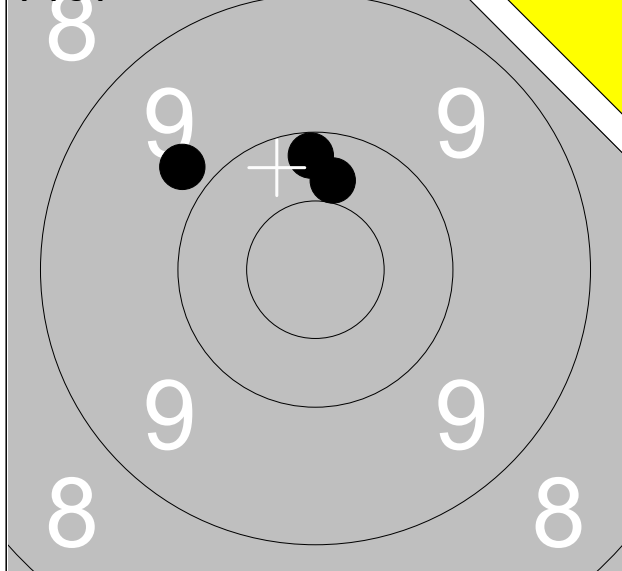

1: 9.8

↖

2: 10.2

↑

3: 10.3

↑

Serie

29.0

Total

229.0

10 Skott

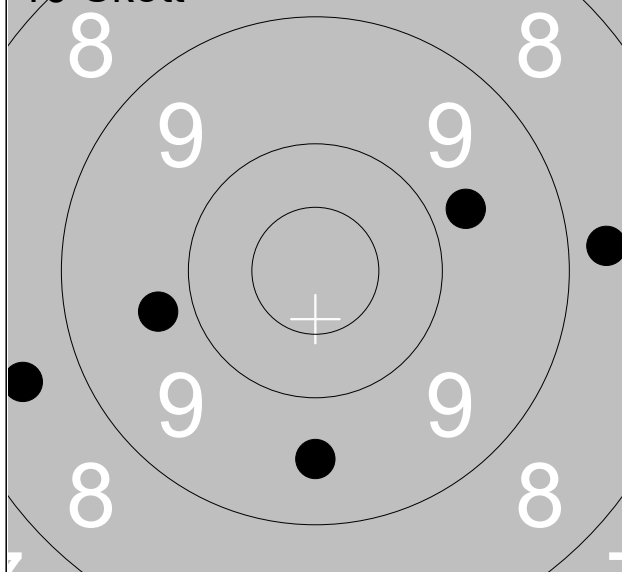

1: 9.7

→

2: 8.7

→

3: 9.7

←

4: 9.5

↓

5: 8.6

←

Serie

43.0

Total

272.0

10 Skott

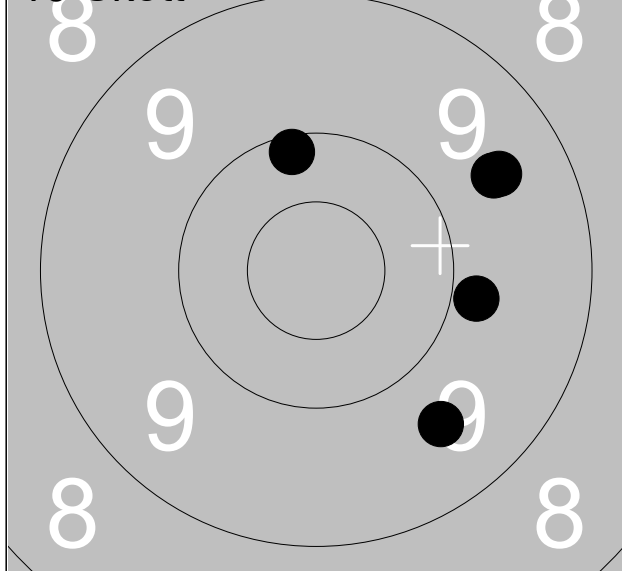

6: 9.6

↘

7: 9.6

↗

8: 9.5

↗

9: 9.9

→

10: 10.1

↑

Serie

46.0

Total

318.0

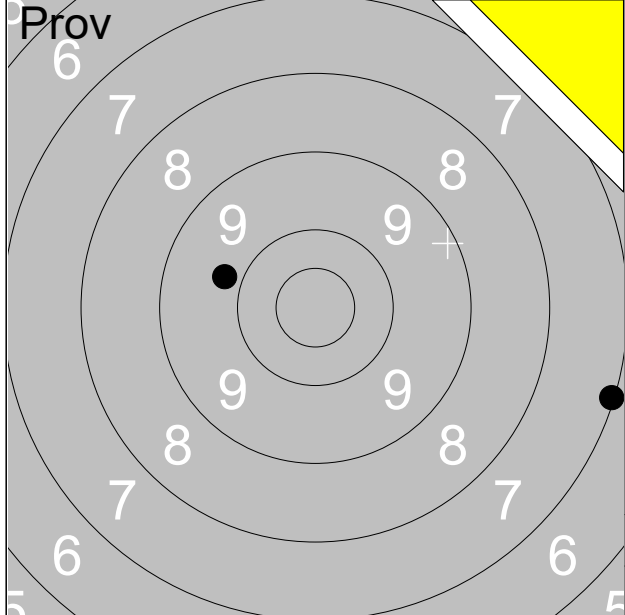

1:	6.9	↗
2:	9.8	↖
3:	7.1	→
Serie		22.0
Total		226.0

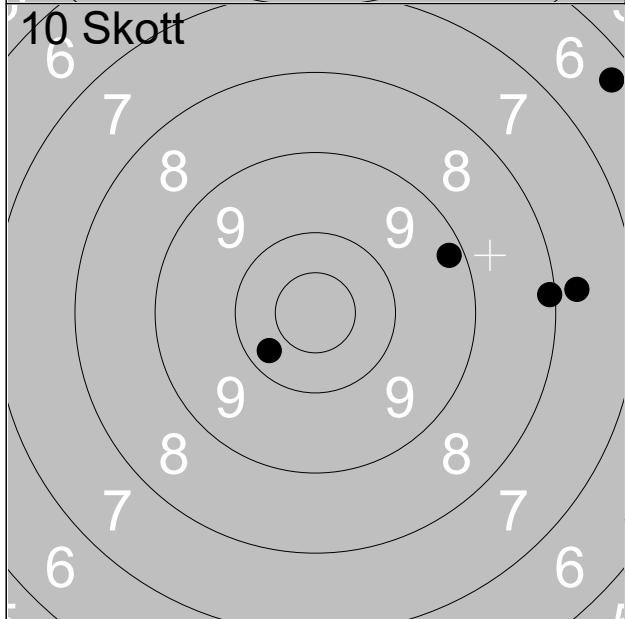

1:	10.3	↙
2:	9.2	→
3:	6.3	↗
4:	7.8	→
5:	8.1	→
Serie		40.0
Total		266.0

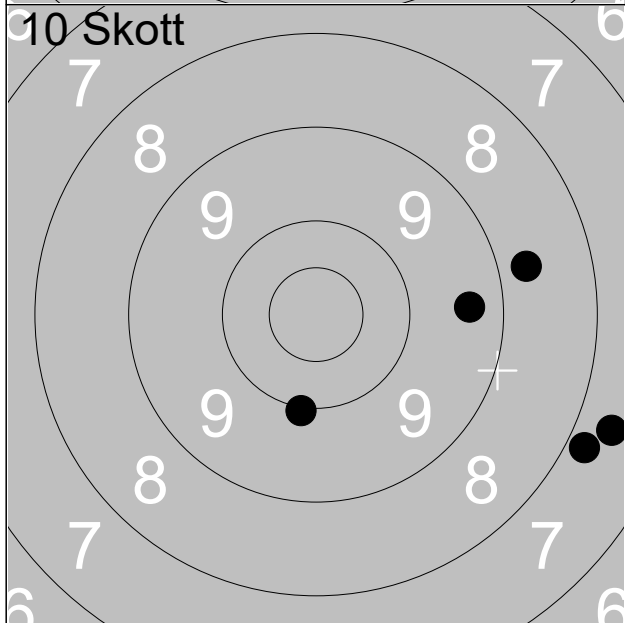

6:	8.7	→
7:	7.6	→
8:	10.0	↓
9:	9.4	→
10:	7.8	→
Serie		41.0
Total		307.0

Skjutlag

Tavla

5

12

Harry Östling

Ramselefors

F 21

Knä

No

13.07.2022

Björkskottet 2022

Ramselefors SKF

Prov

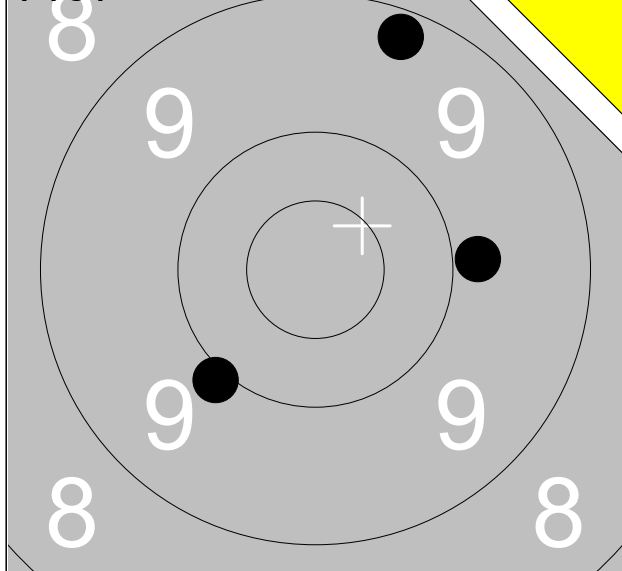

1:	9.2	↗
2:	9.9	↙
3:	9.8	→

Serie	27.0
Total	225.0

10 Skott

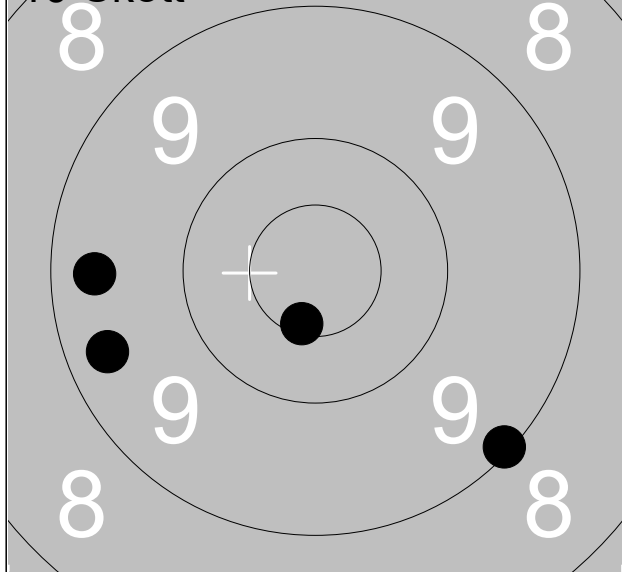

1:	9.1	↘
2:	9.3	←
3:	10.6x	↘
4:	9.4	←
5:	8.7	↗

Serie	45.0
Total	270.0

10 Skott

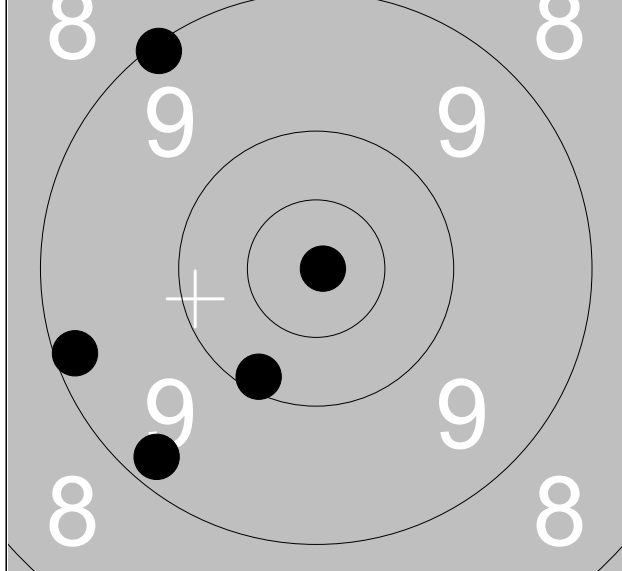

6:	10.1	↘
7:	10.9x	→
8:	9.2	↘
9:	9.2	←
10:	9.1	↗

Serie	47.0
Total	317.0

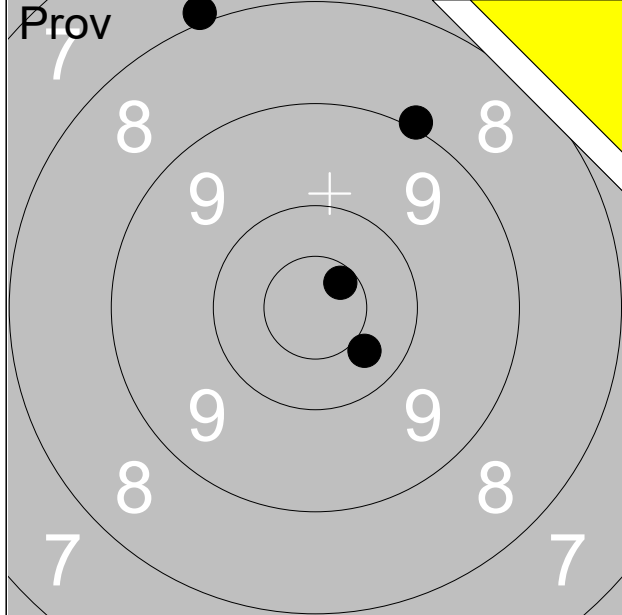

1:	7.9	↑
2:	10.6x	↗
3:	9.0	↗
4:	10.4	↘
Serie		36.0
Total		223.0

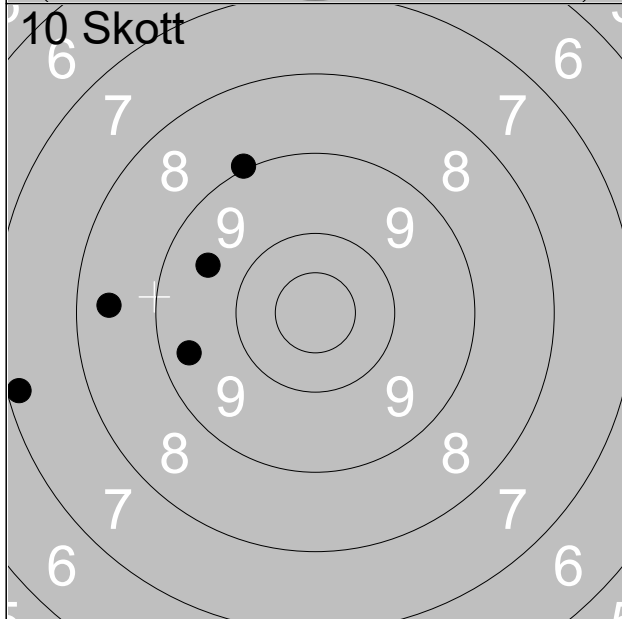

1:	9.6	←
2:	9.0	↑
3:	8.4	←
4:	9.4	←
5:	7.2	←
Serie		42.0
Total		265.0

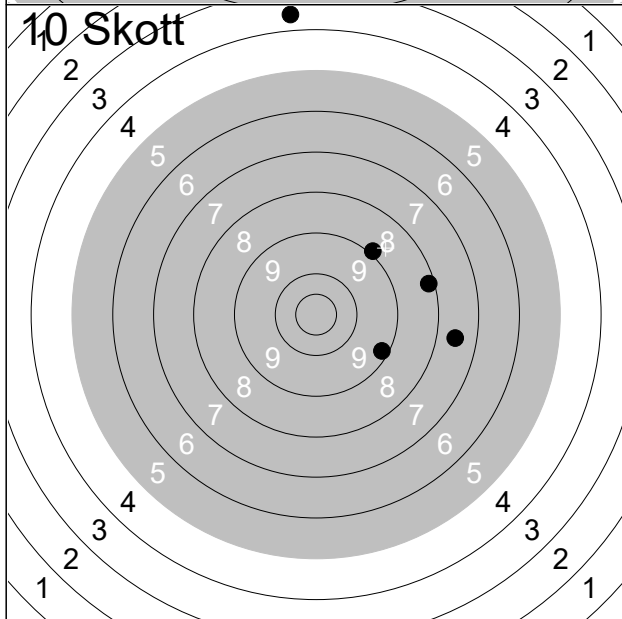

6:	3.6	↑
7:	9.2	→
8:	7.6	→
9:	8.2	→
10:	8.9	↗
Serie		35.0
Total		300.0

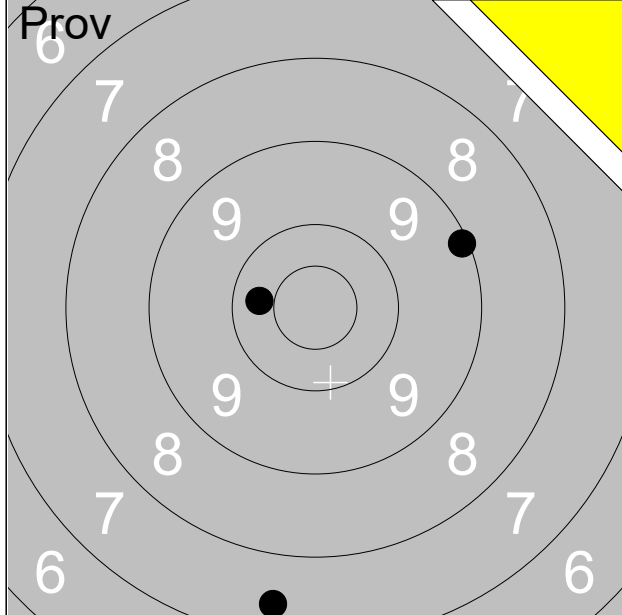

1:	9.1	→
2:	10.3	←
3:	7.4	↓
Serie		26.0
Total		220.0

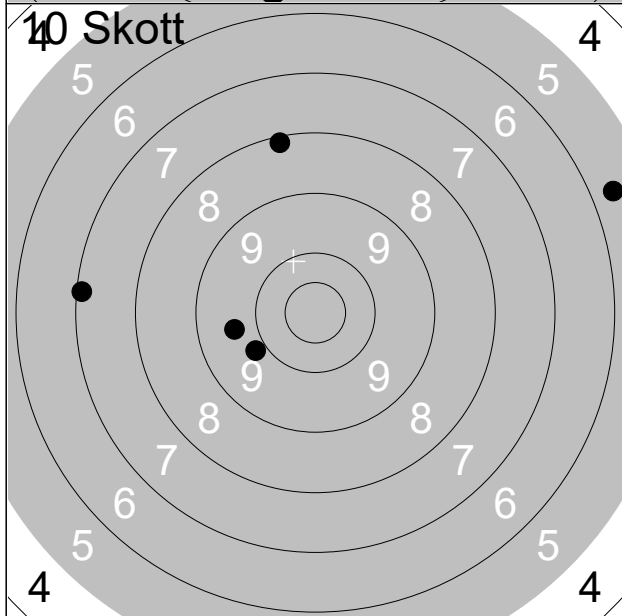

1:	9.8	←
2:	5.7	→
3:	9.6	←
4:	8.1	↑
5:	7.1	←
Serie		38.0
Total		258.0

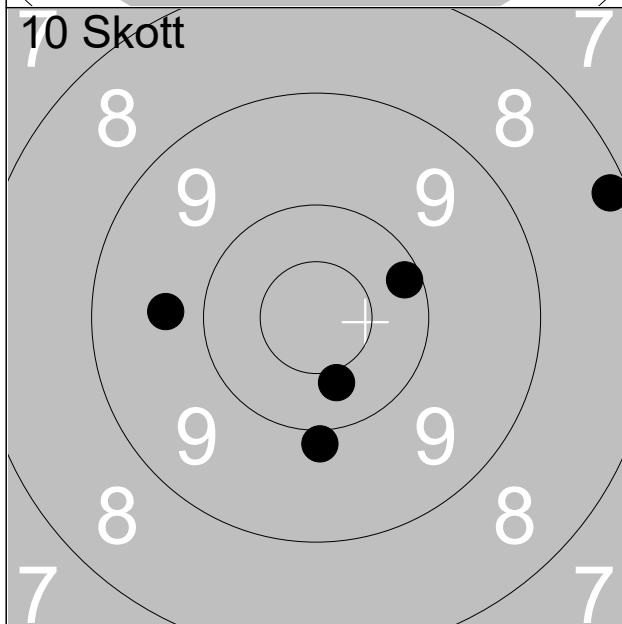

6:	8.2	→
7:	10.4	↓
8:	9.9	↓
9:	9.7	←
10:	10.2	→
Serie		46.0
Total		304.0

Skjutlag

Tavla

5

15

Kasper Svensson

Ramselefors

Eggvena-Brättensby

Knä

Vg

13.07.2022

Björkskottet 2022

Ramselefors SKF

Prov

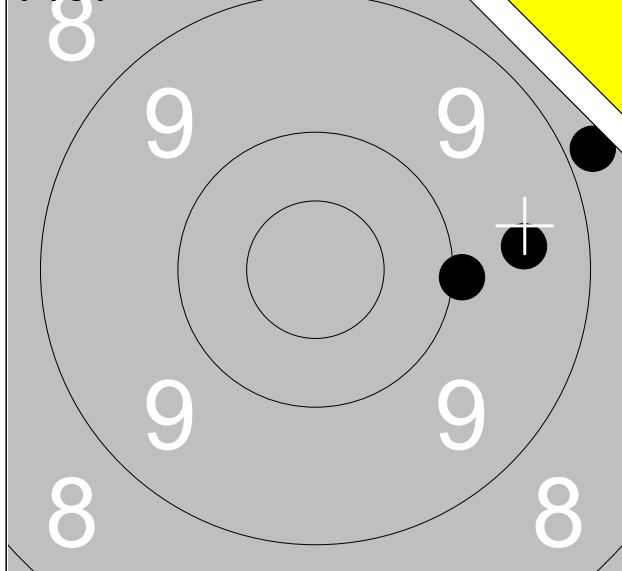

1:	9.5	→
2:	10.0	→
3:	8.8	→

Serie	27.0
Total	219.0

10 Skott

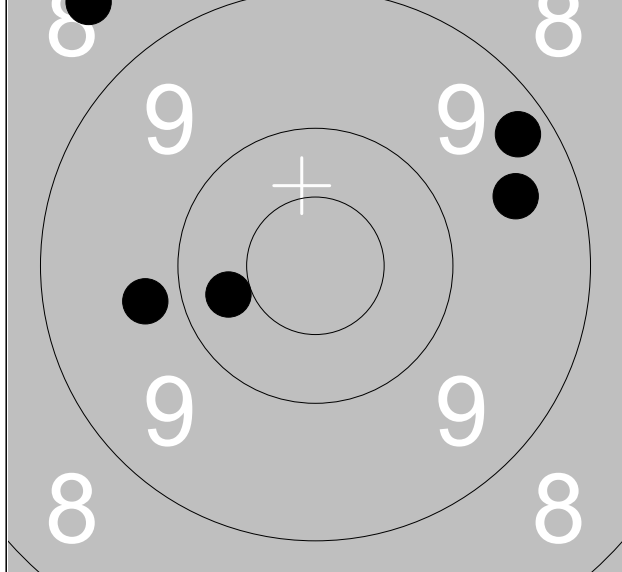

1:	9.8	←
2:	8.5	↖
3:	9.3	↗
4:	10.3	←
5:	9.5	→

Serie	45.0
Total	264.0

10 Skott

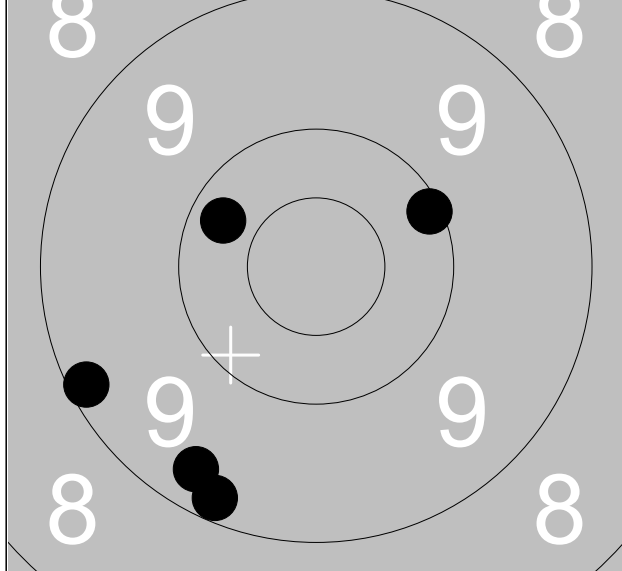

6:	10.1	↗
7:	10.3	↖
8:	9.2	↓
9:	9.3	↓
10:	9.2	←

Serie	47.0
Total	311.0

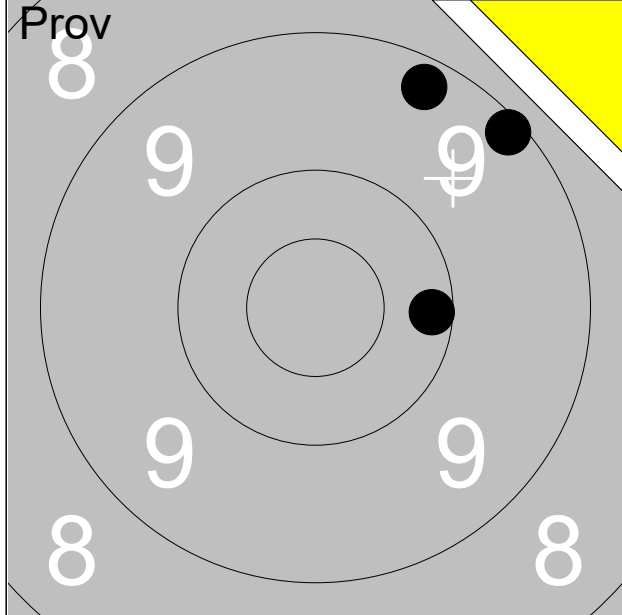

1:	9.1	↗
2:	10.2	→
3:	9.2	↗
Serie		28.0
Total		211.0

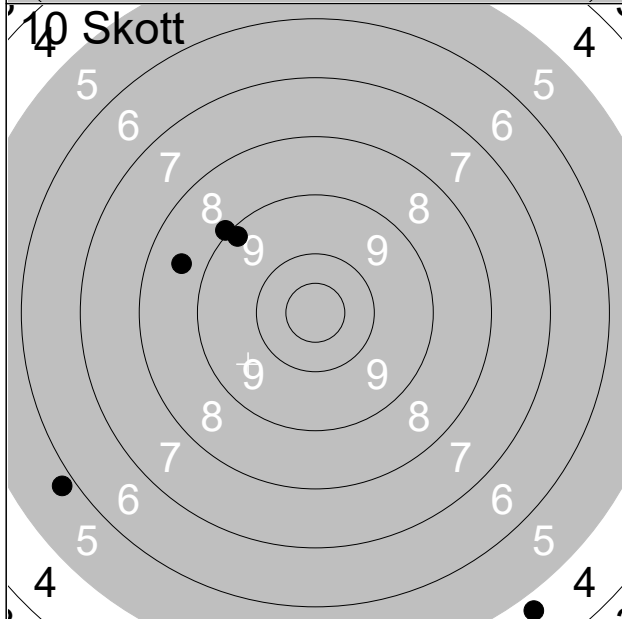

1:	4.7	↘
2:	8.6	↗
3:	5.8	↙
4:	9.0	↗
5:	9.2	↗
Serie		35.0
Total		246.0

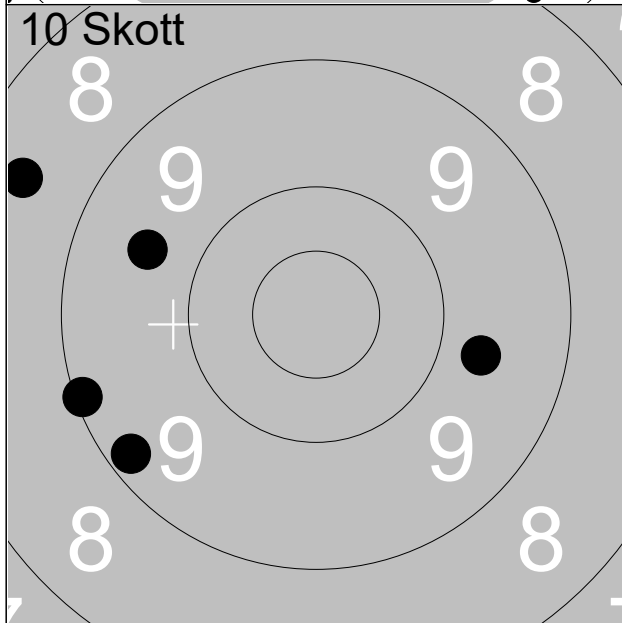

6:	9.2	↙
7:	9.7	→
8:	9.1	↙
9:	9.6	↗
10:	8.5	↗
Serie		44.0
Total		290.0

Skjutlag

Tavla

5

18

Torbjörn Karlsson

Ramselefors

Vrenaorten

Knä

Sö

13.07.2022

Björskottet 2022

Ramselefors SKF

Prov

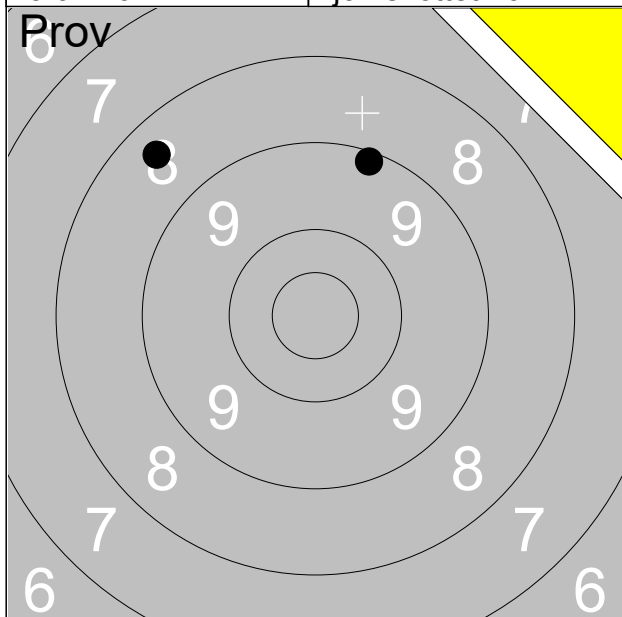

1:	9.1	↑
2:	6.6	↗
3:	8.4	↘

Serie	23.0
-------	------

Total	206.0
-------	-------

10 Skott

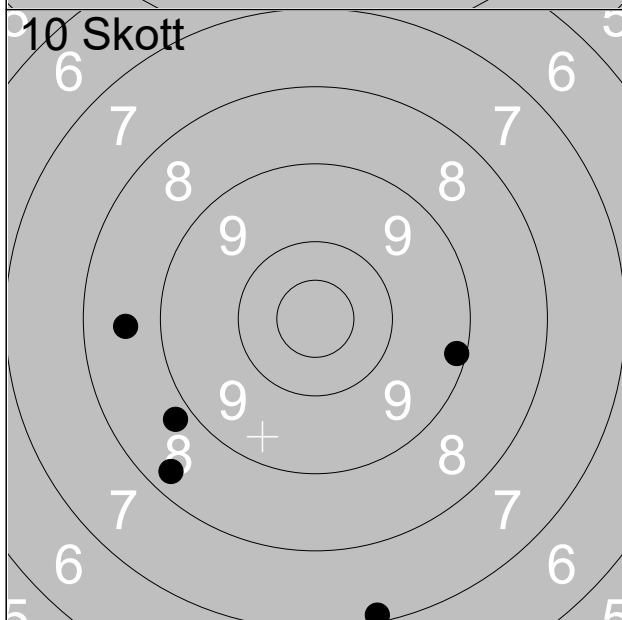

1:	8.3	↙
2:	9.2	→
3:	7.1	↓
4:	8.8	↙
5:	8.6	←

Serie	40.0
-------	------

Total	246.0
-------	-------

10 Skott

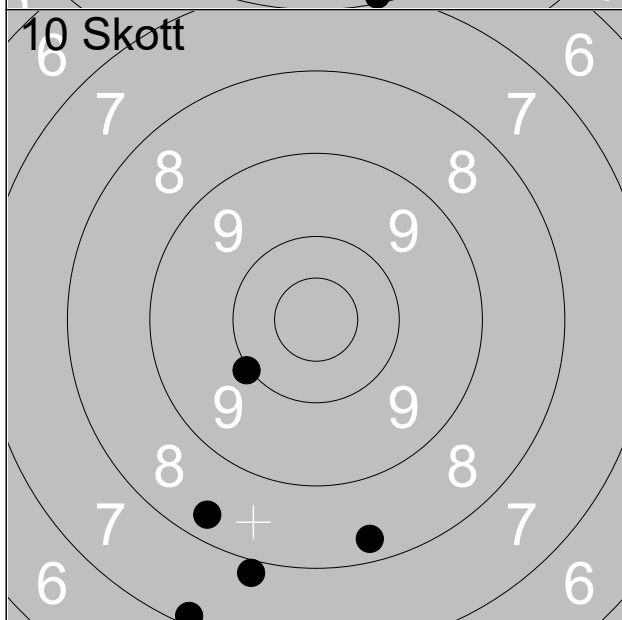

6:	7.9	↓
7:	10.0	↙
8:	8.3	↓
9:	7.1	↙
10:	8.3	↙

Serie	40.0
-------	------

Total	286.0
-------	-------

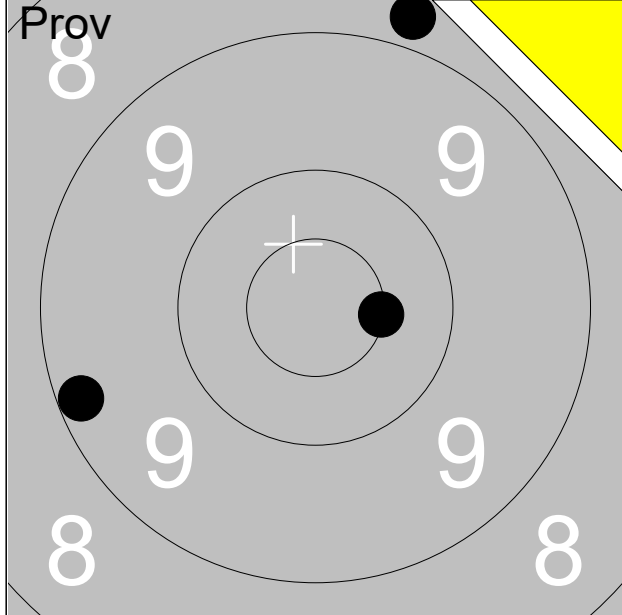

1:	10.5x	→
2:	9.2	←
3:	8.8	↑
Serie		27.0
Total		237.0

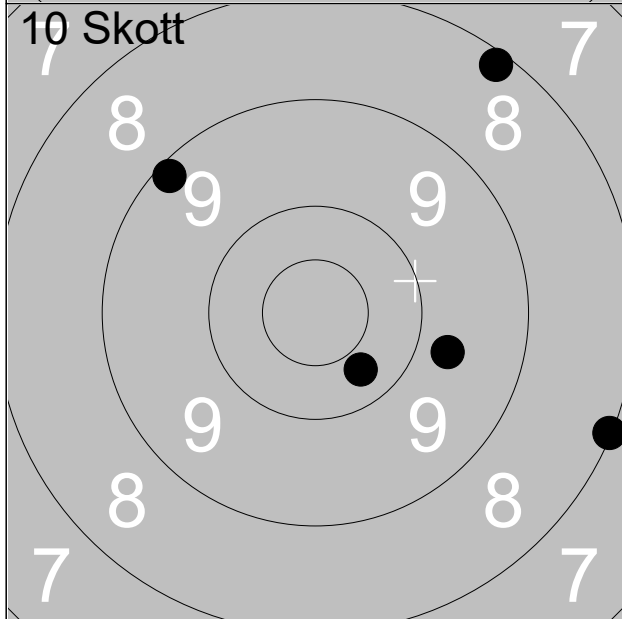

1:	8.0	→
2:	8.1	↗
3:	9.7	→
4:	9.2	↗
5:	10.3	↘
Serie		44.0
Total		281.0

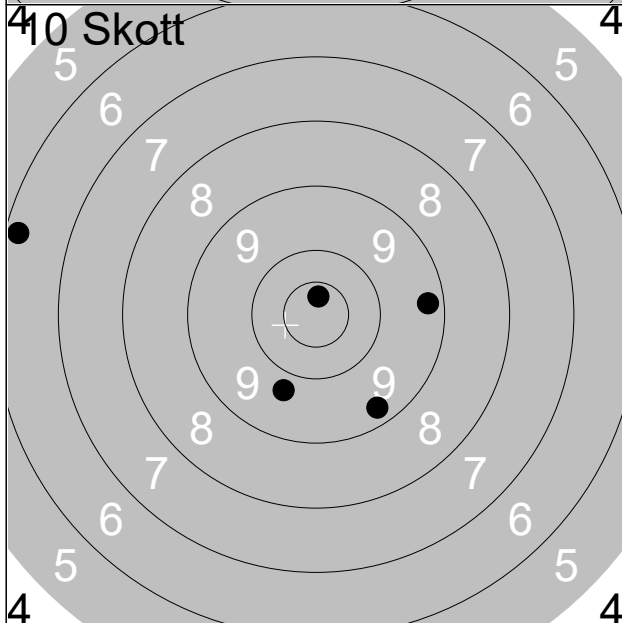

6:	6.2	←
7:	10.7x	↑
8:	9.8	↘
9:	9.3	↘
10:	9.3	→
Serie		43.0
Total		324.0

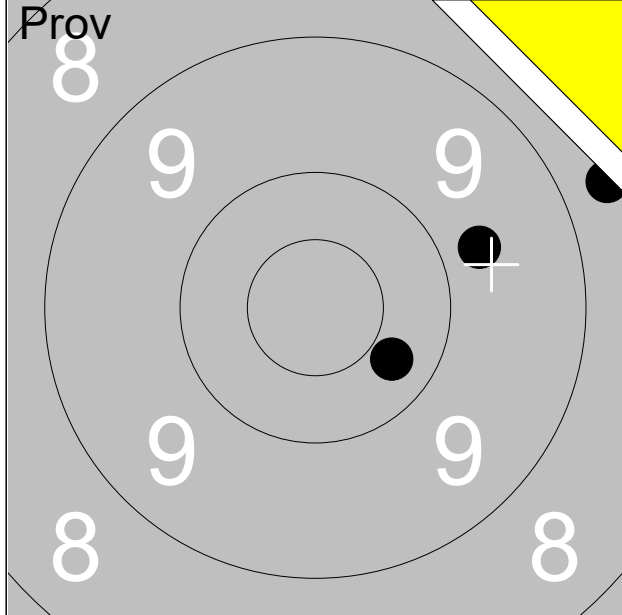

1:	8.7	→
2:	9.7	→
3:	10.3	→

Serie	27.0
-------	------

Total	232.0
-------	-------

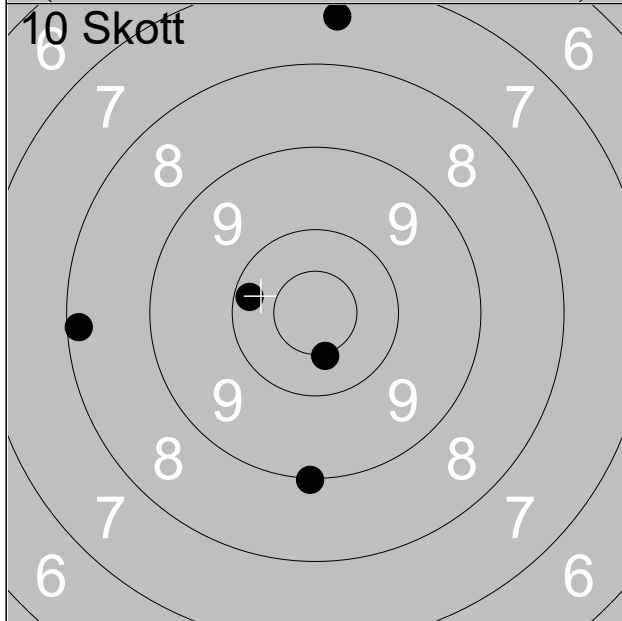

1:	8.2	←
2:	10.2	←
3:	7.4	↑
4:	10.5x	↓
5:	9.0	↓

Serie	44.0
-------	------

Total	276.0
-------	-------

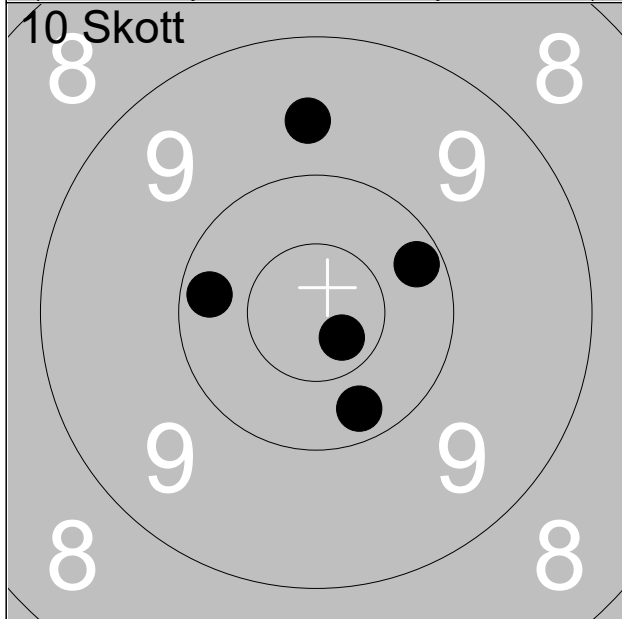

6:	10.2	←
7:	9.6	↑
8:	10.2	↓
9:	10.7x	↓
10:	10.2	→

Serie	49.0
-------	------

Total	325.0
-------	-------

Skjutlag

Tavla

6

3

Olle Gabrielsson

Ramselefors

Rommehed

NM

Da

13.07.2022

Björkskottet 2022

Ramselefors SKF

Prov

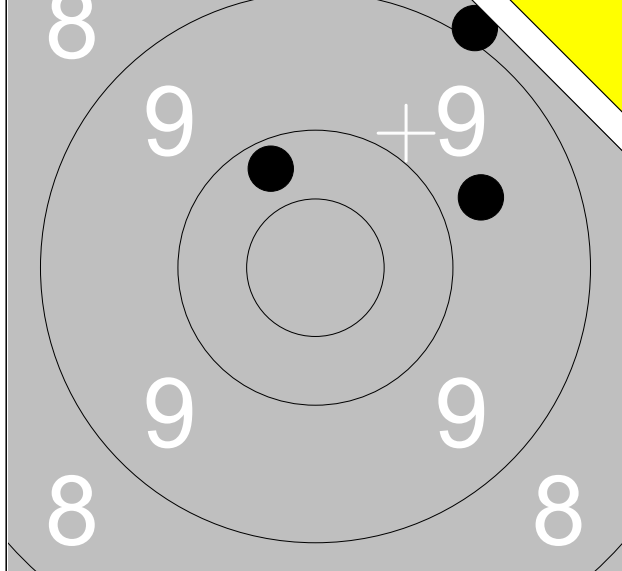

1:	8.9	↗
2:	9.7	→
3:	10.2	↗

Serie	27.0
Total	231.0

40 Skott

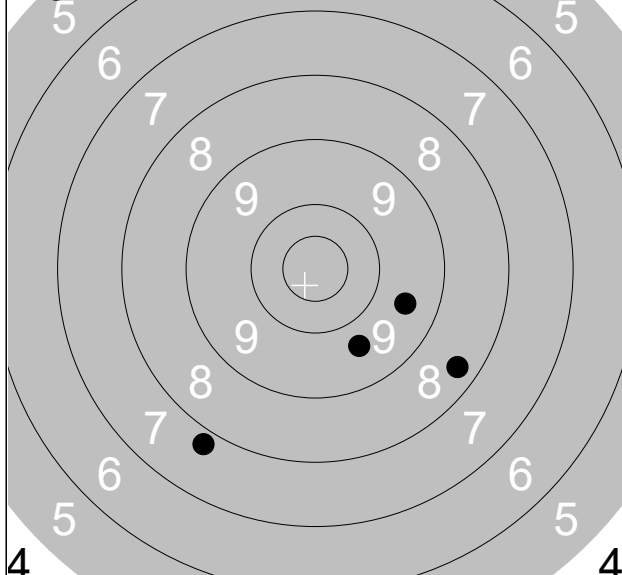

1:	9.7	↘
2:	5.3	↗
3:	7.8	↘
4:	8.4	↘
5:	9.5	↘

Serie	38.0
Total	269.0

10 Skott

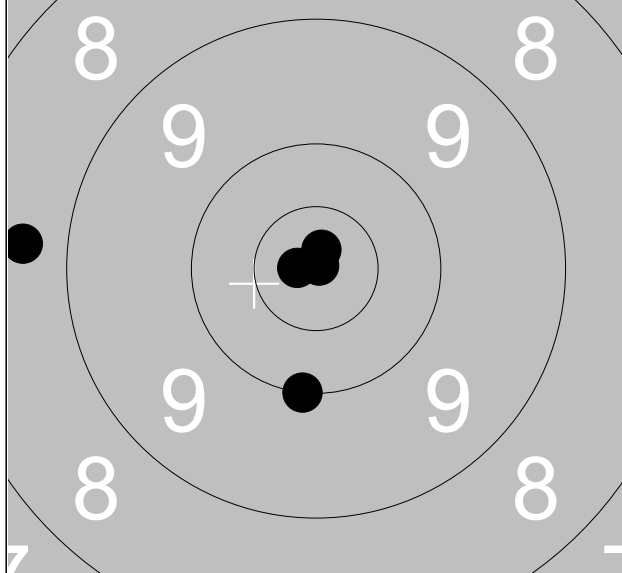

6:	8.7	←
7:	10.8x	←
8:	10.0	↓
9:	10.9x	↗
10:	10.8x	↑

Serie	48.0
Total	317.0

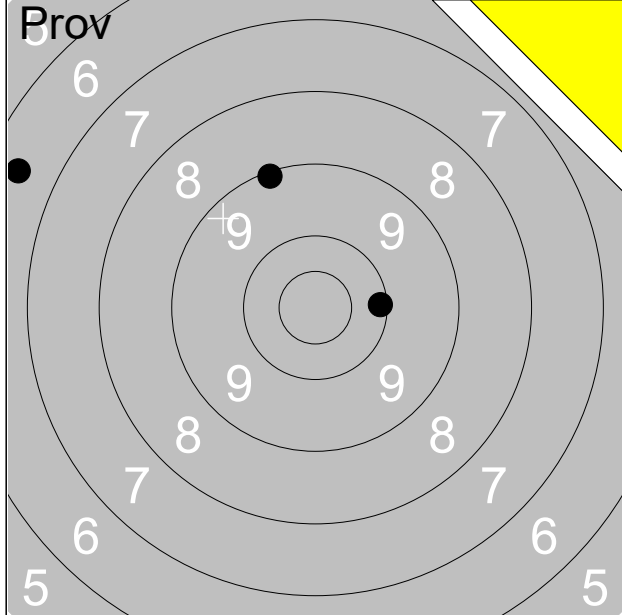

1:	6.5	↖
2:	9.1	↑
3:	10.1	→
Serie		25.0
Total		229.0

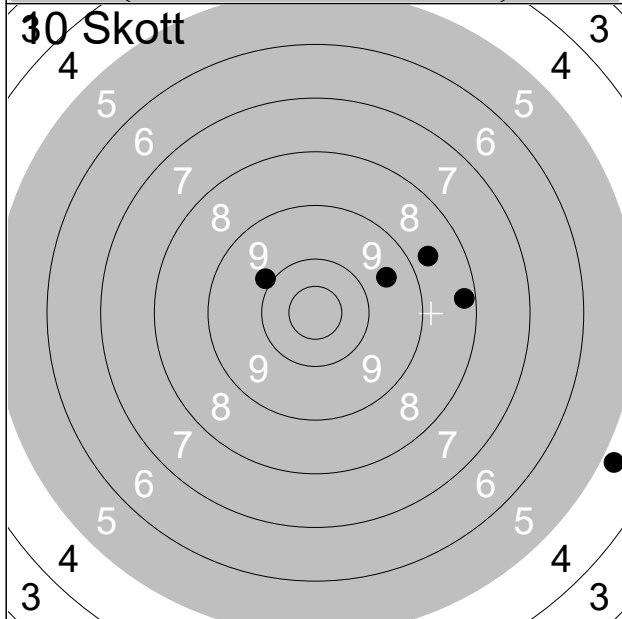

1:	9.5	↗
2:	4.8	↘
3:	8.7	↗
4:	8.2	→
5:	9.9	↖
Serie		38.0
Total		267.0

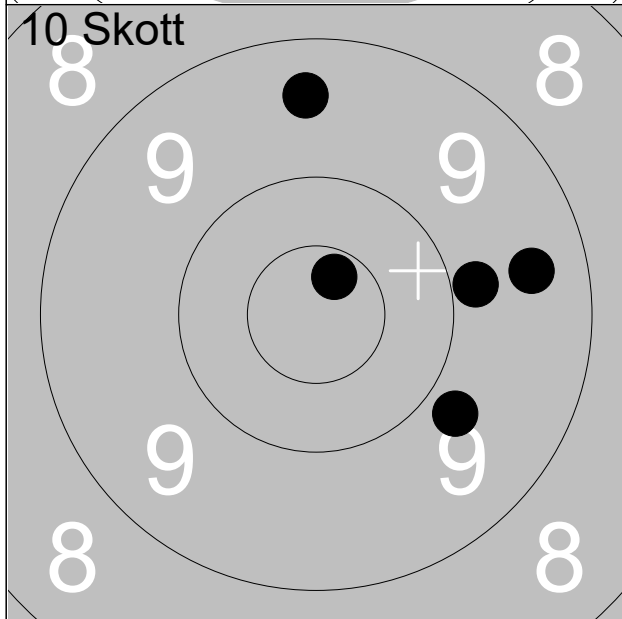

6:	10.7x	↗
7:	9.4	→
8:	9.4	↑
9:	9.8	↘
10:	9.9	→
Serie		46.0
Total		313.0

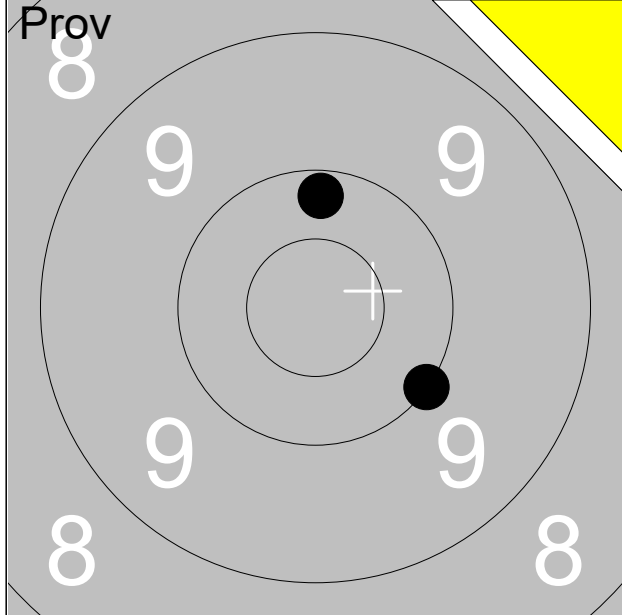

1:	10.2	↑
2:	10.0	↘

Serie	20.0
-------	------

Total	226.0
-------	-------

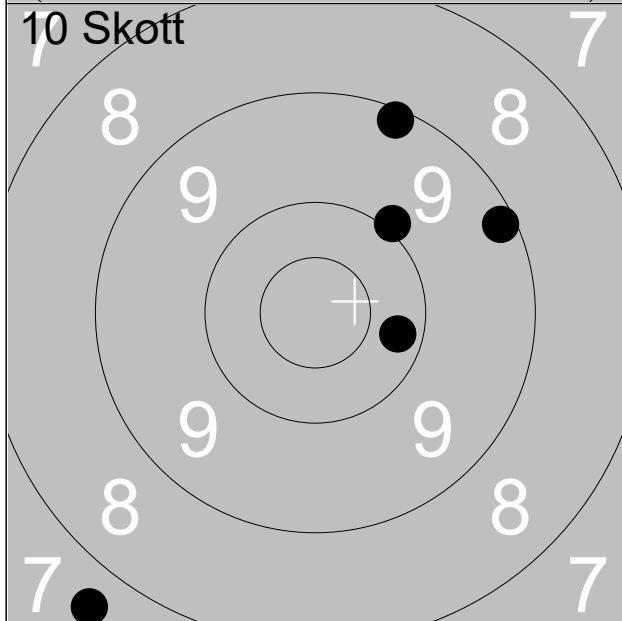

1:	9.2	↗
2:	7.7	↙
3:	10.2	→
4:	9.1	↑
5:	10.0	↗

Serie	45.0
-------	------

Total	271.0
-------	-------

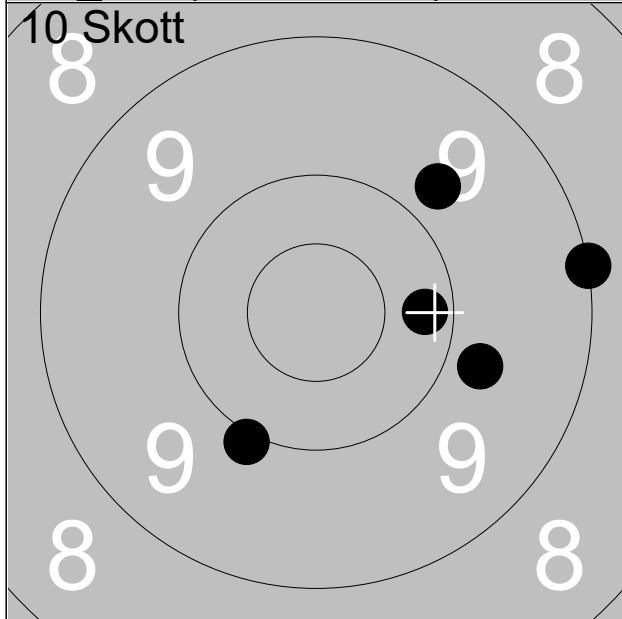

6:	10.2	→
7:	9.0	→
8:	9.8	↗
9:	9.8	→
10:	10.0	↙

Serie	47.0
-------	------

Total	318.0
-------	-------

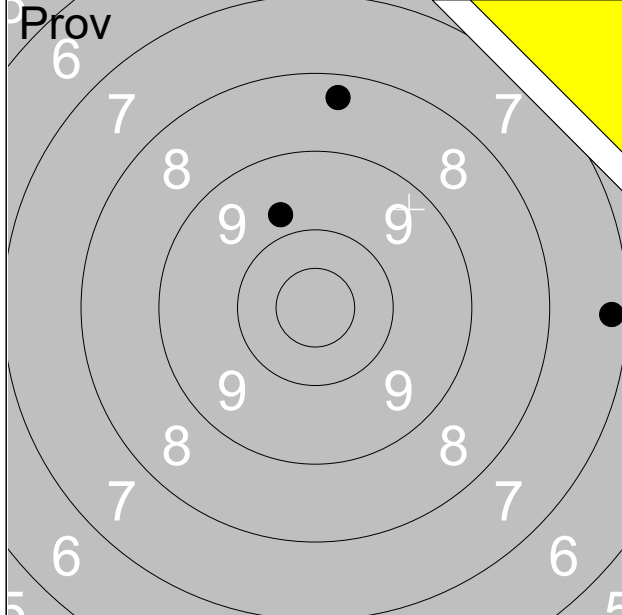

1:	7.2	→
2:	9.8	↑
3:	8.3	↑
Serie		24.0
Total		224.0

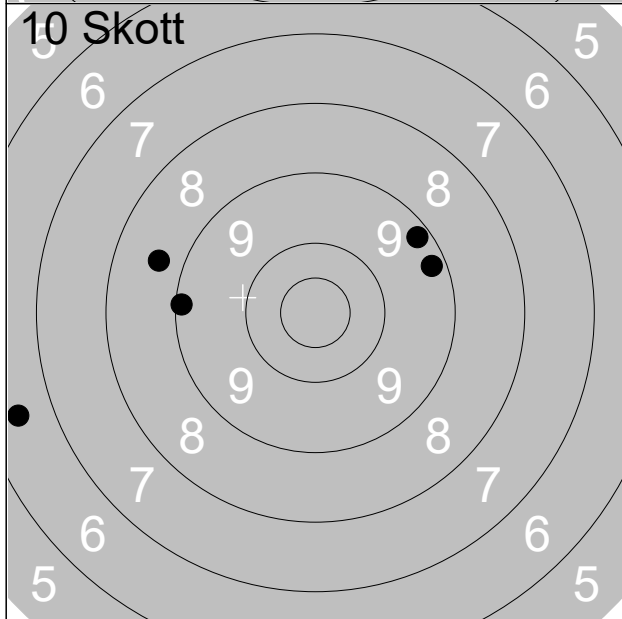

1:	9.1	←
2:	9.2	↗
3:	8.7	←
4:	6.5	←
5:	9.2	↗
Serie		41.0
Total		265.0

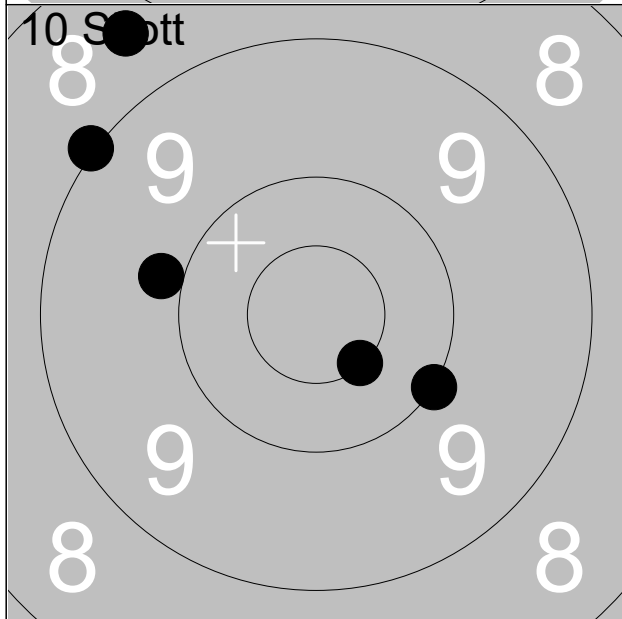

6:	10.5x	↘
7:	9.0	↗
8:	8.6	↗
9:	9.9	←
10:	10.0	↘
Serie		46.0
Total		311.0

Skjutlag

Tavla

6

7

Liam Bernhardsson

Ramselefors

Mönsterås

NM

Sm

13.07.2022

Björkskottet 2022

Ramselefors SKF

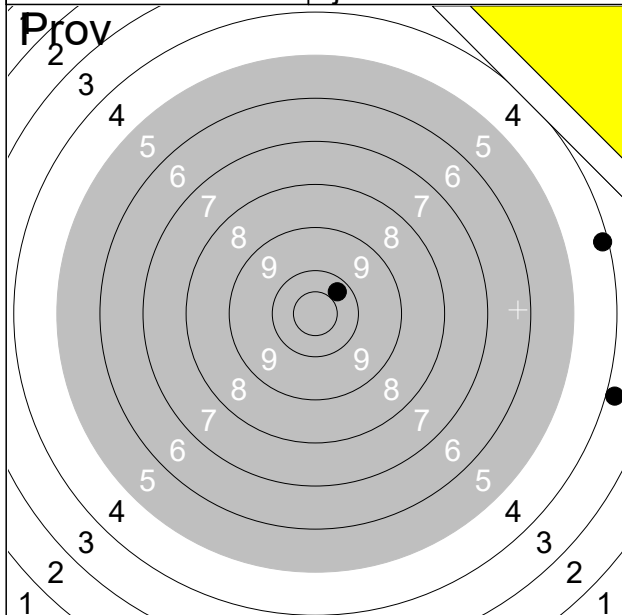

1:	10.3	↗
2:	3.8	→
3:	4.2	→

Serie	17.0
Total	222.0

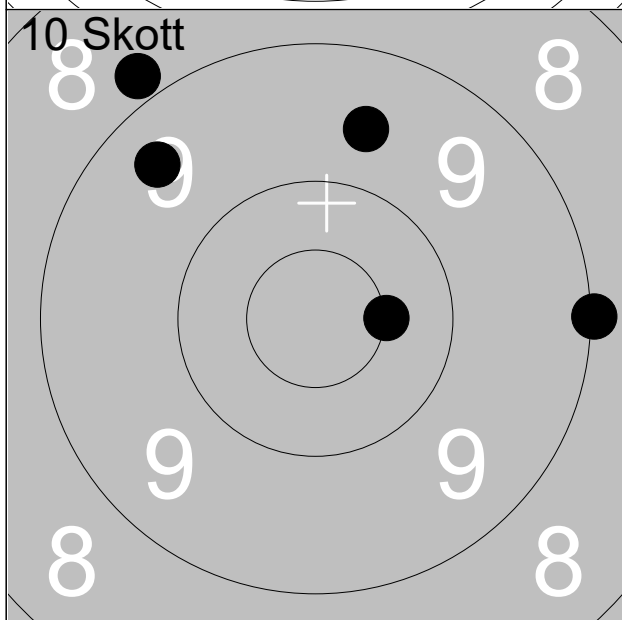

1:	10.5x	→
2:	9.0	→
3:	9.4	↗
4:	9.6	↑
5:	8.8	↖

Serie	45.0
Total	267.0

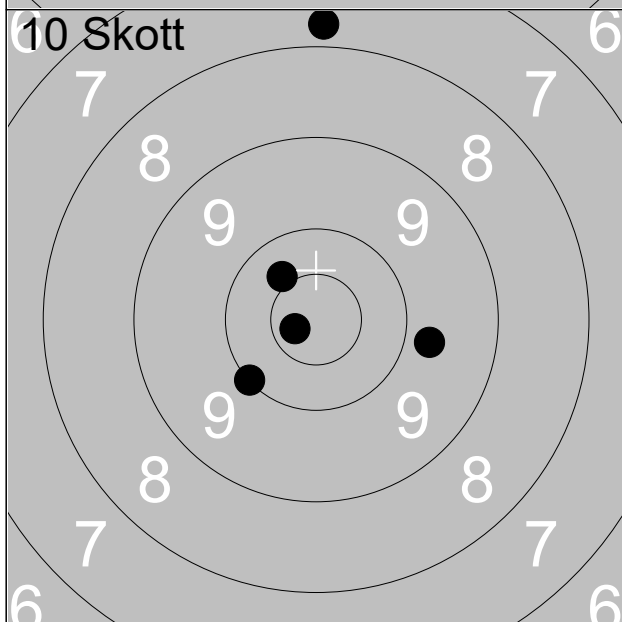

6:	7.8	↑
7:	9.8	→
8:	10.4	↗
9:	10.0	↖
10:	10.7x	↖

Serie	46.0
Total	313.0

Skjutlag

Tavla

6

8

Peter Lundqvist

Ramselefors

Ununge

NM

St

13.07.2022

Björkskottet 2022

Ramselefors SKF

Färov

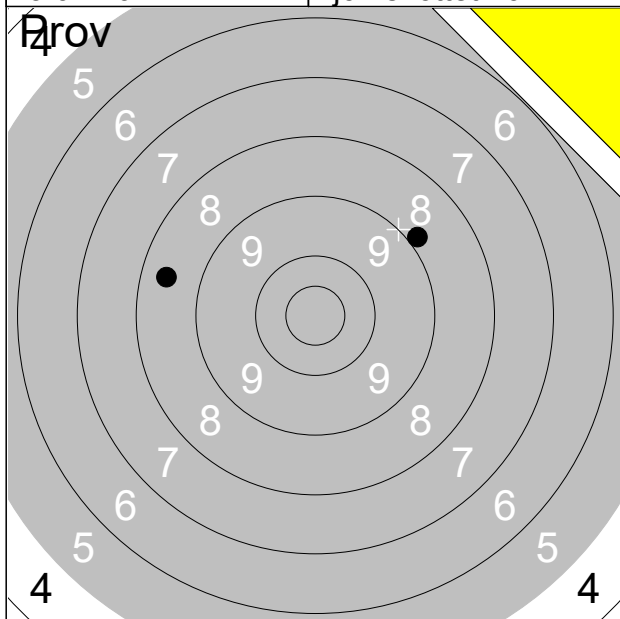

1:	8.5	←
2:	8.9	↗
3:	5.5	↗

Serie	21.0
Total	222.0

10 Skott

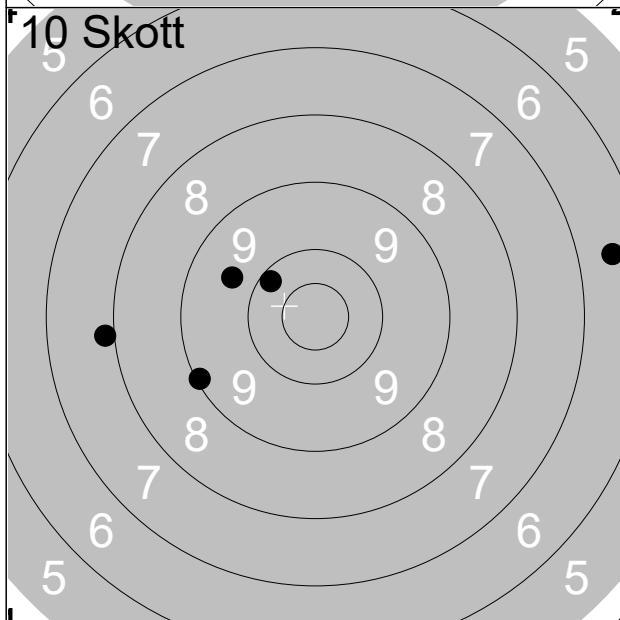

1:	6.5	→
2:	7.9	←
3:	9.1	←
4:	9.7	↖
5:	10.2	↖

Serie	41.0
Total	263.0

10 Skott

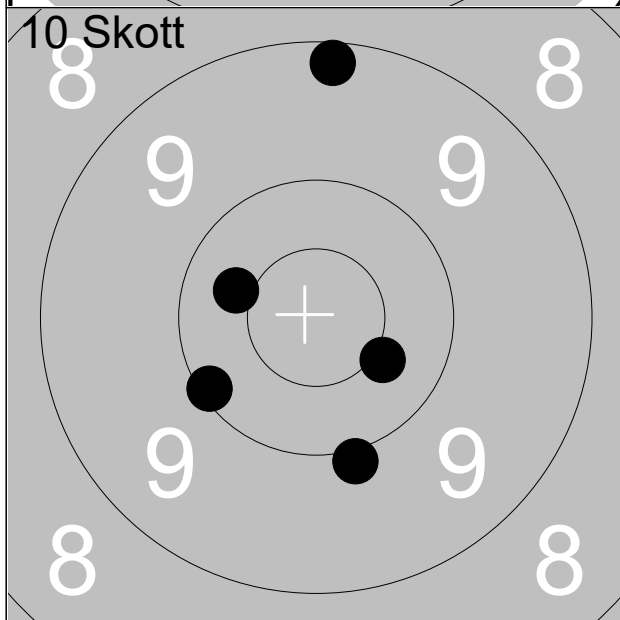

6:	10.0	↓
7:	9.2	↑
8:	10.4x	↘
9:	10.4	←
10:	10.1	↖

Serie	49.0
Total	312.0

Skjutlag

Tavla

6

9

Clas Bernhardsson

Ramselefors

Mönsterås

NM

Sm

13.07.2022

Björkskottet 2022

Ramselefors SKF

Prov

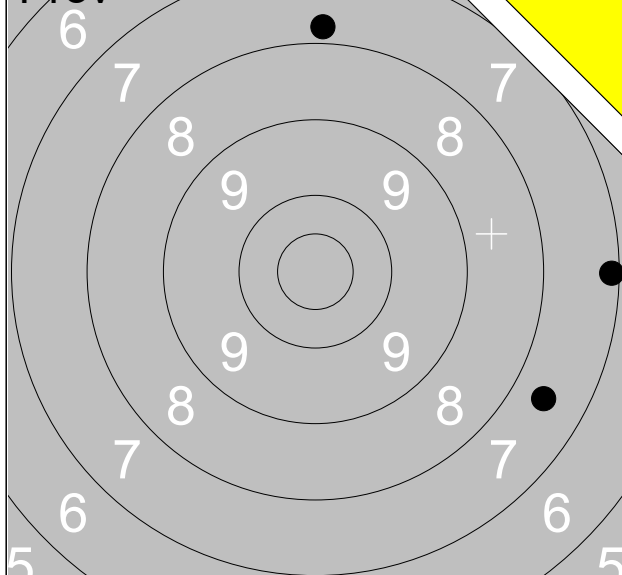

1: 7.8

↑

2: 7.1

→

3: 7.6

↘

Serie

21.0

Total

221.0

10 Skott

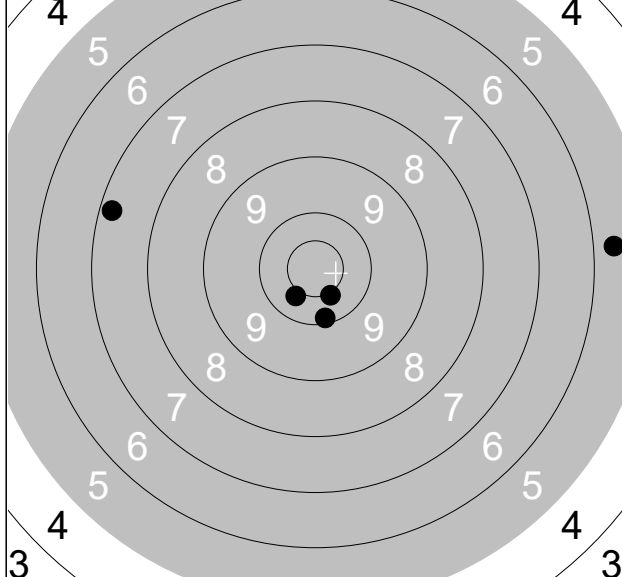

1: 10.1

↓

2: 10.4

↙

3: 5.7

→

4: 7.2

←

5: 10.4x

↓

Serie

42.0

Total

263.0

10 Skott

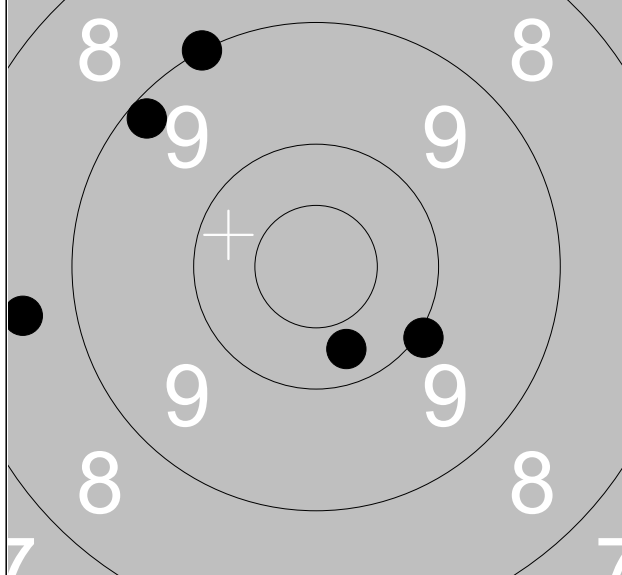

6: 8.6

←

7: 10.0

↘

8: 9.0

↗

9: 9.2

↗

10: 10.3

↓

Serie

46.0

Total

309.0

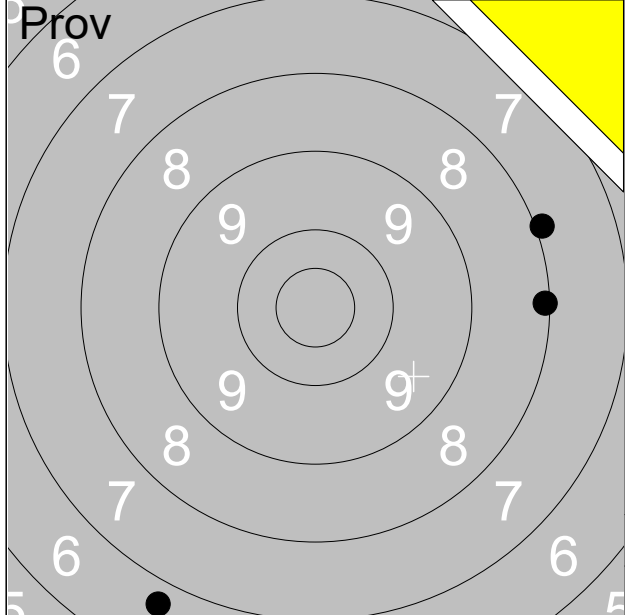

1:	7.9	→
2:	8.1	→
3:	6.7	↓
Serie		21.0
Total		221.0

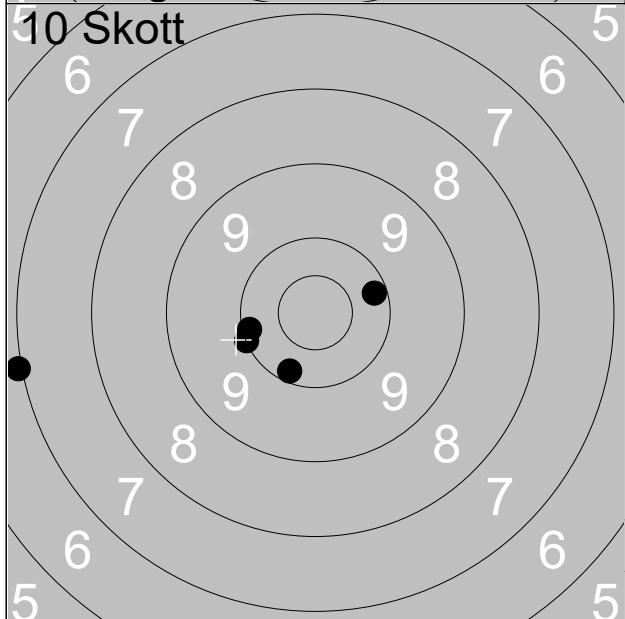

1:	7.0	←
2:	10.2	→
3:	10.0	←
4:	10.1	←
5:	10.2	↓
Serie		47.0
Total		268.0

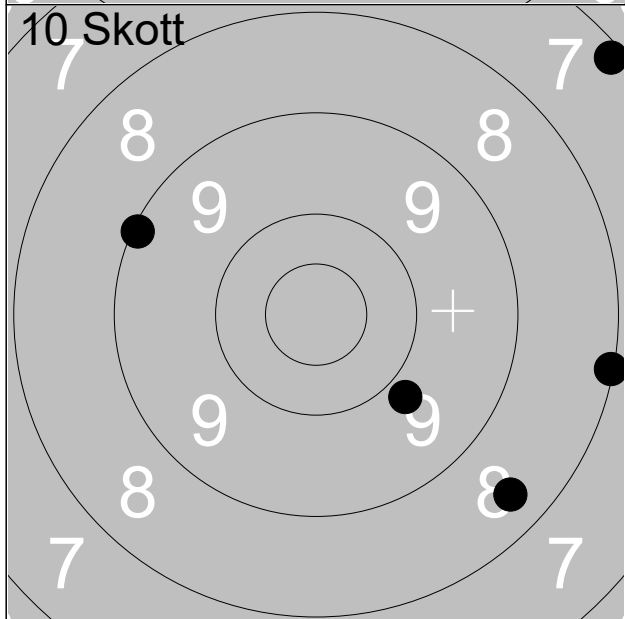

6:	9.8	↓
7:	7.2	↗
8:	8.1	→
9:	9.1	↗
10:	8.4	↓
Serie		41.0
Total		309.0

Skjutlag

Tavla

6

11

André Engström

Ramselefors

Piteå

NM

No

13.07.2022

Björskottet 2022

Ramselefors SKF

Prov

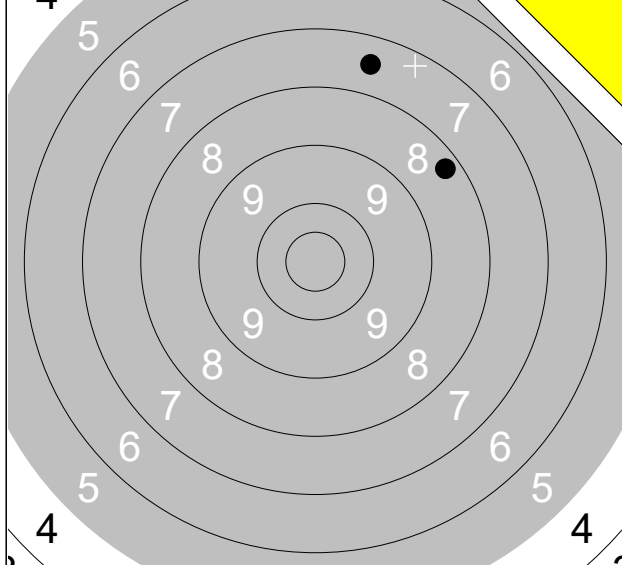

1:	8.3	↗
2:	5.5	↑
3:	7.5	↑

Serie	20.0
Total	220.0

10 Skott

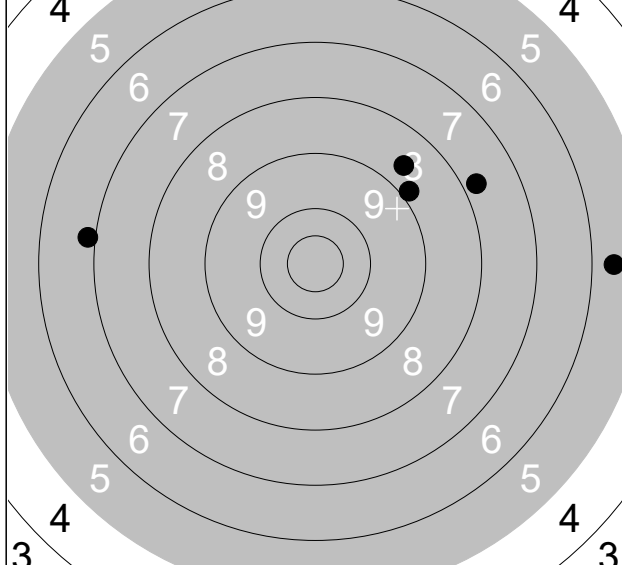

1:	8.6	↗
2:	6.9	←
3:	7.8	↗
4:	5.6	→
5:	8.9	↗

Serie	34.0
Total	254.0

10 Skott

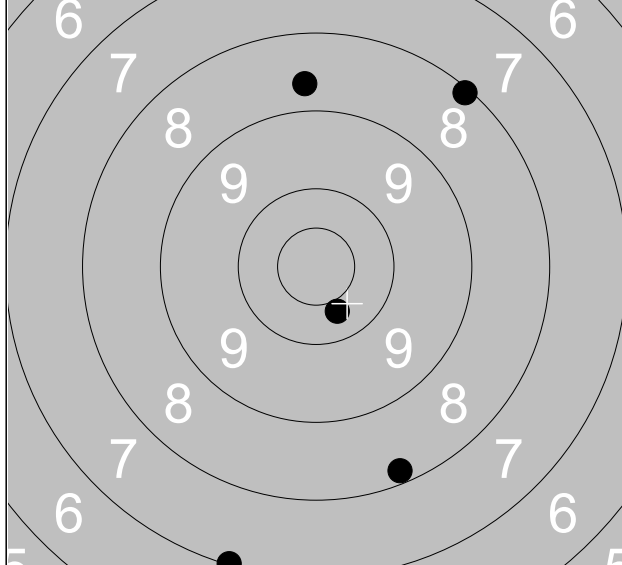

6:	8.7	↑
7:	8.1	↗
8:	7.1	↓
9:	10.4	↓
10:	8.2	↓

Serie	41.0
Total	295.0

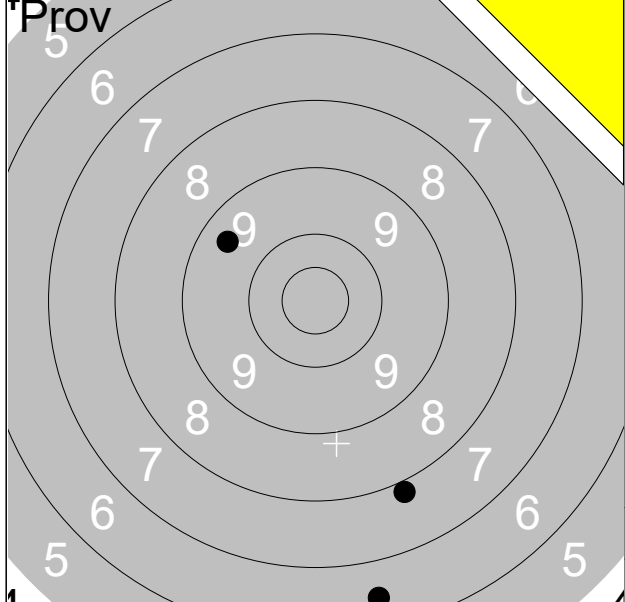

1:	6.5				↓
2:	7.9				↓
3:	9.4				↗
Serie					22.0
Total					218.0

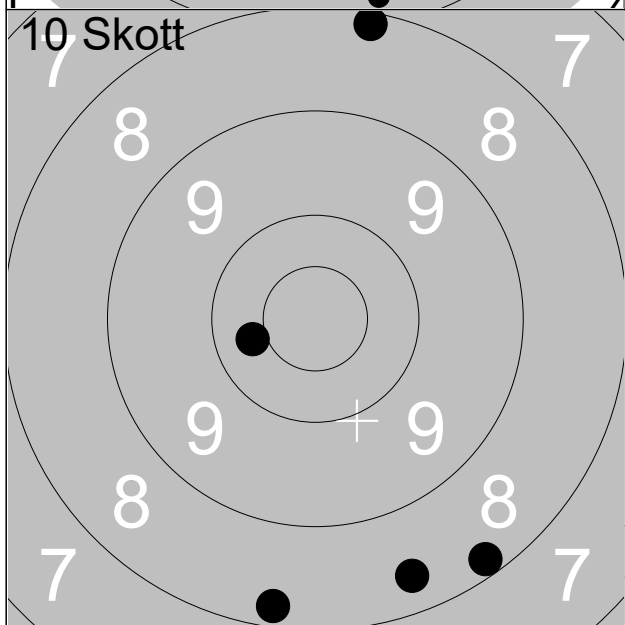

1:	8.2				↓
2:	8.4				↓
3:	8.2				↓
4:	8.1				↑
5:	10.4				←
Serie					42.0
Total					260.0

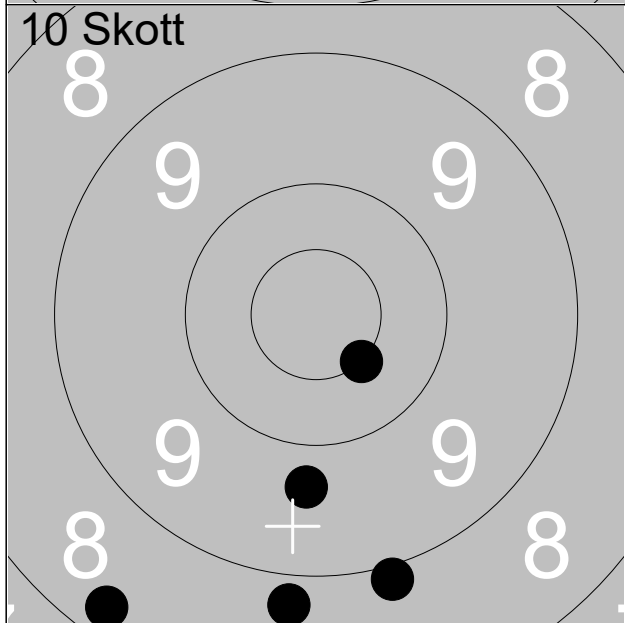

6:	8.8				↓
7:	8.3				↙
8:	8.9				↓
9:	10.5x				↓
10:	9.7				↓
Serie					43.0
Total					303.0

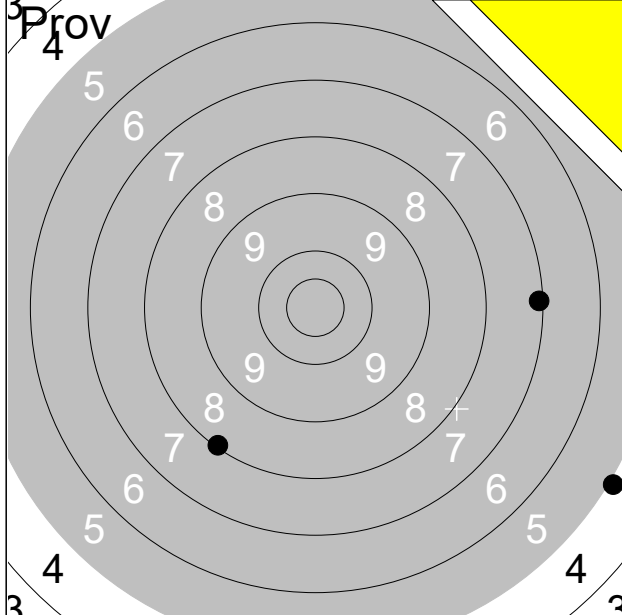

1:	4.9	↘
2:	7.1	→
3:	8.1	↙
Serie		19.0
Total		215.0

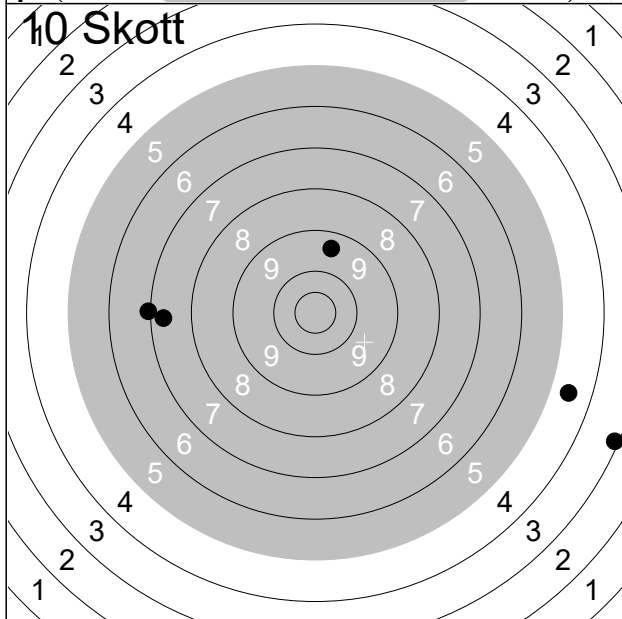

1:	7.3	←
2:	9.4	↑
3:	3.1	→
4:	7.0	←
5:	4.6	→
Serie		30.0
Total		245.0

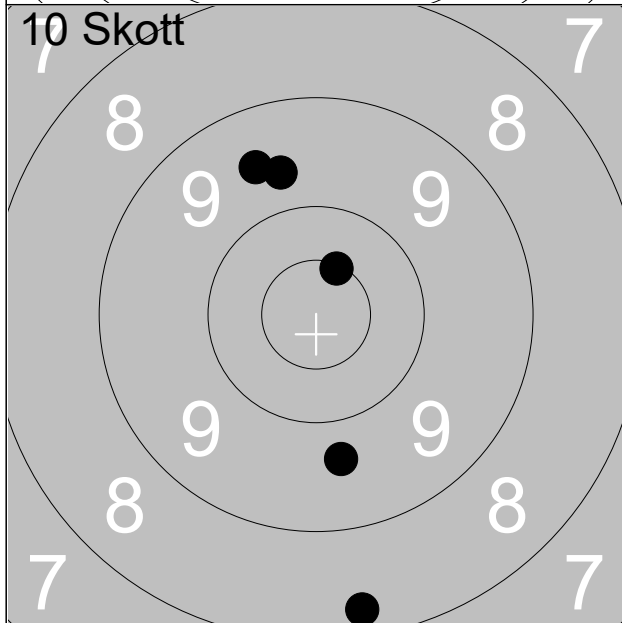

6:	9.7	↑
7:	8.3	↓
8:	9.7	↓
9:	9.6	↑
10:	10.5x	↗
Serie		45.0
Total		290.0

Skjutlag

Tavla

6

17

Linda Gustavsson

Ramselefors

Umeå

Ställning

Vb

13.07.2022

Björkskottet 2022

Ramselefors SKF

Pröv

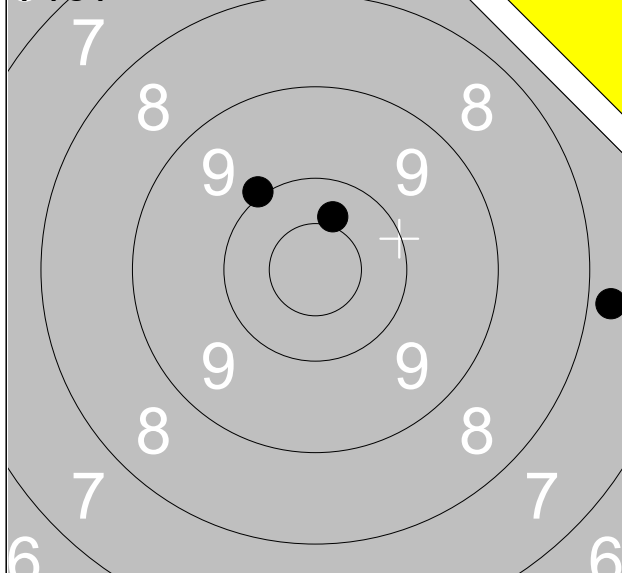

1: 10.0

↗

2: 10.4

↑

3: 7.8

→

Serie

27.0

Total

236.0

10 Skott

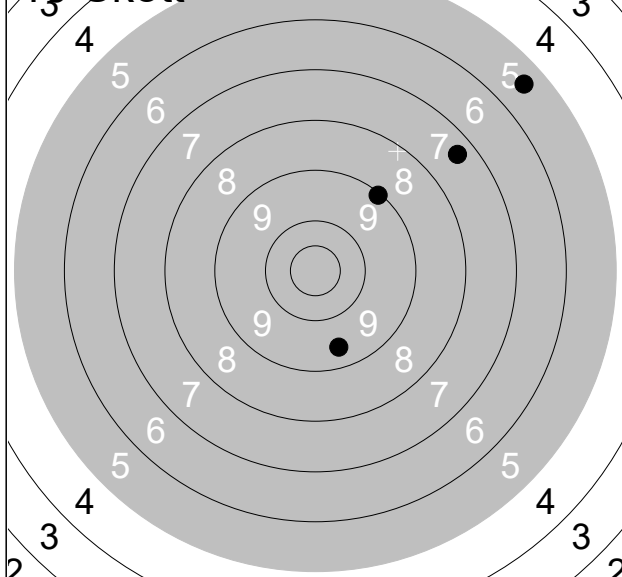

1: 5.1

↑

2: 5.5

↗

3: 9.1

↗

4: 7.4

↗

5: 9.4

↓

Serie

35.0

Total

271.0

10 Skott

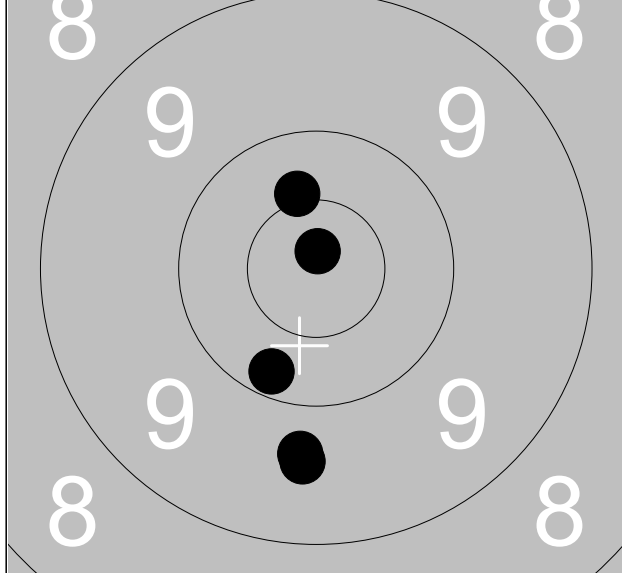

6: 10.8x

↑

7: 10.4x

↑

8: 10.2

↓

9: 9.6

↓

10: 9.7

↓

Serie

48.0

Total

319.0

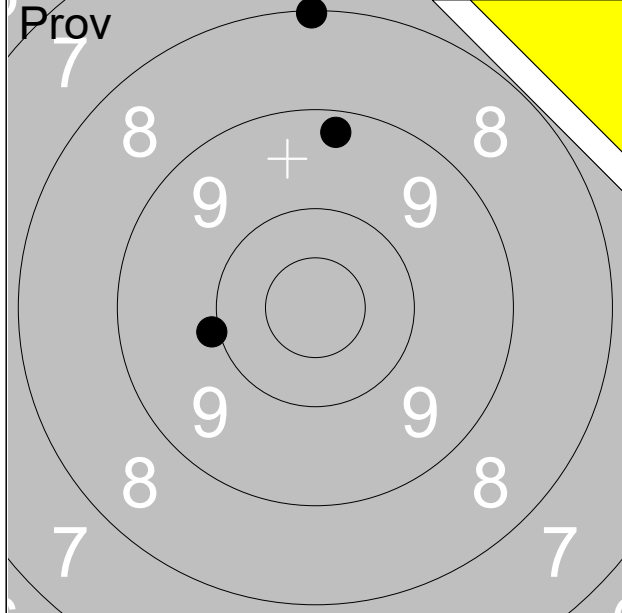

1:	9.2	↑
2:	10.0	←
3:	8.1	↑
Serie		27.0
Total		224.0

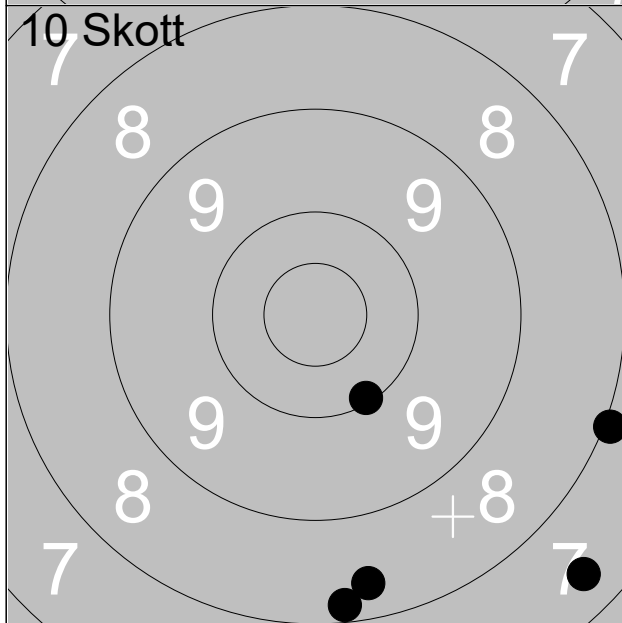

1:	8.0	→
2:	8.2	↓
3:	8.4	↓
4:	7.4	↓
5:	10.1	↓
Serie		41.0
Total		265.0

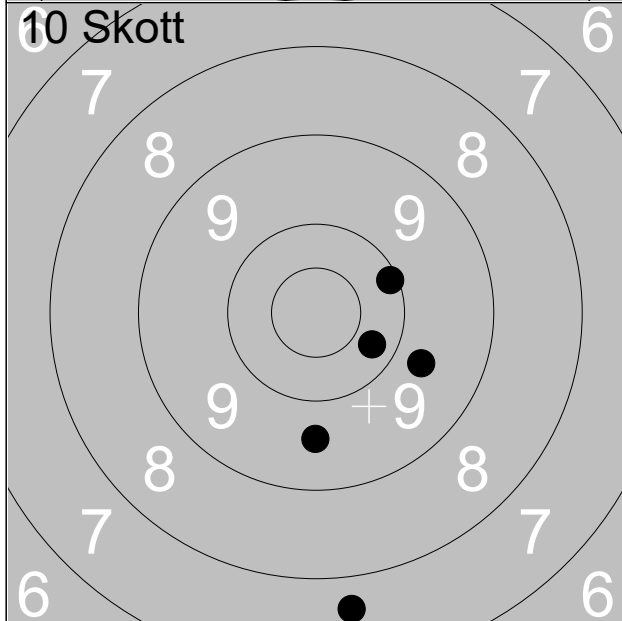

6:	7.7	↓
7:	9.7	→
8:	9.6	↓
9:	10.1	→
10:	10.3	→
Serie		45.0
Total		310.0

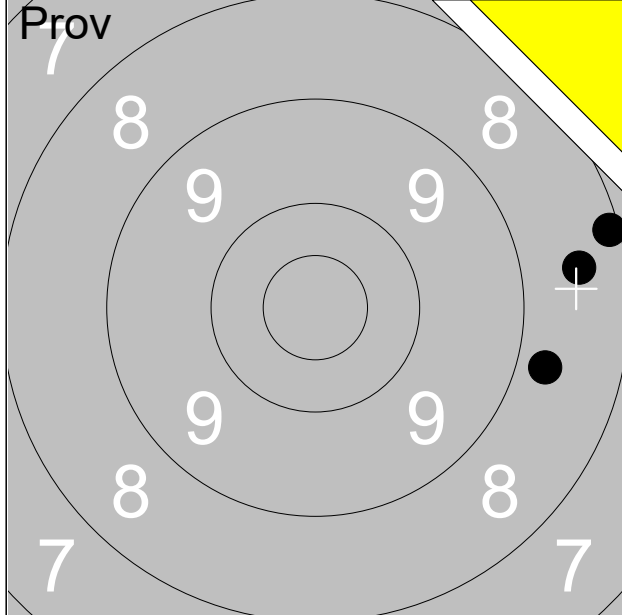

1:	8.1	→
2:	8.5	→
3:	8.8	→
Serie		24.0
Total		219.0

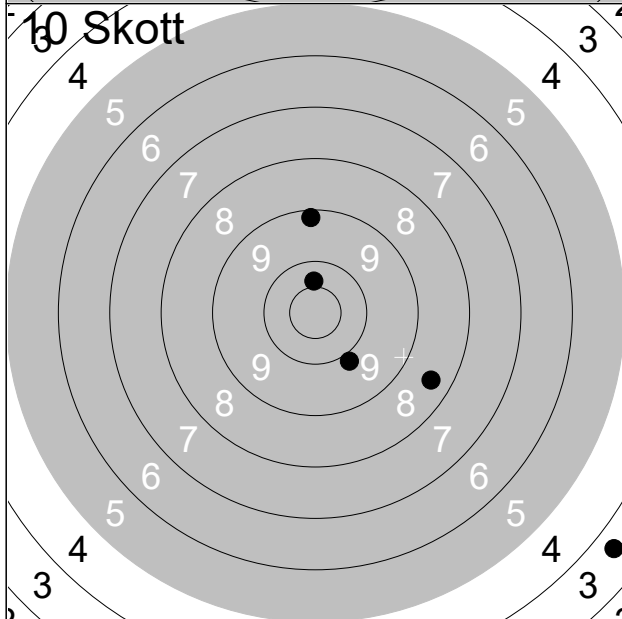

1:	8.4	↘
2:	9.2	↑
3:	3.6	↘
4:	10.4	↑
5:	9.9	↘
Serie		39.0
Total		258.0

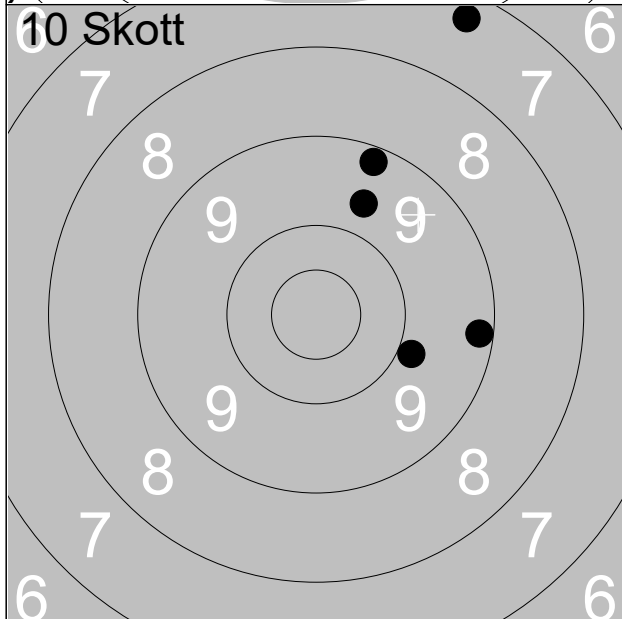

6:	7.3	↗
7:	9.7	↗
8:	9.2	↗
9:	9.2	→
10:	9.9	→
Serie		43.0
Total		301.0

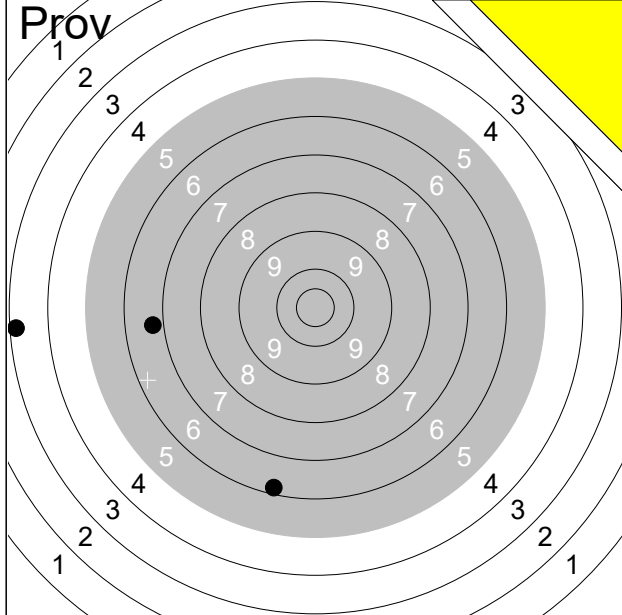

1:	3.2	←
2:	6.8	←
3:	6.2	↓
Serie		15.0
Total		218.0

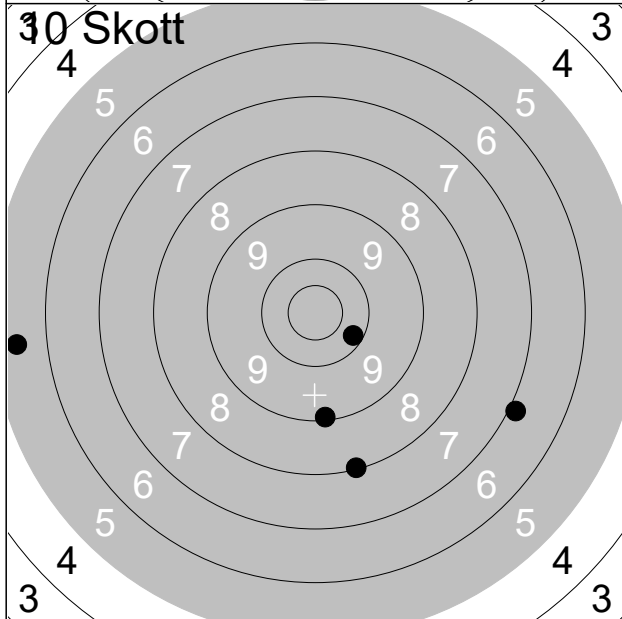

1:	10.2	↘
2:	5.5	←
3:	8.1	↓
4:	9.1	↓
5:	6.9	↘
Serie		38.0
Total		256.0

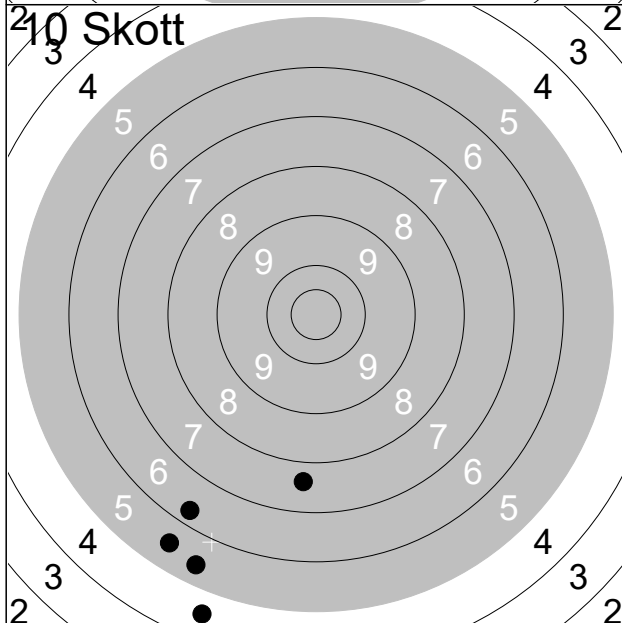

6:	5.4	↓
7:	6.3	↓
8:	5.5	↓
9:	4.6	↓
10:	7.7	↓
Serie		27.0
Total		283.0

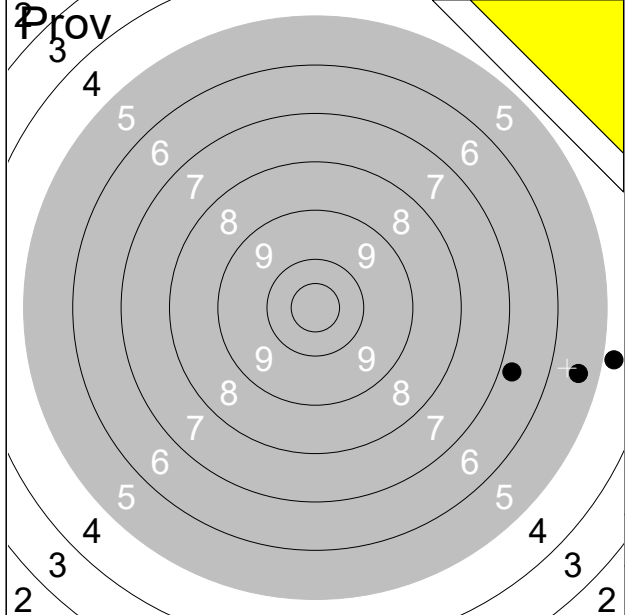

1:	6.8	→
2:	5.5	→
3:	4.8	→
Serie		15.0
Total		214.0

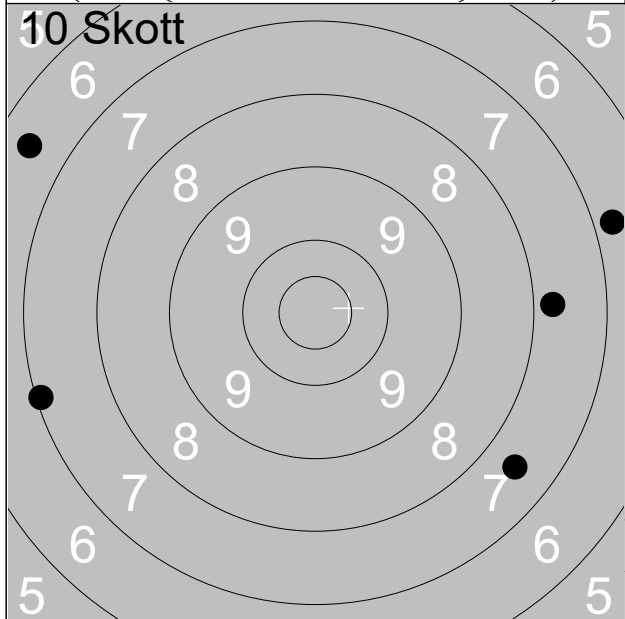

1:	6.8	→
2:	7.6	↘
3:	7.1	←
4:	7.8	→
5:	6.5	↗
Serie		33.0
Total		247.0

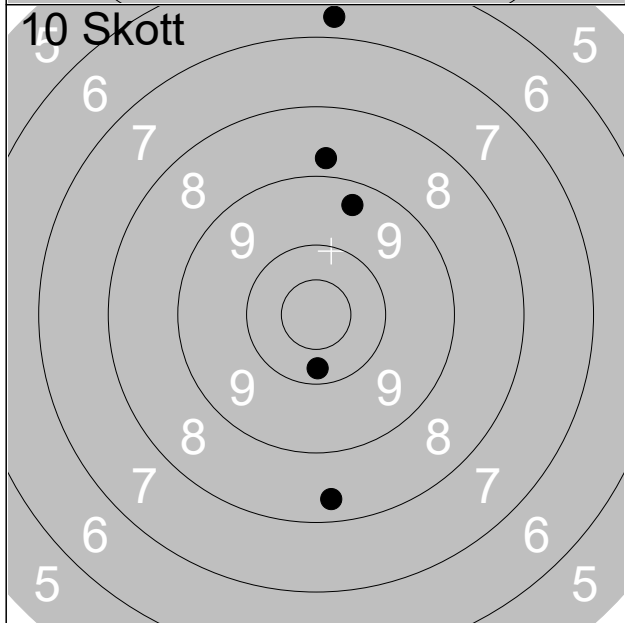

6:	6.7	↑
7:	8.4	↓
8:	8.8	↑
9:	10.2	↓
10:	9.4	↑
Serie		41.0
Total		288.0

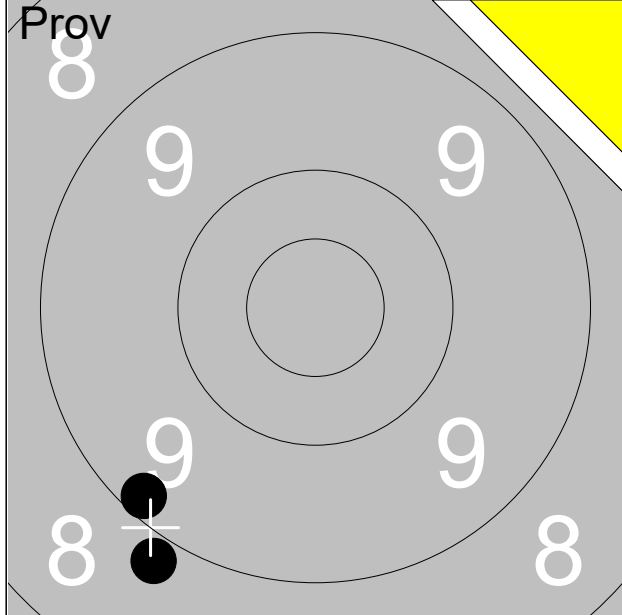

1:	8.8	↙
2:	9.2	↙
Serie		17.0
Total		183.0

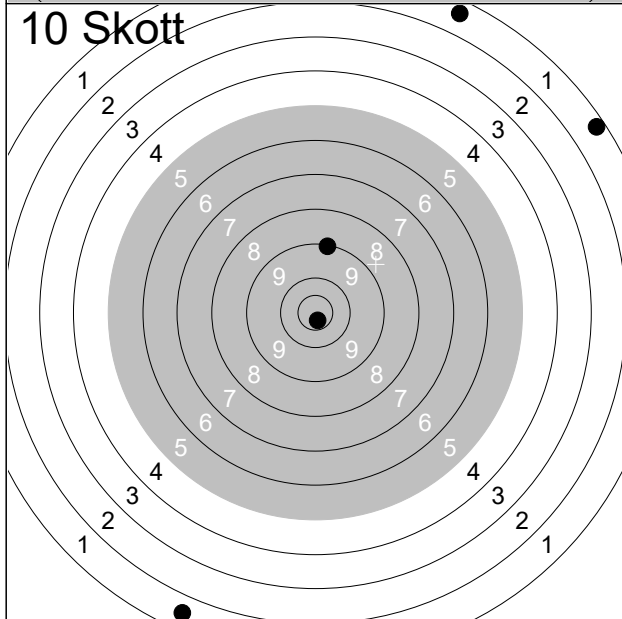

1:	1.3	↗
2:	1.4	↑
3:	1.5	↙
4:	10.7x	↘
5:	9.1	↑
Serie		22.0
Total		205.0

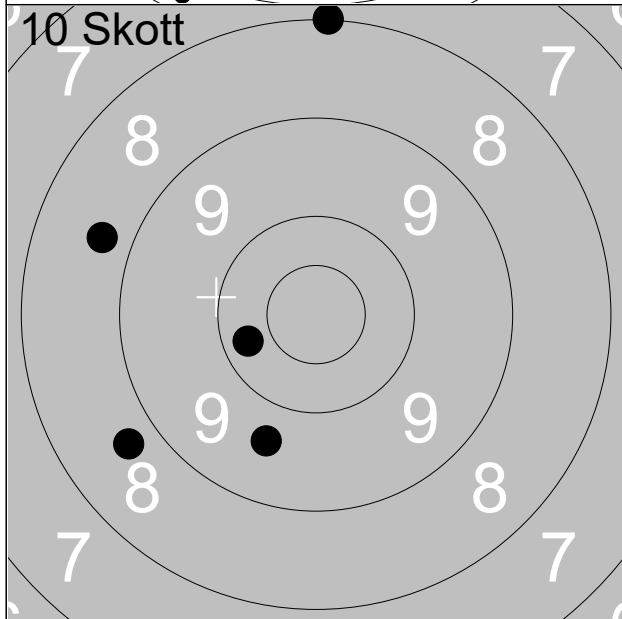

6:	8.0	↑
7:	8.7	↙
8:	10.3	←
9:	9.6	↙
10:	8.7	↙
Serie		43.0
Total		248.0