

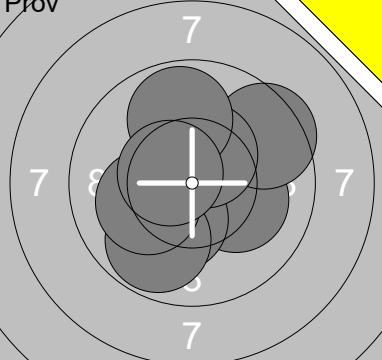

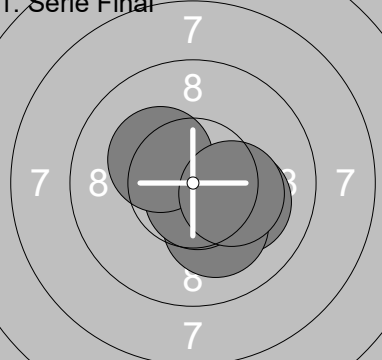











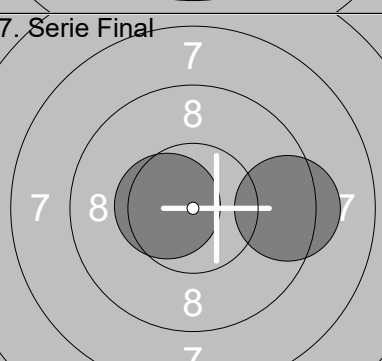

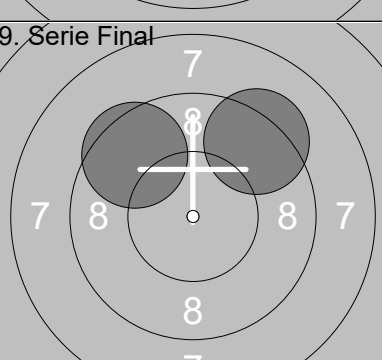

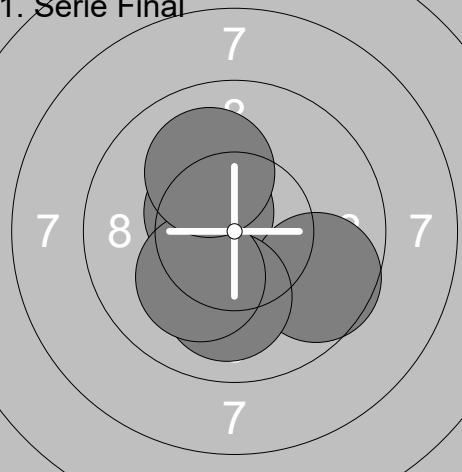
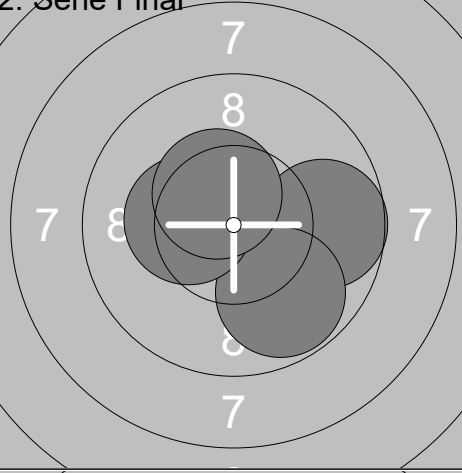
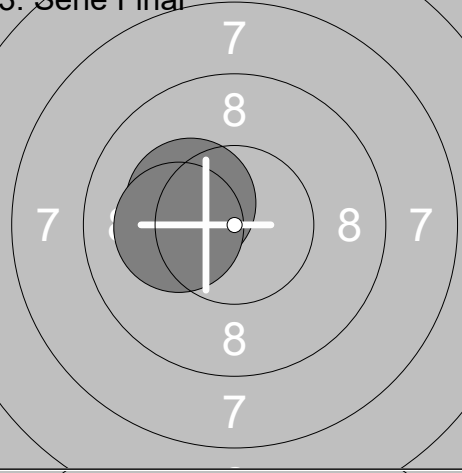
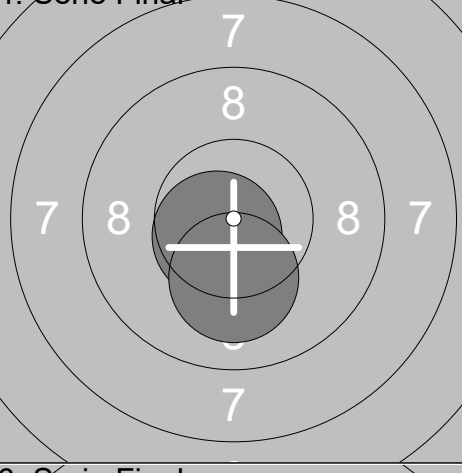
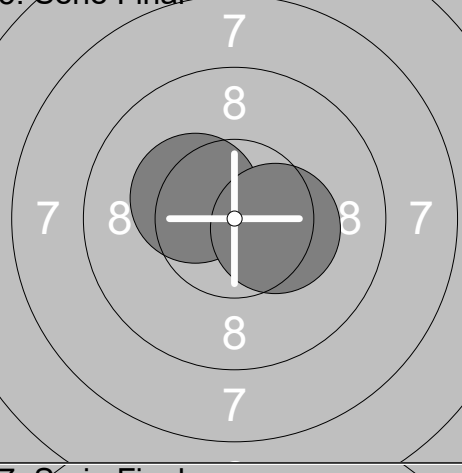
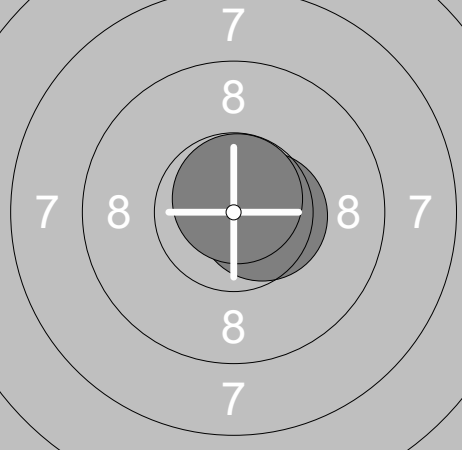
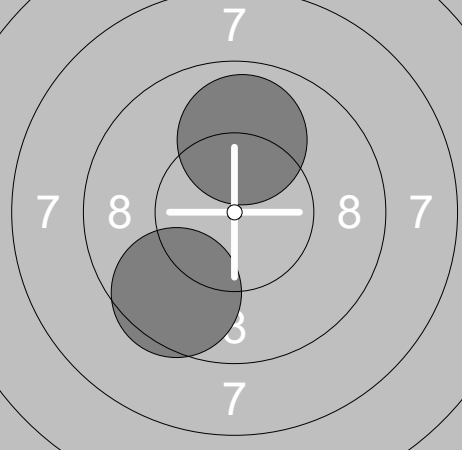
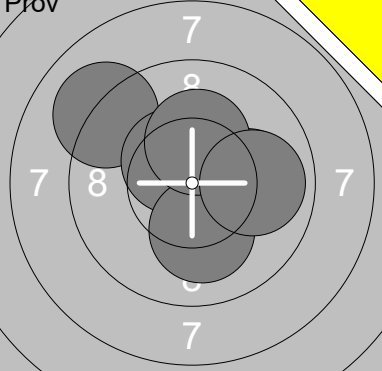
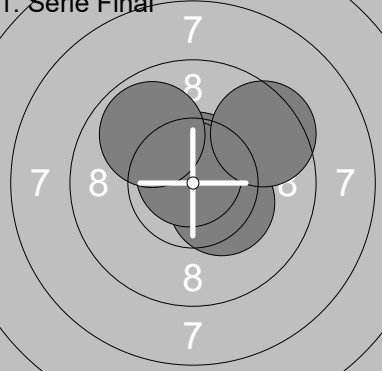
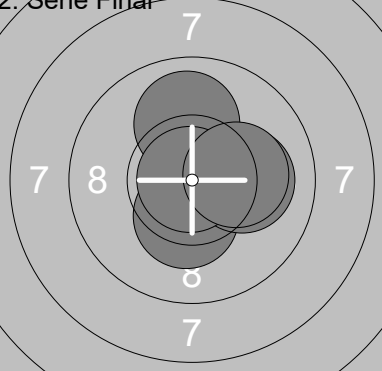
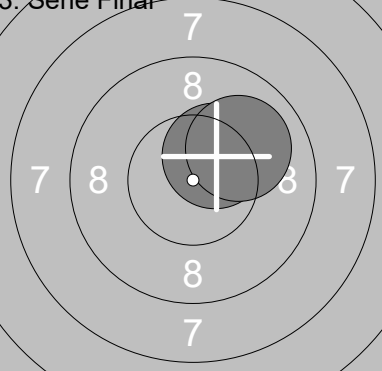
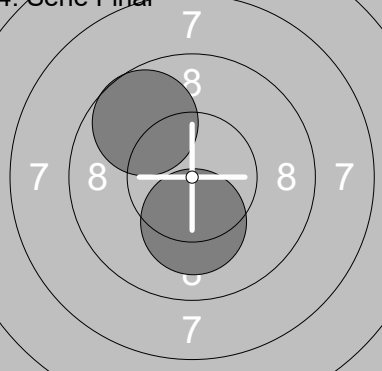
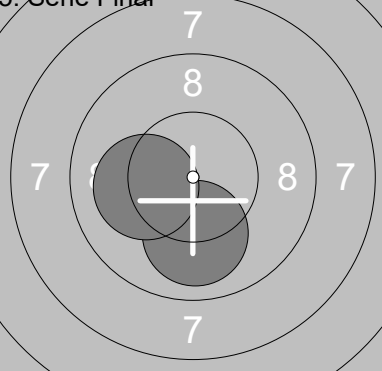
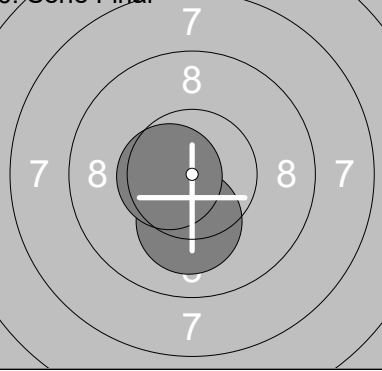

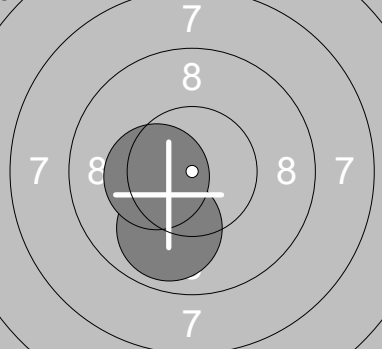
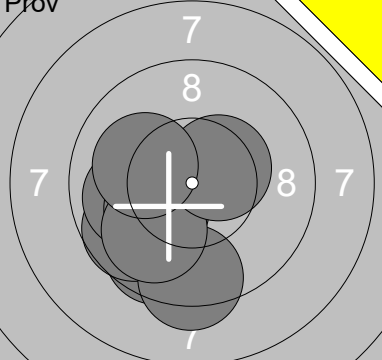

Skjutlag	Tavla	Frans Rasmusson		
5	21	Ramselefors	Sjöbo	A Sk
10.04.2022	SM Luftgevär 2022	Ramselefors SKF		
Prov 	1: 9.7 → 2: 9.6 ↓ 3: 9.5 → 4: 10.6x ↓ 5: 9.9 ↓ 6: 10.4x ←	1. Serie Final 	1: 10.8x ↑ 2: 9.2 ↖ 3: 10.3x → 4: 10.0 → 5: 10.6x ↙	
	Serie 59.7		Serie 50.9	
	Total 0.0		Total 50.9	
2. Serie Final 	1: 9.7 ↖ 2: 10.2x ↙ 3: 9.9 ↓ 4: 10.3x ↗ 5: 10.0 ←	3. Serie Final 	1: 9.6 ↖ 2: 10.0 ↑	
	Serie 50.1		Serie 19.6	
	Total 101.0		Total 120.6	
4. Serie Final 	1: 8.7 ← 2: 10.5x ↑			
	Serie 19.2			
	Total 139.8			

Pröv 	1: 10.1 → 2: 9.5 ↗ 3: 10.3x ↓ 4: 10.4x ↑ 5: 9.8 ↓ 6: 10.1 ← 7: 9.9 ↑ 8: 10.5x ↖	1. Serie Final 	1: 10.1 → 2: 10.1 ↓ 3: 10.7x ↓ 4: 10.3x ↗ 5: 10.3x →
	Serie 80.6		Serie 51.5
	Total 0.0		Total 51.5
2. Serie Final 	1: 10.5x ↓ 2: 10.2x ↗ 3: 10.8x ↗ 4: 9.4 ← 5: 10.0 ↑	3. Serie Final 	1: 10.3x ↖ 2: 10.6x ←
	Serie 50.9		Serie 20.9
	Total 102.4		Total 123.3
4. Serie Final 	1: 10.1 ↗ 2: 10.6x ↓	5. Serie Final 	1: 10.2x ← 2: 10.5x →
	Serie 20.7		Serie 20.7
	Total 144.0		Total 164.7
6. Serie Final 	1: 10.4x ↗ 2: 10.7x →	7. Serie Final 	1: 9.4 → 2: 10.5x ←
	Serie 21.1		Serie 19.9
	Total 185.8		Total 205.7
8. Serie Final 	1: 9.9 ↓ 2: 10.1 →	9. Serie Final 	1: 9.5 ↖ 2: 9.3 ↗
	Serie 20.0		Serie 18.8
	Total 225.7		Total 244.5

Prov 	1: 10.5x ↗ 2: 10.2x ↓ 3: 10.1 ↙ 4: 10.7x ↙ 5: 10.8x ↗ <hr/> Serie 52.3 Total 0.0	1. Serie Final 	1: 10.5x ↖ 2: 9.6 ↘ 3: 10.0 ↓ 4: 10.2x ↙ 5: 10.1 ↗ <hr/> Serie 50.4 Total 50.4
2. Serie Final 	1: 10.6x ↗ 2: 9.7 → 3: 9.8 ↘ 4: 10.3x ↖ 5: 10.5x ↗ <hr/> Serie 50.9 Total 101.3	3. Serie Final 	1: 10.3x ↖ 2: 10.2x ← <hr/> Serie 20.5 Total 121.8
4. Serie Final 	1: 10.6x ↙ 2: 10.1 ↓ <hr/> Serie 20.7 Total 142.5	5. Serie Final 	1: 10.3x ↖ 2: 10.4x → <hr/> Serie 20.7 Total 163.2
6. Serie Final 	1: 10.5x → 2: 10.8x ↑ <hr/> Serie 21.3 Total 184.5	7. Serie Final 	1: 9.6 ↙ 2: 9.9 ↑ <hr/> Serie 19.5 Total 204.0

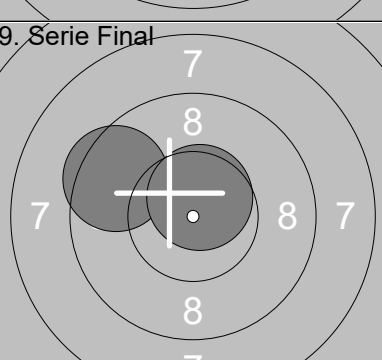
Pröv 	1: 9.1 ↖ 2: 10.5x ↖ 3: 10.0 → 4: 10.1 ↓ 5: 10.2x ↑ 6: 9.9 →	1. Serie Final 	1: 10.6x ↑ 2: 10.4x ↘ 3: 10.8x ↖ 4: 9.5 ↗ 5: 9.9 ↖
	Serie 59.8		Serie 51.2
	Total 0.0		Total 51.2
2. Serie Final 	1: 10.0 ↑ 2: 10.3x ↓ 3: 10.1 → 4: 10.9x ← 5: 10.2x →	3. Serie Final 	1: 10.4x ↗ 2: 10.0 ↗
	Serie 51.5		Serie 20.4
	Total 102.7		Total 123.1
4. Serie Final 	1: 10.2x ↓ 2: 9.7 ↖	5. Serie Final 	1: 10.0 ↓ 2: 10.1 ←
	Serie 19.9		Serie 20.1
	Total 143.0		Total 163.1
6. Serie Final 	1: 10.2x ↓ 2: 10.6x ←	7. Serie Final 	1: 10.6x ↘ 2: 10.4x ←
	Serie 20.8		Serie 21.0
	Total 183.9		Total 204.9
8. Serie Final 	1: 9.9 ↓ 2: 10.3x ←		
	Serie 20.2		
	Total 225.1		

Pröv 	1: 9.6 ↘ 2: 9.7 ↙ 3: 10.0 ← 4: 9.3 ↓ 5: 10.2x ↙ 6: 9.9 ↙ 7: 10.4x → 8: 10.1 ← <hr/> Serie 79.2 Total 0.0	1. Serie Final 	1: 10.4x ← 2: 10.6x → 3: 10.4x → 4: 10.4x ↙ 5: 10.6x → <hr/> Serie 52.4 Total 52.4
2. Serie Final 	1: 10.7x → 2: 10.3x → 3: 10.4x → 4: 10.2x ↘ 5: 10.6x ↗ <hr/> Serie 52.2 Total 104.6	3. Serie Final 	1: 10.3x ↑ 2: 10.4x ↗ <hr/> Serie 20.7 Total 125.3
4. Serie Final 	1: 10.3x ← 2: 10.5x ↑ <hr/> Serie 20.8 Total 146.1	5. Serie Final 	1: 10.2x ↗ 2: 10.7x ↗ <hr/> Serie 20.9 Total 167.0
6. Serie Final 	1: 10.5x → 2: 10.2x ← <hr/> Serie 20.7 Total 187.7	7. Serie Final 	1: 10.6x ← 2: 10.6x ↓ <hr/> Serie 21.2 Total 208.9
8. Serie Final 	1: 10.4x ↗ 2: 9.9 → <hr/> Serie 20.3 Total 229.2	9. Serie Final 	1: 9.5 ← 2: 10.6x ↑ <hr/> Serie 20.1 Total 249.3

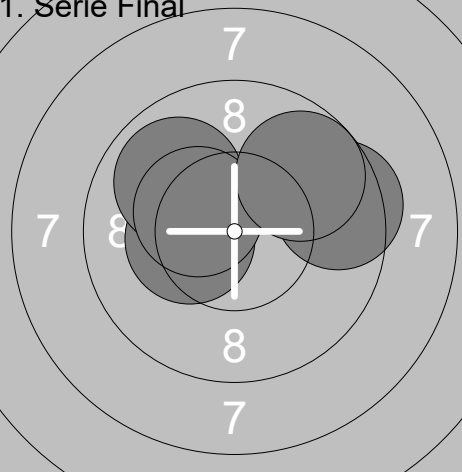
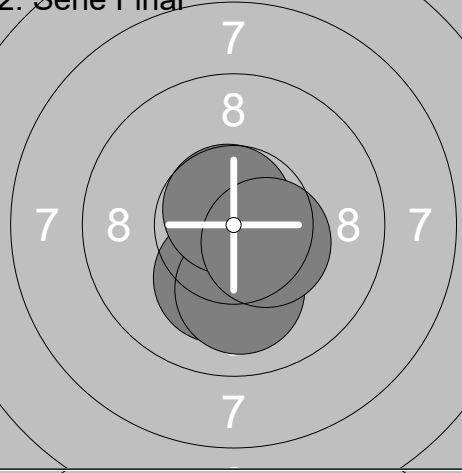
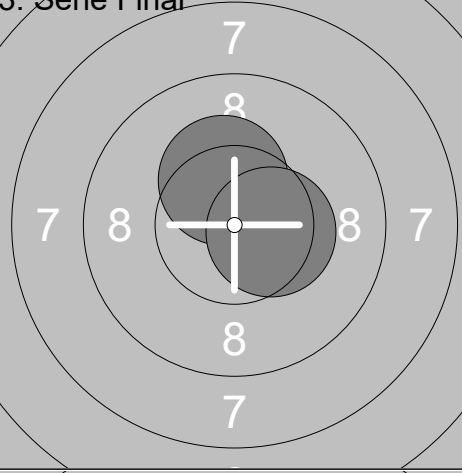
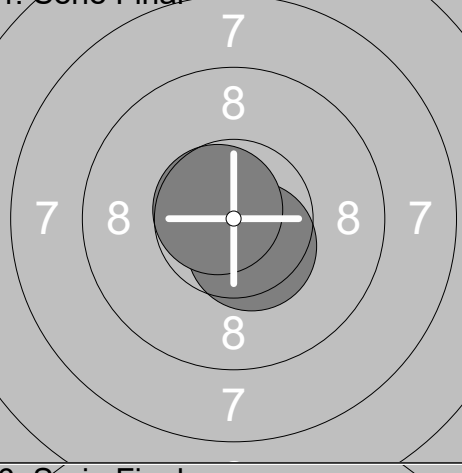
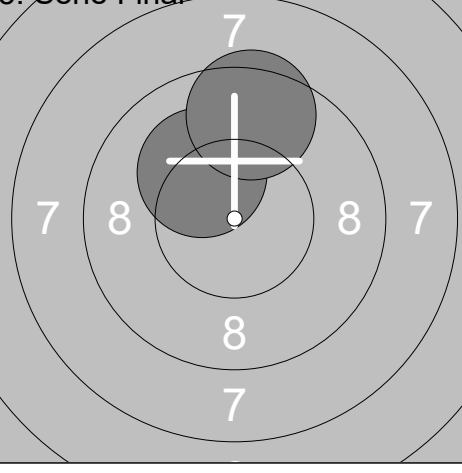
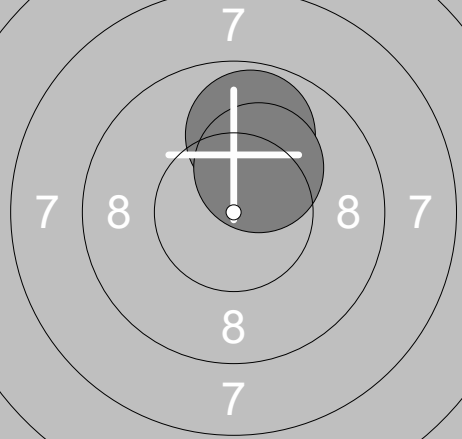
Prov 	1: 9.2 ↙ 2: 10.6x ← 3: 9.8 ↙ 4: 9.7 ↘ 5: 10.1 ↑ 6: 8.8 ↘ 7: 10.3x ↗ Serie 68.5 Total 0.0	1. Serie Final 	1: 10.3x ← 2: 9.9 ↗ 3: 10.4x ↗ 4: 9.5 → 5: 9.8 ↗ Serie 49.9 Total 49.9
2. Serie Final 	1: 10.2x ↓ 2: 10.7x ↘ 3: 10.1 ↘ 4: 10.7x ↗ 5: 10.4x ↘ Serie 52.1 Total 102.0	3. Serie Final 	1: 10.3x ↑ 2: 10.4x → Serie 20.7 Total 122.7
4. Serie Final 	1: 10.5x ↘ 2: 10.7x ↗ Serie 21.2 Total 143.9	5. Serie Final 	1: 10.2x ↗ 2: 9.5 ↑ Serie 19.7 Total 163.6
6. Serie Final 	1: 9.9 ↑ 2: 10.2x ↗ Serie 20.1 Total 183.7		

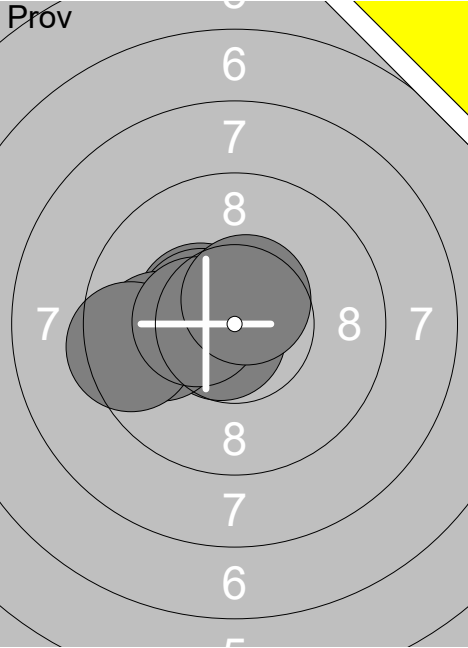
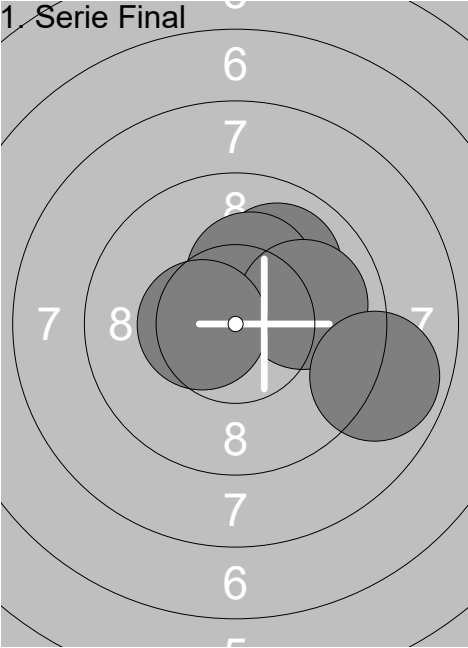
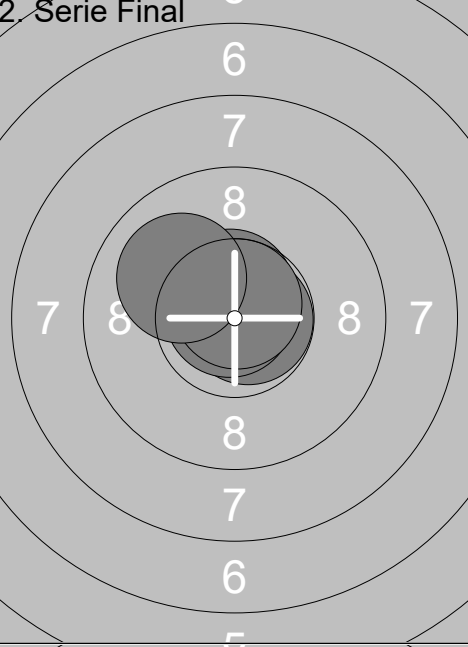
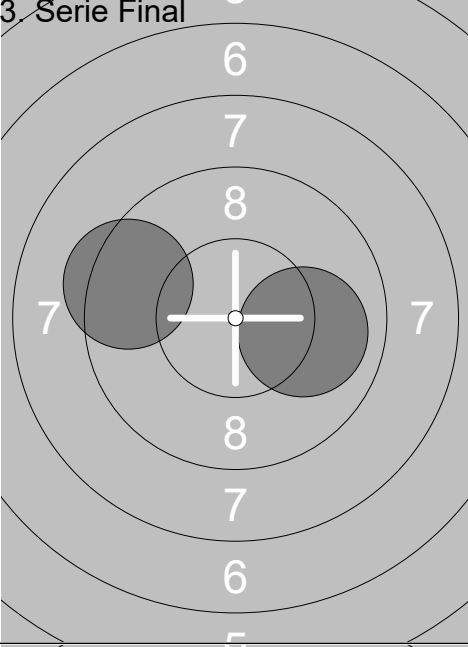
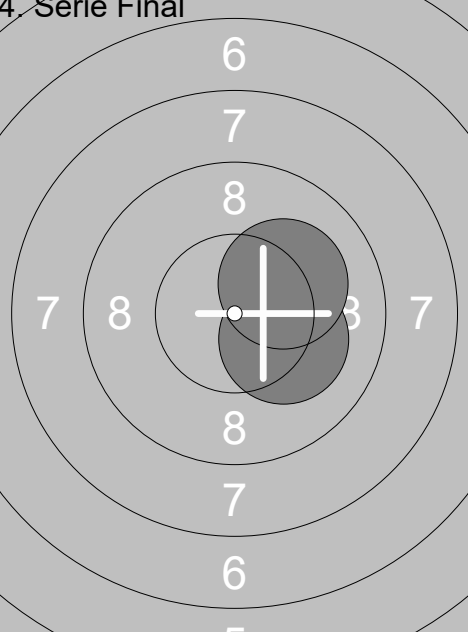
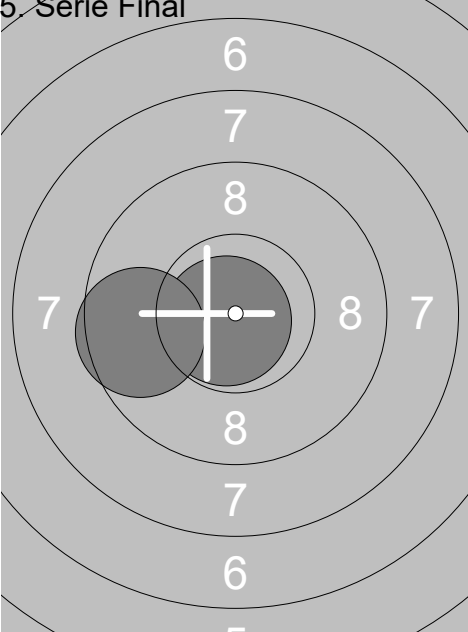
Skjutlag 5	Tavla 27	Anders Henricsson	
Ramselefors	Linköping	G	Ös
10.04.2022	SM Luftgevär 2022	Ramselefors SKF	
Prov 	1: 10.4x ↙ 2: 10.5x ↙ 3: 10.7x ↘ 4: 9.9 ← 5: 9.5 ← 6: 10.4x ↙ 7: 10.6x ↗	1. Serie Final 	1: 10.0 ↗ 2: 10.3x ↗ 3: 10.0 → 4: 10.5x ↙ 5: 8.9 →
	Serie 72.0		Serie 49.7
	Total 0.0		Total 49.7
2. Serie Final 	1: 10.8x → 2: 10.8x ↗ 3: 10.6x ↗ 4: 10.8x ↗ 5: 10.0 ↙	3. Serie Final 	1: 9.4 ← 2: 10.0 →
	Serie 53.0		Serie 19.4
	Total 102.7		Total 122.1
4. Serie Final 	1: 10.2x → 2: 10.2x ↗	5. Serie Final 	1: 10.8x ↘ 2: 9.6 ←
	Serie 20.4		Serie 20.4
	Total 142.5		Total 162.9

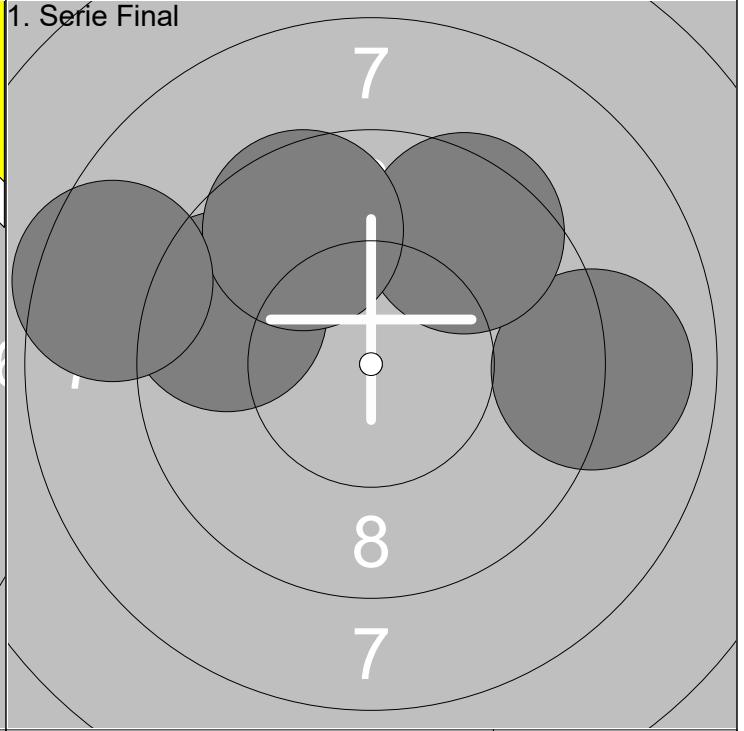
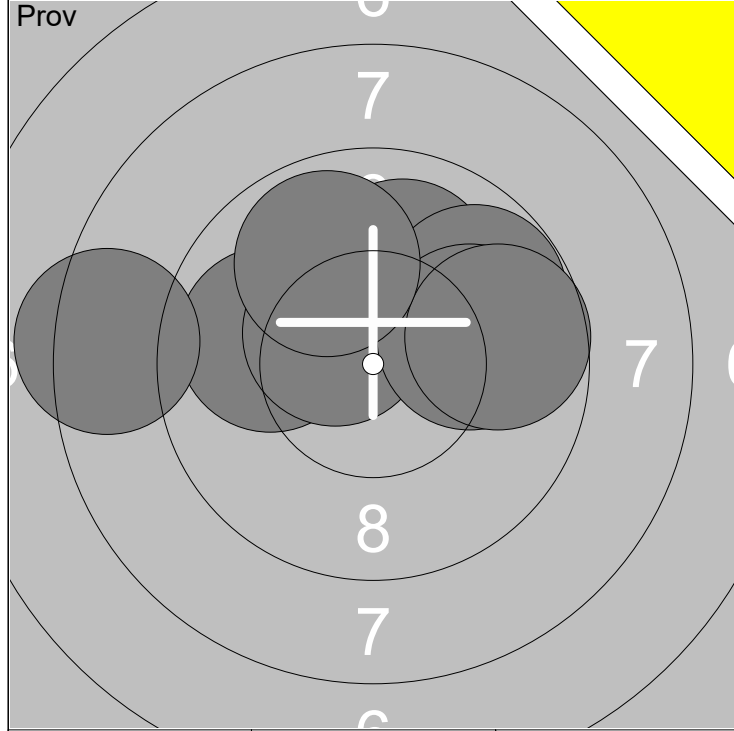



1: 10.0 ↗	6: 10.0 →		
2: 9.8 ↗	7: 9.7 →		
3: 9.9 ←	8: 9.9 ↗	Serie	78.2
4: 8.4 ←		Total	0.0
5: 10.5x ↗			

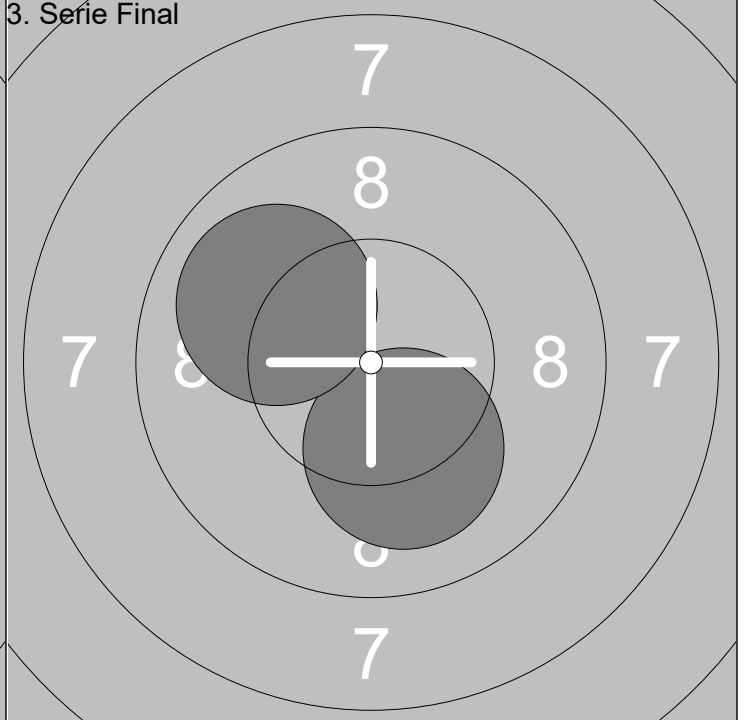
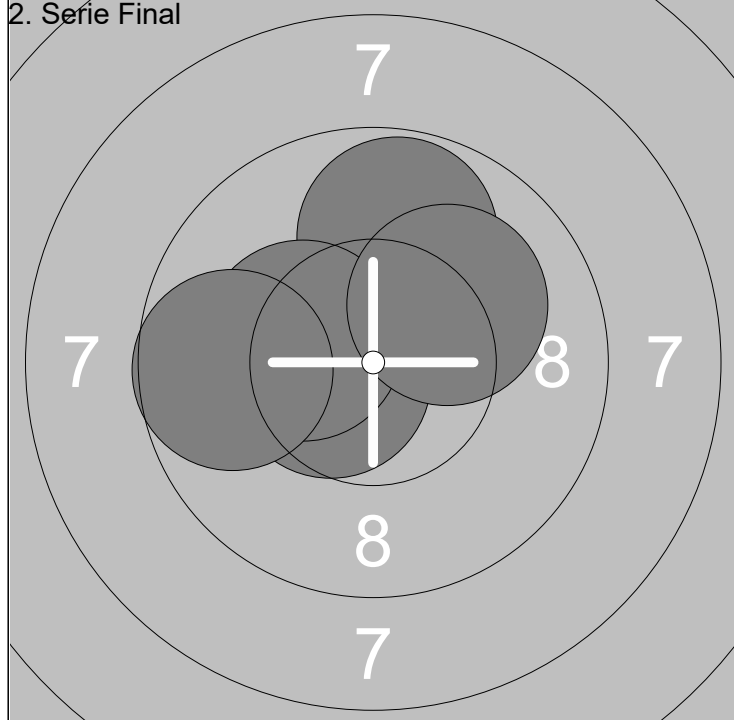





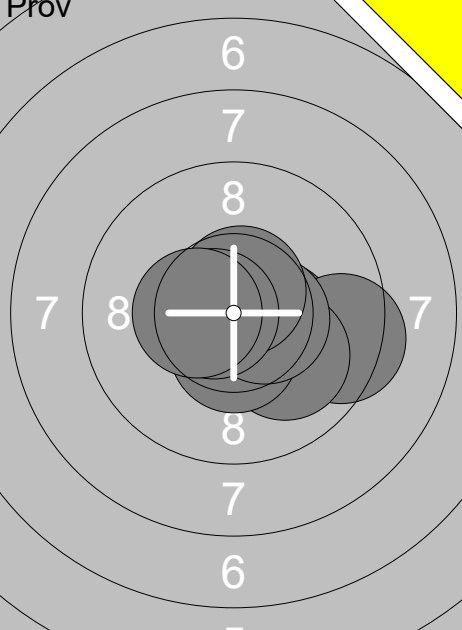
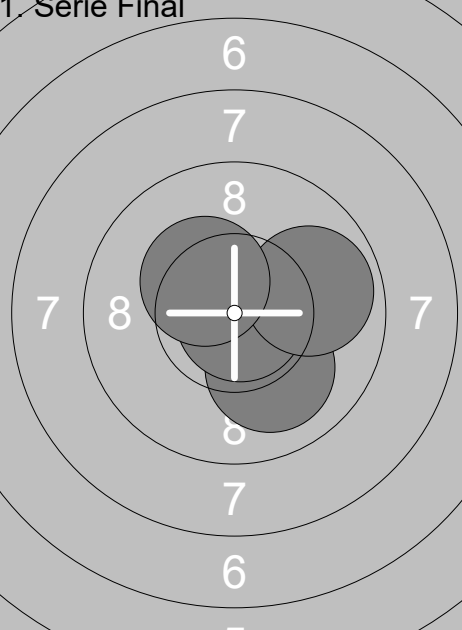
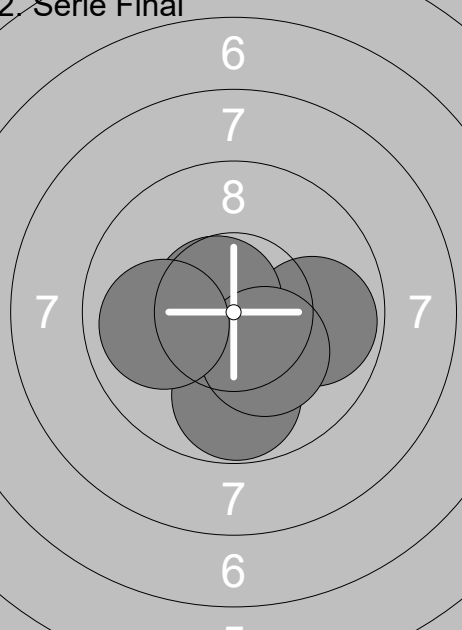
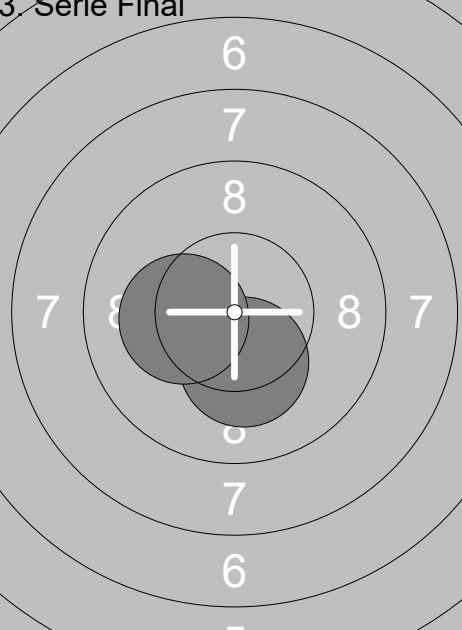

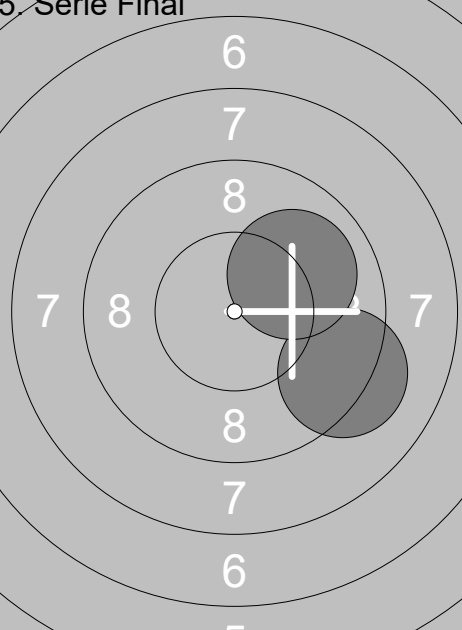

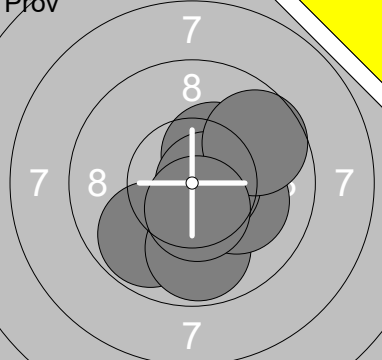
1: 9.0 →			
2: 9.5 ↗			
3: 9.6 ←	Serie	46.2	
4: 9.6 ↗	Total	46.2	
5: 8.5 ←			











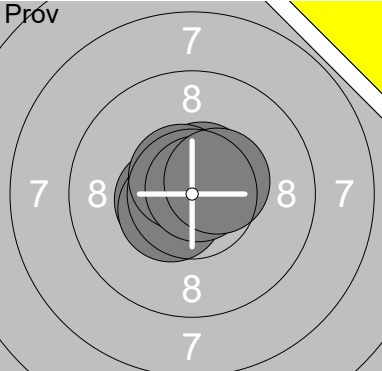
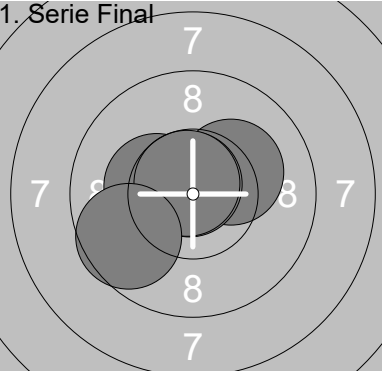





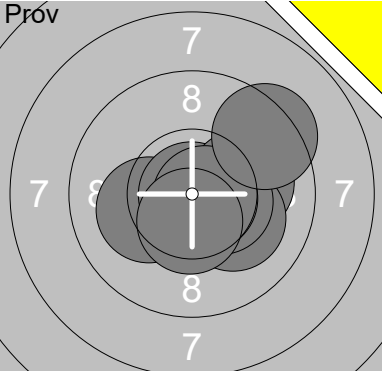
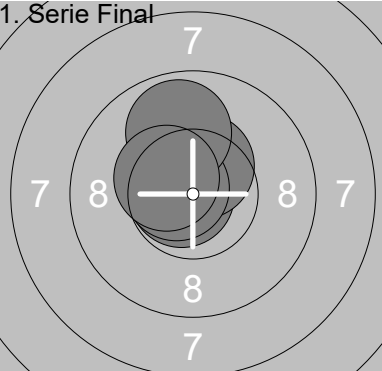

1: 10.5x ←			
2: 9.8 ↗			
3: 10.3x ←	Serie	50.4	
4: 10.1 ↗	Total	96.6	
5: 9.7 ←			

1: 10.1 ↓			
2: 10.0 ↗			
	Serie	20.1	
	Total	116.7	

Prov 	1: 10.4x → 2: 9.4 → 3: 10.7x ↓ 4: 10.0 ↓ 5: 10.5x ↓ 6: 10.5x → 7: 10.6x ↑ 8: 10.7x ← 9: 10.4x ← <hr/> Serie 93.2 Total 0.0	1. Serie Final 	1: 10.5x → 2: 10.0 ↓ 3: 10.8x ↘ 4: 9.9 → 5: 10.4x ↖ <hr/> Serie 51.6 Total 51.6
2. Serie Final 	1: 9.8 → 2: 10.7x ↖ 3: 9.8 ↓ 4: 10.3x ↘ 5: 10.0 ← <hr/> Serie 50.6 Total 102.2	3. Serie Final 	1: 10.2x ↓ 2: 10.2x ← <hr/> Serie 20.4 Total 122.6
4. Serie Final 	1: 10.4x ↗ 2: 10.6x → <hr/> Serie 21.0 Total 143.6	5. Serie Final 	1: 9.2 ↘ 2: 10.0 ↗ <hr/> Serie 19.2 Total 162.8

Pröv 	1: 9.8 ↙ 2: 10.6x ↘ 3: 10.3x ↗ 4: 10.3x ↓ 5: 9.8 ↓ 6: 10.1 → 7: 10.7x → 8: 9.7 ↗ 9: 10.5x ↓	1. Serie Final 	1: 10.7x ← 2: 10.8x ↘ 3: 10.5x ↗ 4: 10.8x ← 5: 10.3x ↗
	Serie 91.8		Serie 53.1
	Total 0.0		Total 53.1
2. Serie Final 	1: 9.8 ↗ 2: 10.6x ↙ 3: 10.0 ↑ 4: 9.5 ↗ 5: 10.5x ↑	3. Serie Final 	1: 10.5x ↓ 2: 10.4x ↑
	Serie 50.4		Serie 20.9
	Total 103.5		Total 124.4
4. Serie Final 	1: 10.4x ↗ 2: 10.3x ↗	5. Serie Final 	1: 10.8x ↙ 2: 10.8x ↗
	Serie 20.7		Serie 21.6
	Total 145.1		Total 166.7
6. Serie Final 	1: 10.4x ↑ 2: 9.9 ↖	7. Serie Final 	1: 10.6x → 2: 10.5x ↙
	Serie 20.3		Serie 21.1
	Total 187.0		Total 208.1
8. Serie Final 	1: 9.7 ↗ 2: 10.6x ↓	9. Serie Final 	1: 10.8x ← 2: 10.4x ↓
	Serie 20.3		Serie 21.2
	Total 228.4		Total 249.6



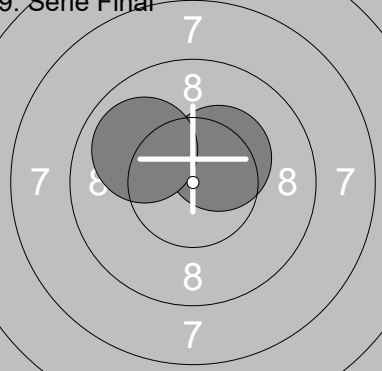

Skjutlag	Tavla	Isabelle Johansson	
6	23		
Ramselefors	Anderstorp	C	Sm
10.04.2022	SM Luftgevär 2022	Ramselefors SKF	
Pröv 	1: 10.5x ← 2: 10.6x ↗ 3: 10.5x ↙ 4: 10.8x ↗ 5: 10.6x ↗ 6: 10.8x ↗ 7: 10.5x →	1. Serie Final 	1: 10.3x ← 2: 10.2x ↗ 3: 10.8x ↗ 4: 10.7x ↗ 5: 9.6 ↙
	Serie 74.3		Serie 51.6
	Total 0.0		Total 51.6
2. Serie Final 	1: 10.3x → 2: 9.8 ← 3: 10.5x ↗ 4: 10.2x ↓ 5: 10.6x ↓	3. Serie Final 	1: 10.2x ↓ 2: 10.3x ←
	Serie 51.4		Serie 20.5
	Total 103.0		Total 123.5
4. Serie Final 	1: 10.1 → 2: 10.4x ↗	5. Serie Final 	1: 10.6x ↙ 2: 10.6x →
	Serie 20.5		Serie 21.2
	Total 144.0		Total 165.2
6. Serie Final 	1: 10.3x ↓ 2: 10.7x ←	7. Serie Final 	1: 10.3x ↓ 2: 10.4x ↗
	Serie 21.0		Serie 20.7
	Total 186.2		Total 206.9
8. Serie Final 	1: 10.4x ↗ 2: 10.2x ↙		
	Serie 20.6		
	Total 227.5		

Skjutlag	Tavla	Amanda Carlsson		
6	24	Gullabo	D	Sm
10.04.2022	SM Luftgevär 2022	Ramselefors SKF		
Pröv 	1: 10.7x ↓ 2: 10.2x ← 3: 10.9x ↓ 4: 10.1 → 5: 10.1 ↘ 6: 10.5x → 7: 10.7x → 8: 9.4 ↗ 9: 10.5x ↓ Serie 93.1 Total 0.0	1. Serie Final 	1: 10.8x ← 2: 10.5x ↑ 3: 10.6x ↖ 4: 9.9 ↑ 5: 10.4x ↖ Serie 52.2 Total 52.2	
2. Serie Final 	1: 10.6x ↖ 2: 10.4x ↑ 3: 10.4x → 4: 10.3x → 5: 10.3x → Serie 52.0 Total 104.2	3. Serie Final 	1: 10.8x → 2: 10.9x ↘ Serie 21.7 Total 125.9	
4. Serie Final 	1: 10.6x ↖ 2: 10.6x ↙ Serie 21.2 Total 147.1	5. Serie Final 	1: 10.6x ↑ 2: 10.6x ↘ Serie 21.2 Total 168.3	
6. Serie Final 	1: 10.5x → 2: 10.4x ↑ Serie 20.9 Total 189.2	7. Serie Final 	1: 10.9x ← 2: 10.8x → Serie 21.7 Total 210.9	
8. Serie Final 	1: 10.8x ← 2: 10.4x ↙ Serie 21.2 Total 232.1	9. Serie Final 	1: 10.4x ↗ 2: 10.0 ↖ Serie 20.4 Total 252.5	

<p>Prov</p>	<p>1: 10.1 ↖ 2: 9.7 ← 3: 10.7x↙ 4: 9.9 ← 5: 10.2x↖ 6: 10.6x↙</p>	<p>1. Serie Final</p>	<p>1: 9.3 ↘ 2: 9.5 ↗ 3: 10.0 ↗ 4: 10.8x ↗ 5: 10.3x →</p>
Serie 61.2	Total 0.0	Serie 49.9	Total 49.9

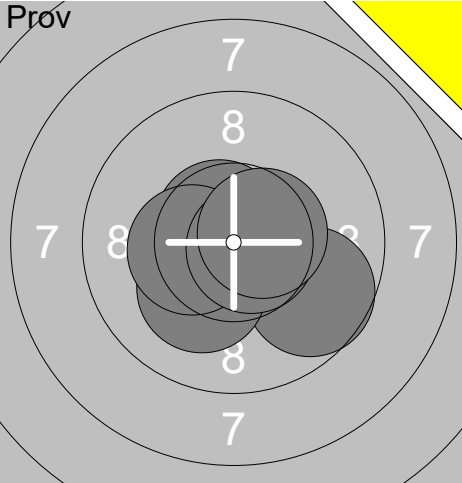
<p>2. Serie Final</p>	<p>1: 9.9 → 2: 10.2x↙ 3: 9.9 ↑ 4: 10.7x↙ 5: 10.1 ←</p>	<p>3. Serie Final</p>	<p>1: 10.5x ↓ 2: 10.9x ↘</p>
Serie 50.8	Total 100.7	Serie 21.4	Total 122.1

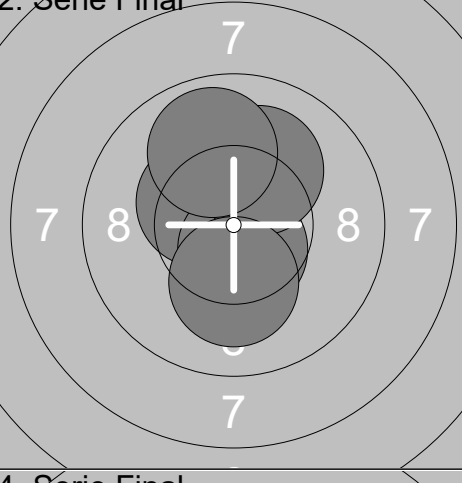
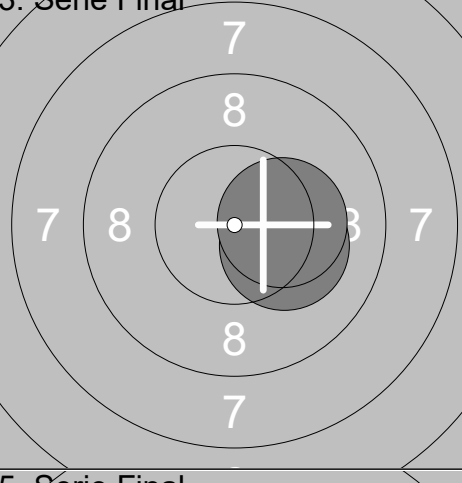
<p>4. Serie Final</p>	<p>1: 10.5x → 2: 10.7x →</p>		
Serie 21.2	Total 143.3		

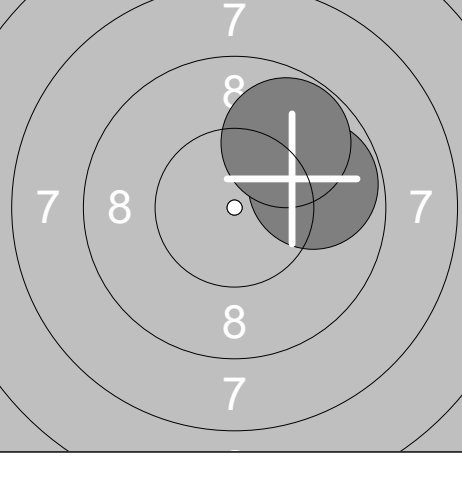
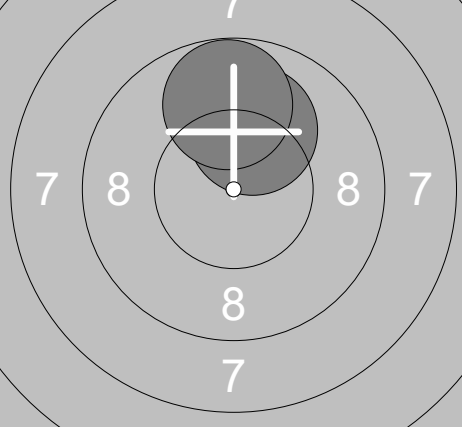
Skjutlag 6	Tavla 26	Hannah Göransson		
Ramselefors	Aleholm	F	Sm	
10.04.2022	SM Luftgevär 2022	Ramselefors SKF		
Prov 	1: 9.7 ↘ 2: 10.2x ↓ 3: 10.6x ↗ 4: 10.4x ← 5: 10.7x ↘ 6: 10.5x →	1. Serie Final 	1: 9.5 ↘ 2: 10.5x ↓ 3: 10.3x ↓ 4: 10.4x ↘ 5: 10.3x ←	
	Serie 62.1 Total 0.0		Serie 51.0 Total 51.0	
2. Serie Final 	1: 10.4x ↖ 2: 10.6x ↓ 3: 10.1 ↗ 4: 10.2x ↓ 5: 9.9 ↗	3. Serie Final 	1: 10.2x → 2: 10.3x →	
	Serie 51.2 Total 102.2		Serie 20.5 Total 122.7	
4. Serie Final 	1: 10.5x ↑ 2: 10.6x ↖	5. Serie Final 	1: 9.8 → 2: 9.8 ↗	
	Serie 21.1 Total 143.8		Serie 19.6 Total 163.4	
6. Serie Final 	1: 10.1 ↗ 2: 9.8 ↑			
	Serie 19.9 Total 183.3			

Skjutlag	Tavla	Anna Mårtensson		
6	27	Ramselefors	Kyrkås	G Jä
10.04.2022	SM Luftgevär 2022	Ramselefors SKF		
Prov 	1: 9.9 ← 2: 10.1 ↙ 3: 10.5x ↓ 4: 10.3x ↗ 5: 10.8x ↘ 6: 10.5x ↖ 7: 10.0 ↗ 8: 10.4x ↖	1. Serie Final 	1: 10.4x ← 2: 9.9 ↗ 3: 10.0 ↗ 4: 10.2x ↗ 5: 10.3x →	
	Serie 82.5		Serie 50.8	
	Total 0.0		Total 50.8	
2. Serie Final 	1: 10.8x ← 2: 10.4x ↑ 3: 10.0 ↓ 4: 10.4x ← 5: 9.7 →	3. Serie Final 	1: 10.2x → 2: 10.6x ↖	
	Serie 51.3		Serie 20.8	
	Total 102.1		Total 122.9	
4. Serie Final 	1: 10.2x ↘ 2: 10.3x ↘	5. Serie Final 	1: 10.3x → 2: 10.7x →	
	Serie 20.5		Serie 21.0	
	Total 143.4		Total 164.4	
6. Serie Final 	1: 9.9 ↑ 2: 9.9 →	7. Serie Final 	1: 10.5x ← 2: 10.8x ←	
	Serie 19.8		Serie 21.3	
	Total 184.2		Total 205.5	

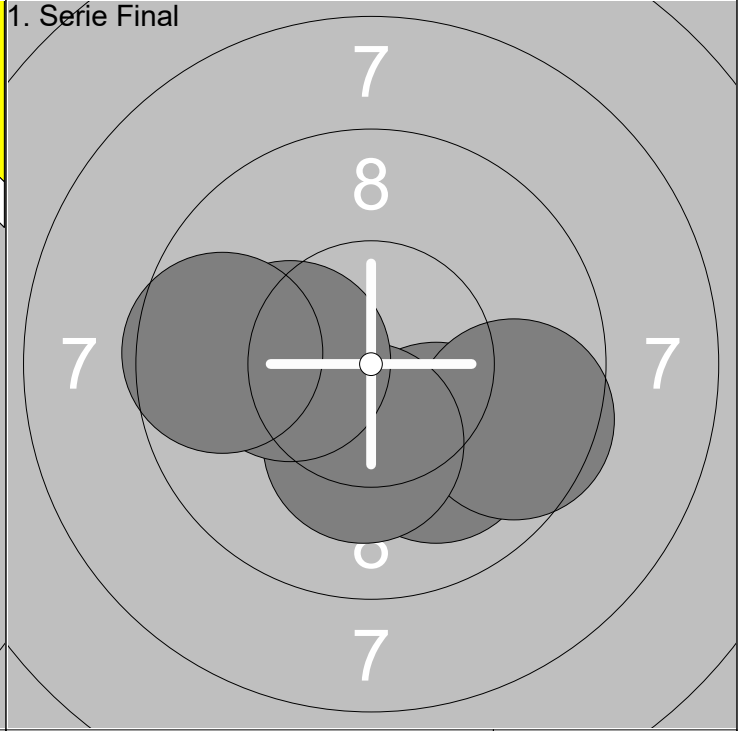
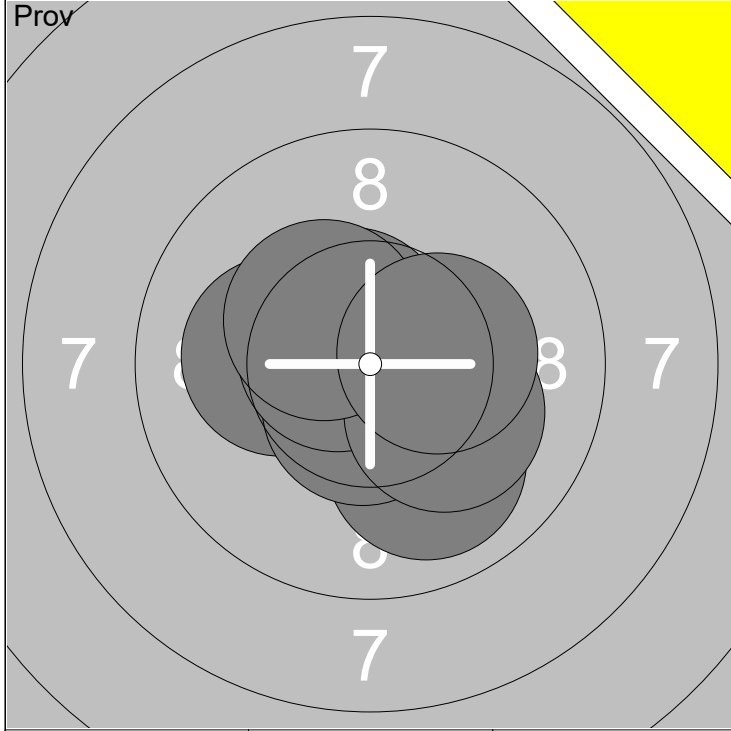

1: 10.0 ↘	6: 10.2x ↘	Serie	82.9
2: 10.6x ↗	7: 10.4x ↗		
3: 10.2x ←	8: 10.3x →	Total	0.0
4: 10.6x ↓			
5: 10.6x ↖			

1: 10.0 ↘	Serie	49.6
2: 9.6 ↘		
3: 10.2x ↓	Total	49.6
4: 10.2x ←		
5: 9.6 ←		



1: 10.2x ←	Serie	51.0
2: 10.6x →		
3: 10.4x →	Total	100.6
4: 10.1 ↗		
5: 9.7 ↖		

1: 10.0 ↖	Serie	19.9
2: 9.9 ↗		
	Total	120.5