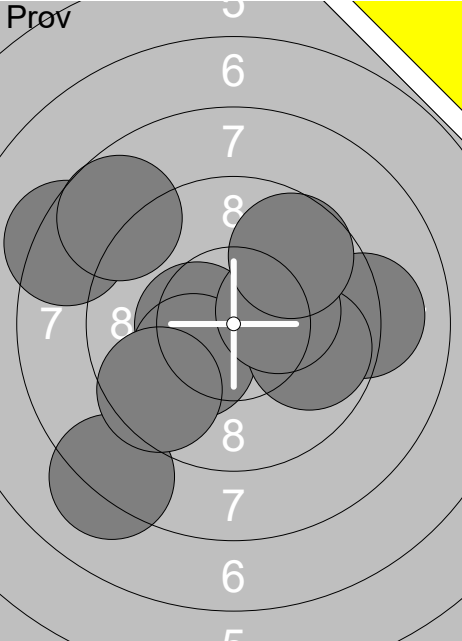
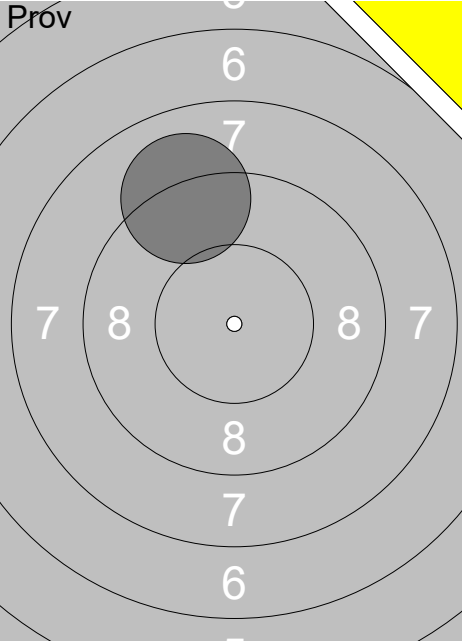
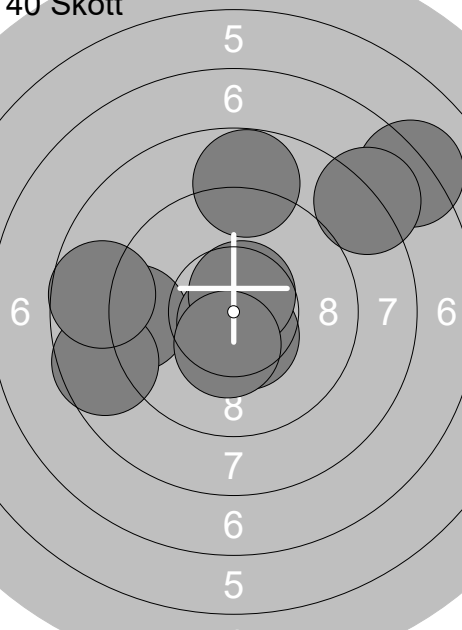
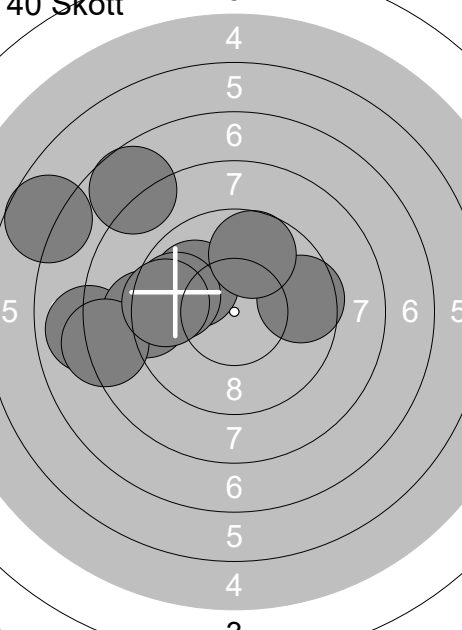
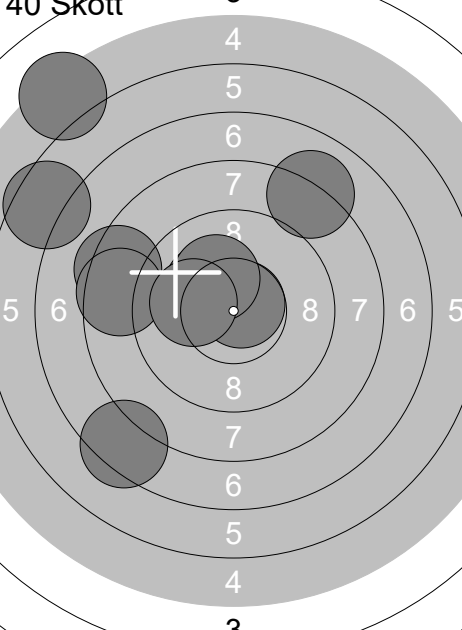
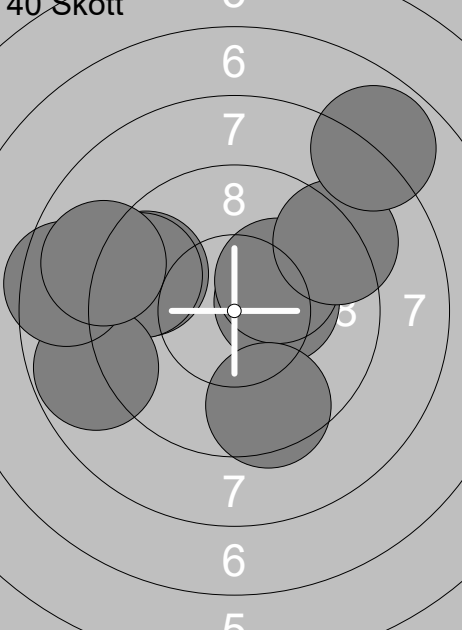
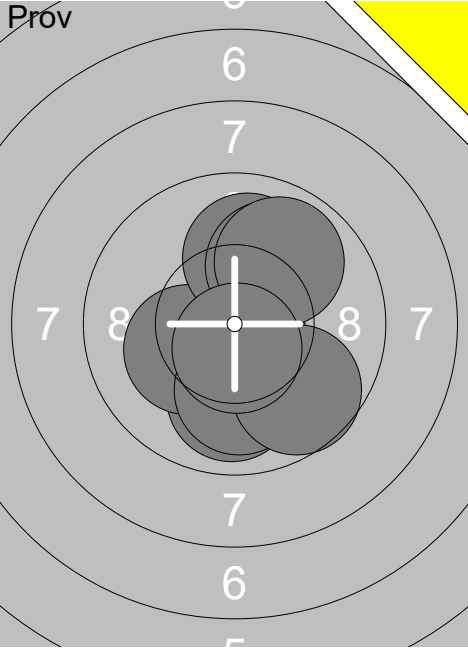
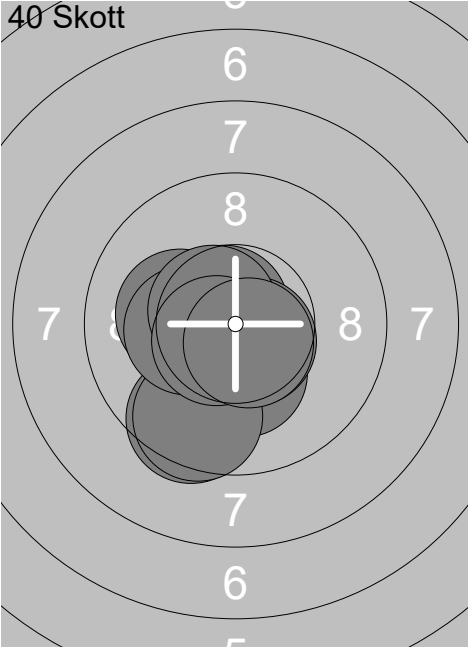
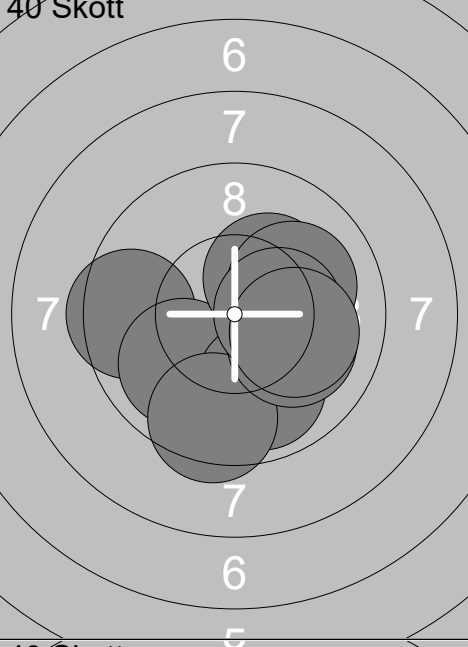
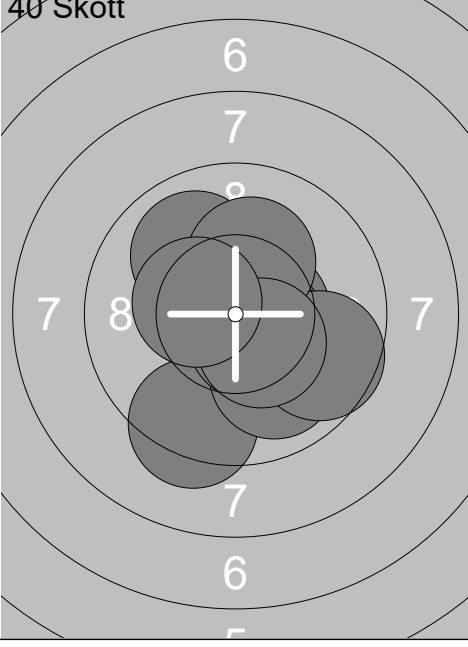
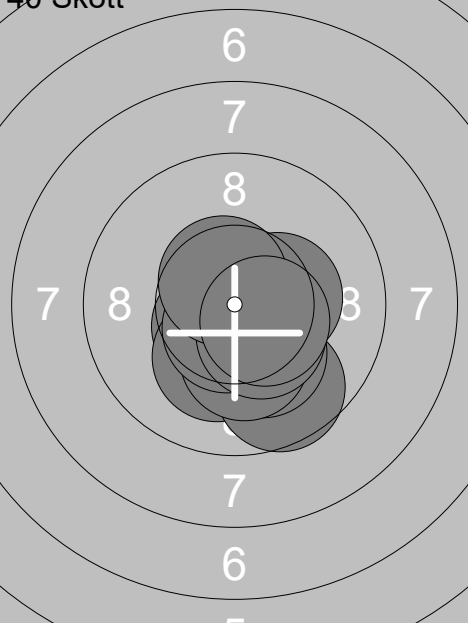
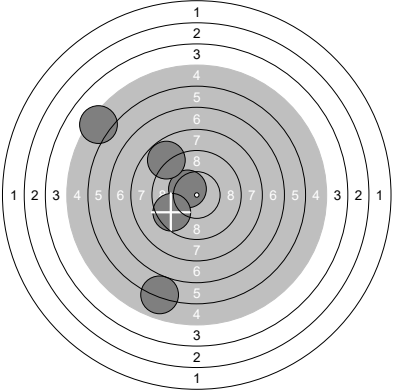
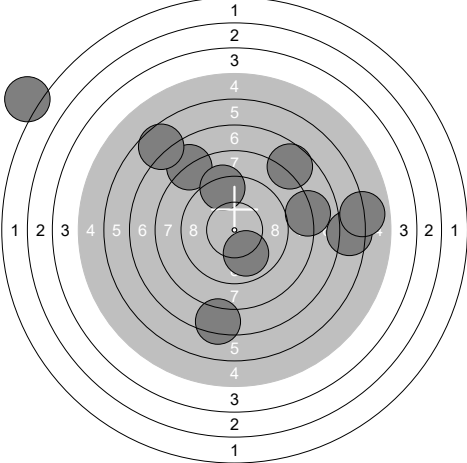
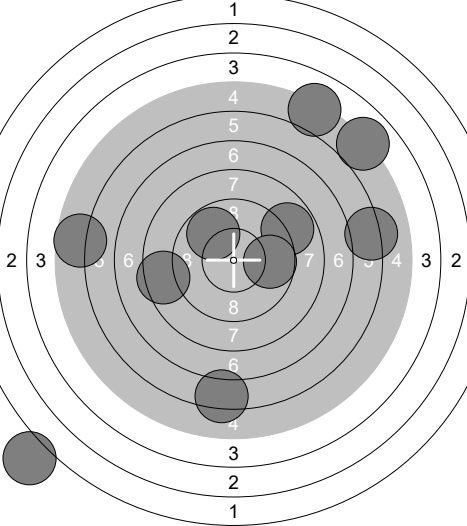
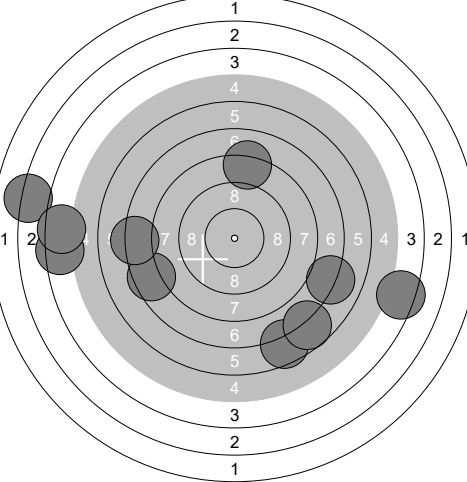
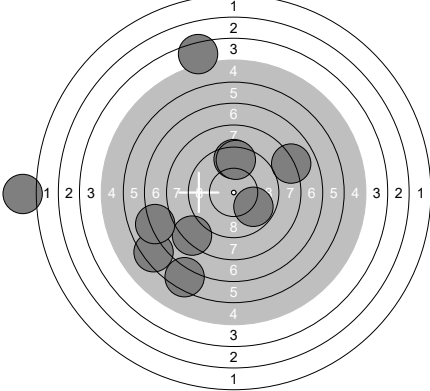
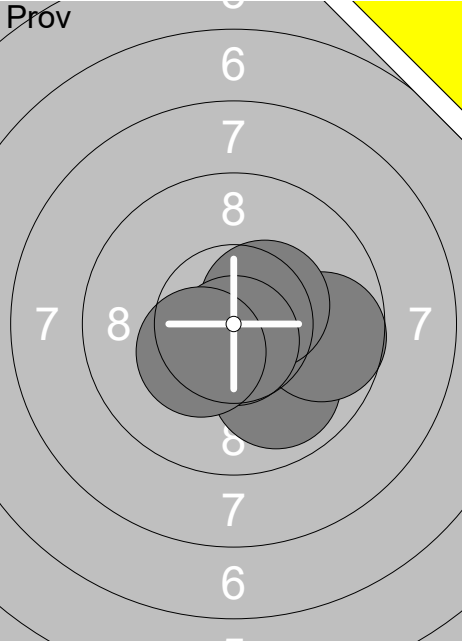
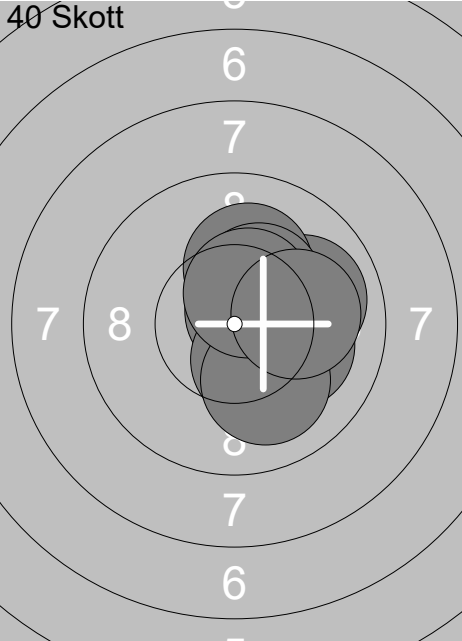
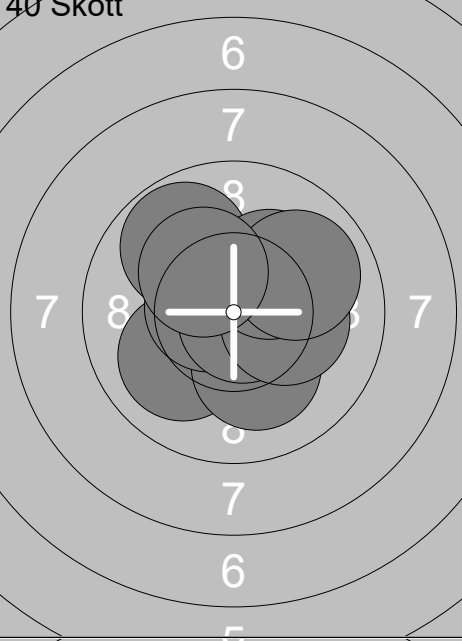
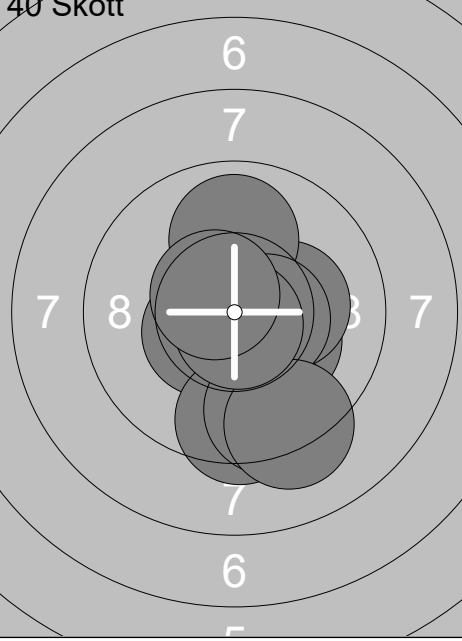
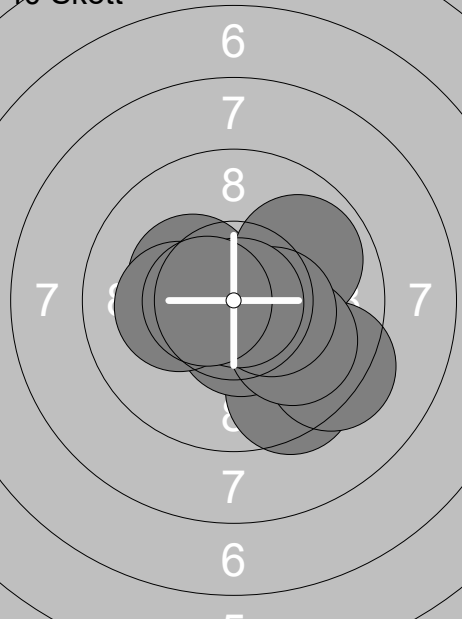

Skjutlag	Tavla	Valentin Häggström			
1	11	Ramselefors	Ramselefors	Mini	Vb
15.01.2022		Skyttiaden Distriktsomgång 2022	Ramselefors SKF		
	1: 8.3 ↖		11: 9.1 ↗		
	2: 8.7 ↖				
	3: 10.4x↔				
	4: 10.2x↙				
	5: 9.1 →				
	6: 9.8 →				
	7: 10.3x→				
	8: 8.2 ↘				
	9: 9.7 ↗				
	10: 9.5 ↘				
	Serie 94.2		Serie 9.1		
	Total 0.0		Total 0.0		
	1: 7.2 ↗		11: 10.0 ↖		
	2: 9.3 ←				
	3: 8.8 ↑				
	4: 8.0 ↗		12: 9.7 ←		
	5: 8.6 ←		13: 9.6 →		
	6: 10.8x↘		14: 8.0 ←		
	7: 8.7 ←		15: 9.7 ↑		
	8: 10.5x↘		16: 9.1 ←		
	9: 10.6x↗		17: 7.7 ↗		
	10: 10.4x↘		18: 8.2 ←		
	Serie 92.9		Serie 88.2		
	Total 92.9		Total 181.1		
	21: 10.2x↖		31: 10.3x→		
	22: 7.4 ↘				
	23: 8.4 ←				
	24: 5.3 ↗		32: 9.6 ←		
	25: 8.1 ↗		33: 9.5 ←		
	26: 10.7x↗		34: 10.2x↗		
	27: 6.5 ←		35: 8.8 ←		
	28: 10.2x↖		36: 8.5 ←		
	29: 8.6 ←		37: 9.5 ↘		
	30: 10.1 ←		38: 8.9 ←		
	Serie 85.5		Serie 92.4		
	Total 266.6		Total 359.0		

Skjutlag	Tavla	Melker Häggström			
1	12	Ramselefors	Ramselefors	Mini	Vb
15.01.2022		Skyttiaden Distriktsomgång 2022	Ramselefors SKF		
	1: 9.9 ↓		1: 10.3x ↓		
	2: 10.7x ↓		2: 10.2x ←		
	3: 10.2x ↗		3: 9.5 ↓		
	4: 10.2x ↖		4: 9.6 ↓		
	5: 10.0 ↑		5: 10.3x ←		
	6: 10.0 ↗		6: 10.7x ↗		
	7: 10.0 ↓		7: 10.6x ↘		
	8: 9.7 ↘		8: 10.6x ↖		
	9: 9.9 ↗		9: 10.6x ↙		
	10: 10.6x ↓		10: 10.6x ↘		
	Serie 101.2		Serie 103.0		
	Total 0.0		Total 103.0		
	11: 10.3x ↓		21: 9.3 ↓		
	12: 9.5 ←		22: 10.0 ↘		
	13: 10.0 ↙		23: 10.5x →		
	14: 10.3x ↗		24: 10.6x →		
	15: 10.1 →		25: 10.6x ↘		
	16: 9.9 ↓		26: 9.6 →		
	17: 9.5 ↓		27: 10.0 ↗		
	18: 10.1 ↘		28: 10.2x ↑		
	19: 10.3x →		29: 10.4x ↘		
	20: 10.1 →		30: 10.4x ←		
	Serie 100.1		Serie 101.6		
	Total 203.1		Total 304.7		
	31: 10.6x ↙				
	32: 10.2x ↓				
	33: 9.6 ↓				
	34: 10.2x ↘				
	35: 10.3x →				
	36: 10.2x ↓				
	37: 10.6x ↓				
	38: 10.4x ↘				
	39: 10.6x ↗				
	40: 10.5x ↘				
	Serie 103.2				
	Total 407.9				

Skjutlag	Tavla	Esther Häggström	
1	13	Ramselefors	Mini Vb
15.01.2022	Skyttiaden Distriktsomgång 2022	Ramselefors SKF	
Prov		40 Skott	40 Skott
	1: 0.0 ← 2: 10.5x ↖ 3: 5.9 ↓ 4: 8.8 ↗ 5: 0.0 → 6: 5.3 ↖ 7: 9.5 ↙		1: 7.3 ↓ 2: 6.5 → 3: 7.9 ↗ 4: 9.2 ↑ 5: 5.9 → 6: 8.0 → 7: 6.6 ↗ 8: 1.4 ↖ 9: 9.9 ↓ 10: 7.7 ↗
	Serie 40.0		Serie 70.4
	Total 0.0		Total 70.4
40 Skott		40 Skott	
	11: 5.1 ↗ 12: 5.0 ↗ 13: 9.8 ↖ 14: 6.3 ↓ 15: 8.8 ↗ 16: 5.7 ← 17: 9.7 → 18: 6.1 → 19: 1.2 ↙ 20: 8.5 ←		21: 6.6 ↓ 22: 7.5 ← 23: 4.4 ← 24: 3.1 ← 25: 7.2 ← 26: 6.7 ↓ 27: 7.0 → 28: 4.4 → 29: 4.5 ← 30: 8.2 ↑
	Serie 66.2		Serie 59.6
	Total 136.6		Total 196.2
40 Skott			
	31: 9.4 ↑ 32: 9.5 ↑ 33: 8.2 ↙ 34: 1.2 ← 35: 6.3 ↙ 36: 6.4 ↙ 37: 7.0 ← 38: 4.4 ↑ 39: 8.0 ↗ 40: 9.8 ↘		
	Serie 70.2		
	Total 266.4		

Skjuttag	Tavla	Adrian Fredriksson			
1	16	Ramselefors	Ramselefors	Mini	Vb
15.01.2022		Skyttiaden Distriktsomgång 2022	Ramselefors SKF		
Prov 	1: 9.8 ←	Prov 	11: 10.3x →		
	2: 9.8 ←		12: 10.1 ↙		
	3: 9.6 ↗		13: 9.9 ↘		
	4: 9.8 ←				
	5: 9.9 ↗				
	6: 10.0 ↗				
	7: 8.9 ↑				
	8: 10.0 ↑				
	9: 10.6x ↗				
	10: 10.5x ←				
	Serie 98.9		Serie 30.3		
	Total 0.0		Total 0.0		
40 Skott 	1: 10.0 →	40 Skott 	11: 9.3 ↑		
	2: 9.4 ↑		12: 10.4x ↑		
	3: 10.1 ←		13: 9.5 ↘		
	4: 10.5x ↘		14: 9.8 ↑		
	5: 8.6 ←		15: 8.7 ←		
	6: 10.1 ←		16: 9.3 ←		
	7: 9.4 ←		17: 10.4x ↗		
	8: 9.1 ↗		18: 9.0 ↗		
	9: 8.4 ↗		19: 10.4x ↗		
	10: 9.3 ↑		20: 10.4x ↗		
	Serie 94.9		Serie 97.2		
	Total 94.9		Total 192.1		
40 Skott 	21: 9.6 ↑	40 Skott 	31: 8.9 ↖		
	22: 9.5 ↑		32: 7.6 ↖		
	23: 8.9 ↙		33: 10.2x ↖		
	24: 8.6 ←		34: 9.7 ↗		
	25: 10.6x ↑		35: 10.1 ↓		
	26: 8.7 ←		36: 8.3 ↑		
	27: 10.4x ↑		37: 9.7 →		
	28: 8.9 →		38: 8.9 ↓		
	29: 9.7 ↓		39: 9.9 ↓		
	30: 10.6x ↖		40: 10.7x ↓		
	Serie 95.5		Serie 94.0		
	Total 287.6		Total 381.6		

Skjutlag	Tavla	Samuel Österlund		
1	18	Ramselefors	Mini	Vb
15.01.2022	Skyttiaden Distriktsomgång 2022	Ramselefors SKF		
Prov 	1: 9.9 ↘	40 Skott 	1: 10.0 →	
	2: 9.7 →		2: 10.2x ↑	
	3: 10.4x ↗		3: 10.5x ↗	
	4: 10.7x ↓		4: 10.7x ↗	
	5: 10.4x ↙		5: 10.4x ↓	
	Serie 51.1		Serie 102.9	
	Total 0.0		Total 102.9	
40 Skott 	11: 10.5x →	40 Skott 	21: 10.5x ↙	
	12: 9.8 ↗		22: 10.2x ↘	
	13: 10.0 ↙		23: 9.5 ↓	
	14: 10.2x ↓		24: 10.2x →	
	15: 10.6x ↖		25: 9.9 ↑	
	16: 10.8x ↘		26: 9.5 ↓	
	17: 10.2x →		27: 10.5x →	
	18: 10.2x ↗		28: 9.2 ↓	
	19: 9.9 ↗		29: 10.8x ↓	
	20: 10.3x ↘		30: 10.6x ↖	
	Serie 102.5		Serie 100.9	
	Total 205.4		Total 306.3	
40 Skott 	31: 9.5 ↓			
	32: 9.3 ↓			
	33: 10.3x ↖			
	34: 9.9 ↗			
	35: 10.5x ↓			
	36: 10.0 ↓			
	37: 10.4x →			
	38: 10.9x ↘			
	39: 10.2x ↖			
	40: 10.6x ↖			
	Serie 101.6			
	Total 407.9			

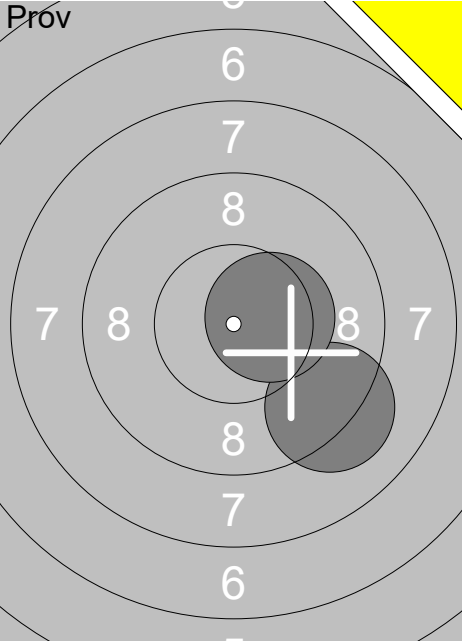
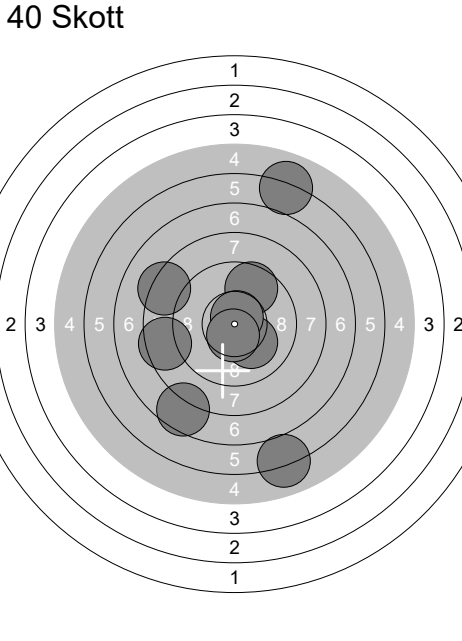
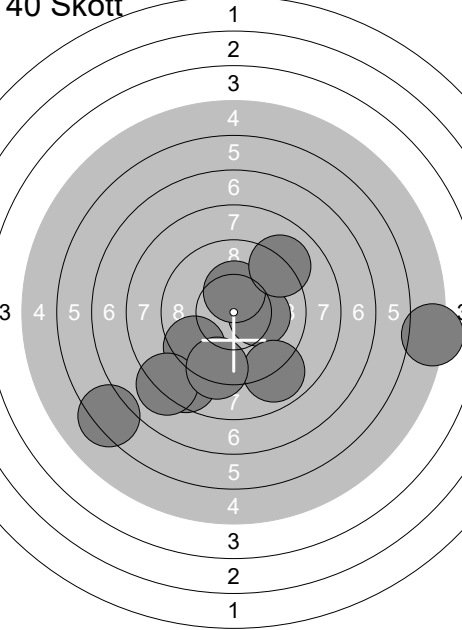
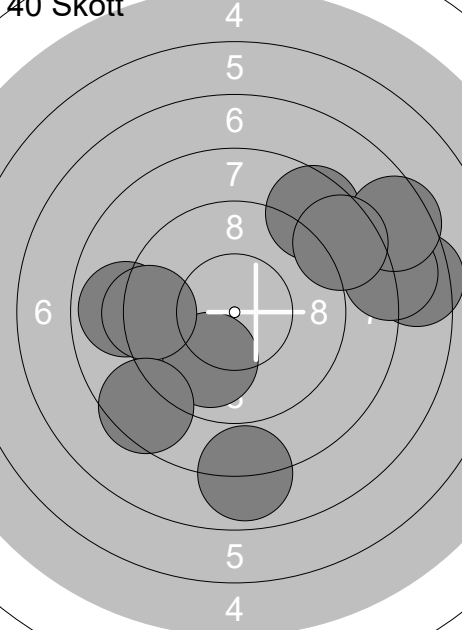
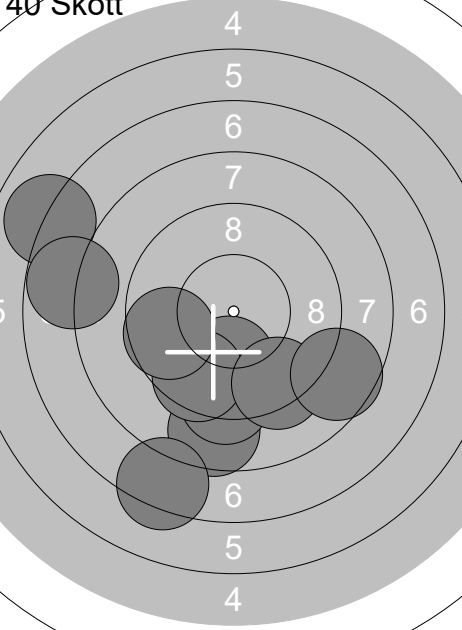
Skjutlag 1	Tavla 22	Alwin Långström	
Ramselefors	Ramselefors	Mini	Vb
15.01.2022	Skyttiaden Distriktsomgång 2022	Ramselefors SKF	
Prov 	1: 9.2 ↘ 2: 10.4x →	40 Skott 	1: 8.5 ← 2: 0.0 ↓ 3: 10.1 ↘ 4: 6.0 ↗ 5: 8.3 ← 6: 6.0 ↓ 7: 9.6 ↗ 8: 10.7x ↗ 9: 7.6 ↓ 10: 10.6x ↓
	Serie 19.6		Serie 77.4
	Total 0.0		Total 77.4
40 Skott 	11: 10.2x → 12: 8.5 ↓ 13: 9.4 ← 14: 8.9 ↘ 15: 10.4x ↗ 16: 5.2 → 17: 8.1 ↓ 18: 6.3 ← 19: 9.3 ↓ 20: 9.1 ↗	40 Skott 	21: 7.5 → 22: 8.6 ↗ 23: 7.9 ↓ 24: 7.9 → 25: 8.9 ← 26: 9.9 ↓ 27: 7.5 ↗ 28: 9.3 ← 29: 8.5 ↓ 30: 8.6 ↗
	Serie 85.4		Serie 84.6
	Total 162.8		Total 247.4
40 Skott 	31: 10.0 ↓ 32: 7.0 ← 33: 8.6 ↓ 34: 9.2 ↓ 35: 9.5 ↓ 36: 9.6 ← 37: 7.8 ← 38: 9.3 ↓ 39: 7.3 ↓ 40: 8.6 ↘		
	Serie 86.9		
	Total 334.3		

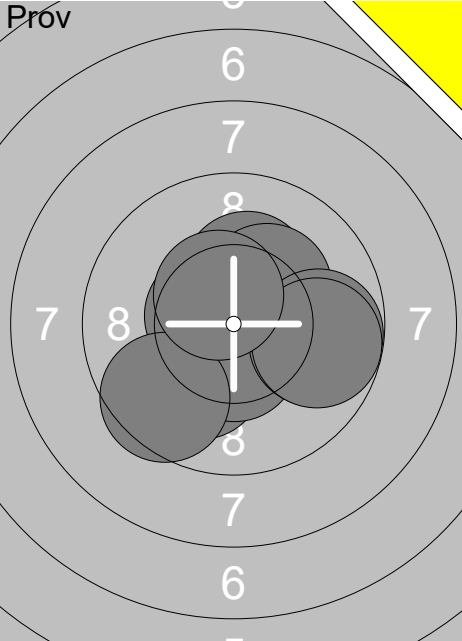
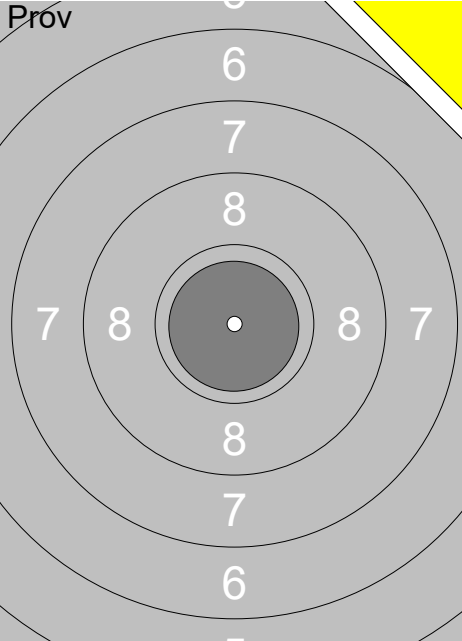
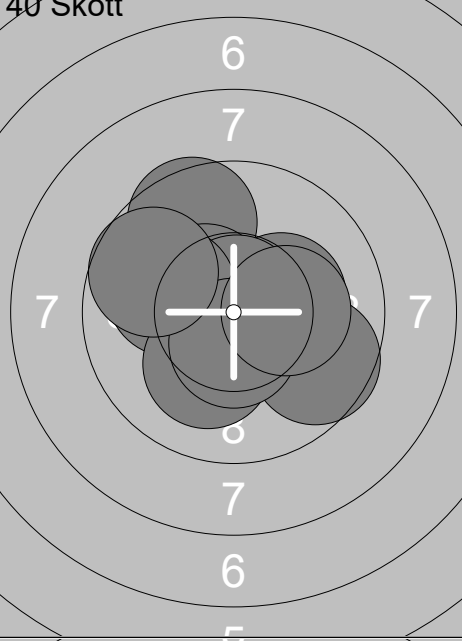
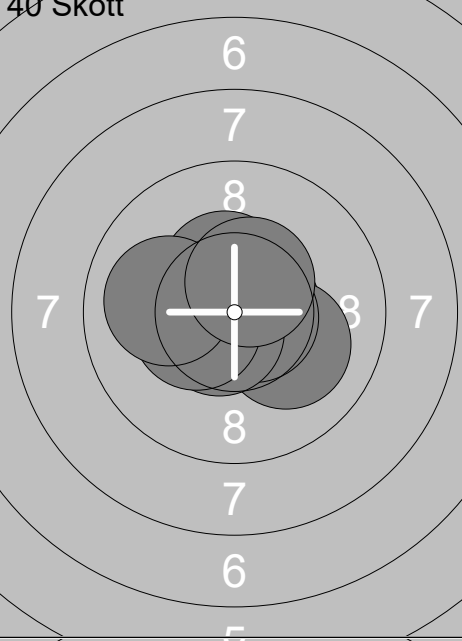
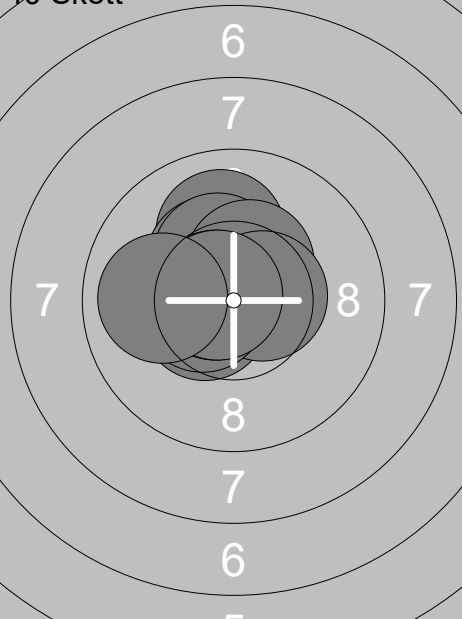
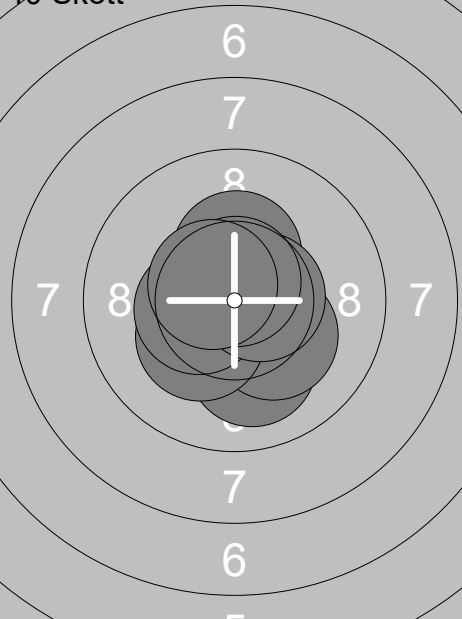
Skjutlag	Tavla	William Långström		
1	23	Ramselefors	15	Vb
15.01.2022	Skyttiaden Distriktsomgång 2022	Ramselefors SKF		
Prov 	1: 10.1 ↘	Prov 	11: 10.9x ↘	
	2: 10.3x ↑			
	3: 10.6x ↙			
	4: 10.5x ↓			
	5: 9.6 ↘			
	6: 9.8 →			
	7: 10.3x ↗			
	8: 9.8 →			
	9: 9.8 →			
	10: 10.5x ↖			
	Serie 101.3		Serie 10.9	
	Total 0.0		Total 0.0	
40 Skott 	1: 9.6 ↖	40 Skott 	11: 10.6x →	
	2: 10.3x →		12: 10.5x ↙	
	3: 10.4x ↙		13: 10.1 ↘	
	4: 10.8x ↑		14: 10.7x ↙	
	5: 10.0 ↙		15: 10.7x →	
	6: 10.1 ↓		16: 10.6x ↘	
	7: 9.6 →		17: 10.4x ↑	
	8: 10.5x ↓		18: 10.4x ↙	
	9: 9.7 ↙		19: 10.0 ↙	
	10: 10.2x →		20: 10.5x ↗	
	Serie 101.2		Serie 104.5	
	Total 101.2		Total 205.7	
40 Skott 	21: 10.0 ↑	40 Skott 	31: 10.7x ↘	
	22: 10.3x ↖		32: 10.1 ↓	
	23: 10.3x ↗		33: 10.3x ↑	
	24: 10.4x ↗		34: 10.2x ↘	
	25: 10.5x ↙		35: 10.9x ↖	
	26: 10.5x →		36: 10.3x ↘	
	27: 10.5x ↙		37: 10.4x ↙	
	28: 10.7x ↙		38: 10.6x →	
	29: 10.7x ↙		39: 10.7x ↑	
	30: 10.0 ↙		40: 10.6x ↙	
	Serie 103.9		Serie 104.8	
	Total 309.6		Total 414.4	

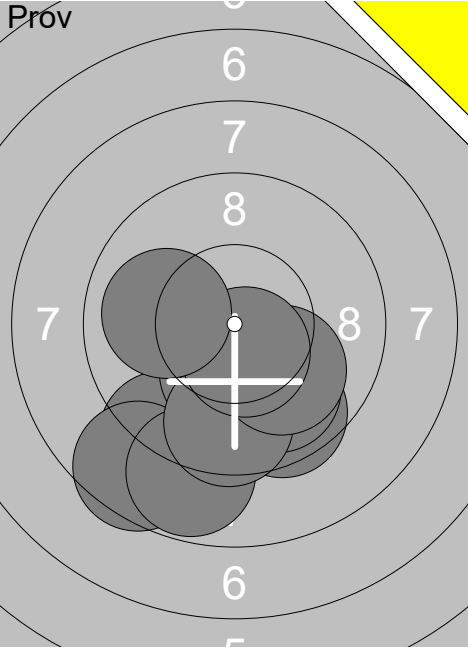
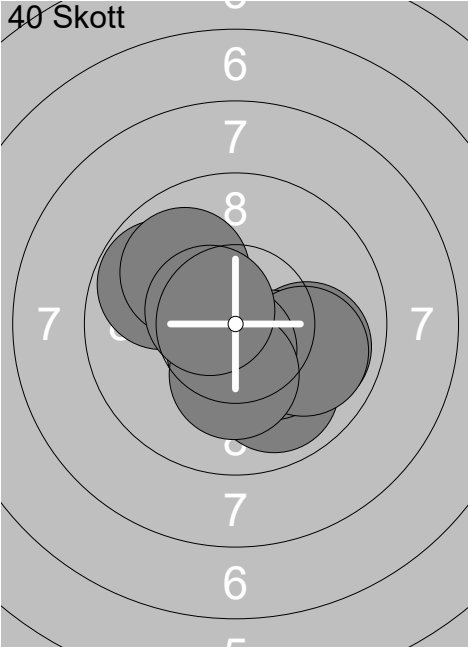
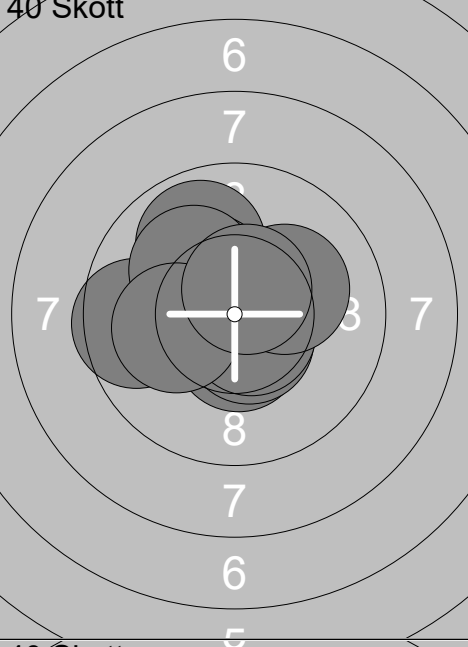
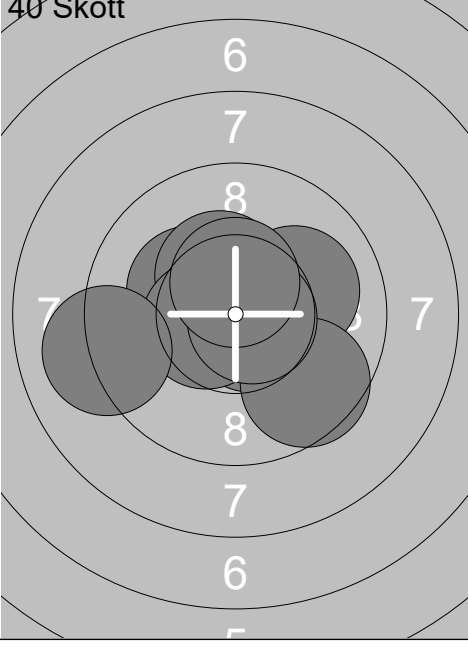
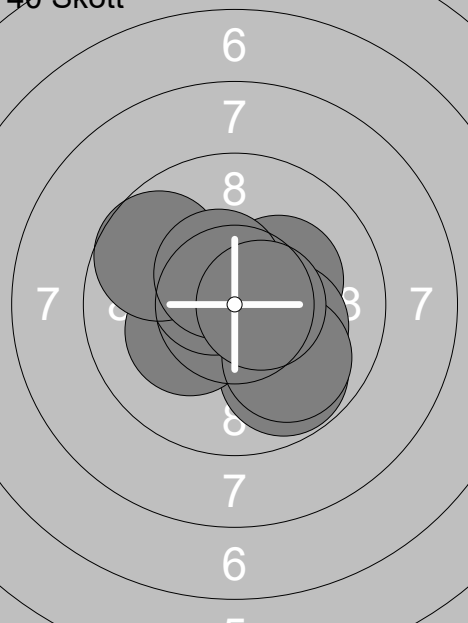
Skjutlag	Tavla	Emmy Långström	
1	24	Ramselefors	Vb
15.01.2022	Skyttiaden Distriktsomgång 2022	Ramselefors SKF	
Prov		40 Skott	
	1: 9.1 ↘ 2: 8.6 ↘ 3: 10.3x ↘ 4: 8.8 ↘ 5: 9.6 ↘ 6: 9.9 ↘ 7: 9.6 ↘ 8: 10.0 ↘ 9: 10.5x ↘ 10: 10.0 ←		1: 10.2x ↘ 2: 9.9 → 3: 9.9 ↘ 4: 10.3x ↘ 5: 9.9 → 6: 9.8 ↗ 7: 10.0 ↗ 8: 10.6x ↘ 9: 10.2x ↘ 10: 10.6x ↖
	Serie 96.4		Serie 101.4
	Total 0.0		Total 101.4
40 Skott		40 Skott	
	11: 10.5x ↘ 12: 10.6x ↘ 13: 9.9 ↗ 14: 10.6x ↘ 15: 9.6 ← 16: 10.3x ↗ 17: 10.1 ↗ 18: 10.1 ← 19: 10.2x → 20: 10.6x ↗		21: 10.6x → 22: 10.1 → 23: 10.3x ↖ 24: 10.4x ↗ 25: 10.7x ↘ 26: 9.6 ↘ 27: 10.5x ↖ 28: 10.7x → 29: 9.1 ← 30: 10.5x ↑
	Serie 102.5		Serie 102.5
	Total 203.9		Total 306.4
40 Skott			
	31: 9.8 ↘ 32: 10.2x → 33: 10.8x ↖ 34: 10.2x ↖ 35: 10.6x ↖ 36: 10.2x → 37: 9.7 ↗ 38: 9.9 ↘ 39: 10.5x ↗ 40: 10.6x →		
	Serie 102.5		
	Total 408.9		

Skjutlag	Tavla	Mattias Näslund	
1	26	Ramselefors	Sitt Vb
15.01.2022	Skyttiaden Distriktsomgång 2022	Ramselefors SKF	
Prov 	1: 9.6 → 2: 10.0 → 3: 10.5x → 4: 10.7x ↗ 5: 10.3x ↗ 6: 10.8x → 7: 10.0 ↑ 8: 10.4x ↑ 9: 10.0 ↖ 10: 10.1 ↑ Serie 102.4 Total 0.0	Prov 	11: 9.7 ↖ 12: 10.4x ↗ 13: 10.4x ↘ 14: 10.4x ← 15: 10.7x ↗ Serie 51.6 Total 0.0
40 Skott 	1: 10.1 ← 2: 10.4x ← 3: 10.5x ↖ 4: 10.6x ↗ 5: 10.1 ← 6: 10.7x ↖ 7: 10.5x ↓ 8: 10.6x ↓ 9: 10.2x → 10: 10.7x ↘ Serie 104.4 Total 104.4	40 Skott 	11: 10.8x → 12: 10.3x ↘ 13: 10.4x ↓ 14: 10.5x ↖ 15: 10.6x ↘ 16: 10.9x ↓ 17: 10.6x ↖ 18: 10.6x → 19: 10.7x ← 20: 10.2x ← Serie 105.6 Total 210.0
40 Skott 	21: 10.5x → 22: 10.7x ↖ 23: 10.7x ↘ 24: 10.3x ↖ 25: 10.7x → 26: 10.9x → 27: 10.7x ↗ 28: 10.7x ↖ 29: 10.1 ← 30: 10.7x ← Serie 106.0 Total 316.0	40 Skott 	31: 10.7x ↗ 32: 10.6x → 33: 10.5x ↖ 34: 9.9 ↓ 35: 10.4x ↘ 36: 10.1 ↓ 37: 10.3x ↗ 38: 10.7x ← 39: 10.2x ← 40: 10.9x ↘ Serie 104.3 Total 420.3

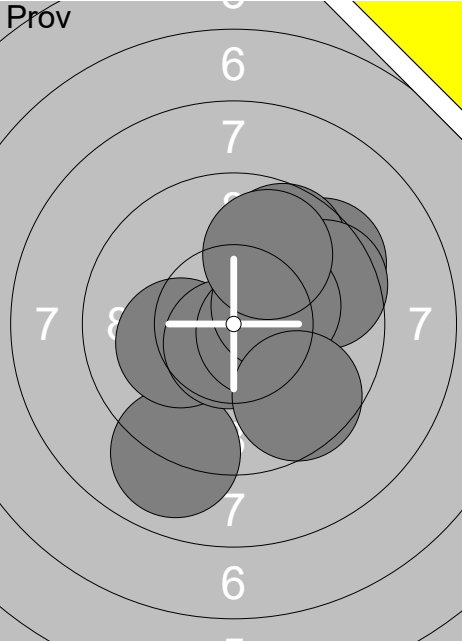
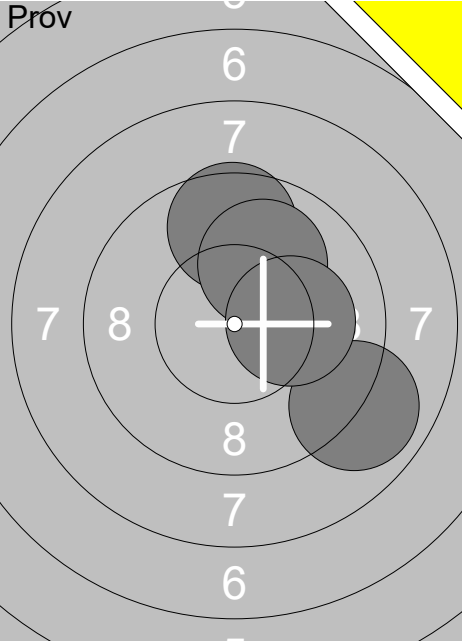
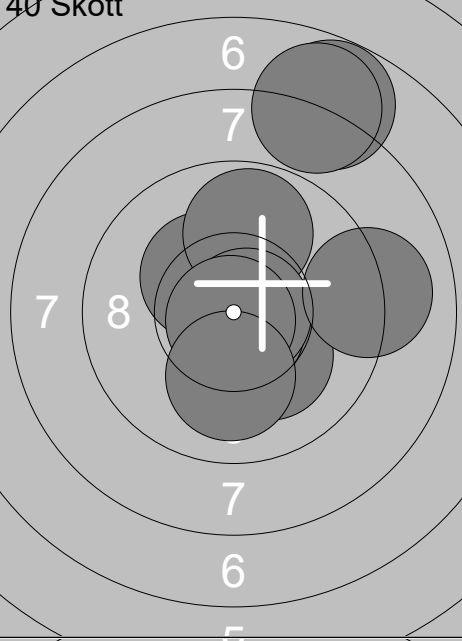
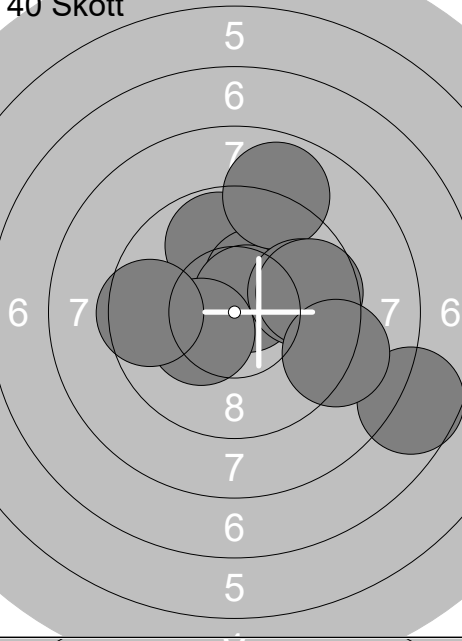
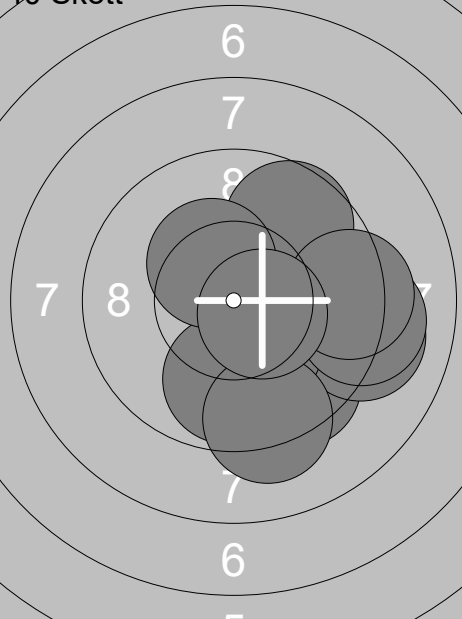
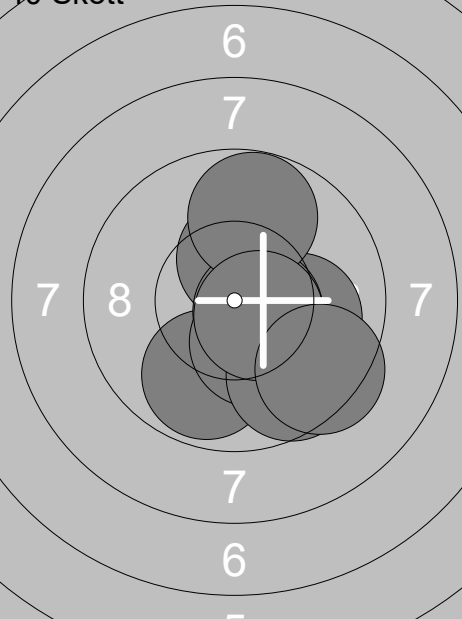
Skjuttag	Tavla	Filip Grenholm		
1	32	Ramselefors	Vännäs	11 Vb
15.01.2022	Skyttiaden Distriktsomgång 2022	Ramselefors SKF		
Prov 	1: 9.0 ↘ 2: 10.2x ← 3: 10.7x ↓ 4: 9.5 ↗ 5: 10.6x → 6: 9.7 ↗ 7: 9.6 ↗ 8: 10.3x → 9: 9.6 ↘ 10: 9.9 ↗ Serie 99.1 Total 0.0	Prov 	11: 8.9 ↘ 12: 9.6 ↑ 13: 10.0 ↗ 14: 10.2x → Serie 38.7 Total 0.0	
40 Skott 	1: 10.3x ↗ 2: 9.8 ↑ 3: 10.2x ↘ 4: 10.7x ↓ 5: 10.8x → 6: 7.8 ↗ 7: 10.8x ↓ 8: 10.1 ↓ 9: 9.1 → 10: 7.9 ↗ Serie 97.5 Total 97.5	40 Skott 	11: 9.8 ↑ 12: 10.3x ↗ 13: 10.6x ↗ 14: 8.9 ↑ 15: 9.8 → 16: 7.7 ↘ 17: 9.7 → 18: 9.1 ↘ 19: 10.3x ← 20: 9.5 ← Serie 95.7 Total 193.2	
40 Skott 	21: 9.5 ↘ 22: 9.1 → 23: 10.3x ↘ 24: 9.2 → 25: 9.7 ↗ 26: 9.9 ↓ 27: 9.2 ↓ 28: 9.3 → 29: 10.4x ↗ 30: 10.5x → Serie 97.1 Total 290.3	40 Skott 	31: 9.8 ↓ 32: 10.5x ↘ 33: 10.4x ↑ 34: 10.0 → 35: 10.6x → 36: 9.8 ↑ 37: 10.3x ↓ 38: 9.6 ↘ 39: 10.6x → 40: 9.4 ↘ Serie 101.0 Total 391.3	

Skjutlag	Tavla	Emma Söderlund		
1	36	Ramselefors	Vännäs	11 Vb
15.01.2022	Skyttiaden Distriktsomgång 2022	Ramselefors SKF		
Prov 	1: 9.3 ← 2: 10.0 ↗ 3: 10.0 ↗ 4: 9.7 ↘ 5: 10.1 ↗ 6: 9.5 ↗ 7: 10.3x ↓ 8: 10.2x ↓ 9: 9.8 ↘ 10: 9.6 ↘	Prov 	11: 10.1 ↗ 12: 9.3 ↓ 13: 10.3x ↖ 14: 10.4x ➡ 15: 10.3x ↗ 16: 10.7x ↗	
	Serie 98.5		Serie 61.1	
	Total 0.0		Total 0.0	
40 Skott 	1: 9.8 ← 2: 9.5 ← 3: 10.4x ↗ 4: 10.3x ➡ 5: 8.8 ➡ 6: 10.2x ↗ 7: 10.2x ➡ 8: 9.9 ↘ 9: 9.9 ↗ 10: 10.2x ➡	40 Skott 	11: 10.8x ↗ 12: 9.8 ➡ 13: 10.3x ↖ 14: 9.4 ➡ 15: 10.3x ➡ 16: 10.0 ↘ 17: 9.2 ↗ 18: 10.2x ↘ 19: 9.5 ↘ 20: 9.4 ↘	
	Serie 99.2		Serie 98.9	
	Total 99.2		Total 198.1	
40 Skott 	21: 10.3x ➡ 22: 9.3 ↘ 23: 10.3x ↗ 24: 9.3 ➡ 25: 9.8 ➡ 26: 10.2x ↖ 27: 10.1 ← 28: 10.2x ↘ 29: 9.8 ↘ 30: 10.3x ↗	40 Skott 	31: 8.9 ← 32: 9.7 ↓ 33: 9.9 ↗ 34: 9.9 ➡ 35: 9.3 ➡ 36: 9.7 ↗ 37: 9.8 ↘ 38: 9.3 ➡ 39: 9.2 ➡ 40: 10.5x ↗	
	Serie 99.6		Serie 96.2	
	Total 297.7		Total 393.9	

Skjutlag 1	Tavla 38	Isak Östlund	
Ramselefors	Vännäs	13	Vb
15.01.2022	Skyttiaden Distriktsomgång 2022	Ramselefors SKF	
Prov 	1: 9.7 ↗ 2: 9.1 ↗ 3: 9.8 ➤ 4: 10.3x ↘ 5: 10.6x ← 6: 10.3x ↑ 7: 10.4x ➔	40 Skott 	1: 10.5x ← 2: 10.6x ↗ 3: 10.3x ← 4: 9.5 ➔ 5: 10.3x ➤ 6: 10.1 ➔ 7: 10.3x ➔ 8: 10.4x ↘ 9: 9.9 ↓ 10: 9.9 ➔
	Serie 70.2		Serie 101.8
	Total 0.0		Total 101.8
40 Skott 	11: 10.3x ➔ 12: 10.4x ← 13: 10.1 ← 14: 9.9 ↙ 15: 10.6x ↙ 16: 10.5x ↘ 17: 10.3x ↗ 18: 10.2x ↓ 19: 10.5x ↑ 20: 9.8 ↘	40 Skott 	21: 10.5x ← 22: 10.5x ↑ 23: 10.4x ↘ 24: 10.2x ➔ 25: 10.1 ↗ 26: 10.2x ↓ 27: 10.5x ↓ 28: 10.5x ➤ 29: 9.7 ↓ 30: 10.4x ➔
	Serie 102.6		Serie 103.0
	Total 204.4		Total 307.4
40 Skott 	31: 10.6x ↘ 32: 10.4x ↙ 33: 10.2x ↗ 34: 9.7 ↓ 35: 10.4x ↘ 36: 10.2x ↑ 37: 10.2x ↑ 38: 10.3x ↗ 39: 10.6x ↘ 40: 10.7x ↑		
	Serie 103.3		
	Total 410.7		

Skjuttag	Tavla	Sture Lönnefjord						
1	39	Ramselefors	Ramselefors	Funk	Vb			
15.01.2022		Skyttiaden Distriktsomgång 2022	Ramselefors SKF					
Prov 	1: 9.9 ↗ 2: 10.3x ↘ 3: 10.3x → 4: 10.6x ↑ 5: 9.9 ↑ 6: 10.5x → 7: 10.0 ↗ 8: 10.7x ↗ 9: 10.5x ← 10: 10.0 ↘	Serie 102.7 Total 0.0	Prov 	11: 9.7 ↘ 12: 10.8x ↘	Serie 20.5 Total 0.0			
	40 Skott 			1: 10.3x ↖ 2: 10.2x ← 3: 10.3x ↑ 4: 10.3x → 5: 10.7x ↖ 6: 10.4x ← 7: 9.8 ↑ 8: 10.1 ← 9: 10.8x ↖ 10: 10.2x ↖		Serie 103.1 Total 103.1	11: 10.6x ↗ 12: 10.2x → 13: 10.4x → 14: 10.8x ↑ 15: 10.4x ↗ 16: 10.2x ↘ 17: 10.4x ↙ 18: 10.3x ← 19: 10.6x → 20: 9.6 ←	Serie 103.5 Total 206.6
	40 Skott 			21: 9.9 ↑ 22: 10.5x ↘ 23: 10.8x ↖ 24: 10.8x ↘ 25: 9.9 ↑ 26: 9.9 ↗ 27: 10.4x ← 28: 9.8 ← 29: 10.8x ↖ 30: 10.4x ←			Serie 103.2 Total 309.8	

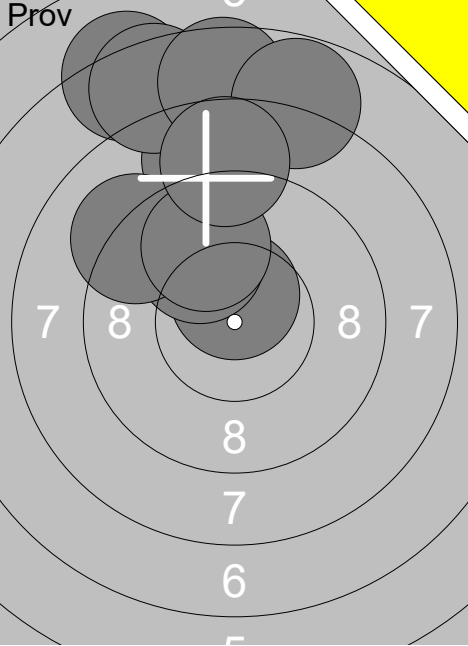
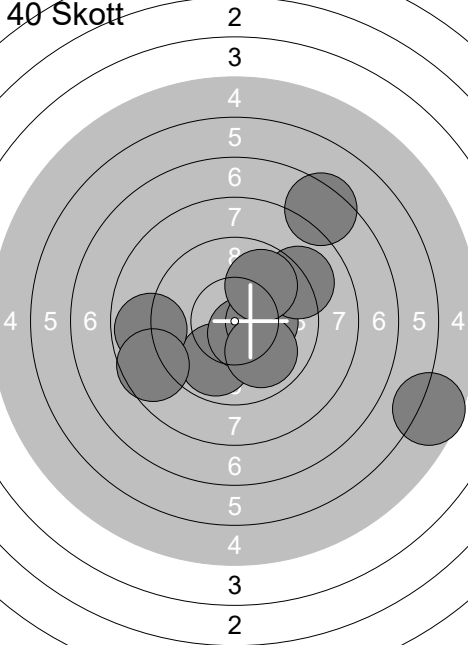
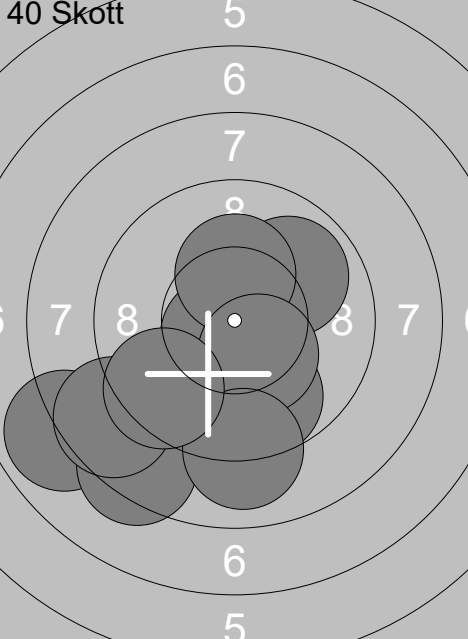
Skjuttag	Tavla	Oskar Nygren		Funk	Vb
1	40	Ramselefors	Ramselefors		
15.01.2022		Skyttiaden Distriktsomgång 2022	Ramselefors SKF		
Prov		1: 7.2 ↗ 2: 8.7 ↑ 3: 7.5 ↗ 4: 10.6x ↑ 5: 9.9 ↗ 6: 9.2 ↖ 7: 7.6 ↑ 8: 7.8 ↑ 9: 9.8 ↗ 10: 8.7 ↑ Serie 87.0 Total 0.0	11: 9.4 ↗ 12: 9.6 ↑ 13: 9.8 ↗ 14: 9.8 ↖ 15: 9.3 ↓ 16: 10.1 → Serie 58.0 Total 0.0		
40 Skott		1: 9.9 ↓ 2: 7.4 ↗ 3: 5.6 → 4: 8.9 ← 5: 10.6x ↓ 6: 10.3x → 7: 9.1 ↗ 8: 8.6 ← 9: 10.0 ↓ 10: 9.8 ↗ Serie 90.2 Total 90.2	11: 9.3 ← 12: 10.9x → 13: 9.8 ← 14: 10.5x ← 15: 10.0 ↓ 16: 8.7 ← 17: 10.3x ↑ 18: 10.3x ↓ 19: 10.4x ↓ 20: 9.5 ↖ Serie 99.7 Total 189.9		
40 Skott		21: 10.6x ↓ 22: 9.9 ↗ 23: 7.9 ← 24: 9.7 ↓ 25: 8.3 ↓ 26: 10.3x ↑ 27: 10.3x ↓ 28: 9.0 ↓ 29: 8.6 ← 30: 9.5 ↓ Serie 94.1 Total 284.0	31: 9.5 → 32: 9.8 ↗ 33: 9.0 ↖ 34: 10.8x ↓ 35: 9.8 ↓ 36: 9.7 ↓ 37: 9.2 ↗ 38: 9.8 ↓ 39: 10.0 → 40: 8.0 ↖ Serie 95.6 Total 379.6		

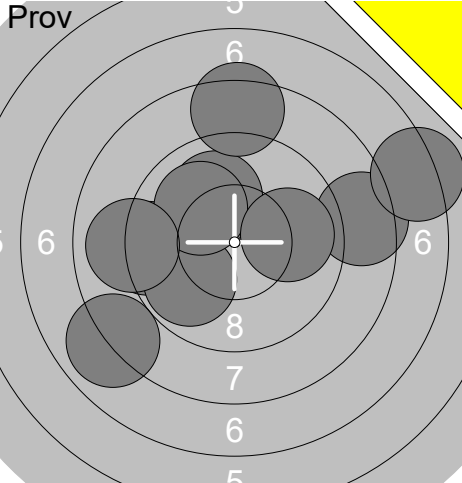
Skjuttag	Tavla	Mats Österlund	
2	1	Ramselefors	Ramselefors
15.01.2022	Skyttiaden Distriktsomgång 2022	Ramselefors SKF	Sen Vb
Prov 	1: 8.3 ↙ 2: 9.7 ↘ 3: 9.7 → 4: 7.9 ← 5: 10.1 ← 6: 9.4 ← 7: 8.8 → 8: 9.8 ↙ 9: 8.0 ↗ 10: 9.8 ↑	Prov 	11: 9.3 ← 12: 8.5 → 13: 10.0 ↗ 14: 7.2 → 15: 9.8 ↙ 16: 10.0 ↗ 17: 8.4 ↑ 18: 9.0 ← 19: 8.0 ↙ 20: 9.9 →
	Serie 91.5		Serie 90.1
	Total 0.0		Total 0.0
Prov 	21: 10.0 ↗ 22: 9.3 ↗ 23: 8.7 ↗ 24: 10.4x ↗ 25: 10.0 ↘ 26: 10.3x ↗ 27: 8.0 ↗	40 Skott 	1: 9.8 ← 2: 9.0 ↗ 3: 8.3 → 4: 8.6 ↗ 5: 8.3 → 6: 9.4 ↘ 7: 9.4 ↗ 8: 9.4 ↑ 9: 10.5x ↗ 10: 9.6 ←
	Serie 66.7		Serie 92.3
	Total 0.0		Total 92.3
40 Skott 	11: 10.3x ← 12: 8.0 ← 13: 9.0 → 14: 8.2 ← 15: 10.0 ↘ 16: 8.5 ↗ 17: 9.4 ↘ 18: 9.2 ↗ 19: 10.1 → 20: 9.3 ↘	40 Skott 	21: 9.0 → 22: 10.5x ↘ 23: 8.8 → 24: 10.1 ↑ 25: 9.2 → 26: 9.9 → 27: 10.0 → 28: 9.9 ↘ 29: 7.3 ↗ 30: 10.4x ↘
	Serie 92.0		Serie 95.1
	Total 184.3		Total 279.4
40 Skott 	31: 9.2 ↗ 32: 9.2 ↗ 33: 10.3x → 34: 9.5 ↗ 35: 8.2 ← 36: 8.7 ↗ 37: 9.1 → 38: 8.9 ↗ 39: 9.2 ↗ 40: 10.0 ↗		
	Serie 92.3		
	Total 371.7		

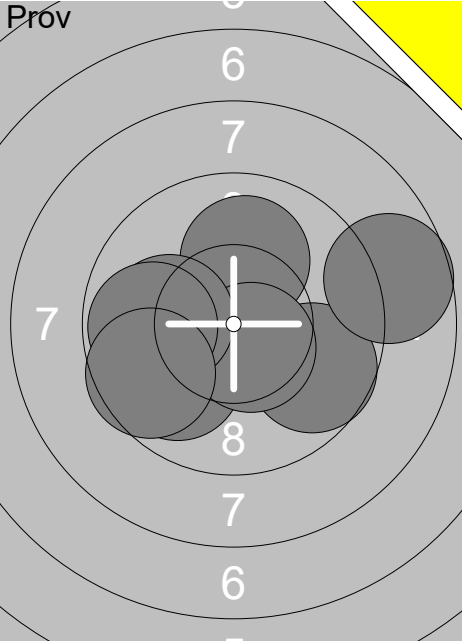
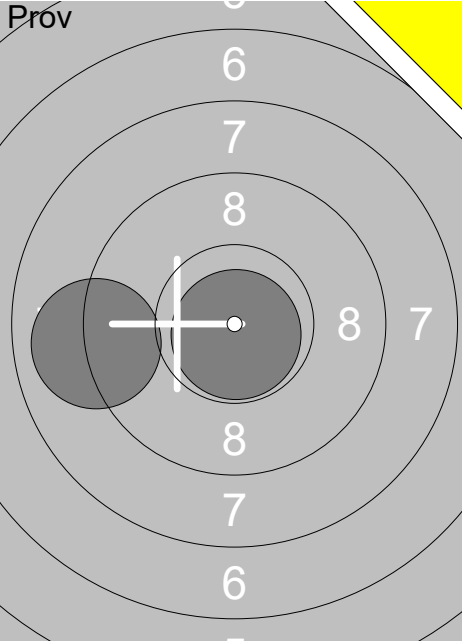
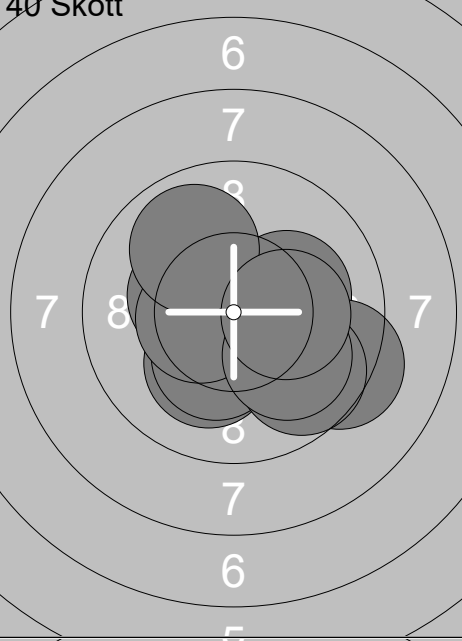
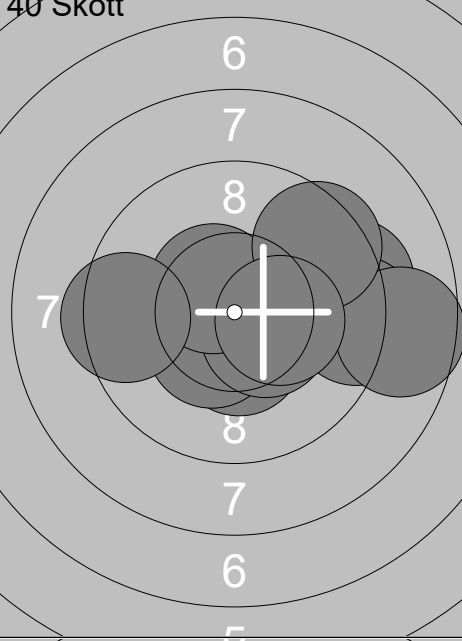
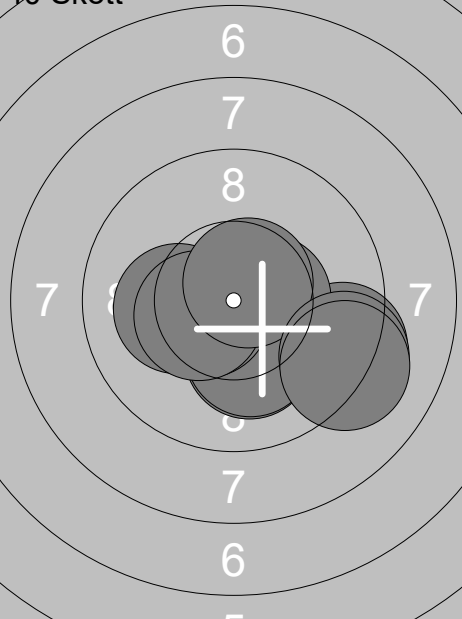
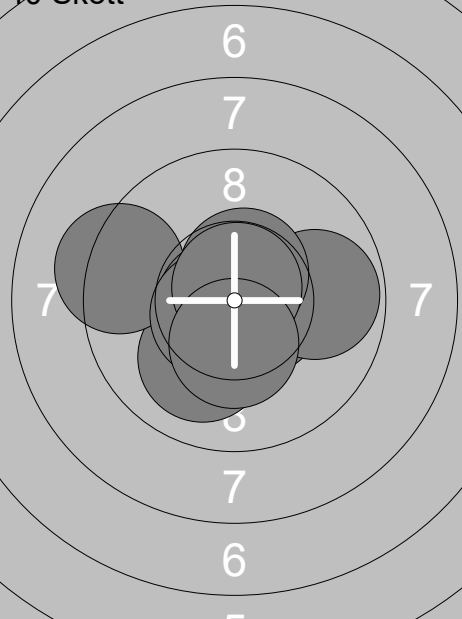
Skjutlag	Tavla	Kristina Hermansson			
2	3	Ramselefors	Ramselefors	Sen	Vb
15.01.2022		Skyttiaden Distriktsomgång 2022	Ramselefors SKF		
Prov		1: 9.7 → 2: 10.0 ← 3: 9.9 ↙ 4: 10.1 ↑ 5: 10.0 ← 6: 10.5x ↘ 7: 10.1 ← 8: 9.8 ← 9: 8.7 → 10: 9.6 ↙	Prov		11: 9.0 ← 12: 10.8x ↘
		Serie 98.4		Serie 19.8	
		Total 0.0		Total 0.0	
40 Skott		1: 10.2x ↘ 2: 10.3x ↙ 3: 10.2x → 4: 9.3 → 5: 10.3x ↘ 6: 10.5x ← 7: 9.7 ↘ 8: 10.0 ↘ 9: 9.9 ↗ 10: 10.2x →	40 Skott		11: 9.3 → 12: 10.4x ↘ 13: 10.4x ↘ 14: 9.3 → 15: 10.4x ↘ 16: 10.5x ↖ 17: 8.6 → 18: 9.5 ↗ 19: 10.3x → 20: 9.4 ←
		Serie 100.6		Serie 98.1	
		Total 100.6		Total 198.7	
40 Skott		21: 10.2x ↘ 22: 9.3 → 23: 10.5x → 24: 10.2x ↘ 25: 10.5x ← 26: 10.2x ← 27: 10.4x ← 28: 10.6x ↗ 29: 9.2 → 30: 9.2 →	40 Skott		31: 10.0 ↘ 32: 10.6x → 33: 9.3 ← 34: 10.8x ← 35: 10.7x ↗ 36: 9.8 → 37: 10.6x ↑ 38: 10.6x ↙ 39: 10.8x ↑ 40: 10.4x ↘
		Serie 100.3		Serie 103.6	
		Total 299.0		Total 402.6	

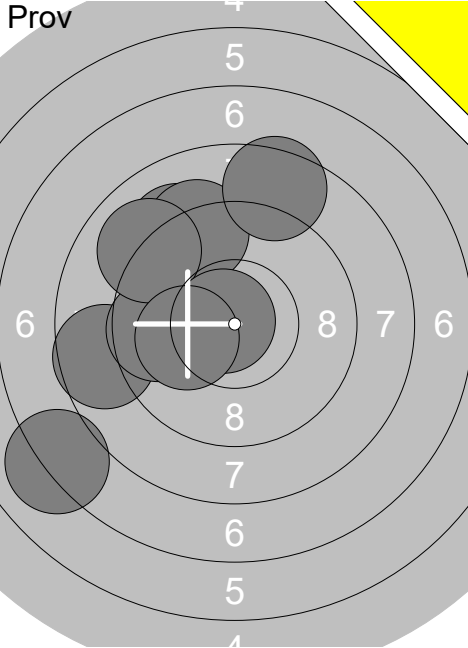
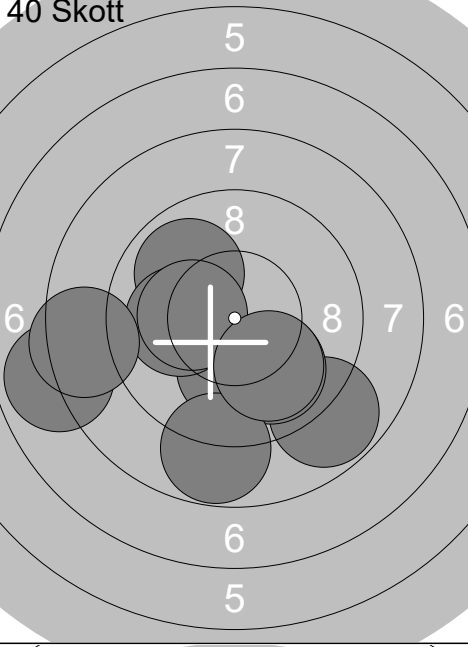
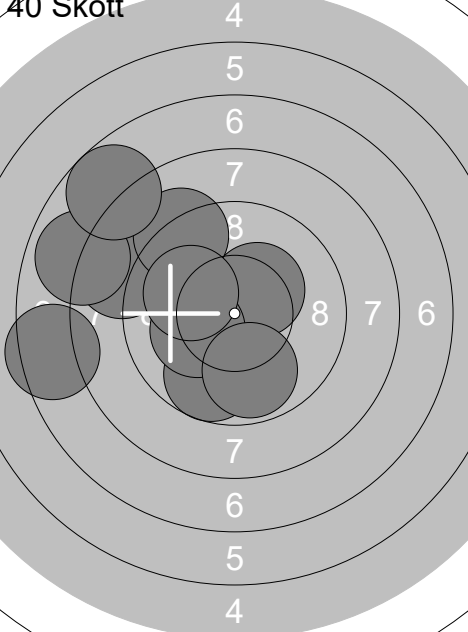
Skjuttag	Tavla	Emma Eriksson		
2	7	Ramselefors	Ramselefors	17S Vb
15.01.2022	Skyttiaden Distriktsomgång 2022	Ramselefors SKF		
Prov		1: 9.1 ↗ 2: 10.4x↙ 3: 8.6 ← 4: 9.2 ↗ 5: 9.6 ← 6: 8.5 ↗ 7: 9.0 ↗ 8: 10.7x↙ 9: 10.1 ← 10: 7.1 ↙	Prov	11: 10.2x↙
		Serie 92.3		Serie 10.2
		Total 0.0		Total 0.0
40 Skott		1: 9.9 ↗ 2: 10.1 ↓ 3: 8.8 ↘ 4: 10.1 ← 5: 9.9 ↘ 6: 8.8 ↓ 7: 7.9 ← 8: 8.5 ← 9: 10.3x↙ 10: 10.0 ↘	40 Skott	11: 9.2 ↓ 12: 9.1 ← 13: 9.1 ↓ 14: 10.1 → 15: 9.2 ↑ 16: 9.4 ↙ 17: 10.2x↑ 18: 9.1 ↙ 19: 9.9 ↓ 20: 10.4x↗
		Serie 94.3		Serie 95.7
		Total 94.3		Total 190.0
40 Skott		21: 8.7 ← 22: 9.7 ↓ 23: 10.3x↗ 24: 9.2 ↗ 25: 10.2x↙ 26: 10.0 ← 27: 7.5 ← 28: 9.8 ↓ 29: 7.9 ← 30: 7.7 ↗	40 Skott	31: 9.6 ↑ 32: 10.1 ↗ 33: 9.7 ↑ 34: 9.0 ← 35: 10.5x→ 36: 10.7x↗ 37: 8.7 ← 38: 9.5 ← 39: 9.5 ← 40: 8.9 ↙
		Serie 91.0		Serie 96.2
		Total 281.0		Total 377.2

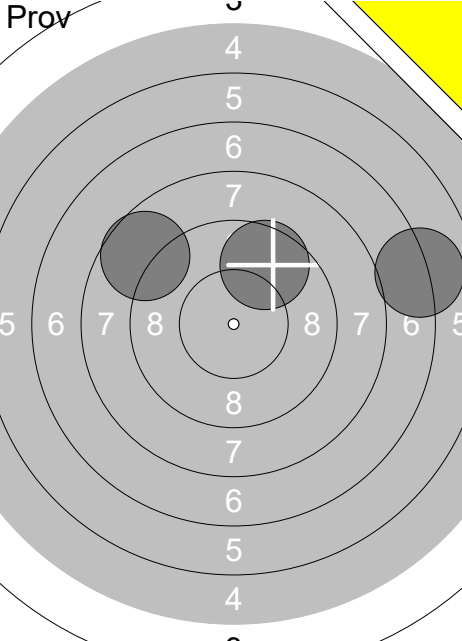
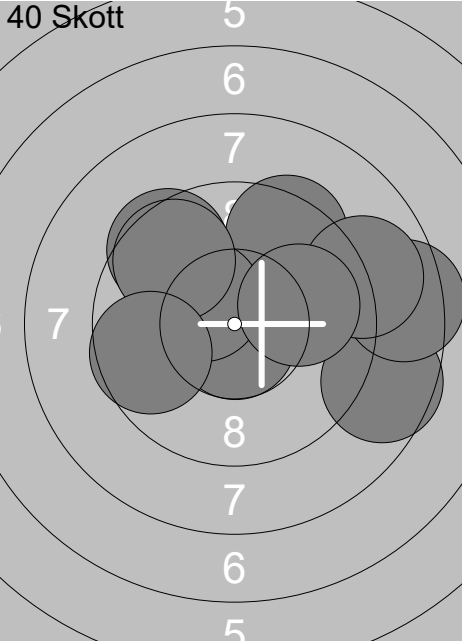
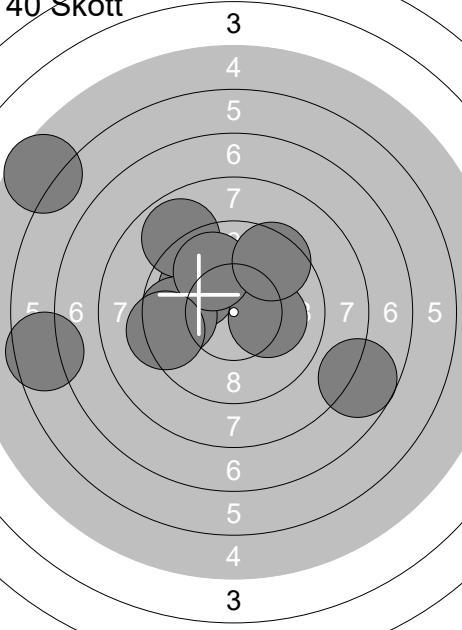
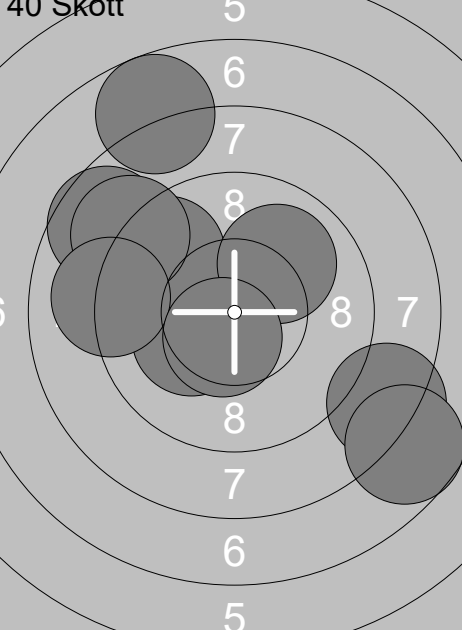
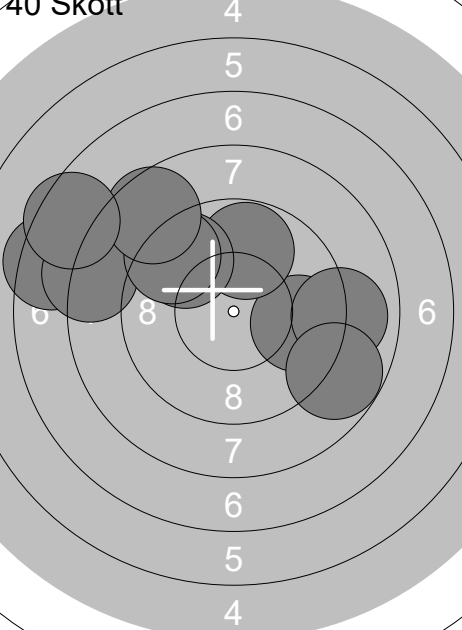
Skjutlag 2	Tavla 9	Jacob Hedman			
Ramselefors	Umeå	15S	Vb		
15.01.2022	Skyttiaden Distriktsomgång 2022	Ramselefors SKF			
Prov		1: 8.7 ↖ 2: 9.6 ↗ 3: 7.0 →	40 Skott		1: 10.7x ↓ 2: 9.4 ↗ 3: 9.5 ↗ 4: 8.6 → 5: 10.4x ↖ 6: 8.4 → 7: 9.7 ↗ 8: 8.9 → 9: 10.0 → 10: 9.6 ←
	Serie 25.3 Total 0.0			Serie 95.2 Total 95.2	
40 Skott		11: 10.0 ↖ 12: 5.6 ↖ 13: 8.9 ↗ 14: 7.7 → 15: 10.2x → 16: 9.7 ← 17: 9.9 ↗ 18: 9.5 ↗ 19: 6.5 ← 20: 9.3 ←	40 Skott		21: 10.2x ↙ 22: 9.6 ↗ 23: 8.3 → 24: 7.7 → 25: 7.7 ↗ 26: 10.0 ↗ 27: 8.6 ↗ 28: 9.0 ↖ 29: 9.1 ← 30: 10.5x ↓
	Serie 87.3 Total 182.5			Serie 90.7 Total 273.2	
40 Skott		31: 9.7 → 32: 9.0 → 33: 8.8 → 34: 7.4 ← 35: 9.8 ↗ 36: 8.2 ← 37: 9.6 ↗ 38: 9.4 ↗ 39: 8.6 ↗ 40: 7.5 ↖			
	Serie 88.0 Total 361.2				

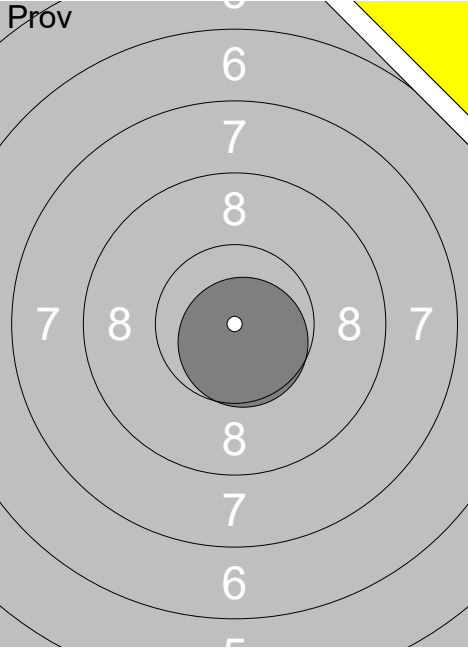
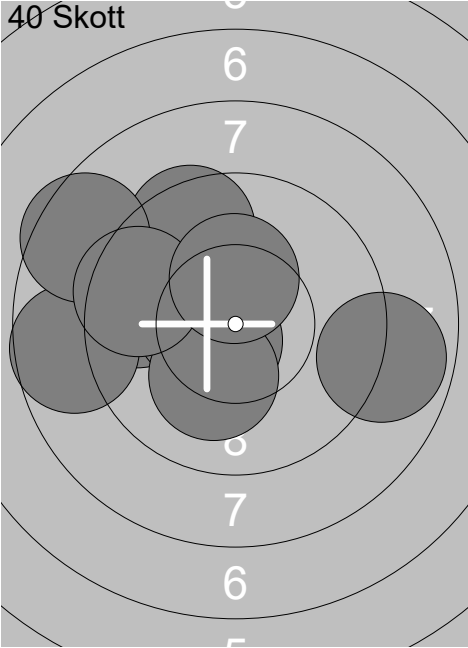
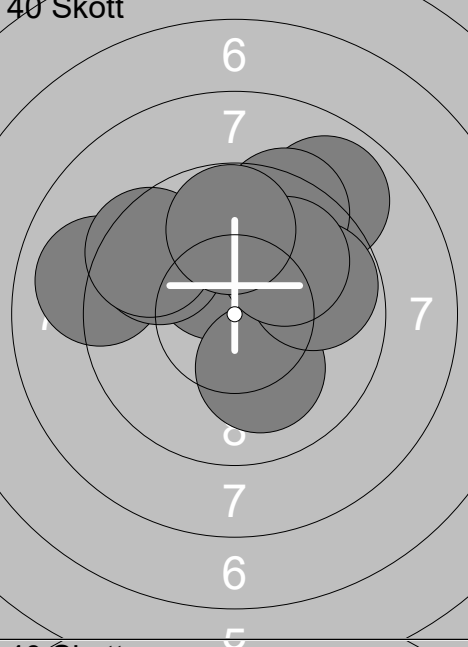
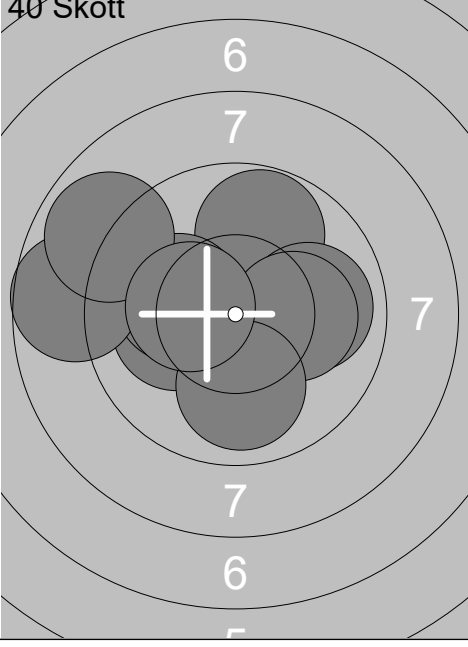
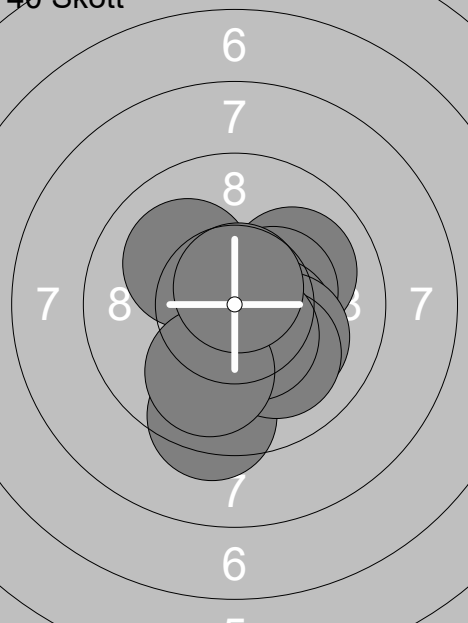
Skjutlag 2	Tavla 11	Hanna Johansson	
Ramselefors	Umeå	17S	Vb
15.01.2022	Skyttiaden Distriktsomgång 2022	Ramselefors SKF	
Prov	1: 10.7x ↓	40 Skott	1: 9.6 ←
			2: 10.4x ←
			3: 9.5 ↗
			4: 8.7 ←
			5: 10.6x ↙
			6: 10.2x ↓
			7: 8.9 →
			8: 8.5 ↖
			9: 9.5 ←
			10: 10.3x ↑
	Serie 10.7		Serie 96.2
	Total 0.0		Total 96.2
40 Skott	11: 8.9 ↗	40 Skott	21: 9.4 ←
			22: 9.8 ↑
	12: 9.4 ↗		23: 10.1 ←
	13: 10.4x ↗		24: 10.1 ←
	14: 10.1 ↓		25: 8.7 ←
	15: 9.8 →		26: 9.9 →
	16: 9.0 ←		27: 8.9 ↖
	17: 9.7 ↖		28: 10.1 →
	18: 9.9 ↗		29: 10.0 ↓
	19: 9.5 ↖		30: 10.3x ←
	20: 9.8 ↑		
	Serie 96.5		Serie 97.3
	Total 192.7		Total 290.0
40 Skott	31: 10.1 ↖		
			
	32: 10.0 ↗		
	33: 9.4 ↓		
	34: 10.4x →		
	35: 10.4x →		
	36: 10.1 ↓		
	37: 10.1 ↓		
	38: 10.4x ↓		
	39: 10.0 ↓		
	40: 10.7x ↑		
	Serie 101.6		
	Total 391.6		

Skjutlag	Tavla	Helena Perkiömäki	
2	15	Umeå	17S Vb
15.01.2022	Skyttiaden Distriktsomgång 2022	Ramselefors SKF	
Prov	1: 9.9 →	40 Skott	1: 9.8 ←
			2: 9.9 ↑
			3: 9.6 ↗
			4: 10.7x ↓
			5: 10.2x ←
			6: 10.1 ↖
			7: 10.6x ↘
			8: 10.5x ↓
			9: 10.6x ↗
			10: 10.2x ↑
	Serie 9.9		Serie 102.2
	Total 0.0		Total 102.2
40 Skott	11: 9.4 ←	40 Skott	21: 10.2x →
	12: 10.0 ↖		22: 9.9 →
	13: 9.7 ←		23: 9.6 ↓
	14: 9.9 ↓		24: 9.2 →
	15: 8.2 →		25: 10.4x ↙
	16: 10.9x ↑		26: 10.7x ↖
	17: 9.8 ←		27: 10.6x ↖
	18: 9.7 →		28: 10.4x ↑
	19: 10.5x ↗		29: 9.7 ←
	20: 10.6x ↓		30: 10.3x ↑
	Serie 98.7		Serie 101.0
	Total 200.9		Total 301.9
40 Skott	31: 8.8 ←		
	32: 10.4x ↑		
	33: 9.9 ←		
	34: 10.0 ↑		
	35: 9.6 ←		
	36: 9.8 ↘		
	37: 9.6 →		
	38: 9.5 ←		
	39: 9.4 ↓		
	40: 10.1 ↖		
	Serie 97.1		
	Total 399.0		

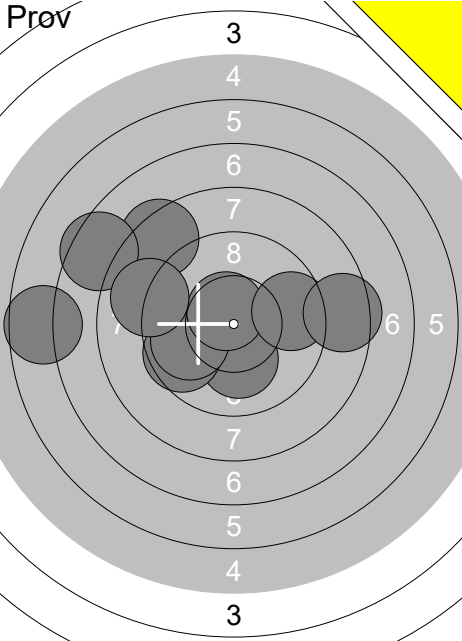
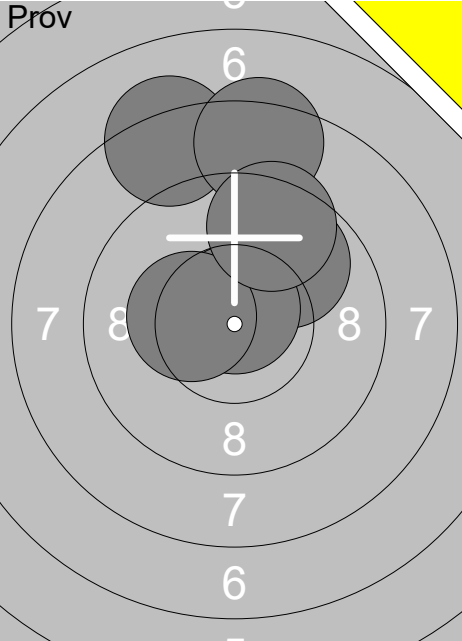
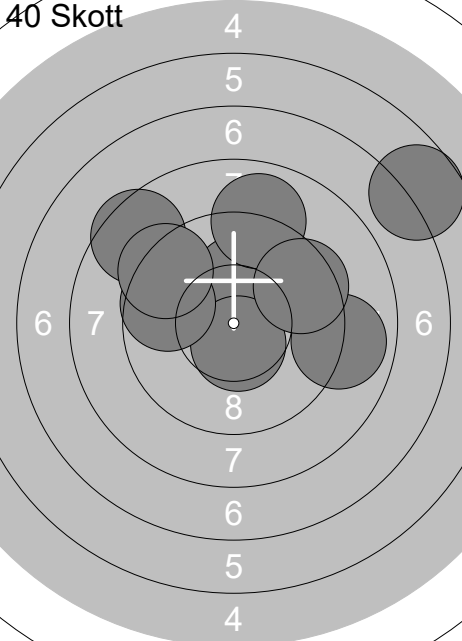
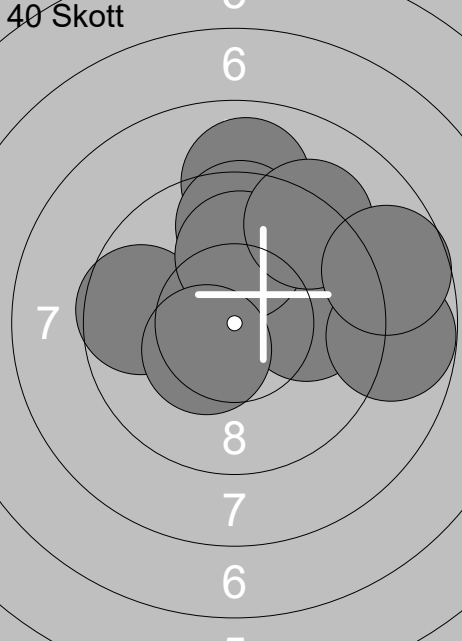
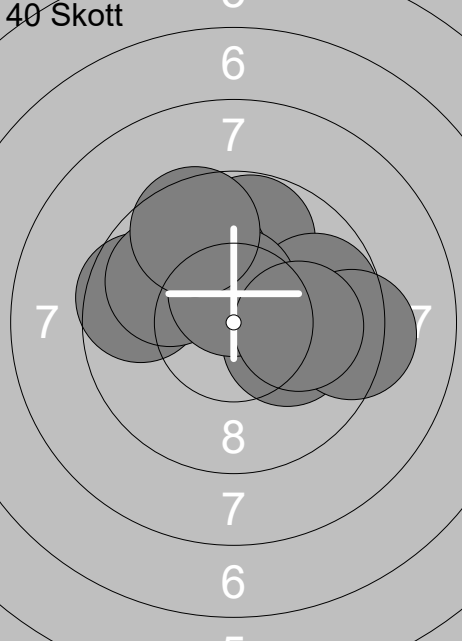
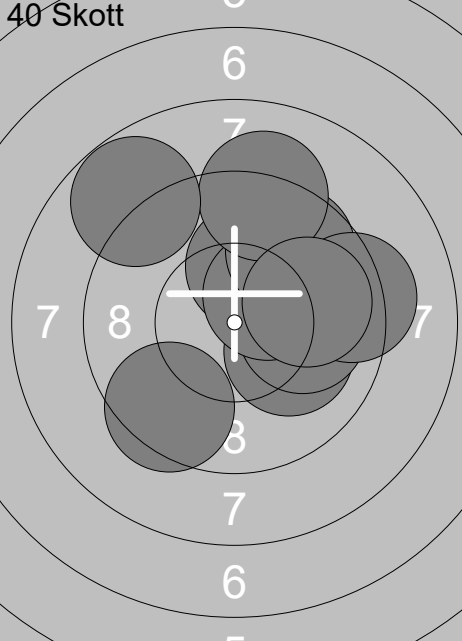

Skjuttag	Tavla	Ida Lundmark	
2	17	Ramselefors	Drängsmark
15.01.2022	Skyttiaden Distriktsomgång 2022	Ramselefors SKF	
Prov 	1: 6.6 ← 2: 10.1 ↓ 3: 9.6 ← 4: 9.9 ← 5: 10.6x ↗ 6: 9.6 → 7: 8.4 ↗ 8: 7.5 ← 9: 8.5 → 10: 9.0 ←	Prov 	11: 9.9 ↗ 12: 8.3 ↖ 13: 10.7x ↑ 14: 10.3x ← 15: 8.4 ↑ 16: 9.5 ↗
	Serie 89.8		Serie 57.1
	Total 0.0		Total 0.0
40 Skott 	1: 10.4x ↗ 2: 10.2x ↑ 3: 9.0 ↑ 4: 8.9 → 5: 10.6x ↓ 6: 6.7 ↗ 7: 8.5 ↗ 8: 9.6 ← 9: 9.5 ↗ 10: 9.3 ↖	40 Skott 	11: 9.0 ↑ 12: 9.6 ↑ 13: 10.2x ↗ 14: 9.9 → 15: 9.6 ← 16: 8.8 → 17: 10.0 ↑ 18: 10.4x ↙ 19: 9.2 ↗ 20: 8.7 →
	Serie 92.7		Serie 95.4
	Total 92.7		Total 188.1
40 Skott 	21: 9.8 ↑ 22: 10.0 ↖ 23: 10.2x → 24: 9.6 ← 25: 9.9 ↖ 26: 9.8 → 27: 9.3 → 28: 10.5x ↑ 29: 9.6 ↖ 30: 10.0 →	40 Skott 	31: 10.1 → 32: 10.1 ↑ 33: 10.0 → 34: 10.4x ↗ 35: 9.7 ↗ 36: 9.1 ↑ 37: 9.5 ↙ 38: 8.8 ↖ 39: 9.3 → 40: 9.9 →
	Serie 98.7		Serie 96.9
	Total 286.8		Total 383.7

Skjuttag	Tavla	Emma Johansson				
2	19	Ramselefors	Ramselefors	21S	Vb	
15.01.2022		Skyttiaden Distriktsomgång 2022		Ramselefors SKF		
Prov 	1: 9.9 ↓	Prov 	11: 10.0 →			
	2: 9.8 ↖		12: 10.6x ↗			
	3: 9.3 ←					
	4: 8.6 ↙					
	5: 9.5 →					
	6: 9.9 ↘					
	7: 9.1 →					
	8: 9.7 →					
	9: 10.3x →					
	10: 9.2 ↗					
	Serie 95.3				Serie 20.6	
	Total 0.0				Total 0.0	
40 Skott 	1: 9.9 ↖	40 Skott 	11: 9.8 ↘			
	2: 10.0 ↑		12: 10.4x ↙			
	3: 9.3 →		13: 9.6 ↓			
	4: 10.5x →		14: 10.5x ←			
	5: 9.5 ↓		15: 9.1 ↗			
	6: 10.6x ↑		16: 10.7x ←			
	7: 9.1 ←		17: 10.1 ↗			
	8: 10.4x ←		18: 9.2 ↗			
	9: 10.2x ↑		19: 10.7x ↑			
	10: 10.3x ←		20: 9.7 →			
	Serie 99.8				Serie 99.8	
	Total 99.8				Total 199.6	
40 Skott 	21: 9.4 ↖	40 Skott 	31: 10.3x →			
	22: 9.9 ↘		32: 10.0 ↗			
	23: 10.3x ↓		33: 10.0 ↗			
	24: 10.1 ←		34: 9.2 ↖			
	25: 9.6 ↗		35: 9.7 ←			
	26: 10.1 ↘		36: 9.9 ↑			
	27: 10.0 ↓		37: 9.7 ↓			
	28: 10.2x ↙		38: 10.8x ↖			
	29: 10.8x ↙		39: 10.9x ↓			
	30: 10.2x ↓		40: 9.3 ↖			
	Serie 100.6				Serie 99.8	
	Total 300.2				Total 400.0	

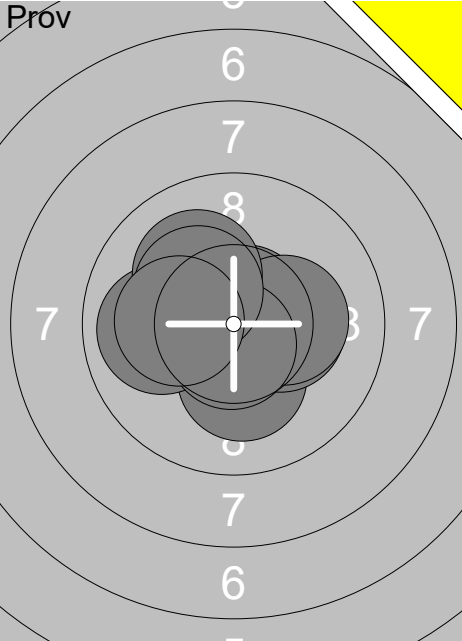
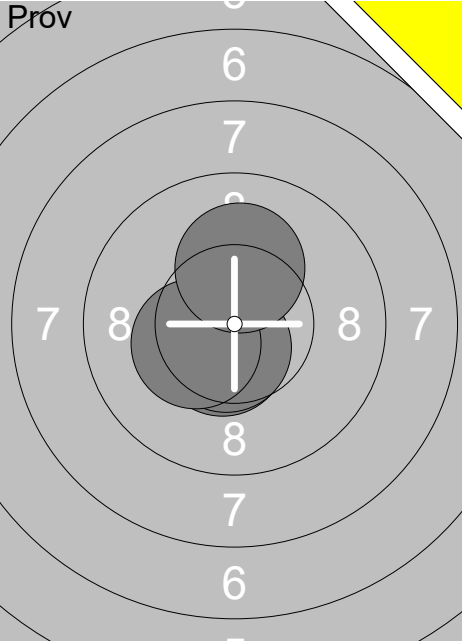
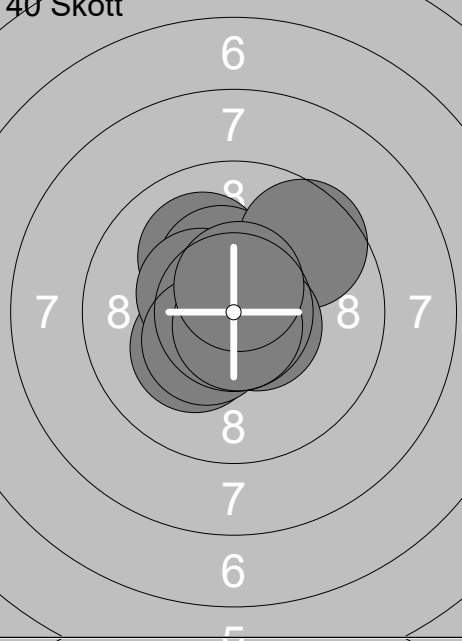
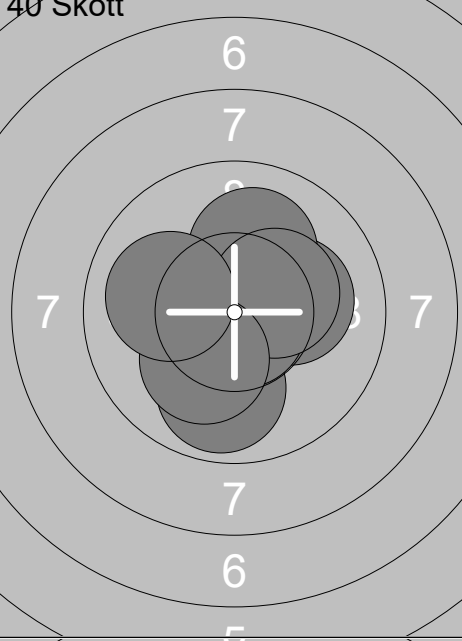
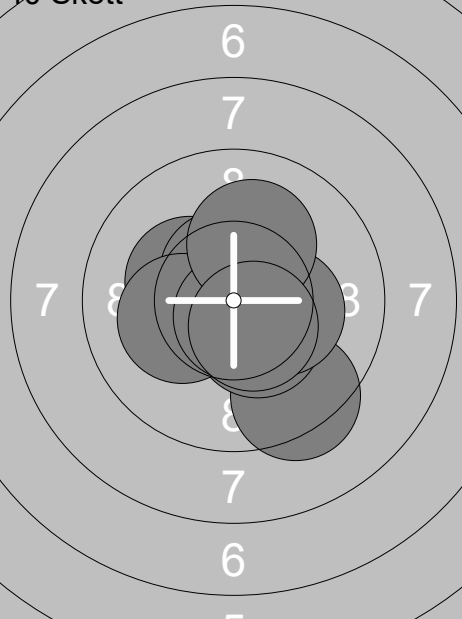
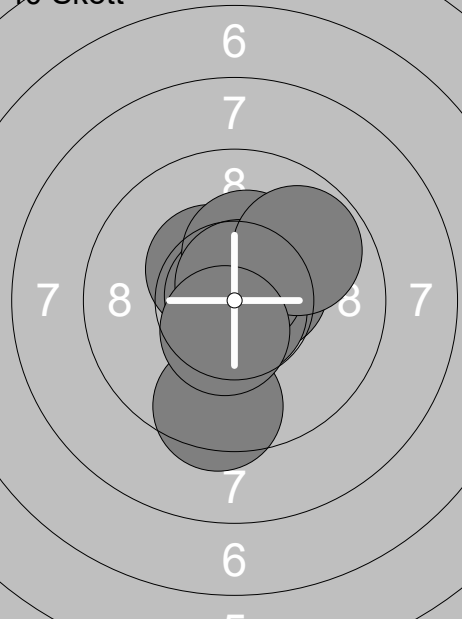

Skjutlag	Tavla	Elias Renman	
2	20	Ramselefors	Sitt Vb
15.01.2022	Skyttiaden Distriktsomgång 2022	Ramselefors SKF	
Prov 	1: 7.8 ↗ 2: 9.3 ↗ 3: 10.4x ↗ 4: 10.2x ↗ 5: 9.4 ↖ 6: 9.5 ↗ 7: 10.8x ↙ 8: 9.8 ↗	40 Skott 	1: 10.3x ↙ 2: 10.1 ↘ 3: 10.5x ↖ 4: 10.5x ↖ 5: 10.5x ↙ 6: 10.2x ↙ 7: 10.1 ↗ 8: 10.4x ↙ 9: 10.6x ↓ 10: 10.8x →
	Serie 77.2		Serie 104.0
	Total 0.0		Total 104.0
40 Skott 	11: 10.5x ↙ 12: 10.8x ↗ 13: 10.2x ↗ 14: 10.4x → 15: 10.5x ↓ 16: 10.6x ↓ 17: 10.6x ↗ 18: 10.2x ↘ 19: 10.5x ↖ 20: 10.2x ↓	40 Skott 	21: 10.2x ↘ 22: 10.6x ↖ 23: 10.5x ↙ 24: 9.2 ↗ 25: 10.7x ↙ 26: 10.7x ↖ 27: 9.9 ↗ 28: 10.4x ↓ 29: 10.5x ↙ 30: 10.7x ↓
	Serie 104.5		Serie 103.4
	Total 208.5		Total 311.9
40 Skott 	31: 10.5x ↗ 32: 10.6x ↖ 33: 10.5x ↙ 34: 10.3x ↖ 35: 9.9 ↗ 36: 10.5x ↙ 37: 10.7x ↗ 38: 10.0 ↘ 39: 10.9x ↓ 40: 10.6x →		
	Serie 104.5		
	Total 416.4		

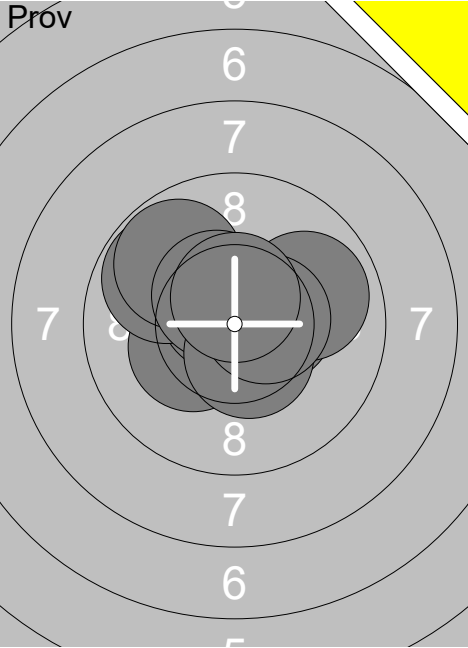
Skjutlag	Tavla	Tore Tiburzi		
2	22	Drängsmark	11	Vb
15.01.2022	Skyttiaden Distriktsomgång 2022	Ramselefors SKF		
Prov 	1: 10.2x ↓	Prov 	11: 10.5x ↓	
	3: 10.3x →		12: 10.6x ↓	
	4: 10.7x ↗		13: 10.4x ↙	
	5: 10.3x →		14: 10.2x ↑	
	6: 9.9 ←			
	7: 10.7x ↓			
	8: 10.1 ↗			
	9: 10.3x ↖			
	10: 10.2x ←			
	Serie 92.7		Serie 41.7	
	Total 0.0		Total 0.0	
40 Skott 	1: 10.1 ↖	40 Skott 	11: 10.7x ↓	
	2: 10.4x ↗		12: 10.8x ↖	
	3: 10.2x ↙		13: 9.9 ↓	
	4: 10.3x ↑		14: 10.2x →	
	5: 9.6 ↗		15: 10.8x ↘	
	6: 10.6x ↘		16: 10.4x ↙	
	7: 10.4x ↖		17: 10.1 ↑	
	8: 10.4x ↙		18: 10.3x →	
	9: 10.8x ↓		19: 10.2x ↓	
	10: 10.6x ↑		20: 10.0 ←	
	Serie 103.4		Serie 103.4	
	Total 103.4		Total 206.8	
40 Skott 	21: 10.3x ↖	40 Skott 	31: 9.5 ↓	
	22: 9.4 ↓		32: 10.5x →	
	23: 10.6x ↗		33: 10.4x ↖	
	24: 10.4x ↓		34: 10.6x ↑	
	25: 10.3x →		35: 10.9x ↖	
	26: 10.6x ↑		36: 10.3x ↑	
	27: 10.2x ←		37: 10.8x ↘	
	28: 10.7x ↓		38: 10.7x ↑	
	29: 10.1 ↑		39: 9.8 ↗	
	30: 10.5x ↘		40: 10.5x ↓	
	Serie 103.1		Serie 104.0	
	Total 309.9		Total 413.9	

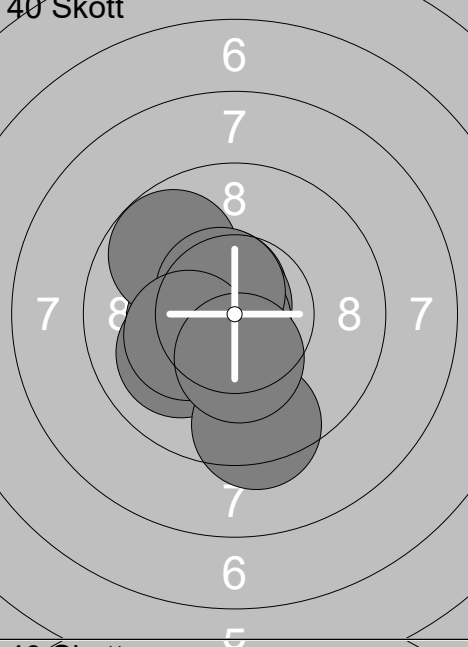
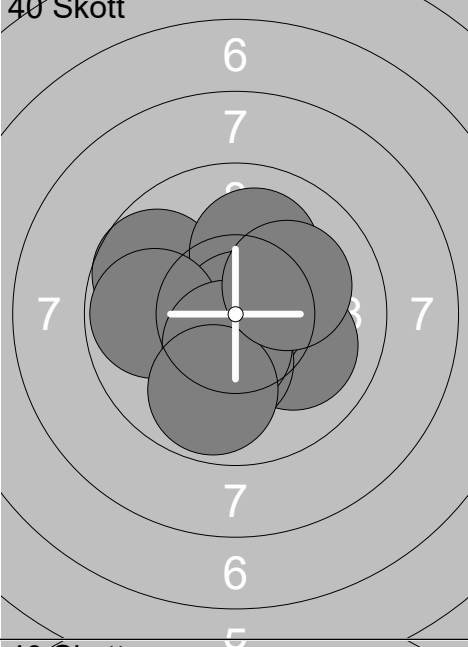
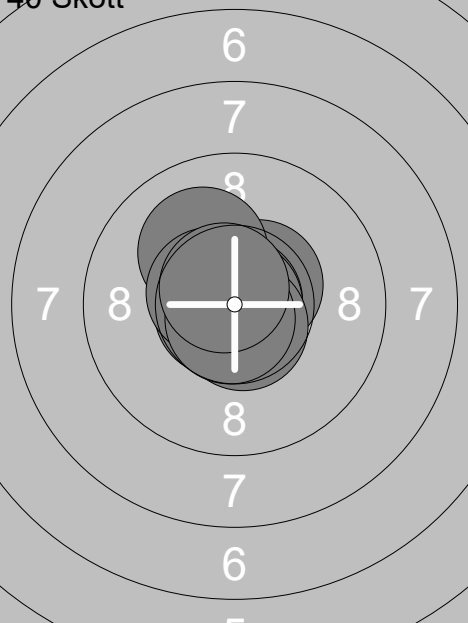
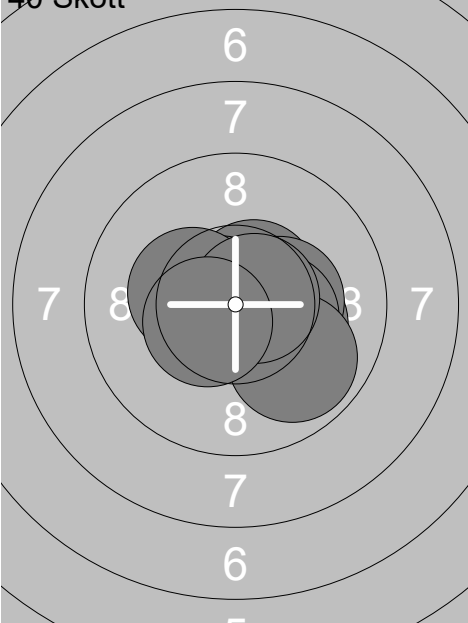

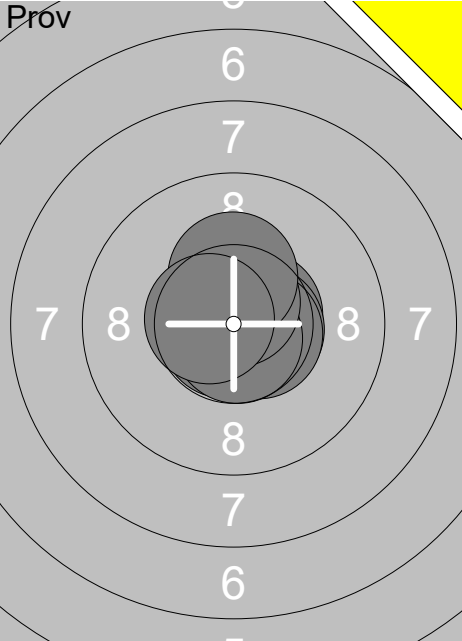
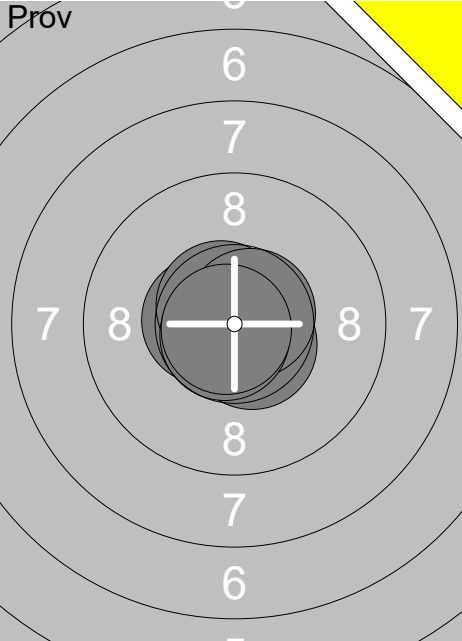
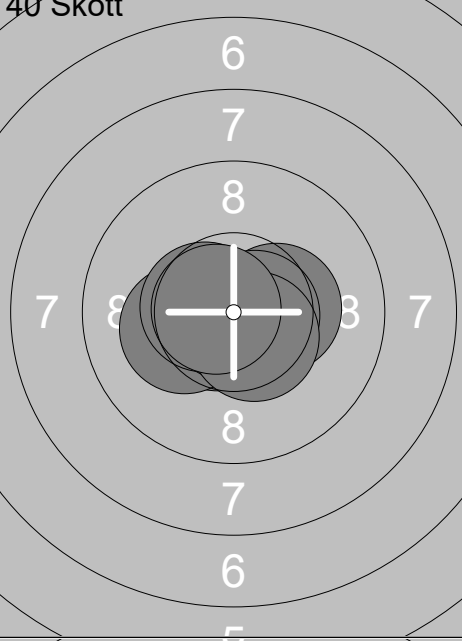
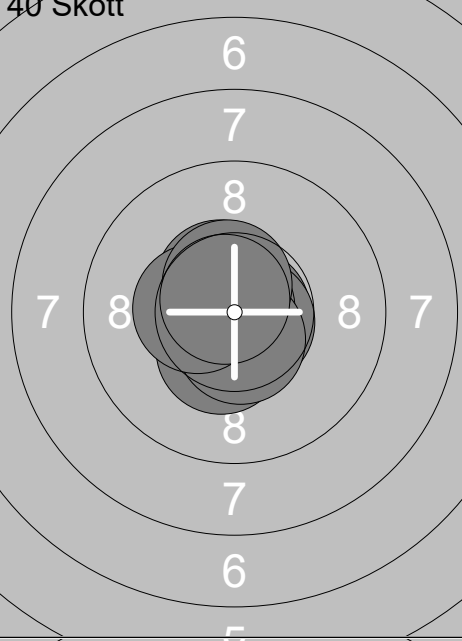
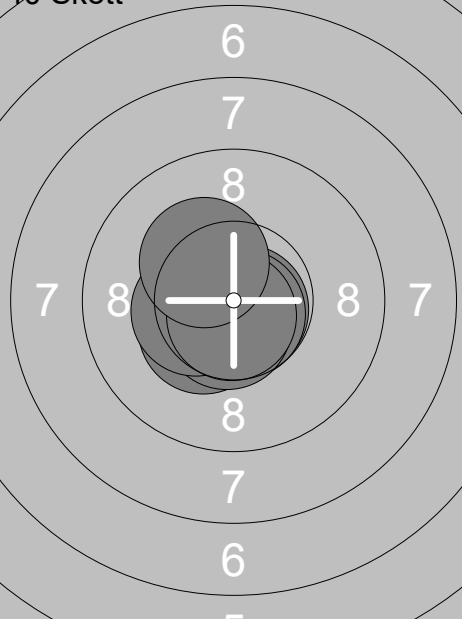
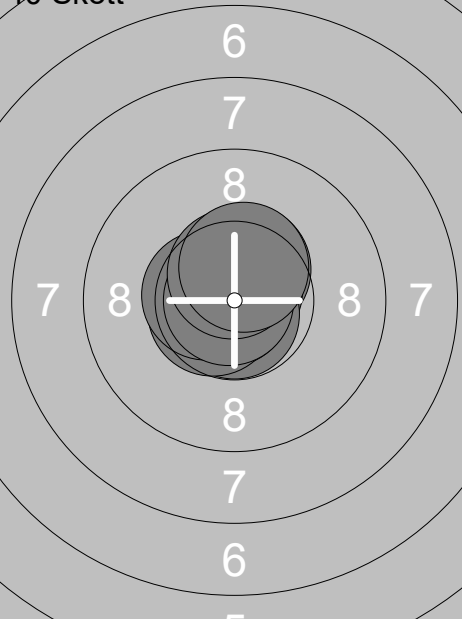
Skjuttag	Tavla	Emil Holmlund		
2	26	Ramselefors	Umeå	11 Vb
15.01.2022	Skyttiaden Distriktsomgång 2022	Ramselefors SKF		
Prov 	1: 10.4x ↙ 2: 10.5x ↓ 3: 10.1 ↓ 4: 10.0 → 5: 10.7x ← 6: 10.5x ↗ 7: 10.4x → 8: 10.3x ↗ 9: 10.8x ← 10: 10.4x →	Prov 	11: 10.5x ↗ 12: 10.6x ↗	
	Serie 104.1		Serie 21.1	
	Total 0.0		Total 0.0	
40 Skott 	1: 10.5x ↓ 2: 10.8x ↓ 3: 10.5x → 4: 10.5x ↗ 5: 10.6x ↓ 6: 10.9x ← 7: 10.5x ↓ 8: 10.6x ← 9: 10.6x ← 10: 10.7x ↓	40 Skott 	11: 10.0 ↓ 12: 10.5x ↓ 13: 10.4x ↙ 14: 10.4x ↙ 15: 10.3x ← 16: 10.5x → 17: 10.1 ↖ 18: 10.8x ↓ 19: 10.3x ↗ 20: 10.5x ↓	
	Serie 106.2		Serie 103.8	
	Total 106.2		Total 210.0	
40 Skott 	21: 10.3x ↗ 22: 10.1 ↓ 23: 10.7x ↖ 24: 10.8x ↙ 25: 10.9x → 26: 10.9x ↖ 27: 10.7x ↖ 28: 10.4x ← 29: 10.4x ↗ 30: 10.6x ↗	40 Skott 	31: 10.6x ↗ 32: 10.3x ← 33: 10.9x ↗ 34: 10.8x ← 35: 10.2x ↖ 36: 10.1 ↖ 37: 10.7x ↗ 38: 10.3x ↓ 39: 10.7x ↗ 40: 10.6x ←	
	Serie 105.8		Serie 105.2	
	Total 315.8		Total 421.0	

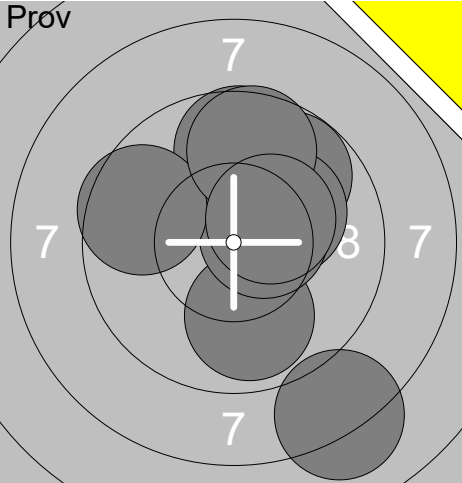
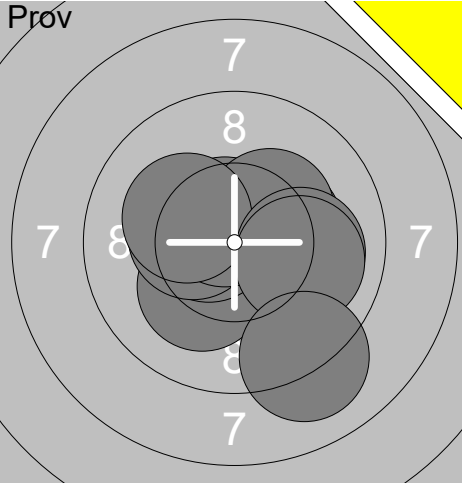
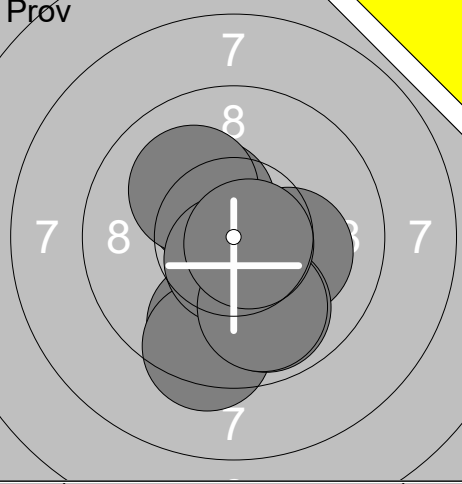
Skjutlag	Tavla	Robin Alfredsson		
2	28	Umeå	11	Vb
15.01.2022	Skyttiaden Distriktsomgång 2022	Ramselefors SKF		
Prov 	1: 10.5x →	Prov 	11: 10.4x ↖	
	2: 9.9 →		12: 10.8x ⇒	
	3: 10.3x ↙			
	4: 10.7x ↗			
	5: 9.8 ↖			
	6: 9.8 ↗			
	7: 10.5x ↗			
	8: 10.5x ↓			
	9: 10.5x →			
	10: 10.6x ↑			
	Serie 103.1		Serie 21.2	
	Total 0.0		Total 0.0	
40 Skott 	1: 10.0 ↙	40 Skott 	11: 9.7 ↖	
	2: 10.3x ↙		12: 10.0 ⇒	
	3: 10.6x ↗		13: 10.1 ↑	
	4: 9.8 ↖		14: 10.5x ↓	
	5: 10.8x ↗		15: 10.9x ⇒	
	6: 10.8x ↙		16: 9.8 ←	
	7: 10.6x ↗		17: 10.3x ↓	
	8: 9.4 ↓		18: 10.5x ↓	
	9: 10.2x ↙		19: 9.8 ↓	
	10: 10.3x ↓		20: 10.1 ↗	
	Serie 102.8		Serie 101.7	
	Total 102.8		Total 204.5	
40 Skott 	21: 10.7x ↓	40 Skott 	31: 10.2x ⇒	
	22: 10.5x ↗		32: 10.8x ↙	
	23: 10.9x ↗		33: 10.6x ↗	
	24: 10.7x ↙		34: 10.7x ↙	
	25: 10.9x ⇒		35: 10.3x ⇒	
	26: 10.1 ↗		36: 10.4x ⇒	
	27: 10.6x ↙		37: 10.3x ↙	
	28: 10.6x ↓		38: 9.9 ↓	
	29: 10.7x ↓		39: 10.7x ⇒	
	30: 10.7x ↗		40: 10.5x ↙	
	Serie 106.4		Serie 104.4	
	Total 310.9		Total 415.3	

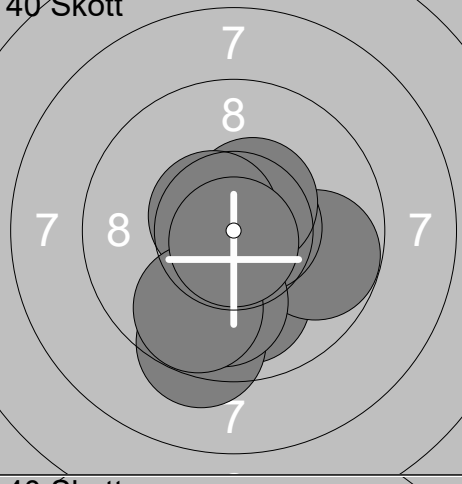
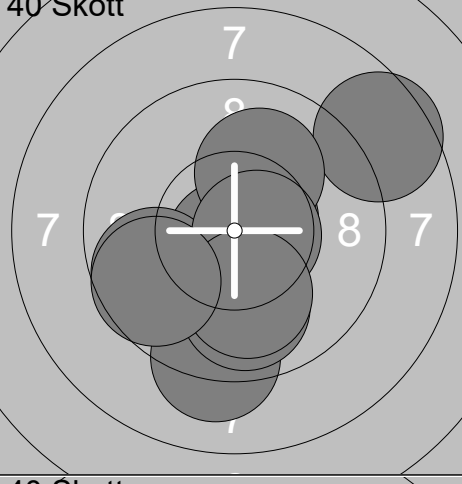
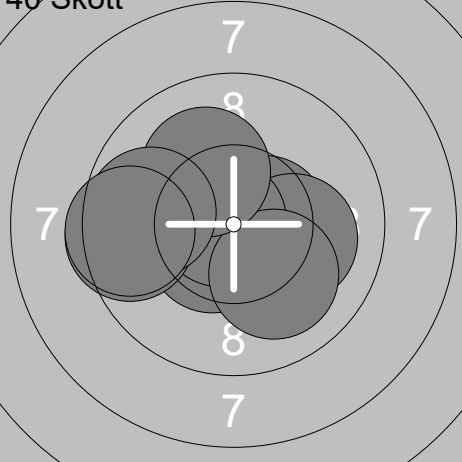
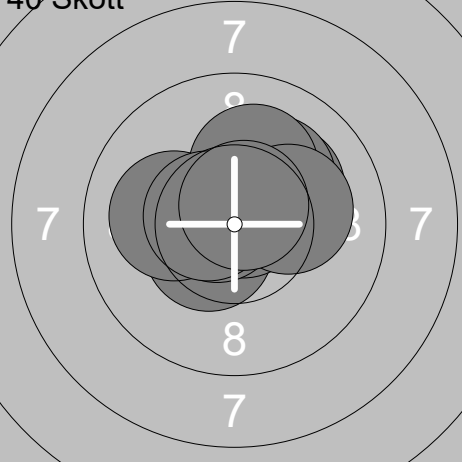
Skjutlag	Tavla	Rasmus Alfredsson		
2	29	Umeå	13	Vb
15.01.2022	Skyttiaden Distriktsomgång 2022	Ramselefors SKF		
Prov 	1: 10.6x →	Prov 	11: 10.8x ↗	
	2: 10.9x ↓		12: 10.6x ←	
	3: 10.8x ↙		13: 10.6x ↘	
	4: 10.6x →		14: 10.8x ↑	
	5: 10.7x ↑		15: 10.6x ↖	
	6: 10.6x →		16: 10.7x ↗	
	7: 10.7x ↓		17: 10.7x ↙	
	8: 10.6x ↑		18: 10.8x ↘	
	9: 10.3x ↑			
	10: 10.6x ←			
	Serie 106.4		Serie 85.6	
	Total 0.0		Total 0.0	
40 Skott 	1: 10.7x ↙	40 Skott 	11: 10.8x →	
	2: 10.6x →		12: 10.7x ←	
	3: 10.6x ←		13: 10.7x ↘	
	4: 10.2x ←		14: 10.5x ↖	
	5: 10.3x →		15: 10.9x ↖	
	6: 10.9x ↙		16: 10.4x ↓	
	7: 10.7x →		17: 10.6x ↓	
	8: 10.5x ←		18: 10.4x ←	
	9: 10.5x ↘		19: 10.6x ↑	
	10: 10.7x ←		20: 10.7x ↖	
	Serie 105.7		Serie 106.3	
	Total 105.7		Total 212.0	
40 Skott 	21: 10.8x ↘	40 Skott 	31: 10.5x ↑	
	22: 10.6x ←		32: 10.6x ↑	
	23: 10.7x ↓		33: 10.8x ↑	
	24: 10.6x ←		34: 10.8x ↓	
	25: 10.4x ↙		35: 10.8x ←	
	26: 10.7x ↓		36: 10.6x ←	
	27: 10.6x ↓		37: 10.5x ←	
	28: 10.4x ←		38: 10.9x ←	
	29: 10.7x ↓		39: 10.6x ↑	
	30: 10.3x ↖		40: 10.5x ↑	
	Serie 105.8		Serie 106.6	
	Total 317.8		Total 424.4	

Skjuttag	Tavla	Dennis Alenius		
2	31	Ramselefors	11	Vb
15.01.2022	Skyttiaden Distriktsomgång 2022	Ramselefors SKF		
Prov 	1: 9.9 ↓ 2: 8.1 ↓ 3: 9.8 ↗ 4: 10.1 ↑ 5: 10.2x ↗ 6: 10.5x → 7: 9.7 ↑ 8: 9.6 ← 9: 9.7 ↑ 10: 10.3x ↗	Prov 	11: 10.3x → 12: 10.2x ↓ 13: 10.6x ← 14: 10.4x ← 15: 10.6x ↗ 16: 10.3x ↗ 17: 10.2x ↗ 18: 10.0 → 19: 10.0 → 20: 9.1 ↓	
	Serie 97.9		Serie 101.7	
	Total 0.0		Total 0.0	
Prov 	21: 10.6x ↓ 22: 10.2x → 23: 10.4x ↗ 24: 9.7 ↓ 25: 9.4 ↓ 26: 9.9 ↓ 27: 10.1 ↗ 28: 10.6x ↓ 29: 9.9 ↓ 30: 10.7x →	Prov 	31: 10.7x →	
	Serie 101.5		Serie 10.7	
	Total 0.0		Total 0.0	
40 Skott 	1: 10.5x ↓ 2: 10.0 ↓ 3: 9.3 ↓ 4: 9.8 → 5: 10.6x → 6: 10.0 ↓ 7: 10.5x ↗ 8: 10.6x ↗ 9: 9.8 ↓ 10: 10.8x ↓	40 Skott 	11: 8.6 ↗ 12: 10.7x ↗ 13: 10.8x ↓ 14: 9.7 ← 15: 9.2 ↓ 16: 10.1 ↗ 17: 9.9 ↓ 18: 10.6x → 19: 10.1 ↓ 20: 9.7 ←	
	Serie 101.9		Serie 99.4	
	Total 101.9		Total 201.3	
40 Skott 	21: 10.5x ↓ 22: 10.5x → 23: 10.1 → 24: 10.2x ↗ 25: 10.8x ← 26: 10.1 ↓ 27: 9.5 ← 28: 10.1 ↗ 29: 9.8 ← 30: 9.5 ←	40 Skott 	31: 10.5x ↓ 32: 10.8x ↗ 33: 10.1 ↗ 34: 10.1 ← 35: 10.1 ↗ 36: 10.1 ↗ 37: 10.7x ← 38: 10.2x → 39: 10.6x ← 40: 10.7x ↗	
	Serie 101.1		Serie 103.9	
	Total 302.4		Total 406.3	

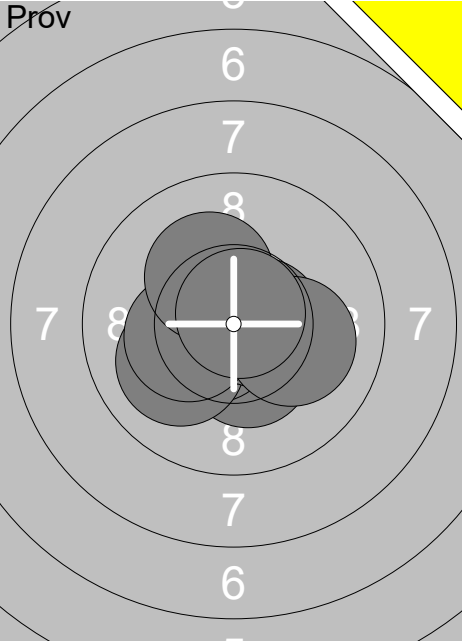
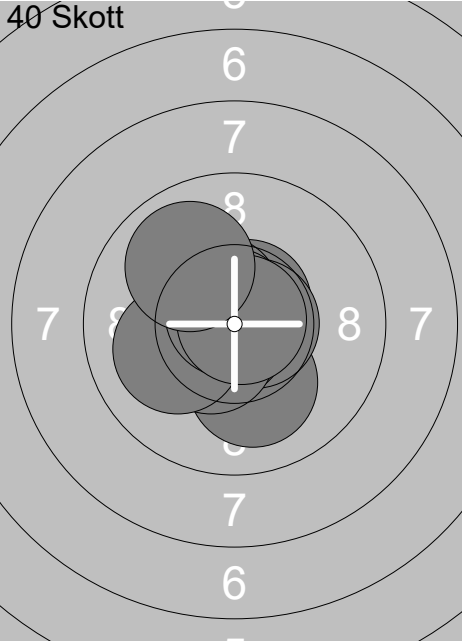
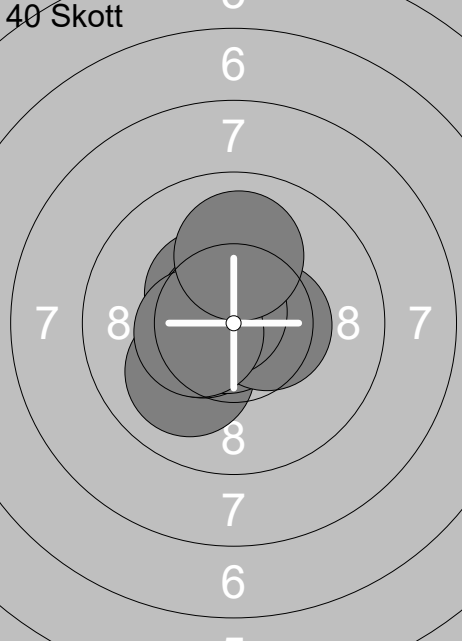
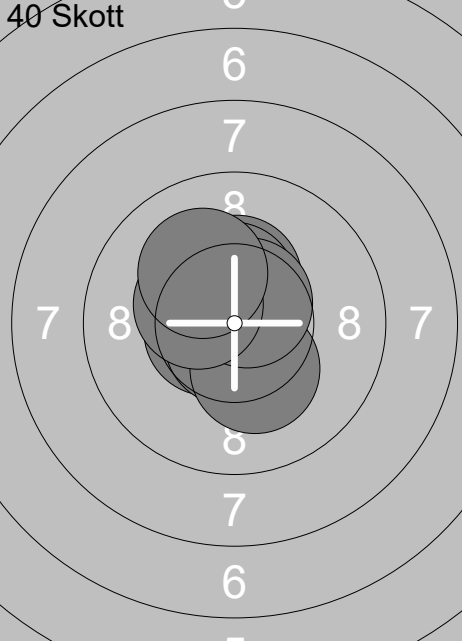
Skjutlag	Tavla	Ellen Alenius	
2	32	Ramselefors	Mini Vb
15.01.2022	Skyttiaden Distriktsomgång 2022	Ramselefors SKF	
Prov 	1: 9.3 ← 2: 9.8 ← 3: 9.9 ↑ 4: 10.5x ↗ 5: 10.3x ← 6: 10.2x ↗ 7: 10.2x ↑ 8: 10.4x ↓ 9: 9.0 ↓ 10: 10.5x ↓	Prov 	11: 10.2x ↓ 12: 9.9 ↓ 13: 10.4x → 14: 10.3x ↙ 15: 9.6 ↓ 16: 10.5x ↓
	Serie 100.1		Serie 60.9
	Total 0.0		Total 0.0
40 Skott 	1: 9.9 ↓ 2: 10.9x ↓ 3: 10.2x ← 4: 10.3x ↗ 5: 10.2x ← 6: 9.3 ↑ 7: 9.8 → 8: 10.5x ↑ 9: 10.2x ↑ 10: 10.7x ↘	40 Skott 	11: 10.8x ↓ 12: 10.3x ↓ 13: 10.0 ↓ 14: 10.8x ↑ 15: 10.6x ↗ 16: 10.6x ↗ 17: 10.3x ← 18: 10.4x ↓ 19: 10.5x → 20: 9.6 ↑
	Serie 102.0		Serie 103.9
	Total 102.0		Total 205.9
40 Skott 	21: 10.4x ↓ 22: 9.9 ← 23: 10.7x → 24: 10.5x ↓ 25: 10.2x ↓ 26: 10.2x ↑ 27: 9.6 ↑ 28: 9.8 ← 29: 10.5x → 30: 10.2x ↑	40 Skott 	31: 10.4x ↙ 32: 9.6 ↘ 33: 10.4x ↓ 34: 9.7 ↓ 35: 9.7 ↗ 36: 10.1 ↗ 37: 10.5x ↑ 38: 9.3 ← 39: 9.8 ↓ 40: 10.8x →
	Serie 102.0		Serie 100.3
	Total 307.9		Total 408.2

Skjutlag 2	Tavla 34	Emelie Albihn	
Ramselefors	Vännäs	13	Vb
15.01.2022	Skyttiaden Distriktsomgång 2022	Ramselefors SKF	
	1: 10.4x ↘ 2: 10.6x ↙ 3: 10.1 ↙ 4: 10.6x ← 5: 10.4x ← 6: 10.6x → 7: 10.3x ← 8: 10.1 → 9: 10.2x ↗ 10: 10.8x ↗ Serie 104.1 Total 0.0		1: 10.1 ↘ 2: 10.6x ↗ 3: 10.5x ↖ 4: 10.7x → 5: 10.7x ↘ 6: 10.5x ↘ 7: 10.1 ← 8: 10.8x ↗ 9: 10.8x ↗ 10: 9.9 ↖ Serie 104.7 Total 104.7
	11: 10.8x ↑ 12: 10.0 ↘ 13: 10.5x ← 14: 10.4x ↗ 15: 10.8x ↙ 16: 10.4x ↖ 17: 10.5x → 18: 10.7x ↖ 19: 10.5x ← 20: 10.0 ↑ Serie 104.6 Total 209.3		21: 10.6x ← 22: 10.3x ↑ 23: 10.4x ↖ 24: 10.7x ↘ 25: 10.4x ↑ 26: 10.7x ↑ 27: 10.3x ↘ 28: 10.6x ↗ 29: 10.4x ↖ 30: 10.1 ↖ Serie 104.5 Total 313.8
	31: 10.1 ↑ 32: 10.2x ↑ 33: 10.4x → 34: 10.6x ↗ 35: 10.8x ↖ 36: 10.4x ↘ 37: 10.6x ↘ 38: 10.4x ← 39: 10.5x → 40: 10.9x ↗ Serie 104.9 Total 418.7		

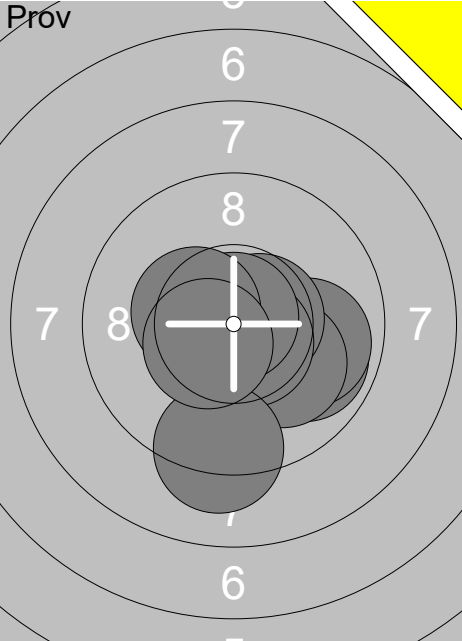
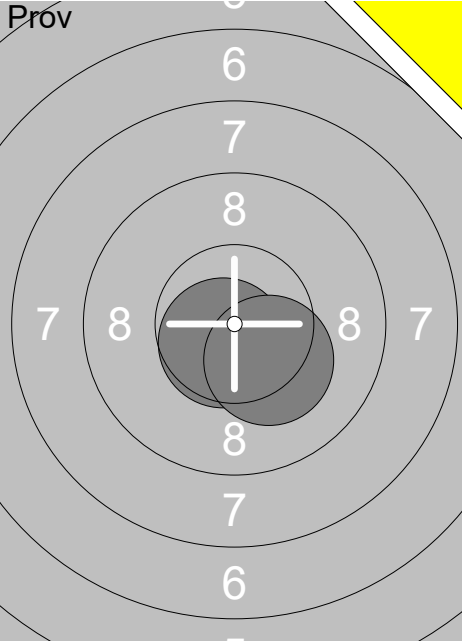
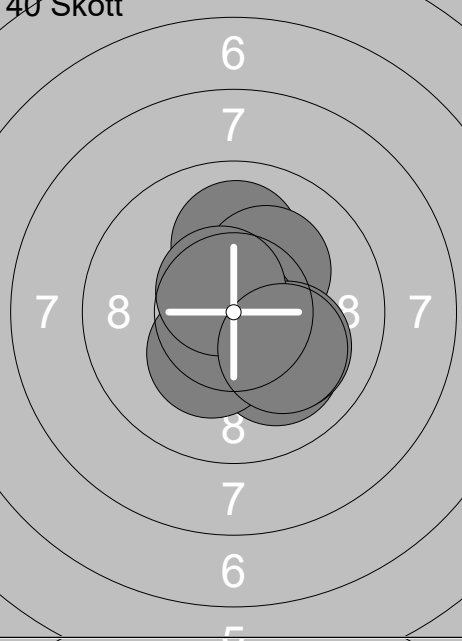
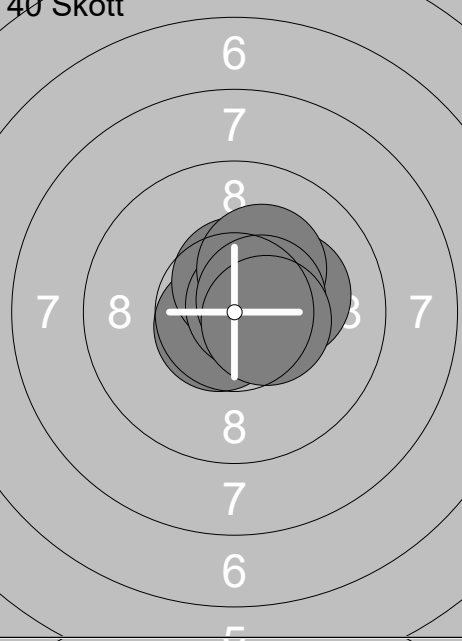
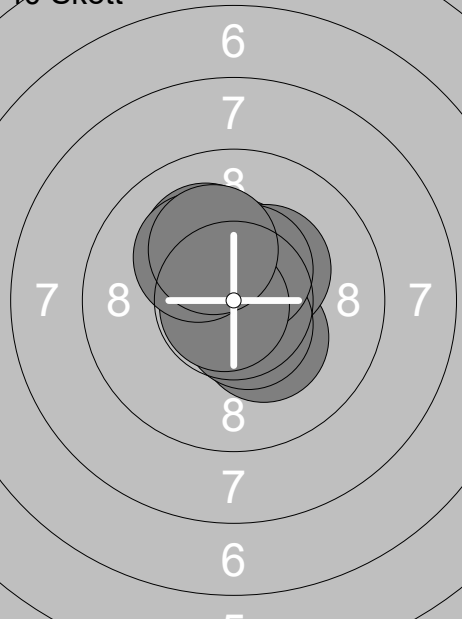
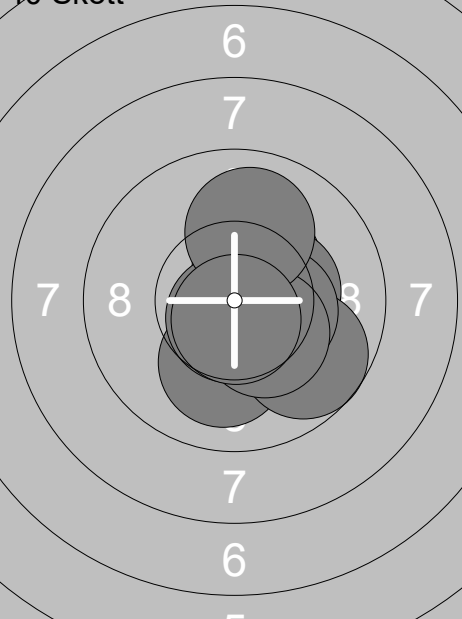
Skjuttag	Tavla	Henrik Albihn		
2	35	Ramselefors	Vännäs	15 Vb
15.01.2022	Skyttiaden Distriktsomgång 2022	Ramselefors SKF		
Prov 	1: 9.9 ↘	Prov 	11: 10.6x ↙	
	2: 9.9 →		12: 10.3x ↘	
	3: 10.1 ↘			
	4: 10.7x ↘			
	5: 10.6x →			
	6: 10.6x ↘			
	7: 10.9x ↑			
	8: 9.2 ↓			
	9: 10.4x ↙			
	10: 10.5x ↙			
	Serie 102.8		Serie 20.9	
	Total 0.0		Total 0.0	
40 Skott 	1: 10.6x ↗	40 Skott 	11: 10.6x →	
	2: 10.0 ↑		12: 10.7x ↙	
	3: 10.1 ↘		13: 10.4x ↗	
	4: 10.2x ↗		14: 10.5x ↑	
	5: 10.9x ↓		15: 10.6x →	
	6: 10.6x ↘		16: 10.7x →	
	7: 10.1 ↘		17: 10.2x →	
	8: 10.3x ↙		18: 10.2x ↗	
	9: 10.6x ↗		19: 10.5x →	
	10: 10.1 ↘		20: 10.5x →	
	Serie 103.5		Serie 104.9	
	Total 103.5		Total 208.4	
40 Skott 	21: 10.7x ↘	40 Skott 	31: 10.1 ↓	
	22: 10.3x ↘		32: 10.4x ↗	
	23: 10.1 ↗		33: 10.7x ↘	
	24: 10.4x ↑		34: 10.4x →	
	25: 10.3x ↗		35: 9.7 ↘	
	26: 10.6x ↘		36: 10.4x →	
	27: 10.5x ↗		37: 10.7x ↓	
	28: 10.8x ↙		38: 10.3x ↘	
	29: 10.2x ↗		39: 10.0 ↑	
	30: 10.2x ↗		40: 10.7x ↓	
	Serie 104.1		Serie 103.4	
	Total 312.5		Total 415.9	

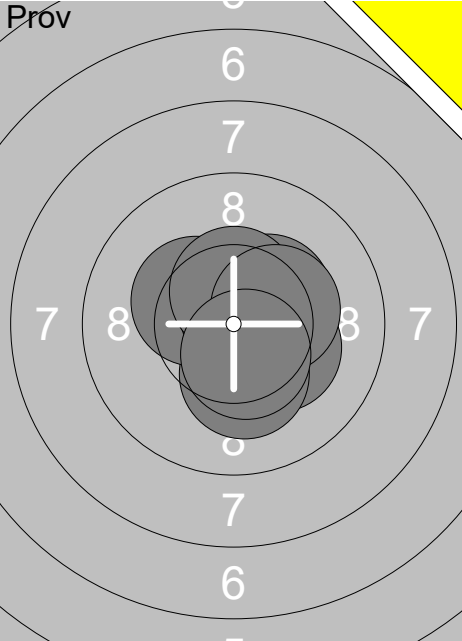
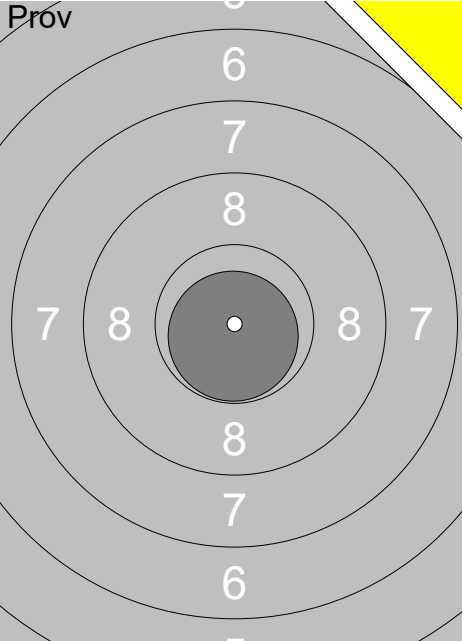
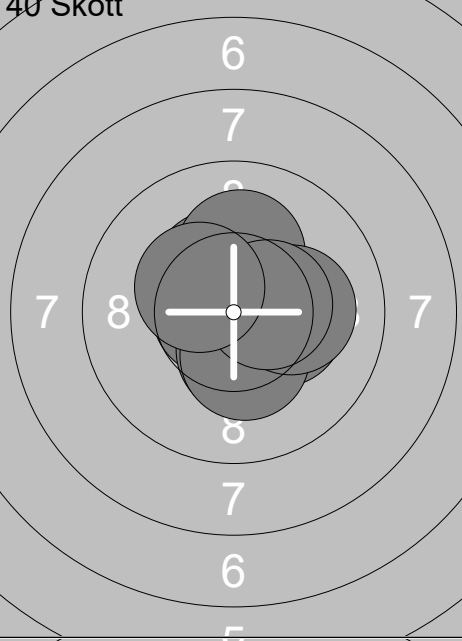
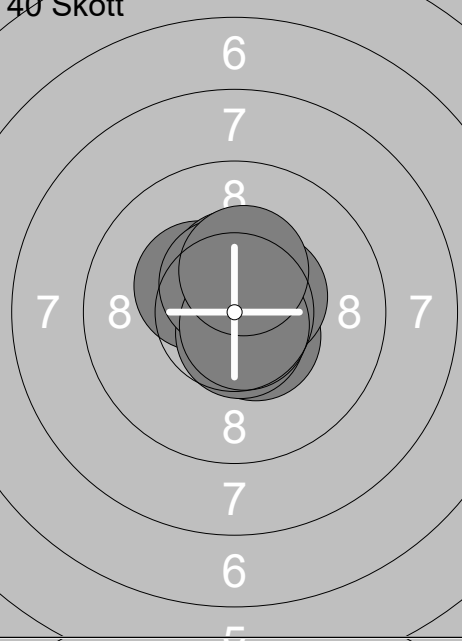
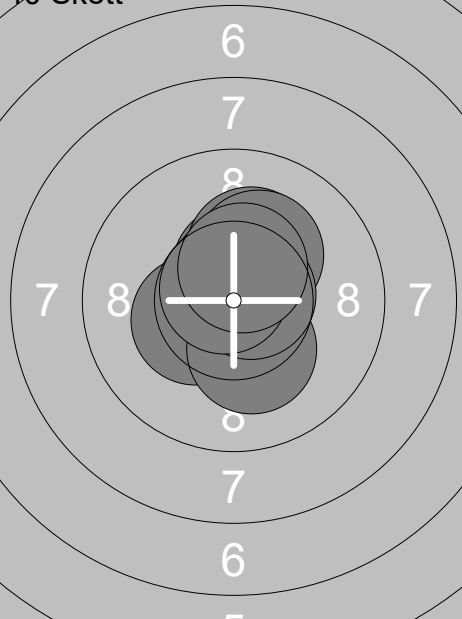
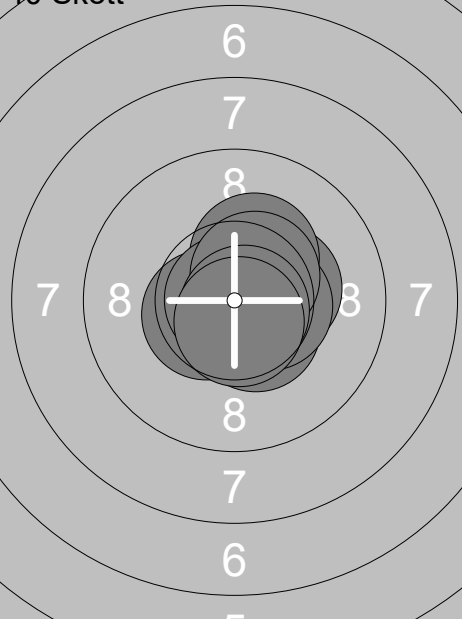
Skjutlag	Tavla	Filip Hansson		
2	37	Ramselefors	Vännäs	15
15.01.2022	Skyttiaden Distriktsomgång 2022	Ramselefors SKF		
Prov 	1: 10.3x → 3: 10.2x ↓ 4: 10.4x ↗ 5: 10.6x → 6: 10.3x ↖ 7: 10.7x ↗ 8: 10.5x ↑ 9: 10.3x → 10: 10.5x ↓	Prov 	11: 10.8x ↓	
Serie	93.8	Serie	10.8	
Total	0.0	Total	0.0	
40 Skott 	1: 10.5x → 2: 10.7x ← 3: 10.4x ↗ 4: 10.4x ↓ 5: 10.3x → 6: 10.1 ↑ 7: 10.3x ↓ 8: 10.2x → 9: 10.5x → 10: 10.4x ↖	40 Skott 	11: 10.6x ↗ 12: 10.5x ↓ 13: 10.8x ↖ 14: 10.3x ↖ 15: 10.4x ↑ 16: 10.5x ↗ 17: 10.6x ↓ 18: 10.5x ↗ 19: 10.7x ↓ 20: 10.4x ↑	
Serie	103.8	Serie	105.3	
Total	103.8	Total	209.1	
40 Skott 	21: 10.9x ↗ 22: 10.5x ↑ 23: 10.2x ↗ 24: 10.2x ↗ 25: 10.4x ↖ 26: 10.2x ↓ 27: 10.6x ↑ 28: 10.7x → 29: 10.7x ↖ 30: 10.5x ↑	40 Skott 	31: 10.5x ↖ 32: 10.3x → 33: 10.5x ↓ 34: 10.3x ↗ 35: 10.9x ← 36: 10.7x → 37: 10.5x → 38: 10.5x ↗ 39: 10.8x ↓ 40: 10.6x ↓	
Serie	104.9	Serie	105.6	
Total	314.0	Total	419.6	

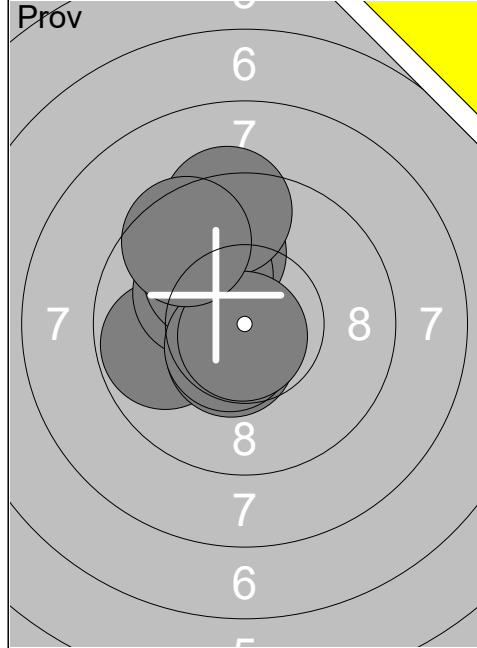

1: 9.8	←
3: 10.5x	↓
4: 10.2x	↖
5: 9.9	↑
6: 10.1	↗
7: 10.6x	↓
8: 9.4	↑
9: 10.8x	↓
10: 9.5	↖
Serie	90.8
Total	0.0

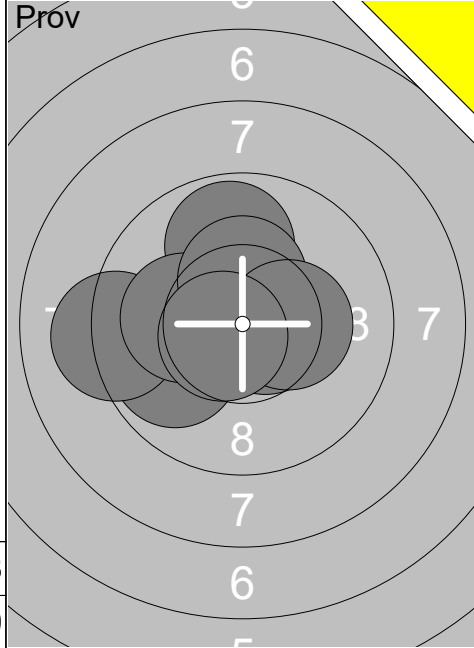

11: 10.6x	→
12: 9.9	↑
13: 9.9	↖
14: 9.2	←
15: 10.2x	↖
16: 10.4x	↑
17: 10.3x	→
18: 10.6x	↖
Serie	81.1
Total	0.0

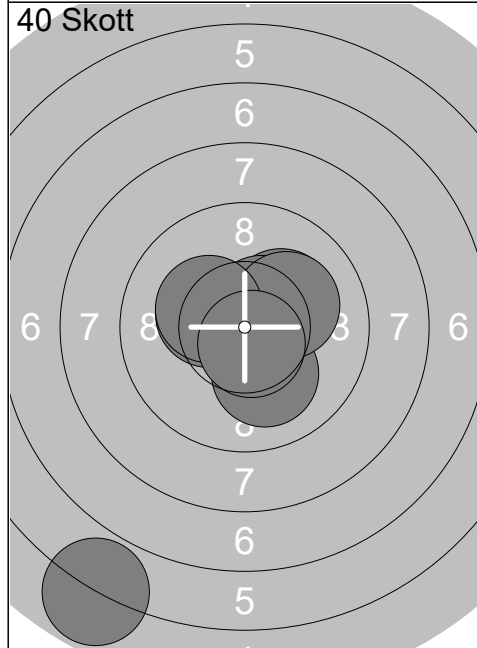

1: 10.2x	↗
2: 10.7x	→
3: 10.1	↓
4: 5.8	↓
5: 10.8x	→
6: 10.3x	↖
7: 10.5x	↗
8: 10.2x	↗
9: 10.3x	↖
10: 10.7x	↓
Serie	99.6
Total	99.6

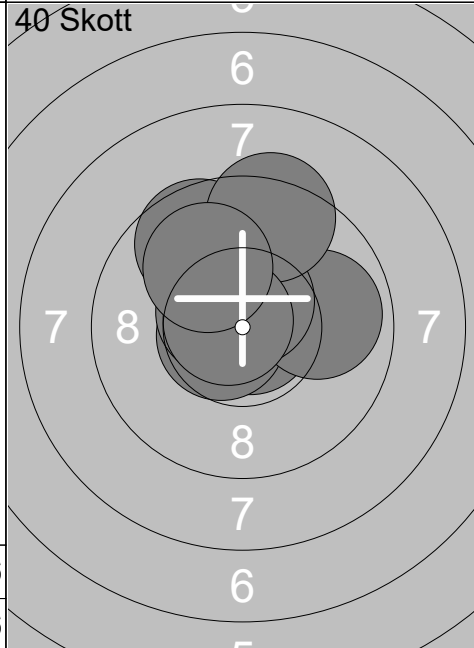

11: 10.8x	→
12: 10.5x	↗
13: 9.6	↖
14: 10.6x	↖
15: 10.6x	↖
16: 9.9	→
17: 10.6x	↑
18: 9.4	↑
19: 10.7x	↖
20: 10.0	↖
Serie	102.7
Total	202.3

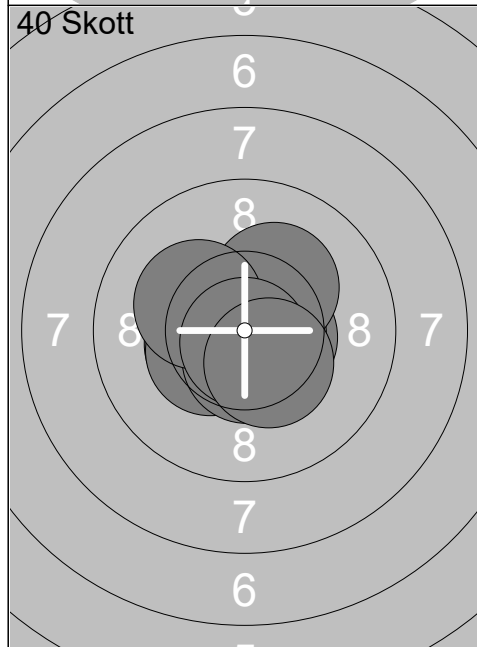

21: 10.5x	→
22: 10.7x	→
23: 10.4x	↖
24: 10.2x	↗
25: 10.5x	↖
26: 10.4x	↖
27: 10.6x	↓
28: 10.2x	↖
29: 10.8x	↓
30: 10.4x	↓
Serie	104.7
Total	307.0

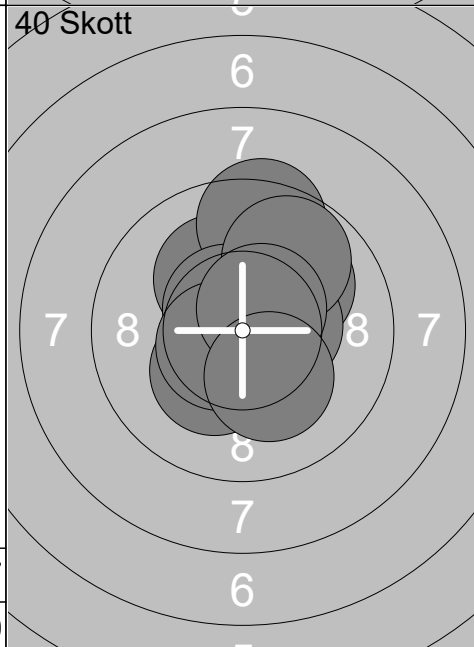

31: 10.3x	↖
32: 10.0	↗
33: 10.2x	↖
34: 9.4	↑
35: 10.5x	→
36: 10.6x	↖
37: 10.6x	↖
38: 9.8	↗
39: 10.5x	↗
40: 10.2x	↓
Serie	102.1
Total	409.1