

1: 9.3 ↙	Serie 47
2: 9.0 ↙	
3: 10.8x ↙	
4: 10.2 ↗	
5: 9.9 ↗	
Total 0	

1: 9.9 ↓	Serie 46
2: 9.8 ↓	
3: 10.6x ↙	
4: 10.0 ↙	
5: 8.9 ←	
Total 46	

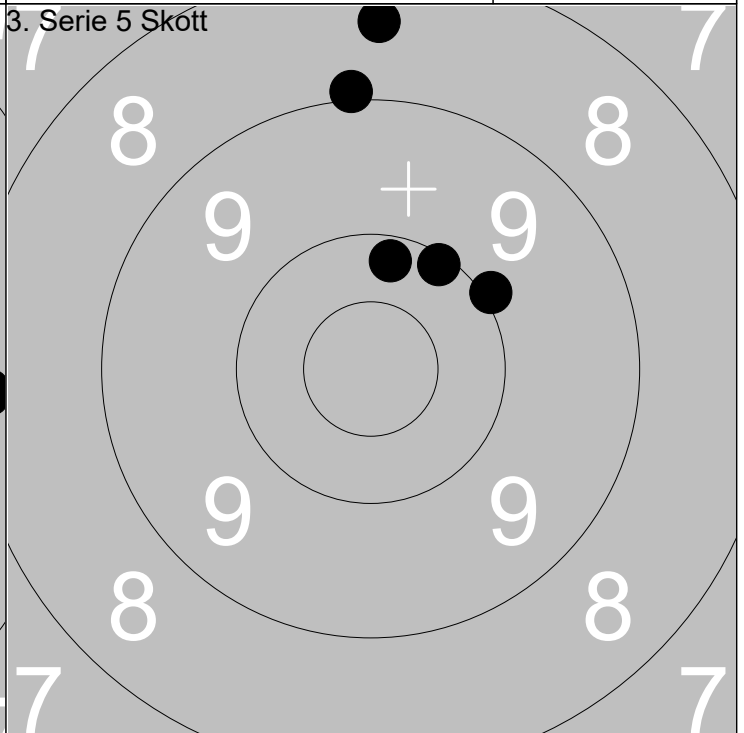
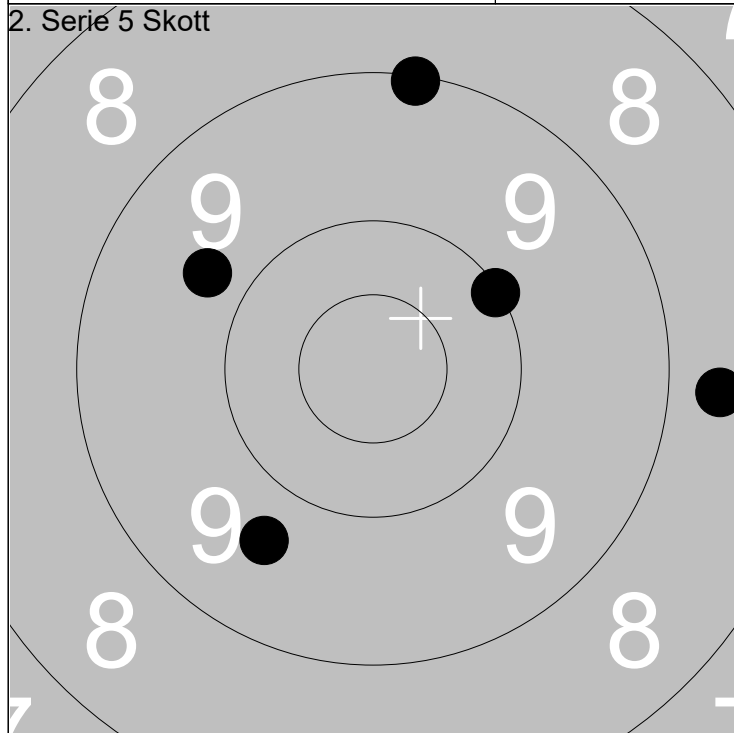

1: 9.7 ↙	Serie 45
2: 8.7 →	
3: 9.1 ↑	
4: 10.0 ↗	
5: 9.7 ↙	
Total 91	

1: 10.1 ↗	Serie 47
2: 10.2 ↑	
3: 10.0 ↗	
4: 8.4 ↑	
5: 9.0 ↑	
Total 138	

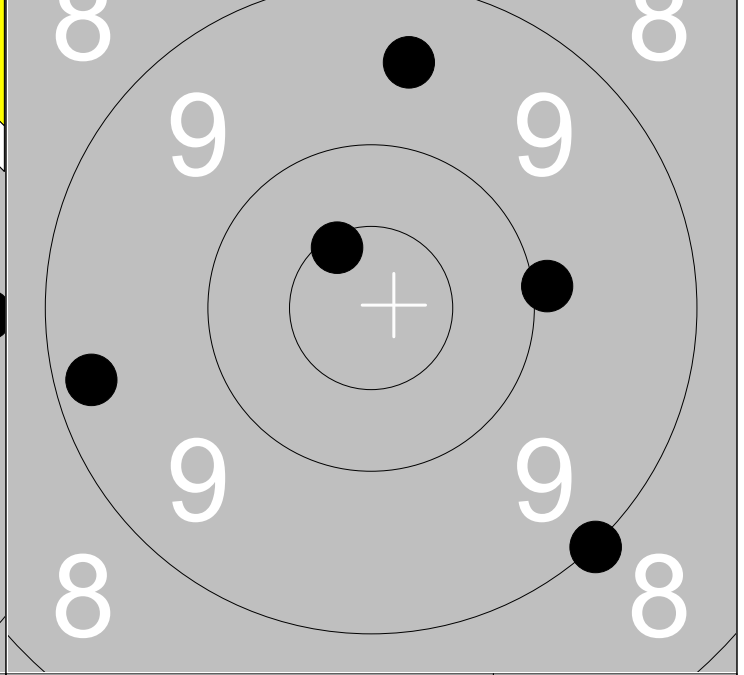
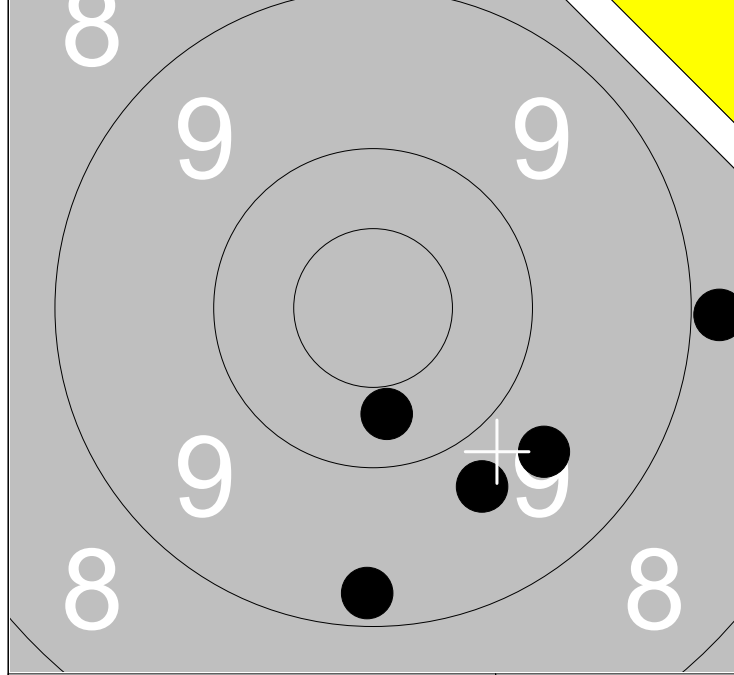

1: 9.2	↓
2: 10.3	↓
3: 9.7	↓
4: 9.6	↓
5: 8.9	→

Serie	45
Total	0

1: 9.3	←
2: 10.6x	↖
3: 9.9	→
4: 9.5	↑
5: 9.0	↘

Serie	46
Total	46

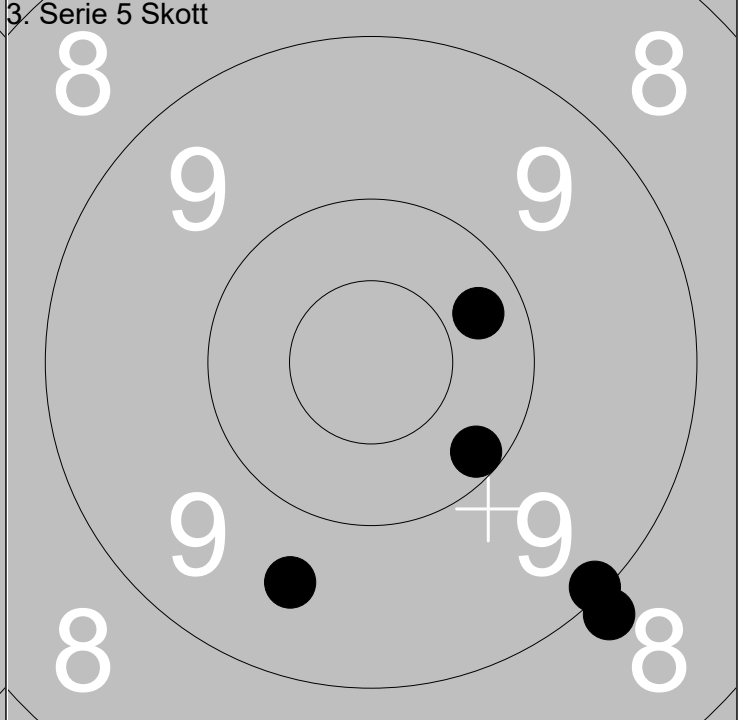
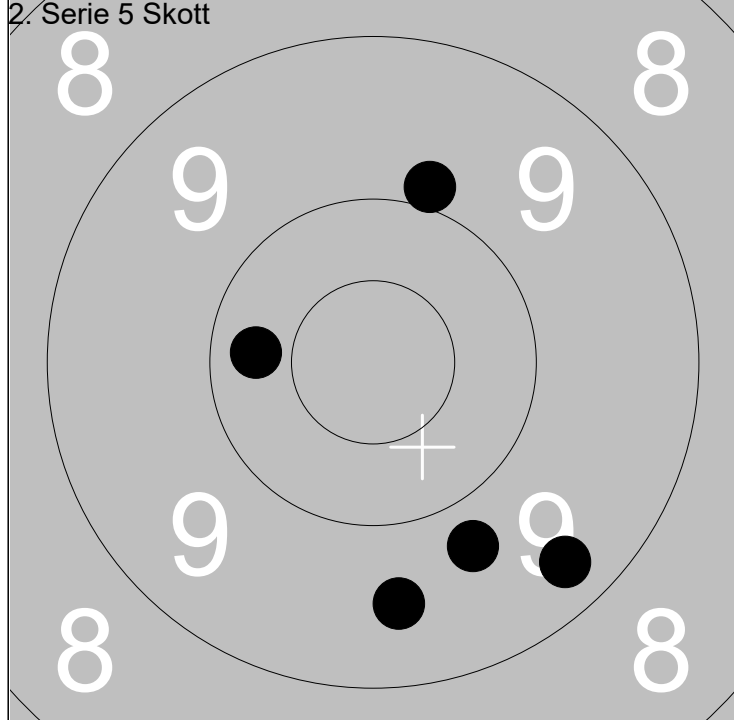

1: 10.3	←
2: 9.7	↓
3: 9.5	↓
4: 9.9	↑
5: 9.3	↘

Serie	46
Total	92

1: 9.6	↓
2: 9.1	↓
3: 10.3	↗
4: 10.2	↓
5: 8.9	↓

Serie	46
Total	138

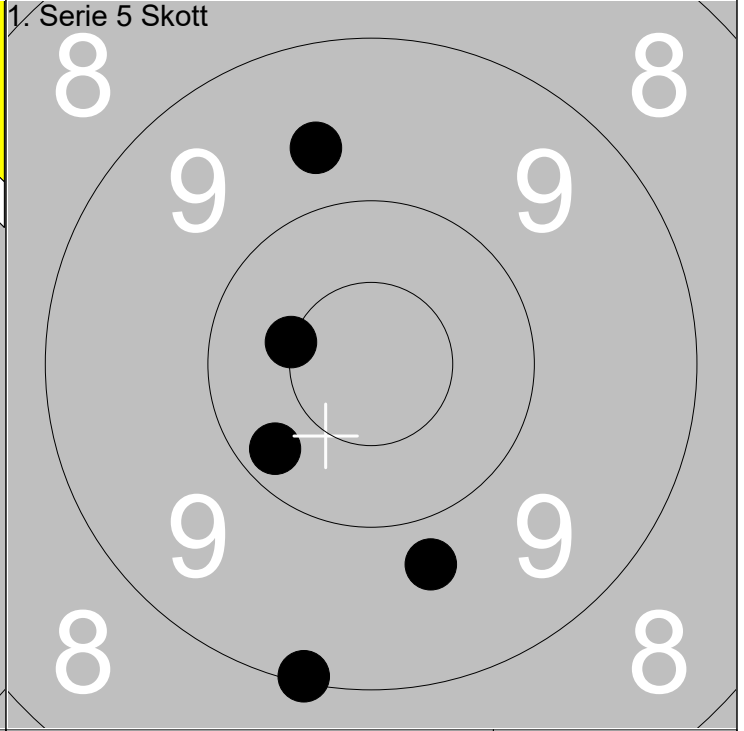
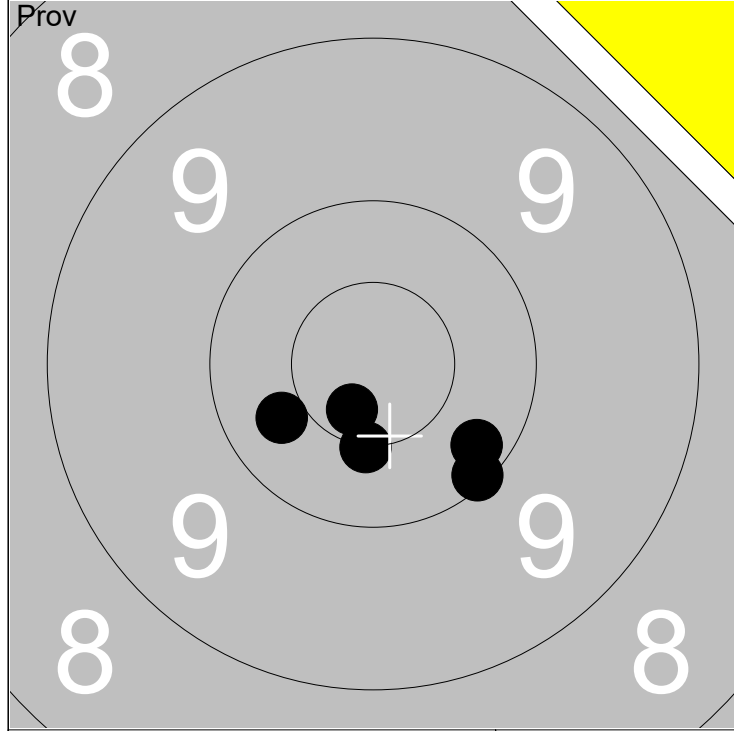

1: 10.7x	↓
2: 10.1	↓
3: 10.2	↓
4: 10.3	↙
5: 10.5x	↓

Serie	50
Total	
	0

1: 9.7	↑
2: 10.2	↙
3: 10.5x	↖
4: 9.1	↓
5: 9.7	↓

Serie	47
Total	
	47

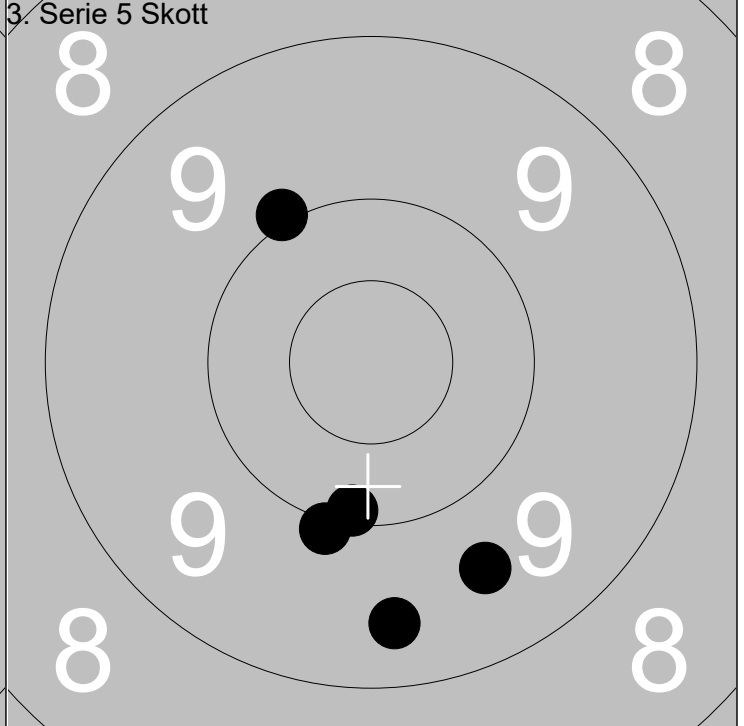
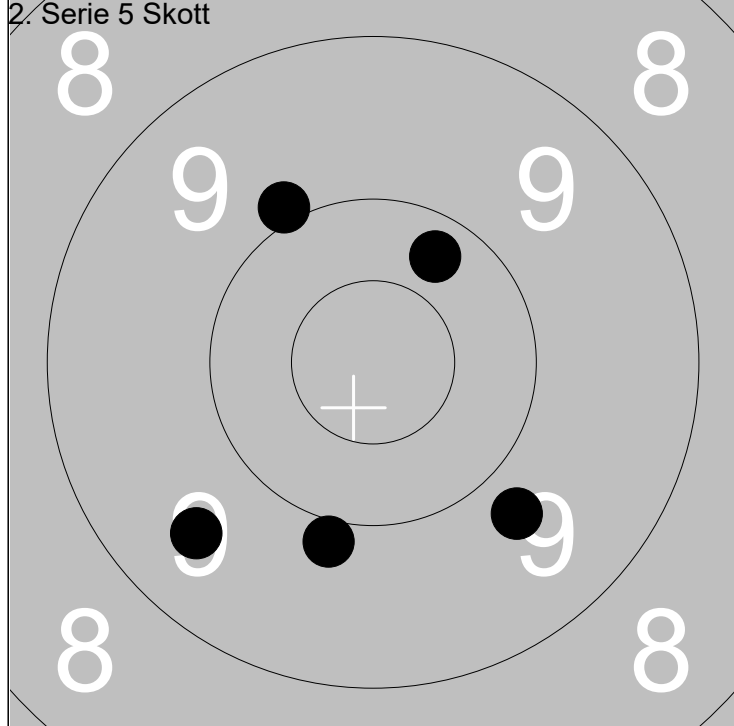

1: 10.3	↗
2: 9.9	↗
3: 9.9	↓
4: 9.5	↙
5: 9.8	↓

Serie	46
Total	
	93

1: 10.0	↗
2: 9.4	↓
3: 9.6	↓
4: 10.1	↓
5: 10.0	↓

Serie	48
Total	
	141

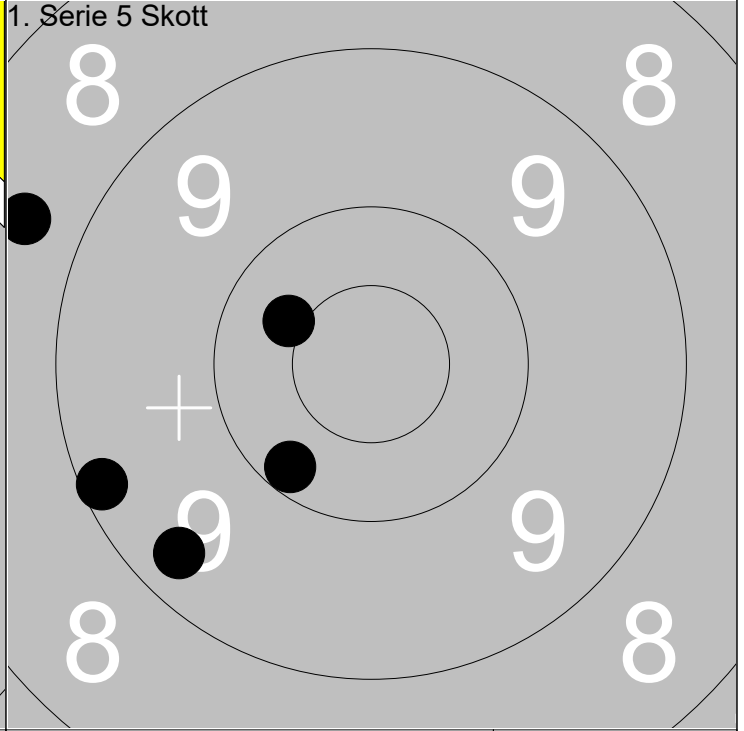
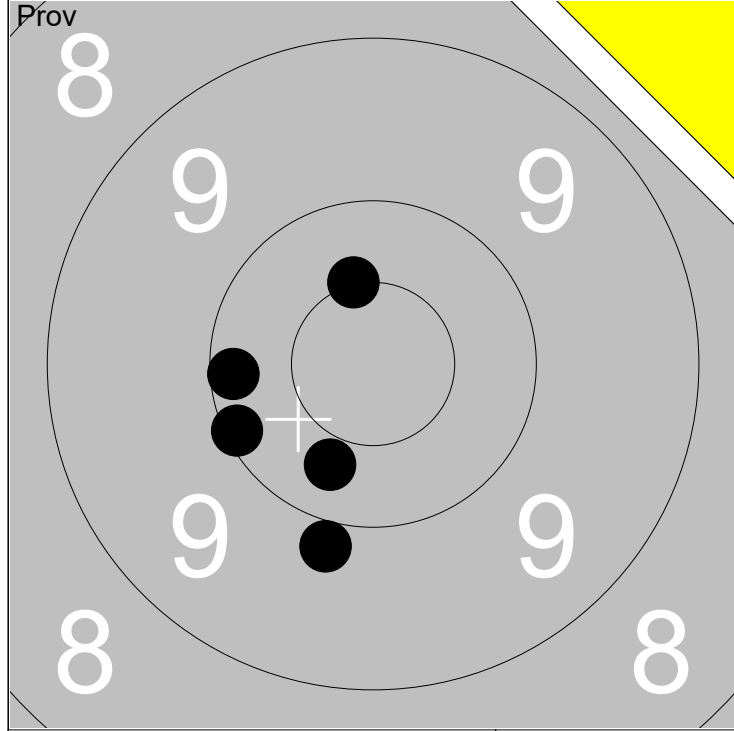

1: 10.2 ←
2: 10.1 ←
3: 9.9 ↓
4: 10.3 ↓
5: 10.5x ↑

Serie	49
Total	0

1: 8.6 ↖
2: 10.4 ↖
3: 10.2 ↓
4: 9.3 ↓
5: 9.2 ←

Serie	46
Total	46

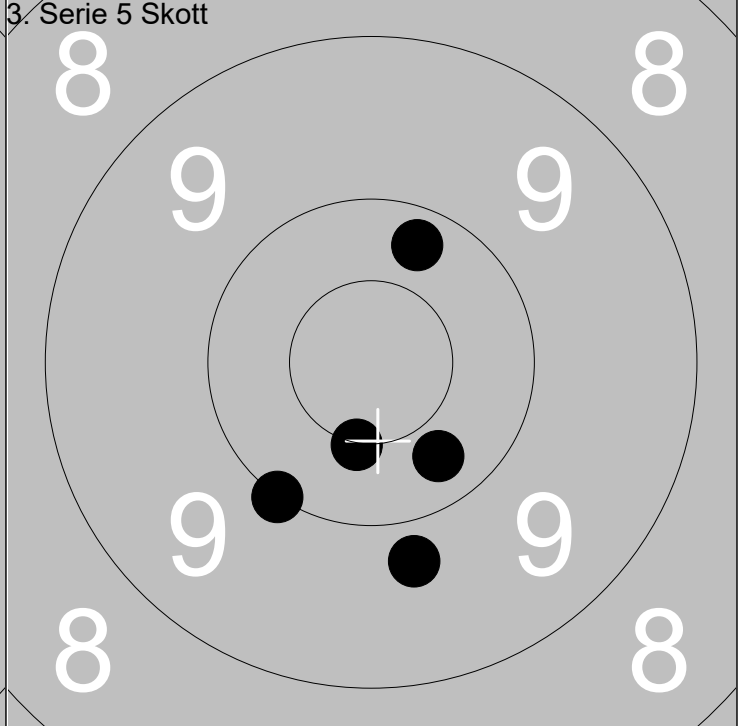
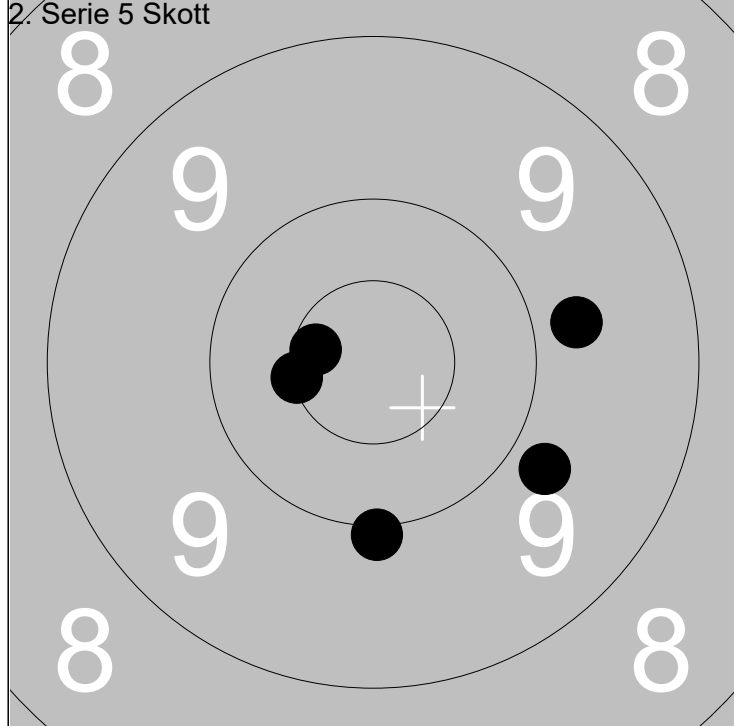

1: 10.5x ←
2: 10.6x ←
3: 10.0 ↓
4: 9.8 →
5: 9.8 ↘

Serie	48
Total	94

1: 10.2 ↑
2: 10.5x ↓
3: 10.0 ↓
4: 10.3 ↓
5: 9.8 ↓

Serie	49
Total	143

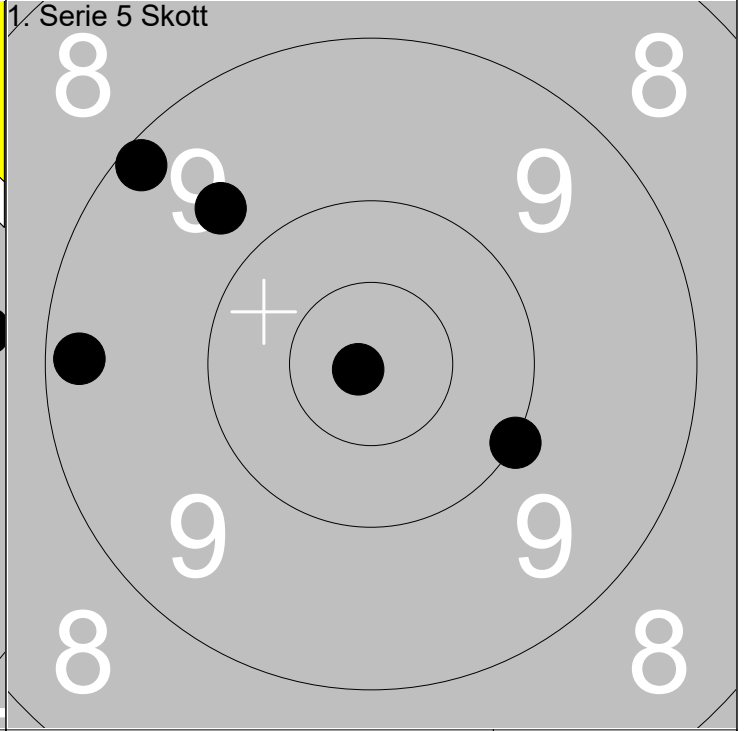
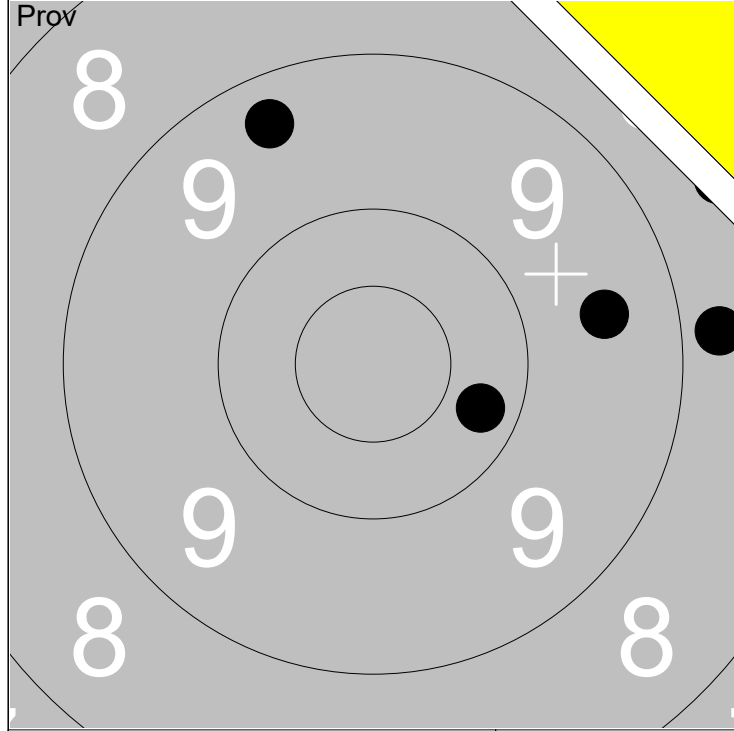

1: 8.5 ↗	Serie	44
2: 8.8 →		
3: 9.3 ↖		
4: 10.3 ↘		
5: 9.5 →		
Total		0

1: 9.7 ↖	Serie	47
2: 9.2 ↗		
3: 10.9x ←		
4: 9.2 ←		
5: 10.0 ↘		
Total		47

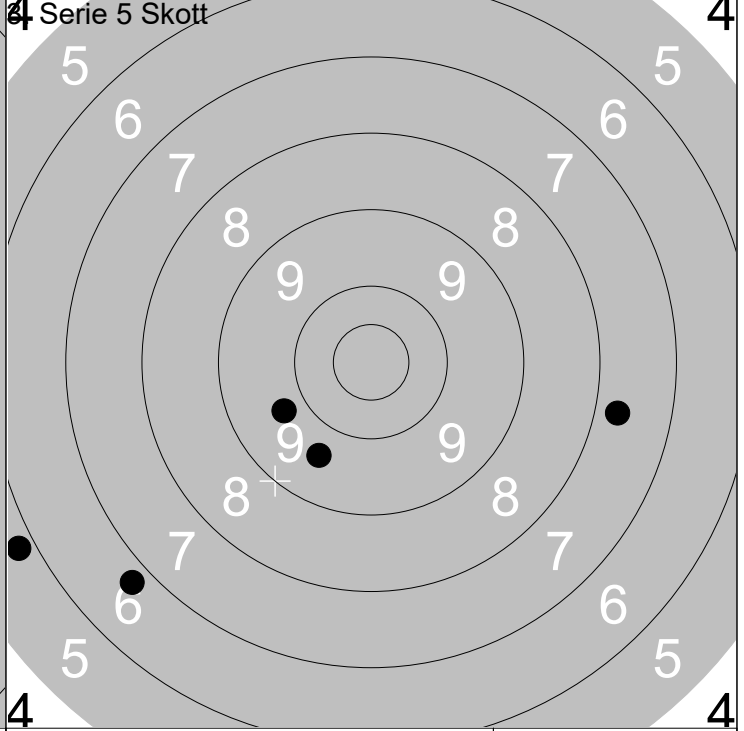
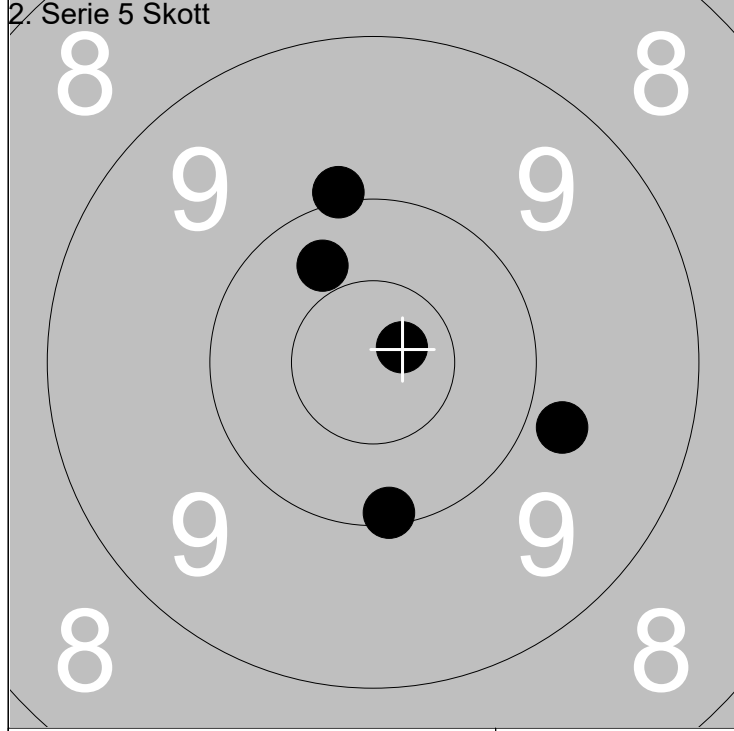

1: 10.3 ↖	Serie	49
2: 10.8x ↗		
3: 10.1 ↓		
4: 10.0 ↖		
5: 9.8 ↘		
Total		96

1: 7.7 →	Serie	36
2: 9.7 ←		
3: 6.8 ↘		
4: 9.6 ↘		
5: 5.8 ←		
Total		132

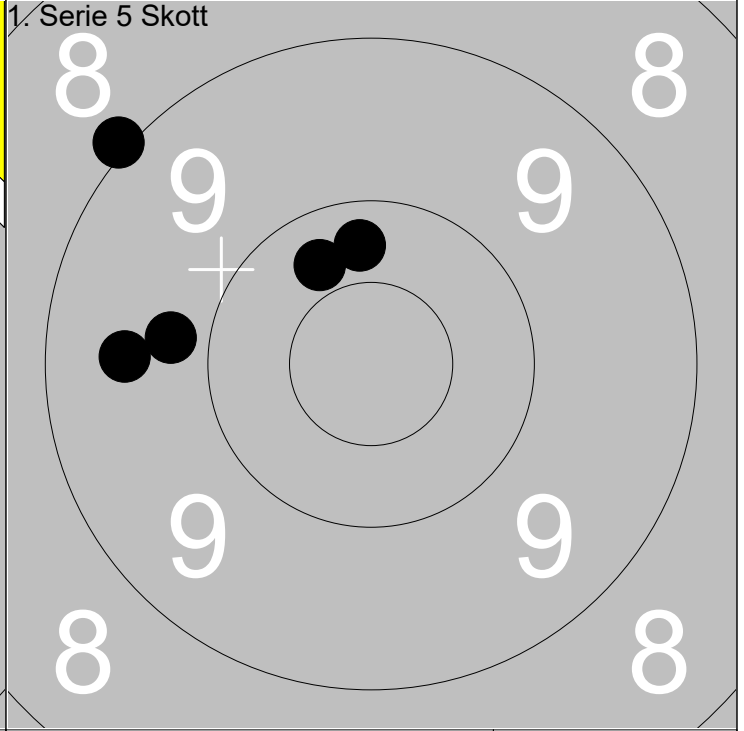
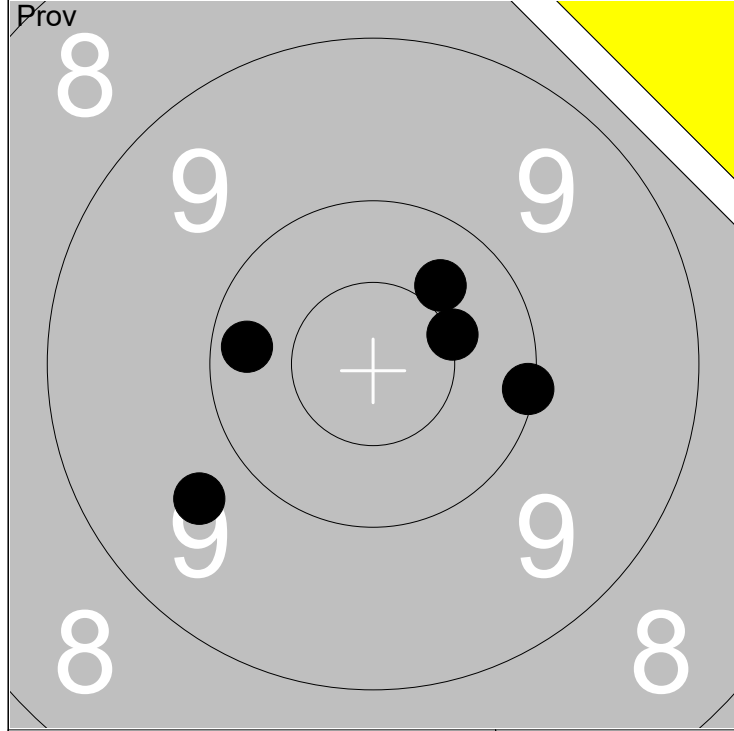

1: 10.4 ↗
2: 10.2 ←
3: 10.5x →
4: 9.7 ↙
5: 10.1 →

Serie	49
Total	0

1: 9.0 ↖
2: 10.3 ↗
3: 10.3 ↑
4: 9.5 ←
5: 9.8 ←

Serie	47
Total	47

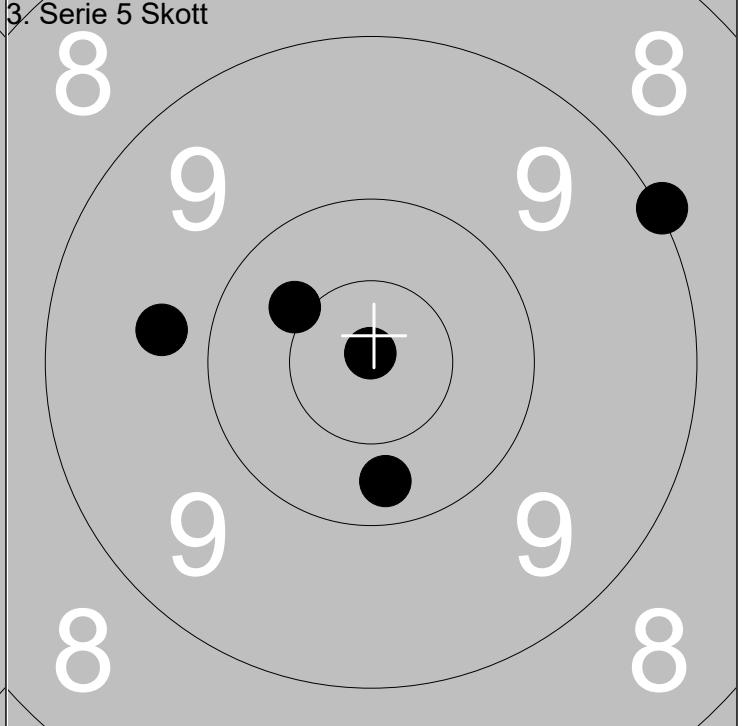
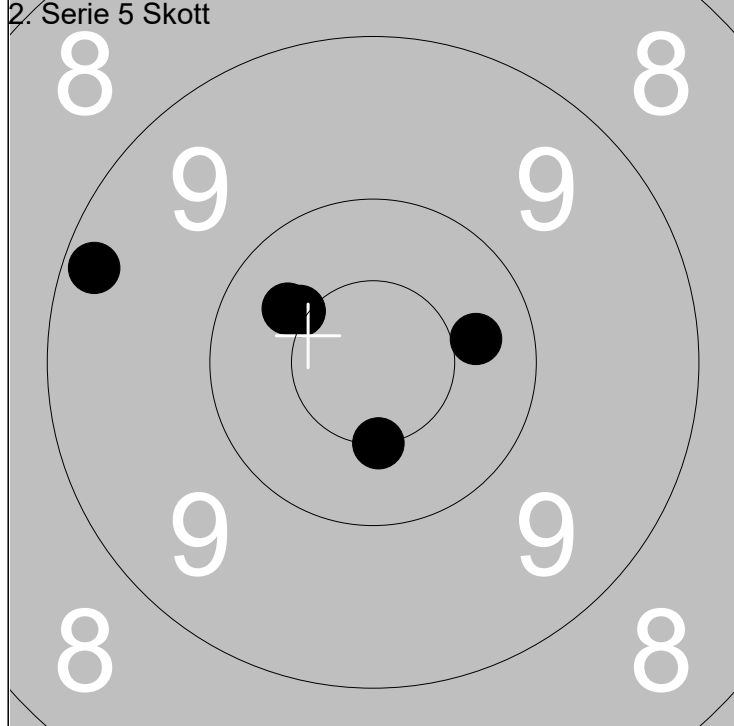

1: 10.4 →
2: 10.5x ↓
3: 10.4x ↗
4: 10.4 ↗
5: 9.2 ←

Serie	49
Total	96

1: 9.0 ↗
2: 10.3 ↓
3: 9.7 ←
4: 10.4x ↖
5: 10.9x ↑

Serie	48
Total	144

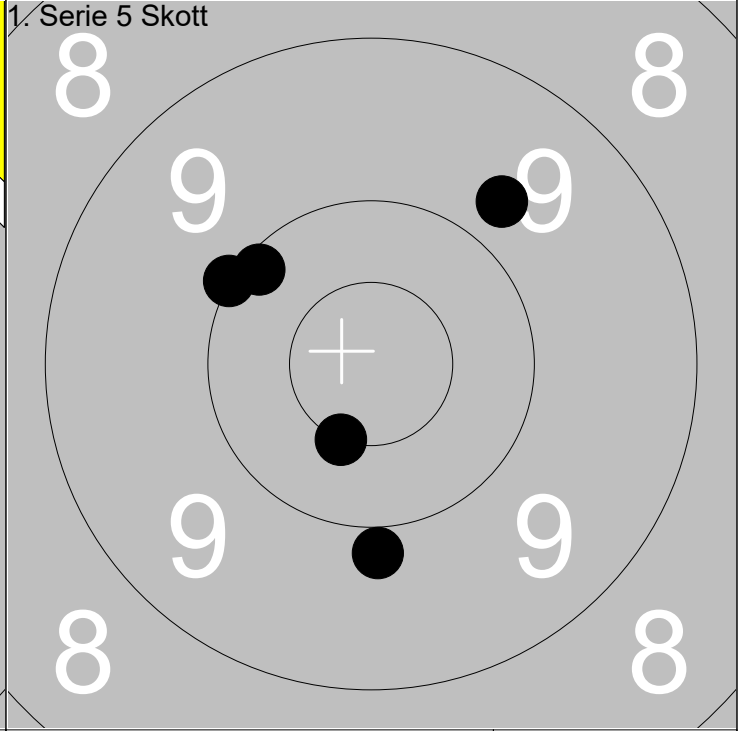
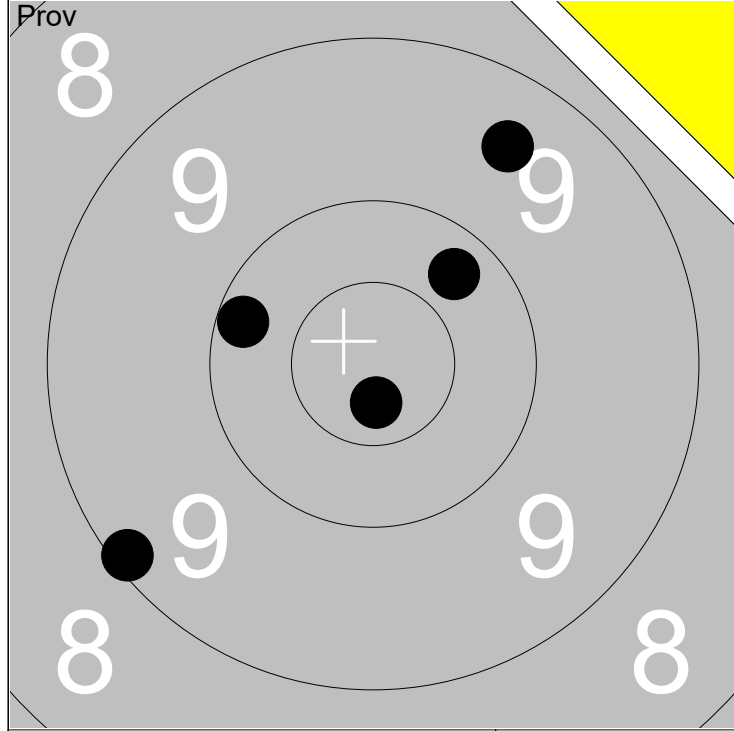

1: 9.5 ↗
2: 10.3 ↗
3: 10.2 ↖
4: 9.1 ↙
5: 10.7x ↓

Serie	48
Total	0

1: 9.8 ↗
2: 10.0 ↖
3: 10.5x ↓
4: 10.1 ↖
5: 9.9 ↓

Serie	48
Total	48

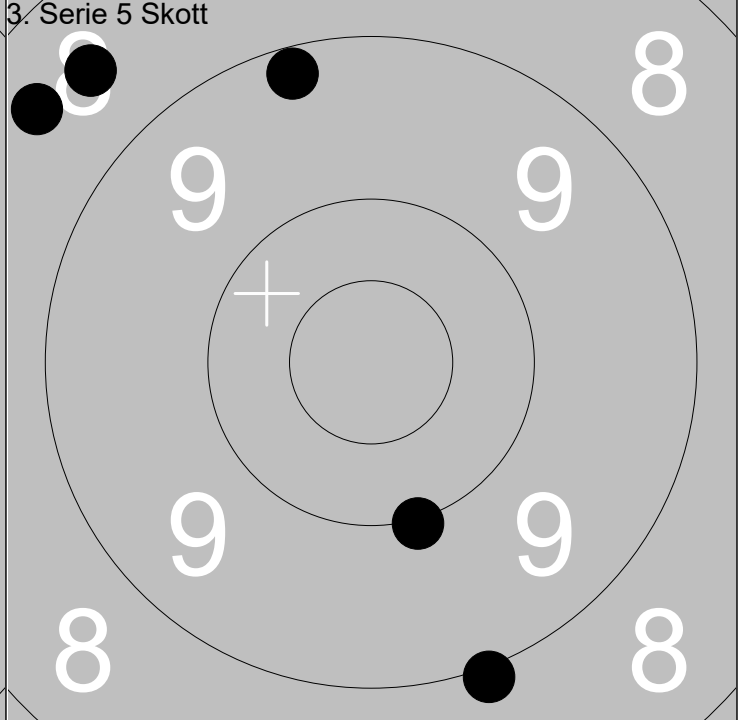
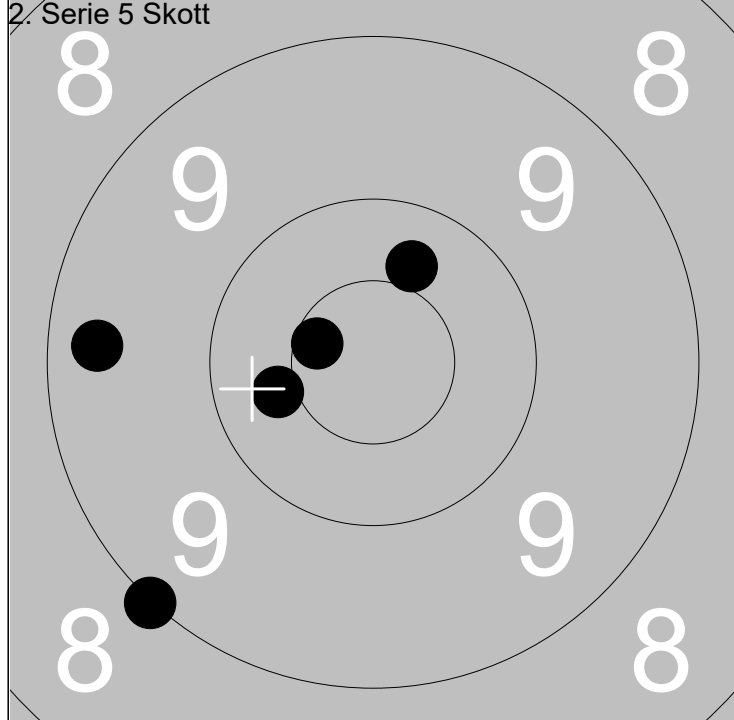

1: 10.6x ↖
2: 9.3 ↖
3: 10.4 ↖
4: 10.4 ↗
5: 9.0 ↙

Serie	48
Total	96

1: 9.2 ↗
2: 8.5 ↗
3: 8.5 ↗
4: 9.0 ↓
5: 10.0 ↓

Serie	44
Total	140

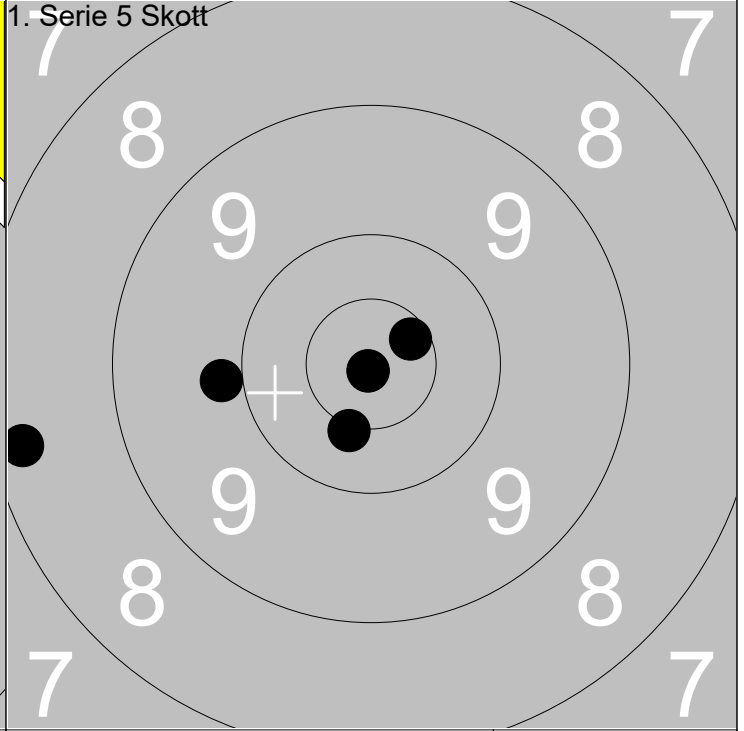
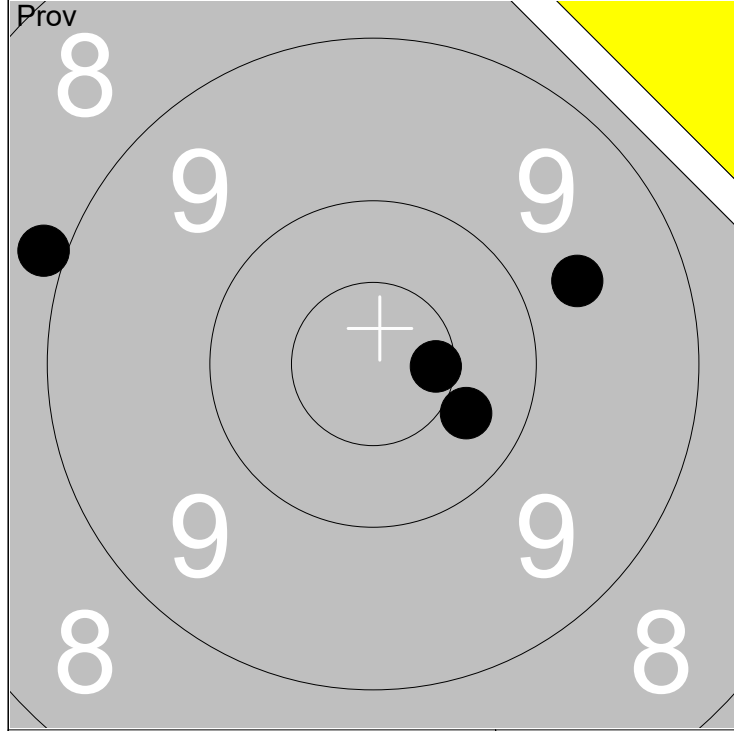

1: 10.4	↘
2: 9.7	↗
3: 8.9	↖
4: 10.6x	→

Serie	37
Total	0

1: 8.3	←
2: 10.5x	↓
3: 10.6x	↗
4: 10.9x	↓
5: 9.9	←

Serie	47
Total	47

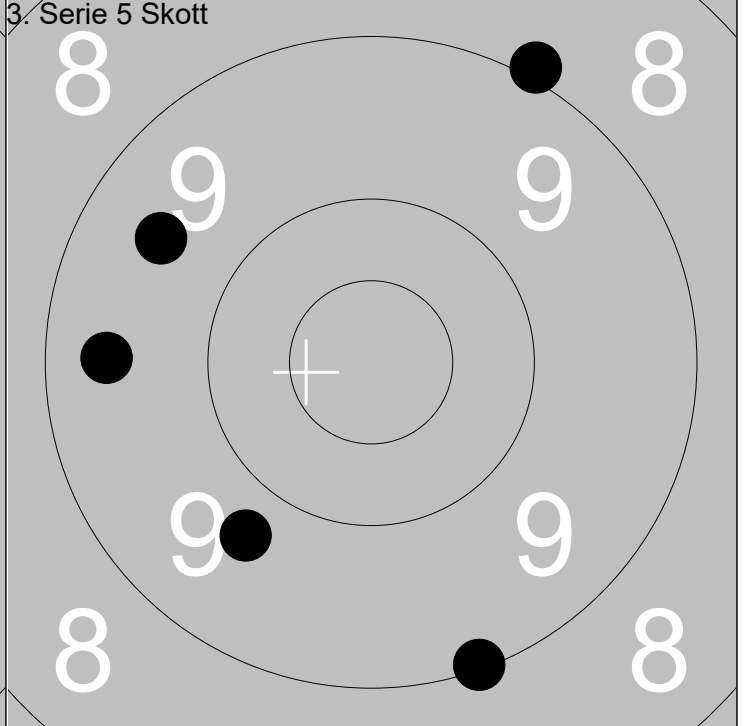
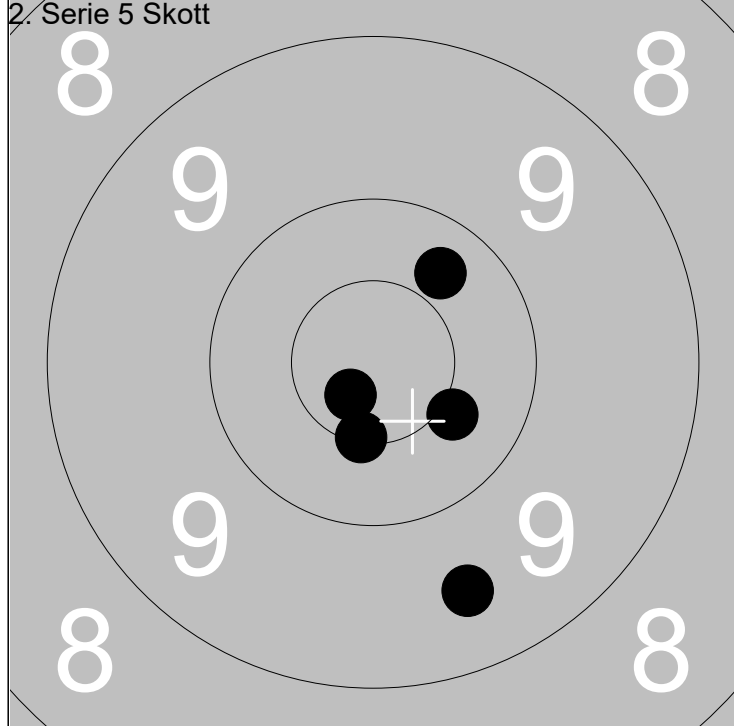

1: 10.3	↗
2: 10.5x	↓
3: 9.5	↓
4: 10.4	↘
5: 10.7x	↙

Serie	49
Total	96

1: 9.4	←
2: 9.5	↖
3: 9.7	↙
4: 9.0	↗
5: 9.1	↓

Serie	45
Total	141

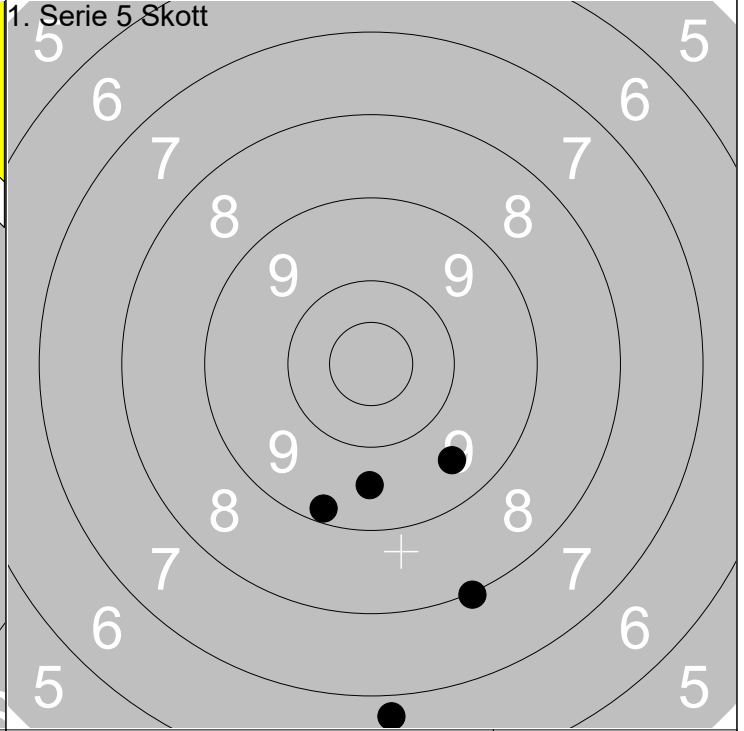
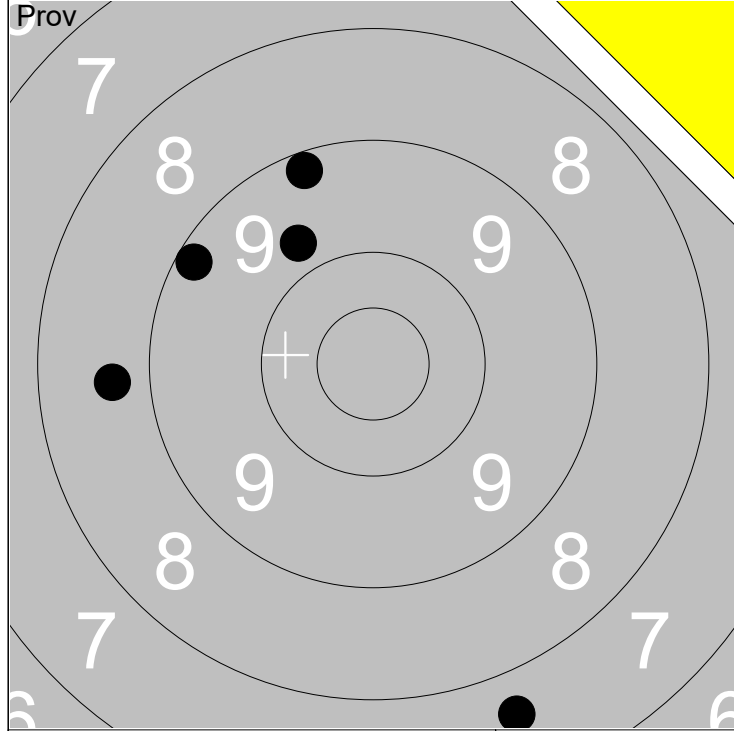

1:	9.2	↗
2:	8.7	←
3:	9.2	↗
4:	9.8	↗
5:	7.7	↘

Serie	42
Total	0

1:	9.6	↓
2:	8.0	↓
3:	6.8	↓
4:	9.2	↓
5:	9.5	↘

Serie	41
Total	41

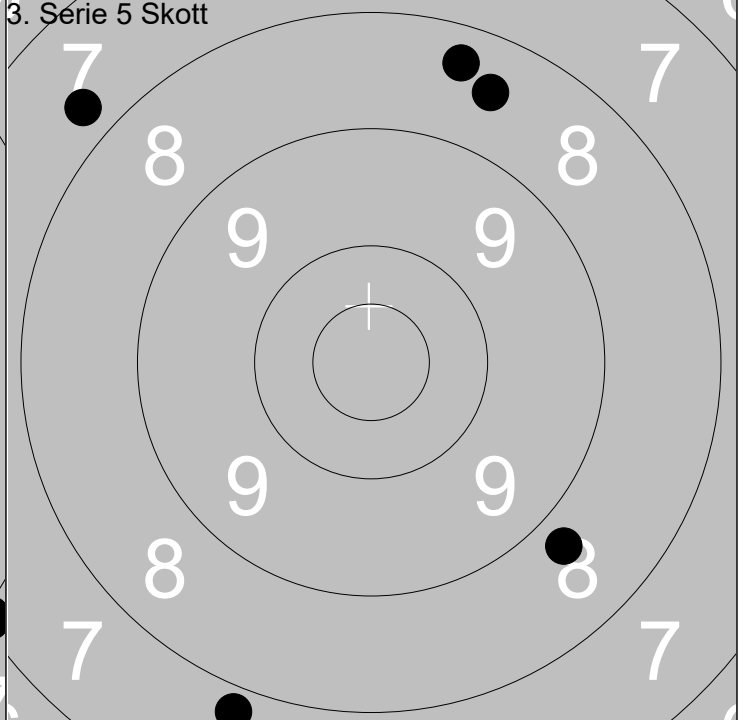
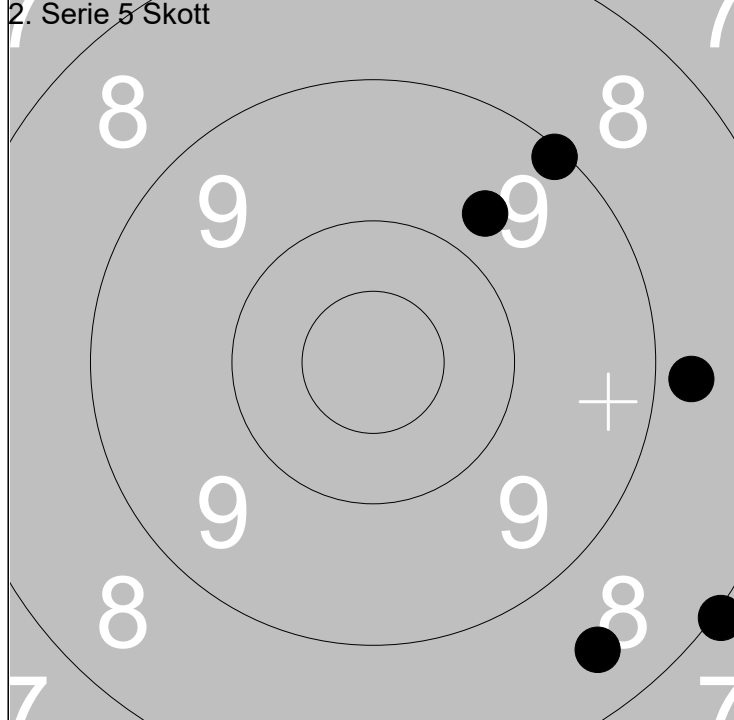

1:	8.5	↘
2:	8.0	↘
3:	9.7	↗
4:	8.8	→
5:	9.1	↗

Serie	42
Total	83

1:	8.4	↗
2:	8.8	↘
3:	8.5	↗
4:	7.7	↖
5:	7.8	↘

Serie	38
Total	121

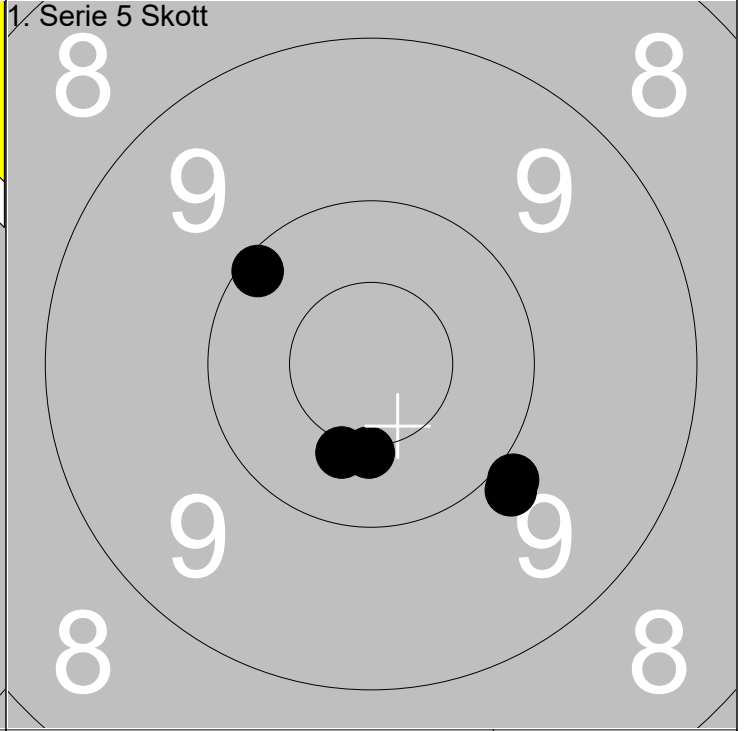
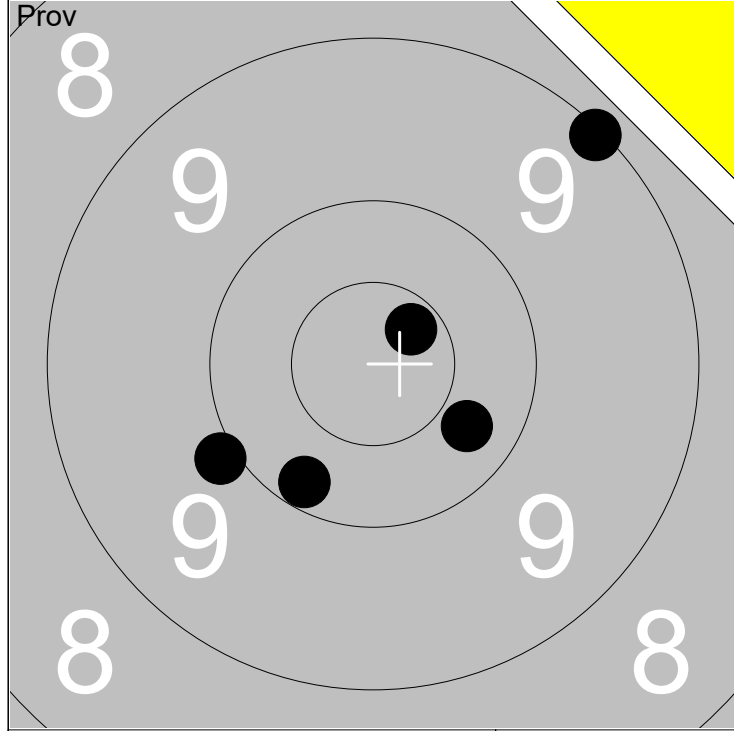

1: 10.7x ↗
2: 10.3 ↘
3: 9.9 ↙
4: 9.1 ↗
5: 10.2 ↘

Serie	48
Total	0

1: 10.1 ↖
2: 10.4x ↓
3: 9.9 ↘
4: 9.9 ↘
5: 10.4x ↘

Serie	48
Total	48

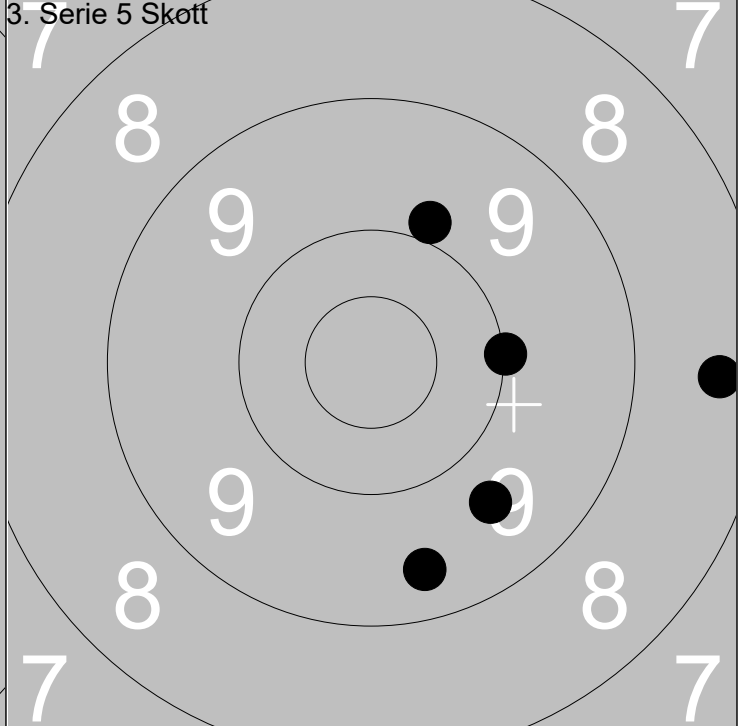
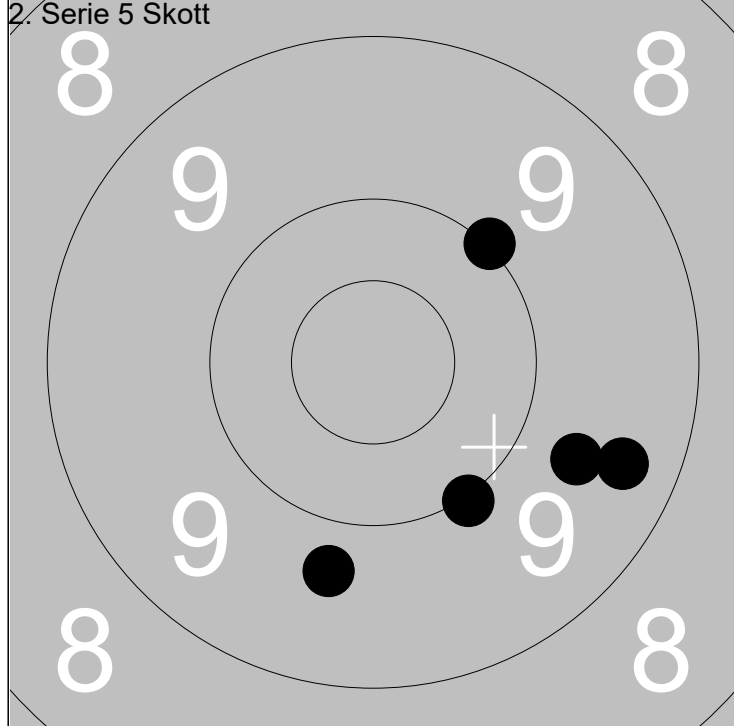

1: 10.0 ↗
2: 10.0 ↘
3: 9.4 →
4: 9.7 ↘
5: 9.7 →

Serie	47
Total	95

1: 9.9 ↗
2: 9.4 ↘
3: 10.0 →
4: 8.4 →
5: 9.6 ↘

Serie	45
Total	140

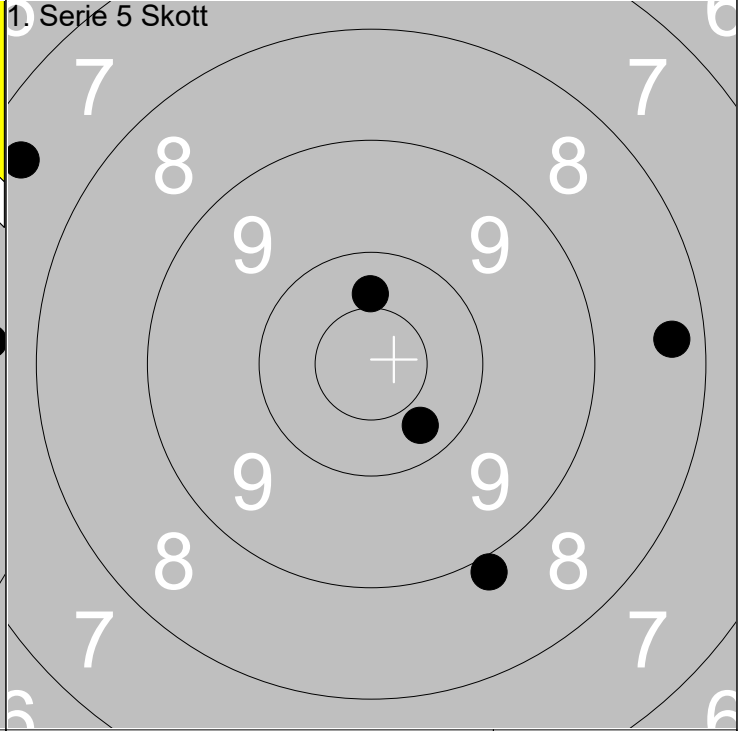
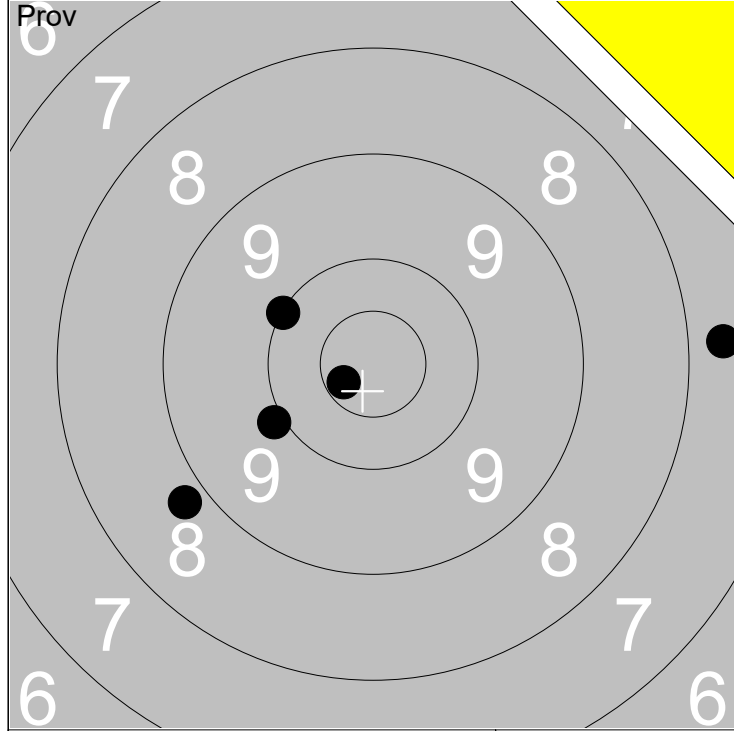

1: 7.7 →
2: 10.0 ↖
3: 9.9 ↙
4: 8.8 ↙
5: 10.6x ↙

Serie	44
Total	0

1: 8.3 →
2: 8.9 ↘
3: 10.4 ↑
4: 7.4 ↖
5: 10.3 ↘

Serie	43
Total	43

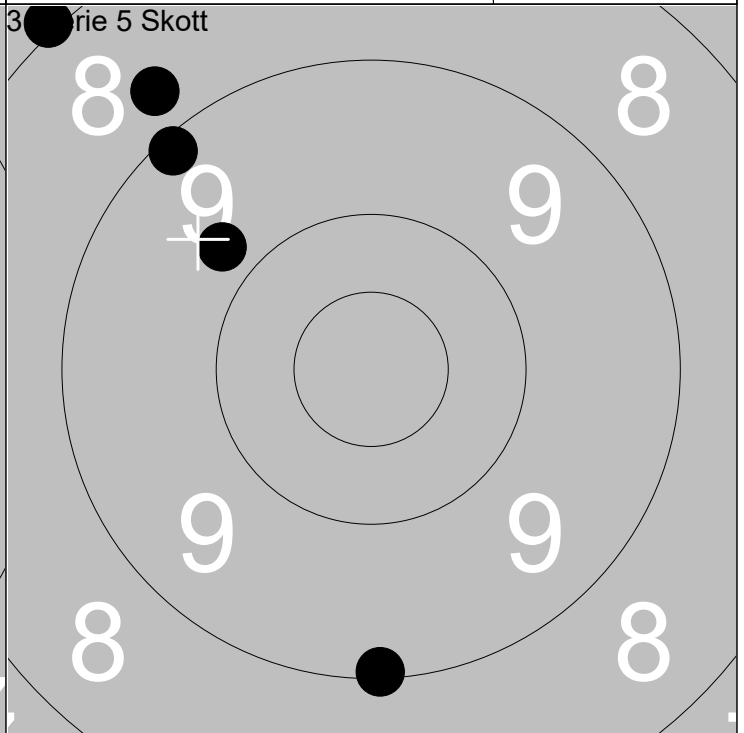
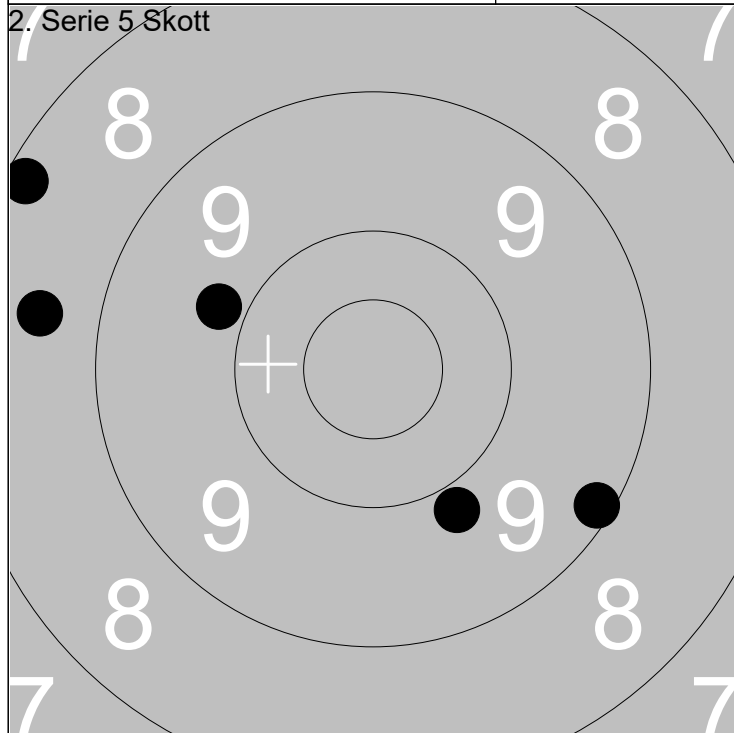

1: 9.8 ↘
2: 9.8 ↖
3: 8.6 ←
4: 8.2 ↖
5: 9.1 ↘

Serie	43
Total	86

1: 9.1 ↘
2: 9.8 ↖
3: 8.7 ↖
4: 9.1 ↖
5: 8.0 ↖

Serie	43
Total	129

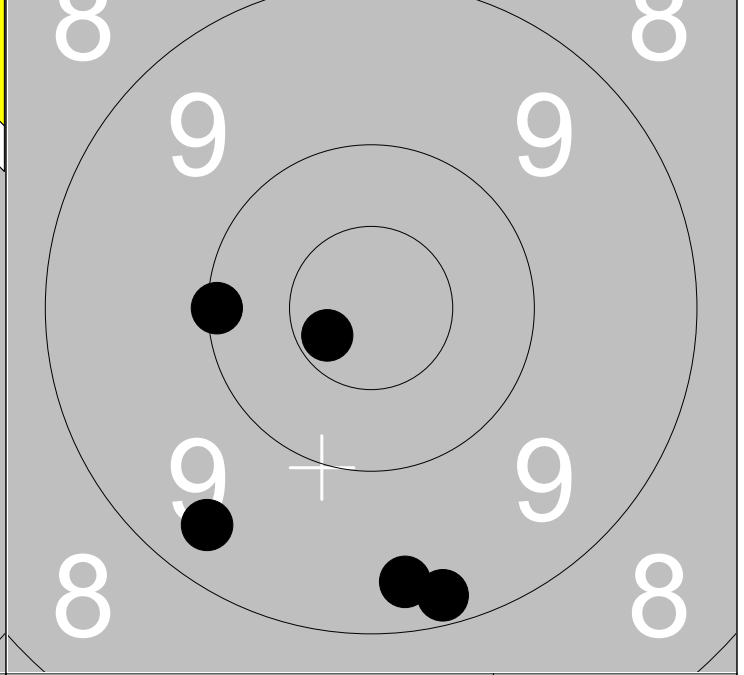
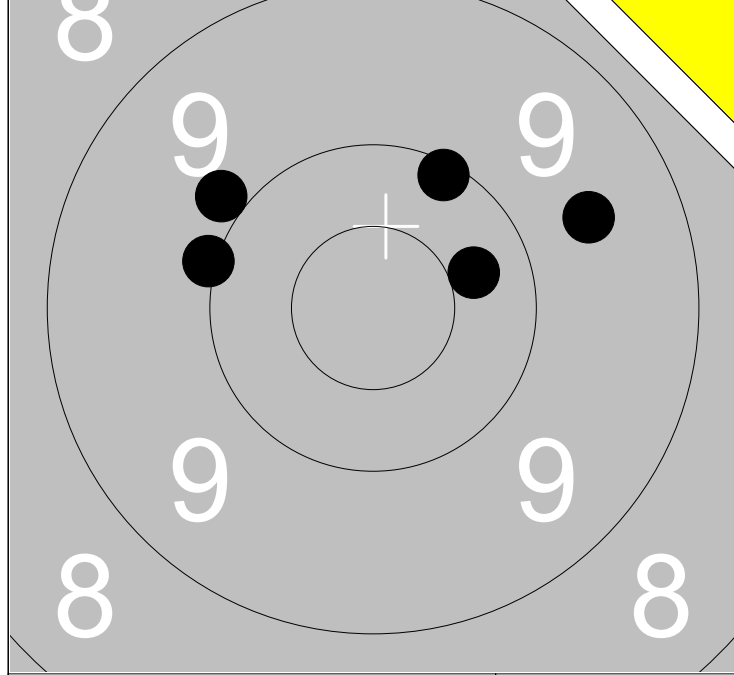

1: 10.3 →
2: 10.1 ↗
3: 9.9 ↖
4: 10.0 ←
5: 9.6 →

Serie	48
Total	0

1: 10.7x ↙
2: 9.3 ↓
3: 9.2 ↓
4: 10.1 ←
5: 9.4 ↘

Serie	47
Total	47

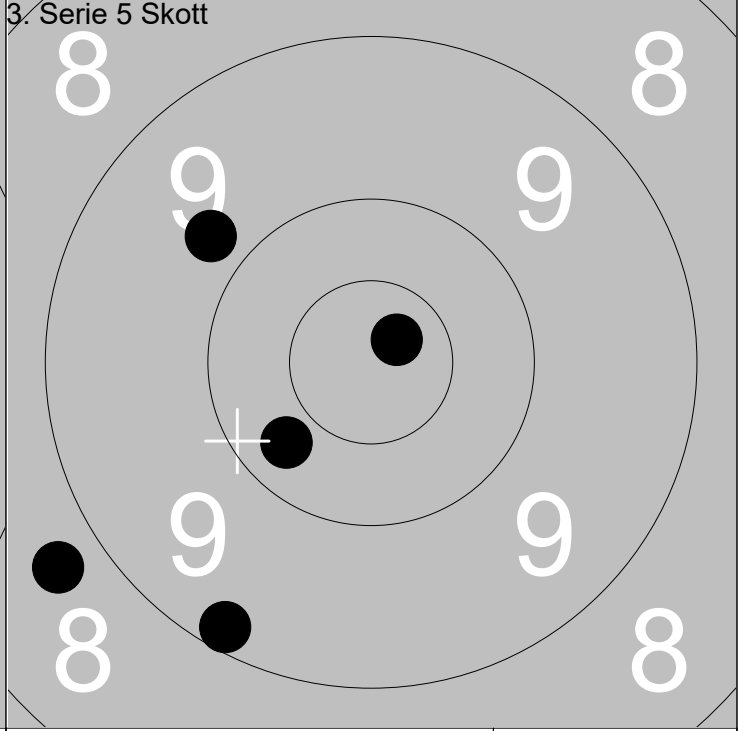
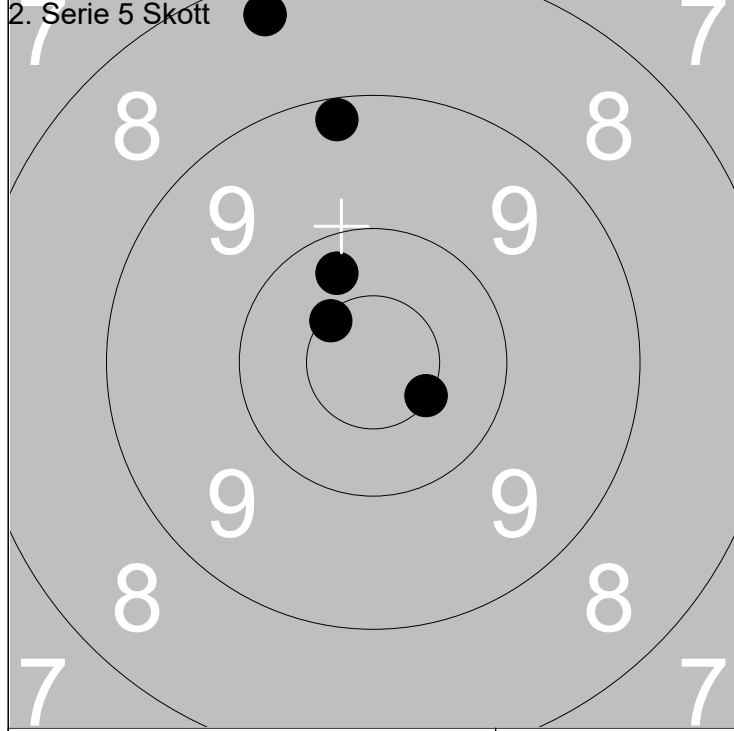

1: 8.3 ↗
2: 10.3 ↗
3: 10.5x ↖
4: 9.2 ↗
5: 10.5x ↘

Serie	47
Total	94

1: 9.2 ↘
2: 9.8 ↖
3: 8.7 ↖
4: 10.8x ↗
5: 10.3 ↘

Serie	46
Total	140

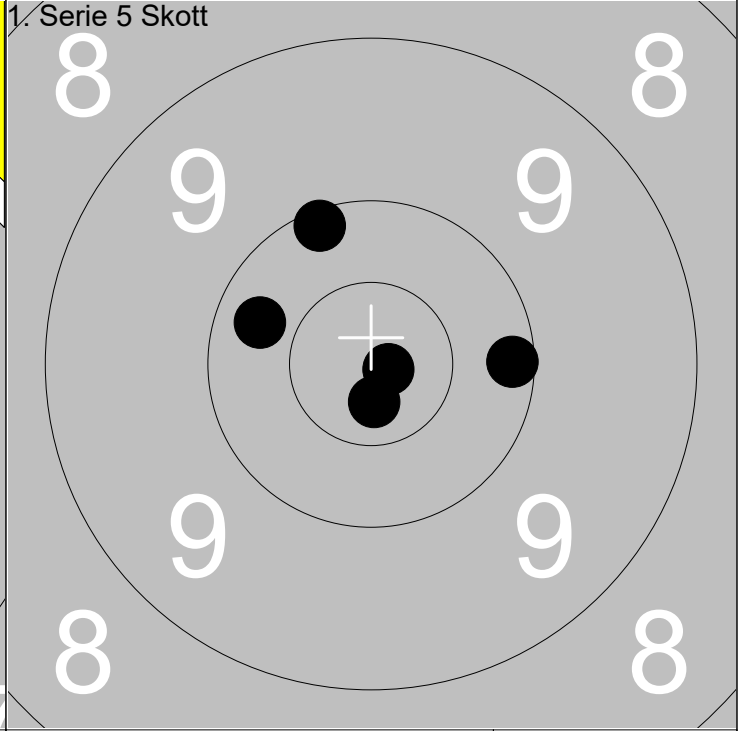
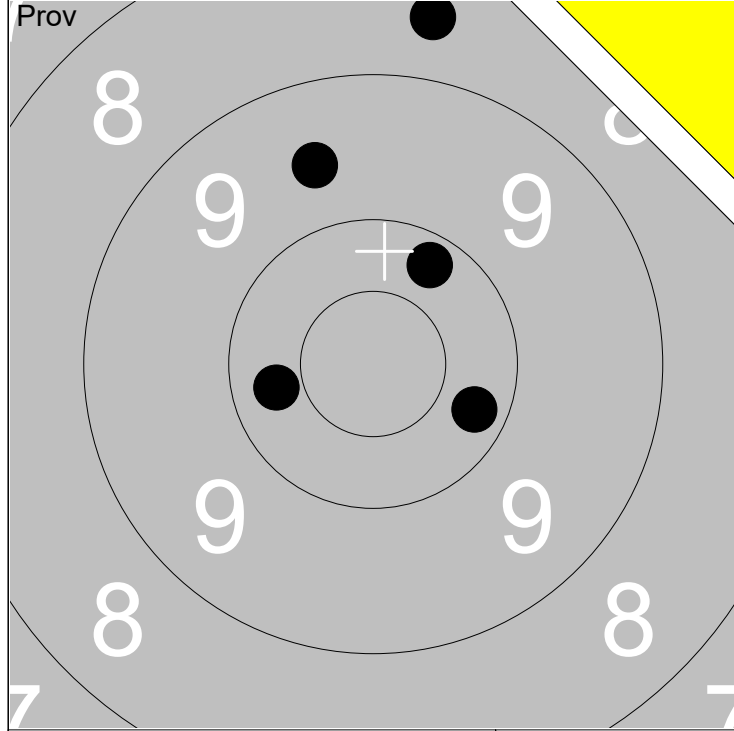

1: 8.6	↑
2: 10.2	→
3: 10.2	↗
4: 9.6	↑
5: 10.3	←

Serie	47
Total	0

1: 10.8x	→
2: 10.1	→
3: 10.3	←
4: 10.1	↑
5: 10.7x	↓

Serie	50
Total	50

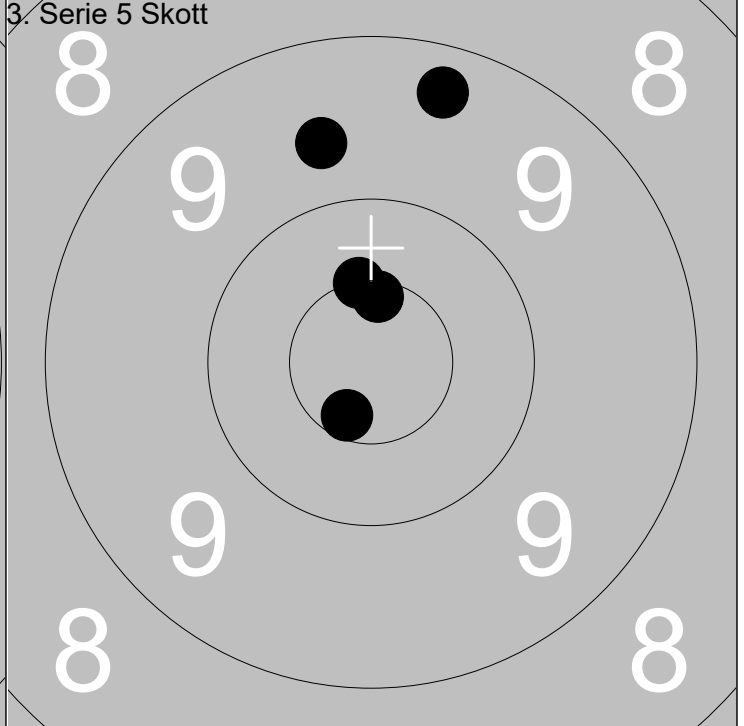
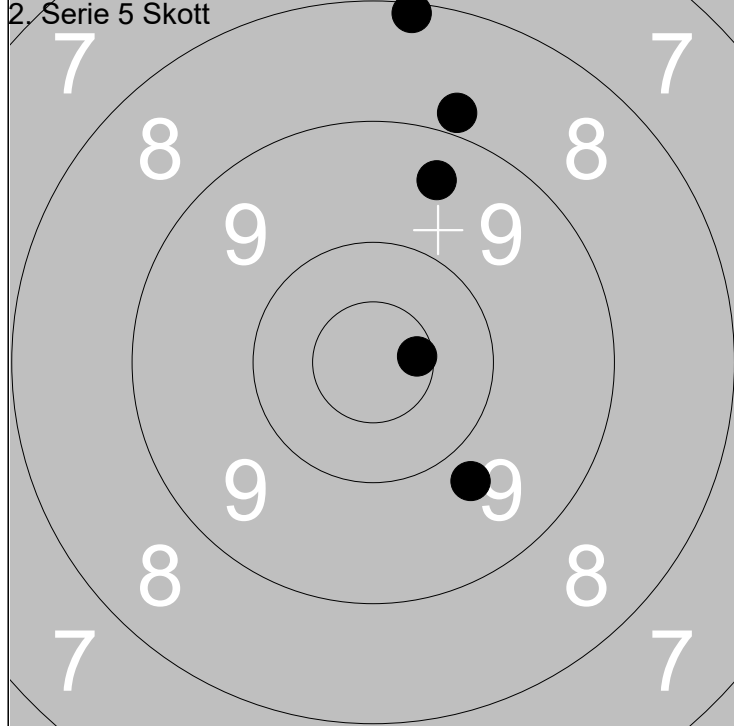

1: 10.6x	→
2: 9.8	↘
3: 9.4	↑
4: 8.8	↑
5: 8.1	↑

Serie	44
Total	94

1: 10.5x	↑
2: 10.6x	↑
3: 9.6	↑
4: 9.3	↑
5: 10.6x	↓

Serie	48
Total	142

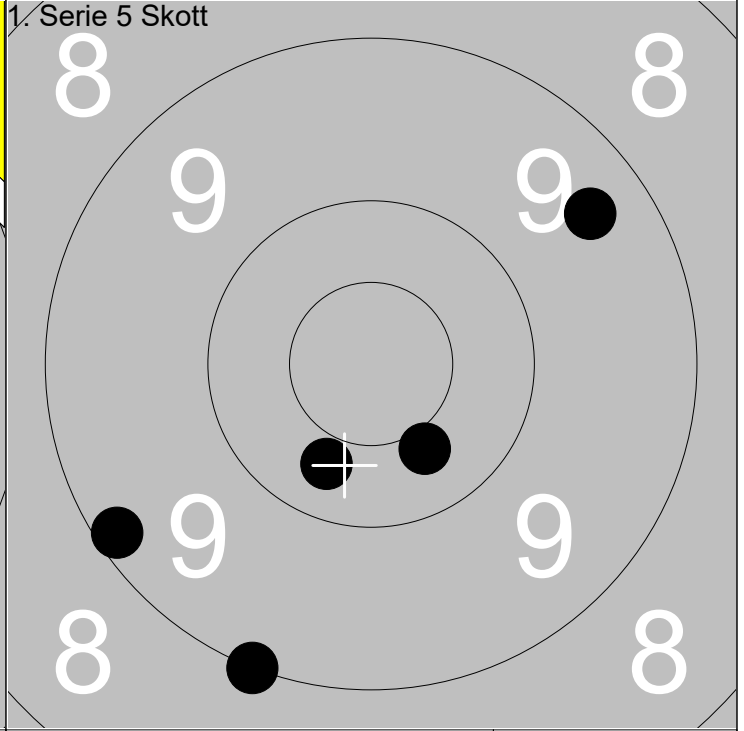
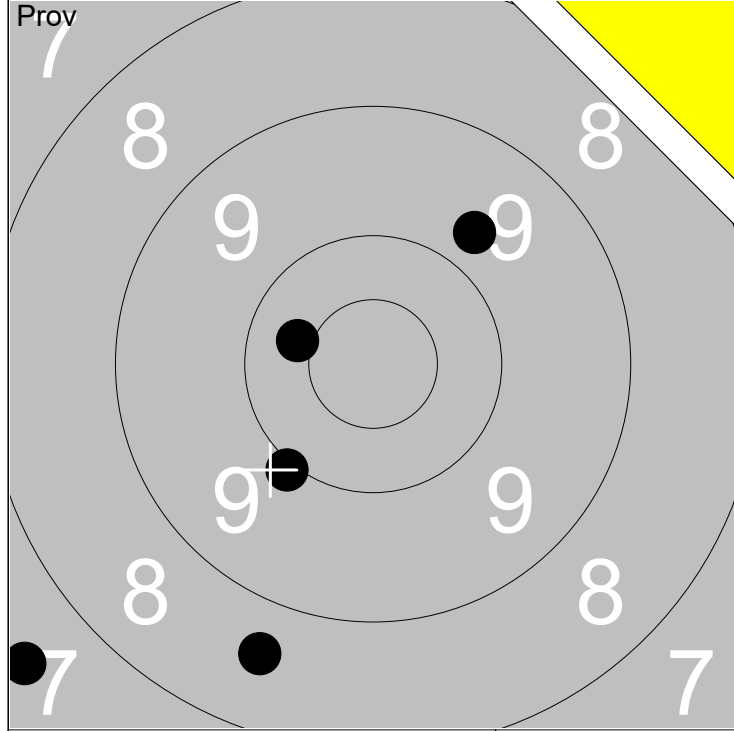

1:	10.0	↙
2:	7.5	↙
3:	9.7	↗
4:	10.4	↖
5:	8.6	↘

Serie	44
Total	0

1:	9.4	↗
2:	9.0	↘
3:	10.3	↘
4:	10.4	↘
5:	9.2	↙

Serie	47
Total	47

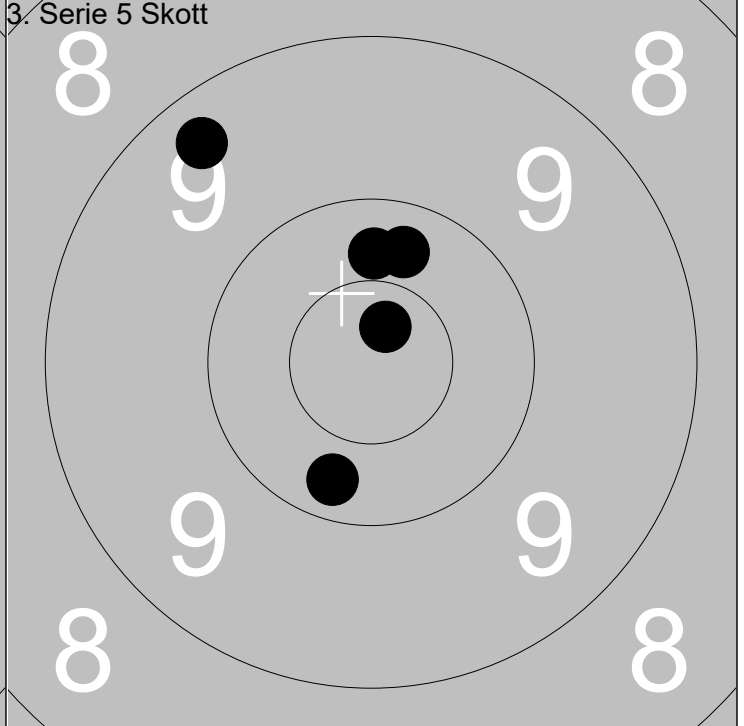
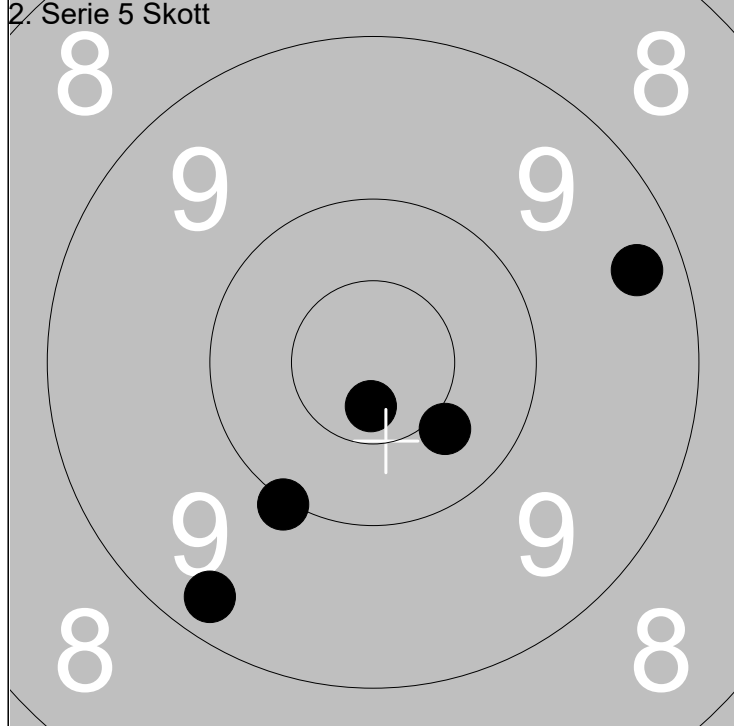

1:	9.3	↗
2:	10.4	↘
3:	10.7x	↘
4:	9.3	↘
5:	10.0	↘

Serie	48
Total	95

1:	10.7x	↗
2:	10.2	↘
3:	10.3	↗
4:	10.3	↗
5:	9.3	↖

Serie	49
Total	144

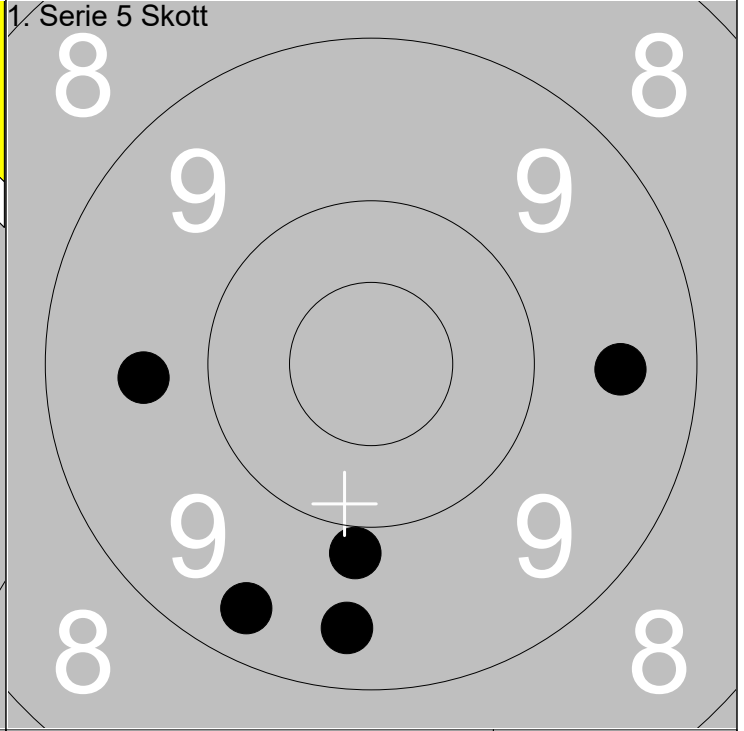
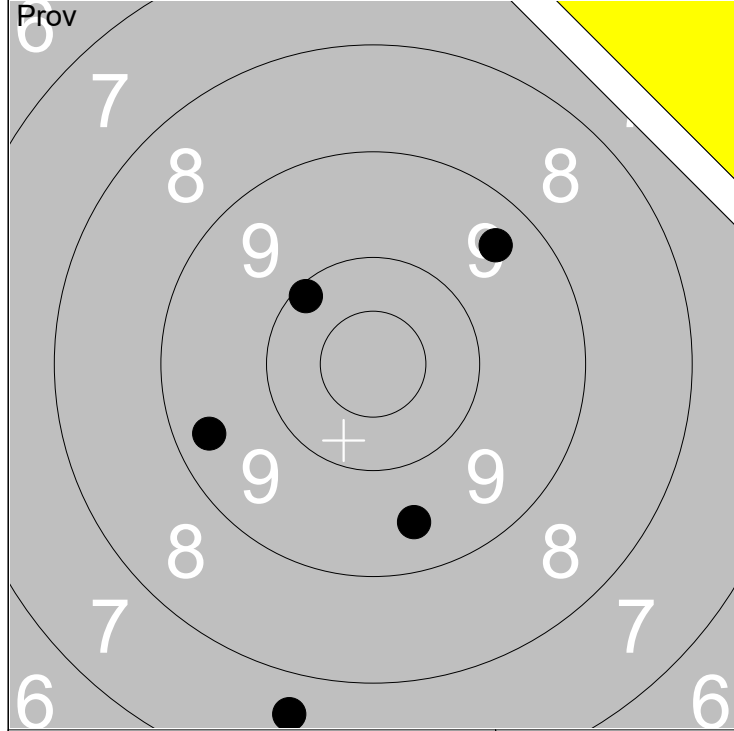

1: 7.6	↓
2: 9.5	↓
3: 9.4	←
4: 9.4	↗
5: 10.1	↖

Serie	44
Total	0

1: 9.4	↙
2: 9.6	←
3: 9.4	↓
4: 9.9	↓
5: 9.5	→

Serie	45
Total	45

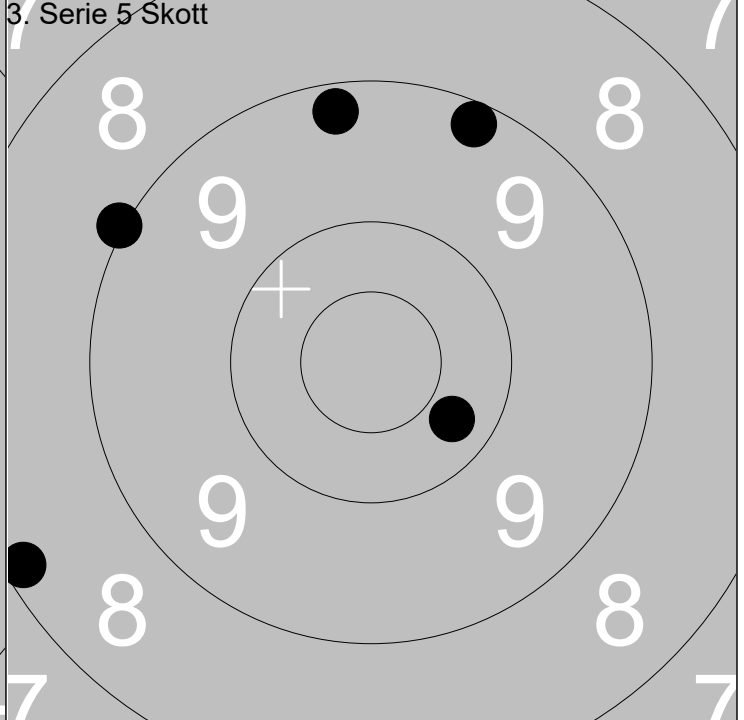
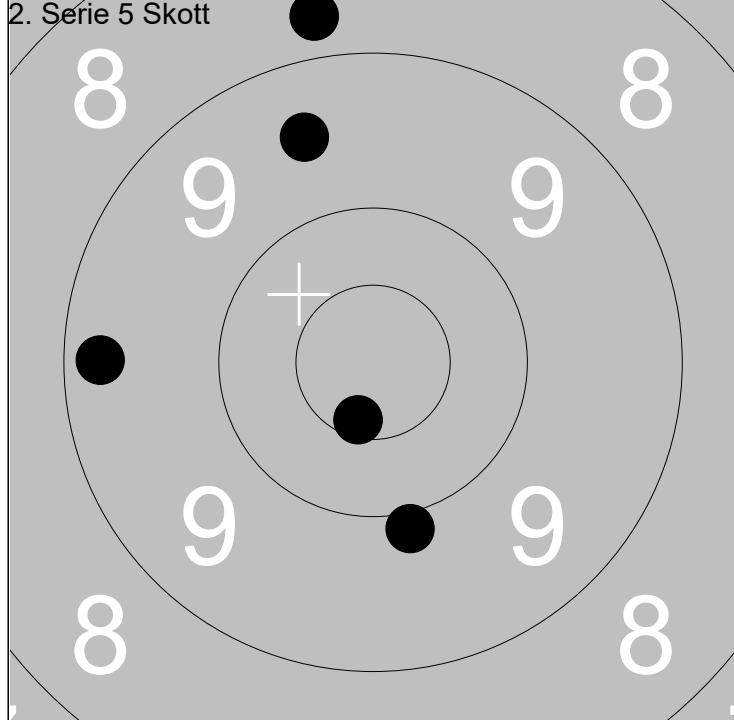

1: 9.3	←
2: 8.8	↑
3: 9.5	↑
4: 10.6x	↓
5: 9.9	↓

Serie	45
Total	90

1: 10.3	↘
2: 8.2	←
3: 9.2	↑
4: 9.0	↖
5: 9.2	↑

Serie	45
Total	135

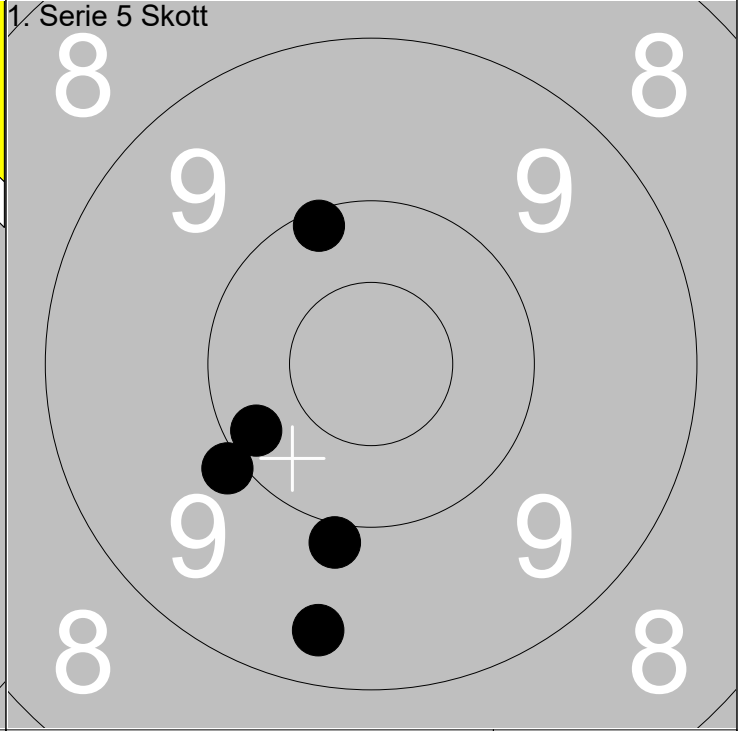
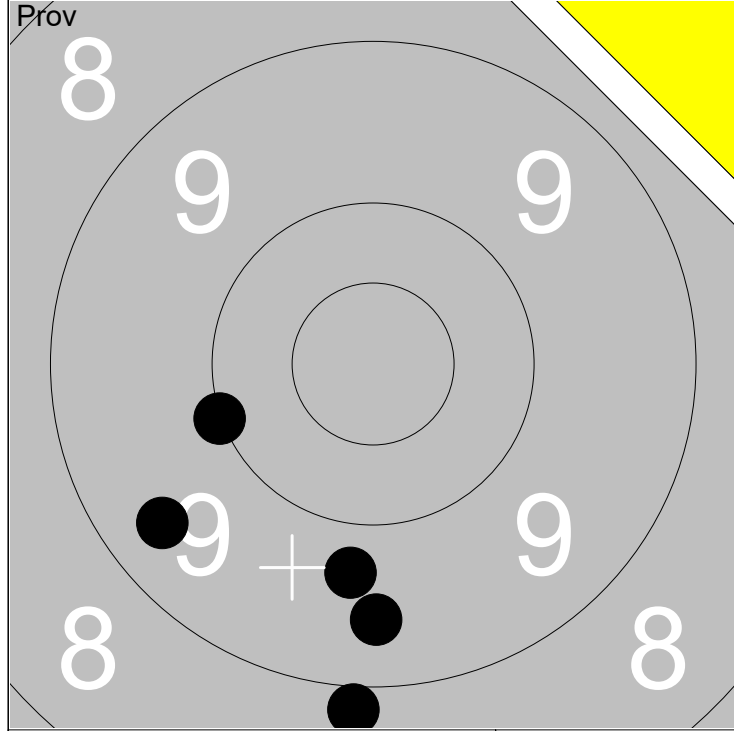

1: 9.4 ↙
2: 9.4 ↓
3: 9.7 ↓
4: 10.0 ←
5: 8.9 ↓

Serie	45
Total	0

1: 10.2 ↙
2: 9.9 ↙
3: 9.9 ↓
4: 9.4 ↓
5: 10.1 ↗

Serie	47
Total	47

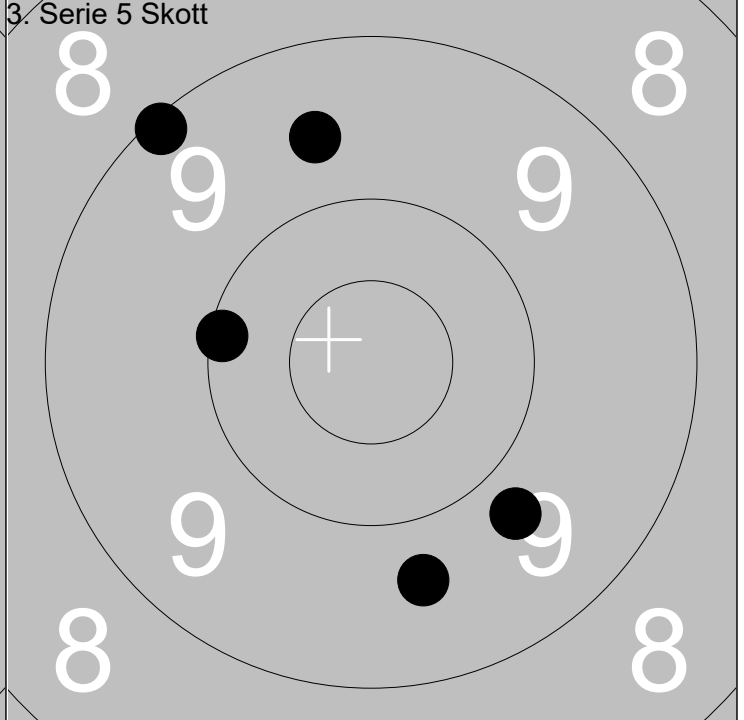
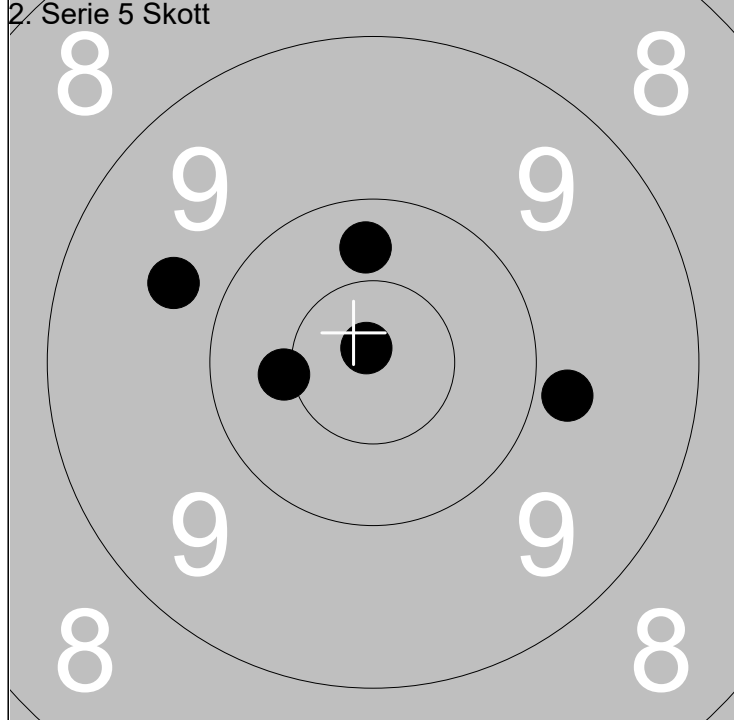

1: 10.3 ↑
2: 9.7 ↙
3: 10.9x ↗
4: 10.4x ←
5: 9.8 →

Serie	48
Total	95

1: 9.1 ↗
2: 9.6 ↑
3: 9.7 ↓
4: 10.1 ←
5: 9.7 ↓

Serie	46
Total	141

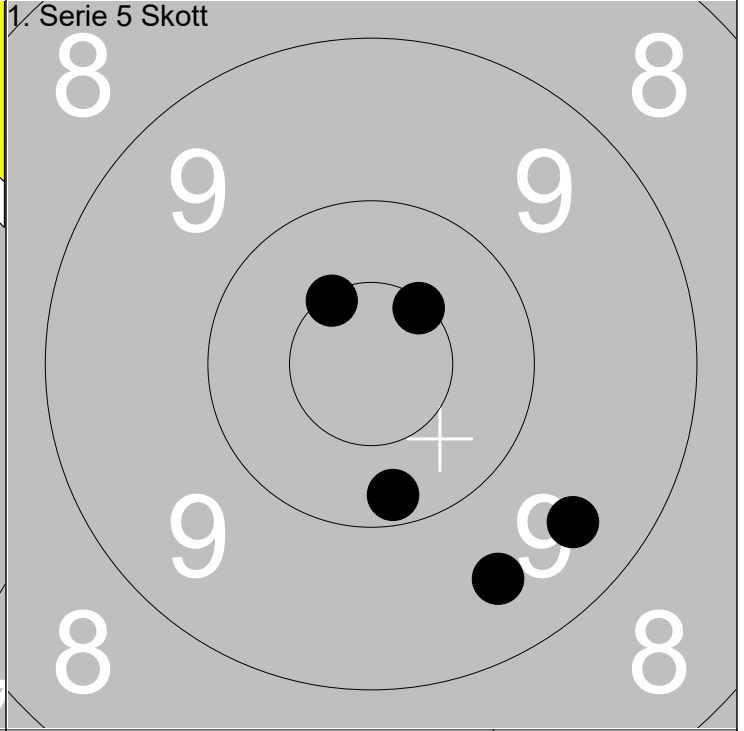
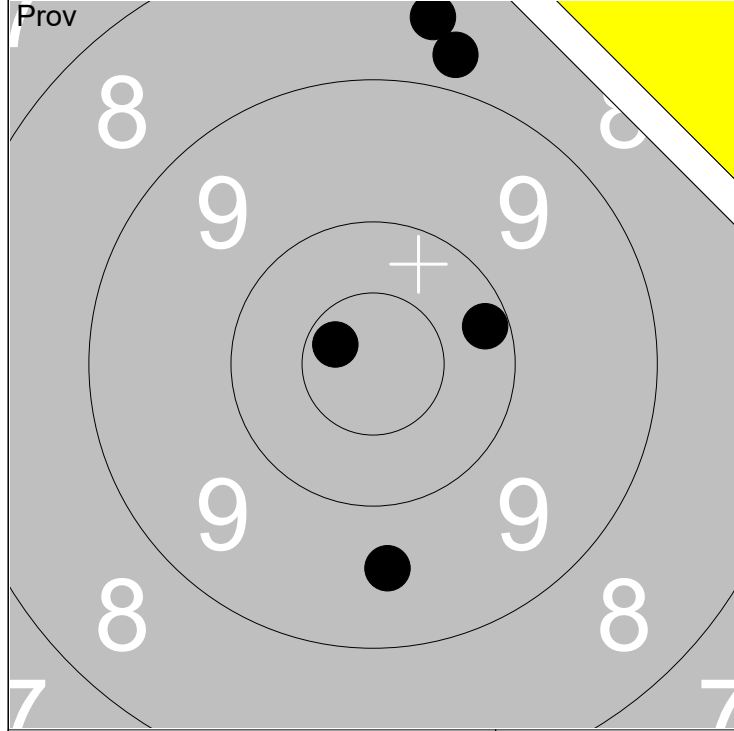

1: 8.5	↑
2: 8.8	↑
3: 10.2	→
4: 9.6	↓
5: 10.7x	↖

Serie	45
Total	0

1: 9.5	↓
2: 10.5x	↖
3: 10.5x	↗
4: 10.2	↓
5: 9.5	↓

Serie	48
Total	48

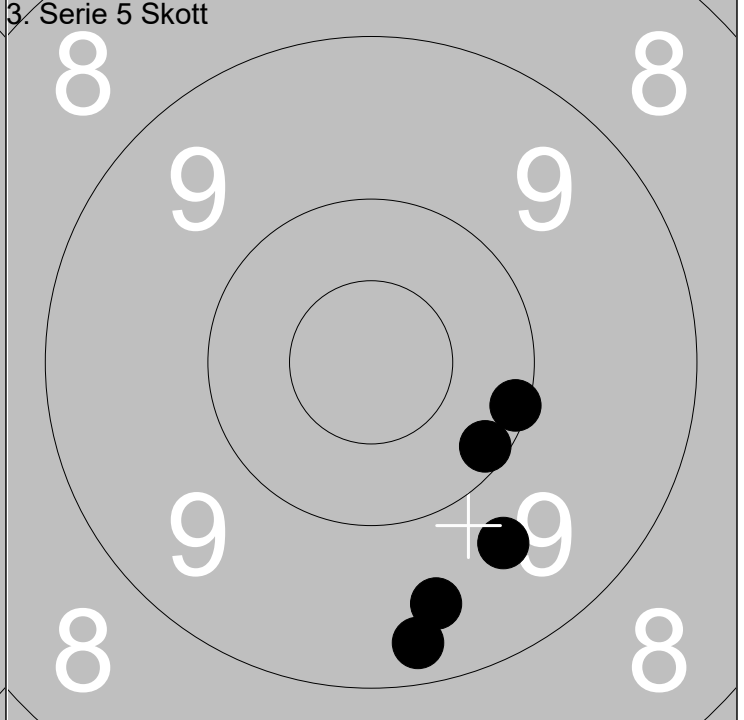
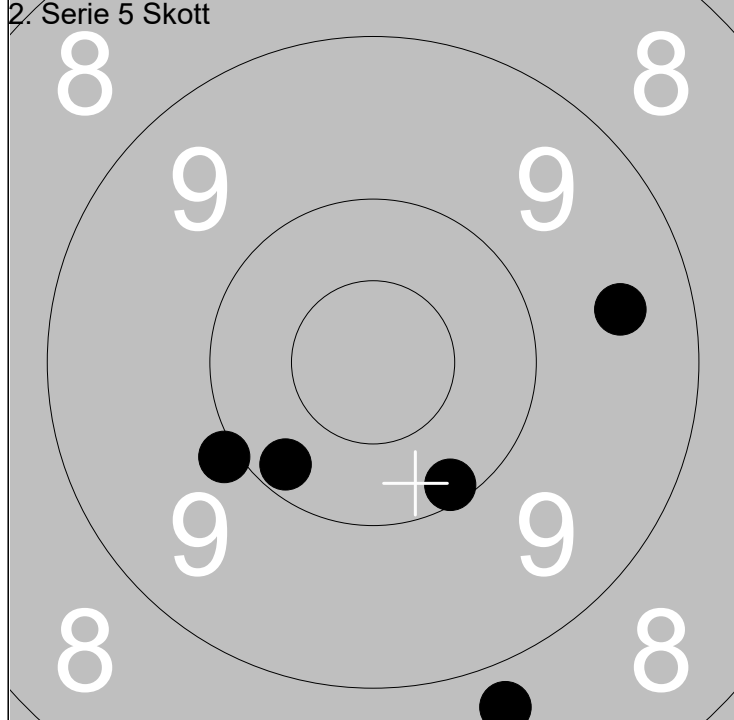

1: 9.9	↖
2: 10.2	↖
3: 9.5	→
4: 8.8	↓
5: 10.1	↓

Serie	46
Total	94

1: 10.1	↘
2: 9.5	↓
3: 10.1	→
4: 9.7	↓
5: 9.3	↓

Serie	47
Total	141

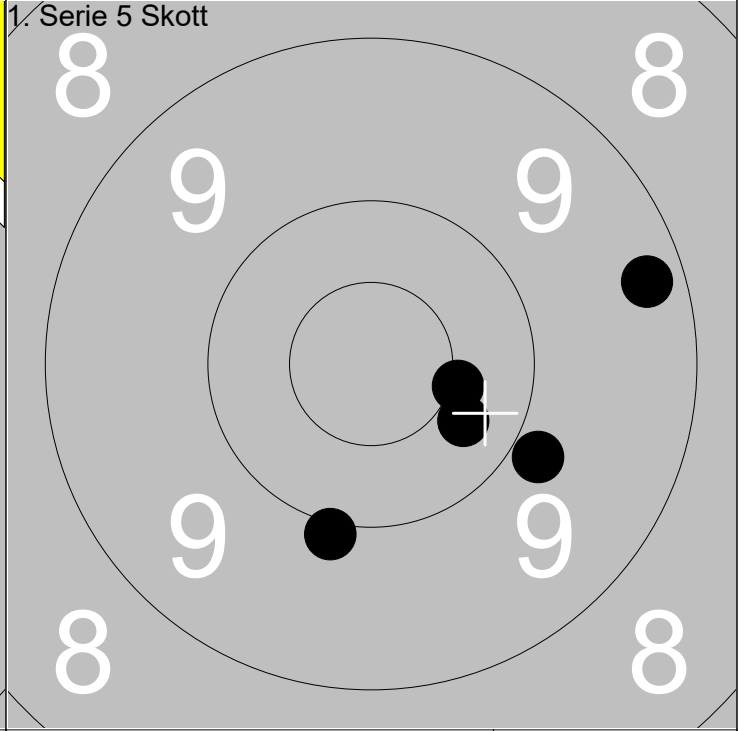
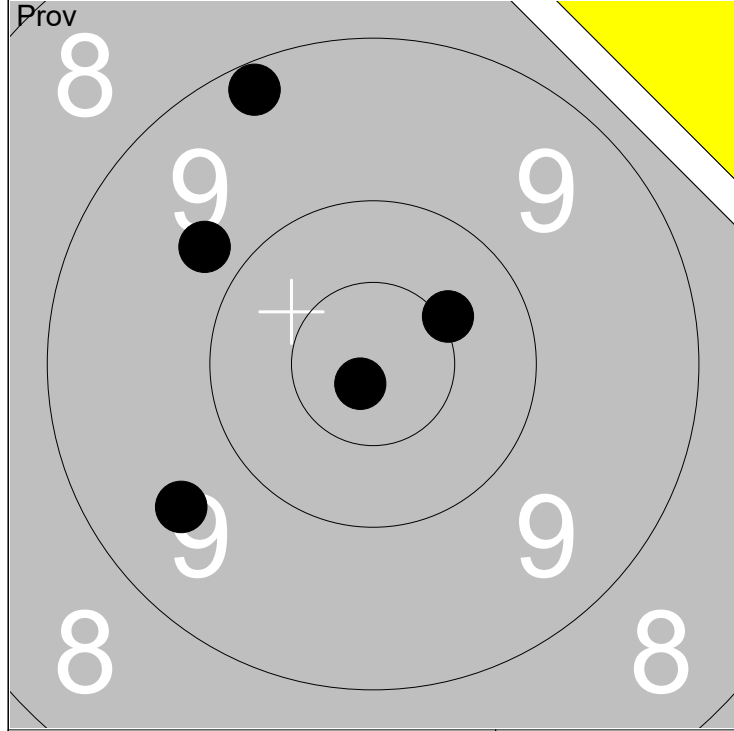

1: 9.2 ↖
2: 10.8x ↘
3: 9.8 ↖
4: 9.6 ↘
5: 10.4x ↗

Serie	47
Total	0

1: 10.4x →
2: 9.3 →
3: 9.9 ↘
4: 10.3 ↘
5: 10.0 ↓

Serie	48
Total	48

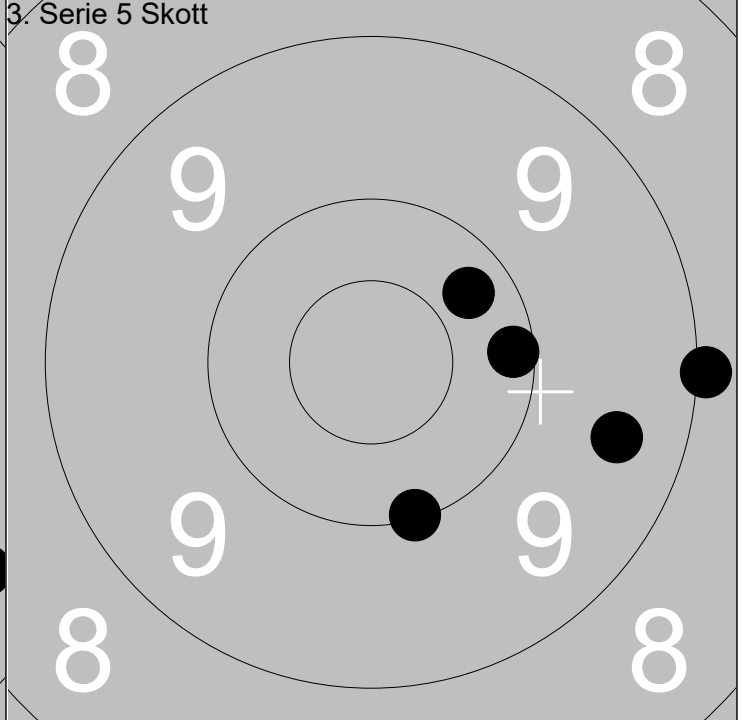
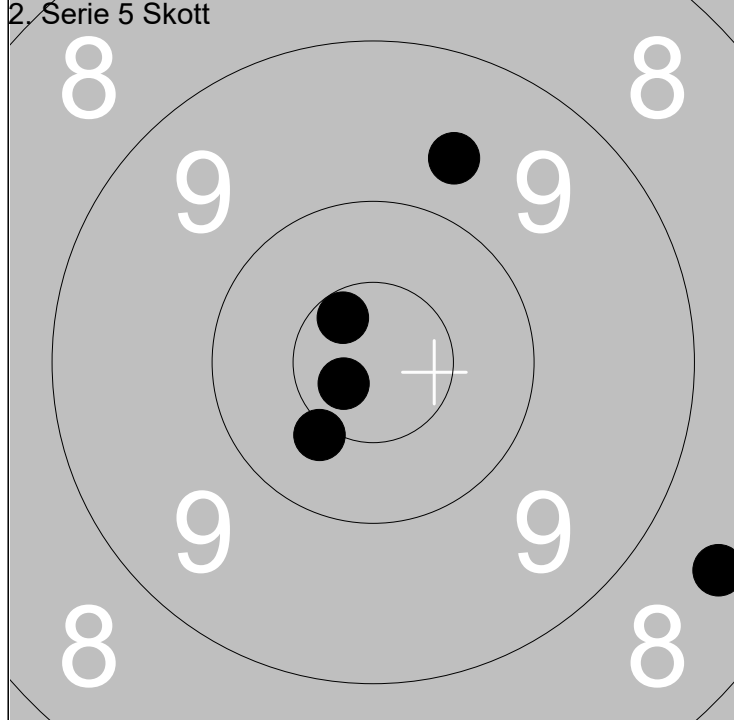

1: 10.4x ↘
2: 8.5 →
3: 9.7 ↗
4: 10.7x ↘
5: 10.6x ↖

Serie	47
Total	95

1: 10.3 ↗
2: 9.0 →
3: 10.1 →
4: 10.0 ↓
5: 9.5 →

Serie	48
Total	143

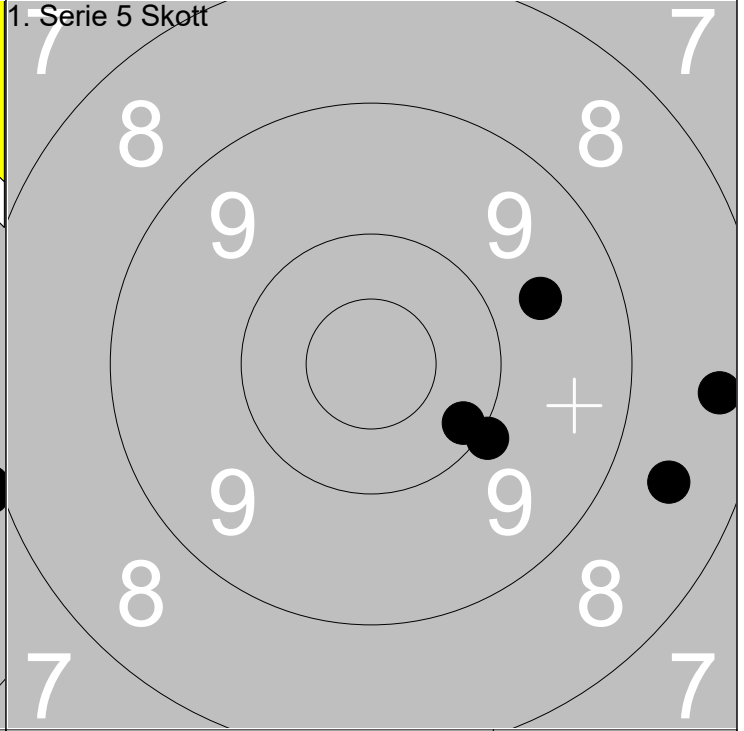
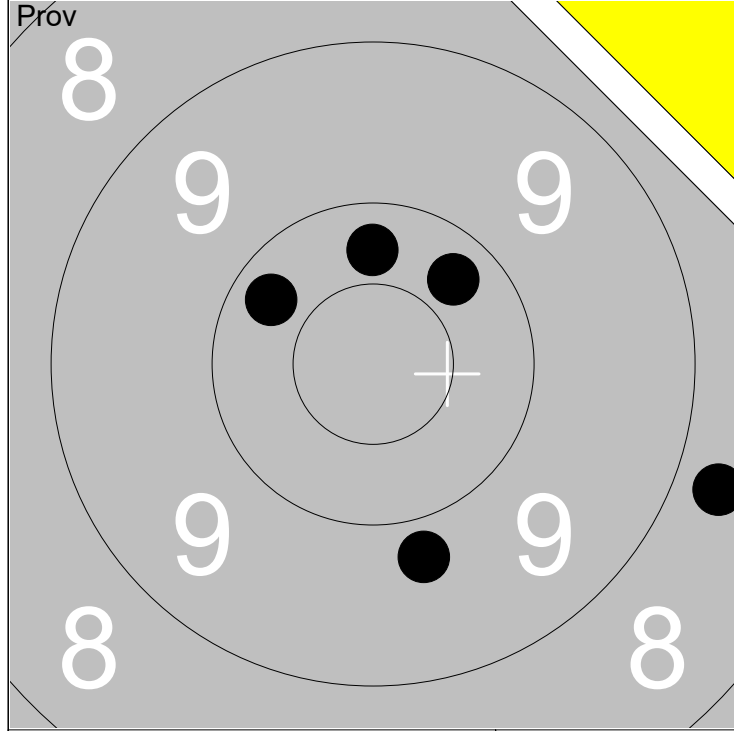

1: 9.8	↓
2: 8.7	→
3: 10.3	↗
4: 10.3	↑
5: 10.3	↖

Serie	47
Total	0

1: 9.6	↗
2: 8.3	→
3: 10.2	↘
4: 8.6	→
5: 10.0	↘

Serie	45
Total	45

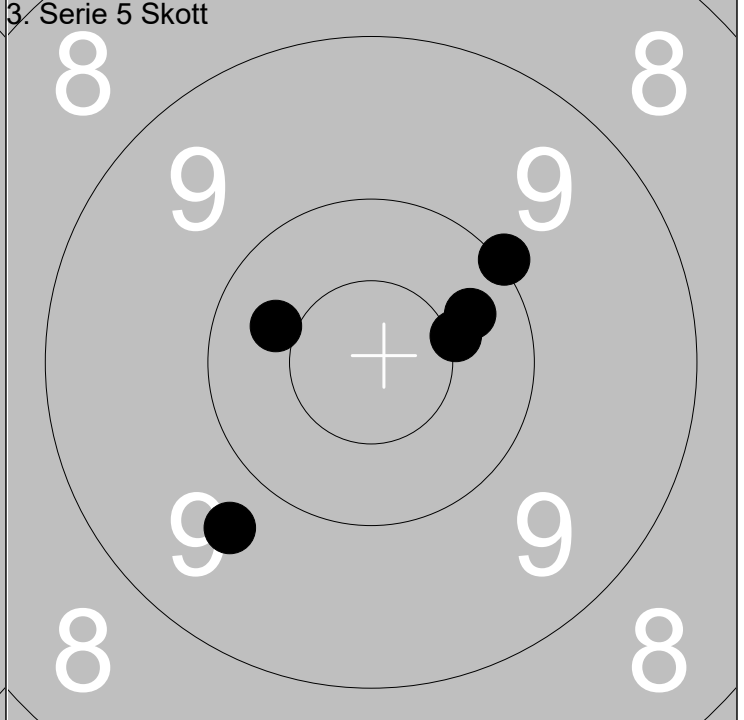
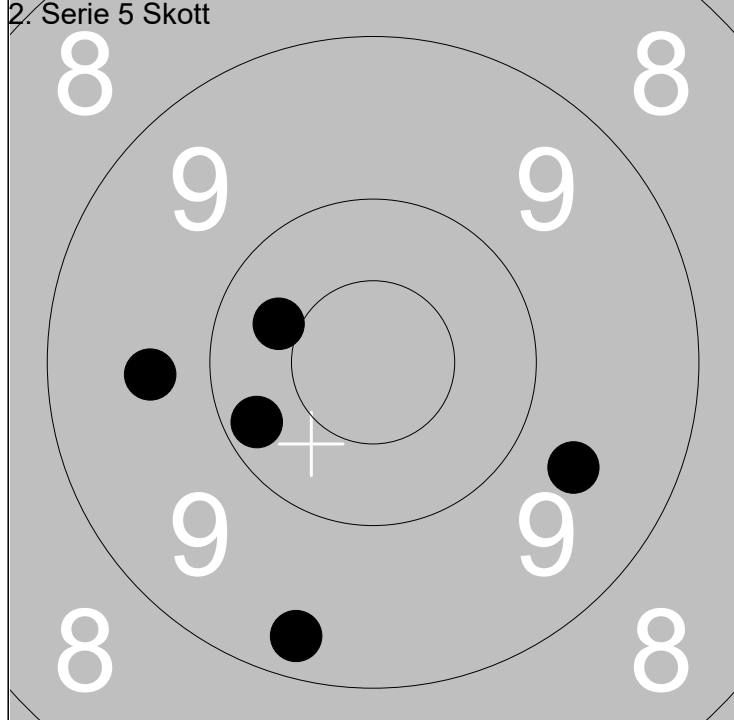

1: 9.3	↓
2: 10.4	↖
3: 9.7	←
4: 9.6	→
5: 10.2	↙

Serie	47
Total	92

1: 9.7	↙
2: 10.4	↖
3: 10.3	↗
4: 10.4x	→
5: 10.0	↗

Serie	49
Total	141

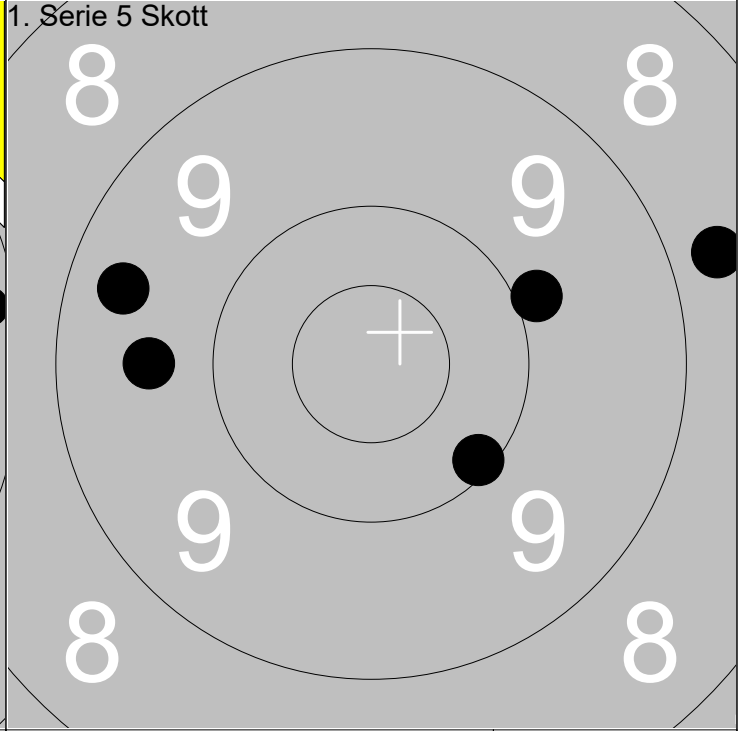
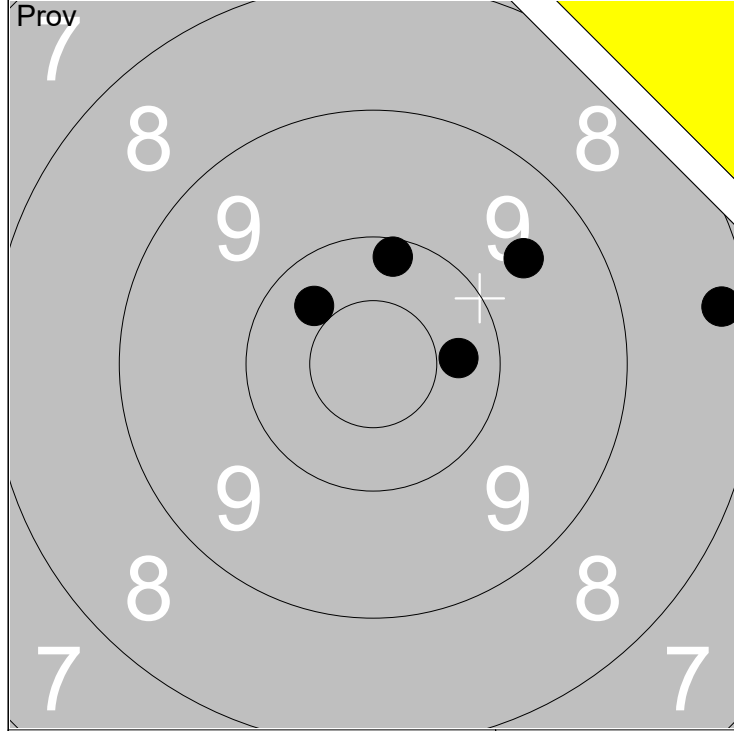

1: 8.3 →
2: 10.3 →
3: 9.6 ↗
4: 10.3 ↖
5: 10.2 ↑

Serie	47
Total	0

1: 8.7 →
2: 9.4 ←
3: 10.1 ↘
4: 9.6 ←
5: 9.9 →

Serie	45
Total	45

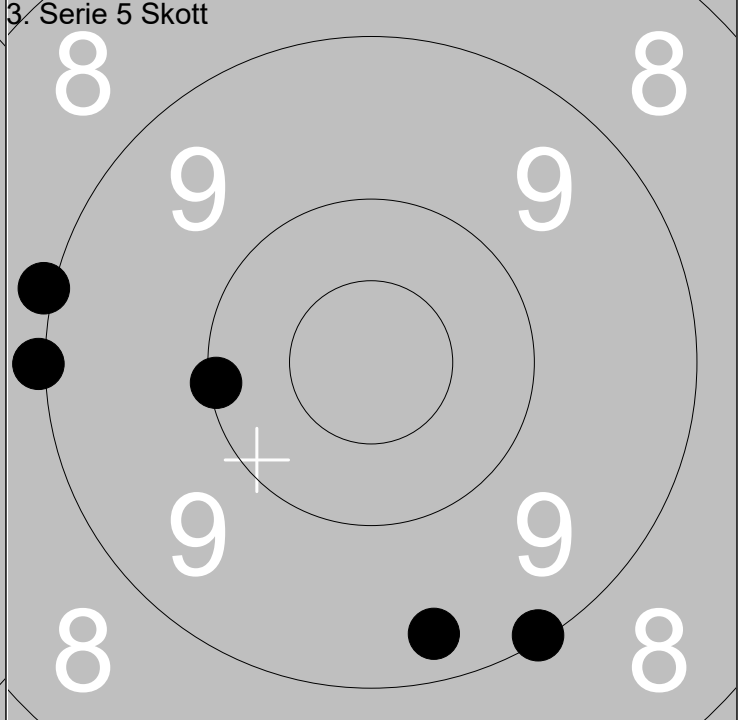
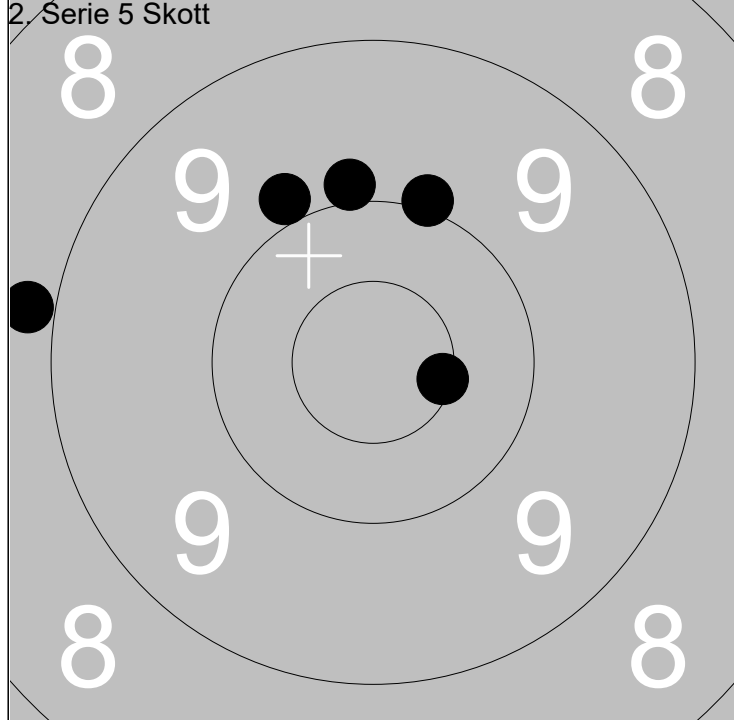

1: 9.9 ↑
2: 9.9 ↖
3: 10.0 ↗
4: 8.9 ←
5: 10.5x →

Serie	46
Total	91

1: 9.3 ↓
2: 9.0 ←
3: 9.1 ↘
4: 10.1 ←
5: 9.0 ←

Serie	46
Total	137

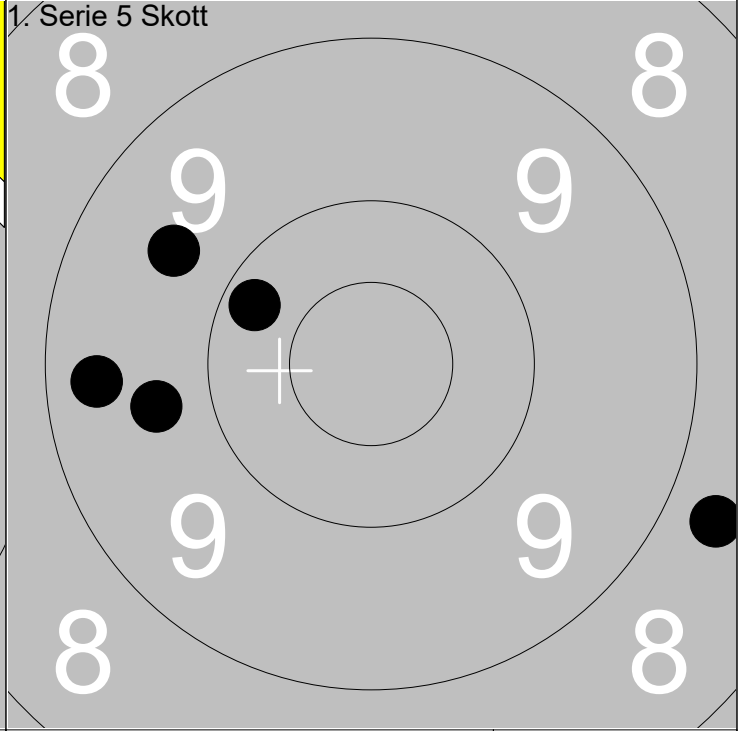
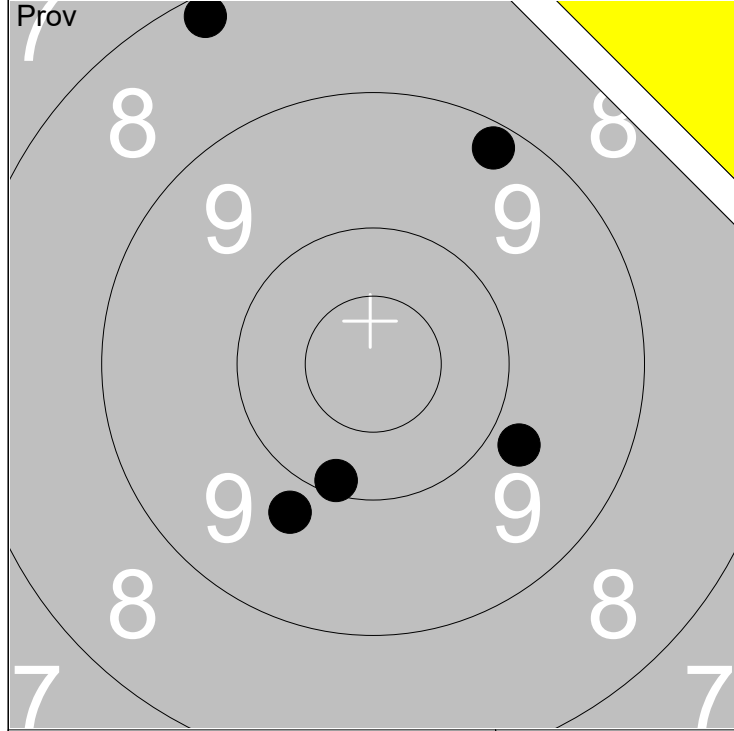

1: 9.8	↘
2: 9.2	↗
3: 8.2	↖
4: 10.1	↙
5: 9.8	↘

Serie	45
Total	0

1: 9.3	←
2: 9.7	←
3: 10.2	↖
4: 8.7	↘
5: 9.6	↖

Serie	45
Total	45

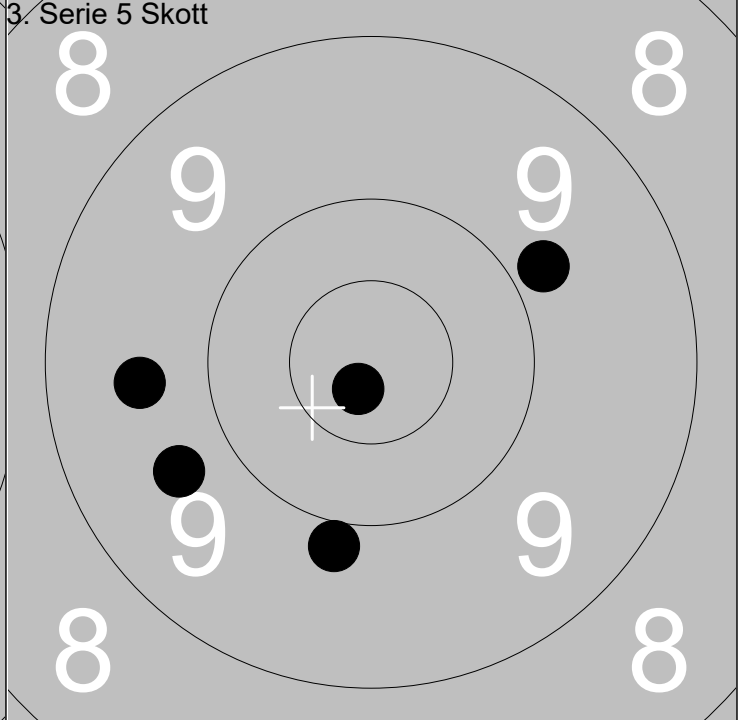
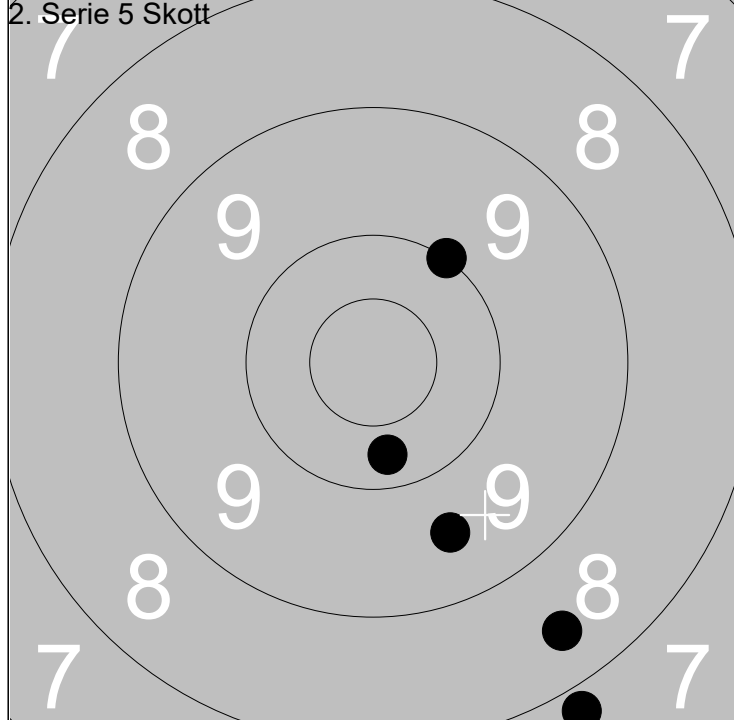

1: 7.8	↘
2: 10.3	↘
3: 8.5	↘
4: 10.0	↗
5: 9.6	↘

Serie	44
Total	89

1: 9.9	↘
2: 9.8	↗
3: 10.8x	↘
4: 9.7	←
5: 9.6	←

Serie	46
Total	135

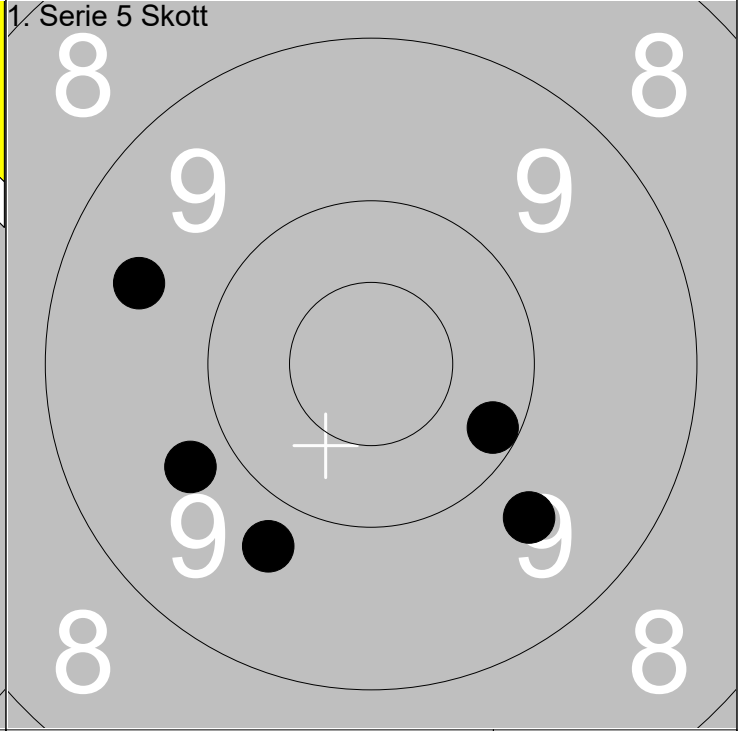
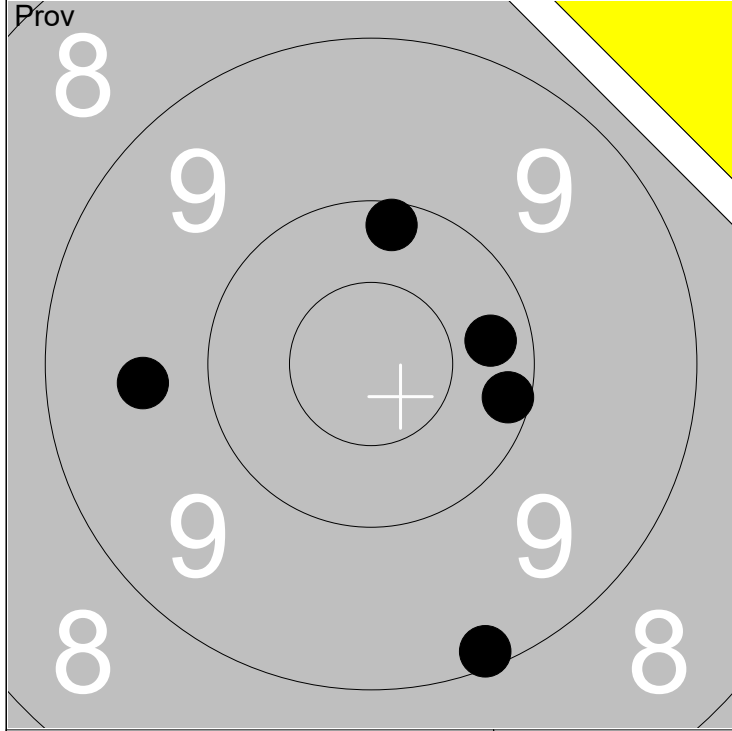

1: 10.3 →	Serie	48
2: 10.1 →		
3: 9.1 ↓		
4: 9.6 ←		
5: 10.2 ↑		
Total		0

1: 9.7 ↘	Serie	46
2: 10.2 →		
3: 9.8 ←		
4: 9.7 ↓		
5: 9.5 ←		
Total		46

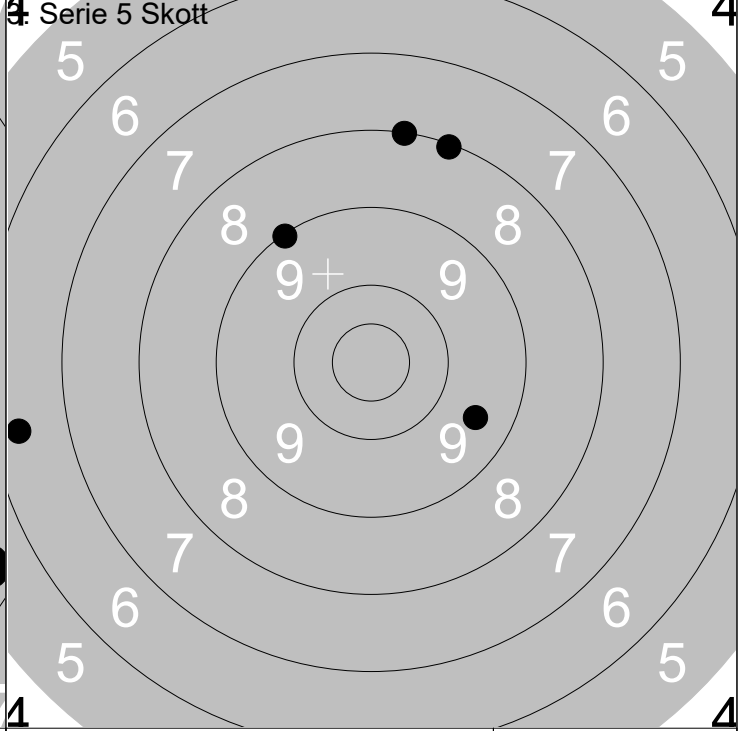
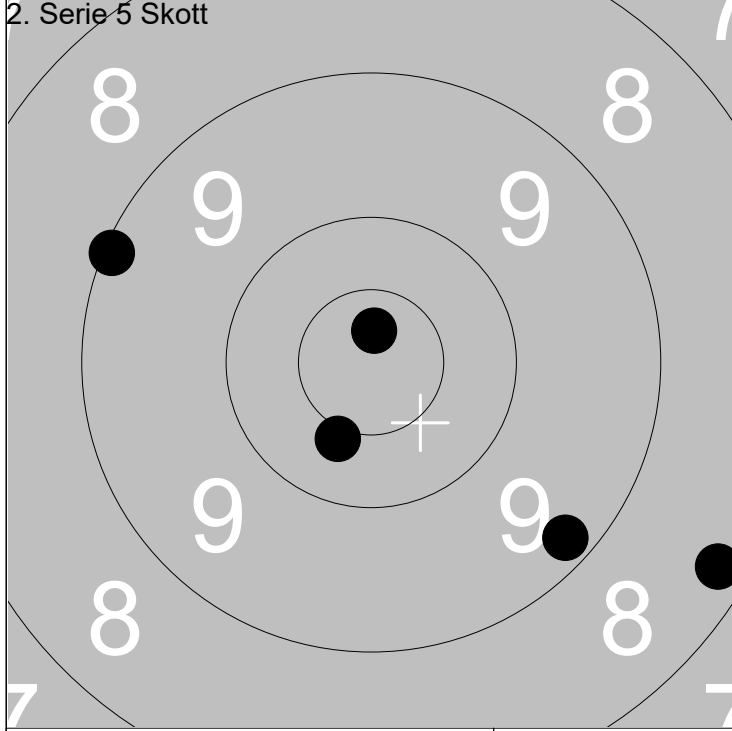

1: 9.2 ↓	Serie	46
2: 10.4x ↓		
3: 8.2 →		
4: 9.1 ←		
5: 10.7x ↑		
Total		92

1: 6.4 ←	Serie	40
2: 9.1 ↗		
3: 8.0 ↑		
4: 9.5 →		
5: 8.1 ↑		
Total		132

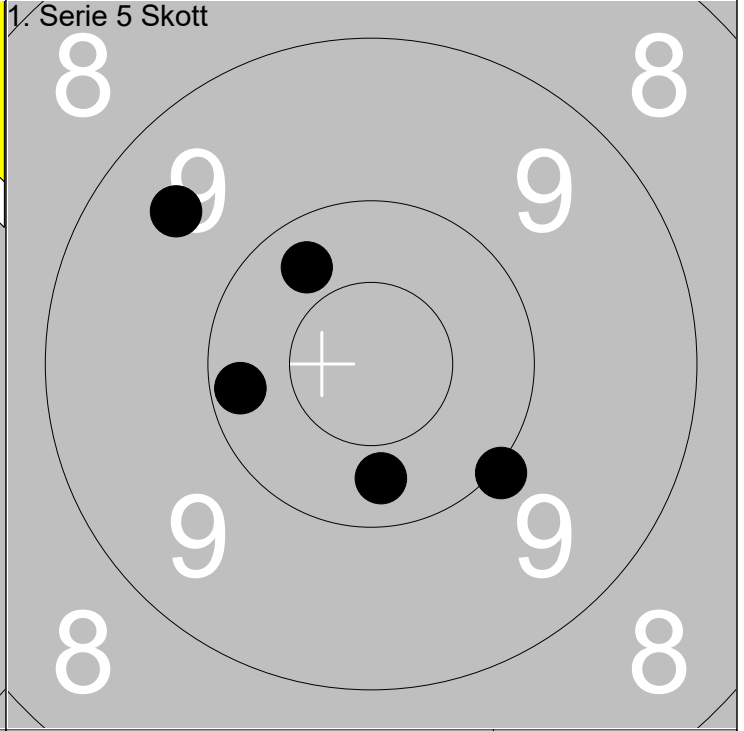
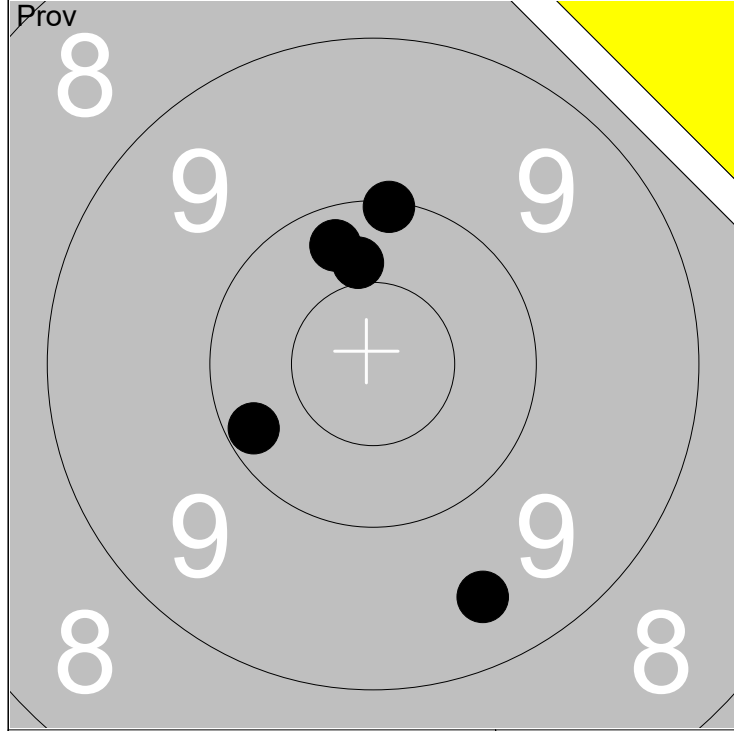

1: 10.4	↑
2: 9.5	↓
3: 10.2	↙
4: 10.2	↑
5: 10.1	↑

Serie	49
Total	0

1: 10.3	↓
2: 10.2	←
3: 9.5	↗
4: 10.3	↗
5: 10.0	↓

Serie	49
Total	49

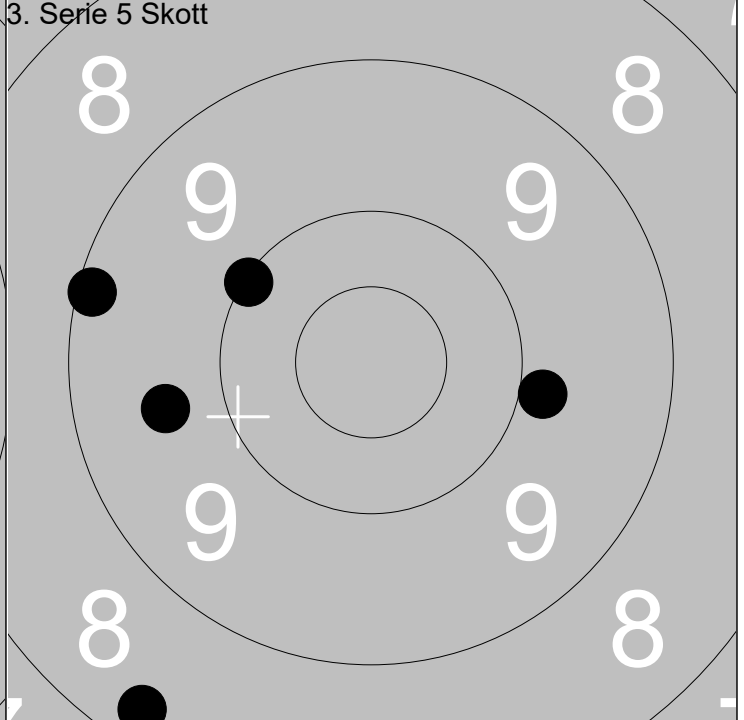
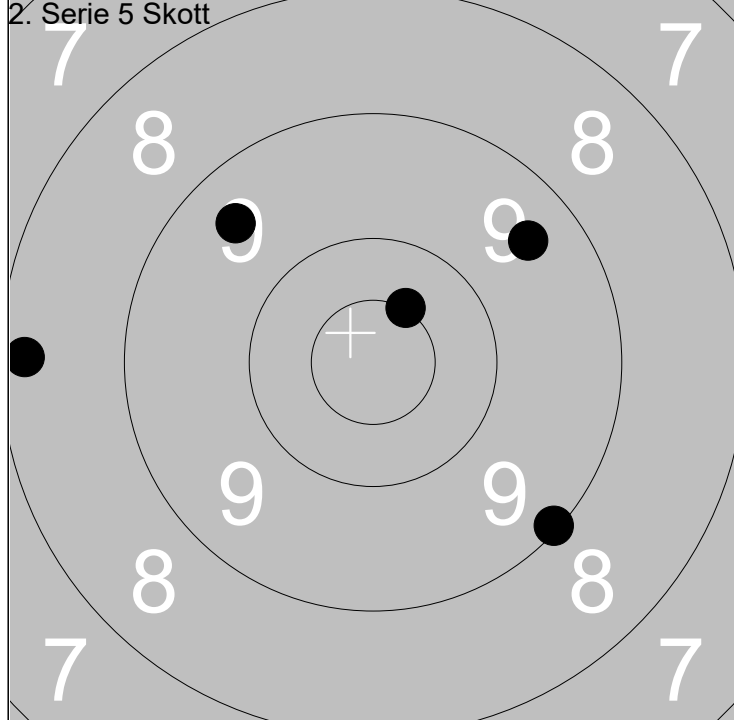

1: 9.4	↗
2: 9.5	↖
3: 10.5x	↗
4: 8.2	←
5: 9.1	↓

Serie	45
Total	94

1: 10.1	↖
2: 8.3	↓
3: 9.9	→
4: 9.6	←
5: 9.1	←

Serie	45
Total	139

Skjutlag

2

Tavla

12

Stefan Jonasson

Ramselefors

Hogdal

Knä

Jä

11.07.2021

Tavelstafetten 2021

Ramselefors SKF

Prov

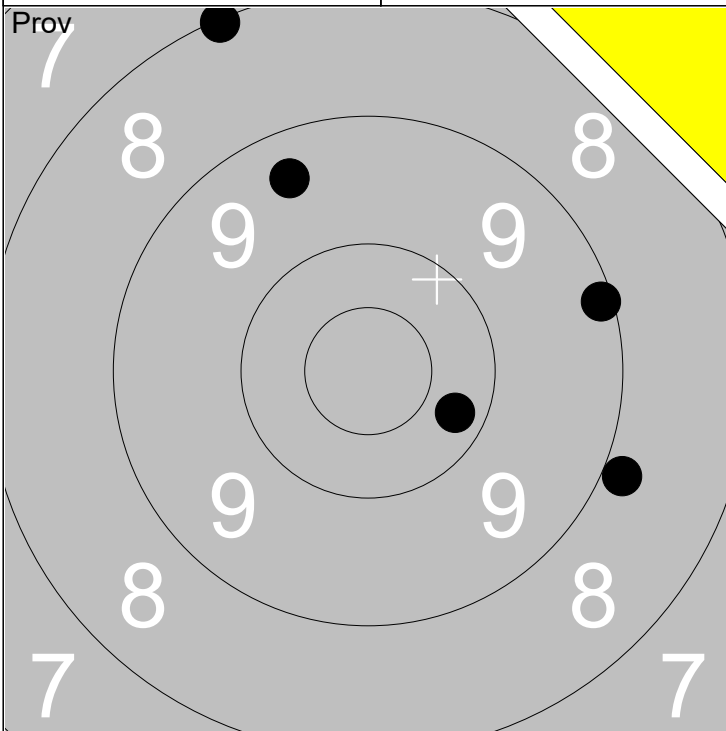

1. Serie 5 Skott

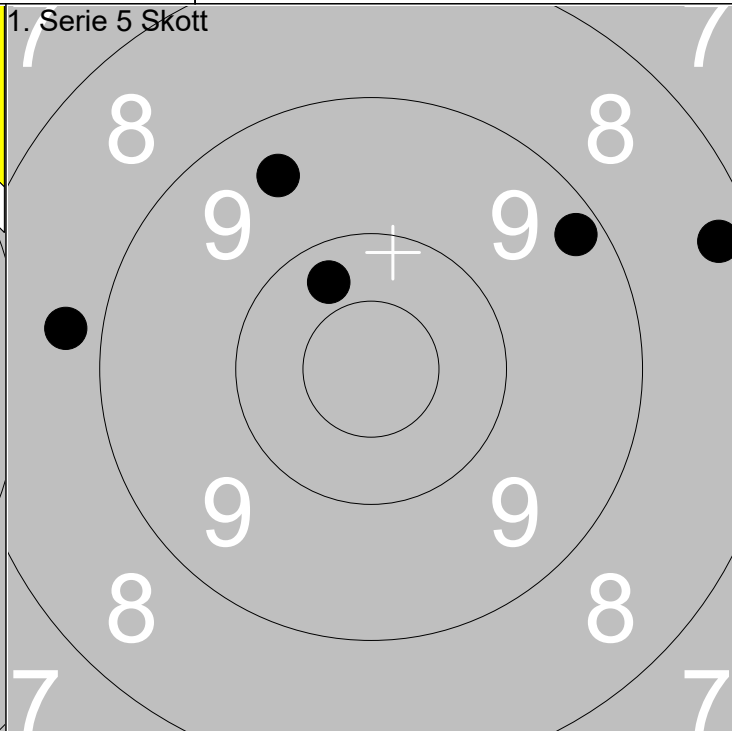

1: 8.1 ↗
 2: 9.4 ↗
 3: 8.9 ↘
 4: 10.3 ↘
 5: 9.1 →

Serie 44

Total 0

1: 8.3 →
 2: 9.2 ↗
 3: 9.4 ↗
 4: 8.8 ←
 5: 10.3 ↗

Serie 44

Total 44

2. Serie 5 Skott

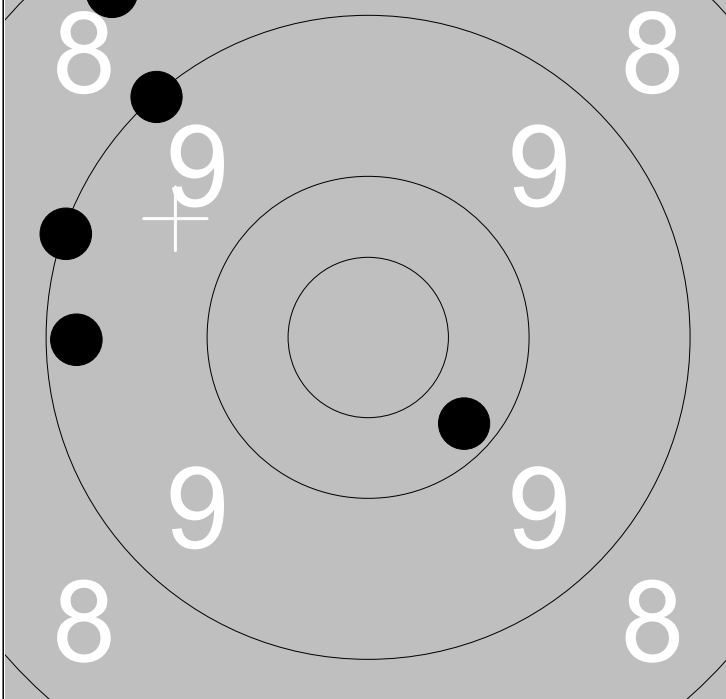

3. Serie 5 Skott

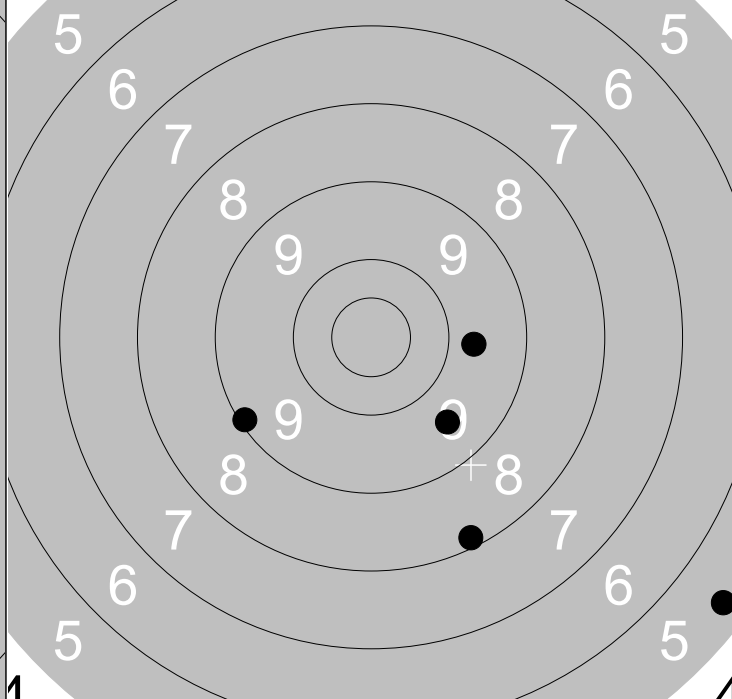

1: 9.2 ←
 2: 8.4 ↗
 3: 10.2 ↘
 4: 9.0 ↗
 5: 9.0 ↗

Serie 45

Total 89

1: 5.4 ↘
 2: 8.2 ↘
 3: 9.7 →
 4: 9.1 ←
 5: 9.6 ↘

Serie 40

Total 129

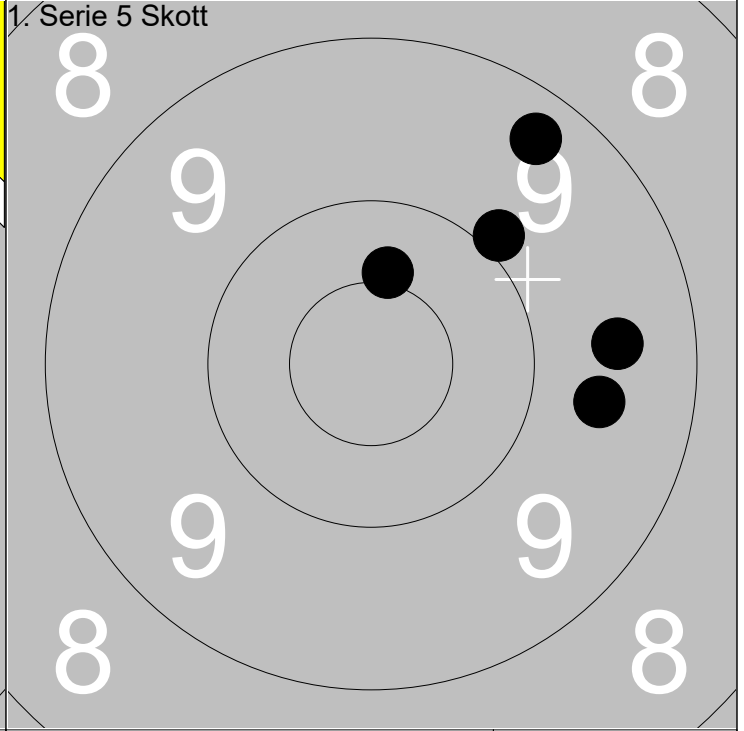
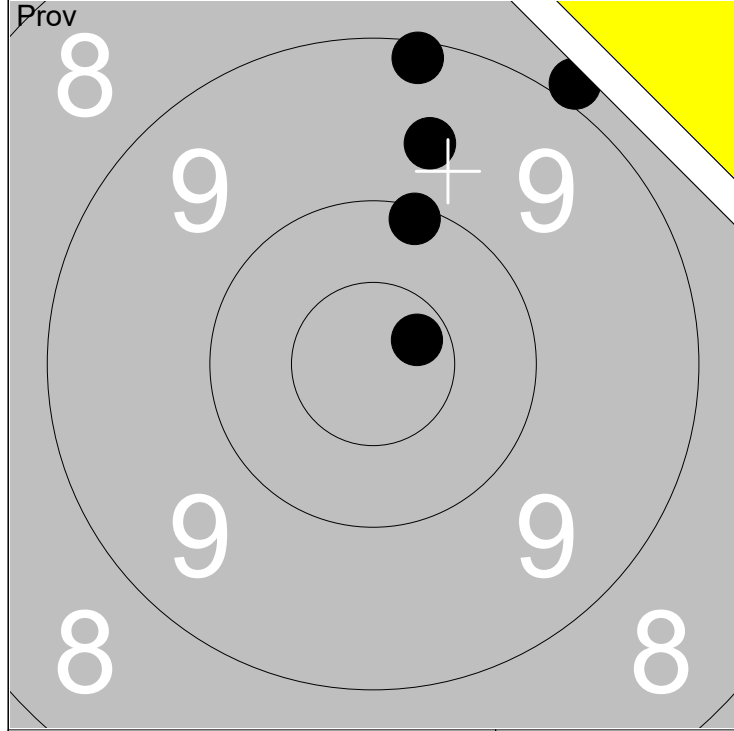

1: 10.7x ↗
2: 8.9 ↗
3: 10.1 ↑
4: 9.1 ↑
5: 9.6 ↑

Serie	46
Total	0

1: 9.6 →
2: 9.5 →
3: 10.4x ↑
4: 9.9 ↗
5: 9.3 ↗

Serie	46
Total	46

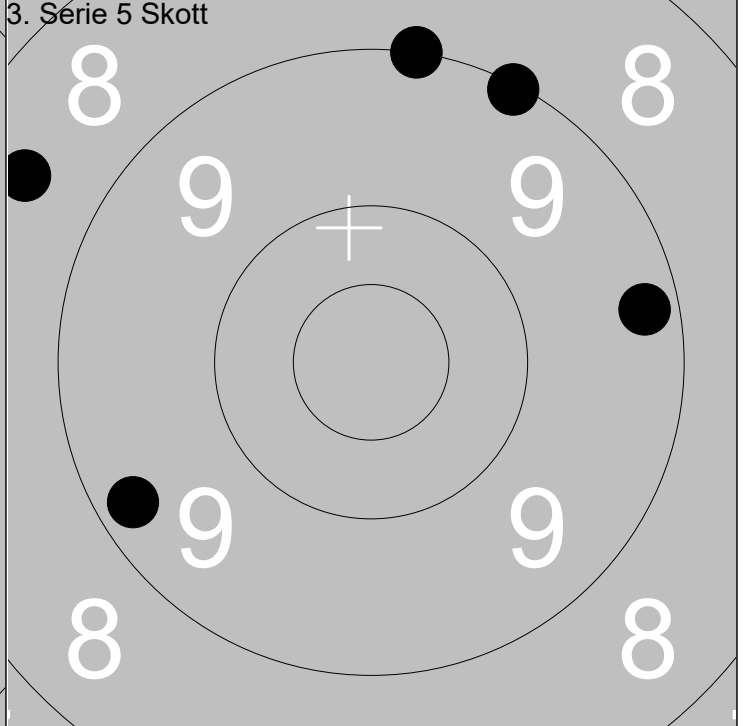
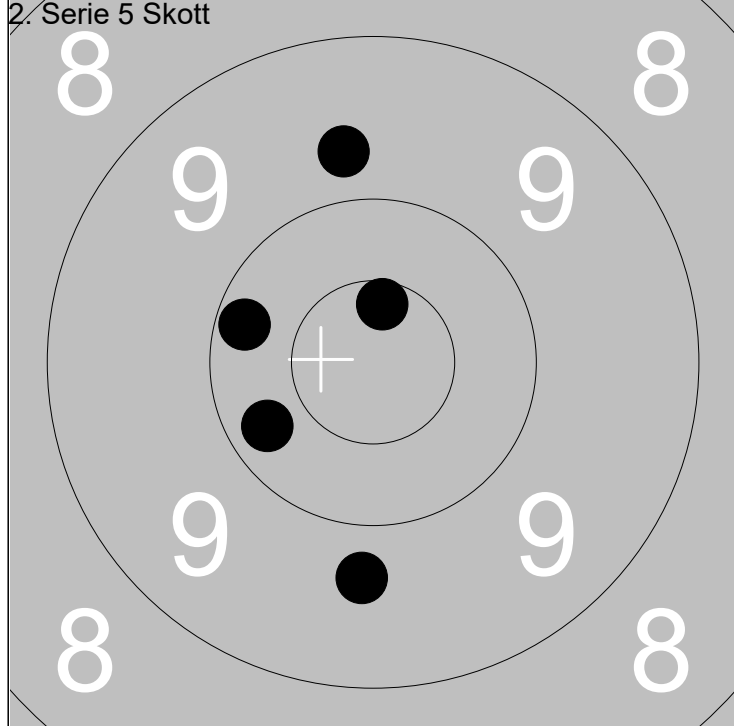

1: 10.2 ←
2: 10.2 ↙
3: 9.7 ↑
4: 10.6x ↑
5: 9.7 ↓

Serie	48
Total	94

1: 9.3 ↙
2: 9.0 ↑
3: 8.5 ↙
4: 9.3 →
5: 9.1 ↑

Serie	44
Total	138

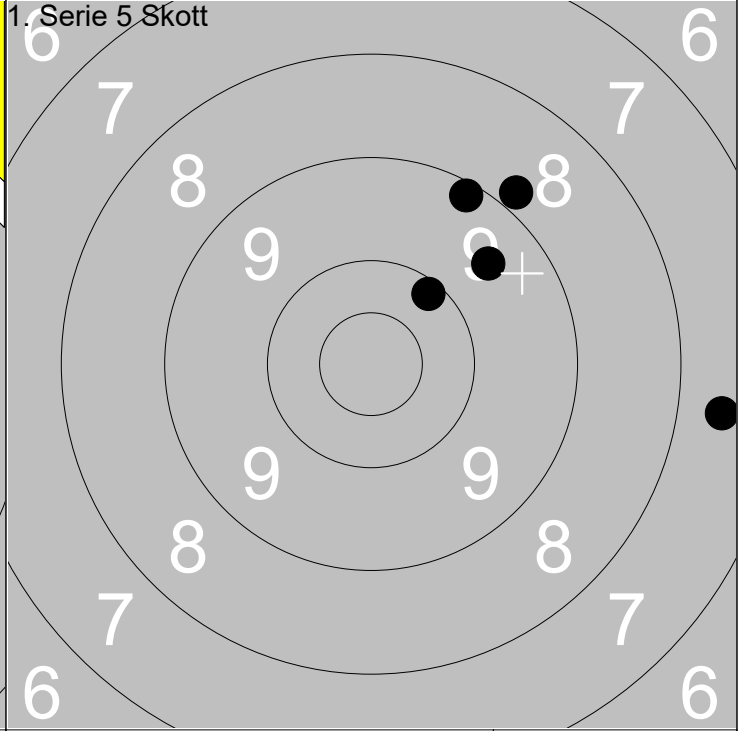
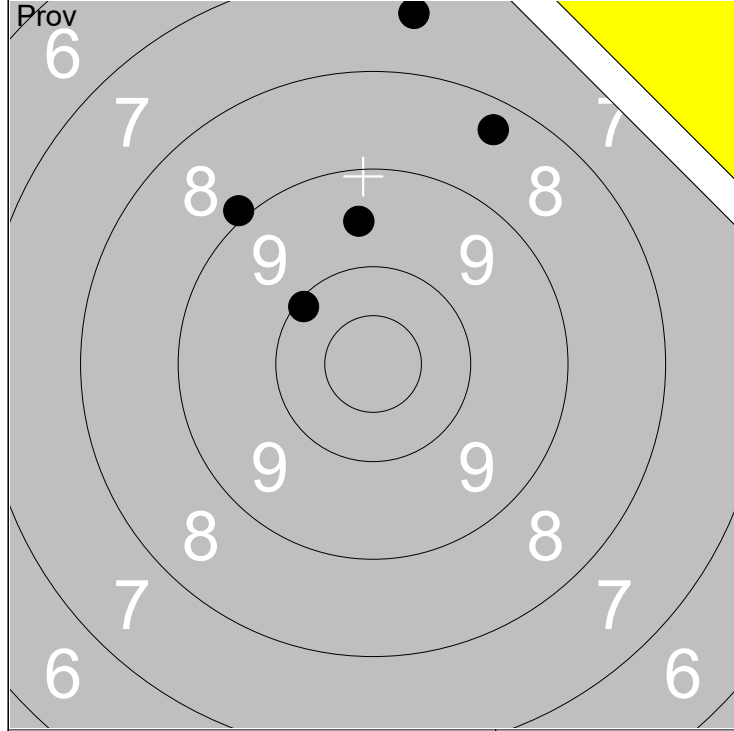

1: 8.3 ↗
2: 7.4 ↑
3: 10.1 ↖
4: 8.9 ↖
5: 9.6 ↑

Serie	42
Total	0

1: 9.5 ↗
2: 7.6 →
3: 9.2 ↗
4: 10.1 ↗
5: 8.9 ↗

Serie	43
Total	43

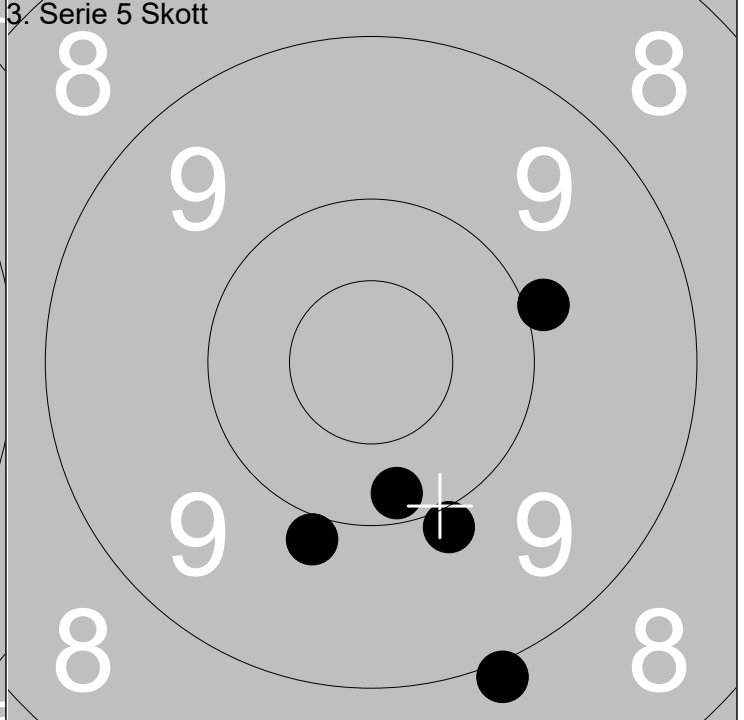
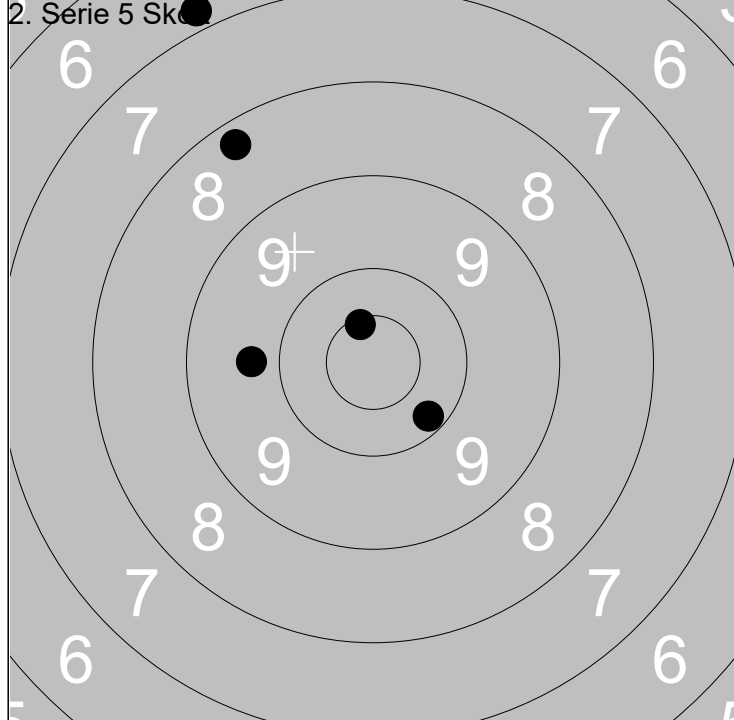

1: 9.7 ←
2: 8.3 ↗
3: 10.6x ↗
4: 10.2 ↓
5: 6.8 ↗

Serie	43
Total	86

1: 9.9 ↓
2: 9.9 ↓
3: 10.2 ↓
4: 9.9 →
5: 8.9 ↓

Serie	45
Total	131

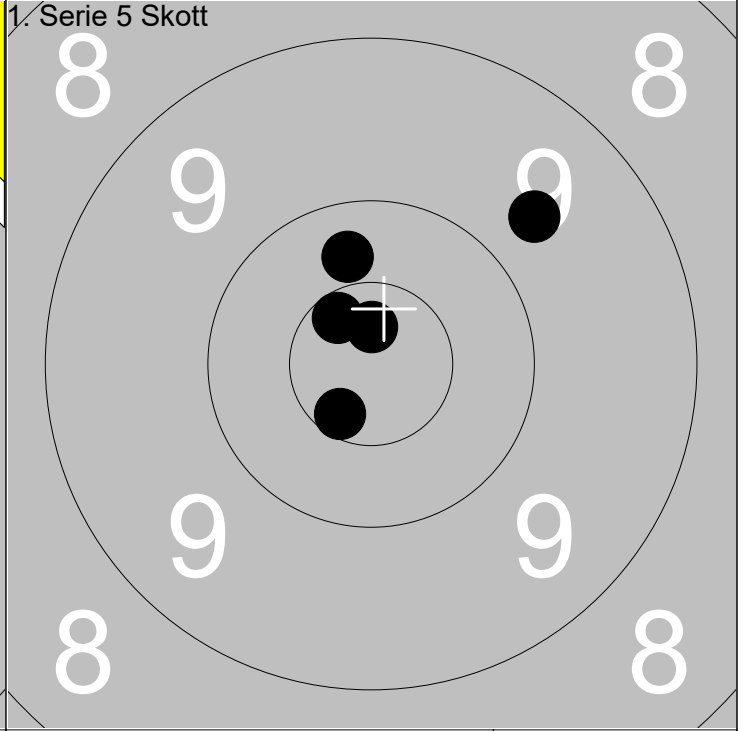
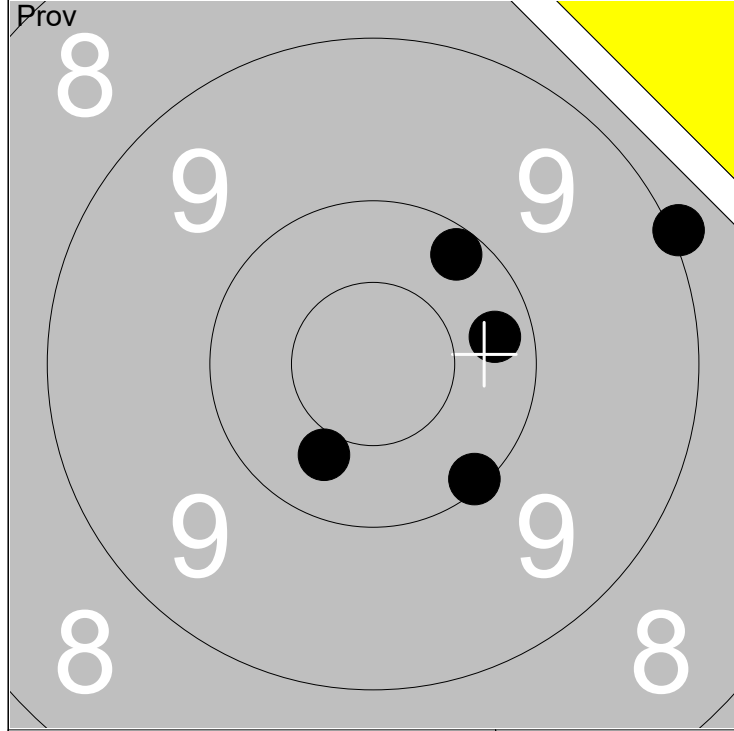

1: 9.0 →
2: 10.2 ↗
3: 10.4 ↘
4: 10.2 →
5: 10.1 ↘

Serie	49
Total	0

1: 10.6x ↙
2: 10.3 ↗
3: 10.7x ↑
4: 9.7 ↗
5: 10.6x ↘

Serie	49
Total	49

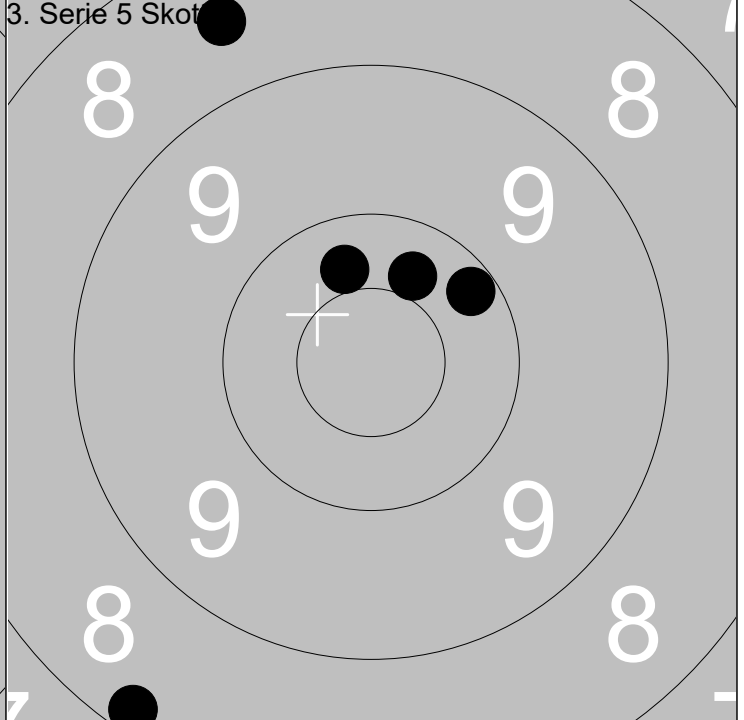
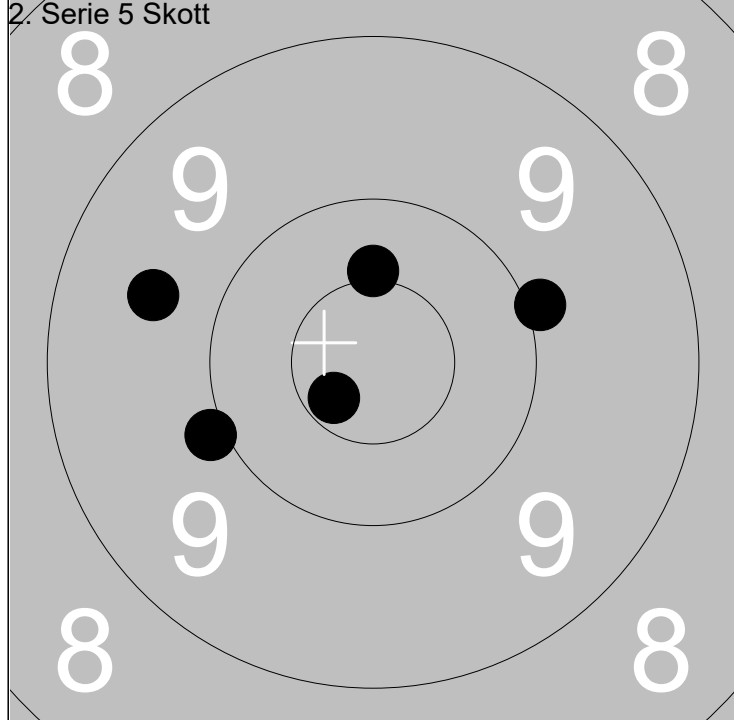

1: 9.9 →
2: 10.6x ↘
3: 9.6 ←
4: 9.9 ←
5: 10.4x ↑

Serie	47
Total	96

1: 10.4 ↗
2: 10.2 ↗
3: 10.3 ↗
4: 8.5 ↗
5: 8.2 ↘

Serie	46
Total	142

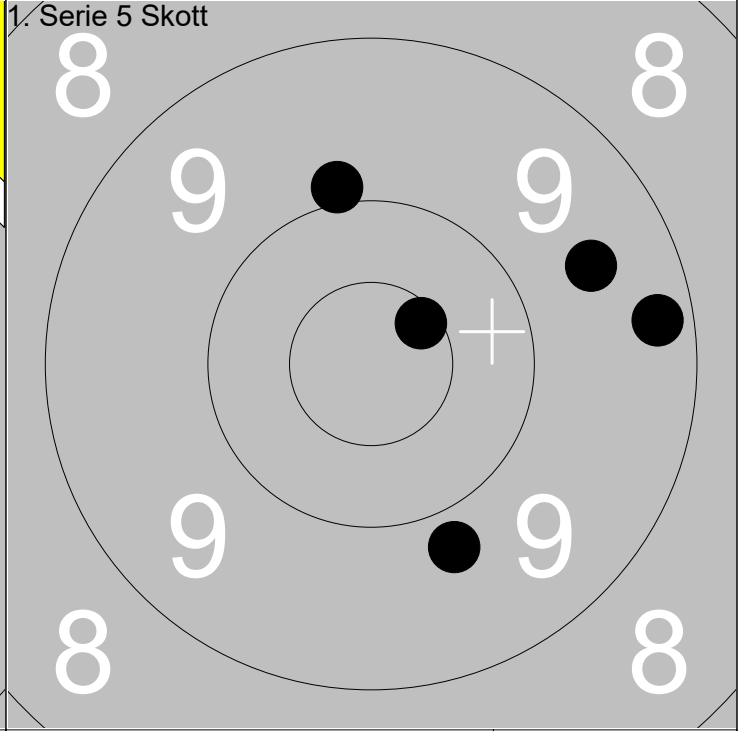
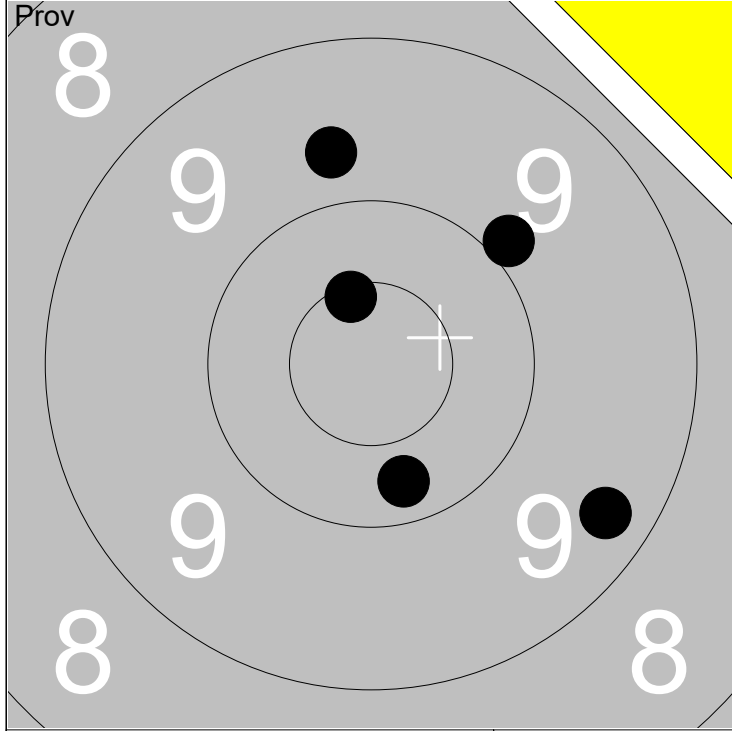

1: 9.9 ↗
2: 9.3 ↘
3: 10.5x ↗
4: 9.7 ↗
5: 10.3 ↘

Serie	47
Total	0

1: 9.3 →
2: 9.8 ↘
3: 9.9 ↗
4: 10.6x ↗
5: 9.6 →

Serie	46
Total	46

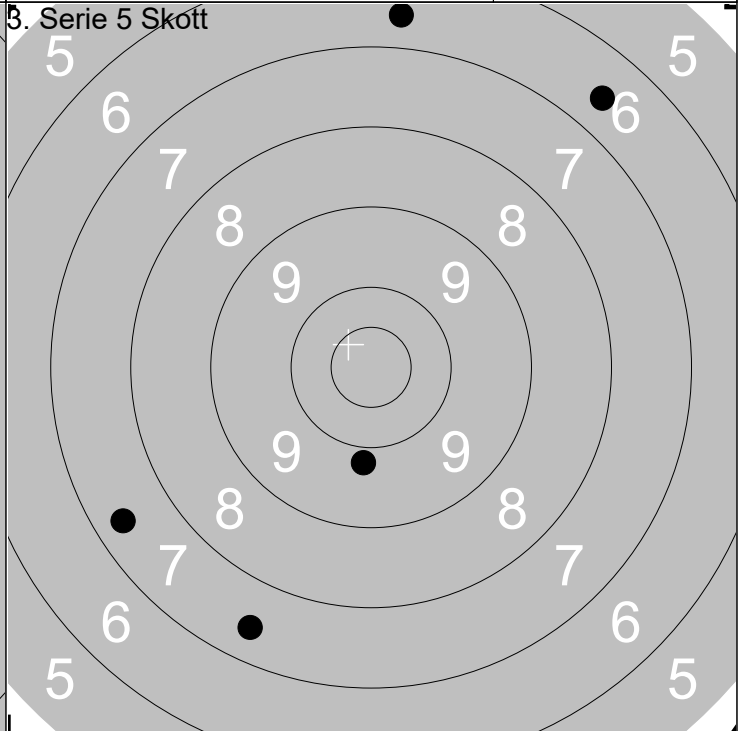
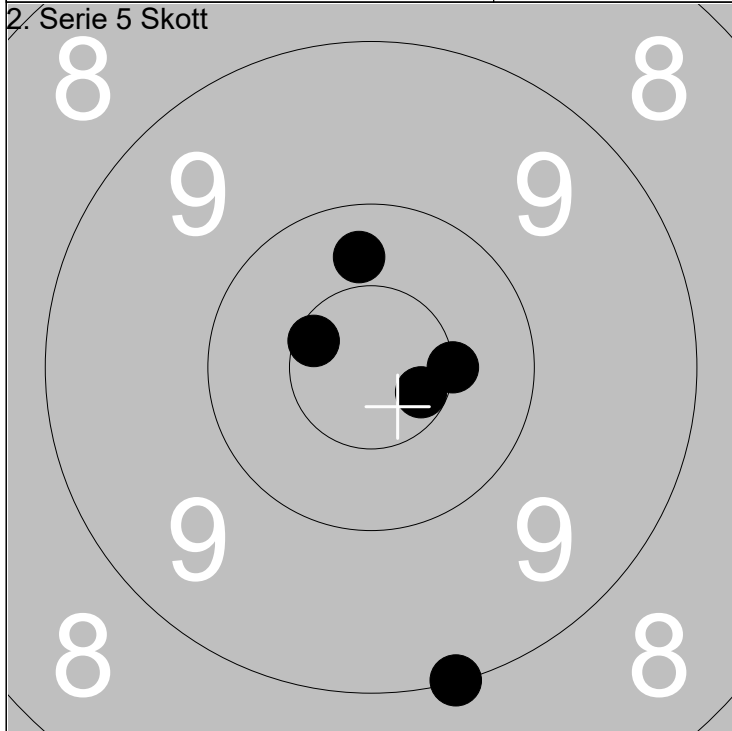

1: 10.3 ↗
2: 9.0 ↘
3: 10.6x ↗
4: 10.6x ↘
5: 10.5x →

Serie	49
Total	95

1: 9.8 ↘
2: 7.4 ↙
3: 7.4 ↘
4: 6.6 ↗
5: 6.6 ↗

Serie	35
Total	130

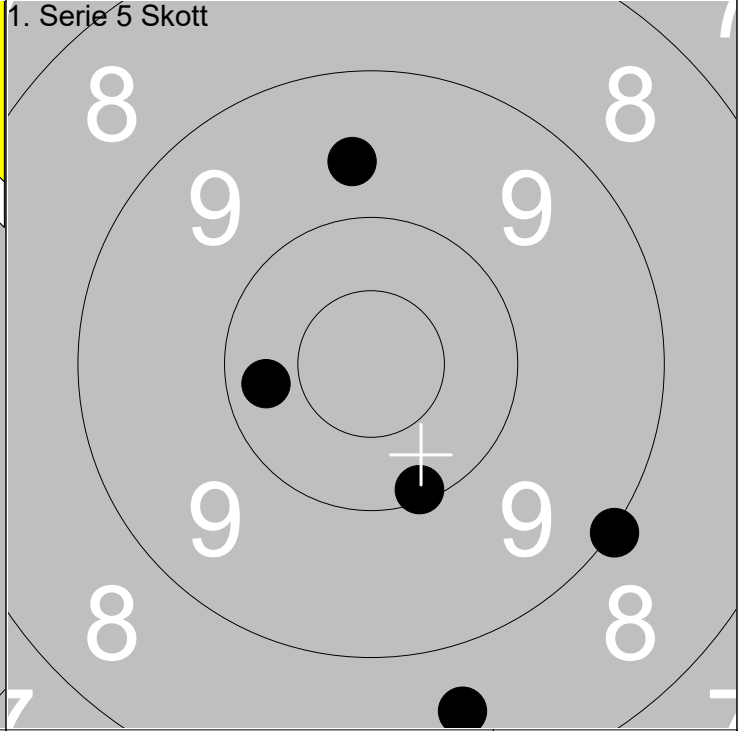
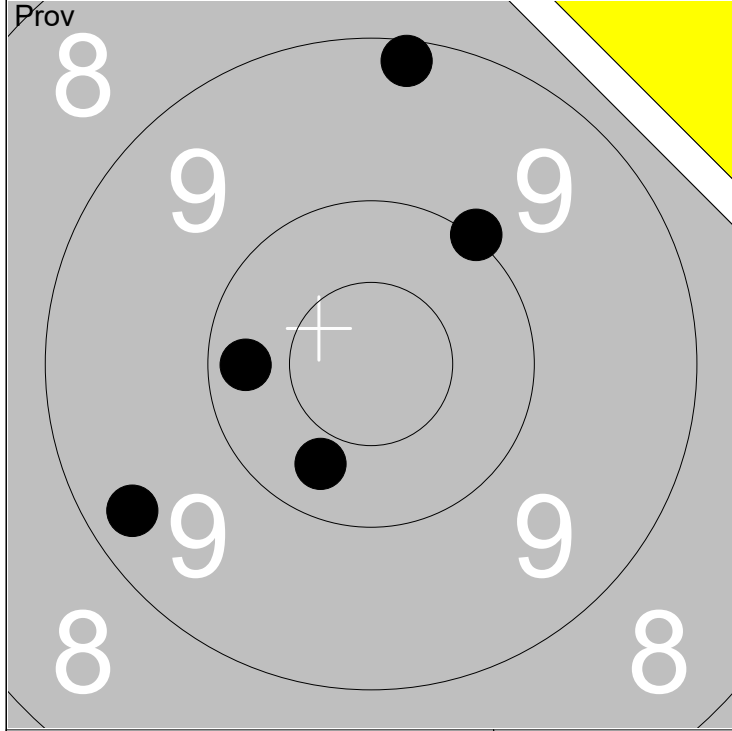

1: 9.2	↑
2: 10.0	↗
3: 10.2	←
4: 10.3	↘
5: 9.3	↙

Serie	48
Total	0

1: 9.6	↑
2: 10.1	↘
3: 10.3	←
4: 9.0	↘
5: 8.6	↘

Serie	46
Total	46

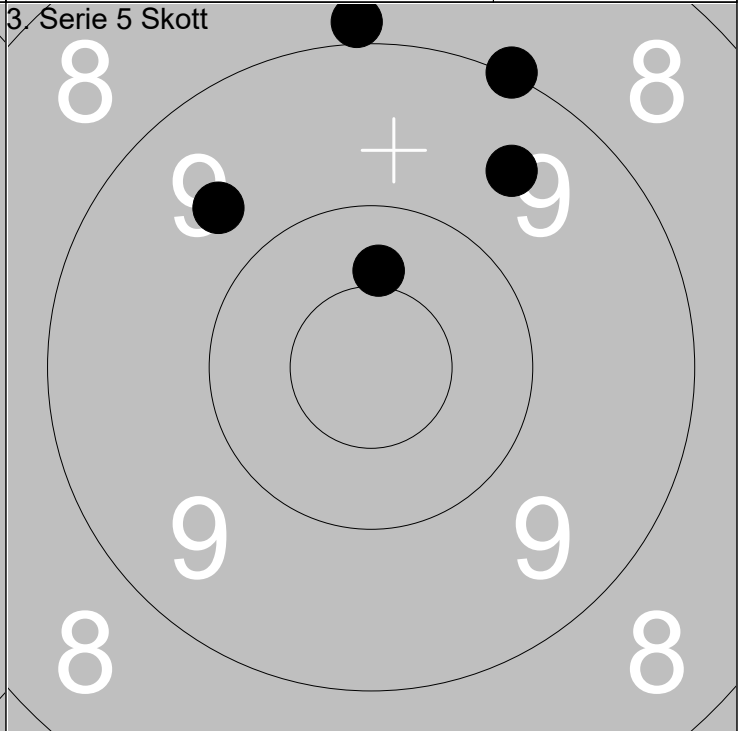
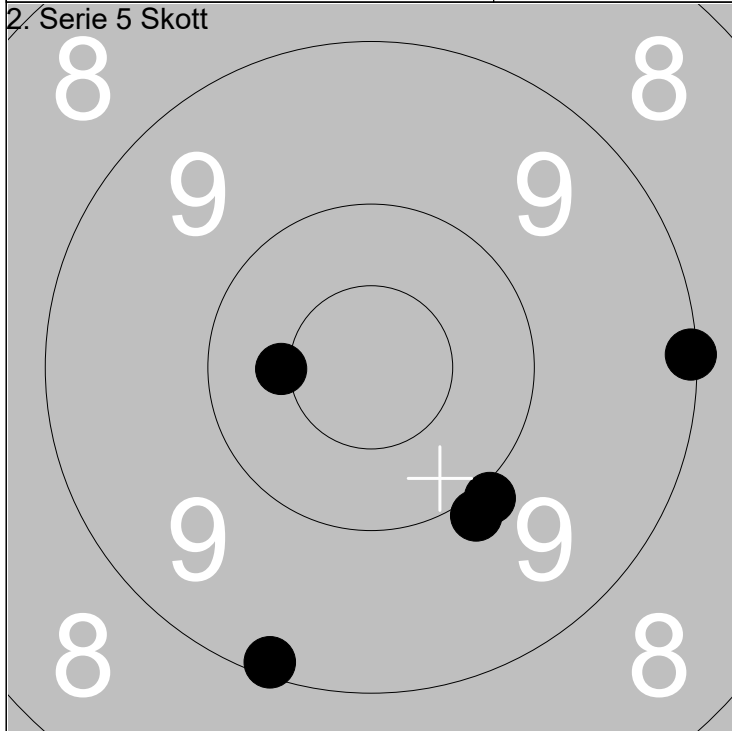

1: 9.1	→
2: 9.9	↘
3: 10.4x	←
4: 9.1	↘
5: 9.9	↘

Serie	46
Total	92

1: 9.0	↗
2: 9.7	↖
3: 9.5	↗
4: 8.9	↑
5: 10.4	↑

Serie	45
Total	137

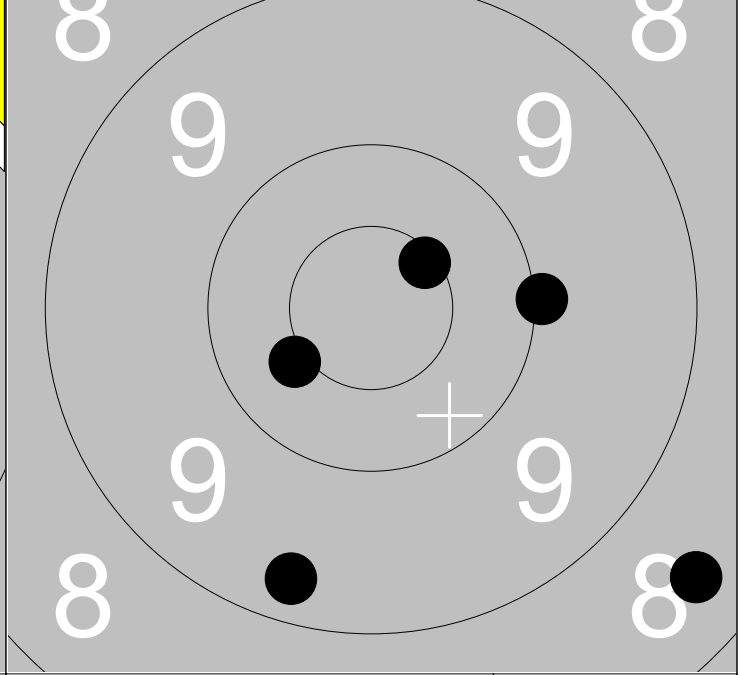
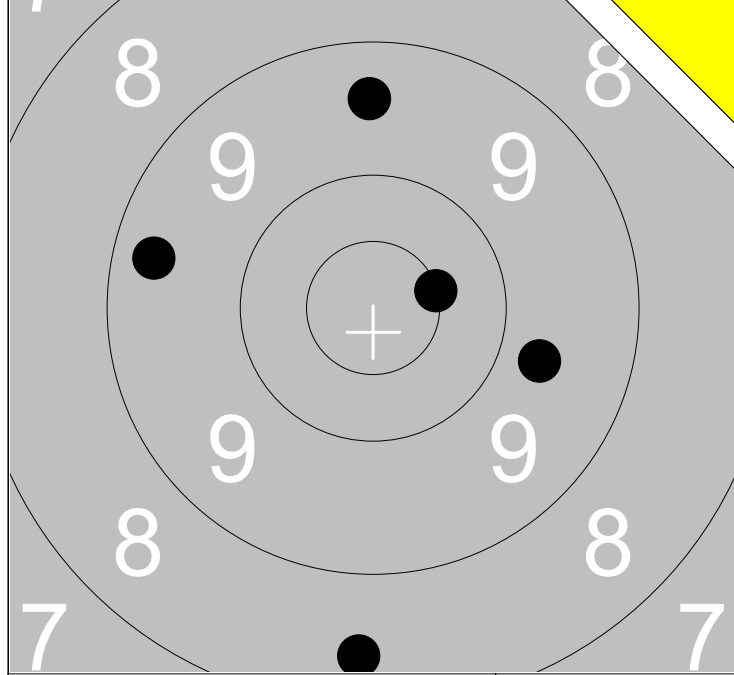

1: 9.3	←
2: 10.5x	→
3: 8.4	↓
4: 9.7	→
5: 9.5	↑

Serie	45
Total	0

1: 10.6x	↗
2: 9.3	↓
3: 10.4x	↙
4: 10.0	→
5: 8.4	↘

Serie	47
Total	47

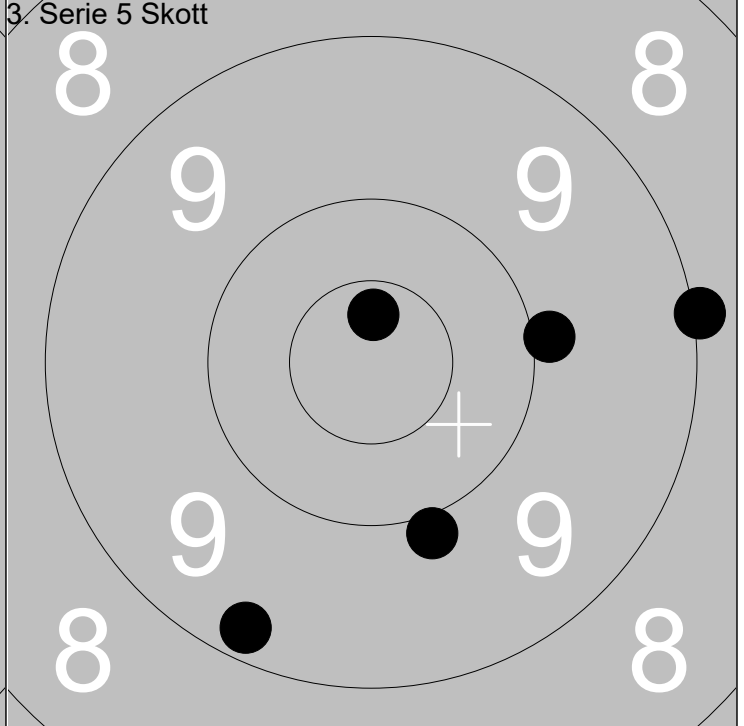
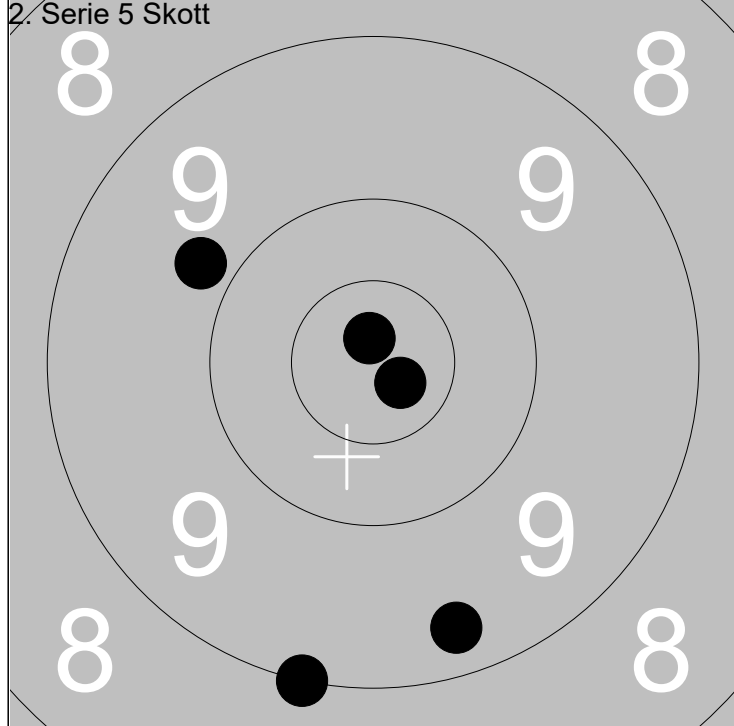

1: 9.3	↓
2: 9.0	↓
3: 10.8x	↑
4: 9.8	↖
5: 10.8x	↘

Serie	47
Total	94

1: 9.9	→
2: 10.7x	↑
3: 9.9	↓
4: 9.2	↓
5: 9.0	→

Serie	46
Total	140

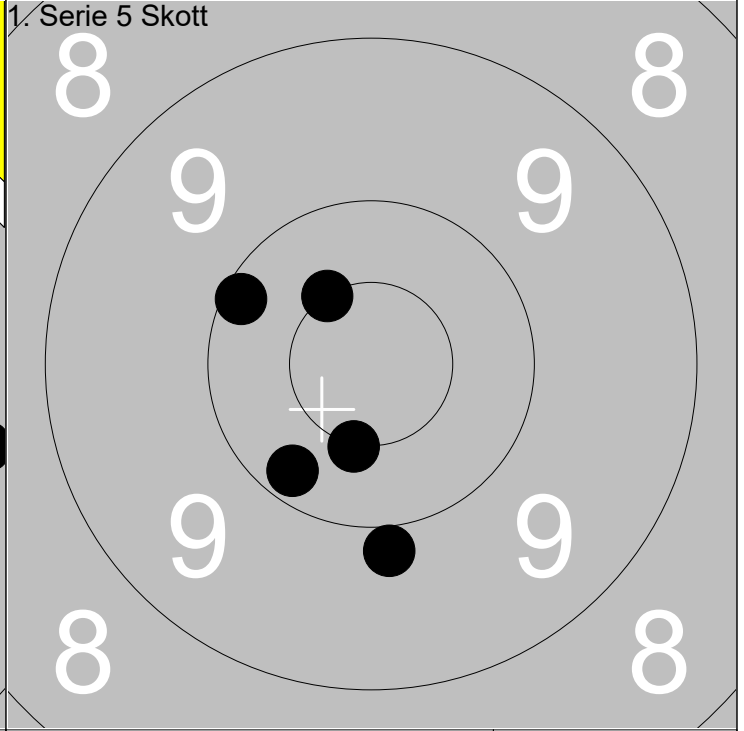
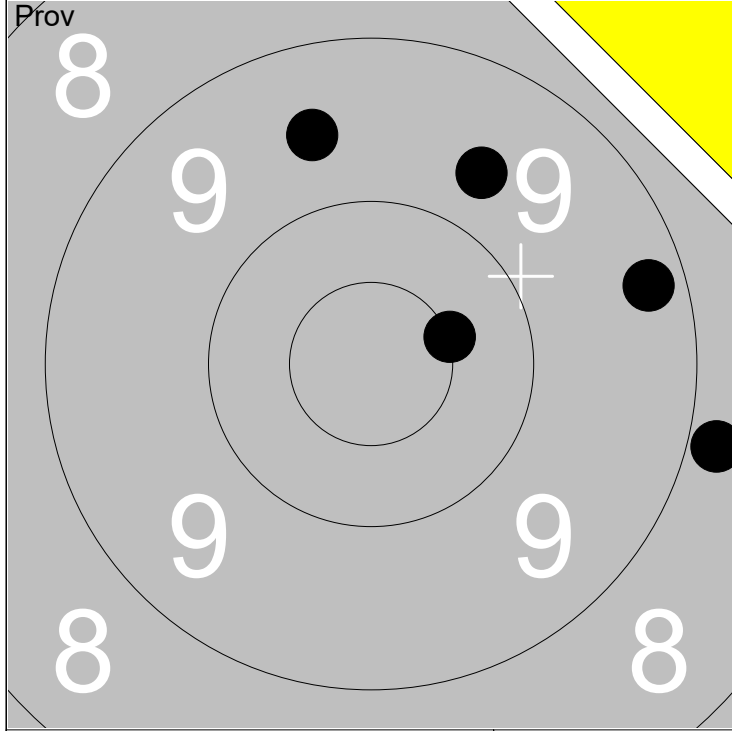

1: 9.7 ↗	Serie 45
2: 8.8 →	
3: 9.3 →	
4: 10.5x →	
5: 9.6 ↗	
Total 0	

1: 10.1 ↖	Serie 49
2: 10.5x ↖	
3: 10.5x ↓	
4: 9.9 ↓	
5: 10.2 ↘	
Total 49	

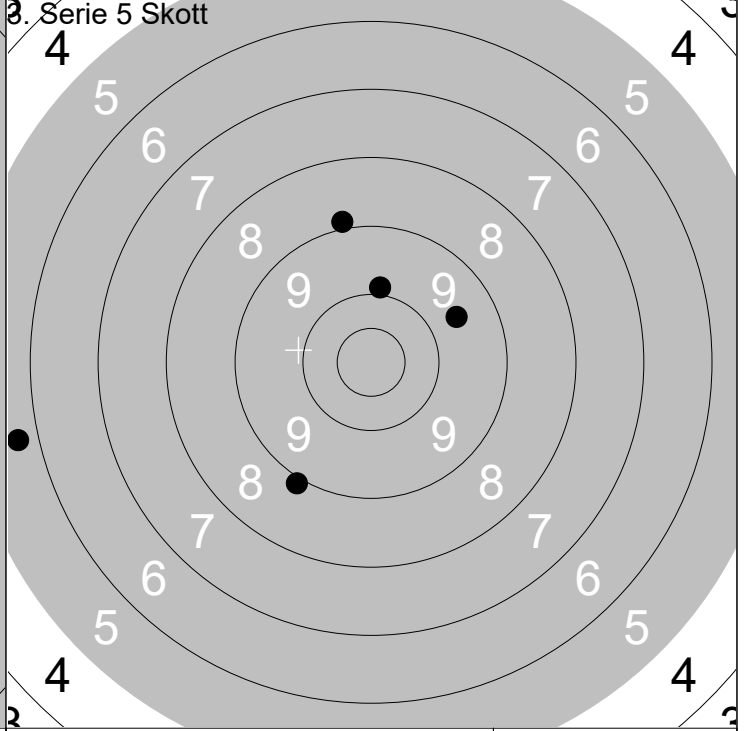
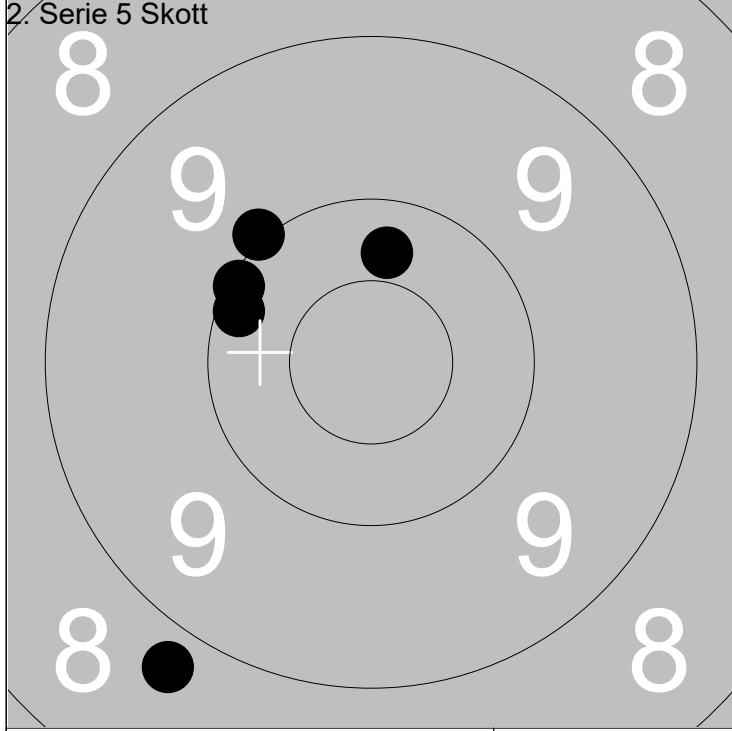

1: 10.3 ↑	Serie 48
2: 10.1 ↖	
3: 10.0 ↖	
4: 10.1 ↖	
5: 8.8 ↘	
Total 97	

1: 9.9 ↑	Serie 39
2: 9.6 →	
3: 8.9 ↑	
4: 8.9 ↓	
5: 5.7 ←	
Total 136	

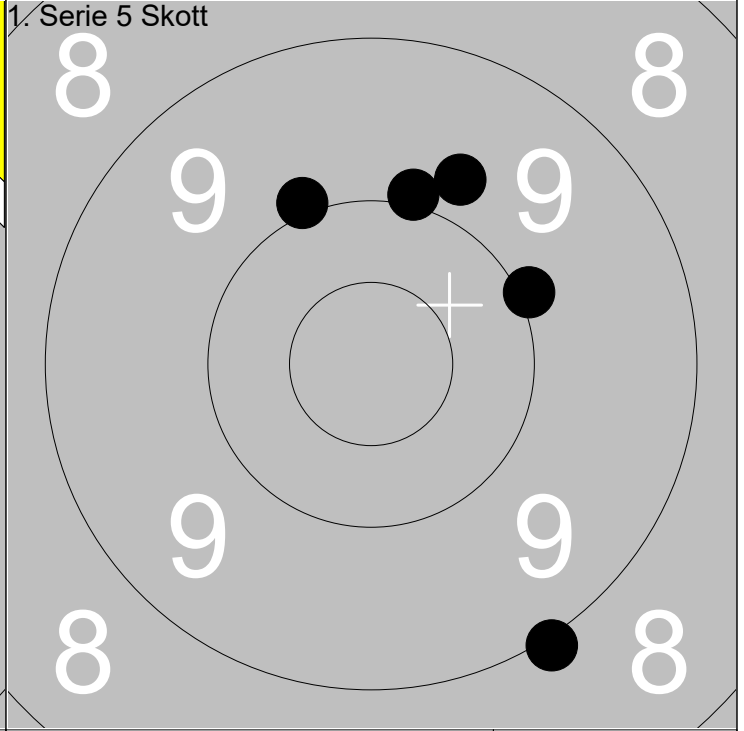
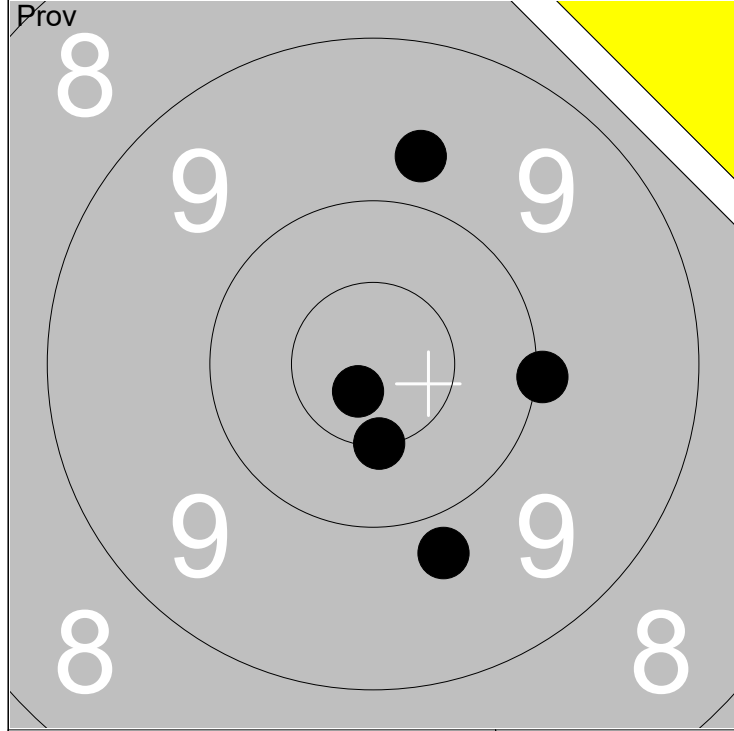

1: 9.7	↑
2: 10.0	→
3: 9.8	↓
4: 10.8x	↙
5: 10.5x	↓

Serie	48
Total	0

1: 9.8	↑
2: 10.0	→
3: 10.0	↑
4: 10.0	↑
5: 9.0	↓

Serie	48
Total	48

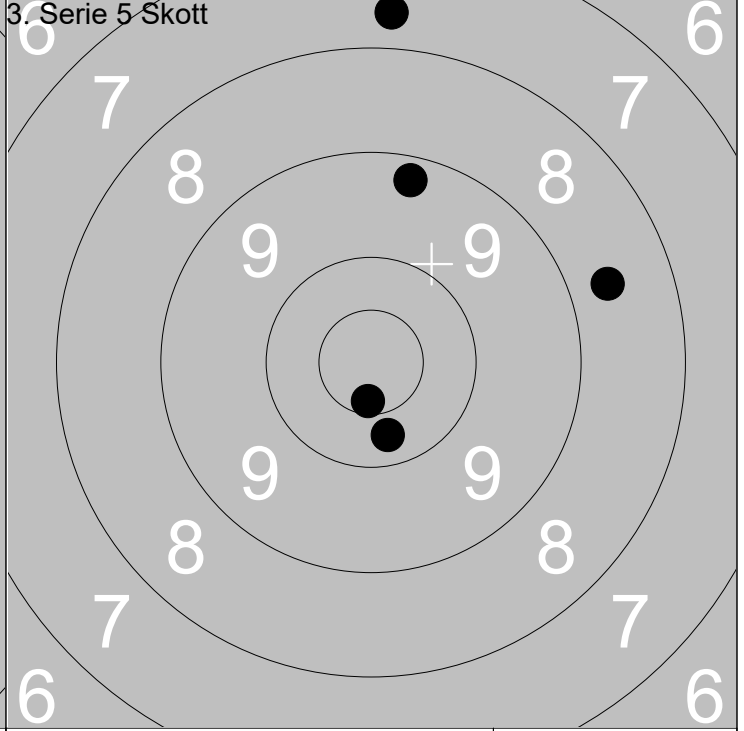
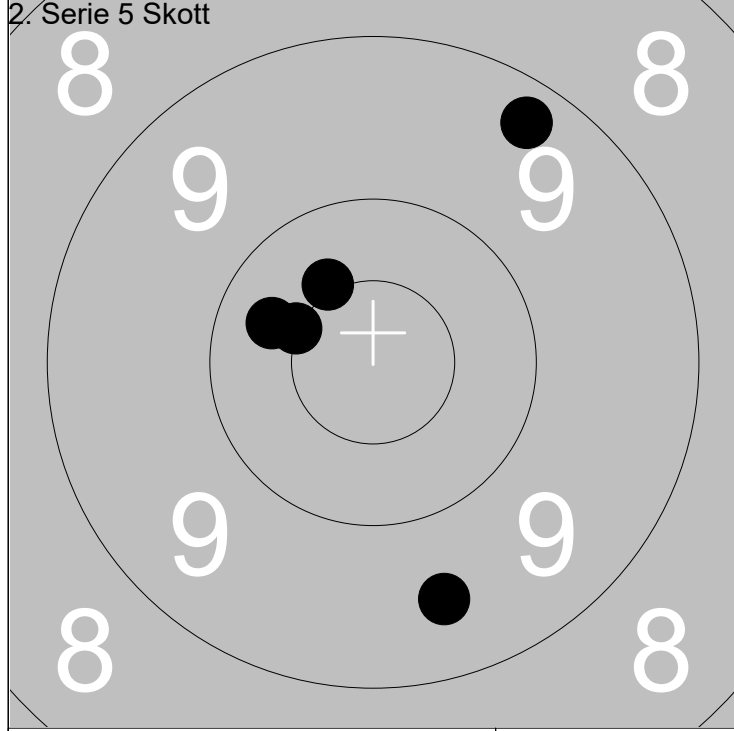

1: 9.3	↗
2: 10.4x	↗
3: 10.3	↖
4: 9.5	↓
5: 10.5x	↖

Serie	48
Total	96

1: 10.6x	↓
2: 8.7	→
3: 9.3	↑
4: 7.7	↑
5: 10.3	↓

Serie	44
Total	140

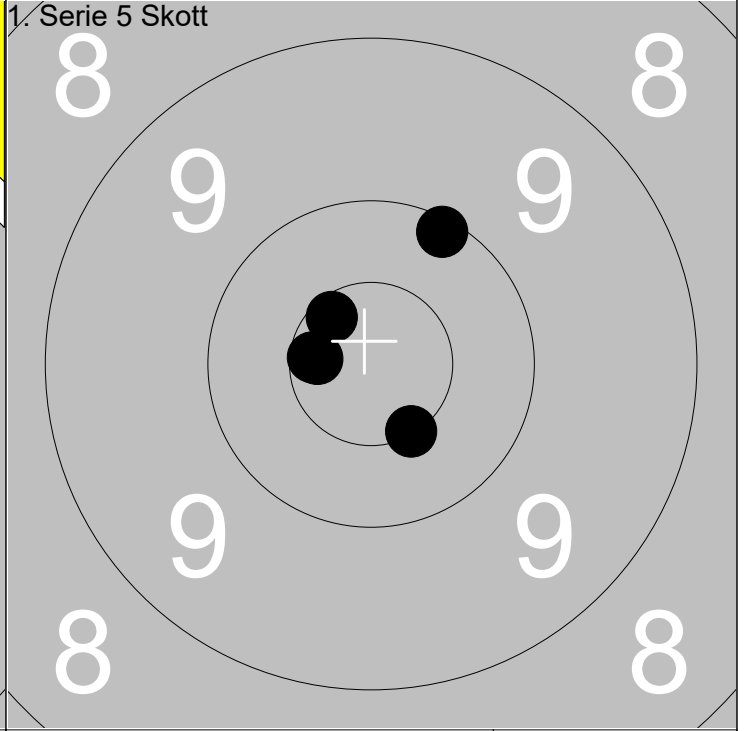
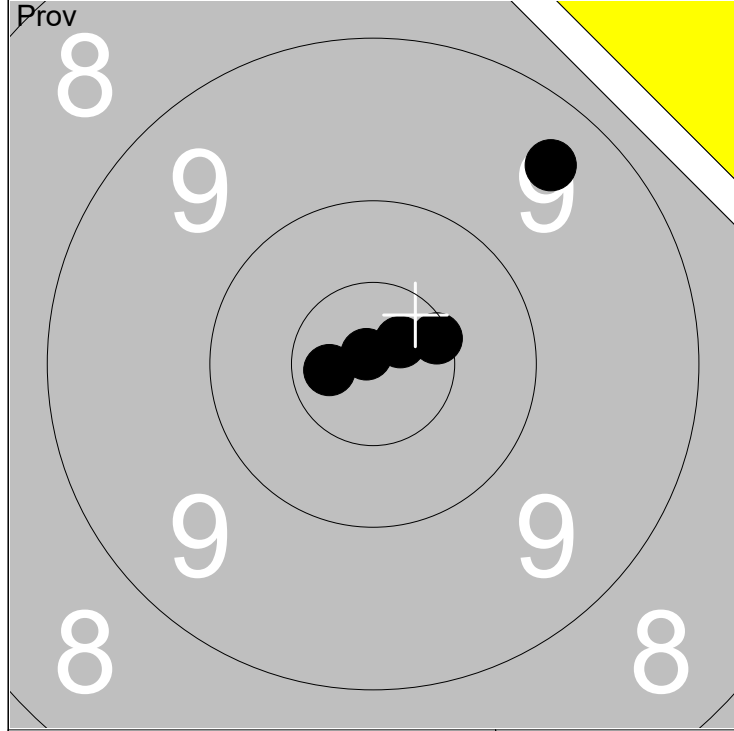

1: 9.4 ↗	Serie	49
2: 10.8x ↗		
3: 10.6x →		
4: 10.9x ↖		
5: 10.7x ←		
Total		0

1: 10.6x ←	Serie	50
2: 10.5x ↘		
3: 10.1 ↗		
4: 10.6x ←		
5: 10.6x ↖		
Total		50

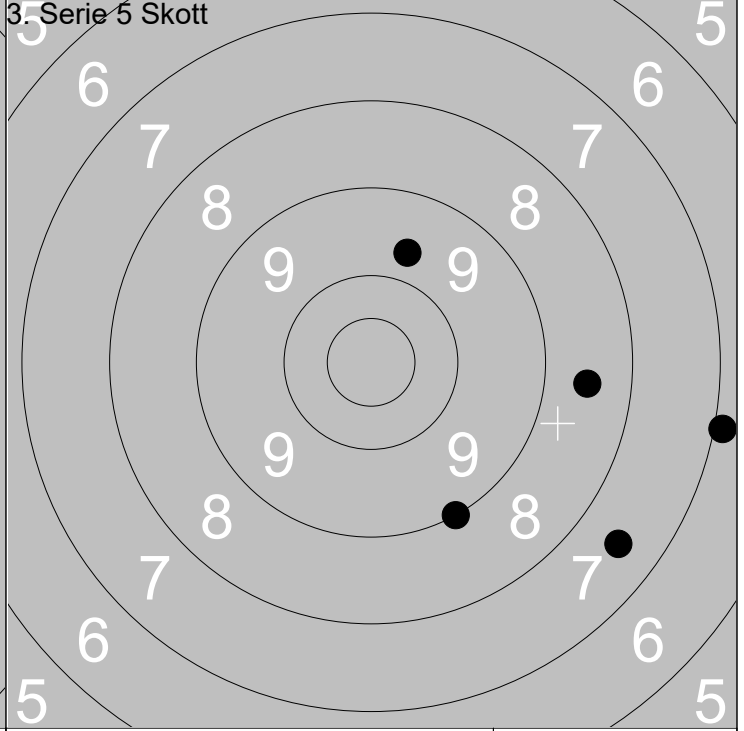
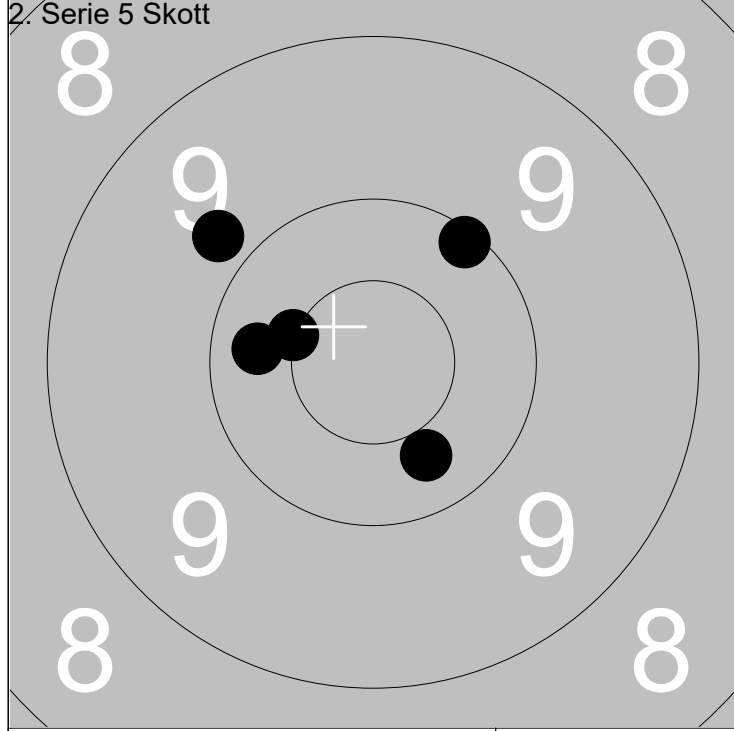

1: 10.5x ←	Serie	49
2: 10.3 ←		
3: 9.8 ↗		
4: 10.3 ↘		
5: 10.1 ↗		
Total		99

1: 9.7 ↗	Serie	39
2: 9.0 ↘		
3: 8.5 →		
4: 7.5 ↘		
5: 6.9 →		
Total		138

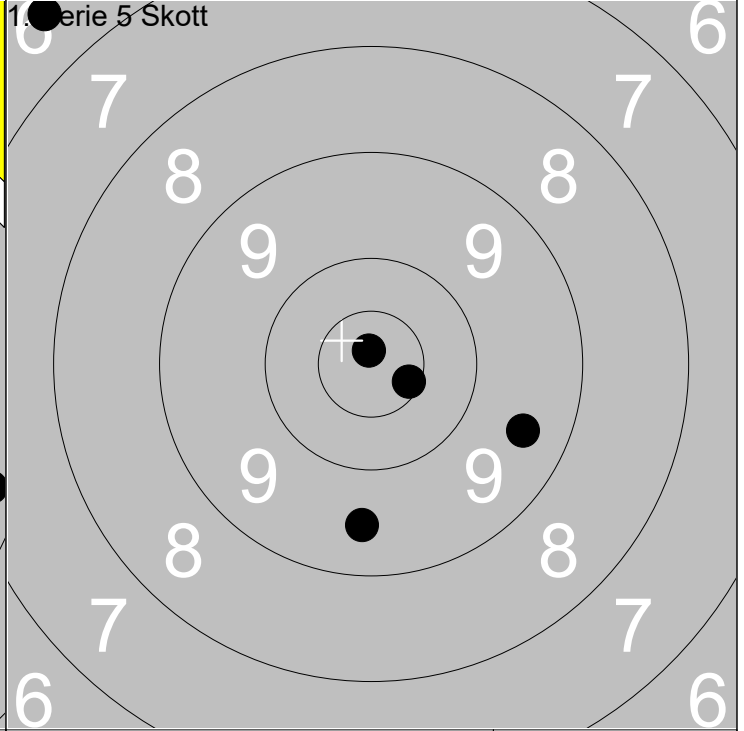
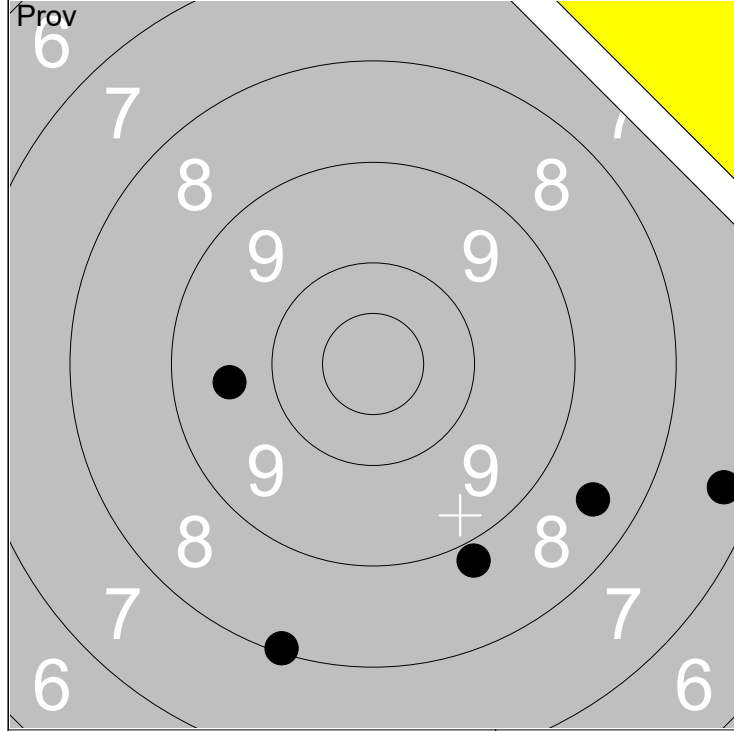

1: 7.4	➔
2: 8.5	➘
3: 8.1	➙
4: 8.8	➘
5: 9.6	➔

Serie	40
Total	0

1: 6.5	↖
2: 10.8x	↗
3: 9.5	➔
4: 9.5	➙
5: 10.6x	➔

Serie	44
Total	44

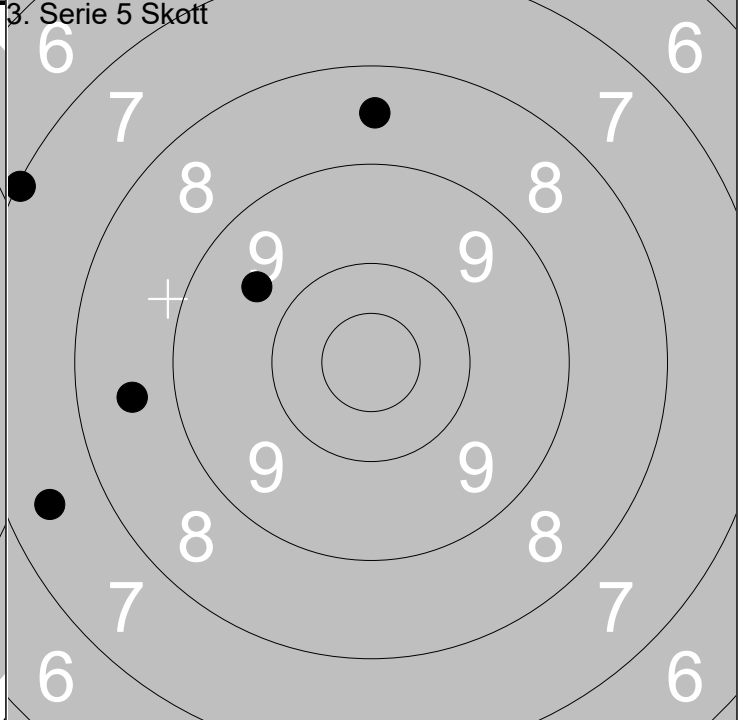
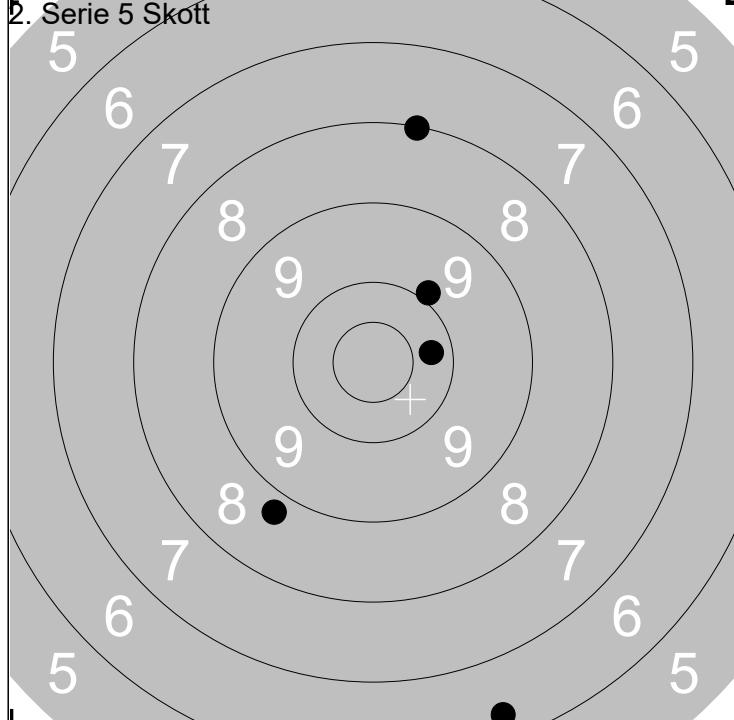

1: 6.3	➙
2: 8.0	↗
3: 9.9	↗
4: 10.3	➔
5: 8.8	➙

Serie	41
Total	85

1: 8.5	↗
2: 7.5	↖
3: 9.6	↖
4: 8.6	↖
5: 7.1	↖

Serie	39
Total	124

Skjutlag

3

Tavla

7

Kasper Svensson

Ramselefors

Eggvena-Bråttensby

Ställn

Vg

11.07.2021

Tavelstafetten 2021

Ramselefors SKF

Prov

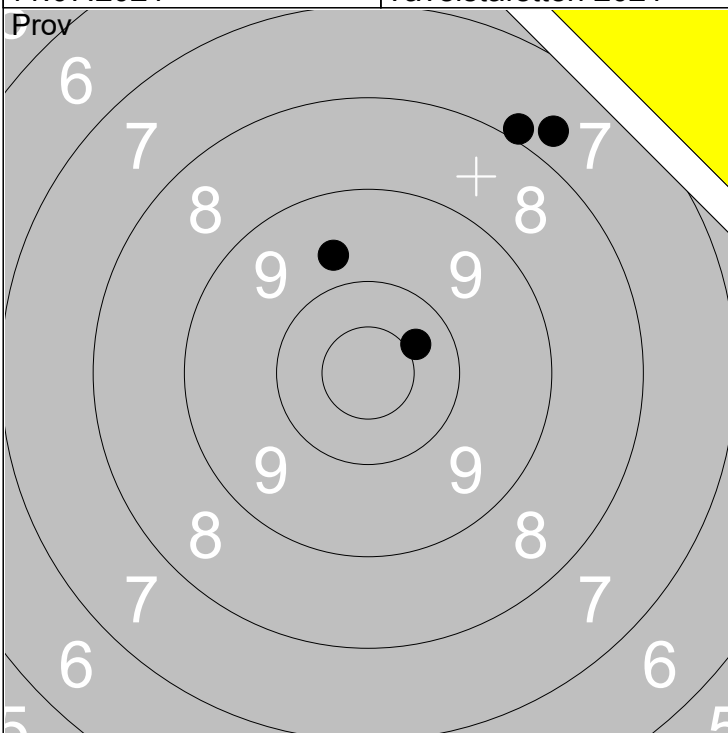

1. Serie 5 Skott

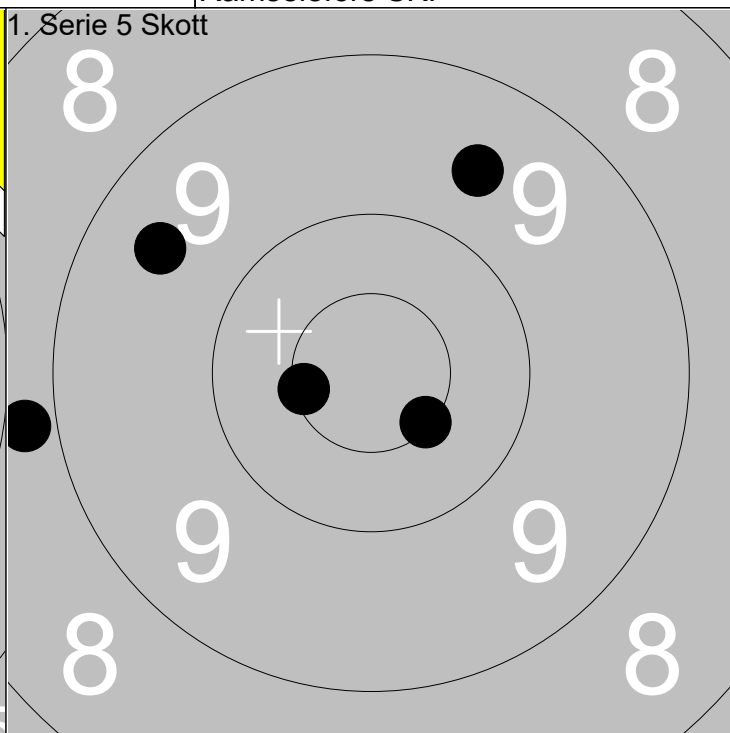

1: 10.4 ↗
 2: 7.7 ↗
 3: 7.9 ↗
 4: 6.7 ↗
 5: 9.7 ↗

Serie 39

Total 0

1: 9.5 ↖
 2: 8.8 ←
 3: 10.5x ←
 4: 10.5x ↘
 5: 9.6 ↗

Serie 46

Total 46

2. Serie 5 Skott

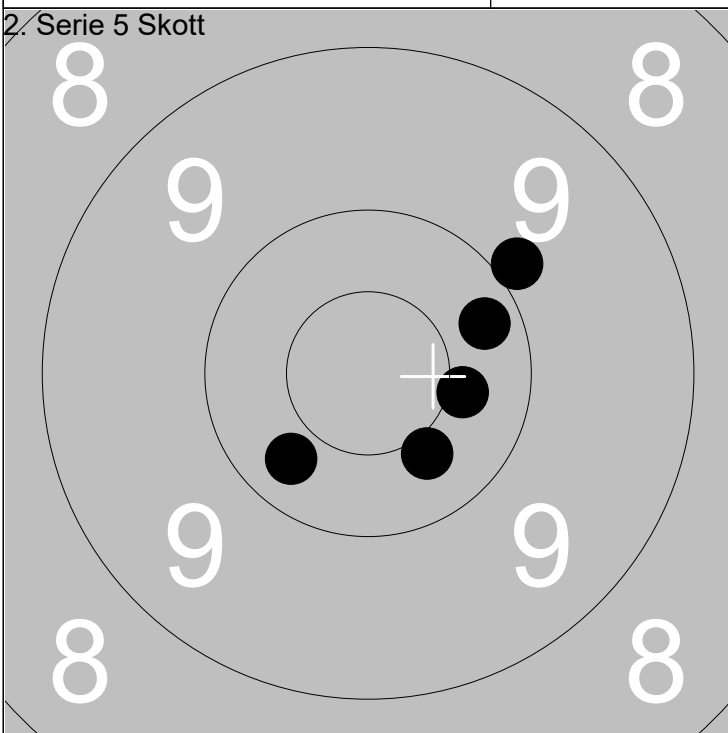

3. Serie 5 Skott

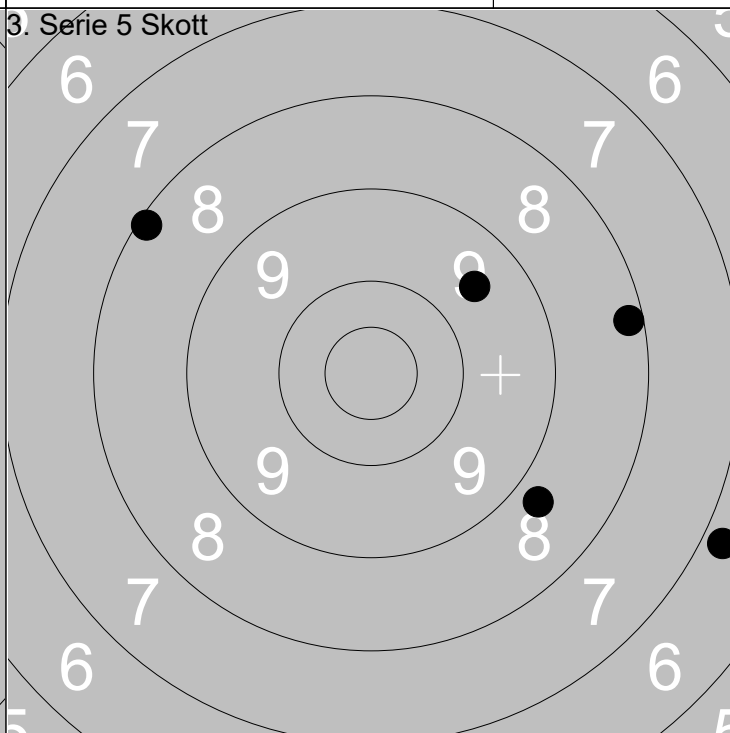

1: 10.2 ↗
 2: 10.3 ↘
 3: 10.4 →
 4: 10.4 ↘
 5: 9.9 ↗

Serie 49

Total 95

1: 8.1 ↖
 2: 8.7 ↘
 3: 8.2 →
 4: 6.8 ↘
 5: 9.6 ↗

Serie 39

Total 134

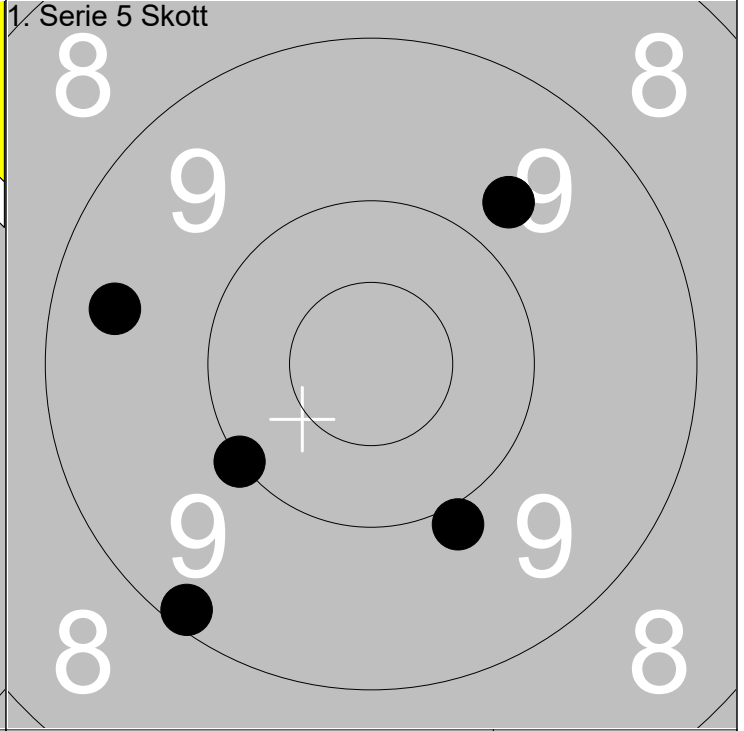
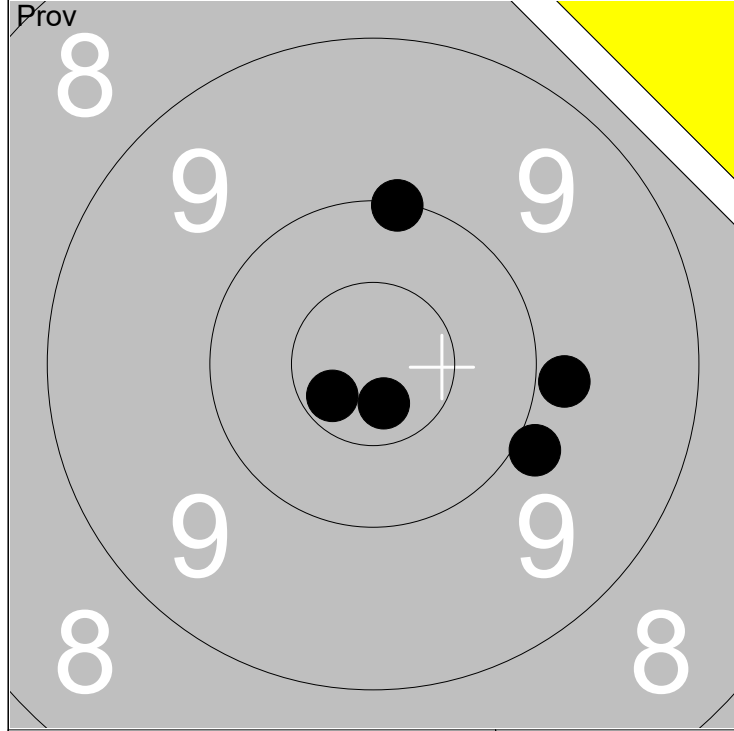

1: 10.0	↑
2: 9.9	→
3: 9.9	↘
4: 10.7x	↓
5: 10.7x	↙

Serie	48
Total	0

1: 10.0	↙
2: 9.4	←
3: 9.1	↘
4: 9.7	↗
5: 9.9	↓

Serie	46
Total	46

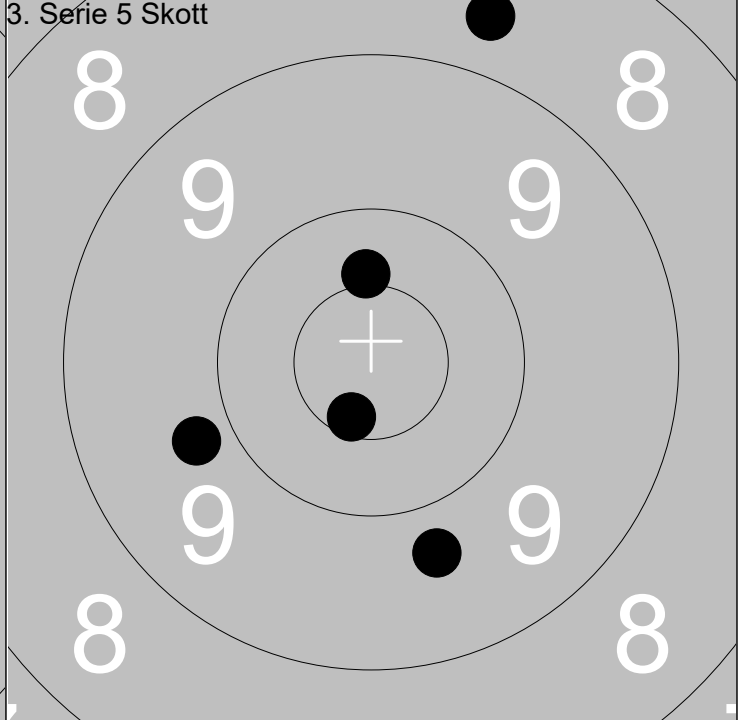
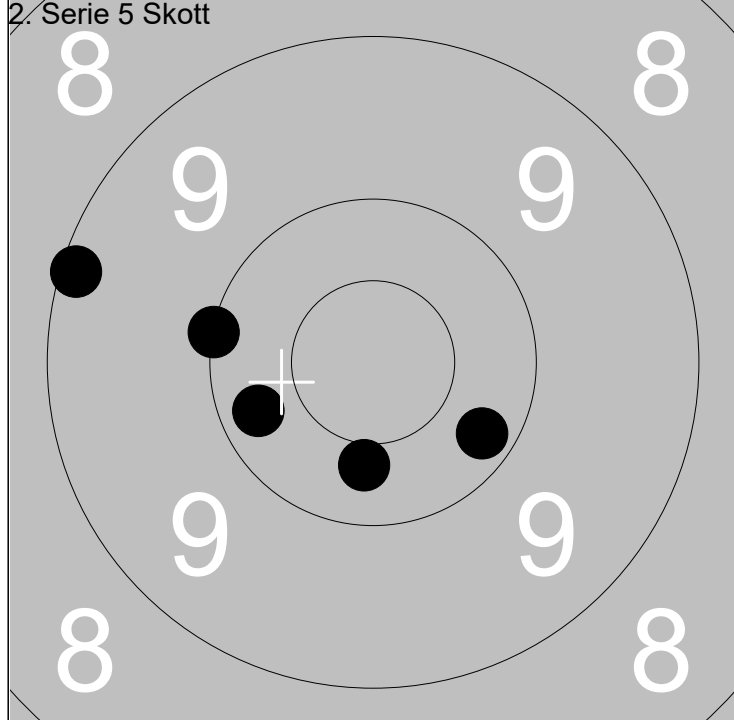

1: 10.2	←
2: 10.0	←
3: 9.1	←
4: 10.2	↘
5: 10.4	↓

Serie	49
Total	95

1: 9.7	↓
2: 9.8	←
3: 10.6x	↘
4: 10.4x	↑
5: 8.6	↗

Serie	46
Total	141

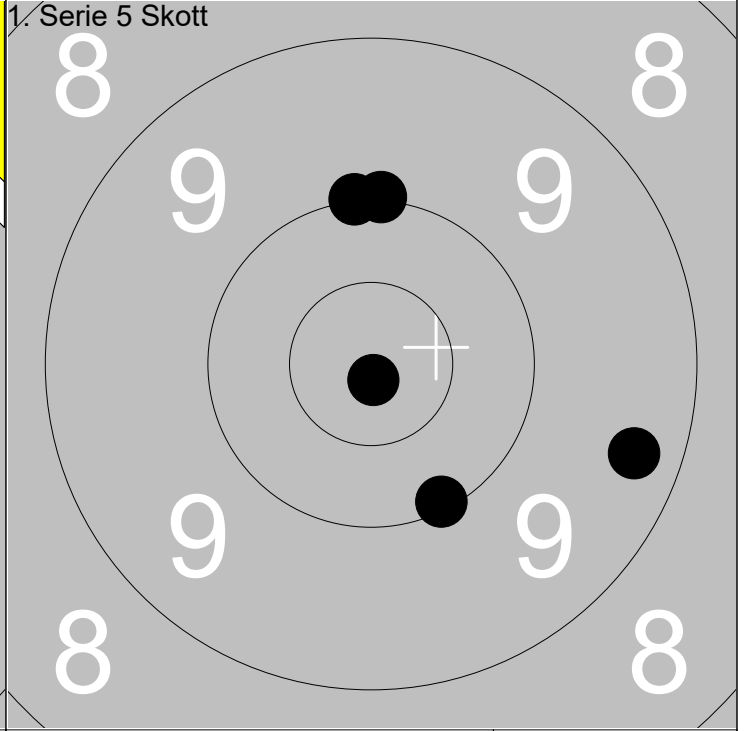
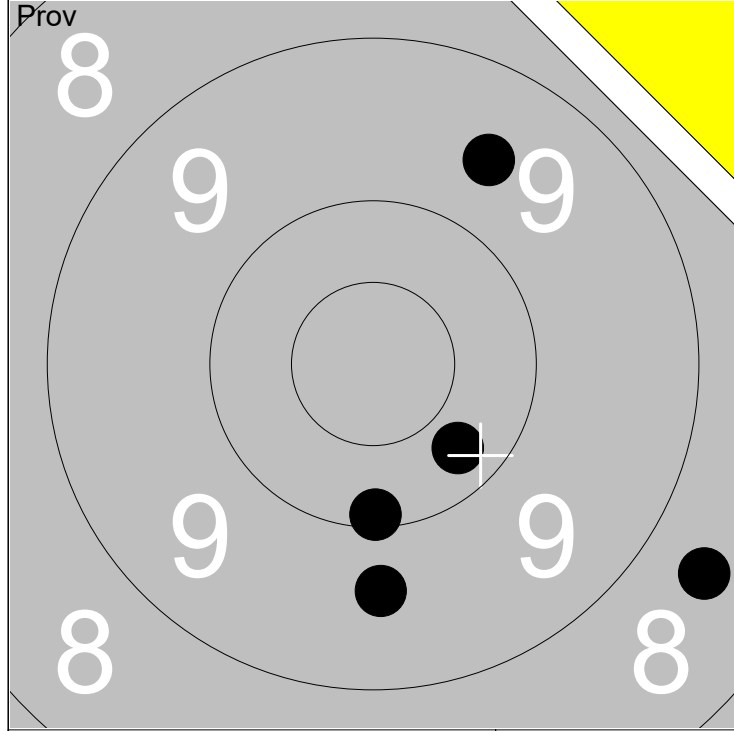

1: 9.6 ↗	Serie 46
2: 10.3 ↘	
3: 8.6 ↘	
4: 9.6 ↓	
5: 10.1 ↓	
Total 0	

1: 10.0 ↑	Serie 49
2: 10.0 ↑	
3: 10.9x ↓	
4: 10.1 ↓	
5: 9.3 ↘	
Total 49	

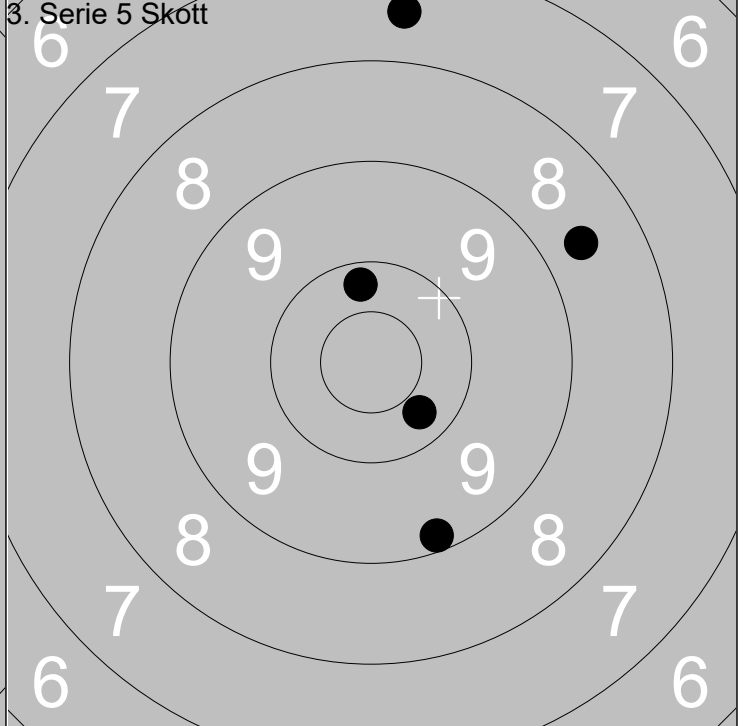
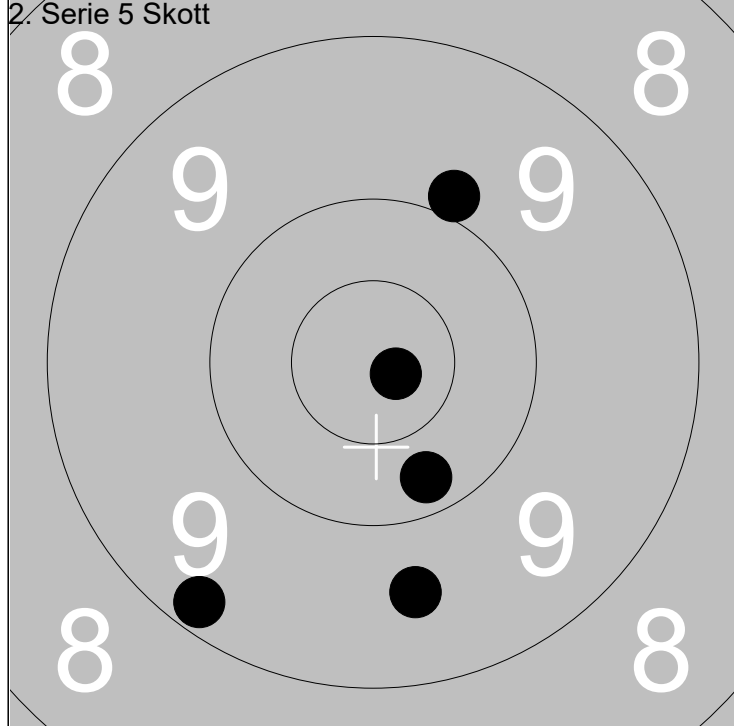

1: 9.9 ↗	Serie 47
2: 10.8x ↘	
3: 10.2 ↓	
4: 9.2 ↙	
5: 9.6 ↓	
Total 96	

1: 10.2 ↑	Serie 44
2: 10.3 ↘	
3: 9.2 ↓	
4: 8.6 ↗	
5: 7.5 ↑	
Total 140	

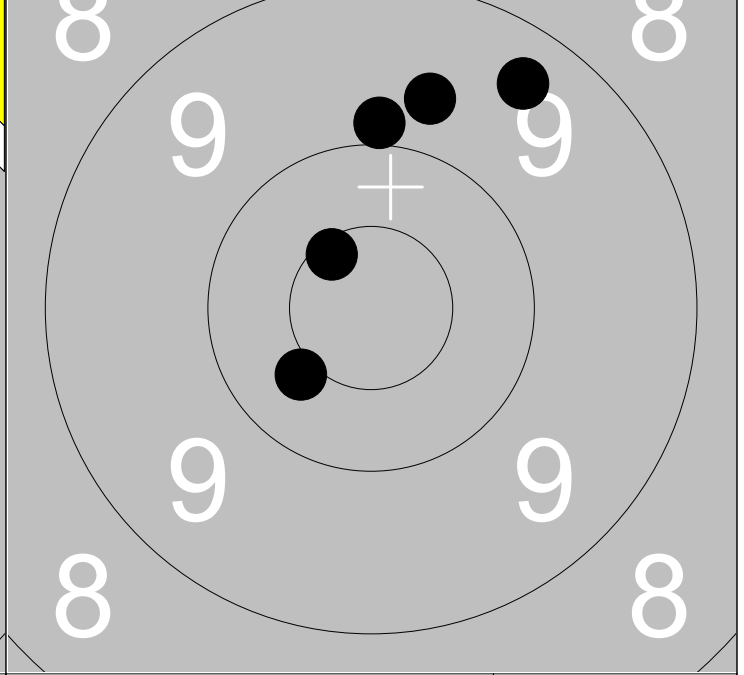
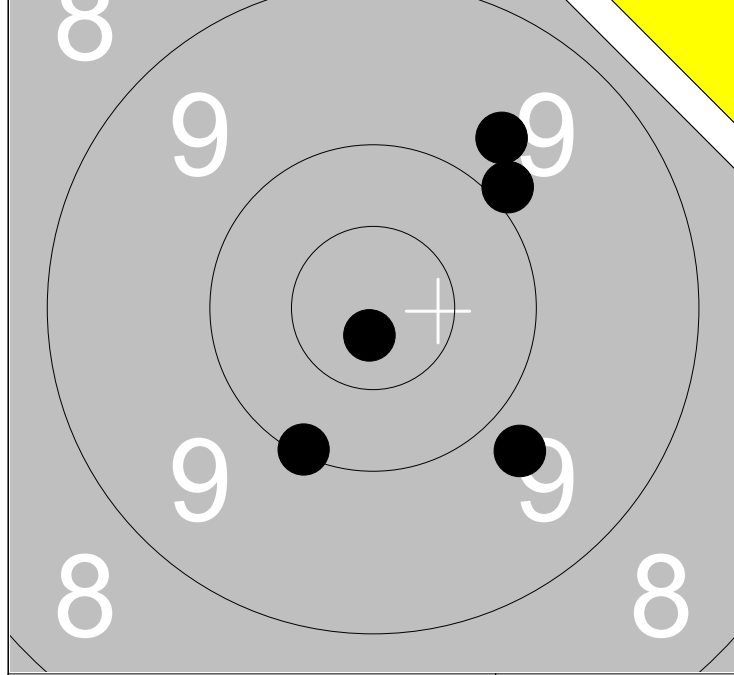

1: 9.9 ↗	Serie	47
2: 9.7 ↗		
3: 9.8 ↘	Total	0
4: 10.8x ↓		
5: 10.1 ↓		

1: 9.7 ↑	Serie	47
2: 9.4 ↗		
3: 9.9 ↑	Total	47
4: 10.4 ↙		
5: 10.6x ↖		

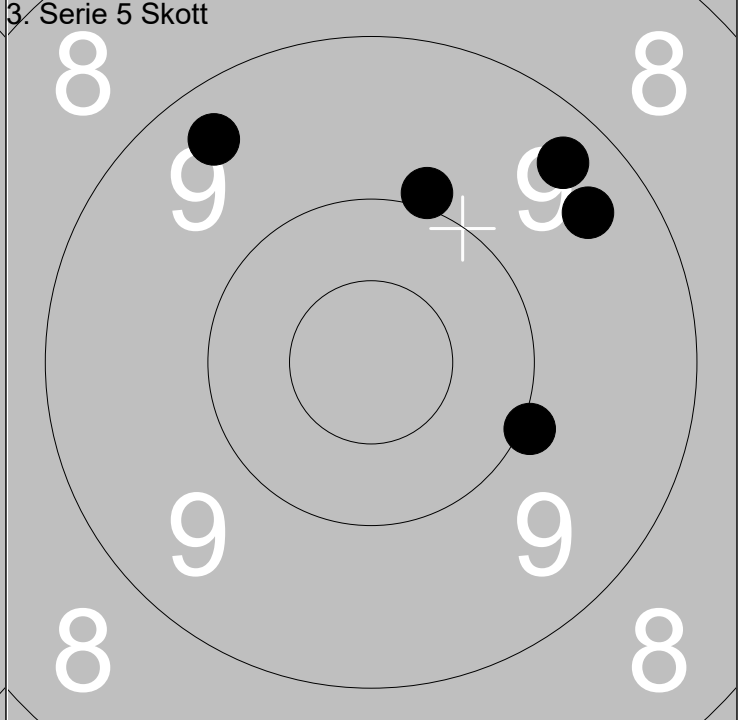
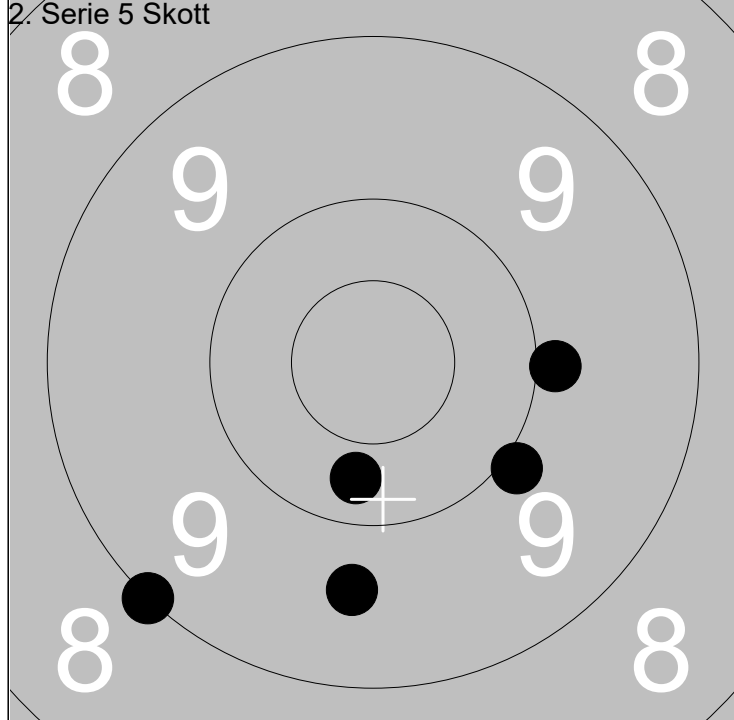

1: 9.6 ↓	Serie	46
2: 9.9 →		
3: 9.9 ↘	Total	93
4: 9.0 ↙		
5: 10.3 ↓		

1: 9.3 ↗	Serie	46
2: 9.4 ↗		
3: 9.4 ↖	Total	139
4: 9.9 ↑		
5: 10.0 →		

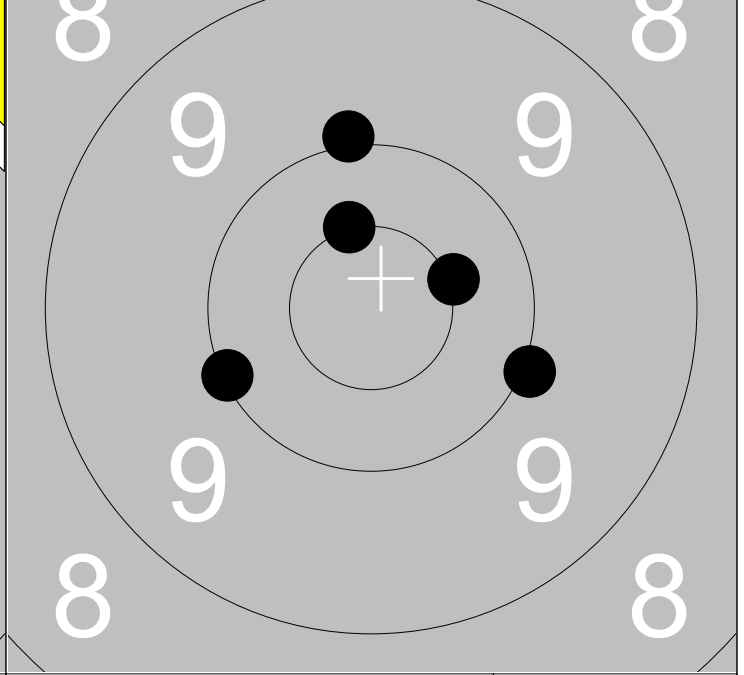
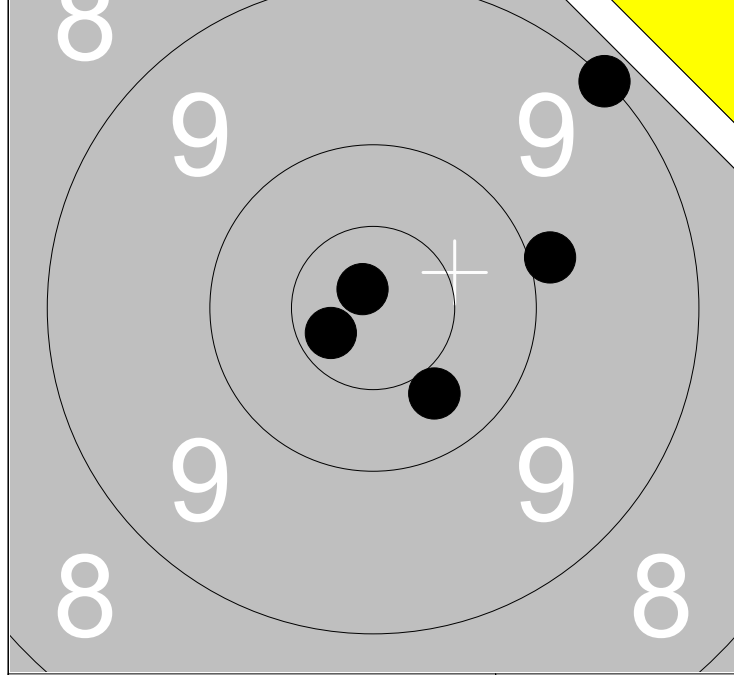

1: 10.7x ↙	Serie	48
2: 9.9 →		
3: 9.0 ↗		
4: 10.4 ↘		
5: 10.8x ↖		

Total	0
-------	---

1: 10.0 ↑	Serie	50
2: 10.5x →		
3: 10.5x ↑		
4: 10.0 →		
5: 10.0 ↙		

Total	50
-------	----

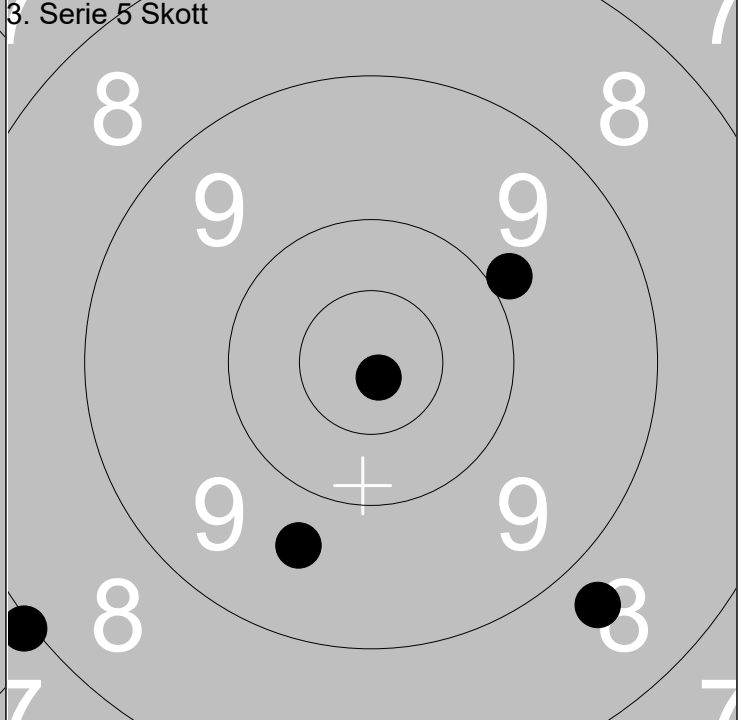
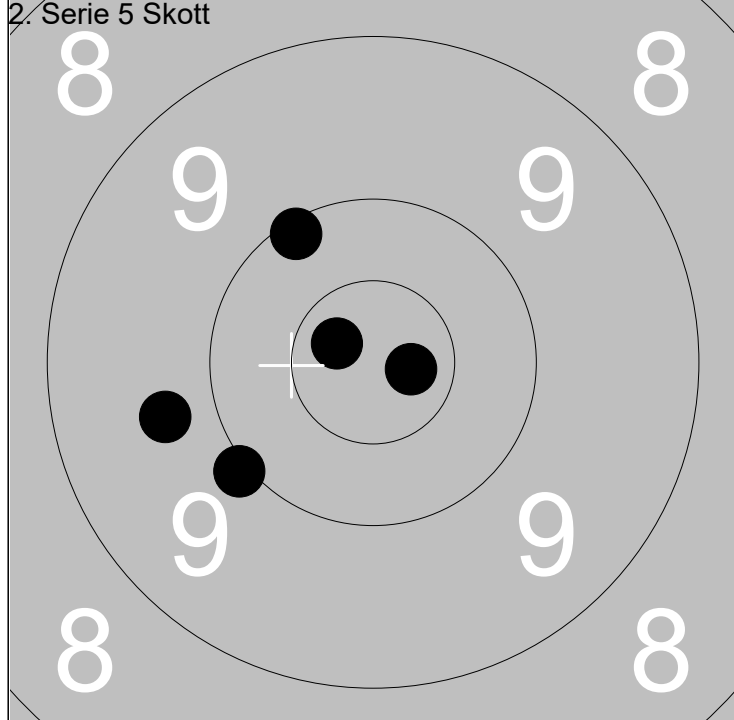

1: 10.1 ↗	Serie	49
2: 10.7x ↖		
3: 10.7x →		
4: 9.7 ↙		
5: 10.0 ↘		

Total	99
-------	----

1: 8.0 ↙	Serie	44
2: 10.8x ↘		
3: 9.9 ↗		
4: 9.7 ↘		
5: 8.7 ↘		

Total	143
-------	-----

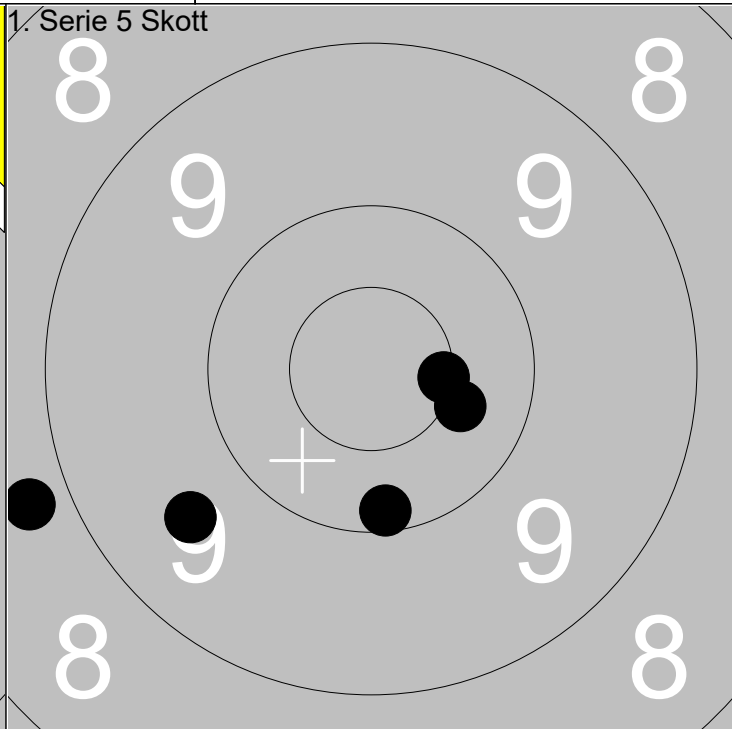
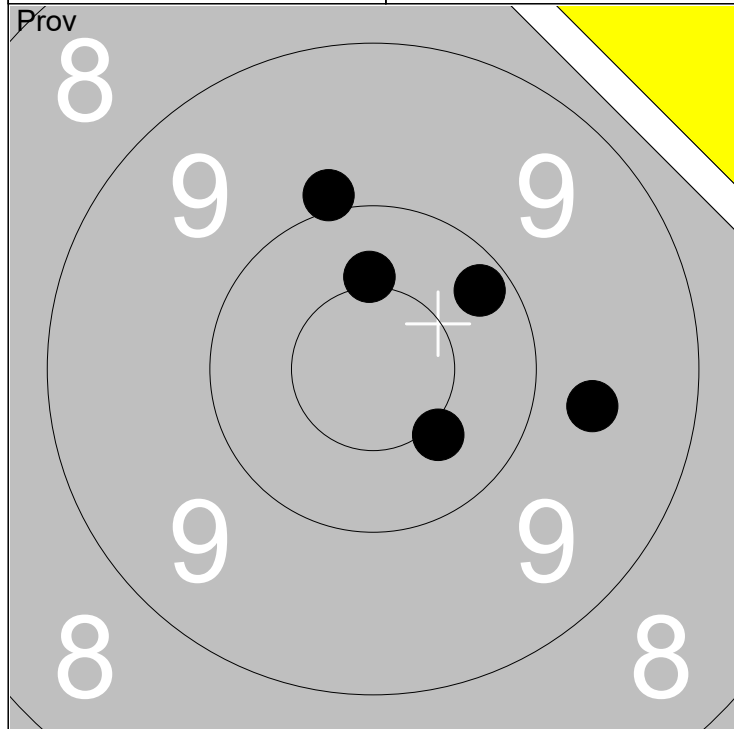

1: 9.7 →	Serie 48
2: 10.2 ↗	
3: 10.4x ↑	
4: 10.4x ↘	
5: 9.9 ↑	
Total 0	

1: 8.8 ←	Serie 47
2: 9.6 ↙	
3: 10.1 ↓	
4: 10.5x →	
5: 10.4 ↘	
Total 47	

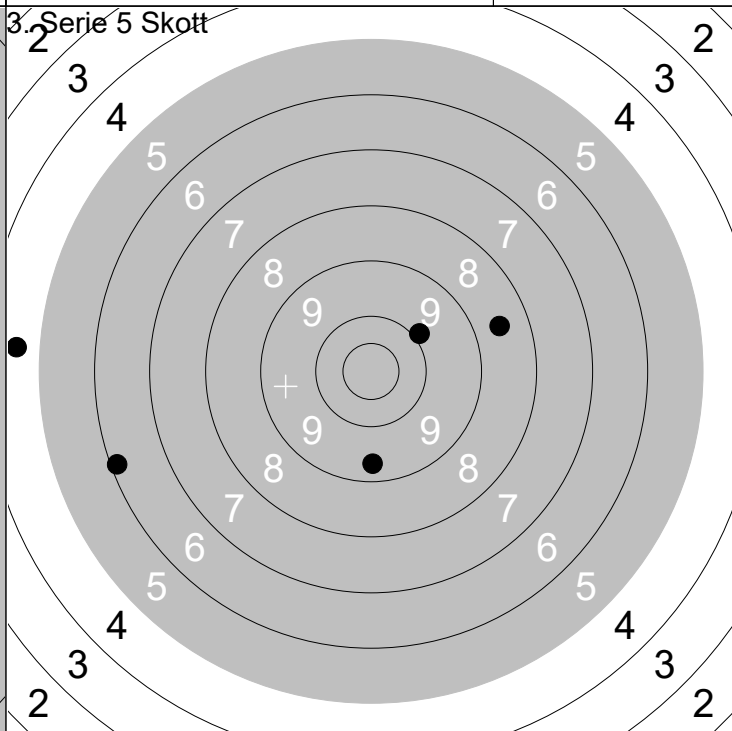
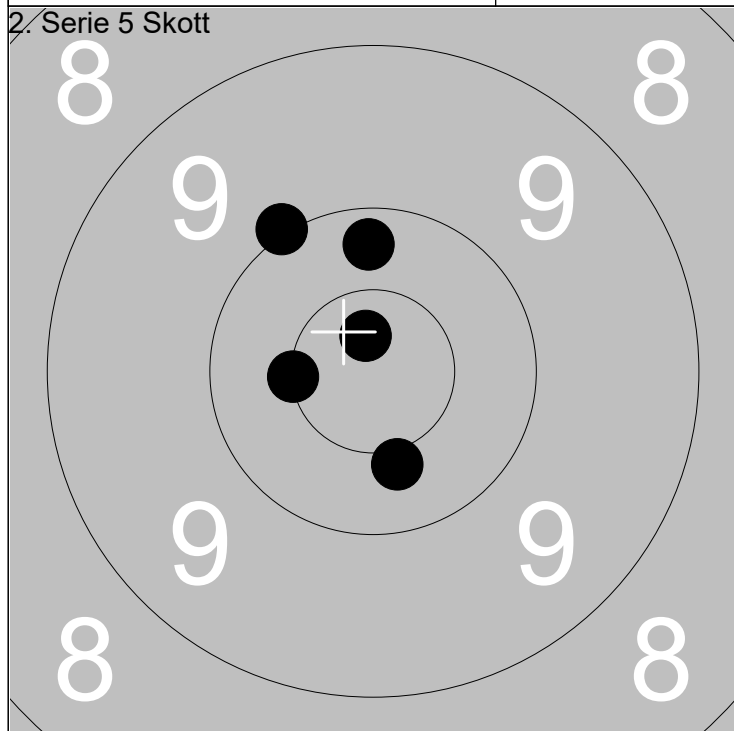

1: 10.2 ↑	Serie 50
2: 10.7x ↑	
3: 10.0 ↗	
4: 10.4 ↓	
5: 10.5x ←	
Total 97	

1: 9.4 ↓	Serie 36
2: 8.6 →	
3: 9.9 ↗	
4: 4.6 ←	
5: 6.1 ←	
Total 133	

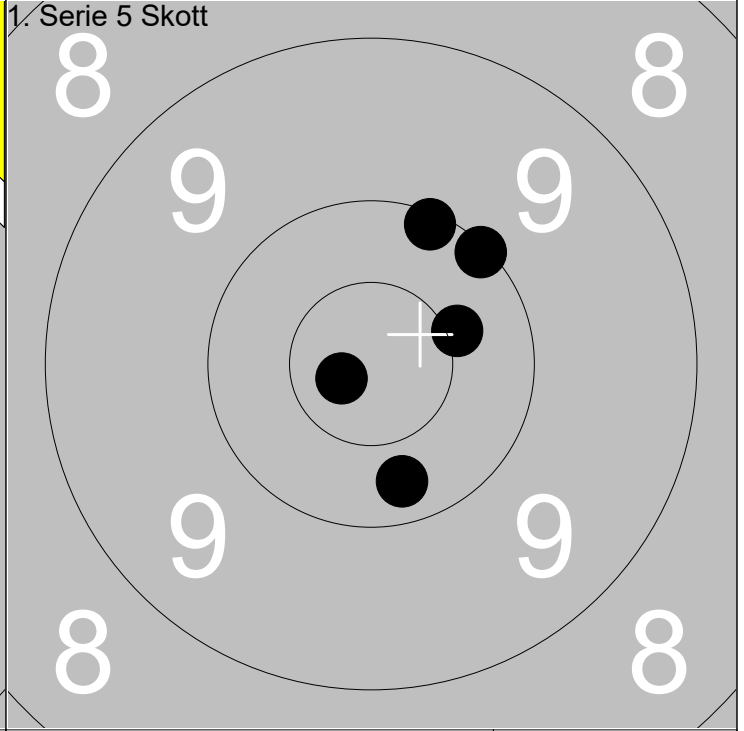
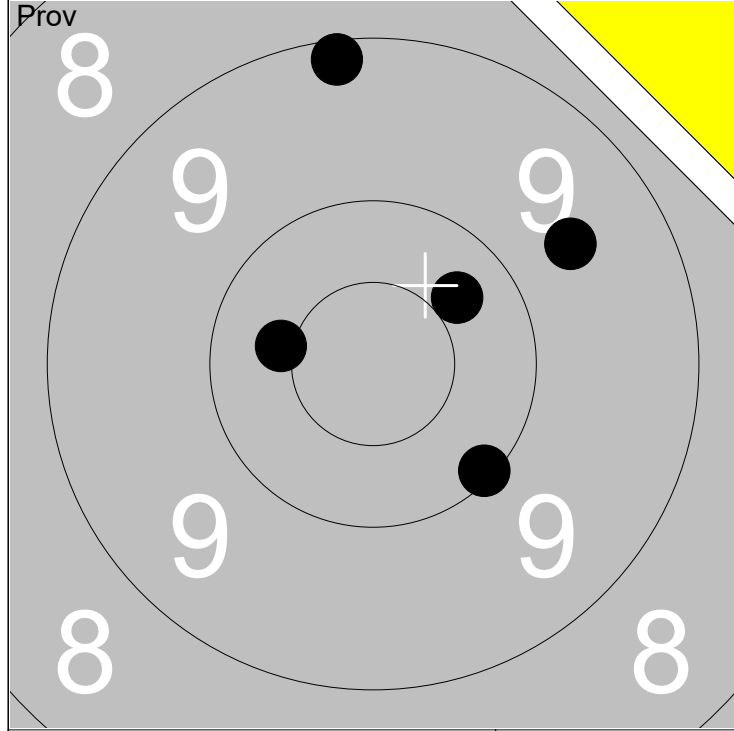

1: 9.1	↑
2: 10.4x	←
3: 10.3	↗
4: 10.1	↘
5: 9.6	↗

Serie	48
Total	0

1: 10.4x	↗
2: 10.8x	←
3: 10.1	↗
4: 10.3	↘
5: 10.1	↑

Serie	50
Total	50

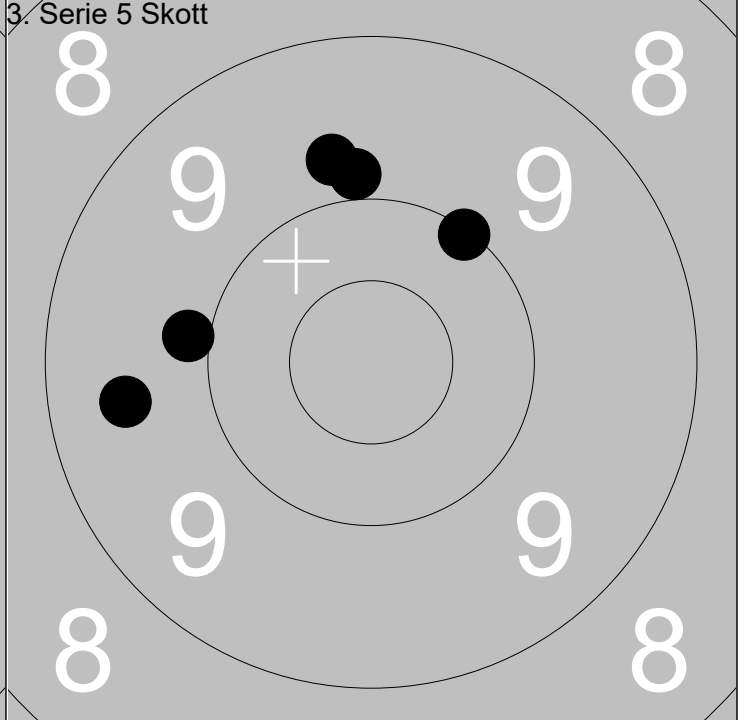
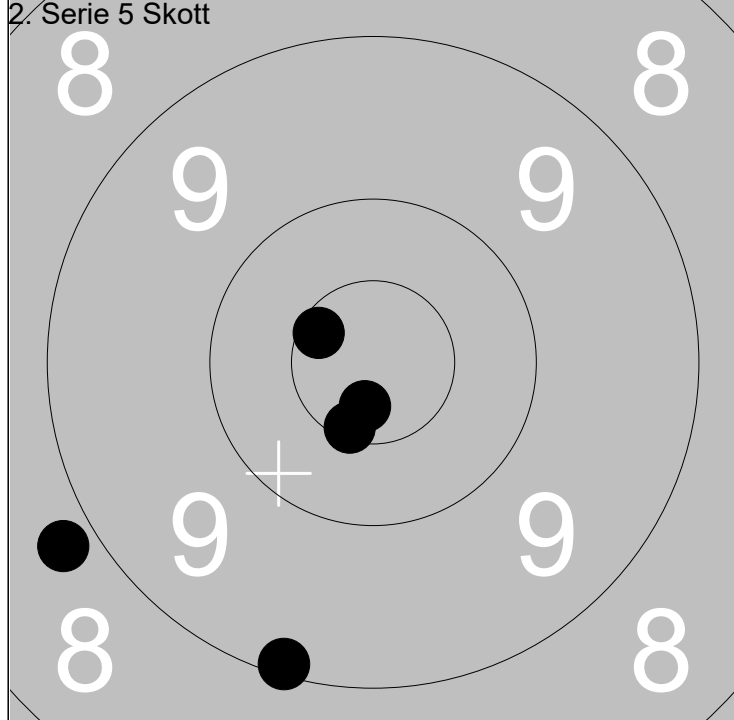

1: 10.7x	↘
2: 10.6x	↖
3: 9.1	↘
4: 10.6x	↘
5: 8.8	↖

Serie	47
Total	97

1: 9.9	←
2: 10.1	↗
3: 9.8	↑
4: 9.9	↑
5: 9.5	←

Serie	46
Total	143

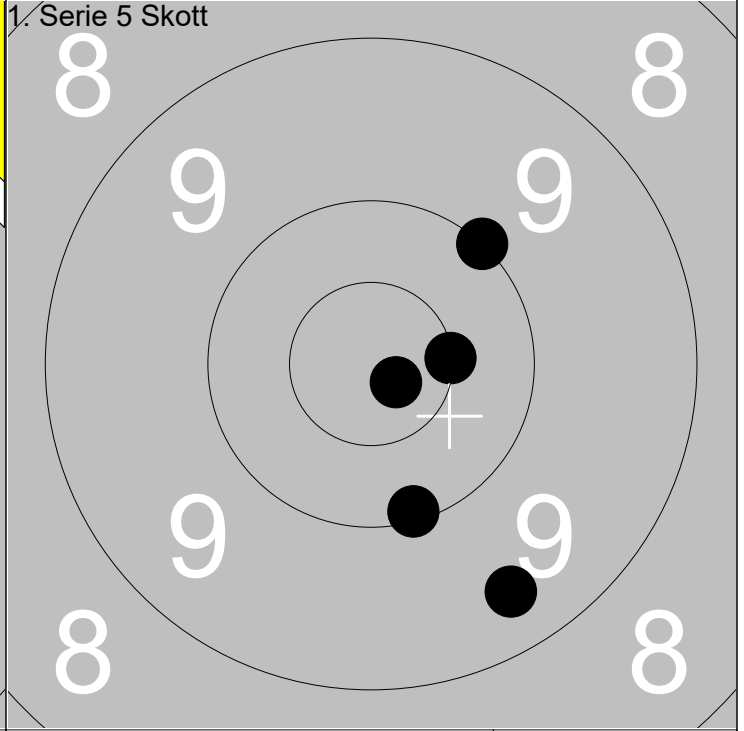
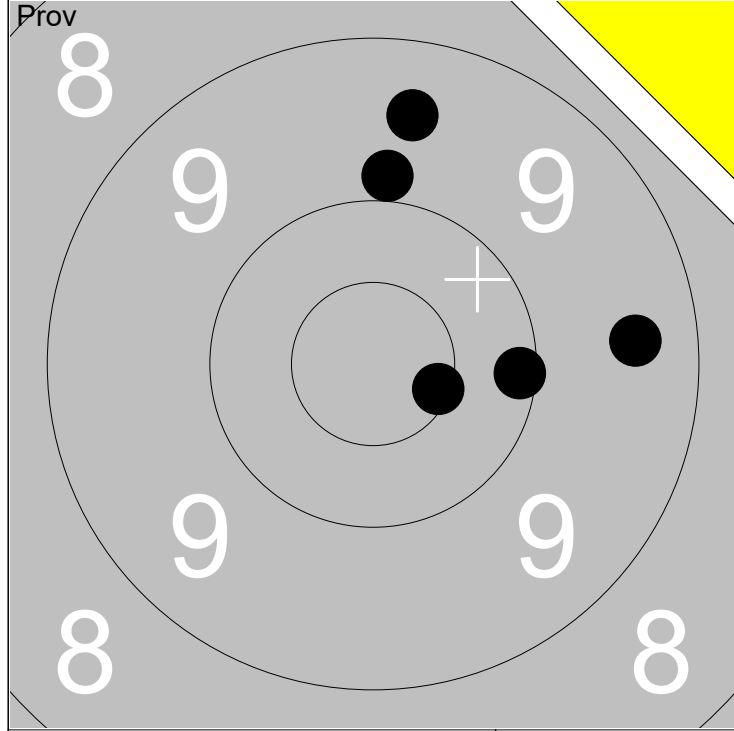

1: 9.5	↑
2: 10.6x	➤
3: 9.4	➔
4: 9.9	↑
5: 10.1	➔

Serie	47
Total	0

1: 10.0	↗
2: 9.4	↘
3: 10.8x	↘
4: 10.1	↘
5: 10.5x	➔

Serie	49
Total	49

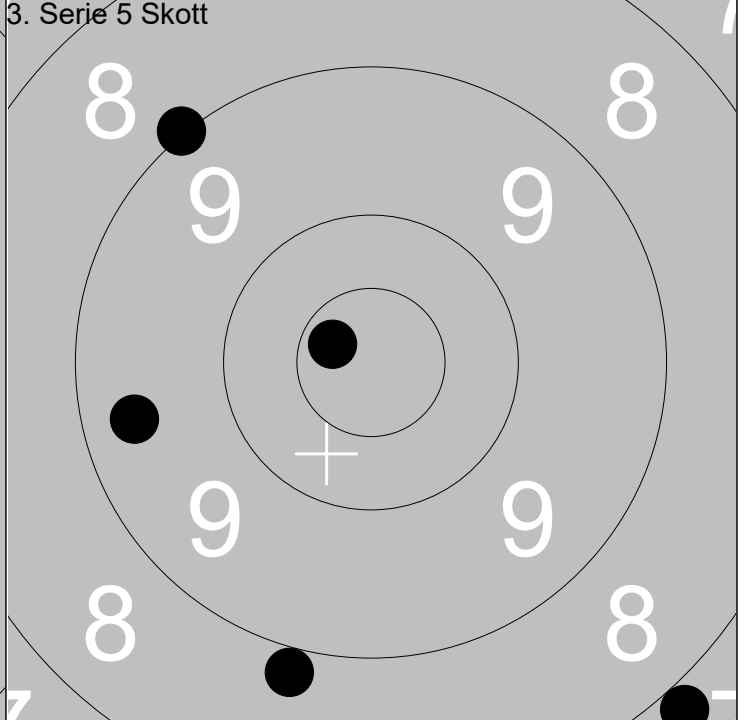
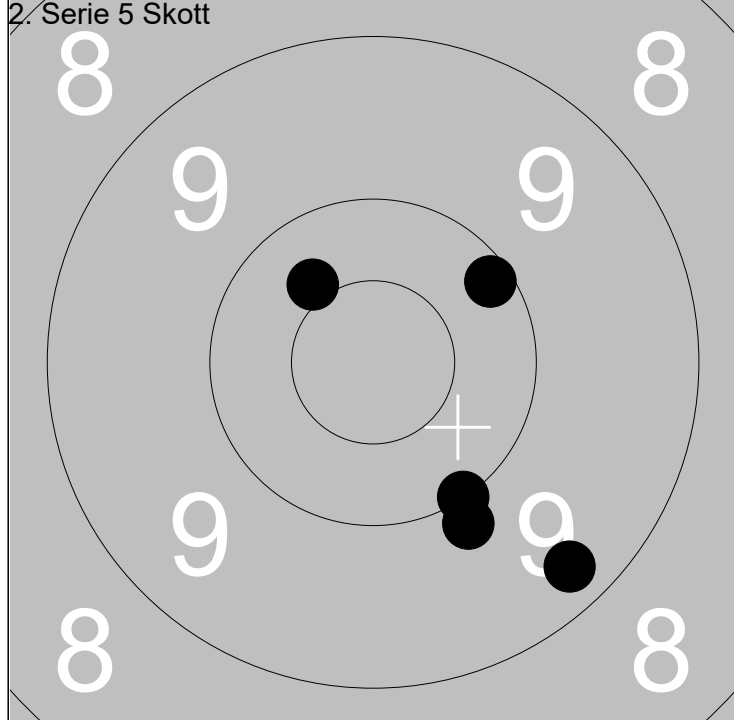

1: 10.1	↗
2: 9.9	↘
3: 9.3	↘
4: 10.0	↘
5: 10.4	↗

Serie	48
Total	97

1: 7.9	↘
2: 8.9	↘
3: 10.7x	↖
4: 9.0	↗
5: 9.4	←

Serie	43
Total	140

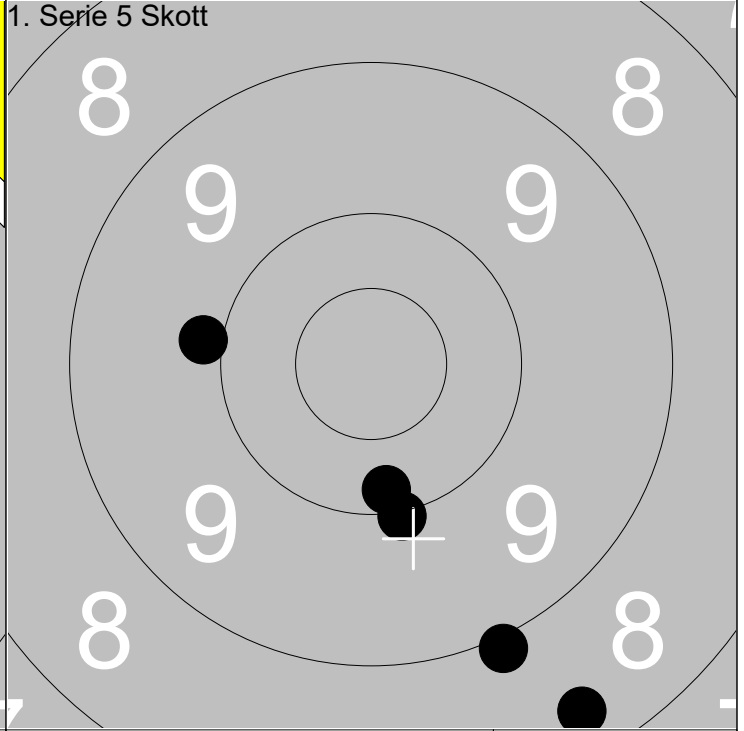
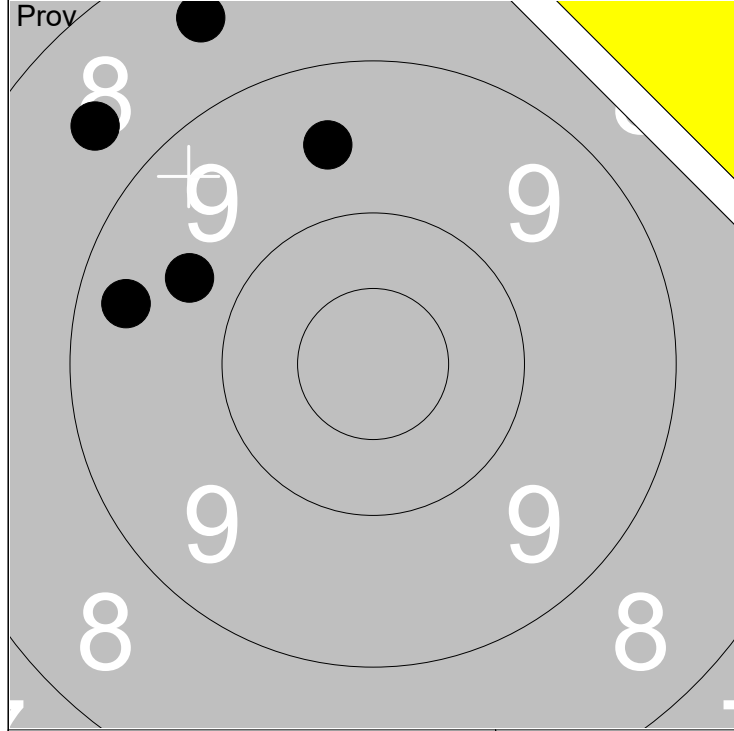

1: 8.6 ↗
2: 9.3 ←
3: 8.5 ↗
4: 9.5 ↗
5: 9.7 ←

Serie	43
Total	0

1: 9.9 ←
2: 9.0 ↓
3: 10.2 ↓
4: 8.3 ↓
5: 10.0 ↓

Serie	46
Total	46

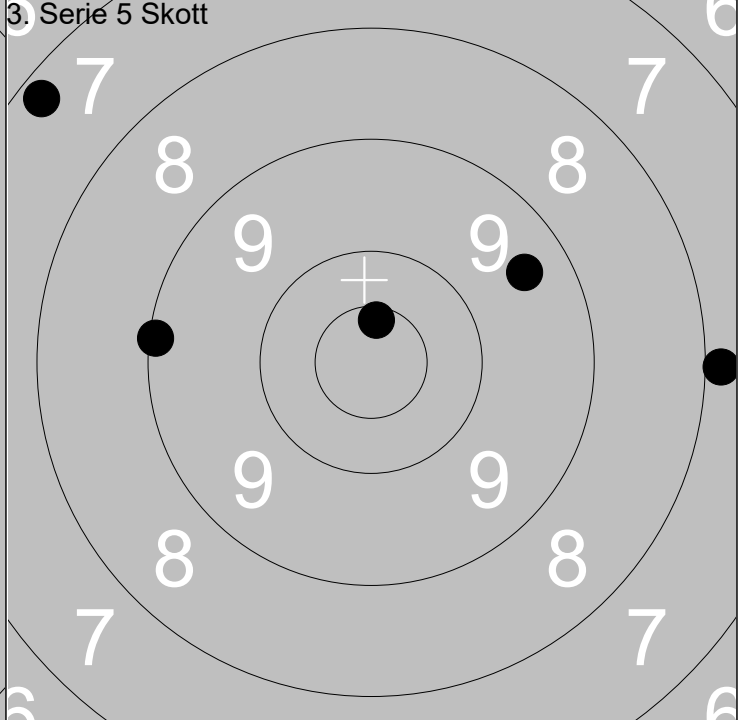
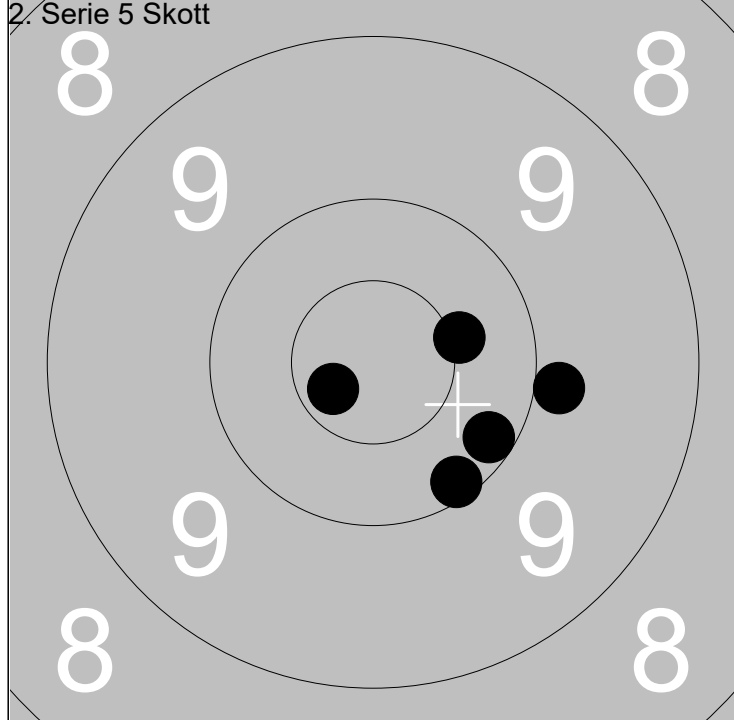

1: 10.4x →
2: 10.7x ↙
3: 9.9 →
4: 10.2 ↓
5: 10.1 ↓

Serie	49
Total	95

1: 10.6x ↑
2: 9.4 ↗
3: 7.9 →
4: 7.2 ↙
5: 9.1 ←

Serie	42
Total	137

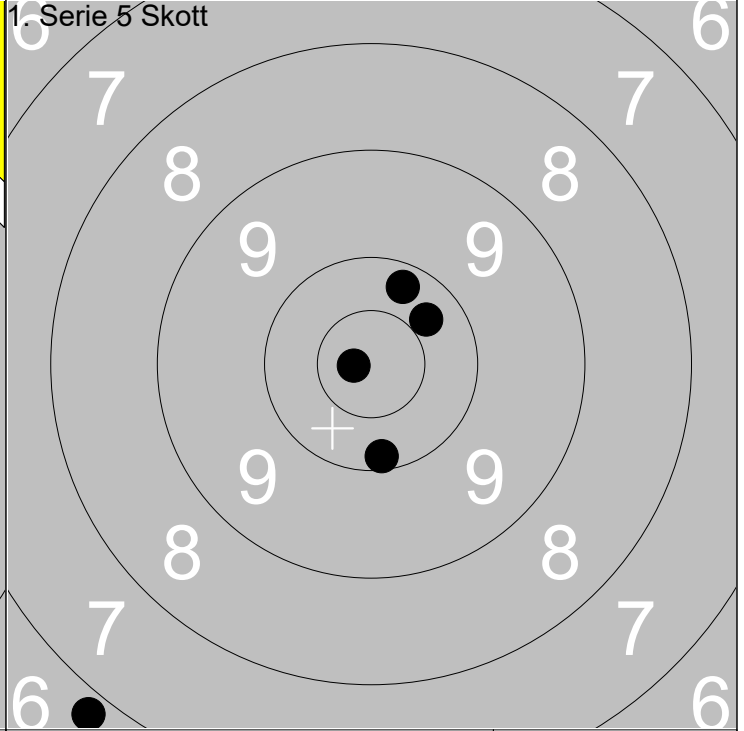
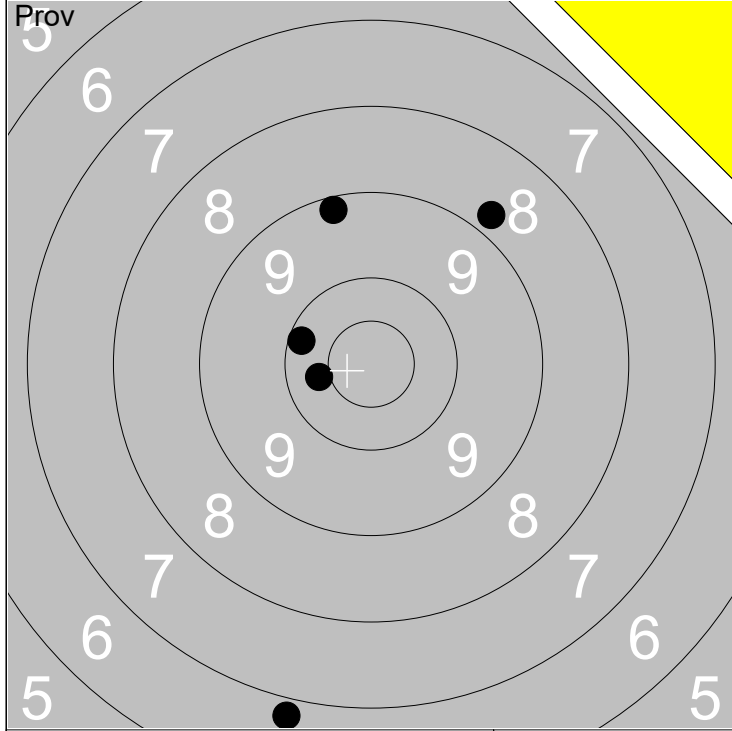

1: 8.8 ↗	Serie 43
2: 9.2 ↑	
3: 10.4 ←	
4: 10.2 ↖	
5: 6.8 ↓	
Total 0	

1: 10.3 ↗	Serie 46
2: 10.8x ←	
3: 10.2 ↑	
4: 10.1 ↓	
5: 6.8 ↘	
Total 46	

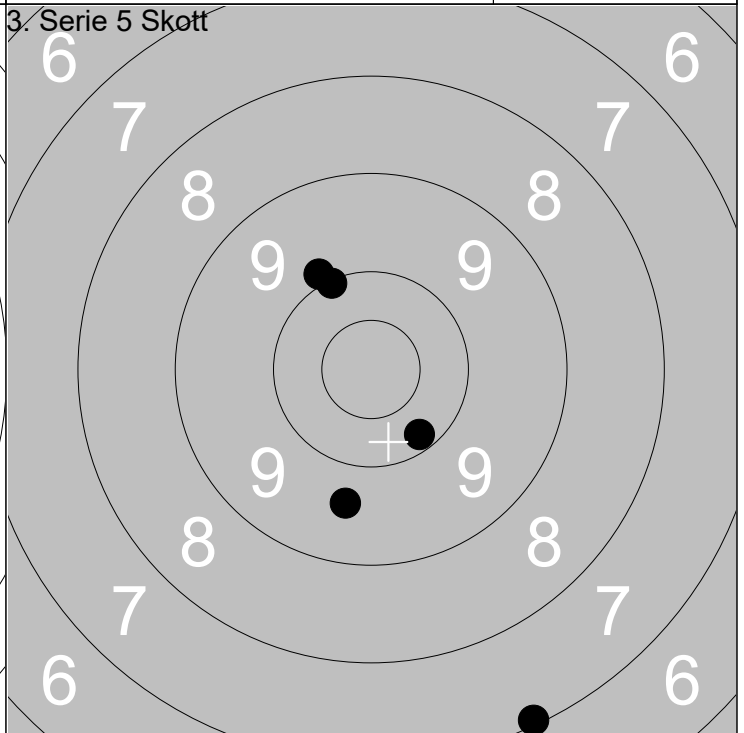
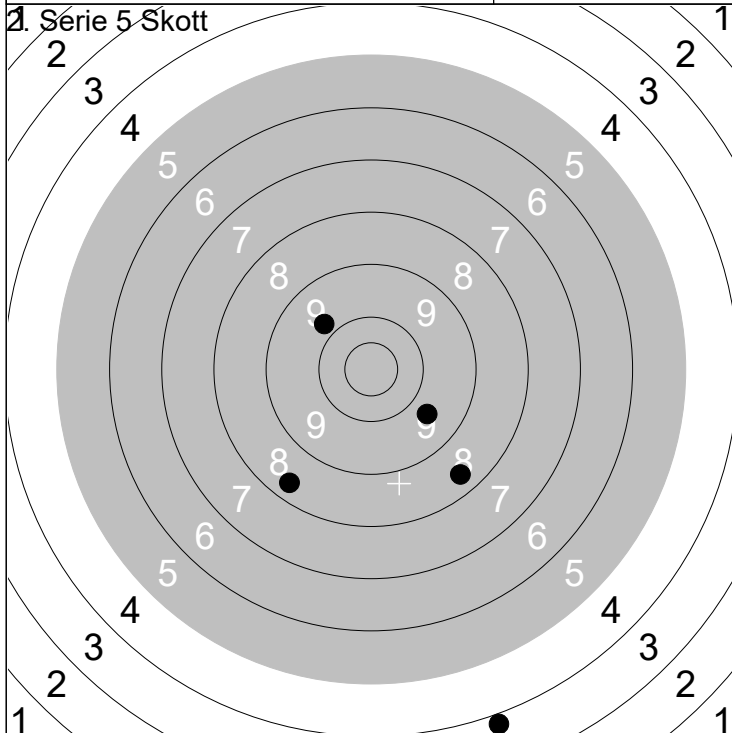

1: 3.8 ↓	Serie 37
2: 8.4 ↘	
3: 9.8 ↗	
4: 8.4 ↓	
5: 9.7 ↓	
Total 83	

1: 10.2 ↘	Serie 45
2: 10.1 ↗	
3: 9.9 ↗	
4: 7.1 ↓	
5: 9.6 ↓	
Total 128	

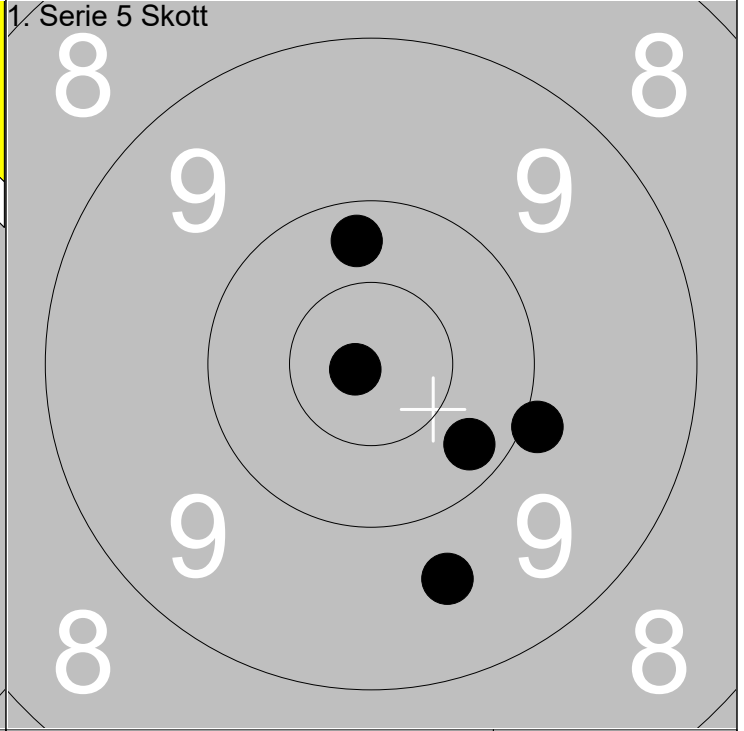
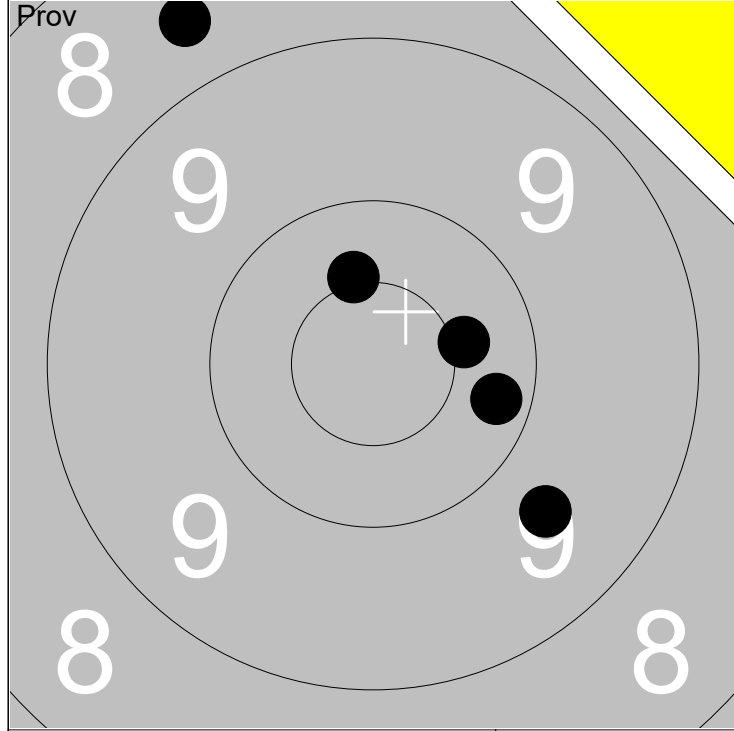

1: 10.4x ↗				
2: 8.6 ↗				
3: 9.6 ↘				
4: 10.4x →				
5: 10.2 →				

Serie	47
Total	0

1: 10.2 ↗				
2: 10.9x ↖				
3: 9.6 ↘				
4: 9.9 →				
5: 10.2 ↘				

Serie	48
Total	48

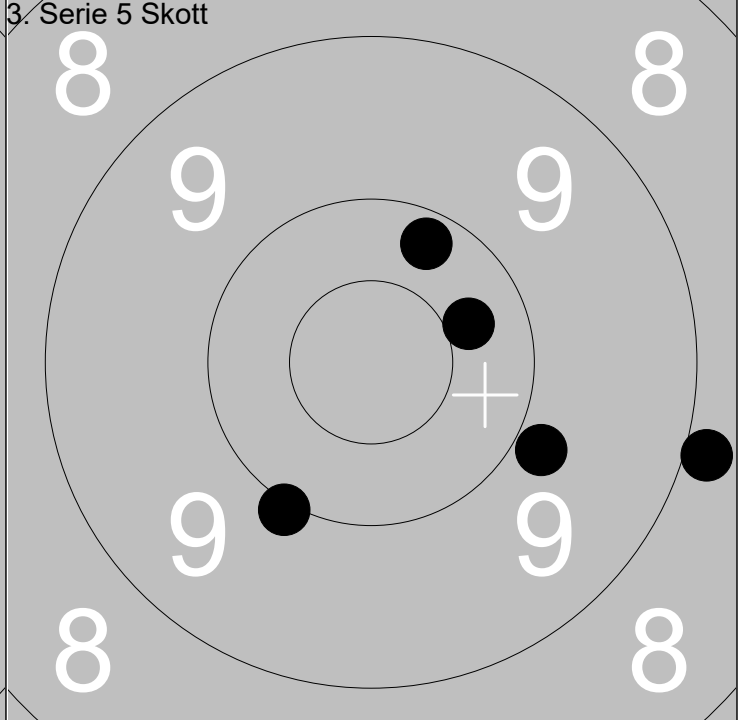
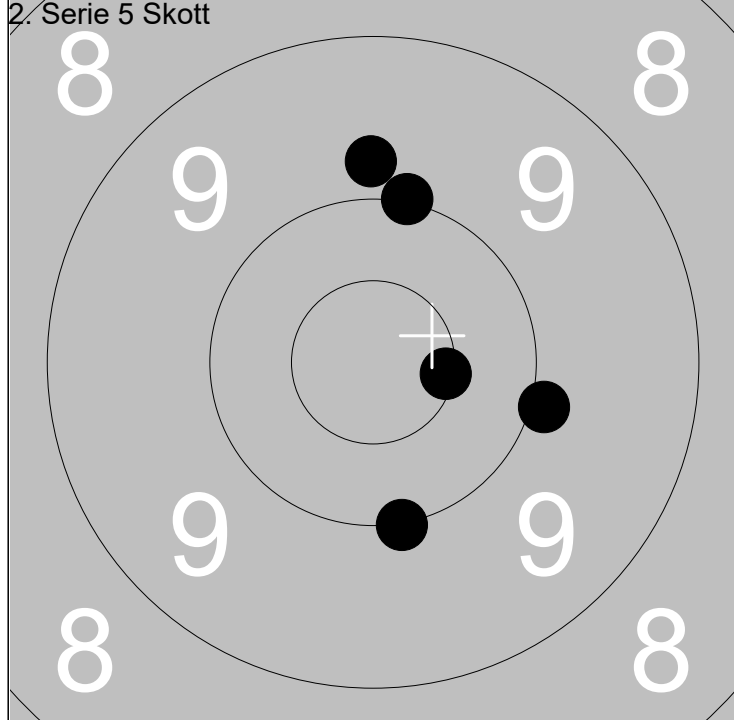

1: 9.9 →				
2: 10.0 ↗				
3: 10.0 ↘				
4: 9.8 ↗				
5: 10.5x →				

Serie	48
Total	96

1: 8.9 →				
2: 9.9 ↘				
3: 10.4 →				
4: 10.2 ↗				
5: 10.0 ↘				

Serie	47
Total	143

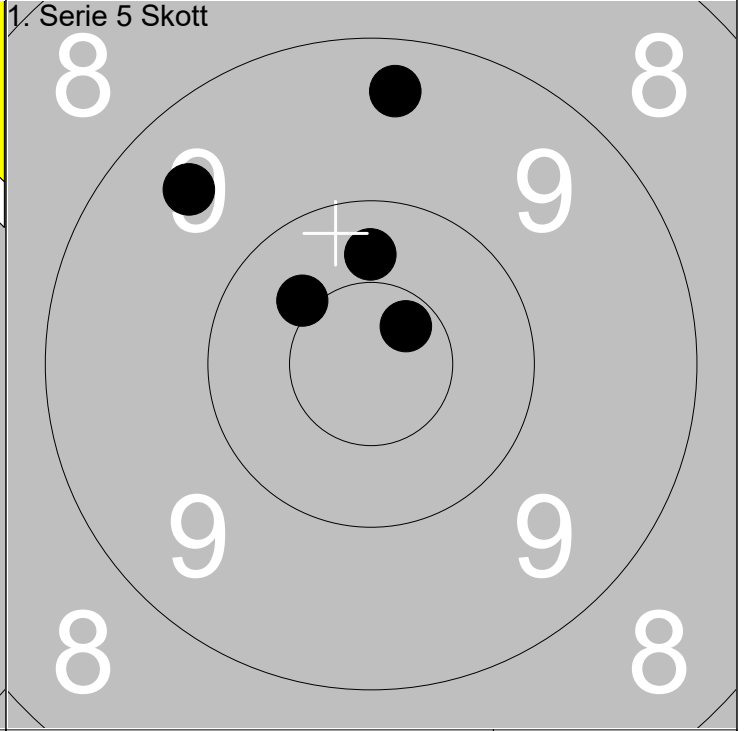
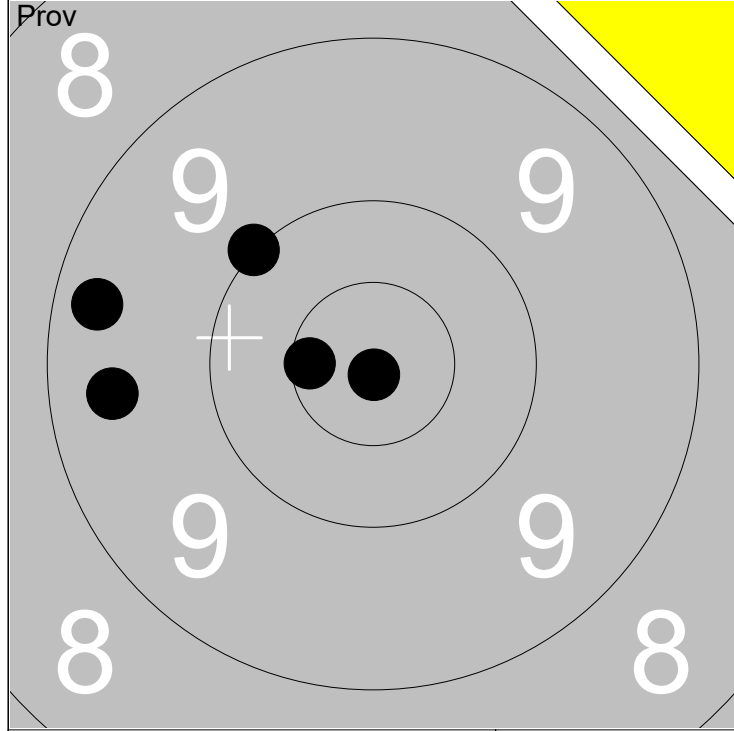

1: 10.9x ↓	Serie 48
2: 9.4 ←	
3: 9.3 ←	
4: 10.6x ←	
5: 10.0 ↖	
Total 0	

1: 10.3 ↑	Serie 48
2: 9.5 ↖	
3: 9.3 ↑	
4: 10.4x ↖	
5: 10.7x ↗	
Total 48	

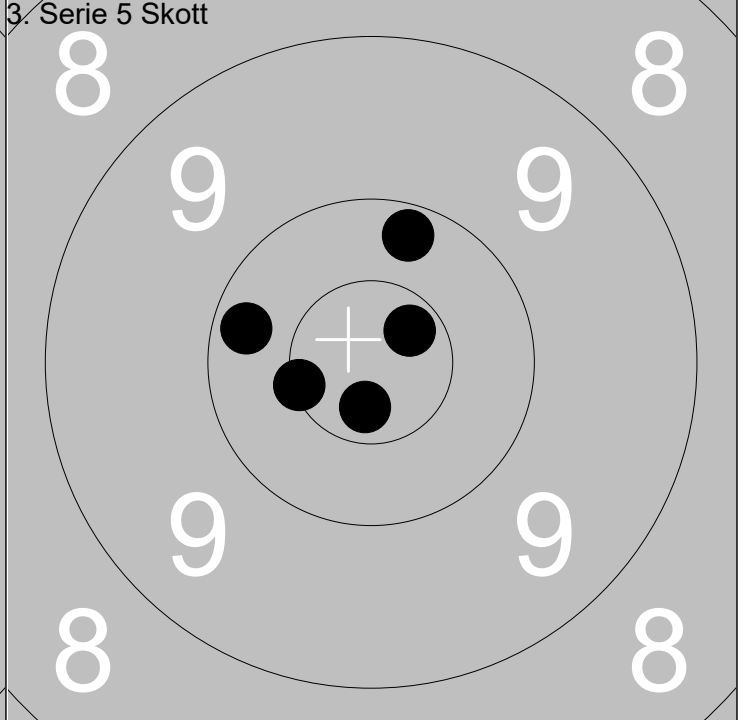
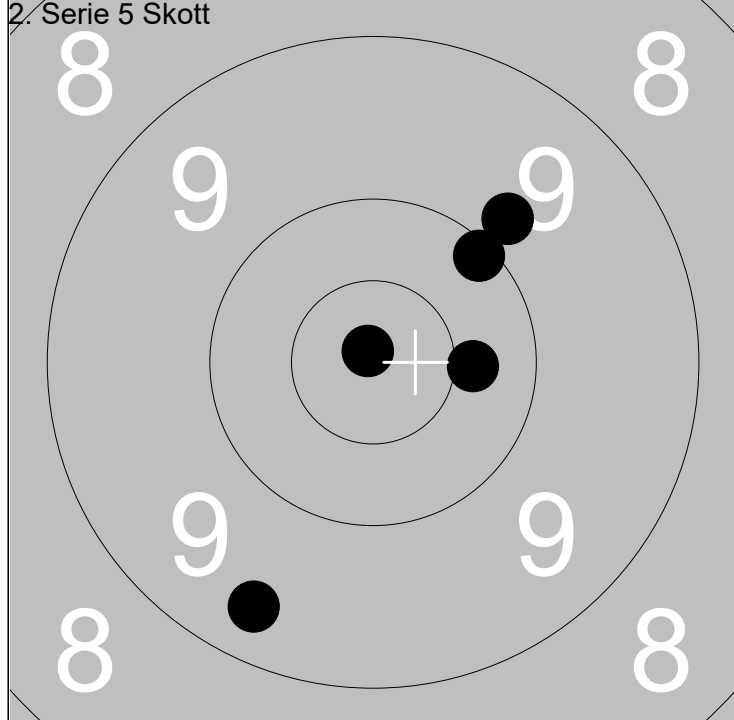

1: 10.1 ↗	Serie 48
2: 10.4 →	
3: 9.8 ↗	
4: 10.9x ↖	
5: 9.4 ↓	
Total 96	

1: 10.2 ←	Serie 50
2: 10.2 ↑	
3: 10.7x ↗	
4: 10.5x ←	
5: 10.7x ↓	
Total 146	

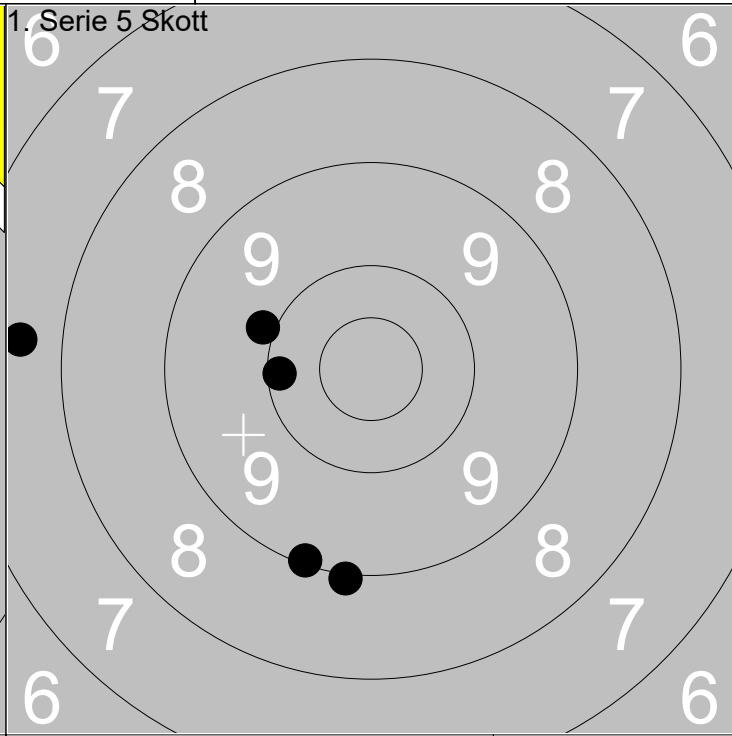
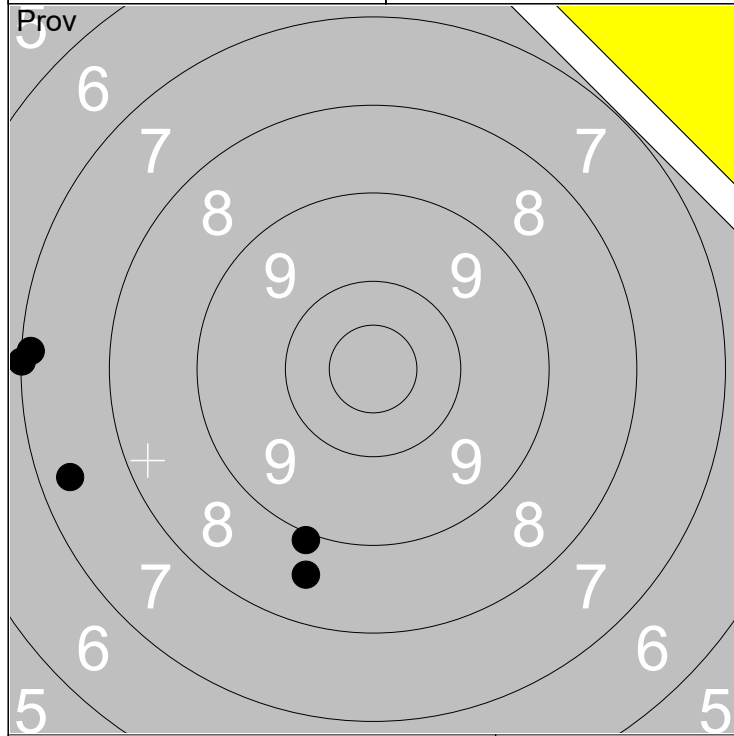

1:	7.1	←
2:	7.4	←
3:	8.9	↓
4:	7.0	←
5:	8.6	↓

Serie	37
Total	0

1:	10.1	←
2:	7.6	←
3:	9.1	↓
4:	9.9	←
5:	9.0	↓

Serie	44
Total	44

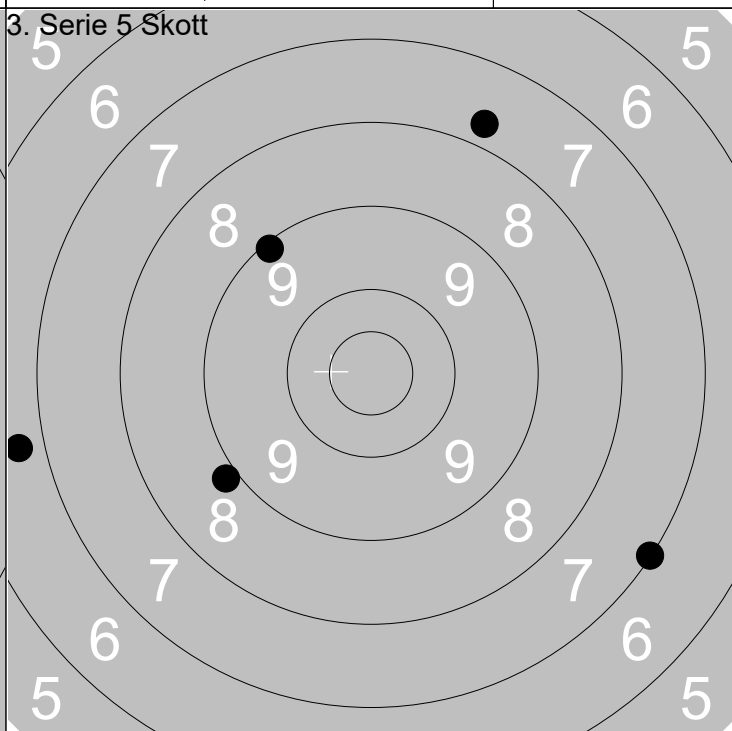
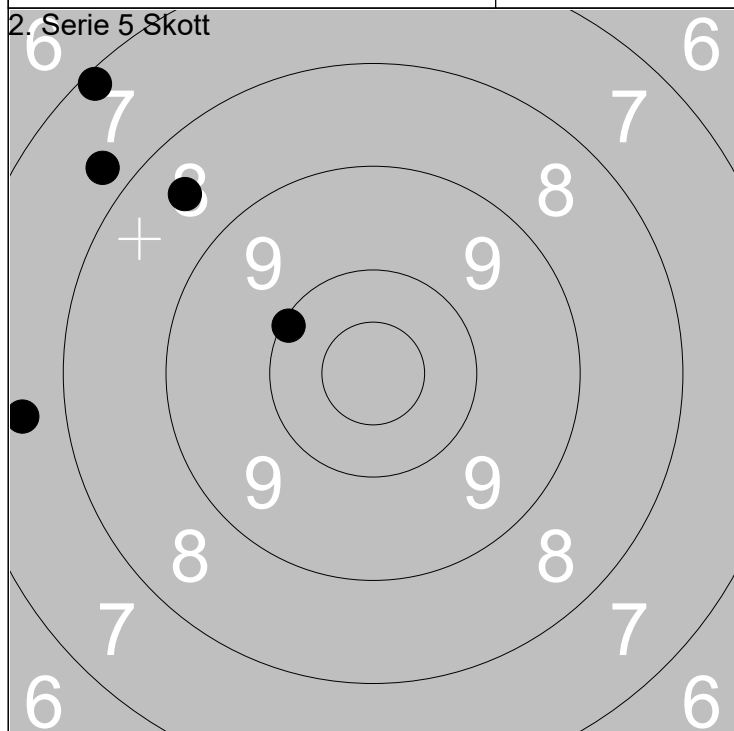

1:	7.6	←
2:	10.1	↗
3:	7.7	↗
4:	8.5	↗
5:	7.1	↗

Serie	39
Total	83

1:	8.9	↖
2:	9.1	↖
3:	7.8	↖
4:	6.7	←
5:	7.0	↘

Serie	37
Total	120

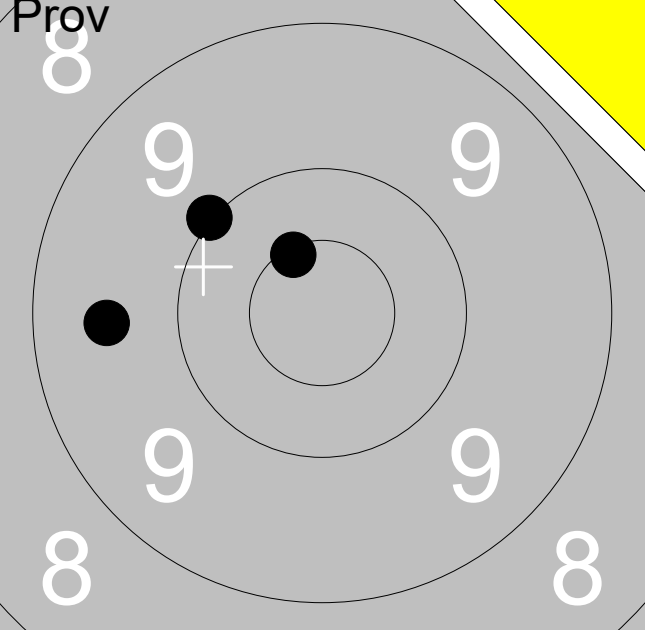
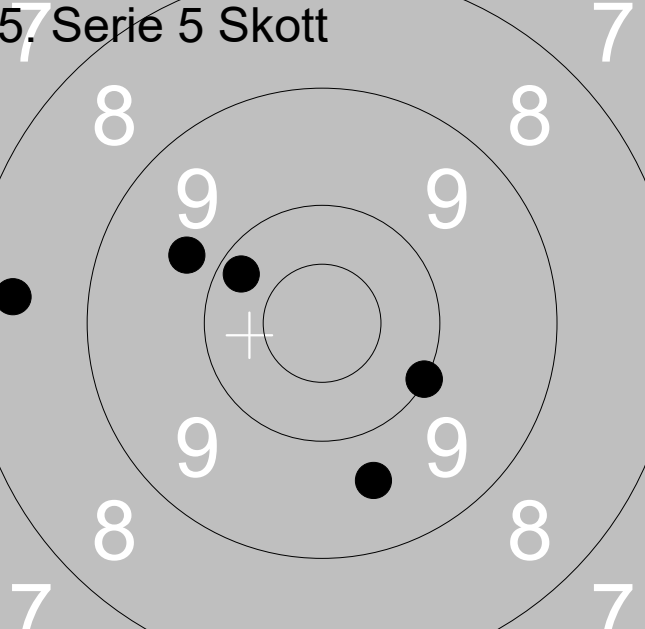
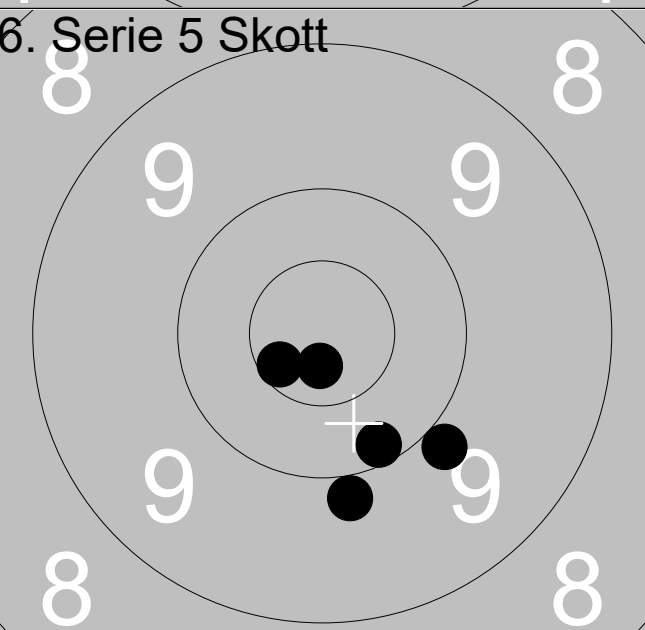
11.07.2021	Tavelstafetten 2021	Ramselefors SKF
Prov 	1: 10.5x	↗
	2: 10.0	↗
	3: 9.5	↖
	Serie	29
Total		0
57 Serie 5 Skott 	1: 8.4	↖
	2: 10.2	↗
	3: 9.6	↘
	4: 10.0	↘
	5: 9.7	↗
	Serie	46
Total		46
6. Serie 5 Skott 	1: 10.6x	↖
	2: 10.7x	↘
	3: 9.9	↘
	4: 10.1	↘
	5: 9.9	↘
	Serie	48
Total		94

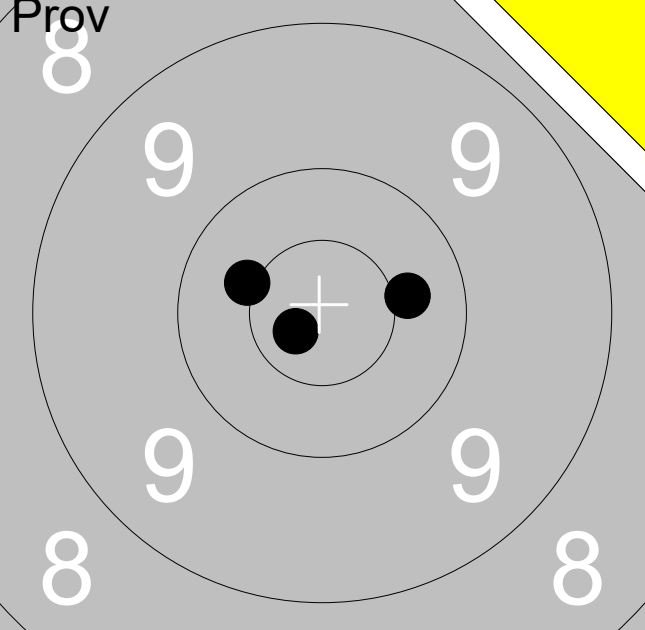
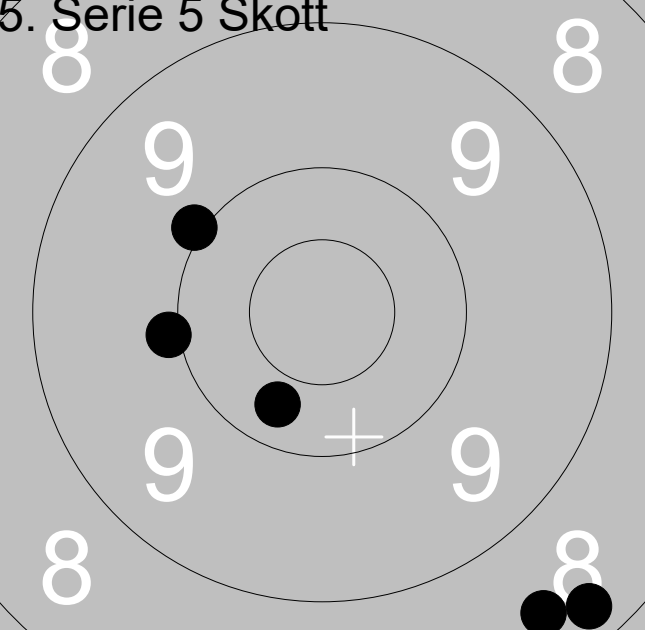
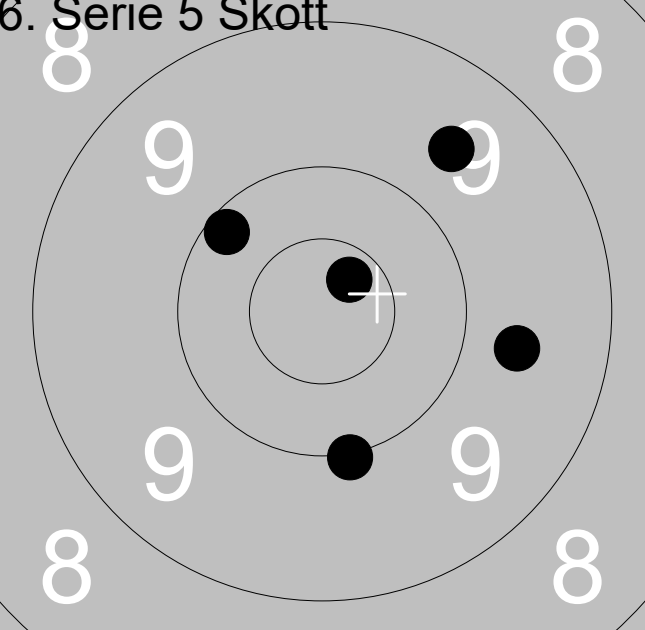
11.07.2021	Tavelstafetten 2021	Ramselefors SKF														
Prov 	<table style="width:100%; border-collapse: collapse;"> <tr><td style="width:10%;">1:</td><td style="width:70%;">10.7x</td><td style="width:20%; text-align: right;">↙</td></tr> <tr><td>2:</td><td>10.4</td><td style="text-align: right;">→</td></tr> <tr><td>3:</td><td>10.4x</td><td style="text-align: right;">↖</td></tr> </table>	1:	10.7x	↙	2:	10.4	→	3:	10.4x	↖						
1:	10.7x	↙														
2:	10.4	→														
3:	10.4x	↖														
Serie		30														
Total		0														
5. Serie 5 Skott 	<table style="width:100%; border-collapse: collapse;"> <tr><td style="width:10%;">1:</td><td style="width:70%;">10.3</td><td style="width:20%; text-align: right;">↘</td></tr> <tr><td>2:</td><td>10.0</td><td style="text-align: right;">←</td></tr> <tr><td>3:</td><td>8.3</td><td style="text-align: right;">↘</td></tr> <tr><td>4:</td><td>10.0</td><td style="text-align: right;">↗</td></tr> <tr><td>5:</td><td>8.4</td><td style="text-align: right;">↘</td></tr> </table>	1:	10.3	↘	2:	10.0	←	3:	8.3	↘	4:	10.0	↗	5:	8.4	↘
1:	10.3	↘														
2:	10.0	←														
3:	8.3	↘														
4:	10.0	↗														
5:	8.4	↘														
Serie		46														
Total		46														
6. Serie 5 Skott 	<table style="width:100%; border-collapse: collapse;"> <tr><td style="width:10%;">1:</td><td style="width:70%;">9.6</td><td style="width:20%; text-align: right;">↗</td></tr> <tr><td>2:</td><td>10.2</td><td style="text-align: right;">↖</td></tr> <tr><td>3:</td><td>10.7x</td><td style="text-align: right;">↗</td></tr> <tr><td>4:</td><td>9.7</td><td style="text-align: right;">→</td></tr> <tr><td>5:</td><td>10.0</td><td style="text-align: right;">↘</td></tr> </table>	1:	9.6	↗	2:	10.2	↖	3:	10.7x	↗	4:	9.7	→	5:	10.0	↘
1:	9.6	↗														
2:	10.2	↖														
3:	10.7x	↗														
4:	9.7	→														
5:	10.0	↘														
Serie		48														
Total		94														

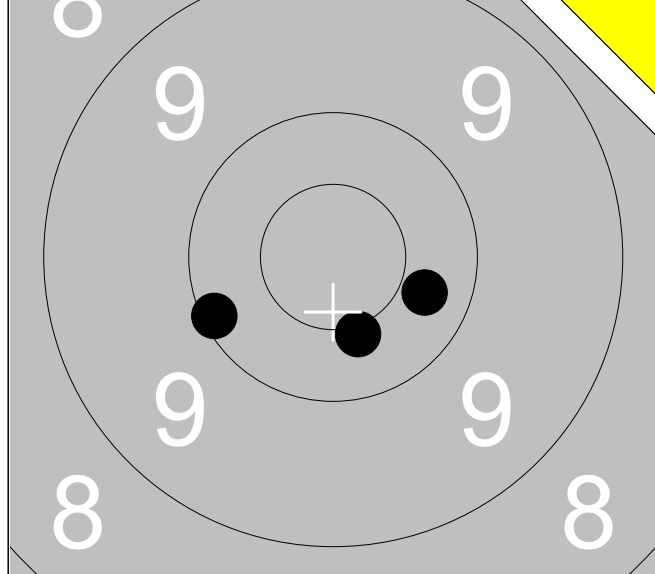

1:	10.3	→
2:	10.1	←
3:	10.4x	↓
Serie		30
Total		0

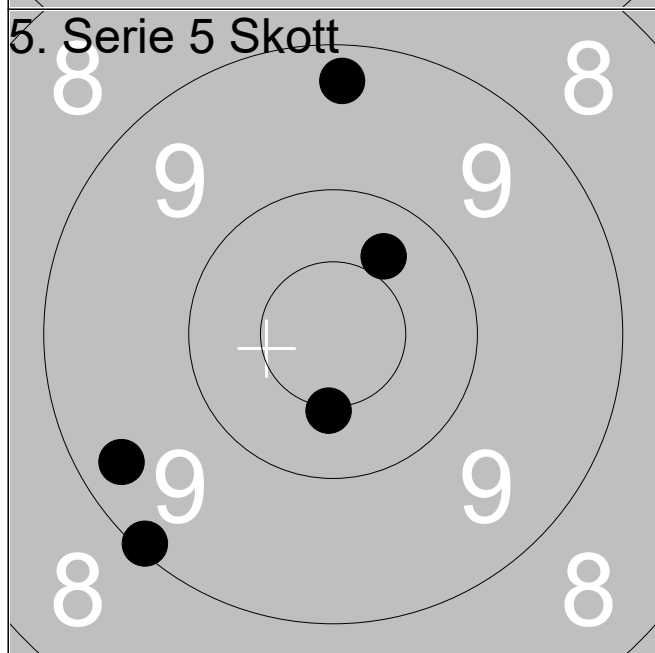

1:	9.3	↑
2:	10.5x	↓
3:	9.3	←
4:	9.1	↙
5:	10.4	↗
Serie		47
Total		47

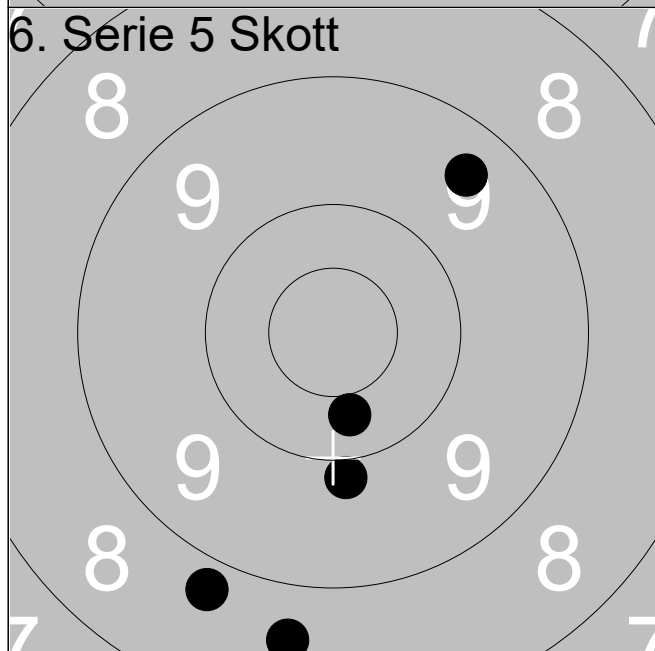

1:	9.4	↗
2:	8.6	↓
3:	8.8	↙
4:	10.3	↓
5:	9.9	↓
Serie		44
Total		91

11.07.2021	Tavelstafetten 2021	Ramselefors SKF
------------	---------------------	-----------------

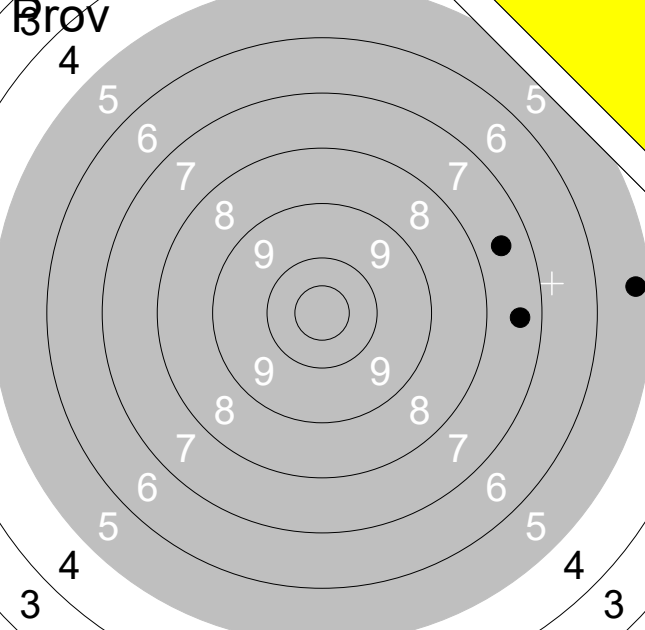

Brov 4

1:	7.4	→
2:	7.5	→
3:	5.3	→

Serie	19
Total	0

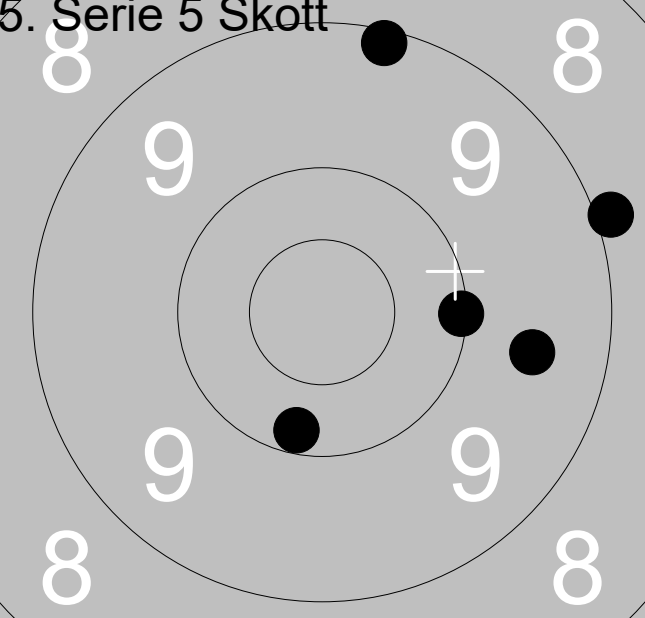

5. Serie 5 Skott

1:	9.5	→
2:	10.1	→
3:	8.9	→
4:	10.2	↓
5:	9.1	↑

Serie	46
Total	46

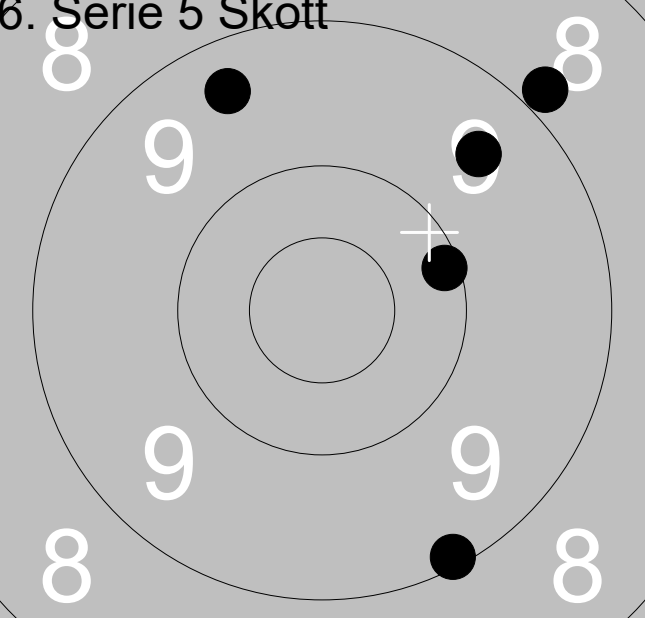

6. Serie 5 Skott

1:	9.1	↓
2:	9.5	↗
3:	8.9	↗
4:	10.1	→
5:	9.4	↑

Serie	45
Total	91

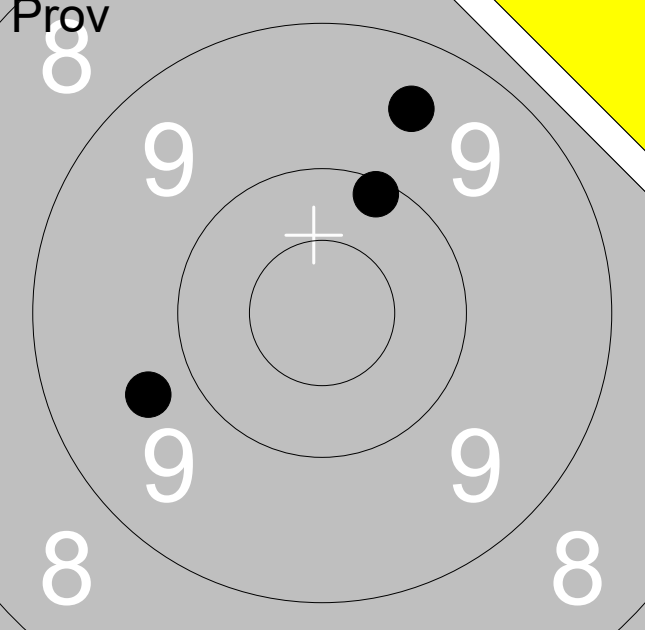
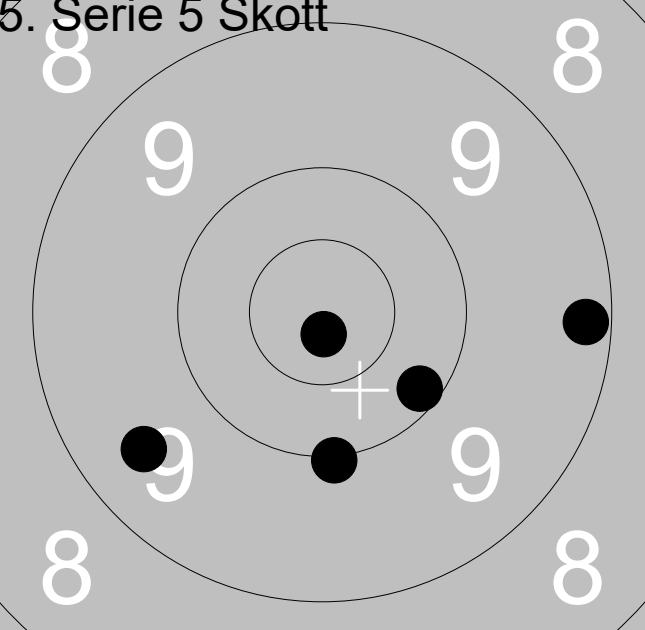
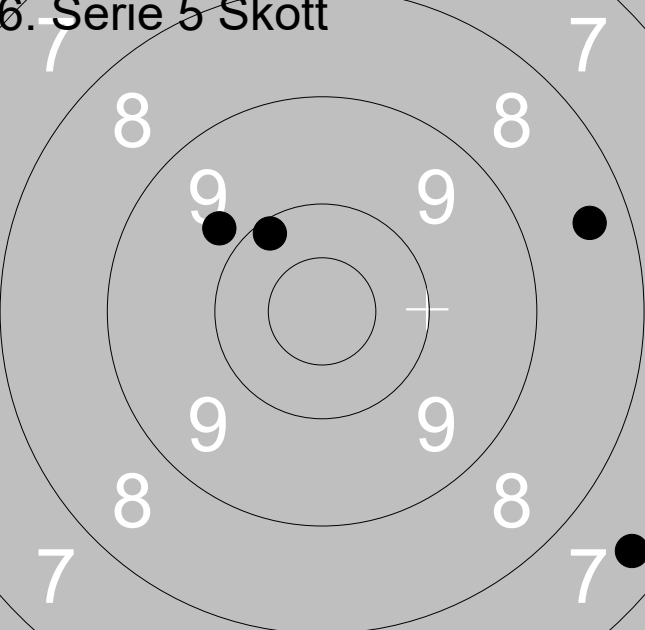
11.07.2021	Tavelstafetten 2021	Ramselefors SKF	
Prov 	1:	9.5	↗
	2:	10.1	↗
	3:	9.7	↖
	Serie		28
Total		0	
5. Serie 5 Skott 	1:	9.5	↖
	2:	9.2	→
	3:	10.2	↘
	4:	10.8x	↓
	5:	10.0	↓
	Serie		48
Total		48	
6. Serie 5 Skott 	1:	0.0	
	2:	8.4	→
	3:	10.1	↗
	4:	9.8	↗
	5:	7.4	↘
	Serie		34
Total		82	

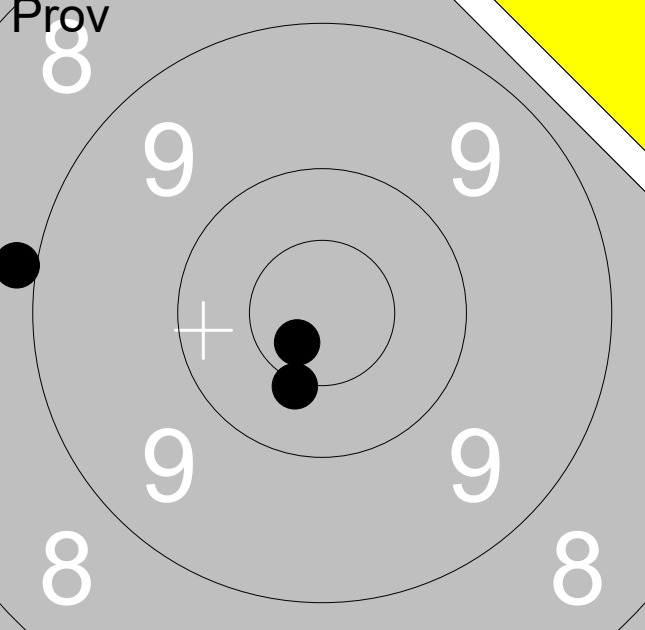
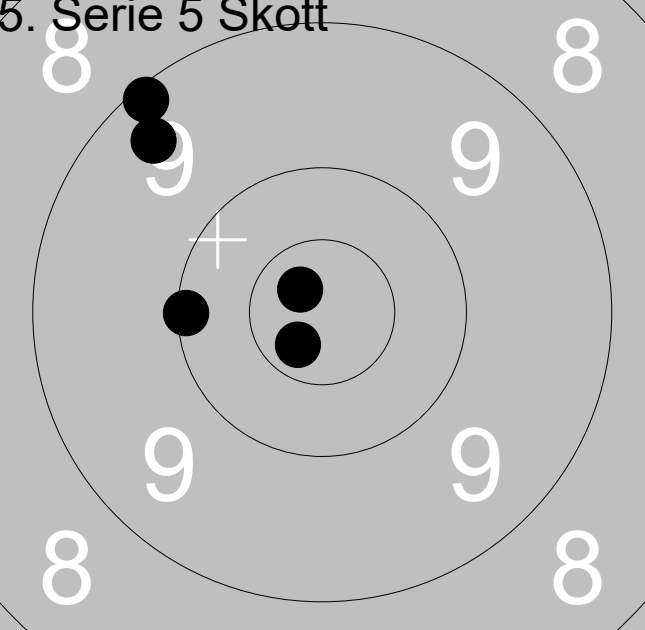
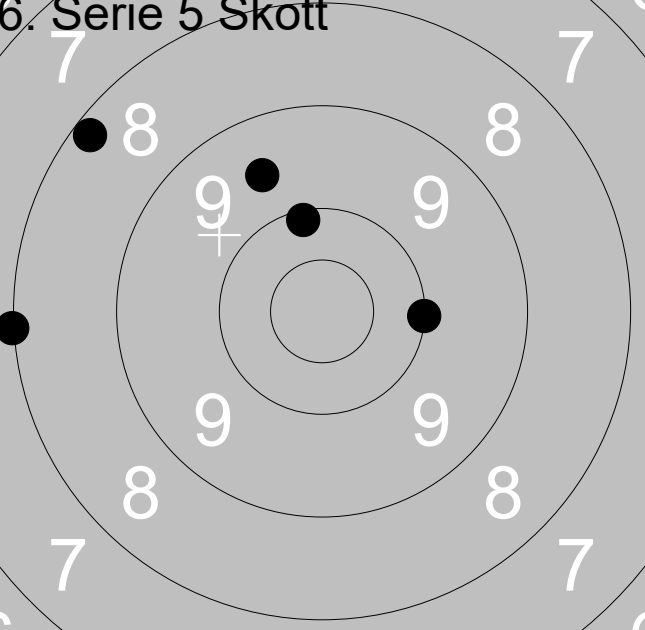
11.07.2021	Tavelstafetten 2021	Ramselefors SKF														
Prov 	<table style="width: 100%; border-collapse: collapse;"> <tr><td style="width: 10%;">1:</td><td style="width: 70%;">8.9</td><td style="width: 20%; text-align: right;">←</td></tr> <tr><td>2:</td><td>10.4x</td><td style="text-align: right;">↓</td></tr> <tr><td>3:</td><td>10.7x</td><td style="text-align: right;">↘</td></tr> </table>	1:	8.9	←	2:	10.4x	↓	3:	10.7x	↘						
1:	8.9	←														
2:	10.4x	↓														
3:	10.7x	↘														
		<table style="width: 100%; border-collapse: collapse;"> <tr><td style="width: 80%;">Serie</td><td style="text-align: right;">28</td></tr> <tr><td>Total</td><td style="text-align: right;">0</td></tr> </table>	Serie	28	Total	0										
Serie	28															
Total	0															
5. Serie 5 Skott 	<table style="width: 100%; border-collapse: collapse;"> <tr><td style="width: 10%;">1:</td><td style="width: 70%;">9.4</td><td style="width: 20%; text-align: right;">↗</td></tr> <tr><td>2:</td><td>10.7x</td><td style="text-align: right;">↓</td></tr> <tr><td>3:</td><td>10.8x</td><td style="text-align: right;">↗</td></tr> <tr><td>4:</td><td>9.1</td><td style="text-align: right;">↗</td></tr> <tr><td>5:</td><td>10.1</td><td style="text-align: right;">←</td></tr> </table>	1:	9.4	↗	2:	10.7x	↓	3:	10.8x	↗	4:	9.1	↗	5:	10.1	←
1:	9.4	↗														
2:	10.7x	↓														
3:	10.8x	↗														
4:	9.1	↗														
5:	10.1	←														
		<table style="width: 100%; border-collapse: collapse;"> <tr><td style="width: 80%;">Serie</td><td style="text-align: right;">48</td></tr> <tr><td>Total</td><td style="text-align: right;">48</td></tr> </table>	Serie	48	Total	48										
Serie	48															
Total	48															
6. Serie 5 Skott 	<table style="width: 100%; border-collapse: collapse;"> <tr><td style="width: 10%;">1:</td><td style="width: 70%;">8.0</td><td style="width: 20%; text-align: right;">←</td></tr> <tr><td>2:</td><td>10.0</td><td style="text-align: right;">→</td></tr> <tr><td>3:</td><td>10.1</td><td style="text-align: right;">↑</td></tr> <tr><td>4:</td><td>8.2</td><td style="text-align: right;">↗</td></tr> <tr><td>5:</td><td>9.6</td><td style="text-align: right;">↗</td></tr> </table>	1:	8.0	←	2:	10.0	→	3:	10.1	↑	4:	8.2	↗	5:	9.6	↗
1:	8.0	←														
2:	10.0	→														
3:	10.1	↑														
4:	8.2	↗														
5:	9.6	↗														
		<table style="width: 100%; border-collapse: collapse;"> <tr><td style="width: 80%;">Serie</td><td style="text-align: right;">45</td></tr> <tr><td>Total</td><td style="text-align: right;">93</td></tr> </table>	Serie	45	Total	93										
Serie	45															
Total	93															

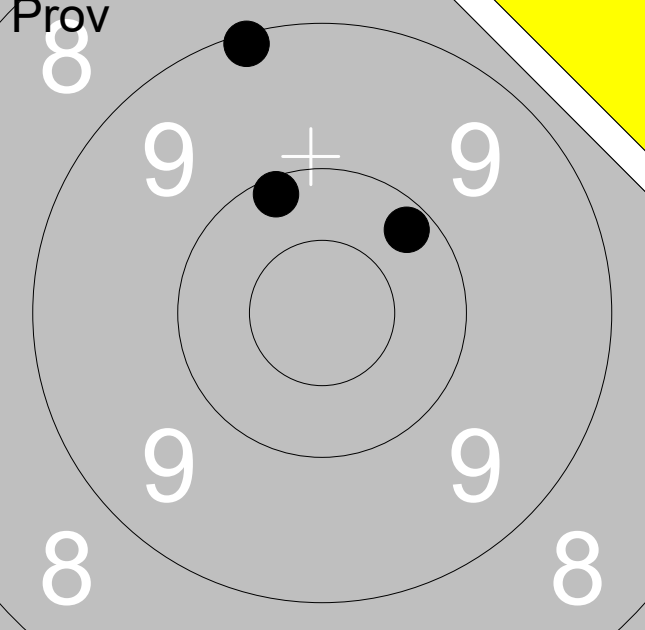
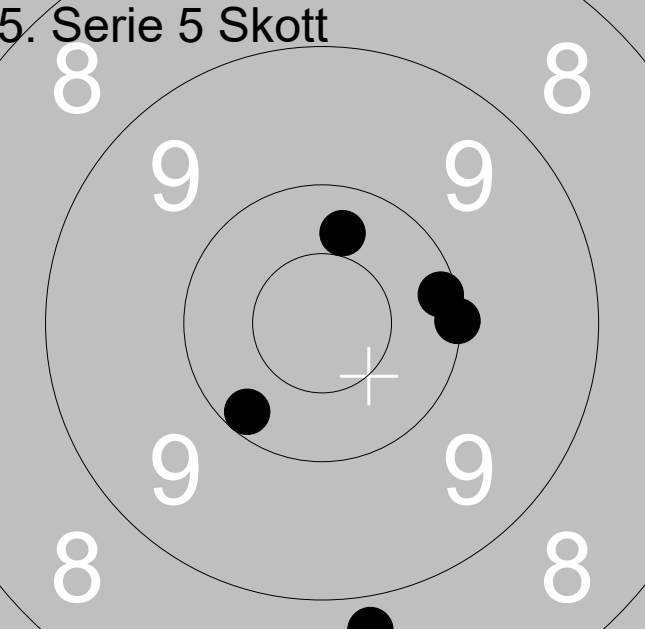
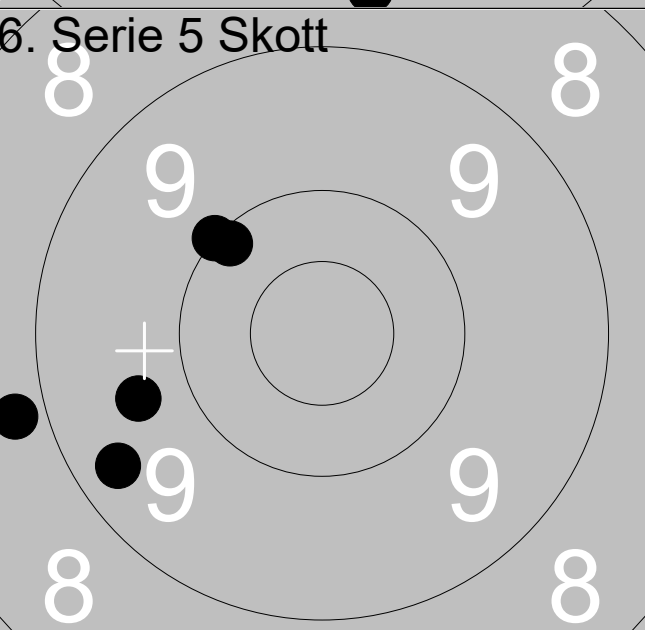
11.07.2021	Tavelstafetten 2021	Ramselefors SKF															
Prov 	<table style="width:100%;"> <tr><td>1:</td><td style="text-align: right;">10.2</td><td style="text-align: right;">↗</td></tr> <tr><td>2:</td><td style="text-align: right;">9.1</td><td style="text-align: right;">↑</td></tr> <tr><td>3:</td><td style="text-align: right;">10.1</td><td style="text-align: right;">↗</td></tr> </table>	1:	10.2	↗	2:	9.1	↑	3:	10.1	↗							
1:	10.2	↗															
2:	9.1	↑															
3:	10.1	↗															
Serie		29															
Total		0															
5. Serie 5 Skott 	<table style="width:100%;"> <tr><td>1:</td><td style="text-align: right;">10.1</td><td style="text-align: right;">→</td></tr> <tr><td>2:</td><td style="text-align: right;">10.0</td><td style="text-align: right;">→</td></tr> <tr><td>3:</td><td style="text-align: right;">8.8</td><td style="text-align: right;">↓</td></tr> <tr><td>4:</td><td style="text-align: right;">10.2</td><td style="text-align: right;">↙</td></tr> <tr><td>5:</td><td style="text-align: right;">10.3</td><td style="text-align: right;">↑</td></tr> </table>	1:	10.1	→	2:	10.0	→	3:	8.8	↓	4:	10.2	↙	5:	10.3	↑	
1:	10.1	→															
2:	10.0	→															
3:	8.8	↓															
4:	10.2	↙															
5:	10.3	↑															
Serie		48															
Total		48															
6. Serie 5 Skott 	<table style="width:100%;"> <tr><td>1:</td><td style="text-align: right;">8.8</td><td style="text-align: right;">←</td></tr> <tr><td>2:</td><td style="text-align: right;">9.3</td><td style="text-align: right;">←</td></tr> <tr><td>3:</td><td style="text-align: right;">10.0</td><td style="text-align: right;">↗</td></tr> <tr><td>4:</td><td style="text-align: right;">10.1</td><td style="text-align: right;">↗</td></tr> <tr><td>5:</td><td style="text-align: right;">9.7</td><td style="text-align: right;">←</td></tr> </table>	1:	8.8	←	2:	9.3	←	3:	10.0	↗	4:	10.1	↗	5:	9.7	←	
1:	8.8	←															
2:	9.3	←															
3:	10.0	↗															
4:	10.1	↗															
5:	9.7	←															
Serie		46															
Total		94															

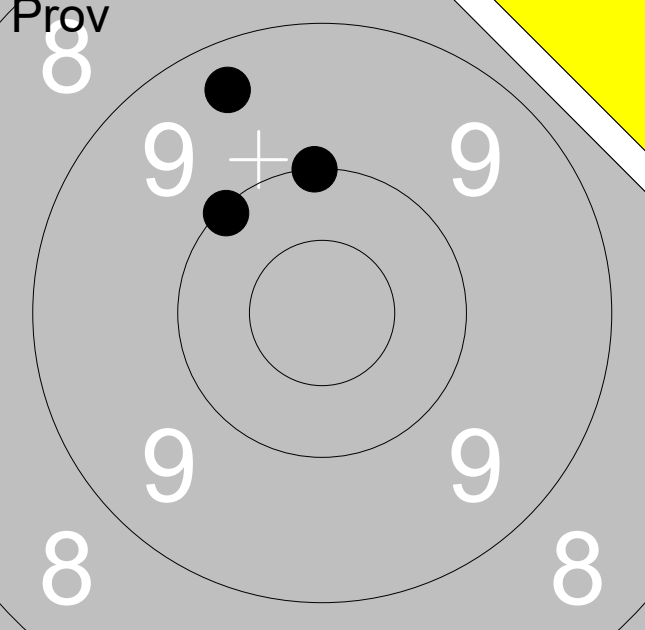
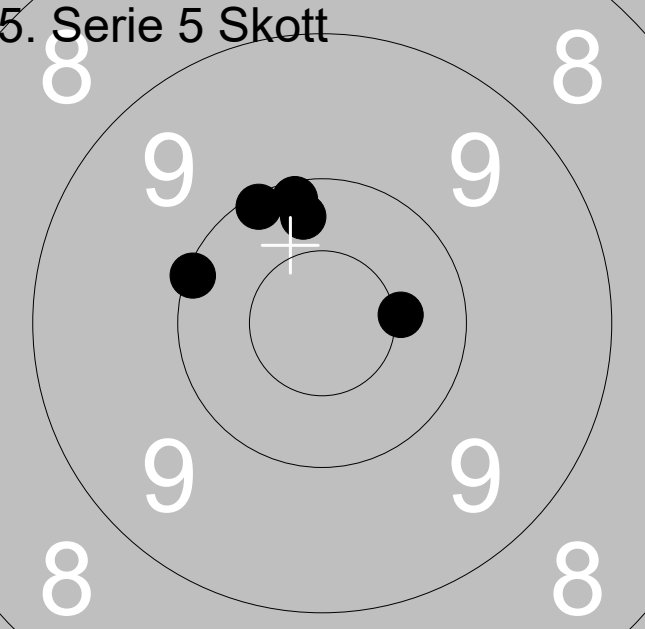
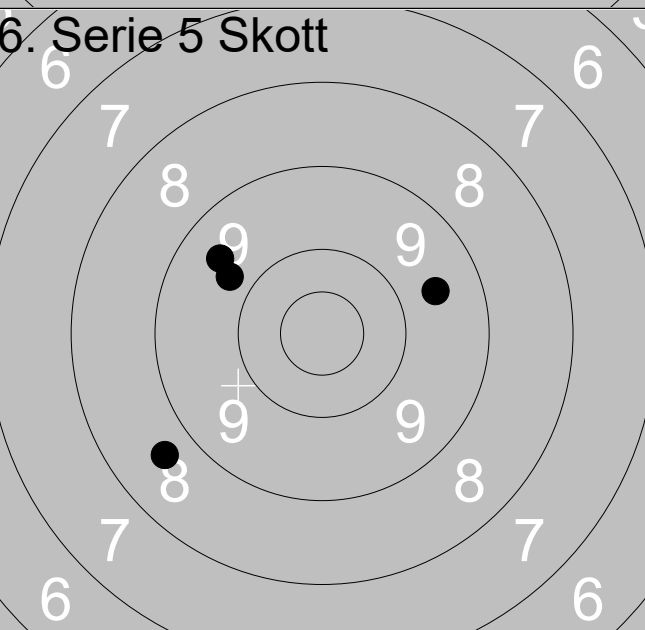
11.07.2021	Tavelstafetten 2021	Ramselefors SKF	
Prov 	1:	10.1	↗
	2:	9.4	↗
	3:	10.0	↗
	Serie		29
Total		0	
5. Serie 5 Skott 	1:	10.1	↖
	2:	10.1	↗
	3:	10.1	↗
	4:	10.3	↗
	5:	10.4x	→
	Serie		50
Total		50	
6. Serie 5 Skott 	1:	9.6	↗
	2:	6.7	↘
	3:	8.7	↖
	4:	9.7	↖
	5:	9.5	↗
	Serie		41
Total		91	

11.07.2021	Tavelstafetten 2021	Ramselefors SKF
------------	---------------------	-----------------

Prov

1:	9.5	↑
2:	9.7	←
3:	9.8	↗

Serie	27
Total	0

5. Serie 5 Skott

1:	10.3	←
2:	9.4	↘
3:	9.3	←
4:	10.6x	←
5:	10.8x	←

Serie	48
Total	48



6. Serie 5 Skott

1:	10.1	←
2:	9.8	↑
3:	10.4	←
4:	8.0	↖
5:	8.9	↑

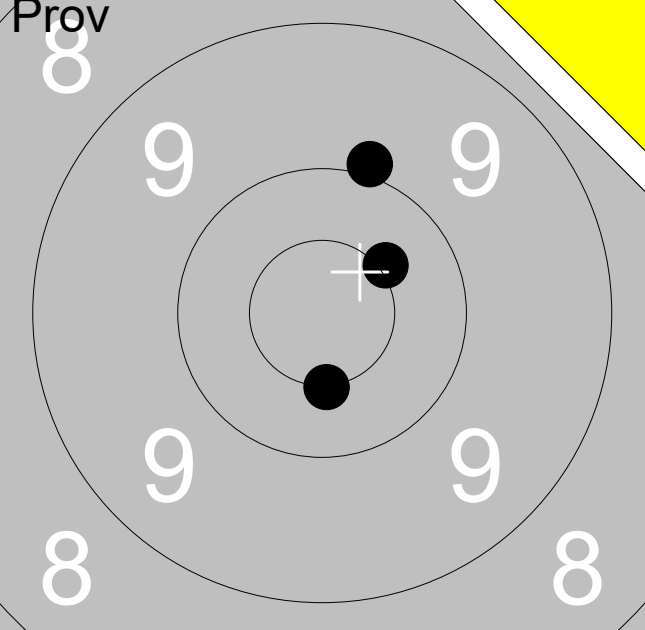
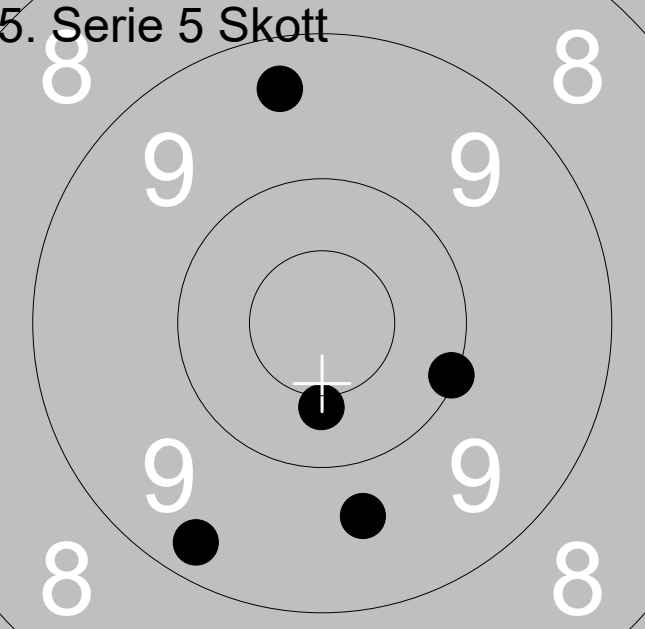
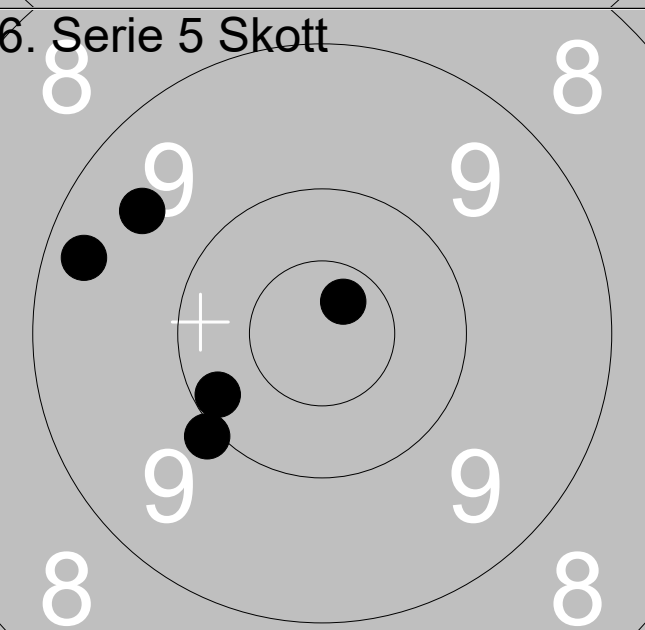

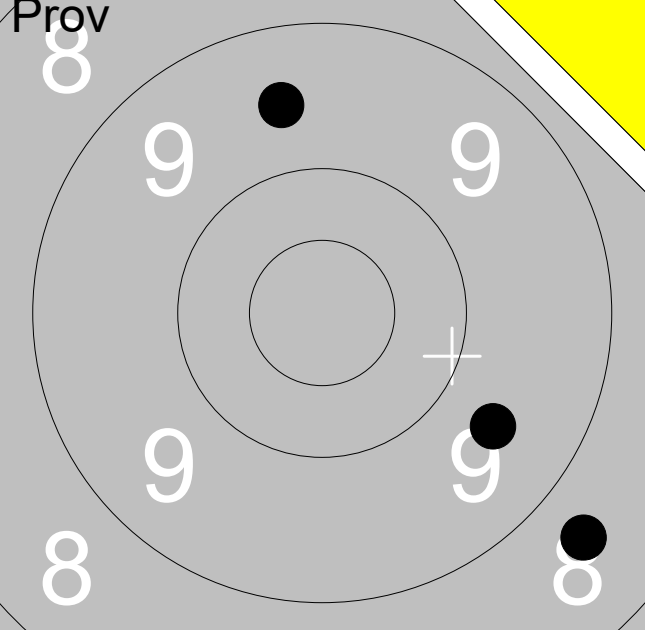
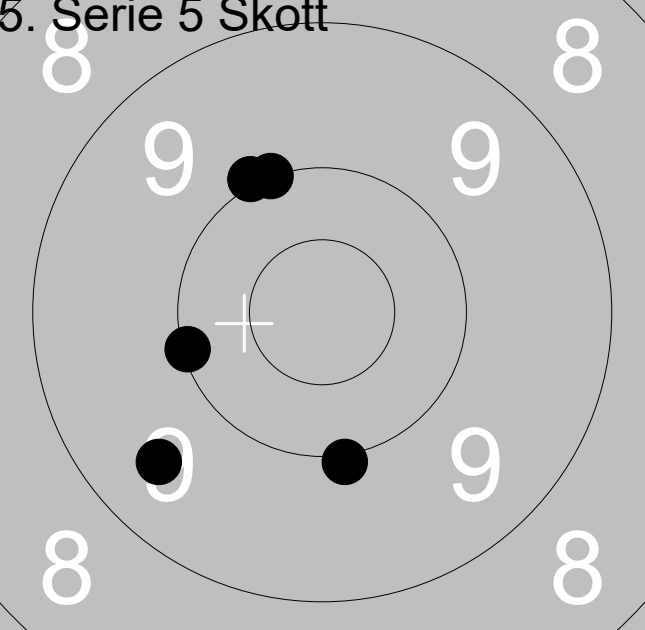
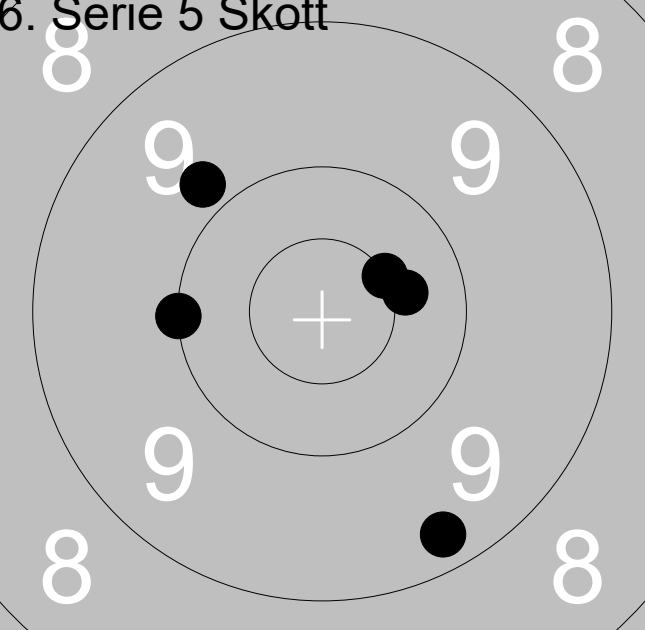
Serie	45
Total	93

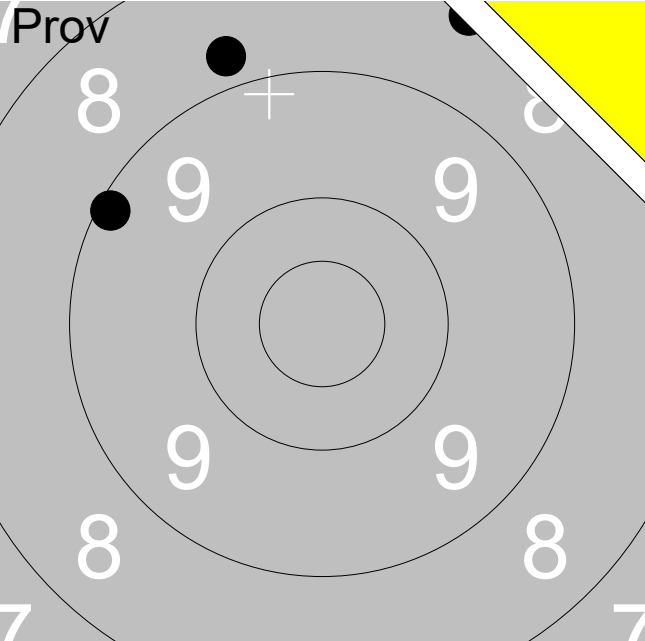
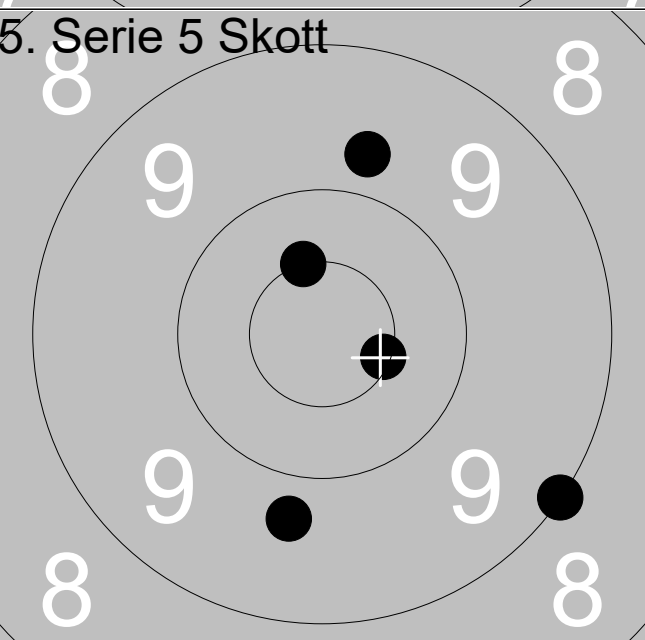
11.07.2021	Tavelstafetten 2021	Ramselefors SKF														
Prov 	<table style="width:100%; border-collapse: collapse;"> <tr> <td style="width:10%;">1:</td> <td style="width:70%;">9.9</td> <td style="width:20%; text-align: right;">↗</td> </tr> <tr> <td>2:</td> <td>10.4x</td> <td style="text-align: right;">↘</td> </tr> <tr> <td>3:</td> <td>10.5x</td> <td style="text-align: right;">↓</td> </tr> </table>	1:	9.9	↗	2:	10.4x	↘	3:	10.5x	↓						
1:	9.9	↗														
2:	10.4x	↘														
3:	10.5x	↓														
Serie		29														
Total		0														
5. Serie 5 Skott 	<table style="width:100%; border-collapse: collapse;"> <tr> <td style="width:10%;">1:</td> <td style="width:70%;">9.4</td> <td style="width:20%; text-align: right;">↗</td> </tr> <tr> <td>2:</td> <td>10.1</td> <td style="text-align: right;">→</td> </tr> <tr> <td>3:</td> <td>9.3</td> <td style="text-align: right;">↙</td> </tr> <tr> <td>4:</td> <td>10.4</td> <td style="text-align: right;">↓</td> </tr> <tr> <td>5:</td> <td>9.7</td> <td style="text-align: right;">↓</td> </tr> </table>	1:	9.4	↗	2:	10.1	→	3:	9.3	↙	4:	10.4	↓	5:	9.7	↓
1:	9.4	↗														
2:	10.1	→														
3:	9.3	↙														
4:	10.4	↓														
5:	9.7	↓														
Serie		47														
Total		47														
6. Serie 5 Skott 	<table style="width:100%; border-collapse: collapse;"> <tr> <td style="width:10%;">1:</td> <td style="width:70%;">10.7x</td> <td style="width:20%; text-align: right;">↗</td> </tr> <tr> <td>2:</td> <td>9.5</td> <td style="text-align: right;">↖</td> </tr> <tr> <td>3:</td> <td>10.0</td> <td style="text-align: right;">↙</td> </tr> <tr> <td>4:</td> <td>10.2</td> <td style="text-align: right;">↖</td> </tr> <tr> <td>5:</td> <td>9.3</td> <td style="text-align: right;">↖</td> </tr> </table>	1:	10.7x	↗	2:	9.5	↖	3:	10.0	↙	4:	10.2	↖	5:	9.3	↖
1:	10.7x	↗														
2:	9.5	↖														
3:	10.0	↙														
4:	10.2	↖														
5:	9.3	↖														
Serie		48														
Total		95														

11.07.2021	Tavelstafetten 2021	Ramselefors SKF															
Prov 	<table style="width:100%; border-collapse: collapse;"> <tr> <td style="width:10%;">1:</td> <td style="width:10%;">8.6</td> <td style="width:10%; text-align: right;">↘</td> </tr> <tr> <td>2:</td> <td>9.6</td> <td style="text-align: right;">↑</td> </tr> <tr> <td>3:</td> <td>9.6</td> <td style="text-align: right;">↘</td> </tr> </table>	1:	8.6	↘	2:	9.6	↑	3:	9.6	↘							
1:	8.6	↘															
2:	9.6	↑															
3:	9.6	↘															
		Serie 26															
		Total 0															
5. Serie 5 Skott 	<table style="width:100%; border-collapse: collapse;"> <tr> <td style="width:10%;">1:</td> <td style="width:10%;">10.0</td> <td style="width:10%; text-align: right;">↗</td> </tr> <tr> <td>2:</td> <td>10.1</td> <td style="text-align: right;">←</td> </tr> <tr> <td>3:</td> <td>10.0</td> <td style="text-align: right;">↓</td> </tr> <tr> <td>4:</td> <td>9.5</td> <td style="text-align: right;">↙</td> </tr> <tr> <td>5:</td> <td>10.0</td> <td style="text-align: right;">↗</td> </tr> </table>	1:	10.0	↗	2:	10.1	←	3:	10.0	↓	4:	9.5	↙	5:	10.0	↗	
1:	10.0	↗															
2:	10.1	←															
3:	10.0	↓															
4:	9.5	↙															
5:	10.0	↗															
		Serie 49															
		Total 49															
6. Serie 5 Skott 	<table style="width:100%; border-collapse: collapse;"> <tr> <td style="width:10%;">1:</td> <td style="width:10%;">10.4</td> <td style="width:10%; text-align: right;">→</td> </tr> <tr> <td>2:</td> <td>10.5x</td> <td style="text-align: right;">↗</td> </tr> <tr> <td>3:</td> <td>9.3</td> <td style="text-align: right;">↓</td> </tr> <tr> <td>4:</td> <td>10.0</td> <td style="text-align: right;">←</td> </tr> <tr> <td>5:</td> <td>9.8</td> <td style="text-align: right;">↗</td> </tr> </table>	1:	10.4	→	2:	10.5x	↗	3:	9.3	↓	4:	10.0	←	5:	9.8	↗	
1:	10.4	→															
2:	10.5x	↗															
3:	9.3	↓															
4:	10.0	←															
5:	9.8	↗															
		Serie 48															
		Total 97															

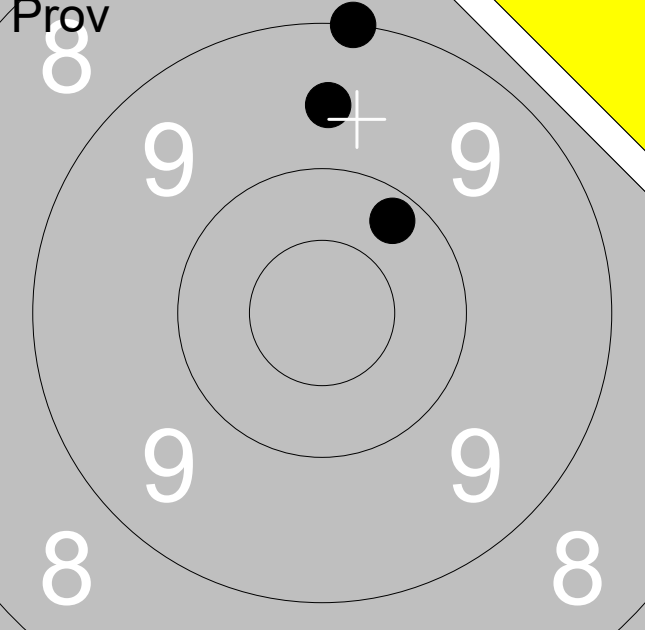
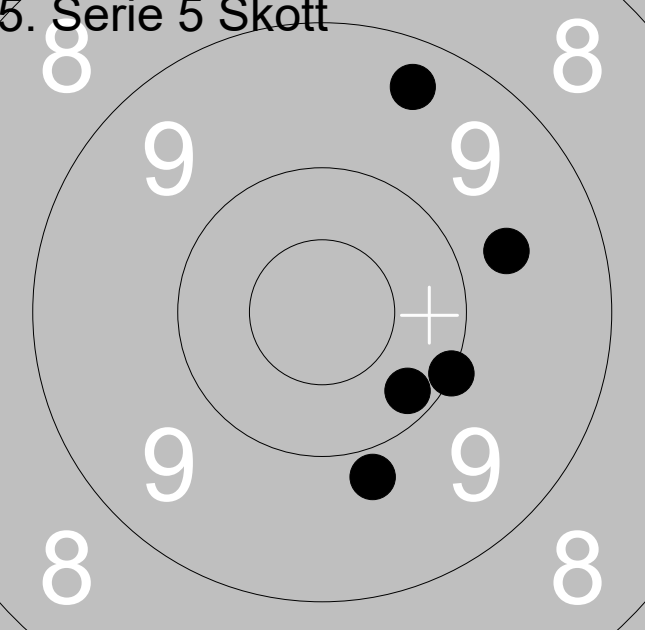
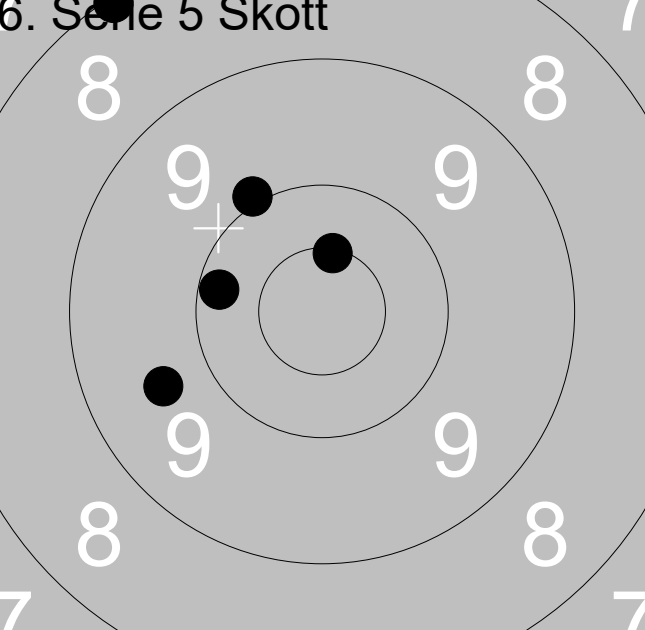
11.07.2021	Tavelstafetten 2021	Ramselefors SKF															
Prov 	<table style="width:100%; border-collapse: collapse;"> <tr><td style="width:10%;">1:</td><td style="width:15%;">9.1</td><td style="width:10%; text-align: right;">↖</td></tr> <tr><td>2:</td><td>8.3</td><td style="text-align: right;">↗</td></tr> <tr><td>3:</td><td>8.8</td><td style="text-align: right;">↗</td></tr> </table>	1:	9.1	↖	2:	8.3	↗	3:	8.8	↗							
1:	9.1	↖															
2:	8.3	↗															
3:	8.8	↗															
Serie		25															
Total		0															
5. Serie 5 Skott 	<table style="width:100%; border-collapse: collapse;"> <tr><td style="width:10%;">1:</td><td style="width:15%;">10.5x</td><td style="width:10%; text-align: right;">→</td></tr> <tr><td>2:</td><td>9.7</td><td style="text-align: right;">↓</td></tr> <tr><td>3:</td><td>10.5x</td><td style="text-align: right;">↗</td></tr> <tr><td>4:</td><td>9.0</td><td style="text-align: right;">↘</td></tr> <tr><td>5:</td><td>9.7</td><td style="text-align: right;">↗</td></tr> </table>	1:	10.5x	→	2:	9.7	↓	3:	10.5x	↗	4:	9.0	↘	5:	9.7	↗	
1:	10.5x	→															
2:	9.7	↓															
3:	10.5x	↗															
4:	9.0	↘															
5:	9.7	↗															
Serie		47															
Total		47															
6. Serie 5 Skott 	<table style="width:100%; border-collapse: collapse;"> <tr><td style="width:10%;">1:</td><td style="width:15%;">0.0</td><td style="width:10%;"></td></tr> <tr><td>2:</td><td>10.5x</td><td style="text-align: right;">↓</td></tr> <tr><td>3:</td><td>10.2</td><td style="text-align: right;">→</td></tr> <tr><td>4:</td><td>10.8x</td><td style="text-align: right;">↗</td></tr> <tr><td>5:</td><td>8.3</td><td style="text-align: right;">↖</td></tr> </table>	1:	0.0		2:	10.5x	↓	3:	10.2	→	4:	10.8x	↗	5:	8.3	↖	
1:	0.0																
2:	10.5x	↓															
3:	10.2	→															
4:	10.8x	↗															
5:	8.3	↖															
Serie		38															
Total		85															

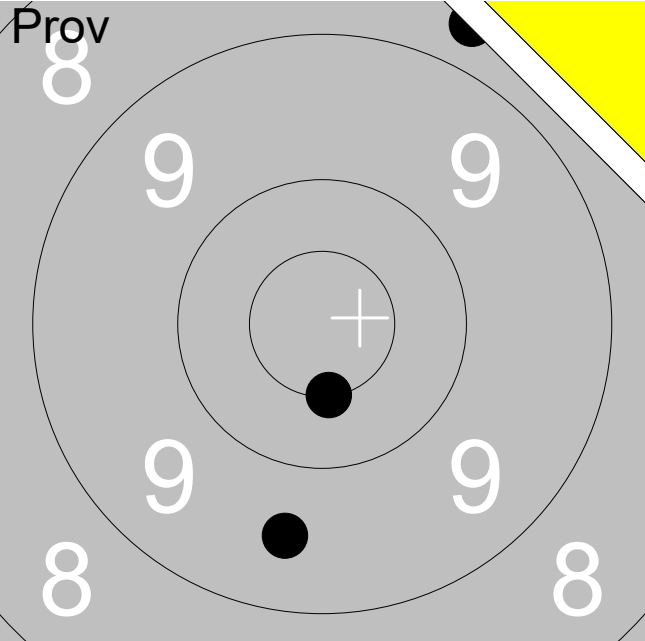
11.07.2021	Tavelstafetten 2021	Ramselefors SKF	
Prov 	1:	9.0	↑
	2:	9.6	↑
	3:	10.2	↗
	Serie		28
Total		0	
5. Serie 5 Skott 	1:	9.7	→
	2:	9.4	↑
	3:	9.8	↓
	4:	10.2	↘
	5:	10.0	↘
	Serie		47
Total		47	
6. Serie 5 Skott 	1:	10.0	↗
	2:	10.5x	↑
	3:	8.1	↗
	4:	10.2	←
	5:	9.6	←
	Serie		47
Total		94	

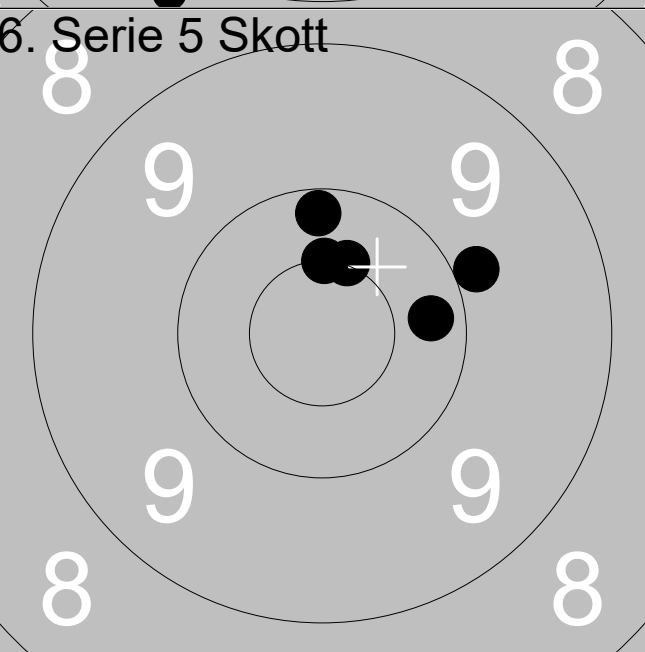
11.07.2021	Tavelstafetten 2021	Ramselefors SKF															
Prov		<table border="1"> <tr><td>1:</td><td>8.7</td><td>↗</td></tr> <tr><td>2:</td><td>9.5</td><td>↓</td></tr> <tr><td>3:</td><td>10.5x</td><td>↓</td></tr> </table>	1:	8.7	↗	2:	9.5	↓	3:	10.5x	↓						
1:	8.7	↗															
2:	9.5	↓															
3:	10.5x	↓															
Serie		27															
Total		0															
5. Serie 5 Skott		<table border="1"> <tr><td>1:</td><td>8.9</td><td>↗</td></tr> <tr><td>2:</td><td>10.5x</td><td>↖</td></tr> <tr><td>3:</td><td>7.8</td><td>↓</td></tr> <tr><td>4:</td><td>10.1</td><td>↑</td></tr> <tr><td>5:</td><td>10.3</td><td>↖</td></tr> </table>	1:	8.9	↗	2:	10.5x	↖	3:	7.8	↓	4:	10.1	↑	5:	10.3	↖
1:	8.9	↗															
2:	10.5x	↖															
3:	7.8	↓															
4:	10.1	↑															
5:	10.3	↖															
Serie		45															
Total		45															
6. Serie 5 Skott		<table border="1"> <tr><td>1:</td><td>9.9</td><td>↗</td></tr> <tr><td>2:</td><td>10.5x</td><td>↑</td></tr> <tr><td>3:</td><td>10.5x</td><td>↑</td></tr> <tr><td>4:</td><td>10.2</td><td>→</td></tr> <tr><td>5:</td><td>10.2</td><td>↑</td></tr> </table>	1:	9.9	↗	2:	10.5x	↑	3:	10.5x	↑	4:	10.2	→	5:	10.2	↑
1:	9.9	↗															
2:	10.5x	↑															
3:	10.5x	↑															
4:	10.2	→															
5:	10.2	↑															
Serie		49															
Total		94															

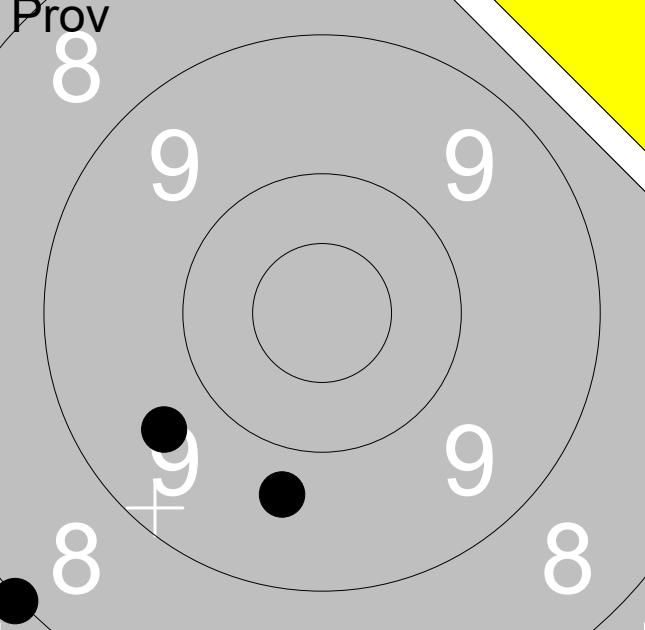
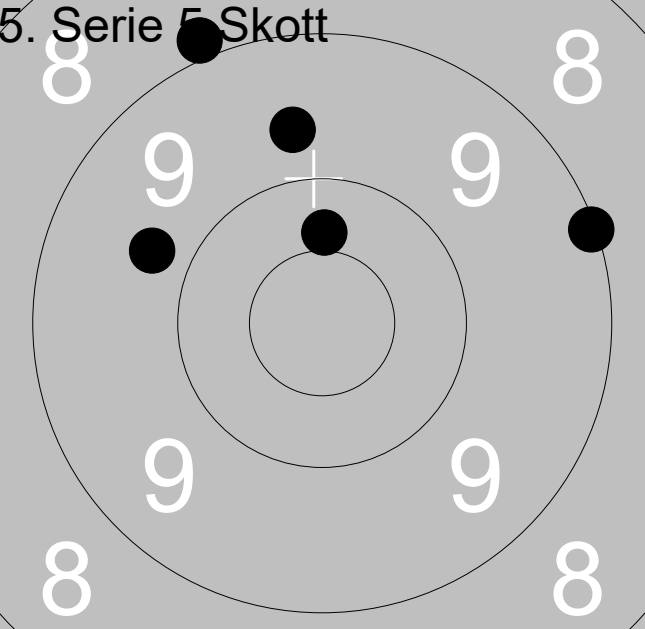
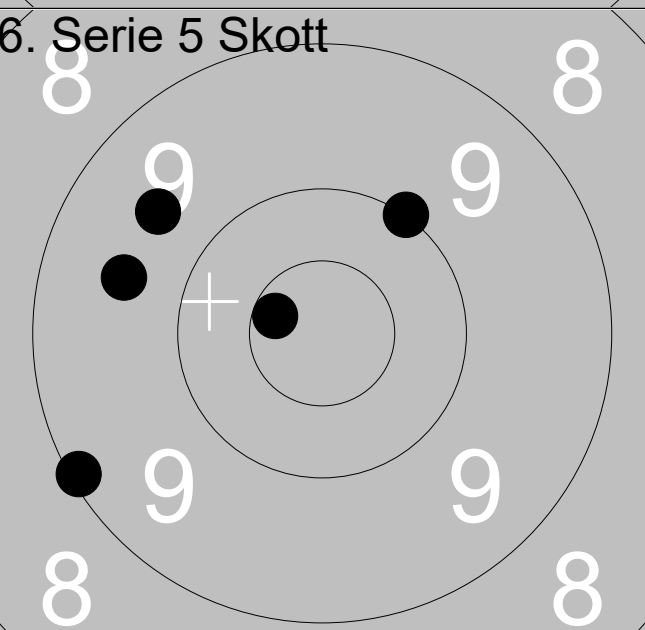
11.07.2021	Tavelstafetten 2021	Ramselefors SKF															
Prov 	<table style="width:100%; border-collapse: collapse;"> <tr><td style="width:10%;">1:</td><td style="width:10%;">9.6</td><td style="width:10%; text-align: right;">↙</td></tr> <tr><td>2:</td><td>9.7</td><td style="text-align: right;">↓</td></tr> <tr><td>3:</td><td>8.0</td><td style="text-align: right;">↘</td></tr> </table>	1:	9.6	↙	2:	9.7	↓	3:	8.0	↘							
1:	9.6	↙															
2:	9.7	↓															
3:	8.0	↘															
		<table style="width:100%; border-collapse: collapse;"> <tr><td style="width:10%;">Serie</td><td style="width:10%;"></td><td style="width:10%; text-align: right;">26</td></tr> <tr><td>Total</td><td></td><td style="text-align: right;">0</td></tr> </table>	Serie		26	Total		0									
Serie		26															
Total		0															
5. Serie 5 Skott 	<table style="width:100%; border-collapse: collapse;"> <tr><td style="width:10%;">1:</td><td style="width:10%;">9.1</td><td style="width:10%; text-align: right;">→</td></tr> <tr><td>2:</td><td>10.4</td><td style="text-align: right;">↑</td></tr> <tr><td>3:</td><td>9.7</td><td style="text-align: right;">↑</td></tr> <tr><td>4:</td><td>8.9</td><td style="text-align: right;">↗</td></tr> <tr><td>5:</td><td>9.8</td><td style="text-align: right;">↖</td></tr> </table>	1:	9.1	→	2:	10.4	↑	3:	9.7	↑	4:	8.9	↗	5:	9.8	↖	
1:	9.1	→															
2:	10.4	↑															
3:	9.7	↑															
4:	8.9	↗															
5:	9.8	↖															
		<table style="width:100%; border-collapse: collapse;"> <tr><td style="width:10%;">Serie</td><td style="width:10%;"></td><td style="width:10%; text-align: right;">45</td></tr> <tr><td>Total</td><td></td><td style="text-align: right;">45</td></tr> </table>	Serie		45	Total		45									
Serie		45															
Total		45															
6. Serie 5 Skott 	<table style="width:100%; border-collapse: collapse;"> <tr><td style="width:10%;">1:</td><td style="width:10%;">9.6</td><td style="width:10%; text-align: right;">↖</td></tr> <tr><td>2:</td><td>9.1</td><td style="text-align: right;">↙</td></tr> <tr><td>3:</td><td>9.6</td><td style="text-align: right;">↙</td></tr> <tr><td>4:</td><td>10.6x</td><td style="text-align: right;">↙</td></tr> <tr><td>5:</td><td>10.0</td><td style="text-align: right;">↗</td></tr> </table>	1:	9.6	↖	2:	9.1	↙	3:	9.6	↙	4:	10.6x	↙	5:	10.0	↗	
1:	9.6	↖															
2:	9.1	↙															
3:	9.6	↙															
4:	10.6x	↙															
5:	10.0	↗															
		<table style="width:100%; border-collapse: collapse;"> <tr><td style="width:10%;">Serie</td><td style="width:10%;"></td><td style="width:10%; text-align: right;">47</td></tr> <tr><td>Total</td><td></td><td style="text-align: right;">92</td></tr> </table>	Serie		47	Total		92									
Serie		47															
Total		92															

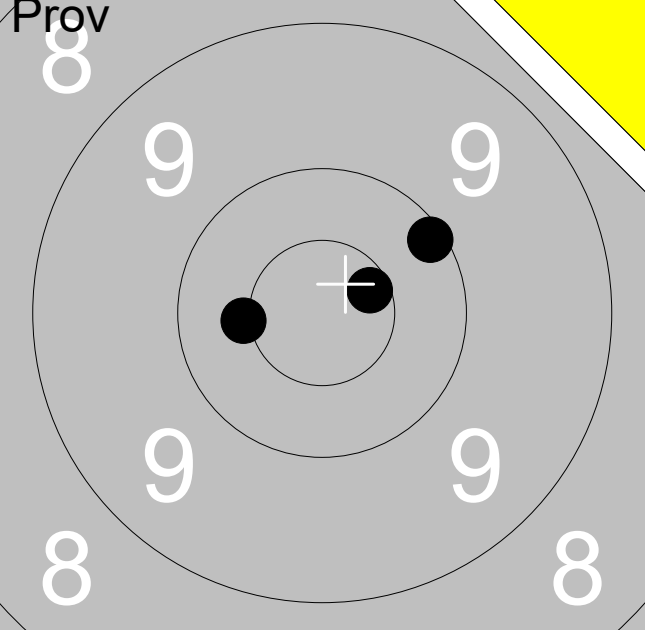
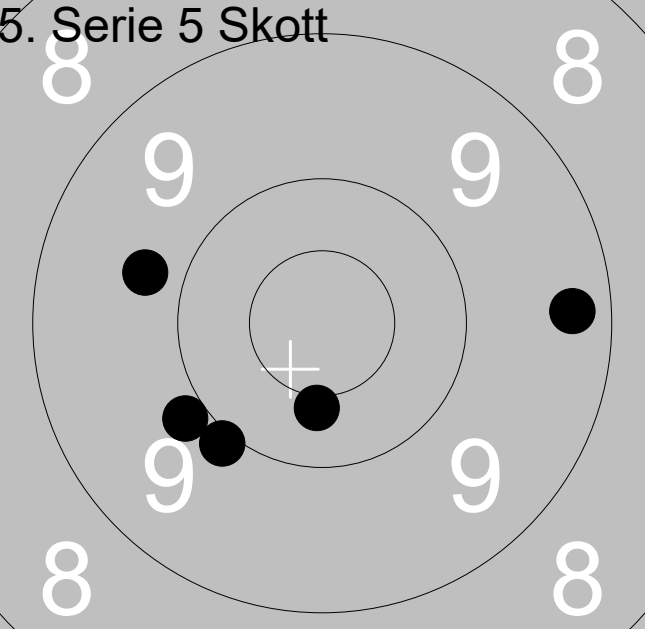
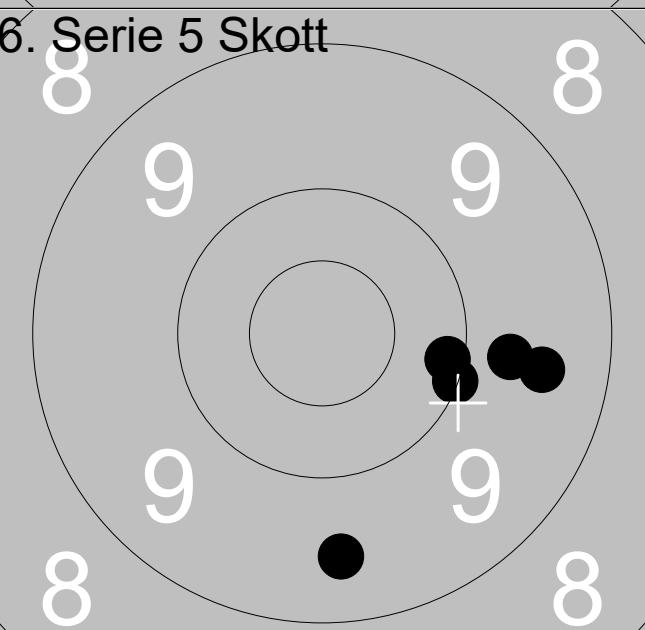
11.07.2021	Tavelstafetten 2021	Ramselefors SKF															
Prov		<table border="1"> <tr><td>1:</td><td>10.4x</td><td>←</td></tr> <tr><td>2:</td><td>10.1</td><td>↗</td></tr> <tr><td>3:</td><td>10.6x</td><td>↗</td></tr> </table>	1:	10.4x	←	2:	10.1	↗	3:	10.6x	↗						
1:	10.4x	←															
2:	10.1	↗															
3:	10.6x	↗															
Serie		30															
Total		0															
5. Serie 5 Skott		<table border="1"> <tr><td>1:</td><td>9.9</td><td>↙</td></tr> <tr><td>2:</td><td>9.3</td><td>→</td></tr> <tr><td>3:</td><td>9.8</td><td>←</td></tr> <tr><td>4:</td><td>10.4</td><td>↓</td></tr> <tr><td>5:</td><td>9.9</td><td>↙</td></tr> </table>	1:	9.9	↙	2:	9.3	→	3:	9.8	←	4:	10.4	↓	5:	9.9	↙
1:	9.9	↙															
2:	9.3	→															
3:	9.8	←															
4:	10.4	↓															
5:	9.9	↙															
Serie		46															
Total		46															
6. Serie 5 Skott		<table border="1"> <tr><td>1:</td><td>9.5</td><td>↓</td></tr> <tr><td>2:</td><td>9.7</td><td>→</td></tr> <tr><td>3:</td><td>10.0</td><td>↗</td></tr> <tr><td>4:</td><td>10.1</td><td>→</td></tr> <tr><td>5:</td><td>9.5</td><td>↗</td></tr> </table>	1:	9.5	↓	2:	9.7	→	3:	10.0	↗	4:	10.1	→	5:	9.5	↗
1:	9.5	↓															
2:	9.7	→															
3:	10.0	↗															
4:	10.1	→															
5:	9.5	↗															
Serie		47															
Total		93															

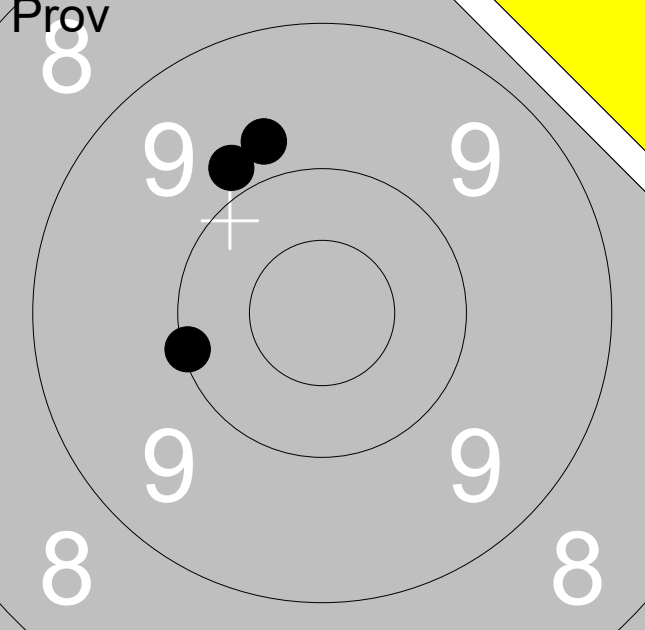
11.07.2021	Tavelstafetten 2021	Ramselefors SKF															
Prov		<table border="1"> <tr><td>1:</td><td>9.8</td><td>↗</td></tr> <tr><td>2:</td><td>9.8</td><td>↗</td></tr> <tr><td>3:</td><td>10.1</td><td>↖</td></tr> </table>	1:	9.8	↗	2:	9.8	↗	3:	10.1	↖						
1:	9.8	↗															
2:	9.8	↗															
3:	10.1	↖															
5. Serie 5 Skott		<table border="1"> <tr><td>1:</td><td>9.4</td><td>↗</td></tr> <tr><td>2:</td><td>10.0</td><td>↗</td></tr> <tr><td>3:</td><td>10.5x</td><td>→</td></tr> <tr><td>4:</td><td>10.7x</td><td>↗</td></tr> <tr><td>5:</td><td>10.8x</td><td>↗</td></tr> </table>	1:	9.4	↗	2:	10.0	↗	3:	10.5x	→	4:	10.7x	↗	5:	10.8x	↗
1:	9.4	↗															
2:	10.0	↗															
3:	10.5x	→															
4:	10.7x	↗															
5:	10.8x	↗															
6. Serie 5 Skott		<table border="1"> <tr><td>1:</td><td>10.3</td><td>↘</td></tr> <tr><td>2:</td><td>9.6</td><td>↖</td></tr> <tr><td>3:</td><td>10.3</td><td>↓</td></tr> <tr><td>4:</td><td>10.2</td><td>↓</td></tr> <tr><td>5:</td><td>9.6</td><td>↘</td></tr> </table>	1:	10.3	↘	2:	9.6	↖	3:	10.3	↓	4:	10.2	↓	5:	9.6	↘
1:	10.3	↘															
2:	9.6	↖															
3:	10.3	↓															
4:	10.2	↓															
5:	9.6	↘															
Serie		28															
Total		0															
Serie		49															
Total		49															
Serie		48															
Total		97															

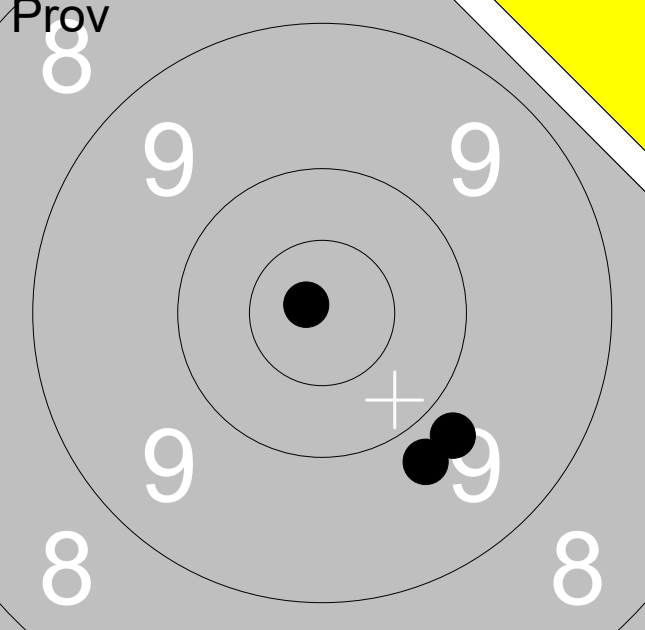
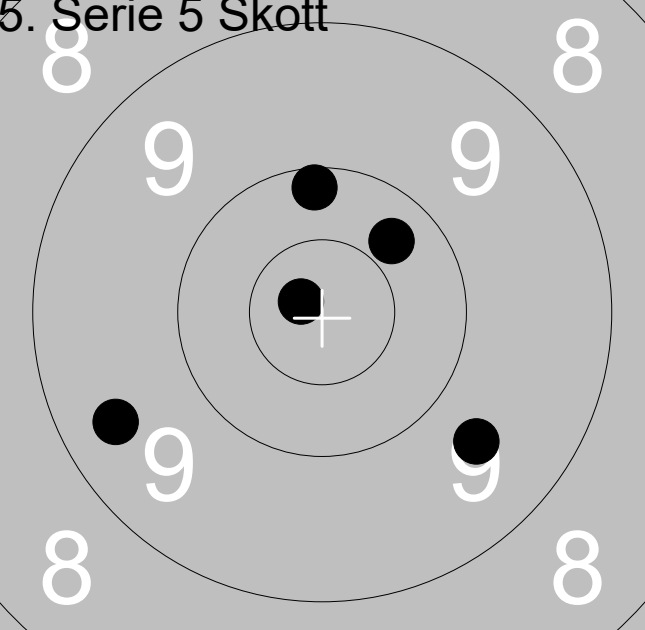
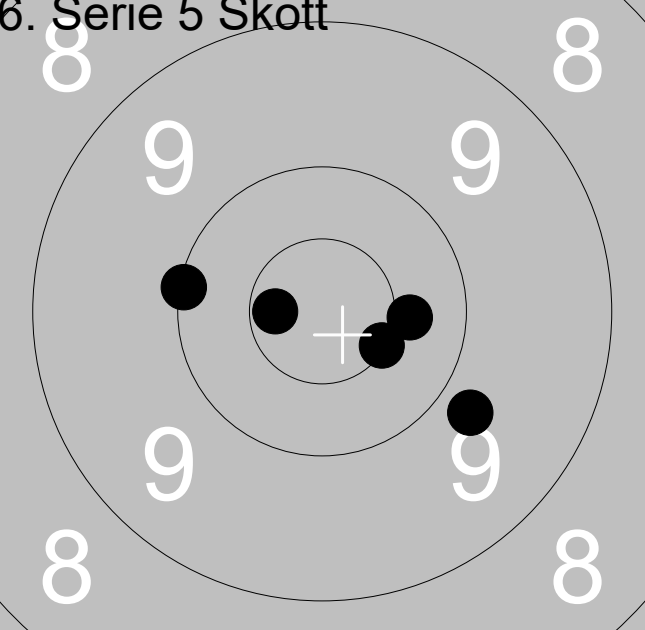
11.07.2021	Tavelstafetten 2021	Ramselefors SKF															
Prov 	<table style="width:100%; border-collapse: collapse;"> <tr> <td style="width:10%;">1:</td> <td style="width:80%;">9.8</td> <td style="width:10%; text-align: right;">↘</td> </tr> <tr> <td>2:</td> <td>10.8x</td> <td style="text-align: right;">↗</td> </tr> <tr> <td>3:</td> <td>9.8</td> <td style="text-align: right;">↘</td> </tr> </table>	1:	9.8	↘	2:	10.8x	↗	3:	9.8	↘							
1:	9.8	↘															
2:	10.8x	↗															
3:	9.8	↘															
		Serie 28															
		Total 0															
5. Serie 5 Skott 	<table style="width:100%; border-collapse: collapse;"> <tr> <td style="width:10%;">1:</td> <td style="width:80%;">9.6</td> <td style="width:10%; text-align: right;">↘</td> </tr> <tr> <td>2:</td> <td>10.8x</td> <td style="text-align: right;">↖</td> </tr> <tr> <td>3:</td> <td>10.3</td> <td style="text-align: right;">↗</td> </tr> <tr> <td>4:</td> <td>10.1</td> <td style="text-align: right;">↑</td> </tr> <tr> <td>5:</td> <td>9.4</td> <td style="text-align: right;">↙</td> </tr> </table>	1:	9.6	↘	2:	10.8x	↖	3:	10.3	↗	4:	10.1	↑	5:	9.4	↙	
1:	9.6	↘															
2:	10.8x	↖															
3:	10.3	↗															
4:	10.1	↑															
5:	9.4	↙															
		Serie 48															
		Total 48															
6. Serie 5 Skott 	<table style="width:100%; border-collapse: collapse;"> <tr> <td style="width:10%;">1:</td> <td style="width:80%;">10.1</td> <td style="width:10%; text-align: right;">←</td> </tr> <tr> <td>2:</td> <td>10.4</td> <td style="text-align: right;">→</td> </tr> <tr> <td>3:</td> <td>9.8</td> <td style="text-align: right;">↘</td> </tr> <tr> <td>4:</td> <td>10.5x</td> <td style="text-align: right;">↘</td> </tr> <tr> <td>5:</td> <td>10.6x</td> <td style="text-align: right;">←</td> </tr> </table>	1:	10.1	←	2:	10.4	→	3:	9.8	↘	4:	10.5x	↘	5:	10.6x	←	
1:	10.1	←															
2:	10.4	→															
3:	9.8	↘															
4:	10.5x	↘															
5:	10.6x	←															
		Serie 49															
		Total 97															

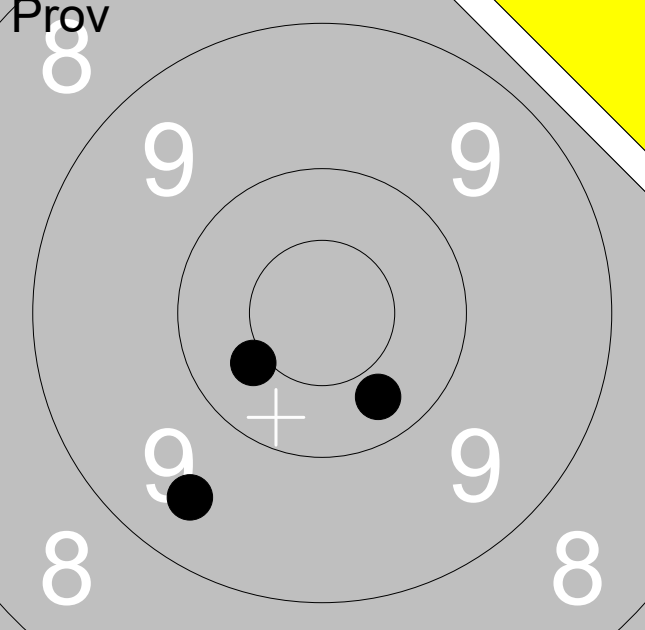
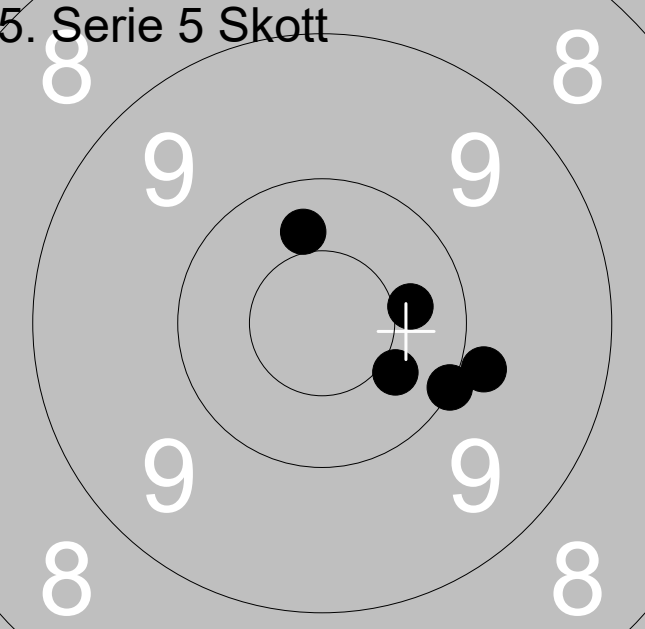
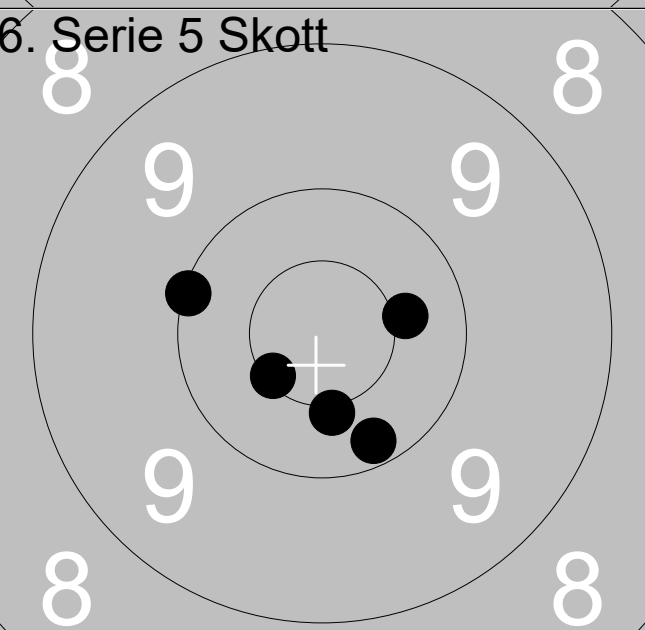
11.07.2021	Tavelstafetten 2021	Ramselefors SKF
Prov 	1: 10.3	↘
	2: 10.4	↙
	3: 9.5	↘
	Serie	29
Total	0	
5. Serie 5 Skott 	1: 10.4	↘
	2: 9.9	→
	3: 10.0	↘
	4: 10.4	→
	5: 10.4	↑
	Serie	49
Total	49	
6. Serie 5 Skott 	1: 10.4	→
	2: 10.1	↙
	3: 10.5x	↘
	4: 10.2	↘
	5: 10.4x	↘
	Serie	50
Total	99	

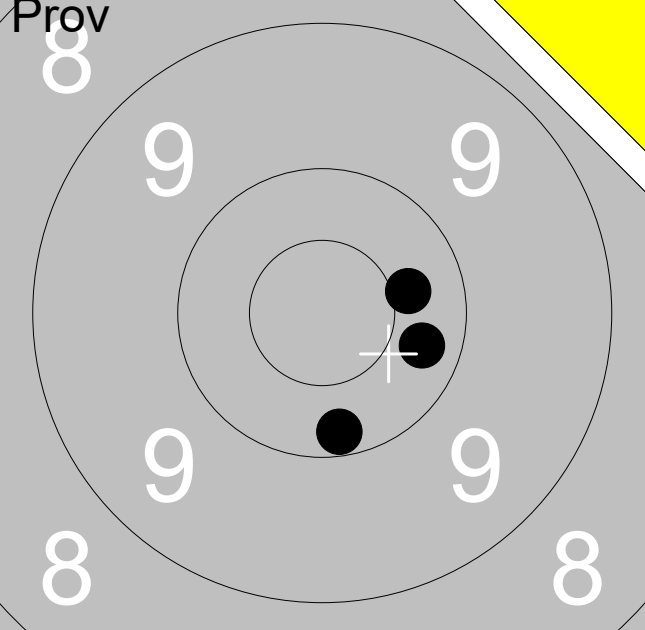
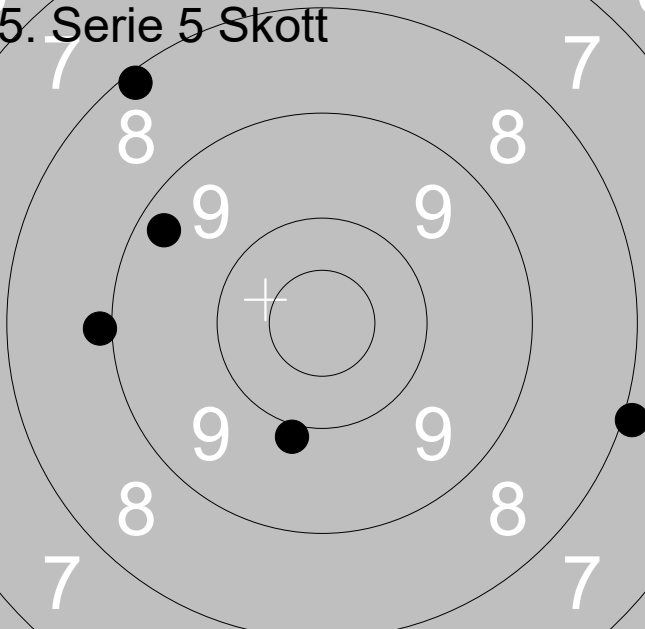
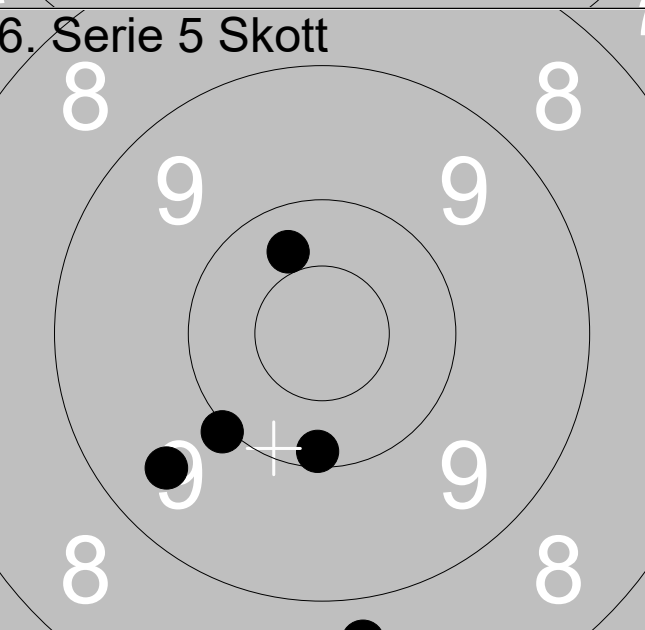
11.07.2021	Tavelstafetten 2021	Ramselefors SKF
Prov 	1: 10.3	→
	2: 10.2	↓
	3: 10.4	→
	Serie	30
Total		0
5. Serie 5 Skott 	1: 9.9	↓
	2: 8.9	←
	3: 7.9	→
	4: 9.3	↗
	5: 8.1	↗
	Serie	41
Total		41
6. Serie 5 Skott 	1: 9.5	↙
	2: 10.0	↙
	3: 10.3	↗
	4: 8.7	↓
	5: 10.1	↓
	Serie	47
Total		88

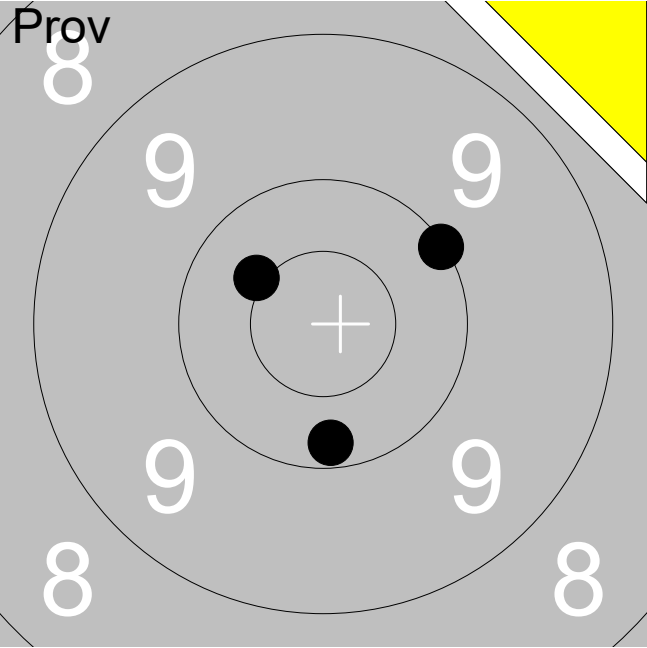
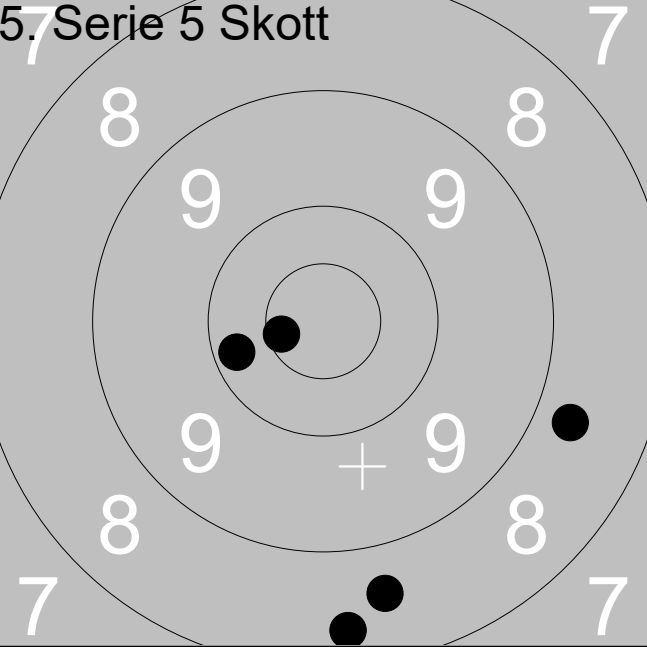
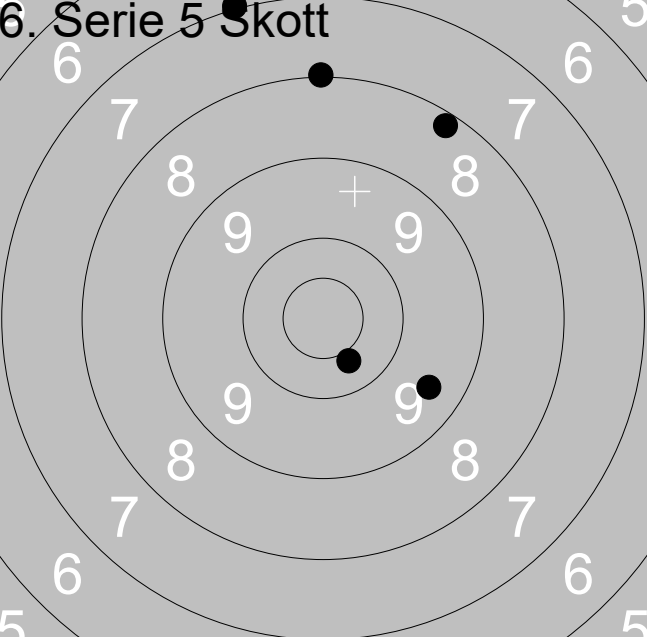
Skjuttag	Tavla	Jan-Erik Karlsson		
5	8	Ramselefors	Ramselefors	Knä
11.07.2021		Tavelstafetten 2021	Ramselefors SKF	Vb
Prov 	1:	10.0	↗	
	2:	10.4x	↖	
	3:	10.2	↓	
	Serie		30	
Total		0		
5. Serie 5 Skott 	1:	8.7	↗	
	2:	10.6x	↖	
	3:	8.3	↓	
	4:	10.2	↖	
	5:	8.6	↓	
	Serie		44	
Total		44		
6. Serie 5 Skott 	1:	8.2	↗	
	2:	9.5	↘	
	3:	10.4	↘	
	4:	8.0	↑	
	5:	7.0	↑	
	Serie		42	
Total		86		

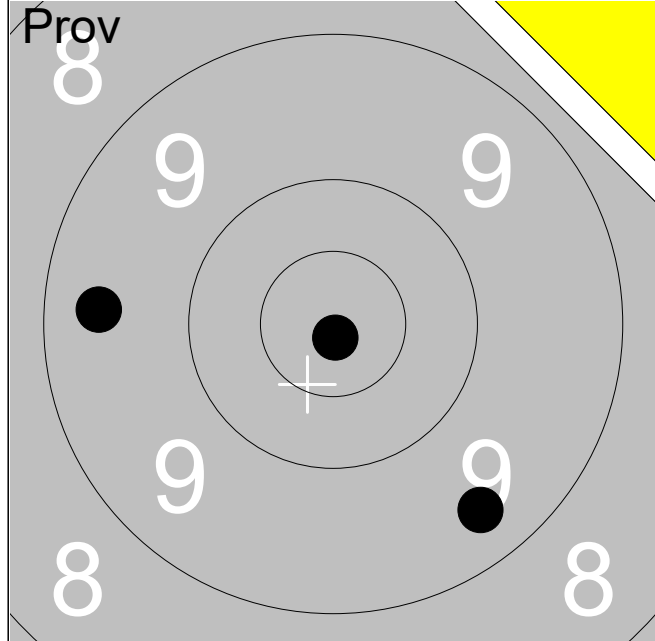

1:	9.4	↘
2:	9.4	←
3:	10.9x	↓
Serie		28
Total		0

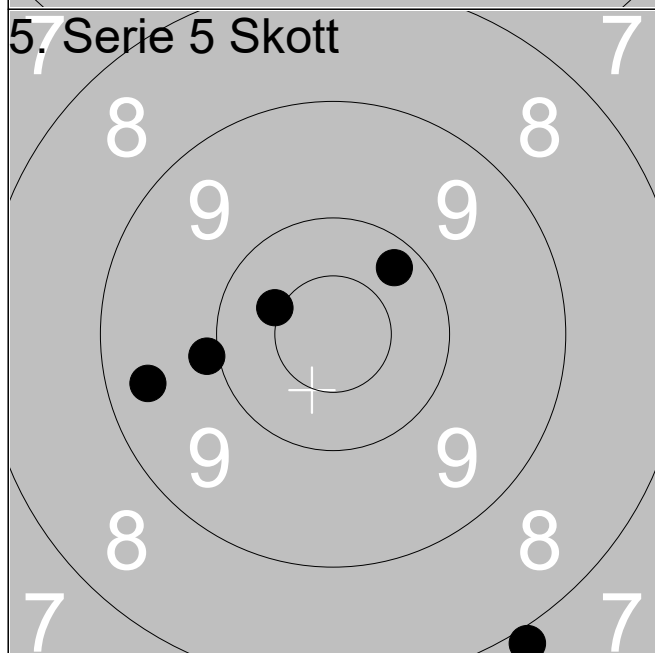

1:	9.4	←
2:	10.2	↗
3:	9.9	←
4:	10.4x	↖
5:	7.9	↓
Serie		45
Total		45

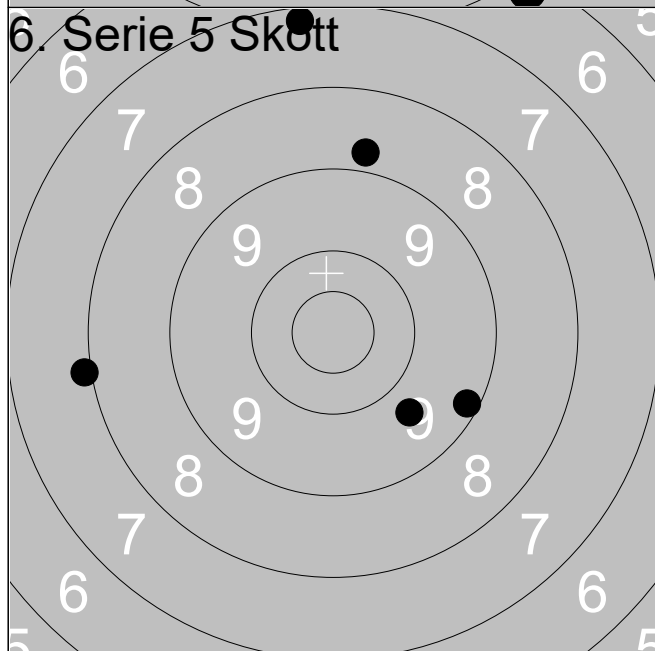

1:	9.2	↘
2:	7.2	↑
3:	8.8	↑
4:	7.9	←
5:	9.7	↘
Serie		40
Total		85

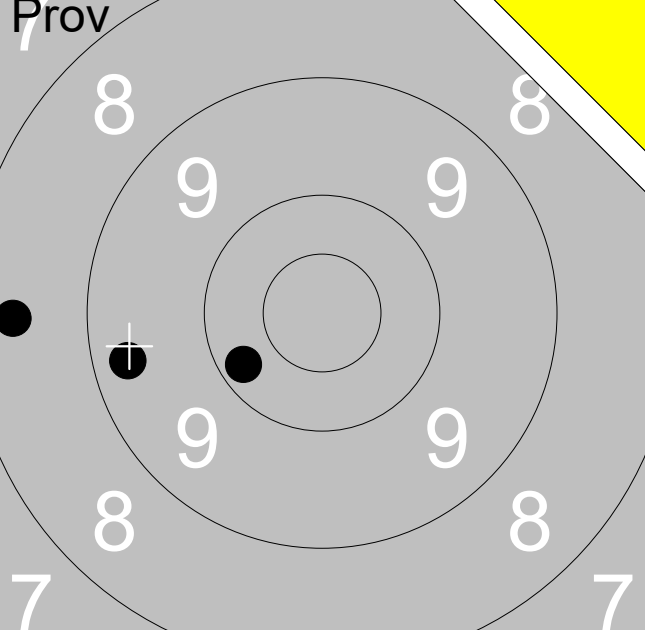
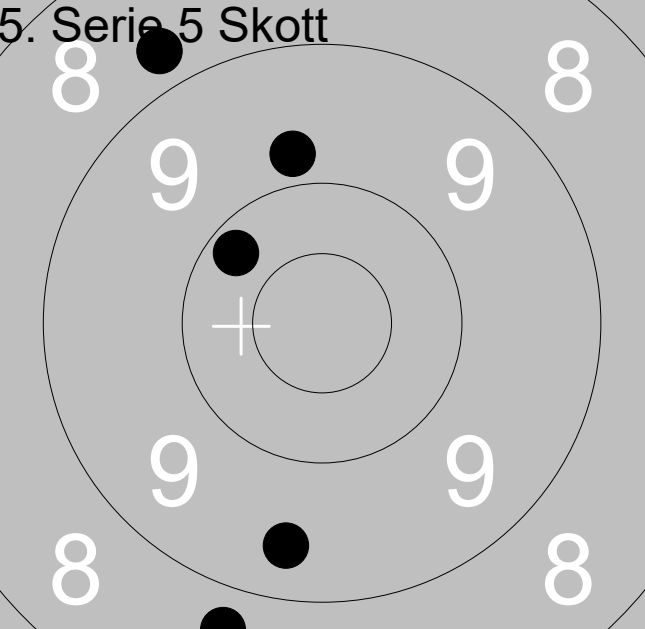
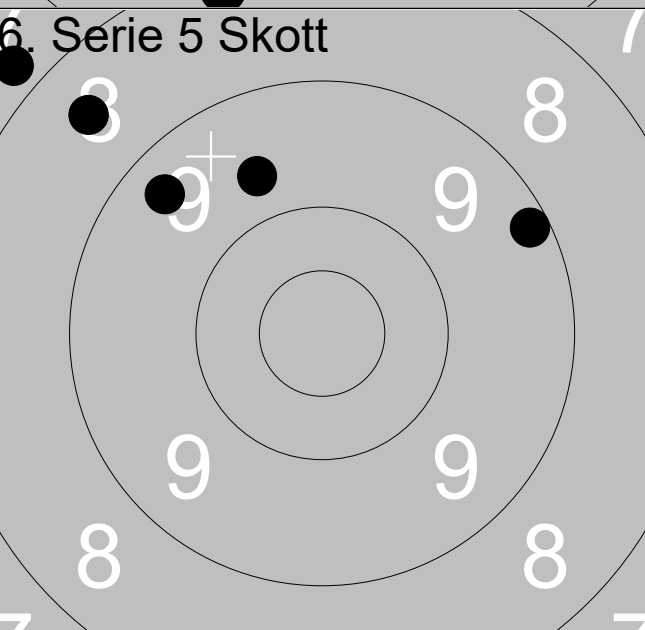
11.07.2021	Tavelstafetten 2021	Ramselefors SKF	
7 Prov 	1:	8.4	←
	2:	9.3	←
	3:	10.2	↙
	Serie		27
Total		0	
5. Serie 5 Skott 	1:	8.8	↗
	2:	9.8	↑
	3:	10.2	↗
	4:	9.4	↓
	5:	8.7	↓
	Serie		44
Total		44	
6. Serie 5 Skott 	1:	9.4	↗
	2:	7.8	↗
	3:	8.5	↗
	4:	9.7	↑
	5:	9.2	↗
	Serie		42
Total		86	

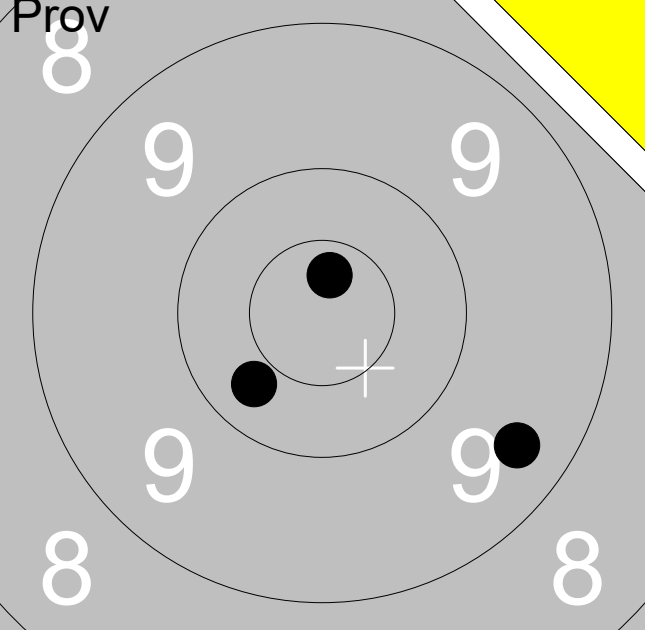
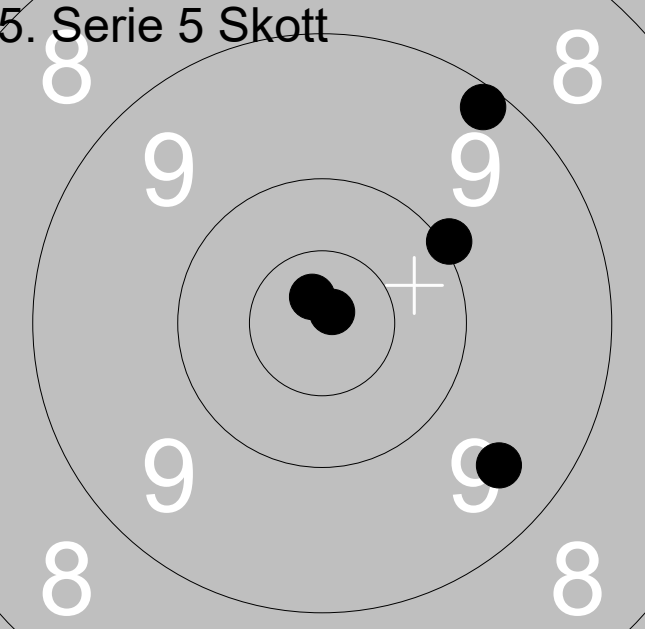
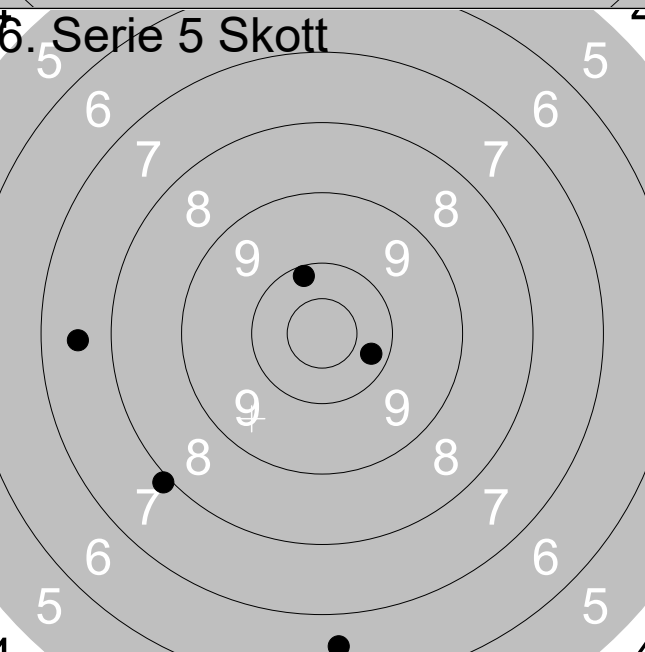
11.07.2021	Tavelstafetten 2021	Ramselefors SKF														
Prov 	<table style="width:100%; border-collapse: collapse;"> <tr> <td style="width:10%;">1:</td> <td style="width:70%;">10.7x</td> <td style="width:20%; text-align: center;">↑</td> </tr> <tr> <td>2:</td> <td>9.4</td> <td style="text-align: center;">↘</td> </tr> <tr> <td>3:</td> <td>10.3</td> <td style="text-align: center;">↙</td> </tr> </table>	1:	10.7x	↑	2:	9.4	↘	3:	10.3	↙						
1:	10.7x	↑														
2:	9.4	↘														
3:	10.3	↙														
		Serie 29														
		Total 0														
5. Serie 5 Skott 	<table style="width:100%; border-collapse: collapse;"> <tr> <td style="width:10%;">1:</td> <td style="width:70%;">9.2</td> <td style="width:20%; text-align: center;">↗</td> </tr> <tr> <td>2:</td> <td>9.5</td> <td style="text-align: center;">↘</td> </tr> <tr> <td>3:</td> <td>10.9x</td> <td style="text-align: center;">↗</td> </tr> <tr> <td>4:</td> <td>10.0</td> <td style="text-align: center;">↗</td> </tr> <tr> <td>5:</td> <td>10.8x</td> <td style="text-align: center;">↑</td> </tr> </table>	1:	9.2	↗	2:	9.5	↘	3:	10.9x	↗	4:	10.0	↗	5:	10.8x	↑
1:	9.2	↗														
2:	9.5	↘														
3:	10.9x	↗														
4:	10.0	↗														
5:	10.8x	↑														
		Serie 48														
		Total 48														
6. Serie 5 Skott 	<table style="width:100%; border-collapse: collapse;"> <tr> <td style="width:10%;">1:</td> <td style="width:70%;">7.9</td> <td style="width:20%; text-align: center;">↙</td> </tr> <tr> <td>2:</td> <td>7.6</td> <td style="text-align: center;">←</td> </tr> <tr> <td>3:</td> <td>10.2</td> <td style="text-align: center;">↑</td> </tr> <tr> <td>4:</td> <td>10.2</td> <td style="text-align: center;">↘</td> </tr> <tr> <td>5:</td> <td>6.6</td> <td style="text-align: center;">↓</td> </tr> </table>	1:	7.9	↙	2:	7.6	←	3:	10.2	↑	4:	10.2	↘	5:	6.6	↓
1:	7.9	↙														
2:	7.6	←														
3:	10.2	↑														
4:	10.2	↘														
5:	6.6	↓														
		Serie 40														
		Total 88														

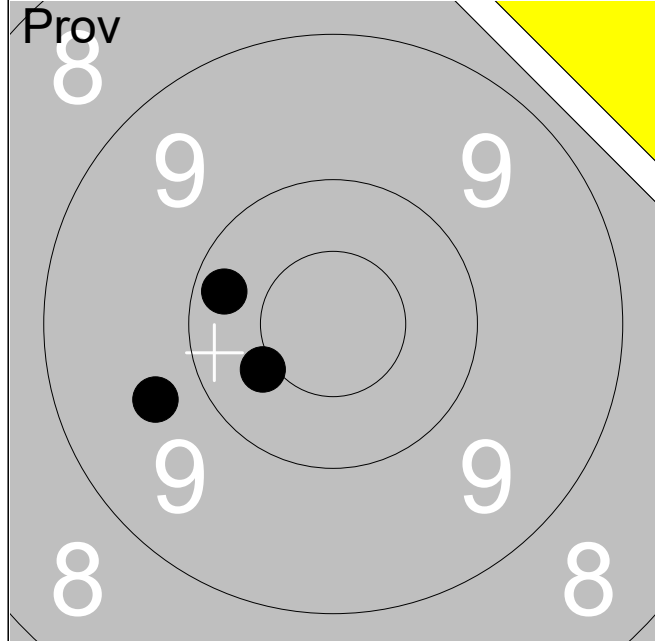

1:	9.7	←
2:	10.4x	←
3:	10.2	←
Serie		29
Total		0

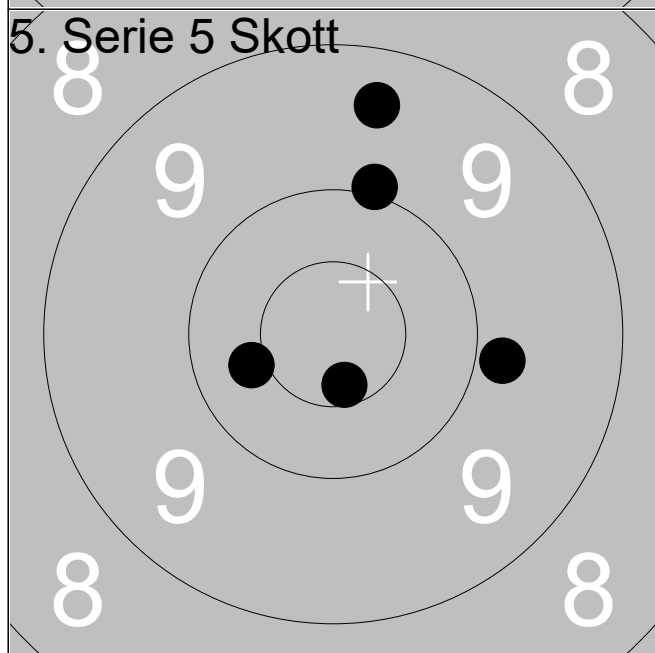

1:	9.8	→
2:	10.6x	↓
3:	10.4	←
4:	9.4	↑
5:	10.0	↑
Serie		48
Total		48

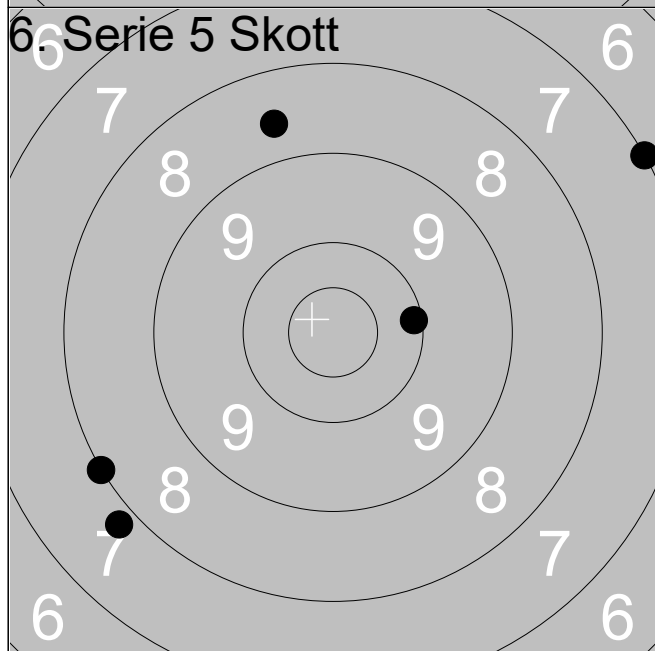

1:	8.0	←
2:	7.8	←
3:	10.1	→
4:	7.0	↗
5:	8.6	↑
Serie		40
Total		88

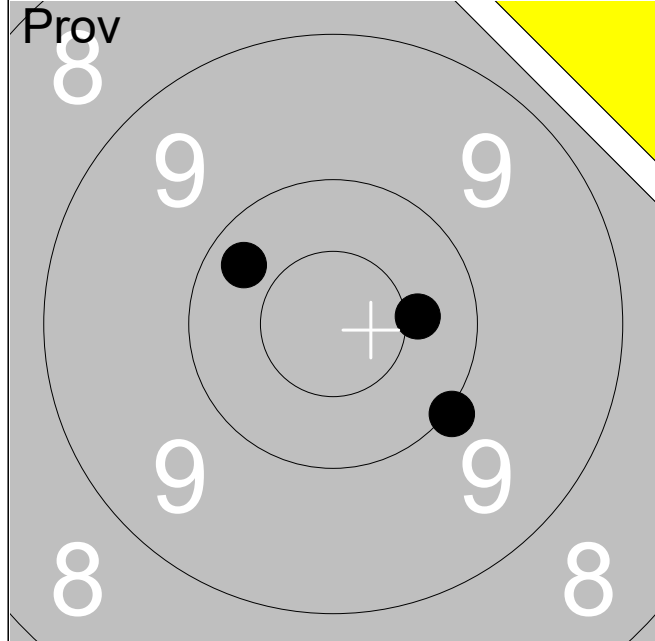

1:	10.3	↗
2:	10.0	↘
3:	10.4	→
Serie		30
Total		0

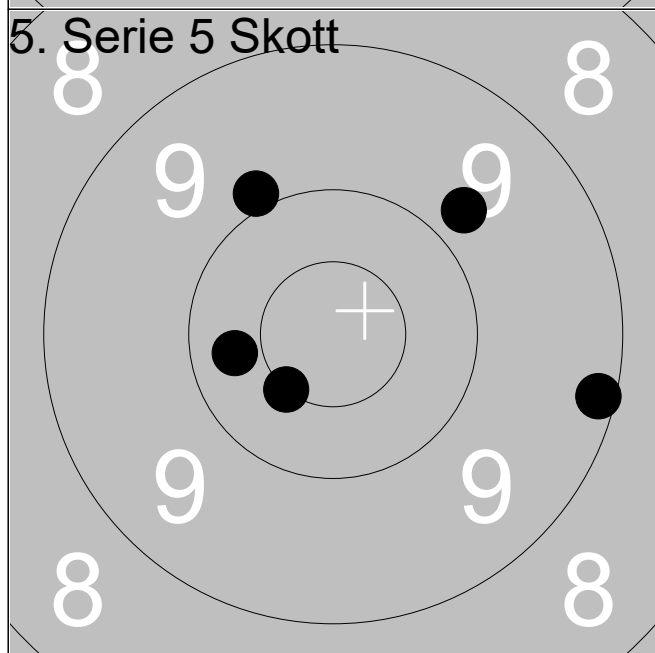

1:	10.3	←
2:	9.9	↗
3:	10.5x	↘
4:	9.8	↗
5:	9.1	→
Serie		47
Total		47

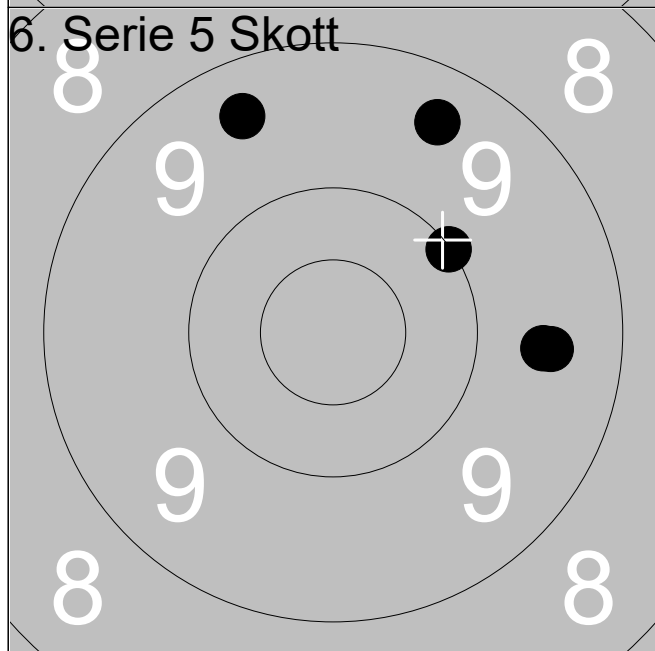

1:	9.4	↗
2:	9.6	→
3:	9.5	→
4:	10.0	↗
5:	9.4	↗
Serie		46
Total		93

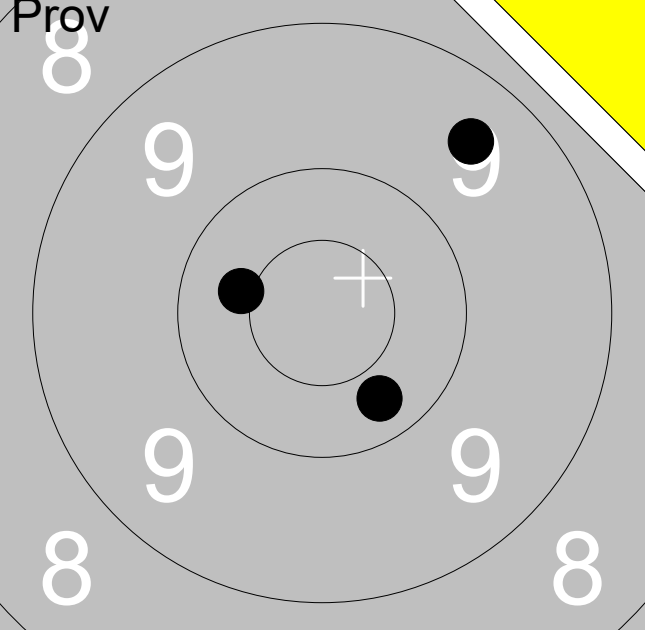
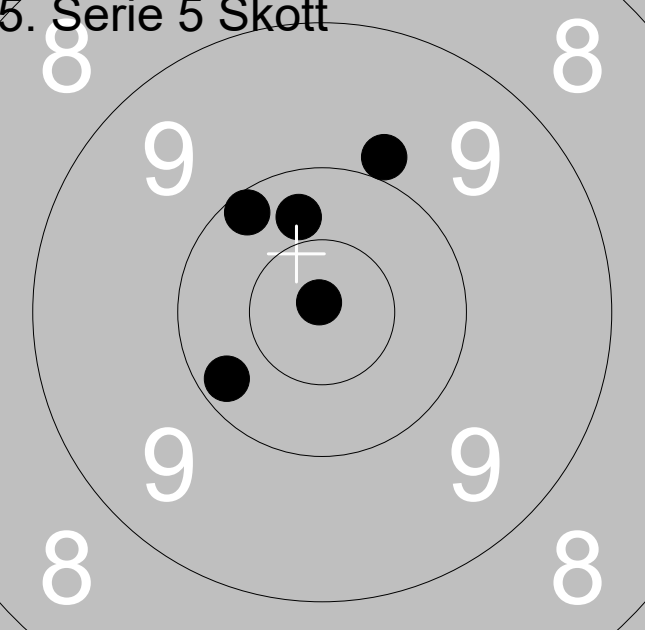
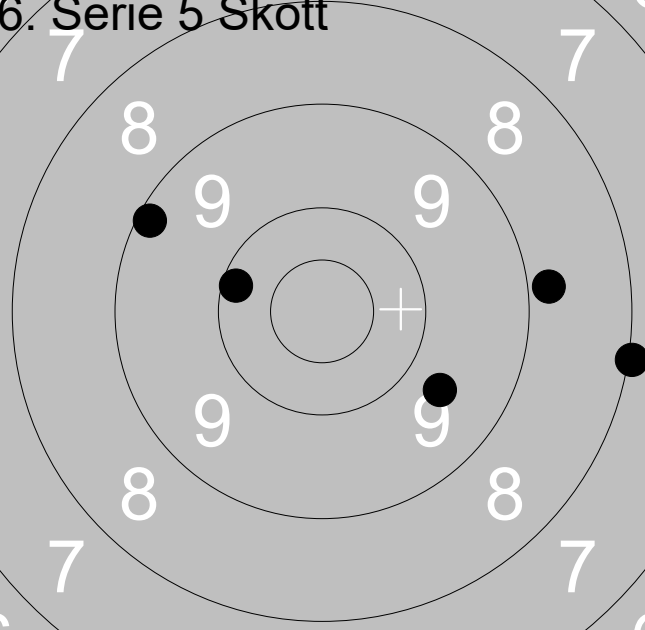
11.07.2021	Tavelstafetten 2021	Ramselefors SKF															
Prov 	<table style="width:100%; border-collapse: collapse;"> <tr> <td style="width:10%;">1:</td> <td style="width:10%;">10.3</td> <td style="width:10%; text-align: right;">↘</td> </tr> <tr> <td>2:</td> <td>9.5</td> <td style="text-align: right;">↗</td> </tr> <tr> <td>3:</td> <td>10.4x</td> <td style="text-align: right;">←</td> </tr> </table>	1:	10.3	↘	2:	9.5	↗	3:	10.4x	←							
1:	10.3	↘															
2:	9.5	↗															
3:	10.4x	←															
Serie		29															
Total		0															
5. Serie 5 Skott 	<table style="width:100%; border-collapse: collapse;"> <tr> <td style="width:10%;">1:</td> <td style="width:10%;">10.2</td> <td style="width:10%; text-align: right;">↙</td> </tr> <tr> <td>2:</td> <td>10.9x</td> <td style="text-align: right;">↗</td> </tr> <tr> <td>3:</td> <td>10.2</td> <td style="text-align: right;">↗</td> </tr> <tr> <td>4:</td> <td>9.9</td> <td style="text-align: right;">↗</td> </tr> <tr> <td>5:</td> <td>10.3</td> <td style="text-align: right;">↗</td> </tr> </table>	1:	10.2	↙	2:	10.9x	↗	3:	10.2	↗	4:	9.9	↗	5:	10.3	↗	
1:	10.2	↙															
2:	10.9x	↗															
3:	10.2	↗															
4:	9.9	↗															
5:	10.3	↗															
Serie		49															
Total		49															
6. Serie 5 Skott 	<table style="width:100%; border-collapse: collapse;"> <tr> <td style="width:10%;">1:</td> <td style="width:10%;">9.7</td> <td style="width:10%; text-align: right;">↘</td> </tr> <tr> <td>2:</td> <td>8.8</td> <td style="text-align: right;">→</td> </tr> <tr> <td>3:</td> <td>9.2</td> <td style="text-align: right;">↗</td> </tr> <tr> <td>4:</td> <td>10.1</td> <td style="text-align: right;">←</td> </tr> <tr> <td>5:</td> <td>8.0</td> <td style="text-align: right;">→</td> </tr> </table>	1:	9.7	↘	2:	8.8	→	3:	9.2	↗	4:	10.1	←	5:	8.0	→	
1:	9.7	↘															
2:	8.8	→															
3:	9.2	↗															
4:	10.1	←															
5:	8.0	→															
Serie		44															
Total		93															

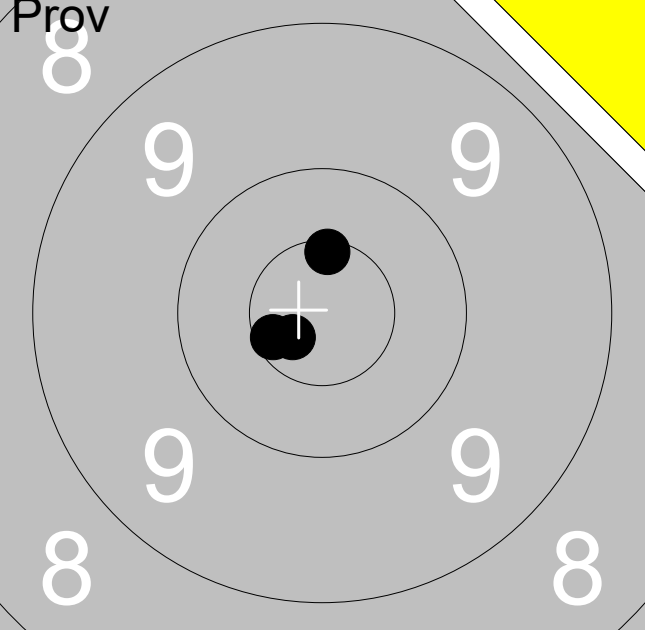
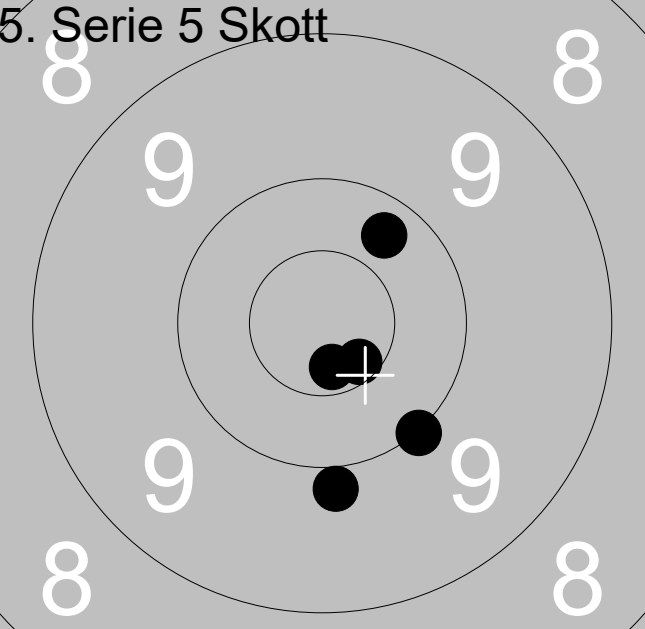
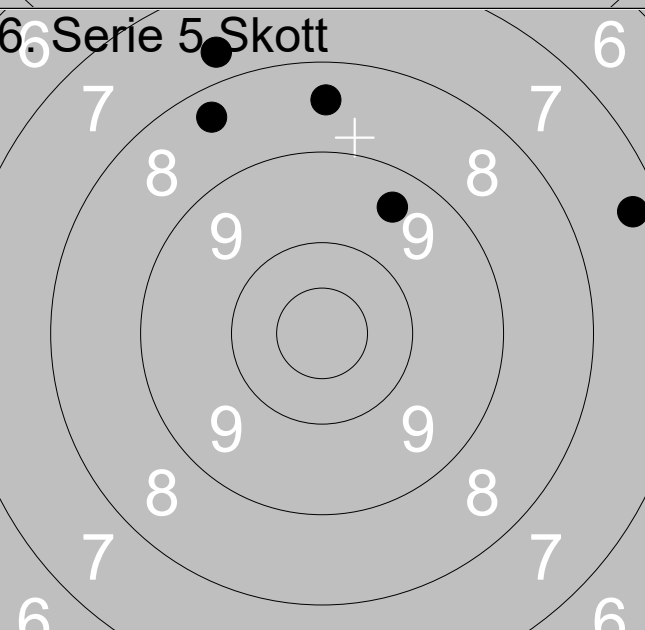
11.07.2021	Tavelstafetten 2021	Ramselefors SKF
Prov 		1: 10.6x ↙
		2: 10.6x ↑
		3: 10.7x ↘
	Serie	30
Total		0
5. Serie 5 Skott 		1: 10.3 ↗
		2: 10.0 ↘
		3: 9.9 ↓
		4: 10.6x ↘
		5: 10.7x ↓
	Serie	49
Total		49
6. Serie 5 Skott 		1: 8.4 ↑
		2: 8.3 ↖
		3: 9.4 ↗
		4: 7.3 →
		5: 7.7 ↑
	Serie	39
Total		88

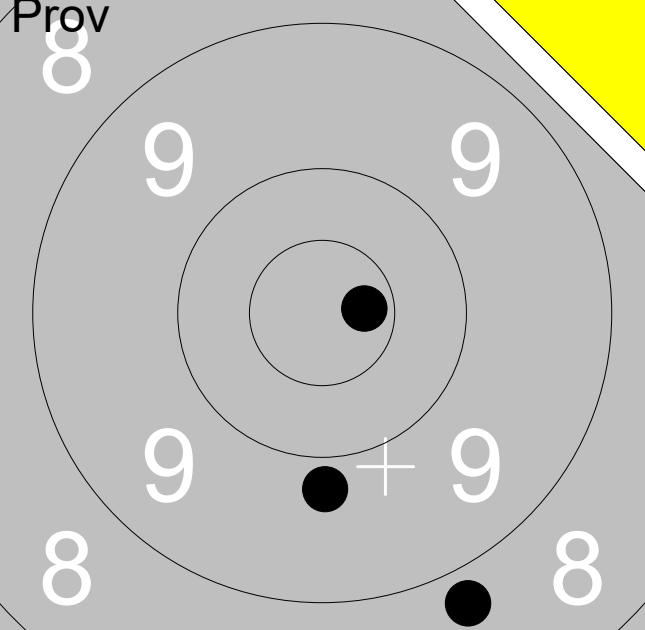
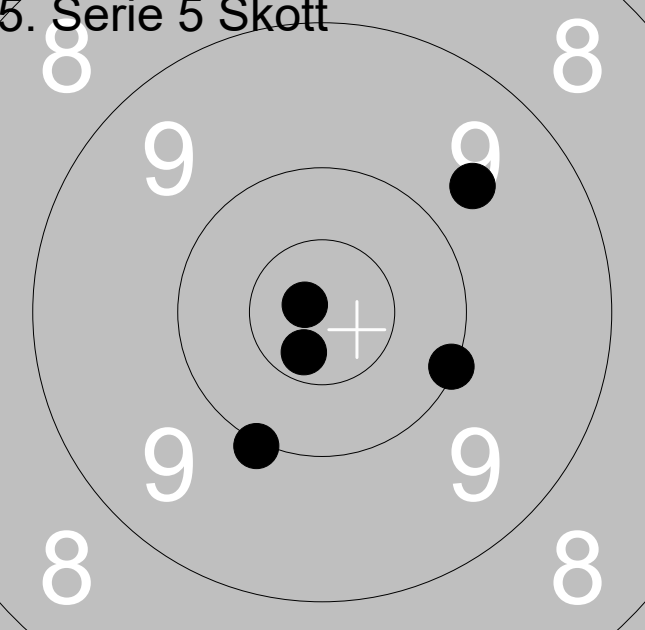
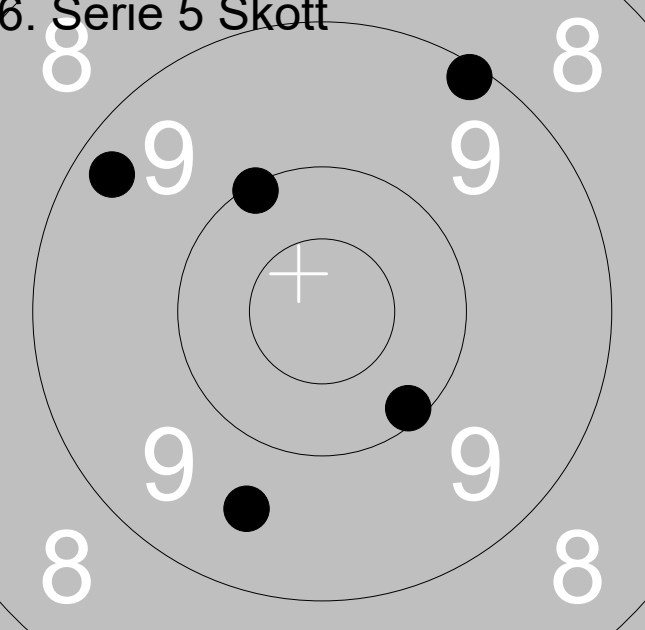
11.07.2021	Tavelstafetten 2021	Ramselefors SKF	
Prov 	1:	10.7x	→
	2:	8.8	↓
	3:	9.8	↓
	Serie		27
Total		0	
5. Serie 5 Skott 	1:	10.8x	←
	2:	10.0	↓
	3:	10.1	→
	4:	10.7x	↓
	5:	9.7	↗
	Serie		49
Total		49	
6. Serie 5 Skott 	1:	10.1	↗
	2:	10.1	↓
	3:	9.3	↗
	4:	9.6	↓
	5:	9.1	↗
	Serie		47
Total		96	

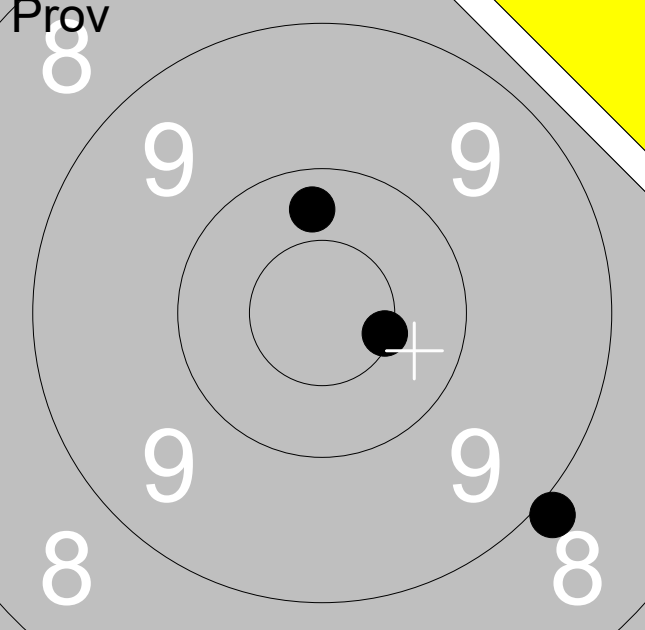
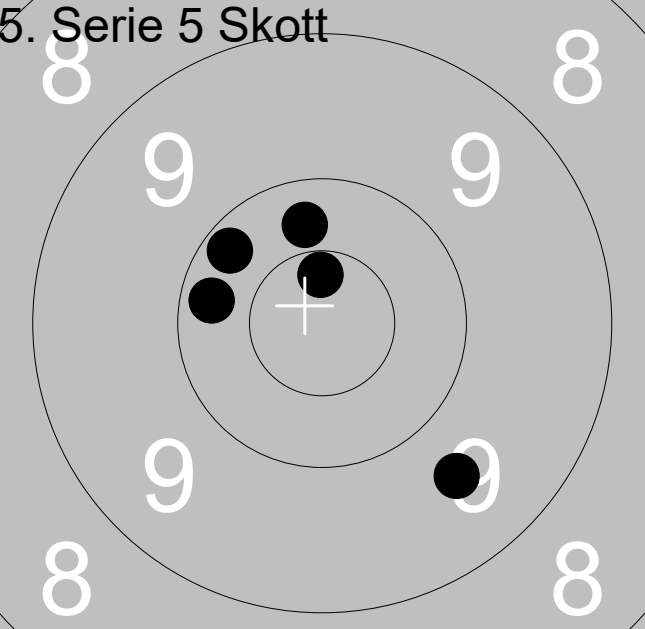
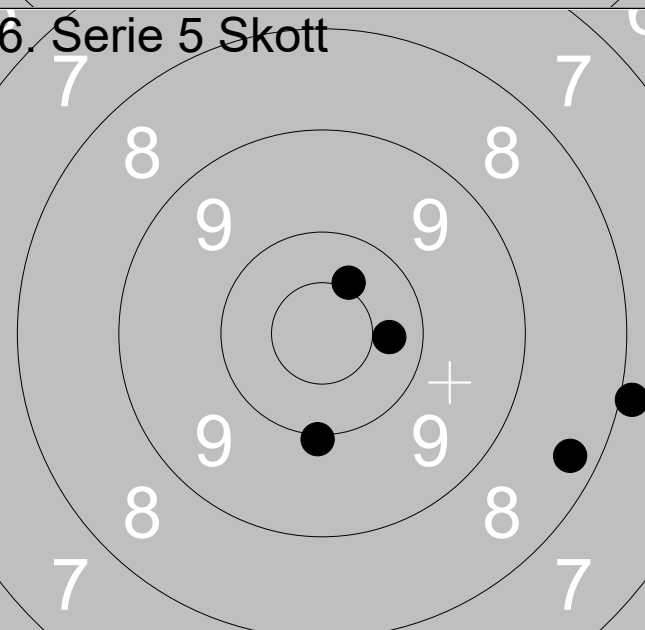
11.07.2021	Tavelstafetten 2021	Ramselefors SKF	
Prov 	1:	10.3	↑
	2:	8.9	↘
	3:	10.5x	→
	Serie		28
Total		0	
5. Serie 5 Skott 	1:	10.2	←
	2:	10.3	↑
	3:	10.2	↗
	4:	10.6x	↑
	5:	9.6	↘
	Serie		49
Total		49	
6. Serie 5 Skott 	1:	7.9	→
	2:	10.4x	↗
	3:	10.0	↓
	4:	8.3	↘
	5:	10.3	→
	Serie		45
Total		94	

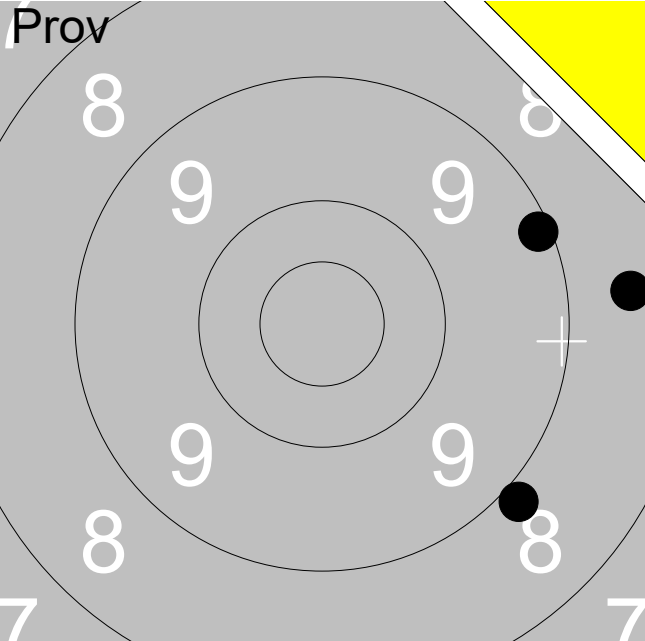
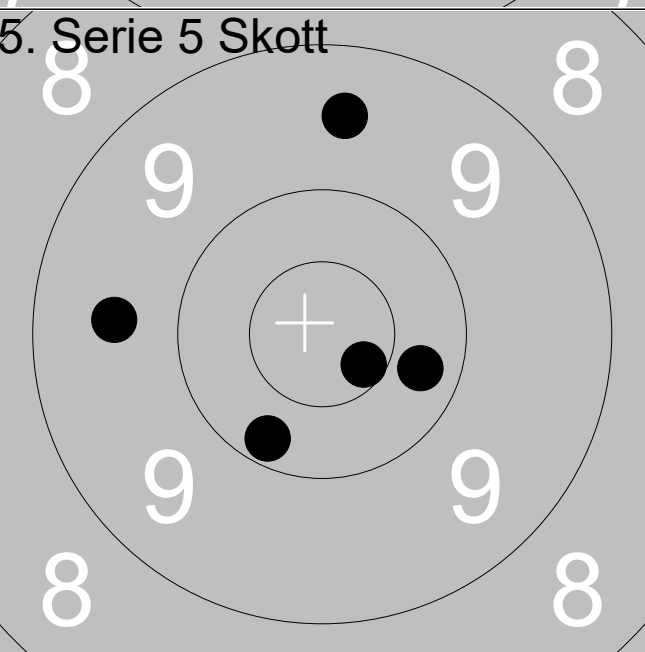
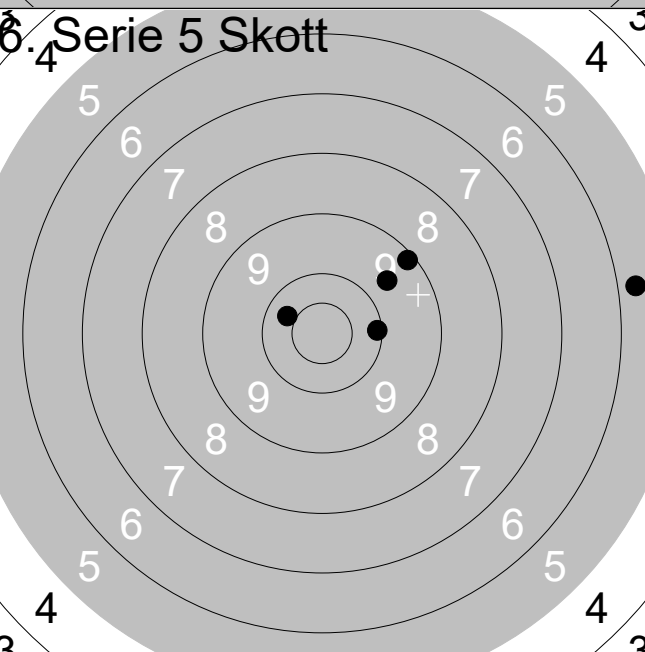
11.07.2021	Tavelstafetten 2021	Ramselefors SKF
Prov 		1: 9.1 → 2: 8.9 ↘ 3: 8.5 →
Serie		25
Total		0
5. Serie 5 Skott 		1: 9.5 ↑ 2: 9.6 ← 3: 10.2 ↓ 4: 10.3 → 5: 10.6x ↘
Serie		48
Total		48
6. Serie 5 Skott 		1: 9.6 ↗ 2: 10.1 → 3: 10.4 ↖ 4: 9.1 ↗ 5: 5.7 →
Serie		43
Total		91

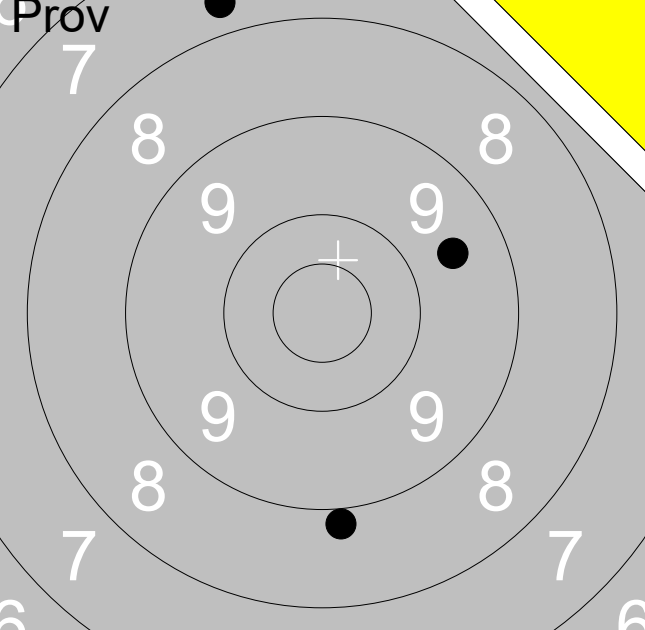
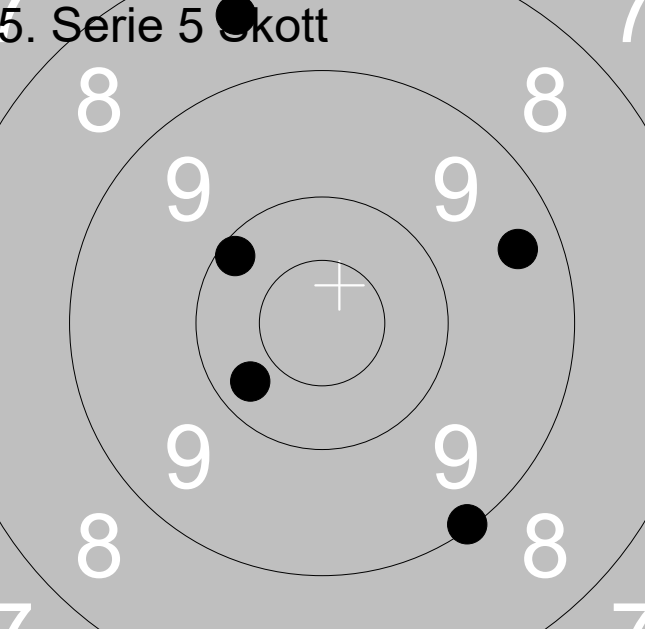
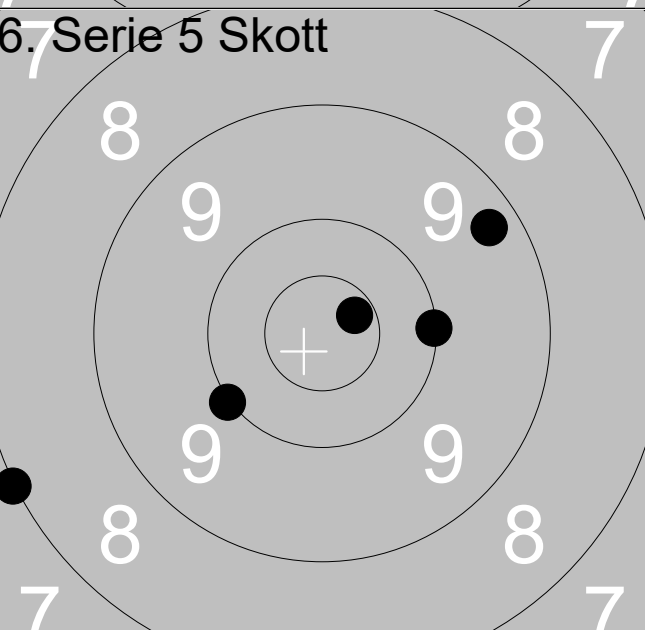
11.07.2021	Tavelstafetten 2021	Ramselefors SKF	
Prov 	1:	8.9	↓
	2:	7.7	↑
	3:	9.6	→
	Serie		24
Total		0	
5. Serie 5 Skott 	1:	8.5	↑
	2:	10.3	↙
	3:	10.1	↖
	4:	9.1	↘
	5:	9.4	→
	Serie		46
Total		46	
6. Serie 5 Skott 	1:	10.0	→
	2:	10.0	↙
	3:	8.0	↖
	4:	9.3	↗
	5:	10.6x	↗
	Serie		47
Total		93	

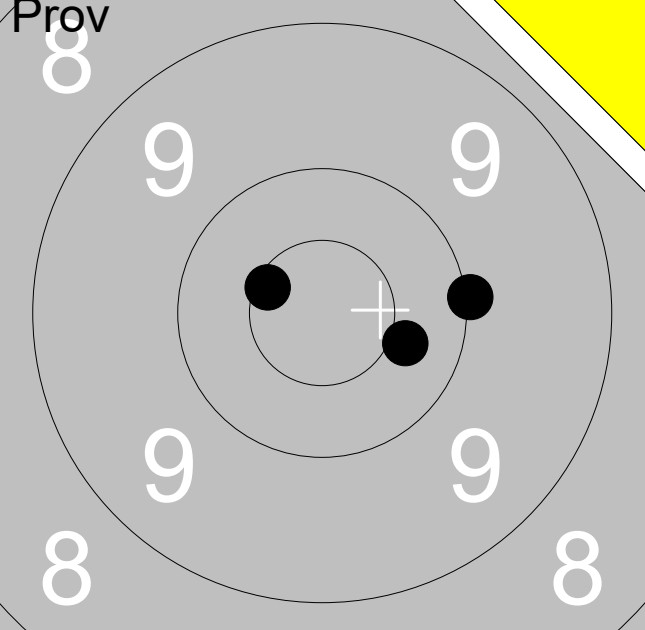
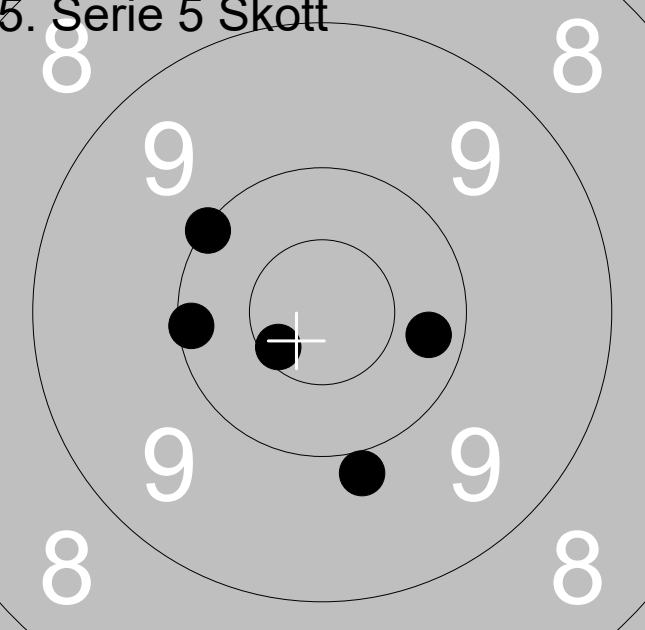
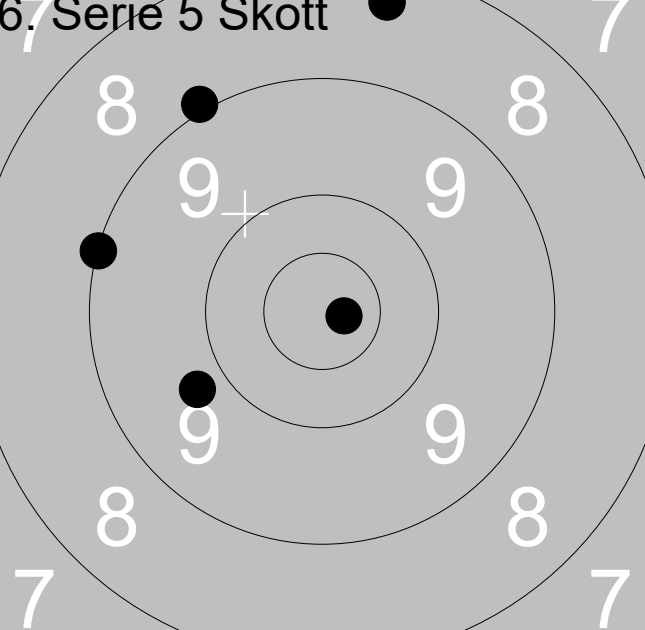
11.07.2021	Tavelstafetten 2021	Ramselefors SKF															
Prov 	<table style="width:100%; border-collapse: collapse;"> <tr><td style="width:10%;">1:</td><td style="width:60%;">10.4</td><td style="width:10%; text-align: right;">→</td></tr> <tr><td>2:</td><td>10.0</td><td style="text-align: right;">→</td></tr> <tr><td>3:</td><td>10.6x</td><td style="text-align: right;">↖</td></tr> </table>	1:	10.4	→	2:	10.0	→	3:	10.6x	↖							
1:	10.4	→															
2:	10.0	→															
3:	10.6x	↖															
		Serie 30															
		Total 0															
5. Serie 5 Skott 	<table style="width:100%; border-collapse: collapse;"> <tr><td style="width:10%;">1:</td><td style="width:60%;">10.1</td><td style="width:10%; text-align: right;">↖</td></tr> <tr><td>2:</td><td>10.3</td><td style="text-align: right;">→</td></tr> <tr><td>3:</td><td>10.1</td><td style="text-align: right;">←</td></tr> <tr><td>4:</td><td>9.9</td><td style="text-align: right;">↓</td></tr> <tr><td>5:</td><td>10.6x</td><td style="text-align: right;">↙</td></tr> </table>	1:	10.1	↖	2:	10.3	→	3:	10.1	←	4:	9.9	↓	5:	10.6x	↙	
1:	10.1	↖															
2:	10.3	→															
3:	10.1	←															
4:	9.9	↓															
5:	10.6x	↙															
		Serie 49															
		Total 49															
6. Serie 5 Skott 	<table style="width:100%; border-collapse: collapse;"> <tr><td style="width:10%;">1:</td><td style="width:60%;">10.8x</td><td style="width:10%; text-align: right;">→</td></tr> <tr><td>2:</td><td>8.3</td><td style="text-align: right;">↑</td></tr> <tr><td>3:</td><td>9.0</td><td style="text-align: right;">←</td></tr> <tr><td>4:</td><td>9.8</td><td style="text-align: right;">↙</td></tr> <tr><td>5:</td><td>9.0</td><td style="text-align: right;">↖</td></tr> </table>	1:	10.8x	→	2:	8.3	↑	3:	9.0	←	4:	9.8	↙	5:	9.0	↖	
1:	10.8x	→															
2:	8.3	↑															
3:	9.0	←															
4:	9.8	↙															
5:	9.0	↖															
		Serie 45															
		Total 94															

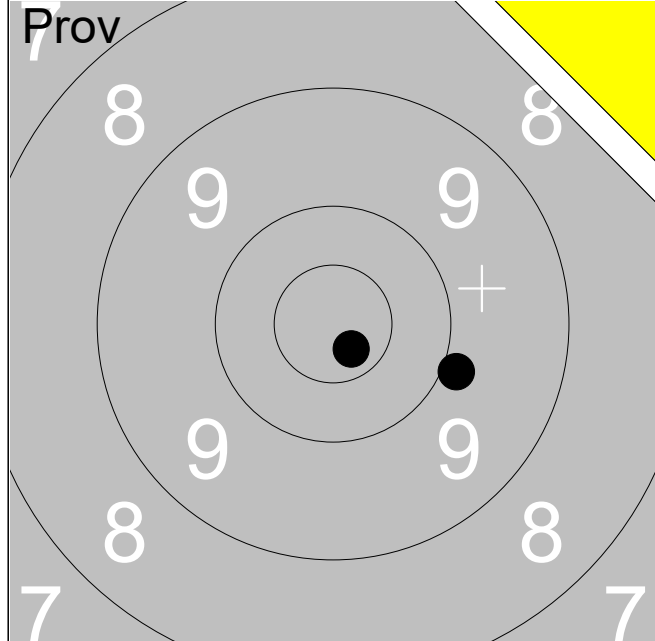

1:	10.7x	↘
2:	8.0	↗
3:	9.9	↘
Serie		27
Total		0

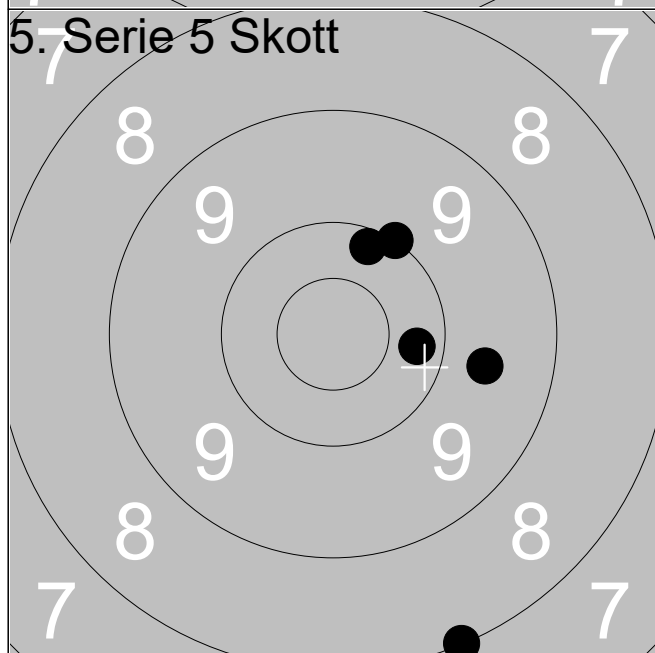

1:	10.2	↗
2:	10.3	→
3:	9.6	→
4:	8.0	↘
5:	10.0	↗
Serie		47
Total		47

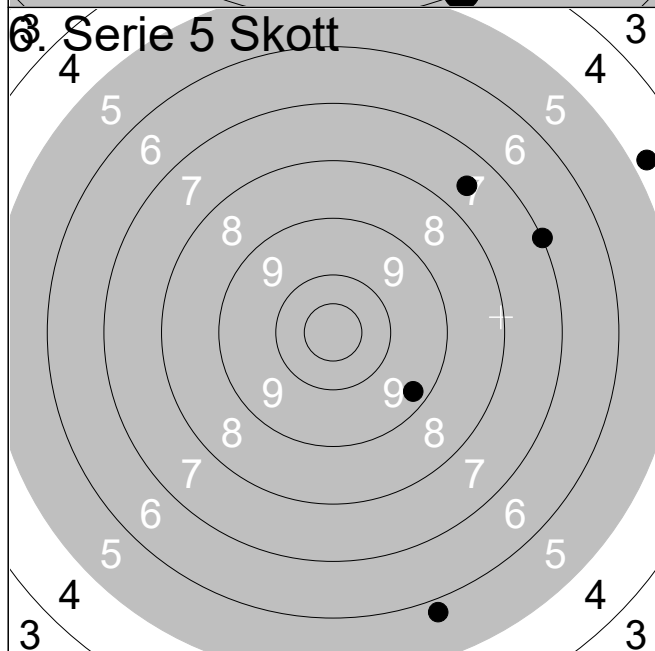

1:	7.0	↗
2:	7.6	↗
3:	9.3	↘
4:	4.8	↗
5:	5.8	↘
Serie		32
Total		79

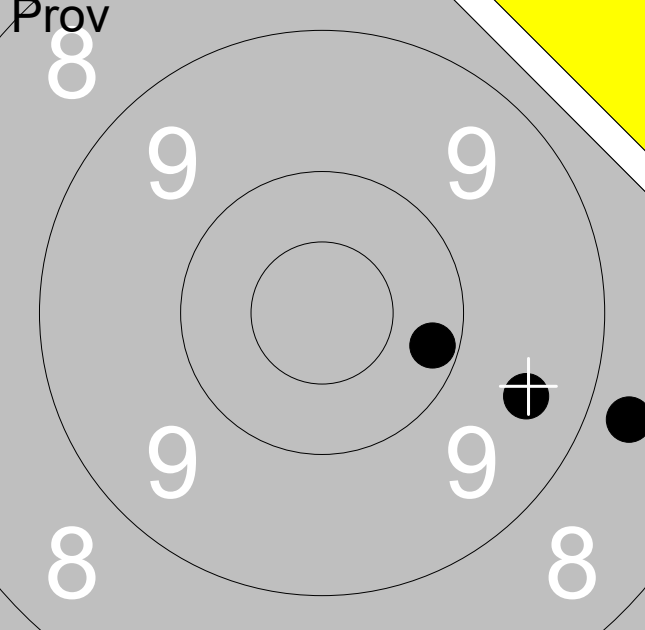
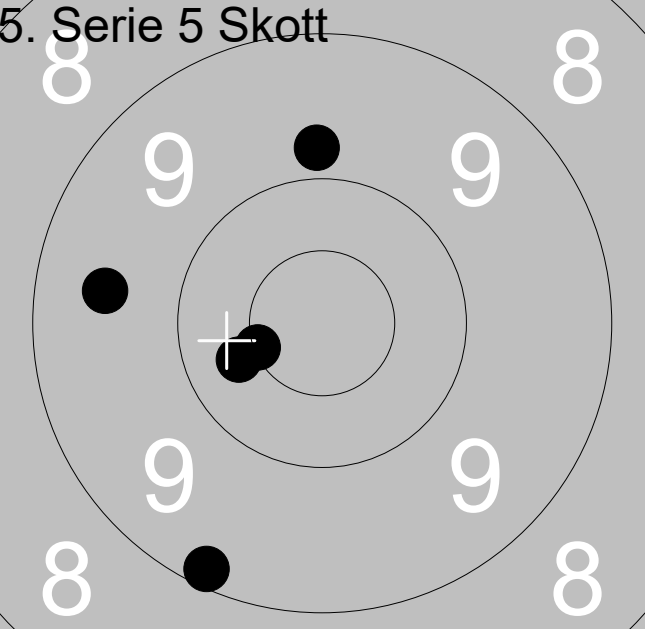
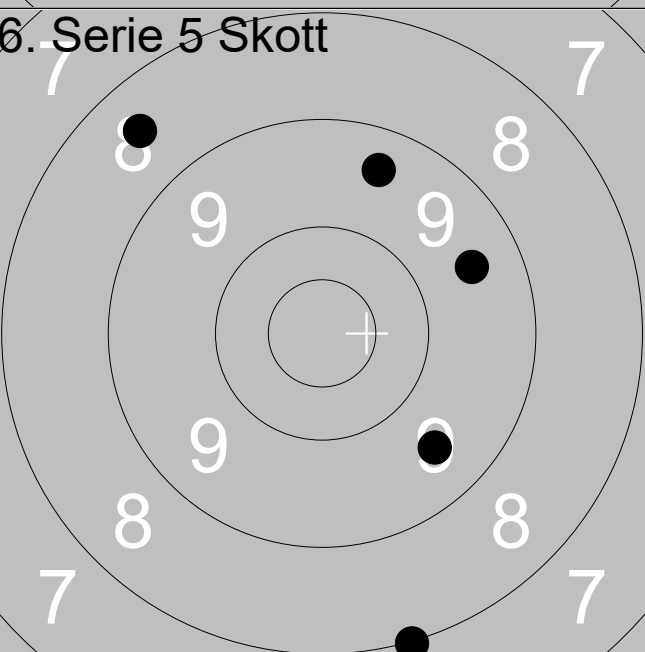
11.07.2021	Tavelstafetten 2021	Ramselefors SKF
Prov 		1: 8.7 → 2: 9.5 → 3: 10.2 →
Serie		27
Total		0
5. Serie 5 Skott 		1: 10.5x ← 2: 9.8 ↑ 3: 9.5 ← 4: 10.4 ← 5: 9.2 ↓
Serie		47
Total		47
6. Serie 5 Skott 		1: 9.5 → 2: 8.5 ↗ 3: 9.4 ↑ 4: 8.0 ↓ 5: 9.5 ↓
Serie		43
Total		90

11.07.2021	Tavelstafetten 2021	Ramselefors SKF														
Prov 	<table style="width:100%; border-collapse: collapse;"> <tr><td style="width:10%;">1:</td><td style="width:80%;">10.1</td><td style="width:10%; text-align: right;">↓</td></tr> <tr><td>2:</td><td>9.8</td><td style="text-align: right;">↓</td></tr> <tr><td>3:</td><td>9.3</td><td style="text-align: right;">↓</td></tr> </table>	1:	10.1	↓	2:	9.8	↓	3:	9.3	↓						
1:	10.1	↓														
2:	9.8	↓														
3:	9.3	↓														
Serie		28														
Total		0														
5. Serie 5 Skott 	<table style="width:100%; border-collapse: collapse;"> <tr><td style="width:10%;">1:</td><td style="width:80%;">9.5</td><td style="width:10%; text-align: right;">←</td></tr> <tr><td>2:</td><td>9.7</td><td style="text-align: right;">↗</td></tr> <tr><td>3:</td><td>9.2</td><td style="text-align: right;">↑</td></tr> <tr><td>4:</td><td>10.8x</td><td style="text-align: right;">↗</td></tr> <tr><td>5:</td><td>10.4</td><td style="text-align: right;">↑</td></tr> </table>	1:	9.5	←	2:	9.7	↗	3:	9.2	↑	4:	10.8x	↗	5:	10.4	↑
1:	9.5	←														
2:	9.7	↗														
3:	9.2	↑														
4:	10.8x	↗														
5:	10.4	↑														
Serie		47														
Total		47														
6. Serie 5 Skott 	<table style="width:100%; border-collapse: collapse;"> <tr><td style="width:10%;">1:</td><td style="width:80%;">10.5x</td><td style="width:10%; text-align: right;">↓</td></tr> <tr><td>2:</td><td>10.3</td><td style="text-align: right;">↓</td></tr> <tr><td>3:</td><td>10.1</td><td style="text-align: right;">↓</td></tr> <tr><td>4:</td><td>6.8</td><td style="text-align: right;">←</td></tr> <tr><td>5:</td><td>9.8</td><td style="text-align: right;">→</td></tr> </table>	1:	10.5x	↓	2:	10.3	↓	3:	10.1	↓	4:	6.8	←	5:	9.8	→
1:	10.5x	↓														
2:	10.3	↓														
3:	10.1	↓														
4:	6.8	←														
5:	9.8	→														
Serie		45														
Total		92														

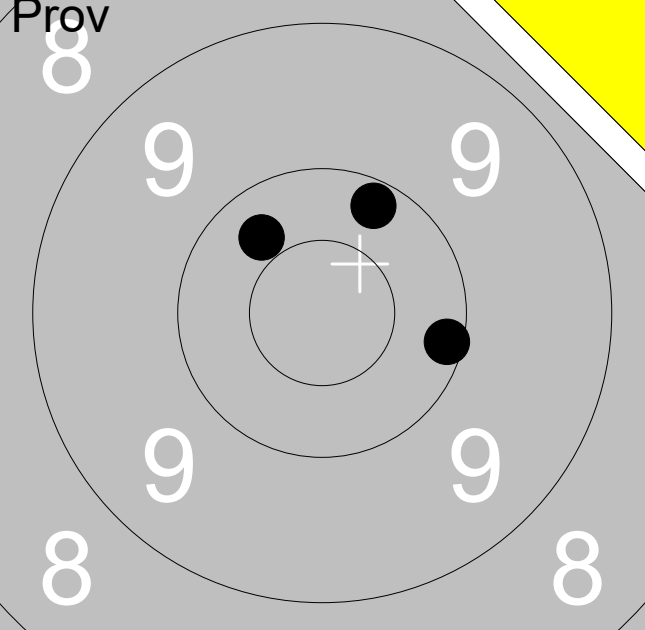
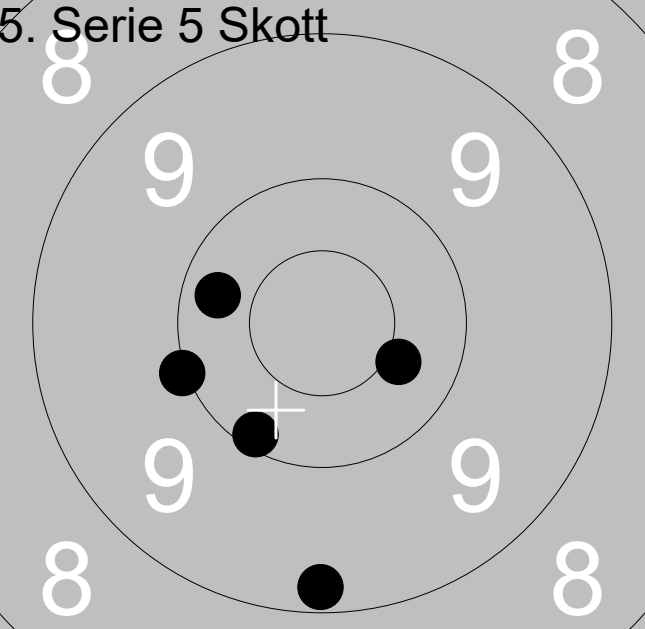
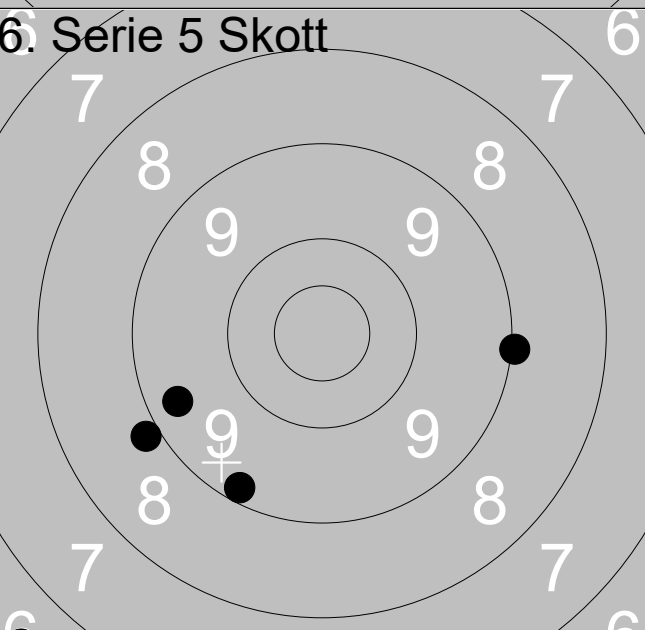
11.07.2021	Tavelstafetten 2021	Ramselefors SKF															
Prov 	<table style="width:100%; border-collapse: collapse;"> <tr><td style="width:10%;">1:</td><td style="width:15%;">10.2</td><td style="width:10%; text-align: right;">↗</td></tr> <tr><td>2:</td><td>10.1</td><td style="text-align: right;">→</td></tr> <tr><td>3:</td><td>10.3</td><td style="text-align: right;">↗</td></tr> </table>	1:	10.2	↗	2:	10.1	→	3:	10.3	↗							
1:	10.2	↗															
2:	10.1	→															
3:	10.3	↗															
		Serie 30															
		Total 0															
5. Serie 5 Skott 	<table style="width:100%; border-collapse: collapse;"> <tr><td style="width:10%;">1:</td><td style="width:15%;">10.3</td><td style="width:10%; text-align: right;">↖</td></tr> <tr><td>2:</td><td>10.0</td><td style="text-align: right;">↖</td></tr> <tr><td>3:</td><td>9.2</td><td style="text-align: right;">↓</td></tr> <tr><td>4:</td><td>10.1</td><td style="text-align: right;">↘</td></tr> <tr><td>5:</td><td>10.4</td><td style="text-align: right;">↘</td></tr> </table>	1:	10.3	↖	2:	10.0	↖	3:	9.2	↓	4:	10.1	↘	5:	10.4	↘	
1:	10.3	↖															
2:	10.0	↖															
3:	9.2	↓															
4:	10.1	↘															
5:	10.4	↘															
		Serie 49															
		Total 49															
6. Serie 5 Skott 	<table style="width:100%; border-collapse: collapse;"> <tr><td style="width:10%;">1:</td><td style="width:15%;">8.9</td><td style="width:10%; text-align: right;">↖</td></tr> <tr><td>2:</td><td>9.2</td><td style="text-align: right;">↘</td></tr> <tr><td>3:</td><td>9.3</td><td style="text-align: right;">↖</td></tr> <tr><td>4:</td><td>6.5</td><td style="text-align: right;">↘</td></tr> <tr><td>5:</td><td>9.0</td><td style="text-align: right;">→</td></tr> </table>	1:	8.9	↖	2:	9.2	↘	3:	9.3	↖	4:	6.5	↘	5:	9.0	→	
1:	8.9	↖															
2:	9.2	↘															
3:	9.3	↖															
4:	6.5	↘															
5:	9.0	→															
		Serie 41															
		Total 90															

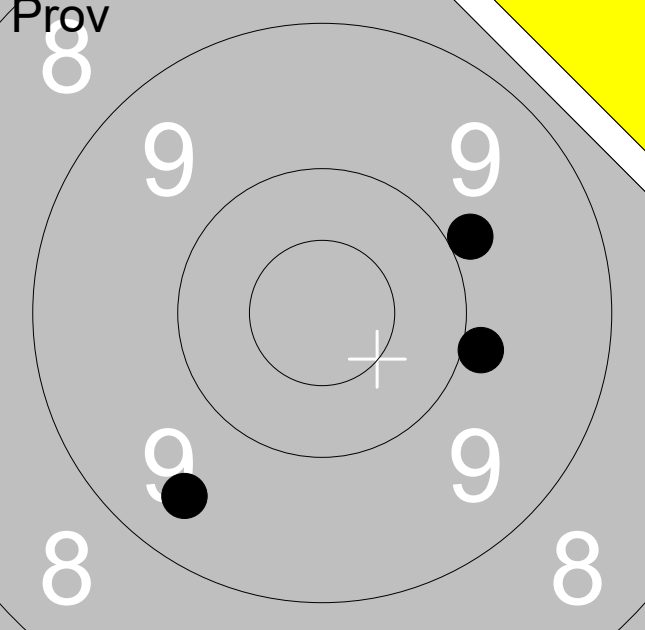
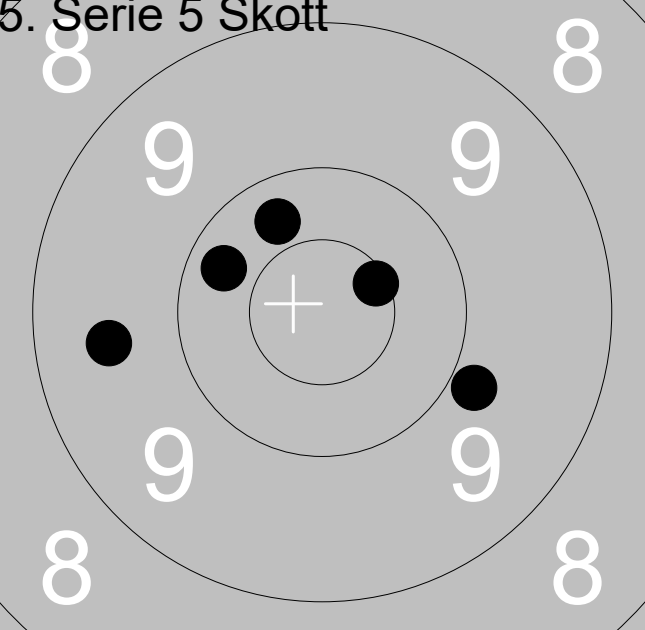
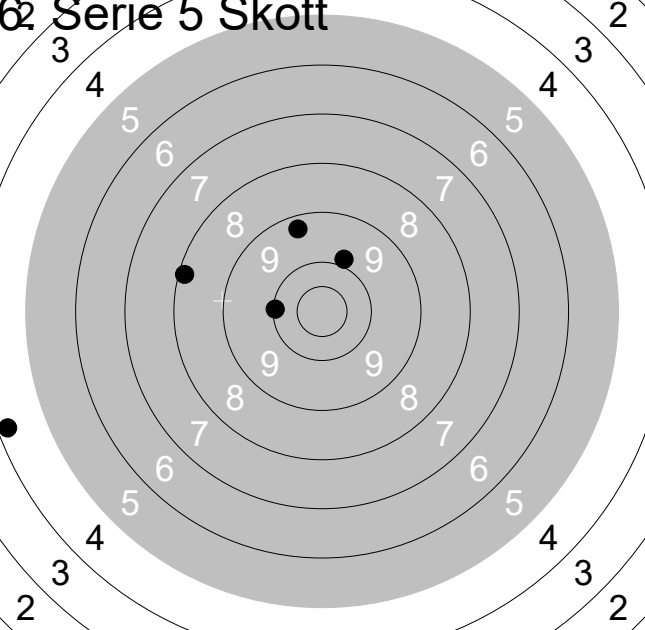
11.07.2021	Tavelstafetten 2021	Ramselefors SKF
Prov 	1: 9.9	↗
	2: 9.9	→
	3: 9.4	↘
	Serie 27	
Total 0		
5. Serie 5 Skott 	1: 10.6x	↗
	2: 10.3	↑
	3: 9.9	↘
	4: 9.5	←
	5: 10.3	↖
	Serie 48	
Total 48		
6. Serie 5 Skott 	1: 9.3	↑
	2: 9.9	↑
	3: 10.1	←
	4: 8.1	↖
	5: 4.2	←
	Serie 40	
Total 88		

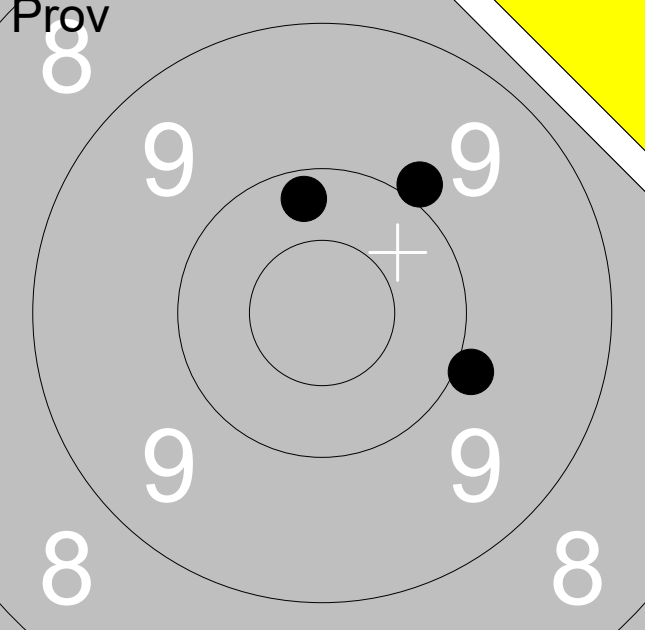
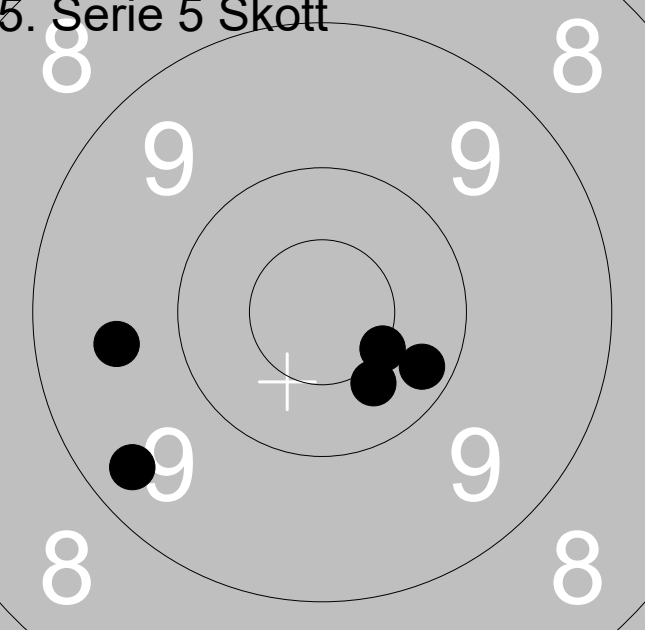
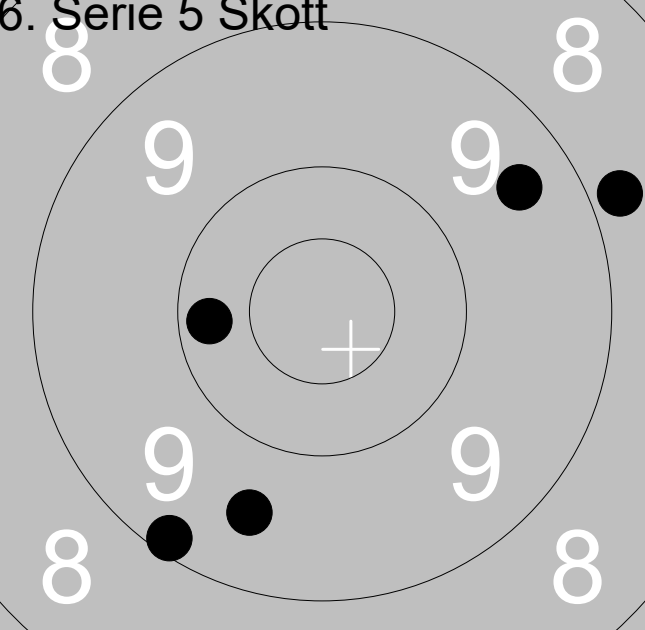
11.07.2021	Tavelstafetten 2021	Ramselefors SKF
Prov 	1: 10.2	↑
	2: 9.9	↗
	3: 9.9	→
	Serie	28
Total		0
5. Serie 5 Skott 	1: 9.3	↙
	2: 9.6	←
	3: 10.5x	↘
	4: 10.2	↘
	5: 10.4	↘
	Serie	48
Total		48
6. Serie 5 Skott 	1: 8.8	↗
	2: 9.6	↓
	3: 10.2	←
	4: 9.1	↘
	5: 9.4	↗
	Serie	45
Total		93

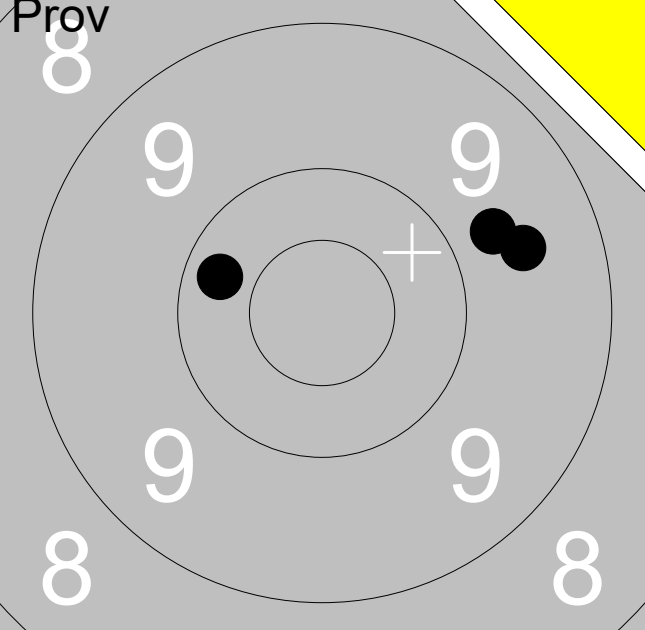
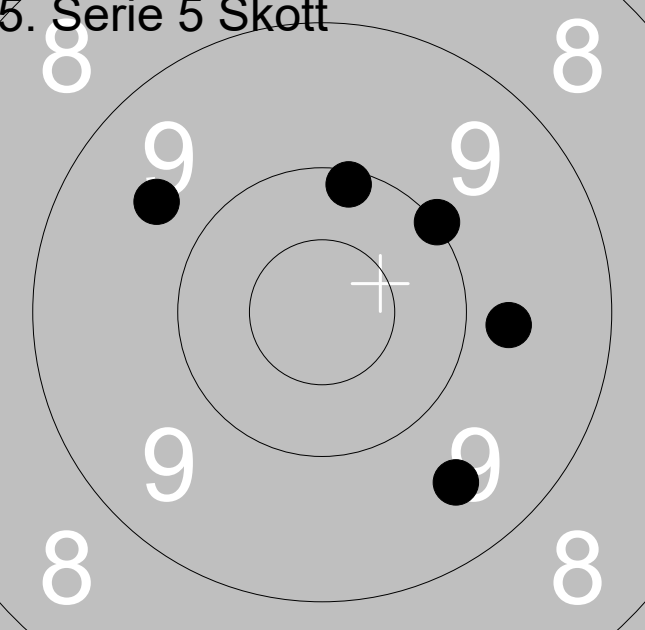
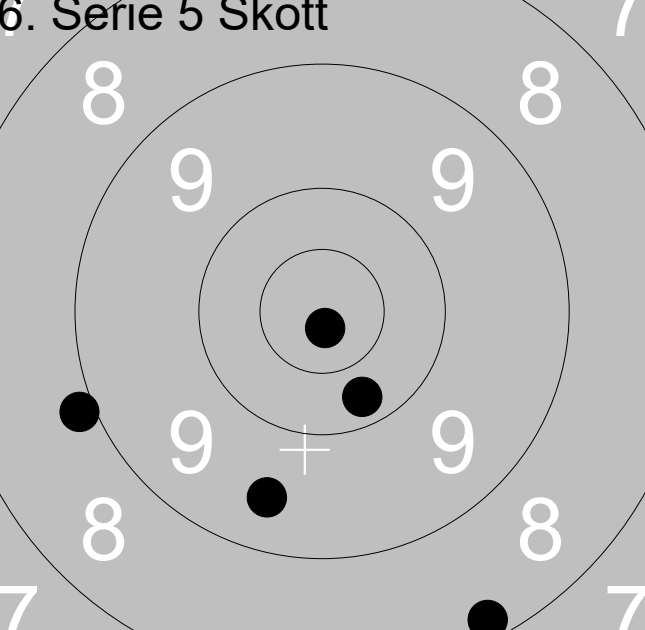
11.07.2021	Tavelstafetten 2021	Ramselefors SKF														
Prov 	<table style="width:100%; border-collapse: collapse;"> <tr><td style="width:10%;">1:</td><td style="width:15%;">9.6</td><td style="width:10%; text-align: right;">→</td></tr> <tr><td>2:</td><td>9.7</td><td style="text-align: right;">→</td></tr> <tr><td>3:</td><td>10.3</td><td style="text-align: right;">←</td></tr> </table>	1:	9.6	→	2:	9.7	→	3:	10.3	←						
1:	9.6	→														
2:	9.7	→														
3:	10.3	←														
Serie		28														
Total		0														
5. Serie 5 Skott 	<table style="width:100%; border-collapse: collapse;"> <tr><td style="width:10%;">1:</td><td style="width:15%;">9.7</td><td style="width:10%; text-align: right;">↖</td></tr> <tr><td>2:</td><td>10.1</td><td style="text-align: right;">↑</td></tr> <tr><td>3:</td><td>9.7</td><td style="text-align: right;">→</td></tr> <tr><td>4:</td><td>10.0</td><td style="text-align: right;">↗</td></tr> <tr><td>5:</td><td>9.5</td><td style="text-align: right;">↘</td></tr> </table>	1:	9.7	↖	2:	10.1	↑	3:	9.7	→	4:	10.0	↗	5:	9.5	↘
1:	9.7	↖														
2:	10.1	↑														
3:	9.7	→														
4:	10.0	↗														
5:	9.5	↘														
Serie		47														
Total		47														
6. Serie 5 Skott 	<table style="width:100%; border-collapse: collapse;"> <tr><td style="width:10%;">1:</td><td style="width:15%;">10.8x</td><td style="width:10%; text-align: right;">↓</td></tr> <tr><td>2:</td><td>10.2</td><td style="text-align: right;">↓</td></tr> <tr><td>3:</td><td>9.5</td><td style="text-align: right;">↓</td></tr> <tr><td>4:</td><td>8.9</td><td style="text-align: right;">←</td></tr> <tr><td>5:</td><td>8.2</td><td style="text-align: right;">↓</td></tr> </table>	1:	10.8x	↓	2:	10.2	↓	3:	9.5	↓	4:	8.9	←	5:	8.2	↓
1:	10.8x	↓														
2:	10.2	↓														
3:	9.5	↓														
4:	8.9	←														
5:	8.2	↓														
Serie		45														
Total		92														

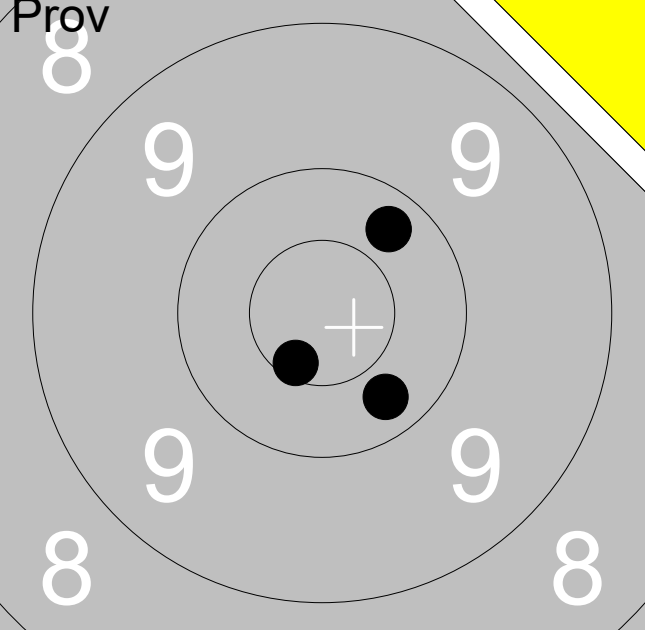
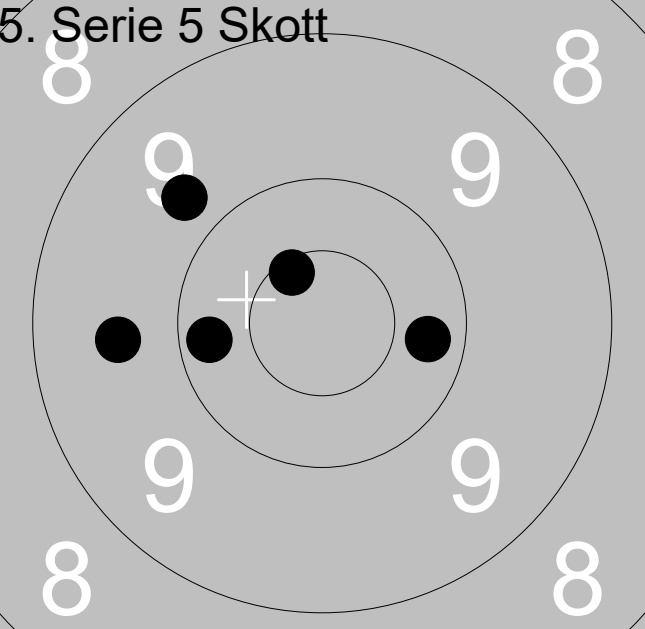
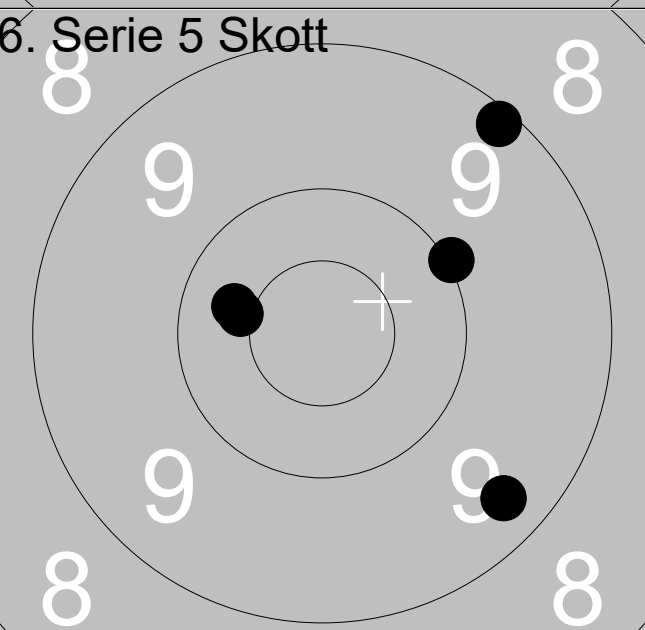
11.07.2021	Tavelstafetten 2021	Ramselefors SKF														
Prov 	<table style="width:100%;"> <tr><td>1:</td><td>10.3</td><td style="text-align: right;">↗</td></tr> <tr><td>2:</td><td>10.3</td><td style="text-align: right;">↘</td></tr> <tr><td>3:</td><td>10.6x</td><td style="text-align: right;">↘</td></tr> </table>	1:	10.3	↗	2:	10.3	↘	3:	10.6x	↘						
1:	10.3	↗														
2:	10.3	↘														
3:	10.6x	↘														
Serie		30														
Total		0														
5. Serie 5 Skott 	<table style="width:100%;"> <tr><td>1:</td><td>10.6x</td><td style="text-align: right;">↗</td></tr> <tr><td>2:</td><td>9.7</td><td style="text-align: right;">↗</td></tr> <tr><td>3:</td><td>9.6</td><td style="text-align: right;">←</td></tr> <tr><td>4:</td><td>10.2</td><td style="text-align: right;">←</td></tr> <tr><td>5:</td><td>10.3</td><td style="text-align: right;">→</td></tr> </table>	1:	10.6x	↗	2:	9.7	↗	3:	9.6	←	4:	10.2	←	5:	10.3	→
1:	10.6x	↗														
2:	9.7	↗														
3:	9.6	←														
4:	10.2	←														
5:	10.3	→														
Serie		48														
Total		48														
6. Serie 5 Skott 	<table style="width:100%;"> <tr><td>1:</td><td>9.1</td><td style="text-align: right;">↗</td></tr> <tr><td>2:</td><td>10.0</td><td style="text-align: right;">↗</td></tr> <tr><td>3:</td><td>10.4</td><td style="text-align: right;">←</td></tr> <tr><td>4:</td><td>9.3</td><td style="text-align: right;">↘</td></tr> <tr><td>5:</td><td>10.4x</td><td style="text-align: right;">←</td></tr> </table>	1:	9.1	↗	2:	10.0	↗	3:	10.4	←	4:	9.3	↘	5:	10.4x	←
1:	9.1	↗														
2:	10.0	↗														
3:	10.4	←														
4:	9.3	↘														
5:	10.4x	←														
Serie		48														
Total		96														

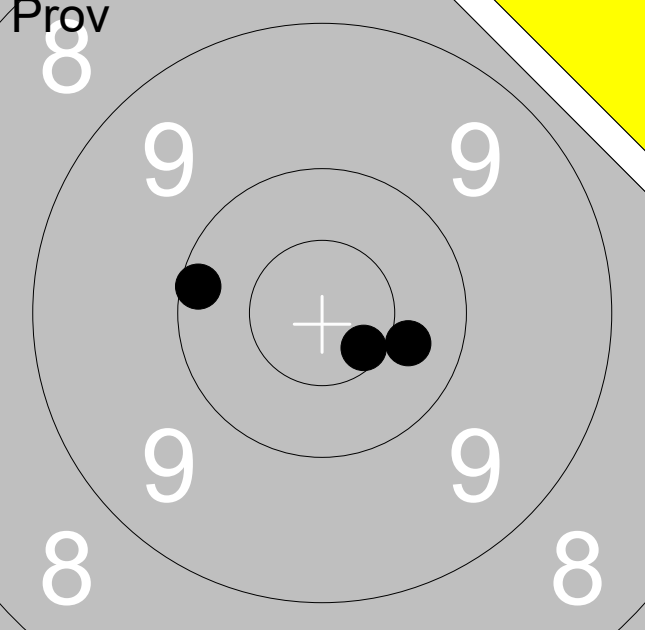
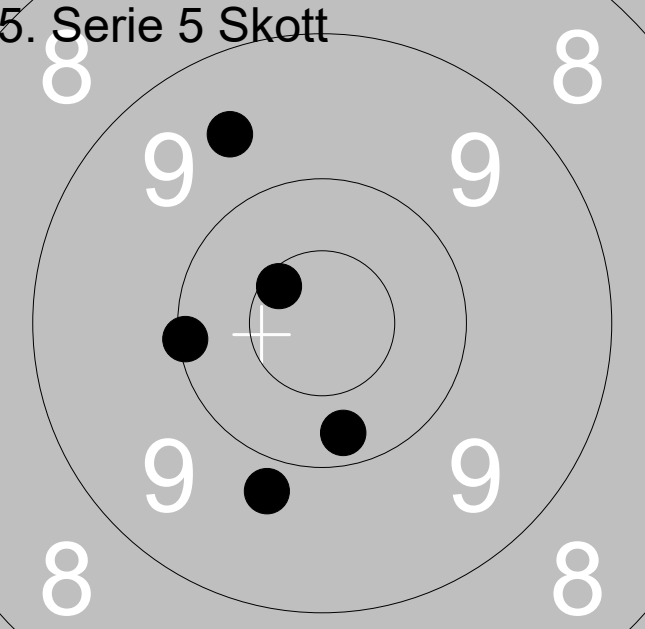
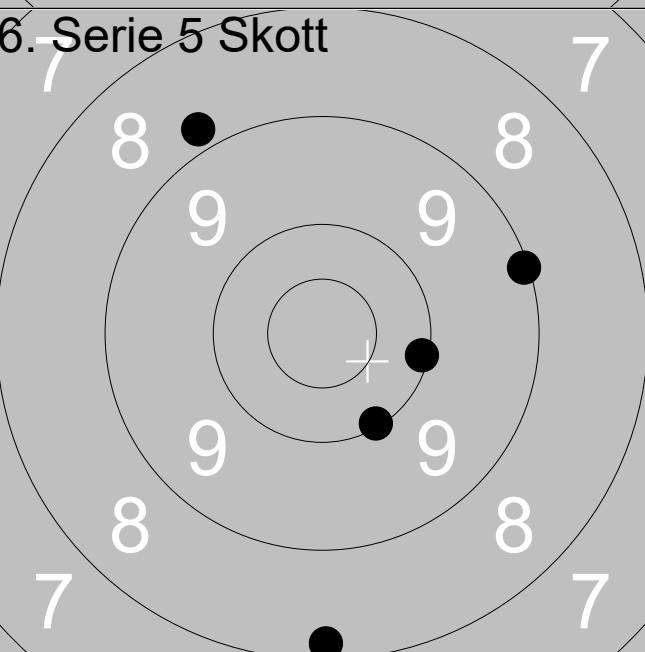
11.07.2021	Tavelstafetten 2021	Ramselefors SKF															
Prov 	<table style="width:100%; border-collapse: collapse;"> <tr> <td style="width:10%;">1:</td> <td style="width:10%;">10.4</td> <td style="width:10%; text-align: right;">↘</td> </tr> <tr> <td>2:</td> <td>10.6x</td> <td style="text-align: right;">↘</td> </tr> <tr> <td>3:</td> <td>10.1</td> <td style="text-align: right;">↖</td> </tr> </table>	1:	10.4	↘	2:	10.6x	↘	3:	10.1	↖							
1:	10.4	↘															
2:	10.6x	↘															
3:	10.1	↖															
		Serie 30															
		Total 0															
5. Serie 5 Skott 	<table style="width:100%; border-collapse: collapse;"> <tr> <td style="width:10%;">1:</td> <td style="width:10%;">9.8</td> <td style="width:10%; text-align: right;">↘</td> </tr> <tr> <td>2:</td> <td>10.2</td> <td style="text-align: right;">↘</td> </tr> <tr> <td>3:</td> <td>9.6</td> <td style="text-align: right;">↗</td> </tr> <tr> <td>4:</td> <td>10.1</td> <td style="text-align: right;">↖</td> </tr> <tr> <td>5:</td> <td>10.6x</td> <td style="text-align: right;">↗</td> </tr> </table>	1:	9.8	↘	2:	10.2	↘	3:	9.6	↗	4:	10.1	↖	5:	10.6x	↗	
1:	9.8	↘															
2:	10.2	↘															
3:	9.6	↗															
4:	10.1	↖															
5:	10.6x	↗															
		Serie 48															
		Total 48															
6. Serie 5 Skott 	<table style="width:100%; border-collapse: collapse;"> <tr> <td style="width:10%;">1:</td> <td style="width:10%;">8.2</td> <td style="width:10%; text-align: right;">↘</td> </tr> <tr> <td>2:</td> <td>10.1</td> <td style="text-align: right;">↘</td> </tr> <tr> <td>3:</td> <td>10.1</td> <td style="text-align: right;">→</td> </tr> <tr> <td>4:</td> <td>9.1</td> <td style="text-align: right;">→</td> </tr> <tr> <td>5:</td> <td>8.8</td> <td style="text-align: right;">↗</td> </tr> </table>	1:	8.2	↘	2:	10.1	↘	3:	10.1	→	4:	9.1	→	5:	8.8	↗	
1:	8.2	↘															
2:	10.1	↘															
3:	10.1	→															
4:	9.1	→															
5:	8.8	↗															
		Serie 45															
		Total 93															

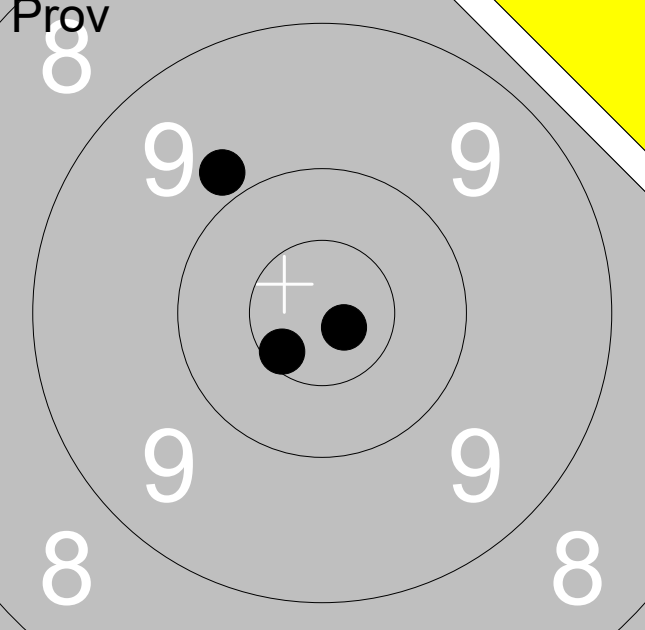
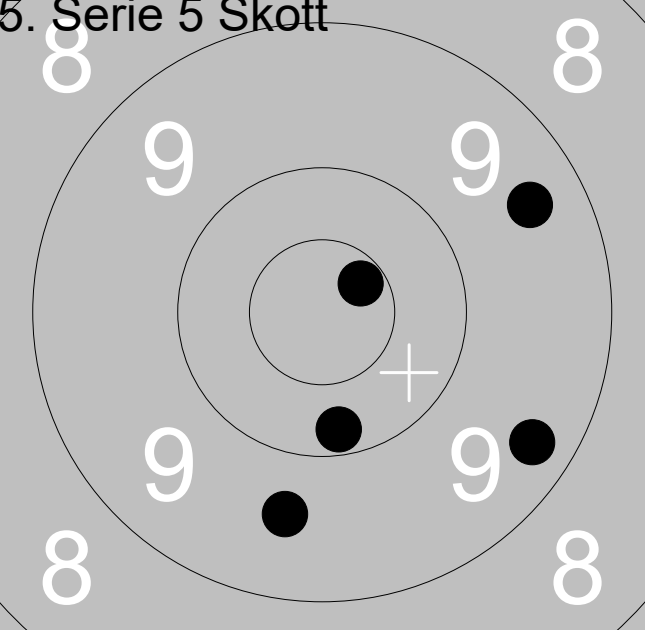
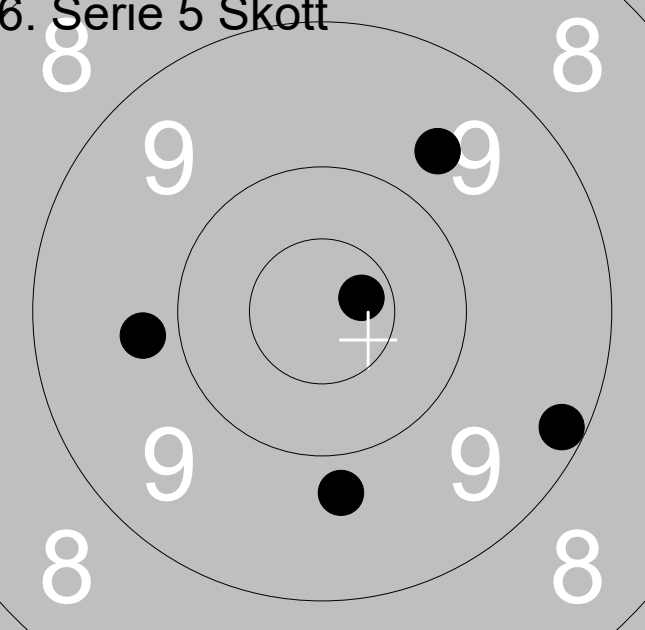
11.07.2021	Tavelstafetten 2021	Ramselefors SKF														
Prov 	<table style="width:100%; border-collapse: collapse;"> <tr> <td style="width:10%;">1:</td> <td style="width:80%;">9.8</td> <td style="width:10%; text-align: right;">↗</td> </tr> <tr> <td>2:</td> <td>10.8x</td> <td style="text-align: right;">↘</td> </tr> <tr> <td>3:</td> <td>10.6x</td> <td style="text-align: right;">↙</td> </tr> </table>	1:	9.8	↗	2:	10.8x	↘	3:	10.6x	↙						
1:	9.8	↗														
2:	10.8x	↘														
3:	10.6x	↙														
		Serie 29														
		Total 0														
5. Serie 5 Skott 	<table style="width:100%; border-collapse: collapse;"> <tr> <td style="width:10%;">1:</td> <td style="width:80%;">9.3</td> <td style="width:10%; text-align: right;">↘</td> </tr> <tr> <td>2:</td> <td>9.4</td> <td style="text-align: right;">↗</td> </tr> <tr> <td>3:</td> <td>10.2</td> <td style="text-align: right;">↓</td> </tr> <tr> <td>4:</td> <td>10.6x</td> <td style="text-align: right;">↗</td> </tr> <tr> <td>5:</td> <td>9.6</td> <td style="text-align: right;">↓</td> </tr> </table>	1:	9.3	↘	2:	9.4	↗	3:	10.2	↓	4:	10.6x	↗	5:	9.6	↓
1:	9.3	↘														
2:	9.4	↗														
3:	10.2	↓														
4:	10.6x	↗														
5:	9.6	↓														
		Serie 47														
		Total 47														
6. Serie 5 Skott 	<table style="width:100%; border-collapse: collapse;"> <tr> <td style="width:10%;">1:</td> <td style="width:80%;">9.7</td> <td style="width:10%; text-align: right;">↗</td> </tr> <tr> <td>2:</td> <td>10.7x</td> <td style="text-align: right;">↗</td> </tr> <tr> <td>3:</td> <td>9.2</td> <td style="text-align: right;">↘</td> </tr> <tr> <td>4:</td> <td>9.8</td> <td style="text-align: right;">←</td> </tr> <tr> <td>5:</td> <td>9.8</td> <td style="text-align: right;">↓</td> </tr> </table>	1:	9.7	↗	2:	10.7x	↗	3:	9.2	↘	4:	9.8	←	5:	9.8	↓
1:	9.7	↗														
2:	10.7x	↗														
3:	9.2	↘														
4:	9.8	←														
5:	9.8	↓														
		Serie 46														
		Total 93														

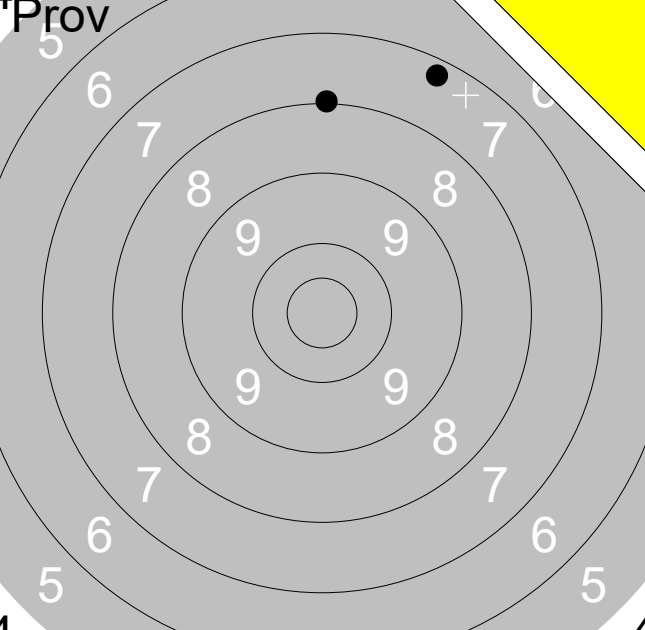
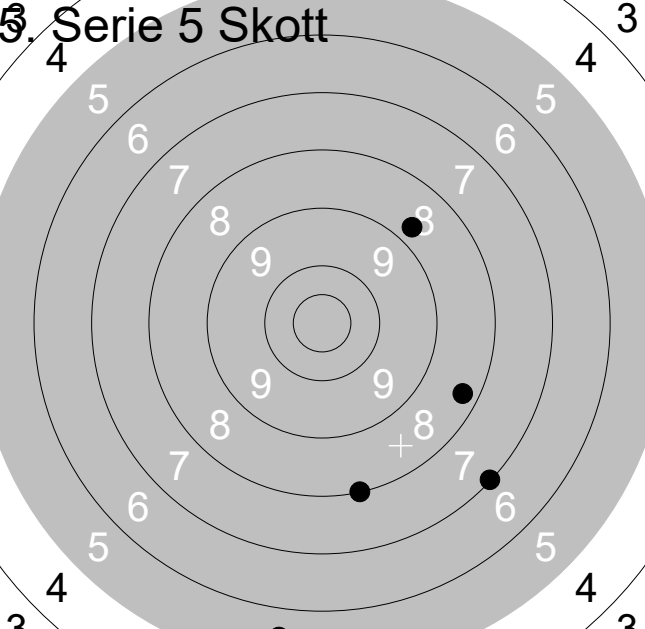
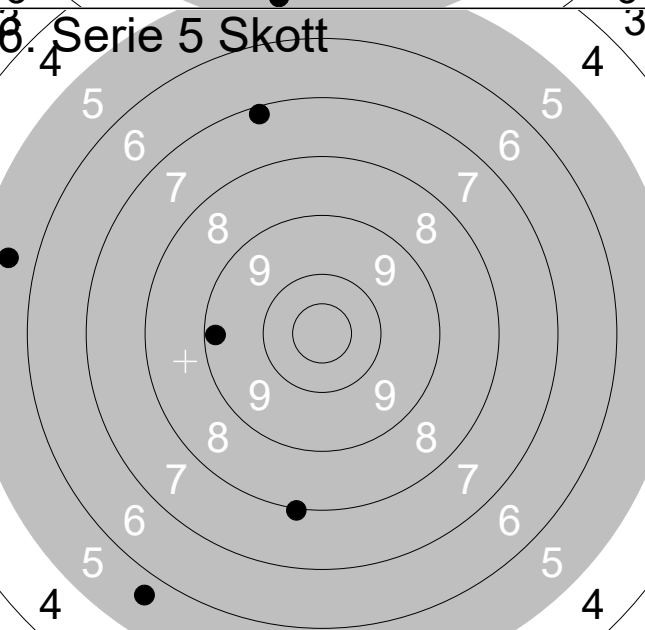
11.07.2021	Tavelstafetten 2021	Ramselefors SKF	
1. Proov 		1: 7.3	↗
		2: 5.7	↗
		3: 8.0	↑
	Serie	20	
	Total	0	
3. Serie 5 Skott 		1: 8.3	↘
		2: 8.8	↗
		3: 8.0	↓
		4: 5.5	↓
		5: 7.0	↘
	Serie	36	
	Total	36	
6. Serie 5 Skott 		1: 8.0	↓
		2: 5.7	↘
		3: 9.2	←
		4: 7.2	↑
		5: 5.6	←
	Serie	34	
	Total	70	

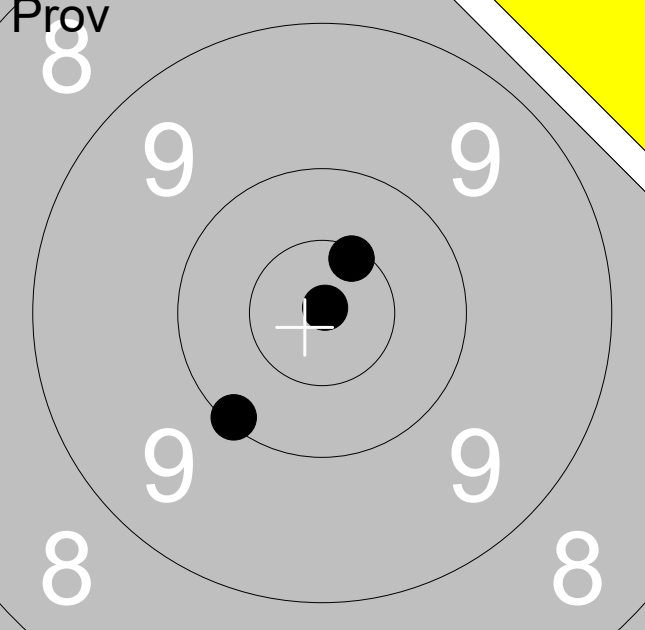
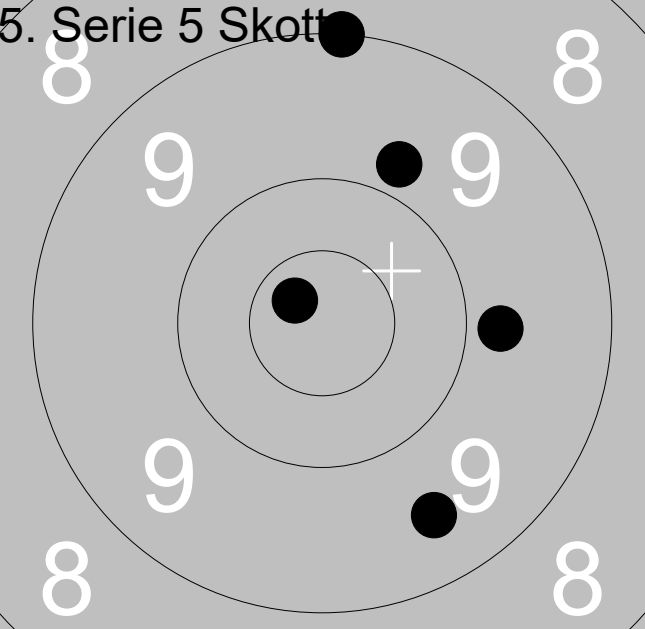
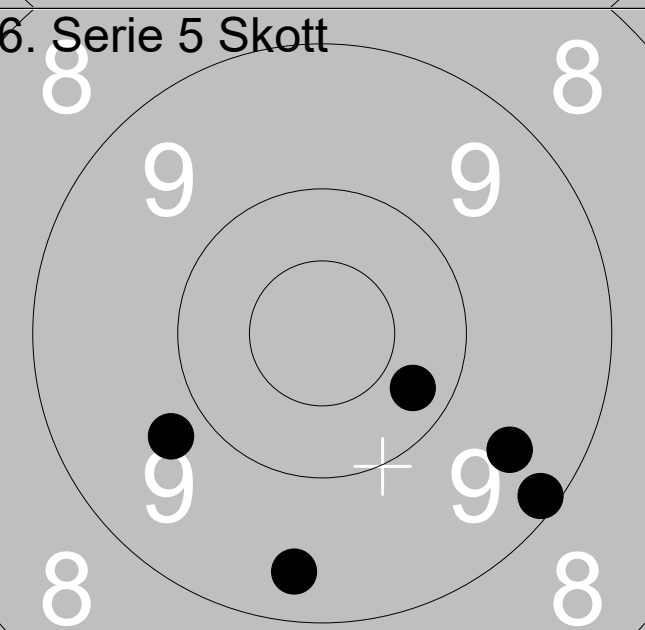
11.07.2021	Tavelstafetten 2021	Ramselefors SKF														
Prov 	<table style="width:100%; border-collapse: collapse;"> <tr> <td style="width:10%;">1:</td> <td style="width:70%;">10.6x</td> <td style="width:20%; text-align: right;">↗</td> </tr> <tr> <td>2:</td> <td>10.1</td> <td style="text-align: right;">↘</td> </tr> <tr> <td>3:</td> <td>10.9x</td> <td style="text-align: right;">↗</td> </tr> </table>	1:	10.6x	↗	2:	10.1	↘	3:	10.9x	↗						
1:	10.6x	↗														
2:	10.1	↘														
3:	10.9x	↗														
Serie		30														
Total		0														
5. Serie 5 Skott 	<table style="width:100%; border-collapse: collapse;"> <tr> <td style="width:10%;">1:</td> <td style="width:70%;">9.8</td> <td style="width:20%; text-align: right;">↗</td> </tr> <tr> <td>2:</td> <td>9.0</td> <td style="text-align: right;">↑</td> </tr> <tr> <td>3:</td> <td>10.7x</td> <td style="text-align: right;">↗</td> </tr> <tr> <td>4:</td> <td>9.8</td> <td style="text-align: right;">→</td> </tr> <tr> <td>5:</td> <td>9.5</td> <td style="text-align: right;">↘</td> </tr> </table>	1:	9.8	↗	2:	9.0	↑	3:	10.7x	↗	4:	9.8	→	5:	9.5	↘
1:	9.8	↗														
2:	9.0	↑														
3:	10.7x	↗														
4:	9.8	→														
5:	9.5	↘														
Serie		46														
Total		46														
6. Serie 5 Skott 	<table style="width:100%; border-collapse: collapse;"> <tr> <td style="width:10%;">1:</td> <td style="width:70%;">9.5</td> <td style="width:20%; text-align: right;">↘</td> </tr> <tr> <td>2:</td> <td>9.4</td> <td style="text-align: right;">↓</td> </tr> <tr> <td>3:</td> <td>10.3</td> <td style="text-align: right;">↘</td> </tr> <tr> <td>4:</td> <td>9.8</td> <td style="text-align: right;">↖</td> </tr> <tr> <td>5:</td> <td>9.2</td> <td style="text-align: right;">↘</td> </tr> </table>	1:	9.5	↘	2:	9.4	↓	3:	10.3	↘	4:	9.8	↖	5:	9.2	↘
1:	9.5	↘														
2:	9.4	↓														
3:	10.3	↘														
4:	9.8	↖														
5:	9.2	↘														
Serie		46														
Total		92														

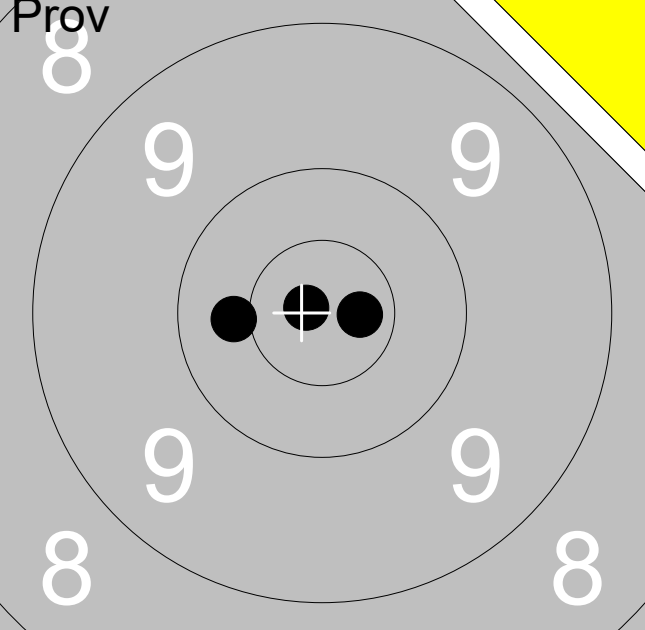
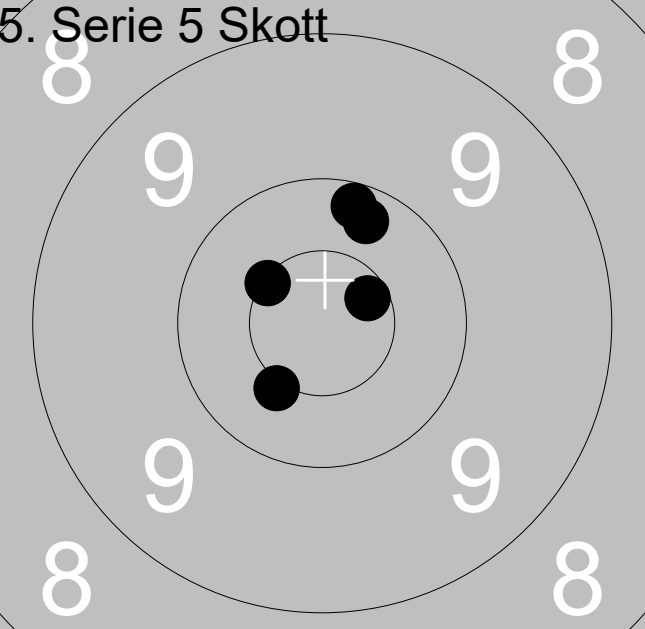
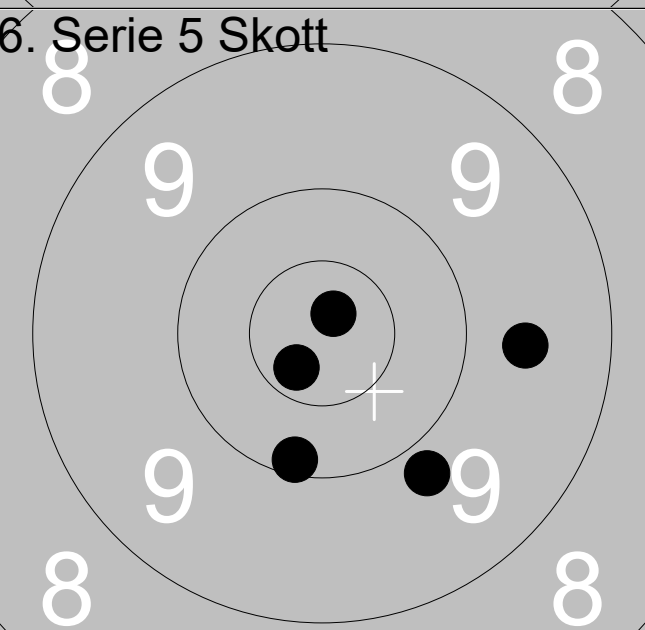
11.07.2021	Tavelstafetten 2021	Ramselefors SKF														
Prov 	<table style="width:100%; border-collapse: collapse;"> <tr><td style="width:10%;">1:</td><td style="width:70%;">10.7x</td><td style="width:20%; text-align: right;">→</td></tr> <tr><td>2:</td><td>10.4</td><td style="text-align: right;">←</td></tr> <tr><td>3:</td><td>10.8x</td><td style="text-align: right;">↖</td></tr> </table>	1:	10.7x	→	2:	10.4	←	3:	10.8x	↖						
1:	10.7x	→														
2:	10.4	←														
3:	10.8x	↖														
Serie		30														
Total		0														
5. Serie 5 Skott 	<table style="width:100%; border-collapse: collapse;"> <tr><td style="width:10%;">1:</td><td style="width:70%;">10.2</td><td style="width:20%; text-align: right;">↗</td></tr> <tr><td>2:</td><td>10.5x</td><td style="text-align: right;">↖</td></tr> <tr><td>3:</td><td>10.4x</td><td style="text-align: right;">↘</td></tr> <tr><td>4:</td><td>10.6x</td><td style="text-align: right;">↗</td></tr> <tr><td>5:</td><td>10.2</td><td style="text-align: right;">↗</td></tr> </table>	1:	10.2	↗	2:	10.5x	↖	3:	10.4x	↘	4:	10.6x	↗	5:	10.2	↗
1:	10.2	↗														
2:	10.5x	↖														
3:	10.4x	↘														
4:	10.6x	↗														
5:	10.2	↗														
Serie		50														
Total		50														
6. Serie 5 Skott 	<table style="width:100%; border-collapse: collapse;"> <tr><td style="width:10%;">1:</td><td style="width:70%;">10.8x</td><td style="width:20%; text-align: right;">↗</td></tr> <tr><td>2:</td><td>10.1</td><td style="text-align: right;">↘</td></tr> <tr><td>3:</td><td>9.6</td><td style="text-align: right;">→</td></tr> <tr><td>4:</td><td>10.7x</td><td style="text-align: right;">↘</td></tr> <tr><td>5:</td><td>9.8</td><td style="text-align: right;">↘</td></tr> </table>	1:	10.8x	↗	2:	10.1	↘	3:	9.6	→	4:	10.7x	↘	5:	9.8	↘
1:	10.8x	↗														
2:	10.1	↘														
3:	9.6	→														
4:	10.7x	↘														
5:	9.8	↘														
Serie		48														
Total		98														

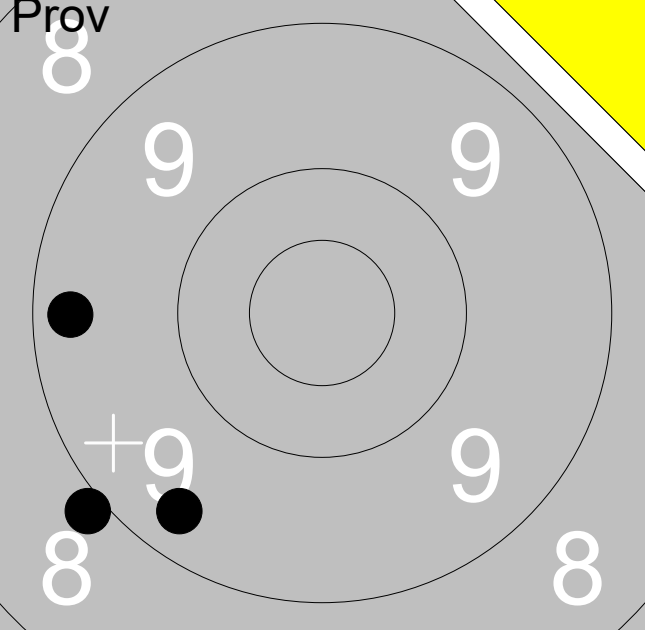
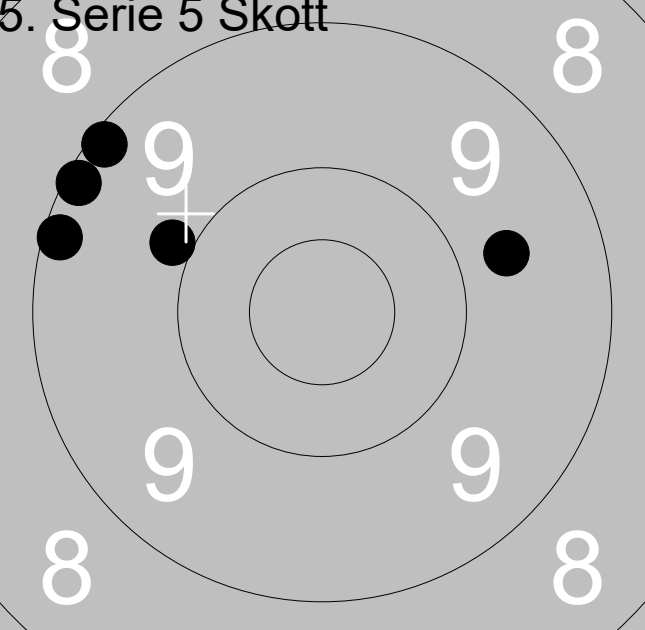
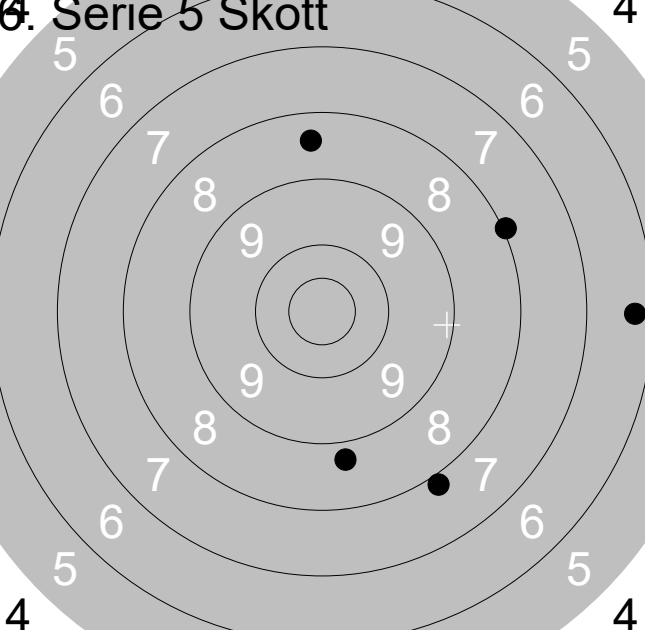
11.07.2021	Tavelstafetten 2021	Ramselefors SKF															
Prov 	<table style="width:100%; border-collapse: collapse;"> <tr> <td style="width:10%;">1:</td> <td style="width:20%;">9.3</td> <td style="width:10%; text-align: right;">←</td> </tr> <tr> <td>2:</td> <td>8.9</td> <td style="text-align: right;">↙</td> </tr> <tr> <td>3:</td> <td>9.3</td> <td style="text-align: right;">↘</td> </tr> </table>	1:	9.3	←	2:	8.9	↙	3:	9.3	↘							
1:	9.3	←															
2:	8.9	↙															
3:	9.3	↘															
Serie		26															
Total		0															
5. Serie 5 Skott 	<table style="width:100%; border-collapse: collapse;"> <tr> <td style="width:10%;">1:</td> <td style="width:20%;">9.1</td> <td style="width:10%; text-align: right;">←</td> </tr> <tr> <td>2:</td> <td>9.1</td> <td style="text-align: right;">↖</td> </tr> <tr> <td>3:</td> <td>9.9</td> <td style="text-align: right;">↖</td> </tr> <tr> <td>4:</td> <td>9.7</td> <td style="text-align: right;">→</td> </tr> <tr> <td>5:</td> <td>9.1</td> <td style="text-align: right;">↗</td> </tr> </table>	1:	9.1	←	2:	9.1	↖	3:	9.9	↖	4:	9.7	→	5:	9.1	↗	
1:	9.1	←															
2:	9.1	↖															
3:	9.9	↖															
4:	9.7	→															
5:	9.1	↗															
Serie		45															
Total		45															
6. Serie 5 Skott 	<table style="width:100%; border-collapse: collapse;"> <tr> <td style="width:10%;">1:</td> <td style="width:20%;">8.8</td> <td style="width:10%; text-align: right;">↓</td> </tr> <tr> <td>2:</td> <td>8.0</td> <td style="text-align: right;">↗</td> </tr> <tr> <td>3:</td> <td>7.9</td> <td style="text-align: right;">↘</td> </tr> <tr> <td>4:</td> <td>8.4</td> <td style="text-align: right;">↑</td> </tr> <tr> <td>5:</td> <td>6.3</td> <td style="text-align: right;">→</td> </tr> </table>	1:	8.8	↓	2:	8.0	↗	3:	7.9	↘	4:	8.4	↑	5:	6.3	→	
1:	8.8	↓															
2:	8.0	↗															
3:	7.9	↘															
4:	8.4	↑															
5:	6.3	→															
Serie		37															
Total		82															