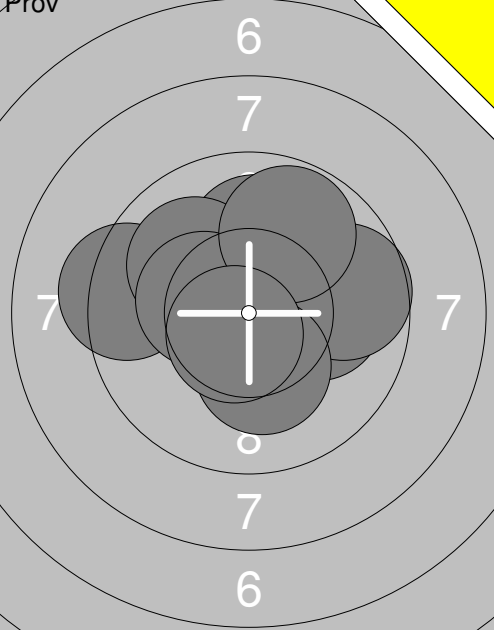
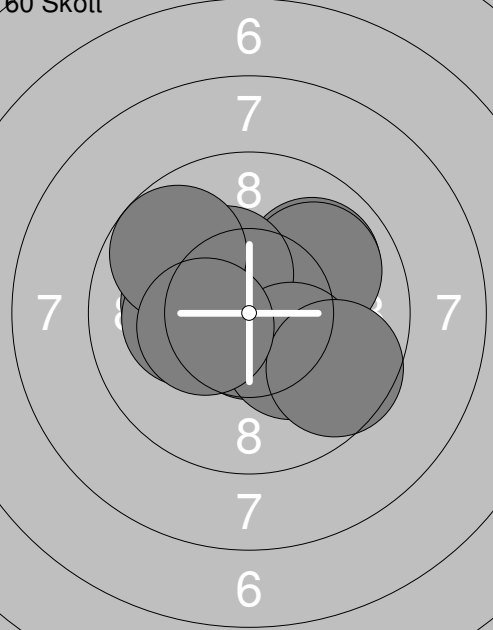
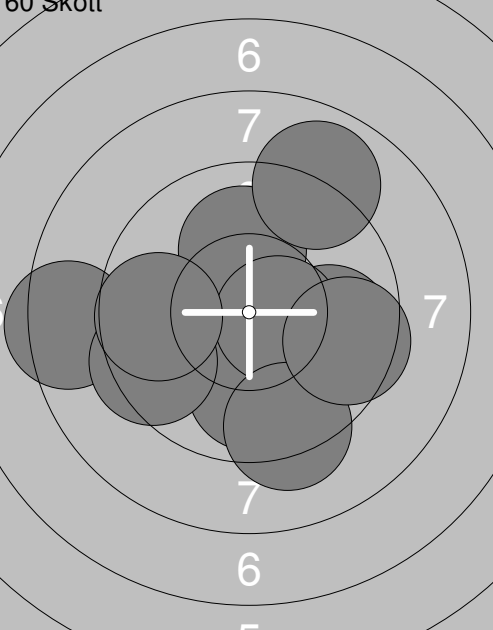
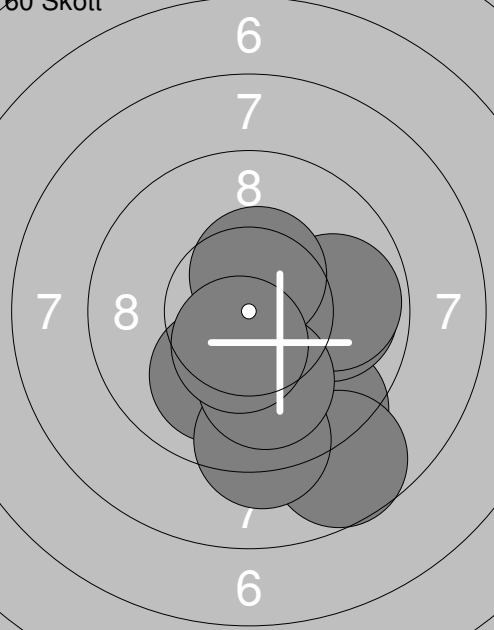
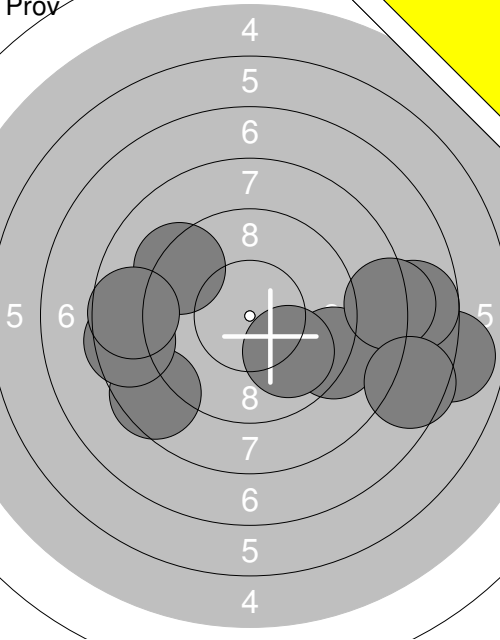
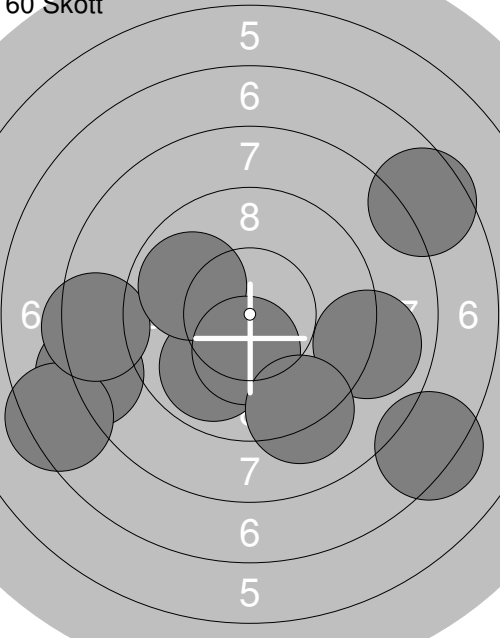
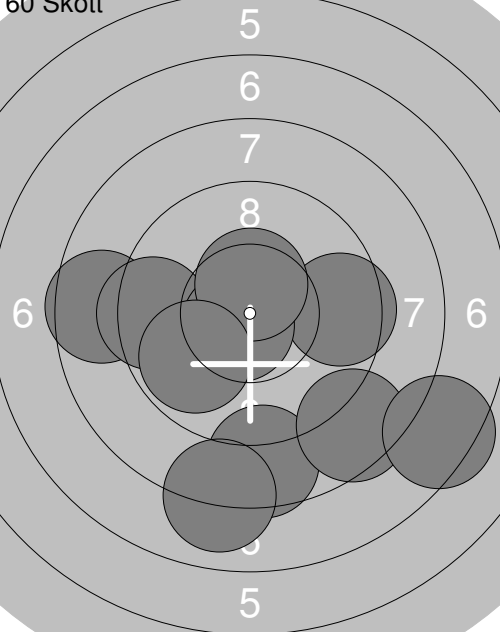

<p>Prov</p> 	<p>60 Skott</p> 	<p>60 Skott</p> 
<p>1: 9.3 ← 2: 10.0 ↑ 3: 10.1 → 4: 10.7x ↗ 5: 9.7 → 6: 10.0 ↖ 7: 10.3x ↖ 8: 9.8 ↗ 9: 10.2x ↓ 10: 10.6x ↓</p> <p>Serie 97.0 Total 0.0</p>	<p>1: 10.2x ↖ 2: 9.9 ↗ 3: 10.7x ↓ 4: 9.9 ↗ 5: 10.4x ↖ 6: 10.2x ↖ 7: 10.2x ↓ 8: 9.6 ↘ 9: 9.7 ↖ 10: 10.4x ↖</p> <p>Serie 96.0 Total 96.0</p>	<p>11: 10.0 ↓ 12: 10.3x ↗ 13: 8.7 → 14: 10.3x ↓ 15: 9.1 ← 16: 9.9 ← 17: 9.6 ↓ 18: 10.6x ↓ 19: 10.0 ↘ 20: 9.9 →</p> <p>Serie 94.0 Total 190.0</p>
<p>60 Skott</p> 	<p>21: 8.4 ← 22: 10.1 ↑ 23: 9.8 → 24: 9.9 ↓ 25: 8.9 ↗ 26: 10.5x → 27: 9.4 ← 28: 9.7 ← 29: 9.3 ↓ 30: 9.5 →</p> <p>Serie 90.0 Total 280.0</p>	
<p>31: 9.4 ↓ 32: 10.2x → 33: 9.9 → 34: 8.7 ↓ 35: 9.9 → 36: 10.5x ↗ 37: 10.0 ↓ 38: 9.3 ↓ 39: 10.0 ↓ 40: 10.5x ↓</p> <p>Serie 94.0 Total 374.0</p>		

<p>Prov</p>	<p>60 Skott</p>	<p>1: 8.6 ↙ 2: 10.2x↔ 3: 10.4x↘ 4: 10.3x→ 5: 10.6x↗</p> <p>1: 10.5x↖ 2: 9.5 ← 3: 10.1 ← 4: 9.6 ↙ 5: 10.2x↘ 6: 9.6 ↙ 7: 9.9 ↓ 8: 10.2x↖ 9: 9.2 ↖ 10: 10.4x↓</p>
Serie 48.0	Serie 95.0	
Total 0.0	Total 95.0	

<p>60 Skott</p>	<p>60 Skott</p>	<p>11: 10.8x↘ 12: 8.4 ↑ 13: 10.0 → 14: 10.7x↘ 15: 9.6 ↘ 16: 10.1 ↓ 17: 10.4x↖ 18: 9.1 ↘ 19: 8.0 ↘ 20: 9.2 →</p> <p>21: 10.0 ↗ 22: 10.3x↔ 23: 10.6x↓ 24: 10.3x→ 25: 10.3x↗ 26: 9.8 → 27: 9.5 → 28: 9.5 ↘ 29: 10.1 ↑ 30: 10.4x→</p>
Serie 93.0	Serie 97.0	
Total 188.0	Total 285.0	

<p>60 Skott</p>	<p>31: 10.4x↘ 32: 9.3 ↘ 33: 10.4x↘ 34: 10.4x↘ 35: 9.8 ↑ 36: 10.5x↘ 37: 9.5 → 38: 9.8 ↘ 39: 10.1 ← 40: 10.3x↔</p>	
Serie 96.0		
Total 381.0		

Skjutlag	Tavla	Anton Lind	
1	24		
S	Skoga-Ekshärad Skf		
04.11.2017	Nationellt Mästerskap 2017		Umeå skytteallians
Prov		1: 9.1 ➔ 2: 9.3 ↖ 3: 8.6 ↙ 4: 8.5 ← 5: 8.7 ← 6: 7.0 ➔ 7: 7.7 ➔ 8: 8.2 ➔ 9: 7.6 ➔ 10: 9.9 ↘ Serie 80.0 Total 0.0	11: 7.1 ➔ 12: 9.3 ← 13: 8.5 ← 14: 9.8 ↓ 15: 8.9 ← 16: 9.8 ↓ Serie 50.0 Total 0.0
60 Skott		1: 7.3 ↘ 2: 8.1 ← 3: 9.9 ↓ 4: 9.0 ➔ 5: 7.4 ← 6: 8.4 ← 7: 7.6 ↗ 8: 9.9 ← 9: 10.3x↓ 10: 9.2 ↘ Serie 83.0 Total 83.0	11: 9.1 ↗ 12: 9.7 ← 13: 9.6 ↑ 14: 9.5 ↓ 15: 8.8 ➔ 16: 9.0 ➔ 17: 9.6 ↙ 18: 9.9 ↑ 19: 8.4 ← 20: 10.0 ↗ Serie 89.0 Total 172.0
60 Skott		21: 8.6 ↓ 22: 8.5 ↘ 23: 9.5 ➔ 24: 8.6 ← 25: 8.0 ↓ 26: 9.4 ← 27: 10.7x↙ 28: 7.4 ➔ 29: 10.5x↑ 30: 9.9 ← Serie 86.0 Total 258.0	31: 8.8 ← 32: 10.1 ➔ 33: 9.7 ↙ 34: 9.3 ← 35: 8.0 ← 36: 9.7 ↙ 37: 9.4 ↓ 38: 9.7 ↗ 39: 9.9 ➔ 40: 10.1 ↓ Serie 90.0 Total 348.0

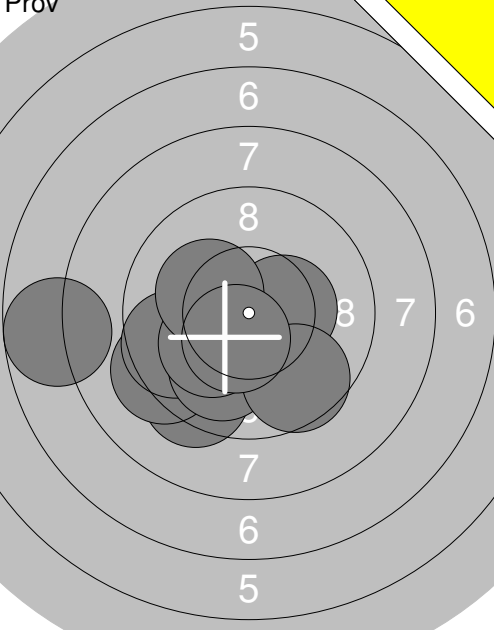
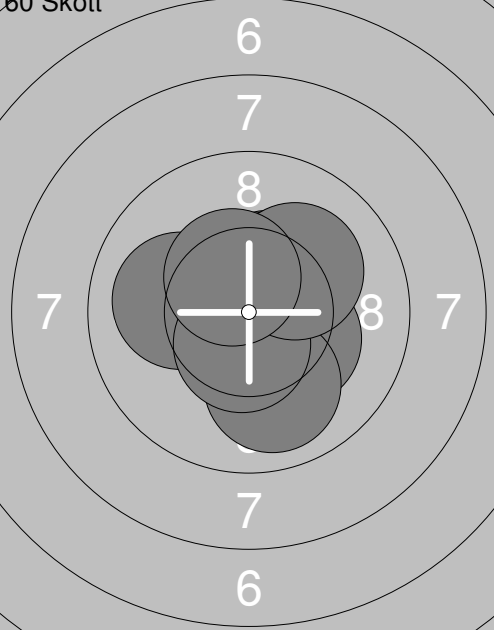
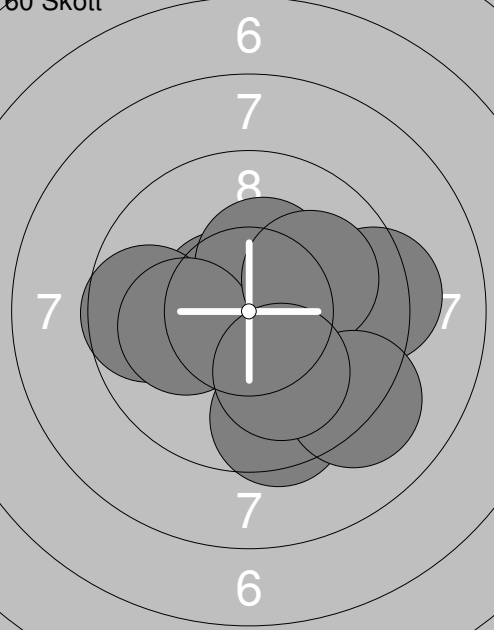
Skjutlag	Tavla	Hanna Lundin	
S	Umeå Skf		
04.11.2017	Nationellt Mästerskap 2017	Umeå skytteallians	
Prov		1: 9.3 ↘ 2: 9.3 ↙ 3: 9.6 ← 4: 10.4x → 5: 10.0 ↓ 6: 9.6 ↘ 7: 10.2x ↘ 8: 7.8 ← 9: 10.2x ↘ 10: 10.5x ↘ Serie 93.0 Total 0.0	11: 9.6 ↘ 12: 9.9 ↓ 13: 10.1 ← 14: 10.4x ↘ 15: 9.6 ↘ 16: 9.4 ↘ 17: 10.1 ← Serie 66.0 Total 0.0
60 Skott		1: 10.4x ↗ 2: 10.3x ↘ 3: 10.6x ↘ 4: 10.7x ↗ 5: 10.4x ↗ 6: 10.1 ← 7: 10.0 ↓ 8: 10.5x ↓ 9: 10.1 ↗ 10: 10.4x ↗ Serie 100.0 Total 100.0	11: 10.4x ↗ 12: 9.2 → 13: 10.6x ← 14: 10.5x ↘ 15: 9.3 ↘ 16: 10.7x ↗ 17: 10.2x ↘ 18: 9.5 ↓ 19: 9.3 ← 20: 9.8 ↘ Serie 95.0 Total 195.0
60 Skott		21: 10.6x ↘ 22: 10.6x ↘ 23: 10.3x ↗ 24: 9.5 ↓ 25: 9.6 ← 26: 9.3 → 27: 10.1 ← 28: 10.0 ↗ 29: 9.2 ↘ 30: 10.1 ↓ Serie 96.0 Total 291.0	31: 10.3x ↓ 32: 10.8x ← 33: 10.8x ↗ 34: 10.6x ↘ 35: 10.3x ↗ 36: 9.7 → 37: 10.8x ↗ 38: 9.3 ← 39: 10.3x ↗ 40: 8.0 → Serie 96.0 Total 387.0

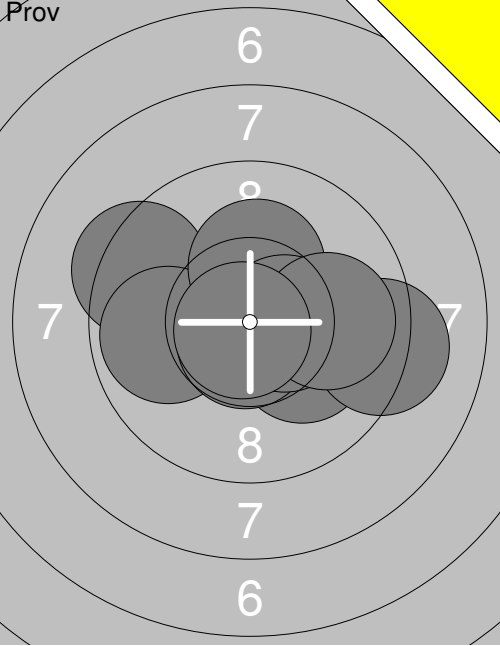
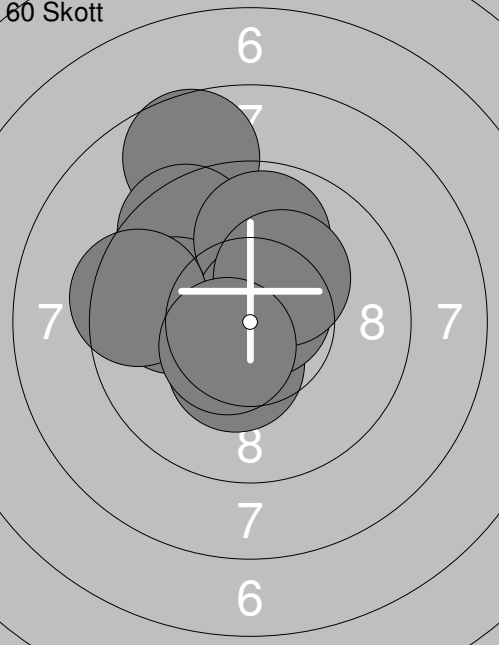
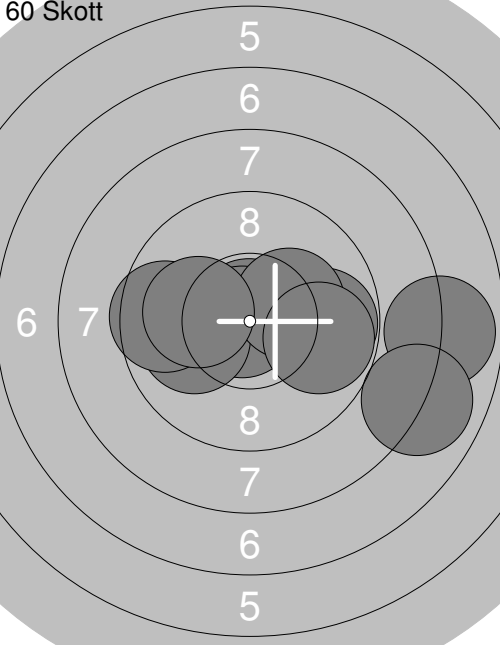
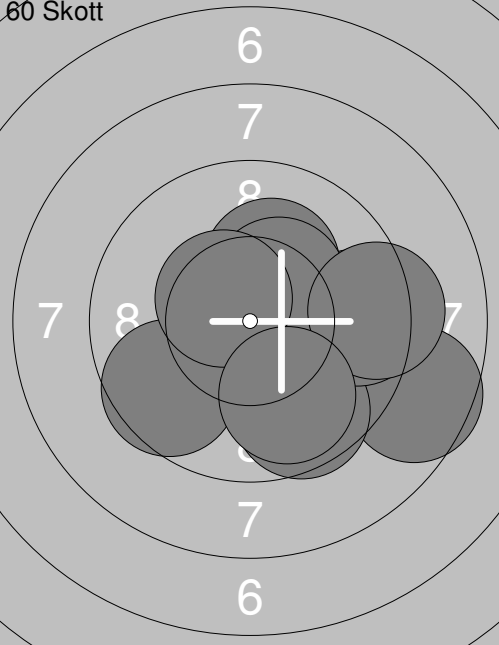
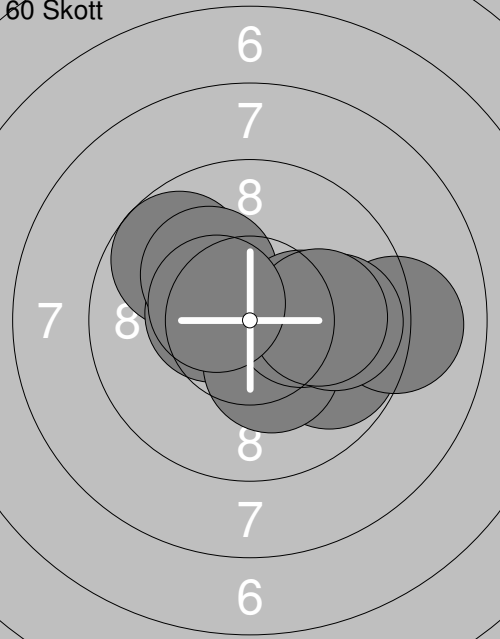
Skjutlag 1	Tavla 27	Kevin Westberg	
S		Söderala AIK	
04.11.2017		Nationellt Mästerskap 2017	
Umeå skytteallians			
	1: 9.9 ← 2: 9.4 ← 3: 10.2x↘ 4: 9.9 ← 5: 10.2x↑ 6: 9.2 → 7: 10.7x↓ 8: 10.5x→ 9: 9.9 → 10: 10.8x↘ Serie 95.0 Total 0.0		1: 10.8x↑ 2: 8.7 ↑ 3: 9.5 ↖ 4: 10.4x↓ 5: 9.9 ← 6: 9.9 ↑ 7: 10.7x↗ 8: 10.2x↑ 9: 9.5 ← 10: 10.5x↘ Serie 94.0 Total 94.0
	11: 9.8 → 12: 10.8x↑ 13: 10.8x← 14: 10.0← 15: 9.6 ← 16: 10.3x↗ 17: 7.9 → 18: 8.0 → 19: 9.8 → 20: 10.1← Serie 92.0 Total 186.0		21: 8.6 → 22: 10.2x↑ 23: 10.5x↓ 24: 9.6 ↓ 25: 9.6 ↙ 26: 9.5 → 27: 10.3x↗ 28: 10.5x↘ 29: 9.3 → 30: 9.9 ↓ Serie 93.0 Total 279.0
	31: 9.7 ↖ 32: 9.8 ↘ 33: 9.1 → 34: 10.5x← 35: 10.2x↘ 36: 10.3x↓ 37: 10.3x→ 38: 9.8 → 39: 10.1→ 40: 10.5x↘ Serie 96.0 Total 375.0		

<p>Prov</p> 	<p>60 Skott</p> 	<p>1: 10.9x ↘ 2: 10.3x ← 3: 9.2 ← 4: 9.8 ← 5: 10.0 ↓ 6: 10.3x ← 7: 8.2 ↓ 8: 9.9 ← 9: 10.6x ↘ 10: 9.9 ↑</p> <p>Serie 94.0 Total 0.0</p>	<p>1: 10.7x ⇒ 2: 10.1 → 3: 10.6x ↘ 4: 10.0 → 5: 10.0 ↑ 6: 10.0 ↑ 7: 9.4 ↗ 8: 10.7x ↘ 9: 10.4x ⇒ 10: 10.2x ↘</p> <p>Serie 99.0 Total 99.0</p>
--	--	--	--

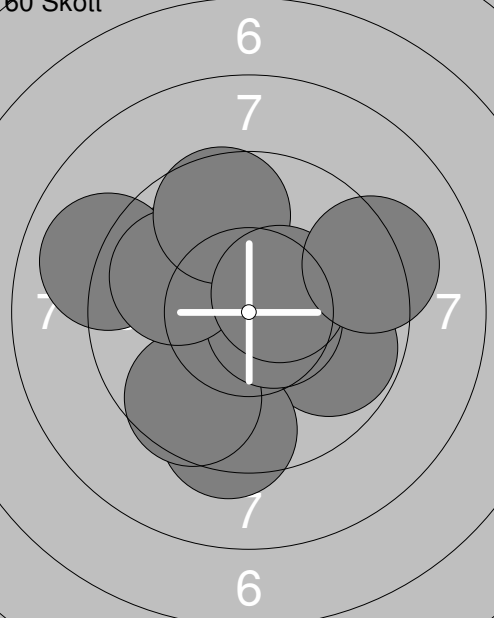
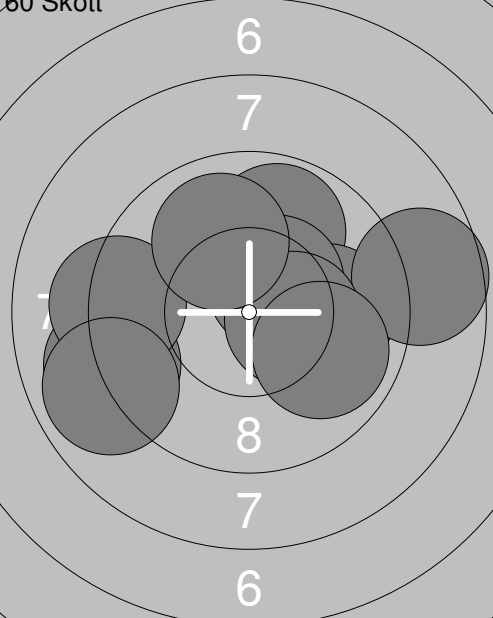
<p>60 Skott</p> 	<p>60 Skott</p> 	<p>11: 9.9 ← 12: 9.8 ⇒ 13: 9.0 ← 14: 9.4 ↓ 15: 9.6 ↓ 16: 10.6x ⇒ 17: 9.9 ← 18: 9.6 ↑ 19: 10.5x ↗ 20: 9.2 ⇒</p> <p>Serie 92.0 Total 191.0</p>	<p>21: 9.8 ↑ 22: 9.9 → 23: 10.4x ↗ 24: 8.7 → 25: 10.4x ⇒ 26: 9.0 ← 27: 9.2 ← 28: 9.9 ⇒ 29: 10.0 ↑ 30: 8.9 ←</p> <p>Serie 91.0 Total 282.0</p>
---	---	--	---

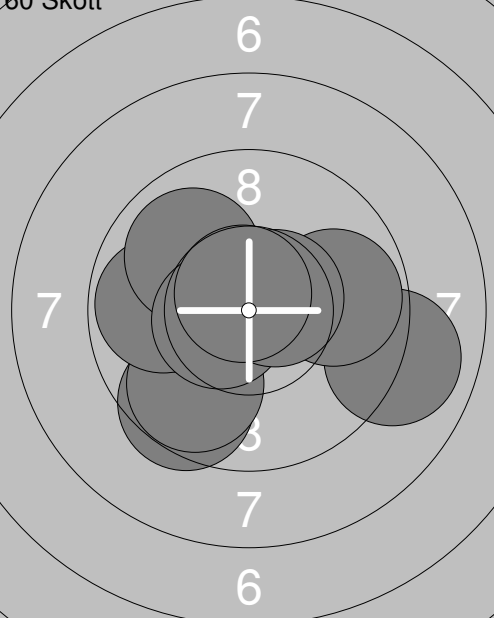
<p>60 Skott</p> 	<p>31: 9.0 ⇒ 32: 9.5 ↓ 33: 9.8 ↓ 34: 10.3x ← 35: 9.8 ← 36: 9.9 ↖ 37: 10.6x ← 38: 9.8 → 39: 10.6x ↗ 40: 10.7x ↘</p> <p>Serie 94.0 Total 376.0</p>		
--	--	--	--

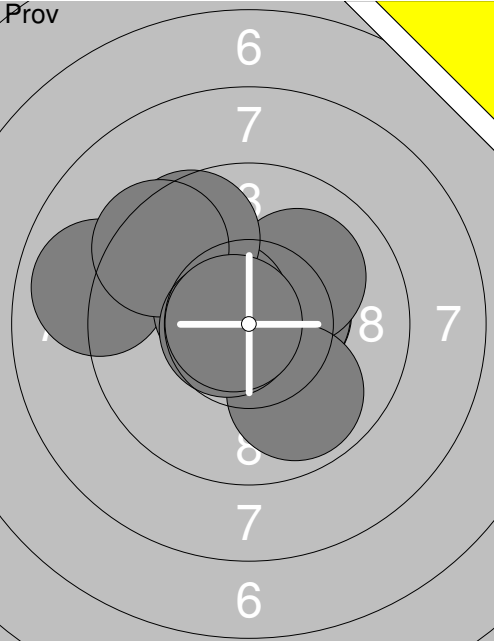
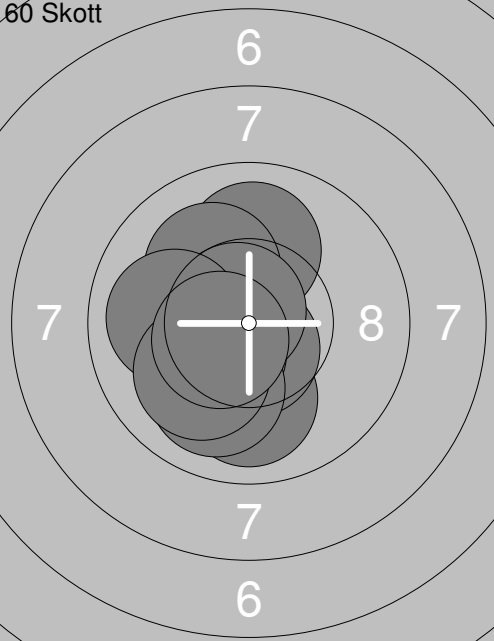
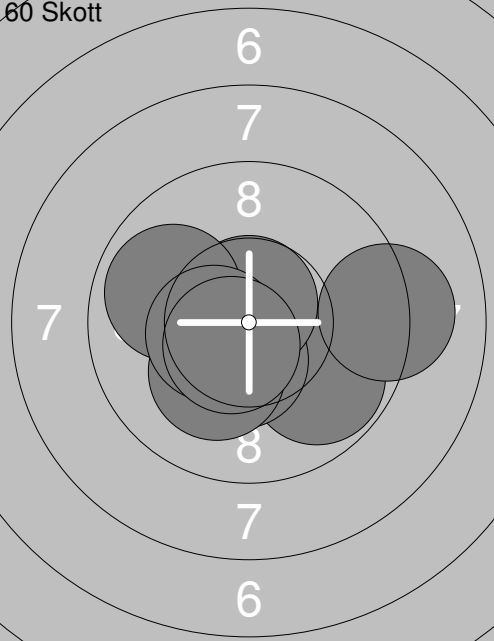
Skjutlag	Tavla	Anna Mårtensson	
1	29		
S	Kyrkås Skf		
04.11.2017	Nationellt Mästerskap 2017	Umeå skytteallians	
Prov		1: 8.9 ← 2: 10.5x → 3: 10.5x → 4: 10.1 ↗ 5: 10.5x ↘ 6: 9.6 ↗ 7: 9.4 ↖ 8: 9.9 ↘ 9: 10.7x ↘ 10: 10.7x ↖ Serie 95.0 Total 0.0	11: 10.5x ↘ 12: 10.4x ↘ 13: 9.6 ↘ 14: 9.9 ← 15: 10.7x ↘ 16: 10.6x ↗ 17: 9.9 ← 18: 9.7 ← 19: 10.2x ↘ 20: 10.3x ↘ Serie 96.0 Total 0.0
60 Skott		1: 10.0 ↑ 2: 10.0 ↓ 3: 10.6x ↓ 4: 10.4x ↘ 5: 10.1 ↖ 6: 10.7x ↘ 7: 10.0 ↓ 8: 10.0 ← 9: 10.1 ↘ 10: 10.5x ↘ Serie 100.0 Total 100.0	11: 10.6x ↘ 12: 10.4x ↗ 13: 10.2x ↘ 14: 10.5x → 15: 10.0 ↗ 16: 10.3x ↘ 17: 10.7x ↘ 18: 9.6 → 19: 9.8 → 20: 10.6x ↘ Serie 98.0 Total 198.0
60 Skott		21: 9.8 ↘ 22: 10.4x ↘ 23: 10.8x ↘ 24: 10.4x ↘ 25: 10.2x ↘ 26: 10.7x ↗ 27: 9.9 ← 28: 9.1 → 29: 10.5x ↘ 30: 10.6x ↘ Serie 97.0 Total 295.0	31: 9.7 ↖ 32: 9.5 ↘ 33: 10.1 → 34: 10.6x ↗ 35: 10.3x ↘ 36: 9.8 ↘ 37: 10.4x → 38: 10.1 ↗ 39: 10.3x ↘ 40: 10.7x ↘ Serie 97.0 Total 392.0

<p>Prov</p>	<p>1: 9.5 ↘ 2: 9.7 ← 3: 9.0 ↓ 4: 9.8 ↓ 5: 9.4 ↓ 6: 10.1 ↓ 7: 8.0 → 8: 10.1 ↑ 9: 9.1 ← 10: 10.2 ✕</p> <p>Serie 92.0 Total 0.0</p>	<p>Prov</p> <p>11: 10.2 ✕</p> <p>Serie 10.0 Total 0.0</p>
<p>60 Skott</p>	<p>1: 10.6 ✕ 2: 9.5 ↖ 3: 8.2 ↖ 4: 10.3 ✕ 5: 10.5 ✕ 6: 10.1 ↓ 7: 10.8 ✕ 8: 8.5 ← 9: 9.7 → 10: 10.1 ↓</p> <p>Serie 94.0 Total 94.0</p>	<p>60 Skott</p> <p>11: 9.7 → 12: 8.6 ← 13: 10.6 ✕ 14: 8.7 ↑ 15: 10.7 ✕ 16: 10.2 ✕ 17: 10.0 ↑ 18: 9.9 ↑ 19: 10.7 ✕ 20: 10.2 ✕</p> <p>Serie 94.0 Total 188.0</p>
<p>60 Skott</p>	<p>21: 9.5 ↖ 22: 9.5 ↓ 23: 10.3 ✕ 24: 10.6 ✕ 25: 10.0 ↑ 26: 10.1 → 27: 9.9 ← 28: 9.1 ↖ 29: 10.5 ✕ 30: 9.8 ↓</p> <p>Serie 95.0 Total 283.0</p>	<p>60 Skott</p> <p>31: 9.7 ↓ 32: 10.4 ✕ 33: 10.2 ✕ 34: 9.2 ↓ 35: 10.5 ✕ 36: 10.5 ✕ 37: 10.6 ✕ 38: 10.1 → 39: 10.3 ✕ 40: 10.1 ↖</p> <p>Serie 98.0 Total 381.0</p>

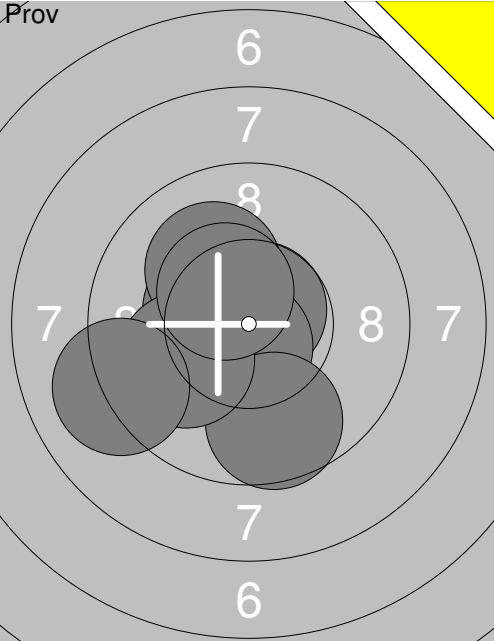
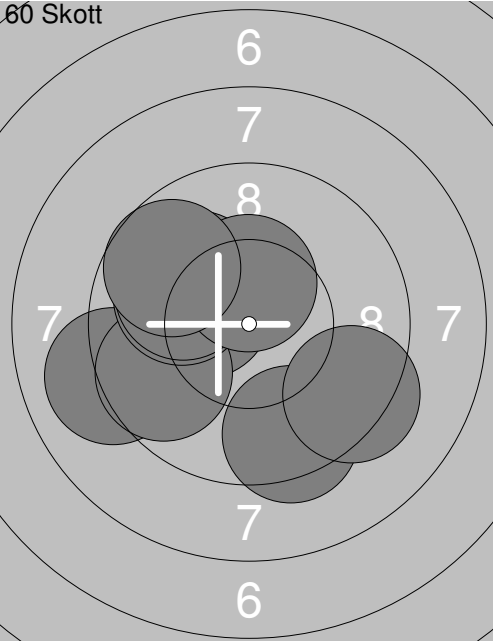
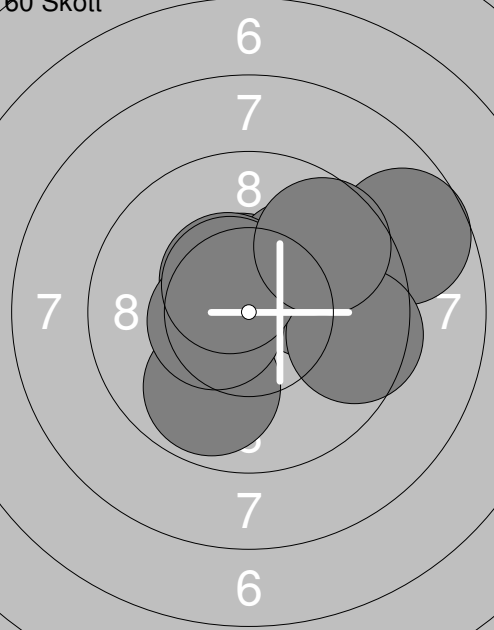
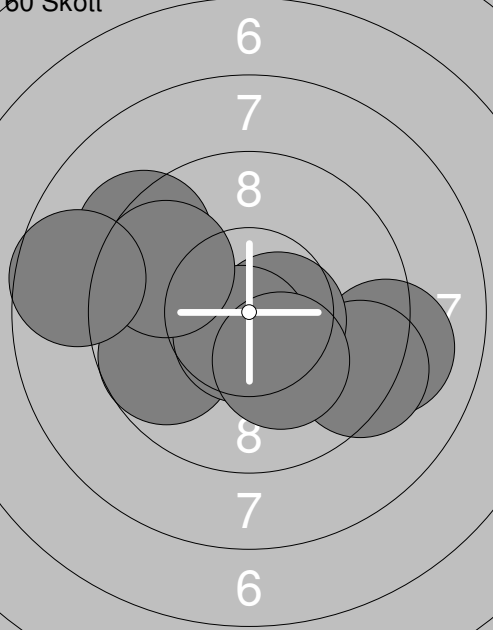
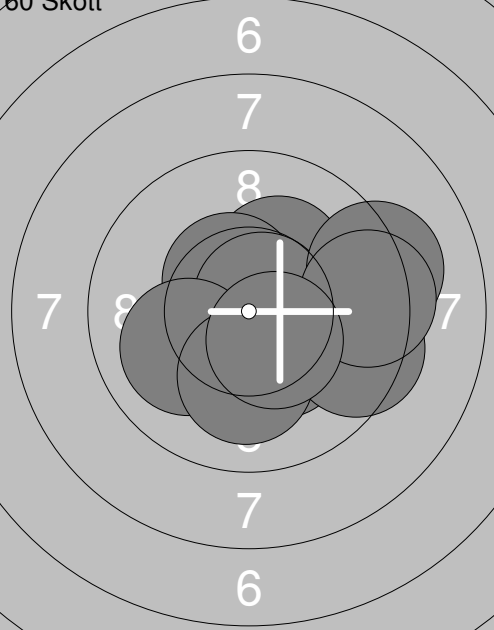
Skjutlag 1	Tavla 31	Nicolle Nygren	
S		Umeå Skf	
04.11.2017		Nationellt Mästerskap 2017	
Umeå skytteallians			
Prov 	1: 10.7x ↗ 2: 10.4x ↘ 3: 10.7x ↘ 4: 9.7 ↓ 5: 10.1 ↖ 6: 10.0 ↙ 7: 9.1 ← 8: 10.4x ↘	60 Skott 	1: 9.1 ← 2: 9.4 ↓ 3: 10.0 ↗ 4: 9.3 ↘ 5: 10.3x ↘ 6: 9.7 ↙ 7: 10.0 ↙ 8: 10.0 ↙ 9: 10.4x ↗ 10: 9.7 ↖
	Serie 78.0		Serie 95.0
	Total 0.0		Total 95.0
60 Skott 	11: 9.9 ↓ 12: 10.5x ↗ 13: 8.7 → 14: 10.1 ↗ 15: 10.1 → 16: 10.5x ↘ 17: 10.5x ↙ 18: 9.5 → 19: 10.5x ↘ 20: 9.7 ↗	60 Skott 	21: 9.1 → 22: 10.0 ↙ 23: 9.3 ↘ 24: 9.7 ↙ 25: 9.3 ↖ 26: 10.6x → 27: 10.6x ↘ 28: 9.7 ↙ 29: 8.7 ← 30: 10.2x ↘
	Serie 95.0		Serie 93.0
	Total 190.0		Total 283.0
60 Skott 	31: 10.3x ↘ 32: 10.2x ↗ 33: 9.5 → 34: 10.5x ↘ 35: 10.7x ↗ 36: 10.0 ↙ 37: 9.2 → 38: 9.4 → 39: 10.1 ↓ 40: 10.4x ↘		
	Serie 97.0		
	Total 380.0		

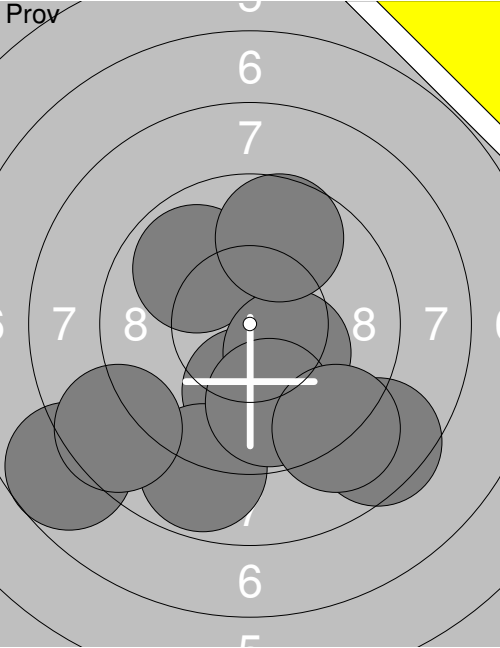
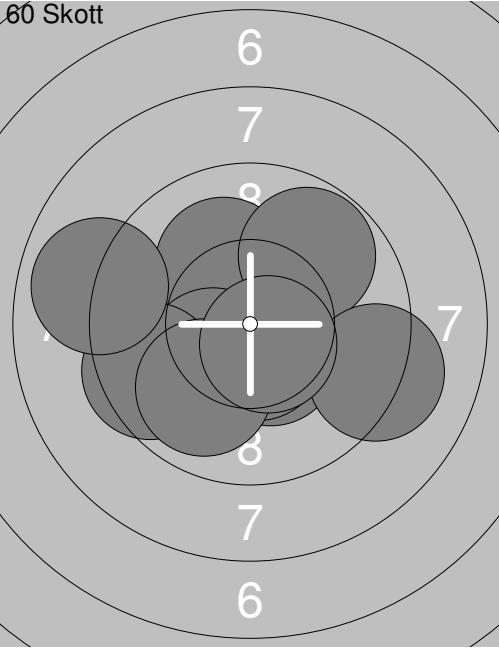
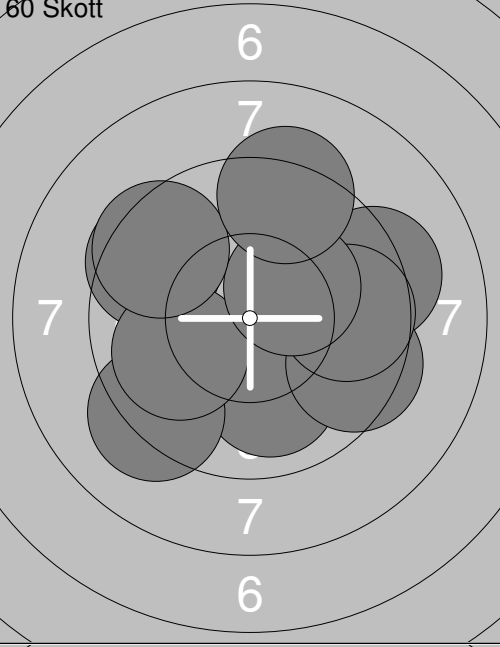
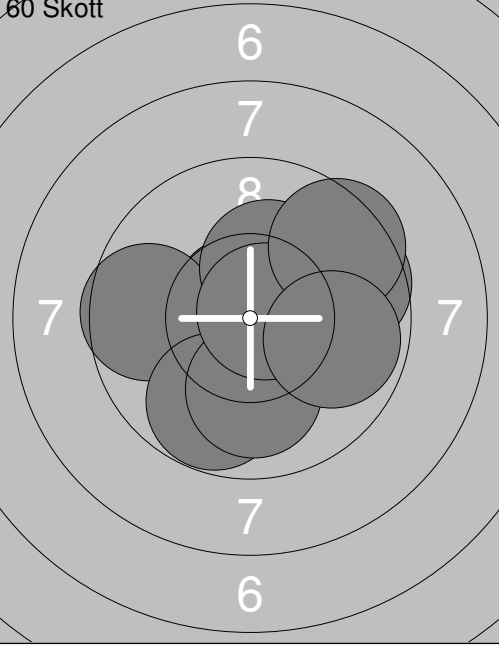
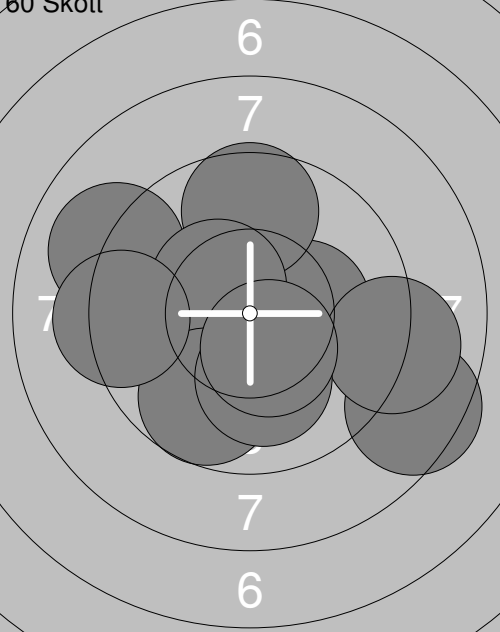
Skjutlag 1	Tavla 33	Emma Johansson	
S		Ramselefors Skf	
04.11.2017		Nationellt Mästerskap 2017	
Prov		Umeå skytteallians	
	1: 10.0 ↓		1: 10.4x ↘
	2: 8.8 ↓		2: 10.1 ↗
	3: 7.7 ↙		3: 9.8 ↗
	4: 8.6 ↙		4: 10.6x ↘
	5: 9.9 ↖		5: 10.3x ↘
	6: 8.5 ↓		6: 9.2 →
	7: 10.3x ↘		7: 9.5 ↙
	8: 9.7 ↑		8: 9.9 ↓
	9: 9.8 ↓		9: 10.6x ↘
	10: 9.1 ↓		10: 8.9 ←
	Serie 87.0		Serie 94.0
	Total 0.0		Total 94.0
	11: 10.0 ↓		21: 10.4x ↗
	12: 9.3 →		22: 10.7x ↘
	13: 9.5 →		23: 9.6 ←
	14: 9.7 →		24: 9.8 ↓
	15: 9.5 ↖		25: 10.0 ↓
	16: 9.2 ↙		26: 9.7 →
	17: 9.9 ←		27: 10.3x ↗
	18: 10.3x ↗		28: 10.7x ↗
	19: 9.5 ↖		29: 9.5 ↗
	20: 9.3 ↑		30: 9.8 →
	Serie 92.0		Serie 95.0
	Total 186.0		Total 281.0
	31: 10.3x →		
	32: 9.0 ←		
	33: 9.6 ↑		
	34: 10.4x ↘		
	35: 8.5 →		
	36: 9.0 →		
	37: 9.7 ↓		
	38: 9.3 ←		
	39: 10.1 ↓		
	40: 10.4x ↘		
	Serie 93.0		
	Total 374.0		

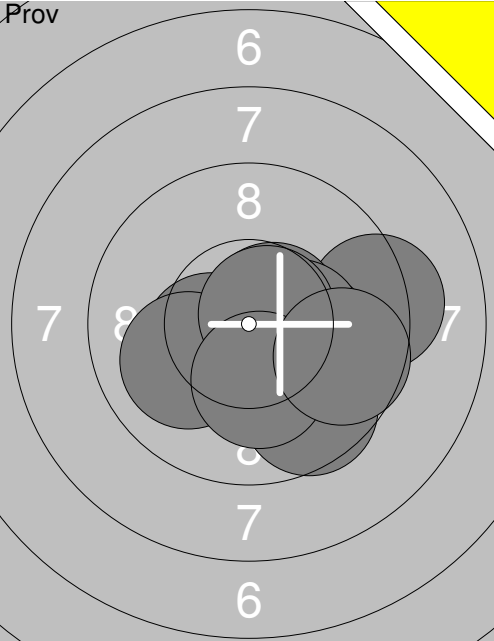
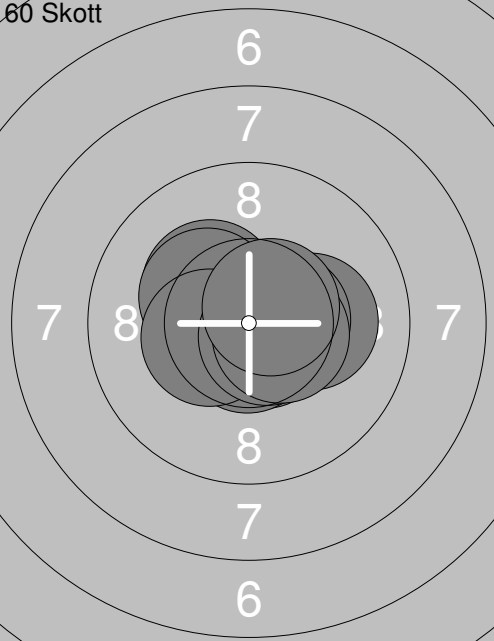
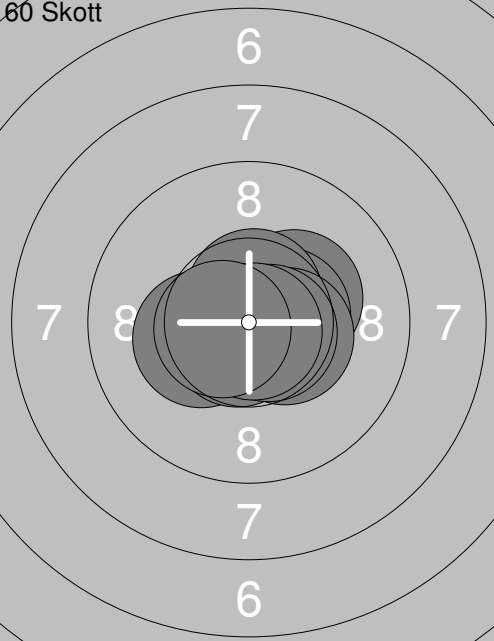
Skjuttag	Tavla	Lotten Johansson	
2	9		
S	Ramselefors Skf		
04.11.2017	Nationellt Mästerskap 2017	Umeå skytteallians	
Prov		1: 9.3 → 2: 9.6 ↘ 3: 10.1 → 4: 10.4 ✗ 5: 10.0 ↙ 6: 10.6 ✗ ↗ 7: 10.3 ✗ → 8: 10.7 ✗ ↗ 9: 10.2 ✗ ↓ 10: 9.7 →	11: 10.2 ✗ ↓ 12: 10.6 ✗ ↘ 13: 10.2 ✗ ↗ 14: 10.5 ✗ ↘ 15: 10.4 ✗ ↓ 16: 10.8 ✗ ↗ 17: 10.1 ↓ 18: 10.8 ✗ →
	Serie 97.0	Serie 80.0	
	Total 0.0	Total 0.0	
60 Skott		1: 10.7 ✗ ↘ 2: 10.2 ✗ → 3: 10.3 ✗ ↘ 4: 10.3 ✗ ↘ 5: 10.7 ✗ ↓ 6: 10.4 ✗ ↙ 7: 10.5 ✗ → 8: 10.7 ✗ ↘ 9: 10.5 ✗ → 10: 10.6 ✗ ↗	11: 10.3 ✗ ↘ 12: 10.4 ✗ ↙ 13: 10.3 ✗ → 14: 10.1 ↙ 15: 10.5 ✗ ↓ 16: 10.3 ✗ ↙ 17: 9.9 ↘ 18: 10.3 ✗ ↓ 19: 10.5 ✗ ↙ 20: 10.7 ✗ ↗
	Serie 100.0	Serie 99.0	
	Total 100.0	Total 199.0	
60 Skott		21: 10.3 ✗ ↙ 22: 10.8 ✗ → 23: 10.3 ✗ ↗ 24: 10.5 ✗ → 25: 10.7 ✗ ↓ 26: 10.6 ✗ ↗ 27: 10.4 ✗ → 28: 10.7 ✗ ↘ 29: 10.8 ✗ ↓ 30: 10.6 ✗ ↙	31: 10.6 ✗ ↘ 32: 9.9 ↗ 33: 10.0 ↘ 34: 10.2 ✗ ↗ 35: 10.6 ✗ ↗ 36: 10.2 ✗ ↙ 37: 10.5 ✗ → 38: 10.8 ✗ ↘ 39: 10.7 ✗ ↓ 40: 10.1 ↗
	Serie 100.0	Serie 99.0	
	Total 299.0	Total 398.0	

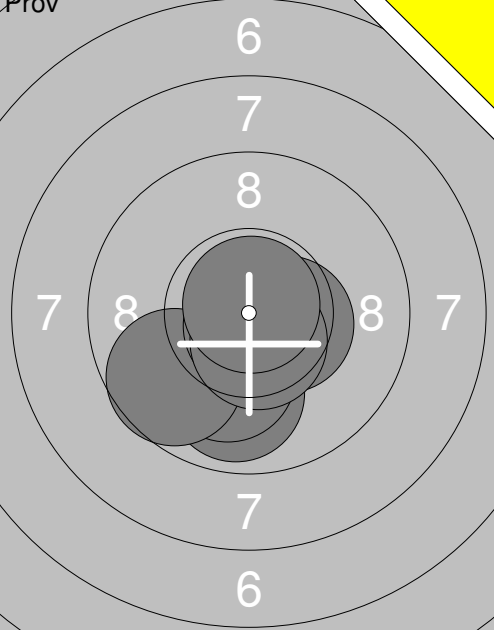
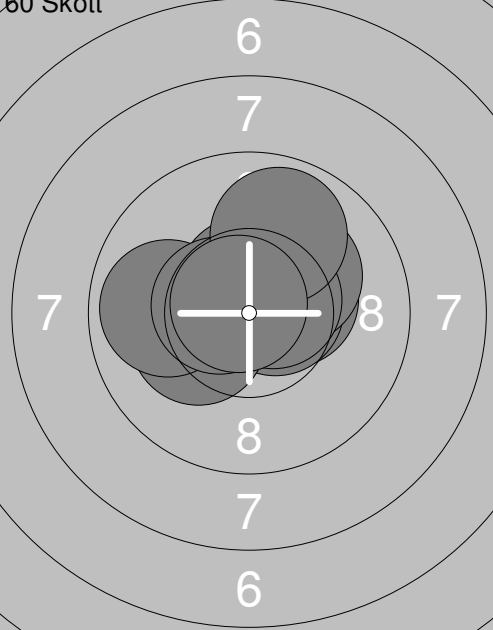
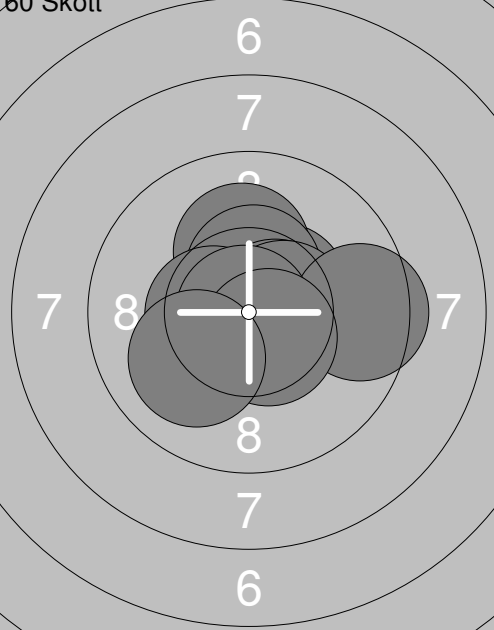
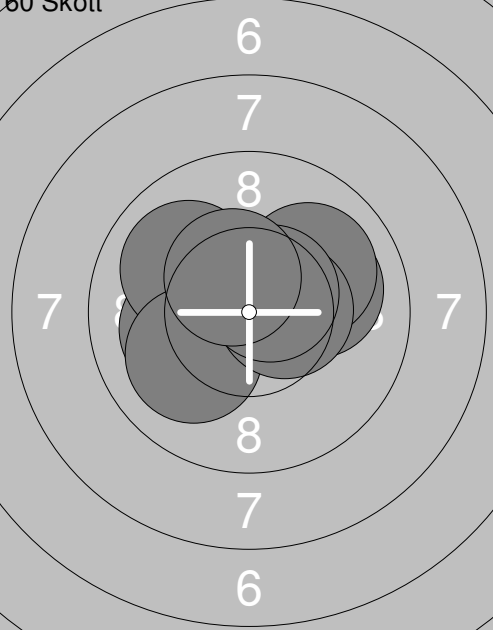
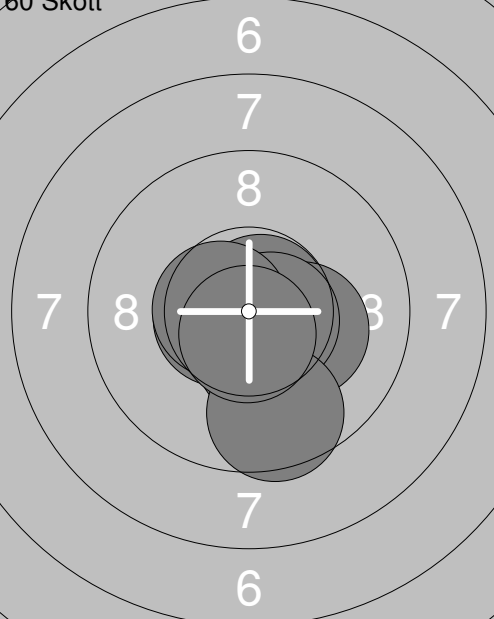
<p>Prov</p> 	<p>60 Skott</p> 	<p>1: 9.9 ↓</p> <p>2: 10.1 ↓</p> <p>3: 10.5x➤</p> <p>4: 9.7 ↙</p> <p>5: 10.8x↓</p> <p>6: 10.6x↓</p> <p>7: 10.8x↗</p> <hr/> <p>Serie 68.0</p> <p>Total 0.0</p>	<p>1: 10.4x➤</p> <p>2: 10.6x➤</p> <p>3: 10.2x↗</p> <p>4: 10.6x↗</p> <p>5: 10.2x↙</p> <p>6: 10.6x➤</p> <p>7: 9.9 ←</p> <p>8: 10.6x↙</p> <p>9: 9.9 ↗</p> <p>10: 10.8x↙</p> <hr/> <p>Serie 98.0</p> <p>Total 98.0</p>
<p>60 Skott</p> 	<p>60 Skott</p> 	<p>11: 10.5x↗</p> <p>12: 10.2x↗</p> <p>13: 10.4x↗</p> <p>14: 10.6x➤</p> <p>15: 10.5x↙</p> <p>16: 10.5x➤</p> <p>17: 9.5 ➡</p> <p>18: 10.9x↙</p> <p>19: 10.5x↘</p> <p>20: 10.0 ↙</p> <hr/> <p>Serie 99.0</p> <p>Total 197.0</p>	<p>21: 10.0 ➡</p> <p>22: 10.7x↙</p> <p>23: 10.0 ➡</p> <p>24: 10.5x↙</p> <p>25: 10.1 ←</p> <p>26: 10.0 ↙</p> <p>27: 10.0 ↙</p> <p>28: 10.5x➤</p> <p>29: 10.6x↗</p> <p>30: 10.4x↘</p> <hr/> <p>Serie 100.0</p> <p>Total 297.0</p>
<p>60 Skott</p> 	<p>Serie 99.0</p> <p>Total 396.0</p>		

	1: 9.7 ↓ 2: 9.0 ↙ 3: 10.3x ↘ 4: 10.6x → 5: 9.6 ↖ 6: 9.9 ↖ 7: 9.7 ↑ 8: 9.6 → 9: 10.2x ↗ 10: 10.1 ↑		11: 10.7x ↘ 12: 10.3x ↘ 13: 10.2x → 14: 10.4x ↓ 15: 9.5 → 16: 9.4 → 17: 10.3x ↓
	Serie 94.0		Serie 68.0
	Total 0.0		Total 0.0

	1: 10.2x ↑ 2: 10.7x ↘ 3: 10.5x ↓ 4: 10.6x ← 5: 10.6x ↘ 6: 10.2x ↘ 7: 10.6x → 8: 10.3x ↘ 9: 10.7x ↑ 10: 10.1 ←		11: 10.3x ← 12: 10.3x ↗ 13: 10.2x → 14: 10.4x ↓ 15: 10.6x ↓ 16: 10.5x ↑ 17: 9.9 ↘ 18: 10.5x → 19: 10.2x ↑ 20: 10.5x ↘
	Serie 100.0		Serie 99.0
	Total 100.0		Total 199.0

	21: 10.3x ↗ 22: 10.1 → 23: 10.6x ↓ 24: 10.6x ↓ 25: 10.7x ↘ 26: 10.1 ↑ 27: 10.5x ↓ 28: 10.7x → 29: 10.8x ↘ 30: 10.1 ↓		31: 9.5 → 32: 10.6x → 33: 10.4x → 34: 10.3x ← 35: 10.5x ↖ 36: 9.9 ↓ 37: 10.6x ↑ 38: 9.9 ↗ 39: 10.1 ↑ 40: 10.3x ↗
	Serie 100.0		Serie 97.0
	Total 299.0		Total 396.0

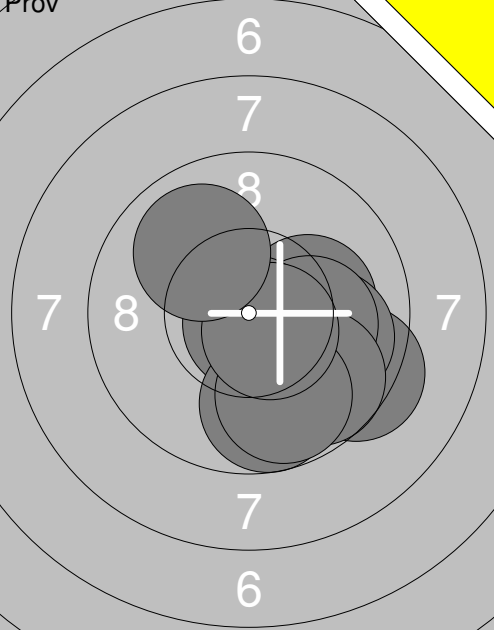
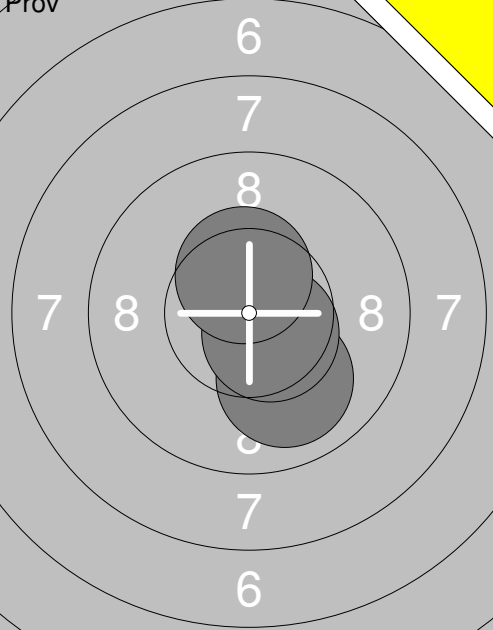
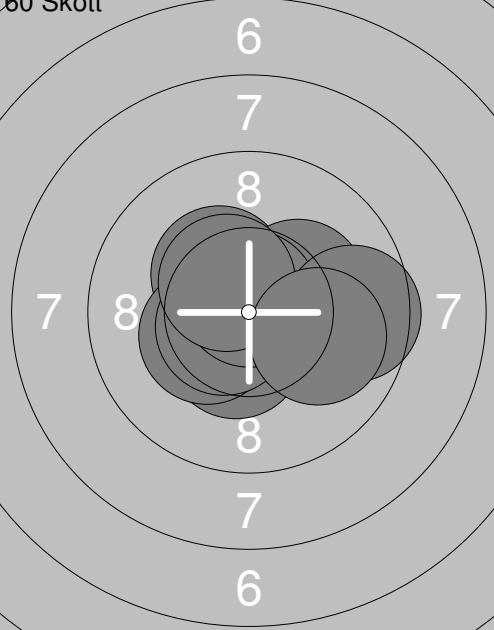
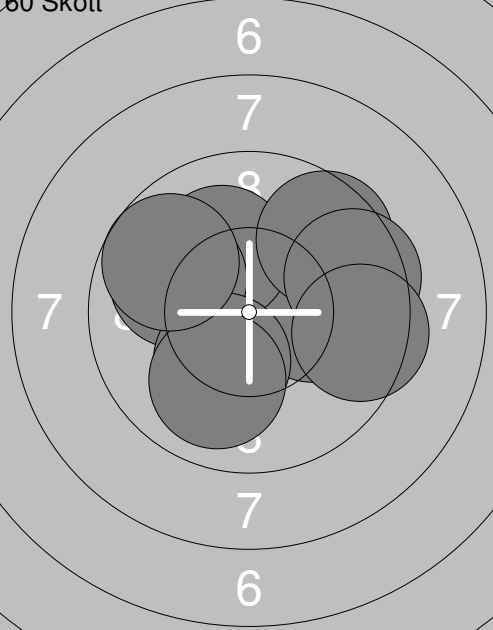
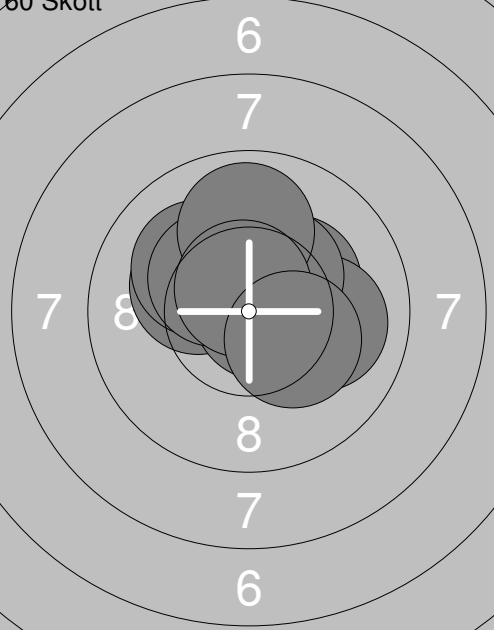
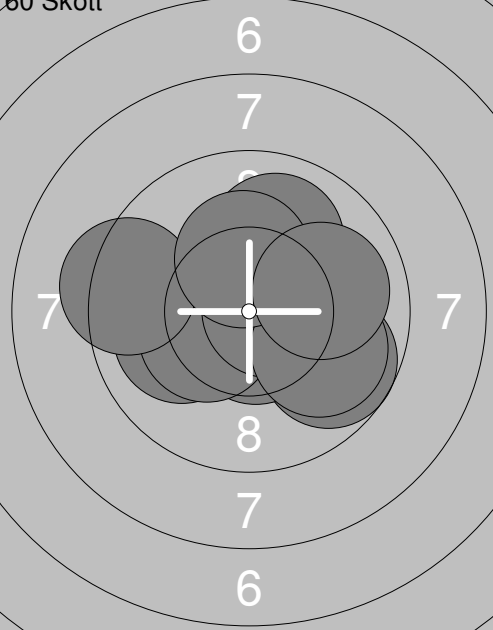
<p>Prov</p> 	<p>1: 9.3 ↘ 2: 10.2x→ 3: 9.9 → 4: 10.1 → 5: 9.7 ↘ 6: 10.8x↓ 7: 9.7 ↓ 8: 9.8 ↓ 9: 10.6x↘ 10: 10.0 ↖</p> <p>Serie 95.0 Total 0.0</p>	<p>Prov</p> 	<p>11: 10.0 ↓ 12: 10.6x↘ 13: 10.4x↗</p> <p>Serie 30.0 Total 0.0</p>
<p>60 Skott</p> 	<p>1: 10.4x↘ 2: 10.3x↘ 3: 10.4x↘ 4: 10.3x↘ 5: 10.2x↗ 6: 10.6x↘ 7: 10.8x↑ 8: 10.5x↘ 9: 9.6 → 10: 10.0 →</p> <p>Serie 99.0 Total 99.0</p>	<p>60 Skott</p> 	<p>11: 10.2x↘ 12: 10.1 → 13: 10.1 ↖ 14: 9.6 ↗ 15: 9.5 → 16: 9.9 ↖ 17: 10.2x↘ 18: 10.0 ↓ 19: 9.5 → 20: 9.7 ↖</p> <p>Serie 95.0 Total 194.0</p>
<p>60 Skott</p> 	<p>21: 10.2x↘ 22: 10.8x→ 23: 10.3x↗ 24: 10.1 ↖ 25: 10.3x↘ 26: 10.0 → 27: 10.4x↗ 28: 9.9 ↑ 29: 10.6x↗ 30: 10.3x↘</p> <p>Serie 99.0 Total 293.0</p>	<p>60 Skott</p> 	<p>31: 9.7 ↘ 32: 10.0 ← 33: 10.0 ↗ 34: 10.6x↓ 35: 10.3x↘ 36: 10.7x→ 37: 9.9 ↘ 38: 9.3 ← 39: 10.3x↗ 40: 10.0 →</p> <p>Serie 97.0 Total 390.0</p>

<div style="text-align: center;"> </div>	<div style="text-align: center;"> </div>	<div style="text-align: center;"> </div>
1: 10.7x↑ 2: 10.4x↘ 3: 10.6x↘ 4: 9.7 ↘ 5: 10.0← 6: 9.8 ↗ 7: 10.3x↘ 8: 10.2x→ 9: 9.4 ← 10: 10.6x↘ <hr/> Serie 97.0 Total 0.0	11: 10.2x↘ 12: 9.6 ↓ 13: 10.8x↗ 14: 10.3x↗ 15: 10.6x↘ <hr/> Serie 49.0 Total 0.0	21: 10.5x↗ 22: 10.5x↘ 23: 10.9x↗ 24: 9.7 ↖ 25: 10.5x↗ 26: 9.9 ↑ 27: 9.8 ↖ 28: 9.9 ↘ 29: 10.5x↘ 30: 10.0← <hr/> Serie 96.0 Total 290.0
<div style="text-align: center;"> </div>	<div style="text-align: center;"> </div>	<div style="text-align: center;"> </div>
31: 9.9 ↘ 32: 10.1← 33: 10.5x↗ 34: 9.8 ↓ 35: 9.3 ↓ 36: 10.4x→ 37: 10.2x↖ 38: 10.1↗ 39: 10.4x↘ 40: 9.3 ↗ <hr/> Serie 96.0 Total 386.0	41: 10.5x↘ 42: 10.3x↓ 43: 9.9 → 44: 10.5x↘ 45: 9.8 → 46: 9.5 ↗ 47: 10.4x↖ 48: 10.4x↓ 49: 10.0→ 50: 9.1 ← <hr/> Serie 96.0 Total 96.0	51: 10.1→ 52: 10.1← 53: 9.4 ↗ 54: 10.6x↖ 55: 10.1← 56: 10.2x→ 57: 10.0 ↓ 58: 10.3x↗ 59: 10.6x↖ 60: 9.9 ↓ <hr/> Serie 98.0 Total 194.0

<p>Prov</p>	<p>1: 10.2x↙ 2: 10.6x↓ 3: 10.5x↘ 4: 10.3x↗ 5: 10.7x↘ 6: 10.5x↘ 7: 10.4x↗ 8: 9.8 ← 9: 10.4x↓ 10: 8.3 ↓</p> <p>Serie 97.0 Total 0.0</p>	<p>Prov</p>	<p>11: 10.2x↙ 12: 10.7x↗ 13: 10.5x↙ 14: 10.8x↘</p> <p>Serie 40.0 Total 0.0</p>
<p>60 Skott</p>	<p>1: 9.6 ↑ 2: 10.4x↙ 3: 9.6 ↑ 4: 10.5x↗ 5: 10.2x↘ 6: 10.6x→ 7: 9.7 → 8: 10.9x↗ 9: 10.2x↗ 10: 10.3x↙</p> <p>Serie 97.0 Total 97.0</p>	<p>60 Skott</p>	<p>11: 10.5x↗ 12: 10.4x↗ 13: 9.8 ← 14: 10.4x↙ 15: 10.3x↗ 16: 9.8 ↓ 17: 10.8x↓ 18: 10.6x↗ 19: 10.7x↙ 20: 10.6x↗</p> <p>Serie 98.0 Total 195.0</p>
<p>60 Skott</p>	<p>21: 9.9 ↙ 22: 10.4x↗ 23: 10.4x↙ 24: 10.6x→ 25: 10.8x↓ 26: 9.7 ↘ 27: 10.2x↘ 28: 10.3x↘ 29: 10.5x↓ 30: 10.3x↗</p> <p>Serie 98.0 Total 293.0</p>	<p>60 Skott</p>	<p>31: 10.9x↗ 32: 9.9 ↘ 33: 9.7 ↘ 34: 10.4x↙ 35: 10.6x↗ 36: 10.3x→ 37: 10.6x↙ 38: 10.1 ↓ 39: 9.6 ↓ 40: 9.6 ↓</p> <p>Serie 96.0 Total 389.0</p>

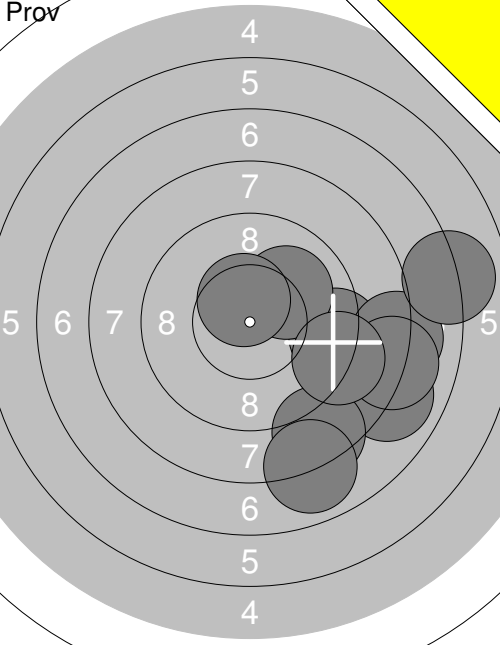
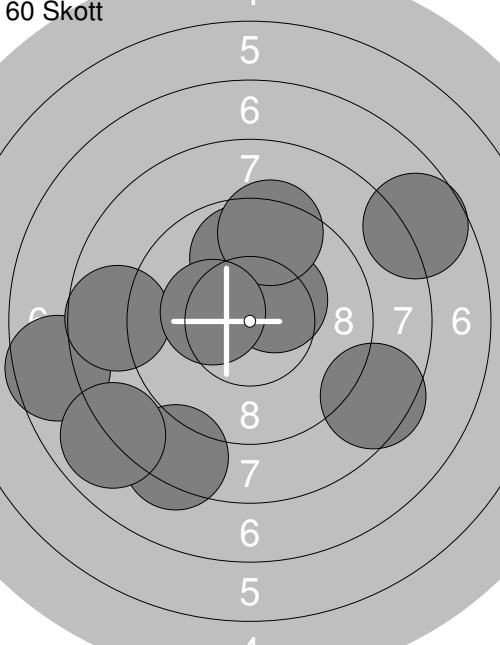
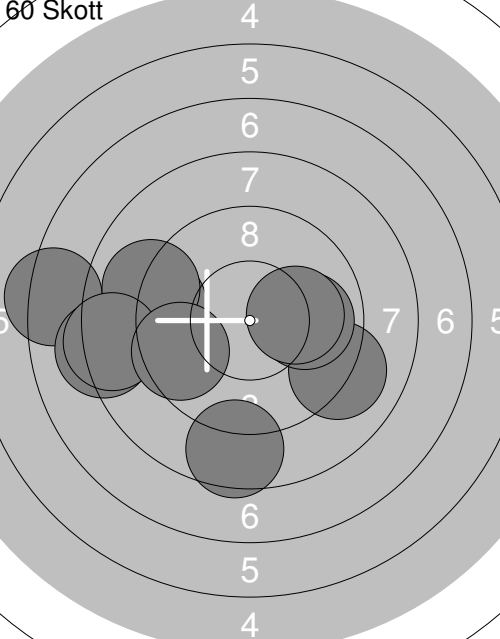
Skjutlag	Tavla	Mattias Lind	
S		Skoga-Ekshärad Skf	
04.11.2017		Nationellt Mästerskap 2017	Umeå skytteallians
Prov		1: 9.3 → 2: 10.0 ↗ 3: 8.0 → 4: 8.4 ↓ 5: 7.9 ↓ 6: 8.1 → 7: 7.0 → 8: 8.1 → 9: 10.5x ↗ 10: 9.1 → Serie 84.0 Total 0.0	11: 9.9 ↗ 12: 10.1 ↙ Serie 19.0 Total 0.0
60 Skott		1: 7.6 ← 2: 7.7 ↗ 3: 8.7 ← 4: 8.5 → 5: 9.9 ↑ 6: 10.4x ↗ 7: 8.3 ↓ 8: 7.9 ← 9: 9.4 ↑ 10: 10.3x ↙ Serie 83.0 Total 83.0	11: 9.3 ↗ 12: 8.6 ↙ 13: 7.8 ← 14: 9.7 ↑ 15: 8.3 ↗ 16: 8.1 → 17: 7.8 ← 18: 9.5 ↓ 19: 7.1 ↓ 20: 8.2 ← Serie 80.0 Total 163.0
60 Skott		21: 9.2 ← 22: 9.1 → 23: 9.9 → 24: 7.3 ← 25: 9.0 ← 26: 8.2 ← 27: 8.6 ↓ 28: 10.1 → 29: 8.4 ← 30: 9.6 ← Serie 86.0 Total 249.0	31: 9.5 ↓ 32: 9.0 ↓ 33: 9.4 ↓ 34: 10.3x ↙ 35: 7.6 ↓ 36: 9.5 ↓ 37: 9.9 ↓ 38: 8.7 → 39: 6.8 ← 40: 10.1 ↙ Serie 86.0 Total 335.0

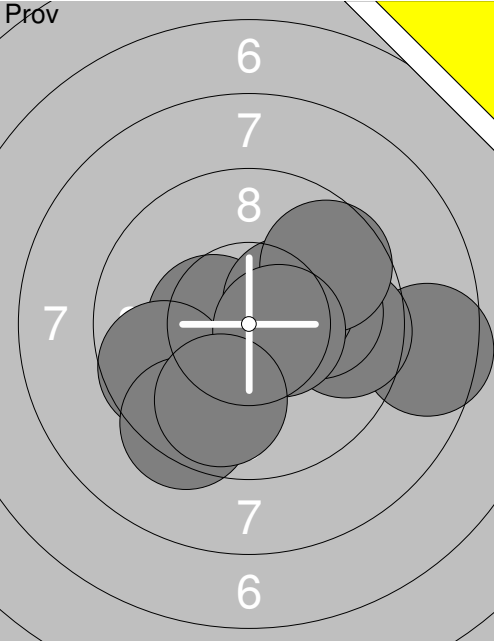
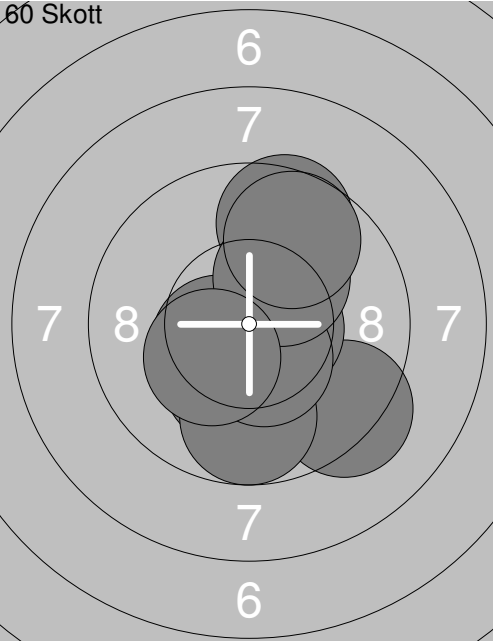
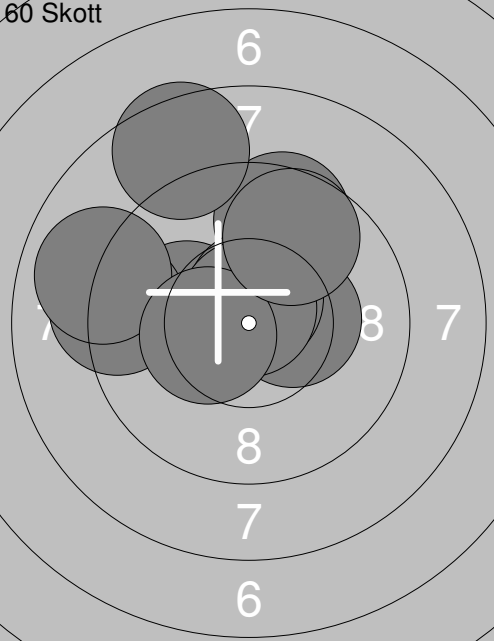
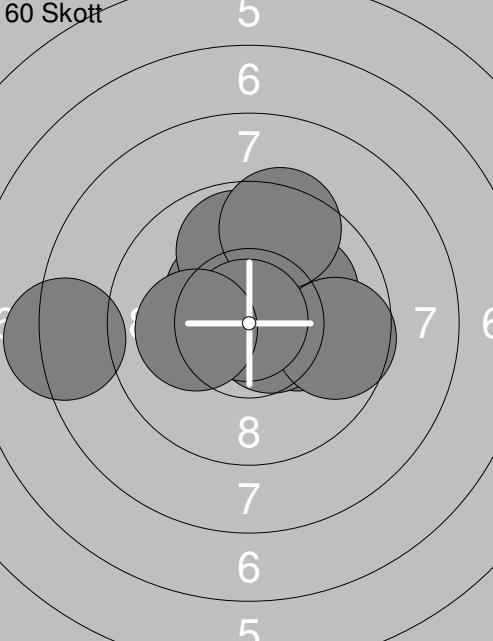
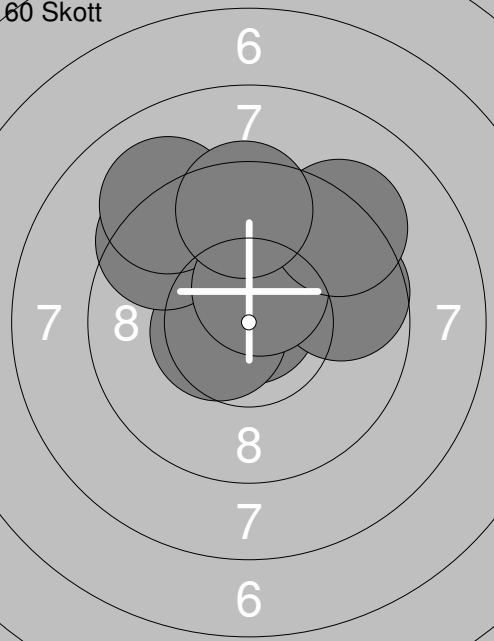
Skjutlag 2	Tavla 17	Anders Andersson	
S		Skoga-Ekshärad Skf	
04.11.2017		Nationellt Mästerskap 2017	
Prov		Umeå skytteallians	
	1: 8.5 →		1: 9.3 ↘
	2: 10.5 ✕		2: 10.2 ✕
	3: 9.6 →		3: 9.8 ↓
	4: 9.7 ↙		4: 9.6 ↑
	5: 10.0 →		5: 10.6 ✕
	6: 9.4 ↓		6: 10.5 ✕
	7: 10.3 ✕		7: 10.5 ✕
	8: 9.7 ↗		8: 10.2 ✕
	9: 10.5 ✕		9: 9.7 ↑
	10: 9.9 ↓		10: 10.3 ✕
	Serie 93.0		Serie 96.0
	Total 0.0		Total 96.0
	11: 10.4 ✕		21: 10.4 ✕
	12: 9.5 ↑		22: 10.2 ✕
	13: 10.1 ↙		23: 10.1 ↗
	14: 10.6 ✕		24: 10.6 ✕
	15: 8.5 ↑		25: 9.7 →
	16: 10.7 ✕		26: 8.2 ↙
	17: 9.2 ↙		27: 9.9 ↑
	18: 9.0 ↙		28: 9.5 ↑
	19: 10.4 ✕		29: 10.9 ✕
	20: 9.7 ↗		30: 10.2 ✕
	Serie 94.0		Serie 95.0
	Total 190.0		Total 285.0
	31: 10.9 ✕		
	32: 9.6 ↗		
	33: 9.7 →		
	34: 10.6 ✕		
	35: 10.5 ✕		
	36: 9.4 ↙		
	37: 9.1 ↙		
	38: 10.5 ✕		
	39: 9.2 ↗		
	40: 9.5 ↑		
	Serie 94.0		
	Total 379.0		

<p>Prov</p>	<p>1: 9.2 ←</p> <p>2: 10.2x↘</p> <p>3: 9.9 ←</p> <p>4: 10.1 ↗</p> <p>5: 10.2x↘</p> <p>6: 9.6 ↘</p> <p>7: 9.7 ↘</p> <p>8: 9.1 ←</p> <p>9: 10.2x↗</p> <p>10: 10.5x></p> <p>Serie 95.0</p> <p>Total 0.0</p>	<p>Prov</p>	<p>11: 9.5 ↗</p> <p>12: 10.5x↘</p> <p>13: 10.3x↘</p> <p>Serie 29.0</p> <p>Total 0.0</p>
<p>60 Skott</p>	<p>1: 10.3x↘</p> <p>2: 10.0 ↗</p> <p>3: 8.2 ↗</p> <p>4: 10.6x↗</p> <p>5: 9.4 ←</p> <p>6: 8.9 →</p> <p>7: 9.9 ↗</p> <p>8: 9.9 ←</p> <p>9: 9.2 ↗</p> <p>10: 10.5x↘</p> <p>Serie 92.0</p> <p>Total 92.0</p>	<p>60 Skott</p>	<p>11: 9.4 →</p> <p>12: 9.7 →</p> <p>13: 9.7 ↗</p> <p>14: 9.8 ↘</p> <p>15: 8.6 ←</p> <p>16: 9.2 ↗</p> <p>17: 10.1 →</p> <p>18: 8.9 ↗</p> <p>19: 10.4x↘</p> <p>20: 9.4 ←</p> <p>Serie 90.0</p> <p>Total 182.0</p>
<p>60 Skott</p>	<p>21: 9.9 →</p> <p>22: 10.7x↘</p> <p>23: 9.3 ←</p> <p>24: 8.7 ↗</p> <p>25: 9.0 ←</p> <p>26: 9.1 ↗</p> <p>27: 10.8x></p> <p>28: 10.0 ↘</p> <p>29: 10.4x></p> <p>30: 10.1 ←</p> <p>Serie 94.0</p> <p>Total 276.0</p>	<p>60 Skott</p>	<p>31: 9.8 ↘</p> <p>32: 9.0 →</p> <p>33: 9.9 ↘</p> <p>34: 10.3x↘</p> <p>35: 10.2x></p> <p>36: 9.7 ↗</p> <p>37: 9.8 ↘</p> <p>38: 9.7 ↗</p> <p>39: 10.2x></p> <p>40: 9.9 ↗</p> <p>Serie 93.0</p> <p>Total 369.0</p>

<p>Prov</p>	<p>1: 10.0 ↗ 2: 10.0 ← 3: 10.3x → 4: 9.9 ← 5: 10.2x ↓</p>	<p>60 Skott</p>		<p>1: 9.3 ← 2: 9.0 → 3: 10.1 ↓ 4: 9.7 ↗ 5: 9.6 → 6: 9.2 ← 7: 9.2 ↓ 8: 10.4x → 9: 9.6 ↑ 10: 10.8x ↘</p>
Serie 49.0		Serie 93.0		Serie 93.0
Total 0.0		Total 93.0		Total 93.0
<p>60 Skott</p>	<p>11: 9.4 ← 12: 10.1 ↑ 13: 10.1 ↑ 14: 8.9 ← 15: 10.1 ↓ 16: 10.2x ↑ 17: 10.6x ↘ 18: 9.4 ↗ 19: 10.7x ↓ 20: 10.2x ↓</p>	<p>60 Skott</p>		<p>21: 10.1 → 22: 9.4 ↓ 23: 10.3x ↓ 24: 9.8 ← 25: 10.3x ↓ 26: 9.5 ↓ 27: 8.2 ← 28: 10.7x ↘ 29: 8.8 ↖ 30: 10.2x ↘</p>
Serie 96.0		Serie 93.0		Serie 93.0
Total 189.0		Total 282.0		Total 282.0
<p>60 Skott</p>	<p>31: 10.4x → 32: 10.4x ↘ 33: 10.5x ↘ 34: 10.4x ↘ 35: 9.1 ← 36: 9.7 ↗ 37: 10.2x ↗ 38: 9.1 ↓ 39: 9.5 ↑ 40: 10.3x ↘</p>			
Serie 96.0				
Total 378.0				

<p>Prov</p>	<p>60 Skott</p>	<p>1: 10.0 ↖ 2: 10.1 ↖ 3: 10.7x ↘ 4: 10.2x ↗ 5: 10.8x ➤</p> <p>Serie 50.0 Total 0.0</p>	<p>1: 10.2x ➤ 2: 9.8 ↙ 3: 10.3x ↘ 4: 10.5x ← 5: 9.9 ↙ 6: 10.5x ← 7: 10.5x ↗ 8: 9.7 ➔ 9: 10.1 ↗ 10: 9.1 ←</p> <p>Serie 96.0 Total 96.0</p>
-------------	-----------------	---	---

<p>60 Skott</p>	<p>60 Skott</p>	<p>11: 9.4 ➔ 12: 10.1 ↗ 13: 9.9 ← 14: 10.2x ← 15: 10.4x ↗ 16: 9.7 ↖ 17: 10.5x ↗ 18: 10.0 ← 19: 9.7 ← 20: 10.3x ↘</p> <p>Serie 96.0 Total 192.0</p>	<p>21: 10.4x ↘ 22: 10.6x ↗ 23: 9.5 ➔ 24: 9.9 ➔ 25: 10.2x ↗ 26: 10.1 ↘ 27: 10.1 ↖ 28: 9.8 ← 29: 10.5x ↗ 30: 10.7x ↗</p> <p>Serie 97.0 Total 289.0</p>
-----------------	-----------------	--	--

<p>60 Skott</p>	<p>31: 7.9 ➔ 32: 10.0 ↗ 33: 10.4x ← 34: 9.2 ➔ 35: 10.2x ↘ 36: 10.7x ← 37: 10.4x ← 38: 10.1 ↗ 39: 9.1 ➔ 40: 10.7x ↘</p> <p>Serie 95.0 Total 384.0</p>	
-----------------	--	--

<p>Prov</p>	<p>1: 10.3x➤</p> <p>2: 10.1↙</p> <p>3: 10.6x↓</p> <p>4: 10.5x↓</p> <p>5: 10.6x➤</p> <p>6: 10.8x↗</p> <p>7: 10.1↑</p> <p>8: 10.3x↗</p> <p>9: 10.5x↓</p> <p>10: 9.6↙</p> <p>Serie 99.0</p> <p>Total 0.0</p>	<p>Prov</p>	<p>11: 10.0↙</p> <p>12: 10.3x↙</p> <p>13: 9.8↖</p> <p>14: 9.9➔</p> <p>15: 10.1➔</p> <p>16: 10.4x↓</p> <p>17: 10.7x↙</p> <p>Serie 68.0</p> <p>Total 0.0</p>
<p>60 Skott</p>	<p>1: 10.0↙</p> <p>2: 9.2↙</p> <p>3: 10.3x↓</p> <p>4: 9.9↓</p> <p>5: 10.0↓</p> <p>6: 10.7x↙</p> <p>7: 10.7x↙</p> <p>8: 10.4x↙</p> <p>9: 10.8x↓</p> <p>10: 10.2x↙</p> <p>Serie 98.0</p> <p>Total 98.0</p>	<p>60 Skott</p>	<p>11: 10.7x➤</p> <p>12: 9.8↓</p> <p>13: 10.1↓</p> <p>14: 10.4x↙</p> <p>15: 10.0↙</p> <p>16: 10.0➔</p> <p>17: 10.3x➤</p> <p>18: 10.6x↗</p> <p>19: 10.9x↗</p> <p>20: 10.8x↓</p> <p>Serie 99.0</p> <p>Total 197.0</p>
<p>60 Skott</p>	<p>21: 9.9↖</p> <p>22: 10.4x↗</p> <p>23: 10.4x↙</p> <p>24: 10.1↖</p> <p>25: 10.6x↓</p> <p>26: 10.7x➤</p> <p>27: 10.6x↗</p> <p>28: 10.2x↙</p> <p>29: 10.4x➤</p> <p>30: 10.3x↙</p> <p>Serie 99.0</p> <p>Total 296.0</p>	<p>60 Skott</p>	<p>31: 10.6x↗</p> <p>32: 10.3x↙</p> <p>33: 10.4x↓</p> <p>34: 9.9➔</p> <p>35: 10.0➔</p> <p>36: 10.2x↙</p> <p>37: 9.6↖</p> <p>38: 10.5x↙</p> <p>39: 10.7x➤</p> <p>40: 10.1↓</p> <p>Serie 98.0</p> <p>Total 394.0</p>

<p>Pröv</p>	<p>Pröv</p>	<p>11: 8.5 →</p> <p>12: 10.7x↑</p> <p>13: 10.0 ↑</p> <p>14: 10.1 ↙</p> <p>15: 10.3x↔</p> <p>16: 10.7x↑</p>
<p>1: 9.9 →</p> <p>2: 9.0 ↓</p> <p>3: 9.9 →</p> <p>4: 9.3 ↑</p> <p>5: 10.3x↓</p> <p>6: 10.4x↔</p> <p>7: 10.4x↙</p> <p>8: 9.2 ↙</p> <p>9: 8.9 ↖</p> <p>10: 9.7 ↓</p>	<p>11: 8.5 →</p> <p>12: 10.7x↑</p> <p>13: 10.0 ↑</p> <p>14: 10.1 ↙</p> <p>15: 10.3x↔</p> <p>16: 10.7x↑</p>	<p>Serie 92.0</p> <p>Total 0.0</p>
<p>60 Skott</p>	<p>60 Skott</p>	<p>11: 8.9 ←</p> <p>12: 10.7x↔</p> <p>13: 10.6x↓</p> <p>14: 10.5x↘</p> <p>15: 10.6x↔</p> <p>16: 9.4 ↑</p> <p>17: 10.0 ↑</p> <p>18: 10.2x↔</p> <p>19: 9.8 ↖</p> <p>20: 10.1 →</p>
<p>1: 10.7x↔</p> <p>2: 9.1 ↖</p> <p>3: 10.2x↙</p> <p>4: 9.9 ↘</p> <p>5: 10.1 →</p> <p>6: 9.8 ↗</p> <p>7: 9.4 ↖</p> <p>8: 10.7x↔</p> <p>9: 9.5 →</p> <p>10: 9.6 →</p>	<p>11: 8.9 ←</p> <p>12: 10.7x↔</p> <p>13: 10.6x↓</p> <p>14: 10.5x↘</p> <p>15: 10.6x↔</p> <p>16: 9.4 ↑</p> <p>17: 10.0 ↑</p> <p>18: 10.2x↔</p> <p>19: 9.8 ↖</p> <p>20: 10.1 →</p>	<p>Serie 94.0</p> <p>Total 94.0</p>
<p>60 Skott</p>	<p>60 Skott</p>	<p>31: 10.0 ↙</p> <p>32: 10.2x↘</p> <p>33: 10.1 ↗</p> <p>34: 9.2 ↖</p> <p>35: 10.5x↑</p> <p>36: 10.6x↓</p> <p>37: 9.9 ↗</p> <p>38: 10.6x↔</p> <p>39: 10.1 ↘</p> <p>40: 9.5 ↓</p>
<p>21: 9.2 ↓</p> <p>22: 9.1 →</p> <p>23: 10.5x↑</p> <p>24: 10.0 ↓</p> <p>25: 9.8 ↖</p> <p>26: 10.0 →</p> <p>27: 9.7 ↓</p> <p>28: 9.6 ↑</p> <p>29: 9.2 ↖</p> <p>30: 10.3x↗</p>	<p>31: 10.0 ↙</p> <p>32: 10.2x↘</p> <p>33: 10.1 ↗</p> <p>34: 9.2 ↖</p> <p>35: 10.5x↑</p> <p>36: 10.6x↓</p> <p>37: 9.9 ↗</p> <p>38: 10.6x↔</p> <p>39: 10.1 ↘</p> <p>40: 9.5 ↓</p>	<p>Serie 94.0</p> <p>Total 284.0</p>
<p>Serie 92.0</p> <p>Total 0.0</p>	<p>Serie 96.0</p> <p>Total 190.0</p>	<p>Serie 97.0</p> <p>Total 381.0</p>

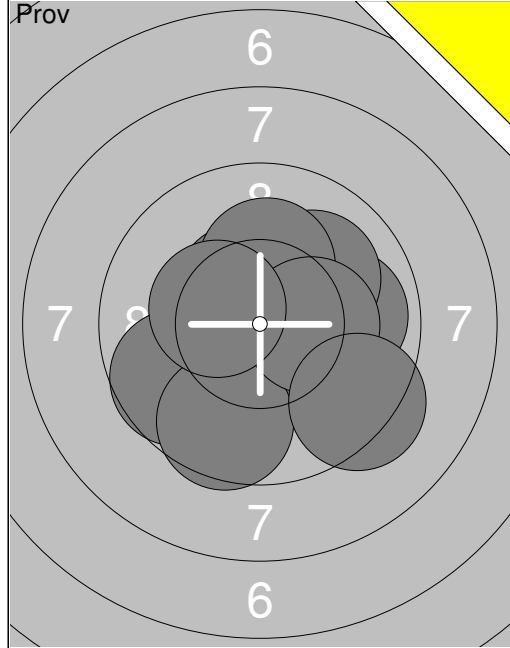

1:	10.2x ↘
2:	9.7 ↙
3:	9.9 →
4:	10.0 ↗
5:	10.5x ↘
6:	9.6 ↓
7:	10.2x ↗
8:	10.3x →
9:	10.4x ↖
10:	9.3 ↘
Serie	96.0
Total	0.0

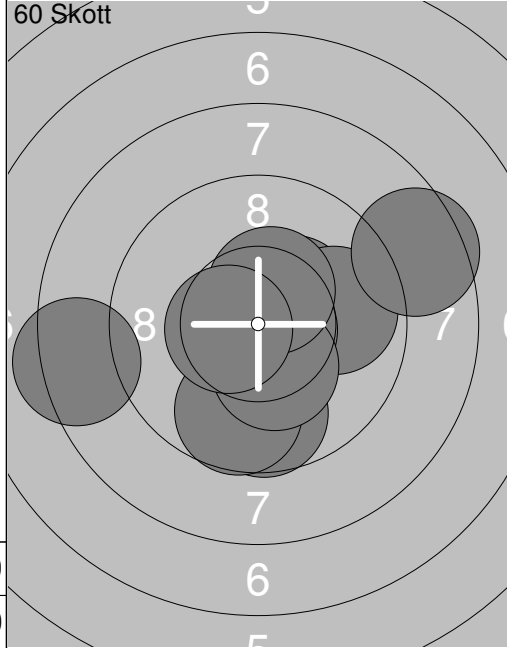

1:	10.4x ↗
2:	9.7 ↓
3:	9.9 →
4:	9.7 ↓
5:	10.7x →
6:	10.3x ↘
7:	10.4x ↗
8:	10.5x ↖
9:	8.3 ←
10:	8.5 →
Serie	93.0
Total	93.0

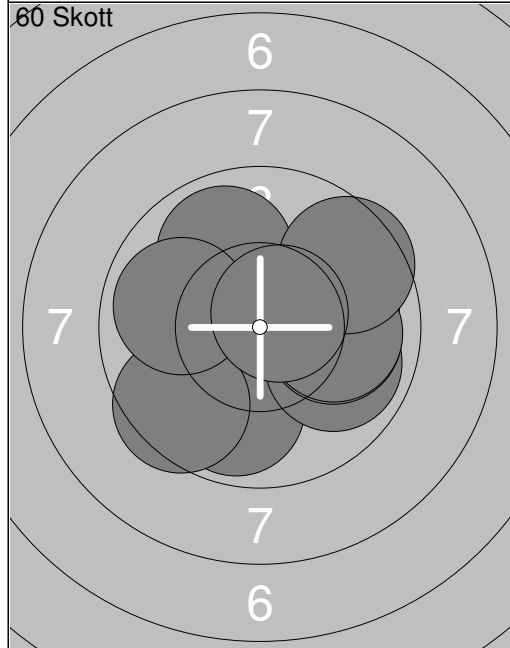

11:	9.9 ↓
12:	9.9 →
13:	9.9 ↗
14:	10.0 →
15:	9.5 ↙
16:	10.0 →
17:	10.0 →
18:	9.9 ←
19:	9.6 ↗
20:	10.6x ↗
Serie	94.0
Total	187.0

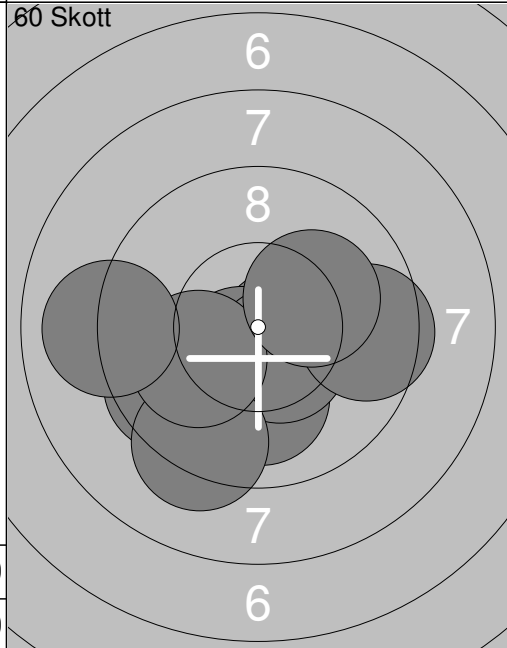

21:	10.6x →
22:	10.5x ↘
23:	10.0 ↓
24:	10.5x ↘
25:	9.6 ↙
26:	9.3 ↓
27:	9.5 →
28:	10.1 ←
29:	10.2x ↗
30:	9.0 ←
Serie	96.0
Total	283.0

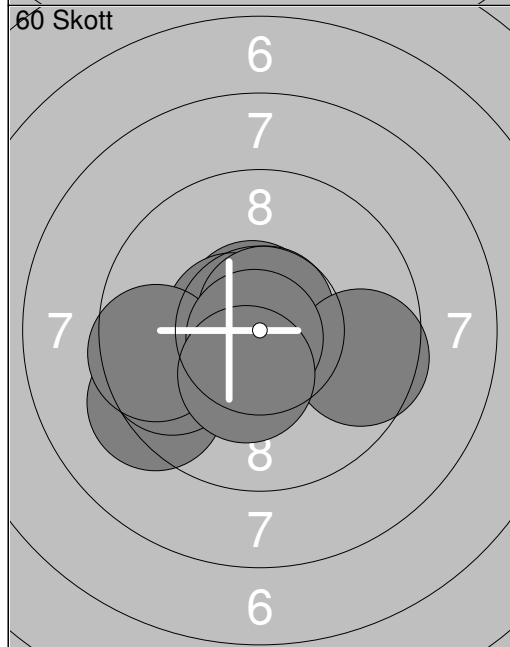

31:	10.7x ↘
32:	9.6 ↙
33:	9.3 ↙
34:	10.6x ↖
35:	10.7x ↗
36:	9.7 ↙
37:	9.6 →
38:	9.6 ↙
39:	10.8x ↘
40:	10.4x ↘
Serie	95.0
Total	378.0

	1: 8.9 ↗		1: 10.0 ↗
	2: 10.6x↘		2: 10.8x↘
	3: 10.8x↘		3: 9.8 ←
	4: 10.6x↘		4: 9.7 ↑
	5: 9.8 ↓		5: 10.2x↗
	6: 9.5 →		6: 10.4x→
	7: 10.4x↑		7: 10.5x↑
	8: 9.6 ←		8: 10.2x↘
	9: 9.9 ↓		9: 9.6 ↘
	10: 10.2x↘		10: 9.4 ↖
Serie 94.0		Serie 96.0	
Total 0.0		Total 96.0	

	11: 10.5x↑		21: 10.1 ↖
	12: 9.4 ↘		22: 9.9 ↓
	13: 7.6 ↑		23: 10.8x↑
	14: 10.6x↘		24: 10.5x↘
	15: 10.8x↘		25: 9.4 →
	16: 10.0 ↑		26: 9.4 ↓
	17: 9.3 ↖		27: 9.7 ↑
	18: 9.4 ↑		28: 10.2x↗
	19: 10.3x↗		29: 9.7 →
	20: 10.3x↘		30: 9.2 ←
Serie 94.0		Serie 94.0	
Total 190.0		Total 284.0	

	31: 10.1 ↗	
	32: 10.1 ↗	
	33: 10.9x↘	
	34: 10.5x↗	
	35: 10.2x↘	
	36: 8.5 ↗	
	37: 10.3x↑	
	38: 10.8x↘	
	39: 10.9x↘	
	40: 9.9 ↖	
Serie 97.0		
Total 381.0		

<p>Prov</p>	<p>1: 9.8 ↗ 2: 10.2x↔ 3: 10.6x↗ 4: 10.1 ↑ 5: 8.9 ➔ 6: 9.7 ← 7: 8.7 ← 8: 10.0↙ 9: 9.9 ← 10: 9.4 ←</p> <p>Serie 92.0 Total 0.0</p>	<p>Prov</p>	<p>11: 8.6 ← 12: 9.9 ↖ 13: 10.9x↔ 14: 10.7x↗</p> <p>Serie 37.0 Total 0.0</p>
-------------	---	-------------	---

<p>60 Skott</p>	<p>1: 10.6x↔ 2: 9.4 ← 3: 9.5 ➔ 4: 9.7 ➔ 5: 9.6 ← 6: 10.5x↙ 7: 9.1 ← 8: 9.9 ➔ 9: 10.3x↓ 10: 8.3 ➔</p> <p>Serie 92.0 Total 92.0</p>	<p>60 Skott</p>	<p>11: 10.5x↓ 12: 10.0↖ 13: 9.0 ← 14: 9.5 ↖ 15: 9.7 ← 16: 10.5x↓ 17: 9.8 ➔ 18: 10.7x↗ 19: 9.9 ➔ 20: 10.2x↓</p> <p>Serie 95.0 Total 187.0</p>
-----------------	--	-----------------	---

<p>60 Skott</p>	<p>21: 10.4x↗ 22: 9.9 ↑ 23: 9.5 ← 24: 10.1 ➔ 25: 10.0↙ 26: 10.4x↗ 27: 10.0↙ 28: 10.8x↗ 29: 10.4x↓ 30: 8.5 ←</p> <p>Serie 96.0 Total 283.0</p>	<p>60 Skott</p>	<p>31: 10.3x➔ 32: 9.8 ↑ 33: 9.0 ↗ 34: 9.6 ↖ 35: 9.9 ➔ 36: 9.9 ↑ 37: 10.1➔ 38: 9.0 ← 39: 10.2x↖ 40: 9.4 ↓</p> <p>Serie 93.0 Total 376.0</p>
-----------------	--	-----------------	---

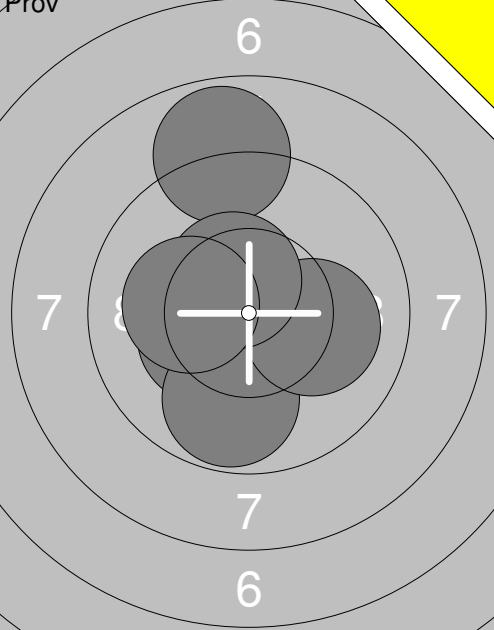
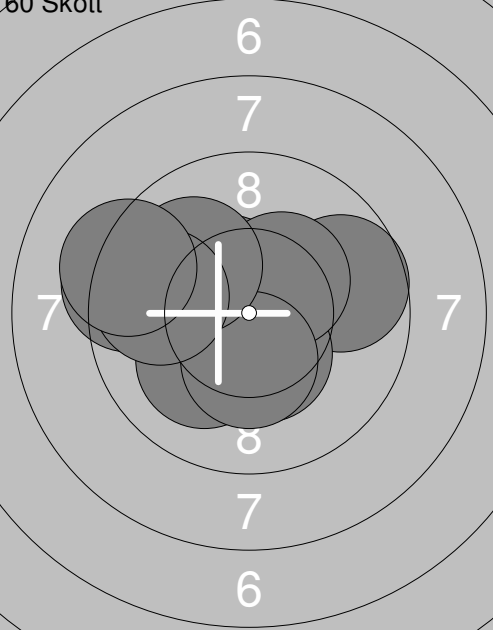
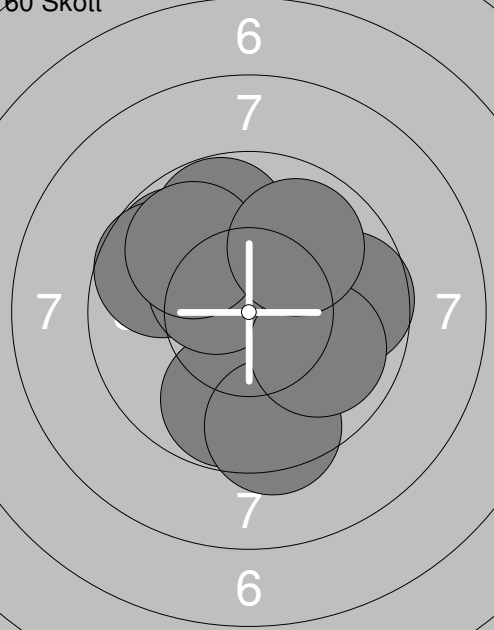
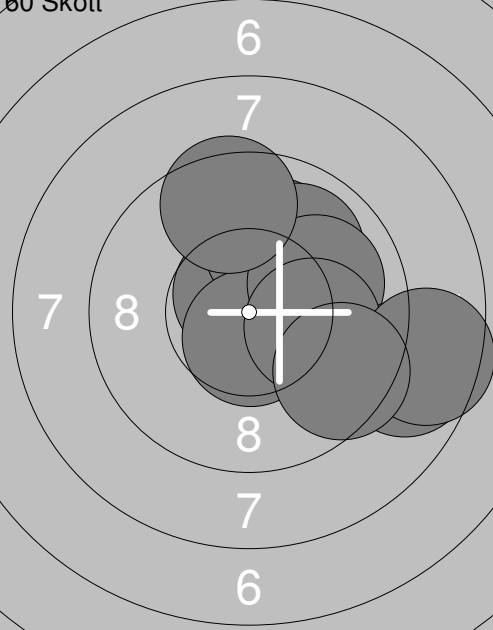
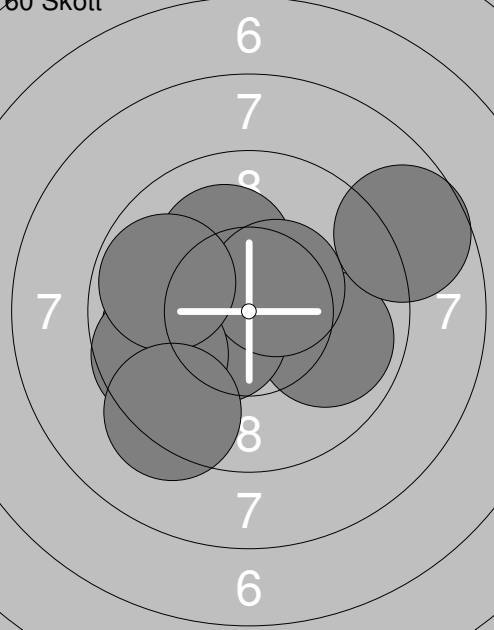
<p>Prov</p>  <p style="text-align: center;">6 7 7 7 6</p>	<p>1: 10.6x ↘ 2: 10.3x ↘ 3: 9.8 ↓ 4: 10.1 → 5: 8.9 ↑ 6: 10.5x ↗ 8: 10.2x ↖</p> <table border="1" style="width:100%; border-collapse: collapse;"> <tr><td>Serie</td><td>67.0</td></tr> <tr><td>Total</td><td>0.0</td></tr> </table>	Serie	67.0	Total	0.0	<p>60 Skott</p>  <p style="text-align: center;">6 7 8 7 6</p> <p>1: 9.7 → 2: 10.4x ↘ 3: 10.1 ↘ 4: 10.5x ↗ 5: 10.4x ↗ 6: 9.3 ← 7: 10.3x ↘ 8: 10.0 ↖ 9: 9.8 ← 10: 9.3 ←</p> <table border="1" style="width:100%; border-collapse: collapse;"> <tr><td>Serie</td><td>96.0</td></tr> <tr><td>Total</td><td>96.0</td></tr> </table>	Serie	96.0	Total	96.0
Serie	67.0									
Total	0.0									
Serie	96.0									
Total	96.0									
<p>60 Skott</p>  <p style="text-align: center;">6 7 7 7 6</p>	<p>11: 9.8 ↖ 12: 9.7 ↖ 13: 9.8 ↓ 14: 9.7 → 15: 9.4 ↓ 16: 10.4x ↗ 17: 9.8 ↑ 18: 9.9 → 19: 9.9 ↖ 20: 9.9 ↗</p> <table border="1" style="width:100%; border-collapse: collapse;"> <tr><td>Serie</td><td>91.0</td></tr> <tr><td>Total</td><td>187.0</td></tr> </table>	Serie	91.0	Total	187.0	<p>60 Skott</p>  <p style="text-align: center;">6 7 8 7 6</p> <p>21: 10.7x ↗ 22: 10.0 ↑ 23: 9.9 ↗ 24: 10.6x ↘ 25: 10.0 → 26: 8.8 → 27: 10.1 → 28: 8.6 → 29: 9.5 ↘ 30: 9.5 ↑</p> <table border="1" style="width:100%; border-collapse: collapse;"> <tr><td>Serie</td><td>93.0</td></tr> <tr><td>Total</td><td>280.0</td></tr> </table>	Serie	93.0	Total	280.0
Serie	91.0									
Total	187.0									
Serie	93.0									
Total	280.0									
<p>60 Skott</p>  <p style="text-align: center;">6 7 8 7 6</p>	<p>31: 9.9 → 32: 10.5x ↖ 33: 9.9 ← 34: 10.1 ↖ 35: 10.5x ↗ 36: 10.5x ↗ 37: 8.7 → 38: 9.7 ← 39: 9.8 ← 40: 9.3 ↘</p> <table border="1" style="width:100%; border-collapse: collapse;"> <tr><td>Serie</td><td>93.0</td></tr> <tr><td>Total</td><td>373.0</td></tr> </table>	Serie	93.0	Total	373.0					
Serie	93.0									
Total	373.0									

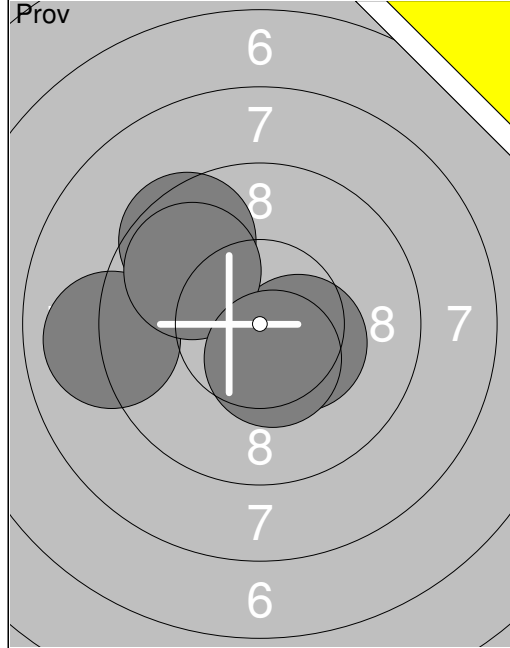

1:	10.4x
2:	9.0
3:	9.5
4:	9.8
5:	10.5x
Serie 47.0	
Total 0.0	

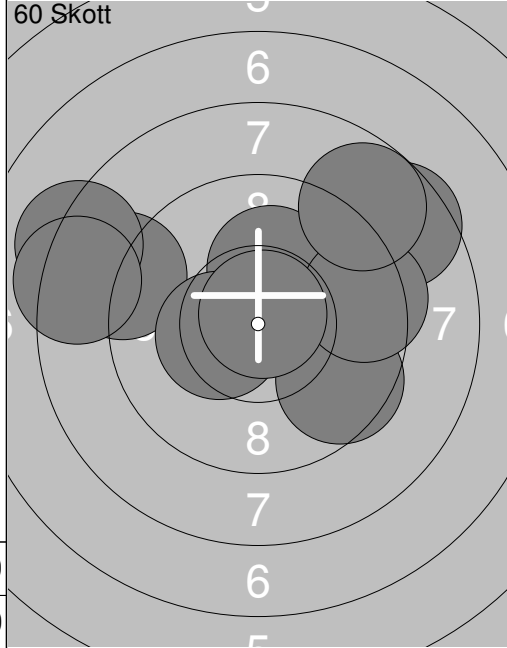

1:	8.6
2:	8.9
3:	9.6
4:	10.2x
5:	8.2
6:	9.4
7:	10.4x
8:	8.3
9:	10.8x
10:	8.8
Serie 88.0	
Total 88.0	

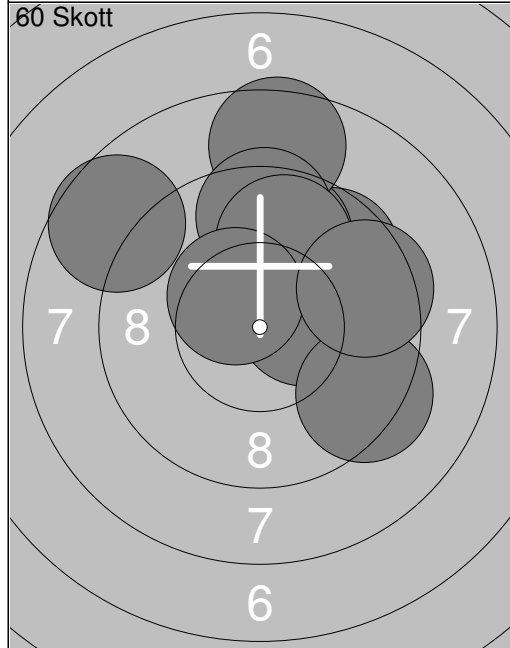

11:	8.6
12:	9.6
13:	9.7
14:	8.6
15:	9.5
16:	10.4x
17:	9.3
18:	9.8
19:	10.4x
20:	9.5
Serie 90.0	
Total 178.0	

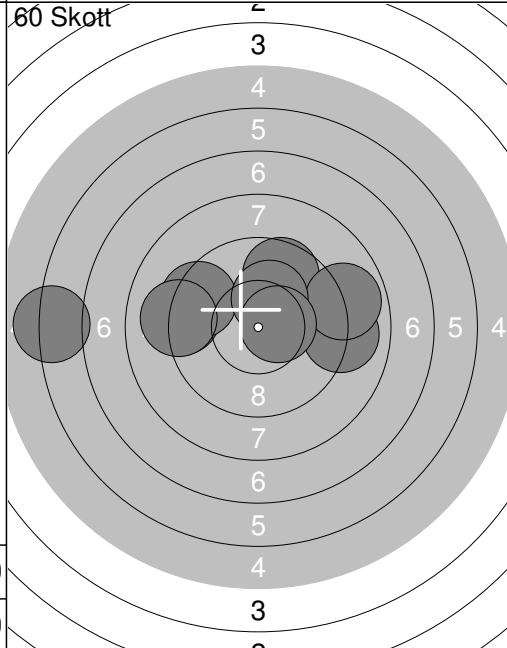

21:	9.1
22:	9.4
23:	6.1
24:	9.1
25:	9.0
26:	10.0
27:	9.7
28:	8.9
29:	10.2x
30:	10.5x
Serie 89.0	
Total 267.0	

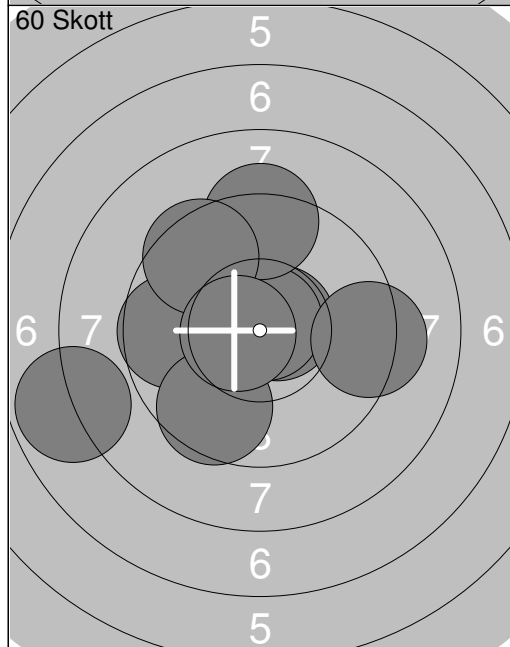

31:	10.7x
32:	10.3x
33:	9.7
34:	10.8x
35:	9.6
36:	9.3
37:	9.5
38:	9.3
39:	7.9
40:	10.6x
Serie 92.0	
Total 359.0	

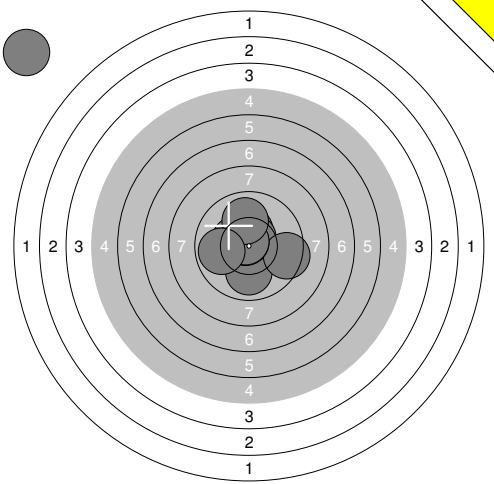
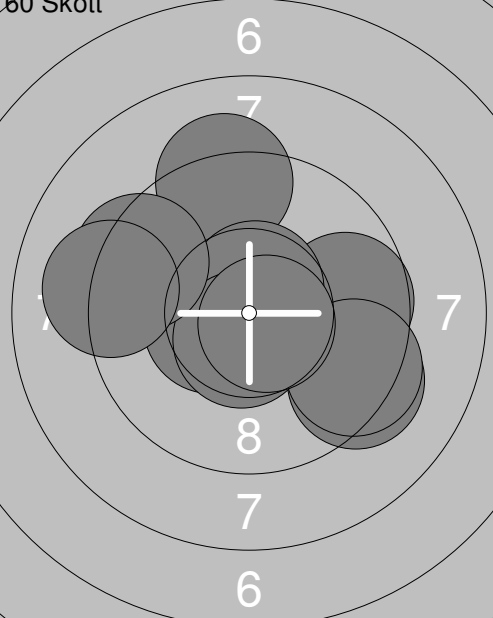
<p>Prov</p> 	<p>60 Skott</p> 	<table style="width:100%; border-collapse: collapse;"> <tr><td>1:</td><td>10.0 ↓</td><td>1:</td><td>9.3 ↘</td></tr> <tr><td>2:</td><td>10.3x ↑</td><td>2:</td><td>9.2 ↑</td></tr> <tr><td>3:</td><td>0.0 ↖</td><td>3:</td><td>10.4x ↖</td></tr> <tr><td>4:</td><td>10.6x ↗</td><td>4:</td><td>9.7 →</td></tr> <tr><td>5:</td><td>10.4x ↖</td><td>5:</td><td>9.4 ↘</td></tr> <tr><td>6:</td><td>9.4 →</td><td>6:</td><td>10.6x ↗</td></tr> <tr><td>7:</td><td>10.8x ↖</td><td>7:</td><td>10.6x ↓</td></tr> <tr><td>8:</td><td>10.7x ↖</td><td>8:</td><td>10.7x ↘</td></tr> <tr><td>9:</td><td>10.0 ↑</td><td>9:</td><td>9.4 ↖</td></tr> <tr><td>10:</td><td>9.9 ←</td><td>10:</td><td>9.1 ←</td></tr> <tr><td colspan="2">Serie 88.0</td><td colspan="2">Serie 94.0</td></tr> <tr><td colspan="2">Total 0.0</td><td colspan="2">Total 94.0</td></tr> </table>	1:	10.0 ↓	1:	9.3 ↘	2:	10.3x ↑	2:	9.2 ↑	3:	0.0 ↖	3:	10.4x ↖	4:	10.6x ↗	4:	9.7 →	5:	10.4x ↖	5:	9.4 ↘	6:	9.4 →	6:	10.6x ↗	7:	10.8x ↖	7:	10.6x ↓	8:	10.7x ↖	8:	10.7x ↘	9:	10.0 ↑	9:	9.4 ↖	10:	9.9 ←	10:	9.1 ←	Serie 88.0		Serie 94.0		Total 0.0		Total 94.0	
1:	10.0 ↓	1:	9.3 ↘																																															
2:	10.3x ↑	2:	9.2 ↑																																															
3:	0.0 ↖	3:	10.4x ↖																																															
4:	10.6x ↗	4:	9.7 →																																															
5:	10.4x ↖	5:	9.4 ↘																																															
6:	9.4 →	6:	10.6x ↗																																															
7:	10.8x ↖	7:	10.6x ↓																																															
8:	10.7x ↖	8:	10.7x ↘																																															
9:	10.0 ↑	9:	9.4 ↖																																															
10:	9.9 ←	10:	9.1 ←																																															
Serie 88.0		Serie 94.0																																																
Total 0.0		Total 94.0																																																

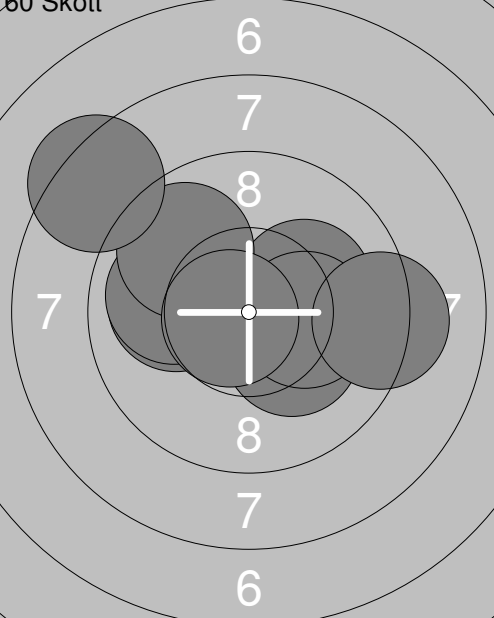
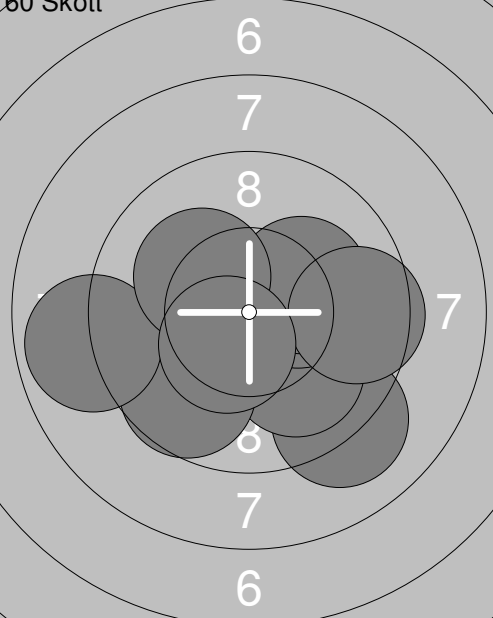
<p>60 Skott</p> 	<p>60 Skott</p> 	<table style="width:100%; border-collapse: collapse;"> <tr><td>11:</td><td>10.1 ↖</td><td>21:</td><td>9.1 ↘</td></tr> <tr><td>12:</td><td>10.2x ↘</td><td>22:</td><td>10.6x ↖</td></tr> <tr><td>13:</td><td>10.2x ↗</td><td>23:</td><td>10.0 ↓</td></tr> <tr><td>14:</td><td>10.2x →</td><td>24:</td><td>9.7 ↘</td></tr> <tr><td>15:</td><td>10.0 ↖</td><td>25:</td><td>10.3x ↗</td></tr> <tr><td>16:</td><td>10.0 ↖</td><td>26:</td><td>8.9 ←</td></tr> <tr><td>17:</td><td>9.2 →</td><td>27:</td><td>10.2x ↗</td></tr> <tr><td>18:</td><td>9.8 ↖</td><td>28:</td><td>10.2x ↖</td></tr> <tr><td>19:</td><td>8.3 ↖</td><td>29:</td><td>9.5 →</td></tr> <tr><td>20:</td><td>10.7x ↖</td><td>30:</td><td>10.4x ↓</td></tr> <tr><td colspan="2">Serie 96.0</td><td colspan="2">Serie 95.0</td></tr> <tr><td colspan="2">Total 190.0</td><td colspan="2">Total 285.0</td></tr> </table>	11:	10.1 ↖	21:	9.1 ↘	12:	10.2x ↘	22:	10.6x ↖	13:	10.2x ↗	23:	10.0 ↓	14:	10.2x →	24:	9.7 ↘	15:	10.0 ↖	25:	10.3x ↗	16:	10.0 ↖	26:	8.9 ←	17:	9.2 →	27:	10.2x ↗	18:	9.8 ↖	28:	10.2x ↖	19:	8.3 ↖	29:	9.5 →	20:	10.7x ↖	30:	10.4x ↓	Serie 96.0		Serie 95.0		Total 190.0		Total 285.0	
11:	10.1 ↖	21:	9.1 ↘																																															
12:	10.2x ↘	22:	10.6x ↖																																															
13:	10.2x ↗	23:	10.0 ↓																																															
14:	10.2x →	24:	9.7 ↘																																															
15:	10.0 ↖	25:	10.3x ↗																																															
16:	10.0 ↖	26:	8.9 ←																																															
17:	9.2 →	27:	10.2x ↗																																															
18:	9.8 ↖	28:	10.2x ↖																																															
19:	8.3 ↖	29:	9.5 →																																															
20:	10.7x ↖	30:	10.4x ↓																																															
Serie 96.0		Serie 95.0																																																
Total 190.0		Total 285.0																																																

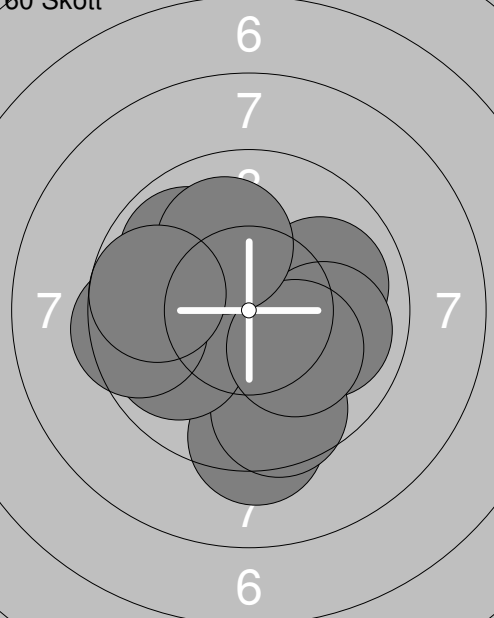
<p>60 Skott</p> 	<table style="width:100%; border-collapse: collapse;"> <tr><td>31:</td><td>9.3 ↓</td></tr> <tr><td>32:</td><td>10.0 →</td></tr> <tr><td>33:</td><td>9.9 ↖</td></tr> <tr><td>34:</td><td>9.9 →</td></tr> <tr><td>35:</td><td>9.6 ↓</td></tr> <tr><td>36:</td><td>9.9 ↖</td></tr> <tr><td>37:</td><td>10.2x ↘</td></tr> <tr><td>38:</td><td>10.0 ↑</td></tr> <tr><td>39:</td><td>9.5 ←</td></tr> <tr><td>40:</td><td>9.7 ←</td></tr> <tr><td colspan="2">Serie 93.0</td></tr> <tr><td colspan="2">Total 378.0</td></tr> </table>	31:	9.3 ↓	32:	10.0 →	33:	9.9 ↖	34:	9.9 →	35:	9.6 ↓	36:	9.9 ↖	37:	10.2x ↘	38:	10.0 ↑	39:	9.5 ←	40:	9.7 ←	Serie 93.0		Total 378.0	
31:	9.3 ↓																								
32:	10.0 →																								
33:	9.9 ↖																								
34:	9.9 →																								
35:	9.6 ↓																								
36:	9.9 ↖																								
37:	10.2x ↘																								
38:	10.0 ↑																								
39:	9.5 ←																								
40:	9.7 ←																								
Serie 93.0																									
Total 378.0																									

<p>Prov</p>	<p>1: 10.8x ↘ 2: 9.4 ↘ 3: 9.6 ↓ 4: 8.4 ↖ 5: 8.7 ↗ 6: 10.1 ↖ 7: 9.7 ↗ 8: 10.1 ↘ 9: 9.9 ← 10: 8.5 ↖</p> <p>Serie 90.0 Total 0.0</p>	<p>Prov</p>	<p>11: 9.7 ↑ 12: 8.7 ↙ 13: 10.0 ↗ 14: 10.3x ↑ 15: 9.9 ↖</p> <p>Serie 46.0 Total 0.0</p>
<p>60 Skott</p>	<p>1: 10.6x ↘ 2: 9.9 ← 3: 10.4x ↘ 4: 10.1 → 5: 9.8 ↘ 6: 9.5 ↖ 7: 9.8 → 8: 10.2x → 9: 10.0 ↖ 10: 9.5 ↖</p> <p>Serie 95.0 Total 95.0</p>	<p>60 Skott</p>	<p>11: 10.2x ↓ 12: 10.3x ↘ 13: 10.6x ↘ 14: 10.0 ↗ 15: 10.4x → 16: 10.0 ↗ 17: 10.0 ↗ 18: 9.6 ↑ 19: 9.1 ← 20: 9.3 ↙</p> <p>Serie 97.0 Total 192.0</p>
<p>60 Skott</p>	<p>21: 9.7 ← 22: 10.0 ↙ 23: 9.8 ↖ 24: 9.5 → 25: 10.0 → 26: 9.2 ← 27: 9.4 ↘ 28: 10.8x ↑ 29: 9.0 ↖ 30: 8.2 ↗</p> <p>Serie 92.0 Total 284.0</p>	<p>60 Skott</p>	<p>31: 10.8x ↗ 32: 8.4 ← 33: 10.3x ↘ 34: 10.7x ↓ 35: 10.1 ↓ 36: 10.5x ↘ 37: 10.1 ↑ 38: 9.9 ↖ 39: 10.0 ↘ 40: 9.7 ↗</p> <p>Serie 96.0 Total 380.0</p>

	<p>Prov</p> <p>1: 8.9 ←</p> <p>2: 10.1 ↘</p> <p>3: 9.1 ↗</p> <p>4: 10.4x ↘</p> <p>5: 7.8 ↗</p> <p>6: 9.0 →</p> <p>7: 9.1 →</p> <p>8: 7.6 ←</p> <p>9: 9.4 ↓</p> <p>10: 7.8 ↘</p>	<p>Prov</p> <p>11: 10.1 ↘</p> <p>12: 9.1 ↘</p> <p>13: 9.3 ↗</p> <p>14: 8.2 ←</p> <p>15: 9.7 →</p> <p>16: 9.2 →</p> <p>17: 9.7 →</p>
Serie 85.0	Serie 63.0	Serie 63.0
Total 0.0	Total 0.0	Total 0.0

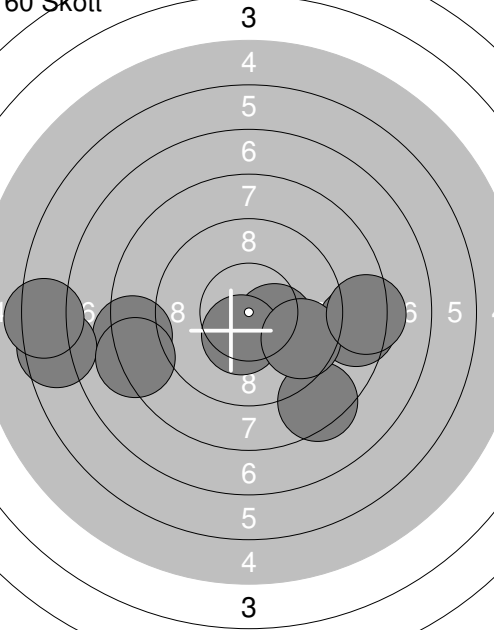
	<p>60 Skott</p> <p>1: 10.3x ↘</p> <p>2: 8.4 ↘</p> <p>3: 10.4x ↘</p> <p>4: 8.3 ←</p> <p>5: 6.6 ←</p> <p>6: 8.5 →</p> <p>7: 9.6 →</p> <p>8: 8.2 ←</p> <p>9: 6.4 ←</p> <p>10: 8.3 →</p>	<p>60 Skott</p> <p>11: 8.7 →</p> <p>12: 8.9 ↙</p> <p>13: 8.9 ↓</p> <p>14: 8.2 ←</p> <p>15: 10.7x ↘</p> <p>16: 9.3 ←</p> <p>17: 7.2 ↘</p> <p>18: 9.8 ↘</p> <p>19: 10.8x ↘</p> <p>20: 10.1 ↑</p>
Serie 81.0	Serie 87.0	Serie 87.0
Total 81.0	Total 168.0	Total 168.0

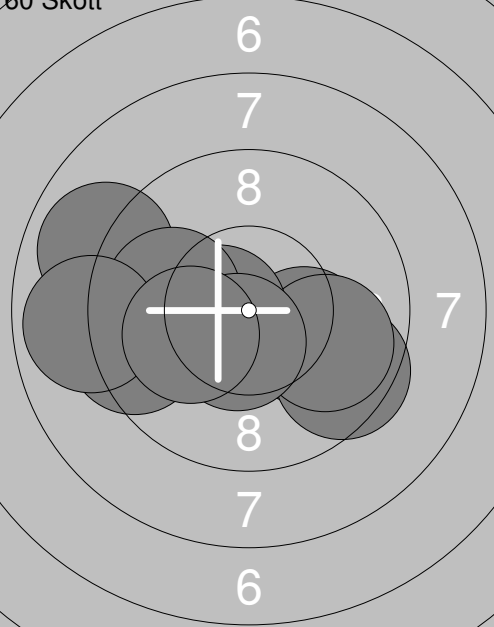
	<p>60 Skott</p> <p>21: 9.4 ←</p> <p>22: 10.2x ↘</p> <p>23: 8.9 ←</p> <p>24: 9.5 ↘</p> <p>25: 9.9 →</p> <p>26: 10.6x ←</p> <p>27: 9.9 ←</p> <p>28: 8.9 ←</p> <p>29: 10.5x ↘</p> <p>30: 10.1 ←</p>	<p>60 Skott</p> <p>31: 9.3 ←</p> <p>32: 10.4x ↗</p> <p>33: 9.7 →</p> <p>34: 8.6 ←</p> <p>35: 8.6 ↗</p> <p>36: 7.9 ←</p> <p>37: 7.2 ↗</p> <p>38: 8.9 ←</p> <p>39: 9.9 ←</p> <p>40: 9.7 ↓</p>
Serie 92.0	Serie 84.0	Serie 84.0
Total 260.0	Total 344.0	Total 344.0

<p>Prov</p>	<p>1: 10.5x ↘ 2: 10.4x ↗ 3: 7.8 → 4: 9.2 ↘ 5: 7.5 → 6: 8.7 ↘ 7: 9.6 ↘ 8: 10.3x ↘ 9: 10.8x ↘ 10: 8.7 →</p> <p>Serie 88.0 Total 0.0</p>	<p>Prov</p>	<p>11: 9.4 ↓ 12: 10.2x ↘</p> <p>Serie 19.0 Total 0.0</p>
-------------	--	-------------	---

<p>60 Skott</p>	<p>1: 9.7 ↘ 2: 9.9 ← 3: 10.6x ↘ 4: 10.7x ↘ 5: 10.3x ↘ 6: 10.7x ↘ 7: 9.2 → 8: 10.1 ↘ 9: 9.6 ↘ 10: 10.8x ↗</p> <p>Serie 96.0 Total 96.0</p>	<p>60 Skott</p>	<p>11: 10.7x ↘ 12: 9.9 ↘ 13: 9.9 ↘ 14: 9.6 ↘ 15: 9.2 ↘ 16: 9.6 → 17: 8.3 ← 18: 10.6x ↘ 19: 10.6x ↘ 20: 8.7 ↘</p> <p>Serie 91.0 Total 187.0</p>
-----------------	--	-----------------	---

<p>60 Skott</p>	<p>21: 9.4 ← 22: 9.6 → 23: 9.4 → 24: 9.8 ↘ 25: 10.5x ↘ 26: 8.6 → 27: 10.2x ↘ 28: 9.9 → 29: 9.0 → 30: 9.9 ↘</p> <p>Serie 91.0 Total 278.0</p>	<p>60 Skott</p>	<p>31: 10.8x ↘ 32: 9.5 ↘ 33: 9.3 ↘ 34: 9.9 ↘ 35: 10.9x ↘ 36: 9.4 ↘ 37: 10.0 → 38: 9.9 ← 39: 10.3x ↘ 40: 10.5x ↗</p> <p>Serie 95.0 Total 373.0</p>
-----------------	---	-----------------	--