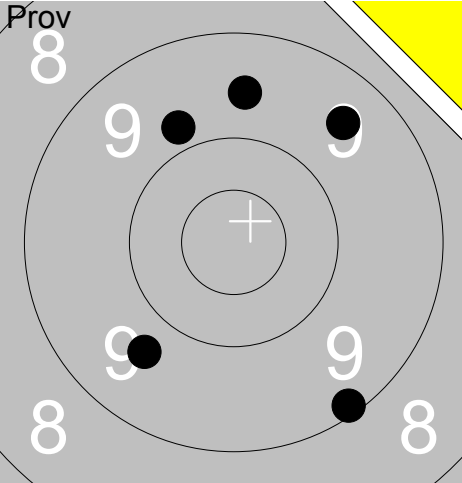
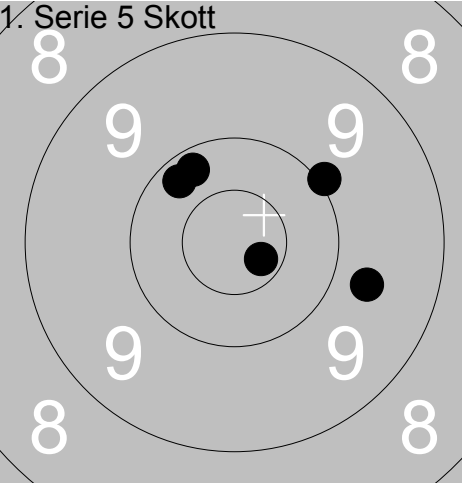
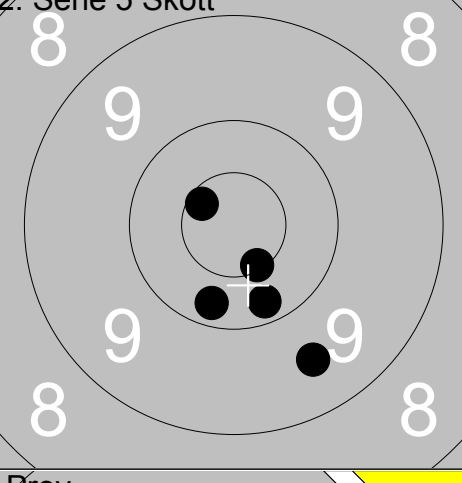
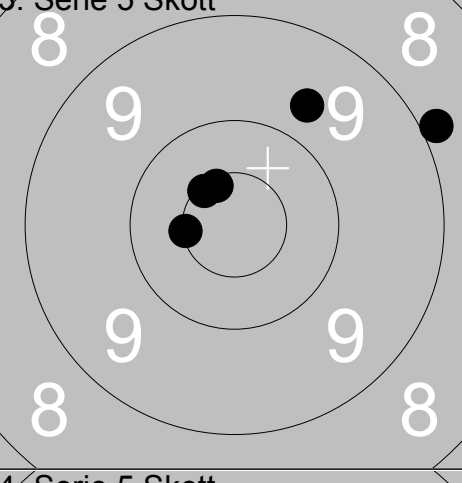
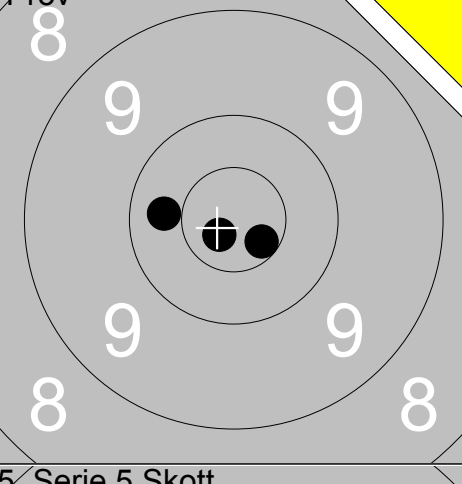
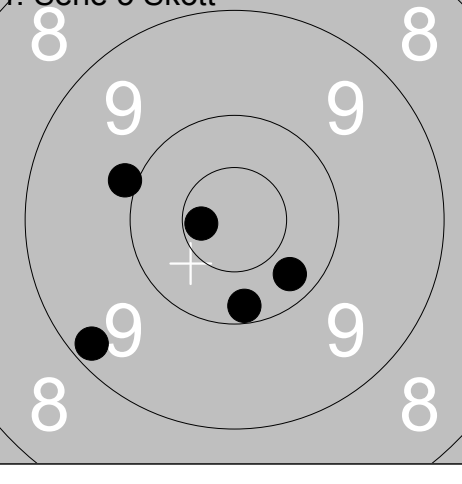
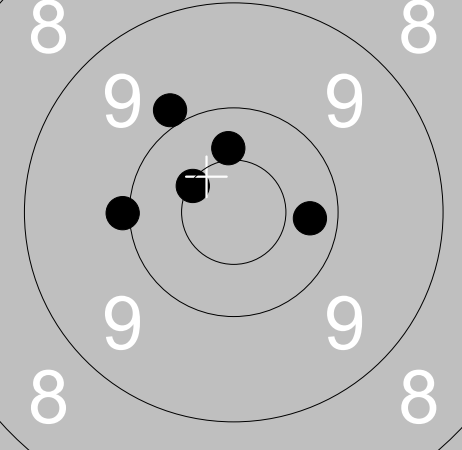
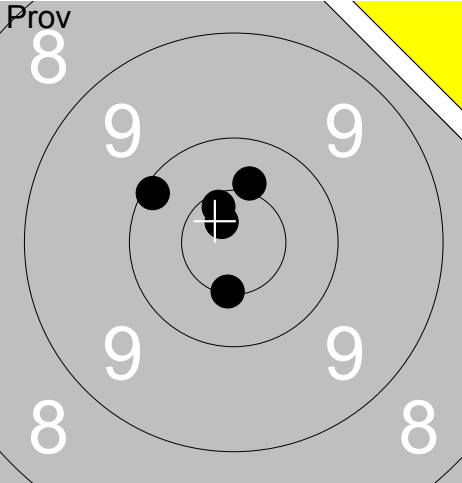
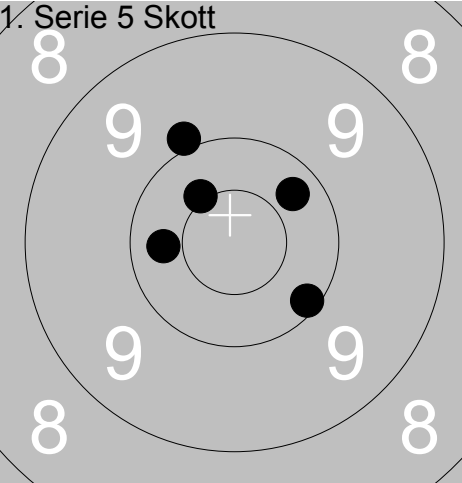
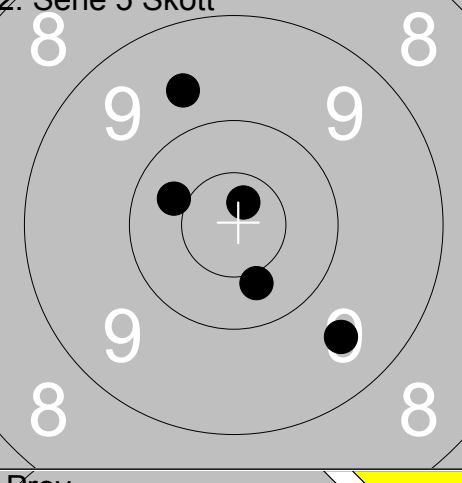
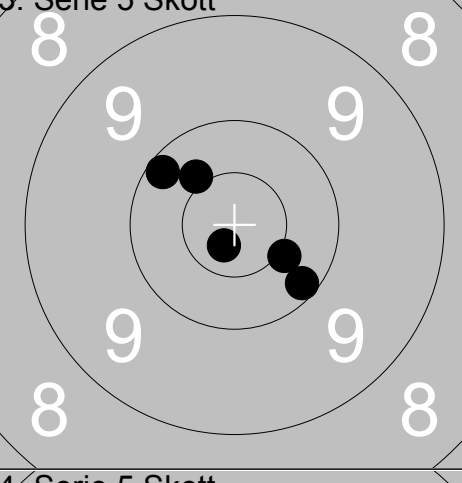
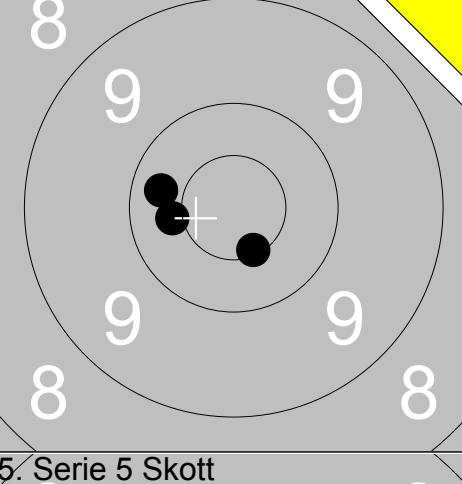
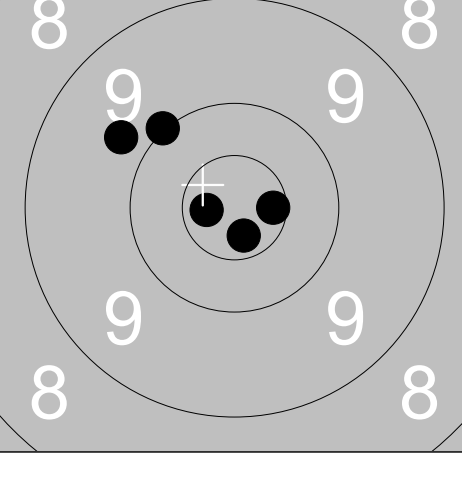
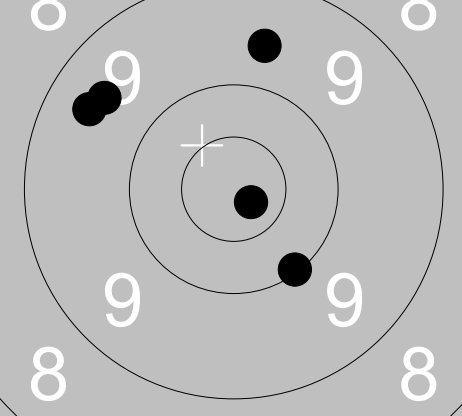
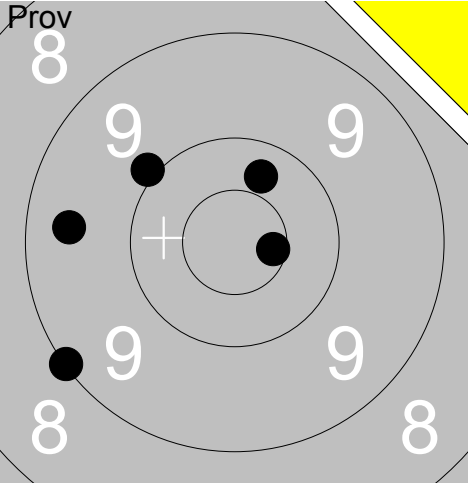
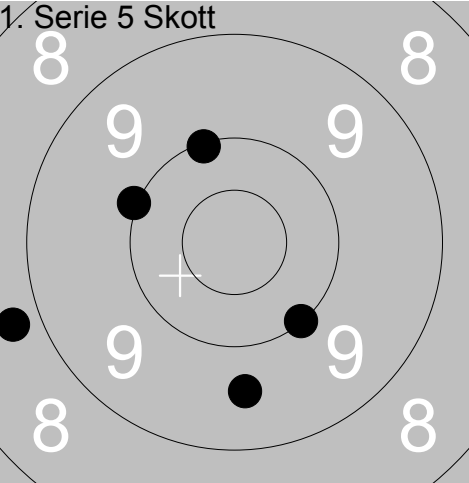
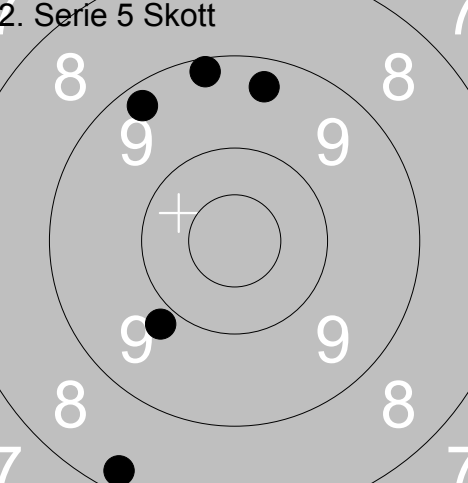
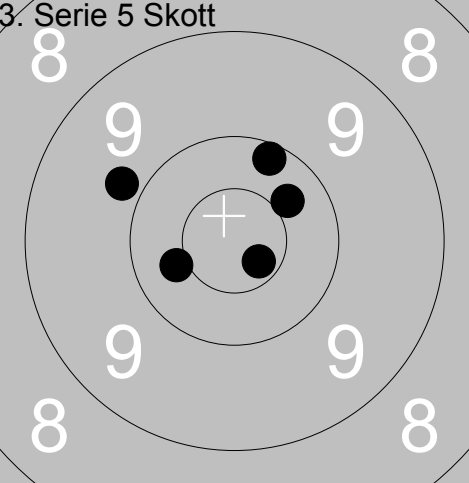
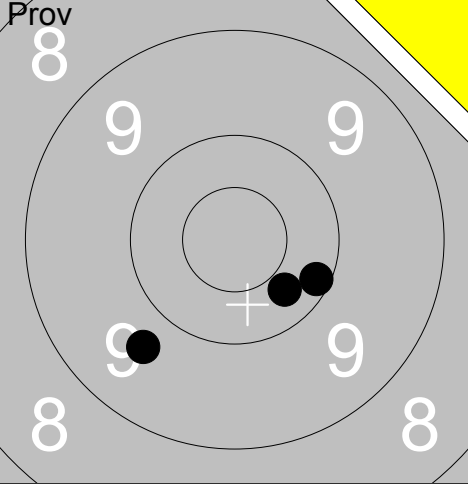
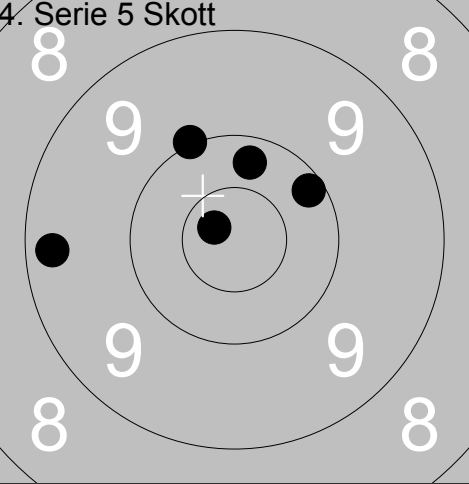
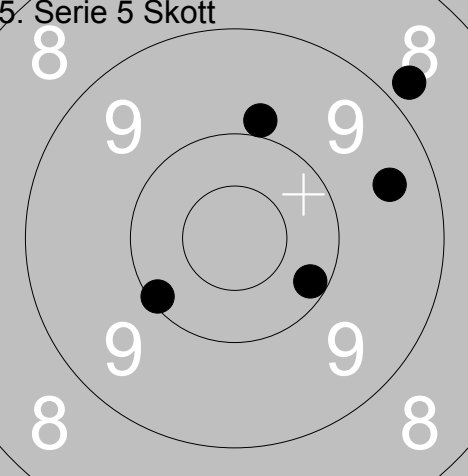
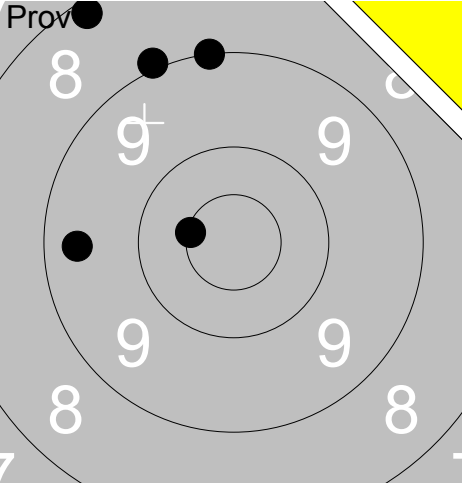
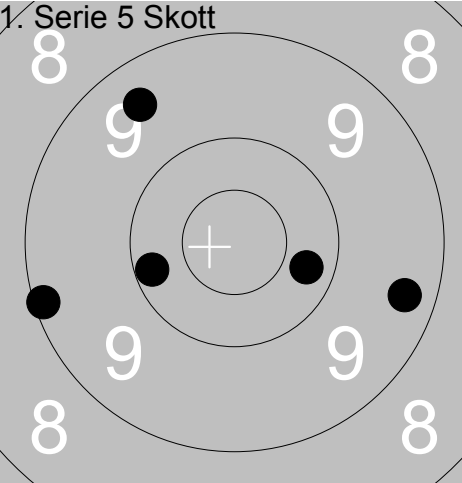
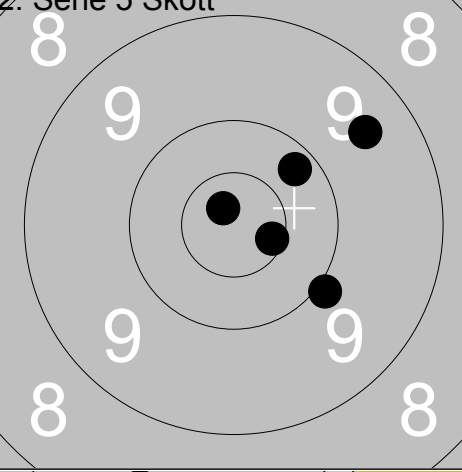
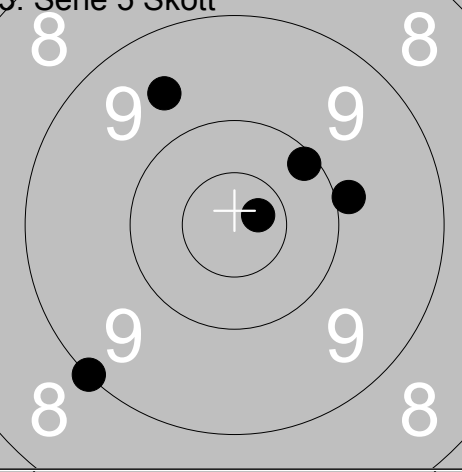
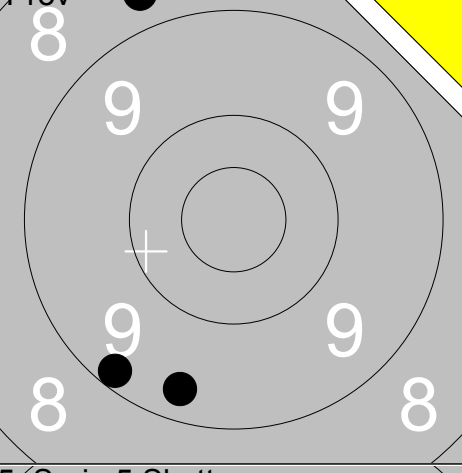
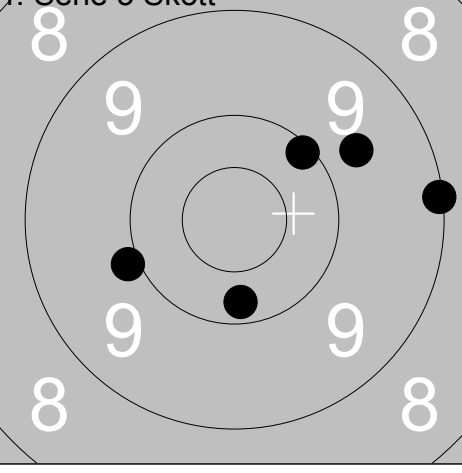
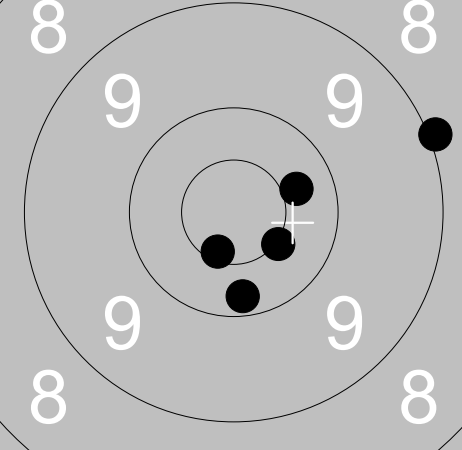

Skjutlag 1	Tavla 1	Dan-Ivan Karlsson			
Ramselefors		Ramselefors		Vet	Vb
12.08.2017		SM Banskytte Liggande 2017		Ramselefors SKF	
Prov		1: 9.9 ↑ 2: 10.0 ↑ 3: 8.9 ↑ 4: 9.5 ↘ 5: 8.5 ↑	1. Serie 5 Skott		1: 10.2 ← 2: 9.8 ↓ 3: 10.2 ← 4: 10.1 ↗ 5: 10.1 ↗
		Serie 44		Serie 49	
		Total 0		Total 49	
2. Serie 5 Skott		1: 10.2 ↑ 2: 10.4 ↗ 3: 10.2 ↓ 4: 10.1 ← 5: 9.3 ←	3. Serie 5 Skott		1: 10.5x ← 2: 9.6 ↗ 3: 10.5x ↓ 4: 9.8 ← 5: 10.3 ←
		Serie 49		Serie 48	
		Total 98		Total 146	
Prov		1: 10.1 ↙ 2: 10.1 ↗ 3: 10.7x ↘	4. Serie 5 Skott		1: 9.6 ← 2: 8.6 ← 3: 9.9 → 4: 9.5 ← 5: 9.7 ↙
		Serie 30		Serie 44	
		Total 146		Total 190	
5. Serie 5 Skott		1: 9.3 ↑ 2: 9.9 ↗ 3: 10.2 ↙ 4: 7.8 ↑ 5: 8.5 →			
		Serie 43			
		Total 233			

Skjutlag 1	Tavla 2	Björn Johansson	
Ramselefors	Kvistbro	Öpp	Ör
12.08.2017	SM Banskytte Liggande 2017	Ramselefors SKF	
Prov 	1: 9.8 ↗ 2: 9.5 ↗ 3: 9.1 ↘ 4: 9.7 ↘ 5: 9.6 ↑ Serie 45 Total 0	1. Serie 5 Skott 	1: 10.0 ↗ 2: 9.7 → 3: 10.2 ↗ 4: 10.7x ↘ 5: 10.2 ↗ Serie 49 Total 49
2. Serie 5 Skott 	1: 10.6x ↗ 2: 10.5x ↘ 3: 10.2 ↘ 4: 9.5 ↘ 5: 10.2 ↘ Serie 49 Total 98	3. Serie 5 Skott 	1: 10.6x ↗ 2: 9.7 ↗ 3: 8.9 → 4: 10.6x ↗ 5: 10.5x ← Serie 47 Total 145
Prov 	1: 10.8x ↘ 2: 10.3 ← 3: 10.6x ↘ Serie 30 Total 145	4. Serie 5 Skott 	1: 10.2 ↘ 2: 9.9 ← 3: 10.3 ↘ 4: 10.7x ← 5: 9.2 ↘ Serie 48 Total 193
5. Serie 5 Skott 	1: 9.9 ↗ 2: 10.0 ← 3: 10.4 ↑ 4: 10.5x ↗ 5: 10.3 → Serie 49 Total 242		

Skjutlag	Tavla	Casper Fredriksson			
1	5	Ramselefors	Ramselefors	Öpp	Vb
12.08.2017		SM Banskytte Liggande 2017	Ramselefors SKF		
Prov 	1: 10.1 ↖ 2: 10.4 ↗ 3: 10.6x ↗ 4: 10.5x ↓ 5: 10.7x ↗	1. Serie 5 Skott 	1: 10.1 ↘ 2: 9.9 ↗ 3: 10.3 ↗ 4: 10.3 ← 5: 10.4x ↗	Serie 50 Total 0	Serie 49 Total 49
2. Serie 5 Skott 	1: 9.7 ↗ 2: 10.4 ↓ 3: 10.7x ↗ 4: 10.4 ↗ 5: 9.5 ↓	3. Serie 5 Skott 	1: 10.7x ↓ 2: 10.4 ↗ 3: 10.2 ↓ 4: 10.2 ↗ 5: 10.4x ↓	Serie 48 Total 97	Serie 50 Total 147
Prov 	1: 10.3 ← 2: 10.5x ↓ 3: 10.4 ←	4. Serie 5 Skott 	1: 9.8 ↗ 2: 10.6x → 3: 10.7x ← 4: 10.0 ↗ 5: 10.7x ↓	Serie 30 Total 147	Serie 49 Total 196
5. Serie 5 Skott 	1: 9.6 ↗ 2: 9.5 ↗ 3: 9.5 ↗ 4: 10.1 ↓ 5: 10.8x ↓			Serie 47 Total 243	

Skjutlag 1	Tavla 6	Linda Bergman			
Ramselefors		Ununge		Öpp	St
12.08.2017		SM Banskytte Liggande 2017		Ramselefors SKF	
Prov		1: 9.4 ← 2: 9.9 ↗ 3: 9.0 ↘ 4: 10.3 ↗ 5: 10.6x →	1. Serie 5 Skott		1: 9.6 ↓ 2: 10.0 ↘ 3: 10.0 ↗ 4: 10.1 ↗ 5: 8.8 ←
		Serie 47 Total 0			Serie 47 Total 47
2. Serie 5 Skott		1: 9.8 ↘ 2: 9.3 ↗ 3: 9.3 ↗ 4: 9.2 ↗ 5: 8.3 ↓	3. Serie 5 Skott		1: 10.4 ← 2: 10.4 ↗ 3: 10.7x ↘ 4: 10.2 ↗ 5: 9.8 ↗
		Serie 44 Total 91			Serie 49 Total 140
Prov		1: 9.7 ↘ 2: 10.3 ↘ 3: 10.1 ↘	4. Serie 5 Skott		1: 10.0 ↗ 2: 10.3 ↗ 3: 10.2 ↗ 4: 10.7x ↗ 5: 9.3 ←
		Serie 29 Total 140			Serie 49 Total 189
5. Serie 5 Skott		1: 10.2 → 2: 10.1 ↘ 3: 9.5 → 4: 8.8 ↗ 5: 9.9 ↗			
		Serie 46 Total 235			

Skjutlag 1	Tavla 7	Maja Lindberg			
Ramselefors		Ramselefors		Öpp	Vb
12.08.2017		SM Banskytte Liggande 2017		Ramselefors SKF	
Prov 		1: 8.2 ↗ 2: 9.0 ↑ 3: 9.0 ↑ 4: 10.5x ← 5: 9.4 ←	1. Serie 5 Skott 	1: 9.1 ← 2: 9.4 ↗ 3: 10.2 ← 4: 9.3 → 5: 10.3 →	
		Serie 45 Total 0		Serie 47 Total 47	
2. Serie 5 Skott 		1: 9.9 ↘ 2: 9.5 ↗ 3: 10.8x ↗ 4: 10.2 ↗ 5: 10.6x →	3. Serie 5 Skott 	1: 9.0 ↘ 2: 9.6 ↗ 3: 10.7x → 4: 10.1 ↗ 5: 9.9 →	
		Serie 48 Total 95		Serie 47 Total 142	
Prov 		1: 9.2 ↘ 2: 8.7 ↗ 3: 9.3 ↘	4. Serie 5 Skott 	1: 10.2 ↓ 2: 9.9 ← 3: 9.1 → 4: 9.7 ↗ 5: 10.1 ↗	
		Serie 26 Total 142		Serie 47 Total 189	
5. Serie 5 Skott 		1: 10.6x ↓ 2: 10.2 ↓ 3: 10.5x ↘ 4: 10.4 → 5: 9.0 →			
		Serie 49 Total 238			

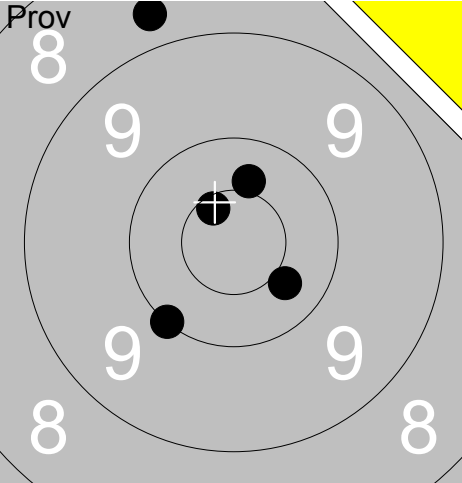
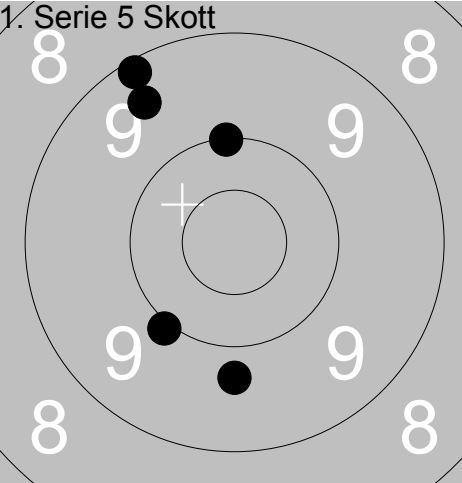
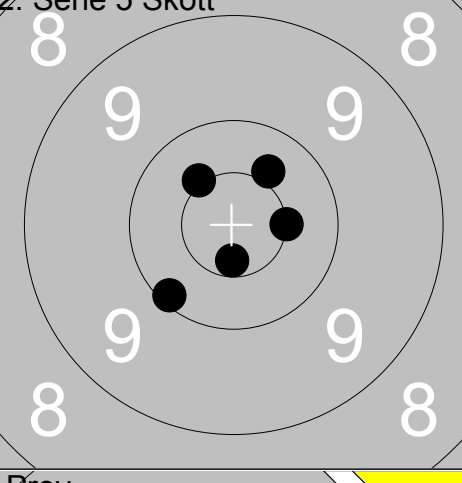
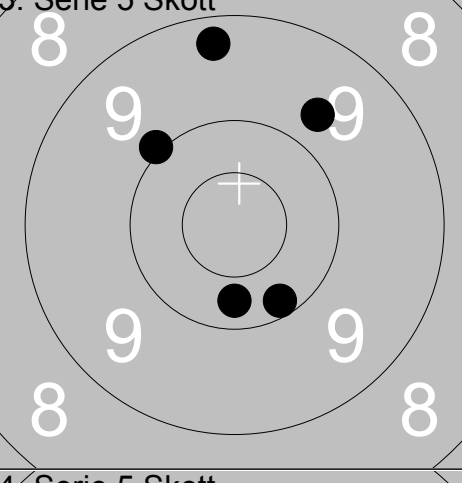
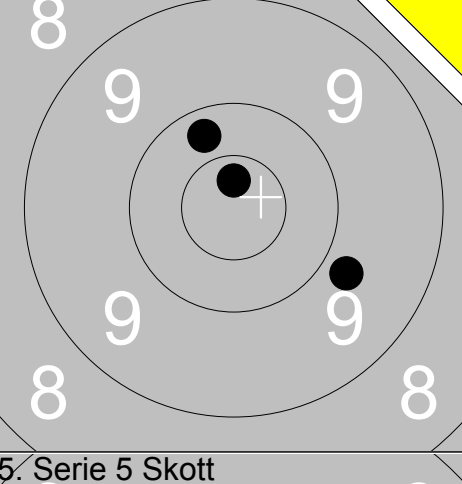
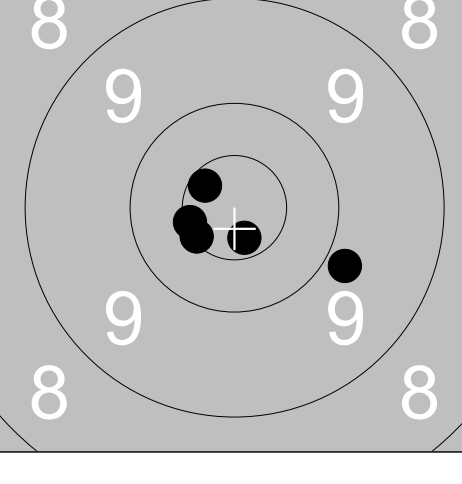
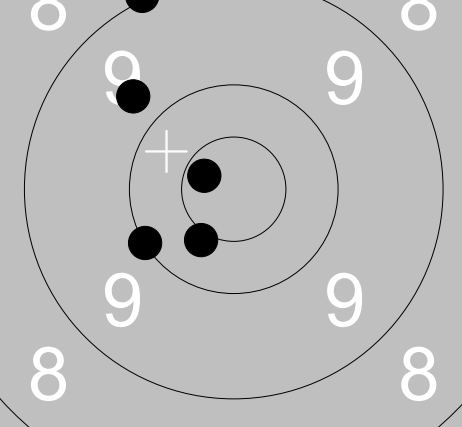
Skjutlag 1	Tavla 8	Peter Lundqvist			
Ramselefors		Ununge		Öpp	St
12.08.2017		SM Banskytte Liggande 2017		Ramselefors SKF	
Prov 	1: 8.7 ↗ 2: 10.4 ↗ 3: 10.0 ↘ 4: 10.6x ↗ 5: 10.4 ↘	1. Serie 5 Skott 	1: 9.4 ↗ 2: 9.7 ↓ 3: 10.0 ↘ 4: 9.1 ↗ 5: 10.0 ↑	Serie 48 Total 0	
2. Serie 5 Skott 	1: 10.4 ↗ 2: 10.5x ↗ 3: 10.5x → 4: 10.1 ↘ 5: 10.6x ↓	3. Serie 5 Skott 	1: 9.3 ↑ 2: 10.0 ↗ 3: 9.7 ↗ 4: 10.3 ↓ 5: 10.2 ↓	Serie 50 Total 97	
Prov 	1: 10.7x ↑ 2: 9.8 ↘ 3: 10.3 ↗	4. Serie 5 Skott 	1: 10.5x ← 2: 10.5x ← 3: 10.6x ↗ 4: 9.8 → 5: 10.7x ↓	Serie 29 Total 145	
5. Serie 5 Skott 	1: 9.0 ↗ 2: 10.7x ↗ 3: 10.4x ↘ 4: 9.7 ↗ 5: 10.0 ←				
Serie 48 Total 242		Serie 47 Total 47			
Serie 48 Total 97		Serie 48 Total 145			
Serie 29 Total 145		Serie 49 Total 194			

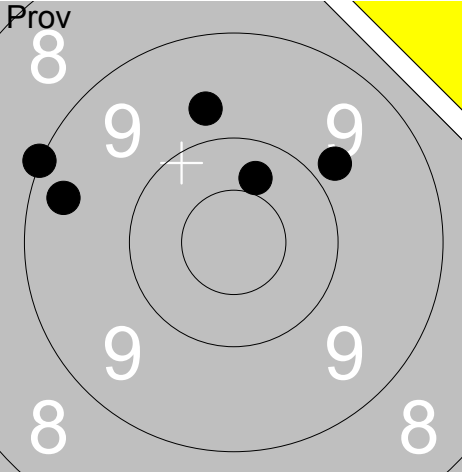
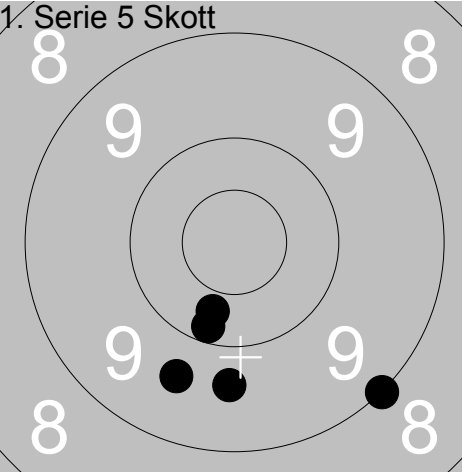
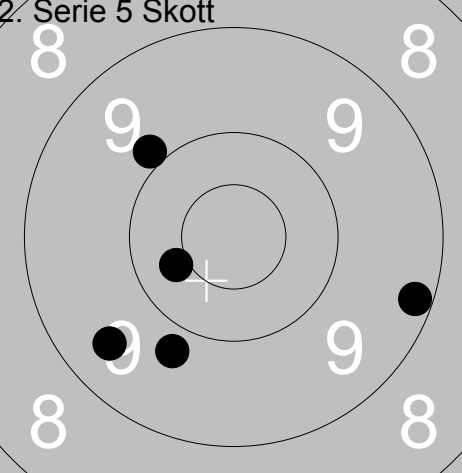
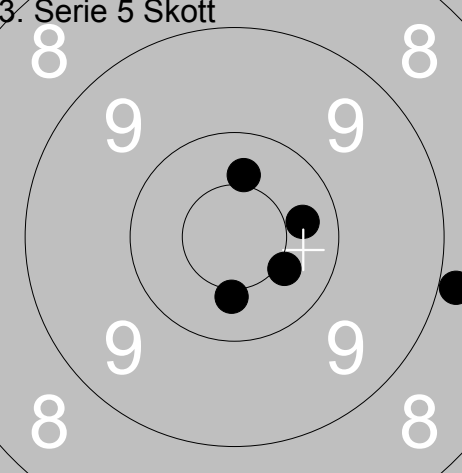
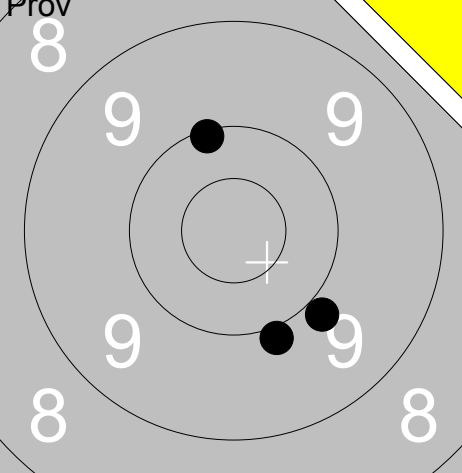
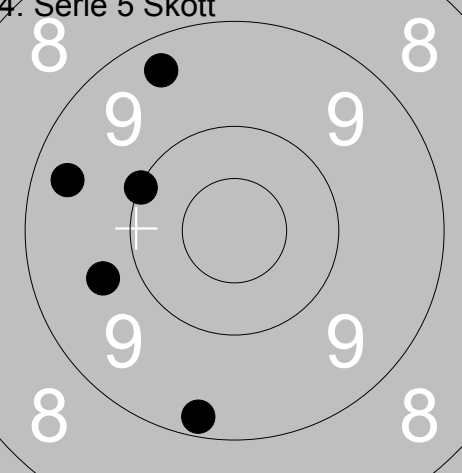
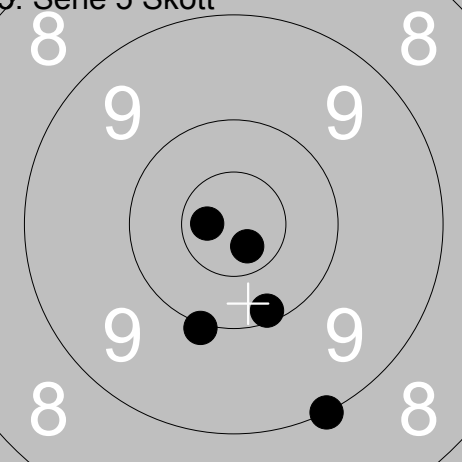
Skjutlag 1	Tavla 9	Tomas Strömberg					
Ramselefors		Vännäs		Öpp	Vb		
12.08.2017		SM Banskytte Liggande 2017		Ramselefors SKF			
Prov 	1: 9.3 ← 2: 9.0 ↖ 3: 9.8 ↗ 4: 10.4 ↗ 5: 9.7 ↗	1. Serie 5 Skott 	1: 9.0 ↘ 2: 10.2 ↓ 3: 9.7 ↓ 4: 10.3 ↓ 5: 9.6 ↓	Serie 46 Total 0		Serie 47 Total 47	
2. Serie 5 Skott 	1: 10.4 ← 2: 9.2 ↘ 3: 9.8 ↓ 4: 9.5 ↖ 5: 9.9 ↗	3. Serie 5 Skott 	1: 10.4x ↘ 2: 10.4 ↑ 3: 8.9 → 4: 10.3 → 5: 10.4x ↓	Serie 46 Total 93		Serie 48 Total 141	
Prov 	1: 9.9 ↓ 2: 9.9 ↓ 3: 10.1 ↗	4. Serie 5 Skott 	1: 10.0 ↖ 2: 9.2 ↓ 3: 9.4 ↖ 4: 9.7 ↖ 5: 9.3 ↗	Serie 28 Total 141		Serie 46 Total 187	
5. Serie 5 Skott 	1: 9.0 ↓ 2: 10.1 ↓ 3: 10.7x ↓ 4: 10.7x ← 5: 10.0 ↓			Serie 49 Total 236			

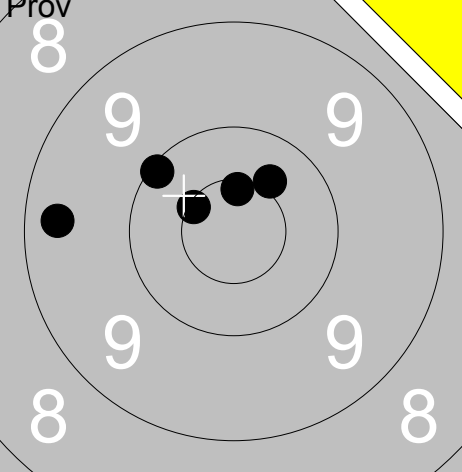
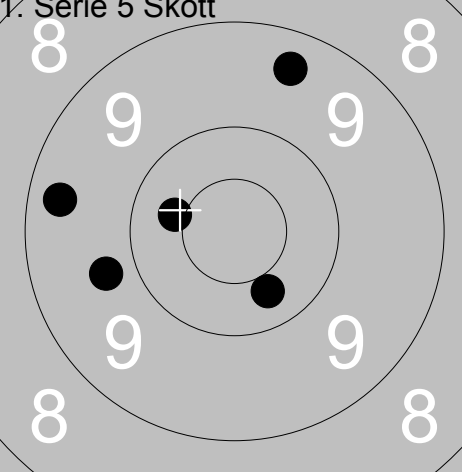
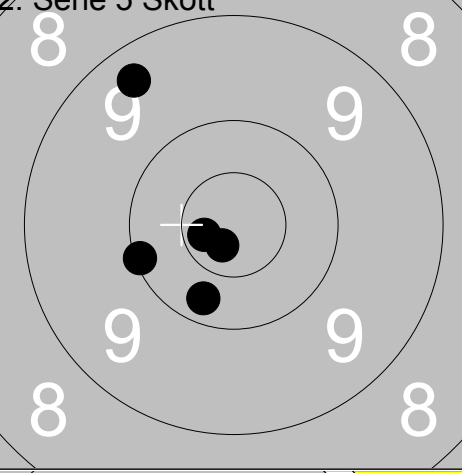
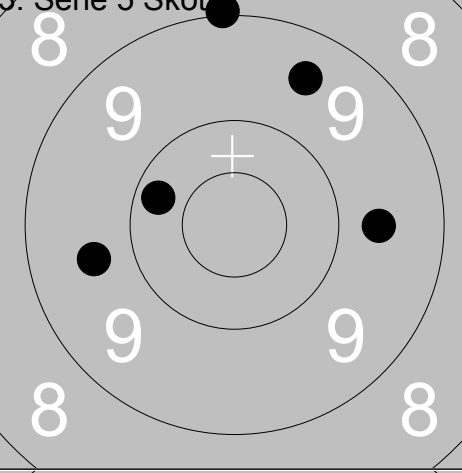
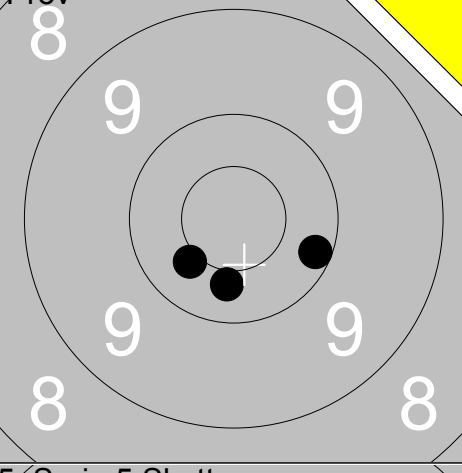
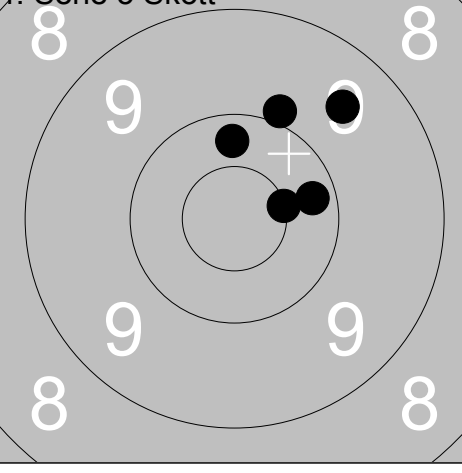
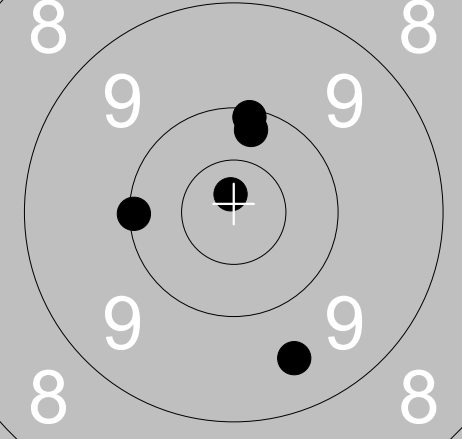
Prov 	1: 10.4 ↗ 2: 9.3 ← 3: 10.6x ↑ 4: 10.5x ↗ 5: 10.1 ↗ <hr/> Serie 49 Total 0	1. Serie 5 Skott 	1: 9.3 ← 2: 9.4 ↑ 3: 10.3 ↘ 4: 9.7 ← 5: 10.4 ← <hr/> Serie 47 Total 47
2. Serie 5 Skott 	1: 10.2 ↘ 2: 10.7x ← 3: 9.4 ↗ 4: 10.7x ↘ 5: 10.1 ← <hr/> Serie 49 Total 96	3. Serie 5 Skott 	1: 9.5 ↑ 2: 9.6 ← 3: 9.7 → 4: 9.0 ↑ 5: 10.2 ← <hr/> Serie 46 Total 142
Prov 	1: 10.2 → 2: 10.4 ↓ 3: 10.4 ↘ <hr/> Serie 30 Total 142	4. Serie 5 Skott 	1: 10.2 → 2: 10.3 ↑ 3: 9.5 ↗ 4: 9.9 ↑ 5: 10.5x → <hr/> Serie 48 Total 190
5. Serie 5 Skott 	1: 10.2 ↑ 2: 10.1 ↑ 3: 9.5 ↘ 4: 10.8x ↑ 5: 10.1 ← <hr/> Serie 49 Total 239		

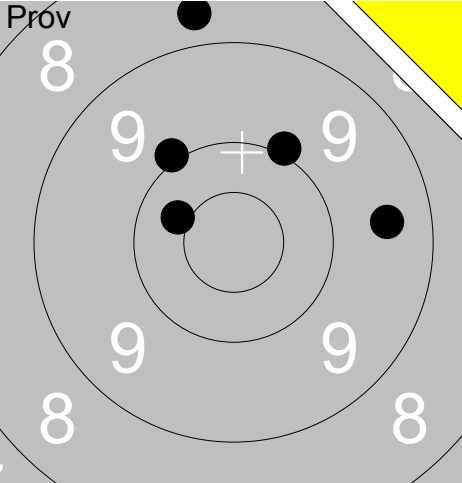
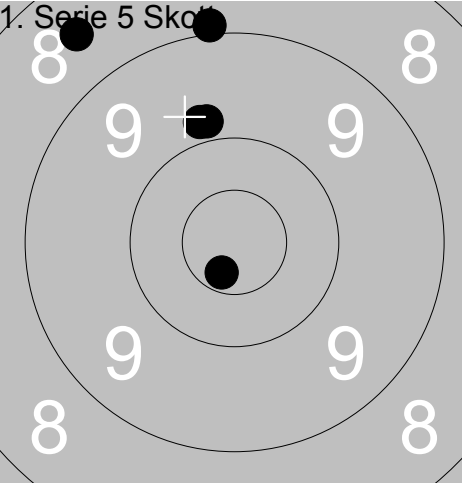
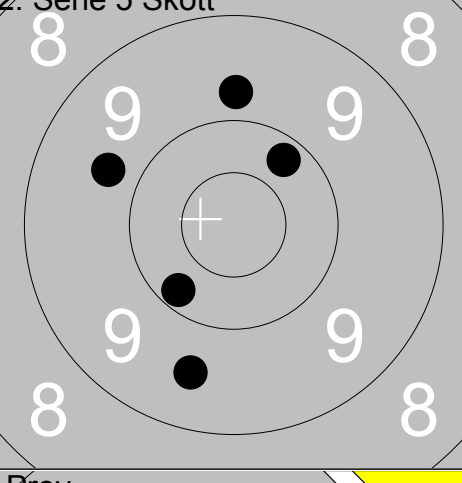
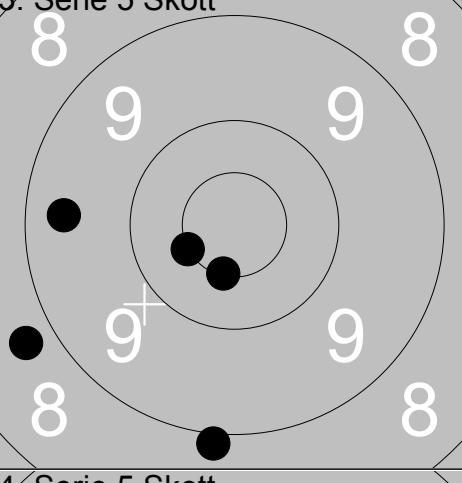
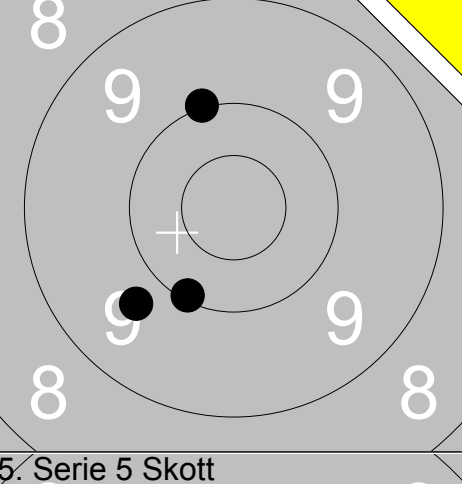
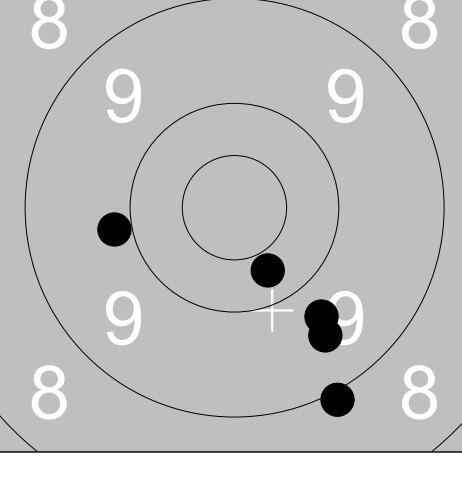
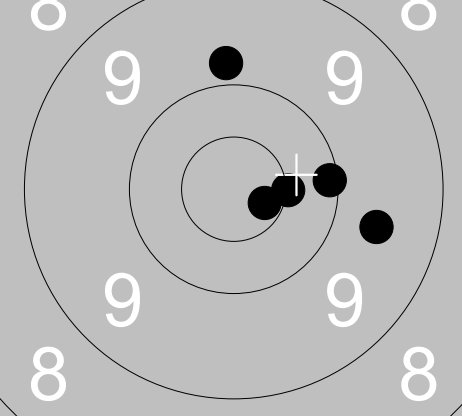
Skjuttag	Tavla	Jan-Olof Lampinen			
1	11	Ramselefors	S 3	Vet	No
12.08.2017	SM Banskytte Liggande 2017	Ramselefors SKF			
Prov 	1: 10.0 ↗ 2: 9.5 → 3: 10.0 ↗ 4: 8.7 ↗ 5: 10.4 ↖ Serie 47 Total 0	1. Serie 5 Skott 	1: 9.8 ↗ 2: 10.7x ↓ 3: 9.8 ↗ 4: 8.9 ↗ 5: 8.5 ↖ Serie 44 Total 44		
2. Serie 5 Skott 	1: 9.8 ↗ 2: 10.2 ↗ 3: 9.6 ↓ 4: 9.7 ↖ 5: 10.2 ↖ Serie 47 Total 91	3. Serie 5 Skott 	1: 9.4 ← 2: 8.7 ← 3: 10.5x ↓ 4: 8.9 ↓ 5: 10.5x ← Serie 45 Total 136		
Prov 	1: 10.0 ↗ 2: 9.7 ← 3: 10.1 ↓ Serie 29 Total 136	4. Serie 5 Skott 	1: 9.9 ← 2: 10.3 ↓ 3: 9.5 ↓ 4: 8.9 ↓ 5: 9.7 ↓ Serie 45 Total 181		
5. Serie 5 Skott 	1: 9.8 ↗ 2: 10.6x ↘ 3: 10.5x → 4: 9.6 ↘ 5: 10.1 → Serie 48 Total 229				

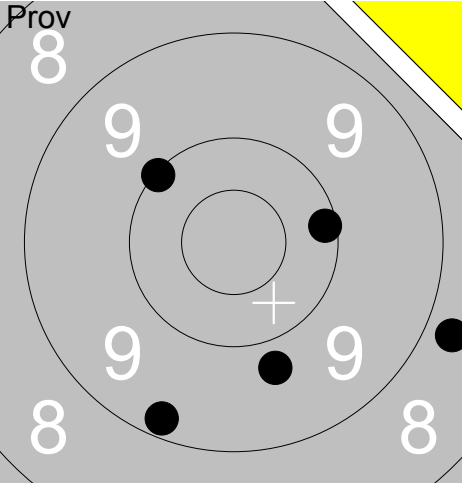
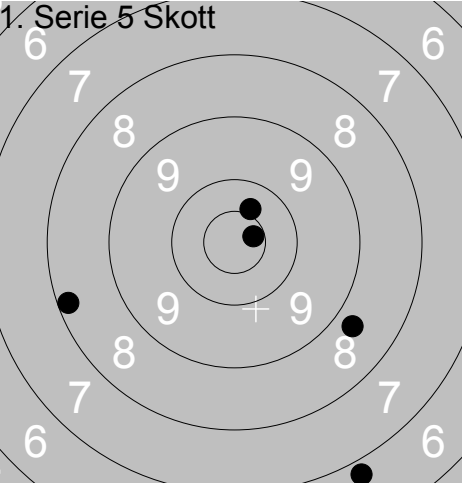
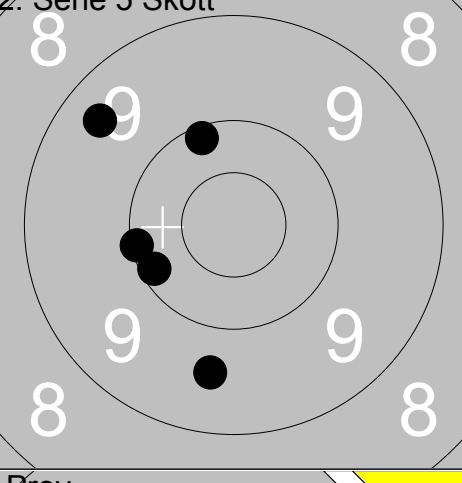
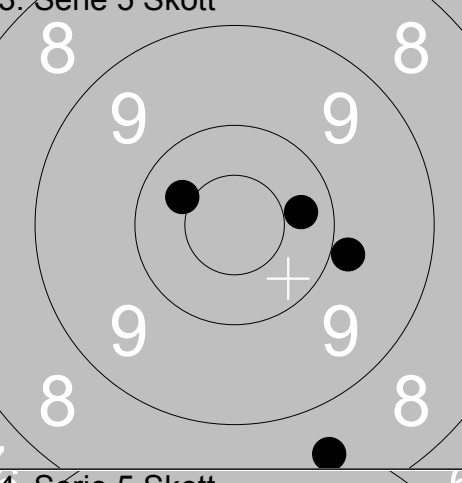
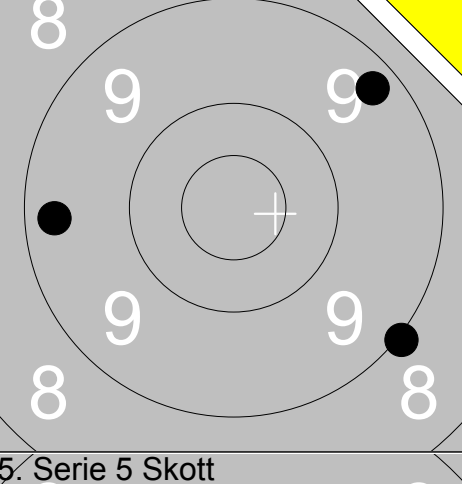
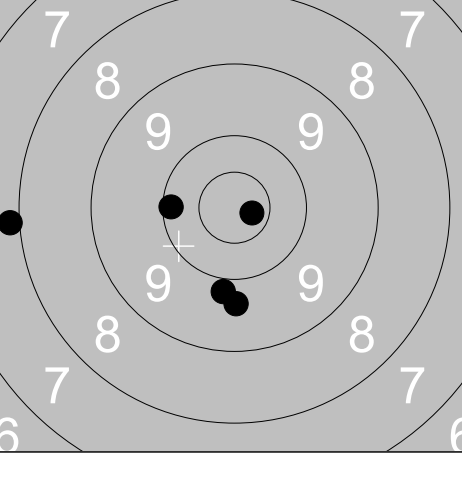
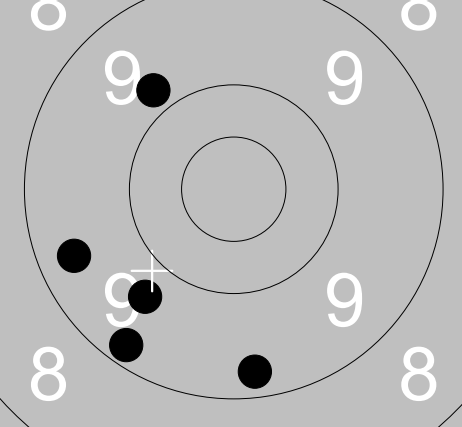
Skjutlag	Tavla	Bert-Ove Hägglund			
1	12	Ramselefors	Ramselefors	Vet	Vb
12.08.2017		SM Banskytte Liggande 2017	Ramselefors SKF		
Prov 	1: 9.8 ↘ 2: 8.8 → 3: 10.1 ↗ 4: 10.1 → 5: 9.2 ↘	1. Serie 5 Skott 	1: 10.7x → 2: 8.7 ↘ 3: 10.4 ↗ 4: 6.8 ↘ 5: 8.2 ←		
	Serie 46		Serie 42		
	Total 0		Total 42		
2. Serie 5 Skott 	1: 9.4 ↗ 2: 10.1 ↗ 3: 10.1 ← 4: 10.1 ← 5: 9.6 ↘	3. Serie 5 Skott 	1: 10.4 ↖ 2: 8.6 ↘ 3: 10.3 → 4: 9.9 → 5: 0.0		
	Serie 48		Serie 37		
	Total 90		Total 127		
Prov 	1: 9.0 ↘ 2: 9.3 ↗ 3: 9.3 ←	4. Serie 5 Skott 	1: 7.9 ← 2: 10.7x → 3: 9.7 ↘ 4: 9.9 ↘ 5: 10.1 ←		
	Serie 27		Serie 45		
	Total 127		Total 172		
5. Serie 5 Skott 	1: 9.7 ↘ 2: 9.8 ↗ 3: 9.3 ↘ 4: 9.4 ← 5: 9.2 ↘				
	Serie 45				
	Total 217				

Skjutlag 1	Tavla 13	Roger Andersson			
Ramselefors		S 3		Öpp	No
12.08.2017		SM Banskytte Liggande 2017		Ramselefors SKF	
Prov		1: 10.2 → 2: 10.3 ↓ 3: 9.5 ← 4: 10.0 ← 5: 10.7x →	1. Serie 5 Skott		1: 9.3 ↓ 2: 10.1 ↙ 3: 10.2 ← 4: 9.7 ↓ 5: 10.0 →
		Serie 49 Total 0			Serie 48 Total 48
2. Serie 5 Skott		1: 9.9 ↙ 2: 10.3 ↗ 3: 10.5x ↗ 4: 9.4 ↓ 5: 8.9 ↓	3. Serie 5 Skott		1: 10.0 ↓ 2: 10.3 ↖ 3: 9.6 → 4: 9.5 → 5: 10.6x ←
		Serie 46 Total 94			Serie 48 Total 142
Prov		1: 10.2 ↗ 2: 10.4x ← 3: 10.5x ↓	4. Serie 5 Skott		1: 10.5x → 2: 10.0 ↓ 3: 10.1 ↓ 4: 9.6 ↓ 5: 9.8 ↓
		Serie 30 Total 142			Serie 48 Total 190
5. Serie 5 Skott		1: 9.4 ↘ 2: 10.6x → 3: 10.4 → 4: 10.5x ↑ 5: 9.8 ↑			
		Serie 48 Total 238			

Skjutlag 1	Tavla 14	Urban Magnusson			
Ramselefors		Häggenås		Vet	Jä
12.08.2017		SM Banskytte Liggande 2017		Ramselefors SKF	
Prov		1: 9.7 ↗ 2: 9.2 ↑ 3: 9.6 ↖ 4: 9.0 ↑ 5: 9.8 ←	1. Serie 5 Skott		1: 8.2 ↗ 2: 9.0 ↑ 3: 8.8 ↖ 4: 9.3 ↑ 5: 9.5 ←
		Serie 45 Total 0			Serie 43 Total 43
2. Serie 5 Skott		1: 8.6 ↑ 2: 8.9 ↑ 3: 9.0 ↑ 4: 8.9 ↑ 5: 9.3 ←	3. Serie 5 Skott		1: 10.3 ↘ 2: 9.7 ↘ 3: 9.7 ↑ 4: 9.9 → 5: 10.3 ↘
		Serie 42 Total 85			Serie 47 Total 132
Prov		1: 10.4 ↗ 2: 9.8 ↑ 3: 10.5x ↖	4. Serie 5 Skott		1: 8.0 ↑ 2: 9.9 ↘ 3: 9.7 ↘ 4: 9.8 → 5: 9.9 ↘
		Serie 29 Total 132			Serie 44 Total 176
5. Serie 5 Skott		1: 10.7x ↑ 2: 10.8x ↖ 3: 10.3 ↖ 4: 10.5x ↘ 5: 9.2 ↑			
		Serie 49 Total 225			

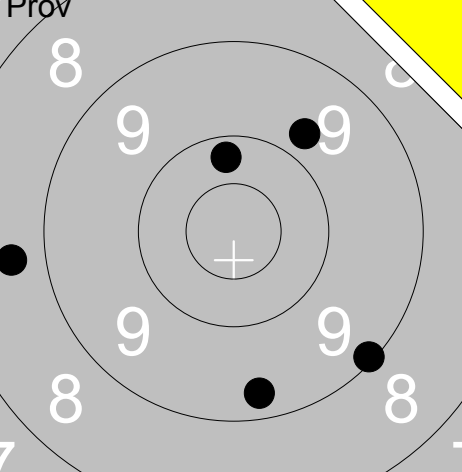
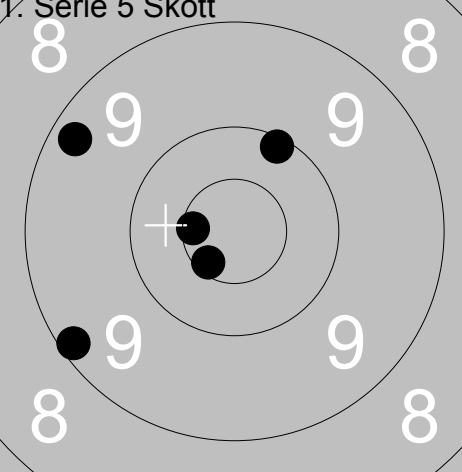
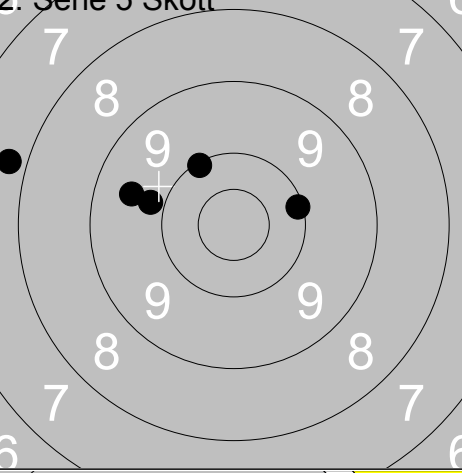
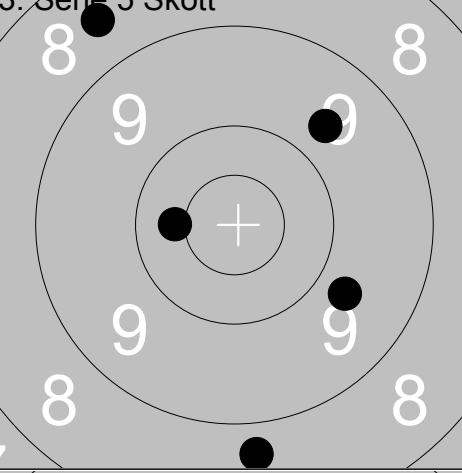
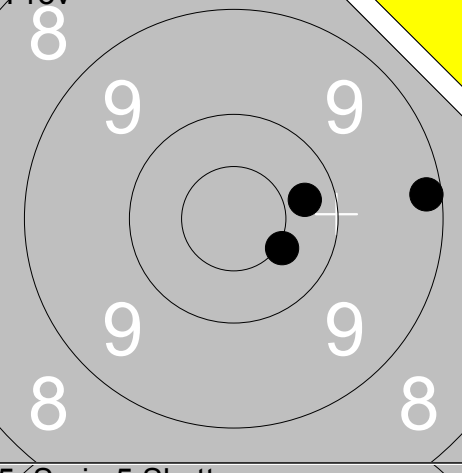
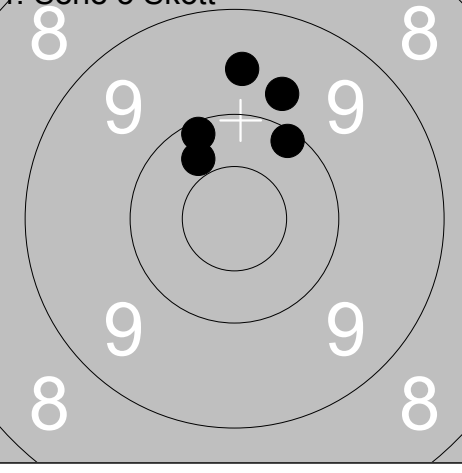
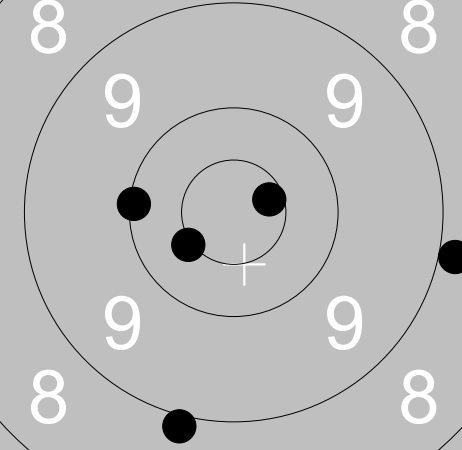
<p>Prov</p>  <p>7</p>	<p>1: 9.8 ↗ 2: 10.2 ↑ 3: 8.7 ← 4: 9.3 ↓ 5: 9.1 ↘</p> <p>Serie 45 Total 0</p>	<p>1. Serie 5 Skott</p>  <p>8</p> <p>1: 10.6x ← 2: 10.1 ↑ 3: 10.6x ↓ 4: 9.3 ↖ 5: 9.2 ↙</p> <p>Serie 48 Total 48</p>
<p>2. Serie 5 Skott</p>  <p>6</p>	<p>1: 10.1 ↑ 2: 9.5 ← 3: 10.1 → 4: 7.8 ← 5: 9.8 ←</p> <p>Serie 45 Total 93</p>	<p>3. Serie 5 Skott</p>  <p>8</p> <p>1: 9.7 ↘ 2: 8.7 ↓ 3: 9.7 ↗ 4: 10.4 ← 5: 8.6 ↖</p> <p>Serie 44 Total 137</p>
<p>Prov</p>  <p>8</p>	<p>1: 9.2 → 2: 10.4x ↘ 3: 10.3 →</p> <p>Serie 29 Total 137</p>	<p>4. Serie 5 Skott</p>  <p>8</p> <p>1: 10.1 ↖ 2: 10.1 ↗ 3: 10.3 ↖ 4: 9.6 ↑ 5: 9.8 ↑</p> <p>Serie 48 Total 185</p>
<p>5. Serie 5 Skott</p>  <p>8</p>	<p>1: 8.9 → 2: 10.5x ↙ 3: 10.6x → 4: 8.9 ↓ 5: 10.1 ←</p> <p>Serie 46 Total 231</p>	

Skjutlag	Tavla	Johan Nilsson			
1	16	Ramselefors	Ramselefors	Öpp	Vb
12.08.2017		SM Banskytte Liggande 2017	Ramselefors SKF		
Prov 	1: 6.8 ↖ 2: 8.4 ← 3: 9.9 ← 4: 10.7x ↖ 5: 8.7 ↙	1. Serie 5 Skott 	1: 7.8 ↖ 2: 9.9 ↓ 3: 9.9 → 4: 9.9 ← 5: 10.4x ↑	Serie 41 Total 0	Serie 44 Total 44
2. Serie 5 Skott 	1: 8.7 ↖ 2: 9.9 → 3: 9.8 ← 4: 10.5x ↓ 5: 8.0 ↙	3. Serie 5 Skott 	1: 9.2 ↖ 2: 10.6x ← 3: 9.8 ↓ 4: 9.3 ← 5: 9.6 ←	Serie 44 Total 88	Serie 46 Total 134
Prov 	1: 9.0 ↖ 2: 9.0 ← 3: 9.9 ↙	4. Serie 5 Skott 	1: 10.6x ← 2: 10.3 ↓ 3: 9.5 ↓ 4: 10.0 ↑ 5: 10.1 ↓	Serie 27 Total 134	Serie 49 Total 183
5. Serie 5 Skott 	1: 10.0 ↑ 2: 9.9 ↖ 3: 8.5 ↙ 4: 9.3 ↙ 5: 10.2 ←			Serie 46 Total 229	

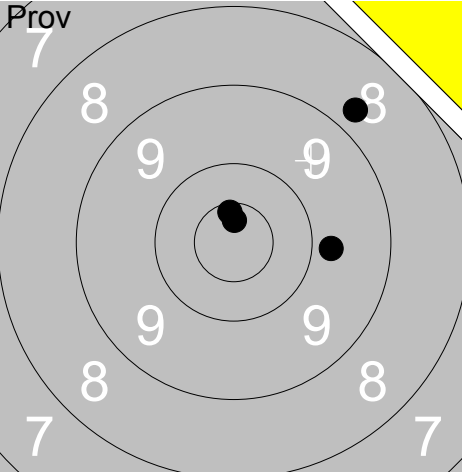
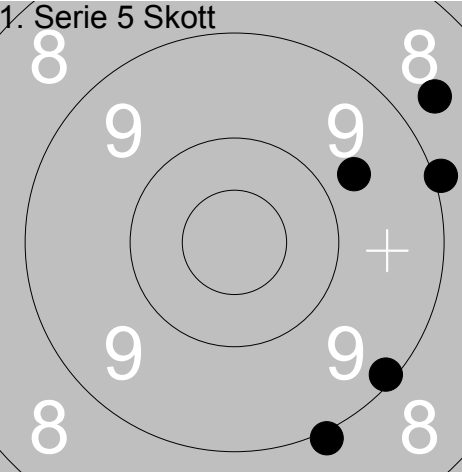
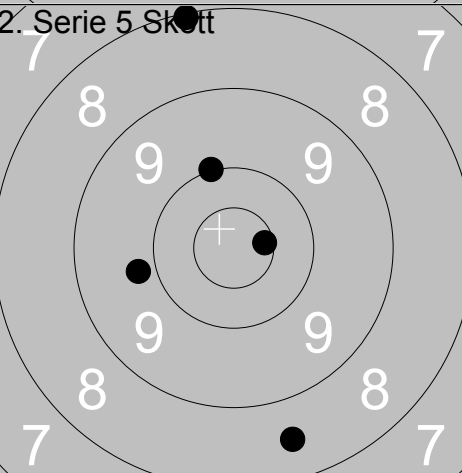
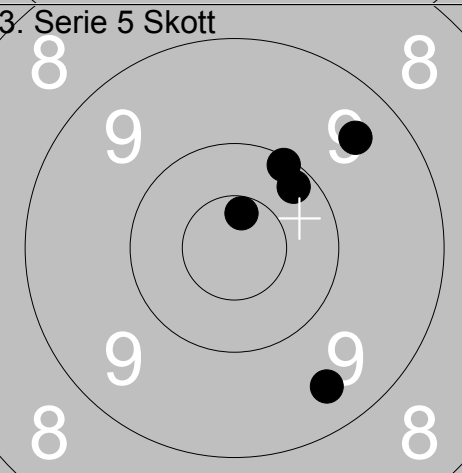
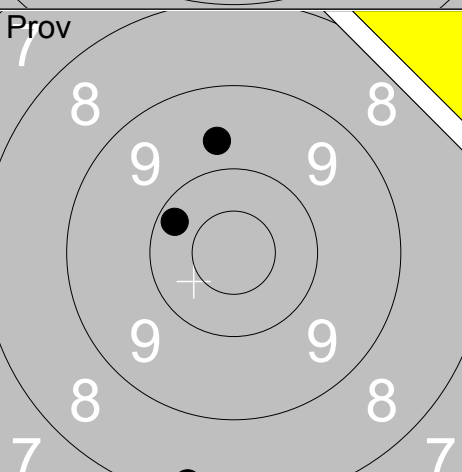
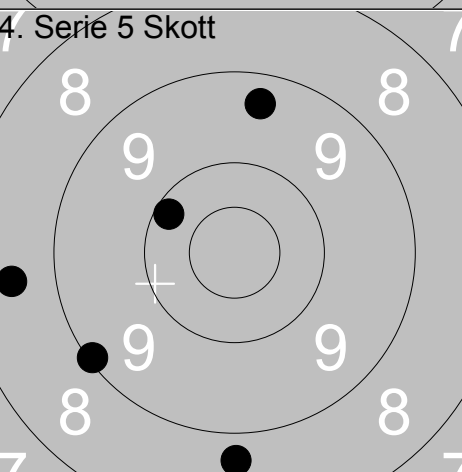
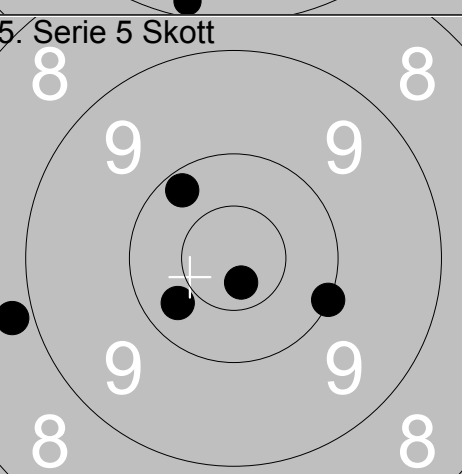
Skjutlag	Tavla	Jennifer Gustafsson			
1	21	Ramselefors	Ramselefors	Ung	Vb
12.08.2017	SM Banskytte Liggande 2017	Ramselefors SKF			
Prov 	1: 7.3 ↗ 2: 10.6x ↑ 3: 9.8 → 4: 8.7 ↗ 5: 10.7x ↑ Serie 44 Total 0	1. Serie 5 Skott 	1: 9.0 ↓ 2: 9.7 ↗ 3: 9.1 ↓ 4: 8.7 ↗ 5: 9.0 → Serie 44 Total 44		
2. Serie 5 Skott 	1: 8.5 ↓ 2: 10.6x → 3: 8.1 ↑ 4: 9.8 ← 5: 10.0 ↑ Serie 45 Total 89	3. Serie 5 Skott 	1: 9.4 ↓ 2: 10.1 ↑ 3: 10.2 ↗ 4: 9.5 ↗ 5: 10.6x ↑ Serie 48 Total 137		
Prov 	1: 10.2 ↖ 2: 9.7 ↑ 3: 8.2 ↓ Serie 27 Total 137	4. Serie 5 Skott 	1: 9.1 ↖ 2: 9.4 ↑ 3: 8.7 ↓ 4: 10.2 ↖ 5: 8.5 ← Serie 44 Total 181		
5. Serie 5 Skott 	1: 10.0 → 2: 10.3 ↖ 3: 10.2 ↗ 4: 8.8 ← 5: 10.7x ↓ Serie 48 Total 229				

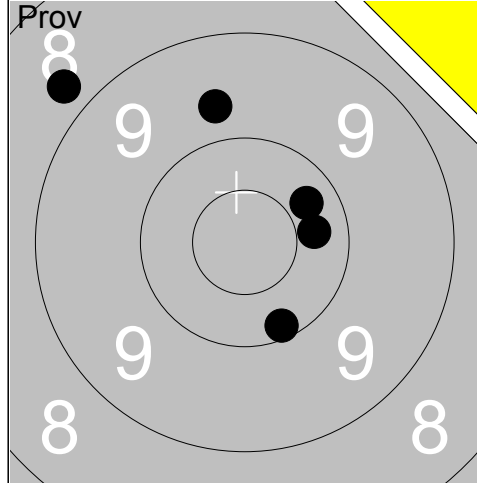

1:	8.8	↖
2:	10.3	→
3:	10.3	↗
4:	9.7	↖
5:	10.1	↘
Serie		47
Total		0

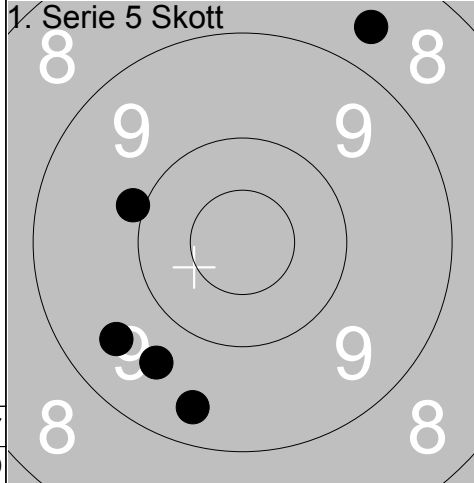

1:	8.6	↖
2:	9.6	↘
3:	9.5	↘
4:	9.9	↖
5:	9.4	↘
Serie		44
Total		44

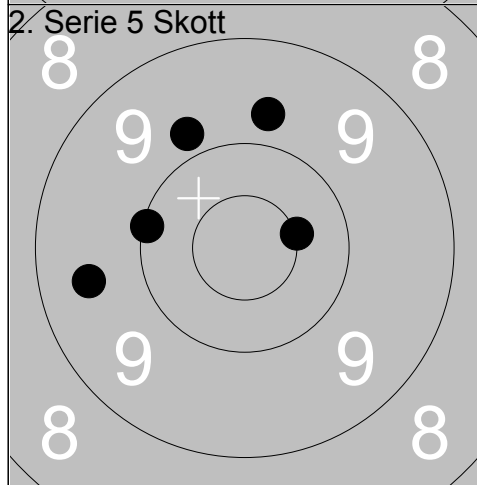

1:	9.7	↖
2:	9.8	↖
3:	9.5	↖
4:	10.1	↖
5:	10.5x	→
Serie		47
Total		91

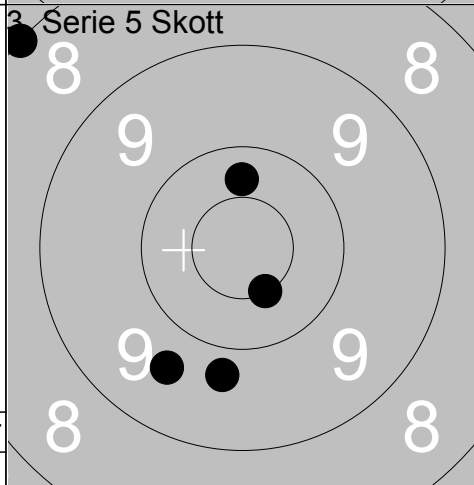

1:	8.0	↖
2:	9.6	↘
3:	10.5x	↘
4:	10.3	↖
5:	9.8	↘
Serie		46
Total		137

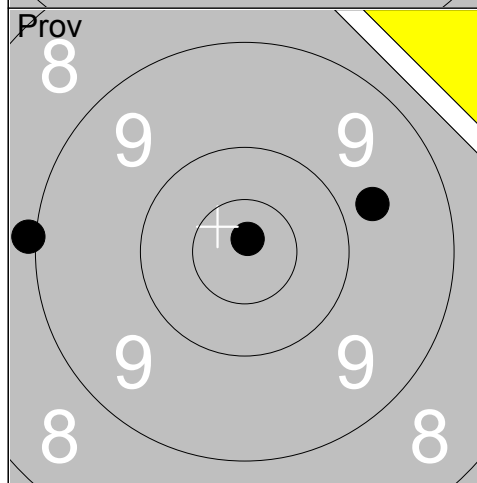

1:	9.0	↖
2:	10.8x	↖
3:	9.7	→
Serie		28
Total		137

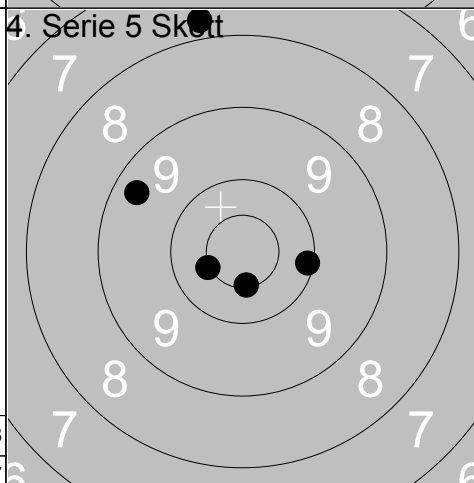

1:	7.8	↖
2:	10.5x	↖
3:	9.3	↖
4:	10.5x	↘
5:	10.1	→
Serie		46
Total		183

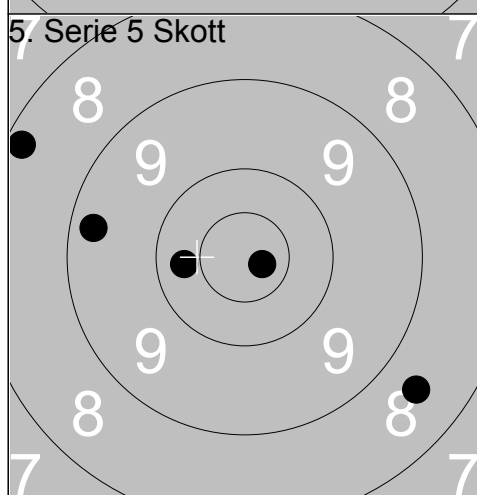

1:	8.2	↖
2:	10.3	↖
3:	9.3	↖
4:	10.8x	↘
5:	8.6	↘
Serie		45
Total		228

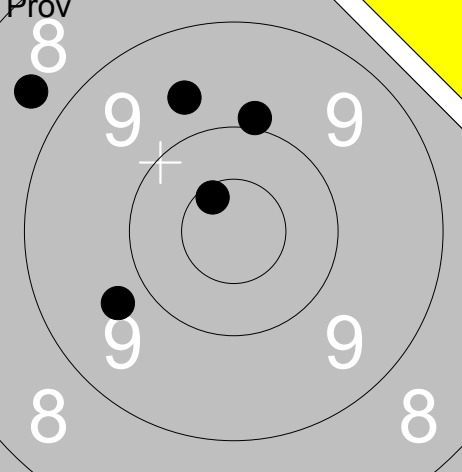
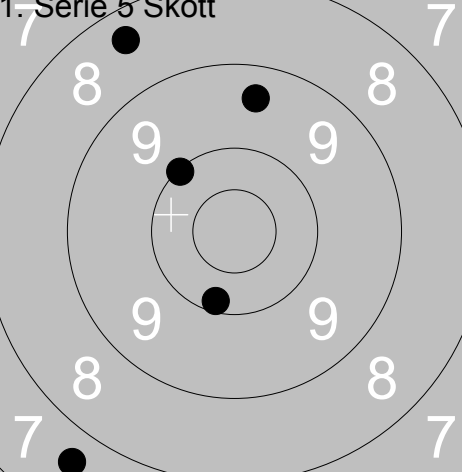
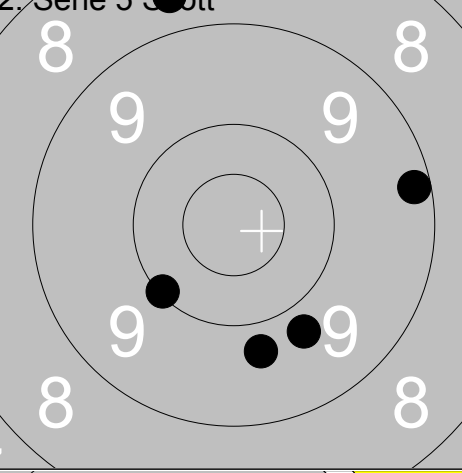
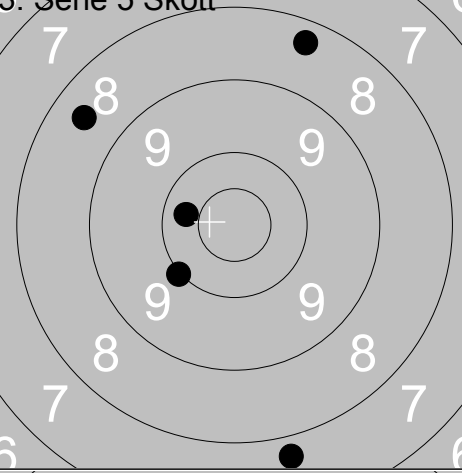
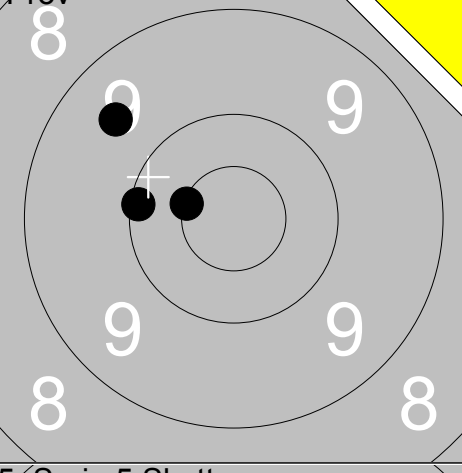
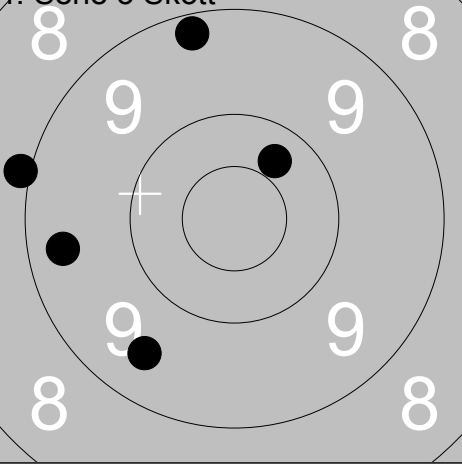
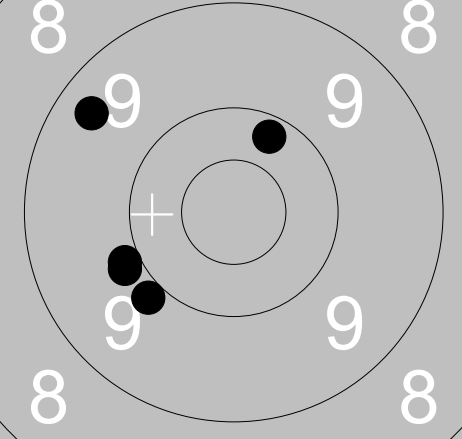
<p>Prov</p> 	<table border="1" style="width:100%; border-collapse: collapse;"> <tr><td>1:</td><td>9.9</td><td>↑</td></tr> <tr><td>2:</td><td>9.7</td><td>↑</td></tr> <tr><td>3:</td><td>8.7</td><td>↗</td></tr> <tr><td>4:</td><td>9.7</td><td>↖</td></tr> <tr><td>5:</td><td>10.6x</td><td>↗</td></tr> <tr><td colspan="2">Serie</td><td>45</td></tr> <tr><td colspan="2">Total</td><td>0</td></tr> </table>	1:	9.9	↑	2:	9.7	↑	3:	8.7	↗	4:	9.7	↖	5:	10.6x	↗	Serie		45	Total		0	<p>1. Serie 5 Skott</p> 	<table border="1" style="width:100%; border-collapse: collapse;"> <tr><td>1:</td><td>9.4</td><td>↑</td></tr> <tr><td>2:</td><td>10.0</td><td>↖</td></tr> <tr><td>3:</td><td>10.1</td><td>↓</td></tr> <tr><td>4:</td><td>7.7</td><td>↖</td></tr> <tr><td>5:</td><td>8.4</td><td>↗</td></tr> <tr><td colspan="2">Serie</td><td>44</td></tr> <tr><td colspan="2">Total</td><td>44</td></tr> </table>	1:	9.4	↑	2:	10.0	↖	3:	10.1	↓	4:	7.7	↖	5:	8.4	↗	Serie		44	Total		44
1:	9.9	↑																																											
2:	9.7	↑																																											
3:	8.7	↗																																											
4:	9.7	↖																																											
5:	10.6x	↗																																											
Serie		45																																											
Total		0																																											
1:	9.4	↑																																											
2:	10.0	↖																																											
3:	10.1	↓																																											
4:	7.7	↖																																											
5:	8.4	↗																																											
Serie		44																																											
Total		44																																											
<p>2. Serie 5 Skott</p> 	<table border="1" style="width:100%; border-collapse: collapse;"> <tr><td>1:</td><td>9.7</td><td>↓</td></tr> <tr><td>2:</td><td>9.8</td><td>↓</td></tr> <tr><td>3:</td><td>8.7</td><td>↗</td></tr> <tr><td>4:</td><td>9.2</td><td>→</td></tr> <tr><td>5:</td><td>10.1</td><td>↖</td></tr> <tr><td colspan="2">Serie</td><td>45</td></tr> <tr><td colspan="2">Total</td><td>89</td></tr> </table>	1:	9.7	↓	2:	9.8	↓	3:	8.7	↗	4:	9.2	→	5:	10.1	↖	Serie		45	Total		89	<p>3. Serie 5 Skott</p> 	<table border="1" style="width:100%; border-collapse: collapse;"> <tr><td>1:</td><td>8.3</td><td>↑</td></tr> <tr><td>2:</td><td>10.3</td><td>←</td></tr> <tr><td>3:</td><td>10.0</td><td>↖</td></tr> <tr><td>4:</td><td>8.5</td><td>↗</td></tr> <tr><td>5:</td><td>7.7</td><td>↓</td></tr> <tr><td colspan="2">Serie</td><td>43</td></tr> <tr><td colspan="2">Total</td><td>132</td></tr> </table>	1:	8.3	↑	2:	10.3	←	3:	10.0	↖	4:	8.5	↗	5:	7.7	↓	Serie		43	Total		132
1:	9.7	↓																																											
2:	9.8	↓																																											
3:	8.7	↗																																											
4:	9.2	→																																											
5:	10.1	↖																																											
Serie		45																																											
Total		89																																											
1:	8.3	↑																																											
2:	10.3	←																																											
3:	10.0	↖																																											
4:	8.5	↗																																											
5:	7.7	↓																																											
Serie		43																																											
Total		132																																											
<p>Prov</p> 	<table border="1" style="width:100%; border-collapse: collapse;"> <tr><td>1:</td><td>10.1</td><td>←</td></tr> <tr><td>2:</td><td>10.5x</td><td>←</td></tr> <tr><td>3:</td><td>9.6</td><td>↗</td></tr> <tr><td colspan="2">Serie</td><td>29</td></tr> <tr><td colspan="2">Total</td><td>132</td></tr> </table>	1:	10.1	←	2:	10.5x	←	3:	9.6	↗	Serie		29	Total		132	<p>4. Serie 5 Skott</p> 	<table border="1" style="width:100%; border-collapse: collapse;"> <tr><td>1:</td><td>9.2</td><td>↑</td></tr> <tr><td>2:</td><td>8.9</td><td>←</td></tr> <tr><td>3:</td><td>10.3</td><td>↗</td></tr> <tr><td>4:</td><td>9.5</td><td>↖</td></tr> <tr><td>5:</td><td>9.4</td><td>←</td></tr> <tr><td colspan="2">Serie</td><td>45</td></tr> <tr><td colspan="2">Total</td><td>177</td></tr> </table>	1:	9.2	↑	2:	8.9	←	3:	10.3	↗	4:	9.5	↖	5:	9.4	←	Serie		45	Total		177						
1:	10.1	←																																											
2:	10.5x	←																																											
3:	9.6	↗																																											
Serie		29																																											
Total		132																																											
1:	9.2	↑																																											
2:	8.9	←																																											
3:	10.3	↗																																											
4:	9.5	↖																																											
5:	9.4	←																																											
Serie		45																																											
Total		177																																											
<p>5. Serie 5 Skott</p> 	<table border="1" style="width:100%; border-collapse: collapse;"> <tr><td>1:</td><td>10.2</td><td>↑</td></tr> <tr><td>2:</td><td>9.4</td><td>↖</td></tr> <tr><td>3:</td><td>9.9</td><td>↖</td></tr> <tr><td>4:</td><td>9.9</td><td>↖</td></tr> <tr><td>5:</td><td>9.9</td><td>↖</td></tr> <tr><td colspan="2">Serie</td><td>46</td></tr> <tr><td colspan="2">Total</td><td>223</td></tr> </table>	1:	10.2	↑	2:	9.4	↖	3:	9.9	↖	4:	9.9	↖	5:	9.9	↖	Serie		46	Total		223																							
1:	10.2	↑																																											
2:	9.4	↖																																											
3:	9.9	↖																																											
4:	9.9	↖																																											
5:	9.9	↖																																											
Serie		46																																											
Total		223																																											

Skjutlag 2	Tavla 3	Ulf Ohlsson			
Ramselefors		Umeå		Öpp	Vb
12.08.2017		SM Banskytte Liggande 2017		Ramselefors SKF	
Prov		1: 8.7 → 2: 9.9 → 3: 9.2 → 4: 8.9 ← 5: 9.7 ↓	1. Serie 5 Skott		1: 10.2 ↓ 2: 10.6x ↖ 3: 9.7 ↖ 4: 10.0 ← 5: 10.2 ↗
		Serie 43 Total 0			Serie 49 Total 49
2. Serie 5 Skott		1: 9.3 → 2: 10.3 ↓ 3: 10.5x → 4: 9.2 → 5: 9.5 ↘	3. Serie 5 Skott		1: 9.6 ← 2: 10.8x ← 3: 10.0 ↘ 4: 10.6x ↗ 5: 10.1 ↗
		Serie 47 Total 96			Serie 49 Total 145
Prov		1: 10.2 ← 2: 10.3 ← 3: 10.2 ←	4. Serie 5 Skott		1: 9.5 ↑ 2: 9.4 → 3: 10.5x ← 4: 9.7 ↓ 5: 9.5 ↓
		Serie 30 Total 145			Serie 46 Total 191
5. Serie 5 Skott		1: 9.6 ← 2: 10.4x ← 3: 9.6 ↓ 4: 9.4 ↓ 5: 10.1 →			
		Serie 47 Total 238			

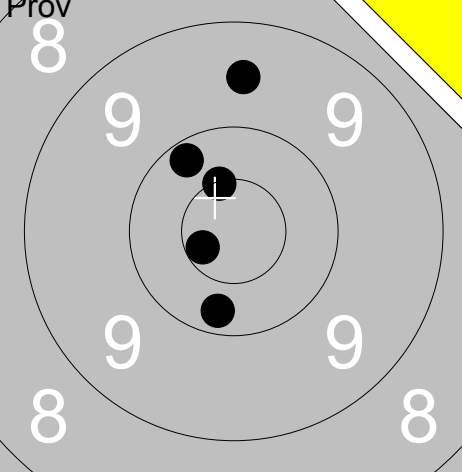
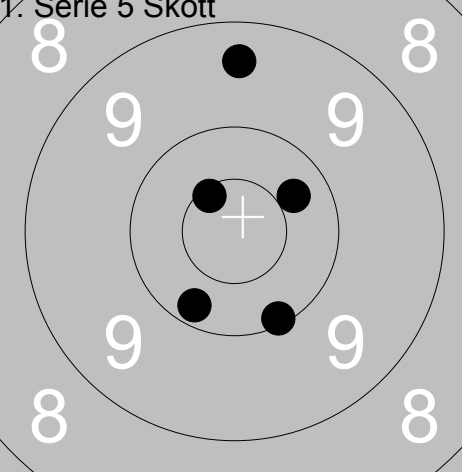
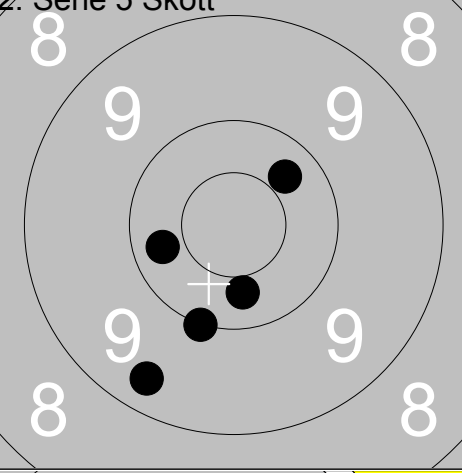
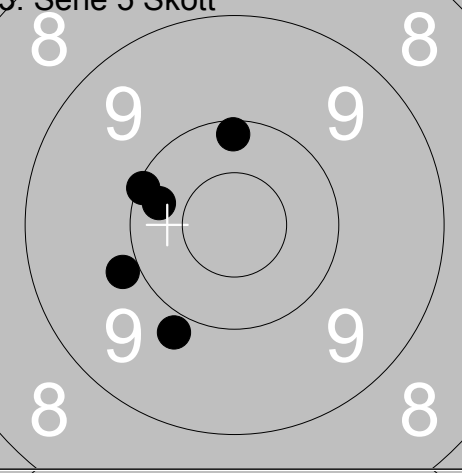
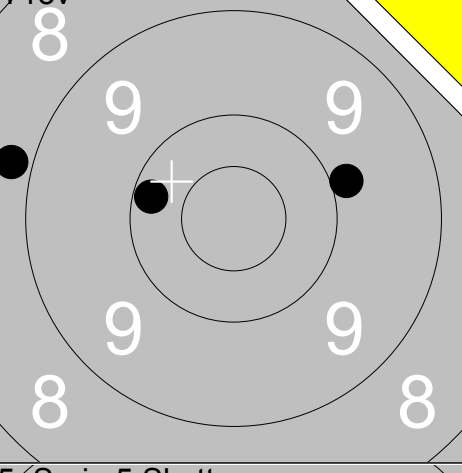
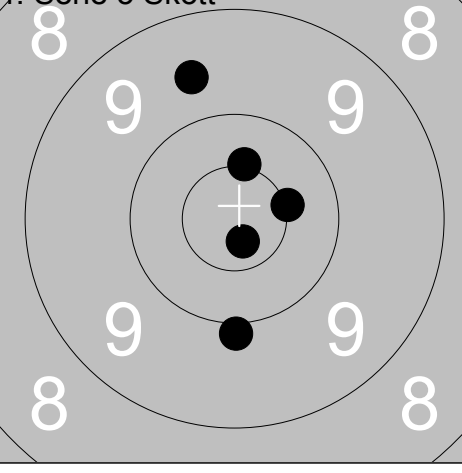
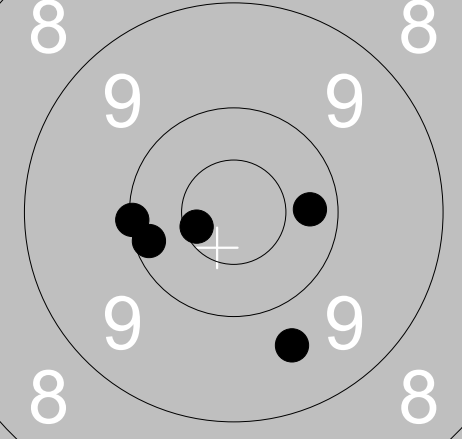
<p>Prov</p> 	<p>1: 10.6x ↙ 2: 9.6 ↑ 3: 10.5x ↑ 4: 10.2 ↖ 5: 10.2 ↓</p> <p>Serie 49 Total 0</p>	<p>1. Serie 5 Skott</p> 	<p>1: 9.4 ↑ 2: 10.1 ↓ 3: 10.6x ↖ 4: 10.2 ↓ 5: 10.3 ↗</p> <p>Serie 49 Total 49</p>
<p>2. Serie 5 Skott</p> 	<p>1: 10.3 ↗ 2: 9.3 ↓ 3: 10.3 ↓ 4: 10.3 ← 5: 10.0 ↓</p> <p>Serie 49 Total 98</p>	<p>3. Serie 5 Skott</p> 	<p>1: 10.1 ← 2: 10.1 ↑ 3: 10.3 ← 4: 9.9 ↓ 5: 9.9 ←</p> <p>Serie 48 Total 146</p>
<p>Prov</p> 	<p>1: 8.8 ← 2: 10.2 ← 3: 9.9 →</p> <p>Serie 27 Total 146</p>	<p>4. Serie 5 Skott</p> 	<p>1: 10.7x ↓ 2: 10.5x → 3: 9.9 ↓ 4: 10.5x ↑ 5: 9.6 ↑</p> <p>Serie 48 Total 194</p>
<p>5. Serie 5 Skott</p> 	<p>1: 10.1 ← 2: 10.3 → 3: 9.6 ↓ 4: 10.2 ← 5: 10.6x ←</p> <p>Serie 49 Total 243</p>		

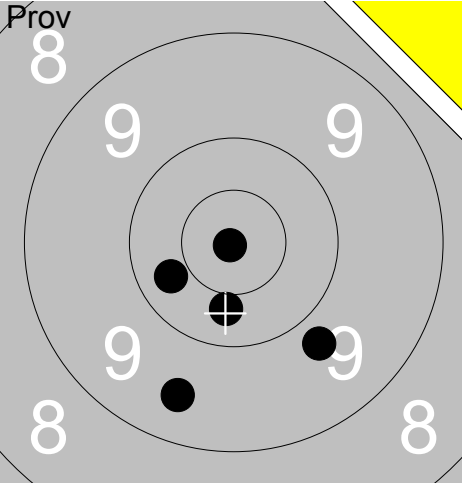
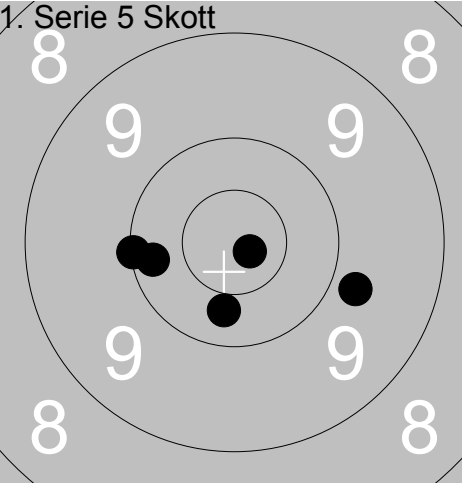
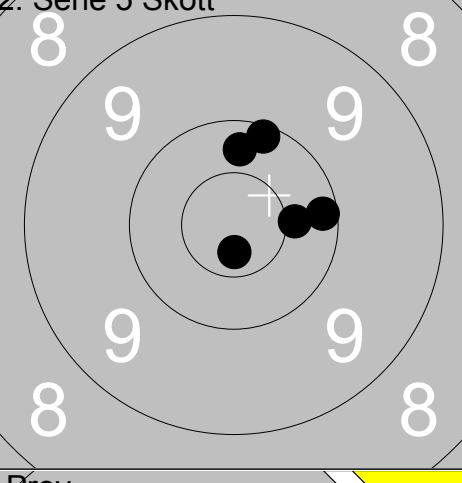
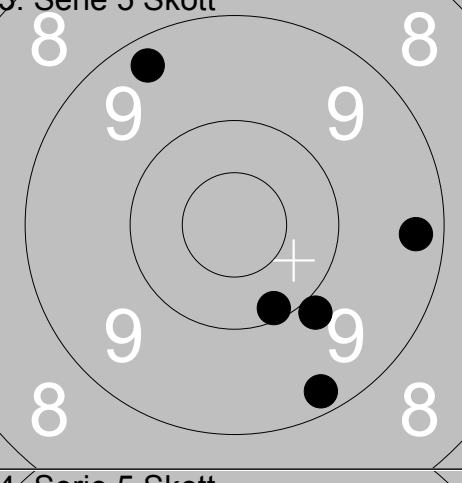
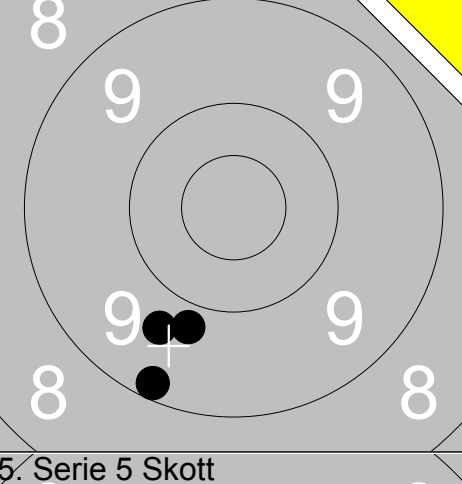
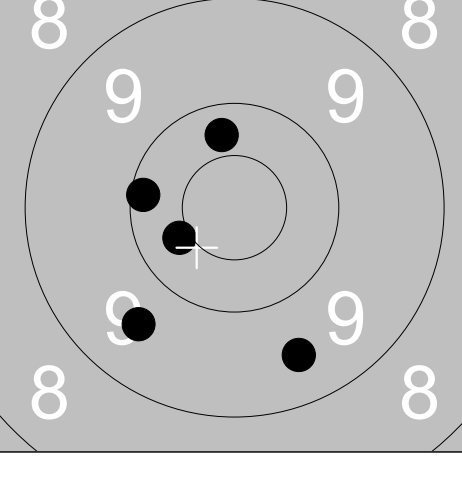
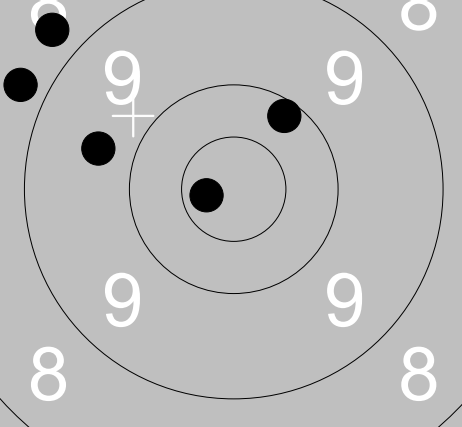
Skjutlag	Tavla	Marlene Forsell Forsman		
2	5	Ramselefors	Ramselefors	Öpp
12.08.2017	SM Banskytte Liggande 2017	Ramselefors SKF		
Prov 	1: 10.9x ↙ 2: 9.5 ↓ 3: 10.3 ↙ 4: 10.4 ↓ 5: 9.8 ↘	1. Serie 5 Skott 	1: 10.2 ← 2: 10.8x ↘ 3: 9.8 → 4: 10.1 ← 5: 10.3 ↓	
	Serie 48 Total 0		Serie 49 Total 49	
2. Serie 5 Skott 	1: 10.1 ↑ 2: 10.7x ↓ 3: 10.2 → 4: 10.4 → 5: 10.3 ↑	3. Serie 5 Skott 	1: 9.3 ↗ 2: 9.9 ↘ 3: 9.3 → 4: 9.2 ↘ 5: 10.1 ↘	
	Serie 50 Total 99		Serie 46 Total 145	
Prov 	1: 9.2 ↓ 2: 9.8 ↓ 3: 9.7 ↓	4. Serie 5 Skott 	1: 10.3 ↗ 2: 9.6 ↙ 3: 9.5 ↘ 4: 10.1 ← 5: 10.4 ←	
	Serie 27 Total 145		Serie 48 Total 193	
5. Serie 5 Skott 	1: 8.8 ↗ 2: 8.7 ↗ 3: 10.7x ← 4: 9.7 ↙ 5: 10.2 ↗			
	Serie 45 Total 238			

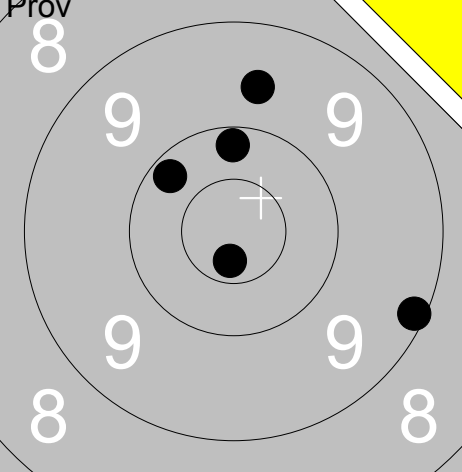
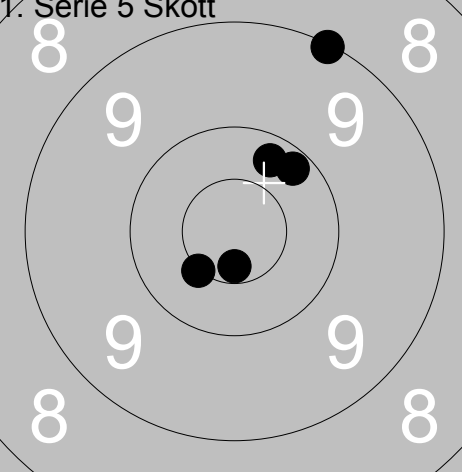
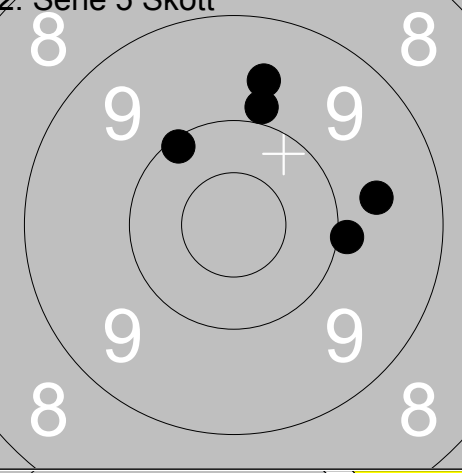
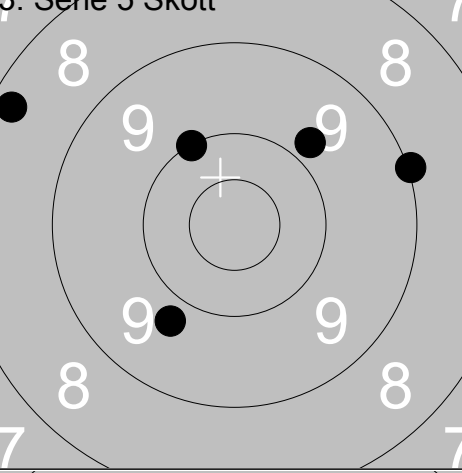
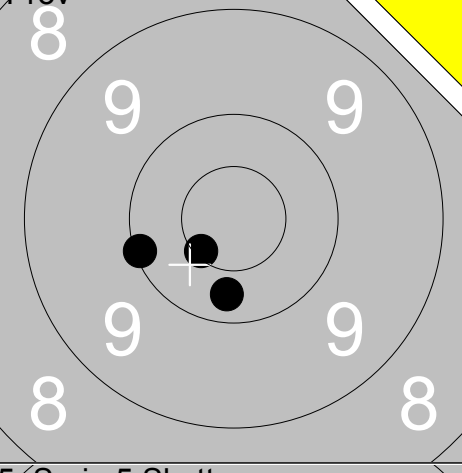
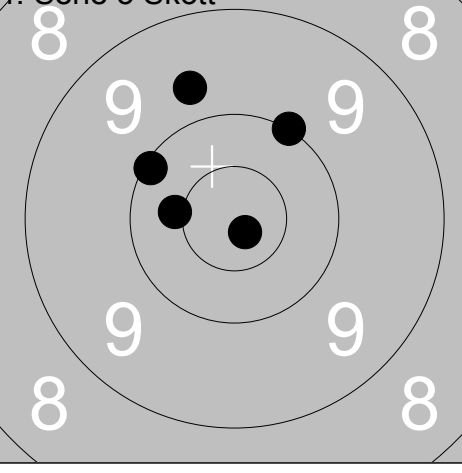
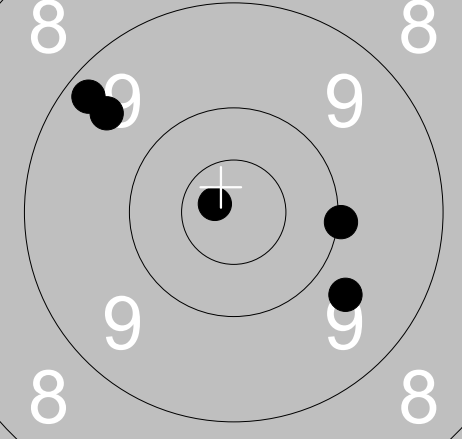
<p>Prov</p> 	<table border="1" style="width:100%; border-collapse: collapse;"> <tr><td>1:</td><td>10.7x</td><td>↓</td></tr> <tr><td>2:</td><td>9.1</td><td>→</td></tr> <tr><td>3:</td><td>9.6</td><td>↑</td></tr> <tr><td>4:</td><td>10.2</td><td>↑</td></tr> <tr><td>5:</td><td>10.2</td><td>↗</td></tr> <tr><td colspan="2">Serie</td><td>48</td></tr> <tr><td colspan="2">Total</td><td>0</td></tr> </table>	1:	10.7x	↓	2:	9.1	→	3:	9.6	↑	4:	10.2	↑	5:	10.2	↗	Serie		48	Total		0	<p>1. Serie 5 Skott</p> 	<table border="1" style="width:100%; border-collapse: collapse;"> <tr><td>1:</td><td>9.1</td><td>↗</td></tr> <tr><td>2:</td><td>10.2</td><td>↗</td></tr> <tr><td>3:</td><td>10.2</td><td>↗</td></tr> <tr><td>4:</td><td>10.5x</td><td>↙</td></tr> <tr><td>5:</td><td>10.6x</td><td>↓</td></tr> <tr><td colspan="2">Serie</td><td>49</td></tr> <tr><td colspan="2">Total</td><td>49</td></tr> </table>	1:	9.1	↗	2:	10.2	↗	3:	10.2	↗	4:	10.5x	↙	5:	10.6x	↓	Serie		49	Total		49
1:	10.7x	↓																																											
2:	9.1	→																																											
3:	9.6	↑																																											
4:	10.2	↑																																											
5:	10.2	↗																																											
Serie		48																																											
Total		0																																											
1:	9.1	↗																																											
2:	10.2	↗																																											
3:	10.2	↗																																											
4:	10.5x	↙																																											
5:	10.6x	↓																																											
Serie		49																																											
Total		49																																											
<p>2. Serie 5 Skott</p> 	<table border="1" style="width:100%; border-collapse: collapse;"> <tr><td>1:</td><td>9.6</td><td>→</td></tr> <tr><td>2:</td><td>9.9</td><td>↑</td></tr> <tr><td>3:</td><td>10.1</td><td>↗</td></tr> <tr><td>4:</td><td>9.6</td><td>↑</td></tr> <tr><td>5:</td><td>9.9</td><td>→</td></tr> <tr><td colspan="2">Serie</td><td>46</td></tr> <tr><td colspan="2">Total</td><td>95</td></tr> </table>	1:	9.6	→	2:	9.9	↑	3:	10.1	↗	4:	9.6	↑	5:	9.9	→	Serie		46	Total		95	<p>3. Serie 5 Skott</p> 	<table border="1" style="width:100%; border-collapse: collapse;"> <tr><td>1:</td><td>9.8</td><td>↙</td></tr> <tr><td>2:</td><td>9.8</td><td>↗</td></tr> <tr><td>3:</td><td>10.0</td><td>↗</td></tr> <tr><td>4:</td><td>8.3</td><td>↗</td></tr> <tr><td>5:</td><td>9.0</td><td>→</td></tr> <tr><td colspan="2">Serie</td><td>45</td></tr> <tr><td colspan="2">Total</td><td>140</td></tr> </table>	1:	9.8	↙	2:	9.8	↗	3:	10.0	↗	4:	8.3	↗	5:	9.0	→	Serie		45	Total		140
1:	9.6	→																																											
2:	9.9	↑																																											
3:	10.1	↗																																											
4:	9.6	↑																																											
5:	9.9	→																																											
Serie		46																																											
Total		95																																											
1:	9.8	↙																																											
2:	9.8	↗																																											
3:	10.0	↗																																											
4:	8.3	↗																																											
5:	9.0	→																																											
Serie		45																																											
Total		140																																											
<p>Prov</p> 	<table border="1" style="width:100%; border-collapse: collapse;"> <tr><td>1:</td><td>10.1</td><td>↙</td></tr> <tr><td>2:</td><td>10.3</td><td>↓</td></tr> <tr><td>3:</td><td>10.5x</td><td>↙</td></tr> <tr><td colspan="2">Serie</td><td>30</td></tr> <tr><td colspan="2">Total</td><td>140</td></tr> </table>	1:	10.1	↙	2:	10.3	↓	3:	10.5x	↙	Serie		30	Total		140	<p>4. Serie 5 Skott</p> 	<table border="1" style="width:100%; border-collapse: collapse;"> <tr><td>1:</td><td>10.0</td><td>↗</td></tr> <tr><td>2:</td><td>10.4x</td><td>←</td></tr> <tr><td>3:</td><td>10.8x</td><td>↙</td></tr> <tr><td>4:</td><td>9.7</td><td>↗</td></tr> <tr><td>5:</td><td>10.1</td><td>↗</td></tr> <tr><td colspan="2">Serie</td><td>49</td></tr> <tr><td colspan="2">Total</td><td>189</td></tr> </table>	1:	10.0	↗	2:	10.4x	←	3:	10.8x	↙	4:	9.7	↗	5:	10.1	↗	Serie		49	Total		189						
1:	10.1	↙																																											
2:	10.3	↓																																											
3:	10.5x	↙																																											
Serie		30																																											
Total		140																																											
1:	10.0	↗																																											
2:	10.4x	←																																											
3:	10.8x	↙																																											
4:	9.7	↗																																											
5:	10.1	↗																																											
Serie		49																																											
Total		189																																											
<p>5. Serie 5 Skott</p> 	<table border="1" style="width:100%; border-collapse: collapse;"> <tr><td>1:</td><td>9.3</td><td>↗</td></tr> <tr><td>2:</td><td>9.7</td><td>↙</td></tr> <tr><td>3:</td><td>9.5</td><td>↗</td></tr> <tr><td>4:</td><td>10.0</td><td>→</td></tr> <tr><td>5:</td><td>10.8x</td><td>↗</td></tr> <tr><td colspan="2">Serie</td><td>47</td></tr> <tr><td colspan="2">Total</td><td>236</td></tr> </table>	1:	9.3	↗	2:	9.7	↙	3:	9.5	↗	4:	10.0	→	5:	10.8x	↗	Serie		47	Total		236																							
1:	9.3	↗																																											
2:	9.7	↙																																											
3:	9.5	↗																																											
4:	10.0	→																																											
5:	10.8x	↗																																											
Serie		47																																											
Total		236																																											

Skjutlag	Tavla	Lars Evaldsson			
2	7	Ramselefors	Göteborg	Vet	Vs
12.08.2017		SM Banskytte Liggande 2017	Ramselefors SKF		
Prov		1: 10.1 ↑ 2: 9.8 ↑ 3: 10.2 → 4: 10.3 ↓ 5: 9.5 ↓	1. Serie 5 Skott		1: 10.0 ← 2: 10.0 → 3: 10.6x ← 4: 10.1 ← 5: 10.4x ↑
		Serie 48 Total 0			Serie 50 Total 50
2. Serie 5 Skott		1: 10.0 ↑ 2: 9.5 ↑ 3: 10.2 ↑ 4: 9.2 → 5: 9.2 ↓	3. Serie 5 Skott		1: 10.6x → 2: 10.6x ↓ 3: 7.8 → 4: 9.9 → 5: 9.6 ↓
		Serie 47 Total 97			Serie 45 Total 142
Prov		1: 8.8 ↑ 2: 8.5 ↓ 3: 9.9 ↓	4. Serie 5 Skott		1: 9.9 ↗ 2: 9.1 ↑ 3: 10.2 ↓ 4: 8.8 ↗ 5: 10.7x ↑
		Serie 25 Total 142			Serie 46 Total 188
5. Serie 5 Skott		1: 7.8 ↗ 2: 10.1 ↑ 3: 9.6 ↑ 4: 10.0 ↗ 5: 10.8x ↗			
		Serie 46 Total 234			

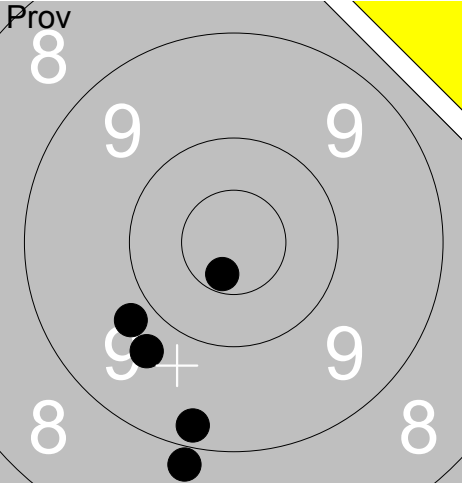
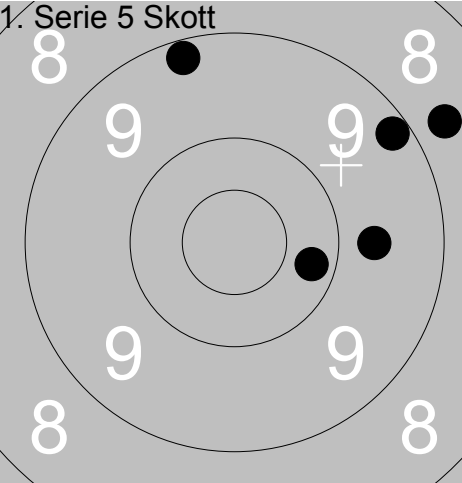
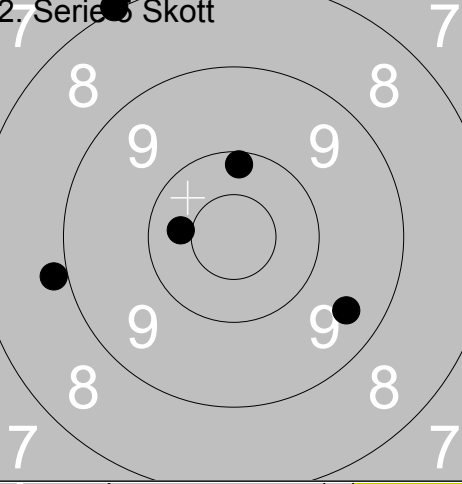
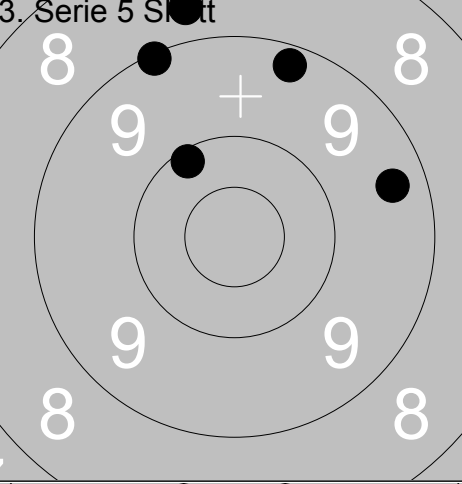
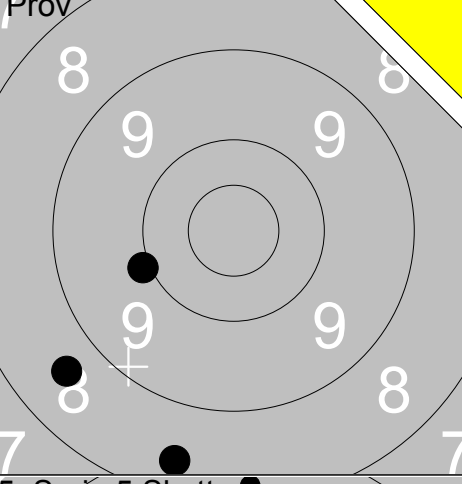
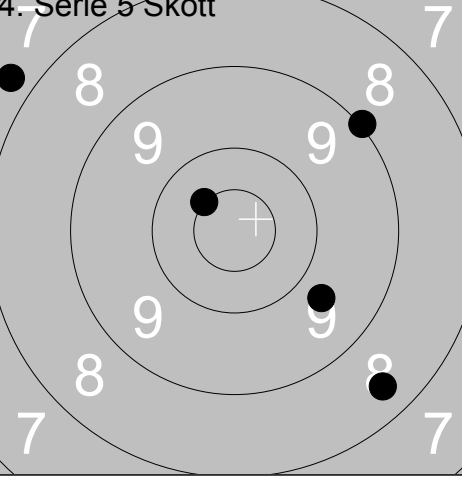
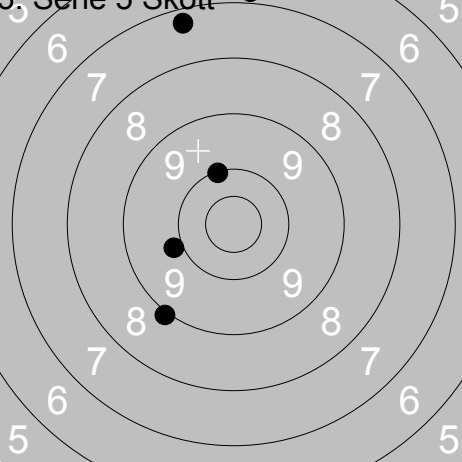
Skjutlag 2	Tavla 8	Anders Andersson			
Ramselefors		Hammerdal		Öpp	Jä
12.08.2017		SM Banskytte Liggande 2017		Ramselefors SKF	
Prov 8		1: 8.9 ↓ 2: 9.8 ← 3: 10.7x ↓ 4: 9.2 ↓ 5: 9.7 ↓	1. Serie 5 Skott 	1: 10.2 → 2: 9.2 ↑ 3: 9.2 ↗ 4: 9.7 → 5: 8.7 ↗	
		Serie 45 Total 0		Serie 45 Total 45	
2. Serie 5 Skott 7		1: 8.9 ← 2: 8.0 ↑ 3: 10.4 ← 4: 9.5 ↘ 5: 10.2 ↑	3. Serie 5 Skott 	1: 8.7 ↑ 2: 9.4 → 3: 9.2 ↑ 4: 10.1 ↑ 5: 9.1 ↑	
		Serie 45 Total 90		Serie 45 Total 135	
Prov 8		1: 8.4 ↓ 2: 9.9 ← 3: 8.6 ↓	4. Serie 5 Skott 	1: 9.7 ↘ 2: 8.4 ↘ 3: 9.0 ↗ 4: 7.7 ↑ 5: 10.5x ↑	
		Serie 25 Total 135		Serie 43 Total 178	
5. Serie 5 Skott 5		1: 9.0 ↓ 2: 10.1 ↑ 3: 9.9 ← 4: 6.8 ↑ 5: 7.3 ↑			
		Serie 41 Total 219			

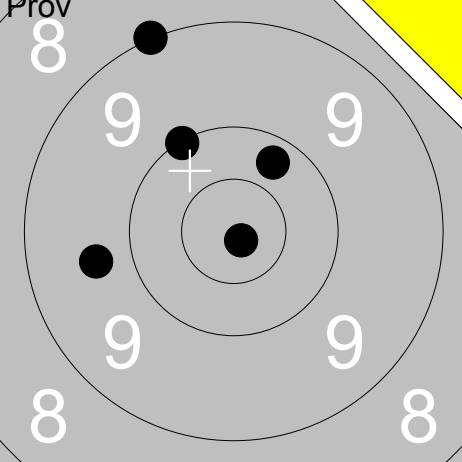
<p>Prov</p> 	<p>1: 9.7 ←</p> <p>2: 9.0 ↗</p> <p>3: 10.0 ↗</p> <p>4: 10.2 ↗</p> <p>5: 10.8x ↘</p>	<p>1. Serie 5 Skott</p> 	<p>1: 10.1 ↗</p> <p>2: 9.5 ↗</p> <p>3: 9.4 ↗</p> <p>4: 9.9 ↘</p> <p>5: 9.4 ↘</p>
Serie 48	Total 0	Serie 46	Total 46

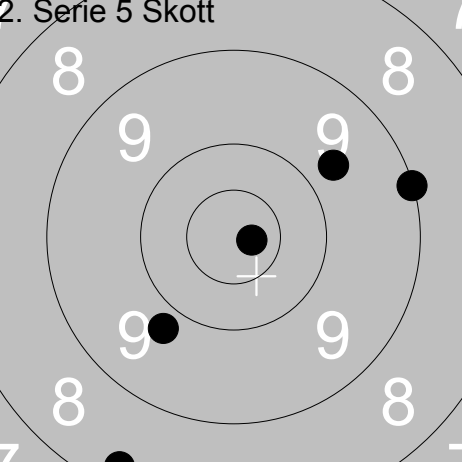
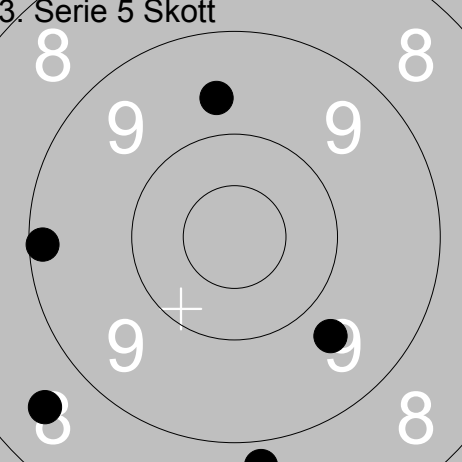
<p>2. Serie 5 Skott</p> 	<p>1: 8.3 ↘</p> <p>2: 10.8x →</p> <p>3: 9.7 ↗</p> <p>4: 9.0 →</p> <p>5: 9.8 ↘</p>	<p>3. Serie 5 Skott</p> 	<p>1: 8.8 ↘</p> <p>2: 9.7 ↘</p> <p>3: 8.6 ↘</p> <p>4: 9.2 ←</p> <p>5: 9.7 ↗</p>
Serie 45	Total 91	Serie 43	Total 134

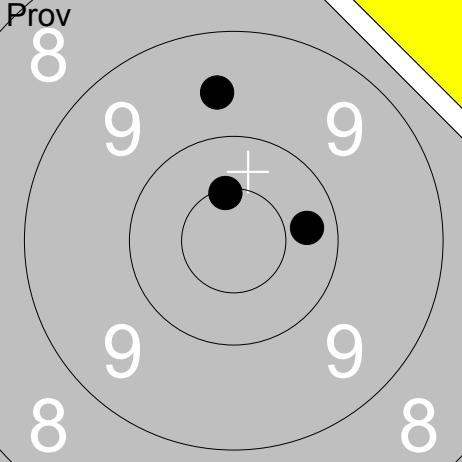
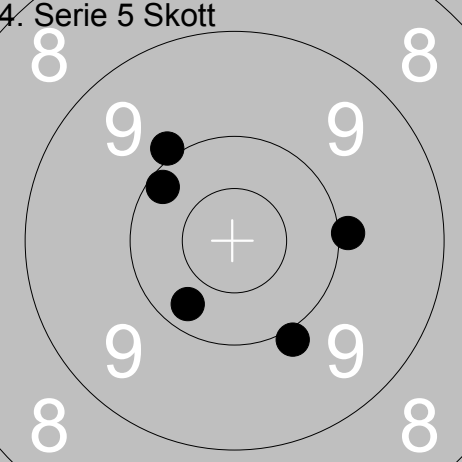
<p>Prov</p> 	<p>1: 10.5x ↗</p> <p>2: 10.3 →</p> <p>3: 9.6 ↗</p>	<p>4. Serie 5 Skott</p> 	<p>1: 9.9 ↘</p> <p>2: 9.9 →</p> <p>3: 9.9 ↗</p> <p>4: 10.2 ↗</p> <p>5: 10.2 ↘</p>
Serie 29	Total 134	Serie 47	Total 181

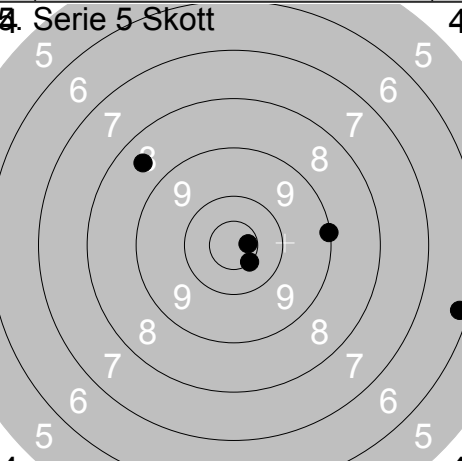
<p>4. Serie 5 Skott</p> 	<p>1: 8.5 ↗</p> <p>2: 10.7x →</p> <p>3: 10.5x ↘</p> <p>4: 9.1 →</p> <p>5: 6.2 ↘</p>		
Serie 43	Total 224		

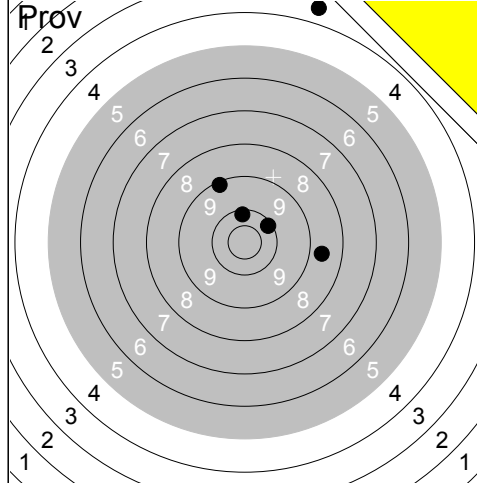

1:	8.7	→
2:	10.1	↗
3:	10.2	↑
4:	9.1	↖
5:	3.5	↑
Serie		40
Total		0

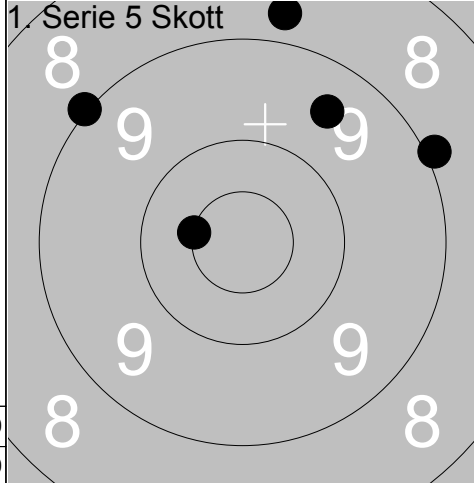

1:	9.5	↗
2:	8.7	↑
3:	8.9	↗
4:	9.0	↖
5:	10.5x	←
Serie		44
Total		44

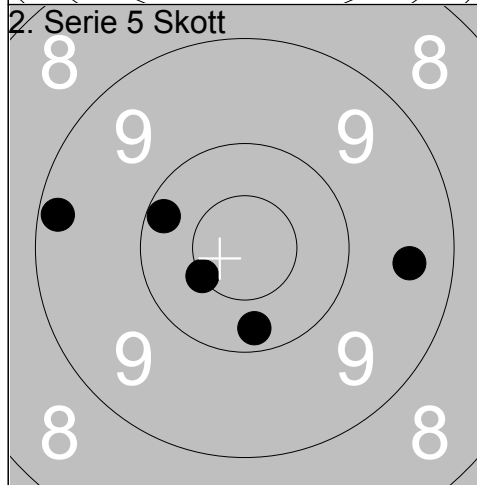

1:	9.5	→
2:	10.2	↓
3:	10.5x	←
4:	10.2	↖
5:	9.2	←
Serie		48
Total		92

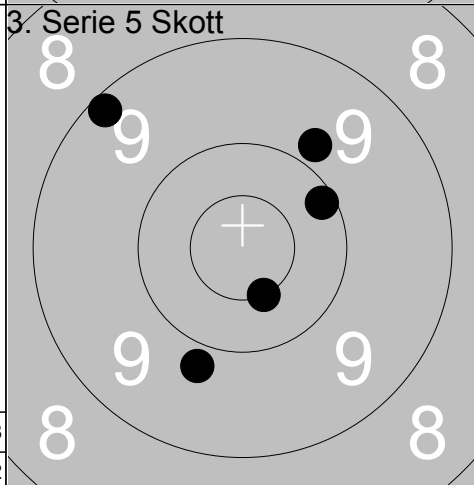

1:	10.5x	↓
2:	9.8	↗
3:	9.2	↖
4:	10.1	↗
5:	9.8	↓
Serie		47
Total		139

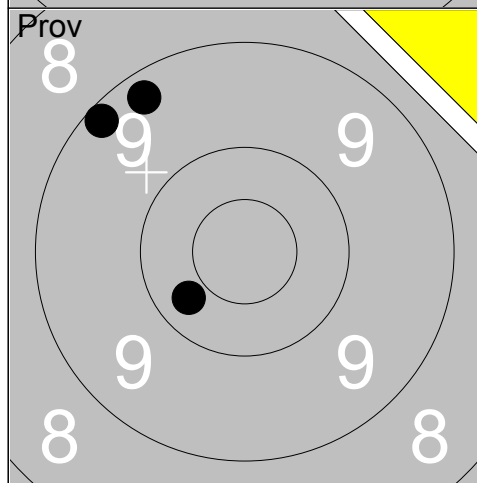

1:	9.3	↖
2:	9.2	↗
3:	10.3	↖
Serie		28
Total		139

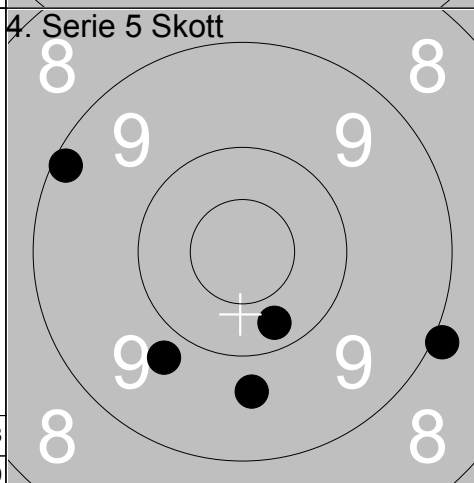

1:	9.7	↓
2:	9.1	↖
3:	9.8	↖
4:	8.9	↗
5:	10.3	↓
Serie		45
Total		184

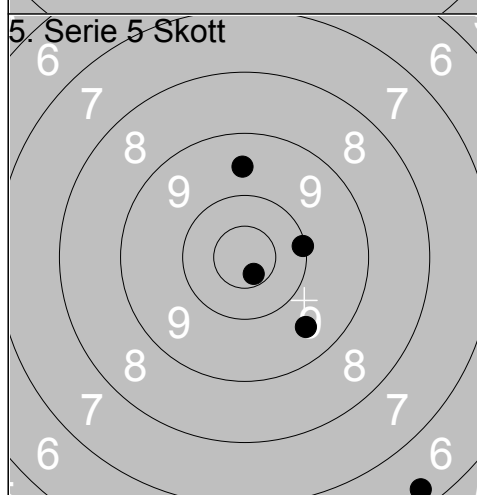

1:	10.1	→
2:	6.3	↓
3:	9.5	↓
4:	10.7x	↓
5:	9.6	↑
Serie		44
Total		228

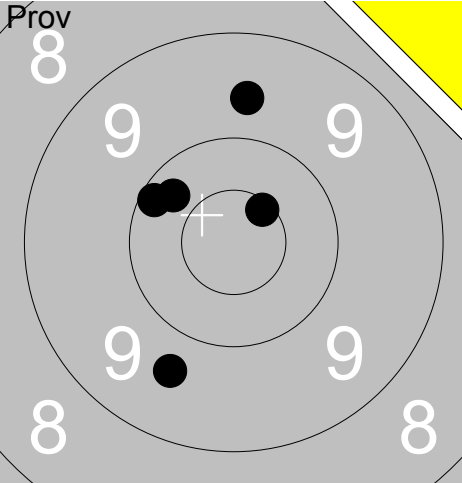
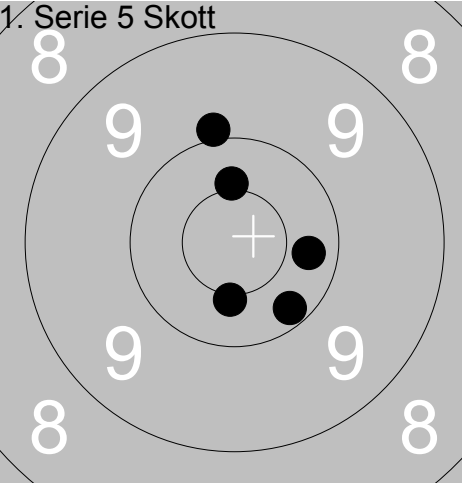
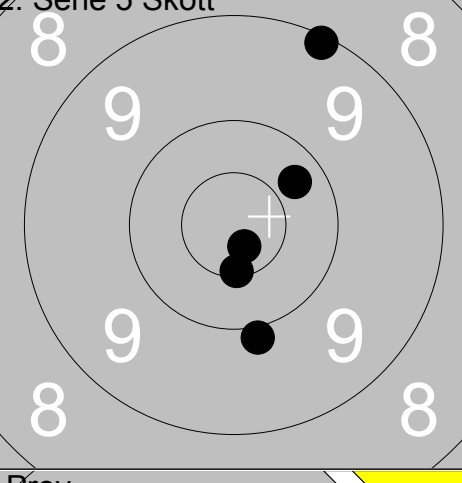
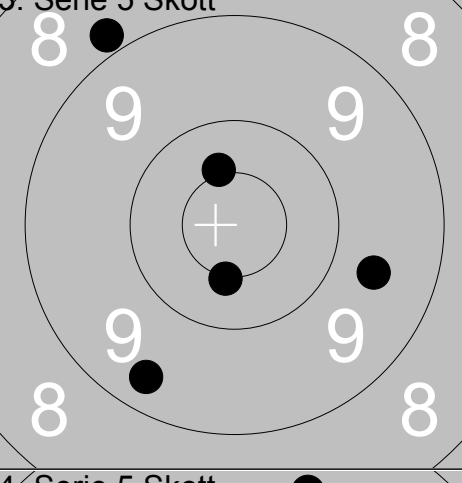
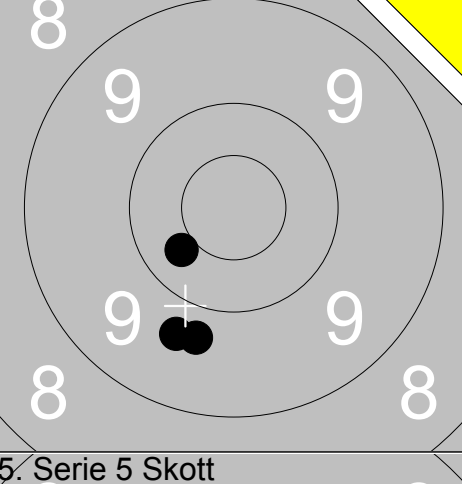
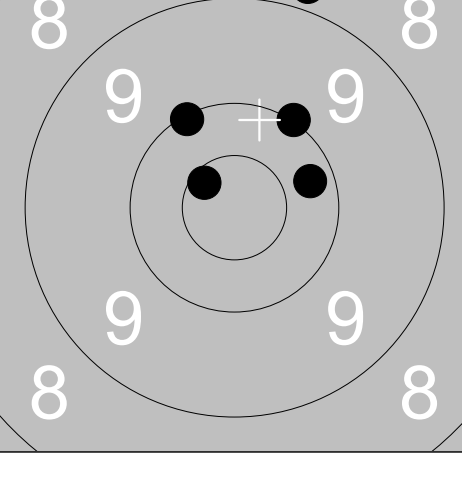
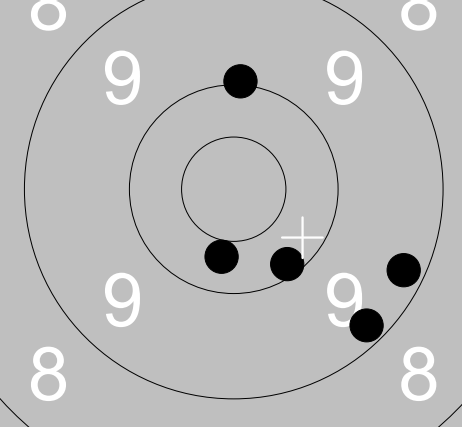
Skjutlag	Tavla	Caroline Törnvall		
2	12	Ramselefors	Ultuna	Öpp
12.08.2017		SM Banskytte Liggande 2017	Ramselefors SKF	Up
Prov 	1: 9.6 ↑ 2: 10.2 ↖ 3: 10.3 ↗ 4: 10.6x ↗ 5: 9.7 ↘	1. Serie 5 Skott 	1: 10.2 ↘ 2: 10.4x ↑ 3: 10.4x ↓ 4: 10.3 → 5: 9.9 ↑	
	Serie 48 Total 0		Serie 49 Total 49	
2. Serie 5 Skott 	1: 10.5x ↓ 2: 10.3 ↗ 3: 9.1 ↗ 4: 10.7x ↓ 5: 9.9 ↓	3. Serie 5 Skott 	1: 8.8 ↗ 2: 10.4x ↗ 3: 9.3 ↘ 4: 10.5x ↓ 5: 9.6 →	
	Serie 48 Total 97		Serie 46 Total 143	
Prov 	1: 9.7 ↘ 2: 10.4 ↖ 3: 9.7 ↘	4. Serie 5 Skott 	1: 10.1 ↗ 2: 10.0 ↗ 3: 10.6x ↖ 4: 8.8 ↑ 5: 10.2 →	
	Serie 28 Total 143		Serie 48 Total 191	
5. Serie 5 Skott 	1: 10.3 ↓ 2: 10.1 ↘ 3: 10.0 ↑ 4: 9.2 ↘ 5: 9.2 ↘			
	Serie 48 Total 239			

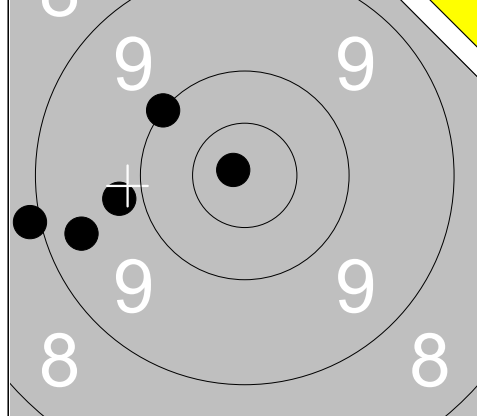

1:	9.8	←
2:	8.9	←
3:	10.8x	↗
4:	10.0	↗
5:	9.4	←
Serie		46
Total		0

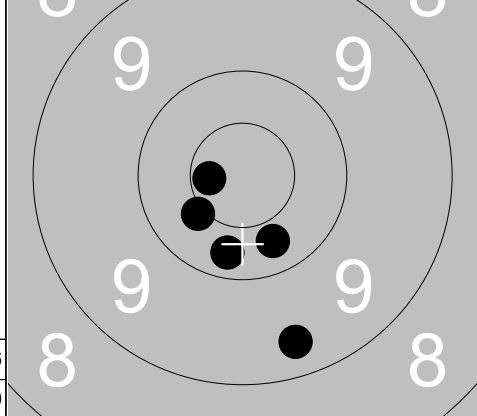

1:	9.4	↓
2:	10.3	↓
3:	10.3	↓
4:	10.7x	←
5:	10.4x	↙
Serie		49
Total		49

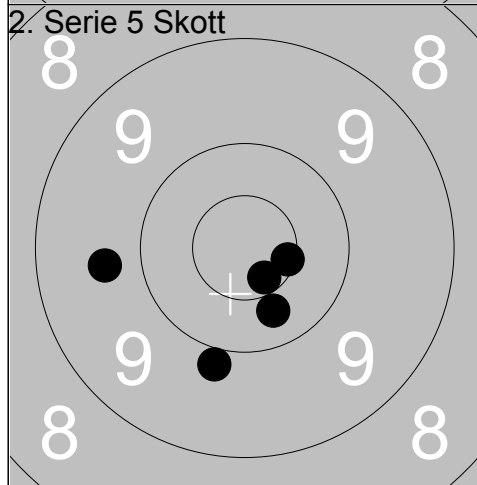

1:	10.6x	↓
2:	10.6x	→
3:	9.9	↓
4:	9.7	←
5:	10.3	↓
Serie		48
Total		97

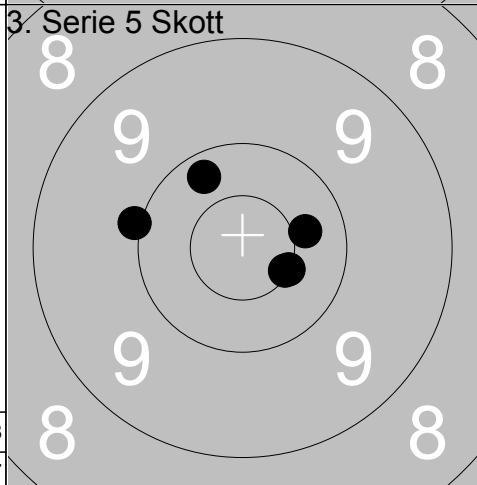

1:	10.4	→
2:	10.0	←
3:	10.5x	→
4:	10.5x	→
5:	10.2	↗
Serie		50
Total		147

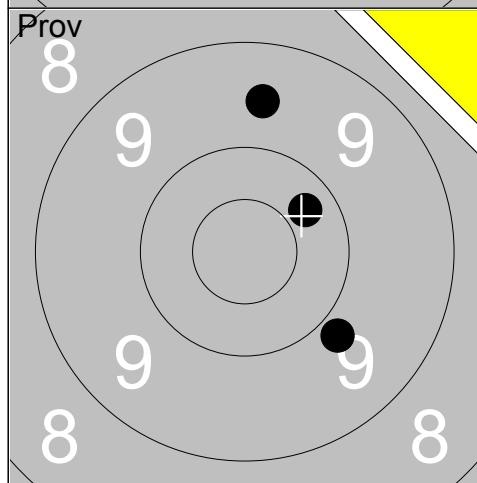

1:	9.8	↘
2:	9.6	↑
3:	10.3	↗
Serie		28
Total		147

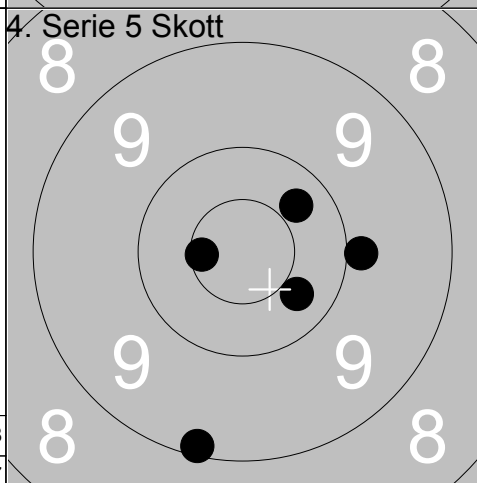

1:	10.6x	←
2:	10.3	↗
3:	10.3	↓
4:	9.9	→
5:	9.1	↓
Serie		48
Total		195

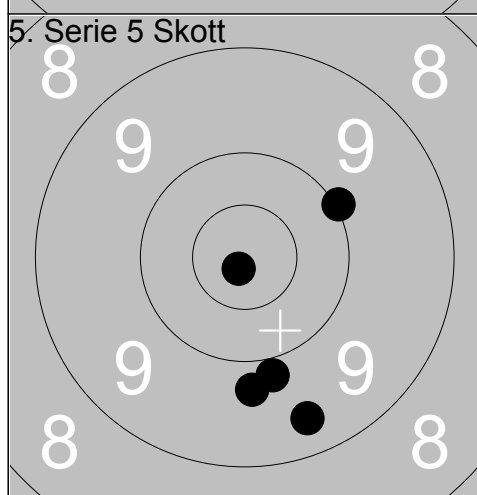

1:	9.8	↓
2:	10.0	↗
3:	9.4	↓
4:	10.8x	↙
5:	9.9	↓
Serie		47
Total		242

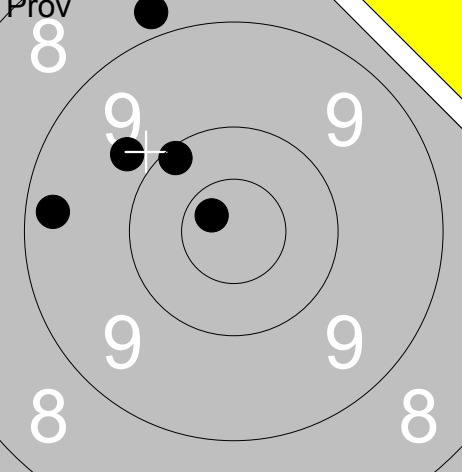
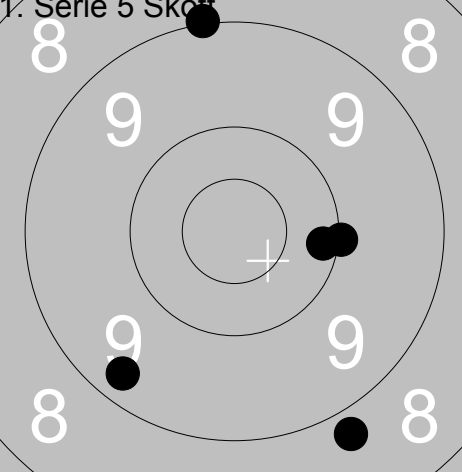
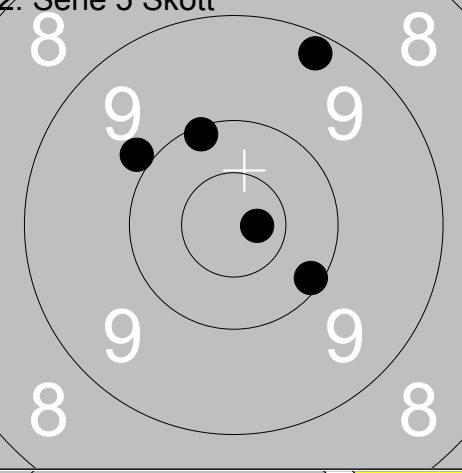
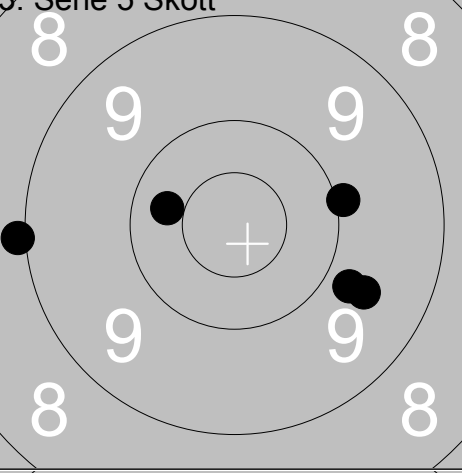
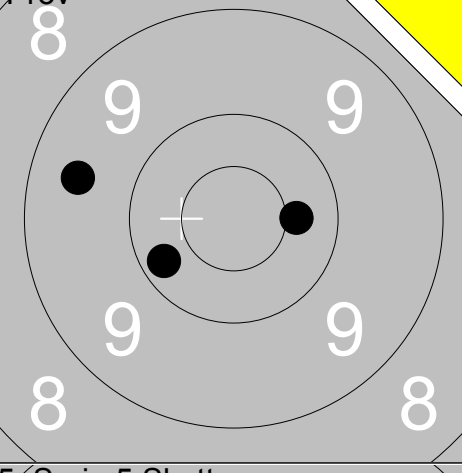
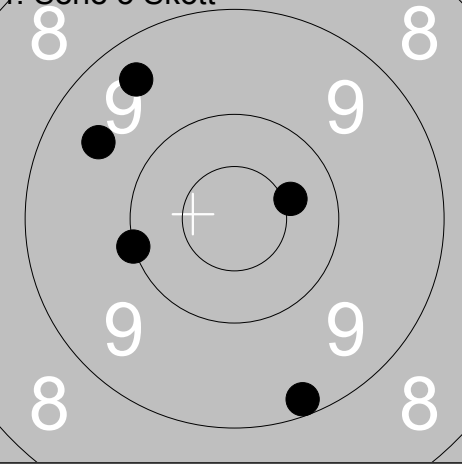
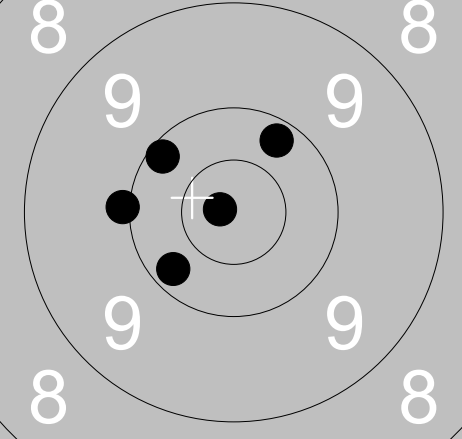
Prov 	1: 8.8 ↗ 2: 9.3 ← 3: 10.7x ↗ 4: 9.8 ↗ 5: 10.1 ↗ <hr/> Serie 46 Total 0	1. Serie 5 Skott 	1: 9.0 ↗ 2: 8.8 ↘ 3: 10.2 → 4: 9.3 ↘ 5: 10.0 → <hr/> Serie 46 Total 46
2. Serie 5 Skott 	1: 9.2 ↗ 2: 10.7x → 3: 9.9 ↗ 4: 10.1 ↗ 5: 10.1 ↘ <hr/> Serie 48 Total 94	3. Serie 5 Skott 	1: 10.3 ← 2: 9.6 ↘ 3: 10.0 → 4: 9.8 ↘ 5: 9.0 ← <hr/> Serie 47 Total 141
Prov 	1: 10.4 → 2: 10.2 ← 3: 9.5 ← <hr/> Serie 29 Total 141	4. Serie 5 Skott 	1: 10.4x → 2: 9.5 ↗ 3: 10.0 ← 4: 9.4 ↗ 5: 9.2 ↘ <hr/> Serie 47 Total 188
5. Serie 5 Skott 	1: 10.0 ← 2: 10.2 ↘ 3: 10.2 ↗ 4: 10.2 ↗ 5: 10.8x ← <hr/> Serie 50 Total 238		

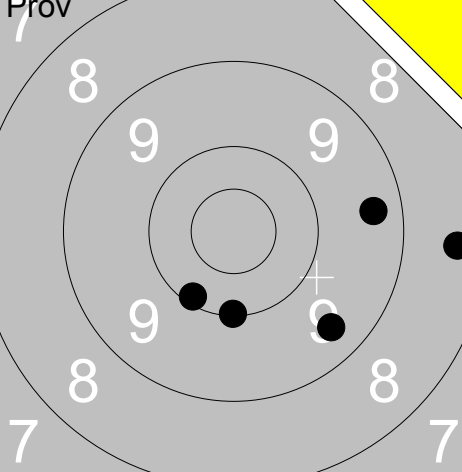
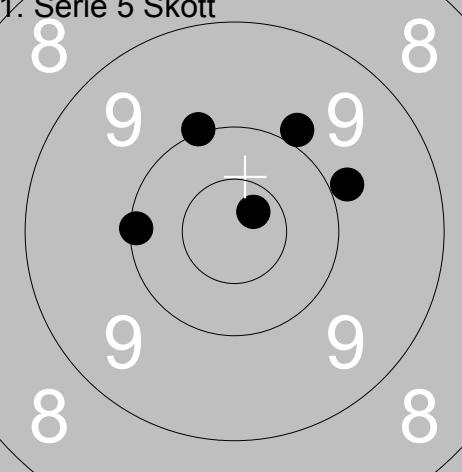
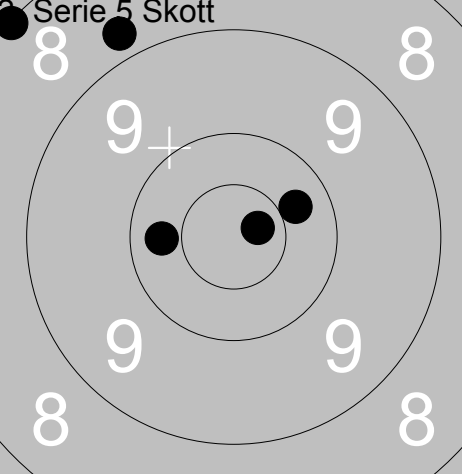
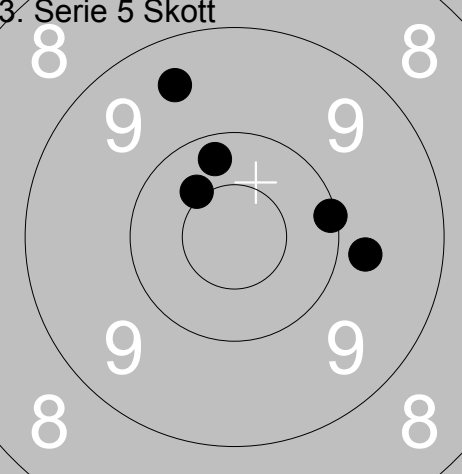
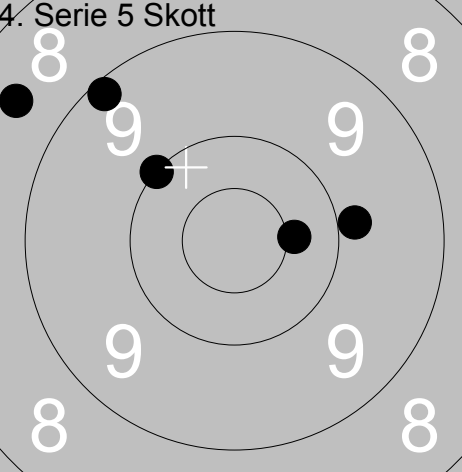
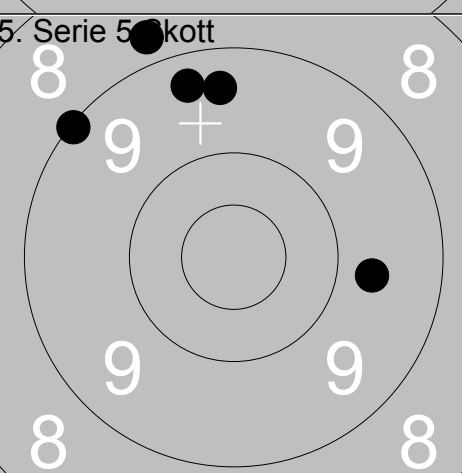
<p>Prov</p>  <p>7 8 9 8 7</p>	<p>1: 8.4 →</p> <p>2: 10.1 ↓</p> <p>3: 9.4 →</p> <p>4: 9.4 ↓</p> <p>5: 10.1 ↓</p> <hr/> <p>Serie 46</p> <p>Total 0</p>	<p>1. Serie 5 Skott</p>  <p>8 9 9 8 8</p> <p>1: 10.0 ↗</p> <p>2: 9.9 →</p> <p>3: 10.7x ↗</p> <p>4: 9.9 ↗</p> <p>5: 10.1 ←</p> <hr/> <p>Serie 48</p> <p>Total 48</p>
<p>2. Serie 5 Skott</p>  <p>8 9 9 8 8</p> <p>1: 8.8 ↗</p> <p>2: 10.3 ←</p> <p>3: 8.1 ↗</p> <p>4: 10.7x →</p> <p>5: 10.3 →</p> <hr/> <p>Serie 46</p> <p>Total 94</p>	<p>3. Serie 5 Skott</p>  <p>8 9 9 8 8</p> <p>1: 9.8 →</p> <p>2: 10.2 ↗</p> <p>3: 9.5 ↗</p> <p>4: 10.4x ↗</p> <p>5: 10.1 →</p> <hr/> <p>Serie 48</p> <p>Total 142</p>	<p>4. Serie 5 Skott</p>  <p>8 9 9 8 8</p> <p>1: 9.9 →</p> <p>2: 10.0 ↗</p> <p>3: 9.2 ↗</p> <p>4: 8.6 ↗</p> <p>5: 10.4x →</p> <hr/> <p>Serie 46</p> <p>Total 188</p>
<p>5. Serie 5 Skott</p>  <p>8 9 9 8 8</p> <p>1: 9.4 ↗</p> <p>2: 9.7 →</p> <p>3: 9.3 ↗</p> <p>4: 9.1 ↗</p> <p>5: 8.8 ↗</p> <hr/> <p>Serie 44</p> <p>Total 232</p>		

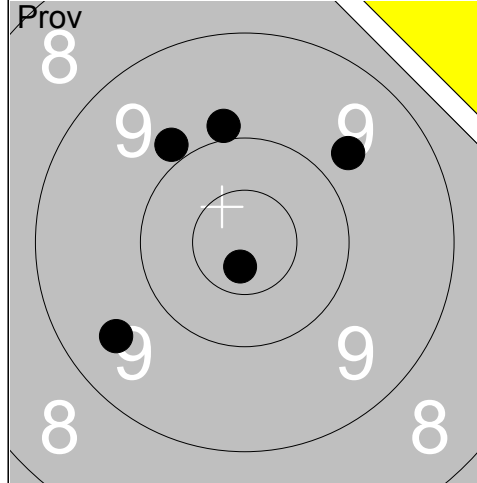

1:	9.7	↗
2:	9.9	↑
3:	9.9	↗
4:	10.7x	↓
5:	9.5	↖
Serie		46
Total		0

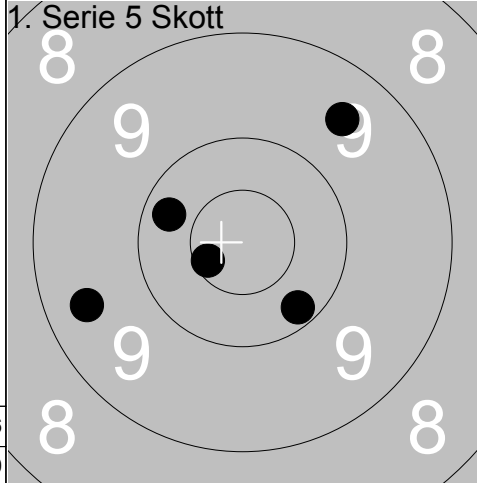

1:	9.5	↗
2:	9.4	↖
3:	10.2	↘
4:	10.6x	↖
5:	10.3	↖
Serie		48
Total		48

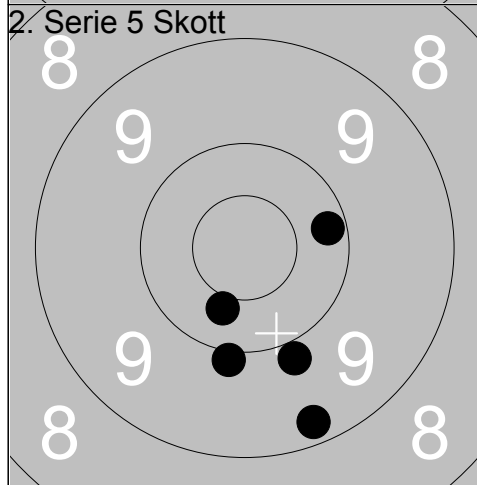

1:	10.0	↓
2:	10.2	→
3:	9.2	↓
4:	10.4	↓
5:	9.9	↓
Serie		48
Total		96

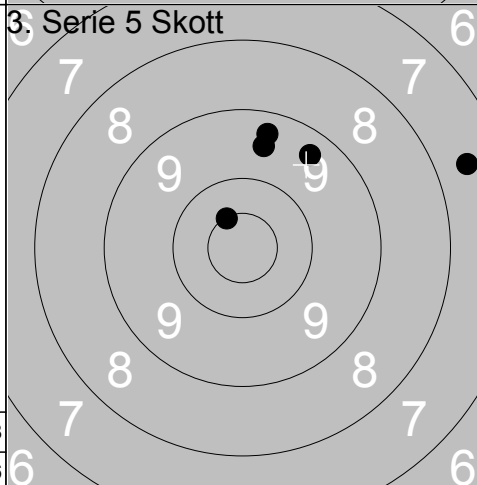

1:	7.6	→
2:	9.5	↑
3:	9.3	↑
4:	10.5x	↗
5:	9.4	↗
Serie		44
Total		140

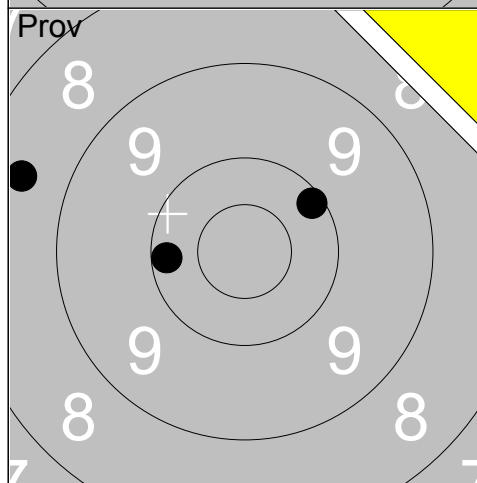

1:	8.5	↖
2:	10.2	←
3:	10.1	↗
Serie		28
Total		140

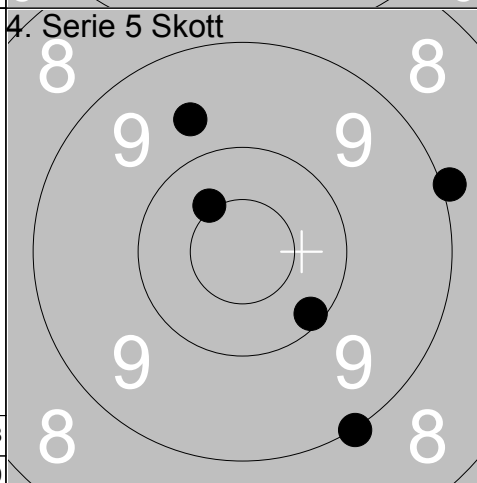

1:	9.7	↗
2:	9.0	↓
3:	10.1	↓
4:	10.4x	↗
5:	8.9	→
Serie		46
Total		186

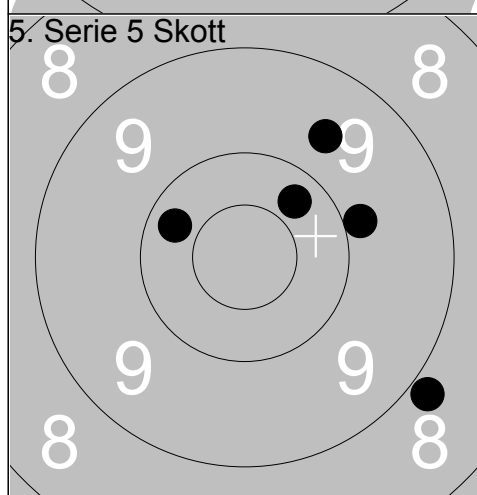

1:	10.3	↖
2:	9.6	↗
3:	9.9	→
4:	10.3	↗
5:	8.8	↘
Serie		46
Total		232

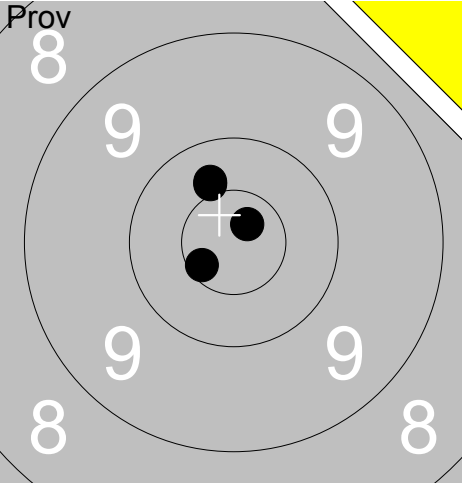
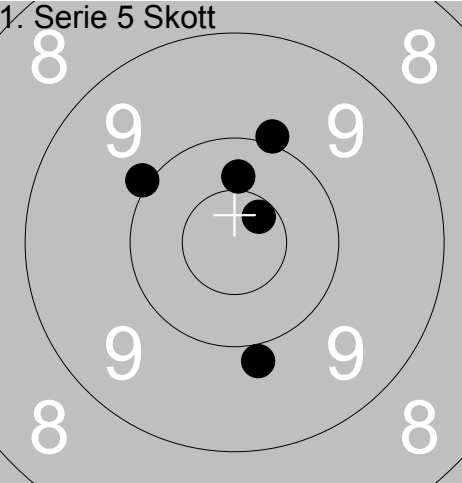
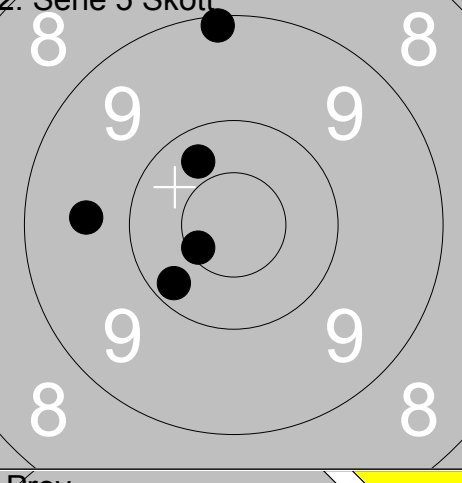
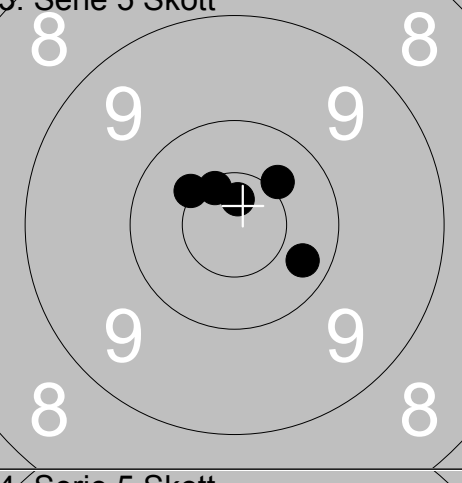
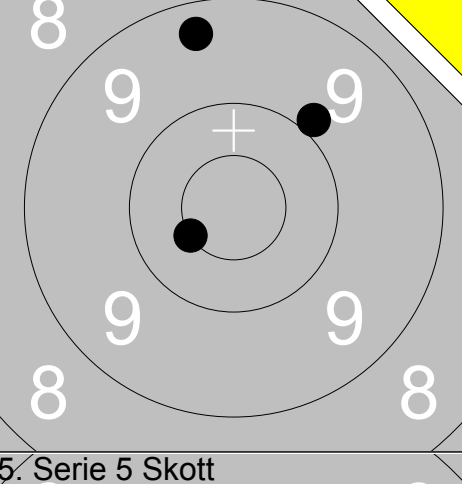
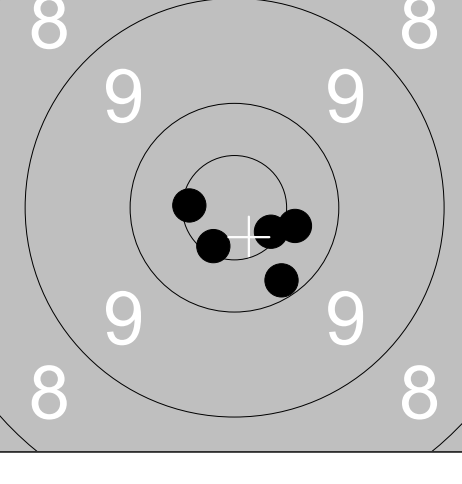
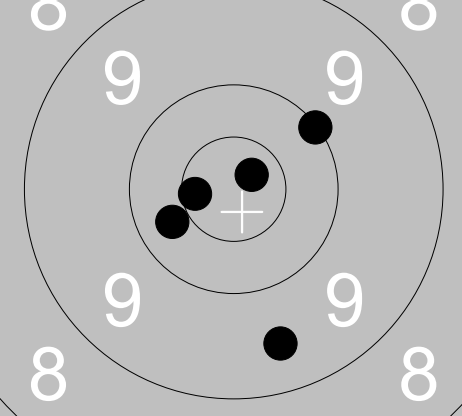
Skjutlag 2	Tavla 17	Olle Gabrielsson					
Ramselefors		Rommehed		Öpp	Da		
12.08.2017		SM Banskytte Liggande 2017		Ramselefors SKF			
Prov 		1: 10.4 ↗ 2: 10.6x ↙ 3: 10.7x ↗ 4: 10.4 ↗ Serie 40 Total 0		1. Serie 5 Skott 		1: 10.4 ↗ 2: 10.6x ↗ 3: 10.0 ↗ 4: 9.9 ↘ 5: 10.0 ↗ Serie 49 Total 49	
2. Serie 5 Skott 		1: 9.1 ↗ 2: 10.6x ↙ 3: 9.6 ↙ 4: 10.3 ↗ 5: 10.2 ↙ Serie 48 Total 97		3. Serie 5 Skott 		1: 10.3 ➡ 2: 10.7x ↗ 3: 10.4x ↗ 4: 10.5x ↗ 5: 10.6x ↗ Serie 50 Total 147	
Prov 		1: 9.9 ↗ 2: 10.5x ↙ 3: 9.3 ↗ Serie 28 Total 147		4. Serie 5 Skott 		1: 10.6x ↘ 2: 10.2 ↘ 3: 10.5x ↙ 4: 10.6x ↘ 5: 10.4 ➡ Serie 50 Total 197	
5. Serie 5 Skott 		1: 9.5 ↘ 2: 10.3 ↙ 3: 10.0 ↗ 4: 10.6x ↙ 5: 10.7x ↗ Serie 49 Total 246					

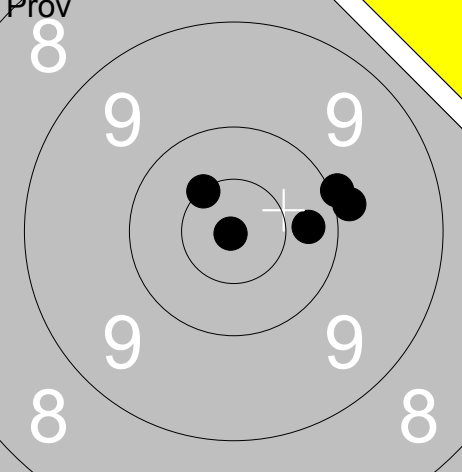
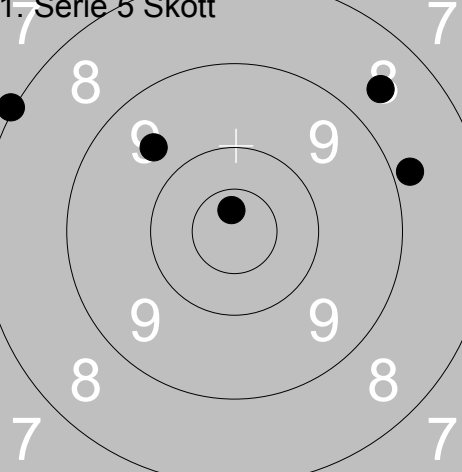
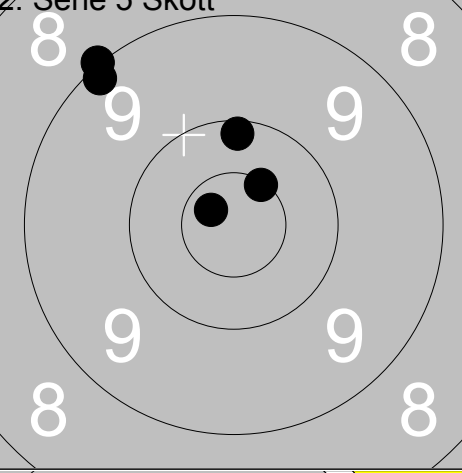
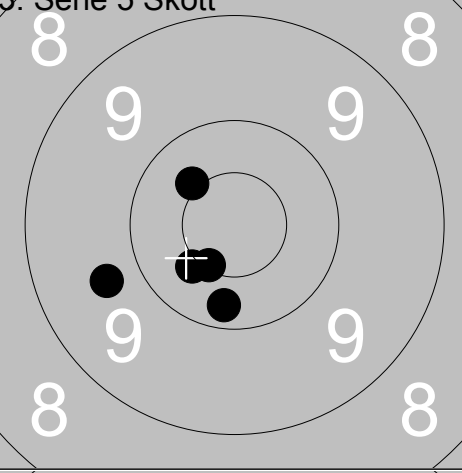
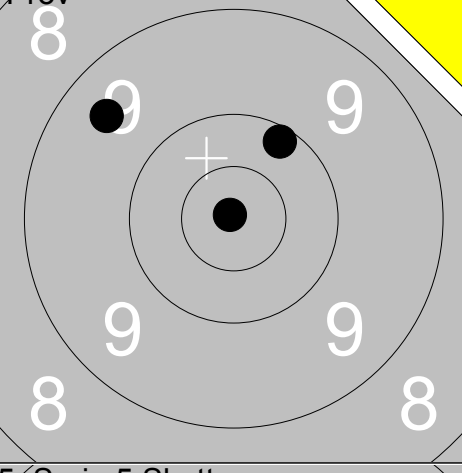
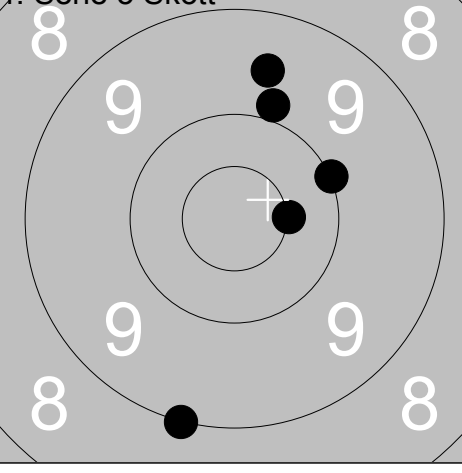
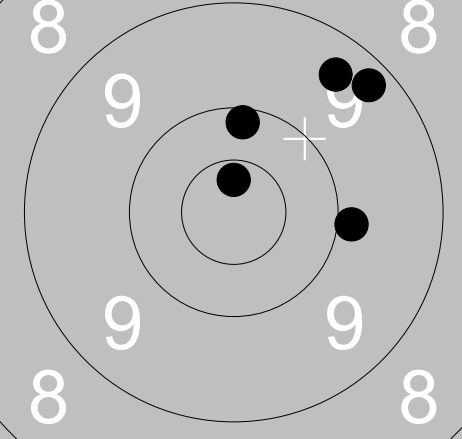
Prov 	1: 10.0 → 2: 10.5x ↗ 3: 10.9x ↖ 4: 9.9 → 5: 10.3 → <hr/> Serie 49 Total 0	1. Serie 5 Skott 	1: 8.6 ↗ 2: 10.7x ↑ 3: 8.8 → 4: 9.6 ↗ 5: 8.0 ↖ <hr/> Serie 43 Total 43
2. Serie 5 Skott 	1: 10.1 ↑ 2: 10.5x ↗ 3: 9.1 ↗ 4: 9.0 ↗ 5: 10.7x ↗ <hr/> Serie 48 Total 91	3. Serie 5 Skott 	1: 10.4x ↖ 2: 10.2 ↓ 3: 10.5x ↖ 4: 9.7 ↖ 5: 10.4x ↖ <hr/> Serie 49 Total 140
Prov 	1: 10.9x ↖ 2: 9.5 ↗ 3: 10.2 ↗ <hr/> Serie 29 Total 140	4. Serie 5 Skott 	1: 9.9 ↑ 2: 9.6 ↑ 3: 10.5x → 4: 9.0 ↓ 5: 10.0 → <hr/> Serie 47 Total 187
5. Serie 5 Skott 	1: 10.2 ↑ 2: 9.9 → 3: 9.3 ↗ 4: 10.7x ↑ 5: 9.4 ↗ <hr/> Serie 47 Total 234		

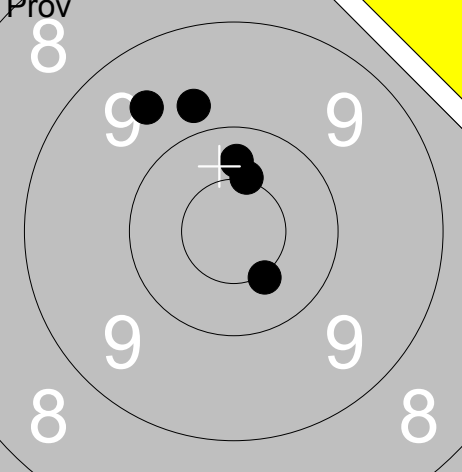
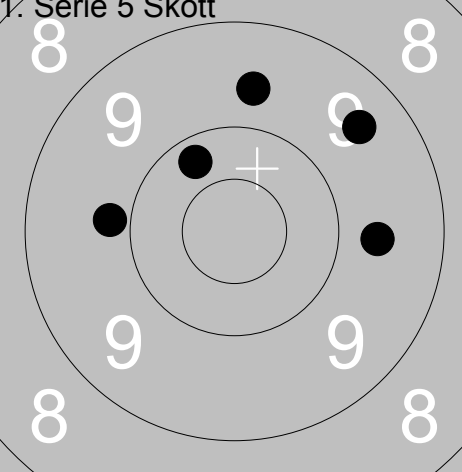
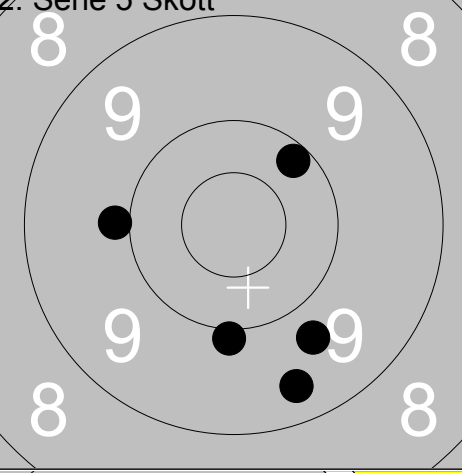
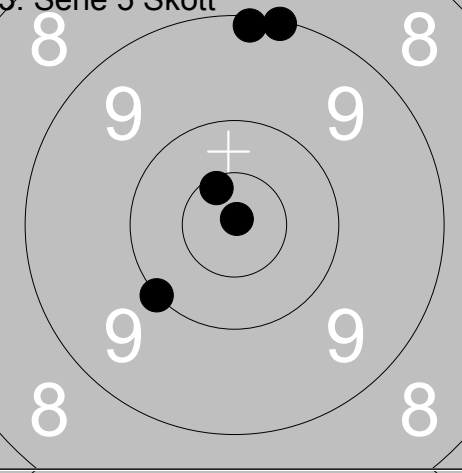
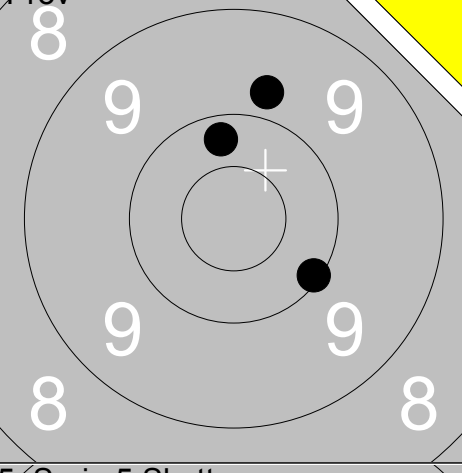
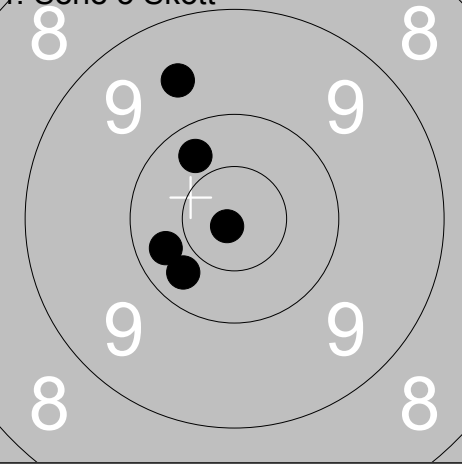
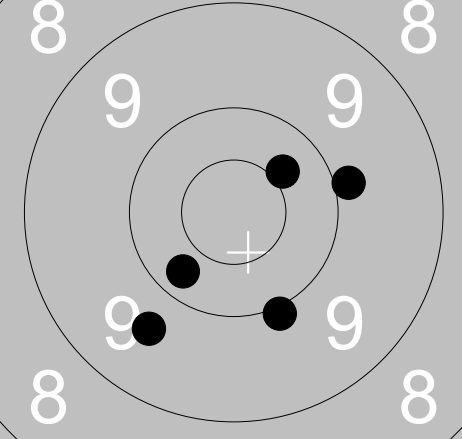
Prov 	1: 9.8 ↑ 2: 9.6 ↖ 3: 10.5x ↑ 4: 10.3 ↑ 5: 10.5x ↘ <hr/> Serie 48 Total 0	1. Serie 5 Skott 	1: 9.7 → 2: 10.2 ↖ 3: 9.7 ↑ 4: 9.5 ↗ 5: 9.8 ← <hr/> Serie 46 Total 46
2. Serie 5 Skott 	1: 9.9 ↓ 2: 9.4 ↓ 3: 9.9 ← 4: 9.7 ↘ 5: 10.2 ↗ <hr/> Serie 46 Total 92	3. Serie 5 Skott 	1: 9.1 ↑ 2: 9.1 ↑ 3: 10.6x ↖ 4: 10.9x ↑ 5: 10.0 ↙ <hr/> Serie 48 Total 140
Prov 	1: 10.2 ↑ 2: 9.8 ↑ 3: 10.1 ↘ <hr/> Serie 29 Total 140	4. Serie 5 Skott 	1: 9.6 ↖ 2: 10.3 ← 3: 10.9x ↙ 4: 10.3 ↖ 5: 10.3 ↙ <hr/> Serie 49 Total 189
5. Serie 5 Skott 	1: 10.3 ↙ 2: 9.9 → 3: 10.0 ↘ 4: 10.4 ↗ 5: 9.7 ↙ <hr/> Serie 48 Total 237		

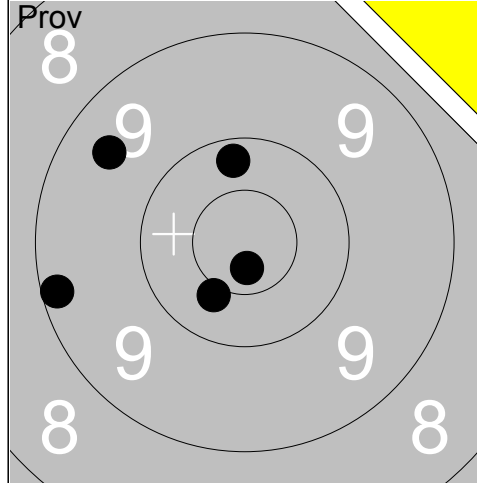

1:	10.2	↑
2:	9.2	←
3:	10.7x	↓
4:	9.5	↗
5:	10.4	↘

Serie	48
Total	0

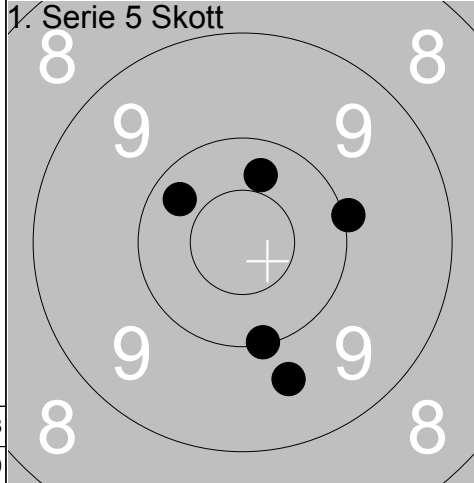

1:	10.1	↓
2:	10.3	↑
3:	10.3	↗
4:	10.0	→
5:	9.7	↓

Serie	49
Total	49

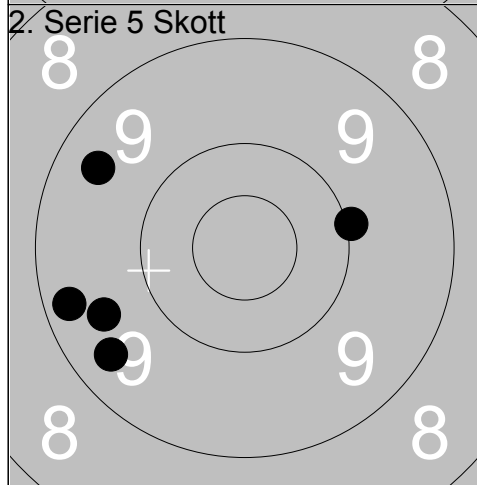

1:	9.4	↖
2:	9.4	↙
3:	9.3	←
4:	9.5	↙
5:	10.0	→

Serie	46
Total	95

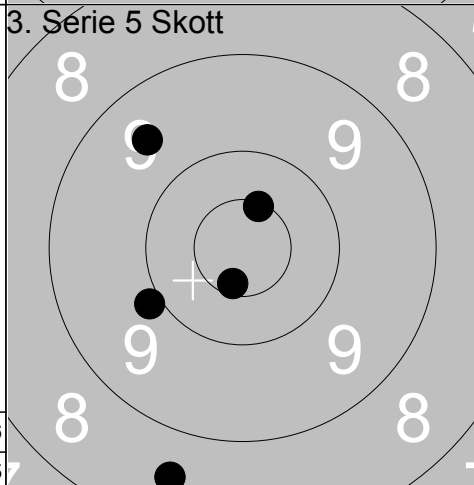

1:	10.6x	↓
2:	10.5x	↑
3:	9.5	↗
4:	9.9	↙
5:	8.5	↓

Serie	46
Total	141

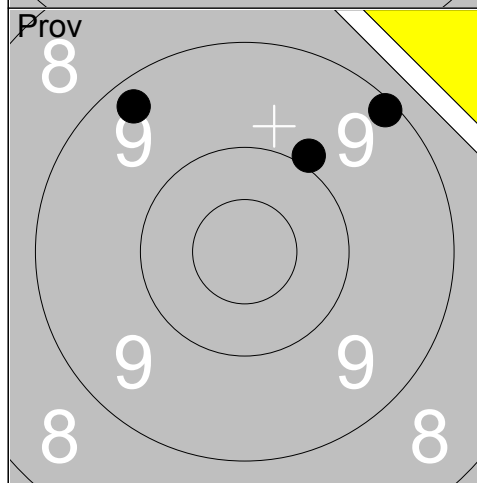

1:	9.1	↗
2:	9.9	↗
3:	9.3	↗

Serie	27
Total	141

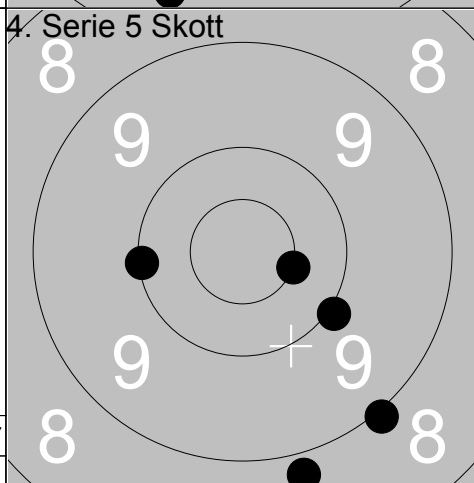

1:	10.1	←
2:	8.8	↓
3:	10.5x	→
4:	10.0	↓
5:	9.0	↓

Serie	47
Total	188

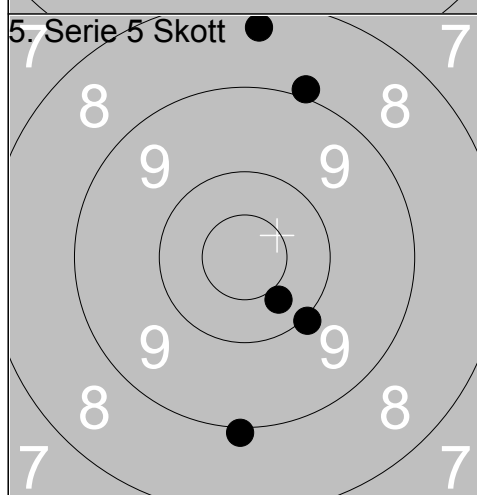

1:	8.3	↑
2:	8.9	↑
3:	10.0	↘
4:	9.0	↓
5:	10.4	↘

Serie	45
Total	233

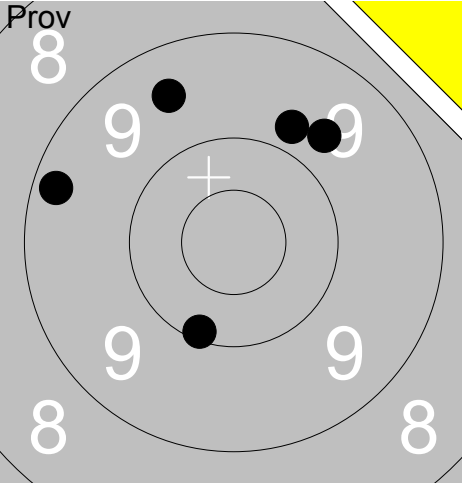
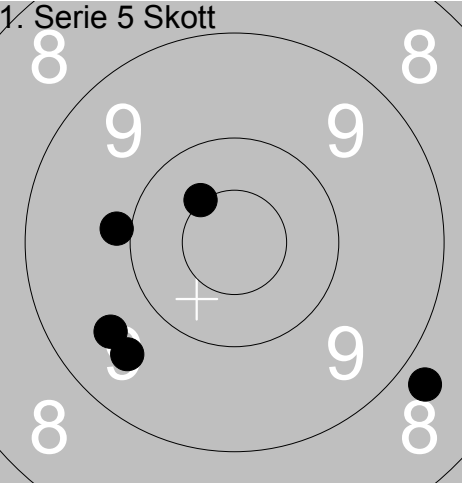
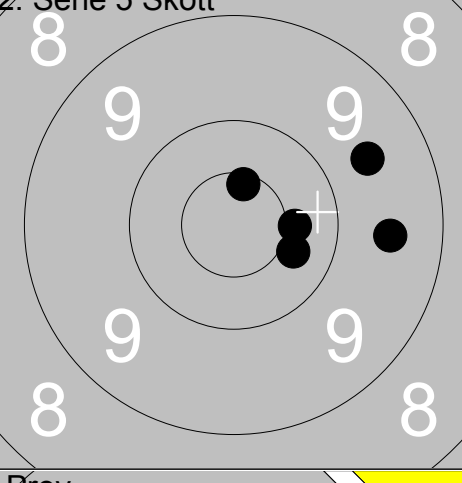
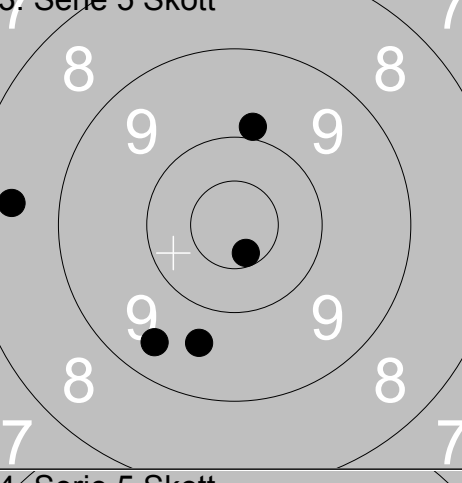
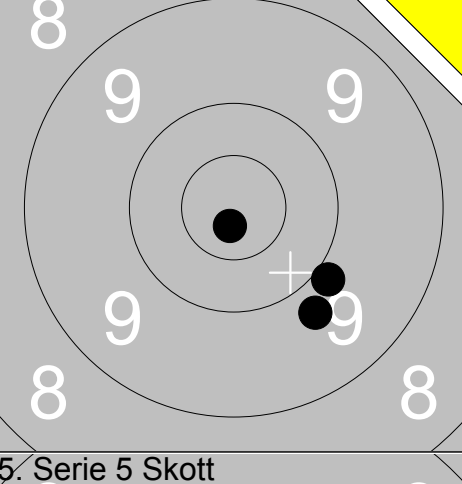
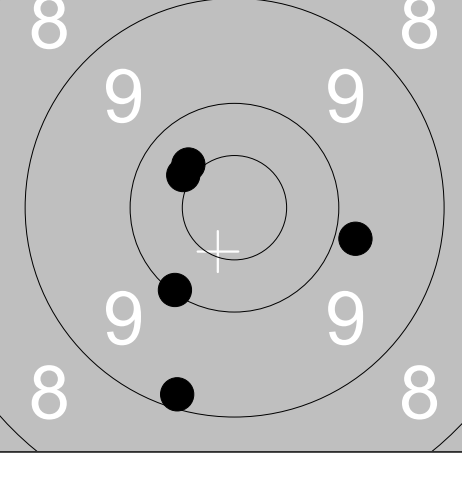
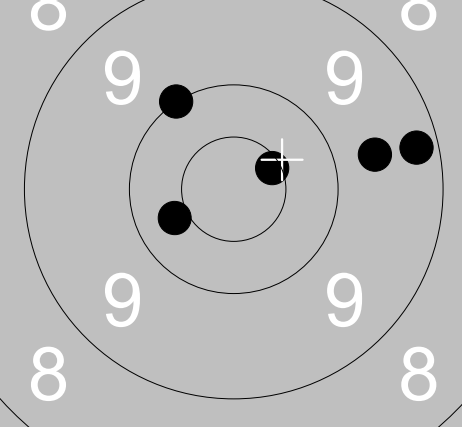
Skjutlag	Tavla	Göran Jansson		
2	21	Ramselefors	Vaksala	Vet Up
12.08.2017	SM Banskytte Liggande 2017	Ramselefors SKF		
Prov 	1: 9.7 ↗ 2: 9.3 ← 3: 9.8 ↗ 4: 9.5 ↗ 5: 10.1 ↓	1. Serie 5 Skott 	1: 8.8 ↘ 2: 10.5x ↗ 3: 9.5 ↘ 4: 9.6 ↘ 5: 9.9 ←	
	Serie 46		Serie 45	
	Total 0		Total 45	
2. Serie 5 Skott 	1: 10.4 → 2: 10.4 → 3: 10.6x ↑ 4: 9.6 → 5: 9.5 →	3. Serie 5 Skott 	1: 9.6 ↓ 2: 8.5 ← 3: 10.6x ↓ 4: 9.9 ↑ 5: 9.4 ↓	
	Serie 48		Serie 45	
	Total 93		Total 138	
Prov 	1: 9.9 ↘ 2: 10.8x ↓ 3: 9.8 ↓	4. Serie 5 Skott 	1: 10.4 ↗ 2: 10.4x ↗ 3: 10.0 ↘ 4: 9.2 ↓ 5: 9.8 →	
	Serie 28		Serie 48	
	Total 138		Total 186	
5. Serie 5 Skott 	1: 9.2 → 2: 10.0 ↗ 3: 9.6 → 4: 10.4 ← 5: 10.6x →			
	Serie 48			
	Total 234			

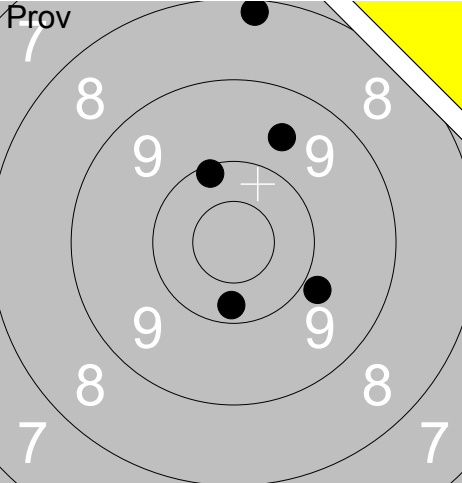
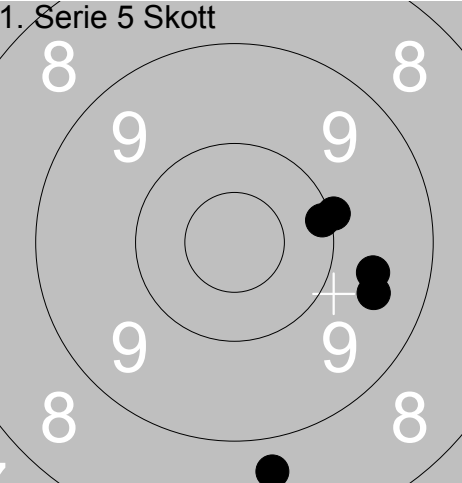
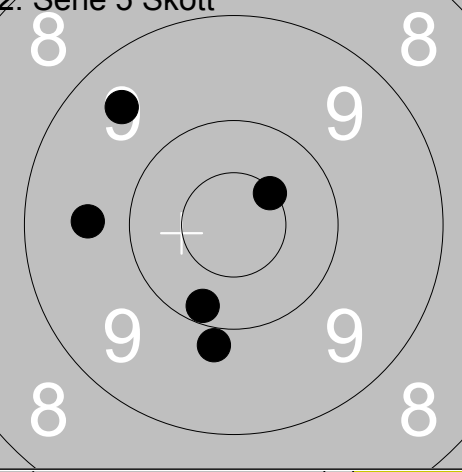
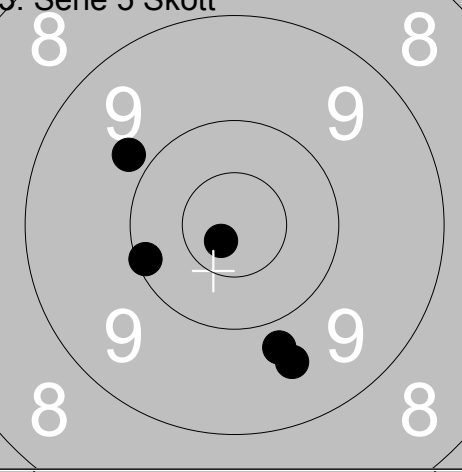
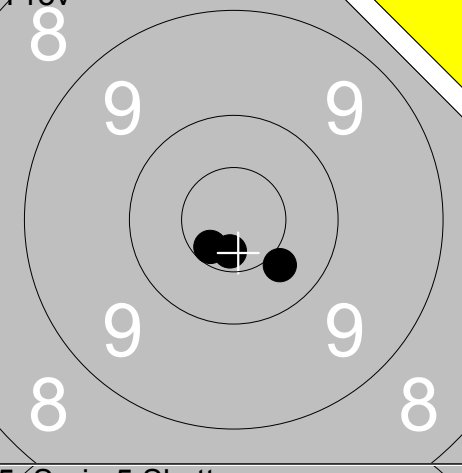
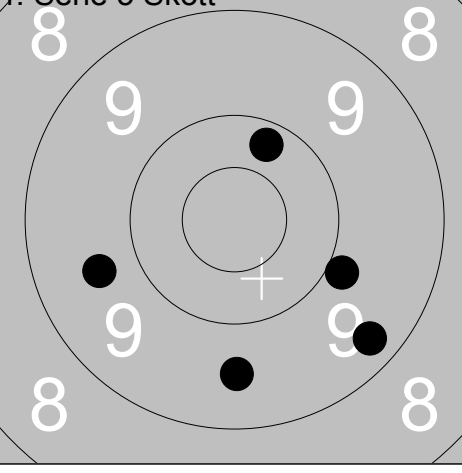
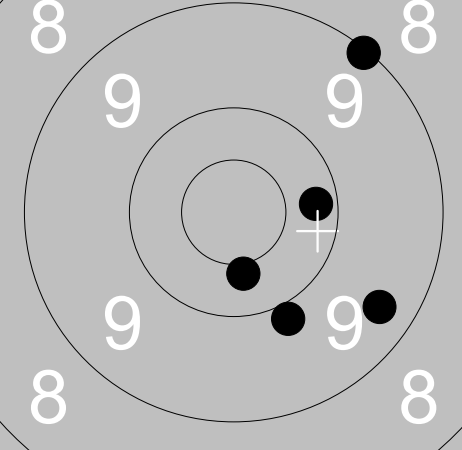
Skjuttag 2	Tavla 22	Kjell Lind	
Ramselefors		Bälinge-Jumkil	Vet Up
12.08.2017	SM Banskytte Liggande 2017	Ramselefors SKF	
Prov 7		1: 10.1 ↗ 2: 8.2 ↑ 3: 9.6 ↗ 4: 9.8 ↘ 5: 10.2 ↓	1. Serie 5 Skott  1: 10.0 → 2: 10.1 → 3: 9.6 → 4: 9.5 → 5: 8.7 ↓
	Serie 46 Total 0		Serie 46 Total 46
2. Serie 5 Skott		1: 9.5 ↗ 2: 10.5x ↗ 3: 9.6 ← 4: 10.2 ↓ 5: 9.9 ↓	3. Serie 5 Skott  1: 9.6 ↓ 2: 10.1 ← 3: 9.8 ↗ 4: 9.8 ↓ 5: 10.8x ↘
	Serie 47 Total 93		Serie 47 Total 140
Prov 8		1: 10.4 ↘ 2: 10.6x ↘ 3: 10.7x ↓	4. Serie 5 Skott  1: 9.6 ← 2: 10.2 ↗ 3: 9.3 ↘ 4: 9.6 ↓ 5: 9.9 ↘
	Serie 30 Total 140		Serie 46 Total 186
5. Serie 5 Skott		1: 9.1 ↗ 2: 9.4 ↘ 3: 9.9 ↓ 4: 10.2 → 5: 10.4 ↓	
	Serie 47 Total 233		

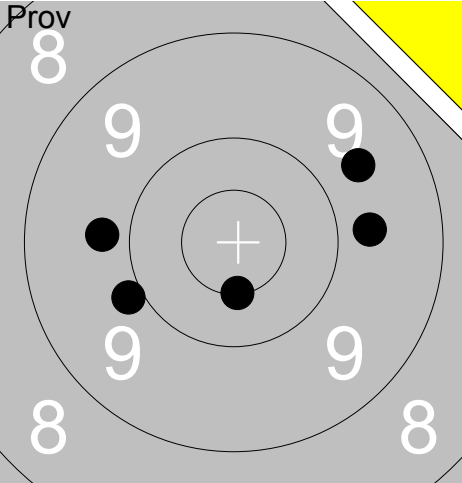
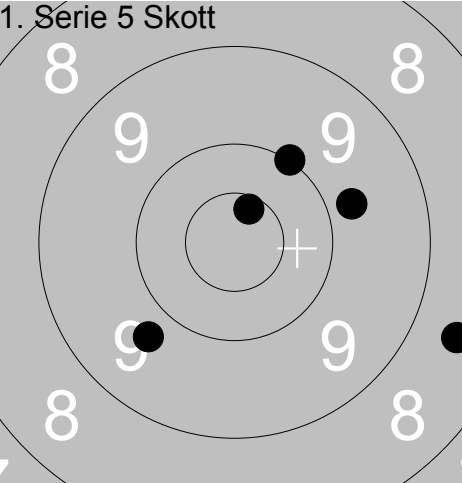
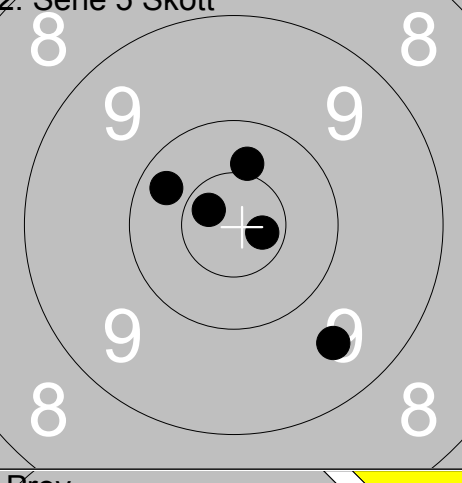
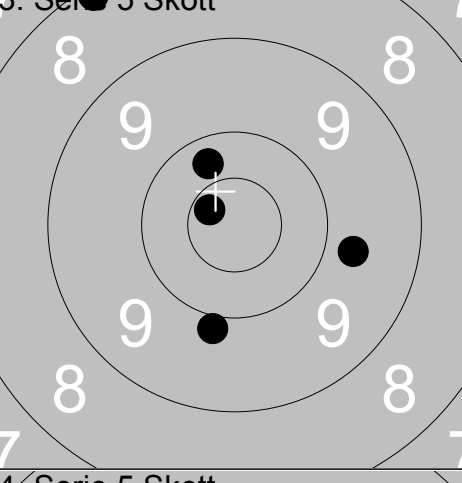
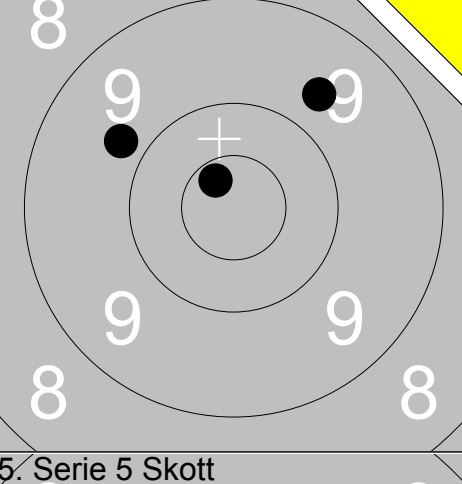
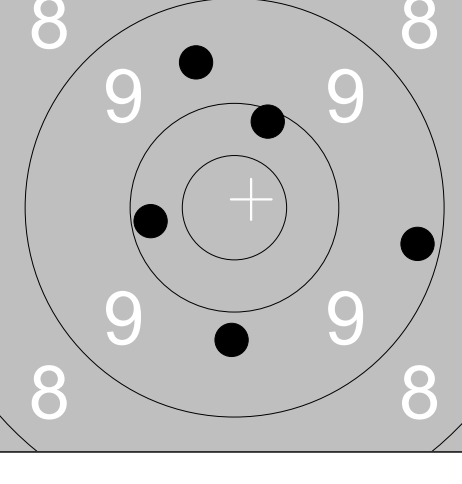
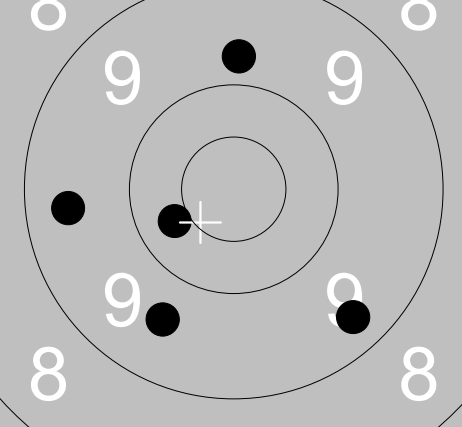
Skjutlag 3	Tavla 1	Jan-Erik Karlsson			
Ramselefors		Ramselefors		Vet	Vb
12.08.2017		SM Banskytte Liggande 2017		Ramselefors SKF	
Prov		1: 10.5x ↓ 2: 9.6 ↗ 3: 9.8 ← 4: 9.7 → 5: 9.9 ↖	1. Serie 5 Skott		1: 10.6x ↗ 2: 9.8 → 3: 10.0 ↗ 4: 9.7 ↘ 5: 8.6 →
		Serie 46		Serie 46	
		Total 0		Total 46	
2. Serie 5 Skott		1: 10.7x → 2: 9.6 ↘ 3: 10.4 ↗ 4: 10.7x ↗ 5: 10.3 ↗	3. Serie 5 Skott		1: 8.1 ↗ 2: 9.9 ↘ 3: 9.7 → 4: 10.7x ↗ 5: 10.3 ↗
		Serie 49		Serie 46	
		Total 95		Total 141	
Prov		1: 9.8 ↖ 2: 10.7x ↗ 3: 9.7 ↗	4. Serie 5 Skott		1: 10.2 ← 2: 9.8 ↘ 3: 9.2 → 4: 10.1 ↗ 5: 9.6 ↗
		Serie 28		Serie 47	
		Total 141		Total 188	
5. Serie 5 Skott		1: 9.4 ← 2: 10.4 ← 3: 9.4 ↘ 4: 9.6 ↘ 5: 9.8 ↑			
		Serie 46			
		Total 234			

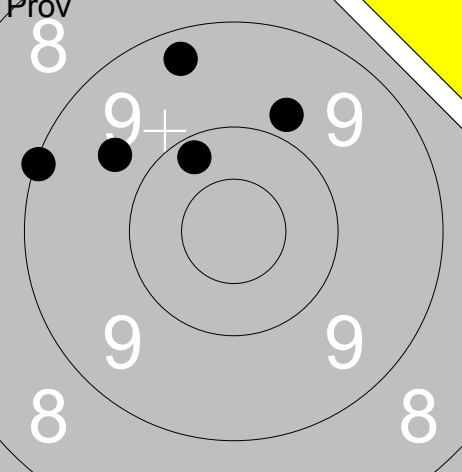
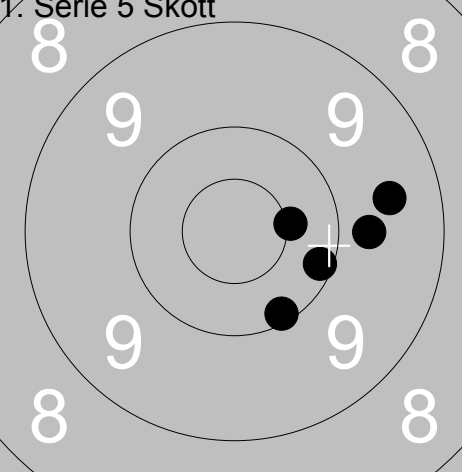
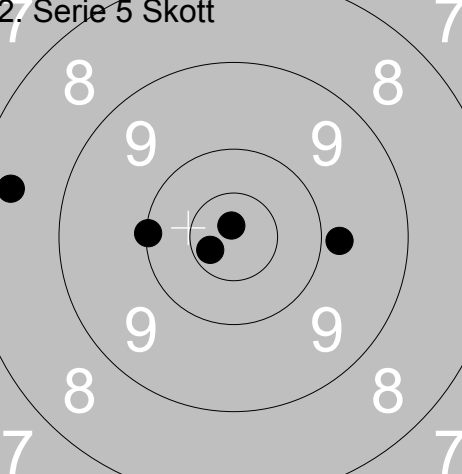
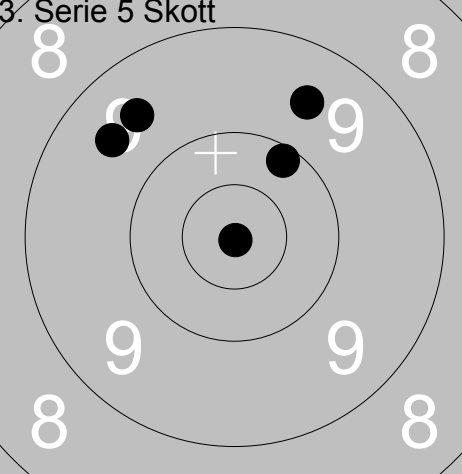
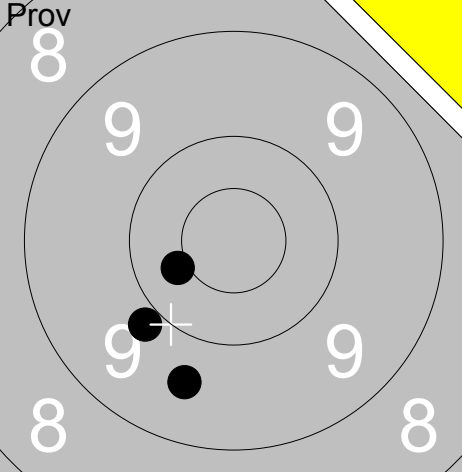
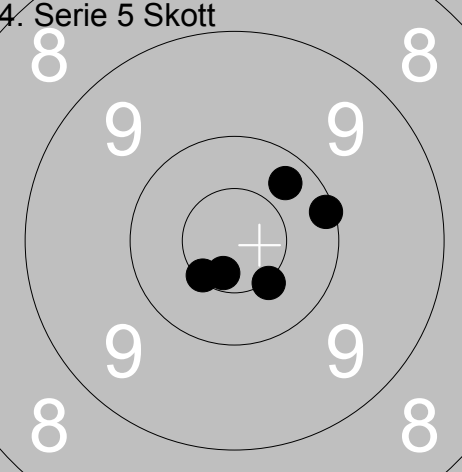
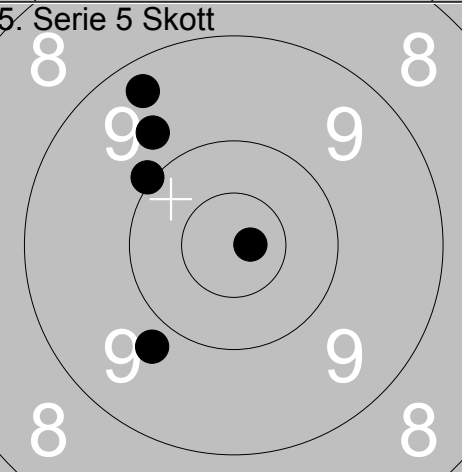
<p>Prov</p> 	<p>1: 9.1 ↙ 2: 9.8 ↗ 3: 10.2 ↗ 4: 9.3 ↗ 5: 9.7 ↗</p> <p>Serie 46 Total 0</p>	<p>1. Serie 5 Skott</p> 	<p>1: 10.1 ↘ 2: 9.7 → 3: 9.5 → 4: 10.5x → 5: 10.1 ↘</p> <p>Serie 48 Total 48</p>
<p>2. Serie 5 Skott</p> 	<p>1: 8.4 ↙ 2: 10.8x ↗ 3: 9.8 → 4: 10.7x ↙ 5: 10.0 ↙</p> <p>Serie 47 Total 95</p>	<p>3. Serie 5 Skott</p> 	<p>1: 9.5 ↗ 2: 10.2 ↗ 3: 10.9x ↘ 4: 9.5 ↗ 5: 9.6 ↗</p> <p>Serie 47 Total 142</p>
<p>Prov</p> 	<p>1: 9.9 ↘ 2: 10.4 ↙ 3: 9.6 ↘</p> <p>Serie 28 Total 142</p>	<p>4. Serie 5 Skott</p> 	<p>1: 10.5x ↘ 2: 10.3 ↗ 3: 10.6x ↘ 4: 10.5x ↘ 5: 10.1 →</p> <p>Serie 50 Total 192</p>
<p>5. Serie 5 Skott</p> 	<p>1: 10.8x → 2: 9.7 ↗ 3: 10.0 ↗ 4: 9.3 ↗ 5: 9.8 ↘</p> <p>Serie 47 Total 239</p>		

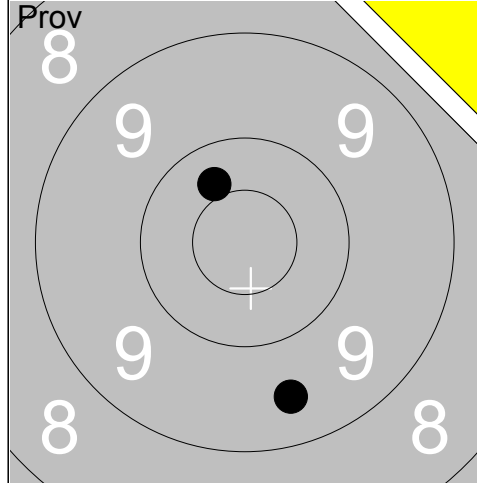

1:	9.5	↘
2:	10.4	↗
Serie 19		
Total 0		

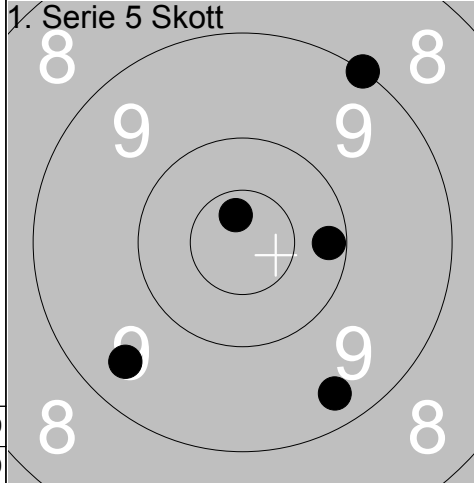

1:	10.2	→
2:	9.3	↘
3:	9.0	↗
4:	10.7x	↗
5:	9.4	↙
Serie 47		
Total 47		

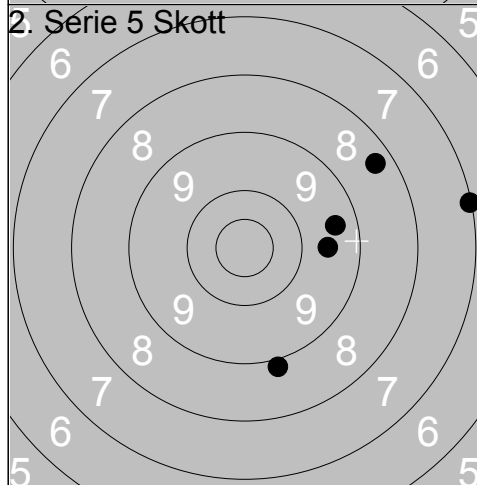

1:	9.6	→
2:	8.3	↗
3:	7.0	→
4:	8.9	↘
5:	9.4	→
Serie 41		
Total 88		

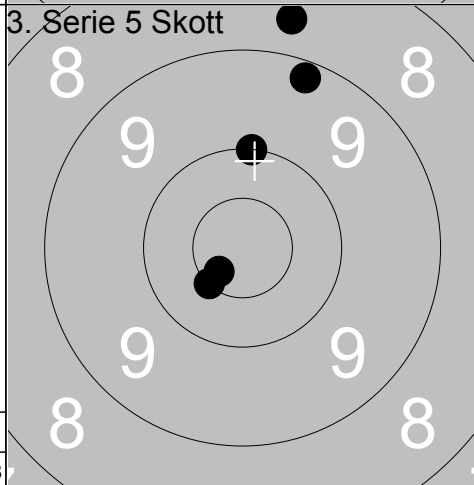

1:	10.5x	↙
2:	9.2	↗
3:	10.6x	↙
4:	8.7	↗
5:	10.0	↗
Serie 47		
Total 135		

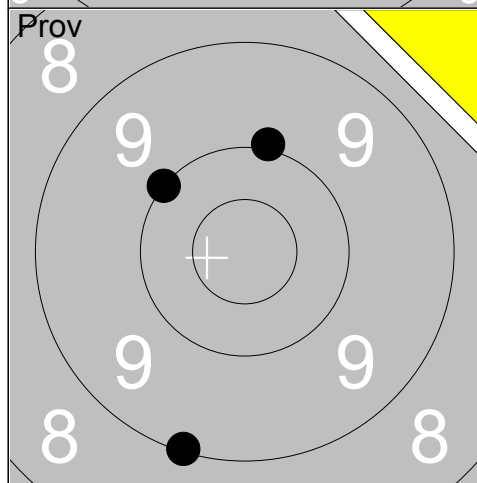

1:	9.1	↘
2:	10.0	↗
3:	10.0	↖
Serie 29		
Total 135		

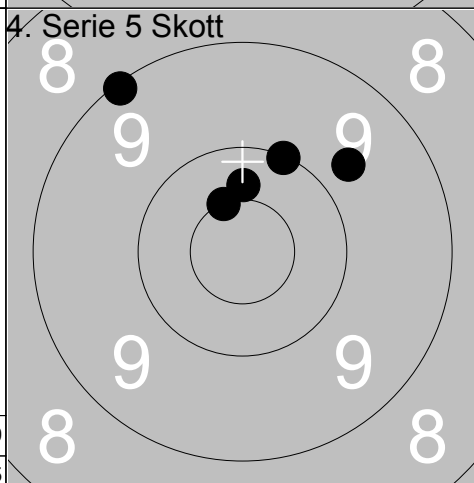

1:	10.5x	↖
2:	9.7	↗
3:	9.1	↖
4:	10.4	↗
5:	10.0	↗
Serie 48		
Total 183		

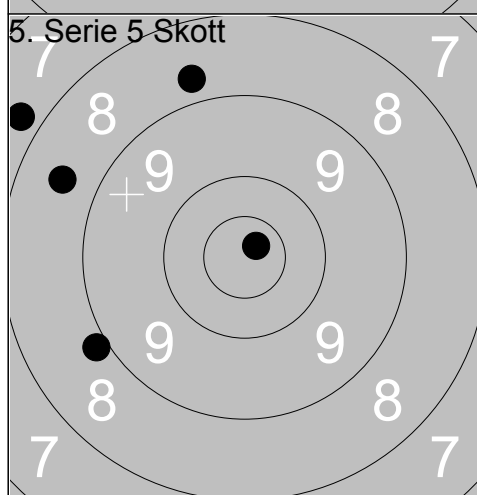

1:	8.6	↖
2:	10.8x	↗
3:	8.9	↙
4:	7.8	↖
5:	8.7	↗
Serie 41		
Total 224		

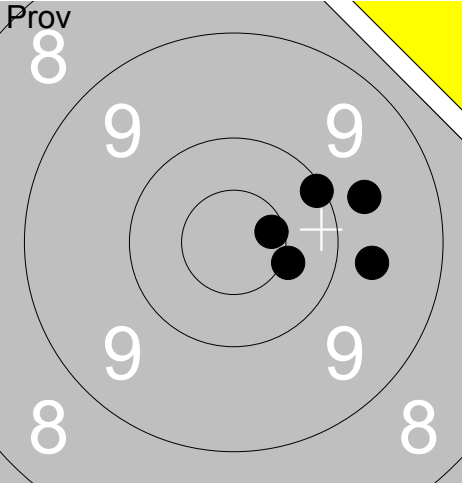
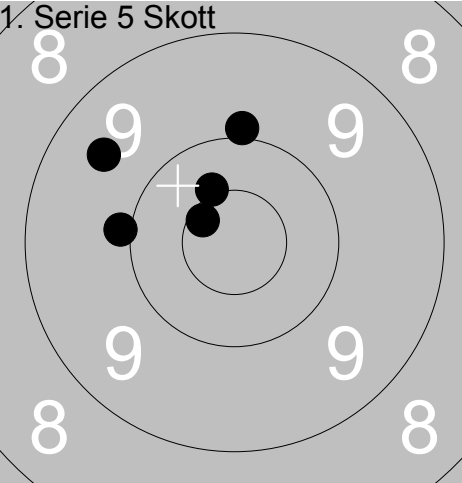
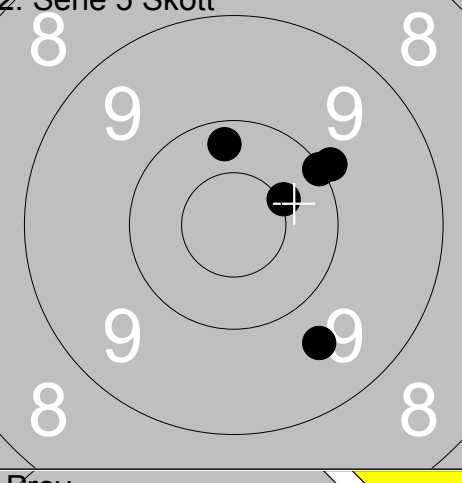
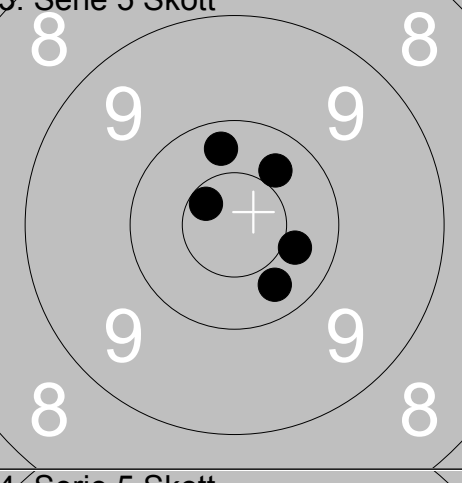
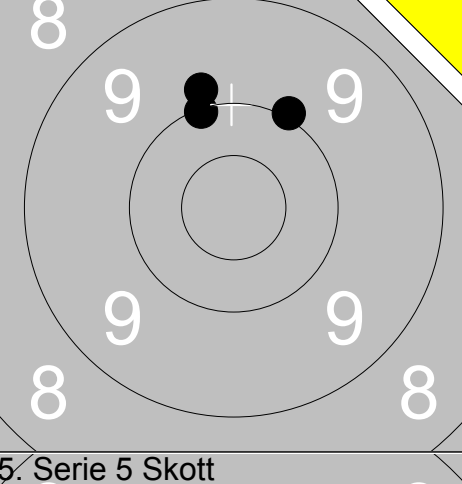
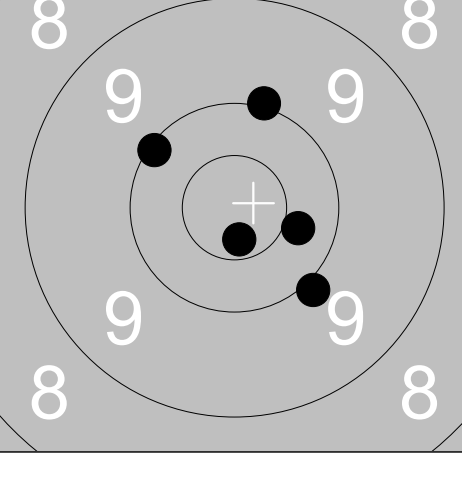
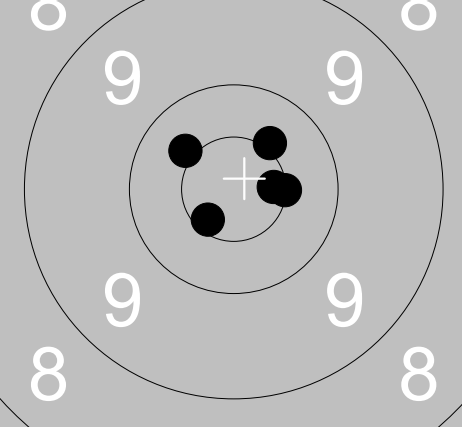
Skjutlag 3	Tavla 4	Marcus Åhlin	
Ramselefors		Bälgviken	Öpp
12.08.2017		SM Banskytte Liggande 2017	Ramselefors SKF
Prov		1: 10.1 ↗ 2: 10.6x → 3: 9.7 → 4: 9.7 → 5: 10.4x →	1. Serie 5 Skott
		Serie 48 Total 0	
			1: 10.4x ↗ 2: 9.5 ↗ 3: 10.6x ↗ 4: 9.9 ← 5: 9.9 ↑
			Serie 47 Total 47
2. Serie 5 Skott		1: 9.9 ↗ 2: 10.0 ↗ 3: 10.5x ↗ 4: 9.6 ↘ 5: 10.2 ↑	3. Serie 5 Skott
		Serie 48 Total 95	
			1: 10.4 → 2: 10.3 ↘ 3: 10.3 ↗ 4: 10.3 ↑ 5: 10.6x ↗
			Serie 50 Total 145
Prov		1: 10.1 ↗ 2: 10.0 ↗ 3: 9.9 ↑	4. Serie 5 Skott
		Serie 29 Total 145	
			1: 9.9 ↘ 2: 10.1 ↗ 3: 10.7x ↘ 4: 10.0 ↑ 5: 10.4 →
			Serie 49 Total 194
5. Serie 5 Skott		1: 10.4x ↗ 2: 10.5x → 3: 10.6x → 4: 10.6x ↘ 5: 10.4 ↗	
		Serie 50 Total 244	

Skjutlag	Tavla	Lars Möllsten		
3	5	Ramselefors	Umeå	Öpp
12.08.2017		SM Banskytte Liggande 2017	Ramselefors SKF	Vb
Prov		1: 10.4 ↙ 2: 10.3 ↑ 3: 10.6x ↘ 4: 9.8 ↗ 5: 10.5x ↖	1. Serie 5 Skott	1: 9.1 ↑ 2: 10.3 → 3: 9.1 → 4: 9.9 ↗ 5: 10.7x ↖
		Serie 49		Serie 47
		Total 0		Total 47
2. Serie 5 Skott		1: 9.9 ↗ 2: 10.1 ↘ 3: 10.6x ↘ 4: 9.7 ↖ 5: 10.6x ↓	3. Serie 5 Skott	1: 10.2 ↑ 2: 10.0 ↑ 3: 9.8 ← 4: 9.3 ← 5: 9.8 ↓
		Serie 48		Serie 47
		Total 95		Total 142
Prov		1: 9.4 ↘ 2: 10.7x ↘ 3: 10.3 ↘	4. Serie 5 Skott	1: 9.6 ↑ 2: 9.9 ↘ 3: 9.9 ↖ 4: 10.0 → 5: 10.1 ↘
		Serie 29		Serie 47
		Total 142		Total 189
5. Serie 5 Skott		1: 10.7x ← 2: 9.3 ↖ 3: 9.9 ↖ 4: 10.6x ↓ 5: 10.2 →		
		Serie 48		
		Total 237		

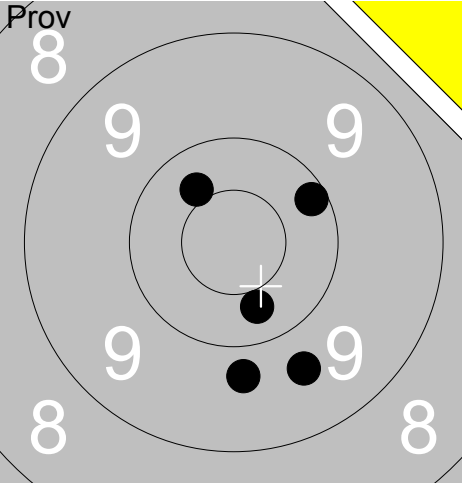
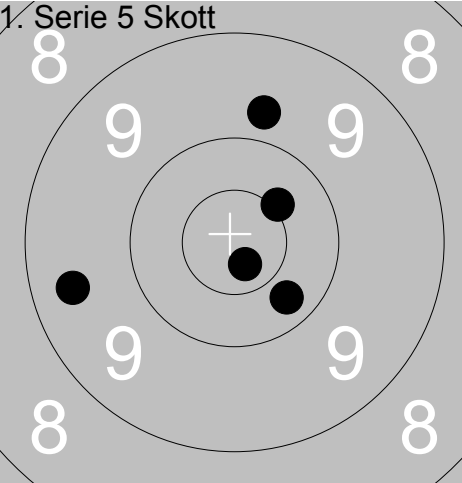
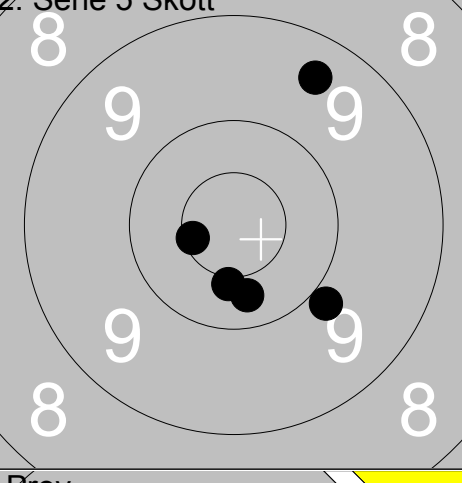
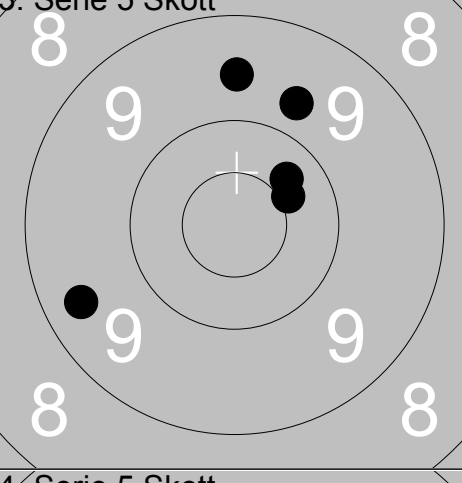
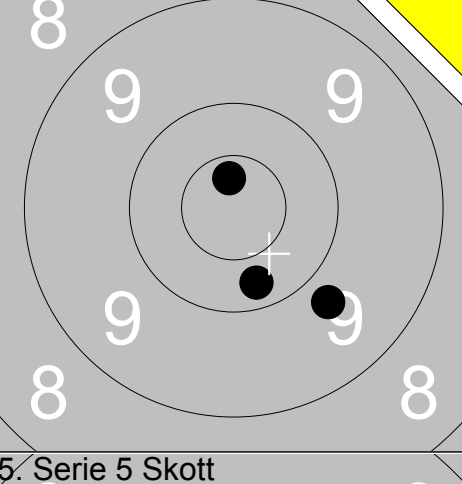
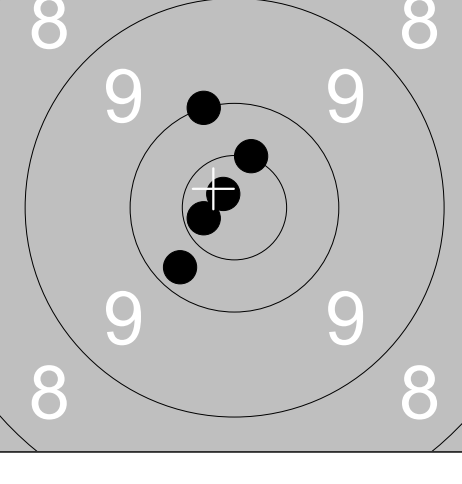
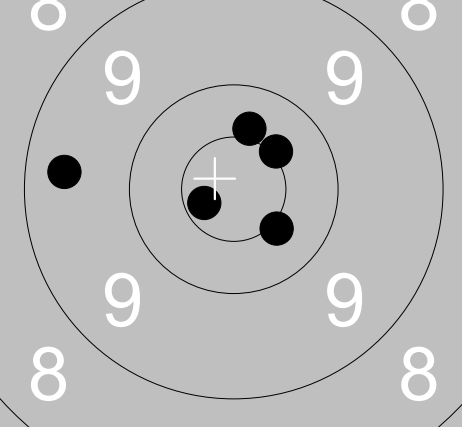
Skjutlag 3	Tavla 6	Göran Åhlin	
Ramselefors		Bälgviken	Öpp Sö
12.08.2017		SM Banskytte Liggande 2017	Ramselefors SKF
Prov 	1: 9.7 ↓ 2: 9.7 ↓ 3: 10.2 → 4: 10.3 ↓ 5: 10.4 ↗	1. Serie 5 Skott 	1: 9.8 ↑ 2: 10.3 ↓ 3: 10.7x ↓ 4: 10.4x → 5: 9.4 ←
	Serie 48 Total 0		Serie 48 Total 48
2. Serie 5 Skott 	1: 10.4x ↓ 2: 10.3 ↓ 3: 9.9 ↓ 4: 9.4 ↗ 5: 10.6x ←	3. Serie 5 Skott 	1: 10.3 ↗ 2: 9.7 ↑ 3: 9.4 ← 4: 9.6 ↑ 5: 10.4 →
	Serie 48 Total 96		Serie 47 Total 143
Prov 	1: 10.3 ↓ 2: 9.7 ↓ 3: 10.7x ↑	4. Serie 5 Skott 	1: 10.5x ↑ 2: 10.2 ↓ 3: 10.8x ↗ 4: 10.7x ← 5: 10.0 ↑
	Serie 29 Total 143		Serie 50 Total 193
5. Serie 5 Skott 	1: 10.4 ↑ 2: 9.4 ← 3: 10.7x ← 4: 10.4x ↓ 5: 10.4x ↗		
	Serie 49 Total 242		

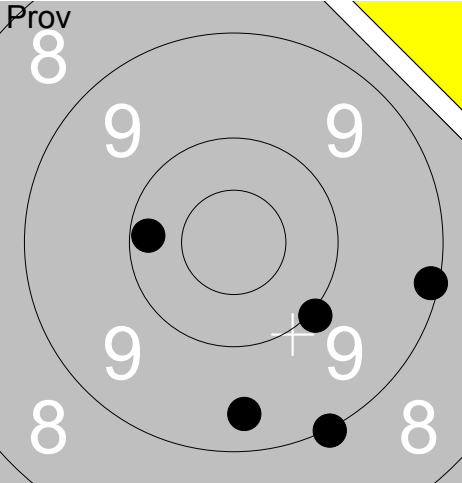
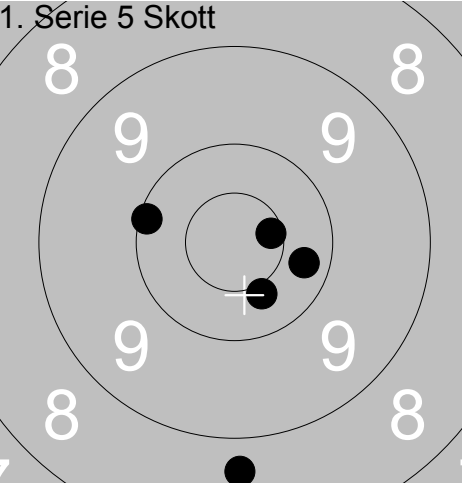
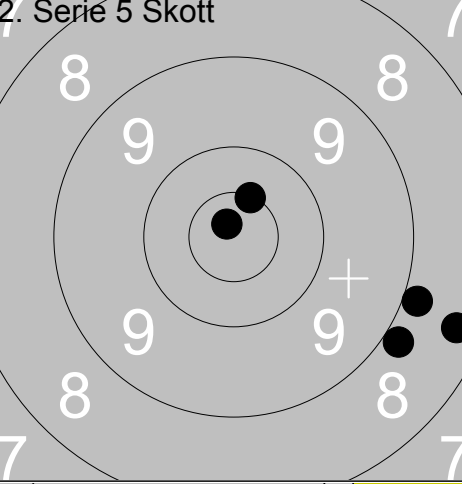
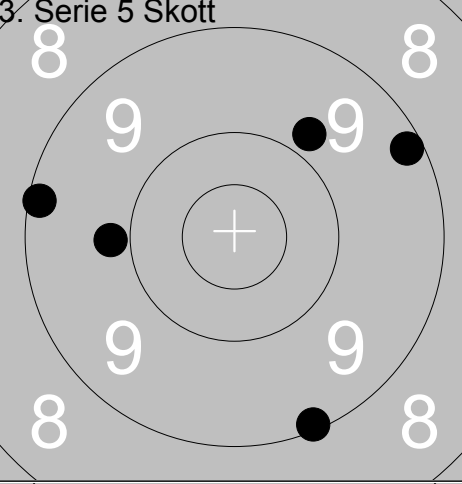
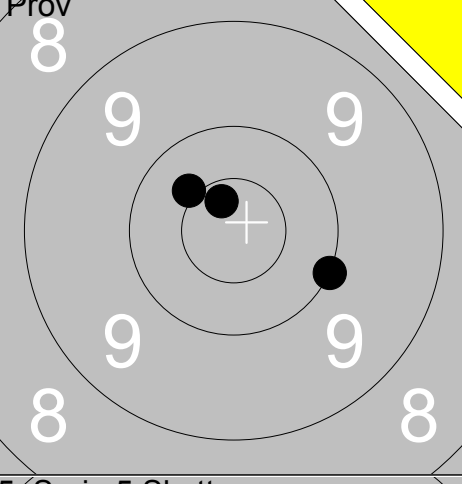
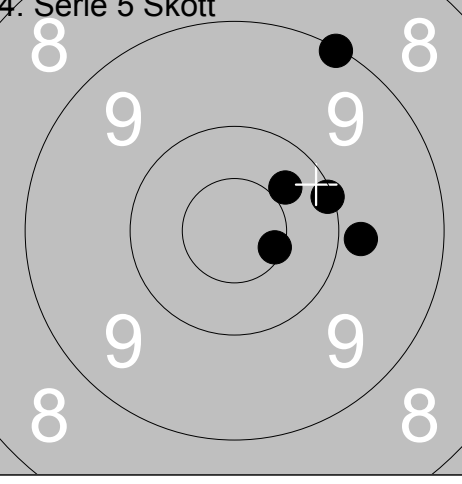
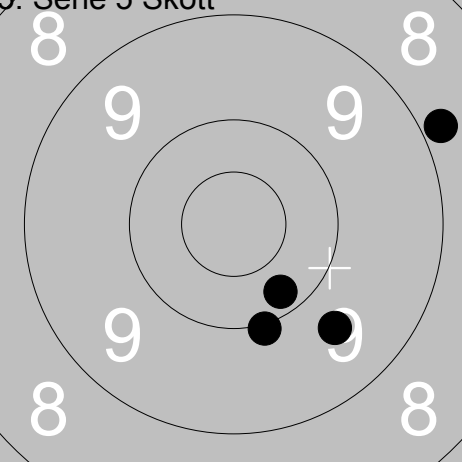
Skjutlag	Tavla	Andres Delgado		
3	7	Ramselefors	Norrköping	Öpp
12.08.2017	SM Banskytte Liggande 2017	Ramselefors SKF		
Prov 	1: 9.1 → 2: 10.0 ↓ 3: 10.2 ← 4: 9.0 ↓ 5: 9.4 ↓	1. Serie 5 Skott 	1: 10.6x → 2: 10.1 ← 3: 10.3 → 4: 8.7 ↓ 5: 10.4 ↓	
	Serie 47 Total 0		Serie 48 Total 48	
2. Serie 5 Skott 	1: 8.9 → 2: 8.9 ↓ 3: 8.3 → 4: 10.8x ↗ 5: 10.5x ↗	3. Serie 5 Skott 	1: 9.2 ↗ 2: 9.1 ↓ 3: 9.1 ← 4: 9.8 ↗ 5: 9.8 ←	
	Serie 44 Total 92		Serie 45 Total 137	
Prov 	1: 10.4x ↗ 2: 10.0 → 3: 10.7x ↗	4. Serie 5 Skott 	1: 10.1 ↗ 2: 9.8 → 3: 10.4 ↗ 4: 9.1 ↗ 5: 10.6x →	
	Serie 30 Total 137		Serie 48 Total 185	
5. Serie 5 Skott 	1: 8.8 → 2: 9.6 ↓ 3: 10.2 ↓ 4: 10.0 ↓ 5: 0.0			
	Serie 37 Total 222			

Skjutlag 3	Tavla 8	Daniel Wallberg		
Ramselefors		Loos		Öpp
12.08.2017		SM Banskytte Liggande 2017		Ramselefors SKF
Prov		1: 10.1 ↗ 2: 8.6 ↗ 3: 10.0 ↘ 4: 10.5x → 5: 10.2 ↘	1. Serie 5 Skott	1: 9.8 ↗ 2: 10.7x ← 3: 10.3 ↗ 4: 9.2 → 5: 9.9 ↗
		Serie 48 Total 0		Serie 47 Total 47
2. Serie 5 Skott		1: 9.7 → 2: 9.6 ↓ 3: 10.2 ← 4: 10.6x ↘ 5: 9.7 ←	3. Serie 5 Skott	1: 10.2 ← 2: 10.7x ↗ 3: 8.9 ← 4: 8.9 ← 5: 9.7 ↗
		Serie 47 Total 94		Serie 45 Total 139
Prov		1: 9.1 ↗ 2: 10.3 ← 3: 9.3 →	4. Serie 5 Skott	1: 9.4 ↓ 2: 10.1 ↗ 3: 10.1 ↗ 4: 10.4x ↗ 5: 10.5x ↘
		Serie 28 Total 139		Serie 49 Total 188
5. Serie 5 Skott		1: 10.9x ↗ 2: 10.2 ↗ 3: 10.2 → 4: 10.1 ↗ 5: 9.9 ↓		
		Serie 49 Total 237		

Skjutlag 3	Tavla 9	Elin Åhlin	
Ramselefors		Bälgviken	Öpp Sö
12.08.2017		SM Banskytte Liggande 2017	Ramselefors SKF
Prov		1: 10.4 → 2: 10.5x ↓ 3: 10.3 ↓ 4: 10.6x ↓ 5: 10.4 ↓	1. Serie 5 Skott
		Serie 50 Total 0	1: 10.3 → 2: 9.7 → 3: 10.1 ↙ 4: 10.0 ↓ 5: 10.4 ↗
2. Serie 5 Skott		Serie 49 Total 98	
		1: 10.1 → 2: 9.9 ↓ 3: 10.1 ← 4: 10.1 ↑ 5: 10.1 ↙	3. Serie 5 Skott
		Serie 49 Total 147	1: 10.0 → 2: 10.5x ↗ 3: 10.3 ↗ 4: 10.5x ↗ 5: 9.4 ←
Prov		1: 10.1 ↑ 2: 9.8 ← 3: 9.4 ↓	4. Serie 5 Skott
		Serie 28 Total 147	1: 10.1 ↗ 2: 10.6x ← 3: 8.5 ← 4: 10.4 ↙ 5: 10.3 ↗
5. Serie 5 Skott		Serie 48 Total 243	
		1: 9.7 ↓ 2: 10.4x ↑ 3: 10.4x ← 4: 9.9 ↙ 5: 10.9x ↗	
		Serie 48 Total 243	

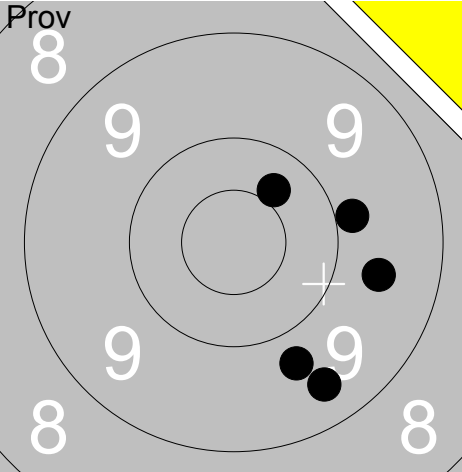
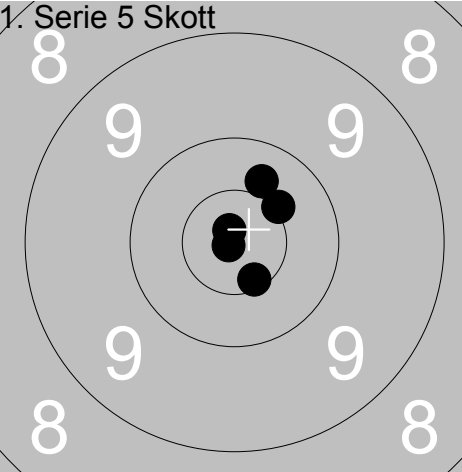
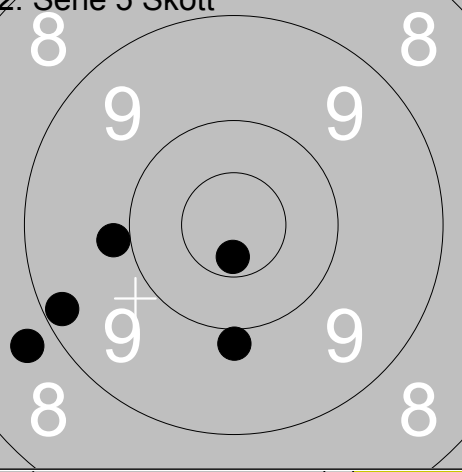
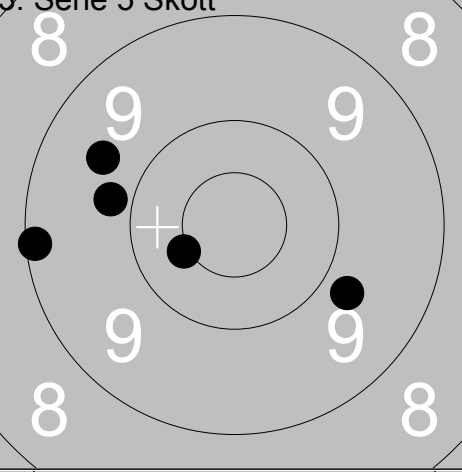
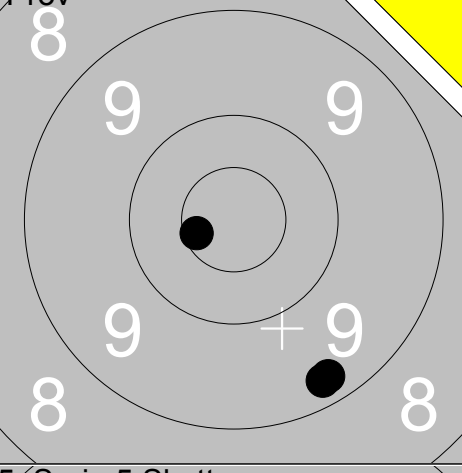
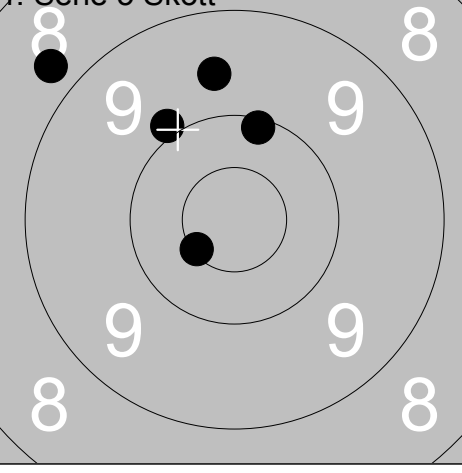
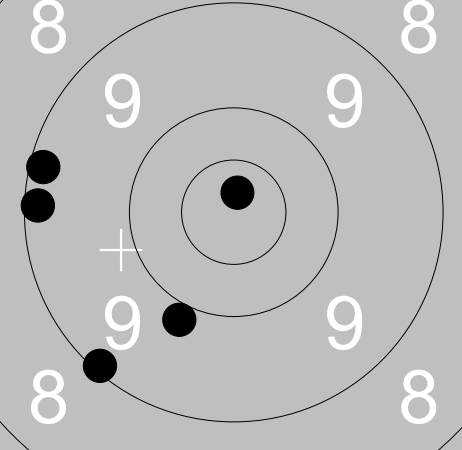
Skjutlag 3	Tavla 10	Jane Jönsson	
Ramselefors		Öved-Östraby	Öpp Sk
12.08.2017		SM Banskytte Liggande 2017	Ramselefors SKF
Prov 	1: 9.9 → 2: 9.4 ↘ 3: 9.7 ↘ 4: 9.6 → 5: 10.4 ↗ Serie 46 Total 0	1. Serie 5 Skott 	1: 10.6x ↘ 2: 10.9x ↙ 3: 10.5x ↗ 4: 10.8x ↗ 5: 10.4 ↗ Serie 50 Total 50
2. Serie 5 Skott 	1: 10.7x ↓ 2: 9.2 ↙ 3: 9.9 ↓ 4: 9.9 ↙ 5: 8.7 ↙ Serie 45 Total 95	3. Serie 5 Skott 	1: 9.8 ↘ 2: 9.8 ↙ 3: 9.1 ↙ 4: 9.6 ↗ 5: 10.4x ↙ Serie 46 Total 141
Prov 	1: 10.6x ↙ 2: 9.3 ↘ 3: 9.3 ↘ Serie 28 Total 141	4. Serie 5 Skott 	1: 10.5x ↙ 2: 10.1 ↗ 3: 9.9 ↗ 4: 8.7 ↗ 5: 9.6 ↗ Serie 46 Total 187
5. Serie 5 Skott 	1: 10.8x ↗ 2: 9.9 ↘ 3: 9.2 ↙ 4: 9.2 ↙ 5: 9.1 ↙ Serie 46 Total 233		

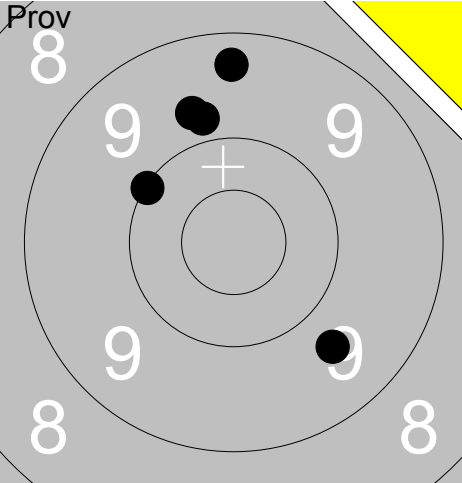
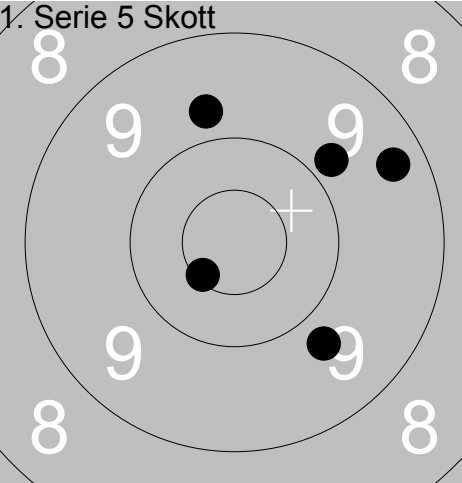
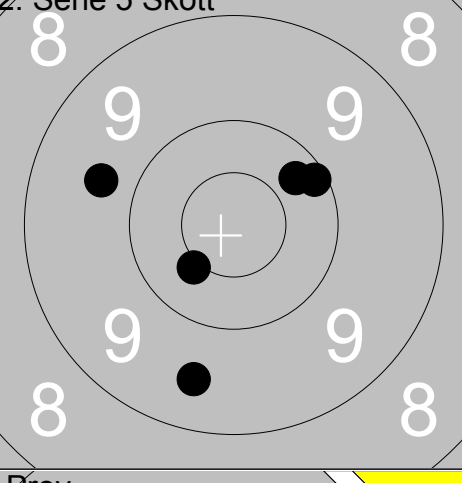
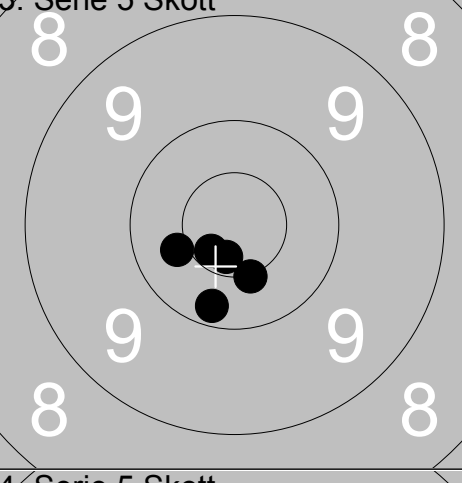
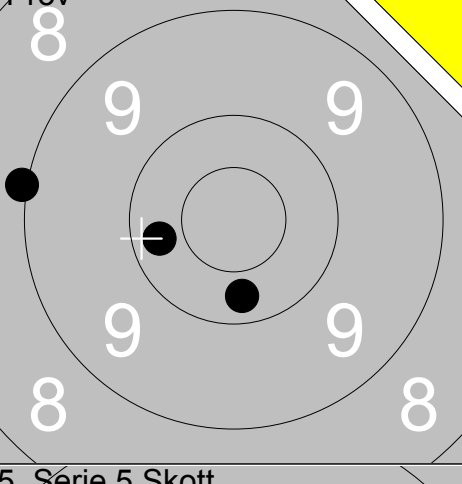
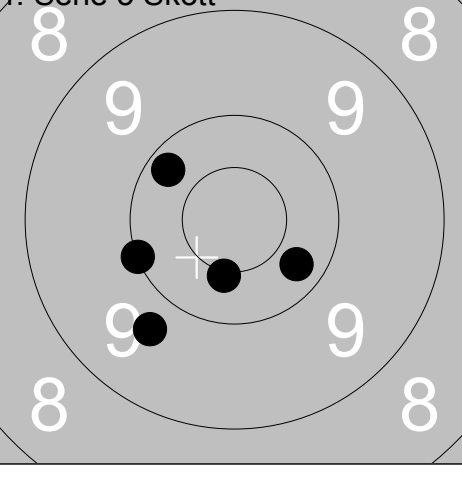
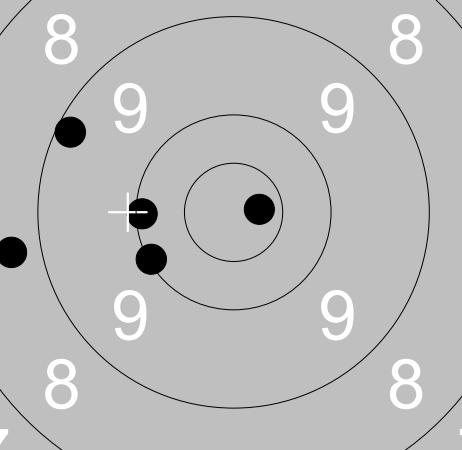
Skjutlag	Tavla	Anna Eklöf	
3	11	Ramselefors	Storfors
12.08.2017	SM Banskytte Liggande 2017	Öpp	Vä
12.08.2017	SM Banskytte Liggande 2017	Ramselefors SKF	
Prov 	1: 9.8 ↑ 2: 9.3 ↑ 3: 10.0 ↗ 4: 9.7 ↗ 5: 9.7 ↘ Serie 46 Total 0	1. Serie 5 Skott 	1: 9.3 ↗ 2: 9.7 ↑ 3: 10.5x ↘ 4: 9.8 ↗ 5: 9.7 ↘ Serie 46 Total 46
2. Serie 5 Skott 	1: 10.1 ↗ 2: 10.3 ↗ 3: 9.5 ↘ 4: 9.7 ← 5: 10.4x ↘ Serie 48 Total 94	3. Serie 5 Skott 	1: 10.5x ↘ 2: 10.7x ↘ 3: 10.6x ↘ 4: 10.2 ↘ 5: 10.4 ← Serie 50 Total 144
Prov 	1: 10.3 ← 2: 9.0 ← 3: 10.3 ↓ Serie 29 Total 144	4. Serie 5 Skott 	1: 10.3 ↘ 2: 10.2 ↗ 3: 10.0 ← 4: 9.7 ↘ 5: 10.4x ↘ Serie 49 Total 193
5. Serie 5 Skott 	1: 10.7x → 2: 9.2 ↗ 3: 10.1 ← 4: 8.7 ← 5: 10.1 ← Serie 47 Total 240		

Skjutlag 3	Tavla 12	Berit Olsson	
Ramselefors		Öved-Östraby	Öpp Sk
12.08.2017		SM Banskytte Liggande 2017	Ramselefors SKF
Prov		1: 10.2 ↙ 2: 9.7 → 3: 10.7x ↗ 4: 10.7x → 5: 10.6x ↘	1. Serie 5 Skott 1: 10.3 ↘ 2: 10.3 ↗ 3: 9.9 ↗ 4: 10.4 ↘ 5: 10.6x ←
		Serie 49 Total 0	Serie 49 Total 49
2. Serie 5 Skott		1: 9.8 ↗ 2: 10.4x ↘ 3: 10.2 ↗ 4: 10.2 ← 5: 9.2 ↗	3. Serie 5 Skott 1: 9.2 ↘ 2: 10.2 ↗ 3: 10.0 ↗ 4: 10.6x → 5: 10.5x ↗
		Serie 48 Total 97	Serie 49 Total 146
Prov		1: 9.1 ↗ 2: 10.0 ↘ 3: 10.1 ↗	4. Serie 5 Skott 1: 9.9 ↘ 2: 10.3 ↗ 3: 10.9x → 4: 9.9 ↗ 5: 10.7x →
		Serie 29 Total 146	Serie 48 Total 194
5. Serie 5 Skott		1: 10.2 → 2: 9.4 ↘ 3: 9.8 ↗ 4: 10.6x ↗ 5: 10.4 ↗	
		Serie 48 Total 242	

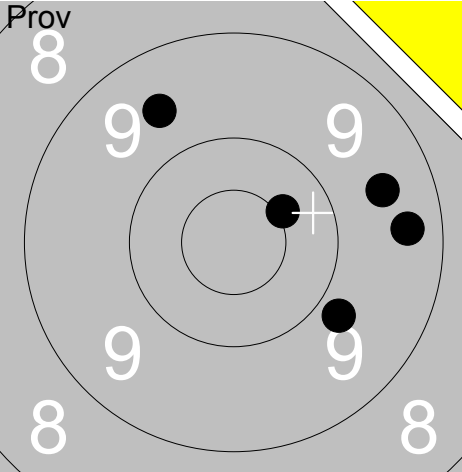
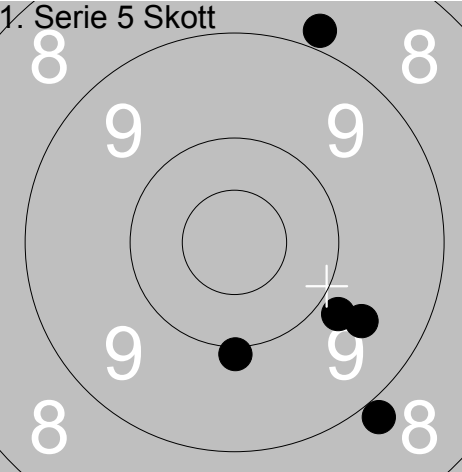
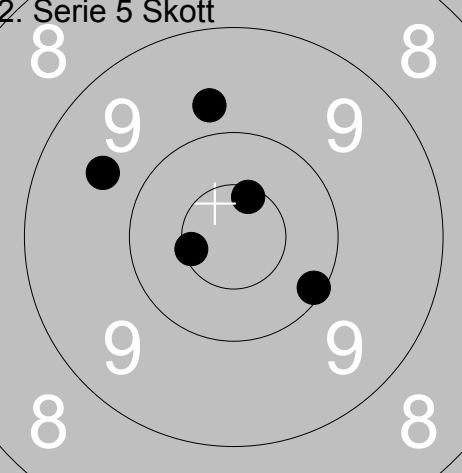
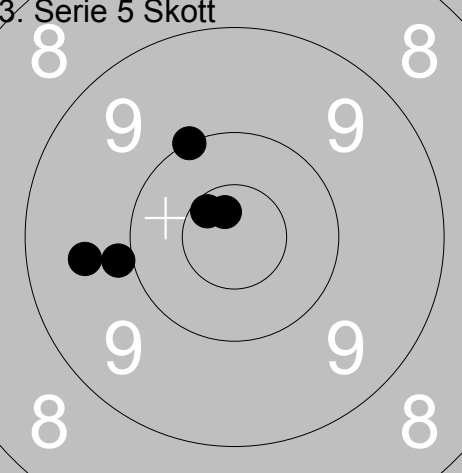
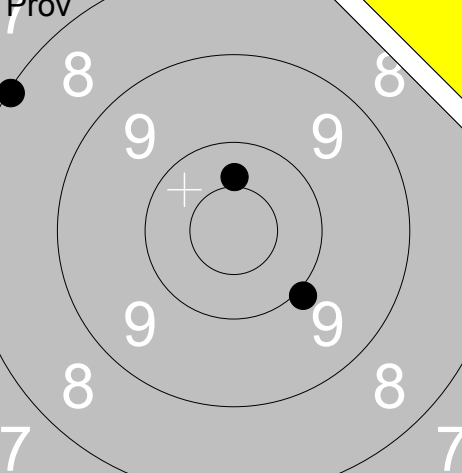
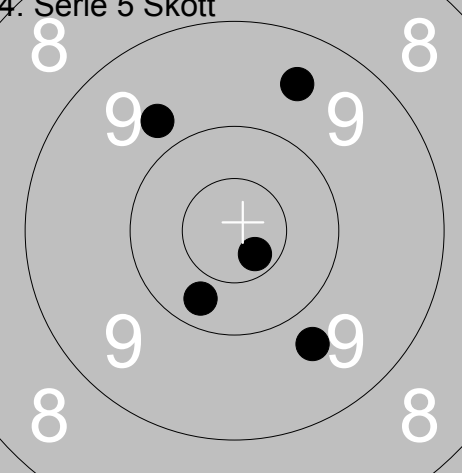
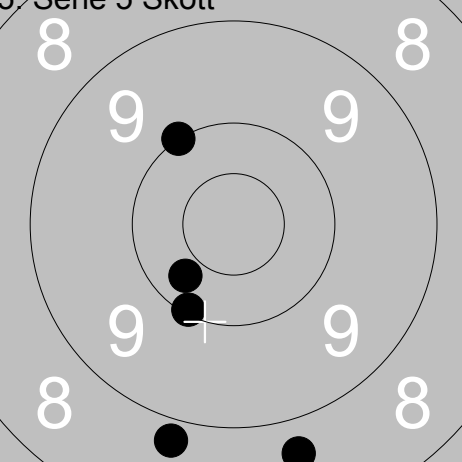
Skjutlag	Tavla	Niklas Larsson	
3	13	Ramselefors	Storfors
12.08.2017	SM Banskytte Liggande 2017	Öpp	Vä
12.08.2017	SM Banskytte Liggande 2017	Ramselefors SKF	
Prov 	1: 9.6 ↗ 2: 9.4 → 3: 10.4x ↗ 4: 9.8 ↘ 5: 9.5 → Serie 46 Total 0	1. Serie 5 Skott 	1: 8.9 ↘ 2: 9.6 ↘ 3: 10.0 ↓ 4: 9.8 ↘ 5: 8.8 ↑ Serie 44 Total 44
2. Serie 5 Skott 	1: 9.7 ↗ 2: 10.1 ↘ 3: 10.6x ← 4: 9.6 ↗ 5: 10.6x ↑ Serie 48 Total 92	3. Serie 5 Skott 	1: 10.6x ↗ 2: 10.0 ↗ 3: 10.7x ↗ 4: 9.9 ← 5: 9.6 ← Serie 48 Total 140
Prov 	1: 8.1 ↗ 2: 10.4 ↑ 3: 9.9 ↘ Serie 27 Total 140	4. Serie 5 Skott 	1: 9.5 ↑ 2: 9.7 ↘ 3: 10.7x ↘ 4: 9.7 ↗ 5: 10.3 ↘ Serie 47 Total 187
5. Serie 5 Skott 	1: 10.0 ↗ 2: 8.7 ↘ 3: 10.1 ↘ 4: 8.8 ↘ 5: 10.3 ↘ Serie 46 Total 233		

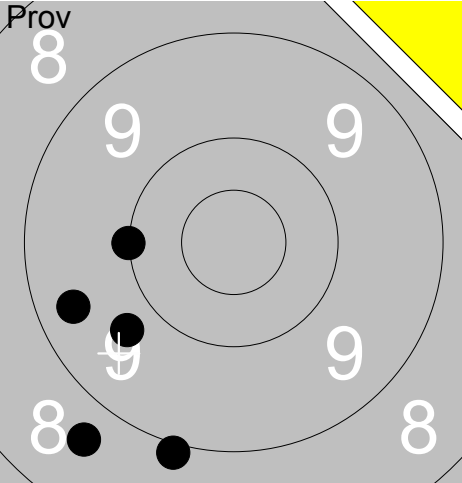
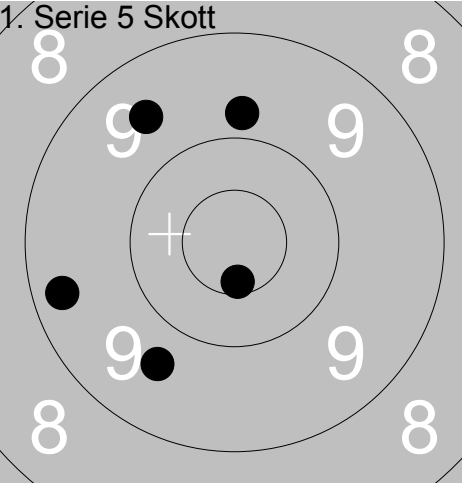
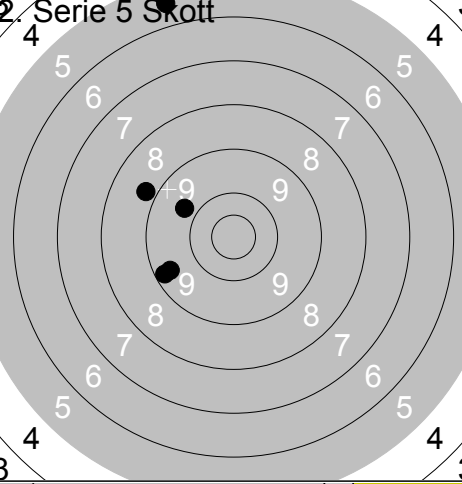
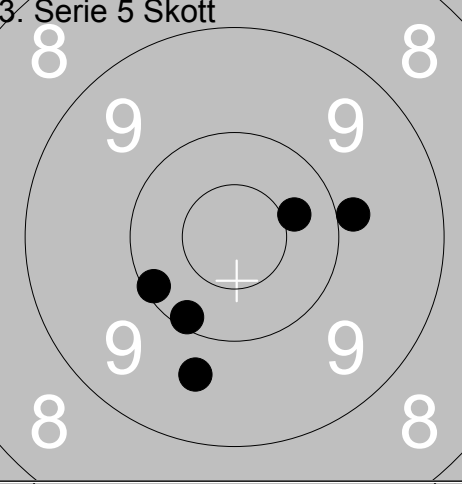
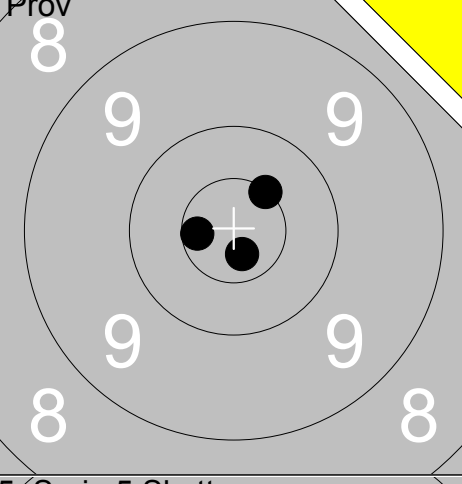
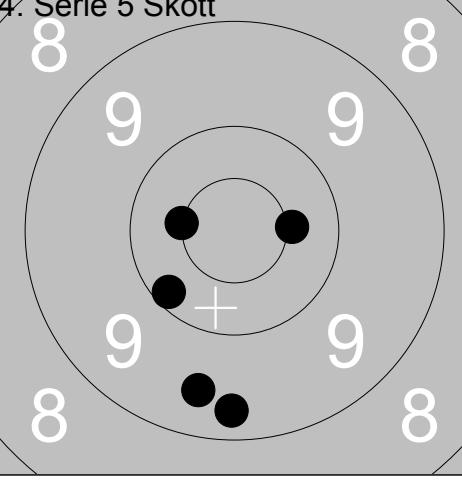
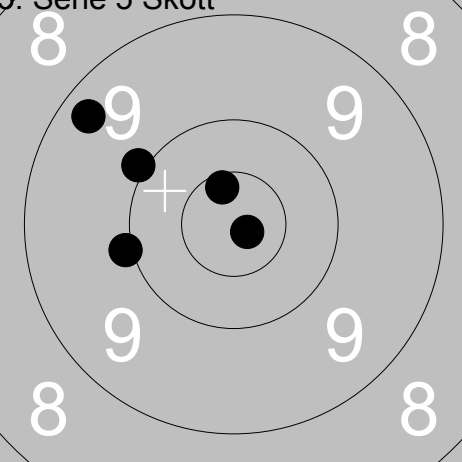
Skjutlag 3	Tavla 14	Henrik Olsson	
Ramselefors		Öved-Östraby	Öpp Sk
12.08.2017		SM Banskytte Liggande 2017	Ramselefors SKF
Prov 	1: 9.4 ← 2: 8.9 ↓ 3: 8.7 ↓ 4: 10.0 ← 5: 9.7 ↙ Serie 44 Total 0	1. Serie 5 Skott 	1: 9.6 ↗ 2: 9.8 ↑ 3: 9.3 ← 4: 9.7 ↓ 5: 10.6x ↓ Serie 46 Total 46
2. Serie 5 Skott 	1: 5.5 ↗ 2: 9.4 ← 3: 8.8 ↗ 4: 9.3 ← 5: 9.7 ↗ Serie 40 Total 86	3. Serie 5 Skott 	1: 9.9 → 2: 10.1 ↓ 3: 10.1 ← 4: 10.4 → 5: 9.7 ↓ Serie 48 Total 134
Prov 	1: 10.6x ← 2: 10.5x ↗ 3: 10.7x ↓ Serie 30 Total 134	4. Serie 5 Skott 	1: 10.4x → 2: 9.3 ↓ 3: 10.2 ← 4: 10.5x ← 5: 9.5 ↓ Serie 48 Total 182
5. Serie 5 Skott 	1: 10.0 ↗ 2: 9.3 ↗ 3: 10.0 ← 4: 10.6x ↗ 5: 10.8x ↘ Serie 49 Total 231		

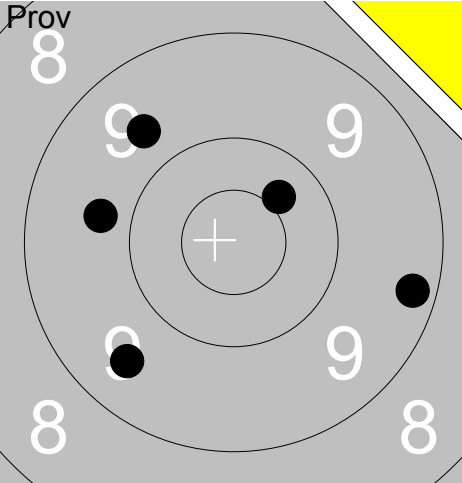
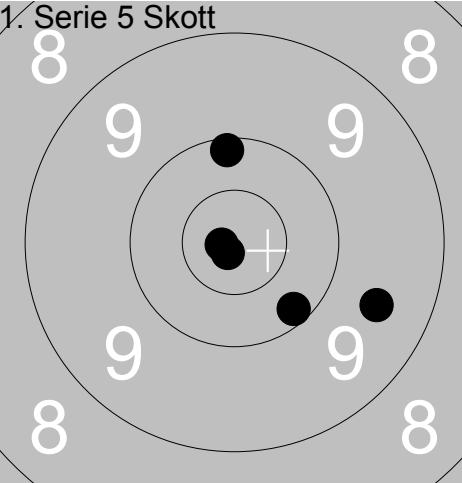
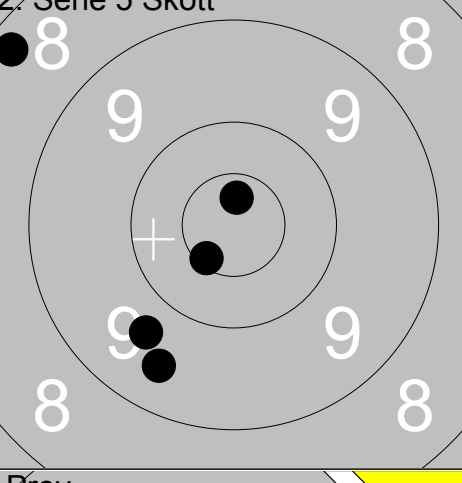
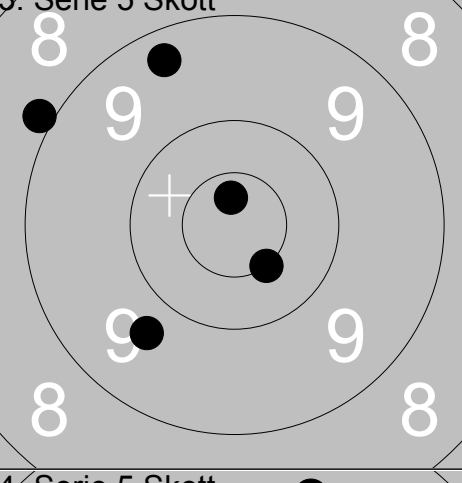
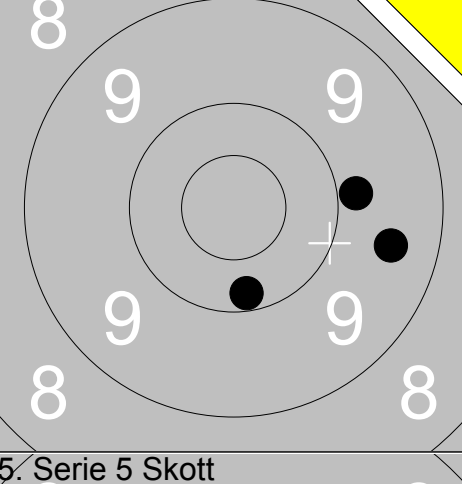
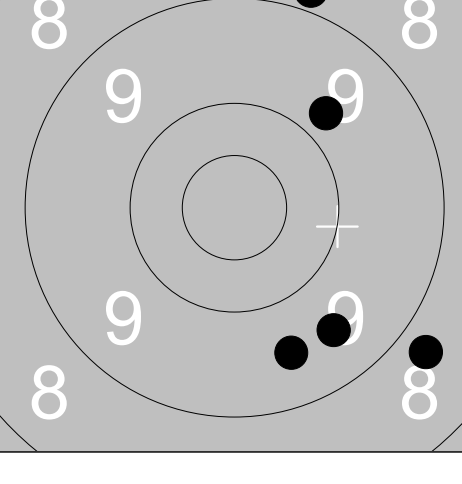
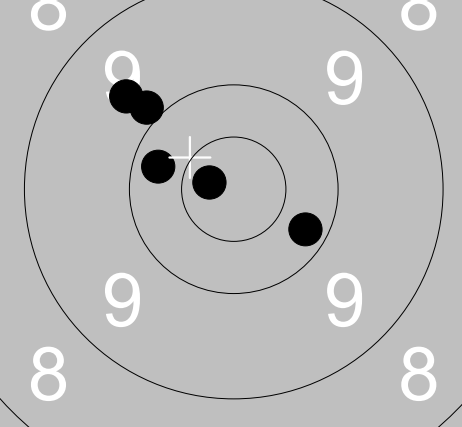
Skjutlag 3	Tavla 15	Johan Larsson	
Ramselefors	Storfors	Öpp	Vä
12.08.2017	SM Banskytte Liggande 2017	Ramselefors SKF	
Prov 	1: 9.7 ↗ 2: 9.7 ← 3: 9.5 ↘ 4: 9.3 → 5: 10.4 ↗ Serie 46 Total 0	1. Serie 5 Skott 	1: 9.5 → 2: 10.2 ↘ 3: 10.8x ← 4: 10.1 ↑ 5: 10.8x ↘ Serie 49 Total 49
2. Serie 5 Skott 	1: 10.6x ↘ 2: 9.5 ↘ 3: 8.3 ↗ 4: 9.7 ↘ 5: 10.7x ↑ Serie 46 Total 95	3. Serie 5 Skott 	1: 9.3 ↑ 2: 8.9 ↗ 3: 9.7 ↘ 4: 10.7x ↑ 5: 10.5x ↘ Serie 46 Total 141
Prov 	1: 9.9 → 2: 10.2 ↓ 3: 9.5 → Serie 28 Total 141	4. Serie 5 Skott 	1: 9.5 ↘ 2: 8.7 ↘ 3: 9.5 ↘ 4: 8.8 ↑ 5: 9.8 ↗ Serie 43 Total 184
5. Serie 5 Skott 	1: 9.7 ↗ 2: 9.9 ↗ 3: 10.3 ↗ 4: 10.7x ↗ 5: 10.2 ↘ Serie 48 Total 232		

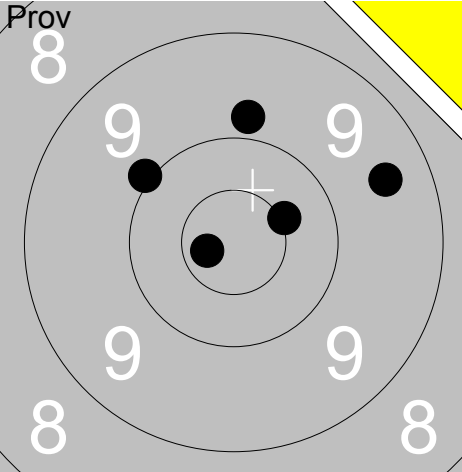
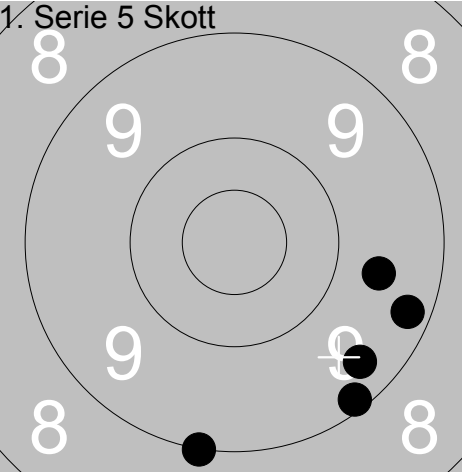
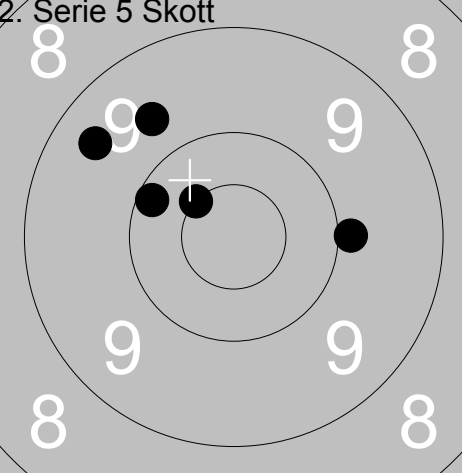
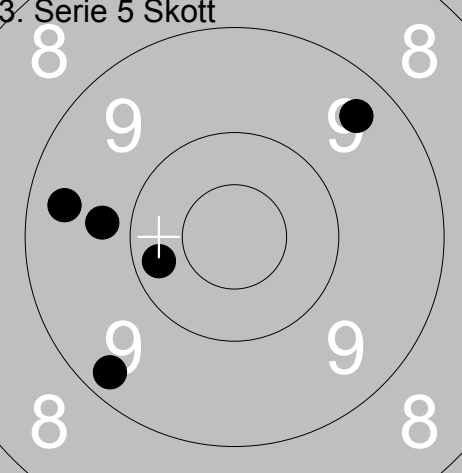
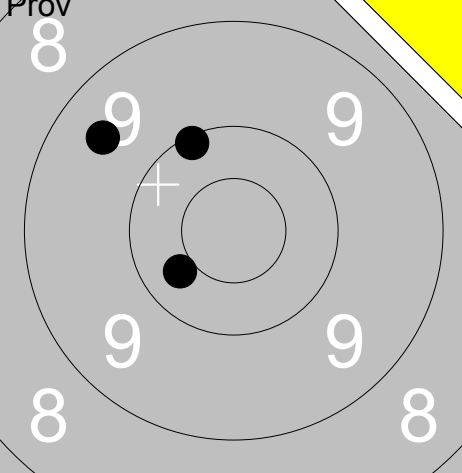
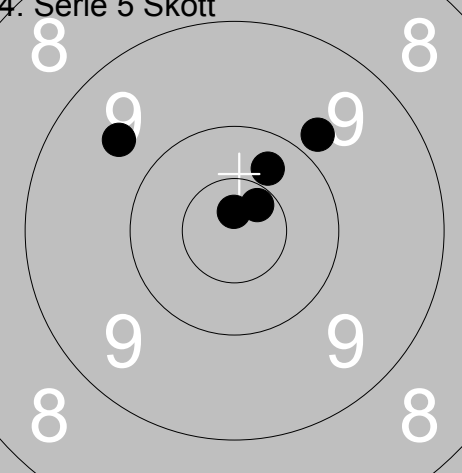
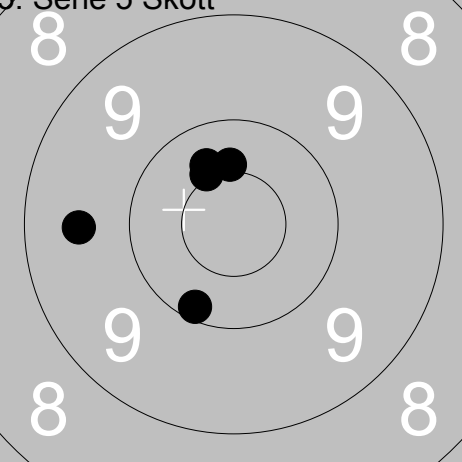
Skjutlag 3	Tavla 16	Jan-Ola Olsson	
Ramselefors		Öved-Östraby	Öpp Sk
12.08.2017		SM Banskytte Liggande 2017	Ramselefors SKF
Prov 	1: 10.5x → 2: 10.0 ↖ 3: 9.5 → 4: 9.8 ↑ 5: 10.7x ←	1. Serie 5 Skott 	1: 9.2 → 2: 9.1 ↘ 3: 9.0 ↘ 4: 9.4 ↘ 5: 9.6 →
	Serie 48 Total 0		Serie 45 Total 45
2. Serie 5 Skott 	1: 9.9 → 2: 10.5x ↗ 3: 9.4 ↗ 4: 9.7 ↗ 5: 10.2 ↗	3. Serie 5 Skott 	1: 9.4 ↗ 2: 10.2 ← 3: 9.3 ↘ 4: 9.4 ← 5: 9.8 ←
	Serie 47 Total 92		Serie 46 Total 138
Prov 	1: 10.4 ↖ 2: 10.1 ↗ 3: 9.5 ↗	4. Serie 5 Skott 	1: 9.8 ↗ 2: 10.7x ↗ 3: 9.6 ↖ 4: 10.8x ↑ 5: 10.3 ↗
	Serie 29 Total 138		Serie 48 Total 186
5. Serie 5 Skott 	1: 10.4x ↗ 2: 9.5 ← 3: 10.4 ↗ 4: 10.1 ↘ 5: 10.4x ↑		
	Serie 49 Total 235		

Skjutlag	Tavla	Jan-Erik Fäldt		Vet	Vä
3	17	Ramselefors	Storfors		
12.08.2017		SM Banskytte Liggande 2017		Ramselefors SKF	
Prov			1. Serie 5 Skott		
		1: 9.7 ← 2: 10.5x ← 3: 9.6 ↗ 4: 9.7 ↓ 5: 10.4x →		1: 10.7x ↑ 2: 9.9 ↘ 3: 10.4 ↗ 4: 10.1 ↗ 5: 9.8 ↑	
		Serie 47 Total 0		Serie 48 Total 48	
2. Serie 5 Skott		1: 8.6 ↑ 2: 9.0 ↑ 3: 9.5 ↓ 4: 10.4 ↙ 5: 8.9 ↓	3. Serie 5 Skott	1: 8.7 ↗ 2: 10.3 ↑ 3: 10.2 ↙ 4: 8.7 ↙ 5: 10.0 ↓	
		Serie 44 Total 92		Serie 46 Total 138	
Prov		1: 10.4 ↗ 2: 10.4 ← 3: 9.0 ↓	4. Serie 5 Skott	1: 9.2 → 2: 10.7x → 3: 10.7x ↑ 4: 10.1 → 5: 9.7 ↓	
		Serie 29 Total 138		Serie 48 Total 186	
5. Serie 5 Skott		1: 9.9 ← 2: 9.8 ↓ 3: 10.1 ↗ 4: 10.1 ↓ 5: 9.4 ←			
		Serie 47 Total 233			

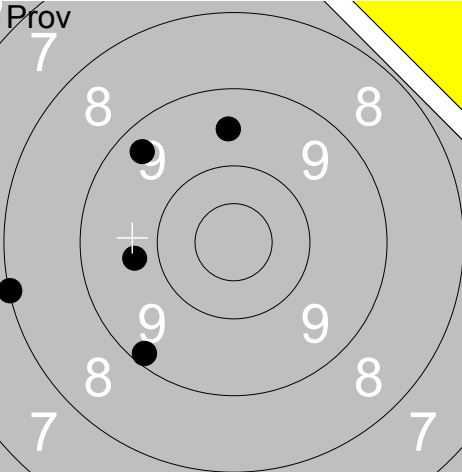
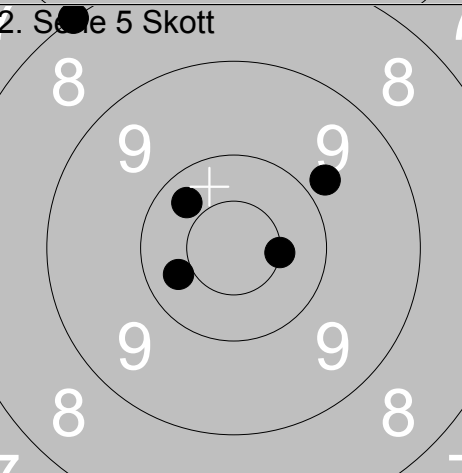
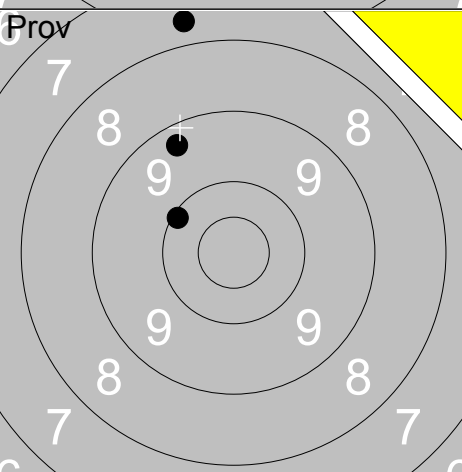
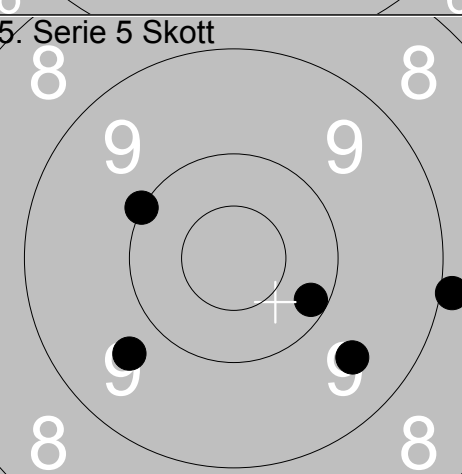
Skjutlag 3	Tavla 19	Håkan Engman		
Ramselefors		Lindesberg		Vet
12.08.2017		SM Banskytte Liggande 2017		Ramselefors SKF
Prov 7		1: 9.5 ↑ 2: 9.4 ↖ 3: 8.0 ← 4: 9.2 ↙ 5: 9.7 ←	1. Serie 5 Skott 8	1: 9.6 ↓ 2: 10.2 ↓ 3: 9.1 ← 4: 9.9 ← 5: 9.6 ←
		Serie 44 Total 0		Serie 46 Total 46
2. Serie 5 Skott 7		1: 8.0 ↗ 2: 10.5x → 3: 10.3 ← 4: 9.8 ↗ 5: 10.3 ↖	3. Serie 5 Skott 8	1: 9.9 → 2: 10.7x ↑ 3: 9.9 ↗ 4: 9.7 ← 5: 10.3 ↓
		Serie 47 Total 93		Serie 47 Total 140
Prov 7		1: 7.7 ↑ 2: 10.1 ↖ 3: 9.3 ↗	4. Serie 5 Skott 8	1: 9.8 ↖ 2: 10.6x ↑ 3: 9.7 ↗ 4: 9.8 → 5: 8.7 ↓
		Serie 26 Total 140		Serie 45 Total 185
5. Serie 5 Skott 8		1: 9.7 ↖ 2: 10.2 ↓ 3: 8.9 → 4: 10.0 ↗ 5: 9.6 ↓		
		Serie 46 Total 231		

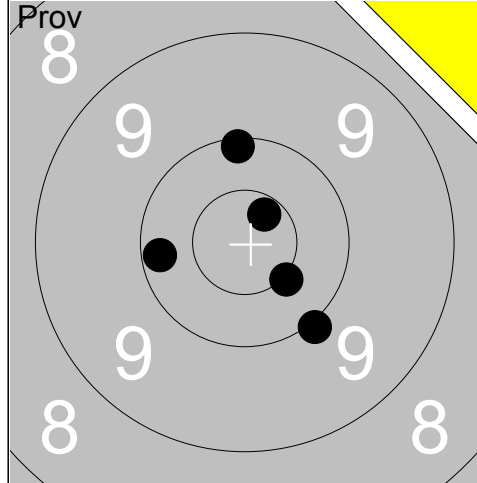

1:	10.0	↘
2:	10.5x	↘
3:	10.1	↑
4:	10.2	←
5:	10.6x	↗
Serie		50
Total		0

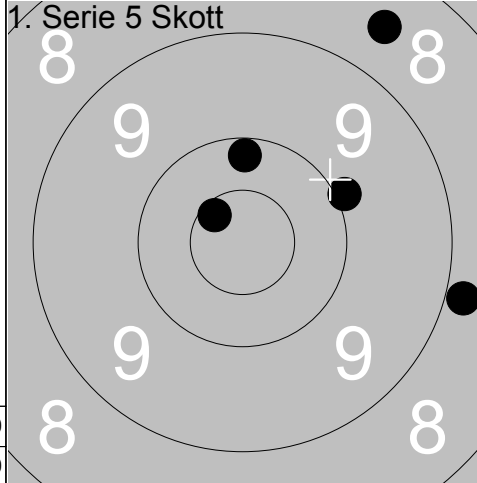

1:	10.6x	↖
2:	9.9	→
3:	8.6	↗
4:	10.2	↑
5:	8.9	→
Serie		45
Total		45

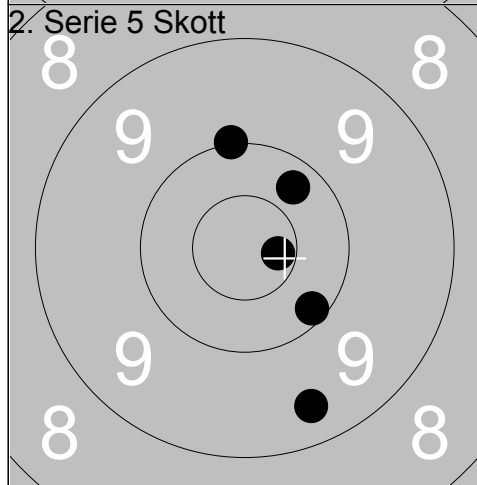

1:	10.0	↑
2:	10.7x	→
3:	10.1	↘
4:	10.3	↗
5:	9.4	↘
Serie		49
Total		94

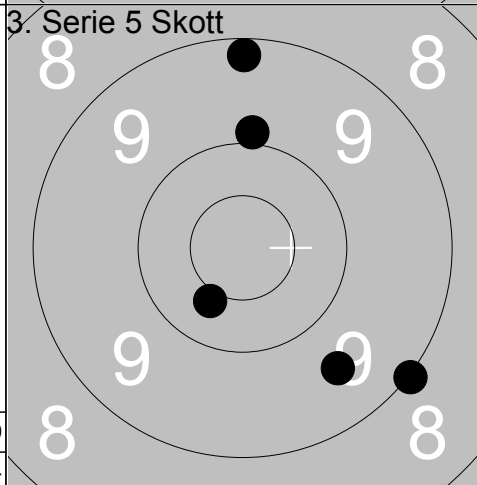

1:	9.9	↑
2:	9.2	↑
3:	9.6	↘
4:	9.0	↘
5:	10.4	↘
Serie		46
Total		140

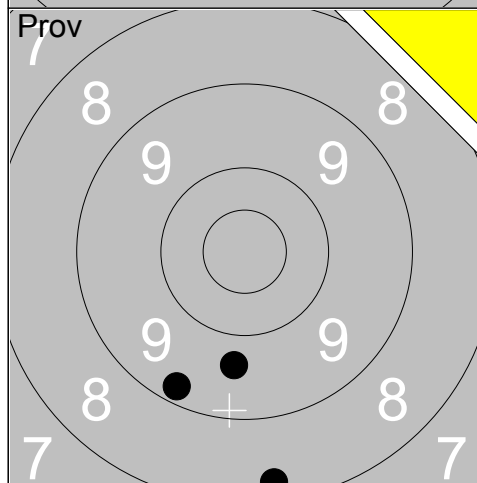

1:	9.7	↘
2:	9.2	↘
3:	8.3	↘
Serie		26
Total		140

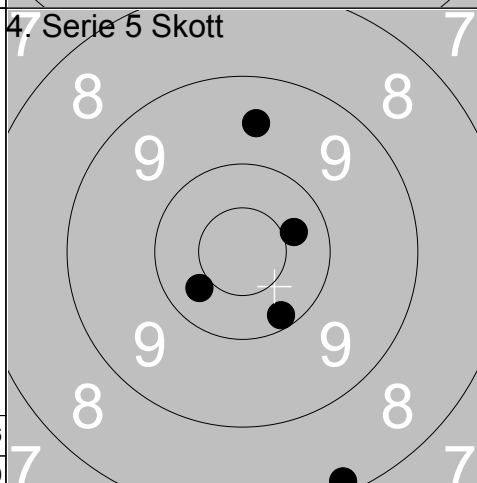

1:	10.4	→
2:	9.6	↑
3:	8.2	↘
4:	10.2	↘
5:	10.4	↖
Serie		47
Total		187

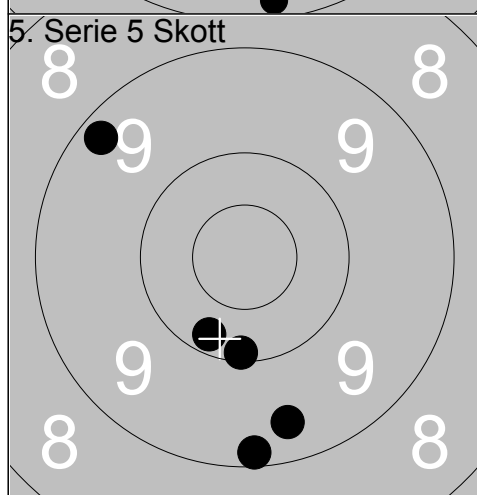

1:	9.4	↘
2:	10.1	↘
3:	9.2	↘
4:	9.2	↗
5:	10.2	↘
Serie		47
Total		234

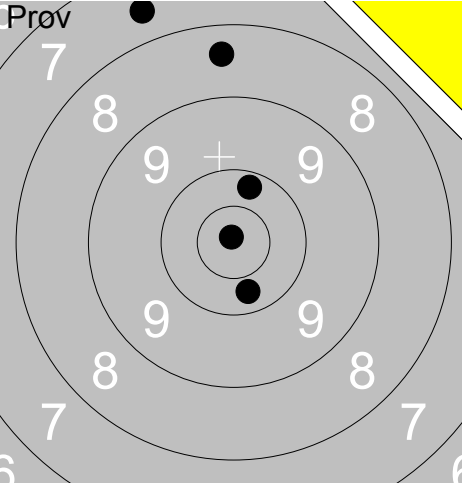
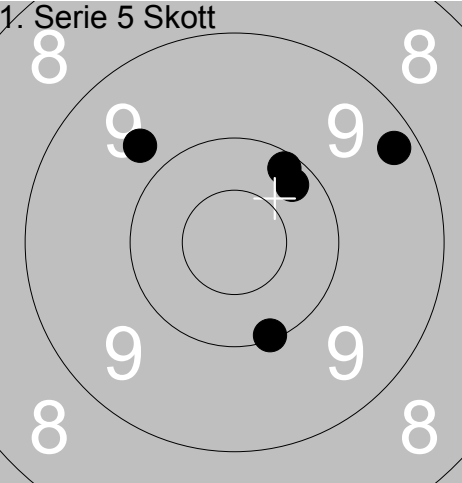
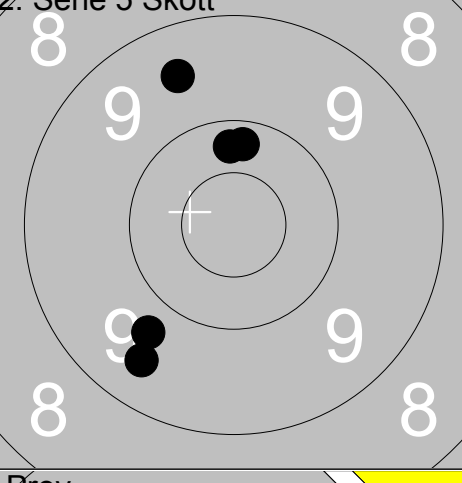
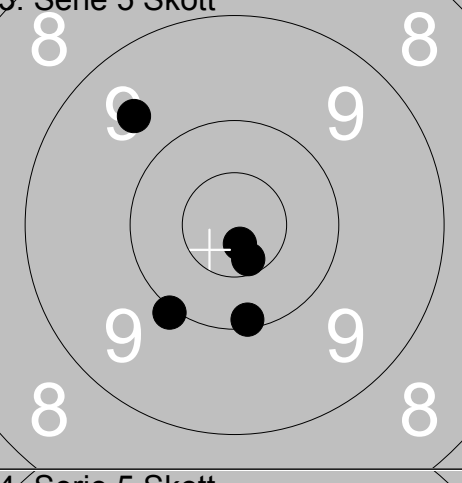
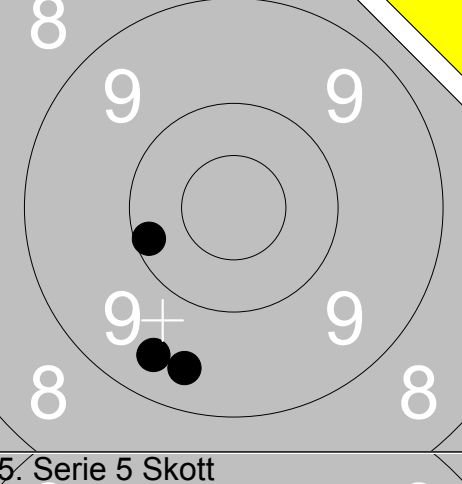
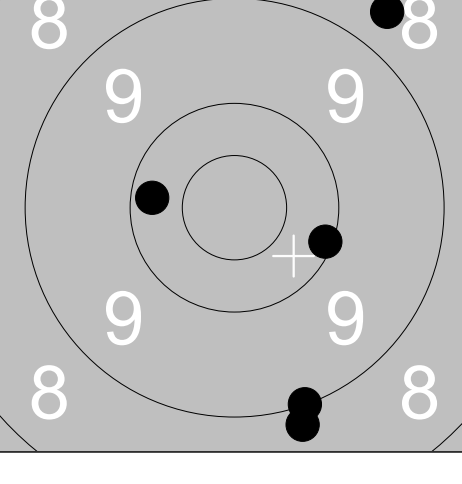
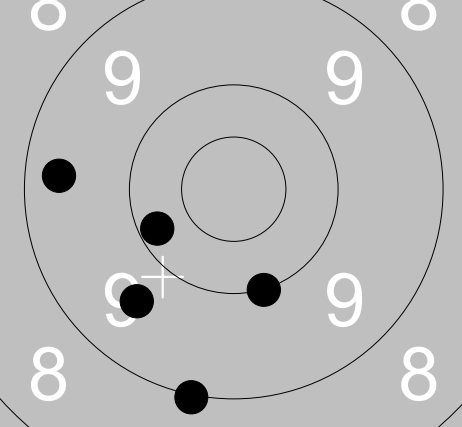
Skjutlag 3	Tavla 22	Jonny Fritzon					
Ramselefors		Kinneved		Öpp	Vg		
12.08.2017		SM Banskytte Liggande 2017		Ramselefors SKF			
Prov 	1: 10.2 ↑ 2: 8.4 ↑ 3: 7.6 ↑ 4: 10.3 ↓ 5: 10.9x ↑	1. Serie 5 Skott 	1: 10.1 ↓ 2: 9.7 ↖ 3: 10.2 ↗ 4: 10.2 ↗ 5: 9.3 ↗	Serie	45	Serie	48
	Total	0	Total	48			
2. Serie 5 Skott 	1: 9.5 ↖ 2: 9.7 ↘ 3: 9.5 ↘ 4: 10.2 ↑ 5: 10.3 ↑	3. Serie 5 Skott 	1: 10.1 ↓ 2: 10.8x ↓ 3: 10.0 ↘ 4: 10.6x ↓ 5: 9.6 ↗	Serie	47	Serie	49
	Total	95	Total	144			
Prov 	1: 9.4 ↓ 2: 10.2 ← 3: 9.4 ↓	4. Serie 5 Skott 	1: 10.1 → 2: 9.0 ↓ 3: 10.2 ← 4: 8.9 ↓ 5: 8.7 ↗	Serie	28	Serie	45
	Total	144	Total	189			
5. Serie 5 Skott 	1: 10.2 ← 2: 9.4 ← 3: 10.0 ↓ 4: 9.6 ↘ 5: 9.0 ↓			Serie	47		
	Total	236					

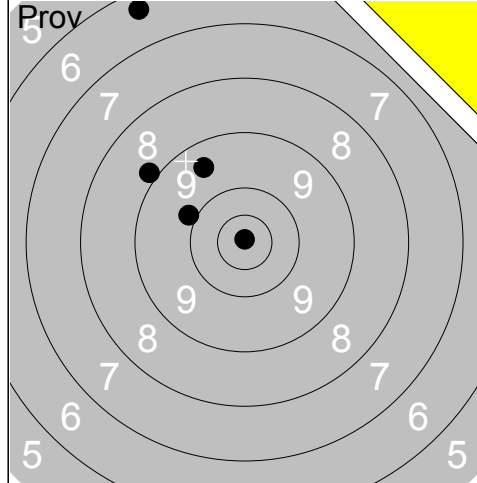

1:	6.4	↗
2:	8.9	↗
3:	10.9x	↑
4:	9.5	↗
5:	9.9	↗
Serie		42
Total		0

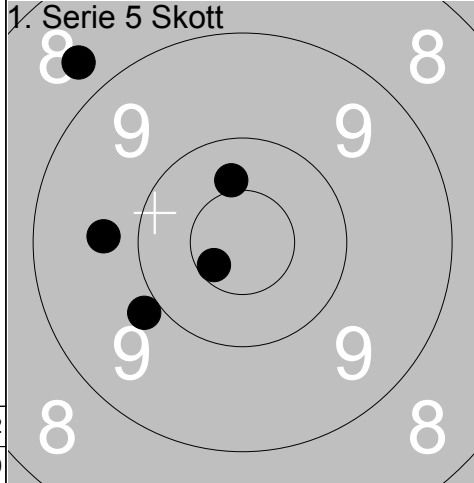

1:	8.7	↖
2:	10.4	↑
3:	9.9	↙
4:	9.7	←
5:	10.6x	↙
Serie		46
Total		46

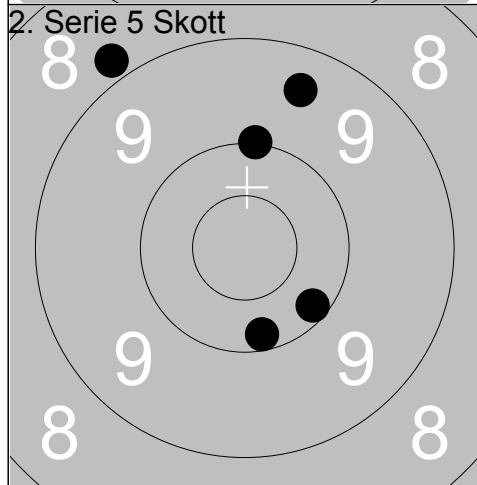

1:	8.8	↗
2:	10.2	↘
3:	10.2	↘
4:	10.0	↑
5:	9.4	↑
Serie		47
Total		93

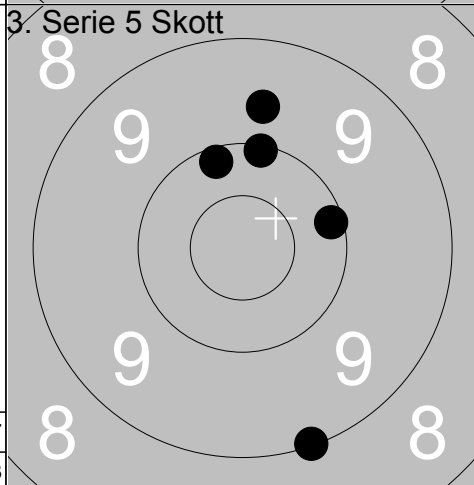

1:	10.2	↑
2:	9.7	↑
3:	9.0	↘
4:	10.1	↑
5:	10.1	→
Serie		48
Total		141

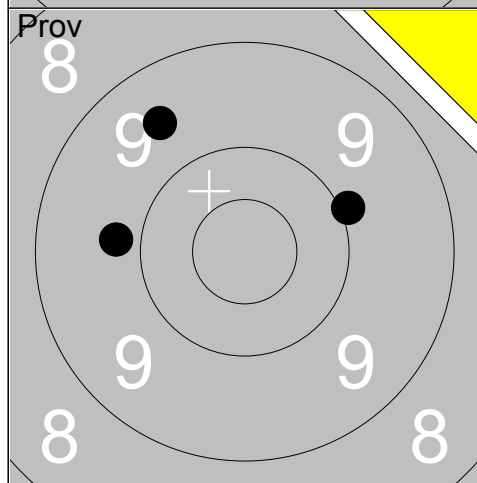

1:	10.0	→
2:	9.8	←
3:	9.6	↗
Serie		28
Total		141

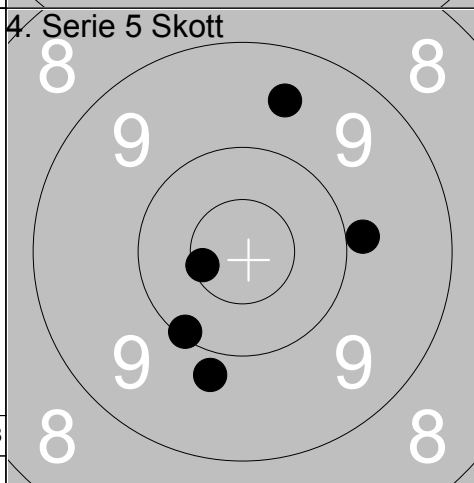

1:	9.5	↑
2:	10.6x	←
3:	10.1	↙
4:	9.9	→
5:	9.8	↘
Serie		47
Total		188

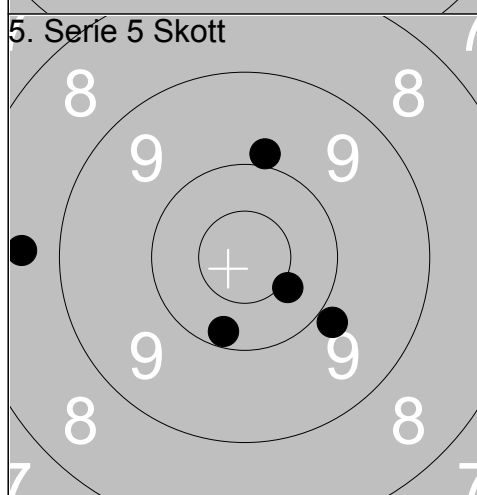

1:	9.9	↑
2:	10.4x	↘
3:	10.2	↘
4:	9.9	↘
5:	8.6	←
Serie		46
Total		234

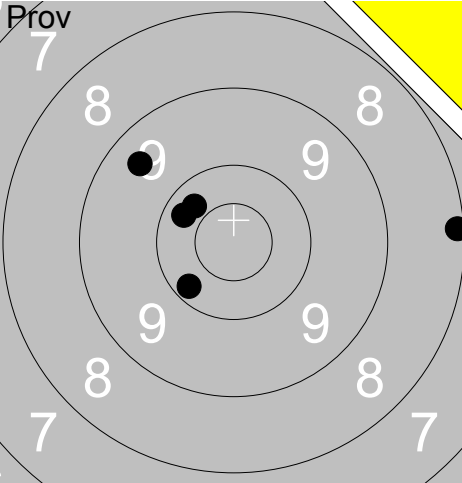
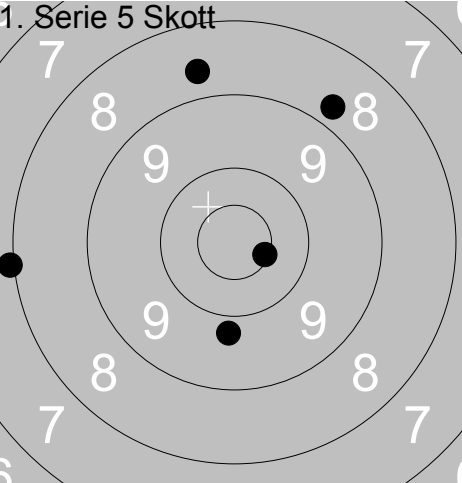
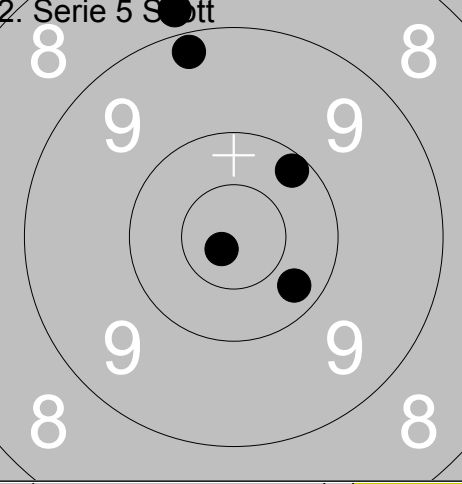
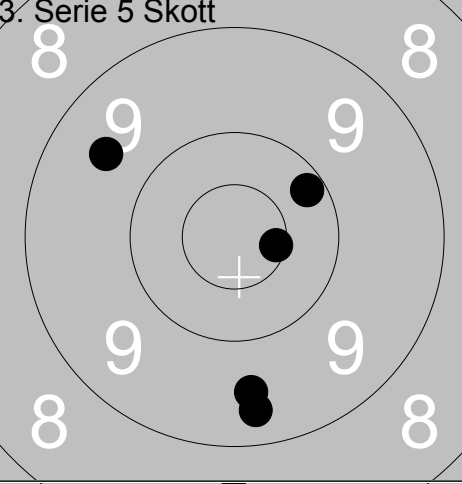
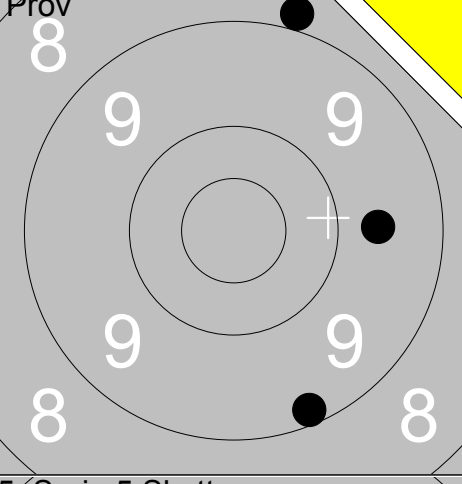
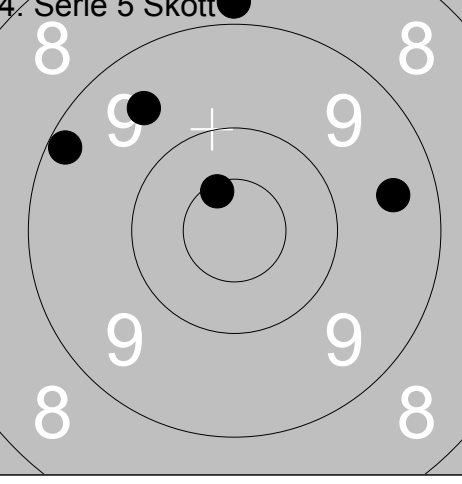
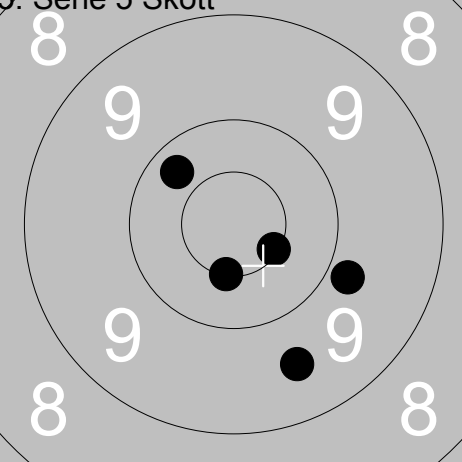
Skjutlag 4	Tavla 2	Lennart Jakobsson			
Ramselefors		Ramselefors		Vet	Vb
12.08.2017		SM Banskytte Liggande 2017		Ramselefors SKF	
Prov		1: 8.1 → 2: 10.3 ↗ 3: 10.3 ↗ 4: 9.4 ↗ 5: 10.2 ↘	1. Serie 5 Skott		1: 8.8 ↗ 2: 9.8 ↓ 3: 10.5x → 4: 8.7 ↗ 5: 8.0 ←
		Serie 47 Total 0			Serie 43 Total 43
2. Serie 5 Skott		1: 8.8 ↑ 2: 10.8x ↘ 3: 10.2 ↗ 4: 9.2 ↗ 5: 10.3 ↘	3. Serie 5 Skott		1: 10.2 ↗ 2: 9.6 ↗ 3: 9.5 ↓ 4: 10.6x → 5: 9.4 ↓
		Serie 47 Total 90			Serie 47 Total 137
Prov		1: 8.9 ↑ 2: 9.2 ↓ 3: 9.7 →	4. Serie 5 Skott		1: 9.2 ↗ 2: 9.4 → 3: 9.5 ↗ 4: 8.8 ↑ 5: 10.6x ↗
		Serie 26 Total 137			Serie 45 Total 182
5. Serie 5 Skott		1: 10.5x ↘ 2: 10.3 ↗ 3: 10.5x ↓ 4: 9.6 ↓ 5: 9.8 ↘			
		Serie 48 Total 230			

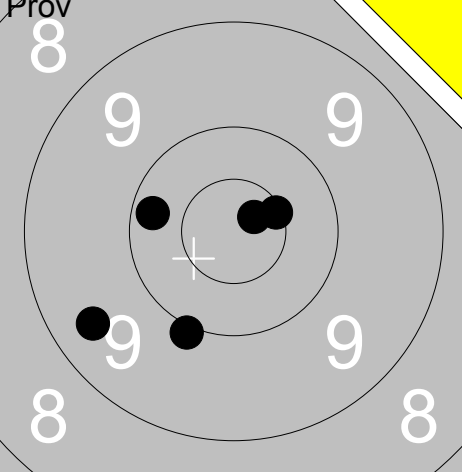
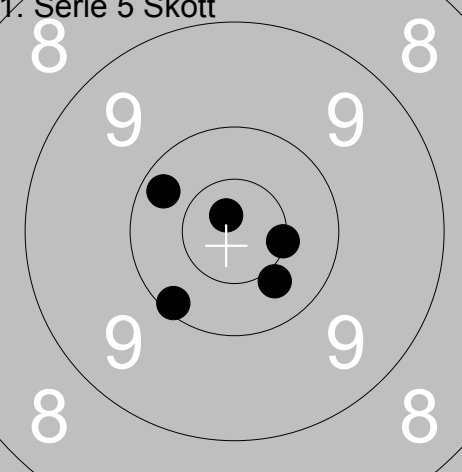
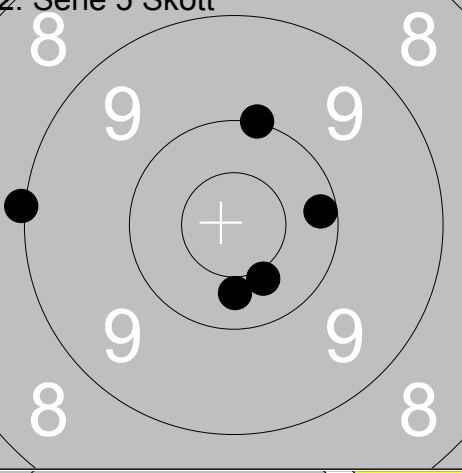
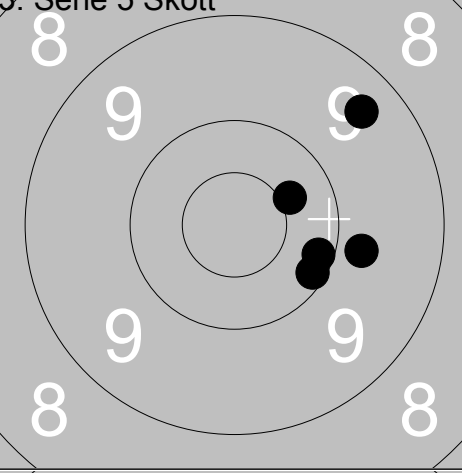
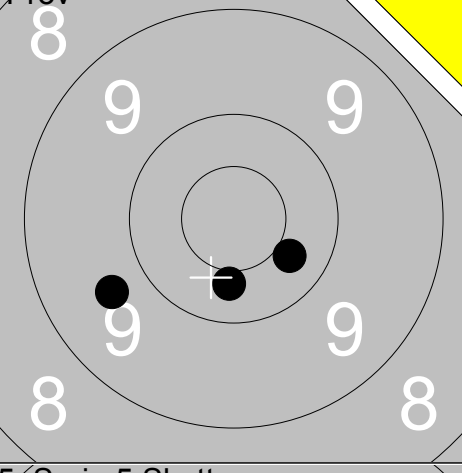
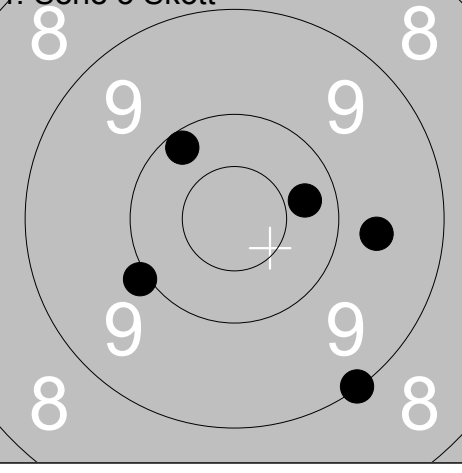
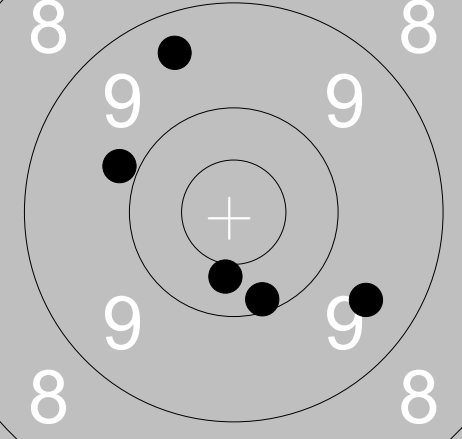
Prov 	1: 10.2 ← 2: 10.0 ↓ 3: 9.4 ← 4: 10.5x → 5: 10.7x → <hr/> Serie 49 Total 0	1. Serie 5 Skott 	1: 10.5x → 2: 10.4 ↓ 3: 10.1 ← 4: 10.2 ↗ 5: 10.8x ↗ <hr/> Serie 50 Total 50
2. Serie 5 Skott 	1: 9.0 ← 2: 10.4 ↓ 3: 10.0 ↗ 4: 10.3 ↓ 5: 10.2 → <hr/> Serie 49 Total 99	3. Serie 5 Skott 	1: 9.4 ↗ 2: 10.4 → 3: 10.1 ↓ 4: 10.2 → 5: 9.8 → <hr/> Serie 48 Total 147
Prov 	1: 10.4 ↓ 2: 9.7 ← 3: 10.4 ↓ <hr/> Serie 29 Total 147	4. Serie 5 Skott 	1: 9.7 → 2: 9.0 ↓ 3: 10.2 ↗ 4: 10.0 ← 5: 10.3 → <hr/> Serie 48 Total 195
5. Serie 5 Skott 	1: 9.4 ↗ 2: 10.4 ↓ 3: 10.1 ↓ 4: 9.5 ↓ 5: 9.9 ↗ <hr/> Serie 47 Total 242		

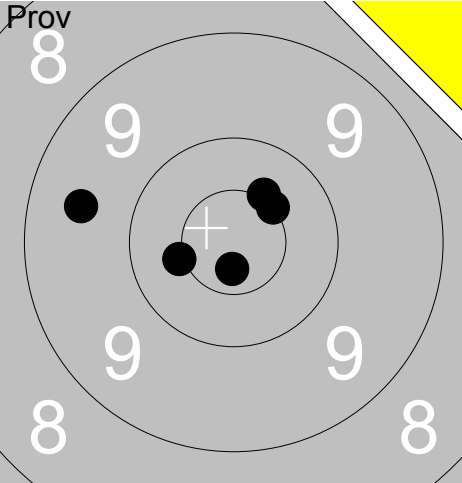
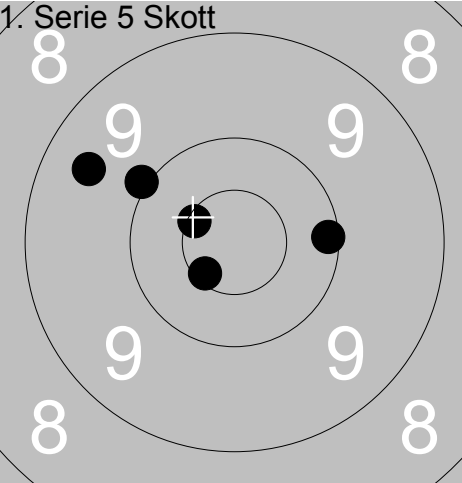
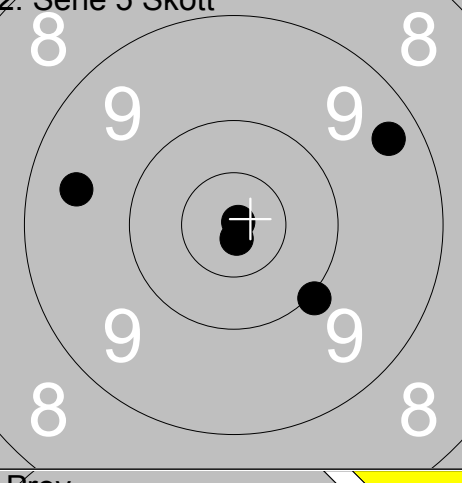
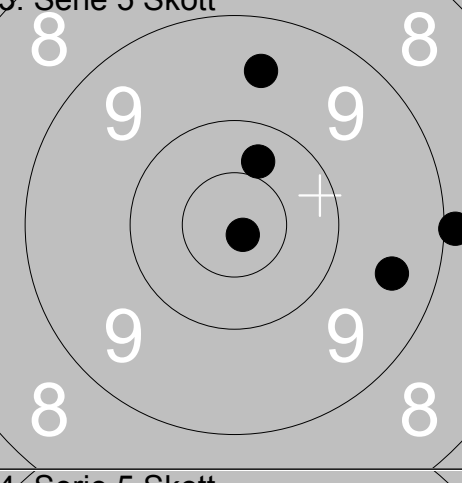
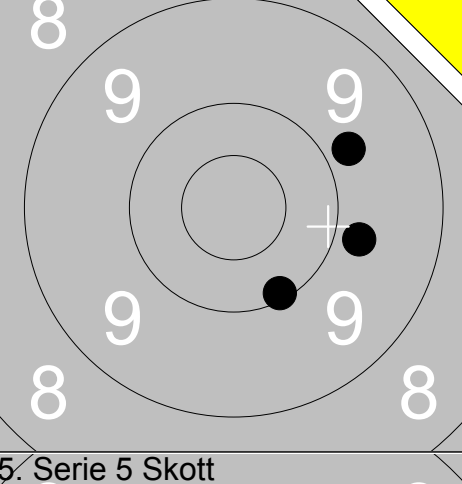
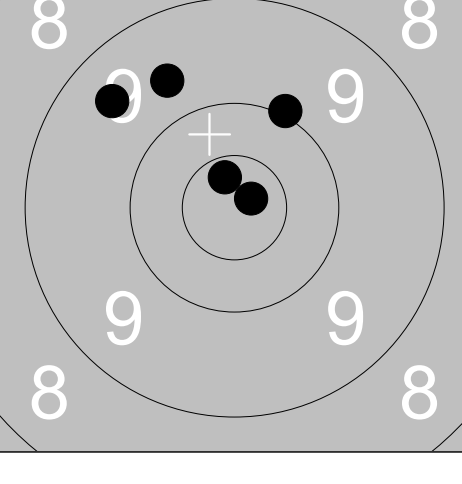
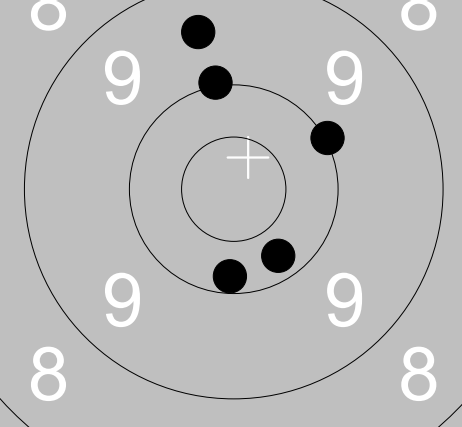
Skjutlag 4	Tavla 4	Martin Nilsson	
Ramselefors		Kvistbro	Öpp Ör
12.08.2017		SM Banskytte Liggande 2017	Ramselefors SKF
Prov 	1: 10.4x ← 2: 9.5 ← 3: 10.5x ↗ 4: 10.4x ↗ 5: 10.7x ↓	1. Serie 5 Skott 	1: 10.1 → 2: 10.0 ↗ 3: 10.5x ↗ 4: 10.6x ↙ 5: 9.5 ↗
	Serie 49 Total 0		Serie 49 Total 49
2. Serie 5 Skott 	1: 9.5 ← 2: 10.0 ↘ 3: 10.8x ↓ 4: 10.9x ↗ 5: 9.3 ↗	3. Serie 5 Skott 	1: 9.5 ↑ 2: 10.8x ↘ 3: 10.4 ↑ 4: 9.5 → 5: 8.9 →
	Serie 48 Total 97		Serie 46 Total 143
Prov 	1: 9.8 → 2: 10.1 ↘ 3: 9.8 ↗	4. Serie 5 Skott 	1: 9.5 ↗ 2: 10.0 ↗ 3: 10.8x ↗ 4: 9.7 ↗ 5: 10.7x ↗
	Serie 28 Total 143		Serie 48 Total 191
5. Serie 5 Skott 	1: 9.5 ↑ 2: 10.2 ↓ 3: 10.2 ↓ 4: 10.0 ↗ 5: 10.0 ↑		
	Serie 49 Total 240		

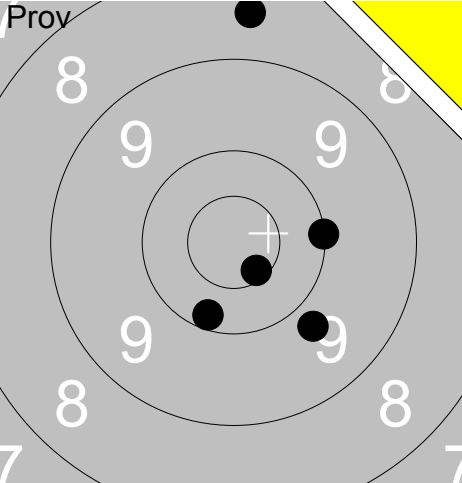
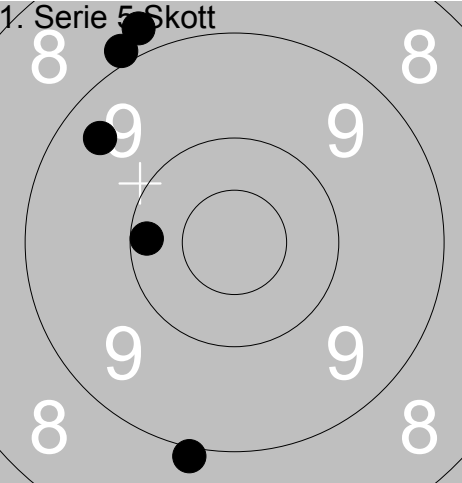
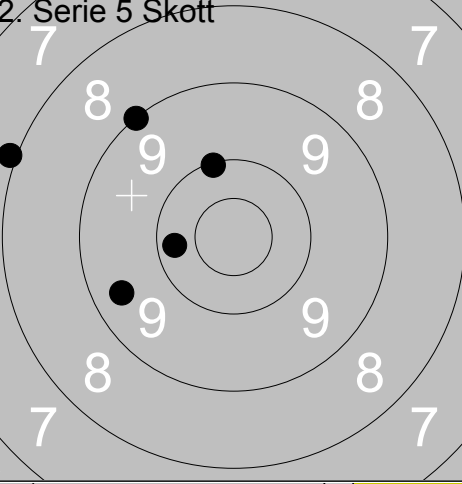
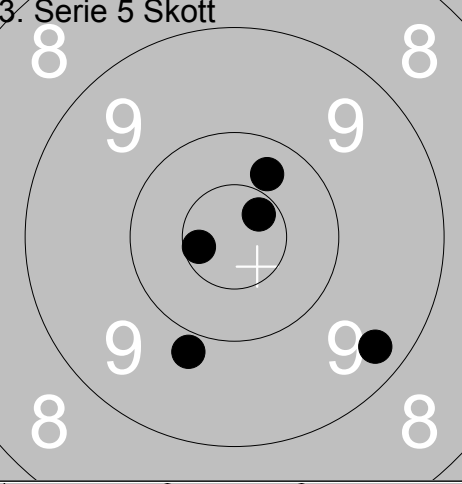
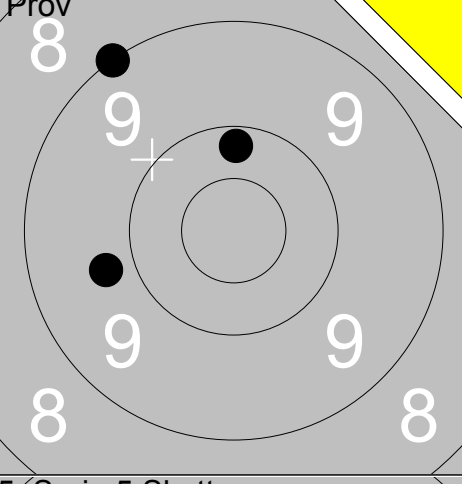
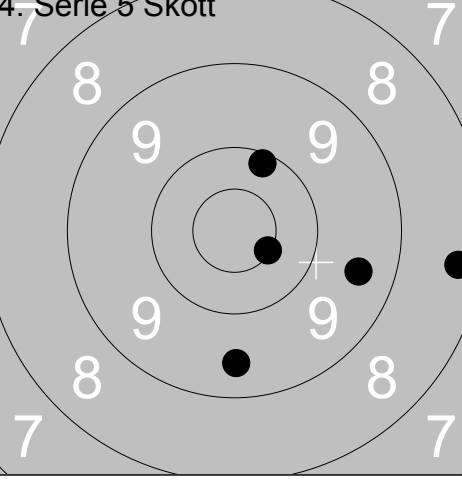
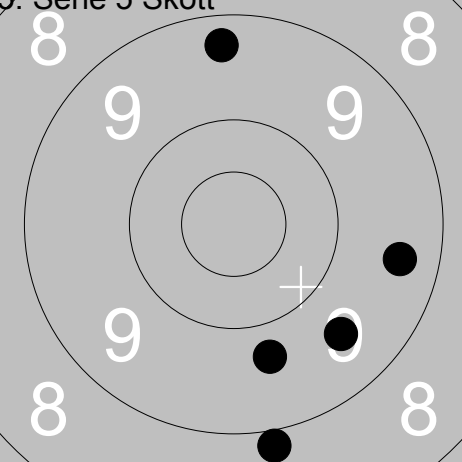
Skjutlag 4	Tavla 5	Åke Arbrink			
Ramselefors		Rosersberg	Vet	St	
12.08.2017		SM Banskytte Liggande 2017	Ramselefors SKF		
Prov		1: 8.5 ↑ 2: 9.8 ↓ 3: 10.2 ↓ 4: 10.0 → 5: 10.6x ↓	1. Serie 5 Skott		1: 8.9 ↗ 2: 10.2 ← 3: 8.8 ↗ 4: 9.4 ↗ 5: 8.9 ↓
		Serie 47		Serie 43	
		Total 0		Total 43	
2. Serie 5 Skott		1: 7.9 ← 2: 10.2 ← 3: 10.1 ↗ 4: 9.0 ↗ 5: 9.4 ←	3. Serie 5 Skott		1: 10.7x ↗ 2: 9.8 ↓ 3: 10.6x ← 4: 10.3 ↗ 5: 9.3 ↓
		Serie 45		Serie 48	
		Total 88		Total 136	
Prov		1: 10.2 ↑ 2: 9.0 ↗ 3: 9.8 ←	4. Serie 5 Skott		1: 10.5x ↗ 2: 10.1 ↗ 3: 8.3 → 4: 9.5 → 5: 9.4 ↓
		Serie 28		Serie 46	
		Total 136		Total 182	
5. Serie 5 Skott		1: 9.3 ↑ 2: 8.9 ↓ 3: 9.7 ↓ 4: 9.4 → 5: 9.6 ↓			
		Serie 44			
		Total 226			

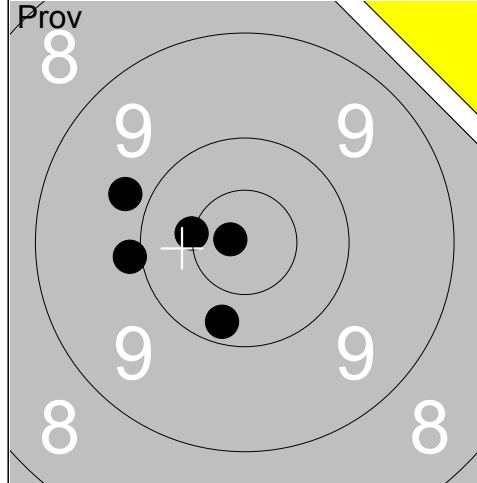

1:	10.5x	←
2:	9.8	↖
3:	10.8x	←
4:	9.9	←
5:	10.2	↓
Serie		48
Total		0

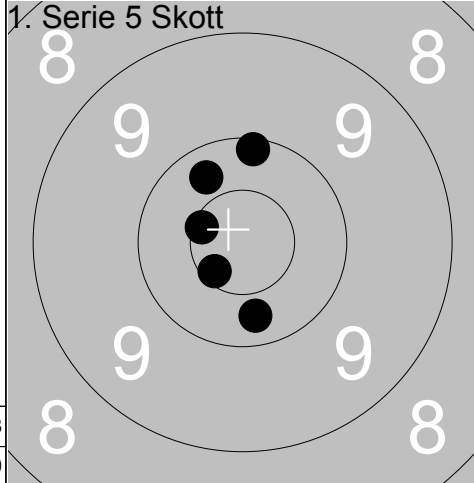

1:	10.3	↓
2:	10.3	↗
3:	10.6x	↙
4:	10.1	↑
5:	10.6x	←
Serie		50
Total		50

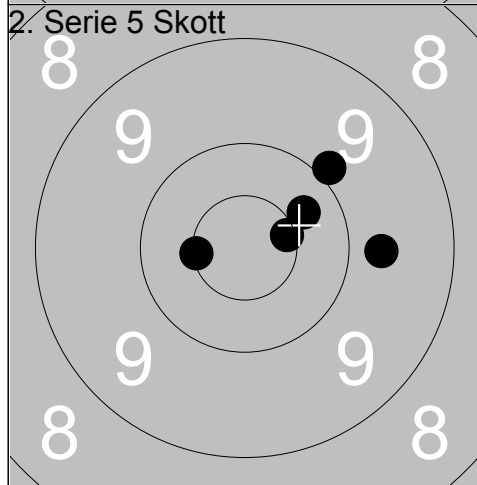

1:	10.6x	→
2:	9.7	→
3:	10.5x	←
4:	9.9	↗
5:	10.3	↗
Serie		48
Total		98

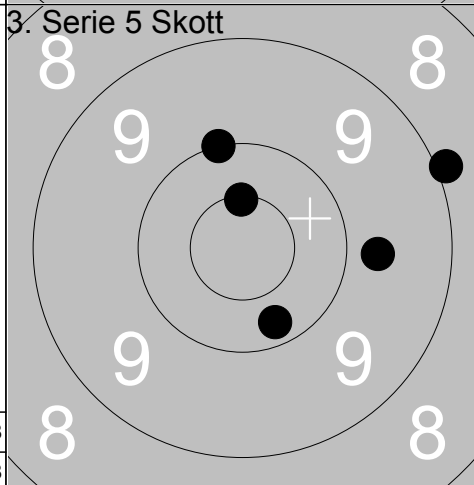

1:	10.2	↓
2:	8.9	→
3:	10.0	↑
4:	9.7	→
5:	10.5x	↑
Serie		47
Total		145

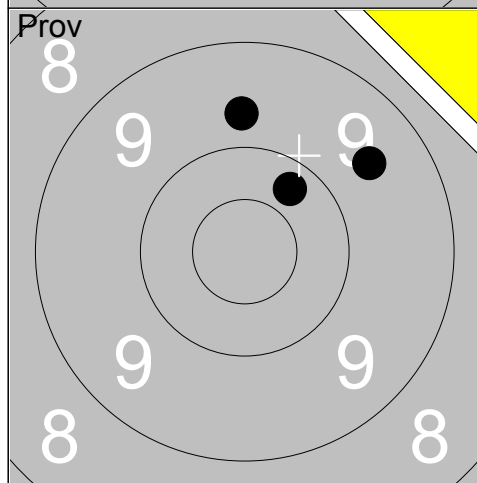

1:	9.6	↗
2:	9.7	↑
3:	10.3	↗
Serie		28
Total		145

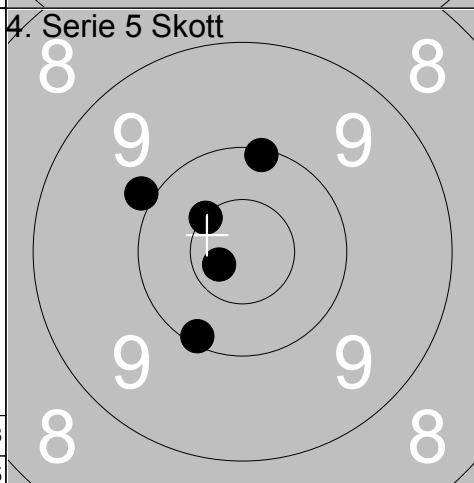

1:	9.9	↖
2:	10.1	↑
3:	10.7x	←
4:	10.1	↓
5:	10.5x	↖
Serie		49
Total		194

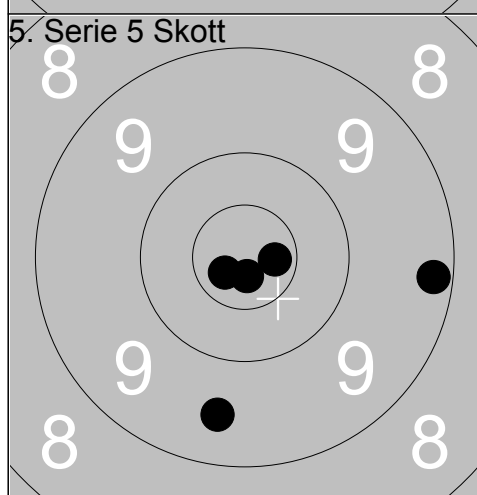

1:	10.7x	↖
2:	10.7x	→
3:	10.8x	↓
4:	9.2	→
5:	9.5	↓
Serie		48
Total		242

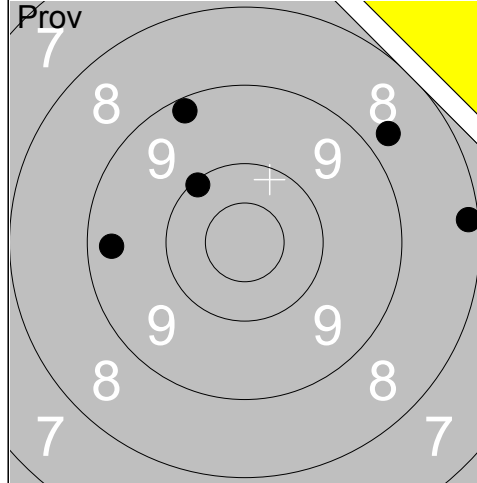

1:	8.7	↗
2:	8.2	→
3:	10.1	↗
4:	9.2	↗
5:	9.3	←
Serie		44
Total		0

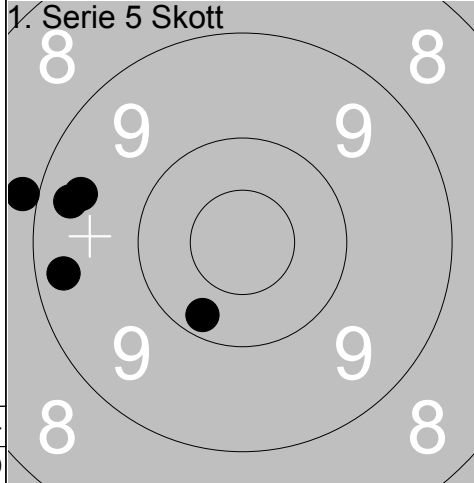

1:	9.3	←
2:	9.4	←
3:	10.2	↘
4:	9.3	←
5:	8.9	←
Serie		45
Total		45

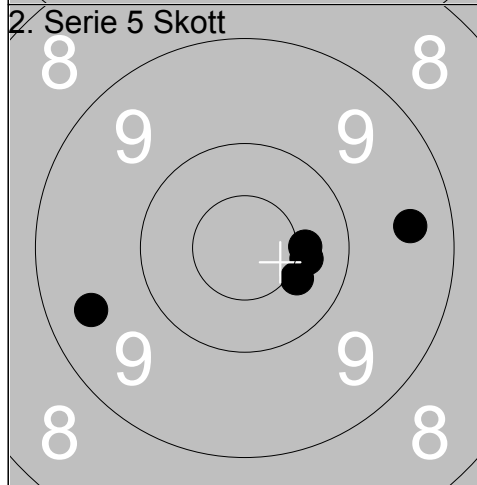

1:	9.4	←
2:	10.4	→
3:	10.4x	→
4:	10.4x	↘
5:	9.4	→
Serie		48
Total		93

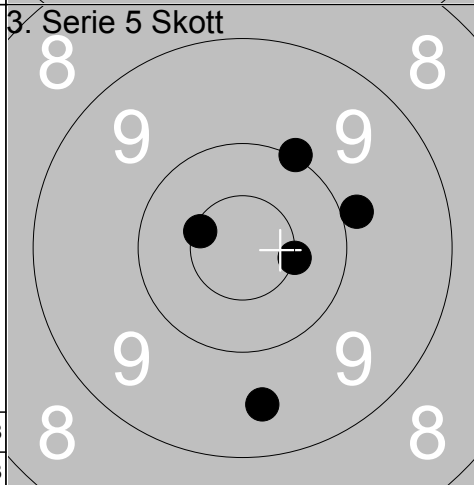

1:	10.5x	←
2:	9.5	↓
3:	10.5x	→
4:	10.0	↗
5:	9.9	→
Serie		48
Total		141

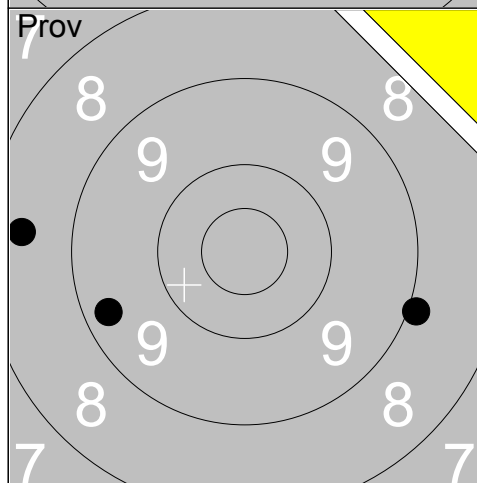

1:	9.3	←
2:	8.4	←
3:	8.9	↘
Serie		25
Total		141

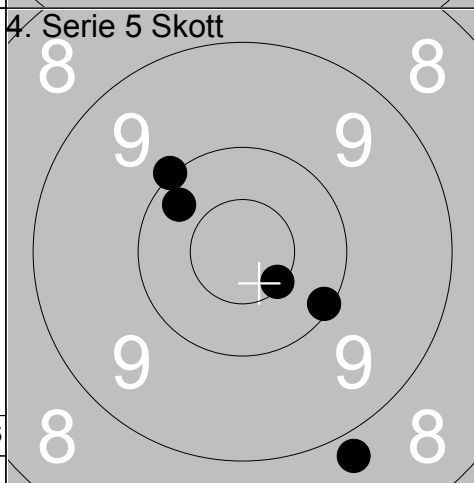

1:	10.5x	↘
2:	10.1	↘
3:	8.8	↘
4:	10.0	↗
5:	10.2	↗
Serie		48
Total		189

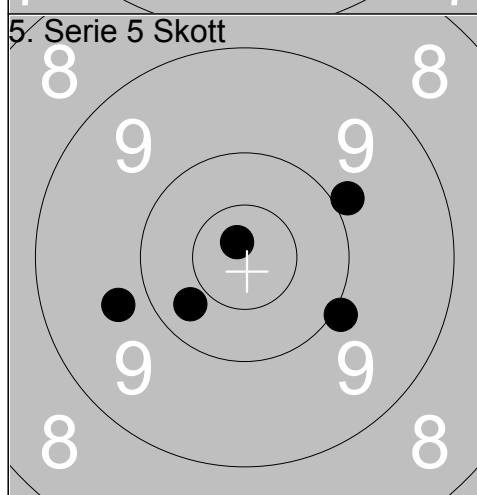

1:	9.7	←
2:	10.0	↘
3:	10.8x	↗
4:	10.3	↘
5:	9.9	↗
Serie		48
Total		237

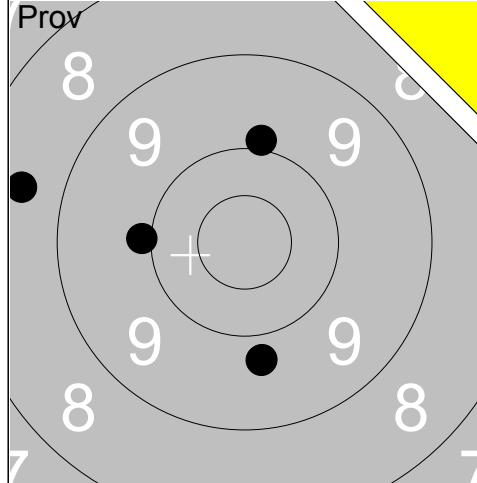

1:	8.6	←
2:	9.9	↑
3:	9.8	↓
4:	9.8	↓
5:	9.9	←
Serie		44
Total		0

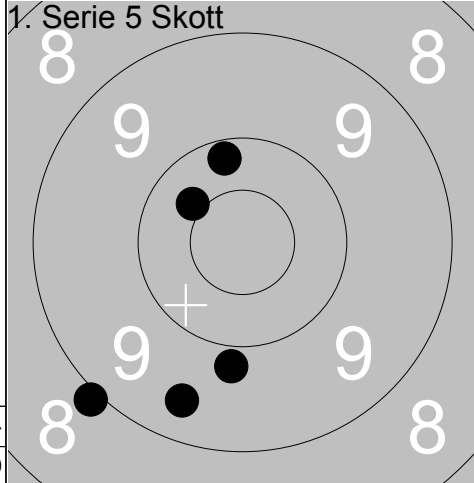

1:	10.2	↑
2:	9.4	↓
3:	10.4	↖
4:	9.8	↓
5:	8.9	↙
Serie		46
Total		46

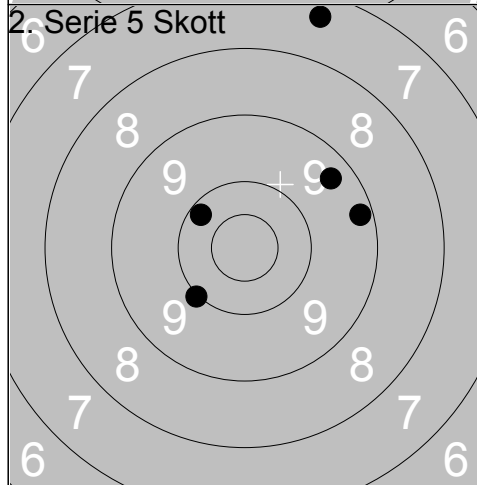

1:	10.2	↖
2:	10.0	↙
3:	9.4	↗
4:	7.4	↑
5:	9.2	→
Serie		45
Total		91

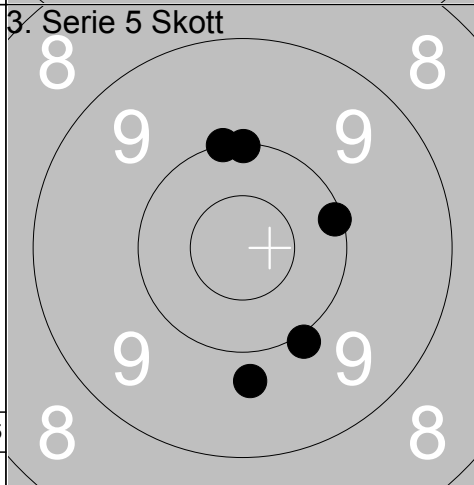

1:	9.8	↓
2:	10.0	↑
3:	10.0	↘
4:	10.1	→
5:	10.0	↑
Serie		49
Total		140

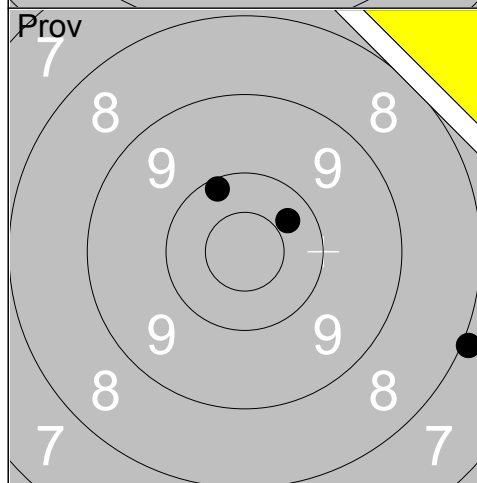

1:	10.3	↗
2:	10.1	↑
3:	7.9	↘
Serie		27
Total		140

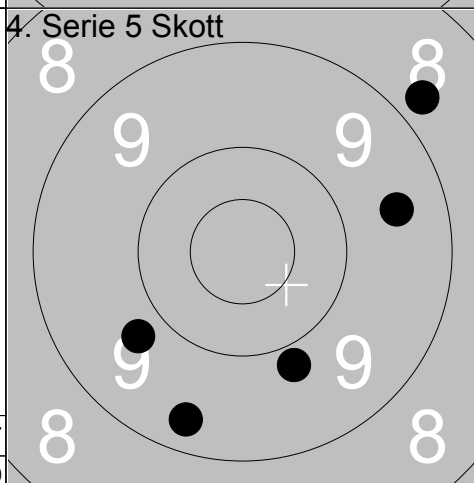

1:	9.7	↙
2:	9.5	→
3:	9.8	↓
4:	9.3	↓
5:	8.8	↗
Serie		44
Total		184

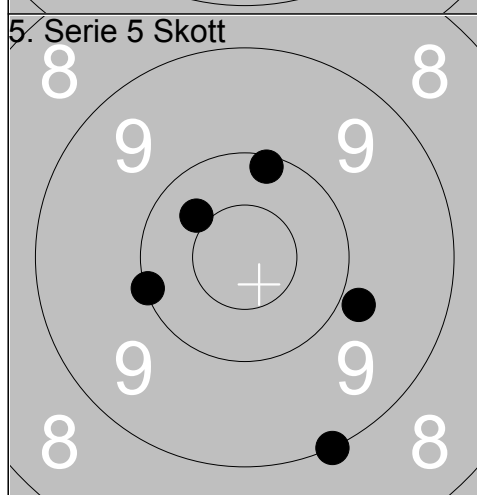

1:	10.4	↗
2:	10.1	↑
3:	10.1	←
4:	9.8	↘
5:	9.0	↘
Serie		48
Total		232

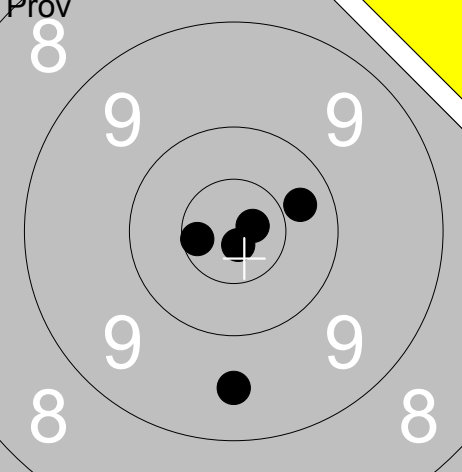
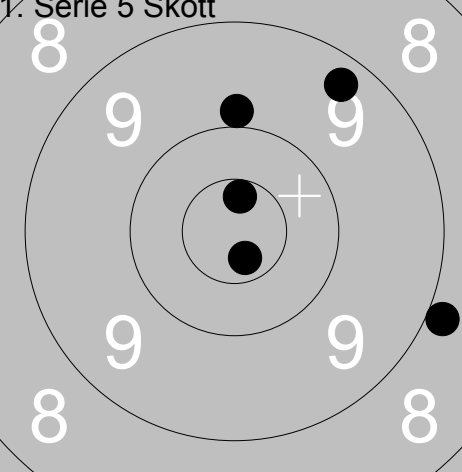
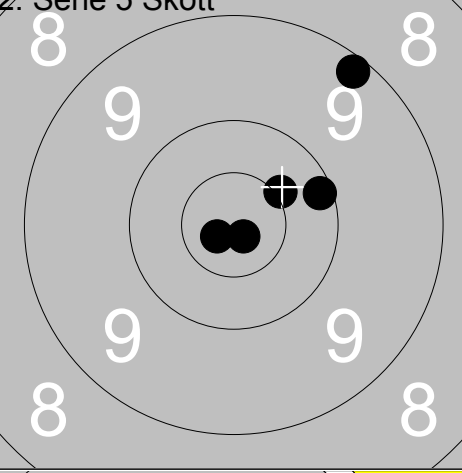
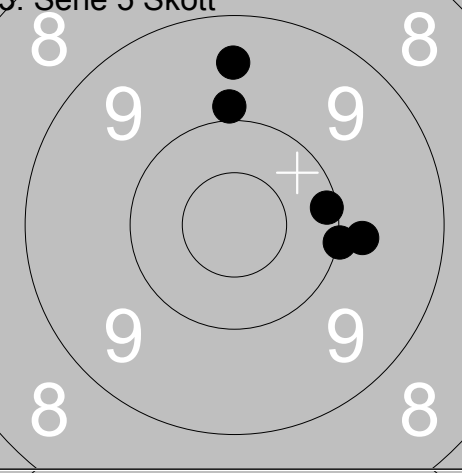
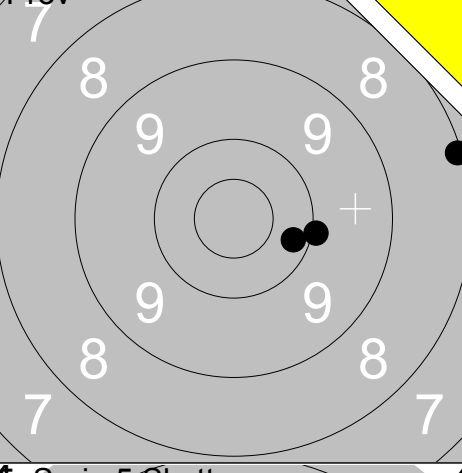
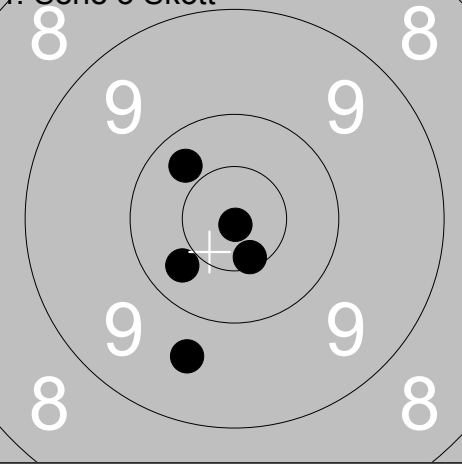
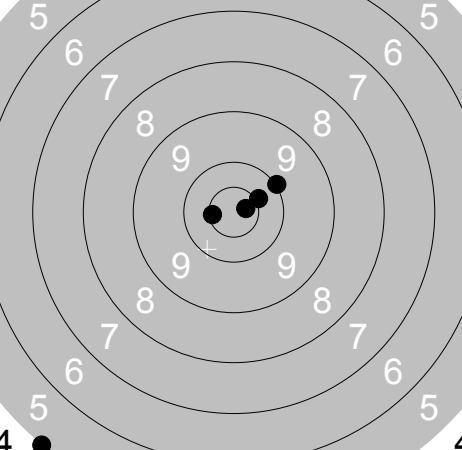
<p>Prov</p>  <p style="text-align: right;">8</p>	<p>1: 10.8x ↓</p> <p>2: 10.6x ←</p> <p>3: 9.5 ↓</p> <p>4: 10.8x →</p> <p>5: 10.3 →</p> <hr/> <p>Serie 49</p> <p>Total 0</p>	<p>1. Serie 5 Skott</p>  <p style="text-align: right;">8</p>	<p>1: 10.7x ↓</p> <p>2: 8.9 →</p> <p>3: 9.3 ↗</p> <p>4: 9.9 ↑</p> <p>5: 10.6x ↑</p> <hr/> <p>Serie 46</p> <p>Total 46</p>
<p>2. Serie 5 Skott</p>  <p style="text-align: right;">8</p>	<p>1: 10.8x ←</p> <p>2: 10.4x ↗</p> <p>3: 10.8x ↓</p> <p>4: 9.2 ↗</p> <p>5: 10.1 →</p> <hr/> <p>Serie 49</p> <p>Total 95</p>	<p>3. Serie 5 Skott</p>  <p style="text-align: right;">8</p>	<p>1: 9.9 ↑</p> <p>2: 10.1 →</p> <p>3: 9.5 ↑</p> <p>4: 10.0 →</p> <p>5: 9.8 →</p> <hr/> <p>Serie 47</p> <p>Total 142</p>
<p>Prov</p>  <p style="text-align: right;">7</p>	<p>1: 8.1 →</p> <p>2: 10.2 →</p> <p>3: 10.0 →</p> <hr/> <p>Serie 28</p> <p>Total 142</p>	<p>4. Serie 5 Skott</p>  <p style="text-align: right;">8</p>	<p>1: 10.6x ↓</p> <p>2: 10.3 ←</p> <p>3: 10.9x ↓</p> <p>4: 10.3 ↗</p> <p>5: 9.6 ↓</p> <hr/> <p>Serie 49</p> <p>Total 191</p>
<p>5. Serie 5 Skott</p>  <p style="text-align: right;">4</p>	<p>1: 10.6x ←</p> <p>2: 5.0 ↓</p> <p>3: 10.7x →</p> <p>4: 10.0 ↗</p> <p>5: 10.4x →</p> <hr/> <p>Serie 45</p> <p>Total 236</p>		

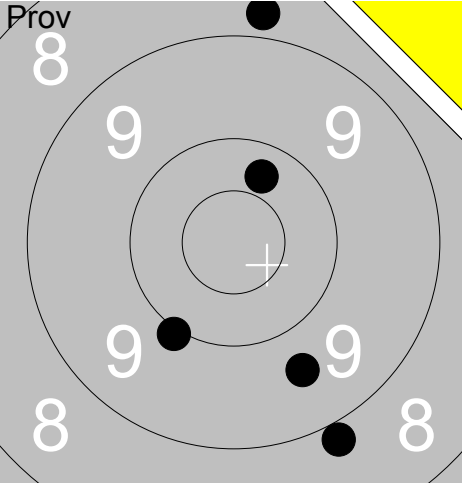
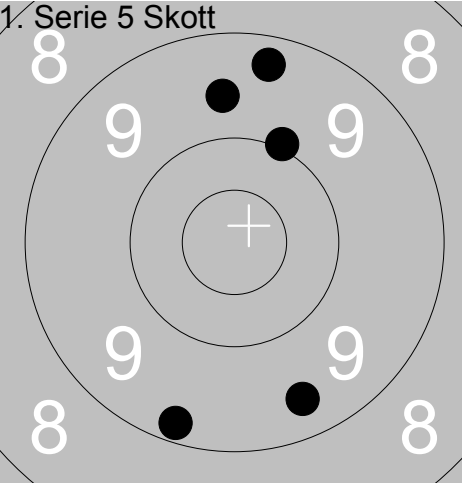
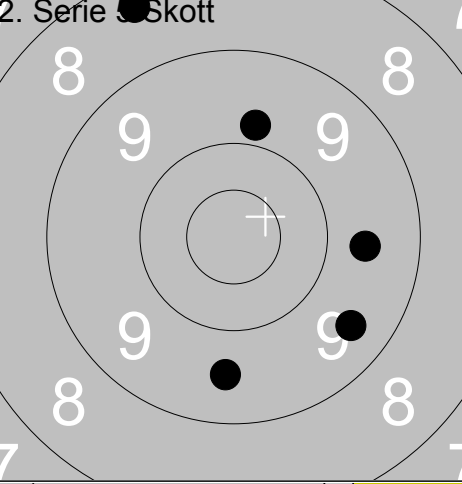
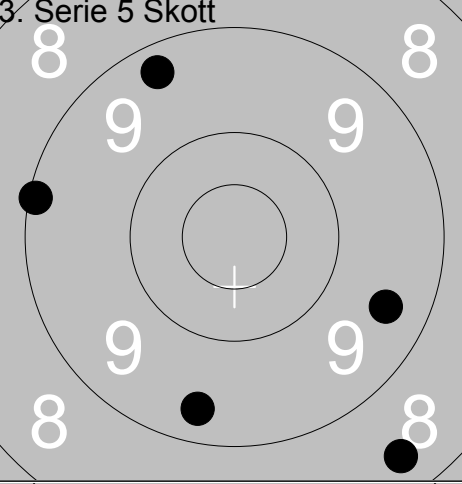
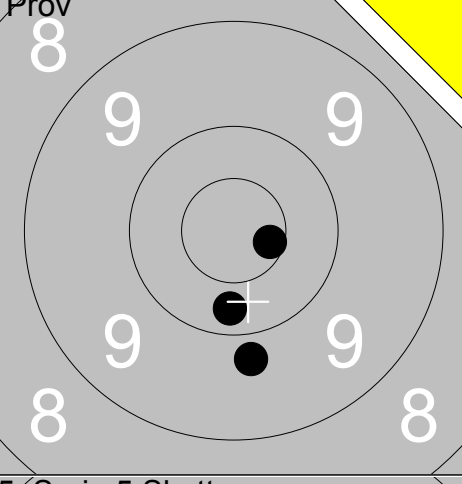
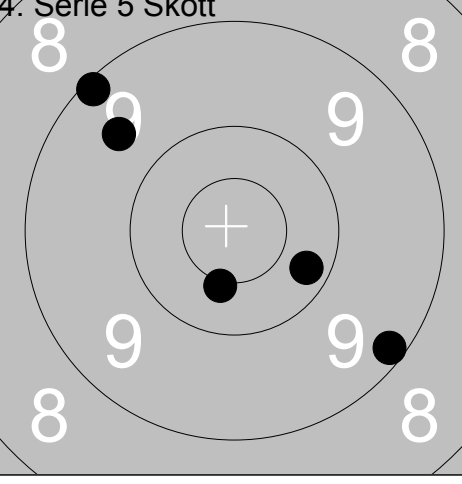
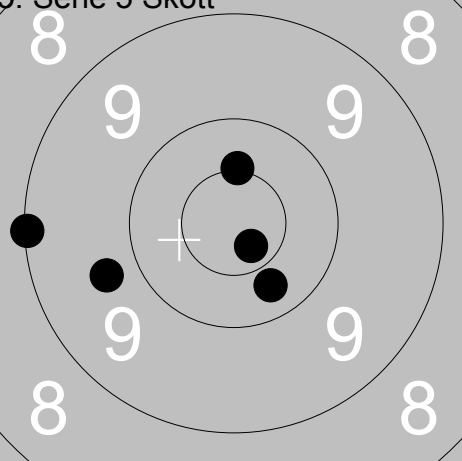
Skjutlag	Tavla	Mikael Carlsson		
4	10	Ramselefors	Ramsberg	Öpp
12.08.2017	SM Banskytte Liggande 2017	Ramselefors SKF		
Prov 	1: 8.8 ↑ 2: 8.9 ↓ 3: 9.6 ↓ 4: 10.0 ↓ 5: 10.3 ↑ Serie 45 Total 0	1. Serie 5 Skott 	1: 9.3 ↑ 2: 9.6 ↑ 3: 10.0 ↑ 4: 9.4 ↓ 5: 9.2 ↓ Serie 46 Total 46	
2. Serie 5 Skott 	1: 8.4 ↑ 2: 9.6 ↓ 3: 9.8 ↑ 4: 9.6 → 5: 9.5 ↓ Serie 44 Total 90	3. Serie 5 Skott 	1: 9.3 ↑ 2: 9.4 ↓ 3: 9.1 ← 4: 8.4 ↓ 5: 9.4 ↓ Serie 44 Total 134	
Prov 	1: 10.6x → 2: 9.8 ↓ 3: 10.3 ↓ Serie 29 Total 134	4. Serie 5 Skott 	1: 9.1 ↑ 2: 9.2 ↓ 3: 10.4x ↓ 4: 9.6 ↑ 5: 10.2 ↓ Serie 47 Total 181	
5. Serie 5 Skott 	1: 10.5x ↑ 2: 10.3 ↓ 3: 9.1 ← 4: 9.7 ← 5: 10.7x ↓ Serie 48 Total 229			

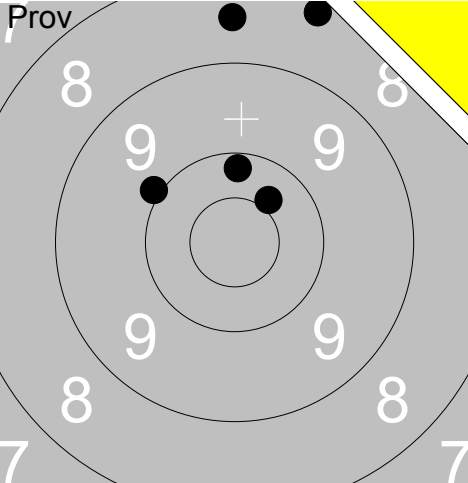
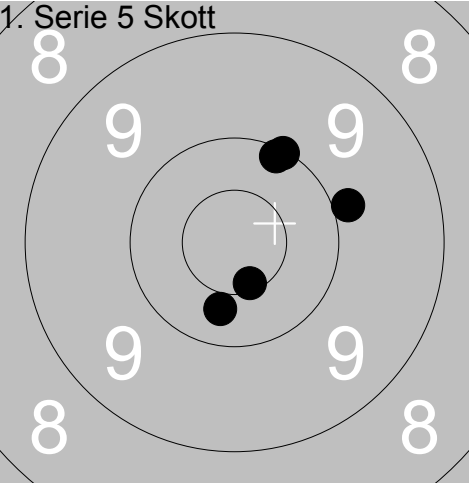
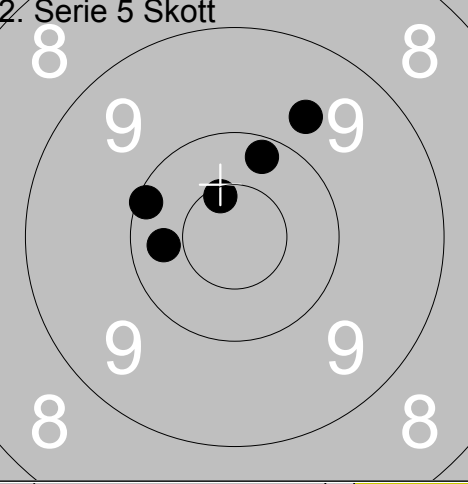
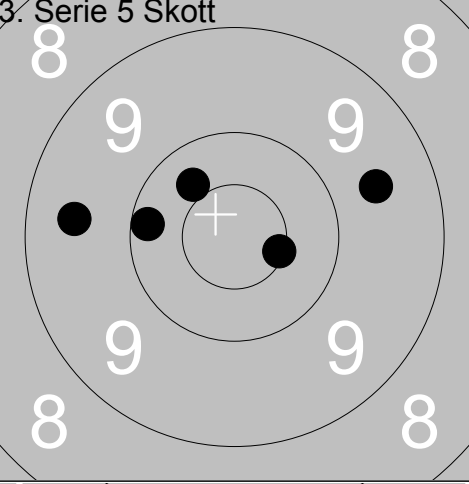
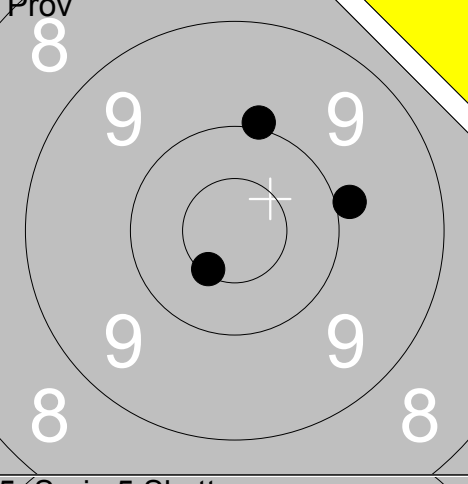
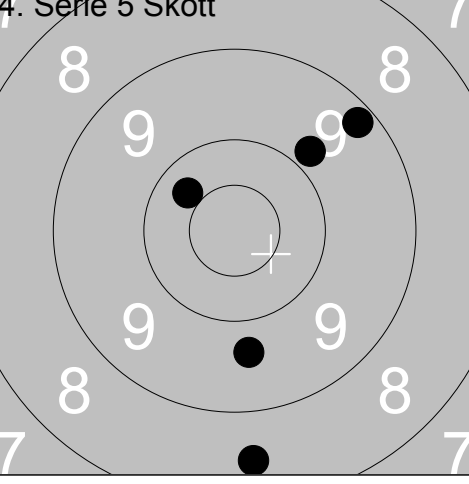
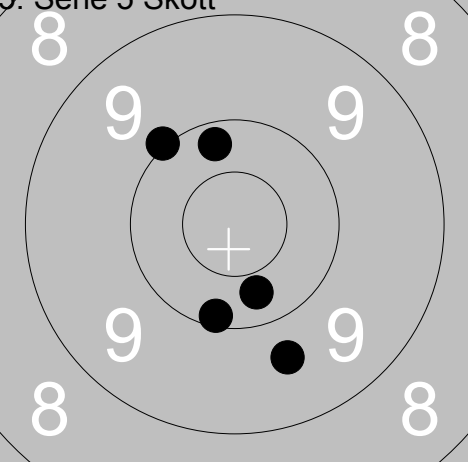
Skjutlag	Tavla	Linda Gustavsson			
4	11	Ramselefors	Moälven / Modo	Öpp Vn	
12.08.2017	SM Banskytte Liggande 2017	Ramselefors SKF			
Prov		1: 8.3 ↗ 2: 10.2 ↑ 3: 8.5 ↑ 4: 10.0 ↖ 5: 10.4 ↗	1. Serie 5 Skott		1: 10.6x ↓ 2: 10.3 ↓ 3: 9.9 → 4: 10.1 ↗ 5: 10.1 ↗
		Serie 46		Serie 49	
		Total 0		Total 49	
2. Serie 5 Skott		1: 10.1 ← 2: 10.3 ← 3: 10.6x ↗ 4: 10.2 ↗ 5: 9.7 ↗	3. Serie 5 Skott		1: 10.4 ↗ 2: 10.2 ← 3: 10.5x → 4: 9.5 ← 5: 9.6 →
		Serie 49		Serie 48	
		Total 98		Total 146	
Prov		1: 9.9 → 2: 10.5x ↖ 3: 10.0 ↑	4. Serie 5 Skott		1: 10.3 ↖ 2: 9.8 ↗ 3: 9.2 ↗ 4: 9.7 ↓ 5: 8.5 ↓
		Serie 29		Serie 45	
		Total 146		Total 191	
5. Serie 5 Skott		1: 10.0 ↖ 2: 9.7 ↓ 3: 10.2 ↗ 4: 10.3 ↓ 5: 10.1 ↓			
		Serie 49			
		Total 240			

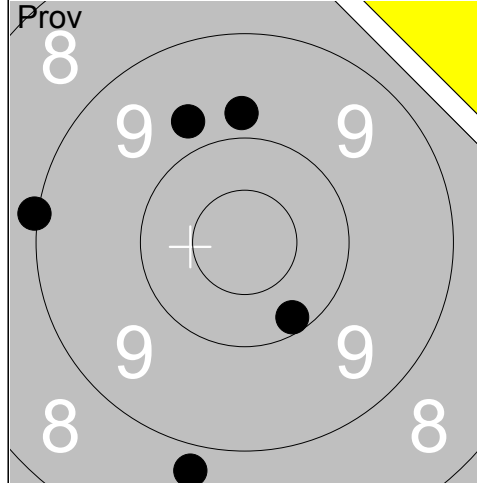

1:	9.0	←
2:	10.2	↘
3:	9.8	↑
4:	9.7	↗
5:	8.8	↘
Serie		45
Total		0

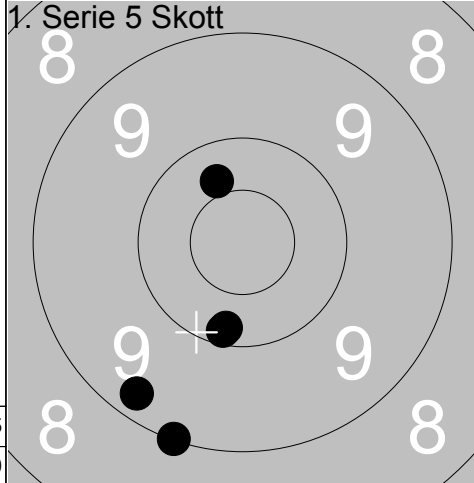

1:	10.2	↓
2:	10.2	↓
3:	9.0	↓
4:	9.3	↙
5:	10.4	↗
Serie		48
Total		48

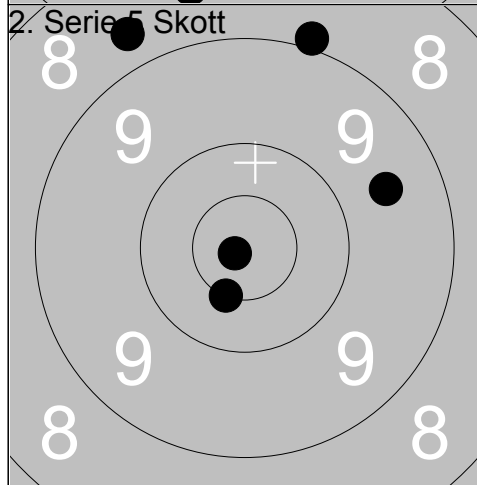

1:	8.7	↗
2:	8.9	↑
3:	10.9x	←
4:	9.6	→
5:	10.5x	↓
Serie		45
Total		93

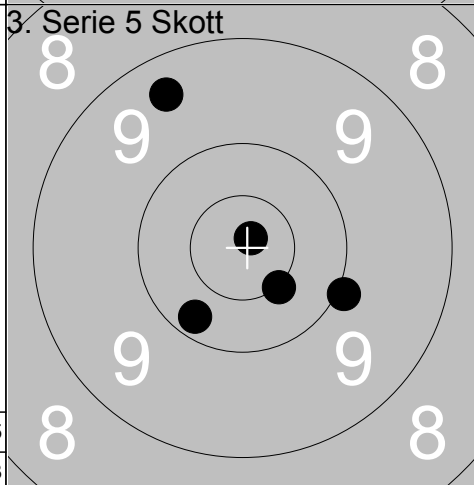

1:	10.8x	↗
2:	9.4	↗
3:	10.5x	↘
4:	10.2	↓
5:	10.0	→
Serie		49
Total		142

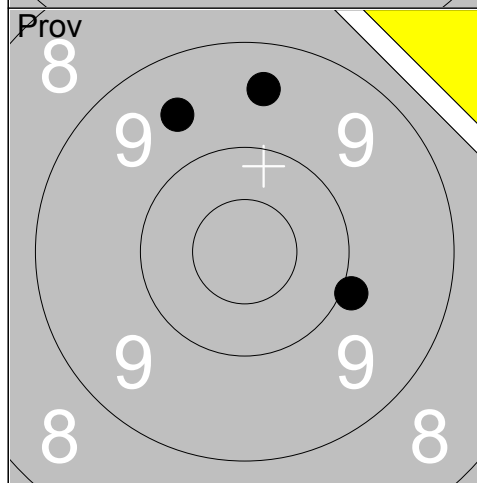

1:	9.9	→
2:	9.6	↗
3:	9.5	↑
Serie		27
Total		142

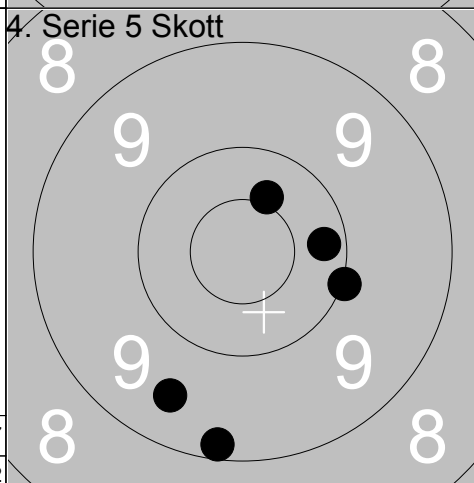

1:	9.2	↓
2:	9.5	↓
3:	10.2	→
4:	10.4x	↗
5:	10.0	→
Serie		48
Total		190

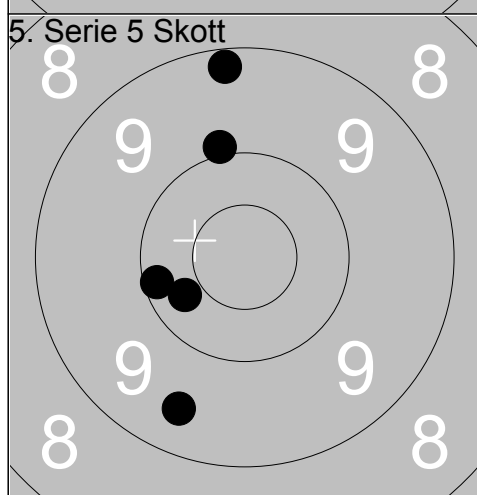

1:	9.5	↓
2:	10.1	←
3:	10.3	↙
4:	9.2	↑
5:	9.9	↗
Serie		47
Total		237

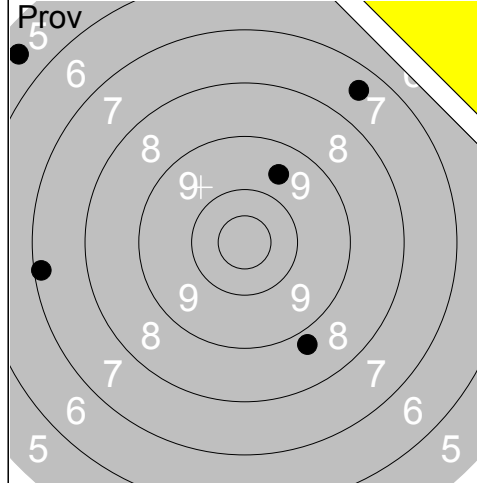

1:	5.5	↖
2:	7.2	←
3:	8.8	↘
4:	9.6	↗
5:	7.4	↗
Serie		36
Total		0

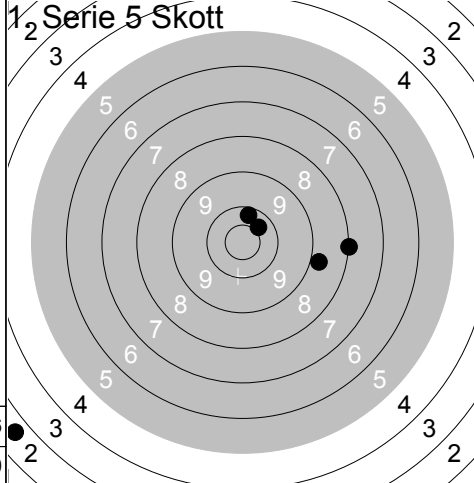

1:	10.4	↗
2:	10.2	↑
3:	8.0	→
4:	2.6	↘
5:	8.8	→
Serie		38
Total		38

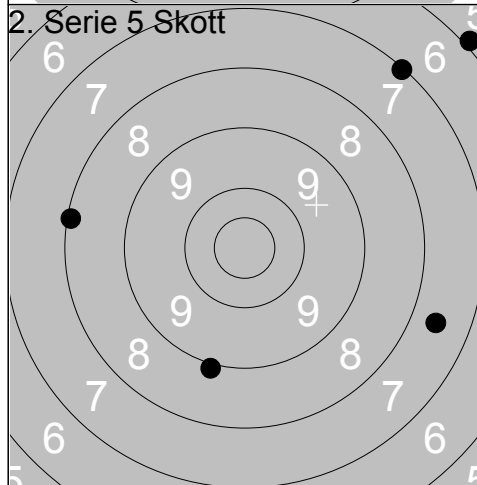

1:	7.6	→
2:	8.9	↘
3:	8.1	←
4:	5.9	↗
5:	7.1	↗
Serie		35
Total		73

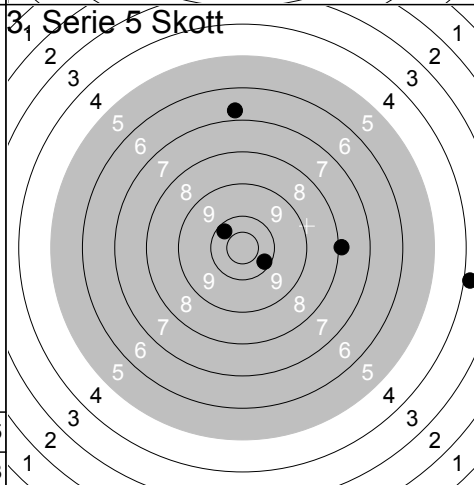

1:	7.9	→
2:	6.7	↑
3:	3.8	→
4:	10.2	↘
5:	10.2	↗
Serie		36
Total		109

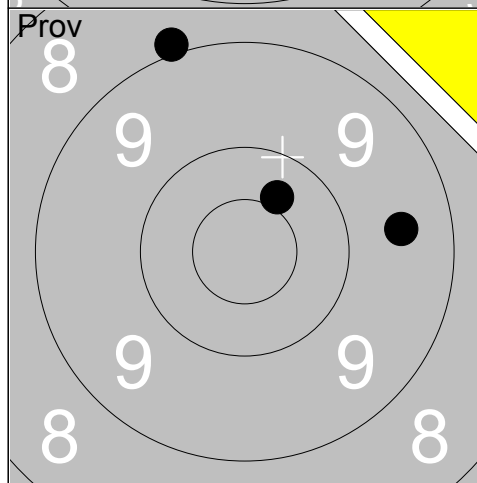

1:	8.9	↖
2:	10.4	↗
3:	9.5	→
Serie		27
Total		109

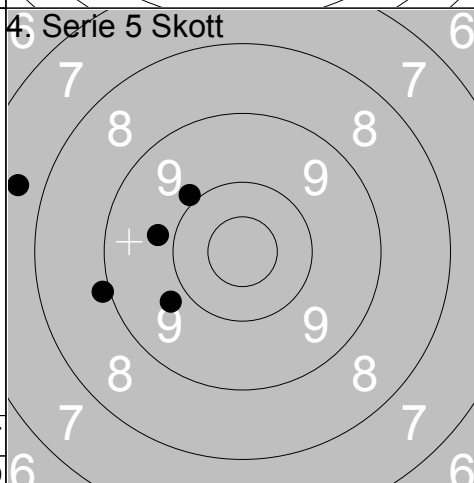

1:	9.8	←
2:	9.9	↗
3:	9.8	↘
4:	7.6	←
5:	8.9	←
Serie		42
Total		151

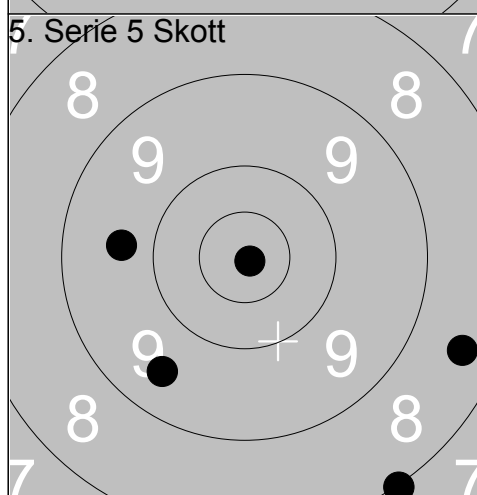

1:	9.7	←
2:	9.5	↘
3:	8.4	→
4:	10.9x	↘
5:	8.0	↘
Serie		44
Total		195

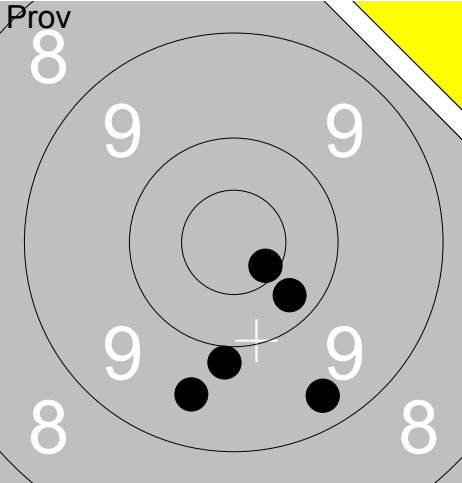
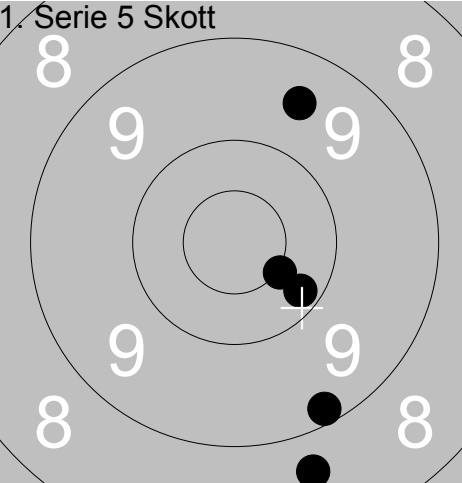
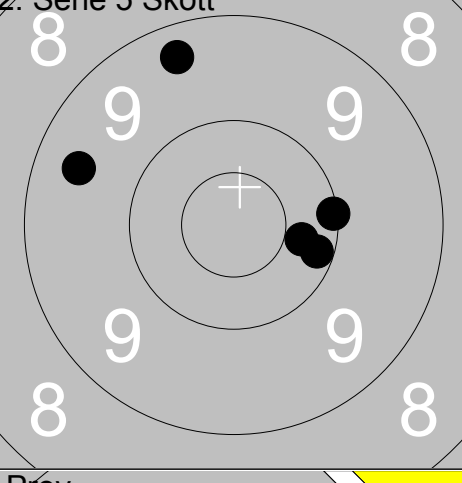
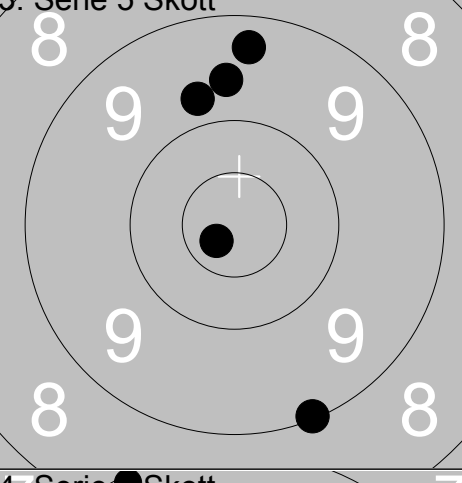
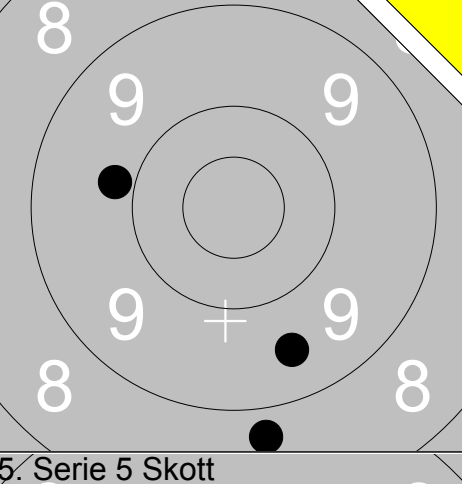
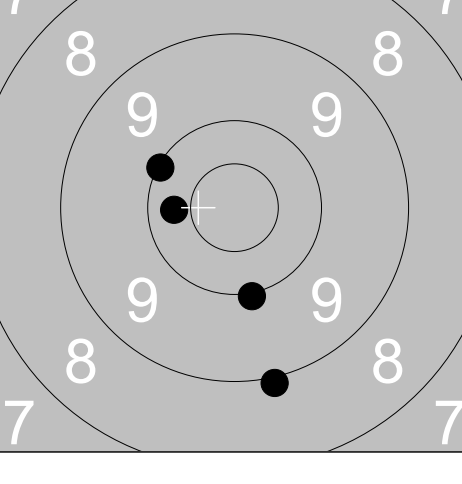
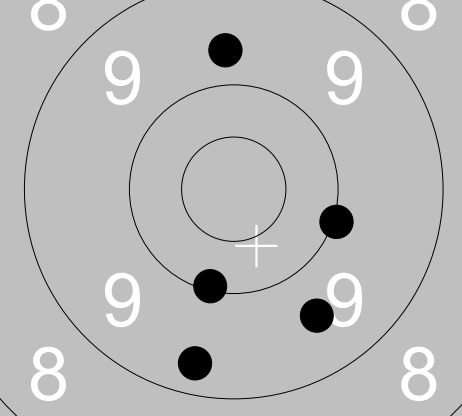
Skjutlag 4	Tavla 14	Lars Lindgren	
Ramselefors	Fagersta	Vet	Vm
12.08.2017	SM Banskytte Liggande 2017	Ramselefors SKF	
Prov 	1: 10.6x ↘ 2: 9.3 ↘ 3: 9.5 ↘ 4: 10.3 ↘ 5: 9.9 ↘ Serie 47 Total 0	1. Serie 5 Skott 	1: 9.5 ↗ 2: 8.7 ↘ 3: 9.2 ↘ 4: 10.5x ↘ 5: 10.2 ↘ Serie 46 Total 46
2. Serie 5 Skott 	1: 10.2 → 2: 9.4 ↗ 3: 10.1 → 4: 9.3 ↗ 5: 10.3 → Serie 48 Total 94	3. Serie 5 Skott 	1: 9.3 ↗ 2: 9.6 ↗ 3: 9.8 ↗ 4: 10.7x ↘ 5: 9.1 ↘ Serie 46 Total 140
Prov 	1: 9.8 ← 2: 8.8 ↘ 3: 9.5 ↘ Serie 26 Total 140	4. Serie 5 Skott 	1: 10.3 ← 2: 10.1 ↗ 3: 8.1 ↗ 4: 10.0 ↘ 5: 9.0 ↘ Serie 47 Total 187
5. Serie 5 Skott 	1: 9.6 ↘ 2: 9.3 ↘ 3: 10.0 → 4: 9.7 ↗ 5: 10.1 ↘ Serie 47 Total 234		

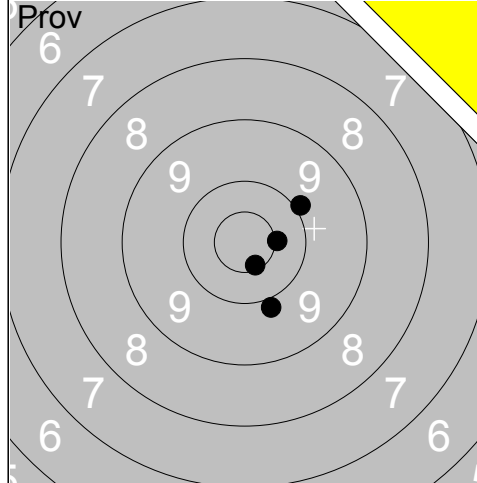

1:	9.9	↓
2:	6.9	→
3:	10.6x	↓
4:	10.5x	→
5:	9.9	→
Serie		44
Total		0

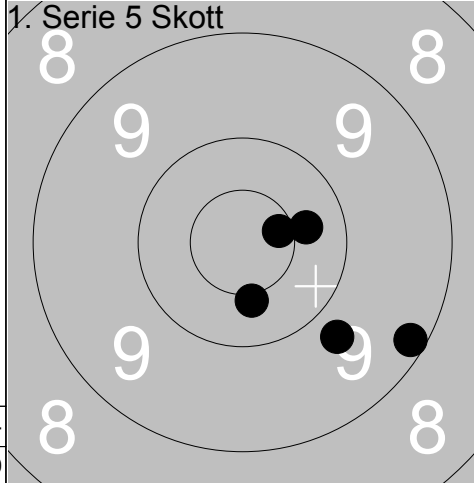

1:	10.4x	↓
2:	9.8	↓
3:	10.6x	→
4:	10.4	→
5:	9.2	↓
Serie		48
Total		48

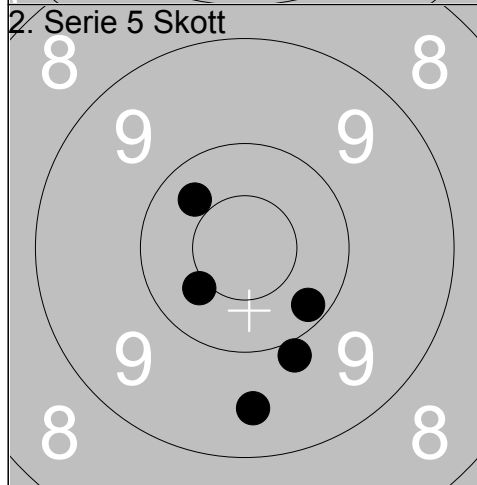

1:	10.3	↗
2:	10.4	↖
3:	10.2	↓
4:	9.5	↓
5:	9.9	↓
Serie		48
Total		96

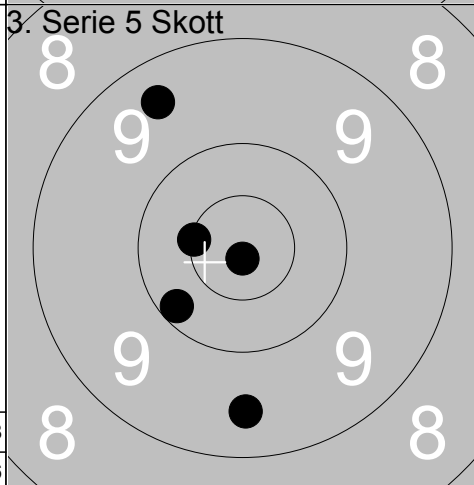

1:	10.2	↙
2:	10.5x	←
3:	9.4	↗
4:	10.9x	↓
5:	9.5	↓
Serie		48
Total		144

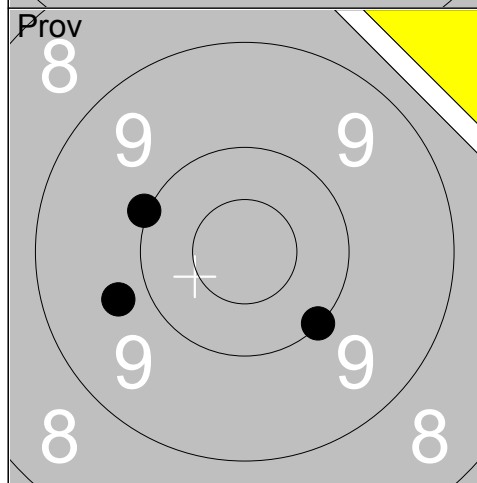

1:	9.7	←
2:	10.0	↗
3:	10.0	↓
Serie		29
Total		144

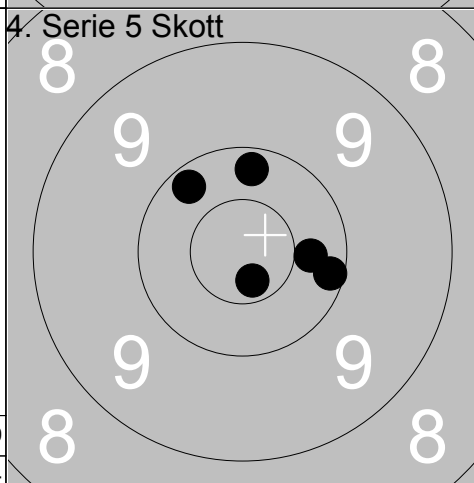

1:	10.2	↑
2:	10.2	↗
3:	10.7x	↓
4:	10.3	→
5:	10.1	↘
Serie		50
Total		194

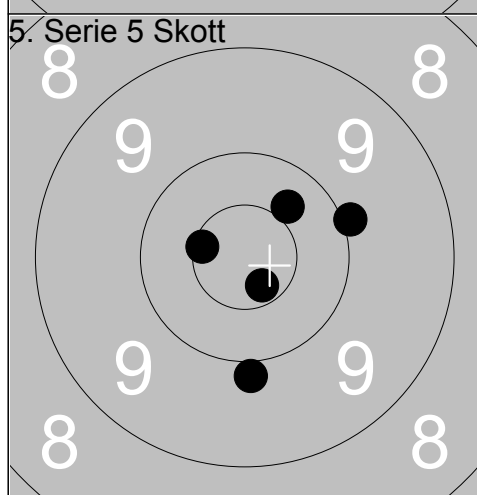

1:	10.7x	↓
2:	9.9	↓
3:	10.0	→
4:	10.4	↗
5:	10.6x	←
Serie		49
Total		243

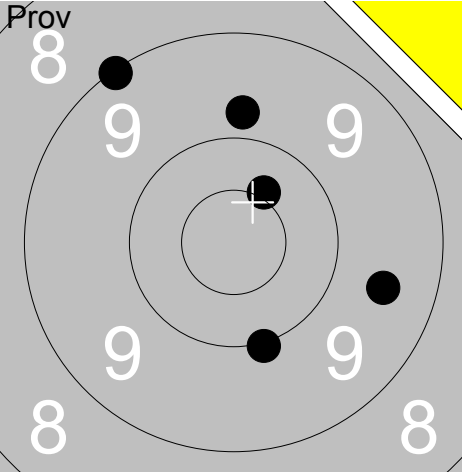
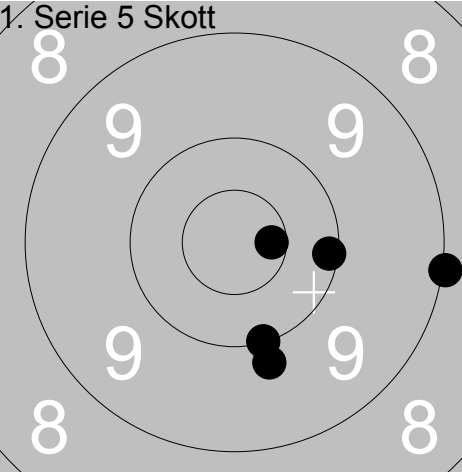
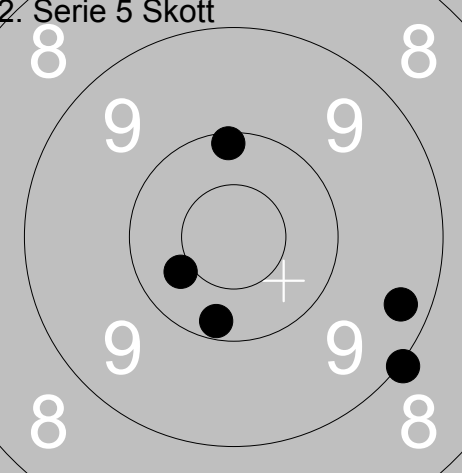
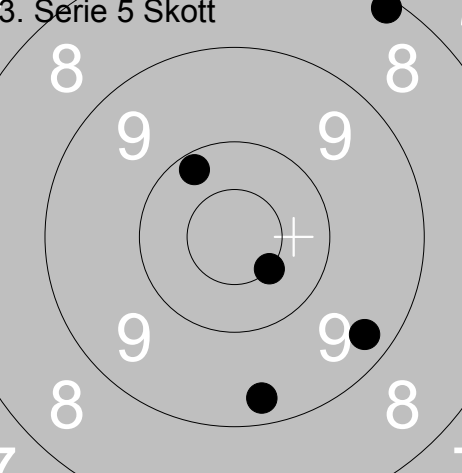
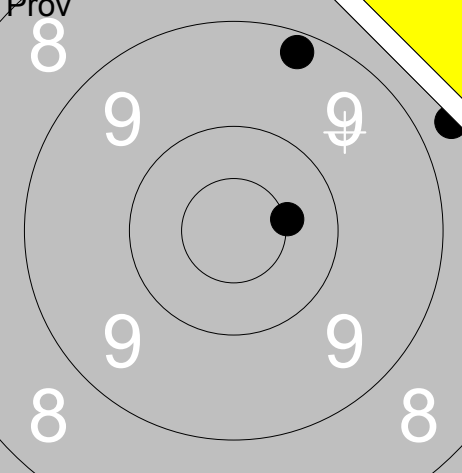
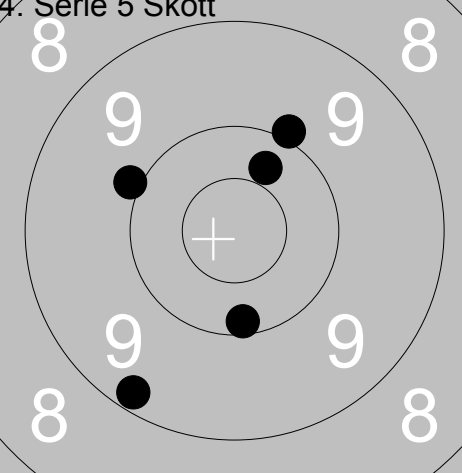
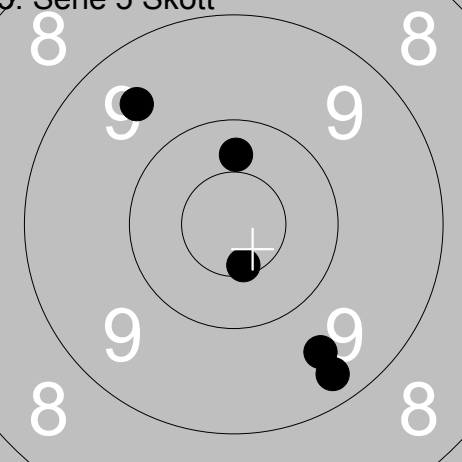
Skjutlag	Tavla	Mikael Nilsson		
4	16	Bromma-Solna	Öpp	St
12.08.2017	SM Banskytte Liggande 2017	Ramselefors SKF		
Prov 	1: 9.1 ↖ 2: 9.8 ↑ 3: 10.4x ↗ 4: 9.5 → 5: 10.0 ↓	1. Serie 5 Skott 	1: 9.0 → 2: 10.6x → 3: 10.0 ↓ 4: 9.8 ↓ 5: 10.1 →	
	Serie 47		Serie 48	
	Total 0		Total 48	
2. Serie 5 Skott 	1: 10.4 ↙ 2: 10.2 ↓ 3: 9.0 ↘ 4: 10.1 ↑ 5: 9.3 →	3. Serie 5 Skott 	1: 9.3 ↓ 2: 10.5x ↘ 3: 9.3 ↘ 4: 8.1 ↗ 5: 10.2 ↗	
	Serie 48		Serie 46	
	Total 96		Total 142	
Prov 	1: 10.5x → 2: 9.2 ↑ 3: 8.7 →	4. Serie 5 Skott 	1: 9.2 ↙ 2: 10.3 ↑ 3: 9.9 ↖ 4: 10.1 ↓ 5: 10.0 ↑	
	Serie 27		Serie 48	
	Total 142		Total 190	
5. Serie 5 Skott 	1: 9.6 ↗ 2: 10.6x ↓ 3: 9.6 ↓ 4: 9.3 ↓ 5: 10.3 ↑			
	Serie 47			
	Total 237			

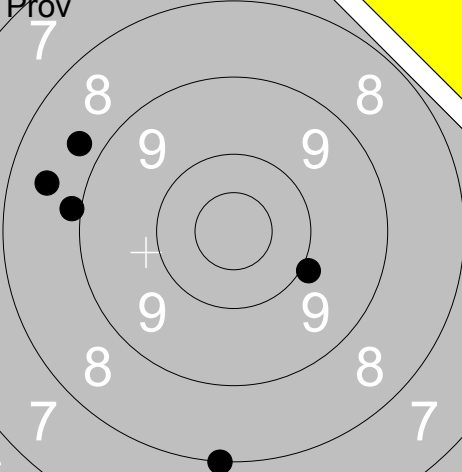
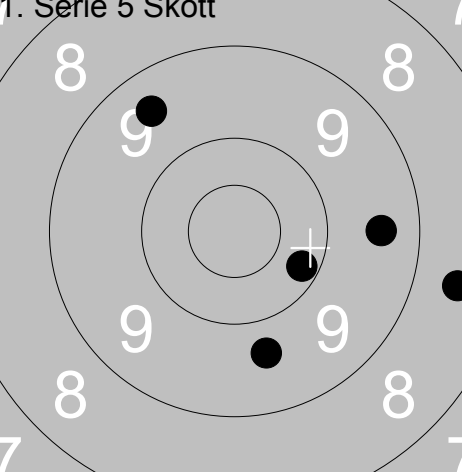
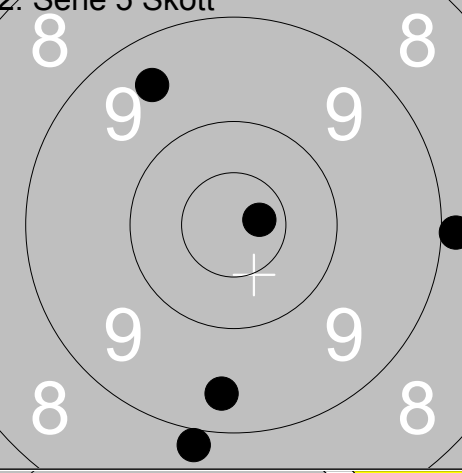
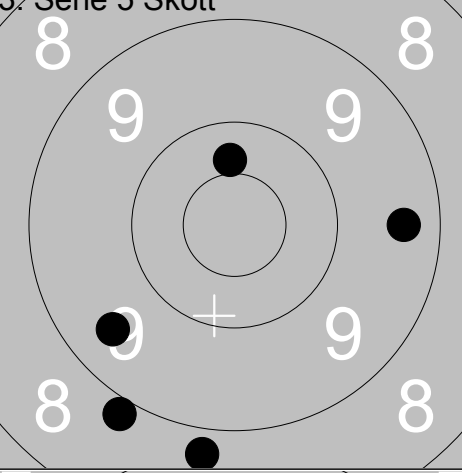
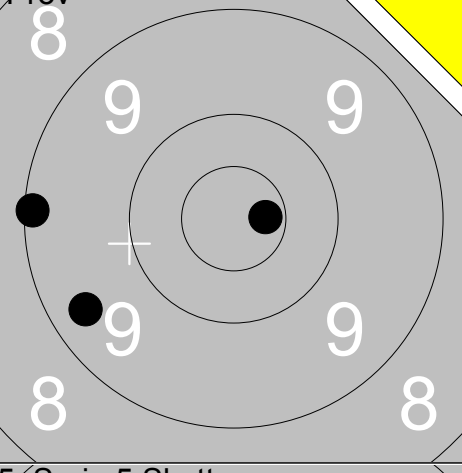
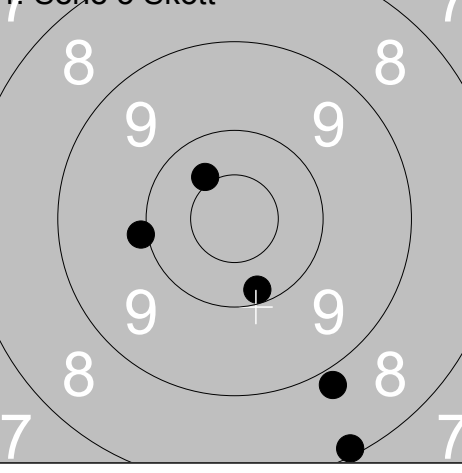
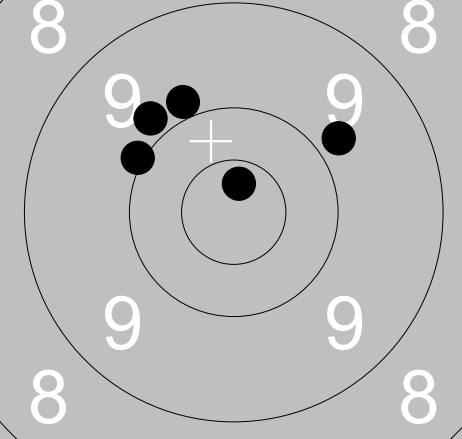
Prov 	<table border="1" style="width:100%; border-collapse: collapse;"> <tr><td>1:</td><td>8.0</td><td>↓</td></tr> <tr><td>2:</td><td>8.9</td><td>←</td></tr> <tr><td>3:</td><td>8.7</td><td>↗</td></tr> <tr><td>4:</td><td>8.5</td><td>↖</td></tr> <tr><td>5:</td><td>9.9</td><td>↘</td></tr> <tr><td colspan="2">Serie</td><td>41</td></tr> <tr><td colspan="2">Total</td><td>0</td></tr> </table>	1:	8.0	↓	2:	8.9	←	3:	8.7	↗	4:	8.5	↖	5:	9.9	↘	Serie		41	Total		0	1. Serie 5 Skott  <table border="1" style="width:100%; border-collapse: collapse;"> <tr><td>1:</td><td>9.7</td><td>↓</td></tr> <tr><td>2:</td><td>8.6</td><td>→</td></tr> <tr><td>3:</td><td>10.2</td><td>↘</td></tr> <tr><td>4:</td><td>9.4</td><td>→</td></tr> <tr><td>5:</td><td>9.5</td><td>↗</td></tr> <tr><td colspan="2">Serie</td><td>45</td></tr> <tr><td colspan="2">Total</td><td>45</td></tr> </table>	1:	9.7	↓	2:	8.6	→	3:	10.2	↘	4:	9.4	→	5:	9.5	↗	Serie		45	Total		45
1:	8.0	↓																																										
2:	8.9	←																																										
3:	8.7	↗																																										
4:	8.5	↖																																										
5:	9.9	↘																																										
Serie		41																																										
Total		0																																										
1:	9.7	↓																																										
2:	8.6	→																																										
3:	10.2	↘																																										
4:	9.4	→																																										
5:	9.5	↗																																										
Serie		45																																										
Total		45																																										
2. Serie 5 Skott 	<table border="1" style="width:100%; border-collapse: collapse;"> <tr><td>1:</td><td>8.9</td><td>→</td></tr> <tr><td>2:</td><td>8.9</td><td>↓</td></tr> <tr><td>3:</td><td>10.7x</td><td>→</td></tr> <tr><td>4:</td><td>9.5</td><td>↗</td></tr> <tr><td>5:</td><td>9.4</td><td>↓</td></tr> <tr><td colspan="2">Serie</td><td>44</td></tr> <tr><td colspan="2">Total</td><td>89</td></tr> </table>	1:	8.9	→	2:	8.9	↓	3:	10.7x	→	4:	9.5	↗	5:	9.4	↓	Serie		44	Total		89	3. Serie 5 Skott  <table border="1" style="width:100%; border-collapse: collapse;"> <tr><td>1:</td><td>9.5</td><td>↙</td></tr> <tr><td>2:</td><td>10.4</td><td>↑</td></tr> <tr><td>3:</td><td>9.4</td><td>→</td></tr> <tr><td>4:</td><td>8.8</td><td>↓</td></tr> <tr><td>5:</td><td>8.9</td><td>↙</td></tr> <tr><td colspan="2">Serie</td><td>44</td></tr> <tr><td colspan="2">Total</td><td>133</td></tr> </table>	1:	9.5	↙	2:	10.4	↑	3:	9.4	→	4:	8.8	↓	5:	8.9	↙	Serie		44	Total		133
1:	8.9	→																																										
2:	8.9	↓																																										
3:	10.7x	→																																										
4:	9.5	↗																																										
5:	9.4	↓																																										
Serie		44																																										
Total		89																																										
1:	9.5	↙																																										
2:	10.4	↑																																										
3:	9.4	→																																										
4:	8.8	↓																																										
5:	8.9	↙																																										
Serie		44																																										
Total		133																																										
Prov 	<table border="1" style="width:100%; border-collapse: collapse;"> <tr><td>1:</td><td>9.4</td><td>↙</td></tr> <tr><td>2:</td><td>10.7x</td><td>→</td></tr> <tr><td>3:</td><td>9.1</td><td>←</td></tr> <tr><td colspan="2">Serie</td><td>28</td></tr> <tr><td colspan="2">Total</td><td>133</td></tr> </table>	1:	9.4	↙	2:	10.7x	→	3:	9.1	←	Serie		28	Total		133	4. Serie 5 Skott  <table border="1" style="width:100%; border-collapse: collapse;"> <tr><td>1:</td><td>10.2</td><td>↓</td></tr> <tr><td>2:</td><td>10.0</td><td>←</td></tr> <tr><td>3:</td><td>8.8</td><td>↘</td></tr> <tr><td>4:</td><td>10.4x</td><td>↗</td></tr> <tr><td>5:</td><td>8.1</td><td>↘</td></tr> <tr><td colspan="2">Serie</td><td>46</td></tr> <tr><td colspan="2">Total</td><td>179</td></tr> </table>	1:	10.2	↓	2:	10.0	←	3:	8.8	↘	4:	10.4x	↗	5:	8.1	↘	Serie		46	Total		179						
1:	9.4	↙																																										
2:	10.7x	→																																										
3:	9.1	←																																										
Serie		28																																										
Total		133																																										
1:	10.2	↓																																										
2:	10.0	←																																										
3:	8.8	↘																																										
4:	10.4x	↗																																										
5:	8.1	↘																																										
Serie		46																																										
Total		179																																										
5. Serie 5 Skott 	<table border="1" style="width:100%; border-collapse: collapse;"> <tr><td>1:</td><td>10.0</td><td>↗</td></tr> <tr><td>2:</td><td>9.9</td><td>↗</td></tr> <tr><td>3:</td><td>9.8</td><td>↗</td></tr> <tr><td>4:</td><td>9.8</td><td>↗</td></tr> <tr><td>5:</td><td>10.7x</td><td>↑</td></tr> <tr><td colspan="2">Serie</td><td>47</td></tr> <tr><td colspan="2">Total</td><td>226</td></tr> </table>	1:	10.0	↗	2:	9.9	↗	3:	9.8	↗	4:	9.8	↗	5:	10.7x	↑	Serie		47	Total		226																						
1:	10.0	↗																																										
2:	9.9	↗																																										
3:	9.8	↗																																										
4:	9.8	↗																																										
5:	10.7x	↑																																										
Serie		47																																										
Total		226																																										

Skjutlag 4	Tavla 18	Henry Lindström		
Ramselefors		I 19 / A 9		Vet
12.08.2017		SM Banskytte Liggande 2017		Ramselefors SKF
Prov		1: 10.4 ↘ 2: 10.5x ← 3: 10.2 ↗ 4: 10.2 ↗ 5: 10.2 ↘	1. Serie 5 Skott	1: 10.5x ↑ 2: 10.7x ↘ 3: 10.8x ↘ 4: 9.0 ↙ 5: 10.1 ↑
		Serie 50 Total 0		Serie 49 Total 49
2. Serie 5 Skott		1: 10.4 ↑ 2: 9.9 ↓ 3: 9.7 → 4: 10.7x → 5: 10.2 ↖	3. Serie 5 Skott	1: 9.6 ↙ 2: 10.6x → 3: 10.3 ↓ 4: 10.3 ↙ 5: 10.5x ↖
		Serie 48 Total 97		Serie 49 Total 146
Prov		1: 10.0 ↘ 2: 9.3 ↙ 3: 9.9 →	4. Serie 5 Skott	1: 10.6x ↑ 2: 9.6 ↙ 3: 9.9 ↑ 4: 8.5 → 5: 9.9 ↘
		Serie 28 Total 146		Serie 45 Total 191
5. Serie 5 Skott		1: 10.1 ↘ 2: 10.2 ↘ 3: 10.2 ↗ 4: 9.4 ↘ 5: 9.4 ↙		
		Serie 48 Total 239		

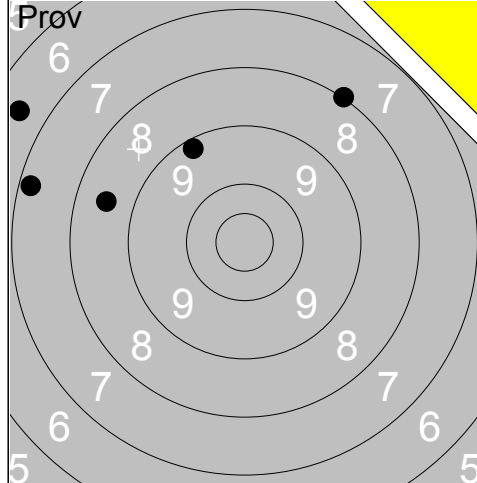

1:	7.2	←
2:	8.6	←
3:	6.5	↗
4:	9.2	↗
5:	8.0	↗
Serie		38
Total		07

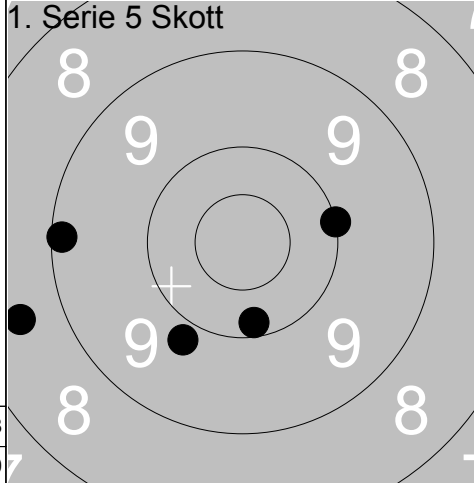

1:	10.0	→
2:	10.2	↓
3:	9.1	←
4:	9.8	↓
5:	8.6	←
Serie		46
Total		46

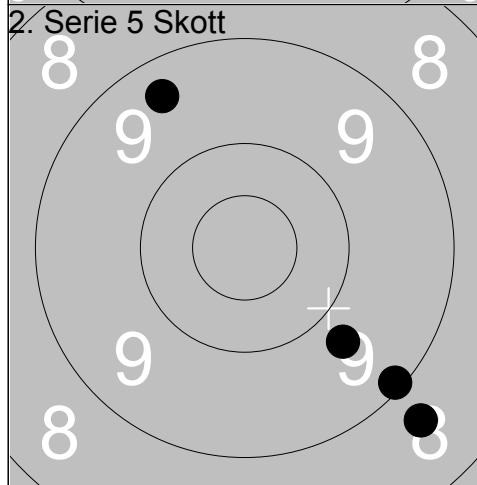

1:	9.1	↘
2:	9.7	↘
3:	9.4	↗
4:	8.7	↘
5:	0.0	
Serie		35
Total		81

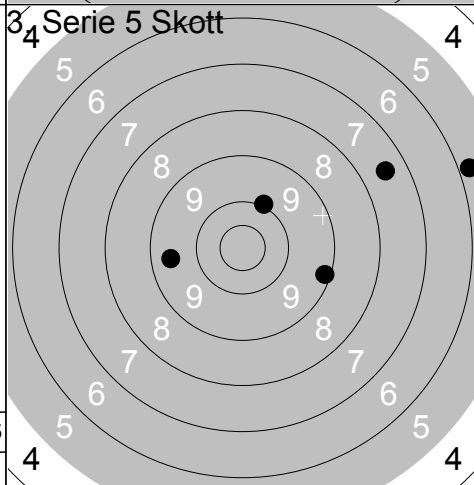

1:	7.5	↗
2:	5.8	→
3:	10.0	↗
4:	9.4	←
5:	9.2	→
Serie		40
Total		121

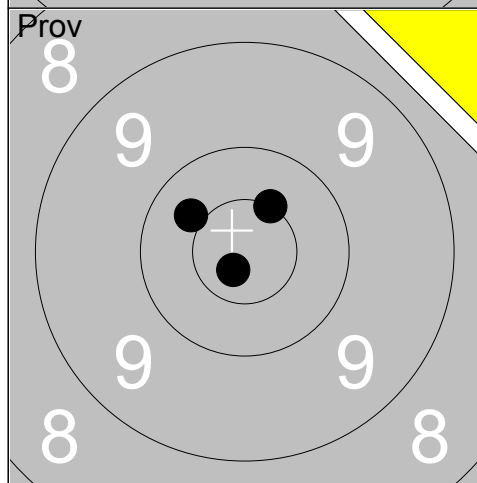

1:	10.8x	↘
2:	10.4	↗
3:	10.5x	↗
Serie		30
Total		121

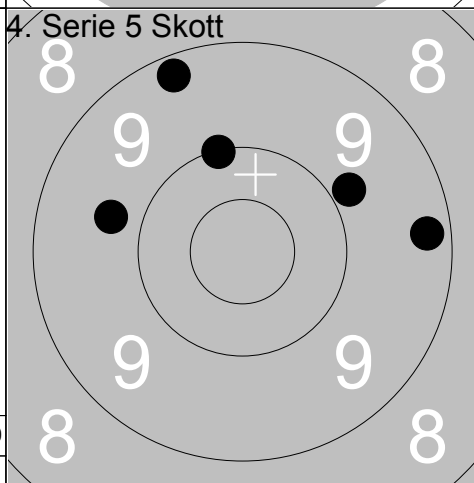

1:	9.9	↗
2:	10.0	↗
3:	9.2	↗
4:	9.3	→
5:	9.7	←
Serie		46
Total		167

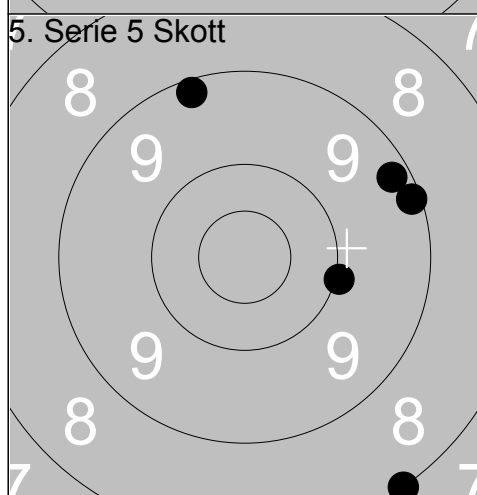

1:	10.0	→
2:	9.1	→
3:	9.2	↗
4:	9.2	↗
5:	8.0	↘
Serie		45
Total		212

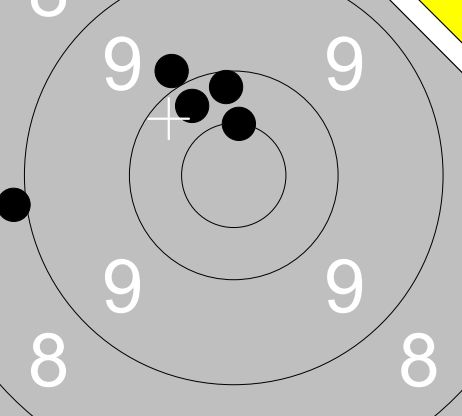
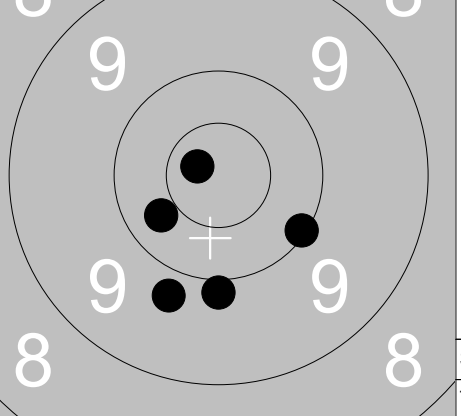
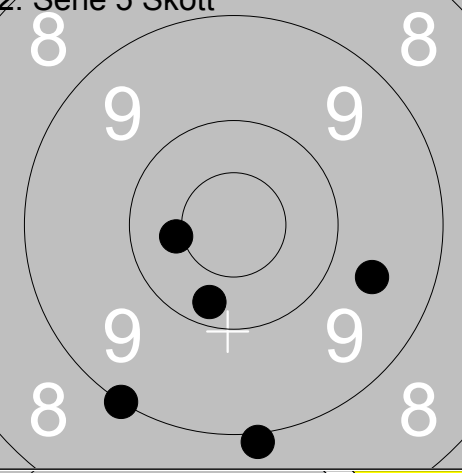
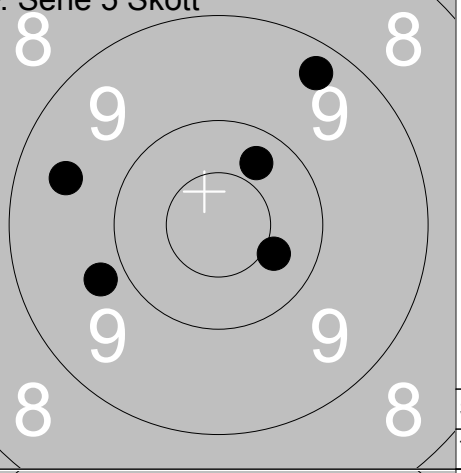
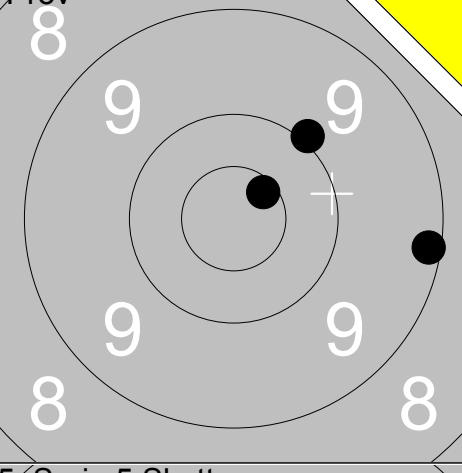
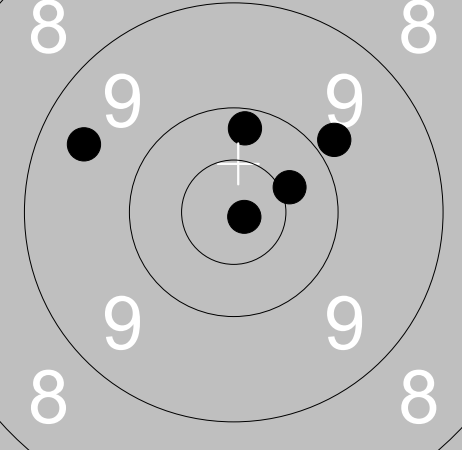
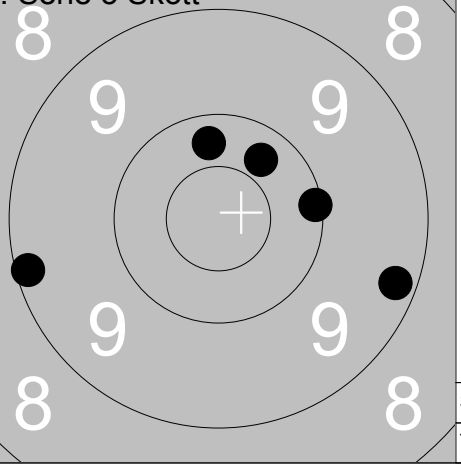
<p>Prov</p>  <p>1: 8.9 ← 2: 9.9 ↗ 3: 10.2 ↗ 4: 10.5x ↑ 5: 10.2 ↑</p> <p>Serie 47 Total 0</p>	<p>1. Serie 5 Skott</p>  <p>1: 9.8 ↓ 2: 10.3 ↙ 3: 9.9 ↓ 4: 10.1 ↘ 5: 10.7x ↖</p> <p>Serie 48 Total 48</p>	
<p>2. Serie 5 Skott</p>  <p>1: 9.0 ↓ 2: 10.2 ↓ 3: 10.4x ← 4: 9.6 → 5: 8.9 ↓</p> <p>Serie 46 Total 94</p>	<p>3. Serie 5 Skott</p>  <p>1: 9.8 ← 2: 9.3 ↗ 3: 10.3 ↗ 4: 9.5 ← 5: 10.4 →</p> <p>Serie 47 Total 141</p>	<p>Prov</p>  <p>1: 10.0 ↗ 2: 10.6x ↗ 3: 9.1 →</p> <p>Serie 29 Total 141</p>
<p>5. Serie 5 Skott</p>  <p>1: 10.2 ↑ 2: 9.8 ↗ 3: 9.5 ↖ 4: 10.8x ↘ 5: 10.4 →</p> <p>Serie 48 Total 237</p>	<p>4. Serie 5 Skott</p>  <p>1: 10.3 ↗ 2: 9.2 → 3: 10.3 ↑ 4: 9.1 ← 5: 10.1 →</p> <p>Serie 48 Total 189</p>	

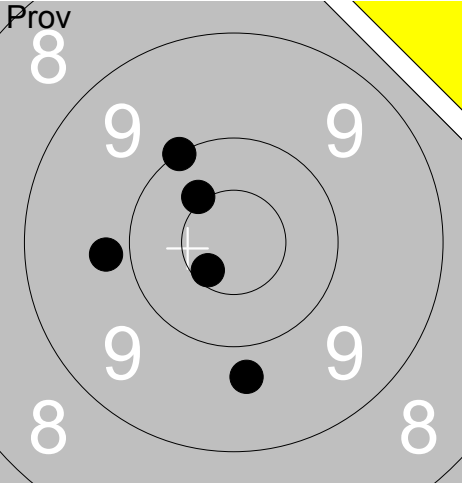
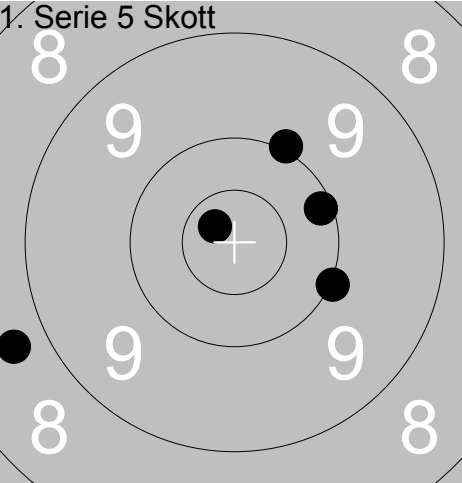
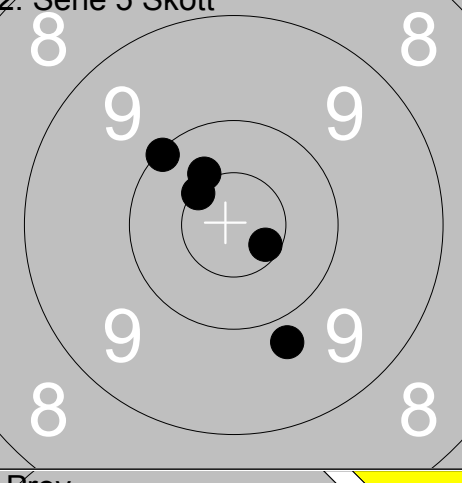
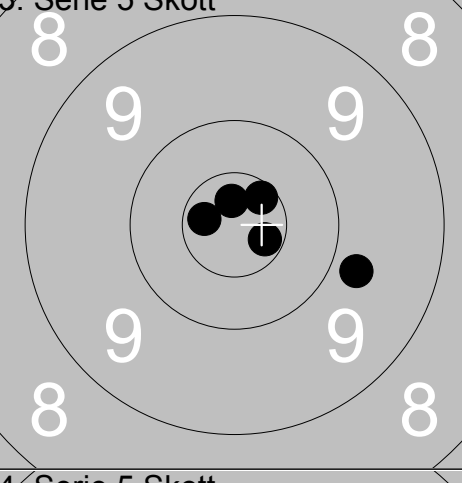
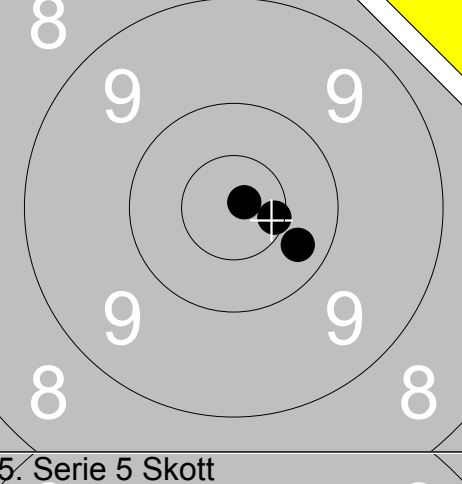
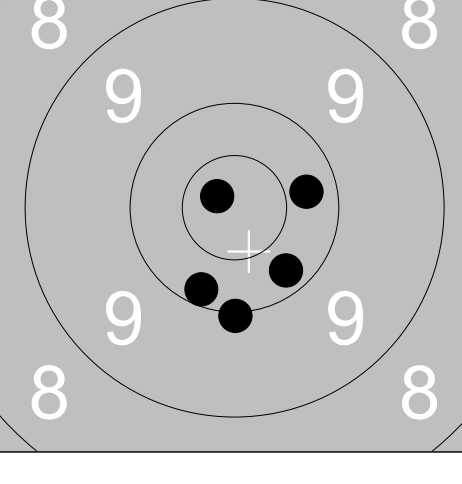
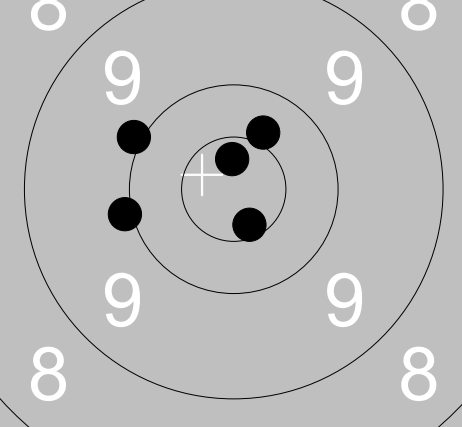
Skjutlag 4	Tavla 21	Roger Strandh	
Ramselefors	Mariestad	Öpp	Vg
12.08.2017	SM Banskytte Liggande 2017	Ramselefors SKF	
Prov 	1: 10.4x ↗ 2: 10.0 ↗ 3: 9.8 ← 4: 10.6x ↘ 5: 9.7 ↓	1. Serie 5 Skott 	1: 10.0 ↗ 2: 10.0 → 3: 10.1 → 4: 8.7 ← 5: 10.7x ↗
	Serie 48 Total 0		Serie 48 Total 48
2. Serie 5 Skott 	1: 9.8 ↓ 2: 10.5x ↗ 3: 10.4x ↗ 4: 10.1 ↗ 5: 10.6x ↘	3. Serie 5 Skott 	1: 9.8 → 2: 10.7x ↑ 3: 10.6x ↗ 4: 10.7x → 5: 10.7x ←
	Serie 49 Total 97		Serie 49 Total 146
Prov 	1: 10.8x → 2: 10.6x → 3: 10.3 ↓	4. Serie 5 Skott 	1: 10.2 ↓ 2: 10.0 ↓ 3: 10.3 → 4: 10.8x ↗ 5: 10.2 ↓
	Serie 30 Total 146		Serie 50 Total 196
5. Serie 5 Skott 	1: 10.0 ↗ 2: 10.0 ← 3: 10.6x ↘ 4: 10.7x ↑ 5: 10.4 ↗		
	Serie 50 Total 246		

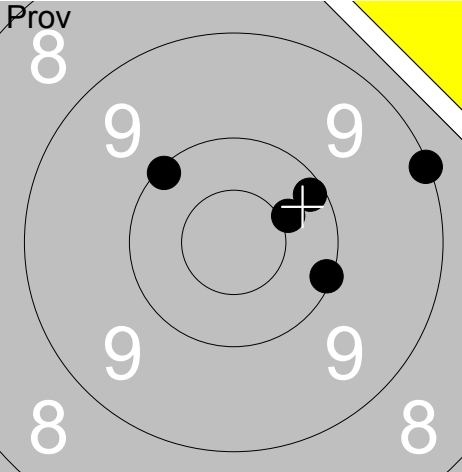
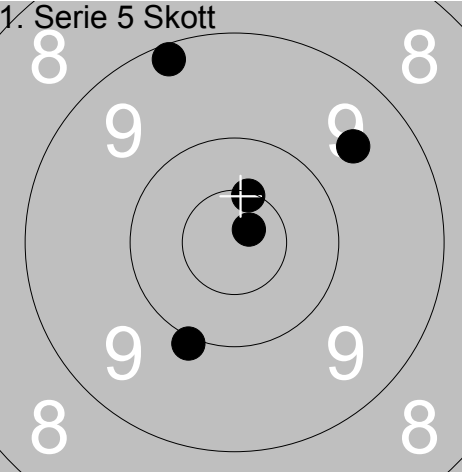
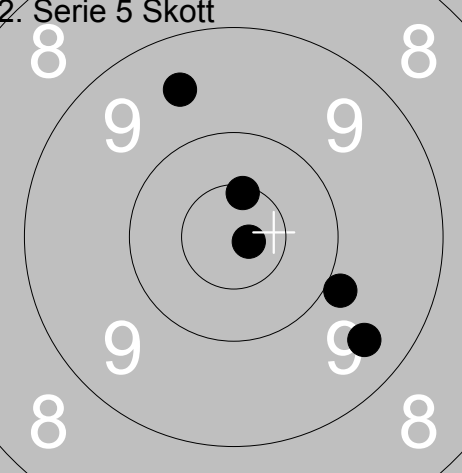
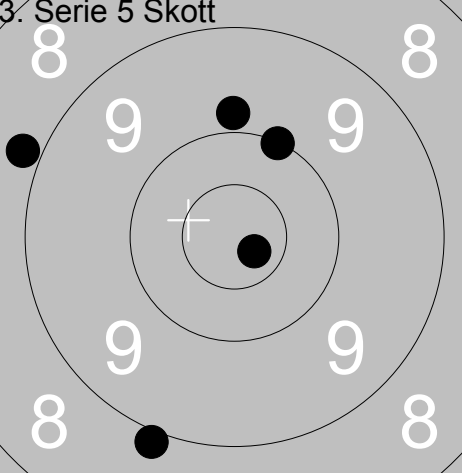
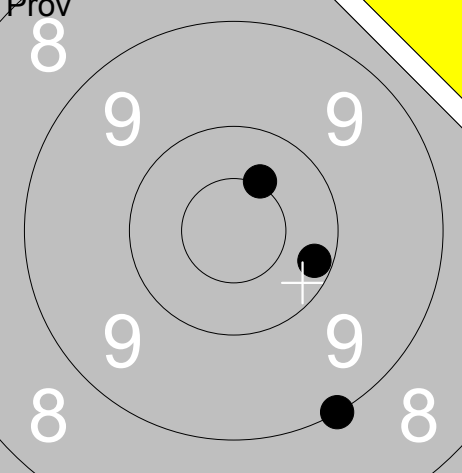
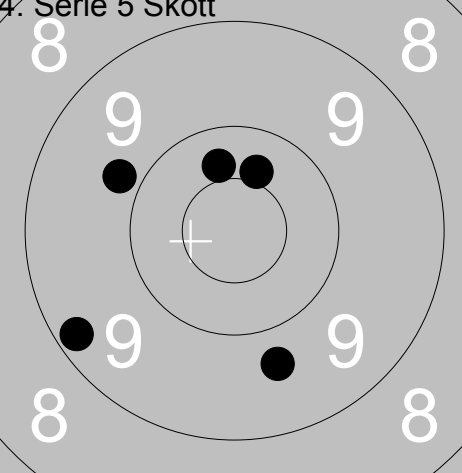
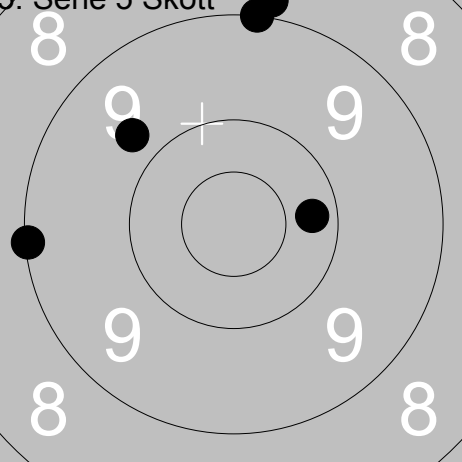

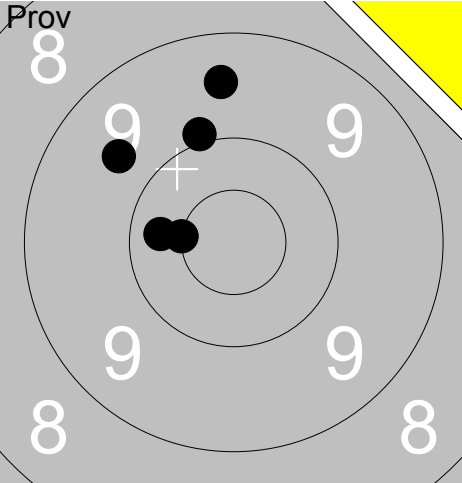
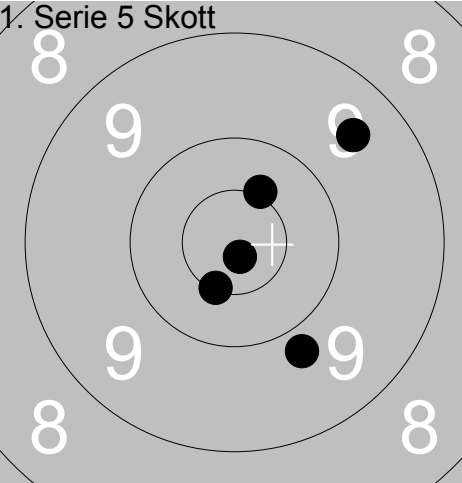
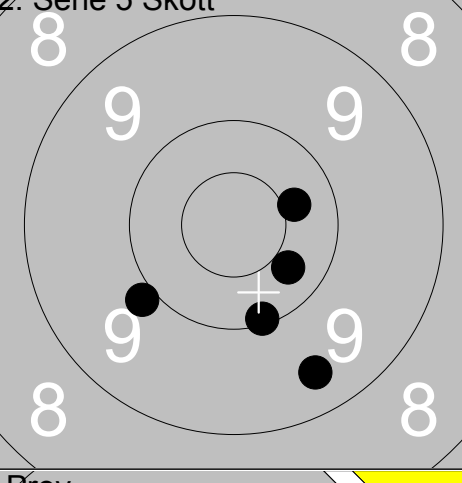
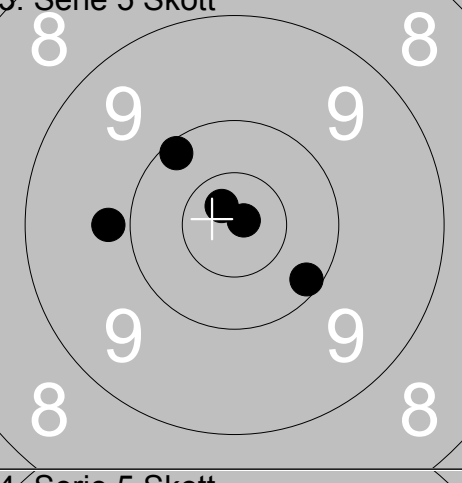
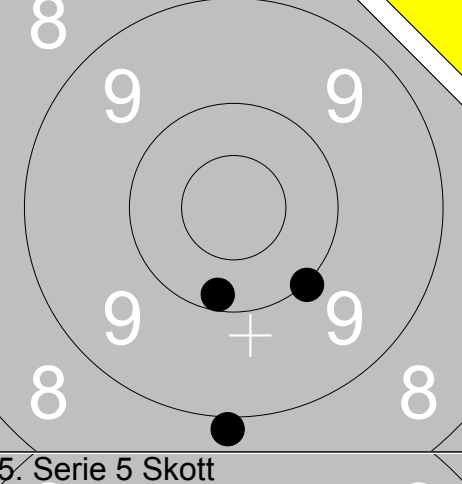
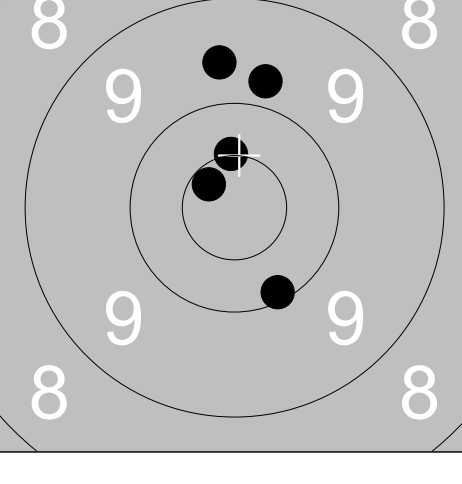
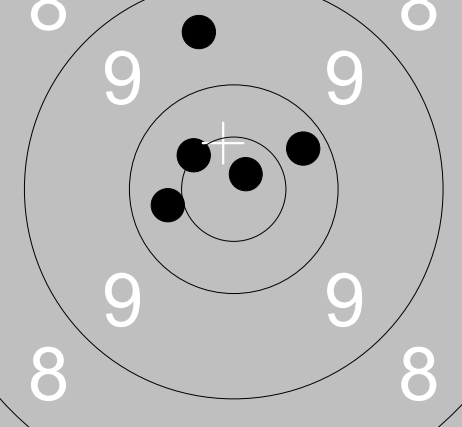
Skjutlag	Tavla	Bengt Bengtsson			
5	1	Ramselefors	Tyringe	Vet	Sk
12.08.2017		SM Banskytte Liggande 2017		Ramselefors SKF	
Prov 	1: 10.1 → 2: 10.1 ↖ 3: 10.4 → 4: 9.1 → 5: 10.2 →	1. Serie 5 Skott 	1: 9.2 ↗ 2: 10.0 ↓ 3: 9.6 ↗ 4: 10.5x ↑ 5: 10.8x ↗		
	Serie 49		Serie 48		
	Total 0		Total 48		
2. Serie 5 Skott 	1: 10.6x ↑ 2: 9.9 ↘ 3: 9.5 ↗ 4: 9.4 ↘ 5: 10.8x →	3. Serie 5 Skott 	1: 9.8 ↑ 2: 8.9 ↓ 3: 10.7x ↘ 4: 10.0 ↑ 5: 8.9 ↖		
	Serie 47		Serie 45		
	Total 95		Total 140		
Prov 	1: 10.2 → 2: 10.5x ↑ 3: 9.0 ↓	4. Serie 5 Skott 	1: 10.4 ↗ 2: 9.7 ↓ 3: 9.8 ↖ 4: 9.2 ↖ 5: 10.4 ↑		
	Serie 29		Serie 47		
	Total 140		Total 187		
5. Serie 5 Skott 	1: 8.9 ↑ 2: 9.1 ← 3: 9.7 ↗ 4: 9.0 ↑ 5: 10.2 →				
	Serie 45				
	Total 232				

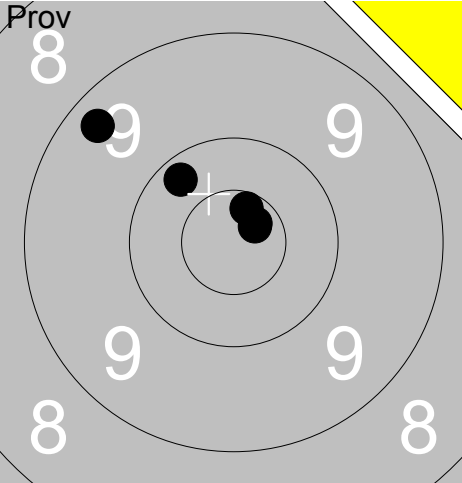
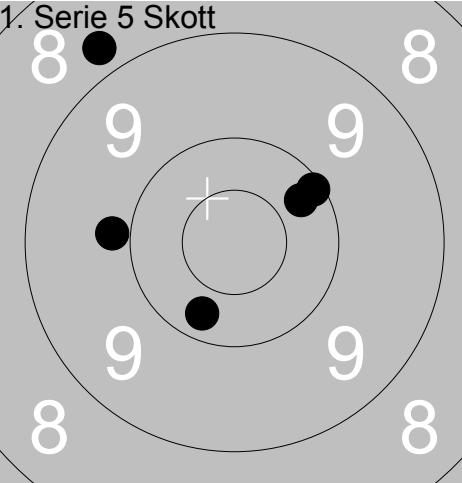
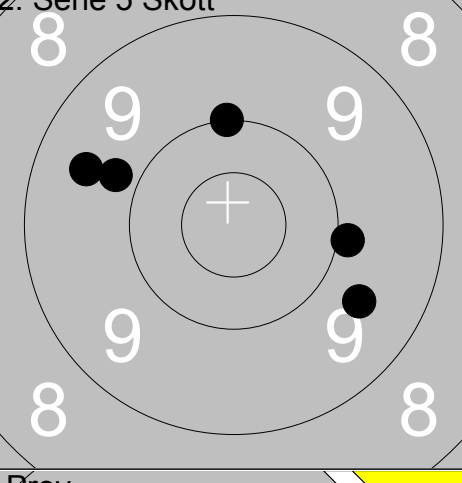
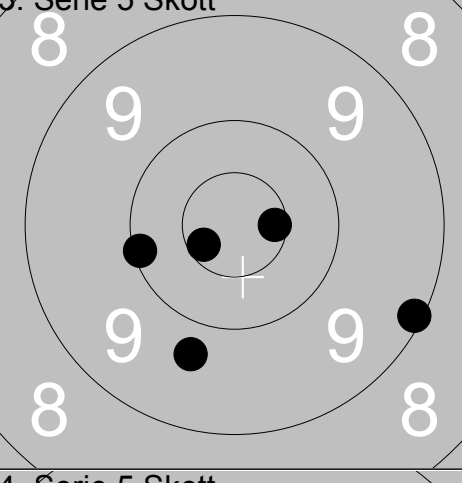
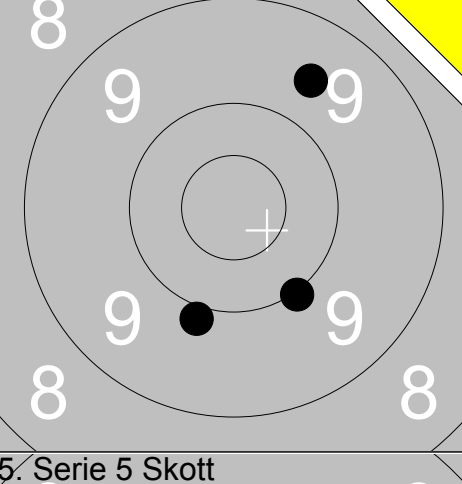
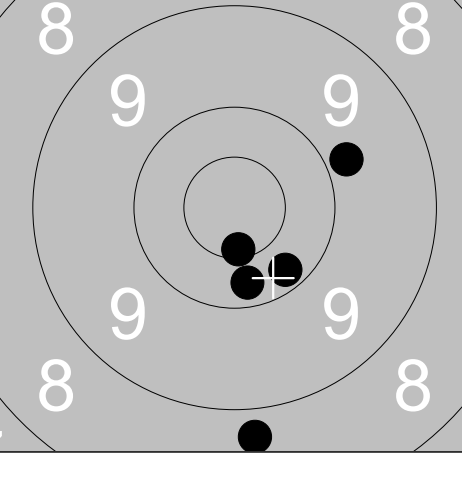
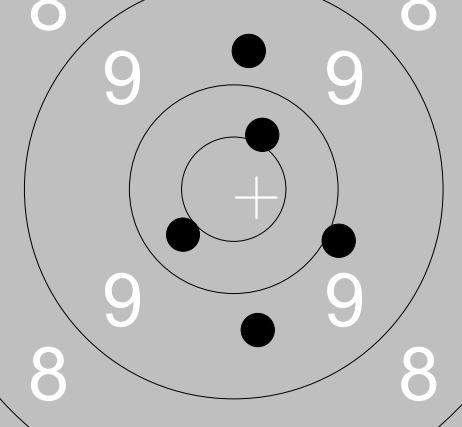
Skjutlag 5	Tavla 2	Fredrik Thyberg	
Ramselefors		Edsbjörke	Öpp Vä
12.08.2017		SM Banskytte Liggande 2017	Ramselefors SKF
Prov 	1: 9.9 ↗ 2: 9.7 ↘ 3: 10.3 ← 4: 9.5 ↑ 5: 10.5x ←	1. Serie 5 Skott 	1: 10.8x ↓ 2: 9.5 ↗ 3: 10.5x ↓ 4: 9.8 ↓ 5: 10.4x ↗
	Serie 47 Total 0		Serie 48 Total 48
2. Serie 5 Skott 	1: 10.3 ↘ 2: 9.4 ↘ 3: 10.1 ↘ 4: 10.4 → 5: 9.9 ↙	3. Serie 5 Skott 	1: 10.2 ↘ 2: 10.9x → 3: 10.7x ↗ 4: 10.1 ↗ 5: 9.8 ←
	Serie 48 Total 96		Serie 49 Total 145
Prov 	1: 10.2 ↓ 2: 8.9 ↓ 3: 10.0 ↓	4. Serie 5 Skott 	1: 9.8 ↑ 2: 10.1 ↓ 3: 9.6 ↑ 4: 10.6x ↗ 5: 10.5x ↑
	Serie 28 Total 145		Serie 48 Total 193
5. Serie 5 Skott 	1: 10.8x ↗ 2: 9.5 ↑ 3: 10.3 ← 4: 10.5x ↗ 5: 10.2 ↗		
	Serie 49 Total 242		

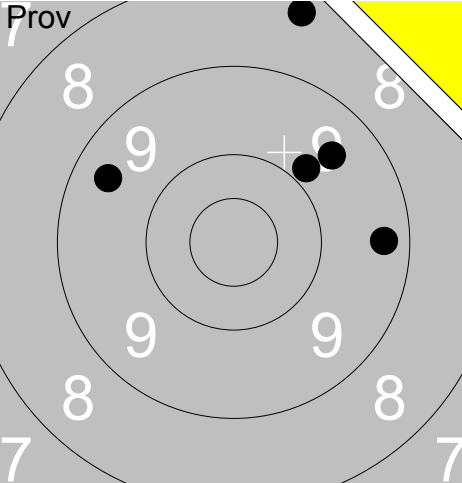
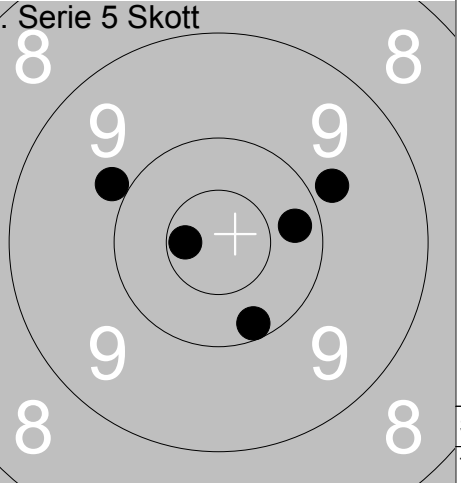
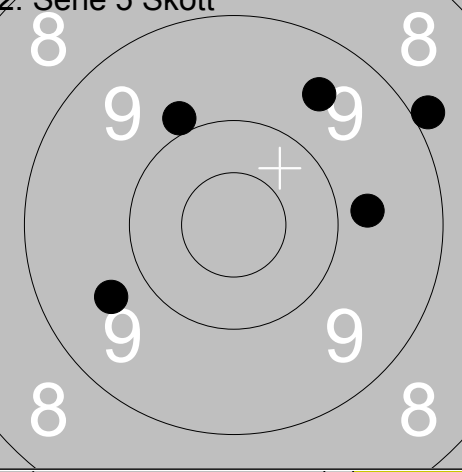
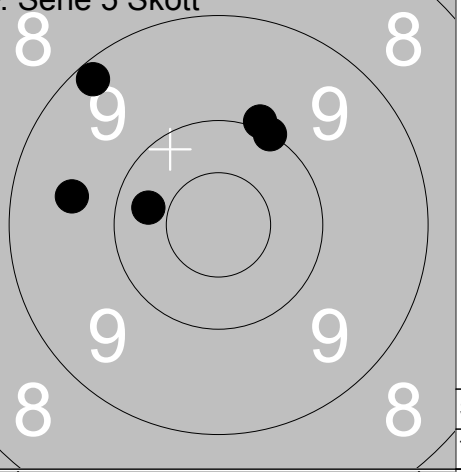
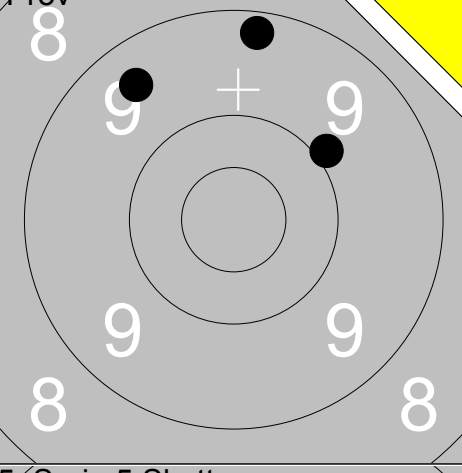
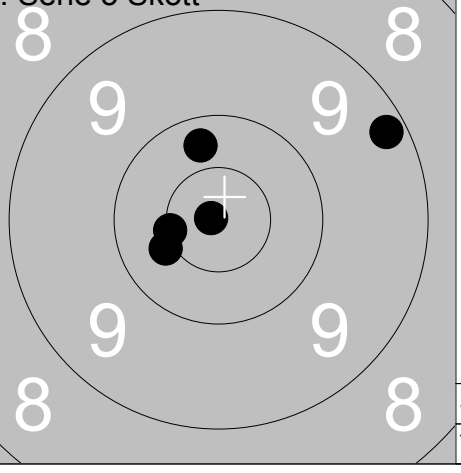
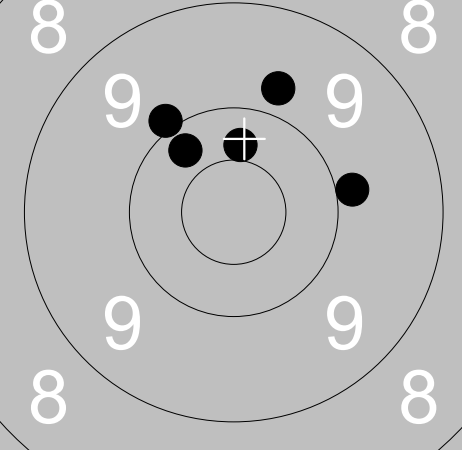
Skjutlag 5	Tavla 3	Håkan Lidman					
Ramselefors		Piteå		Vet	No		
12.08.2017		SM Banskytte Liggande 2017		Ramselefors SKF			
Prov 		1: 10.7x ↗ 2: 10.7x ↗ 3: 10.2 ↗ 4: 9.3 ↗ 5: 10.6x ↗		1. Serie 5 Skott 		1: 10.2 ↗ 2: 8.8 ↗ 3: 10.1 ↗ 4: 9.9 ← 5: 10.3 ↓	
Serie 49 Total 0		Serie 47 Total 47					
2. Serie 5 Skott 		1: 9.8 ← 2: 9.5 ↗ 3: 10.0 ↑ 4: 9.9 → 5: 9.6 ↘		3. Serie 5 Skott 		1: 10.1 ← 2: 10.6x → 3: 9.1 → 4: 10.6x ↙ 5: 9.7 ↓	
Serie 46 Total 93		Serie 48 Total 141					
Prov 		1: 9.9 ↓ 2: 10.0 ↓ 3: 9.6 ↗		4. Serie 5 Skott 		1: 8.8 ↓ 2: 9.8 → 3: 10.6x ↓ 4: 10.2 ↓ 5: 10.3 ↓	
Serie 28 Total 141		Serie 47 Total 188					
5. Serie 5 Skott 		1: 9.7 ↓ 2: 9.9 → 3: 9.7 ↑ 4: 10.3 ↙ 5: 10.4 ↗					
Serie 47 Total 235							

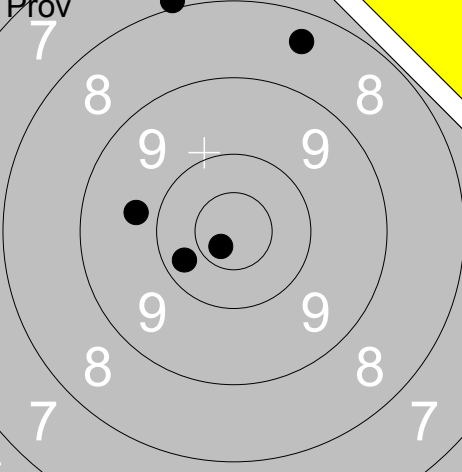
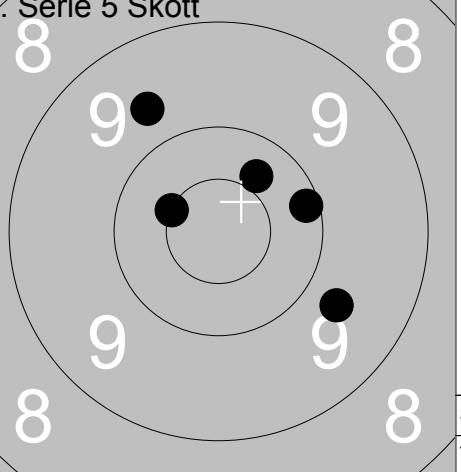
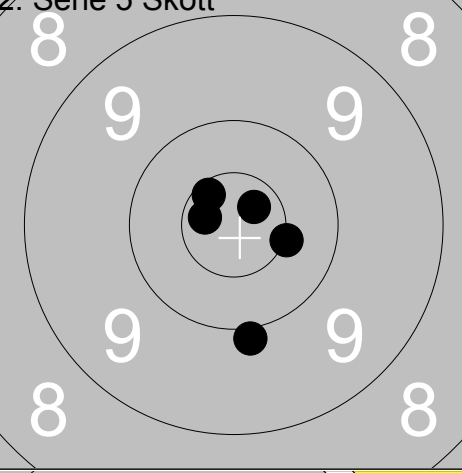
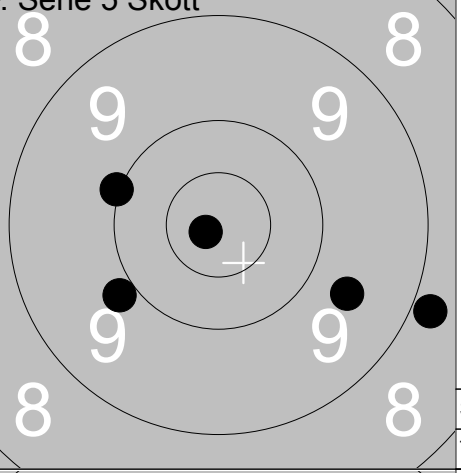
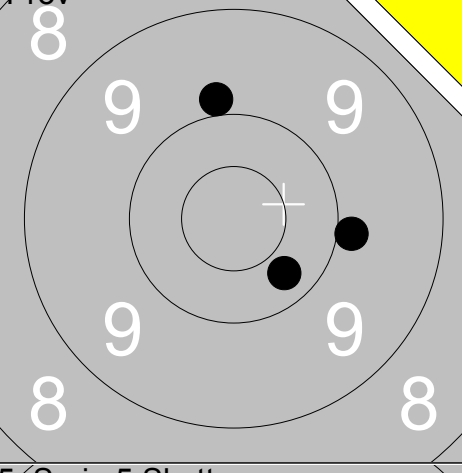
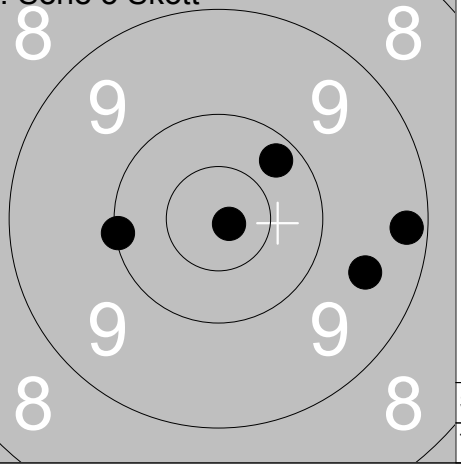
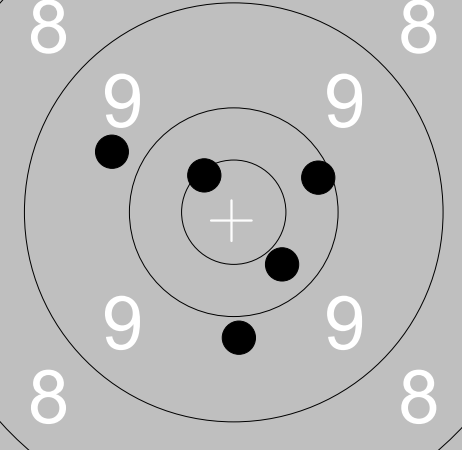
Skjutlag 5	Tavla 4	Fanny Storm	
Ramselefors		Loos	Öpp Gä
12.08.2017		SM Banskytte Liggande 2017	Ramselefors SKF
Prov 	1: 9.3 → 2: 9.9 ↗ 3: 8.3 ↑ 4: 9.4 ← 5: 9.5 ↗ Serie 44 Total 0	1. Serie 5 Skott 	1: 10.3 → 2: 10.2 ↓ 3: 9.9 ↗ 4: 9.8 ↗ 5: 10.7x ← Serie 48 Total 48
2. Serie 5 Skott 	1: 9.5 ↗ 2: 9.7 ← 3: 9.7 → 4: 8.9 ↗ 5: 9.9 ↗ Serie 44 Total 92	3. Serie 5 Skott 	1: 9.2 ↗ 2: 10.3 ← 3: 10.0 ↗ 4: 9.6 ← 5: 10.0 ↗ Serie 48 Total 140
Prov 	1: 9.4 ↗ 2: 9.2 ↑ 3: 9.9 ↗ Serie 27 Total 140	4. Serie 5 Skott 	1: 10.9x ← 2: 9.2 ↗ 3: 10.4x ← 4: 10.3 ↑ 5: 10.5x ← Serie 49 Total 189
5. Serie 5 Skott 	1: 9.9 ↗ 2: 10.3 ↗ 3: 10.4 ↑ 4: 9.8 ↑ 5: 9.9 → Serie 47 Total 236		

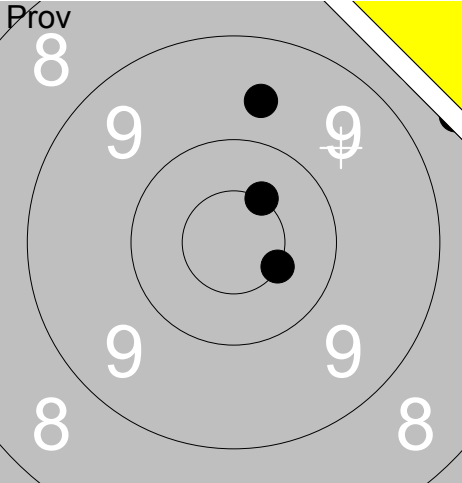
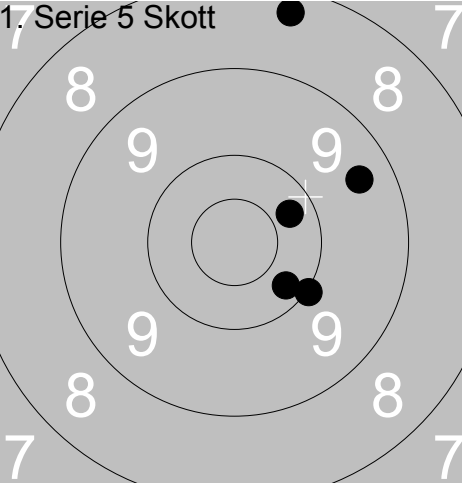
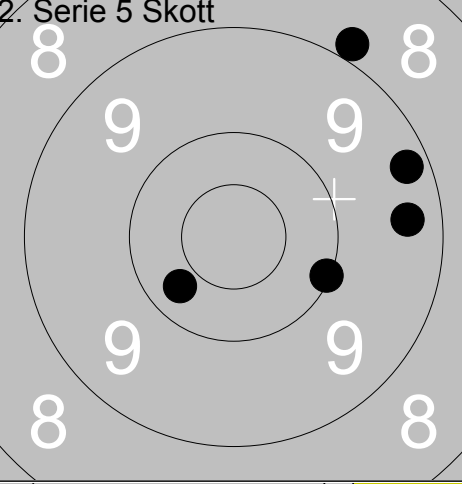
Prov 	<table style="width:100%; border-collapse: collapse;"> <tr><td>1:</td><td>8.4</td><td>↗</td></tr> <tr><td>2:</td><td>7.9</td><td>↗</td></tr> <tr><td>3:</td><td>10.7x</td><td>↘</td></tr> <tr><td>4:</td><td>10.3</td><td>↙</td></tr> <tr><td>5:</td><td>9.7</td><td>←</td></tr> </table> <table style="width:100%; border-collapse: collapse; margin-top: 5px;"> <tr><td style="border-top: 1px solid black;">Serie</td><td style="border-top: 1px solid black; text-align: right;">44</td></tr> <tr><td style="border-top: 1px solid black;">Total</td><td style="border-top: 1px solid black; text-align: right;">0</td></tr> </table>	1:	8.4	↗	2:	7.9	↗	3:	10.7x	↘	4:	10.3	↙	5:	9.7	←	Serie	44	Total	0	1. Serie 5 Skott 	<table style="width:100%; border-collapse: collapse;"> <tr><td>1:</td><td>10.5x</td><td>↖</td></tr> <tr><td>2:</td><td>9.7</td><td>↗</td></tr> <tr><td>3:</td><td>10.4</td><td>↗</td></tr> <tr><td>4:</td><td>9.7</td><td>↘</td></tr> <tr><td>5:</td><td>10.1</td><td>→</td></tr> </table> <table style="width:100%; border-collapse: collapse; margin-top: 5px;"> <tr><td style="border-top: 1px solid black;">Serie</td><td style="border-top: 1px solid black; text-align: right;">48</td></tr> <tr><td style="border-top: 1px solid black;">Total</td><td style="border-top: 1px solid black; text-align: right;">48</td></tr> </table>	1:	10.5x	↖	2:	9.7	↗	3:	10.4	↗	4:	9.7	↘	5:	10.1	→	Serie	48	Total	48
1:	8.4	↗																																							
2:	7.9	↗																																							
3:	10.7x	↘																																							
4:	10.3	↙																																							
5:	9.7	←																																							
Serie	44																																								
Total	0																																								
1:	10.5x	↖																																							
2:	9.7	↗																																							
3:	10.4	↗																																							
4:	9.7	↘																																							
5:	10.1	→																																							
Serie	48																																								
Total	48																																								
2. Serie 5 Skott 	<table style="width:100%; border-collapse: collapse;"> <tr><td>1:</td><td>10.5x</td><td>→</td></tr> <tr><td>2:</td><td>10.6x</td><td>↗</td></tr> <tr><td>3:</td><td>10.7x</td><td>←</td></tr> <tr><td>4:</td><td>9.9</td><td>↘</td></tr> <tr><td>5:</td><td>10.7x</td><td>↗</td></tr> </table> <table style="width:100%; border-collapse: collapse; margin-top: 5px;"> <tr><td style="border-top: 1px solid black;">Serie</td><td style="border-top: 1px solid black; text-align: right;">49</td></tr> <tr><td style="border-top: 1px solid black;">Total</td><td style="border-top: 1px solid black; text-align: right;">97</td></tr> </table>	1:	10.5x	→	2:	10.6x	↗	3:	10.7x	←	4:	9.9	↘	5:	10.7x	↗	Serie	49	Total	97	3. Serie 5 Skott 	<table style="width:100%; border-collapse: collapse;"> <tr><td>1:</td><td>9.6</td><td>→</td></tr> <tr><td>2:</td><td>10.8x</td><td>↖</td></tr> <tr><td>3:</td><td>8.8</td><td>→</td></tr> <tr><td>4:</td><td>9.9</td><td>↖</td></tr> <tr><td>5:</td><td>10.0</td><td>↖</td></tr> </table> <table style="width:100%; border-collapse: collapse; margin-top: 5px;"> <tr><td style="border-top: 1px solid black;">Serie</td><td style="border-top: 1px solid black; text-align: right;">46</td></tr> <tr><td style="border-top: 1px solid black;">Total</td><td style="border-top: 1px solid black; text-align: right;">143</td></tr> </table>	1:	9.6	→	2:	10.8x	↖	3:	8.8	→	4:	9.9	↖	5:	10.0	↖	Serie	46	Total	143
1:	10.5x	→																																							
2:	10.6x	↗																																							
3:	10.7x	←																																							
4:	9.9	↘																																							
5:	10.7x	↗																																							
Serie	49																																								
Total	97																																								
1:	9.6	→																																							
2:	10.8x	↖																																							
3:	8.8	→																																							
4:	9.9	↖																																							
5:	10.0	↖																																							
Serie	46																																								
Total	143																																								
Prov 	<table style="width:100%; border-collapse: collapse;"> <tr><td>1:</td><td>10.3</td><td>↘</td></tr> <tr><td>2:</td><td>9.9</td><td>↗</td></tr> <tr><td>3:</td><td>9.9</td><td>→</td></tr> </table> <table style="width:100%; border-collapse: collapse; margin-top: 5px;"> <tr><td style="border-top: 1px solid black;">Serie</td><td style="border-top: 1px solid black; text-align: right;">28</td></tr> <tr><td style="border-top: 1px solid black;">Total</td><td style="border-top: 1px solid black; text-align: right;">143</td></tr> </table>	1:	10.3	↘	2:	9.9	↗	3:	9.9	→	Serie	28	Total	143	4. Serie 5 Skott 	<table style="width:100%; border-collapse: collapse;"> <tr><td>1:</td><td>10.0</td><td>←</td></tr> <tr><td>2:</td><td>9.2</td><td>→</td></tr> <tr><td>3:</td><td>9.5</td><td>→</td></tr> <tr><td>4:</td><td>10.2</td><td>↗</td></tr> <tr><td>5:</td><td>10.8x</td><td>↘</td></tr> </table> <table style="width:100%; border-collapse: collapse; margin-top: 5px;"> <tr><td style="border-top: 1px solid black;">Serie</td><td style="border-top: 1px solid black; text-align: right;">48</td></tr> <tr><td style="border-top: 1px solid black;">Total</td><td style="border-top: 1px solid black; text-align: right;">191</td></tr> </table>	1:	10.0	←	2:	9.2	→	3:	9.5	→	4:	10.2	↗	5:	10.8x	↘	Serie	48	Total	191						
1:	10.3	↘																																							
2:	9.9	↗																																							
3:	9.9	→																																							
Serie	28																																								
Total	143																																								
1:	10.0	←																																							
2:	9.2	→																																							
3:	9.5	→																																							
4:	10.2	↗																																							
5:	10.8x	↘																																							
Serie	48																																								
Total	191																																								
5. Serie 5 Skott 	<table style="width:100%; border-collapse: collapse;"> <tr><td>1:</td><td>10.5x</td><td>↗</td></tr> <tr><td>2:</td><td>9.8</td><td>↘</td></tr> <tr><td>3:</td><td>9.7</td><td>↗</td></tr> <tr><td>4:</td><td>10.1</td><td>↗</td></tr> <tr><td>5:</td><td>10.3</td><td>↘</td></tr> </table> <table style="width:100%; border-collapse: collapse; margin-top: 5px;"> <tr><td style="border-top: 1px solid black;">Serie</td><td style="border-top: 1px solid black; text-align: right;">48</td></tr> <tr><td style="border-top: 1px solid black;">Total</td><td style="border-top: 1px solid black; text-align: right;">239</td></tr> </table>	1:	10.5x	↗	2:	9.8	↘	3:	9.7	↗	4:	10.1	↗	5:	10.3	↘	Serie	48	Total	239																					
1:	10.5x	↗																																							
2:	9.8	↘																																							
3:	9.7	↗																																							
4:	10.1	↗																																							
5:	10.3	↘																																							
Serie	48																																								
Total	239																																								

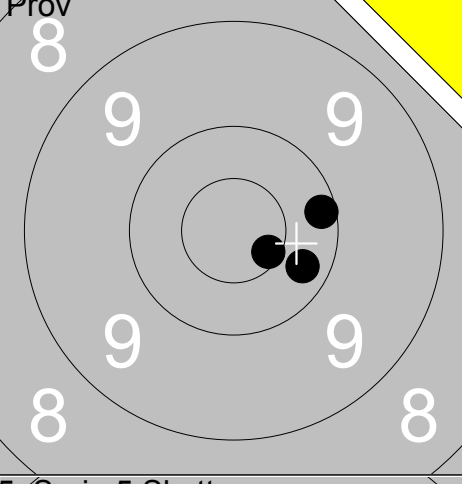
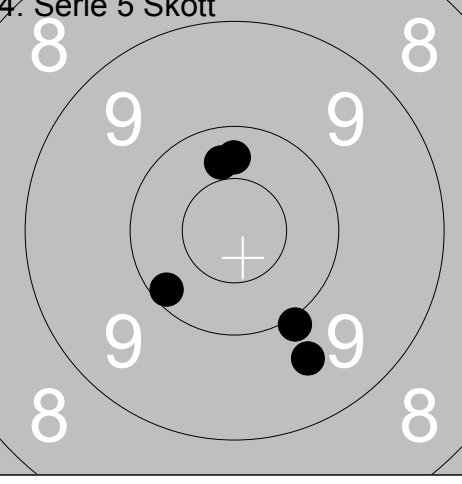
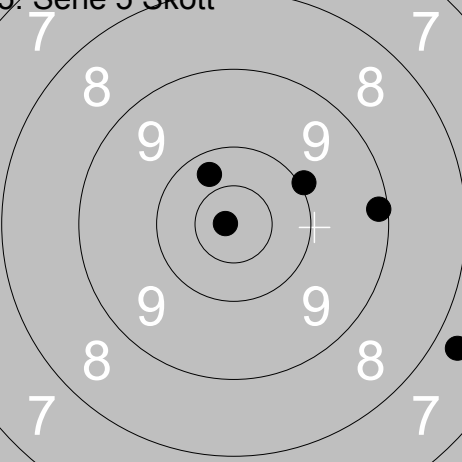
Skjutlag	Tavla	Jan-Olof Svensson					
5	6	Ramselefors	Edsbjörke	Vet	Vä		
12.08.2017		SM Banskytte Liggande 2017		Ramselefors SKF			
Prov 	1: 9.6 ↑ 2: 10.5x → 3: 8.5 → 4: 10.5x ↑ 5: 8.2 ↗	1. Serie 5 Skott 	1: 8.3 ↑ 2: 9.4 → 3: 10.3 → 4: 10.0 ↘ 5: 10.2 ↘	Serie	45	Serie	47
	Total	0	Total	47			
2. Serie 5 Skott 	1: 8.9 ↑ 2: 9.2 → 3: 9.4 → 4: 10.1 ↘ 5: 10.3 ↙	3. Serie 5 Skott 	1: 8.5 ↑ 2: 9.6 ↖ 3: 10.6x ↑ 4: 10.2 ↖ 5: 10.3 ↗	Serie	46	Serie	47
	Total	93	Total	140			
Prov 	1: 10.6x ↘ 2: 10.3 ↘ 3: 10.2 →	4. Serie 5 Skott 	1: 10.3 ↑ 2: 9.6 ↘ 3: 10.0 ↘ 4: 10.3 ↑ 5: 10.2 ↙	Serie	30	Serie	49
	Total	140	Total	189			
5. Serie 5 Skott 	1: 10.3 ↖ 2: 9.1 → 3: 10.0 → 4: 7.7 ↘ 5: 10.9x ←			Serie	46		
	Total	235					

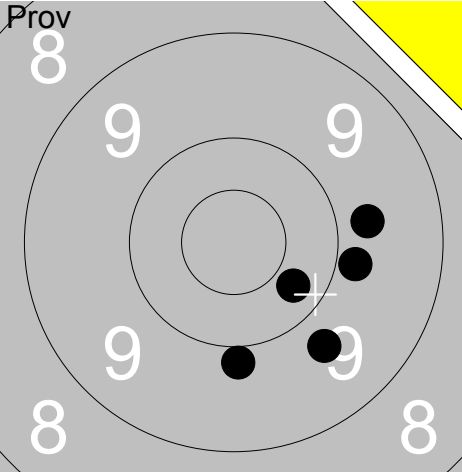
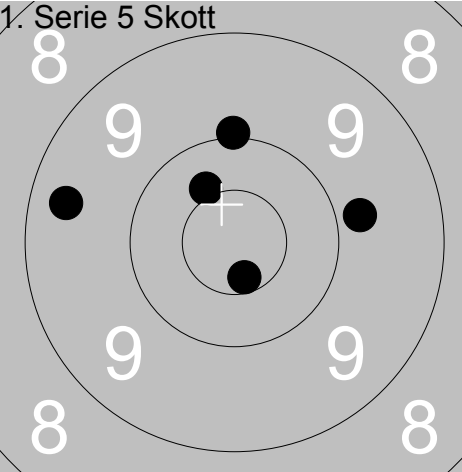
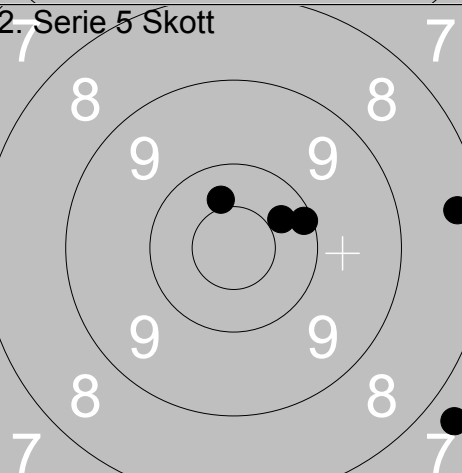
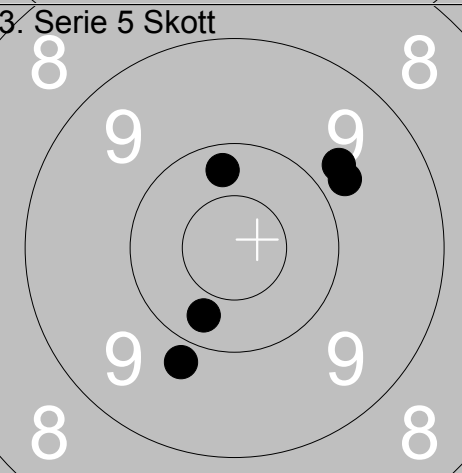
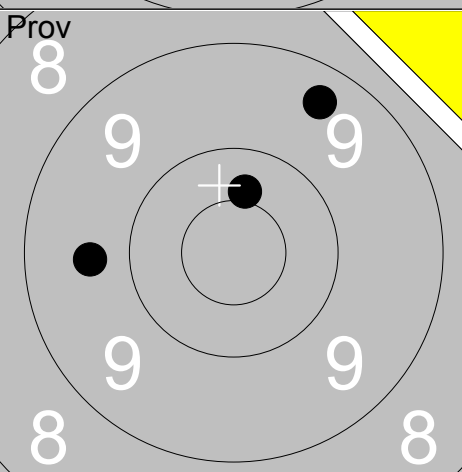
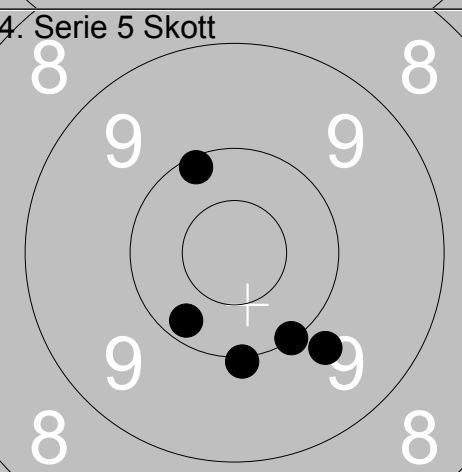
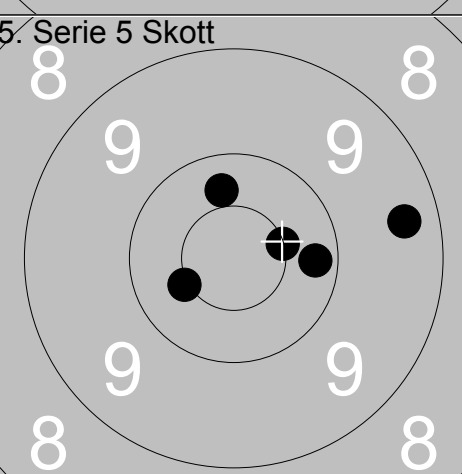
Skjutlag	Tavla	Ingemar Månsson			
5	7	Ramselefors	Helsingborg	Vet	Sk
12.08.2017	SM Banskytte Liggande 2017	Ramselefors SKF			
Prov 	1: 9.9 ↓ 2: 10.3 ↘ 3: 9.9 → 4: 9.7 ↘ 5: 9.7 →	1. Serie 5 Skott 	1: 9.4 ← 2: 10.0 ↑ 3: 10.4 ↗ 4: 9.8 → 5: 10.6x ↓		
	Serie 46 Total 0		Serie 48 Total 48		
2. Serie 5 Skott 	1: 10.4 ↑ 2: 10.3 ↗ 3: 10.1 → 4: 8.3 → 5: 7.7 ↘	3. Serie 5 Skott 	1: 10.3 ↓ 2: 9.8 ↗ 3: 9.8 → 4: 9.8 ↓ 5: 10.3 ↑		
	Serie 45 Total 93		Serie 47 Total 140		
Prov 	1: 10.4 ↑ 2: 9.4 ↑ 3: 9.7 ←	4. Serie 5 Skott 	1: 10.1 ↗ 2: 10.0 ↓ 3: 10.0 ↓ 4: 10.2 ↓ 5: 9.8 ↓		
	Serie 28 Total 140		Serie 49 Total 189		
5. Serie 5 Skott 	1: 10.3 ↑ 2: 10.5x ← 3: 10.2 → 4: 9.4 → 5: 10.5x →				
	Serie 49 Total 238				

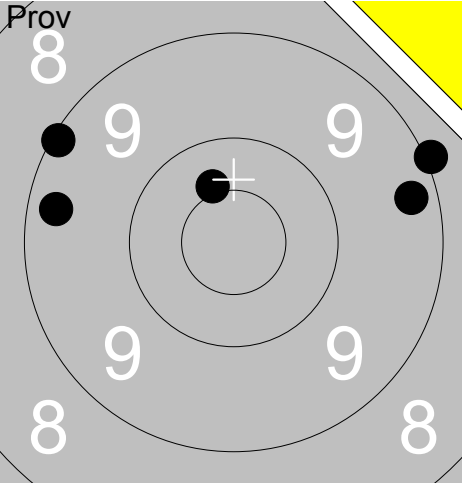
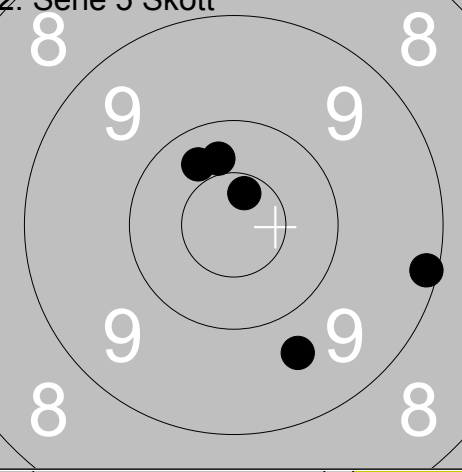
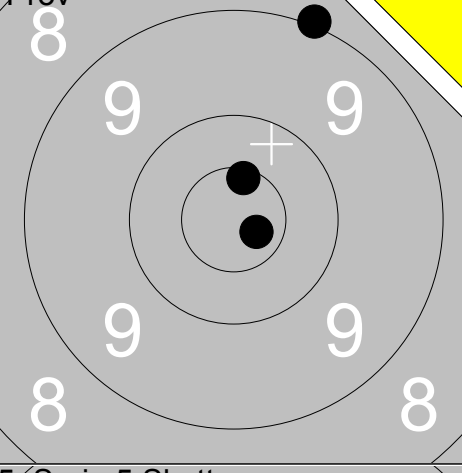
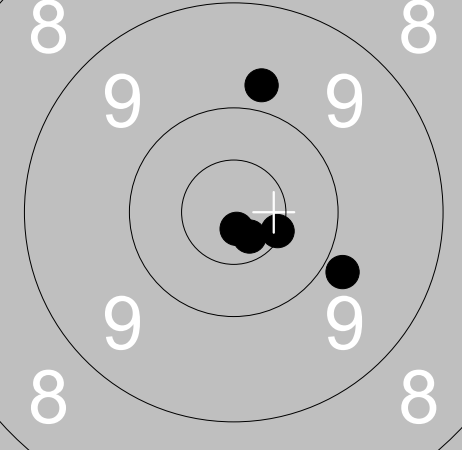
Skjutlag 5	Tavla 8	Donald Johansson		
Ramselefors		Ale		Vet
12.08.2017		SM Banskytte Liggande 2017		Ramselefors SKF
Prov		1: 10.4x ↑ 2: 9.3 → 3: 9.0 → 4: 9.1 ↗ 5: 9.3 ↖	1. Serie 5 Skott	1: 10.0 ↑ 2: 8.6 → 3: 9.1 → 4: 10.9x ↗ 5: 10.5x ↓
		Serie 46 Total 0		Serie 47 Total 47
2. Serie 5 Skott		1: 9.7 ↓ 2: 10.3 ↗ 3: 10.3 ↗ 4: 9.1 → 5: 10.7x ↑	3. Serie 5 Skott	1: 10.7x ↓ 2: 10.3 → 3: 10.3 → 4: 9.5 ↓ 5: 10.0 ↗
		Serie 48 Total 95		Serie 49 Total 144
Prov		1: 10.6x ↑ 2: 9.0 ↑ 3: 10.7x ↘	4. Serie 5 Skott	1: 10.2 → 2: 9.7 ↗ 3: 10.0 ↑ 4: 10.4 ↘ 5: 10.1 ↖
		Serie 29 Total 144		Serie 49 Total 193
5. Serie 5 Skott		1: 9.8 ↑ 2: 9.8 ↘ 3: 10.5x ↘ 4: 10.8x ↓ 5: 10.7x ↘		
		Serie 48 Total 241		

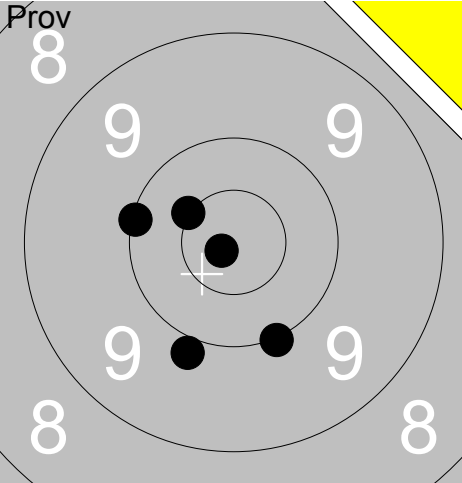
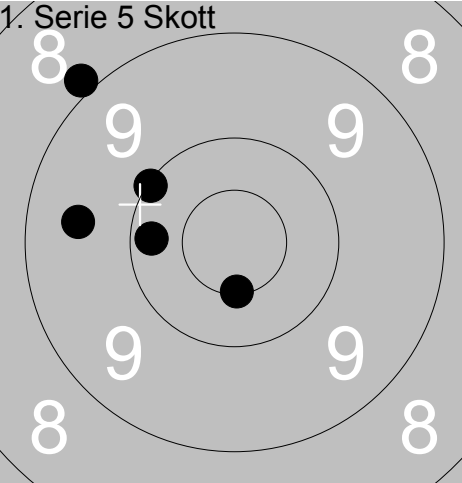
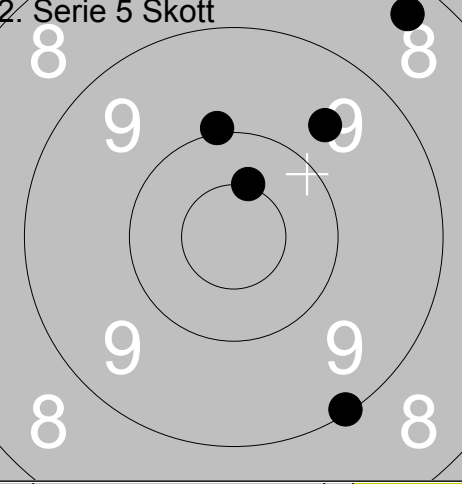
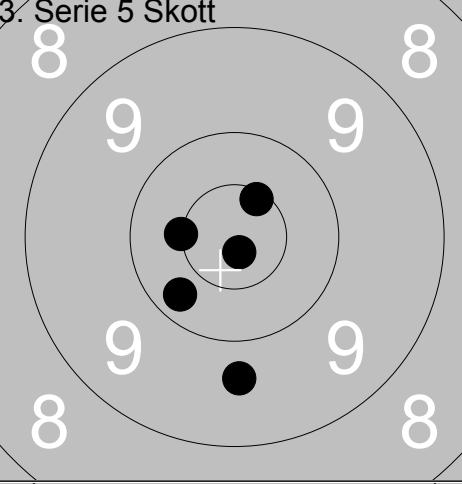
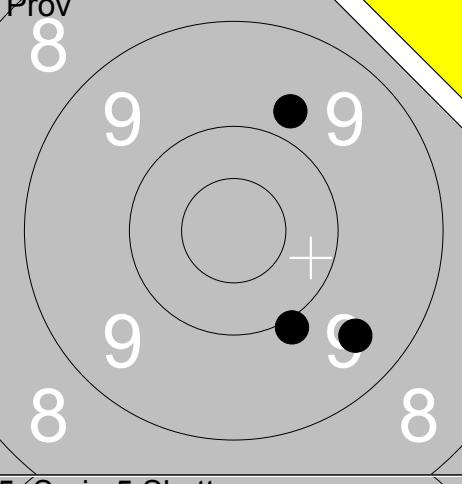
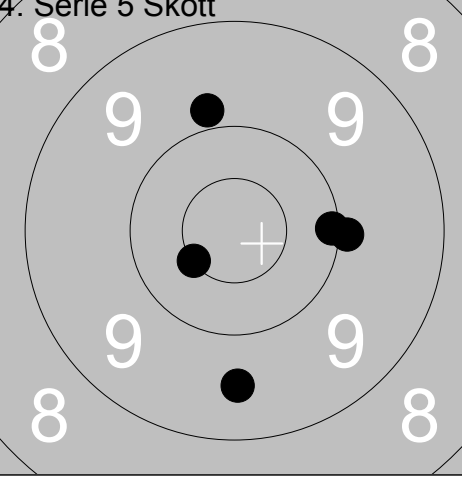
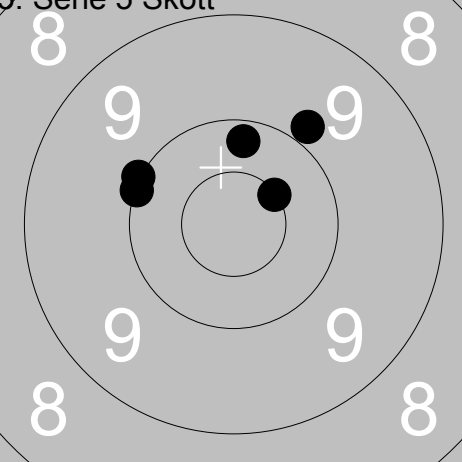
Skjutlag 5	Tavla 9	Lars Hedlund	
Ramselefors		Edsbjörke	Öpp Vä
12.08.2017		SM Banskytte Liggande 2017	Ramselefors SKF
Prov 	<ul style="list-style-type: none"> 1: 10.5x ↖ 2: 10.0 ↓ 3: 9.9 ↓ 4: 10.8x ↖ 5: 10.1 ← 	1. Serie 5 Skott 	<ul style="list-style-type: none"> 1: 9.5 ← 2: 8.9 ↗ 3: 10.5x ↓ 4: 10.1 ↗ 5: 10.2 ←
	Serie 49 Total 0		Serie 47 Total 47
2. Serie 5 Skott 	<ul style="list-style-type: none"> 1: 10.5x ↑ 2: 8.3 ↗ 3: 10.0 ↑ 4: 9.6 ↗ 5: 9.1 ↓ 	3. Serie 5 Skott 	<ul style="list-style-type: none"> 1: 10.6x ↗ 2: 10.3 ↖ 3: 10.8x ↓ 4: 9.7 ↓ 5: 10.5x ←
	Serie 46 Total 93		Serie 49 Total 142
Prov 	<ul style="list-style-type: none"> 1: 9.9 ↓ 2: 9.8 ↑ 3: 9.5 ↓ 	4. Serie 5 Skott 	<ul style="list-style-type: none"> 1: 10.5x ↖ 2: 9.9 ↑ 3: 10.0 → 4: 9.5 ↓ 5: 10.1 →
	Serie 27 Total 142		Serie 48 Total 190
5. Serie 5 Skott 	<ul style="list-style-type: none"> 1: 10.5x ↗ 2: 10.0 ↖ 3: 10.2 ↑ 4: 10.0 ↖ 5: 9.9 ↗ 		
	Serie 49 Total 239		

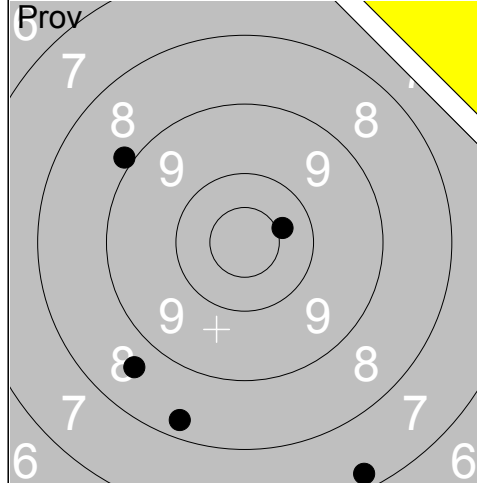

1. Serie 5 Skott

1:	8.6	↙
2:	7.3	↘
3:	10.4	→
4:	8.3	↘
5:	8.9	↗
Serie		41
Total		0

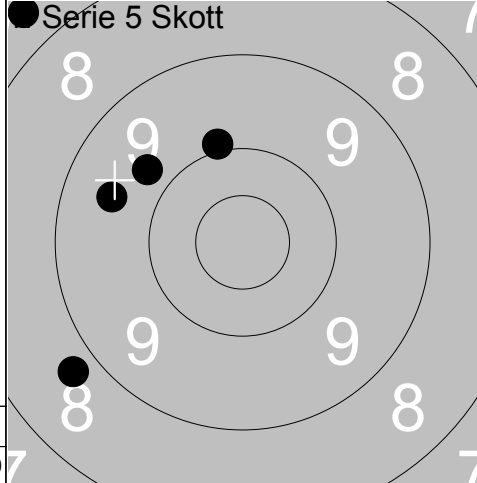

2. Serie 5 Skott

1:	7.6	↗
2:	9.6	↖
3:	9.9	↑
4:	9.8	↖
5:	8.8	↘
Serie		42
Total		42

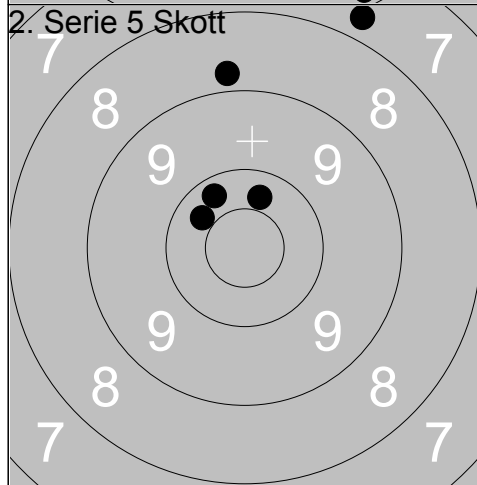

3. Serie 5 Skott

1:	7.7	↗
2:	10.3	↖
3:	10.2	↗
4:	8.8	↑
5:	10.3	↑
Serie		45
Total		87

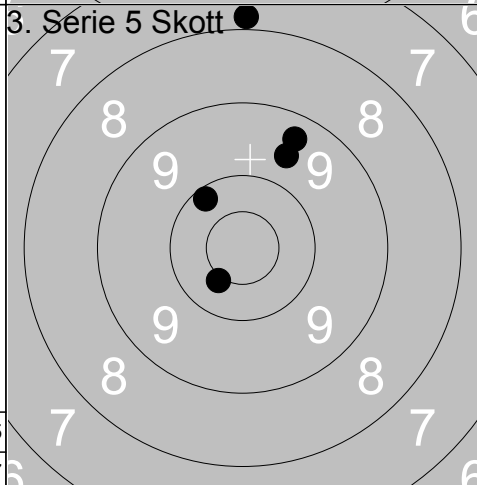

4. Serie 5 Skott

1:	7.9	↑
2:	9.6	↑
3:	10.4x	↘
4:	9.4	↑
5:	10.2	↖
Serie		45
Total		132

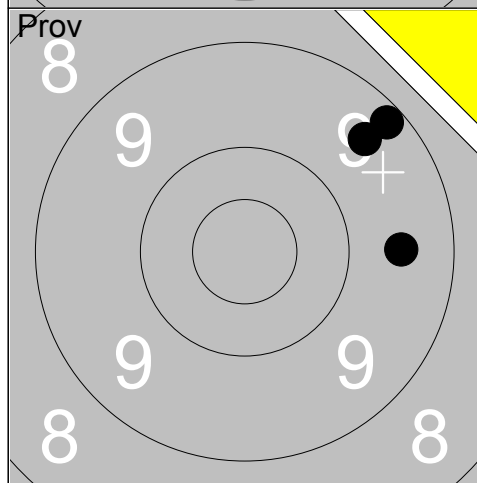

5. Serie 5 Skott

1:	9.5	↗
2:	9.2	↗
3:	9.5	→
Serie		27
Total		132

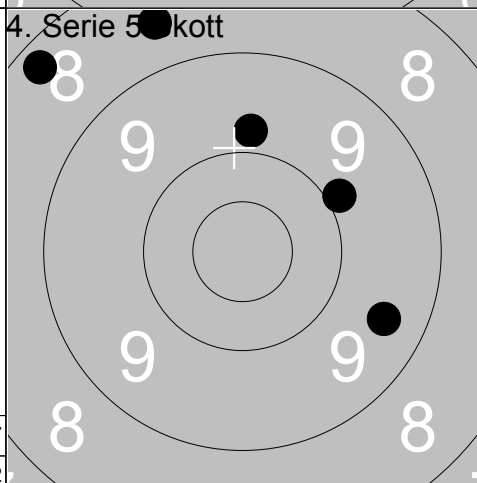

6. Serie 5 Skott

1:	8.6	↖
2:	8.3	↖
3:	9.9	↗
4:	9.8	↑
5:	9.5	↘
Serie		43
Total		175

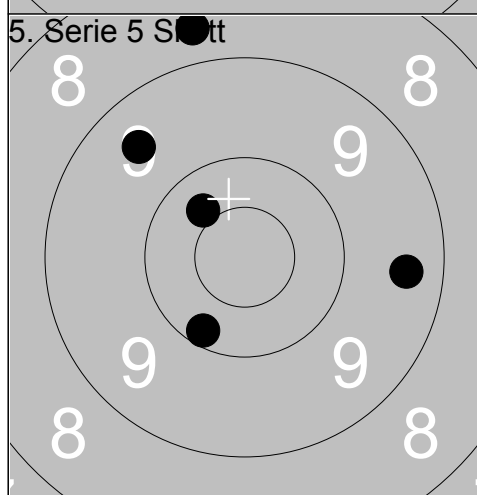

7. Serie 5 Skott

1:	8.7	↑
2:	9.4	→
3:	10.4	↗
4:	9.5	↗
5:	10.2	↘
Serie		46
Total		221

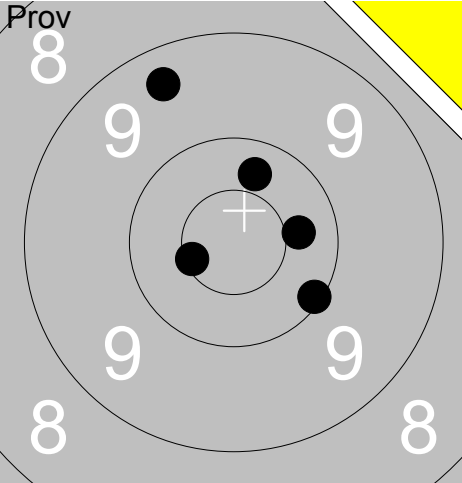
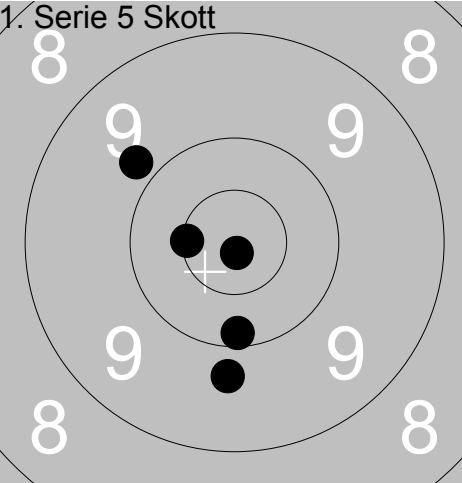
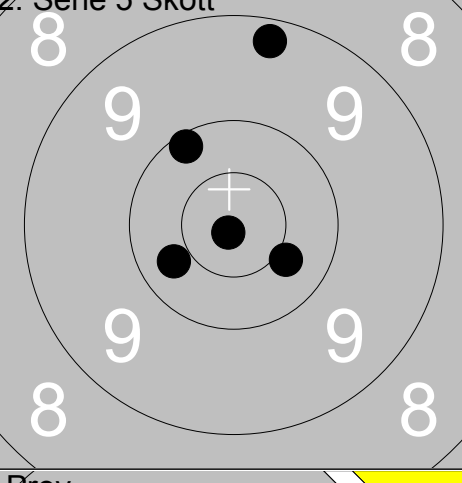
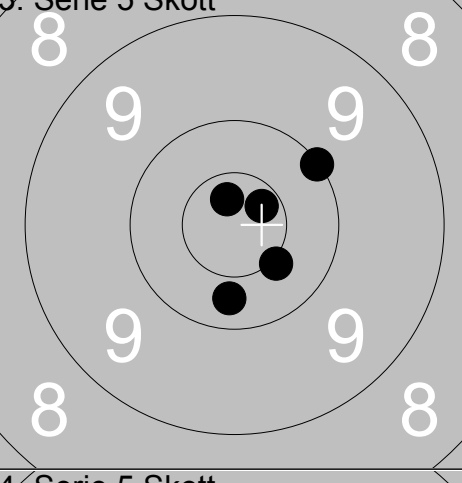
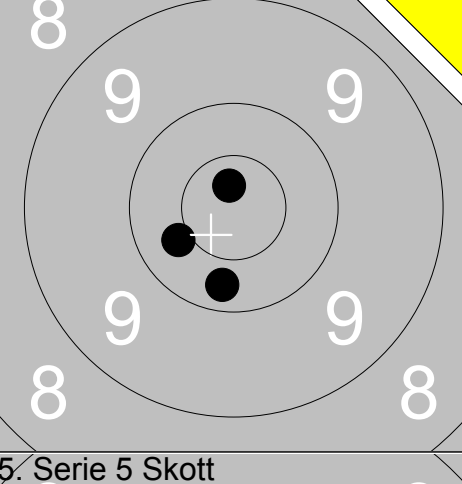
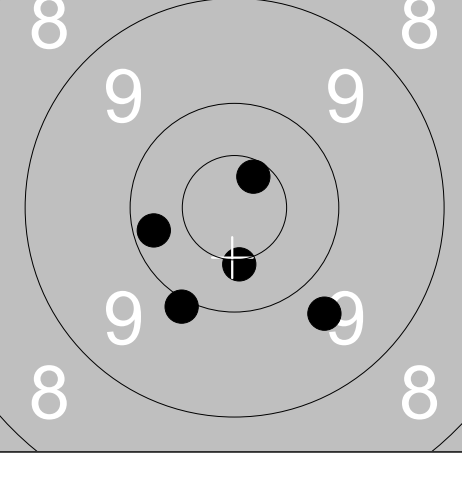
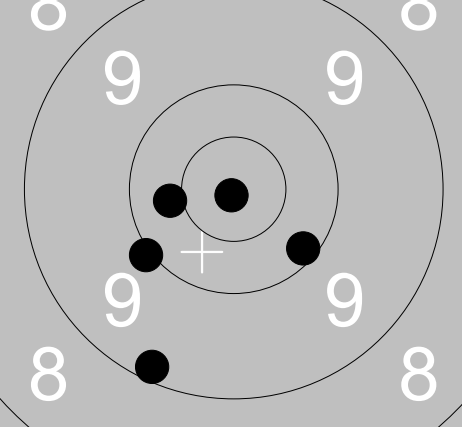
Skjutlag	Tavla	Anna Nilsson		Öpp	Vä
5	11	Ramselefors	Arvika		
12.08.2017		SM Banskytte Liggande 2017		Ramselefors SKF	
Prov		1: 10.1 ↘ 2: 10.4 → 3: 10.3 ↑ 4: 10.6x ← 5: 9.4 ↗	1. Serie 5 Skott		1: 10.9x ↓ 2: 10.5x ← 3: 10.1 ↓ 4: 9.8 ↖ 5: 9.8 ↓
		Serie 49		Serie 48	
		Total 0		Total 48	
2. Serie 5 Skott		1: 9.2 ↑ 2: 10.9x ↓ 3: 10.4 ↘ 4: 10.3 ← 5: 10.1 ↗	3. Serie 5 Skott		1: 10.0 ↗ 2: 10.7x ↑ 3: 10.4x ↘ 4: 10.3 ↓ 5: 10.7x ↗
		Serie 49		Serie 50	
		Total 97		Total 147	
Prov		1: 10.4 ← 2: 10.3 ↓ 3: 10.8x ↑	4. Serie 5 Skott		1: 9.7 ↘ 2: 10.6x ↑ 3: 10.4x ↓ 4: 10.0 ↓ 5: 10.2 ←
		Serie 30		Serie 49	
		Total 147		Total 196	
5. Serie 5 Skott		1: 10.0 ← 2: 10.4 ← 3: 9.2 ↓ 4: 10.1 ↘ 5: 10.9x ↓			
		Serie 49			
		Total 245			

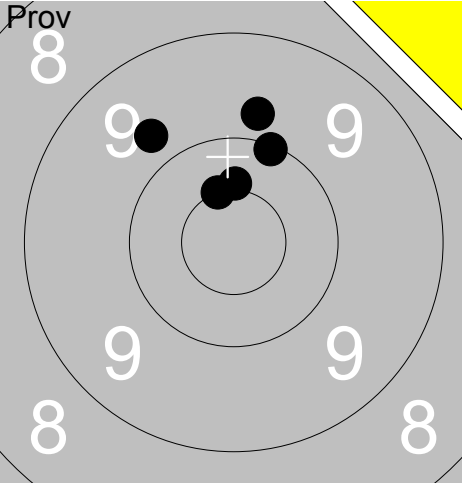
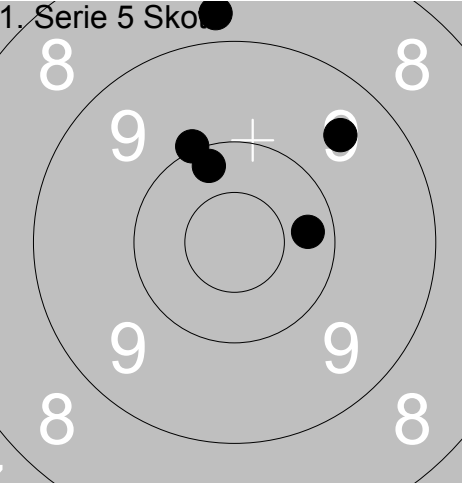
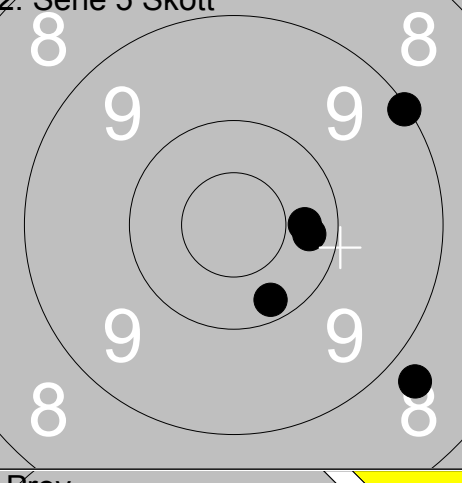
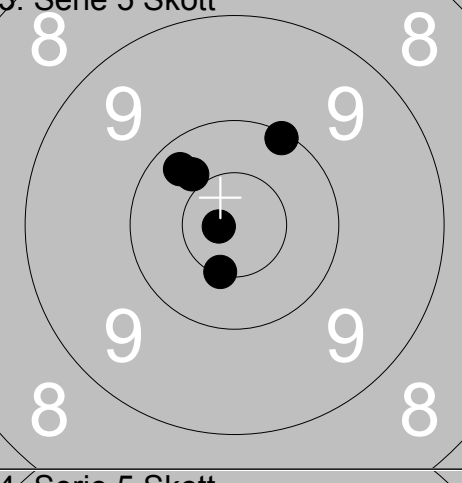
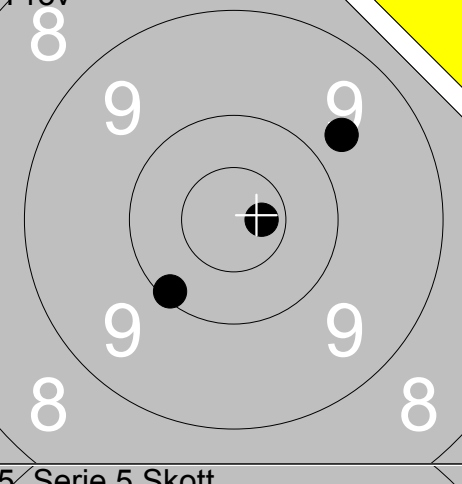
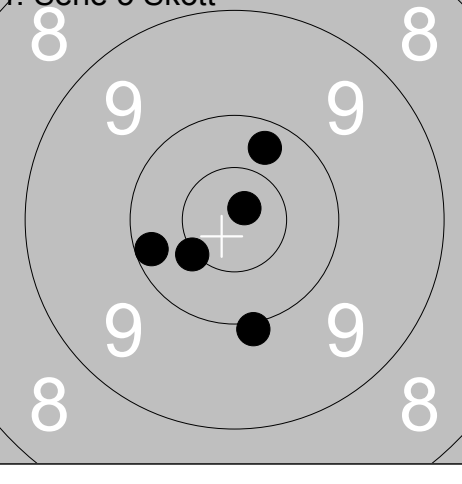
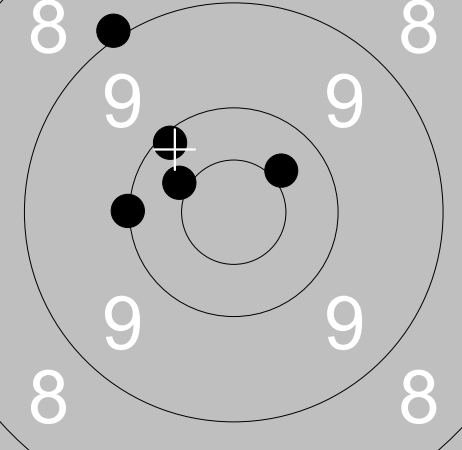
Skjutlag 5	Tavla 12	Helena Jansson	
Ramselefors	Söderala	Öpp	Gä
12.08.2017	SM Banskytte Liggande 2017	Ramselefors SKF	
Prov 	1: 10.4x ↑ 2: 10.5x ↑ 3: 10.1 ↑ 4: 9.7 ↖ 5: 9.8 ↑ Serie 48 Total 0	1. Serie 5 Skott 	1: 10.2 ↑ 2: 10.3 → 3: 10.0 ↑ 4: 8.7 ↑ 5: 9.5 ↗ Serie 47 Total 47
2. Serie 5 Skott 	1: 10.2 ↓ 2: 10.3 → 3: 10.3 → 4: 8.7 ↓ 5: 9.1 ↗ Serie 47 Total 94	3. Serie 5 Skott 	1: 10.8x ← 2: 10.5x ↓ 3: 10.3 ↖ 4: 10.1 ↑ 5: 10.4 ↖ Serie 50 Total 144
Prov 	1: 10.7x → 2: 9.7 ↗ 3: 10.1 ↙ Serie 29 Total 144	4. Serie 5 Skott 	1: 10.0 ↓ 2: 10.2 ← 3: 10.5x ↙ 4: 10.8x ↗ 5: 10.3 ↑ Serie 50 Total 194
5. Serie 5 Skott 	1: 10.4 ↗ 2: 10.0 ← 3: 10.4 ↗ 4: 8.9 ↗ 5: 10.1 ↗ Serie 48 Total 242		

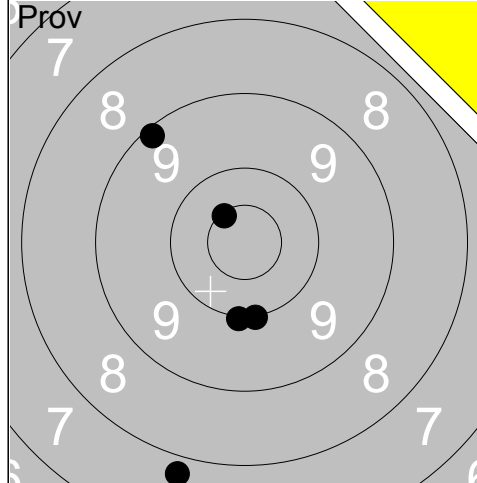

1:	10.0	↓
2:	10.0	↓
3:	10.5x	↗
4:	7.8	↓
5:	9.1	↗
Serie		46
Total		0

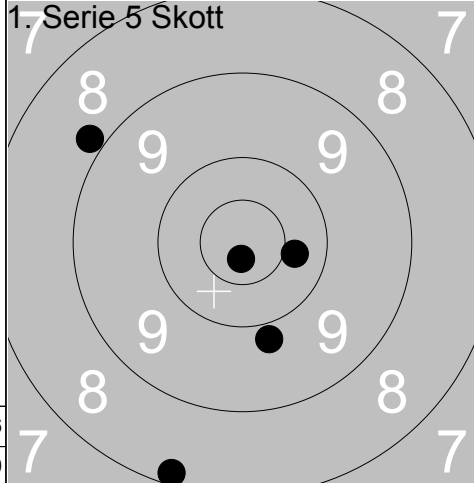

1:	8.8	↖
2:	9.8	↓
3:	10.8x	↓
4:	8.2	↓
5:	10.4	→
Serie		45
Total		45

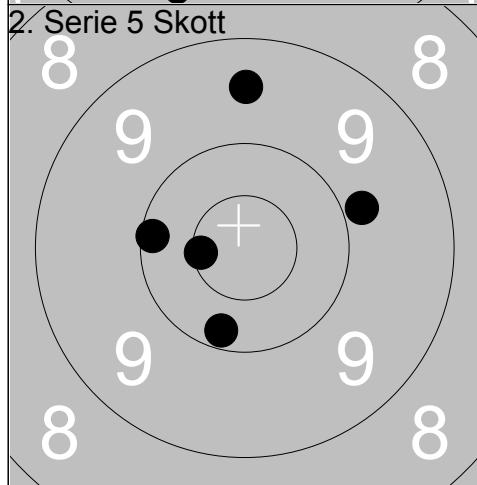

1:	9.8	→
2:	9.5	↑
3:	10.1	←
4:	10.2	↓
5:	10.6x	←
Serie		48
Total		93

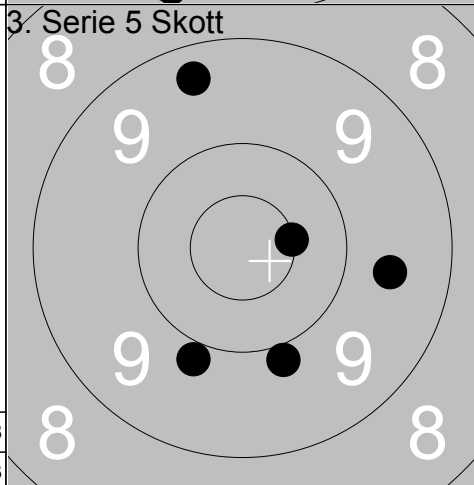

1:	9.3	↑
2:	9.9	↓
3:	9.6	→
4:	10.5x	→
5:	9.9	↓
Serie		46
Total		139

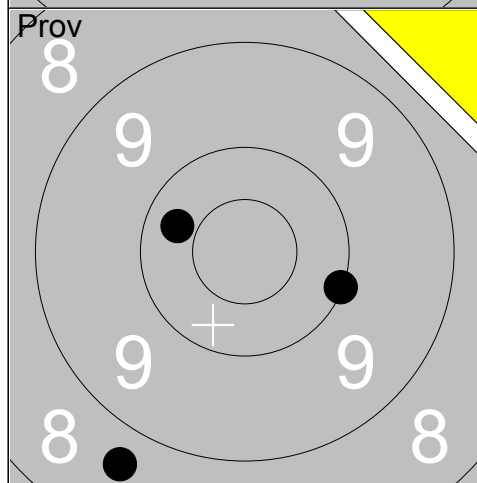

1:	10.3	←
2:	10.0	→
3:	8.7	↓
Serie		28
Total		139

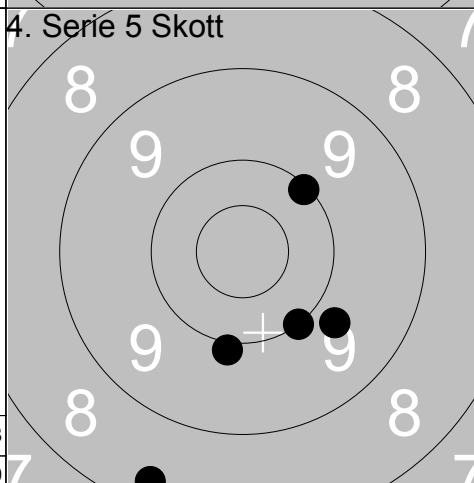

1:	10.1	↗
2:	9.9	↓
3:	10.0	↓
4:	9.8	↓
5:	8.3	↓
Serie		46
Total		185

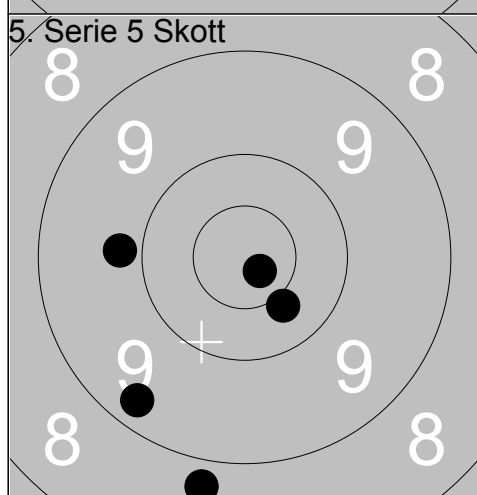

1:	10.4	↓
2:	9.3	↓
3:	9.8	←
4:	10.8x	↓
5:	8.8	↓
Serie		46
Total		231

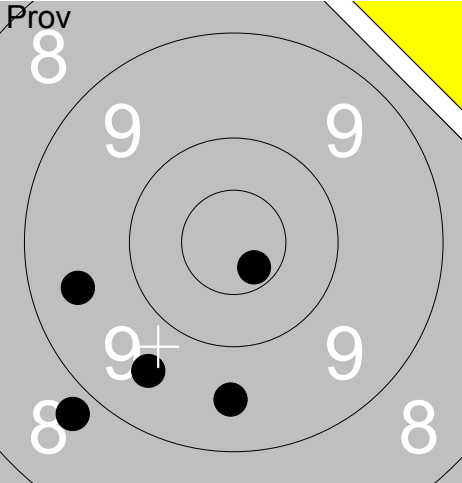
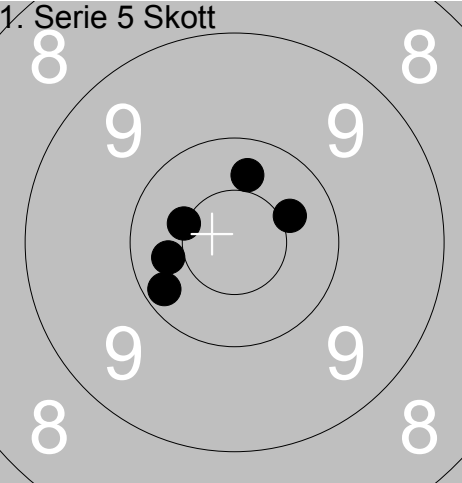
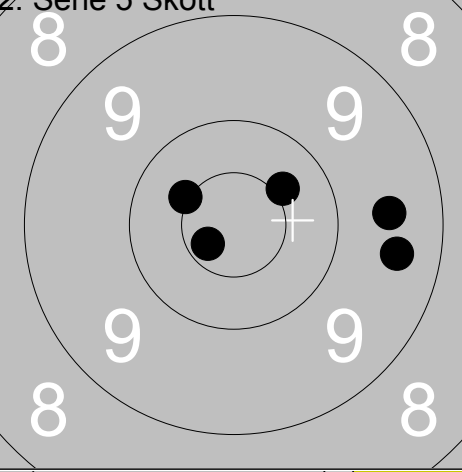
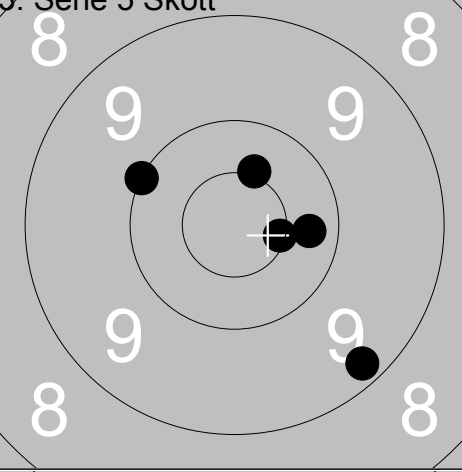
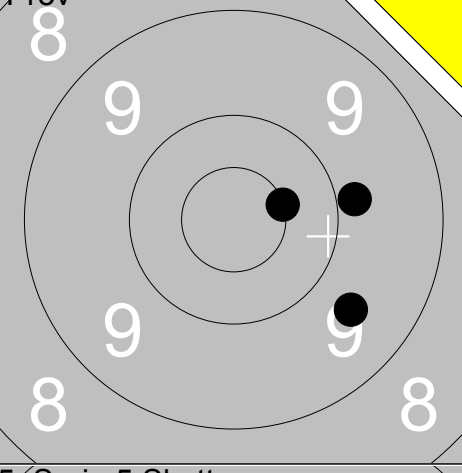
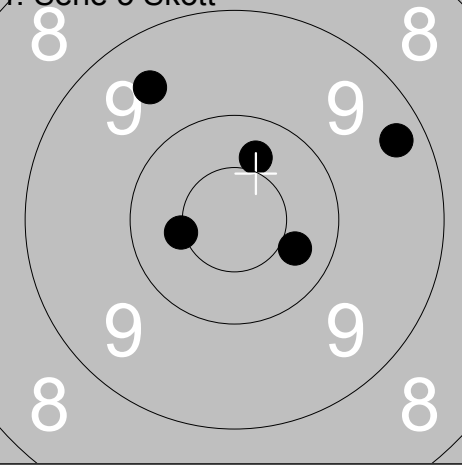
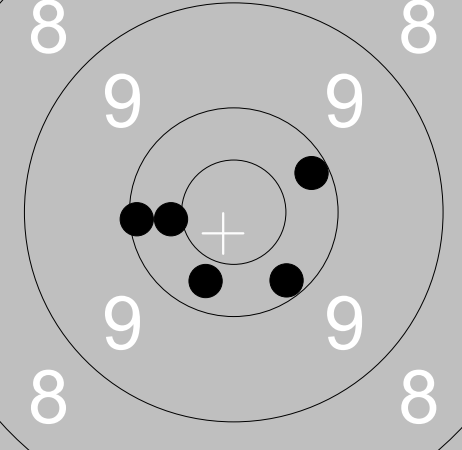
Skjutlag 5	Tavla 14	Urban Johansson	
Ramselefors	F 21	Öpp	No
12.08.2017	SM Banskytte Liggande 2017	Ramselefors SKF	
Prov		1: 9.6 ↙ 2: 8.8 ↙ 3: 9.5 ↓ 4: 10.7x ↘ 5: 9.5 ←	1. Serie 5 Skott
		Serie 45 Total 0	 1: 10.5x ← 2: 10.3 ← 3: 10.4 → 4: 10.2 ↙ 5: 10.3 ↑
2. Serie 5 Skott		1: 9.4 → 2: 9.5 → 3: 10.4 ↗ 4: 10.5x ↖ 5: 10.7x ↙	3. Serie 5 Skott
		Serie 48 Total 98	 1: 10.3 → 2: 10.5x → 3: 9.2 ↘ 4: 10.4x ↑ 5: 10.0 ←
Prov		1: 9.9 → 2: 9.6 ↘ 3: 10.5x →	4. Serie 5 Skott
		Serie 28 Total 147	 1: 10.4 → 2: 9.3 → 3: 9.5 ↖ 4: 10.4 ↑ 5: 10.5x ←
5. Serie 5 Skott		1: 10.2 → 2: 10.2 ↘ 3: 10.1 ← 4: 10.4 ← 5: 10.3 ↘	
		Serie 50 Total 245	

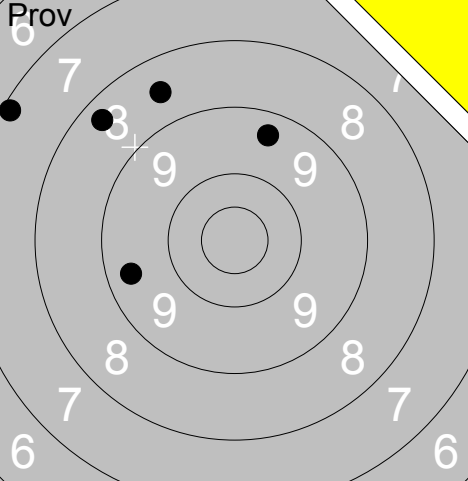
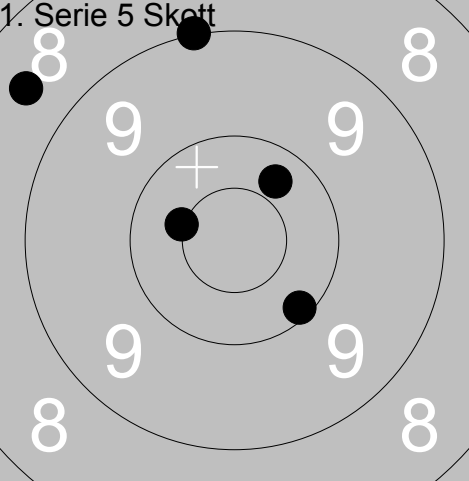
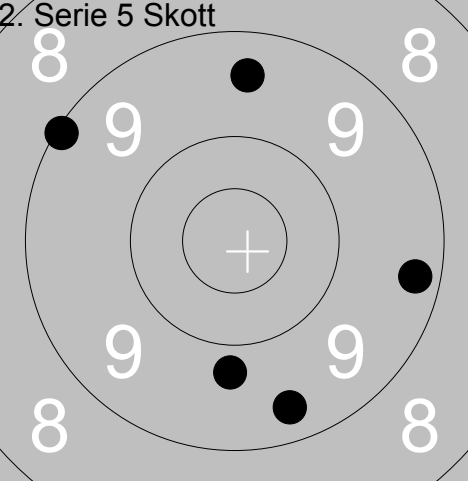
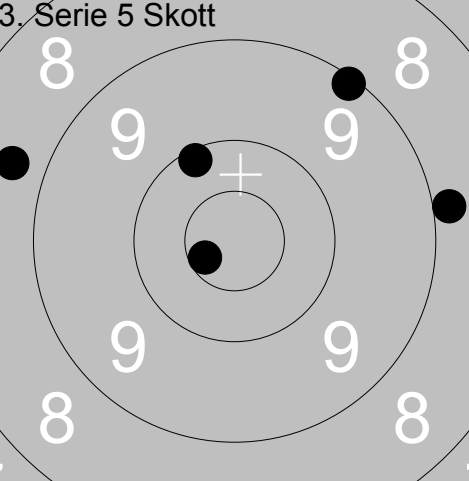
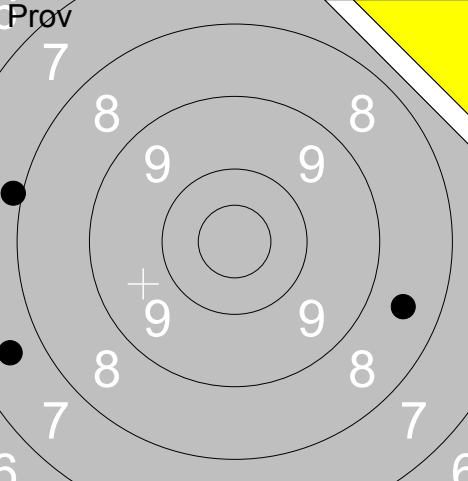
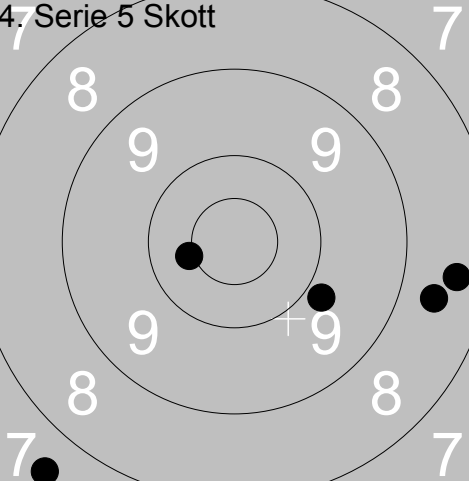
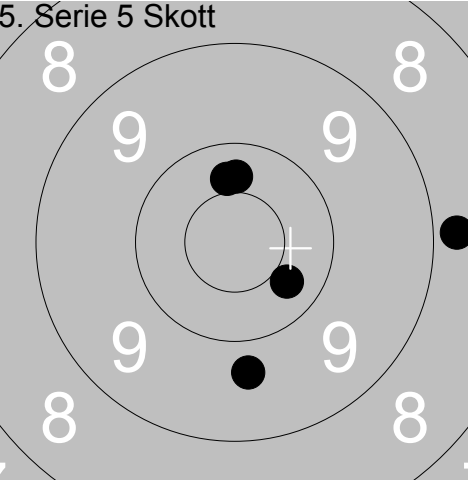
Skjutlag 5	Tavla 15	Mattias Nordlander	
Ramselefors	KA 2	Öpp	Bl
12.08.2017	SM Banskytte Liggande 2017	Ramselefors SKF	
Prov 	1: 9.4 ↑ 2: 8.5 ↑ 3: 7.1 ↑ 4: 8.3 ↑ 5: 9.4 ←	1. Serie 5 Skott 	1: 10.5x ← 2: 9.0 ↑ 3: 10.3 ↑ 4: 8.6 ↑ 5: 10.1 ↓
	Serie 41 Total 0		Serie 47 Total 47
2. Serie 5 Skott 	1: 9.1 ↖ 2: 9.4 ↑ 3: 9.4 ↓ 4: 9.3 → 5: 9.8 ↓	3. Serie 5 Skott 	1: 8.9 → 2: 9.1 ↗ 3: 10.6x ← 4: 10.1 ↗ 5: 8.7 ↖
	Serie 45 Total 92		Serie 45 Total 137
Prov 	1: 8.5 → 2: 7.6 ← 3: 7.9 ←	4. Serie 5 Skott 	1: 7.6 ↙ 2: 10.4x ← 3: 8.6 → 4: 9.8 ↓ 5: 8.4 →
	Serie 22 Total 137		Serie 42 Total 179
5. Serie 5 Skott 	1: 10.3 ↑ 2: 10.3 ↘ 3: 8.8 → 4: 10.4 ↑ 5: 9.7 ↓		
	Serie 47 Total 226		

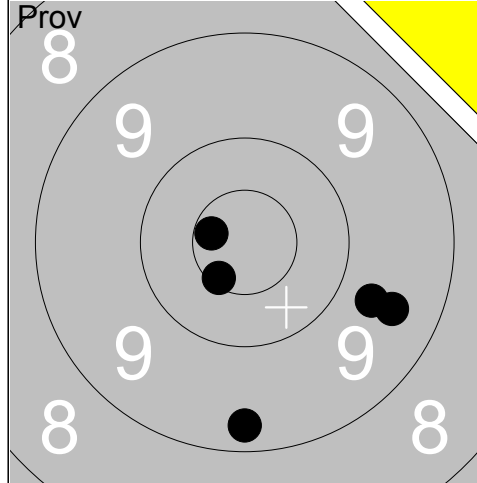

1:	10.6x	↖
2:	9.5	→
3:	10.6x	↙
4:	9.3	↓
5:	9.7	→

Serie	47
Total	0

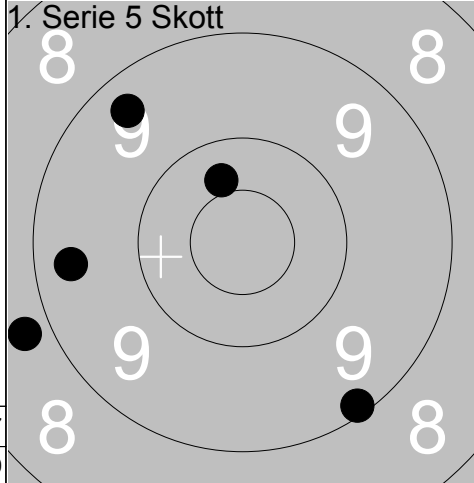

1:	9.4	↗
2:	8.8	↙
3:	10.4	↗
4:	9.4	↙
5:	9.1	↘

Serie	45
Total	45

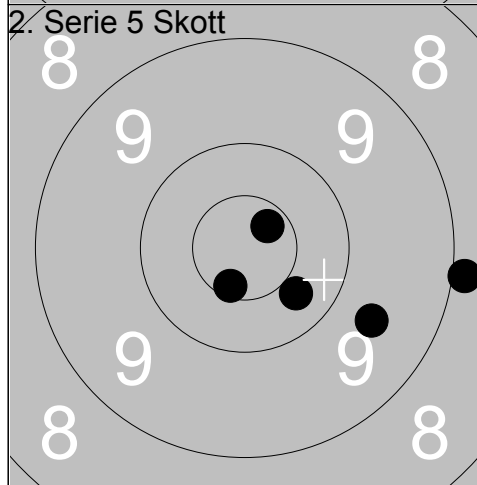

1:	10.7x	↗
2:	10.6x	↙
3:	8.9	→
4:	9.6	↘
5:	10.3	↘

Serie	47
Total	92

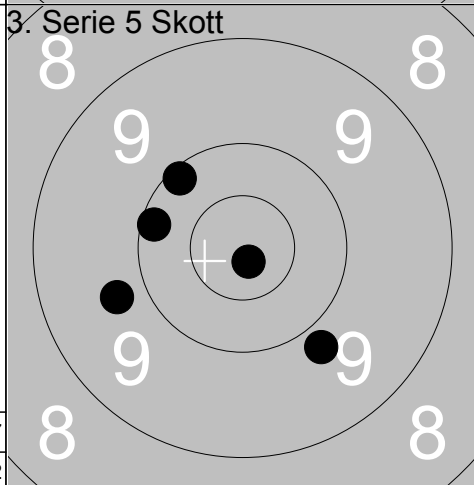

1:	10.1	↙
2:	10.1	↗
3:	10.8x	↘
4:	9.8	↘
5:	9.7	↙

Serie	48
Total	140

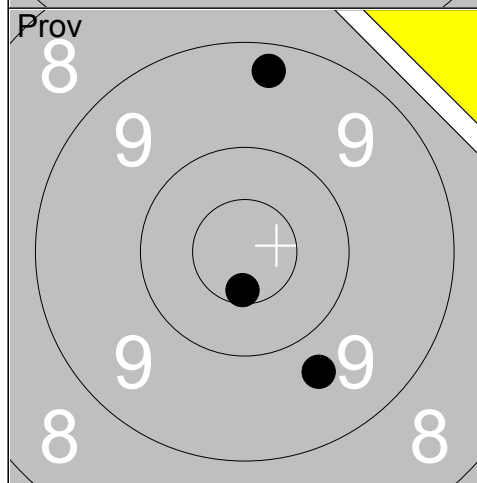

1:	10.6x	↓
2:	9.7	↘
3:	9.3	↑

Serie	28
Total	140

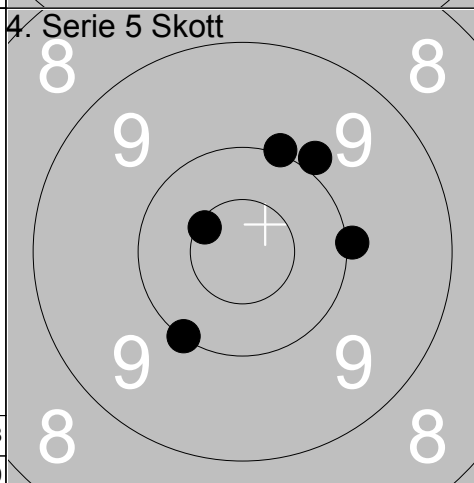

1:	10.0	↗
2:	10.0	↙
3:	9.9	↗
4:	10.6x	↙
5:	10.0	→

Serie	49
Total	189

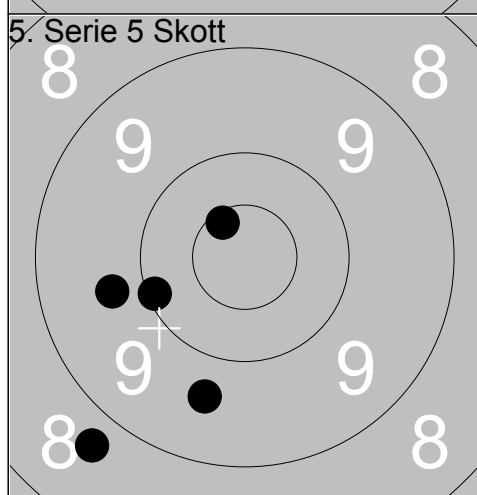

1:	10.1	↙
2:	8.7	↙
3:	10.6x	↗
4:	9.7	↙
5:	9.6	↘

Serie	46
Total	235

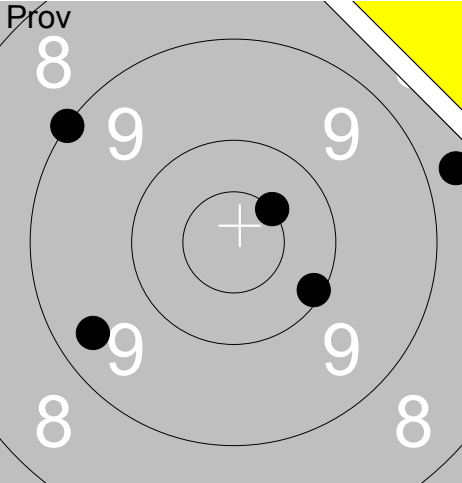
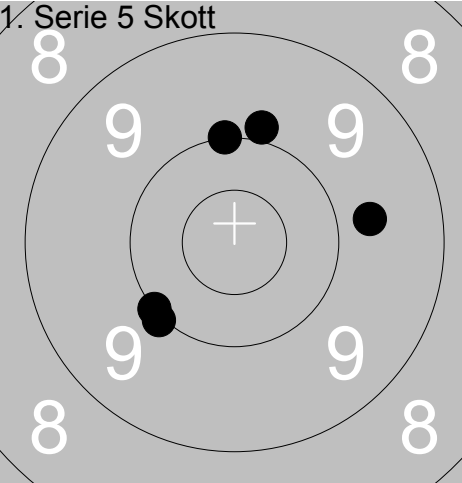
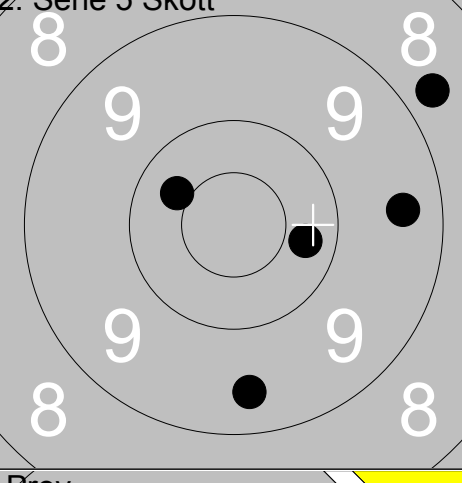
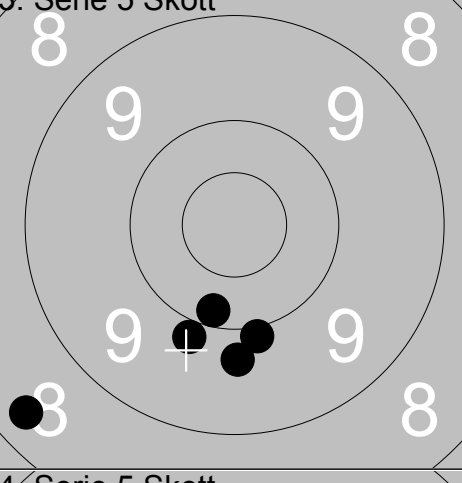
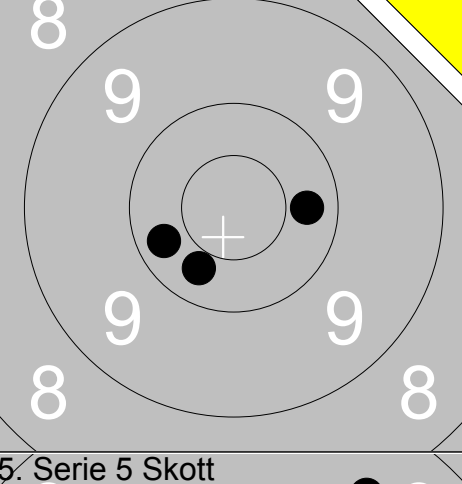
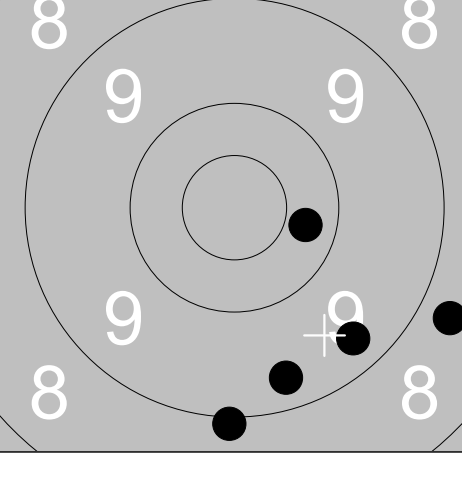
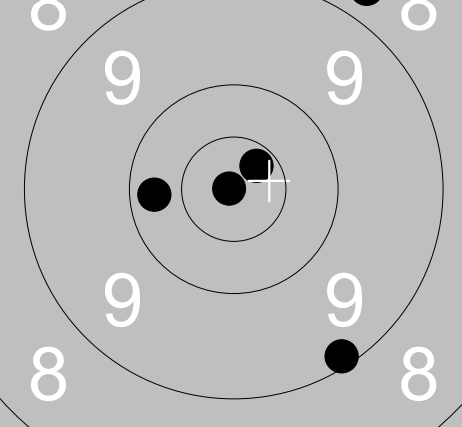
Skjutlag	Tavla	Tore Bjurvén			
5	17	Ramselefors	Lidingö	Vet	St
12.08.2017	SM Banskytte Liggande 2017	Ramselefors SKF			
Prov 	1: 9.4 ↙ 2: 8.7 → 3: 10.5x ↗ 4: 10.1 ↘ 5: 9.0 ↗	1. Serie 5 Skott 	1: 10.0 ↑ 2: 9.9 ↑ 3: 9.7 → 4: 10.0 ↙ 5: 10.0 ↙		
	Serie 46 Total 0		Serie 48 Total 48		
2. Serie 5 Skott 	1: 8.7 ↗ 2: 10.4 ↗ 3: 9.4 → 4: 10.3 ↘ 5: 9.4 ↓	3. Serie 5 Skott 	1: 10.2 ↓ 2: 8.3 ↙ 3: 9.9 ↓ 4: 9.9 ↓ 5: 9.7 ↓		
	Serie 46 Total 94		Serie 45 Total 139		
Prov 	1: 10.3 ↙ 2: 10.3 ↙ 3: 10.3 →	4. Serie 5 Skott 	1: 10.3 → 2: 9.3 ↘ 3: 8.7 ↘ 4: 9.3 ↓ 5: 9.0 ↓		
	Serie 30 Total 139		Serie 45 Total 184		
5. Serie 5 Skott 	1: 10.7x ↗ 2: 9.1 ↘ 3: 8.7 ↗ 4: 10.9x ↙ 5: 10.2 ↙				
	Serie 47 Total 231				

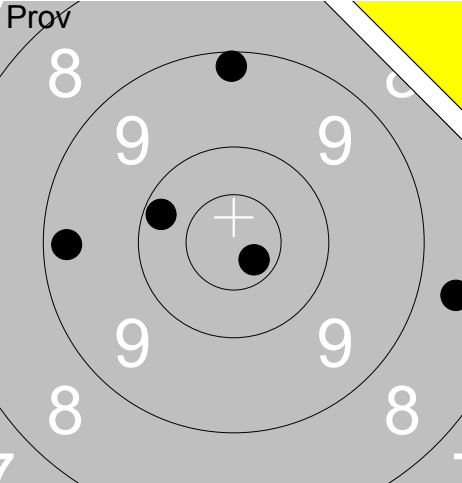
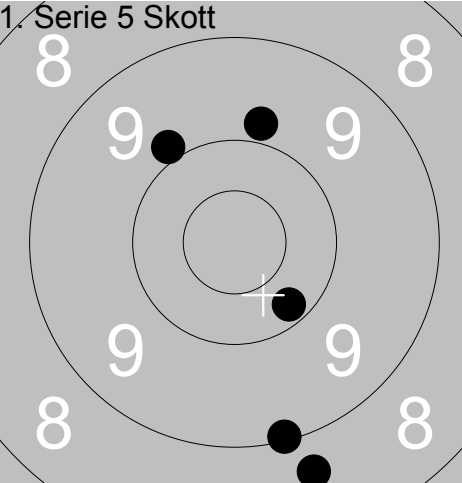
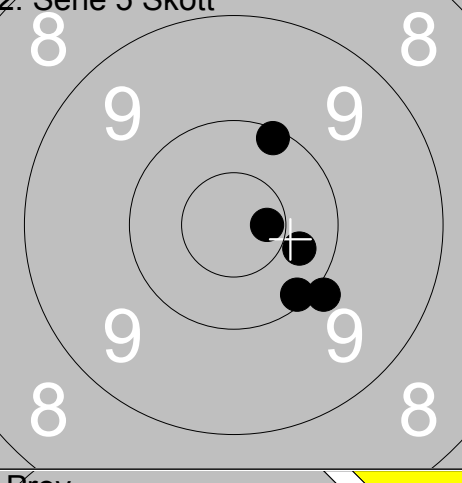
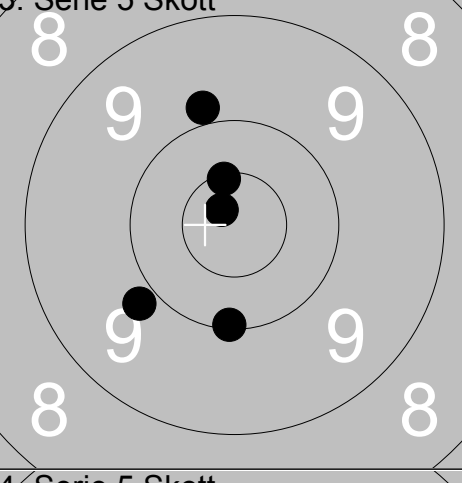
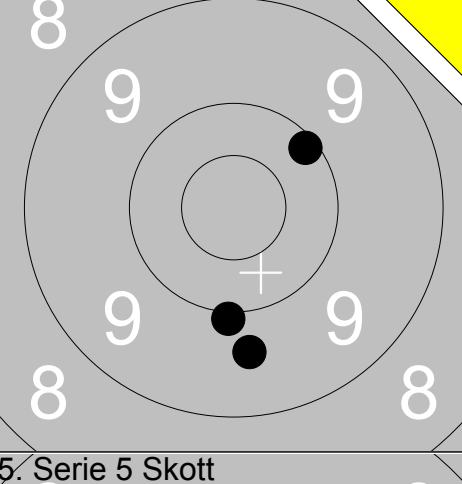
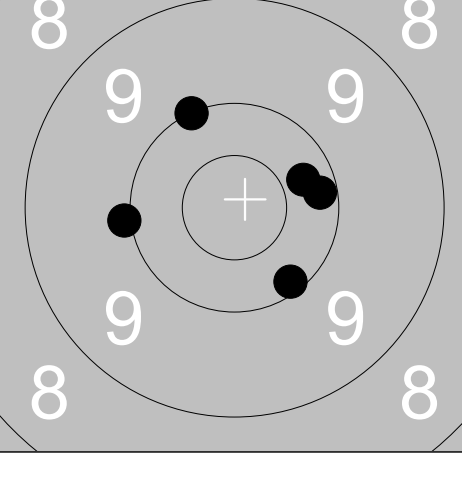
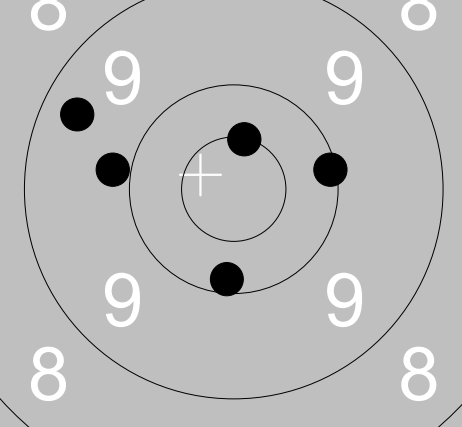
Skjutlag 5	Tavla 18	Bengt Jansson																																											
Ramselefors	Söderala	Öpp	Gä																																										
12.08.2017	SM Banskytte Liggande 2017	Ramselefors SKF																																											
Prov	 <table border="1"> <tr><td>1:</td><td>8.6</td><td>→</td></tr> <tr><td>2:</td><td>10.7x</td><td>↘</td></tr> <tr><td>3:</td><td>9.2</td><td>↑</td></tr> <tr><td>4:</td><td>10.2</td><td>↖</td></tr> <tr><td>5:</td><td>9.3</td><td>←</td></tr> <tr><td>Serie</td><td>46</td><td></td></tr> <tr><td>Total</td><td>0</td><td></td></tr> </table>	1:	8.6	→	2:	10.7x	↘	3:	9.2	↑	4:	10.2	↖	5:	9.3	←	Serie	46		Total	0		1. Serie 5 Skott	 <table border="1"> <tr><td>1:</td><td>9.9</td><td>↖</td></tr> <tr><td>2:</td><td>9.8</td><td>↑</td></tr> <tr><td>3:</td><td>9.1</td><td>↘</td></tr> <tr><td>4:</td><td>8.7</td><td>↘</td></tr> <tr><td>5:</td><td>10.2</td><td>↘</td></tr> <tr><td>Serie</td><td>45</td><td></td></tr> <tr><td>Total</td><td>45</td><td></td></tr> </table>	1:	9.9	↖	2:	9.8	↑	3:	9.1	↘	4:	8.7	↘	5:	10.2	↘	Serie	45		Total	45	
1:	8.6	→																																											
2:	10.7x	↘																																											
3:	9.2	↑																																											
4:	10.2	↖																																											
5:	9.3	←																																											
Serie	46																																												
Total	0																																												
1:	9.9	↖																																											
2:	9.8	↑																																											
3:	9.1	↘																																											
4:	8.7	↘																																											
5:	10.2	↘																																											
Serie	45																																												
Total	45																																												
2. Serie 5 Skott	 <table border="1"> <tr><td>1:</td><td>10.1</td><td>↖</td></tr> <tr><td>2:</td><td>10.1</td><td>↘</td></tr> <tr><td>3:</td><td>9.9</td><td>↘</td></tr> <tr><td>4:</td><td>10.7x</td><td>→</td></tr> <tr><td>5:</td><td>10.3</td><td>↘</td></tr> <tr><td>Serie</td><td>49</td><td></td></tr> <tr><td>Total</td><td>94</td><td></td></tr> </table>	1:	10.1	↖	2:	10.1	↘	3:	9.9	↘	4:	10.7x	→	5:	10.3	↘	Serie	49		Total	94		3. Serie 5 Skott	 <table border="1"> <tr><td>1:</td><td>10.5x</td><td>↖</td></tr> <tr><td>2:</td><td>10.1</td><td>↘</td></tr> <tr><td>3:</td><td>9.9</td><td>↖</td></tr> <tr><td>4:</td><td>10.8x</td><td>↖</td></tr> <tr><td>5:</td><td>9.9</td><td>↖</td></tr> <tr><td>Serie</td><td>48</td><td></td></tr> <tr><td>Total</td><td>142</td><td></td></tr> </table>	1:	10.5x	↖	2:	10.1	↘	3:	9.9	↖	4:	10.8x	↖	5:	9.9	↖	Serie	48		Total	142	
1:	10.1	↖																																											
2:	10.1	↘																																											
3:	9.9	↘																																											
4:	10.7x	→																																											
5:	10.3	↘																																											
Serie	49																																												
Total	94																																												
1:	10.5x	↖																																											
2:	10.1	↘																																											
3:	9.9	↖																																											
4:	10.8x	↖																																											
5:	9.9	↖																																											
Serie	48																																												
Total	142																																												
Prov	 <table border="1"> <tr><td>1:</td><td>9.6</td><td>↘</td></tr> <tr><td>2:</td><td>10.1</td><td>↖</td></tr> <tr><td>3:</td><td>10.0</td><td>↘</td></tr> <tr><td>Serie</td><td>29</td><td></td></tr> <tr><td>Total</td><td>142</td><td></td></tr> </table>	1:	9.6	↘	2:	10.1	↖	3:	10.0	↘	Serie	29		Total	142		4. Serie 5 Skott	 <table border="1"> <tr><td>1:</td><td>10.3</td><td>→</td></tr> <tr><td>2:</td><td>10.2</td><td>→</td></tr> <tr><td>3:</td><td>10.0</td><td>←</td></tr> <tr><td>4:</td><td>10.0</td><td>↖</td></tr> <tr><td>5:</td><td>10.1</td><td>↘</td></tr> <tr><td>Serie</td><td>50</td><td></td></tr> <tr><td>Total</td><td>192</td><td></td></tr> </table>	1:	10.3	→	2:	10.2	→	3:	10.0	←	4:	10.0	↖	5:	10.1	↘	Serie	50		Total	192							
1:	9.6	↘																																											
2:	10.1	↖																																											
3:	10.0	↘																																											
Serie	29																																												
Total	142																																												
1:	10.3	→																																											
2:	10.2	→																																											
3:	10.0	←																																											
4:	10.0	↖																																											
5:	10.1	↘																																											
Serie	50																																												
Total	192																																												
5. Serie 5 Skott	 <table border="1"> <tr><td>1:</td><td>9.4</td><td>↖</td></tr> <tr><td>2:</td><td>10.5x</td><td>↑</td></tr> <tr><td>3:</td><td>10.2</td><td>↘</td></tr> <tr><td>4:</td><td>10.1</td><td>→</td></tr> <tr><td>5:</td><td>9.9</td><td>←</td></tr> <tr><td>Serie</td><td>48</td><td></td></tr> <tr><td>Total</td><td>240</td><td></td></tr> </table>	1:	9.4	↖	2:	10.5x	↑	3:	10.2	↘	4:	10.1	→	5:	9.9	←	Serie	48		Total	240																								
1:	9.4	↖																																											
2:	10.5x	↑																																											
3:	10.2	↘																																											
4:	10.1	→																																											
5:	9.9	←																																											
Serie	48																																												
Total	240																																												

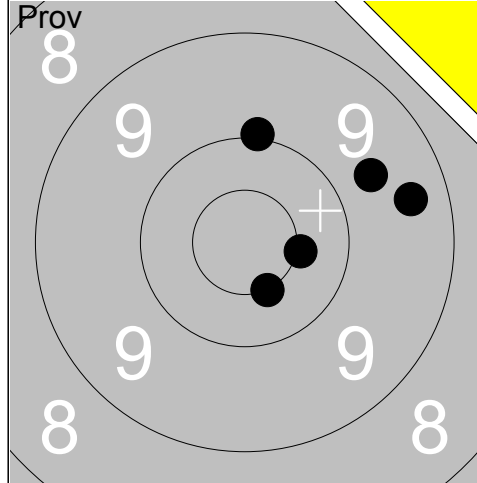

1:	9.4	→
2:	10.0	↑
3:	10.5x	→
4:	9.7	→
5:	10.5x	↓
Serie		48
Total		0

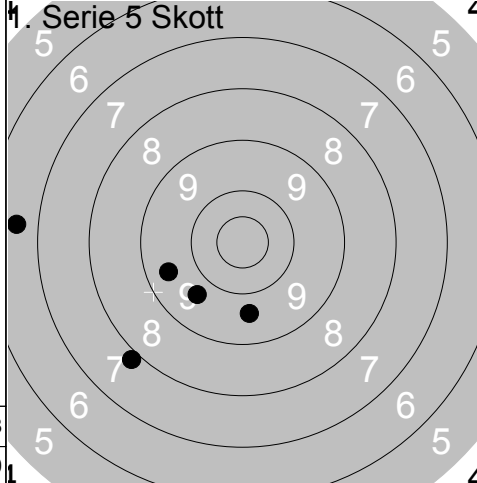

1:	9.6	↓
2:	7.9	↙
3:	9.7	↙
4:	9.5	←
5:	6.6	←
Serie		40
Total		40

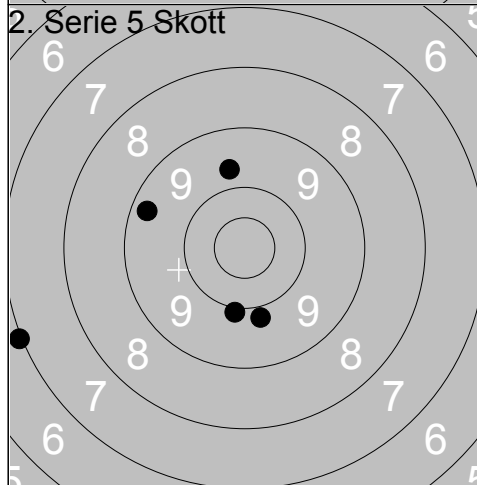

1:	9.7	↑
2:	9.9	↓
3:	7.0	←
4:	9.8	↓
5:	9.3	←
Serie		43
Total		83

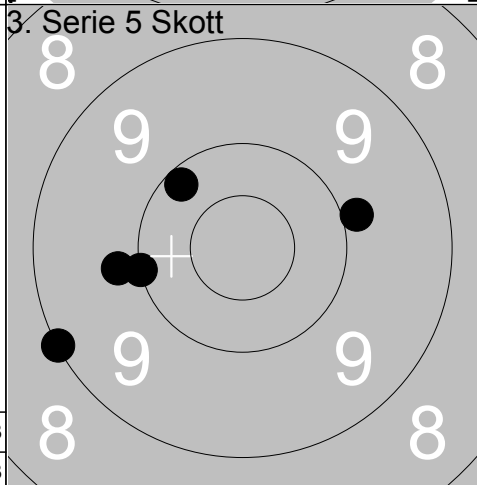

1:	10.0	←
2:	9.8	←
3:	9.0	←
4:	10.2	↗
5:	9.9	→
Serie		47
Total		130

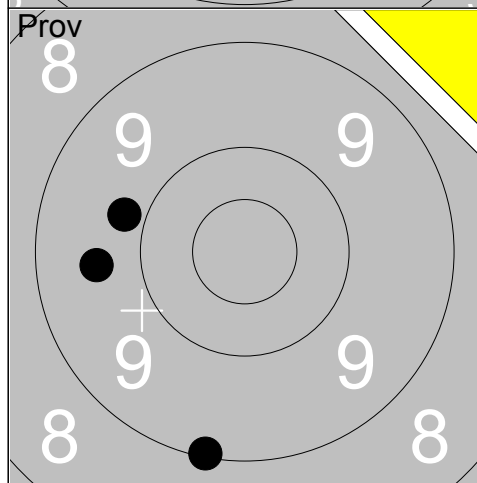

1:	9.6	←
2:	9.8	←
3:	9.1	↓
Serie		27
Total		130

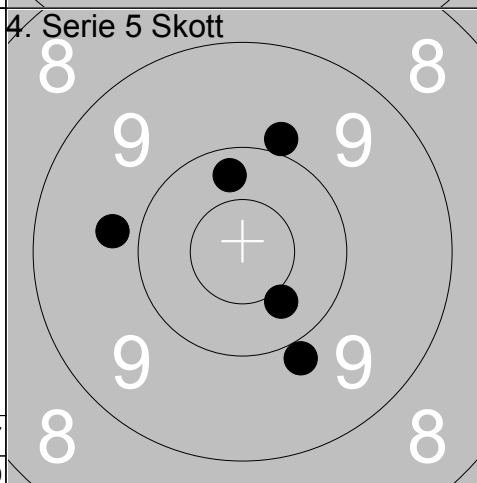

1:	10.4	↘
2:	9.9	↑
3:	9.8	←
4:	10.3	↑
5:	9.9	↓
Serie		47
Total		177

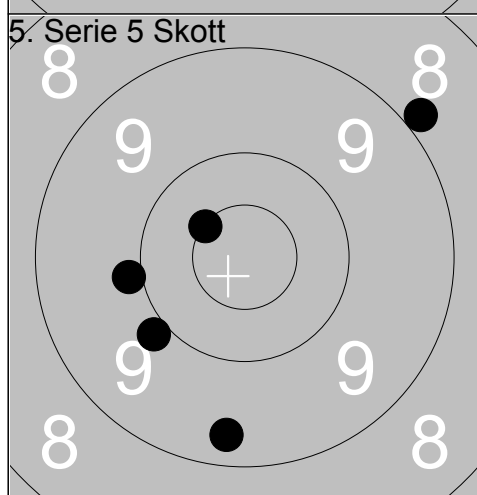

1:	8.9	↗
2:	9.9	↙
3:	9.9	←
4:	9.3	↓
5:	10.5x	↗
Serie		45
Total		222

Skjutlag	Tavla	Mattias Eriksson	
5	21	Ramselefors	Ramselefors
12.08.2017	SM Banskytte Liggande 2017	Ramselefors SKF	Öpp Vb
Prov		1. Serie 5 Skott	
	1: 10.2 ↗ 2: 9.0 → 3: 10.3 ↘ 4: 9.8 → 5: 7.7 ↘ Serie 45 Total 0		1: 10.4 ← 2: 10.2 ↘ 3: 9.7 ← 4: 9.9 ← 5: 9.7 ↗ Serie 47 Total 47
2. Serie 5 Skott		3. Serie 5 Skott	
	1: 9.3 → 2: 7.6 ↘ 3: 8.8 ↘ 4: 8.4 ↘ 5: 10.5x ↗ Serie 42 Total 89		1: 10.2 ↗ 2: 10.2 → 3: 10.3 ← 4: 9.9 ↗ 5: 10.1 ↘ Serie 49 Total 138
Prov		4. Serie 5 Skott	
	1: 10.1 ← 2: 9.9 → 3: 8.9 ↘ Serie 27 Total 138		1: 7.4 ↗ 2: 8.4 ↗ 3: 10.1 ↘ 4: 7.7 ↘ 5: 7.3 ↘ Serie 39 Total 177
5. Serie 5 Skott			
	1: 8.4 ↗ 2: 9.5 ↗ 3: 8.8 ← 4: 10.2 ↗ 5: 10.0 ↗ Serie 45 Total 222		