

Skjutlag	Tavla	Lars Möllsten	
S		Umeå Skf	
09.04.2017		Startskottet 2017	Umeå skytteallians
Prov Ligg		1: 9.3 ↗ 2: 7.8 ↖ 3: 8.9 ↖ 4: 8.6 ↑ 5: 10.4x ↖ 6: 10.7x ↓ 7: 9.9 ↗ 8: 9.6 ↗ 9: 9.8 ↑ 10: 9.7 →	11: 9.9 → 12: 10.5x ← 13: 10.1 ↑ 14: 9.1 ↖ 15: 10.3 → 16: 10.4x ↑ 17: 10.5x ↓ 18: 10.8x ↖ 19: 10.0 ←
		Serie 94.7	Serie 91.6
		Total 0.0	Total 0.0
60 Ligg		1: 10.6x → 2: 9.6 ← 3: 10.3 ↗ 4: 9.2 → 5: 10.4x ↓ 6: 10.1 ↗ 7: 10.1 ← 8: 10.4x ↗ 9: 9.9 → 10: 9.6 →	11: 9.2 ← 12: 9.8 → 13: 9.1 ↓ 14: 10.2 ↖ 15: 9.6 ← 16: 8.9 ← 17: 9.6 ← 18: 9.4 → 19: 10.1 → 20: 10.5x →
		Serie 100.2	Serie 96.4
		Total 100.2	Total 196.6
60 Ligg		21: 10.0 → 22: 10.5x → 23: 10.0 ← 24: 9.5 ↓ 25: 10.8x ↑ 26: 10.6x ← 27: 10.0 ← 28: 9.9 ↗ 29: 9.8 ↓ 30: 10.3x ↓	31: 10.2 → 32: 10.0 ↗ 33: 8.9 ← 34: 9.8 ← 35: 9.9 ↙ 36: 10.0 ↓ 37: 10.6x ↙ 38: 9.9 ↑ 39: 9.5 ← 40: 10.4x ↓
		Serie 101.4	Serie 99.2
		Total 298.0	Total 397.2
60 Ligg		41: 10.4x ↘ 42: 9.8 ← 43: 9.8 ↘ 44: 10.3 ← 45: 9.7 → 46: 10.1 ↘ 47: 10.7x → 48: 10.0 ↑ 49: 9.7 → 50: 10.7x ↓	51: 10.8x ↗ 52: 10.5x ↓ 53: 10.7x ↗ 54: 8.9 ↘ 55: 10.3x ↗ 56: 9.7 ↗ 57: 10.9x ↖ 58: 9.9 ↑ 59: 10.8x ↑ 60: 9.4 →
		Serie 101.2	Serie 101.9
		Total 498.4	Total 600.3
Prov Stå		1: 7.2 ↖ 2: 8.9 ↑ 3: 9.1 ↑ 4: 9.3 → 5: 9.3 ↗ 6: 8.1 ← 7: 8.2 ↗ 8: 9.3 ← 9: 9.0 ↘ 10: 8.5 ↑	11: 9.4 ↗ 12: 9.2 ↗
		Serie 86.9	Serie 18.6
		Total 600.3	Total 600.3

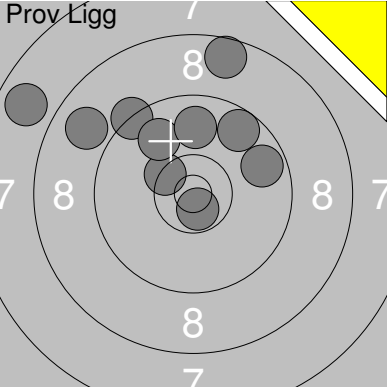

1:	10.2	←
2:	10.3	↗
3:	8.8	←
4:	8.7	↓
5:	7.9	→
6:	9.4	←
7:	10.6x	↑
8:	8.7	↓
9:	8.0	↗
10:	9.9	↑
Serie	92.5	
Total	692.8	

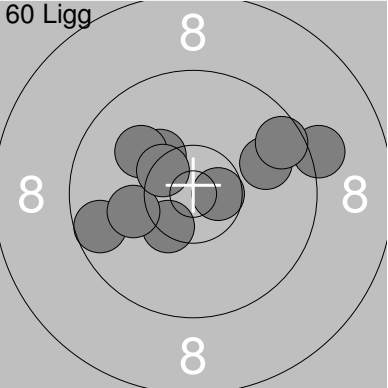
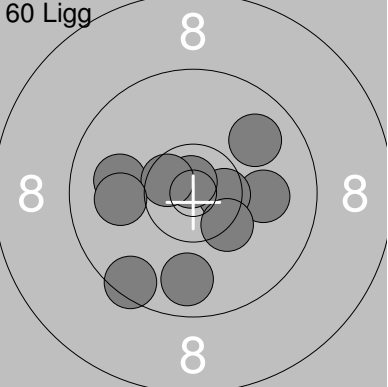
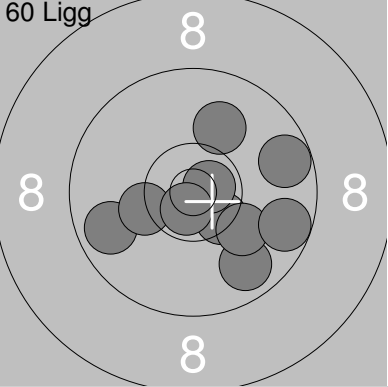
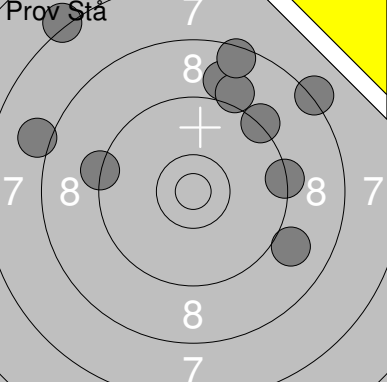
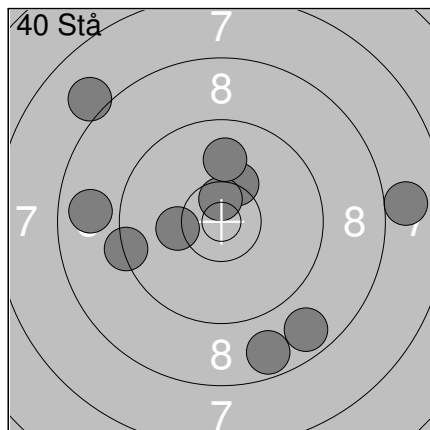
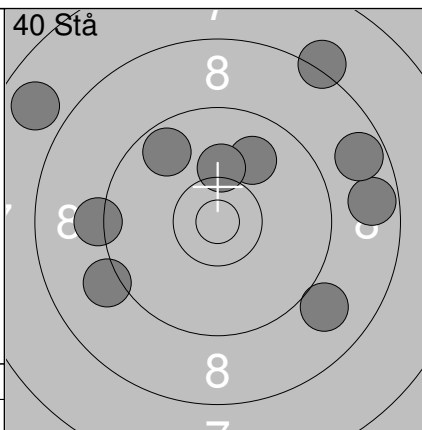

11:	9.1	↙
12:	8.7	→
13:	7.8	↗
14:	8.2	↗
15:	9.0	↓
16:	9.7	↗
17:	9.2	←
18:	9.9	↗
19:	8.7	→
20:	10.2	↑
Serie	90.5	
Total	783.3	

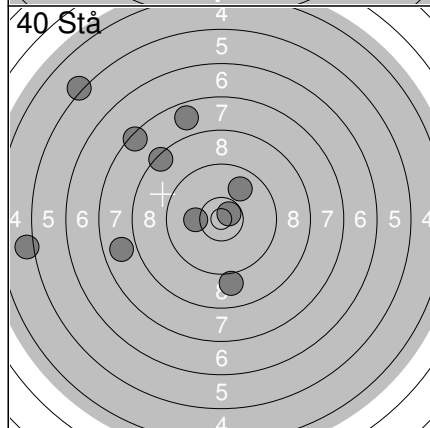

21:	8.4	↗
22:	10.2	←
23:	5.1	←
24:	9.9	↗
25:	7.4	↗
26:	7.8	←
27:	5.2	↗
28:	9.0	↓
29:	10.7x	↗
30:	7.8	↑
Serie	81.5	
Total	864.8	

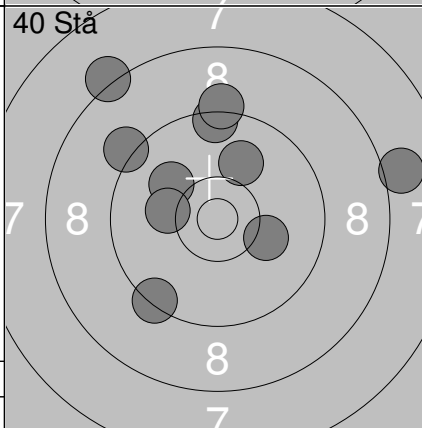

31:	9.4	↑
32:	9.2	↖
33:	9.4	↙
34:	10.1	→
35:	10.0	↑
36:	8.2	↗
37:	8.0	→
38:	10.1	↖
39:	9.2	↑
40:	10.2	←
Serie	93.8	
Total	958.6	

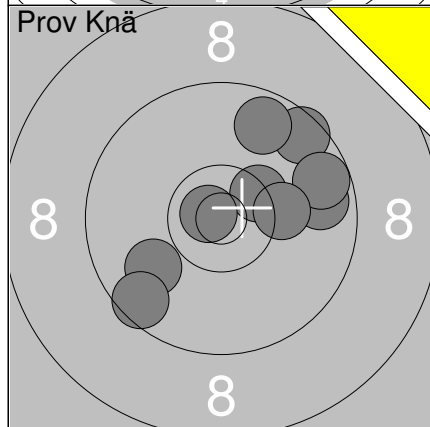

1:	9.9	↙
2:	9.6	↙
3:	9.5	↗
4:	9.7	→
5:	9.7	→
6:	9.7	↑
7:	10.4x	↗
8:	10.2	→
9:	10.8x	←
Serie	89.5	
Total	958.6	

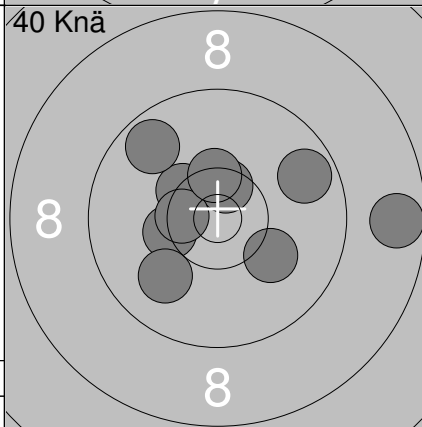

1:	10.3x	←
2:	10.4x	↗
3:	10.5x	↑
4:	9.7	↗
5:	10.0	↙
6:	10.5x	←
7:	10.1	↓
8:	9.7	↗
9:	10.4x	↑
10:	8.7	→
Serie	100.3	
Total	1058.9	

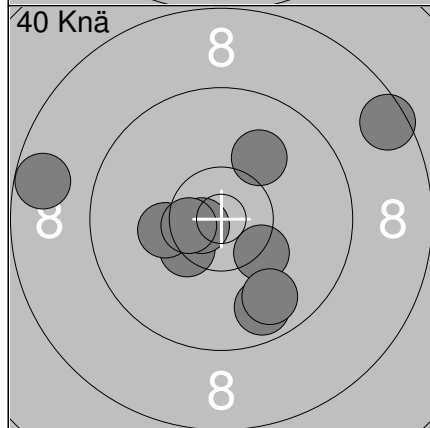

11:	8.7	←
12:	9.7	↓
13:	10.0	↗
14:	10.4x	↙
15:	10.7x	←
16:	10.3x	↓
17:	10.2	←
18:	8.5	↗
19:	9.8	↓
20:	10.5x	←
Serie	98.8	
Total	1157.7	

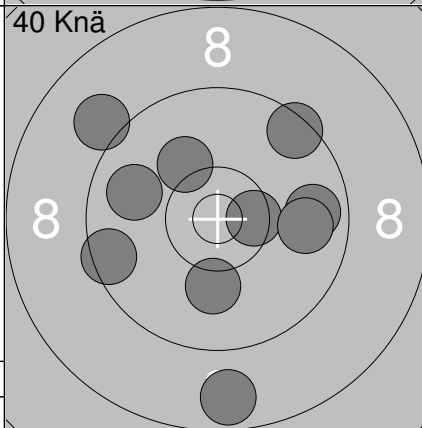

21:	9.5	←
22:	9.1	↖
23:	8.7	↓
24:	9.5	↗
25:	10.5x	→
26:	9.9	←
27:	10.1	↓
28:	10.2	↗
29:	9.8	→
30:	9.9	→
Serie	97.2	
Total	1254.9	

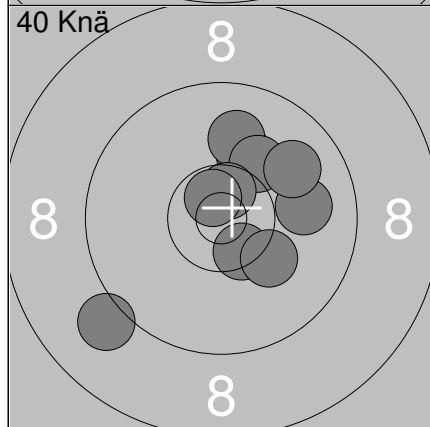

31:	10.1	↑
32:	10.0	↑
33:	9.9	→
34:	10.2	↗
35:	10.6x	↑
36:	10.5x	↓
37:	9.9	↗
38:	10.7x	↗
39:	10.2	↓
40:	9.1	↙
Serie	101.2	
Total	1356.1	

Skjuttag	Tavla	Casper Fredriksson	
S		Ramselefors Skf	
09.04.2017		Startskottet 2017	Umeå skytteallians
Prov Ligg		1: 8.6 ←	11: 9.7 ↙
		2: 9.4 ↘	12: 10.1 ↓
		3: 9.8 ↗	13: 10.7x →
		4: 9.3 ↗	14: 9.9 ↓
		5: 10.5x ↗	15: 10.3 ↑
		6: 9.9 →	16: 10.9x ↗
		7: 10.2 ↘	17: 9.3 ↑
		8: 8.7 ↗	18: 10.7x →
		9: 9.3 ↙	19: 9.6 ↖
		10: 10.4x ↗	20: 9.2 ←
		Serie 96.1	Serie 100.4
		Total 0.0	Total 0.0
Prov Ligg		21: 10.2 ↗	31: 9.7 ↑
		22: 9.1 ↗	32: 10.9x ↗
		23: 10.2 ↗	33: 10.0 ↗
		24: 9.9 ↘	
		25: 10.7x ↘	
		26: 10.2 →	
		27: 10.7x ↑	
		28: 9.0 ↓	
		29: 10.3 ↗	
		30: 10.2 ↘	
		Serie 100.5	Serie 30.6
		Total 0.0	Total 0.0
60 Ligg		1: 9.6 ↓	11: 10.0 ↑
		2: 9.6 ↓	12: 10.5x ↗
		3: 10.4x ↗	13: 9.5 ↖
		4: 10.3 ←	14: 9.3 ↖
		5: 10.3x →	15: 9.6 ↗
		6: 10.3x →	16: 9.9 ←
		7: 10.6x ↗	17: 9.8 ↙
		8: 10.1 ↗	18: 10.1 ↓
		9: 10.0 ↗	19: 10.2 ↗
		10: 10.0 ↓	20: 9.1 ↙
		Serie 101.2	Serie 98.0
		Total 101.2	Total 199.2
60 Ligg		21: 10.6x ↓	31: 9.8 →
		22: 10.1 ↙	32: 10.0 ↓
		23: 10.1 ↗	33: 10.4x ←
		24: 10.7x ←	34: 9.3 ←
		25: 10.1 ↖	35: 9.8 ↗
		26: 10.7x ←	36: 10.4x ↘
		27: 10.7x ↙	37: 10.2 ↑
		28: 10.5x ↓	38: 10.4x ←
		29: 10.9x ↓	39: 10.7x ↗
		30: 10.7x ↓	40: 10.3x ←
		Serie 105.1	Serie 101.3
		Total 304.3	Total 405.6
60 Ligg		41: 10.5x ↗	51: 10.4x ↓
		42: 10.0 ↑	52: 10.6x ↓
		43: 10.3 ↘	53: 9.6 ←
		44: 10.5x ↑	54: 9.9 ↑
		45: 10.4x ↘	55: 10.7x ↓
		46: 9.9 ↗	56: 9.3 ↙
		47: 9.3 ↗	57: 9.1 ↑
		48: 10.6x ↗	58: 10.6x ↙
		49: 10.7x →	59: 10.3 →
		50: 10.3x ↗	60: 10.6x ↗
		Serie 102.5	Serie 101.1
		Total 508.1	Total 609.2

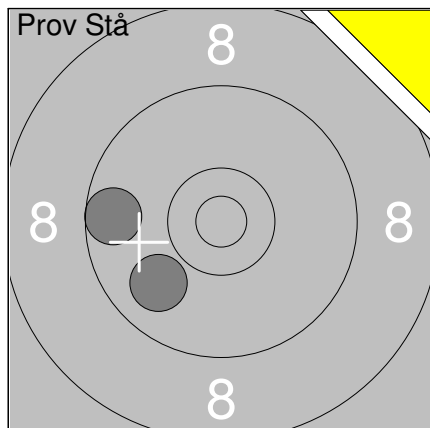

1:	9.6	←
2:	9.9	↙
Serie 19.5		
Total	609.2	

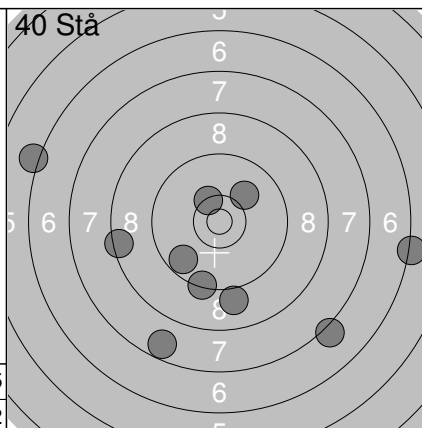

1:	9.7	↘
2:	7.7	↙
3:	8.5	←
4:	7.1	↘
5:	9.4	↘
6:	6.2	↖
7:	10.4x	↗
8:	9.0	↘
9:	6.2	→
10:	10.1	↗
Serie 84.3		
Total	693.5	

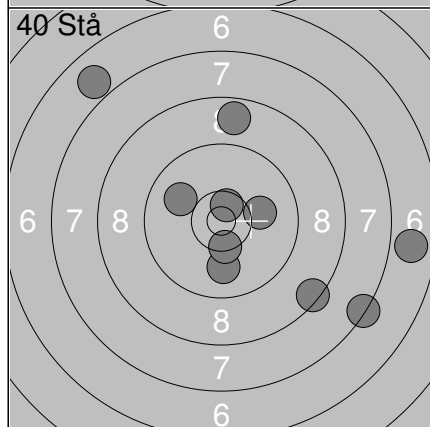

11:	8.7	↑
12:	7.3	↘
13:	10.0	↘
14:	6.8	→
15:	10.0	↗
16:	10.6x	↑
17:	8.4	↘
18:	10.1	→
19:	6.9	↗
20:	10.4x	↘
Serie 89.2		
Total	782.7	

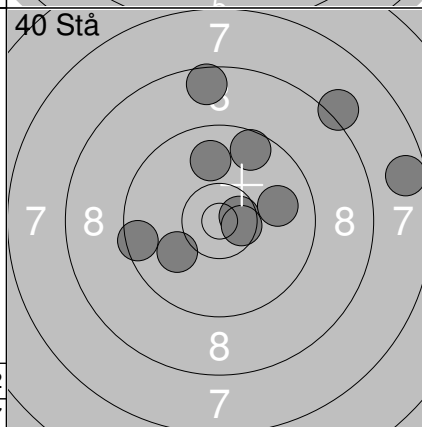

21:	8.6	↑
22:	10.6x	→
23:	9.9	↑
24:	9.5	←
25:	8.2	↗
26:	9.6	↑
27:	7.7	→
28:	10.6x	→
29:	10.1	↖
30:	9.9	→
Serie 94.7		
Total	877.4	

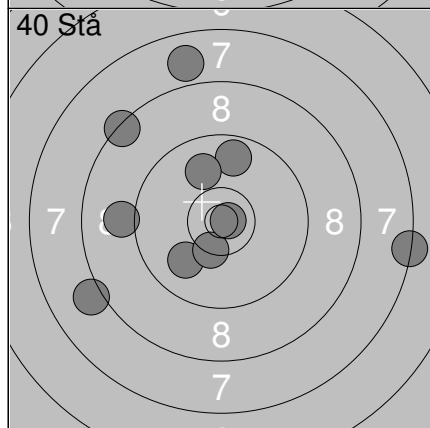

31:	9.9	↙
32:	8.1	↖
33:	9.1	←
34:	9.7	↑
35:	7.3	→
36:	10.4x	↘
37:	9.9	↗
38:	8.4	↗
39:	7.9	↑
40:	10.8x	→
Serie 91.5		
Total	968.9	

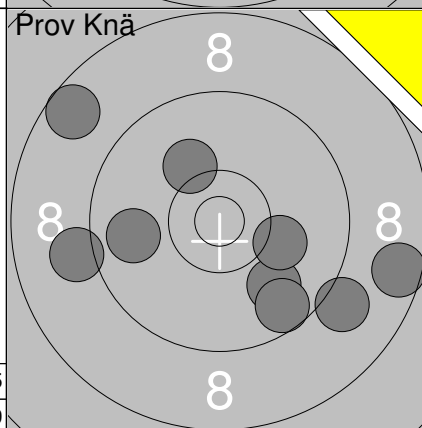

1:	8.6	↖
2:	9.9	↘
3:	9.8	←
4:	9.1	↘
5:	8.6	→
6:	9.1	←
7:	10.1	↘
8:	10.2	↗
9:	9.6	↘
Serie 85.0		
Total	968.9	

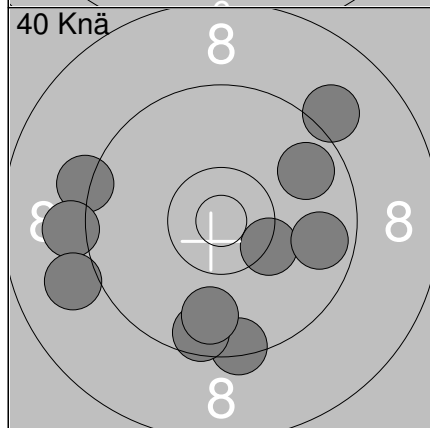

1:	9.4	↘
2:	9.1	↗
3:	9.2	↖
4:	9.6	↘
5:	9.1	←
6:	9.0	←
7:	10.3x	↘
8:	9.8	↘
9:	9.7	→
10:	9.8	↗
Serie 95.0		
Total	1063.9	

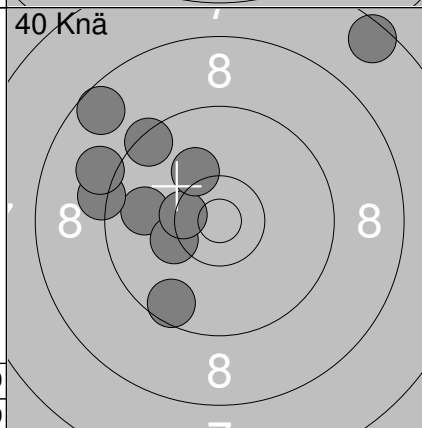

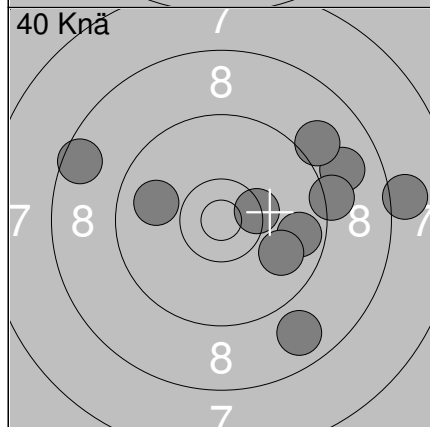

11:	9.9	←
12:	9.6	↘
13:	8.6	↗
14:	10.2	←
15:	10.4x	←
16:	9.4	↗
17:	9.2	←
18:	7.5	↗
19:	10.2	↗
20:	9.1	←
Serie 94.1		
Total	1158.0	

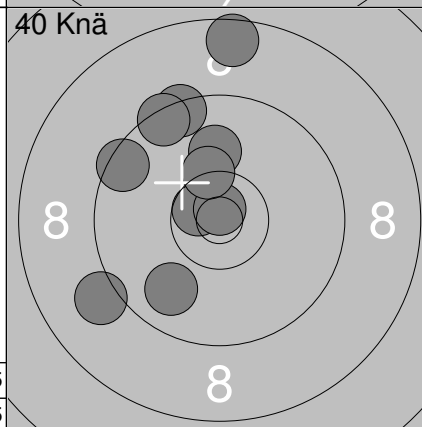

21:	10.4x	→
22:	8.1	→
23:	8.9	→
24:	9.9	←
25:	9.7	→
26:	9.0	↗
27:	8.8	↘
28:	9.2	→
29:	9.9	↘
30:	8.6	↖
Serie 92.5		
Total	1250.5	

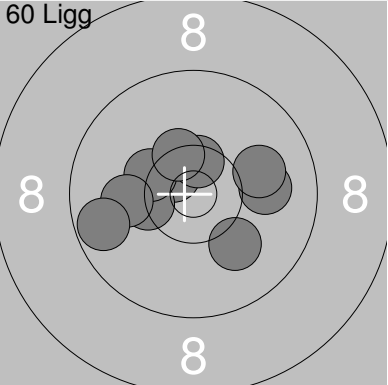
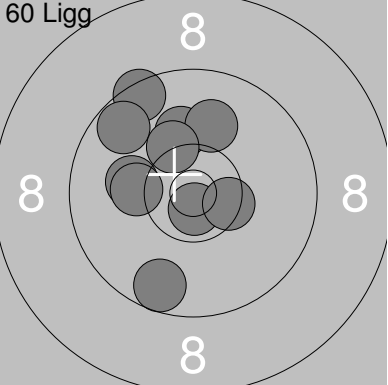
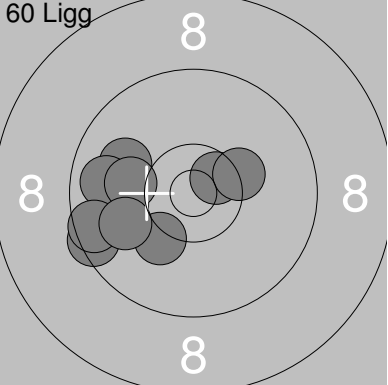
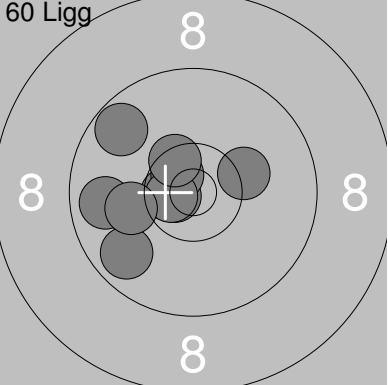
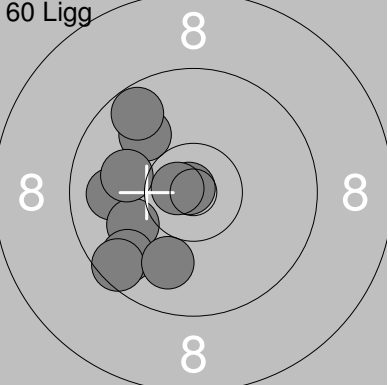
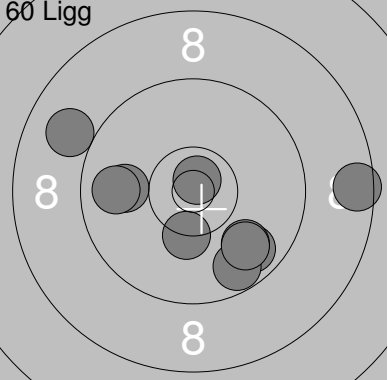

31:	8.6	↑
32:	10.0	↑
33:	10.6x	↖
34:	9.8	↘
35:	9.1	↖
36:	9.4	↗
37:	10.8x	↑
38:	10.3x	↑
39:	9.4	↗
40:	9.5	↖
Serie 97.5		
Total	1348.0	

Skjutlag 1	Tavla 5	Ellinor Axelsson Vaughn			
S		Djurö Ssf			
09.04.2017		Startskottet 2017		Umeå skytteallians	
Prov Ligg 	1: 9.8 ↑ 2: 10.2 ← 3: 9.9 ← 4: 9.3 ↓ 5: 10.3 ↓ 6: 10.0 ↓ 7: 9.5 → 8: 9.3 → 9: 10.7x ↑ 10: 10.2 ↓	Prov Ligg 	11: 10.4x ↓ 12: 10.8x ↗ 13: 10.2 ↗ 14: 10.3 ↗ 15: 10.0 ← 16: 10.6x ↗ 17: 10.5x ↗ 18: 10.6x ↓ 19: 10.4x ↗ 20: 10.3x ↓	Serie 99.2 Total 0.0	
Prov Ligg 	21: 10.4x ↗ 22: 10.3x ↗ 23: 9.8 ↗ 24: 9.9 ↗ 25: 10.2 ↓	60 Ligg 	1: 10.6x ↗ 2: 10.3x ← 3: 10.3x ↗ 4: 10.5x ↑ 5: 10.4x ↗ 6: 10.1 ↓ 7: 10.0 → 8: 10.1 ← 9: 10.0 → 10: 9.7 ←	Serie 50.6 Total 0.0	
60 Ligg 	11: 10.1 ↑ 12: 10.7x ↓ 13: 9.5 ↗ 14: 10.0 ↑ 15: 9.6 ↓ 16: 9.7 ↗ 17: 10.1 ← 18: 10.3 ↗ 19: 10.5x → 20: 10.2 ←	60 Ligg 	21: 10.0 ← 22: 10.2 ↓ 23: 10.0 ← 24: 9.5 ← 25: 9.8 ← 26: 10.1 ← 27: 9.6 ← 28: 10.6x ↗ 29: 10.0 ← 30: 10.3x →	Serie 100.7 Total 202.7	
60 Ligg 	31: 9.8 ← 32: 10.6x ← 33: 10.7x ← 34: 9.8 ↓ 35: 10.6x ↗ 36: 10.7x ← 37: 10.1 ← 38: 9.7 ↗ 39: 10.2 → 40: 10.5x ↗	60 Ligg 	41: 10.0 ↗ 42: 9.9 ← 43: 10.0 ← 44: 9.7 ↓ 45: 10.0 ← 46: 10.9x ↗ 47: 9.6 ↓ 48: 9.7 ↗ 49: 10.7x ← 50: 10.0 ↓	Serie 102.7 Total 405.5	
60 Ligg 	51: 10.8x ↑ 52: 10.3x ↓ 53: 9.8 ↓ 54: 9.9 ↓ 55: 9.9 ← 56: 9.8 ← 57: 8.9 ↗ 58: 9.7 ↓ 59: 9.8 ↓ 60: 8.5 →			Serie 97.4 Total 603.4	

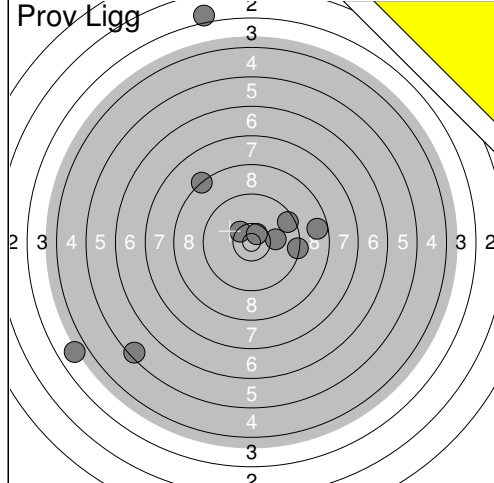

1:	5.5	↙
2:	3.9	↙
3:	3.0	↗
4:	8.3	↗
5:	10.4x	↗
6:	9.4	→
7:	10.1	→
8:	9.5	↗
9:	8.7	→
10:	10.6x	↗

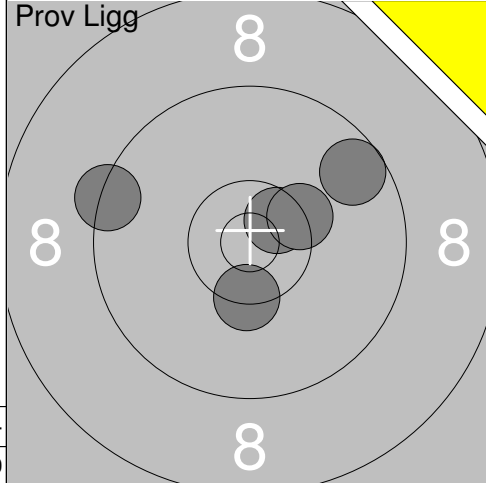

11:	9.6	↗
12:	10.6x	↗
13:	10.4x	↓
14:	10.4x	↗
15:	9.4	↖

Serie	79.4
Total	0.0

Serie	50.4
Total	0.0

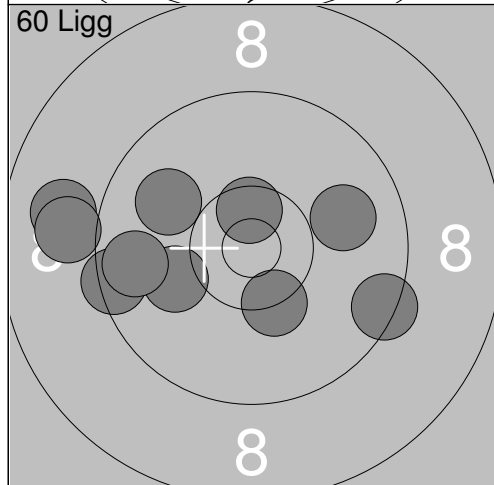

1:	10.6x	↑
2:	9.9	→
3:	8.9	↖
4:	9.5	↖
5:	10.3x	↓
6:	9.4	→
7:	10.1	↖
8:	9.0	↖
9:	9.9	↗
10:	9.7	↖

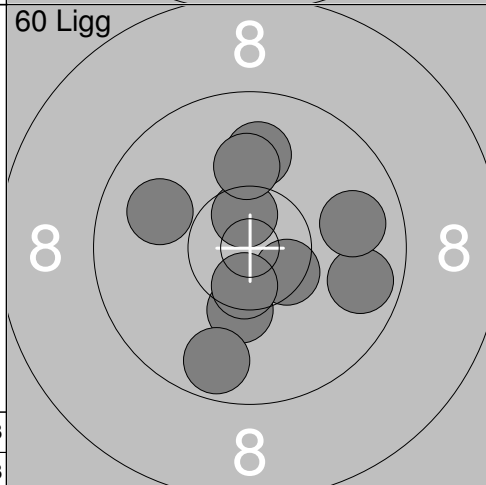

11:	10.3	↓
12:	10.6x	↑
13:	9.7	→
14:	10.0	↑
15:	10.5x	↘
16:	10.1	↑
17:	10.6x	↓
18:	9.7	↓
19:	9.9	↖
20:	9.8	→

Serie	97.3
Total	97.3

Serie	101.2
Total	198.5

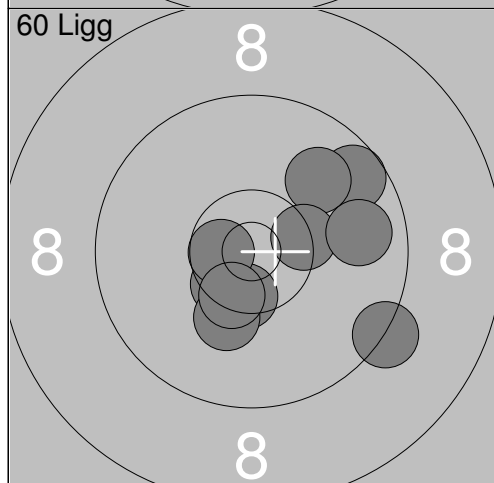

21:	10.5x	↖
22:	10.5x	↓
23:	9.3	↘
24:	10.6x	↖
25:	9.6	↗
26:	10.2	↓
27:	10.4x	↓
28:	9.9	↗
29:	10.4x	→
30:	9.8	→

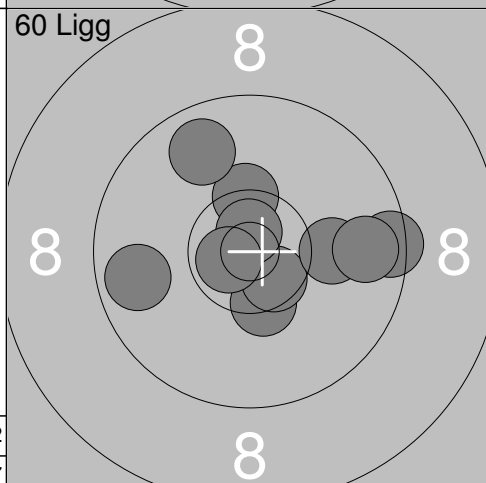

31:	10.4x	↓
32:	9.5	→
33:	10.4x	↑
34:	10.6x	↘
35:	10.7x	↑
36:	9.8	↗
37:	10.7x	↖
38:	10.1	→
39:	9.7	↖
40:	9.7	→

Serie	101.2
Total	299.7

Serie	101.6
Total	401.3

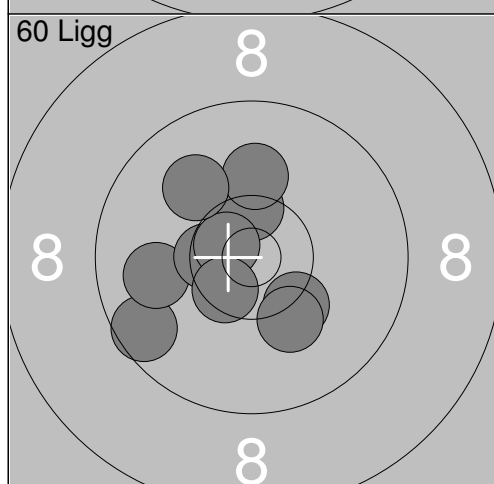

41:	10.4x	↑
42:	9.6	↖
43:	9.9	↖
44:	10.5x	↖
45:	10.7x	↗
46:	10.5x	↖
47:	10.3	↘
48:	10.1	↑
49:	10.0	↗
50:	10.2	↘

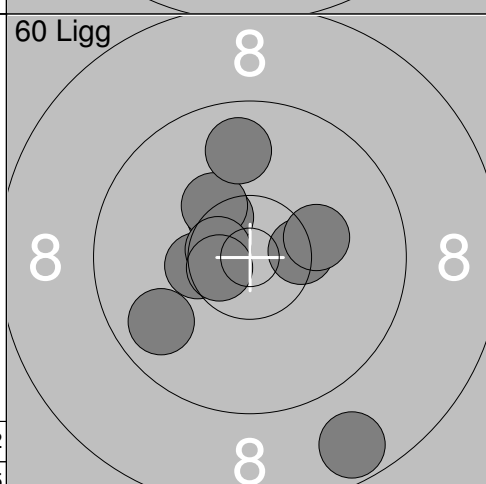

51:	10.4x	→
52:	10.4x	↗
53:	10.4x	↖
54:	10.3x	↗
55:	10.2	→
56:	10.6x	↖
57:	10.6x	↖
58:	8.7	↓
59:	9.8	↖
60:	9.8	↑

Serie	102.2
Total	503.5

Serie	101.2
Total	604.7

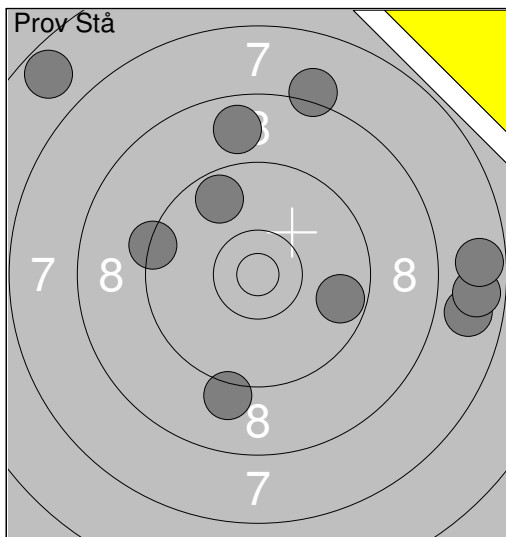

1:	9.1	↓
2:	7.8	→
3:	6.7	↗
4:	9.7	→
5:	8.8	↑
6:	9.4	←
7:	7.7	→
8:	8.2	↑
9:	9.7	↗
10:	7.7	→
Serie		84.8
Total		604.7

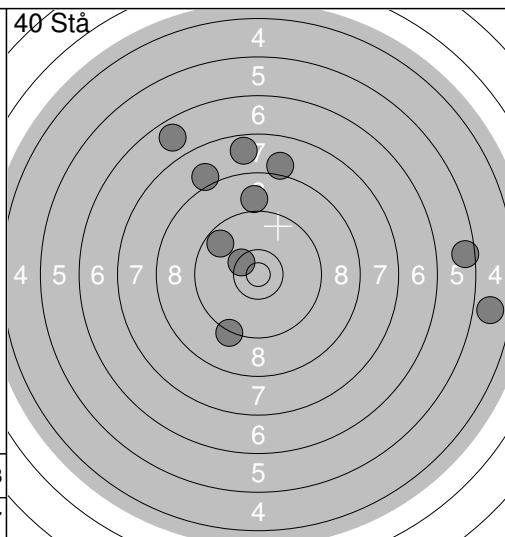

1:	7.7	↑
2:	8.1	↗
3:	9.3	↓
4:	6.8	↗
5:	9.7	↖
6:	8.1	↑
7:	9.0	↑
8:	4.9	→
9:	5.6	→
10:	10.4x	↖
Serie		79.6
Total		684.3

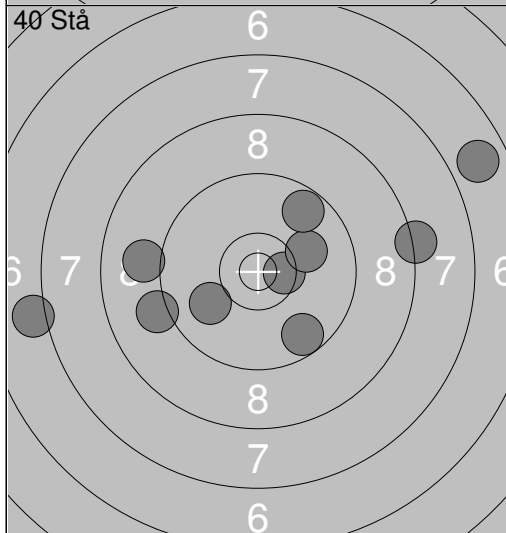

11:	6.8	↗
12:	9.1	←
13:	10.5x	→
14:	7.1	←
15:	9.7	↓
16:	8.2	→
17:	10.0	←
18:	10.1	↗
19:	9.7	↗
20:	9.0	←
Serie		90.2
Total		774.5

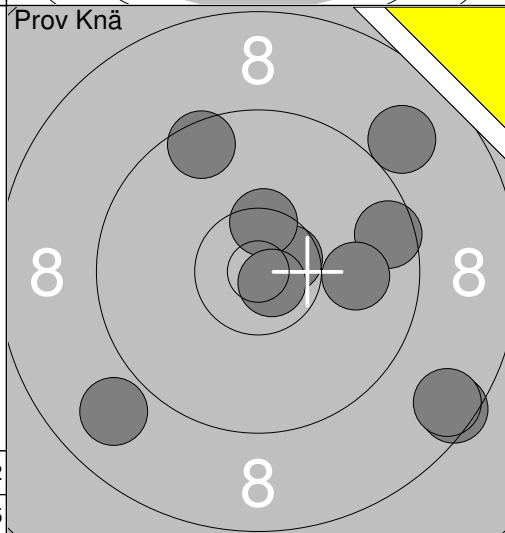

1:	9.5	↖
2:	10.6x	↗
3:	10.4x	↑
4:	9.6	→
5:	8.5	↘
6:	10.8x	↘
7:	10.0	→
8:	9.0	↗
9:	8.9	↘
10:	8.6	↘
Serie		95.9
Total		774.5

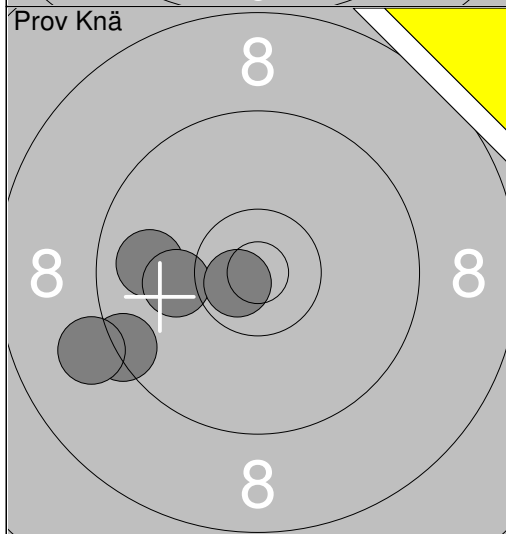

11:	9.8	←
12:	9.4	↖
13:	9.1	↖
14:	10.1	←
15:	10.7x	↖
Serie		49.1
Total		774.5

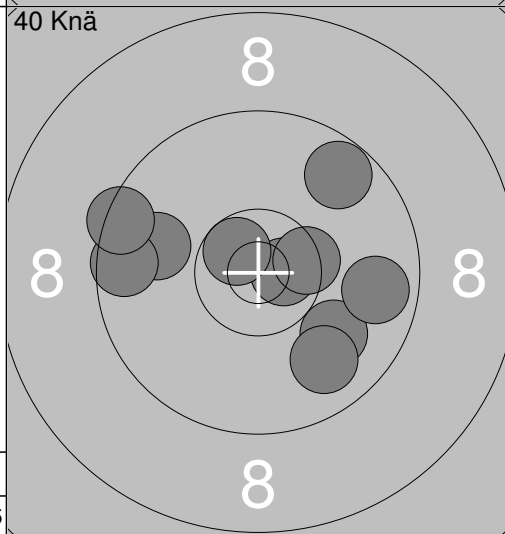

1:	10.7x	→
2:	9.9	←
3:	9.6	←
4:	10.6x	↗
5:	10.4x	→
6:	10.0	↘
7:	9.4	↖
8:	9.7	↗
9:	9.7	→
10:	9.8	↘
Serie		99.8
Total		874.3

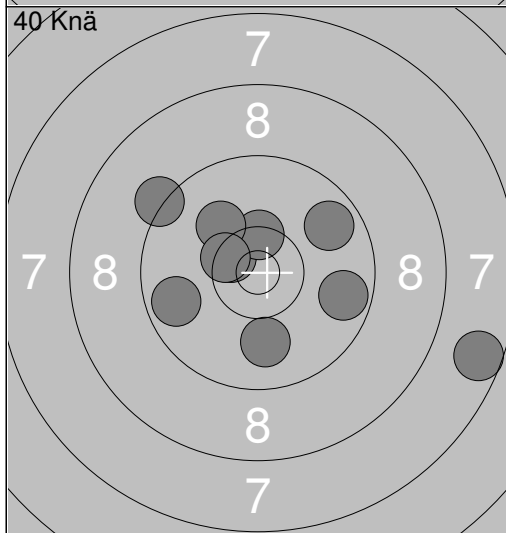

11:	9.7	→
12:	10.5x	↗
13:	7.6	→
14:	9.7	←
15:	10.0	↓
16:	10.4x	↑
17:	9.2	↗
18:	10.1	↗
19:	10.4x	↖
20:	9.8	↗
Serie		97.4
Total		971.7

<p>Prov Ligg</p>	<p>Prov Ligg</p>	
<p>60 Ligg</p>	<p>60 Ligg</p>	
<p>60 Ligg</p>	<p>60 Ligg</p>	
<p>60 Ligg</p>	<p>60 Ligg</p>	

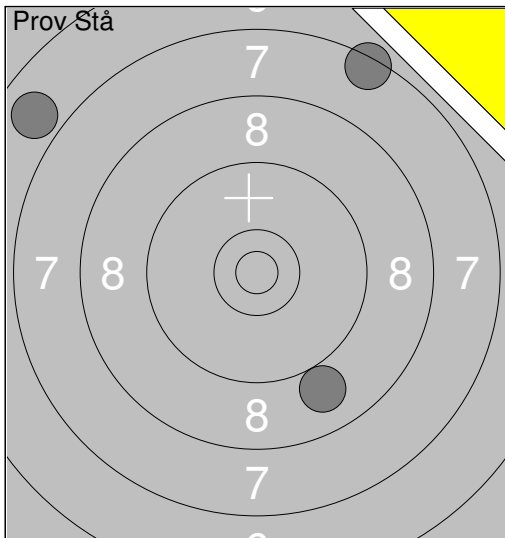

- 1: 6.9 ↖
- 2: 7.4 ↗
- 3: 9.0 ↘

Serie	23.3
Total	591.0

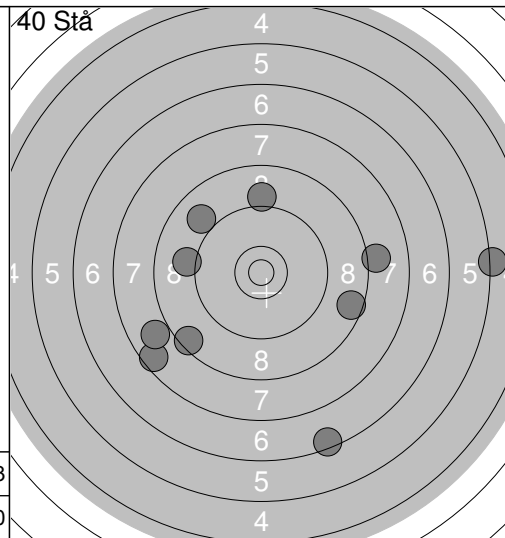

- 1: 7.6 ↖
- 2: 9.1 ←
- 3: 8.1 →
- 4: 7.9 ↖
- 5: 8.5 ↖
- 6: 9.0 ↗
- 7: 5.2 →
- 8: 9.1 ↑
- 9: 6.5 ↘
- 10: 8.6 →

Serie	79.6
Total	670.6

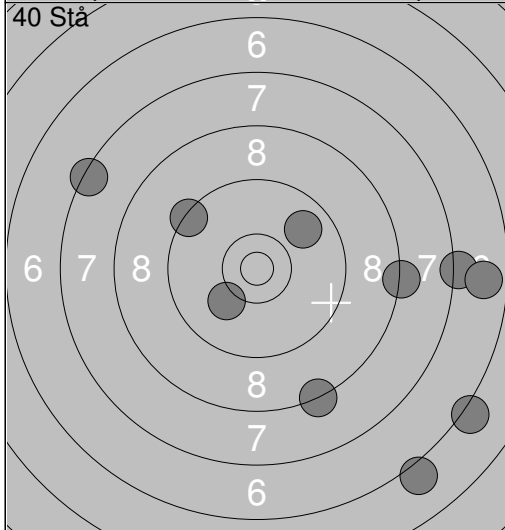

- 11: 6.2 ↘
- 12: 10.1 ↘
- 13: 8.3 ↘
- 14: 6.1 ↘
- 15: 7.4 ↗
- 16: 7.2 →
- 17: 8.3 →
- 18: 9.8 ↗
- 19: 6.7 →
- 20: 9.4 ↖

Serie	79.5
Total	750.1

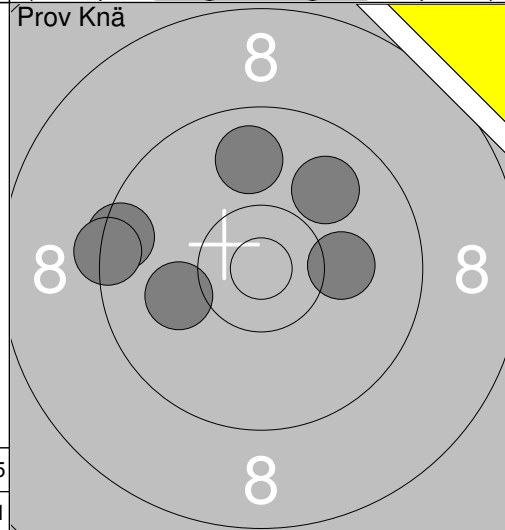

- 1: 9.5 ←
- 2: 9.9 ↗
- 3: 9.4 ←
- 4: 10.1 ←
- 5: 10.1 →
- 6: 9.8 ↑

Serie	58.8
Total	750.1

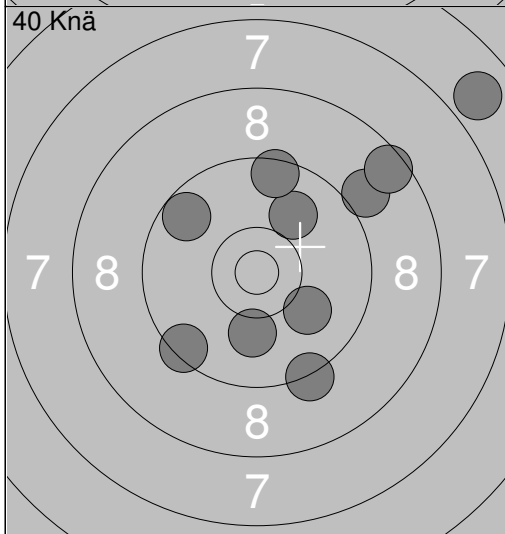

- 1: 6.9 ↗
- 2: 9.4 ↖
- 3: 10.0 ↘
- 4: 9.0 ↗
- 5: 8.5 ↗
- 6: 10.0 ↗
- 7: 9.7 ↖
- 8: 9.5 ↑
- 9: 9.3 ↘
- 10: 10.1 ↘

Serie	92.4
Total	842.5

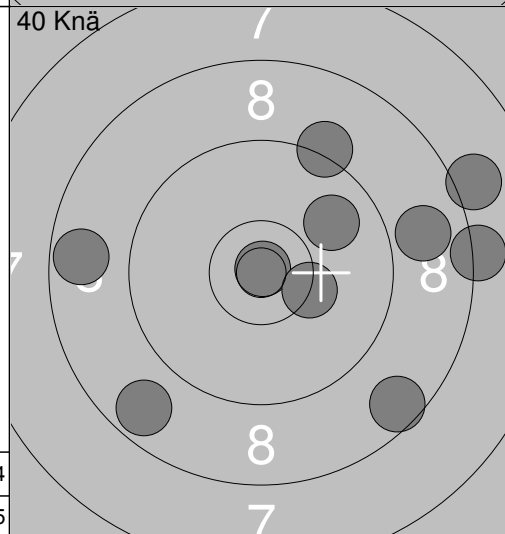

- 11: 10.9x ↗
- 12: 8.2 →
- 13: 8.1 →
- 14: 8.9 →
- 15: 8.7 ←
- 16: 9.9 ↗
- 17: 9.2 ↗
- 18: 8.7 ↖
- 19: 8.6 ↘
- 20: 10.3x →

Serie	91.5
Total	934.0

Skjuttag	Tavla	Marie Wingård	
S		Ramselefors Skf	
09.04.2017		Startskottet 2017	Umeå skytteallians
Prov Ligg		1: 7.9 ↑ 2: 7.9 ↑ 3: 10.4x ↗ 4: 10.0 → 5: 9.9 ← 6: 10.8x ↗ 7: 10.2 ↓ 8: 10.8x ↓ 9: 10.5x ↗ 10: 10.0 ↑ Serie 98.4 Total 0.0	11: 10.3x → 12: 10.3x → 13: 10.4x ↘ 14: 10.1 ← 15: 9.6 ↓ 16: 9.9 ↘ Serie 60.6 Total 0.0
60 Ligg		1: 10.3x ↘ 2: 10.6x ↑ 3: 10.0 → 4: 9.5 ↘ 5: 9.9 ↓ 6: 10.3 ↗ 7: 9.6 ↓ 8: 10.6x ↘ 9: 10.4x ↘ 10: 10.4x ↑ Serie 101.6 Total 101.6	11: 10.1 ← 12: 10.3x ↓ 13: 10.4x ↘ 14: 10.7x ↑ 15: 10.8x ↑ 16: 10.1 ↗ 17: 10.7x ↑ 18: 10.2 → 19: 10.8x → 20: 10.0 ↘ Serie 104.1 Total 205.7
60 Ligg		21: 9.2 ↓ 22: 10.0 ↓ 23: 10.3x ↑ 24: 10.1 ↓ 25: 10.5x → 26: 9.8 ↓ 27: 9.5 ↑ 28: 10.0 ↑ 29: 10.8x ↓ 30: 10.1 ← Serie 100.3 Total 306.0	31: 10.7x ← 32: 10.7x → 33: 10.5x ↓ 34: 10.3 ↗ 35: 9.6 ← 36: 10.2 ↗ 37: 10.7x ↗ 38: 9.8 ↗ 39: 10.2 ↗ 40: 9.3 ↗ Serie 102.0 Total 408.0
60 Ligg		41: 10.4x ↗ 42: 9.6 ↑ 43: 10.0 ← 44: 9.9 → 45: 10.5x ← 46: 10.1 ↑ 47: 10.2 ↑ 48: 9.9 → 49: 10.7x → 50: 10.8x → Serie 102.1 Total 510.1	51: 10.7x → 52: 10.4x → 53: 10.5x → 54: 10.3x ↗ 55: 10.1 ↗ 56: 10.3x → 57: 10.6x ↗ 58: 10.6x ← 59: 10.6x ↓ 60: 10.1 ↑ Serie 104.2 Total 614.3

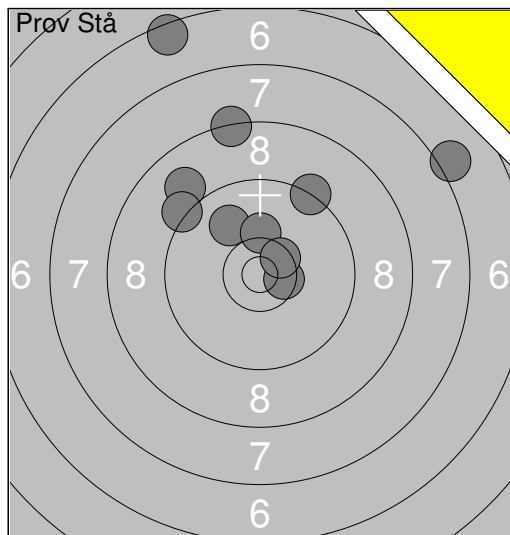

1:	9.3	↗
2:	9.0	↗
3:	9.9	↗
4:	7.1	↗
5:	10.2	↑
6:	8.3	↑
7:	10.5x	→
8:	6.5	↑
9:	9.2	↗
10:	10.5x	↗
Serie		90.5
Total		614.3

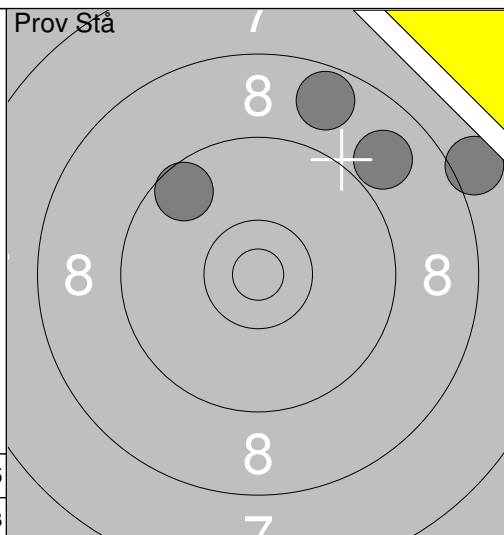

11:	8.9	↗
12:	8.0	↗
13:	8.7	↗
14:	9.6	↖
Serie		35.2
Total		614.3

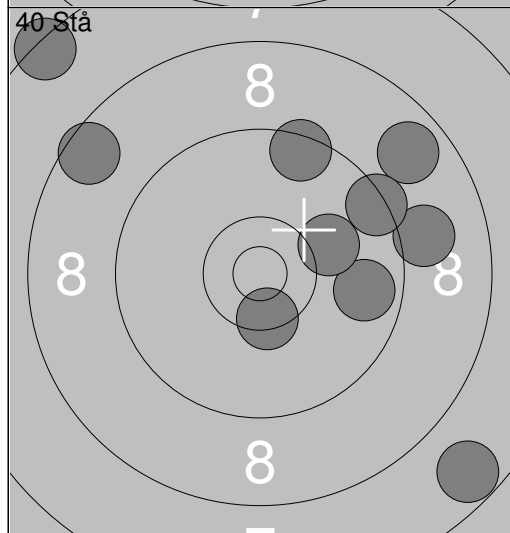

1:	9.7	→
2:	9.5	↑
3:	10.1	→
4:	7.4	↗
5:	9.0	→
6:	8.8	↗
7:	8.6	↖
8:	7.7	↘
9:	10.4x	↘
10:	9.4	↗
Serie		90.6
Total		704.9

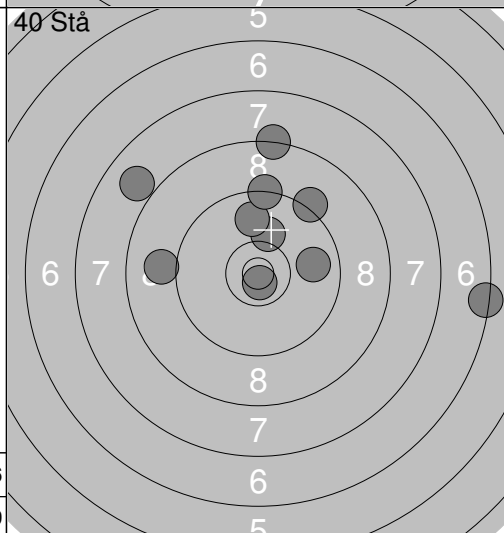

11:	9.8	→
12:	10.8x	↘
13:	7.9	↖
14:	10.1	↑
15:	9.0	←
16:	9.9	↑
17:	6.4	→
18:	9.2	↗
19:	8.3	↑
20:	9.3	↑
Serie		90.7
Total		795.6

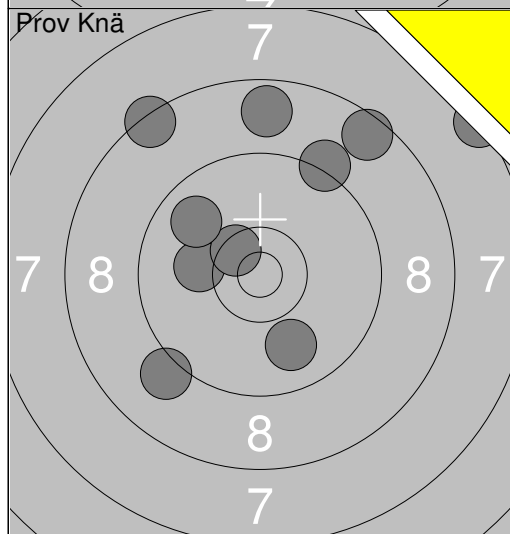

1:	10.1	←
2:	7.3	↗
3:	8.7	↑
4:	8.4	↗
5:	8.6	↗
6:	10.5x	↗
7:	9.2	↗
8:	9.8	↗
9:	9.9	↘
10:	9.1	↘
Serie		91.6
Total		795.6

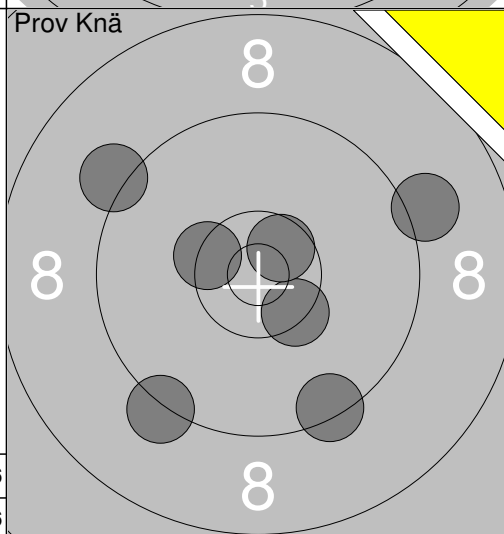

11:	9.4	↘
12:	10.4x	←
13:	9.1	↗
14:	10.4x	↘
15:	10.6x	↗
16:	9.2	↖
17:	9.3	↘
Serie		68.4
Total		795.6

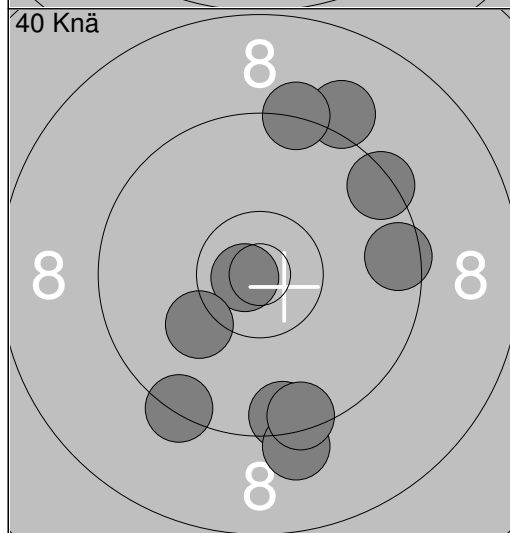

1:	9.5	↘
2:	10.8x	←
3:	9.2	↘
4:	10.2	↘
5:	9.4	↘
6:	9.5	↘
7:	9.1	↗
8:	9.5	→
9:	9.4	↗
10:	9.3	↑
Serie		95.9
Total		891.5

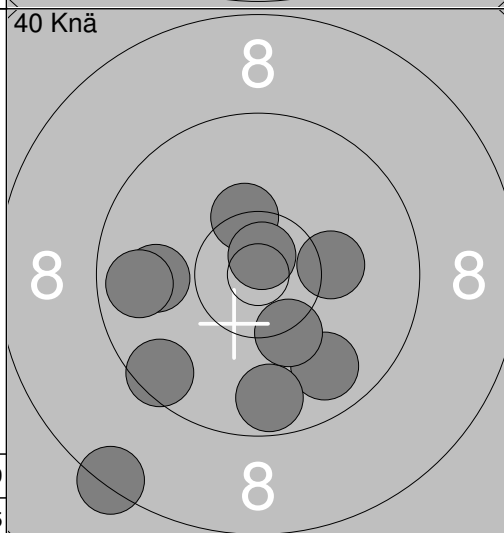

11:	9.9	←
12:	8.4	↘
13:	9.8	↘
14:	9.7	↘
15:	10.3	↘
16:	10.3x	↑
17:	10.8x	↑
18:	9.5	↘
19:	9.7	←
20:	10.2	→
Serie		98.6
Total		990.1

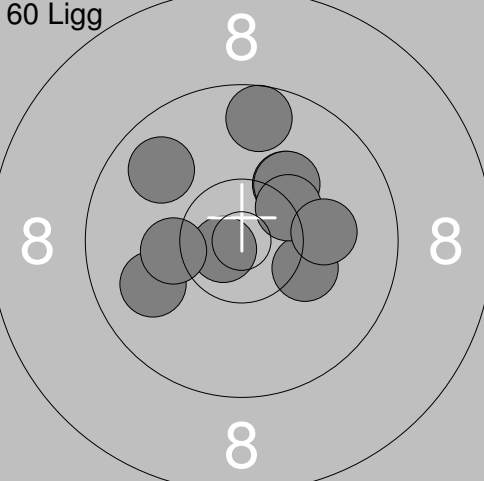
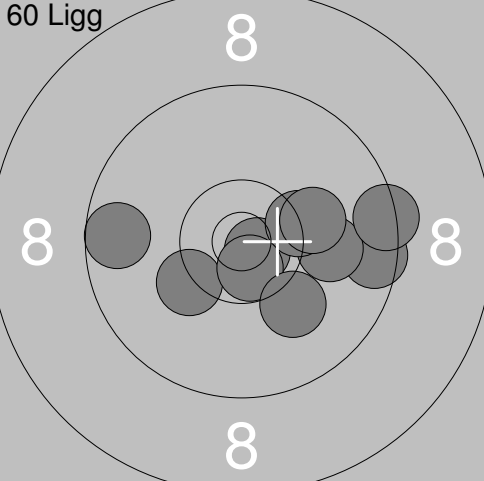
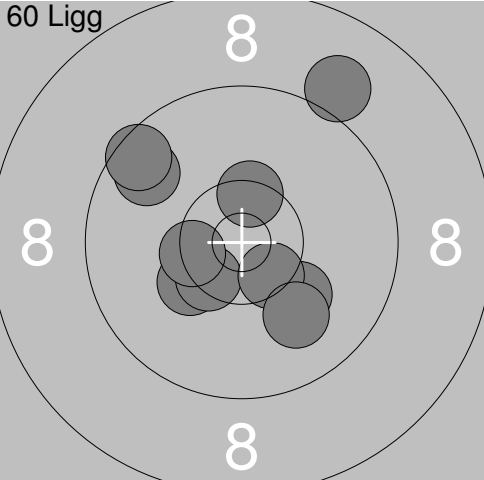
Skjuttag	Tavla	Marlene Forsell Forsman	
1	12		
S	Ramselefors Skf		
09.04.2017	Startskottet 2017	Umeå skytteallians	
Prov Ligg		1: 9.1 ↑ 2: 9.5 ← 3: 10.2 ↗ 4: 9.7 ↗ 5: 10.6x ↓ 6: 10.1 ← 7: 10.4x ↑ 8: 10.1 → 9: 10.7x → 10: 10.2 ↗ Serie 100.6 Total 0.0	11: 10.5x ↑ 12: 10.4x ↓ 13: 10.1 ↗ 14: 10.6x → 15: 10.4x ↘ Serie 52.0 Total 0.0
60 Ligg		1: 10.2 → 2: 10.7x ← 3: 9.9 ← 4: 10.2 ↗ 5: 10.2 ← 6: 10.2 ↗ 7: 10.3x ↗ 8: 9.8 ↗ 9: 10.1 → 10: 9.6 ↑ Serie 101.2 Total 101.2	11: 9.8 ↓ 12: 10.0 ↘ 13: 9.9 ↘ 14: 10.2 → 15: 10.0 ↗ 16: 9.6 ↑ 17: 10.3x ↘ 18: 9.4 ↑ 19: 10.2 ↗ 20: 10.4x ↑ Serie 99.8 Total 201.0
60 Ligg		21: 9.5 → 22: 10.3 ← 23: 10.0 → 24: 10.8x ↘ 25: 9.4 → 26: 10.3x → 27: 10.2 → 28: 10.7x ↓ 29: 10.1 ↓ 30: 9.6 ← Serie 100.9 Total 301.9	31: 10.5x → 32: 9.9 ↗ 33: 10.2 ← 34: 10.3x ↗ 35: 10.0 → 36: 10.2 ↘ 37: 10.6x ↘ 38: 10.7x ↘ 39: 10.2 → 40: 9.9 ← Serie 102.5 Total 404.4
60 Ligg		41: 10.3 ← 42: 9.7 ↗ 43: 9.5 ↗ 44: 10.1 ↓ 45: 10.4x ← 46: 10.4x ↑ 47: 10.4x ← 48: 10.5x ↓ 49: 9.0 ↗ 50: 10.0 ↓ Serie 100.3 Total 504.7	51: 10.0 ↑ 52: 9.8 ↗ 53: 10.3 ↓ 54: 9.7 ↗ 55: 10.0 ↓ 56: 10.2 ↓ 57: 10.7x ↗ 58: 9.5 → 59: 10.3x ↓ 60: 9.7 ↑ Serie 100.2 Total 604.9

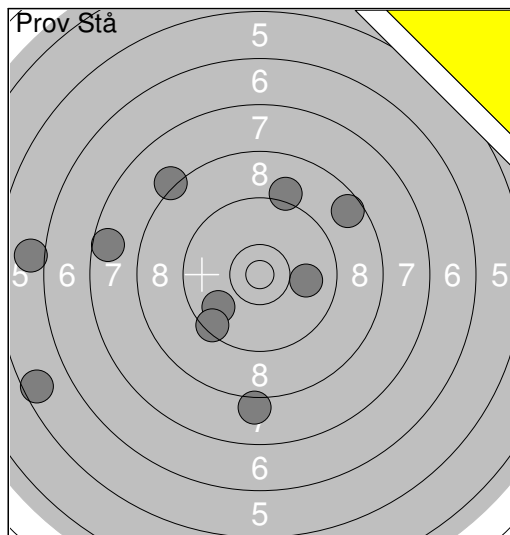

1:	10.0	→
2:	8.6	↗
3:	6.0	←
4:	9.8	↙
5:	7.6	←
6:	8.1	↓
7:	9.5	↙
8:	5.6	←
9:	8.2	↗
10:	9.1	↗
Serie		82.5
Total		604.9

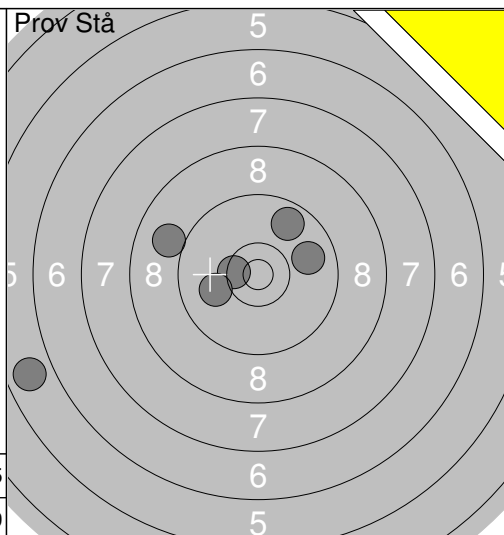

11:	9.0	←
12:	10.4x	←
13:	5.8	↙
14:	9.7	↗
15:	9.9	→
16:	10.0	←
Serie		54.8
Total		604.9

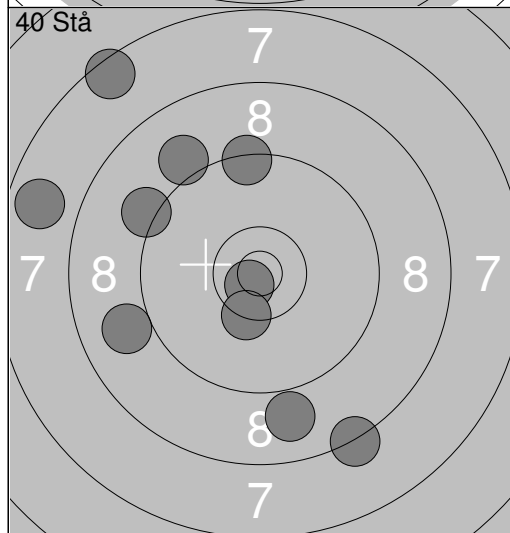

1:	10.7x	↙
2:	9.0	←
3:	9.2	↗
4:	10.4x	↓
5:	8.9	↓
6:	7.5	↗
7:	8.3	↘
8:	7.8	←
9:	9.1	↗
10:	9.4	↗
Serie		90.3
Total		695.2

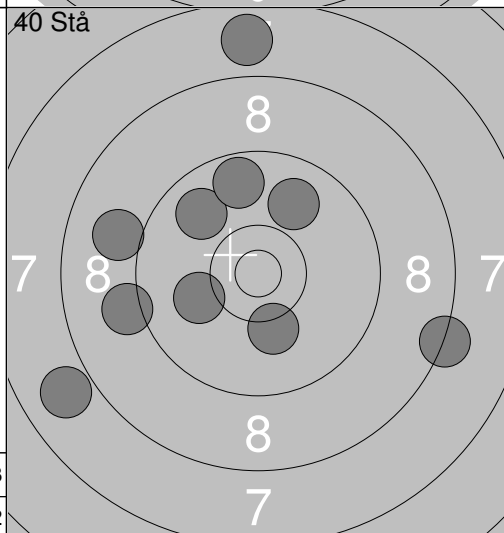

11:	7.8	↑
12:	9.0	←
13:	9.9	↗
14:	9.8	↖
15:	10.2	↓
16:	9.7	↑
17:	10.1	←
18:	8.3	→
19:	7.9	↙
20:	9.1	←
Serie		91.8
Total		787.0

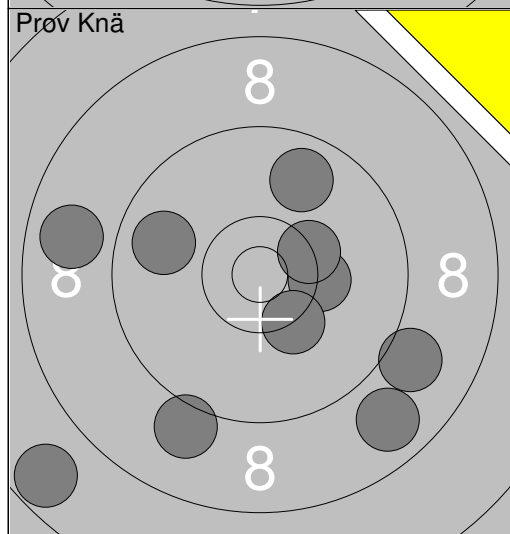

1:	7.7	↙
2:	10.3x	→
3:	9.1	↘
4:	10.3x	→
5:	8.8	↘
6:	10.3x	↘
7:	9.0	↘
8:	9.8	←
9:	8.8	←
10:	9.8	↗
Serie		93.9
Total		787.0



11:	10.4x	↘
12:	10.5x	↓
13:	9.7	↓
14:	10.0	↓
Serie		40.6
Total		787.0

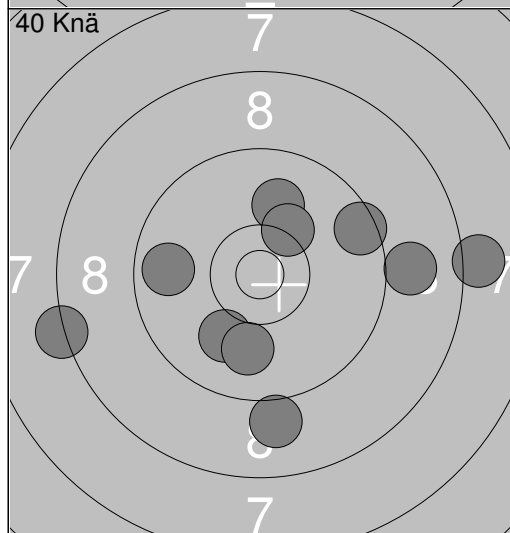

1:	9.0	↓
2:	10.0	↗
3:	8.1	→
4:	10.0	↘
5:	10.3	↗
6:	8.3	←
7:	9.8	←
8:	9.5	→
9:	9.0	→
10:	10.0	↓
Serie		94.0
Total		881.0

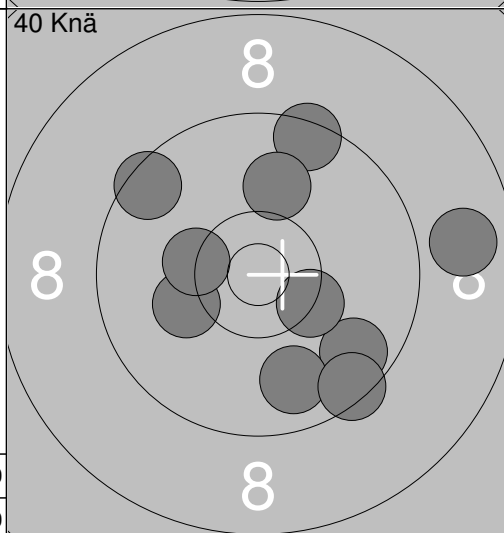

11:	10.2	←
12:	9.7	↘
13:	9.8	↘
14:	9.5	↘
15:	9.5	↗
16:	9.5	↗
17:	10.3x	←
18:	8.8	→
19:	10.3x	↘
20:	10.0	↗
Serie		97.6
Total		978.6

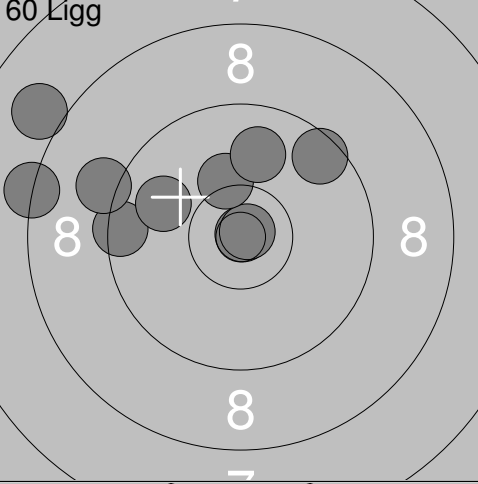
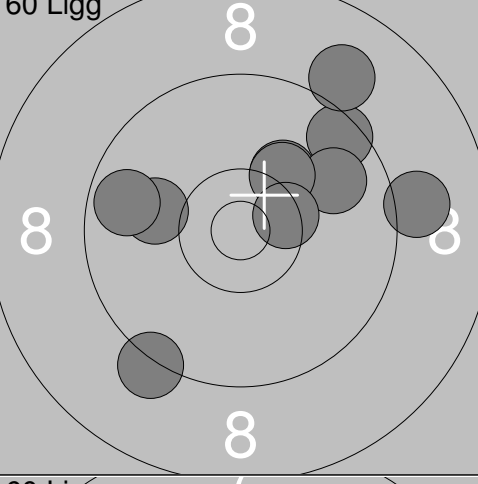
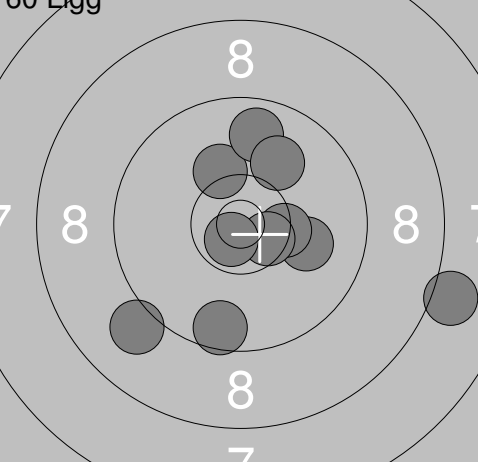
Skjuttag	Tavla	Maja Lindberg	
S		Ramselefors Skf	
09.04.2017		Startskottet 2017	Umeå skytteallians
Prov Ligg		1: 7.8 ↘ 2: 9.0 → 3: 9.9 → 4: 9.6 → 5: 7.6 → 6: 8.7 → 7: 9.9 → 8: 10.0 ↘ 9: 10.2 ↗ 10: 9.9 ↘ Serie 92.6 Total 0.0	11: 9.4 ← 12: 10.7x ↖ 13: 8.6 ↘ 14: 9.5 → 15: 9.3 ↘ 16: 9.2 ↘ 17: 9.5 ↘ 18: 9.7 ↘ 19: 9.8 ↗ 20: 10.1 ↗ Serie 95.8 Total 0.0
60 Ligg		1: 9.5 ← 2: 10.9x ↗ 3: 9.5 ↗ 4: 9.9 ↗ 5: 10.8x ↗ 6: 8.0 ↗ 7: 9.1 ↗ 8: 10.2 ↗ 9: 8.3 ← 10: 9.9 ↗ Serie 96.1 Total 96.1	11: 10.7x ← 12: 10.5x ↗ 13: 10.9x ← 14: 10.5x ↖ 15: 8.3 ↗ 16: 9.6 ↗ 17: 9.7 ↗ 18: 10.4x ↗ 19: 10.0 ↘ 20: 9.8 ↗ Serie 100.4 Total 196.5
60 Ligg		21: 10.2 ↗ 22: 10.0 ← 23: 9.5 ↗ 24: 9.7 ← 25: 9.8 → 26: 9.1 → 27: 10.2 ↗ 28: 9.0 ↗ 29: 9.2 ↘ 30: 10.4x → Serie 97.1 Total 293.6	31: 8.6 ↗ 32: 10.0 → 33: 9.3 → 34: 9.4 ↗ 35: 7.7 ↗ 36: 9.5 ← 37: 9.6 ↖ 38: 10.1 ↗ 39: 10.3x ↗ 40: 9.3 ← Serie 93.8 Total 387.4
60 Ligg		41: 10.2 ↗ 42: 9.8 ↗ 43: 8.1 → 44: 10.0 ↗ 45: 10.1 → 46: 10.4x → 47: 9.1 ↖ 48: 10.5x ↘ 49: 10.7x ↘ 50: 9.6 ↘ Serie 98.5 Total 485.9	51: 9.2 ← 52: 10.0 ↘ 53: 10.4x → 54: 10.5x ↘ 55: 10.0 ← 56: 9.2 ↘ 57: 10.3 ↗ 58: 10.0 ↗ 59: 9.4 ← 60: 9.5 ↘ Serie 98.5 Total 584.4

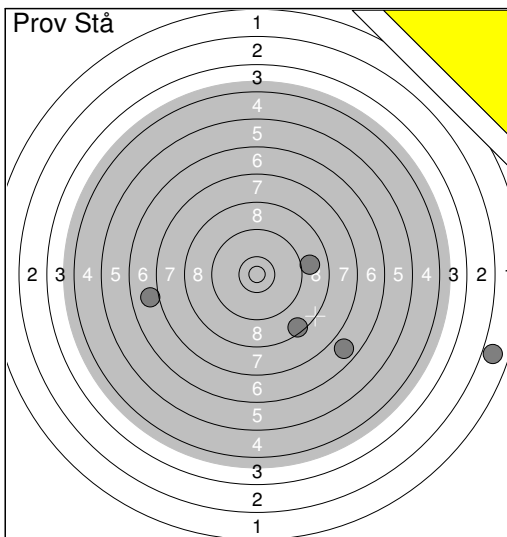

1:	7.0	←
2:	1.9	→
3:	6.8	↘
4:	9.0	→
5:	8.5	↘
Serie		33.2
Total		584.4

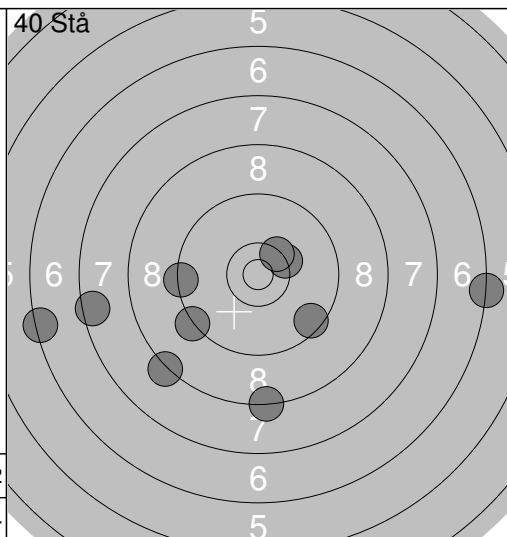

1:	9.4	←
2:	7.5	←
3:	8.2	↘
4:	10.3x	↗
5:	9.3	↘
6:	8.3	↓
7:	10.4x	↗
8:	9.5	↘
9:	6.3	→
10:	6.4	←
Serie		85.6
Total		670.0

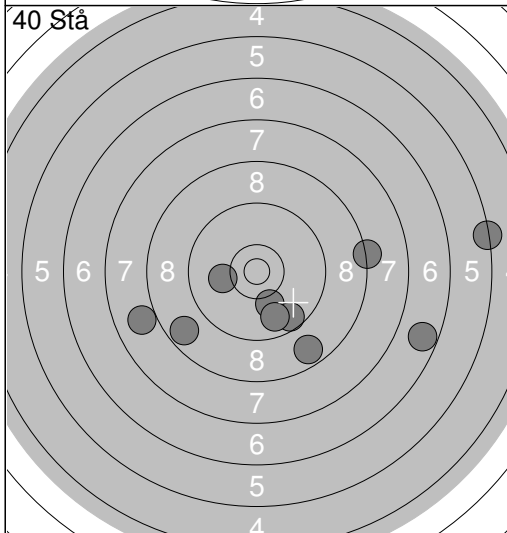

11:	6.7	→
12:	8.7	↘
13:	8.3	→
14:	10.1	↘
15:	8.0	←
16:	10.1	←
17:	5.3	→
18:	8.7	←
19:	9.6	↘
20:	9.8	↘
Serie		85.3
Total		755.3

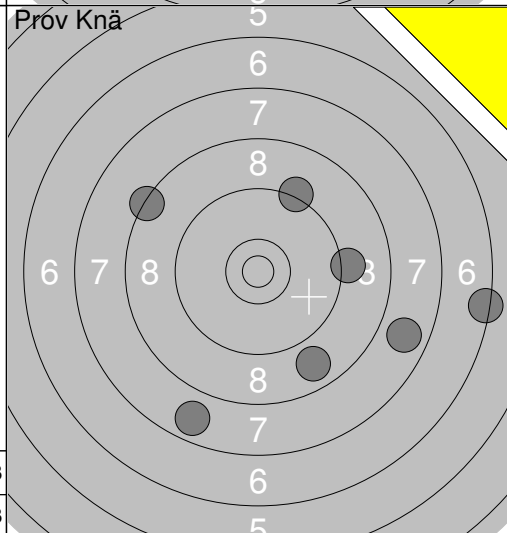

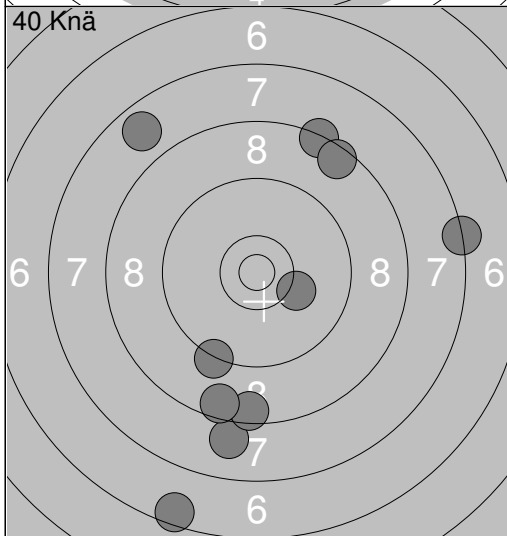

1:	8.8	↘
2:	6.4	→
3:	9.2	→
4:	7.8	→
5:	8.4	↗
6:	7.8	↘
7:	9.2	↗
Serie		57.6
Total		755.3

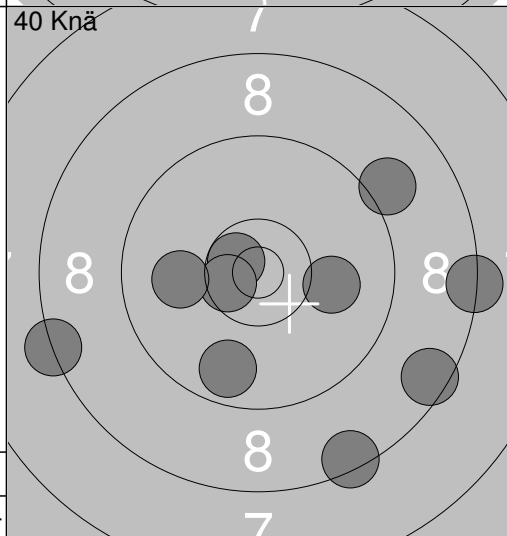

1:	10.2	→
2:	9.3	↘
3:	8.0	↘
4:	8.4	↗
5:	7.8	↗
6:	6.5	↘
7:	8.5	↘
8:	8.6	↘
9:	7.3	→
10:	8.5	↗
Serie		83.1
Total		838.4



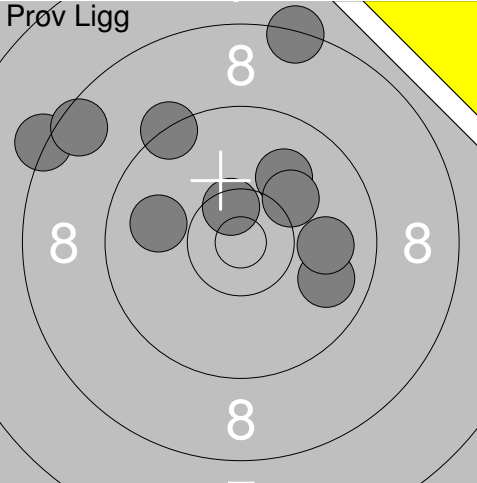

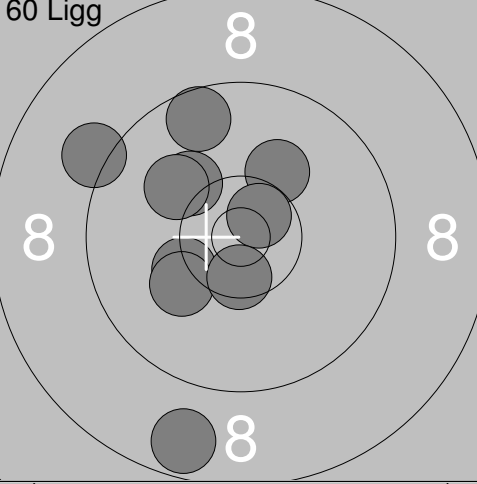
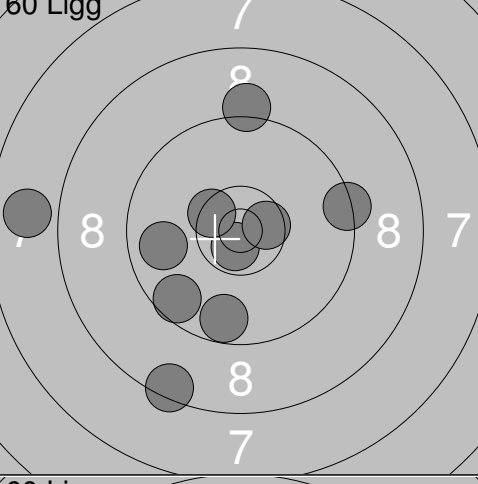
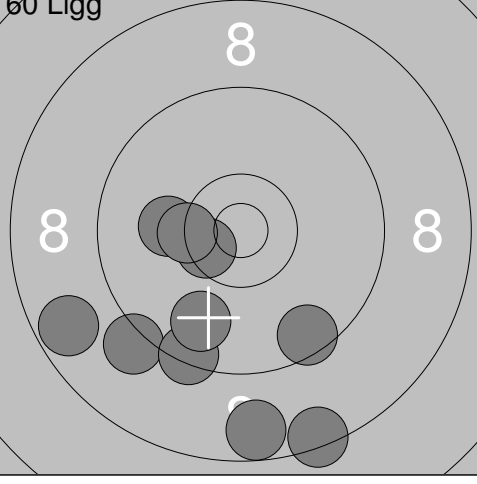
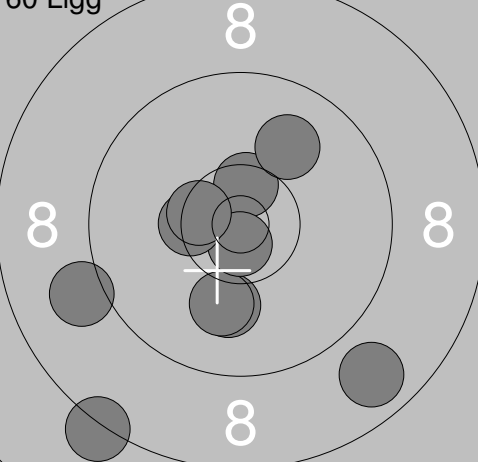
11:	8.4	↘
12:	9.7	↘
13:	8.5	↘
14:	10.6x	↗
15:	10.6x	←
16:	8.3	→
17:	10.0	→
18:	8.3	←
19:	9.1	↗
20:	10.0	←
Serie		93.5
Total		931.9

Skjutlag 1	Tavla 14	Emma Eriksson			
S		Ramselefors Skf			
09.04.2017		Startskottet 2017		Umeå skytteallians	
Prov Ligg		1: 9.1 ↗ 2: 9.6 ↗ 3: 9.7 ↘ 4: 9.6 ← 5: 8.0 ← 6: 10.1 ↗ 7: 9.4 ↗ 8: 8.6 ← 9: 10.8x ↑ 10: 9.0 ↘	Prov Ligg		11: 10.0 ↗ 12: 10.5x ↗ 13: 8.3 ↑ 14: 9.3 ↑ 15: 9.8 ↘ 16: 9.9 → 17: 9.9 ← 18: 10.1 ↗ 19: 8.3 ↗ 20: 8.5 ↗
		Serie 93.9 Total 0.0			Serie 94.6 Total 0.0
Prov Ligg		21: 9.8 ↑ 22: 9.5 ← 23: 7.8 ← 24: 10.3x ↗ 25: 9.2 ↗	60 Ligg		1: 10.2 ↗ 2: 10.2 ↗ 3: 10.1 ↗ 4: 9.6 ↑ 5: 9.2 ↗ 6: 10.7x ↗ 7: 10.2 ← 8: 10.1 ← 9: 10.5x ↓ 10: 8.7 ↓
		Serie 46.6 Total 0.0			Serie 99.5 Total 99.5
60 Ligg		11: 10.7x ↓ 12: 10.5x ↗ 13: 9.4 → 14: 9.8 ← 15: 10.6x → 16: 8.4 ↓ 17: 9.7 ↓ 18: 9.2 ↑ 19: 7.9 ← 20: 9.6 ↘	60 Ligg		21: 8.4 ↓ 22: 10.1 ← 23: 10.5x ← 24: 10.3x ← 25: 9.1 ↘ 26: 8.7 ← 27: 9.4 ↓ 28: 9.8 ↓ 29: 8.7 ↓ 30: 9.5 ↘
		Serie 95.8 Total 195.3			Serie 94.5 Total 289.8
60 Ligg		31: 8.8 ↘ 32: 10.1 ↓ 33: 10.1 ↓ 34: 10.5x ↑ 35: 8.2 ↘ 36: 10.7x ↓ 37: 10.4x ← 38: 10.5x ← 39: 9.1 ← 40: 10.0 ↗			
		Serie 98.4 Total 388.2			

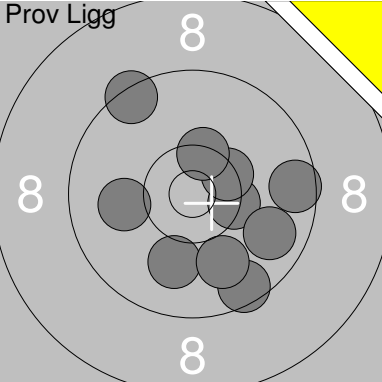
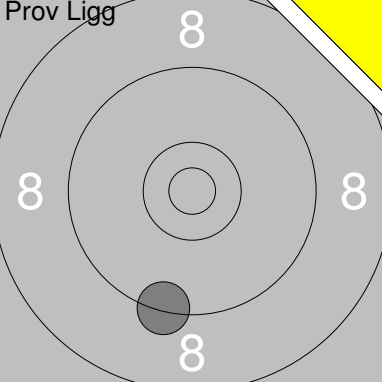
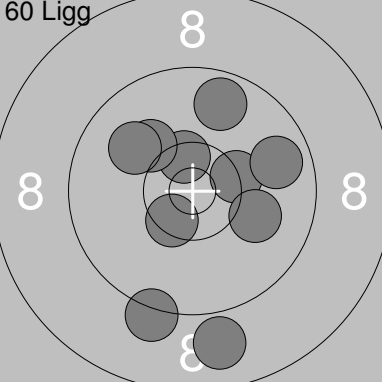
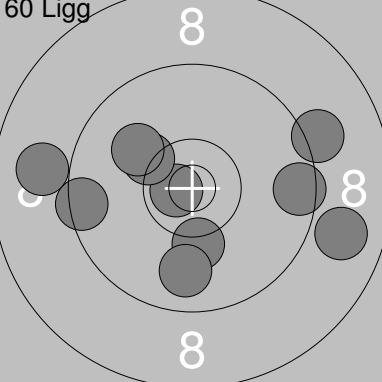
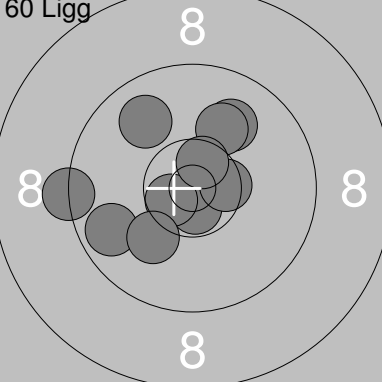
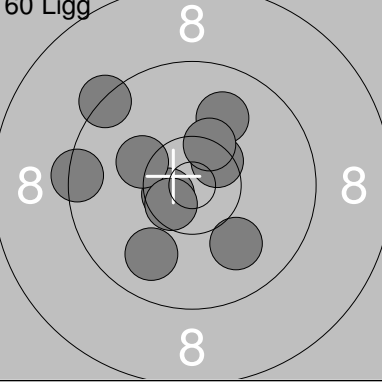
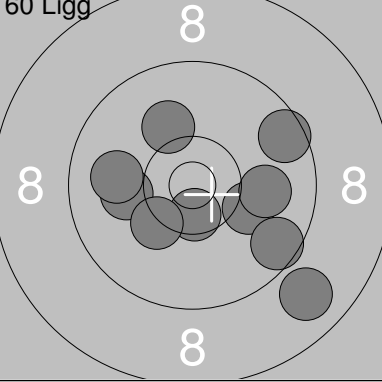
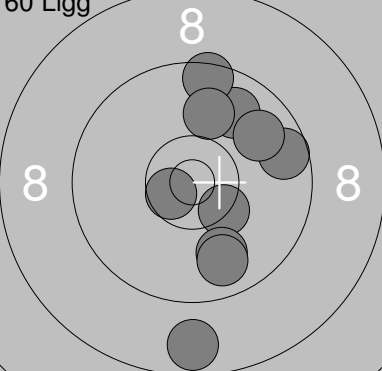

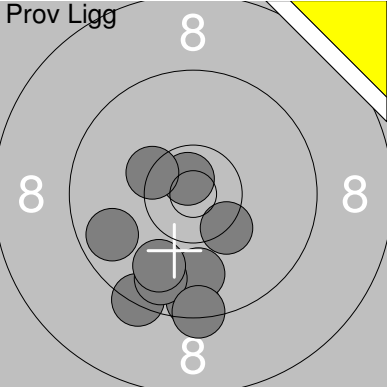
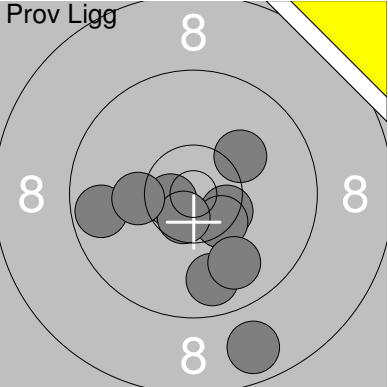
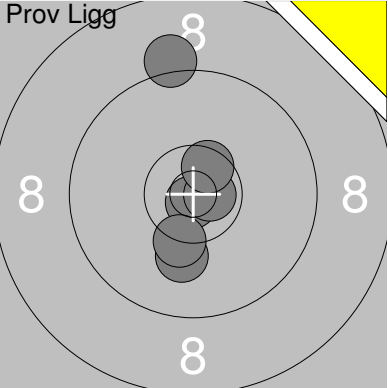
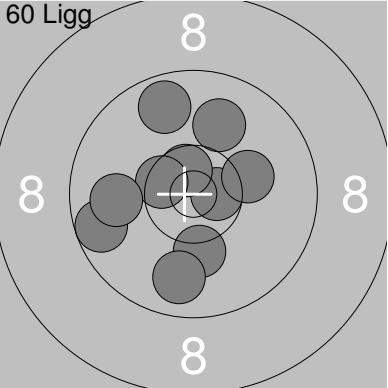
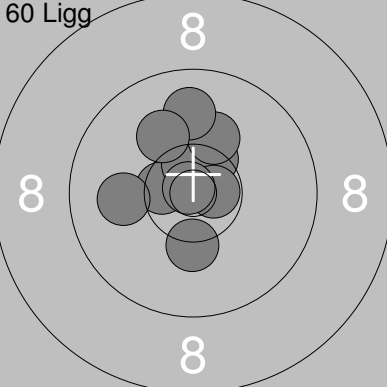
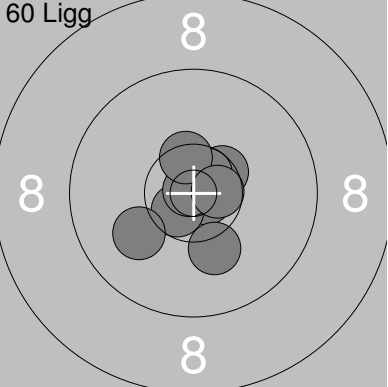
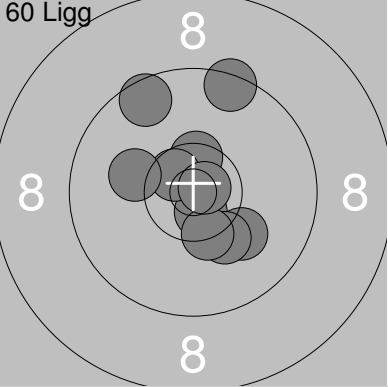
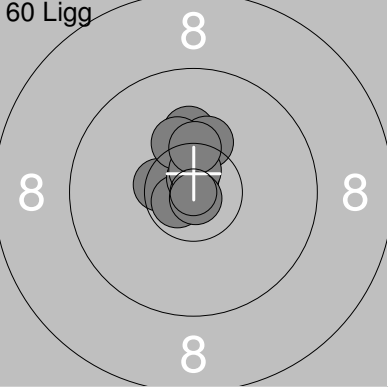
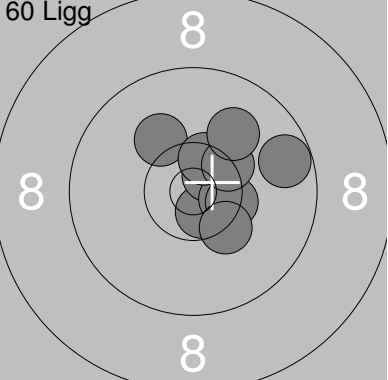
<p>Prov Ligg</p>	<p>1: 5.2 ↗ 2: 7.8 → 3: 10.0 → 4: 9.3 → 5: 10.5x ↘ 6: 10.6x → 7: 10.1 ↗ 8: 10.1 → 9: 10.0 → 10: 10.2 ↗</p> <p>Serie 93.8 Total 0.0</p>	<p>Prov Ligg</p>	<p>11: 9.3 ↑ 12: 9.5 ↗</p> <p>Serie 18.8 Total 0.0</p>
<p>60 Ligg</p>	<p>1: 10.8x ← 2: 8.6 ↑ 3: 10.1 ← 4: 10.1 → 5: 9.8 ↗ 6: 10.3x ↗ 7: 10.3x ← 8: 10.7x ↗ 9: 10.5x ↗ 10: 9.5 ↓</p> <p>Serie 100.7 Total 100.7</p>	<p>60 Ligg</p>	<p>11: 10.3x ↑ 12: 10.2 ↘ 13: 9.8 ← 14: 10.5x ↗ 15: 10.4x ↘ 16: 9.8 → 17: 9.8 ↗ 18: 10.0 → 19: 10.4x → 20: 10.0 ↑</p> <p>Serie 101.2 Total 201.9</p>
<p>60 Ligg</p>	<p>21: 10.2 ↗ 22: 10.2 ← 23: 10.7x ↗ 24: 10.3 ↗ 25: 10.1 ↗ 26: 10.6x ← 27: 10.6x ↓ 28: 10.8x ↑ 29: 10.5x ↘ 30: 9.5 ↗</p> <p>Serie 103.5 Total 305.4</p>	<p>60 Ligg</p>	<p>31: 9.4 → 32: 9.3 → 33: 10.1 ↗ 34: 9.2 ↘ 35: 9.8 ↑ 36: 10.1 ↑ 37: 10.1 ↗ 38: 10.3x ↓ 39: 9.5 ↓ 40: 9.6 ↓</p> <p>Serie 97.4 Total 402.8</p>
<p>60 Ligg</p>	<p>41: 9.8 ↗ 42: 10.2 ↘ 43: 10.3x ← 44: 10.6x ↘ 45: 9.9 ↗ 46: 10.1 ↗ 47: 9.9 ↗ 48: 9.8 ← 49: 10.0 ↓ 50: 10.4x ←</p> <p>Serie 101.0 Total 503.8</p>	<p>60 Ligg</p>	<p>51: 9.6 → 52: 9.6 ↘ 53: 10.2 ↗ 54: 9.6 ↗ 55: 10.3x ↘ 56: 10.0 ↘ 57: 9.2 ← 58: 10.9x ↗ 59: 9.7 ↘ 60: 9.1 ↘</p> <p>Serie 98.2 Total 602.0</p>

Skjutlag	Tavla	Markus-Pekka Dreyer Perkiömäki	
2	5		
S	Umeå Skf		
09.04.2017	Startskottet 2017	Umeå skytteallians	
	1: 9.4 ↙ 2: 7.5 ↓ 3: 8.2 ↓ 4: 8.8 ← 5: 9.8 → 6: 9.5 ↓ 7: 8.6 ← 8: 9.8 ↗ 9: 10.2 ↖ 10: 10.3x →		11: 9.6 ↓ 12: 9.4 ↗ 13: 10.0 ← 14: 10.4x → 15: 10.4x ↗ 16: 10.4x ↑ 17: 9.8 ↘ 18: 10.0 ↓ 19: 10.0 ↓ 20: 9.6 →
	Serie 92.1		Serie 99.6
	Total 0.0		Total 0.0
	21: 9.3 ↓		1: 9.2 ↓ 2: 9.7 ↑ 3: 10.5x ↑ 4: 10.1 ↗ 5: 10.3x → 6: 10.0 ↗ 7: 10.1 → 8: 9.8 → 9: 8.9 ↓ 10: 10.5x ↙
	Serie 9.3		Serie 99.1
	Total 0.0		Total 99.1
	11: 9.1 → 12: 9.5 ← 13: 9.5 → 14: 10.7x ← 15: 8.9 ← 16: 10.2 ↗ 17: 10.1 ↗ 18: 10.2 ↓ 19: 8.9 → 20: 9.9 ↓		21: 9.9 ↗ 22: 9.7 ← 23: 10.7x ↓ 24: 10.5x → 25: 10.6x ← 26: 10.0 ↗ 27: 10.1 ↙ 28: 10.1 ↗ 29: 9.3 ← 30: 10.6x ↑
	Serie 97.0		Serie 101.5
	Total 196.1		Total 297.6
	31: 10.0 ↑ 32: 10.6x ← 33: 10.5x ↗ 34: 10.2 ↖ 35: 9.3 ↗ 36: 10.0 ↓ 37: 9.4 ← 38: 10.6x ↖ 39: 9.9 ↓ 40: 10.4x ↑		41: 10.1 ← 42: 9.9 ← 43: 8.9 ↘ 44: 10.6x ↓ 45: 10.1 → 46: 9.6 ↗ 47: 10.3 ↖ 48: 10.0 → 49: 9.6 ↘ 50: 10.1 ↗
	Serie 100.9		Serie 99.2
	Total 398.5		Total 497.7
	51: 9.6 → 52: 10.4x ↘ 53: 9.9 ↓ 54: 9.8 ↗ 55: 9.5 ↑ 56: 9.8 ↓ 57: 9.8 ↗ 58: 10.0 ↑ 59: 10.6x ← 60: 8.7 ↓		
	Serie 98.1		
	Total 595.8		

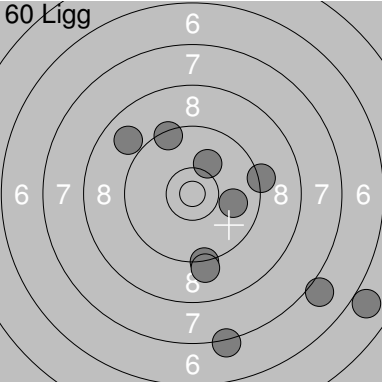
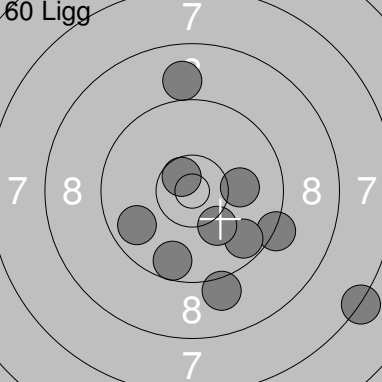
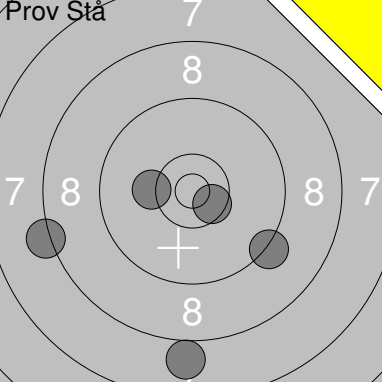
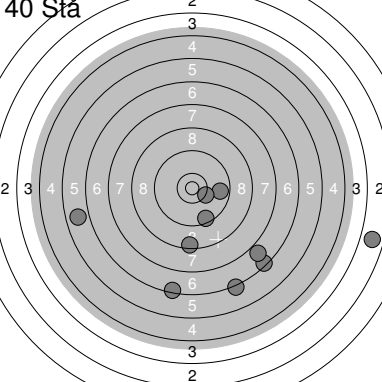
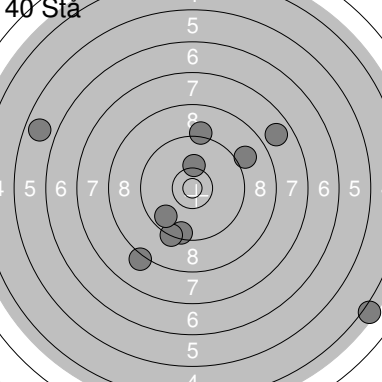
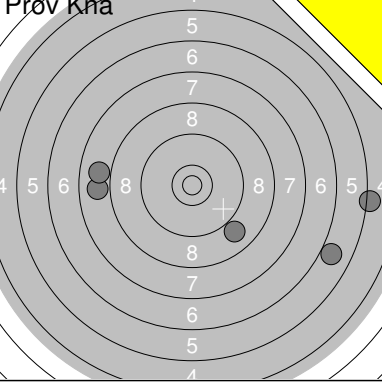
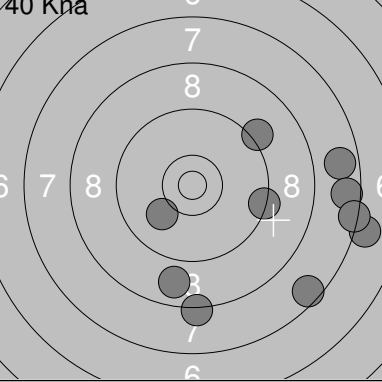
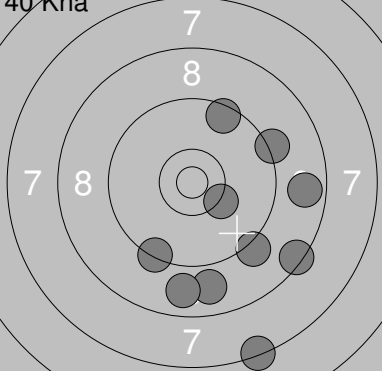
Skjuttag 2	Tavla 6	Mika Tikkanen	
S		Lapin ampujat (Fin)	
09.04.2017		Startskottet 2017	Umeå skytteallians
Prov Ligg 	1: 10.3x 2: 9.4 3: 9.5 4: 9.9 5: 9.7 6: 9.9 7: 10.7x 8: 10.3x 9: 9.7 10: 9.4	Prov Ligg 	11: 9.8 12: 8.8 13: 10.4x 14: 10.4x 15: 10.2 16: 10.6x 17: 10.6x 18: 9.7 19: 10.2 20: 9.9
	Serie 98.8 Total 0.0		Serie 100.6 Total 0.0
Prov Ligg 	21: 9.2 22: 10.1 23: 10.8x 24: 10.3x 25: 10.7x 26: 10.5x	60 Ligg 	1: 10.2 2: 10.6x 3: 9.7 4: 10.6x 5: 9.7 6: 9.8 7: 10.5x 8: 10.0 9: 9.9 10: 10.2
	Serie 61.6 Total 0.0		Serie 101.2 Total 101.2
60 Ligg 	11: 10.5x 12: 10.4x 13: 10.6x 14: 10.2 15: 10.3 16: 9.9 17: 10.1 18: 10.7x 19: 10.0 20: 10.9x	60 Ligg 	21: 10.8x 22: 10.8x 23: 10.5x 24: 10.7x 25: 10.6x 26: 10.9x 27: 10.5x 28: 10.6x 29: 10.2 30: 10.1
	Serie 103.6 Total 204.8		Serie 105.7 Total 310.5
60 Ligg 	31: 10.7x 32: 10.1 33: 9.6 34: 10.5x 35: 10.2 36: 10.6x 37: 10.1 38: 10.4x 39: 10.8x 40: 9.4	60 Ligg 	41: 10.5x 42: 10.2 43: 10.5x 44: 10.3 45: 10.7x 46: 10.8x 47: 10.3 48: 10.7x 49: 10.4x 50: 10.9x
	Serie 102.4 Total 412.9		Serie 105.3 Total 518.2
60 Ligg 	51: 10.7x 52: 10.1 53: 10.7x 54: 10.5x 55: 10.5x 56: 10.4x 57: 10.3x 58: 10.4x 59: 10.0 60: 9.7		
	Serie 103.3 Total 621.5		

Skjutlag	Tavla	Emma Eriksson		
2	14			
S	Ramselefors Skf			
09.04.2017	Startskottet 2017	Umeå skytteallians		
Prov Ligg		1: 8.0 → 2: 9.5 ↗ 3: 9.4 ↘ 4: 7.9 ← 5: 10.4x ↘ 6: 10.2 ↘ 7: 10.1 → 8: 10.7x ↘ 9: 8.6 ↘ 10: 10.2 ↗	60 Ligg 	1: 7.0 ↘ 2: 8.9 ↗ 3: 5.9 ↘ 4: 9.3 ↘ 5: 10.1 ↗ 6: 9.1 ↘ 7: 7.2 ↘ 8: 9.4 ↗ 9: 9.2 → 10: 9.9 →
	Serie 95.0	Total 0.0	Serie 86.0	Total 86.0
60 Ligg		11: 9.6 ↘ 12: 9.3 ↘ 13: 10.1 → 14: 10.6x ↗ 15: 7.3 ↘ 16: 9.7 ↘ 17: 9.0 ↗ 18: 9.1 ↘ 19: 10.2 ↘ 20: 9.8 ←	Prov Stå 	1: 10.2 ← 2: 8.2 ← 3: 9.3 ↘ 4: 10.5x ↘ 5: 8.0 ↓
	Serie 94.7	Total 180.7	Serie 46.2	Total 180.7
40 Stå		1: 8.5 ↘ 2: 5.8 ← 3: 9.7 → 4: 2.8 → 5: 6.4 ↘ 6: 6.9 ↘ 7: 9.5 ↘ 8: 10.3x ↘ 9: 6.4 ↘ 10: 6.2 ↘	40 Stå 	11: 8.2 ↘ 12: 5.8 ← 13: 10.2 ↑ 14: 9.5 ↘ 15: 9.2 ↑ 16: 9.3 ↘ 17: 7.8 ↗ 18: 9.7 ↘ 19: 4.1 ↘ 20: 9.0 ↗
	Serie 72.5	Total 253.2	Serie 82.8	Total 336.0
Prov Knä		1: 7.9 ← 2: 5.9 ↘ 3: 5.2 → 4: 7.9 ← 5: 8.9 ↘	40 Knä 	1: 7.6 ↘ 2: 7.7 → 3: 9.2 ↗ 4: 8.8 ↘ 5: 9.3 → 6: 7.1 → 7: 8.2 ↘ 8: 7.6 → 9: 10.1 ↘ 10: 7.4 →
	Serie 35.8	Total 336.0	Serie 83.0	Total 419.0
40 Knä		11: 9.3 ↘ 12: 7.3 ↘ 13: 8.7 → 14: 9.2 → 15: 8.9 ↘ 16: 10.3 ↘ 17: 9.5 ↗ 18: 9.2 ↘ 19: 8.4 ↘ 20: 8.8 ↘		
	Serie 89.6	Total 508.6		

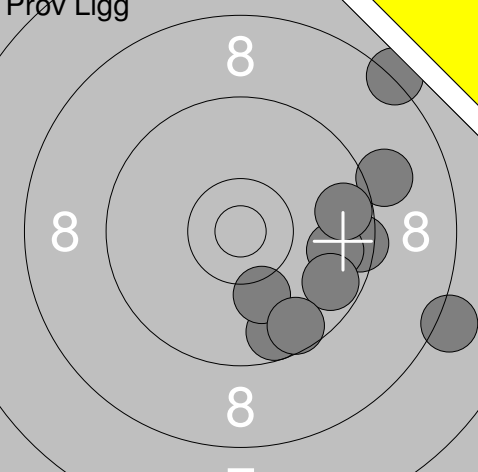
Skjutlag	Tavla	Emma Johansson	
S		Ramselefors Skf	
09.04.2017	Startskottet 2017	Umeå skytteallians	
Prov Ligg 	1: 4.4 ↗ 2: 4.2 ↖ 3: 7.2 ↗ 4: 8.4 ↘ 5: 9.8 ↗ 6: 8.9 ↘ 7: 9.6 ↗ 8: 10.3x ↗ 9: 9.9 ↘ 10: 9.7 ↘ Serie 82.4 Total 0.0	Prov Ligg 	11: 9.1 ↗ Serie 9.1 Total 0.0
60 Ligg 	1: 10.4x ↘ 2: 10.2 ↘ 3: 8.8 ↖ 4: 9.9 ↖ 5: 10.2 ↘ 6: 10.6x ↗ 7: 9.6 ↘ 8: 10.2 ↗ 9: 8.1 ↖ 10: 9.1 ↖ Serie 97.1 Total 97.1	60 Ligg 	11: 9.4 ↘ 12: 9.5 ↘ 13: 9.0 ↗ 14: 10.2 ↗ 15: 8.7 ↗ 16: 8.9 ↗ 17: 10.3 ↗ 18: 8.9 ↘ 19: 9.5 ↘ 20: 9.8 ↖ Serie 94.2 Total 191.3
Prov Stå 	1: 9.5 → 2: 9.5 ↗ 3: 5.4 ↗ 4: 9.1 ↗ Serie 33.5 Total 191.3	40 Stå 	1: 10.0 ↘ 2: 4.4 ↗ 3: 9.9 ↗ 4: 7.9 ↗ 5: 8.1 ↗ 6: 9.8 ↖ 7: 9.7 ↗ 8: 8.5 ↗ 9: 7.0 ↖ 10: 8.3 ↗ Serie 83.6 Total 274.9
40 Stå 	11: 8.3 ↗ 12: 8.3 ↗ 13: 8.9 ↗ 14: 7.6 ↗ 15: 6.8 ↗ 16: 7.6 ↗ 17: 8.2 ↗ 18: 9.2 ↖ 19: 9.3 ↖ 20: 9.2 ↖ Serie 83.4 Total 358.3	Prov Knä 	1: 6.7 ↖ 2: 8.7 ↖ 3: 9.4 ↘ 4: 8.3 ↖ 5: 8.4 ↗ Serie 41.5 Total 358.3
40 Knä 	1: 9.1 ↗ 2: 8.6 ↘ 3: 9.0 ↗ 4: 10.1 ↗ 5: 9.9 ↘ 6: 10.7x ↘ 7: 8.6 ↗ 8: 4.3 ↖ 9: 9.7 ↗ 10: 9.6 ↖ Serie 89.6 Total 447.9	40 Knä 	11: 9.2 ↖ 12: 8.5 ↗ 13: 10.1 ↗ 14: 10.3 ↘ 15: 9.3 ↗ 16: 9.6 ↗ 17: 10.3 ↗ 18: 8.9 ↘ 19: 4.8 ↖ 20: 10.2 ↖ Serie 91.2 Total 539.1

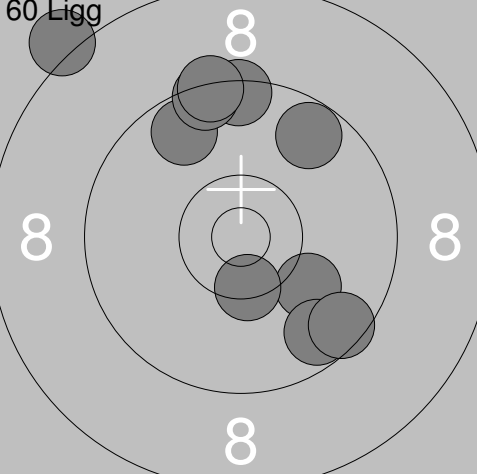
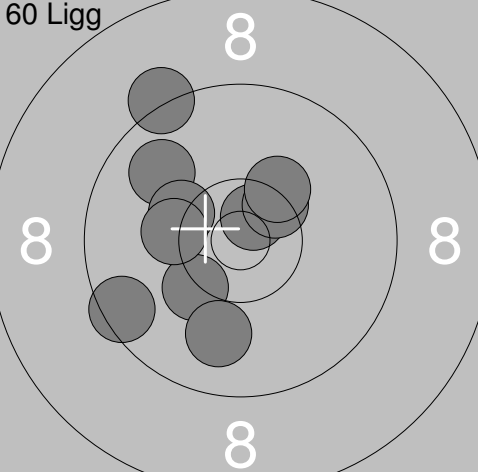
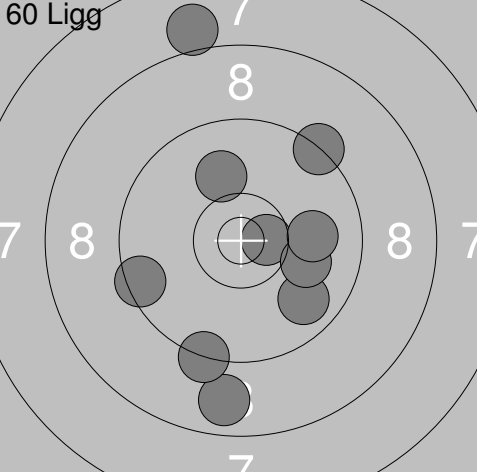
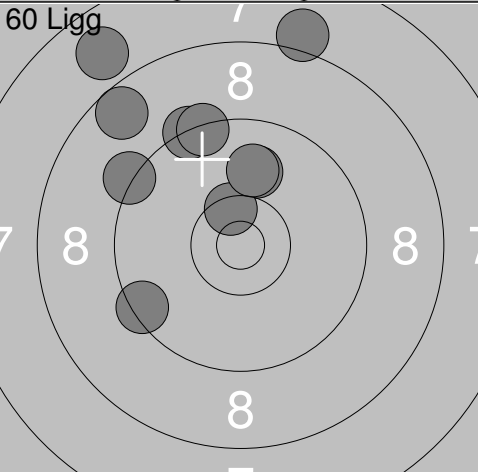
<p>Prov Ligg</p>  <table border="1" style="width:100%; border-collapse: collapse;"> <tr><td>1:</td><td>8.3</td><td>↗</td></tr> <tr><td>2:</td><td>8.2</td><td>→</td></tr> <tr><td>3:</td><td>9.5</td><td>→</td></tr> <tr><td>4:</td><td>9.8</td><td>→</td></tr> <tr><td>5:</td><td>9.1</td><td>→</td></tr> <tr><td>6:</td><td>9.7</td><td>↘</td></tr> <tr><td>7:</td><td>9.6</td><td>↘</td></tr> <tr><td>8:</td><td>10.1</td><td>↘</td></tr> <tr><td>9:</td><td>9.6</td><td>↘</td></tr> <tr><td>10:</td><td>9.7</td><td>→</td></tr> <tr><td colspan="2">Serie</td><td>93.6</td></tr> <tr><td colspan="2">Total</td><td>0.0</td></tr> </table>	1:	8.3	↗	2:	8.2	→	3:	9.5	→	4:	9.8	→	5:	9.1	→	6:	9.7	↘	7:	9.6	↘	8:	10.1	↘	9:	9.6	↘	10:	9.7	→	Serie		93.6	Total		0.0	<p>Prov Ligg</p>  <table border="1" style="width:100%; border-collapse: collapse;"> <tr><td>11:</td><td>9.4</td><td>↘</td></tr> <tr><td>12:</td><td>10.2</td><td>↘</td></tr> <tr><td>13:</td><td>9.6</td><td>↗</td></tr> <tr><td>14:</td><td>10.1</td><td>↘</td></tr> <tr><td>15:</td><td>10.6x</td><td>↗</td></tr> <tr><td>16:</td><td>10.5x</td><td>↘</td></tr> <tr><td>17:</td><td>9.8</td><td>→</td></tr> <tr><td>18:</td><td>10.6x</td><td>↗</td></tr> <tr><td>19:</td><td>10.1</td><td>↑</td></tr> <tr><td>20:</td><td>10.5x</td><td>←</td></tr> <tr><td colspan="2">Serie</td><td>101.4</td></tr> <tr><td colspan="2">Total</td><td>0.0</td></tr> </table>	11:	9.4	↘	12:	10.2	↘	13:	9.6	↗	14:	10.1	↘	15:	10.6x	↗	16:	10.5x	↘	17:	9.8	→	18:	10.6x	↗	19:	10.1	↑	20:	10.5x	←	Serie		101.4	Total		0.0
1:	8.3	↗																																																																							
2:	8.2	→																																																																							
3:	9.5	→																																																																							
4:	9.8	→																																																																							
5:	9.1	→																																																																							
6:	9.7	↘																																																																							
7:	9.6	↘																																																																							
8:	10.1	↘																																																																							
9:	9.6	↘																																																																							
10:	9.7	→																																																																							
Serie		93.6																																																																							
Total		0.0																																																																							
11:	9.4	↘																																																																							
12:	10.2	↘																																																																							
13:	9.6	↗																																																																							
14:	10.1	↘																																																																							
15:	10.6x	↗																																																																							
16:	10.5x	↘																																																																							
17:	9.8	→																																																																							
18:	10.6x	↗																																																																							
19:	10.1	↑																																																																							
20:	10.5x	←																																																																							
Serie		101.4																																																																							
Total		0.0																																																																							
<p>Prov Ligg</p>  <table border="1" style="width:100%; border-collapse: collapse;"> <tr><td>21:</td><td>10.1</td><td>↗</td></tr> <tr><td>22:</td><td>10.5x</td><td>↗</td></tr> <tr><td>23:</td><td>9.2</td><td>→</td></tr> <tr><td>24:</td><td>10.3x</td><td>→</td></tr> <tr><td>25:</td><td>8.7</td><td>↗</td></tr> <tr><td>26:</td><td>8.9</td><td>↘</td></tr> <tr><td colspan="2">Serie</td><td>57.7</td></tr> <tr><td colspan="2">Total</td><td>0.0</td></tr> </table>	21:	10.1	↗	22:	10.5x	↗	23:	9.2	→	24:	10.3x	→	25:	8.7	↗	26:	8.9	↘	Serie		57.7	Total		0.0	<p>60 Ligg</p>  <table border="1" style="width:100%; border-collapse: collapse;"> <tr><td>1:</td><td>9.4</td><td>↑</td></tr> <tr><td>2:</td><td>10.1</td><td>↘</td></tr> <tr><td>3:</td><td>9.7</td><td>↗</td></tr> <tr><td>4:</td><td>10.4x</td><td>↘</td></tr> <tr><td>5:</td><td>9.7</td><td>↘</td></tr> <tr><td>6:</td><td>9.4</td><td>↑</td></tr> <tr><td>7:</td><td>9.5</td><td>↘</td></tr> <tr><td>8:</td><td>9.7</td><td>↗</td></tr> <tr><td>9:</td><td>8.2</td><td>↗</td></tr> <tr><td>10:</td><td>9.4</td><td>↑</td></tr> <tr><td colspan="2">Serie</td><td>95.5</td></tr> <tr><td colspan="2">Total</td><td>95.5</td></tr> </table>	1:	9.4	↑	2:	10.1	↘	3:	9.7	↗	4:	10.4x	↘	5:	9.7	↘	6:	9.4	↑	7:	9.5	↘	8:	9.7	↗	9:	8.2	↗	10:	9.4	↑	Serie		95.5	Total		95.5												
21:	10.1	↗																																																																							
22:	10.5x	↗																																																																							
23:	9.2	→																																																																							
24:	10.3x	→																																																																							
25:	8.7	↗																																																																							
26:	8.9	↘																																																																							
Serie		57.7																																																																							
Total		0.0																																																																							
1:	9.4	↑																																																																							
2:	10.1	↘																																																																							
3:	9.7	↗																																																																							
4:	10.4x	↘																																																																							
5:	9.7	↘																																																																							
6:	9.4	↑																																																																							
7:	9.5	↘																																																																							
8:	9.7	↗																																																																							
9:	8.2	↗																																																																							
10:	9.4	↑																																																																							
Serie		95.5																																																																							
Total		95.5																																																																							
<p>60 Ligg</p>  <table border="1" style="width:100%; border-collapse: collapse;"> <tr><td>11:</td><td>10.7x</td><td>↗</td></tr> <tr><td>12:</td><td>10.4x</td><td>↗</td></tr> <tr><td>13:</td><td>9.9</td><td>↗</td></tr> <tr><td>14:</td><td>9.5</td><td>←</td></tr> <tr><td>15:</td><td>10.3</td><td>↗</td></tr> <tr><td>16:</td><td>10.3</td><td>↘</td></tr> <tr><td>17:</td><td>10.3</td><td>↗</td></tr> <tr><td>18:</td><td>9.9</td><td>↘</td></tr> <tr><td>19:</td><td>10.2</td><td>←</td></tr> <tr><td>20:</td><td>9.3</td><td>↗</td></tr> <tr><td colspan="2">Serie</td><td>100.8</td></tr> <tr><td colspan="2">Total</td><td>196.3</td></tr> </table>	11:	10.7x	↗	12:	10.4x	↗	13:	9.9	↗	14:	9.5	←	15:	10.3	↗	16:	10.3	↘	17:	10.3	↗	18:	9.9	↘	19:	10.2	←	20:	9.3	↗	Serie		100.8	Total		196.3	<p>60 Ligg</p>  <table border="1" style="width:100%; border-collapse: collapse;"> <tr><td>21:</td><td>9.3</td><td>↗</td></tr> <tr><td>22:</td><td>10.0</td><td>↑</td></tr> <tr><td>23:</td><td>10.6x</td><td>→</td></tr> <tr><td>24:</td><td>8.0</td><td>↑</td></tr> <tr><td>25:</td><td>9.8</td><td>↘</td></tr> <tr><td>26:</td><td>10.0</td><td>→</td></tr> <tr><td>27:</td><td>10.0</td><td>→</td></tr> <tr><td>28:</td><td>8.8</td><td>↘</td></tr> <tr><td>29:</td><td>9.5</td><td>←</td></tr> <tr><td>30:</td><td>9.3</td><td>↘</td></tr> <tr><td colspan="2">Serie</td><td>95.3</td></tr> <tr><td colspan="2">Total</td><td>291.6</td></tr> </table>	21:	9.3	↗	22:	10.0	↑	23:	10.6x	→	24:	8.0	↑	25:	9.8	↘	26:	10.0	→	27:	10.0	→	28:	8.8	↘	29:	9.5	←	30:	9.3	↘	Serie		95.3	Total		291.6
11:	10.7x	↗																																																																							
12:	10.4x	↗																																																																							
13:	9.9	↗																																																																							
14:	9.5	←																																																																							
15:	10.3	↗																																																																							
16:	10.3	↘																																																																							
17:	10.3	↗																																																																							
18:	9.9	↘																																																																							
19:	10.2	←																																																																							
20:	9.3	↗																																																																							
Serie		100.8																																																																							
Total		196.3																																																																							
21:	9.3	↗																																																																							
22:	10.0	↑																																																																							
23:	10.6x	→																																																																							
24:	8.0	↑																																																																							
25:	9.8	↘																																																																							
26:	10.0	→																																																																							
27:	10.0	→																																																																							
28:	8.8	↘																																																																							
29:	9.5	←																																																																							
30:	9.3	↘																																																																							
Serie		95.3																																																																							
Total		291.6																																																																							
<p>60 Ligg</p>  <table border="1" style="width:100%; border-collapse: collapse;"> <tr><td>31:</td><td>9.4</td><td>←</td></tr> <tr><td>32:</td><td>10.0</td><td>↑</td></tr> <tr><td>33:</td><td>9.3</td><td>↗</td></tr> <tr><td>34:</td><td>9.3</td><td>↗</td></tr> <tr><td>35:</td><td>7.9</td><td>↗</td></tr> <tr><td>36:</td><td>9.4</td><td>↗</td></tr> <tr><td>37:</td><td>8.6</td><td>↗</td></tr> <tr><td>38:</td><td>8.1</td><td>↑</td></tr> <tr><td>39:</td><td>10.5x</td><td>↑</td></tr> <tr><td>40:</td><td>10.0</td><td>↑</td></tr> <tr><td colspan="2">Serie</td><td>92.5</td></tr> <tr><td colspan="2">Total</td><td>384.1</td></tr> </table>	31:	9.4	←	32:	10.0	↑	33:	9.3	↗	34:	9.3	↗	35:	7.9	↗	36:	9.4	↗	37:	8.6	↗	38:	8.1	↑	39:	10.5x	↑	40:	10.0	↑	Serie		92.5	Total		384.1																																					
31:	9.4	←																																																																							
32:	10.0	↑																																																																							
33:	9.3	↗																																																																							
34:	9.3	↗																																																																							
35:	7.9	↗																																																																							
36:	9.4	↗																																																																							
37:	8.6	↗																																																																							
38:	8.1	↑																																																																							
39:	10.5x	↑																																																																							
40:	10.0	↑																																																																							
Serie		92.5																																																																							
Total		384.1																																																																							

<p>Prov Ligg</p>	<table border="1" style="width:100%; border-collapse: collapse;"> <tr><td>1:</td><td>7.9</td><td>↘</td></tr> <tr><td>2:</td><td>9.8</td><td>→</td></tr> <tr><td>3:</td><td>9.3</td><td>↗</td></tr> <tr><td>4:</td><td>10.1</td><td>↗</td></tr> <tr><td>5:</td><td>10.3x</td><td>↗</td></tr> <tr><td>6:</td><td>8.8</td><td>↘</td></tr> <tr><td>7:</td><td>3.9</td><td>↘</td></tr> <tr><td>8:</td><td>9.5</td><td>↘</td></tr> <tr><td>9:</td><td>9.9</td><td>↗</td></tr> <tr><td>10:</td><td>7.3</td><td>↘</td></tr> <tr><td colspan="2">Serie</td><td>86.8</td></tr> <tr><td colspan="2">Total</td><td>0.0</td></tr> </table>	1:	7.9	↘	2:	9.8	→	3:	9.3	↗	4:	10.1	↗	5:	10.3x	↗	6:	8.8	↘	7:	3.9	↘	8:	9.5	↘	9:	9.9	↗	10:	7.3	↘	Serie		86.8	Total		0.0	<p>Prov Ligg</p>	<table border="1" style="width:100%; border-collapse: collapse;"> <tr><td>11:</td><td>9.9</td><td>←</td></tr> <tr><td>12:</td><td>10.0</td><td>↗</td></tr> <tr><td>13:</td><td>10.1</td><td>↗</td></tr> <tr><td colspan="2">Serie</td><td>30.0</td></tr> <tr><td colspan="2">Total</td><td>0.0</td></tr> </table>	11:	9.9	←	12:	10.0	↗	13:	10.1	↗	Serie		30.0	Total		0.0																					
1:	7.9	↘																																																																									
2:	9.8	→																																																																									
3:	9.3	↗																																																																									
4:	10.1	↗																																																																									
5:	10.3x	↗																																																																									
6:	8.8	↘																																																																									
7:	3.9	↘																																																																									
8:	9.5	↘																																																																									
9:	9.9	↗																																																																									
10:	7.3	↘																																																																									
Serie		86.8																																																																									
Total		0.0																																																																									
11:	9.9	←																																																																									
12:	10.0	↗																																																																									
13:	10.1	↗																																																																									
Serie		30.0																																																																									
Total		0.0																																																																									
<p>60 Ligg</p>	<table border="1" style="width:100%; border-collapse: collapse;"> <tr><td>1:</td><td>9.8</td><td>←</td></tr> <tr><td>2:</td><td>7.8</td><td>↘</td></tr> <tr><td>3:</td><td>8.3</td><td>↘</td></tr> <tr><td>4:</td><td>8.2</td><td>↘</td></tr> <tr><td>5:</td><td>8.6</td><td>↘</td></tr> <tr><td>6:</td><td>10.7x</td><td>↗</td></tr> <tr><td>7:</td><td>8.5</td><td>↗</td></tr> <tr><td>8:</td><td>9.3</td><td>↗</td></tr> <tr><td>9:</td><td>10.5x</td><td>↘</td></tr> <tr><td>10:</td><td>9.8</td><td>←</td></tr> <tr><td colspan="2">Serie</td><td>91.5</td></tr> <tr><td colspan="2">Total</td><td>91.5</td></tr> </table>	1:	9.8	←	2:	7.8	↘	3:	8.3	↘	4:	8.2	↘	5:	8.6	↘	6:	10.7x	↗	7:	8.5	↗	8:	9.3	↗	9:	10.5x	↘	10:	9.8	←	Serie		91.5	Total		91.5	<p>60 Ligg</p>	<table border="1" style="width:100%; border-collapse: collapse;"> <tr><td>11:</td><td>8.7</td><td>↗</td></tr> <tr><td>12:</td><td>10.1</td><td>↘</td></tr> <tr><td>13:</td><td>10.2</td><td>↘</td></tr> <tr><td>14:</td><td>10.2</td><td>↘</td></tr> <tr><td>15:</td><td>10.0</td><td>↘</td></tr> <tr><td>16:</td><td>9.6</td><td>↘</td></tr> <tr><td>17:</td><td>10.4x</td><td>↗</td></tr> <tr><td>18:</td><td>8.5</td><td>↗</td></tr> <tr><td>19:</td><td>8.9</td><td>↗</td></tr> <tr><td>20:</td><td>10.0</td><td>←</td></tr> <tr><td colspan="2">Serie</td><td>96.6</td></tr> <tr><td colspan="2">Total</td><td>188.1</td></tr> </table>	11:	8.7	↗	12:	10.1	↘	13:	10.2	↘	14:	10.2	↘	15:	10.0	↘	16:	9.6	↘	17:	10.4x	↗	18:	8.5	↗	19:	8.9	↗	20:	10.0	←	Serie		96.6	Total		188.1
1:	9.8	←																																																																									
2:	7.8	↘																																																																									
3:	8.3	↘																																																																									
4:	8.2	↘																																																																									
5:	8.6	↘																																																																									
6:	10.7x	↗																																																																									
7:	8.5	↗																																																																									
8:	9.3	↗																																																																									
9:	10.5x	↘																																																																									
10:	9.8	←																																																																									
Serie		91.5																																																																									
Total		91.5																																																																									
11:	8.7	↗																																																																									
12:	10.1	↘																																																																									
13:	10.2	↘																																																																									
14:	10.2	↘																																																																									
15:	10.0	↘																																																																									
16:	9.6	↘																																																																									
17:	10.4x	↗																																																																									
18:	8.5	↗																																																																									
19:	8.9	↗																																																																									
20:	10.0	←																																																																									
Serie		96.6																																																																									
Total		188.1																																																																									
<p>60 Ligg</p>	<table border="1" style="width:100%; border-collapse: collapse;"> <tr><td>21:</td><td>10.4x</td><td>↘</td></tr> <tr><td>22:</td><td>10.0</td><td>←</td></tr> <tr><td>23:</td><td>10.8x</td><td>→</td></tr> <tr><td>24:</td><td>9.8</td><td>↗</td></tr> <tr><td>25:</td><td>9.6</td><td>↘</td></tr> <tr><td>26:</td><td>9.4</td><td>←</td></tr> <tr><td>27:</td><td>9.5</td><td>↘</td></tr> <tr><td>28:</td><td>9.3</td><td>↘</td></tr> <tr><td>29:</td><td>9.1</td><td>↘</td></tr> <tr><td>30:</td><td>9.3</td><td>←</td></tr> <tr><td colspan="2">Serie</td><td>97.2</td></tr> <tr><td colspan="2">Total</td><td>285.3</td></tr> </table>	21:	10.4x	↘	22:	10.0	←	23:	10.8x	→	24:	9.8	↗	25:	9.6	↘	26:	9.4	←	27:	9.5	↘	28:	9.3	↘	29:	9.1	↘	30:	9.3	←	Serie		97.2	Total		285.3	<p>60 Ligg</p>	<table border="1" style="width:100%; border-collapse: collapse;"> <tr><td>31:</td><td>8.8</td><td>↘</td></tr> <tr><td>32:</td><td>9.7</td><td>↗</td></tr> <tr><td>33:</td><td>7.8</td><td>↘</td></tr> <tr><td>34:</td><td>7.2</td><td>↘</td></tr> <tr><td>35:</td><td>8.8</td><td>↘</td></tr> <tr><td>36:</td><td>8.0</td><td>↘</td></tr> <tr><td>37:</td><td>8.9</td><td>↗</td></tr> <tr><td>38:</td><td>9.9</td><td>↘</td></tr> <tr><td>39:</td><td>7.4</td><td>↗</td></tr> <tr><td>40:</td><td>9.6</td><td>↘</td></tr> <tr><td colspan="2">Serie</td><td>86.1</td></tr> <tr><td colspan="2">Total</td><td>371.4</td></tr> </table>	31:	8.8	↘	32:	9.7	↗	33:	7.8	↘	34:	7.2	↘	35:	8.8	↘	36:	8.0	↘	37:	8.9	↗	38:	9.9	↘	39:	7.4	↗	40:	9.6	↘	Serie		86.1	Total		371.4
21:	10.4x	↘																																																																									
22:	10.0	←																																																																									
23:	10.8x	→																																																																									
24:	9.8	↗																																																																									
25:	9.6	↘																																																																									
26:	9.4	←																																																																									
27:	9.5	↘																																																																									
28:	9.3	↘																																																																									
29:	9.1	↘																																																																									
30:	9.3	←																																																																									
Serie		97.2																																																																									
Total		285.3																																																																									
31:	8.8	↘																																																																									
32:	9.7	↗																																																																									
33:	7.8	↘																																																																									
34:	7.2	↘																																																																									
35:	8.8	↘																																																																									
36:	8.0	↘																																																																									
37:	8.9	↗																																																																									
38:	9.9	↘																																																																									
39:	7.4	↗																																																																									
40:	9.6	↘																																																																									
Serie		86.1																																																																									
Total		371.4																																																																									
<p>60 Ligg</p>	<table border="1" style="width:100%; border-collapse: collapse;"> <tr><td>41:</td><td>9.6</td><td>↗</td></tr> <tr><td>42:</td><td>9.2</td><td>↗</td></tr> <tr><td>43:</td><td>8.2</td><td>↗</td></tr> <tr><td>44:</td><td>10.2</td><td>↘</td></tr> <tr><td>45:</td><td>9.5</td><td>↗</td></tr> <tr><td>46:</td><td>9.5</td><td>↗</td></tr> <tr><td>47:</td><td>9.7</td><td>←</td></tr> <tr><td>48:</td><td>10.8x</td><td>←</td></tr> <tr><td>49:</td><td>8.9</td><td>←</td></tr> <tr><td>50:</td><td>8.9</td><td>←</td></tr> <tr><td colspan="2">Serie</td><td>94.5</td></tr> <tr><td colspan="2">Total</td><td>465.9</td></tr> </table>	41:	9.6	↗	42:	9.2	↗	43:	8.2	↗	44:	10.2	↘	45:	9.5	↗	46:	9.5	↗	47:	9.7	←	48:	10.8x	←	49:	8.9	←	50:	8.9	←	Serie		94.5	Total		465.9	<p>60 Ligg</p>	<table border="1" style="width:100%; border-collapse: collapse;"> <tr><td>51:</td><td>10.6x</td><td>↗</td></tr> <tr><td>52:</td><td>9.4</td><td>←</td></tr> <tr><td>53:</td><td>9.0</td><td>↘</td></tr> <tr><td>54:</td><td>10.4x</td><td>↘</td></tr> <tr><td>55:</td><td>10.1</td><td>↘</td></tr> <tr><td>56:</td><td>8.7</td><td>←</td></tr> <tr><td>57:</td><td>9.7</td><td>↗</td></tr> <tr><td>58:</td><td>9.5</td><td>←</td></tr> <tr><td>59:</td><td>9.0</td><td>↗</td></tr> <tr><td>60:</td><td>8.6</td><td>←</td></tr> <tr><td colspan="2">Serie</td><td>95.0</td></tr> <tr><td colspan="2">Total</td><td>560.9</td></tr> </table>	51:	10.6x	↗	52:	9.4	←	53:	9.0	↘	54:	10.4x	↘	55:	10.1	↘	56:	8.7	←	57:	9.7	↗	58:	9.5	←	59:	9.0	↗	60:	8.6	←	Serie		95.0	Total		560.9
41:	9.6	↗																																																																									
42:	9.2	↗																																																																									
43:	8.2	↗																																																																									
44:	10.2	↘																																																																									
45:	9.5	↗																																																																									
46:	9.5	↗																																																																									
47:	9.7	←																																																																									
48:	10.8x	←																																																																									
49:	8.9	←																																																																									
50:	8.9	←																																																																									
Serie		94.5																																																																									
Total		465.9																																																																									
51:	10.6x	↗																																																																									
52:	9.4	←																																																																									
53:	9.0	↘																																																																									
54:	10.4x	↘																																																																									
55:	10.1	↘																																																																									
56:	8.7	←																																																																									
57:	9.7	↗																																																																									
58:	9.5	←																																																																									
59:	9.0	↗																																																																									
60:	8.6	←																																																																									
Serie		95.0																																																																									
Total		560.9																																																																									

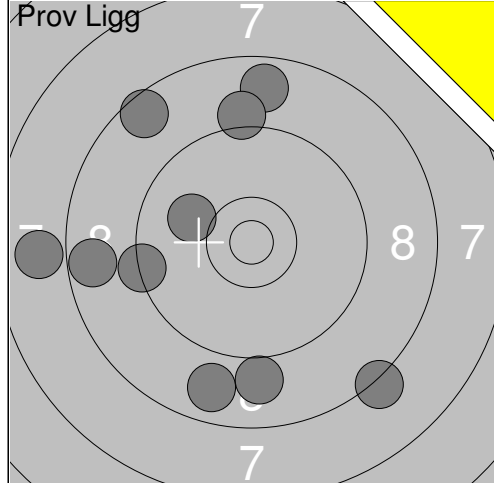

1:	8.7	↑
2:	9.0	↓
3:	10.0	↗
4:	8.8	↓
5:	8.7	←
6:	8.6	↗
7:	7.9	←
8:	9.1	↑
9:	9.3	←
10:	8.2	↘

Serie	88.3
Total	0.0

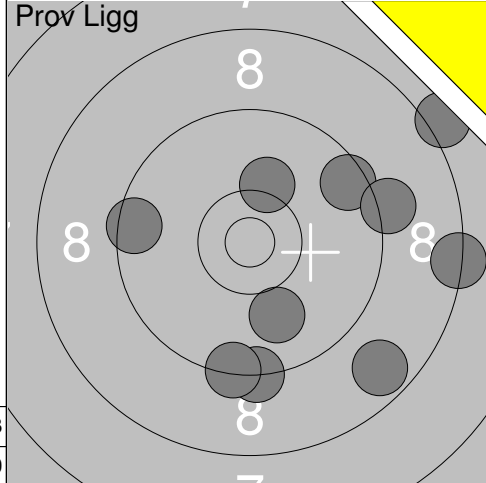

11:	9.3	↓
12:	9.5	↗
13:	9.2	↗
14:	9.5	←
15:	8.3	→
16:	8.1	↗
17:	9.4	↓
18:	10.0	↓
19:	10.2	↑
20:	8.7	↘

Serie	92.2
Total	0.0

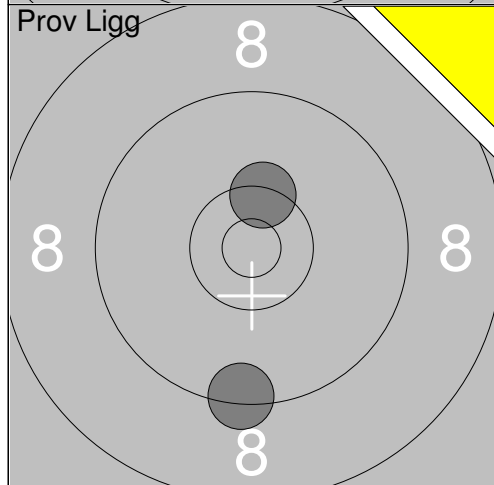

22:	9.4	↓
23:	10.4x	↑

Serie	19.8
Total	0.0

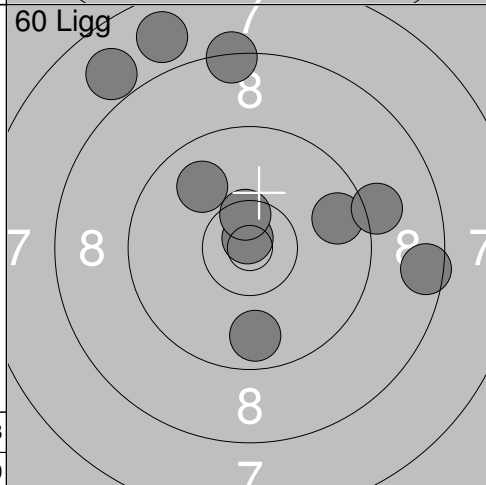

1:	7.8	↑
2:	8.5	→
3:	10.8x	↑
4:	8.4	↑
5:	7.9	↗
6:	9.9	↗
7:	9.7	→
8:	9.8	↓
9:	9.1	→
10:	10.5x	↑

Serie	92.4
Total	92.4

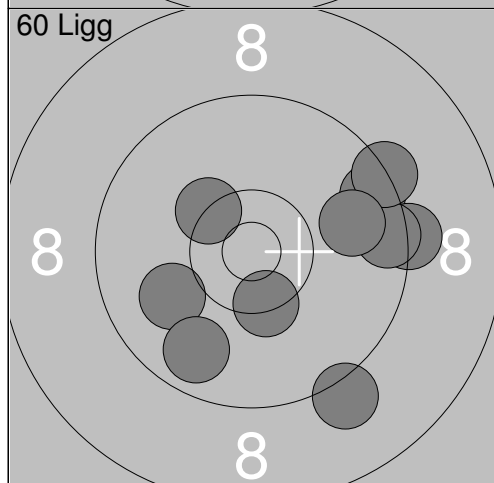

11:	10.4x	↓
12:	9.5	↗
13:	9.3	→
14:	9.1	↘
15:	9.5	→
16:	9.3	↗
17:	10.0	←
18:	9.8	↓
19:	9.8	→
20:	10.3x	↗

Serie	97.0
Total	189.4

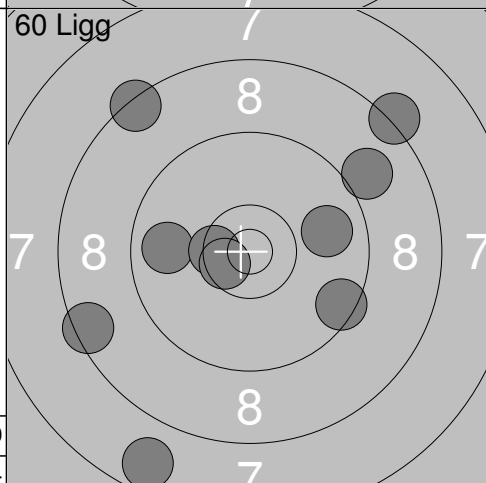

21:	9.8	←
22:	9.5	↘
23:	10.5x	←
24:	9.0	↗
25:	9.9	→
26:	10.6x	←
27:	7.7	↓
28:	8.4	↖
29:	8.2	↗
30:	8.5	←

Serie	92.1
Total	281.5

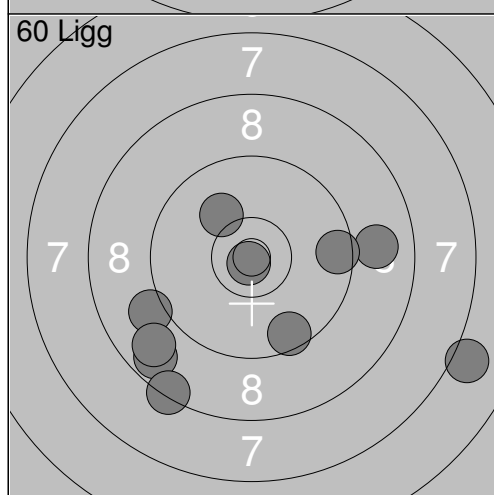

31:	8.7	↘
32:	9.1	←
33:	8.8	↘
34:	8.4	↘
35:	10.1	↗
36:	10.8x	↘
37:	9.6	↘
38:	8.9	→
39:	9.5	→
40:	7.1	↘

Serie	91.0
Total	372.5

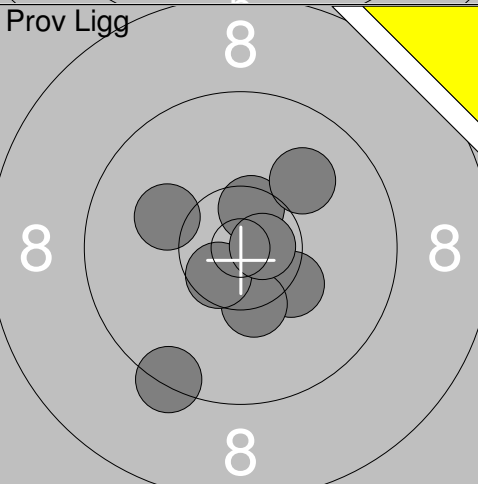
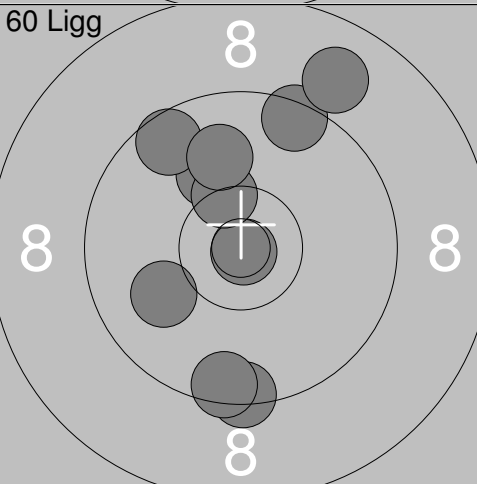
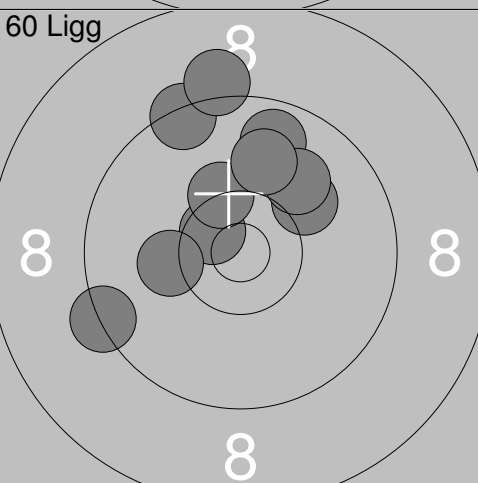
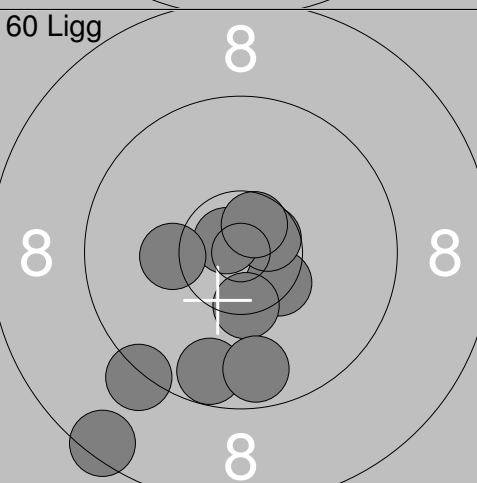
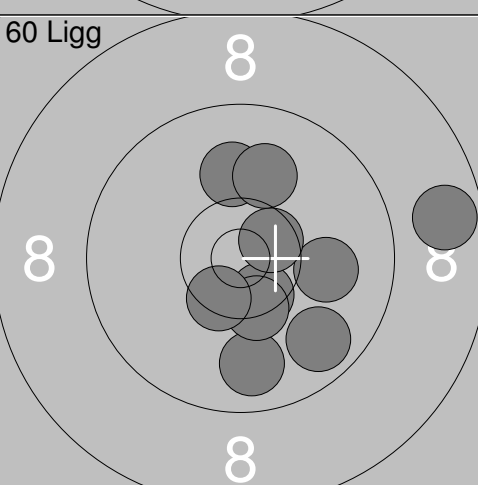
Skjutlag	Tavla	Anton Lind	
3	6		
S	Skoga-Ekshärad Skf		
09.04.2017	Startskottet 2017	Umeå skytteallians	
Prov Ligg		1: 7.2 → 2: 9.6 ← 3: 9.2 ↑ 4: 9.8 ↑ 5: 9.8 ↑ 6: 10.5x ↓ 7: 9.8 → 8: 9.6 → 9: 10.8x ↖ 10: 10.7x ↓ Serie 97.0 Total 0.0	11: 9.9 ↓ 12: 10.2 ↓ 13: 9.6 ← 14: 10.4x ↓ 15: 10.2 ↓ 16: 10.2 ← 17: 10.3x ↖ 18: 9.1 ↓ 19: 9.7 ↓ 20: 9.9 ← Serie 99.5 Total 0.0
Prov Ligg		21: 10.1 ↖ 22: 10.5x ↑ 23: 10.3x ↘ 24: 10.3x ↓ 25: 9.4 ↓ 26: 10.0 ↗ 27: 10.6x ↘ 28: 10.7x → Serie 81.9 Total 0.0	60 Ligg 
60 Ligg		11: 10.6x ↖ 12: 9.7 ↑ 13: 9.4 ↑ 14: 9.1 ↑ 15: 10.3x ↑ 16: 10.1 ↗ 17: 10.0 ↗ 18: 10.0 ↑ 19: 10.2 ← 20: 9.3 ↙ Serie 98.7 Total 197.0	60 Ligg 
60 Ligg		21: 8.5 ↙ 22: 10.4x ↘ 23: 9.2 ↙ 24: 10.6x → 25: 10.8x ↖ 26: 10.4x ↓ 27: 10.2 ← 28: 9.7 ↓ 29: 9.7 ↓ 30: 10.6x ↗ Serie 100.1 Total 297.1	31: 10.5x ↓ 32: 10.0 → 33: 10.0 ↑ 34: 8.7 → 35: 10.6x ↗ 36: 9.8 ↓ 37: 9.7 ↓ 38: 10.0 ↑ 39: 10.4x ↓ 40: 10.5x ↙ Serie 100.2 Total 397.3

<p>Prov Ligg</p>	<table border="1" style="width:100%; border-collapse: collapse;"> <tr><td>1:</td><td>7.8</td><td>↓</td></tr> <tr><td>2:</td><td>8.7</td><td>↓</td></tr> <tr><td>3:</td><td>9.4</td><td>→</td></tr> <tr><td>4:</td><td>9.1</td><td>↓</td></tr> <tr><td>5:</td><td>9.3</td><td>↓</td></tr> <tr><td>6:</td><td>10.2</td><td>↓</td></tr> <tr><td>7:</td><td>9.8</td><td>↓</td></tr> <tr><td>8:</td><td>8.2</td><td>↓</td></tr> <tr><td>9:</td><td>9.3</td><td>→</td></tr> <tr><td>10:</td><td>10.1</td><td>↓</td></tr> <tr><td colspan="2">Serie</td><td>91.9</td></tr> <tr><td colspan="2">Total</td><td>0.0</td></tr> </table>	1:	7.8	↓	2:	8.7	↓	3:	9.4	→	4:	9.1	↓	5:	9.3	↓	6:	10.2	↓	7:	9.8	↓	8:	8.2	↓	9:	9.3	→	10:	10.1	↓	Serie		91.9	Total		0.0	<p>Prov Ligg</p>	<table border="1" style="width:100%; border-collapse: collapse;"> <tr><td>11:</td><td>10.3x</td><td>↓</td></tr> <tr><td>12:</td><td>10.6x</td><td>↑</td></tr> <tr><td>13:</td><td>8.1</td><td>↓</td></tr> <tr><td>14:</td><td>9.5</td><td>↓</td></tr> <tr><td>15:</td><td>8.6</td><td>↓</td></tr> <tr><td>16:</td><td>7.8</td><td>↓</td></tr> <tr><td>17:</td><td>9.0</td><td>↗</td></tr> <tr><td>18:</td><td>9.1</td><td>↓</td></tr> <tr><td>19:</td><td>9.2</td><td>→</td></tr> <tr><td>20:</td><td>9.8</td><td>↗</td></tr> <tr><td colspan="2">Serie</td><td>92.0</td></tr> <tr><td colspan="2">Total</td><td>0.0</td></tr> </table>	11:	10.3x	↓	12:	10.6x	↑	13:	8.1	↓	14:	9.5	↓	15:	8.6	↓	16:	7.8	↓	17:	9.0	↗	18:	9.1	↓	19:	9.2	→	20:	9.8	↗	Serie		92.0	Total		0.0
1:	7.8	↓																																																																									
2:	8.7	↓																																																																									
3:	9.4	→																																																																									
4:	9.1	↓																																																																									
5:	9.3	↓																																																																									
6:	10.2	↓																																																																									
7:	9.8	↓																																																																									
8:	8.2	↓																																																																									
9:	9.3	→																																																																									
10:	10.1	↓																																																																									
Serie		91.9																																																																									
Total		0.0																																																																									
11:	10.3x	↓																																																																									
12:	10.6x	↑																																																																									
13:	8.1	↓																																																																									
14:	9.5	↓																																																																									
15:	8.6	↓																																																																									
16:	7.8	↓																																																																									
17:	9.0	↗																																																																									
18:	9.1	↓																																																																									
19:	9.2	→																																																																									
20:	9.8	↗																																																																									
Serie		92.0																																																																									
Total		0.0																																																																									
<p>Prov Ligg</p>	<table border="1" style="width:100%; border-collapse: collapse;"> <tr><td>21:</td><td>9.1</td><td>↓</td></tr> <tr><td>22:</td><td>8.0</td><td>→</td></tr> <tr><td>23:</td><td>9.3</td><td>→</td></tr> <tr><td>24:</td><td>10.6x</td><td>↑</td></tr> <tr><td>25:</td><td>10.2</td><td>↓</td></tr> <tr><td>26:</td><td>9.1</td><td>↓</td></tr> <tr><td>27:</td><td>9.5</td><td>→</td></tr> <tr><td>28:</td><td>8.1</td><td>↓</td></tr> <tr><td>29:</td><td>8.8</td><td>←</td></tr> <tr><td>30:</td><td>7.6</td><td>↑</td></tr> <tr><td colspan="2">Serie</td><td>90.3</td></tr> <tr><td colspan="2">Total</td><td>0.0</td></tr> </table>	21:	9.1	↓	22:	8.0	→	23:	9.3	→	24:	10.6x	↑	25:	10.2	↓	26:	9.1	↓	27:	9.5	→	28:	8.1	↓	29:	8.8	←	30:	7.6	↑	Serie		90.3	Total		0.0	<p>60 Ligg</p>	<table border="1" style="width:100%; border-collapse: collapse;"> <tr><td>1:</td><td>8.4</td><td>↓</td></tr> <tr><td>2:</td><td>10.1</td><td>↓</td></tr> <tr><td>3:</td><td>8.9</td><td>↓</td></tr> <tr><td>4:</td><td>8.6</td><td>↓</td></tr> <tr><td>5:</td><td>9.9</td><td>←</td></tr> <tr><td>6:</td><td>9.0</td><td>↓</td></tr> <tr><td>7:</td><td>8.0</td><td>↑</td></tr> <tr><td>8:</td><td>7.3</td><td>↑</td></tr> <tr><td>9:</td><td>9.5</td><td>↑</td></tr> <tr><td>10:</td><td>10.6x</td><td>↗</td></tr> <tr><td colspan="2">Serie</td><td>90.3</td></tr> <tr><td colspan="2">Total</td><td>90.3</td></tr> </table>	1:	8.4	↓	2:	10.1	↓	3:	8.9	↓	4:	8.6	↓	5:	9.9	←	6:	9.0	↓	7:	8.0	↑	8:	7.3	↑	9:	9.5	↑	10:	10.6x	↗	Serie		90.3	Total		90.3
21:	9.1	↓																																																																									
22:	8.0	→																																																																									
23:	9.3	→																																																																									
24:	10.6x	↑																																																																									
25:	10.2	↓																																																																									
26:	9.1	↓																																																																									
27:	9.5	→																																																																									
28:	8.1	↓																																																																									
29:	8.8	←																																																																									
30:	7.6	↑																																																																									
Serie		90.3																																																																									
Total		0.0																																																																									
1:	8.4	↓																																																																									
2:	10.1	↓																																																																									
3:	8.9	↓																																																																									
4:	8.6	↓																																																																									
5:	9.9	←																																																																									
6:	9.0	↓																																																																									
7:	8.0	↑																																																																									
8:	7.3	↑																																																																									
9:	9.5	↑																																																																									
10:	10.6x	↗																																																																									
Serie		90.3																																																																									
Total		90.3																																																																									
<p>60 Ligg</p>	<table border="1" style="width:100%; border-collapse: collapse;"> <tr><td>11:</td><td>6.8</td><td>↖</td></tr> <tr><td>12:</td><td>10.4x</td><td>←</td></tr> <tr><td>13:</td><td>8.0</td><td>↑</td></tr> <tr><td>14:</td><td>7.2</td><td>↑</td></tr> <tr><td>15:</td><td>9.8</td><td>↗</td></tr> <tr><td>16:</td><td>9.6</td><td>↑</td></tr> <tr><td>17:</td><td>9.3</td><td>↑</td></tr> <tr><td>18:</td><td>8.7</td><td>↑</td></tr> <tr><td>19:</td><td>10.6x</td><td>←</td></tr> <tr><td>20:</td><td>10.4x</td><td>↓</td></tr> <tr><td colspan="2">Serie</td><td>90.8</td></tr> <tr><td colspan="2">Total</td><td>181.1</td></tr> </table>	11:	6.8	↖	12:	10.4x	←	13:	8.0	↑	14:	7.2	↑	15:	9.8	↗	16:	9.6	↑	17:	9.3	↑	18:	8.7	↑	19:	10.6x	←	20:	10.4x	↓	Serie		90.8	Total		181.1	<p>60 Ligg</p>	<table border="1" style="width:100%; border-collapse: collapse;"> <tr><td>21:</td><td>10.6x</td><td>↗</td></tr> <tr><td>22:</td><td>9.7</td><td>←</td></tr> <tr><td>23:</td><td>10.2</td><td>↓</td></tr> <tr><td>24:</td><td>9.9</td><td>←</td></tr> <tr><td>25:</td><td>8.1</td><td>←</td></tr> <tr><td>26:</td><td>8.2</td><td>↓</td></tr> <tr><td>27:</td><td>9.3</td><td>←</td></tr> <tr><td>28:</td><td>9.5</td><td>↖</td></tr> <tr><td>29:</td><td>10.3x</td><td>↗</td></tr> <tr><td>30:</td><td>10.1</td><td>→</td></tr> <tr><td colspan="2">Serie</td><td>95.9</td></tr> <tr><td colspan="2">Total</td><td>277.0</td></tr> </table>	21:	10.6x	↗	22:	9.7	←	23:	10.2	↓	24:	9.9	←	25:	8.1	←	26:	8.2	↓	27:	9.3	←	28:	9.5	↖	29:	10.3x	↗	30:	10.1	→	Serie		95.9	Total		277.0
11:	6.8	↖																																																																									
12:	10.4x	←																																																																									
13:	8.0	↑																																																																									
14:	7.2	↑																																																																									
15:	9.8	↗																																																																									
16:	9.6	↑																																																																									
17:	9.3	↑																																																																									
18:	8.7	↑																																																																									
19:	10.6x	←																																																																									
20:	10.4x	↓																																																																									
Serie		90.8																																																																									
Total		181.1																																																																									
21:	10.6x	↗																																																																									
22:	9.7	←																																																																									
23:	10.2	↓																																																																									
24:	9.9	←																																																																									
25:	8.1	←																																																																									
26:	8.2	↓																																																																									
27:	9.3	←																																																																									
28:	9.5	↖																																																																									
29:	10.3x	↗																																																																									
30:	10.1	→																																																																									
Serie		95.9																																																																									
Total		277.0																																																																									
<p>60 Ligg</p>	<table border="1" style="width:100%; border-collapse: collapse;"> <tr><td>31:</td><td>8.7</td><td>→</td></tr> <tr><td>32:</td><td>10.6x</td><td>↑</td></tr> <tr><td>33:</td><td>9.5</td><td>↑</td></tr> <tr><td>34:</td><td>9.0</td><td>→</td></tr> <tr><td>35:</td><td>9.6</td><td>↑</td></tr> <tr><td>36:</td><td>10.3</td><td>↑</td></tr> <tr><td>37:</td><td>9.7</td><td>↓</td></tr> <tr><td>38:</td><td>9.8</td><td>↓</td></tr> <tr><td>39:</td><td>9.4</td><td>↗</td></tr> <tr><td>40:</td><td>9.4</td><td>←</td></tr> <tr><td colspan="2">Serie</td><td>96.0</td></tr> <tr><td colspan="2">Total</td><td>373.0</td></tr> </table>	31:	8.7	→	32:	10.6x	↑	33:	9.5	↑	34:	9.0	→	35:	9.6	↑	36:	10.3	↑	37:	9.7	↓	38:	9.8	↓	39:	9.4	↗	40:	9.4	←	Serie		96.0	Total		373.0																																						
31:	8.7	→																																																																									
32:	10.6x	↑																																																																									
33:	9.5	↑																																																																									
34:	9.0	→																																																																									
35:	9.6	↑																																																																									
36:	10.3	↑																																																																									
37:	9.7	↓																																																																									
38:	9.8	↓																																																																									
39:	9.4	↗																																																																									
40:	9.4	←																																																																									
Serie		96.0																																																																									
Total		373.0																																																																									

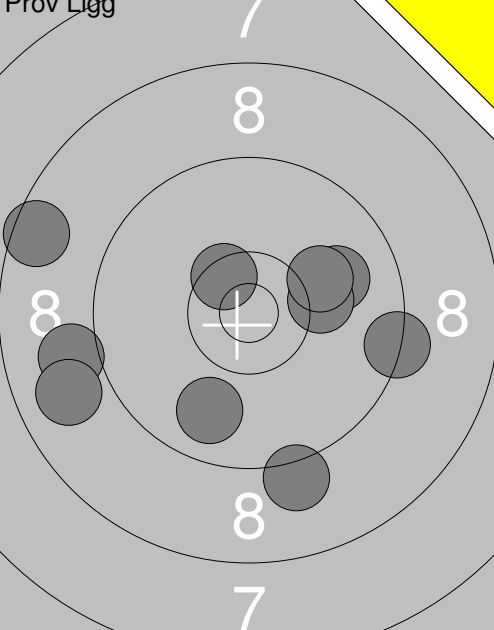
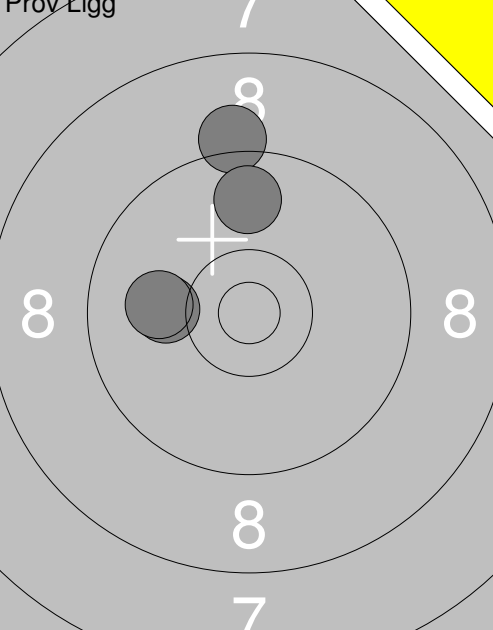
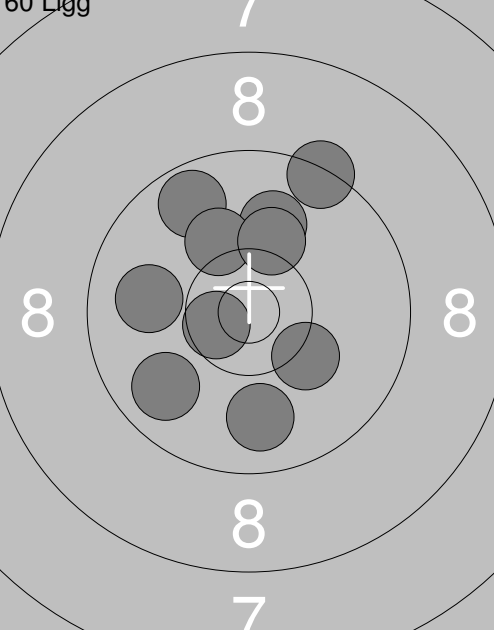
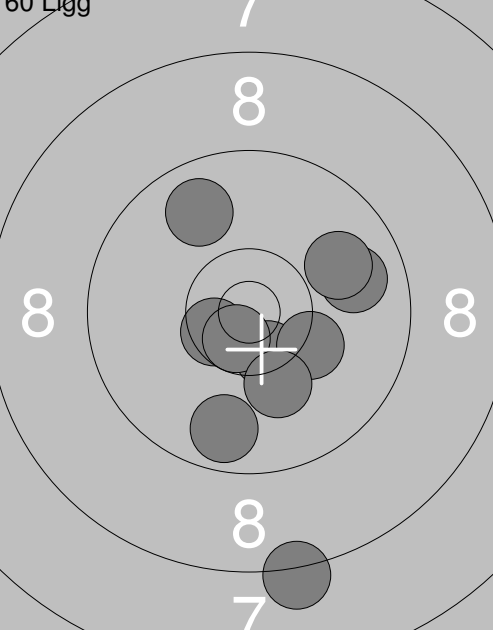
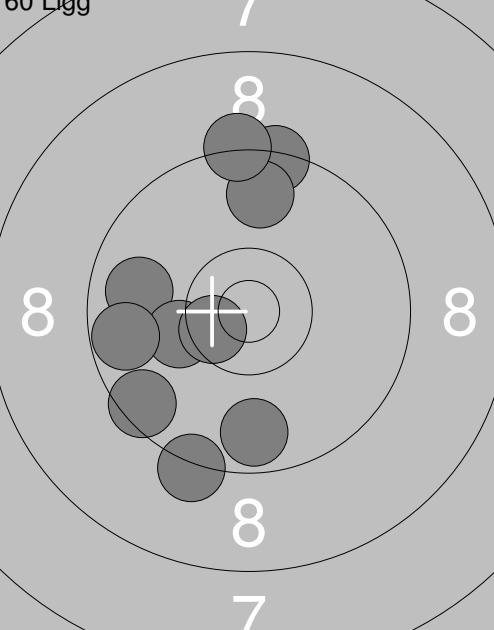
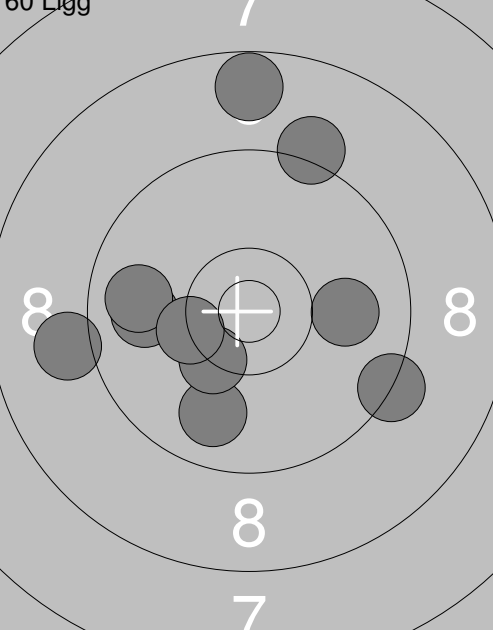
<p>Prov Ligg</p>  <p style="text-align: center;">7 8 8 8 7</p>	<p>1: 8.6 ← 2: 9.0 ← 3: 10.0 → 4: 10.2 → 5: 10.5x ↘ 6: 9.1 ↓ 7: 9.3 → 8: 9.8 ↓ 9: 8.9 ← 10: 10.1 →</p> <p>Serie 95.5 Total 0.0</p>	<p>Prov Ligg</p>  <p style="text-align: center;">7 8 8 8 7</p>	<p>11: 9.2 ↑ 12: 10.1 ← 13: 9.8 ↑ 14: 10.0 ←</p> <p>Serie 39.1 Total 0.0</p>
<p>60 Ligg</p>  <p style="text-align: center;">7 8 8 8 7</p>	<p>1: 9.9 ← 2: 9.9 ↓ 3: 9.8 ← 4: 9.4 ↗ 5: 10.0 ↑ 6: 10.6x ← 7: 9.7 ↖ 8: 10.2 ↖ 9: 10.2 ↑ 10: 10.2 ↘</p> <p>Serie 99.9 Total 99.9</p>	<p>60 Ligg</p>  <p style="text-align: center;">7 8 8 8 7</p>	<p>11: 10.5x ↓ 12: 10.2 ↘ 13: 9.8 → 14: 9.8 ↖ 15: 9.9 → 16: 10.5x ← 17: 10.6x ↓ 18: 8.2 ↓ 19: 10.2 ↓ 20: 9.7 ↓</p> <p>Serie 99.4 Total 199.3</p>
<p>60 Ligg</p>  <p style="text-align: center;">7 8 8 8 7</p>	<p>21: 9.5 ↘ 22: 9.4 ↑ 23: 9.3 ↓ 24: 9.8 ← 25: 10.2 ← 26: 9.8 ↑ 27: 9.7 ↓ 28: 9.3 ↑ 29: 9.7 ← 30: 10.5x ←</p> <p>Serie 97.2 Total 296.5</p>	<p>60 Ligg</p>  <p style="text-align: center;">7 8 8 8 7</p>	<p>31: 10.0 → 32: 9.9 ↓ 33: 9.3 → 34: 10.3x ← 35: 9.9 ← 36: 9.1 ← 37: 9.8 ← 38: 10.3x ← 39: 8.7 ↑ 40: 9.2 ↑</p> <p>Serie 96.5 Total 393.0</p>

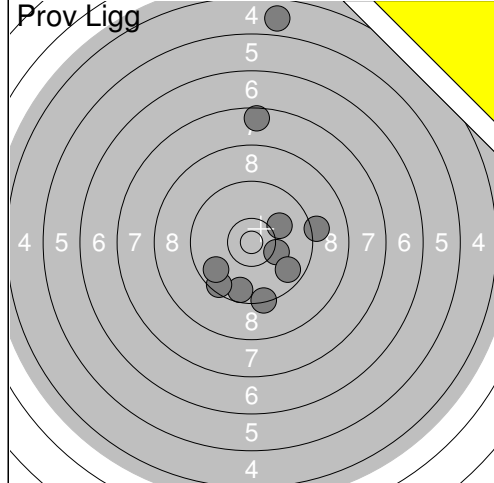

1:	4.8	↑
2:	7.6	↑
3:	10.1	→
4:	10.2	→
5:	9.7	→
6:	9.6	↓
7:	9.3	↓
8:	9.5	↓
9:	9.1	→
10:	9.7	↙
Serie		89.6
Total		0.0

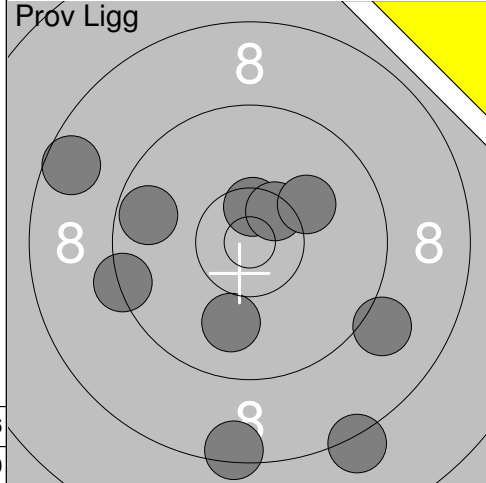

11:	10.5x	↑
12:	8.6	↖
13:	9.7	↖
14:	9.1	↘
15:	10.5x	↗
16:	8.2	↓
17:	9.4	↖
18:	10.0	↓
19:	8.5	↓
20:	10.1	↗
Serie		94.6
Total		0.0

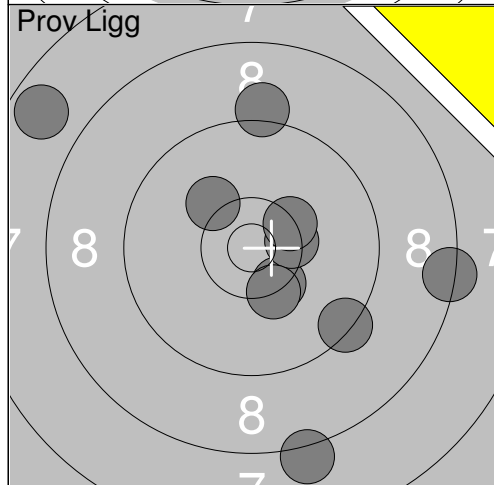

21:	8.2	↓
22:	10.2	↗
23:	10.4x	↘
24:	10.4x	→
25:	7.7	↗
26:	9.2	↑
27:	9.4	↘
28:	10.3x	↘
29:	10.4x	↗
30:	8.4	→
Serie		94.6
Total		0.0

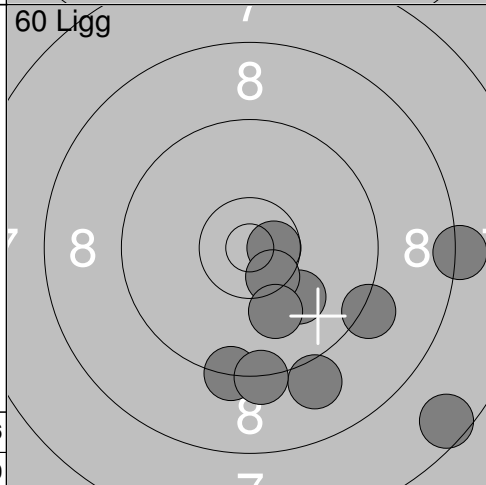

1:	10.6x	→
2:	9.2	↘
3:	8.2	→
4:	10.1	↘
5:	9.3	↓
6:	7.6	↘
7:	9.0	↘
8:	10.5x	↘
9:	10.1	↘
10:	9.3	↓
Serie		93.9
Total		93.9

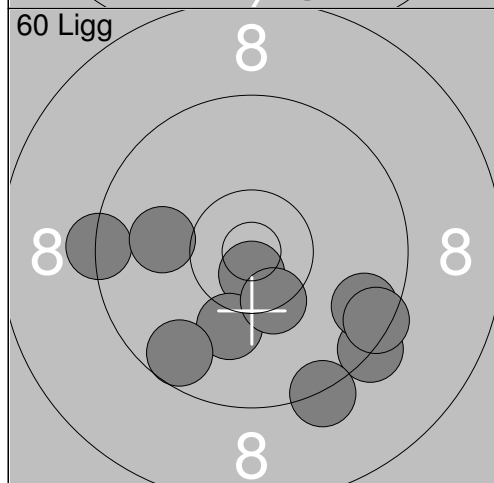

11:	9.3	↘
12:	10.7x	↓
13:	9.6	↘
14:	9.4	↘
15:	10.1	↓
16:	9.3	↖
17:	10.4x	↘
18:	9.6	↘
19:	9.3	↘
20:	10.0	↖
Serie		97.7
Total		191.6

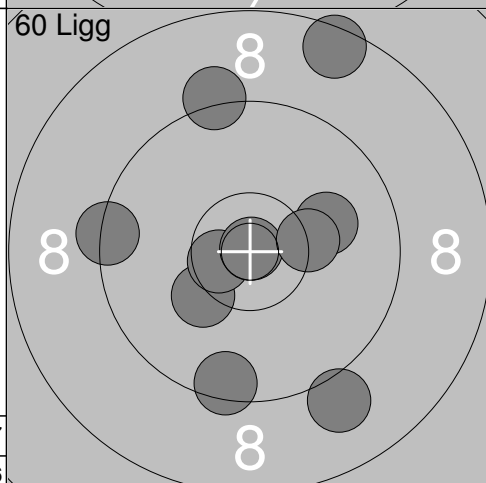

21:	9.5	↓
22:	10.1	→
23:	10.2	↖
24:	10.6x	↖
25:	9.0	↘
26:	10.9x	↗
27:	9.2	↑
28:	8.5	↑
29:	9.4	↖
30:	10.3x	→
Serie		97.7
Total		289.3

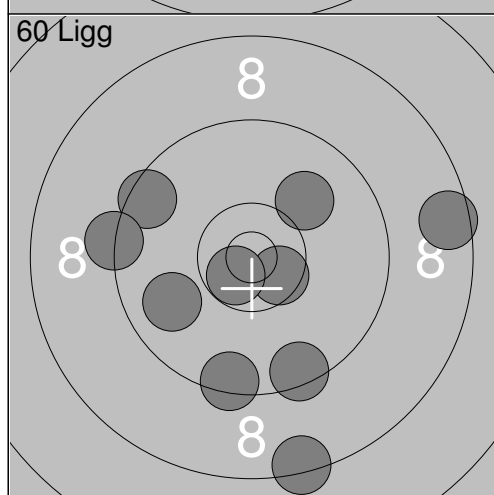

31:	8.6	→
32:	9.5	↗
33:	9.4	↓
34:	9.3	↖
35:	8.4	↓
36:	9.9	↖
37:	9.5	↓
38:	10.5x	↘
39:	10.0	↗
40:	10.7x	↘
Serie		95.8
Total		385.1

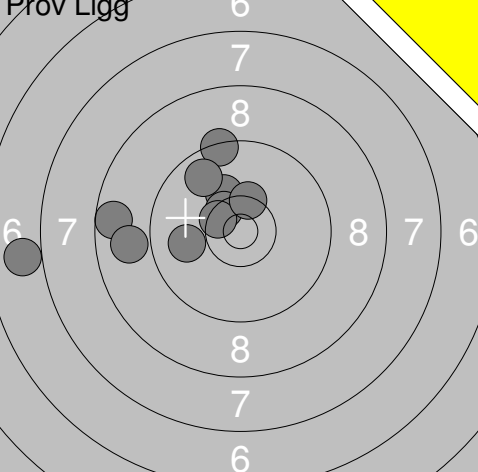
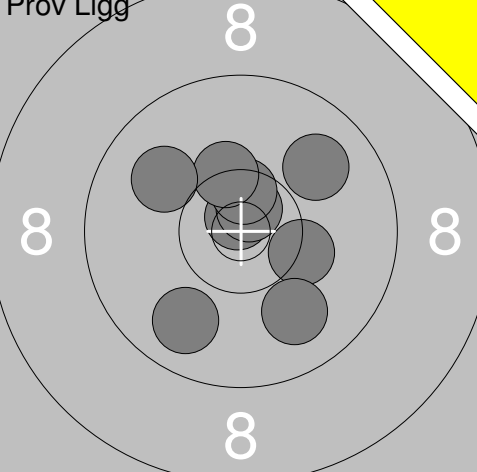
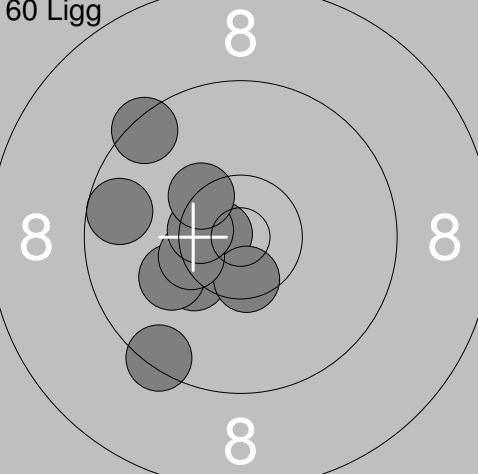
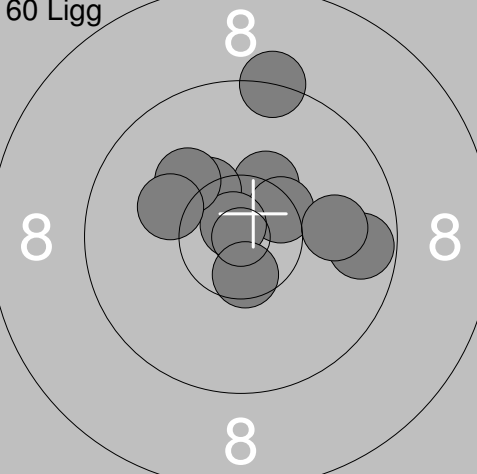
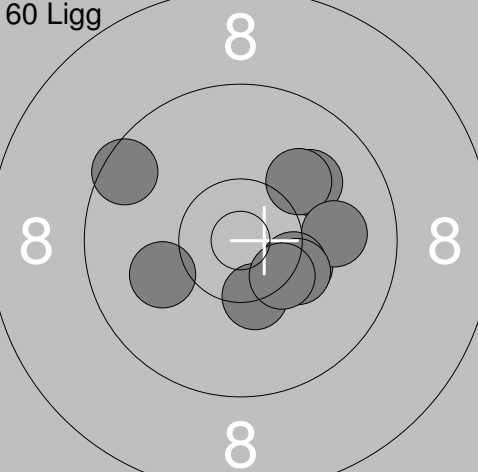
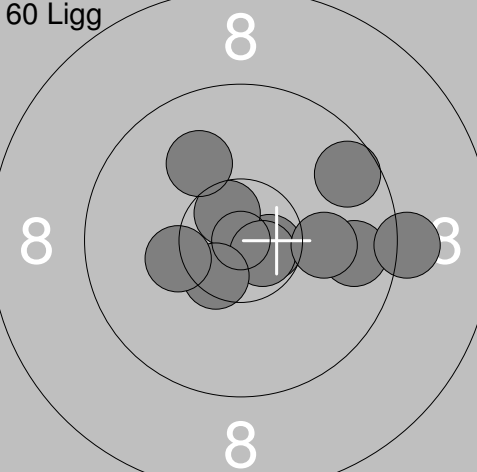
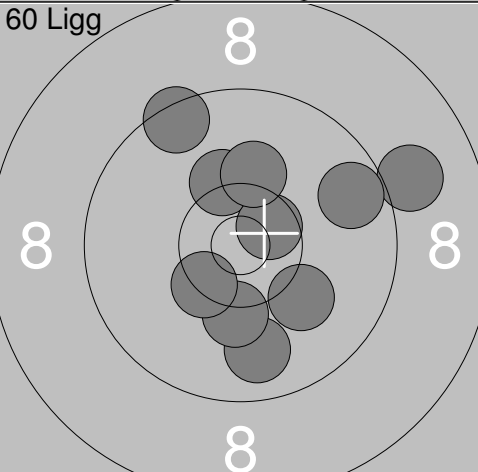
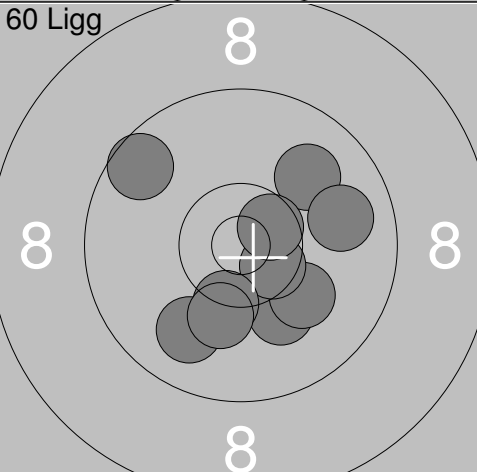
Pröv Ligg 	<table border="1" style="width:100%; border-collapse: collapse;"> <tr><td>1:</td><td>9.4</td><td>↗</td></tr> <tr><td>2:</td><td>7.0</td><td>←</td></tr> <tr><td>3:</td><td>10.0</td><td>←</td></tr> <tr><td>4:</td><td>8.6</td><td>←</td></tr> <tr><td>5:</td><td>10.2</td><td>↗</td></tr> <tr><td>6:</td><td>9.8</td><td>↗</td></tr> <tr><td>7:</td><td>10.5x</td><td>↗</td></tr> <tr><td>8:</td><td>10.5x</td><td>↗</td></tr> <tr><td>9:</td><td>8.9</td><td>←</td></tr> <tr><td>10:</td><td>10.4x</td><td>↗</td></tr> <tr><td colspan="2">Serie</td><td>95.3</td></tr> <tr><td colspan="2">Total</td><td>0.0</td></tr> </table>	1:	9.4	↗	2:	7.0	←	3:	10.0	←	4:	8.6	←	5:	10.2	↗	6:	9.8	↗	7:	10.5x	↗	8:	10.5x	↗	9:	8.9	←	10:	10.4x	↗	Serie		95.3	Total		0.0	Pröv Ligg 	<table border="1" style="width:100%; border-collapse: collapse;"> <tr><td>11:</td><td>9.8</td><td>↘</td></tr> <tr><td>12:</td><td>10.8x</td><td>↗</td></tr> <tr><td>13:</td><td>10.7x</td><td>↗</td></tr> <tr><td>14:</td><td>10.5x</td><td>↗</td></tr> <tr><td>15:</td><td>10.3x</td><td>↗</td></tr> <tr><td>16:</td><td>10.3</td><td>→</td></tr> <tr><td>17:</td><td>10.0</td><td>↗</td></tr> <tr><td>18:</td><td>9.9</td><td>↗</td></tr> <tr><td>19:</td><td>9.9</td><td>↘</td></tr> <tr><td colspan="2">Serie</td><td>92.2</td></tr> <tr><td colspan="2">Total</td><td>0.0</td></tr> </table>	11:	9.8	↘	12:	10.8x	↗	13:	10.7x	↗	14:	10.5x	↗	15:	10.3x	↗	16:	10.3	→	17:	10.0	↗	18:	9.9	↗	19:	9.9	↘	Serie		92.2	Total		0.0			
1:	9.4	↗																																																																									
2:	7.0	←																																																																									
3:	10.0	←																																																																									
4:	8.6	←																																																																									
5:	10.2	↗																																																																									
6:	9.8	↗																																																																									
7:	10.5x	↗																																																																									
8:	10.5x	↗																																																																									
9:	8.9	←																																																																									
10:	10.4x	↗																																																																									
Serie		95.3																																																																									
Total		0.0																																																																									
11:	9.8	↘																																																																									
12:	10.8x	↗																																																																									
13:	10.7x	↗																																																																									
14:	10.5x	↗																																																																									
15:	10.3x	↗																																																																									
16:	10.3	→																																																																									
17:	10.0	↗																																																																									
18:	9.9	↗																																																																									
19:	9.9	↘																																																																									
Serie		92.2																																																																									
Total		0.0																																																																									
60 Ligg 	<table border="1" style="width:100%; border-collapse: collapse;"> <tr><td>1:</td><td>10.7x</td><td>←</td></tr> <tr><td>2:</td><td>10.3x</td><td>↘</td></tr> <tr><td>3:</td><td>9.4</td><td>↘</td></tr> <tr><td>4:</td><td>9.4</td><td>↗</td></tr> <tr><td>5:</td><td>9.6</td><td>←</td></tr> <tr><td>6:</td><td>10.5x</td><td>↘</td></tr> <tr><td>7:</td><td>10.1</td><td>←</td></tr> <tr><td>8:</td><td>10.4x</td><td>←</td></tr> <tr><td>9:</td><td>10.5x</td><td>←</td></tr> <tr><td>10:</td><td>10.4x</td><td>↗</td></tr> <tr><td colspan="2">Serie</td><td>101.3</td></tr> <tr><td colspan="2">Total</td><td>101.3</td></tr> </table>	1:	10.7x	←	2:	10.3x	↘	3:	9.4	↘	4:	9.4	↗	5:	9.6	←	6:	10.5x	↘	7:	10.1	←	8:	10.4x	←	9:	10.5x	←	10:	10.4x	↗	Serie		101.3	Total		101.3	60 Ligg 	<table border="1" style="width:100%; border-collapse: collapse;"> <tr><td>11:</td><td>9.7</td><td>→</td></tr> <tr><td>12:</td><td>10.3x</td><td>↗</td></tr> <tr><td>13:</td><td>10.4x</td><td>↗</td></tr> <tr><td>14:</td><td>10.3x</td><td>↗</td></tr> <tr><td>15:</td><td>10.8x</td><td>↗</td></tr> <tr><td>16:</td><td>10.5x</td><td>↘</td></tr> <tr><td>17:</td><td>10.1</td><td>↗</td></tr> <tr><td>18:</td><td>9.3</td><td>↗</td></tr> <tr><td>19:</td><td>10.0</td><td>→</td></tr> <tr><td>20:</td><td>10.1</td><td>↖</td></tr> <tr><td colspan="2">Serie</td><td>101.5</td></tr> <tr><td colspan="2">Total</td><td>202.8</td></tr> </table>	11:	9.7	→	12:	10.3x	↗	13:	10.4x	↗	14:	10.3x	↗	15:	10.8x	↗	16:	10.5x	↘	17:	10.1	↗	18:	9.3	↗	19:	10.0	→	20:	10.1	↖	Serie		101.5	Total		202.8
1:	10.7x	←																																																																									
2:	10.3x	↘																																																																									
3:	9.4	↘																																																																									
4:	9.4	↗																																																																									
5:	9.6	←																																																																									
6:	10.5x	↘																																																																									
7:	10.1	←																																																																									
8:	10.4x	←																																																																									
9:	10.5x	←																																																																									
10:	10.4x	↗																																																																									
Serie		101.3																																																																									
Total		101.3																																																																									
11:	9.7	→																																																																									
12:	10.3x	↗																																																																									
13:	10.4x	↗																																																																									
14:	10.3x	↗																																																																									
15:	10.8x	↗																																																																									
16:	10.5x	↘																																																																									
17:	10.1	↗																																																																									
18:	9.3	↗																																																																									
19:	10.0	→																																																																									
20:	10.1	↖																																																																									
Serie		101.5																																																																									
Total		202.8																																																																									
60 Ligg 	<table border="1" style="width:100%; border-collapse: collapse;"> <tr><td>21:</td><td>10.3x</td><td>↘</td></tr> <tr><td>22:</td><td>10.3</td><td>→</td></tr> <tr><td>23:</td><td>10.0</td><td>↗</td></tr> <tr><td>24:</td><td>10.1</td><td>↗</td></tr> <tr><td>25:</td><td>10.1</td><td>←</td></tr> <tr><td>26:</td><td>9.5</td><td>↗</td></tr> <tr><td>27:</td><td>10.0</td><td>→</td></tr> <tr><td>28:</td><td>10.3x</td><td>↘</td></tr> <tr><td>29:</td><td>10.3</td><td>↘</td></tr> <tr><td>30:</td><td>10.4x</td><td>↘</td></tr> <tr><td colspan="2">Serie</td><td>101.3</td></tr> <tr><td colspan="2">Total</td><td>304.1</td></tr> </table>	21:	10.3x	↘	22:	10.3	→	23:	10.0	↗	24:	10.1	↗	25:	10.1	←	26:	9.5	↗	27:	10.0	→	28:	10.3x	↘	29:	10.3	↘	30:	10.4x	↘	Serie		101.3	Total		304.1	60 Ligg 	<table border="1" style="width:100%; border-collapse: collapse;"> <tr><td>31:</td><td>10.6x</td><td>→</td></tr> <tr><td>32:</td><td>10.6x</td><td>↗</td></tr> <tr><td>33:</td><td>10.7x</td><td>↘</td></tr> <tr><td>34:</td><td>10.5x</td><td>↘</td></tr> <tr><td>35:</td><td>9.7</td><td>→</td></tr> <tr><td>36:</td><td>10.0</td><td>↗</td></tr> <tr><td>37:</td><td>10.3</td><td>←</td></tr> <tr><td>38:</td><td>9.2</td><td>→</td></tr> <tr><td>39:</td><td>9.6</td><td>↗</td></tr> <tr><td>40:</td><td>10.1</td><td>→</td></tr> <tr><td colspan="2">Serie</td><td>101.3</td></tr> <tr><td colspan="2">Total</td><td>405.4</td></tr> </table>	31:	10.6x	→	32:	10.6x	↗	33:	10.7x	↘	34:	10.5x	↘	35:	9.7	→	36:	10.0	↗	37:	10.3	←	38:	9.2	→	39:	9.6	↗	40:	10.1	→	Serie		101.3	Total		405.4
21:	10.3x	↘																																																																									
22:	10.3	→																																																																									
23:	10.0	↗																																																																									
24:	10.1	↗																																																																									
25:	10.1	←																																																																									
26:	9.5	↗																																																																									
27:	10.0	→																																																																									
28:	10.3x	↘																																																																									
29:	10.3	↘																																																																									
30:	10.4x	↘																																																																									
Serie		101.3																																																																									
Total		304.1																																																																									
31:	10.6x	→																																																																									
32:	10.6x	↗																																																																									
33:	10.7x	↘																																																																									
34:	10.5x	↘																																																																									
35:	9.7	→																																																																									
36:	10.0	↗																																																																									
37:	10.3	←																																																																									
38:	9.2	→																																																																									
39:	9.6	↗																																																																									
40:	10.1	→																																																																									
Serie		101.3																																																																									
Total		405.4																																																																									
60 Ligg 	<table border="1" style="width:100%; border-collapse: collapse;"> <tr><td>41:</td><td>9.0</td><td>→</td></tr> <tr><td>42:</td><td>10.1</td><td>↘</td></tr> <tr><td>43:</td><td>9.8</td><td>↘</td></tr> <tr><td>44:</td><td>9.7</td><td>↗</td></tr> <tr><td>45:</td><td>9.5</td><td>↗</td></tr> <tr><td>46:</td><td>10.3</td><td>↗</td></tr> <tr><td>47:</td><td>10.2</td><td>↘</td></tr> <tr><td>48:</td><td>10.6x</td><td>↗</td></tr> <tr><td>49:</td><td>10.2</td><td>↗</td></tr> <tr><td>50:</td><td>10.4x</td><td>↘</td></tr> <tr><td colspan="2">Serie</td><td>99.8</td></tr> <tr><td colspan="2">Total</td><td>505.2</td></tr> </table>	41:	9.0	→	42:	10.1	↘	43:	9.8	↘	44:	9.7	↗	45:	9.5	↗	46:	10.3	↗	47:	10.2	↘	48:	10.6x	↗	49:	10.2	↗	50:	10.4x	↘	Serie		99.8	Total		505.2	60 Ligg 	<table border="1" style="width:100%; border-collapse: collapse;"> <tr><td>51:</td><td>10.1</td><td>↘</td></tr> <tr><td>52:</td><td>10.1</td><td>↘</td></tr> <tr><td>53:</td><td>9.6</td><td>↗</td></tr> <tr><td>54:</td><td>9.9</td><td>↗</td></tr> <tr><td>55:</td><td>10.6x</td><td>↘</td></tr> <tr><td>56:</td><td>10.6x</td><td>↗</td></tr> <tr><td>57:</td><td>10.3x</td><td>↘</td></tr> <tr><td>58:</td><td>9.9</td><td>→</td></tr> <tr><td>59:</td><td>9.9</td><td>↘</td></tr> <tr><td>60:</td><td>10.2</td><td>↘</td></tr> <tr><td colspan="2">Serie</td><td>101.2</td></tr> <tr><td colspan="2">Total</td><td>606.4</td></tr> </table>	51:	10.1	↘	52:	10.1	↘	53:	9.6	↗	54:	9.9	↗	55:	10.6x	↘	56:	10.6x	↗	57:	10.3x	↘	58:	9.9	→	59:	9.9	↘	60:	10.2	↘	Serie		101.2	Total		606.4
41:	9.0	→																																																																									
42:	10.1	↘																																																																									
43:	9.8	↘																																																																									
44:	9.7	↗																																																																									
45:	9.5	↗																																																																									
46:	10.3	↗																																																																									
47:	10.2	↘																																																																									
48:	10.6x	↗																																																																									
49:	10.2	↗																																																																									
50:	10.4x	↘																																																																									
Serie		99.8																																																																									
Total		505.2																																																																									
51:	10.1	↘																																																																									
52:	10.1	↘																																																																									
53:	9.6	↗																																																																									
54:	9.9	↗																																																																									
55:	10.6x	↘																																																																									
56:	10.6x	↗																																																																									
57:	10.3x	↘																																																																									
58:	9.9	→																																																																									
59:	9.9	↘																																																																									
60:	10.2	↘																																																																									
Serie		101.2																																																																									
Total		606.4																																																																									

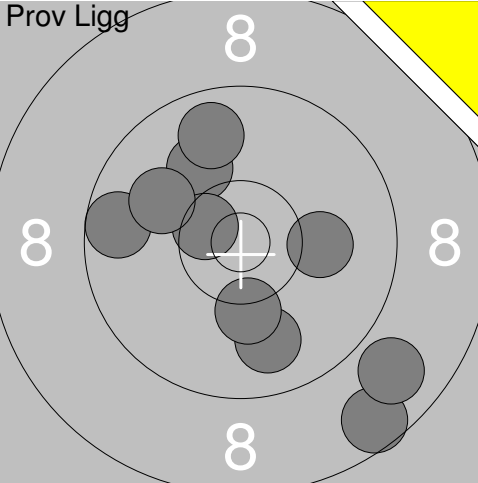
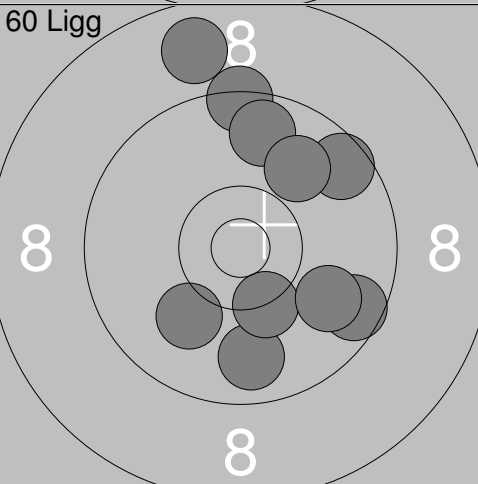
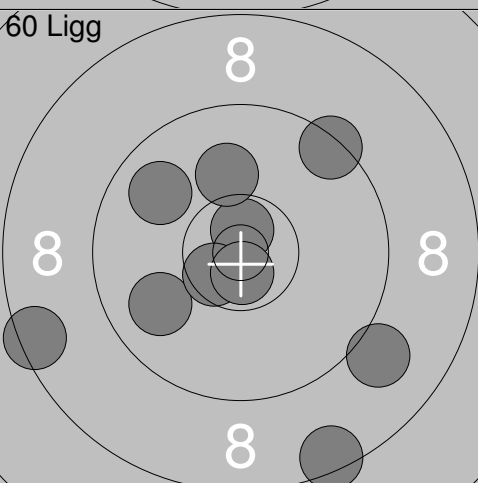
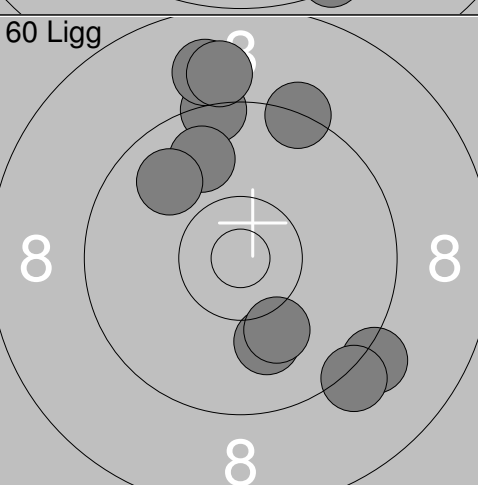
Skjuttlag	Tavla	William Öster	
3	13		
S	Umeå Skf		
09.04.2017	Startskottet 2017	Umeå skytteallians	
Prov Ligg		1: 9.9 ↓ 2: 8.6 ↓ 3: 8.9 ↓ 4: 10.2 ↓ 5: 10.1 ↗ 6: 10.1 → 7: 9.6 ← 8: 10.5x ↗ 9: 10.0 ↗ 10: 9.8 ↗	11: 10.2 ↓ 12: 10.0 ↗ 13: 10.2 → 14: 10.9x ↓ 15: 10.5x ↓ 16: 10.3x ↑ 17: 10.0 ↗ 18: 10.8x ↓ 19: 10.7x ↗
	Serie 97.7 Total 0.0		Serie 93.6 Total 0.0
60 Ligg		1: 8.8 ↑ 2: 9.6 ↗ 3: 9.4 ↑ 4: 9.6 ↘ 5: 9.8 ↓ 6: 9.7 ↑ 7: 9.9 ↗ 8: 10.3x ↓ 9: 10.0 ↓ 10: 9.9 ↘	11: 10.2 ↓ 12: 10.1 ↓ 13: 8.2 → 14: 8.6 ↗ 15: 8.7 ↓ 16: 9.6 → 17: 9.7 ↑ 18: 10.5x ↘ 19: 10.2 ↗ 20: 10.6x ↗
	Serie 97.0 Total 97.0		Serie 96.4 Total 193.4
60 Ligg		21: 8.5 ↓ 22: 8.5 ← 23: 10.7x ↑ 24: 9.9 ← 25: 9.8 ↗ 26: 10.6x ← 27: 10.1 ↑ 28: 10.7x ↓ 29: 9.4 ↗ 30: 9.0 ↓	31: 10.0 → 32: 10.6x ↓ 33: 9.3 ↓ 34: 8.2 ↓ 35: 9.9 ↓ 36: 9.2 ↓ 37: 10.6x ↗ 38: 9.7 ↓ 39: 8.5 ↓ 40: 9.3 →
	Serie 97.2 Total 290.6		Serie 95.3 Total 385.9
60 Ligg		41: 9.3 ↑ 42: 9.4 ↑ 43: 9.2 ↓ 44: 9.8 ↗ 45: 9.2 ↓ 46: 10.0 ↓ 47: 9.0 ↗ 48: 9.0 ↗ 49: 9.8 ↗ 50: 10.1 ↓	51: 9.8 ↗ 52: 7.7 ↗ 53: 10.3x ↗ 54: 9.7 ↗ 55: 9.4 → 56: 9.3 ↓ 57: 10.1 ← 58: 10.2 ← 59: 10.2 ← 60: 9.0 ↓
	Serie 94.8 Total 480.7		Serie 95.7 Total 576.4

<p>Prov Ligg</p>	<p>Prov Ligg</p>
<p>60 Ligg</p>	<p>60 Ligg</p>
<p>60 Ligg</p>	<p>60 Ligg</p>
<p>60 Ligg</p>	<p>60 Ligg</p>

<p>Prov Ligg</p>	<p>1: 10.7x↓ 2: 10.5x↓ 3: 10.7x↔ 4: 9.5 ↓ 5: 10.7x↓ 6: 10.4x↓ 7: 9.3 ↓ 8: 9.3 → 9: 10.4x↓ 10: 9.2 ↓</p> <p>Serie 100.7 Total 0.0</p>	<p>Prov Ligg</p>	<p>11: 10.3x↔ 12: 9.8 ↓ 13: 9.8 ↙ 14: 10.2 ↑ 15: 10.3x↔</p> <p>Serie 50.4 Total 0.0</p>
<p>60 Ligg</p>	<p>1: 10.1 ↙ 2: 10.1 ↙ 3: 9.7 → 4: 9.4 ↑ 5: 9.9 ↙ 6: 10.4x↔ 7: 9.7 ↓ 8: 10.1 ↙ 9: 9.4 ↓ 10: 10.1 ↓</p> <p>Serie 98.9 Total 98.9</p>	<p>60 Ligg</p>	<p>11: 9.6 ↓ 12: 10.6x↔ 13: 10.4x↔ 14: 10.2 ↓ 15: 10.1 ↓ 16: 9.1 ↓ 17: 10.3x↓ 18: 10.2 ↓ 19: 10.7x↓ 20: 10.5x↓</p> <p>Serie 101.7 Total 200.6</p>
<p>60 Ligg</p>	<p>21: 10.6x↑ 22: 10.7x↔ 23: 9.2 ↑ 24: 9.8 ↓ 25: 10.3x↑ 26: 10.9x↔ 27: 9.1 ↑ 28: 9.8 ↑ 29: 9.6 ↓ 30: 10.3x↗</p> <p>Serie 100.3 Total 300.9</p>	<p>60 Ligg</p>	<p>31: 9.9 ↓ 32: 10.7x↔ 33: 9.5 ↓ 34: 9.8 ↓ 35: 10.2 → 36: 10.4x↔ 37: 10.5x↔ 38: 9.7 ↓ 39: 10.2 ↙ 40: 10.7x↓</p> <p>Serie 101.6 Total 402.5</p>