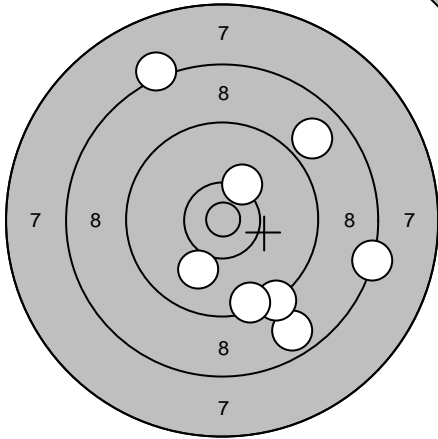
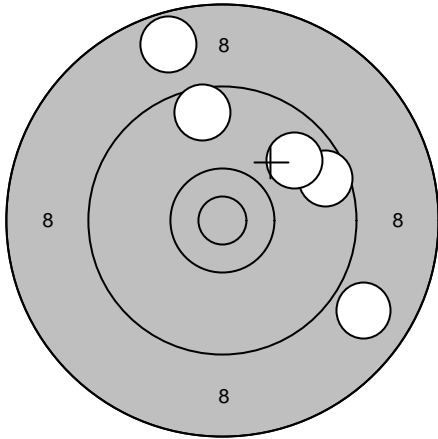
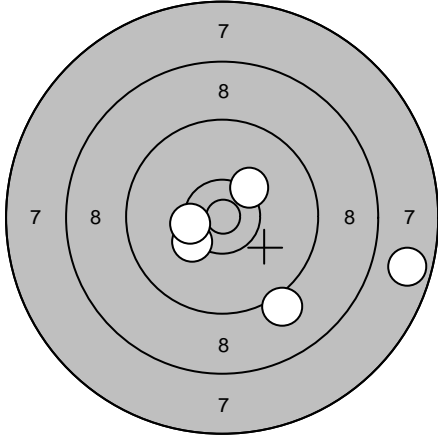
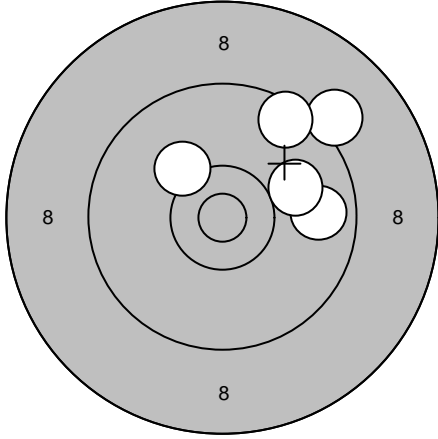
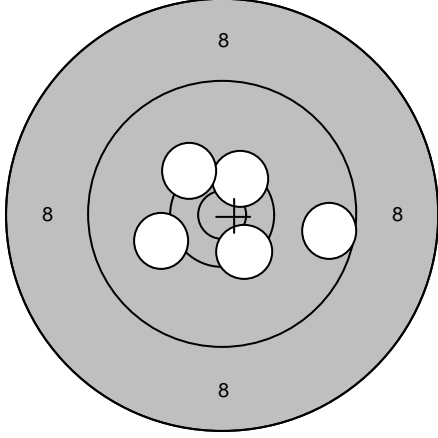
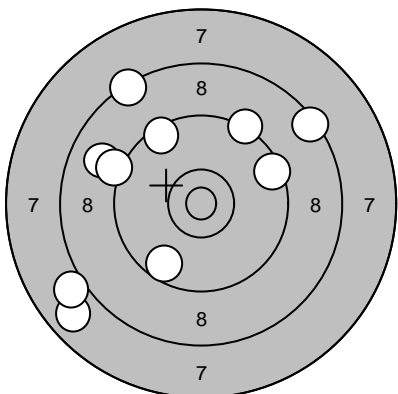
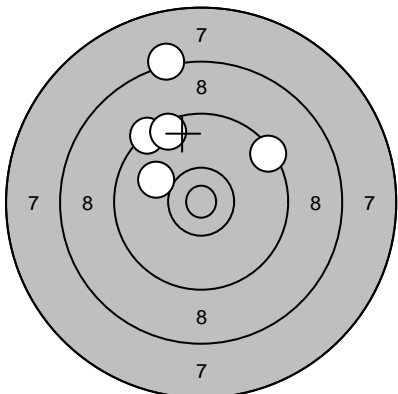
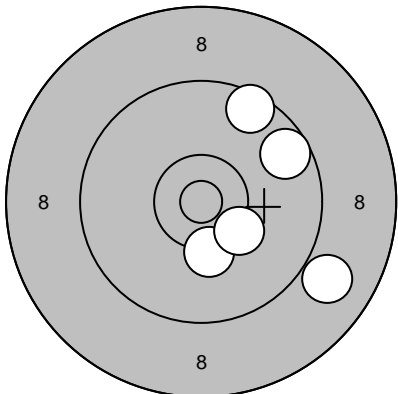
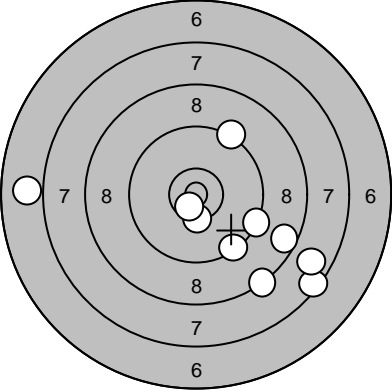
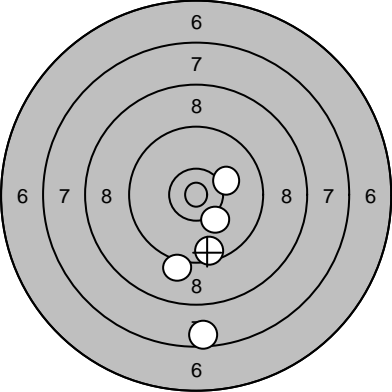
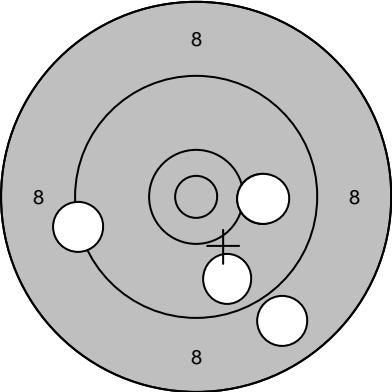
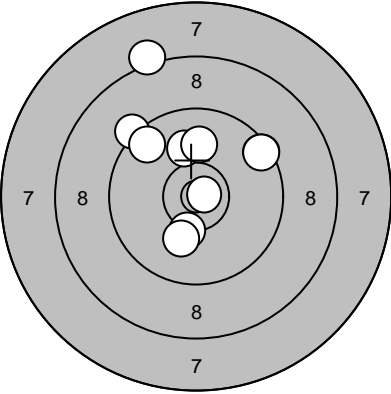
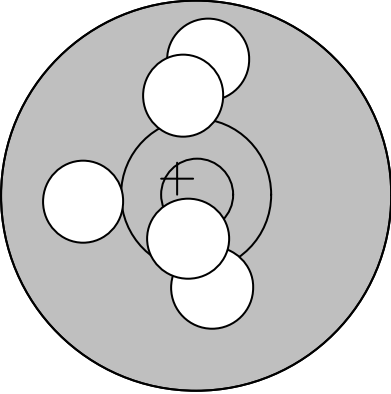
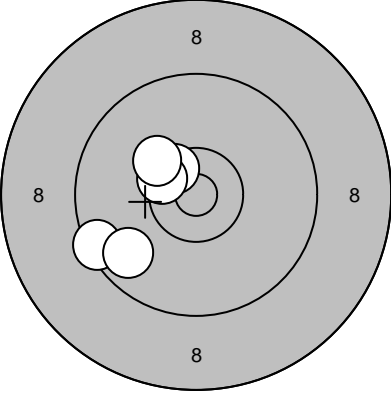
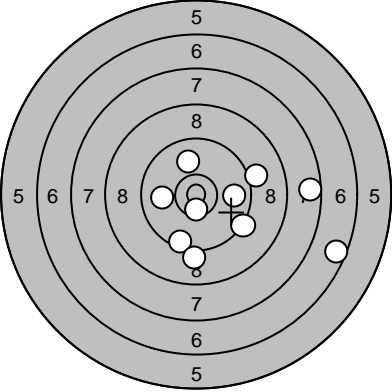
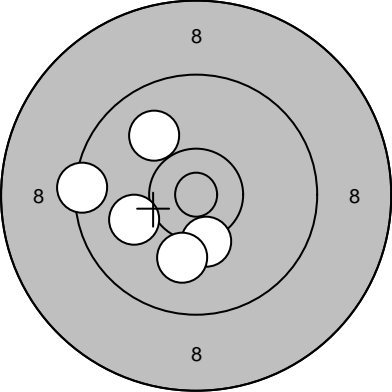
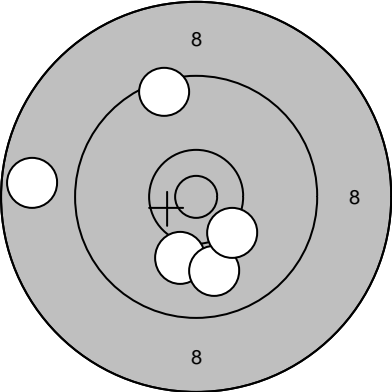

Skjutlag	Tavla		
1	1	André Olsén	
		Umeå	
2008-08-30	Höstträffen 2008	Ramselefors SKF	
Prov		1: 8,2 ↗ 2: 8,3 → 3: 8,7 ↘ 4: 9,3 ↘ 5: 9,5 ↘ 6: 10,0 ↘ 7: 8,9 ↗ 8: 10,3 ↗	Serie 
	Serie 70,0 Totalt 0,0	1: 9,6 → 2: 9,6 ↑ 3: 8,9 ↘ 4: 9,8 ↗ 5: 8,7 ↑	Serie 43,0 Totalt 43,0
Serie		6: 10,3 ↙ 7: 7,7 → 8: 10,4* ← 9: 9,1 ↘ 10: 10,3 ↗	Serie 
	Serie 46,0 Totalt 89,0	11: 9,1 ↗ 12: 9,8 → 13: 10,0 → 14: 10,2 ↖ 15: 9,5 ↗	Serie 47,0 Totalt 136,0
Serie		16: 9,6 → 17: 10,5* ↗ 18: 10,3* ↗ 19: 10,1 ← 20: 10,4* ↘	
	Serie 49,0 Totalt 185,0		

Skjutlag	Tavla	William Öster		
1	2	Umeå		
2008-08-30	Höstträffen 2008	Ramselefors SKF		
Prov		1: 8,4 ↖ 2: 9,3 ↗ 3: 8,4 ↗ 4: 9,5 ↗ 5: 9,5 ↖ 6: 7,8 ↙ 7: 8,9 ↖ 8: 8,0 ↙ 9: 9,2 ↖ 10: 9,6 ↙	11: 9,2 ↙ 12: 9,7 ↖ 13: 10,4* ↑ 14: 7,6 ↗	
	Serie	84,0	Serie	35,0
	Totalt	0,0	Totalt	0,0
Serie		1: 10,0 ↖ 2: 9,4 ↗ 3: 9,4 ↖ 4: 9,5 ↗ 5: 8,3 ↗	6: 9,0 ↖ 7: 9,3 ↙ 8: 9,8 ↙ 9: 9,8 ↗ 10: 9,0 ↖	
	Serie	45,0	Serie	45,0
	Totalt	45,0	Totalt	90,0
Serie		11: 10,3 ↓ 12: 8,9 ➡ 13: 10,3* ➡ 14: 9,6 ↗ 15: 9,5 ↗	16: 10,3 ↖ 17: 8,7 ↙ 18: 9,9 ↙ 19: 9,8 ↙ 20: 9,6 ↗	
	Serie	46,0	Serie	45,0
	Totalt	136,0	Totalt	181,0

Skjutlag	Tavla	Marcus Mattsson	
1	3	Ramselefors	
2008-08-30	Höstträffen 2008	Ramselefors SKF	
Prov		1: 6,9 ← 2: 10,4* ↓ 3: 9,4 ↘ 4: 8,6 → 5: 9,4 → 6: 7,4 ↘ 7: 8,3 ↘ 8: 7,8 ↘ 9: 10,6* ↘ 10: 9,3 ↗	11: 10,3 ↓ 12: 9,8 ↓ 13: 9,7 ← 14: 8,8 ↓ 15: 9,8 ↓ 16: 10,1 ↓ 17: 10,0 ↓ 18: 9,7 ↗
	Serie 83,0	Serie 74,0	
	Totalt 0,0	Totalt 0,0	
Serie		1: 10,1 ↗ 2: 10,2 ↓ 3: 7,6 ↓ 4: 9,2 ↓ 5: 9,6 ↓	6: 10,4* ↓ 7: 10,2 ← 8: 9,7 ↓ 9: 10,6* ↓ 10: 10,4* ↘
	Serie 45,0	Serie 49,0	
	Totalt 45,0	Totalt 94,0	
Serie		11: 9,3 ← 12: 10,1 → 13: 10,0 → 14: 9,8 ↓ 15: 8,9 ↓	16: 10,3* ↓ 17: 10,0 ↗ 18: 10,0 ↓ 19: 8,8 ↗ 20: 9,9 ↗
	Serie 46,0	Serie 47,0	
	Totalt 140,0	Totalt 187,0	

Skjutlag	Tavla	Edward Yu	
1	4	Umeå	
2008-08-30	Höstträffen 2008	Ramselefors SKF	
Prov		1: 9,5 ↗ 2: 9,5 ↗ 3: 10,3 ↓ 4: 8,2 ↗ 5: 10,0 ↗ 6: 10,0 ↗ 7: 10,1 ↓ 8: 10,8* → 9: 9,3 ↗ 10: 9,6 ↗	11: 9,6 ↖ 12: 9,2 ↗ 13: 10,0 ↓ 14: 9,8 ↓ 15: 7,0 ↗ 16: 9,6 ↗ 17: 9,9 ← 18: 10,2 ↘
	Serie 94,0		Serie 72,0
	Totalt 0,0		Totalt 0,0
Serie		1: 9,8 ↑ 2: 10,2 ↓ 3: 10,6* ↓ 4: 10,0 ← 5: 10,1 ↑	6: 9,8 ↓ 7: 10,6* ← 8: 10,4* ↗ 9: 9,7 ↘ 10: 7,7 ↗
	Serie 49,0		Serie 45,0
	Totalt 49,0		Totalt 94,0
Serie		11: 10,5* ↖ 12: 10,4* ↖ 13: 9,5 ← 14: 10,3 ↗ 15: 9,7 ↘	16: 10,8* ↖ 17: 10,1 ↓ 18: 10,1 ↘ 19: 9,8 ← 20: 9,8 ←
	Serie 48,0		Serie 48,0
	Totalt 142,0		Totalt 190,0

Skjutlag	Tavla	Marlene Forsell	
1	5	Ramselefors	
2008-08-30	Höstträffen 2008	Ramselefors SKF	
Prov		1: 9,1 → 2: 6,6 → 3: 7,6 → 4: 10,5* ↓ 5: 9,9 → 6: 9,3 ↘ 7: 9,5 ↓ 8: 10,0 ↑ 9: 9,2 ↓ 10: 10,0 ←	11: 10,7* ↘ 12: 10,4* ← 13: 10,5* ↑ 14: 9,6 ↓ 15: 9,8 ↙
	Serie 88,0		Serie 48,0
	Totalt 0,0		Totalt 0,0
Serie		1: 9,4 ← 2: 10,0 ↗ 3: 10,3* ↓ 4: 10,1 ↓ 5: 10,0 ←	6: 10,6* ↖ 7: 10,3* ↑ 8: 9,9 ↗ 9: 10,8* ↑ 10: 10,6* ↙
	Serie 49,0		Serie 49,0
	Totalt 49,0		Totalt 98,0
Serie		11: 9,5 ↑ 12: 10,1 ↓ 13: 9,9 ↓ 14: 10,2 ↓ 15: 8,7 ←	16: 10,3* ↖ 17: 9,9 ← 18: 10,2 ↗ 19: 10,5* ↗ 20: 10,8* ↖
	Serie 46,0		Serie 49,0
	Totalt 144,0		Totalt 193,0

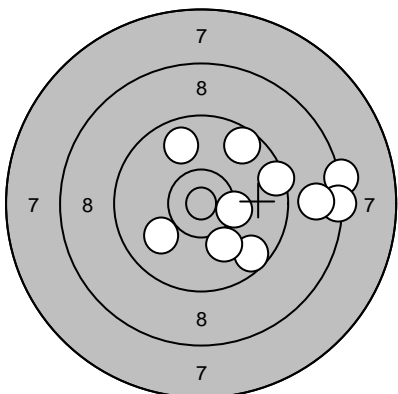
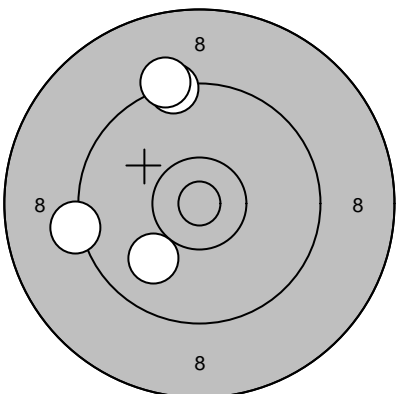
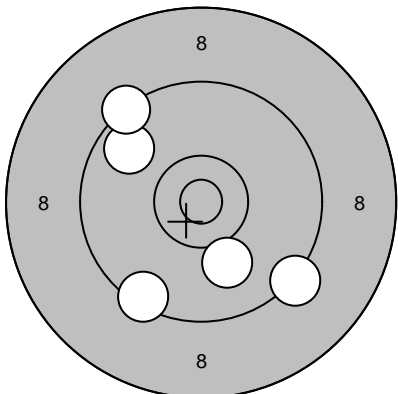
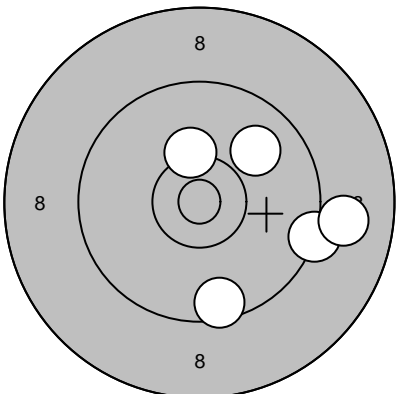
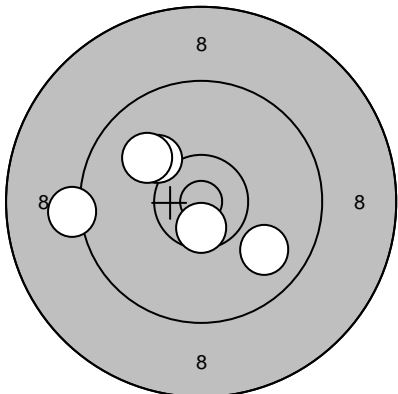
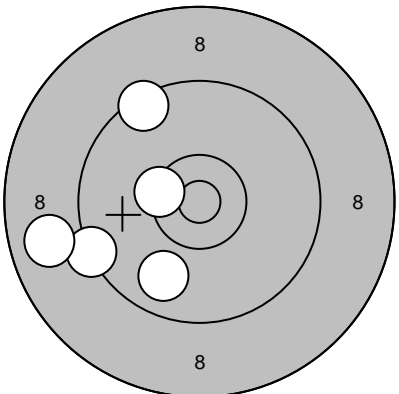
Skjutlag	Tavla	Johan Nilsson	
1	6	Ramselefors	
2008-08-30	Höstträffen 2008	Ramselefors SKF	
Prov		1: 9,8 ↗ 2: 8,3 → 3: 8,4 → 4: 8,8 → 5: 9,6 ↘ 6: 9,5 → 7: 9,6 ↗ 8: 10,3* → 9: 10,0 ↘ 10: 10,1 ↘	Prov 
	Serie 90,0		11: 10,0 ↘
	Totalt 0,0		12: 9,3 ←
			13: 9,4 ↗
			14: 9,3 ↗
			Serie 37,0
			Totalt 0,0
Serie		1: 9,7 ↗ 2: 9,3 ↗ 3: 9,4 ↘ 4: 10,0 ↘ 5: 9,3 ↘	Serie 
	Serie 46,0		6: 9,9 ↗
	Totalt 46,0		7: 10,3 ↗
			8: 9,6 ↘
			9: 9,3 →
			10: 9,0 →
			Serie 46,0
			Totalt 92,0
Serie		11: 9,2 ← 12: 10,1 ↗ 13: 9,9 ↘ 14: 10,6* ↘ 15: 10,0 ↗	Serie 
	Serie 48,0		16: 9,5 ↗
	Totalt 140,0		17: 9,8 ↘
			18: 9,3 ←
			19: 8,9 ←
			20: 10,4* ←
			Serie 45,0
			Totalt 185,0

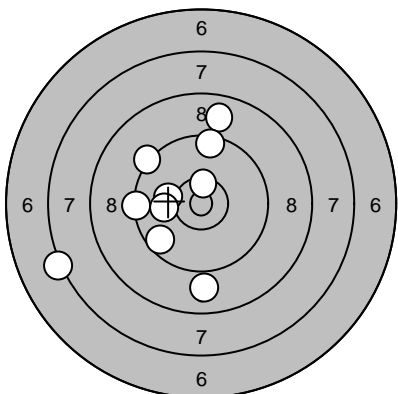
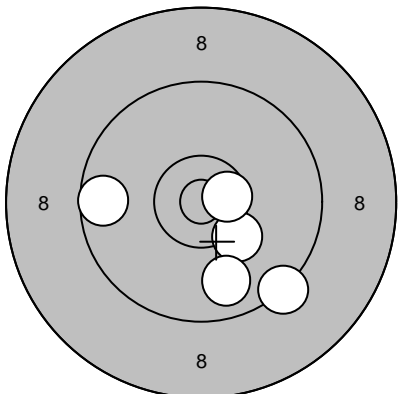
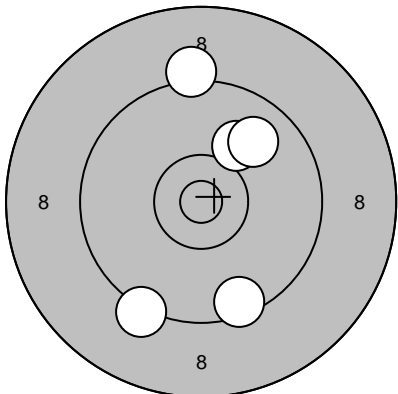
Skjutlag	Tavla	Dan-Ivan Karlsson	
1	7	Ramselefors	
2008-08-30	Höstträffen 2008	Ramselefors SKF	
Prov		1: 7,3 ↙ 2: 9,7 ↘ 3: 9,3 ↖ 4: 10,5* ↑ 5: 8,9 ↑ 6: 9,5 ↑ 7: 8,9 ↓ 8: 10,2 ← 9: 9,4 ← 10: 10,1 ←	11: 10,0 ↗ 12: 10,5* ↖ 13: 10,7* ↘ 14: 8,8 ← 15: 9,3 ↖
	Serie	89,0	Serie 47,0
	Totalt	0,0	Totalt 0,0
Serie		1: 9,6 ← 2: 10,3 ↘ 3: 10,6* → 4: 9,3 ↘ 5: 9,8 ↘	6: 10,6* ← 7: 10,7* ↖ 8: 10,4* ↘ 9: 9,3 ↘ 10: 10,1 →
	Serie	47,0	Serie 49,0
	Totalt	47,0	Totalt 96,0
Serie		11: 9,3 ↘ 12: 9,5 ↘ 13: 10,1 ↗ 14: 9,2 ↑ 15: 9,9 ↗	16: 9,9 ← 17: 10,0 ← 18: 9,2 ↘ 19: 10,2 ↗ 20: 10,0 ↓
	Serie	46,0	Serie 48,0
	Totalt	142,0	Totalt 190,0

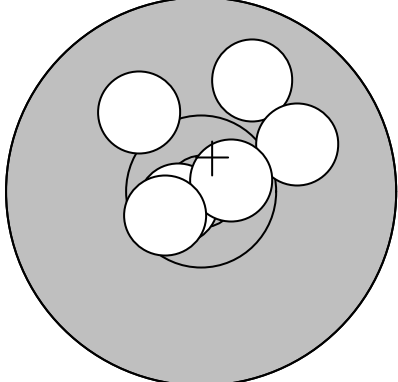
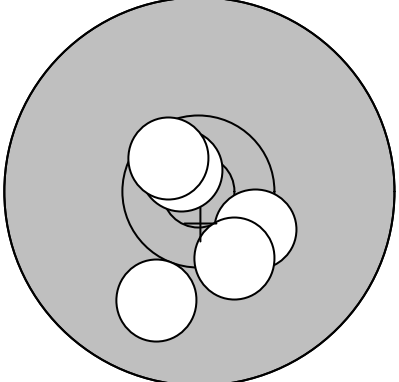
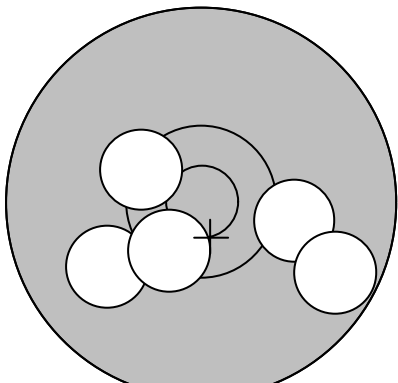
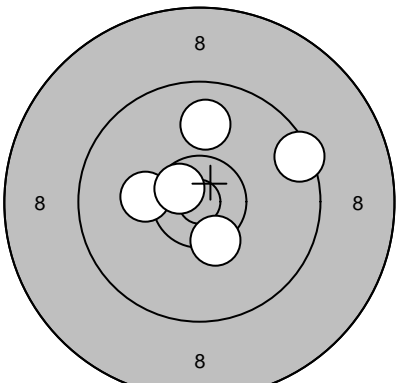
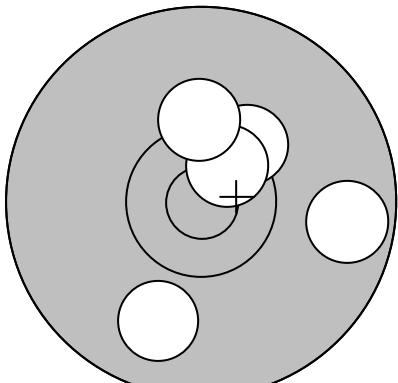
Skjutlag	Tavla	Christian Lejon	
1	9		
		Umeå	
2008-08-30	Höstträffen 2008	Ramselefors SKF	
Prov 	1: 9,9 ↗	Serie 	1: 10,7* ↗
	2: 10,7* ↙		2: 10,4* ↘
	3: 10,0 →		3: 10,6* ↗
	4: 10,7* →		4: 10,0 ↘
	5: 10,6* ↙		5: 10,3* ↘
	6: 10,1 ↖		
	Serie 59,0		Serie 50,0
	Totalt 0,0		Totalt 50,0
Serie 	6: 10,0 ↙	Serie 	11: 9,9 ↑
	7: 10,5* ↘		12: 10,2 ←
	8: 10,1 →		13: 10,4* ↘
	9: 9,7 ↘		14: 10,6* ↗
	10: 10,4* ↖		15: 9,5 →
	Serie 49,0		Serie 48,0
	Totalt 99,0		Totalt 147,0
Serie 	16: 9,9 ↘		
	17: 9,7 →		
	18: 10,3* ↗		
	19: 10,6* ↗		
	20: 10,3 ↑		
	Serie 48,0		
	Totalt 195,0		

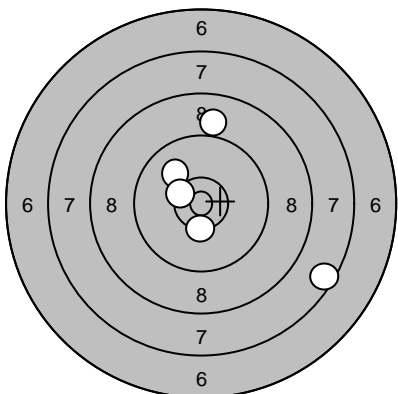
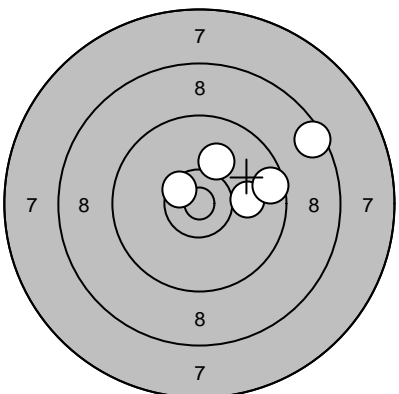
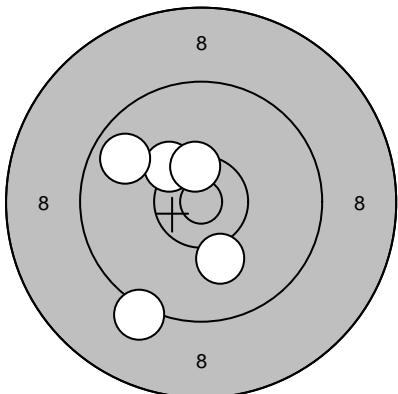
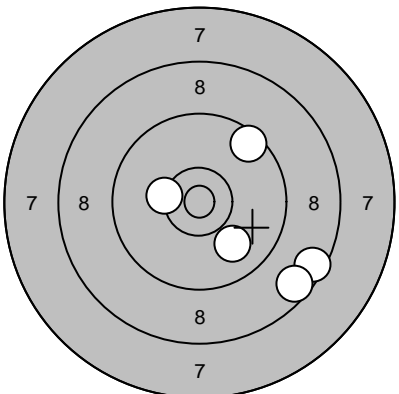
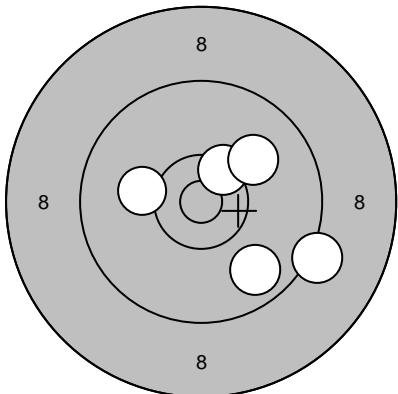
Skjutlag	Tavla	Staffan Samuelsson	
1	10		
		Rundvik	
2008-08-30	Höstträffen 2008	Ramselefors SKF	
Prov		1: 10,0 ↖ 2: 7,5 → 3: 9,0 ↑ 4: 10,4* ↓ 5: 10,4* ←	Serie 
		Serie 46,0 Totalt 0,0	1: 10,5* ↖ 2: 10,0 → 3: 10,1 ↑ 4: 8,5 ↗ 5: 9,6 →
			Serie 47,0 Totalt 47,0
Serie		6: 10,3* ↖ 7: 10,5* ↑ 8: 9,2 ↙ 9: 9,8 ↗ 10: 10,1 ↓	Serie 
		Serie 48,0 Totalt 95,0	11: 8,5 ↘ 12: 10,0 ↙ 13: 8,6 ↘ 14: 9,5 ↗ 15: 10,3* ←
			Serie 45,0 Totalt 140,0
Serie		16: 10,4* ↗ 17: 9,2 → 18: 9,8 ↘ 19: 10,1 ← 20: 10,1 ↗	
		Serie 48,0 Totalt 188,0	

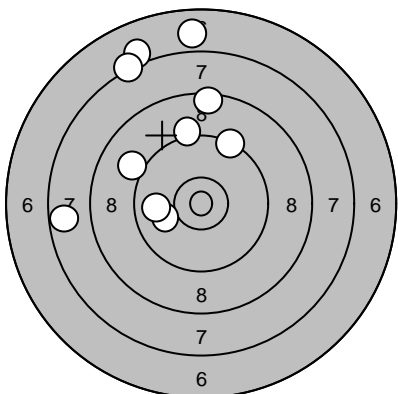
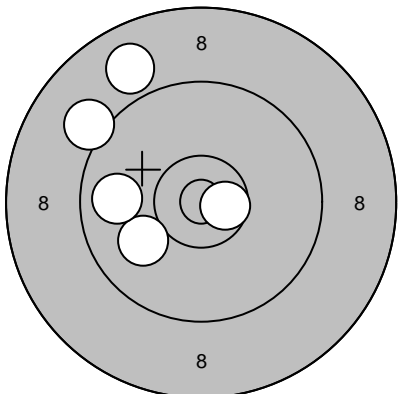
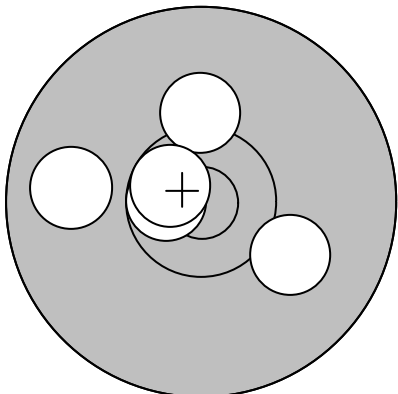
Skjutlag	Tavla	Lars Sandström	
1	11	Ramselefors	
2008-08-30	Höstträffen 2008	Ramselefors SKF	
Prov		1: 7,7 ← 2: 7,1 ↗ 3: 8,5 ↑ 4: 7,3 ↗ 5: 6,9 ↑ 6: 9,4 ↗ 7: 9,2 ↑ 8: 9,1 ↗ 9: 10,0 ← 10: 9,9 ←	11: 10,6* ← 12: 10,4* ↗ 13: 10,0 ↗ 14: 9,5 ↗ 15: 10,3* ← 16: 10,1 ↘ 17: 10,1 ↗
	Serie	81,0	Serie 69,0
	Totalt	0,0	Totalt 0,0
Serie		1: 8,9 ↗ 2: 10,6* → 3: 10,0 ↘ 4: 9,8 ← 5: 9,1 ↗	6: 10,0 ← 7: 10,3 ← 8: 9,4 ↑ 9: 9,2 ↗ 10: 10,4* ↗
	Serie	46,0	Serie 48,0
	Totalt	46,0	Totalt 94,0
Serie		11: 10,2 ↑ 12: 10,7* ← 13: 9,9 ← 14: 10,7* ↗ 15: 10,1 ↘	16: 9,7 ↗ 17: 10,8* → 18: 10,5* ↗ 19: 9,9 ← 20: 9,8 ↗
	Serie	49,0	Serie 47,0
	Totalt	143,0	Totalt 190,0

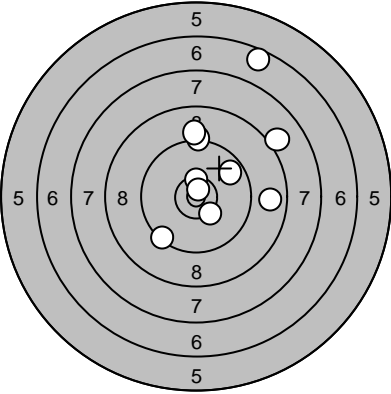
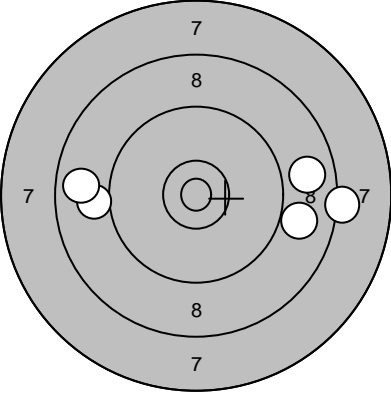
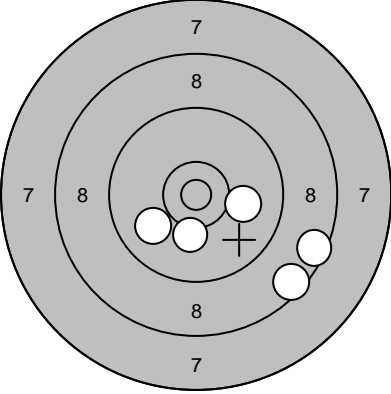
Skjutlag	Tavla	Therese Karlsson	
1	12	Drängsmark	
2008-08-30	Höstträffen 2008	Ramselefors SKF	
Prov		1: 6,6 ↗ 2: 8,1 ↗ 3: 9,4 ↘ 4: 9,3 ↑ 5: 8,8 → 6: 10,5* ↑ 7: 10,8* ↑ 8: 9,8 ↗ 9: 10,3* ↘ 10: 9,1 ↑	11: 9,8 ↗
	Serie 88,0		Serie 9,0
	Totalt 0,0		Totalt 0,0
Serie		1: 9,0 ← 2: 8,8 ← 3: 8,8 → 4: 9,0 → 5: 8,2 →	6: 10,4* ↘ 7: 10,0 → 8: 9,1 ↘ 9: 9,1 → 10: 9,8 ↗
	Serie 42,0		Serie 47,0
	Totalt 42,0		Totalt 89,0
Serie		11: 10,0 ↘ 12: 8,5 → 13: 10,2 ↓ 14: 10,1 → 15: 8,5 ↘	16: 8,2 ↘ 17: 9,9 → 18: 9,8 ↘ 19: 10,4* → 20: 9,5 ↘
	Serie 46,0		Serie 45,0
	Totalt 135,0		Totalt 180,0

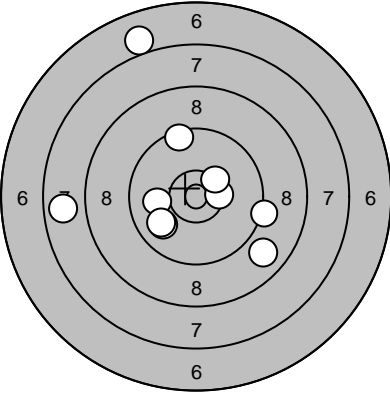
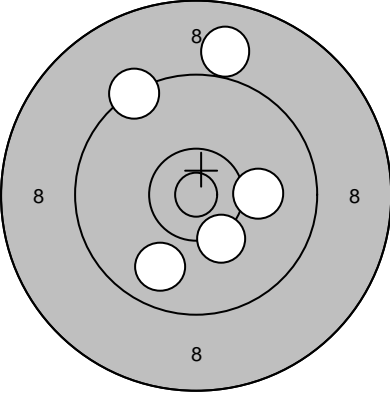
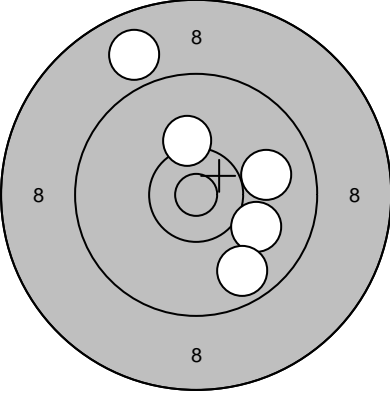
Skjutlag	Tavla	Lennart Westermark	
1	13	Drängsmark	
2008-08-30	Höstträffen 2008	Ramselefors SKF	
Prov		1: 7,0 ↗ 2: 10,4* → 3: 9,3 → 4: 8,9 ↓ 5: 9,5 ↑ 6: 7,8 ← 7: 9,9 ↓ 8: 10,0 ← 9: 10,3* ↗ 10: 9,9 ↙	11: 9,9 ↙ 12: 10,8* ↙
	Serie 88,0		Serie 19,0
	Totalt 0,0		Totalt 0,0
Serie		1: 10,3 ↓ 2: 10,1 → 3: 9,9 ↓ 4: 9,3 ↗ 5: 9,0 ↑	6: 9,9 ↗ 7: 10,1 ↙ 8: 8,2 ← 9: 7,8 ↓ 10: 9,7 ↑
	Serie 47,0		Serie 43,0
	Totalt 47,0		Totalt 90,0
Serie		11: 10,2 ↑ 12: 10,0 → 13: 8,9 ↗ 14: 10,0 → 15: 9,7 ↓	16: 10,0 ↗ 17: 10,2 ↓ 18: 10,6* ↗ 19: 10,1 ↗ 20: 10,3 ↓
	Serie 47,0		Serie 50,0
	Totalt 137,0		Totalt 187,0

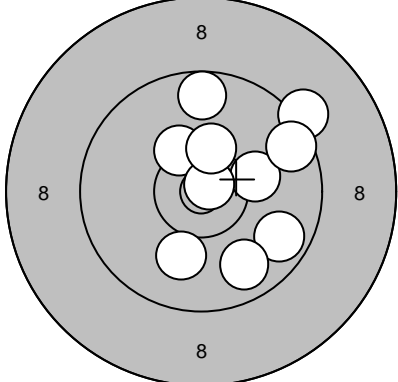
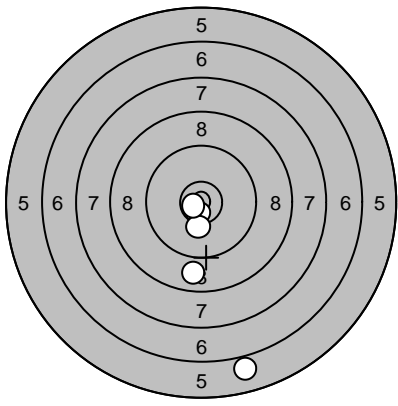
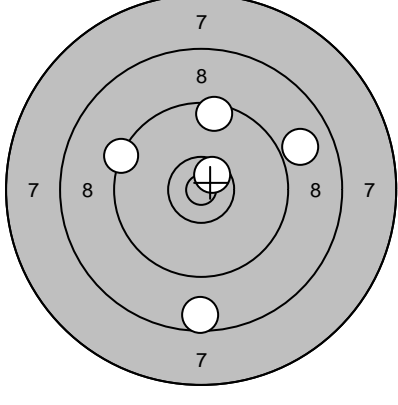
Skjutlag	Tavla	Ida Lundmark	
1	14	Drängsmark	
2008-08-30	Höstträffen 2008	Ramselefors SKF	
Prov		1: 9,7 ↑ 2: 10,2 → 3: 9,2 ↗ 4: 9,6 → 5: 9,7 → 6: 10,0 ↓ 7: 10,3* ↑ 8: 10,8* ↗ 9: 9,8 ↓ 10: 10,3* ↑	11: 10,2 ↘ 12: 10,3* ↑ 13: 10,2 ↓ 14: 10,7* ↓ 15: 10,4* ↓
	Serie	95,0	Serie 50,0
	Totalt	0,0	Totalt 0,0
Serie		1: 6,0 ↓ 2: 10,6* ↓ 3: 10,2 ↓ 4: 10,7* ↙ 5: 8,9 ↓	6: 8,7 ↙ 7: 10,5* ↑ 8: 8,8 ↓ 9: 8,9 ↓ 10: 8,9 ↙
	Serie	44,0	Serie 42,0
	Totalt	44,0	Totalt 86,0
Serie		11: 9,3 ↙ 12: 8,6 ↓ 13: 9,5 ↑ 14: 8,9 → 15: 10,6* ↗	16: 9,2 ↗ 17: 10,4* ↓ 18: 8,4 ↑ 19: 10,7* ↘ 20: 10,6* ↗
	Serie	44,0	Serie 47,0
	Totalt	130,0	Totalt 177,0

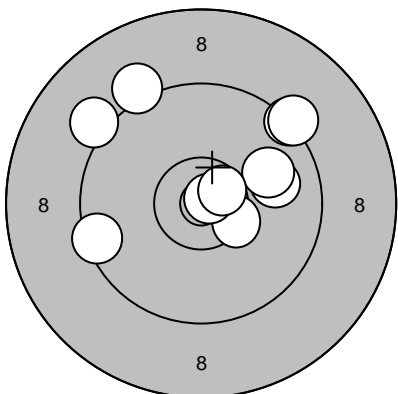
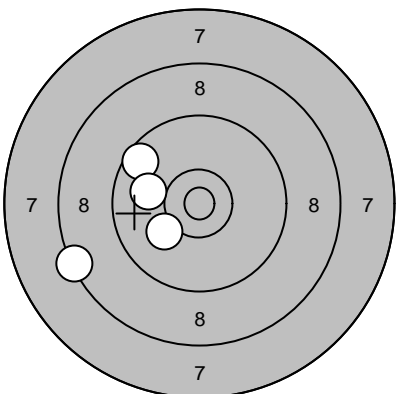
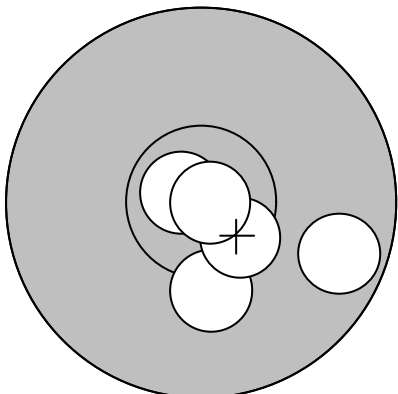
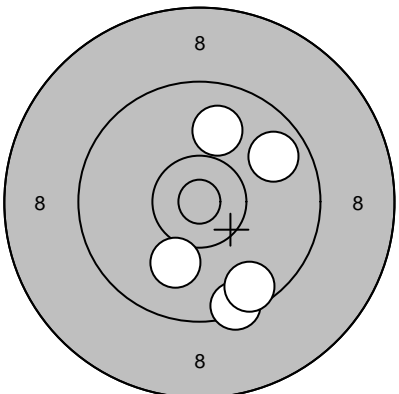
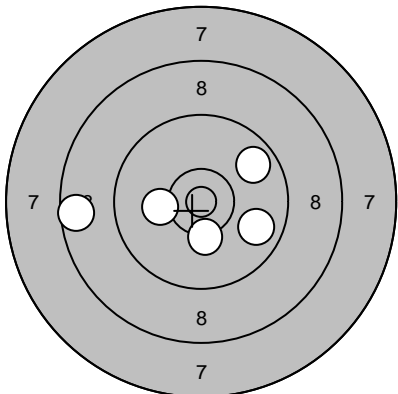
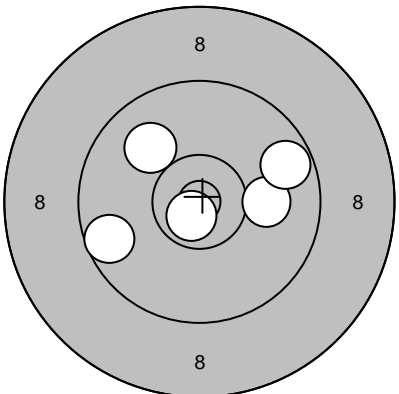
Skjutlag	Tavla	Emil Bergman	
1	15	Umeå	
2008-08-30	Höstträffen 2008	Ramselefors SKF	
Prov	 1: 9,2 ↖ 2: 10,4* → 3: 9,3 ↗ 4: 9,9 → 5: 9,9 ↗ 6: 10,8* ↗ 7: 9,3 ↗ 8: 10,6* ↗ 9: 9,1 ↖ 10: 9,5 ←	Prov	 11: 8,4 ← 12: 9,6 ↖ 13: 10,1 ↙ 14: 10,0 ←
	Serie 93,0		Serie 37,0
	Totalt 0,0		Totalt 0,0
Serie	 1: 10,2 ↓ 2: 9,7 → 3: 10,5* ↘ 4: 10,8* ↖ 5: 10,9* →	Serie	 6: 10,1 ↓ 7: 9,5 ↓ 8: 10,0 ↑ 9: 9,6 ↘ 10: 9,8 ↗
	Serie 49,0		Serie 47,0
	Totalt 49,0		Totalt 96,0
Serie	 11: 8,6 ← 12: 9,8 ↗ 13: 9,8 → 14: 10,2 ← 15: 10,3* ↓	Serie	 16: 9,6 ← 17: 10,0 ↖ 18: 10,7* ↘ 19: 10,0 → 20: 9,7 ↗
	Serie 46,0		Serie 48,0
	Totalt 142,0		Totalt 190,0

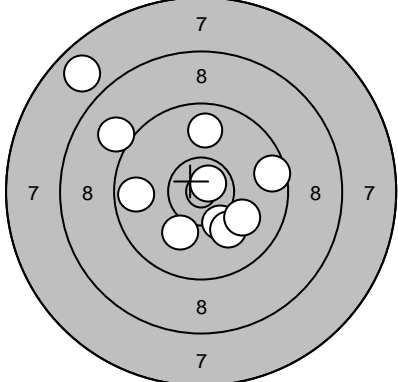
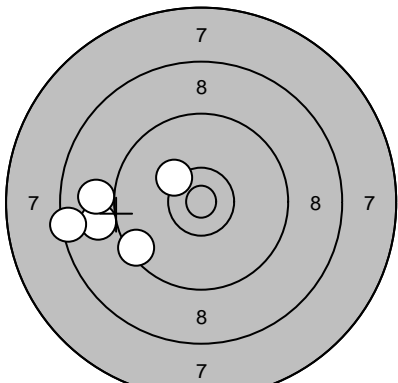
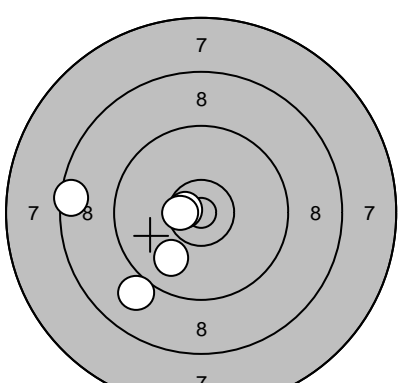
Skjutlag	Tavla	Oscar Kieri	
1	16	Umeå	
2008-08-30	Höstträffen 2008	Ramselefors SKF	
Prov		1: 9,6 → 2: 10,3 ↓ 3: 10,1 ↓ 4: 7,8 ↗ 5: 10,7* ↗ 6: 10,0 → 7: 9,7 ← 8: 10,1 ↓ 9: 9,8 ↑ 10: 9,0 ↖	11: 9,6 ↙ 12: 9,7 ↗ 13: 9,9 ↙ 14: 9,7 ↖ 15: 10,6* ↙
	Serie 93,0		Serie 46,0
	Totalt 0,0		Totalt 0,0
Serie		1: 9,0 ← 2: 9,5 ↙ 3: 10,3 ↗ 4: 8,4 ← 5: 9,0 ←	6: 10,7* ↓ 7: 9,8 ↓ 8: 8,0 ↗ 9: 9,0 ↖ 10: 10,5* ↑
	Serie 45,0		Serie 46,0
	Totalt 45,0		Totalt 91,0
Serie		11: 9,0 ↙ 12: 10,7* ← 13: 8,5 ← 14: 9,9 ↓ 15: 10,6* ←	16: 9,7 ↓ 17: 9,9 ↗ 18: 10,5* ↓ 19: 8,9 ← 20: 8,1 ←
	Serie 46,0		Serie 44,0
	Totalt 137,0		Totalt 181,0

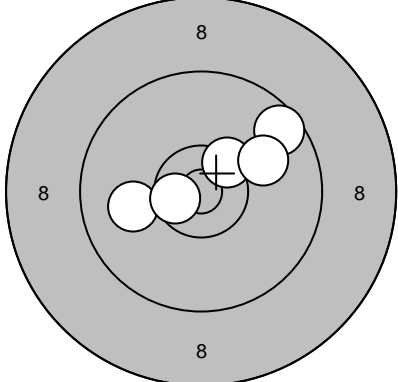
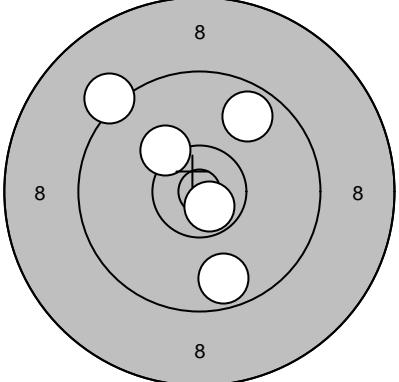
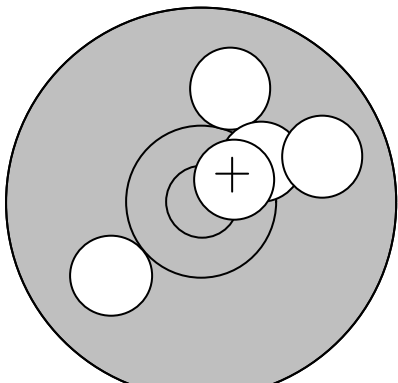
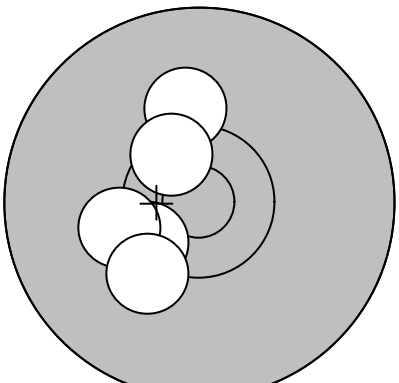
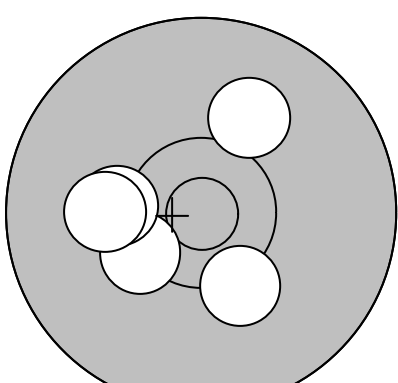
Skjutlag	Tavla	Lars Evaldsson		
1	18	Göteborg		
2008-08-30	Höstträffen 2008	Ramselefors SKF		
Prov		1: 10,4* ↗ 2: 10,0 ← 3: 9,6 ↗ 4: 10,0 → 5: 10,6* ←	Serie 	1: 10,7* ↓ 2: 9,2 ↗ 3: 9,7 ↗ 4: 10,2 ↗ 5: 9,7 ↓
		Serie 49,0	Serie 47,0	
		Totalt 0,0	Totalt 47,0	
Serie		6: 10,0 ↑ 7: 10,0 ← 8: 10,3* ↗ 9: 10,6* ↗ 10: 9,9 →	Serie 	11: 10,2 ↑ 12: 10,4* ← 13: 10,3 ← 14: 10,2 ↓ 15: 10,5* ↗
		Serie 49,0	Serie 50,0	
		Totalt 96,0	Totalt 146,0	
Serie		16: 10,3* ← 17: 10,2 ↓ 18: 10,0 ↗ 19: 10,2 ← 20: 10,1 ←		
		Serie 50,0		
		Totalt 196,0		

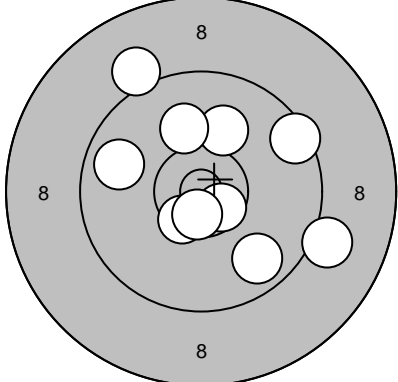
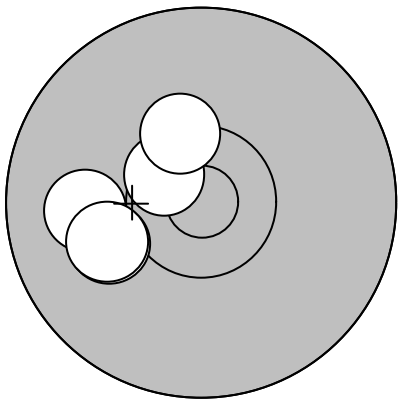
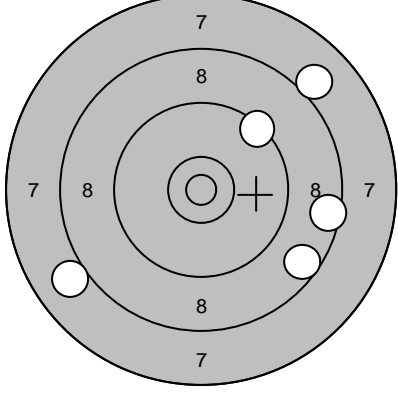
Skjutlag	Tavla	Marlene Forsell		
2	5	Ramselefors		
2008-08-30	Höstträffen 2008	Ramselefors SKF		
Prov		1: 9,1 ↗ 2: 9,5 → 3: 10,5* ↘ 4: 10,6* ↘ 5: 9,1 → 6: 9,8 ↘ 7: 9,8 ← 8: 10,1 ↗ 9: 10,1 ↗ 10: 10,6* ↘	11: 9,9 → 12: 10,8* ↘ 13: 10,5* ↗ 14: 9,9 ↗ 15: 10,0 ↘ 16: 9,6 ↗	
	Serie	95,0	Serie	57,0
	Totalt	0,0	Totalt	0,0
Serie		1: 10,6* ↗ 2: 10,1 ← 3: 10,4* ↗ 4: 10,0 ← 5: 10,1 ←	6: 10,4* ↗ 7: 10,3* ↘ 8: 9,9 ↗ 9: 10,1 ← 10: 9,9 ↗	
	Serie	50,0	Serie	48,0
	Totalt	50,0	Totalt	98,0
Serie		11: 8,0 ↘ 12: 9,4 ↗ 13: 8,6 ↘ 14: 8,5 → 15: 8,0 ↗	16: 8,5 ↗ 17: 8,3 ↘ 18: 9,7 ↘ 19: 9,0 ↘ 20: 9,9 ↘	
	Serie	41,0	Serie	43,0
	Totalt	139,0	Totalt	182,0

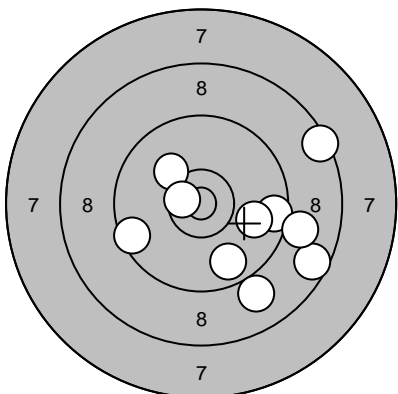
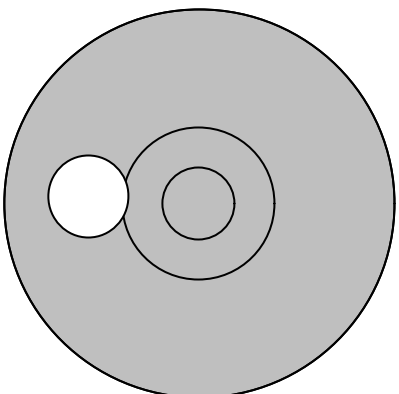
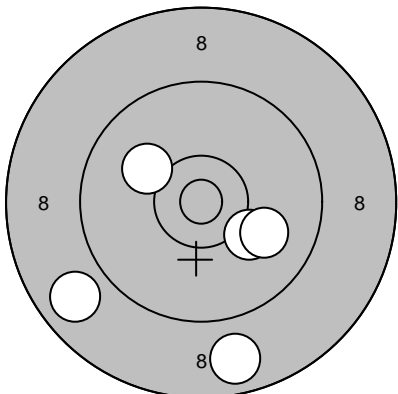
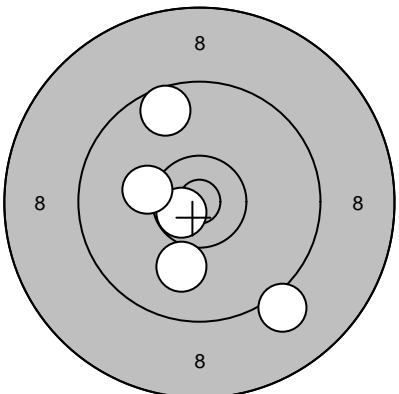
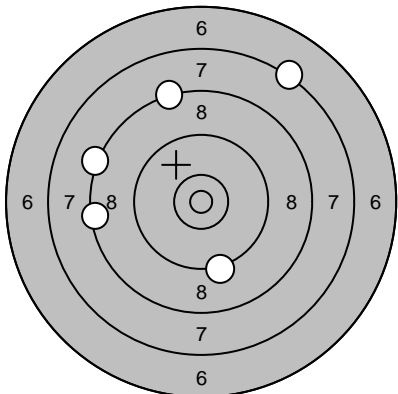
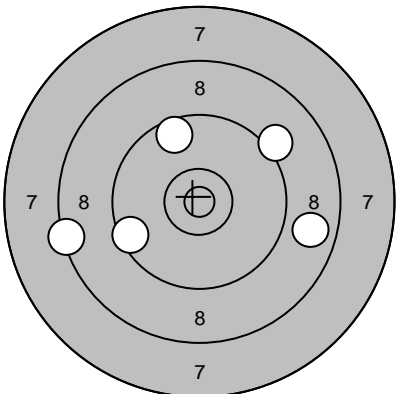
Skjutlag	Tavla	Johan Nilsson	
2	6		
		Ramselefors	
2008-08-30	Höstträffen 2008	Ramselefors SKF	
Prov 	1: 9,5 ←	Prov 	11: 10,0 ←
	2: 8,5 →		
	3: 8,6 ↘		
	4: 10,1 ↗		
	5: 9,7 ↘		
	6: 9,6 →		
	7: 9,0 →		
	8: 9,9 →		
	9: 9,0 ↘		
	10: 10,6* ←		
	Serie 90,0		Serie 10,0
	Totalt 0,0		Totalt 0,0
Serie 	1: 10,2 ↘	Serie 	6: 10,7* ←
	2: 10,0 →		7: 9,1 ↘
	3: 10,1 ↗		8: 9,6 ↗
	4: 8,8 ↘		9: 10,0 ↘
	5: 8,8 ↙		10: 10,2 ←
	Serie 46,0		Serie 48,0
	Totalt 46,0		Totalt 94,0
Serie 	11: 8,3 ←	Serie 	16: 8,4 ←
	12: 8,3 ↑		17: 9,2 ↗
	13: 7,3 ↗		18: 9,5 ←
	14: 8,4 ←		19: 8,8 →
	15: 9,3 ↘		20: 9,6 ↗
	Serie 40,0		Serie 43,0
	Totalt 134,0		Totalt 177,0

Skjutlag

Tavla

2

7

Dan-Ivan Karlsson

Ramselefors

2008-08-30

Höstträffen 2008

Ramselefors SKF

Prov

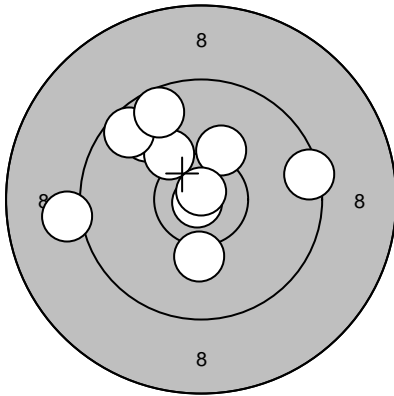

1: 10,2 ↗
 2: 9,8 ↖
 3: 10,9* ↙
 4: 10,2 ↓
 5: 9,4 →
 6: 10,2 ↗
 7: 10,8* ↑
 8: 9,6 ↗
 9: 9,1 ←
 10: 9,6 ↗

Serie 95,0

Totalt 0,0

Serie

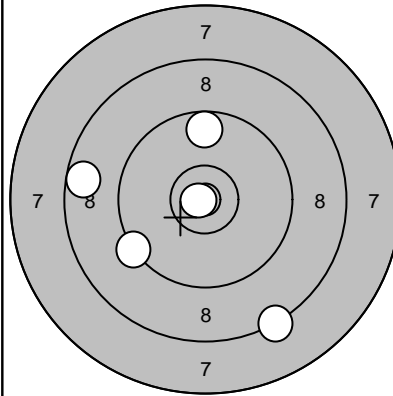

1: 8,3 ↘
 2: 10,8* ←
 3: 9,7 ↑
 4: 8,7 ←
 5: 9,3 ↙

Serie 44,0

Totalt 44,0

Serie

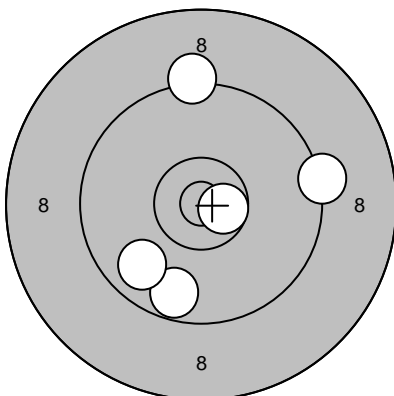

6: 9,7 ↘
 7: 10,6* →
 8: 9,3 →
 9: 9,3 ↑
 10: 9,8 ↙

Serie 46,0

Totalt 90,0

Serie

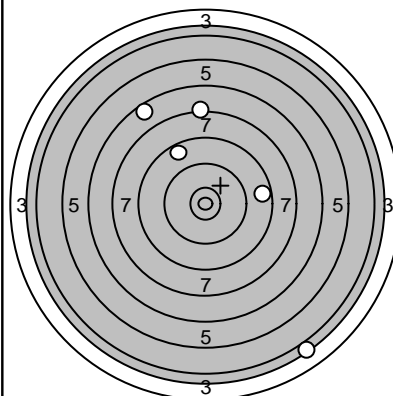

11: 8,7 →
 12: 8,7 ↗
 13: 7,3 ↑
 14: 4,0 ↘
 15: 6,6 ↗

Serie 33,0

Totalt 123,0

Serie

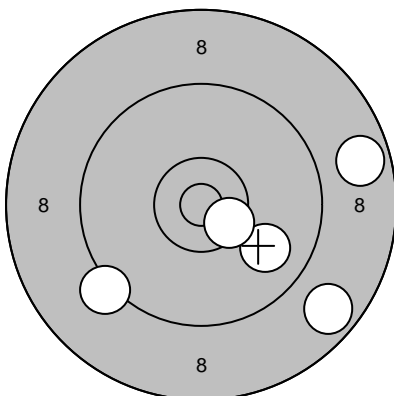

16: 9,9 ↘
 17: 10,5* ↘
 18: 9,2 ↙
 19: 8,7 ↘
 20: 8,7 →

Serie 44,0

Totalt 167,0

Skjutlag 2	Tavla 9	Christian Lejon	
		Umeå	
2008-08-30	Höstträffen 2008	Ramselefors SKF	
Serie		Serie	
1: 9,3 ←	Serie 48,0	6: 9,9 ↗	Serie 49,0
2: 9,9 ↓		7: 10,2 →	
3: 10,2 ↓	Totalt 48,0	8: 10,1 →	Totalt 97,0
4: 10,1 ↗		9: 10,5* →	
5: 10,7* ↑		10: 10,1 ↑	
Serie		Serie	
11: 8,1 ↗	Serie 39,0	16: 9,6 →	Serie 47,0
12: 8,5 ←		17: 9,7 ↓	
13: 8,9 →	Totalt 136,0	18: 10,1 ←	Totalt 183,0
14: 7,8 ↑		19: 9,4 ↓	
15: 8,8 ↗		20: 10,1 ←	

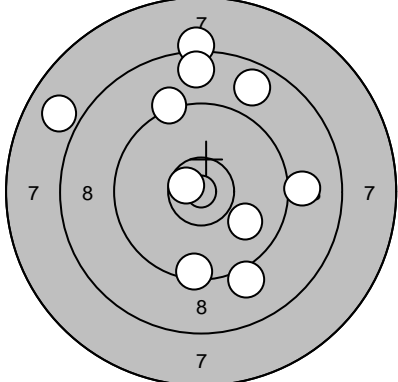
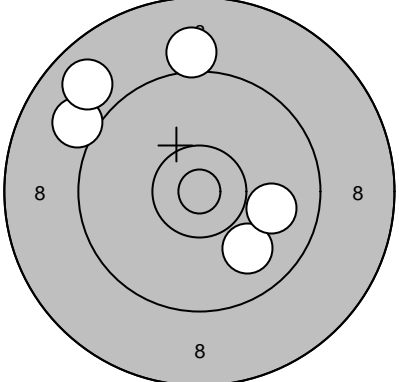
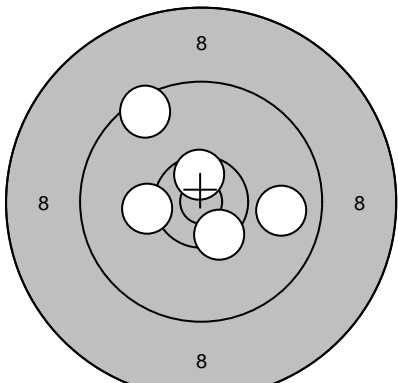
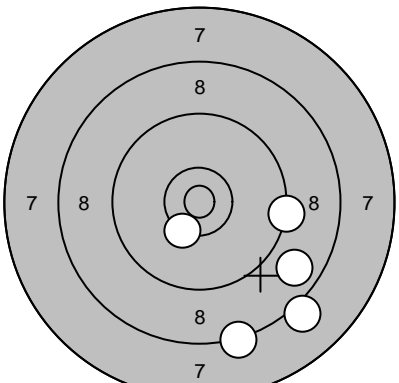
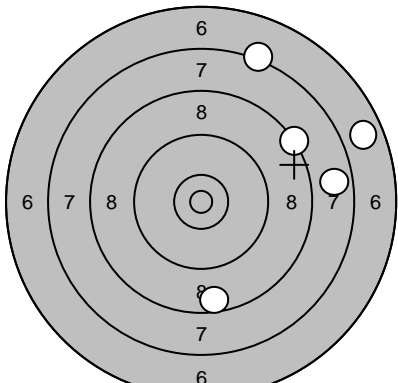
Skjutlag	Tavla	Staffan Samuelsson	
2	10		
		Rundvik	
2008-08-30	Höstträffen 2008	Ramselefors SKF	
Prov		1: 9,1 → 2: 8,2 ↑ 3: 9,2 ↗ 4: 8,8 ↗ 5: 9,9 → 6: 9,1 ↓ 7: 9,5 ↓ 8: 8,7 ↑ 9: 7,9 ↖ 10: 10,7* ↖	Serie 
	Serie 86,0 Totalt 0,0	1: 9,9 ↓ 2: 10,0 → 3: 9,1 ↗ 4: 8,9 ↗ 5: 9,1 ↑	Serie 45,0 Totalt 45,0
Serie		6: 10,2 ← 7: 10,4* ↓ 8: 10,6* ↑ 9: 9,5 ↗ 10: 9,9 →	Serie 
	Serie 48,0 Totalt 93,0	11: 8,8 ↓ 12: 8,3 ↓ 13: 9,3 → 14: 10,3* ↓ 15: 8,1 ↓	Serie 43,0 Totalt 136,0
Serie		16: 8,6 ↓ 17: 7,7 → 18: 8,3 ↗ 19: 6,8 → 20: 7,3 ↑	
	Serie 36,0 Totalt 172,0		

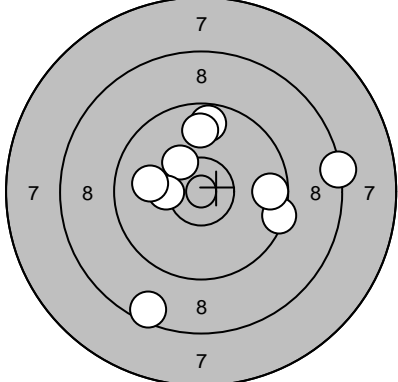
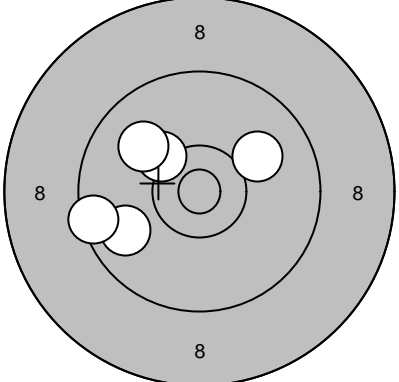
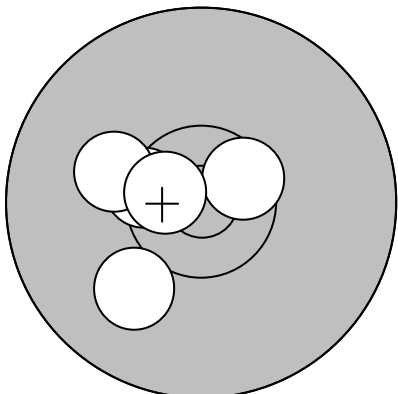
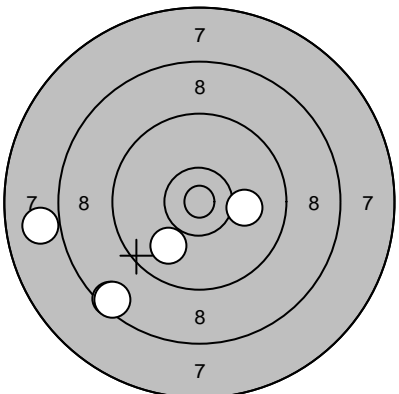
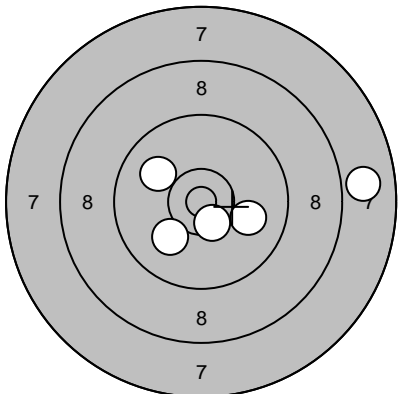
Skjutlag 2	Tavla 11	Lars Sandström		
		Ramselefors		
2008-08-30	Höstträffen 2008	Ramselefors SKF		
Prov		1: 8,5 ↘ 2: 8,4 → 3: 9,4 → 4: 9,7 → 5: 9,7 ↑ 6: 9,8 ↑ 7: 10,3 ↗ 8: 10,3* ← 9: 10,0 ←	Serie 	1: 10,0 ↗ 2: 10,2 ↖ 3: 9,8 ↙ 4: 9,5 ← 5: 10,0 ↖
	Serie 82,0		Serie 48,0	
	Totalt 0,0		Totalt 48,0	
Serie		6: 10,5* ← 7: 10,2 ← 8: 10,0 ↘ 9: 10,5* ↗ 10: 10,6* ←	Serie 	11: 9,9 ↘ 12: 8,0 ← 13: 8,5 ↘ 14: 8,5 ↘ 15: 10,1 →
	Serie 50,0		Serie 43,0	
	Totalt 98,0		Totalt 141,0	
Serie		16: 7,9 → 17: 10,1 ↘ 18: 10,0 ↗ 19: 10,5* ↘ 20: 10,0 →		
	Serie 47,0			
	Totalt 188,0			

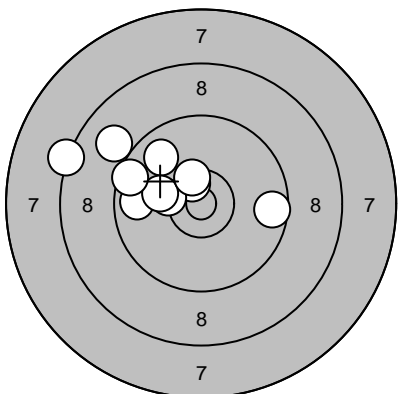
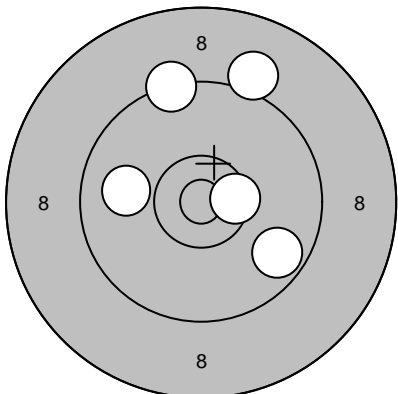
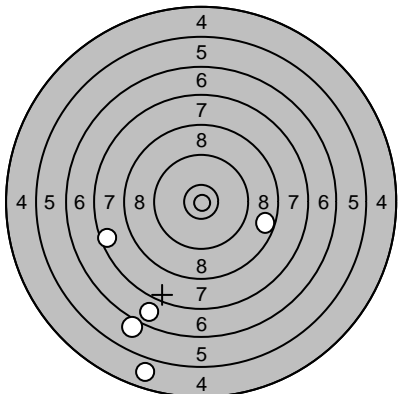
Skjutlag	Tavla	Therese Karlsson	
2	12	Drängsmark	
2008-08-30	Höstträffen 2008	Ramselefors SKF	
Prov		1: 10,5* ↗ 2: 9,8 ← 3: 9,6 → 4: 10,3* ← 5: 8,3 ↗ 6: 9,8 ↗ 7: 10,2 ← 8: 9,0 ↗ 9: 10,4* ↗ 10: 9,5 ←	11: 9,2 ←
	Serie 93,0		Serie 9,0
	Totalt 0,0		Totalt 0,0
Serie		1: 9,4 ↗ 2: 9,7 ↘ 3: 9,1 ↗ 4: 10,5* → 5: 9,9 ←	6: 9,9 ↗ 7: 9,6 ← 8: 9,4 ↗ 9: 10,4* ↘ 10: 10,1 →
	Serie 46,0		Serie 47,0
	Totalt 46,0		Totalt 93,0
Serie		11: 4,9 ↘ 12: 6,8 ↘ 13: 6,1 ↘ 14: 8,6 → 15: 7,5 ←	16: 10,5* ↘ 17: 7,6 ← 18: 6,5 ← 19: 9,5 ↘ 20: 9,5 ↘
	Serie 31,0		Serie 41,0
	Totalt 124,0		Totalt 165,0

Skjutlag

Tavla

2

13

Lennart Westermark

Drängsmark

2008-08-30

Höstträffen 2008

Ramselefors SKF

Prov

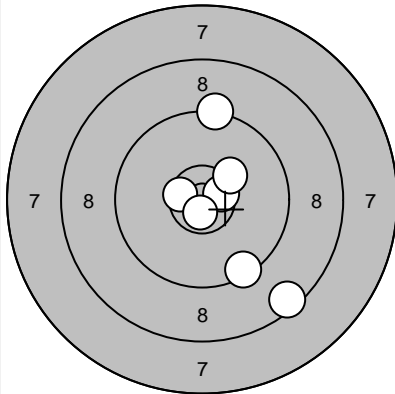

1: 10,6* →
 2: 9,4 ↓
 3: 9,3 ↑
 4: 10,5* ←
 5: 8,5 ↓
 6: 10,7* ↓
 7: 10,3 ↗

Serie

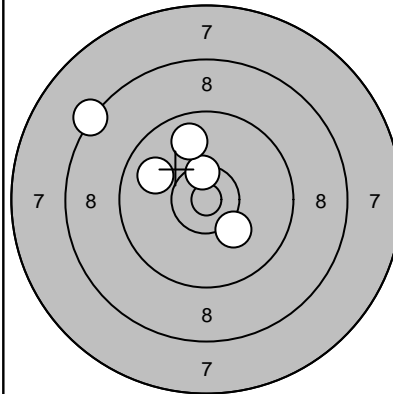

1: 8,3 ↖
 2: 10,2 ↘
 3: 10,4* ↑
 4: 9,8 ↑
 5: 9,9 ↖

Serie 66,0

Totalt 0,0

Serie 46,0

Totalt 46,0

Serie

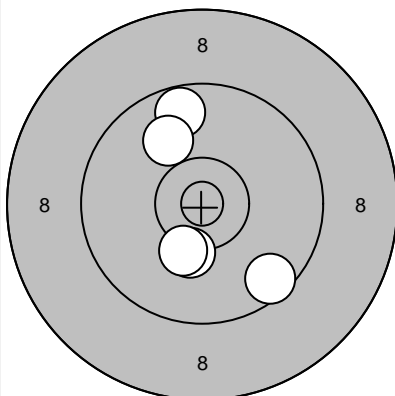

6: 10,3 ↓
 7: 10,3 ↓
 8: 9,6 ↘
 9: 9,7 ↑
 10: 10,0 ↗

Serie

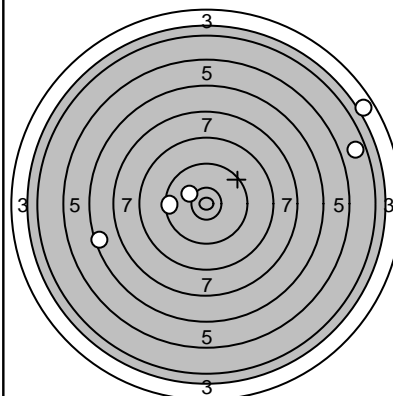

11: 10,2 ↖
 12: 6,6 ←
 13: 4,7 →
 14: 3,7 ↗
 15: 9,5 ←

Serie 48,0

Totalt 94,0

Serie 32,0

Totalt 126,0

Serie

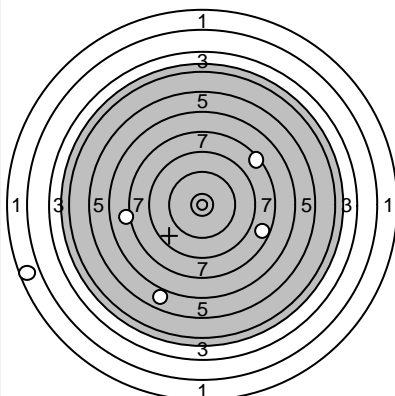

16: 7,5 ↗
 17: 6,0 ↓
 18: 1,7 ←
 19: 7,7 →
 20: 7,3 ←

Serie 28,0

Totalt 154,0

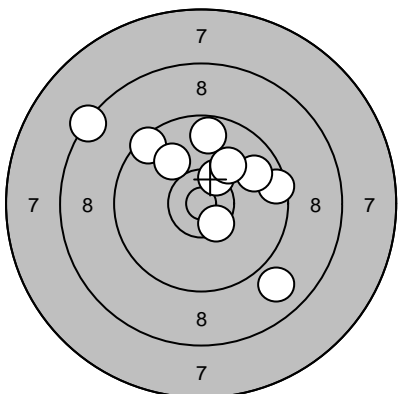
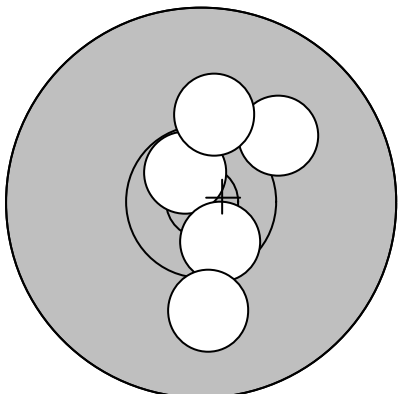
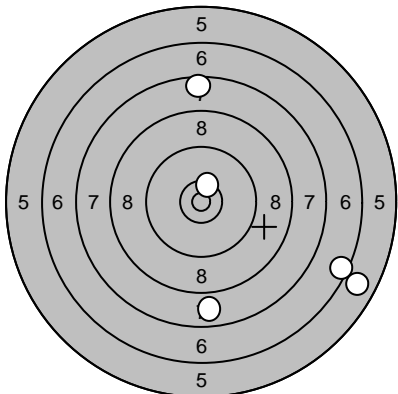
Skjutlag	Tavla	Ida Lundmark	
2	14	Drängsmark	
2008-08-30	Höstträffen 2008	Ramselefors SKF	
Prov		1: 10,5* ↘ 2: 8,9 ↘ 3: 9,5 → 4: 8,4 ↗ 5: 10,4* ↗ 6: 9,8 → 7: 9,7 ↑ 8: 9,5 ↗ 9: 10,0 ↗ 10: 10,1 ↗	11: 9,1 ↗ 12: 9,7 → 13: 9,5 ↓
	Serie 92,0		Serie 27,0
	Totalt 0,0		Totalt 0,0
Serie		1: 10,7* ↗ 2: 10,1 ↗ 3: 10,6* ↘ 4: 10,2 ↑ 5: 10,0 ↓	6: 10,4* ↗ 7: 10,2 ↓ 8: 10,1 ↗ 9: 10,1 ↗ 10: 10,1 ↗
	Serie 50,0		Serie 50,0
	Totalt 50,0		Totalt 100,0
Serie		11: 7,6 ↑ 12: 7,8 ↓ 13: 6,5 → 14: 5,9 → 15: 10,4* ↗	16: 8,2 ↗ 17: 6,2 → 18: 8,2 ↗ 19: 7,3 ↗ 20: 9,3 ↗
	Serie 35,0		Serie 38,0
	Totalt 135,0		Totalt 173,0

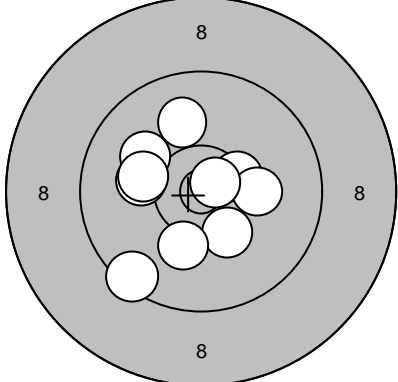
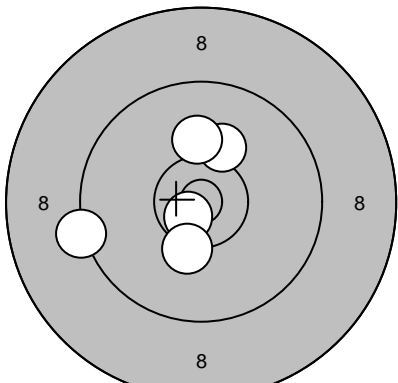
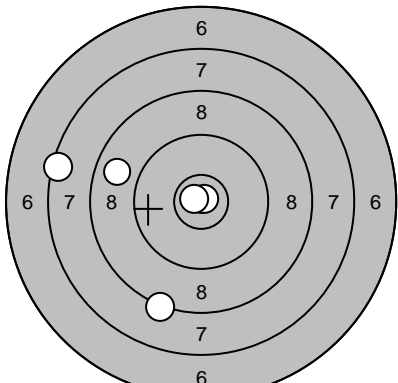
Skjutlag	Tavla	Oscar Kieri	
2	16	Umeå	
2008-08-30	Höstträffen 2008	Ramselefors SKF	
Prov		1: 10,0 ↗ 2: 10,1 ← 3: 10,3* ↘ 4: 10,1 ↗ 5: 10,1 ← 6: 10,4* → 7: 10,2 → 8: 10,2 ↓ 9: 10,7* → 10: 9,5 ↘	11: 9,2 ↗ 12: 10,2 ← 13: 10,2 ↑ 14: 9,8 ↓ 15: 9,5 ↑
	Serie 99,0	Serie 47,0	
	Totalt 0,0	Totalt 0,0	
Serie		1: 10,2 ↗ 2: 10,1 ↑ 3: 10,7* ↘ 4: 10,3 ↓ 5: 9,3 ←	6: 9,8 → 7: 10,0 ↗ 8: 10,3* ↑ 9: 9,5 ↗ 10: 9,0 ↘
	Serie 49,0	Serie 47,0	
	Totalt 49,0	Totalt 96,0	
Serie		11: 7,5 ← 12: 8,3 ↓ 13: 10,8* → 14: 10,8* ↗ 15: 8,8 ←	16: 6,9 ↑ 17: 9,3 ↗ 18: 6,2 ← 19: 9,3 → 20: 8,0 ↑
	Serie 43,0	Serie 38,0	
	Totalt 139,0	Totalt 177,0	

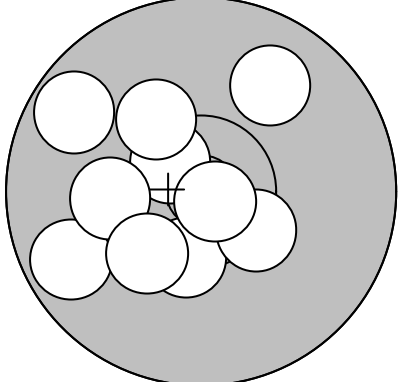
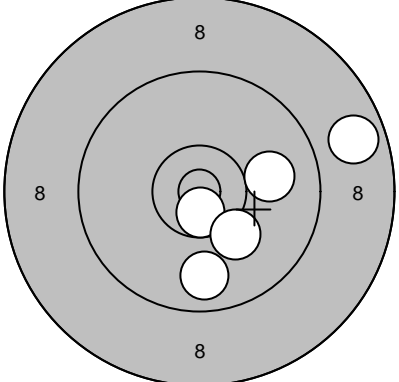
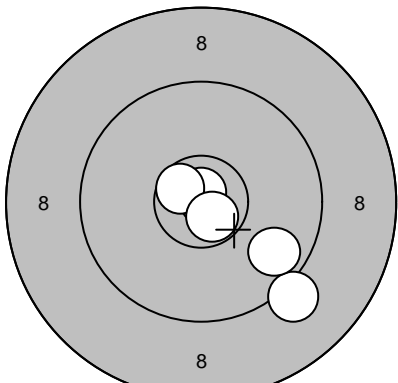
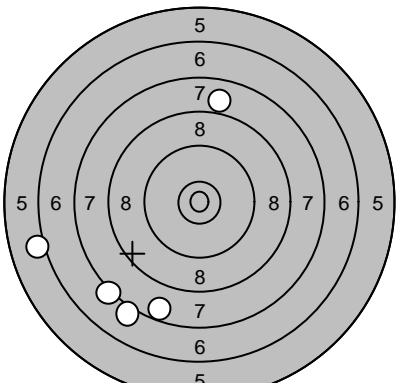
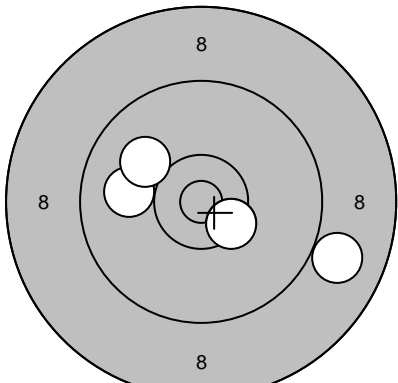
Skjutlag 2	Tavla 18	Lars Evaldsson	
		Göteborg	
2008-08-30	Höstträffen 2008	Ramselefors SKF	
Prov 	1: 9,7 ↙	Serie 	1: 8,7 →
	2: 10,6* ↗		2: 10,7* ↓
	3: 10,2 ↗		3: 10,0 →
	4: 9,7 ↗		4: 9,8 ↓
	5: 9,9 ↗		5: 10,2 ↘
	6: 10,2 ←		
	7: 10,4* ↓		
	8: 10,4* ↘		
	9: 10,3 ↙		
	10: 10,8* ↘		
	Serie 97,0		Serie 47,0
	Totalt 0,0		Totalt 47,0
Serie 	6: 9,2 ↘	Serie 	11: 7,2 ↙
	7: 10,8* ↑		12: 7,1 ↘
	8: 10,6* ↗		13: 6,1 ←
	9: 10,7* ↘		14: 7,7 ↓
	10: 9,7 ↘		15: 8,0 ↑
	Serie 48,0		Serie 35,0
	Totalt 95,0		Totalt 130,0
Serie 	16: 10,0 ←		
	17: 8,9 ↘		
	18: 10,0 ↗		
	19: 10,4* ↘		
	20: 10,4* ↘		
	Serie 48,0		
	Totalt 178,0		