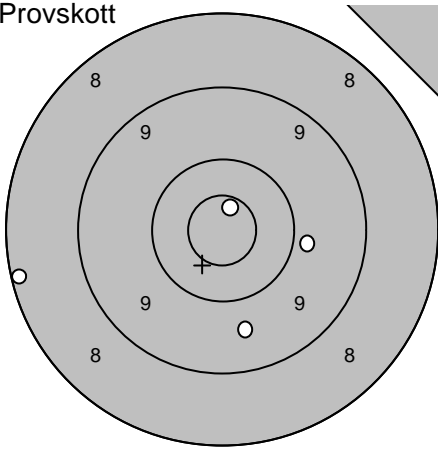
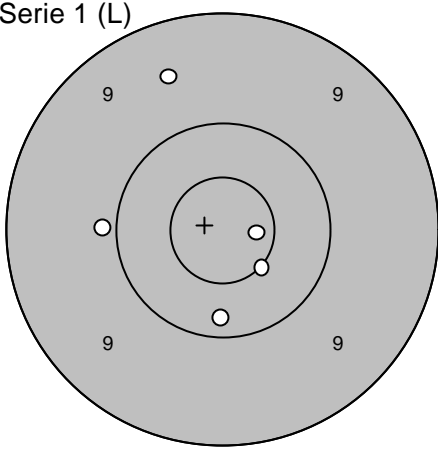
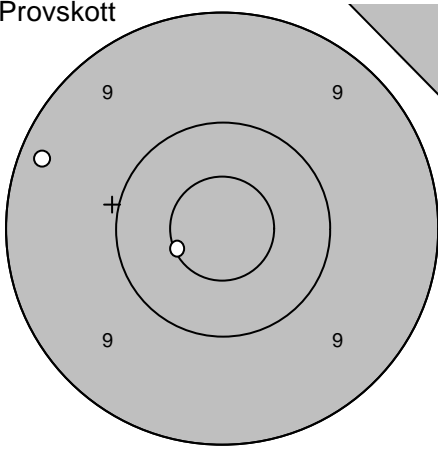
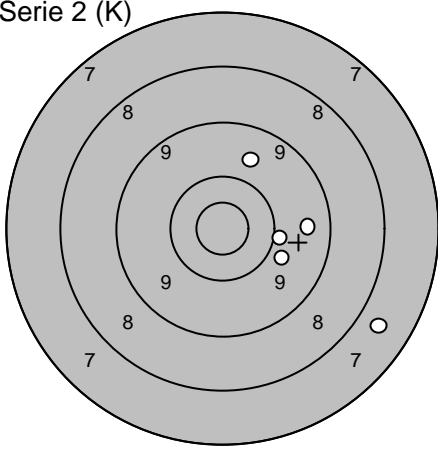
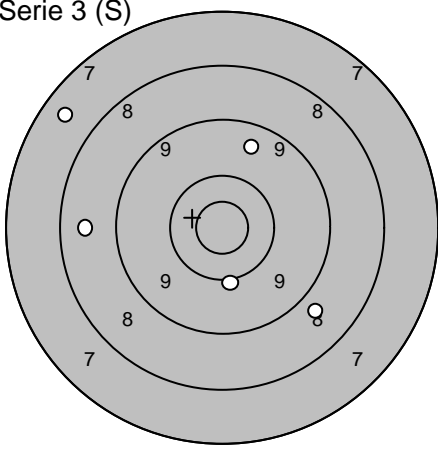
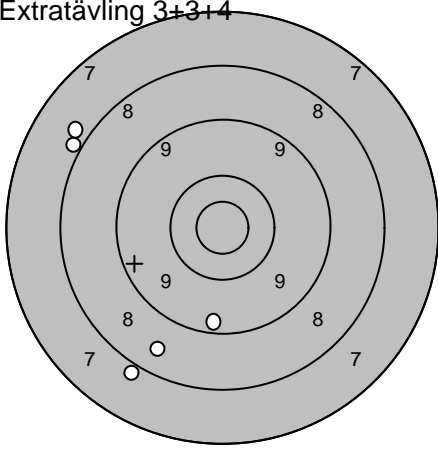
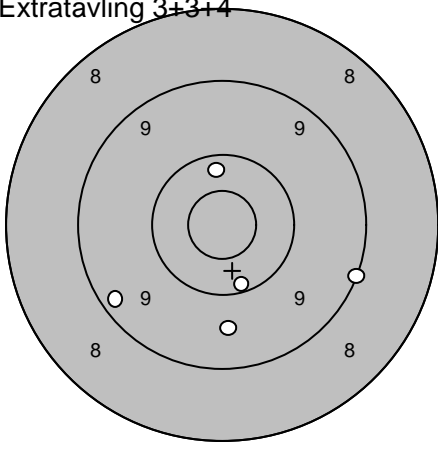

Skjutlag <b>1</b>	Tavla <b>1</b>	<b>Jan-Olof Lampinen</b>	
		S 3	
2008-07-13	Tavelträffen B 2008	Ramselefors SKF	
Provskott		1: 8,2 ← 2: 9,7 ↓ 3: 9,9 → 4: 10,7* ↑	Serie 1 (L) 
		1: 9,5 ↑ 2: 10,7* → 3: 9,9 ← 4: 10,5* ↓ 5: 10,2 ↓	
		Serie 36,0 Totalt 0,0	Serie 48,0 Totalt 48,0
Provskott		1: 9,2 ← 2: 10,6* ←	Serie 2 (K) 
			1: 9,7 ↑ 2: 9,5 → 3: 9,9 → 4: 7,7 → 5: 10,0 →
		Serie 19,0 Totalt 48,0	Serie 44,0 Totalt 92,0
Serie 3 (S)		1: 8,8 ↘ 2: 8,6 ← 3: 7,5 ↗ 4: 10,1 ↓ 5: 9,5 ↑	Extratävling 3+3+4 
			1: 8,5 ↓ 2: 8,0 ↖ 3: 7,9 ↗ 4: 7,9 ↓ 5: 9,3 ↓
		Serie 42,0 Totalt 134,0	Serie 39,0 Totalt 173,0
Extratävling 3+3+4		6: 9,3 ← 7: 9,1 → 8: 9,6 ↓ 9: 10,2 ↓ 10: 10,3 ↑	
		Serie 47,0 Totalt 220,0	

OBS!

På grund av tekniska problem har vi problem med detta skjutkort som därför tagits bort ur denna fil.

Vi ber om ursäkt för det inträffade och kommer att göra allt för att det inte ska inträffa igen.

//Ramselefors Skytteförening

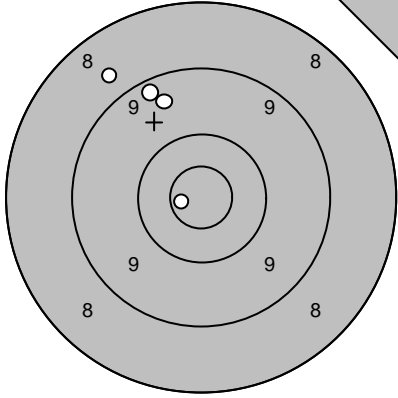
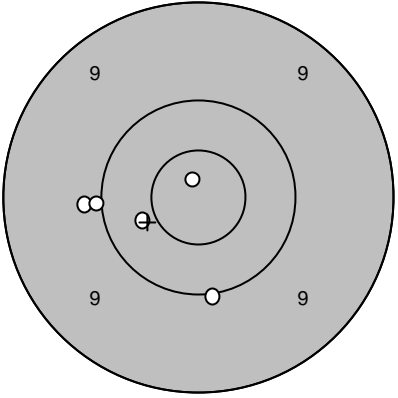
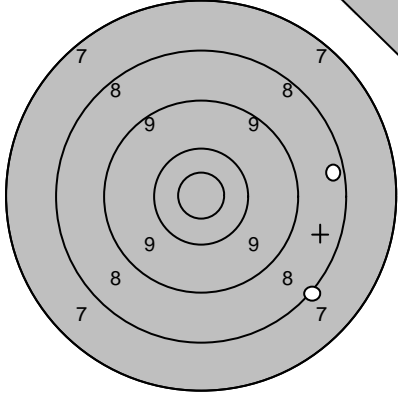
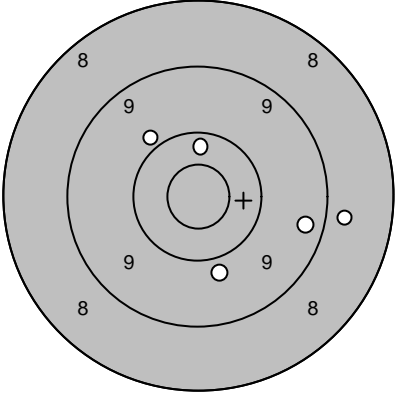
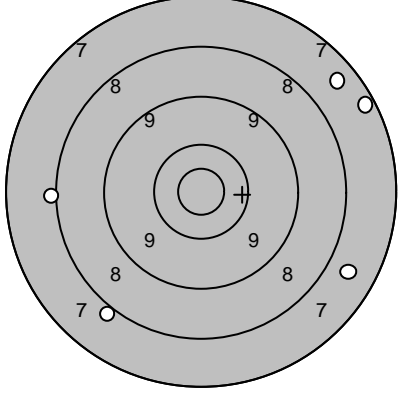
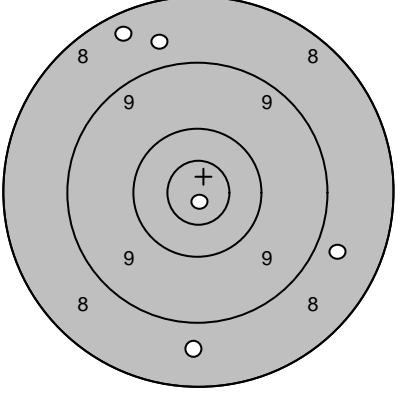
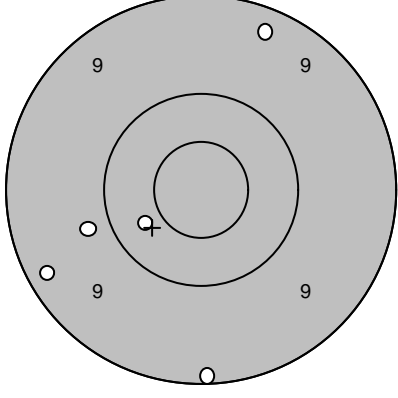
Skjutlag	Tavla	<b>Liselott Danielsson</b>	
<b>1</b>	<b>3</b>		
Växjö			
2008-07-13	Tavelträffen B 2008	Ramselefors SKF	
<b>Provskott</b> 	1: 10,8* ← 2: 9,5 ↗ 3: 9,3 ↗ 4: 8,7 ↗	<b>Serie 1 (L)</b> 	1: 10,0 ↓ 2: 10,8* ↗ 3: 10,4 ← 4: 9,9 ← 5: 10,0 ←
	<b>Serie</b> 36,0 <b>Totalt</b> 0,0		<b>Serie</b> 49,0 <b>Totalt</b> 49,0
<b>Provskott</b> 	1: 8,4 → 2: 8,1 ↘	<b>Serie 2 (K)</b> 	1: 10,3 ↑ 2: 9,9 ↗ 3: 9,4 → 4: 8,8 → 5: 9,9 ↓
	<b>Serie</b> 16,0 <b>Totalt</b> 49,0		<b>Serie</b> 45,0 <b>Totalt</b> 94,0
<b>Serie 3 (S)</b> 	1: 7,3 ↗ 2: 7,7 → 3: 8,1 ← 4: 7,5 ↗ 5: 8,0 ↘	<b>Extratävling 3+3+4</b> 	1: 8,4 ↗ 2: 8,7 ↓ 3: 10,9* ↓ 4: 8,7 ↗ 5: 8,8 →
	<b>Serie</b> 37,0 <b>Totalt</b> 131,0		<b>Serie</b> 42,0 <b>Totalt</b> 173,0
<b>Extratävling 3+3+4</b> 	6: 9,3 ↗ 7: 9,8 ← 8: 9,2 ← 9: 10,4 ← 10: 9,1 ↓		
	<b>Serie</b> 46,0 <b>Totalt</b> 219,0		

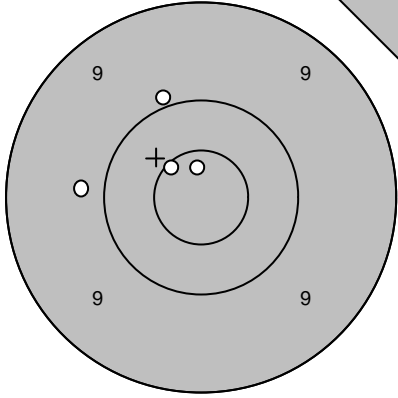
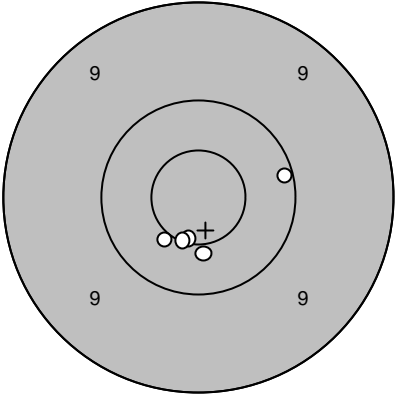
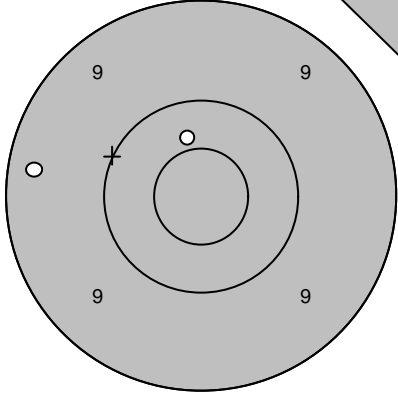
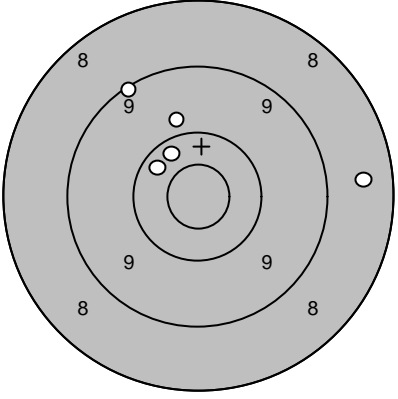
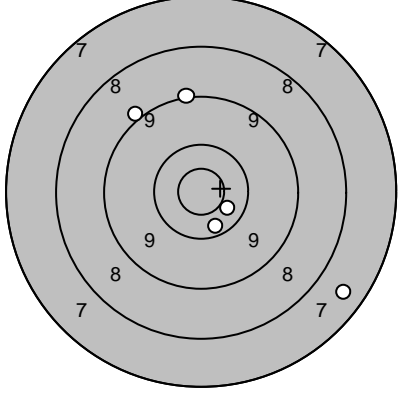
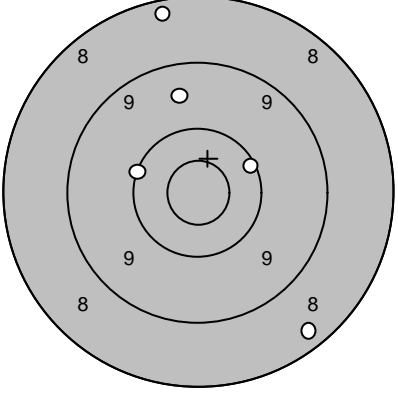
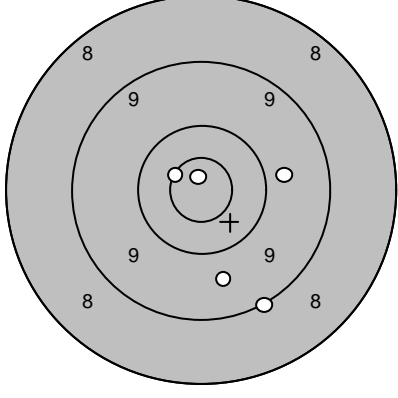
Skjutlag	Tavla	<b>Jane Jönsson</b>	
<b>1</b>	<b>4</b>		
		Skurup	
2008-07-13	Tavelträffen B 2008	Ramselefors SKF	
Provskott		1: 9,8 ← 2: 10,0 ↑ 3: 10,7* ↑ 4: 10,6* ↖  Serie 39,0 Totalt 0,0	Serie 1 (L)  1: 10,6* ↓ 2: 10,5* ↓ 3: 10,6* ↓ 4: 10,1 → 5: 10,5* ↘  Serie 50,0 Totalt 50,0
Provskott		1: 9,3 ← 2: 10,4 ↑  Serie 19,0 Totalt 50,0	Serie 2 (K)  1: 8,5 → 2: 9,9 ↑ 3: 10,3 ↗ 4: 10,3 ↗ 5: 9,1 ↗  Serie 46,0 Totalt 96,0
Serie 3 (S)		1: 9,1 ↑ 2: 7,6 → 3: 10,4 ↓ 4: 10,5* ↓ 5: 9,0 ↗  Serie 45,0 Totalt 141,0	Extratävling 3+3+4  1: 8,3 ↑ 2: 9,6 ↑ 3: 10,1 ← 4: 10,2 → 5: 8,4 ↘  Serie 45,0 Totalt 186,0
Extratävling 3+3+4		6: 10,6* ↖ 7: 9,7 ↓ 8: 9,1 ↓ 9: 9,8 → 10: 10,9* ↑  Serie 47,0 Totalt 233,0	

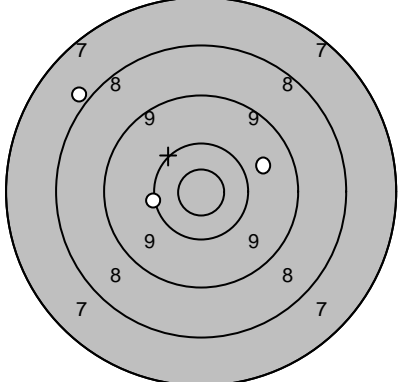
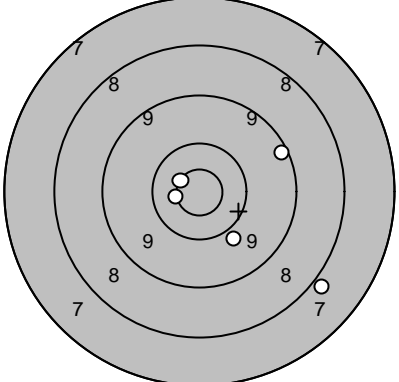
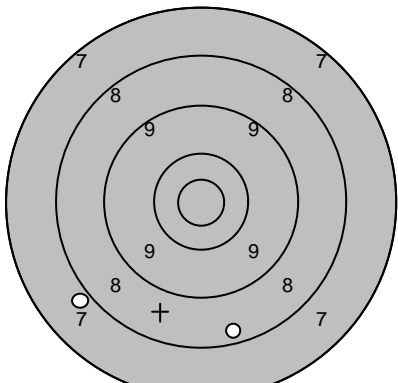
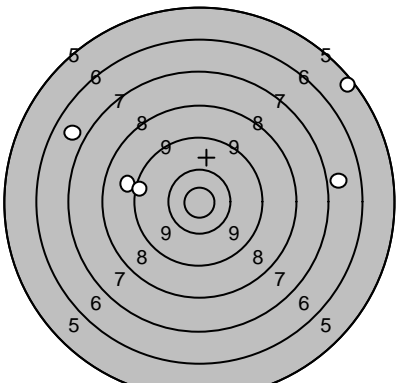
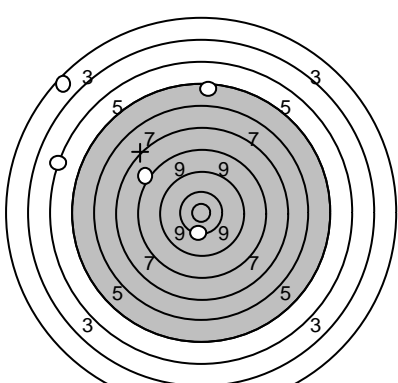
Skjutlag	Tavla	<b>Henry Ludvigsson</b>	
<b>1</b>	<b>5</b>		
		Björkfors	
2008-07-13	Tavelträffen B 2008	Ramselefors SKF	
Provskott 	1: 10,1 ←	Serie 1 (L) 	1: 10,7* ↖
	2: 7,9 ↖		2: 8,0 ↘
	3: 9,7 →		3: 9,9 ↘
			4: 9,3 →
			5: 10,6* ←
	Serie 26,0		Serie 46,0
	Totalt 0,0		Totalt 46,0
Provskott 	1: 7,9 ↙	Serie 2 (K) 	1: 9,0 ←
	2: 8,4 ↓		2: 6,8 ↖
			3: 6,9 →
			4: 9,3 ←
			5: 5,4 ↗
	Serie 15,0		Serie 35,0
	Totalt 46,0		Totalt 81,0
Serie 3 (S) 	1: 8,3 ↖		
	2: 10,4 ↓		
	3: 2,7 ↖		
	4: 5,6 ↑		
	5: 4,4 ←		
	Serie 29,0		
	Totalt 110,0		

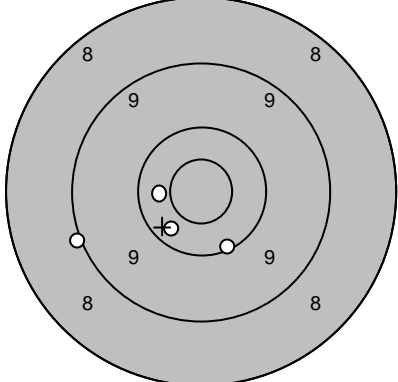
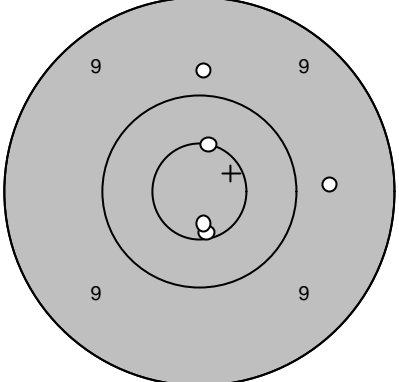
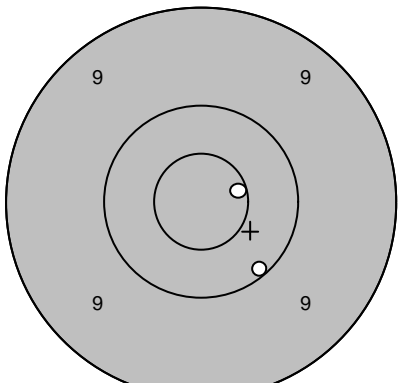
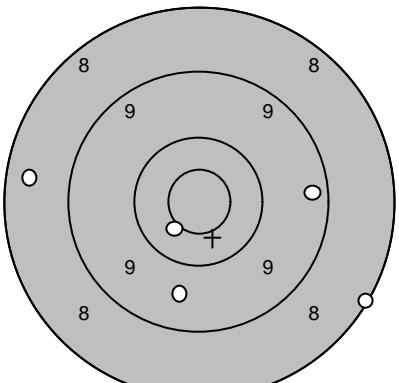
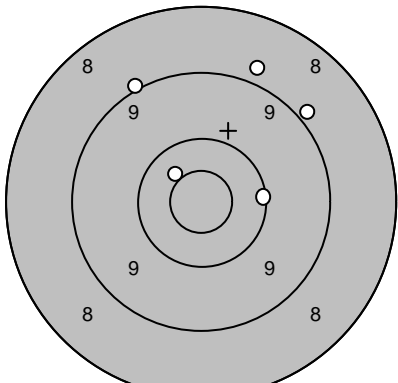
Skjutlag	Tavla	<b>Peter Östling</b>	
<b>1</b>	<b>6</b>		
2008-07-13		F 21	
2008-07-13		Tavelträffen B 2008	Ramselefors SKF
Provskott		1: 10,3 ↙ 2: 10,4 ← 3: 9,0 ← 4: 10,1 ↘	Serie 1 (L) 
		Serie 39,0 Totalt 0,0	1: 9,7 → 2: 9,8 ↑ 3: 10,6* ↓ 4: 10,6* ↑ 5: 10,7* ↓ Serie 48,0 Totalt 48,0
Provskott		1: 10,1 ↘ 2: 10,6* →	Serie 2 (K) 
		Serie 20,0 Totalt 48,0	1: 8,1 ↘ 2: 10,5* ↙ 3: 8,5 ← 4: 9,6 ↓ 5: 9,3 → Serie 44,0 Totalt 92,0
Serie 3 (S)		1: 8,9 ↗ 2: 9,0 ↗ 3: 10,5* ↗ 4: 8,8 ↑ 5: 10,1 →	
		Serie 45,0 Totalt 137,0	

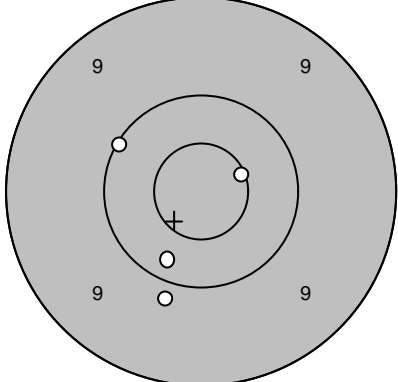
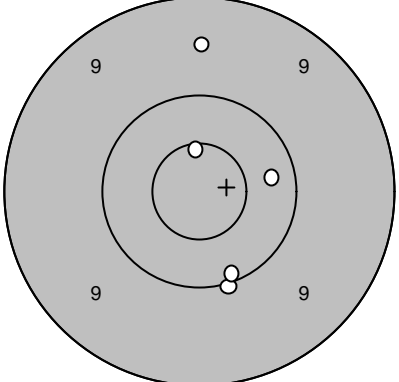
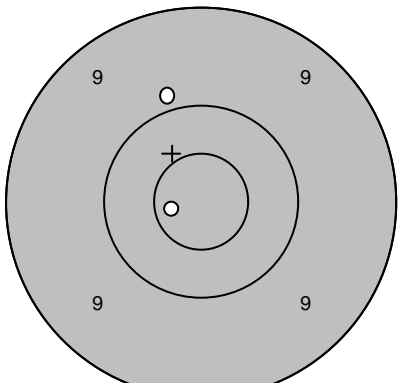
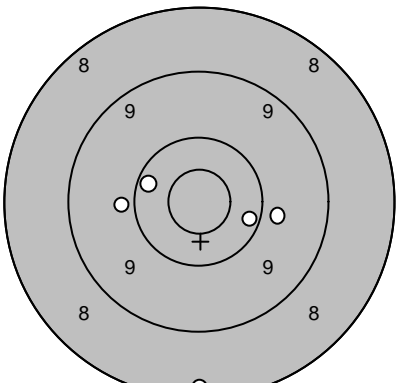
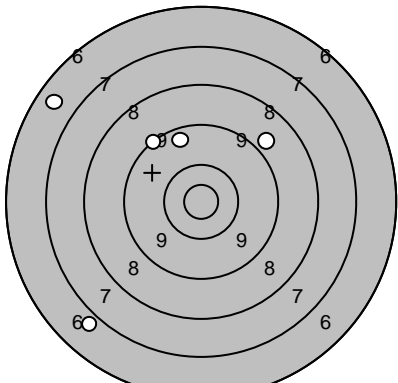
Skjutlag	Tavla	<b>Harry Östling</b>		
<b>1</b>	<b>7</b>			
		F 21		
2008-07-13	Tavelträffen B 2008	Ramselefors SKF		
Provsnitt		1: 10,6* → 2: 9,9 ↓ 3: 10,1 ↖ 4: 10,3 ↓	Serie 1 (L) 	1: 9,5 ↑ 2: 10,6* ↑ 3: 10,3 → 4: 10,0 ↓ 5: 10,1 ↓
		Serie 39,0	Serie 49,0	
		Totalt 0,0	Totalt 49,0	
Provsnitt		1: 9,9 ↑ 2: 10,7* ←	Serie 2 (K) 	1: 8,2 ↓ 2: 10,3 → 3: 9,8 → 4: 9,9 ← 5: 10,3 ←
		Serie 19,0	Serie 46,0	
		Totalt 49,0	Totalt 95,0	
Serie 3 (S)		1: 8,9 ↗ 2: 6,6 ↖ 3: 9,5 ↑ 4: 6,9 ↓ 5: 9,2 ↗		
		Serie 38,0		
		Totalt 133,0		

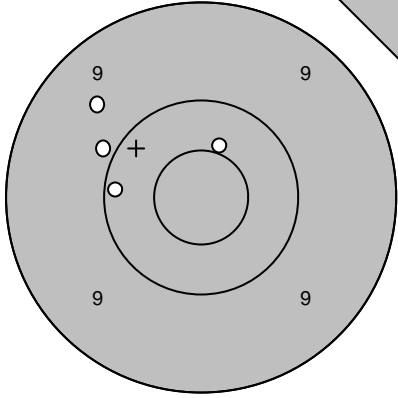
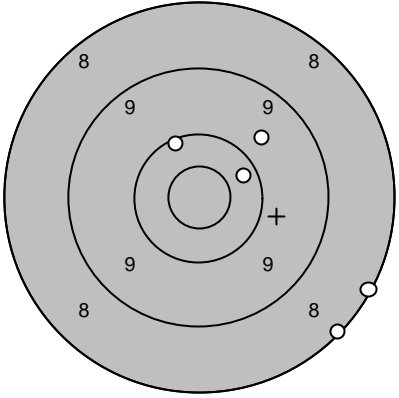
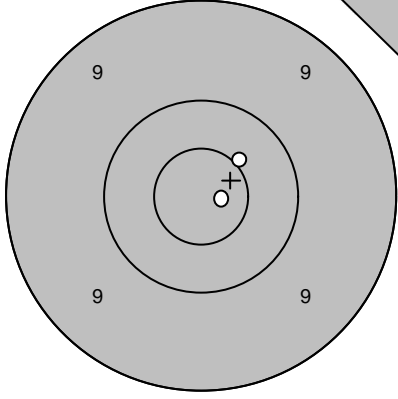
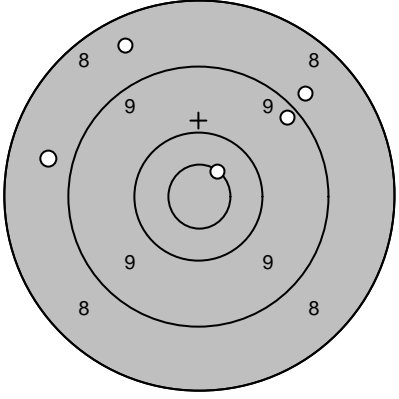
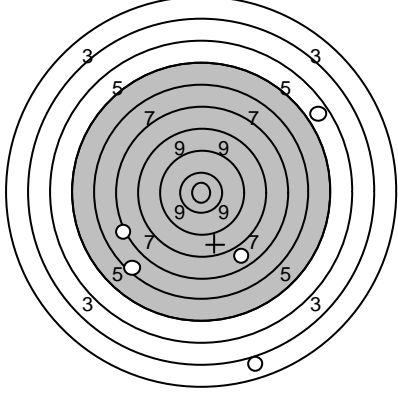
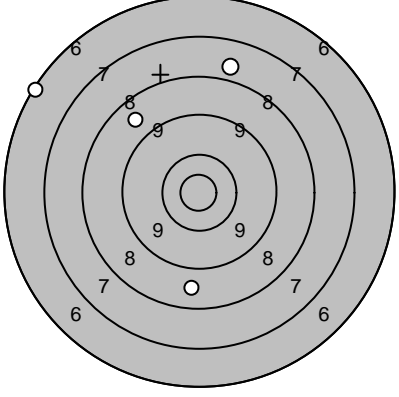
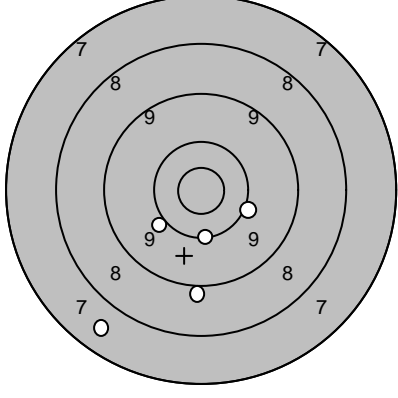
Skjutlag	Tavla	<b>Håkan Engman</b>		
<b>1</b>	<b>8</b>	Lindesberg		
2008-07-13	Tavelträffen B 2008	Ramselefors SKF		
Provskott		1: 9,9 ← 2: 10,2 ← 3: 9,6 ↗ 4: 10,5* ↑	Serie 1 (L) 	1: 8,1 ↘ 2: 8,1 ↘ 3: 10,3 → 4: 10,2 ↑ 5: 9,7 ↗
		Serie 38,0		Serie 45,0
		Totalt 0,0		Totalt 45,0
Provskott		1: 10,5* ↗ 2: 10,8* →	Serie 2 (K) 	1: 10,6* ↗ 2: 8,5 ↑ 3: 8,7 ← 4: 9,3 ↗ 5: 8,8 ↗
		Serie 20,0		Serie 43,0
		Totalt 45,0		Totalt 88,0
Serie 3 (S)		1: 4,8 ↗ 2: 7,3 ← 3: 6,7 ↘ 4: 3,0 ↓ 5: 7,9 ↓	Extratävling 3+3+4 	1: 0,0 ↑ 2: 7,9 ↑ 3: 6,2 ↗ 4: 8,7 ↗ 5: 8,7 ↓
		Serie 27,0		Serie 29,0
		Totalt 115,0		Totalt 144,0
Extratävling 3+3+4		6: 7,6 ↘ 7: 10,0 ← 8: 9,0 ↓ 9: 10,2 ↓ 10: 10,1 →		
		Serie 46,0		
		Totalt 190,0		

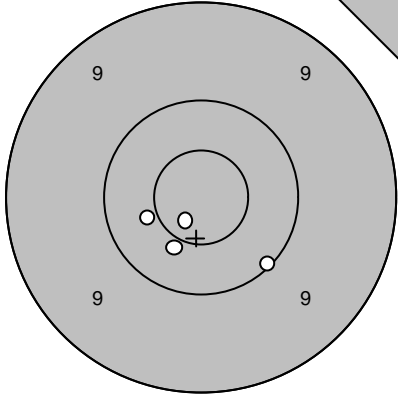
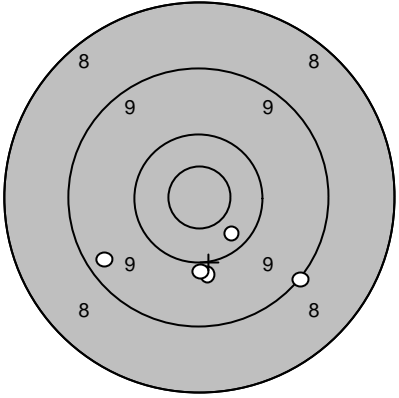
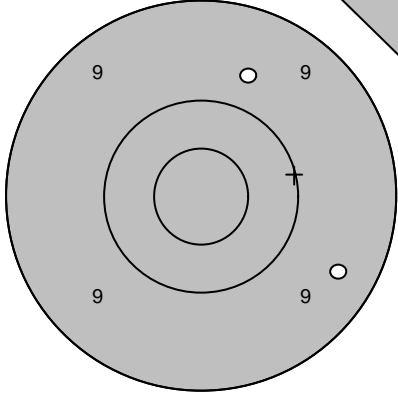
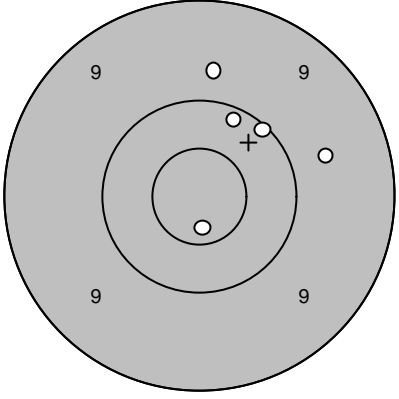
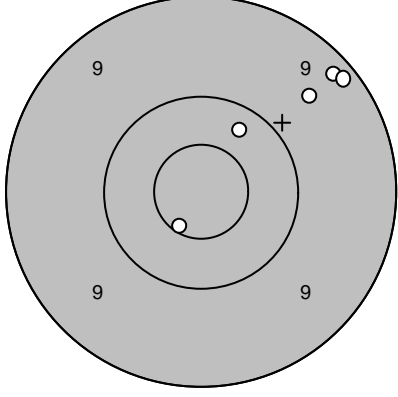
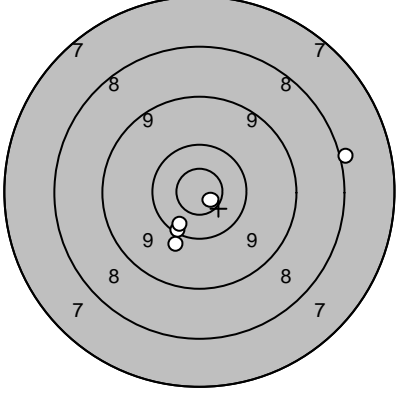
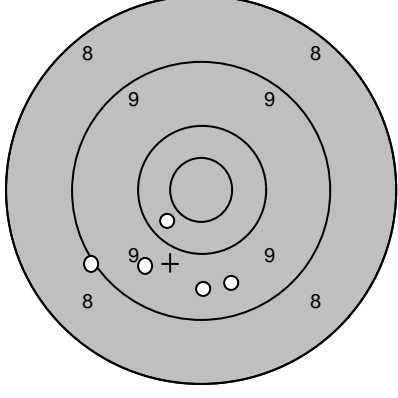

Skjutlag	Tavla	<b>Marie Arvidsson</b>	
<b>1</b>	<b>9</b>		
		Lidingö	
2008-07-13	Tavelträffen B 2008	Ramselefors SKF	
Provskott		1: 10,7* ↘ 2: 10,5* ← 3: 10,5* ↘ 4: 10,1 ↘	Serie 1 (L) 
		Serie 40,0 Totalt 0,0	1: 9,1 ↘ 2: 9,9 ↓ 3: 10,3 ↘ 4: 9,4 ↙ 5: 9,9 ↓
			Serie 46,0 Totalt 46,0
Provskott		1: 9,7 ↑ 2: 9,4 →	Serie 2 (K) 
		Serie 18,0 Totalt 46,0	1: 9,7 → 2: 10,2 ↑ 3: 9,7 ↑ 4: 10,1 ↗ 5: 10,7* ↓
			Serie 48,0 Totalt 94,0
Serie 3 (S)		1: 9,2 ↗ 2: 9,2 ↗ 3: 9,6 ↗ 4: 10,3 ↗ 5: 10,6* ↓	Extratävling 3+3+4 
		Serie 47,0 Totalt 141,0	1: 10,2 ↓ 2: 10,8* → 3: 8,0 → 4: 10,4 ↓ 5: 10,0 ↓
			Serie 48,0 Totalt 189,0
Extratävling 3+3+4		6: 9,6 ↓ 7: 9,6 ↓ 8: 10,4 ↙ 9: 9,0 ↙ 10: 9,6 ↘	
		Serie 46,0 Totalt 235,0	

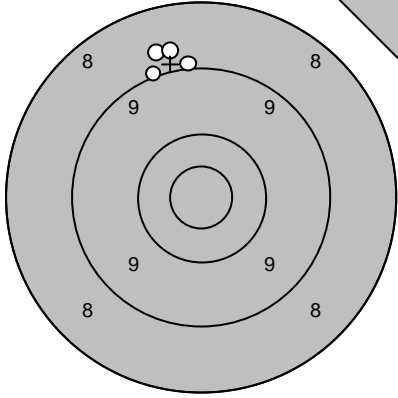
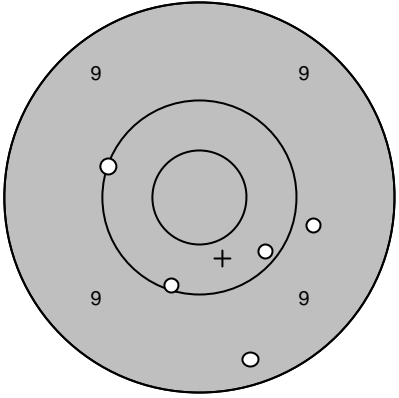
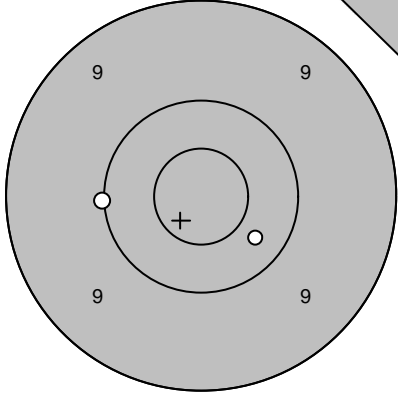
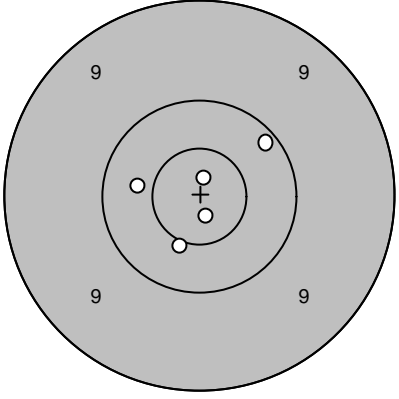
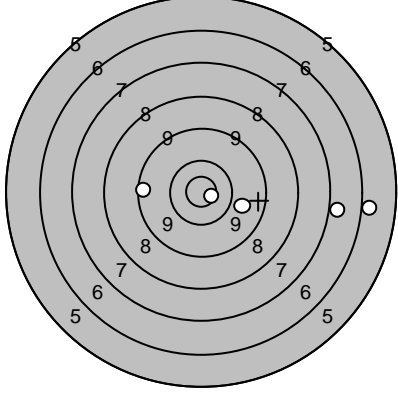
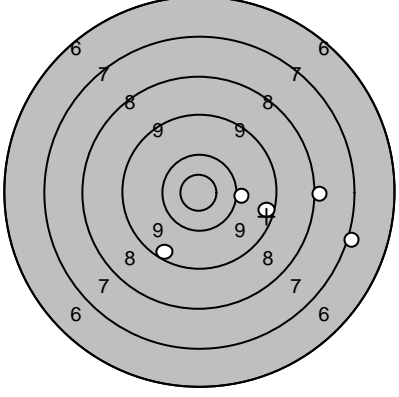
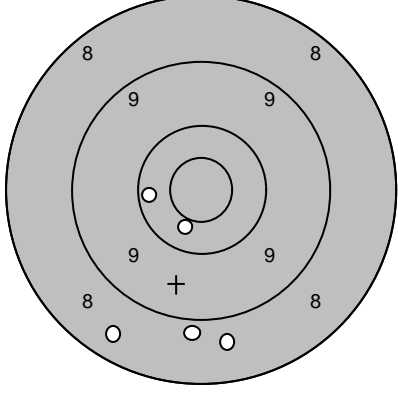
Skjutlag	Tavla	<b>Helena Jansson</b>		
<b>1</b>	<b>10</b>			
Söderala				
2008-07-13	Tavelträffen B 2008	Ramselefors SKF		
Provskott		1: 9,0 ↑ 2: 9,1 ↗ 3: 8,8 ↑ 4: 8,8 ↑	Serie 1 (L) 	1: 9,8 → 2: 10,1 ↓ 3: 10,2 ↘ 4: 10,1 ↖ 5: 9,3 ↓
	Serie 34,0 Totalt 0,0		Serie 48,0 Totalt 48,0	
Provskott		1: 10,3 ↘ 2: 10,0 ←	Serie 2 (K) 	1: 10,2 ↗ 2: 10,5* ↓ 3: 10,8* ↑ 4: 10,4 ← 5: 10,8* ↓
	Serie 20,0 Totalt 48,0		Serie 50,0 Totalt 98,0	
Serie 3 (S)		1: 7,0 → 2: 10,8* → 3: 9,5 ← 4: 6,0 → 5: 9,9 →	Extratävling 3+3+4 	1: 9,4 → 2: 7,1 → 3: 8,1 → 4: 10,1 → 5: 9,4 ↓
	Serie 41,0 Totalt 139,0		Serie 43,0 Totalt 182,0	
Extratävling 3+3+4		6: 10,5* ↓ 7: 10,3 ← 8: 8,9 ↓ 9: 8,7 ↓ 10: 8,5 ↘		
	Serie 44,0 Totalt 226,0			

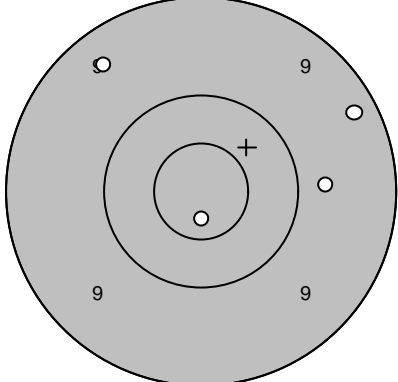
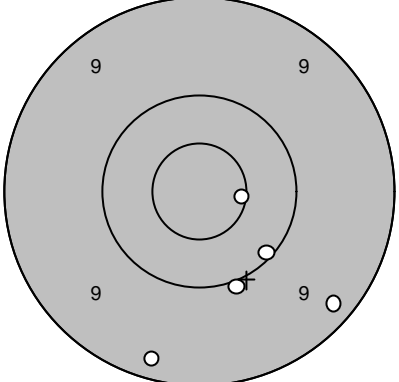
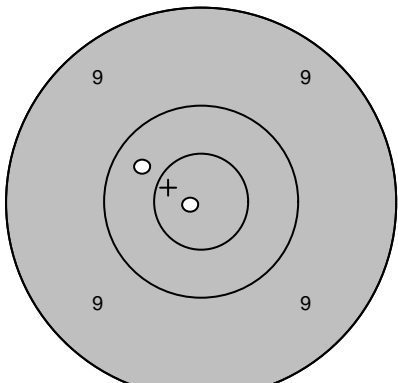
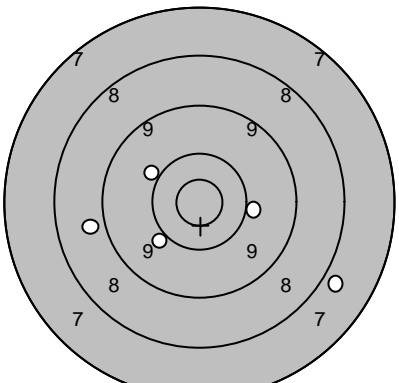
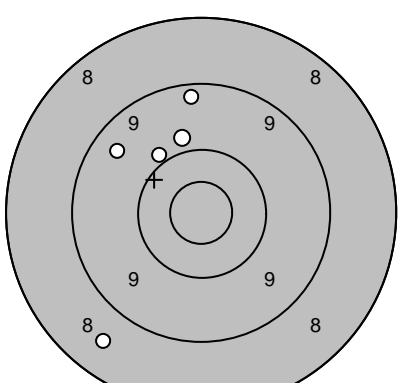
Skjutlag	Tavla	<b>Urban Brännström</b>	
<b>1</b>	<b>11</b>		
		I 19 / A 9	
2008-07-13	Tavelträffen B 2008	Ramselefors SKF	
Provskott		1: 10,8* ↓ 2: 9,8 → 3: 9,3 → 4: 9,4 ↖	Serie 1 (L) 
		1: 9,3 ↓ 2: 10,0 ↓ 3: 9,2 ↓ 4: 10,1 ↓ 5: 10,6* →	
		Serie 37,0	Serie 48,0
		Totalt 0,0	Totalt 48,0
Provskott		1: 10,3 ↖ 2: 10,9* ←	Serie 2 (K) 
			1: 7,9 ↘ 2: 10,0 → 3: 10,0 ↘ 4: 8,9 ← 5: 10,0 ↖
		Serie 20,0	Serie 45,0
		Totalt 48,0	Totalt 93,0
Serie 3 (S)		1: 9,3 ↑ 2: 10,0 ↖ 3: 8,6 ↘ 4: 9,9 ↑ 5: 9,5 ↖	
		Serie 45,0	
		Totalt 138,0	

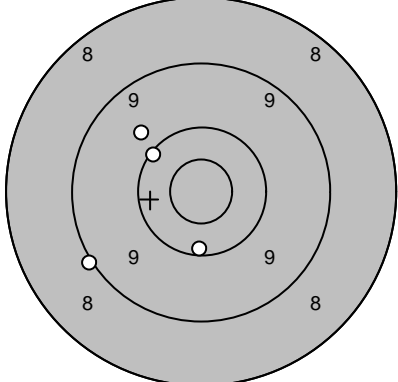
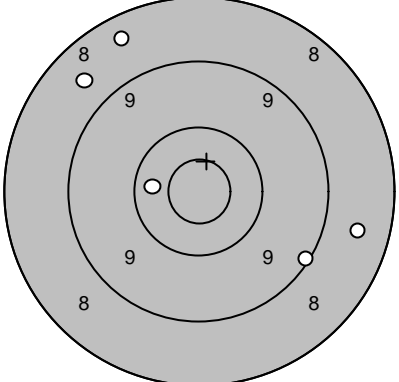
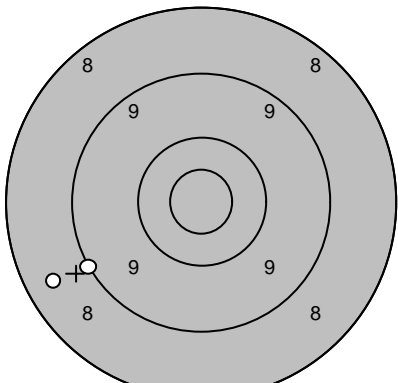
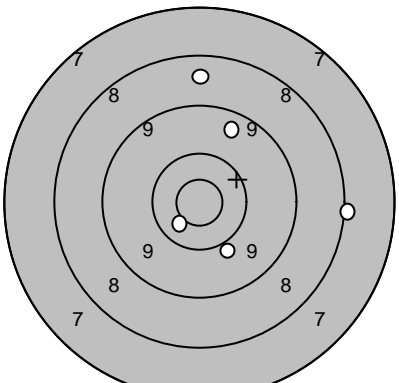
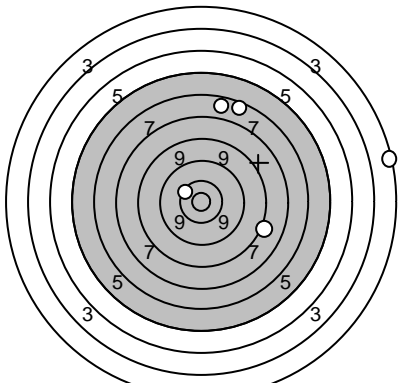
Skjutlag	Tavla	<b>Tommy Åkerström</b>	
<b>1</b>	<b>12</b>		
		Niemisel	
2008-07-13	Tavelträffen B 2008	Ramselefors SKF	
Provskott 	1: 9,8 ↖	Serie 1 (L) 	1: 9,1 ↘
	2: 9,0 ↙		2: 8,6 →
	3: 10,2 ↖		3: 10,4 ←
	4: 10,2 ↓		4: 8,5 ↗
			5: 8,6 ↗
	Serie 38,0		Serie 43,0
	Totalt 0,0		Totalt 43,0
Provskott 	1: 9,1 ↙	Serie 2 (K) 	1: 9,5 ↗
	2: 8,5 ↙		2: 10,5* ↙
			3: 10,0 ↓
			4: 8,6 ↑
			5: 8,1 →
	Serie 17,0		Serie 45,0
	Totalt 43,0		Totalt 88,0
Serie 3 (S) 	1: 2,5 →		
	2: 6,7 ↑		
	3: 10,5* ↖		
	4: 8,2 →		
	5: 6,8 ↑		
	Serie 32,0		
	Totalt 120,0		

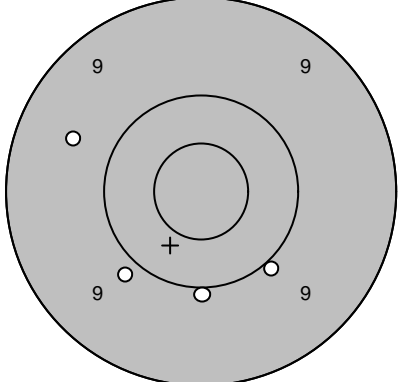
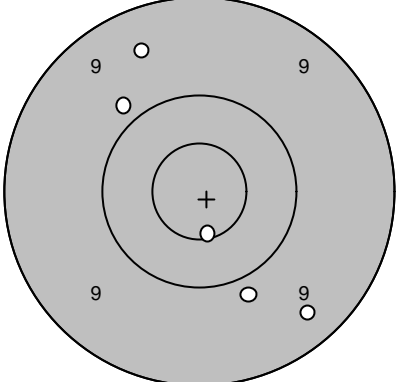
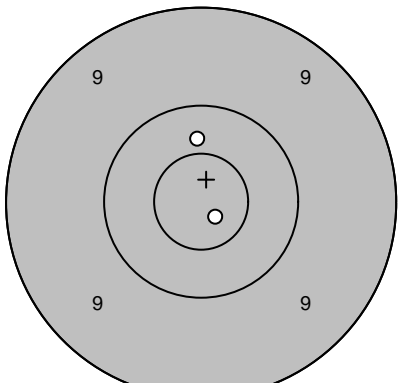
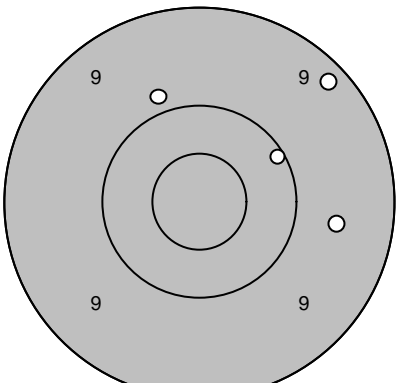
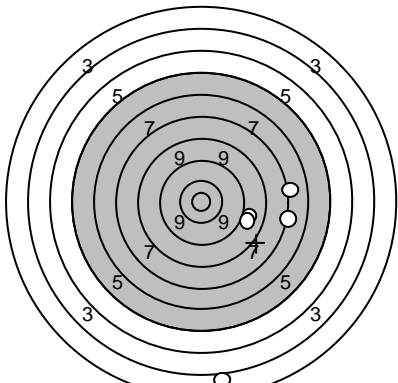
Skjutlag	Tavla		
1	15	Magnus Lindkvist	
		Umeå	
2008-07-13	Tavelträffen B 2008	Ramselefors SKF	
Provsnitt		Serie 1 (L)	
	1: 10,0 ↘ 2: 9,9 ↙ 3: 9,6 ← 4: 10,0 ↓		1: 9,5 ↗ 2: 10,6* ↓ 3: 9,9 ↗ 4: 9,9 ↓ 5: 9,4 ↓
	Serie 38,0		Serie 46,0
	Totalt 0,0		Totalt 46,0
Provsnitt		Serie 2 (K)	
	1: 10,4 ↑ 2: 10,8* ↓		1: 9,9 ↗ 2: 9,2 ↗ 3: 10,1 ↗ 4: 9,6 → 5: 0,0 ↗
	Serie 20,0		Serie 37,0
	Totalt 46,0		Totalt 83,0
Serie 3 (S)			
	1: 7,2 → 2: 3,1 ↓ 3: 7,2 → 4: 9,0 → 5: 9,0 →		
	Serie 35,0		
	Totalt 118,0		

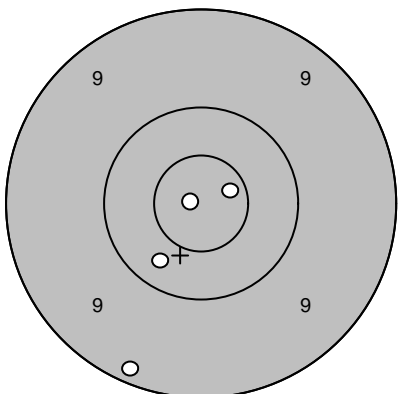
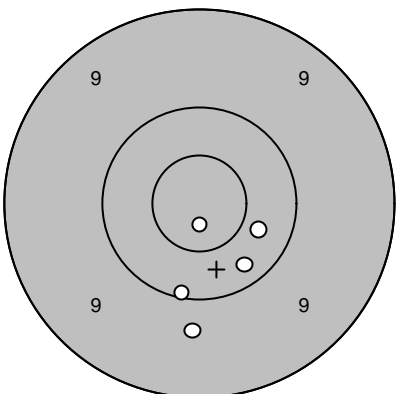
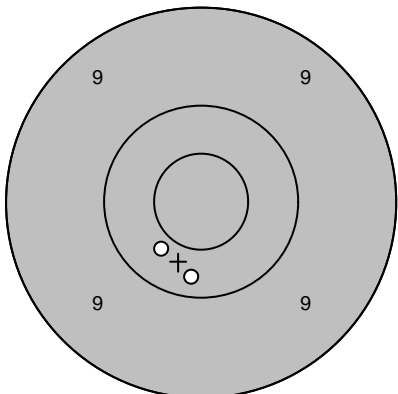
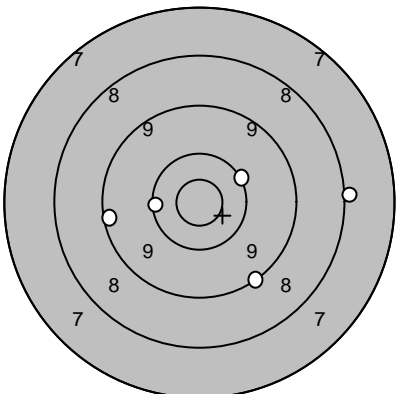
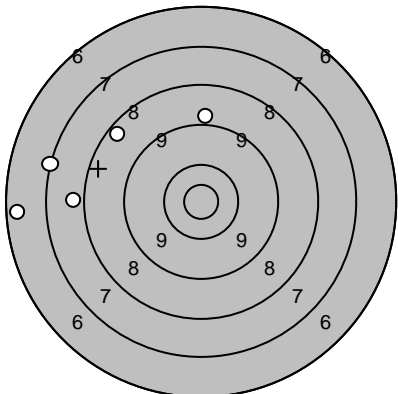
Skjutlag	Tavla		
<b>1</b>	<b>16</b>	<b>Lars Möllsten</b>	
		Umeå	
2008-07-13	Tavelträffen B 2008	Ramselefors SKF	
Provskott		1: 9,2 ↘ 2: 10,7* → 3: 10,9* ← 4: 10,3 ↘	Serie 1 (L) 
			1: 10,3 ↘ 2: 10,8* ↓ 3: 10,4 ↘ 4: 9,7 ↓ 5: 10,1 ↓
		Serie 39,0	Serie 49,0
		Totalt 0,0	Totalt 49,0
Provskott		1: 10,4 ↘ 2: 10,3 ↓	Serie 2 (K) 
			1: 10,1 → 2: 9,2 ↓ 3: 10,2 ← 4: 8,0 → 5: 9,3 ←
		Serie 20,0	Serie 46,0
		Totalt 49,0	Totalt 95,0
Serie 3 (S)		1: 8,4 ↖ 2: 7,2 ← 3: 7,9 ← 4: 9,0 ↑ 5: 6,5 ←	
		Serie 37,0	
		Totalt 132,0	

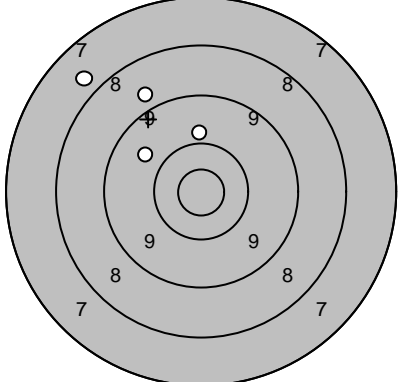
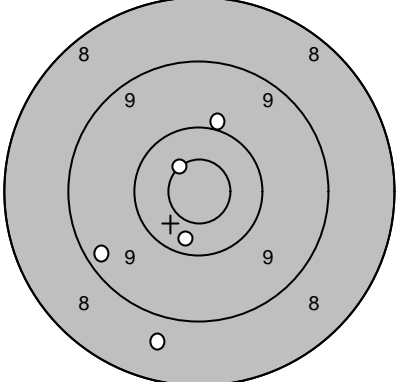
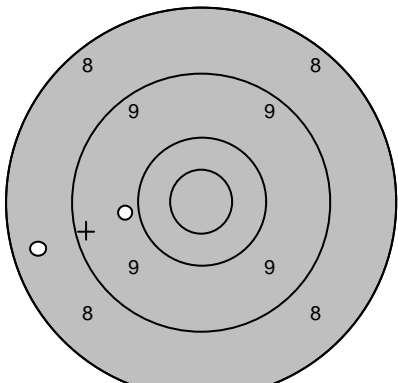
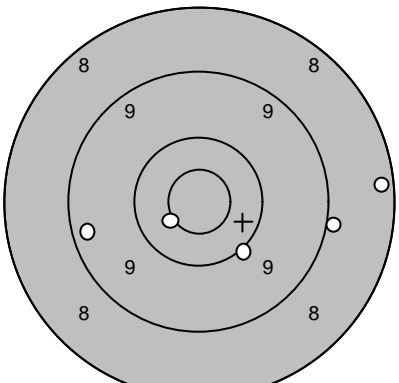
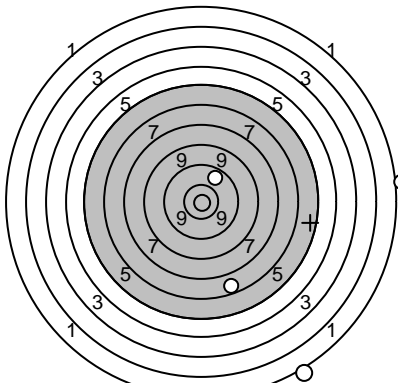
Skjutlag	Tavla	<b>Tony Ericson</b>	
<b>1</b>	<b>17</b>		
2008-07-13		Loos	
2008-07-13		Tavelträffen B 2008	Ramselefors SKF
Provskott 	1: 9,9 ↑	Serie 1 (L) 	1: 10,0 ↗
	2: 9,8 ↗		2: 10,6* ↖
	3: 8,8 ↗		3: 9,3 ↙
	4: 7,8 ↗		4: 8,7 ↓
			5: 10,3 ↓
	Serie 33,0		Serie 47,0
	Totalt 0,0		Totalt 47,0
Provskott 	1: 9,9 ←	Serie 2 (K) 	1: 9,0 →
	2: 8,5 ←		2: 8,3 →
			3: 10,5* ↙
			4: 9,3 ←
			5: 10,0 ↘
	Serie 17,0		Serie 46,0
	Totalt 47,0		Totalt 93,0
Serie 3 (S) 	1: 10,0 ↗		
	2: 1,1 →		
	3: 6,8 ↓		
	4: 0,0 →		
	5: 1,2 ↓		
	Serie 18,0		
	Totalt 111,0		

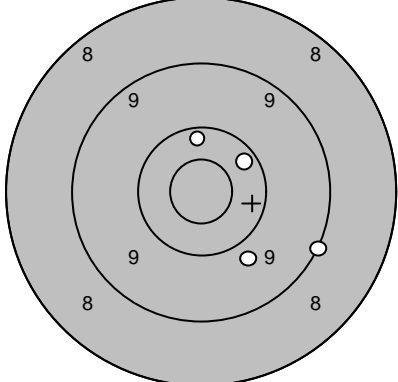
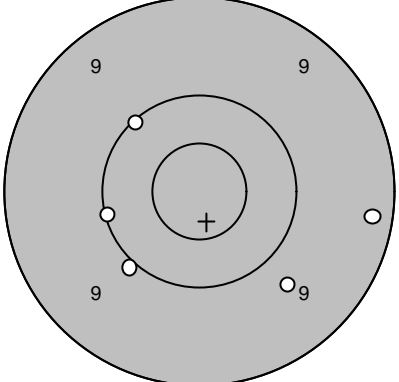
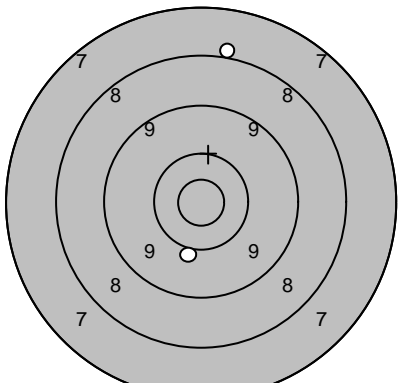
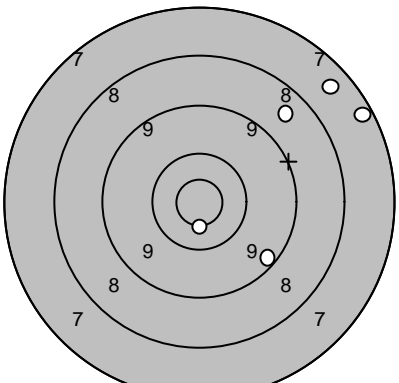
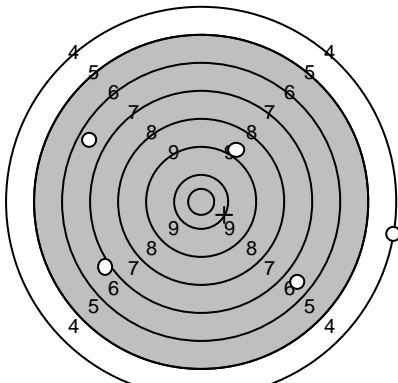
Skjutlag	Tavla	<b>Johnny Wallberg</b>	
<b>1</b>	<b>18</b>		
Loos			
2008-07-13	Tavelträffen B 2008	Ramselefors SKF	
Provs-kott 	1: 10,3 ↑	Serie 1 (L) 	1: 10,0 ↘
	2: 10,3 ↗		2: 10,1 ↗
	3: 9,1 →		3: 9,7 ↘
	4: 9,8 ↘		4: 10,1 ←
			5: 9,3 →
	Serie 38,0		Serie 48,0
	Totalt 0,0		Totalt 48,0
Provs-kott 	1: 8,0 ↑	Serie 2 (K) 	1: 9,3 ↘
	2: 10,0 ↓		2: 7,6 ↗
			3: 8,6 ↗
			4: 10,6* ↓
			5: 7,3 ↗
	Serie 18,0		Serie 41,0
	Totalt 48,0		Totalt 89,0
Serie 3 (S) 	1: 4,3 →		
	2: 9,0 ↗		
	3: 7,1 ↘		
	4: 6,7 ↗		
	5: 6,8 ↘		
	Serie 32,0		
	Totalt 121,0		

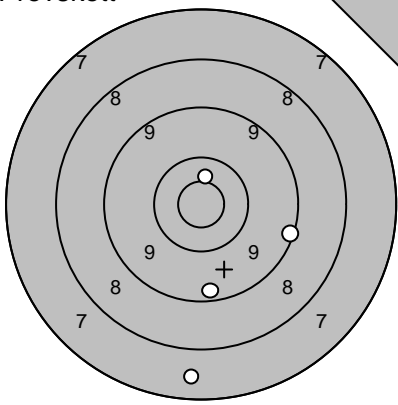
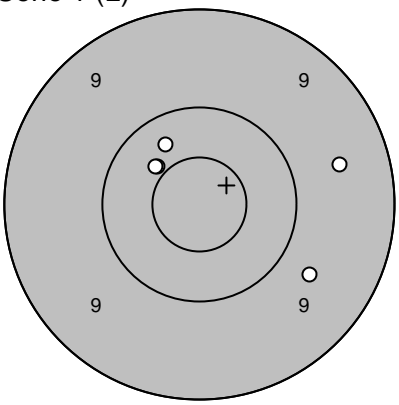
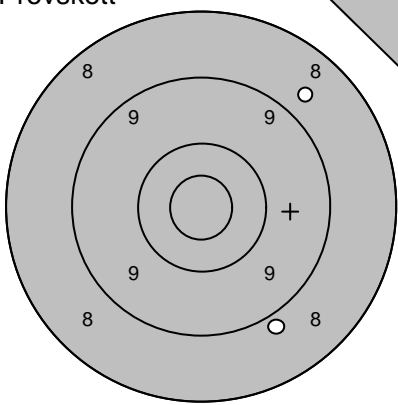
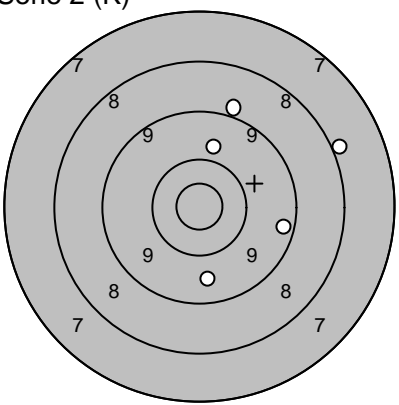
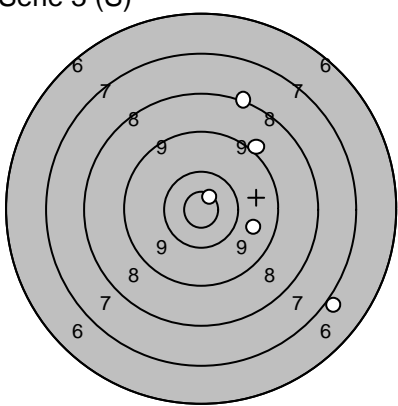
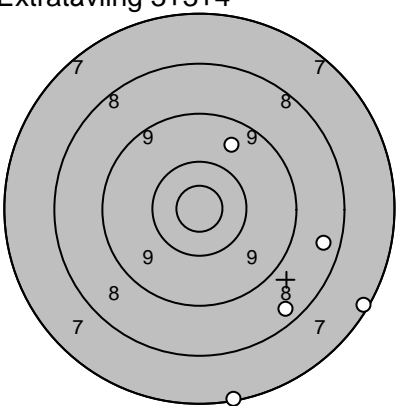
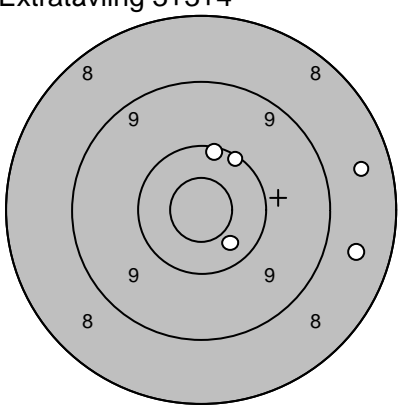

Skjutlag	Tavla	<b>Stefan Arnström</b>	
<b>1</b>	<b>19</b>		
Älmhult			
2008-07-13	Tavelträffen B 2008	Ramselefors SKF	
Provskott		1: 7,6 ↓ 2: 9,2 → 3: 9,4 ↓ 4: 10,5* ↑	Serie 1 (L) 
	Serie 35,0 Totalt 0,0		1: 10,5* ↗ 2: 9,7 ↘ 3: 9,6 → 4: 10,3 ↗ 5: 10,4 ↗
			Serie 48,0 Totalt 48,0
Provskott		1: 8,9 ↓ 2: 8,7 ↗	Serie 2 (K) 
	Serie 16,0 Totalt 48,0		1: 9,0 ↑ 2: 9,9 ↑ 3: 9,6 ↓ 4: 9,4 → 5: 8,0 →
			Serie 44,0 Totalt 92,0
Serie 3 (S)		1: 9,8 → 2: 7,0 → 3: 10,8* ↗ 4: 8,2 ↑ 5: 9,0 ↗	Extratävling 3+3+4 
	Serie 43,0 Totalt 135,0		1: 7,2 → 2: 8,5 → 3: 8,4 ↘ 4: 7,2 ↓ 5: 9,7 ↗
			Serie 39,0 Totalt 174,0
Extratävling 3+3+4		6: 8,5 → 7: 8,6 → 8: 10,1 ↗ 9: 10,4 ↘ 10: 10,2 ↑	
	Serie 46,0 Totalt 220,0		

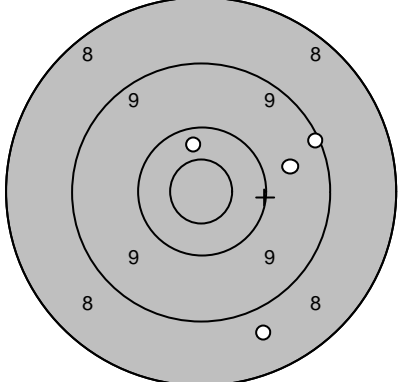
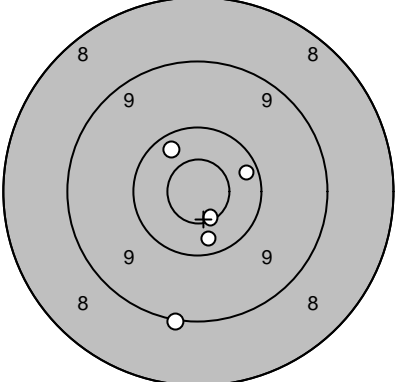
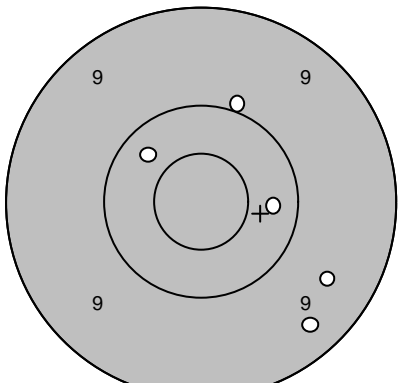
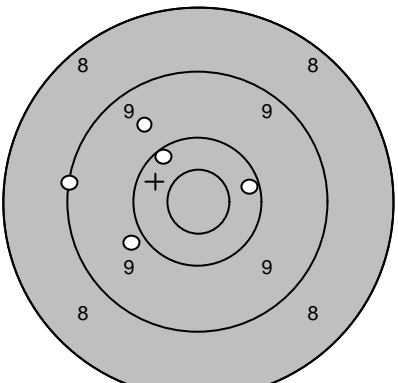
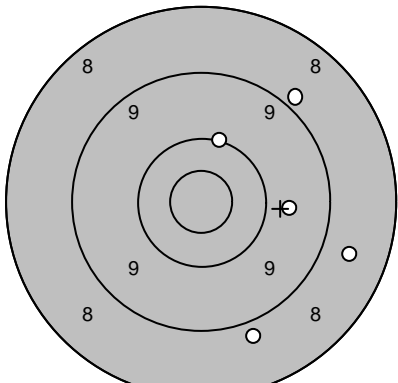
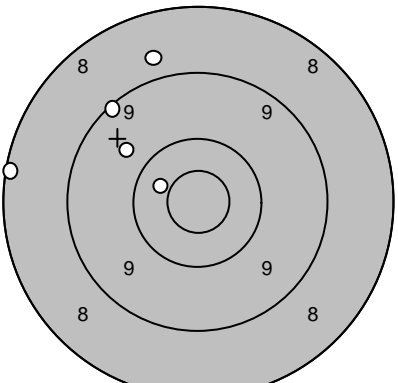
Skjutlag	Tavla	<b>Rolf Eklund</b>	
<b>1</b>	<b>20</b>		
		Lidingö	
2008-07-13	Tavelträffen B 2008	Ramselefors SKF	
Provskott		1: 8,7 ↓ 2: 9,7 → 3: 9,2 → 4: 10,3 ↑	Serie 1 (L) 
			1: 10,3 ↓ 2: 10,6* ↓ 3: 10,3 ↗ 4: 10,3 → 5: 9,0 ↓
		Serie 36,0	Serie 49,0
		Totalt 0,0	Totalt 49,0
Serie 2 (K)		1: 10,3 ↖ 2: 10,3 → 3: 9,4 ↓ 4: 9,5 → 5: 10,0 ↑	Serie 3 (S) 
			1: 9,6 ↖ 2: 10,3 → 3: 9,9 ↙ 4: 9,1 ← 5: 10,2 ↖
		Serie 48,0	Serie 47,0
		Totalt 97,0	Totalt 144,0
Extratävling 3+3+4		1: 10,1 ↑ 2: 9,7 → 3: 8,9 ↗ 4: 8,7 → 5: 8,9 ↓	Extratävling 3+3+4 
			6: 8,2 ← 7: 10,5* ← 8: 8,8 ↑ 9: 9,1 ↗ 10: 9,7 ↖
		Serie 43,0	Serie 44,0
		Totalt 187,0	Totalt 231,0

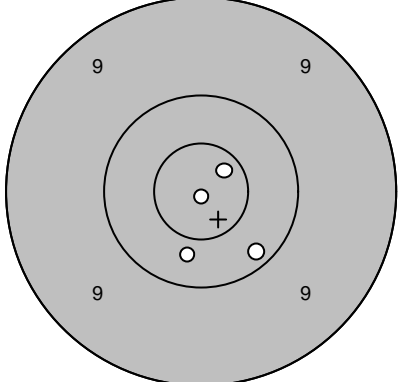
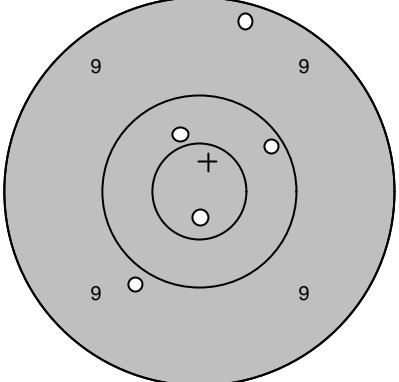
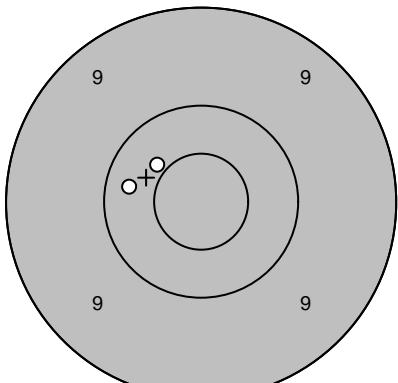
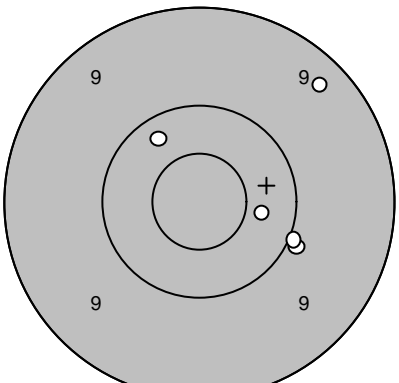
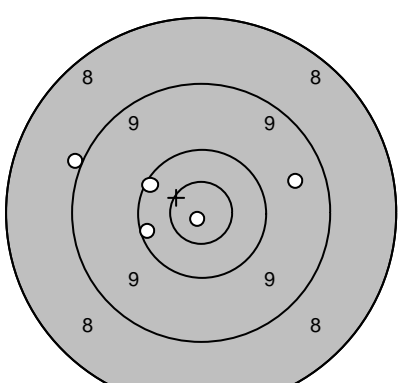
Skjutlag	Tavla	<b>Stefan Thorin</b>		
<b>1</b>	<b>21</b>			
		Umeå		
2008-07-13	Tavelträffen B 2008	Ramselefors SKF		
Provskott		1: 10,2 ↘ 2: 10,4 ↓ 3: 10,7* ↗ 4: 10,9* ↓	Serie 1 (L) 	1: 9,2 ↑ 2: 10,2 ↗ 3: 10,8* ↓ 4: 9,9 ↙ 5: 10,4 ↑
		Serie 40,0		Serie 48,0
		Totalt 0,0		Totalt 48,0
Provskott		1: 10,3 ← 2: 10,4 ↗	Serie 2 (K) 	1: 9,3 ↗ 2: 9,9 → 3: 10,4 → 4: 10,0 → 5: 10,3 ↗
		Serie 20,0		Serie 48,0
		Totalt 48,0		Totalt 96,0
Serie 3 (S)		1: 9,6 → 2: 9,0 ← 3: 10,9* ↓ 4: 10,2 ↗ 5: 10,2 ←		
		Serie 48,0		
		Totalt 144,0		

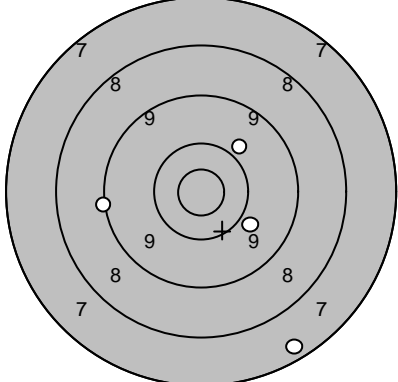
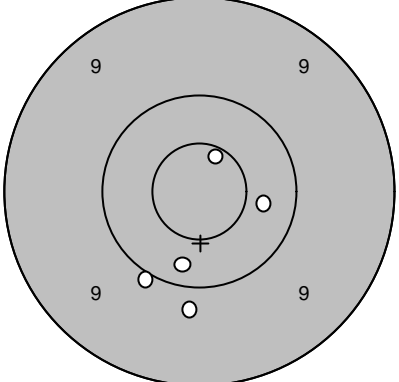
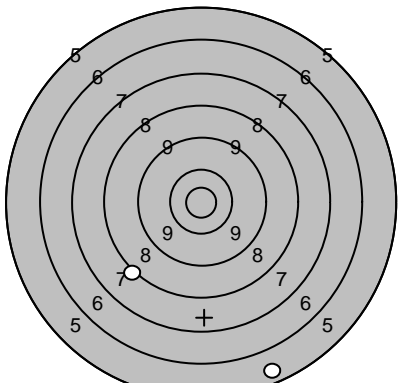
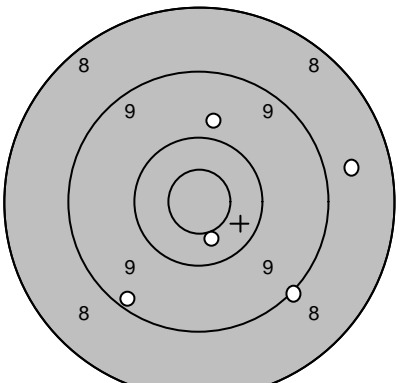
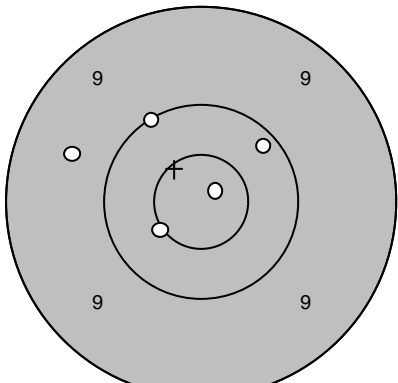
Skjutlag <b>1</b>	Tavla <b>23</b>	<b>Jörgen Åström</b>	
		Brattby	
2008-07-13	Tavelträffen B 2008	Ramselefors SKF	
Provskott		1: 9,9 ↗ 2: 9,9 ↘ 3: 7,4 ↘ 4: 9,1 ←	Serie 1 (L) 
			1: 9,8 ↓ 2: 10,0 ↘ 3: 10,6* ↗ 4: 10,4 → 5: 10,3 ↓
		Serie 34,0	Serie 49,0
		Totalt 0,0	Totalt 49,0
Provskott		1: 5,6 ↓ 2: 8,2 ↘	Serie 2 (K) 
			1: 9,1 ↘ 2: 8,7 → 3: 9,2 ↘ 4: 10,5* ↓ 5: 9,8 ↑
		Serie 13,0	Serie 45,0
		Totalt 49,0	Totalt 94,0
Serie 3 (S)		1: 10,2 ↗ 2: 10,9* ↗ 3: 9,6 ← 4: 10,5* ↘ 5: 10,1 ↗	
		Serie 49,0	
		Totalt 143,0	

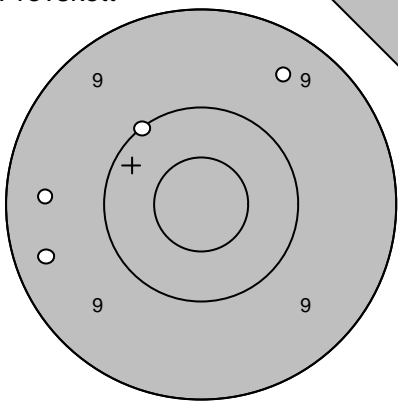
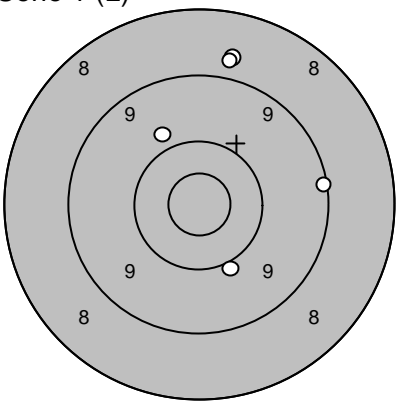
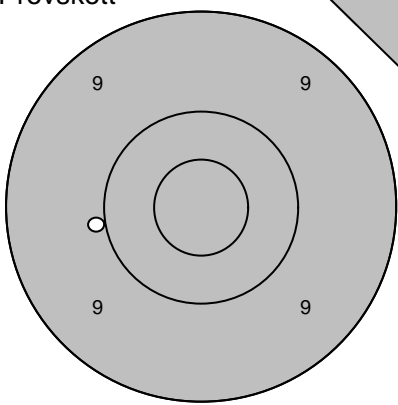
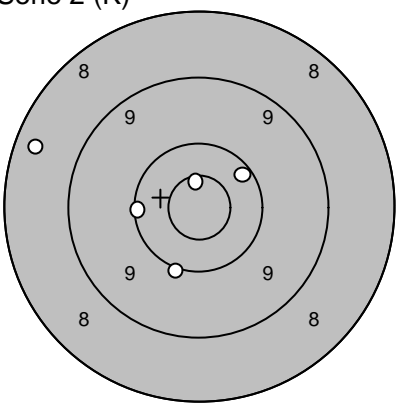
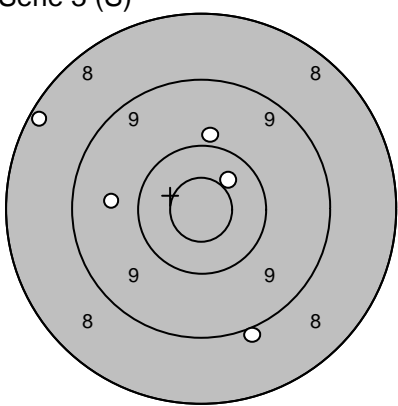
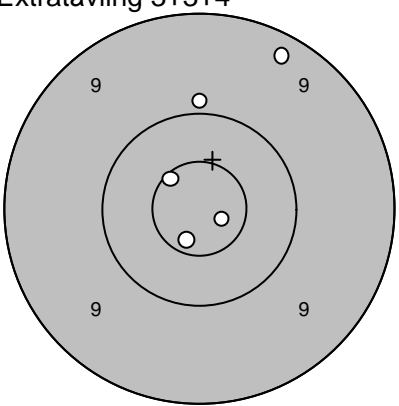
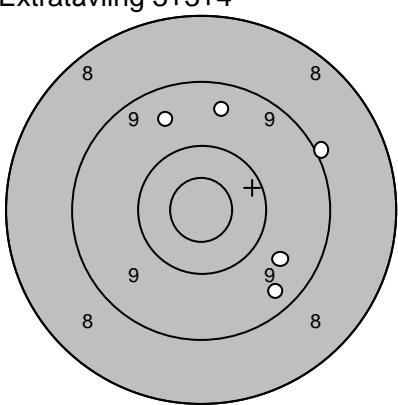
Skjutlag	Tavla	<b>Leif Sigfridsson</b>		
<b>1</b>	<b>24</b>	Ramselefors		
2008-07-13	Tavelträffen B 2008	Ramselefors SKF		
Provkott		1: 9,4 ← 2: 9,4 ← 3: 10,1 ↗ 4: 9,5 ↗	Serie 1 (L) 	1: 8,8 ↑ 2: 9,1 → 3: 9,9 ↗ 4: 8,8 ↑ 5: 10,0 ↓
		Serie 37,0		Serie 44,0
		Totalt 0,0		Totalt 44,0
Provkott		1: 9,9 ←	Serie 2 (K) 	1: 10,1 ← 2: 10,2 ↗ 3: 10,7* ↑ 4: 8,4 ← 5: 10,1 ↓
		Serie 9,0		Serie 48,0
		Totalt 44,0		Totalt 92,0
Serie 3 (S)		1: 10,5* ↗ 2: 9,7 ← 3: 9,0 ↓ 4: 8,2 ↗ 5: 9,9 ↑	Extratävling 3+3+4 	1: 10,7* ↓ 2: 10,8* → 3: 10,6* ↗ 4: 9,9 ↑ 5: 9,3 ↗
		Serie 45,0		Serie 48,0
		Totalt 137,0		Totalt 185,0
Extratävling 3+3+4		6: 9,5 ↑ 7: 9,6 → 8: 9,6 ↗ 9: 9,0 ↗ 10: 9,4 ↓		
		Serie 45,0		
		Totalt 230,0		

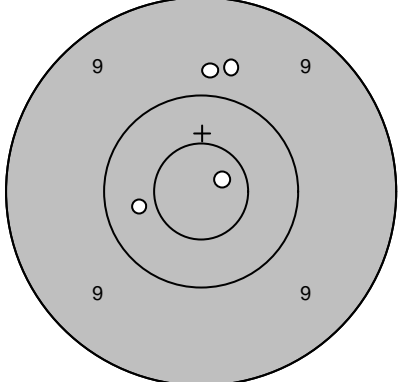
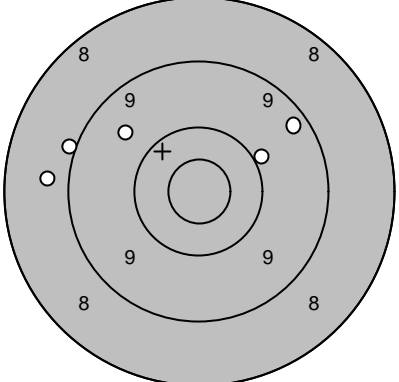
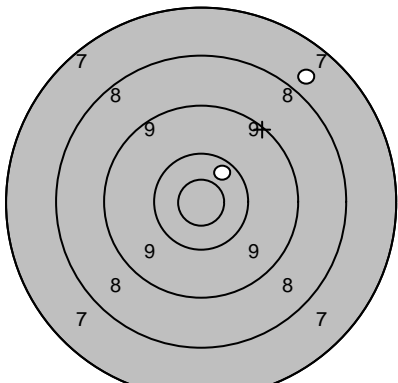
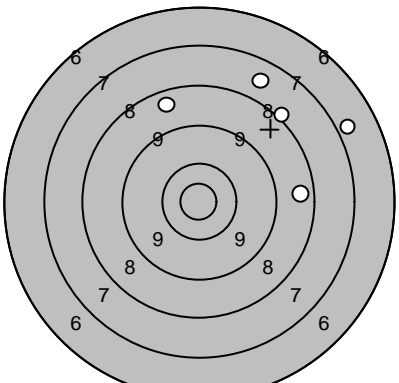
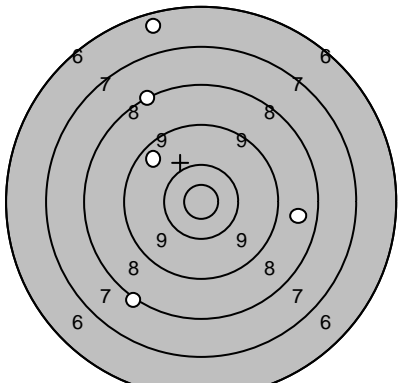
Skjutlag <b>2</b>	Tavla <b>1</b>	<b>Johan Nilsson</b>	
		Ramselefors	
2008-07-13	Tavelträffen B 2008	Ramselefors SKF	
Provskott		1: 9,8 ↑ 2: 9,7 ↑ 3: 10,8* → 4: 10,4 ←	Serie 1 (L) 
			1: 9,6 ↖ 2: 9,0 ← 3: 8,8 ← 4: 9,3 ↗ 5: 10,0 →
		Serie 38,0	Serie 45,0
		Totalt 0,0	Totalt 45,0
Provskott		1: 7,8 ↗ 2: 10,4 ↗	Serie 2 (K) 
			1: 8,1 ↗ 2: 8,6 ↑ 3: 6,9 → 4: 7,7 ↗ 5: 8,6 →
		Serie 17,0	Serie 37,0
		Totalt 45,0	Totalt 82,0
Serie 3 (S)		1: 6,5 ↑ 2: 8,1 ↘ 3: 8,2 ↑ 4: 8,7 → 5: 9,5 ↗	
		Serie 39,0	
		Totalt 121,0	

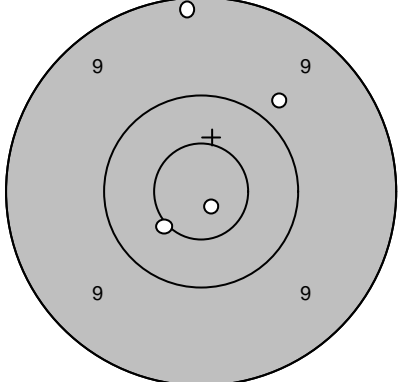
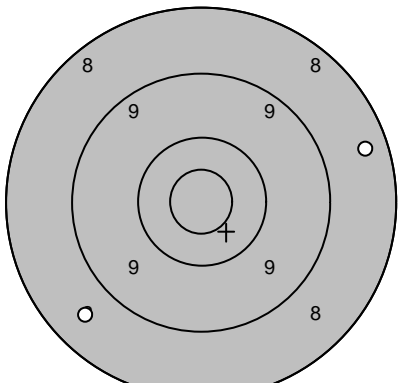
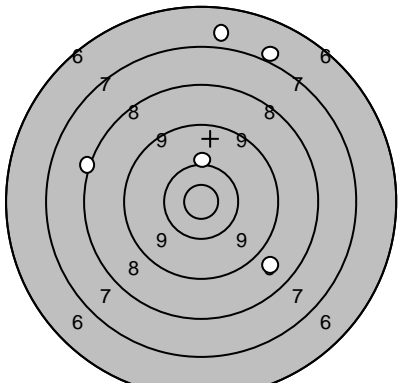
Skjutlag	Tavla	Fredrik Forsgren		
2	2			
		Ramselefors		
2008-07-13	Tavelträffen B 2008	Ramselefors SKF		
Provskott		1: 9,2 ↑	Serie 1 (L)	1: 9,5 ↑
		2: 9,8 ↗		2: 10,0 ↘
		3: 10,5* ↙		3: 9,2 ↙
		4: 10,8* ↘		4: 9,4 ←
				5: 8,8 ←
		Serie 38,0		Serie 45,0
		Totalt 0,0		Totalt 45,0
Provskott		1: 8,4 →	Serie 2 (K)	1: 9,2 →
		2: 8,6 ↙		2: 9,7 ↘
				3: 10,5* ↑
				4: 8,0 ↗
				5: 10,2 ←
		Serie 16,0		Serie 46,0
		Totalt 45,0		Totalt 91,0
Serie 3 (S)		1: 10,1 ↑		
		2: 6,8 ↑		
		3: 7,0 ↗		
		4: 8,1 ←		
		5: 8,8 ↘		
		Serie 39,0		
		Totalt 130,0		

OBS!

På grund av tekniska problem har vi problem med detta skjutkort som därför tagits bort ur denna fil.

Vi ber om ursäkt för det inträffade och kommer att göra allt för att det inte ska inträffa igen.

//Ramselefors Skytteförening



OBS!

På grund av tekniska problem har vi problem med detta skjutkort som därför tagits bort ur denna fil.

Vi ber om ursäkt för det inträffade och kommer att göra allt för att det inte ska inträffa igen.

//Ramselefors Skytteförening

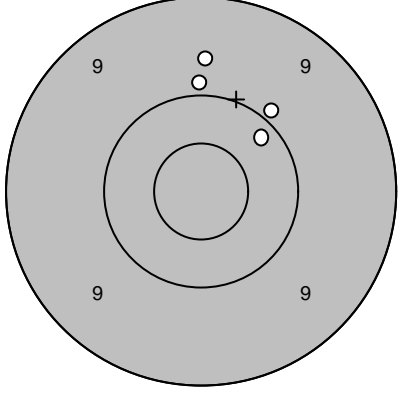
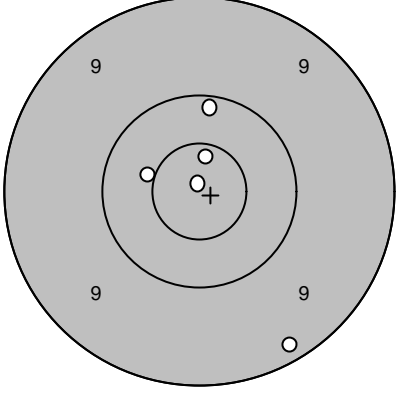
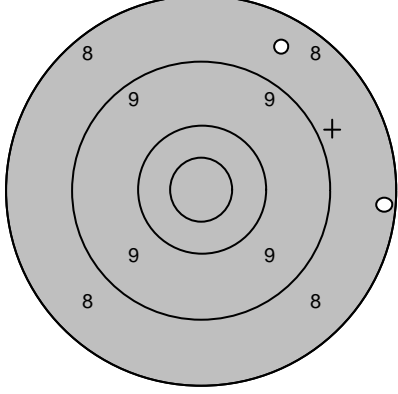
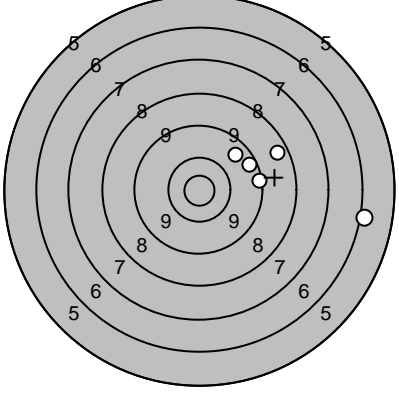
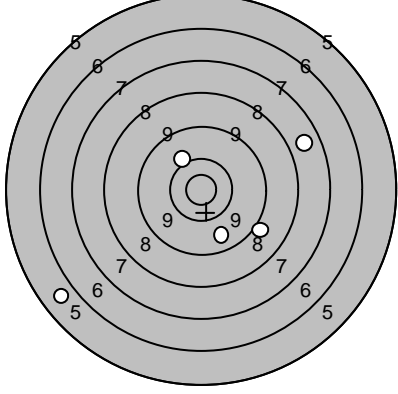
Skjutlag	Tavla	<b>Berndt Steffen</b>		
<b>2</b>	<b>5</b>			
Frötuna				
2008-07-13	Tavelträffen B 2008	Ramselefors SKF		
Provs-kott		1: 9,9 ↗ 2: 9,7 ↑ 3: 9,9 ↑ 4: 10,2 ↗	<b>Serie 1 (L)</b> 	1: 10,2 ↑ 2: 10,7* ↑ 3: 9,2 ↓ 4: 10,5* ← 5: 10,9* ↑
	Serie 37,0 Totalt 0,0		Serie 49,0 Totalt 49,0	
Provs-kott		1: 8,3 → 2: 8,6 ↑	<b>Serie 2 (K)</b> 	1: 8,5 ↗ 2: 9,5 ↗ 3: 6,1 → 4: 9,3 → 5: 9,7 ↗
	Serie 16,0 Totalt 49,0		Serie 41,0 Totalt 90,0	
<b>Serie 3 (S)</b>		1: 9,0 ↘ 2: 10,1 ↗ 3: 9,7 ↓ 4: 5,8 ↙ 5: 7,7 →		
	Serie 40,0 Totalt 130,0			

OBS!

På grund av tekniska problem har vi problem med detta skjutkort som därför tagits bort ur denna fil.

Vi ber om ursäkt för det inträffade och kommer att göra allt för att det inte ska inträffa igen.

//Ramselefors Skytteförening

Skjutlag

Tavla

2

7

Sture Nilsson

Piteå

2008-07-13

Tavelträffen B 2008

Ramselefors SKF

Provskott

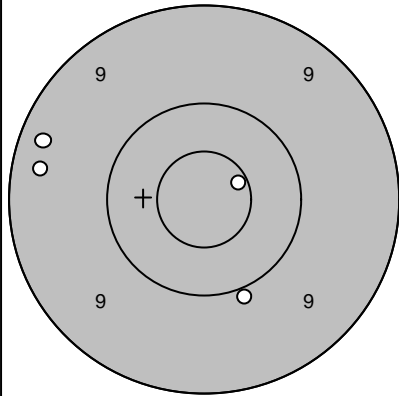

1: 9,3 ←  
 2: 10,6\* →  
 3: 9,3 ←  
 4: 10,0 ↓

Serie 1 (L)

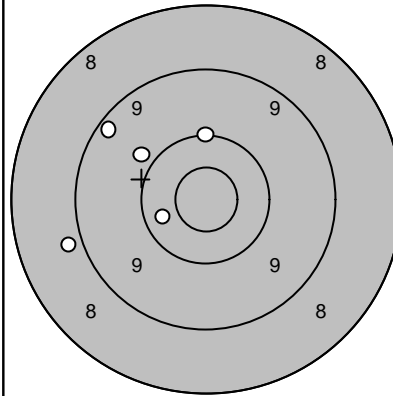

1: 9,2 ↖  
 2: 8,9 ←  
 3: 10,1 ↑  
 4: 10,4 ←  
 5: 9,9 ↖

Serie 38,0

Totalt 0,0

Serie 46,0

Totalt 46,0

Provskott

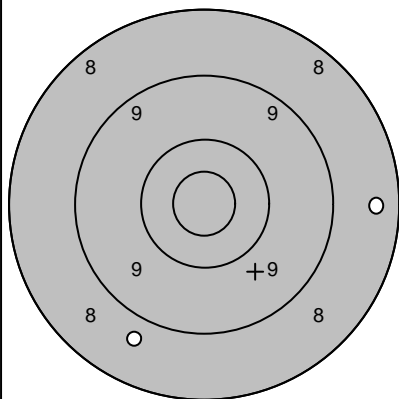

1: 8,4 →  
 2: 8,7 ↘

Serie 2 (K)

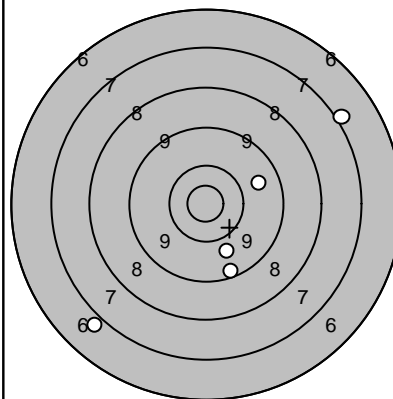

1: 9,9 ↓  
 2: 7,0 ↙  
 3: 7,1 ↗  
 4: 9,7 →  
 5: 9,3 ↓

Serie 16,0

Totalt 46,0

Serie 41,0

Totalt 87,0

Serie 3 (S)

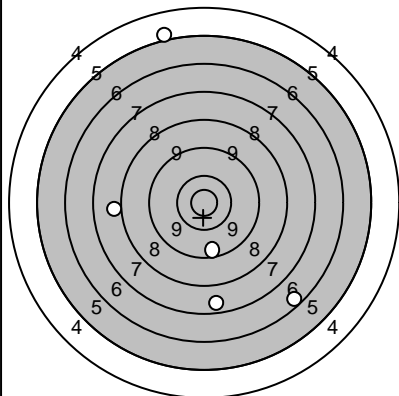

1: 7,6 ↓  
 2: 6,5 ↓  
 3: 8,0 ←  
 4: 5,1 ↑  
 5: 9,5 ↓

Serie 35,0

Totalt 122,0

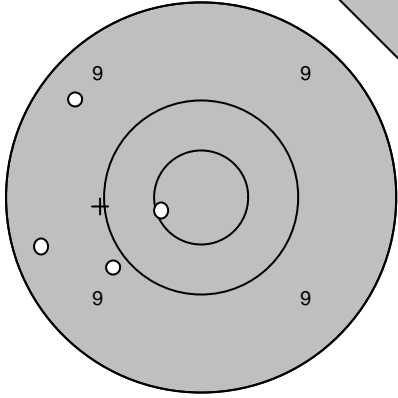
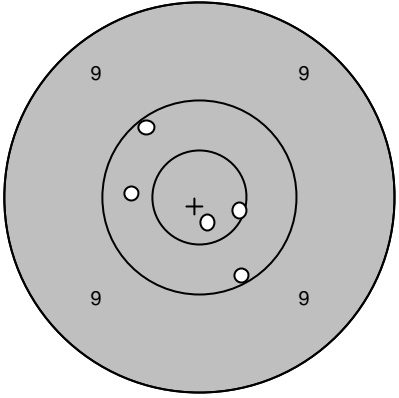
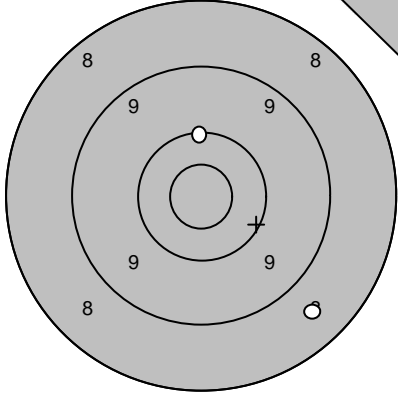
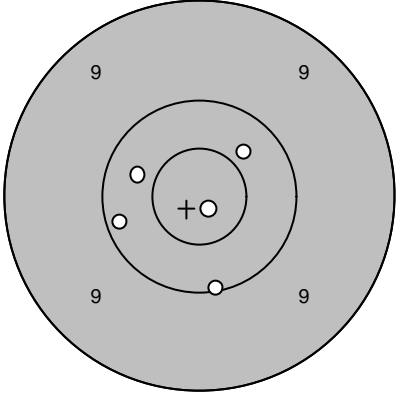
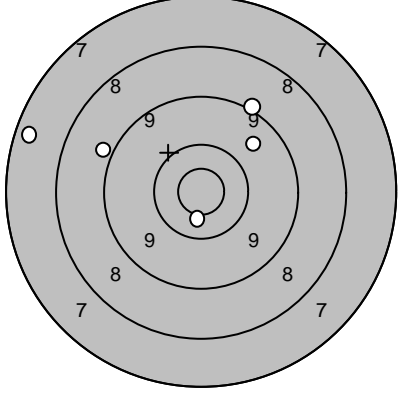
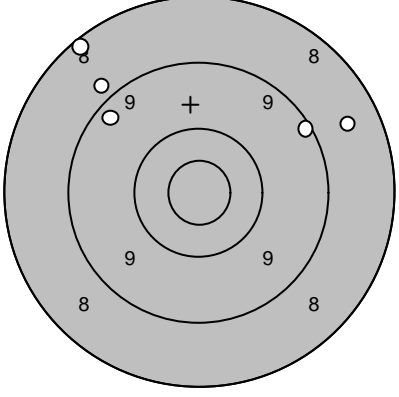
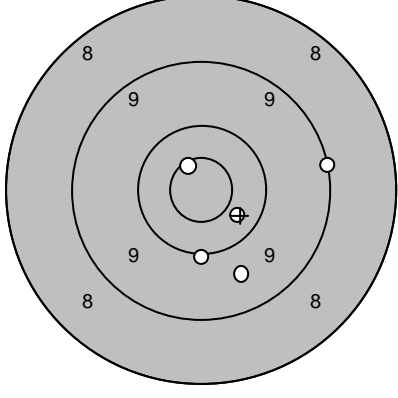
Skjutlag <b>2</b>	Tavla <b>8</b>	<b>Maria Falck</b>	
		Moälven/Modo	
2008-07-13	Tavelträffen B 2008	Ramselefors SKF	
<b>Provskott</b> 	1: 9,9 ↙ 2: 10,6* ← 3: 9,4 ↗ 4: 9,3 ←	<b>Serie 1 (L)</b> 	1: 10,6* → 2: 10,4 ← 3: 10,1 ↗ 4: 10,1 ↘ 5: 10,8* ↓
	Serie 37,0		Serie 50,0
	Totalt 0,0		Totalt 50,0
<b>Provskott</b> 	1: 10,1 ↑ 2: 8,6 ↘	<b>Serie 2 (K)</b> 	1: 10,4 ↗ 2: 10,9* ↘ 3: 10,2 ← 4: 10,4 ← 5: 10,1 ↓
	Serie 18,0		Serie 50,0
	Totalt 50,0		Totalt 100,0
<b>Serie 3 (S)</b> 	1: 10,6* ↓ 2: 8,9 ← 3: 9,1 ↗ 4: 7,4 ← 5: 9,7 ↗	<b>Extratävling 3+3+4</b> 	1: 8,6 ↗ 2: 8,9 ↗ 3: 8,2 ↗ 4: 9,2 → 5: 9,3 ↗
	Serie 43,0		Serie 42,0
	Totalt 143,0		Totalt 185,0
<b>Extratävling 3+3+4</b> 	6: 10,0 ↓ 7: 10,7* ↗ 8: 9,6 ↘ 9: 9,1 → 10: 10,4 ↘		
	Serie 48,0		
	Totalt 233,0		

OBS!

På grund av tekniska problem har vi problem med detta skjutkort som därför tagits bort ur denna fil.

Vi ber om ursäkt för det inträffade och kommer att göra allt för att det inte ska inträffa igen.

//Ramselefors Skytteförening

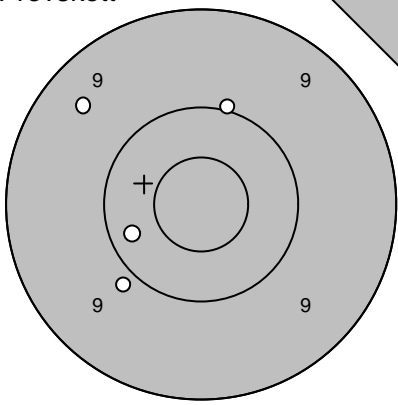
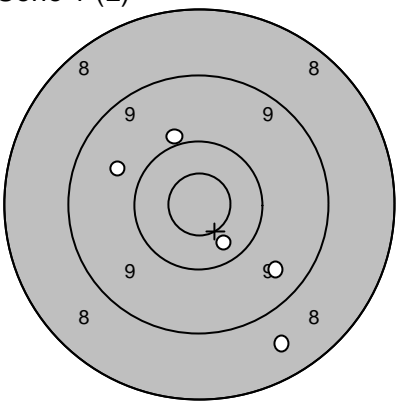
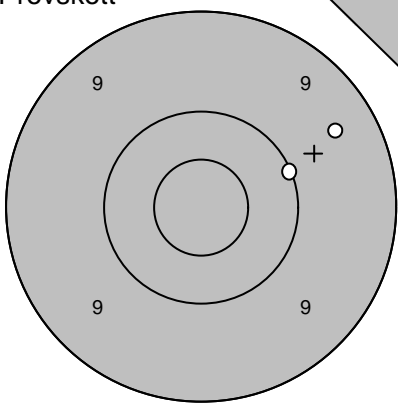
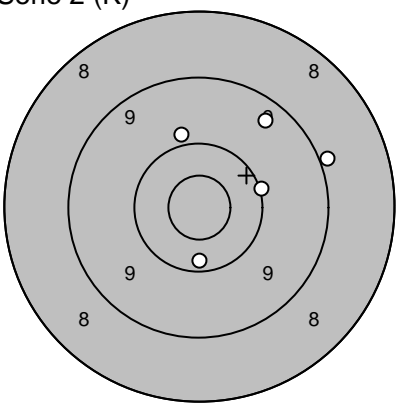
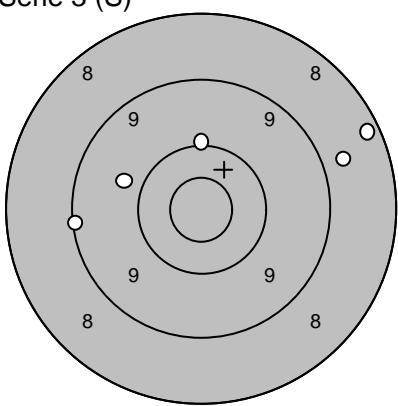
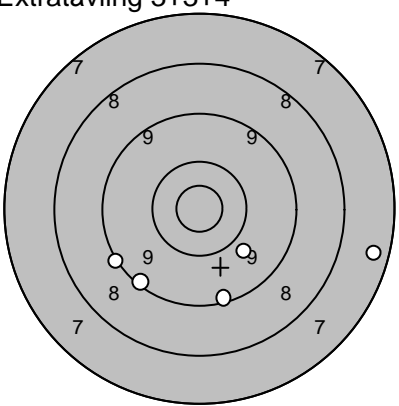
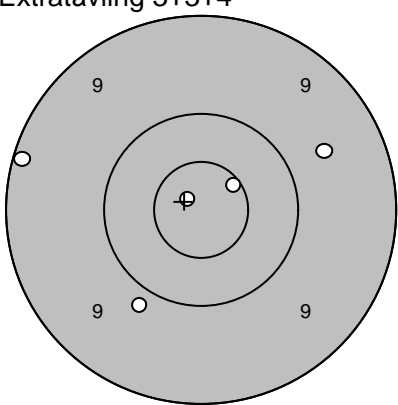
Skjutlag <b>2</b>	Tavla <b>10</b>	<b>Bengt Jansson</b>	
		Söderala	
2008-07-13	Tavelträffen B 2008	Ramselefors SKF	
<b>Provskott</b> 	1: 10,0 ↑ 2: 9,5 ↖ 3: 10,3 ← 4: 9,9 ↙	<b>Serie 1 (L)</b> 	1: 9,7 ← 2: 10,0 ↗ 3: 10,4 ↓ 4: 8,6 ↘ 5: 9,5 ↘
	Serie 38,0		Serie 46,0
	Totalt 0,0		Totalt 46,0
<b>Provskott</b> 	1: 9,4 ↗ 2: 10,1 →	<b>Serie 2 (K)</b> 	1: 9,4 ↗ 2: 9,0 → 3: 10,2 ↓ 4: 10,1 → 5: 9,9 ↑
	Serie 19,0		Serie 47,0
	Totalt 46,0		Totalt 93,0
<b>Serie 3 (S)</b> 	1: 8,3 → 2: 10,1 ↑ 3: 9,8 ↖ 4: 9,1 ← 5: 8,8 →	<b>Extratävling 3+3+4</b> 	1: 7,5 → 2: 9,2 ↘ 3: 9,1 ↖ 4: 9,2 ↘ 5: 9,9 ↘
	Serie 44,0		Serie 43,0
	Totalt 137,0		Totalt 180,0
<b>Extratävling 3+3+4</b> 	6: 9,1 ← 7: 9,6 → 8: 9,9 ↘ 9: 10,9* ↖ 10: 10,6* ↗		
	Serie 47,0		
	Totalt 227,0		

OBS!

På grund av tekniska problem har vi problem med detta skjutkort som därför tagits bort ur denna fil.

Vi ber om ursäkt för det inträffade och kommer att göra allt för att det inte ska inträffa igen.

//Ramselefors Skytteförening

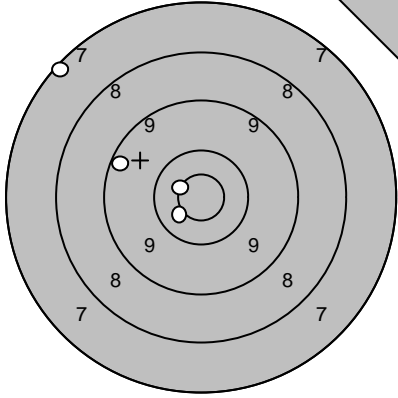
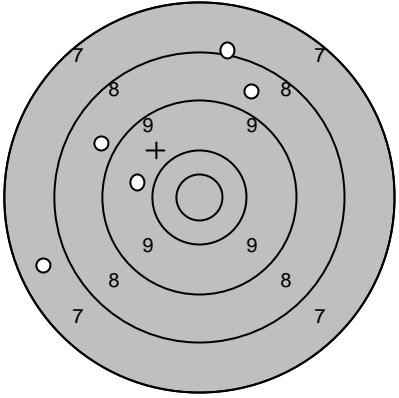
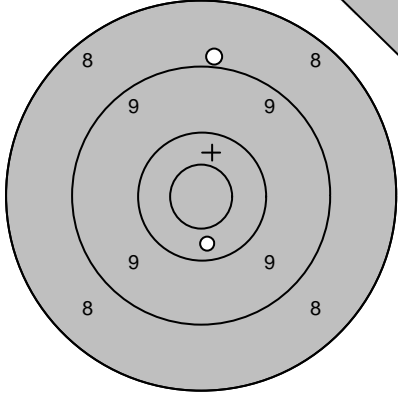
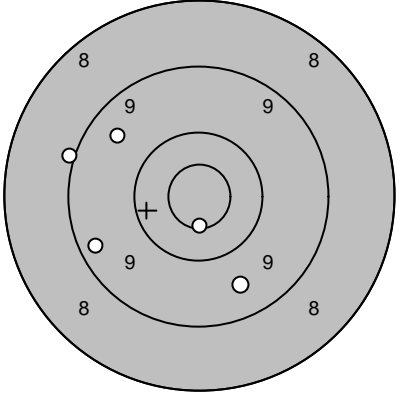
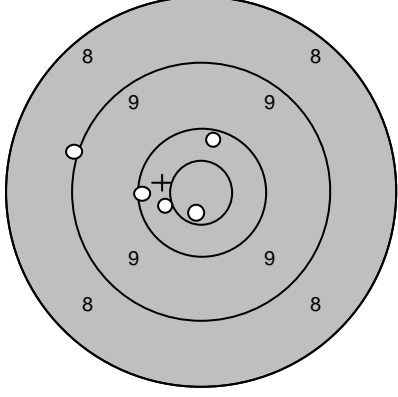
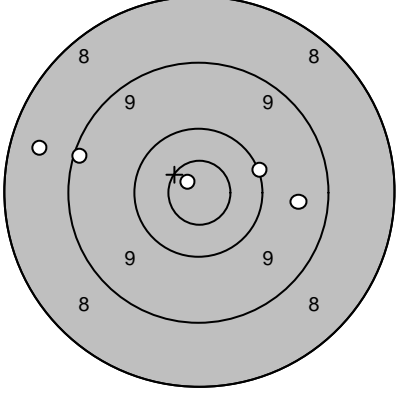
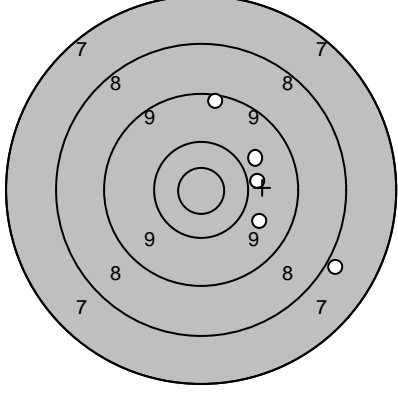

Skjutlag	Tavla	<b>Oliver Åkerström</b>		
<b>2</b>	<b>12</b>			
		Niemisel		
2008-07-13	Tavelträffen B 2008	Ramselefors SKF		
Provskott		1: 9,3 ← 2: 10,6* ↖ 3: 7,2 ↗ 4: 10,6* ↘	Serie 1 (L) 	1: 9,8 ← 2: 8,9 ↖ 3: 8,7 ↗ 4: 8,1 ↑ 5: 7,7 ↙
		Serie 36,0		Serie 40,0
		Totalt 0,0		Totalt 40,0
Provskott		1: 8,9 ↑ 2: 10,3 ↓	Serie 2 (K) 	1: 9,3 ← 2: 9,6 ↓ 3: 9,0 ↗ 4: 9,5 ↗ 5: 10,6* ↓
		Serie 18,0		Serie 46,0
		Totalt 40,0		Totalt 86,0
Serie 3 (S)		1: 10,3 ↑ 2: 10,5* ← 3: 10,2 ← 4: 10,7* ↓ 5: 9,1 ←	Extratävling 3+3+4 	1: 10,1 → 2: 10,8* ↗ 3: 8,5 ↖ 4: 9,2 ↗ 5: 9,5 →
		Serie 49,0		Serie 46,0
		Totalt 135,0		Totalt 181,0
Extratävling 3+3+4		6: 9,8 ↗ 7: 10,0 → 8: 9,3 ↑ 9: 9,8 ↗ 10: 7,9 ↘		
		Serie 44,0		
		Totalt 225,0		

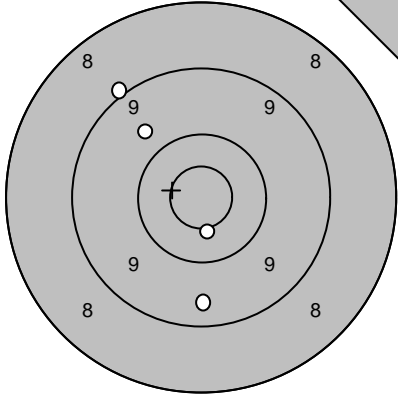
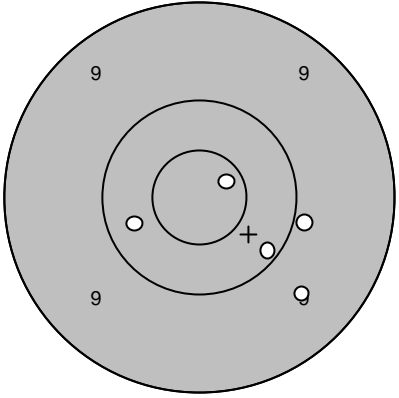
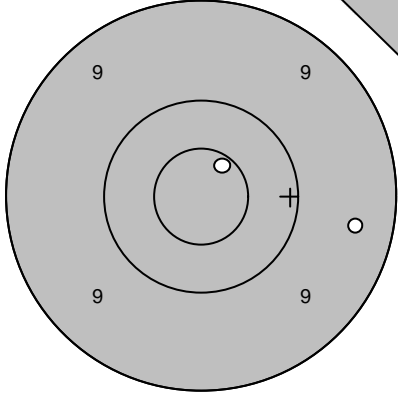
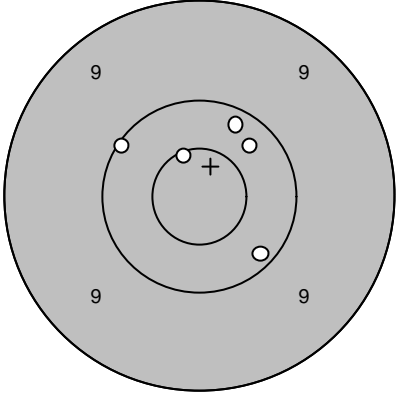
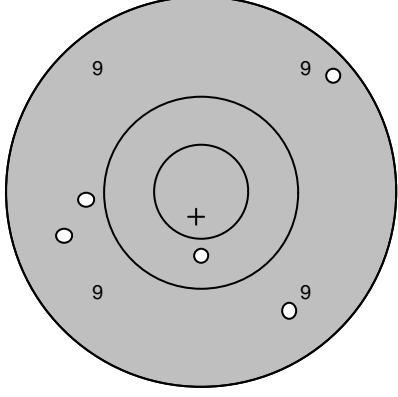
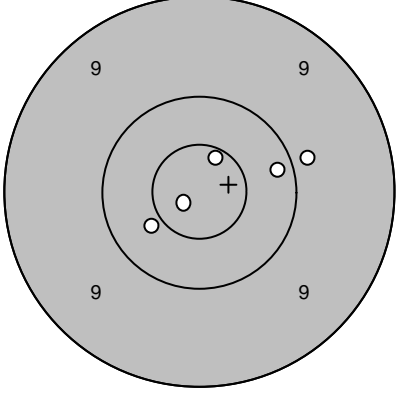
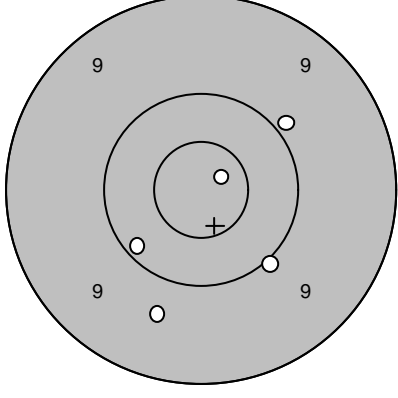
Skjutlag <b>2</b>	Tavla <b>14</b>	<b>Johan Olsson</b>	
		Öved-Östraby	
2008-07-13	Tavelträffen B 2008	Ramselefors SKF	
<b>Provsnitt</b> 	1: 9,7 ↖ 2: 9,0 ↖ 3: 10,5* ↓ 4: 9,5 ↓	<b>Serie 1 (L)</b> 	1: 10,3 ← 2: 9,9 → 3: 10,1 ↘ 4: 9,6 ↘ 5: 10,7* →
	Serie 37,0		Serie 48,0
	Totalt 0,0		Totalt 48,0
<b>Provsnitt</b> 	1: 10,7* ↗ 2: 9,4 →	<b>Serie 2 (K)</b> 	1: 10,3 ↗ 2: 10,2 ↘ 3: 10,6* ↗ 4: 10,2 ↗ 5: 10,1 ↖
	Serie 19,0		Serie 50,0
	Totalt 48,0		Totalt 98,0
<b>Serie 3 (S)</b> 	1: 9,6 ← 2: 9,9 ← 3: 10,4 ↓ 4: 9,5 ↘ 5: 9,2 ↗	<b>Extratävling 3+3+4</b> 	1: 10,2 → 2: 9,9 → 3: 10,6* ↗ 4: 10,8* ← 5: 10,4 ←
	Serie 46,0		Serie 49,0
	Totalt 144,0		Totalt 193,0
<b>Extratävling 3+3+4</b> 	6: 10,2 ↘ 7: 10,8* ↗ 8: 9,7 ↓ 9: 10,0 ↘ 10: 9,9 ↗		
	Serie 48,0		
	Totalt 241,0		

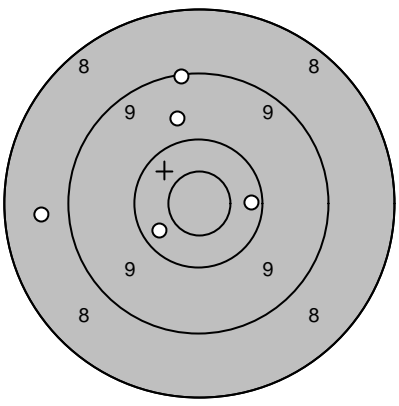
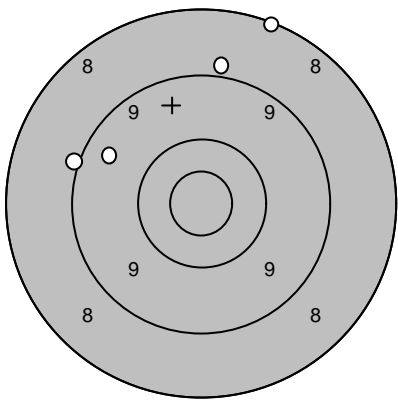
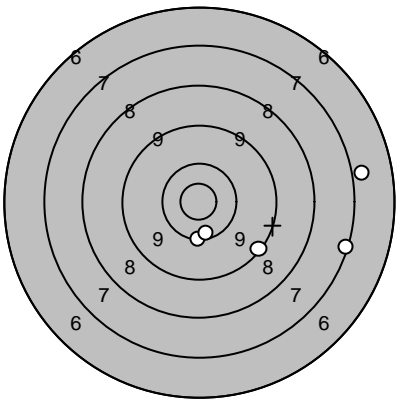
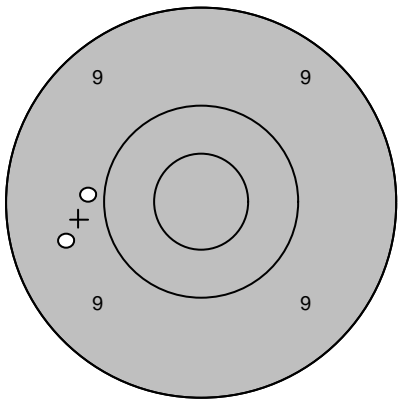
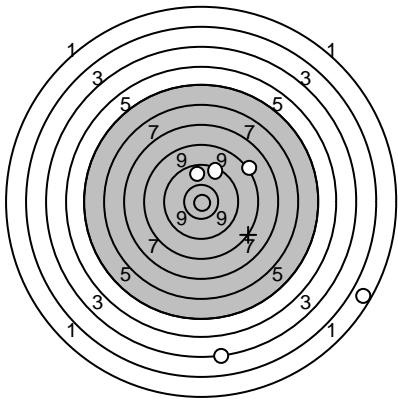
Skjutlag	Tavla		
<b>2</b>	<b>15</b>	<b>Henrik Olsson</b>	
		Öved-Östraby	
2008-07-13	Tavelträffen B 2008	Ramselefors SKF	
Provskott		1: 8,9 ↑ 2: 8,1 ↑ 3: 9,0 ← 4: 9,5 ↖	Serie 1 (L) 
			
		Serie 34,0 Totalt 0,0	Serie 46,0 Totalt 46,0
Provskott		1: 9,9 ← 2: 9,6 ←	Serie 2 (K) 
			
		Serie 18,0 Totalt 46,0	Serie 43,0 Totalt 89,0
Serie 3 (S)		1: 8,3 ↗ 2: 9,6 ↑ 3: 1,8 → 4: 3,4 ↓ 5: 9,9 ↑	
			
		Serie 30,0 Totalt 119,0	

Skjutlag	Tavla	Marcus Andersson
2	16	

Bälinge-Jumkil		
----------------	--	--

2008-07-13	Tavelträffen B 2008	Ramselefors SKF
------------	---------------------	-----------------

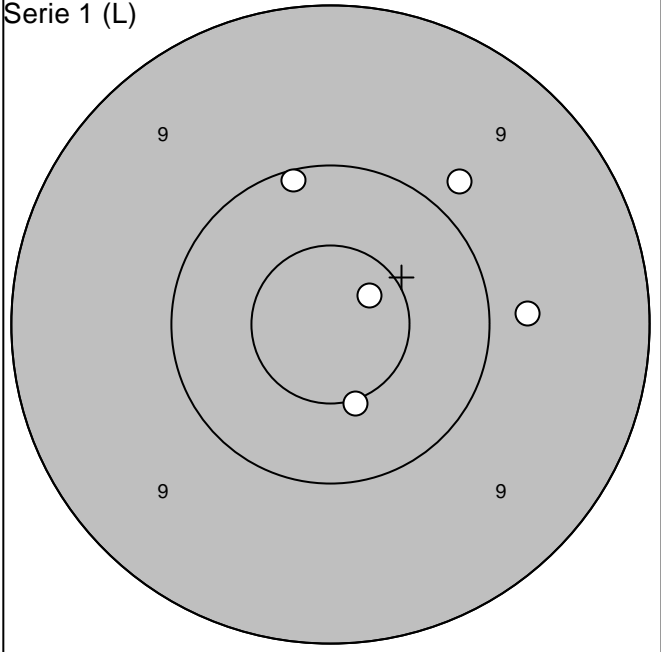
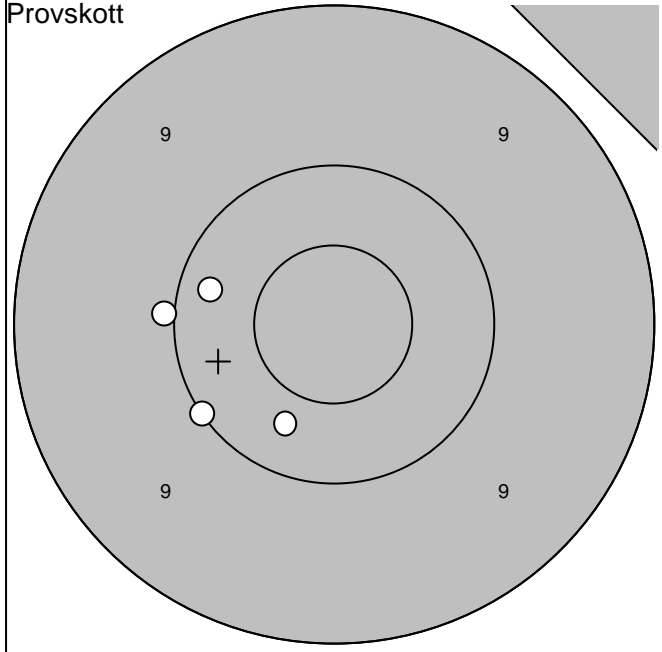

1:10,2 ←	Serie	40,0
2:10,0 ↙		
3:10,3 ↘	Totalt	0,0
4:10,0 ←		

1:10,1 ↑	Serie	48,0
2:10,7* ↗		
3:10,5* ↓	Totalt	48,0
4: 9,8 →		
5: 9,8 ↗		

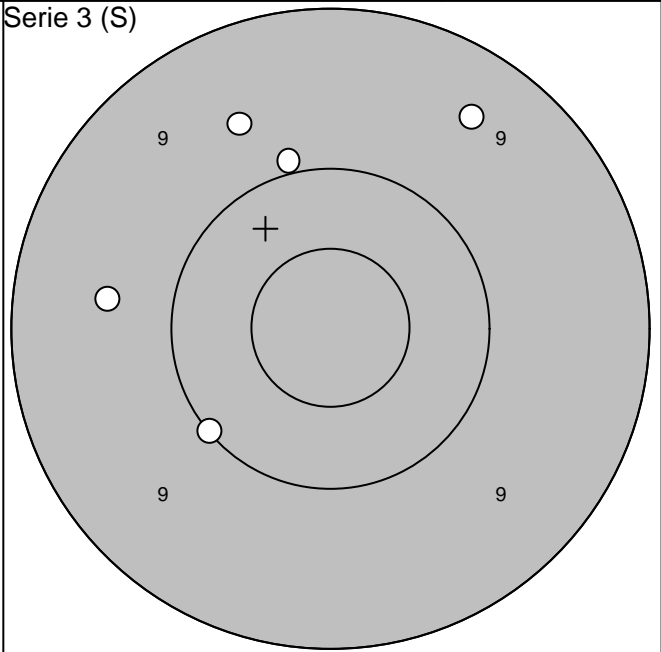
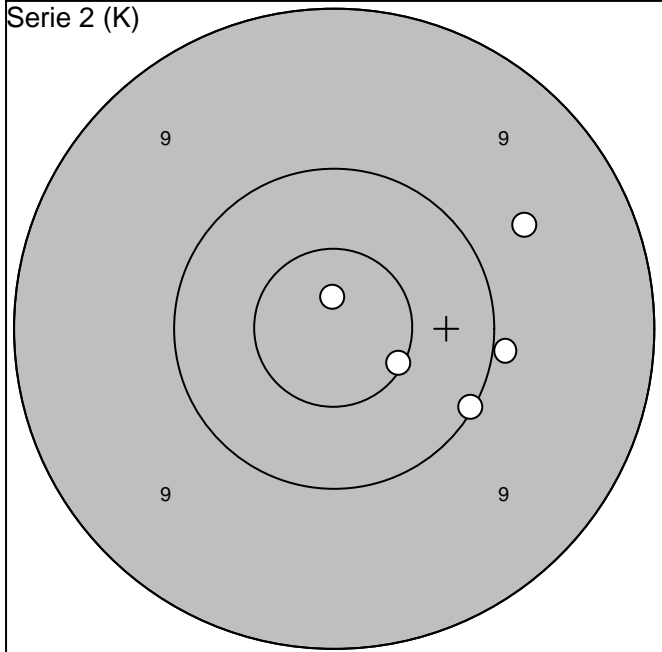

1:10,0 ➤	Serie	49,0
2: 9,7 ↗		
3:10,0 →	Totalt	97,0
4:10,6* ➤		
5:10,8* ↑		

1:10,0 ↙	Serie	47,0
2: 9,4 ↗		
3: 9,6 ↑	Totalt	144,0
4: 9,6 ←		
5:10,0 ↑		

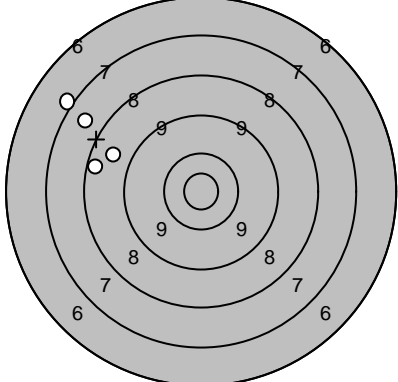
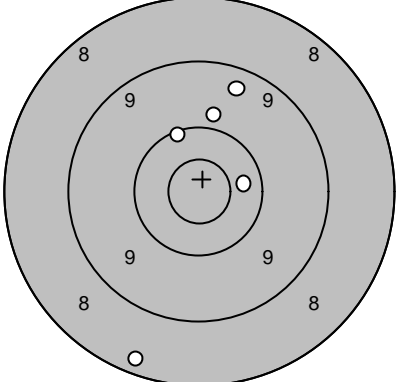
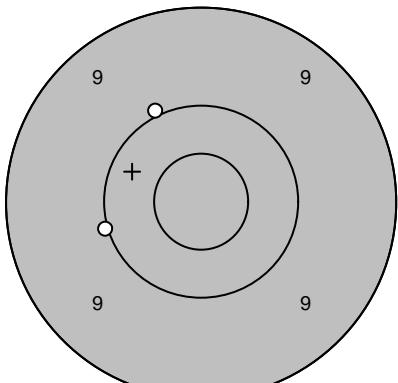
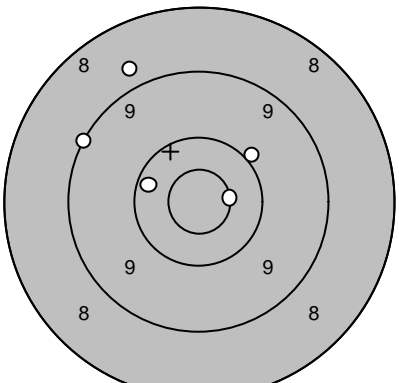
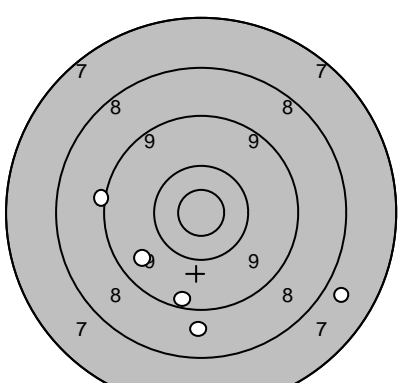
Skjutlag	Tavla	<b>Gustav Karlsson</b>	
<b>2</b>	<b>18</b>		
Loos			
2008-07-13	Tavelträffen B 2008	Ramselefors SKF	
Provskott 	1: 7,7 ↖	Serie 1 (L) 	1: 9,4 ↗
	2: 8,4 ↖		2: 10,2 ↖
	3: 8,8 ↗		3: 10,4 →
	4: 7,0 ↗		4: 9,9 ↑
	5: 8,3 ↓		
	Serie 30,0		Serie 46,0
	Totalt 0,0		Totalt 46,0
Provskott 	1: 10,0 ↗	Serie 2 (K) 	1: 10,6* →
	2: 10,0 ↖		2: 8,8 ↖
			3: 10,0 ↗
			4: 10,3 ↖
	5: 9,1 ↖		
	Serie 20,0		Serie 47,0
	Totalt 46,0		Totalt 93,0
Serie 3 (S) 	1: 8,7 ↓		
	2: 9,3 ↓		
	3: 7,8 →		
	4: 9,1 ↖		
	5: 9,6 ↖		
	Serie 42,0		
	Totalt 135,0		

OBS!

På grund av tekniska problem har vi problem med detta skjutkort som därför tagits bort ur denna fil.

Vi ber om ursäkt för det inträffade och kommer att göra allt för att det inte ska inträffa igen.

//Ramselefors Skytteförening

Skjutlag	Tavla	<b>Peter Ericson</b>	
<b>2</b>	<b>20</b>		
2008-07-13		Loos	
2008-07-13		Tavelträffen B 2008	Ramselefors SKF
Provskott		1: 10,2 ↑ 2: 10,4 ← 3: 10,4 ↗ 4: 10,0 ↗ 5: 10,2 ↗	Serie 1 (L)
		Serie 50,0	
		Totalt 0,0	1: 10,0 ← 2: 10,2 ↗ 3: 10,7* ← 4: 10,4 ↓ 5: 10,2 →
			Serie 50,0
			Totalt 50,0
Provskott		1: 9,6 ↗	Serie 2 (K)
		Serie 9,0	
		Totalt 50,0	1: 10,6* ↘ 2: 10,6* ↗ 3: 10,6* ↗ 4: 10,6* ↘ 5: 9,6 →
			Serie 49,0
			Totalt 99,0
Serie 3 (S)		1: 10,5* → 2: 9,7 ↘ 3: 10,7* ↗ 4: 10,3 ← 5: 9,9 ↘	Extratävling 3+3+4
		Serie 48,0	
		Totalt 147,0	1: 10,9* ↑ 2: 10,6* ← 3: 10,2 → 4: 10,2 ↗ 5: 9,6 →
			Serie 49,0
			Totalt 196,0
Extratävling 3+3+4		6: 9,9 → 7: 10,0 ↓ 8: 10,6* ↗ 9: 10,1 ↘ 10: 10,0 →	
		Serie 49,0	
		Totalt 245,0	

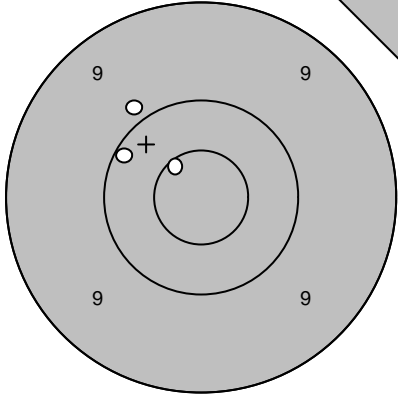
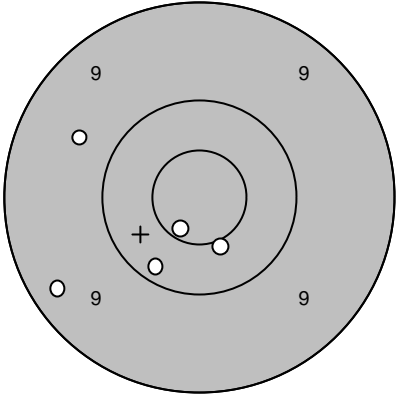
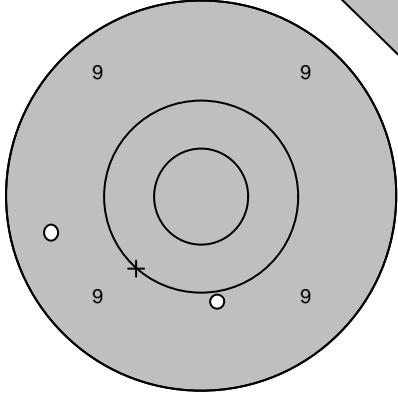
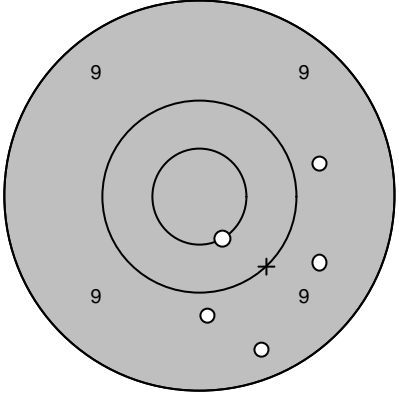
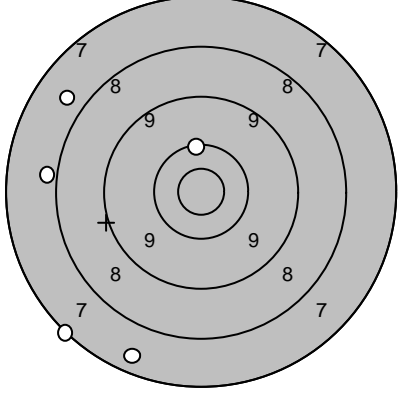
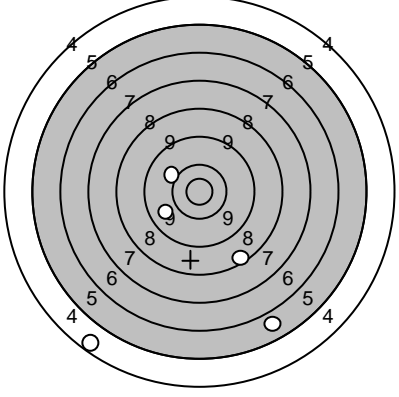
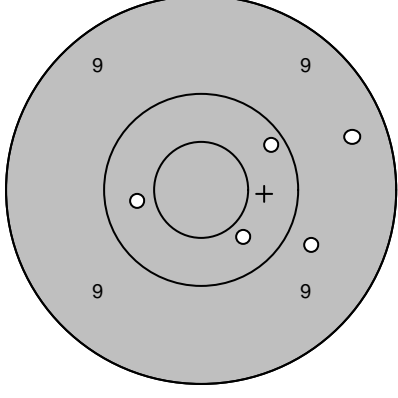
Skjutlag <b>2</b>	Tavla <b>21</b>	<b>Rune Utterström</b>	
		Ale	
2008-07-13	Tavelträffen B 2008	Ramselefors SKF	
<b>Provkott</b> 	1: 10,1 ↖ 2: 9,9 ↗ 3: 10,6* ↗	<b>Serie 1 (L)</b> 	1: 10,2 ↘ 2: 10,7* ↘ 3: 10,5* ↘ 4: 9,7 ↗ 5: 9,3 ↘
	Serie 29,0 Totalt 0,0		Serie 48,0 Totalt 48,0
<b>Provkott</b> 	1: 9,5 ← 2: 9,9 ↓	<b>Serie 2 (K)</b> 	1: 9,8 ↓ 2: 9,3 ↓ 3: 10,5* ↓ 4: 9,8 → 5: 9,6 ↘
	Serie 18,0 Totalt 48,0		Serie 46,0 Totalt 94,0
<b>Serie 3 (S)</b> 	1: 7,8 ↖ 2: 7,1 ↘ 3: 7,5 ↘ 4: 10,2 ↑ 5: 8,0 ←	<b>Extratävling 3+3+4</b> 	1: 4,6 ↘ 2: 5,9 ↘ 3: 8,5 ↘ 4: 10,1 ↗ 5: 9,9 ↘
	Serie 39,0 Totalt 133,0		Serie 36,0 Totalt 169,0
<b>Extratävling 3+3+4</b> 	6: 10,4 ↘ 7: 10,2 ↗ 8: 9,8 ↘ 9: 9,4 → 10: 10,4 ←		
	Serie 48,0 Totalt 217,0		



OBS!

På grund av tekniska problem har vi problem med detta skjutkort som därför tagits bort ur denna fil.

Vi ber om ursäkt för det inträffade och kommer att göra allt för att det inte ska inträffa igen.

//Ramselefors Skytteförening

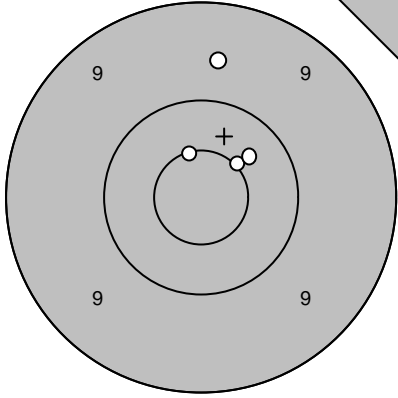
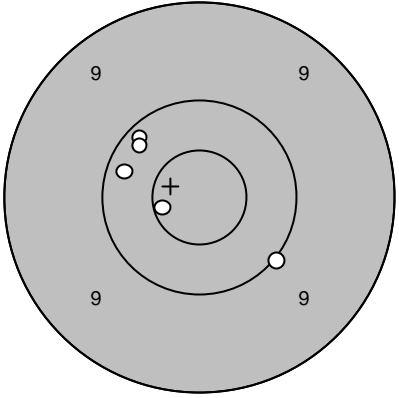
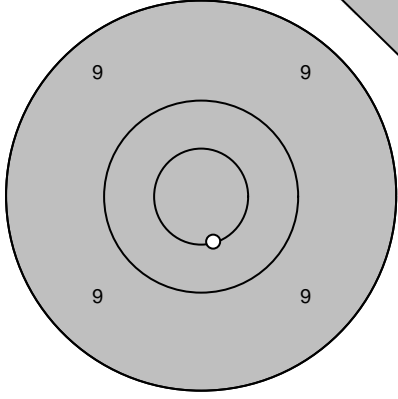
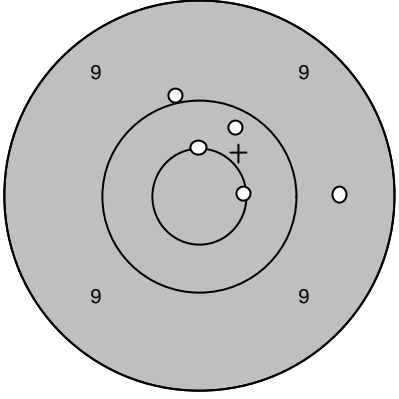
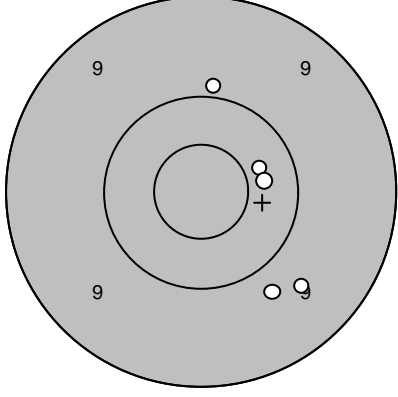
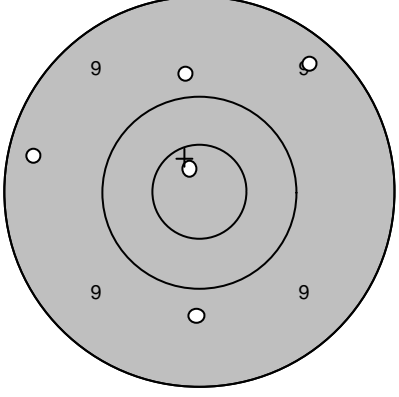
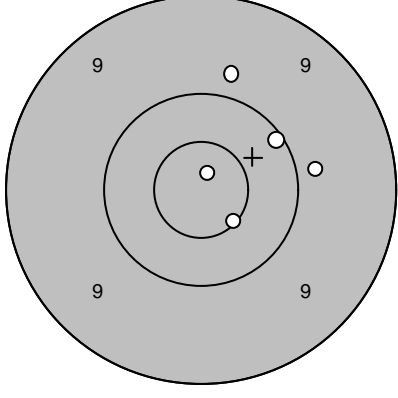
Skjutlag	Tavla	Elina Högström		
		Ramselefors		
2008-07-13	Tavelträffen B 2008	Ramselefors SKF		
Provkott		1: 9,6 ↑ 2: 10,5* ↗ 3: 10,6* ↑ 4: 10,4 ↗	Serie 1 (L) 	1: 10,6* ← 2: 10,0 ↘ 3: 10,2 ↗ 4: 10,2 ↗ 5: 10,2 ↑
		Serie 39,0	Serie 50,0	
		Totalt 0,0	Totalt 50,0	
Provkott		1: 10,6* ↓	Serie 2 (K) 	1: 10,2 ↑ 2: 10,6* → 3: 10,0 ↑ 4: 9,6 → 5: 10,5* ↑
		Serie 10,0	Serie 49,0	
		Totalt 50,0	Totalt 99,0	
Serie 3 (S)		1: 9,9 ↑ 2: 9,6 ↘ 3: 9,8 ↘ 4: 10,4 → 5: 10,4 →	Extratävling 3+3+4 	1: 9,3 ↗ 2: 9,8 ↑ 3: 9,3 ← 4: 9,8 ↓ 5: 10,8* ↑
		Serie 47,0	Serie 46,0	
		Totalt 146,0	Totalt 192,0	
Extratävling 3+3+4		6: 9,9 → 7: 10,6* ↘ 8: 10,9* ↑ 9: 9,8 ↑ 10: 10,1 ↗		
		Serie 48,0		
		Totalt 240,0		

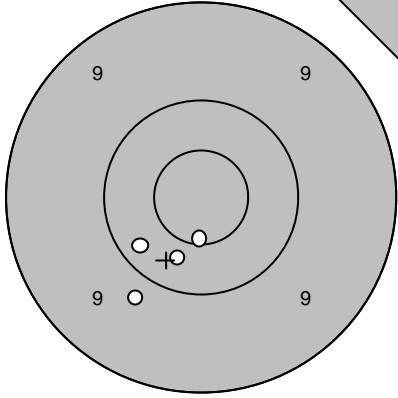
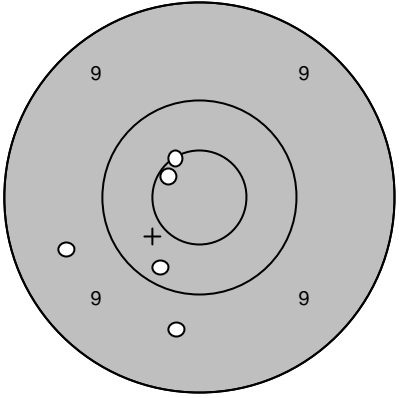
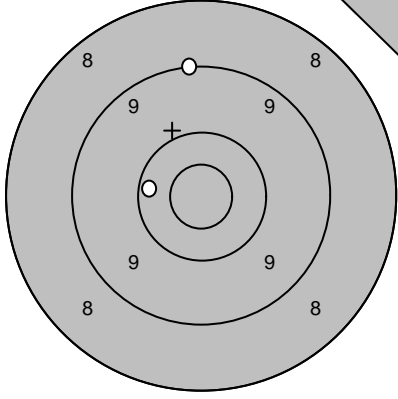
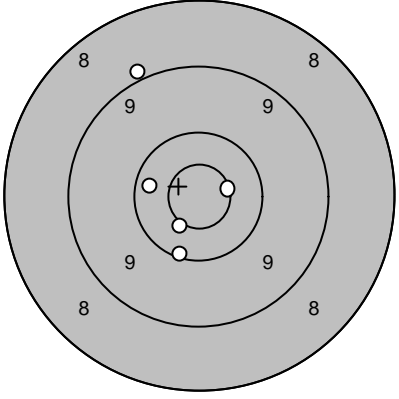
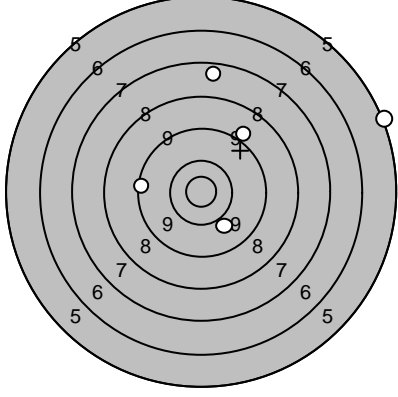
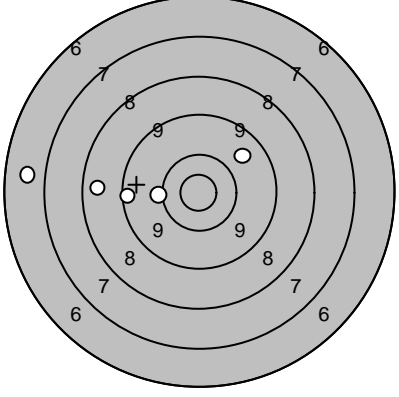
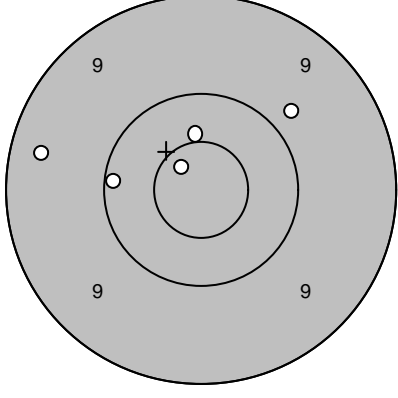
Skjutlag <b>3</b>	Tavla <b>1</b>	<b>L-G Lundqvist</b>	
		Ununge	
2008-07-13	Tavelträffen B 2008	Ramselefors SKF	
<b>Provskott</b> 	1: 9,8 ↘ 2: 10,2 ↙ 3: 10,6* ↓ 4: 10,4 ↓	<b>Serie 1 (L)</b> 	1: 10,6* ↗ 2: 10,2 ↓ 3: 9,7 ↓ 4: 10,7* ↖ 5: 9,6 ←
	Serie 39,0		Serie 48,0
	Totalt 0,0		Totalt 48,0
<b>Provskott</b> 	1: 9,1 ↑ 2: 10,3 ←	<b>Serie 2 (K)</b> 	1: 9,0 ↗ 2: 10,1 ↓ 3: 10,6* → 4: 10,3 ← 5: 10,5* ↓
	Serie 19,0		Serie 49,0
	Totalt 48,0		Totalt 97,0
<b>Serie 3 (S)</b> 	1: 9,9 ↘ 2: 9,4 ← 3: 7,6 ↑ 4: 5,2 → 5: 9,0 ↗	<b>Extratävling 3+3+4</b> 	1: 10,1 ← 2: 9,7 ↗ 3: 6,8 ← 4: 8,6 ← 5: 9,4 ←
	Serie 39,0		Serie 42,0
	Totalt 136,0		Totalt 178,0
<b>Extratävling 3+3+4</b> 	6: 9,4 ← 7: 10,1 ← 8: 9,8 ↗ 9: 10,5* ↑ 10: 10,7* ↖		
	Serie 48,0		
	Totalt 226,0		

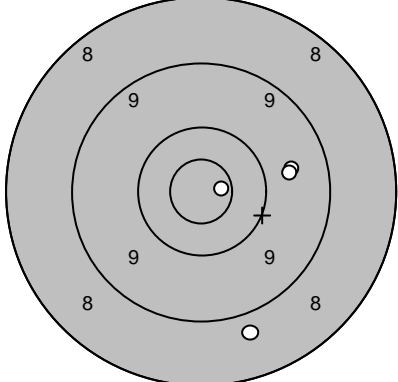
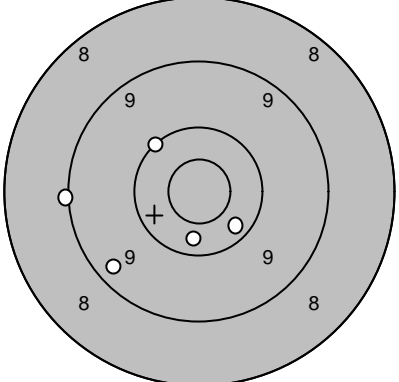
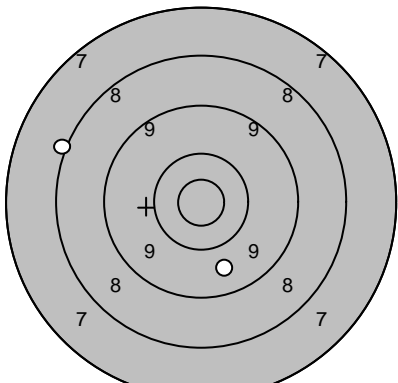
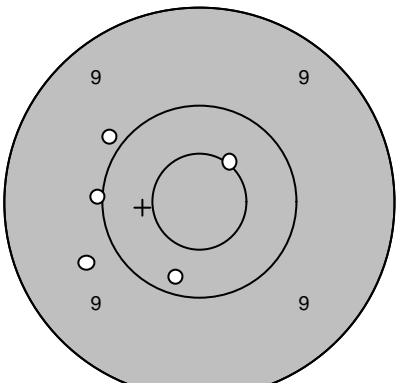
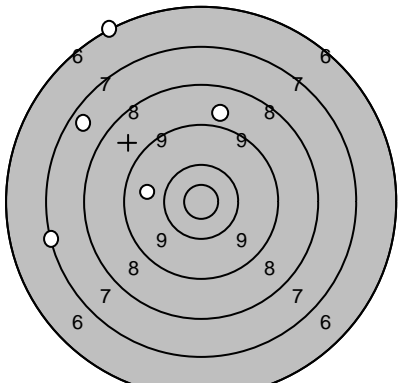
Skjutlag <b>3</b>	Tavla <b>3</b>	<b>Stefan Lundqvist</b>	
		Ununge	
2008-07-13	Tavelträffen B 2008	Ramselefors SKF	
Provsnitt 	1: 8,8 ↓ 2: 9,6 → 3: 10,8* → 4: 9,7 →	Serie 1 (L) 	1: 10,3 ↘ 2: 10,4 ↓ 3: 10,1 ↗ 4: 9,0 ← 5: 9,3 ↙
	Serie 36,0		Serie 48,0
	Totalt 0,0		Totalt 48,0
Provsnitt 	1: 9,7 ↓ 2: 8,1 ←	Serie 2 (K) 	1: 9,7 ← 2: 10,5* ↗ 3: 10,0 ← 4: 10,2 ↓ 5: 9,9 ↙
	Serie 17,0		Serie 48,0
	Totalt 48,0		Totalt 96,0
Serie 3 (S) 	1: 6,2 ↖ 2: 8,8 ↑ 3: 7,5 ↖ 4: 9,8 ← 5: 7,2 ←		
	Serie 37,0		
	Totalt 133,0		

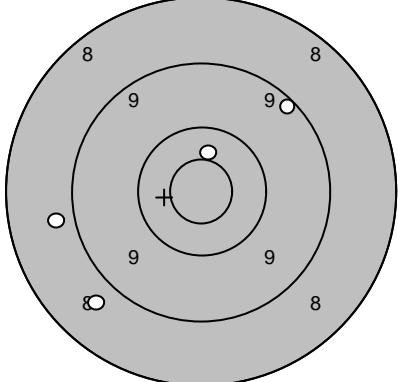
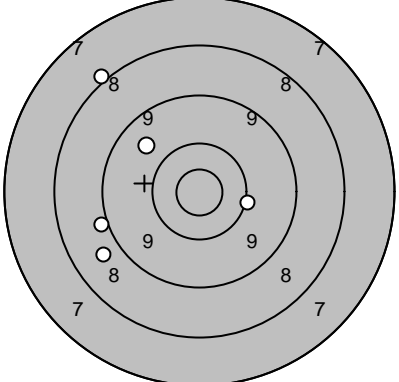
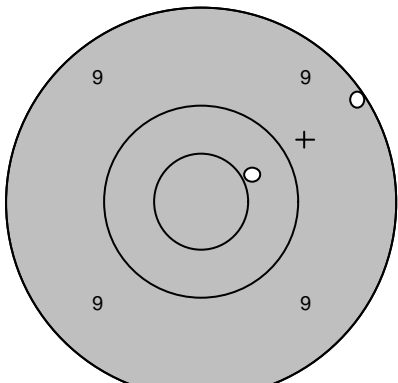
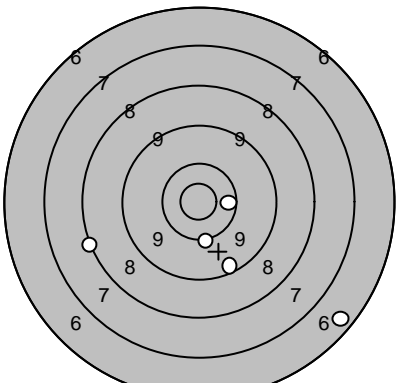
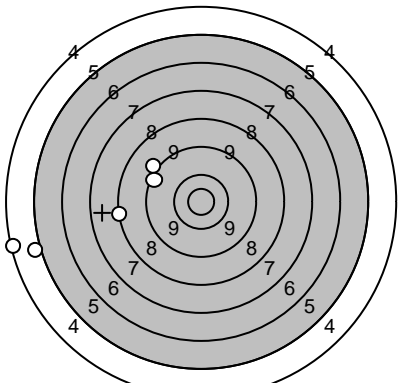
Skjutlag	Tavla	<b>Peter Lundqvist</b>	
<b>3</b>	<b>4</b>		
		Ununge	
2008-07-13	Tavelträffen B 2008	Ramselefors SKF	
Provskott 	1: 8,7 ↙	Serie 1 (L) 	1: 8,0 ↗
	2: 9,2 ↗		2: 10,1 →
	3: 10,5* ↑		3: 8,8 ↙
	4: 8,8 ←		4: 9,7 ↗
			5: 9,0 ←
	Serie 35,0		Serie 44,0
	Totalt 0,0		Totalt 44,0
Provskott 	1: 9,1 ↗	Serie 2 (K) 	1: 8,1 ←
	2: 10,4 ↗		2: 6,5 ↘
			3: 9,4 ↘
			4: 10,2 ↘
			5: 10,4 →
	Serie 19,0		Serie 43,0
	Totalt 44,0		Totalt 87,0
Serie 3 (S) 	1: 5,1 ←		
	2: 8,3 ←		
	3: 4,4 ←		
	4: 9,1 ↗		
	5: 9,4 ↗		
	Serie 35,0		
	Totalt 122,0		

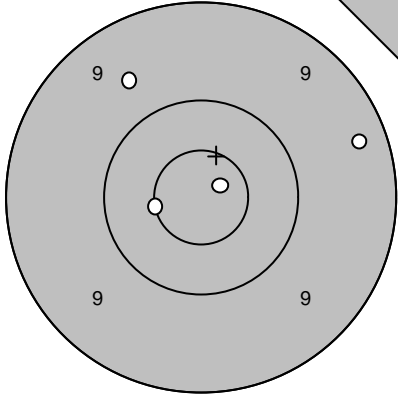
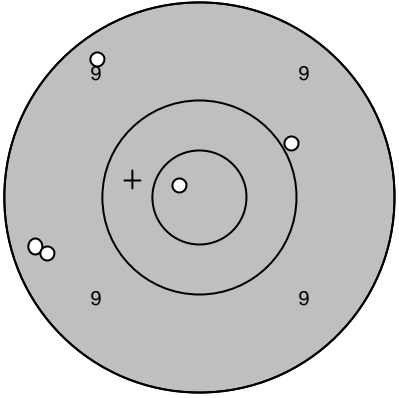
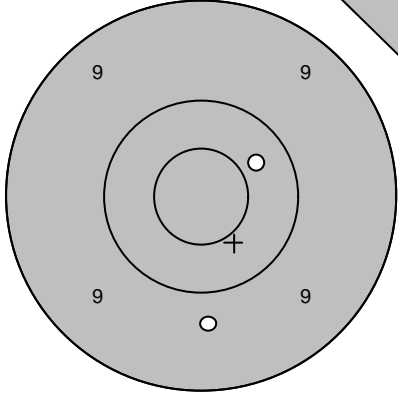
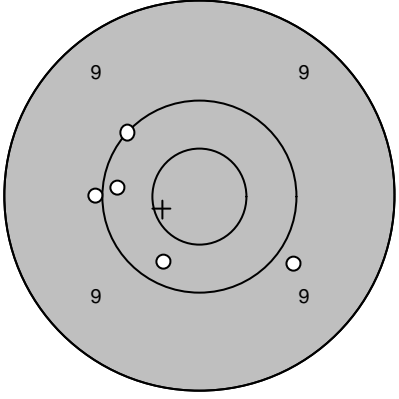
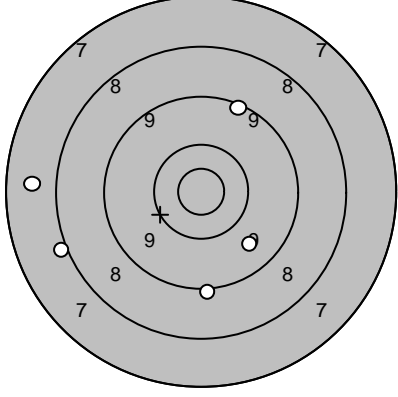
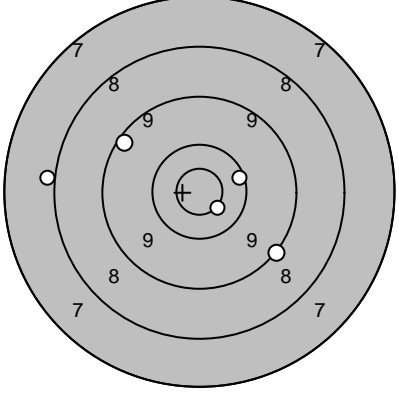
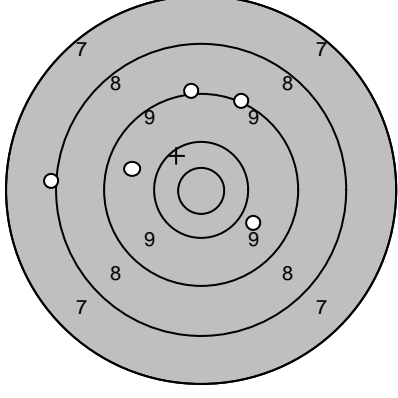
Skjutlag	Tavla	<b>Jan Wallerström</b>	
<b>3</b>	<b>5</b>		
		Ununge	
2008-07-13	Tavelträffen B 2008	Ramselefors SKF	
Provskott		1: 9,3 → 2: 10,8* ↗ 3: 10,6* ← 4: 9,6 ↖	Serie 1 (L) 
		1: 9,9 ↗ 2: 10,8* ↖ 3: 9,3 ← 4: 9,3 ↗ 5: 9,4 ←	
		Serie 38,0	Serie 46,0
		Totalt 0,0	Totalt 46,0
Provskott		1: 10,4 ↗ 2: 9,7 ↓	Serie 2 (K) 
		1: 10,2 ← 2: 10,1 ↗ 3: 10,3 ↓ 4: 9,8 ↘ 5: 10,0 ←	
		Serie 19,0	Serie 49,0
		Totalt 46,0	Totalt 95,0
Serie 3 (S)		1: 9,7 ↘ 2: 7,7 ← 3: 8,0 ← 4: 9,1 ↓ 5: 9,2 ↑	Extratävling 3+3+4 
		1: 10,6* ↘ 2: 9,1 ↘ 3: 8,0 ← 4: 10,2 → 5: 9,3 ↗	
		Serie 42,0	Serie 46,0
		Totalt 137,0	Totalt 183,0
Extratävling 3+3+4		6: 8,0 ← 7: 9,1 ↗ 8: 9,1 ↑ 9: 9,9 ↘ 10: 9,7 ←	
		Serie 44,0	
		Totalt 227,0	

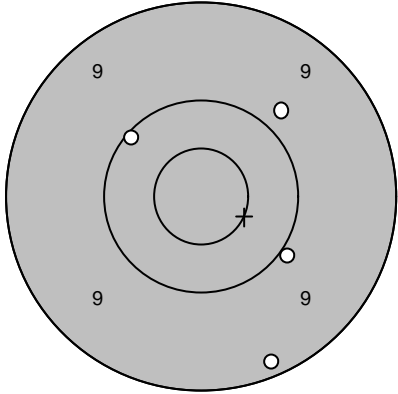
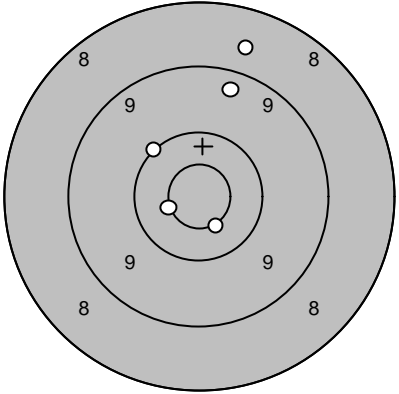
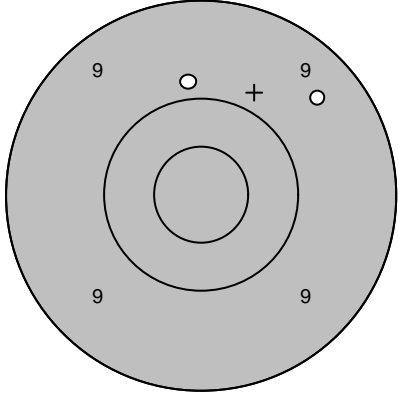
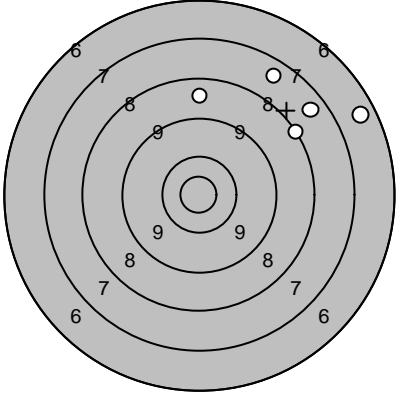
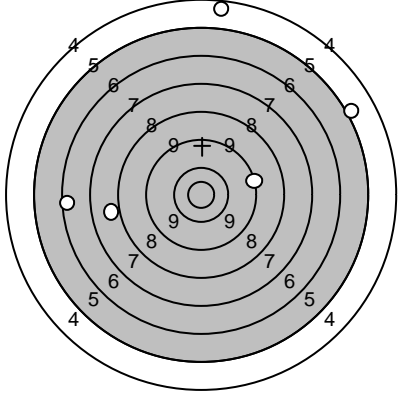
Skjutlag	Tavla	<b>Tony Jansson</b>	
<b>3</b>	<b>6</b>		
		Ununge	
2008-07-13	Tavelträffen B 2008	Ramselefors SKF	
Provskott 	1: 9,2 ↘	Serie 1 (L) 	1: 10,1 ↖
	2: 9,8 ↗		2: 10,6* ←
	3: 10,1 ↖		3: 8,7 ↑
	4: 10,0 ↘		4: 9,4 ↑
			5: 10,6* ↘
	Serie 38,0		Serie 47,0
	Totalt 0,0		Totalt 47,0
Provskott 	1: 9,9 ↑	Serie 2 (K) 	1: 8,6 ↑
	2: 9,5 ↗		2: 7,6 ↗
			3: 6,6 ↗
			4: 8,2 ↗
			5: 7,6 ↗
	Serie 18,0		Serie 36,0
	Totalt 47,0		Totalt 83,0
Serie 3 (S) 	1: 4,6 ↑		
	2: 6,5 ←		
	3: 8,0 ←		
	4: 5,1 ↗		
	5: 9,3 →		
	Serie 32,0		
	Totalt 115,0		

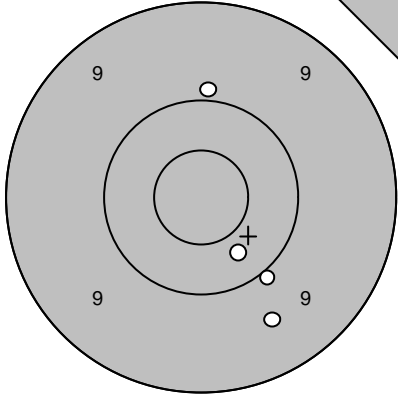
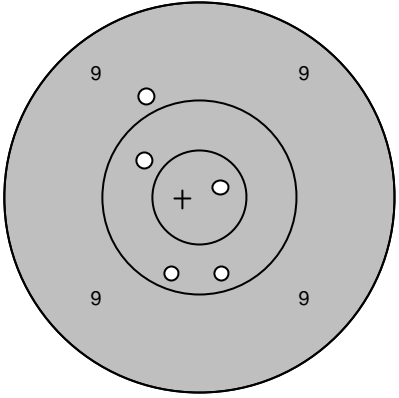
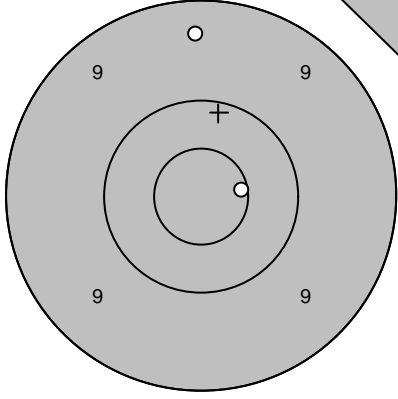
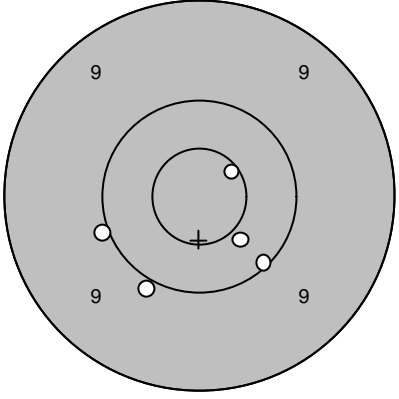
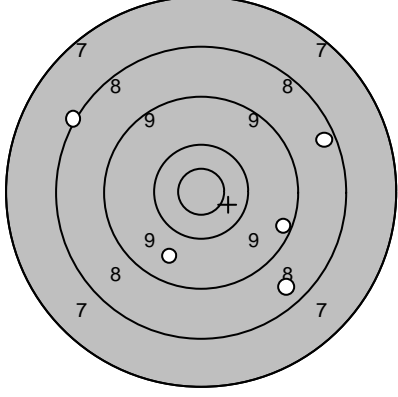
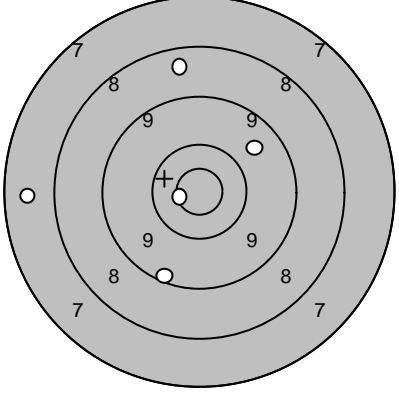
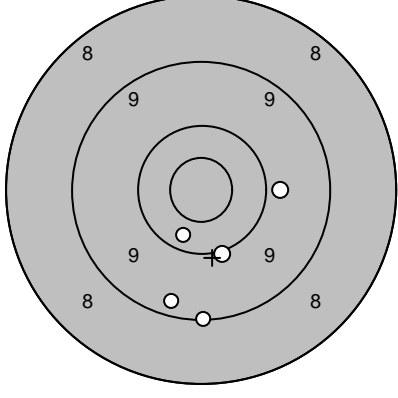
Skjutlag	Tavla	<b>Mikael Olofsson</b>	
<b>3</b>	<b>8</b>		
		Moälven/Modo	
2008-07-13	Tavelträffen B 2008	Ramselefors SKF	
Provskott		1: 10,0 ↘ 2: 9,6 ↘ 3: 9,9 ↑ 4: 10,3 ↘	Serie 1 (L) 
		Serie 38,0 Totalt 0,0	1: 10,2 ↓ 2: 9,9 ↗ 3: 10,8* → 4: 10,4 ↗ 5: 10,2 ↓
			Serie 49,0 Totalt 49,0
Provskott		1: 9,4 ↑ 2: 10,6* →	Serie 2 (K) 
		Serie 19,0 Totalt 49,0	1: 10,0 ← 2: 10,6* ↗ 3: 10,1 ↘ 4: 10,0 ↓ 5: 10,4 ↘
			Serie 50,0 Totalt 99,0
Serie 3 (S)		1: 8,4 → 2: 8,5 ↘ 3: 8,1 ↗ 4: 9,3 ↘ 5: 9,7 ↘	Extratävling 3+3+4 
		Serie 42,0 Totalt 141,0	1: 10,7* ← 2: 9,3 ↓ 3: 7,6 ← 4: 8,5 ↑ 5: 9,7 ↗
			Serie 43,0 Totalt 184,0
Extratävling 3+3+4		6: 10,3 ↓ 7: 9,1 ↓ 8: 10,0 ↓ 9: 9,3 ↓ 10: 9,9 →	
		Serie 47,0 Totalt 231,0	

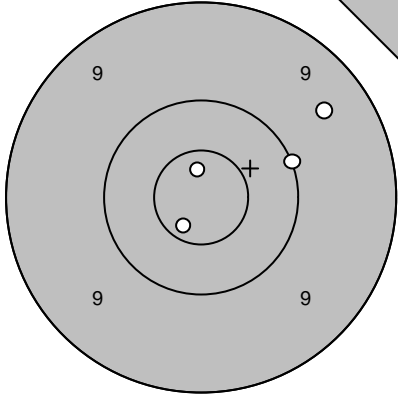
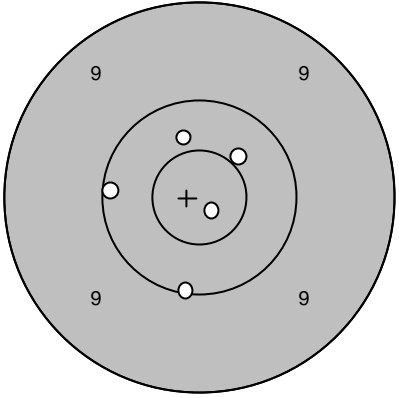
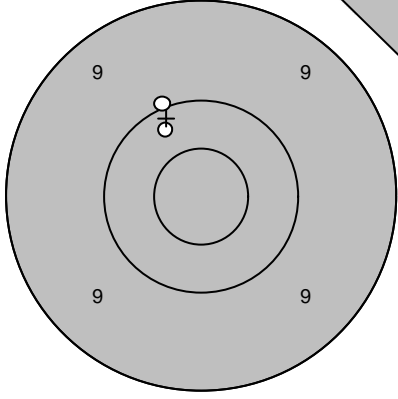
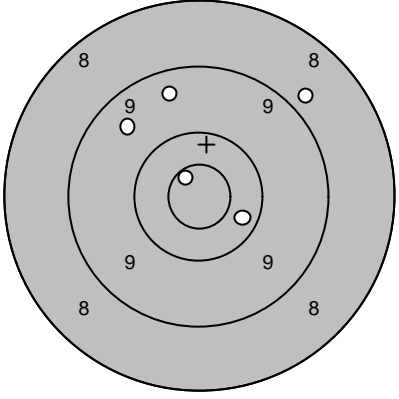
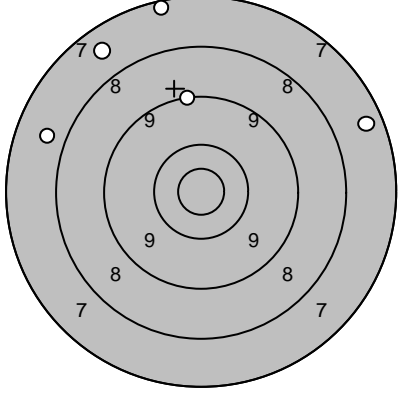
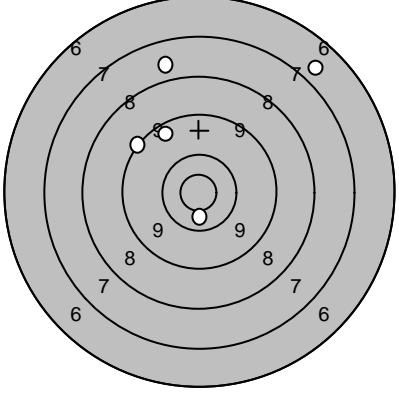
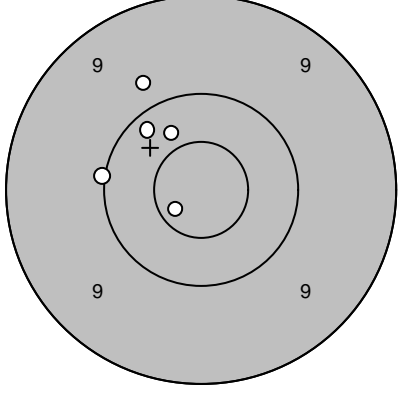

Skjutlag	Tavla	<b>Petter Eriksson</b>	
<b>3</b>	<b>9</b>		
		Moälven/Modo	
2008-07-13	Tavelträffen B 2008	Ramselefors SKF	
Provskott		1: 10,7* ↑ 2: 9,5 ↗ 3: 10,0 → 4: 10,7* ↘	<b>Serie 1 (L)</b> 
		1: 10,5* ↗ 2: 10,1 ↓ 3: 10,8* ↘ 4: 10,4 ↑ 5: 10,1 ←	
		<b>Serie</b> 39,0 <b>Totalt</b> 0,0	<b>Serie</b> 50,0 <b>Totalt</b> 50,0
Provskott		1: 10,0 ↑ 2: 10,3 ↖	<b>Serie 2 (K)</b> 
		1: 10,7* ↖ 2: 8,8 ↗ 3: 9,5 ↗ 4: 9,5 ↑ 5: 10,3 ↘	
		<b>Serie</b> 20,0 <b>Totalt</b> 50,0	<b>Serie</b> 46,0 <b>Totalt</b> 96,0
Serie 3 (S)		1: 7,6 ↖ 2: 7,8 ← 3: 9,2 ↑ 4: 7,5 → 5: 7,3 ↑	<b>Extratävling 3+3+4</b> 
		1: 7,8 ↑ 2: 6,8 ↗ 3: 9,5 ↗ 4: 10,5* ↓ 5: 9,2 ↖	
		<b>Serie</b> 37,0 <b>Totalt</b> 133,0	<b>Serie</b> 41,0 <b>Totalt</b> 174,0
Extratävling 3+3+4		6: 9,8 ↖ 7: 10,7* ↖ 8: 10,0 ← 9: 10,2 ↖ 10: 10,4 ↖	
		<b>Serie</b> 49,0 <b>Totalt</b> 223,0	

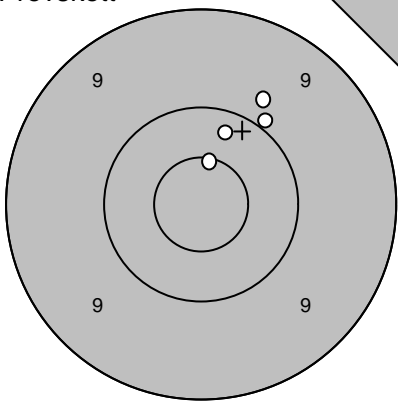
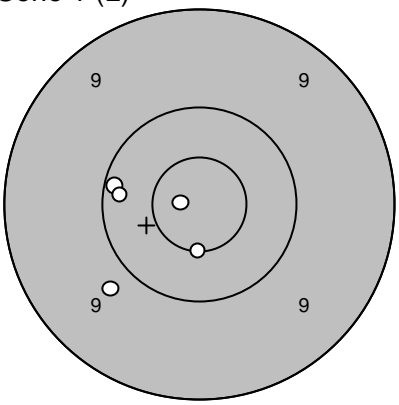
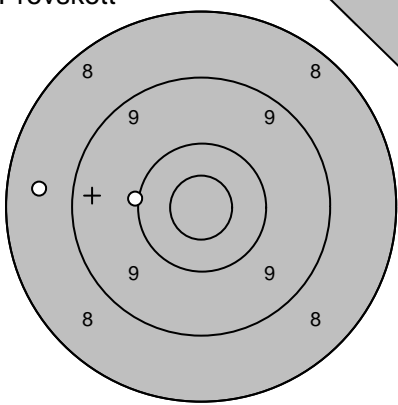
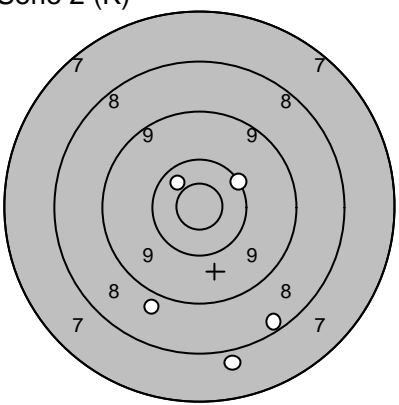
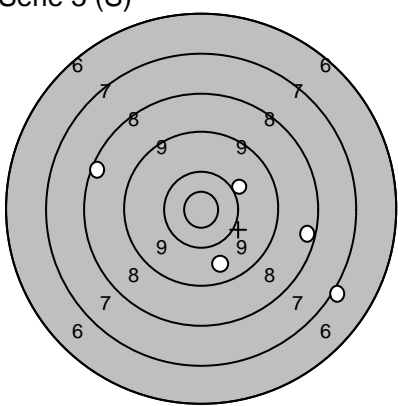
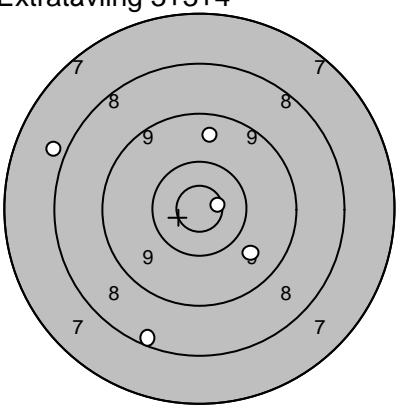
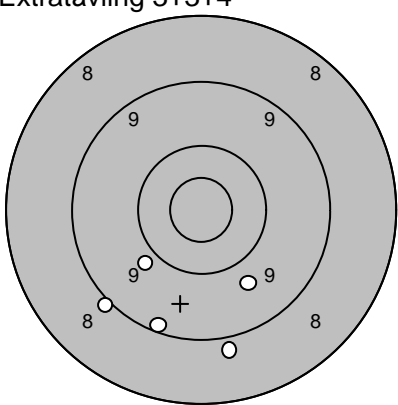
Skjutlag	Tavla	Ulf Ohlsson	
3	10	Umeå	
2008-07-13	Tavelträffen B 2008	Ramselefors SKF	
Provkott		1: 9,8 ↗ 2: 10,6* ↑ 3: 10,3 ↑ 4: 10,0 ↗	Serie 1 (L) 
			1: 10,2 ← 2: 10,8* ← 3: 10,6* ↓ 4: 10,2 ← 5: 9,8 ↙
		Serie 39,0	Serie 49,0
		Totalt 0,0	Totalt 49,0
Provkott		1: 8,6 ← 2: 10,1 ←	Serie 2 (K) 
			1: 10,2 ↗ 2: 8,9 ↓ 3: 8,3 ↓ 4: 7,9 ↓ 5: 10,5* ↗
		Serie 18,0	Serie 43,0
		Totalt 49,0	Totalt 92,0
Serie 3 (S)		1: 7,1 → 2: 10,0 ↗ 3: 8,3 ← 4: 9,7 ↓ 5: 8,4 →	Extratävling 3+3+4 
			1: 10,7* → 2: 8,3 ↓ 3: 7,9 ← 4: 9,6 ↑ 5: 9,7 ↘
		Serie 42,0	Serie 43,0
		Totalt 134,0	Totalt 177,0
Extratävling 3+3+4		6: 9,0 ↙ 7: 9,9 ↙ 8: 8,9 ↓ 9: 9,7 ↓ 10: 9,2 ↓	
		Serie 44,0	
		Totalt 221,0	

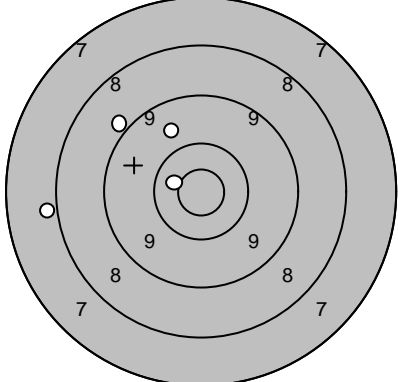
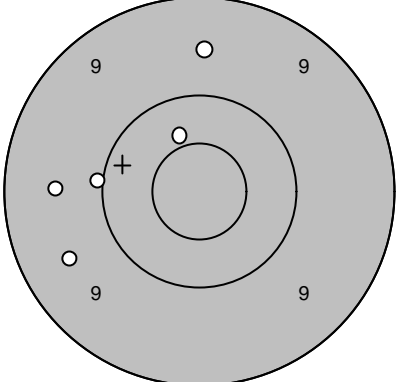
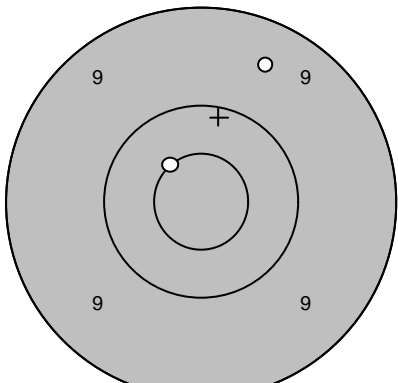
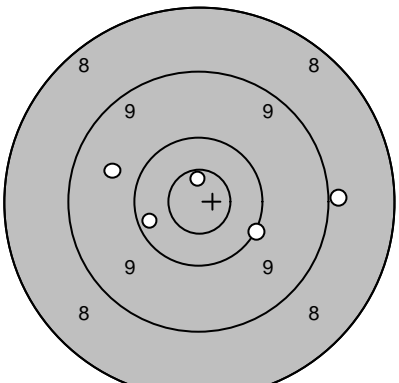
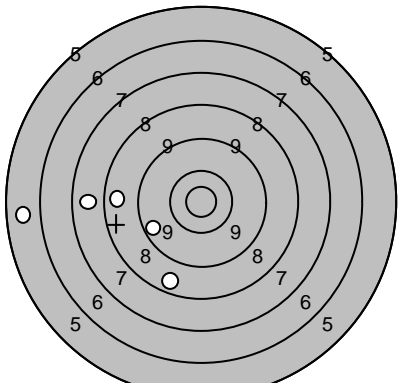
Skjutlag	Tavla	<b>Sören Olsson</b>	
<b>3</b>	<b>11</b>		
		Umeå	
2008-07-13	Tavelträffen B 2008	Ramselefors SKF	
Provskott 	1: 8,0 ←	Serie 1 (L) 	1: 9,6 ←
	2: 9,0 ↗		2: 10,4 ↑
	3: 9,7 ↗		3: 10,0 ←
	4: 10,5* ↖		4: 9,6 ↑
	5: 9,5 ↖		
	Serie 36,0		Serie 47,0
	Totalt 0,0		Totalt 47,0
Provskott 	1: 9,5 ↗	Serie 2 (K) 	1: 10,3 ←
	2: 10,6* ↖		2: 8,9 →
			3: 10,7* ↑
			4: 9,7 ←
	5: 10,1 ↘		
	Serie 19,0		Serie 47,0
	Totalt 47,0		Totalt 94,0
Serie 3 (S) 	1: 5,7 ←		
	2: 7,8 ←		
	3: 9,6 ←		
	4: 8,6 ←		
	5: 8,6 ↘		
	Serie 37,0		
	Totalt 131,0		

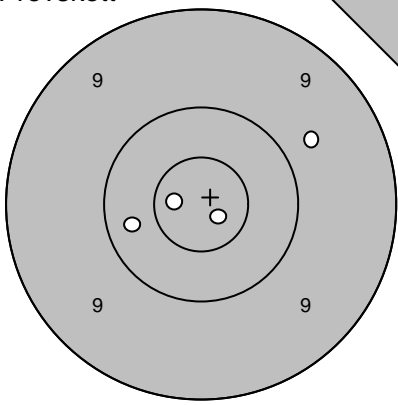
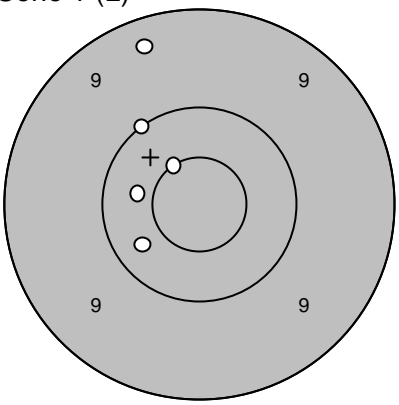
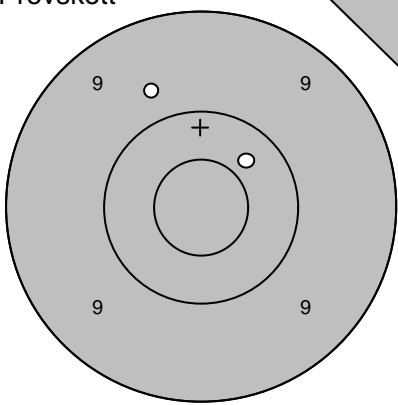
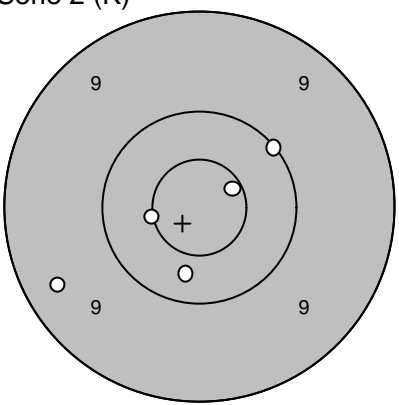
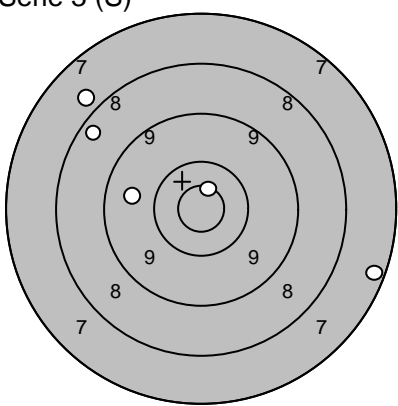
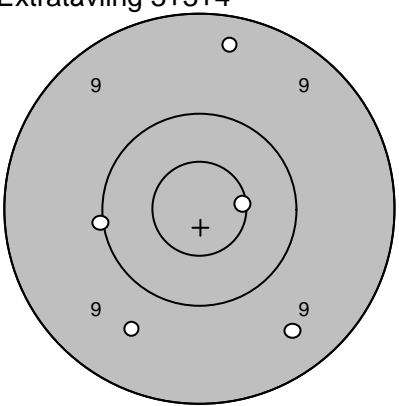
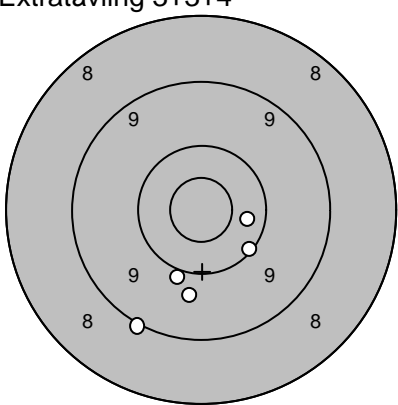
Skjutlag	Tavla	<b>Anders Brolund</b>		
<b>3</b>	<b>12</b>			
Arvika				
2008-07-13	Tavelträffen B 2008	Ramselefors SKF		
Provskott		1: 9,7 ↗ 2: 10,8* ↘ 3: 10,3 ← 4: 10,8* ←	Serie 1 (L) 	1: 10,3 ↙ 2: 9,3 ↗ 3: 10,4 ← 4: 10,6* ↗ 5: 10,0 ↗
	Serie 39,0 Totalt 0,0		Serie 49,0 Totalt 49,0	
Provskott		1: 10,4 ↗ 2: 9,7 ↗	Serie 2 (K) 	1: 10,1 ↗ 2: 10,5* ← 3: 10,3 ↓ 4: 10,6* ↗ 5: 9,4 ←
	Serie 19,0 Totalt 49,0		Serie 49,0 Totalt 98,0	
Serie 3 (S)		1: 9,7 ← 2: 7,9 ↗ 3: 7,3 ↘ 4: 8,4 ↗ 5: 10,7* ↑	Extratävling 3+3+4 	1: 10,0 ← 2: 9,6 ↓ 3: 9,5 ↘ 4: 9,3 ↑ 5: 10,6* →
	Serie 41,0 Totalt 139,0		Serie 47,0 Totalt 186,0	
Extratävling 3+3+4		6: 10,3 → 7: 10,0 ↓ 8: 9,1 ↘ 9: 10,1 ↘ 10: 9,8 ↓		
	Serie 48,0 Totalt 234,0			

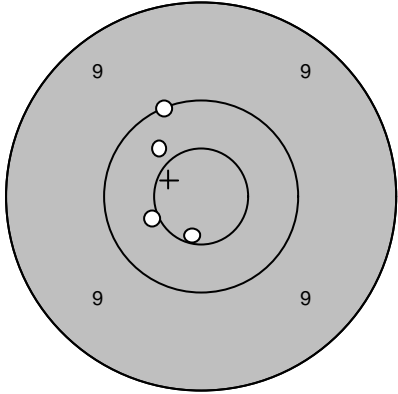
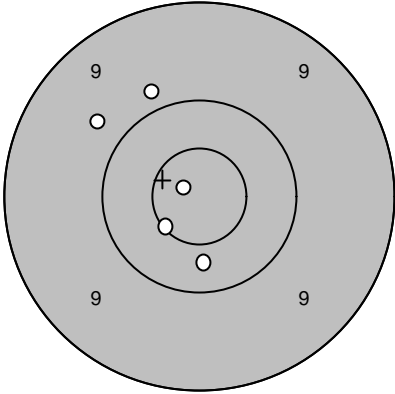
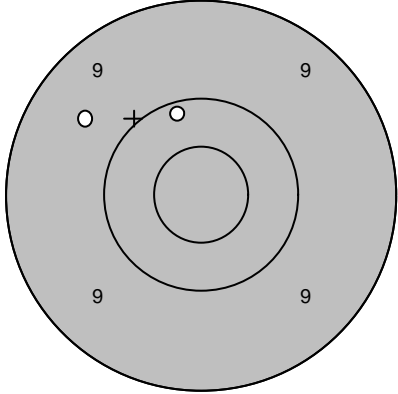
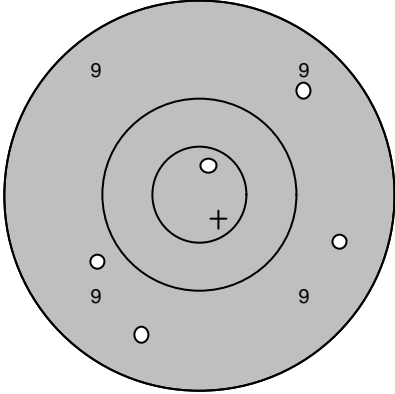
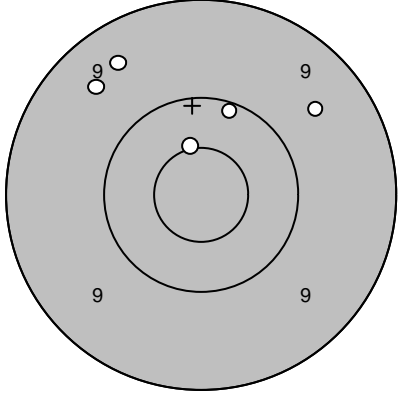
Skjutlag	Tavla		
<b>3</b>	<b>14</b>	<b>Berit Olsson</b>	
		Öved-Östraby	
2008-07-13	Tavelträffen B 2008	Ramselefors SKF	
Provskott		1: 10,4 ↖ 2: 10,1 ↑ 3: 10,6* ↓ 4: 10,5* ←	Serie 1 (L) 
			1: 9,9 ↗ 2: 10,9* ↖ 3: 10,6* ↙ 4: 9,7 ↖ 5: 10,4 ↓
		Serie 40,0	Serie 48,0
		Totalt 0,0	Totalt 48,0
Provskott		1: 10,2 ↑ 2: 9,6 ↖	Serie 2 (K) 
			1: 9,5 ↗ 2: 9,5 → 3: 10,7* ↑ 4: 9,5 ↓ 5: 9,8 ←
		Serie 19,0	Serie 46,0
		Totalt 48,0	Totalt 94,0
Serie 3 (S)		1: 9,5 ↖ 2: 10,5* ↑ 3: 9,4 ↖ 4: 10,1 ↑ 5: 9,6 ↗	
		Serie 47,0	
		Totalt 141,0	

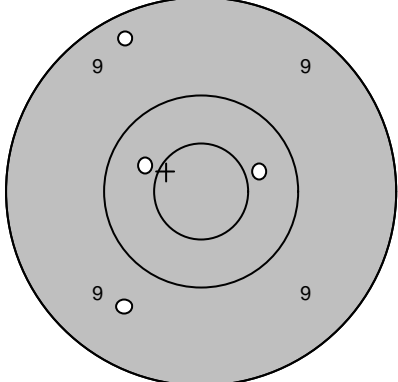
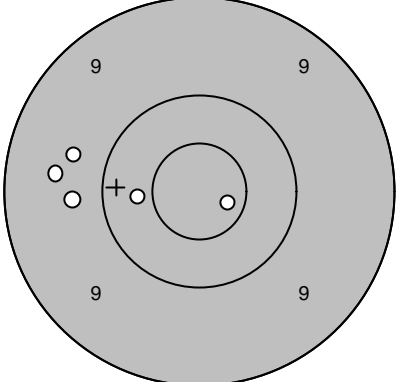
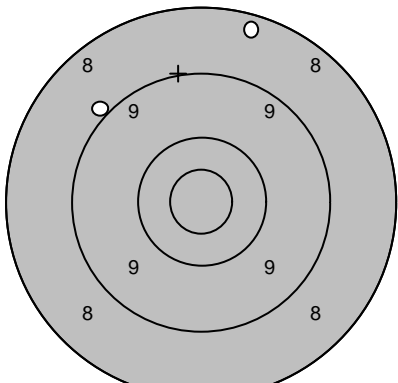
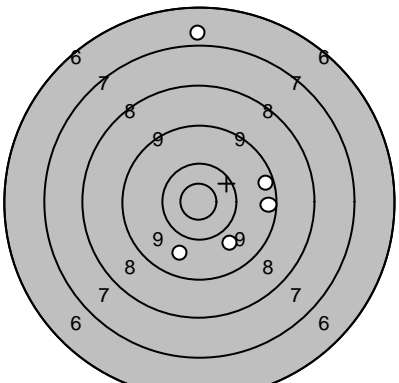
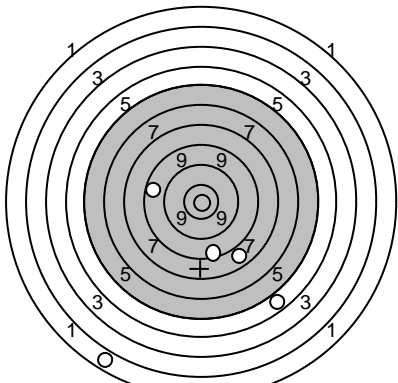
Skjutlag	Tavla	Jan-Ola Olsson	
3	15		
		Öved-Östraby	
2008-07-13	Tavelträffen B 2008	Ramselefors SKF	
Provskott 	1: 9,3 ↖	Serie 1 (L) 	1: 9,7 ←
	2: 10,4 →		2: 9,6 ←
	3: 9,6 ↙		3: 9,7 ←
	4: 10,4 ←		4: 10,7* →
			5: 10,4 ←
	Serie 38,0		Serie 47,0
	Totalt 0,0		Totalt 47,0
Provskott 	1: 9,0 ↖	Serie 2 (K) 	1: 9,4 →
	2: 8,3 ↑		2: 9,4 →
			3: 9,9 ↙
			4: 6,8 ↑
			5: 9,7 ↙
	Serie 17,0		Serie 42,0
	Totalt 47,0		Totalt 89,0
Serie 3 (S) 	1: 1,9 ↙		
	2: 8,7 ↙		
	3: 8,0 ↙		
	4: 4,9 ↙		
	5: 8,9 ←		
	Serie 29,0		
	Totalt 118,0		

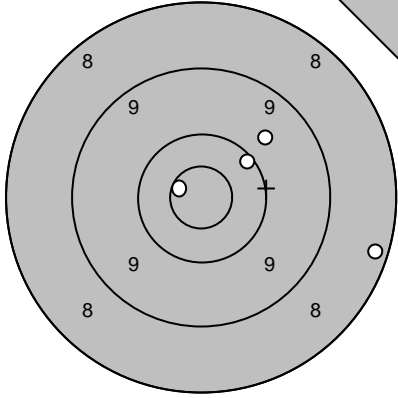
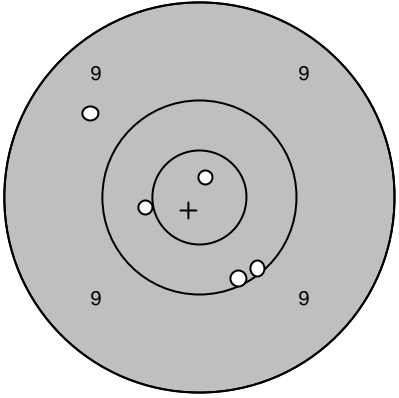
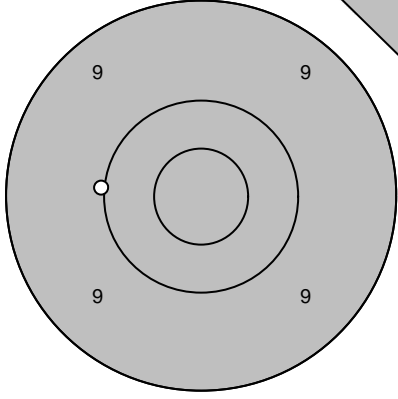
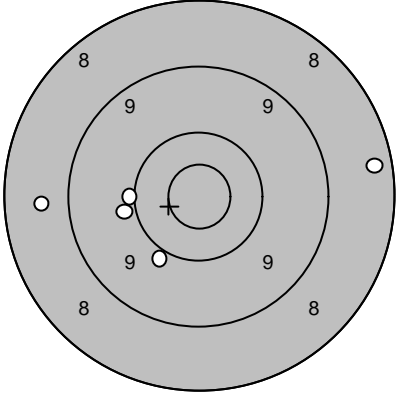
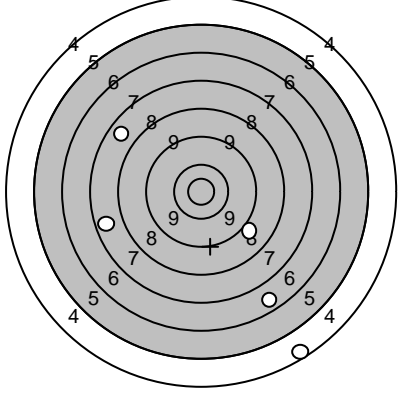
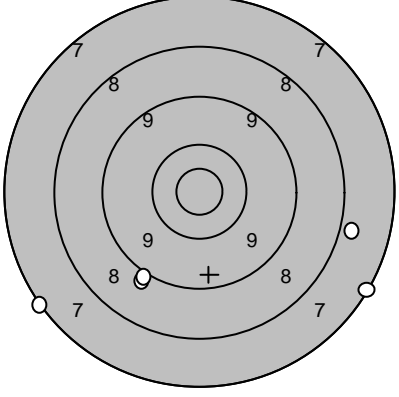
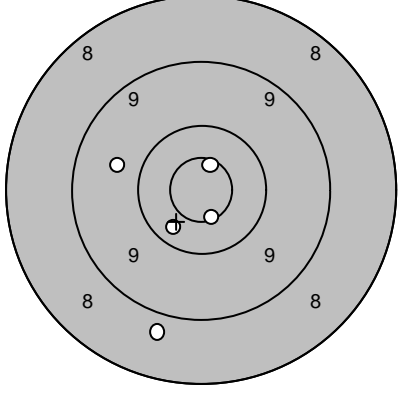
Skjutlag	Tavla	<b>Torvald Andersson</b>	
<b>3</b>	<b>16</b>		
		Bälinge-Jumkil	
2008-07-13	Tavelträffen B 2008	Ramselefors SKF	
Provskott		1: 10,2 ↗ 2: 8,3 → 3: 9,7 ↗ 4: 10,7* ↖	Serie 1 (L) 
		Serie 37,0 Totalt 0,0	1: 10,8* ↗ 2: 10,1 ↓ 3: 9,6 ↗ 4: 10,5* ← 5: 10,1 ↓ Serie 49,0 Totalt 49,0
Provskott		1: 10,0 ←	Serie 2 (K) 
		Serie 10,0 Totalt 49,0	1: 9,9 ← 2: 10,0 ← 3: 8,4 → 4: 9,9 ↓ 5: 8,7 ← Serie 44,0 Totalt 93,0
Serie 3 (S)		1: 7,7 ↗ 2: 4,5 ↓ 3: 9,1 ↓ 4: 6,7 ↓ 5: 7,7 ←	Extratävling 3+3+4 
		Serie 33,0 Totalt 126,0	1: 7,9 → 2: 7,2 → 3: 7,1 ← 4: 9,0 ↓ 5: 9,1 ↓ Serie 39,0 Totalt 165,0
Extratävling 3+3+4		6: 8,8 ↓ 7: 9,7 ← 8: 10,6* ↓ 9: 10,7* ↗ 10: 10,4 ↓	
		Serie 47,0 Totalt 212,0	

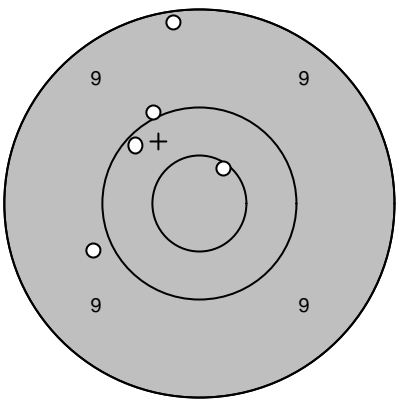
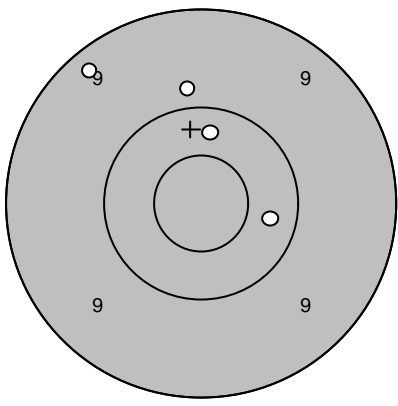
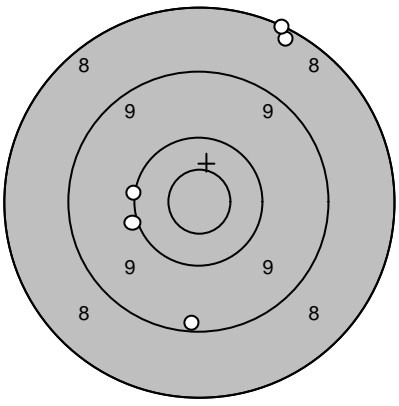
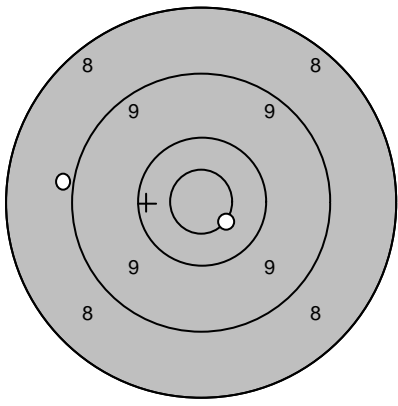
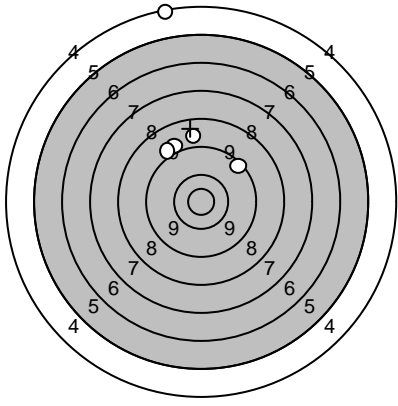
Skjutlag	Tavla		
<b>3</b>	<b>17</b>	<b>K-A Falk</b>	
		I 19 / A 9	
2008-07-13	Tavelträffen B 2008	Ramselefors SKF	
Provsjott		1: 9,2 ↖ 2: 9,9 ↑ 3: 10,3 → 4: 10,3 ↑	Serie 1 (L)  1: 10,6* ↗ 2: 10,0 ↖ 3: 9,2 ↑ 4: 9,9 ← 5: 10,2 ↖
		Serie 38,0 Totalt 0,0	Serie 48,0 Totalt 48,0
Provsjott		1: 10,6* ↘ 2: 8,9 ←	Serie 2 (K)  1: 9,2 ↓ 2: 10,0 ← 3: 8,3 ↗ 4: 8,1 ↗ 5: 10,1 ←
		Serie 18,0 Totalt 48,0	Serie 45,0 Totalt 93,0
Serie 3 (S)		1: 4,3 ↑ 2: 9,0 ↖ 3: 9,4 ↗ 4: 9,1 ↖ 5: 8,9 ↑	
		Serie 39,0 Totalt 132,0	

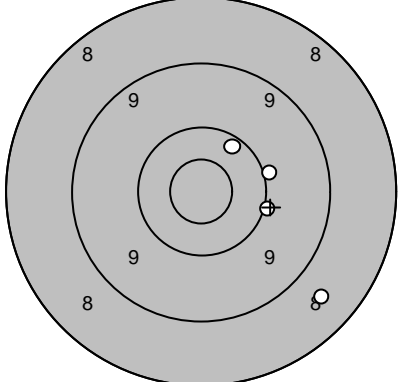
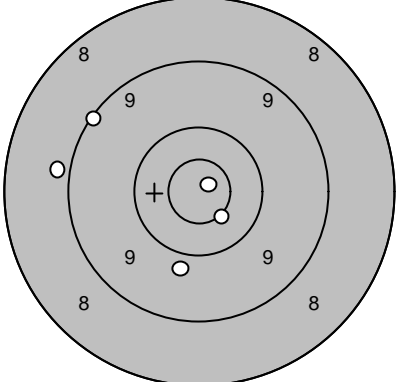
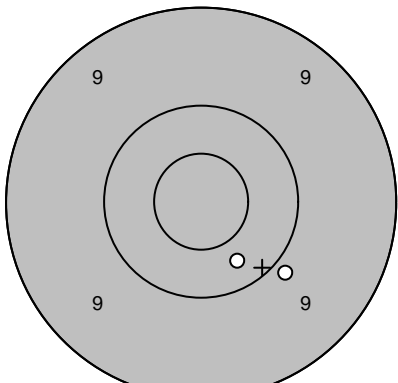
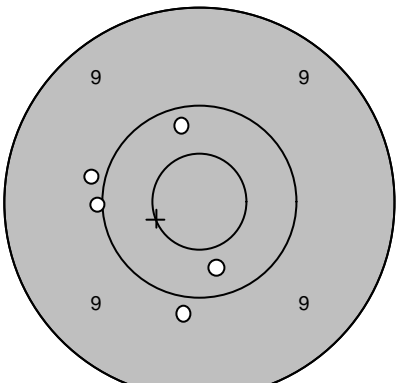
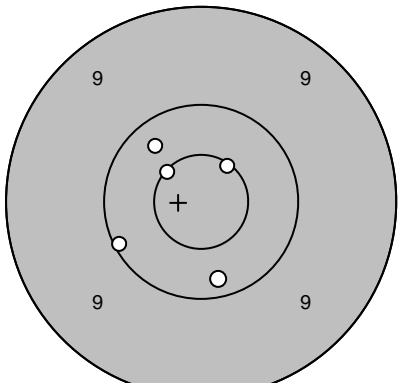

Skjutlag	Tavla	<b>Rolf Åström</b>	
<b>3</b>	<b>18</b>		
Brattby			
2008-07-13	Tavelträffen B 2008	Ramselefors SKF	
Provskott 	1: 8,6 ↘	Serie 1 (L) 	1: 10,9* ↗
	2: 10,0 →		2: 10,6* ↘
	3: 10,3 ↗		3: 9,1 ↖
	4: 10,0 →		4: 9,9 ↓
			5: 8,9 ←
	Serie 38,0		Serie 46,0
	Totalt 0,0		Totalt 46,0
Provskott 	1: 10,3 ↘	Serie 2 (K) 	1: 10,0 ←
	2: 9,9 ↘		2: 10,2 ↑
			3: 10,3 ↓
			4: 9,9 ↓
			5: 9,9 ←
	Serie 19,0		Serie 48,0
	Totalt 46,0		Totalt 94,0
Serie 3 (S) 	1: 10,1 ←		
	2: 10,6* ↖		
	3: 10,2 ↓		
	4: 10,6* ↗		
	5: 10,3 ↗		
	Serie 50,0		
	Totalt 144,0		

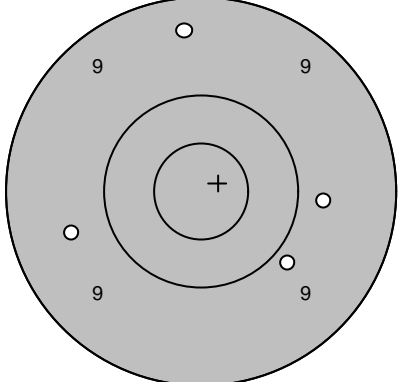
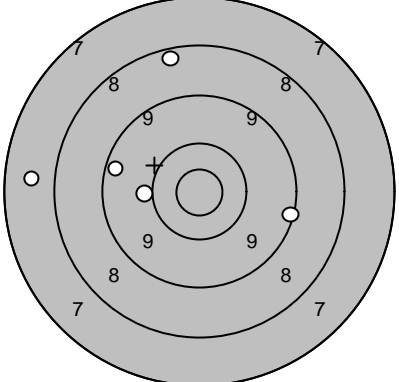
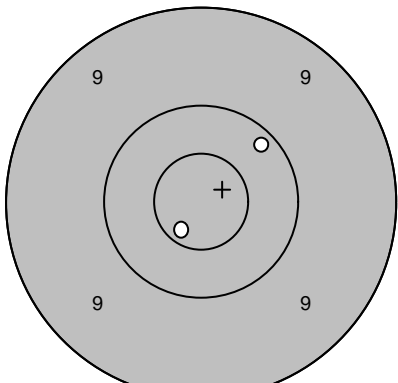
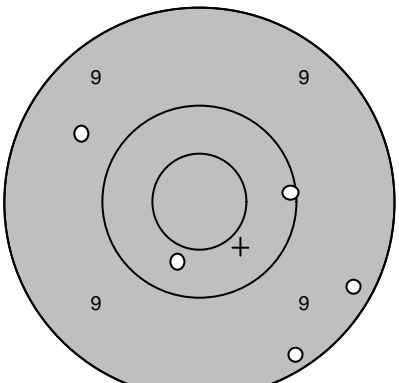
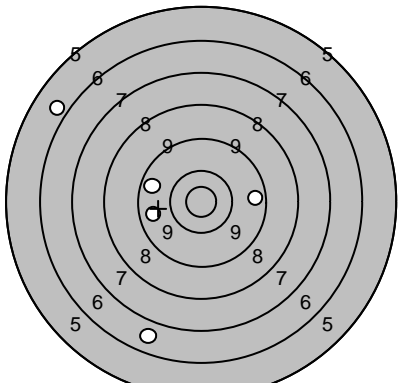
Skjutlag	Tavla	Andreas Halfvars		
3	19			
		Hofors		
2008-07-13	Tavelträffen B 2008	Ramselefors SKF		
Provskott		1: 9,8 → 2: 9,9 ↘ 3: 9,4 ↑ 4: 9,6 ←	Serie 1 (L) 	1: 8,4 ↑ 2: 10,0 ← 3: 7,7 ← 4: 9,4 ← 5: 9,2 →
		Serie 36,0		Serie 43,0
		Totalt 0,0		Totalt 43,0
Provskott		1: 10,2 ↗ 2: 10,7* ↘	Serie 2 (K) 	1: 9,2 ↘ 2: 9,7 ↗ 3: 9,2 ↓ 4: 10,4 ↓ 5: 10,1 →
		Serie 20,0		Serie 47,0
		Totalt 43,0		Totalt 90,0
Serie 3 (S)		1: 9,6 ← 2: 6,0 ↗ 3: 9,5 → 4: 9,7 ← 5: 6,8 ↓		
		Serie 39,0		
		Totalt 129,0		

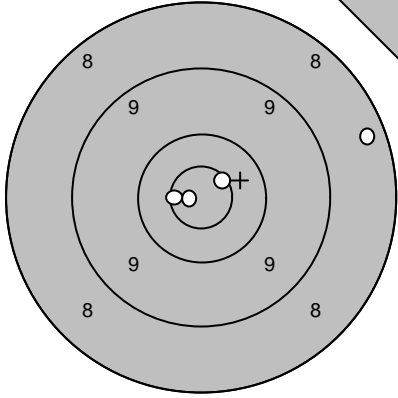
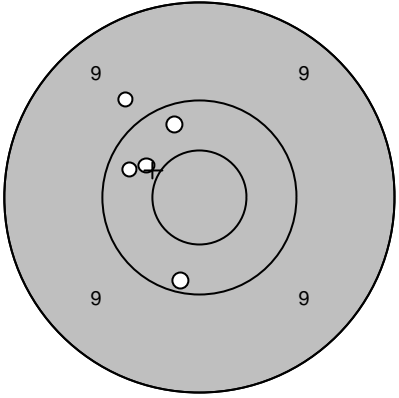
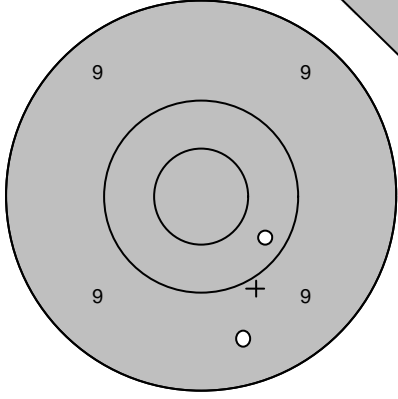
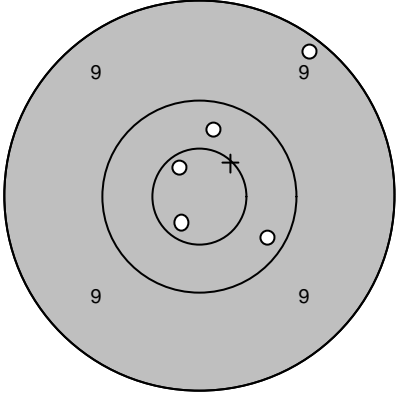
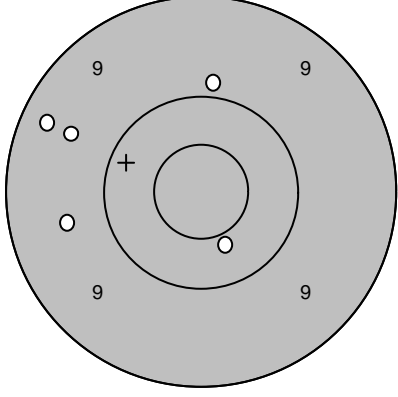
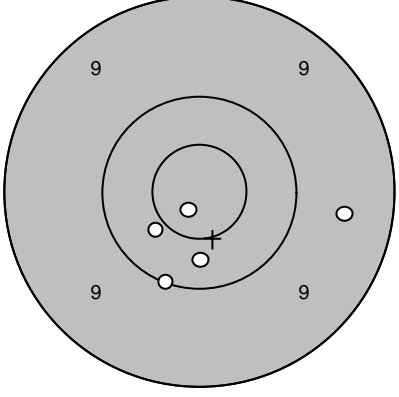
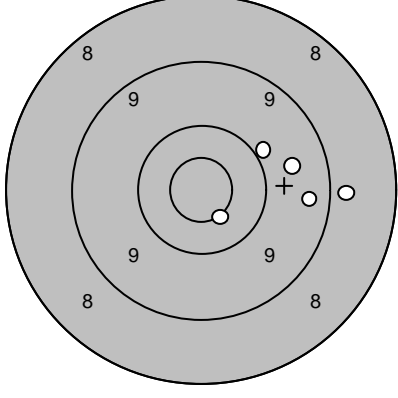
Skjutlag	Tavla	<b>Jennie Ericson</b>	
<b>3</b>	<b>20</b>		
Loos			
2008-07-13	Tavelträffen B 2008	Ramselefors SKF	
Provskott		1: 8,4 → 2: 10,9* ← 3: 10,7* ↗ 4: 10,7* ←	Serie 1 (L) 
		1: 10,4 ↖ 2: 10,2 ↗ 3: 10,3 ↖ 4: 9,8 ↗ 5: 10,2 ↓	
		Serie 38,0	Serie 49,0
		Totalt 0,0	Totalt 49,0
Provskott		1: 10,3 ↘ 2: 9,5 ↓	Serie 2 (K) 
		1: 10,3 ↑ 2: 10,7* ↗ 3: 10,7* ↓ 4: 10,2 ↘ 5: 9,2 ↗	
		Serie 19,0	Serie 49,0
		Totalt 49,0	Totalt 98,0
Serie 3 (S)		1: 9,6 ↖ 2: 9,3 ↖ 3: 9,6 ← 4: 10,4 ↓ 5: 9,9 ↑	Extratävling 3+3+4 
		1: 9,5 → 2: 10,3 ↓ 3: 10,1 ↓ 4: 10,8* ↓ 5: 10,4 ↖	
		Serie 46,0	Serie 49,0
		Totalt 144,0	Totalt 193,0
Extratävling 3+3+4		6: 9,4 → 7: 8,8 → 8: 9,9 ↗ 9: 9,6 → 10: 10,6* ↓	
		Serie 45,0	
		Totalt 238,0	

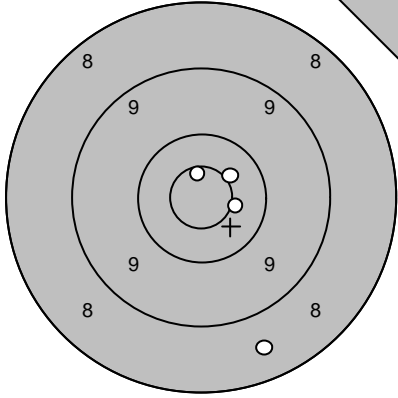
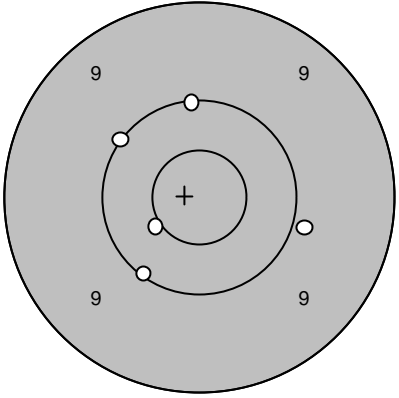
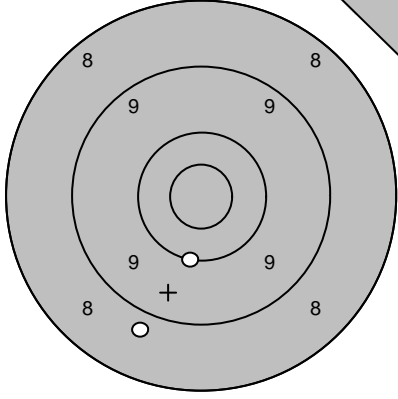
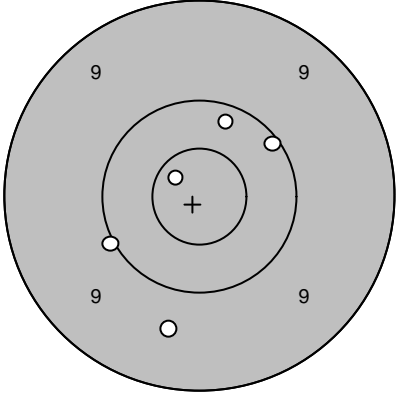
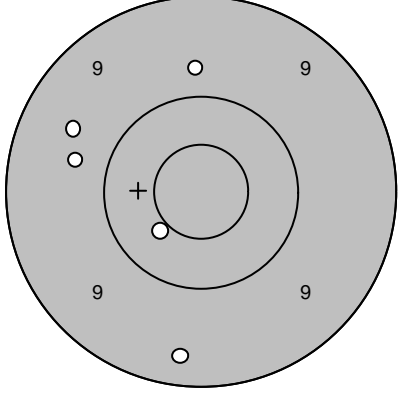
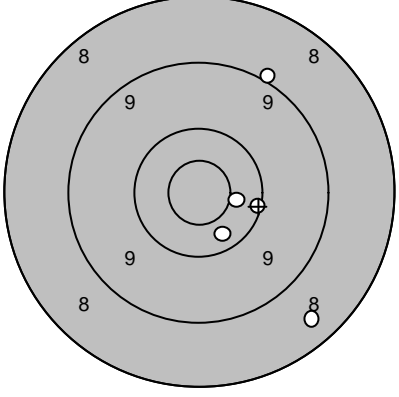
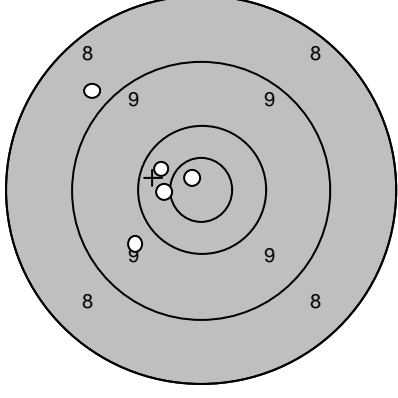
Skjutlag	Tavla	<b>Petter Ivarsson</b>		
<b>3</b>	<b>21</b>	Loos		
2008-07-13	Tavelträffen B 2008	Ramselefors SKF		
Provkott		1: 10,5* → 2: 10,5* ↗ 3: 10,7* ↑ 4: 8,6 ↓	<b>Serie 1 (L)</b> 	1: 10,1 ↘ 2: 10,0 ↖ 3: 10,5* ↙ 4: 10,1 ↑ 5: 9,9 →
		Serie 38,0		Serie 49,0
		Totalt 0,0		Totalt 49,0
Provkott		1: 8,8 ↓ 2: 10,1 ↓	<b>Serie 2 (K)</b> 	1: 10,0 ↙ 2: 9,6 ↓ 3: 10,2 ↑ 4: 10,1 ↗ 5: 10,7* ↖
		Serie 18,0		Serie 49,0
		Totalt 49,0		Totalt 98,0
Serie 3 (S)		1: 9,6 ↖ 2: 9,7 ← 3: 9,8 ↑ 4: 9,3 ↓ 5: 10,5* ↙	<b>Extratävling 3+3+4</b> 	1: 10,2 → 2: 10,5* → 3: 8,5 ↘ 4: 10,4 ↘ 5: 9,0 ↗
		Serie 46,0		Serie 47,0
		Totalt 144,0		Totalt 191,0
Extratävling 3+3+4		6: 10,4 ↖ 7: 8,8 ↗ 8: 10,9* ↗ 9: 9,8 ↙ 10: 10,5* ←		
		Serie 47,0		
		Totalt 238,0		

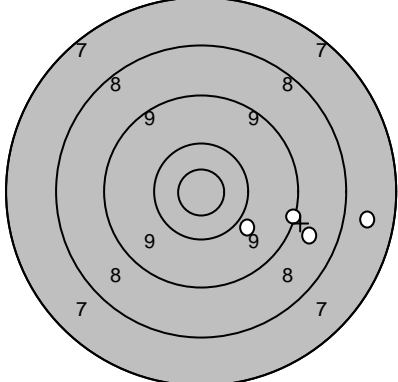
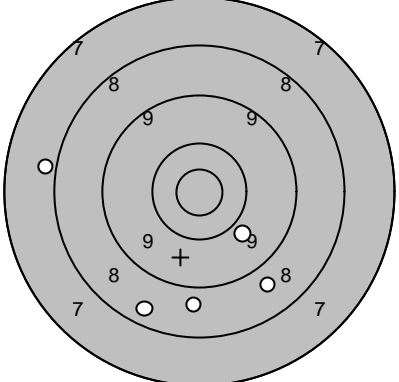
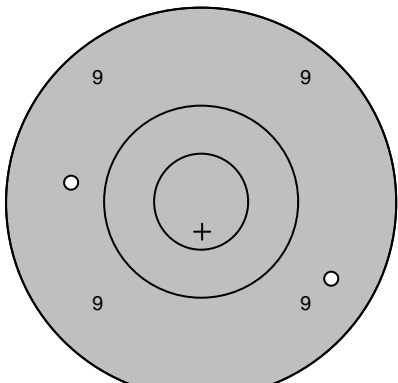
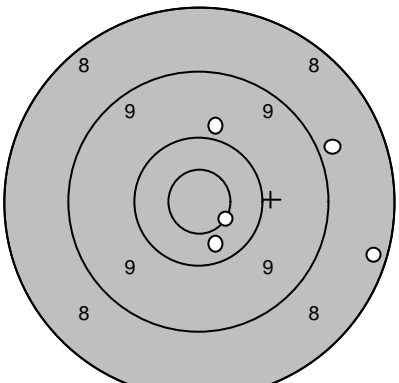
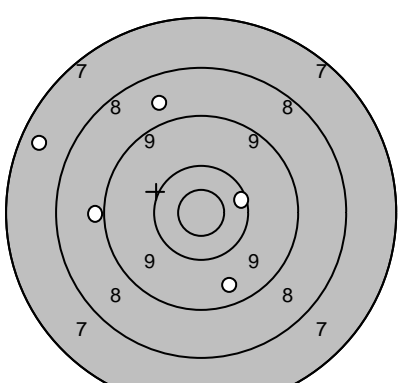
Skjutlag	Tavla	<b>Peder Gustavsson</b>	
<b>3</b>	<b>22</b>		
		Moälven-Modo	
2008-07-13	Tavelträffen B 2008	Ramselefors SKF	
Provskott 	1: 8,7 →	Serie 1 (L) 	1: 8,5 ↓
	2: 9,2 →		2: 8,8 ↓
	3: 7,7 →		3: 8,0 ←
	4: 9,9 ↓		4: 8,8 ↓
			5: 9,9 ↓
	Serie 33,0		Serie 41,0
	Totalt 0,0		Totalt 41,0
Provskott 	1: 9,5 →	Serie 2 (K) 	1: 8,3 →
	2: 9,7 ←		2: 9,9 ↑
			3: 8,9 →
			4: 10,4 ↓
			5: 10,6* ↓
	Serie 18,0		Serie 45,0
	Totalt 41,0		Totalt 86,0
Serie 3 (S) 	1: 9,5 ↓		
	2: 9,0 ←		
	3: 8,7 ↑		
	4: 10,3 →		
	5: 7,5 ←		
	Serie 43,0		
	Totalt 129,0		

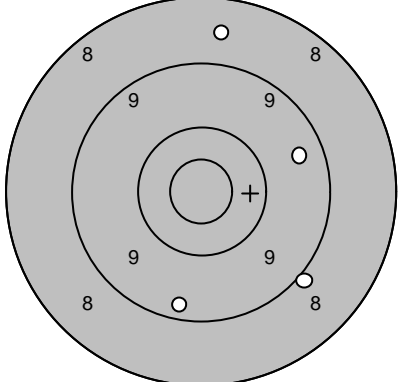
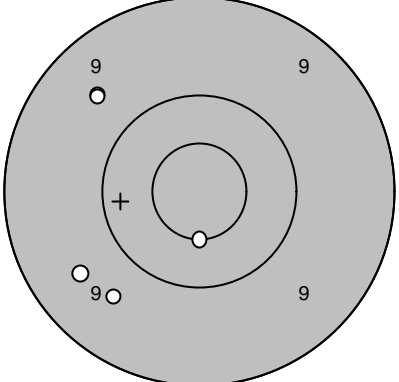
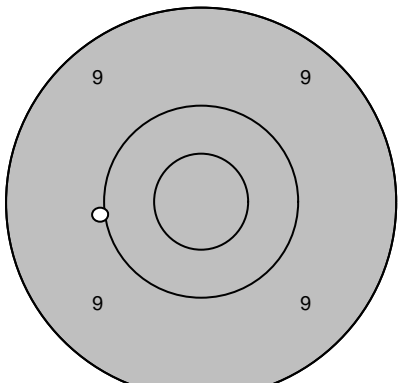
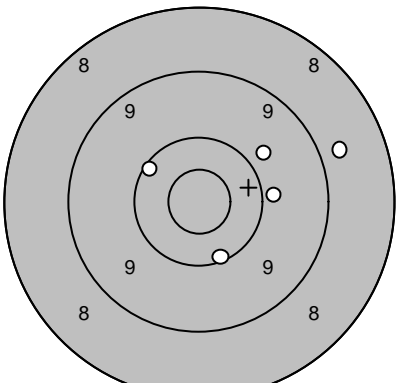
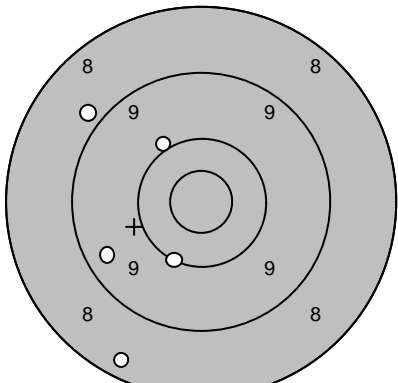
Skjutlag	Tavla	Elina Johansson	
3	23	Ale	
2008-07-13	Tavelträffen B 2008	Ramselefors SKF	
Provskott		1: 9,5 → 2: 8,6 ↑ 3: 9,0 ↘ 4: 9,3 ↓	Serie 1 (L) 
			1: 9,6 ↖ 2: 10,5* ↓ 3: 9,6 ↗ 4: 9,7 ↘ 5: 9,6 ↙
		Serie 35,0	Serie 46,0
		Totalt 0,0	Totalt 46,0
Provskott		1: 10,0 ←	Serie 2 (K) 
			1: 9,9 → 2: 8,8 → 3: 10,2 ↓ 4: 9,8 ↗ 5: 10,2 ↖
		Serie 10,0	Serie 46,0
		Totalt 46,0	Totalt 92,0
Serie 3 (S)		1: 10,1 ↓ 2: 8,9 ↖ 3: 9,4 ← 4: 8,4 ↓ 5: 10,0 ↗	
		Serie 45,0	
		Totalt 137,0	

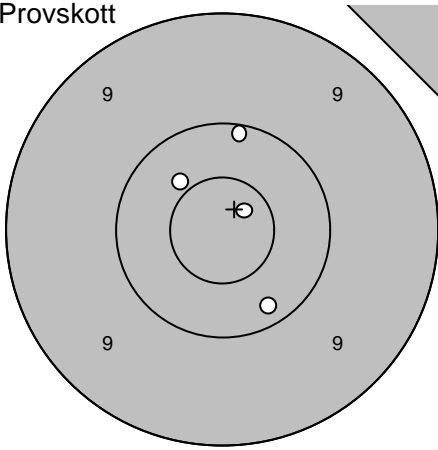
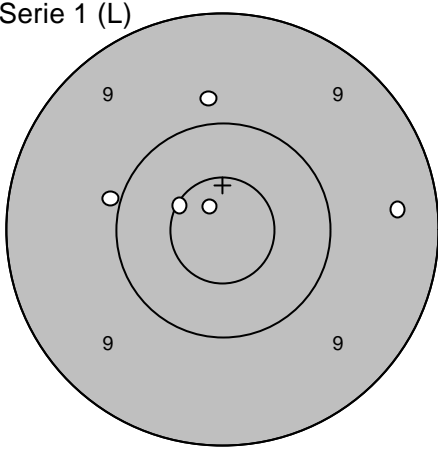
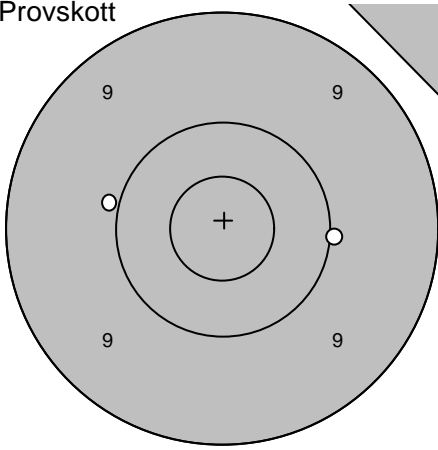
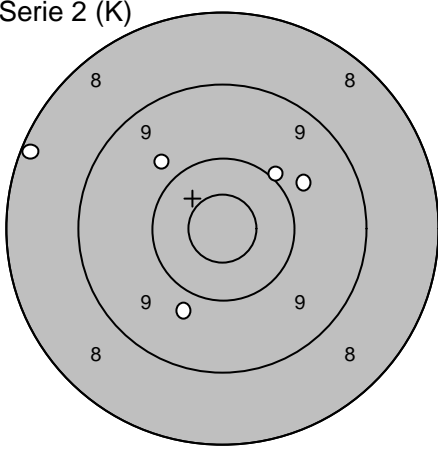
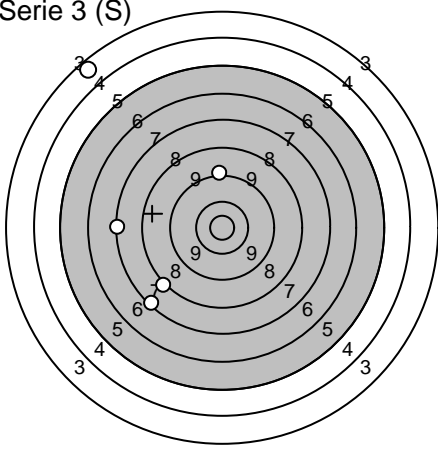
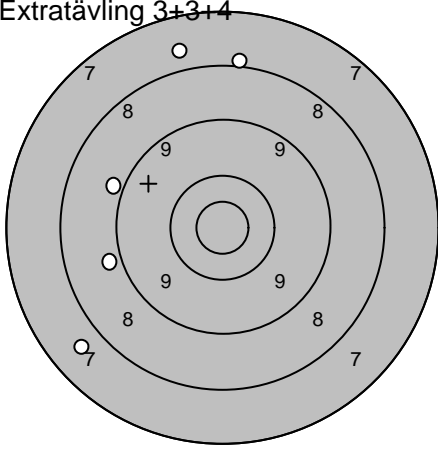
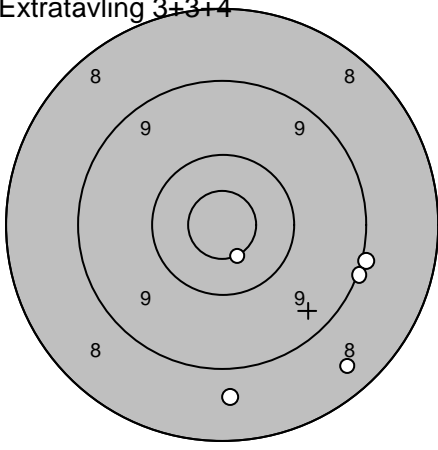
Skjutlag <b>4</b>	Tavla <b>1</b>	<b>Lars Evaldsson</b>	
		Göteborg	
2008-07-13	Tavelträffen B 2008	Ramselefors SKF	
Provskott 	1: 10,7* ↗ 2: 10,1 ↑ 3: 10,4 ↗ 4: 10,2 ↓	Serie 1 (L) 	1: 9,8 ↑ 2: 10,8* ↗ 3: 9,4 → 4: 10,0 ← 5: 10,6* ↗
	Serie 40,0 Totalt 0,0		Serie 48,0 Totalt 48,0
Provskott 	1: 10,0 → 2: 10,0 ←	Serie 2 (K) 	1: 9,8 ↖ 2: 10,0 ↗ 3: 8,2 ← 4: 9,8 ↗ 5: 9,8 ↓
	Serie 20,0 Totalt 48,0		Serie 45,0 Totalt 93,0
Serie 3 (S) 	1: 7,4 ← 2: 7,4 ↙ 3: 3,6 ↗ 4: 8,2 ↙ 5: 9,3 ↑	Extratävling 3+3+4 	1: 7,7 ↙ 2: 7,7 ↑ 3: 8,0 ↑ 4: 9,0 ← 5: 8,9 ←
	Serie 34,0 Totalt 127,0		Serie 39,0 Totalt 166,0
Extratävling 3+3+4 	6: 8,7 ↓ 7: 10,6* ↙ 8: 8,5 ↙ 9: 9,0 → 10: 9,0 ↘		
	Serie 44,0 Totalt 210,0		

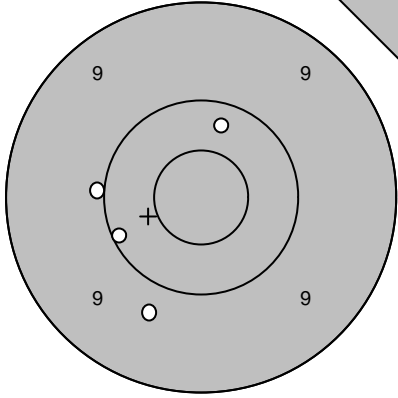
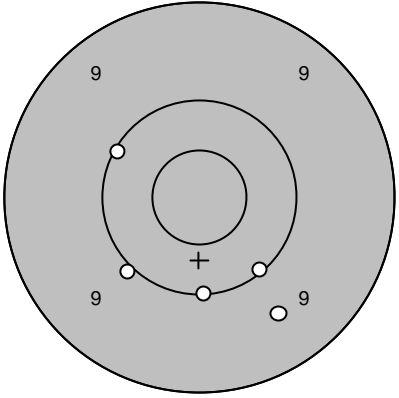
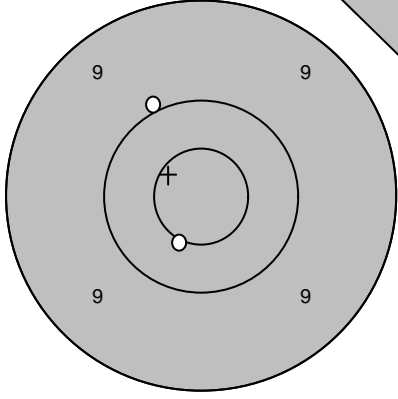
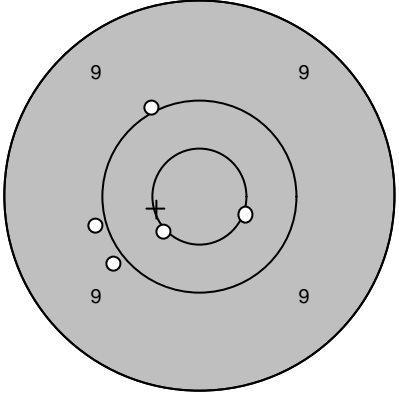
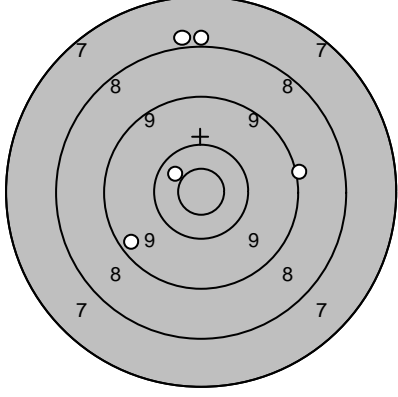
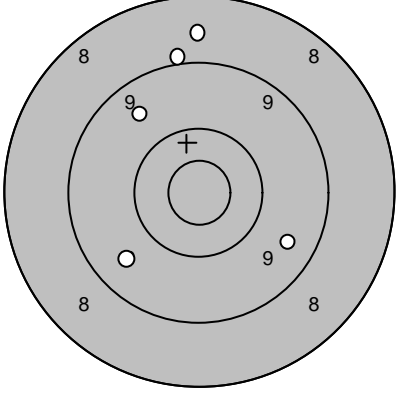
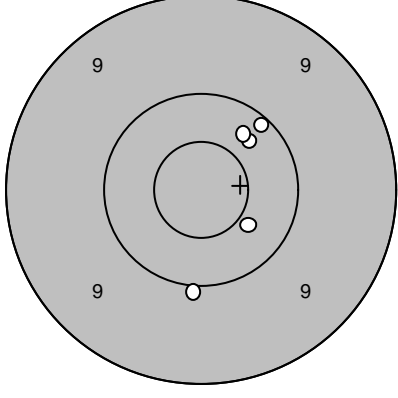
Skjutlag <b>4</b>	Tavla <b>2</b>	<b>Urban Johansson</b>	
		F 21	
2008-07-13	Tavelträffen B 2008	Ramselefors SKF	
<b>Provkott</b> 	1: 9,7 ↘ 2: 10,3 ↑ 3: 10,0 ← 4: 10,1 ←	<b>Serie 1 (L)</b> 	1: 10,1 ↓ 2: 10,1 ↗ 3: 10,0 ↘ 4: 10,1 ↘ 5: 9,6 ↓
	Serie 39,0		Serie 49,0
	Totalt 0,0		Totalt 49,0
<b>Provkott</b> 	1: 10,0 ↘ 2: 10,5* ↓	<b>Serie 2 (K)</b> 	1: 10,5* → 2: 10,5* ↘ 3: 10,0 ↗ 4: 9,9 ← 5: 9,9 ↘
	Serie 20,0		Serie 48,0
	Totalt 49,0		Totalt 97,0
<b>Serie 3 (S)</b> 	1: 10,5* ↘ 2: 9,4 ↘ 3: 8,0 ↑ 4: 9,1 → 5: 8,0 ↑	<b>Extratävling 3+3+4</b> 	1: 8,6 ↑ 2: 9,0 ↑ 3: 9,5 ↘ 4: 9,6 ↘ 5: 9,6 ↗
	Serie 44,0		Serie 44,0
	Totalt 141,0		Totalt 185,0
<b>Extratävling 3+3+4</b> 	6: 10,3 ↗ 7: 10,4 ↘ 8: 10,1 ↗ 9: 10,3 ↗ 10: 10,0 ↓		
	Serie 50,0		
	Totalt 235,0		

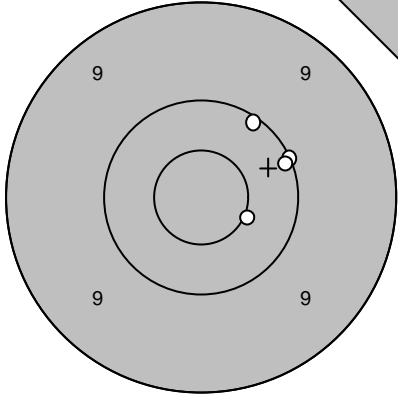
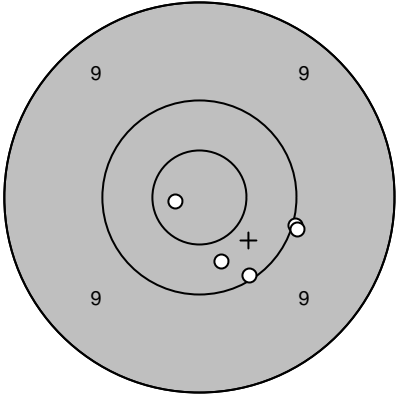
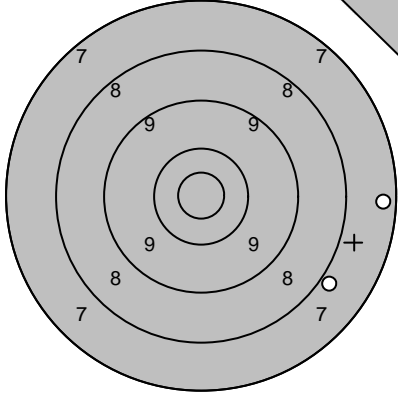
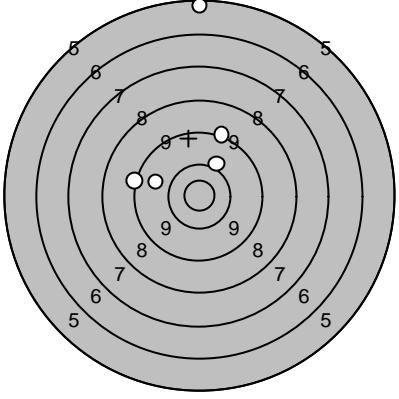
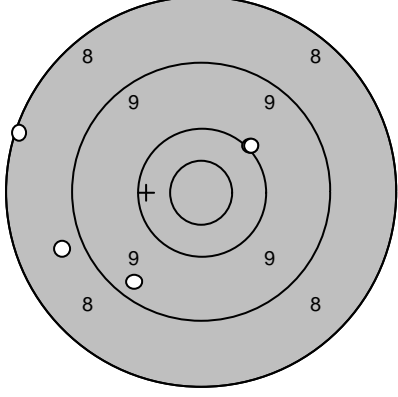
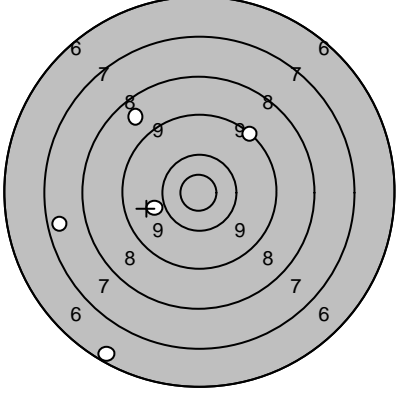
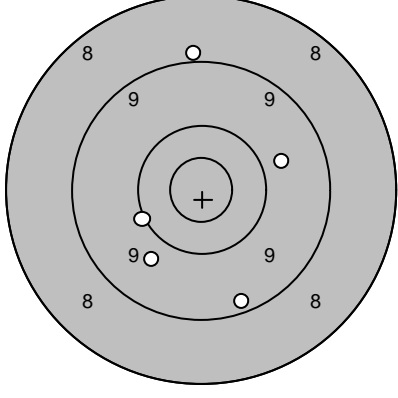

Skjutlag	Tavla	<b>Michael Normann</b>		
<b>4</b>	<b>3</b>	I 16 / Lv 6		
2008-07-13	Tavelträffen B 2008	Ramselefors SKF		
Provkott		1: 10,5* → 2: 10,1 → 3: 10,1 ↗ 4: 10,1 →	Serie 1 (L) 	1: 10,3 ↓ 2: 10,8* ← 3: 10,0 → 4: 10,0 → 5: 10,1 ↓
		Serie 40,0		Serie 50,0
		Totalt 0,0		Totalt 50,0
Provkott		1: 8,0 ↘ 2: 7,4 →	Serie 2 (K) 	1: 10,1 ↗ 2: 5,4 ↑ 3: 9,2 ↗ 4: 9,2 ← 5: 9,8 ←
		Serie 15,0		Serie 42,0
		Totalt 50,0		Totalt 92,0
Serie 3 (S)		1: 10,0 ↗ 2: 10,0 ↗ 3: 8,2 ← 4: 8,8 ← 5: 9,4 ↓	Extratävling 3+3+4 	1: 10,0 ← 2: 7,5 ← 3: 6,4 ↓ 4: 9,2 ↗ 5: 8,7 ↗
		Serie 45,0		Serie 40,0
		Totalt 137,0		Totalt 177,0
Extratävling 3+3+4		6: 9,0 ↑ 7: 10,1 ← 8: 9,8 ↓ 9: 9,3 ↓ 10: 9,8 →		
		Serie 46,0		
		Totalt 223,0		

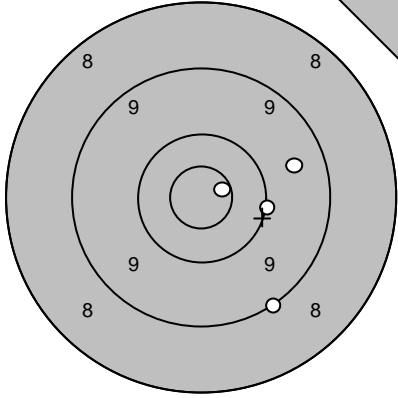
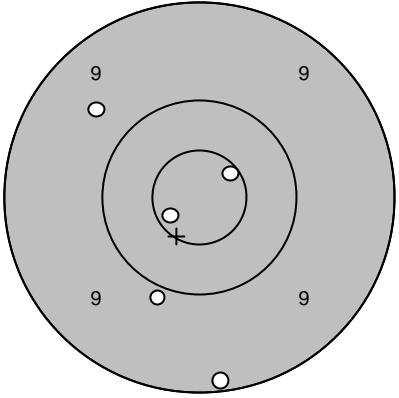
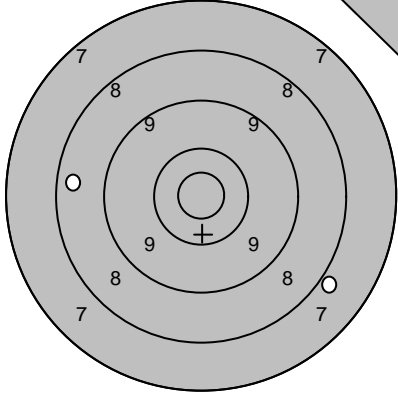
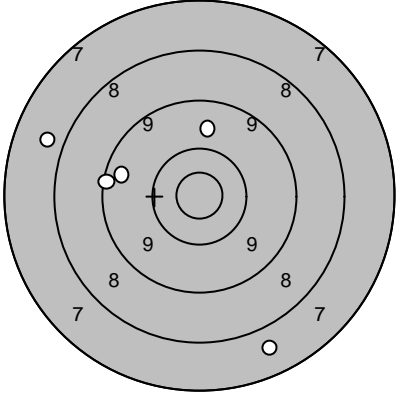
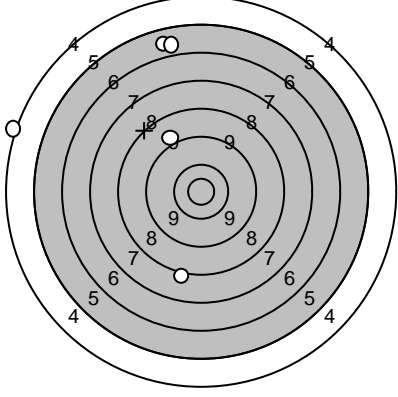
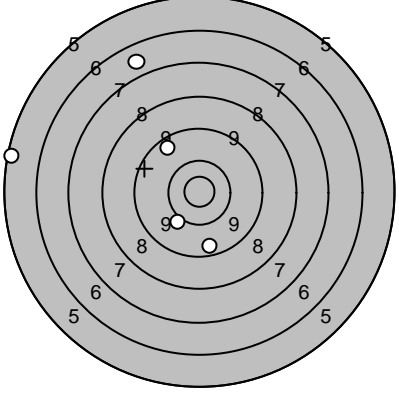
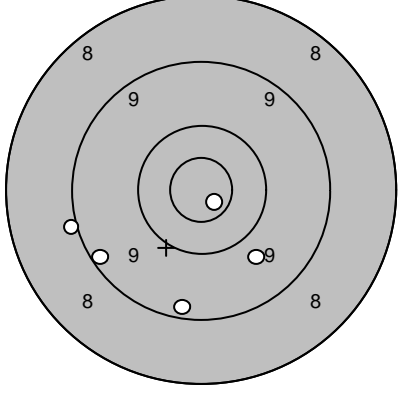
Skjutlag <b>4</b>	Tavla <b>4</b>	<b>Stefan Jonasson</b>	
		Hogdal	
2008-07-13	Tavelträffen B 2008	Ramselefors SKF	
<b>Provkott</b> 	1: 10,7* → 2: 9,1 ↘ 3: 10,0 → 4: 9,6 →	<b>Serie 1 (L)</b> 	1: 9,9 ↓ 2: 10,7* ↙ 3: 9,7 ↗ 4: 10,6* ↗ 5: 9,2 ↓
	Serie 38,0		Serie 47,0
	Totalt 0,0		Totalt 47,0
<b>Provkott</b> 	1: 8,5 ← 2: 7,9 ↘	<b>Serie 2 (K)</b> 	1: 9,7 ↑ 2: 9,5 ← 3: 7,8 ↗ 4: 7,7 ↓ 5: 9,2 ←
	Serie 15,0		Serie 41,0
	Totalt 47,0		Totalt 88,0
<b>Serie 3 (S)</b> 	1: 5,8 ↑ 2: 8,2 ↓ 3: 5,9 ↑ 4: 4,2 ↖ 5: 9,0 ↗	<b>Extratävling 3+3+4</b> 	1: 9,6 ↗ 2: 6,8 ↗ 3: 5,4 ← 4: 10,1 ↙ 5: 9,6 ↓
	Serie 31,0		Serie 39,0
	Totalt 119,0		Totalt 158,0
<b>Extratävling 3+3+4</b> 	6: 9,2 ← 7: 9,7 ↓ 8: 9,3 ↓ 9: 9,0 ← 10: 10,8* ↓		
	Serie 46,0		
	Totalt 204,0		

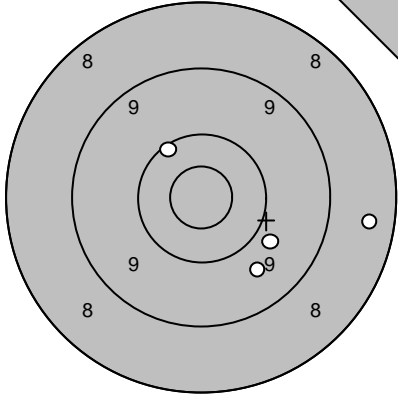
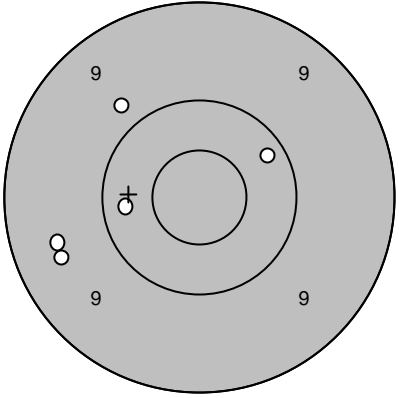
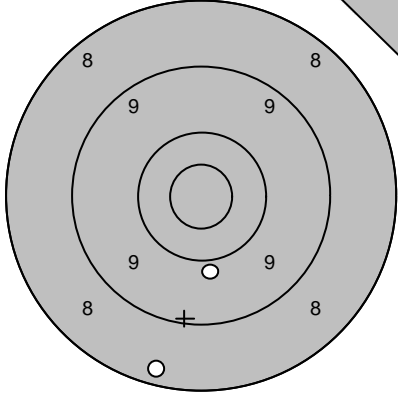
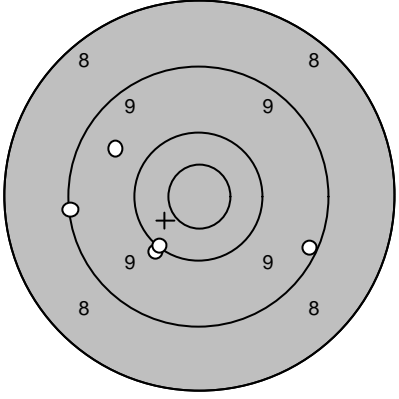
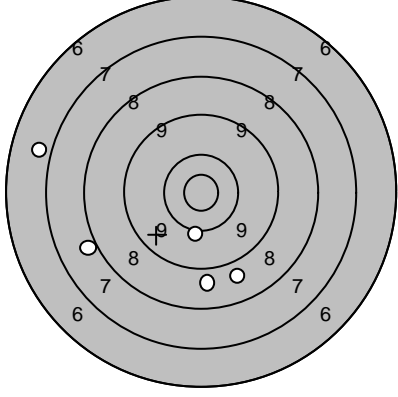
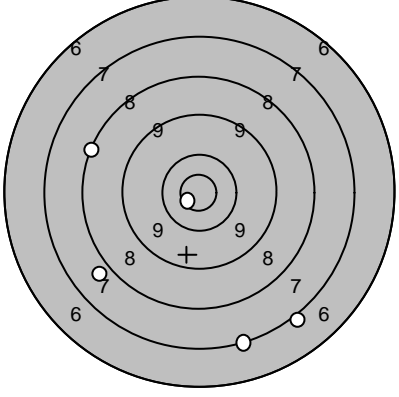
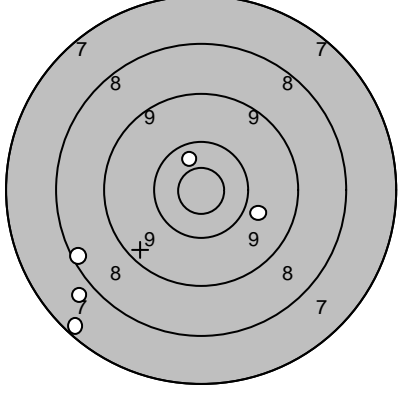
Skjutlag	Tavla	<b>Carina Norling</b>		
<b>4</b>	<b>5</b>			
Söderala				
2008-07-13	Tavelträffen B 2008	Ramselefors SKF		
Provskott		1: 8,5 → 2: 9,8 ↘ 3: 9,7 ↘ 4: 10,2 ↗	<b>Serie 1 (L)</b> 	1: 9,5 ← 2: 10,2 ↗ 3: 9,8 ↗ 4: 10,3 ← 5: 9,5 ←
	Serie 36,0 Totalt 0,0		Serie 47,0 Totalt 47,0	
Provskott		1: 8,3 ↓ 2: 9,9 ↓	<b>Serie 2 (K)</b> 	1: 9,6 ↗ 2: 9,2 → 3: 10,0 ↓ 4: 9,1 ← 5: 10,1 ↓
	Serie 17,0 Totalt 47,0		Serie 47,0 Totalt 94,0	
Serie 3 (S)		1: 8,8 ↓ 2: 10,1 ↓ 3: 7,9 ← 4: 8,8 ↓ 5: 6,9 ←	<b>Extratävling 3+3+4</b> 	1: 7,1 ↓ 2: 7,2 ↓ 3: 7,9 ↘ 4: 10,8* ← 5: 8,2 ←
	Serie 39,0 Totalt 133,0		Serie 39,0 Totalt 172,0	
Extratävling 3+3+4		6: 10,4 ↗ 7: 7,3 ↘ 8: 7,8 ↘ 9: 8,3 ← 10: 9,9 →		
	Serie 41,0 Totalt 213,0			

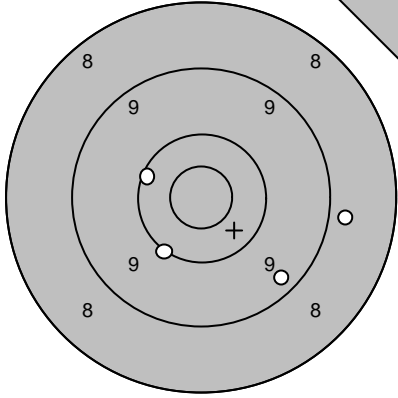
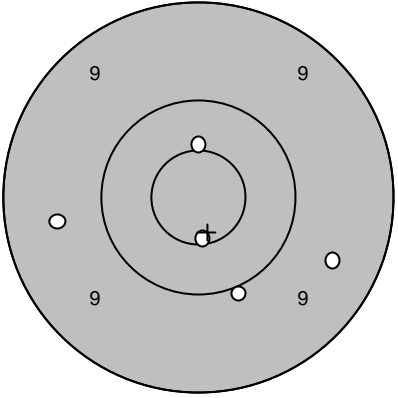
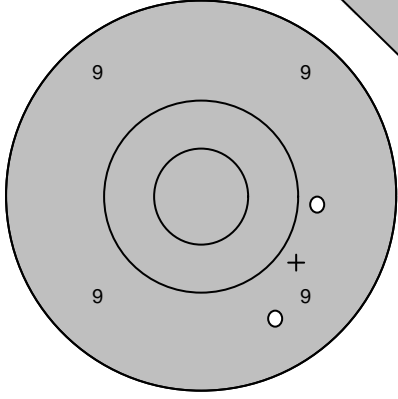
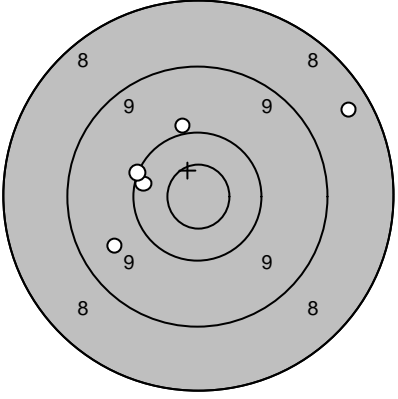
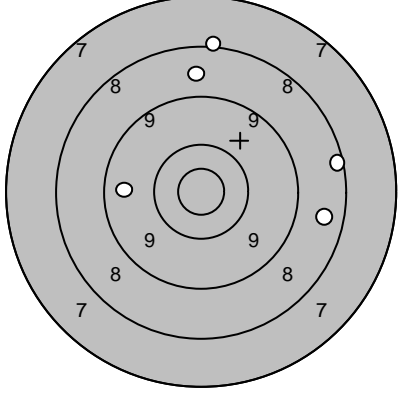
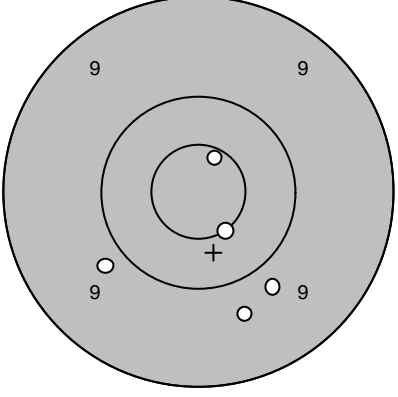
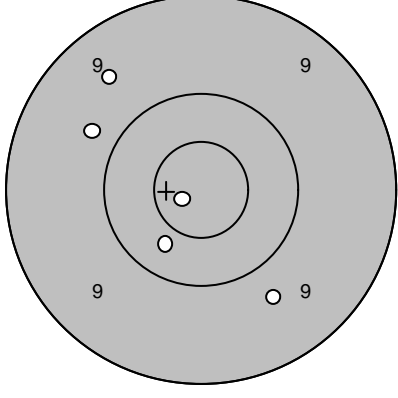
Skjutlag	Tavla	Linda Bergman	
4	6		
		Ununge	
2008-07-13	Tavelträffen B 2008	Ramselefors SKF	
Provskott		1: 10,2 ← 2: 10,1 ↙ 3: 8,8 → 4: 9,3 ↘	Serie 1 (L) 
		Serie 37,0 Totalt 0,0	1: 10,0 ↓ 2: 9,6 ← 3: 10,6* ↓ 4: 10,5* ↑ 5: 9,5 ↘
			Serie 48,0 Totalt 48,0
Provskott		1: 9,8 → 2: 9,6 ↘	Serie 2 (K) 
		Serie 18,0 Totalt 48,0	1: 10,0 ↑ 2: 10,2 ← 3: 9,6 ↙ 4: 10,1 ← 5: 8,4 ↗
			Serie 47,0 Totalt 95,0
Serie 3 (S)		1: 8,1 ↑ 2: 9,6 ← 3: 8,3 → 4: 8,7 ↑ 5: 8,5 →	Extratävling 3+3+4 
		Serie 41,0 Totalt 136,0	1: 10,6* ↓ 2: 9,8 ↓ 3: 10,6* ↗ 4: 9,8 ↙ 5: 9,7 ↓
			Serie 47,0 Totalt 183,0
Extratävling 3+3+4		6: 9,7 ↘ 7: 10,8* ← 8: 9,6 ↗ 9: 9,8 ↗ 10: 10,4 ↘	
		Serie 47,0 Totalt 230,0	

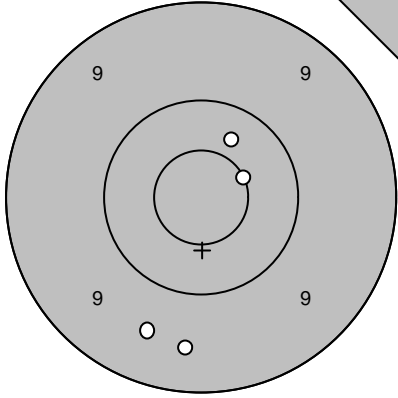
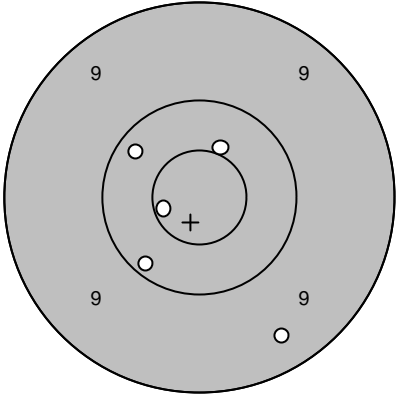
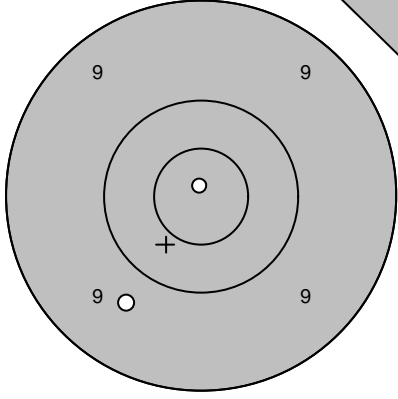
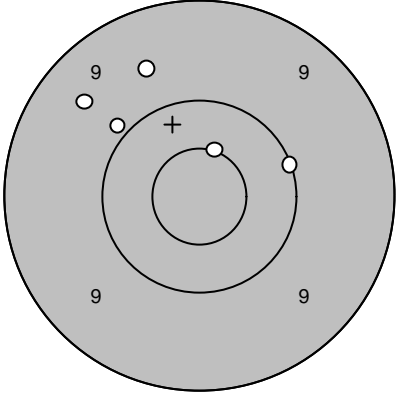
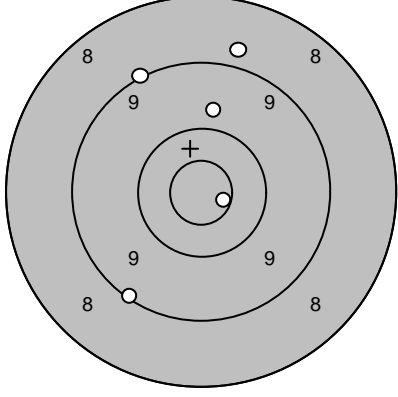
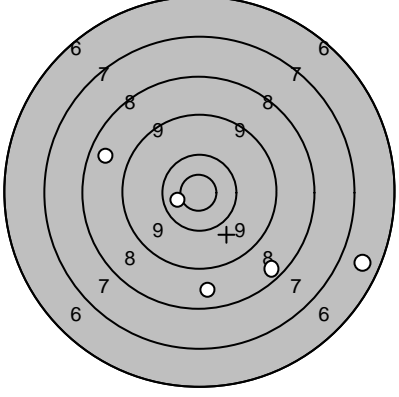
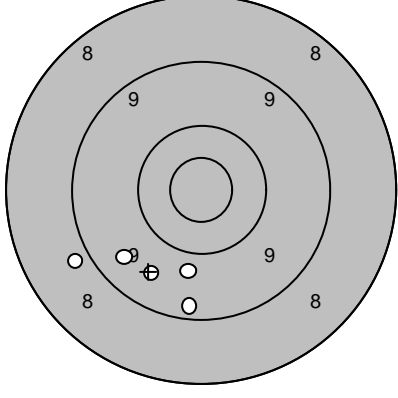
Skjutlag	Tavla	Therese Danielsson		
4	7	Ununge		
2008-07-13	Tavelträffen B 2008	Ramselefors SKF		
Provskott		1: 9,5 ↓ 2: 9,6 ↓ 3: 10,6* → 4: 10,4 ↗	Serie 1 (L) 	1: 10,2 ↗ 2: 9,4 ↓ 3: 10,7* ← 4: 10,5* ↗ 5: 10,2 ↓
		Serie 38,0		Serie 49,0
		Totalt 0,0		Totalt 49,0
Provskott		1: 9,7 ↘ 2: 10,9* ↑	Serie 2 (K) 	1: 10,1 → 2: 10,5* ↑ 3: 9,5 ↗ 4: 9,6 ↗ 5: 9,9 ↗
		Serie 19,0		Serie 47,0
		Totalt 49,0		Totalt 96,0
Serie 3 (S)		1: 10,7* → 2: 9,8 ↑ 3: 8,8 ↑ 4: 9,1 ↗ 5: 9,2 ↓	Extratävling 3+3+4 	1: 10,6* ← 2: 8,5 ↓ 3: 6,6 → 4: 8,7 ↓ 5: 8,6 ↗
		Serie 45,0		Serie 40,0
		Totalt 141,0		Totalt 181,0
Extratävling 3+3+4		6: 9,6 ↘ 7: 9,3 ↓ 8: 9,8 ↓ 9: 9,5 ↘ 10: 8,9 ↘		
		Serie 44,0		
		Totalt 225,0		

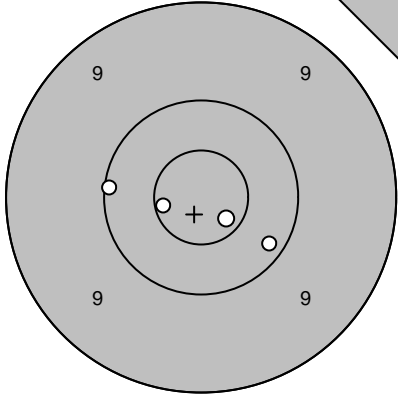
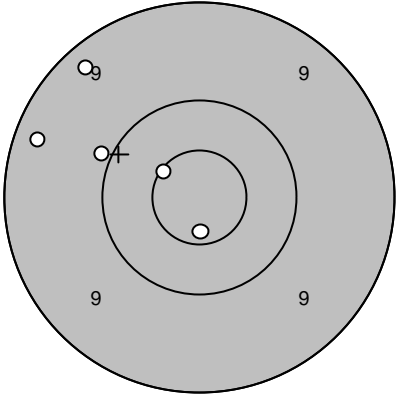
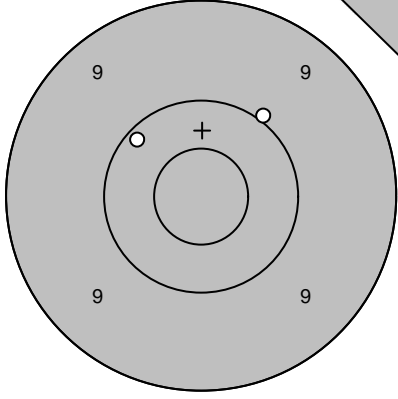
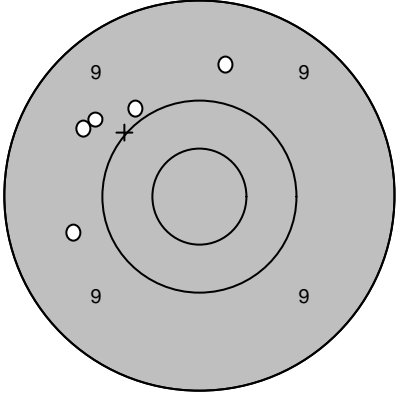
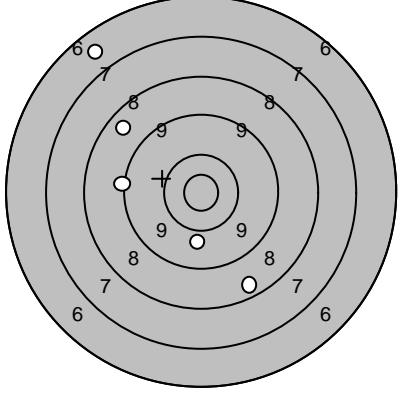
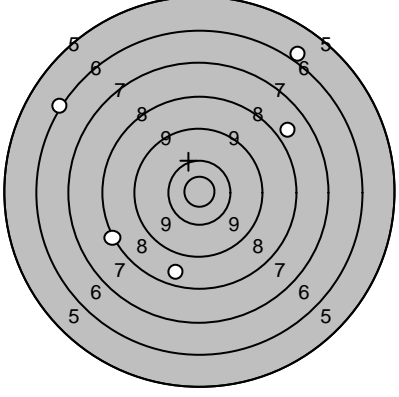
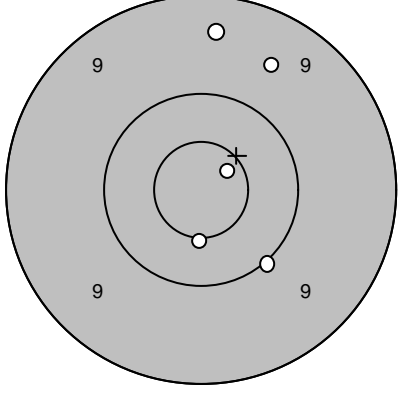
Skjutlag <b>4</b>	Tavla <b>8</b>	<b>Sandra Danielsson</b>	
		Ununge	
2008-07-13	Tavelträffen B 2008	Ramselefors SKF	
Provskott 	1: 10,1 ← 2: 10,6* ← 3: 10,2 ↘ 4: 10,7* ↘ Serie 40,0 Totalt 0,0	Serie 1 (L) 	1: 10,7* ↓ 2: 9,9 ↗ 3: 9,3 ↗ 4: 9,3 ↗ 5: 10,6* ↗ Serie 47,0 Totalt 47,0
Provskott 	1: 10,2 ↗ 2: 10,0 ↗ Serie 20,0 Totalt 47,0	Serie 2 (K) 	1: 9,7 ↑ 2: 9,7 ↗ 3: 9,9 ↗ 4: 9,7 ← 5: 9,7 ↗ Serie 45,0 Totalt 92,0
Serie 3 (S) 	1: 9,9 ↓ 2: 8,6 ↗ 3: 9,1 ← 4: 8,5 ↘ 5: 6,7 ↗ Serie 40,0 Totalt 132,0	Extratävling 3+3+4 	1: 6,2 ↗ 2: 6,0 ↗ 3: 7,9 ↗ 4: 8,7 ↓ 5: 8,2 ← Serie 35,0 Totalt 167,0
Extratävling 3+3+4 	6: 10,7* ↗ 7: 9,4 ↑ 8: 9,6 ↗ 9: 10,5* ↓ 10: 10,0 ↘ Serie 48,0 Totalt 215,0		

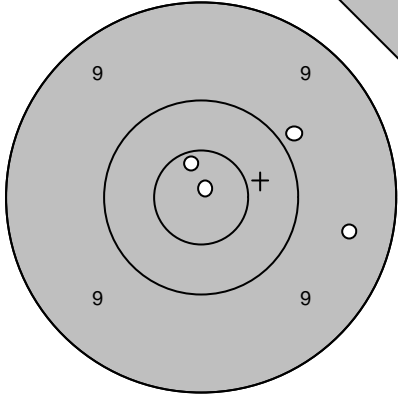
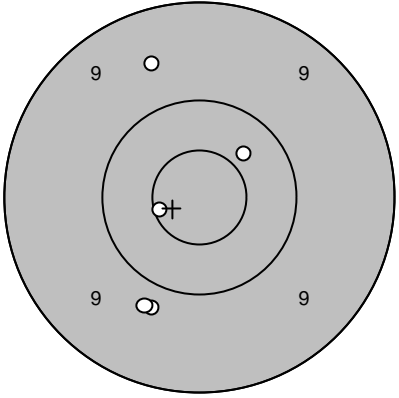
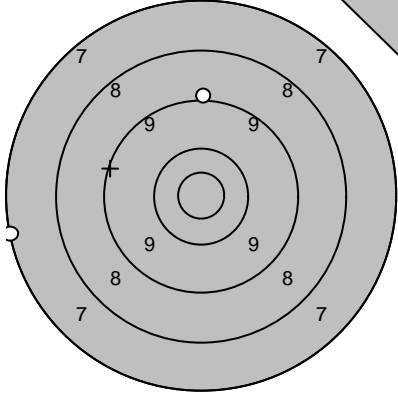
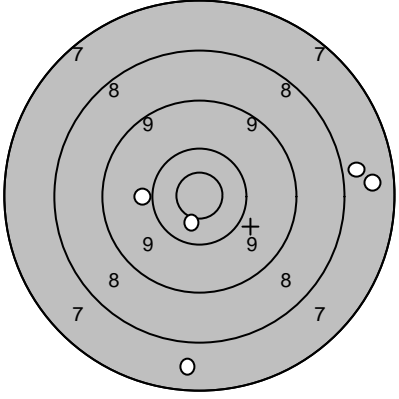
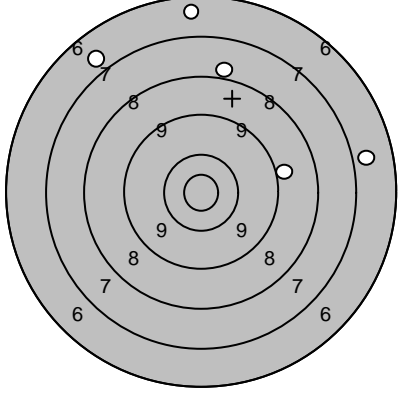
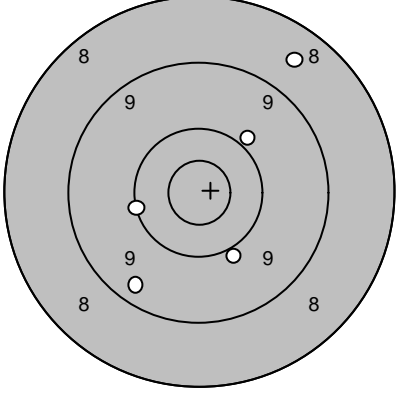
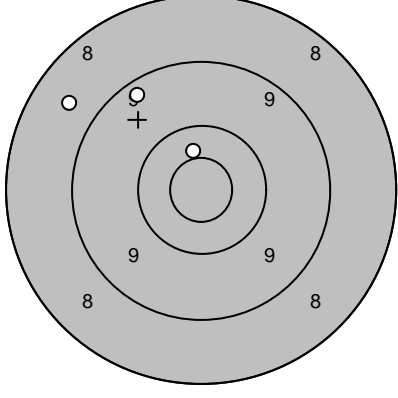
Skjutlag	Tavla	<b>Roger Hjalström</b>		
<b>4</b>	<b>9</b>	Ununge		
2008-07-13	Tavelträffen B 2008	Ramselefors SKF		
Provskott		1: 9,5 → 2: 9,9 ↗ 3: 10,7* ↑ 4: 10,9* ↗	Serie 1 (L) 	1: 10,6* ← 2: 9,8 ↓ 3: 9,8 ↓ 4: 9,6 ↑ 5: 10,4 ↗
		Serie 38,0		Serie 47,0
		Totalt 0,0		Totalt 47,0
Provskott		1: 9,1 ↑ 2: 7,2 ←	Serie 2 (K) 	1: 10,6* ↓ 2: 7,9 → 3: 10,0 ← 4: 7,6 → 5: 7,6 ↓
		Serie 16,0		Serie 41,0
		Totalt 47,0		Totalt 88,0
Serie 3 (S)		1: 6,9 → 2: 8,0 ↑ 3: 9,0 → 4: 6,8 ↗ 5: 6,6 ↑	Extratävling 3+3+4 	1: 10,0 ↗ 2: 8,6 ↗ 3: 10,0 ↓ 4: 10,1 ← 5: 9,4 ↓
		Serie 35,0		Serie 47,0
		Totalt 123,0		Totalt 170,0
Extratävling 3+3+4		6: 10,5* ↑ 7: 9,3 ↗ 8: 8,7 ←		
		Serie 27,0		
		Totalt 197,0		

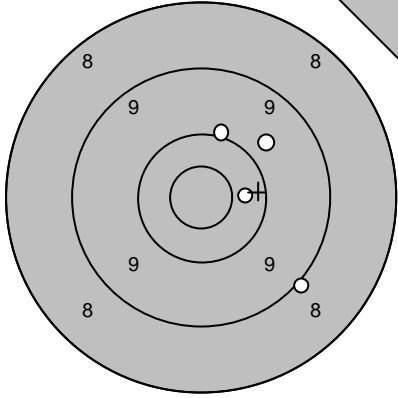
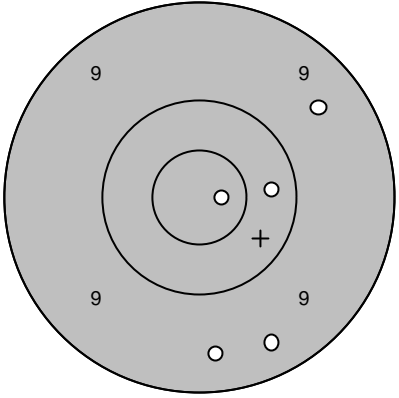
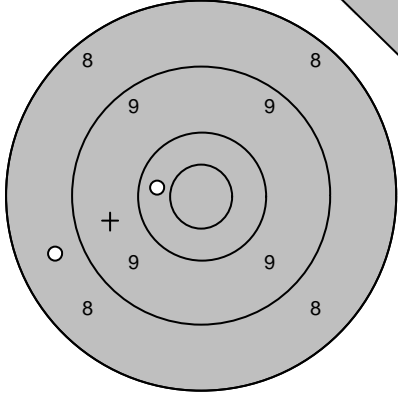
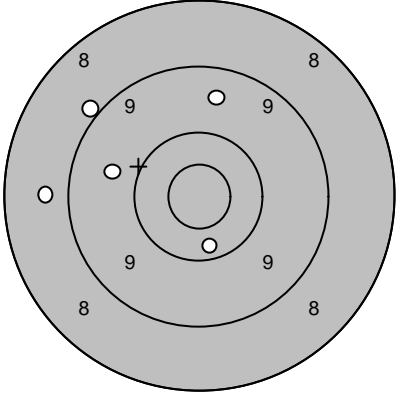
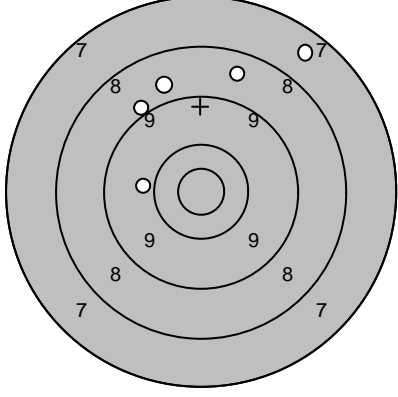
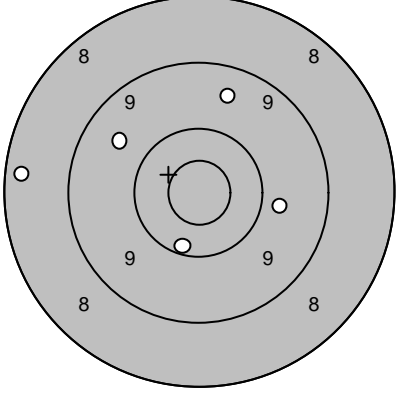
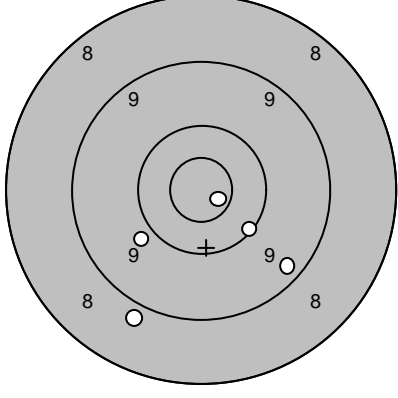
Skjutlag <b>4</b>	Tavla <b>10</b>	<b>Anders Petersson</b>	
		Älmhult	
2008-07-13	Tavelträffen B 2008	Ramselefors SKF	
<b>Provskott</b> 	1: 9,8 ↗ 2: 10,0 ↑ 3: 9,0 ↘ 4: 10,4 →	<b>Serie 1 (L)</b> 	1: 9,4 ↓ 2: 10,8* → 3: 9,4 ↘ 4: 10,3 → 5: 9,5 ↗
	Serie 38,0		Serie 47,0
	Totalt 0,0		Totalt 47,0
<b>Provskott</b> 	1: 8,7 ← 2: 10,4 ←	<b>Serie 2 (K)</b> 	1: 8,7 ← 2: 9,7 ← 3: 8,9 ↗ 4: 9,6 ↑ 5: 10,3 ↓
	Serie 18,0		Serie 44,0
	Totalt 47,0		Totalt 91,0
<b>Serie 3 (S)</b> 	1: 8,8 ↑ 2: 9,0 ↗ 3: 9,9 ← 4: 7,6 ↗ 5: 8,6 ↑	<b>Extratävling 3+3+4</b> 	1: 9,5 ↑ 2: 9,6 ↗ 3: 8,3 ← 4: 10,2 ↓ 5: 9,8 →
	Serie 41,0		Serie 45,0
	Totalt 132,0		Totalt 177,0
<b>Extratävling 3+3+4</b> 	6: 10,8* → 7: 8,9 ↘ 8: 9,9 ↘ 9: 9,3 ↘ 10: 10,1 ↘		
	Serie 46,0		
	Totalt 223,0		

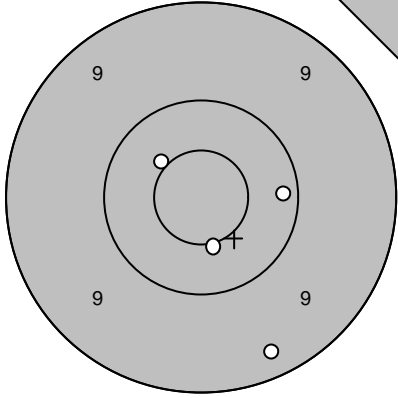
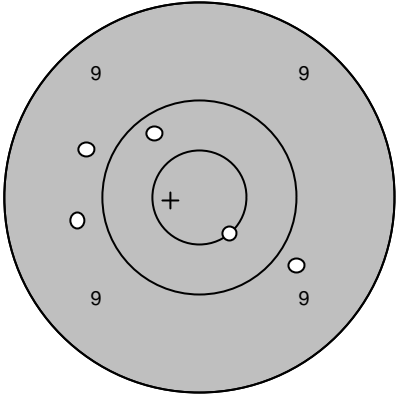
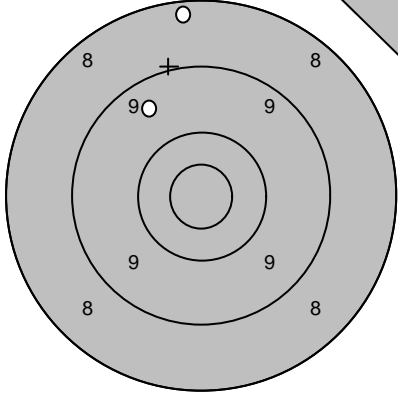
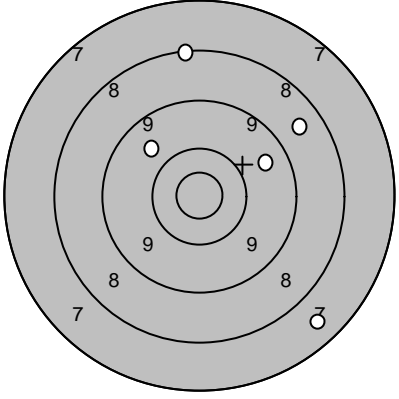
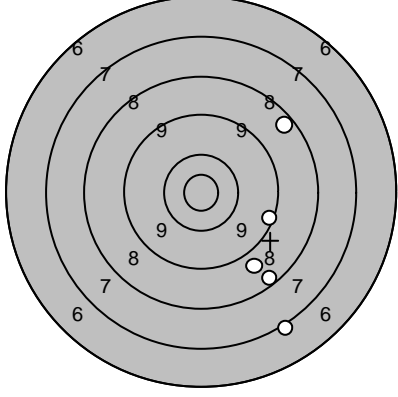
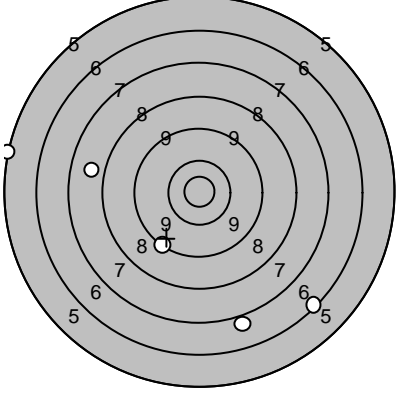
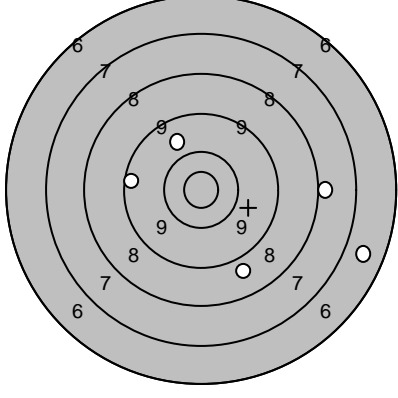

Skjutlag	Tavla	Jonas Bromihh		
4	11			
Älmhult				
2008-07-13	Tavelträffen B 2008	Ramselefors SKF		
Provskott		1: 10,5* ↓ 2: 9,3 ↓ 3: 10,5* ↗ 4: 10,2 →	Serie 1 (L) 	1: 9,8 ← 2: 9,8 ↗ 3: 9,8 ↓ 4: 10,2 ↗ 5: 10,6* ↓
	Serie 39,0 Totalt 0,0		Serie 47,0 Totalt 47,0	
Provskott		1: 8,3 ↑ 2: 9,5 ↗	Serie 2 (K) 	1: 8,6 ↗ 2: 8,2 ↑ 3: 9,8 ↗ 4: 7,6 ↓ 5: 9,6 ↗
	Serie 17,0 Totalt 47,0		Serie 41,0 Totalt 88,0	
Serie 3 (S)		1: 8,4 ↓ 2: 8,4 ↗ 3: 9,3 ↓ 4: 8,8 ↓ 5: 7,1 ↓	Extratävling 3+3+4 	1: 6,3 ↓ 2: 6,9 ↓ 3: 9,2 ↓ 4: 7,9 ← 5: 5,2 ←
	Serie 40,0 Totalt 128,0		Serie 33,0 Totalt 161,0	
Extratävling 3+3+4		6: 9,8 ↗ 7: 9,4 ← 8: 6,7 → 9: 8,9 ↓ 10: 8,0 →		
	Serie 40,0 Totalt 201,0			

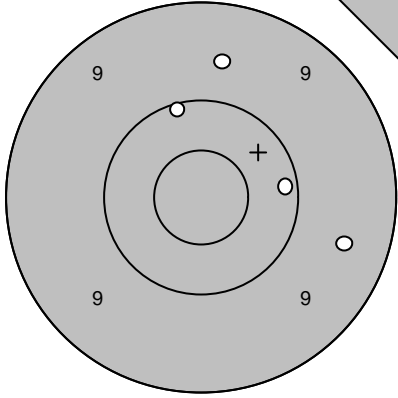
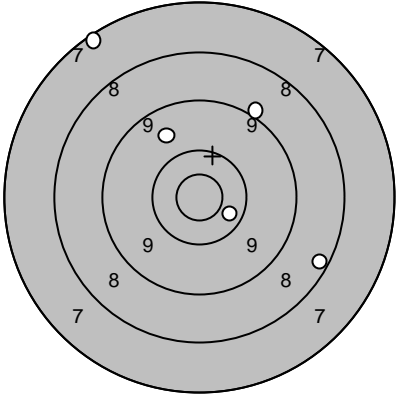
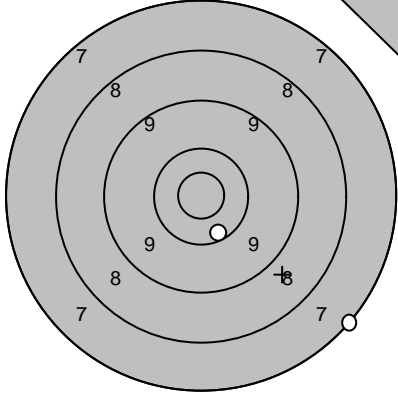
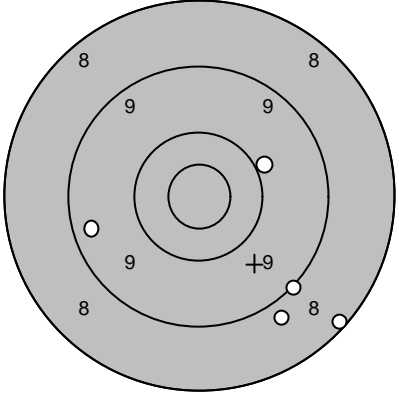
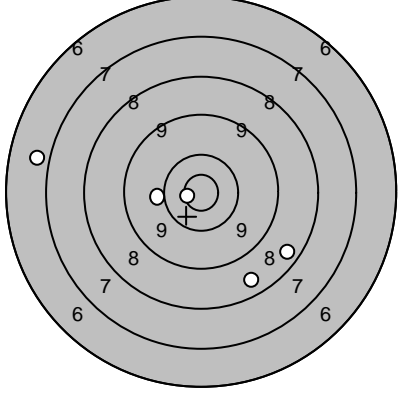
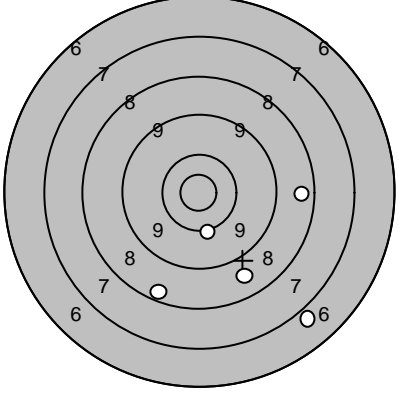
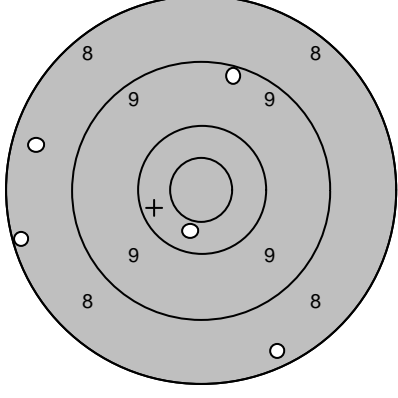
Skjutlag	Tavla	Linda Pettersson	
4	12		
		Älmhult	
2008-07-13	Tavelträffen B 2008	Ramselefors SKF	
Provskott		1: 10,1 ↑ 2: 9,5 → 3: 9,6 ↑ 4: 10,2 →	Serie 1 (L) 
		Serie 38,0 Totalt 0,0	1: 9,0 ↗ 2: 7,3 ↗ 3: 10,4 ↘ 4: 9,7 ↗ 5: 8,3 ↘
			Serie 43,0 Totalt 43,0
Provskott		1: 7,2 ↘ 2: 10,3 ↘	Serie 2 (K) 
		Serie 17,0 Totalt 43,0	1: 10,0 → 2: 8,8 ↘ 3: 9,1 ↘ 4: 8,2 ↘ 5: 9,4 ←
			Serie 44,0 Totalt 87,0
Serie 3 (S)		1: 10,0 ← 2: 8,6 ↘ 3: 6,9 ← 4: 10,8* ← 5: 8,5 ↘	Extratävling 3+3+4 
		Serie 42,0 Totalt 129,0	1: 8,6 → 2: 10,1 ↘ 3: 8,4 ↘ 4: 6,9 ↘ 5: 8,7 ↘
			Serie 40,0 Totalt 169,0
Extratävling 3+3+4		6: 9,3 ↑ 7: 8,3 ↘ 8: 8,2 ← 9: 10,4 ↘ 10: 8,5 ←	
		Serie 43,0 Totalt 212,0	

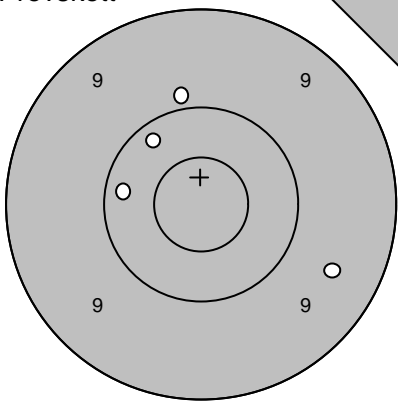
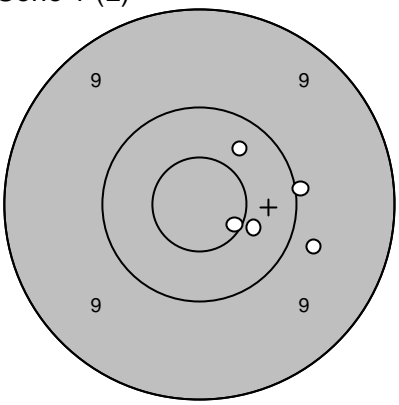
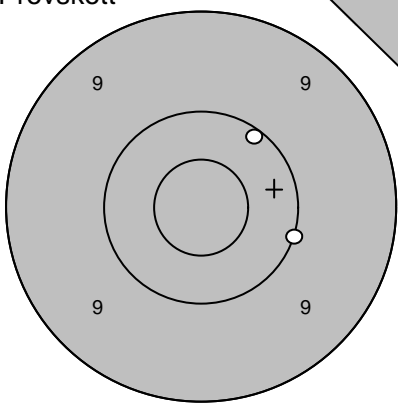
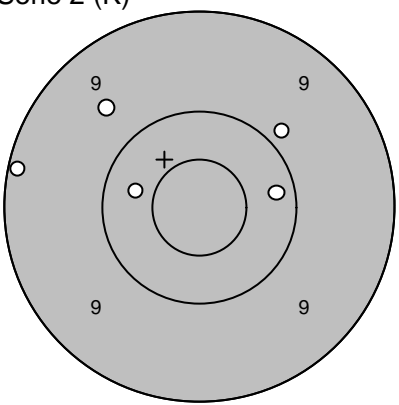
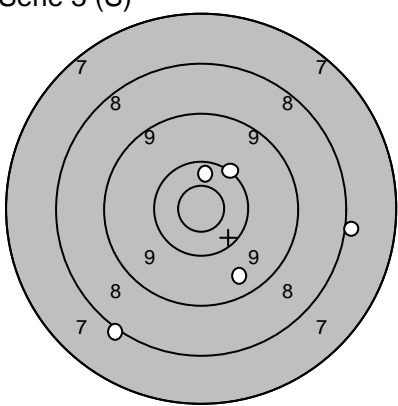
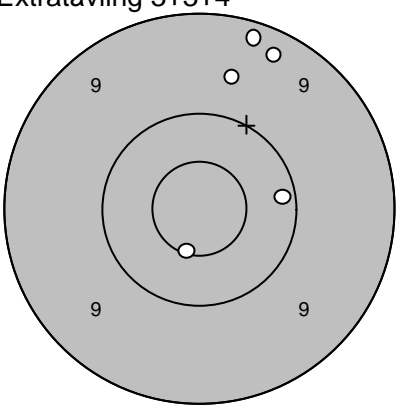
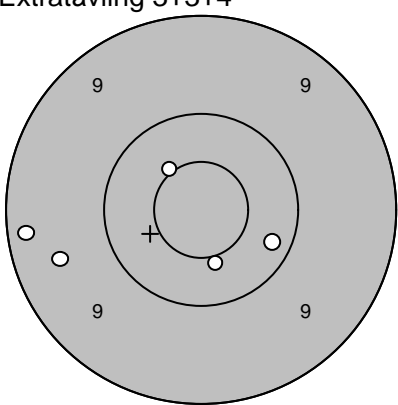
Skjutlag	Tavla	<b>Gustav Lövgren</b>		
<b>4</b>	<b>14</b>			
		Niemisel		
2008-07-13	Tavelträffen B 2008	Ramselefors SKF		
Provskott		1: 9,9 ↗ 2: 10,2 ↗ 3: 10,2 ← 4: 9,5 ↘	<b>Serie 1 (L)</b> 	1: 10,4 → 2: 10,3 ↗ 3: 9,8 ↘ 4: 10,0 → 5: 10,6* ↘
		Serie 38,0		Serie 49,0
		Totalt 0,0		Totalt 49,0
Provskott		1: 10,1 ↗ 2: 10,0 →	<b>Serie 2 (K)</b> 	1: 9,6 ↗ 2: 9,9 ↗ 3: 10,4 ← 4: 10,2 → 5: 9,1 ←
		Serie 20,0		Serie 47,0
		Totalt 49,0		Totalt 96,0
Serie 3 (S)		1: 10,1 ↗ 2: 9,5 ↘ 3: 8,0 → 4: 8,1 ↘ 5: 10,4 ↑	<b>Extratävling 3+3+4</b> 	1: 10,2 → 2: 9,2 ↑ 3: 9,3 ↑ 4: 9,6 ↑ 5: 10,6* ↓
		Serie 45,0		Serie 47,0
		Totalt 141,0		Totalt 188,0
Extratävling 3+3+4		6: 9,2 ← 7: 9,5 ← 8: 10,5* ↓ 9: 10,5* ↗ 10: 10,2 ↘		
		Serie 48,0		
		Totalt 236,0		

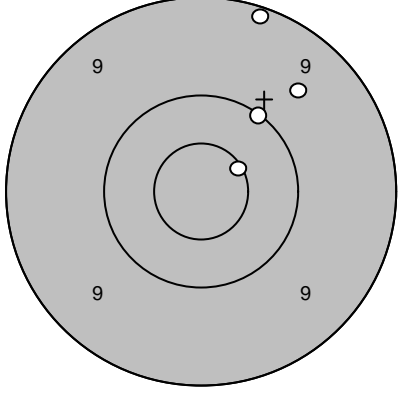
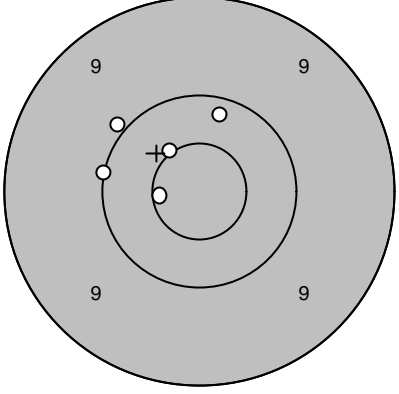
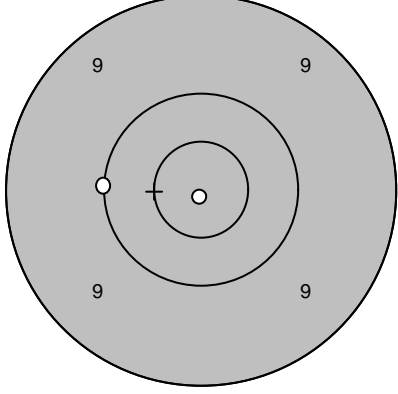
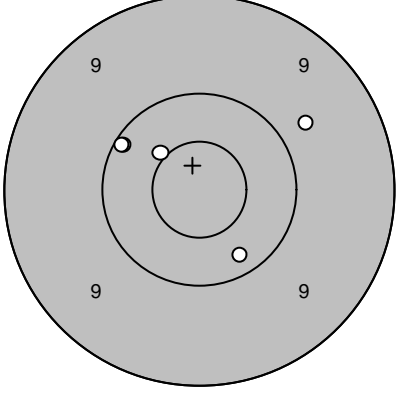
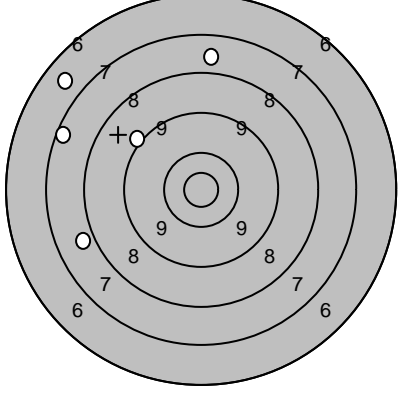
Skjutlag	Tavla	Bo Allansson	
4	15		
		Stenungsund	
2008-07-13	Tavelträffen B 2008	Ramselefors SKF	
Provskott		1: 10,1 ↗ 2: 9,6 ↗ 3: 9,2 ↗ 4: 10,6* ↗	Serie 1 (L) 
			1: 10,6* ← 2: 10,2 ↑ 3: 10,0 ↗ 4: 10,1 ← 5: 10,5* ↗
		Serie 38,0	Serie 50,0
		Totalt 0,0	Totalt 50,0
Provskott		1: 10,9* ↓ 2: 10,0 ←	Serie 2 (K) 
			1: 9,7 ↗ 2: 10,1 ↗ 3: 10,5* ↗ 4: 10,1 ↗ 5: 10,3 ↓
		Serie 20,0	Serie 49,0
		Totalt 50,0	Totalt 99,0
Serie 3 (S)		1: 7,4 ← 2: 7,9 ← 3: 6,7 ↗ 4: 9,1 ↗ 5: 7,8 ↑	
		Serie 36,0	
		Totalt 135,0	

Skjutlag	Tavla	Sture Allansson		
4	16			
Stenungsund				
2008-07-13	Tavelträffen B 2008	Ramselefors SKF		
Provskott		1: 9,6 ↗	Serie 1 (L)	1: 9,4 ↗
		2: 9,4 ↑		2: 8,9 ↖
		3: 8,4 ↓		3: 10,4 ↗
		4: 7,6 →		4: 8,0 ↗
				5: 9,3 →
		Serie 33,0		Serie 44,0
		Totalt 0,0		Totalt 44,0
Provskott		1: 9,4 →	Serie 2 (K)	1: 9,1 →
		2: 8,3 ↓		2: 10,5* ↖
				3: 10,8* ↓
				4: 9,4 ↗
				5: 9,3 ←
		Serie 17,0		Serie 47,0
		Totalt 44,0		Totalt 91,0
Serie 3 (S)		1: 8,9 ↙		
		2: 7,1 ↖		
		3: 5,6 ←		
		4: 8,4 ↑		
		5: 8,5 ↑		
		Serie 36,0		
		Totalt 127,0		

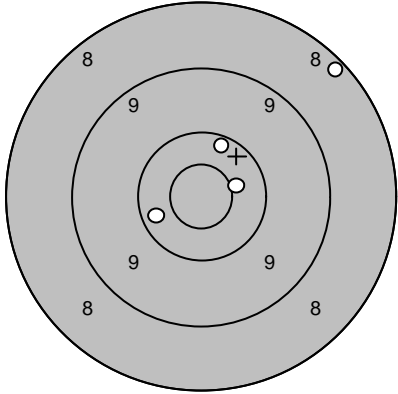
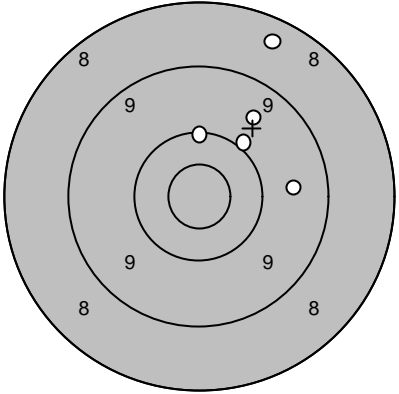
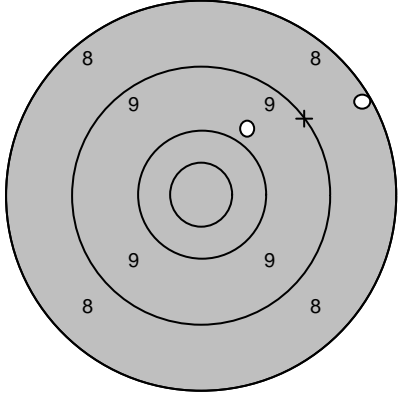
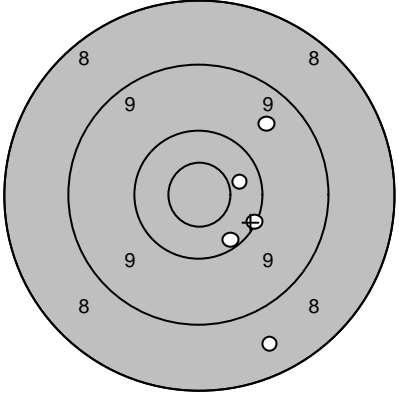
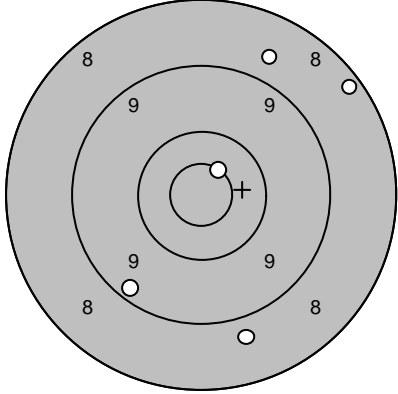
Skjutlag	Tavla	<b>Börje Erlandsson</b>	
<b>4</b>	<b>17</b>		
		Vikingen	
2008-07-13	Tavelträffen B 2008	Ramselefors SKF	
Provskott 	1: 8,2 ↗	Serie 1 (L) 	1: 9,6 ↗
	2: 10,3 ←		2: 10,0 ↗
	3: 10,2 ↑		3: 10,1 ↑
	4: 10,5* →		4: 8,4 ↗
			5: 9,6 →
	Serie 38,0		Serie 46,0
	Totalt 0,0		Totalt 46,0
Provskott 	1: 9,8 ↗	Serie 2 (K) 	1: 8,5 ↓
	2: 8,2 →		2: 10,4 →
			3: 10,2 ↓
			4: 9,6 ↗
			5: 10,1 ↘
	Serie 17,0		Serie 47,0
	Totalt 46,0		Totalt 93,0
Serie 3 (S) 	1: 8,7 ↗		
	2: 9,3 ↓		
	3: 8,3 ↗		
	4: 8,8 ↓		
	5: 10,6* ↗		
	Serie 43,0		
	Totalt 136,0		

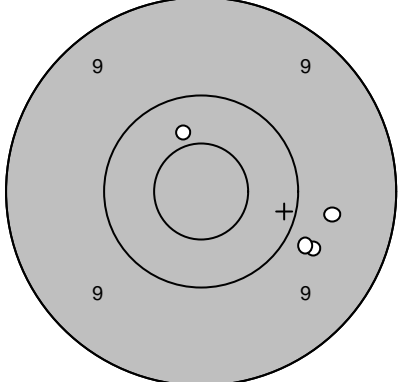
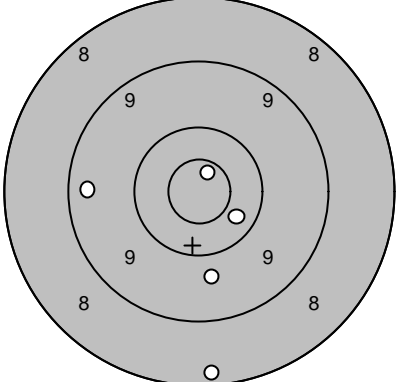
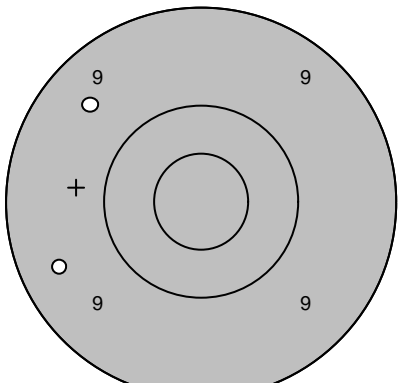
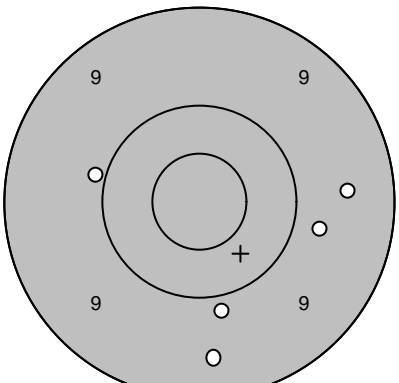
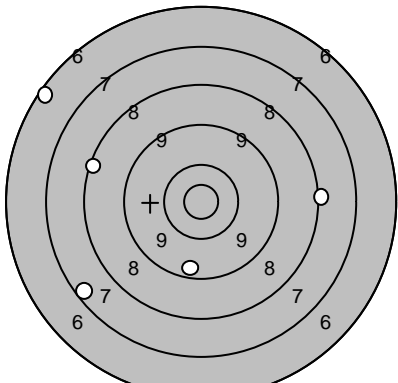

Skjutlag	Tavla	<b>Claes Gustafsson</b>			
<b>4</b>	<b>19</b>				
		Hofors			
2008-07-13	Tavelträffen B 2008	Ramselefors SKF			
Provsnitt 	1: 10,4 ↗ 2: 9,8 → 3: 9,8 → 4: 9,7 →	Serie 1 (L) 	1: 9,4 ← 2: 10,4 → 3: 8,3 ↓ 4: 10,8* ↗ 5: 9,7 ↓		
	Serie		37,0	Serie	46,0
	Totalt		0,0	Totalt	46,0
Provsnitt 	1: 9,4 ← 2: 9,5 ↗	Serie 2 (K) 	1: 9,5 → 2: 9,9 ↓ 3: 9,8 → 4: 9,9 ← 5: 9,4 ↓		
	Serie		18,0	Serie	45,0
	Totalt		46,0	Totalt	91,0
Serie 3 (S) 	1: 7,4 ↙ 2: 9,4 ↓ 3: 8,1 → 4: 6,3 ↗ 5: 8,3 ↖				
	Serie	38,0			
	Totalt	129,0			

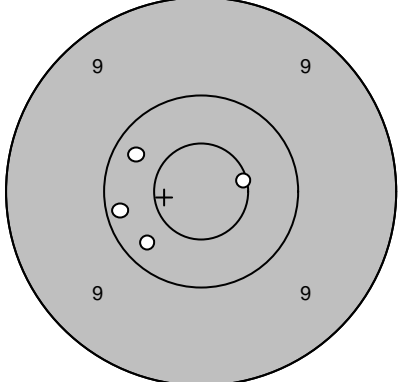
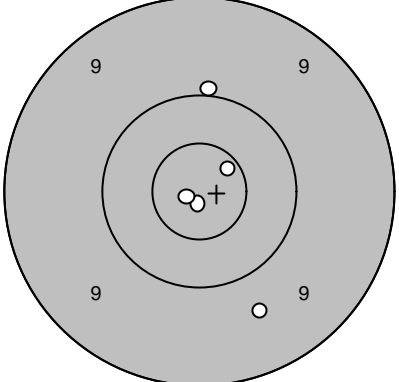
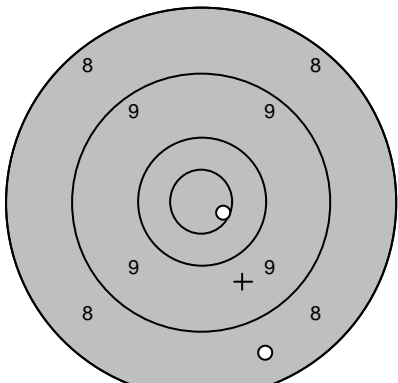
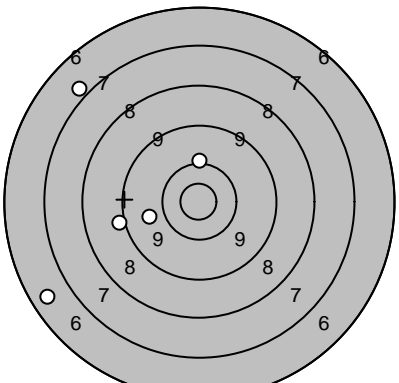
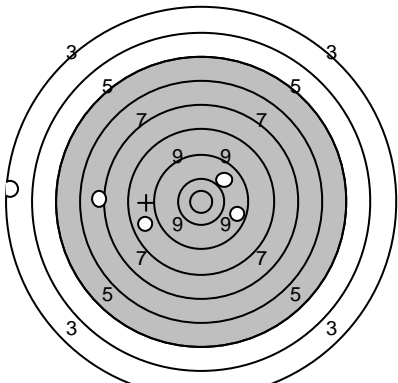

Skjutlag	Tavla	<b>Fredrik Ågren</b>	
<b>4</b>	<b>20</b>		
		I 19 / A 9	
2008-07-13	Tavelträffen B 2008	Ramselefors SKF	
Provskott		1: 10,3 ↖ 2: 10,2 ← 3: 10,3 ↙ 4: 10,6* →	Serie 1 (L) 
		1: 10,0 ↑ 2: 10,9* ↓ 3: 9,7 ↘ 4: 10,7* ↗ 5: 10,9* ←	
		Serie 40,0	Serie 49,0
		Totalt 0,0	Totalt 49,0
Provskott		1: 10,7* → 2: 8,5 ↓	Serie 2 (K) 
		1: 9,1 ← 2: 6,6 ← 3: 7,0 ↖ 4: 9,9 ← 5: 10,1 ↑	
		Serie 18,0	Serie 41,0
		Totalt 49,0	Totalt 90,0
Serie 3 (S)		1: 10,0 ↗ 2: 7,1 ← 3: 8,8 ← 4: 3,5 ← 5: 9,7 →	
		Serie 37,0	
		Totalt 127,0	

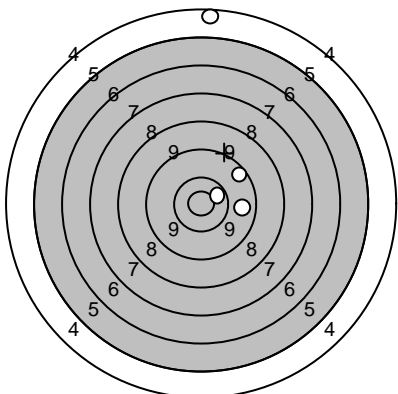
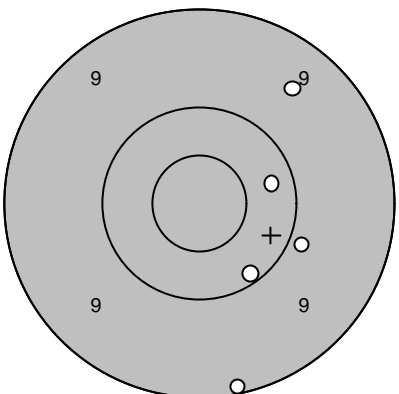
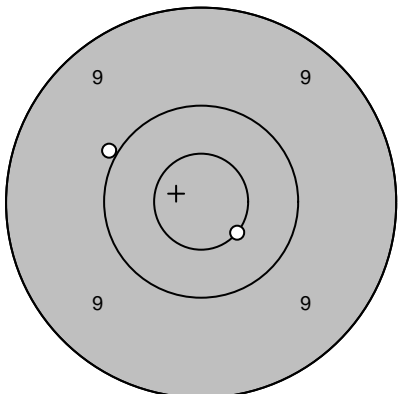
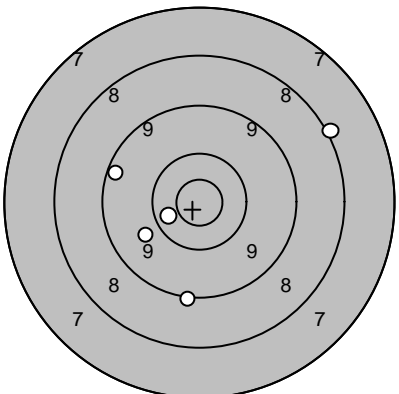
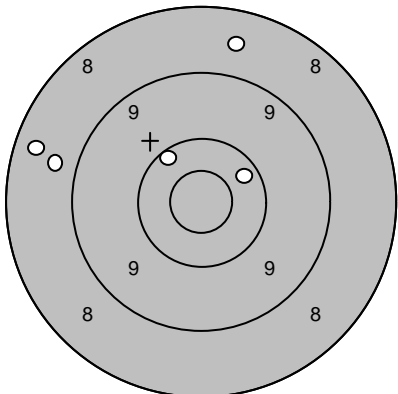
Skjutlag	Tavla	Anton Lindfors			
4	21	I 19 / A 9			
2008-07-13	Tavelträffen B 2008	Ramselefors SKF			
Provs-kott		1: 4,5    ↑ 2: 9,8    → 3: 10,6* → 4: 9,5    ↗	Serie 1 (L)		1: 9,5    ↗ 2: 10,1    ↘ 3: 9,1    ↓ 4: 10,3    → 5: 9,9    →
		Serie 32,0		Serie 47,0	
		Totalt 0,0		Totalt 47,0	
Provs-kott		1: 10,0    ↖ 2: 10,5*    ↘	Serie 2 (K)		1: 9,3    ↖ 2: 8,1    ↗ 3: 10,4    ↖ 4: 9,1    ↓ 5: 9,8    ↖
		Serie 20,0		Serie 45,0	
		Totalt 47,0		Totalt 92,0	
Serie 3 (S)		1: 8,4    ↖ 2: 8,6    ↑ 3: 10,2    ↖ 4: 10,3    ↗ 5: 8,8    ↖			
		Serie 44,0			
		Totalt 136,0			

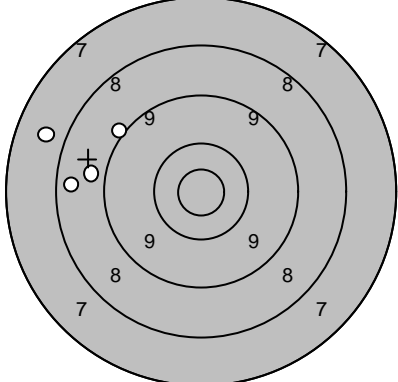
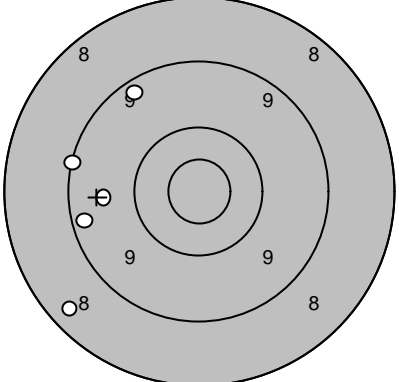
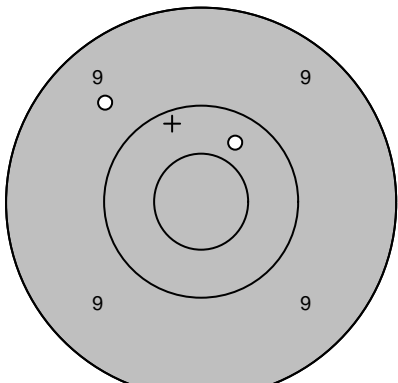
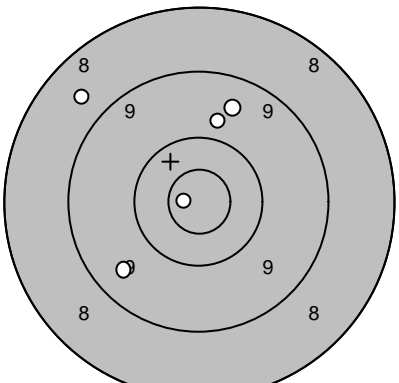
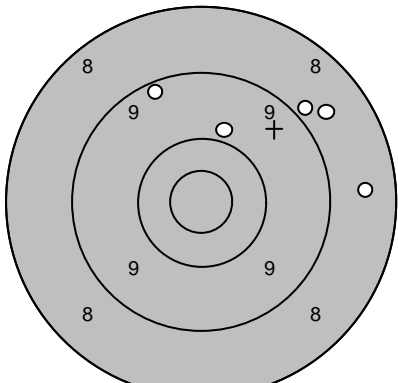
Skjutlag <b>4</b>	Tavla <b>22</b>	<b>Linda Gustavsson</b>		
		Moälven-Modo		
2008-07-13	Tavelträffen B 2008	Ramselefors SKF		
Provskott		1: 7,8 ↙ 2: 8,4 ← 3: 9,0 ↗ 4: 8,8 ←	Serie 1 (L) 	1: 9,6 ← 2: 8,4 ↘ 3: 9,3 ← 4: 9,3 ↗ 5: 9,1 ←
	Serie 32,0		Serie 44,0	
	Totalt 0,0		Totalt 44,0	
Provskott		1: 9,6 ↖ 2: 10,3 ↗	Serie 2 (K) 	1: 9,8 ↗ 2: 9,6 ↗ 3: 8,7 ↖ 4: 10,8* ← 5: 9,5 ↘
	Serie 19,0		Serie 45,0	
	Totalt 44,0		Totalt 89,0	
Serie 3 (S)		1: 8,6 → 2: 9,9 ↗ 3: 8,7 ↗ 4: 9,3 ↗ 5: 8,9 ↗		
	Serie 42,0			
	Totalt 131,0			

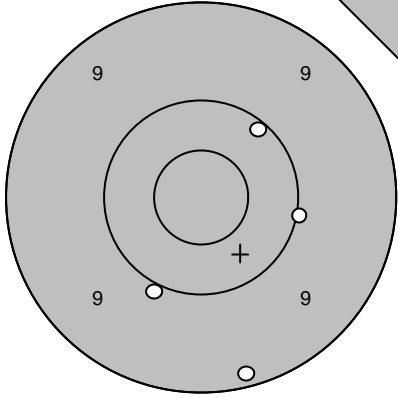
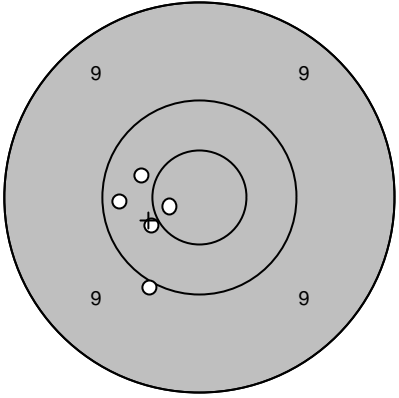
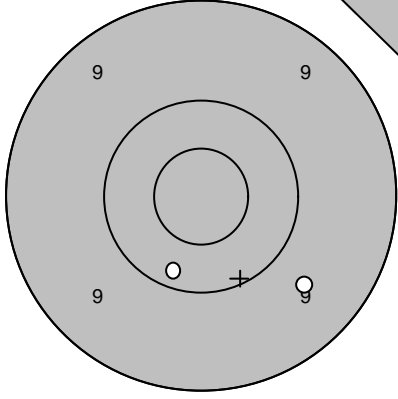
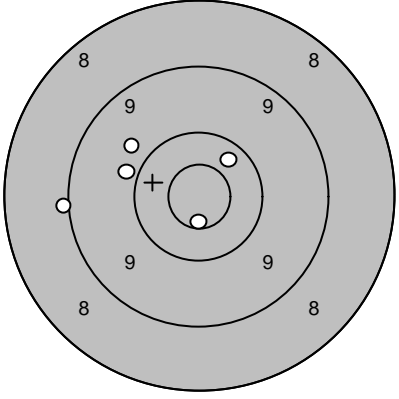
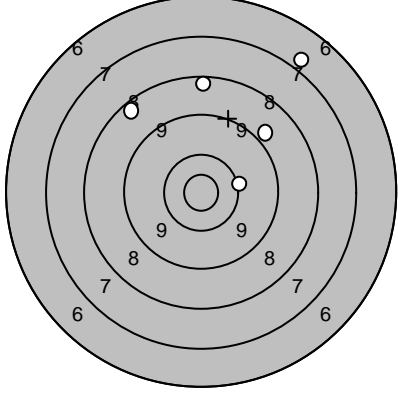
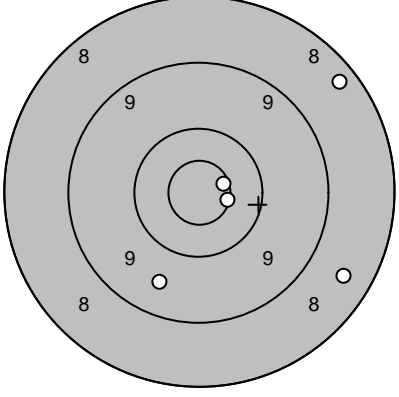
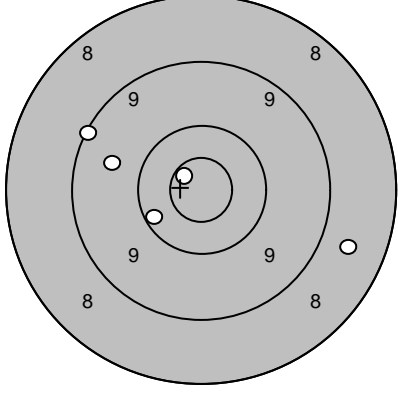
Skjutlag	Tavla	Donald Johansson	
4	23	Ale	
2008-07-13	Tavelträffen B 2008	Ramselefors SKF	
<b>Provsnitt</b> 	1: 10,0 ↙ 2: 10,0 → 3: 10,1 ↗ 4: 9,2 ↓	<b>Serie 1 (L)</b> 	1: 10,7* ← 2: 10,0 ↓ 3: 10,5* ← 4: 10,4 ↖ 5: 10,2 ←
	Serie 39,0		Serie 50,0
	Totalt 0,0		Totalt 50,0
<b>Provsnitt</b> 	1: 10,2 ↙ 2: 9,6 ↘	<b>Serie 2 (K)</b> 	1: 10,7* ↓ 2: 10,4 ↗ 3: 9,9 ↖ 4: 9,8 ↗ 5: 9,0 ←
	Serie 19,0		Serie 47,0
	Totalt 50,0		Totalt 97,0
<b>Serie 3 (S)</b> 	1: 8,4 ↑ 2: 10,2 → 3: 8,4 ↖ 4: 6,9 ↗ 5: 8,9 ↗	<b>Extratävling 3+3+4</b> 	1: 8,3 ↗ 2: 8,5 ↘ 3: 10,6* → 4: 10,7* → 5: 9,6 ↓
	Serie 40,0		Serie 45,0
	Totalt 137,0		Totalt 182,0
<b>Extratävling 3+3+4</b> 	6: 8,7 → 7: 10,3 ← 8: 9,1 ↖ 9: 9,7 ↖ 10: 10,7* ↗		
	Serie 46,0		
	Totalt 228,0		

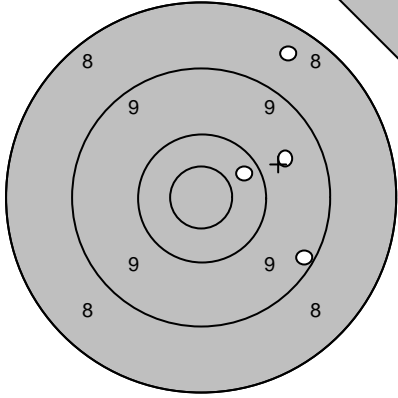
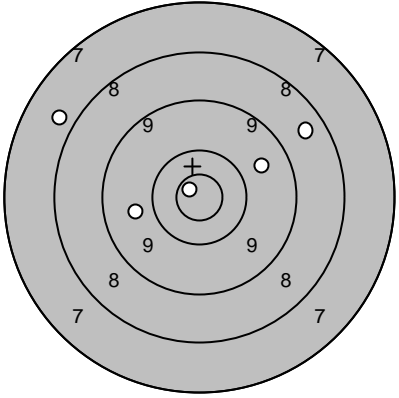
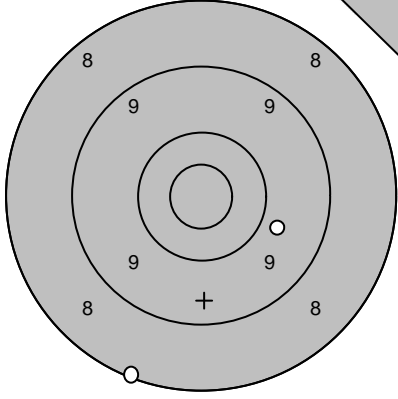
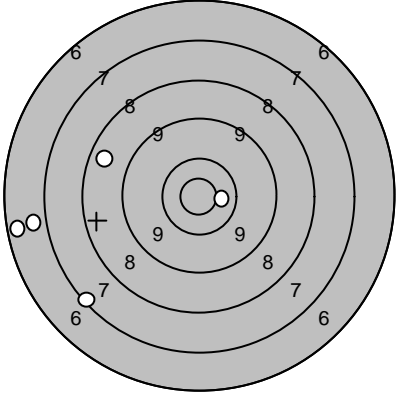
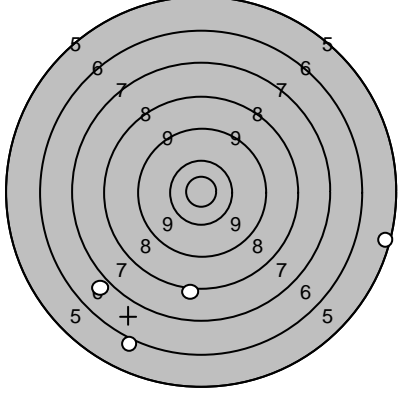
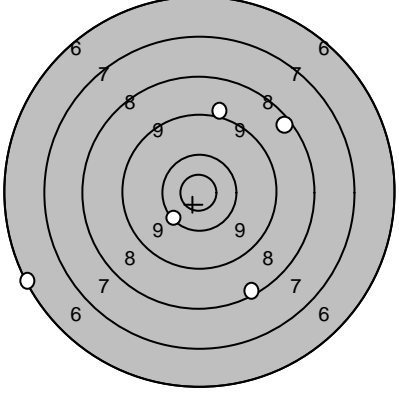
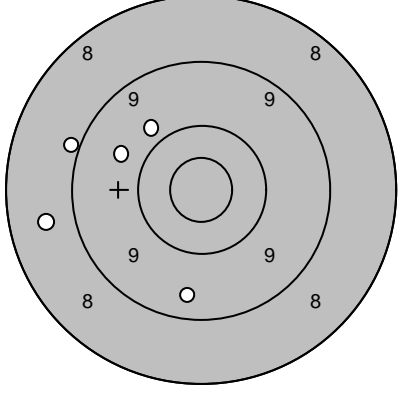
Skjutlag	Tavla	Alf Edin	
4	24	Ale	
2008-07-13	Tavelträffen B 2008	Ramselefors SKF	
<b>Provsnitt</b> 	1: 8,5 ↗ 2: 9,2 ↘ 3: 10,3 ↗ 4: 9,7 →	<b>Serie 1 (L)</b> 	1: 7,8 ↖ 2: 9,8 ← 3: 8,6 ↗ 4: 10,9* ↖ 5: 9,7 →
	Serie 36,0		Serie 43,0
	Totalt 0,0		Totalt 43,0
<b>Provsnitt</b> 	1: 8,1 ↓ 2: 9,8 →	<b>Serie 2 (K)</b> 	1: 6,9 ← 2: 6,5 ← 3: 10,6* → 4: 7,3 ↙ 5: 8,6 ↖
	Serie 17,0		Serie 37,0
	Totalt 43,0		Totalt 80,0
<b>Serie 3 (S)</b> 	1: 6,9 ↙ 2: 5,4 → 3: 0,0 ← 4: 6,1 ↙ 5: 8,1 ↓	<b>Extratävling 3+3+4</b> 	1: 8,3 ↓ 2: 8,4 ↗ 3: 6,2 ← 4: 10,2 ↙ 5: 9,0 ↑
	Serie 25,0		Serie 41,0
	Totalt 105,0		Totalt 146,0
<b>Extratävling 3+3+4</b> 	6: 8,7 ← 7: 9,9 ↗ 8: 9,7 ↖ 9: 9,0 ← 10: 9,5 ↓		
	Serie 44,0		
	Totalt 190,0		

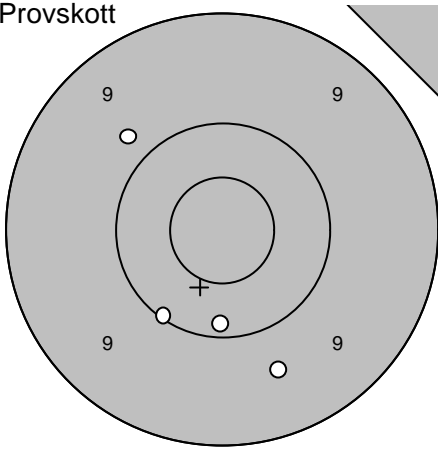
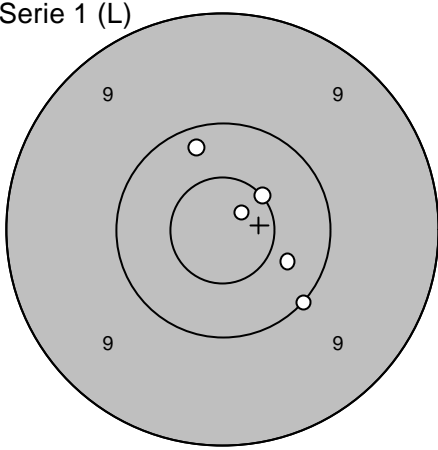
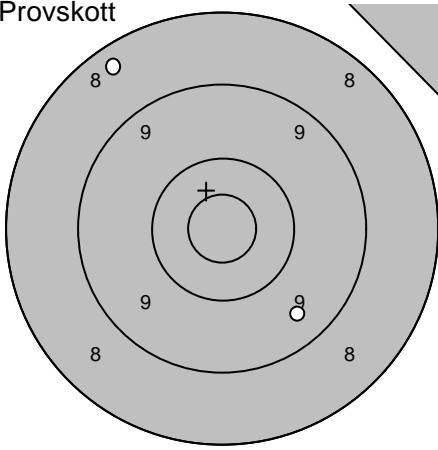
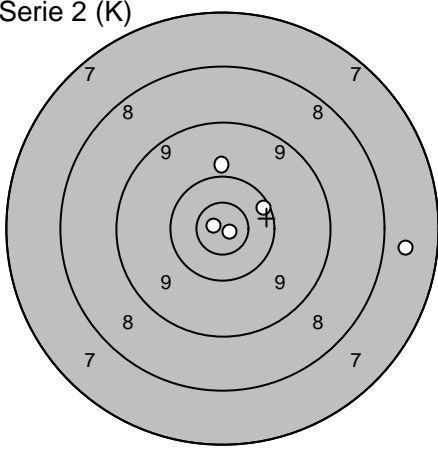
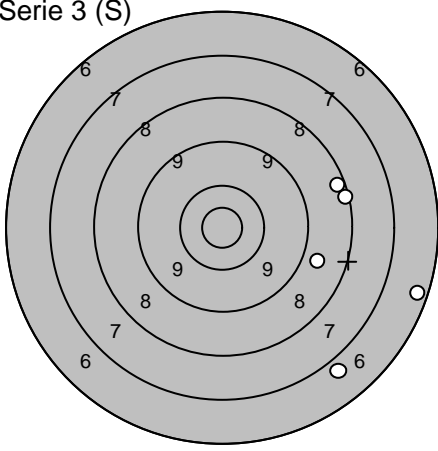
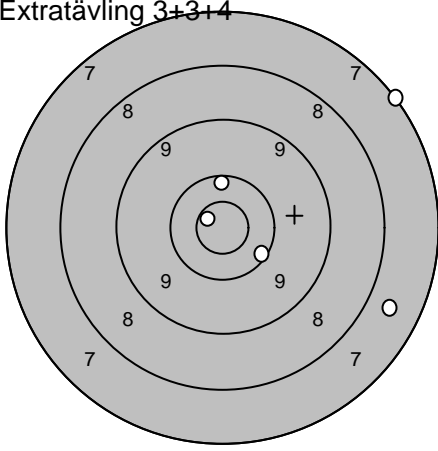
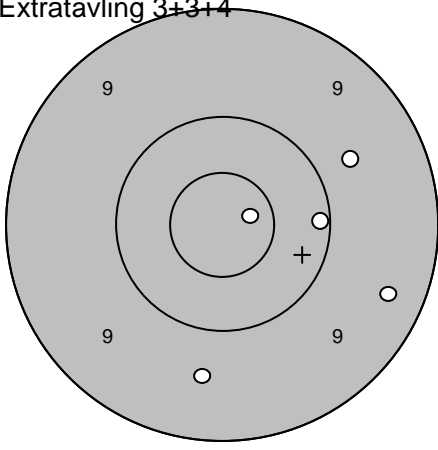
Skjutlag	Tavla	<b>Dan-Ivan Karlsson</b>	
<b>5</b>	<b>1</b>		
		Ramselefors	
2008-07-13	Tavelträffen B 2008	Ramselefors SKF	
Provskott		1: 9,8 ↖ 2: 10,1 ↙ 3: 10,2 ↓ 4: 9,6 ↘	Serie 1 (L) 
	Serie 38,0 Totalt 0,0	1: 10,5* ↗ 2: 10,8* ↗ 3: 10,0 ↘ 4: 10,4 ↘ 5: 10,2 ↑	Serie 50,0 Totalt 50,0
Provskott		1: 8,4 ↖ 2: 9,5 ↘	Serie 2 (K) 
	Serie 17,0 Totalt 50,0	1: 9,9 ↑ 2: 10,2 → 3: 10,9* → 4: 10,9* ← 5: 7,7 →	Serie 46,0 Totalt 96,0
Serie 3 (S)		1: 8,2 → 2: 8,8 → 3: 6,9 ↘ 4: 6,4 → 5: 8,3 →	Extratävling 3+3+4 
	Serie 36,0 Totalt 132,0	1: 10,3 ↑ 2: 7,7 → 3: 10,2 ↘ 4: 7,1 ↗ 5: 10,8* ←	Serie 44,0 Totalt 176,0
Extratävling 3+3+4		6: 10,8* → 7: 9,6 ↓ 8: 9,4 → 9: 9,7 → 10: 10,1 →	
	Serie 47,0 Totalt 223,0		

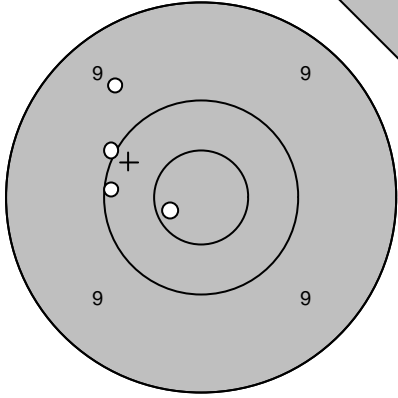
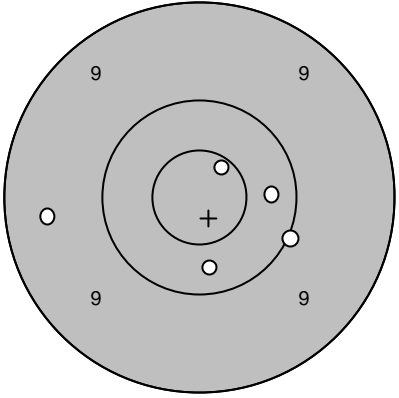
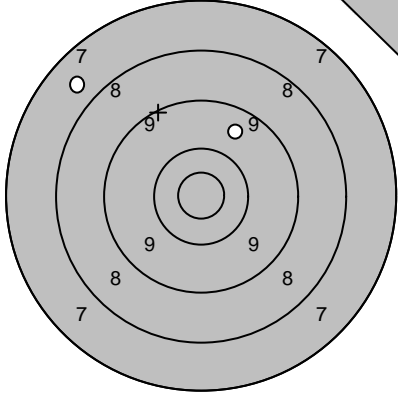
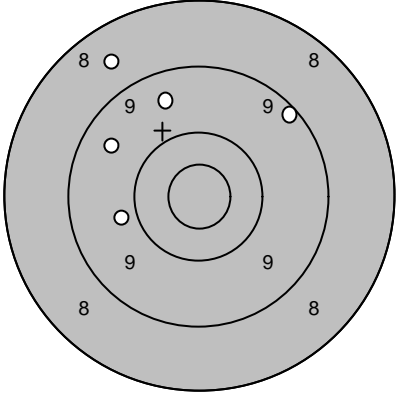
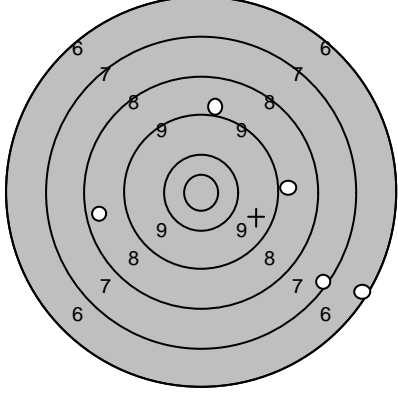
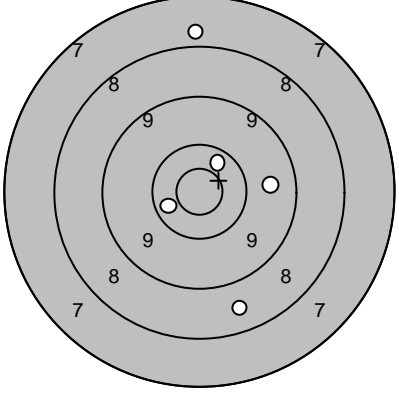
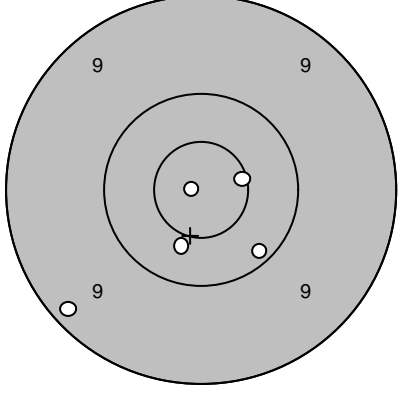
Skjutlag	Tavla	<b>Jan-Erik Karlsson</b>	
<b>5</b>	<b>2</b>	Ramselefors	
2008-07-13	Tavelträffen B 2008	Ramselefors SKF	
<b>Provskott</b> 	1: 9,6 ↗ 2: 10,1 ← 3: 10,0 ↗ 4: 10,7* ←	<b>Serie 1 (L)</b> 	1: 10,7* ↗ 2: 10,0 → 3: 10,3 ↓ 4: 9,5 ← 5: 10,3 →
	Serie 39,0		Serie 49,0
	Totalt 0,0		Totalt 49,0
<b>Provskott</b> 	1: 7,7 ↘ 2: 9,6 ↗	<b>Serie 2 (K)</b> 	1: 8,6 ↗ 2: 9,5 ↗ 3: 9,2 ↗ 4: 9,5 ↗ 5: 9,8 ←
	Serie 16,0		Serie 44,0
	Totalt 49,0		Totalt 93,0
<b>Serie 3 (S)</b> 	1: 8,9 → 2: 6,3 → 3: 9,0 ↑ 4: 7,3 ↓ 5: 8,5 ←	<b>Extratävling 3+3+4</b> 	1: 9,7 → 2: 10,4 ↗ 3: 8,6 ↓ 4: 7,9 ↑ 5: 10,4 ←
	Serie 38,0		Serie 44,0
	Totalt 131,0		Totalt 175,0
<b>Extratävling 3+3+4</b> 	6: 10,6* → 7: 10,4 ↓ 8: 9,2 ↙ 9: 10,9* ← 10: 10,2 ↓		
	Serie 49,0		
	Totalt 224,0		

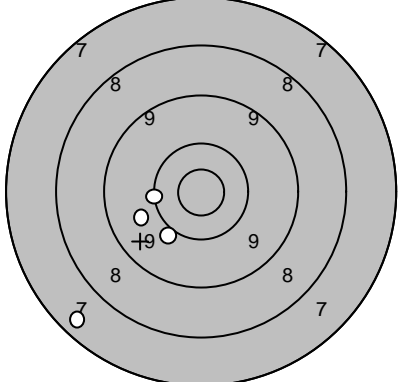
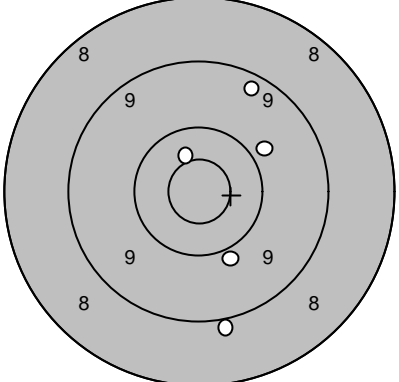
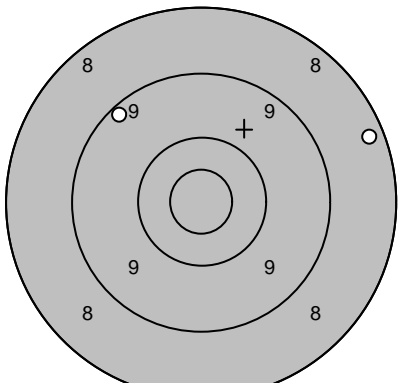
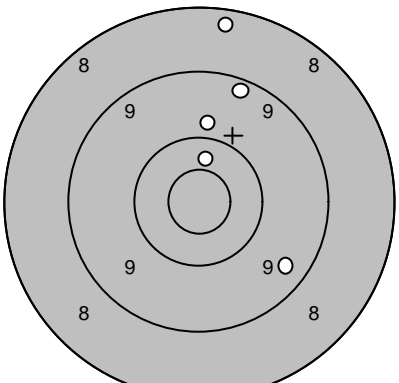
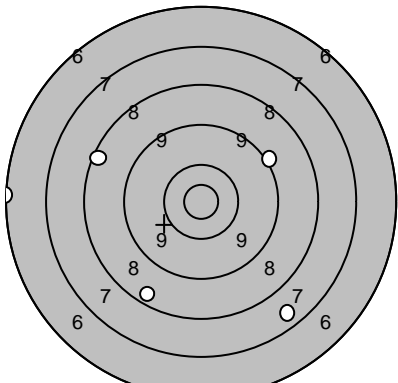
Skjutlag	Tavla	<b>Erik Sigfridsson</b>	
<b>5</b>	<b>3</b>		
		Ramselefors	
2008-07-13	Tavelträffen B 2008	Ramselefors SKF	
Provskott 	1: 7,5 ↙	Serie 1 (L) 	1: 9,0 ↓
	2: 10,0 ↓		2: 9,9 ↓
	3: 10,2 ←		3: 9,9 ↗
	4: 9,8 ←		4: 9,3 ↗
			5: 10,5* ↗
	Serie 36,0		Serie 46,0
	Totalt 0,0		Totalt 46,0
Provskott 	1: 8,3 →	Serie 2 (K) 	1: 8,3 ↑
	2: 9,2 ↖		2: 9,3 ↗
			3: 9,4 ↘
			4: 10,4 ↑
			5: 9,9 ↑
	Serie 17,0		Serie 45,0
	Totalt 46,0		Totalt 91,0
Serie 3 (S) 	1: 7,6 ↘		
	2: 6,1 ←		
	3: 8,3 ↖		
	4: 8,4 ↓		
	5: 9,1 ↗		
	Serie 38,0		
	Totalt 129,0		

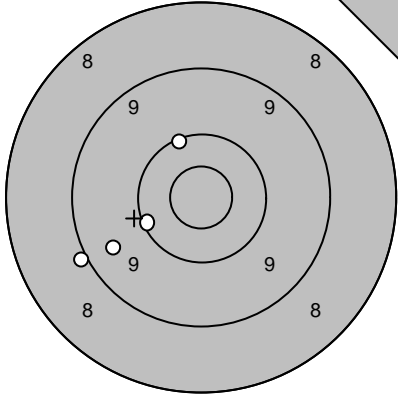
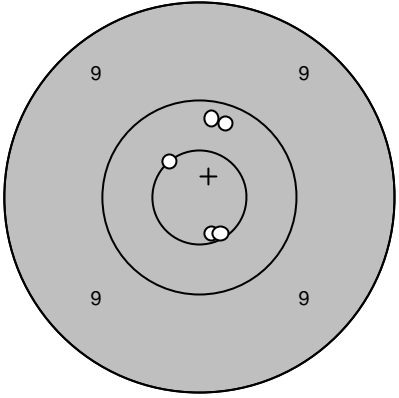
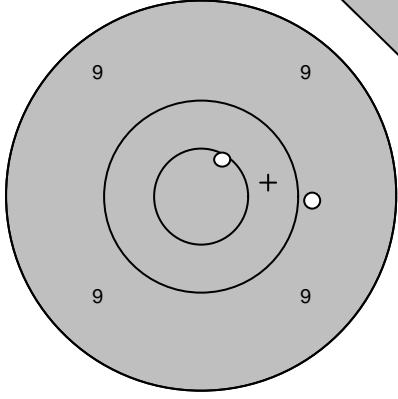
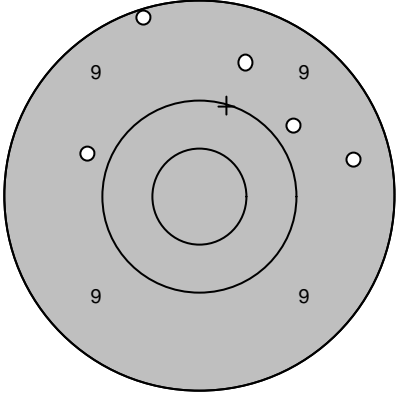
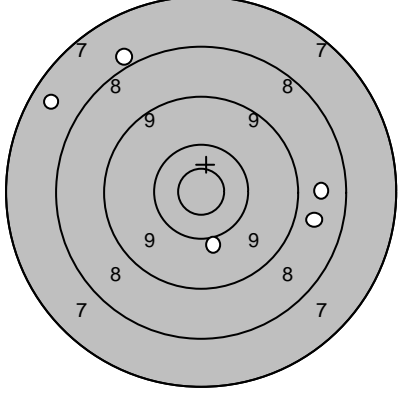
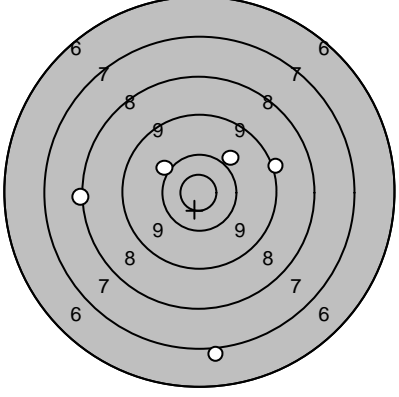
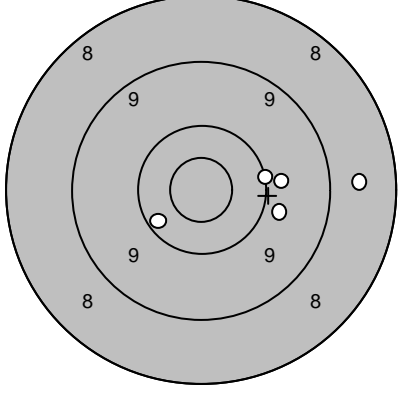

Skjutlag	Tavla	<b>Peder Vahlberg</b>	
<b>5</b>	<b>4</b>		
Ramselefors			
2008-07-13	Tavelträffen B 2008	Ramselefors SKF	
<b>Provkott</b> 	1: 10,2 ↗ 2: 9,5 ↙ 3: 9,0 ↙ 4: 10,2 ↙  <b>Serie</b> 38,0 <b>Totalt</b> 0,0	<b>Serie 1 (L)</b> 	1: 10,2 ↗ 2: 10,2 ↗ 3: 10,7* ↘ 4: 10,6* ↗ 5: 10,6* ↘  <b>Serie</b> 50,0 <b>Totalt</b> 50,0
<b>Provkott</b> 	1: 10,6* ↗ 2: 9,9 →  <b>Serie</b> 19,0 <b>Totalt</b> 50,0	<b>Serie 2 (K)</b> 	1: 9,1 ↗ 2: 9,8 ↗ 3: 9,6 ↗ 4: 9,8 ↙ 5: 9,4 →  <b>Serie</b> 45,0 <b>Totalt</b> 95,0
<b>Serie 3 (S)</b> 	1: 10,0 ↘ 2: 7,9 ↗ 3: 7,6 ↗ 4: 8,7 → 5: 8,7 →  <b>Serie</b> 40,0 <b>Totalt</b> 135,0	<b>Extratävling 3+3+4</b> 	1: 7,0 ↘ 2: 9,1 → 3: 8,1 ↙ 4: 10,0 ↗ 5: 10,1 ↙  <b>Serie</b> 44,0 <b>Totalt</b> 179,0
<b>Extratävling 3+3+4</b> 	6: 8,7 → 7: 9,9 → 8: 10,3 ↙ 9: 10,1 → 10: 9,8 →  <b>Serie</b> 46,0 <b>Totalt</b> 225,0		

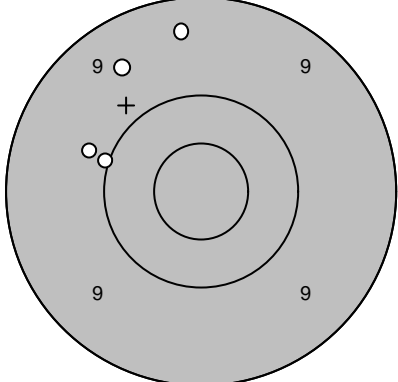
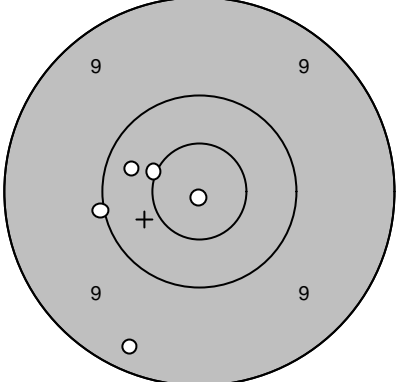
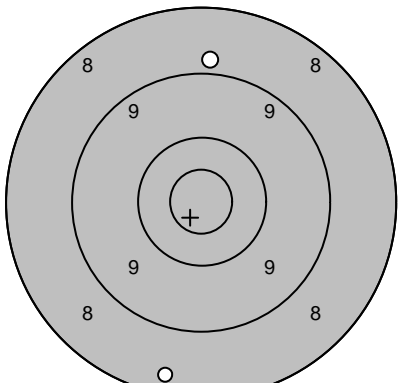
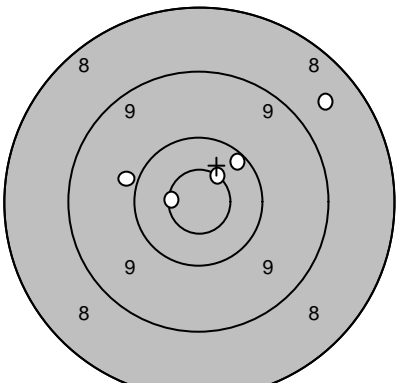
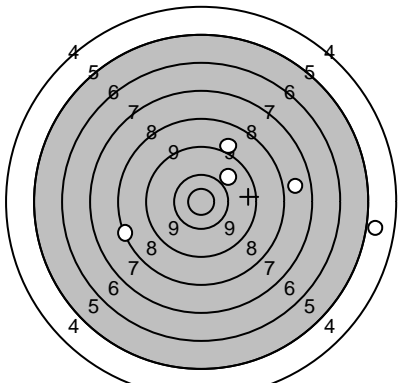
Skjutlag	Tavla	<b>Kjell Marklund</b>			
<b>5</b>	<b>6</b>				
		S 3			
2008-07-13	Tavelträffen B 2008	Ramselefors SKF			
<b>Provskott</b> 	1: 10,0 ← 2: 9,4 ↑ 3: 9,8 ← 4: 9,5 ↑	<b>Serie 1 (L)</b> 	1: 10,5* ← 2: 10,3 ← 3: 10,9* ↓ 4: 9,3 ↓ 5: 10,0 ←		
	Serie		37,0	Serie	49,0
	Totalt		0,0	Totalt	49,0
<b>Provskott</b> 	1: 8,4 ↓ 2: 8,9 ↑	<b>Serie 2 (K)</b> 	1: 10,7* ← 2: 10,6* ↗ 3: 8,6 ↗ 4: 9,9 ← 5: 10,2 ↗		
	Serie		16,0	Serie	47,0
	Totalt		49,0	Totalt	96,0
<b>Serie 3 (S)</b> 	1: 9,9 ↗ 2: 9,0 ↑ 3: 4,9 → 4: 7,8 → 5: 8,3 ←				
	Serie	37,0			
	Totalt	133,0			

Skjutlag

Tavla

5

7

## Hampus Stenlund

I 19 / A 9

2008-07-13

Tavelträffen B 2008

Ramselefors SKF

Provskott

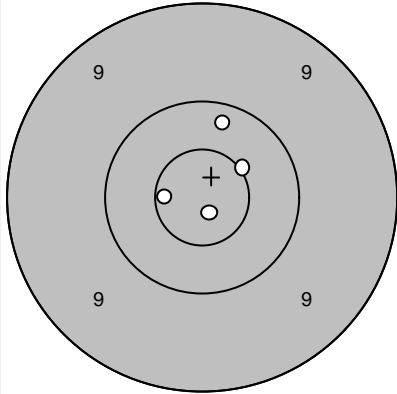

1: 10,5\* ↗  
 2: 10,9\* ↓  
 3: 10,7\* ←  
 4: 10,2 ↑

Serie 1 (L)

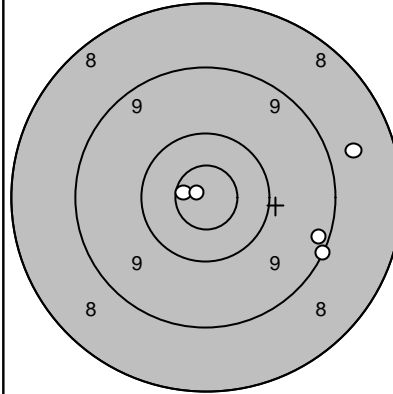

1: 9,1 ↘  
 2: 10,7\* ←  
 3: 9,2 ↘  
 4: 8,7 →  
 5: 10,9\* ←

Serie 40,0

Totalt 0,0

Serie 46,0

Totalt 46,0

Provskott

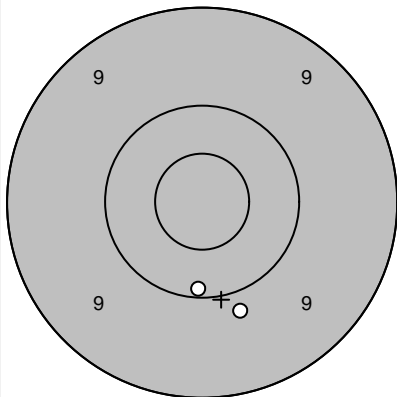

1: 10,2 ↓  
 2: 9,9 ↓

Serie 2 (K)

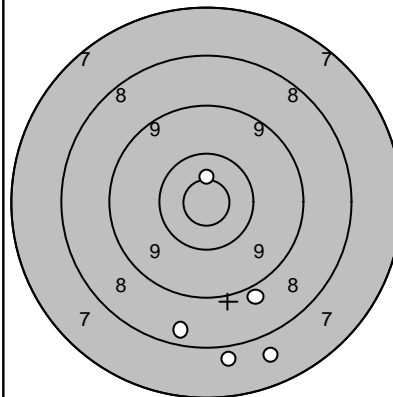

1: 10,6\* ↑  
 2: 7,9 ↓  
 3: 7,7 ↓  
 4: 8,4 ↓  
 5: 8,9 ↓

Serie 19,0

Totalt 46,0

Serie 40,0

Totalt 86,0

Serie 3 (S)

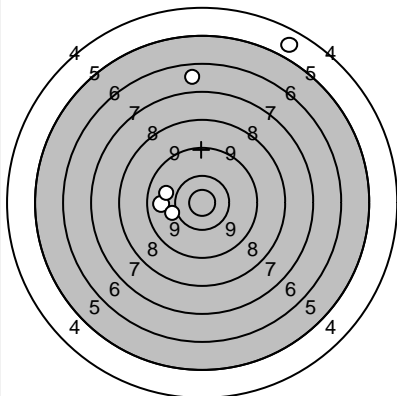

1: 4,8 ↗  
 2: 9,8 ←  
 3: 10,1 ←  
 4: 9,9 ←  
 5: 6,8 ↑

Serie 38,0

Totalt 124,0

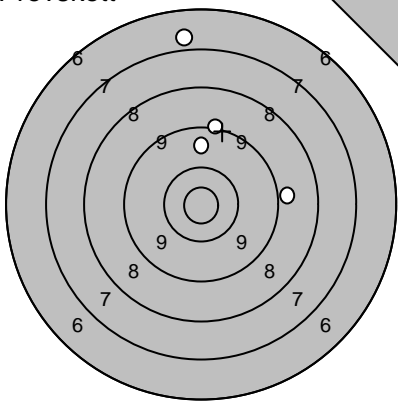
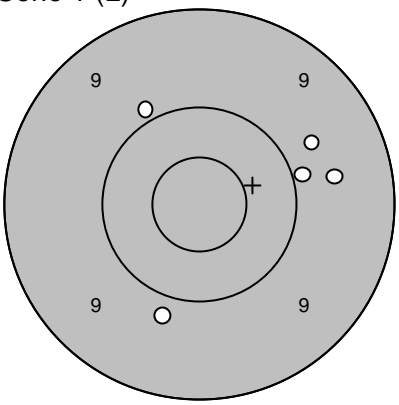
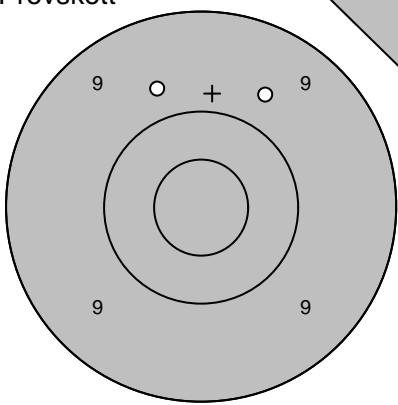
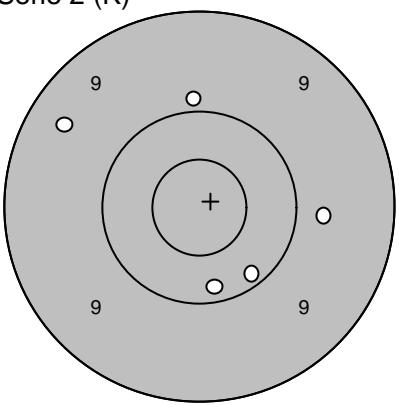
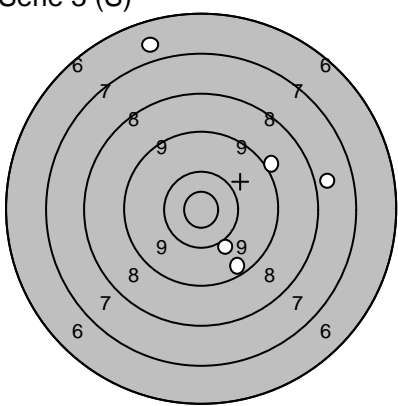
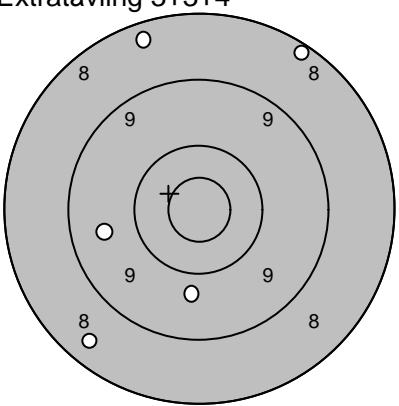
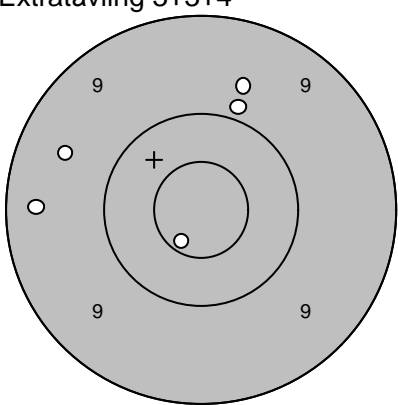
Skjutlag	Tavla	<b>Gunnar Iversen</b>		
<b>5</b>	<b>8</b>			
S 3				
2008-07-13	Tavelträffen B 2008	Ramselefors SKF		
Provkott		1: 6,9 ↑ 2: 9,1 ↑ 3: 9,7 ↑ 4: 8,9 →	Serie 1 (L) 	1: 9,8 ↓ 2: 9,6 → 3: 9,7 ↗ 4: 9,9 ↗ 5: 9,9 →
		Serie 32,0 Totalt 0,0		Serie 45,0 Totalt 45,0
Provkott		1: 9,7 ↗ 2: 9,7 ↗	Serie 2 (K) 	1: 10,2 ↓ 2: 9,4 ↗ 3: 9,9 ↑ 4: 10,2 ↓ 5: 9,8 →
		Serie 18,0 Totalt 45,0		Serie 47,0 Totalt 92,0
Serie 3 (S)		1: 9,4 ↓ 2: 10,0 ↓ 3: 6,8 ↑ 4: 9,1 ↗ 5: 7,9 →	Extratävling 3+3+4 	1: 8,4 ↑ 2: 8,5 ↓ 3: 8,2 ↗ 4: 9,6 ← 5: 9,8 ↓
		Serie 41,0 Totalt 133,0		Serie 42,0 Totalt 175,0
Extratävling 3+3+4		6: 9,5 ← 7: 9,4 ← 8: 10,7* ↓ 9: 9,7 ↑ 10: 9,9 ↗		
		Serie 46,0 Totalt 221,0		

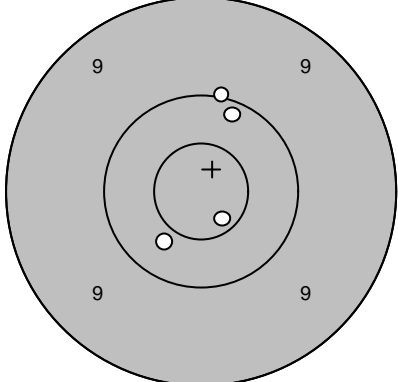
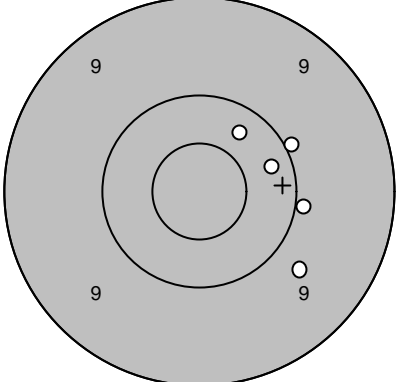
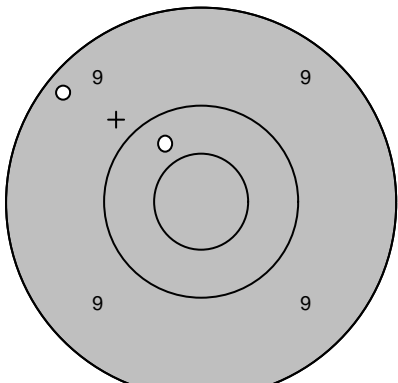
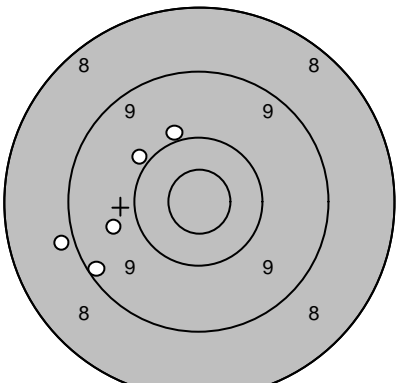
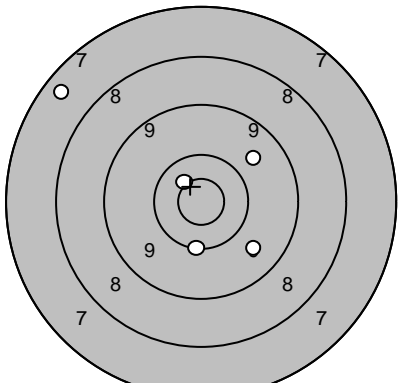
Skjutlag	Tavla	<b>Camilla Lindfors</b>			
<b>5</b>	<b>9</b>				
		I 19 / A 9			
2008-07-13	Tavelträffen B 2008	Ramselefors SKF			
Provs-kott 	1: 10,4 ↙ 2: 10,2 ↗ 3: 10,0 ↗ 4: 10,7* ↘	Serie 1 (L) 	1: 10,3 ↗ 2: 10,0 → 3: 10,0 ↗ 4: 10,3 → 5: 9,7 ↘		
	Serie		40,0	Serie	49,0
	Totalt		0,0	Totalt	49,0
Provs-kott 	1: 10,3 ↗ 2: 9,2 ↗	Serie 2 (K) 	1: 9,9 ↖ 2: 8,9 ← 3: 10,0 ↗ 4: 9,2 ← 5: 9,7 ←		
	Serie		19,0	Serie	45,0
	Totalt		49,0	Totalt	94,0
Serie 3 (S) 	1: 9,7 ↗ 2: 10,6* ↗ 3: 10,2 ↓ 4: 7,5 ↗ 5: 9,7 ↘				
	Serie	45,0			
	Totalt	139,0			

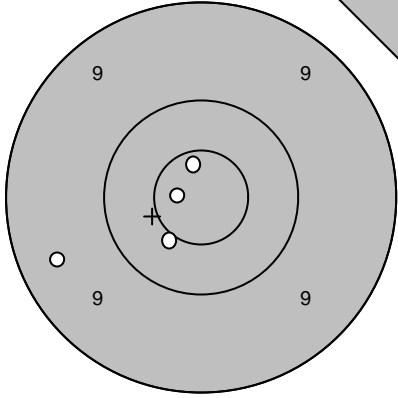
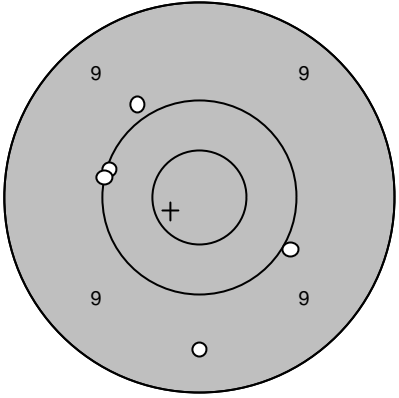
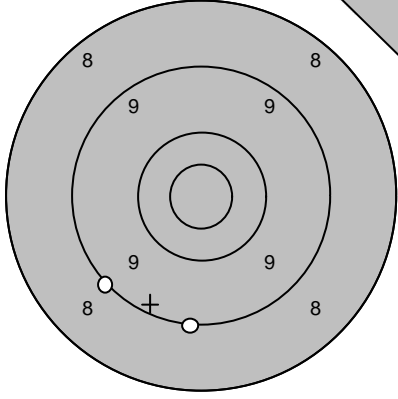
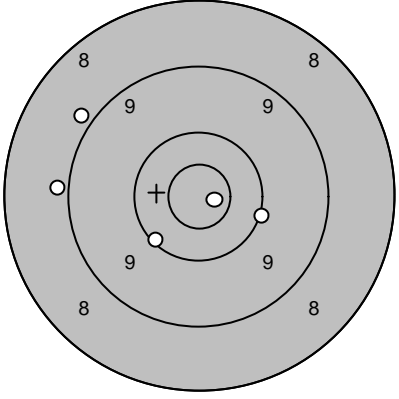
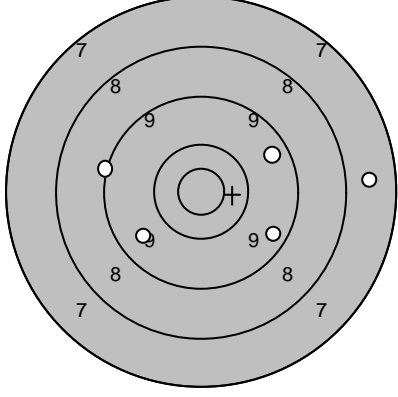
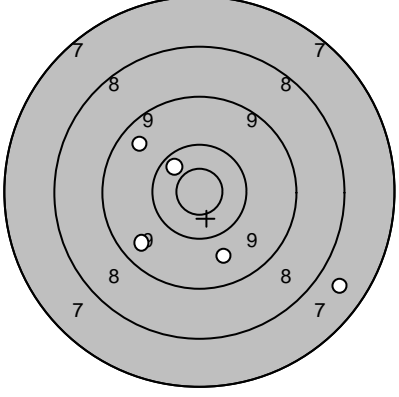
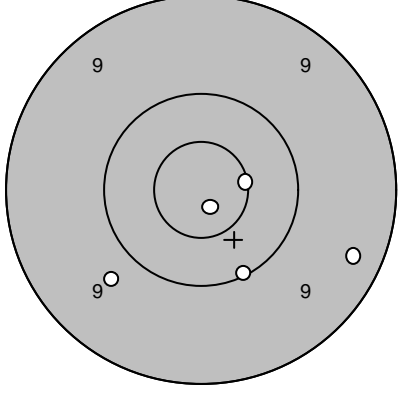
Skjutlag	Tavla	<b>Roger Strand</b>		
<b>5</b>	<b>10</b>			
Mariestad				
2008-07-13	Tavelträffen B 2008	Ramselefors SKF		
Provskott		1: 10,5* ↘ 2: 9,4 ← 3: 10,8* ← 4: 10,7* ↑	Serie 1 (L) 	1: 10,1 ← 2: 10,0 ↘ 3: 9,9 ↗ 4: 10,1 ← 5: 9,5 ↓
	Serie 39,0 Totalt 0,0		Serie 48,0 Totalt 48,0	
Provskott		1: 9,1 ↓ 2: 9,1 ↙	Serie 2 (K) 	1: 10,8* → 2: 8,9 ← 3: 10,1 ↘ 4: 8,9 ↗ 5: 10,1 ↙
	Serie 18,0 Totalt 48,0		Serie 46,0 Totalt 94,0	
Serie 3 (S)		1: 9,4 → 2: 9,5 ↗ 3: 9,1 ← 4: 9,6 ↙ 5: 7,7 →	Extratävling 3+3+4 	1: 7,7 ↘ 2: 9,6 ↙ 3: 9,5 ↗ 4: 9,7 ↙ 5: 10,4 ↗
	Serie 43,0 Totalt 137,0		Serie 44,0 Totalt 181,0	
Extratävling 3+3+4		6: 9,7 ↙ 7: 9,3 → 8: 10,1 ↘ 9: 10,6* → 10: 10,8* ↘		
	Serie 48,0 Totalt 229,0			

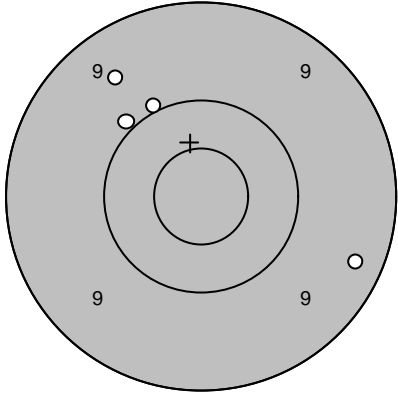
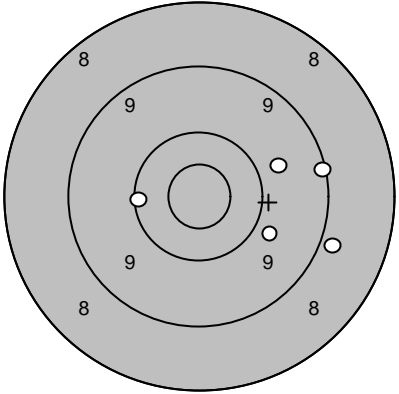
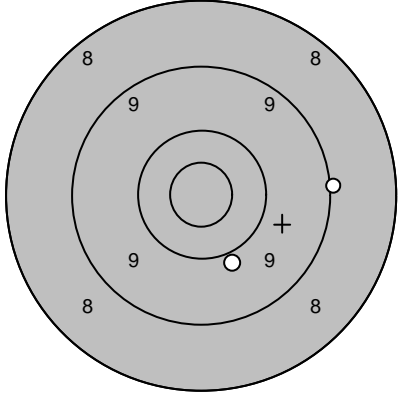
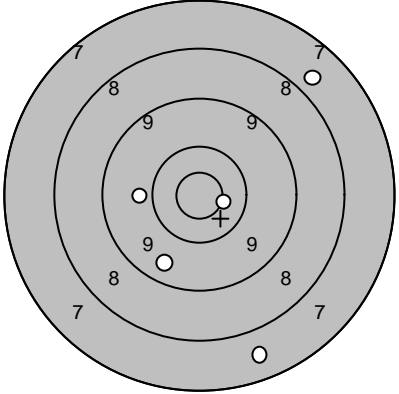
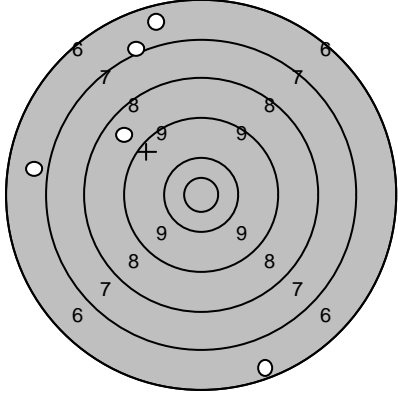
Skjutlag	Tavla	<b>Bror Rantakyrö</b>	
<b>5</b>	<b>11</b>		
		Pello	
2008-07-13	Tavelträffen B 2008	Ramselefors SKF	
Provskott		1: 10,0 ↖ 2: 9,5 ↗ 3: 10,0 ↗ 4: 9,3 ↘	Serie 1 (L) 
		Serie 38,0 Totalt 0,0	1: 10,2 ← 2: 8,9 ↘ 3: 9,8 ↗ 4: 9,9 ↘ 5: 9,1 →
			Serie 45,0 Totalt 45,0
Provskott		1: 9,9 ↓ 2: 9,0 →	Serie 2 (K) 
		Serie 18,0 Totalt 45,0	1: 9,6 ↓ 2: 10,6* → 3: 9,9 ← 4: 7,8 ↗ 5: 7,6 ↓
			Serie 42,0 Totalt 87,0
Serie 3 (S)		1: 7,1 ↖ 2: 6,4 ↓ 3: 6,6 ↗ 4: 8,7 ↗ 5: 6,8 ←	
		Serie 33,0 Totalt 120,0	

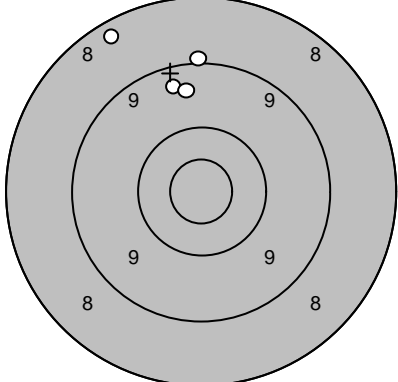
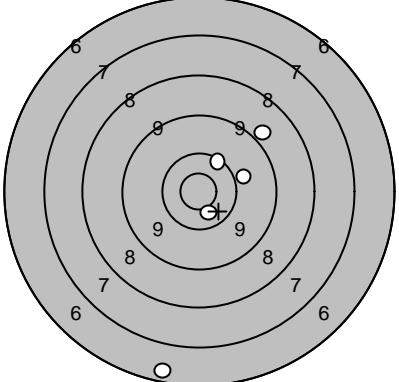
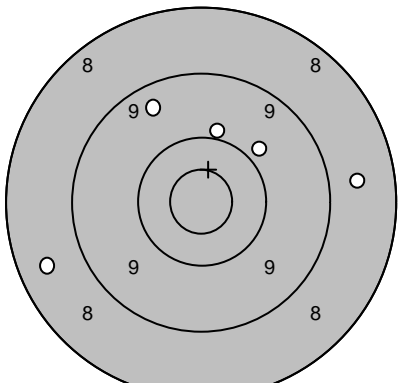
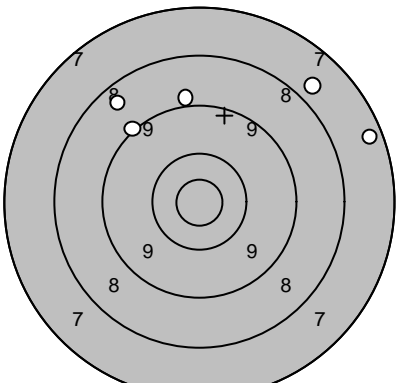
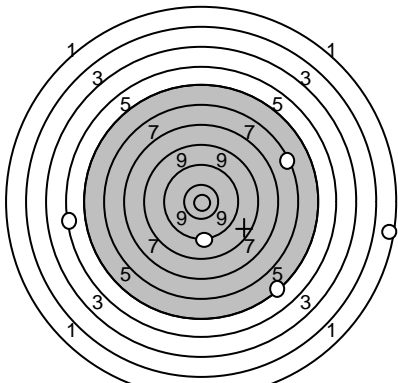
Skjutlag	Tavla		
<b>5</b>	<b>12</b>	<b>Ivar Larsson</b>	
		Närkes Kil	
2008-07-13	Tavelträffen B 2008	Ramselefors SKF	
Provskott		1: 8,3 ↖ 2: 9,0 ↑ 3: 9,4 ↑ 4: 9,5 ↑	Serie 1 (L) 
			1: 10,3 ↗ 2: 10,0 → 3: 9,0 ↗ 4: 6,5 ↓ 5: 10,6* ↓
		Serie 35,0	Serie 45,0
		Totalt 0,0	Totalt 45,0
Provskott		1: 9,9 ↗ 2: 8,7 → 3: 8,5 ← 4: 10,0 ↑ 5: 9,5 ↖	Serie 2 (K) 
			1: 9,1 ↖ 2: 9,0 ↑ 3: 8,5 ↖ 4: 7,8 ↗ 5: 7,4 →
		Serie 44,0	Serie 40,0
		Totalt 45,0	Totalt 85,0
Serie 3 (S)		1: 9,4 ↓ 2: 4,5 ← 3: 6,5 → 4: 1,6 → 5: 5,4 ↘	
		Serie 25,0	
		Totalt 110,0	

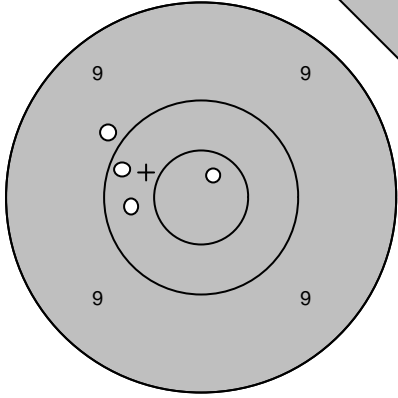
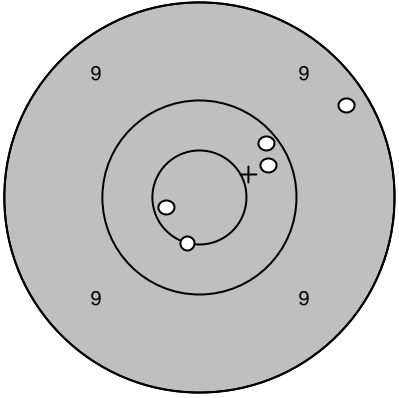
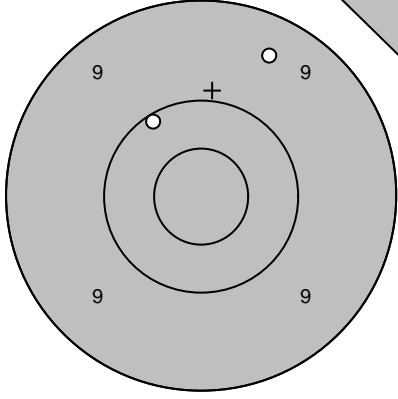
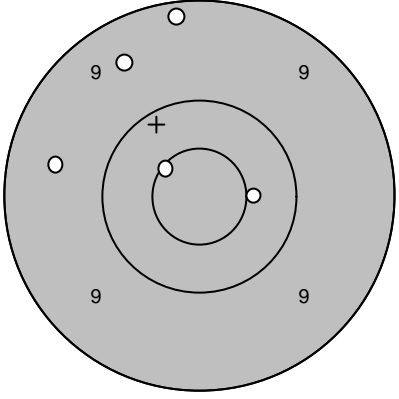
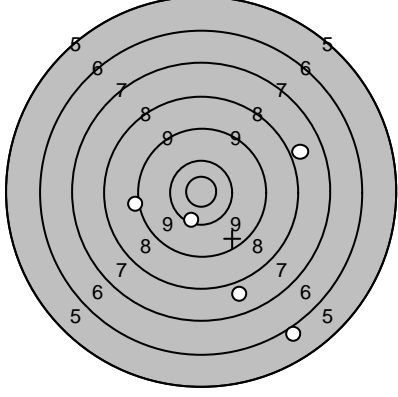
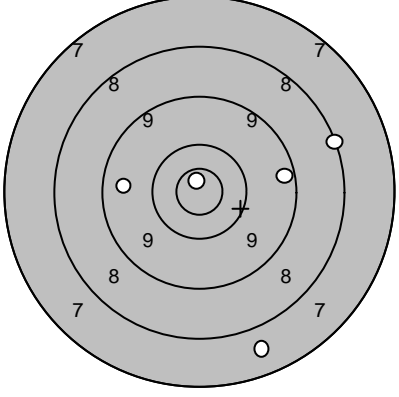
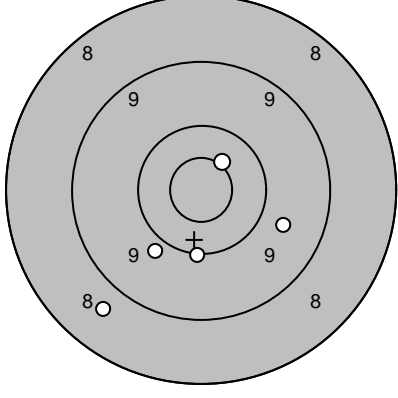

Skjutlag	Tavla	Henry Lindström		
5	14	I 19 / A 9		
2008-07-13	Tavelträffen B 2008	Ramselefors SKF		
Provskott		1: 10,2 ← 2: 10,8* ↗ 3: 10,3 ← 4: 9,9 ↖	Serie 1 (L) 	1: 10,3 → 2: 10,6* ↓ 3: 10,1 ↗ 4: 9,3 ↗ 5: 10,7* ←
	Serie 39,0		Serie 49,0	
	Totalt 0,0		Totalt 49,0	
Provskott		1: 9,4 ↗ 2: 10,1 ↖	Serie 2 (K) 	1: 9,2 ↑ 2: 10,6* ↖ 3: 9,5 ↗ 4: 9,5 ← 5: 10,5* →
	Serie 19,0		Serie 47,0	
	Totalt 49,0		Totalt 96,0	
Serie 3 (S)		1: 10,3 ↓ 2: 9,1 ← 3: 6,0 ↓ 4: 7,8 ↓ 5: 7,9 →	Extratävling 3+3+4 	1: 7,7 ↓ 2: 8,2 → 3: 9,3 → 4: 10,9* ↑ 5: 9,6 ←
	Serie 39,0		Serie 43,0	
	Totalt 135,0		Totalt 178,0	
Extratävling 3+3+4		6: 8,7 ↙ 7: 9,9 ↙ 8: 9,7 → 9: 10,5* ↗ 10: 10,1 ↓		
	Serie 46,0			
	Totalt 224,0			

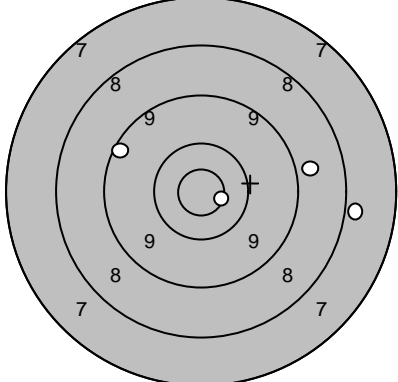
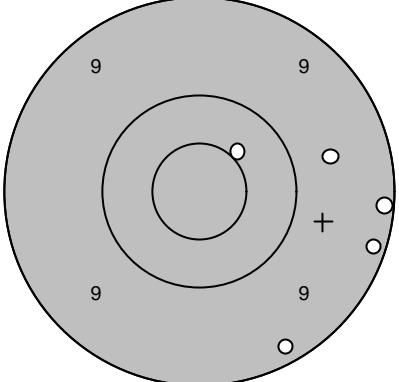
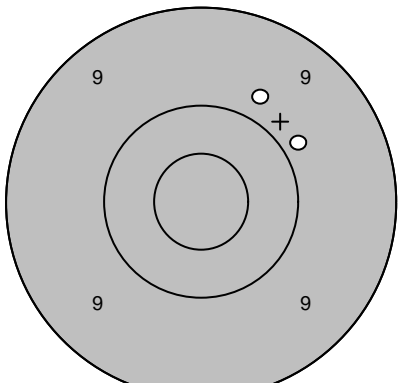
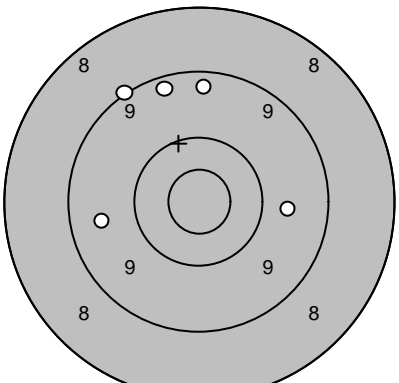
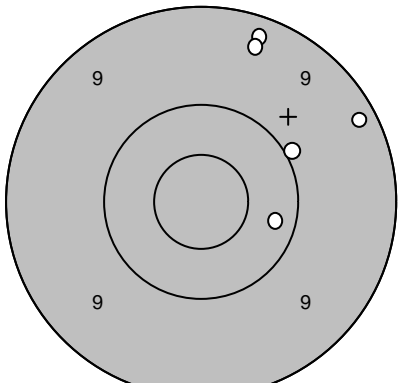

Skjutlag	Tavla		
<b>5</b>	<b>16</b>	<b>Ingvar Uusitalo</b>	
		Pello	
2008-07-13	Tavelträffen B 2008	Ramselefors SKF	
Provs-kott		1: 7,9 → 2: 10,7* → 3: 8,8 → 4: 9,3 ↖	Serie 1 (L) 
			1: 9,1 → 2: 9,6 → 3: 10,5* ↗ 4: 9,2 → 5: 9,2 ↓
		Serie 34,0	Serie 46,0
		Totalt 0,0	Totalt 46,0
Provs-kott		1: 9,9 ↗ 2: 9,8 ↗	Serie 2 (K) 
			1: 9,3 ↑ 2: 9,3 ↑ 3: 9,6 ← 4: 9,1 ↗ 5: 9,7 →
		Serie 18,0	Serie 45,0
		Totalt 46,0	Totalt 91,0
Serie 3 (S)		1: 9,2 ↗ 2: 10,0 ↗ 3: 9,3 ↑ 4: 10,3 → 5: 9,4 ↗	
		Serie 47,0	
		Totalt 138,0	

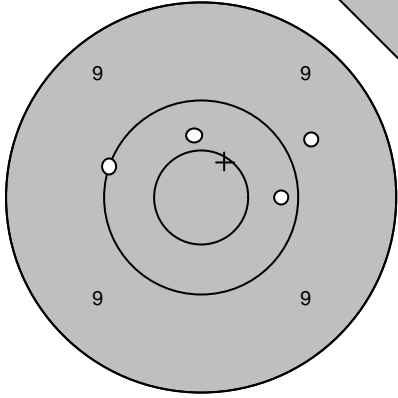
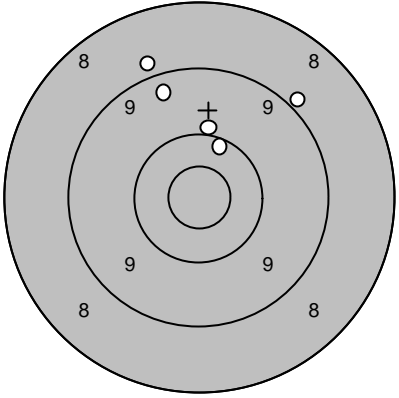
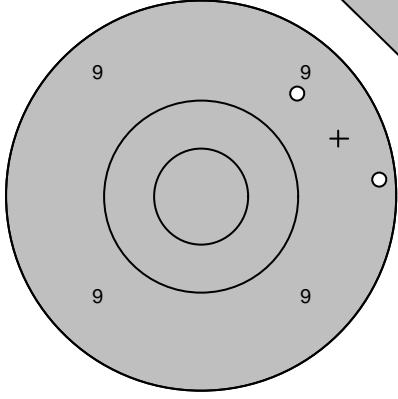
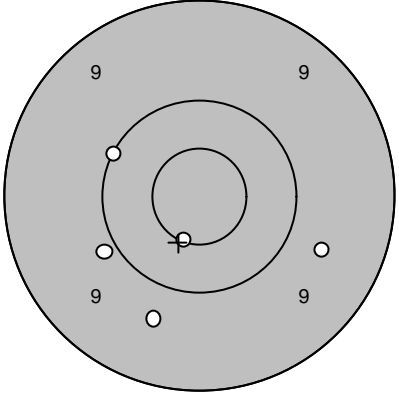
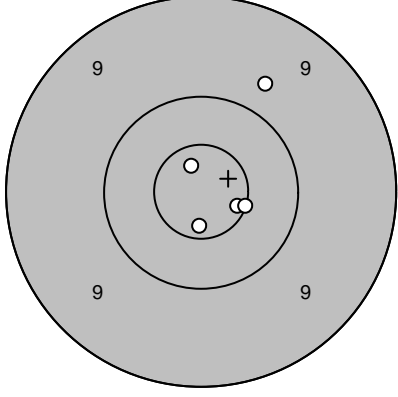
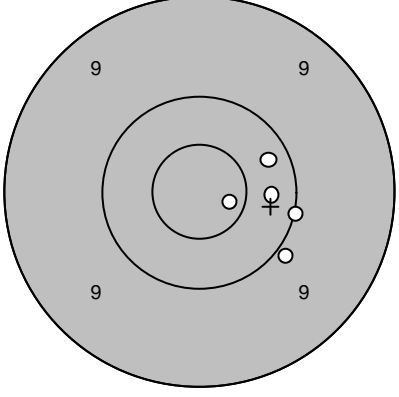
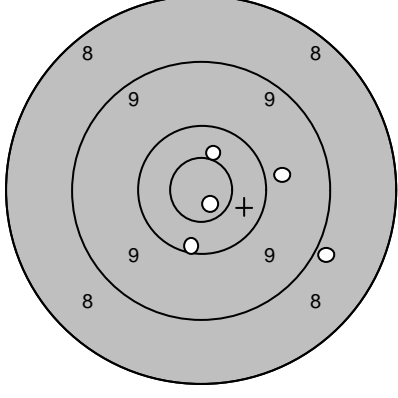

Skjutlag	Tavla		
<b>5</b>	<b>18</b>	<b>Håkan Lidman</b>	
		Skellefteå	
2008-07-13	Tavelträffen B 2008	Ramselefors SKF	
Provkott		1: 10,2 → 2: 10,1 ← 3: 10,4 ↑ 4: 9,8 →	Serie 1 (L) 
			1: 8,9 ↖ 2: 10,2 ↑ 3: 10,0 ↑ 4: 9,0 ↗ 5: 9,4 ↖
		Serie 39,0	Serie 46,0
		Totalt 0,0	Totalt 46,0
Provkott		1: 9,6 ↗ 2: 9,2 →	Serie 2 (K) 
			1: 10,6* ↓ 2: 10,1 ← 3: 9,9 ↙ 4: 9,7 → 5: 9,7 ↓
		Serie 18,0	Serie 47,0
		Totalt 46,0	Totalt 93,0
Serie 3 (S)		1: 10,6* → 2: 9,8 ↗ 3: 10,7* ↓ 4: 10,8* ↑ 5: 10,6* →	Extratävling 3+3+4 
			1: 10,3 → 2: 10,2 → 3: 10,0 → 4: 10,7* → 5: 9,9 ↘
		Serie 49,0	Serie 49,0
		Totalt 142,0	Totalt 191,0
Extratävling 3+3+4		6: 10,5* ↑ 7: 10,8* ↓ 8: 8,9 ↘ 9: 9,8 → 10: 10,2 ↓	
		Serie 47,0	
		Totalt 238,0	

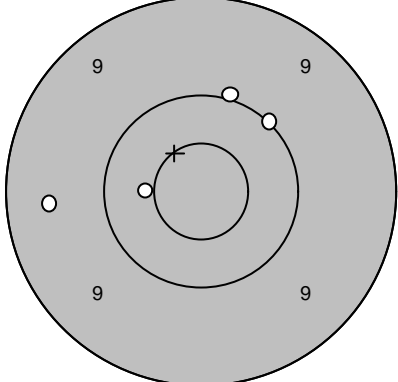
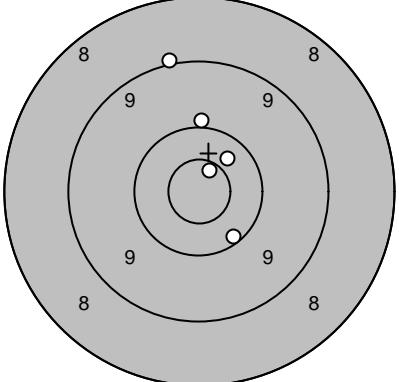
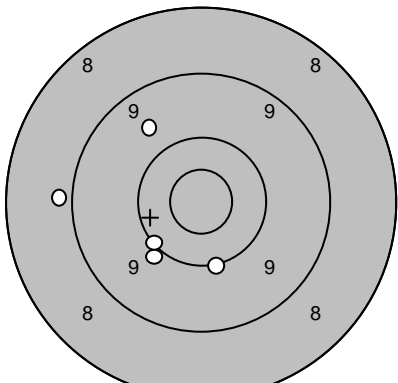
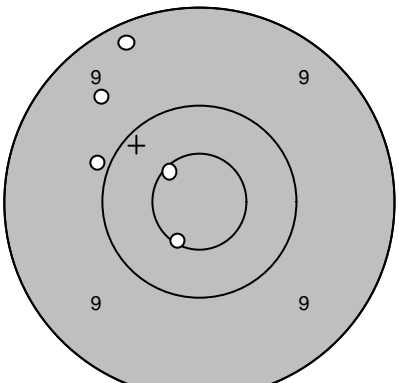
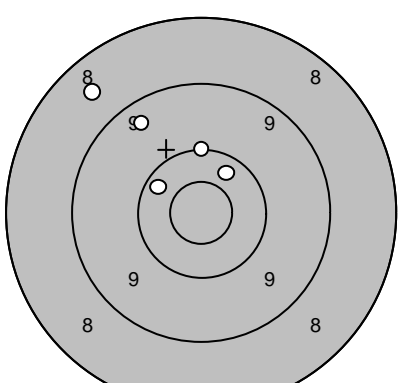
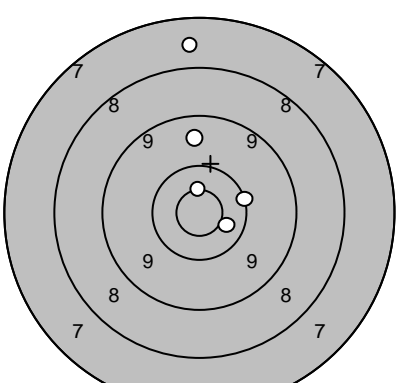
Skjutlag	Tavla	<b>Tommy Lundqvist</b>		
<b>5</b>	<b>19</b>			
		Ununge		
2008-07-13	Tavelträffen B 2008	Ramselefors SKF		
Provskott		1: 10,5* ← 2: 9,5 ← 3: 10,0 ↑ 4: 10,0 ↗	Serie 1 (L) 	1: 10,2 ↘ 2: 10,4 ↗ 3: 10,0 ↑ 4: 9,0 ↑ 5: 10,7* ↗
		Serie 39,0		Serie 49,0
		Totalt 0,0		Totalt 49,0
Serie 2 (K)		1: 10,0 ↘ 2: 10,1 ↘ 3: 8,9 ← 4: 9,7 ↗ 5: 10,1 ↘	Serie 3 (S) 	1: 9,6 ↗ 2: 9,3 ↗ 3: 10,6* ↗ 4: 10,6* ↘ 5: 9,9 ←
		Serie 47,0		Serie 47,0
		Totalt 96,0		Totalt 143,0
Extratävling 3+3+4		1: 9,4 ↗ 2: 10,4 ↗ 3: 10,3 ↗ 4: 10,1 ↑ 5: 8,6 ↗	Extratävling 3+3+4 	6: 7,7 ↑ 7: 10,6* ↑ 8: 10,5* → 9: 10,1 → 10: 9,6 ↑
		Serie 47,0		Serie 46,0
		Totalt 190,0		Totalt 236,0

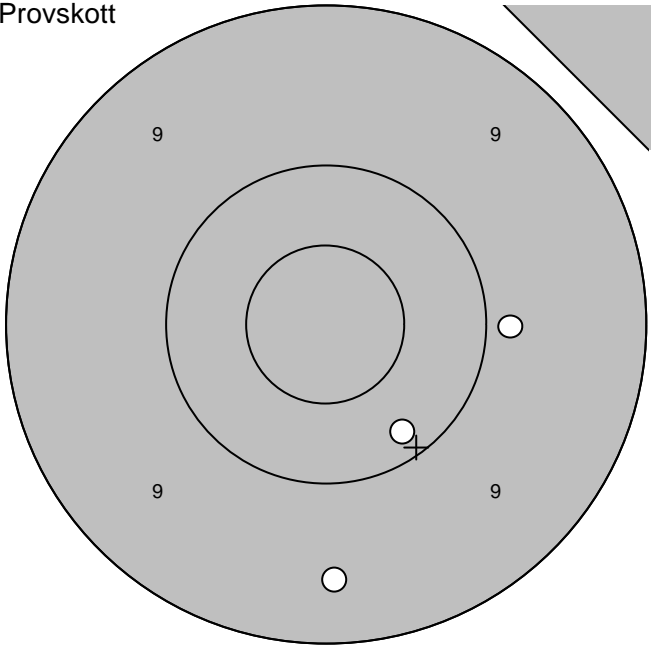
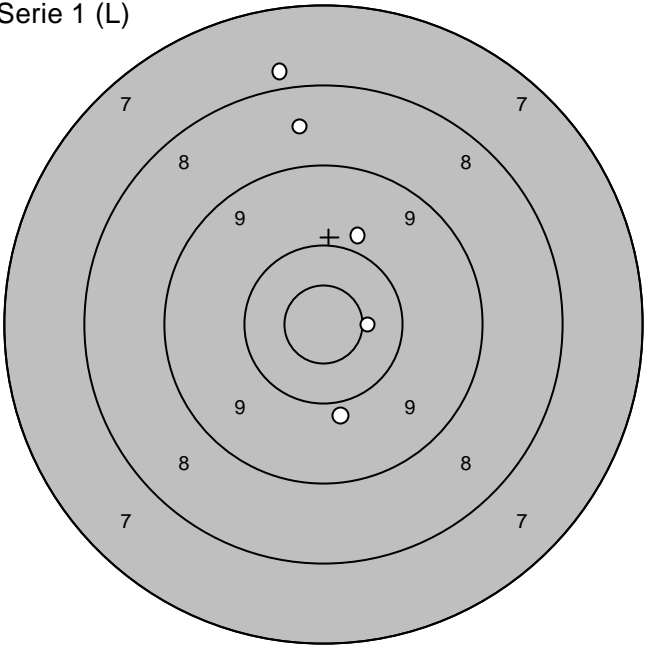
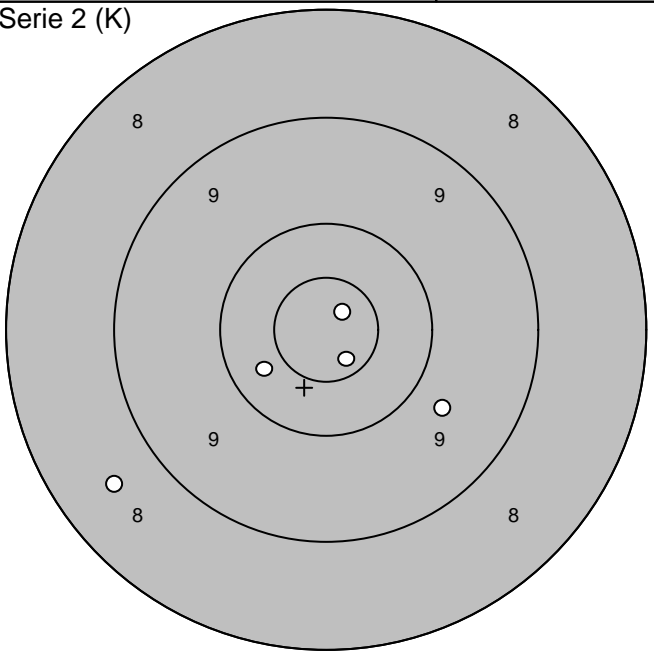
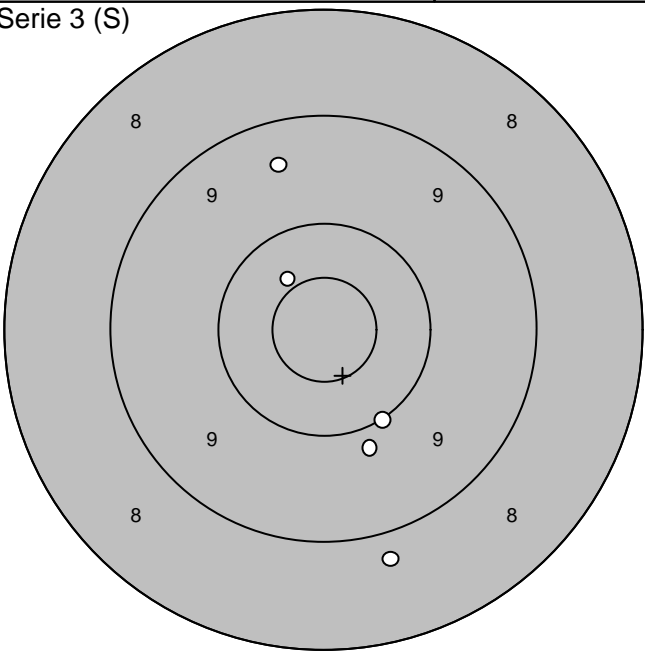
Skjutlag <b>6</b>	Tavla <b>20</b>	<b>Torgny Lindfors</b>	
		I 19 / A 9	
2008-07-13	Tavelträffen B 2008	Ramselefors SKF	
Provskott		Serie 1 (L)	
			
1: 9,4 ↓	Serie 28,0	1: 9,9 ↗	Serie 43,0
2: 10,2 ↘		2: 7,9 ↑	
3: 9,9 →	Totalt 0,0	3: 8,6 ↑	Totalt 43,0
		4: 10,5* →	
		5: 9,9 ↓	
Serie 2 (K)		Serie 3 (S)	
			
1: 9,7 ↘	Serie 47,0	1: 9,4 ↗	Serie 46,0
2: 10,3 ↙		2: 10,5* ↗	
3: 10,8* ↗	Totalt 90,0	3: 8,8 ↓	Totalt 136,0
4: 8,6 ↙		4: 9,8 ↓	
5: 10,7* ↓		5: 10,0 ↓	



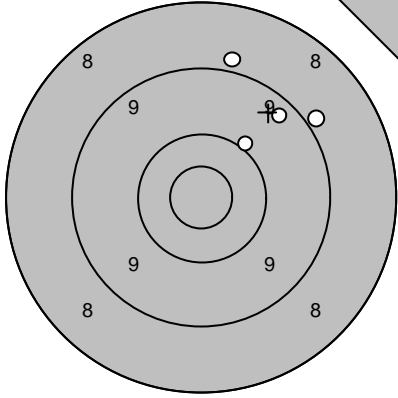
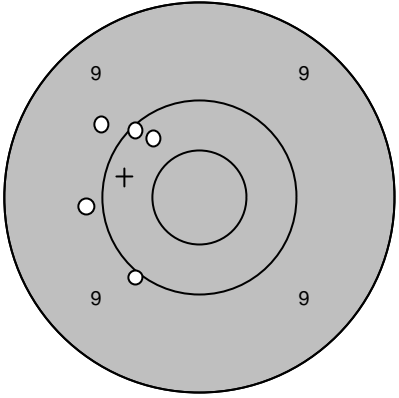
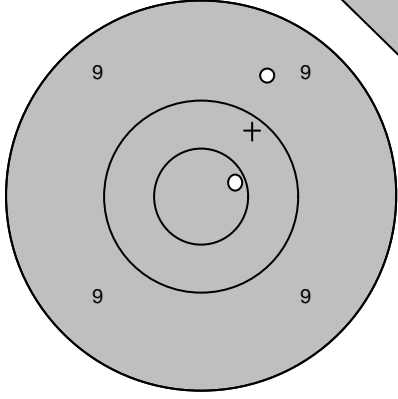
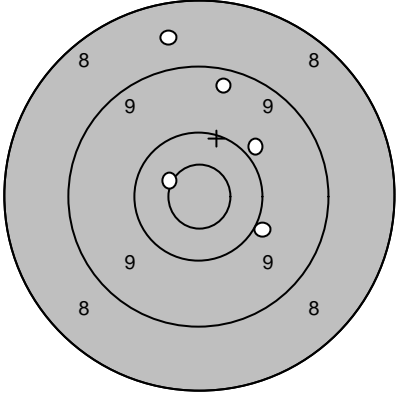
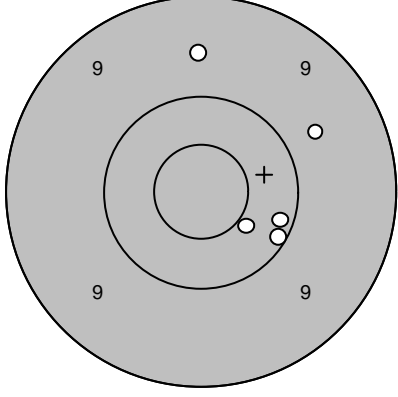
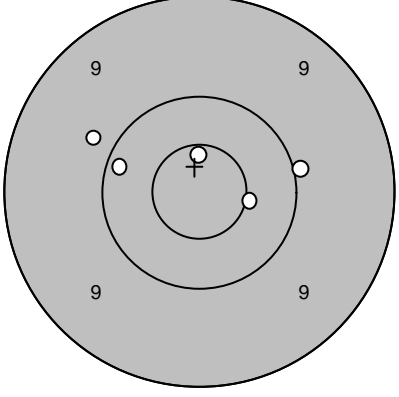
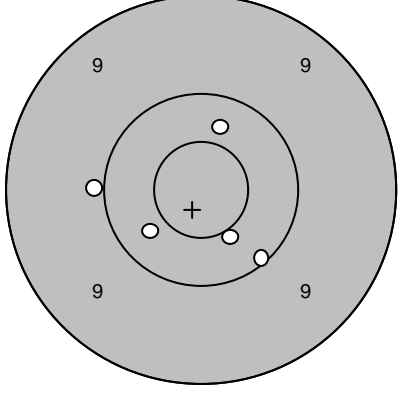

Skjutlag	Tavla	Marlene Forsell	
		Ramselefors	
2008-07-13		Tavelträffen B 2008	
		Ramselefors SKF	
Provkott 	1: 8,9 ↑ 2: 8,9 ↗ 3: 10,0 ↗ 4: 9,3 ↗	Serie 1 (L) 	1: 10,0 ↙ 2: 10,1 ↗ 3: 9,8 ↗ 4: 9,9 ← 5: 10,3 ↗
	Serie 35,0		Serie 48,0
	Totalt 0,0		Totalt 48,0
Provkott 	1: 9,6 ↗ 2: 10,7* →	Serie 2 (K) 	1: 8,6 ↑ 2: 10,6* ↙ 3: 9,3 ↑ 4: 9,9 ↗ 5: 10,0 →
	Serie 19,0		Serie 46,0
	Totalt 48,0		Totalt 94,0
Serie 3 (S) 	1: 9,6 ↑ 2: 10,5* → 3: 10,1 → 4: 10,2 → 5: 9,7 ↗	Extratävling 3+3+4 	1: 10,0 → 2: 9,8 ↗ 3: 10,2 ← 4: 10,5* → 5: 10,7* ↑
	Serie 48,0		Serie 49,0
	Totalt 142,0		Totalt 191,0
Extratävling 3+3+4 	6: 10,4 ↙ 7: 9,9 ← 8: 10,1 ↙ 9: 10,5* ↙ 10: 10,4 ↑		
	Serie 49,0		
	Totalt 240,0		

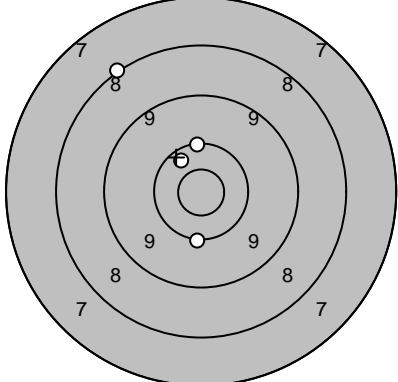
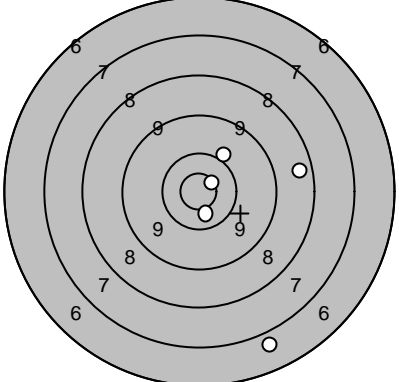
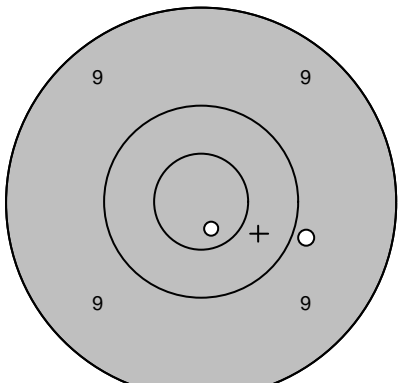
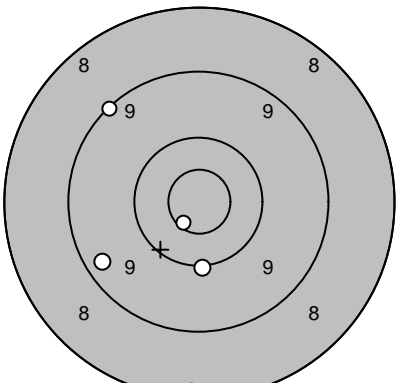
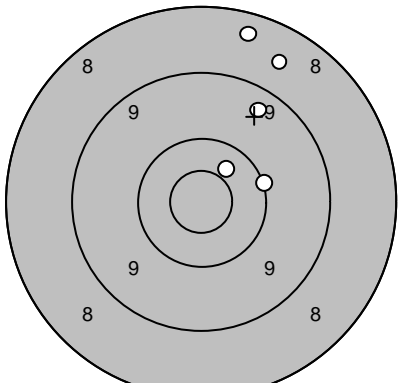
Skjutlag	Tavla	<b>Gerhard Andersson</b>	
<b>5</b>	<b>23</b>		
		Ramselefors	
2008-07-13	Tavelträffen B 2008	Ramselefors SKF	
Provskott 	1: 10,1 ↓	Serie 1 (L) 	1: 10,8* ↗
	2: 10,2 ↑		2: 10,6* ↓
	3: 10,4 ↗		3: 8,5 →
	4: 8,1 ↗		4: 6,9 ↓
			5: 10,0 ↗
	Serie 38,0		Serie 44,0
	Totalt 0,0		Totalt 44,0
Provskott 	1: 10,7* ↓	Serie 2 (K) 	1: 9,1 ↖
	2: 9,9 →		2: 10,7* ↙
			3: 9,3 ←
			4: 8,2 ↓
			5: 10,1 ↓
	Serie 19,0		Serie 46,0
	Totalt 44,0		Totalt 90,0
Serie 3 (S) 	1: 9,4 ↗		
	2: 10,4 ↗		
	3: 8,4 ↑		
	4: 8,6 ↗		
	5: 10,1 →		
	Serie 45,0		
	Totalt 135,0		

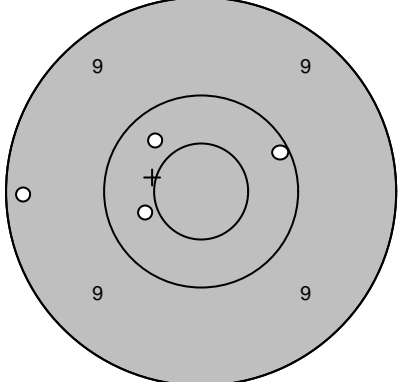
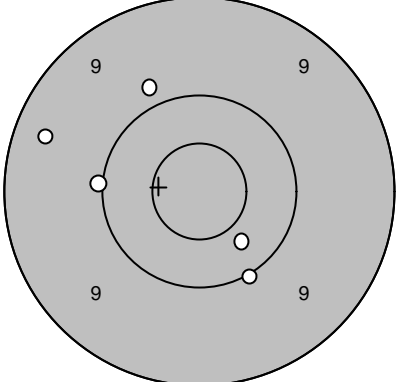
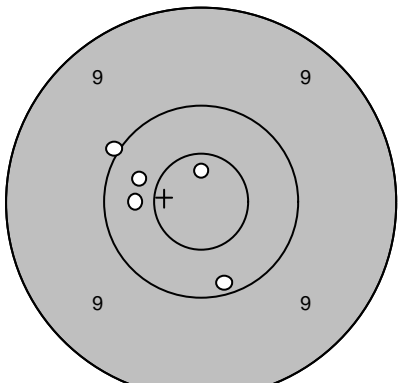
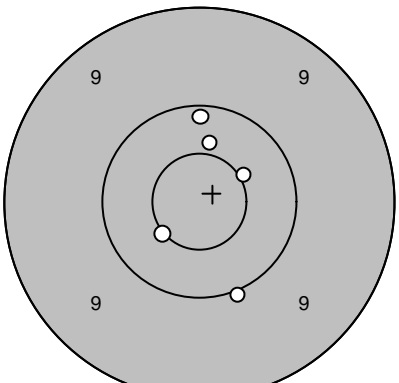
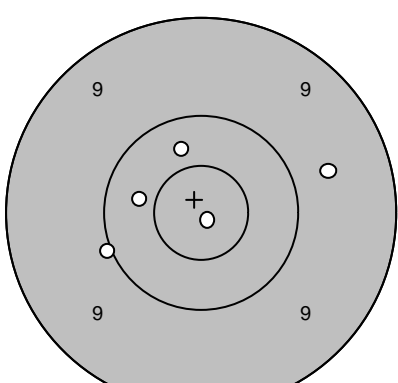
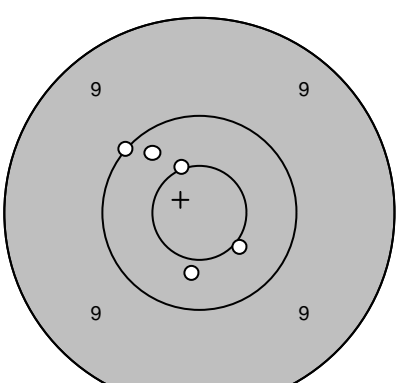
Skjutlag	Tavla	Magnus Lejonclou	
		Ramselefors	
2008-07-13	Tavelträffen B 2008	Ramselefors SKF	
Provs-kott 	1: 10,1 →	Serie 1 (L) 	1: 9,4 ←
	2: 9,2 ←		2: 9,9 ↗
	3: 10,3 ↗		3: 10,0 ←
	4: 10,4 ←		4: 10,4 ↘
	5: 10,4 ←		5: 10,0 ↘
	Serie 39,0		Serie 48,0
	Totalt 0,0		Totalt 48,0
Serie 2 (K) 	1: 10,4 ←	Serie 3 (S) 	1: 10,4 ↑
	2: 10,4 ←		2: 10,2 ↑
	3: 10,7* ↑		3: 10,5* ↙
	4: 10,0 ↗		4: 10,0 ↘
	5: 10,2 ↘		5: 10,5* ↗
	Serie 50,0		Serie 50,0
	Totalt 98,0		Totalt 148,0
Extratävling 3+3+4 	1: 9,7 →	Extratävling 3+3+4 	6: 10,5* ↗
	2: 10,0 ←		7: 10,0 ↗
	3: 10,4 ←		8: 10,3 ↗
	4: 10,3 ↑		9: 10,4 ↘
	5: 10,9* ↘		10: 10,5* ↘
	Serie 49,0		Serie 50,0
	Totalt 197,0		Totalt 247,0