

Skjutlag	Tavla	Gustav Lövgren	
1	1		
		Niemisel	
2007-07-16	Tavelträffen 2007 Final	Ramselefors SKF	
Prov		1: 10,4* ↗ 2: 10,5* → 3: 9,8 ↖ 4: 10,4* ↙ 5: 10,2 ↘ 6: 10,4* ↑ 7: 10,0 ↗ 8: 10,2 ↓ 9: 10,5* → 10: 10,0 ←	Prov 11: 9,5 ←
	Serie 99,0		Serie 9,0
	Totalt 195,0		Totalt 195,0
Serie 1		1: 10,2 ↖ 2: 9,4 ↙ 3: 10,9* ↖ 4: 10,1 ↑ 5: 9,3 ↗	Serie 1 6: 10,3* ↖ 7: 10,2 ↗ 8: 9,2 ← 9: 9,7 ↖ 10: 10,0 ↑
	Serie 48,0		Serie 48,0
	Totalt 243,0		Totalt 291,0
S 1		1: 8,2 ← 2: 9,3 ← 3: 10,0 ↓ 4: 9,5 ↑ 5: 10,2 ←	
	Serie 46,0		
	Totalt 337,0		

Skjutlag <b>1</b>	Tavla <b>2</b>	<b>Christian Lejon</b>				
		Umeå				
2007-07-16		Tavelträffen 2007 Final		Ramselefors SKF		
Prov			Serie 1			
						
1: 9,6 ←	6:10,2 ↘	Serie	85,0	1:10,4* ↗	Serie	48,0
2: 9,1 ←	7: 9,0 ↘		Totalt	195,0		2: 9,8 ←
3:10,0 ↘	8: 9,7 ←				3: 9,9 ↘	
4:10,4* ←	9: 9,3 ↘			4:10,1 ↘		
5:10,1 ←				5:10,3* ↗		
Serie 1			S 1			
						
6:10,6* ↘		Serie	48,0	1:10,0 ↗	Serie	49,0
7: 9,7 →			Totalt	291,0		2:10,0 →
8: 9,2 ←					3:10,0 ↗	
9:10,4* ↗				4: 9,8 →		
10:10,7* ↑				5:10,1 ↗		

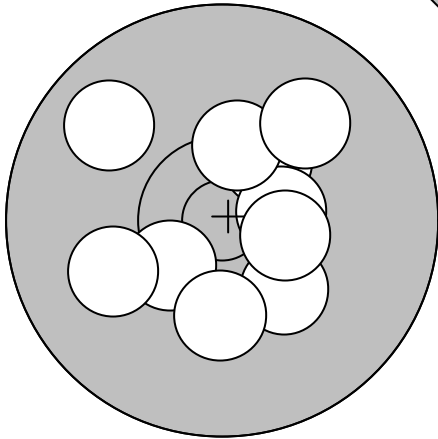
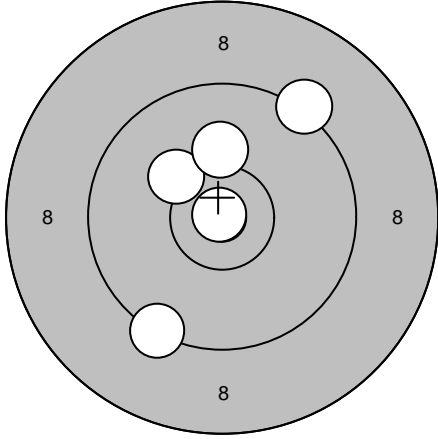
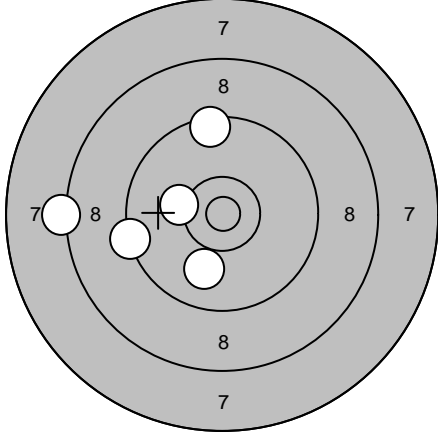
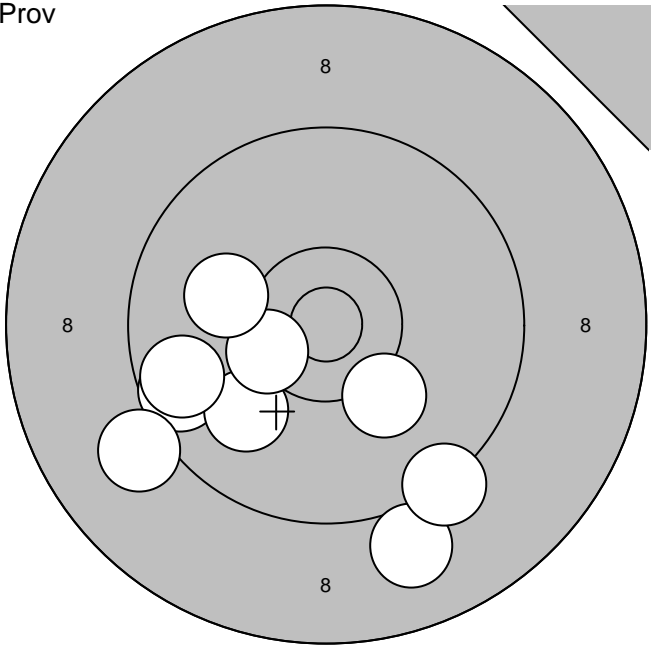
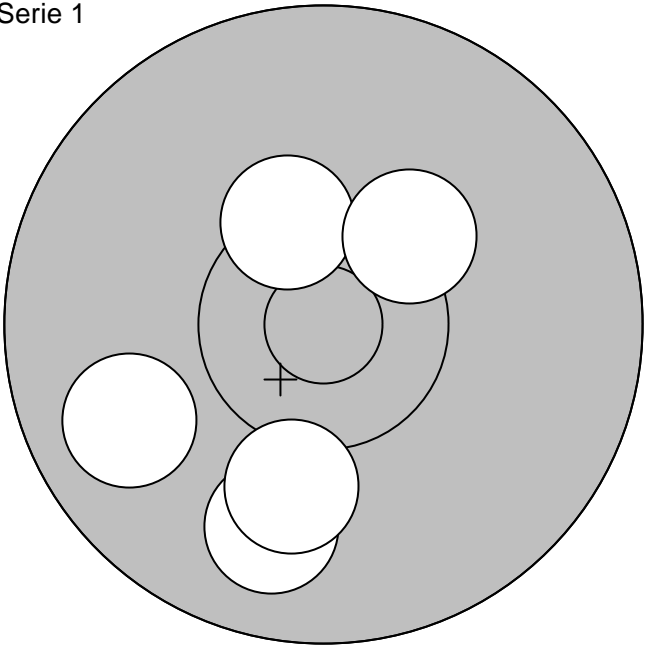
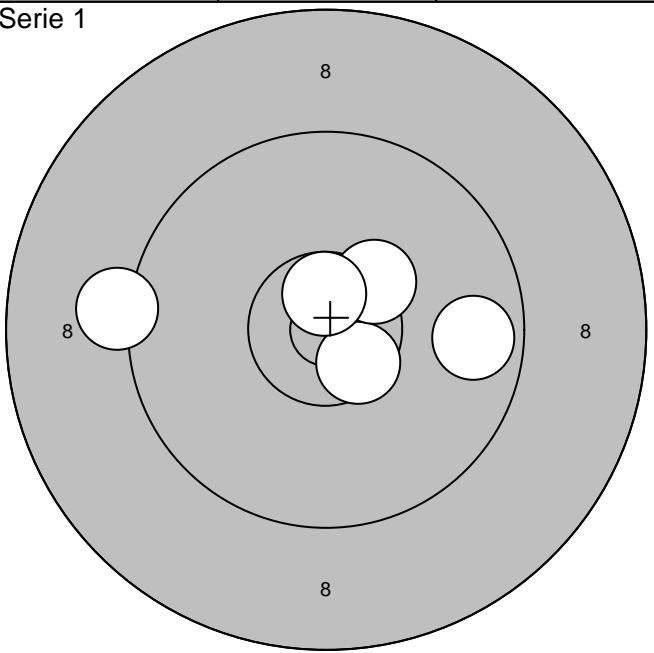
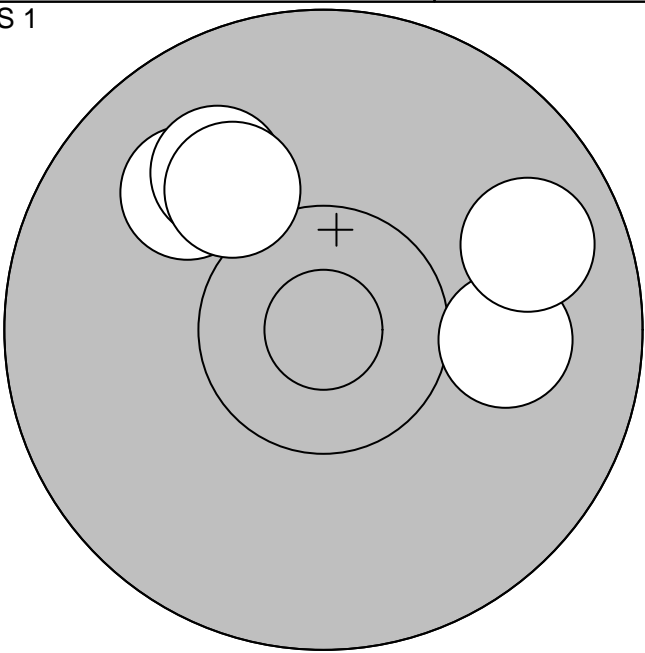
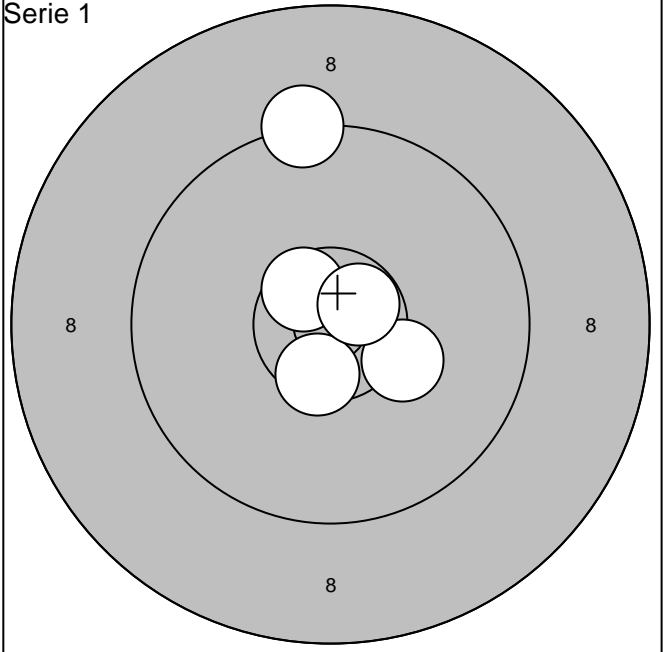
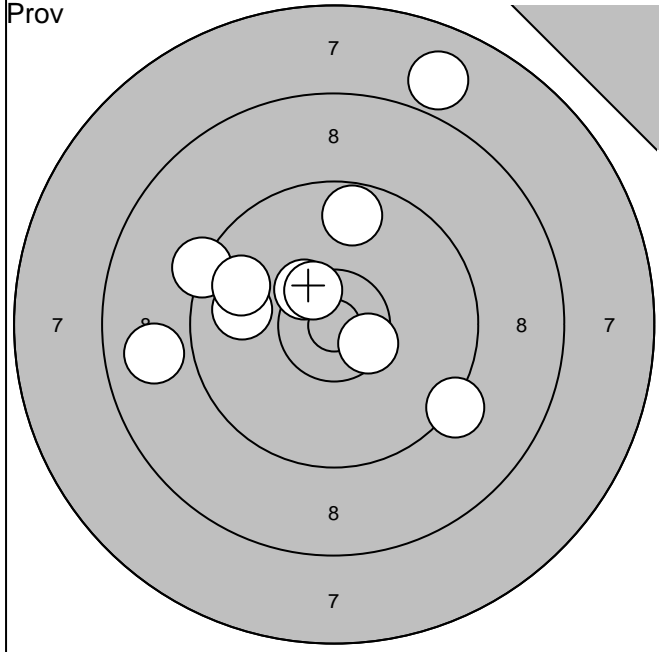

1: 7,9 ↗	6:10,5* ➔	Serie	90,0
2: 9,3 ➘	7: 8,9 ←		
3:10,4* ↗	8: 9,9 ←	Totalt	194,0
4: 9,3 ↖	9: 9,8 ↖		
5:10,5* ↗	10: 9,7 ↑		

1:10,6* ↖	Serie	49,0
2: 9,3 ↑		
3:10,5* ➘	Totalt	243,0
4:10,3 ➔		
5:10,7* ↗		

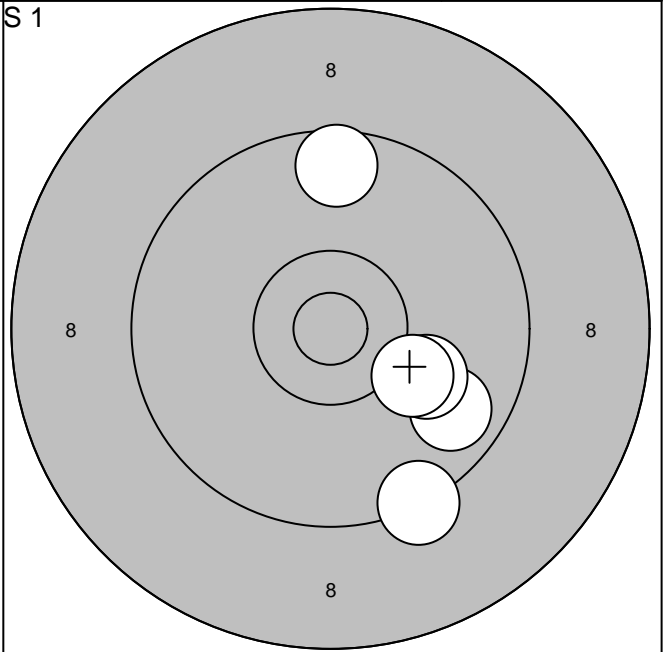
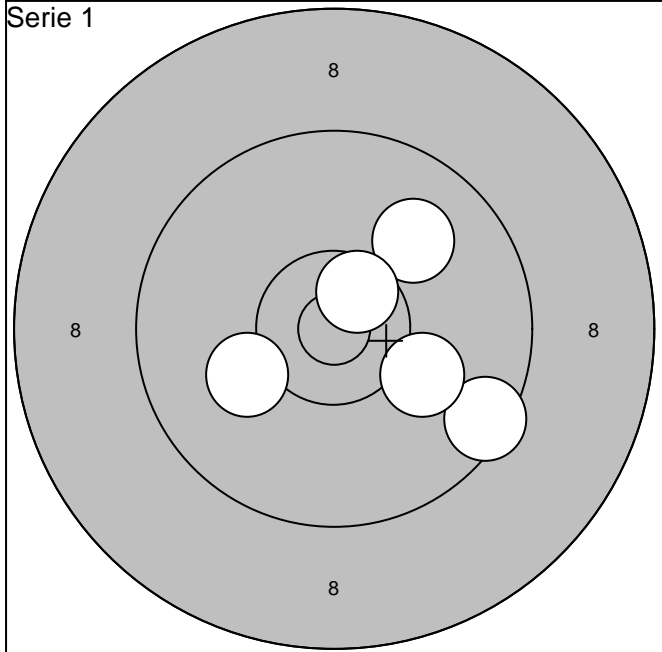

6: 9,5 ➘	Serie	49,0
7:10,0 ↗		
8:10,6* ↗	Totalt	292,0
9:10,1 ↖		
10:10,1 ➔		

1: 9,6 ↑	Serie	47,0
2: 9,8 ➘		
3:10,1 ➔	Totalt	339,0
4:10,2 ➘		
5: 9,3 ➘		

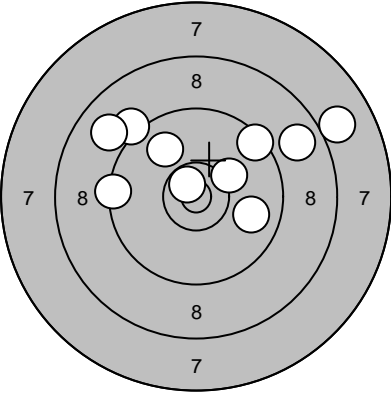
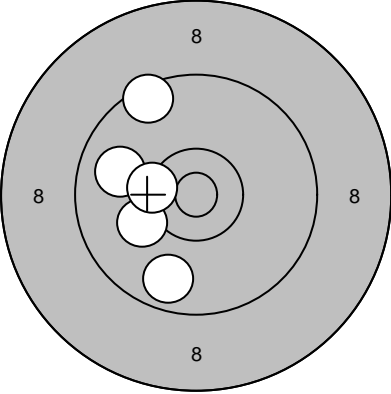
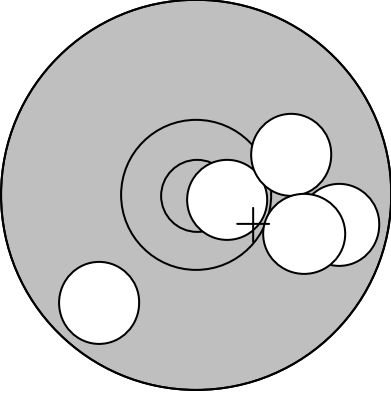
Skjutlag	Tavla	Anders Petersson	
1	4	P 7	
2007-07-16	Tavelträffen 2007 Final	Ramselefors SKF	
Prov		1: 9,9 → 2: 8,0 → 3: 9,4 ↗ 4: 8,8 → 5: 10,2 → 6: 9,2 ↗ 7: 9,9 ↗ 8: 10,7* ↗ 9: 8,9 ↗ 10: 9,4 ←	11: 10,1 ← 12: 10,8* → 13: 9,2 ↘ 14: 10,3* ← 15: 9,4 ← 16: 9,5 ←
	Serie 89,0		Serie 57,0
	Totalt 194,0		Totalt 194,0
Serie 1		1: 9,7 ↓ 2: 9,9 ← 3: 9,5 ↗ 4: 10,1 ← 5: 10,4* ←	6: 9,6 ← 7: 10,7* ← 8: 8,6 → 9: 10,7* ↗ 10: 10,3 →
	Serie 47,0		Serie 47,0
	Totalt 241,0		Totalt 288,0
S 1		1: 10,7* → 2: 10,1 → 3: 9,7 → 4: 10,0 → 5: 9,7 ↘	
	Serie 48,0		
	Totalt 336,0		

Skjutlag	Tavla	<b>Lars Möllsten</b>	
<b>1</b>	<b>5</b>		
		Umeå	
2007-07-16	Tavelträffen 2007 Final	Ramselefors SKF	
Prov		Serie 1	
1: 9,1 ↓	6:10,5* ↓	Serie 86,0	Serie 48,0
2: 9,8 →	7:10,6* ↑		
3:10,0 ↘	8: 9,6 ↓	Totalt 194,0	Totalt 242,0
4:10,2 ↗	9:10,6* ←		
5: 9,7 ↗			
Serie 1		S 1	
6:10,6* ←		Serie 48,0	Serie 46,0
7: 9,9 ↑			
8: 9,5 ↓		Totalt 290,0	Totalt 336,0
9:10,6* ←			
10:10,4* ↓			

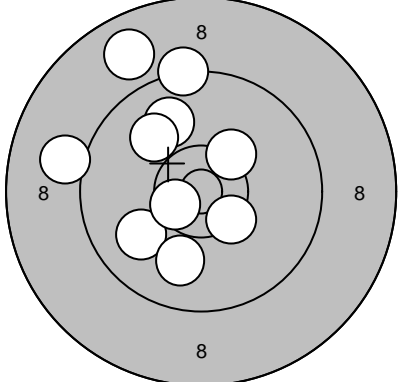
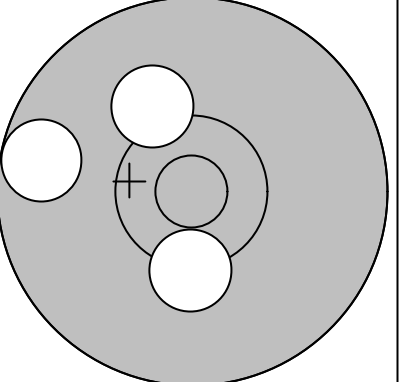
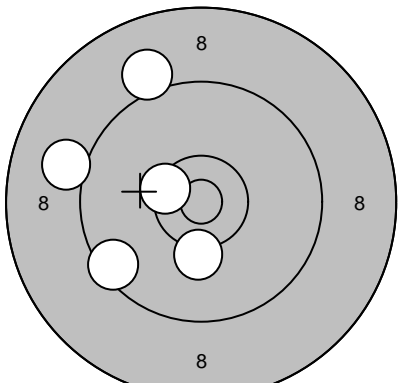
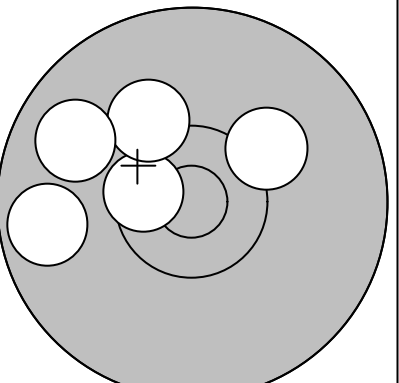
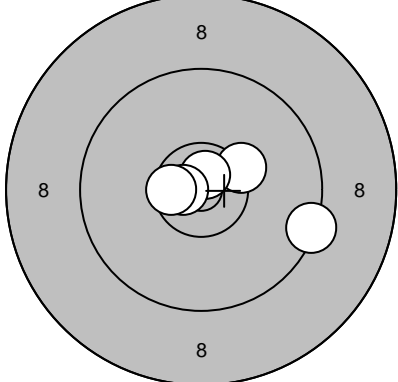
Skjutlag	Tavla	Magnus Lindkvist	
1	6	Umeå	
2007-07-16	Tavelträffen 2007 Final	Ramselefors SKF	
Prov		1: 8,9 ↖ 2: 9,9 ↙ 3: 9,1 ← 4: 10,4* ↘ 5: 10,0 ↓ 6: 9,3 ↑ 7: 9,9 ↗ 8: 10,3* ↗ 9: 10,0 ↖ 10: 10,6* ↙	Prov 
	Serie 94,0		11: 9,7 ←
	Totalt 191,0		12: 10,3 ↓
			13: 10,2 ↗
		Serie 29,0	
		Totalt 191,0	
Serie 1		1: 9,1 ← 2: 10,4* ← 3: 9,1 ↗ 4: 10,2 ↓ 5: 9,5 ↙	Serie 1 
	Serie 47,0		6: 10,5* ←
	Totalt 238,0		7: 9,7 ←
			8: 10,2 ↗
			9: 9,8 ↙
		Serie 48,0	
		Totalt 286,0	
S 1		1: 10,3* ↗ 2: 10,7* ↑ 3: 10,7* ← 4: 10,5* ← 5: 9,4 →	
	Serie 49,0		
	Totalt 335,0		

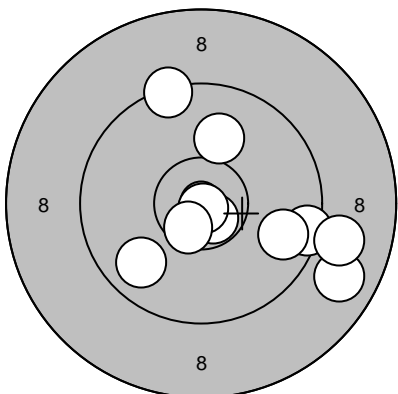
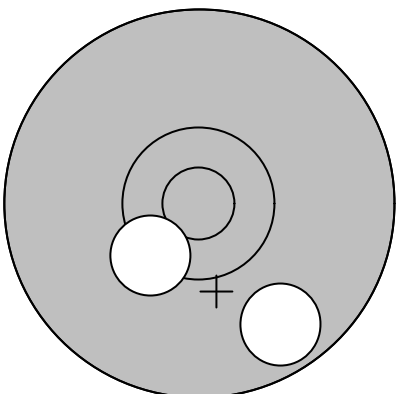
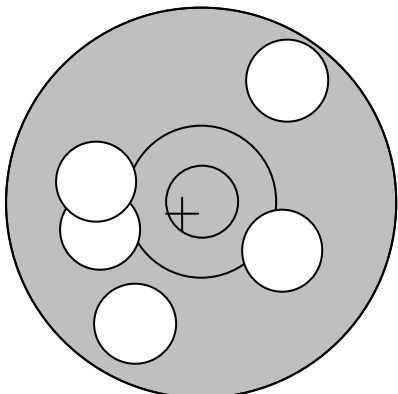
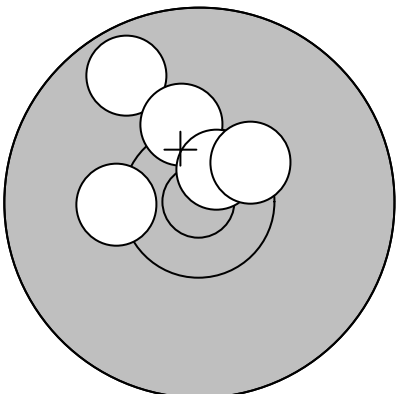
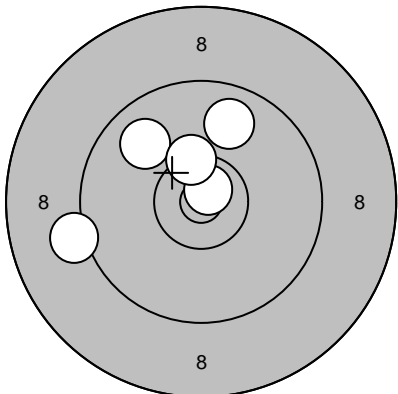
Skjutlag	Tavla	Stefan Thorin	
1	7	Umeå	
2007-07-16	Tavelträffen 2007 Final	Ramselefors SKF	
Prov	 1: 9,8 ↙ 2: 10,7* ↓ 3: 10,9* ↓ 4: 10,0 ↑ 5: 9,5 → 6: 10,6* ↓ 7: 8,8 → 8: 9,4 ↑ 9: 9,0 → 10: 9,8 →	Prov	 11: 10,3* ↙ 12: 9,7 ↓
	Serie 93,0		Serie 19,0
	Totalt 191,0		Totalt 191,0
Serie 1	 1: 10,1 ← 2: 10,0 ← 3: 9,8 ↓ 4: 9,7 ↑ 5: 10,1 →	Serie 1	 6: 10,3 ← 7: 9,7 ↗ 8: 10,3* ↑ 9: 10,6* ↗ 10: 10,4* ↗
	Serie 48,0		Serie 49,0
	Totalt 239,0		Totalt 288,0
S 1	 1: 10,8* ↗ 2: 9,2 ← 3: 9,9 ↗ 4: 9,8 ↑ 5: 10,4* ↑		
	Serie 47,0		
	Totalt 335,0		

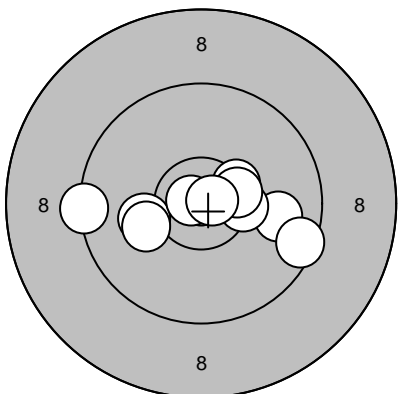
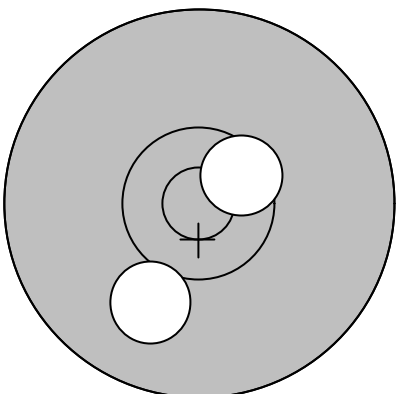
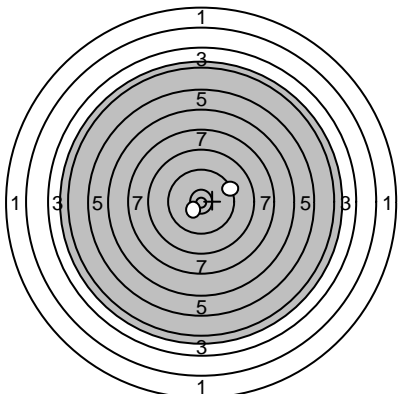
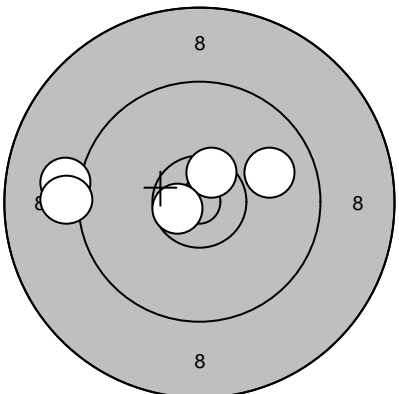
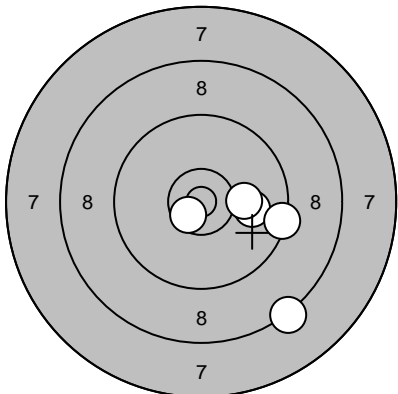
Skjutlag	Tavla	<b>Michael Normann</b>	
<b>1</b>	<b>8</b>		
		I 16 / Lv 6	
2007-07-16	Tavelträffen 2007 Final	Ramselefors SKF	
Prov		1: 9,4 ←	Prov
		2: 9,9 →	
		3: 10,4* →	
		4: 10,2 ←	
		5: 9,5 →	
		6: 10,1 ←	
		7: 10,8* ←	
		8: 10,4* →	
		9: 10,4* →	
		10: 10,8* →	
		Serie 97,0	11: 10,0 ↓
		Totalt 190,0	12: 10,5* ↗
			Serie 20,0
			Totalt 190,0
Serie 1		1: 10,4 ↙	Serie 1
		2: 10,5 ↙	
		3: 9,9 ↙	
		4: 10,4* ↙	
		5: 9,4 →	
		Serie 48,0	6: 9,9 ↗
		Totalt 238,0	7: 9,1 ←
			8: 9,2 ←
			9: 10,5* ↗
			10: 10,6* ←
			Serie 47,0
			Totalt 285,0
S 1		1: 10,0 →	
		2: 10,2 →	
		3: 10,6* ↙	
4: 8,3 ↓			
5: 9,4 →			
		Serie 47,0	
		Totalt 332,0	

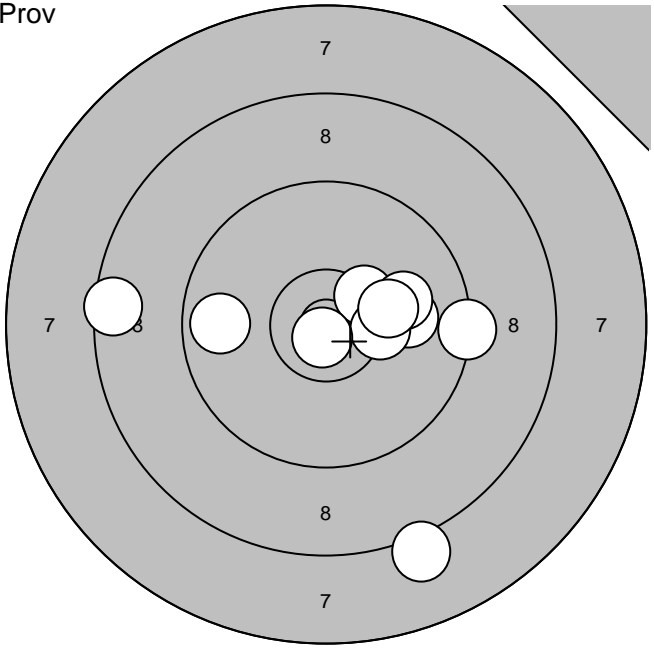
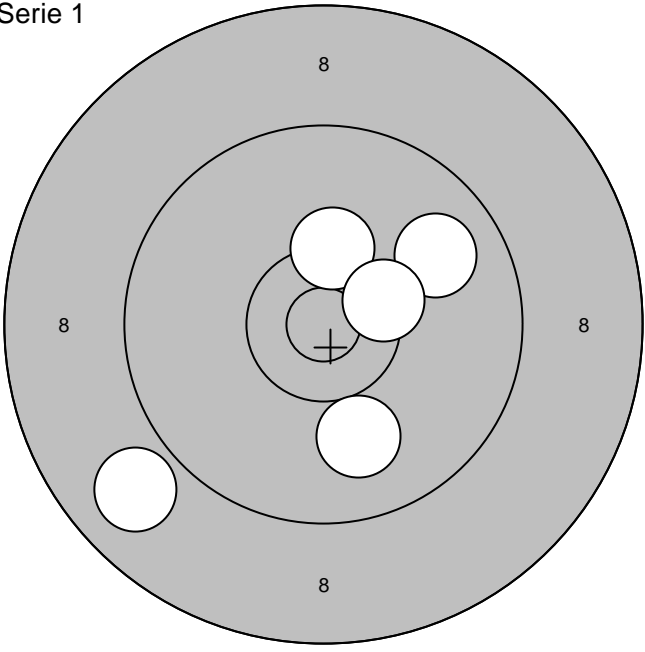
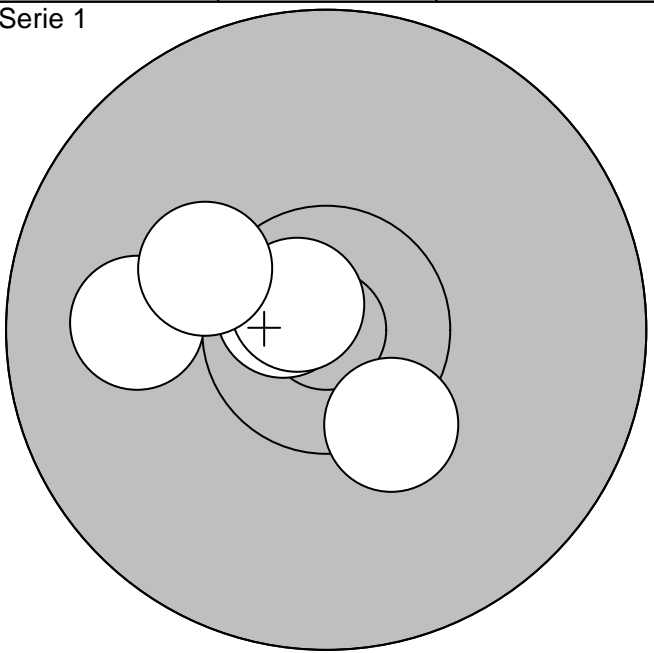
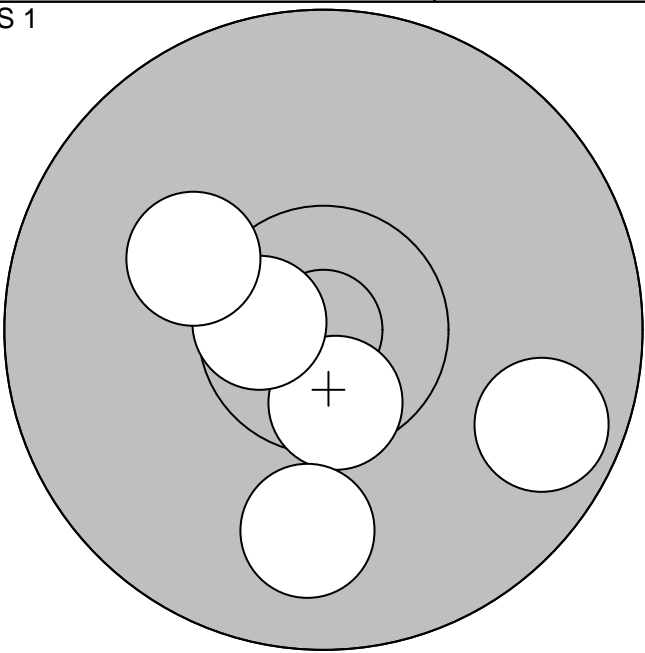

Skjutlag <b>1</b>	Tavla <b>9</b>	<b>Fredrik Ågren</b>	
		I 19	
2007-07-16		Tavelträffen 2007 Final	Ramselefors SKF
Prov		Serie 1	
			
1: 8,5 ←	6:10,0 →	Serie 94,0	Serie 47,0
2: 8,1 ↓	7:10,0 →		
3:10,4* ↗	8:10,3* →	Totalt 190,0	Totalt 237,0
4: 9,7 ←	9:10,2 →		
5: 9,3 →	10:10,8* ↓		
Serie 1		S 1	
			
6:10,7* ↖	Serie 50,0	1:10,6* ↓	Serie 48,0
7:10,0 ←		2: 9,7 →	
8:10,4* ↓	Totalt 287,0	3:10,6* ←	Totalt 335,0
9:10,8* ↗		4: 9,9 ↓	
10:10,3 ↖		5:10,2 ↖	

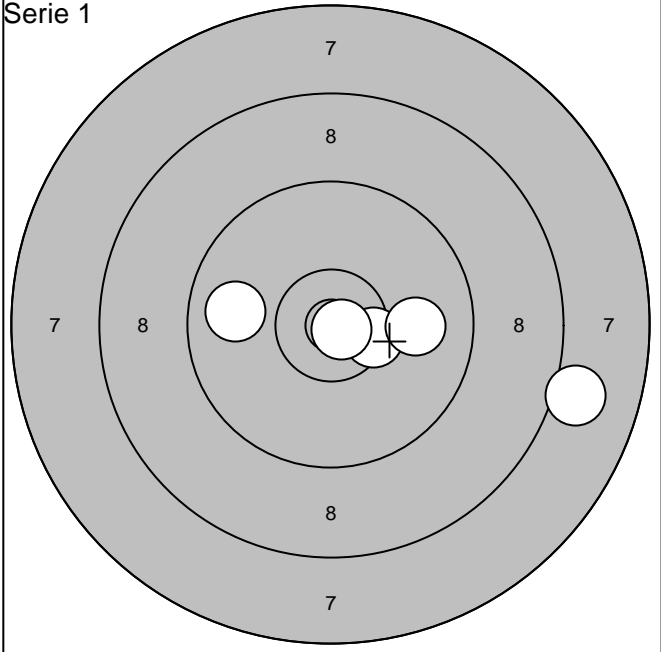
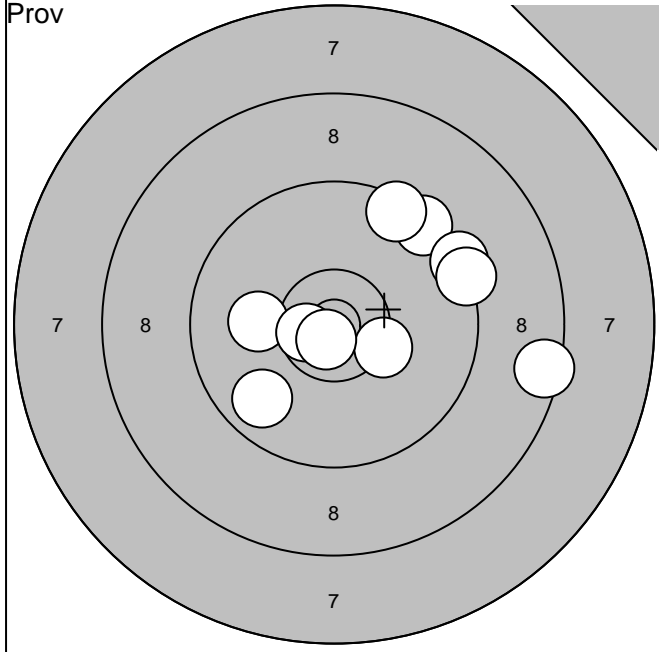

1: 9,4 ↗	6: 9,3 →	Serie	93,0
2: 8,5 →	7: 9,8 ↘		
3: 9,5 ↗	8:10,1 ←	Totalt	189,0
4:10,3* →	9:10,6* ←		
5: 9,3 →	10:10,8* ↘		

1:10,4* →	Serie	47,0
2:10,8* →		
3: 8,1 →	Totalt	236,0
4: 9,9 ←		
5:10,0 →		

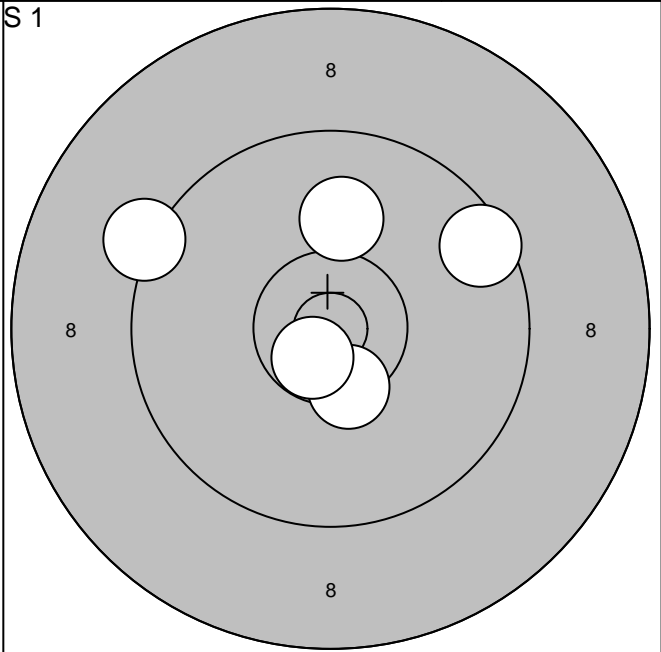
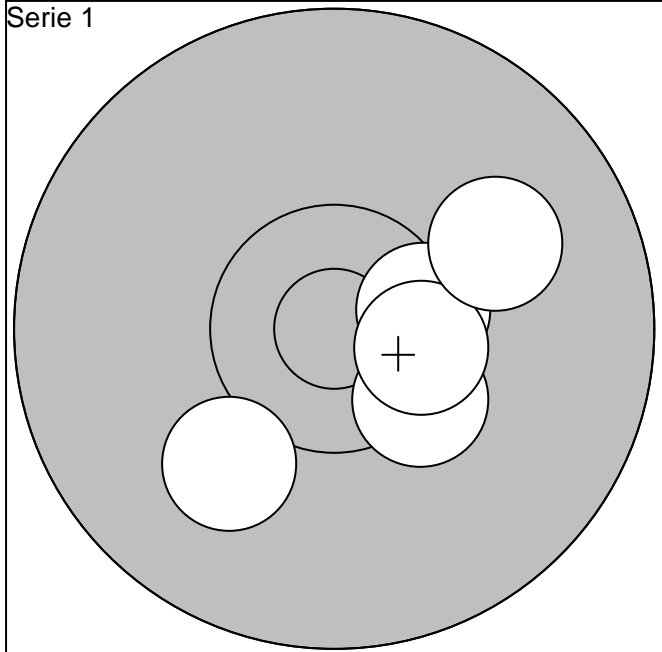

6:10,5* →	Serie	50,0
7:10,4* ↘		
8:10,5* →	Totalt	286,0
9:10,0 →		
10:10,1 ↘		

1:10,0 ↑	Serie	48,0
2:10,4* ↘		
3:10,7* ↘	Totalt	334,0
4: 9,5 →		
5: 9,2 ←		

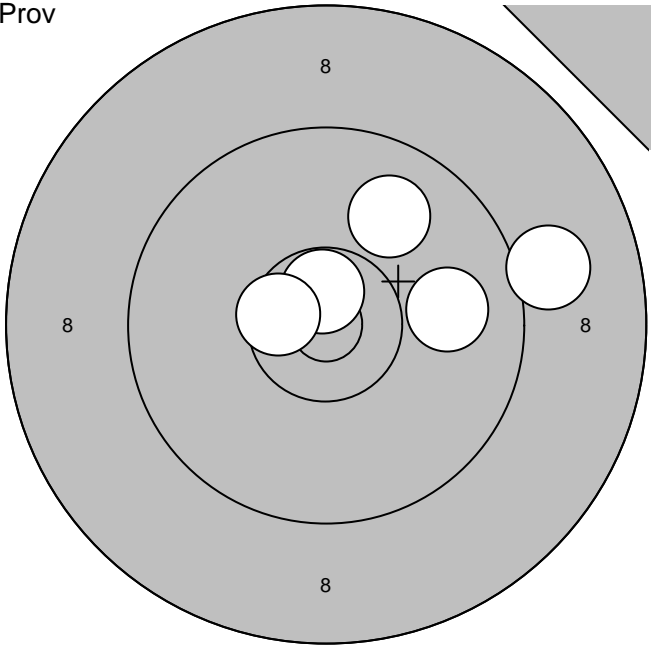
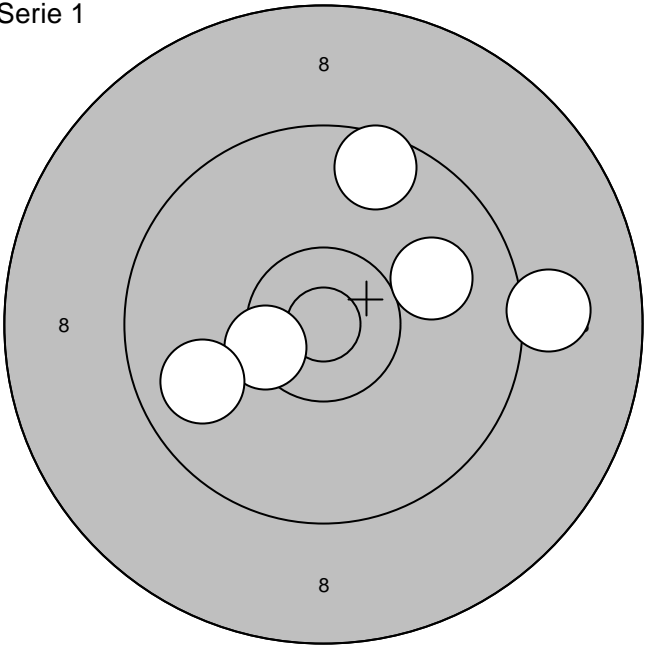
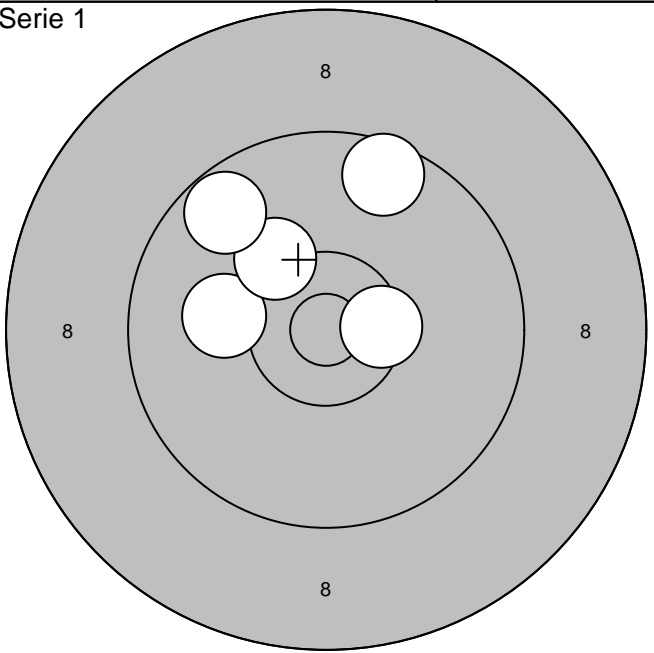
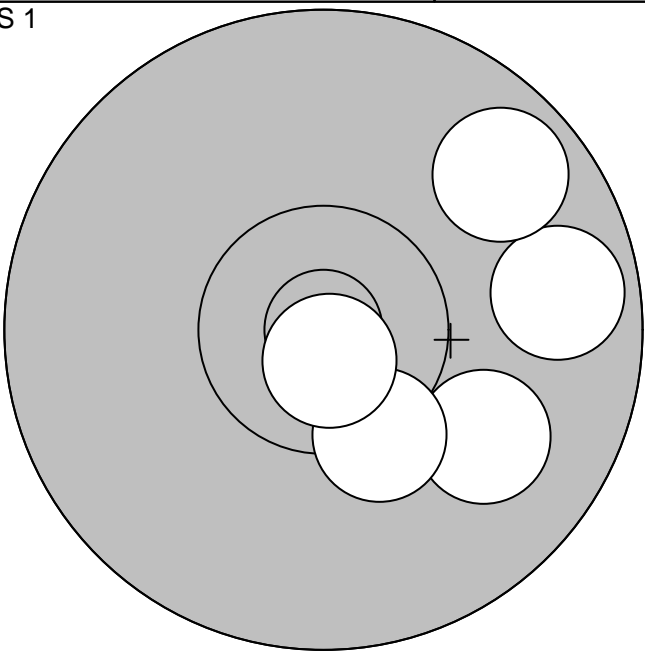
Skjutlag <b>1</b>	Tavla <b>11</b>	<b>Roger Andersson</b>	
		S 3	
2007-07-16	Tavelträffen 2007 Final	Ramselefors SKF	
Prov	Serie 1		
			
1: 9,1 →	Serie 47,0	1:10,4* ←	Serie 47,0
2: 9,9 ↗		2: 9,8 ←	
3:10,7* ↑	Totalt 189,0	3: 9,1 →	Totalt 236,0
4: 9,9 →		4:10,0 →	
5:10,6* ←		5: 9,6 ↗	
Serie 1	S 1		
			
6:10,5* →	Serie 48,0	1:10,0 ↘	Serie 48,0
7: 9,6 ↗		2: 9,7 →	
8:10,1 ←	Totalt 284,0	3: 9,7 ↗	Totalt 332,0
9:10,2 ↗		4:10,3* ↘	
10: 9,7 ↗		5:10,8* ↘	

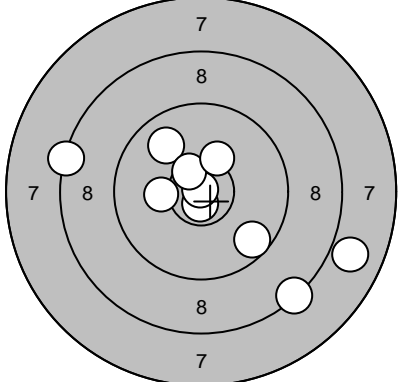
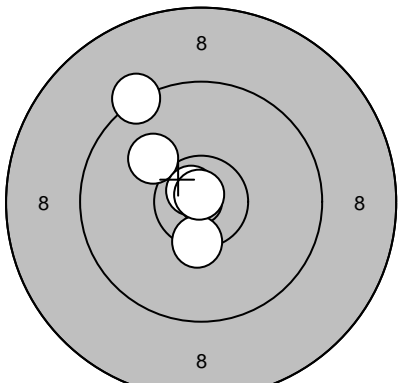
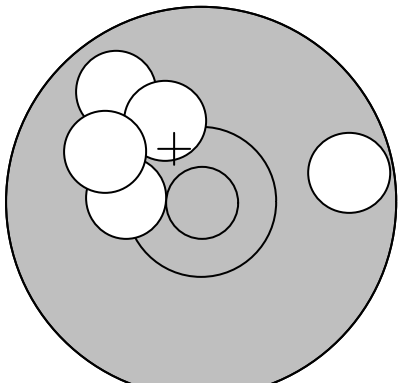
Skjutlag	Tavla	Mikael Olofsson	
1		12	
Moälven-Modo			
2007-07-16		Tavelträffen 2007 Final	
2007-07-16		Ramselefors SKF	
Prov		1: 10,7* ↓ 2: 7,9 → 3: 8,4 ↓ 4: 9,6 ↓ 5: 8,4 ← 6: 10,9* ↗ 7: 9,9 ↗ 8: 10,2 ← 9: 10,5* ↗ 10: 10,3 ↗	11: 9,5 ↑ 12: 10,4* ↖
		Serie 91,0	Serie 19,0
		Totalt 188,0	Totalt 188,0
Serie 1		1: 10,4* ↓ 2: 10,1 ↗ 3: 9,3 ↗ 4: 10,8* ↗ 5: 10,9* ↗	6: 10,5* ↖ 7: 10,2 → 8: 9,1 ↑ 9: 10,2 ↖ 10: 10,3 ←
		Serie 49,0	Serie 49,0
		Totalt 237,0	Totalt 286,0
S 1		1: 9,8 ↖ 2: 10,2 ↗ 3: 9,7 → 4: 10,3* ← 5: 10,0 ↗	
		Serie 48,0	
		Totalt 334,0	

Skjutlag	Tavla	Jan Wallerström	
1	13		
		Ununge	
2007-07-16	Tavelträffen 2007 Final	Ramselefors SKF	
Prov		Serie 1	
1: 8,9 →	6:10,1 ↓	Serie 67,0	1:10,3* ↖
2: 9,4 ↘	7:10,7* →		2:10,0 ↑
3:10,4* ↘		Totalt 185,0	3: 9,9 ↗
4:10,2 ↘			4: 8,9 ↘
5:10,0 ↗			5: 9,4 ↓
Serie 1		S 1	
6:10,4* ↑		Serie 48,0	1:10,7* ↘
7:10,3 ↗			2:10,0 ↓
8: 9,0 →		Totalt 279,0	3: 9,8 ↓
9: 9,7 ↗			4:10,5* ↘
10:10,0 ↓			5: 9,9 ↗
		Serie 46,0	
			Totalt 231,0

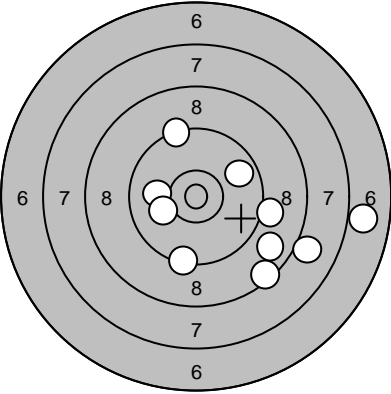
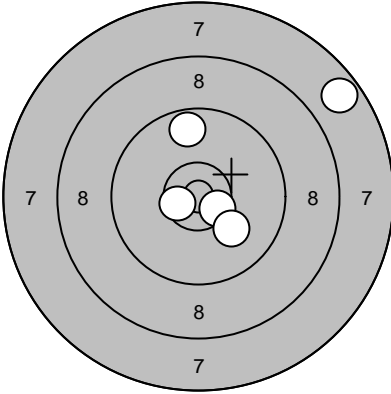
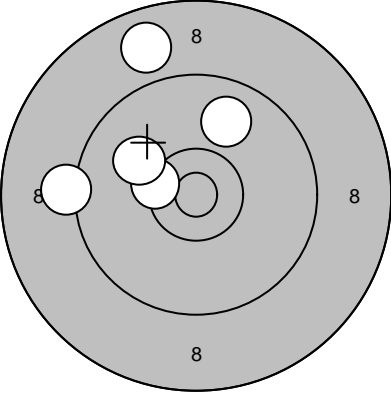
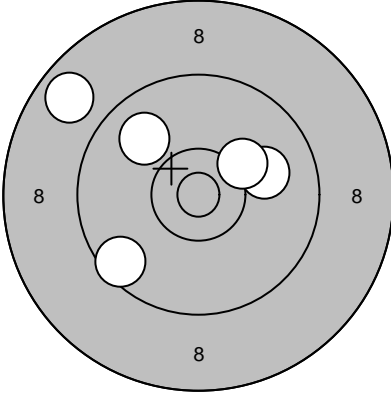
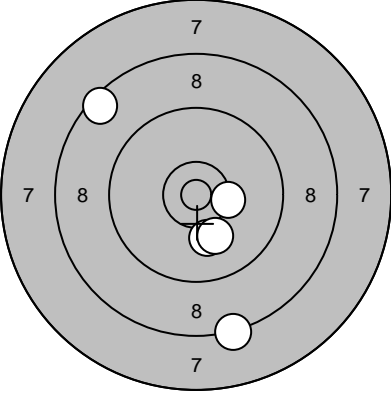
Skjutlag	Tavla		
1	14	Ida Lundmark	
		Drängsmark	
2007-07-16	Tavelträffen 2007 Final	Ramselefors SKF	
Prov		1: 9,4 ↓ 2: 6,9 → 3: 8,0 → 4: 8,4 ↓ 5: 10,0 ← 6: 8,8 ↓ 7: 9,2 → 8: 9,8 → 9: 10,1 ← 10: 9,4 ↑	Prov 
	Serie 86,0		11: 10,5* ←
	Totalt 172,0		12: 10,5* ↘
			13: 7,7 ↗
			14: 9,7 ↑
			15: 10,1 ↘
		Serie 46,0	
		Totalt 172,0	
Serie 1		1: 8,8 ↑ 2: 9,2 ← 3: 10,4* ← 4: 10,1 ↗ 5: 9,9 ↑	Serie 1 
	Serie 46,0		6: 10,0 →
	Totalt 218,0		7: 10,2 ↗
			8: 9,9 ↖
			9: 8,8 ↖
			10: 9,6 ↘
		Serie 46,0	
		Totalt 264,0	
S 1		1: 8,3 ↓ 2: 10,1 ↓ 3: 10,3* → 4: 8,5 ↗ 5: 10,1 ↓	
	Serie 46,0		
	Totalt 310,0		

Skjutlag <b>1</b>	Tavla <b>17</b>	<b>Fredrik Forsgren</b>	
		Ramselefors	
2007-07-16	Tavelträffen 2007 Final	Ramselefors SKF	
Prov		Serie 1	
1: 9,6 →	6: 9,7 ↖	Serie 93,0	Serie 46,0
2: 9,7 →	7: 10,3 →		
3: 9,8 →	8: 9,0 ←	Totalt 196,0	Totalt 242,0
4: 10,3* ↓	9: 10,0 ↗		
5: 10,5* ←	10: 8,9 ←		
Serie 1		S 1	
6: 9,4 ↑	Serie 47,0	1: 10,1 ↑	Serie 47,0
7: 9,8 ↘		2: 9,0 ←	
8: 9,9 ↑	Totalt 289,0	3: 9,3 ↘	Totalt 336,0
9: 10,3 →		4: 9,3 ↘	
10: 10,1 ↖		5: 10,7* ↓	

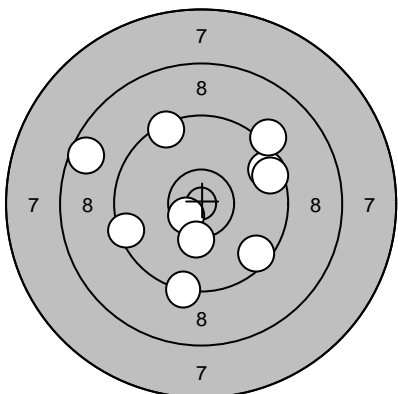
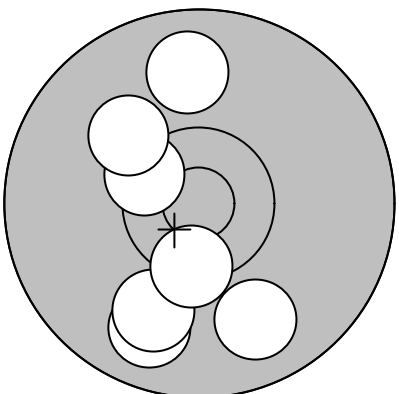
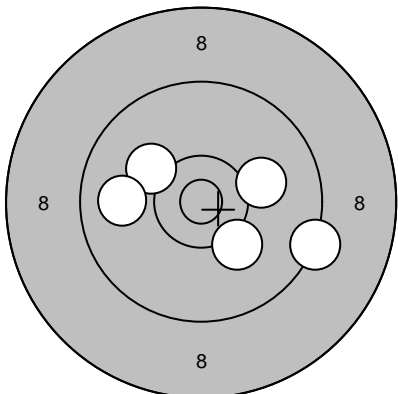
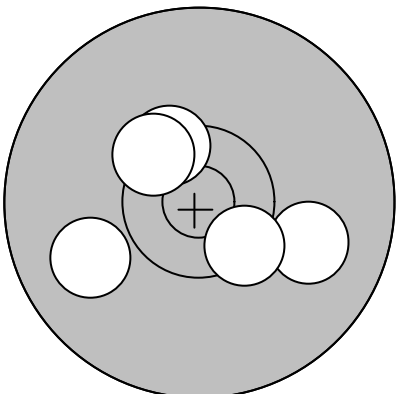
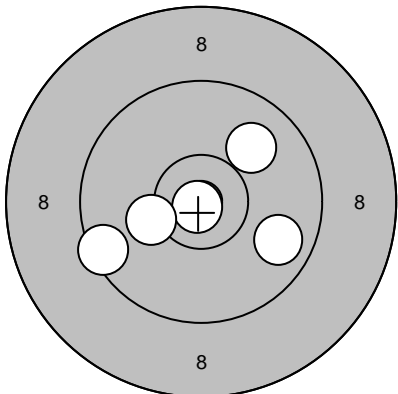
Skjutlag	Tavla	Jonas Bromihn	
1	18	Älmhult	
2007-07-16	Tavelträffen 2007 Final	Ramselefors SKF	
Prov		1: 9,5 ← 2: 9,6 → 3: 10,6* ← 4: 10,3 ↓ 5: 9,6 → 6: 8,6 ← 7: 9,4 ↑ 8: 9,2 ↗ 9: 9,5 → 10: 9,3 ↓	Prov 
	Serie 91,0		11: 9,8 ↓ 12: 9,9 ↓ 13: 10,4* ↗ 14: 10,1 ↗ 15: 10,0 ↓ 16: 9,8 ↑ 17: 10,4* ↓
	Totalt 193,0		Serie 67,0
			Totalt 193,0
Serie 1		1: 10,1 ↗ 2: 9,9 ← 3: 10,1 → 4: 9,3 → 5: 10,2 ↓	Serie 1 
	Serie 48,0		6: 10,4* ↗ 7: 9,9 ← 8: 10,0 → 9: 10,4* ↓ 10: 10,4* ↗
	Totalt 241,0		Serie 49,0
			Totalt 290,0
S 1		1: 9,5 ← 2: 10,0 ↗ 3: 10,9* ← 4: 9,8 → 5: 10,2 ←	
	Serie 48,0		
	Totalt 338,0		

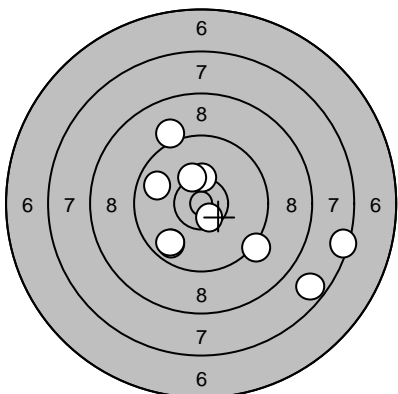
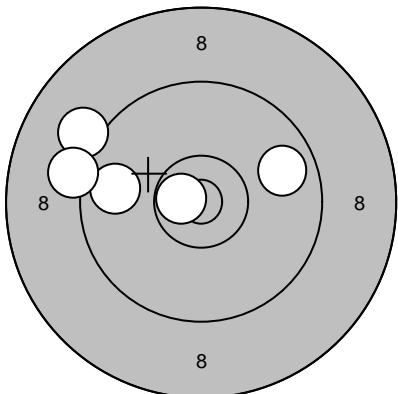
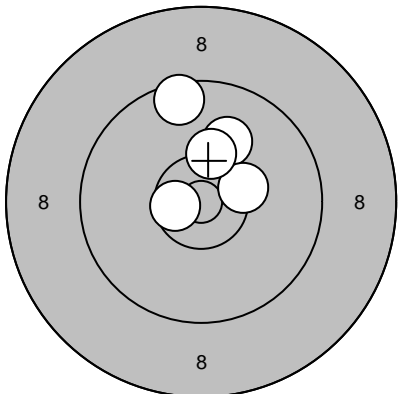

Skjutlag	Tavla	Therese Karlsson	
1	19	Drängsmark	
2007-07-16	Tavelträffen 2007 Final	Ramselefors SKF	
Prov		1: 9,1 ↗ 2: 7,4 → 3: 7,7 ↘ 4: 9,3 ↘ 5: 10,6* ↘ 6: 9,8 ↘ 7: 9,8 ↖ 8: 10,3* ↑ 9: 9,8 ↘ 10: 10,3 ↗	11: 10,6* ↑ 12: 10,2 ↖ 13: 10,8* ↓ 14: 10,1 ↑ 15: 10,4* ↘
	Serie 89,0		Serie 50,0
	Totalt 193,0		Totalt 193,0
Serie 1		1: 9,8 → 2: 9,1 ↖ 3: 9,8 ← 4: 10,7* ← 5: 9,2 ←	6: 10,1 → 7: 9,1 ↘ 8: 10,5* ↖ 9: 10,3* → 10: 10,2 ↗
	Serie 46,0		Serie 49,0
	Totalt 239,0		Totalt 288,0
S 1		1: 9,5 ↑ 2: 10,6* ← 3: 10,1 ↑ 4: 10,3* → 5: 10,3* ↑	
	Serie 49,0		
	Totalt 337,0		

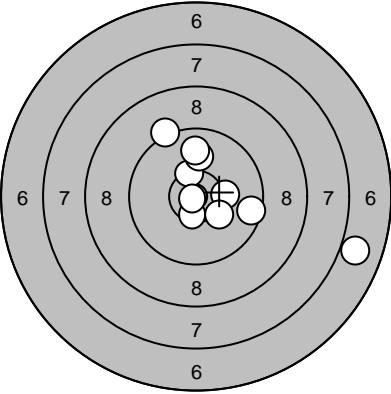
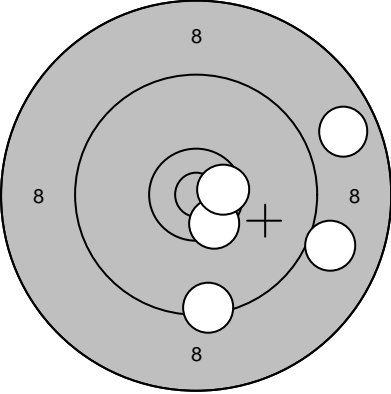
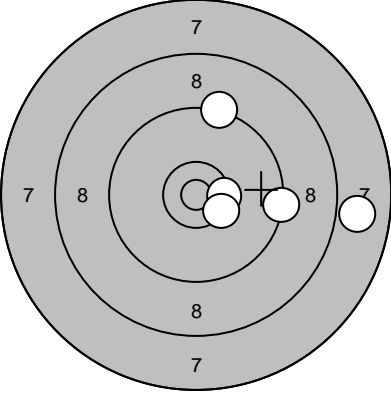
Skjutlag	Tavla	Marlene Forsell	
1	20	Ramselefors	
2007-07-16	Tavelträffen 2007 Final	Ramselefors SKF	
Prov		1: 10,4* ↑ 2: 9,3 ↗ 3: 10,5* ↓ 4: 10,0 ↑ 5: 10,9* ↙ 6: 7,0 → 7: 10,3 → 8: 10,2 ↘ 9: 9,6 → 10: 9,9 ↑	11: 9,1 → 12: 8,9 ↘ 13: 10,8* ↘ 14: 9,5 ↘ 15: 10,2 → 16: 10,4* ↖
	Serie 94,0		Serie 56,0
	Totalt 192,0		Totalt 192,0
Serie 1		1: 10,5* ↘ 2: 10,6* → 3: 9,4 ↓ 4: 8,8 ↗ 5: 9,0 ↘	6: 9,7 ↘ 7: 10,3* ↑ 8: 10,3 → 9: 10,4* ↘ 10: 10,5* →
	Serie 46,0		Serie 49,0
	Totalt 238,0		Totalt 287,0
S 1		1: 9,4 → 2: 7,9 → 3: 9,3 ↑ 4: 10,4* → 5: 10,4* ↘	
	Serie 45,0		
	Totalt 332,0		

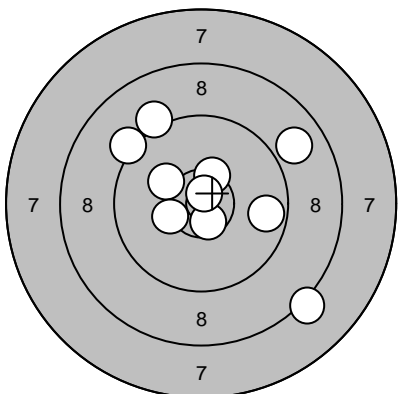
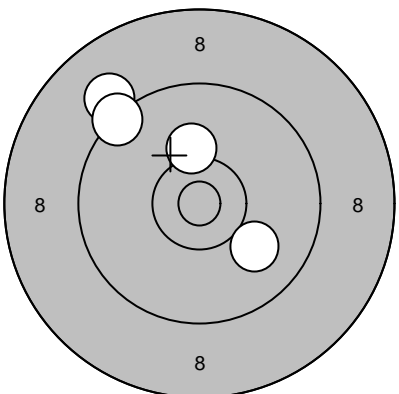
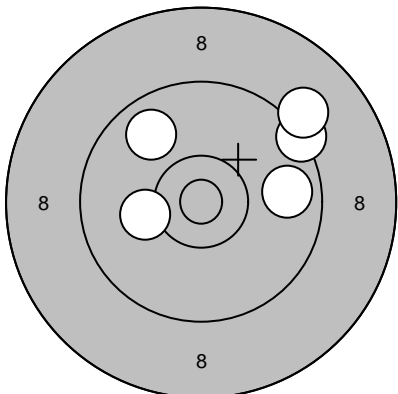
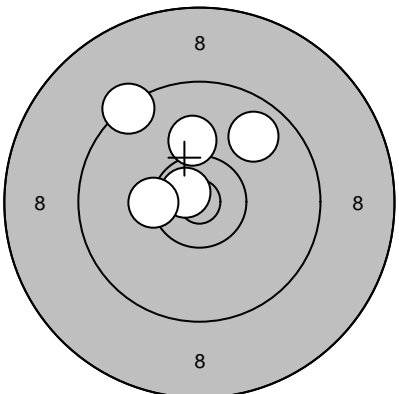
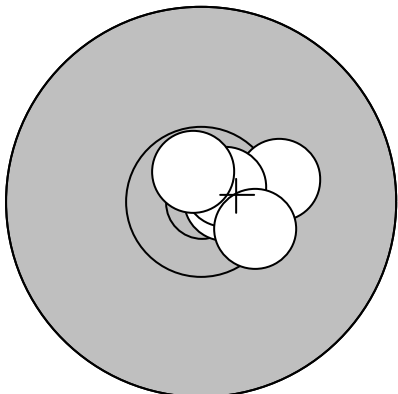
Skjutlag	Tavla	Carina Norling	
1	21	Söderala	
2007-07-16	Tavelträffen 2007 Final	Ramselefors SKF	
Prov	 1: 8,9 ↗ 2: 8,2 ↘ 3: 10,4* ↑ 4: 10,6* ↘ 5: 9,7 → 6: 9,2 ↑ 7: 10,2 ↖ 8: 10,8* ↑ 9: 9,2 ↖ 10: 10,3* ↙	Prov	 11: 9,1 ↗ 12: 10,2 ↑ 13: 9,4 ↗ 14: 10,0 ↘
	Serie 93,0		Serie 38,0
	Totalt 191,0		Totalt 191,0
Serie 1	 1: 9,3 ↗ 2: 10,2 ← 3: 9,8 ↖ 4: 9,1 ↗ 5: 9,8 →	Serie 1	 6: 10,1 ↑ 7: 10,7* ↖ 8: 10,3* ← 9: 9,4 ↖ 10: 9,8 ↗
	Serie 46,0		Serie 48,0
	Totalt 237,0		Totalt 285,0
S 1	 1: 10,7* → 2: 10,3 → 3: 10,7* ↗ 4: 10,4* ↘ 5: 10,7* ↑		
	Serie 50,0		
	Totalt 335,0		

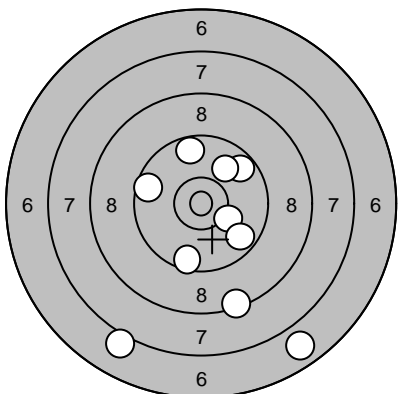
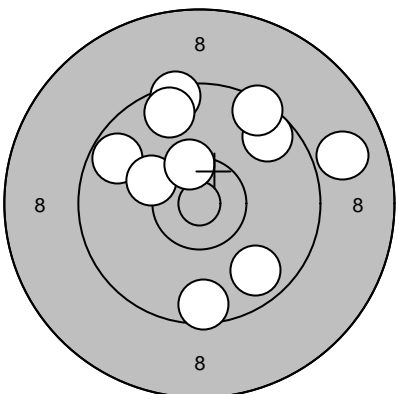
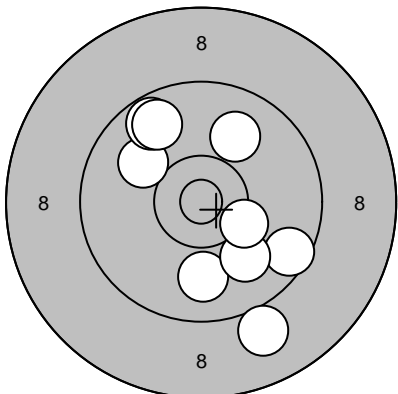
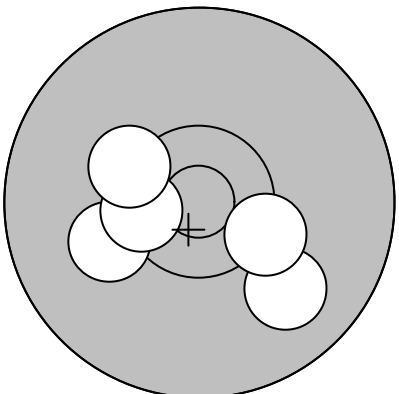
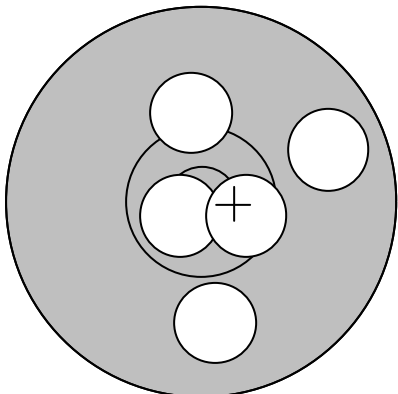
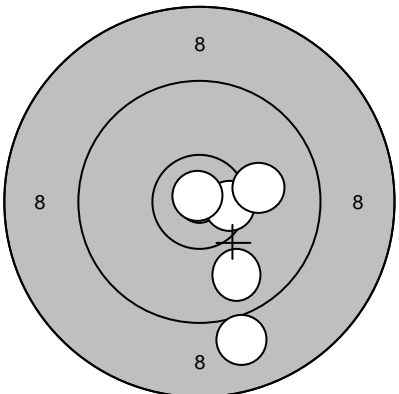
Skjutlag	Tavla	Marie Fjällström			
1	22	Ramselefors			
2007-07-16	Tavelträffen 2007 Final	Ramselefors SKF			
Prov		1: 9,7 ↗ 2: 10,2 → 3: 9,6 ← 4: 9,7 ↑ 5: 9,9 ↗ 6: 6,8 ↓ 7: 8,4 ↓ 8: 7,1 ↓ 9: 9,7 ↓ 10: 9,6 ↓ Serie 85,0 Totalt 190,0	Prov		11: 9,7 ↗ 12: 9,8 ↓ 13: 9,5 ↑ 14: 9,5 ↗ 15: 9,7 ↑ 16: 9,7 ← 17: 10,2 ← 18: 9,6 ↓ 19: 10,4* ↑ 20: 8,9 → Serie 91,0 Totalt 190,0
Prov		21: 9,9 ↗ 22: 9,6 → 23: 9,9 ↓ 24: 9,0 ↓ 25: 10,0 ↓ 26: 10,0 ↗ 27: 9,7 ↗ 28: 10,3* → 29: 9,8 ↗ Serie 84,0 Totalt 190,0	Serie 1		1: 10,1 ← 2: 10,5* ← 3: 10,3* ↗ 4: 9,9 ↓ 5: 10,3* ↘ Serie 49,0 Totalt 239,0
Serie 1		6: 10,7* ← 7: 10,2 ↑ 8: 9,9 ↓ 9: 10,6* → 10: 9,8 → Serie 48,0 Totalt 287,0	S 1		1: 10,5* → 2: 9,0 ↓ 3: 9,8 ↓ 4: 10,1 → 5: 10,9* ↑ Serie 48,0 Totalt 335,0

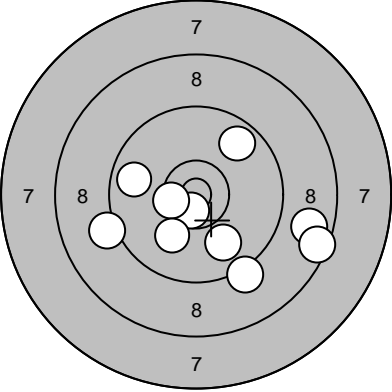
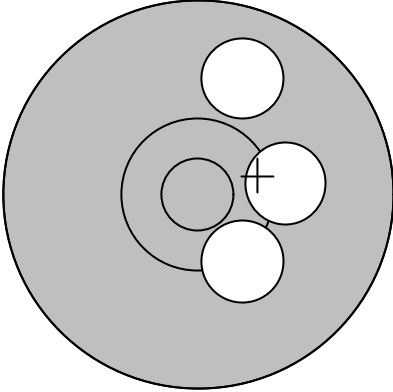
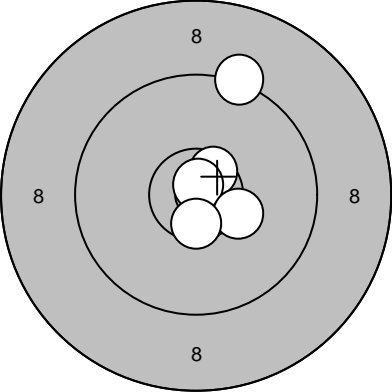
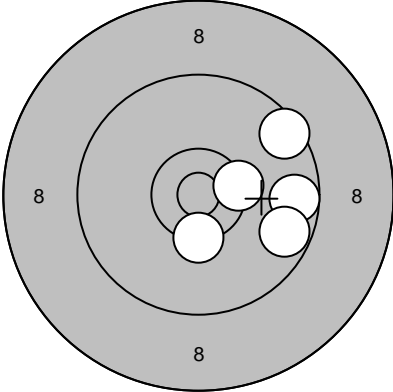
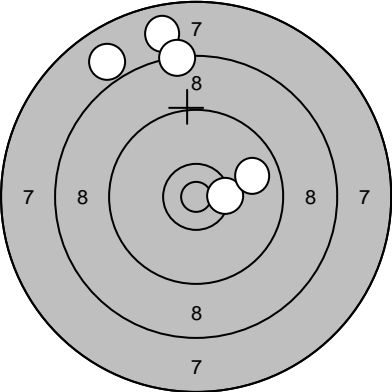
Skjutlag	Tavla	Niklas Westermark	
1	23	Drängsmark	
2007-07-16	Tavelträffen 2007 Final	Ramselefors SKF	
Prov		1: 9,7 ↗ 2: 8,8 → 3: 9,2 ↓ 4: 10,6* ↓ 5: 9,2 ← 6: 9,9 ↓ 7: 10,5* ← 8: 10,1 ↓ 9: 8,5 → 10: 9,8 ←	Prov 
	Serie 91,0		11: 10,3 ↓ 12: 9,9 ↗ 13: 10,2 →
	Totalt 188,0		Serie 29,0
			Totalt 188,0
Serie 1		1: 9,3 ↗ 2: 10,6* ↗ 3: 10,8* ↑ 4: 10,3* → 5: 10,6* ↓	Serie 1 
	Serie 49,0		6: 9,6 → 7: 9,5 ↗ 8: 10,4* ↓ 9: 10,4* → 10: 9,7 →
	Totalt 237,0		Serie 47,0
			Totalt 284,0
S 1		1: 7,9 ↑ 2: 7,9 ↖ 3: 10,4* → 4: 8,3 ↑ 5: 9,8 →	
	Serie 41,0		
	Totalt 325,0		

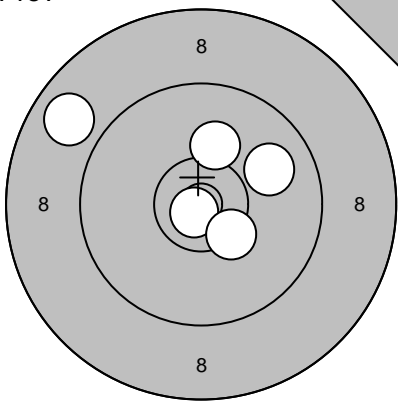
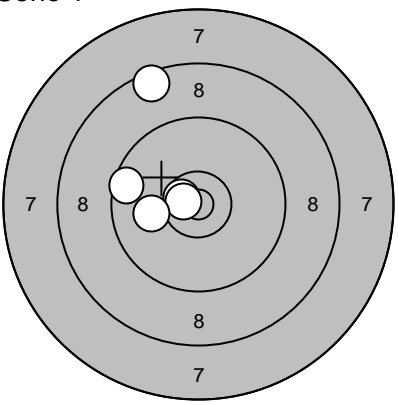
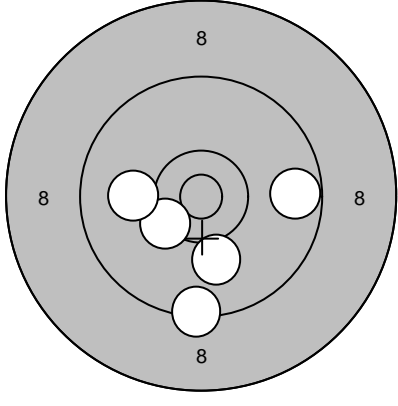
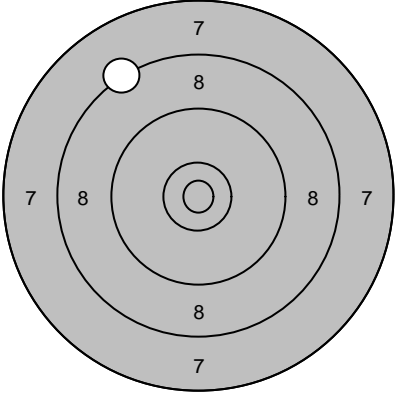
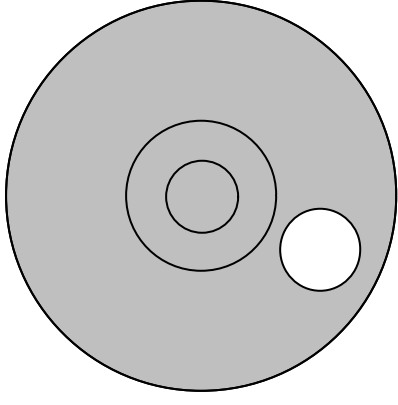
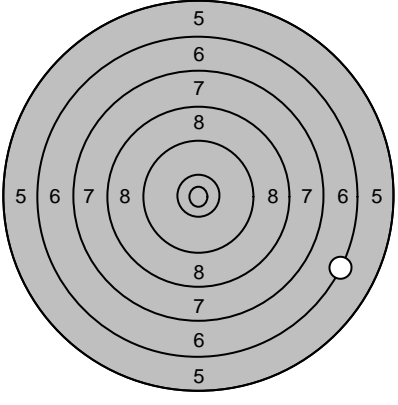
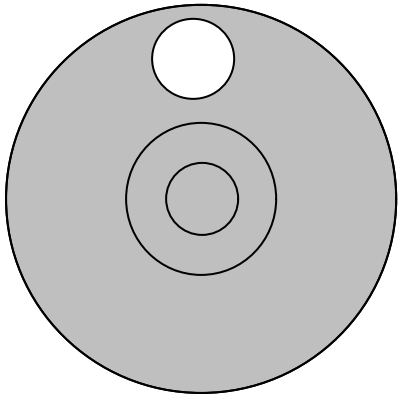
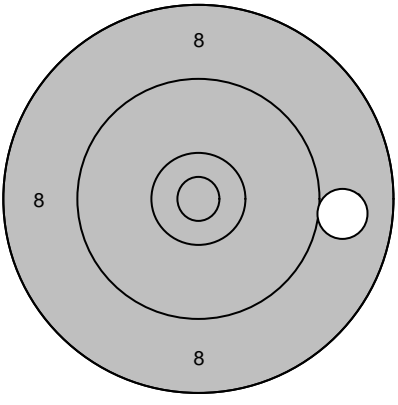
Skjutlag <b>2</b>	Tavla <b>1</b>	<b>Håkan Lidman</b>	
		Skellefteå	
2007-07-16	Tavelträffen 2007 Final	Ramselefors SKF	
Prov		1: 8,8 ↖ 2: 10,8* ↘ 3: 9,9 → 4: 10,1 ↑ 5: 10,4* ↘	Serie 1 
		1: 8,5 ↗ 2: 10,6* ↖ 3: 10,7* ↖ 4: 10,1 ← 5: 9,6 ↖	
		Serie 47,0 Totalt 194,0	Serie 47,0 Totalt 241,0
Serie 1		6: 10,3* ↖ 7: 10,0 ← 8: 10,1 ↘ 9: 9,4 ↘ 10: 9,7 →	S 1 
		1: 8,3 ↗	
		Serie 48,0 Totalt 289,0	Serie 8,0 Totalt 297,0
S 2		1: 9,8 →	S 3 
			1: 6,4 →
		Serie 9,0 Totalt 306,0	Serie 6,0 Totalt 312,0
S 4		1: 9,8 ↑	S 5 
			1: 9,0 →
		Serie 9,0 Totalt 321,0	Serie 9,0 Totalt 330,0

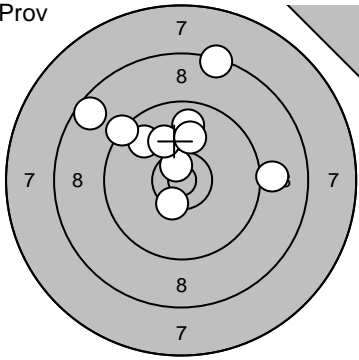
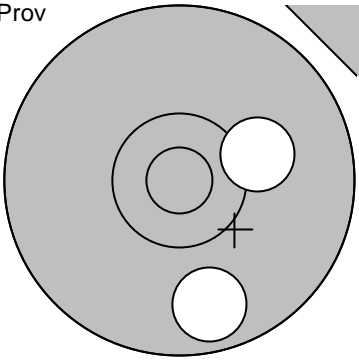
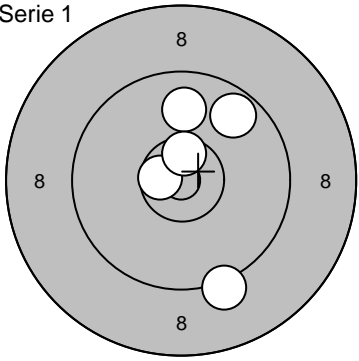
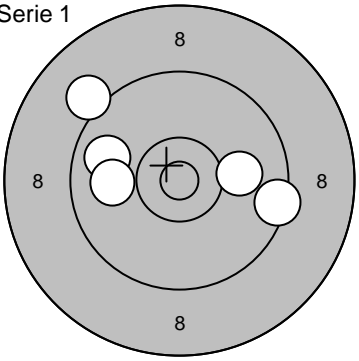
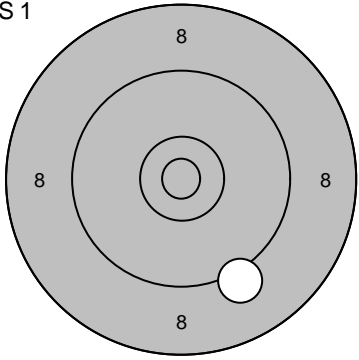
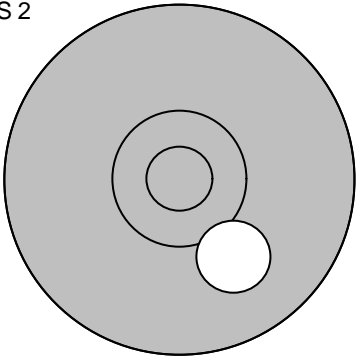
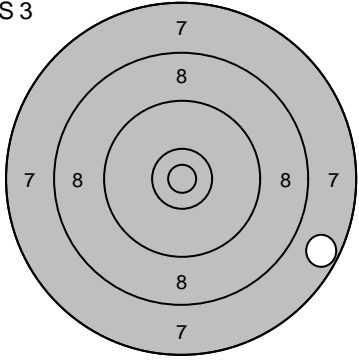
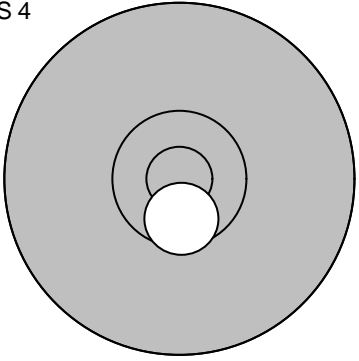
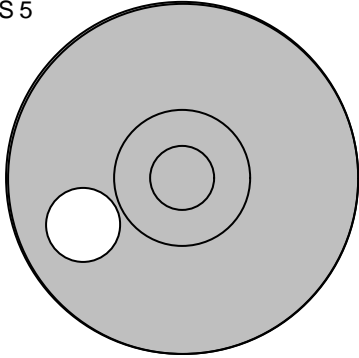
Skjutlag <b>2</b>	Tavla <b>2</b>	<b>Gunnar Iversen</b>	
		S 3	
2007-07-16	Tavelträffen 2007 Final	Ramselefors SKF	
Prov 	1: 9,1 → 2: 10,4* ↓ 3: 9,8 ↑↑ 4: 10,6* ↑↑ 5: 9,8 ↑↑ 6: 8,4 ↑↑ 7: 10,1 ↑↑ 8: 8,6 ↑↑ 9: 9,3 ↑↑ 10: 10,0 ↑	Prov 	11: 10,2 → 12: 9,8 ↓
	Serie 92,0 Totalt 191,0		Serie 19,0 Totalt 191,0
Serie 1 	1: 9,9 ↑ 2: 10,6* ← 3: 10,6* ↑↑ 4: 9,2 ↓↓ 5: 9,7 ↑	Serie 1 	6: 9,1 ↗ 7: 9,8 ↖ 8: 9,9 ← 9: 10,0 → 10: 9,4 ↓
	Serie 47,0 Totalt 238,0		Serie 46,0 Totalt 284,0
S 1 	1: 9,2 ↓	S 2 	1: 10,1 ↓
	Serie 9,0 Totalt 293,0		Serie 10,0 Totalt 303,0
S 3 	1: 7,7 →	S 4 	1: 10,6* ↓
	Serie 7,0 Totalt 310,0		Serie 10,0 Totalt 320,0
S 5 	1: 9,9 ←		
	Serie 9,0 Totalt 329,0		

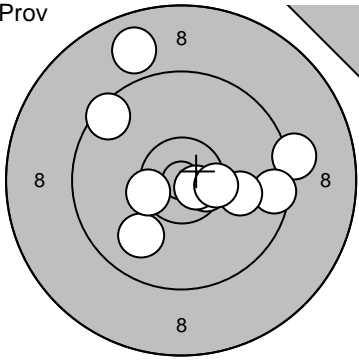
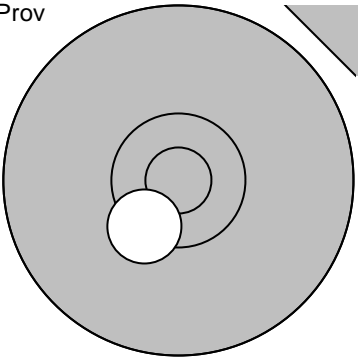
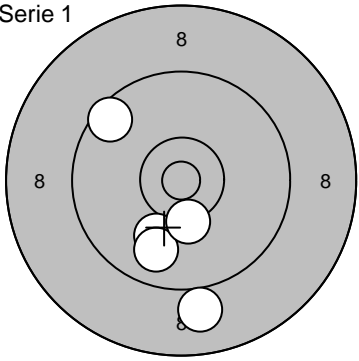
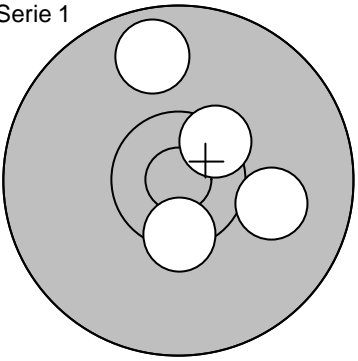
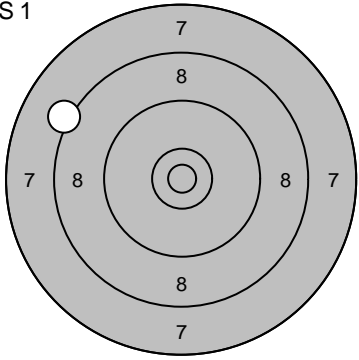
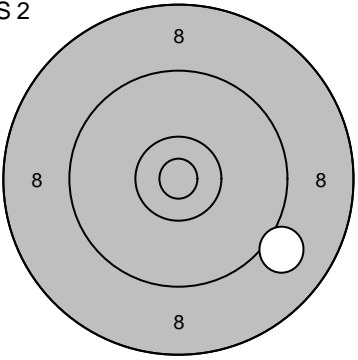
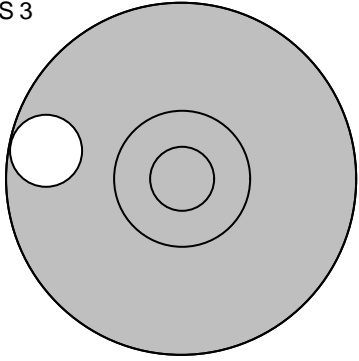
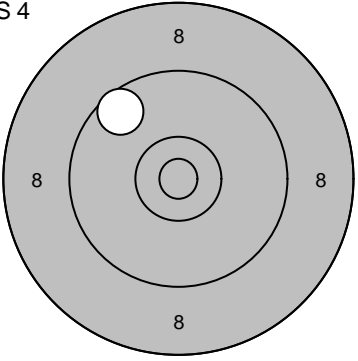
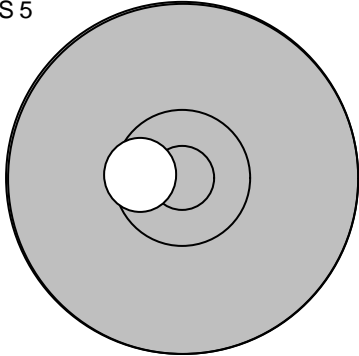
Skjutlag	Tavla	Dan-Ivan Karlsson																																													
2	3	Ramselefors																																													
2007-07-16	Tavelträffen 2007 Final	Ramselefors SKF																																													
Prov	 <table border="1"> <tr><td>1:</td><td>9,5</td><td>↖</td></tr> <tr><td>2:</td><td>8,9</td><td>→</td></tr> <tr><td>3:</td><td>9,2</td><td>→</td></tr> <tr><td>4:</td><td>10,6*</td><td>↘</td></tr> <tr><td>5:</td><td>9,5</td><td>↘</td></tr> <tr><td>6:</td><td>10,0</td><td>↘</td></tr> <tr><td>7:</td><td>10,7*</td><td>↘</td></tr> <tr><td>8:</td><td>10,4*</td><td>→</td></tr> <tr><td>9:</td><td>9,9</td><td>↙</td></tr> <tr><td>10:</td><td>10,4*</td><td>↙</td></tr> <tr><td>Serie</td><td>94,0</td><td></td></tr> <tr><td>Totalt</td><td>191,0</td><td></td></tr> </table>	1:	9,5	↖	2:	8,9	→	3:	9,2	→	4:	10,6*	↘	5:	9,5	↘	6:	10,0	↘	7:	10,7*	↘	8:	10,4*	→	9:	9,9	↙	10:	10,4*	↙	Serie	94,0		Totalt	191,0		 <table border="1"> <tr><td>11:</td><td>10,4*</td><td>↙</td></tr> <tr><td>Serie</td><td>10,0</td><td></td></tr> <tr><td>Totalt</td><td>191,0</td><td></td></tr> </table>	11:	10,4*	↙	Serie	10,0		Totalt	191,0	
1:	9,5	↖																																													
2:	8,9	→																																													
3:	9,2	→																																													
4:	10,6*	↘																																													
5:	9,5	↘																																													
6:	10,0	↘																																													
7:	10,7*	↘																																													
8:	10,4*	→																																													
9:	9,9	↙																																													
10:	10,4*	↙																																													
Serie	94,0																																														
Totalt	191,0																																														
11:	10,4*	↙																																													
Serie	10,0																																														
Totalt	191,0																																														
Serie 1	 <table border="1"> <tr><td>1:</td><td>10,0</td><td>↘</td></tr> <tr><td>2:</td><td>9,8</td><td>↘</td></tr> <tr><td>3:</td><td>9,0</td><td>↘</td></tr> <tr><td>4:</td><td>10,3*</td><td>↘</td></tr> <tr><td>5:</td><td>9,5</td><td>↗</td></tr> <tr><td>Serie</td><td>47,0</td><td></td></tr> <tr><td>Totalt</td><td>238,0</td><td></td></tr> </table>	1:	10,0	↘	2:	9,8	↘	3:	9,0	↘	4:	10,3*	↘	5:	9,5	↗	Serie	47,0		Totalt	238,0		 <table border="1"> <tr><td>6:</td><td>10,4*</td><td>↓</td></tr> <tr><td>7:</td><td>9,8</td><td>↑</td></tr> <tr><td>8:</td><td>10,4*</td><td>↗</td></tr> <tr><td>9:</td><td>10,0</td><td>→</td></tr> <tr><td>10:</td><td>0,0</td><td>↙</td></tr> <tr><td>Serie</td><td>39,0</td><td></td></tr> <tr><td>Totalt</td><td>277,0</td><td></td></tr> </table>	6:	10,4*	↓	7:	9,8	↑	8:	10,4*	↗	9:	10,0	→	10:	0,0	↙	Serie	39,0		Totalt	277,0				
1:	10,0	↘																																													
2:	9,8	↘																																													
3:	9,0	↘																																													
4:	10,3*	↘																																													
5:	9,5	↗																																													
Serie	47,0																																														
Totalt	238,0																																														
6:	10,4*	↓																																													
7:	9,8	↑																																													
8:	10,4*	↗																																													
9:	10,0	→																																													
10:	0,0	↙																																													
Serie	39,0																																														
Totalt	277,0																																														
S 1	 <table border="1"> <tr><td>1:</td><td>8,2</td><td>↖</td></tr> <tr><td>Serie</td><td>8,0</td><td></td></tr> <tr><td>Totalt</td><td>285,0</td><td></td></tr> </table>	1:	8,2	↖	Serie	8,0		Totalt	285,0		 <table border="1"> <tr><td>1:</td><td>9,1</td><td>↘</td></tr> <tr><td>Serie</td><td>9,0</td><td></td></tr> <tr><td>Totalt</td><td>294,0</td><td></td></tr> </table>	1:	9,1	↘	Serie	9,0		Totalt	294,0																												
1:	8,2	↖																																													
Serie	8,0																																														
Totalt	285,0																																														
1:	9,1	↘																																													
Serie	9,0																																														
Totalt	294,0																																														
S 3	 <table border="1"> <tr><td>1:</td><td>9,7</td><td>↖</td></tr> <tr><td>Serie</td><td>9,0</td><td></td></tr> <tr><td>Totalt</td><td>303,0</td><td></td></tr> </table>	1:	9,7	↖	Serie	9,0		Totalt	303,0		 <table border="1"> <tr><td>1:</td><td>9,6</td><td>↖</td></tr> <tr><td>Serie</td><td>9,0</td><td></td></tr> <tr><td>Totalt</td><td>312,0</td><td></td></tr> </table>	1:	9,6	↖	Serie	9,0		Totalt	312,0																												
1:	9,7	↖																																													
Serie	9,0																																														
Totalt	303,0																																														
1:	9,6	↖																																													
Serie	9,0																																														
Totalt	312,0																																														
S 5	 <table border="1"> <tr><td>1:</td><td>10,6*</td><td>↖</td></tr> <tr><td>Serie</td><td>10,0</td><td></td></tr> <tr><td>Totalt</td><td>322,0</td><td></td></tr> </table>	1:	10,6*	↖	Serie	10,0		Totalt	322,0																																						
1:	10,6*	↖																																													
Serie	10,0																																														
Totalt	322,0																																														

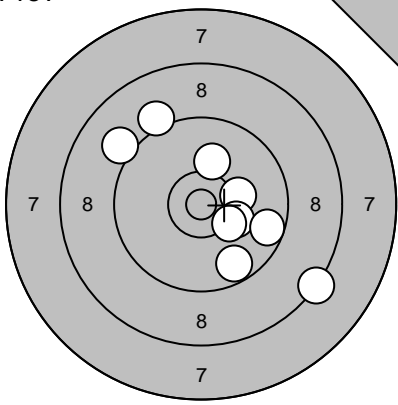
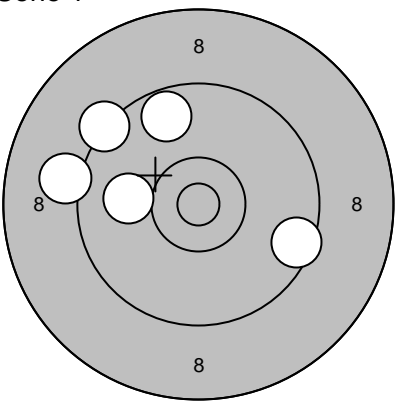
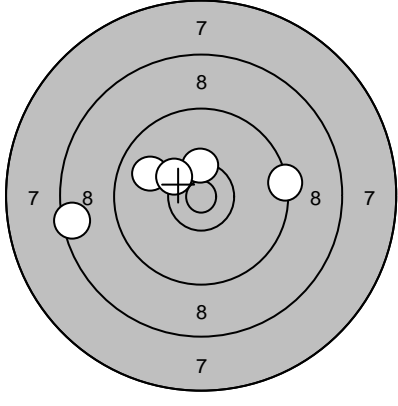
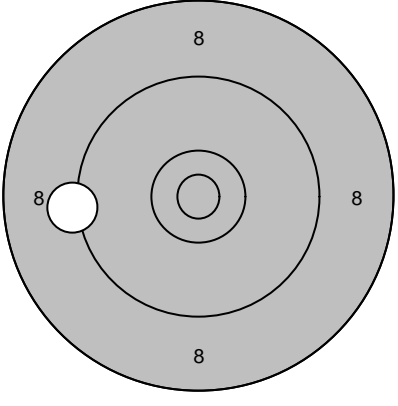
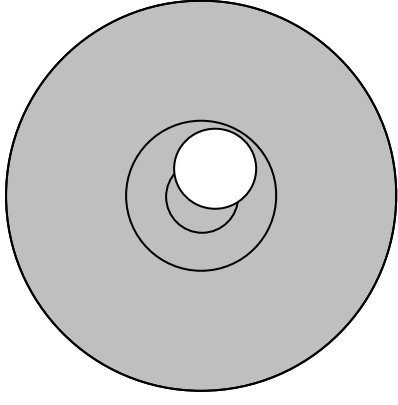
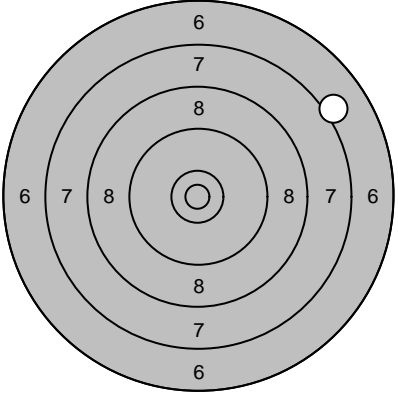
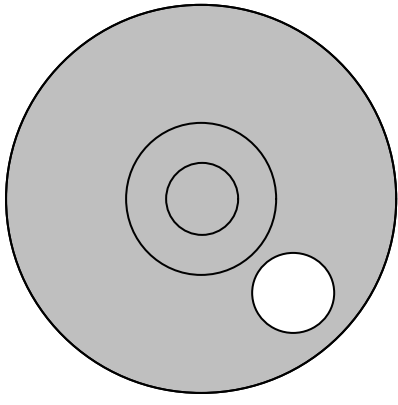
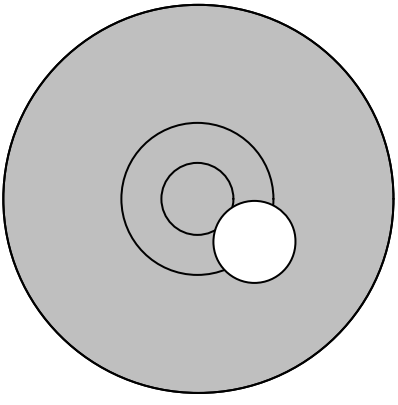

Skjutlag	Tavla	<b>Martin Olofsson</b>		
<b>2</b>	<b>4</b>			
Vännäs				
2007-07-16	Tavelträffen 2007 Final	Ramselefors SKF		
Prov		1: 10,1 ↗ 2: 8,3 ↘ 3: 9,1 ↗ 4: 10,2 → 5: 10,2 ↘ 6: 9,7 ↘ 7: 9,6 ↘ 8: 9,1 ↗ 9: 10,3* ↘ Serie 84,0 Totalt 187,0	Serie 1 	1: 10,0 ← 2: 9,7 ↗ 3: 9,1 ↗ 4: 9,3 ↗ 5: 9,5 ↘ Serie 46,0 Totalt 233,0
Serie 1		6: 8,5 ← 7: 10,4* ↑ 8: 9,9 ↗ 9: 9,4 → 10: 10,3* ↗ Serie 46,0 Totalt 279,0	S 1 	1: 9,2 ← Serie 9,0 Totalt 288,0
S 2		1: 10,7* ↗ Serie 10,0 Totalt 298,0	S 3 	1: 7,1 ↗ Serie 7,0 Totalt 305,0
S 4		1: 9,8 ↘ Serie 9,0 Totalt 314,0	S 5 	1: 10,3* ↘ Serie 10,0 Totalt 324,0

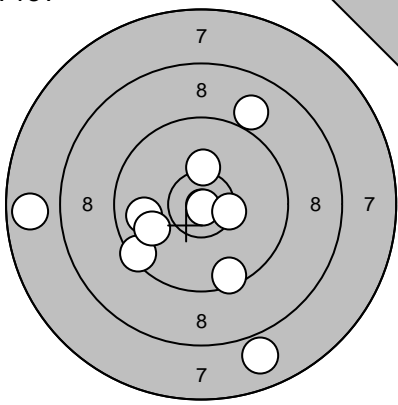
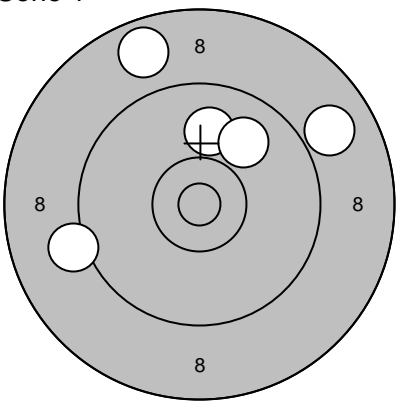
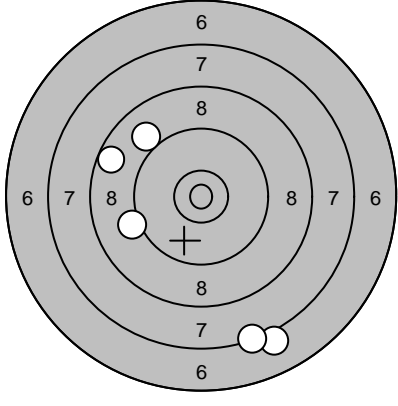
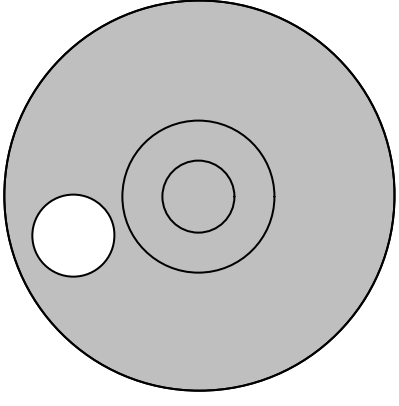
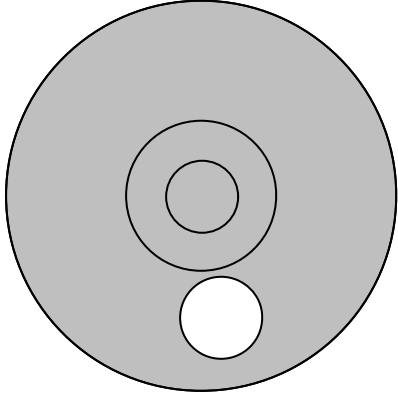
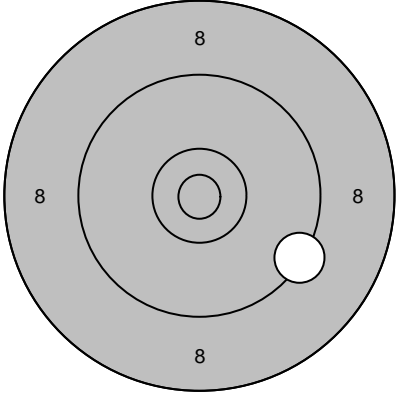
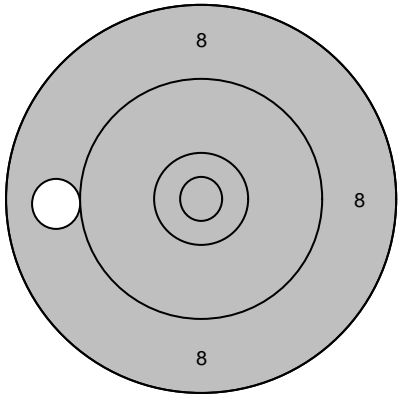
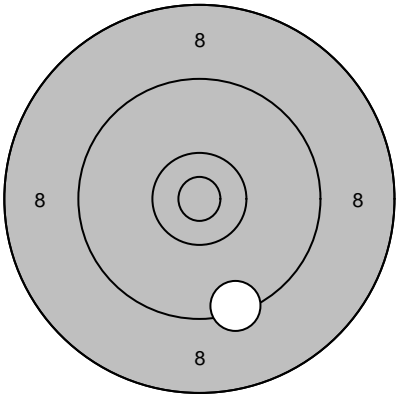
Skjutlag	Tavla	Bertil Ruisniemi		
2	5	Övertorneå		
2007-07-16	Tavelträffen 2007 Final	Ramselefors SKF		
Prov		1: 7,8 ← 2: 9,5 ↙ 3: 7,9 ↓ 4: 10,9* ↓ 5: 10,4* → 6: 9,5 ↓ 7: 9,9 ← 8: 9,9 ← 9: 10,2 ↑ 10: 9,0 ↗	Serie 1 	1: 8,9 ↗ 2: 9,2 ← 3: 8,8 ↗ 4: 10,0 ↑ 5: 9,9 ↗
	Serie 89,0 Totalt 185,0		Serie 44,0 Totalt 229,0	
Serie 1		6: 7,1 ↓ 7: 9,2 ← 8: 9,0 ↗ 9: 8,7 ↖ 10: 7,3 ↓	S 1 	1: 9,8 ←
	Serie 40,0 Totalt 269,0		Serie 9,0 Totalt 278,0	
S 2		1: 9,9 ↓	S 3 	1: 9,4 ↘
	Serie 9,0 Totalt 287,0		Serie 9,0 Totalt 296,0	
S 4		1: 9,0 ←	S 5 	1: 9,4 ↓
	Serie 9,0 Totalt 305,0		Serie 9,0 Totalt 314,0	

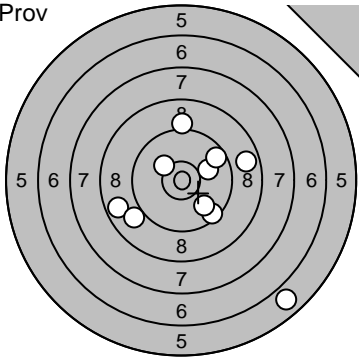
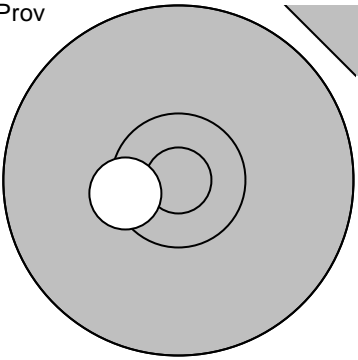
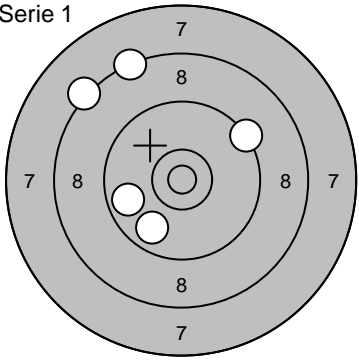
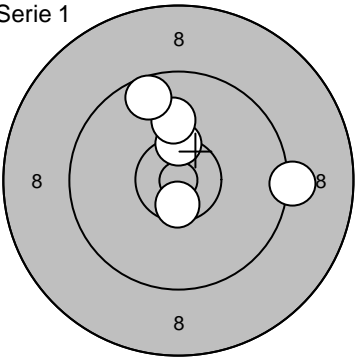
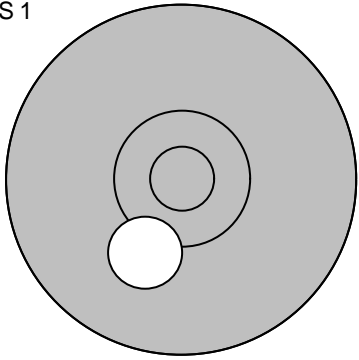
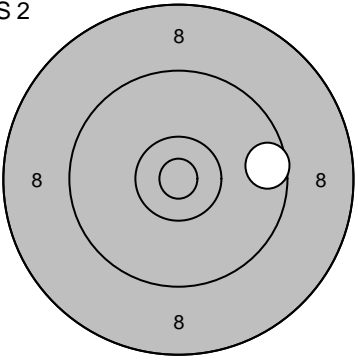
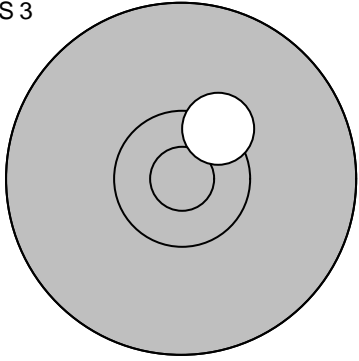
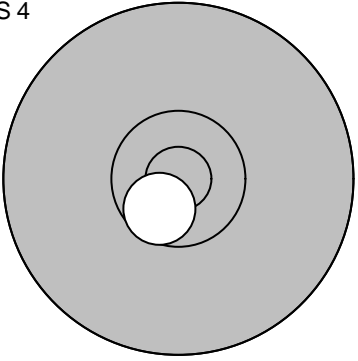
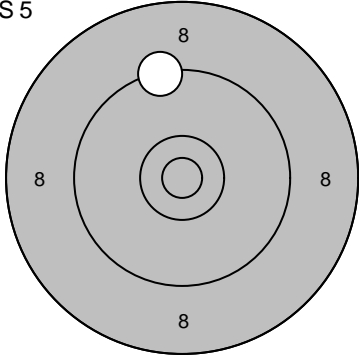
Skjutlag <b>2</b>	Tavla <b>7</b>	<b>Håkan Engman</b>	
		Lindesberg	
2007-07-16	Tavelträffen 2007 Final	Ramselefors SKF	
Prov 	1: 8,7 ← 2: 5,9 ↘ 3: 10,2 ↗ 4: 9,5 ↘ 5: 8,8 → 6: 10,0 → 7: 9,9 ↘ 8: 9,6 ↗ 9: 9,0 ↖ 10: 9,1 ↑ Serie 86,0 Totalt 180,0	Prov 	11: 10,4* ← Serie 10,0 Totalt 180,0
Serie 1 	1: 9,8 ← 2: 9,3 ↗ 3: 9,8 ↖ 4: 8,3 ↗ 5: 8,3 ↗ Serie 43,0 Totalt 223,0	Serie 1 	6: 10,4* ↑ 7: 10,6* ↓ 8: 10,1 ↑ 9: 9,2 → 10: 9,6 ↑ Serie 48,0 Totalt 271,0
S 1 	1: 10,2 ↘ Serie 10,0 Totalt 281,0	S 2 	1: 9,6 → Serie 9,0 Totalt 290,0
S 3 	1: 10,4* ↗ Serie 10,0 Totalt 300,0	S 4 	1: 10,6* ↘ Serie 10,0 Totalt 310,0
S 5 	1: 9,4 ↑ Serie 9,0 Totalt 319,0		

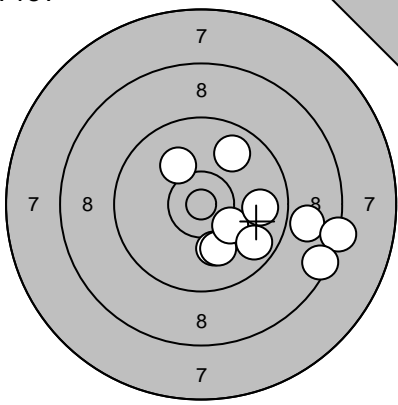
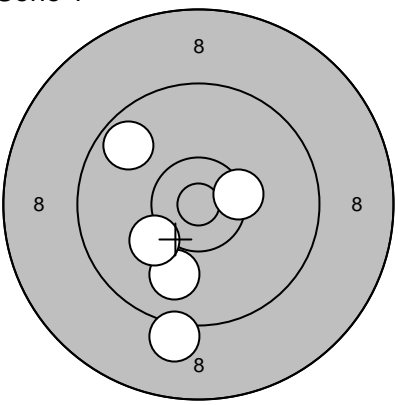
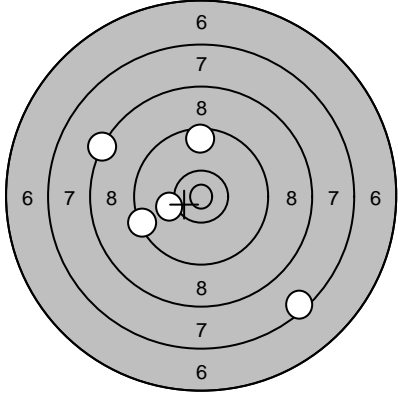
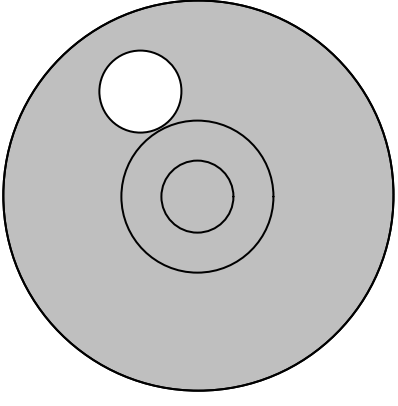
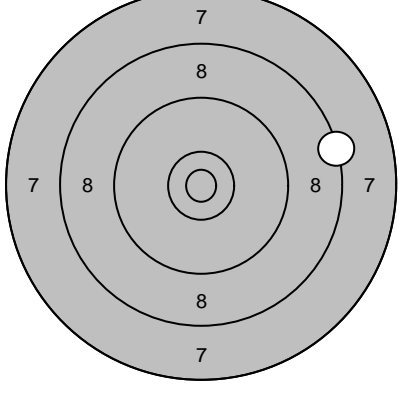
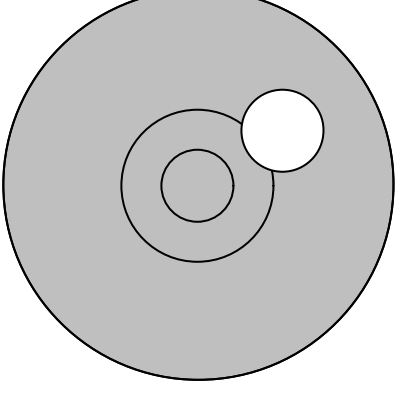
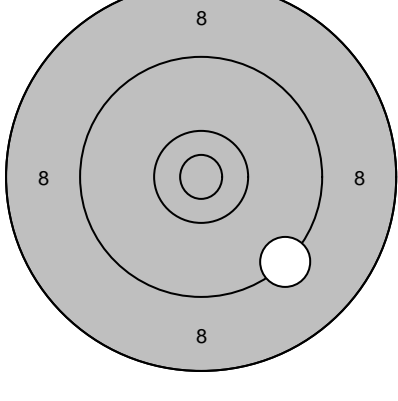
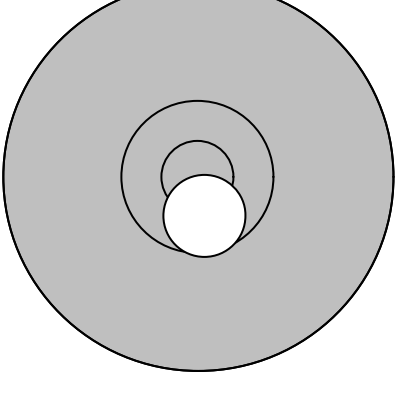
Skjutlag	Tavla	<b>Rolf Lindbäck</b>	
<b>2</b>	<b>8</b>		
Vännäs			
2007-07-16	Tavelträffen 2007 Final	Ramselefors SKF	
Prov		1: 10,1 ↓ 2: 8,9 → 3: 8,3 → 4: 10,1 ↗ 5: 10,1 ↘ 6: 8,5 ↘ 7: 10,3 ↘ 8: 9,8 → 9: 9,7 ↘ 10: 9,8 ↗	Serie 1
		Serie 91,0 Totalt 177,0	
			1: 9,1 ↓ 2: 10,0 ↓ 3: 10,2 ↙ 4: 9,7 ↖ 5: 10,4* →
			Serie 48,0 Totalt 225,0
Serie 1		6: 9,4 ← 7: 8,3 ← 8: 9,6 ↑ 9: 10,2 ← 10: 7,5 ↓	S 1
		Serie 43,0 Totalt 268,0	
			1: 9,9 ↖
			Serie 9,0 Totalt 277,0
S 2		1: 8,3 →	S 3
		Serie 8,0 Totalt 285,0	
			1: 10,1 ↗
			Serie 10,0 Totalt 295,0
S 4		1: 9,3 ↘	S 5
		Serie 9,0 Totalt 304,0	
			1: 10,6* ↓
			Serie 10,0 Totalt 314,0

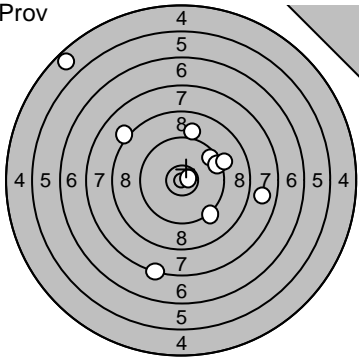
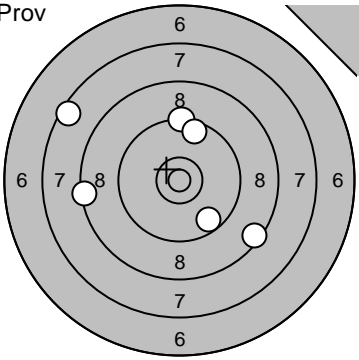
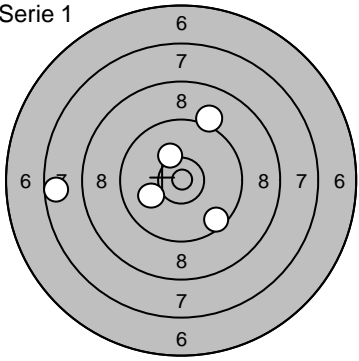
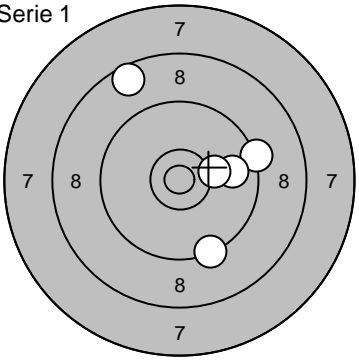
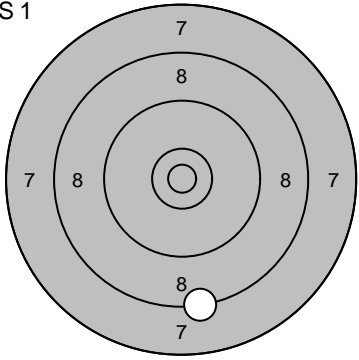
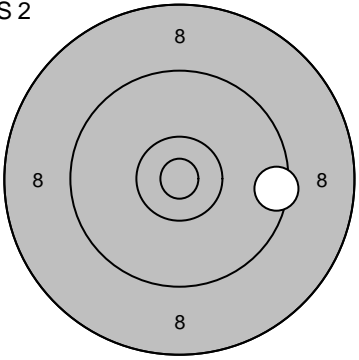
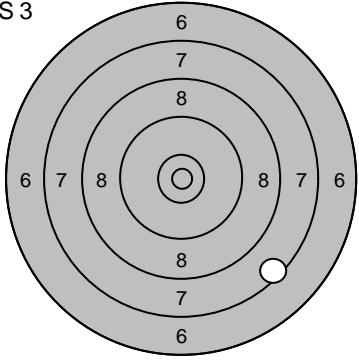
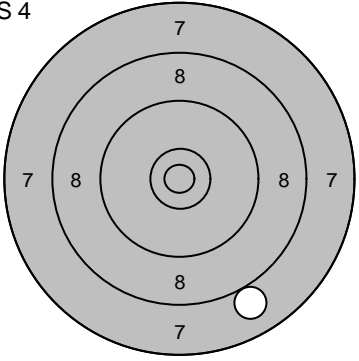
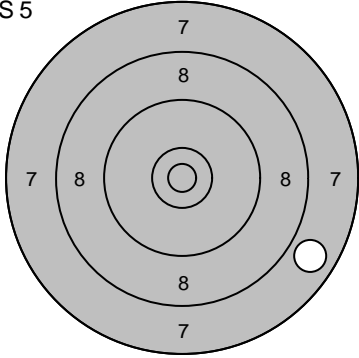
Skjutlag	Tavla	<b>Lennart Westermark</b>			
<b>2</b>	<b>10</b>				
		Drängsmark			
2007-07-16		Tavelträffen 2007 Final	Ramselefors SKF		
Prov		1: 4,7 ↗ 2: 7,8 → 3: 7,4 ↘ 4: 9,6 ↗ 5: 9,1 ↗ 6: 10,7* → 7: 8,2 ↗ 8: 9,2 ↘ 9: 9,5 → 10: 9,2 → Serie 81,0 Totalt 158,0	Prov		11: 9,7 ↘ 12: 8,5 ↘ 13: 8,4 ← 14: 7,5 ↗ 15: 9,4 ↗ 16: 9,6 ↗ Serie 50,0 Totalt 158,0
Serie 1		1: 7,6 ← 2: 10,1 ← 3: 9,2 ↗ 4: 9,5 ↘ 5: 10,3 ↗ Serie 45,0 Totalt 203,0	Serie 1		6: 9,3 ↘ 7: 8,6 ↗ 8: 9,3 → 9: 9,8 → 10: 10,2 → Serie 45,0 Totalt 248,0
S 1		1: 8,3 ↘ Serie 8,0 Totalt 256,0	S 2		1: 9,5 → Serie 9,0 Totalt 265,0
S 3		1: 7,5 ↘ Serie 7,0 Totalt 272,0	S 4		1: 8,0 ↘ Serie 8,0 Totalt 280,0
S 5		1: 7,8 ↗ Serie 7,0 Totalt 287,0			

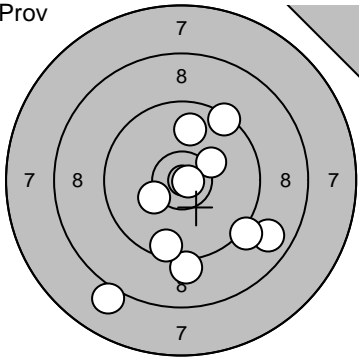
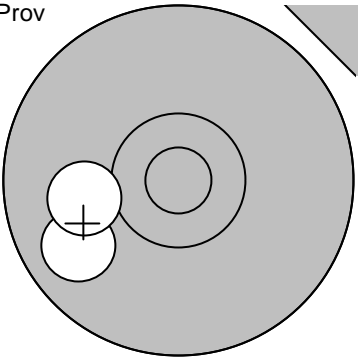
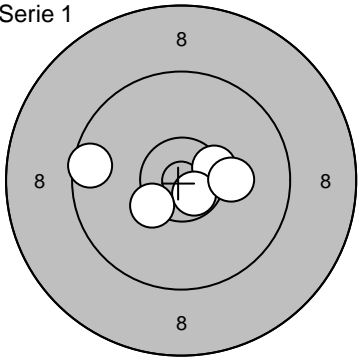
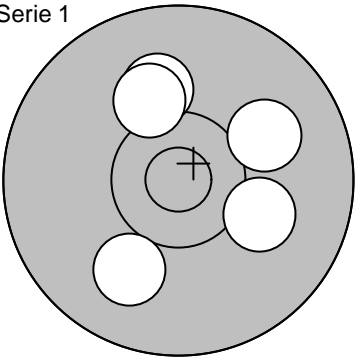
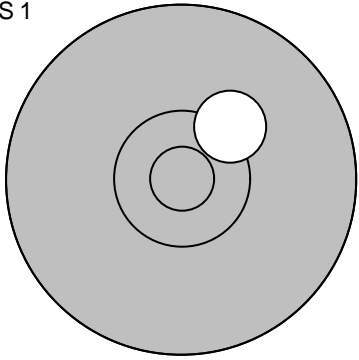
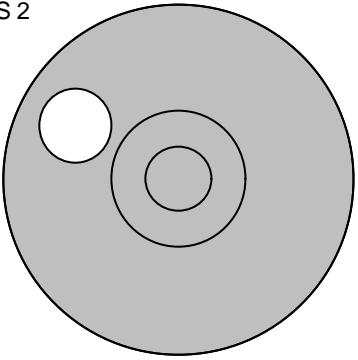
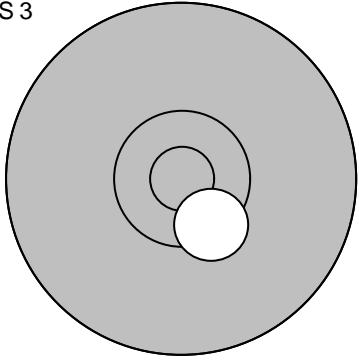
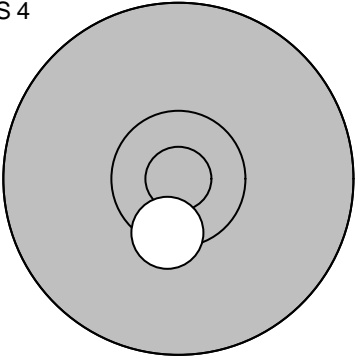
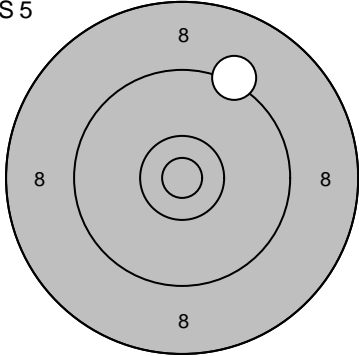
Skjutlag <b>2</b>	Tavla <b>13</b>	<b>Gabriella Johansson</b>	
		Kalmar	
2007-07-16	Tavelträffen 2007 Final	Ramselefors SKF	
Prov 	1: 10,2 → 2: 10,8* → 3: 8,8 ↘ 4: 9,2 ↘ 5: 8,1 ↘ 6: 9,1 ↓ 7: 9,6 ↓ 8: 9,9 ↑ 9: 9,4 ↗ 10: 10,3* ←	Prov 	11: 9,8 ← 12: 10,1 ←
	Serie 91,0 Totalt 192,0		Serie 19,0 Totalt 192,0
Serie 1 	1: 10,4* → 2: 10,7* ↘ 3: 10,4* ↘ 4: 10,2 → 5: 9,6 ←	Serie 1 	6: 10,0 ↓ 7: 10,1 ↑ 8: 10,2 ↑ 9: 10,0 → 10: 10,1 ↘
	Serie 49,0 Totalt 241,0		Serie 50,0 Totalt 291,0
S 1 	1: 10,3 ↗	S 2 	1: 9,9 ←
	Serie 10,0 Totalt 301,0		Serie 9,0 Totalt 310,0
S 3 	1: 10,4* ↘	S 4 	1: 10,4* ↓
	Serie 10,0 Totalt 320,0		Serie 10,0 Totalt 330,0
S 5 	1: 9,3 ↗		
	Serie 9,0 Totalt 339,0		

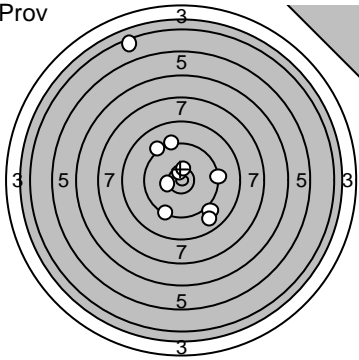
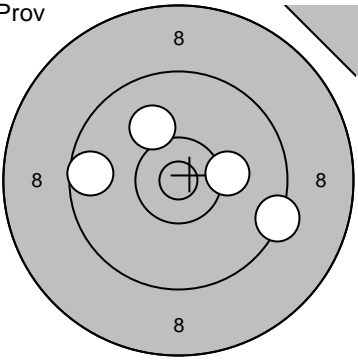
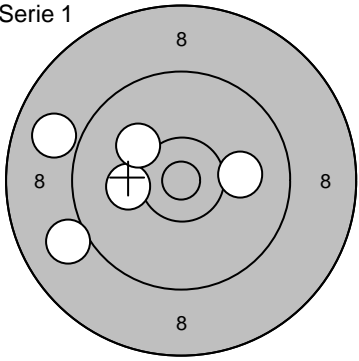
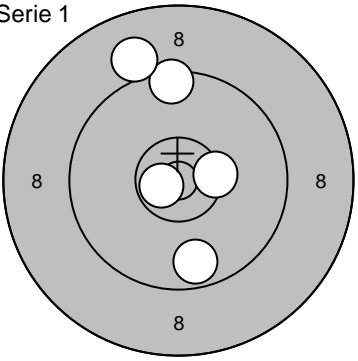
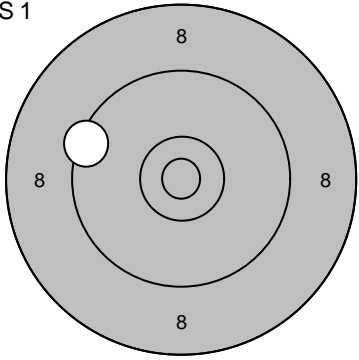
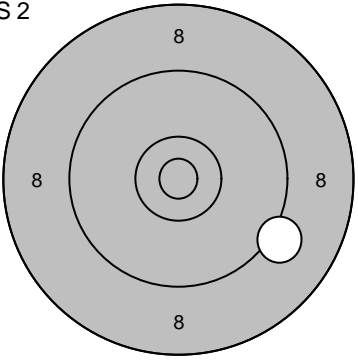
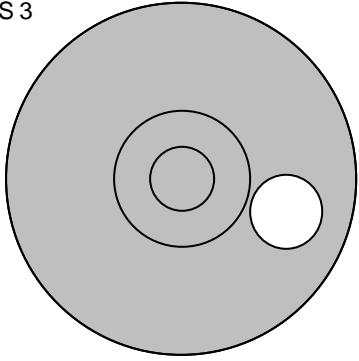
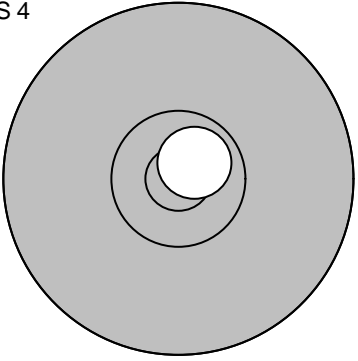
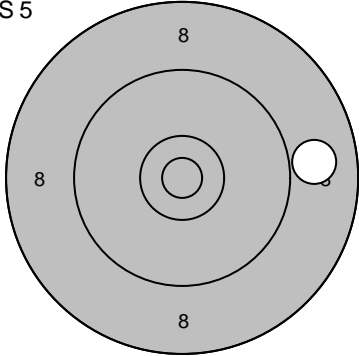
Skjutlag <b>2</b>	Tavla <b>14</b>	<b>Elina Högström</b>	
		Ramselefors	
2007-07-16	Tavelträffen 2007 Final	Ramselefors SKF	
Prov 	1: 4,6 ↗ 2: 9,4 → 3: 9,2 ↘ 4: 8,9 ↘ 5: 9,3 ↘ 6: 9,4 ↘ 7: 9,2 ↗ 8: 10,6* ↗ 9: 10,5* ↗ 10: 10,3* ←	Prov 	11: 9,6 ← 12: 9,4 → 13: 10,1 ↗ 14: 10,2 →
	Serie 87,0 Totalt 190,0		Serie 38,0 Totalt 190,0
Serie 1 	1: 10,2 ← 2: 9,0 ← 3: 10,1 ↗ 4: 10,1 → 5: 8,9 ↗	Serie 1 	6: 9,5 ↑ 7: 10,7* ← 8: 10,4* → 9: 9,7 ↓ 10: 9,0 ↗
	Serie 47,0 Totalt 237,0		Serie 47,0 Totalt 284,0
S 1 	1: 9,4 ←	S 2 	1: 9,2 ↘
	Serie 9,0 Totalt 293,0		Serie 9,0 Totalt 302,0
S 3 	1: 9,9 →	S 4 	1: 10,7* ↗
	Serie 9,0 Totalt 311,0		Serie 10,0 Totalt 321,0
S 5 	1: 9,0 →		
	Serie 9,0 Totalt 330,0		

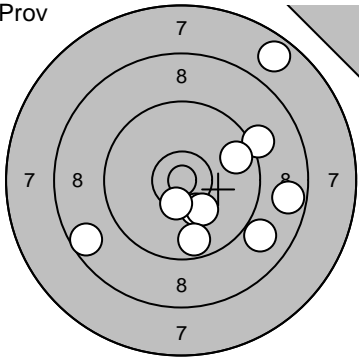
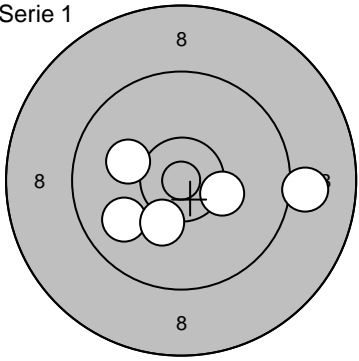
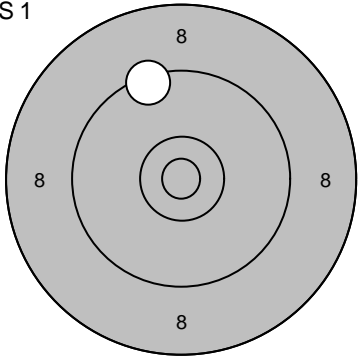
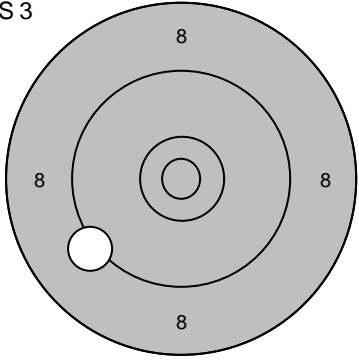
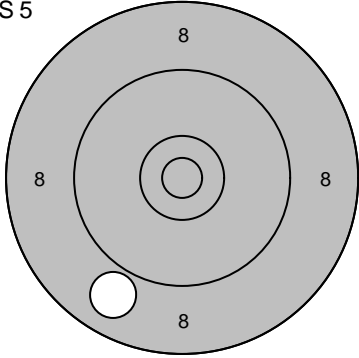
Skjutlag	Tavla	<b>Rodi Hammare</b>	
<b>2</b>	<b>15</b>		
		Umeå	
2007-07-16		Tavelträffen 2007 Final	Ramselefors SKF
Prov		1: 7,7 ↗ 2: 9,0 ↘ 3: 8,7 → 4: 9,2 → 5: 10,3 → 6: 10,2 ↘ 7: 10,4* ↘ 8: 9,7 ↘ 9: 8,6 ↙ 10: 9,7 →	11: 8,4 ↗ 12: 10,8* ↑ 13: 10,7* ↑ 14: 9,6 ↘ 15: 10,1 ↘ 16: 10,8* ↘
		Serie 89,0 Totalt 188,0	Serie 57,0 Totalt 188,0
Serie 1		1: 10,3* → 2: 9,1 → 3: 9,9 ↙ 4: 10,1 ↖ 5: 10,2 ↘	6: 10,6* → 7: 9,8 ← 8: 10,3 → 9: 9,5 ← 10: 10,7* ↘
		Serie 48,0 Totalt 236,0	Serie 48,0 Totalt 284,0
S 1		1: 9,4 ↗	S 2
		Serie 9,0 Totalt 293,0	1: 9,0 ↗ Serie 9,0 Totalt 302,0
S 3		1: 9,2 ↙	S 4
		Serie 9,0 Totalt 311,0	1: 9,1 ↘ Serie 9,0 Totalt 320,0
S 5		1: 8,9 ↘	
		Serie 8,0 Totalt 328,0	

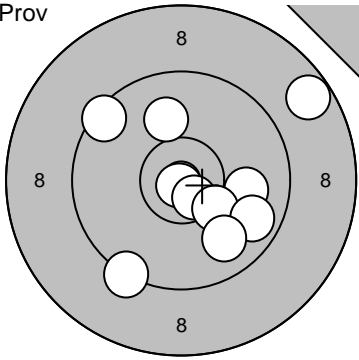
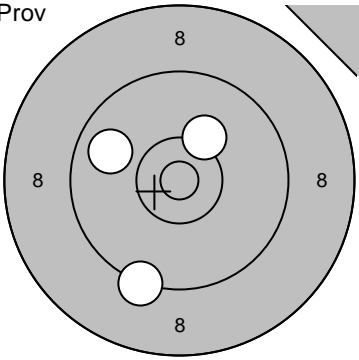
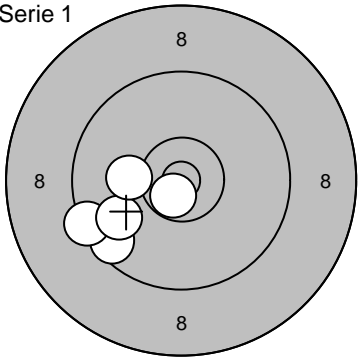
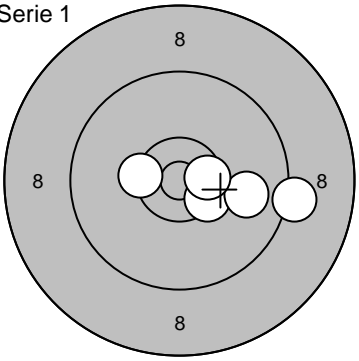
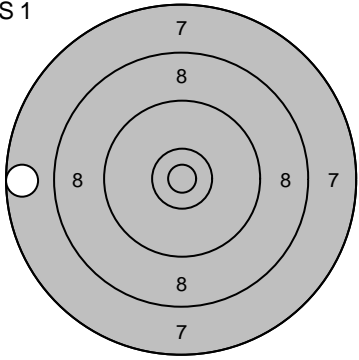
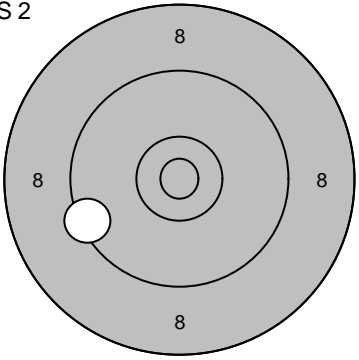
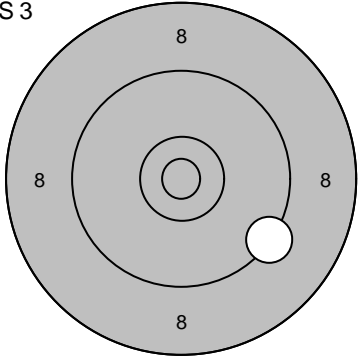
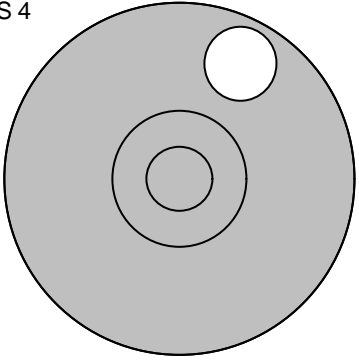
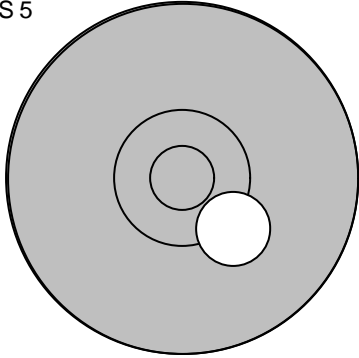

Skjutlag <b>2</b>	Tavla <b>16</b>	<b>Kevin Yu</b>	
		Umeå	
2007-07-16		Tavelträffen 2007 Final	Ramselefors SKF
Prov 	1: 8,7 ↗ 2: 9,5 ↗↗ 3: 10,0 →↗ 4: 10,0 → 5: 9,3 ↘ 6: 10,9* ↘ 7: 10,6* ↘ 8: 10,3* ↘ 9: 9,7 ↘ 10: 9,9 ↘	Prov 	11: 10,2 ↗ 12: 9,8 ↖ 13: 9,3 ↘
	Serie 94,0 Totalt 186,0		Serie 28,0 Totalt 186,0
Serie 1 	1: 9,6 ↘ 2: 10,7* ↘ 3: 9,4 ↖ 4: 9,8 ↖ 5: 10,2 ↖	Serie 1 	6: 10,4* ↘ 7: 9,9 → 8: 10,4* ↖ 9: 10,5* → 10: 9,2 ↘
	Serie 47,0 Totalt 233,0		Serie 48,0 Totalt 281,0
S 1 	1: 7,7 ←	S 2 	1: 9,4 ↖
	Serie 7,0 Totalt 288,0		Serie 9,0 Totalt 297,0
S 3 	1: 9,3 ↘	S 4 	1: 9,7 ↗
	Serie 9,0 Totalt 306,0		Serie 9,0 Totalt 315,0
S 5 	1: 10,3 ↘		
	Serie 10,0 Totalt 325,0		

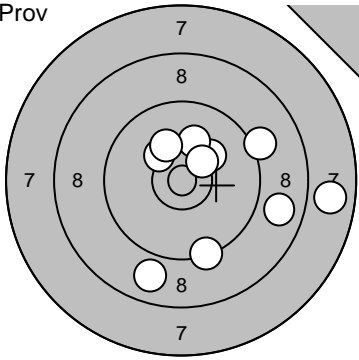
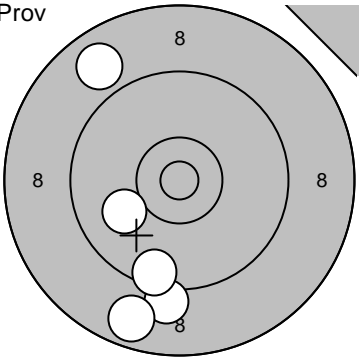
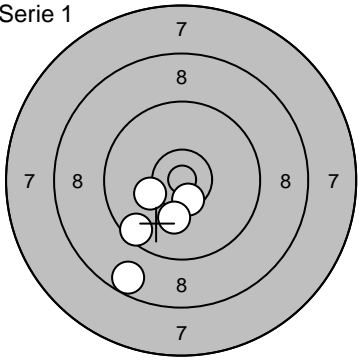
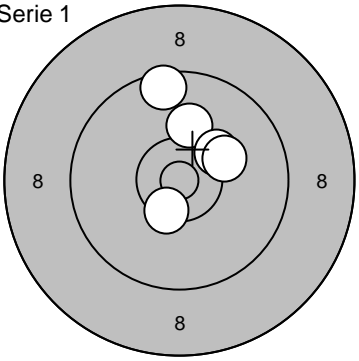
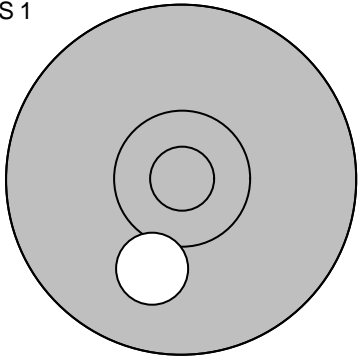
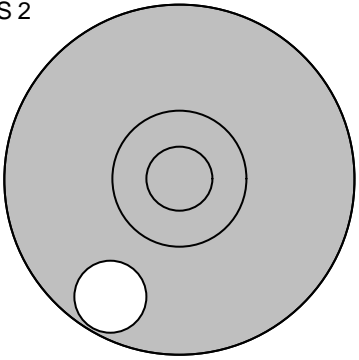
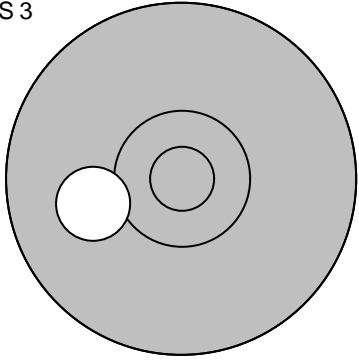
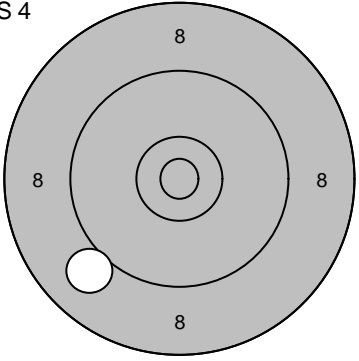
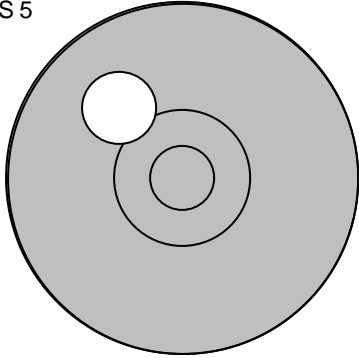
Skjutlag <b>2</b>	Tavla <b>17</b>	<b>Emil Bergman</b>	
		Umeå	
2007-07-16		Tavelträffen 2007 Final	Ramselefors SKF
Prov 	1: 9,4 ↓ 2: 9,1 → 3: 7,9 → 4: 8,8 → 5: 10,2 → 6: 10,1 ↗ 7: 10,3 ↗ 8: 8,9 ↓ 9: 10,4* ↗ 10: 10,2 ↗	Prov 	11: 9,1 ↓ 12: 8,7 ↓ 13: 10,0 ↙ 14: 9,5 ↓ 15: 8,9 ↖
Serie 91,0		Serie 44,0	
Totalt 185,0		Totalt 185,0	
Serie 1 	1: 10,5* ↓ 2: 10,2 ↓ 3: 9,5 ↓ 4: 8,6 ↓ 5: 10,2 ↙	Serie 1 	6: 10,1 ↑ 7: 10,4* ↓ 8: 10,3 → 9: 10,2 → 10: 9,5 ↑
Serie 47,0		Serie 49,0	
Totalt 232,0		Totalt 281,0	
S 1 	1: 10,1 ↓	S 2 	1: 9,7 ↓
Serie 10,0		Serie 9,0	
Totalt 291,0		Totalt 300,0	
S 3 	1: 10,1 ←	S 4 	1: 9,0 ↙
Serie 10,0		Serie 9,0	
Totalt 310,0		Totalt 319,0	
S 5 	1: 10,1 ↖		
Serie 10,0			
Totalt 329,0			

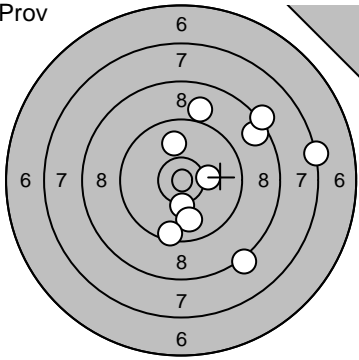
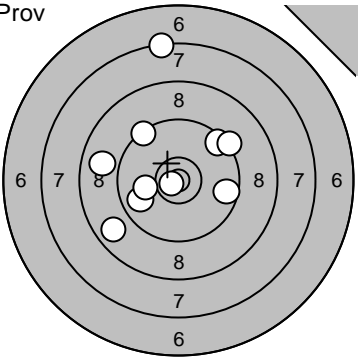
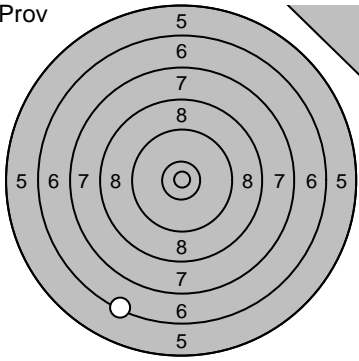
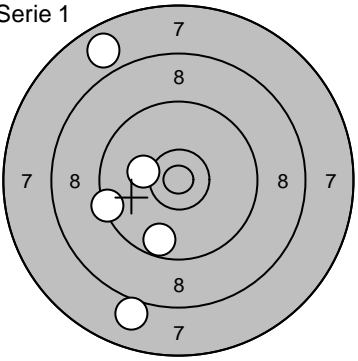
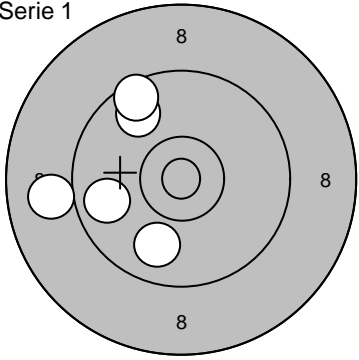
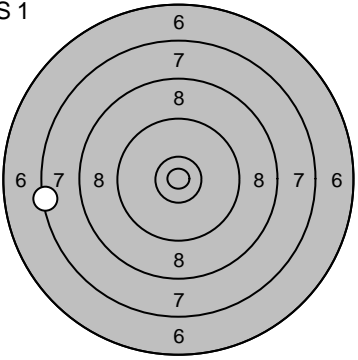
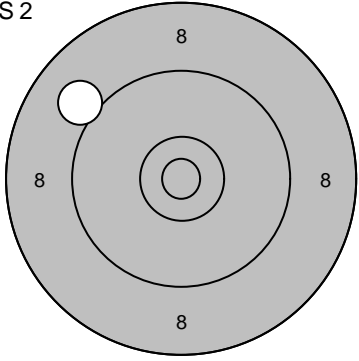
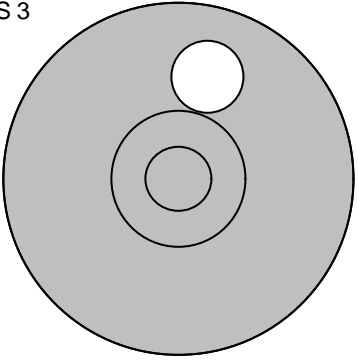
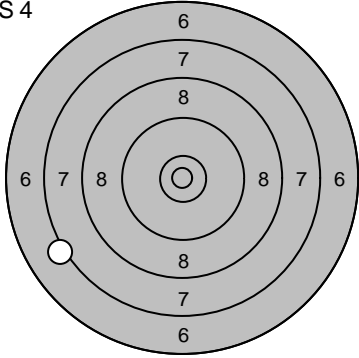
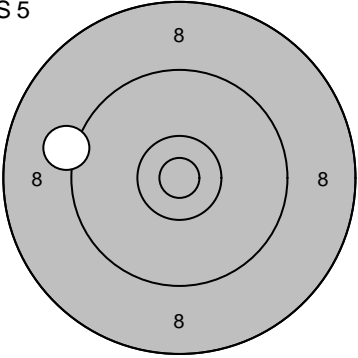
Skjutlag <b>2</b>	Tavla <b>18</b>	<b>André Olsén</b>	
		Umeå	
2007-07-16	Tavelträffen 2007 Final	Ramselefors SKF	
Prov 	1: 9,0 ↑ 2: 10,0 ↑↑ 3: 10,3 ↓ 4: 8,2 ↓↓ 5: 10,2 → 6: 8,7 ↗ 7: 9,9 ↓ 8: 7,3 → 9: 9,5 ↓ 10: 8,3 ↗ <hr/> Serie 88,0 Totalt 181,0	Prov 	11: 9,6 → 12: 9,5 ↗ 13: 9,3 ↗ 14: 8,9 ← 15: 10,7* ↙ 16: 9,4 ↗ 17: 7,4 ↑ 18: 9,8 ← 19: 8,8 ↙ 20: 10,1 ← <hr/> Serie 88,0 Totalt 181,0
Prov 	21: 6,4 ↘ <hr/> Serie 6,0 Totalt 181,0	Serie 1 	1: 10,2 ← 2: 8,0 ↓ 3: 9,7 ↓ 4: 9,4 ← 5: 7,9 ↗ <hr/> Serie 43,0 Totalt 224,0
Serie 1 	6: 9,8 ↑ 7: 9,9 ↓ 8: 9,6 ↗ 9: 9,0 ← 10: 9,8 ← <hr/> Serie 45,0 Totalt 269,0	S 1 	1: 7,4 ← <hr/> Serie 7,0 Totalt 276,0
S 2 	1: 9,1 ↙ <hr/> Serie 9,0 Totalt 285,0	S 3 	1: 10,0 ↑ <hr/> Serie 10,0 Totalt 295,0
S 4 	1: 7,2 ← <hr/> Serie 7,0 Totalt 302,0	S 5 	1: 9,2 ← <hr/> Serie 9,0 Totalt 311,0

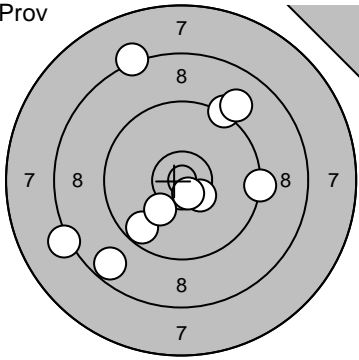
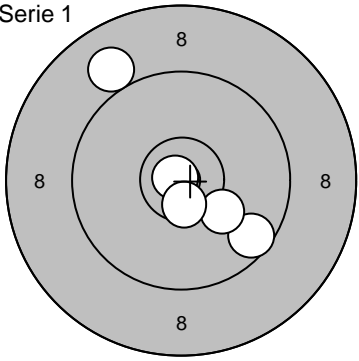
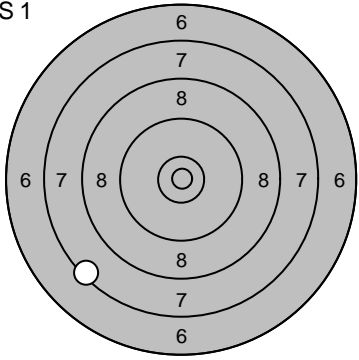
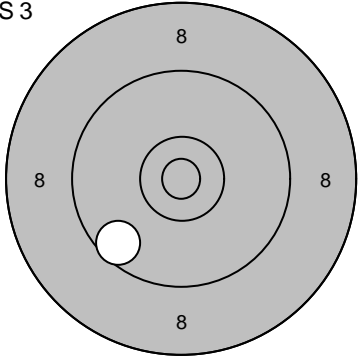
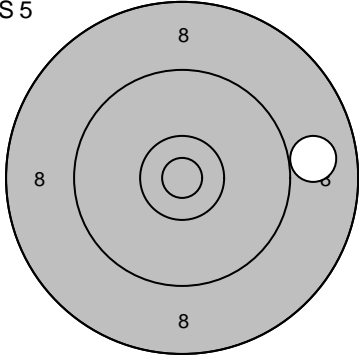
Skjutlag <b>2</b>	Tavla <b>19</b>	<b>Edward Yu</b>		
		Umeå		
2007-07-16	Tavelträffen 2007 Final	Ramselefors SKF		
Prov		1: 8,7 ↙ 2: 9,7 ↘ 3: 9,3 → 4: 8,2 ↘ 5: 10,4* ↘ 6: 9,3 ↗ 7: 10,2 ↘ 8: 9,0 ↗ 9: 10,7* ↘ 10: 8,3 ↗	11: 9,7 ↑ 12: 9,9 ↑ 13: 10,0 → 14: 10,6* ↓ 15: 9,5 ↖ 16: 8,3 ↗ 17: 9,2 ↗ 18: 8,2 ↑ 19: 9,5 ↑	
	Serie 90,0 Totalt 175,0		Serie 81,0 Totalt 175,0	
Serie 1		1: 9,6 ↘ 2: 10,2 ↘ 3: 10,9* ↗ 4: 10,6* ↖ 5: 9,0 ↗	6: 8,6 ↓ 7: 9,7 ↘ 8: 10,4* ↓ 9: 9,6 ↖ 10: 10,7* ↑	
	Serie 48,0 Totalt 223,0		Serie 46,0 Totalt 269,0	
S 1		1: 7,4 ↙	S 2	1: 9,0 ↓
	Serie 7,0 Totalt 276,0		Serie 9,0 Totalt 285,0	
S 3		1: 9,6 ↙	S 4	1: 10,4* ↗
	Serie 9,0 Totalt 294,0		Serie 10,0 Totalt 304,0	
S 5		1: 9,0 →		
	Serie 9,0 Totalt 313,0			

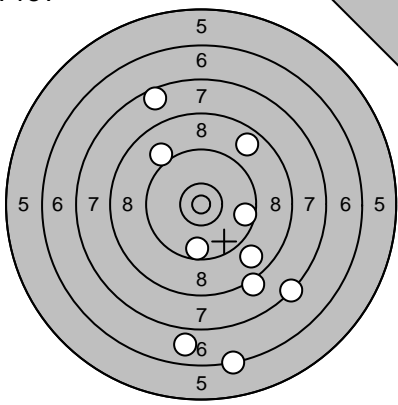
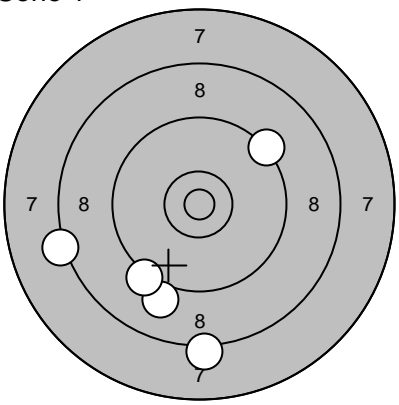
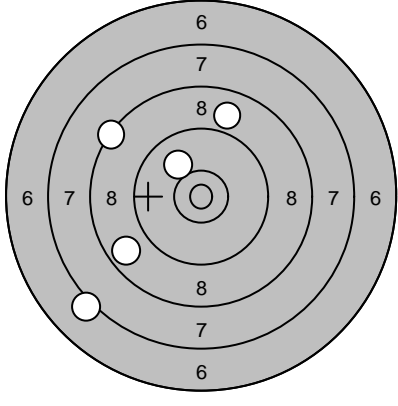
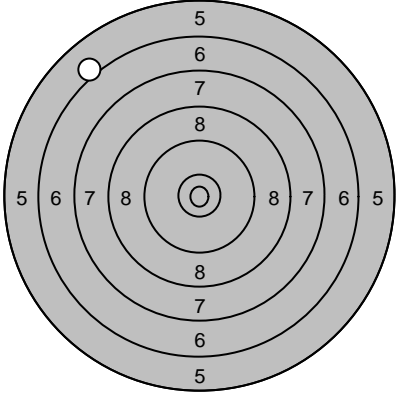
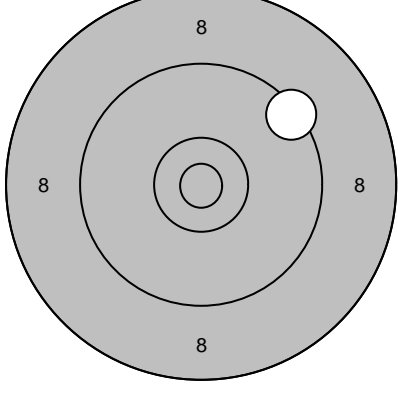
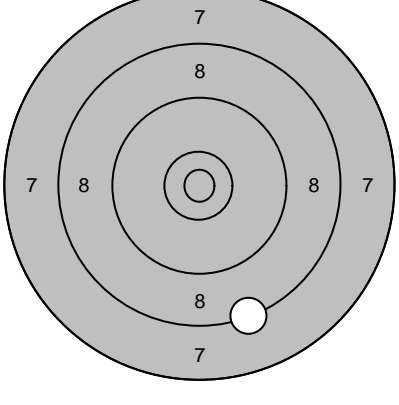
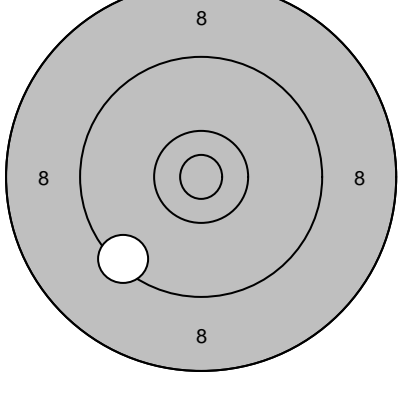
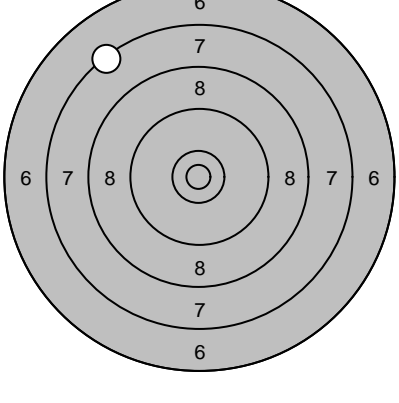
Skjutlag <b>2</b>	Tavla <b>20</b>	<b>Emma Wallerström</b>	
		Ununge	
2007-07-16	Tavelträffen 2007 Final	Ramselefors SKF	
Prov		1: 7,4 ↘ 2: 8,9 ↘ 3: 8,2 ↘ 4: 6,9 ↓ 5: 9,7 ↓ 6: 6,3 ↓ 7: 7,6 ↗ 8: 9,6 → 9: 8,8 ↗ 10: 9,1 ↖	Serie 1 
	Serie 77,0 Totalt 162,0	1: 9,0 ↓ 2: 8,2 ↓ 3: 8,3 ← 4: 9,3 ↗ 5: 9,3 ↓	Serie 43,0 Totalt 205,0
Serie 1		6: 8,8 ↙ 7: 8,4 ↙ 8: 8,9 ↑ 9: 7,1 ↙ 10: 10,0 ↖	S 1 
	Serie 41,0 Totalt 246,0		1: 6,1 ↖ Serie 6,0 Totalt 252,0
S 2		1: 9,4 ↗	S 3 
	Serie 9,0 Totalt 261,0		1: 8,3 ↓ Serie 8,0 Totalt 269,0
S 4		1: 9,4 ↙	S 5 
	Serie 9,0 Totalt 278,0		1: 7,4 ↖ Serie 7,0 Totalt 285,0

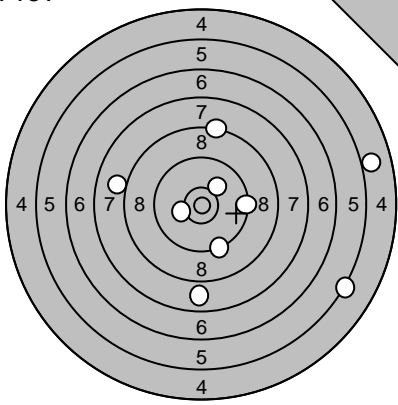
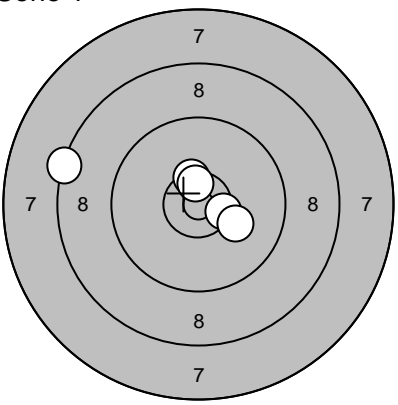
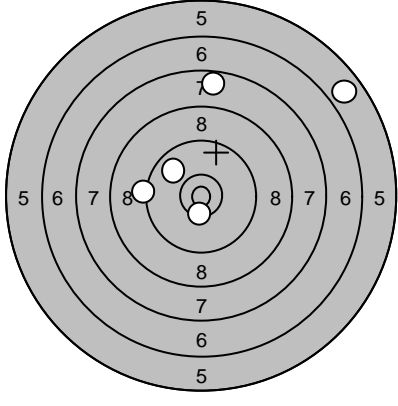
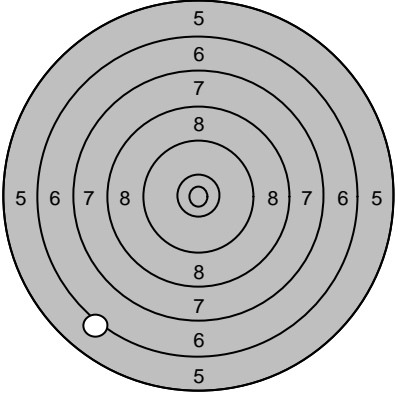
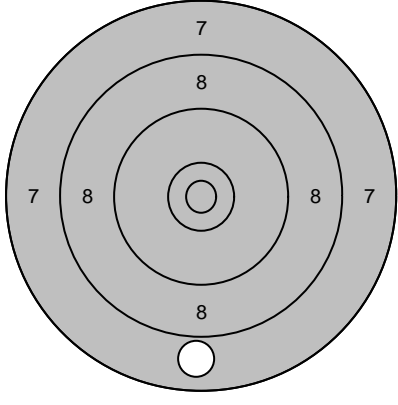
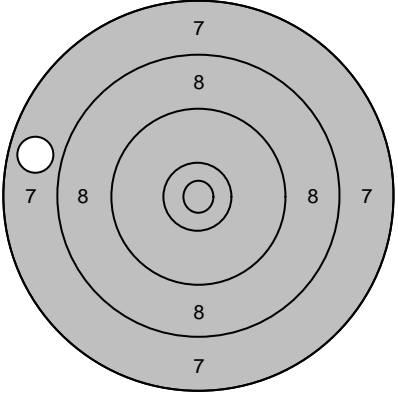
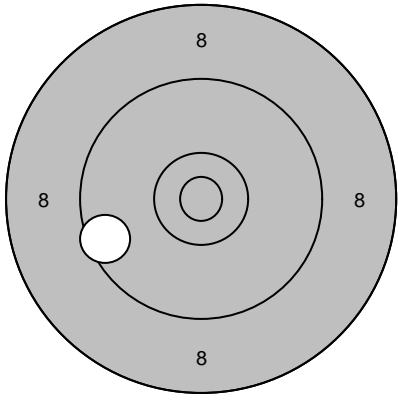
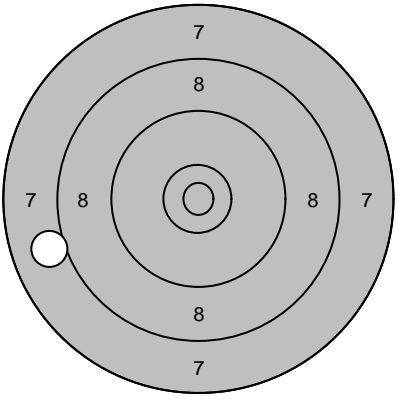
Skjutlag <b>2</b>	Tavla <b>21</b>	<b>Niklas Renström</b>	
		Drängsmark	
2007-07-16		Tavelträffen 2007 Final	Ramselefors SKF
Prov 	1: 5,3 → 2: 5,0 → 3: 9,4 → 4: 8,0 ← 5: 7,8 ↓ 6: 10,1 ↗ 7: 8,3 ↑ 8: 9,4 ↓ 9: 10,2 ←	Serie 1 	1: 10,5* → 2: 10,4* ↑ 3: 10,2 ↗ 4: 8,4 ← 5: 10,6* ↑
	Serie 71,0 Totalt 160,0		Serie 48,0 Totalt 208,0
Serie 1 	6: 10,4* ↓ 7: 7,7 ↑ 8: 9,9 ↖ 9: 9,3 ← 10: 5,8 ↗	S 1 	1: 6,2 ↙
	Serie 40,0 Totalt 248,0		Serie 6,0 Totalt 254,0
S 2 	1: 7,9 ↓	S 3 	1: 7,8 ←
	Serie 7,0 Totalt 261,0		Serie 7,0 Totalt 268,0
S 4 	1: 9,5 ←	S 5 	1: 8,0 ←
	Serie 9,0 Totalt 277,0		Serie 8,0 Totalt 285,0

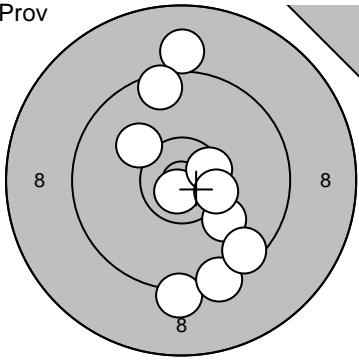
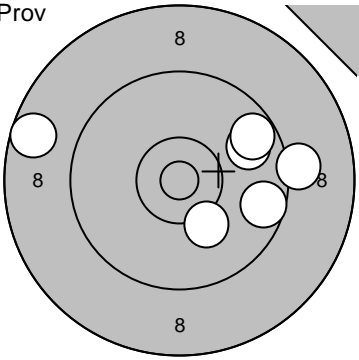
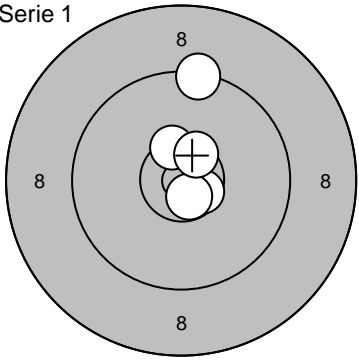
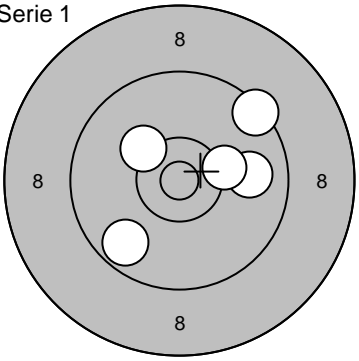
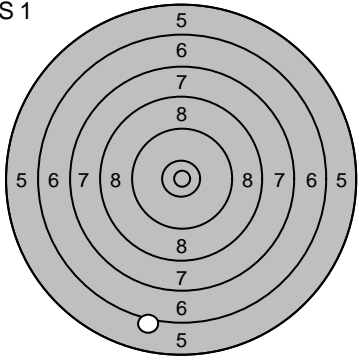
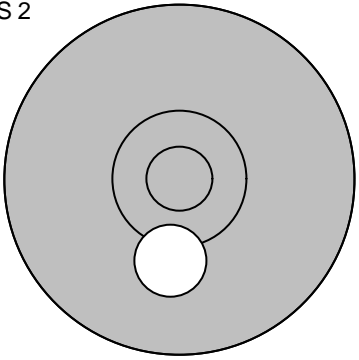
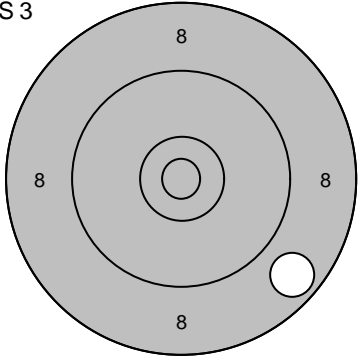
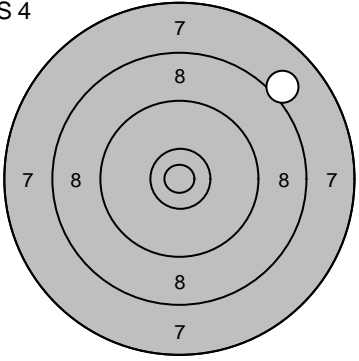
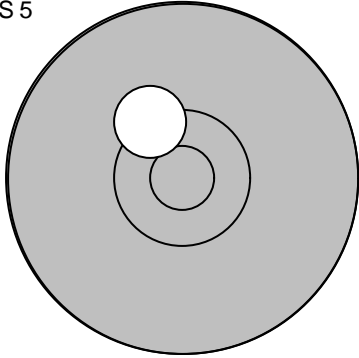
Skjutlag <b>3</b>	Tavla <b>1</b>	<b>Gustav Lövgren</b>	
		Niemisel	
2007-07-16		Tavelträffen 2007 Final	Ramselefors SKF
Prov 	1: 9,0 2: 9,2 3: 10,1 4: 9,4 5: 10,8* 6: 10,5* 7: 9,5 8: 10,1 9: 10,4* 10: 9,5 Serie 95,0 Totalt 189,0	Prov 	11: 9,8 12: 8,7 13: 10,2 14: 9,2 15: 9,6 16: 9,7 Serie 54,0 Totalt 189,0
Serie 1 	1: 10,6* 2: 10,5* 3: 9,4 4: 10,7* 5: 10,5* Serie 49,0 Totalt 238,0	Serie 1 	6: 10,2 7: 9,9 8: 9,7 9: 10,2 10: 9,4 Serie 47,0 Totalt 285,0
S 1 	1: 6,2 Serie 6,0 Totalt 291,0	S 2 	1: 10,2 Serie 10,0 Totalt 301,0
S 3 	1: 8,7 Serie 8,0 Totalt 309,0	S 4 	1: 8,1 Serie 8,0 Totalt 317,0
S 5 	1: 10,3* Serie 10,0 Totalt 327,0		

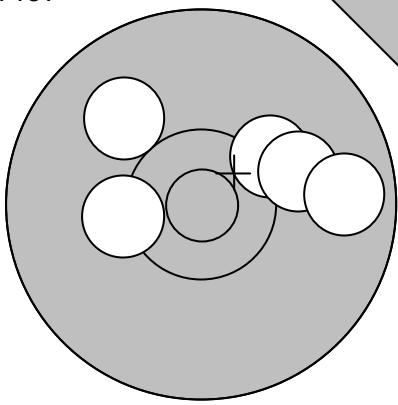
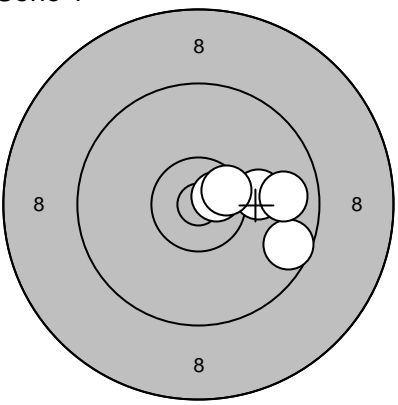
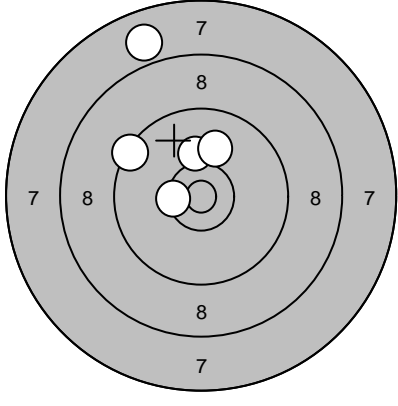
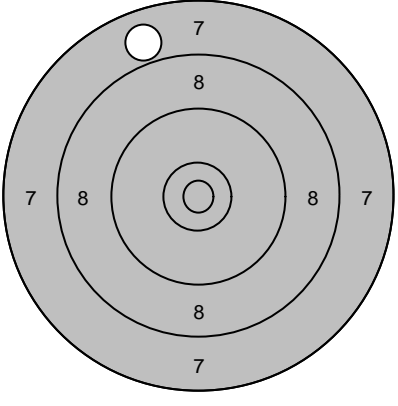
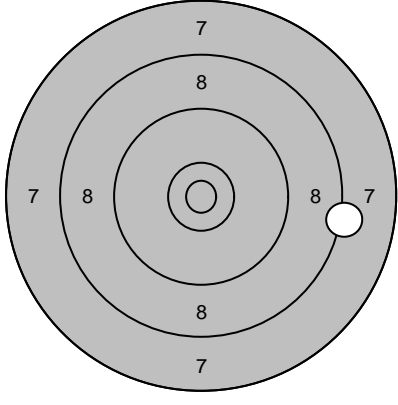
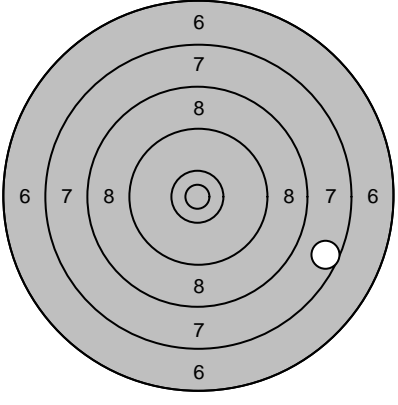
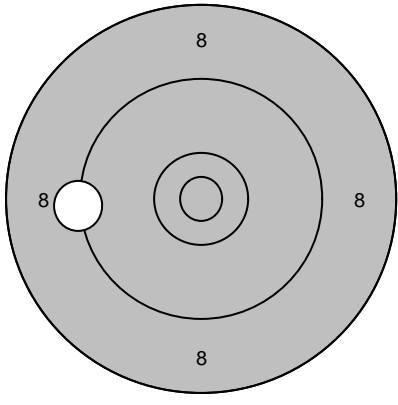
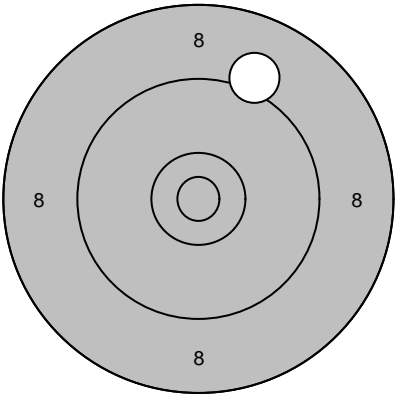
Skjutlag <b>3</b>	Tavla <b>2</b>	<b>Christian Lejon</b>	
		Umeå	
2007-07-16	Tavelträffen 2007 Final	Ramselefors SKF	
Prov 	1: 10,2 ↗ 2: 10,1 → 3: 10,3* ← 4: 10,0 ↖ 5: 9,7 →	Serie 1 	1: 10,7* → 2: 9,6 → 3: 10,1 → 4: 9,8 → 5: 10,5* ↗
	Serie 49,0 Totalt 187,0		Serie 48,0 Totalt 235,0
Serie 1 	6: 7,9 ↑ 7: 10,4* ← 8: 10,2 ↑ 9: 9,4 ↖ 10: 10,0 ↑	S 1 	1: 7,9 ↑
	Serie 46,0 Totalt 281,0		Serie 7,0 Totalt 288,0
S 2 	1: 8,2 →	S 3 	1: 7,6 →
	Serie 8,0 Totalt 296,0		Serie 7,0 Totalt 303,0
S 4 	1: 9,3 ←	S 5 	1: 9,1 ↑
	Serie 9,0 Totalt 312,0		Serie 9,0 Totalt 321,0

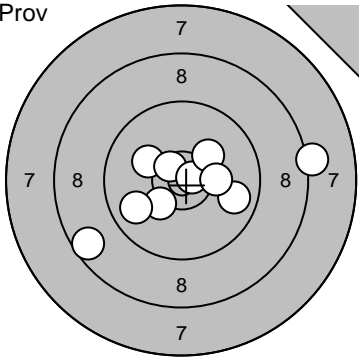
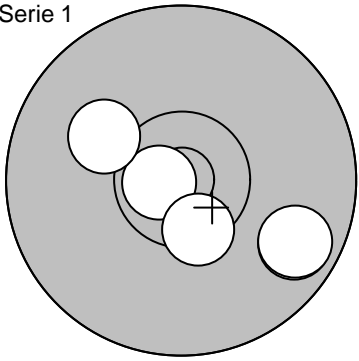
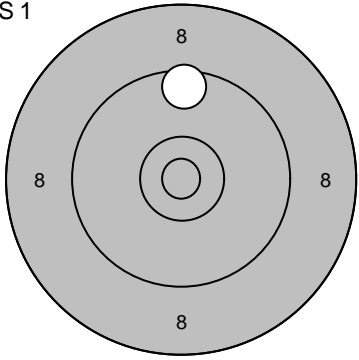
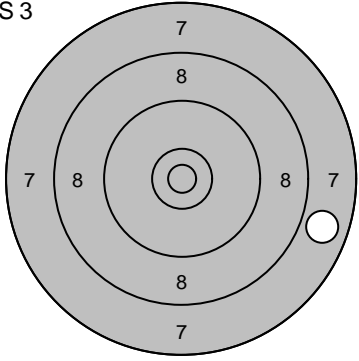
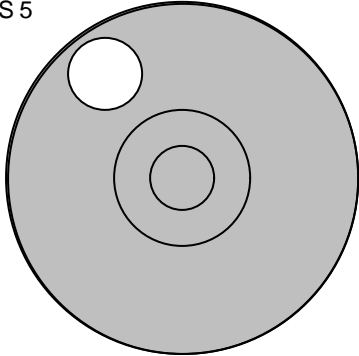

Skjutlag <b>3</b>	Tavla <b>3</b>	<b>Lars Möllsten</b>	
		Umeå	
2007-07-16	Tavelträffen 2007 Final	Ramselefors SKF	
Prov		1: 8,6 ↙ 2: 10,3* ↙ 3: 9,8 ↘ 4: 10,2 ↗ 5: 10,6* ↗ 6: 10,7* ↗ 7: 10,2 ↗ 8: 10,2 → 9: 8,2 → 10: 9,8 ↙	Prov
			11: 9,1 → 12: 10,2 ↗ 13: 10,5* ↗
	Serie 94,0		Serie 29,0
	Totalt 185,0		Totalt 185,0
Serie 1		1: 10,7* ← 2: 10,5* ↙ 3: 9,7 ↘ 4: 10,1 ↗ 5: 9,7 ↘	Serie 1
			6: 9,1 → 7: 8,6 ↘ 8: 9,8 ↗ 9: 8,9 → 10: 8,6 →
	Serie 48,0		Serie 42,0
	Totalt 233,0		Totalt 275,0
S 1		1: 9,6 ↑	S 2
			1: 10,0 ↑
	Serie 9,0		Serie 10,0
	Totalt 284,0		Totalt 294,0
S 3		1: 7,9 →	S 4
			1: 10,0 ↘
	Serie 7,0		Serie 10,0
	Totalt 301,0		Totalt 311,0
S 5		1: 9,7 ↖	
	Serie 9,0		
	Totalt 320,0		

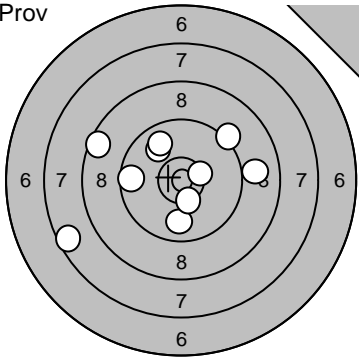
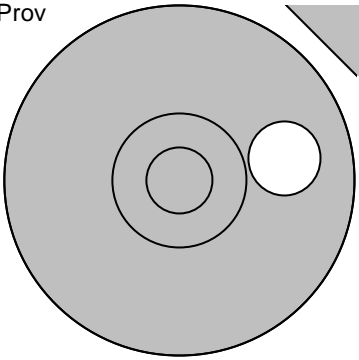
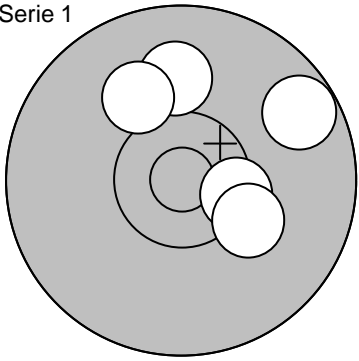
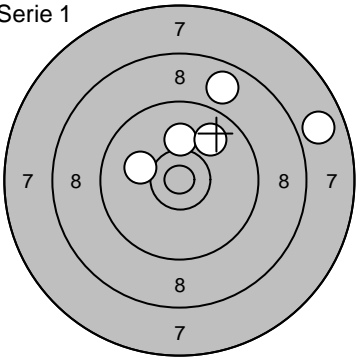
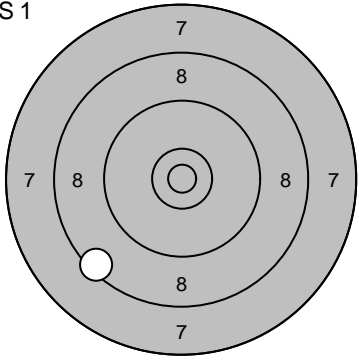
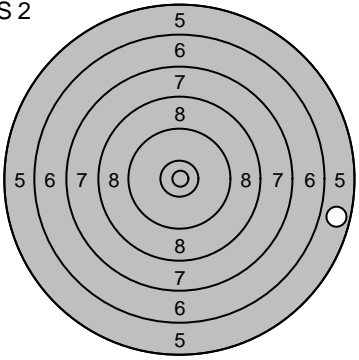
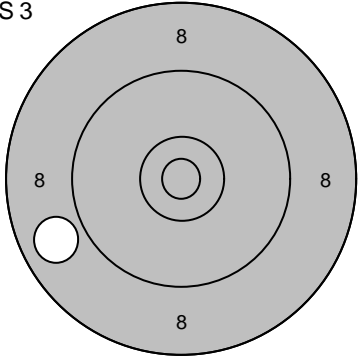
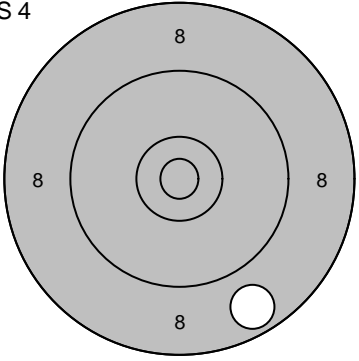
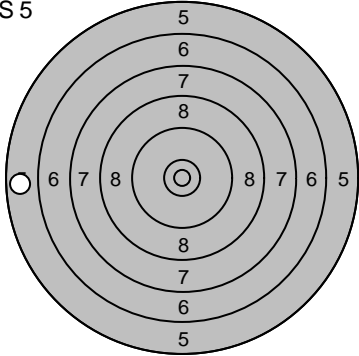
Skjutlag	Tavla	Fredrik Ågren																																													
3	4	I 19																																													
2007-07-16	Tavelträffen 2007 Final	Ramselefors SKF																																													
Prov	 <table border="1"> <tr><td>1:</td><td>7,6</td><td>↙</td></tr> <tr><td>2:</td><td>9,9</td><td>↓</td></tr> <tr><td>3:</td><td>10,4*</td><td>↙</td></tr> <tr><td>4:</td><td>8,6</td><td>↖</td></tr> <tr><td>5:</td><td>9,6</td><td>↑</td></tr> <tr><td>6:</td><td>9,9</td><td>↗</td></tr> <tr><td>7:</td><td>10,4*</td><td>→</td></tr> <tr><td>8:</td><td>9,0</td><td>→</td></tr> <tr><td>9:</td><td>9,8</td><td>↗</td></tr> <tr><td>10:</td><td>9,3</td><td>↗</td></tr> <tr><td>Serie</td><td>89,0</td><td></td></tr> <tr><td>Totalt</td><td>185,0</td><td></td></tr> </table>	1:	7,6	↙	2:	9,9	↓	3:	10,4*	↙	4:	8,6	↖	5:	9,6	↑	6:	9,9	↗	7:	10,4*	→	8:	9,0	→	9:	9,8	↗	10:	9,3	↗	Serie	89,0		Totalt	185,0		 <table border="1"> <tr><td>11:</td><td>9,9</td><td>→</td></tr> <tr><td>Serie</td><td>9,0</td><td></td></tr> <tr><td>Totalt</td><td>185,0</td><td></td></tr> </table>	11:	9,9	→	Serie	9,0		Totalt	185,0	
1:	7,6	↙																																													
2:	9,9	↓																																													
3:	10,4*	↙																																													
4:	8,6	↖																																													
5:	9,6	↑																																													
6:	9,9	↗																																													
7:	10,4*	→																																													
8:	9,0	→																																													
9:	9,8	↗																																													
10:	9,3	↗																																													
Serie	89,0																																														
Totalt	185,0																																														
11:	9,9	→																																													
Serie	9,0																																														
Totalt	185,0																																														
Serie 1	 <table border="1"> <tr><td>1:</td><td>10,4*</td><td>→</td></tr> <tr><td>2:</td><td>10,0</td><td>↑</td></tr> <tr><td>3:</td><td>9,7</td><td>↗</td></tr> <tr><td>4:</td><td>10,1</td><td>↗</td></tr> <tr><td>5:</td><td>10,2</td><td>↓</td></tr> <tr><td>Serie</td><td>49,0</td><td></td></tr> <tr><td>Totalt</td><td>234,0</td><td></td></tr> </table>	1:	10,4*	→	2:	10,0	↑	3:	9,7	↗	4:	10,1	↗	5:	10,2	↓	Serie	49,0		Totalt	234,0		 <table border="1"> <tr><td>6:</td><td>10,1</td><td>↑</td></tr> <tr><td>7:</td><td>7,9</td><td>→</td></tr> <tr><td>8:</td><td>8,8</td><td>↗</td></tr> <tr><td>9:</td><td>9,9</td><td>↗</td></tr> <tr><td>10:</td><td>10,1</td><td>←</td></tr> <tr><td>Serie</td><td>44,0</td><td></td></tr> <tr><td>Totalt</td><td>278,0</td><td></td></tr> </table>	6:	10,1	↑	7:	7,9	→	8:	8,8	↗	9:	9,9	↗	10:	10,1	←	Serie	44,0		Totalt	278,0				
1:	10,4*	→																																													
2:	10,0	↑																																													
3:	9,7	↗																																													
4:	10,1	↗																																													
5:	10,2	↓																																													
Serie	49,0																																														
Totalt	234,0																																														
6:	10,1	↑																																													
7:	7,9	→																																													
8:	8,8	↗																																													
9:	9,9	↗																																													
10:	10,1	←																																													
Serie	44,0																																														
Totalt	278,0																																														
S 1	 <table border="1"> <tr><td>1:</td><td>8,4</td><td>↙</td></tr> <tr><td>Serie</td><td>8,0</td><td></td></tr> <tr><td>Totalt</td><td>286,0</td><td></td></tr> </table>	1:	8,4	↙	Serie	8,0		Totalt	286,0		 <table border="1"> <tr><td>1:</td><td>5,8</td><td>→</td></tr> <tr><td>Serie</td><td>5,0</td><td></td></tr> <tr><td>Totalt</td><td>291,0</td><td></td></tr> </table>	1:	5,8	→	Serie	5,0		Totalt	291,0																												
1:	8,4	↙																																													
Serie	8,0																																														
Totalt	286,0																																														
1:	5,8	→																																													
Serie	5,0																																														
Totalt	291,0																																														
S 3	 <table border="1"> <tr><td>1:</td><td>8,9</td><td>↙</td></tr> <tr><td>Serie</td><td>8,0</td><td></td></tr> <tr><td>Totalt</td><td>299,0</td><td></td></tr> </table>	1:	8,9	↙	Serie	8,0		Totalt	299,0		 <table border="1"> <tr><td>1:</td><td>8,7</td><td>↘</td></tr> <tr><td>Serie</td><td>8,0</td><td></td></tr> <tr><td>Totalt</td><td>307,0</td><td></td></tr> </table>	1:	8,7	↘	Serie	8,0		Totalt	307,0																												
1:	8,9	↙																																													
Serie	8,0																																														
Totalt	299,0																																														
1:	8,7	↘																																													
Serie	8,0																																														
Totalt	307,0																																														
S 5	 <table border="1"> <tr><td>1:</td><td>5,8</td><td>←</td></tr> <tr><td>Serie</td><td>5,0</td><td></td></tr> <tr><td>Totalt</td><td>312,0</td><td></td></tr> </table>	1:	5,8	←	Serie	5,0		Totalt	312,0																																						
1:	5,8	←																																													
Serie	5,0																																														
Totalt	312,0																																														

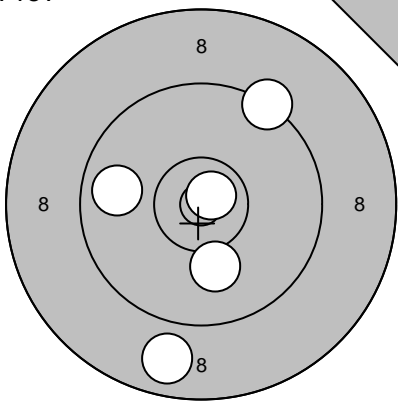
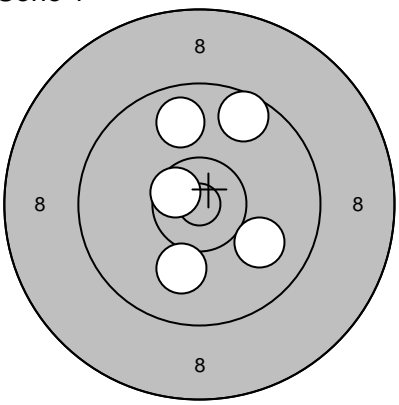
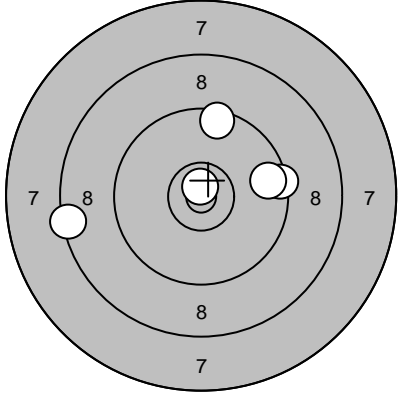
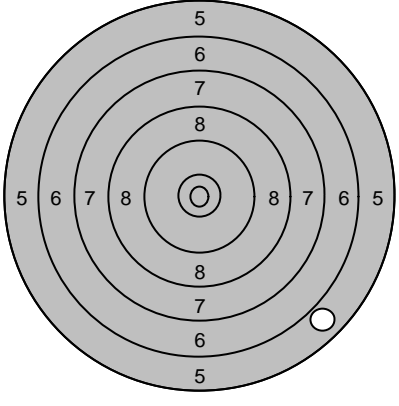
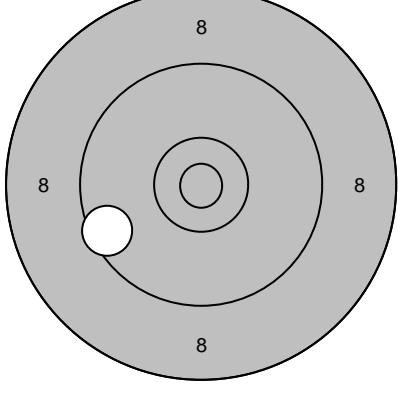
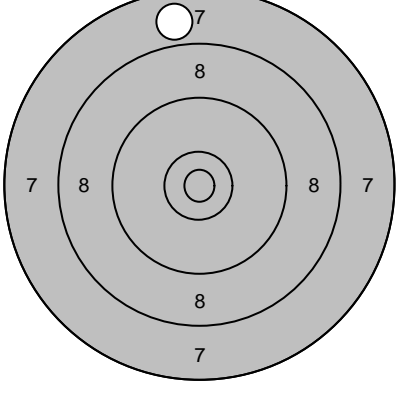
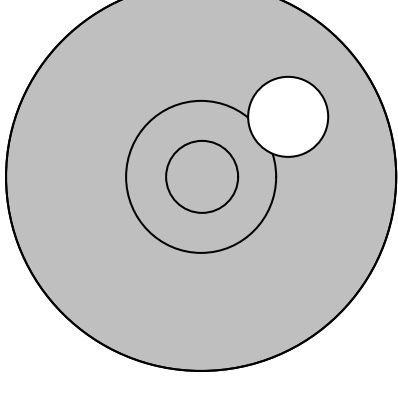
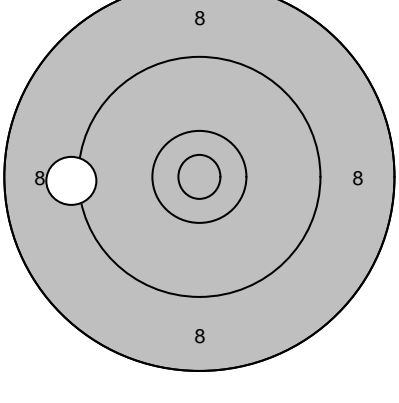
Skjutlag	Tavla	Roger Andersson			
3	5				
		S 3			
2007-07-16	Tavelträffen 2007 Final	Ramselefors SKF			
Prov		1: 9,3 ↗ 2: 8,8 ↓ 3: 10,8* ↗ 4: 9,8 ← 5: 10,1 ↓	Serie 1 	1: 9,8 ↑ 2: 10,1 ↓ 3: 9,6 ↗ 4: 10,6* ← 5: 10,0 ↘	
		Serie 46,0 Totalt 184,0		Serie 48,0 Totalt 232,0	
Serie 1		6: 8,4 ← 7: 10,8* ↑ 8: 9,4 → 9: 9,5 ↑ 10: 9,7 →	S 1		1: 5,9 ↘
		Serie 45,0 Totalt 277,0			Serie 5,0 Totalt 282,0
S 2		1: 9,5 ←	S 3		1: 7,9 ↑
		Serie 9,0 Totalt 291,0			Serie 7,0 Totalt 298,0
S 4		1: 10,1 ↗	S 5		1: 9,2 ←
		Serie 10,0 Totalt 308,0			Serie 9,0 Totalt 317,0

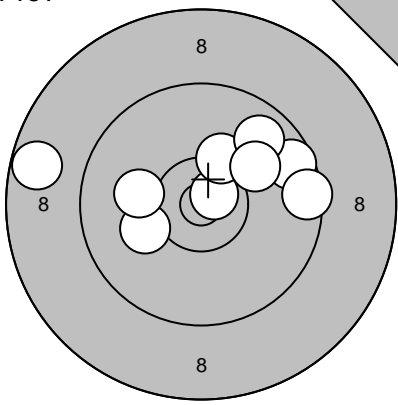
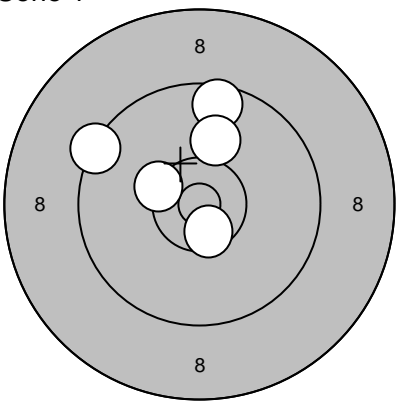
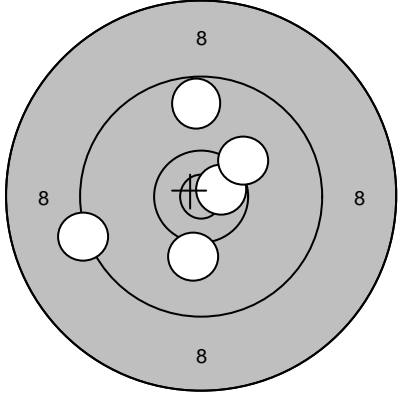
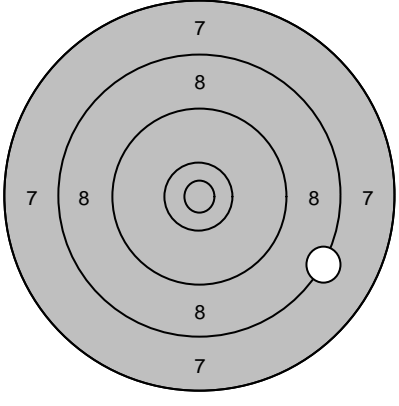
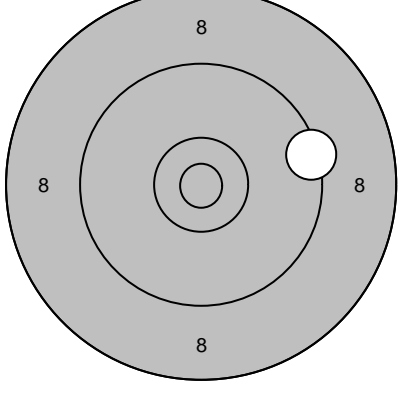
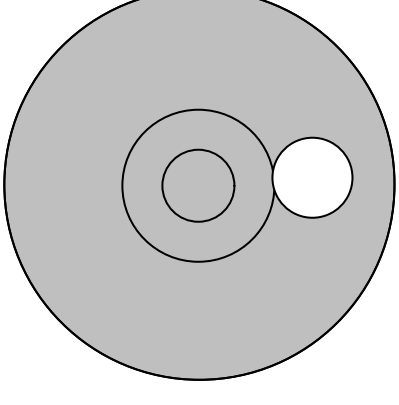
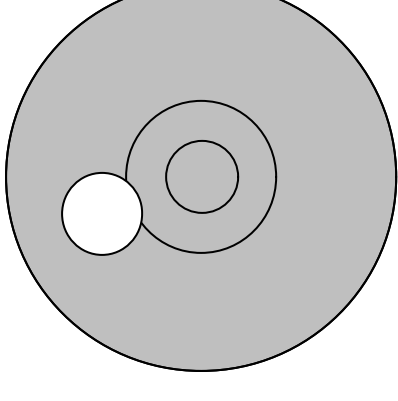
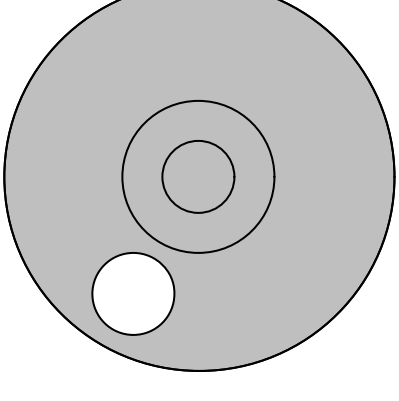
Skjutlag	Tavla	Magnus Lindkvist	
3	6	Umeå	
2007-07-16	Tavelträffen 2007 Final	Ramselefors SKF	
Prov		1: 10,1 ← 2: 9,6 → 3: 9,5 → 4: 10,7* → 5: 10,1 ← 6: 10,3 ↑ 7: 9,8 ↗ 8: 10,1 ↗ 9: 8,7 ←	Serie 1 
	Serie 85,0 Totalt 183,0	1: 10,6* ↓ 2: 9,4 ↖ 3: 9,6 ↑ 4: 10,4* ↖ 5: 10,1 ↑	Serie 48,0 Totalt 231,0
Serie 1		6: 9,7 ↑ 7: 10,7* → 8: 10,1 ↓ 9: 9,3 ← 10: 10,2 ↗	S 1 
	Serie 48,0 Totalt 279,0	1: 8,3 ➤	Serie 8,0 Totalt 287,0
S 2		1: 9,4 ➤	S 3 
	Serie 9,0 Totalt 296,0	1: 10,0 ➤	Serie 10,0 Totalt 306,0
S 4		1: 10,1 ←	S 5 
	Serie 10,0 Totalt 316,0	1: 9,8 ↓	Serie 9,0 Totalt 325,0

Skjutlag

Tavla

3

7

Jan Wallerström

Ununge

2007-07-16

Tavelträffen 2007 Final

Ramselefors SKF

Prov

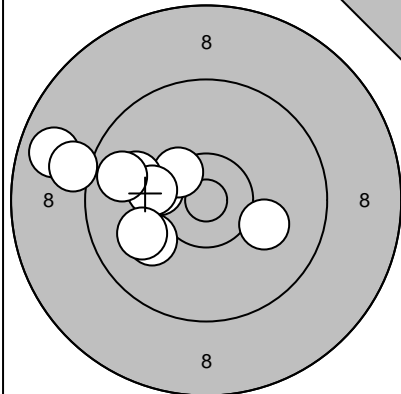

1: 10,1 →  
 2: 10,3\* ←  
 3: 10,4\* ↗  
 4: 9,9 ←  
 5: 10,2 ←  
 6: 10,0 ←  
 7: 8,8 ←  
 8: 9,1 ↗  
 9: 9,8 ↗  
 10: 10,0 ←

Serie 95,0

Totalt 181,0

Serie 1

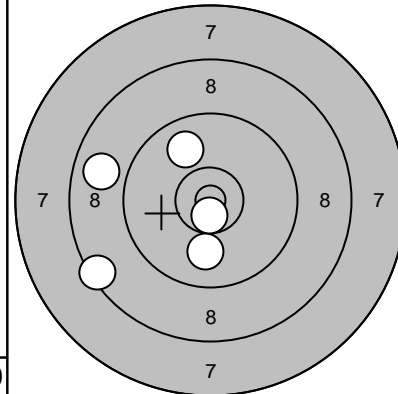

1: 8,5 ↙  
 2: 8,9 ←  
 3: 9,9 ↗  
 4: 10,0 ↓  
 5: 10,7\* ↓

Serie 45,0

Totalt 226,0

Serie 1

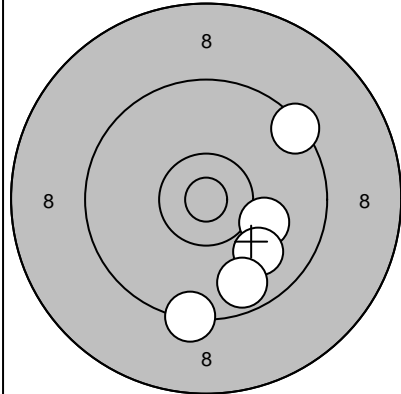

6: 9,4 ↗  
 7: 9,3 ↓  
 8: 10,1 ↗  
 9: 9,9 ↘  
 10: 9,7 ↘

Serie 46,0

Totalt 272,0

S 1

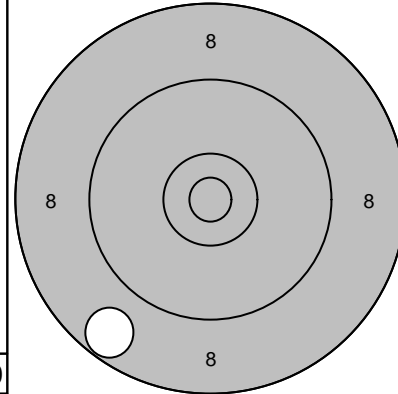

1: 8,7 ↙

Serie 8,0

Totalt 280,0

S 2

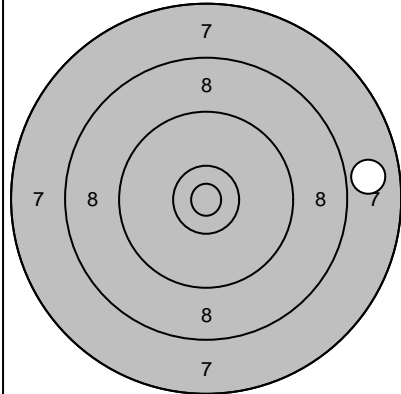

1: 7,9 →

Serie 7,0

Totalt 287,0

S 3

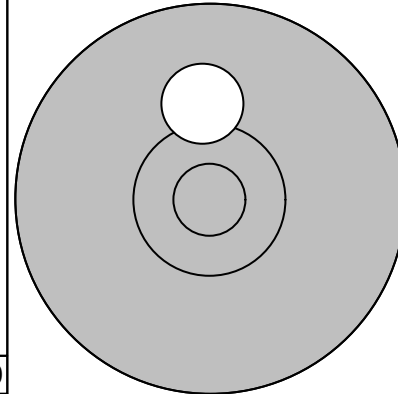

1: 10,1 ↑

Serie 10,0

Totalt 297,0

S 4

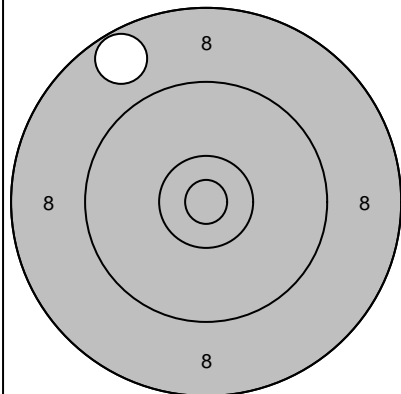

1: 8,7 ↖

Serie 8,0

Totalt 305,0

S 5

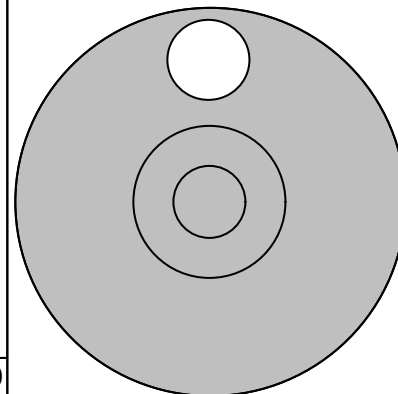

1: 9,8 ↑

Serie 9,0

Totalt 314,0

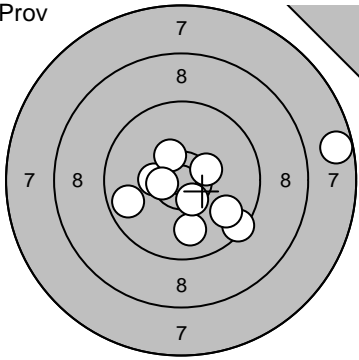
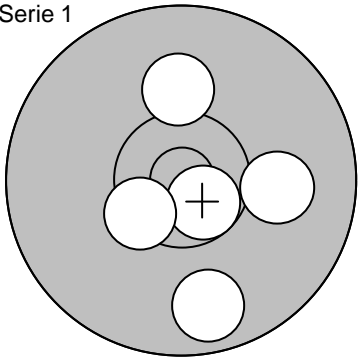
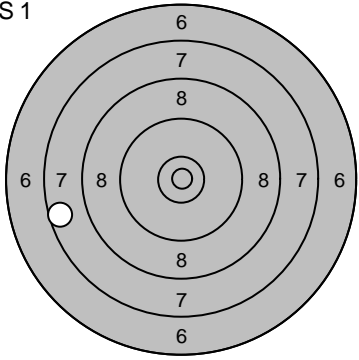
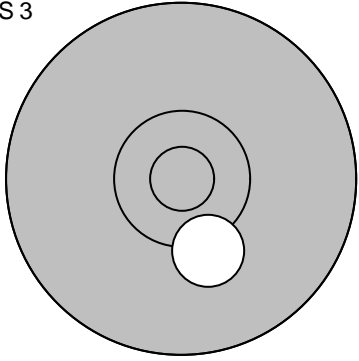
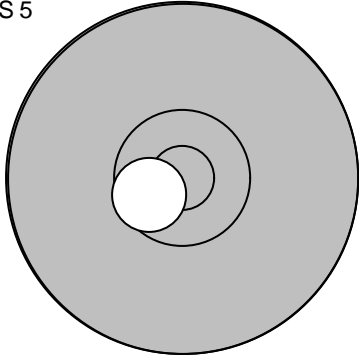
Skjutlag	Tavla	<b>Mikael Olofsson</b>	
<b>3</b>	<b>8</b>		
		Moälven-Modo	
2007-07-16	Tavelträffen 2007 Final	Ramselefors SKF	
Prov		1: 7,7 → 2: 10,4* ← 3: 9,9 ↓ 4: 10,4* → 5: 10,5* ↓ 6: 9,8 ↙ 7: 9,4 ↘ 8: 10,4* → 9: 10,6* ← 10: 9,8 ↓	Prov 11: 10,6* →
	Serie 93,0 Totalt 181,0		Serie 10,0 Totalt 181,0
Serie 1		1: 9,8 ↓ 2: 10,0 → 3: 10,7* ↓ 4: 10,1 ↑ 5: 10,5* ↓	Serie 1 6: 9,5 → 7: 7,7 ← 8: 10,8* ← 9: 7,7 ↘ 10: 9,2 ↓
	Serie 49,0 Totalt 230,0		Serie 42,0 Totalt 272,0
S 1		1: 7,6 ←	S 2 1: 9,1 ↘
	Serie 7,0 Totalt 279,0		Serie 9,0 Totalt 288,0
S 3		1: 10,2 ↓	S 4 1: 8,2 →
	Serie 10,0 Totalt 298,0		Serie 8,0 Totalt 306,0
S 5		1: 10,6* ←	
	Serie 10,0 Totalt 316,0		

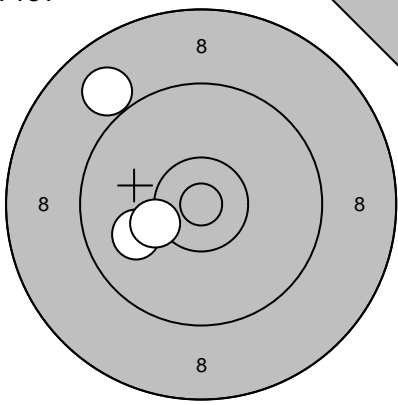
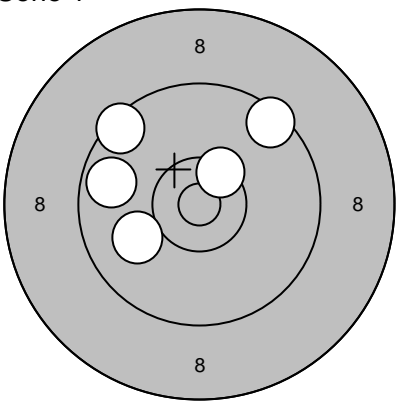
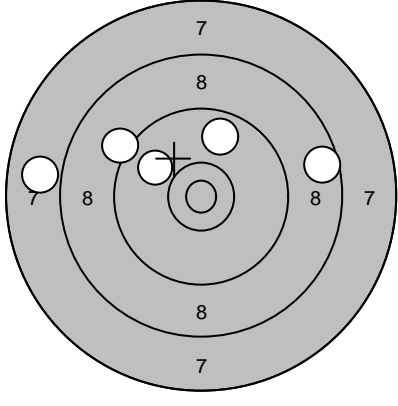
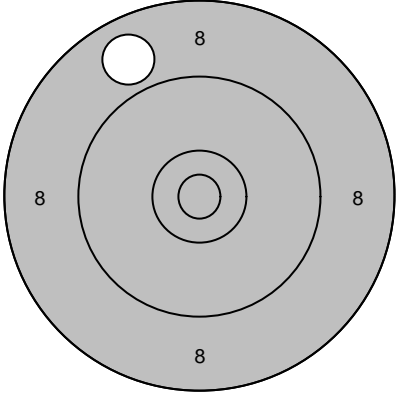
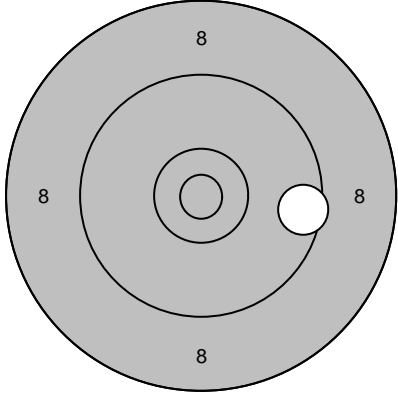
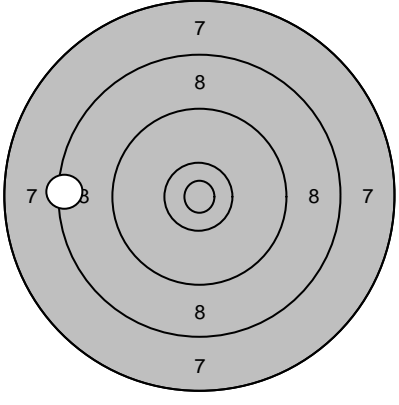
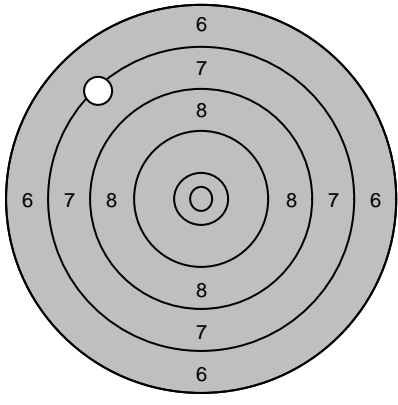
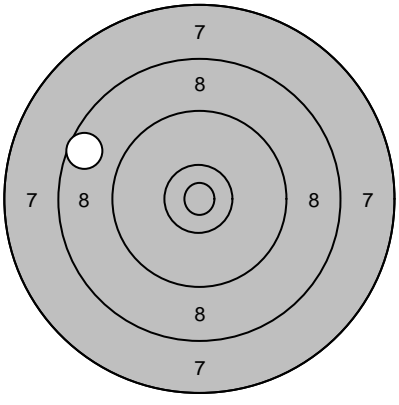
Skjutlag <b>3</b>	Tavla <b>9</b>	<b>Niklas Öhman</b>	
		S 3	
2007-07-16	Tavelträffen 2007 Final	Ramselefors SKF	
Prov	 1: 9,0 ↗ 2: 10,0 ← 3: 10,3 ←	Serie 1	 1: 9,5 ↗ 2: 9,5 ↖ 3: 10,0 ← 4: 10,4* ↗ 5: 9,7 ←
	Serie 29,0		Serie 47,0
	Totalt 180,0		Totalt 227,0
Serie 1	 6: 8,6 → 7: 9,9 ↖ 8: 7,9 ← 9: 9,8 ↑ 10: 9,2 ↖	S 1	 1: 8,9 ↖
	Serie 42,0		Serie 8,0
	Totalt 269,0		Totalt 277,0
S 2	 1: 9,6 →	S 3	 1: 8,4 ←
	Serie 9,0		Serie 8,0
	Totalt 286,0		Totalt 294,0
S 4	 1: 7,4 ↖	S 5	 1: 8,6 ←
	Serie 7,0		Serie 8,0
	Totalt 301,0		Totalt 309,0

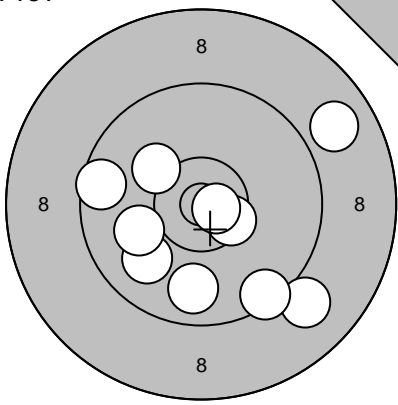
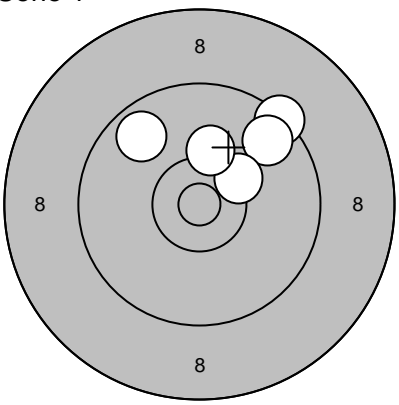
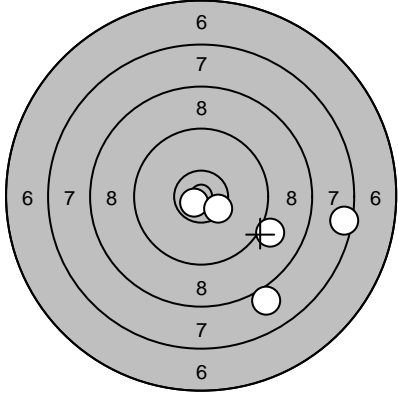
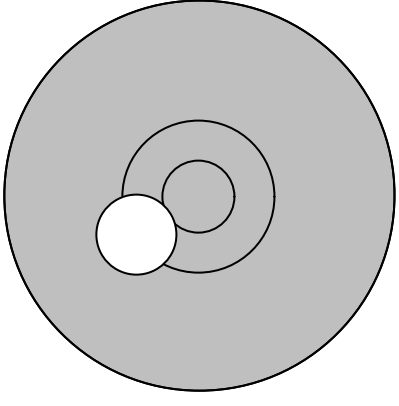
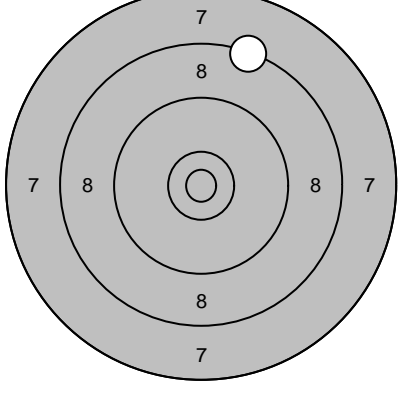
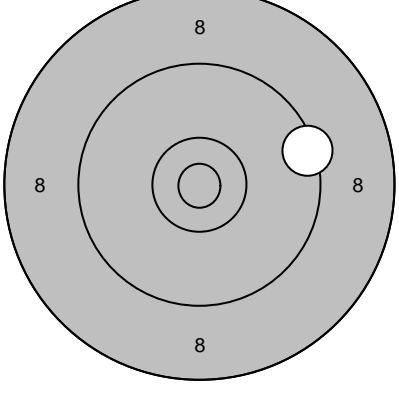
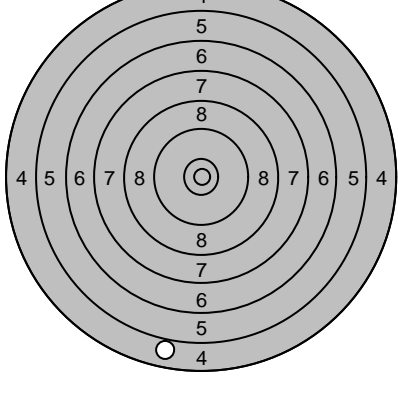
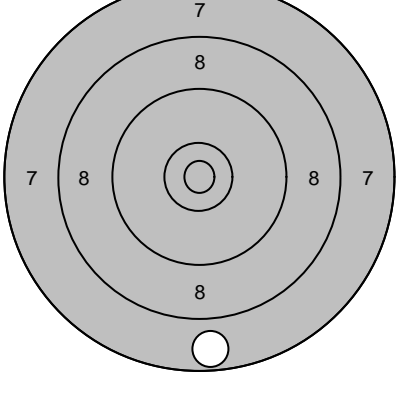
Skjutlag	Tavla	<b>Lars Evaldsson</b>	
<b>3</b>	<b>10</b>		
		Göteborg	
2007-07-16	Tavelträffen 2007 Final	Ramselefors SKF	
Prov		1: 8,9 → 2: 9,8 ↓ 3: 10,5* → 4: 9,0 ↓ 5: 9,9 ↓ 6: 10,2 ↗ 7: 10,7* → 8: 9,6 ← 9: 10,0 ← 10: 9,5 ↓ Serie 93,0 Totalt 178,0	Serie 1 
			1: 9,4 ↗ 2: 9,7 ↗ 3: 10,3* ↗ 4: 10,2 ↑ 5: 9,7 ↖ Serie 47,0 Totalt 225,0
Serie 1		6: 9,1 → 7: 10,7* ↙ 8: 10,5* ↘ 9: 7,5 → 10: 8,0 ↘ Serie 44,0 Totalt 269,0	S 1 
			1: 10,3* ↙ Serie 10,0 Totalt 279,0
S 2		1: 8,4 ↑ Serie 8,0 Totalt 287,0	S 3 
			1: 9,4 → Serie 9,0 Totalt 296,0
S 4		1: 4,9 ↓ Serie 4,0 Totalt 300,0	S 5 
			1: 7,7 ↓ Serie 7,0 Totalt 307,0

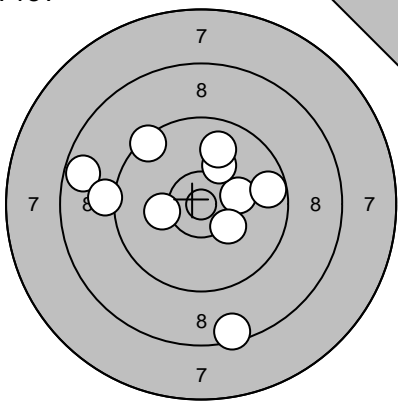
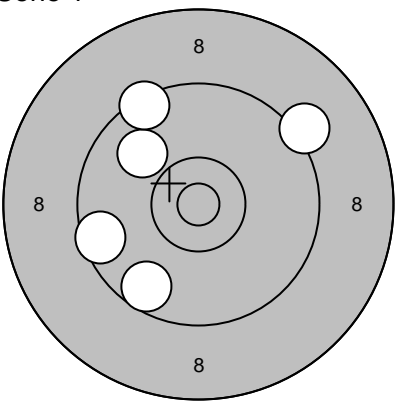
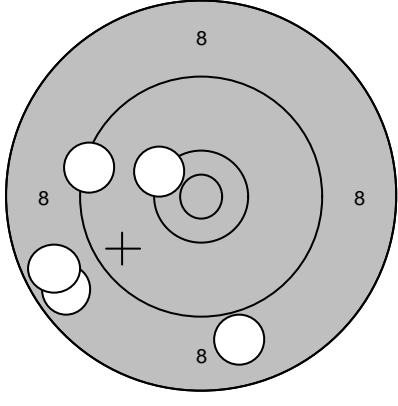
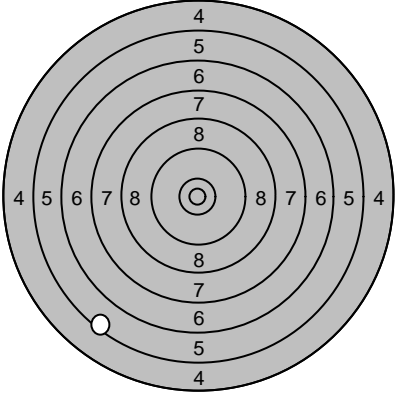
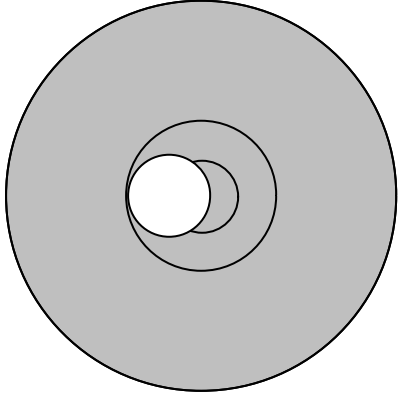
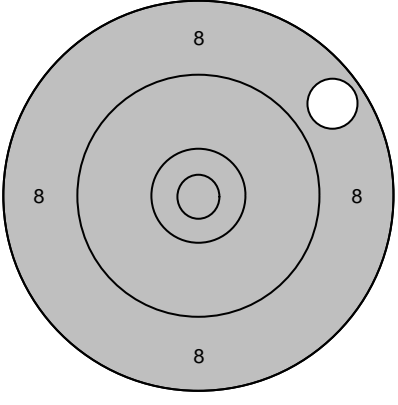
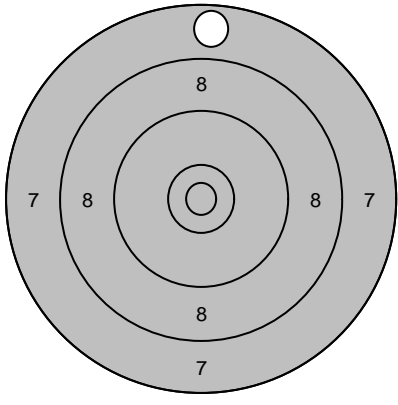
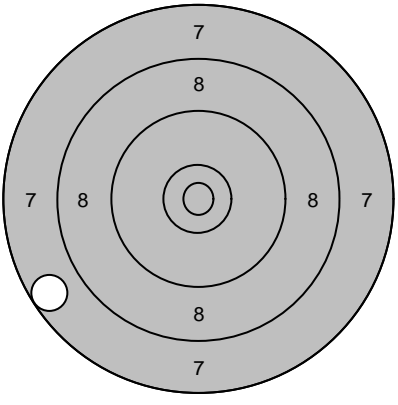

Skjutlag <b>3</b>	Tavla <b>11</b>	<b>Michael Normann</b>	
		I 16 / Lv 6	
2007-07-16	Tavelträffen 2007 Final	Ramselefors SKF	
Prov		1: 8,5 ↓ 2: 10,2 → 3: 10,3* ↓ 4: 9,7 → 5: 8,7 ← 6: 10,2 ↑ 7: 10,2 ← 8: 9,4 ↗ 9: 9,2 ← 10: 9,9 ↑	Serie 1 
	Serie 92,0 Totalt 175,0	1: 9,6 ← 2: 9,9 ↖ 3: 9,2 ↗ 4: 9,4 ↗ 5: 9,6 ↓	Serie 45,0 Totalt 220,0
Serie 1		6: 8,7 ← 7: 8,7 ← 8: 9,4 ← 9: 8,9 ↓ 10: 10,3* ↖	S 1 
	Serie 43,0 Totalt 263,0	1: 5,5 ↓	Serie 5,0 Totalt 268,0
S 2		1: 10,7* ←	S 3 
	Serie 10,0 Totalt 278,0	1: 8,8 ↗	Serie 8,0 Totalt 286,0
S 4		1: 7,8 ↑	S 5 
	Serie 7,0 Totalt 293,0	1: 7,7 ←	Serie 7,0 Totalt 300,0

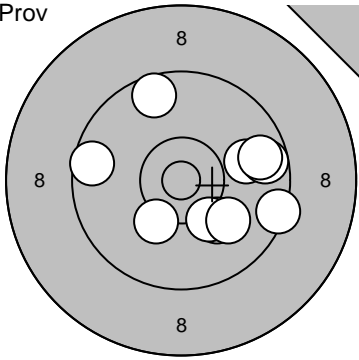
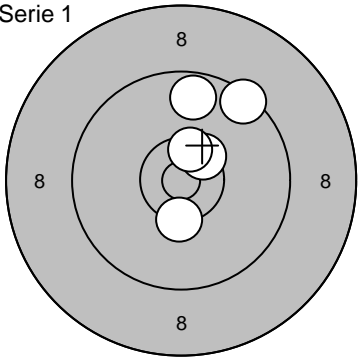
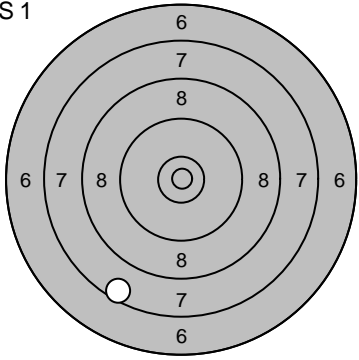
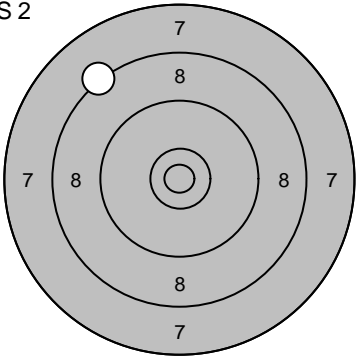
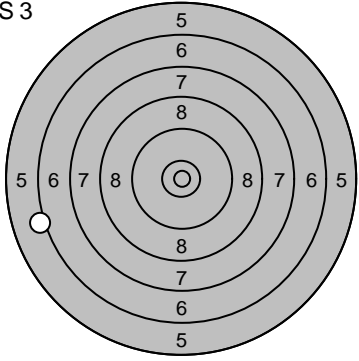
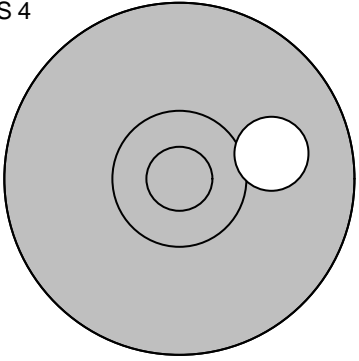
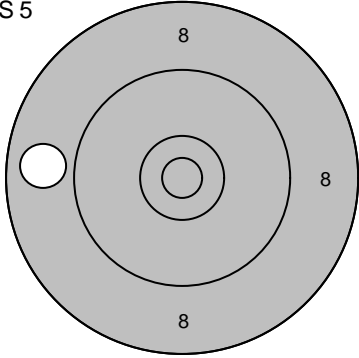
Skjutlag	Tavla	Anders Petersson			
3		12			
P 7					
2007-07-16		Tavelträffen 2007 Final			
2007-07-16		Ramselefors SKF			
Prov		1: 10,1 ↘ 2: 10,2 ↘ 3: 9,4 ↘ 4: 10,2 ↘ 5: 9,9 ↘ 6: 9,6 ↗ 7: 9,6 ↗ 8: 9,7 → 9: 10,0 ↘ 10: 9,7 →	11: 9,7 ↗ 12: 10,1 ← 13: 7,1 ← 14: 7,7 ↗ 15: 10,5* ↗ 16: 10,2 ↑ 17: 9,2 ↗		
Serie		94,0	62,0		
Totalt		175,0	175,0		
Serie 1		1: 9,5 ↗ 2: 10,5* ↗ 3: 10,5* ↗ 4: 9,7 ↗ 5: 10,4* ↓	6: 8,4 ↘ 7: 9,6 ↘ 8: 10,3* ↗ 9: 8,7 ↗ 10: 7,9 ←		
Serie		48,0	42,0		
Totalt		223,0	265,0		
S 1		1: 7,6 ↘	S 2		1: 8,3 ↖
Serie		7,0	Serie		8,0
Totalt		272,0	Totalt		280,0
S 3		1: 6,2 ←	S 4		1: 10,1 →
Serie		6,0	Serie		10,0
Totalt		286,0	Totalt		296,0
S 5		1: 8,9 ←			
Serie		8,0			
Totalt		304,0			

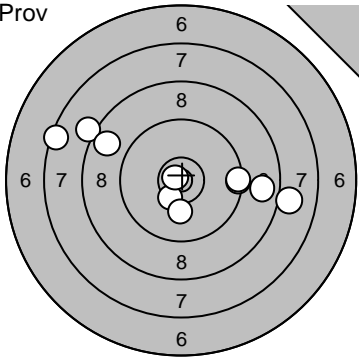
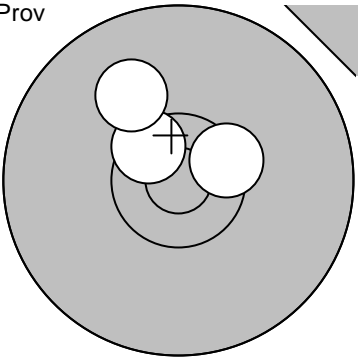
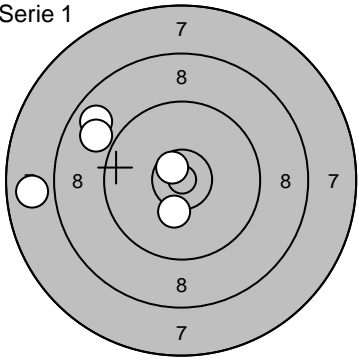
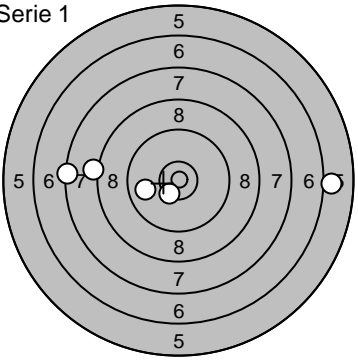
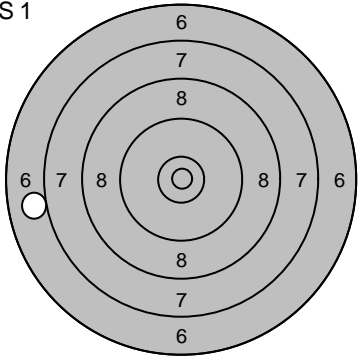
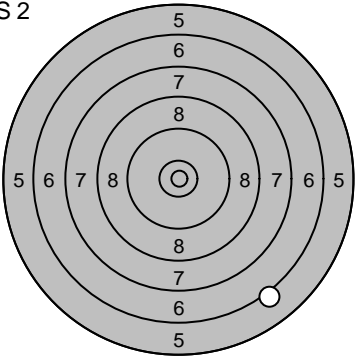
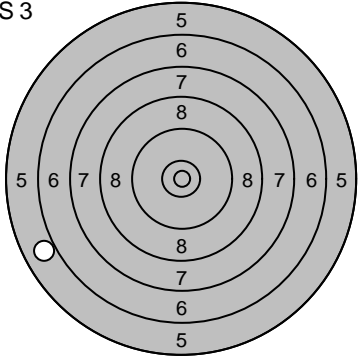
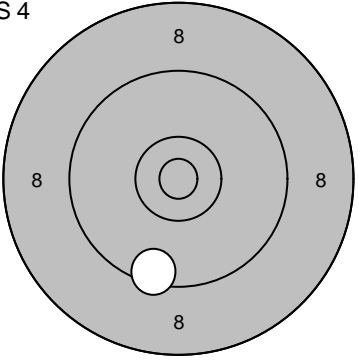
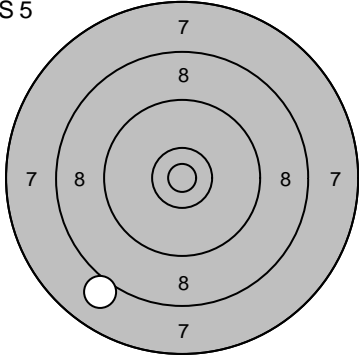
Skjutlag	Tavla	Ida Lundmark		
3	13	Drängsmark		
2007-07-16	Tavelträffen 2007 Final	Ramselefors SKF		
Prov		1: 8,2 ↗ 2: 8,8 → 3: 10,4* ↘ 4: 9,5 → 5: 8,0 ↘ 6: 10,1 ↘ 7: 8,8 ↗ 8: 7,5 ↗ 9: 9,4 → 10: 10,8* ↗ Serie 87,0 Totalt 160,0	Prov 	11: 10,5* ↗ 12: 10,5* ↗ 13: 10,0 ↗ Serie 30,0 Totalt 160,0
Serie 1		1: 8,8 ↗ 2: 10,3 ↘ 3: 9,0 ↗ 4: 7,8 ↗ 5: 10,6* ↗ Serie 44,0 Totalt 204,0	Serie 1 	6: 7,4 ← 7: 8,2 ← 8: 10,5* ↘ 9: 9,8 ← 10: 6,0 → Serie 40,0 Totalt 244,0
S 1		1: 7,0 ← Serie 7,0 Totalt 251,0	S 2 	1: 6,2 ↘ Serie 6,0 Totalt 257,0
S 3		1: 6,0 ← Serie 6,0 Totalt 263,0	S 4 	1: 9,5 ↘ Serie 9,0 Totalt 272,0
S 5		1: 8,1 ↘ Serie 8,0 Totalt 280,0		

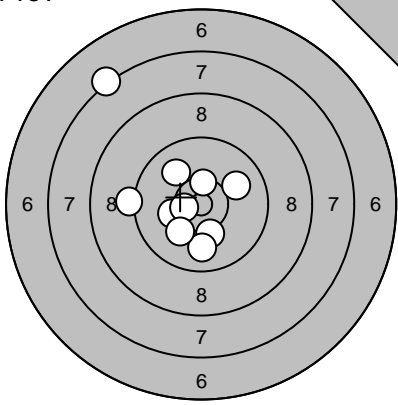
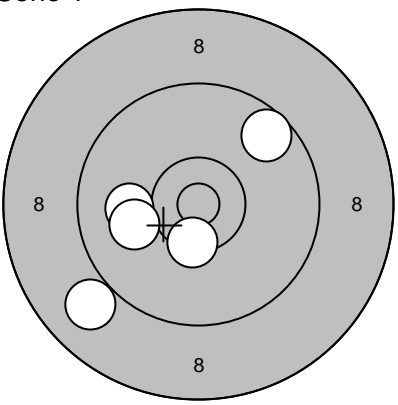
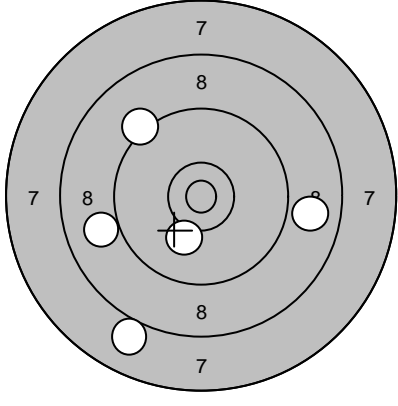
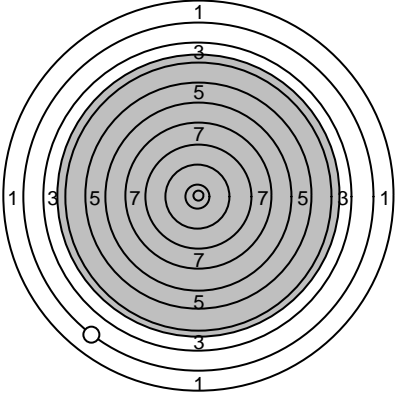
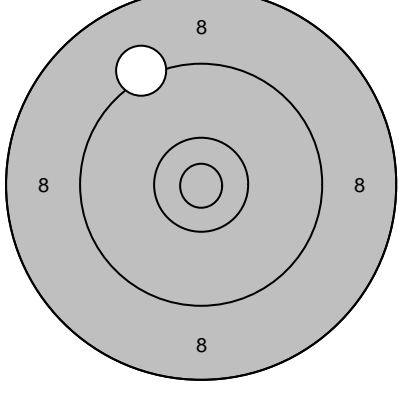
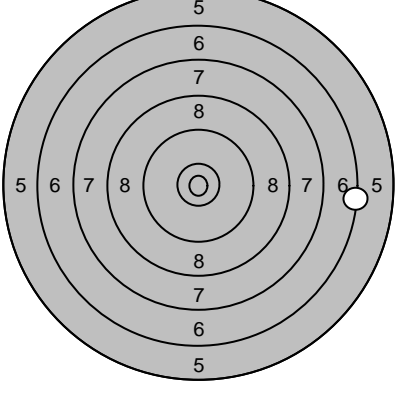
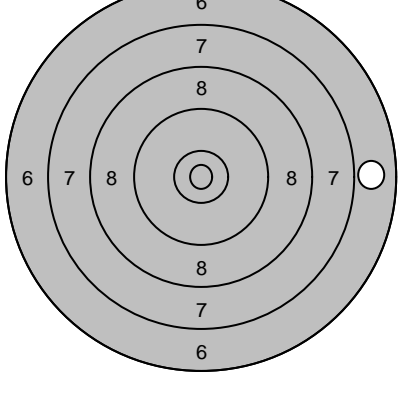
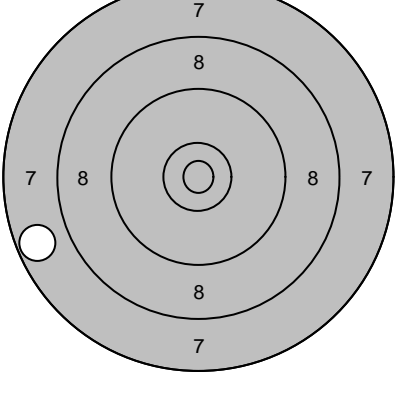
Skjutlag	Tavla	Håkan Lidman	
3	14	Skellefteå	
2007-07-16	Tavelträffen 2007 Final	Ramselefors SKF	
Prov		1: 7,3 ↖ 2: 10,2 ← 3: 10,4* ↑ 4: 10,2 ↓ 5: 10,5* ← 6: 9,9 ↓ 7: 9,2 ← 8: 10,0 ↗ 9: 10,1 ↘ 10: 10,0 ↗	Serie 1
		Serie 95,0 Totalt 181,0	
			1: 9,0 ↙ 2: 10,4* ↓ 3: 10,0 ← 4: 9,6 ↗ 5: 10,1 ←
			Serie 48,0 Totalt 229,0
Serie 1		6: 9,0 ← 7: 10,1 ↓ 8: 9,2 ↗ 9: 8,0 ↓ 10: 8,9 →	S 1
		Serie 44,0 Totalt 273,0	
			1: 2,4 ↙
			Serie 2,0 Totalt 275,0
S 2		1: 9,2 ↖	S 3
		Serie 9,0 Totalt 284,0	
			1: 6,4 →
			Serie 6,0 Totalt 290,0
S 4		1: 6,9 →	S 5
		Serie 6,0 Totalt 296,0	
			1: 7,7 ↙
			Serie 7,0 Totalt 303,0

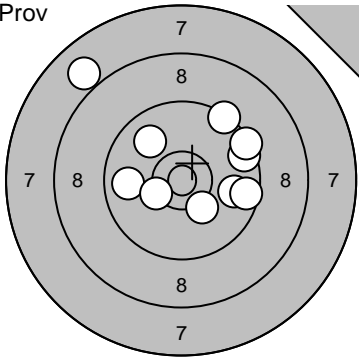
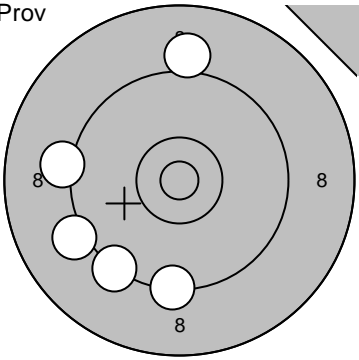
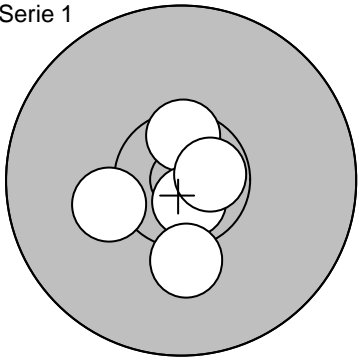
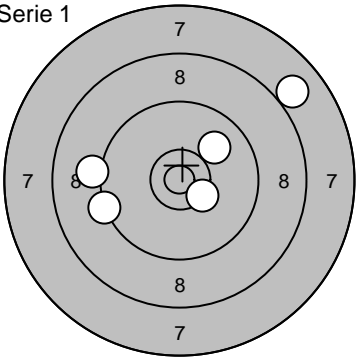
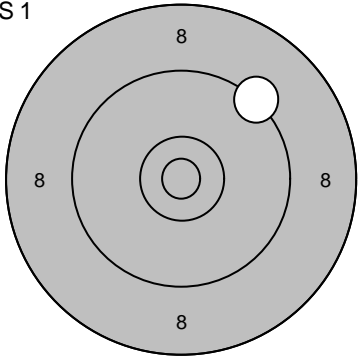
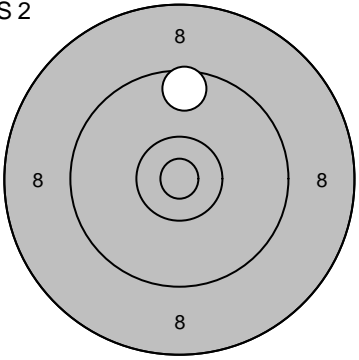
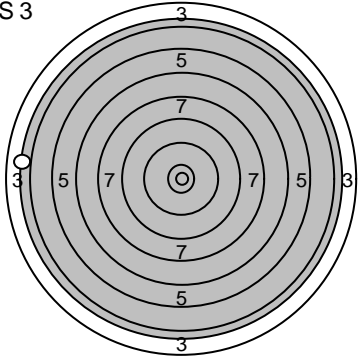
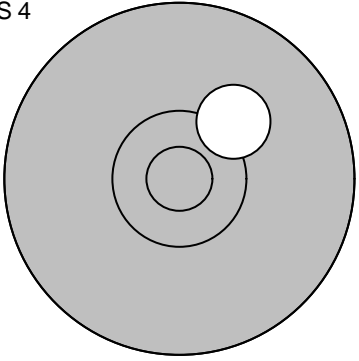
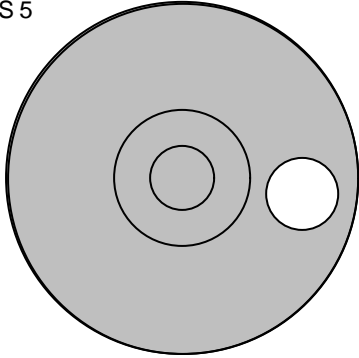
Skjutlag	Tavla	Dan-Ivan Karlsson	
<b>3</b>	<b>15</b>		
		Ramselefors	
2007-07-16	Tavelträffen 2007 Final	Ramselefors SKF	
Prov		1: 8,0 ↗ 2: 9,9 ↗ 3: 9,6 → 4: 9,4 ↗ 5: 10,2 ↗ 6: 9,4 ↗ 7: 9,8 → 8: 9,8 ← 9: 10,3* ← 10: 9,6 →	11: 9,2 ← 12: 9,1 ↑ 13: 9,2 ← 14: 9,3 ↓ 15: 9,3 ↓
	Serie 91,0 Totalt 180,0		Serie 45,0 Totalt 180,0
Serie 1		1: 10,5* ↑ 2: 10,7* ↓ 3: 10,7* → 4: 10,2 ← 5: 10,2 ↓	
	Serie 50,0 Totalt 230,0	Serie 1	
			6: 8,0 ↗ 7: 9,2 ← 8: 9,3 ← 9: 10,0 ↗ 10: 10,4* ↘
	Serie 46,0 Totalt 276,0		
S 1		1: 9,3 ↗	S 2
	Serie 9,0 Totalt 285,0		
			1: 9,6 ↑
			Serie 9,0 Totalt 294,0
S 3		1: 4,0 ←	S 4
	Serie 4,0 Totalt 298,0		
			1: 10,2 ↗
			Serie 10,0 Totalt 308,0
S 5		1: 9,8 →	
	Serie 9,0 Totalt 317,0		

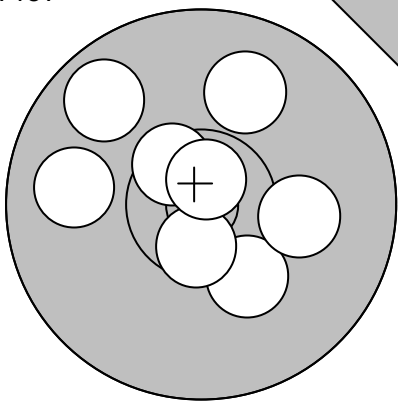
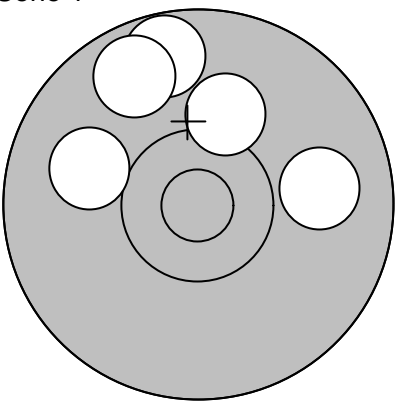
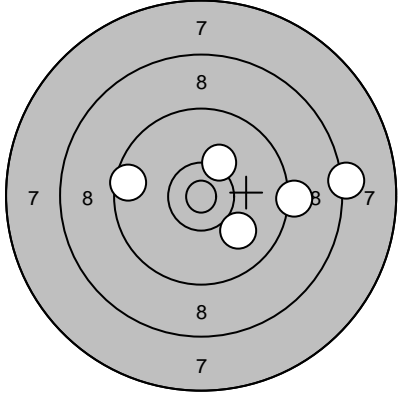
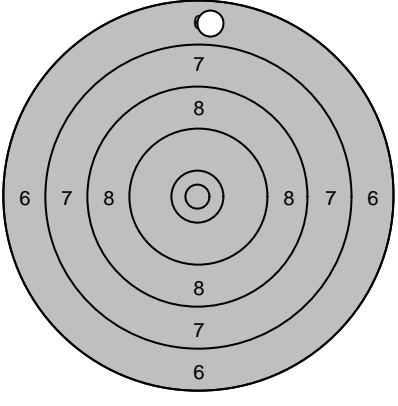
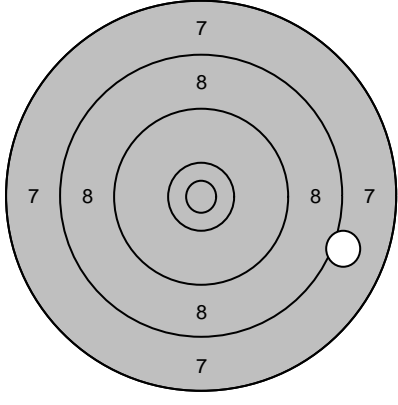
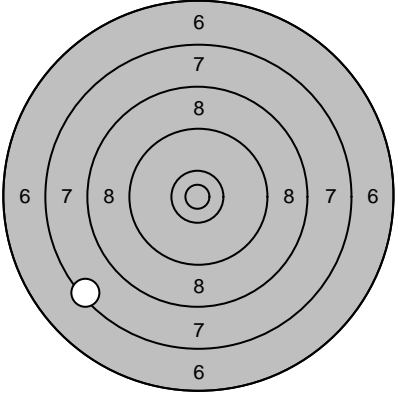
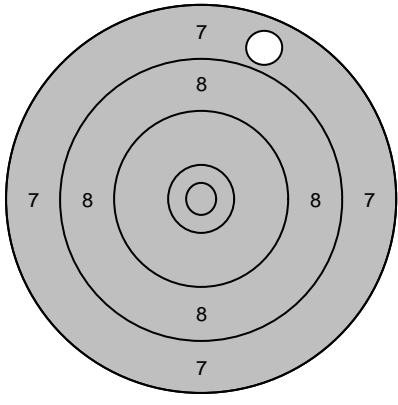
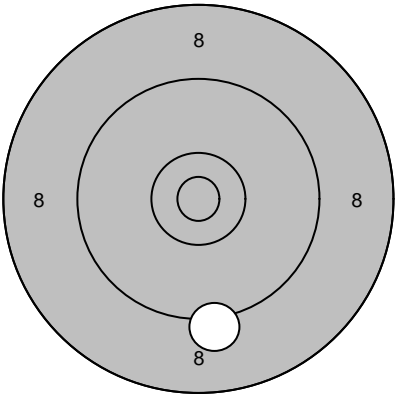
Skjutlag	Tavla	<b>Gunnar Iversen</b>		
<b>3</b>	<b>16</b>			
		S 3		
2007-07-16	Tavelträffen 2007 Final	Ramselefors SKF		
Prov		1: 9,9 ↗ 2: 10,2 ↘ 3: 10,5* ↗ 4: 10,6* ↘ 5: 9,9 ← 6: 10,1 → 7: 9,8 ↗ 8: 10,7* ↑	Serie 1 	1: 9,9 → 2: 9,7 ↑ 3: 10,0 ← 4: 10,2 ↑ 5: 9,7 ↑
	Serie 77,0		Serie 47,0	
	Totalt 175,0		Totalt 222,0	
Serie 1		6: 9,6 ← 7: 10,2 ↗ 8: 10,0 ↘ 9: 9,2 → 10: 8,2 →	S 1 	1: 6,9 ↑
	Serie 46,0		Serie 6,0	
	Totalt 268,0		Totalt 274,0	
S 2		1: 8,1 →	S 3 	1: 7,4 ↙
	Serie 8,0		Serie 7,0	
	Totalt 282,0		Totalt 289,0	
S 4		1: 7,9 ↑	S 5 	1: 9,2 ↓
	Serie 7,0		Serie 9,0	
	Totalt 296,0		Totalt 305,0	

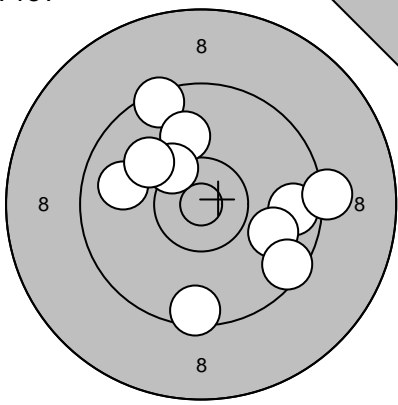
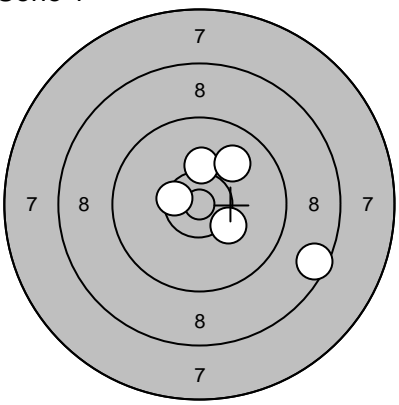
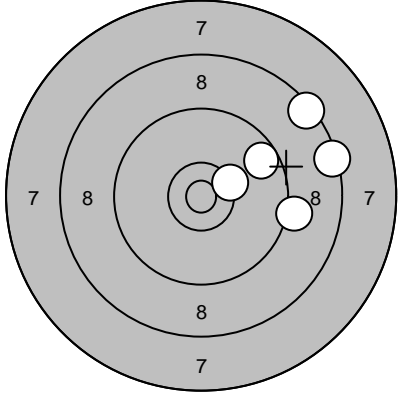
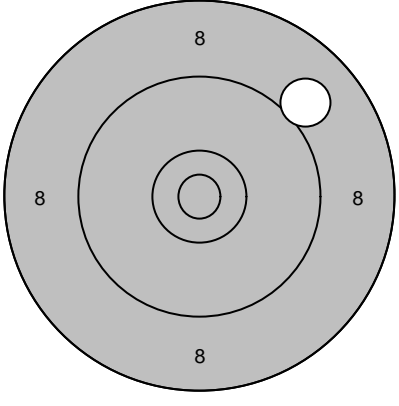
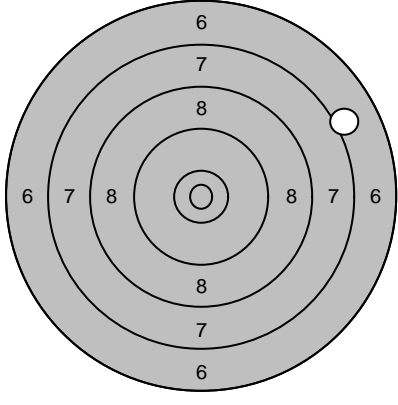
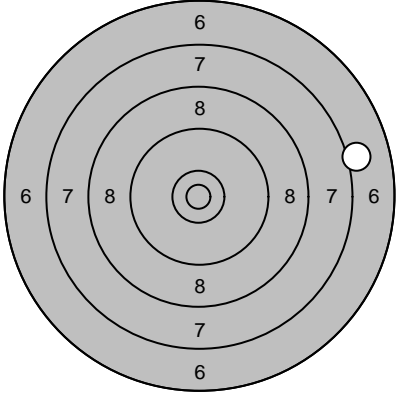
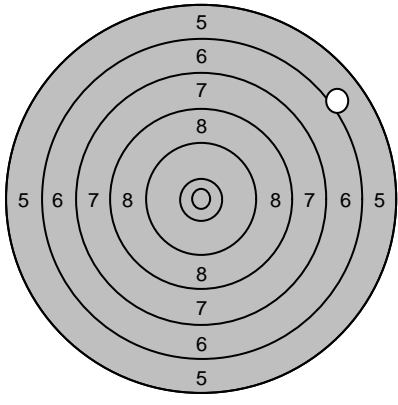
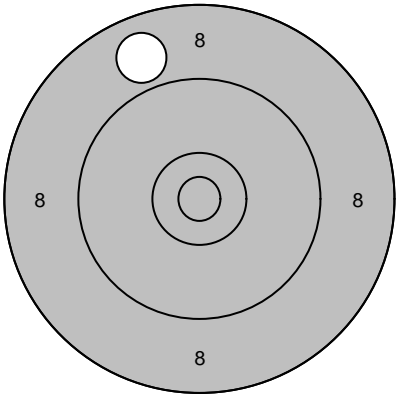
Skjutlag <b>3</b>	Tavla <b>17</b>	<b>Martin Olofsson</b>	
		Vännäs	
2007-07-16	Tavelträffen 2007 Final	Ramselefors SKF	
Prov		1: 9,5 ↗ 2: 9,7 → 3: 9,9 ↘ 4: 9,5 ↘ 5: 9,9 ↖ 6: 9,2 → 7: 9,5 ↓ 8: 10,0 ↑ 9: 10,3* ↗ 10: 10,1 ↖	Serie 1 
	Serie 93,0 Totalt 171,0	1: 10,5* ← 2: 10,2 ↑ 3: 10,0 ↗ 4: 8,5 → 5: 10,3 ↘	Serie 48,0 Totalt 219,0
Serie 1		6: 9,6 ↗ 7: 9,2 → 8: 8,4 → 9: 8,4 ↗ 10: 10,3* →	S 1 
	Serie 44,0 Totalt 263,0		1: 9,0 ↗ Serie 9,0 Totalt 272,0
S 2		1: 7,1 ↗	S 3 
	Serie 7,0 Totalt 279,0		1: 7,1 → Serie 7,0 Totalt 286,0
S 4		1: 6,1 ↗	S 5 
	Serie 6,0 Totalt 292,0		1: 8,9 ↖ Serie 8,0 Totalt 300,0

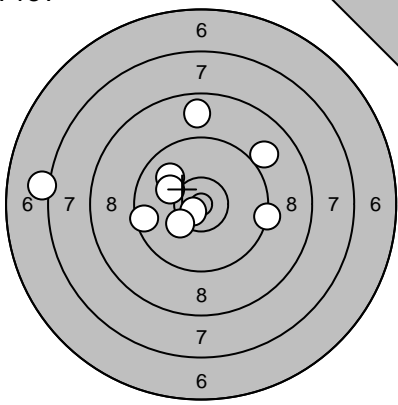
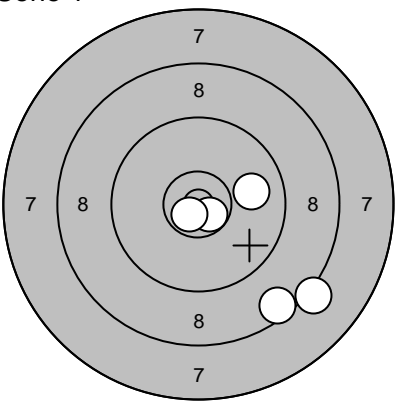
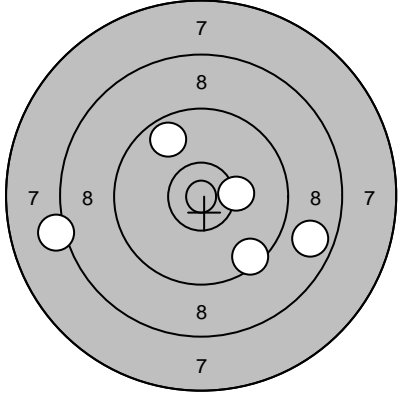
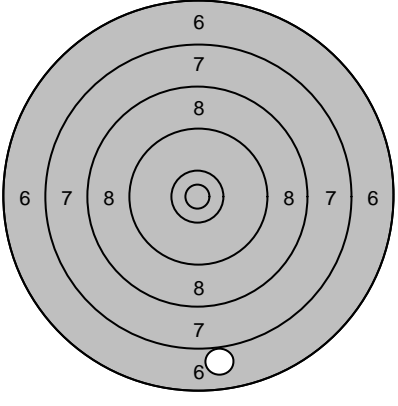
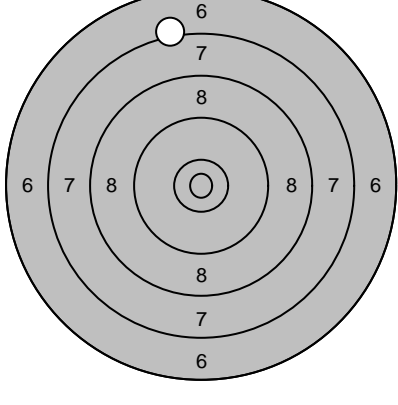
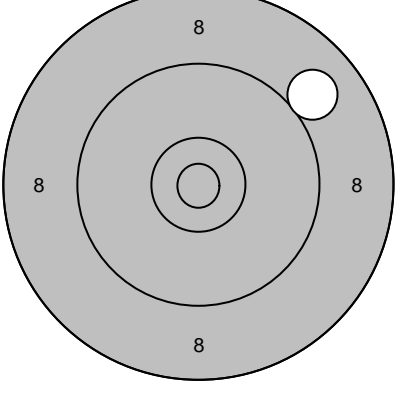
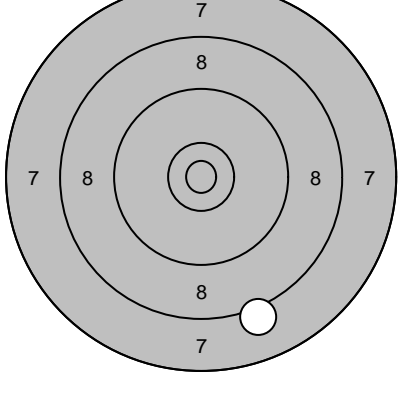
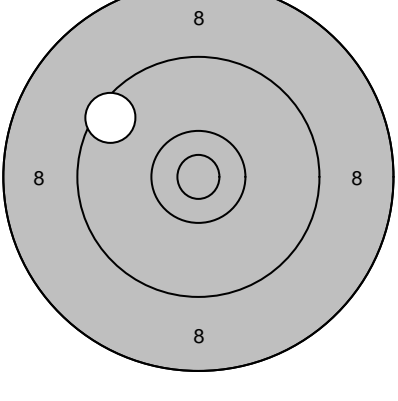
Skjutlag <b>3</b>	Tavla <b>19</b>	<b>Håkan Engman</b>	
		Lindesberg	
2007-07-16	Tavelträffen 2007 Final	Ramselefors SKF	
Prov		1: 9,6 ← 2: 10,7* ↙ 3: 10,3 ↙ 4: 10,0 ↗ 5: 9,0 ↗ 6: 9,3 → 7: 7,2 ← 8: 10,2 ↖ 9: 8,8 ↑	Serie 1 
	Serie 82,0 Totalt 156,0	1: 10,7* ↘ 2: 9,9 → 3: 8,2 ↘ 4: 10,7* ↙ 5: 8,5 ↘	Serie 45,0 Totalt 201,0
Serie 1		6: 9,7 ↗ 7: 9,5 ↘ 8: 10,3* → 9: 8,2 ← 10: 8,8 ↘	S 1 
	Serie 44,0 Totalt 245,0		1: 7,0 ↓ Serie 7,0 Totalt 252,0
S 2		1: 7,2 ↑	S 3 
	Serie 7,0 Totalt 259,0		1: 9,0 ↗ Serie 9,0 Totalt 268,0
S 4		1: 8,1 ↘	S 5 
	Serie 8,0 Totalt 276,0		1: 9,5 ↖ Serie 9,0 Totalt 285,0

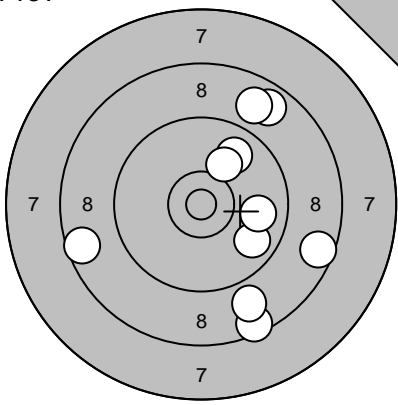
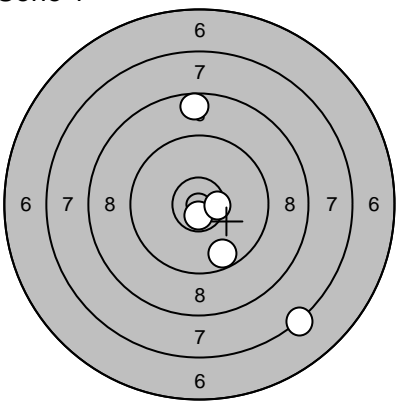
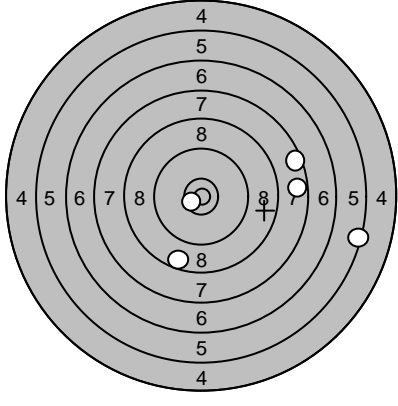
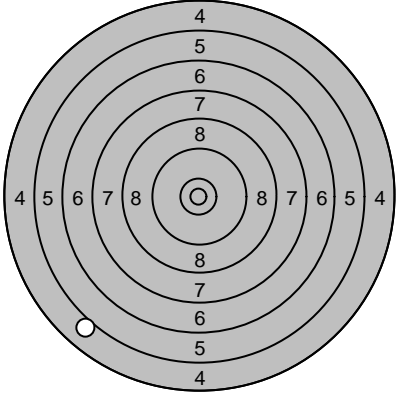
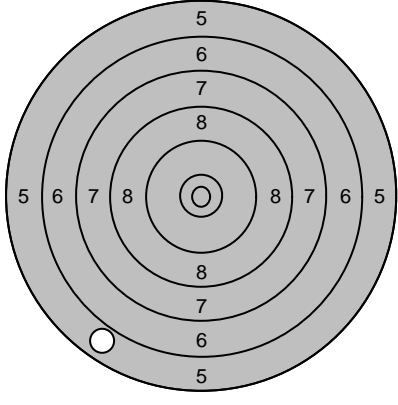
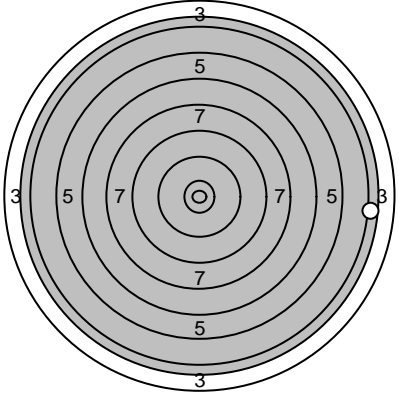
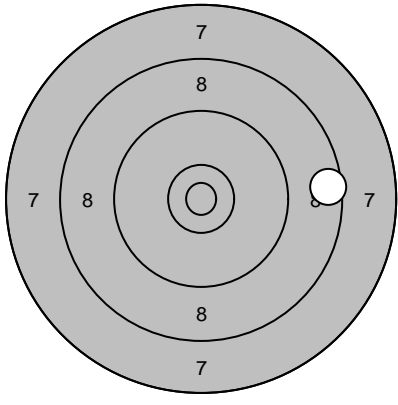
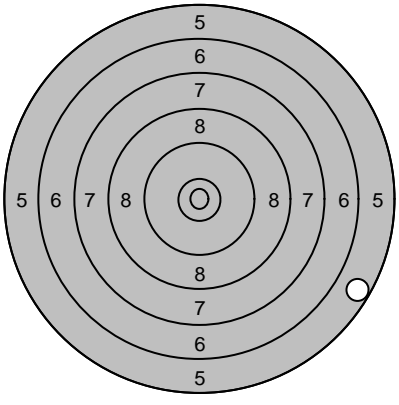

Skjutlag	Tavla	<b>Bertil Ruisniemi</b>	
<b>3</b>	<b>20</b>	Övertorneå	
2007-07-16	Tavelträffen 2007 Final	Ramselefors SKF	
Prov		1: 8,6 ← 2: 8,5 ↓ 3: 9,8 ↘ 4: 8,9 ↓ 5: 9,9 → 6: 8,6 → 7: 9,9 ↗ 8: 8,8 ↗ 9: 8,9 ↗ 10: 10,1 ↗ Serie 85,0 Totalt 152,0	Serie 1 
			1: 8,6 ↑ 2: 9,7 ↓ 3: 7,3 ↓ 4: 10,7* ↓ 5: 10,5* → Serie 44,0 Totalt 196,0
Serie 1		6: 8,6 ↓ 7: 7,6 → 8: 10,6* ← 9: 5,4 → 10: 7,5 → Serie 37,0 Totalt 233,0	S 1 
			1: 5,0 ↙ Serie 5,0 Totalt 238,0
S 2		1: 5,9 ↙ Serie 5,0 Totalt 243,0	S 3 
			1: 4,2 → Serie 4,0 Totalt 247,0
S 4		1: 8,6 → Serie 8,0 Totalt 255,0	S 5 
			1: 5,7 → Serie 5,0 Totalt 260,0

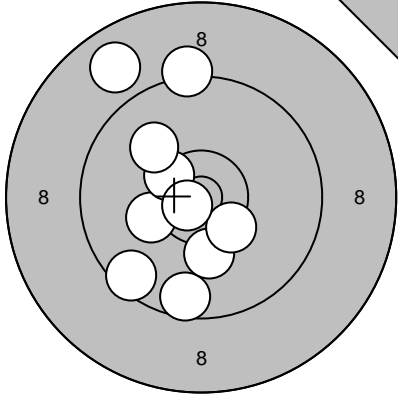
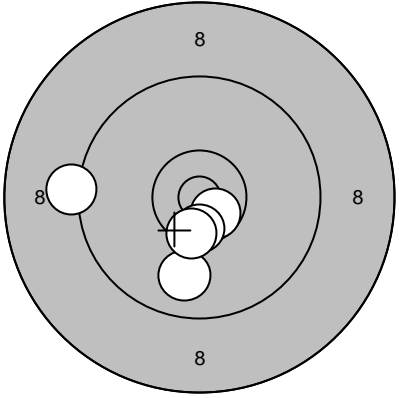
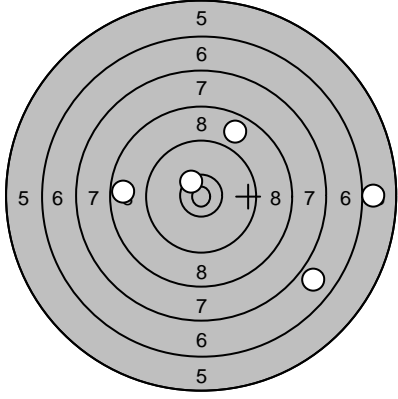
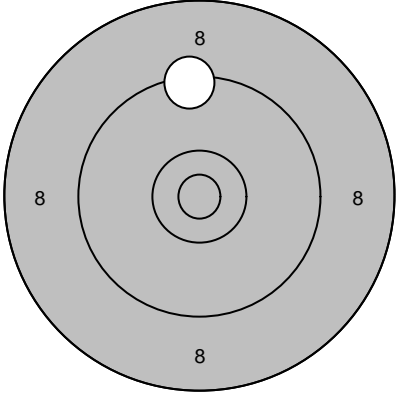
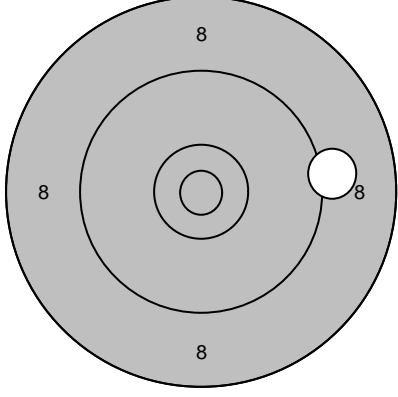
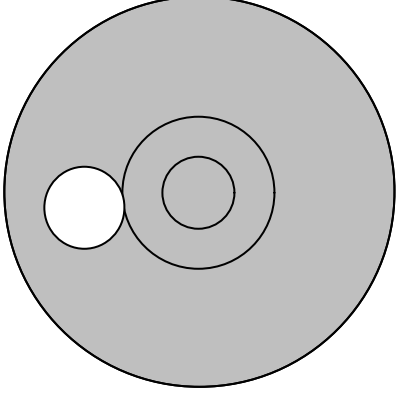
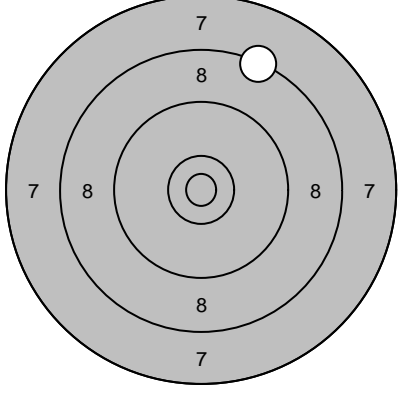
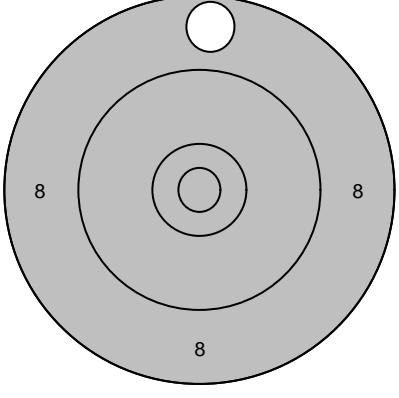
Skjutlag	Tavla	Fredrik Forsgren		
3	21	Ramselefors		
2007-07-16	Tavelträffen 2007 Final	Ramselefors SKF		
Prov		1: 9,2 ↑ 2: 8,8 ↗ 3: 9,6 ↓ 4: 10,2 ← 5: 10,4* ↖ 6: 10,2 ↓ 7: 9,5 ↙ 8: 10,4* ↘ 9: 10,7* ← 10: 10,0 ↗	Serie 1 	1: 9,9 ↓ 2: 10,6* ↘ 3: 9,2 ← 4: 10,5* ↓ 5: 10,4* ↓
	Serie 95,0 Totalt 184,0		Serie 48,0 Totalt 232,0	
Serie 1		6: 10,4* ↖ 7: 8,8 ↗ 8: 6,9 ↘ 9: 6,0 → 10: 8,7 ←	S 1 	1: 9,4 ↑
	Serie 38,0 Totalt 270,0		Serie 9,0 Totalt 279,0	
S 2		1: 9,2 →	S 3 	1: 10,0 ←
	Serie 9,0 Totalt 288,0		Serie 10,0 Totalt 298,0	
S 4		1: 8,4 ↗	S 5 	1: 8,8 ↑
	Serie 8,0 Totalt 306,0		Serie 8,0 Totalt 314,0	

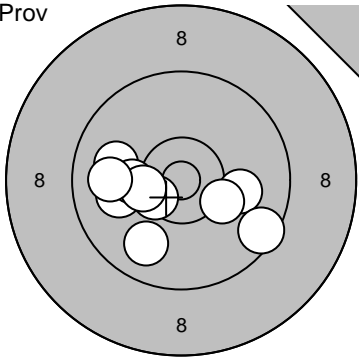
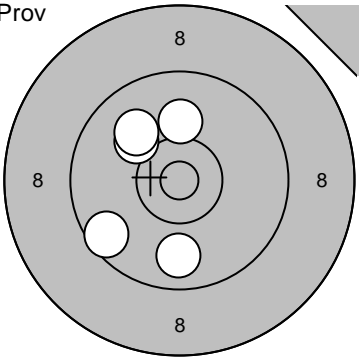
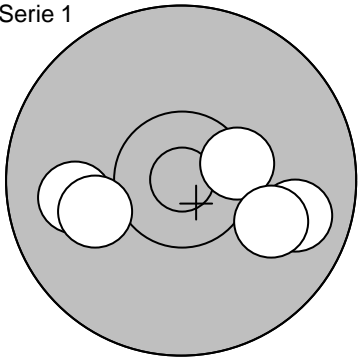
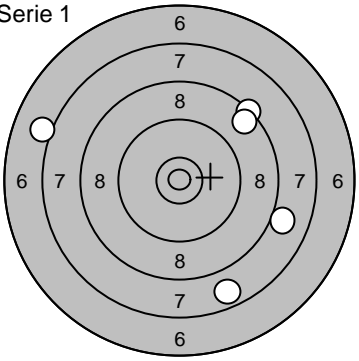
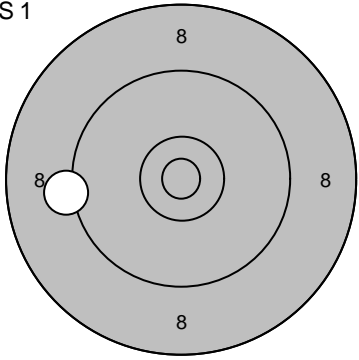
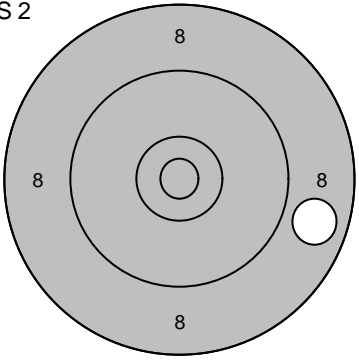
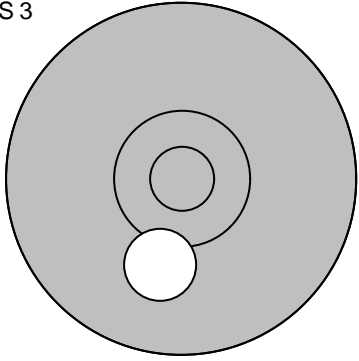
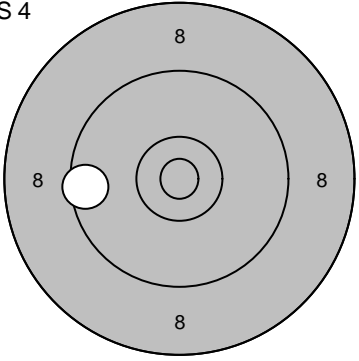
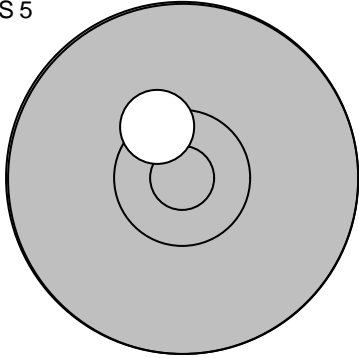
Skjutlag <b>3</b>	Tavla <b>22</b>	<b>Carina Norling</b>	
		Söderala	
2007-07-16		Tavelträffen 2007 Final	Ramselefors SKF
Prov 	1: 10,0 → 2: 10,5* ↘ 3: 9,5 ↘ 4: 10,0 ↘ 5: 9,9 ↗ 6: 10,2 ↗ 7: 10,4* ↗ 8: 9,9 ↗ 9: 9,9 ↘ 10: 10,3 ↘ Serie 96,0 Totalt 179,0	Prov 	11: 9,6 ↖ 12: 9,8 ↘ 13: 10,1 ↗ 14: 10,1 ↗ 15: 10,0 ↗ Serie 48,0 Totalt 179,0
Serie 1 	1: 10,4* → 2: 9,8 → 3: 9,9 ↗ 4: 10,0 ↘ 5: 10,1 ↖ Serie 48,0 Totalt 227,0	Serie 1 	6: 8,4 ↗ 7: 8,6 ↗ 8: 8,0 → 9: 7,7 ↘ 10: 7,1 ↖ Serie 38,0 Totalt 265,0
S 1 	1: 9,2 ← Serie 9,0 Totalt 274,0	S 2 	1: 8,8 → Serie 8,0 Totalt 282,0
S 3 	1: 10,1 ↘ Serie 10,0 Totalt 292,0	S 4 	1: 9,5 ← Serie 9,0 Totalt 301,0
S 5 	1: 10,4* ↖ Serie 10,0 Totalt 311,0		

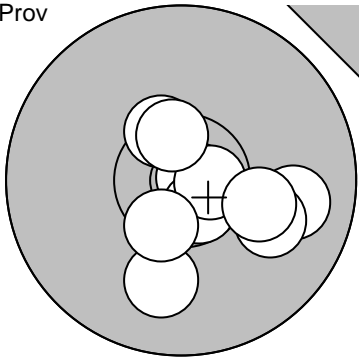
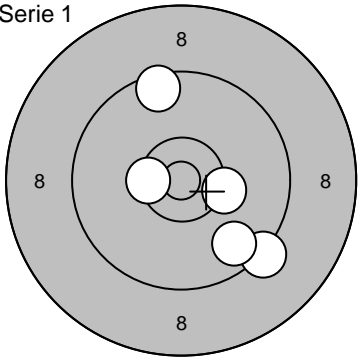
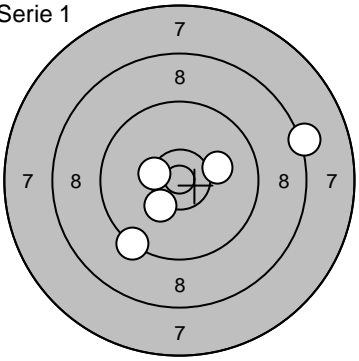
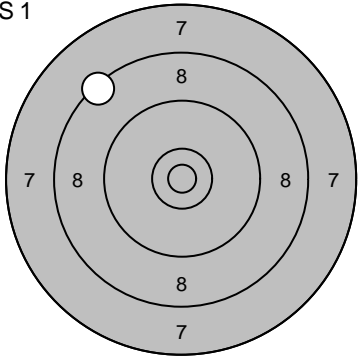
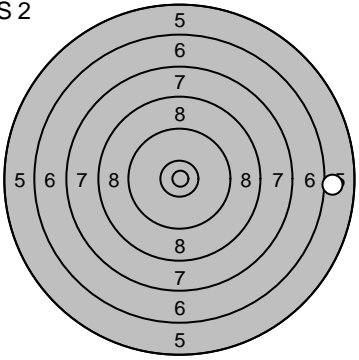
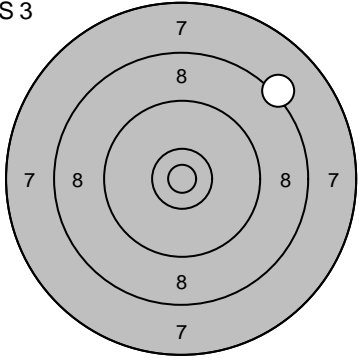
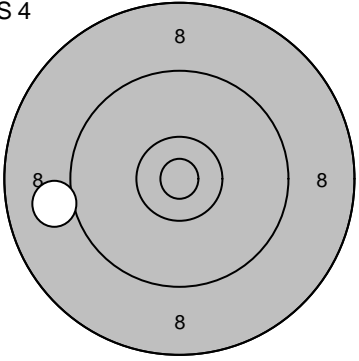
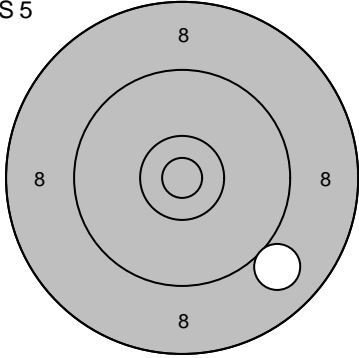
Skjutlag	Tavla	Jonas Bromihn		
3	23	Älmhult		
2007-07-16	Tavelträffen 2007 Final	Ramselefors SKF		
Prov		1: 10,5* ↗ 2: 10,8* → 3: 9,9 → 4: 10,0 → 5: 10,6* ↘ 6: 10,7* ↘ 7: 10,2 ↘ 8: 10,0 ↘ 9: 10,5* ↗ 10: 10,5* ↘ Serie 99,0 Totalt 179,0	11: 9,8 → 12: 10,4* ↑ 13: 9,4 ↘ 14: 10,1 ↘ 15: 10,7* ↗ Serie 48,0 Totalt 179,0	
Serie 1		1: 10,5* ← 2: 10,3 → 3: 9,3 ↘ 4: 9,7 ↘ 5: 9,5 ↗ Serie 47,0 Totalt 226,0	Serie 1 	6: 9,3 ↘ 7: 10,3* ↘ 8: 8,2 → 9: 10,4* ← 10: 10,1 → Serie 47,0 Totalt 273,0
S 1		1: 8,4 ↗ Serie 8,0 Totalt 281,0	S 2 	1: 6,0 → Serie 6,0 Totalt 287,0
S 3		1: 8,3 ↗ Serie 8,0 Totalt 295,0	S 4 	1: 9,0 ← Serie 9,0 Totalt 304,0
S 5		1: 9,0 ↘ Serie 9,0 Totalt 313,0		

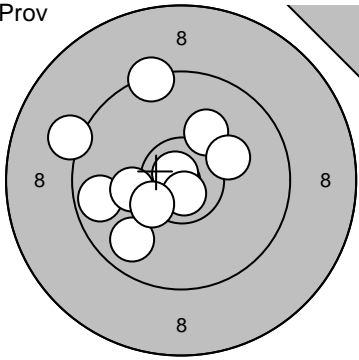
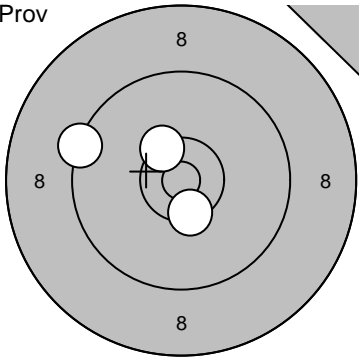
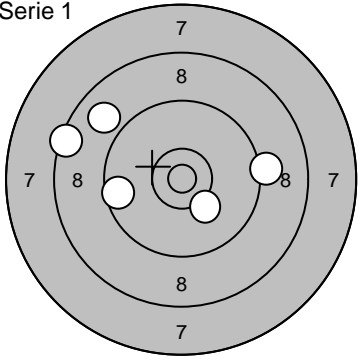
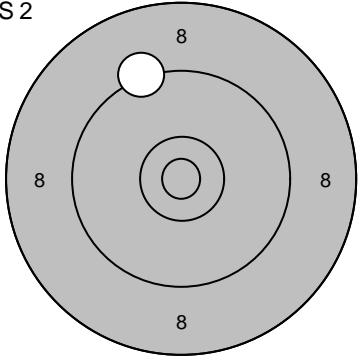
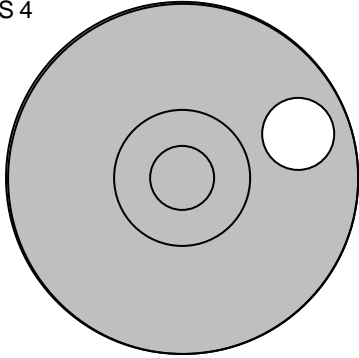
Skjutlag	Tavla	Marie Fjällström	
3		24	
Ramselefors			
2007-07-16		Tavelträffen 2007 Final	
2007-07-16		Ramselefors SKF	
Prov		1: 9,2 ↗ 2: 9,7 ↖ 3: 10,2 ↖ 4: 10,1 ↗ 5: 9,4 ↗ 6: 9,8 ↖ 7: 10,2 ↗ 8: 10,8* ↗ 9: 10,7* ↘ 10: 10,4* ↖	11: 9,8 ↗ 12: 9,4 ↖ 13: 10,0 → 14: 10,0 ↑ 15: 10,5* ↖ 16: 10,6* → 17: 10,0 ↘ 18: 10,2 ↑ 19: 10,0 ↘ 20: 10,4* ↘
		Serie 96,0	Serie 98,0
		Totalt 178,0	Totalt 178,0
Prov		21: 9,4 ↖ 22: 10,4* ↗ 23: 10,4* ↘	Serie 1
		Serie 29,0	1: 9,3 ↖ 2: 9,9 ↖ 3: 10,8* ↘ 4: 9,7 ↖ 5: 10,0 ↘
		Totalt 178,0	Serie 47,0
			Totalt 225,0
Serie 1		6: 8,4 ↗ 7: 9,6 ↖ 8: 9,2 ↗ 9: 8,9 ↗ 10: 10,2 ↘	S 1
		Serie 44,0	1: 7,1 ↑
		Totalt 269,0	Totalt 276,0
S 2		1: 9,3 ↑	S 3
		Serie 9,0	1: 8,6 ↖
		Totalt 285,0	Serie 8,0
			Totalt 293,0
S 4		1: 9,8 →	S 5
		Serie 9,0	1: 10,2 →
		Totalt 302,0	Serie 10,0
			Totalt 312,0