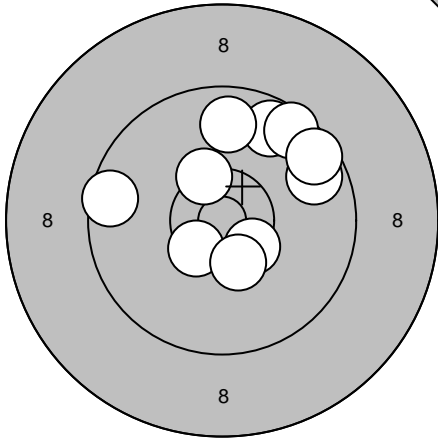
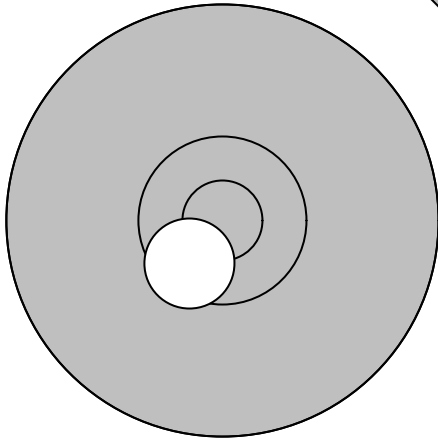
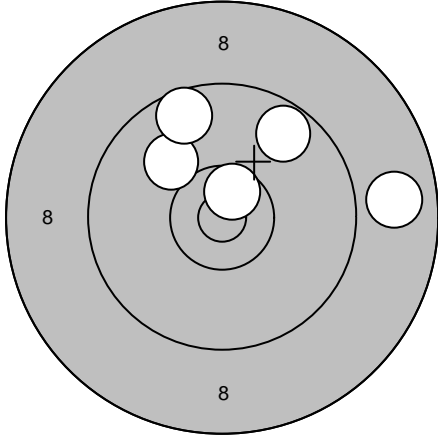
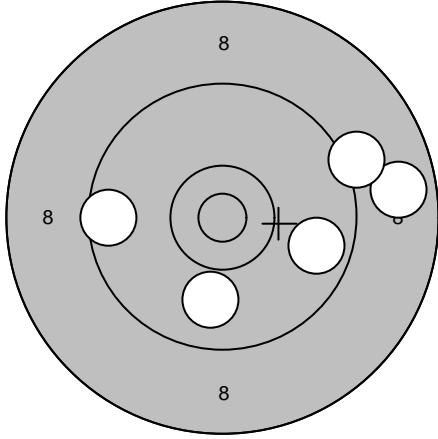
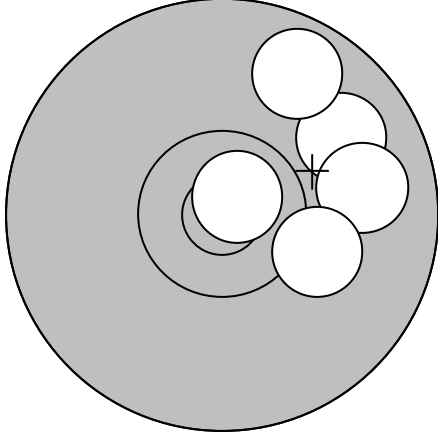
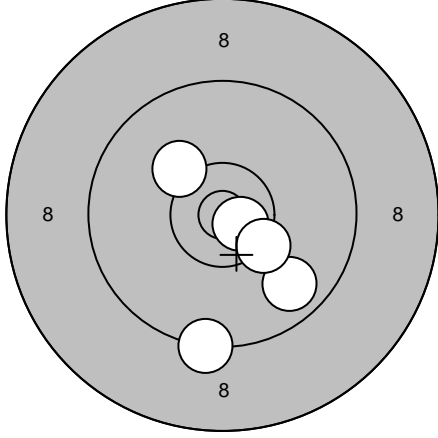
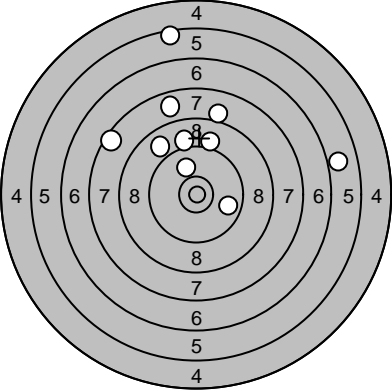
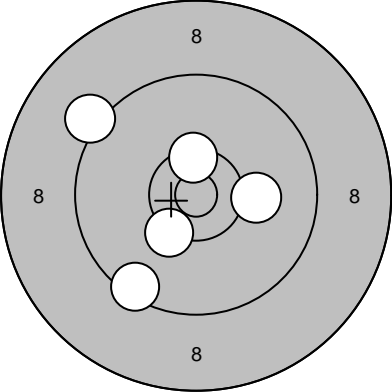
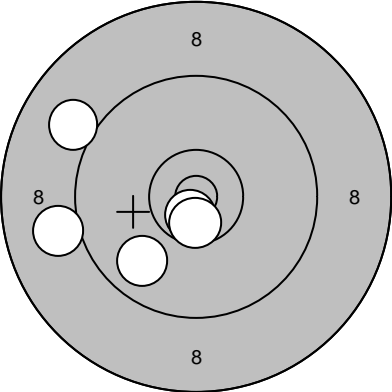
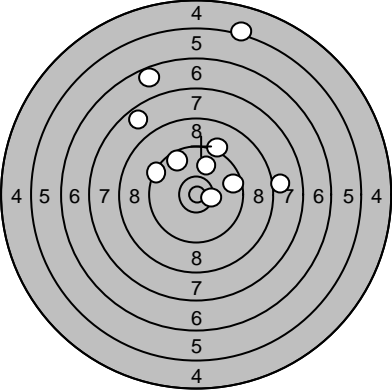
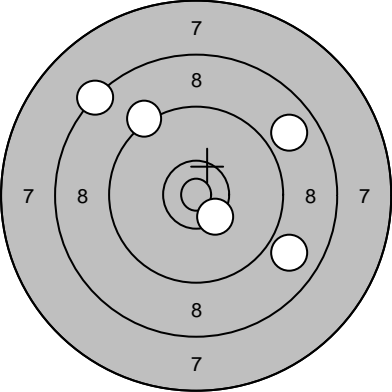
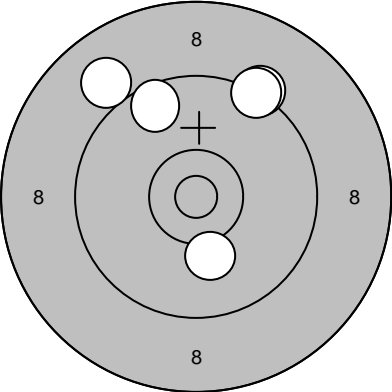
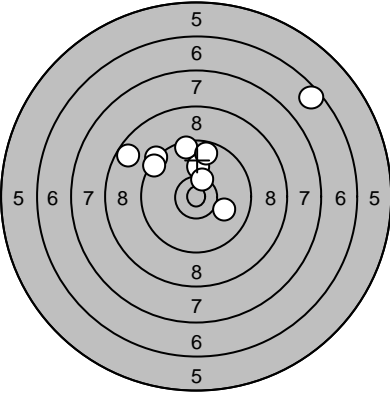
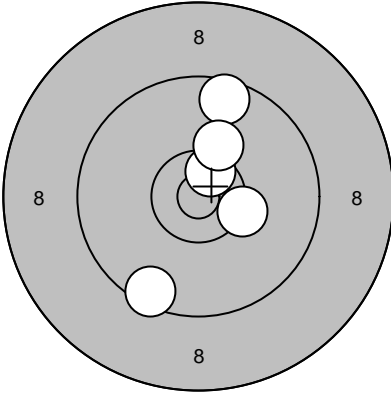
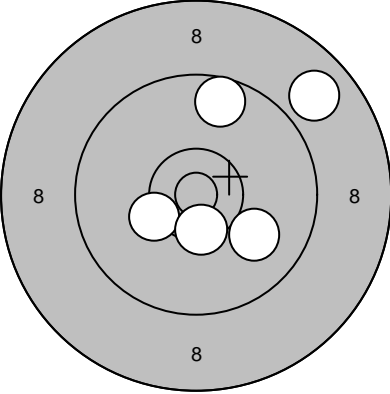
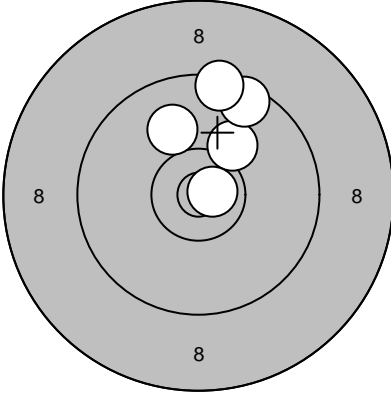
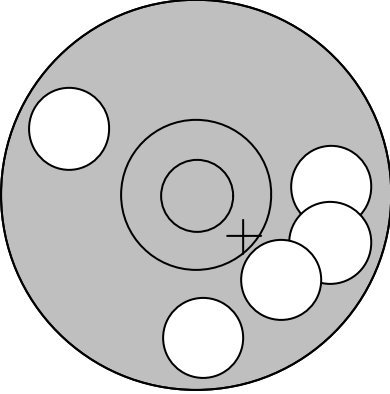
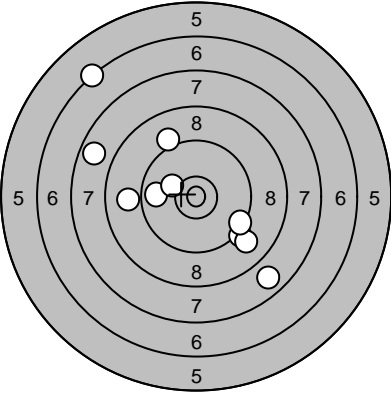
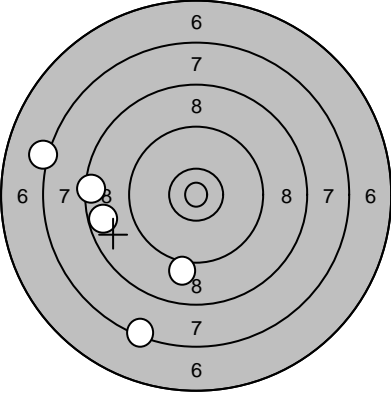
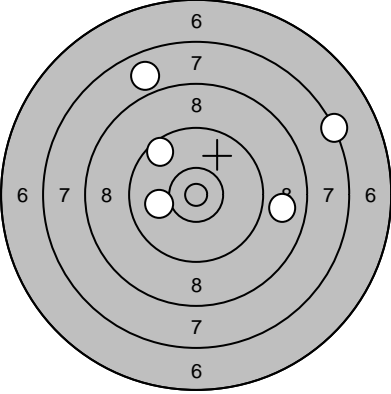

Skjutlag	Tavla	Jan Wallerström	
1	1	Ununge	
2007-07-16	Tavelträffen 2007	Ramselefors SKF	
Prov		1: 9,7 ↗ 2: 9,6 ↗ 3: 10,4* ↖ 4: 9,7 ↗ 5: 9,6 ↗ 6: 9,6 ← 7: 10,5* ↘ 8: 10,4* ↘ 9: 9,8 ↑ 10: 10,4* ↓	Prov 
	Serie 94,0		11: 10,5* ↘
	Totalt 0,0		Serie 10,0
			Totalt 0,0
Serie		1: 10,0 ↖ 2: 9,6 ↖ 3: 10,6* ↗ 4: 9,7 ↗ 5: 8,8 →	Serie 
	Serie 46,0		6: 9,8 →
	Totalt 46,0		7: 9,5 ←
			8: 9,9 ↓
			9: 8,8 →
			10: 9,2 ↗
			Serie 44,0
			Totalt 90,0
Serie		11: 9,9 ↗ 12: 9,7 ↗ 13: 9,9 → 14: 10,8* ↗ 15: 10,2 →	Serie 
	Serie 47,0		16: 10,7* ↘
	Totalt 137,0		17: 9,3 ↓
			18: 9,8 ↘
			19: 10,3* ↘
			20: 10,2 ↗
			Serie 48,0
			Totalt 185,0

Skjutlag	Tavla	Dan-Ivan Karlsson	
1	2	Ramselefors	
2007-07-16	Tavelträffen 2007	Ramselefors SKF	
Prov		1: 5,5 ↑ 2: 7,8 ↑ 3: 8,1 ↑ 4: 6,0 → 5: 9,1 ↑ 6: 8,9 ↑ 7: 9,8 → 8: 10,0 ↑ 9: 9,1 ↑ 10: 7,5 ↙	11: 8,6 ↑ 12: 9,9 ↙ 13: 9,9 ←
	Serie 78,0		Serie 26,0
	Totalt 0,0		Totalt 0,0
Serie		1: 9,5 ↙ 2: 10,5* ↑ 3: 10,3* ↙ 4: 9,2 ↙ 5: 10,1 →	6: 10,1 ↑ 7: 9,3 ← 8: 10,5* ↗ 9: 10,5* ← 10: 10,6* ↙
	Serie 48,0		Serie 49,0
	Totalt 48,0		Totalt 97,0
Serie		11: 10,7* ↙ 12: 9,0 ↙ 13: 9,0 ← 14: 9,8 ↙ 15: 10,6* ↓	16: 9,8 ← 17: 10,3 ↑ 18: 9,9 → 19: 10,4* ↑ 20: 9,8 ↑
	Serie 47,0		Serie 47,0
	Totalt 144,0		Totalt 191,0

Skjutlag	Tavla	Leif Sigfridsson	
1	3	Ramselefors	
2007-07-16	Tavelträffen 2007	Ramselefors SKF	
Prov		1: 5,2 ↗ 2: 9,2 ↗ 3: 6,7 ↗ 4: 7,8 ↗ 5: 9,4 ↗ 6: 10,4* → 7: 9,9 ↗ 8: 8,0 → 9: 9,6 → 10: 9,6 ↗	11: 10,2 ← 12: 9,2 →
	Serie 81,0		Serie 19,0
	Totalt 0,0		Totalt 0,0
Serie		1: 8,3 ↗ 2: 8,9 ↘ 3: 8,9 ↗ 4: 10,4* ↘ 5: 9,2 ↗	6: 9,3 → 7: 9,1 ← 8: 10,4* ↘ 9: 8,5 ↗ 10: 8,7 ↘
	Serie 43,0		Serie 44,0
	Totalt 43,0		Totalt 87,0
Serie		11: 10,1 ↘ 12: 9,6 ↗ 13: 9,3 ↗ 14: 9,0 ↗ 15: 9,3 ↗	16: 6,9 ↗ 17: 9,2 ↗ 18: 8,7 ↗ 19: 9,5 ↗ 20: 7,6 ↗
	Serie 46,0		Serie 39,0
	Totalt 133,0		Totalt 172,0

Skjutlag	Tavla	Mikael Olofsson	
1	4		
		Moälven-Modo	
2007-07-16	Tavelträffen 2007	Ramselefors SKF	
Prov 	1: 6,6 ↗	Serie 	1: 9,6 ↗
	2: 10,1 ↑		2: 9,5 ↓
	3: 9,4 ↗		3: 10,3* →
	4: 9,5 ↑		4: 10,6* ↗
	5: 10,0 →		5: 10,2 ↗
	6: 10,4* ↑		
	7: 8,7 ↗		
	8: 9,4 ↗		
	9: 9,7 ↑		
	Serie 80,0		Serie 48,0
	Totalt 0,0		Totalt 48,0
Serie 	6: 10,3* ←	Serie 	11: 10,1 ↗
	7: 8,9 ↗		12: 9,5 ↗
	8: 10,0 →		13: 9,4 ↑
	9: 10,5* ↓		14: 10,8* →
	10: 9,6 ↑		15: 10,0 ↗
	Serie 47,0		Serie 48,0
	Totalt 95,0		Totalt 143,0
Serie 	16: 9,8 →		
	17: 9,7 ↓		
	18: 9,7 →		
	19: 9,8 ↗		
	20: 9,9 ↓		
	Serie 45,0		
	Totalt 188,0		

Skjutlag	Tavla	Lennart Westermark	
1	5	Drängsmark	
2007-07-16	Tavelträffen 2007	Ramselefors SKF	
Prov		1: 6,3 ↗ 2: 9,8 ← 3: 9,3 ↘ 4: 9,0 ← 5: 7,8 ↗ 6: 7,8 ↘ 7: 10,2 ↗ 8: 9,1 ↗ 9: 9,0 ↘ 10: 9,5 ↘	11: 10,4* ↑ 12: 6,0 ↖ 13: 10,0 ↑ 14: 9,4 ↑ 15: 8,7 ↖
	Serie 84,0	Serie 43,0	
	Totalt 0,0	Totalt 0,0	
Serie		1: 7,2 ← 2: 9,1 ↓ 3: 8,4 ← 4: 8,7 ← 5: 7,4 ↓	6: 7,4 ↖ 7: 6,1 ↖ 8: 6,3 ← 9: 9,5 ↗ 10: 7,6 ↓
	Serie 39,0	Serie 35,0	
	Totalt 39,0	Totalt 74,0	
Serie		11: 10,1 ← 12: 9,6 ↖ 13: 7,9 ↗ 14: 8,9 → 15: 7,3 →	16: 9,8 → 17: 9,4 ↑ 18: 9,8 → 19: 8,2 ↗ 20: 8,6 ↑
	Serie 41,0	Serie 43,0	
	Totalt 115,0	Totalt 158,0	

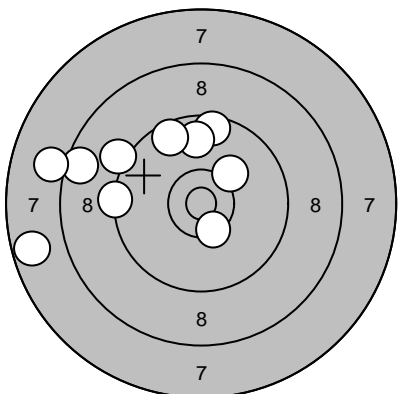
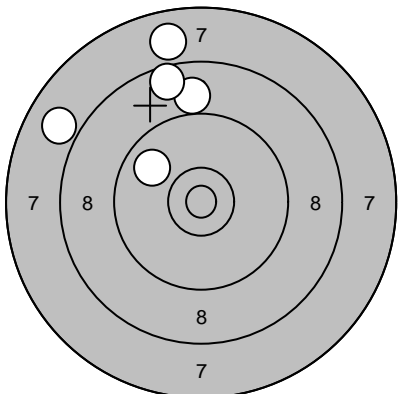
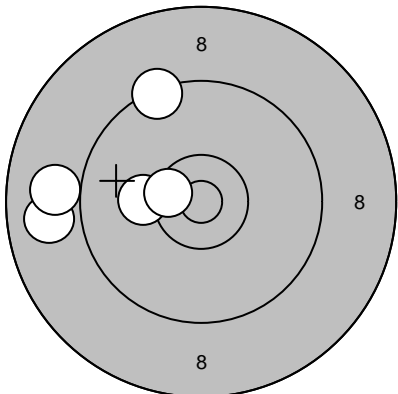
Skjutlag	Tavla	Ida Lundmark	
1	6	Drängsmark	
2007-07-16	Tavelträffen 2007	Ramselefors SKF	
Prov		1: 7,7 ← 2: 9,2 ↖ 3: 10,4* ↓ 4: 8,6 ↖ 5: 9,5 ↑ 6: 8,1 ↖ 7: 9,7 ↑ 8: 9,4 ↖ 9: 9,6 ↗ 10: 10,2 ↗	11: 10,4* ↘ 12: 9,5 ↖ 13: 8,5 ↖ 14: 7,7 ↗ 15: 9,3 ↑
	Serie 88,0		Serie 43,0
	Totalt 0,0		Totalt 0,0
Serie		1: 9,8 ↖ 2: 8,0 ↖ 3: 7,9 ↑ 4: 9,0 ↑ 5: 8,6 ↑	6: 9,6 ↗ 7: 8,0 ↗ 8: 8,3 ↖ 9: 10,7* ↘ 10: 9,7 ↗
	Serie 41,0		Serie 44,0
	Totalt 41,0		Totalt 85,0
Serie		11: 8,9 ← 12: 10,2 ← 13: 9,0 ← 14: 10,5* ← 15: 9,4 ↗	16: 9,5 ↗ 17: 7,9 ↗ 18: 9,3 ← 19: 6,1 ↖ 20: 10,5* ↓
	Serie 46,0		Serie 41,0
	Totalt 131,0		Totalt 172,0

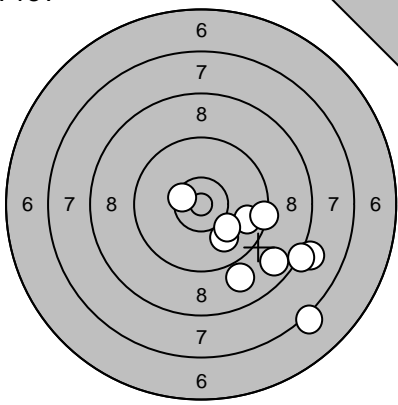
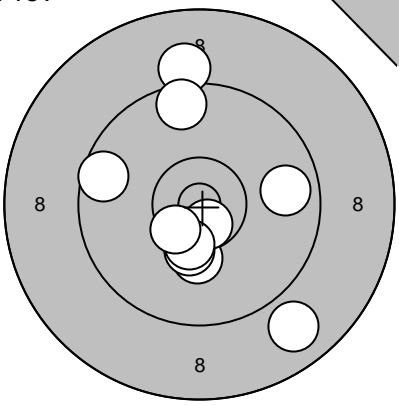
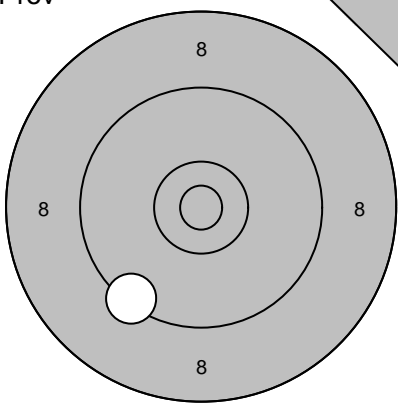
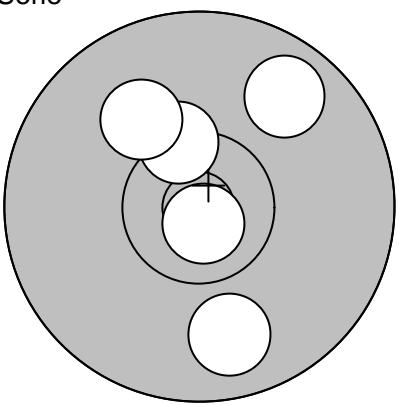
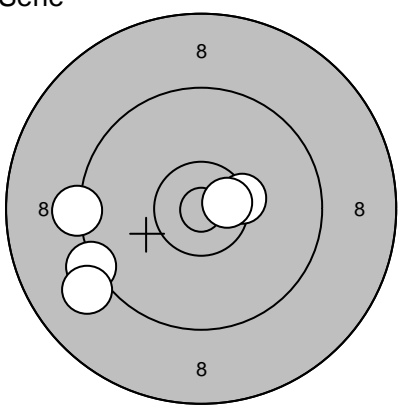
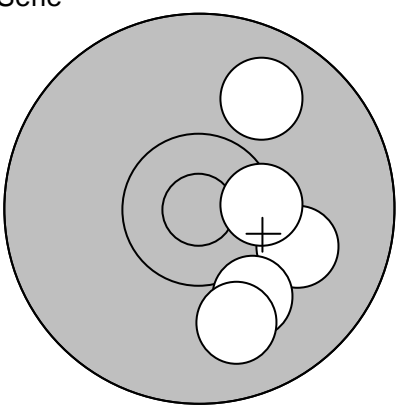
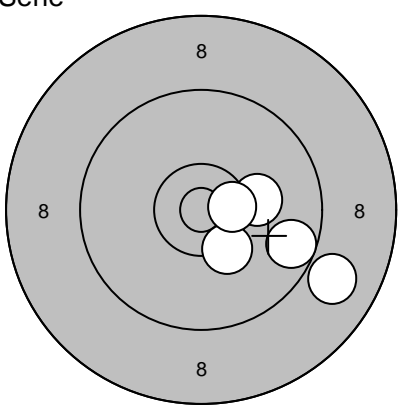
Skjutlag	Tavla	Marie Fjällström		
1	7	Ramselefors		
2007-07-16	Tavelträffen 2007	Ramselefors SKF		
Prov		1: 10,5* ← 2: 7,2 ↘ 3: 8,1 ↘ 4: 9,8 → 5: 8,7 ↘ 6: 8,2 ↘ 7: 10,0 ↘ 8: 9,4 → 9: 9,0 ↘ 10: 10,1 ↘ Serie 88,0 Totalt 0,0	Prov 	11: 10,2 ↓ 12: 9,8 → 13: 10,7* ↓ 14: 10,3* ↓ 15: 8,9 ↓ 16: 10,4* ↓ 17: 10,5* ↙ 18: 9,1 ↑ 19: 9,6 ← 20: 9,6 ↑ Serie 94,0 Totalt 0,0
Prov		21: 9,4 ↘ Serie 9,0 Totalt 0,0	Serie 	1: 10,8* ↓ 2: 9,8 ↗ 3: 10,4* ↗ 4: 9,8 ↓ 5: 10,1 ↗ Serie 48,0 Totalt 48,0
Serie		6: 9,3 ← 7: 9,3 ← 8: 9,1 ← 9: 10,4* → 10: 10,6* → Serie 47,0 Totalt 95,0	Serie 	11: 10,1 ↘ 12: 10,1 ↓ 13: 10,4* → 14: 9,9 ↗ 15: 9,9 ↓ Serie 48,0 Totalt 143,0
Serie		16: 10,2 → 17: 10,3* ↓ 18: 9,6 ↘ 19: 8,9 ↓ 20: 10,5* → Serie 47,0 Totalt 190,0		

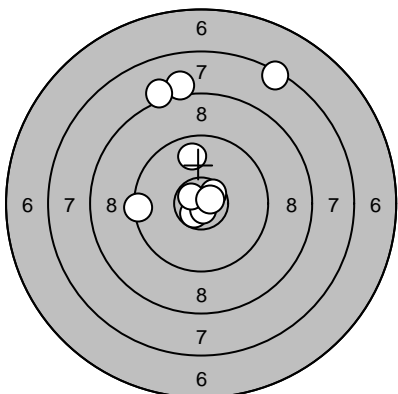
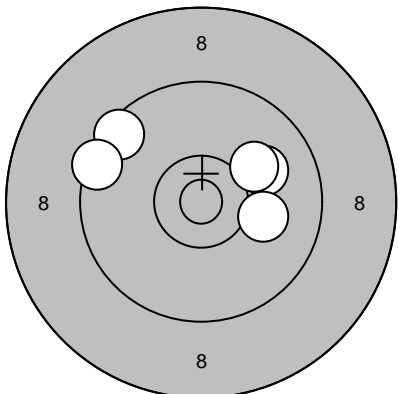
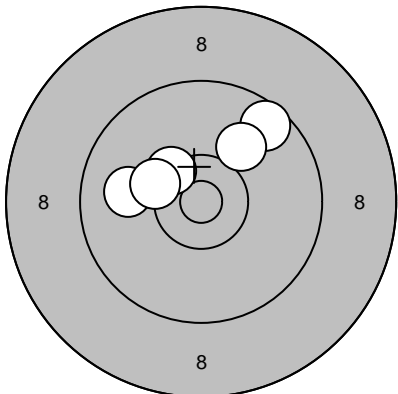
Skjutlag	Tavla	Jonas Bromihh	
1	9	Älmhult	
2007-07-16	Tavelträffen 2007	Ramselefors SKF	
Prov		1: 10,7* ↙ 2: 8,1 ↑ 3: 7,4 ↗ 4: 8,2 ↑ 5: 9,8 ↑ 6: 9,5 ← 7: 10,6* ↗ 8: 10,8* ↓ 9: 10,7* ↖ 10: 10,7* →	11: 10,1 ↘ 12: 10,0 ↓ 13: 9,6 ← 14: 9,0 ← 15: 8,3 ↑
	Serie	91,0	Serie 46,0
	Totalt	0,0	Totalt 0,0
Serie		1: 9,5 ↖ 2: 9,5 ← 3: 10,0 → 4: 10,1 ↗ 5: 10,1 →	6: 9,8 ↙ 7: 9,9 ← 8: 9,8 ↗ 9: 10,9* ↓ 10: 10,0 →
	Serie	48,0	Serie 47,0
	Totalt	48,0	Totalt 95,0
Serie		11: 10,4* ↖ 12: 9,6 ↗ 13: 10,0 ← 14: 10,0 ↗ 15: 10,3 ↖	16: 9,7 ← 17: 10,4* ↗ 18: 10,0 → 19: 10,2 ↗ 20: 10,6* →
	Serie	49,0	Serie 49,0
	Totalt	144,0	Totalt 193,0

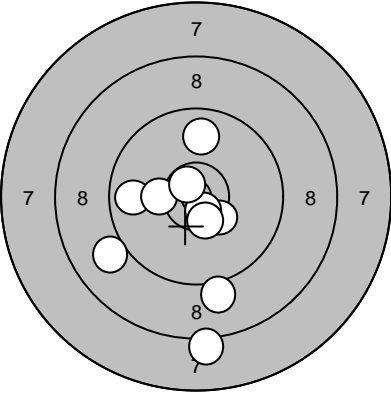
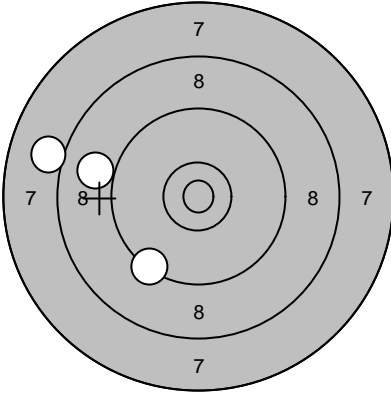
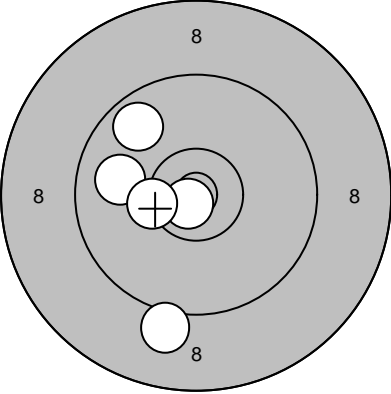
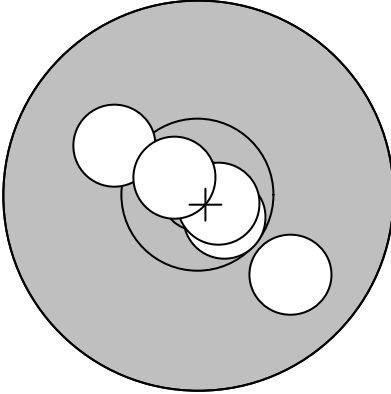
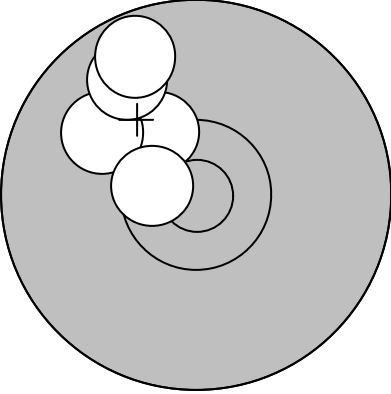
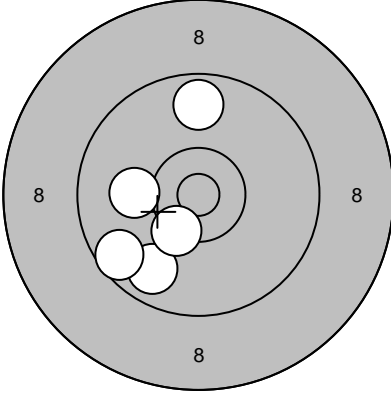
Skjutlag	Tavla	Gunnar Iversen	
1	11	S 3	
2007-07-16	Tavelträffen 2007	Ramselefors SKF	
Prov		1: 10,4* ↘ 2: 10,7* ↘ 3: 9,8 ← 4: 10,3 ← 5: 9,0 ↙ 6: 10,7* ↗ 7: 9,8 ↗ 8: 9,1 ↘ 9: 8,2 ↘ 10: 10,5* ↘	Prov 
	Serie 94,0		11: 9,0 ←
	Totalt 0,0		12: 8,1 ←
			13: 9,3 ↘
		Serie 26,0	
		Totalt 0,0	
Serie		1: 10,8* ↘ 2: 9,1 ↘ 3: 9,7 ↗ 4: 9,9 ← 5: 10,3* ←	Serie 
	Serie 47,0		6: 10,1 ↗
	Totalt 47,0		7: 10,7* ↘
			8: 10,8* ↘
			9: 9,9 ↘
			10: 10,7* ↗
		Serie 49,0	
		Totalt 96,0	
Serie		11: 10,3* ↗ 12: 10,0 ↗ 13: 9,8 ↗ 14: 10,6* ← 15: 9,7 ↗	Serie 
	Serie 48,0		16: 9,7 ↑
	Totalt 144,0		17: 9,8 ↘
			18: 10,4* ↘
			19: 9,6 ↙
			20: 10,1 ←
		Serie 47,0	
		Totalt 191,0	

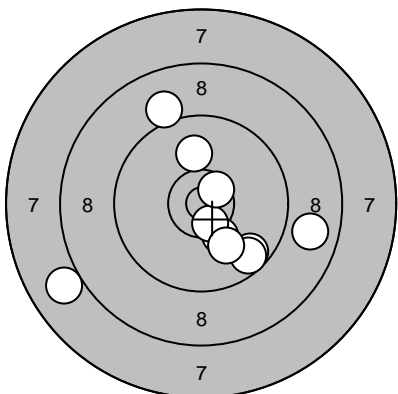
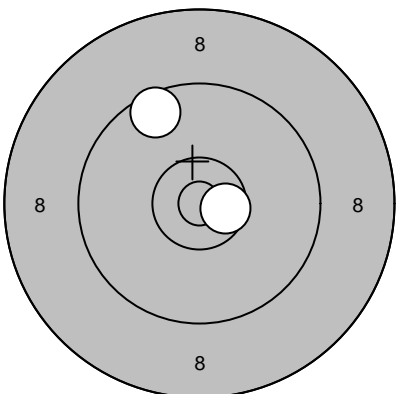
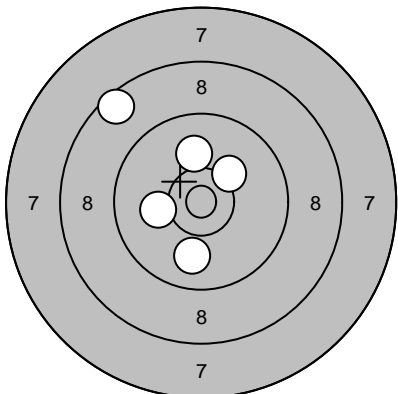
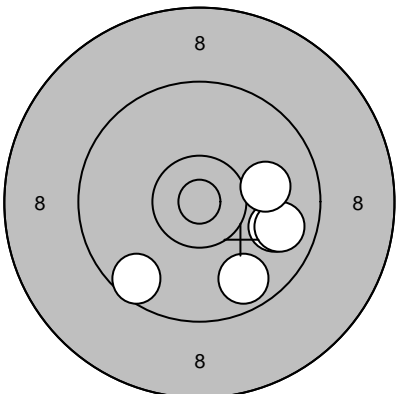
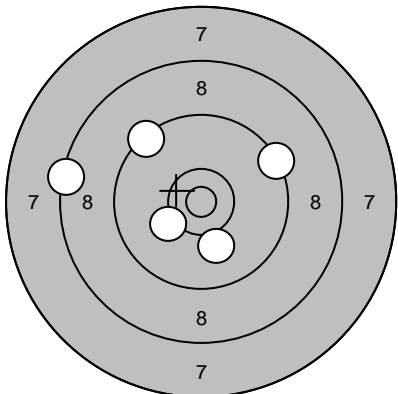
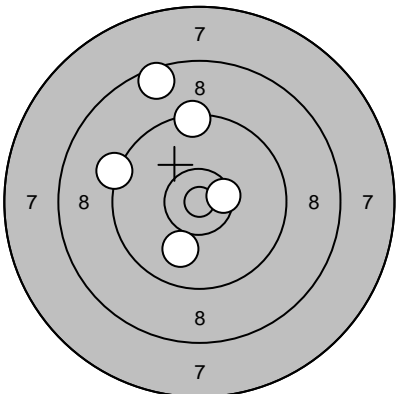
Skjutlag	Tavla	Bertil Ruisniemi	
		Övertorneå	
2007-07-16		Tavelträffen 2007	Ramselefors SKF
Prov		1: 10,2 ↘ 2: 8,0 ↙ 3: 8,8 → 4: 10,5* ↘ 5: 9,7 ↘ 6: 9,6 ↘ 7: 10,0 ↘ 8: 10,6* ↗ 9: 9,1 ↗ 10: 10,0 ↗	Prov 
		Serie 93,0	11: 9,6 ↗
		Totalt 0,0	12: 10,6* →
Serie		1: 9,9 ↘ 2: 10,1 ↗ 3: 10,1 ↙ 4: 8,6 ↗ 5: 10,2 ↗	Serie 
		Serie 47,0	6: 9,9 →
		Totalt 47,0	7: 9,7 ↘
Serie		11: 9,3 ↗ 12: 10,1 ↘ 13: 9,4 ↗ 14: 10,2 ↙ 15: 8,4 ↙	8: 9,8 → 9: 9,6 ↘ 10: 10,0 →
		Serie 46,0	16: 10,5* →
		Totalt 139,0	17: 9,3 ↙
Serie		18: 10,0 ↘ 19: 9,4 ↗ 20: 8,6 ↗	18: 10,0 ↘ 19: 9,4 ↗ 20: 8,6 ↗
		Serie 46,0	16: 10,5* →
		Totalt 185,0	17: 9,3 ↙

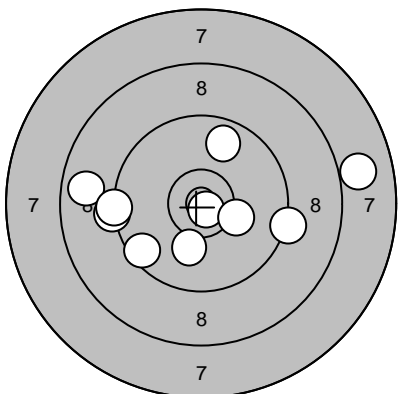
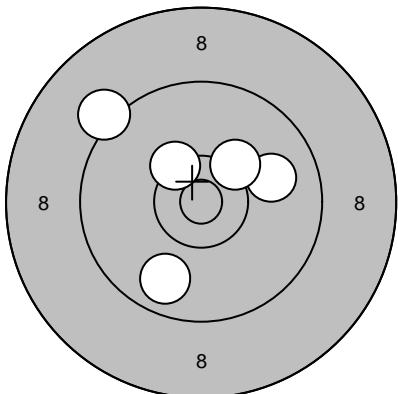
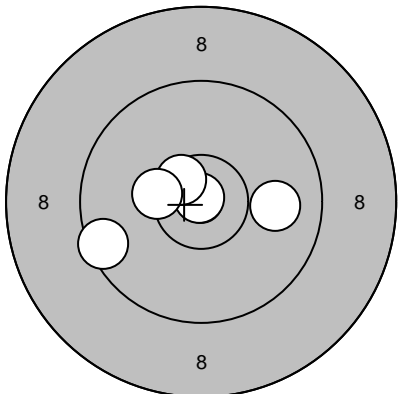
Skjutlag	Tavla	Michael Normann	
1	13	I 16 / Lv 6	
2007-07-16	Tavelträffen 2007	Ramselefors SKF	
Prov		1: 9,3 ← 2: 9,5 ↙ 3: 10,8* ↘ 4: 8,8 ← 5: 9,3 ← 6: 9,8 ↗ 7: 10,1 ↓ 8: 8,0 → 9: 9,3 → 10: 10,2 ↘	11: 9,5 → 12: 10,5* ↗ 13: 9,6 ↗ 14: 9,9 ↗ 15: 8,5 ←
	Serie 91,0		Serie 45,0
	Totalt 0,0		Totalt 0,0
Serie		1: 9,2 ↗ 2: 10,4* ↗ 3: 9,8 ↘ 4: 9,9 → 5: 10,3 ↗	6: 8,4 ← 7: 9,1 ← 8: 10,2 ← 9: 10,7* ↗ 10: 10,6* ↖
	Serie 47,0		Serie 47,0
	Totalt 47,0		Totalt 94,0
Serie		11: 9,9 → 12: 10,9* ↗ 13: 10,6* ↗ 14: 10,3* ← 15: 9,5 ←	16: 10,7* ↗ 17: 9,4 ↖ 18: 9,1 ← 19: 10,1 ↖ 20: 10,1 ←
	Serie 48,0		Serie 48,0
	Totalt 142,0		Totalt 190,0

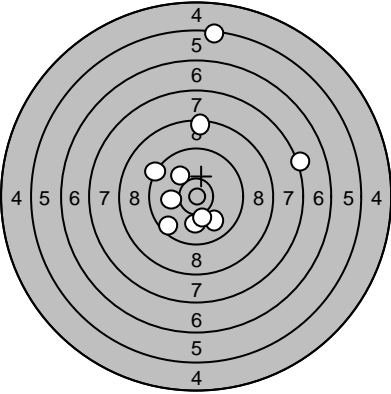
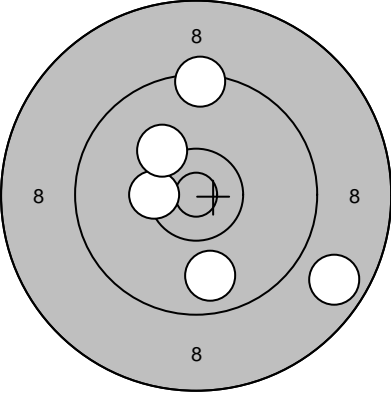
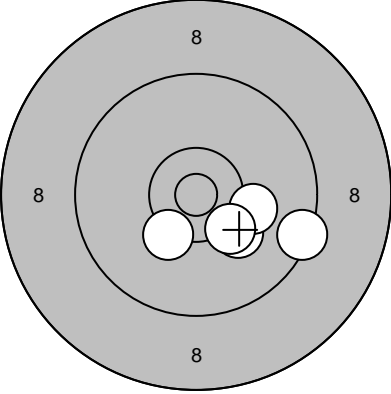
Skjutlag	Tavla		
1	14	Carina Norling	
		Söderala	
2007-07-16	Tavelträffen 2007	Ramselefors SKF	
Prov		1: 5,4 ↑ 2: 7,2 → 3: 8,5 ↑ 4: 10,0 ↗ 5: 10,0 ↓ 6: 9,9 ↘ 7: 9,3 ↗ 8: 9,6 ↘ 9: 10,2 ↓ 10: 10,1 ←	11: 10,0 ↗ 12: 9,2 → 13: 9,4 ← 14: 10,2 → 15: 8,8 →
	Serie 87,0		Serie 46,0
	Totalt 0,0		Totalt 0,0
Serie		1: 8,8 → 2: 9,8 ↓ 3: 10,4* ← 4: 9,4 ↑ 5: 10,2 ↗	6: 9,8 ↘ 7: 9,9 ↑ 8: 10,8* ↗ 9: 9,1 ↗ 10: 10,1 ↓
	Serie 46,0		Serie 47,0
	Totalt 46,0		Totalt 93,0
Serie		11: 10,2 ↘ 12: 9,4 → 13: 10,1 → 14: 10,3 ↘ 15: 10,3* ↘	16: 10,3* ↘ 17: 10,4* → 18: 9,6 → 19: 10,6* ↑ 20: 10,1 ↘
	Serie 49,0		Serie 49,0
	Totalt 142,0		Totalt 191,0

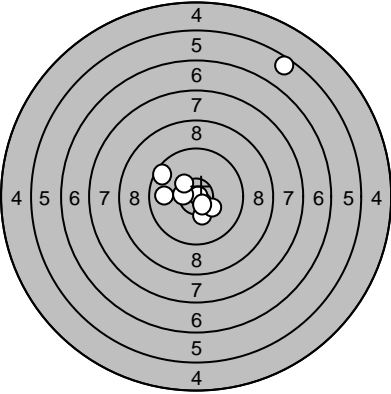
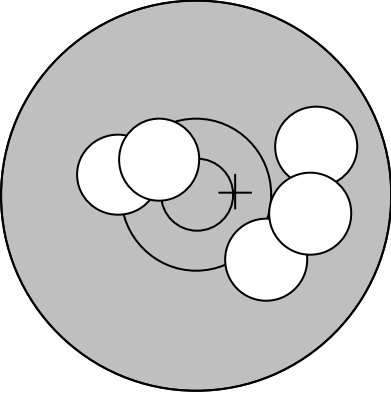
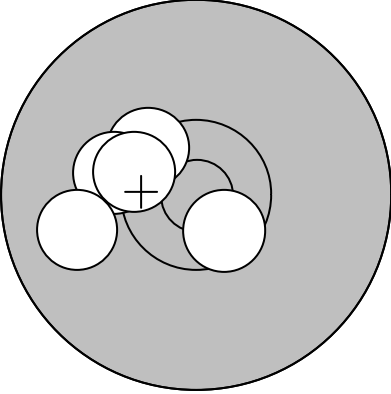
Skjutlag	Tavla	Gustav Lövgren	
1	15	Niemisel	
2007-07-16	Tavelträffen 2007	Ramselefors SKF	
Prov		1: 5,6 ↗ 2: 9,6 ↗ 3: 9,9 ← 4: 10,3 ↓ 5: 10,6* ↓ 6: 10,3 ↓ 7: 10,9* ↗ 8: 10,6* ↓ 9: 10,5* ← 10: 10,4* ↗	11: 9,2 ↗ 12: 8,5 → 13: 9,9 ← 14: 9,2 ↓ 15: 9,4 ↓
	Serie	93,0	Serie 44,0
	Totalt	0,0	Totalt 0,0
Serie		1: 9,9 → 2: 10,3 ← 3: 10,1 ↓ 4: 10,0 → 5: 10,5* ↗	6: 10,4* ↗ 7: 9,7 ↓ 8: 10,2 ↗ 9: 10,6* ↗ 10: 10,6* ↓
	Serie	49,0	Serie 49,0
	Totalt	49,0	Totalt 98,0
Serie		11: 10,4* ↗ 12: 10,2 ← 13: 10,6* ↓ 14: 10,4* ↗ 15: 9,9 ←	16: 9,9 ← 17: 9,8 → 18: 10,5* ↗ 19: 10,1 ↓ 20: 10,1 →
	Serie	49,0	Serie 48,0
	Totalt	147,0	Totalt 195,0

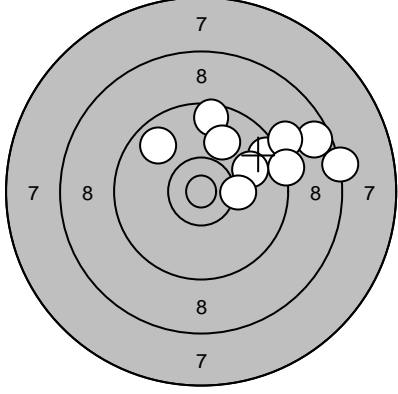
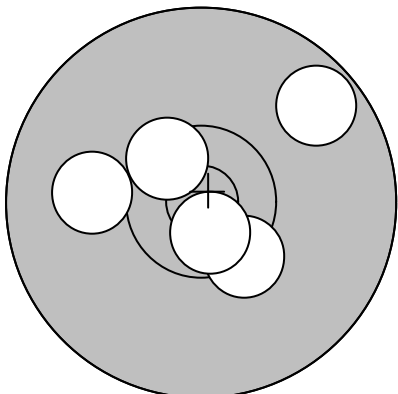
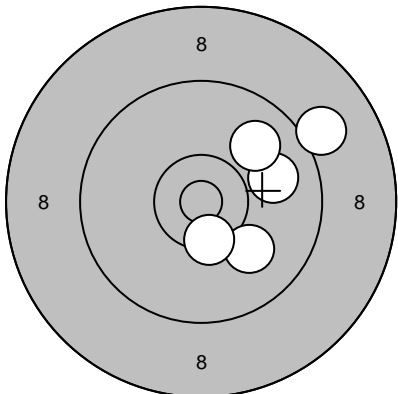
Skjutlag	Tavla	Fredrik Ågren	
1	16	I 19	
2007-07-16	Tavelträffen 2007	Ramselefors SKF	
Prov		1: 8,6 → 2: 9,5 → 3: 9,1 → 4: 9,3 → 5: 9,6 ↑ 6: 10,0 → 7: 8,3 → 8: 10,0 ↑ 9: 9,8 ↖ 10: 10,3 →	Prov 11: 10,4* ↓
	Serie 91,0 Totalt 0,0		Serie 10,0 Totalt 0,0
Serie		1: 10,0 ← 2: 10,4* ↓ 3: 10,7* ↓ 4: 10,5* ↖ 5: 9,7 ↗	Serie 6: 9,3 ↑ 7: 10,1 → 8: 10,1 ↑ 9: 10,8* ← 10: 10,8* ↓
	Serie 49,0 Totalt 49,0		Serie 49,0 Totalt 98,0
Serie		11: 10,0 ↓ 12: 9,9 → 13: 10,4* ↓ 14: 9,9 ↗ 15: 9,1 →	Serie 16: 9,8 ↖ 17: 10,6* ↖ 18: 9,0 ↓ 19: 8,5 → 20: 9,8 ↖
	Serie 47,0 Totalt 145,0		Serie 45,0 Totalt 190,0

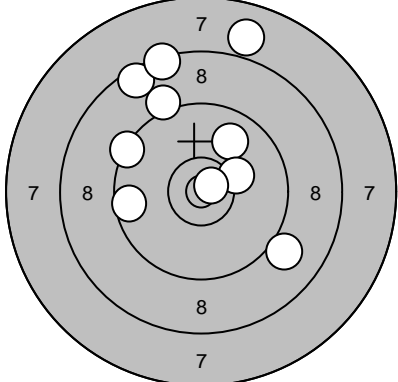
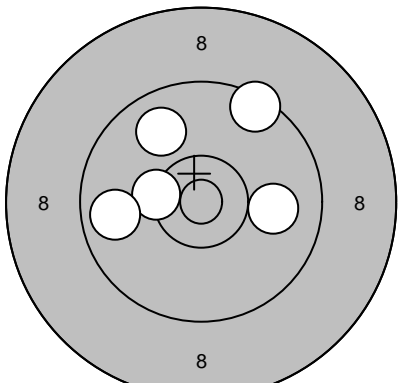
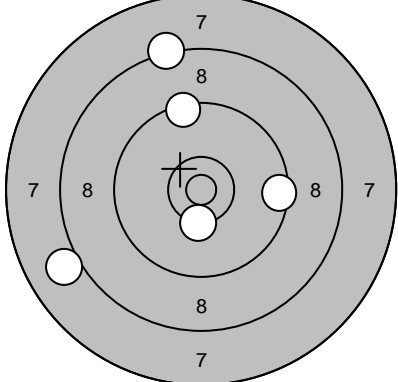
Skjutlag	Tavla	Staffan Samuelsson	
1	17	Rundvik	
2007-07-16	Tavelträffen 2007	Ramselefors SKF	
Prov		1: 9,4 ↙ 2: 9,1 ↑ 3: 8,6 ↖ 4: 9,9 ↗ 5: 10,2 → 6: 8,0 ↑ 7: 9,0 → 8: 9,6 ← 9: 10,7* ↗ 10: 8,4 ↑	11: 9,4 ↗
	Serie 89,0 Totalt 0,0	Serie 9,0 Totalt 0,0	
Serie		1: 10,0 → 2: 10,3* ← 3: 9,5 ↗ 4: 9,9 ↖ 5: 9,8 ←	6: 9,3 ↘ 7: 10,3 ↘ 8: 9,2 ↘ 9: 7,8 → 10: 9,9 ↘
	Serie 47,0 Totalt 47,0	Serie 44,0 Totalt 91,0	
Serie		11: 10,3* ↓ 12: 8,3 ↑ 13: 9,5 → 14: 9,4 ↑ 15: 8,0 ↖	16: 10,2 ↖ 17: 9,7 → 18: 8,8 ↑ 19: 10,2 → 20: 9,5 ↗
	Serie 44,0 Totalt 135,0	Serie 46,0 Totalt 181,0	

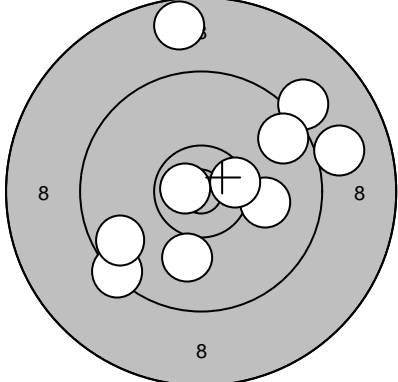
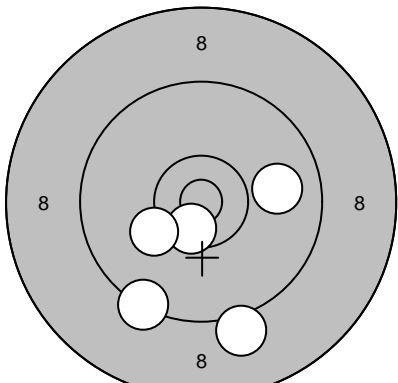
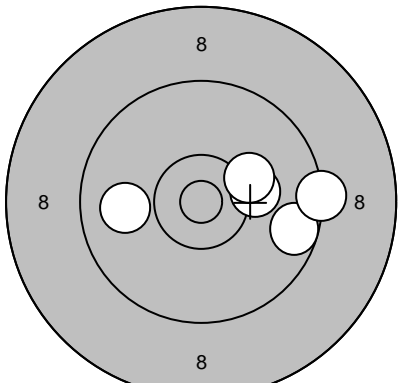
Skjutlag	Tavla	Martin Olofsson	
1	18	Vännäs	
2007-07-16	Tavelträffen 2007	Ramselefors SKF	
Prov		1: 8,7 ↑ 2: 9,0 → 3: 9,1 ↗ 4: 10,1 → 5: 9,6 ↗ 6: 10,5* → 7: 9,4 ↙ 8: 10,7* ← 9: 9,7 ↙ 10: 10,0 ↓	Prov 11: 10,6* ↓
	Serie 93,0		Serie 10,0
	Totalt 0,0		Totalt 0,0
Serie		1: 9,9 → 2: 9,1 ↓ 3: 10,6* ↓ 4: 10,2 ↙ 5: 9,4 ↓	Serie 6: 9,1 → 7: 10,1 ↓ 8: 9,9 ↓ 9: 9,2 ↙ 10: 9,4 ↙
	Serie 47,0		Serie 46,0
	Totalt 47,0		Totalt 93,0
Serie		11: 10,2 → 12: 9,6 → 13: 9,9 ← 14: 10,2 ↗ 15: 9,3 →	Serie 16: 10,0 ↑ 17: 9,7 ↗ 18: 10,3* ↘ 19: 10,2 → 20: 8,4 →
	Serie 47,0		Serie 47,0
	Totalt 140,0		Totalt 187,0

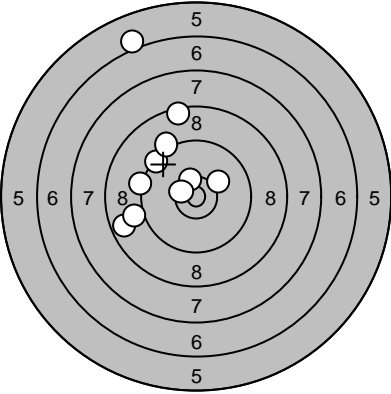
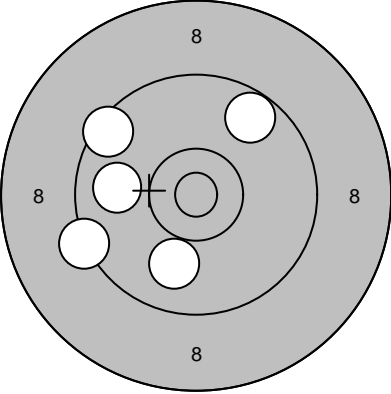
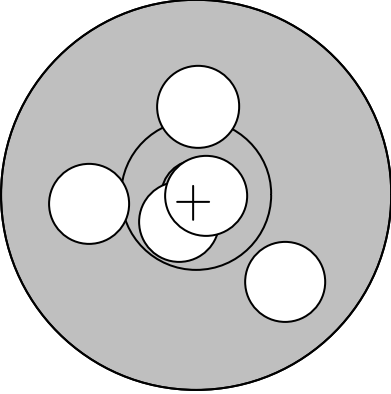
Skjutlag	Tavla	Magnus Lindkvist	
1	19	Umeå	
2007-07-16	Tavelträffen 2007	Ramselefors SKF	
Prov		1: 6,1 ↗ 2: 8,7 ← 3: 9,1 ← 4: 9,4 ↗ 5: 9,3 ← 6: 10,1 ↗ 7: 10,4* ↑ 8: 10,5* ← 9: 8,5 ↑ 10: 9,2 ↗	11: 9,0 ↑ 12: 8,9 ← 13: 10,0 ← 14: 9,2 ↓
	Serie	88,0	Serie 36,0
	Totalt	0,0	Totalt 0,0
Serie		1: 9,7 ↗ 2: 9,5 ↗ 3: 10,0 ↓ 4: 9,3 ← 5: 9,9 ←	6: 10,7* ↗ 7: 10,2 ← 8: 10,4* ↑ 9: 9,8 ↗ 10: 9,2 ←
	Serie	46,0	Serie 48,0
	Totalt	46,0	Totalt 94,0
Serie		11: 10,7* ↓ 12: 9,9 ↘ 13: 10,0 ← 14: 10,2 ↑ 15: 10,9* →	16: 9,3 ↘ 17: 9,0 ← 18: 10,2 ↓ 19: 10,5* ↘ 20: 10,3 ↗
	Serie	49,0	Serie 48,0
	Totalt	143,0	Totalt 191,0

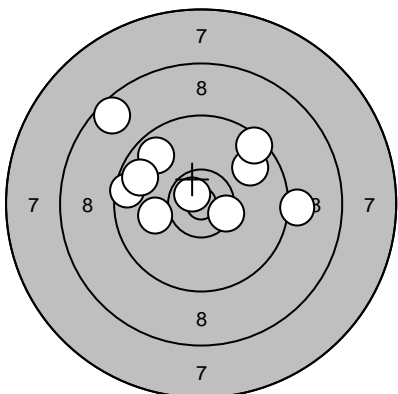
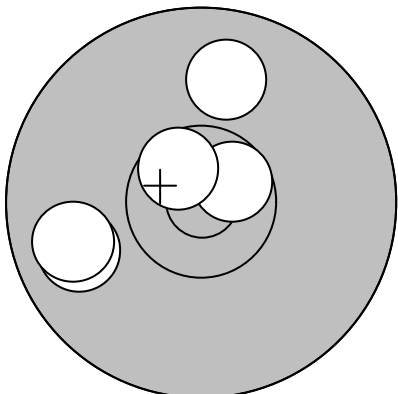
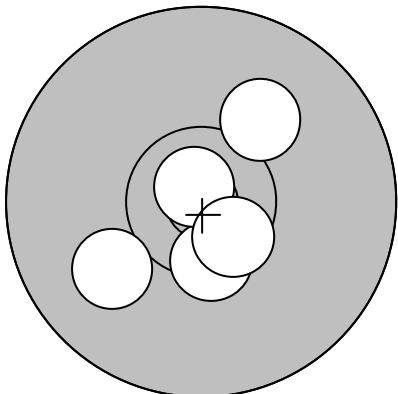
Skjutlag	Tavla	Lars Möllsten	
1	20	Umeå	
2007-07-16	Tavelträffen 2007	Ramselefors SKF	
Prov		1: 9,7 ↖ 2: 8,6 ↗ 3: 9,6 ← 4: 9,8 ↗ 5: 9,2 → 6: 9,7 ↖ 7: 10,1 ← 8: 10,5* → 9: 10,7* ↗ 10: 9,5 ↗	11: 9,6 ← 12: 10,0 → 13: 9,9 →
	Serie 92,0		Serie 28,0
	Totalt 0,0		Totalt 0,0
Serie		1: 10,6* ↗ 2: 9,8 ← 3: 9,9 ↑ 4: 9,8 ← 5: 10,6* ↗	6: 9,9 ↖ 7: 10,0 → 8: 10,1 ↗ 9: 10,6* → 10: 10,0 ↘
	Serie 47,0		Serie 49,0
	Totalt 47,0		Totalt 96,0
Serie		11: 10,4* ↓ 12: 10,0 ↖ 13: 10,1 ↗ 14: 10,8* ↗ 15: 10,5* ↘	16: 9,5 ↘ 17: 9,6 ↘ 18: 10,4* ← 19: 10,1 ← 20: 10,4* ↗
	Serie 50,0		Serie 48,0
	Totalt 146,0		Totalt 194,0

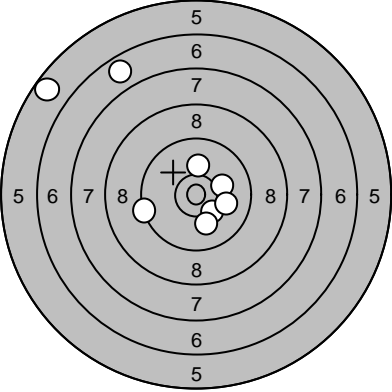
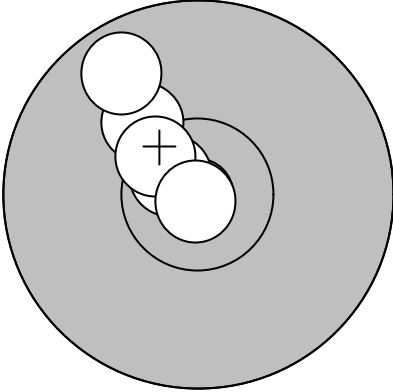
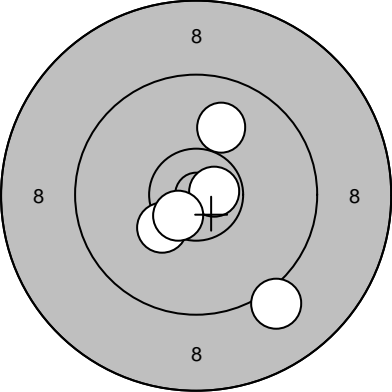
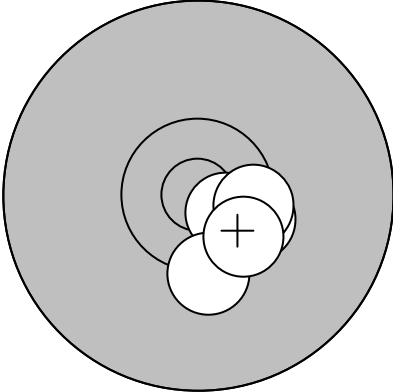
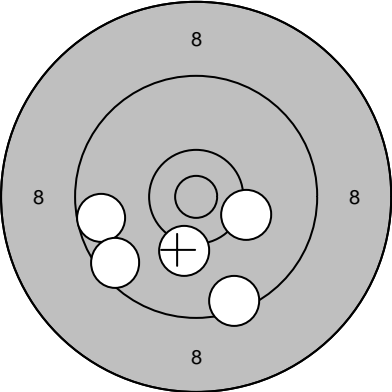
Skjutlag 1	Tavla 21	Christian Lejon	
		Umeå	
2007-07-16	Tavelträffen 2007	Ramselefors SKF	
Prov		1: 5,7 ↖ 2: 6,8 ↗ 3: 10,1 → 4: 10,1 ↑ 5: 10,3 ↓ 6: 10,0 ↓ 7: 10,0 → 8: 9,4 ←	Serie 
	Serie 70,0 Totalt 0,0	1: 10,2 ↗ 2: 10,7* ↗ 3: 10,5* ↗ 4: 9,7 ↗ 5: 10,9* ↓	Serie 49,0 Totalt 49,0
Serie		6: 10,7* → 7: 10,3* ↖ 8: 9,1 ↓ 9: 10,0 ↑ 10: 10,6* ↖	Serie 
	Serie 49,0 Totalt 98,0	11: 10,4* ↘ 12: 10,7* ↘ 13: 10,3 ↓ 14: 10,5* → 15: 10,4* ↘	Serie 50,0 Totalt 148,0
Serie		16: 10,2 ↓ 17: 9,5 ↓ 18: 9,6 ← 19: 10,2 → 20: 9,5 ↖	
	Serie 47,0 Totalt 195,0		

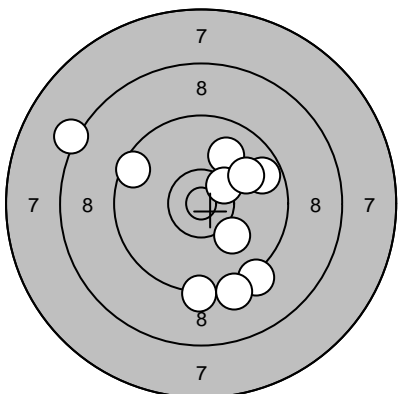
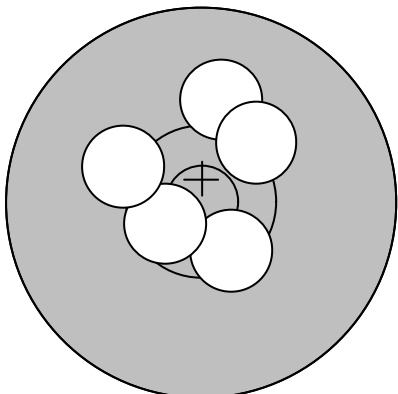
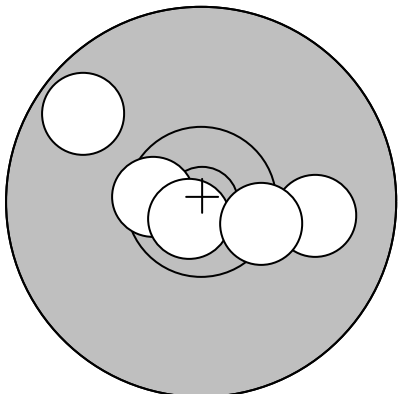
Skjutlag	Tavla	Fredrik Forsgren	
1	22	Ramselefors	
2007-07-16	Tavelträffen 2007	Ramselefors SKF	
Prov		1: 8,2 ↙ 2: 9,9 ↗ 3: 9,5 ↙ 4: 10,4* ↗ 5: 9,3 ↓ 6: 9,2 ↓ 7: 9,2 ↓ 8: 10,1 ↓ 9: 9,7 ↗ 10: 10,0 ↗	11: 10,0 ↗ 12: 9,8 ↓ 13: 9,1 →
	Serie 92,0		Serie 28,0
	Totalt 0,0		Totalt 0,0
Serie		1: 10,5* ↓ 2: 10,6* ↙ 3: 10,1 ↑ 4: 10,3 ↗ 5: 10,2 ↙	6: 10,9* → 7: 10,1 ← 8: 9,6 ↑ 9: 10,5* ↗ 10: 10,9* →
	Serie 50,0		Serie 49,0
	Totalt 50,0		Totalt 99,0
Serie		11: 10,0 → 12: 10,6* ← 13: 10,8* ↙ 14: 10,4* → 15: 9,7 ↗	16: 10,5* ↙ 17: 10,3 ← 18: 10,2 → 19: 9,6 ← 20: 9,7 ↘
	Serie 49,0		Serie 48,0
	Totalt 148,0		Totalt 196,0

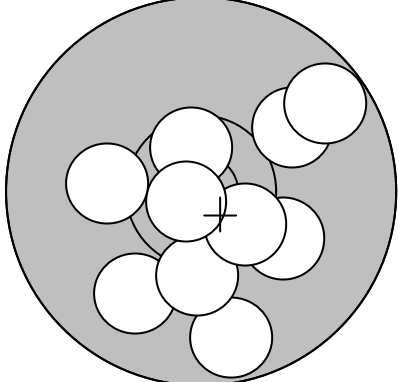
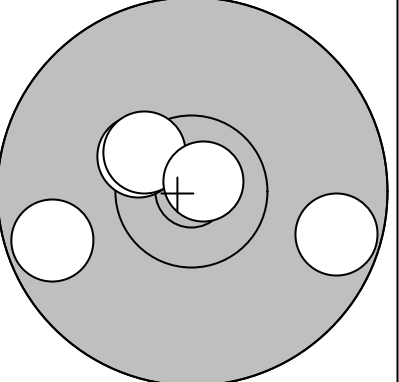
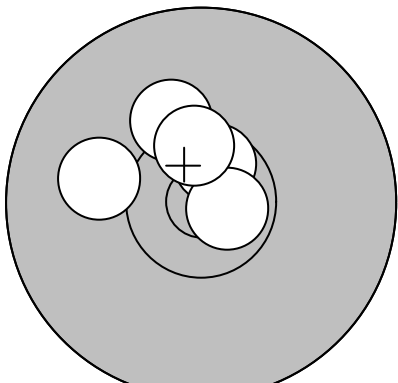
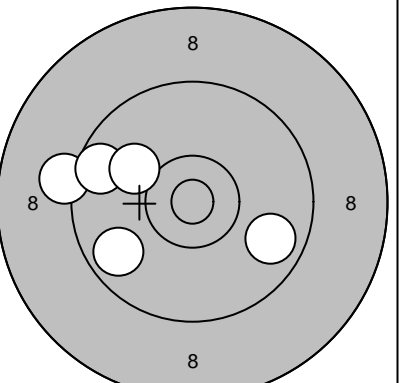
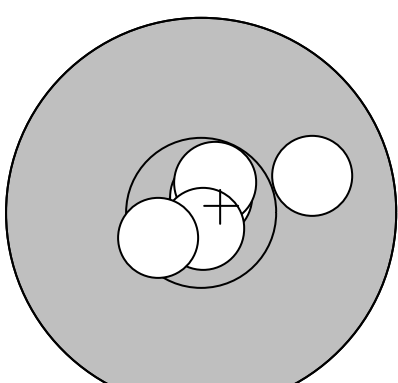
Skjutlag	Tavla	Lars Evaldsson		
1	23	Göteborg		
2007-07-16	Tavelträffen 2007	Ramselefors SKF		
Prov		1: 9,7 ↓ 2: 9,9 ↙ 3: 10,2 → 4: 10,2 ↓ 5: 10,6* ↑ 6: 10,0 ↗ 7: 9,7 ↗ 8: 10,5* → 9: 10,8* ↙ 10: 10,2 ←	Serie 	1: 9,7 → 2: 10,4* ↖ 3: 9,7 ← 4: 10,4* ↖ 5: 10,8* ↗
	Serie 97,0		Serie 48,0	
	Totalt 0,0		Totalt 48,0	
Serie		6: 10,2 ↑ 7: 10,6* ↑ 8: 10,7* → 9: 10,5* ↑ 10: 10,1 ←	Serie 	11: 9,2 ← 12: 9,6 ↖ 13: 9,7 ↙ 14: 10,0 ↖ 15: 9,8 →
	Serie 50,0		Serie 46,0	
	Totalt 98,0		Totalt 144,0	
Serie		16: 10,8* ↗ 17: 10,0 → 18: 10,7* ↑ 19: 10,8* ↓ 20: 10,5* ↙		
	Serie 50,0			
	Totalt 194,0			

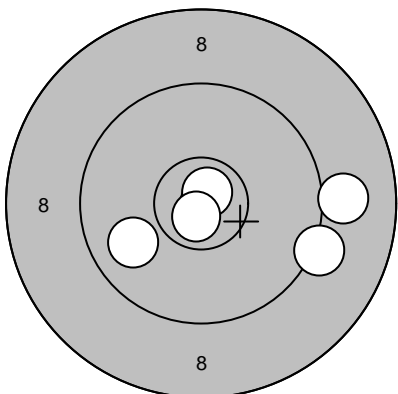
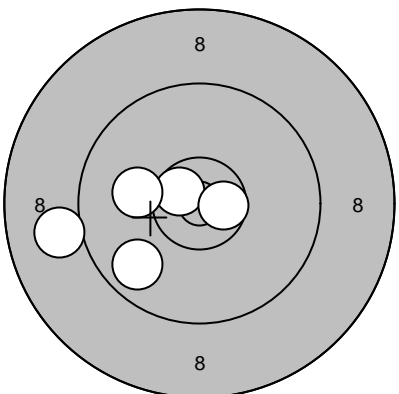
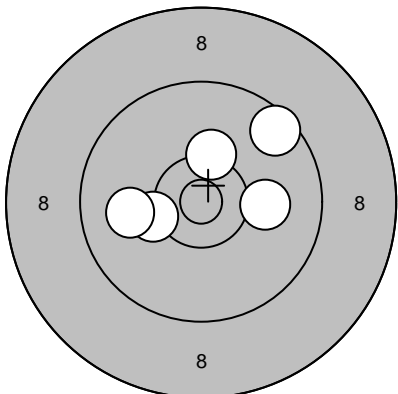
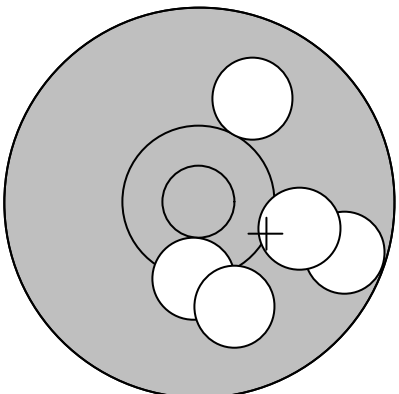
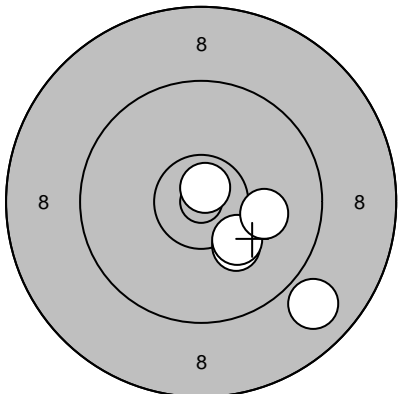
Skjutlag	Tavla		
1	24	Håkan Lidman	
		Skellefteå	
2007-07-16	Tavelträffen 2007	Ramselefors SKF	
Prov		1: 10,8* ↗ 2: 9,2 → 3: 9,0 → 4: 9,9 ↙ 5: 10,8* ↓	Serie 
			1: 9,8 ↘ 2: 10,6* ↖ 3: 9,0 ← 4: 10,6* → 5: 10,1 ←
		Serie 47,0	Serie 48,0
		Totalt 0,0	Totalt 48,0
Serie		6: 10,1 → 7: 10,3 ← 8: 10,0 ← 9: 9,6 ↗ 10: 10,3* ↑	Serie 
			11: 10,0 ↗ 12: 10,3* ↓ 13: 9,7 → 14: 10,0 ↓ 15: 10,1 →
		Serie 49,0	Serie 49,0
		Totalt 97,0	Totalt 146,0
Serie		16: 10,2 ↓ 17: 10,8* ↑ 18: 10,2 ↓ 19: 10,1 → 20: 8,9 ↓	
		Serie 48,0	
		Totalt 194,0	

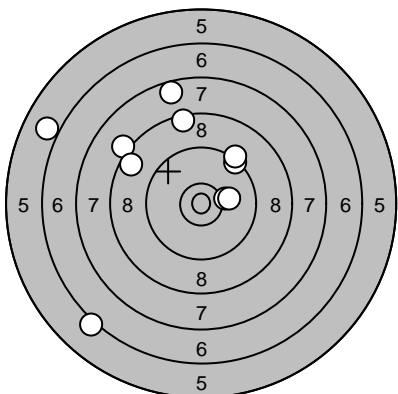
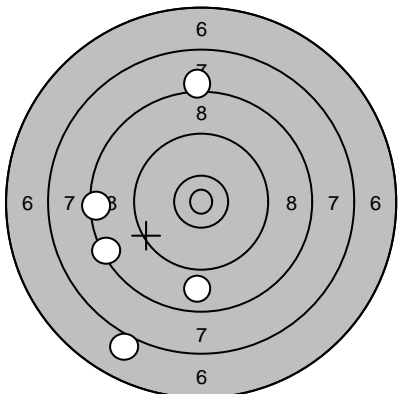
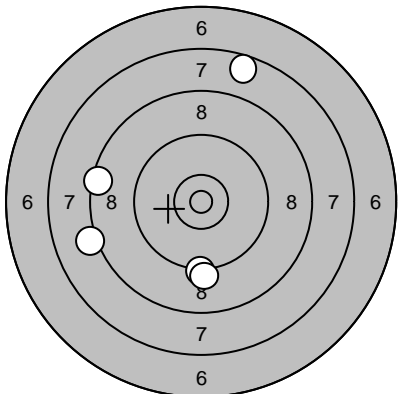
Skjutlag	Tavla	Emma Wallerström	
2	1		
		Ununge	
2007-07-16	Tavelträffen 2007	Ramselefors SKF	
Prov		1: 10,2 → 2: 10,1 → 3: 8,2 ↖ 4: 6,0 ↖ 5: 6,2 ↙ 6: 8,5 ↑ 7: 8,7 ↖ 8: 9,4 ↗ 9: 7,7 ↑ 10: 9,3 ↗	11: 9,1 ↗ 12: 5,9 ↓ 13: 6,6 ←
	Serie 81,0		Serie 20,0
	Totalt 0,0		Totalt 0,0
Serie		1: 8,2 ↑ 2: 8,9 ↓ 3: 7,1 ↙ 4: 8,5 ← 5: 8,4 ←	6: 8,9 ↖ 7: 10,1 ← 8: 10,1 ↗ 9: 7,7 ← 10: 8,7 ↓
	Serie 39,0		Serie 43,0
	Totalt 39,0		Totalt 82,0
Serie		11: 9,3 ↓ 12: 9,2 ↓ 13: 8,2 ← 14: 8,5 ← 15: 7,6 ↑	16: 7,9 ↙ 17: 9,6 ← 18: 6,6 ← 19: 7,1 ↓ 20: 10,7* ↖
	Serie 41,0		Serie 39,0
	Totalt 123,0		Totalt 162,0

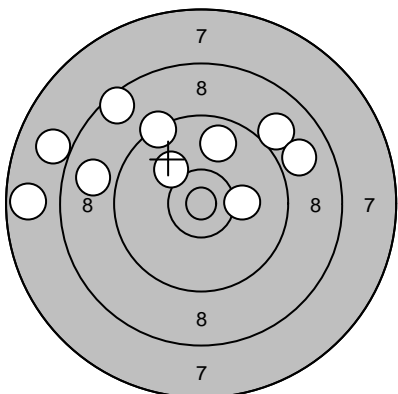
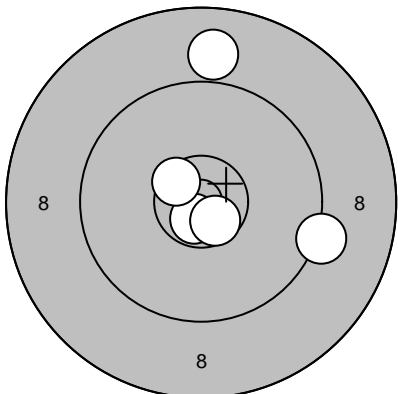
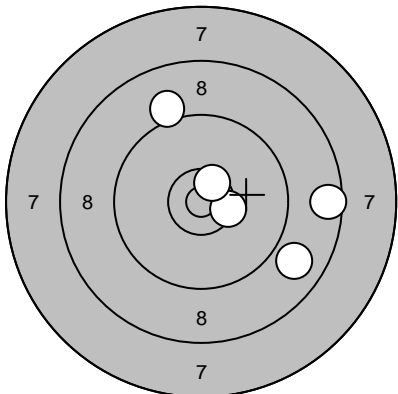
Skjutlag	Tavla	Rodi Hammare	
2	2	Umeå	
2007-07-16	Tavelträffen 2007	Ramselefors SKF	
Prov		1: 7,7 ← 2: 10,1 ↗ 3: 8,5 ↗ 4: 8,9 ← 5: 9,3 ↗ 6: 8,0 ← 7: 9,0 ↗ 8: 9,8 ↑ 9: 8,9 → 10: 10,2 →	11: 8,7 ↗ 12: 9,6 ↖
	Serie 86,0 Totalt 0,0	Serie 17,0 Totalt 0,0	
Serie		1: 10,7* ↓ 2: 9,2 → 3: 10,6* ↓ 4: 9,0 ↑ 5: 10,5* ↗	6: 9,6 → 7: 10,1 → 8: 9,4 ↗ 9: 9,9 ↑ 10: 10,5* ↓
	Serie 48,0 Totalt 48,0	Serie 47,0 Totalt 95,0	
Serie		11: 8,6 → 12: 9,1 ↗ 13: 8,9 ↘ 14: 10,4* → 15: 10,5* ↗	16: 9,3 → 17: 10,0 ↓ 18: 10,5* ↓ 19: 10,6* ↓ 20: 9,2 ↗
	Serie 45,0 Totalt 140,0	Serie 48,0 Totalt 188,0	

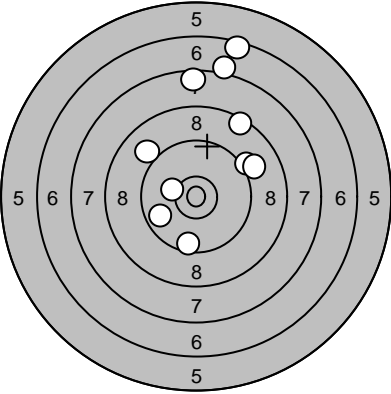
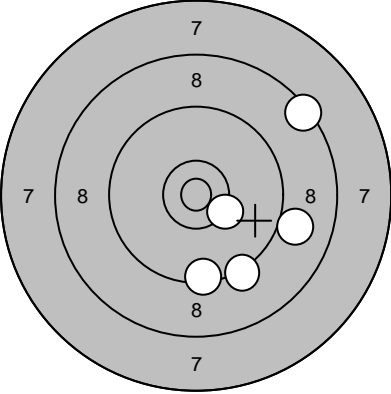
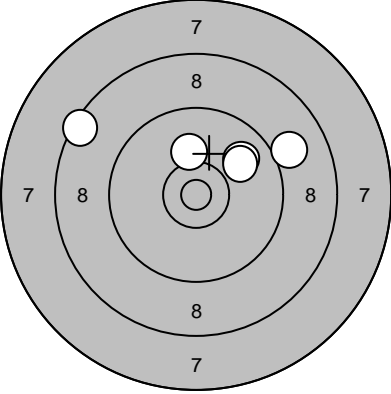
Skjutlag	Tavla	André Olsén	
2	3	Umeå	
2007-07-16	Tavelträffen 2007	Ramselefors SKF	
Prov		1: 6,5 ↑ 2: 7,6 ↑ 3: 9,2 ↗ 4: 9,0 ↖ 5: 9,1 ↗ 6: 7,2 ↑ 7: 9,8 ↖ 8: 8,5 ↗ 9: 10,2 ↖ 10: 9,6 ↓	11: 8,6 ↘ 12: 9,4 ↗ 13: 8,6 ↑ 14: 7,9 ↗ 15: 10,4* ↑ 16: 10,4* ↑ 17: 9,2 ↑ 18: 8,2 ↗ 19: 9,4 ↖
	Serie 83,0		Serie 78,0
	Totalt 0,0		Totalt 0,0
Serie		1: 9,4 ↓ 2: 8,4 ↗ 3: 9,3 ↓ 4: 9,0 → 5: 10,3* ↘	6: 6,5 ↖ 7: 8,6 ↓ 8: 9,2 ↓ 9: 10,3* ↑ 10: 9,6 ↘
	Serie 45,0		Serie 42,0
	Totalt 45,0		Totalt 87,0
Serie		11: 10,1 ↑ 12: 8,5 ↖ 13: 9,0 ↗ 14: 9,9 ↗ 15: 10,0 ↗	16: 10,4* ↗ 17: 10,1 ↓ 18: 10,2 ↓ 19: 9,9 ↖ 20: 9,6 ↖
	Serie 46,0		Serie 48,0
	Totalt 133,0		Totalt 181,0

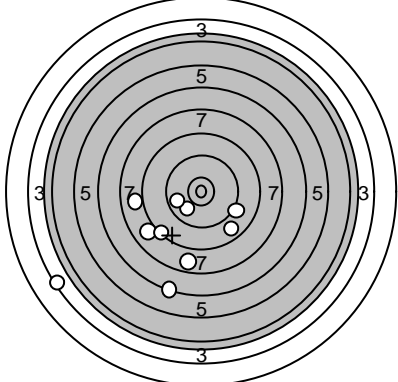
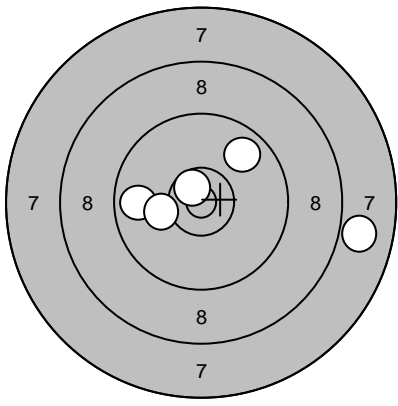
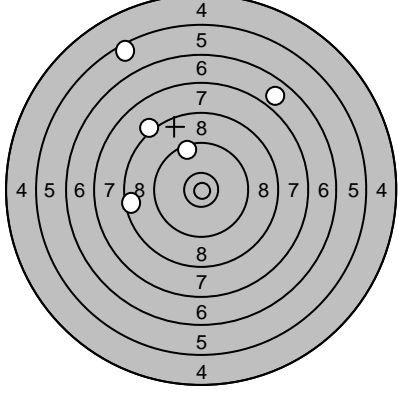
Skjutlag 2	Tavla 4	Niklas Renström	
		Drängsmark	
2007-07-16	Tavelträffen 2007	Ramselefors SKF	
Prov		1: 3,5 ↙ 2: 8,0 ↙ 3: 8,5 ↙ 4: 6,4 ↓ 5: 8,0 ← 6: 10,0 ↓ 7: 8,9 ↘ 8: 9,9 ← 9: 9,2 → 10: 7,8 ↓	11: 7,9 ↙ 12: 7,4 ↑ 13: 10,3 ← 14: 9,2 ↗ 15: 5,5 ↗
	Serie 76,0		Serie 38,0
	Totalt 0,0		Totalt 0,0
Serie		1: 7,9 → 2: 10,7* ↗ 3: 9,8 ← 4: 9,8 ↗ 5: 10,2 ←	6: 9,0 ↖ 7: 7,0 ↗ 8: 6,2 → 9: 10,3* ↓ 10: 8,7 ↗
	Serie 45,0		Serie 40,0
	Totalt 45,0		Totalt 85,0
Serie		11: 5,6 ↖ 12: 9,5 ↗ 13: 8,2 ↖ 14: 8,5 ← 15: 6,9 ↗	16: 5,8 ↑ 17: 8,6 ↗ 18: 9,9 ↗ 19: 9,1 ↓ 20: 8,6 ↗
	Serie 36,0		Serie 39,0
	Totalt 121,0		Totalt 160,0

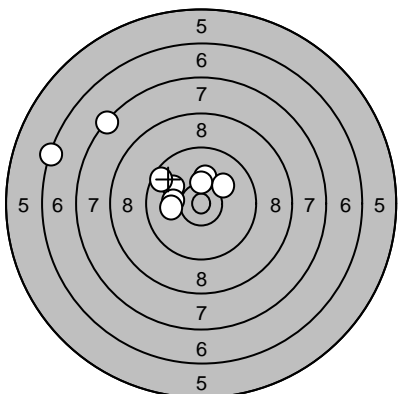
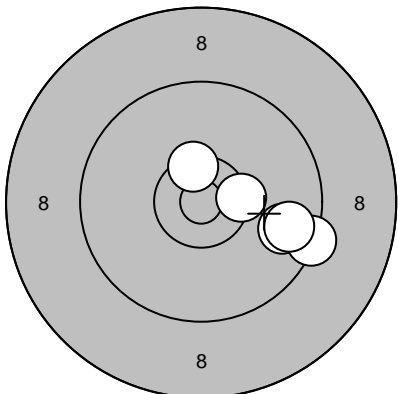
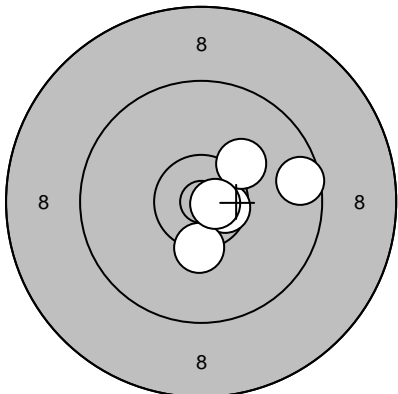
Skjutlag	Tavla	Elina Högström		
2	5	Ramselefors		
2007-07-16	Tavelträffen 2007	Ramselefors SKF		
Prov		1: 7,4 ↖ 2: 10,0 ↖ 3: 10,3* ↑ 4: 6,4 ← 5: 10,1 ↑ 6: 10,1 ↗ 7: 10,3* ↑ 8: 9,6 ↖ 9: 10,1 ← 10: 10,1 ←	11: 8,8 ↘ 12: 9,7 ← 13: 9,8 ← 14: 10,4* ↗ 15: 10,3 ↗ 16: 10,8* ↓	
	Serie	92,0	Serie	56,0
	Totalt	0,0	Totalt	0,0
Serie		1: 9,8 → 2: 9,4 → 3: 9,7 → 4: 10,4* → 5: 10,5* ↑	6: 9,3 → 7: 9,9 ↘ 8: 10,3* → 9: 9,3 ↗ 10: 10,1 ↘	
	Serie	47,0	Serie	47,0
	Totalt	47,0	Totalt	94,0
Serie		11: 9,6 → 12: 10,6* → 13: 10,2 ↗ 14: 10,3* ↓ 15: 10,7* →	16: 10,2 ↘ 17: 8,8 ← 18: 10,2 ↖ 19: 10,8* ↑ 20: 9,7 ↘	
	Serie	49,0	Serie	47,0
	Totalt	143,0	Totalt	190,0

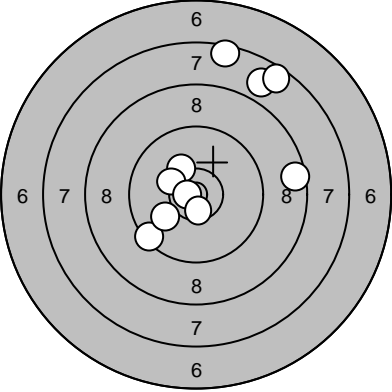
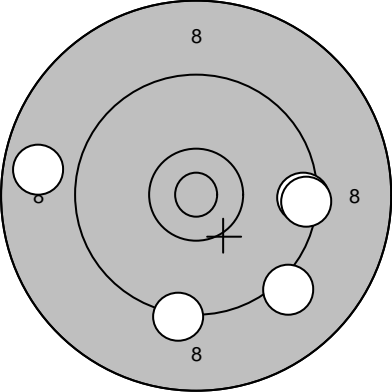
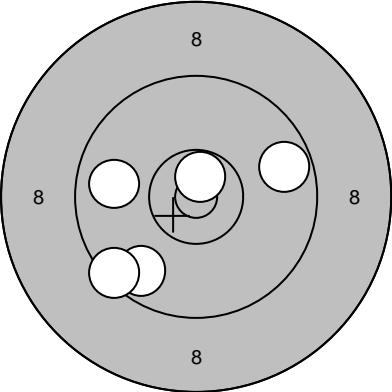
Skjutlag	Tavla	Emil Bergman	
2	6	Umeå	
2007-07-16	Tavelträffen 2007	Ramselefors SKF	
Prov		1: 7,9 ↗ 2: 7,5 ↑ 3: 8,6 → 4: 10,2 ↖ 5: 7,6 ↗ 6: 9,5 ↙ 7: 10,3* ↖ 8: 10,0 ↙ 9: 10,8* ← 10: 10,6* ↓	11: 10,5* ↙ 12: 10,3* → 13: 10,7* ↘ 14: 10,2 ↗ 15: 9,5 ↓ 16: 9,6 ↖
	Serie 88,0	Serie 58,0	
	Totalt 0,0	Totalt 0,0	
Serie		1: 9,3 ↓ 2: 9,5 → 3: 9,4 → 4: 8,8 ← 5: 9,2 ↘	6: 9,3 ↙ 7: 8,5 ↑ 8: 9,8 ↘ 9: 10,7* ↗ 10: 9,8 ←
	Serie 44,0	Serie 45,0	
	Totalt 44,0	Totalt 89,0	
Serie		11: 9,8 ← 12: 10,7* ↑ 13: 9,7 ↙ 14: 9,4 ↙ 15: 9,7 →	16: 10,6* ↖ 17: 10,1 ↑ 18: 10,3* ↑ 19: 10,4* ↗ 20: 10,0 ↓
	Serie 46,0	Serie 50,0	
	Totalt 135,0	Totalt 185,0	

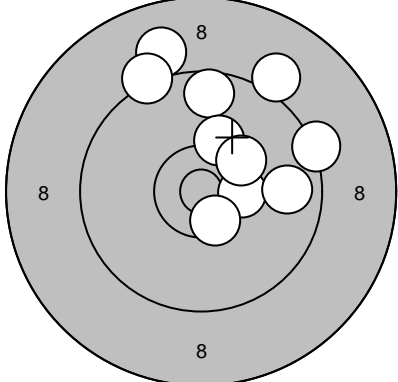
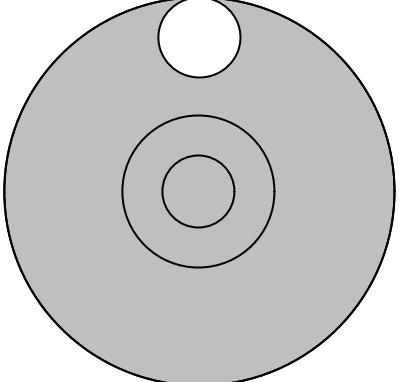
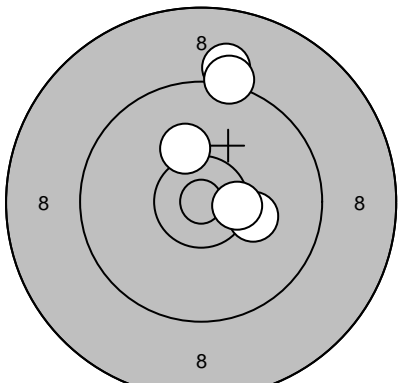
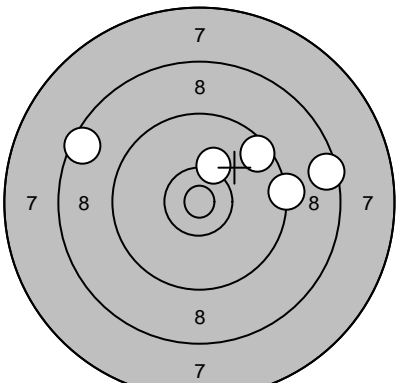
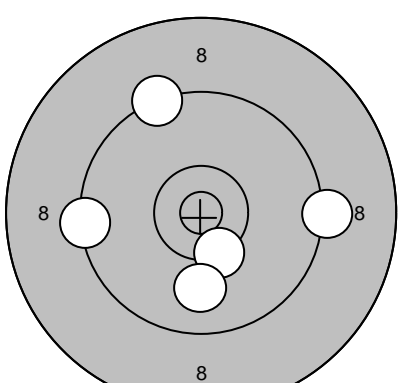
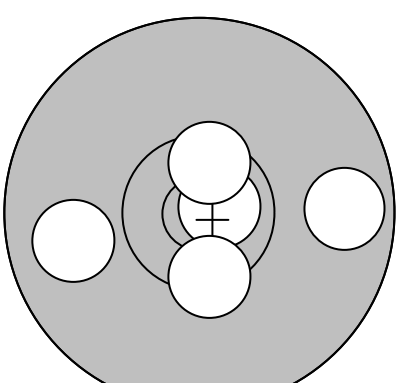
Skjutlag	Tavla	Kevin Yu	
2	7	Umeå	
2007-07-16	Tavelträffen 2007	Ramselefors SKF	
Prov		1: 9,3 → 2: 9,0 ↑ 3: 9,6 ↑ 4: 10,4* → 5: 10,2 ↑ 6: 9,3 ↑ 7: 9,1 ↗ 8: 10,3 ↗ 9: 9,8 → 10: 10,5* ↓	Prov 
	Serie 94,0 Totalt 0,0		11: 9,7 ↑ Serie 9,0 Totalt 0,0
Serie		1: 9,1 ↑ 2: 9,3 ↑ 3: 10,2 → 4: 10,5* → 5: 10,2 ↑	Serie 
	Serie 48,0 Totalt 48,0		6: 9,3 → 7: 8,5 → 8: 10,2 ↑ 9: 8,5 ↖ 10: 9,5 ↗ Serie 44,0 Totalt 92,0
Serie		11: 9,3 ↑ 12: 10,3* ↓ 13: 9,4 ← 14: 9,3 → 15: 9,9 ↓	Serie 
	Serie 46,0 Totalt 138,0		16: 10,8* → 17: 9,9 ← 18: 10,5* ↑ 19: 10,4* ↓ 20: 9,7 → Serie 48,0 Totalt 186,0

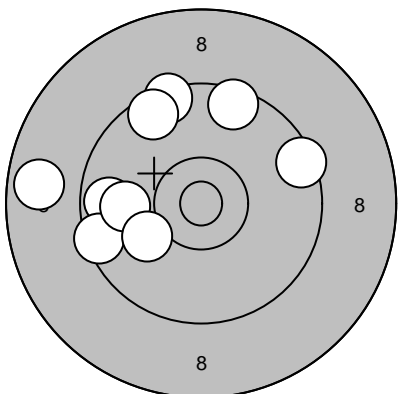
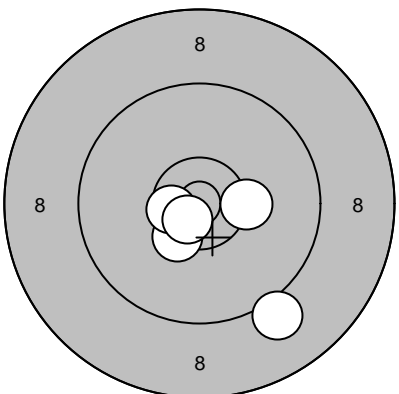
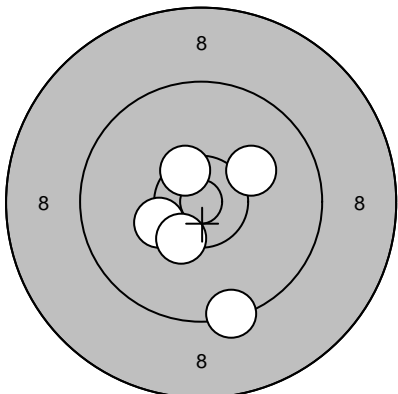
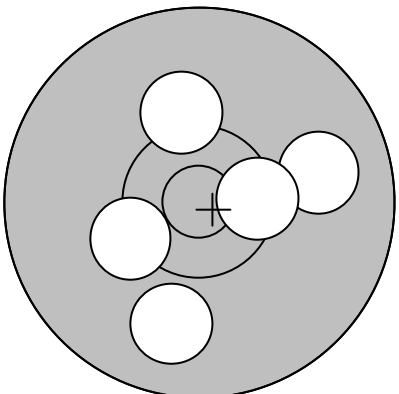
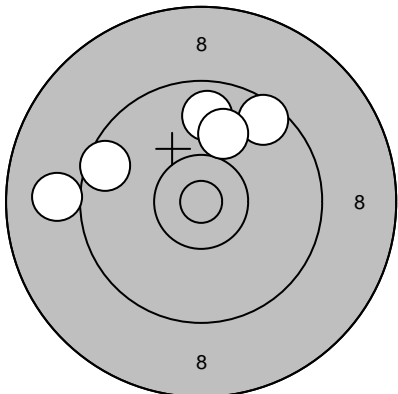
Skjutlag 2	Tavla 9	Gabriella Johansson	
		Kalmar	
2007-07-16	Tavelträffen 2007	Ramselefors SKF	
Prov		1: 9,5 ↑ 2: 8,7 ← 3: 9,7 ← 4: 9,5 ← 5: 9,9 ← 6: 10,1 ← 7: 9,5 → 8: 9,5 ↑ 9: 9,6 ↑	Serie 
			1: 9,1 ↓ 2: 10,3* → 3: 10,4* ↓ 4: 10,6* ← 5: 10,7* ↓
		Serie 81,0	Serie 49,0
		Totalt 0,0	Totalt 49,0
Serie		6: 10,3* ← 7: 10,5* ↑ 8: 10,4* ↓ 9: 10,2 → 10: 9,4 ↓	Serie 
			11: 9,9 ↓ 12: 9,9 → 13: 10,3* ← 14: 10,2 ↑ 15: 10,5* →
		Serie 49,0	Serie 48,0
		Totalt 98,0	Totalt 146,0
Serie		16: 9,8 ↑ 17: 9,6 ↗ 18: 9,0 ← 19: 10,0 ↑ 20: 9,6 ←	
		Serie 46,0	
		Totalt 192,0	

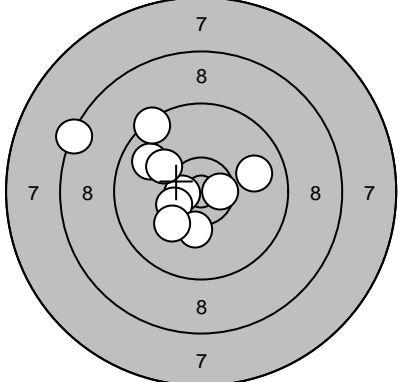
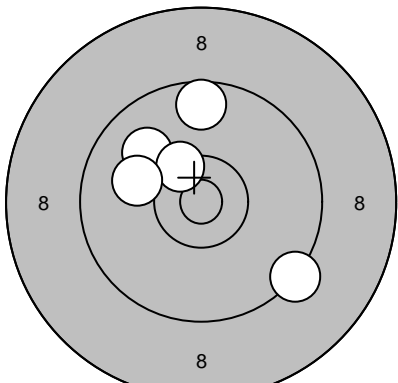
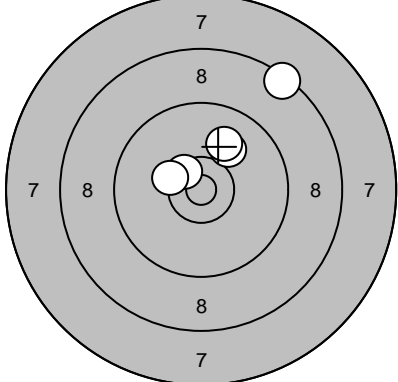
Skjutlag	Tavla	Marlene Forsell	
2		11	
Ramselefors			
2007-07-16		Tavelträffen 2007	
2007-07-16		Ramselefors SKF	
Prov		1: 8,4 ← 2: 10,6* ← 3: 9,8 ↗ 4: 10,4* ← 5: 10,1 ↗ 6: 9,9 → 7: 10,2 ↓ 8: 10,1 ↙ 9: 9,4 ↗ 10: 10,6* →	Prov
		Serie 95,0	11: 9,8 →
		Totalt 0,0	12: 10,5* ←
			13: 10,0 ↑
			14: 10,3 ↙
			15: 10,5* ↘
			16: 10,4* ↗
			17: 9,8 ←
			Serie 68,0
			Totalt 0,0
Serie		1: 10,0 ↗ 2: 9,3 ↘ 3: 9,6 ↑ 4: 10,4* ↗ 5: 10,0 ←	Serie
		Serie 48,0	6: 10,0 ↑
		Totalt 48,0	7: 9,8 ↘
			8: 9,7 ↘
			9: 10,5* ↗
			10: 10,7* ↗
			Serie 48,0
			Totalt 96,0
Serie		11: 10,1 ↗ 12: 8,4 ↗ 13: 10,0 ↗ 14: 10,5* ↗ 15: 10,3* ←	Serie
		Serie 48,0	16: 10,1 ↘
		Totalt 144,0	17: 10,2 ↘
			18: 9,8 ↓
			19: 10,2 →
			20: 9,8 ↑
			Serie 48,0
			Totalt 192,0

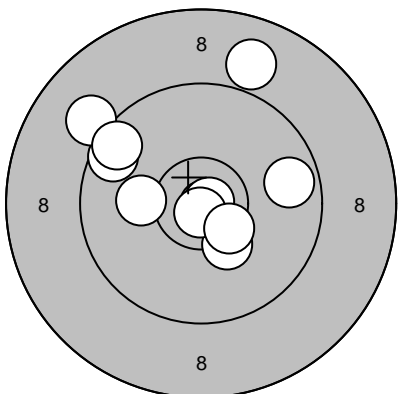
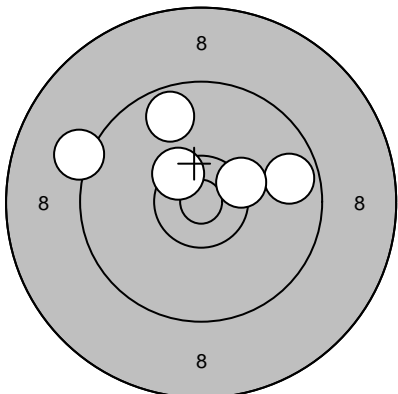
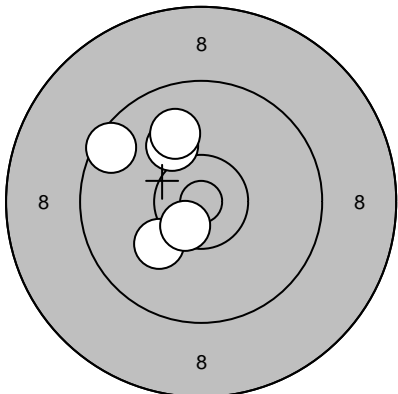
Skjutlag	Tavla	Therese Karlsson	
2	12	Drängsmark	
2007-07-16	Tavelträffen 2007	Ramselefors SKF	
Prov		1: 9,0 ↗ 2: 10,8* → 3: 9,6 ↗ 4: 9,1 ↗ 5: 9,6 ↗ 6: 10,2 ← 7: 10,3 ↘ 8: 10,8* ↘ 9: 10,4* ↘ 10: 9,7 →	11: 10,2 ↖ 12: 9,0 → 13: 10,0 ↑ 14: 10,3* ↓ 15: 10,7* ↑
	Serie 95,0		Serie 49,0
	Totalt 0,0		Totalt 0,0
Serie		1: 9,7 → 2: 9,7 ↗ 3: 10,5* ↗ 4: 10,3* → 5: 9,2 ←	6: 10,6* ↖ 7: 10,2 ↘ 8: 9,8 ↘ 9: 10,6* → 10: 10,6* ↑
	Serie 47,0		Serie 49,0
	Totalt 47,0		Totalt 96,0
Serie		11: 10,1 ↖ 12: 10,0 ↖ 13: 10,1 ↘ 14: 9,5 ↗ 15: 10,5* ↘	16: 9,4 → 17: 10,0 → 18: 10,5* ↘ 19: 10,2 ↗ 20: 9,2 ↗
	Serie 49,0		Serie 48,0
	Totalt 145,0		Totalt 193,0

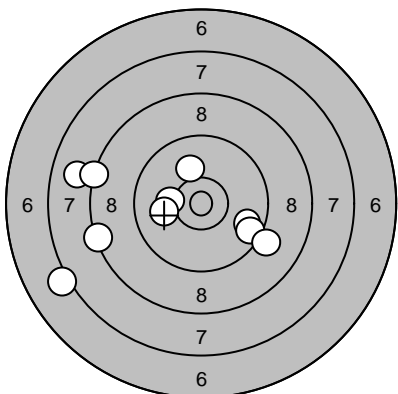
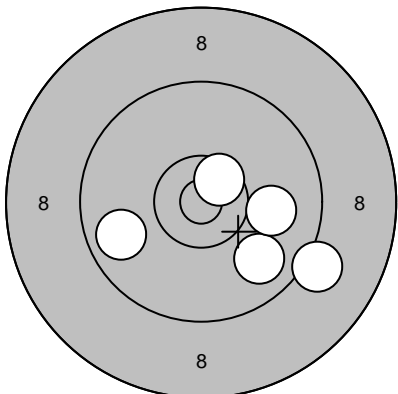
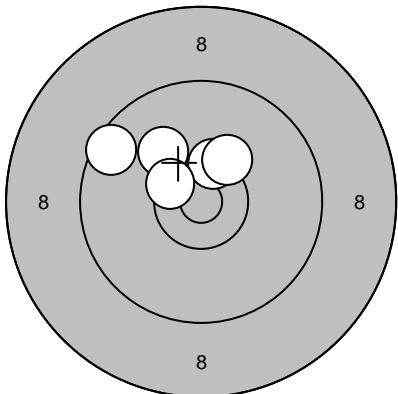
Skjutlag	Tavla	Niklas Westermark	
2		13	
		Drängsmark	
2007-07-16		Tavelträffen 2007	Ramselefors SKF
Prov		1: 7,2 ← 2: 7,9 ← 3: 10,2 ← 4: 8,3 ← 5: 9,8 → 6: 8,4 ← 7: 9,6 → 8: 10,1 ↑ 9: 9,1 → 10: 10,1 ←	11: 9,7 ↓ 12: 9,4 ←
		Serie 87,0	Serie 18,0
		Totalt 0,0	Totalt 0,0
Serie		1: 9,1 → 2: 10,6* ↗ 3: 9,8 ↘ 4: 9,8 ← 5: 10,0 →	6: 9,2 → 7: 10,6* ← 8: 10,6* ↓ 9: 8,8 ↗ 10: 9,7 ↘
		Serie 47,0	Serie 46,0
		Totalt 47,0	Totalt 93,0
Serie		11: 10,4* ↗ 12: 10,1 ↗ 13: 10,5* ← 14: 9,6 ↗ 15: 10,3 ↗	16: 9,6 ↗ 17: 10,2 ↗ 18: 9,8 → 19: 9,6 ↓ 20: 9,9 ↘
		Serie 49,0	Serie 46,0
		Totalt 142,0	Totalt 188,0

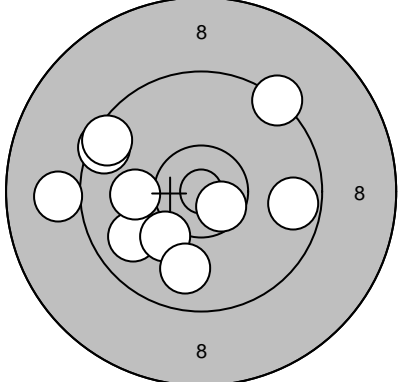
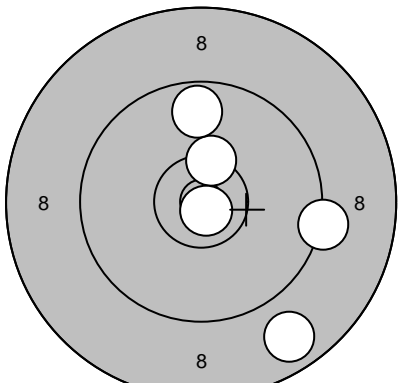
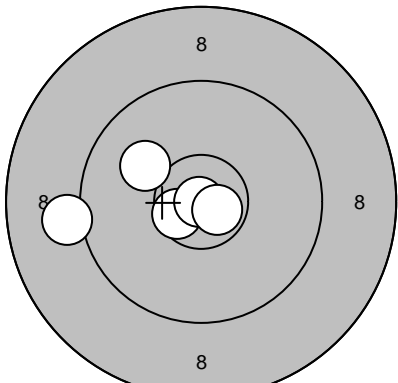
Skjutlag	Tavla	Stefan Thorin	
2	14	Umeå	
2007-07-16	Tavelträffen 2007	Ramselefors SKF	
Prov		1: 10,6* ↘ 2: 9,8 ↙ 3: 9,5 ↗ 4: 9,0 ← 5: 9,5 ↗ 6: 10,1 ← 7: 10,2 ↘ 8: 9,4 ↗ 9: 9,7 → 10: 9,9 ↓	11: 10,1 ↘ 12: 9,1 ↖ 13: 10,7* ↑
	Serie 93,0		Serie 29,0
	Totalt 0,0		Totalt 0,0
Serie		1: 8,8 ↘ 2: 10,4* ↑ 3: 9,7 ↑ 4: 10,8* ↘ 5: 9,3 →	6: 10,3* ↑ 7: 9,3 ↖ 8: 10,3* ↖ 9: 10,1 → 10: 9,8 ↘
	Serie 46,0		Serie 48,0
	Totalt 46,0		Totalt 94,0
Serie		11: 10,6* ↖ 12: 9,1 ← 13: 10,9* ← 14: 10,0 ↗ 15: 10,7* ↘	16: 10,6* ↘ 17: 10,1 ↗ 18: 9,9 ↘ 19: 10,1 ↘ 20: 9,8 ↑
	Serie 49,0		Serie 48,0
	Totalt 143,0		Totalt 191,0

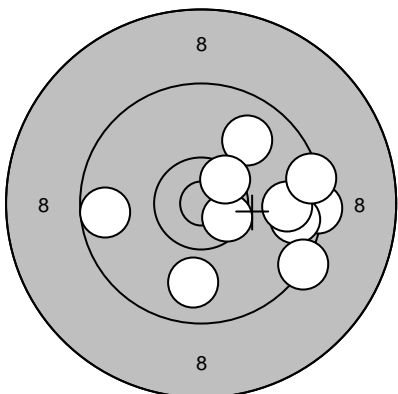
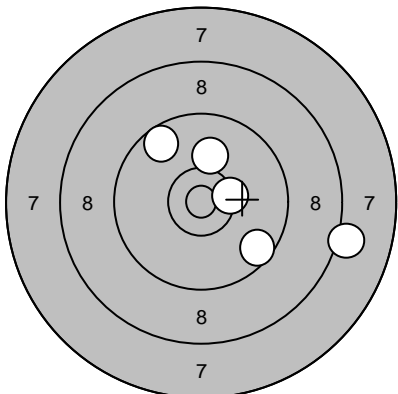
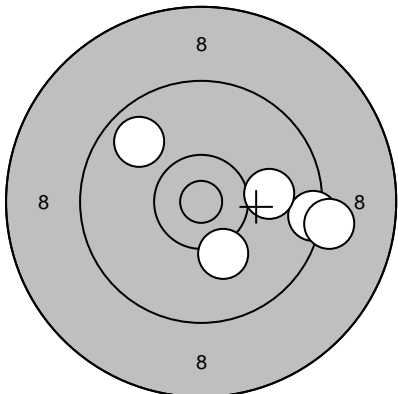
Skjutlag	Tavla	Roger Andersson	
2	15	S 3	
2007-07-16	Tavelträffen 2007	Ramselefors SKF	
Prov		1: 10,5* → 2: 9,9 ↗ 3: 9,7 ← 4: 9,4 → 5: 9,6 → 6: 9,8 → 7: 9,9 ↓ 8: 9,4 → 9: 10,5* ↗ 10: 9,3 ↘	Prov 11: 10,1 ↗
	Serie 92,0		Serie 10,0
	Totalt 0,0		Totalt 0,0
Serie		1: 8,2 → 2: 10,1 ↑ 3: 9,7 ↗ 4: 10,4* → 5: 9,6 ↘	Serie 6: 10,4* → 7: 10,0 ← 8: 10,3 ↖ 9: 10,6* → 10: 10,4* →
	Serie 46,0		Serie 50,0
	Totalt 46,0		Totalt 96,0
Serie		11: 9,4 → 12: 9,8 ↗ 13: 10,2 ↓ 14: 9,2 → 15: 10,0 →	Serie 16: 10,1 ↘ 17: 9,2 → 18: 9,9 ↓ 19: 9,6 ↗ 20: 9,5 ↖
	Serie 47,0		Serie 46,0
	Totalt 143,0		Totalt 189,0

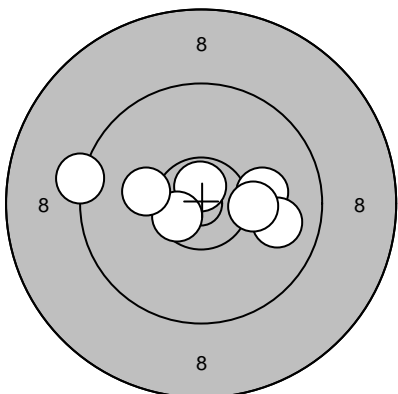
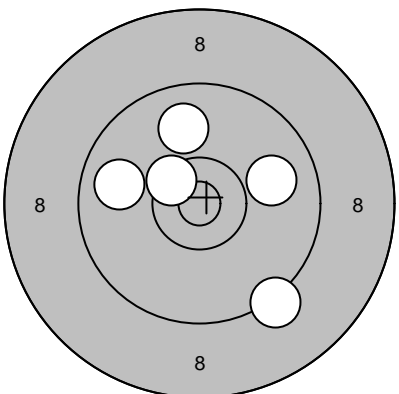
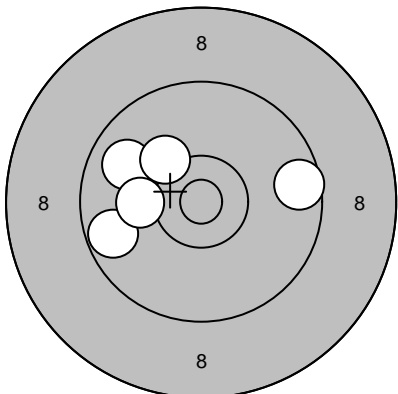
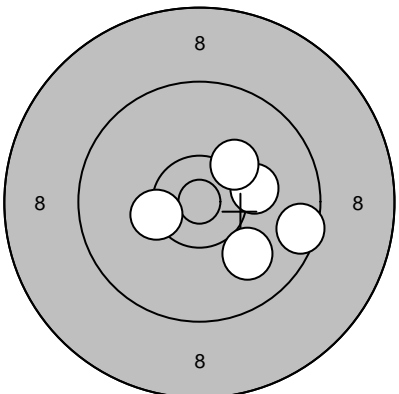
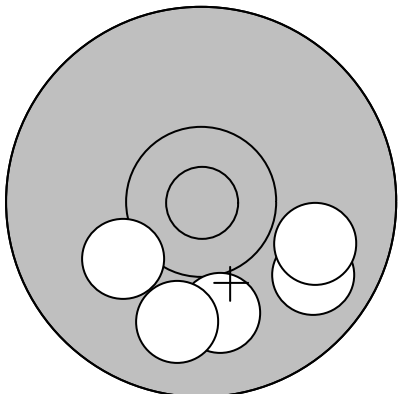
Skjutlag 2	Tavla 16	Niklas Öhman		
		S 3		
2007-07-16	Tavelträffen 2007	Ramselefors SKF		
Prov		1: 10,1 → 2: 10,7* ↑ 3: 9,3 ← 4: 10,6* ← 5: 9,9 → 6: 10,2 ← 7: 10,2 →	Serie 	1: 9,9 → 2: 9,9 ← 3: 9,3 ↓ 4: 9,9 ↑ 5: 10,5* ↗
		Serie 68,0	Serie 46,0	
		Totalt 0,0	Totalt 46,0	
Serie		6: 9,8 ← 7: 9,7 ← 8: 10,1 ← 9: 10,2 ↗ 10: 9,6 →	Serie 	11: 10,3* ← 12: 10,2 → 13: 10,3 ↗ 14: 10,0 ↓ 15: 9,5 →
		Serie 47,0	Serie 49,0	
		Totalt 93,0	Totalt 142,0	
Serie		16: 9,8 ↘ 17: 10,0 ↓ 18: 9,9 ↓ 19: 9,9 → 20: 10,1 ←		
		Serie 47,0		
		Totalt 189,0		

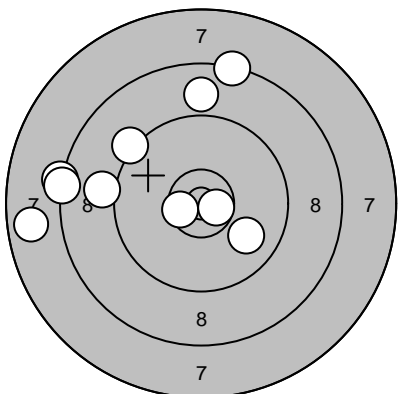
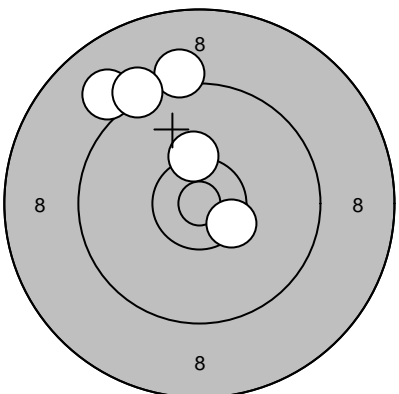
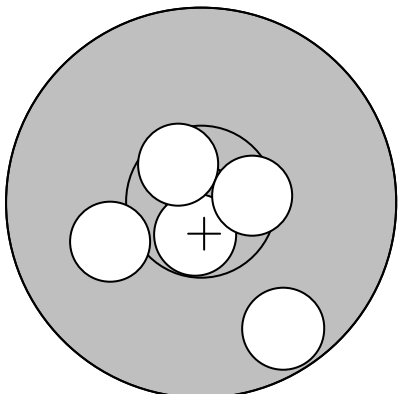
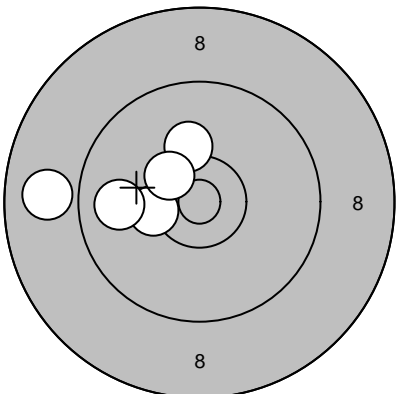
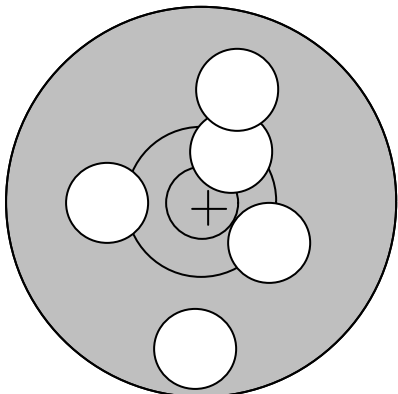
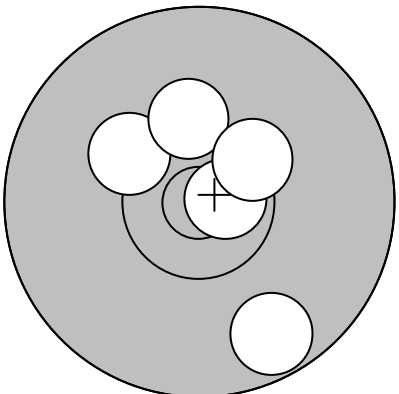
Skjutlag	Tavla	Anders Petersson		
2	17			
		P 7		
2007-07-16	Tavelträffen 2007	Ramselefors SKF		
Prov		1: 8,3 ← 2: 8,4 ↑ 3: 8,9 ↑ 4: 9,3 ↗ 5: 9,9 ↘ 6: 8,3 ← 7: 7,8 ← 8: 9,1 ← 9: 10,5* ← 10: 10,7* →	Prov 	11: 10,4* ↘ 12: 9,0 ↖ 13: 10,3* ↑ 14: 9,2 ↑ 15: 9,2 ↖
	Serie 86,0		Serie 47,0	
	Totalt 0,0		Totalt 0,0	
Serie		1: 9,7 ↘ 2: 10,1 ← 3: 10,7* ↓ 4: 10,6* ↗ 5: 10,5* →	Serie 	6: 10,3* ← 7: 8,9 ← 8: 10,2 ↑ 9: 9,9 ← 10: 10,4* ↖
	Serie 49,0		Serie 47,0	
	Totalt 49,0		Totalt 96,0	
Serie		11: 9,7 ↓ 12: 10,2 ← 13: 10,5* ↗ 14: 10,3 ↘ 15: 10,0 ↑	Serie 	16: 10,2 ↖ 17: 9,7 ↘ 18: 10,7* → 19: 10,2 ↑ 20: 10,4* ↗
	Serie 49,0		Serie 49,0	
	Totalt 145,0		Totalt 194,0	

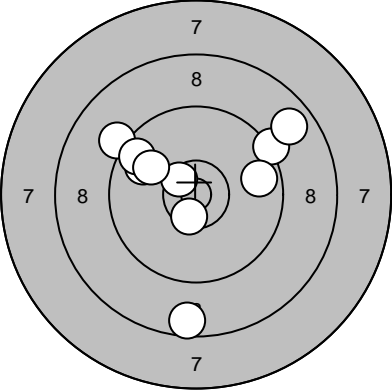
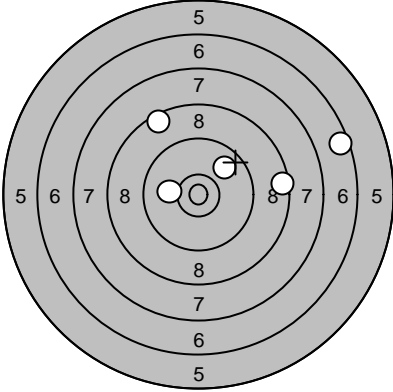
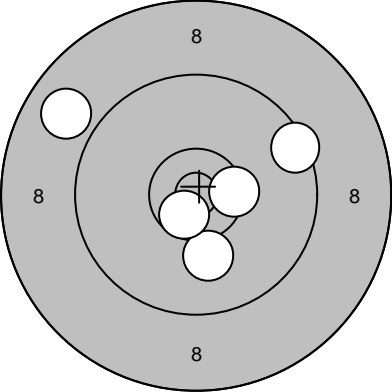
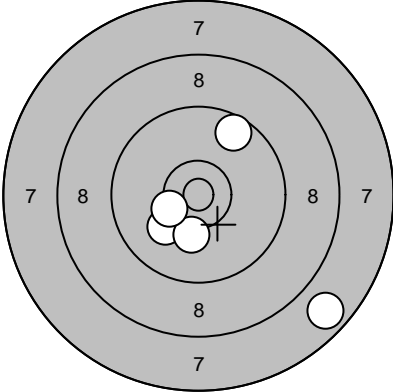
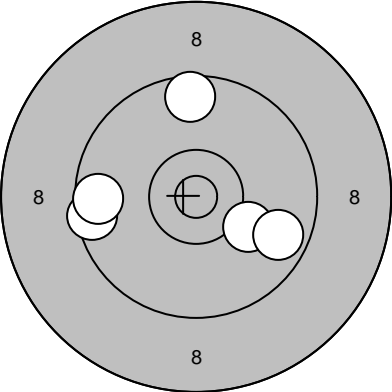
Skjutlag	Tavla	Håkan Engman	
2	18	Lindesberg	
2007-07-16	Tavelträffen 2007	Ramselefors SKF	
Prov		1: 9,3 ↗ 2: 10,5* ↗ 3: 9,2 ↗ 4: 10,5* ↓ 5: 9,9 ↗ 6: 9,6 ↗ 7: 8,8 ↗ 8: 8,6 ↓ 9: 10,0 ↗ 10: 9,7 →	Serie 
	Serie 91,0 Totalt 0,0	1: 6,6 → 2: 8,6 ↗ 3: 8,5 → 4: 10,1 ← 5: 9,9 ↗	Serie 41,0 Totalt 41,0
Serie		6: 10,4* → 7: 8,9 ↗ 8: 10,1 ↓ 9: 10,6* ↓ 10: 9,5 →	Serie 
	Serie 47,0 Totalt 88,0	11: 7,7 ↘ 12: 9,6 ↗ 13: 10,1 ↙ 14: 10,2 ↓ 15: 10,3* ←	Serie 46,0 Totalt 134,0
Serie		16: 9,5 ← 17: 9,6 ← 18: 10,1 → 19: 9,6 ↑ 20: 9,7 →	
	Serie 46,0 Totalt 180,0		

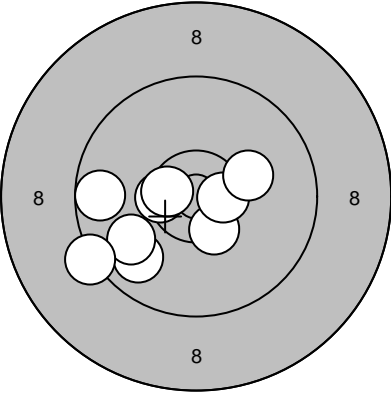
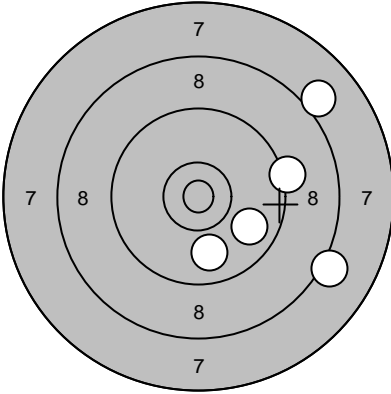
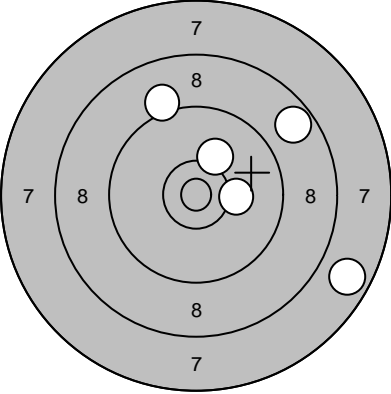
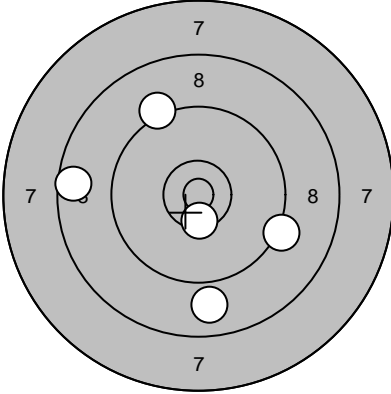
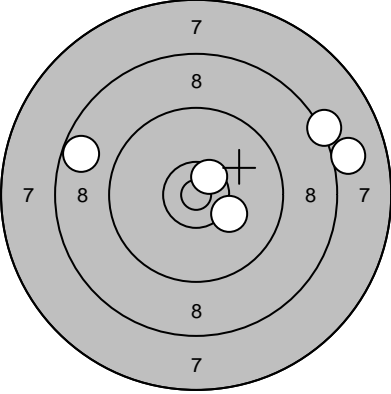

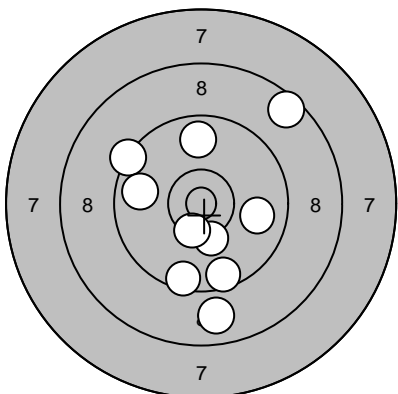
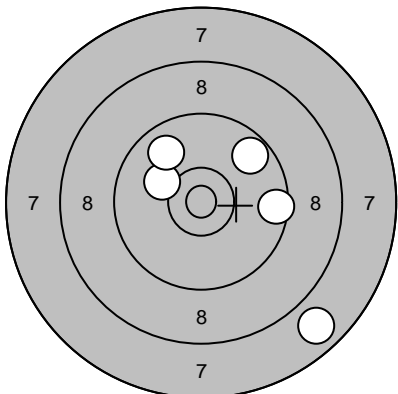
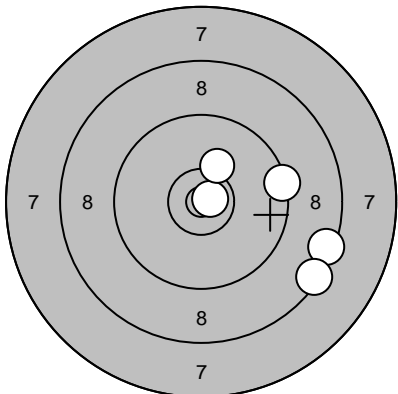
Skjutlag	Tavla	Edward Yu		
2	19	Umeå		
2007-07-16	Tavelträffen 2007	Ramselefors SKF		
Prov		1: 10,4* ↘ 2: 9,6 ← 3: 10,6* → 4: 9,8 ↙ 5: 9,9 ↙ 6: 9,3 ↙ 7: 10,5* ← 8: 10,2 → 9: 10,6* ←	Serie 	1: 8,1 ↘ 2: 9,2 → 3: 9,9 ↓ 4: 8,1 ↗ 5: 9,8 ↘
		Serie 86,0	Serie 43,0	
		Totalt 0,0	Totalt 43,0	
Serie		6: 10,2 ↗ 7: 9,1 ↗ 8: 7,7 → 9: 10,2 → 10: 8,7 ↗	Serie 	11: 9,2 → 12: 10,4* ↓ 13: 9,2 ↗ 14: 8,6 ← 15: 8,9 ↓
		Serie 44,0	Serie 44,0	
		Totalt 87,0	Totalt 131,0	
Serie		16: 10,2 → 17: 8,7 ← 18: 10,5* ↗ 19: 8,3 → 20: 8,0 →		
		Serie 44,0		
		Totalt 175,0		

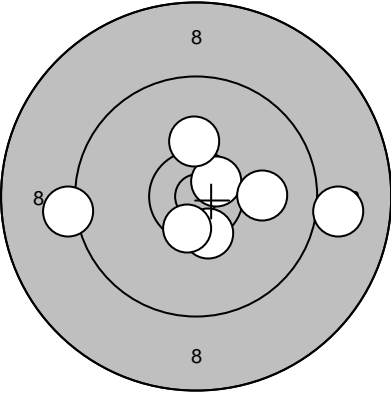
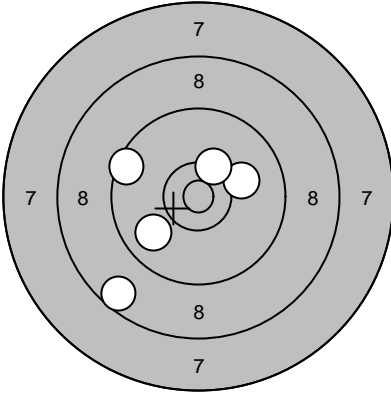
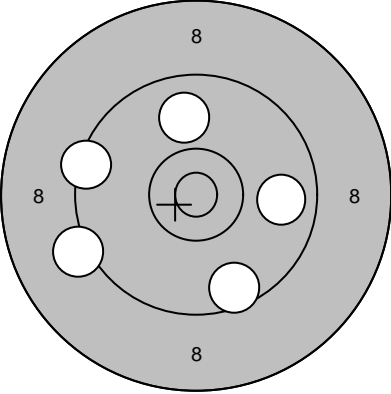
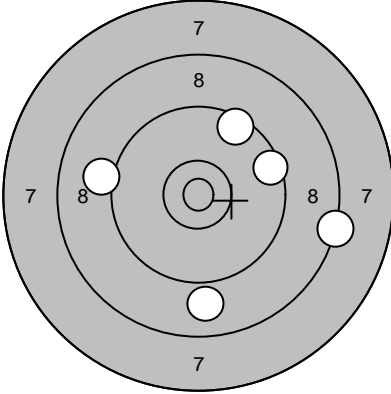
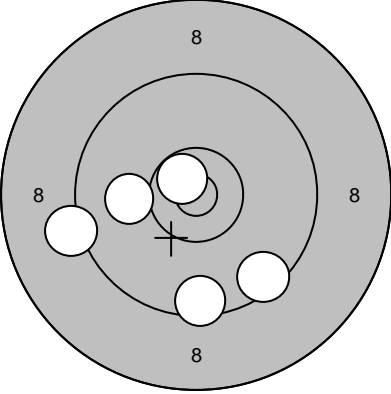
Skjutlag	Tavla	Rolf Lindbäck	
2	20	Vännäs	
2007-07-16	Tavelträffen 2007	Ramselefors SKF	
Prov		1: 8,6 ↗ 2: 9,4 ↖ 3: 8,8 ↓ 4: 9,6 ↓ 5: 9,8 ← 6: 10,3 ↓ 7: 9,5 ↓ 8: 10,4* ↓ 9: 9,9 → 10: 9,7 ↑	11: 8,1 →
	Serie 90,0		Serie 8,0
	Totalt 0,0		Totalt 0,0
Serie		1: 7,8 ↓ 2: 10,1 ↗ 3: 9,8 ↗ 4: 9,5 → 5: 9,7 ↗	6: 9,5 → 7: 10,2 ↗ 8: 9,5 ↗ 9: 9,7 ↗ 10: 9,4 →
	Serie 44,0		Serie 46,0
	Totalt 44,0		Totalt 90,0
Serie		11: 8,5 → 12: 9,4 → 13: 10,8* → 14: 8,4 ↓ 15: 10,2 ↑	16: 8,7 ← 17: 9,2 ↖ 18: 8,9 → 19: 8,8 ↗ 20: 9,7 ↓
	Serie 45,0		Serie 42,0
	Totalt 135,0		Totalt 177,0

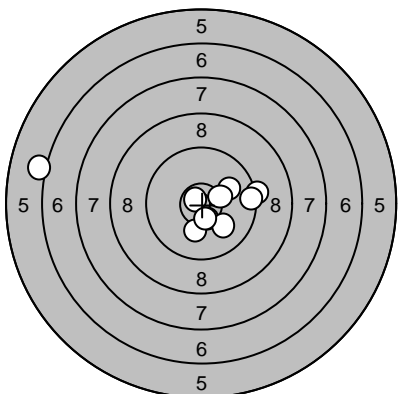
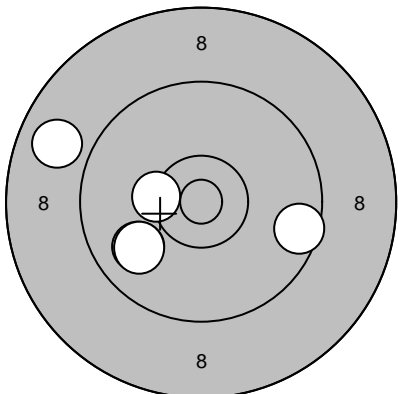
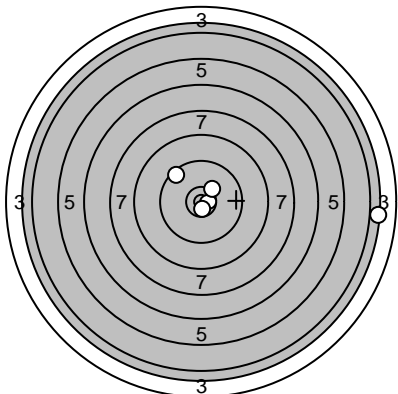
Skjutlag	Tavla		
3	1		
2007-07-16		Tavelträffen 2007	Ramselefors SKF
Prov		1: 9,0 → 2: 10,6* ↗ 3: 10,4* ↓ 4: 10,0 → 5: 9,2 ← 6: 10,2 ↑ 7: 10,5* ↓	Serie  1: 9,5 ← 2: 10,1 → 3: 10,3* ↗ 4: 8,6 ↓ 5: 9,9 ←
		Serie 68,0	Serie 46,0
		Totalt 0,0	Totalt 46,0
Serie		6: 9,2 ← 7: 9,6 ↓ 8: 9,9 ↑ 9: 9,4 ← 10: 9,8 →	Serie  11: 9,5 → 12: 8,9 ↓ 13: 8,3 → 14: 9,1 ← 15: 9,5 ↗
		Serie 45,0	Serie 43,0
		Totalt 91,0	Totalt 134,0
Serie		16: 9,2 ← 17: 9,5 ↓ 18: 10,7* ↗ 19: 10,0 ← 20: 9,5 ↓	
		Serie 47,0	
		Totalt 181,0	

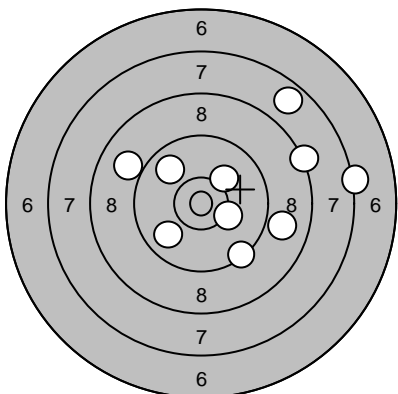
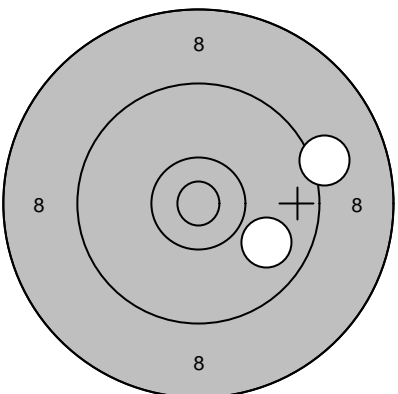
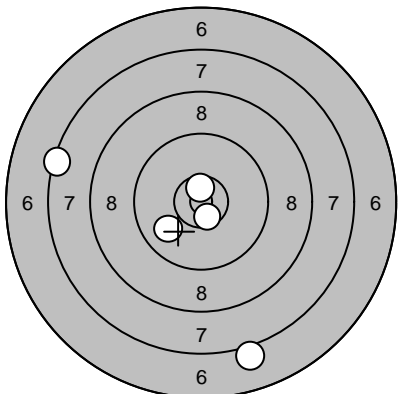
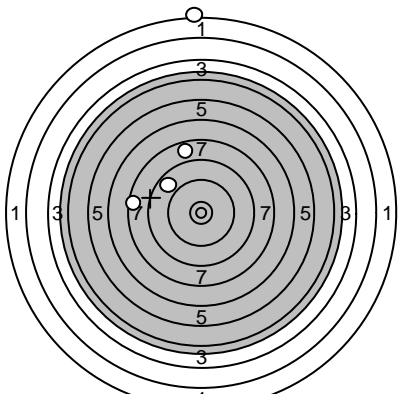
Skjutlag	Tavla		
3	2		
2007-07-16		Tavelträffen 2007	Ramselefors SKF
Prov		1: 6,2 ← 2: 10,5* ↓ 3: 10,1 ↓ 4: 10,1 ↓ 5: 10,8* ↗ 6: 10,5* ↓ 7: 9,3 → 8: 10,0 → 9: 9,5 → 10: 10,3* →	11: 10,3* ← 12: 9,2 ↓ 13: 10,6* ↓ 14: 10,1 ↓ 15: 9,3 ↓ 16: 10,0 ↓ 17: 10,7* →
	Serie 94,0	Serie 68,0	
	Totalt 0,0	Totalt 0,0	
Serie		1: 9,9 ← 2: 9,9 ← 3: 8,8 ← 4: 9,6 → 5: 10,3* ←	6: 9,5 ← 7: 10,5* ← 8: 10,6* ↓ 9: 10,3 ← 10: 9,5 ↖
	Serie 45,0	Serie 48,0	
	Totalt 45,0	Totalt 93,0	
Serie		11: 4,0 → 12: 10,7* → 13: 10,3* ↗ 14: 9,5 ↗ 15: 10,6* ↓	16: 10,6* ↓ 17: 9,4 ← 18: 10,7* ↗ 19: 8,9 ↗ 20: 8,6 →
	Serie 43,0	Serie 45,0	
	Totalt 136,0	Totalt 181,0	

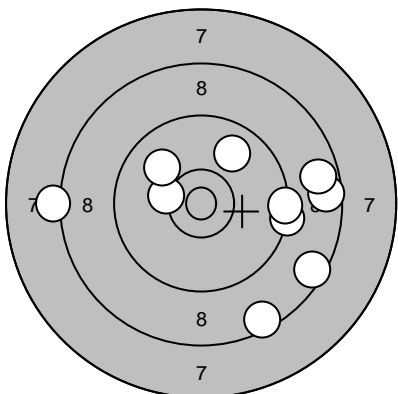
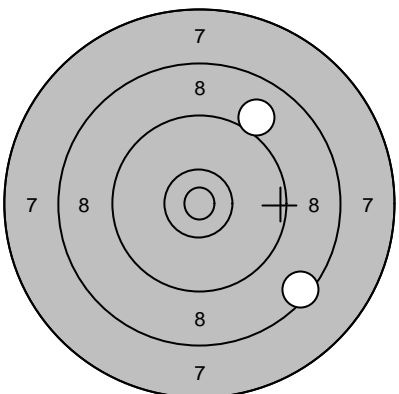
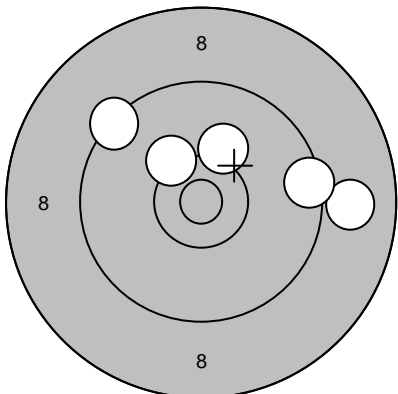
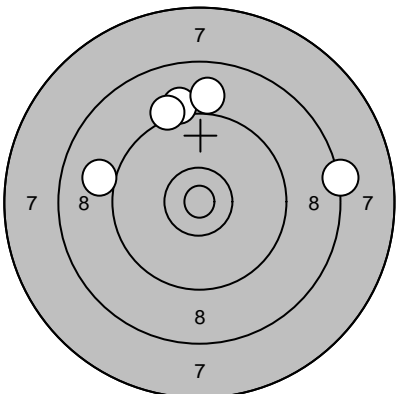
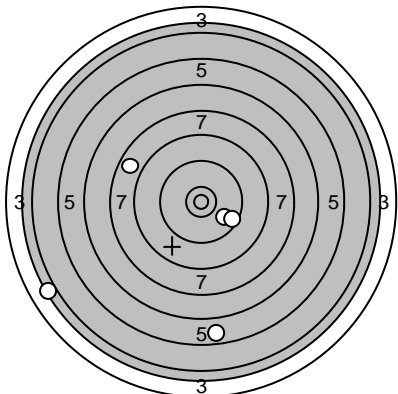
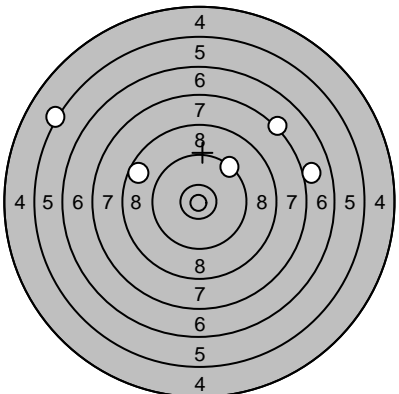
Skjutlag	Tavla		
3	3		
2007-07-16		Tavelträffen 2007	Ramselefors SKF
Prov		1: 9,0 ↖ 2: 7,7 ↗ 3: 9,0 → 4: 9,4 ↓ 5: 9,9 ↗ 6: 7,2 → 7: 10,2 → 8: 8,3 → 9: 9,9 ↖ 10: 10,1 ↗	Prov 
	Serie 87,0		11: 9,1 →
	Totalt 0,0		12: 9,9 ↘
Serie		1: 9,9 ↖ 2: 7,1 ↓ 3: 10,6* ↑ 4: 10,6* ↓ 5: 7,4 ←	Serie
	Serie 43,0		6: 9,2 ↙
	Totalt 43,0		7: 6,6 ↓
			8: 9,0 ↙
			9: 8,0 ↑
			10: 9,3 →
Serie		11: 8,9 ↖ 12: 7,8 ↑ 13: 0,0 ↙ 14: 1,2 ↑ 15: 7,6 ←	Serie
	Serie 23,0		16: 6,1 ↖
	Totalt 107,0		17: 6,1 →
			18: 1,3 ←
			19: 8,2 ↑
			20: 7,1 ←
			Serie 28,0
			Totalt 135,0

Skjutlag	Tavla		
3	4		
2007-07-16		Tavelträffen 2007	Ramselefors SKF
Prov		1: 10,3* ← 2: 8,5 → 3: 8,6 → 4: 8,7 → 5: 9,3 → 6: 8,2 ← 7: 10,0 ↗ 8: 9,4 → 9: 9,9 ↗ 10: 8,5 ↓	Prov 
	Serie 87,0		11: 9,0 ↗
	Totalt 0,0		12: 8,5 ↓
Serie		1: 9,4 ↗ 2: 8,9 → 3: 10,3 ↗ 4: 9,5 → 5: 10,2 ↑	Serie 
	Serie 46,0		6: 8,3 →
	Totalt 46,0		7: 9,1 ↑
Serie		11: 5,8 ↓ 12: 4,0 ← 13: 9,9 ↓ 14: 9,5 → 15: 7,8 ↗	8: 9,2 ↑ 9: 9,0 ← 10: 9,0 ↑
	Serie 34,0		16: 8,7 ←
	Totalt 124,0		17: 5,3 ↖
Serie		16: 8,7 ← 17: 5,3 ↖ 18: 7,3 ↗ 19: 9,4 ↗ 20: 7,0 →	Serie 
	Serie 36,0		21: 8,7 ←
	Totalt 160,0		22: 5,3 ↖

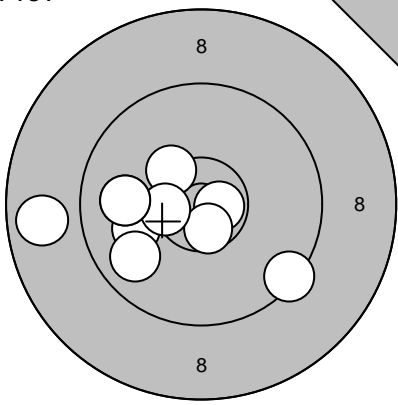
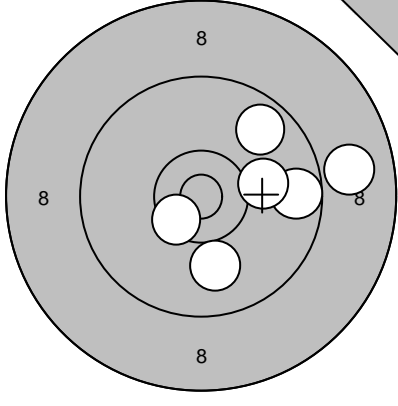
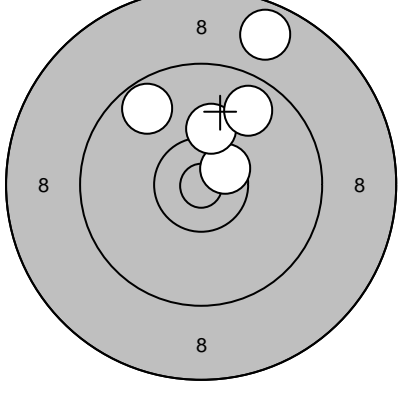
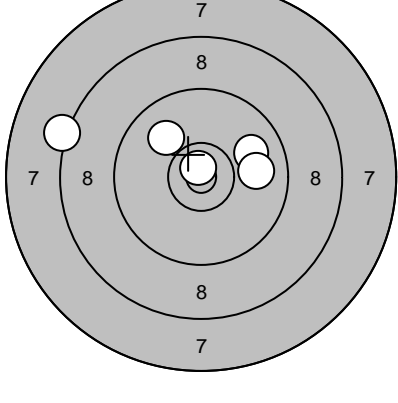
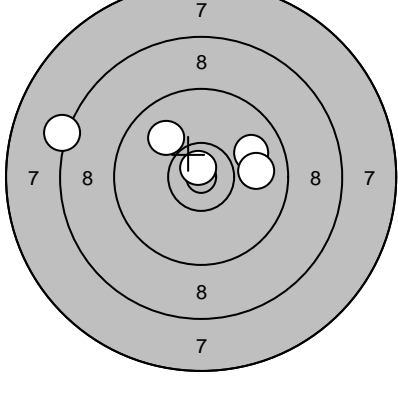
Skjutlag	Tavla		
3	5		
2007-07-16		Tavelträffen 2007	
		Ramselefors SKF	
Prov		1: 9,4 ↘ 2: 8,8 ← 3: 10,0 ← 4: 10,7* → 5: 10,3* ↗ 6: 10,6* ↓ 7: 10,5* ← 8: 9,9 ← 9: 9,8 ↙ 10: 9,9 ←	11: 9,4 ↙ 12: 10,0 ↓ 13: 10,7* ← 14: 9,5 → 15: 9,6 ↓ 16: 10,3 ↓ 17: 9,9 ← 18: 10,1 → 19: 9,2 → 20: 9,6 ↓
		Serie 94,0	Serie 94,0
		Totalt 0,0	Totalt 0,0
Prov		21: 10,5* ↙ 22: 8,9 → 23: 9,7 ↗ 24: 9,7 → 25: 10,0 ↓ 26: 10,1 →	
		Serie 56,0	
		Totalt 0,0	
Serie		1: 10,4* → 2: 8,8 ↗ 3: 8,6 ↓ 4: 9,8 ↓ 5: 10,1 →	
		Serie 45,0	
		Totalt 45,0	
Serie		6: 9,7 ↘ 7: 10,5* ↗ 8: 10,2 ↑ 9: 9,8 ↗ 10: 8,7 ↑	11: 5,6 ↙ 12: 8,8 ↘ 13: 10,1 ↑ 14: 9,5 ↑ 15: 9,3 ↑
		Serie 46,0	Serie 41,0
		Totalt 91,0	Totalt 132,0
Serie		16: 9,9 → 17: 10,8* ↑ 18: 9,9 → 19: 10,0 ↗ 20: 8,2 ←	
		Serie 46,0	
		Totalt 178,0	

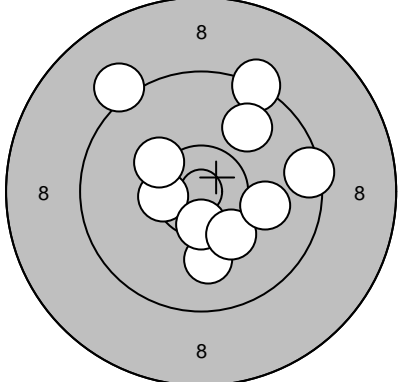
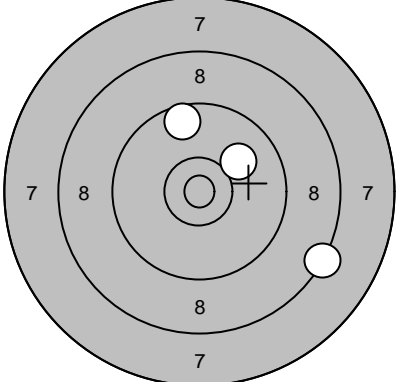
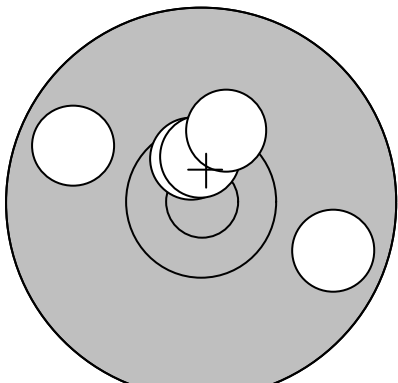
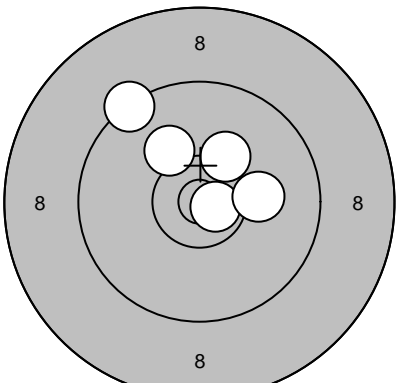
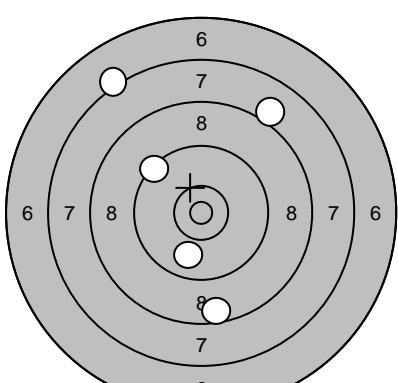
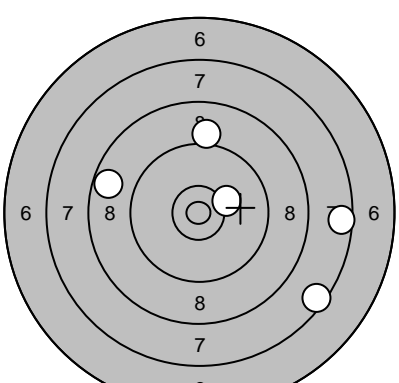
Skjutlag	Tavla		
3	7		
2007-07-16		Tavelträffen 2007	Ramselefors SKF
Prov		1: 10,0 ↓ 2: 9,5 → 3: 9,3 ↗ 4: 9,2 ↗ 5: 10,4* ← 6: 10,3 ↗ 7: 10,5* ↓ 8: 9,9 ↗ 9: 10,2 ↓ 10: 10,1 →	Prov 
	Serie 96,0		11: 9,6 ↑
	Totalt 0,0		12: 8,3 ↘
			13: 10,0 ↗
Serie		1: 10,6* ↑ 2: 10,6* ↑ 3: 9,8 → 4: 9,8 ↖ 5: 10,3* ↑	Serie 
	Serie 48,0		6: 10,7* →
	Totalt 48,0		7: 9,4 ↗
			8: 10,1 →
			9: 10,1 ↗
			10: 10,2 ↗
Serie		11: 8,1 ↗ 12: 7,2 ↗ 13: 9,4 ↗ 14: 9,9 ↓ 15: 8,6 ↓	Serie 
	Serie 41,0		16: 7,5 ↘
	Totalt 138,0		17: 7,6 →
			18: 10,2 →
			19: 8,7 ←
			20: 9,1 ↑
	Serie 41,0		Serie 27,0
	Totalt 179,0		Totalt 0,0

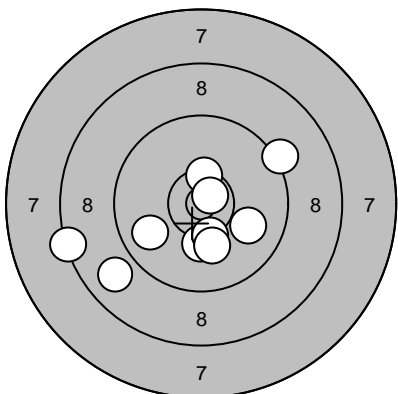
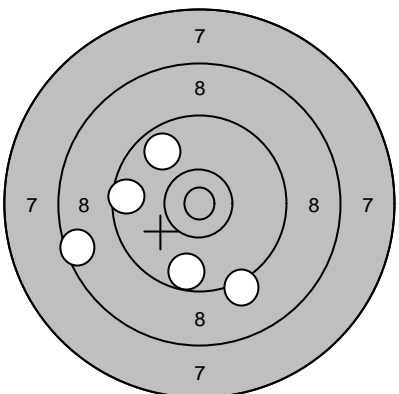
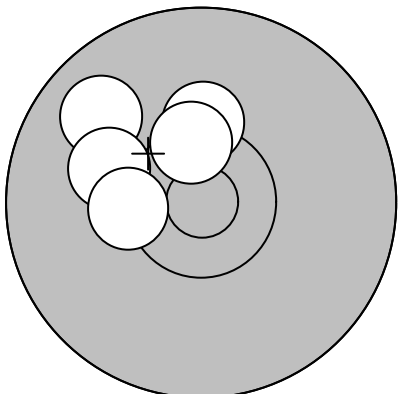
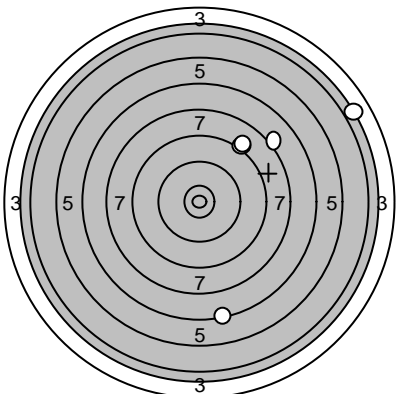
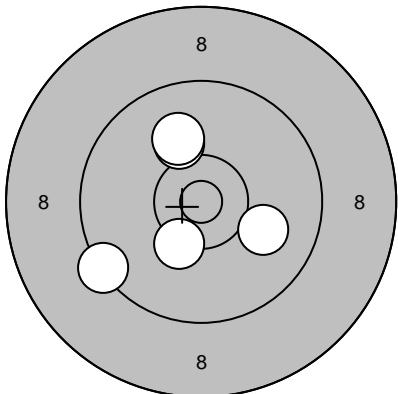
Skjutlag	Tavla		
3	9		
2007-07-16		Tavelträffen 2007	
Prov		Ramselefors SKF	
	1: 9,2 ↗		1: 9,6 ←
	2: 10,2 ↓		2: 9,2 ↓
	3: 10,3* ↓		3: 9,8 ↗
	4: 10,4* ↑		4: 9,7 ↓
	5: 10,1 ↓		5: 8,5 ←
	6: 9,9 ←		
	7: 8,4 ←		
	8: 10,0 →		
	9: 8,9 ↙		
	10: 10,7* ↗		
	Serie 94,0		Serie 44,0
	Totalt 0,0		Totalt 44,0
	6: 9,8 ↙		11: 4,0 ↗
	7: 10,1 ←		12: 8,2 ↗
	8: 10,3 ↑		13: 6,4 ↓
	9: 10,4* ↑		14: 7,2 ↗
	10: 10,3* ←		15: 8,1 ↗
	Serie 49,0		Serie 33,0
	Totalt 93,0		Totalt 126,0
	16: 10,1 ↗		
	17: 9,3 ↙		
	18: 10,0 ↗		
	19: 10,0 →		
	20: 10,3* ↙		
	Serie 49,0		
	Totalt 175,0		

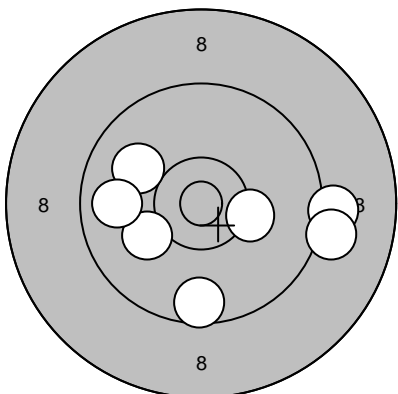
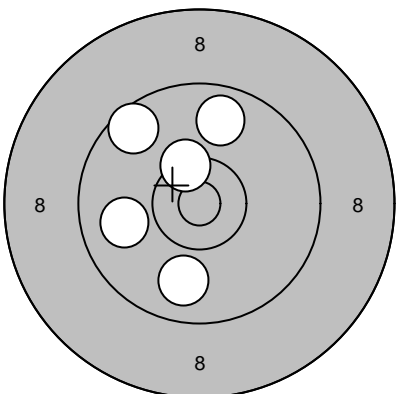
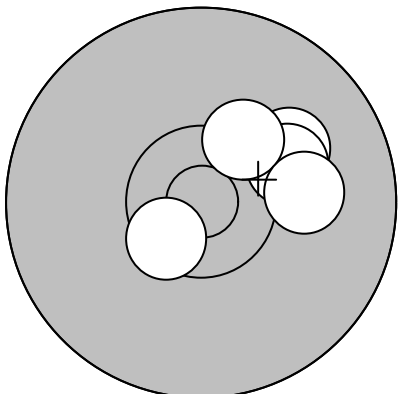
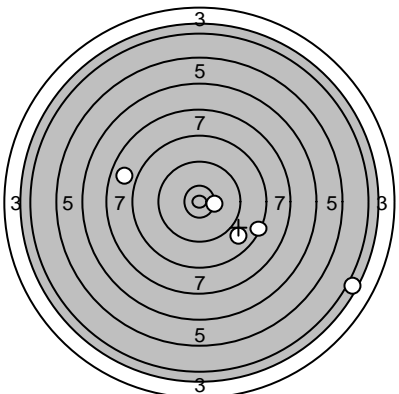
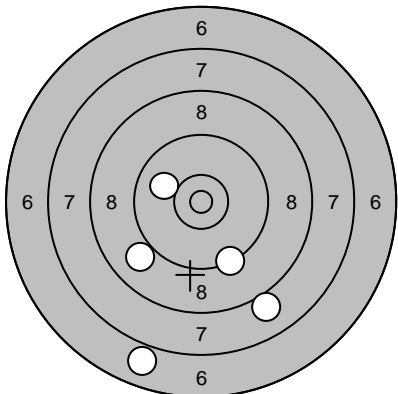
Skjutlag	Tavla		
3	11		
2007-07-16		Tavelträffen 2007	
Prov		Ramselefors SKF	
	1: 10,1 ↙		1: 9,8 ↗
	2: 10,0 ↖		2: 9,9 ↓
	3: 9,6 ↓		3: 10,4* ↗
	4: 9,2 →		4: 9,9 ←
	5: 10,3 →		5: 9,6 ↗
	6: 9,1 →		
	7: 9,8 ←		
	Serie 66,0		Serie 46,0
	Totalt 0,0		Totalt 46,0
	6: 10,1 →		11: 7,9 ←
	7: 10,2 →		12: 10,3* →
	8: 10,5* ↙		13: 4,1 ↘
	9: 10,3* ↗		14: 8,9 ↘
	10: 10,1 →		15: 8,4 ↘
	Serie 50,0		Serie 37,0
	Totalt 96,0		Totalt 133,0
	16: 8,0 ↘		
	17: 10,0 ↖		
	18: 9,4 ↘		
	19: 6,9 ↓		
	20: 9,0 ↙		
	Serie 42,0		
	Totalt 175,0		

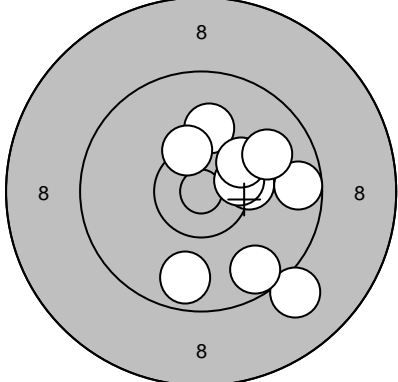
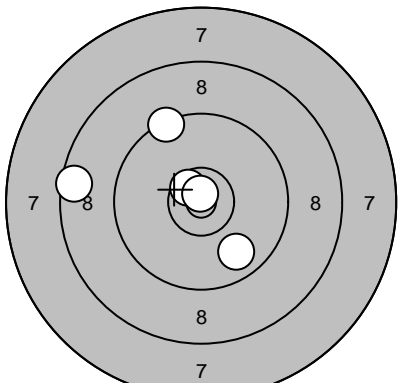
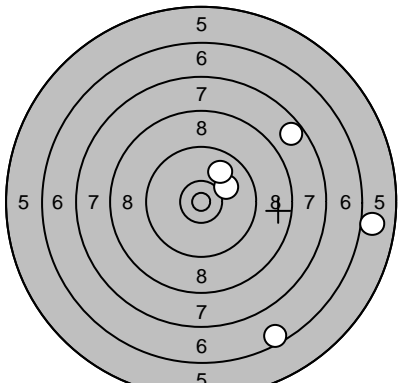
Skjutlag	Tavla		
3	12		
2007-07-16		Tavelträffen 2007	Ramselefors SKF
Prov		1: 9,1 ↘ 2: 9,8 ↓ 3: 10,3* → 4: 9,7 ↘ 5: 10,1 ↑ 6: 9,6 → 7: 10,4* ↑ 8: 10,4* → 9: 10,3 ↗ 10: 9,9 ↗	11: 9,4 ↘ 12: 9,9 ← 13: 10,7* ↗ 14: 9,0 → 15: 10,6* ↗
		Serie 95,0	Serie 47,0
		Totalt 0,0	Totalt 0,0
Serie		1: 10,6* ↗ 2: 9,8 ↘ 3: 9,4 ↑ 4: 10,8* ↑ 5: 8,6 ←	6: 10,3* ↗ 7: 9,7 ← 8: 10,2 ← 9: 10,2 ↓ 10: 10,0 ↗
		Serie 46,0	Serie 49,0
		Totalt 46,0	Totalt 95,0
Serie		11: 10,1 ↗ 12: 9,9 ↗ 13: 6,5 ↘ 14: 7,7 ↗ 15: 6,0 →	16: 9,5 ↘ 17: 10,0 ← 18: 8,4 → 19: 9,0 ← 20: 10,6* ←
		Serie 38,0	Serie 46,0
		Totalt 133,0	Totalt 179,0

2007-07-16

Tavelträffen 2007

Ramselefors SKF

Prov

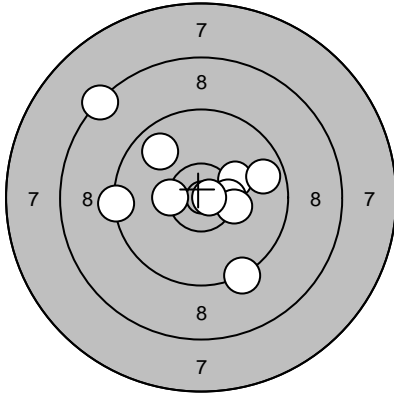

1: 8,4 ↖
 2: 9,3 ↓
 3: 10,4* ←
 4: 10,2 →
 5: 9,4 ←
 6: 9,8 ↗
 7: 10,4* →
 8: 9,7 →
 9: 10,3* →
 10: 10,8* →

Serie 94,0

Totalt 0,0

Prov

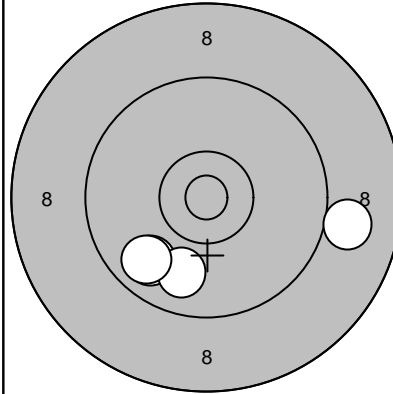

11: 9,8 ↙
 12: 9,9 ↓
 13: 9,0 →
 14: 9,8 ↙

Serie 36,0

Totalt 0,0

Serie

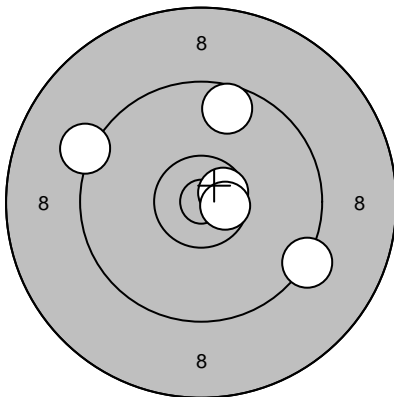

1: 10,6* →
 2: 9,3 ↘
 3: 9,6 ↑
 4: 9,2 ↖
 5: 10,6* →

Serie 47,0

Totalt 47,0

Serie

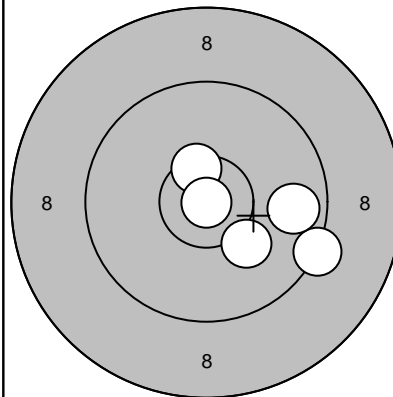

6: 10,2 ↘
 7: 10,5* ↑
 8: 9,3 ↘
 9: 10,9* ↓
 10: 9,8 →

Serie 48,0

Totalt 95,0

Serie

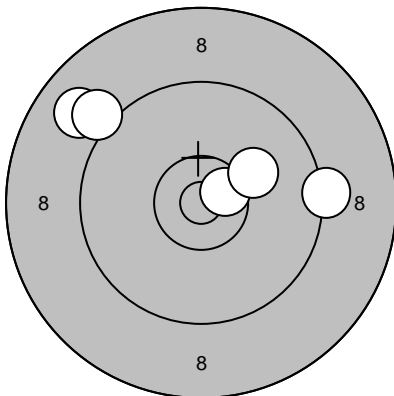

11: 10,6* →
 12: 9,2 →
 13: 10,1 →
 14: 8,9 ↗
 15: 9,1 ↗

Serie 46,0

Totalt 141,0

Serie

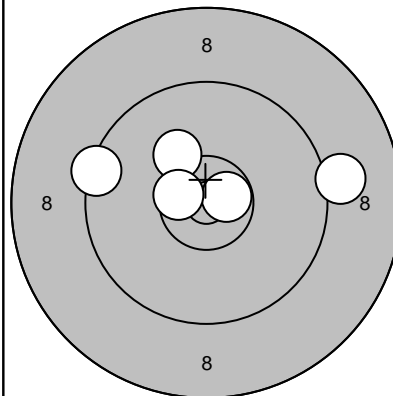

16: 9,4 ←
 17: 10,7* →
 18: 10,2 ↗
 19: 10,6* ←
 20: 9,1 →

Serie 48,0

Totalt 189,0

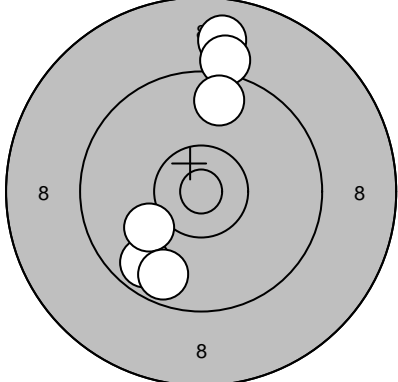
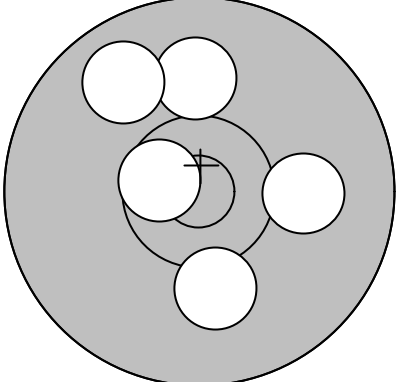
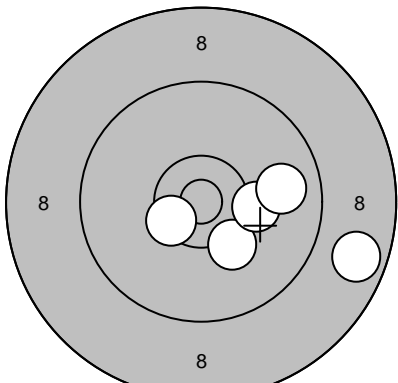
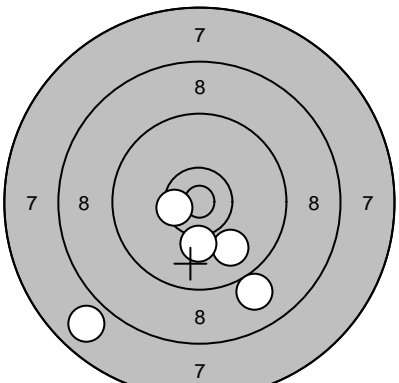
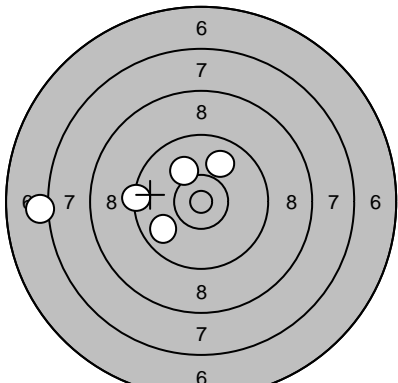
Skjutlag	Tavla		
3	14		
2007-07-16		Tavelträffen 2007	
Prov		Ramselefors SKF	
	1: 9,7 ↙		1: 10,1 ↓
	2: 8,9 ↑		2: 10,6* ←
	3: 10,1 ↙		3: 10,0 ↑
	4: 9,7 ↓		4: 10,1 →
	5: 9,1 ↑		5: 9,8 ↗
	6: 9,7 ↑		
	Serie 54,0		Serie 49,0
	Totalt 0,0		Totalt 49,0
	6: 10,2 ↓		11: 9,0 ↓
	7: 8,7 →		12: 7,8 ↙
	8: 10,2 →		13: 9,9 ↓
	9: 9,9 →		14: 10,2 ↓
	10: 10,5* ↙		15: 10,5* ←
	Serie 47,0		Serie 45,0
	Totalt 96,0		Totalt 141,0
	16: 10,1 ↖		
	17: 9,9 ↗		
	18: 7,1 ←		
	19: 9,4 ←		
	20: 9,8 ↙		
	Serie 44,0		
	Totalt 185,0		

2007-07-16

Tavelträffen 2007

Ramselefors SKF

Prov

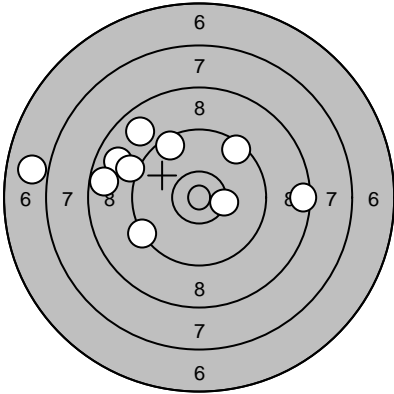

- 1: 8,8 ↖
- 2: 8,7 ←
- 3: 6,9 ←
- 4: 9,6 ↗
- 5: 9,4 ↖
- 6: 9,2 ↗
- 7: 8,9 ↗
- 8: 10,3* →
- 9: 8,5 →
- 10: 9,5 ↗

Serie 84,0
Totalt 0,0

Prov

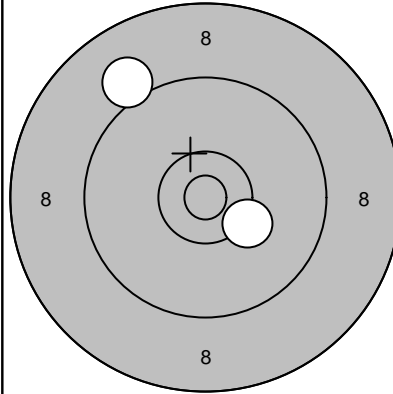

- 11: 9,1 ↗
- 12: 10,3 ↘

Serie 19,0
Totalt 0,0

Serie

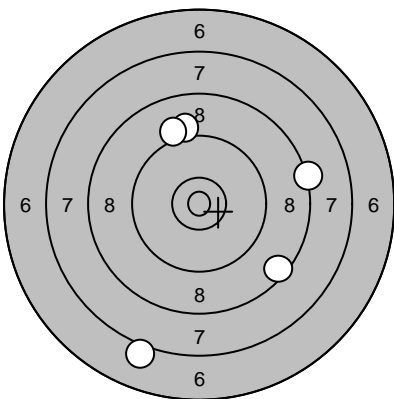

- 1: 8,5 ↘
- 2: 8,3 →
- 3: 9,1 ↗
- 4: 9,1 ↗
- 5: 7,1 ↘

Serie 41,0
Totalt 41,0

Serie

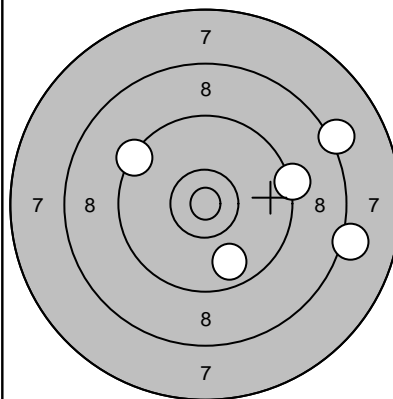

- 6: 8,2 →
- 7: 9,8 ↘
- 8: 9,4 ↗
- 9: 9,3 →
- 10: 8,2 ↗

Serie 43,0
Totalt 84,0

Serie

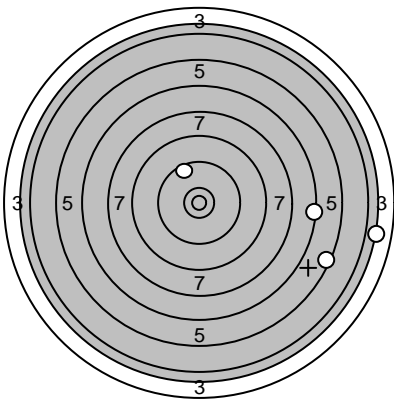

- 11: 0,0 ↘
- 12: 3,9 →
- 13: 9,6 ↗
- 14: 6,4 →
- 15: 5,5 ↘

Serie 23,0
Totalt 107,0

Serie

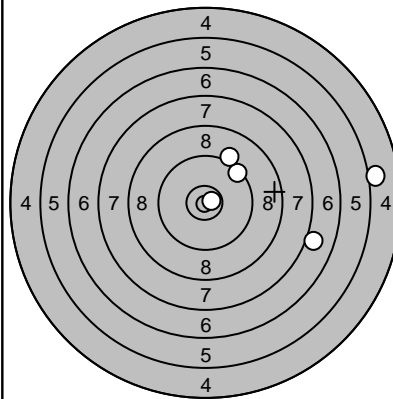

- 16: 9,5 ↗
- 17: 5,1 →
- 18: 7,1 ↘
- 19: 10,7* →
- 20: 9,2 ↗

Serie 40,0
Totalt 147,0

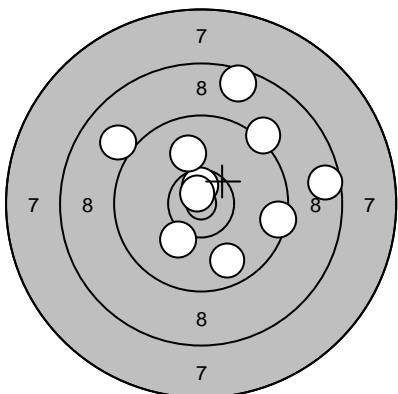
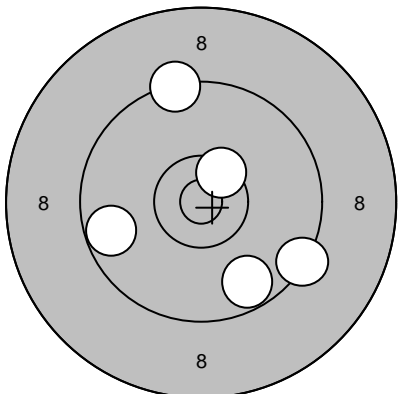
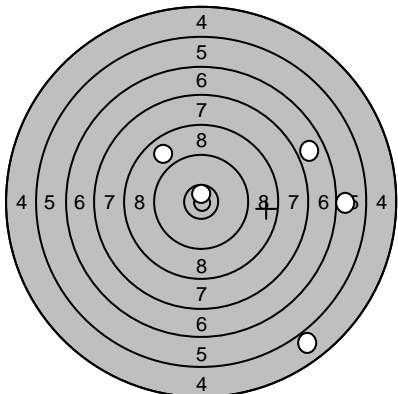
Skjutlag	Tavla		
3	16		
2007-07-16		Tavelträffen 2007	Ramselefors SKF
Prov		1: 9,0 ↖ 2: 10,6* ↑ 3: 9,8 ↓ 4: 10,2 ↙ 5: 8,6 → 6: 8,6 ↑ 7: 9,5 → 8: 9,2 ↗ 9: 10,0 ↑ 10: 10,8* ↑	11: 9,3 ↗
		Serie 92,0	Serie 9,0
		Totalt 0,0	Totalt 0,0
Serie		1: 10,5* ↗ 2: 9,4 ↘ 3: 9,7 ↓ 4: 9,3 ↑ 5: 9,7 ←	6: 10,6* ↓ 7: 10,5* ↖ 8: 8,5 ↘ 9: 9,8 ↑ 10: 10,1 ↙
		Serie 46,0	Serie 47,0
		Totalt 46,0	Totalt 93,0
Serie		11: 6,1 → 12: 4,9 ↓ 13: 10,7* ↑ 14: 6,9 → 15: 8,9 ↖	16: 8,6 ↑ 17: 8,3 ↗ 18: 10,5* ↗ 19: 8,9 ↑ 20: 10,3* →
		Serie 34,0	Serie 44,0
		Totalt 127,0	Totalt 171,0

2007-07-16

Tavelträffen 2007

Ramselefors SKF

Prov

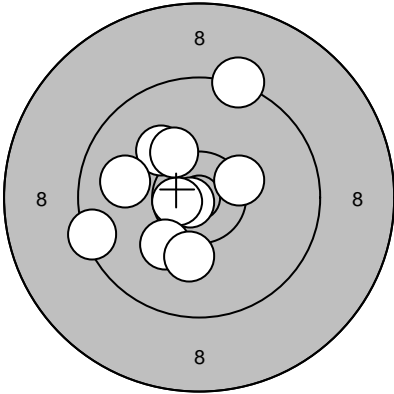

1: 9,3 ↗
 2: 10,8* ↖
 3: 10,1 ↗
 4: 9,9 ↖
 5: 10,6* ↖
 6: 9,4 ↖
 7: 10,4* ↗
 8: 10,3 ↗
 9: 10,2 ↖
 10: 10,1 ↓

Serie 97,0

Totalt 0,0

Prov

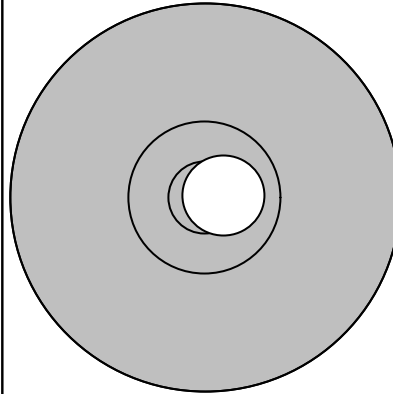

11: 10,8* →

Serie 10,0

Totalt 0,0

Serie

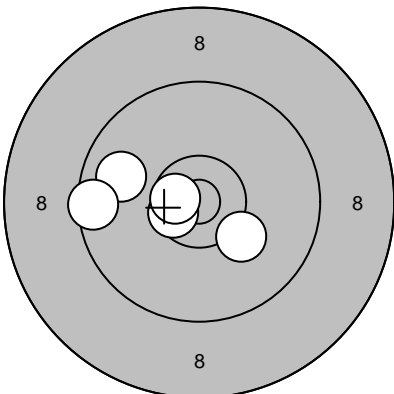

1: 10,6* ↖
 2: 9,9 ↖
 3: 9,5 ↖
 4: 10,6* ↖
 5: 10,2 ↘

Serie 48,0

Totalt 48,0

Serie

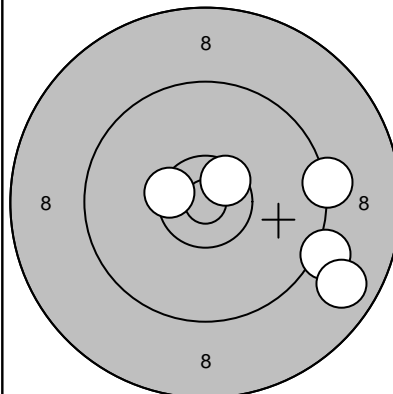

6: 9,3 →
 7: 9,2 →
 8: 8,8 ↘
 9: 10,6* ↗
 10: 10,5* ↖

Serie 46,0

Totalt 94,0

Serie

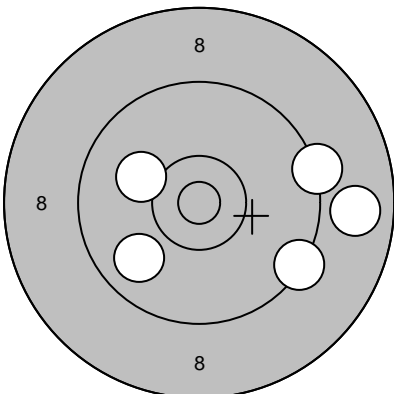

11: 9,4 ↘
 12: 9,8 ↖
 13: 8,8 →
 14: 9,3 →
 15: 10,1 ↖

Serie 45,0

Totalt 139,0

Serie

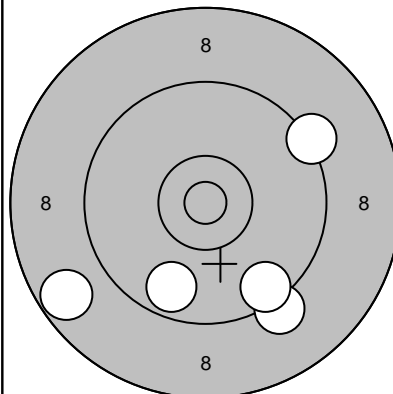

16: 9,3 ↗
 17: 9,7 ↓
 18: 9,2 ↘
 19: 8,7 ↖
 20: 9,5 ↘

Serie 44,0

Totalt 183,0

2007-07-16

Tavelträffen 2007

Ramselefors SKF

Prov

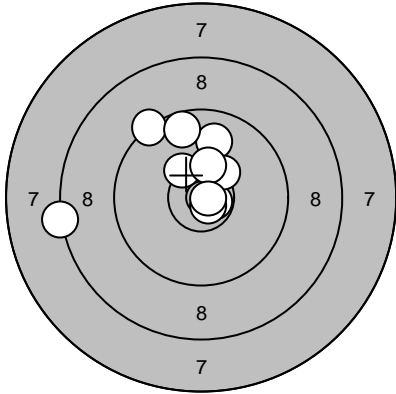

- 1: 8,3 ←
- 2: 9,9 ↑
- 3: 9,3 ↗
- 4: 10,7* →
- 5: 10,7* ↘
- 6: 10,3* ↗
- 7: 10,3* ↗
- 8: 10,3* ↑
- 9: 10,8* →
- 10: 9,6 ↑

Serie 95,0
Totalt 0,0

Prov

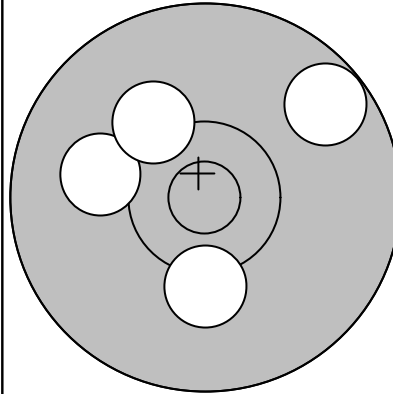

- 11: 10,0 ←
- 12: 9,7 ↗
- 13: 10,2 ↓
- 14: 10,2 ↗

Serie 39,0
Totalt 0,0

Serie

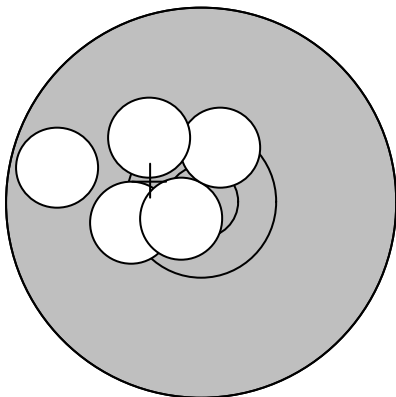

- 1: 10,3* ←
- 2: 10,7* ↘
- 3: 9,7 ←
- 4: 10,5* ↑
- 5: 10,3 ↗

Serie 49,0
Totalt 49,0

Serie

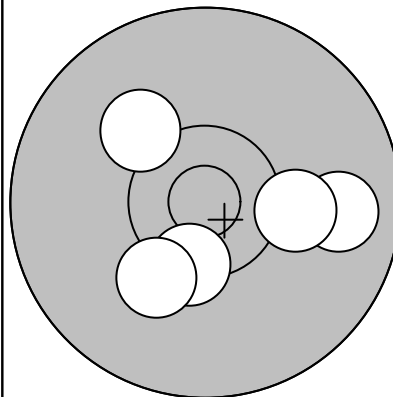

- 6: 10,1 ↗
- 7: 10,4* ↓
- 8: 10,2 ↓
- 9: 9,8 →
- 10: 10,2 →

Serie 49,0
Totalt 98,0

Serie

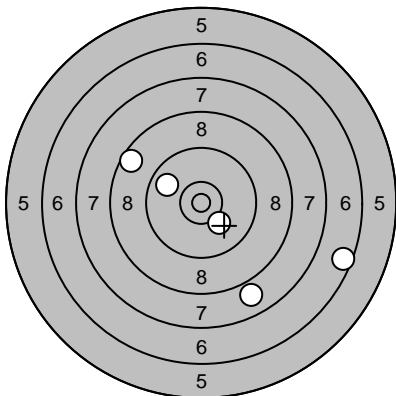

- 11: 7,9 ↓
- 12: 6,5 →
- 13: 10,2 ↘
- 14: 9,8 ↗
- 15: 8,6 ↗

Serie 40,0
Totalt 138,0

Serie

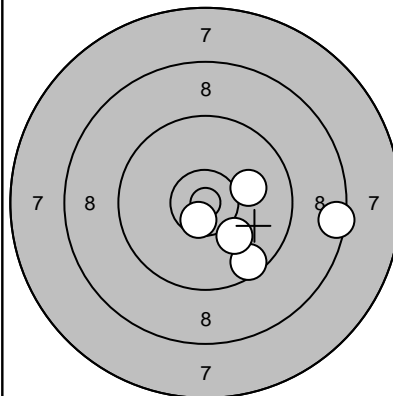

- 16: 10,1 →
- 17: 8,5 →
- 18: 9,6 ↓
- 19: 10,6* ↓
- 20: 10,1 ↓

Serie 47,0
Totalt 185,0

2007-07-16

Tavelträffen 2007

Ramselefors SKF

Prov

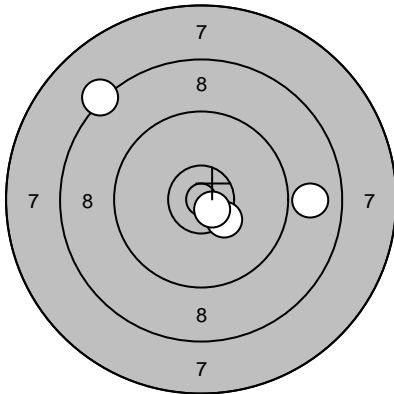

1: 8,3 ↗
 2: 10,4* ↓
 3: 8,9 →
 4: 10,7* ↓

Serie

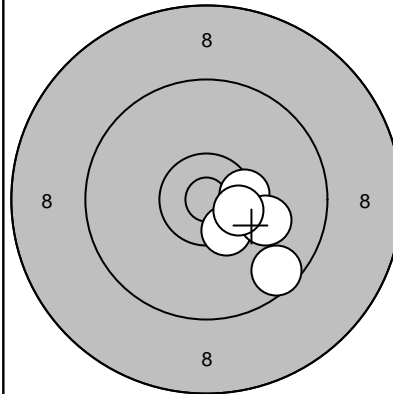

1: 9,6 ↓
 2: 10,4* ↓
 3: 10,4* →
 4: 10,1 →
 5: 10,5* →

Serie 36,0

Totalt 0,0

Serie 49,0

Totalt 49,0

Serie

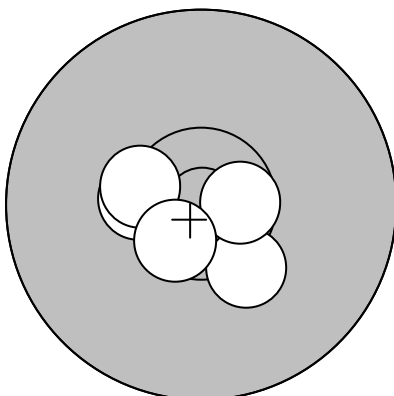

6: 10,3* ↓
 7: 10,4* ←
 8: 10,6* →
 9: 10,4* ←
 10: 10,6* ↓

Serie

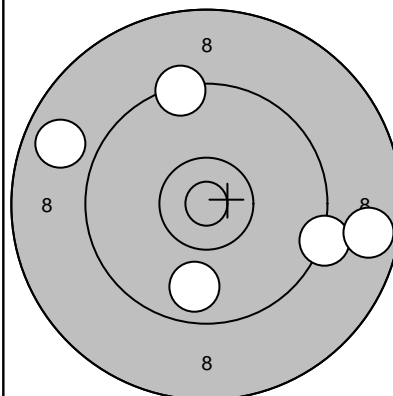

11: 9,4 ↑
 12: 9,8 ↓
 13: 8,8 ↖
 14: 9,3 →
 15: 8,7 →

Serie 50,0

Totalt 99,0

Serie 43,0

Totalt 142,0

Serie

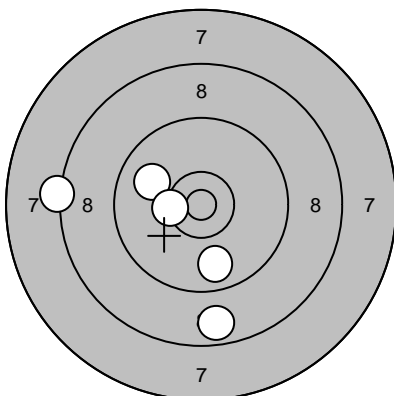

16: 8,3 ←
 17: 8,7 ↓
 18: 10,0 ↗
 19: 10,4* ←
 20: 9,8 ↓

Serie 45,0

Totalt 187,0

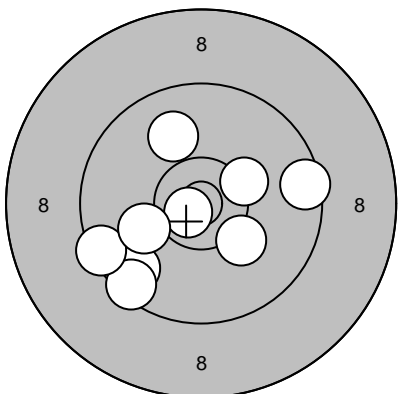
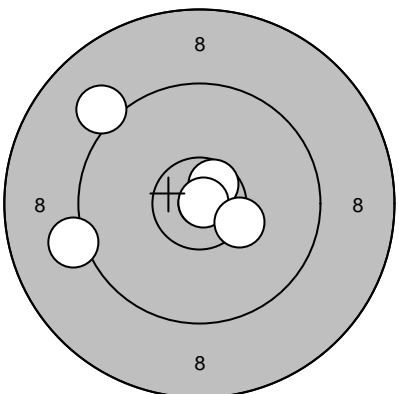
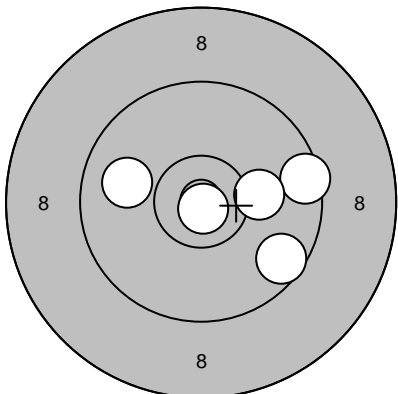
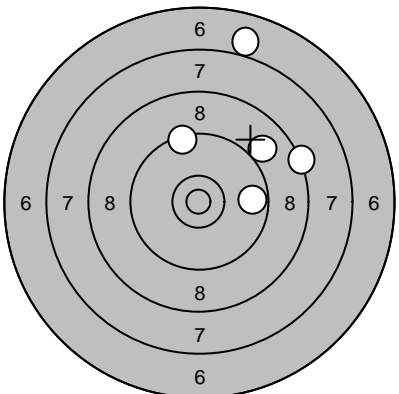
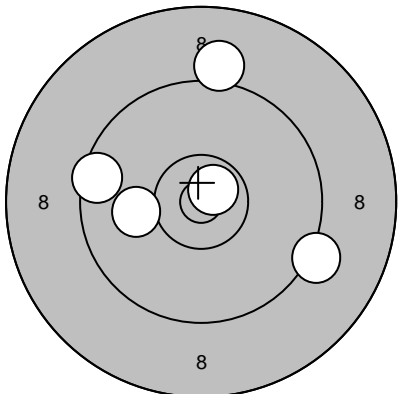
Skjutlag	Tavla		
3	20		
2007-07-16		Tavelträffen 2007	
Prov		Ramselefors SKF	
	1: 9,7 ↙		1: 9,1 ↖
	2: 9,5 ↙		2: 9,2 ←
	3: 9,5 ←		3: 10,6* ↗
	4: 9,5 →		4: 10,9* →
	5: 10,0 ↑		5: 10,3* ↘
	6: 10,3* →		
	7: 10,2 ↘		
	8: 10,7* ↙		
	9: 10,1 ←		
	Serie 86,0		Serie 48,0
	Totalt 0,0		Totalt 48,0
	6: 9,9 ←		11: 8,3 →
	7: 9,5 →		12: 9,5 ↑
	8: 10,8* ↓		13: 9,0 ↗
	9: 9,6 ↘		14: 9,7 →
	10: 10,2 →		15: 7,0 ↑
	Serie 47,0		Serie 42,0
	Totalt 95,0		Totalt 137,0
	16: 9,5 ←		
	17: 10,7* ↗		
	18: 9,2 ↘		
	19: 9,1 ↑		
	20: 10,1 ←		
	Serie 47,0		
	Totalt 184,0		

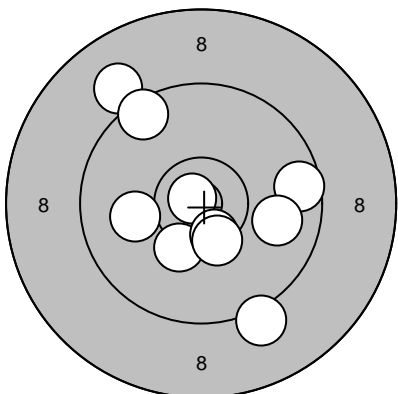
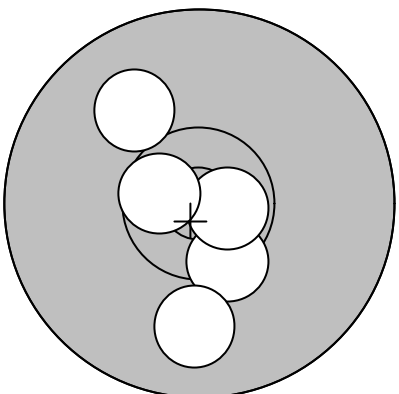
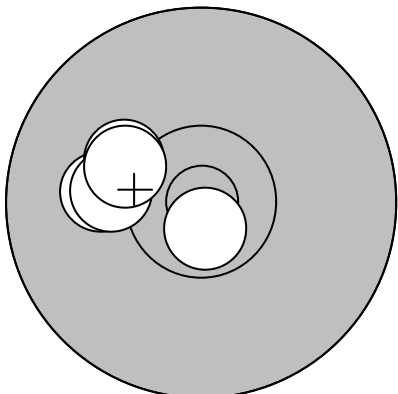
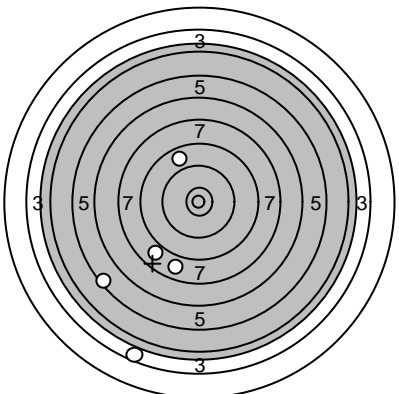
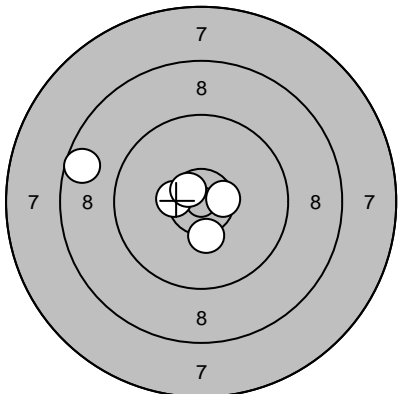
Skjutlag	Tavla		
3	21		
2007-07-16		Tavelträffen 2007	Ramselefors SKF
Prov		1: 9,0 ↗ 2: 9,5 ↗ 3: 9,6 → 4: 10,0 ← 5: 10,3 ↓ 6: 10,8* ↗ 7: 10,5* ↓ 8: 10,4* ↓ 9: 9,2 ↓ 10: 9,9 →	Serie  1: 10,4* ↓ 2: 9,9 ↓ 3: 10,0 ↗ 4: 10,7* → 5: 10,6* ←
		Serie 95,0	Serie 49,0
		Totalt 0,0	Totalt 49,0
Serie		6: 10,1 ← 7: 10,7* ↓ 8: 10,2 ↗ 9: 10,2 ← 10: 10,3 ↗	Serie  11: 5,5 ↙ 12: 8,1 ↙ 13: 8,9 ↗ 14: 7,9 ↓ 15: 3,6 ↓
		Serie 50,0	Serie 31,0
		Totalt 99,0	Totalt 130,0
Serie		16: 10,4* ← 17: 10,3* ↓ 18: 10,6* ↗ 19: 8,6 ← 20: 10,5* →	
		Serie 48,0	
		Totalt 178,0	

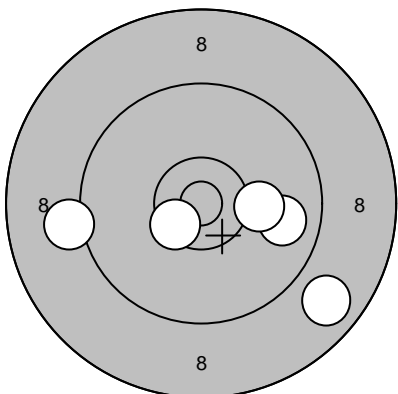
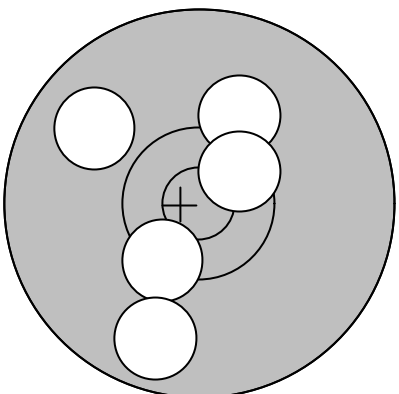
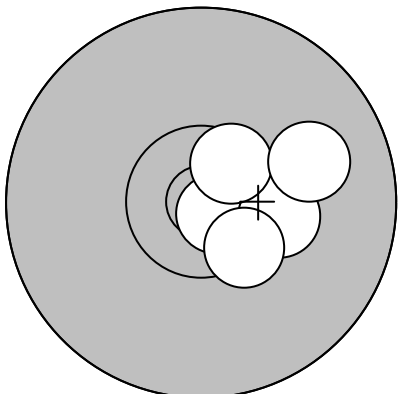
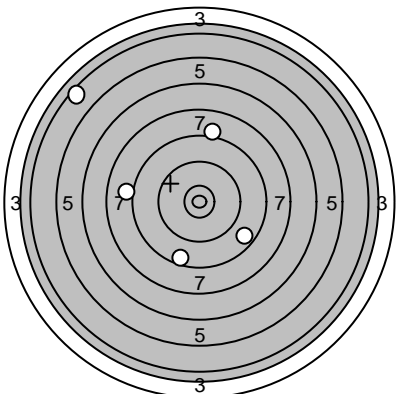
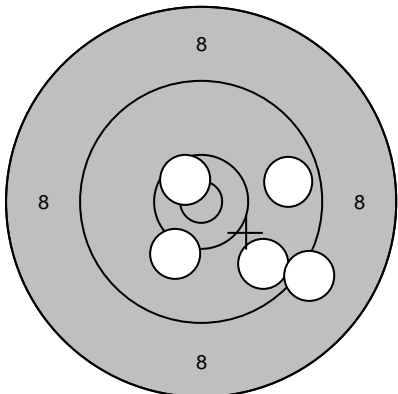
Skjutlag	Tavla		
3	22		
2007-07-16		Tavelträffen 2007	
Prov		Ramselefors SKF	
	1: 9,8 →		1: 10,4* ↓
	2: 9,1 ←		2: 10,1 ↑
	3: 8,8 ↓		3: 9,9 ←
	4: 10,5* ←		4: 10,5* ↗
	5: 10,2 →		5: 9,8 ↓
	Serie 46,0		Serie 48,0
	Totalt 0,0		Totalt 48,0
	6: 10,8* ↓		11: 4,6 ↖
	7: 10,3 →		12: 8,1 ↑
	8: 10,5* ↗		13: 8,1 ←
	9: 10,4* ↓		14: 8,6 ↓
	10: 10,0 →		15: 8,7 ↘
	Serie 50,0		Serie 36,0
	Totalt 98,0		Totalt 134,0
	16: 9,8 ↓		
	17: 10,6* ↗		
	18: 9,7 →		
	19: 9,2 ↓		
	20: 10,2 ↓		
	Serie 47,0		
	Totalt 181,0		

2007-07-16

Tavelträffen 2007

Ramselefors SKF

Prov

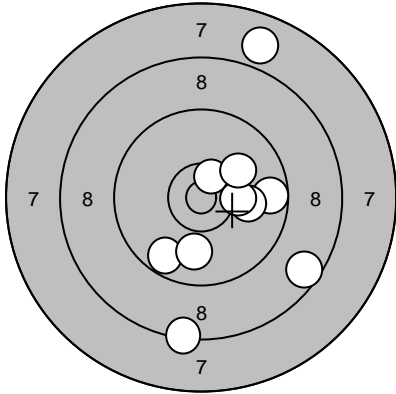

- 1: 7,9 ↗
- 2: 9,7 ↘
- 3: 9,9 ↘
- 4: 8,4 ↘
- 5: 10,5* ↗
- 6: 8,6 ↘
- 7: 9,6 →
- 8: 10,1 →
- 9: 10,2 →
- 10: 10,1 ↗

Serie 90,0
Totalt 0,0

Prov

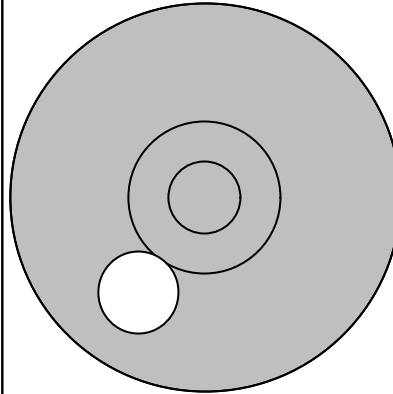

11: 10,0 ↘

Serie 10,0
Totalt 0,0

Serie

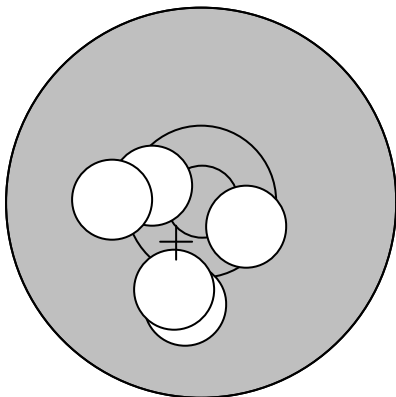

- 1: 10,1 ↘
- 2: 10,2 ↘
- 3: 10,5* ←
- 4: 10,2 ←
- 5: 10,5* ↘

Serie 50,0
Totalt 50,0

Serie

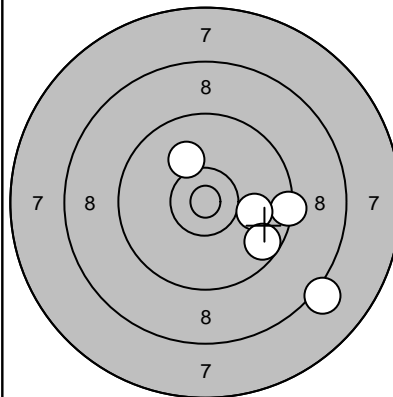

- 6: 8,2 ↘
- 7: 9,4 →
- 8: 10,0 →
- 9: 9,6 ↘
- 10: 10,1 ↗

Serie 46,0
Totalt 96,0

Serie

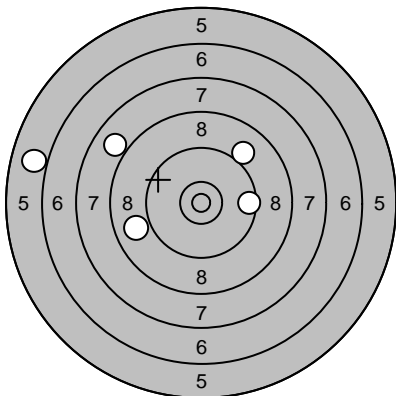

- 11: 6,0 ←
- 12: 9,1 ↗
- 13: 9,5 →
- 14: 8,9 ←
- 15: 8,0 ↗

Serie 40,0
Totalt 136,0

Serie

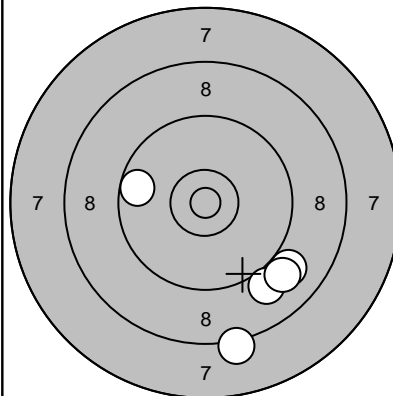

- 16: 9,0 ↘
- 17: 9,0 ↘
- 18: 8,2 ↘
- 19: 9,0 ↘
- 20: 9,7 ←

Serie 44,0
Totalt 180,0

2007-07-16

Tavelträffen 2007

Ramselefors SKF

Prov

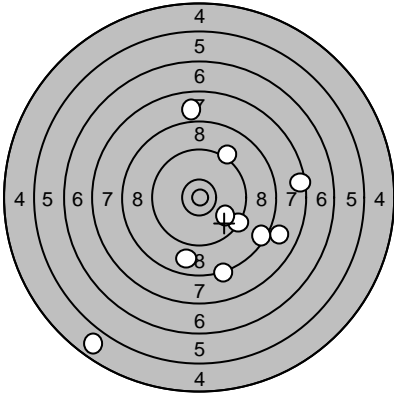

- 1: 9,2 ↗
- 2: 4,8 ↘
- 3: 9,4 →
- 4: 8,0 ↑
- 5: 7,5 →
- 6: 8,8 ↘
- 7: 8,2 ↘
- 8: 7,9 →
- 9: 8,5 →
- 10: 9,9 ↘

Serie 77,0
Totalt 0,0

Prov

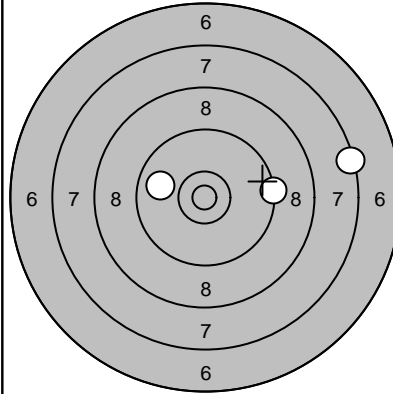

- 11: 9,3 →
- 12: 7,4 →
- 13: 9,9 ←

Serie 25,0
Totalt 0,0

Serie

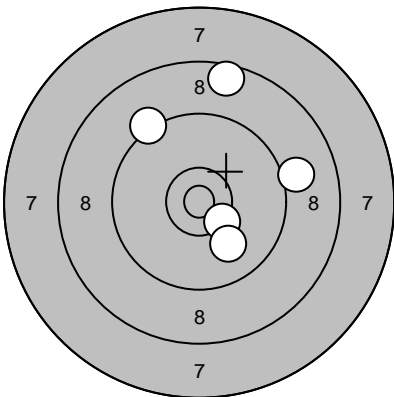

- 1: 9,1 →
- 2: 10,4* ↘
- 3: 8,6 ↑
- 4: 10,0 ↘
- 5: 9,2 ↗

Serie 46,0
Totalt 46,0

Serie

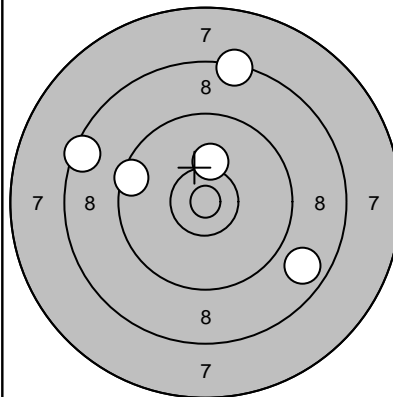

- 6: 10,2 ↑
- 7: 8,4 ↑
- 8: 8,5 ←
- 9: 9,5 ←
- 10: 8,8 ↘

Serie 43,0
Totalt 89,0

Serie

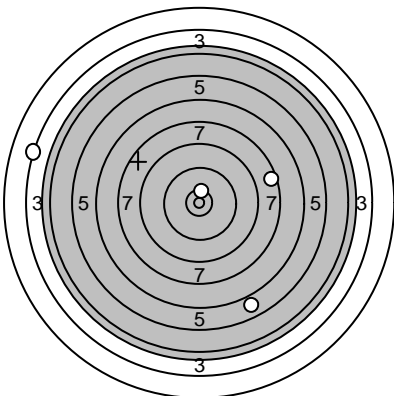

- 11: 7,6 →
- 12: 5,9 ↘
- 13: 0,0 ↗
- 14: 10,4* ↑
- 15: 3,3 ←

Serie 25,0
Totalt 114,0

Serie

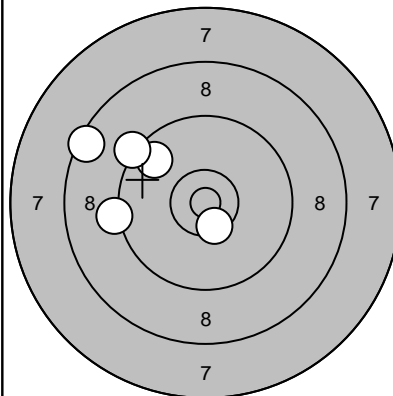

- 16: 8,5 ←
- 17: 10,5* ↘
- 18: 9,7 ↗
- 19: 9,2 ←
- 20: 9,3 ↗

Serie 45,0
Totalt 159,0

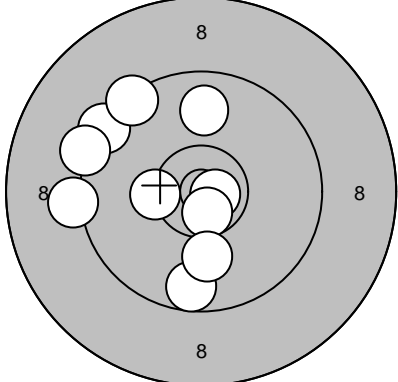
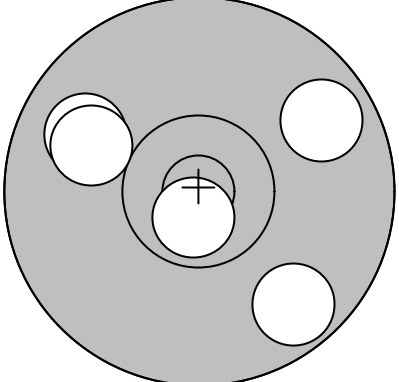
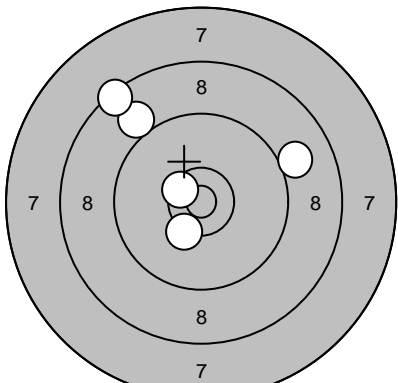
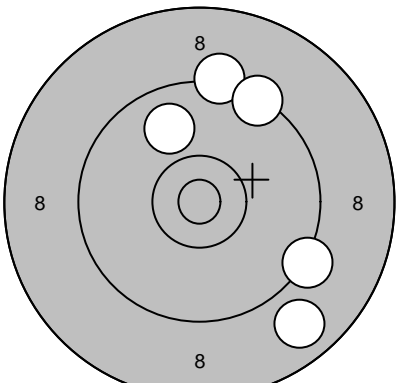
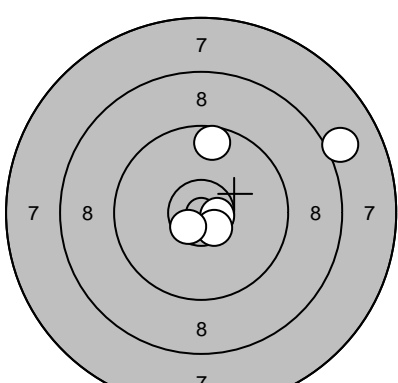
Skjutlag	Tavla	Roger Andersson	
4	1		
		S 3	
2007-07-16	Tavelträffen 2007	Ramselefors SKF	
Prov		1: 10,3* ← 2: 10,7* → 3: 10,6* ↓ 4: 9,6 ↓ 5: 9,2 ← 6: 10,1 ↓ 7: 9,4 ↗ 8: 9,4 ↗ 9: 9,3 ↖ 10: 9,9 ↑	Serie  1: 9,7 ↓ 2: 10,7* ↓ 3: 9,9 ↖ 4: 10,0 ↖ 5: 9,8 ↗
		Serie 94,0	Serie 47,0
		Totalt 0,0	Totalt 47,0
Serie		6: 9,0 → 7: 10,5* ↖ 8: 9,0 ↗ 9: 10,3* ↓ 10: 8,5 ↗	Serie  11: 9,9 ↑ 12: 8,8 ↓ 13: 9,3 ↑ 14: 9,4 ↗ 15: 9,3 ↘
		Serie 46,0	Serie 44,0
		Totalt 93,0	Totalt 137,0
Serie		16: 8,1 ↗ 17: 10,6* → 18: 9,6 ↑ 19: 10,6* ↓ 20: 10,6* ↙	
		Serie 47,0	
		Totalt 184,0	

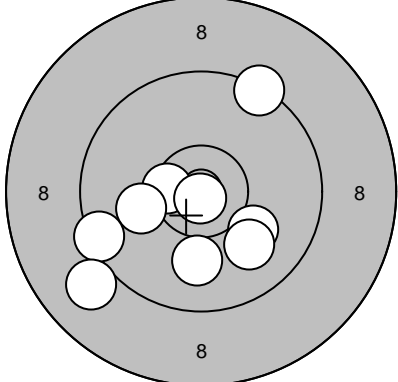
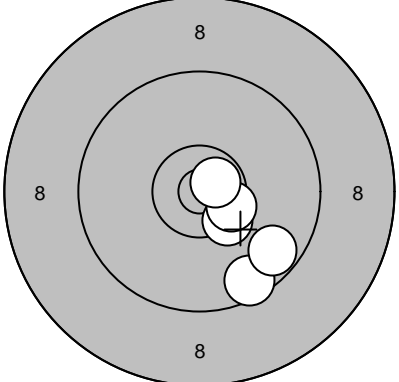
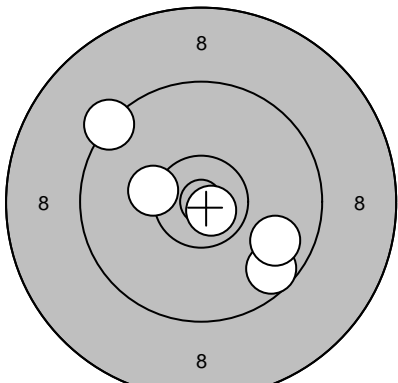
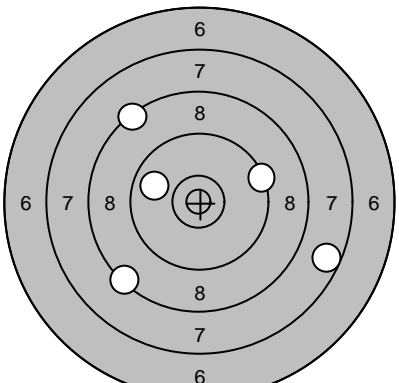
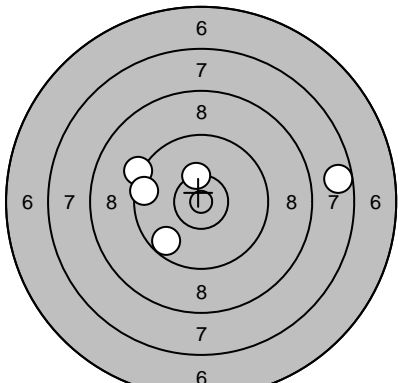
Skjutlag	Tavla	Niklas Öhman	
4	2	S 3	
2007-07-16	Tavelträffen 2007	Ramselefors SKF	
Prov		1: 9,4 ↗ 2: 10,5* ← 3: 10,1 ← 4: 9,4 ← 5: 10,0 ↓ 6: 9,0 ← 7: 10,9* ↓ 8: 10,1 → 9: 10,0 ↓	Serie 
		Serie 87,0 Totalt 0,0	1: 10,4* ↓ 2: 9,6 ↓ 3: 10,5* ↓ 4: 10,7* ↗ 5: 9,7 ↓ Serie 48,0 Totalt 48,0
Serie		6: 9,6 ↓ 7: 10,3* ← 8: 9,8 → 9: 9,3 ↗ 10: 10,8* ↓	Serie 
		Serie 47,0 Totalt 95,0	11: 7,6 → 12: 9,3 → 13: 8,4 ↓ 14: 9,8 ← 15: 8,4 ↗ Serie 41,0 Totalt 136,0
Serie		16: 9,3 ← 17: 9,5 ← 18: 9,7 ↓ 19: 7,6 → 20: 10,3* ↑	
		Serie 44,0 Totalt 180,0	

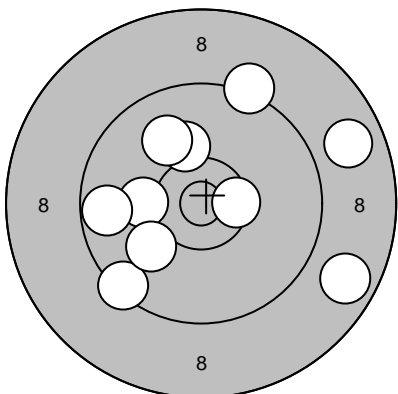
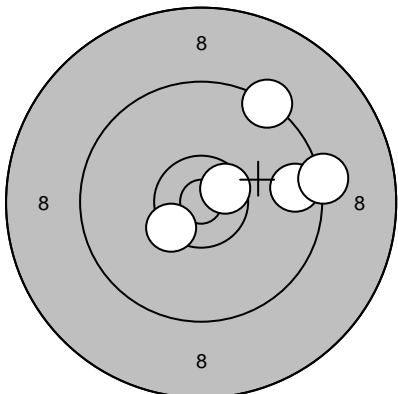
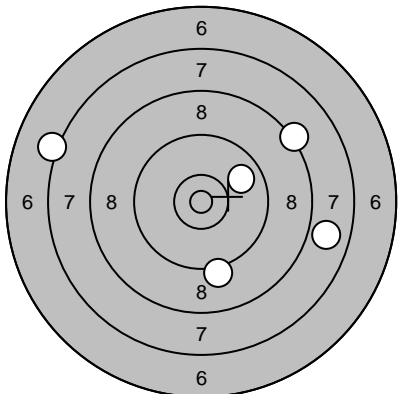
Skjutlag	Tavla	Anders Petersson	
4	3	P 7	
2007-07-16	Tavelträffen 2007	Ramselefors SKF	
Prov		1: 10,2 ↗ 2: 10,0 ↗ 3: 9,3 ↗ 4: 8,8 → 5: 10,5* → 6: 8,8 → 7: 10,2 ← 8: 9,7 ← 9: 9,4 ↘ 10: 10,1 ↘	11: 9,7 ← 12: 10,1 ↑ 13: 10,1 ← 14: 9,8 ↘
	Serie 93,0		Serie 38,0
	Totalt 0,0		Totalt 0,0
Serie		1: 9,7 → 2: 10,6* → 3: 9,3 ↗ 4: 9,3 → 5: 10,4* ↘	6: 10,3* ↑ 7: 10,0 ← 8: 8,3 ← 9: 10,2 ↓ 10: 9,9 ↗
	Serie 47,0		Serie 47,0
	Totalt 47,0		Totalt 94,0
Serie		11: 7,2 ← 12: 8,3 ↗ 13: 9,2 ↓ 14: 7,9 → 15: 9,9 ↗	16: 7,1 ← 17: 8,5 → 18: 9,4 ← 19: 9,4 ← 20: 8,7 ←
	Serie 40,0		Serie 41,0
	Totalt 134,0		Totalt 175,0

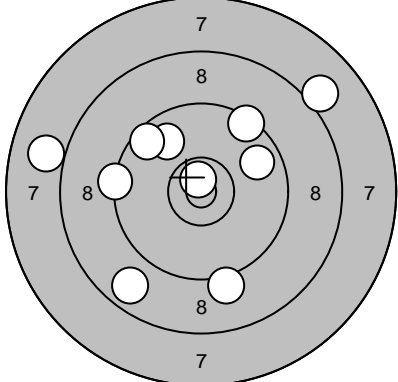
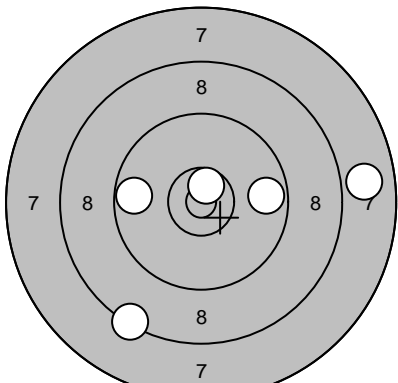
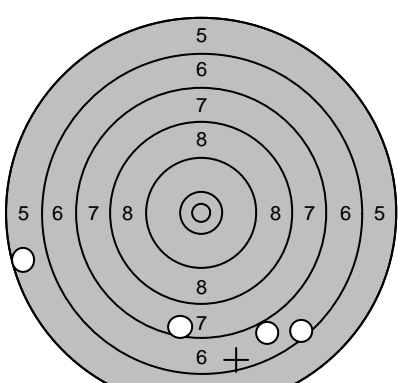
Skjutlag	Tavla	Håkan Engman	
4	4	Lindesberg	
2007-07-16	Tavelträffen 2007	Ramselefors SKF	
Prov		1: 8,8 ↙ 2: 8,1 ↗ 3: 9,8 → 4: 9,8 ↗ 5: 10,7* ↗ 6: 8,0 ← 7: 9,3 ← 8: 9,1 ↓ 9: 9,6 ↗ 10: 9,4 ↗	11: 10,3 ↖ 12: 9,3 →
	Serie 88,0		Serie 19,0
	Totalt 0,0		Totalt 0,0
Serie		1: 7,9 → 2: 9,7 → 3: 9,7 ← 4: 8,3 ↓ 5: 10,6* ↑	6: 9,4 ← 7: 10,4* ↓ 8: 9,8 ↓ 9: 9,9 ← 10: 9,8 ↓
	Serie 43,0		Serie 46,0
	Totalt 43,0		Totalt 89,0
Serie		11: 0,0 ↓ 12: 5,7 ← 13: 7,6 ↓ 14: 7,0 ↓ 15: 6,5 ↓	16: 8,7 ↓ 17: 8,7 ↘ 18: 8,4 ← 19: 10,0 ↓ 20: 8,9 →
	Serie 25,0		Serie 42,0
	Totalt 114,0		Totalt 156,0

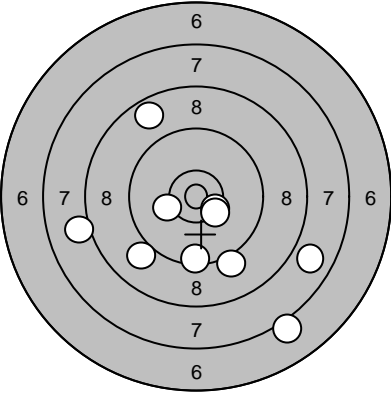
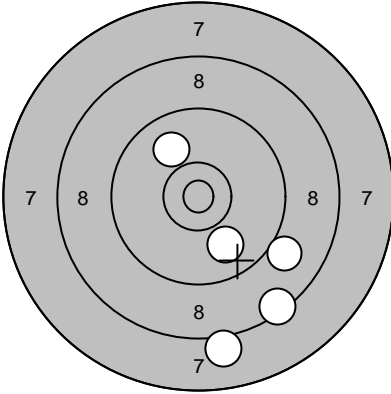
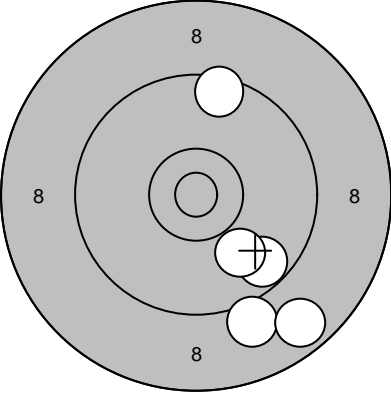
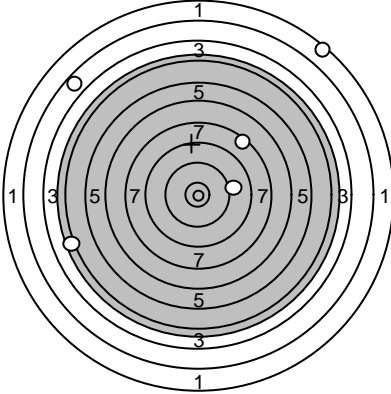
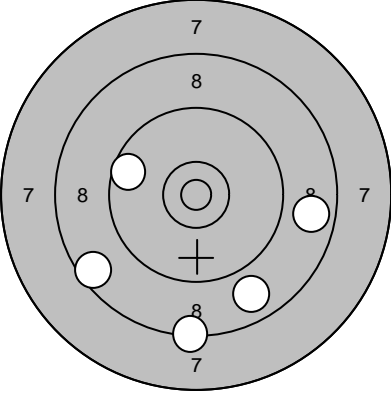
Skjutlag	Tavla	Bertil Ruisniemi	
4	5		
		Övertorneå	
2007-07-16	Tavelträffen 2007	Ramselefors SKF	
Prov		1: 8,1 ← 2: 9,0 ↘ 3: 7,9 → 4: 9,1 ↘ 5: 7,2 ↘ 6: 9,5 ↓ 7: 10,2 ← 8: 8,7 ↗ 9: 10,4* ↘ 10: 10,4* ↘ Serie 87,0 Totalt 0,0	Serie  1: 8,4 ↘ 2: 9,0 ↘ 3: 8,1 ↓ 4: 9,9 ↘ 5: 9,9 ↗ Serie 43,0 Totalt 43,0
Serie		6: 9,7 ↘ 7: 9,1 ↘ 8: 8,7 ↘ 9: 10,0 ↘ 10: 9,5 ↗ Serie 45,0 Totalt 88,0	Serie  11: 9,2 → 12: 2,9 ↖ 13: 1,6 ↗ 14: 7,6 ↗ 15: 4,3 ← Serie 23,0 Totalt 111,0
Serie		16: 9,6 ← 17: 8,8 ↘ 18: 8,4 ↓ 19: 8,8 → 20: 8,6 ← Serie 41,0 Totalt 152,0	