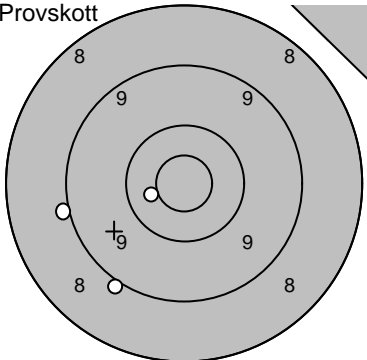
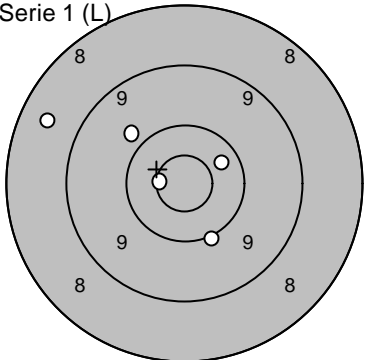
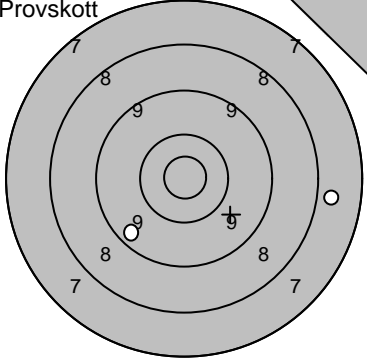
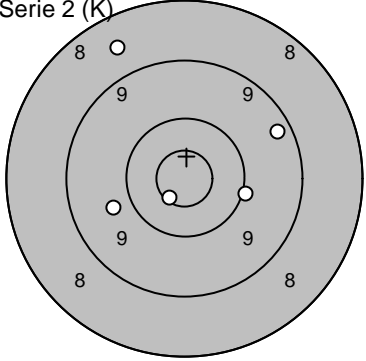
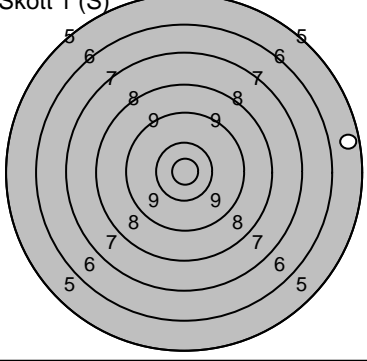
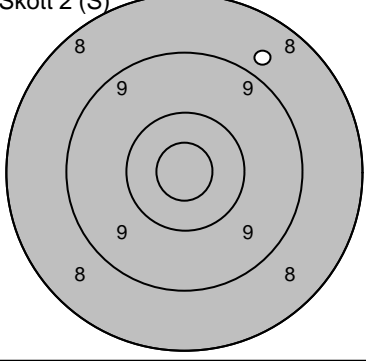
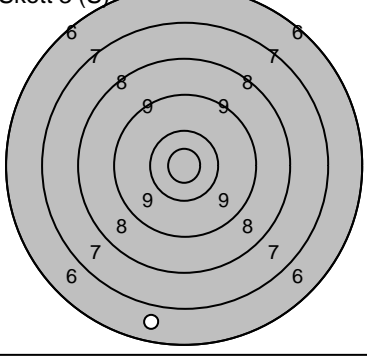
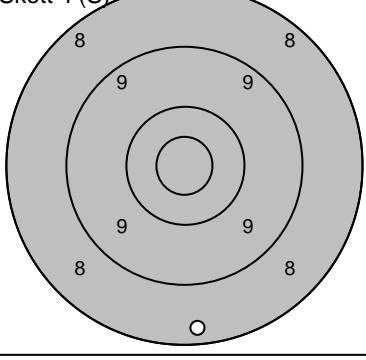
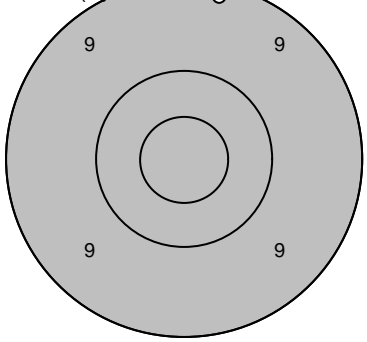
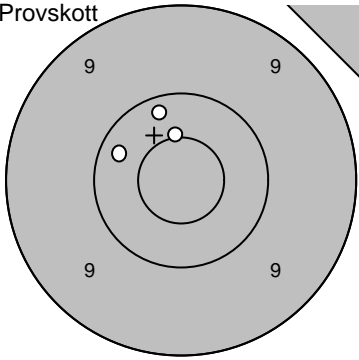
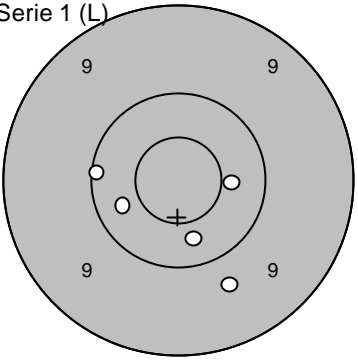
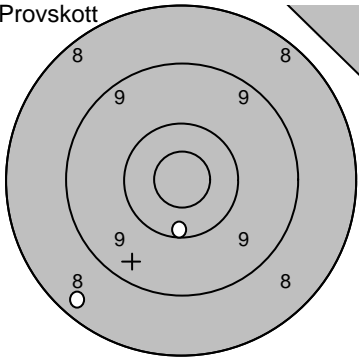
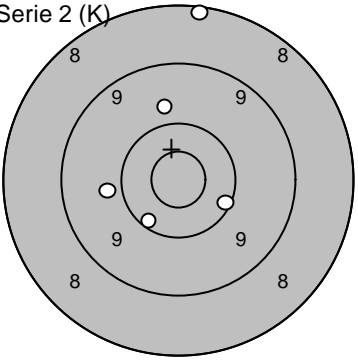
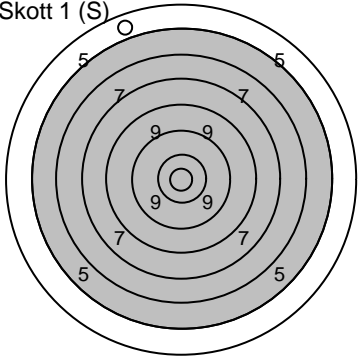
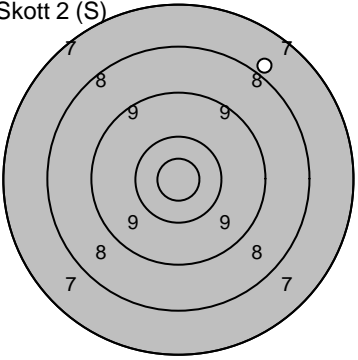
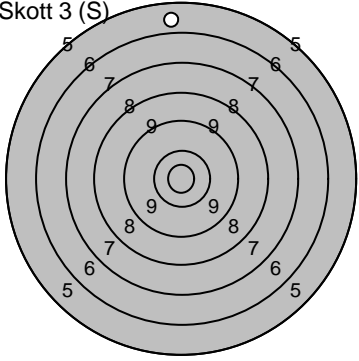
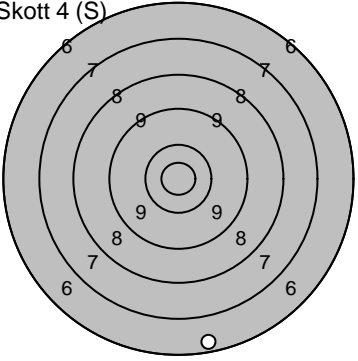
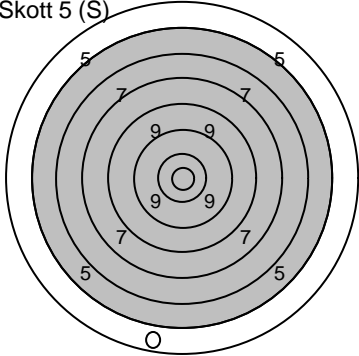
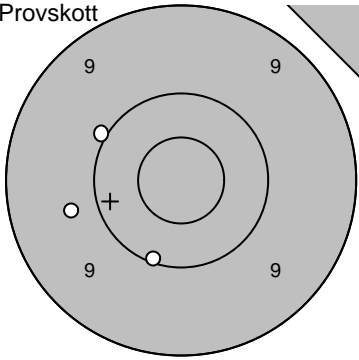
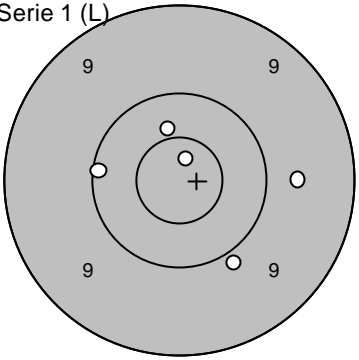
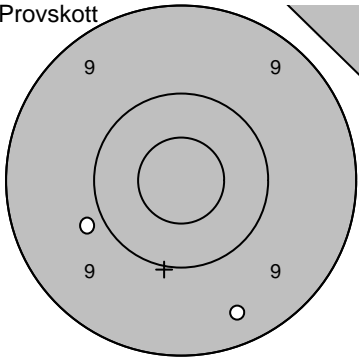
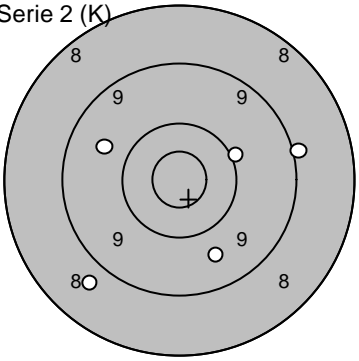
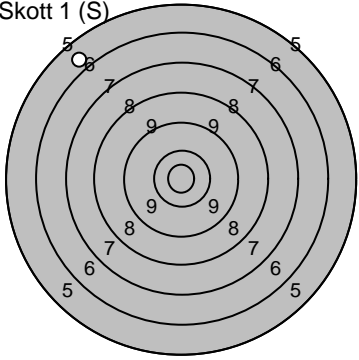
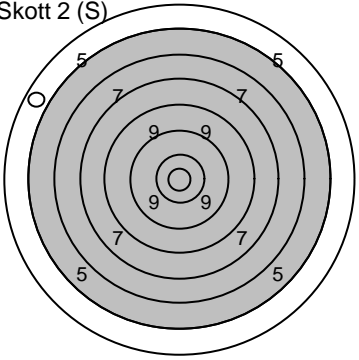
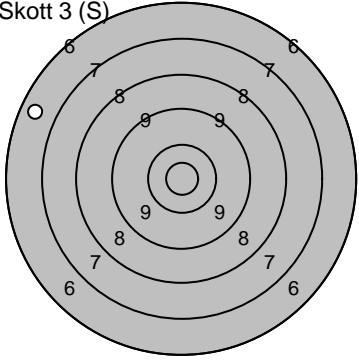
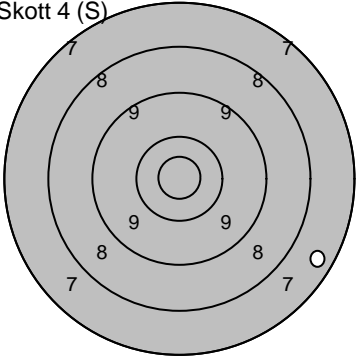
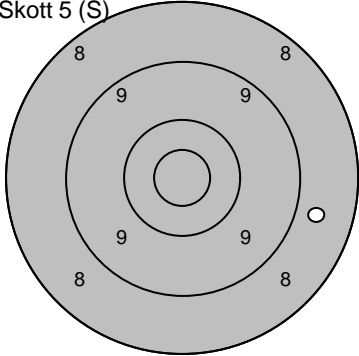
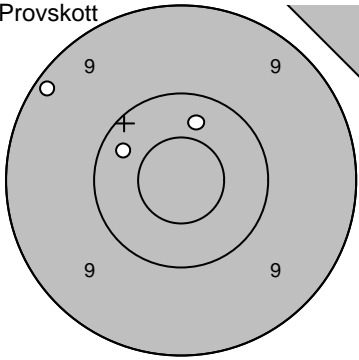
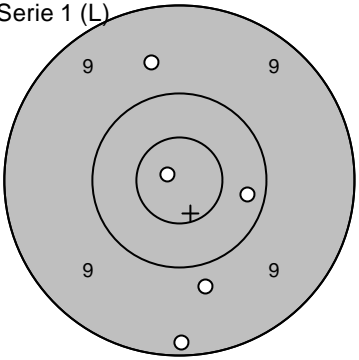
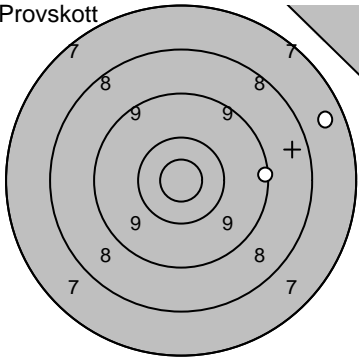
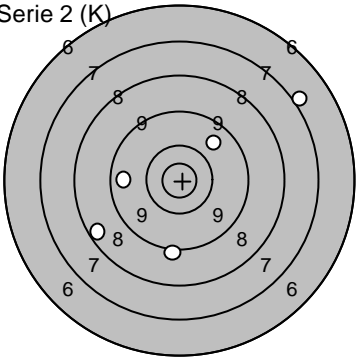
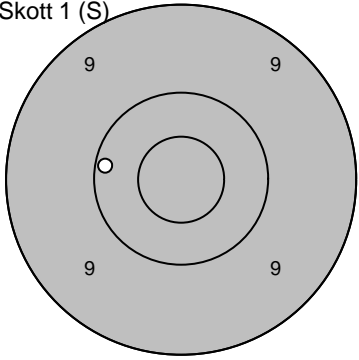
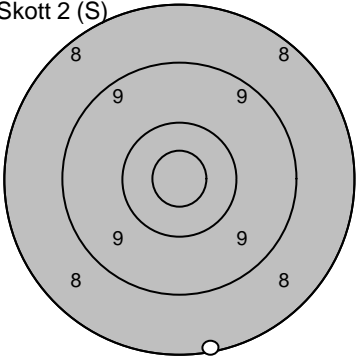
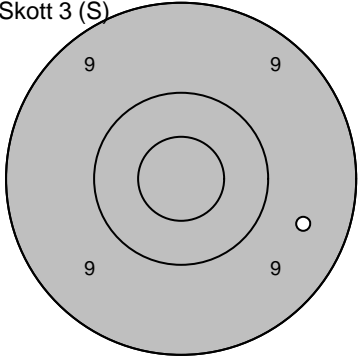
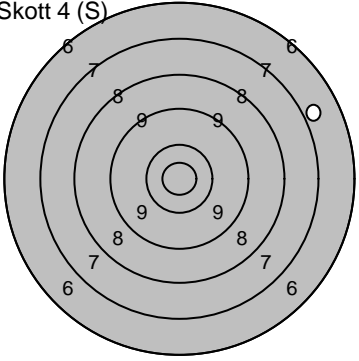
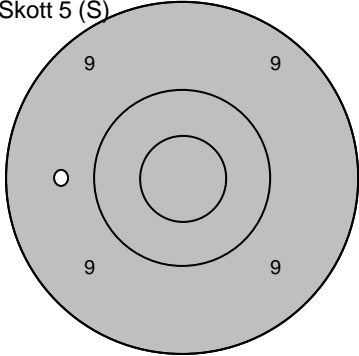

Skjutlag 1	Tavla 1	Bror Rantakyro	
		Pello	
14.07.2007	Tavelträffen B Final 2007	Ramselefors SKF	
Provskott 	1: 9,0 ↘ 2: 10,5* ← 3: 9,0 ←	Serie 1 (L) 	1: 9,9 ↗ 2: 10,7* ← 3: 8,6 ↗ 4: 10,4 ↗ 5: 10,1 ↓
	Serie 28,0 Totalt 281,0		Serie 47,0 Totalt 328,0
Provskott 	1: 9,4 ↘ 2: 7,8 →	Serie 2 (K) 	1: 9,4 ↗ 2: 10,7* ↘ 3: 8,6 ↗ 4: 10,0 → 5: 9,8 ←
	Serie 16,0 Totalt 328,0		Serie 46,0 Totalt 374,0
Skott 1 (S) 	1: 5,7 →	Skott 2 (S) 	1: 8,8 ↗
	Serie 5,0 Totalt 379,0		Serie 8,0 Totalt 387,0
Skott 3 (S) 	1: 6,7 ↓	Skott 4 (S) 	1: 8,4 ↓
	Serie 6,0 Totalt 393,0		Serie 8,0 Totalt 401,0
Skott 5 (S) 	1: 9,2 ↑		
	Serie 9,0 Totalt 410,0		

Skjutlag 1	Tavla 2	Dan-Ivan Karlsson	
		Ramselefors	
14.07.2007	Tavelträffen B Final 2007	Ramselefors SKF	
Provs-kott 	1: 9,8 ↓ 2: 10,4 ↗ 3: 9,9 ↗ Serie 28,0 Totalt 275,0	Serie 1 (L) 	1: 10,0 → 2: 10,9* ↗ 3: 9,3 ↑ 4: 9,9 ↗ 5: 10,5* ↓ Serie 48,0 Totalt 323,0
Provs-kott 	1: 7,2 → 2: 9,9 ↓ Serie 16,0 Totalt 323,0	Serie 2 (K) 	1: 9,8 ↓ 2: 10,6* ↗ 3: 10,9* ← 4: 10,4 ↑ 5: 10,3 ↓ Serie 49,0 Totalt 372,0
Skott 1 (S) 	1: 10,2 → Serie 10,0 Totalt 382,0	Skott 2 (S) 	1: 10,1 ← Serie 10,0 Totalt 392,0
Skott 3 (S) 	1: 8,3 ↗ Serie 8,0 Totalt 400,0	Skott 4 (S) 	1: 6,9 → Serie 6,0 Totalt 406,0
Skott 5 (S) 	1: 8,7 ↑ Serie 8,0 Totalt 414,0		

Skjutlag	Tavla	Nisse Ström	
1	3		
		Övertorneå	
14.07.2007	Tavelträffen B Final 2007	Ramselefors SKF	
Provskott	 <p>1: 10,2 ↑ 2: 10,5* ↑↑ 3: 10,3 ↖</p>	Serie 1 (L)	 <p>1: 10,3 ← 2: 10,4 → 3: 10,4 ↓ 4: 9,7 ↘ 5: 10,1 ←</p>
	Serie 30,0		Serie 49,0
	Totalt 271,0		Totalt 320,0
Provskott	 <p>1: 10,2 ↓ 2: 8,4 ↙</p>	Serie 2 (K)	 <p>1: 8,2 ↑ 2: 9,9 ← 3: 10,2 → 4: 10,2 ↙ 5: 9,8 ↑</p>
	Serie 18,0		Serie 46,0
	Totalt 320,0		Totalt 366,0
Skott 1 (S)	 <p>1: 4,9 ↑</p>	Skott 2 (S)	 <p>1: 7,9 ↗</p>
	Serie 4,0		Serie 7,0
	Totalt 370,0		Totalt 377,0
Skott 3 (S)	 <p>1: 5,8 ↑</p>	Skott 4 (S)	 <p>1: 6,5 ↓</p>
	Serie 5,0		Serie 6,0
	Totalt 382,0		Totalt 388,0
Skott 5 (S)	 <p>1: 4,8 ↓</p>		
	Serie 4,0		
	Totalt 392,0		

Skjutlag 1	Tavla 4	Torvald Andersson	
		Ununge	
14.07.2007	Tavelträffen B Final 2007	Ramselefors SKF	
Provskott 	1: 9,7 ← 2: 10,1 ↙ 3: 10,0 ↗	Serie 1 (L) 	1: 9,7 → 2: 9,9 ↓ 3: 10,1 ← 4: 10,8* ↑ 5: 10,4 ↗
	Serie 29,0 Totalt 268,0		Serie 48,0 Totalt 316,0
Provskott 	1: 9,4 ↓ 2: 9,9 ←	Serie 2 (K) 	1: 10,0 ↗ 2: 9,7 ↙ 3: 9,0 → 4: 8,8 ↙ 5: 9,7 ↓
	Serie 18,0 Totalt 316,0		Serie 45,0 Totalt 361,0
Skott 1 (S) 	1: 5,9 ↙	Skott 2 (S) 	1: 4,8 ↙
	Serie 5,0 Totalt 366,0		Serie 4,0 Totalt 370,0
Skott 3 (S) 	1: 6,7 ↙	Skott 4 (S) 	1: 7,5 ↗
	Serie 6,0 Totalt 376,0		Serie 7,0 Totalt 383,0
Skott 5 (S) 	1: 8,7 →		
	Serie 8,0 Totalt 391,0		

Skjutlag 1	Tavla 5	Jan-Erik Karlsson					
		Ramselefors					
14.07.2007		Tavelträffen B Final 2007		Ramselefors SKF			
Provsnitt 	1: 9,2 ↗ 2: 10,3 ↗ 3: 10,4 ↑	Serie 1 (L) 	1: 9,7 ↑ 2: 10,3 → 3: 9,8 ↓ 4: 10,9* ← 5: 9,2 ↓	Serie 29,0 Totalt 268,0		Serie 47,0 Totalt 315,0	
Provsnitt 	1: 7,6 → 2: 9,2 →	Serie 2 (K) 	1: 7,1 → 2: 9,6 ← 3: 9,1 ↓ 4: 8,5 ← 5: 9,8 ↗	Serie 16,0 Totalt 315,0		Serie 42,0 Totalt 357,0	
Skott 1 (S) 	1: 10,2 ←	Skott 2 (S) 	1: 8,2 ↓	Serie 10,0 Totalt 367,0		Serie 8,0 Totalt 375,0	
Skott 3 (S) 	1: 9,6 →	Skott 4 (S) 	1: 7,0 →	Serie 9,0 Totalt 384,0		Serie 7,0 Totalt 391,0	
Skott 5 (S) 	1: 9,7 ←						
Serie 9,0 Totalt 400,0							

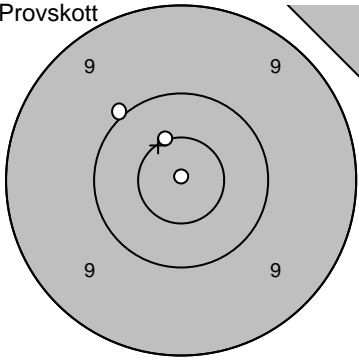
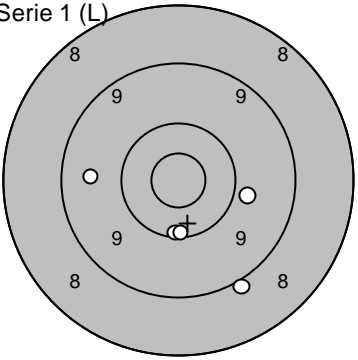
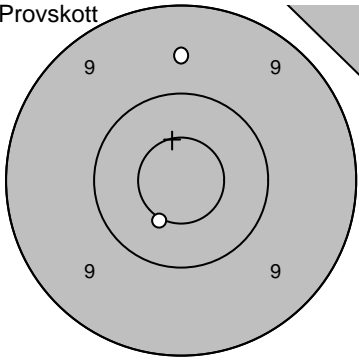
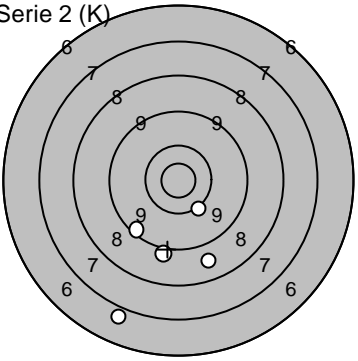
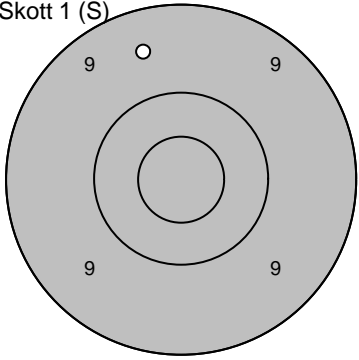
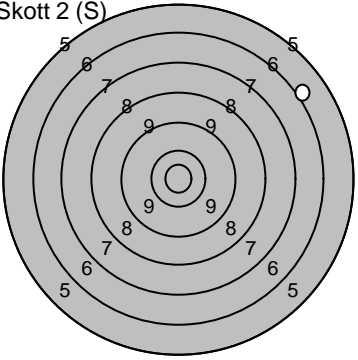
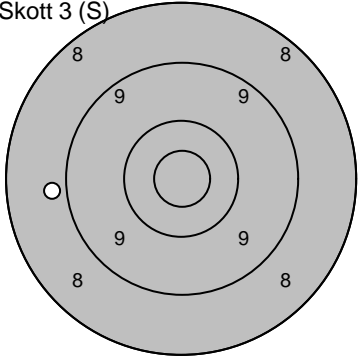
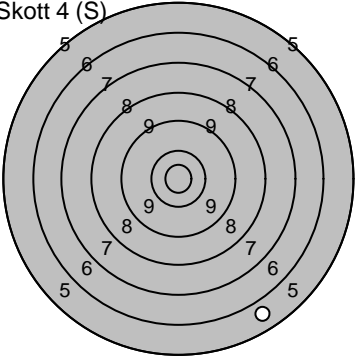
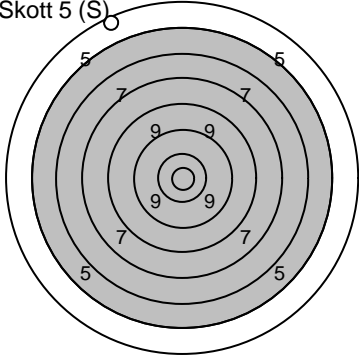
Skjutlag	Tavla	Lennart Högenberg		
1	6	Hajom		
14.07.2007	Tavelträffen B Final 2007	Ramselefors SKF		
Provskott		1: 10,5* ↑ 2: 10,0 ↗ 3: 10,9* ↑	Serie 1 (L) 	1: 10,2 ↓ 2: 9,6 ← 3: 9,9 → 4: 10,2 ↓ 5: 9,0 ↓
		Serie 30,0	Serie 47,0	
		Totalt 267,0	Totalt 314,0	
Provskott		1: 10,5* ↓ 2: 9,6 ↑	Serie 2 (K) 	1: 10,2 ↓ 2: 6,9 ↓ 3: 8,7 ↓ 4: 9,3 ↙ 5: 9,1 ↓
		Serie 19,0	Serie 42,0	
		Totalt 314,0	Totalt 356,0	
Skott 1 (S)		1: 9,5 ↑	Skott 2 (S) 	1: 6,1 ↗
		Serie 9,0	Serie 6,0	
		Totalt 365,0	Totalt 371,0	
Skott 3 (S)		1: 8,9 ←	Skott 4 (S) 	1: 5,8 ↓
		Serie 8,0	Serie 5,0	
		Totalt 379,0	Totalt 384,0	
Skott 5 (S)		1: 4,6 ↑		
		Serie 4,0		
		Totalt 388,0		

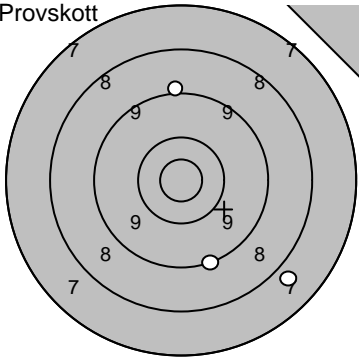
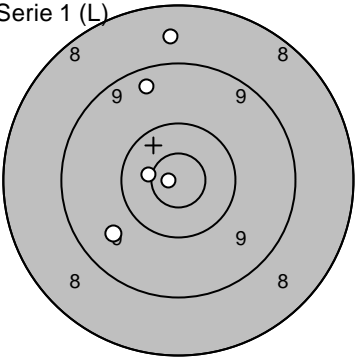
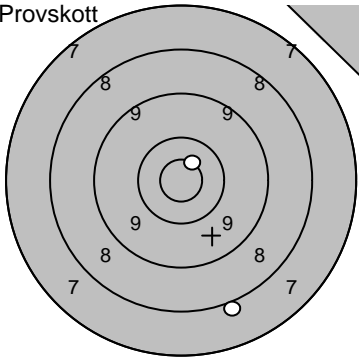
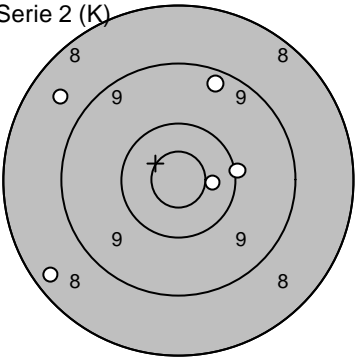
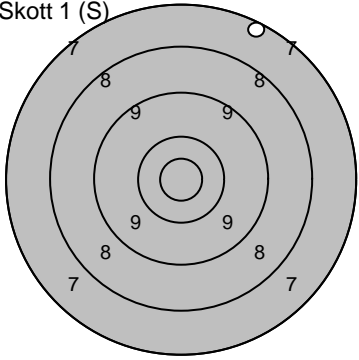
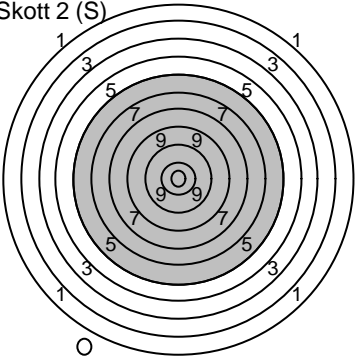
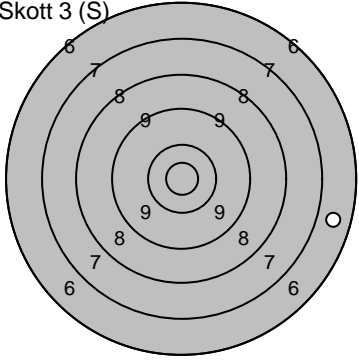
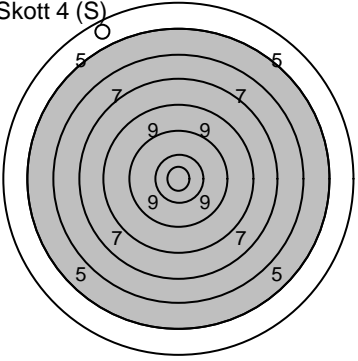
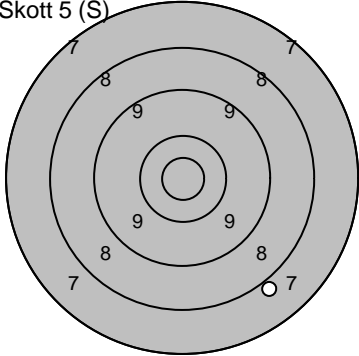
Skjutlag 1	Tavla 7	Håkan Lidman	
		Skellefteå	
14.07.2007		Tavelträffen B Final 2007	Ramselefors SKF
Provsnitt 	1: 7,8 ↘ 2: 9,2 ↘ 3: 9,1 ↑	Serie 1 (L) 	1: 8,7 ↑ 2: 10,9* ← 3: 9,7 ↙ 4: 9,4 ↑ 5: 10,6* ←
	Serie 25,0		Serie 46,0
	Totalt 265,0		Totalt 311,0
Provsnitt 	1: 8,0 ↘ 2: 10,7* ↑	Serie 2 (K) 	1: 10,1 → 2: 10,5* → 3: 8,6 ↗ 4: 8,4 ↙ 5: 9,3 ↑
	Serie 18,0		Serie 45,0
	Totalt 311,0		Totalt 356,0
Skott 1 (S) 	1: 7,4 ↑	Skott 2 (S) 	1: 0,0 ↘
	Serie 7,0		Serie 0,0
	Totalt 363,0		Totalt 363,0
Skott 3 (S) 	1: 6,7 →	Skott 4 (S) 	1: 4,7 ↖
	Serie 6,0		Serie 4,0
	Totalt 369,0		Totalt 373,0
Skott 5 (S) 	1: 7,9 ↘		
	Serie 7,0		
	Totalt 380,0		

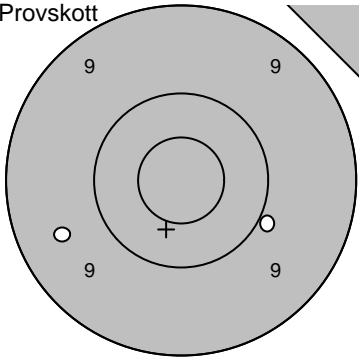
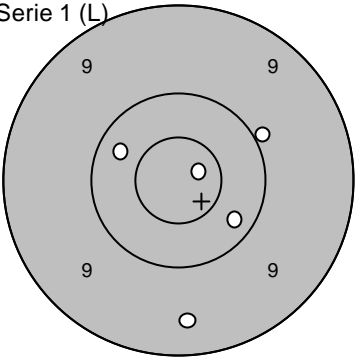
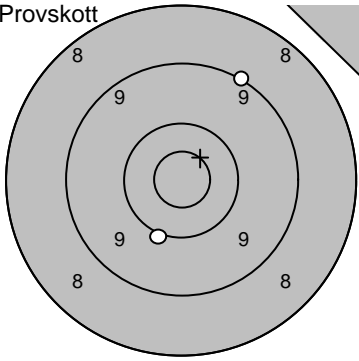
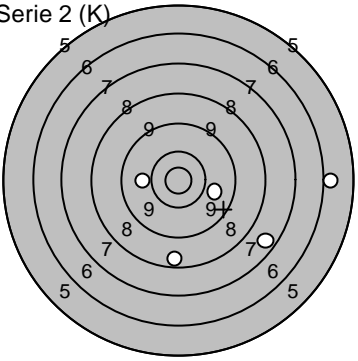
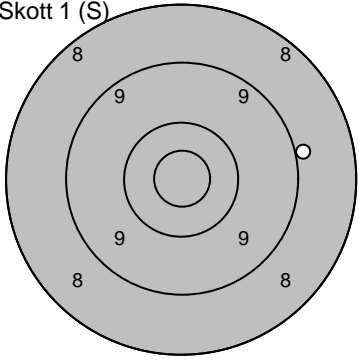
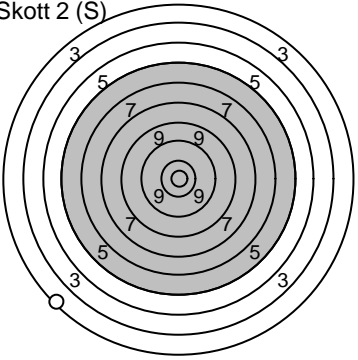
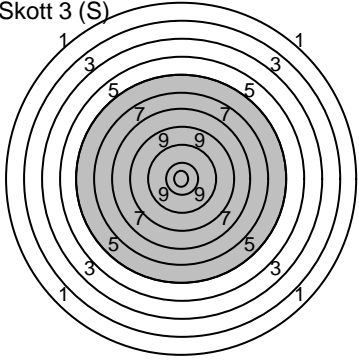
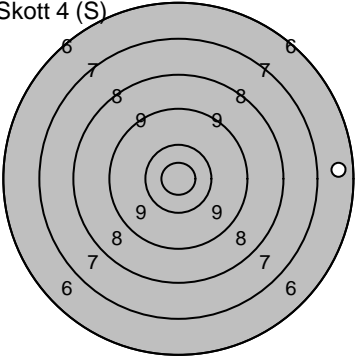
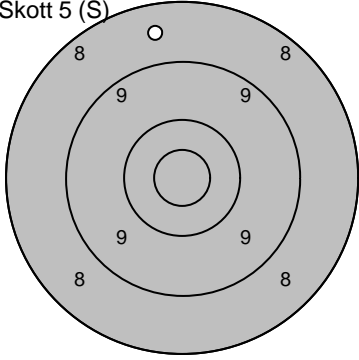
Skjutlag	Tavla	Bengt Heder		
1	8	Evertsberg		
14.07.2007	Tavelträffen B Final 2007	Ramselefors SKF		
Provkott		1: 9,6 ↙ 2: 10,0 → <hr/> Serie 19,0 Totalt 264,0	Serie 1 (L) 	1: 10,3 ↙ 2: 9,4 ↓ 3: 10,8* → 4: 10,0 ↗ 5: 10,3 ↘ <hr/> Serie 49,0 Totalt 313,0
Provkott		1: 10,1 ↘ 2: 9,1 ↗ <hr/> Serie 19,0 Totalt 313,0	Serie 2 (K) 	1: 9,9 → 2: 6,1 → 3: 10,0 ← 4: 8,6 ↓ 5: 7,6 ↘ <hr/> Serie 40,0 Totalt 353,0
Skott 1 (S)		1: 9,0 → <hr/> Serie 9,0 Totalt 362,0	Skott 2 (S) 	1: 2,5 ↙ <hr/> Serie 2,0 Totalt 364,0
Skott 3 (S)		1: 0,0 → <hr/> Serie 0,0 Totalt 364,0	Skott 4 (S) 	1: 6,7 → <hr/> Serie 6,0 Totalt 370,0
Skott 5 (S)		1: 8,6 ↑ <hr/> Serie 8,0 Totalt 378,0		

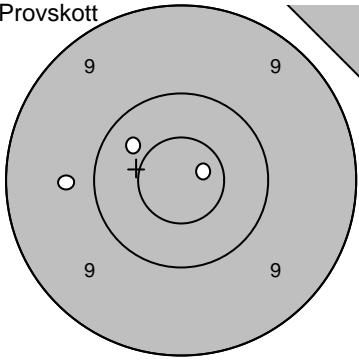
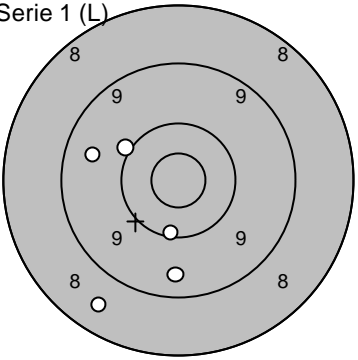
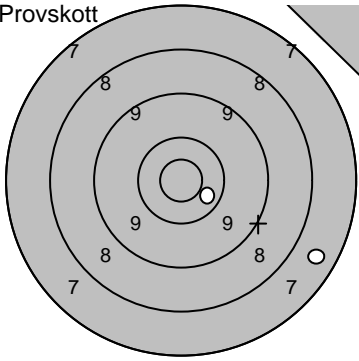
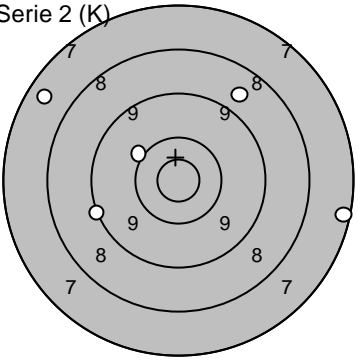
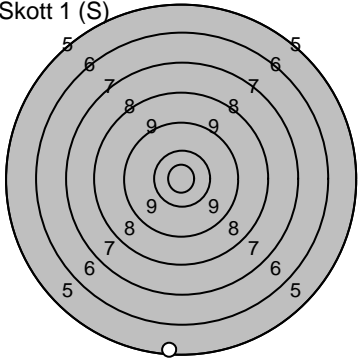
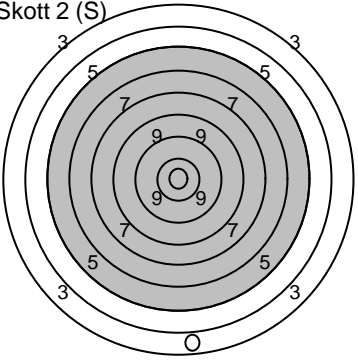
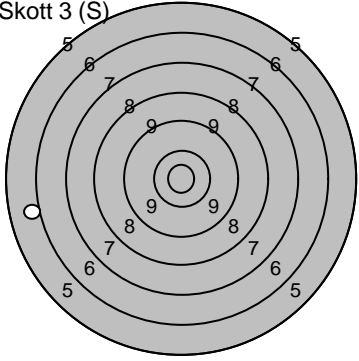
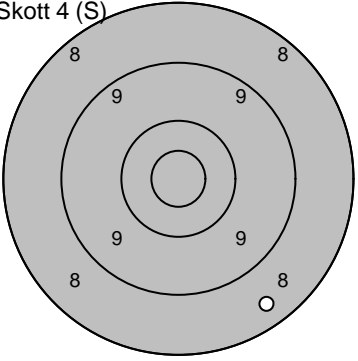
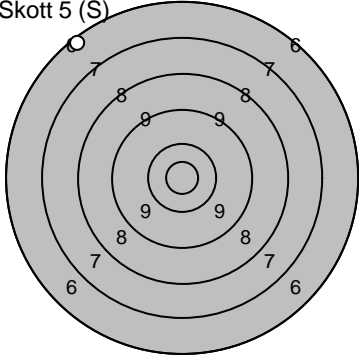
Skjutlag	Tavla	Dennis Sundqvist	
1	9	Piteå	
14.07.2007		Tavelträffen B Final 2007	Ramselefors SKF
Provskott		1: 9,7 ← 2: 10,4 ↗ 3: 10,8* →	Serie 1 (L) 
		Serie 29,0 Totalt 263,0	1: 9,6 ↖ 2: 8,6 ↘ 3: 10,0 ↗ 4: 9,5 ↘ 5: 10,2 ↓
			Serie 46,0 Totalt 309,0
Provskott		1: 10,5* → 2: 7,6 ↘	Serie 2 (K) 
		Serie 17,0 Totalt 309,0	1: 10,1 ↖ 2: 8,8 ↗ 3: 9,1 ↖ 4: 7,6 ↗ 5: 7,3 →
			Serie 41,0 Totalt 350,0
Skott 1 (S)		1: 5,4 ↓	Skott 2 (S) 
		Serie 5,0 Totalt 355,0	1: 3,9 ↓
			Serie 3,0 Totalt 358,0
Skott 3 (S)		1: 6,0 ←	Skott 4 (S) 
		Serie 6,0 Totalt 364,0	1: 8,5 ↘
			Serie 8,0 Totalt 372,0
Skott 5 (S)		1: 6,3 ↖	
		Serie 6,0 Totalt 378,0	

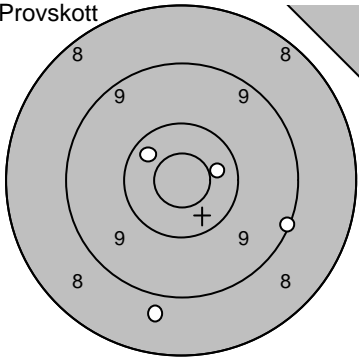
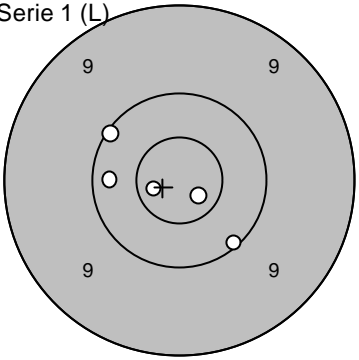
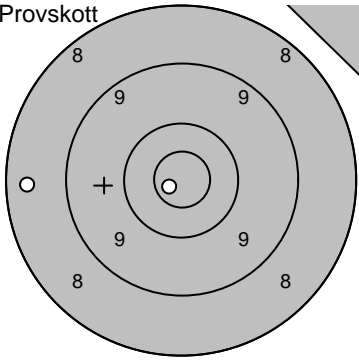
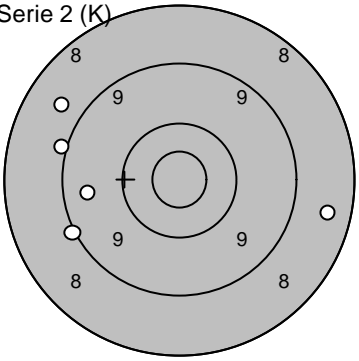
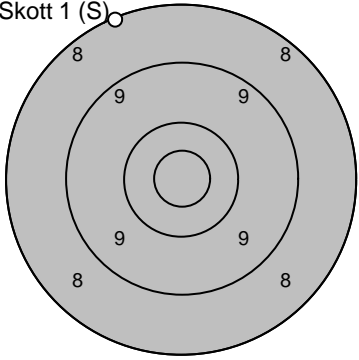
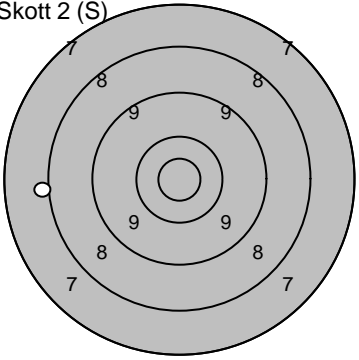
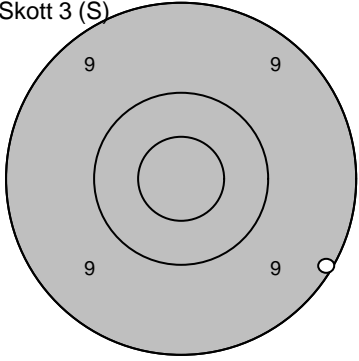
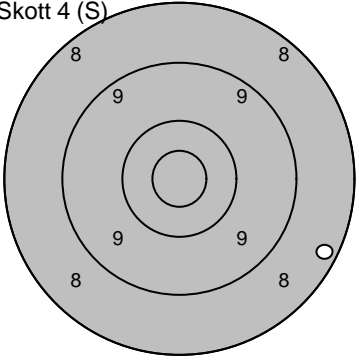
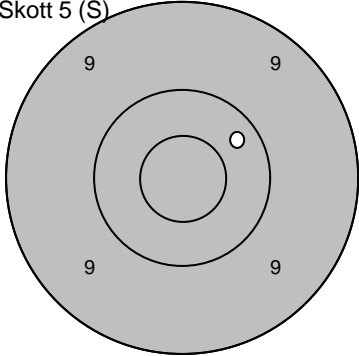
Skjutlag	Tavla	Owe Gustafsson	
1	10		
Solberga			
14.07.2007	Tavelträffen B Final 2007	Ramselefors SKF	
Provsnitt 	1: 10,4 ↖ 2: 10,5* → 3: 8,8 ↓ 4: 9,1 →	Serie 1 (L) 	1: 10,8* ↘ 2: 10,1 ↘ 3: 10,1 ↗ 4: 10,7* ← 5: 10,3 ←
	Serie 37,0 Totalt 262,0		Serie 50,0 Totalt 312,0
Provsnitt 	1: 10,8* ↙ 2: 8,5 ←	Serie 2 (K) 	1: 8,5 → 2: 9,0 ← 3: 8,7 ↗ 4: 9,1 ← 5: 9,5 ←
	Serie 18,0 Totalt 312,0		Serie 43,0 Totalt 355,0
Skott 1 (S) 	1: 8,2 ↖	Skott 2 (S) 	1: 8,0 ←
	Serie 8,0 Totalt 363,0		Serie 8,0 Totalt 371,0
Skott 3 (S) 	1: 9,1 →	Skott 4 (S) 	1: 8,3 →
	Serie 9,0 Totalt 380,0		Serie 8,0 Totalt 388,0
Skott 5 (S) 	1: 10,3 ↗		
	Serie 10,0 Totalt 398,0		

Skjutlag	Tavla	Håkan Engman	
1	11		
		Lindesberg	
14.07.2007		Tavelträffen B Final 2007	Ramselefors SKF
Provskott		Serie 1 (L)	
	Serie 27,0 Totalt 261,0		Serie 49,0 Totalt 310,0
Provskott		Serie 2 (K)	
	Serie 17,0 Totalt 310,0		Serie 38,0 Totalt 348,0
Skott 1 (S)		Skott 2 (S)	
	Serie 6,0 Totalt 354,0		Serie 1,0 Totalt 355,0
Skott 3 (S)		Skott 4 (S)	
	Serie 5,0 Totalt 360,0		Serie 8,0 Totalt 368,0
Skott 5 (S)			
	Serie 4,0 Totalt 372,0		

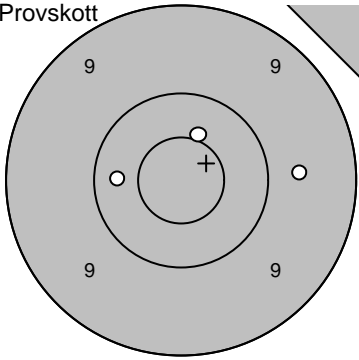
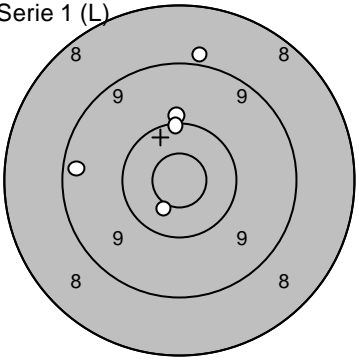
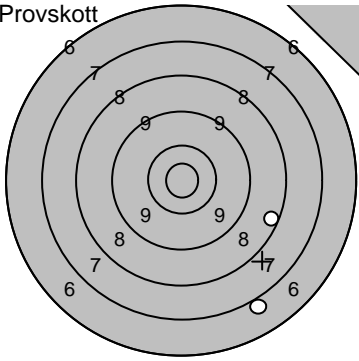
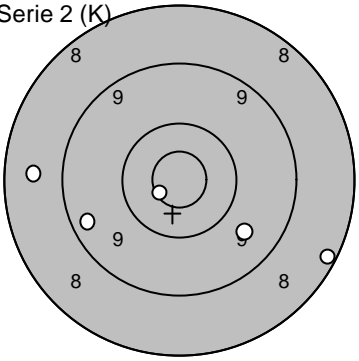
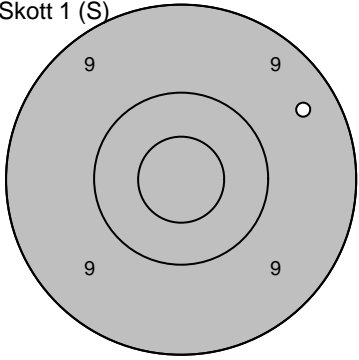
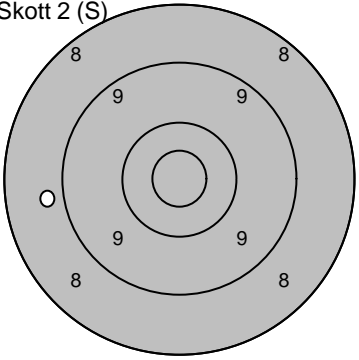
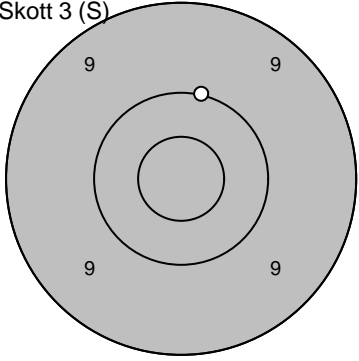
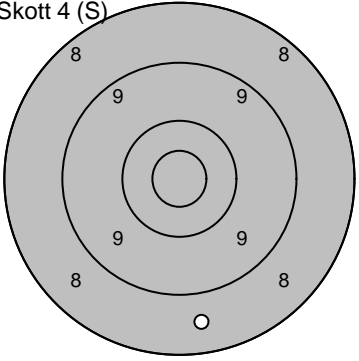
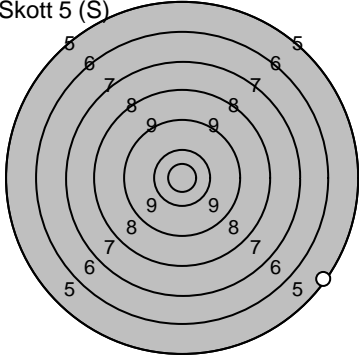
Skjutlag	Tavla		
1	12	Rune Utterström	
		Ale	
14.07.2007	Tavelträffen B Final 2007	Ramselefors SKF	
Provsnitt 	1: 9,7 → 2: 10,5* ↑ 3: 10,3 ←	Serie 1 (L) 	1: 8,9 ↑ 2: 10,0 ↑ 3: 9,3 ← 4: 10,5* ↓ 5: 10,2 ↑
	Serie 29,0		Serie 47,0
	Totalt 279,0		Totalt 326,0
Provsnitt 	1: 7,0 ↓ 2: 8,4 →	Serie 2 (K) 	1: 9,7 ↘ 2: 8,2 ↘ 3: 9,4 ← 4: 10,7* ↙ 5: 8,6 ←
	Serie 15,0		Serie 44,0
	Totalt 326,0		Totalt 370,0
Skott 1 (S) 	1: 9,5 →	Skott 2 (S) 	1: 8,8 ←
	Serie 9,0		Serie 8,0
	Totalt 379,0		Totalt 387,0
Skott 3 (S) 	1: 10,1 ↑	Skott 4 (S) 	1: 8,6 ↓
	Serie 10,0		Serie 8,0
	Totalt 397,0		Totalt 405,0
Skott 5 (S) 	1: 5,3 ↘		
	Serie 5,0		
	Totalt 410,0		

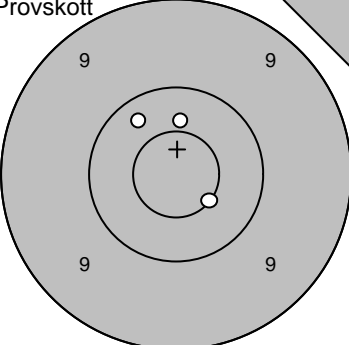
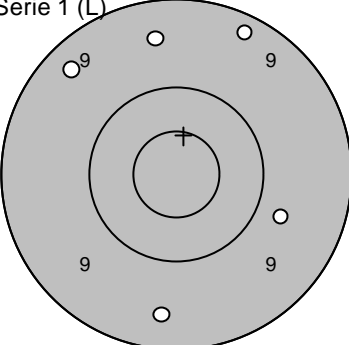
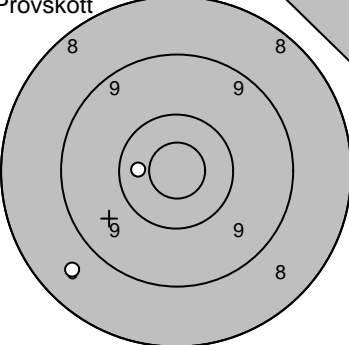
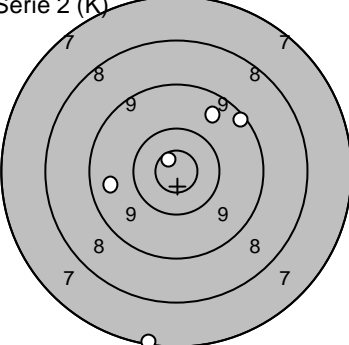
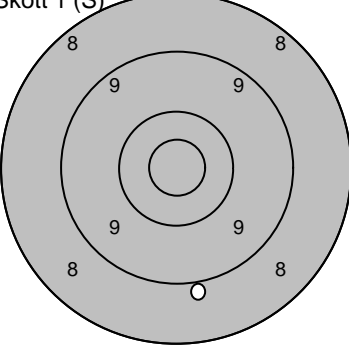
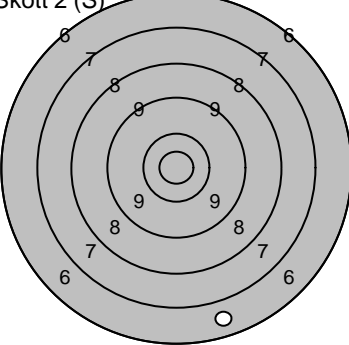
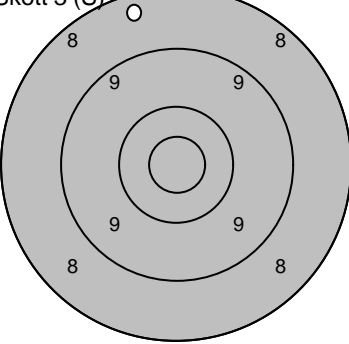
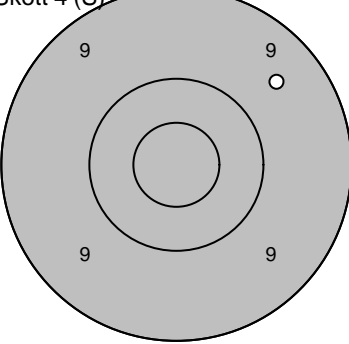
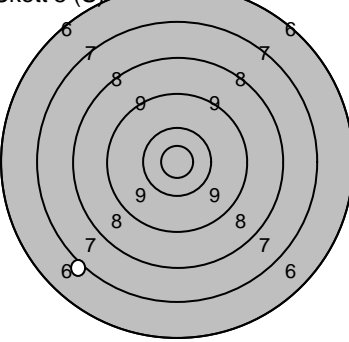
Skjutlag 1	Tavla 13	Gunnar Iversen		
		S 3		
14.07.2007		Tavelträffen B Final 2007	Ramselefors SKF	
Provkott 	1: 10,6* ↘ 2: 10,3 ↗ 3: 10,4 ↑	Serie 1 (L) 	1: 9,3 ↗ 2: 9,8 → 3: 9,5 ↑ 4: 9,5 ↓ 5: 9,4 ↖	
		Serie 30,0	Serie 45,0	
		Totalt 277,0	Totalt 322,0	
Provkott 	1: 8,6 ↙ 2: 10,4 ←	Serie 2 (K) 	1: 9,3 ↗ 2: 7,2 ↓ 3: 9,6 ↑ 4: 10,8* ↗ 5: 9,6 ←	
		Serie 18,0	Serie 44,0	
		Totalt 322,0	Totalt 366,0	
Skott 1 (S) 	1: 8,9 ↓	Skott 2 (S) 	1: 6,7 ↓	
		Serie 8,0	Serie 6,0	
		Totalt 374,0	Totalt 380,0	
Skott 3 (S) 	1: 8,4 ↑	Skott 4 (S) 	1: 9,6 ↗	
		Serie 8,0	Serie 9,0	
		Totalt 388,0	Totalt 397,0	
Skott 5 (S) 	1: 7,1 ↙			
		Serie 7,0		
		Totalt 404,0		

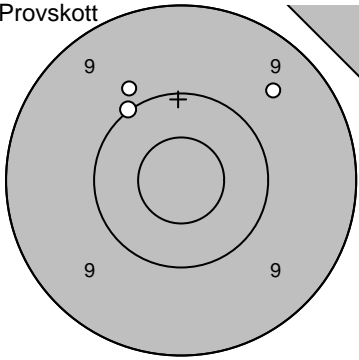
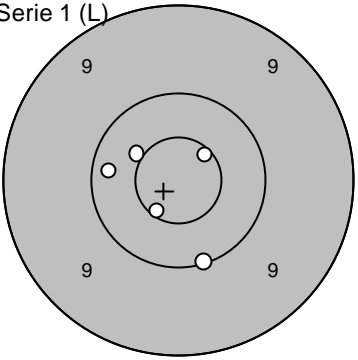
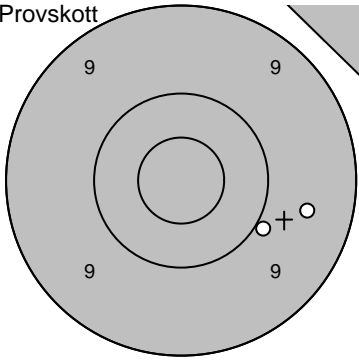
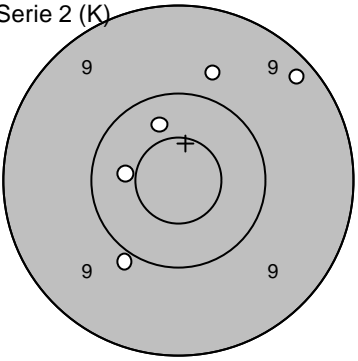
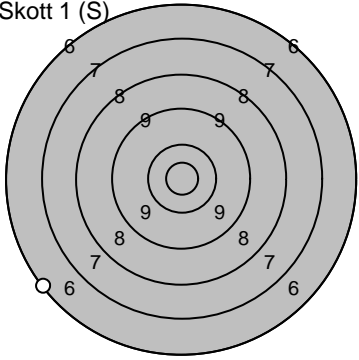
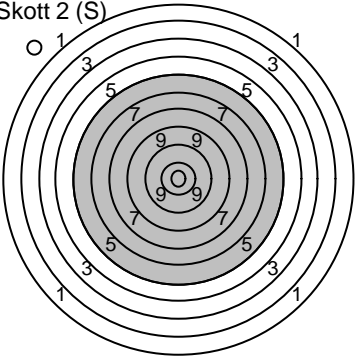
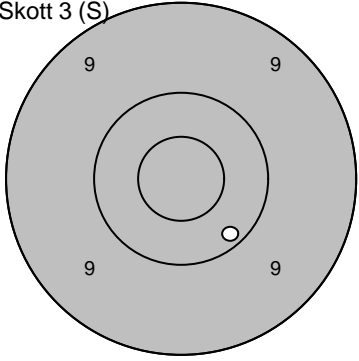
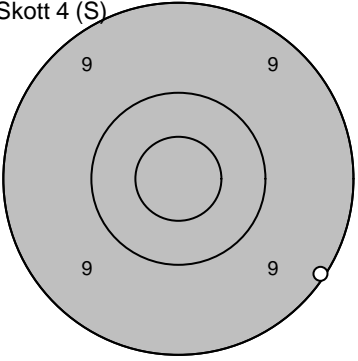
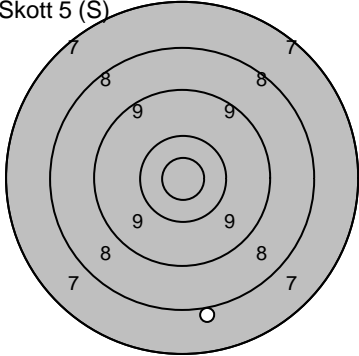
Skjutlag 1	Tavla 14	Kjell Marklund	
		S 3	
14.07.2007		Tavelträffen B Final 2007	
		Ramselefors SKF	
Provskott 	1: 10,0 ↖ 2: 9,9 ↗ 3: 9,6 ↗	Serie 1 (L) 	1: 10,3 ← 2: 10,1 ↓ 3: 10,6* ↗ 4: 10,5* ↖ 5: 10,6* ↓
	Serie 28,0 Totalt 269,0		Serie 50,0 Totalt 319,0
Provskott 	1: 9,6 → 2: 10,0 ↘	Serie 2 (K) 	1: 9,9 ↘ 2: 10,4 ↗ 3: 9,3 ↗ 4: 9,8 ↗ 5: 10,4 ←
	Serie 19,0 Totalt 319,0		Serie 47,0 Totalt 366,0
Skott 1 (S) 	1: 6,2 ↖	Skott 2 (S) 	1: 0,0 ↖
	Serie 6,0 Totalt 372,0		Serie 0,0 Totalt 372,0
Skott 3 (S) 	1: 10,2 ↘	Skott 4 (S) 	1: 9,1 →
	Serie 10,0 Totalt 382,0		Serie 9,0 Totalt 391,0
Skott 5 (S) 	1: 8,0 ↓		
	Serie 8,0 Totalt 399,0		

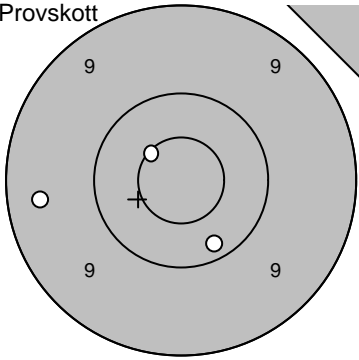
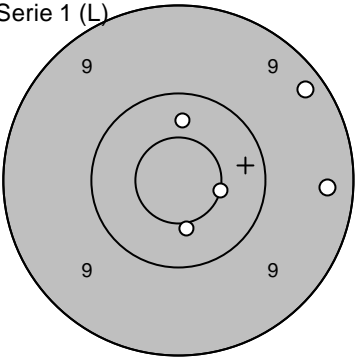
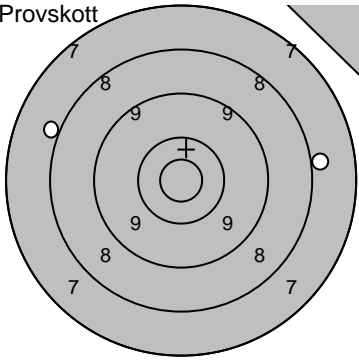
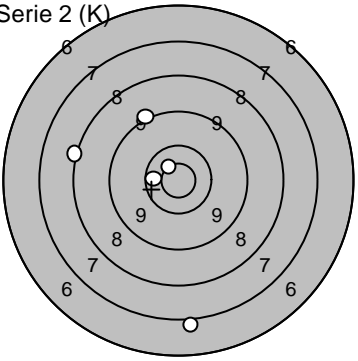
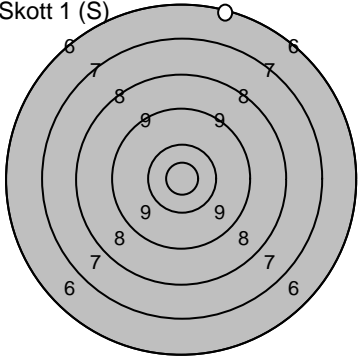
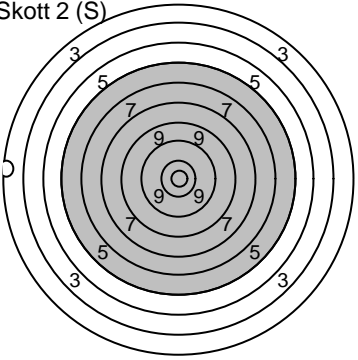
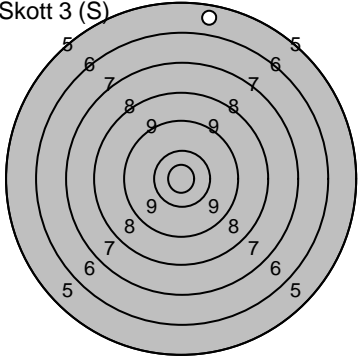
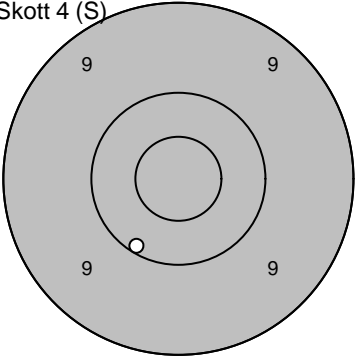
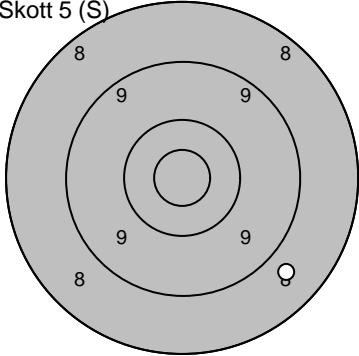
Skjutlag 1	Tavla 15	Marie Fjällström	
		Ramselefors	
14.07.2007		Tavelträffen B Final 2007	Ramselefors SKF
Provsnitt 	1: 10,2 ↘ 2: 9,4 ← 3: 10,6* ↗	Serie 1 (L) 	1: 10,5* → 2: 10,4 ↑ 3: 10,5* ↓ 4: 9,3 ↗ 5: 9,3 →
	Serie 29,0		Serie 48,0
	Totalt 267,0		Totalt 315,0
Provsnitt 	1: 8,0 → 2: 8,0 ↗	Serie 2 (K) 	1: 9,2 ↗ 2: 10,5* ← 3: 10,7* ↗ 4: 8,2 ← 5: 7,1 ↓
	Serie 16,0		Serie 44,0
	Totalt 315,0		Totalt 359,0
Skott 1 (S) 	1: 6,3 ↑	Skott 2 (S) 	1: 2,6 ←
	Serie 6,0		Serie 2,0
	Totalt 365,0		Totalt 367,0
Skott 3 (S) 	1: 5,7 ↑	Skott 4 (S) 	1: 10,2 ↘
	Serie 5,0		Serie 10,0
	Totalt 372,0		Totalt 382,0
Skott 5 (S) 	1: 8,7 ↘		
	Serie 8,0		
	Totalt 390,0		

Skjutlag	Tavla	Martin Olofsson	
1	16		
		Vännäs	
14.07.2007		Tavelträffen B Final 2007	Ramselefors SKF
Provskott		1: 10,0 ↖	Serie 1 (L)
			1: 10,7* ↗ 2: 10,1 ↑ 3: 9,0 ← 4: 9,0 ↗ 5: 10,1 ↘
		Serie 10,0	Serie 48,0
		Totalt 264,0	Totalt 312,0
Provskott		1: 8,8 ↗ 2: 9,8 ↗	Serie 2 (K)
			1: 10,4 ↑ 2: 8,6 → 3: 8,8 ← 4: 9,7 ↗ 5: 8,4 ↑
		Serie 17,0	Serie 43,0
		Totalt 312,0	Totalt 355,0
Skott 1 (S)		1: 7,9 ↓	Skott 2 (S)
			1: 8,0 →
		Serie 7,0	Serie 8,0
		Totalt 362,0	Totalt 370,0
Skott 3 (S)		1: 7,4 →	Skott 4 (S)
			1: 6,7 →
		Serie 7,0	Serie 6,0
		Totalt 377,0	Totalt 383,0
Skott 5 (S)		1: 6,3 ↓	
		Serie 6,0	
		Totalt 389,0	

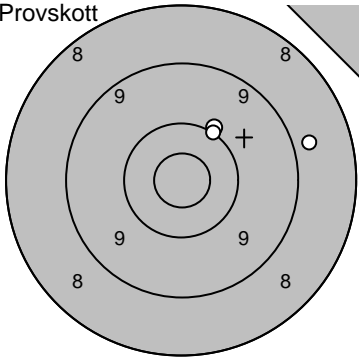
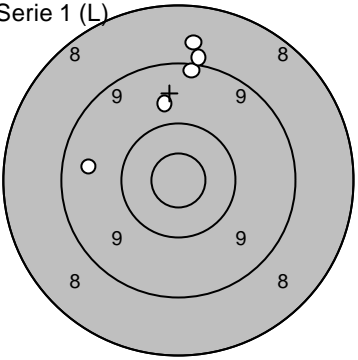
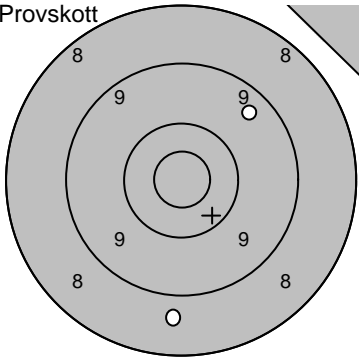
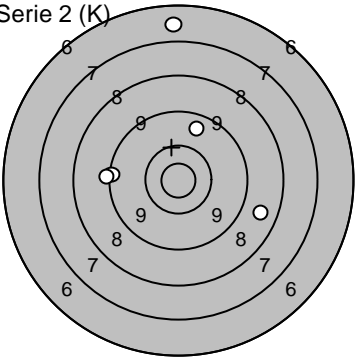
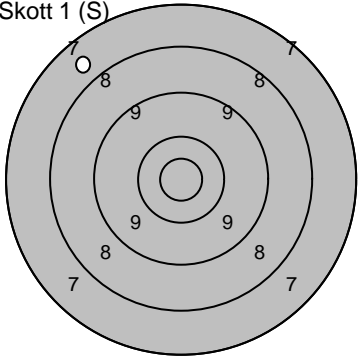
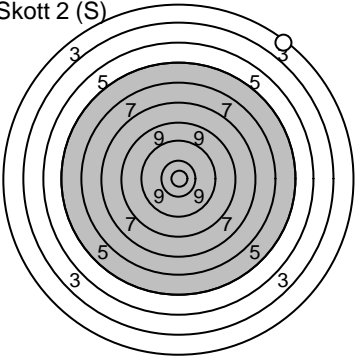
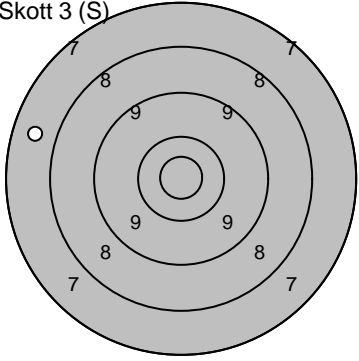
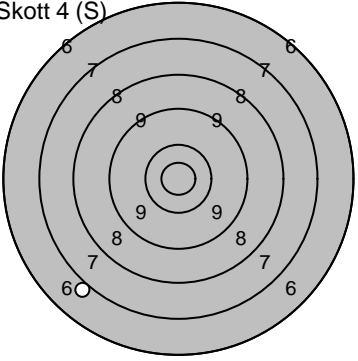
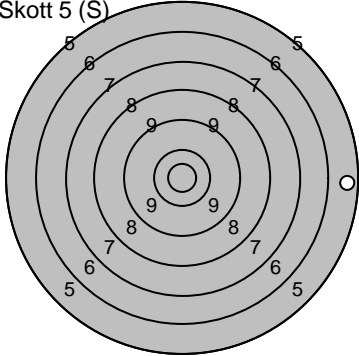
Skjutlag	Tavla	Stefan Wahlström	
1	17	Gideå	
14.07.2007	Tavelträffen B Final 2007	Ramselefors SKF	
Provsnitt 	1: 8,8 → 2: 10,0 ↗ 3: 10,1 ↗	Serie 1 (L) 	1: 9,2 ↑ 2: 9,0 ↑ 3: 8,7 ↑ 4: 9,8 ↑ 5: 9,5 ←
	Serie 28,0		Serie 44,0
	Totalt 260,0		Totalt 304,0
Provsnitt 	1: 8,7 ↓ 2: 9,5 ↗	Serie 2 (K) 	1: 9,7 ↑ 2: 6,8 ↑ 3: 9,3 ← 4: 8,7 → 5: 9,1 ←
	Serie 17,0		Serie 41,0
	Totalt 304,0		Totalt 345,0
Skott 1 (S) 	1: 7,7 ↖	Skott 2 (S) 	1: 2,6 ↗
	Serie 7,0		Serie 2,0
	Totalt 352,0		Totalt 354,0
Skott 3 (S) 	1: 7,7 ←	Skott 4 (S) 	1: 7,0 ↙
	Serie 7,0		Serie 7,0
	Totalt 361,0		Totalt 368,0
Skott 5 (S) 	1: 5,6 →		
	Serie 5,0		
	Totalt 373,0		

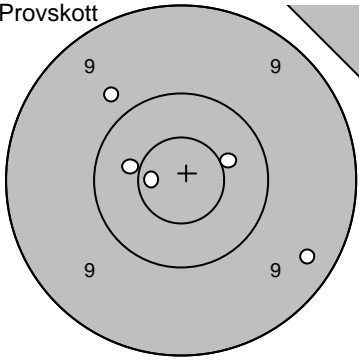
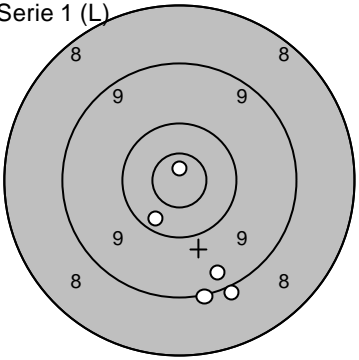
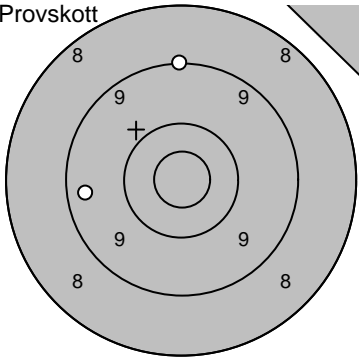
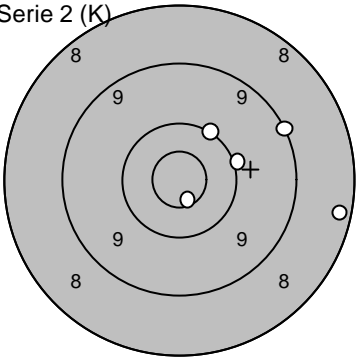
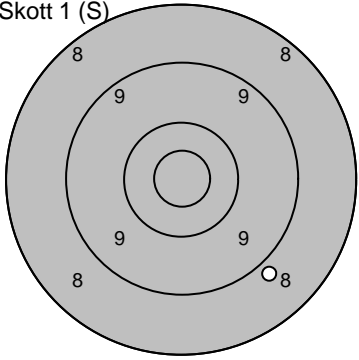
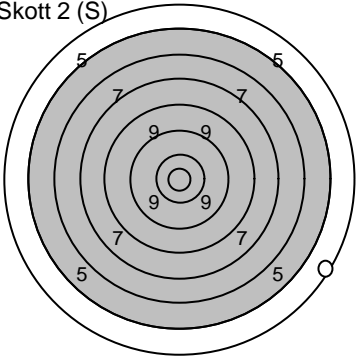
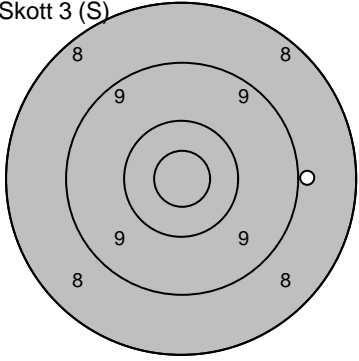
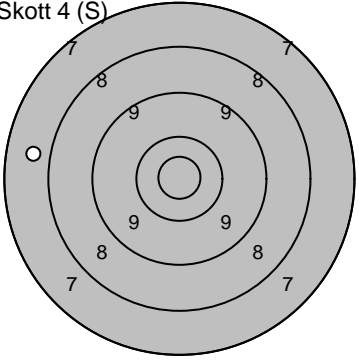
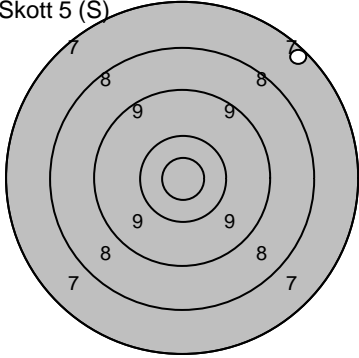
Skjutlag	Tavla	Sture Grahn	
1	18	Piteå	
14.07.2007	Tavelträffen B Final 2007	Ramselefors SKF	
Provskott	 <p>1: 9,8 ↖ 2: 9,4 ↘ 3: 10,4 ↗ 4: 10,5* ↘ 5: 10,7* ←</p>	Serie 1 (L)	 <p>1: 10,3 ↙ 2: 9,0 ↘ 3: 9,4 ↘ 4: 10,9* ↑ 5: 9,1 ↓</p>
	Serie 48,0 Totalt 260,0		Serie 47,0 Totalt 307,0
Provskott	 <p>1: 9,1 ↑ 2: 9,5 ←</p>	Serie 2 (K)	 <p>1: 10,1 ↗ 2: 8,3 → 3: 10,1 ↗ 4: 9,1 ↗ 5: 10,7* ↓</p>
	Serie 18,0 Totalt 307,0		Serie 47,0 Totalt 354,0
Skott 1 (S)	 <p>1: 8,9 ↘</p>	Skott 2 (S)	 <p>1: 4,4 ↘</p>
	Serie 8,0 Totalt 362,0		Serie 4,0 Totalt 366,0
Skott 3 (S)	 <p>1: 8,9 →</p>	Skott 4 (S)	 <p>1: 7,8 ←</p>
	Serie 8,0 Totalt 374,0		Serie 7,0 Totalt 381,0
Skott 5 (S)	 <p>1: 7,3 ↗</p>		
	Serie 7,0 Totalt 388,0		

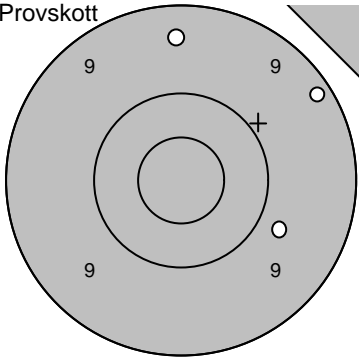
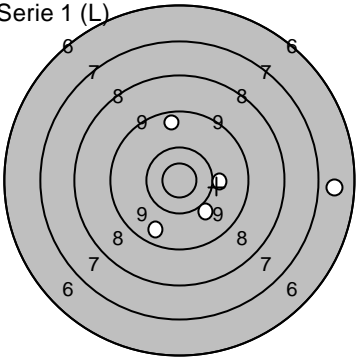
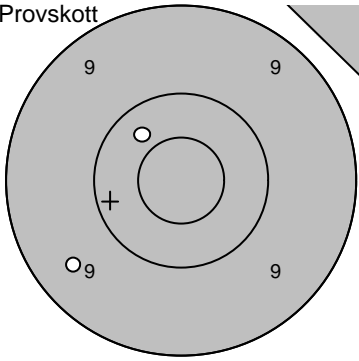
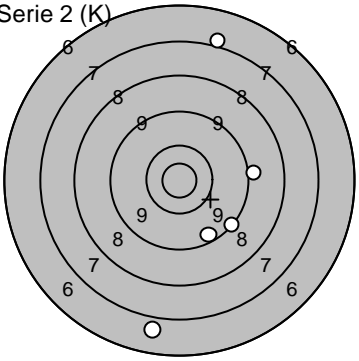
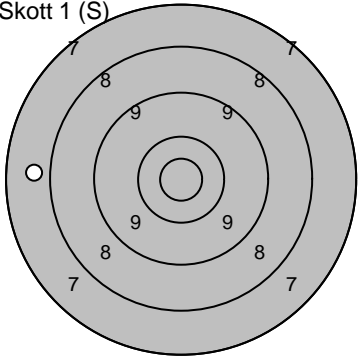
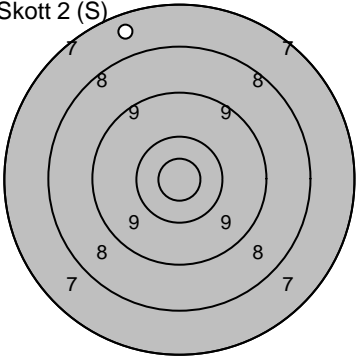
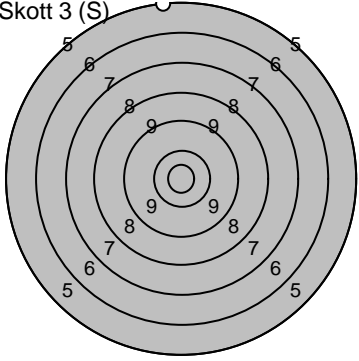
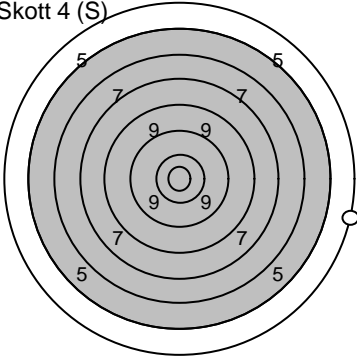
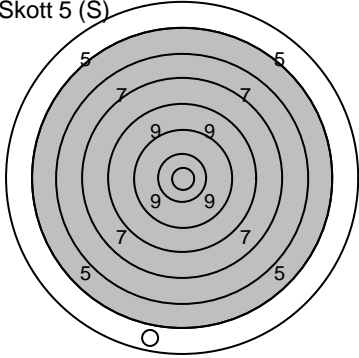
Skjutlag 1	Tavla 19	Kurt-Erik Eriksson	
		Göteborg	
14.07.2007	Tavelträffen B Final 2007	Ramselefors SKF	
Provskott 	1: 9,4 ↑ 2: 9,2 → 3: 9,8 ↘	Serie 1 (L) 	1: 10,0 → 2: 9,5 ↑ 3: 9,6 ↓ 4: 10,0 ↘ 5: 6,8 →
	Serie 27,0 Totalt 259,0		Serie 44,0 Totalt 303,0
Provskott 	1: 10,4 ↖ 2: 9,5 ←	Serie 2 (K) 	1: 7,1 ↑ 2: 9,4 ↓ 3: 9,3 ↘ 4: 9,1 → 5: 6,9 ↓
	Serie 19,0 Totalt 303,0		Serie 40,0 Totalt 343,0
Skott 1 (S) 	1: 7,8 ←	Skott 2 (S) 	1: 7,6 ↑
	Serie 7,0 Totalt 350,0		Serie 7,0 Totalt 357,0
Skott 3 (S) 	1: 5,3 ↑	Skott 4 (S) 	1: 4,3 →
	Serie 5,0 Totalt 362,0		Serie 4,0 Totalt 366,0
Skott 5 (S) 	1: 4,8 ↓		
	Serie 4,0 Totalt 370,0		

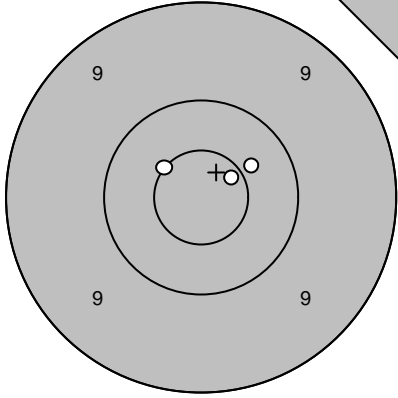
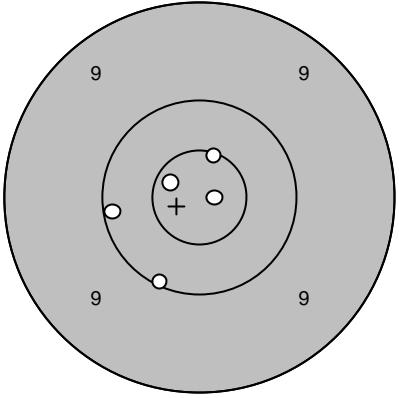
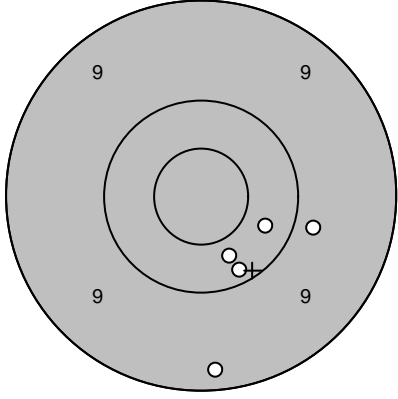
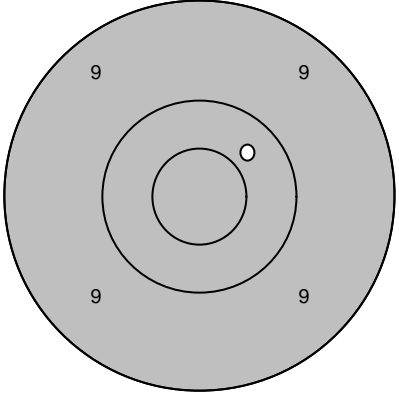
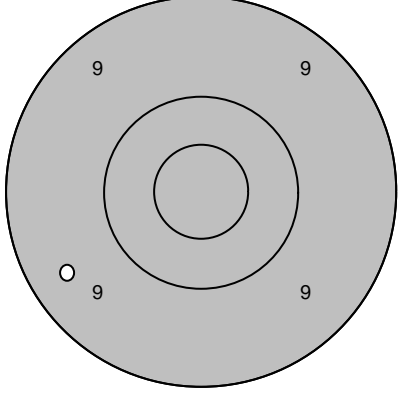
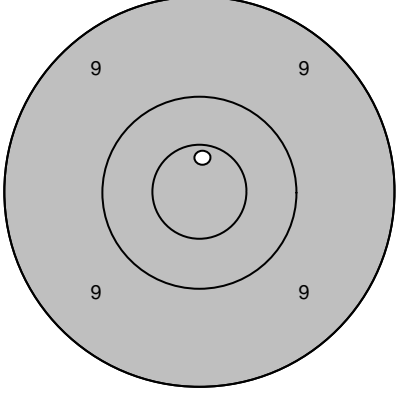
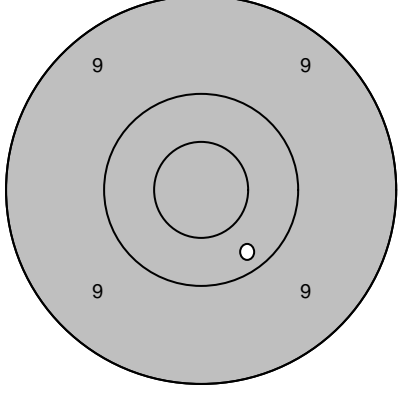
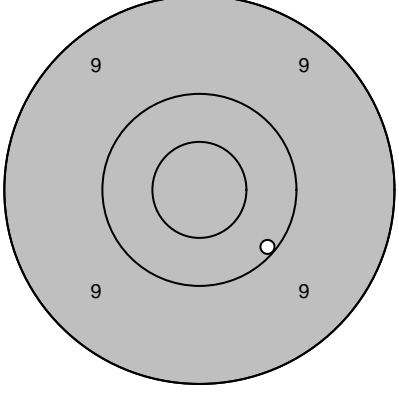
Skjutlag 1	Tavla 20	Jennie Ericson	
		Loos	
14.07.2007	Tavelträffen B Final 2007	Ramselefors SKF	
Provsnitt 	1: 10,4 ↗ 2: 10,6* ↖ 3: 10,7* ↗	Serie 1 (L) 	1: 10,7* ↖ 2: 10,1 ↓ 3: 10,9* → 4: 10,6* ↑ 5: 10,1 ←
	Serie 30,0		Serie 50,0
	Totalt 289,0		Totalt 339,0
Serie 2 (K) 	1: 10,3 → 2: 9,3 ↓ 3: 9,8 → 4: 10,2 ↓ 5: 10,4 ↓	Skott 1 (S) 	1: 10,4 ↗
	Serie 48,0		Serie 10,0
	Totalt 387,0		Totalt 397,0
Skott 2 (S) 	1: 9,4 ↖	Skott 3 (S) 	1: 10,7* ↑
	Serie 9,0		Serie 10,0
	Totalt 406,0		Totalt 416,0
Skott 4 (S) 	1: 10,2 ↓	Skott 5 (S) 	1: 10,1 ↘
	Serie 10,0		Serie 10,0
	Totalt 426,0		Totalt 436,0

Skjutlag	Tavla	Marlene Forsell	
1	21	Ramselefors	
14.07.2007	Tavelträffen B Final 2007	Ramselefors SKF	
Provsjott 	1: 10,0 → 2: 10,8* ← 3: 10,4 ↓	Serie 1 (L) 	1: 9,4 ← 2: 10,3 ← 3: 10,0 ↑ 4: 9,9 ← 5: 9,8 →
	Serie 30,0		Serie 47,0
	Totalt 283,0		Totalt 330,0
Provsjott 	1: 9,7 ↑ 2: 9,9 ↗	Serie 2 (K) 	1: 10,9* ↓ 2: 10,7* → 3: 10,4 ← 4: 10,9* → 5: 9,4 ↘
	Serie 18,0		Serie 49,0
	Totalt 330,0		Totalt 379,0
Skott 1 (S) 	1: 9,8 ↗	Skott 2 (S) 	1: 9,4 ↓
	Serie 9,0		Serie 9,0
	Totalt 388,0		Totalt 397,0
Skott 3 (S) 	1: 10,0 →	Skott 4 (S) 	1: 9,9 ↗
	Serie 10,0		Serie 9,0
	Totalt 407,0		Totalt 416,0
Skott 5 (S) 	1: 10,2 ↓		
	Serie 10,0		
	Totalt 426,0		

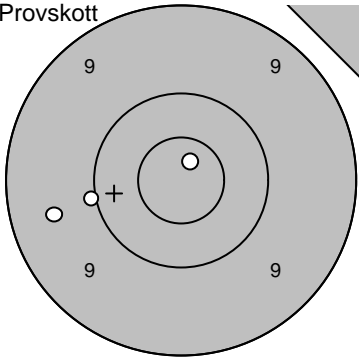
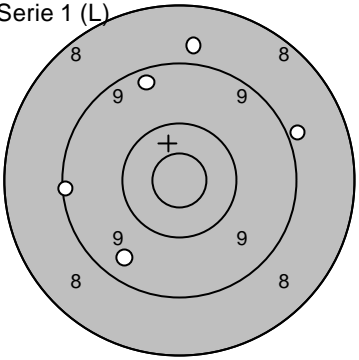
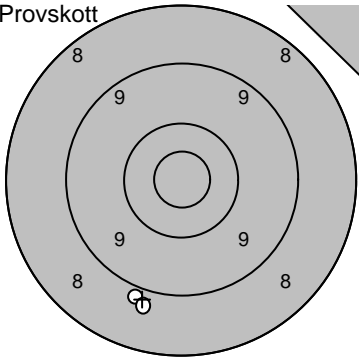
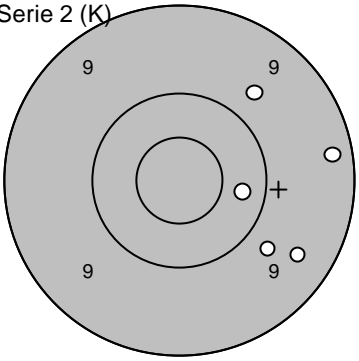
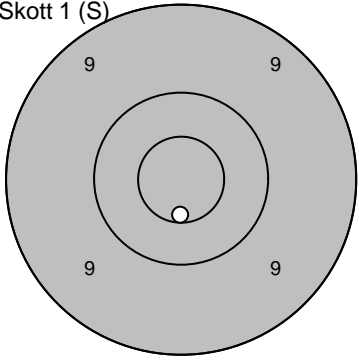
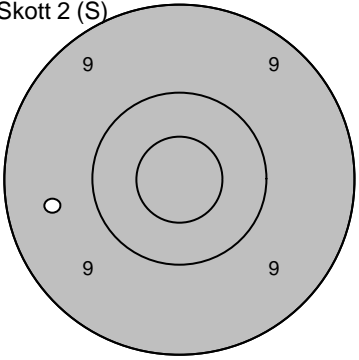
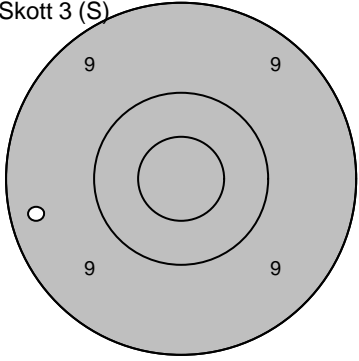
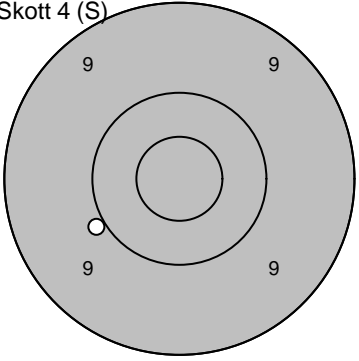
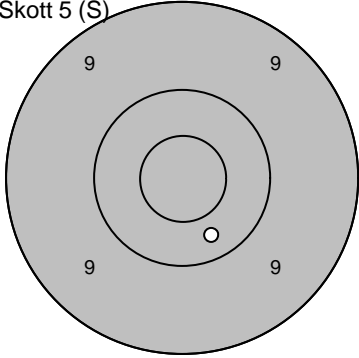
Skjutlag	Tavla	Petter Ivarsson		
1	22			
		Loos		
14.07.2007	Tavelträffen B Final 2007	Ramselefors SKF		
Provsrott		1: 10,0 ← 2: 10,8* ↑ 3: 9,5 ←	Serie 1 (L) 	1: 8,9 → 2: 8,8 ↑ 3: 9,4 ↑ 4: 9,2 ← 5: 9,5 ↓
		Serie 29,0	Serie 43,0	
		Totalt 280,0	Totalt 323,0	
Provsrott		1: 9,0 ↓ 2: 8,9 ↓	Serie 2 (K) 	1: 9,3 → 2: 10,3 → 3: 9,7 ↑ 4: 9,8 ↓ 5: 9,5 ↓
		Serie 17,0	Serie 46,0	
		Totalt 323,0	Totalt 369,0	
Skott 1 (S)		1: 10,6* ↓	Skott 2 (S) 	1: 9,6 ←
		Serie 10,0	Serie 9,0	
		Totalt 379,0	Totalt 388,0	
Skott 3 (S)		1: 9,4 ←	Skott 4 (S) 	1: 10,0 ←
		Serie 9,0	Serie 10,0	
		Totalt 397,0	Totalt 407,0	
Skott 5 (S)		1: 10,3 ↓		
		Serie 10,0		
		Totalt 417,0		

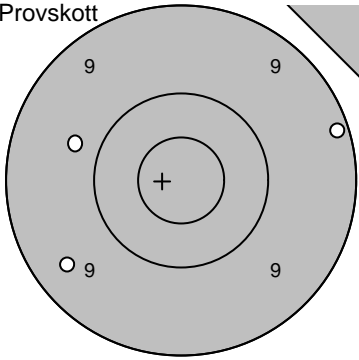
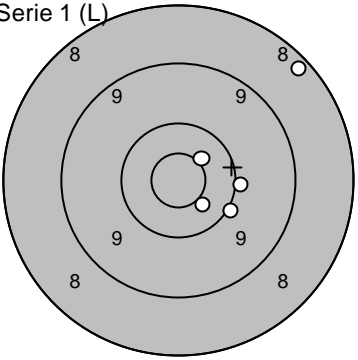
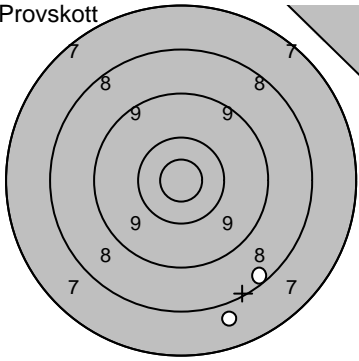
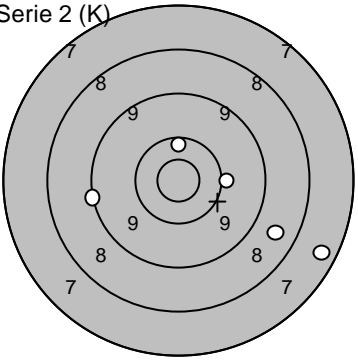
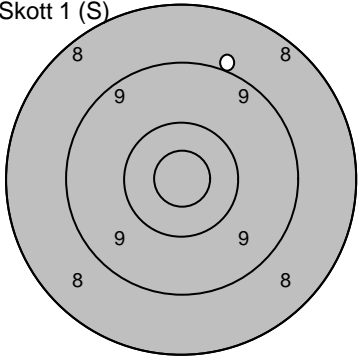
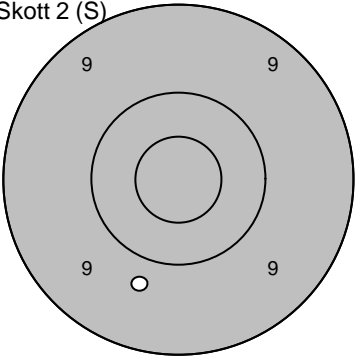
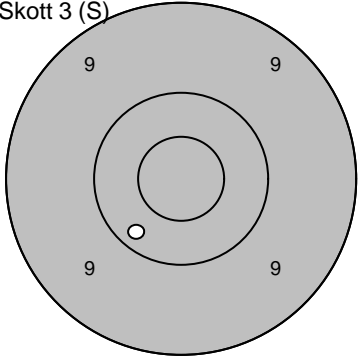
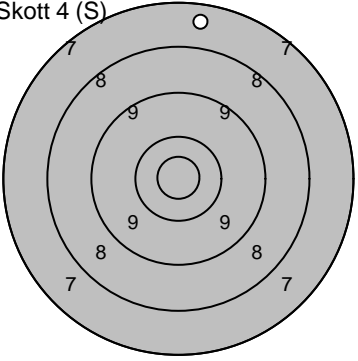
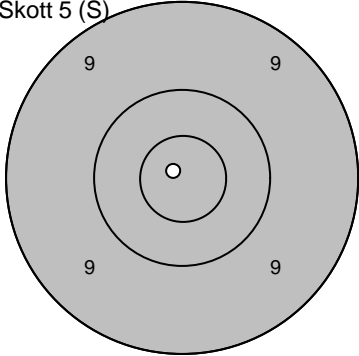
Skjutlag 1	Tavla 23	Rolf Åström	
		Brattby	
14.07.2007	Tavelträffen B Final 2007	Ramselefors SKF	
Provskott 	1: 9,2 → 2: 9,8 ↖ 3: 9,4 ↙	Serie 1 (L) 	1: 10,5* ↘ 2: 10,6* ↗ 3: 8,3 ↗ 4: 10,1 ↘ 5: 10,0 →
	Serie 27,0 Totalt 273,0		Serie 48,0 Totalt 321,0
Provskott 	1: 7,8 ↓ 2: 8,3 ↓	Serie 2 (K) 	1: 8,6 → 2: 10,0 → 3: 7,5 ↘ 4: 10,3 ↑ 5: 9,2 ←
	Serie 15,0 Totalt 321,0		Serie 44,0 Totalt 365,0
Skott 1 (S) 	1: 9,0 ↑	Skott 2 (S) 	1: 9,8 ↓
	Serie 9,0 Totalt 374,0		Serie 9,0 Totalt 383,0
Skott 3 (S) 	1: 10,3 ↗	Skott 4 (S) 	1: 7,6 ↑
	Serie 10,0 Totalt 393,0		Serie 7,0 Totalt 400,0
Skott 5 (S) 	1: 10,9* ↖		
	Serie 10,0 Totalt 410,0		

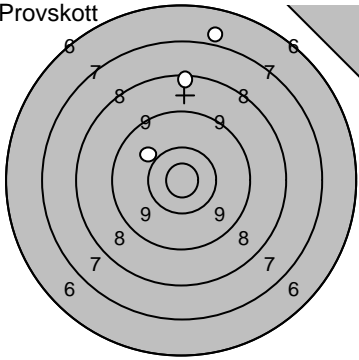
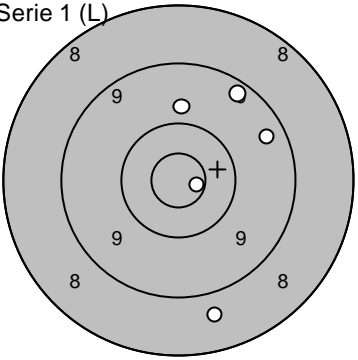
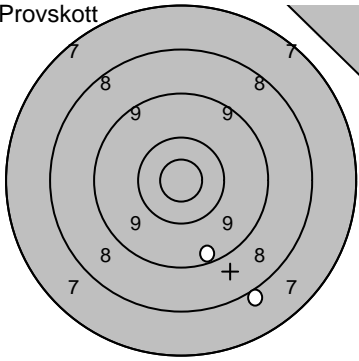
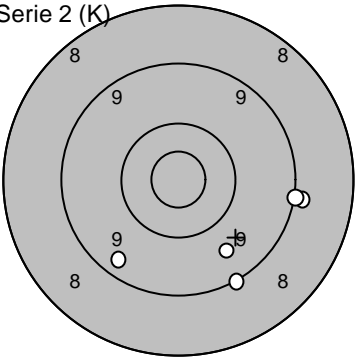
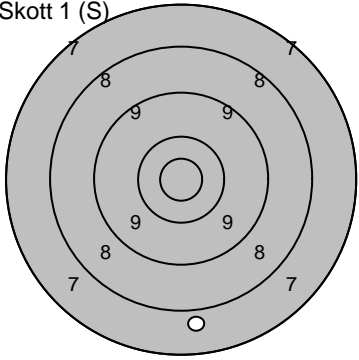
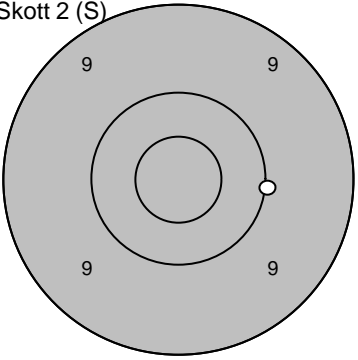
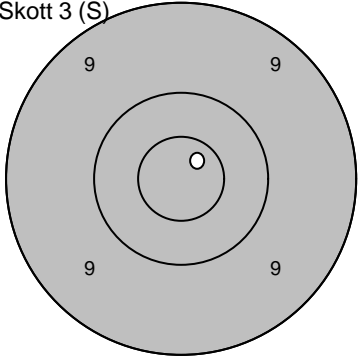
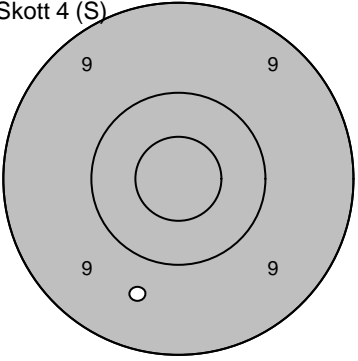
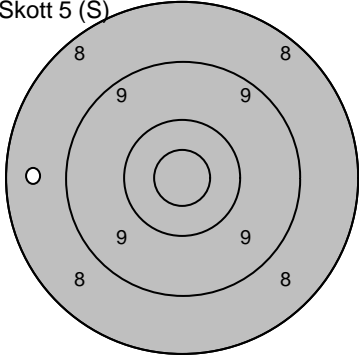
Skjutlag	Tavla	Peter Lundqvist	
1	24	Ununge	
14.07.2007	Tavelträffen B Final 2007	Ramselefors SKF	
Provsnitt 	1: 8,3 ↑ 2: 6,9 ↗ 3: 10,0 ↗	Serie 1 (L) 	1: 10,8* → 2: 9,9 ↑ 3: 9,4 → 4: 9,3 ↗ 5: 8,7 ↓
	Serie 24,0		Serie 45,0
	Totalt 272,0		Totalt 317,0
Provsnitt 	1: 9,4 ↓ 2: 8,0 ↓	Serie 2 (K) 	1: 9,6 ↓ 2: 8,9 → 3: 9,1 → 4: 9,4 ↙ 5: 9,1 ↓
	Serie 17,0		Serie 44,0
	Totalt 317,0		Totalt 361,0
Skott 1 (S) 	1: 7,8 ↓	Skott 2 (S) 	1: 10,0 →
	Serie 7,0		Serie 10,0
	Totalt 368,0		Totalt 378,0
Skott 3 (S) 	1: 10,8* ↗	Skott 4 (S) 	1: 9,7 ↓
	Serie 10,0		Serie 9,0
	Totalt 388,0		Totalt 397,0
Skott 5 (S) 	1: 8,6 ←		
	Serie 8,0		
	Totalt 405,0		

Skjutlag 2	Tavla 1	Josefin Sandberg	
		Kalix	
14.07.2007	Tavelträffen B Final 2007	Ramselefors SKF	
Provsnitt 	1: 10,0 → 2: 10,3 ↗ 3: 10,1 ↓	Serie 1 (L) 	1: 8,5 ↙ 2: 9,3 ↓ 3: 9,2 ↓ 4: 9,7 ↖ 5: 10,2 ↑
Serie 30,0		Serie 45,0	
Totalt 279,0		Totalt 324,0	
Provsnitt 	1: 7,3 ← 2: 7,7 ↖	Serie 2 (K) 	1: 9,4 ↖ 2: 9,6 ↖ 3: 9,5 ↑ 4: 8,7 ↓ 5: 8,0 →
Serie 14,0		Serie 43,0	
Totalt 324,0		Totalt 367,0	
Skott 1 (S) 	1: 9,0 ←	Skott 2 (S) 	1: 8,7 ↓
Serie 9,0		Serie 8,0	
Totalt 376,0		Totalt 384,0	
Skott 3 (S) 	1: 8,6 →	Skott 4 (S) 	1: 9,3 →
Serie 8,0		Serie 9,0	
Totalt 392,0		Totalt 401,0	
Skott 5 (S) 	1: 9,8 ←		
Serie 9,0			
Totalt 410,0			

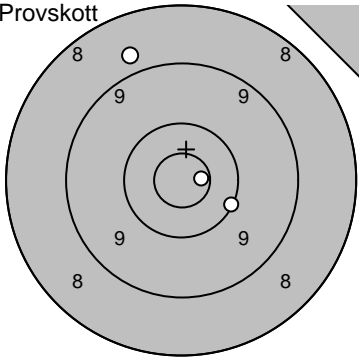
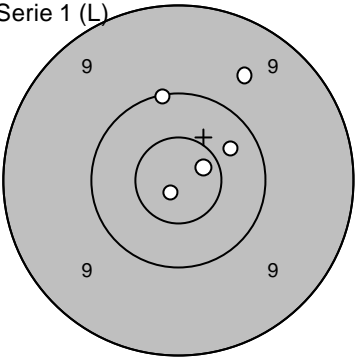
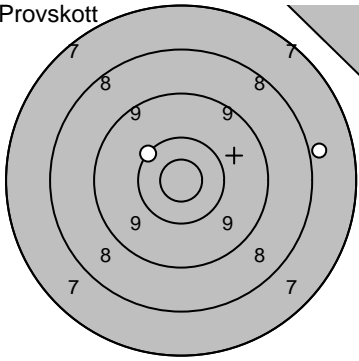
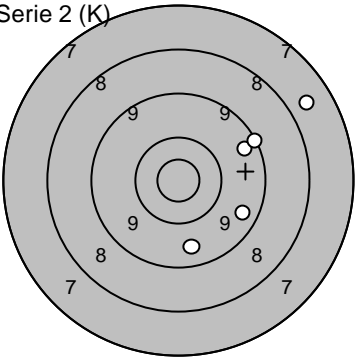
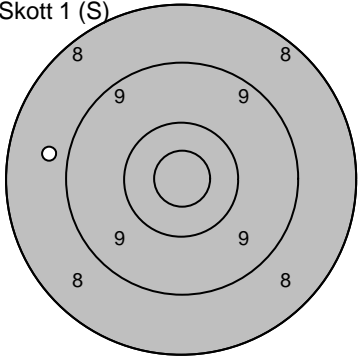
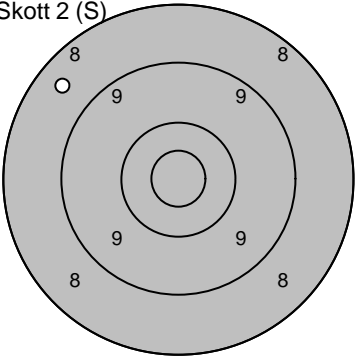
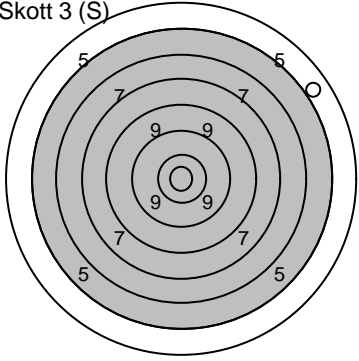
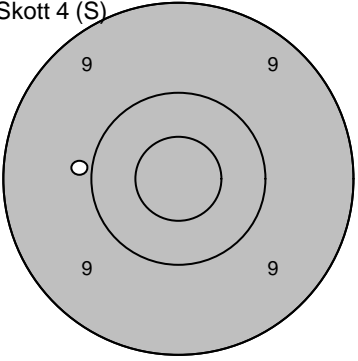
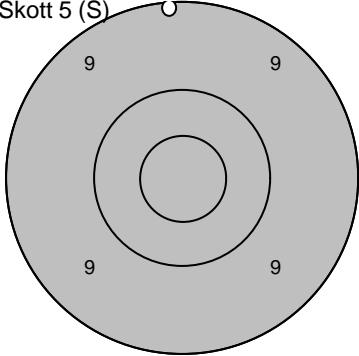
Skjutlag	Tavla	Fredrik Forsgren	
2	2	Ramselefors	
14.07.2007	Tavelträffen B Final 2007	Ramselefors SKF	
Provkott 	1: 8,8 ↖ 2: 10,8* → 3: 10,1 ↘	Serie 1 (L) 	1: 10,1 ↑ 2: 10,9* ↓ 3: 10,3 ↗ 4: 9,6 ↗ 5: 10,7* ↗
	Serie 28,0		Serie 49,0
	Totalt 279,0		Totalt 328,0
Provkott 	1: 10,2 ↖ 2: 7,9 →	Serie 2 (K) 	1: 7,7 ↗ 2: 9,5 ↗ 3: 9,5 → 4: 9,2 ↗ 5: 9,6 ↓
	Serie 17,0		Serie 43,0
	Totalt 328,0		Totalt 371,0
Skott 1 (S) 	1: 8,8 ←	Skott 2 (S) 	1: 8,6 ↖
	Serie 8,0		Serie 8,0
	Totalt 379,0		Totalt 387,0
Skott 3 (S) 	1: 5,0 ↗	Skott 4 (S) 	1: 9,9 ←
	Serie 5,0		Serie 9,0
	Totalt 392,0		Totalt 401,0
Skott 5 (S) 	1: 9,1 ↑		
	Serie 9,0		
	Totalt 410,0		

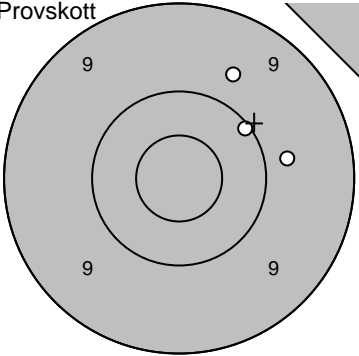
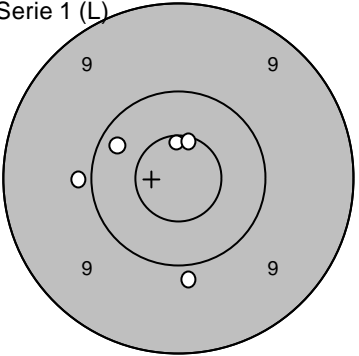
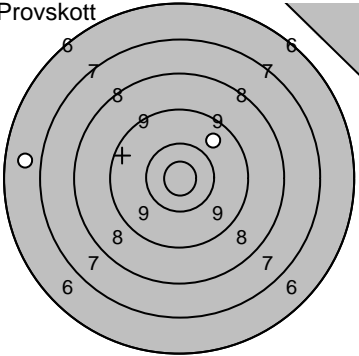
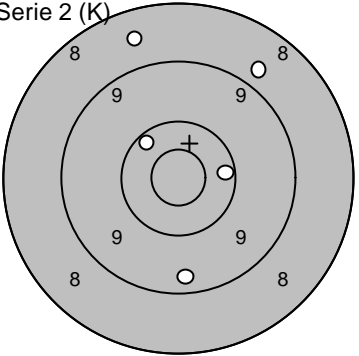
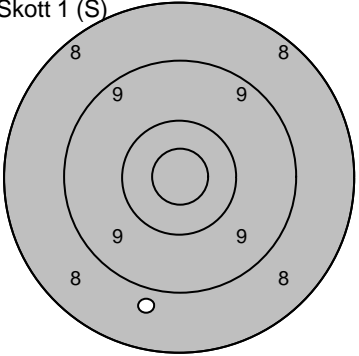
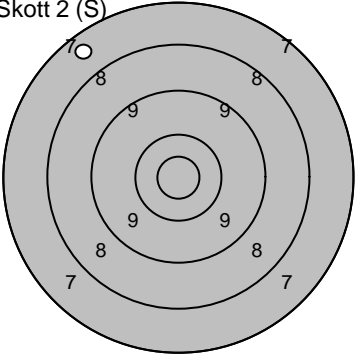
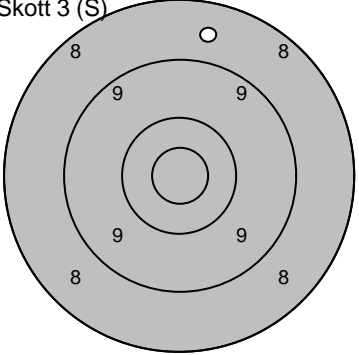
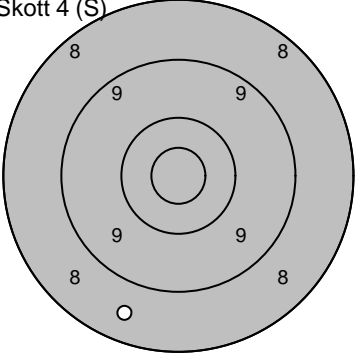
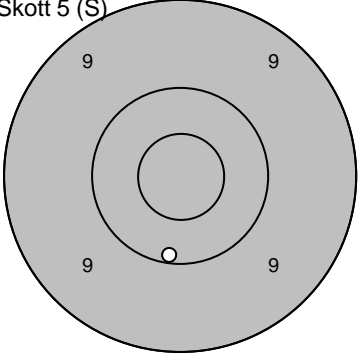
Skjutlag 2	Tavla 3	Håkan Nyberg	
		Mörsil	
14.07.2007	Tavelträffen B Final 2007	Ramselefors SKF	
Provskott 	1: 9,8 → 2: 9,7 ↗ 3: 10,1 ↗	Serie 1 (L) 	1: 10,6* ↑ 2: 9,9 ← 3: 10,3 ↗ 4: 10,6* ↑ 5: 9,9 ↓
Serie 28,0		Serie 48,0	
Totalt 278,0		Totalt 326,0	
Provskott 	1: 6,8 ← 2: 9,8 ↗	Serie 2 (K) 	1: 10,3 ↗ 2: 8,8 ↗ 3: 8,6 ↗ 4: 9,4 ↓ 5: 10,3 →
Serie 15,0		Serie 45,0	
Totalt 326,0		Totalt 371,0	
Skott 1 (S) 	1: 8,8 ↓	Skott 2 (S) 	1: 7,6 ↗
Serie 8,0		Serie 7,0	
Totalt 379,0		Totalt 386,0	
Skott 3 (S) 	1: 8,7 ↑	Skott 4 (S) 	1: 8,6 ↓
Serie 8,0		Serie 8,0	
Totalt 394,0		Totalt 402,0	
Skott 5 (S) 	1: 10,1 ↓		
Serie 10,0			
Totalt 412,0			

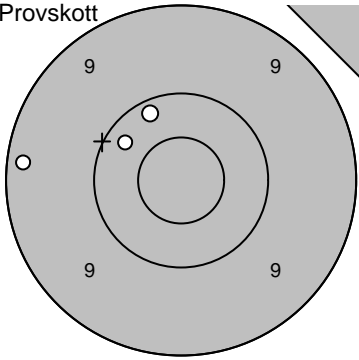
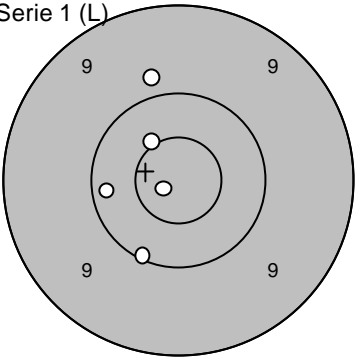
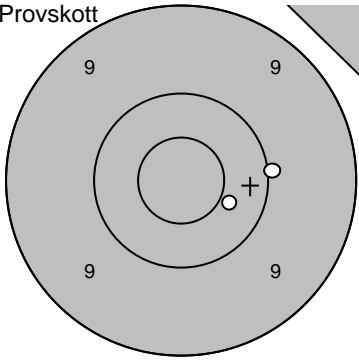
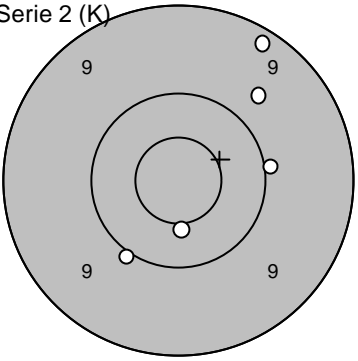
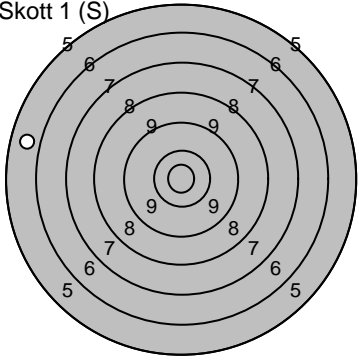
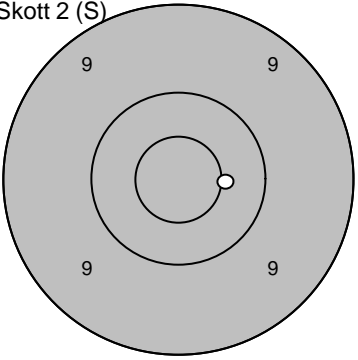
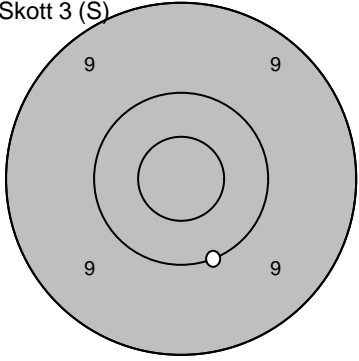
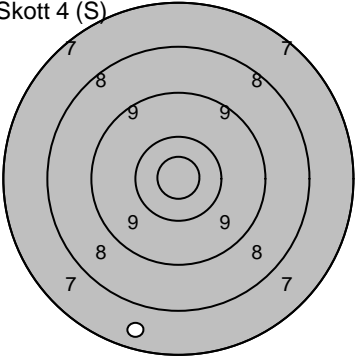
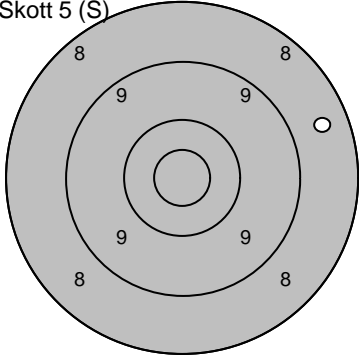
Skjutlag 2	Tavla 4	Therese Danielsson	
		Ununge	
14.07.2007	Tavelträffen B Final 2007	Ramselefors SKF	
Provsnitt 	1: 9,3 ← 2: 10,3 ↗ 3: 10,2 →	Serie 1 (L) 	1: 9,8 ↗ 2: 10,5* ↗ 3: 10,2 ← 4: 10,1 ↓ 5: 10,9* ←
	Serie 29,0		Serie 49,0
	Totalt 277,0		Totalt 326,0
Provsnitt 	1: 10,0 → 2: 10,4 ↘	Serie 2 (K) 	1: 9,7 ↗ 2: 9,2 ↗ 3: 10,5* ↓ 4: 10,0 ↓ 5: 10,0 →
	Serie 20,0		Serie 48,0
	Totalt 326,0		Totalt 374,0
Skott 1 (S) 	1: 5,8 ←	Skott 2 (S) 	1: 10,5* →
	Serie 5,0		Serie 10,0
	Totalt 379,0		Totalt 389,0
Skott 3 (S) 	1: 10,1 ↓	Skott 4 (S) 	1: 7,6 ↓
	Serie 10,0		Serie 7,0
	Totalt 399,0		Totalt 406,0
Skott 5 (S) 	1: 8,5 →		
	Serie 8,0		
	Totalt 414,0		

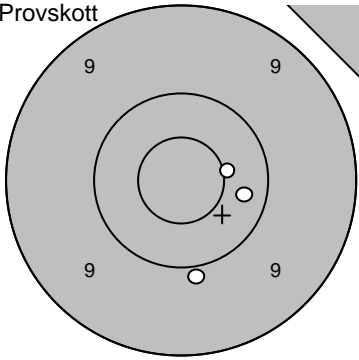
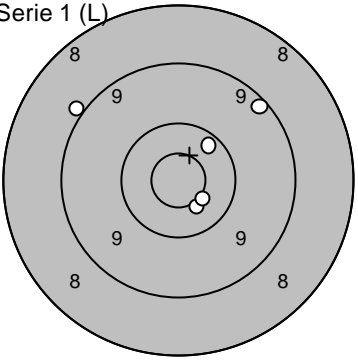
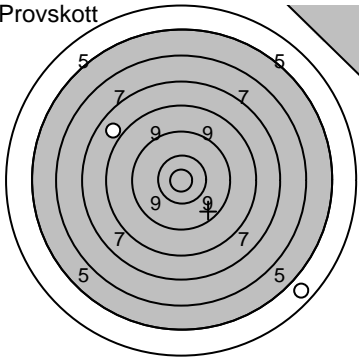
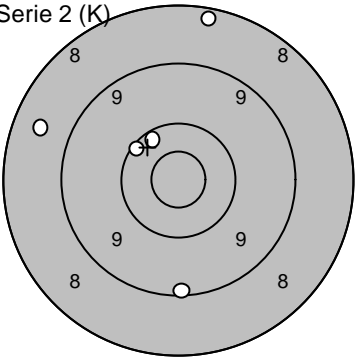
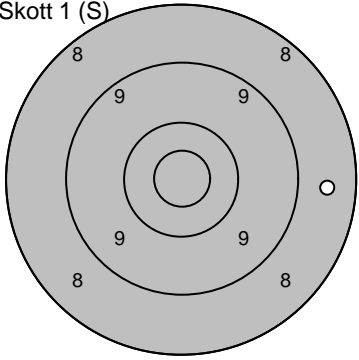
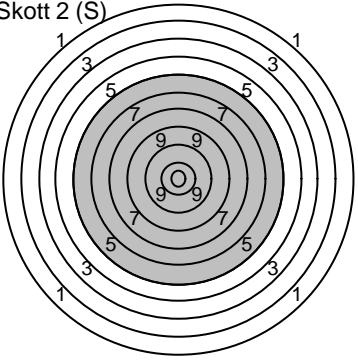
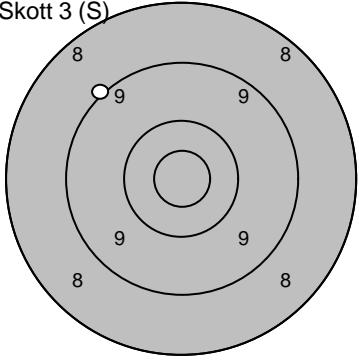
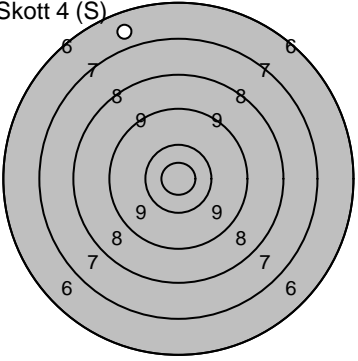
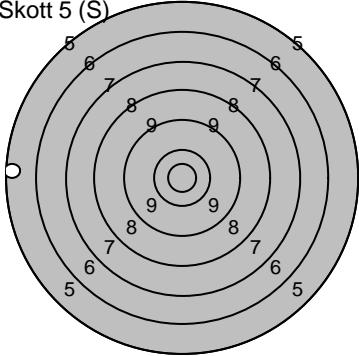
Skjutlag 2	Tavla 5	Johan Zakrisson	
		Ramselefors	
14.07.2007	Tavelträffen B Final 2007	Ramselefors SKF	
Provsnitt 	1: 10,3 → 2: 9,9 ↓ 3: 10,5* →	Serie 1 (L) 	1: 10,6* ↓ 2: 9,0 ↗ 3: 10,3 ↗ 4: 9,2 ↗ 5: 10,6* ↓
	Serie 29,0		Serie 48,0
	Totalt 274,0		Totalt 322,0
Provsnitt 	1: 7,9 ↗ 2: 4,8 ↓	Serie 2 (K) 	1: 8,3 ↑ 2: 8,6 ↗ 3: 9,2 ↓ 4: 10,2 ↗ 5: 10,3 ↗
	Serie 11,0		Serie 45,0
	Totalt 322,0		Totalt 367,0
Skott 1 (S) 	1: 8,6 →	Skott 2 (S) 	1: 0,0 →
	Serie 8,0		Serie 0,0
	Totalt 375,0		Totalt 375,0
Skott 3 (S) 	1: 9,1 ↖	Skott 4 (S) 	1: 6,8 ↖
	Serie 9,0		Serie 6,0
	Totalt 384,0		Totalt 390,0
Skott 5 (S) 	1: 5,5 ←		
	Serie 5,0		
	Totalt 395,0		

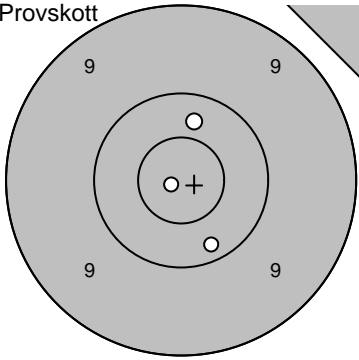
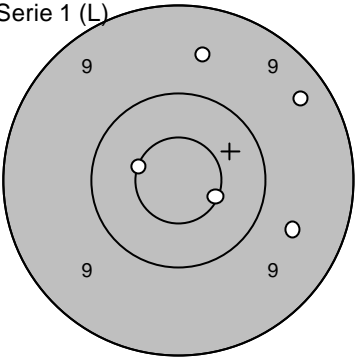
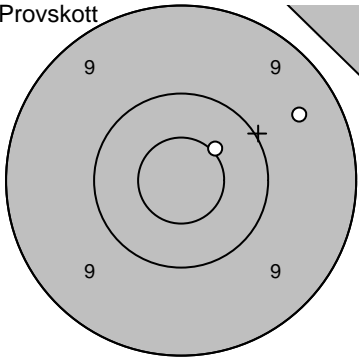
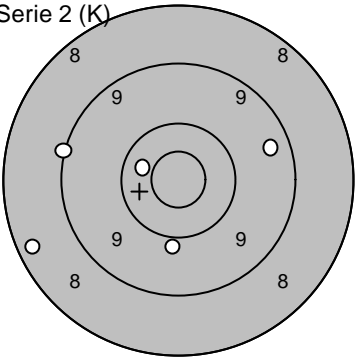
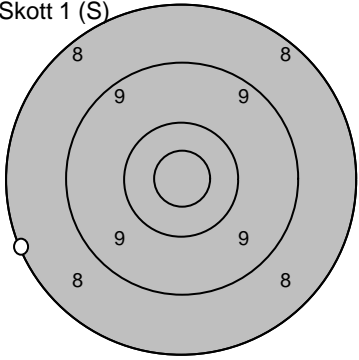
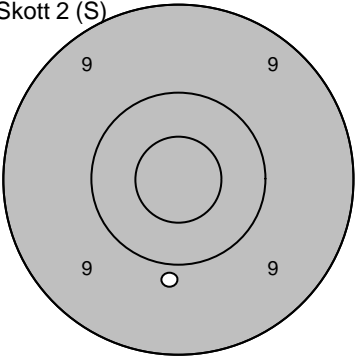
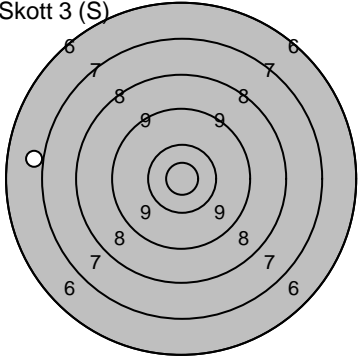
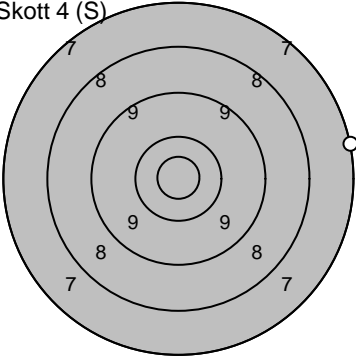
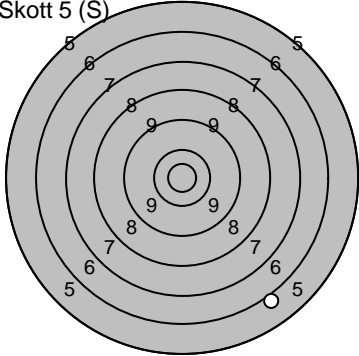
Skjutlag 2	Tavla 6	Per Östling	
		F 21	
14.07.2007	Tavelträffen B Final 2007	Ramselefors SKF	
Provsnitt 	1: 10,4 ↑ 2: 10,9* ← 3: 10,2 ↓	Serie 1 (L) 	1: 10,6* → 2: 9,6 ↑ 3: 9,4 ↗ 4: 9,6 → 5: 10,6* ↖
	Serie 30,0		Serie 47,0
	Totalt 274,0		Totalt 321,0
Provsnitt 	1: 10,5* ↗ 2: 9,5 ↘	Serie 2 (K) 	1: 8,4 ← 2: 9,4 → 3: 10,4 ↖ 4: 10,0 ↓ 5: 9,1 ←
	Serie 19,0		Serie 46,0
	Totalt 321,0		Totalt 367,0
Skott 1 (S) 	1: 8,1 ←	Skott 2 (S) 	1: 9,9 ↓
	Serie 8,0		Serie 9,0
	Totalt 375,0		Totalt 384,0
Skott 3 (S) 	1: 7,0 ←	Skott 4 (S) 	1: 7,1 →
	Serie 7,0		Serie 7,0
	Totalt 391,0		Totalt 398,0
Skott 5 (S) 	1: 6,1 ↓		
	Serie 6,0		
	Totalt 404,0		

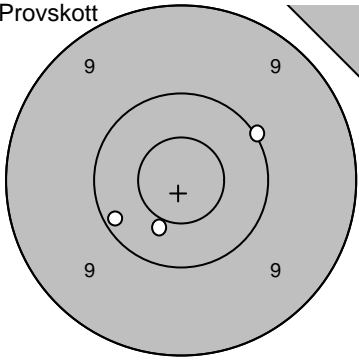
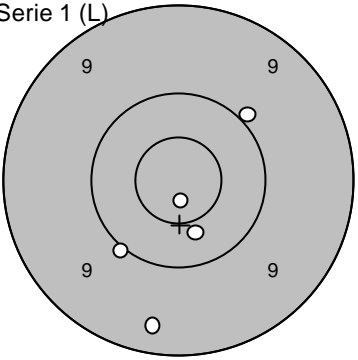
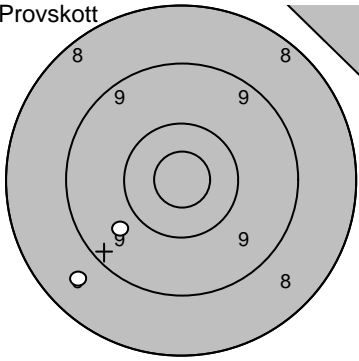
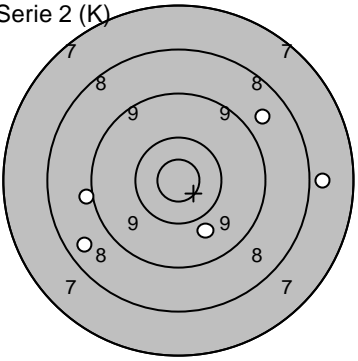
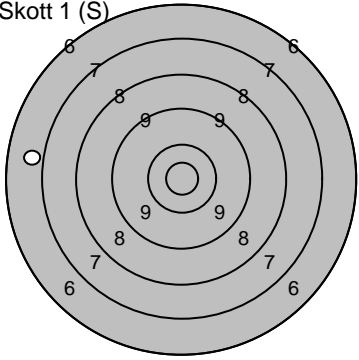
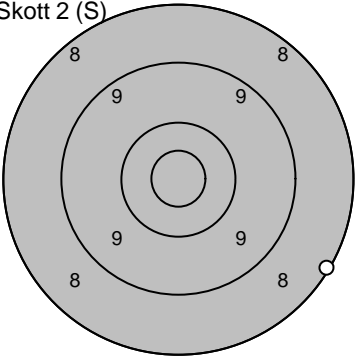
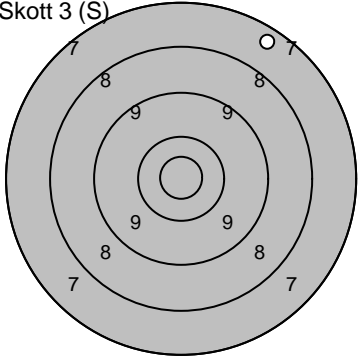
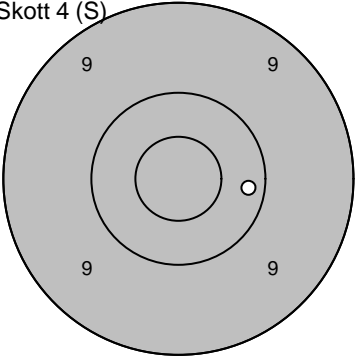
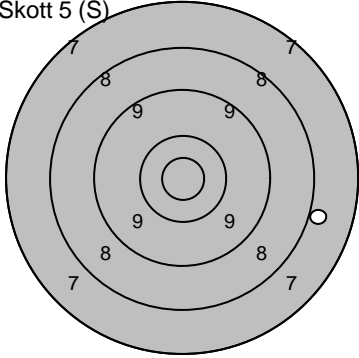
Skjutlag 2	Tavla 7	Börje Erlandsson	
		Vikingen	
14.07.2007	Tavelträffen B Final 2007	Ramselefors SKF	
Provsnitt 	1: 10,0 → 2: 10,2 ↙ 3: 10,5* ↘	Serie 1 (L) 	1: 10,0 ↙ 2: 9,4 ↓ 3: 10,8* ↓ 4: 10,0 ↗ 5: 10,4 ↓
	Serie 30,0		Serie 49,0
	Totalt 273,0		Totalt 322,0
Provsnitt 	1: 8,7 ↘ 2: 9,8 ↙	Serie 2 (K) 	1: 9,0 ← 2: 8,7 ↗ 3: 7,9 → 4: 9,8 ↓ 5: 8,6 ↙
	Serie 17,0		Serie 41,0
	Totalt 322,0		Totalt 363,0
Skott 1 (S) 	1: 6,9 ←	Skott 2 (S) 	1: 8,1 ↘
	Serie 6,0		Serie 8,0
	Totalt 369,0		Totalt 377,0
Skott 3 (S) 	1: 7,5 ↗	Skott 4 (S) 	1: 10,2 →
	Serie 7,0		Serie 10,0
	Totalt 384,0		Totalt 394,0
Skott 5 (S) 	1: 7,9 →		
	Serie 7,0		
	Totalt 401,0		

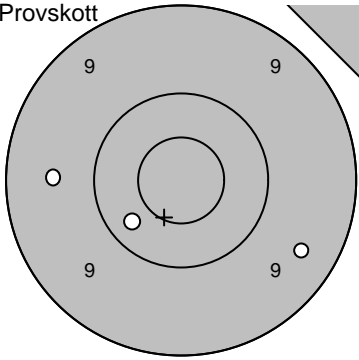
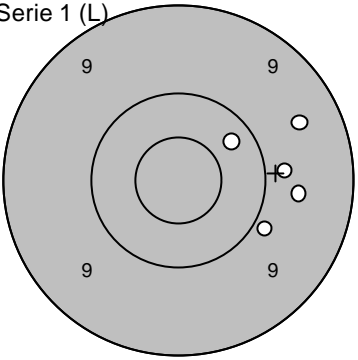
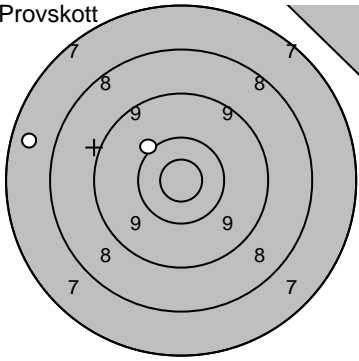
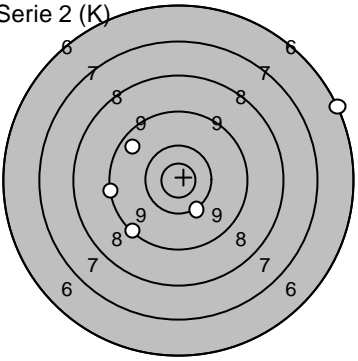
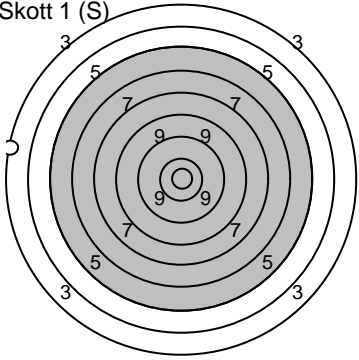
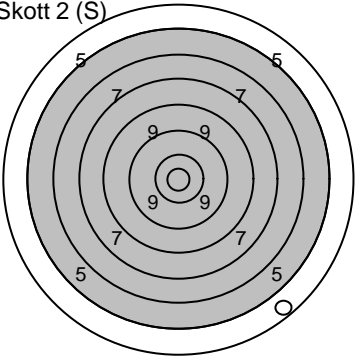
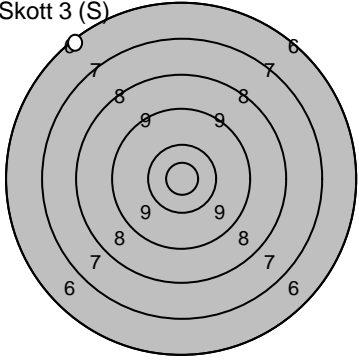
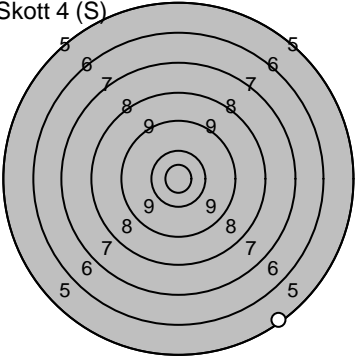
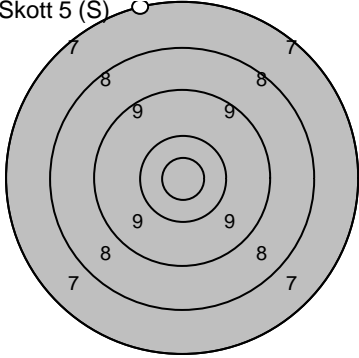
Skjutlag 2	Tavla 8	Sven Magnusson	
		Liden	
14.07.2007	Tavelträffen B Final 2007	Ramselefors SKF	
Provkott 	1: 9,5 → 2: 9,6 ← 3: 10,3 ↙	Serie 1 (L) 	1: 9,7 → 2: 10,3 ↗ 3: 9,8 → 4: 9,5 ↗ 5: 9,9 ↘
	Serie 28,0 Totalt 273,0		Serie 46,0 Totalt 319,0
Provkott 	1: 10,1 ↖ 2: 7,6 ←	Serie 2 (K) 	1: 9,2 ← 2: 6,2 ↗ 3: 10,2 ↓ 4: 9,2 ↙ 5: 9,6 ↗
	Serie 17,0 Totalt 319,0		Serie 43,0 Totalt 362,0
Skott 1 (S) 	1: 3,5 ←	Skott 2 (S) 	1: 4,7 ↘
	Serie 3,0 Totalt 365,0		Serie 4,0 Totalt 369,0
Skott 3 (S) 	1: 6,3 ↖	Skott 4 (S) 	1: 5,3 ↘
	Serie 6,0 Totalt 375,0		Serie 5,0 Totalt 380,0
Skott 5 (S) 	1: 7,2 ↑		
	Serie 7,0 Totalt 387,0		

Skjutlag 2	Tavla 9	Michael Normann	
		I 16 / Lv 6	
14.07.2007		Tavelträffen B Final 2007	
		Ramselefors SKF	
Provskott 	1: 9,6 ↓ 2: 10,3 ↗ 3: 10,4 ↓	Serie 1 (L) 	1: 9,9 ↗ 2: 9,8 ↗ 3: 9,8 ↗ 4: 10,3 → 5: 9,5 ↓
Serie 29,0		Serie 46,0	
Totalt 273,0		Totalt 319,0	
Provskott 	1: 9,0 ↗ 2: 8,4 →	Serie 2 (K) 	1: 8,3 → 2: 10,5* ↗ 3: 8,3 → 4: 9,8 ↓ 5: 10,2 ↓
Serie 17,0		Serie 45,0	
Totalt 319,0		Totalt 364,0	
Skott 1 (S) 	1: 7,4 ↗	Skott 2 (S) 	1: 7,7 ↓
Serie 7,0		Serie 7,0	
Totalt 371,0		Totalt 378,0	
Skott 3 (S) 	1: 8,3 ↖	Skott 4 (S) 	1: 8,5 ↙
Serie 8,0		Serie 8,0	
Totalt 386,0		Totalt 394,0	
Skott 5 (S) 	1: 5,7 ↖		
Serie 5,0			
Totalt 399,0			

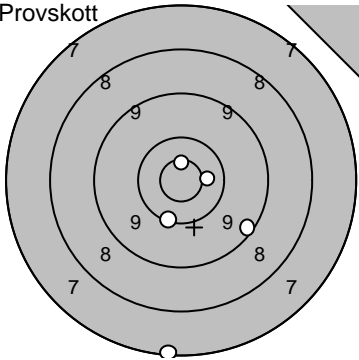
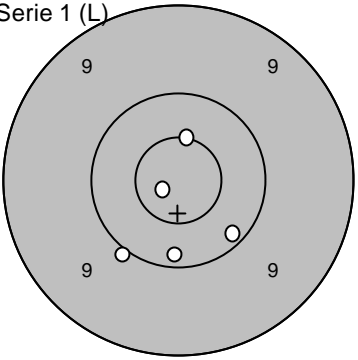
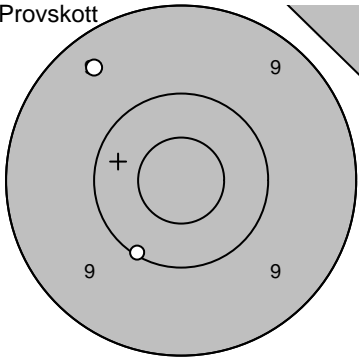
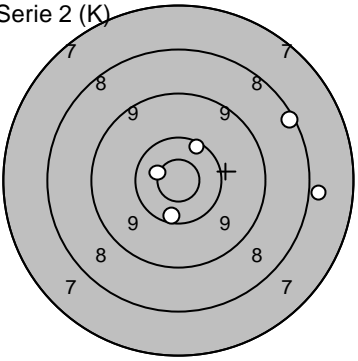
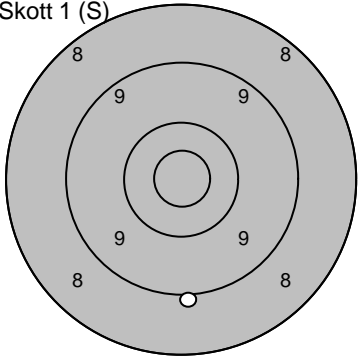
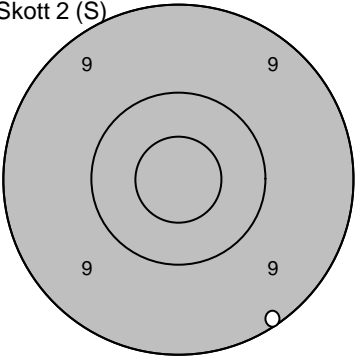
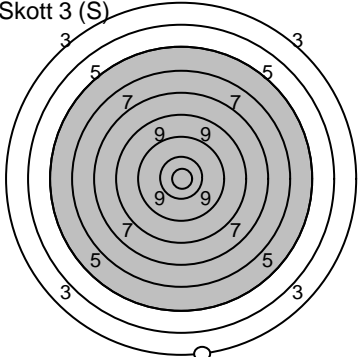
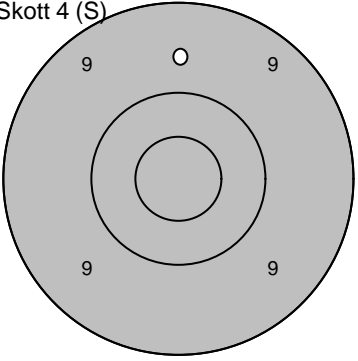
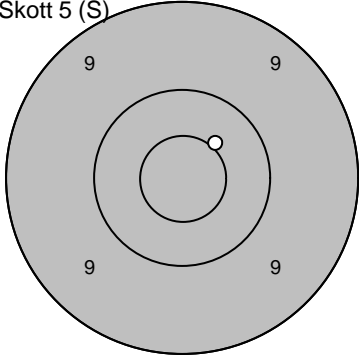
Skjutlag 2	Tavla 10	Berndt Steffen	
		Frötuna	
14.07.2007	Tavelträffen B Final 2007	Ramselefors SKF	
Provsnitt 	1: 7,2 ↓ 2: 10,5* → 3: 10,2 ↓ 4: 9,3 ↓ 5: 10,7* ↑	Serie 1 (L) 	1: 10,0 ↙ 2: 10,5* ↑ 3: 10,8* ↙ 4: 10,2 ↓ 5: 10,2 ↘
	Serie 46,0		Serie 50,0
	Totalt 272,0		Totalt 322,0
Provsnitt 	1: 9,4 ↖ 2: 10,1 ↓	Serie 2 (K) 	1: 8,3 → 2: 10,3 ↓ 3: 7,9 → 4: 10,6* ↖ 5: 10,3 ↗
	Serie 19,0		Serie 45,0
	Totalt 322,0		Totalt 367,0
Skott 1 (S) 	1: 9,0 ↓	Skott 2 (S) 	1: 9,1 ↓
	Serie 9,0		Serie 9,0
	Totalt 376,0		Totalt 385,0
Skott 3 (S) 	1: 3,3 ↓	Skott 4 (S) 	1: 9,7 ↑
	Serie 3,0		Serie 9,0
	Totalt 388,0		Totalt 397,0
Skott 5 (S) 	1: 10,5* ↗		
	Serie 10,0		
	Totalt 407,0		

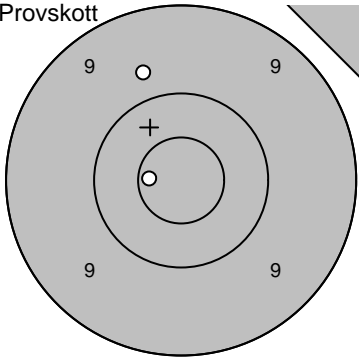
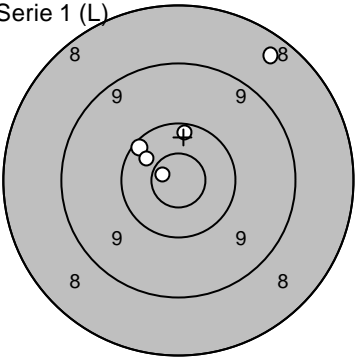
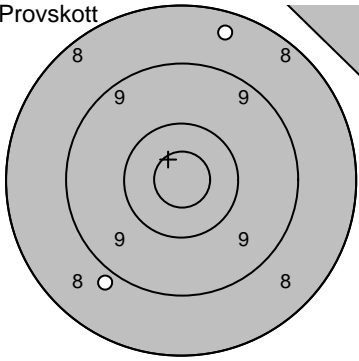
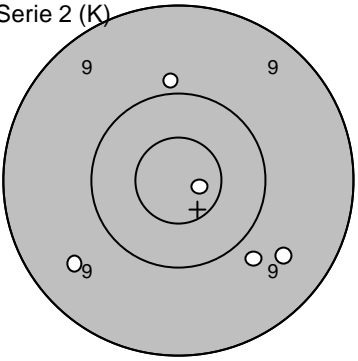
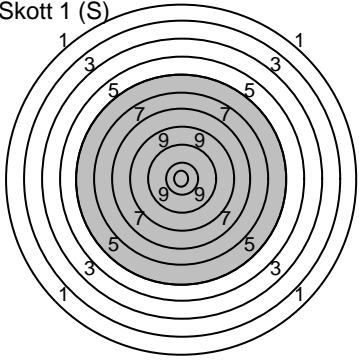
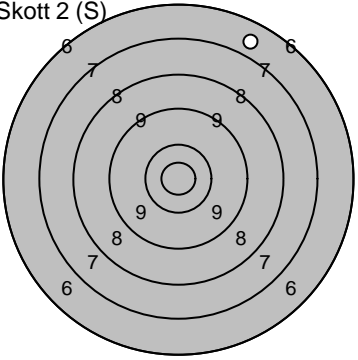
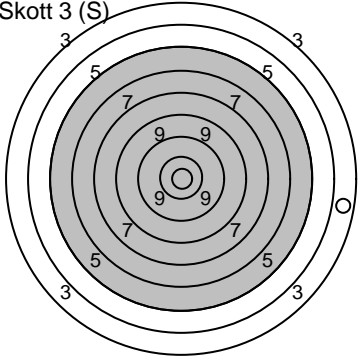
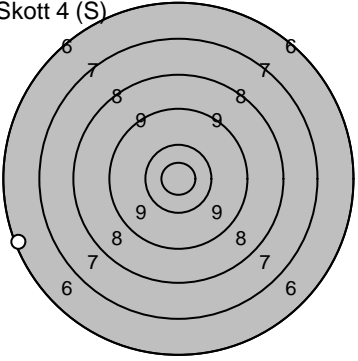
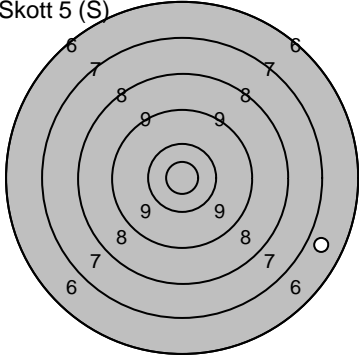
Skjutlag 2	Tavla 11	Alf Edin	
		Ale	
14.07.2007		Tavelträffen B Final 2007	
		Ramselefors SKF	
Provkott 	1: 9,7 ↑ 2: 10,7* ←	Serie 1 (L) 	1: 10,3 ↑ 2: 8,5 ↗ 3: 10,8* ↗ 4: 10,2 ↗ 5: 10,4 ↗
	Serie 19,0 Totalt 271,0		Serie 48,0 Totalt 319,0
Provkott 	1: 8,5 ↑ 2: 8,9 ↘	Serie 2 (K) 	1: 9,9 ↑ 2: 10,8* → 3: 9,8 ↓ 4: 9,5 ↙ 5: 9,6 ↓
	Serie 16,0 Totalt 319,0		Serie 46,0 Totalt 365,0
Skott 1 (S) 	1: 0,0 ↓	Skott 2 (S) 	1: 6,8 ↑
	Serie 0,0 Totalt 365,0		Serie 6,0 Totalt 371,0
Skott 3 (S) 	1: 3,9 →	Skott 4 (S) 	1: 6,3 ←
	Serie 3,0 Totalt 374,0		Serie 6,0 Totalt 380,0
Skott 5 (S) 	1: 6,8 →		
	Serie 6,0 Totalt 386,0		

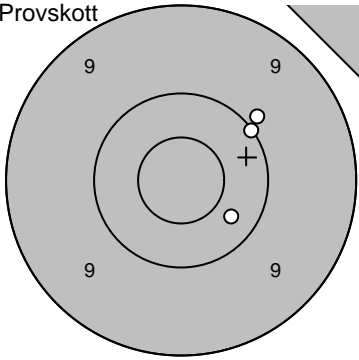
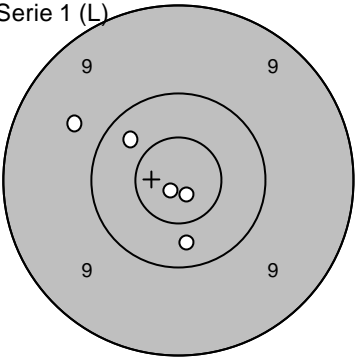
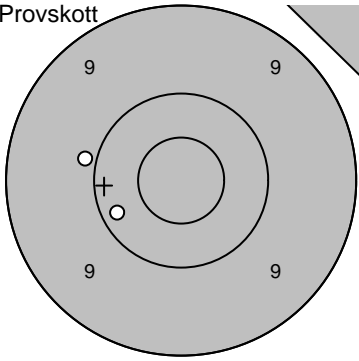
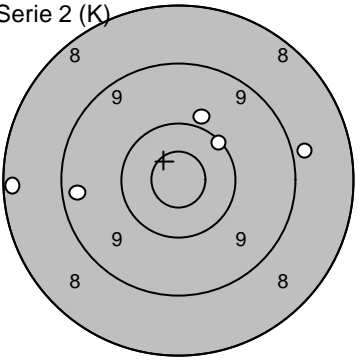
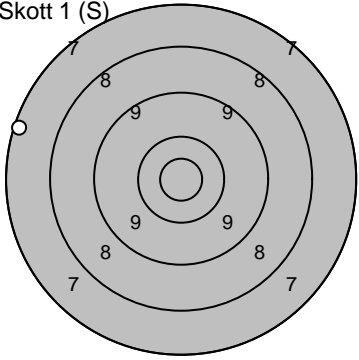
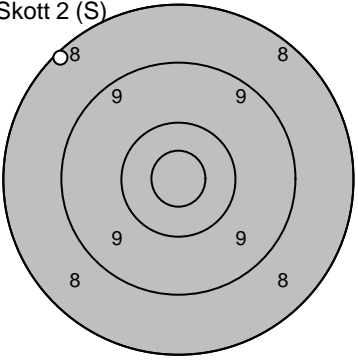
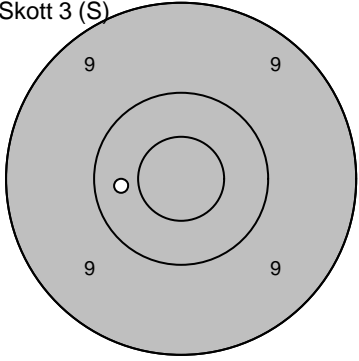
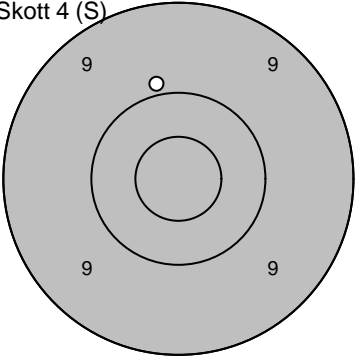
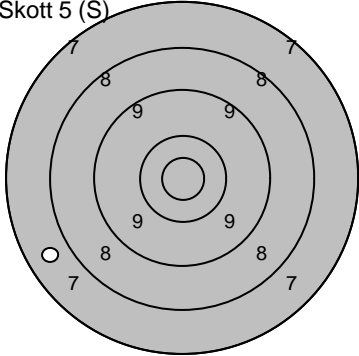
Skjutlag 2	Tavla 12	Stefan Sigfridsson	
		Ramselefors	
14.07.2007	Tavelträffen B Final 2007	Ramselefors SKF	
Provskott 	1: 10,1 ↗ 2: 9,9 ↗ 3: 10,3 ↘	Serie 1 (L) 	1: 9,7 ↖ 2: 10,3 ↗ 3: 10,9* ↘ 4: 10,9* ↘ 5: 10,3 ↓
	Serie 29,0 Totalt 269,0		Serie 49,0 Totalt 318,0
Provskott 	1: 10,2 ↖ 2: 9,9 ↖	Serie 2 (K) 	1: 9,9 ↑ 2: 8,3 ← 3: 8,9 → 4: 9,4 ← 5: 10,2 ↗
	Serie 19,0 Totalt 318,0		Serie 44,0 Totalt 362,0
Skott 1 (S) 	1: 7,3 ↖	Skott 2 (S) 	1: 8,2 ↖
	Serie 7,0 Totalt 369,0		Serie 8,0 Totalt 377,0
Skott 3 (S) 	1: 10,4 ←	Skott 4 (S) 	1: 9,9 ↑
	Serie 10,0 Totalt 387,0		Serie 9,0 Totalt 396,0
Skott 5 (S) 	1: 7,7 ↖		
	Serie 7,0 Totalt 403,0		

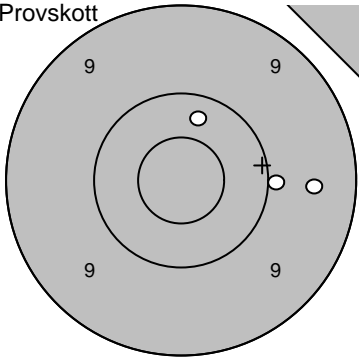
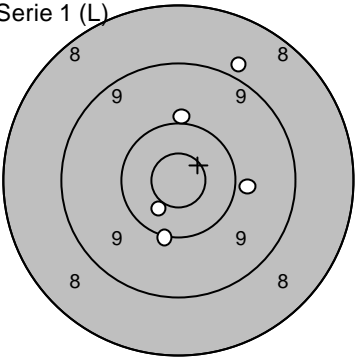
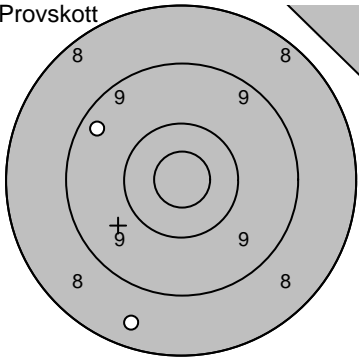
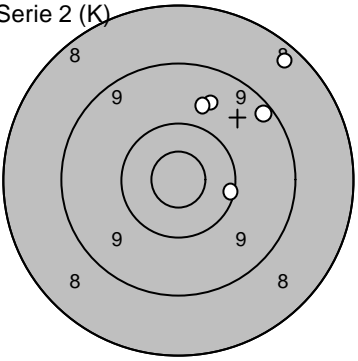
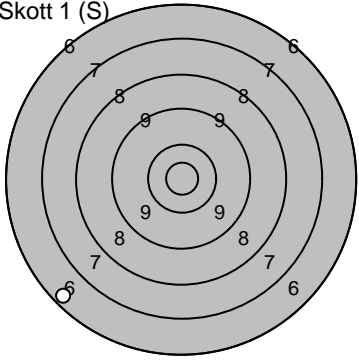
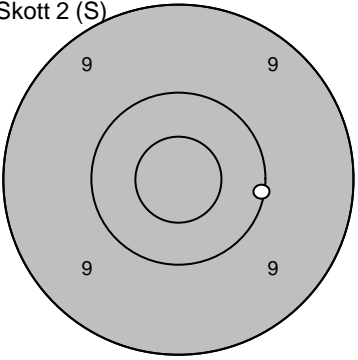
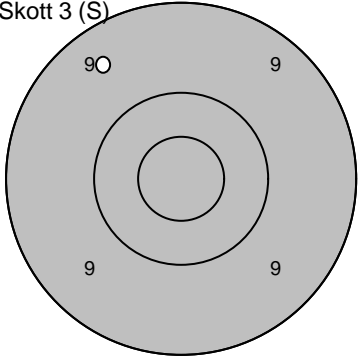
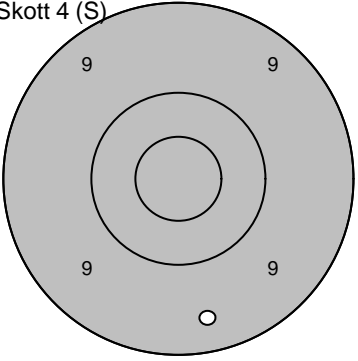
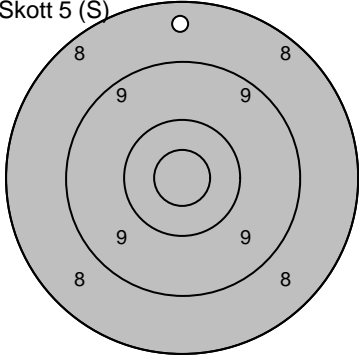
Skjutlag	Tavla	Jan-Erik Fäldt	
2	13		
		Storfors	
14.07.2007	Tavelträffen B Final 2007	Ramselefors SKF	
Provsnitt 	1: 10,0 → 2: 9,5 → 3: 10,3 ↑	Serie 1 (L) 	1: 10,1 ↓ 2: 10,5* ↓ 3: 9,9 → 4: 8,9 ↗ 5: 10,0 ↑
	Serie 29,0		Serie 47,0
	Totalt 268,0		Totalt 315,0
Provsnitt 	1: 9,4 ↖ 2: 8,5 ↓	Serie 2 (K) 	1: 8,4 ↗ 2: 10,2 → 3: 9,7 ↑ 4: 9,3 ↗ 5: 9,8 ↑
	Serie 17,0		Serie 45,0
	Totalt 315,0		Totalt 360,0
Skott 1 (S) 	1: 6,5 ↖	Skott 2 (S) 	1: 10,1 →
	Serie 6,0		Serie 10,0
	Totalt 366,0		Totalt 376,0
Skott 3 (S) 	1: 9,5 ↖	Skott 4 (S) 	1: 9,4 ↓
	Serie 9,0		Serie 9,0
	Totalt 385,0		Totalt 394,0
Skott 5 (S) 	1: 8,5 ↑		
	Serie 8,0		
	Totalt 402,0		

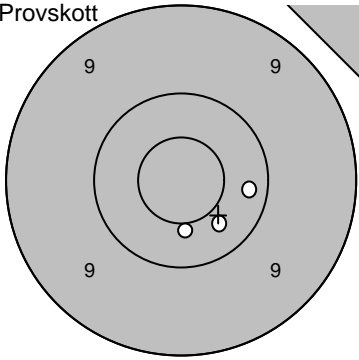
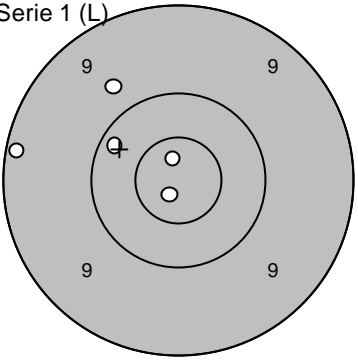
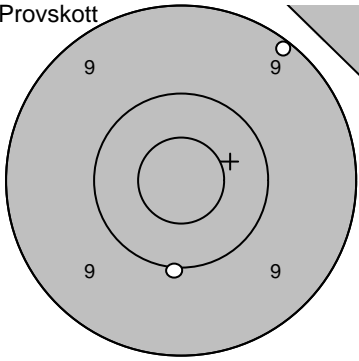
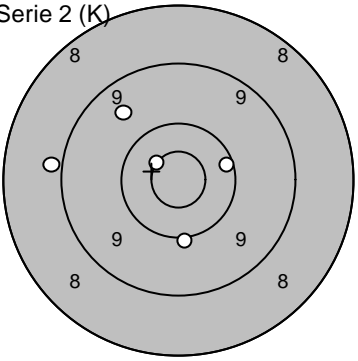
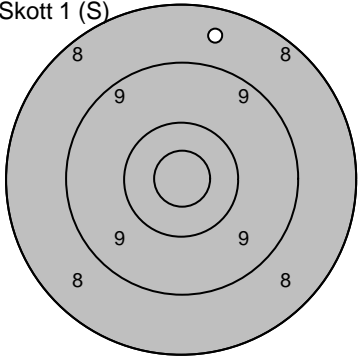
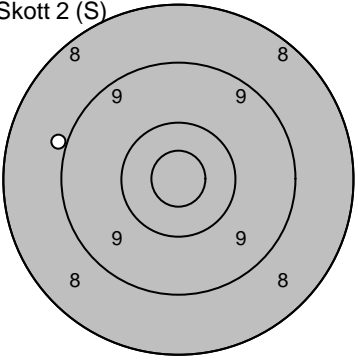
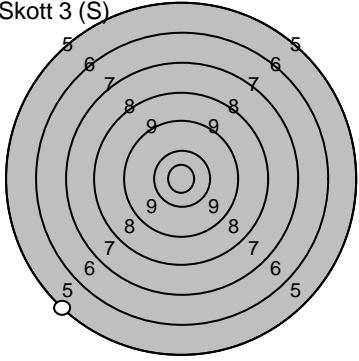
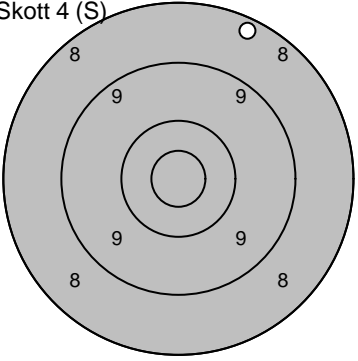
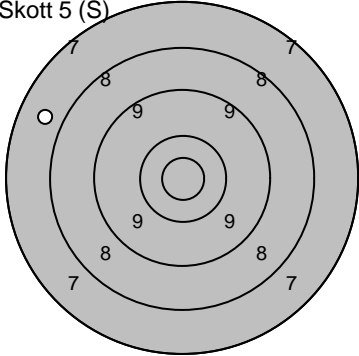
Skjutlag 2	Tavla 14	Daniel Zakrisson	
		Ramselefors	
14.07.2007		Tavelträffen B Final 2007	Ramselefors SKF
Provsnitt 	1: 10,4 ↘ 2: 10,5* ↓ 3: 10,3 →	Serie 1 (L) 	1: 10,2 ↗ 2: 10,9* ↓ 3: 9,8 ↗ 4: 10,8* ↗ 5: 9,2 ↑
	Serie 30,0 Totalt 268,0		Serie 48,0 Totalt 316,0
Provsnitt 	1: 10,0 ↓ 2: 9,2 ↗	Serie 2 (K) 	1: 9,6 ↗ 2: 10,0 ↓ 3: 10,6* ↗ 4: 10,2 → 5: 8,9 ←
	Serie 19,0 Totalt 316,0		Serie 47,0 Totalt 363,0
Skott 1 (S) 	1: 8,6 ↑	Skott 2 (S) 	1: 9,0 ↖
	Serie 8,0 Totalt 371,0		Serie 9,0 Totalt 380,0
Skott 3 (S) 	1: 5,3 ↗	Skott 4 (S) 	1: 8,3 ↑
	Serie 5,0 Totalt 385,0		Serie 8,0 Totalt 393,0
Skott 5 (S) 	1: 7,8 ↖		
	Serie 7,0 Totalt 400,0		

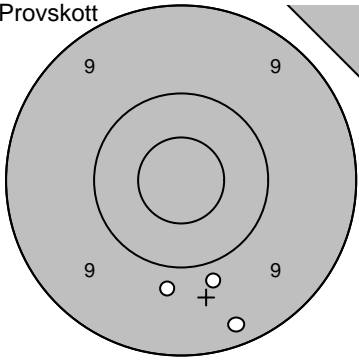
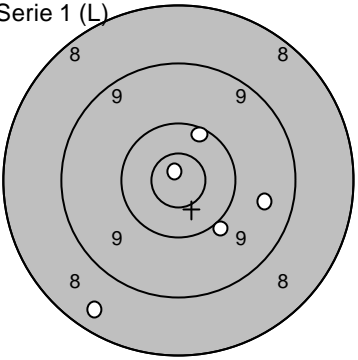
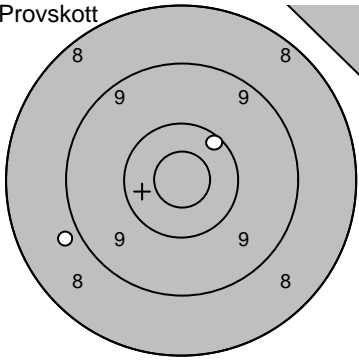
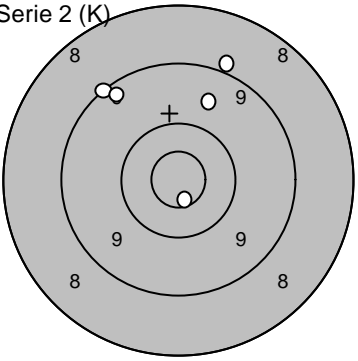
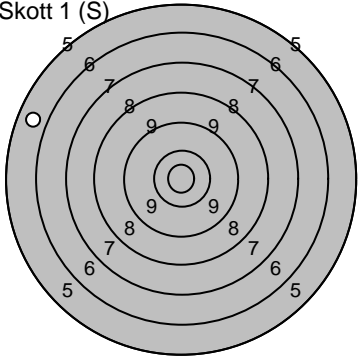
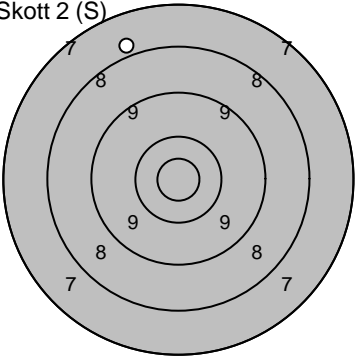
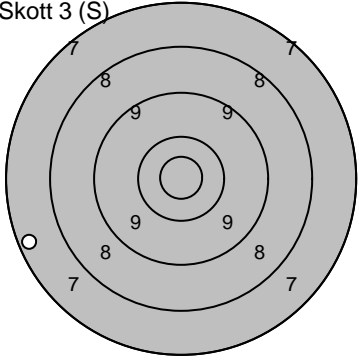
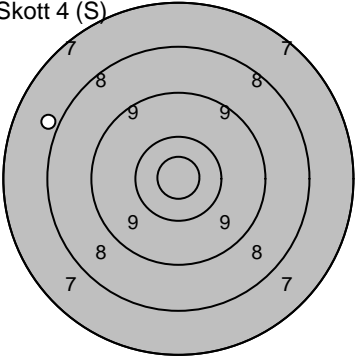
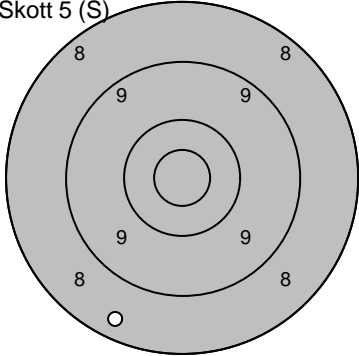
Skjutlag 2	Tavla 15	Sture Allansson	
		Stenungsund	
14.07.2007		Tavelträffen B Final 2007	
		Ramselefors SKF	
Provsnitt 	1: 9,8 ↓ 2: 9,3 ↓↓ 3: 9,8 ↓↓	Serie 1 (L) 	1: 10,9* ↑ 2: 9,6 → 3: 8,5 ↓ 4: 10,0 ↓ 5: 10,2 ↑
	Serie 27,0 Totalt 267,0		Serie 47,0 Totalt 314,0
Provsnitt 	1: 8,9 ← 2: 10,2 ↗	Serie 2 (K) 	1: 9,1 ↖ 2: 9,3 ↖ 3: 9,0 ↑ 4: 10,7* ↓ 5: 9,7 ↑
	Serie 18,0 Totalt 314,0		Serie 46,0 Totalt 360,0
Skott 1 (S) 	1: 5,8 ↖	Skott 2 (S) 	1: 7,9 ↑
	Serie 5,0 Totalt 365,0		Serie 7,0 Totalt 372,0
Skott 3 (S) 	1: 7,4 ←	Skott 4 (S) 	1: 7,9 ↖
	Serie 7,0 Totalt 379,0		Serie 7,0 Totalt 386,0
Skott 5 (S) 	1: 8,4 ↓		
	Serie 8,0 Totalt 394,0		

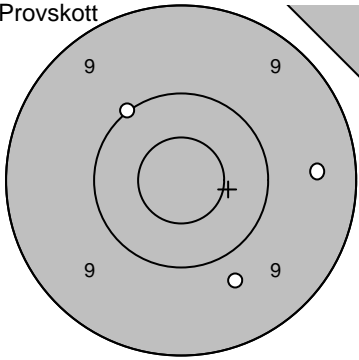
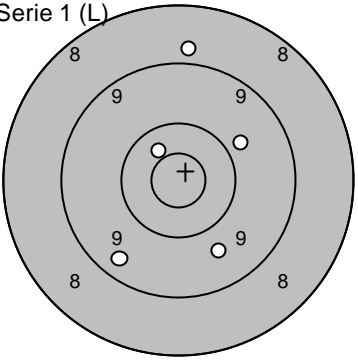
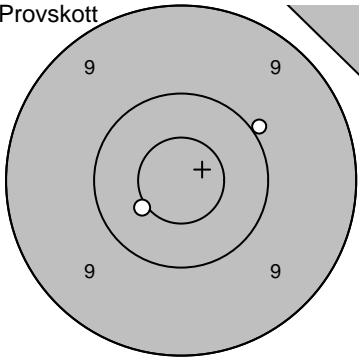
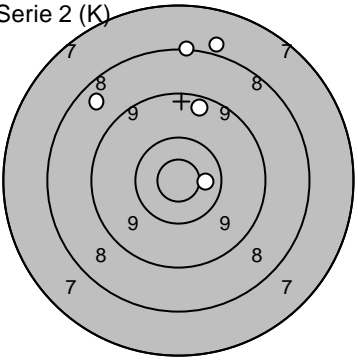
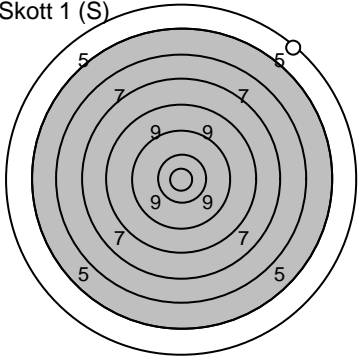
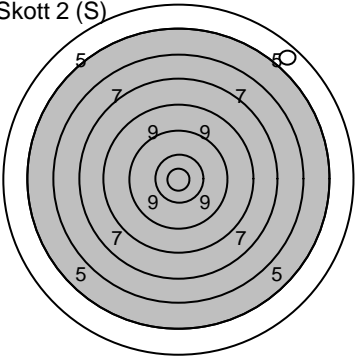
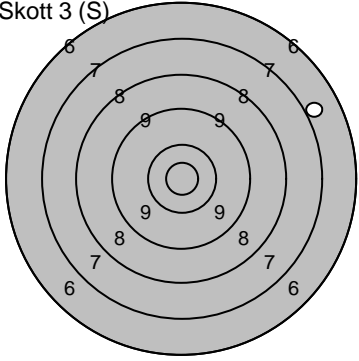
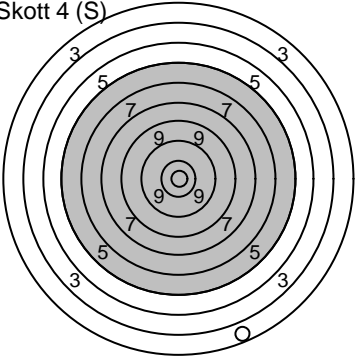
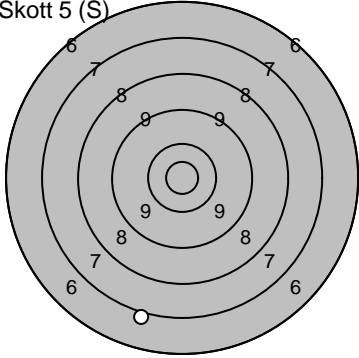
Skjutlag 2	Tavla 17	Stefan Jonasson	
		Hogdal	
14.07.2007	Tavelträffen B Final 2007	Ramselefors SKF	
Provsnitt 	1: 9,5 → 2: 10,1 ↗ 3: 9,8 ↓	Serie 1 (L) 	1: 9,8 → 2: 9,7 ↓ 3: 9,4 ↙ 4: 8,9 ↑ 5: 10,5* ↖
	Serie 28,0		Serie 45,0
	Totalt 267,0		Totalt 312,0
Provsnitt 	1: 10,5* ↖ 2: 10,0 ↗	Serie 2 (K) 	1: 10,5* → 2: 8,6 ↖ 3: 9,4 ↑ 4: 7,9 ↑ 5: 8,1 ↑
	Serie 20,0		Serie 42,0
	Totalt 312,0		Totalt 354,0
Skott 1 (S) 	1: 4,5 ↗	Skott 2 (S) 	1: 4,8 ↗
	Serie 4,0		Serie 4,0
	Totalt 358,0		Totalt 362,0
Skott 3 (S) 	1: 7,0 →	Skott 4 (S) 	1: 2,8 ↓
	Serie 7,0		Serie 2,0
	Totalt 369,0		Totalt 371,0
Skott 5 (S) 	1: 7,1 ↓		
	Serie 7,0		
	Totalt 378,0		

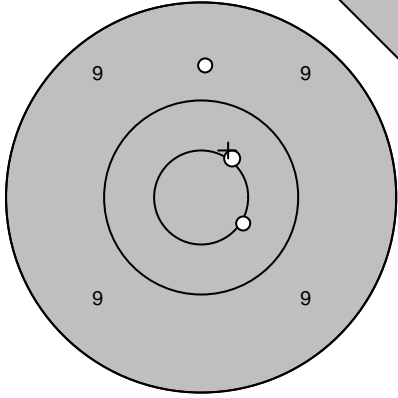
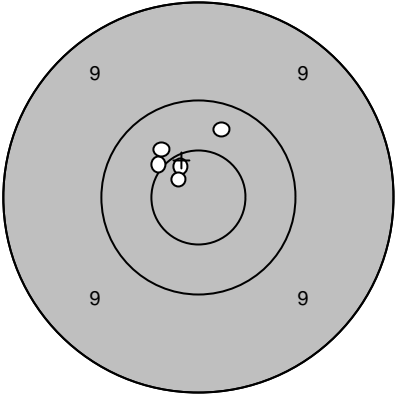
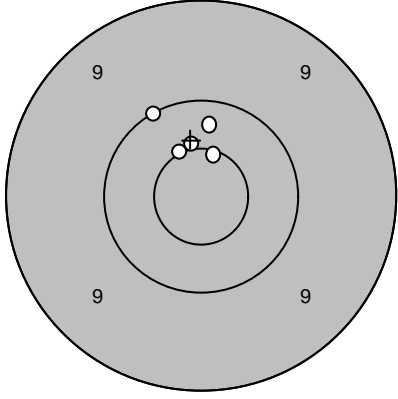
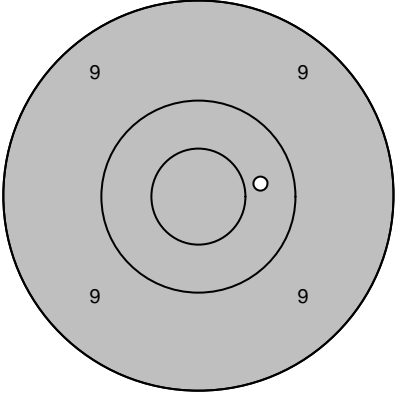
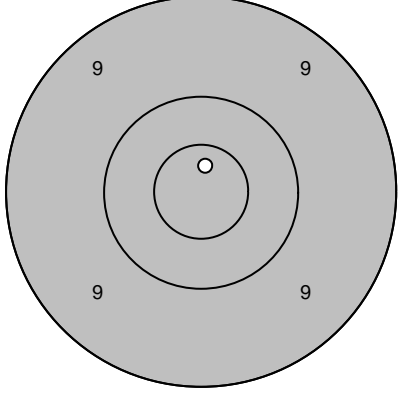
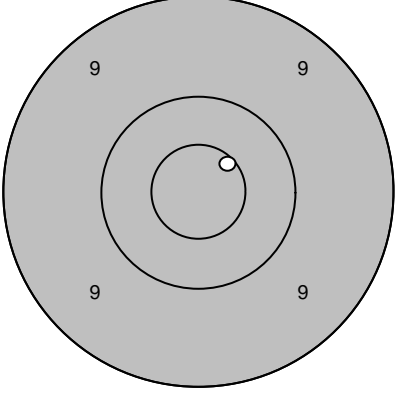
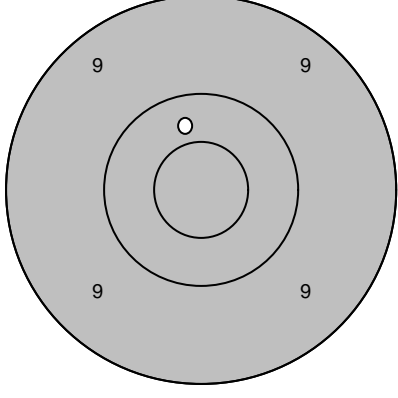
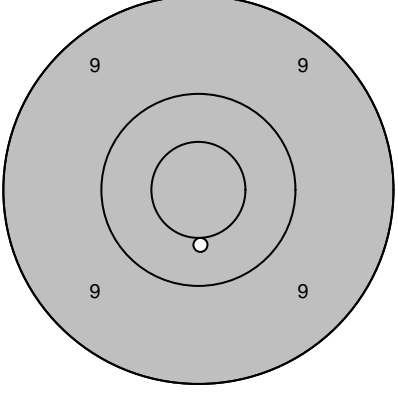
Skjutlag 2	Tavla 18	Peter Ericson	
		Loos	
14.07.2007	Tavelträffen B Final 2007	Ramselefors SKF	
Provsnitt 	1: 9,7 ↑ 2: 10,5* ↗ 3: 10,5* ↘	Serie 1 (L) 	1: 10,3 ↑ 2: 10,5* ↗ 3: 10,4 ↗ 4: 10,7* ↗ 5: 10,8* ↗
	Serie 29,0		Serie 50,0
	Totalt 299,0		Totalt 349,0
Serie 2 (K) 	1: 10,3 ↑ 2: 10,5* ↗ 3: 10,1 ↗ 4: 10,5* ↗ 5: 10,6* ↑	Skott 1 (S) 	1: 10,4 →
	Serie 50,0		Serie 10,0
	Totalt 399,0		Totalt 409,0
Skott 2 (S) 	1: 10,8* ↑	Skott 3 (S) 	1: 10,6* ↗
	Serie 10,0		Serie 10,0
	Totalt 419,0		Totalt 429,0
Skott 4 (S) 	1: 10,4 ↑	Skott 5 (S) 	1: 10,5* ↓
	Serie 10,0		Serie 10,0
	Totalt 439,0		Totalt 449,0

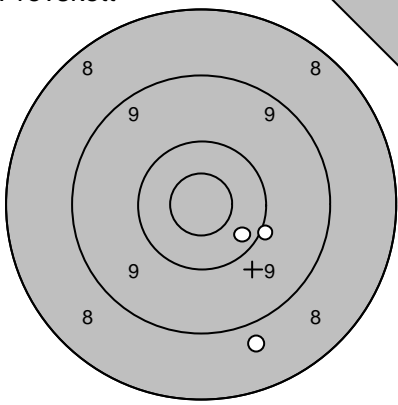
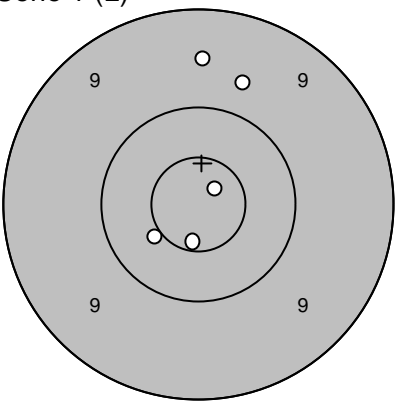
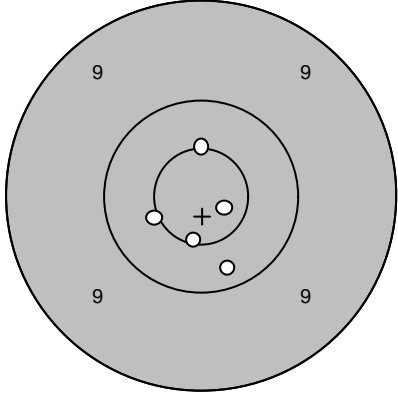
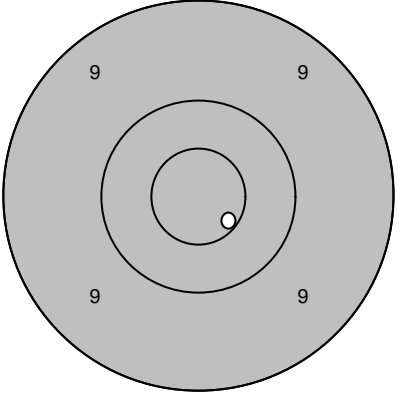
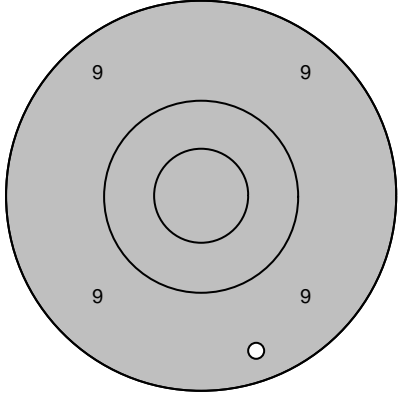
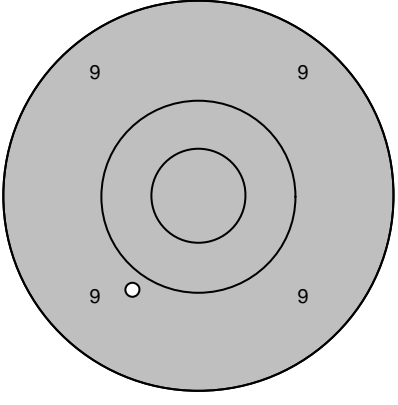
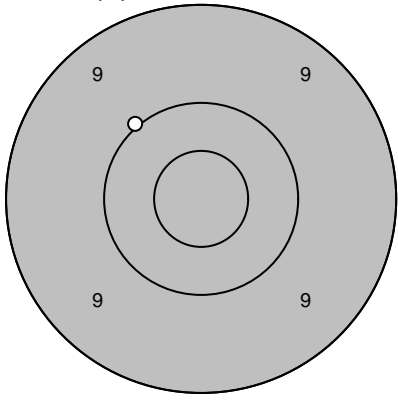
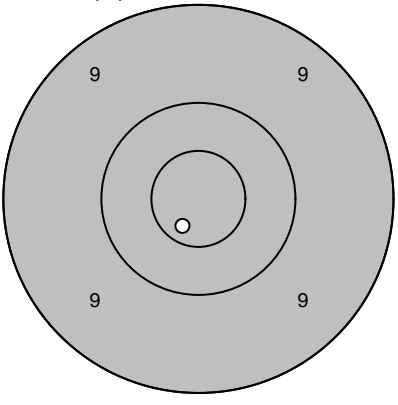
Skjutlag	Tavla	Tommy Lundqvist		
2	19			
Ununge				
14.07.2007	Tavelträffen B Final 2007	Ramselefors SKF		
Provskott	1: 10,0 → 2: 10,3 ↘ 3: 8,8 ↘	Serie 1 (L)	1: 9,7 ↑ 2: 10,8* ↗ 3: 9,6 ↑ 4: 10,5* ↙ 5: 10,7* ↓	
				
	Serie 28,0		Serie 48,0	
	Totalt 290,0		Totalt 338,0	
Serie 2 (K)	1: 10,5* ↑ 2: 10,8* → 3: 10,5* ↙ 4: 10,6* ↘ 5: 10,3 ↘	Skott 1 (S)	1: 10,6* ↘	
				
	Serie 50,0		Serie 10,0	
	Totalt 388,0		Totalt 398,0	
Skott 2 (S)	1: 9,4 ↘	Skott 3 (S)	1: 9,9 ↘	
				
	Serie 9,0		Serie 9,0	
	Totalt 407,0		Totalt 416,0	
Skott 4 (S)	1: 10,0 ↖	Skott 5 (S)	1: 10,7* ↘	
				
	Serie 10,0		Serie 10,0	
	Totalt 426,0		Totalt 436,0	

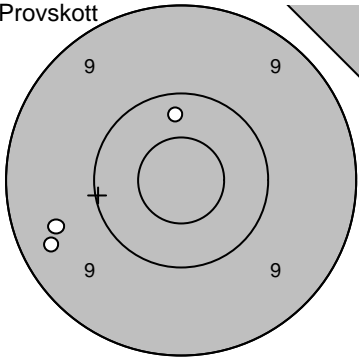
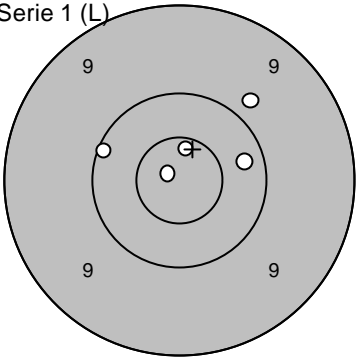
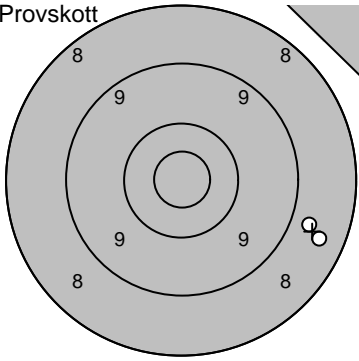
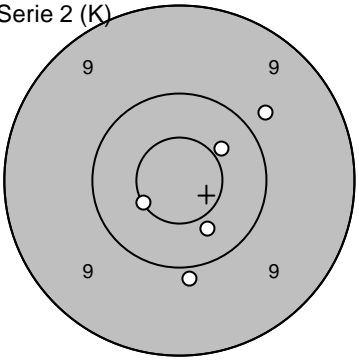
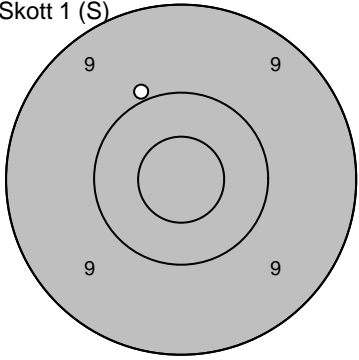
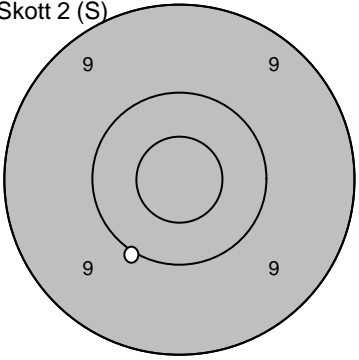
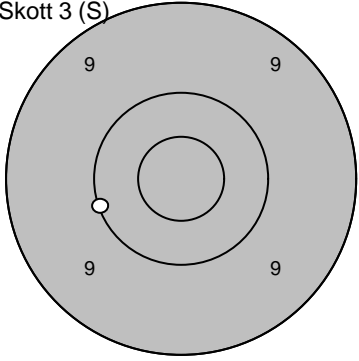
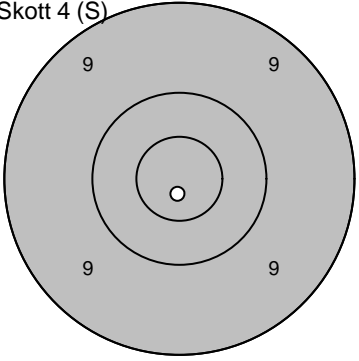
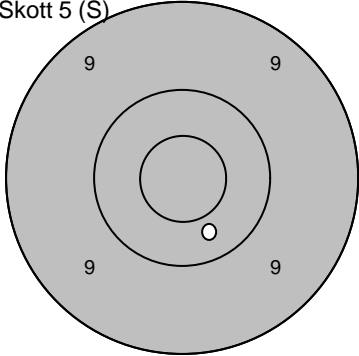
Skjutlag	Tavla	Daniel Wallberg	
2	20	Loos	
14.07.2007	Tavelträffen B Final 2007	Ramselefors SKF	
Provsrott 	1: 9,4 ↙ 2: 10,3 ↑ 3: 9,5 ↖	Serie 1 (L) 	1: 10,3 → 2: 10,7* ↑ 3: 10,9* ↖ 4: 9,8 ↗ 5: 10,1 ↖
	Serie 28,0		Serie 49,0
	Totalt 289,0		Totalt 338,0
Provsrott 	1: 8,5 → 2: 8,8 →	Serie 2 (K) 	1: 9,9 ↓ 2: 10,4 ↓ 3: 9,8 ↗ 4: 10,6* ↖ 5: 10,5* ↗
	Serie 16,0		Serie 48,0
	Totalt 338,0		Totalt 386,0
Skott 1 (S) 	1: 10,0 ↖	Skott 2 (S) 	1: 10,0 ↖
	Serie 10,0		Serie 10,0
	Totalt 396,0		Totalt 406,0
Skott 3 (S) 	1: 10,1 ↖	Skott 4 (S) 	1: 10,9* ↓
	Serie 10,0		Serie 10,0
	Totalt 416,0		Totalt 426,0
Skott 5 (S) 	1: 10,4 ↓		
	Serie 10,0		
	Totalt 436,0		

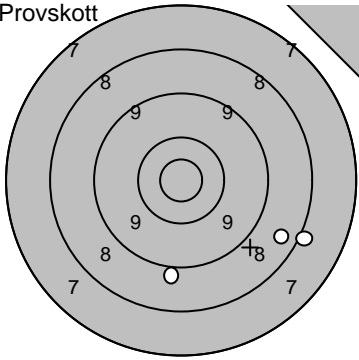
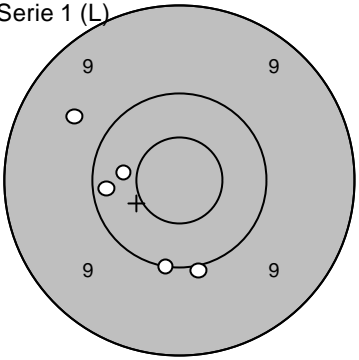
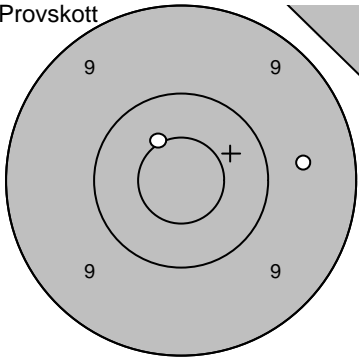
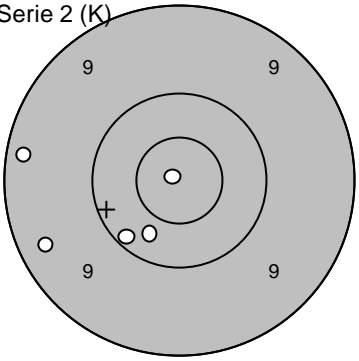
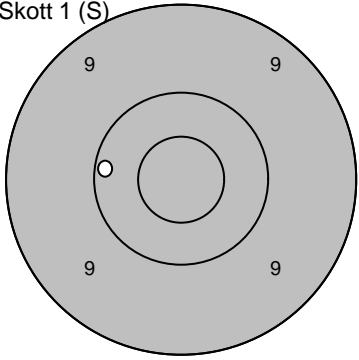
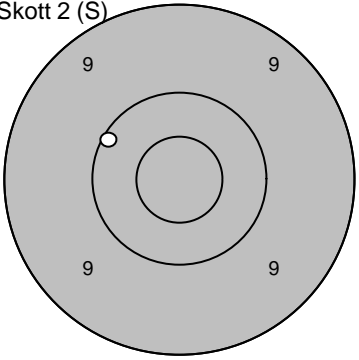
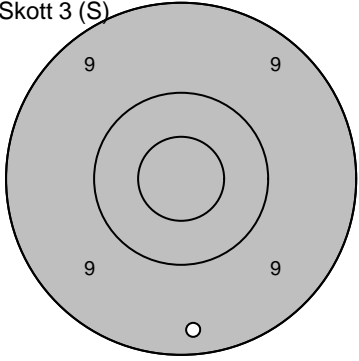
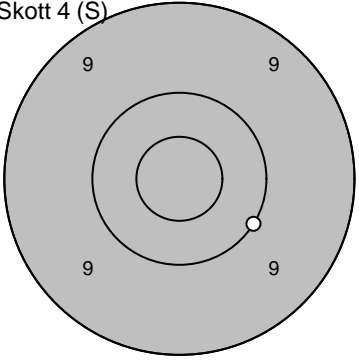
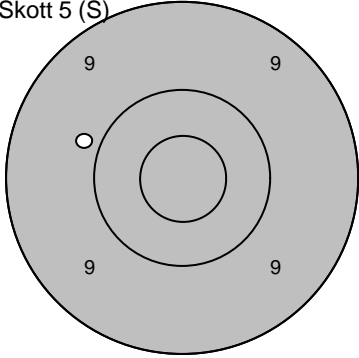
Skjutlag 2	Tavla 21	Elina Johansson	
		Ale	
14.07.2007		Tavelträffen B Final 2007	Ramselefors SKF
Provsnitt 	1: 8,0 → 2: 8,5 ↘ 3: 9,0 ↓	Serie 1 (L) 	1: 10,4 ← 2: 9,7 ↗ 3: 10,1 ↓ 4: 10,2 ← 5: 10,0 ↓
Serie 25,0		Serie 49,0	
Totalt 287,0		Totalt 336,0	
Provsnitt 	1: 9,7 → 2: 10,5* ↗	Serie 2 (K) 	1: 9,3 ← 2: 10,9* ↗ 3: 10,3 ↓ 4: 10,2 ↘ 5: 9,4 ←
Serie 19,0		Serie 48,0	
Totalt 336,0		Totalt 384,0	
Skott 1 (S) 	1: 10,2 ←	Skott 2 (S) 	1: 10,1 ↖
Serie 10,0		Serie 10,0	
Totalt 394,0		Totalt 404,0	
Skott 3 (S) 	1: 9,3 ↓	Skott 4 (S) 	1: 10,1 ↘
Serie 9,0		Serie 10,0	
Totalt 413,0		Totalt 423,0	
Skott 5 (S) 	1: 9,9 ↖		
Serie 9,0			
Totalt 432,0			

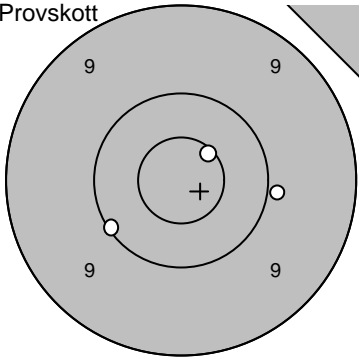
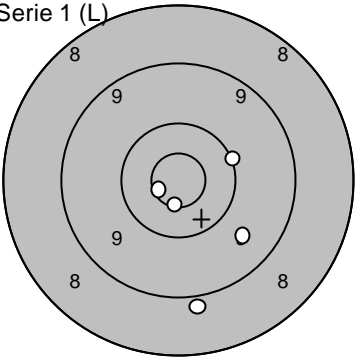
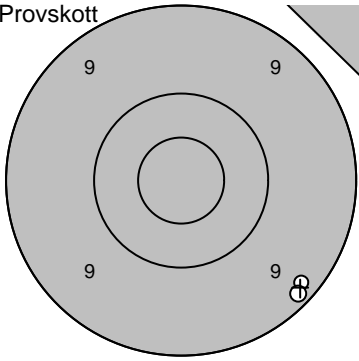
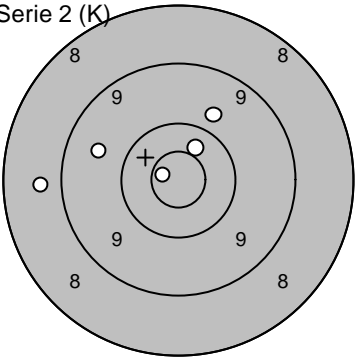
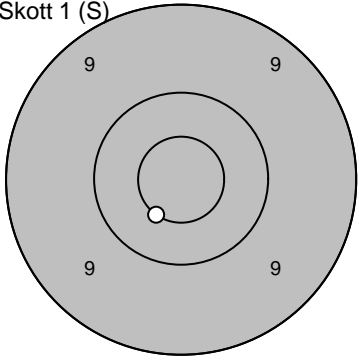
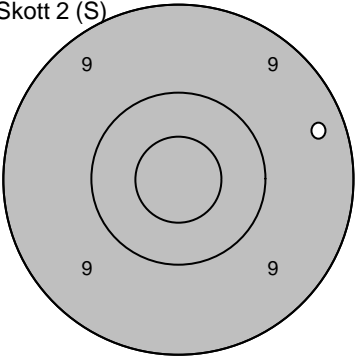
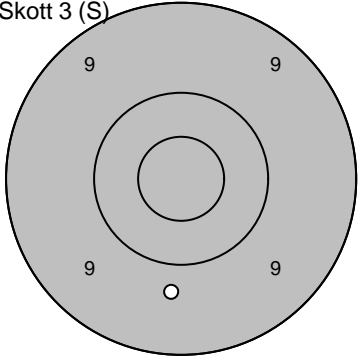
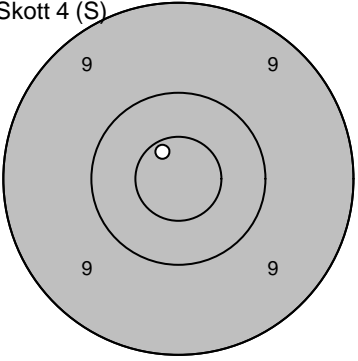
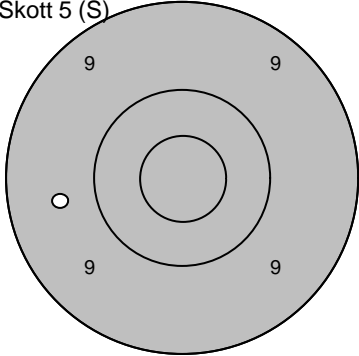
Skjutlag 2	Tavla 22	Elina Högström	
		Ramselefors	
14.07.2007		Tavelträffen B Final 2007	Ramselefors SKF
Provsnitt 	1: 10,1 ↙ 2: 10,0 → 3: 10,6* ↗	Serie 1 (L) 	1: 10,7* ↓ 2: 10,1 → 3: 8,9 ↓ 4: 10,7* ← 5: 9,6 ↘
Serie 30,0		Serie 47,0	
Totalt 283,0		Totalt 330,0	
Provsnitt 	1: 9,2 ↘ 2: 9,2 ↘	Serie 2 (K) 	1: 8,8 ← 2: 10,5* ↗ 3: 10,8* ↖ 4: 9,8 ↗ 5: 9,6 ↖
Serie 18,0		Serie 46,0	
Totalt 330,0		Totalt 376,0	
Skott 1 (S) 	1: 10,5* ↙	Skott 2 (S) 	1: 9,4 →
Serie 10,0		Serie 9,0	
Totalt 386,0		Totalt 395,0	
Skott 3 (S) 	1: 9,7 ↓	Skott 4 (S) 	1: 10,7* ↖
Serie 9,0		Serie 10,0	
Totalt 404,0		Totalt 414,0	
Skott 5 (S) 	1: 9,6 ←		
Serie 9,0			
Totalt 423,0			

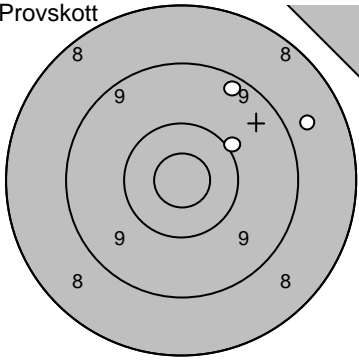
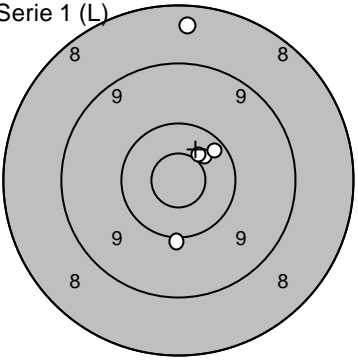
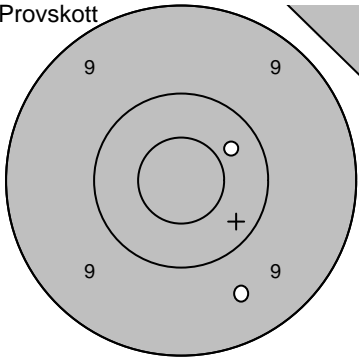
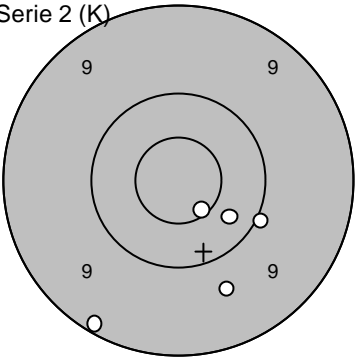
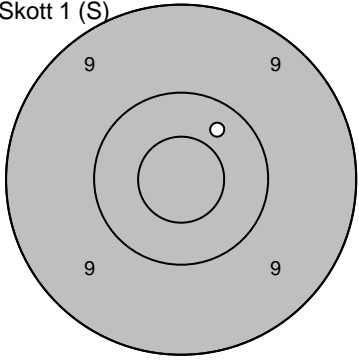
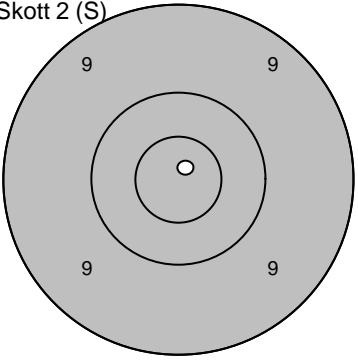
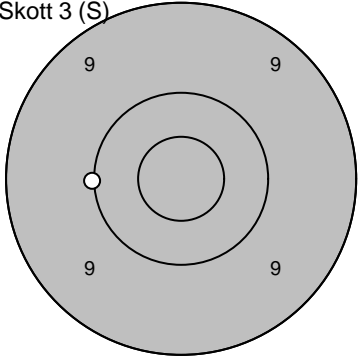
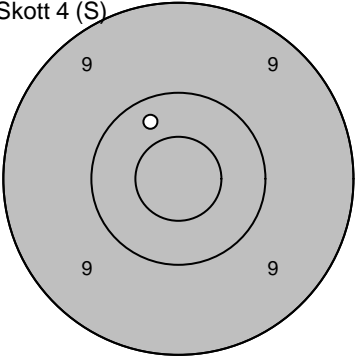
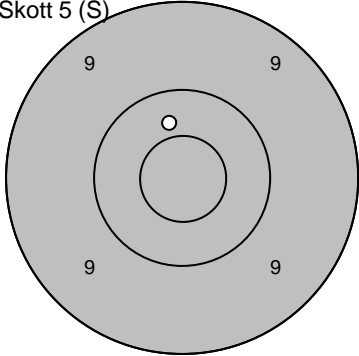
Skjutlag 2	Tavla 23	Markus Andersson	
		Bälinge-Jumkil	
14.07.2007	Tavelträffen B Final 2007	Ramselefors SKF	
Provsnitt 	1: 8,7 ↗ 2: 10,0 ↗ 3: 9,3 ↗	Serie 1 (L) 	1: 10,0 ↓ 2: 10,5* ↗ 3: 8,5 ↑ 4: 10,3 ↗ 5: 10,5* ↗
	Serie 27,0		Serie 48,0
	Totalt 280,0		Totalt 328,0
Provsnitt 	1: 10,4 ↗ 2: 9,6 ↓	Serie 2 (K) 	1: 10,3 ↘ 2: 9,7 ↓ 3: 10,0 ↘ 4: 9,2 ↓ 5: 10,6* ↓
	Serie 19,0		Serie 48,0
	Totalt 328,0		Totalt 376,0
Skott 1 (S) 	1: 10,4 ↗	Skott 2 (S) 	1: 10,9* ↗
	Serie 10,0		Serie 10,0
	Totalt 386,0		Totalt 396,0
Skott 3 (S) 	1: 10,0 ←	Skott 4 (S) 	1: 10,3 ↖
	Serie 10,0		Serie 10,0
	Totalt 406,0		Totalt 416,0
Skott 5 (S) 	1: 10,4 ↑		
	Serie 10,0		
	Totalt 426,0		

Skjutlag 2	Tavla 24	Gustav Karlsson		
		Loos		
14.07.2007		Tavelträffen B Final 2007	Ramselefors SKF	
Provs-kott 	1: 8,5 ↗ 2: 10,0 ↗ 3: 9,0 ↗	Serie 1 (L) 	1: 9,7 ↓ 2: 10,7* ↓ 3: 9,9 ↓ 4: 9,9 → 5: 9,8 ←	
		Serie 27,0	Serie 46,0	
		Totalt 277,0	Totalt 323,0	
Provs-kott 	1: 10,2 ↗ 2: 7,4 →	Serie 2 (K) 	1: 9,8 ← 2: 10,1 ↘ 3: 10,2 ↗ 4: 10,7* ← 5: 9,7 ↓	
		Serie 17,0	Serie 48,0	
		Totalt 323,0	Totalt 371,0	
Skott 1 (S) 	1: 10,5* ↗	Skott 2 (S) 	1: 9,9 ↗	
		Serie 10,0	Serie 9,0	
		Totalt 381,0	Totalt 390,0	
Skott 3 (S) 	1: 8,4 →	Skott 4 (S) 	1: 9,5 →	
		Serie 8,0	Serie 9,0	
		Totalt 398,0	Totalt 407,0	
Skott 5 (S) 	1: 10,1 ↗			
		Serie 10,0		
		Totalt 417,0		

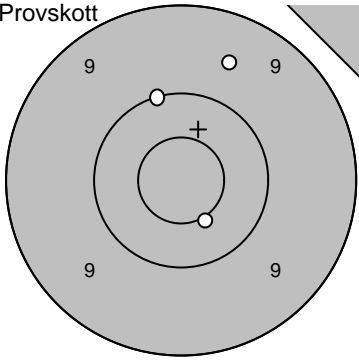
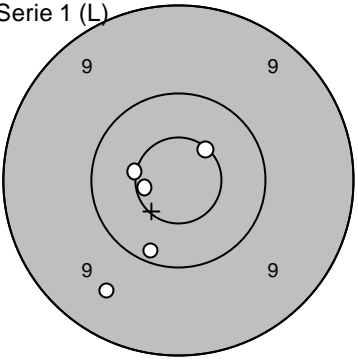
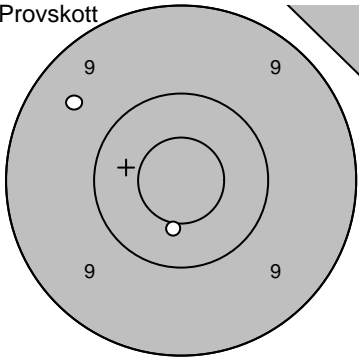
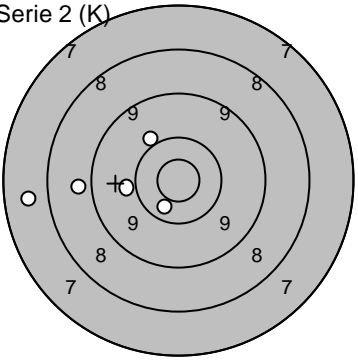
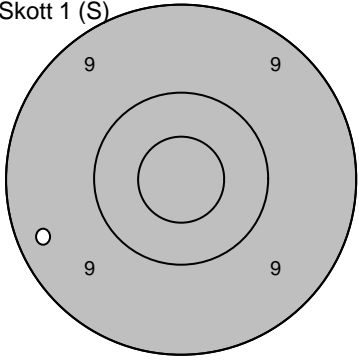
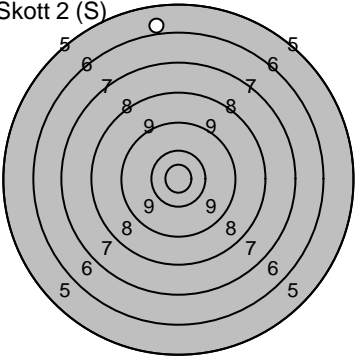
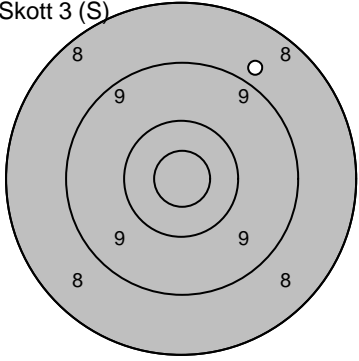
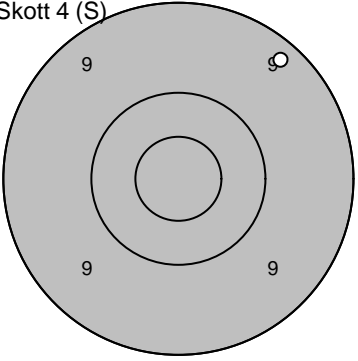
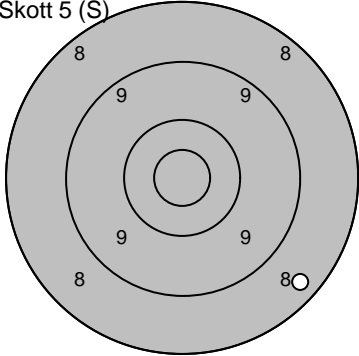
Skjutlag 3	Tavla 1	Petter Eriksson	
		Moälven/Modo	
14.07.2007	Tavelträffen B Final 2007	Ramselefors SKF	
Provskott 	1: 10,1 ↑ 2: 9,6 ↑↑ 3: 10,5* ↓	Serie 1 (L) 	1: 10,6* ↗ 2: 10,5* ← 3: 10,2 ↓ 4: 10,7* ← 5: 9,5 ↓
	Serie 29,0 Totalt 293,0		Serie 49,0 Totalt 342,0
Provskott 	1: 9,6 ↗ 2: 10,5* ↓	Serie 2 (K) 	1: 10,0 ↗ 2: 9,9 ← 3: 8,9 ← 4: 10,5* ↓ 5: 7,7 ←
	Serie 19,0 Totalt 342,0		Serie 44,0 Totalt 386,0
Skott 1 (S) 	1: 9,3 ←	Skott 2 (S) 	1: 6,0 ↑
	Serie 9,0 Totalt 395,0		Serie 6,0 Totalt 401,0
Skott 3 (S) 	1: 8,8 ↗	Skott 4 (S) 	1: 9,3 ↗
	Serie 8,0 Totalt 409,0		Serie 9,0 Totalt 418,0
Skott 5 (S) 	1: 8,4 ↓		
	Serie 8,0 Totalt 426,0		

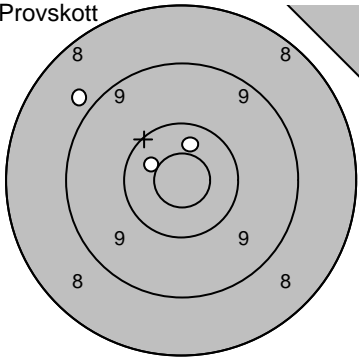
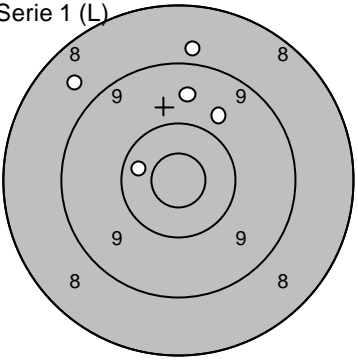
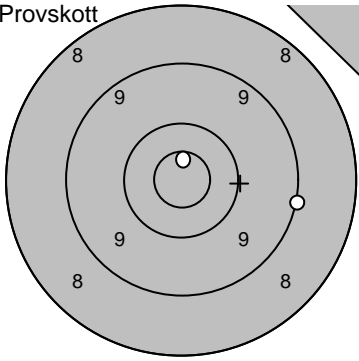
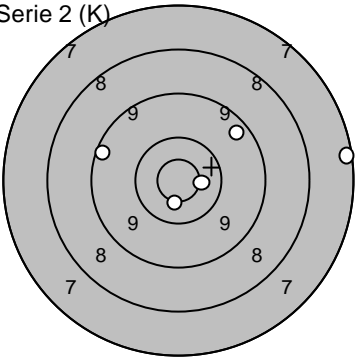
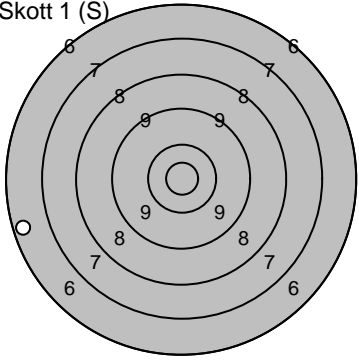
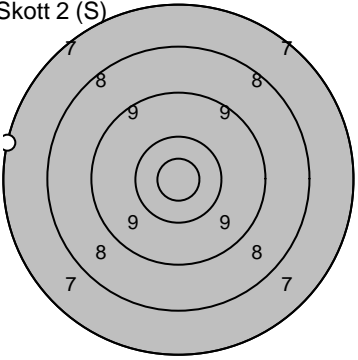
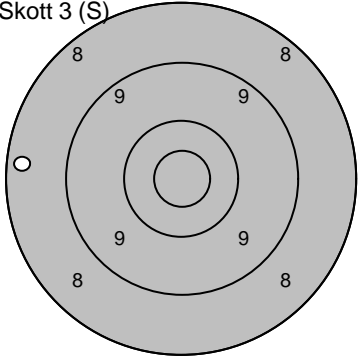
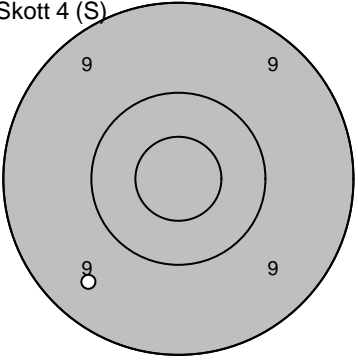
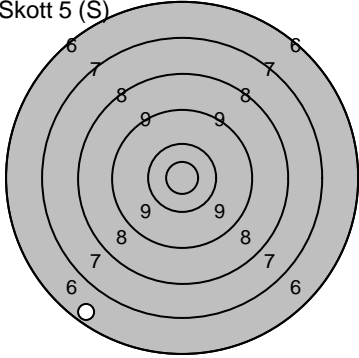
Skjutlag 3	Tavla 2	Lars Evaldsson	
		Göteborg	
14.07.2007	Tavelträffen B Final 2007	Ramselefors SKF	
Provkott 	1: 8,8 ↖ 2: 10,5* ↗ 3: 10,5* ↖ Serie 28,0 Totalt 287,0	Serie 1 (L) 	1: 8,8 ↑ 2: 9,6 ↑ 3: 8,7 ↖ 4: 10,4 ↖ 5: 9,8 ↗ Serie 44,0 Totalt 331,0
Provkott 	1: 10,8* ↑ 2: 9,1 → Serie 19,0 Totalt 331,0	Serie 2 (K) 	1: 9,3 ← 2: 9,4 ↗ 3: 10,6* → 4: 7,3 → 5: 10,6* ↓ Serie 45,0 Totalt 376,0
Skott 1 (S) 	1: 6,5 ← Serie 6,0 Totalt 382,0	Skott 2 (S) 	1: 7,2 ← Serie 7,0 Totalt 389,0
Skott 3 (S) 	1: 8,4 ← Serie 8,0 Totalt 397,0	Skott 4 (S) 	1: 9,5 ↖ Serie 9,0 Totalt 406,0
Skott 5 (S) 	1: 6,5 ↖ Serie 6,0 Totalt 412,0		

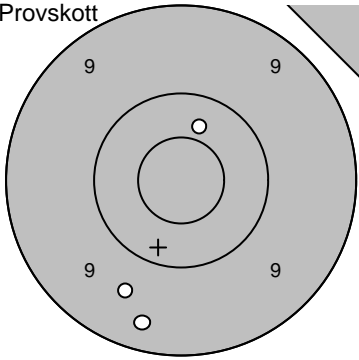
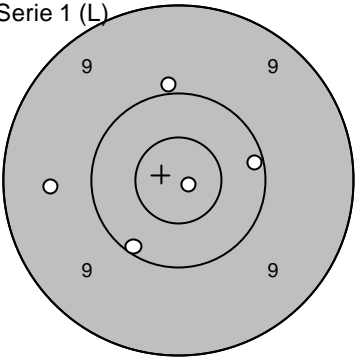
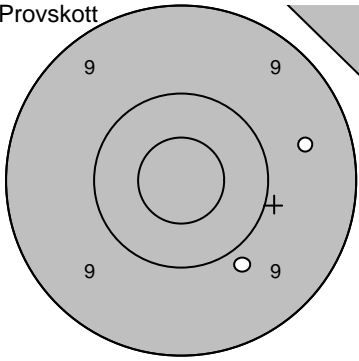
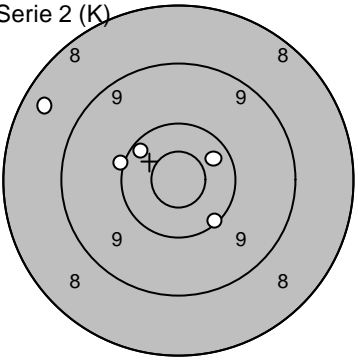
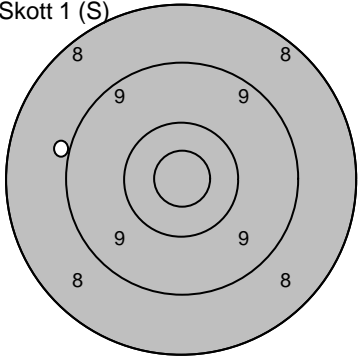
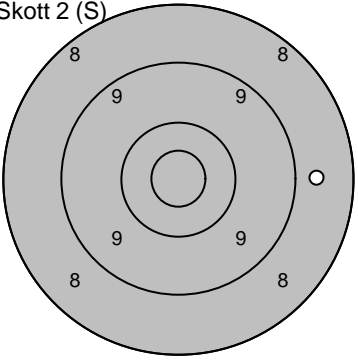
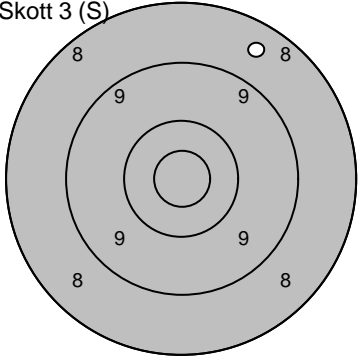
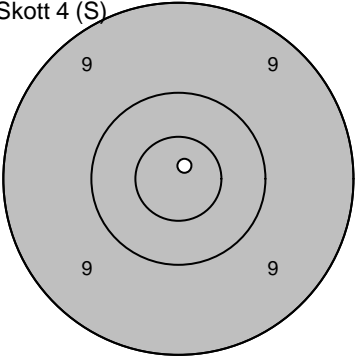
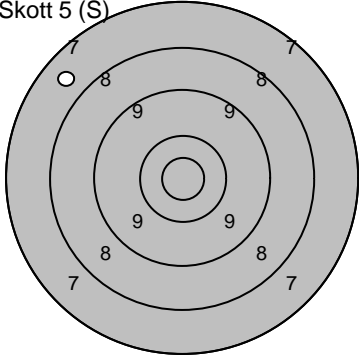
Skjutlag 3	Tavla 3	Linda Bergman	
		Ununge	
14.07.2007	Tavelträffen B Final 2007	Ramselefors SKF	
Provsnitt 	1: 9,6 ↘ 2: 10,4 ↗ 3: 9,4 ↘	Serie 1 (L) 	1: 10,0 ↗ 2: 10,9* → 3: 9,6 ← 4: 10,2 → 5: 10,1 ↘
	Serie 28,0		Serie 49,0
	Totalt 286,0		Totalt 335,0
Provsnitt 	1: 9,6 → 2: 9,9 ↘	Serie 2 (K) 	1: 10,3 ↗ 2: 8,5 ↗ 3: 10,1 ↗ 4: 10,4 → 5: 10,2 ↘
	Serie 18,0		Serie 48,0
	Totalt 335,0		Totalt 383,0
Skott 1 (S) 	1: 9,0 ←	Skott 2 (S) 	1: 8,7 →
	Serie 9,0		Serie 8,0
	Totalt 392,0		Totalt 400,0
Skott 3 (S) 	1: 8,6 ↗	Skott 4 (S) 	1: 10,9* ↗
	Serie 8,0		Serie 10,0
	Totalt 408,0		Totalt 418,0
Skott 5 (S) 	1: 7,7 ↖		
	Serie 7,0		
	Totalt 425,0		

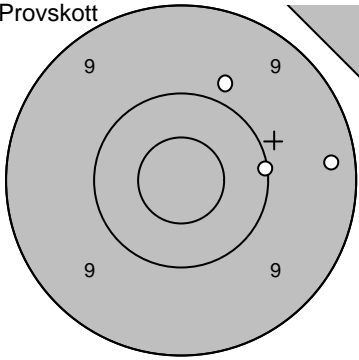
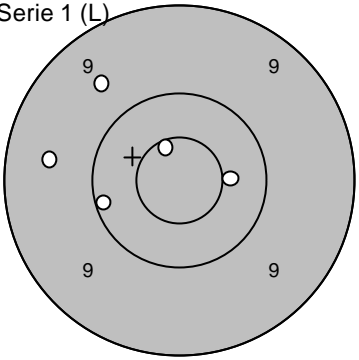
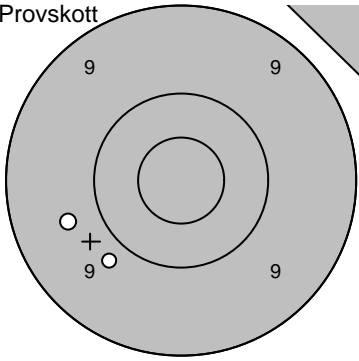
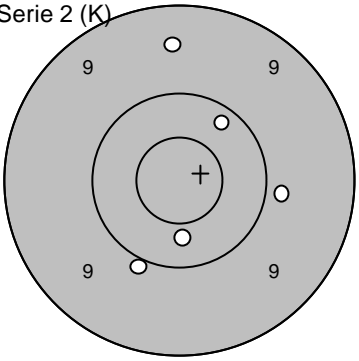
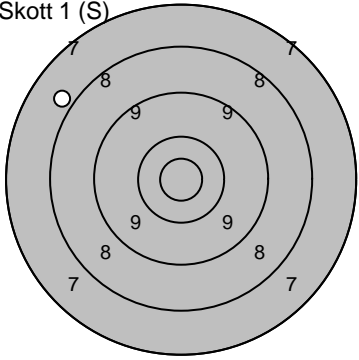
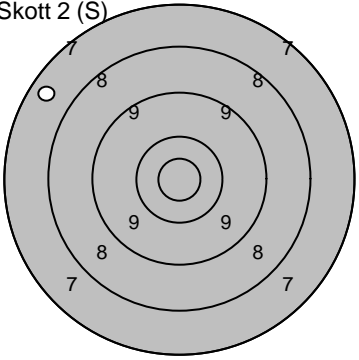
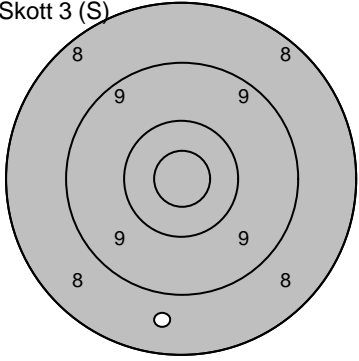
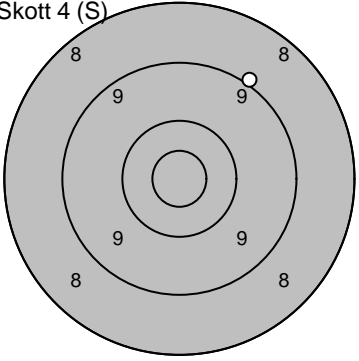
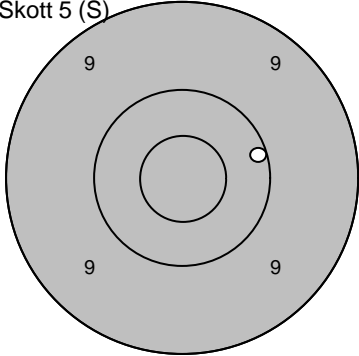
Skjutlag 3	Tavla 4	Lars-Göran Lundqvist	
		Ununge	
14.07.2007	Tavelträffen B Final 2007	Ramselefors SKF	
Provskott 	1: 9,8 ↗ 2: 10,1 → 3: 9,3 →	Serie 1 (L) 	1: 10,5* → 2: 9,6 ← 3: 10,6* ↗ 4: 10,1 ← 5: 9,6 ↗
	Serie 28,0 Totalt 286,0		Serie 48,0 Totalt 334,0
Provskott 	1: 9,7 ← 2: 9,8 ↙	Serie 2 (K) 	1: 10,0 ↓ 2: 10,4 ↓ 3: 10,2 ↗ 4: 9,5 ↑ 5: 9,9 →
	Serie 18,0 Totalt 334,0		Serie 48,0 Totalt 382,0
Skott 1 (S) 	1: 7,9 ↖	Skott 2 (S) 	1: 7,6 ↖
	Serie 7,0 Totalt 389,0		Serie 7,0 Totalt 396,0
Skott 3 (S) 	1: 8,7 ↓	Skott 4 (S) 	1: 9,0 ↗
	Serie 8,0 Totalt 404,0		Serie 9,0 Totalt 413,0
Skott 5 (S) 	1: 10,1 →		
	Serie 10,0 Totalt 423,0		

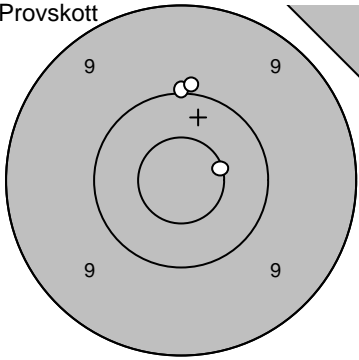
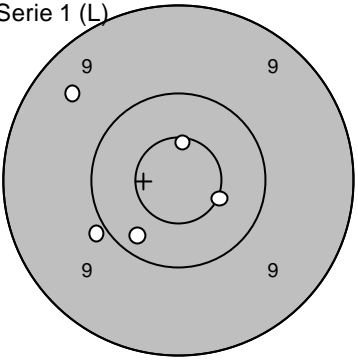
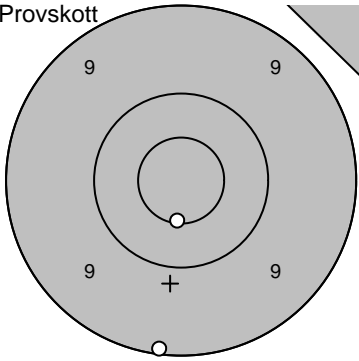
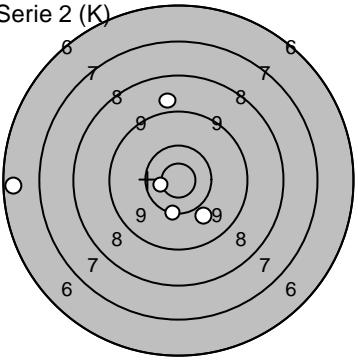
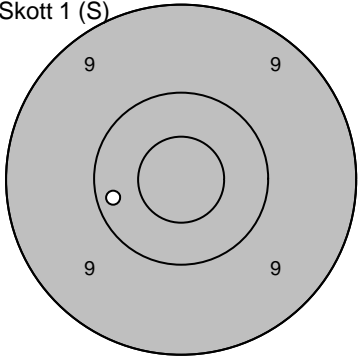
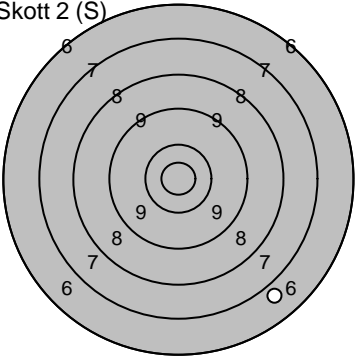
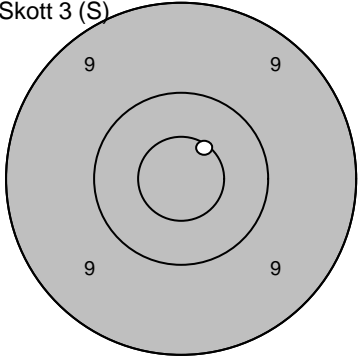
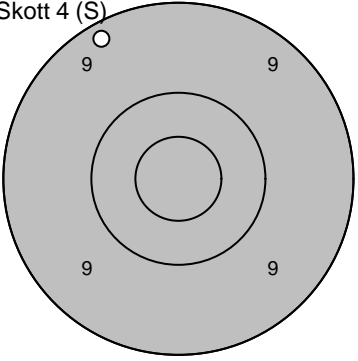
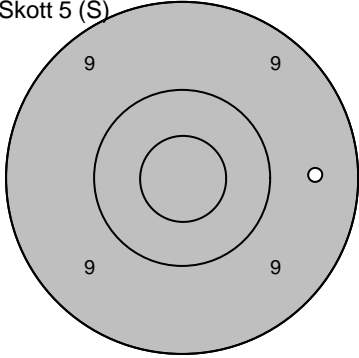
Skjutlag	Tavla	Magnus Lindkvist	
3	5	Umeå	
14.07.2007	Tavelträffen B Final 2007	Ramselefors SKF	
Provsnitt 	1: 10,0 ↑ 2: 10,6* → 3: 10,0 ↑	Serie 1 (L) 	1: 9,5 ↖ 2: 10,6* ↑ 3: 10,5* → 4: 10,3 ↓ 5: 9,9 ↙
	Serie 30,0		Serie 48,0
	Totalt 285,0		Totalt 333,0
Provsnitt 	1: 10,6* ↓ 2: 9,1 ↓	Serie 2 (K) 	1: 8,9 ↑ 2: 10,2 ↓ 3: 10,7* ← 4: 9,9 ↘ 5: 6,5 ←
	Serie 19,0		Serie 43,0
	Totalt 333,0		Totalt 376,0
Skott 1 (S) 	1: 10,2 ←	Skott 2 (S) 	1: 6,9 ↘
	Serie 10,0		Serie 6,0
	Totalt 386,0		Totalt 392,0
Skott 3 (S) 	1: 10,6* ↗	Skott 4 (S) 	1: 9,2 ↖
	Serie 10,0		Serie 9,0
	Totalt 402,0		Totalt 411,0
Skott 5 (S) 	1: 9,5 →		
	Serie 9,0		
	Totalt 420,0		

Skjutlag

Tavla

3

6

Helena Jansson

Söderala

14.07.2007

Tavelträffen B Final 2007

Ramselefors SKF

Provskott

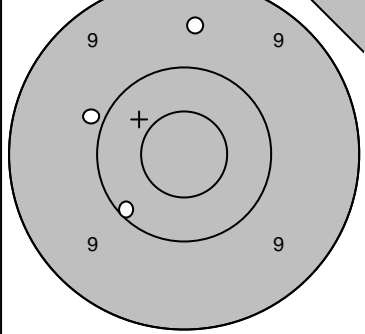

1: 10,1 ↖
 2: 9,6 ↑
 3: 9,9 ↗

Serie 1 (L)

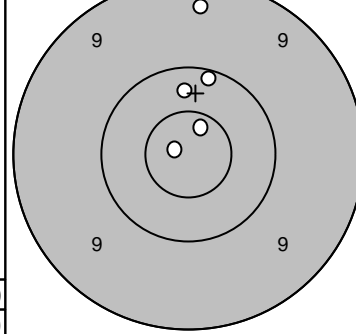

1: 9,4 ↑
 2: 10,3 ↑
 3: 10,7* ↗
 4: 10,1 ↗
 5: 10,9* ↖

Serie 28,0
 Totalt 285,0

Serie 49,0
 Totalt 334,0

Provskott

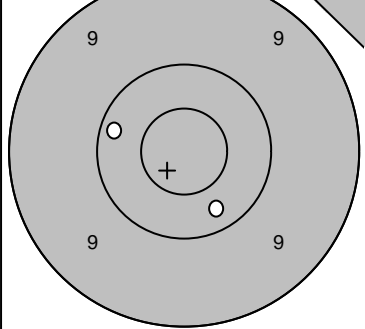

1: 10,3 ↘
 2: 10,2 ↖

Serie 2 (K)

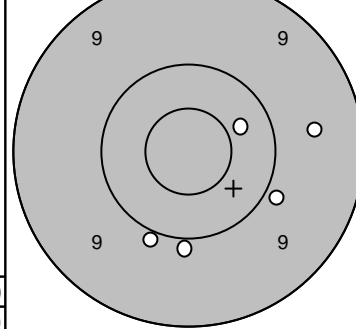

1: 10,4 →
 2: 9,9 ↘
 3: 9,6 →
 4: 9,9 ↓
 5: 10,0 ↓

Serie 20,0
 Totalt 334,0

Serie 47,0
 Totalt 381,0

Skott 1 (S)

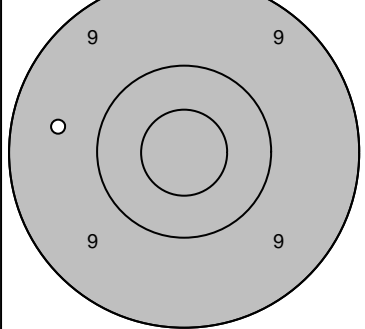

1: 9,6 ↖

Skott 2 (S)

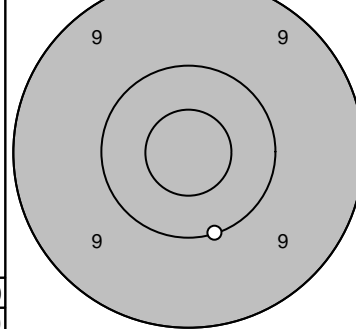

1: 10,1 ↘

Serie 9,0
 Totalt 390,0

Serie 10,0
 Totalt 400,0

Skott 3 (S)

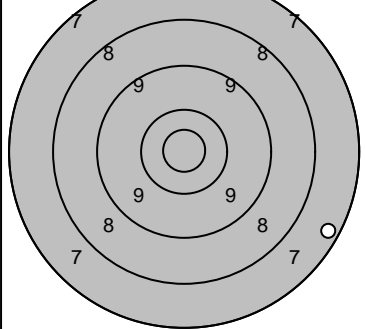

1: 7,4 →

Skott 4 (S)

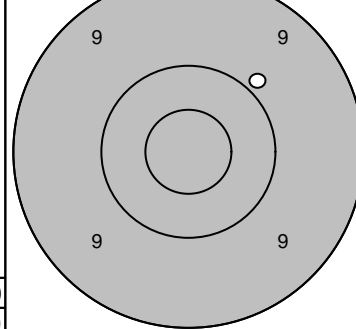

1: 9,9 ↗

Serie 7,0
 Totalt 407,0

Serie 9,0
 Totalt 416,0

Skott 5 (S)

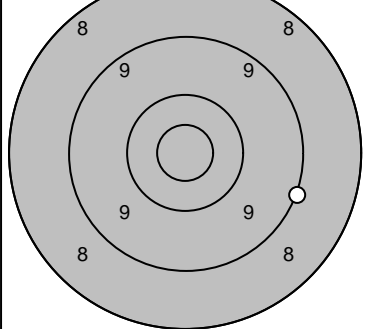

1: 9,1 →

Serie 9,0
 Totalt 425,0

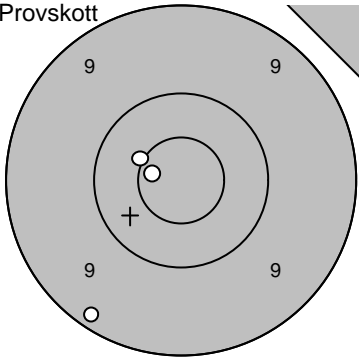
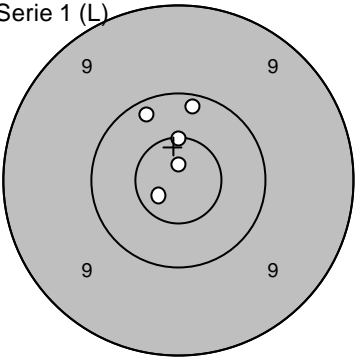
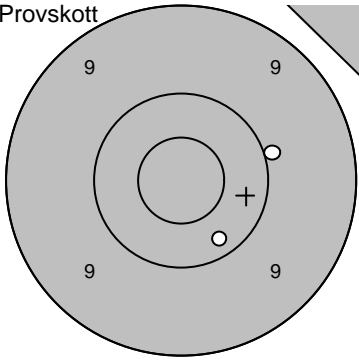
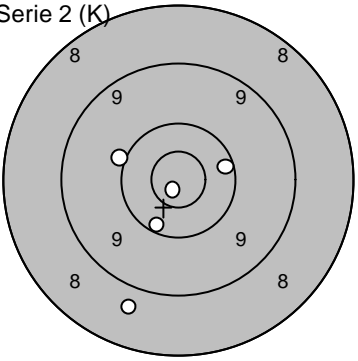
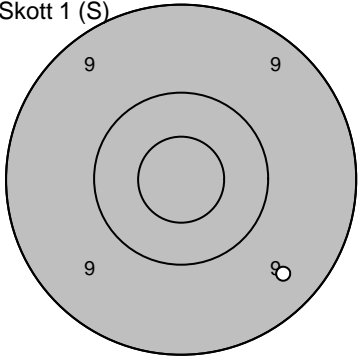
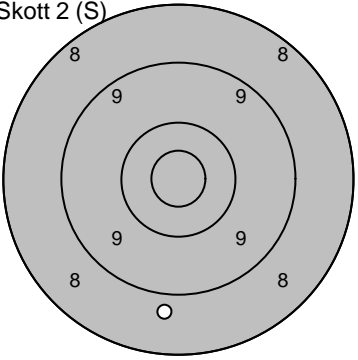
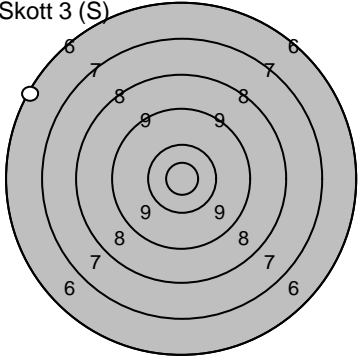
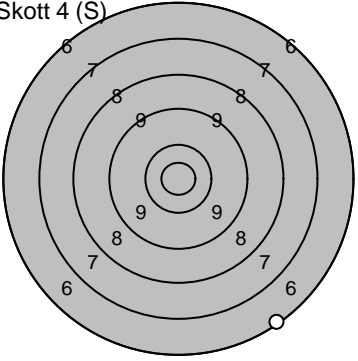
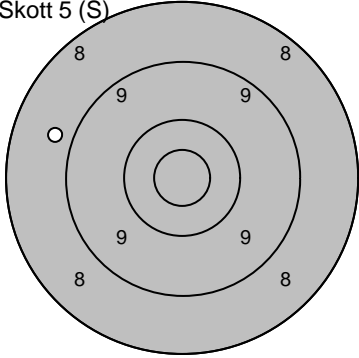
Skjutlag	Tavla	Ulf Ohlsson	
3	7	Umeå	
14.07.2007	Tavelträffen B Final 2007	Ramselefors SKF	
Provsnitt 	1: 10,5* ↗ 2: 9,2 ↙ 3: 10,7* ↗	Serie 1 (L) 	1: 10,8* ↙ 2: 10,6* ↑ 3: 10,9* ↑ 4: 10,2 ↑ 5: 10,2 ↗
	Serie 29,0		Serie 50,0
	Totalt 284,0		Totalt 334,0
Provsnitt 	1: 10,0 → 2: 10,3 ↘	Serie 2 (K) 	1: 10,0 ← 2: 8,8 ↓ 3: 10,2 ↓ 4: 10,9* ↓ 5: 10,3 →
	Serie 20,0		Serie 48,0
	Totalt 334,0		Totalt 382,0
Skott 1 (S) 	1: 9,5 ↘	Skott 2 (S) 	1: 8,8 ↓
	Serie 9,0		Serie 8,0
	Totalt 391,0		Totalt 399,0
Skott 3 (S) 	1: 6,3 ↙	Skott 4 (S) 	1: 6,2 ↘
	Serie 6,0		Serie 6,0
	Totalt 405,0		Totalt 411,0
Skott 5 (S) 	1: 8,8 ↙		
	Serie 8,0		
	Totalt 419,0		

Skjutlag	Tavla		
3	8	Mikael Olofsson	
		Moälven/Modo	
14.07.2007	Tavelträffen B Final 2007	Ramselefors SKF	
Provskott	<p>1: 10,2 → 2: 10,2 ↗ 3: 10,4 ↗</p>	Serie 1 (L)	<p>1: 9,6 ↑ 2: 9,5 ↗ 3: 10,0 ↑ 4: 10,5* ← 5: 10,8* ←</p>
	Serie 30,0		Serie 48,0
	Totalt 283,0		Totalt 331,0
Provskott	<p>1: 10,0 → 2: 10,7* ↓</p>	Serie 2 (K)	<p>1: 8,0 → 2: 10,1 ↑ 3: 9,6 ↗ 4: 10,3 ↑ 5: 8,9 →</p>
	Serie 20,0		Serie 45,0
	Totalt 331,0		Totalt 376,0
Skott 1 (S)	<p>1: 8,9 ↖</p>	Skott 2 (S)	<p>1: 8,1 ↗</p>
	Serie 8,0		Serie 8,0
	Totalt 384,0		Totalt 392,0
Skott 3 (S)	<p>1: 9,8 ←</p>	Skott 4 (S)	<p>1: 10,0 ↖</p>
	Serie 9,0		Serie 10,0
	Totalt 401,0		Totalt 411,0
Skott 5 (S)	<p>1: 10,1 ↖</p>		
	Serie 10,0		
	Totalt 421,0		

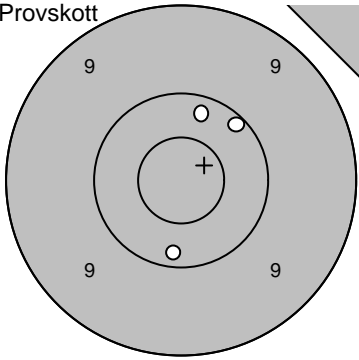
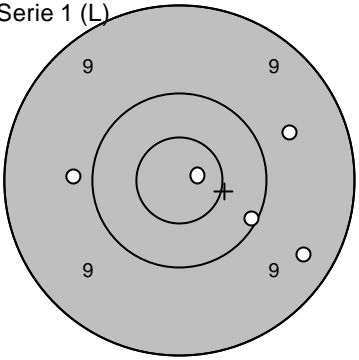
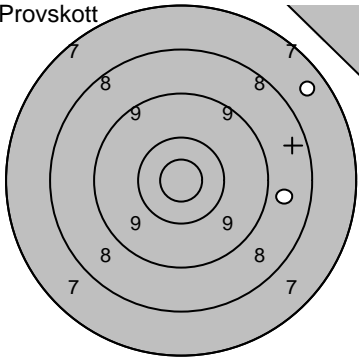
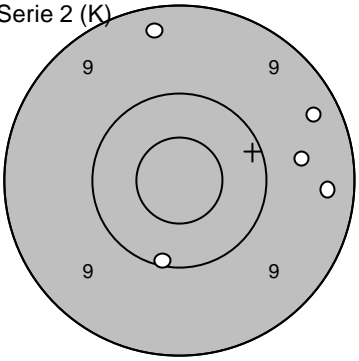
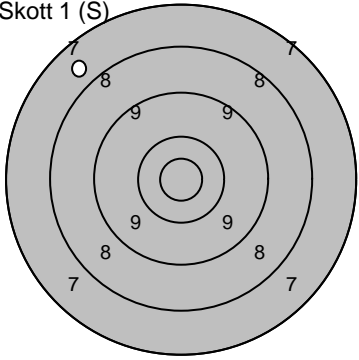
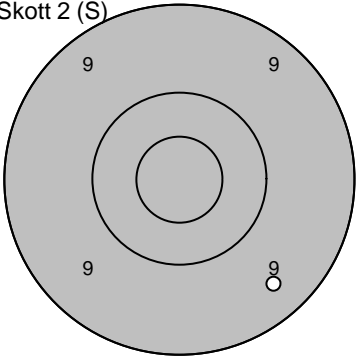
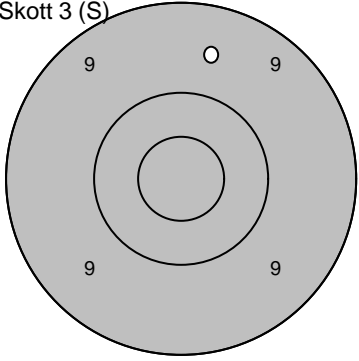
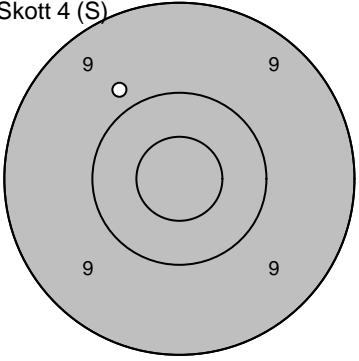
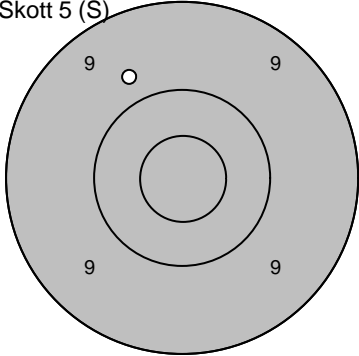
Skjutlag 3	Tavla 9	Stefan Håkansson	
		Östersund	
14.07.2007	Tavelträffen B Final 2007	Ramselefors SKF	
Provsnitt 	1: 10,3 ↑ 2: 10,2 ↗ 3: 10,2 ↓	Serie 1 (L) 	1: 9,8 ← 2: 9,7 → 3: 9,4 ↘ 4: 10,8* → 5: 10,1 ↘
	Serie 30,0		Serie 47,0
	Totalt 283,0		Totalt 330,0
Provsnitt 	1: 8,8 → 2: 7,6 ↗	Serie 2 (K) 	1: 10,1 ↓ 2: 9,3 → 3: 9,6 → 4: 9,3 ↑ 5: 9,4 →
	Serie 15,0		Serie 46,0
	Totalt 330,0		Totalt 376,0
Skott 1 (S) 	1: 7,7 ↖	Skott 2 (S) 	1: 9,4 ↘
	Serie 7,0		Serie 9,0
	Totalt 383,0		Totalt 392,0
Skott 3 (S) 	1: 9,6 ↑	Skott 4 (S) 	1: 9,8 ↖
	Serie 9,0		Serie 9,0
	Totalt 401,0		Totalt 410,0
Skott 5 (S) 	1: 9,8 ↖		
	Serie 9,0		
	Totalt 419,0		

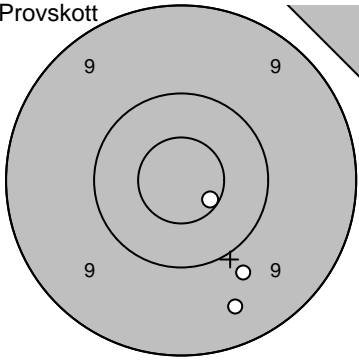
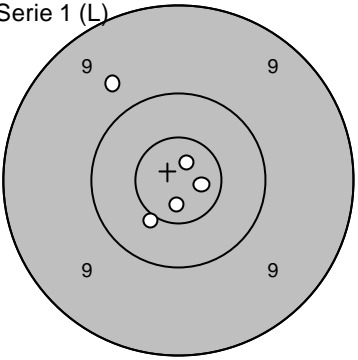
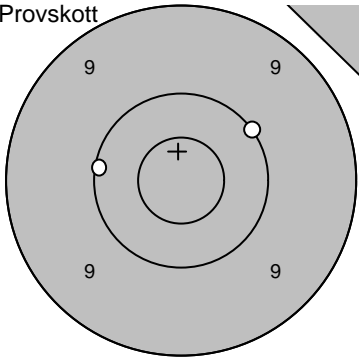
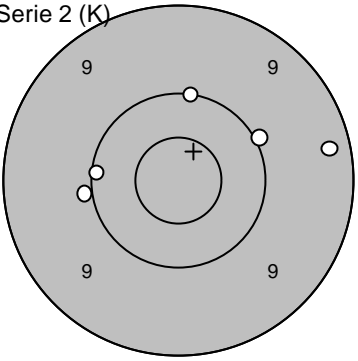
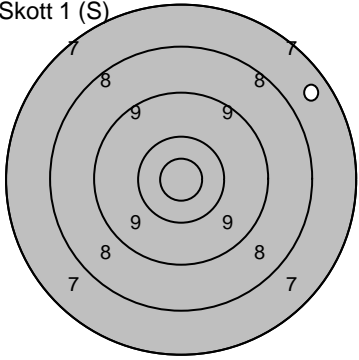
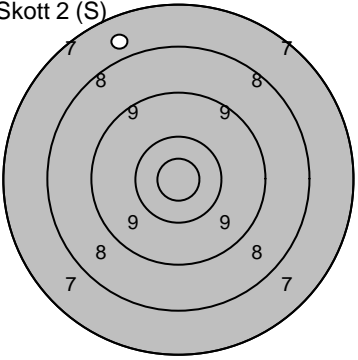
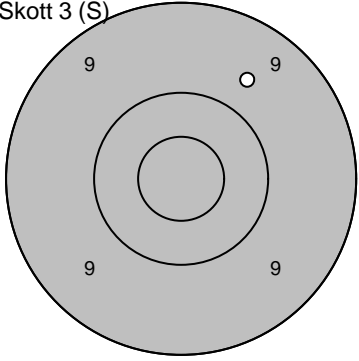
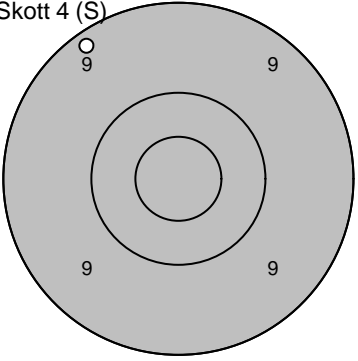
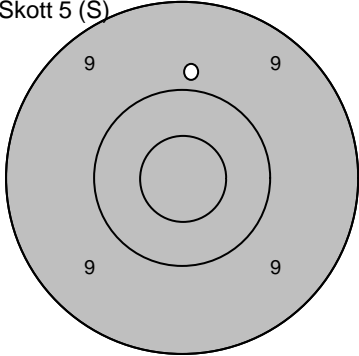
Skjutlag 3	Tavla 10	Donald Johansson	
		Ale	
14.07.2007		Tavelträffen B Final 2007	Ramselefors SKF
Provkott 	1: 10,6* ↘ 2: 9,5 ↙ 3: 9,8 ↘	Serie 1 (L) 	1: 10,8* ↓ 2: 9,7 ↗ 3: 10,5* ↘ 4: 10,8* ↗ 5: 10,8* →
	Serie 28,0 Totalt 282,0		Serie 49,0 Totalt 331,0
Provkott 	1: 10,1 ← 2: 10,1 ↗	Serie 2 (K) 	1: 10,1 ↑ 2: 10,0 ← 3: 9,3 → 4: 10,1 ← 5: 10,0 ↗
	Serie 20,0 Totalt 331,0		Serie 49,0 Totalt 380,0
Skott 1 (S) 	1: 7,6 ↗	Skott 2 (S) 	1: 7,8 ↑
	Serie 7,0 Totalt 387,0		Serie 7,0 Totalt 394,0
Skott 3 (S) 	1: 9,7 ↗	Skott 4 (S) 	1: 9,2 ↗
	Serie 9,0 Totalt 403,0		Serie 9,0 Totalt 412,0
Skott 5 (S) 	1: 9,8 ↑		
	Serie 9,0 Totalt 421,0		

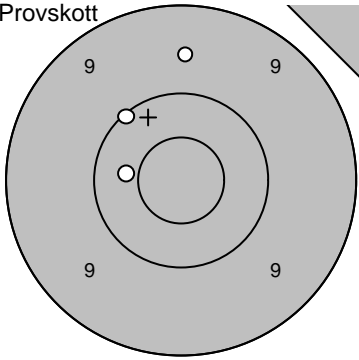
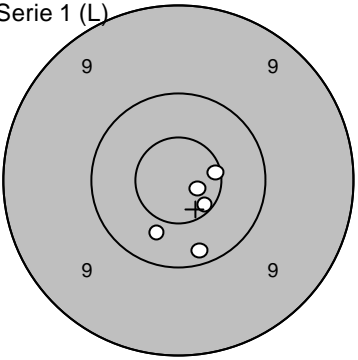
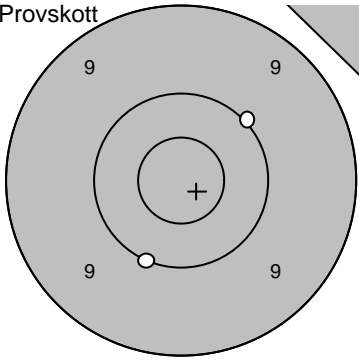
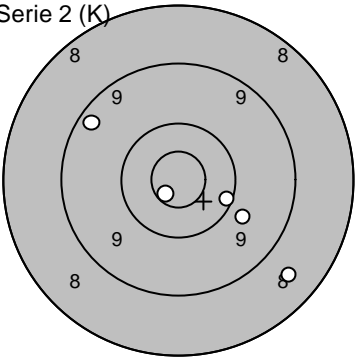
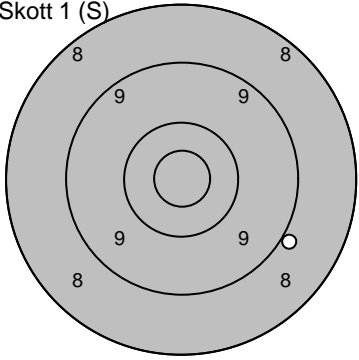
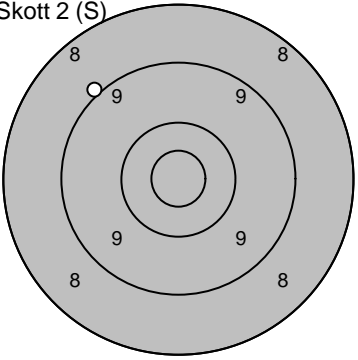
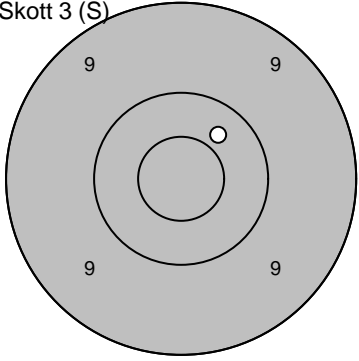
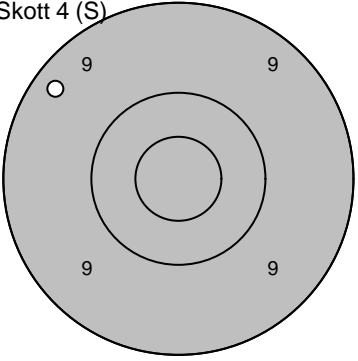
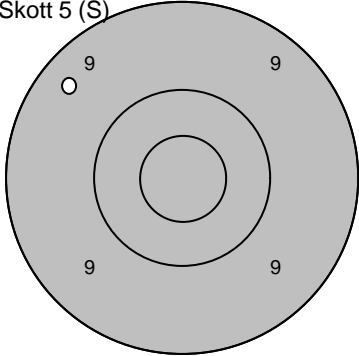
Skjutlag 3	Tavla 11	Stefan Lundqvist	
		Ununge	
14.07.2007	Tavelträffen B Final 2007	Ramselefors SKF	
Provskott 	1: 9,6 ↑ 2: 10,4 ← 3: 10,1 ↗	Serie 1 (L) 	1: 10,6* → 2: 10,2 ↓ 3: 10,6* ↘ 4: 10,8* ↗ 5: 10,4 ↓
	Serie 29,0 Totalt 281,0		Serie 50,0 Totalt 331,0
Provskott 	1: 10,1 ↓ 2: 10,0 ↗	Serie 2 (K) 	1: 9,3 ↖ 2: 10,2 → 3: 9,8 ↘ 4: 10,8* ↙ 5: 8,6 ↓
	Serie 20,0 Totalt 331,0		Serie 46,0 Totalt 377,0
Skott 1 (S) 	1: 9,0 ↘	Skott 2 (S) 	1: 9,0 ↖
	Serie 9,0 Totalt 386,0		Serie 9,0 Totalt 395,0
Skott 3 (S) 	1: 10,4 ↗	Skott 4 (S) 	1: 9,3 ↖
	Serie 10,0 Totalt 405,0		Serie 9,0 Totalt 414,0
Skott 5 (S) 	1: 9,4 ↖		
	Serie 9,0 Totalt 423,0		

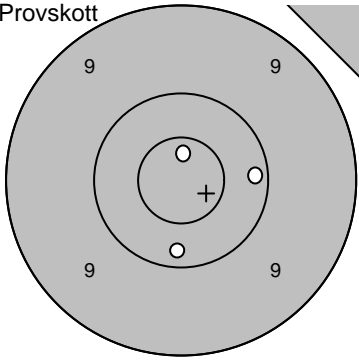
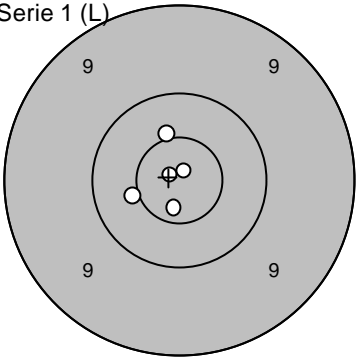
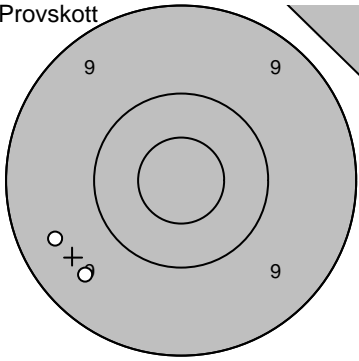
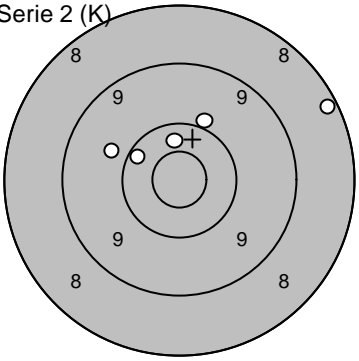
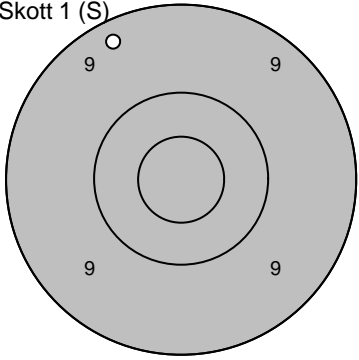
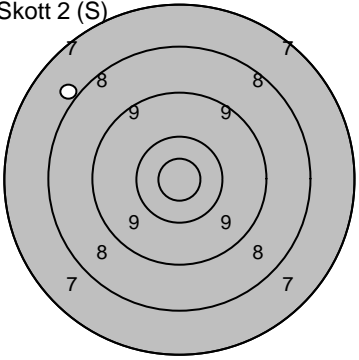
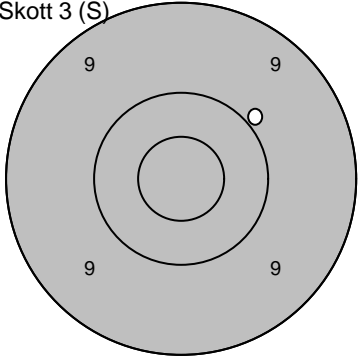
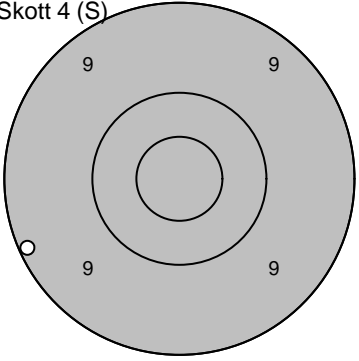
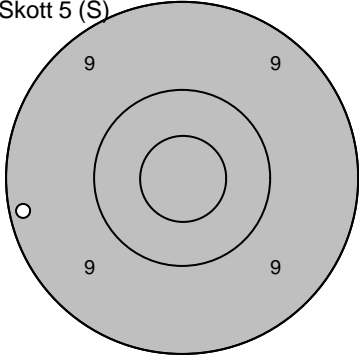
Skjutlag 3	Tavla 12	Bengt Jansson	
		Söderala	
14.07.2007		Tavelträffen B Final 2007	Ramselefors SKF
Provsnitt 	1: 10,2 → 2: 10,7* ↑ 3: 10,3 ↓	Serie 1 (L) 	1: 10,5* ↑ 2: 10,9* ↖ 3: 10,5* ← 4: 10,9* ↑ 5: 10,7* ↓
Serie 30,0		Serie 50,0	
Totalt 280,0		Totalt 330,0	
Provsnitt 	1: 9,5 ↖ 2: 9,5 ↙	Serie 2 (K) 	1: 8,3 → 2: 9,8 ↖ 3: 10,4 ↑ 4: 10,0 ↑ 5: 10,3 ↖
Serie 18,0		Serie 47,0	
Totalt 330,0		Totalt 377,0	
Skott 1 (S) 	1: 9,3 ↑	Skott 2 (S) 	1: 8,0 ↖
Serie 9,0		Serie 8,0	
Totalt 386,0		Totalt 394,0	
Skott 3 (S) 	1: 10,0 ↗	Skott 4 (S) 	1: 9,2 ←
Serie 10,0		Serie 9,0	
Totalt 404,0		Totalt 413,0	
Skott 5 (S) 	1: 9,2 ←		
Serie 9,0			
Totalt 422,0			

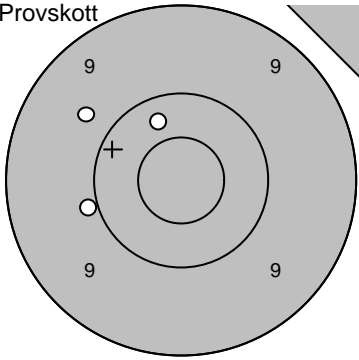
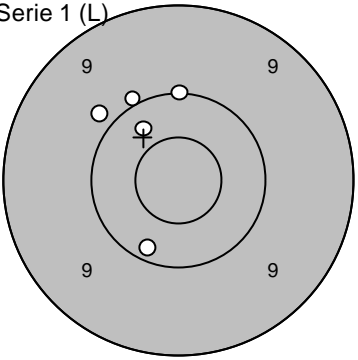
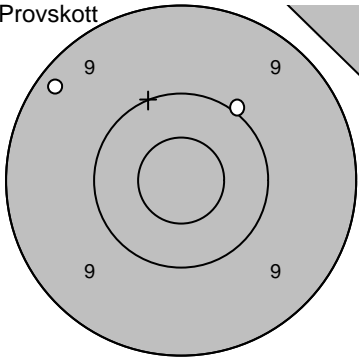
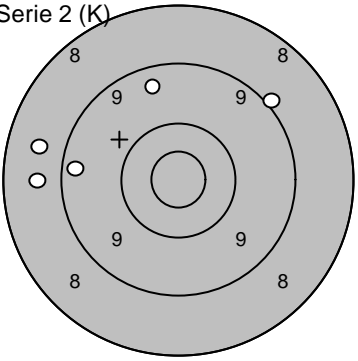
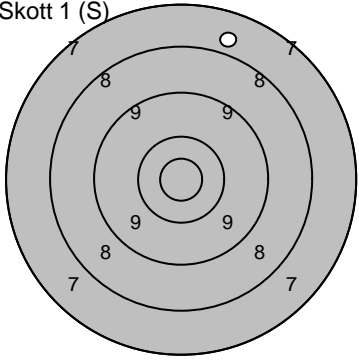
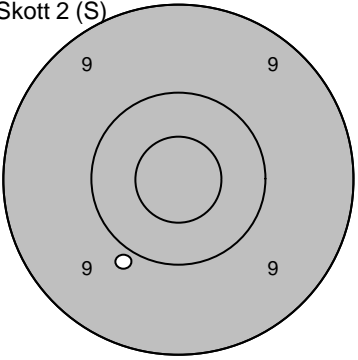
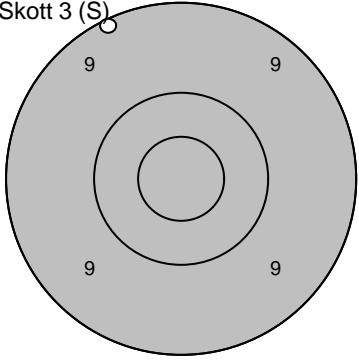
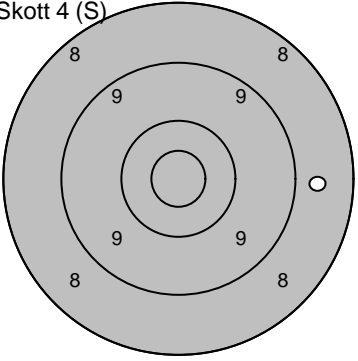
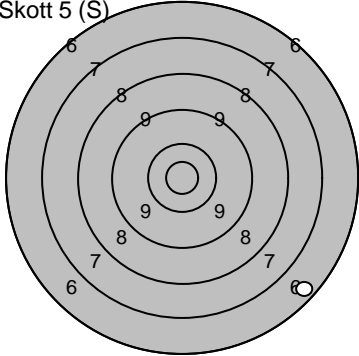
Skjutlag 3	Tavla 13	Harry Östling	
		F 21	
14.07.2007	Tavelträffen B Final 2007	Ramselefors SKF	
Provsnitt 	1: 9,9 ← 2: 9,7 ↗ 3: 10,3 →	Serie 1 (L) 	1: 10,0 ↑ 2: 10,2 ↓ 3: 10,3 ↗ 4: 9,9 ↗ 5: 10,0 ↗
	Serie 28,0		Serie 49,0
	Totalt 280,0		Totalt 329,0
Provsnitt 	1: 9,3 ↗ 2: 10,0 ↗	Serie 2 (K) 	1: 8,7 ← 2: 9,3 ← 3: 9,0 ↗ 4: 8,7 ← 5: 9,5 ↗
	Serie 19,0		Serie 43,0
	Totalt 329,0		Totalt 372,0
Skott 1 (S) 	1: 7,8 ↑	Skott 2 (S) 	1: 9,9 ↘
	Serie 7,0		Serie 9,0
	Totalt 379,0		Totalt 388,0
Skott 3 (S) 	1: 9,1 ↗	Skott 4 (S) 	1: 8,7 →
	Serie 9,0		Serie 8,0
	Totalt 397,0		Totalt 405,0
Skott 5 (S) 	1: 6,5 ↘		
	Serie 6,0		
	Totalt 411,0		

Skjutlag 3	Tavla 14	Lars Möllsten	
		Umeå	
14.07.2007	Tavelträffen B Final 2007	Ramselefors SKF	
Provskott 	1: 10,4 → 2: 10,9* → 3: 9,5 ↘	Serie 1 (L) 	1: 9,8 ↗ 2: 10,7* ↘ 3: 9,9 ↘ 4: 10,6* ← 5: 10,0 ↘
	Serie 29,0		Serie 48,0
	Totalt 279,0		Totalt 327,0
Provskott 	1: 10,6* ↓ 2: 9,7 →	Serie 2 (K) 	1: 9,7 ↗ 2: 10,1 ← 3: 8,9 ↓ 4: 9,5 ↑ 5: 9,8 ↘
	Serie 19,0		Serie 45,0
	Totalt 327,0		Totalt 372,0
Skott 1 (S) 	1: 9,2 ↗	Skott 2 (S) 	1: 8,2 →
	Serie 9,0		Serie 8,0
	Totalt 381,0		Totalt 389,0
Skott 3 (S) 	1: 8,3 ↑	Skott 4 (S) 	1: 9,8 ↘
	Serie 8,0		Serie 9,0
	Totalt 397,0		Totalt 406,0
Skott 5 (S) 	1: 10,0 ↗		
	Serie 10,0		
	Totalt 416,0		

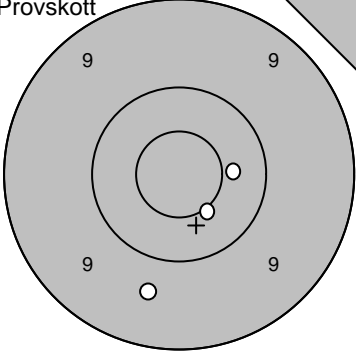
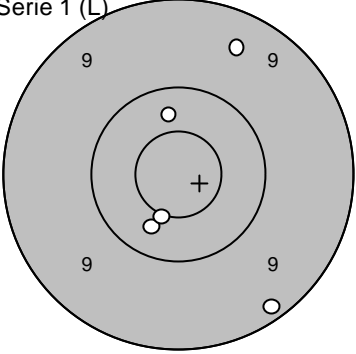
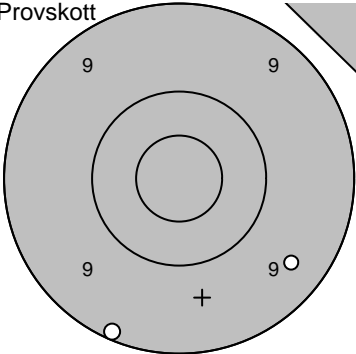
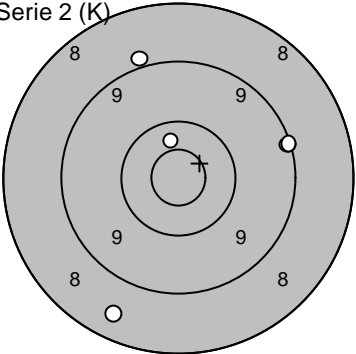
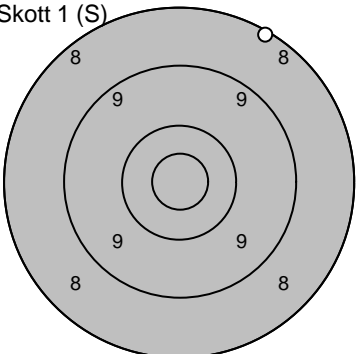
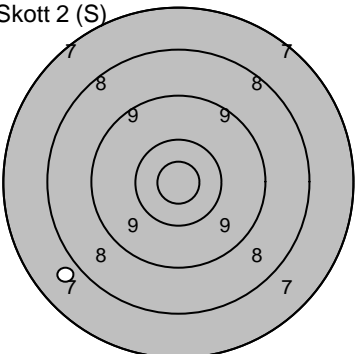
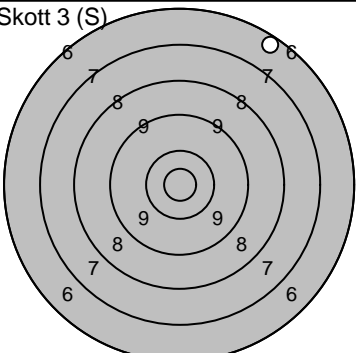
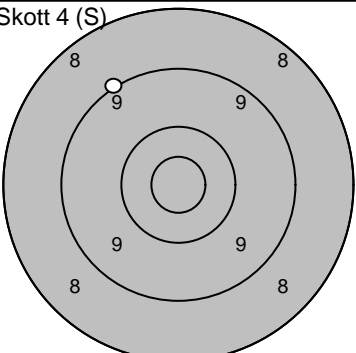
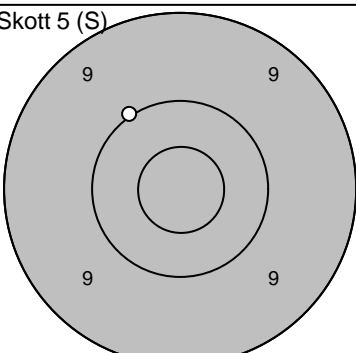
Skjutlag 3	Tavla 15	Anders Petersson	
		P 7	
14.07.2007		Tavelträffen B Final 2007	
		Ramselefors SKF	
Provsnitt 	1: 10,5* ↘ 2: 10,4 → 3: 9,7 ↓ <hr/> Serie 29,0 Totalt 278,0	Serie 1 (L) 	1: 10,4 ↓ 2: 10,5* ↓ 3: 9,5 ↗ 4: 10,4 ↑ 5: 9,2 ↓ <hr/> Serie 48,0 Totalt 326,0
Provsnitt 	1: 9,5 ↘ 2: 9,1 ↓ <hr/> Serie 18,0 Totalt 326,0	Serie 2 (K) 	1: 8,5 ↓ 2: 9,0 ↑ 3: 10,5* ↑ 4: 9,1 → 5: 9,1 → <hr/> Serie 45,0 Totalt 371,0
Skott 1 (S) 	1: 8,2 ↗ <hr/> Serie 8,0 Totalt 379,0	Skott 2 (S) 	1: 7,8 ↙ <hr/> Serie 7,0 Totalt 386,0
Skott 3 (S) 	1: 6,5 ↗ <hr/> Serie 6,0 Totalt 392,0	Skott 4 (S) 	1: 9,1 ↖ <hr/> Serie 9,0 Totalt 401,0
Skott 5 (S) 	1: 10,0 ↖ <hr/> Serie 10,0 Totalt 411,0		

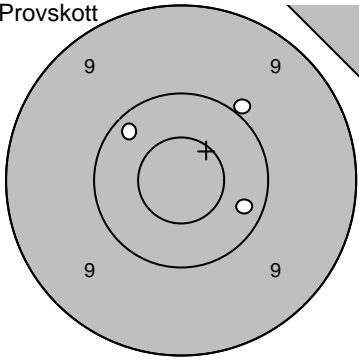
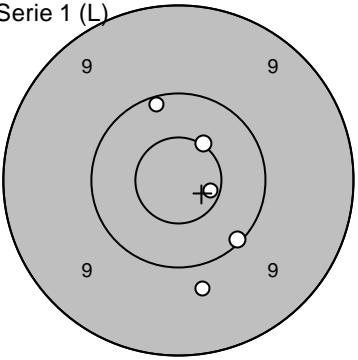
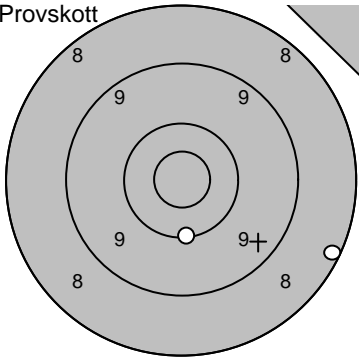
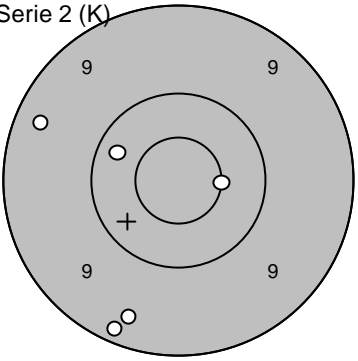
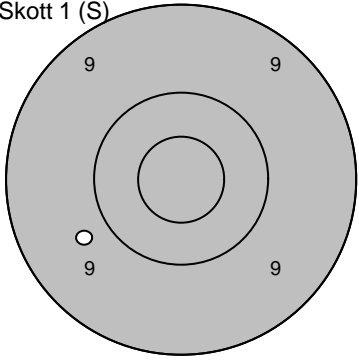
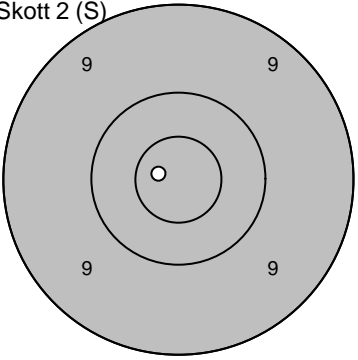
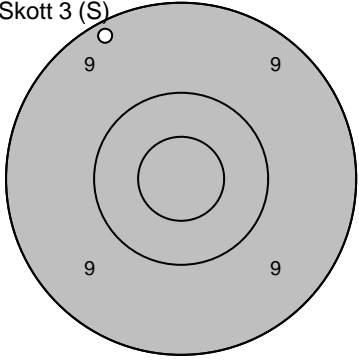
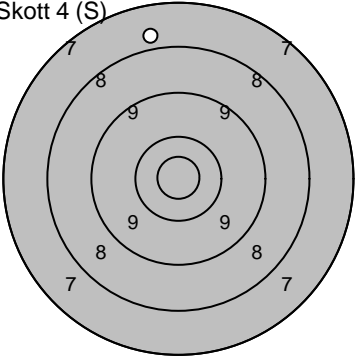
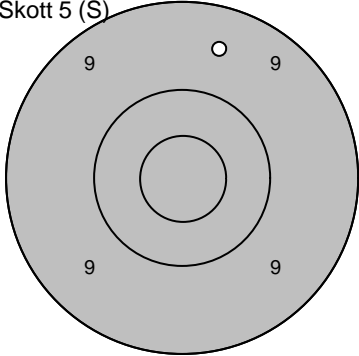
Skjutlag 3	Tavla 16	Bo Allansson	
		Stenungsund	
14.07.2007	Tavelträffen B Final 2007	Ramselefors SKF	
Provsnitt 	1: 10,3 → 2: 10,0 ↗ 3: 10,2 ↖	Serie 1 (L) 	1: 9,8 ↓ 2: 10,5* ↗ 3: 10,1 ↘ 4: 10,2 ↗ 5: 10,7* ↓
	Serie 30,0		Serie 49,0
	Totalt 277,0		Totalt 326,0
Provsnitt 	1: 8,2 → 2: 10,1 ↓	Serie 2 (K) 	1: 9,4 ↓ 2: 10,6* → 3: 9,4 ↗ 4: 9,2 ↓ 5: 10,3 ↖
	Serie 18,0		Serie 47,0
	Totalt 326,0		Totalt 373,0
Skott 1 (S) 	1: 9,7 ↖	Skott 2 (S) 	1: 10,8* ←
	Serie 9,0		Serie 10,0
	Totalt 382,0		Totalt 392,0
Skott 3 (S) 	1: 9,2 ↖	Skott 4 (S) 	1: 7,8 ↑
	Serie 9,0		Serie 7,0
	Totalt 401,0		Totalt 408,0
Skott 5 (S) 	1: 9,5 ↑		
	Serie 9,0		
	Totalt 417,0		

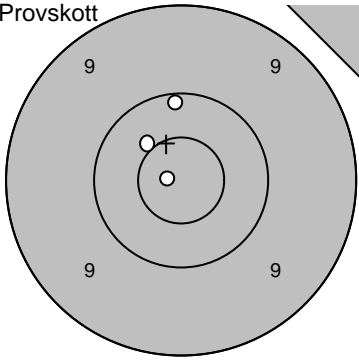
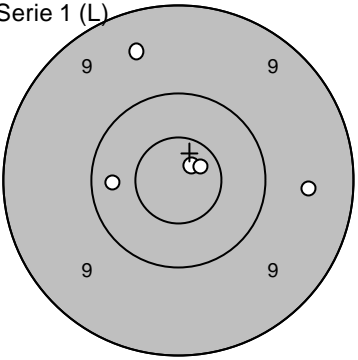
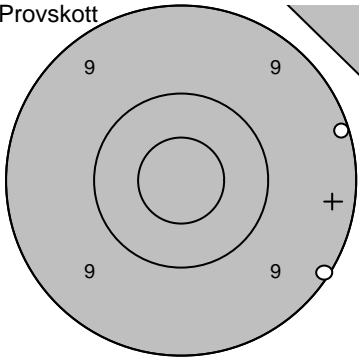
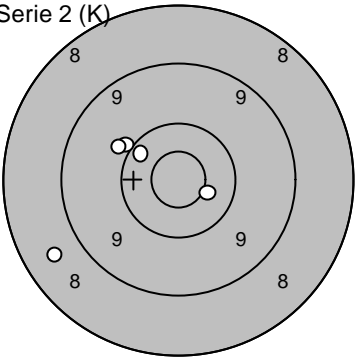
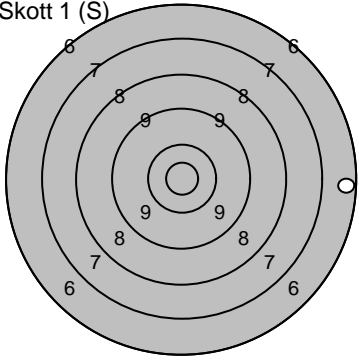
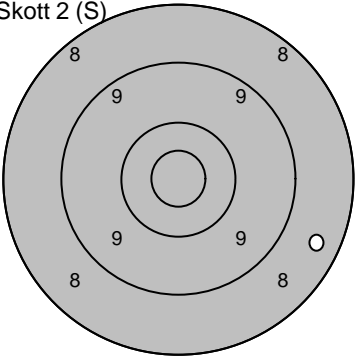
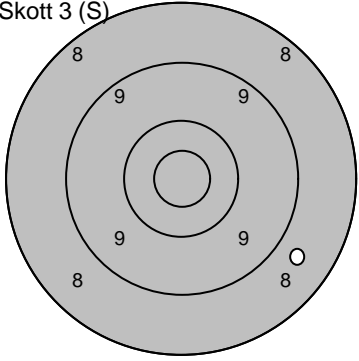
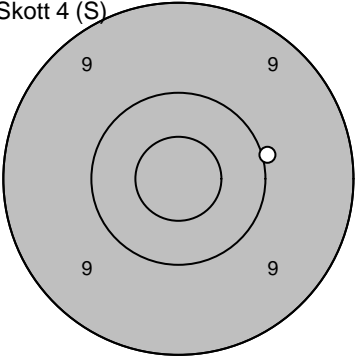
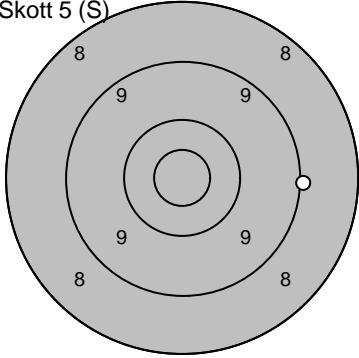
Skjutlag 3	Tavla 17	Peder Vahlberg	
		Ramselefors	
14.07.2007	Tavelträffen B Final 2007	Ramselefors SKF	
Provs-kott 	1: 10,2 ↑ 2: 10,5* ↗ 3: 10,9* ←	Serie 1 (L) 	1: 9,5 ↑ 2: 10,3 ← 3: 10,8* ↗ 4: 9,6 → 5: 10,7* ↗
	Serie 30,0		Serie 48,0
	Totalt 277,0		Totalt 325,0
Provs-kott 	1: 9,1 → 2: 9,1 ↘	Serie 2 (K) 	1: 10,0 ↖ 2: 10,6* → 3: 9,9 ↗ 4: 8,6 ← 5: 10,3 ↗
	Serie 18,0		Serie 47,0
	Totalt 325,0		Totalt 372,0
Skott 1 (S) 	1: 6,5 →	Skott 2 (S) 	1: 8,5 →
	Serie 6,0		Serie 8,0
	Totalt 378,0		Totalt 386,0
Skott 3 (S) 	1: 8,7 →	Skott 4 (S) 	1: 10,0 →
	Serie 8,0		Serie 10,0
	Totalt 394,0		Totalt 404,0
Skott 5 (S) 	1: 9,0 →		
	Serie 9,0		
	Totalt 413,0		

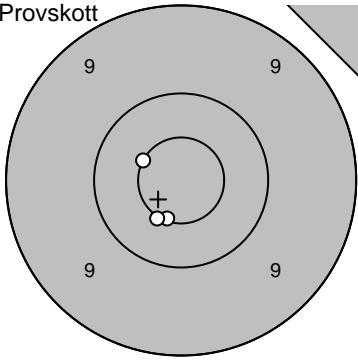
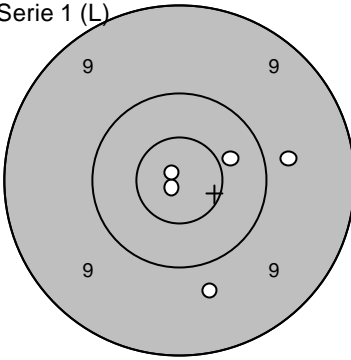
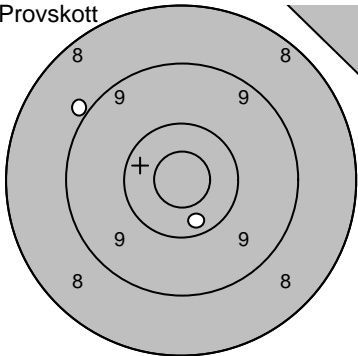
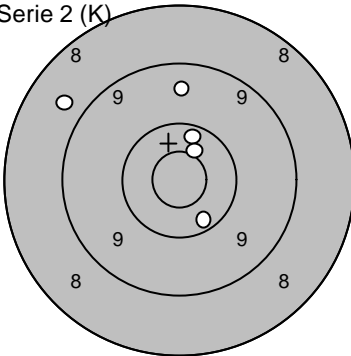
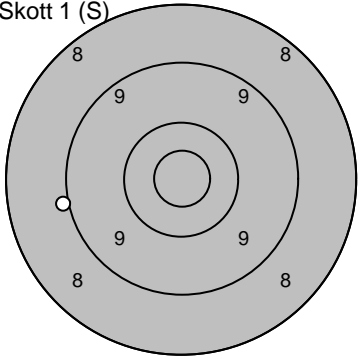
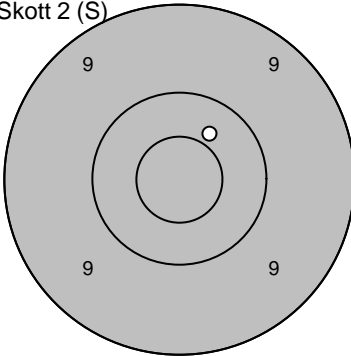
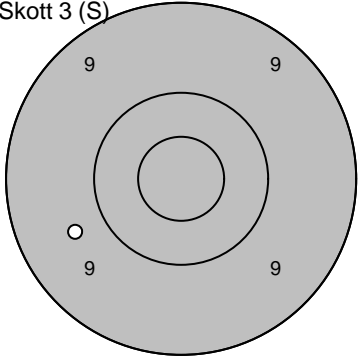
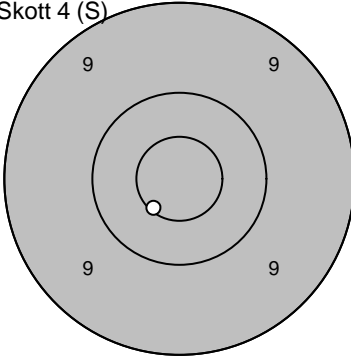
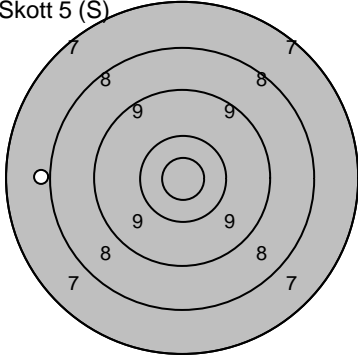
Skjutlag 3	Tavla 18	Gustav Lövgren		
		Niemisel		
14.07.2007		Tavelträffen B Final 2007	Ramselefors SKF	
Provkott 	1: 10,6* ↓ 2: 10,5* ↙ 3: 10,6* ↗	Serie 1 (L) 	1: 10,4 → 2: 9,8 → 3: 10,9* ↙ 4: 9,8 ↘ 5: 10,9* ↗	
		Serie 30,0	Serie 48,0	
		Totalt 277,0	Totalt 325,0	
Provkott 	1: 10,4 ↓ 2: 9,0 ↗	Serie 2 (K) 	1: 10,3 ↑ 2: 9,5 ↑ 3: 10,5* ↗ 4: 8,7 ↖ 5: 10,3 ↘	
		Serie 19,0	Serie 47,0	
		Totalt 325,0	Totalt 372,0	
Skott 1 (S) 	1: 9,0 ←	Skott 2 (S) 	1: 10,4 ↗	
		Serie 9,0	Serie 10,0	
		Totalt 381,0	Totalt 391,0	
Skott 3 (S) 	1: 9,7 ↖	Skott 4 (S) 	1: 10,6* ↘	
		Serie 9,0	Serie 10,0	
		Totalt 400,0	Totalt 410,0	
Skott 5 (S) 	1: 7,9 ←			
		Serie 7,0		
		Totalt 417,0		

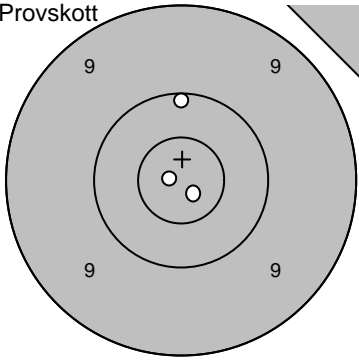
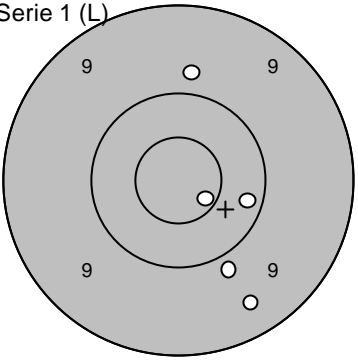
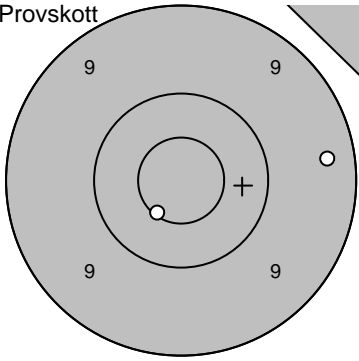
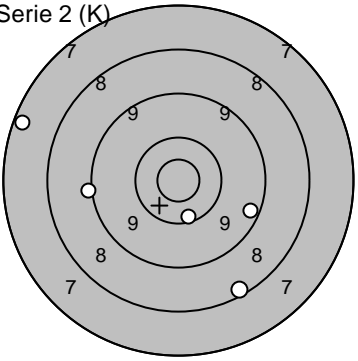
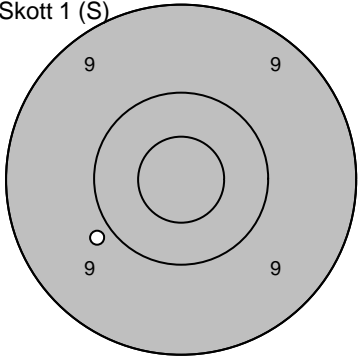
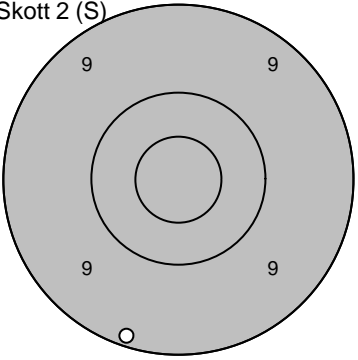
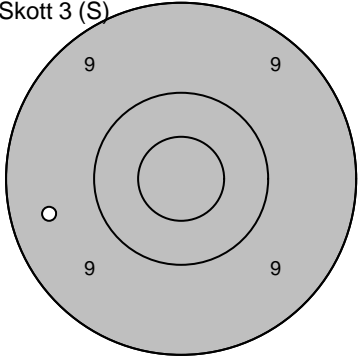
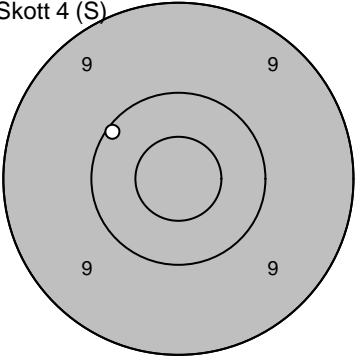
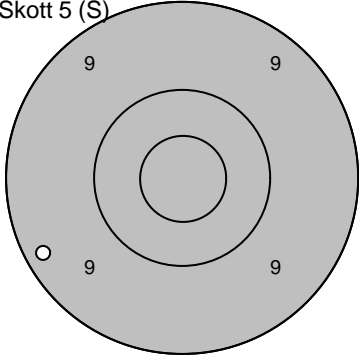
Skjutlag 3	Tavla 19	Peter Östling	
		F 21	
14.07.2007	Tavelträffen B Final 2007	Ramselefors SKF	
Provsnitt 	1: 10,2 ↑ 2: 10,8* ↘ 3: 10,9* ←	Serie 1 (L) 	1: 9,9 ↓ 2: 9,4 ↓ 3: 9,8 ↑ 4: 10,2 → 5: 10,7* ↓
	Serie 30,0		Serie 47,0
	Totalt 277,0		Totalt 324,0
Provsnitt 	1: 9,4 → 2: 10,6* ↙	Serie 2 (K) 	1: 8,3 ↓ 2: 9,4 → 3: 9,1 ← 4: 7,4 ↗ 5: 10,3 ↓
	Serie 19,0		Serie 43,0
	Totalt 324,0		Totalt 367,0
Skott 1 (S) 	1: 9,9 ↙	Skott 2 (S) 	1: 9,2 ↓
	Serie 9,0		Serie 9,0
	Totalt 376,0		Totalt 385,0
Skott 3 (S) 	1: 9,5 ←	Skott 4 (S) 	1: 10,1 ↖
	Serie 9,0		Serie 10,0
	Totalt 394,0		Totalt 404,0
Skott 5 (S) 	1: 9,3 ↙		
	Serie 9,0		
	Totalt 413,0		

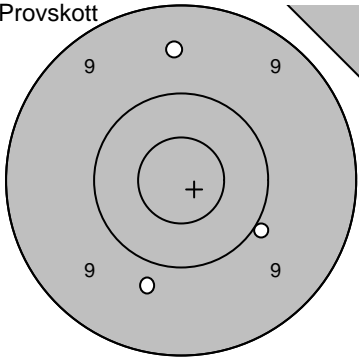
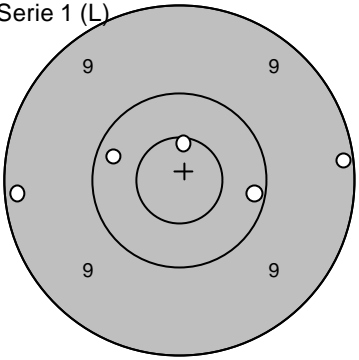
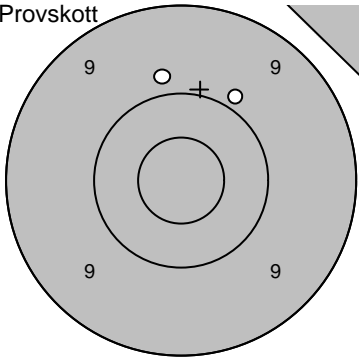
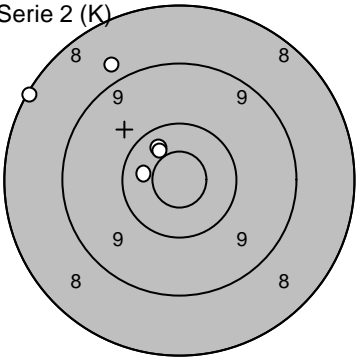
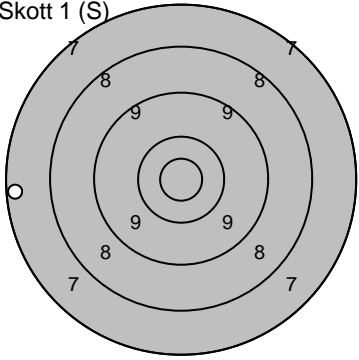
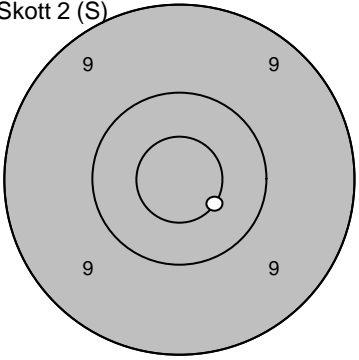
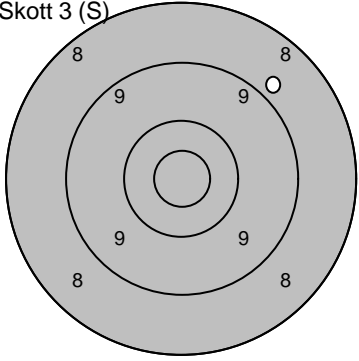
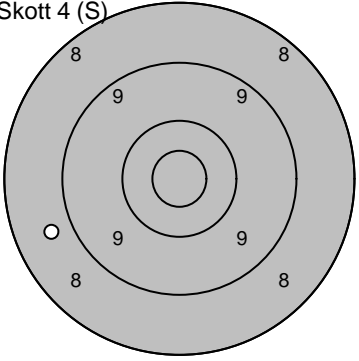
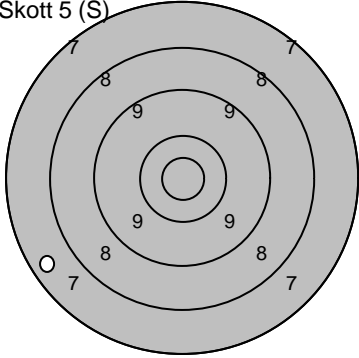
Skjutlag 3	Tavla 21	Urban Johansson	
		F 21	
14.07.2007	Tavelträffen B Final 2007	Ramselefors SKF	
Provsnitt 	1: 10,0 → 2: 9,8 ↓ 3: 9,6 ↑	Serie 1 (L) 	1: 10,2 → 2: 9,2 → 3: 10,6* ↑ 4: 9,2 ← 5: 10,3 ↖
	Serie 28,0		Serie 48,0
	Totalt 276,0		Totalt 324,0
Provsnitt 	1: 9,9 ↗ 2: 9,9 ↑	Serie 2 (K) 	1: 8,8 ↗ 2: 10,4 ↗ 3: 10,5* ↗ 4: 8,2 ↗ 5: 10,5* ↑
	Serie 18,0		Serie 46,0
	Totalt 324,0		Totalt 370,0
Skott 1 (S) 	1: 7,3 ←	Skott 2 (S) 	1: 10,6* ↘
	Serie 7,0		Serie 10,0
	Totalt 377,0		Totalt 387,0
Skott 3 (S) 	1: 8,9 ↗	Skott 4 (S) 	1: 8,7 ←
	Serie 8,0		Serie 8,0
	Totalt 395,0		Totalt 403,0
Skott 5 (S) 	1: 7,5 ←		
	Serie 7,0		
	Totalt 410,0		

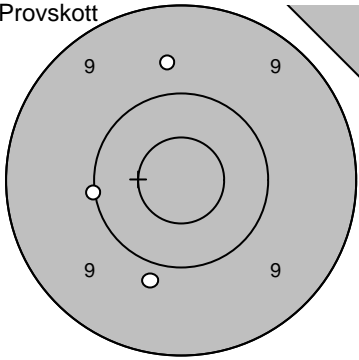
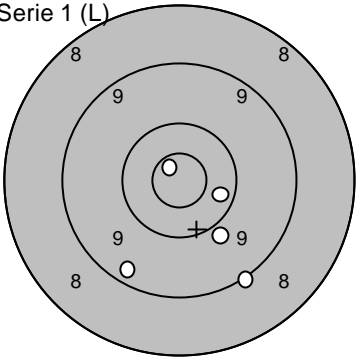
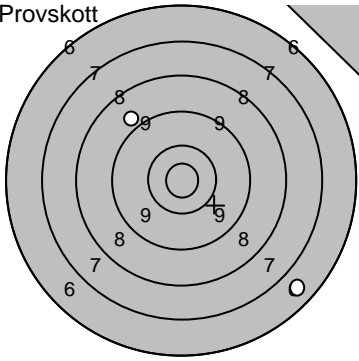
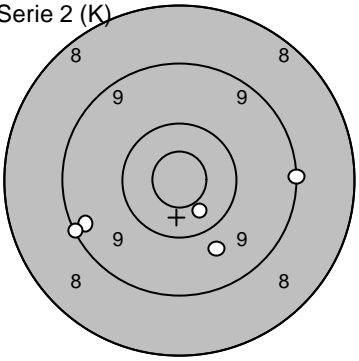
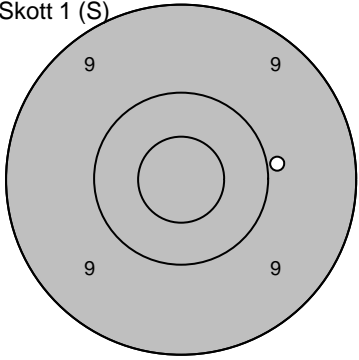
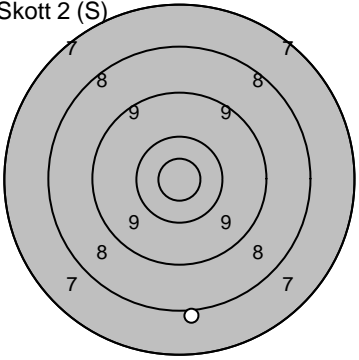
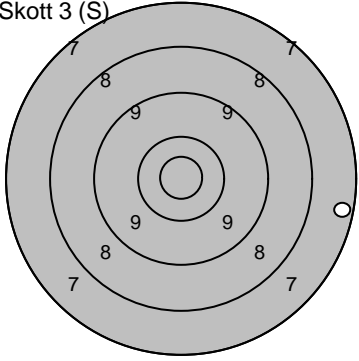
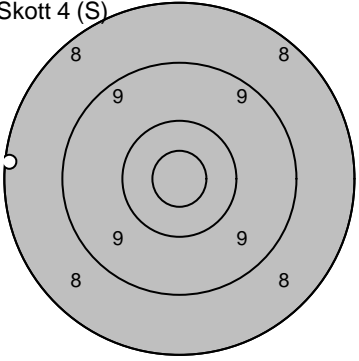
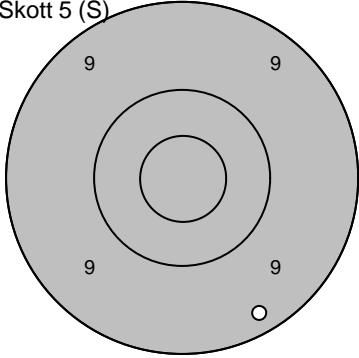
Skjutlag 3	Tavla 22	Leif Sandberg	
		Kalix	
14.07.2007	Tavelträffen B Final 2007	Ramselefors SKF	
Provsnitt 	1: 9,7 ↑ 2: 9,9 ↓ 3: 10,0 ←	Serie 1 (L) 	1: 9,3 ↓ 2: 10,8* ↗ 3: 9,9 ↓ 4: 10,4 ↓ 5: 9,1 ↓
	Serie 28,0		Serie 47,0
	Totalt 273,0		Totalt 320,0
Provsnitt 	1: 6,7 ↓ 2: 9,0 ↗	Serie 2 (K) 	1: 9,1 → 2: 9,3 ← 3: 9,1 ← 4: 10,5* ↓ 5: 9,8 ↓
	Serie 15,0		Serie 46,0
	Totalt 320,0		Totalt 366,0
Skott 1 (S) 	1: 9,9 →	Skott 2 (S) 	1: 8,0 ↓
	Serie 9,0		Serie 8,0
	Totalt 375,0		Totalt 383,0
Skott 3 (S) 	1: 7,4 →	Skott 4 (S) 	1: 8,2 ←
	Serie 7,0		Serie 8,0
	Totalt 390,0		Totalt 398,0
Skott 5 (S) 	1: 9,3 ↓		
	Serie 9,0		
	Totalt 407,0		

Skjutlag	Tavla	Jan Wallerström	
3	23	Ununge	
14.07.2007	Tavelträffen B Final 2007	Ramselefors SKF	
Provsrott 	1: 10,4 ↙ 2: 10,3 ↓ 3: 9,9 ←	Serie 1 (L) 	1: 10,2 ↓ 2: 10,9* ← 3: 10,4 ↗ 4: 10,8* ↘ 5: 10,3 ↑
	Serie 29,0		Serie 50,0
	Totalt 273,0		Totalt 323,0
Provsrott 	1: 9,7 ↑ 2: 9,1 ←	Serie 2 (K) 	1: 10,2 → 2: 10,4 ← 3: 9,9 ↑ 4: 10,5* ↗ 5: 10,8* ↘
	Serie 18,0		Serie 49,0
	Totalt 323,0		Totalt 372,0
Skott 1 (S) 	1: 7,2 →	Skott 2 (S) 	1: 9,5 →
	Serie 7,0		Serie 9,0
	Totalt 379,0		Totalt 388,0
Skott 3 (S) 	1: 7,3 ↗	Skott 4 (S) 	1: 7,8 ↘
	Serie 7,0		Serie 7,0
	Totalt 395,0		Totalt 402,0
Skott 5 (S) 	1: 8,7 ↗		
	Serie 8,0		
	Totalt 410,0		

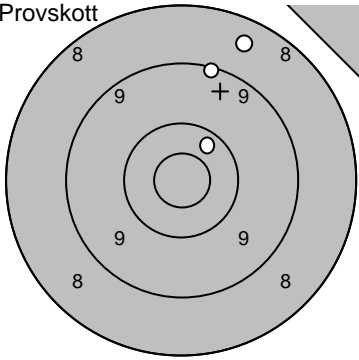
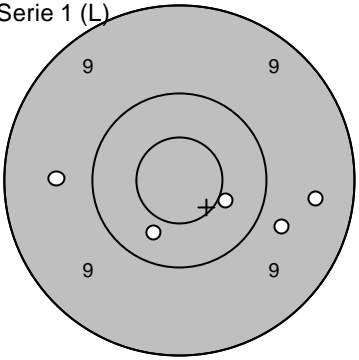
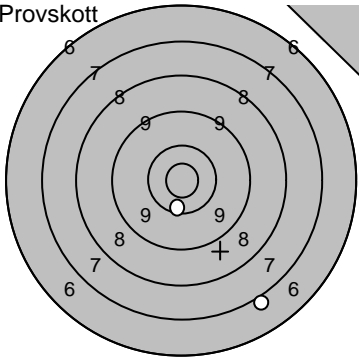
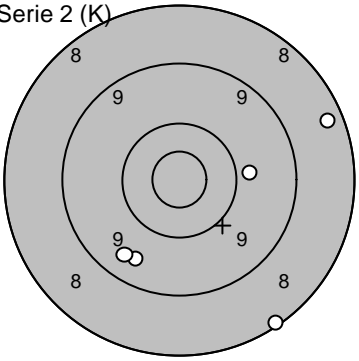
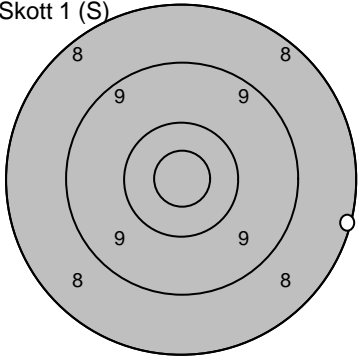
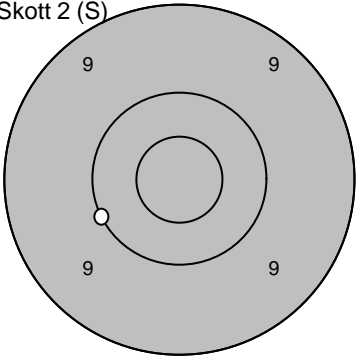
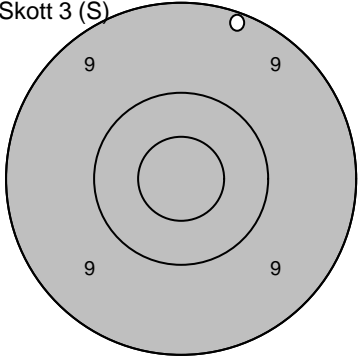
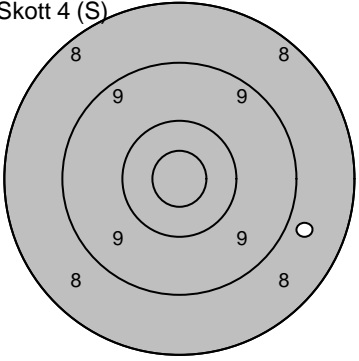
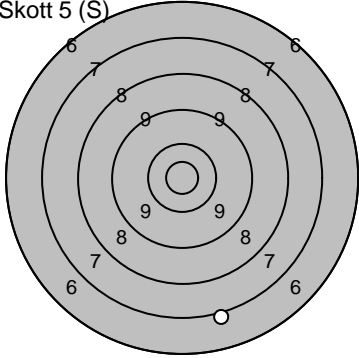
Skjutlag	Tavla	Carina Norling	
3	24		
Söderala			
14.07.2007	Tavelträffen B Final 2007	Ramselefors SKF	
Provsnitt 	1: 10,4 ↗ 2: 8,5 ↗ 3: 9,2 ↗	Serie 1 (L) 	1: 9,7 ← 2: 10,4 ↘ 3: 10,5* ↘ 4: 9,5 → 5: 9,8 ↘
	Serie 27,0 Totalt 271,0		Serie 47,0 Totalt 318,0
Provsnitt 	1: 7,0 ↘ 2: 10,4 ↘	Serie 2 (K) 	1: 9,6 ↘ 2: 8,4 → 3: 9,5 ↘ 4: 9,9 → 5: 8,2 ↘
	Serie 17,0 Totalt 318,0		Serie 43,0 Totalt 361,0
Skott 1 (S) 	1: 8,2 →	Skott 2 (S) 	1: 10,1 ←
	Serie 8,0 Totalt 369,0		Serie 10,0 Totalt 379,0
Skott 3 (S) 	1: 9,2 ↗	Skott 4 (S) 	1: 8,8 →
	Serie 9,0 Totalt 388,0		Serie 8,0 Totalt 396,0
Skott 5 (S) 	1: 7,1 ↘		
	Serie 7,0 Totalt 403,0		