

Skjutlag 1	Tavla 1	Johan Zakrisson	
----------------------	-------------------	------------------------	--

Ramselefors			
-------------	--	--	--

13.07.2007	Tavelträffen A 2007	Ramselefors SKF	
------------	---------------------	-----------------	--

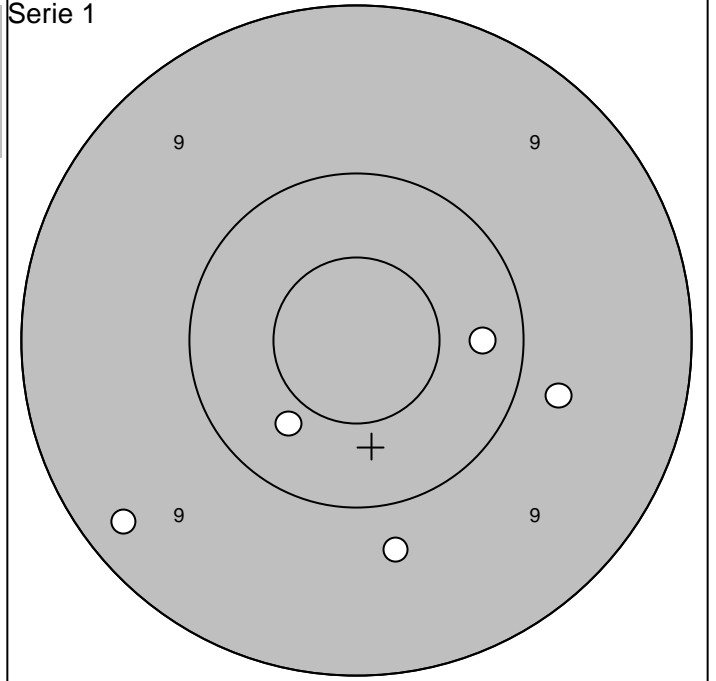
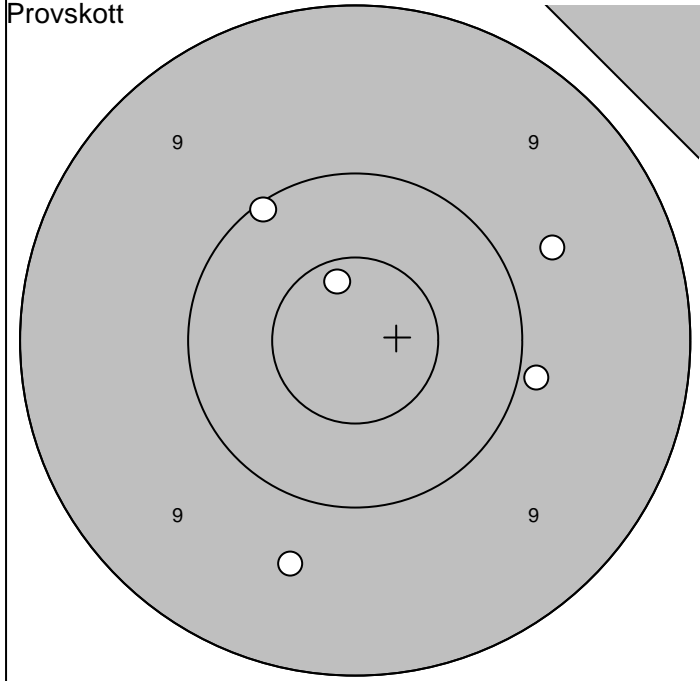

1: 9,7 →	Serie	47,0
2: 10,1 ↗		
3: 10,7* ↗	Totalt	0,0
4: 9,6 ↓		
5: 9,9 →		

1: 10,4 ↙	Serie	47,0
2: 9,3 ↙		
3: 9,8 ↓	Totalt	47,0
4: 10,3 →		
5: 9,8 →		

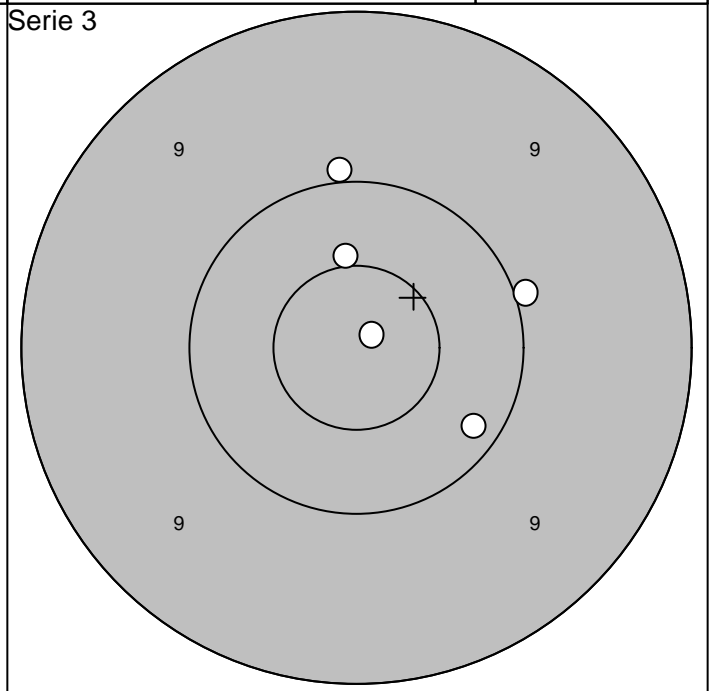
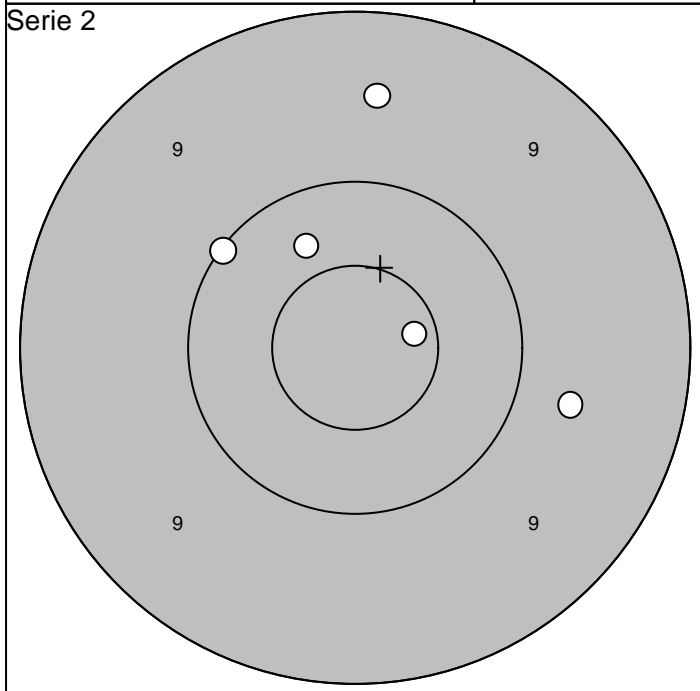

1: 10,1 ↗	Serie	48,0
2: 10,4 ↗		
3: 9,7 →	Totalt	95,0
4: 10,7* →		
5: 9,5 ↑		

1: 10,2 →	Serie	50,0
2: 10,5* ↑		
3: 10,0 →	Totalt	145,0
4: 10,9* ↗		
5: 10,0 ↑		

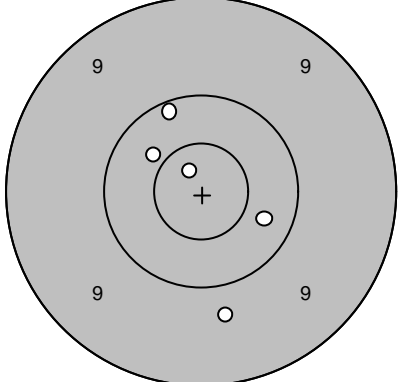
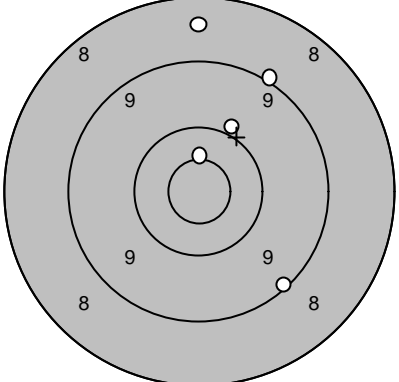
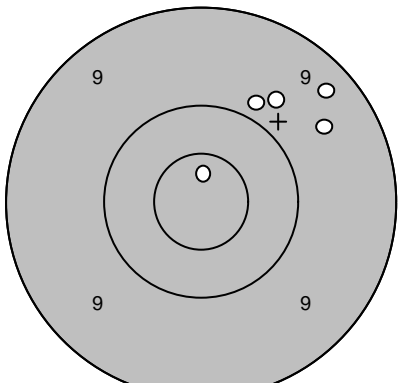
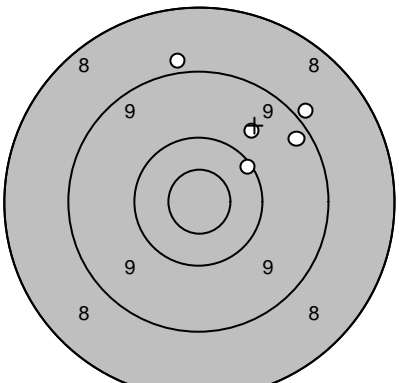
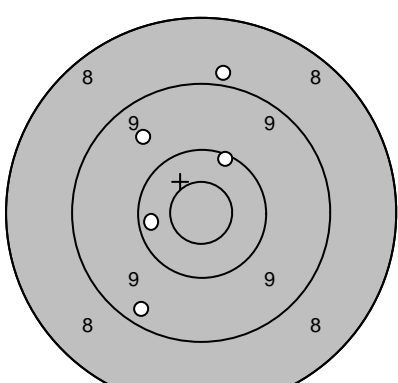
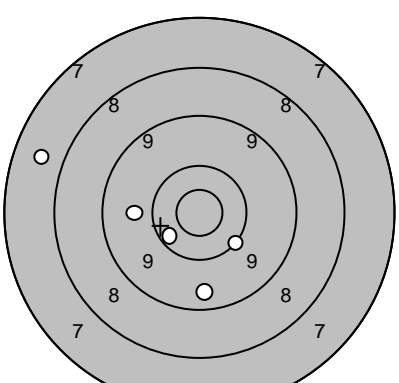
Skjutlag	Tavla	Leif Sigfridsson		
1	2	Ramselefors		
13.07.2007	Tavelträffen A 2007	Ramselefors SKF		
Provskott		1: 9,8 ↓ 2: 10,2 ↗ 3: 10,3 → 4: 10,4 ↗ 5: 10,8* ↗	Serie 1 	1: 8,5 ↑ 2: 9,2 ↘ 3: 10,5* ↑ 4: 9,0 ↗ 5: 10,0 ↗
		Serie 49,0	Serie 46,0	
		Totalt 0,0	Totalt 46,0	
Serie 2		1: 9,9 ↗ 2: 9,3 ↗ 3: 10,8* ↑ 4: 9,7 ↗ 5: 9,6 ↗	Serie 3 	1: 10,2 ↗ 2: 8,9 ↗ 3: 8,9 ↑ 4: 9,3 ↗ 5: 9,7 ↗
		Serie 46,0	Serie 44,0	
		Totalt 92,0	Totalt 136,0	
Extratävling 10		1: 8,9 ↑ 2: 9,6 ↘ 3: 10,3 ← 4: 10,2 ↑ 5: 9,4 ↘	Extratävling 10 	6: 9,5 ↓ 7: 9,8 ← 8: 10,2 ↘ 9: 10,4 ↙ 10: 7,7 ←
		Serie 46,0	Serie 45,0	
		Totalt 182,0	Totalt 227,0	

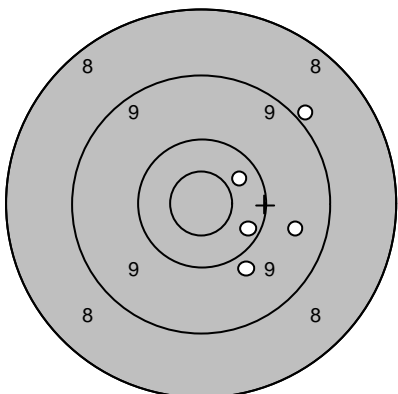
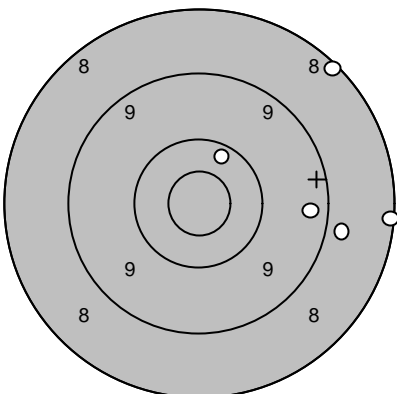
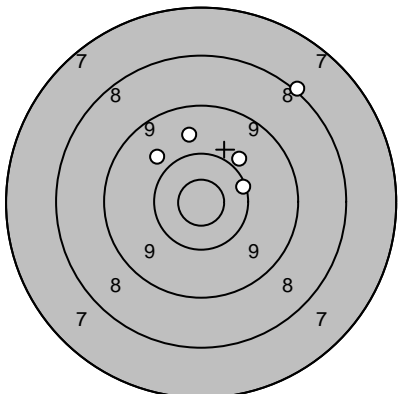
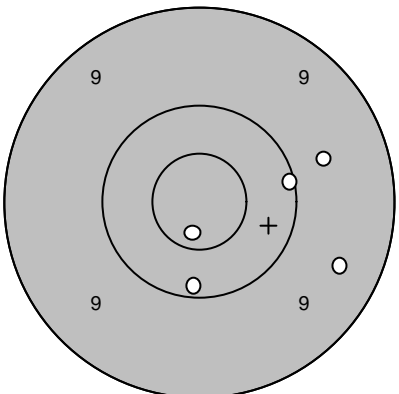
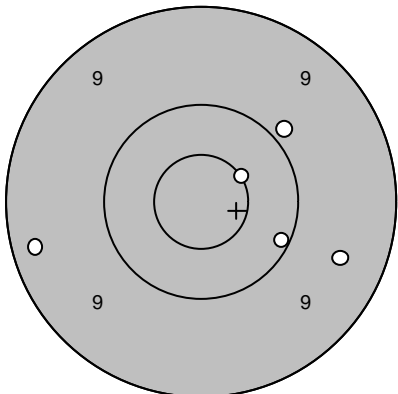
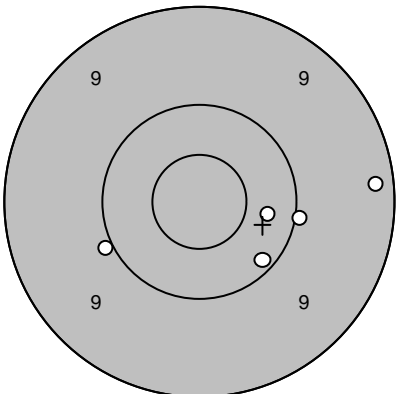
Skjutlag 1	Tavla 3	Erik Sigfridsson	
		Ramselefors	
13.07.2007	Tavelträffen A 2007	Ramselefors SKF	
Provskott		1: 9,6 → 2: 9,9 ↓ 3: 10,3 → 4: 10,4 ↗ 5: 9,0 ↗	Serie 1 
			1: 8,9 → 2: 9,4 → 3: 8,1 → 4: 10,3 ↗ 5: 8,2 ↗
		Serie 47,0	Serie 43,0
		Totalt 0,0	Totalt 43,0
Serie 2		1: 9,9 ↗ 2: 8,1 ↗ 3: 9,8 ↖ 4: 9,7 ↑ 5: 10,2 →	Serie 3 
			1: 10,1 → 2: 9,5 → 3: 9,7 → 4: 10,2 ↓ 5: 10,7* ↓
		Serie 45,0	Serie 48,0
		Totalt 88,0	Totalt 136,0
Extratävling 10		1: 10,5* ↗ 2: 9,3 ← 3: 9,5 → 4: 10,1 → 5: 9,9 ↗	Extratävling 10 
			6: 10,0 ← 7: 9,2 → 8: 10,2 ↓ 9: 10,3 → 10: 10,0 →
		Serie 47,0	Serie 49,0
		Totalt 183,0	Totalt 232,0

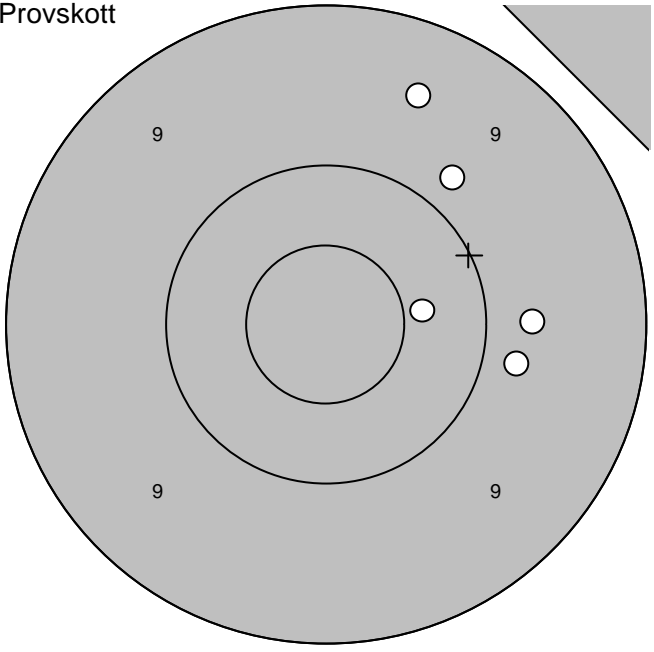
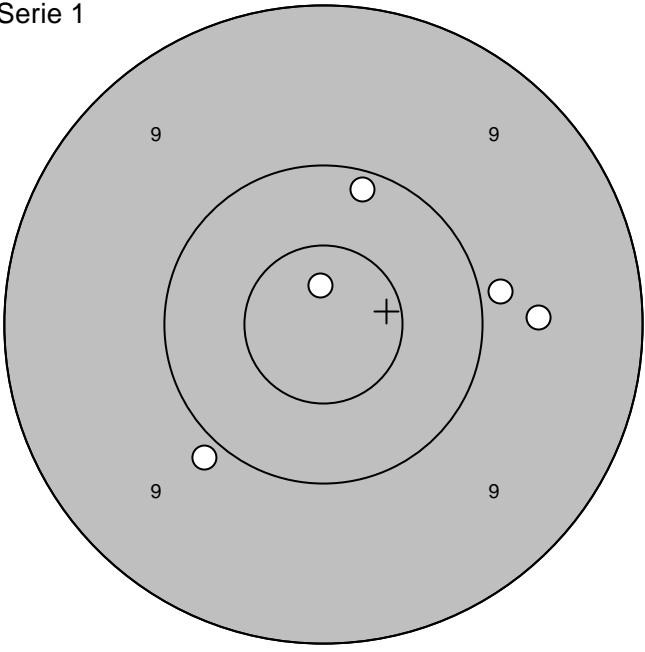
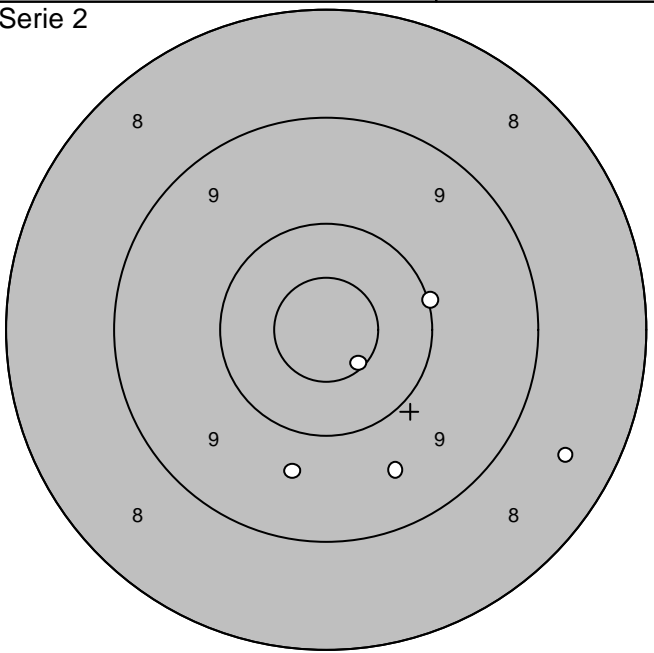
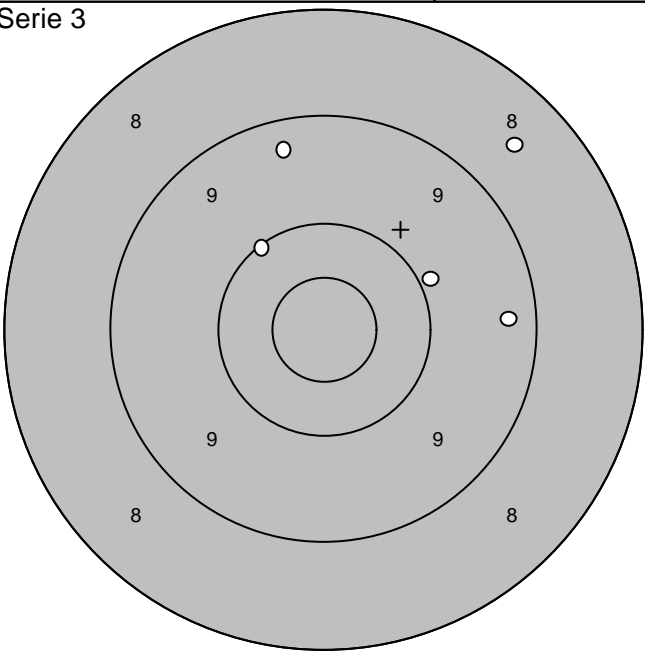
Skjutlag 1	Tavla 4	Anna-Karin Wretell	
		Ramselefors	
13.07.2007	Tavelträffen A 2007	Ramselefors SKF	
Provskott		Serie 1	
			
1: 9,5 ↗	Serie 46,0	1: 9,9 ↙	Serie 47,0
2: 9,8 ↗		2: 10,2 ↗	
3: 10,4 →	Totalt 0,0	3: 9,9 →	Totalt 47,0
4: 9,8 →		4: 9,7 →	
5: 9,7 →		5: 10,8* ↗	
Serie 2		Serie 3	
			
1: 9,7 ↘	Serie 46,0	1: 9,3 →	Serie 45,0
2: 10,6* ↘		2: 8,5 ↗	
3: 9,6 ↘	Totalt 93,0	3: 9,9 →	Totalt 138,0
4: 8,5 ↘		4: 10,1 ↗	
5: 10,0 →		5: 9,3 ↗	

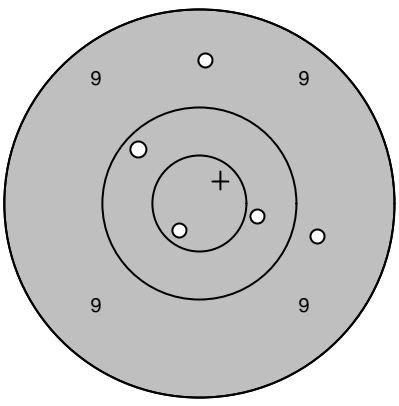
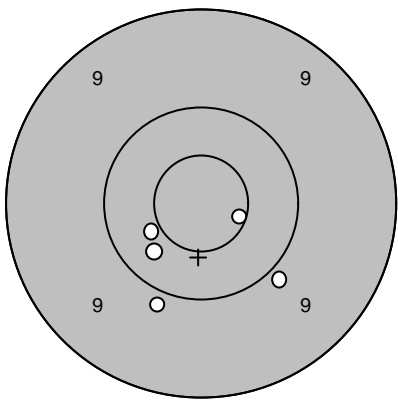
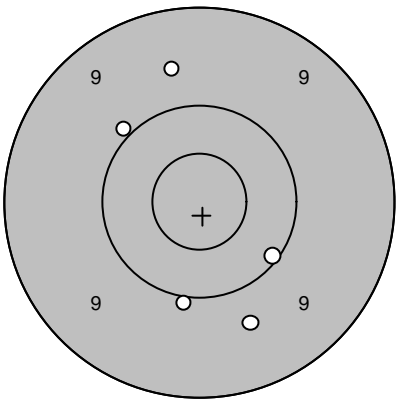
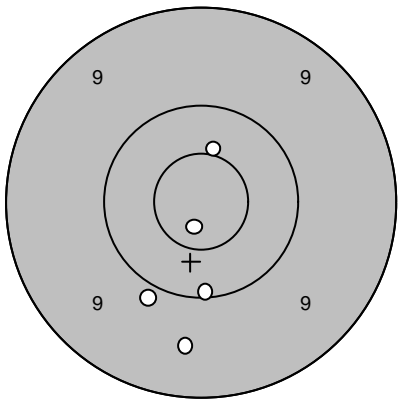
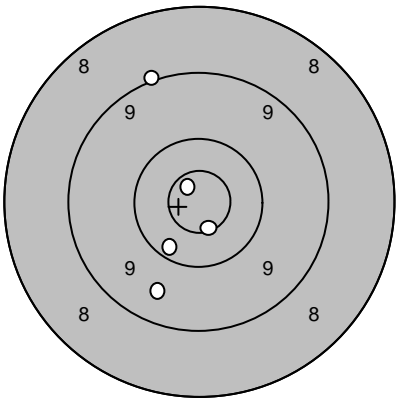
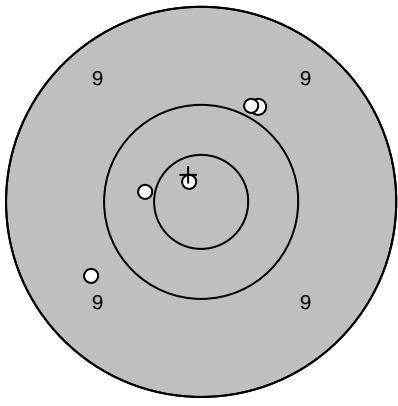
Skjutlag	Tavla	Lennart Jacobsson	
1	5	Ramselefors	
13.07.2007	Tavelträffen A 2007	Ramselefors SKF	
Provskott	1: 9,9 ↙ 2: 9,9 ↘ 3: 10,4 ↙ 4: 10,6* → 5: 10,4 ↙	Serie 1 	1: 9,6 ↑ 2: 10,4 → 3: 9,8 → 4: 10,7* ↘ 5: 10,2 ↗
	Serie 48,0 Totalt 0,0	Serie 48,0 Totalt 48,0	
Serie 2	1: 10,5* ↑ 2: 10,1 ↓ 3: 10,8* ↓ 4: 9,6 ↓ 5: 9,9 ↙	Serie 3 	1: 10,1 ↘ 2: 10,0 ↓ 3: 10,0 ↗ 4: 9,7 ↑ 5: 9,7 ↘
	Serie 48,0 Totalt 96,0	Serie 48,0 Totalt 144,0	
Extratävling 10	1: 9,9 ↗ 2: 10,8* ↗ 3: 9,9 ↗ 4: 10,5* ← 5: 9,7 ↙	Extratävling 10 	6: 9,1 ↗ 7: 10,2 ↘ 8: 10,6* ↘ 9: 9,6 ↘ 10: 10,8* ↗
	Serie 47,0 Totalt 191,0	Serie 48,0 Totalt 239,0	

Skjutlag 1	Tavla 6	Torvald Andersson	
		Ununge	
13.07.2007	Tavelträffen A 2007	Ramselefors SKF	
Provskott		Serie 1	
1: 9,0 ↗	Serie 46,0	1: 9,4 ↖	Serie 45,0
2: 9,9 ↗		2: 9,1 ←	
3: 10,7* ↙	Totalt 0,0	3: 8,8 ↘	Totalt 45,0
4: 9,2 ↓		4: 9,3 ←	
5: 9,1 ↙		5: 10,0 →	
Serie 2		Serie 3	
1: 9,9 ↗	Serie 47,0	1: 9,8 ↗	Serie 47,0
2: 9,6 →		2: 8,7 →	
3: 10,9* ↙	Totalt 92,0	3: 10,2 ↙	Totalt 139,0
4: 10,5* ↙		4: 10,4 ↑	
5: 9,1 →		5: 10,2 ↙	

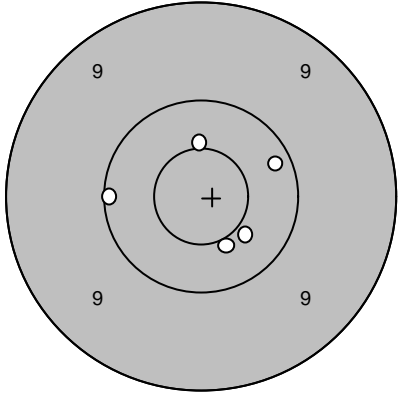
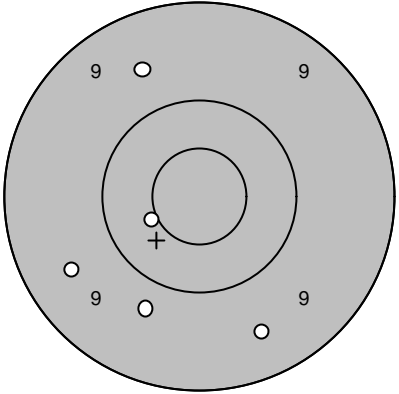
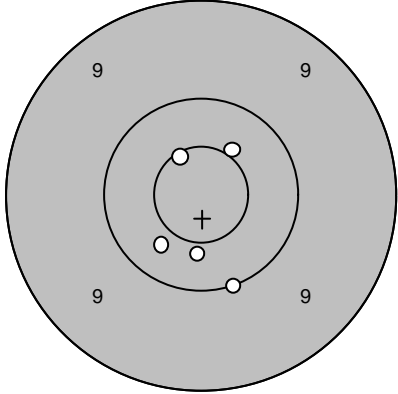
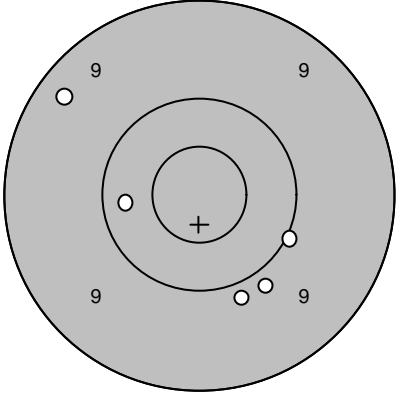
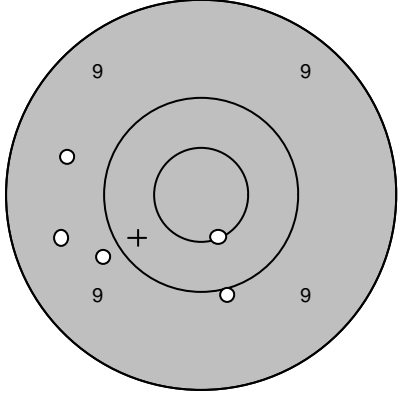
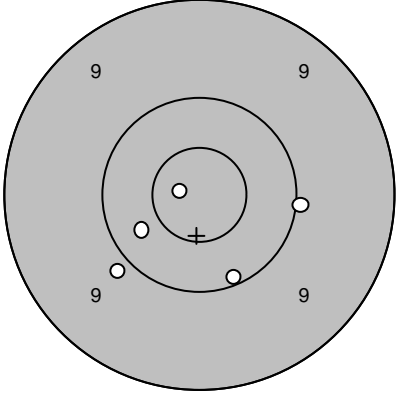
Skjutlag 1	Tavla 7	Therese Danielsson		
		Ununge		
13.07.2007	Tavelträffen A 2007	Ramselefors SKF		
Provskott		1: 10,4 ↘ 2: 10,5* ↑ 3: 10,2 → 4: 10,5* ↓ 5: 10,1 ←	Serie 1 	1: 9,6 ↗ 2: 9,5 ↓ 3: 10,5* ← 4: 9,5 ← 5: 9,8 ↓
	Serie 50,0		Serie 46,0	
	Totalt 0,0		Totalt 46,0	
Serie 2		1: 10,5* ↗ 2: 10,4 ↘ 3: 10,6* ↗ 4: 10,4 ↓ 5: 10,0 ↓	Serie 3 	1: 9,9 ↓ 2: 10,0 ↘ 3: 9,9 ↓ 4: 10,3 ← 5: 9,3 ↗
	Serie 50,0		Serie 47,0	
	Totalt 96,0		Totalt 143,0	
Extratävling 10		1: 9,9 ← 2: 10,0 ↓ 3: 9,5 ← 4: 9,6 ← 5: 10,6* ↓	Extratävling 10 	6: 10,0 → 7: 10,1 ↓ 8: 10,8* ← 9: 9,9 ↓ 10: 10,4 ←
	Serie 47,0		Serie 49,0	
	Totalt 190,0		Totalt 239,0	

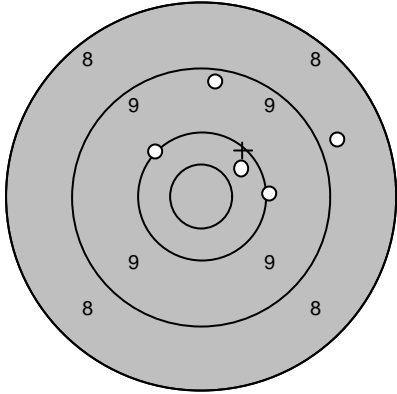
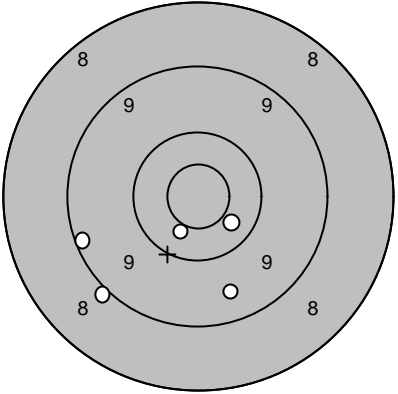
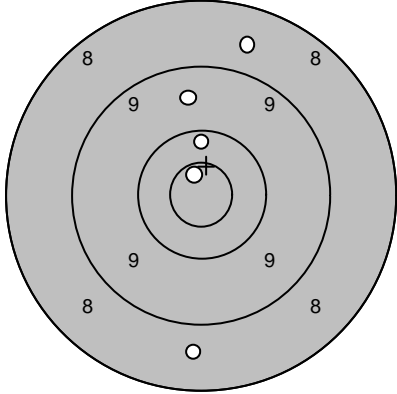
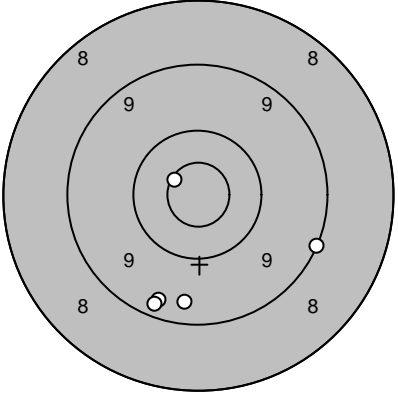
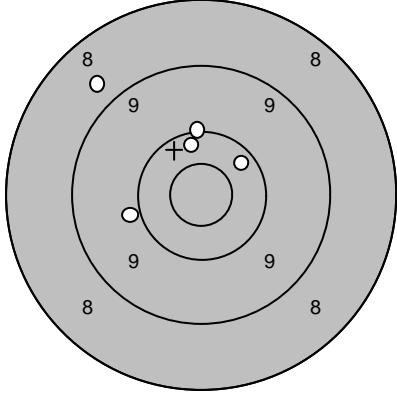
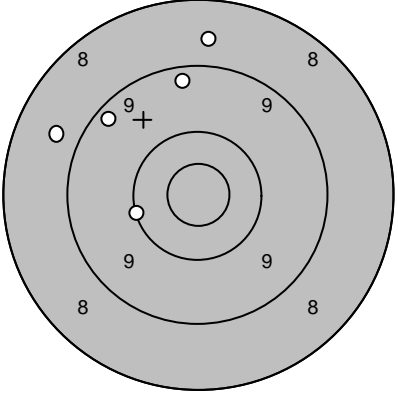
Skjutlag	Tavla	Tony Jansson		
1	8			
		Ununge		
13.07.2007	Tavelträffen A 2007	Ramselefors SKF		
Provskott		1: 9,3 ↑ 2: 8,8 → 3: 10,3 ↗ 4: 10,0 → 5: 10,1 ↖	Serie 1 	1: 9,5 ↓ 2: 10,4 ↘ 3: 10,5* ↓ 4: 9,0 ↙ 5: 9,2 ←
		Serie 47,0	Serie 47,0	
		Totalt 0,0	Totalt 47,0	
Serie 2		1: 9,6 ↑ 2: 8,7 ↗ 3: 10,3 ↑ 4: 10,8* ↖ 5: 8,7 ↓	Serie 3 	1: 10,7* ↖ 2: 9,4 ↓ 3: 9,4 ↓ 4: 9,1 ↘ 5: 9,3 ↓
		Serie 45,0	Serie 46,0	
		Totalt 92,0	Totalt 138,0	
Extratävling 10		1: 8,8 ↖ 2: 9,9 ← 3: 10,3 ↑ 4: 10,3 ↗ 5: 10,1 ↑	Extratävling 10 	6: 8,7 ↖ 7: 9,3 ↑ 8: 9,3 ↖ 9: 8,7 ↑ 10: 10,1 ←
		Serie 47,0	Serie 44,0	
		Totalt 185,0	Totalt 229,0	

Skjutlag 1	Tavla 9	Bror Rantakyrö	
		Pello	
13.07.2007	Tavelträffen A 2007	Ramselefors SKF	
Provskott		Serie 1	
1: 9,6 ←	Serie 46,0	1:10,0 ←	Serie 48,0
2: 9,9 ↓		2:10,6* ←	
3:10,7* ←	Totalt 0,0	3: 9,9 ↗	Totalt 48,0
4: 9,3 ↗		4:10,8* ←	
5: 9,9 ←		5: 9,4 ←	
Serie 2		Serie 3	
1:10,3 ↗	Serie 47,0	1:10,1 ←	Serie 49,0
2: 9,6 →		2:10,3 ↓	
3: 9,3 ↗	Totalt 95,0	3:10,0 ↗	Totalt 144,0
4:10,3 ↗		4: 9,7 ←	
5: 9,2 ↓		5:10,4 ↓	

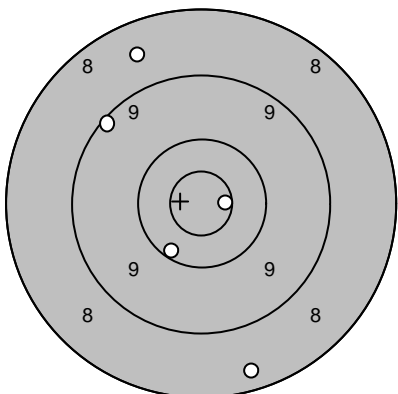
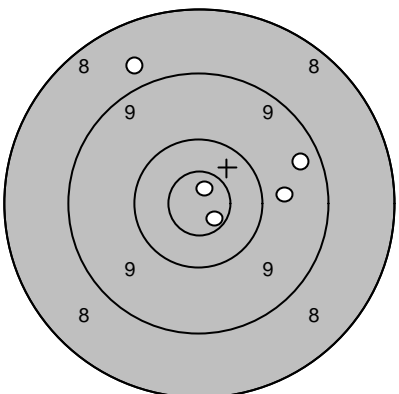
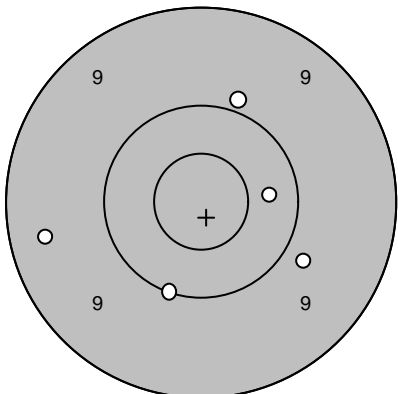
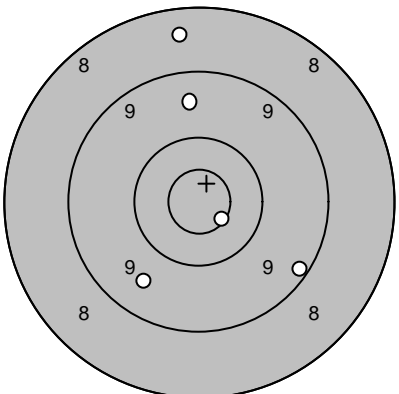
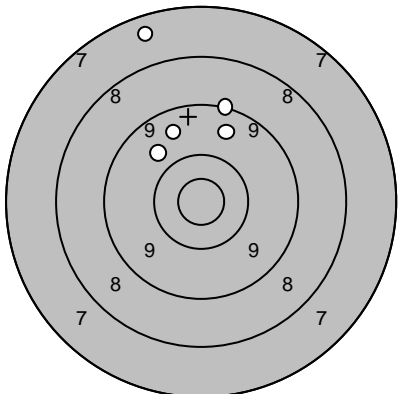
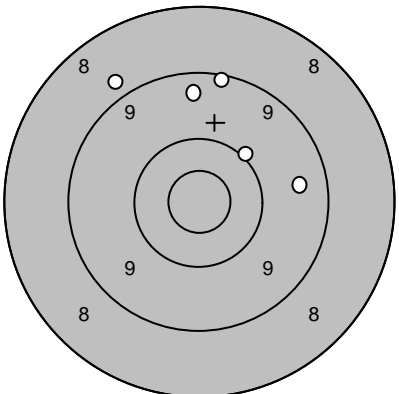
Skjutlag	Tavla	Bengt Heder		
1	10	Evertsberg		
13.07.2007	Tavelträffen A 2007	Ramselefors SKF		
Provskott		1: 8,6 ↖ 2: 8,4 ↓ 3: 10,2 ↙ 4: 10,7* → 5: 9,2 ↗	Serie 1 	1: 10,7* ↘ 2: 8,8 ↗ 3: 9,4 → 4: 9,8 → 5: 10,8* ↗
		Serie 45,0	Serie 46,0	
		Totalt 0,0	Totalt 46,0	
Serie 2		1: 10,3 → 2: 9,8 ↘ 3: 9,4 ← 4: 9,9 ↗ 5: 10,1 ↘	Serie 3 	1: 8,5 ↑ 2: 9,5 ↑ 3: 9,2 ↘ 4: 10,6* ↘ 5: 9,6 ↘
		Serie 47,0	Serie 45,0	
		Totalt 93,0	Totalt 138,0	
Extratävling 10		1: 9,6 ↖ 2: 7,5 ↖ 3: 9,8 ↖ 4: 9,1 ↗ 5: 9,6 ↗	Extratävling 10 	6: 9,2 ↑ 7: 9,4 ↑ 8: 8,8 ↖ 9: 10,1 ↗ 10: 9,5 →
		Serie 43,0	Serie 45,0	
		Totalt 181,0	Totalt 226,0	

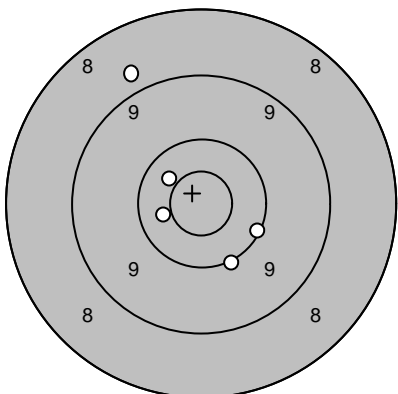
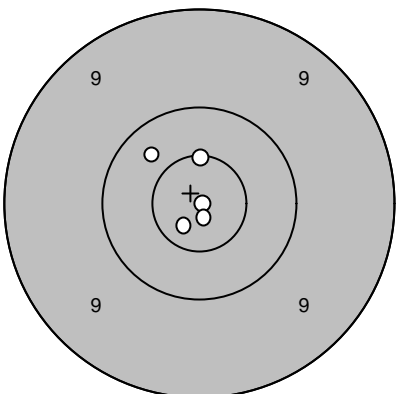
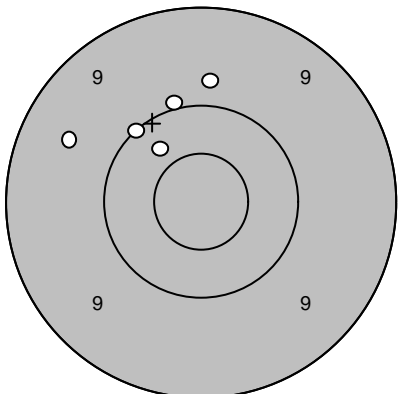
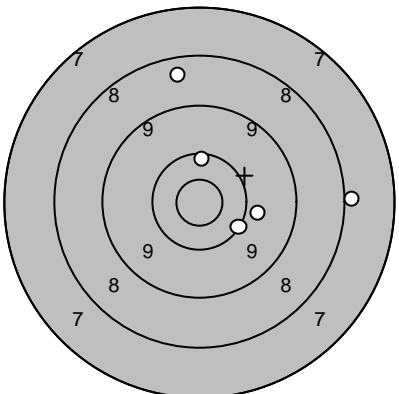
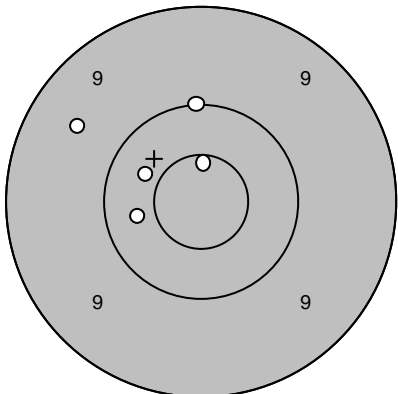
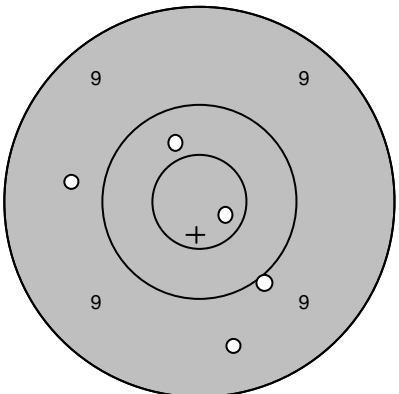
Skjutlag	Tavla	Jan-Olof Lampinen		
1	11	S 3		
13.07.2007	Tavelträffen A 2007	Ramselefors SKF		
Provskott		1: 10,1 ↘ 2: 8,8 ↗ 3: 10,5* ← 4: 10,5* ↗ 5: 10,1 ↘	Serie 1 	1: 10,9* → 2: 10,6* ↑ 3: 10,9* ↘ 4: 10,3 ↗ 5: 10,8* ↘
	Serie 48,0		Serie 50,0	
	Totalt 0,0		Totalt 50,0	
Serie 2		1: 10,0 ↑ 2: 9,8 ↑ 3: 10,1 ↗ 4: 9,5 ↗ 5: 10,4 ↗	Serie 3 	1: 10,2 ↘ 2: 10,2 ↑ 3: 8,0 → 4: 8,5 ↑ 5: 9,9 →
	Serie 48,0		Serie 45,0	
	Totalt 98,0		Totalt 143,0	
Extratävling 10		1: 10,0 ↑ 2: 10,4 ↗ 3: 9,6 ↗ 4: 10,4 ← 5: 10,6* ↑	Extratävling 10 	6: 10,4 ↗ 7: 9,7 ← 8: 10,0 ↘ 9: 10,7* ↘ 10: 9,5 ↘
	Serie 49,0		Serie 48,0	
	Totalt 192,0		Totalt 240,0	

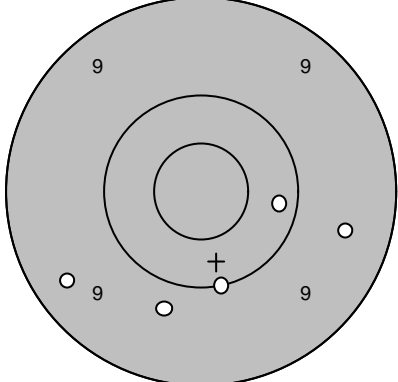
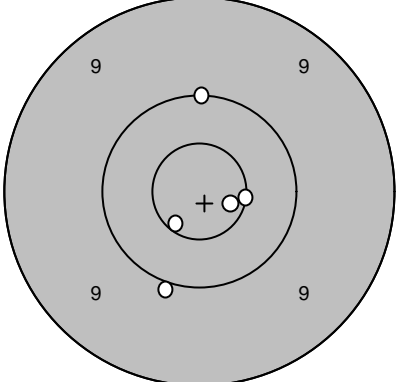
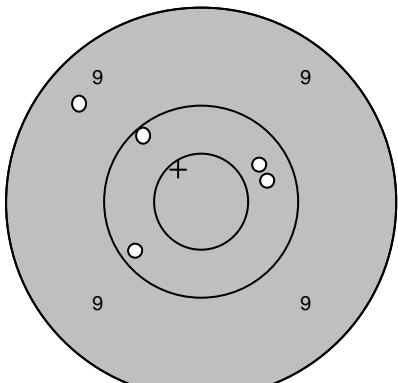
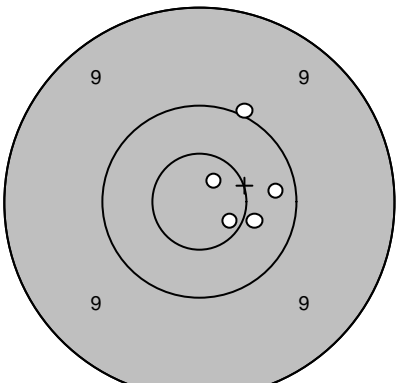
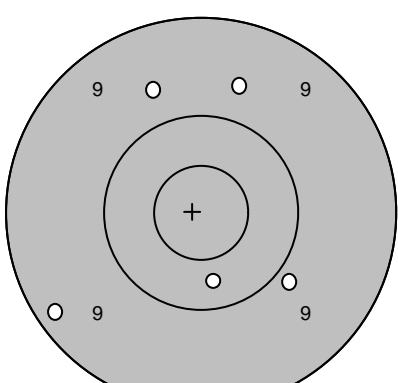
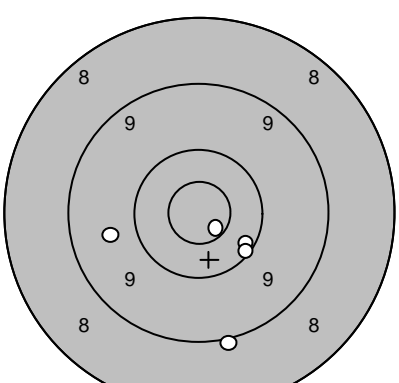
Skjutlag	Tavla	Matthias Lampinen		
1	12	S 3		
13.07.2007	Tavelträffen A 2007	Ramselefors SKF		
Provskott		1: 9,4 ↙ 2: 9,8 ↓ 3: 10,2 → 4: 9,5 → 5: 10,0 ↓	Serie 1 	1: 10,1 ↑ 2: 10,0 ↓ 3: 10,7* → 4: 10,6* → 5: 10,6* ↓
		Serie 47,0	Serie 50,0	
		Totalt 0,0	Totalt 50,0	
Serie 2		1: 9,4 ↖ 2: 10,1 ↖ 3: 10,3 → 4: 10,3 ↗ 5: 10,2 ↙	Serie 3 	1: 10,8* ↗ 2: 10,7* ↘ 3: 10,2 → 4: 10,4 → 5: 10,0 ↗
		Serie 49,0	Serie 50,0	
		Totalt 99,0	Totalt 149,0	
Extratävling 10		1: 9,9 ↘ 2: 9,2 ↙ 3: 9,7 ↑ 4: 9,7 ↑ 5: 10,3 ↓	Extratävling 10 	6: 10,2 ↘ 7: 10,7* ↘ 8: 9,7 ← 9: 9,0 ↓ 10: 10,2 ↘
		Serie 46,0	Serie 48,0	
		Totalt 195,0	Totalt 243,0	

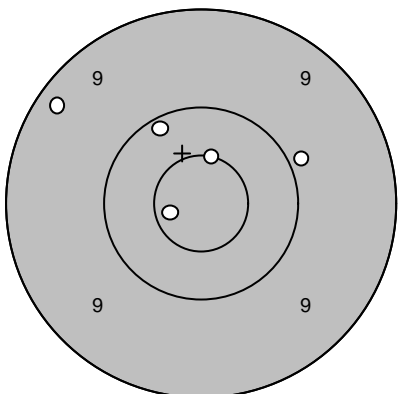
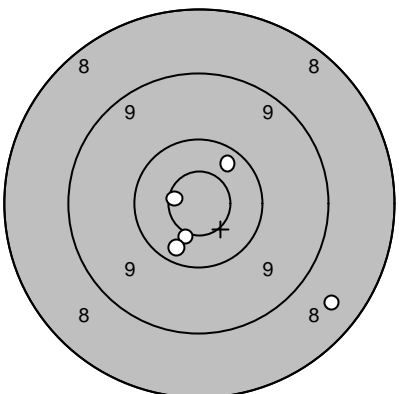
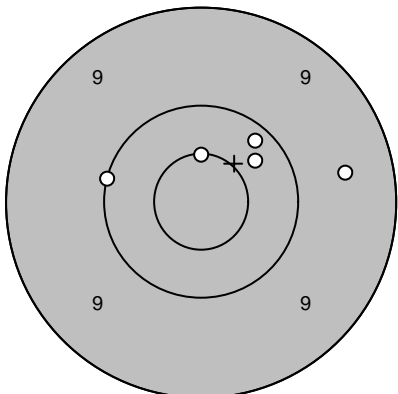
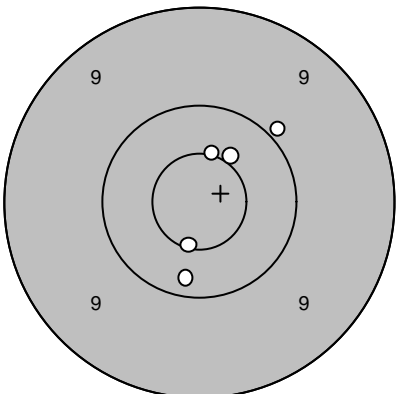
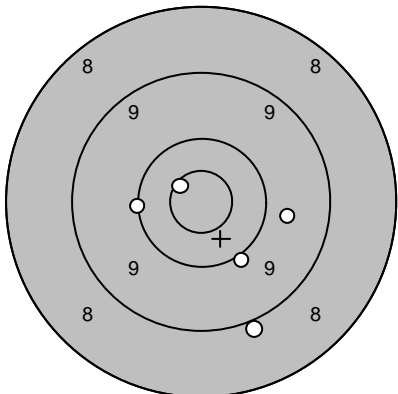
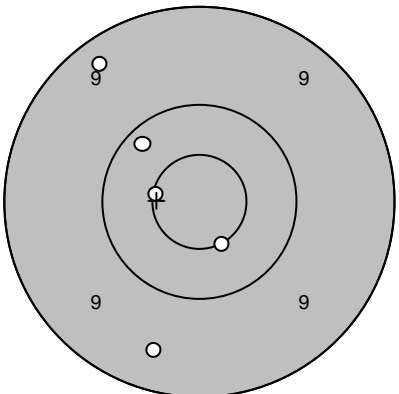
Skjutlag	Tavla	Stefan Jonasson		
1	14	Hogdal		
13.07.2007	Tavelträffen A 2007	Ramselefors SKF		
Provskott		1: 10,2 ↖ 2: 10,5* ↑ 3: 9,3 ↖ 4: 10,7* ← 5: 9,9 →	Serie 1 	1: 10,5* ↓ 2: 10,3 ↓ 3: 10,3 ↗ 4: 10,7* ← 5: 8,5 ↘
		Serie 48,0	Serie 48,0	
		Totalt 0,0	Totalt 48,0	
Serie 2		1: 9,5 → 2: 10,6* ↑ 3: 10,3 ↗ 4: 10,2 ↗ 5: 10,1 ←	Serie 3 	1: 10,6* ↓ 2: 10,2 ↓ 3: 10,5* ↗ 4: 9,9 ↗ 5: 10,5* ↑
		Serie 49,0	Serie 49,0	
		Totalt 97,0	Totalt 146,0	
Extratävling 10		1: 9,0 ↓ 2: 9,7 → 3: 10,0 ↓ 4: 10,7* ↗ 5: 10,1 ←	Extratävling 10 	6: 9,3 ↗ 7: 10,2 ↗ 8: 10,6* ← 9: 10,5* ↓ 10: 9,5 ↓
		Serie 48,0	Serie 48,0	
		Totalt 194,0	Totalt 242,0	

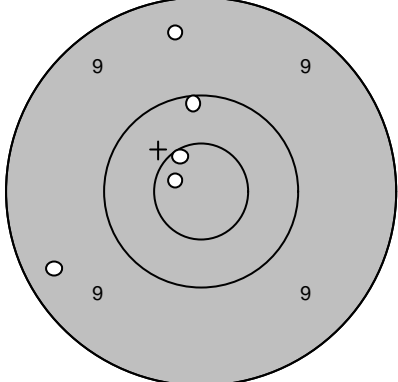
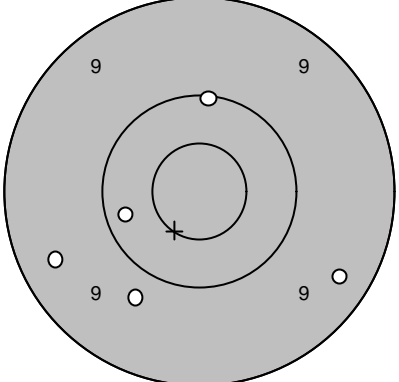
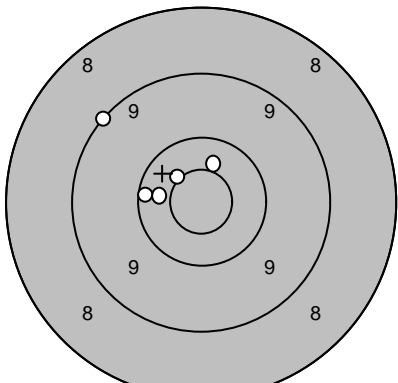
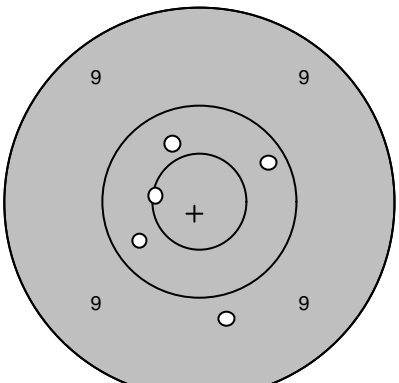
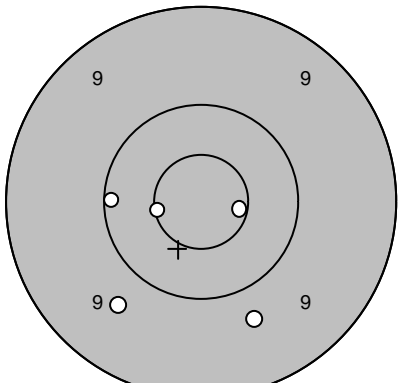
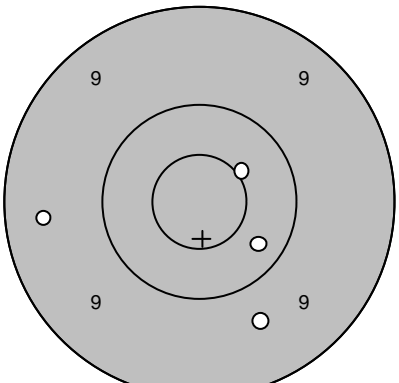
Skjutlag 1	Tavla 15	Håkan Nyberg	
		Mörsil	
13.07.2007	Tavelträffen A 2007	Ramselefors SKF	
Provskott		1: 9,4 ↑ 2: 10,1 ↑ 3: 10,6* ↗ 4: 9,3 ← 5: 10,8* ←	Serie 1 
			1: 9,4 ↘ 2: 9,4 ← 3: 9,8 ↘ 4: 10,1 ↑ 5: 10,2 ←
		Serie 48,0	Serie 47,0
		Totalt 0,0	Totalt 47,0
Serie 2		1: 9,1 ↗ 2: 10,4 ← 3: 10,2 ← 4: 10,5* ↑ 5: 10,5* ↗	Serie 3 
			1: 10,6* ← 2: 10,3 ← 3: 10,2 ↗ 4: 9,8 ↘ 5: 10,4 ↗
		Serie 49,0	Serie 49,0
		Totalt 96,0	Totalt 145,0
Extratävling 10		1: 10,6* ← 2: 10,6* → 3: 9,7 ↘ 4: 10,1 ← 5: 9,7 ↘	Extratävling 10 
			6: 9,7 ↘ 7: 9,4 ← 8: 10,3 ↘ 9: 10,5* ↗
		Serie 48,0	Serie 38,0
		Totalt 193,0	Totalt 231,0

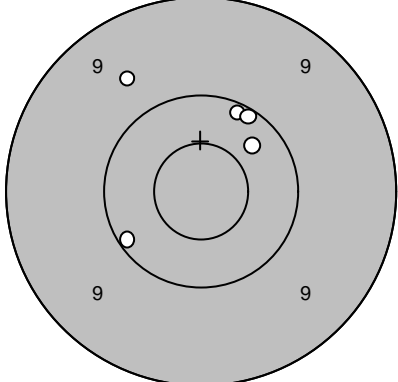
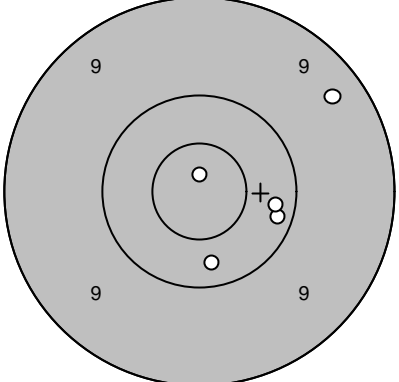
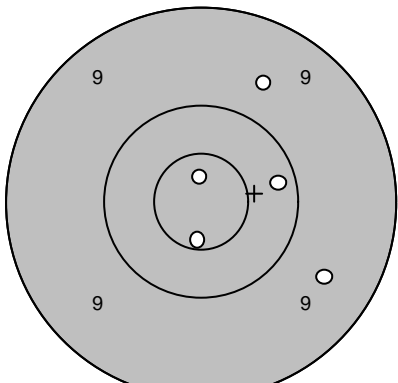
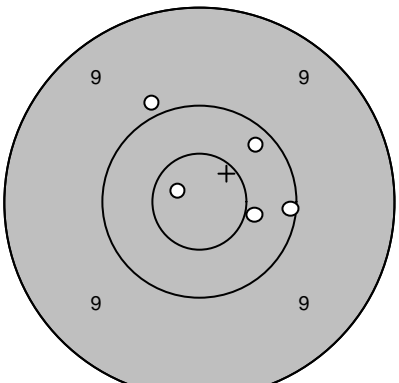
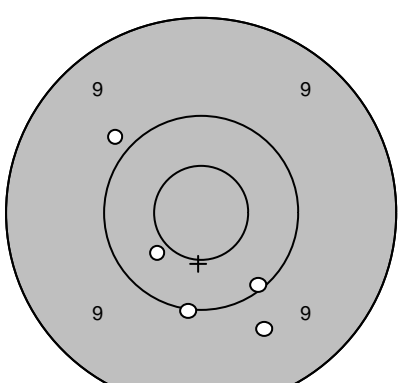
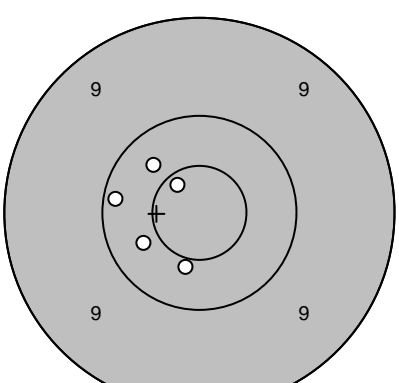
Skjutlag	Tavla	Lars Tegman		
1	16	Umeå		
13.07.2007	Tavelträffen A 2007	Ramselefors SKF		
Provskott		1: 9,7 ↖ 2: 10,3 ↗ 3: 10,1 ↗ 4: 10,1 ↗ 5: 10,1 ↙	Serie 1 	1: 10,9* ↑ 2: 9,4 ↗ 3: 10,2 → 4: 10,2 → 5: 10,3 ↓
		Serie 49,0	Serie 49,0	
		Totalt 0,0	Totalt 49,0	
Serie 2		1: 9,7 ↗ 2: 10,2 → 3: 10,8* ↑ 4: 10,6* ↓ 5: 9,6 ↘	Serie 3 	1: 10,1 → 2: 10,2 ↗ 3: 10,5* → 4: 9,9 ↗ 5: 10,8* ↖
		Serie 48,0	Serie 49,0	
		Totalt 97,0	Totalt 146,0	
Extratävling 10		1: 9,9 ↖ 2: 10,4 ↙ 3: 10,1 ↘ 4: 9,7 ↘ 5: 10,0 ↓	Extratävling 10 	6: 10,2 ← 7: 10,4 ↙ 8: 10,7* ↗ 9: 10,4 ↗ 10: 10,5* ↓
		Serie 48,0	Serie 50,0	
		Totalt 194,0	Totalt 244,0	

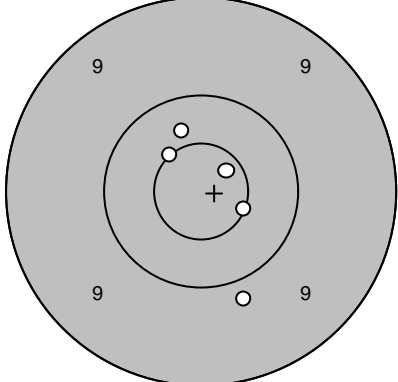
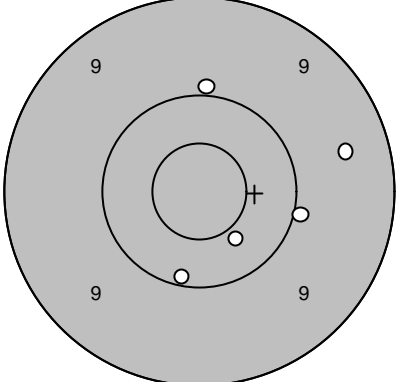
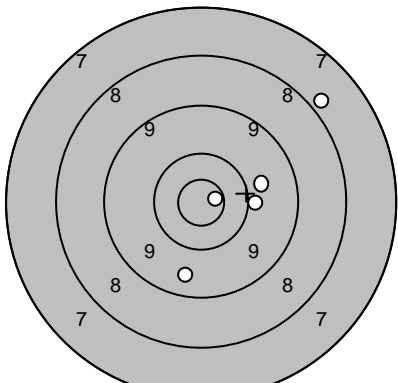
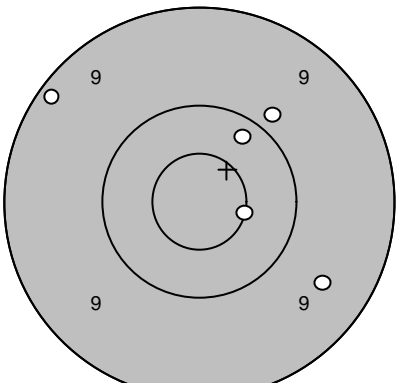
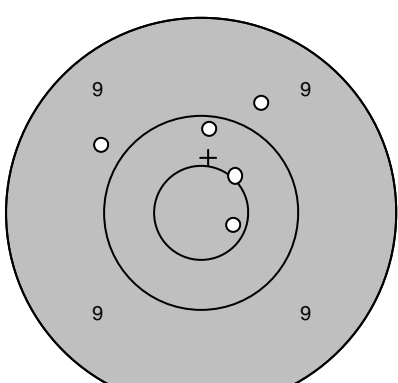
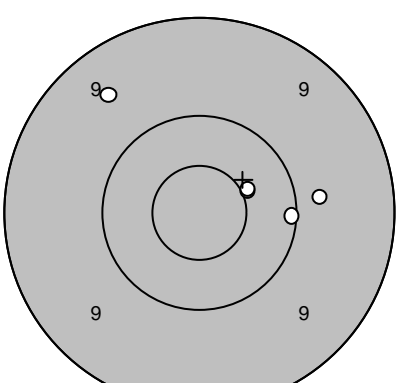
Skjutlag	Tavla	Anders Carlqvist		
1	17	Sjyllberg		
13.07.2007	Tavelträffen A 2007	Ramselefors SKF		
Provskott		1: 9,9 ↘ 2: 10,5* ↗ 3: 10,4 ↗ 4: 10,7* ↗ 5: 10,6* →	Serie 1 	1: 10,4 ↘ 2: 10,0 ↑ 3: 10,0 → 4: 9,5 → 5: 10,1 ↓
		Serie 49,0	Serie 49,0	
		Totalt 0,0	Totalt 49,0	
Serie 2		1: 9,6 ↓ 2: 10,0 → 3: 9,8 → 4: 10,8* → 5: 7,9 ↗	Serie 3 	1: 9,2 ↖ 2: 10,2 ↗ 3: 10,6* → 4: 9,9 ↗ 5: 9,5 ↘
		Serie 45,0	Serie 47,0	
		Totalt 94,0	Totalt 141,0	
Extratävling 10		1: 10,7* → 2: 9,8 ↗ 3: 9,8 ↖ 4: 10,5* ↗ 5: 10,2 ↑	Extratävling 10 	6: 9,5 ↖ 7: 10,5* → 8: 10,5* → 9: 10,1 → 10: 9,8 →
		Serie 48,0	Serie 48,0	
		Totalt 189,0	Totalt 237,0	

Skjutlag	Tavla		
1	18	Martin Olofsson	

Vännäs			
--------	--	--	--

13.07.2007	Tavelträffen A 2007	Ramselefors SKF	
------------	---------------------	-----------------	--

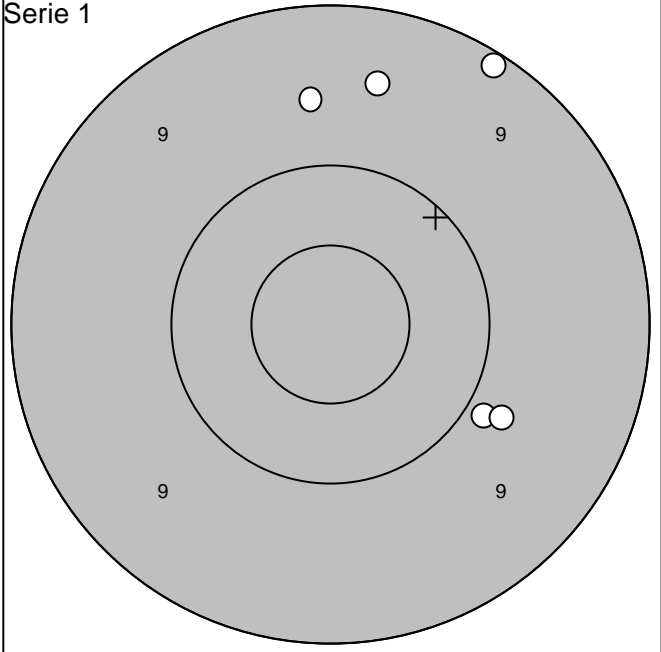
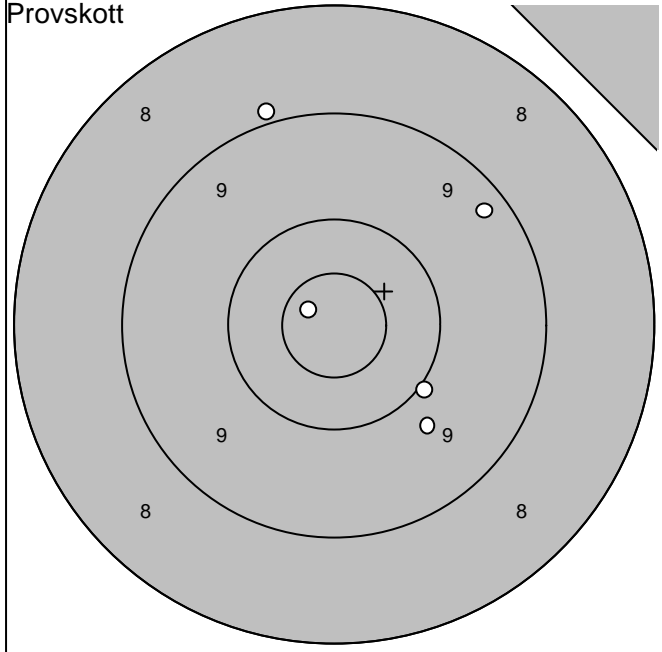

1:10,0 ↘	
2:10,8* ↖	
3: 9,3 ↗	
4: 8,9 ↑	
5: 9,7 ↘	

Serie	46,0
Totalt	0,0

1: 9,9 ↘	
2: 9,8 ↘	
3: 9,6 ↑	
4: 9,1 ↗	
5: 9,5 ↑	

Serie	45,0
Totalt	45,0

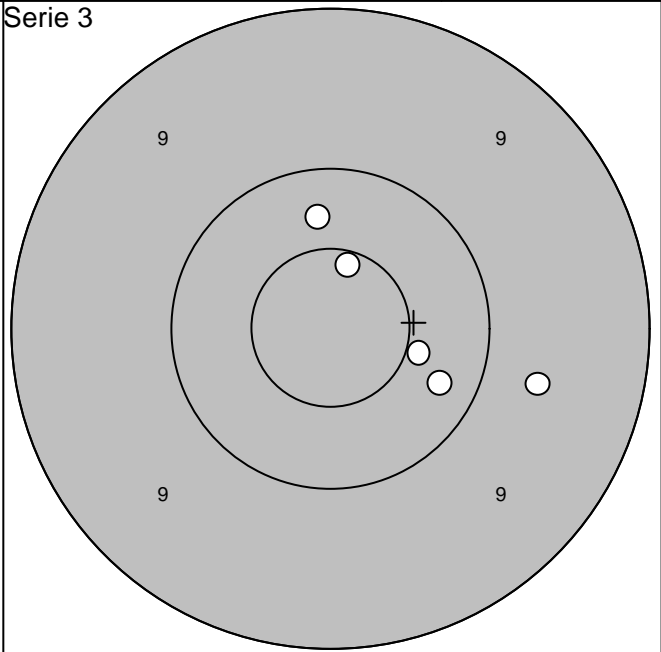
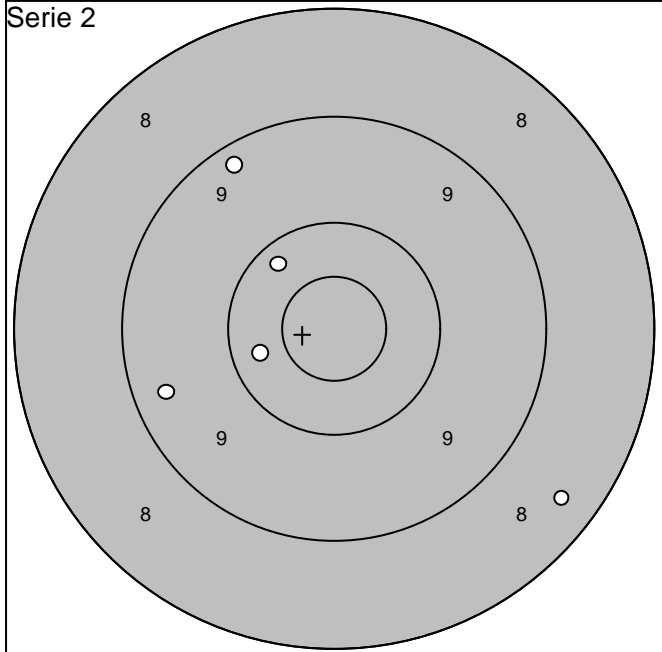

1:10,3 ←	
2: 8,4 ↘	
3:10,2 ↗	
4: 9,2 ↑	
5: 9,4 ←	

Serie	46,0
Totalt	91,0

1:10,3 ↑	
2:10,6* ↑	
3:10,5* ↘	
4:10,3 ↘	
5: 9,7 ↘	

Serie	49,0
Totalt	140,0

Skjutlag 1	Tavla 19	Linda Lidman	
		Piteå	
13.07.2007	Tavelträffen A 2007	Ramselefors SKF	
Provskott		Serie 1	
1: 9,3 ↑	Serie 48,0	1: 9,7 ↘	Serie 48,0
2:10,4 ←		2:10,8* ←	
3: 9,6 ↗	Totalt 0,0	3: 9,9 ↓	Totalt 48,0
4:10,0 ↑		4:10,1 ↖	
5:10,3 ↓		5:10,4 ↓	
Serie 2		Serie 3	
1:10,4 ↗	Serie 48,0	1:10,5* ↗	Serie 49,0
2: 9,8 ↗		2: 9,0 ←	
3:10,8* ←	Totalt 96,0	3:10,7* ↓	Totalt 145,0
4:10,0 ↓		4:10,2 ←	
5: 9,8 ←		5:10,5* ↓	

Skjutlag 1	Tavla 20	Dennis Sundqvist	
		Piteå	
13.07.2007	Tavelträffen A 2007	Ramselefors SKF	
Provskott		Serie 1	
1: 8,6 →	Serie 45,0	1: 9,4 ←	Serie 47,0
2: 8,8 →		2: 9,5 ↓	
3:10,5* ↓	Totalt 0,0	3:10,5* ↗	Totalt 47,0
4:10,7* ↗		4:10,7* ↑	
5: 9,7 ←		5: 9,5 ↑	
Serie 2		Serie 3	
1:10,3 →	Serie 46,0	1:10,4 ↖	Serie 43,0
2: 8,3 ←		2: 8,6 ↓	
3:10,0 ←	Totalt 93,0	3: 8,1 ←	Totalt 136,0
4: 9,8 ↗		4: 7,7 ↓	
5: 9,5 ↓		5:10,2 ↗	

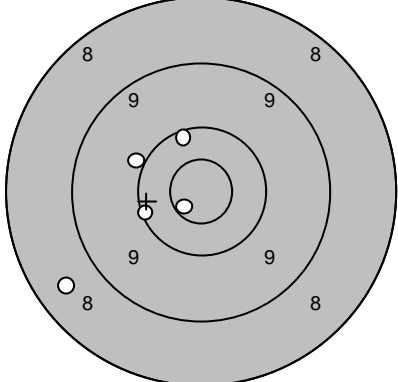
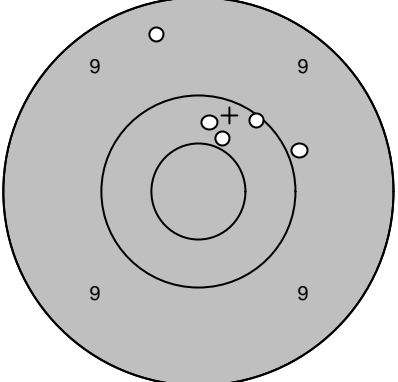
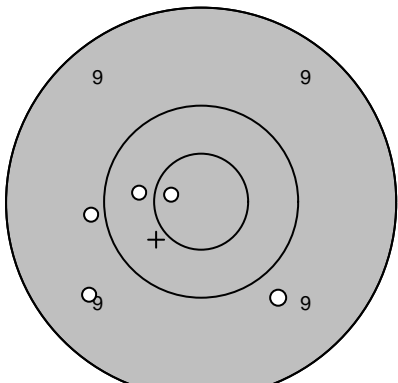
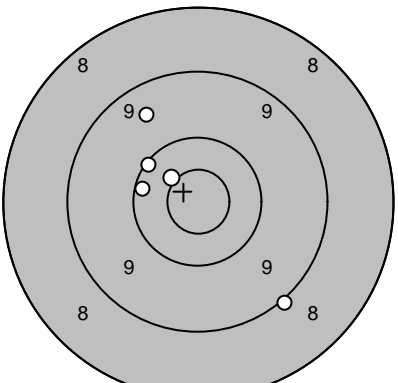
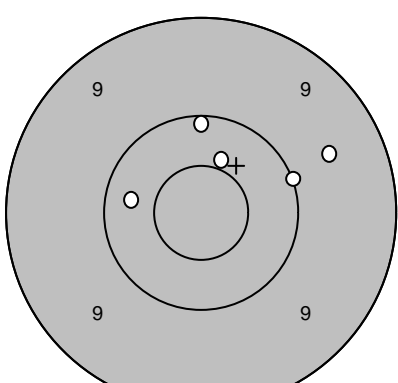
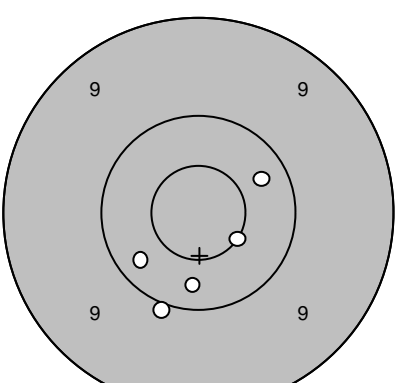
Skjutlag	Tavla	Sören Olsson		
1	21			
		Umeå		
13.07.2007	Tavelträffen A 2007	Ramselefors SKF		
Provskott		1: 8,6 ↙ 2: 10,2 ← 3: 10,2 ↑ 4: 10,7* ↙ 5: 10,0 ↖	Serie 1 	1: 10,4 ↗ 2: 9,9 → 3: 9,4 ↑ 4: 10,1 ↗ 5: 10,3 ↑
		Serie 48,0		Serie 48,0
		Totalt 0,0		Totalt 48,0
Serie 2		1: 9,6 ↙ 2: 10,4 ← 3: 9,8 ↘ 4: 10,7* ← 5: 9,9 ←	Serie 3 	1: 9,0 ↘ 2: 9,5 ↗ 3: 10,1 ↗ 4: 10,2 ← 5: 10,5* ↗
		Serie 47,0		Serie 48,0
		Totalt 95,0		Totalt 143,0
Extratävling 10		1: 10,0 → 2: 10,3 ← 3: 10,5* ↑ 4: 10,1 ↑ 5: 9,6 →	Extratävling 10 	6: 10,3 ↙ 7: 10,5* ↘ 8: 10,0 ↘ 9: 10,3 ↘ 10: 10,3 →
		Serie 49,0		Serie 50,0
		Totalt 192,0		Totalt 242,0

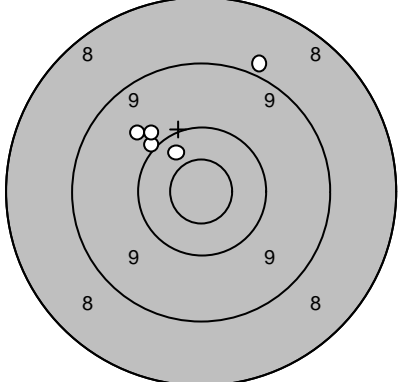
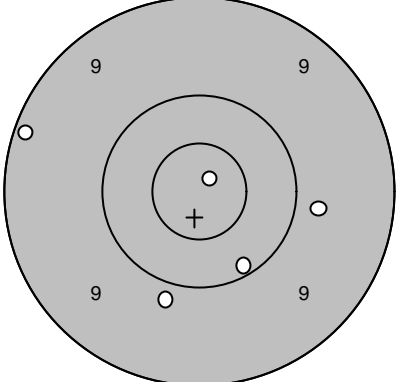
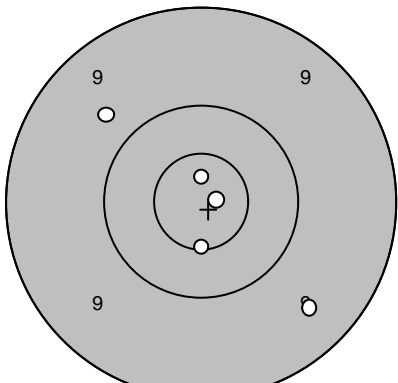
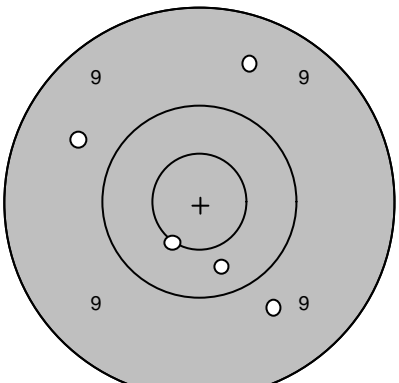
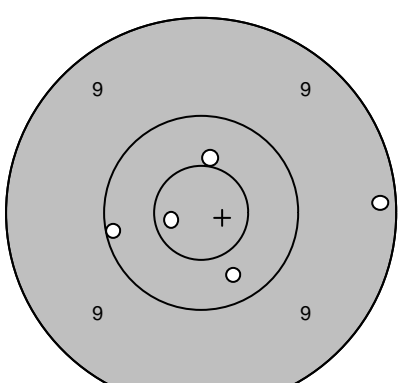
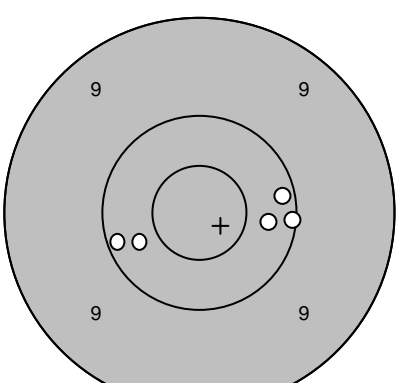
Skjutlag 1	Tavla 22	Ulf Ohlsson		
		Umeå		
13.07.2007	Tavelträffen A 2007	Ramselefors SKF		
Provskott		1: 10,0 ↖ 2: 9,7 ↖ 3: 8,9 ↗ 4: 9,9 ↗ 5: 10,4 ↗	Serie 1 	1: 9,8 → 2: 10,9* ↗ 3: 9,9 ↓ 4: 10,2 ↓ 5: 9,2 ↖
	Serie 46,0		Serie 47,0	
	Totalt 0,0		Totalt 47,0	
Serie 2		1: 9,7 ↖ 2: 10,8* ↑ 3: 9,5 ↓ 4: 10,6* ↓ 5: 10,9* →	Serie 3 	1: 9,5 ↗ 2: 9,7 ↓ 3: 10,3 ↓ 4: 10,5* ↓ 5: 9,7 ↖
	Serie 48,0		Serie 47,0	
	Totalt 95,0		Totalt 142,0	
Extratävling 10		1: 9,2 → 2: 10,1 ← 3: 10,3 ↓ 4: 10,7* ← 5: 10,5* ↑	Extratävling 10 	6: 10,4 ↖ 7: 10,2 → 8: 10,3 → 9: 10,2 ← 10: 10,1 →
	Serie 49,0		Serie 50,0	
	Totalt 191,0		Totalt 241,0	

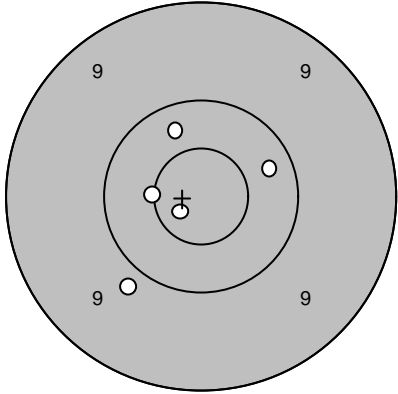
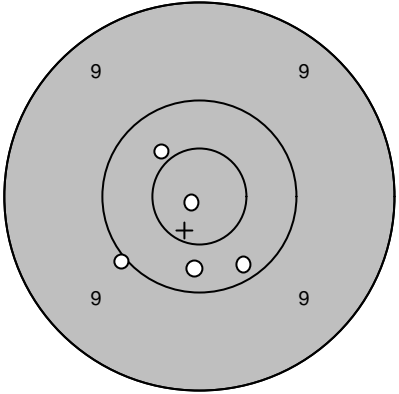
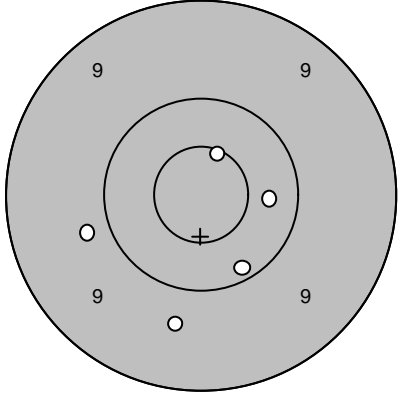
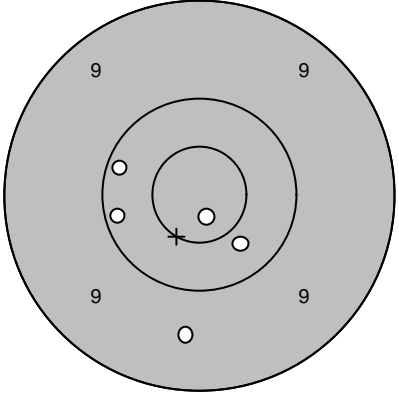
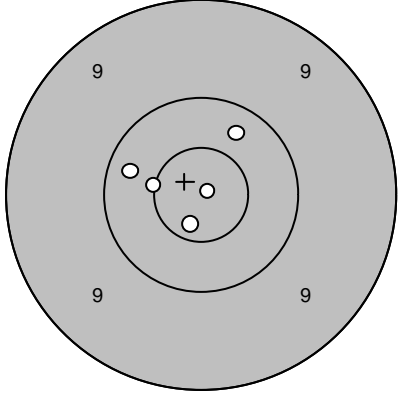
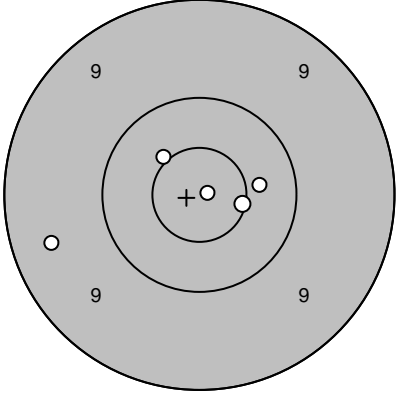
Skjutlag	Tavla	Gillis Engman		
1	24	Rundvik		
13.07.2007	Tavelträffen A 2007	Ramselefors SKF		
Provskott		1: 10,3 ↗ 2: 10,3 → 3: 10,5* ← 4: 10,8* ↙ 5: 9,8 ↘	Serie 1 	1: 10,3 ↓ 2: 10,0 ↙ 3: 10,4 ↗ 4: 10,9* ↙ 5: 10,2 ↘
		Serie 49,0	Serie 50,0	
		Totalt 0,0	Totalt 50,0	
Serie 2		1: 10,3 → 2: 10,6* ↗ 3: 9,8 ← 4: 10,2 ↘ 5: 9,7 ↘	Serie 3 	1: 10,2 ← 2: 10,8* ↓ 3: 10,4 ↘ 4: 10,2 ← 5: 9,6 ↓
		Serie 48,0	Serie 49,0	
		Totalt 98,0	Totalt 147,0	
Extratävling 10		1: 10,3 ← 2: 10,5* ← 3: 10,7* ↘ 4: 10,9* ↗ 5: 10,3 ↗	Extratävling 10 	6: 9,5 ← 7: 10,9* → 8: 10,5* ↗ 9: 10,4 → 10: 10,6* →
		Serie 50,0	Serie 49,0	
		Totalt 197,0	Totalt 246,0	

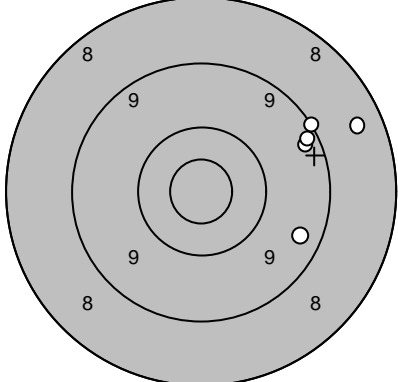
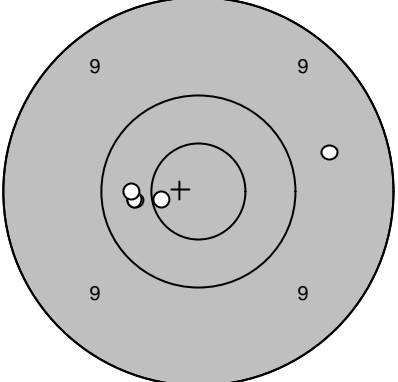
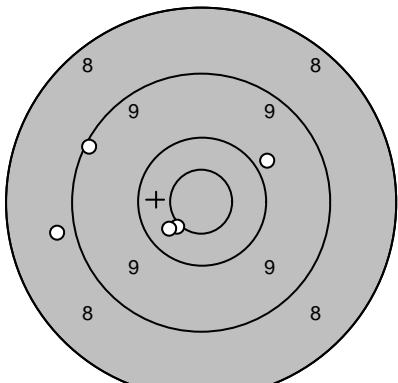
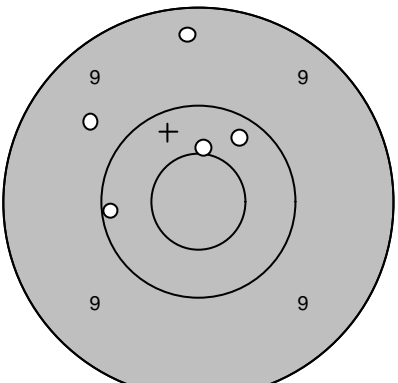
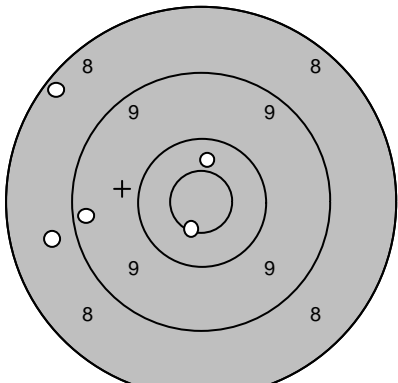
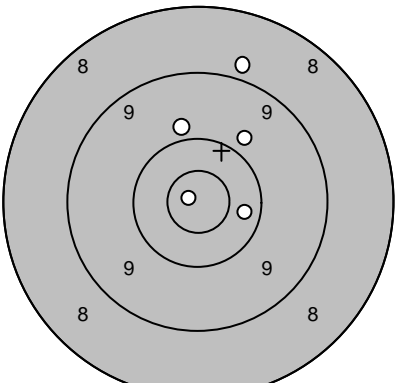
Skjutlag	Tavla	Marlene Forsell	
2	1		
		Ramselefors	
13.07.2007	Tavelträffen A 2007	Ramselefors SKF	
Provskott		1: 8,5 → 2: 9,3 → 3: 9,1 → 4: 9,4 → 5: 9,3 →	Serie 1 
			1: 10,7* ← 2: 9,6 → 3: 10,4 ← 4: 10,4 ← 5: 10,4 ←
		Serie 44,0	Serie 49,0
		Totalt 0,0	Totalt 49,0
Serie 2		1: 9,9 → 2: 10,6* ← 3: 10,4 ← 4: 8,8 ← 5: 9,2 ←	Serie 3 
			1: 9,3 ↑ 2: 10,1 ← 3: 10,3 ↗ 4: 9,7 ↖ 5: 10,5* ↑
		Serie 46,0	Serie 48,0
		Totalt 95,0	Totalt 143,0
Extratävling 10		1: 8,3 ↖ 2: 8,7 ← 3: 9,3 ← 4: 10,6* ↓ 5: 10,4 ↑	Extratävling 10 
			6: 9,9 ↑ 7: 10,9* ↖ 8: 10,3 → 9: 8,9 ↑ 10: 9,9 ↗
		Serie 45,0	Serie 46,0
		Totalt 188,0	Totalt 234,0

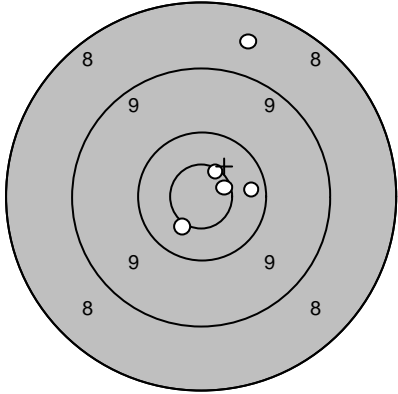
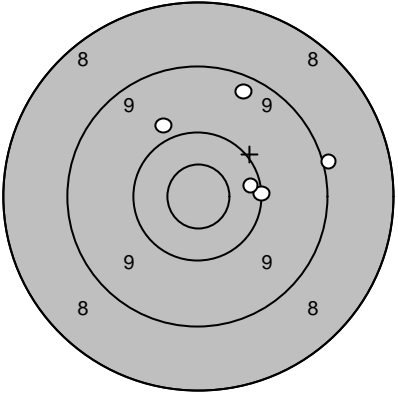
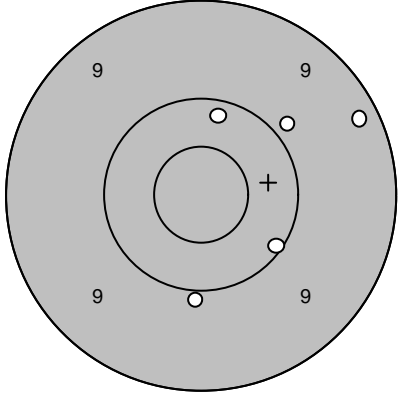
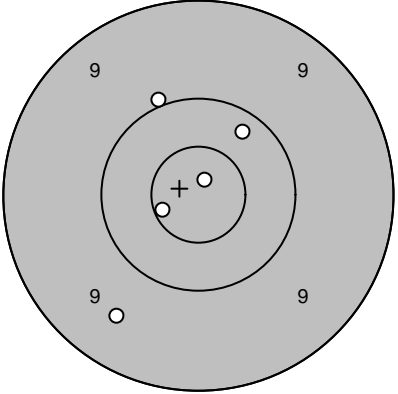
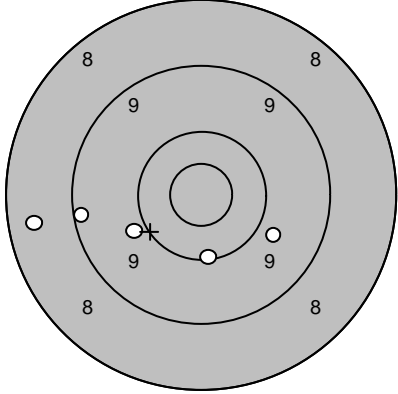
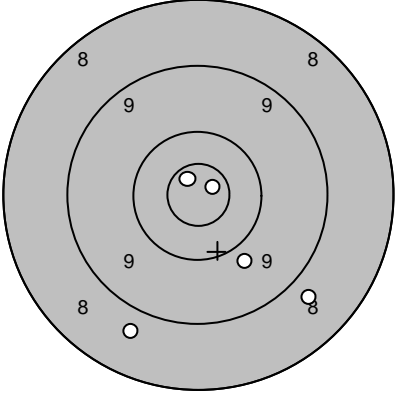
Skjutlag	Tavla	Marie Fjällström	
2	2	Ramselefors	
13.07.2007	Tavelträffen A 2007	Ramselefors SKF	
Provskott	1: 8,6 ↗ 2: 10,7* → 3: 10,6* ↗ 4: 10,5* ↘ 5: 10,3 →	Serie 1	1: 9,3 ↗ 2: 9,9 ↖ 3: 10,1 → 4: 9,0 → 5: 10,3 →
			
	Serie 48,0		Serie 47,0
	Totalt 0,0		Totalt 47,0
Serie 2	1: 9,2 → 2: 10,2 ↗ 3: 10,0 ↘ 4: 9,9 ↗ 5: 10,1 ↘	Serie 3	1: 10,0 ↖ 2: 10,2 ↗ 3: 10,6* ← 4: 10,9* ↗ 5: 9,5 ↘
			
	Serie 48,0		Serie 49,0
	Totalt 95,0		Totalt 144,0
Extratävling 10	1: 10,1 ↘ 2: 8,5 ← 3: 9,9 ← 4: 9,8 → 5: 9,2 ←	Extratävling 10	6: 10,8* ↖ 7: 8,8 ↘ 8: 9,8 ↘ 9: 10,8* → 10: 8,8 ↘
			
	Serie 45,0		Serie 45,0
	Totalt 189,0		Totalt 234,0

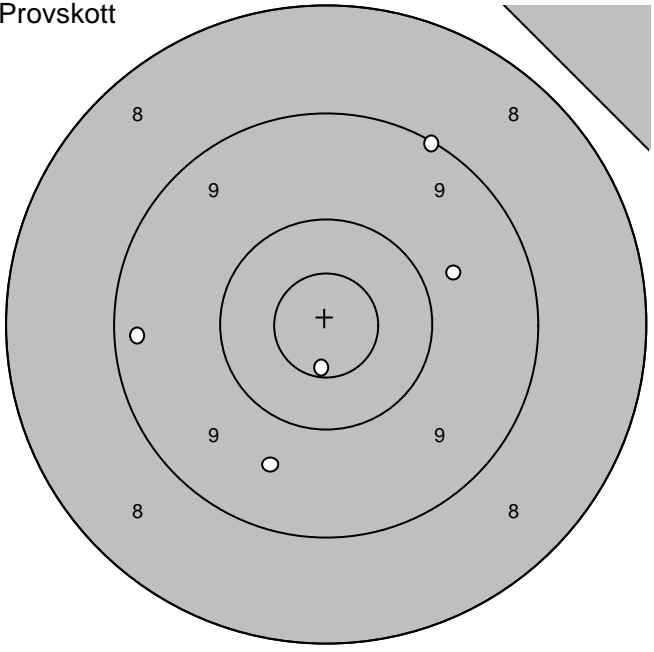
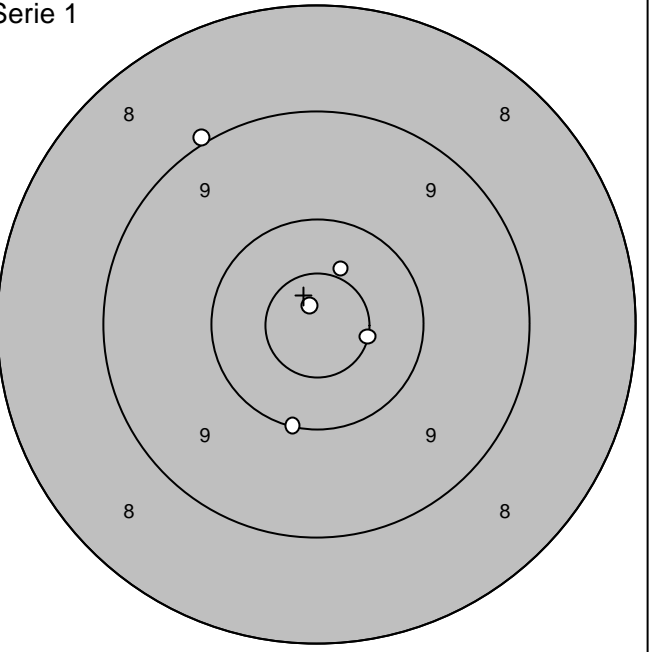
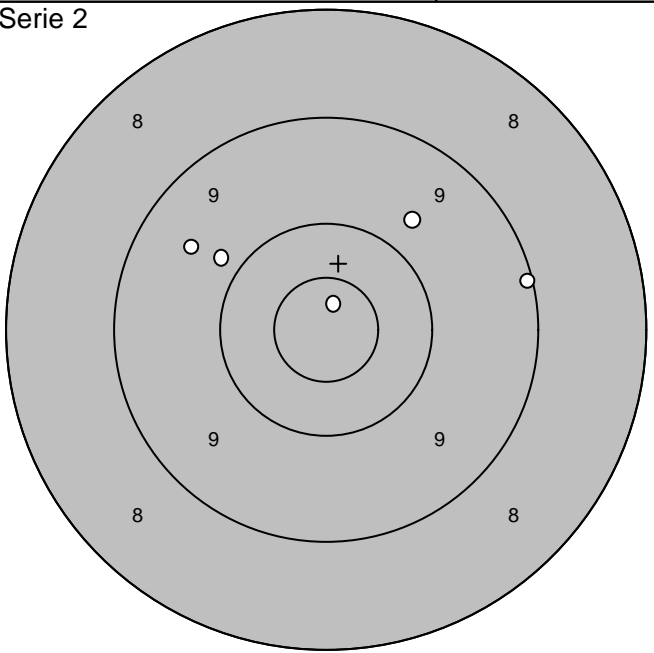
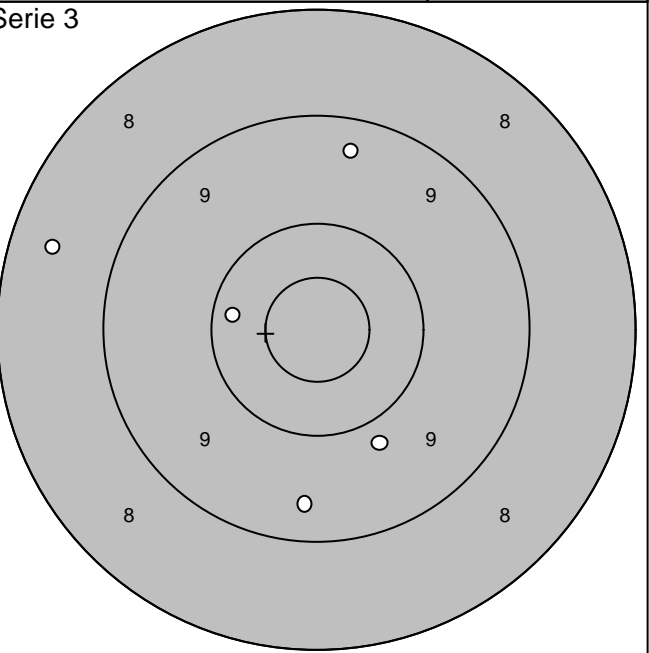
Skjutlag 2	Tavla 3	Kurt-Erik Eriksson	
		Göteborg	
13.07.2007	Tavelträffen A 2007	Ramselefors SKF	
Provskott		Serie 1	
			
1: 9,1 ↗	Serie 46,0	1:10,5* →	Serie 49,0
2: 9,7 →		2: 9,0 ↗	
3:10,6* ↓	Totalt 0,0	3:10,1 ↓	Totalt 49,0
4: 9,6 ↓		4:10,8* ↗	
5: 9,3 ←		5:10,5* ↗	
Serie 2		Serie 3	
			
1: 9,1 →	Serie 46,0	1:10,2 ←	Serie 45,0
2: 9,7 ↗		2: 8,4 ←	
3: 9,8 ↖	Totalt 95,0	3: 9,3 ↗	Totalt 140,0
4:10,8* ↗		4: 9,8 ↓	
5: 9,6 ↖		5: 9,4 ↓	

Skjutlag

Tavla

2

4

Gerhard Andersson

Ramselefors

13.07.2007

Tavelträffen A 2007

Ramselefors SKF

Provskott

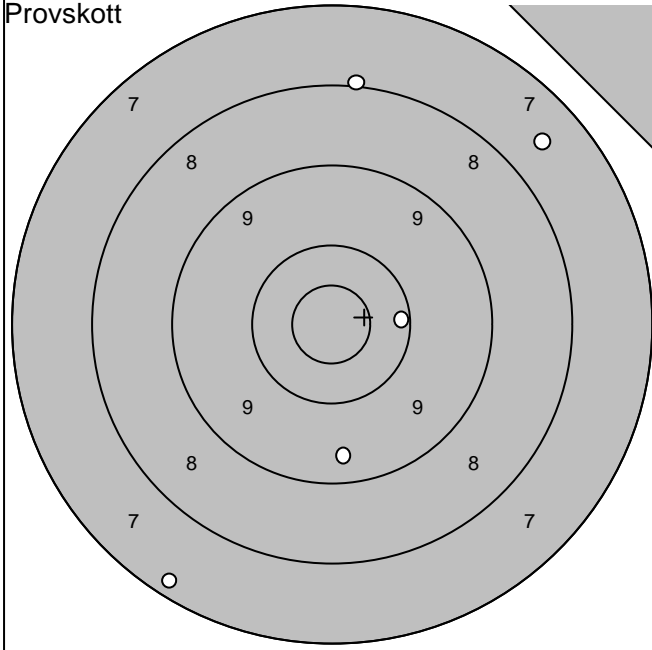

Serie 1

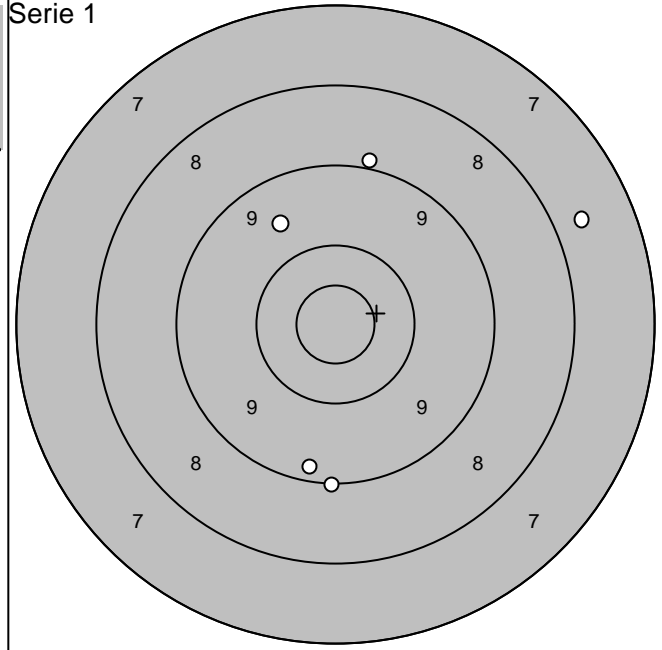

1: 10,2 →

2: 9,4 ↓

3: 7,6 ↗

4: 8,0 ↑

5: 7,3 ↘

Serie 41,0

Totalt 0,0

1: 9,0 ↑

2: 9,6 ↖

3: 9,1 ↓

4: 7,7 →

5: 9,2 ↘

Serie 43,0

Totalt 43,0

Serie 2

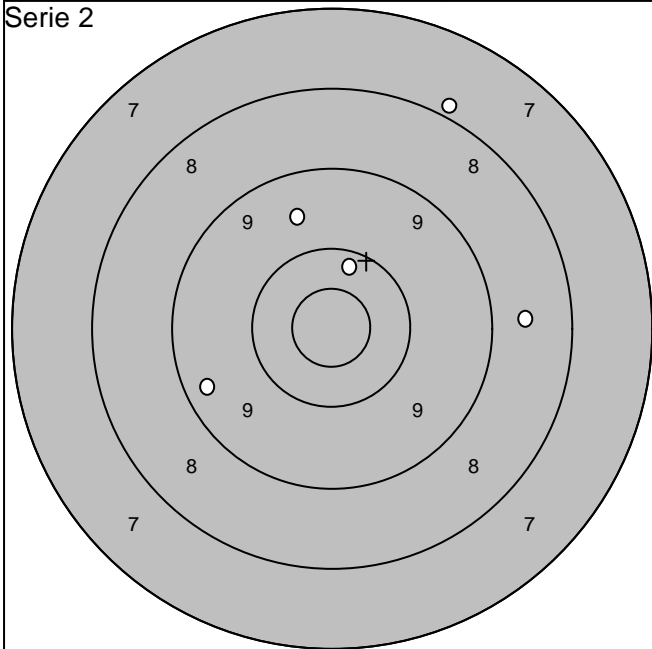

Serie 3

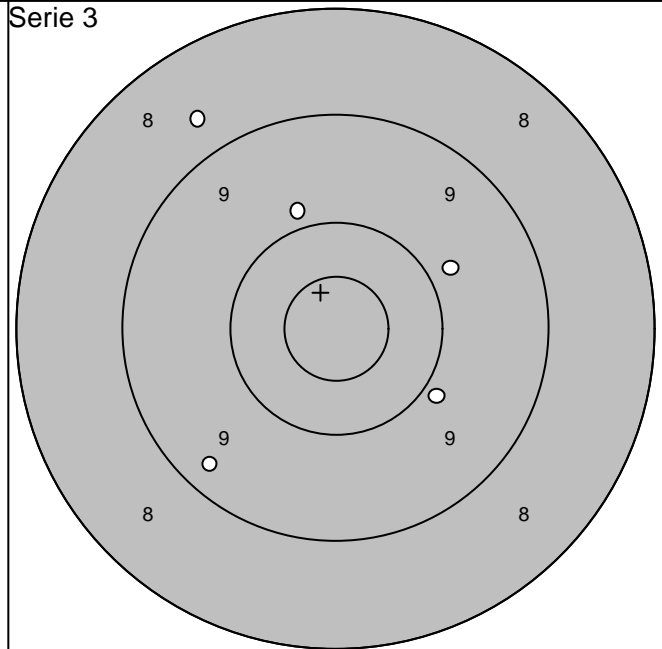

1: 9,3 ←

2: 10,3 ↑

3: 8,6 →

4: 9,6 ↑

5: 7,9 ↗

Serie 43,0

Totalt 86,0

1: 9,3 ↘

2: 8,7 ↖

3: 9,8 →

4: 9,9 ↑

5: 9,9 ↘

Serie 44,0

Totalt 130,0

Skjutlag 2	Tavla 5	Fredrik Forsgren	
		Ramselefors	
13.07.2007	Tavelträffen A 2007	Ramselefors SKF	
Provskott		Serie 1	
1:10,9* ←	Serie 49,0	1: 9,9 ↑	Serie 49,0
2: 9,6 ←		2:10,2 ←	
3:10,2 ↓	Totalt 0,0	3:10,9* ↓	Totalt 49,0
4:10,4 ↗		4:10,6* ↓	
5:10,5* ↗		5:10,2 ↑	
Serie 2		Serie 3	
1:10,0 ↑	Serie 49,0	1:10,4 ↘	Serie 48,0
2: 9,5 ↖		2:10,3 ↓	
3:10,5* ↑	Totalt 98,0	3: 9,9 ↑	Totalt 146,0
4:10,2 ↗		4:10,0 ↑	
5:10,6* ↑		5: 9,4 ↖	

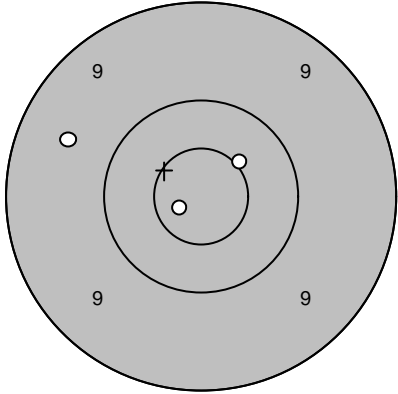
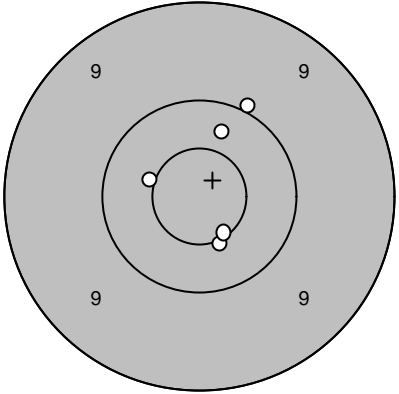
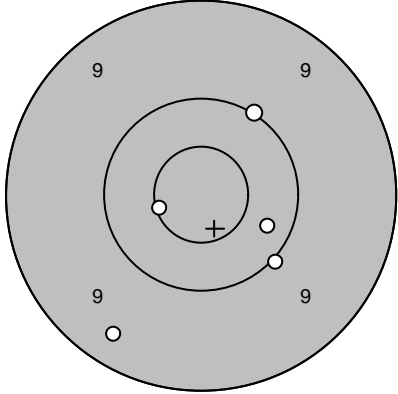
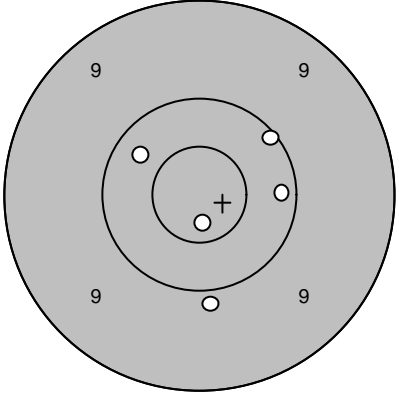
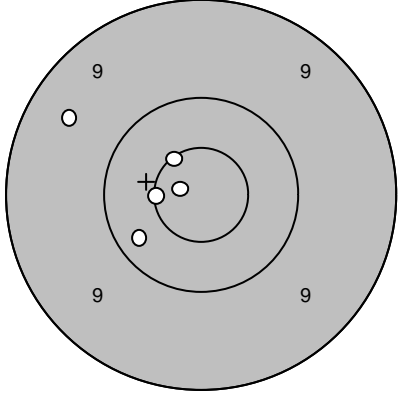
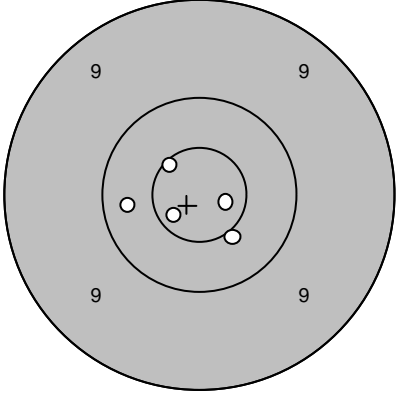
Skjutlag	Tavla	Stefan Sigfridsson	
2	6	Ramselefors	
13.07.2007	Tavelträffen A 2007	Ramselefors SKF	
Provskott	1: 9,6 ↙ 2: 10,5* ↗ 3: 10,8* ↙	Serie 1	1: 10,3 ↗ 2: 10,5* ↙ 3: 10,5* ↘ 4: 10,0 ↗ 5: 10,6* ↘
			
	Serie 29,0		Serie 50,0
	Totalt 0,0		Totalt 50,0
Serie 2	1: 10,0 ↗ 2: 10,0 ↘ 3: 10,3 → 4: 10,6* ↙ 5: 9,4 ↘	Serie 3	1: 10,1 ↗ 2: 10,2 → 3: 10,3 ↙ 4: 9,9 ↘ 5: 10,7* ↘
			
	Serie 49,0		Serie 49,0
	Totalt 99,0		Totalt 148,0
Extratävling 10	1: 9,5 ↙ 2: 10,6* ↗ 3: 10,3 ↙ 4: 10,8* ↙ 5: 10,6* ↙	Extratävling 10	6: 10,7* ↙ 7: 10,6* ↗ 8: 10,8* → 9: 10,5* ↘ 10: 10,3 ↙
			
	Serie 49,0		Serie 50,0
	Totalt 197,0		Totalt 247,0

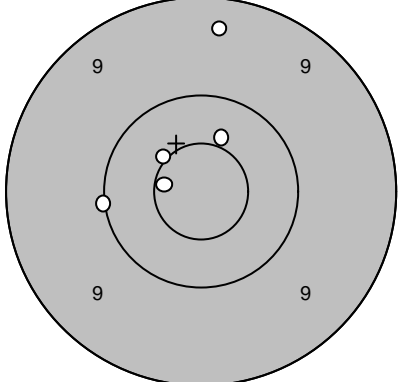
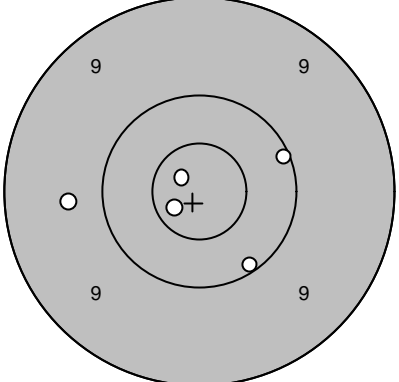
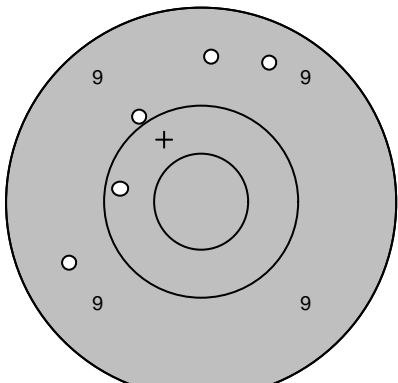
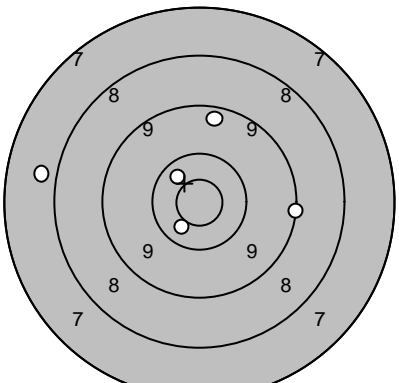
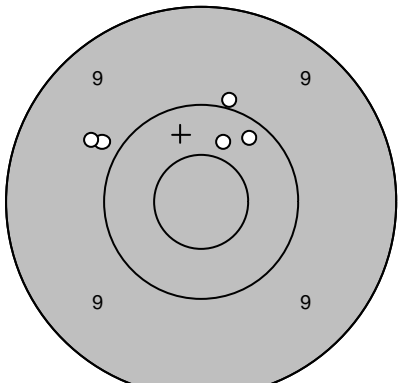
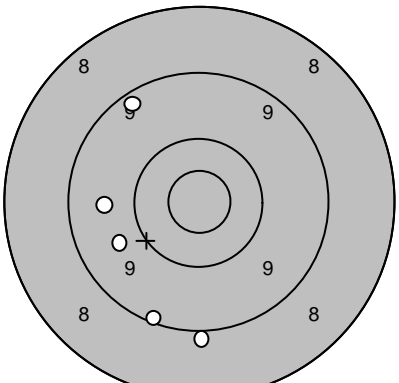
Skjutlag	Tavla	Kjell Marklund	
2	7	S 3	
13.07.2007	Tavelträffen A 2007	Ramselefors SKF	
Provskott	1: 9,4 ↑ 2: 10,5* ↖ 3: 10,7* ← 4: 10,4 ↑ 5: 10,0 ←	Serie 1	1: 10,8* ↖ 2: 10,1 ↘ 3: 10,1 → 4: 10,7* ↙ 5: 9,7 ←
			
	Serie 49,0		Serie 49,0
	Totalt 0,0		Totalt 49,0
Serie 2	1: 9,5 ↑ 2: 9,6 ← 3: 10,2 ← 4: 10,0 ↖ 5: 9,5 ↑	Serie 3	1: 9,4 ↑ 2: 10,5* ↘ 3: 10,5* ↖ 4: 9,1 → 5: 7,9 ←
			
	Serie 47,0		Serie 45,0
	Totalt 96,0		Totalt 141,0
Extratävling 10	1: 10,2 ↗ 2: 9,9 ↖ 3: 10,4 ↑ 4: 9,8 ↖ 5: 10,0 ↑	Extratävling 10	6: 9,6 ← 7: 9,3 ↖ 8: 9,7 ← 9: 9,0 ↓ 10: 9,2 ↘
			
	Serie 48,0		Serie 45,0
	Totalt 189,0		Totalt 234,0

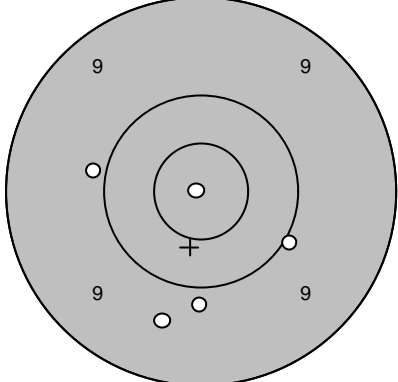
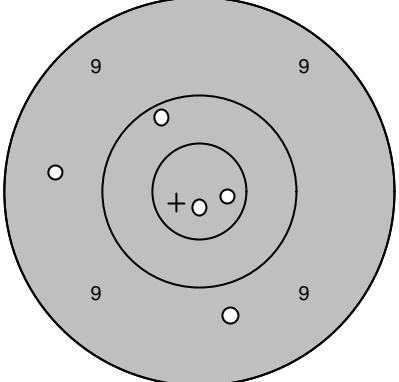
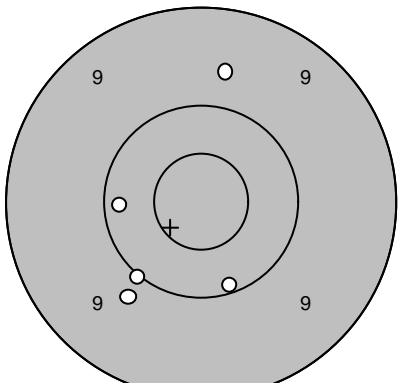
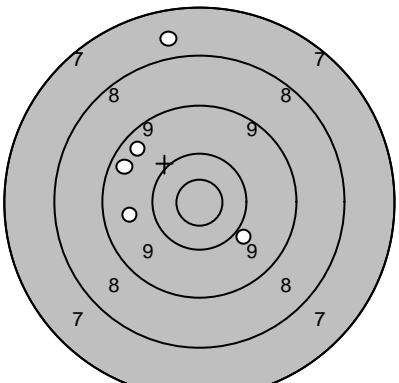
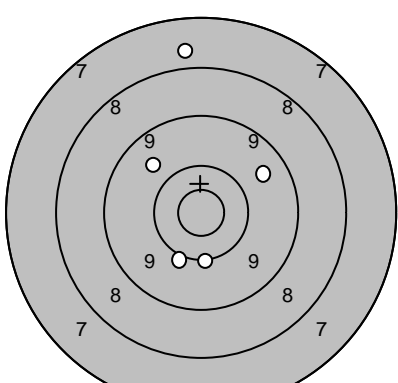
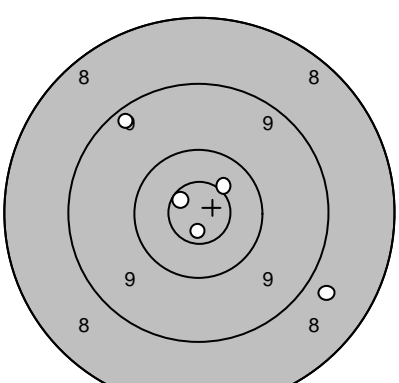
Skjutlag	Tavla	Lars-Gunnar Marklund		
2	8	S 3		
13.07.2007	Tavelträffen A 2007	Ramselefors SKF		
Provskott		1: 9,7 ↘ 2: 9,9 ↓ 3: 10,9* ← 4: 9,9 ← 5: 10,0 ↘	Serie 1 	1: 10,2 ↗ 2: 10,7* → 3: 9,7 ↓ 4: 10,9* ↓ 5: 9,6 ←
		Serie 47,0	Serie 48,0	
		Totalt 0,0	Totalt 48,0	
Serie 2		1: 9,7 ↗ 2: 10,0 ↘ 3: 10,1 ↓ 4: 10,2 ← 5: 9,8 ↘	Serie 3 	1: 9,5 ↗ 2: 9,7 ← 3: 7,7 ↗ 4: 10,0 ↘ 5: 9,5 ←
		Serie 48,0	Serie 44,0	
		Totalt 96,0	Totalt 140,0	
Extratävling 10		1: 9,7 ↗ 2: 10,1 ↓ 3: 9,6 ↗ 4: 10,1 ↓ 5: 7,8 ↗	Extratävling 10 	6: 8,8 ↘ 7: 9,3 ↗ 8: 10,8* ↓ 9: 10,5* ↗ 10: 10,7* ↗
		Serie 45,0	Serie 47,0	
		Totalt 185,0	Totalt 232,0	

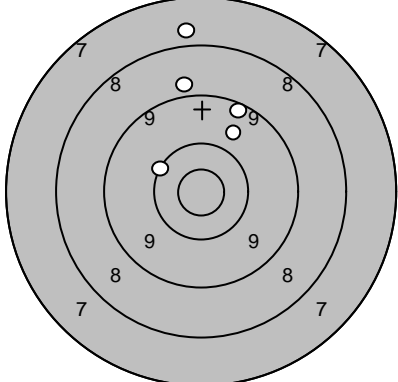
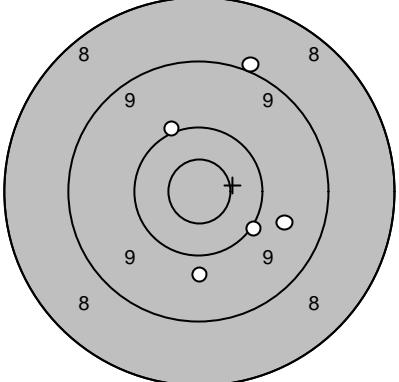
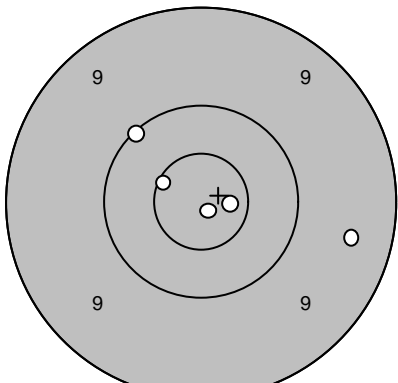
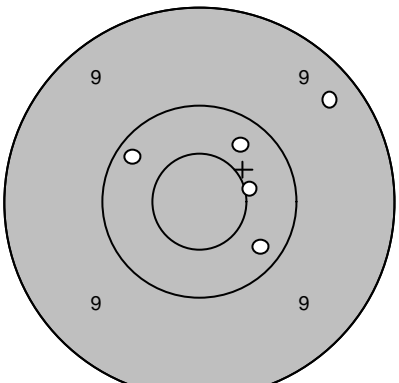
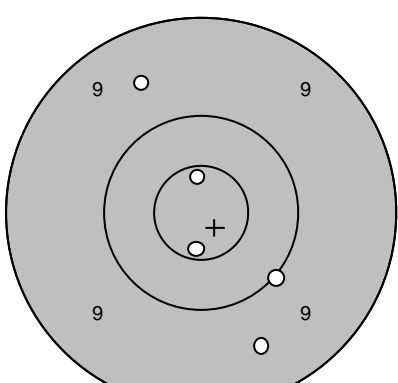
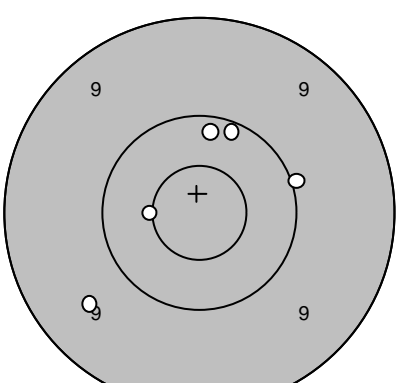
Skjutlag	Tavla	Gunnar Iversen		
2	9	S 3		
13.07.2007	Tavelträffen A 2007	Ramselefors SKF		
Provs-kott		1: 9,3 ↗ 2: 7,8 ↑ 3: 9,8 ↗ 4: 8,9 ↑ 5: 10,2 ↖	Serie 1 	1: 9,7 → 2: 9,8 ↓ 3: 10,0 ↗ 4: 9,0 ↗ 5: 10,1 ↘
	Serie 43,0		Serie 47,0	
	Totalt 0,0		Totalt 47,0	
Serie 2		1: 9,5 → 2: 10,6* ↗ 3: 10,1 ↗ 4: 10,9* ↓ 5: 10,7* →	Serie 3 	1: 10,2 ↖ 2: 10,5* → 3: 10,3 ↗ 4: 9,4 ↗ 5: 10,3 ↘
	Serie 49,0		Serie 49,0	
	Totalt 96,0		Totalt 145,0	
Extratävling 10		1: 9,5 ↓ 2: 10,0 ↓ 3: 10,7* ↓ 4: 9,6 ↗ 5: 10,7* ↑	Extratävling 10 	6: 10,5* ← 7: 9,6 ↖ 8: 10,2 ↗ 9: 10,2 ↑ 10: 10,0 →
	Serie 48,0		Serie 49,0	
	Totalt 193,0		Totalt 242,0	

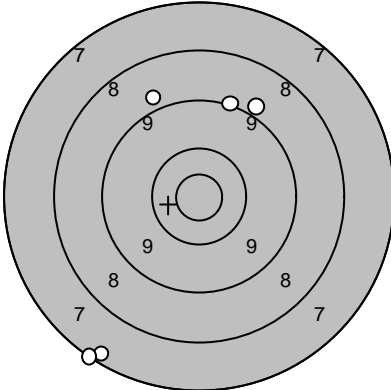
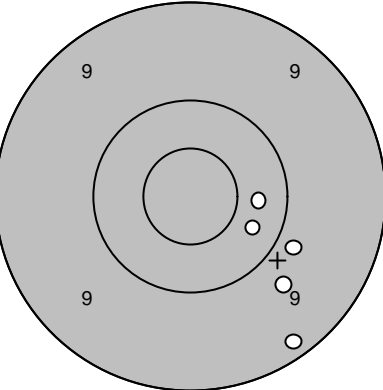
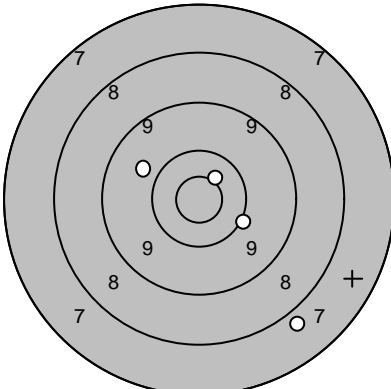
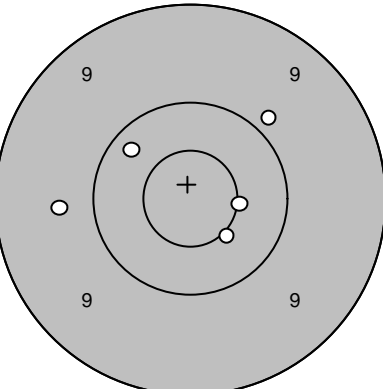
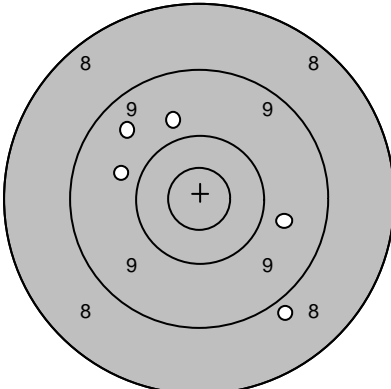
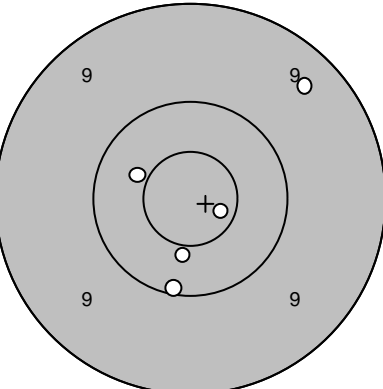
Skjutlag 2	Tavla 10	Johnny Wallberg	
		Loos	
13.07.2007	Tavelträffen A 2007		Ramselefors SKF
Provskott 	1: 9,1 ↗ 2: 8,9 ↗ 3: 7,3 ↓ 4: 7,2 ↓ 5: 8,9 ↗ <hr/> Serie 39,0 Totalt 0,0	Serie 1 	1: 9,2 ↓ 2: 10,3 ↓ 3: 10,3 → 4: 9,9 ↓ 5: 9,7 ↓ <hr/> Serie 47,0 Totalt 47,0
Serie 2 	1: 9,8 ↗ 2: 0,0 → 3: 7,9 ↓ 4: 10,6* ↗ 5: 10,1 ↓ <hr/> Serie 36,0 Totalt 83,0	Serie 3 	1: 10,3 ↗ 2: 9,7 ← 3: 9,9 ↗ 4: 10,5* → 5: 10,5* ↓ <hr/> Serie 48,0 Totalt 131,0
Extratävling 10 	1: 9,7 → 2: 8,9 ↓ 3: 9,8 ↗ 4: 9,6 ↗ 5: 9,8 ↗ <hr/> Serie 44,0 Totalt 175,0	Extratävling 10 	6: 10,7* → 7: 10,4 ← 8: 10,1 ↓ 9: 9,4 ↗ 10: 10,5* ↓ <hr/> Serie 49,0 Totalt 224,0

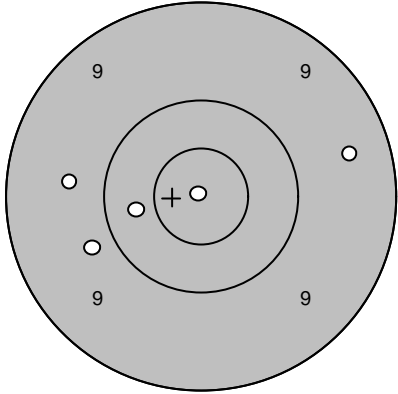
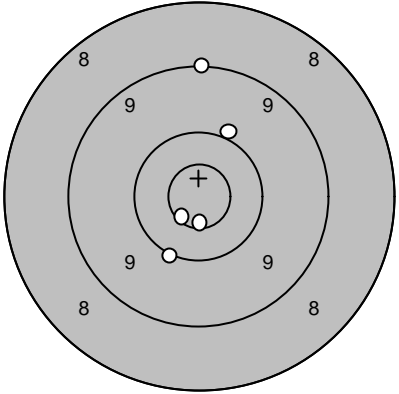
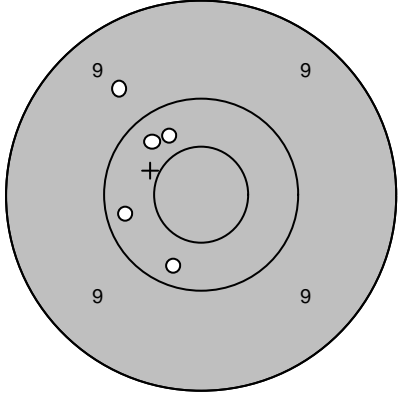
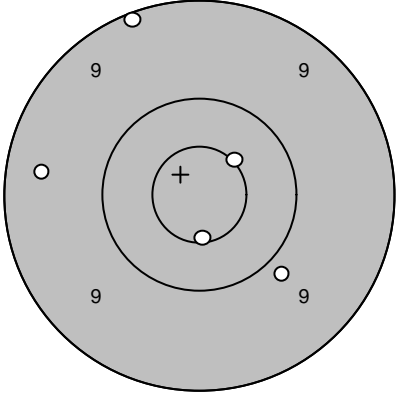
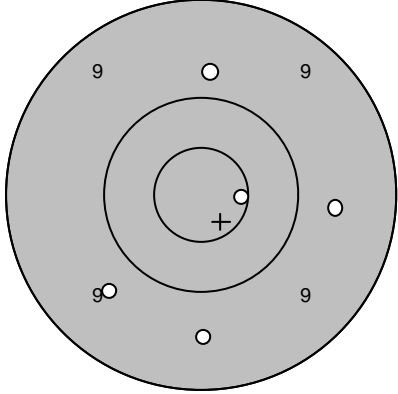
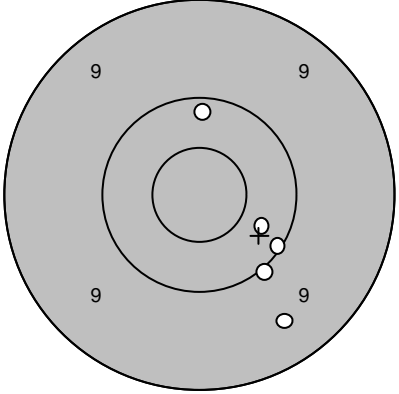
Skjutlag	Tavla	Tony Ericson		
2	11	Loos		
13.07.2007	Tavelträffen A 2007	Ramselefors SKF		
Provskott		1: 9,7 ← 2: 10,9* ↗ 3: 10,4 ← 4: 9,8 ← 5: 9,5 →	Serie 1 	1: 9,1 ↑ 2: 10,7* ↓ 3: 10,0 ↗ 4: 10,1 ↘ 5: 10,7* ↘
		Serie 47,0	Serie 49,0	
		Totalt 0,0	Totalt 49,0	
Serie 2		1: 10,4 ↗ 2: 10,2 ↓ 3: 9,7 ↗ 4: 10,3 ↗ 5: 10,2 ←	Serie 3 	1: 9,4 ← 2: 9,1 ↑ 3: 10,5* ↗ 4: 9,9 ↘ 5: 10,6* ↓
		Serie 49,0	Serie 47,0	
		Totalt 98,0	Totalt 145,0	
Extratävling 10		1: 9,7 ↘ 2: 9,6 ↓ 3: 9,8 ↑ 4: 10,6* → 5: 9,7 →	Extratävling 10 	6: 10,2 ↑ 7: 10,1 ↘ 8: 10,3 ↘ 9: 10,0 ↘ 10: 9,5 ↘
		Serie 46,0	Serie 49,0	
		Totalt 191,0	Totalt 240,0	

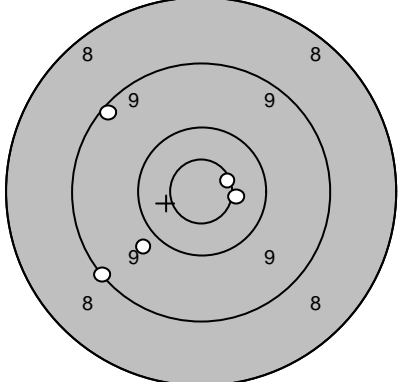
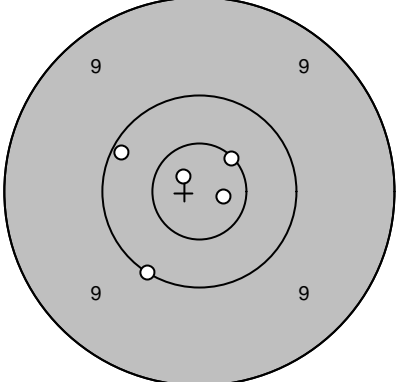
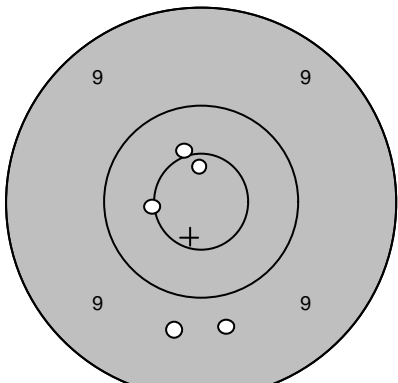
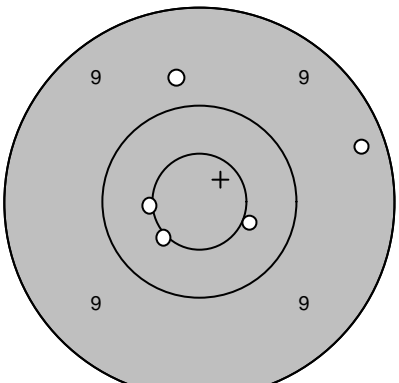
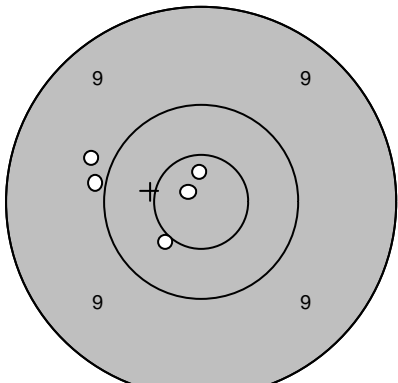
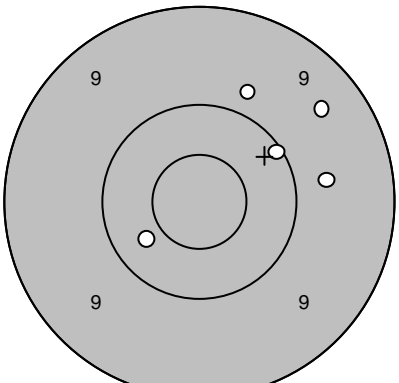
Skjutlag	Tavla	Lars-Göran Lundqvist		
2	13	Ununge		
13.07.2007	Tavelträffen A 2007	Ramselefors SKF		
Provskott		1: 9,8 ↙ 2: 9,2 ↖ 3: 9,1 ↙ 4: 10,7* → 5: 10,5* →	Serie 1 	1: 10,8* ↖ 2: 10,2 ↖ 3: 10,6* ↗ 4: 10,8* → 5: 10,1 ↘
		Serie 47,0	Serie 50,0	
		Totalt 0,0	Totalt 50,0	
Serie 2		1: 10,7* ↑ 2: 10,5* ↑ 3: 10,5* ← 4: 9,7 ↓ 5: 9,7 ↓	Serie 3 	1: 9,8 ↑ 2: 10,5* ↙ 3: 10,5* ← 4: 9,3 → 5: 10,5* →
		Serie 48,0	Serie 48,0	
		Totalt 98,0	Totalt 146,0	
Extratävling 10		1: 9,9 ← 2: 10,9* ↖ 3: 10,5* ↙ 4: 10,7* ↑ 5: 9,8 ↖	Extratävling 10 	6: 10,4 ↙ 7: 9,8 ↗ 8: 10,1 ↗ 9: 9,7 → 10: 9,5 ↗
		Serie 48,0	Serie 47,0	
		Totalt 194,0	Totalt 241,0	

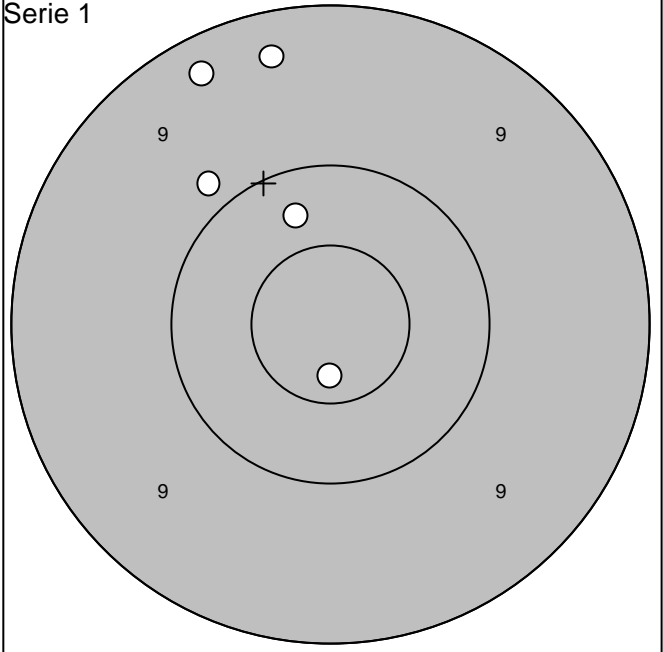
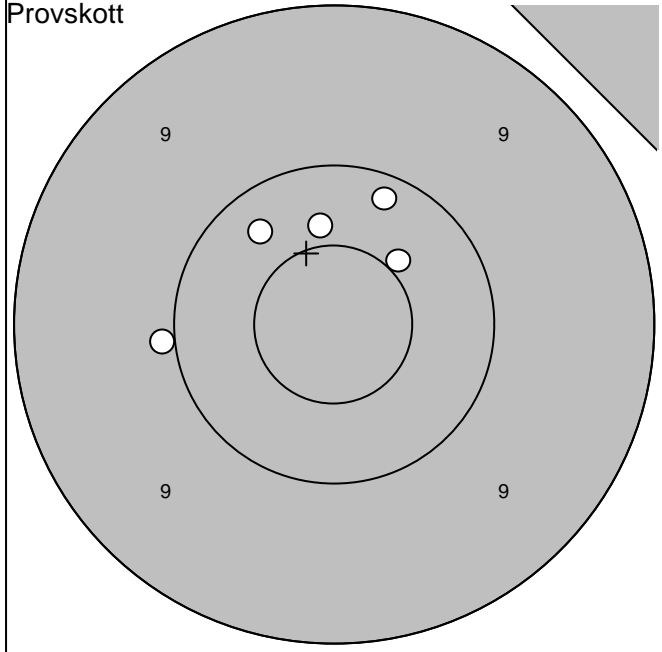

1:10,4 ↑	Serie	50,0
2:10,2 ↗		
3:10,0 ←	Totalt	0,0
4:10,5* ↗		
5:10,3 ↖		

1:10,7* ↓	Serie	47,0
2: 9,3 ↗		
3: 9,3 ↑	Totalt	47,0
4: 9,9 ↖		
5:10,3 ↑		

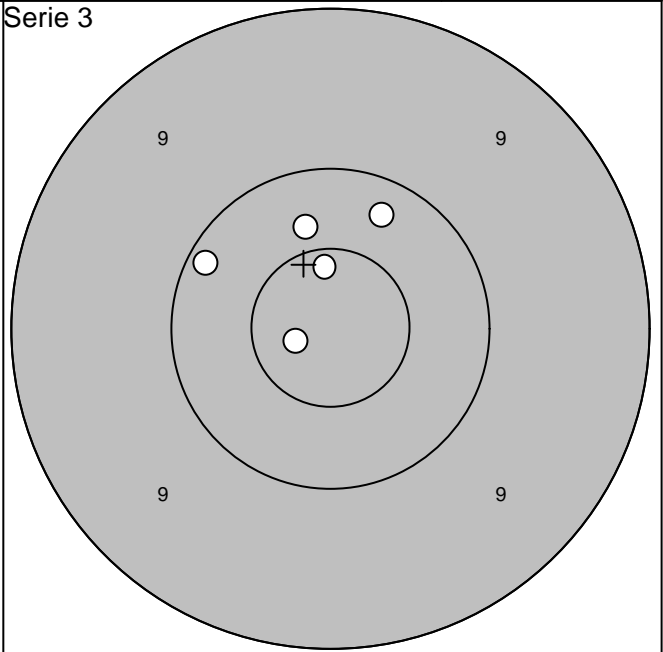
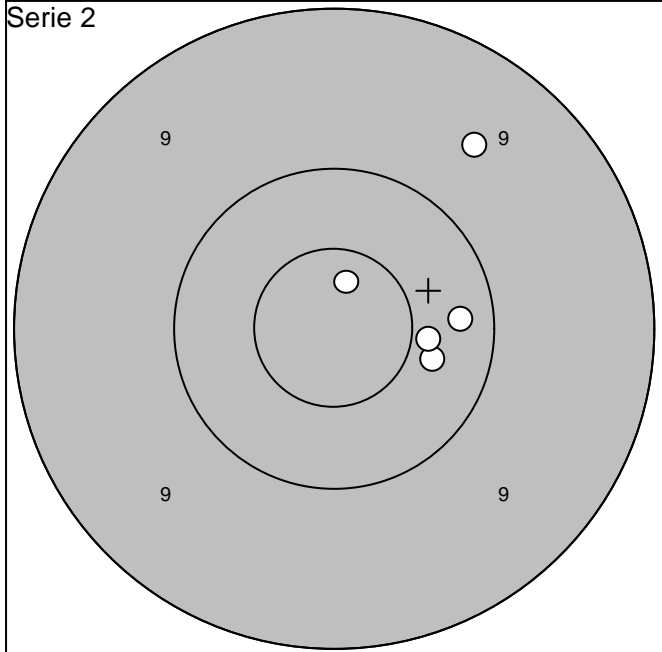

1:10,7* ↑	Serie	49,0
2:10,4 →		
3:10,4 →	Totalt	96,0
4:10,2 →		
5: 9,6 ↗		

1:10,1 ↖	Serie	50,0
2:10,7* ↑		
3:10,3 ↗	Totalt	146,0
4:10,8* ←		
5:10,4 ↑		

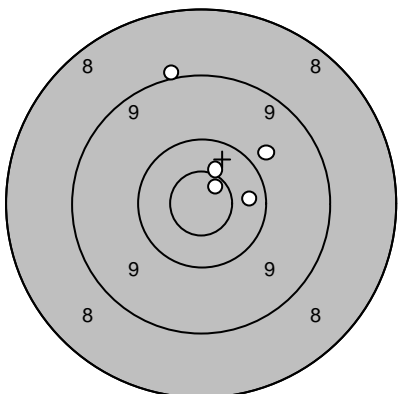
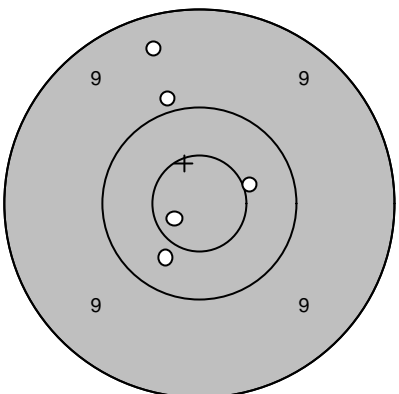
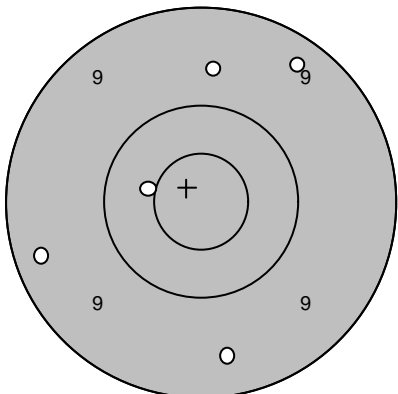
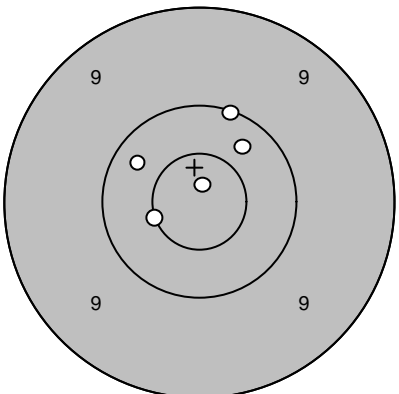
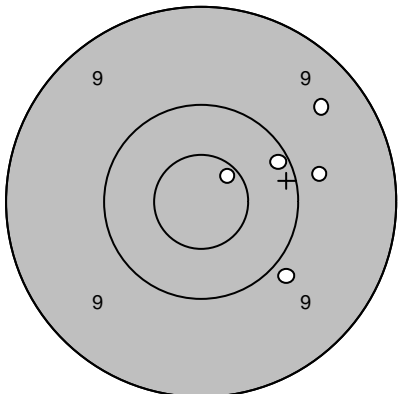
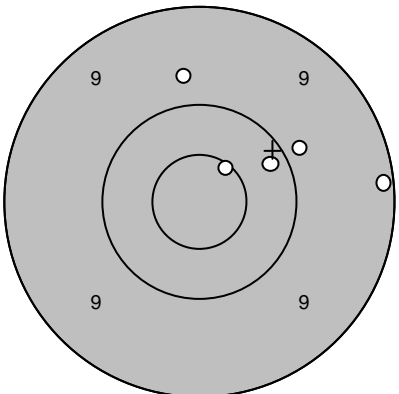
Skjutlag	Tavla			
2	15	Nisse Ström		
		Övertorneå		
13.07.2007	Tavelträffen A 2007	Ramselefors SKF		
Provskott		1: 10,5* ↗ 2: 10,7* ↗ 3: 9,0 ↑ 4: 10,3 → 5: 9,8 ↗	Serie 1 	1: 10,5* → 2: 9,4 ↑ 3: 9,9 ↑ 4: 10,4 ↓ 5: 10,7* ←
	Serie 48,0		Serie 48,0	
	Totalt 0,0		Totalt 48,0	
Serie 2		1: 9,3 ↗ 2: 9,7 ↑ 3: 10,5* ← 4: 9,4 ↓ 5: 9,3 ←	Serie 3 	1: 10,3 ↗ 2: 10,3 ↖ 3: 10,9* ↑ 4: 10,1 ↑ 5: 10,6* ←
	Serie 46,0		Serie 50,0	
	Totalt 94,0		Totalt 144,0	
Extratävling 10		1: 10,7* ↗ 2: 9,5 ↗ 3: 9,8 → 4: 10,1 → 5: 9,9 ↓	Extratävling 10 	6: 9,7 ↑ 7: 10,2 ↗ 8: 10,6* ↗ 9: 9,9 ↗ 10: 9,1 →
	Serie 47,0		Serie 47,0	
	Totalt 191,0		Totalt 238,0	

Skjutlag 2	Tavla 16	Ove Löfgren	
13.07.2007		Övertorneå	
Provskott		Tavelträffen A 2007	Ramselefors SKF
		Serie 1 	
1: 9,3 → 2: 10,1 ↗ 3: 8,6 ← 4: 8,9 ↖ 5: 10,1 ↓	Serie 45,0 Totalt 0,0	1: 9,6 ↓ 2: 9,4 ← 3: 7,6 ↖ 4: 10,6* ← 5: 9,2 ↓	Serie 44,0 Totalt 44,0
Serie 2 		Serie 3 	
1: 10,3 ↖ 2: 8,4 ↑ 3: 9,1 ↗ 4: 8,9 ↑ 5: 10,8* ↘	Serie 45,0 Totalt 89,0	1: 10,6* ↗ 2: 9,9 → 3: 10,2 ↗ 4: 10,5* ↓ 5: 8,1 ↓	Serie 47,0 Totalt 136,0

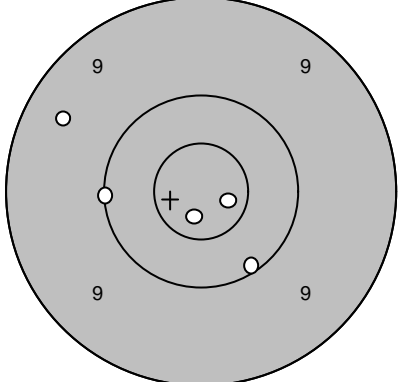
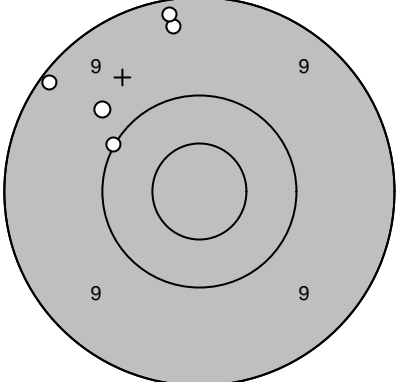
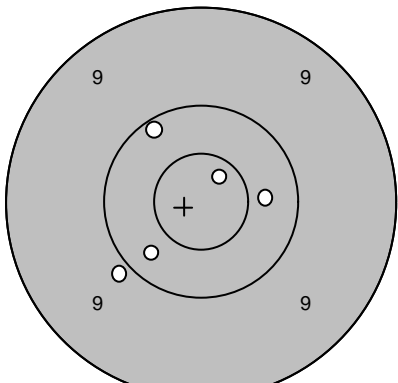
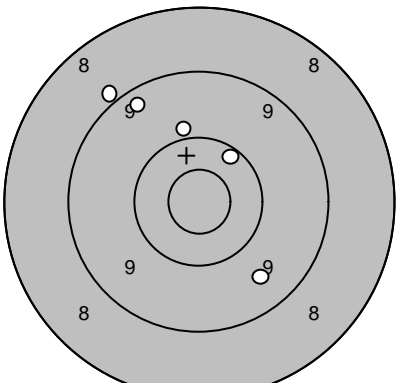
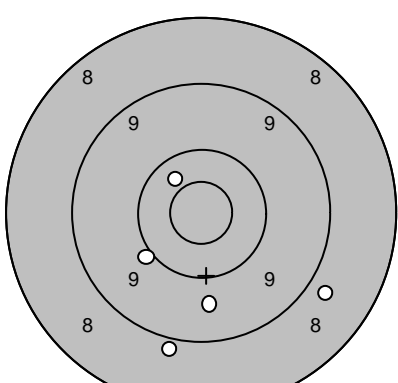
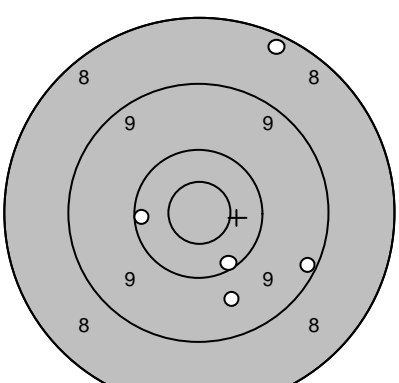
Skjutlag	Tavla	Tommy Åkerström		
2	17	Niemisel		
13.07.2007	Tavelträffen A 2007	Ramselefors SKF		
Provskott		1: 10,8* ↓ 2: 10,1 ↓ 3: 10,7* → 4: 10,0 ← 5: 9,4 ↗	Serie 1 	1: 9,2 ↖ 2: 9,3 ↑ 3: 10,0 ↖ 4: 9,7 ↗ 5: 9,2 ↑
		Serie 49,0	Serie 46,0	
		Totalt 0,0	Totalt 46,0	
Serie 2		1: 10,7* ↗ 2: 10,2 ↗ 3: 9,9 ↙ 4: 10,3 ↙ 5: 10,4 →	Serie 3 	1: 8,9 ↖ 2: 10,2 ↗ 3: 9,6 ↘ 4: 9,3 ↗ 5: 9,9 ↑
		Serie 49,0	Serie 45,0	
		Totalt 95,0	Totalt 140,0	
Extratävling 10		1: 10,4 ↖ 2: 8,8 → 3: 10,0 ↙ 4: 9,7 ↓ 5: 8,9 ↓	Extratävling 10 	6: 10,2 ↘ 7: 8,3 ↗ 8: 9,7 ↘ 9: 9,2 ↘ 10: 10,2 ←
		Serie 45,0	Serie 46,0	
		Totalt 185,0	Totalt 231,0	

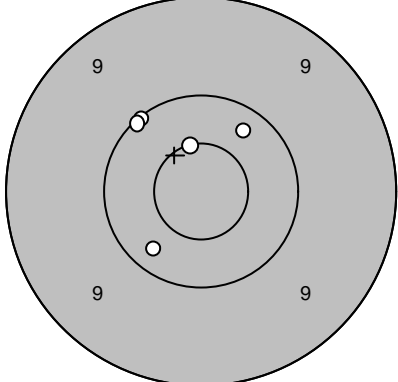
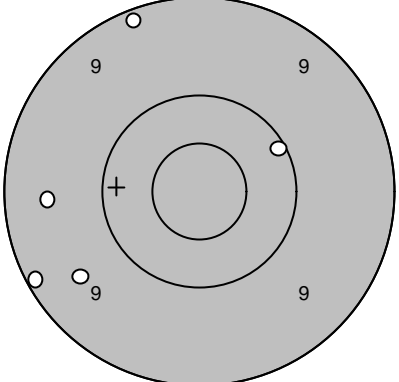
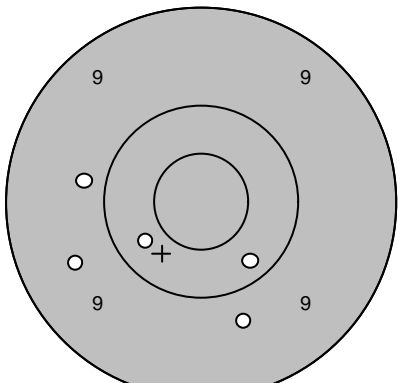
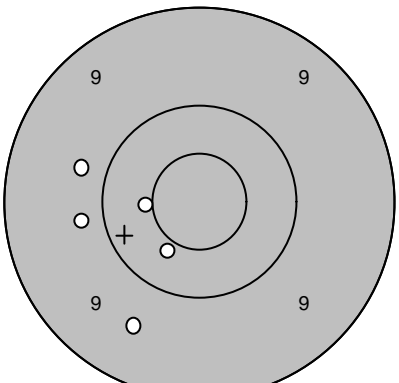
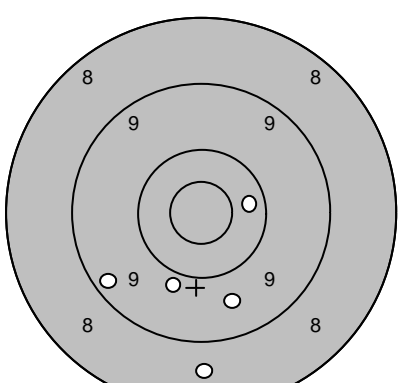
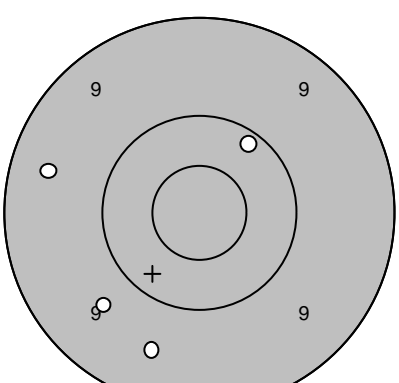
Skjutlag	Tavla	Berndt Steffen		
2	18	Frötuna		
13.07.2007	Tavelträffen A 2007	Ramselefors SKF		
Provskott		1: 10,3 ↙ 2: 10,3 ↗ 3: 10,1 ↗ 4: 10,6* ↗ 5: 10,1 ↗	Serie 1 	1: 9,2 ↗ 2: 9,1 ↙ 3: 9,6 ↙ 4: 9,5 ← 5: 10,1 ↗
	Serie 50,0		Serie 46,0	
	Totalt 0,0		Totalt 46,0	
Serie 2		1: 9,7 ↓ 2: 10,3 ↙ 3: 10,3 ↓ 4: 9,8 ← 5: 9,6 ↙	Serie 3 	1: 9,6 ↓ 2: 9,8 ← 3: 10,4 ↓ 4: 9,8 ← 5: 10,5* ←
	Serie 47,0		Serie 47,0	
	Totalt 93,0		Totalt 140,0	
Extratävling 10		1: 10,3 → 2: 9,3 ↙ 3: 9,9 ↓ 4: 8,7 ↓ 5: 9,6 ↓	Extratävling 10 	6: 10,2 ↗ 7: 9,7 ↙ 8: 9,6 ↓ 9: 9,4 ← 10: 9,1 ↓
	Serie 45,0		Serie 46,0	
	Totalt 185,0		Totalt 231,0	

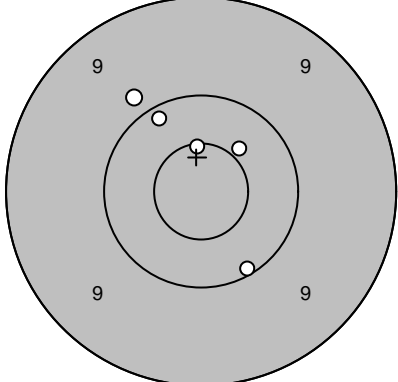
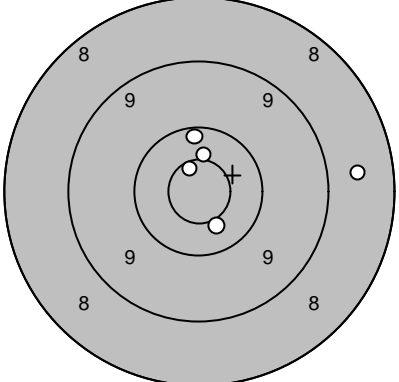
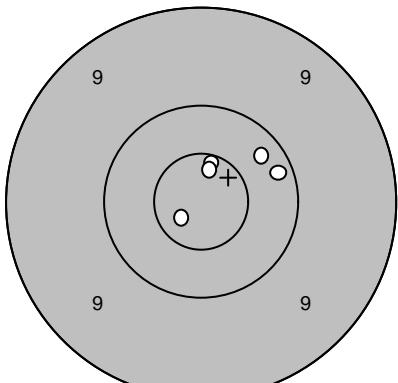
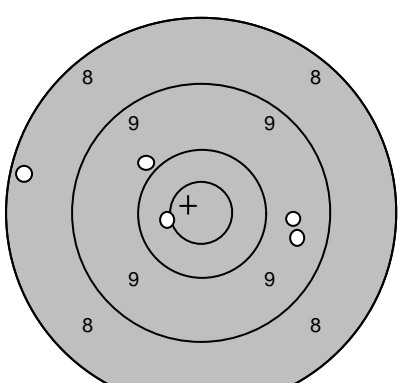
Skjutlag	Tavla	Lars Evaldsson		
2	19			
Göteborg				
13.07.2007	Tavelträffen A 2007	Ramselefors SKF		
Provskott		1: 9,9 ↖ 2: 10,6* ↑ 3: 10,2 ↖ 4: 10,1 ↘ 5: 10,4 ↗	Serie 1	1: 10,5* ↑ 2: 10,7* ↖ 3: 10,2 ↑ 4: 10,5* ↘ 5: 8,6 →
		Serie 49,0		Serie 48,0
		Totalt 0,0		Totalt 48,0
Serie 2		1: 10,2 → 2: 10,8* ↙ 3: 10,6* ↑ 4: 10,3 ↗ 5: 10,7* ↑	Serie 3	1: 10,3 ↖ 2: 9,9 ↙ 3: 10,0 ↘ 4: 9,8 ↑ 5: 10,6* ↘
		Serie 50,0		Serie 48,0
		Totalt 98,0		Totalt 146,0
Extratävling 10		1: 9,9 ↖ 2: 8,3 ← 3: 9,7 → 4: 10,5* ← 5: 9,6 →	Extratävling 10	6: 10,4 ↘ 7: 10,8* ↘ 8: 10,3 ↗ 9: 9,5 ↘ 10: 10,6* ↘
		Serie 45,0		Serie 49,0
		Totalt 191,0		Totalt 240,0

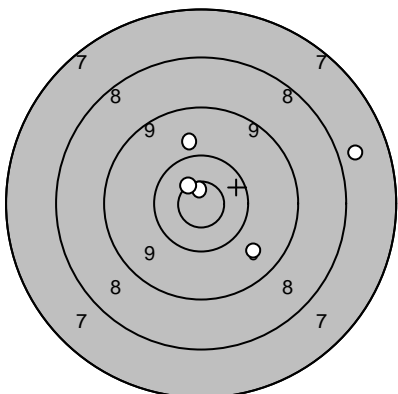
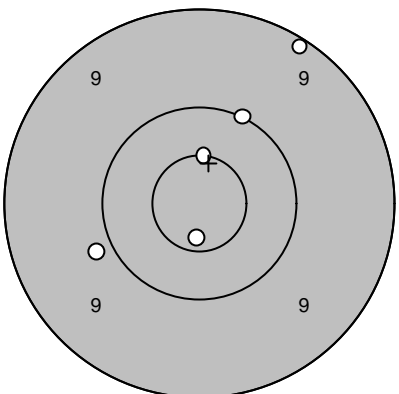
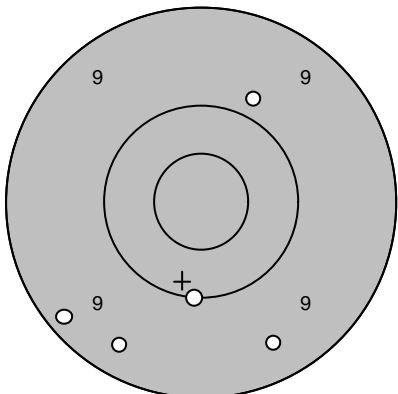
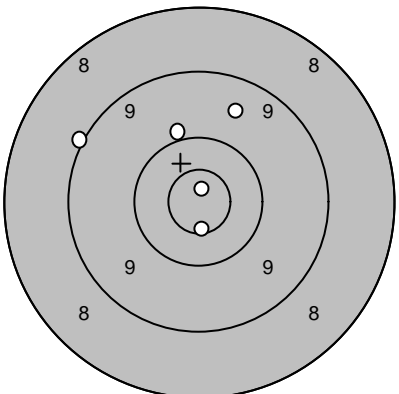
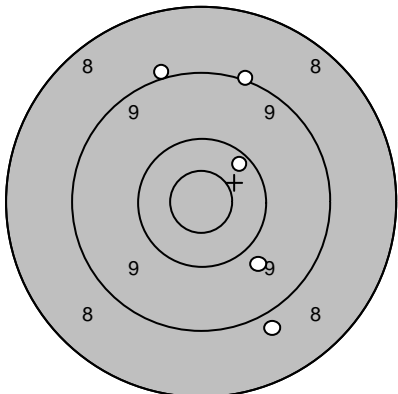
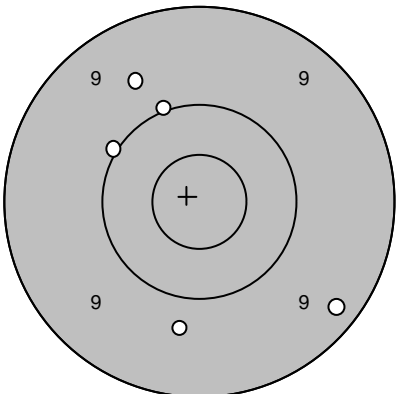
Skjutlag 2	Tavla 20	Lennart Högenberg		
		Hajom		
13.07.2007	Tavelträffen A 2007	Ramselefors SKF		
Provskott		1: 7,8 → 2: 9,8 ↑ 3: 10,8* ↑ 4: 9,7 ↘ 5: 10,7* ↗	Serie 1 	1: 9,1 ↗ 2: 10,0 ↗ 3: 10,5* ↑ 4: 9,9 ← 5: 10,7* ↓
		Serie 45,0	Serie 48,0	
		Totalt 0,0	Totalt 48,0	
Serie 2		1: 9,2 ↙ 2: 9,4 ↘ 3: 9,9 ↗ 4: 9,4 ↙ 5: 10,0 ↓	Serie 3 	1: 10,0 ↑ 2: 10,9* ↑ 3: 9,0 ↙ 4: 10,7* ↓ 5: 9,6 ↗
		Serie 46,0	Serie 48,0	
		Totalt 94,0	Totalt 142,0	
Extratävling 10		1: 10,3 ↗ 2: 9,1 ↑ 3: 9,8 ↘ 4: 8,9 ↘ 5: 9,0 ↗	Extratävling 10 	6: 10,0 ↗ 7: 9,7 ↓ 8: 9,6 ↗ 9: 10,0 ↗ 10: 9,3 ↘
		Serie 45,0	Serie 47,0	
		Totalt 187,0	Totalt 234,0	

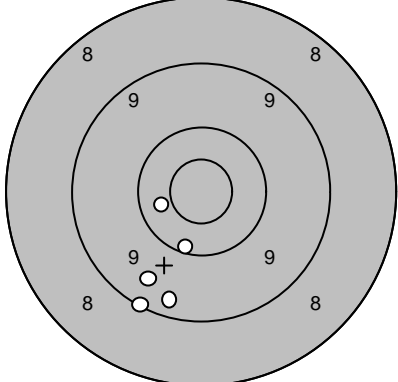
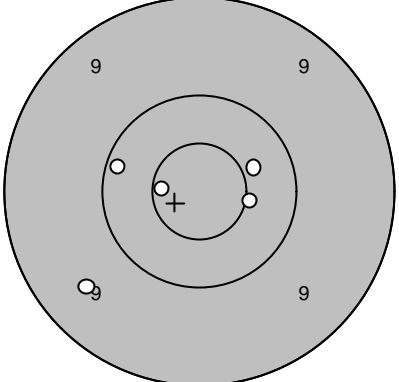
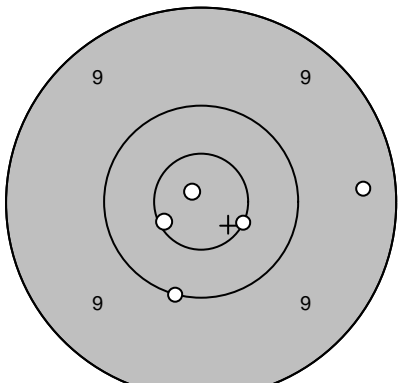
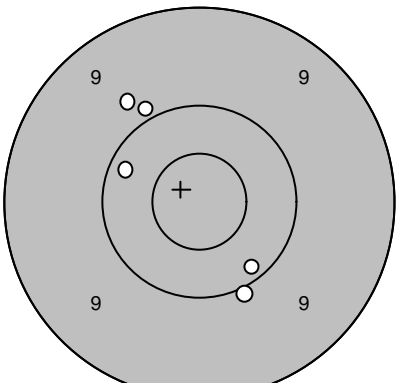
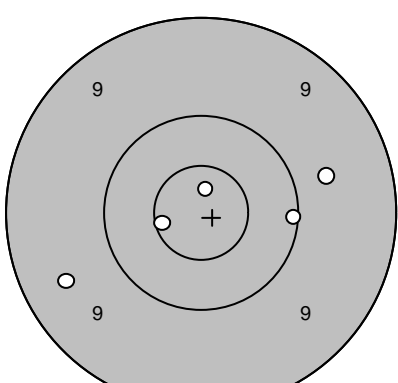
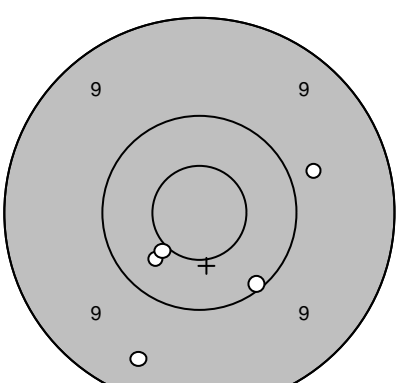
Skjutlag	Tavla	Michael Normann	
		I 16 / Lv 6	
13.07.2007	Tavelträffen A 2007	Ramselefors SKF	
Provskott		1: 9,4 ↘ 2: 9,1 ↘ 3: 9,5 ↘ 4: 10,4 ← 5: 10,2 ↘	Serie 1 
			1: 10,4 → 2: 9,5 ↙ 3: 10,2 ← 4: 10,7* ← 5: 10,5* →
		Serie 47,0	Serie 49,0
		Totalt 0,0	Totalt 49,0
Serie 2		1: 10,0 ↘ 2: 9,4 → 3: 10,6* → 4: 10,9* ↗ 5: 10,6* ↙	Serie 3 
			1: 10,2 ↘ 2: 10,0 ↘ 3: 9,9 ↗ 4: 10,2 ↗ 5: 9,8 ↗
		Serie 49,0	Serie 48,0
		Totalt 98,0	Totalt 146,0
Extratävling 10		1: 9,5 ← 2: 10,1 → 3: 10,6* ← 4: 10,8* ↑ 5: 9,7 →	Extratävling 10 
			6: 10,4 ↙ 7: 9,8 → 8: 9,4 ↘ 9: 10,1 ↘ 10: 10,5* ↙
		Serie 48,0	Serie 48,0
		Totalt 194,0	Totalt 242,0

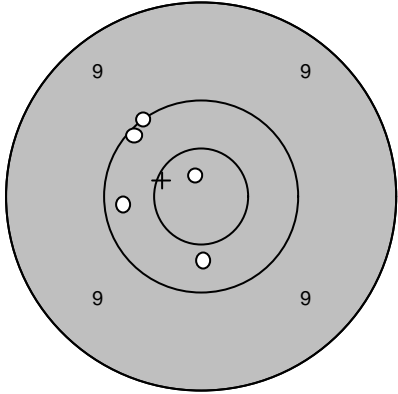
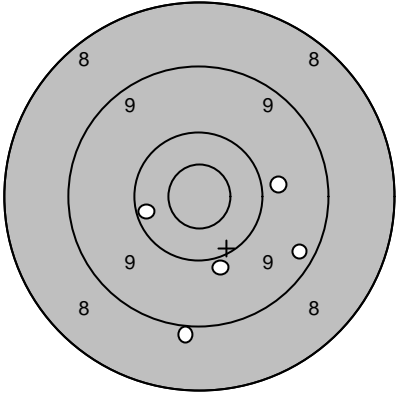
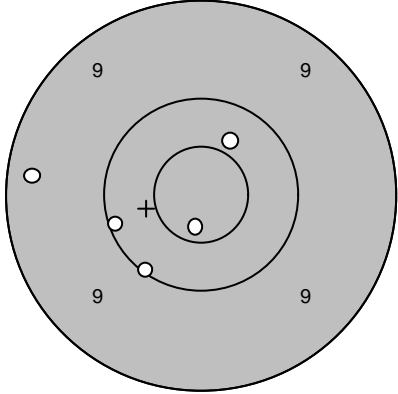
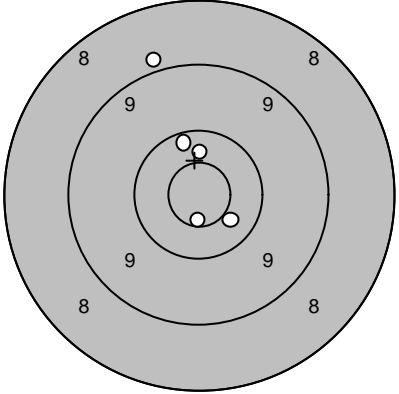
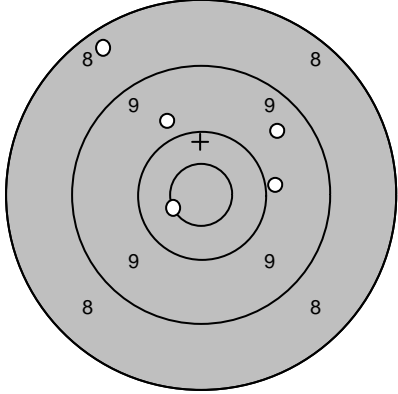
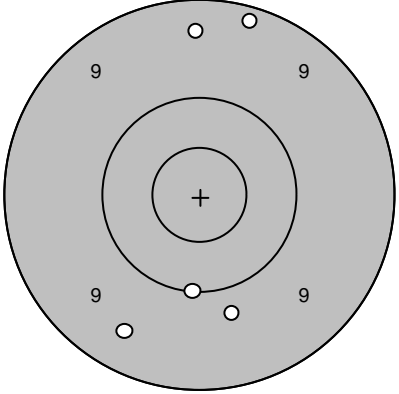
Skjutlag	Tavla	Håkan Engman		
2	22	Lindesberg		
13.07.2007	Tavelträffen A 2007	Ramselefors SKF		
Provskott		1: 10,4 ↓ 2: 10,0 ↗ 3: 10,8* ↑ 4: 10,2 ← 5: 10,1 ↗	Serie 1 	1: 10,2 ← 2: 9,3 ↘ 3: 9,9 ↓ 4: 9,0 ↓ 5: 9,8 →
	Serie 50,0		Serie 46,0	
	Totalt 0,0		Totalt 46,0	
Serie 2		1: 10,4 ↗ 2: 9,3 ← 3: 10,1 ↘ 4: 10,7* ↓ 5: 10,1 ←	Serie 3 	1: 8,9 ↑ 2: 10,7* ↓ 3: 10,3 ↑ 4: 10,5* ↘ 5: 10,4 ↑
	Serie 49,0		Serie 48,0	
	Totalt 95,0		Totalt 143,0	
Extratävling 10		1: 9,9 → 2: 9,6 ↗ 3: 10,6* ← 4: 9,8 ↑ 5: 8,4 ↗	Extratävling 10 	6: 9,2 ↑ 7: 10,0 ↓ 8: 9,8 ↓ 9: 9,4 ↑ 10: 9,5 ↘
	Serie 45,0		Serie 46,0	
	Totalt 188,0		Totalt 234,0	

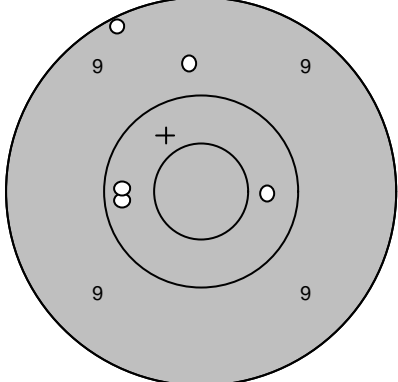
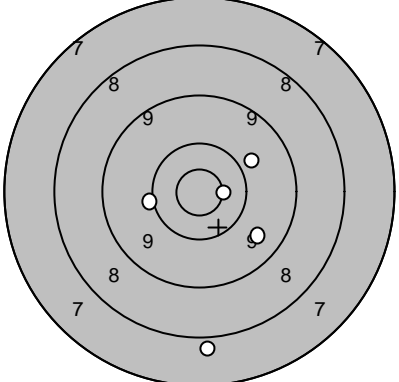
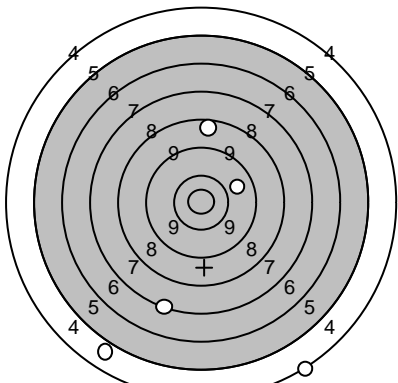
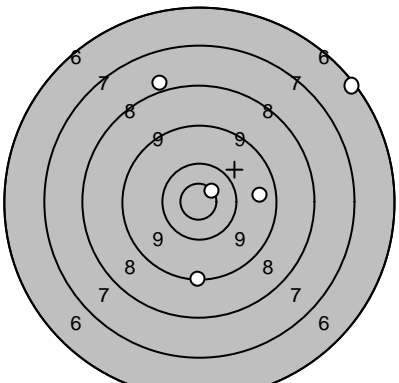
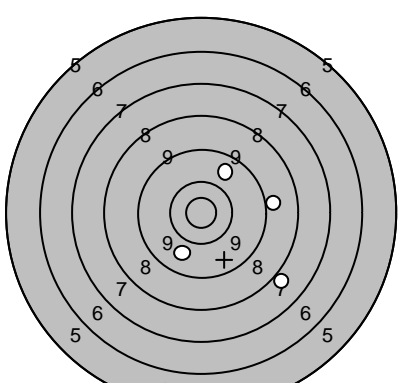
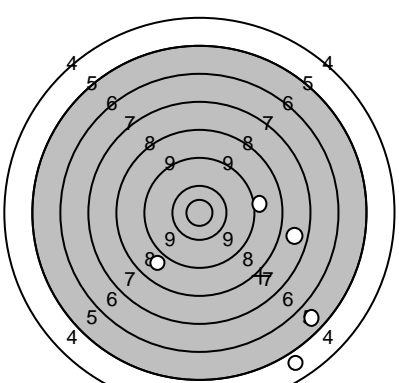
Skjutlag	Tavla	Stig Fredriksson		
2	23			
		Mora		
13.07.2007	Tavelträffen A 2007	Ramselefors SKF		
Provskott		1: 10,2 ← 2: 9,1 ↗ 3: 10,2 ← 4: 10,4 → 5: 9,7 ↗	Serie 1 	1: 9,9 ↗ 2: 10,1 ← 3: 9,6 ↘ 4: 7,9 ↓ 5: 10,6* →
		Serie 48,0	Serie 45,0	
		Totalt 0,0	Totalt 45,0	
Serie 2		1: 8,6 ↗ 2: 9,8 → 3: 4,2 ↘ 4: 4,9 ↘ 5: 7,3 ↘	Serie 3 	1: 8,0 ↗ 2: 10,7* ↗ 3: 9,2 ↓ 4: 9,6 → 5: 6,3 ↗
		Serie 32,0	Serie 42,0	
		Totalt 77,0	Totalt 119,0	
Extratävling 10		1: 9,0 → 2: 9,8 ↘ 3: 9,8 ↗ 4: 8,0 ↘ 5: 5,6 ↓	Extratävling 10 	6: 7,7 → 7: 4,8 ↘ 8: 9,1 → 9: 8,9 ↘ 10: 5,8 ↘
		Serie 40,0	Serie 33,0	
		Totalt 159,0	Totalt 192,0	

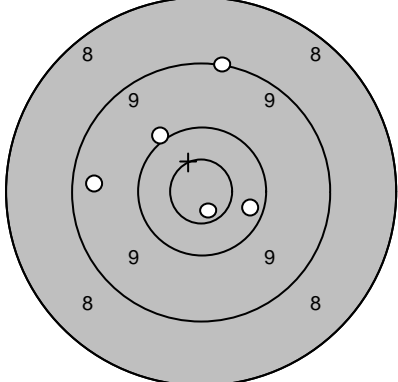
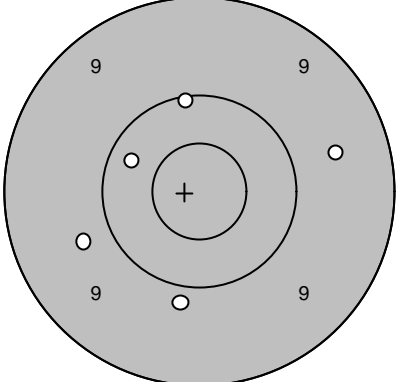
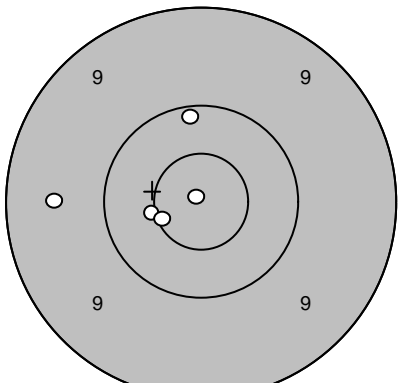
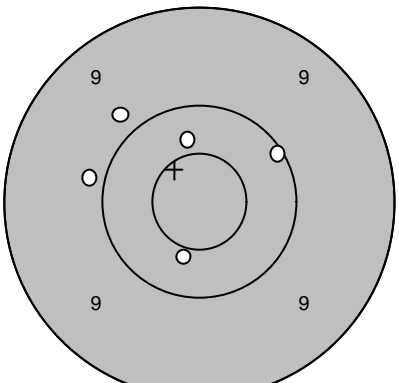
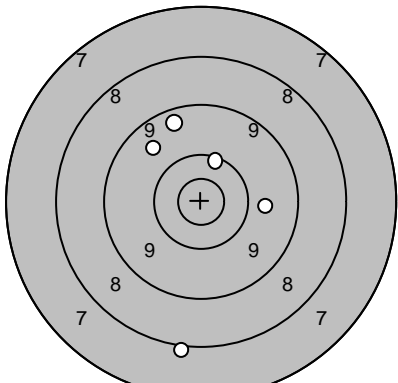
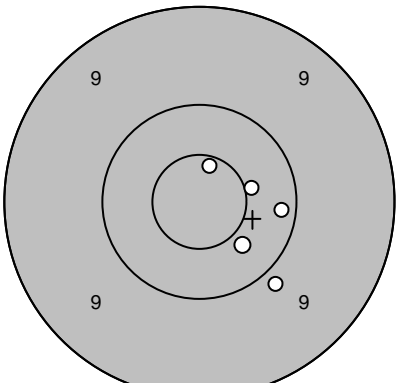
Skjutlag	Tavla	Mikael Olofsson	
2	24	Moälven/Modo	
13.07.2007	Tavelträffen A 2007	Ramselefors SKF	
Provskott		1: 9,4 ← 2: 10,0 ↗ 3: 9,1 ↑ 4: 10,8* ↓ 5: 10,3 →	Serie 1 
			1: 10,1 ↑ 2: 10,3 ↖ 3: 9,7 ↙ 4: 9,6 → 5: 9,9 ↓
		Serie 48,0	Serie 47,0
		Totalt 0,0	Totalt 47,0
Serie 2		1: 10,9* ↗ 2: 10,2 ↑ 3: 9,5 ← 4: 10,5* ← 5: 10,6* ←	Serie 3 
			1: 9,8 ↗ 2: 9,9 ← 3: 10,4 ↓ 4: 10,4 ↑ 5: 10,1 ↗
		Serie 49,0	Serie 48,0
		Totalt 96,0	Totalt 144,0
Extratävling 10		1: 9,6 ↗ 2: 10,2 ↑ 3: 9,8 → 4: 9,4 ↑ 5: 8,1 ↓	Extratävling 10 
			6: 10,5* → 7: 10,2 → 8: 9,9 ↓ 9: 10,4 ↓ 10: 10,6* ↑
		Serie 45,0	Serie 49,0
		Totalt 189,0	Totalt 238,0

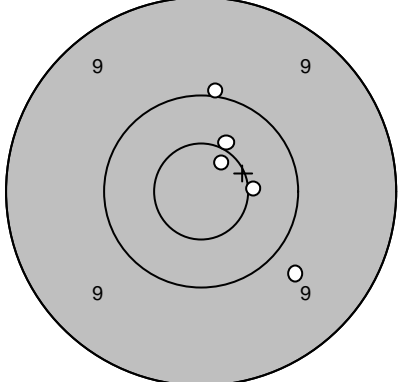
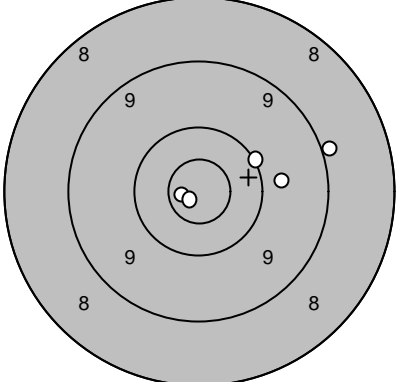
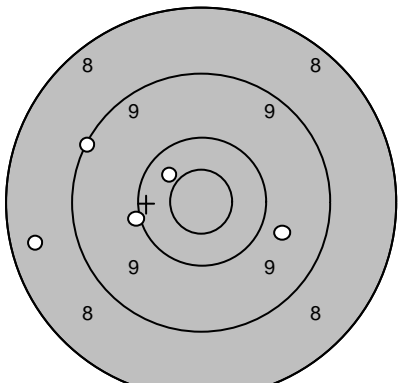
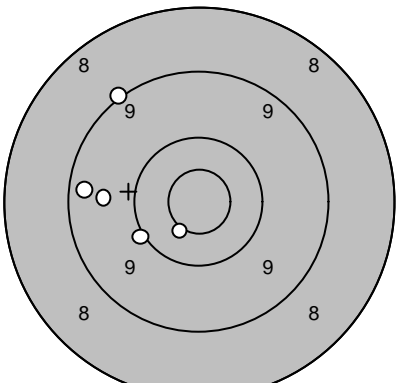
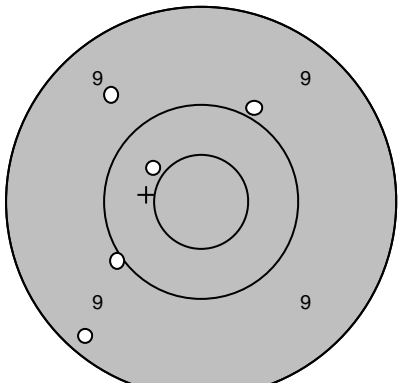
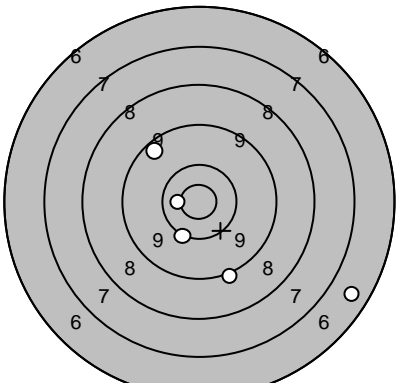
Skjutlag	Tavla	Alf Edin	
3	2		
		Ale	
13.07.2007	Tavelträffen A 2007	Ramselefors SKF	
Provskott 	1: 10,7* ↗ 2: 10,5* → 3: 10,0 ↑ 4: 10,5* ↗ 5: 9,8 ↘	Serie 1 	1: 9,0 → 2: 9,8 → 3: 10,1 ↗ 4: 10,8* ← 5: 10,9* ↘
	Serie 49,0		Serie 48,0
	Totalt 0,0		Totalt 48,0
Serie 2 	1: 10,4 ↗ 2: 9,7 → 3: 9,1 ↗ 4: 8,5 ← 5: 10,0 ←	Serie 3 	1: 9,0 ↖ 2: 9,6 ← 3: 9,3 ← 4: 10,5* ↘ 5: 10,0 ←
	Serie 46,0		Serie 47,0
	Totalt 94,0		Totalt 141,0
Extratävling 10 	1: 9,9 ↗ 2: 10,0 ← 3: 10,4 ↗ 4: 9,6 ↗ 5: 9,2 ↘	Extratävling 10 	6: 9,1 ↘ 7: 9,4 ↗ 8: 10,2 ↘ 9: 10,6* ← 10: 6,6 ↘
	Serie 47,0		Serie 44,0
	Totalt 188,0		Totalt 232,0

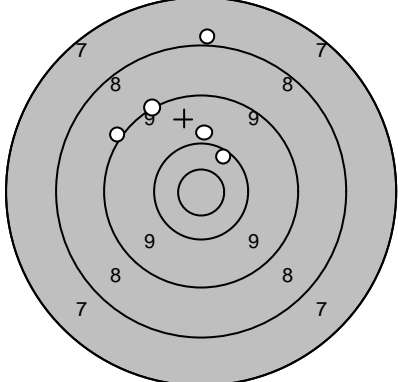
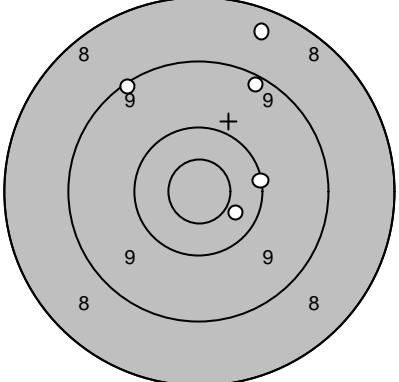
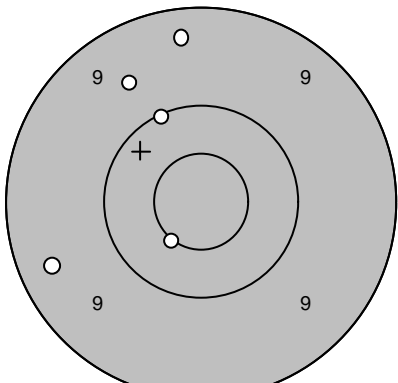
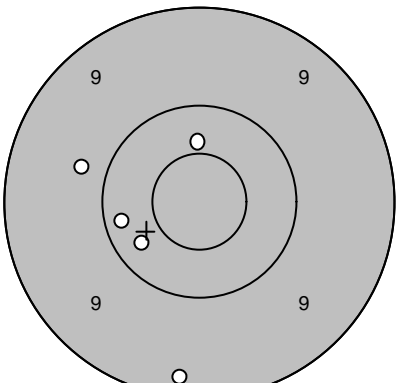
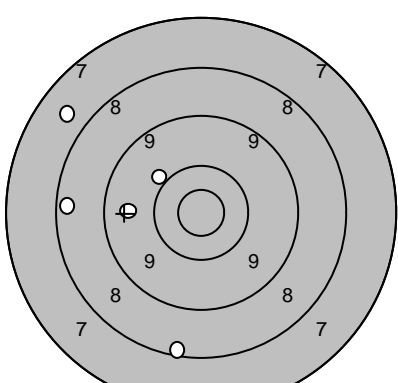
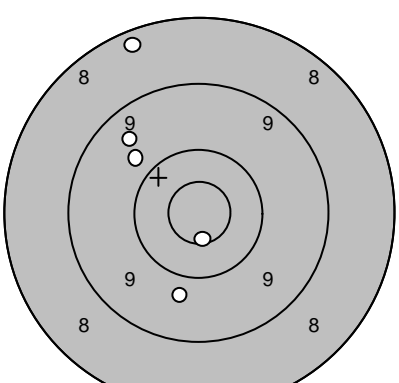
Skjutlag	Tavla	Stefan Wahlström		
3	3	Gideå		
13.07.2007	Tavelträffen A 2007	Ramselefors SKF		
Provskott		1: 8,0 ↑ 2: 9,1 ↗ 3: 9,1 ↖ 4: 9,9 ↑ 5: 10,3 ↗	Serie 1 	1: 8,4 ↗ 2: 9,2 ↗ 3: 10,4 ↘ 4: 10,1 → 5: 9,1 ↗
		Serie 45,0	Serie 46,0	
		Totalt 0,0	Totalt 46,0	
Serie 2		1: 10,1 ↗ 2: 9,6 ↗ 3: 10,5* ↘ 4: 9,4 ← 5: 9,4 ↑	Serie 3 	1: 9,8 ← 2: 9,2 ↓ 3: 10,3 ↖ 4: 10,4 ↑ 5: 10,2 ←
		Serie 47,0	Serie 48,0	
		Totalt 93,0	Totalt 141,0	
Extratävling 10		1: 10,0 ↖ 2: 7,7 ↖ 3: 8,3 ↓ 4: 9,6 ← 5: 8,4 ←	Extratävling 10 	6: 10,7* ↓ 7: 8,3 ↗ 8: 9,8 ↓ 9: 9,5 ↗ 10: 9,8 ↖
		Serie 42,0	Serie 45,0	
		Totalt 183,0	Totalt 228,0	

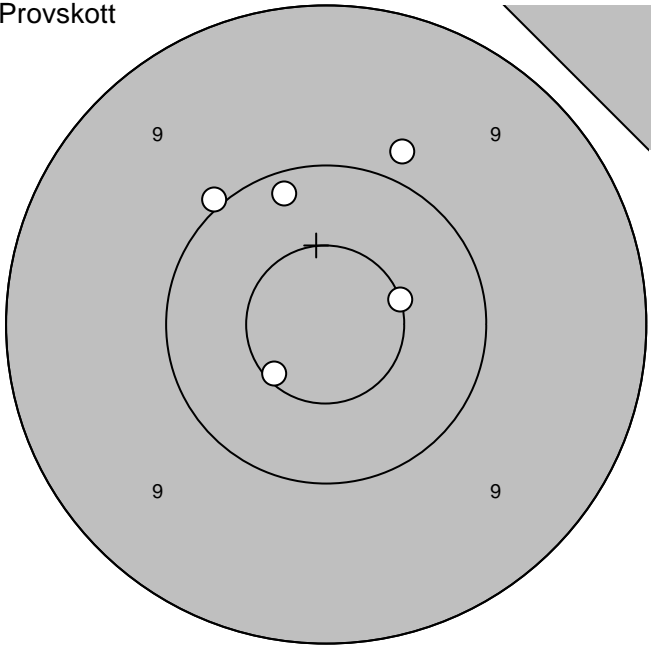
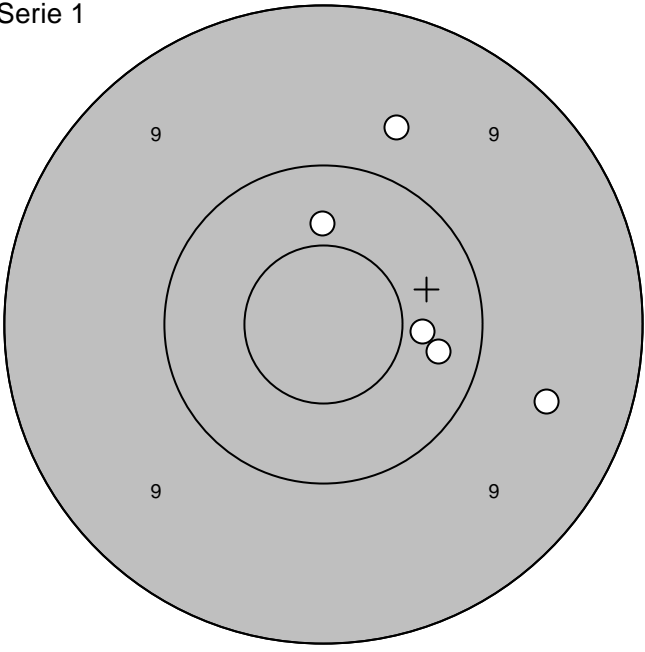
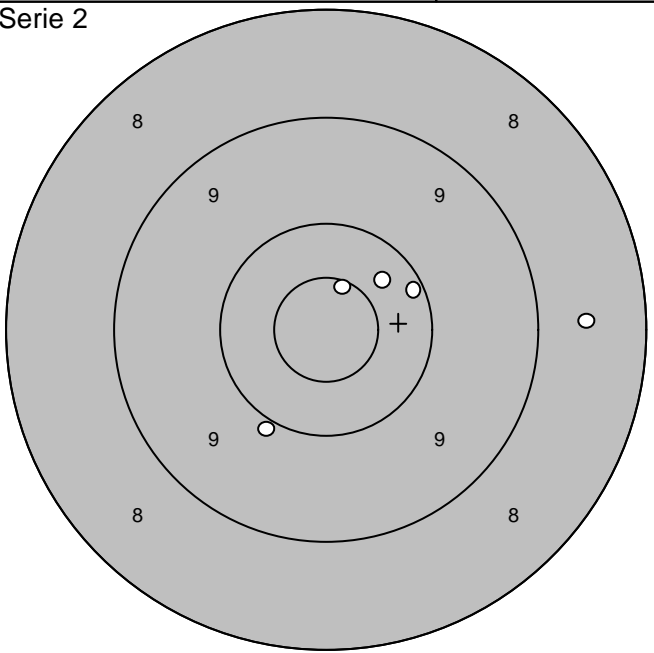
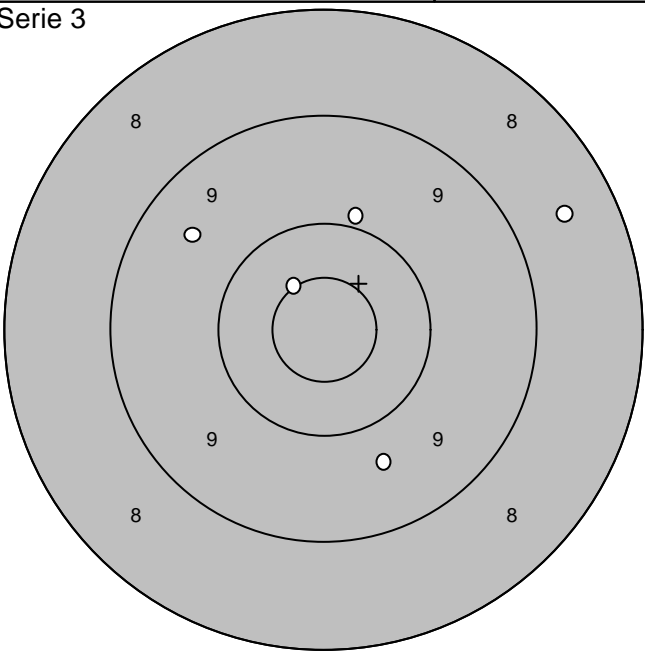
Skjutlag 3	Tavla 4	Torbjörn Karlsson	
13.07.2007		Vrenaorten	
Tavelträffen A 2007		Ramselefors SKF	
Provskott	Serie 1		
			
1:10,6* ↙	Serie 49,0	1: 9,7 ↗	Serie 48,0
2:10,0 ↖		2:10,3 ➡	
3: 9,9 ↗	Totalt 0,0	3:10,4 ➡	Totalt 48,0
4:10,5* ➡		4: 9,6 ➡	
5:10,2 ↗		5:10,4 ↗	
Serie 2	Serie 3		
			
1: 8,6 ➡	Serie 47,0	1: 9,7 ↘	Serie 45,0
2: 9,9 ↘		2: 8,5 ➡	
3:10,6* ↗	Totalt 95,0	3:10,5* ↗	Totalt 140,0
4:10,1 ➡		4: 9,5 ↖	
5:10,3 ↗		5: 9,9 ↗	

Skjutlag	Tavla	Torsten Karlsson	
3	5		
Vrenaorten			
13.07.2007	Tavelträffen A 2007	Ramselefors SKF	
Provskott		Serie 1	
1: 8,7 ↗	Serie 45,0	1:10,4 ↗	Serie 47,0
2: 9,7 ↗		2: 8,7 →	
3:10,3 ↑	Totalt 0,0	3:10,2 ↓	Totalt 47,0
4: 8,4 →		4:10,2 ↙	
5:10,3 ↘		5: 9,9 →	
Serie 2		Serie 3	
1: 6,1 ↑	Serie 45,0	1: 9,9 →	Serie 46,0
2:10,1 ↙		2:10,3 ↘	
3:10,3 →	Totalt 92,0	3: 9,8 ↑	Totalt 138,0
4:10,1 ↙		4: 9,2 ↑	
5: 9,1 ↘		5: 9,8 ↘	

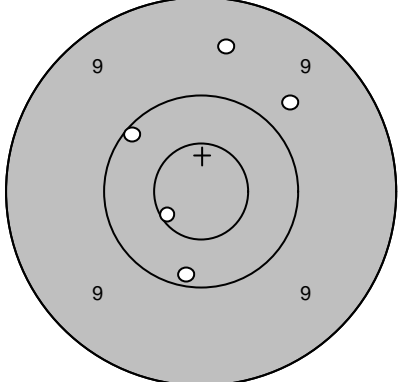
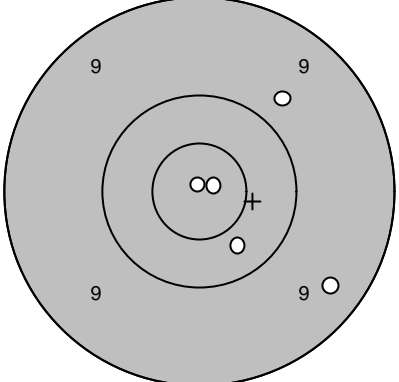
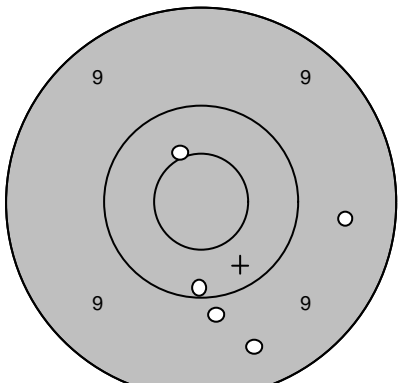
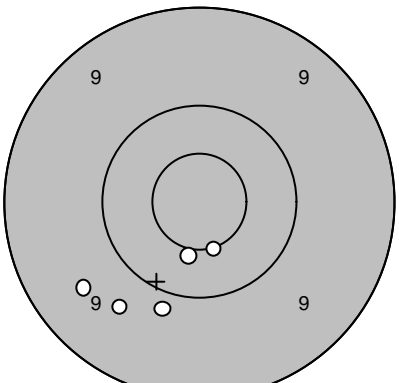
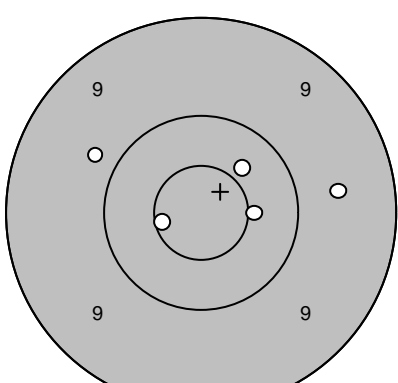
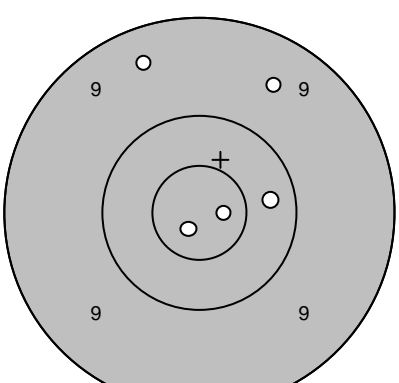
Skjutlag	Tavla	Jan-Erik Fäldt		
3	6	Storfors		
13.07.2007	Tavelträffen A 2007	Ramselefors SKF		
Provskott		1: 9,5 ↗ 2: 10,1 ↖ 3: 9,7 ↗ 4: 10,2 ↓ 5: 10,6* ↙	Serie 1 	1: 9,4 ↘ 2: 10,9* ↑ 3: 9,8 ↗ 4: 10,9* ↗ 5: 10,4 ↓
		Serie 48,0	Serie 48,0	
		Totalt 0,0	Totalt 48,0	
Serie 2		1: 9,5 → 2: 9,5 ↓ 3: 9,9 ↓ 4: 10,2 ↓ 5: 10,5* ↑	Serie 3 	1: 9,9 ↓ 2: 10,5* ↓ 3: 10,5* ↓ 4: 9,6 ↙ 5: 9,7 ↙
		Serie 47,0	Serie 47,0	
		Totalt 95,0	Totalt 142,0	
Extratävling 10		1: 9,6 → 2: 10,6* ← 3: 9,8 ↖ 4: 10,4 ↗ 5: 10,5* →	Extratävling 10 	6: 10,8* → 7: 9,5 ↗ 8: 10,3 → 9: 9,4 ↑ 10: 10,8* ↓
		Serie 48,0	Serie 48,0	
		Totalt 190,0	Totalt 238,0	

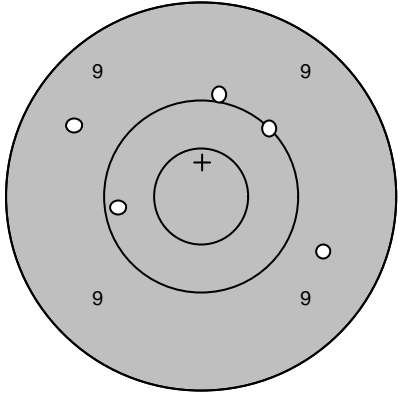
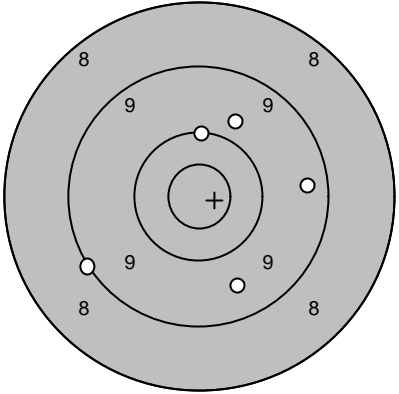
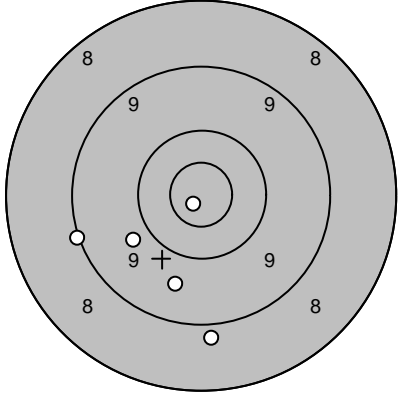
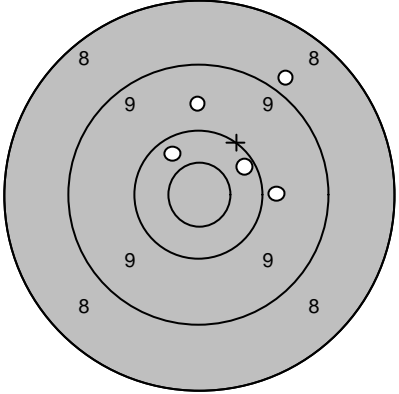
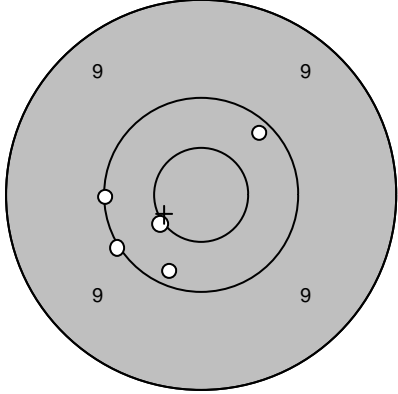
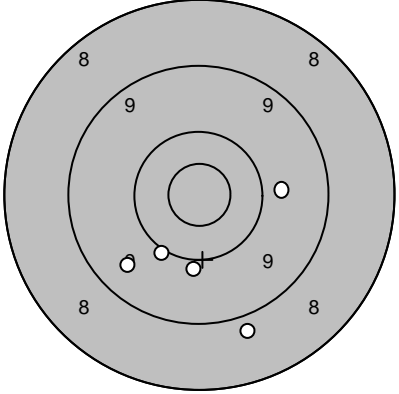
Skjutlag	Tavla	Sven Fäldt	
3	7		
		Storfors	
13.07.2007	Tavelträffen A 2007	Ramselefors SKF	
Provskott		1: 10,0 ↗ 2: 9,6 ↖ 3: 10,2 ← 4: 10,0 ↑ 5: 9,7 →	Serie 1 
			1: 9,8 ↗ 2: 9,6 ↘ 3: 9,4 → 4: 10,1 ↑ 5: 9,1 ↖
		Serie 48,0	Serie 46,0
		Totalt 0,0	Totalt 46,0
Serie 2		1: 10,9* ↘ 2: 9,8 ↖ 3: 9,7 ↘ 4: 9,1 ← 5: 8,9 ↓	Serie 3 
			1: 8,8 ↗ 2: 10,3 ↗ 3: 9,9 → 4: 10,3 ↖ 5: 9,7 ↑
		Serie 45,0	Serie 46,0
		Totalt 91,0	Totalt 137,0
Extratävling 10		1: 10,0 ↖ 2: 10,5* ↖ 3: 10,1 ← 4: 10,2 ↗ 5: 10,2 ↓	Extratävling 10 
			6: 8,9 ↓ 7: 10,0 ↘ 8: 9,9 ↓ 9: 9,5 ↖ 10: 9,8 →
		Serie 50,0	Serie 45,0
		Totalt 187,0	Totalt 232,0

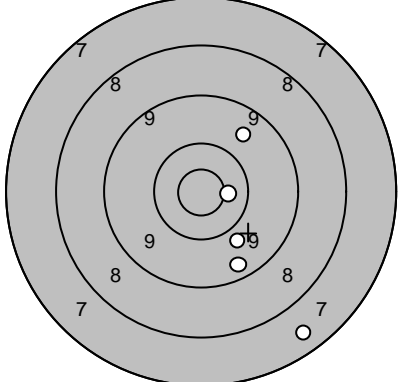
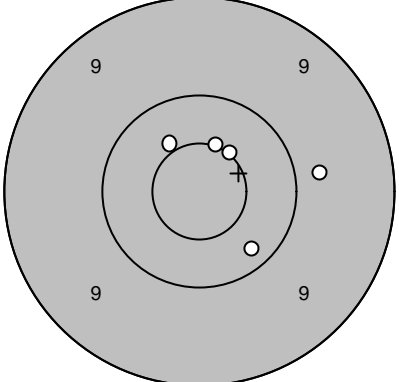
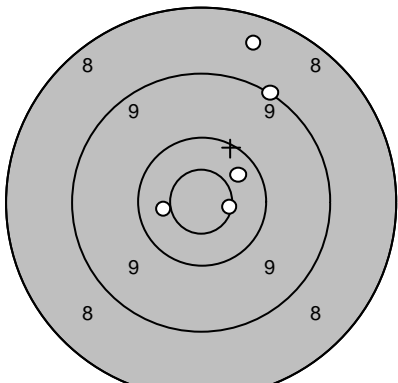
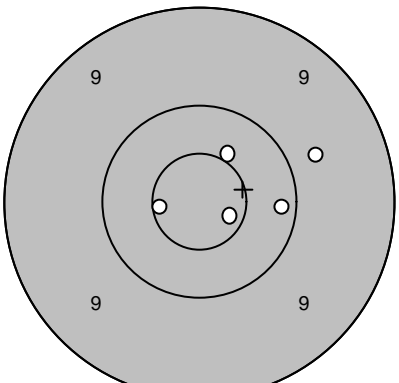
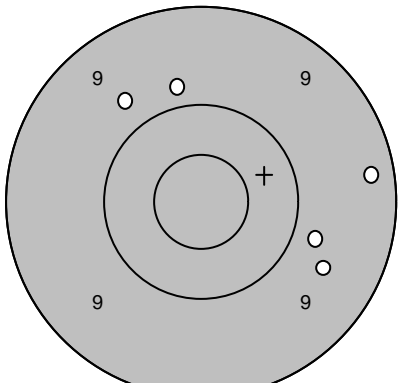
Skjutlag 3	Tavla 8	Magnus Lindkvist	
		Umeå	
13.07.2007	Tavelträffen A 2007	Ramselefors SKF	
Provskott		1: 7,6 ↘ 2: 9,4 ↘ 3: 10,6* → 4: 9,9 ↘ 5: 9,7 ↗	Serie 1 
			1: 10,5* ↗ 2: 10,2 ↘ 3: 10,5* ↗ 4: 9,8 → 5: 10,5* ↗
		Serie 44,0	Serie 49,0
		Totalt 0,0	Totalt 49,0
Serie 2		1: 10,5* ← 2: 10,4 ↗ 3: 8,5 ↗ 4: 10,6* → 5: 9,1 ↗	Serie 3 
			1: 10,7* ↘ 2: 10,6* ← 3: 10,5* ↗ 4: 10,2 → 5: 9,8 →
		Serie 47,0	Serie 49,0
		Totalt 96,0	Totalt 145,0
Extratävling 10		1: 9,8 ↗ 2: 9,7 ↗ 3: 9,8 ↘ 4: 9,3 → 5: 9,6 ↘	
		Serie 45,0	
		Totalt 190,0	

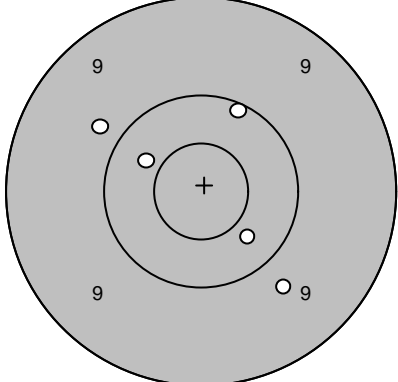
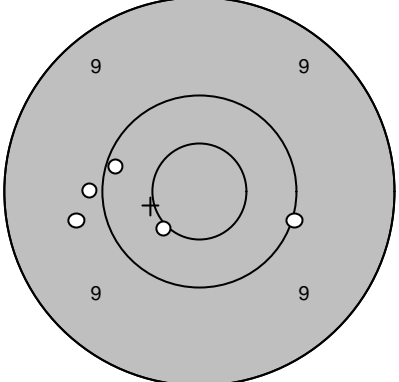
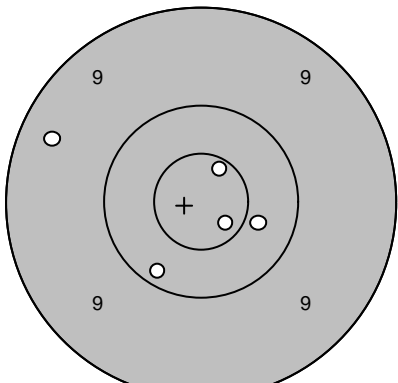
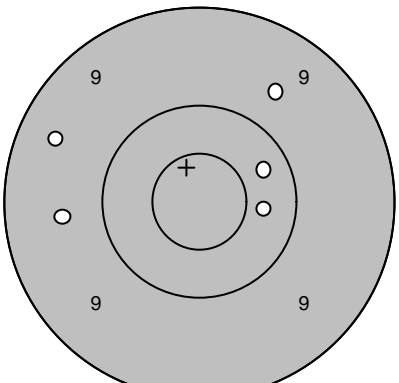
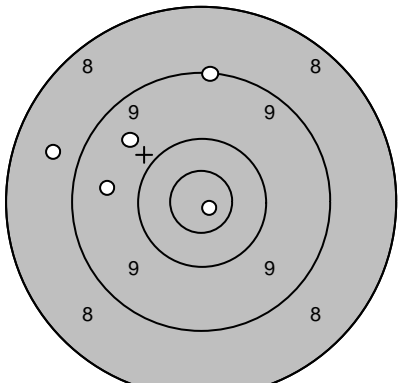
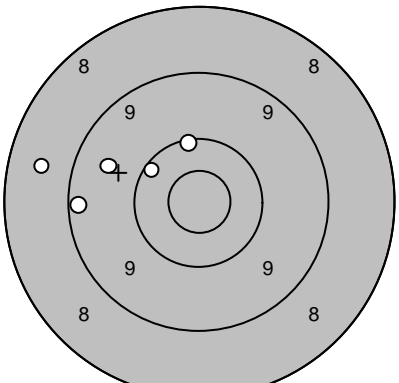
Skjutlag	Tavla	Rune Utterström		
3	9			
		Ale		
13.07.2007	Tavelträffen A 2007	Ramselefors SKF		
Provskott		1: 10,4 ↖ 2: 9,8 ↗ 3: 10,1 ↑ 4: 9,7 ↘ 5: 10,4 ↘	Serie 1 	1: 10,0 → 2: 10,2 ← 3: 9,9 ← 4: 10,5* ↙ 5: 9,8 ←
	Serie 48,0		Serie 48,0	
	Totalt 0,0		Totalt 48,0	
Serie 2		1: 10,7* ↗ 2: 10,7* ↘ 3: 10,4 → 4: 10,2 ↙ 5: 9,4 ←	Serie 3 	1: 9,7 ↗ 2: 10,4 → 3: 9,4 ↖ 4: 10,3 ↗ 5: 9,6 ←
	Serie 49,0		Serie 47,0	
	Totalt 97,0		Totalt 144,0	
Extratävling 10		1: 8,7 ↖ 2: 9,1 ↑ 3: 9,6 ← 4: 10,9* ↘ 5: 9,6 ↗	Extratävling 10 	6: 10,2 ↑ 7: 8,6 ← 8: 9,2 ← 9: 9,6 ↖ 10: 10,2 ↖
	Serie 45,0		Serie 46,0	
	Totalt 189,0		Totalt 235,0	

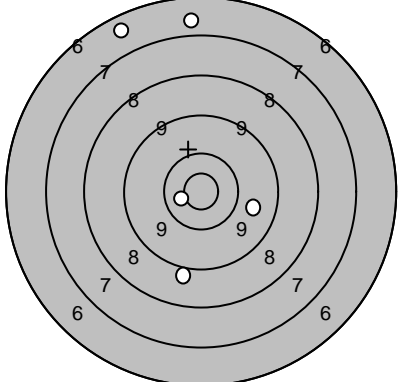
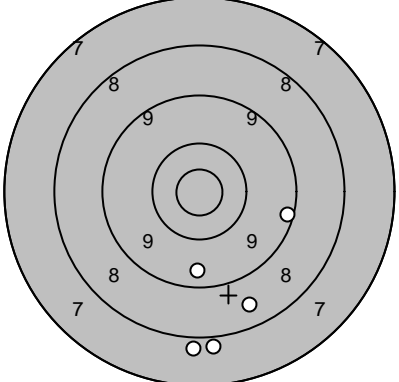
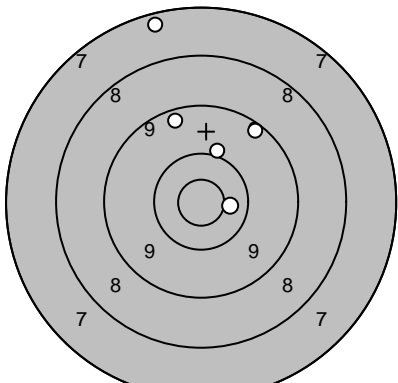
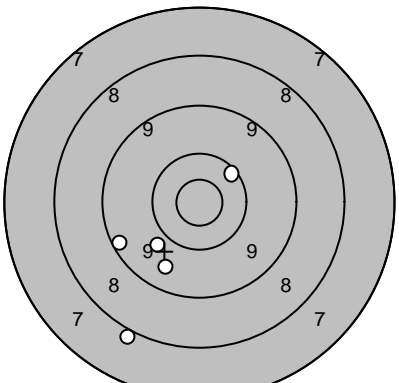
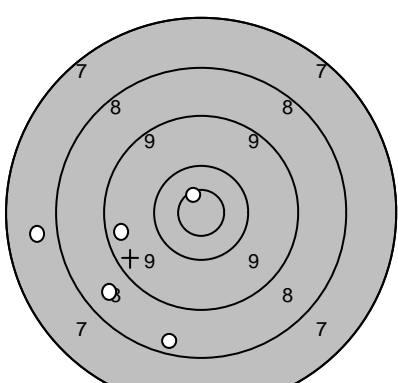
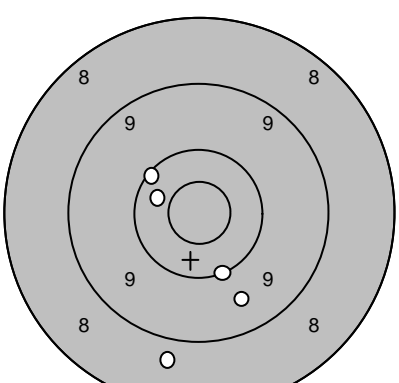
Skjutlag	Tavla	Hampus Stenlund		
3	10	I 19		
13.07.2007	Tavelträffen A 2007	Ramselefors SKF		
Provskott		1: 6,6 ↖ 2: 6,8 ↑ 3: 9,8 → 4: 10,6* ← 5: 9,0 ↓	Serie 1 	1: 9,2 → 2: 9,5 ↓ 3: 7,9 ↓ 4: 8,6 ↓ 5: 7,9 ↓
	Serie 40,0		Serie 40,0	
	Totalt 0,0		Totalt 40,0	
Serie 2		1: 9,3 ↗ 2: 9,4 ↑ 3: 10,0 ↑ 4: 7,4 ↑ 5: 10,5* →	Serie 3 	1: 10,3 ↗ 2: 9,6 ↓ 3: 9,3 ← 4: 9,9 ↓ 5: 8,0 ↓
	Serie 45,0		Serie 45,0	
	Totalt 85,0		Totalt 130,0	
Extratävling 10		1: 8,4 ↓ 2: 7,7 ← 3: 9,4 ← 4: 10,7* ↑ 5: 8,6 ↙	Extratävling 10 	6: 9,6 ↓ 7: 8,8 ↓ 8: 10,4 ← 9: 10,1 ↓ 10: 10,1 ↗
	Serie 42,0		Serie 47,0	
	Totalt 172,0		Totalt 219,0	

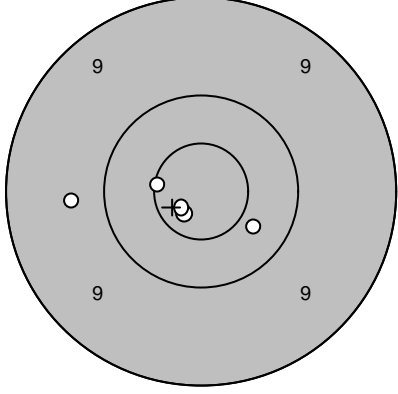
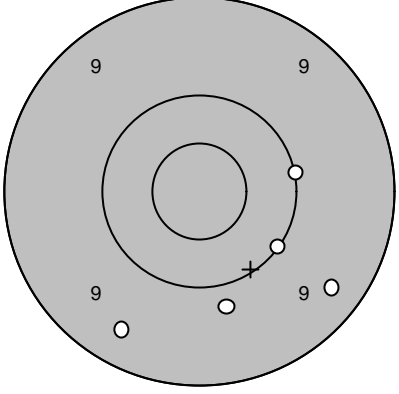
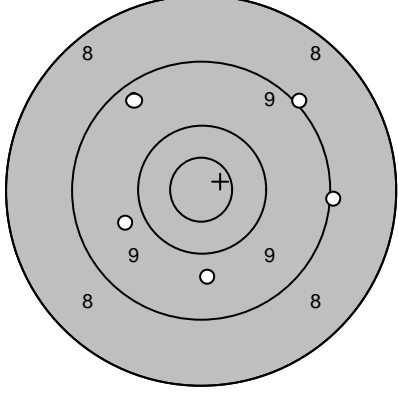
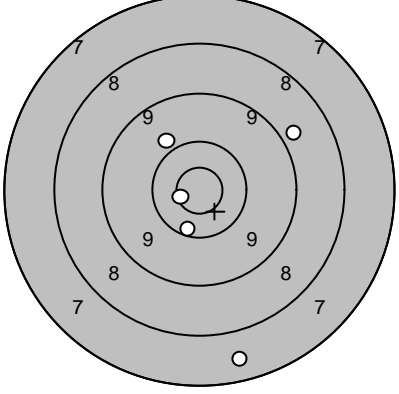
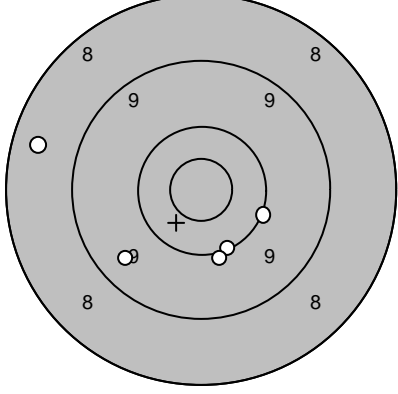
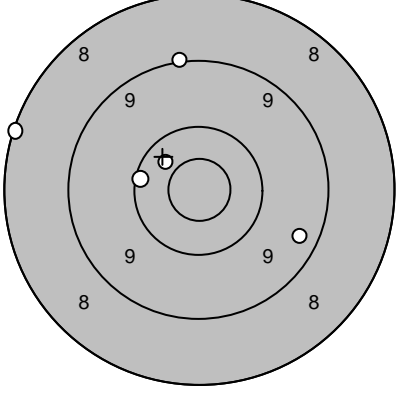
Skjutlag 3	Tavla 11	Roland Nilsson	
		Piteå	
13.07.2007	Tavelträffen A 2007	Ramselefors SKF	
Provskott 	1: 10,4 ↘ 2: 10,8* ↙ 3: 10,8* ↙ 4: 10,6* ← 5: 9,7 ←	Serie 1 	1: 9,8 ↓ 2: 10,1 ↘ 3: 9,4 ↘ 4: 9,4 ↘ 5: 10,0 →
	Serie 49,0		Serie 47,0
	Totalt 0,0		Totalt 47,0
Serie 2 	1: 9,7 ↓ 2: 9,8 ← 3: 9,0 → 4: 9,4 ↗ 5: 9,1 ↗	Serie 3 	1: 9,9 ↗ 2: 8,9 ↗ 3: 10,7* ← 4: 10,3 ↓ 5: 7,6 ↓
	Serie 45,0		Serie 44,0
	Totalt 92,0		Totalt 136,0
Extratävling 10 	1: 8,5 ← 2: 10,1 ↓ 3: 9,5 ↙ 4: 10,1 → 5: 10,0 ↓	Extratävling 10 	6: 10,2 ← 7: 9,1 ↑ 8: 10,4 ↗ 9: 8,1 ← 10: 9,4 ↘
	Serie 47,0		Serie 46,0
	Totalt 183,0		Totalt 229,0

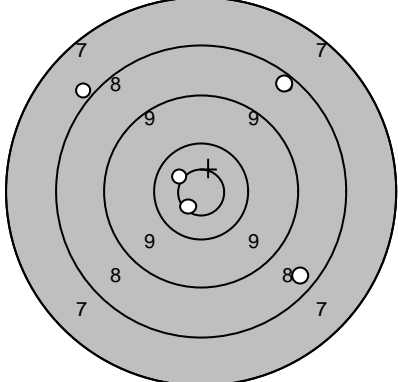
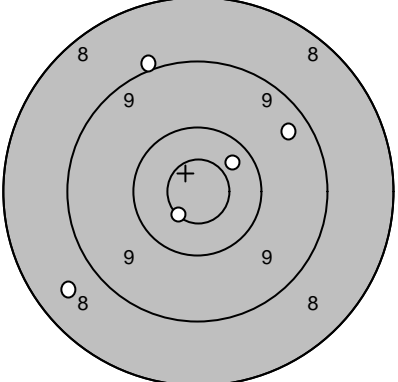
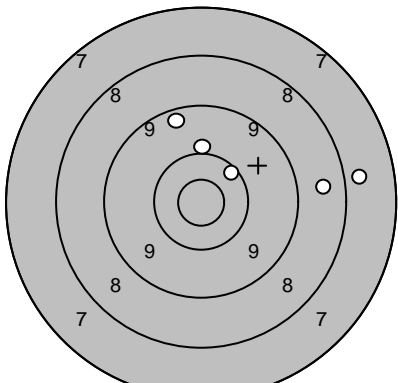
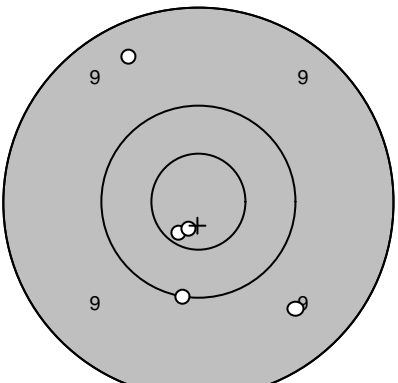
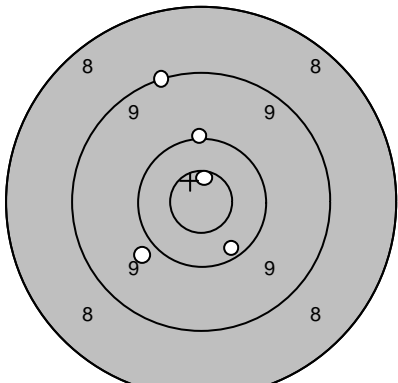
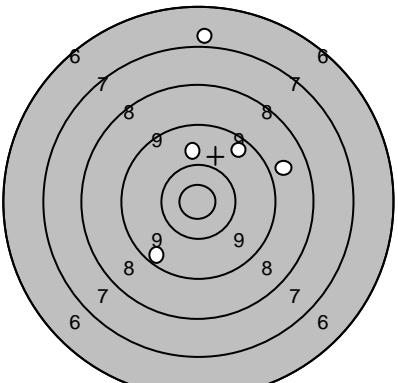
Skjutlag 3	Tavla 12	Rolf Åslin		
		Liden		
13.07.2007	Tavelträffen A 2007	Ramselefors SKF		
Provskott		1: 10,6* ↖ 2: 8,5 ↘ 3: 8,3 ↗ 4: 8,0 ↖ 5: 10,7* ↘	Serie 1 	1: 10,6* ↘ 2: 9,4 ↗ 3: 9,0 ↖ 4: 10,4 ↗ 5: 8,6 ↖
		Serie 44,0	Serie 46,0	
		Totalt 0,0	Totalt 46,0	
Serie 2		1: 7,9 → 2: 10,0 ↑ 3: 8,6 → 4: 9,4 ↑ 5: 10,3 ↗	Serie 3 	1: 10,7* ↘ 2: 9,6 ↘ 3: 9,4 ↖ 4: 10,1 ↘ 5: 10,7* ↘
		Serie 44,0	Serie 48,0	
		Totalt 90,0	Totalt 138,0	
Extratävling 10		1: 9,1 ↖ 2: 9,9 ↘ 3: 10,7* ↑ 4: 10,2 ↘ 5: 10,1 ↑	Extratävling 10 	6: 9,4 ↘ 7: 8,8 → 8: 9,9 ↑ 9: 6,9 ↑ 10: 9,5 ↗
		Serie 48,0	Serie 41,0	
		Totalt 186,0	Totalt 227,0	

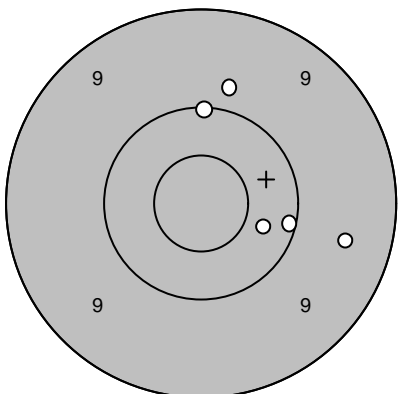
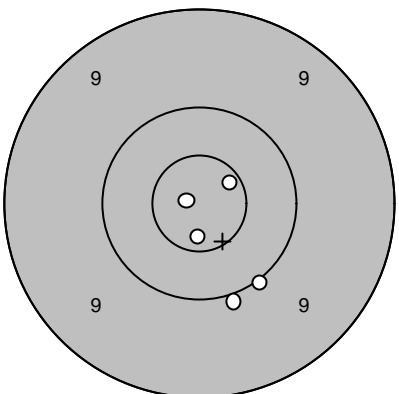
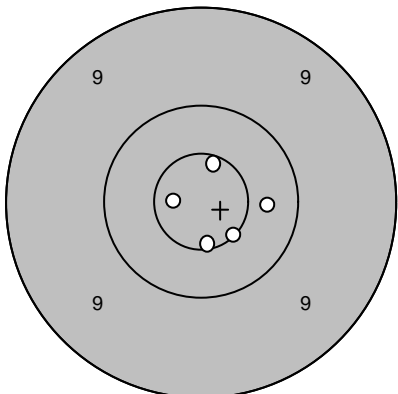
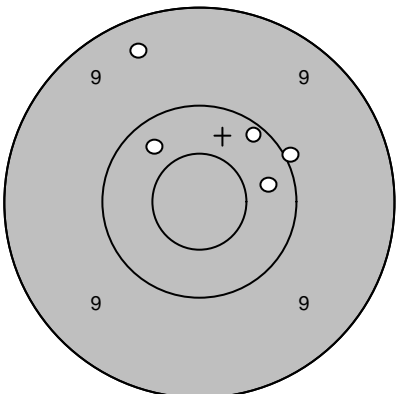
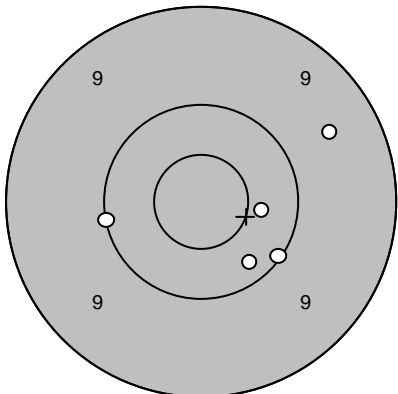
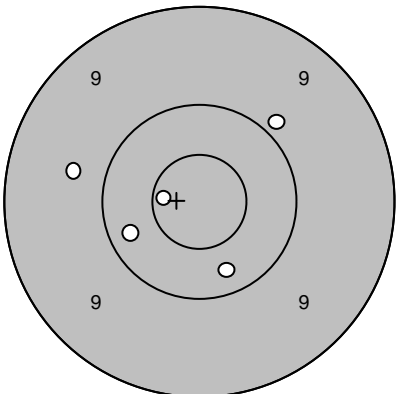
Skjutlag	Tavla	Peter Ericson		
3	13	Loos		
13.07.2007	Tavelträffen A 2007	Ramselefors SKF		
Provskott		1: 10,1 ↑ 2: 9,8 ↑ 3: 10,1 → 4: 10,4 → 5: 9,5 →	Serie 1 	1: 10,9* ← 2: 10,0 ↓ 3: 10,7* ↗ 4: 10,0 ↓ 5: 10,7* ↓
	Serie 48,0		Serie 50,0	
	Totalt 0,0		Totalt 50,0	
Serie 2		1: 10,6* ↑ 2: 10,4 → 3: 10,8* ← 4: 10,6* ↓ 5: 10,6* ↓	Serie 3 	1: 9,4 ↑ 2: 10,2 ↗ 3: 10,3 ↖ 4: 10,3 → 5: 10,0 ↗
	Serie 50,0		Serie 49,0	
	Totalt 100,0		Totalt 149,0	
Extratävling 10		1: 9,5 ↗ 2: 10,4 → 3: 10,0 ← 4: 10,3 ↓ 5: 10,1 ↓	Extratävling 10 	6: 9,9 ↗ 7: 10,7* ← 8: 9,7 ← 9: 10,3 ← 10: 10,3 ↓
	Serie 49,0		Serie 48,0	
	Totalt 198,0		Totalt 246,0	

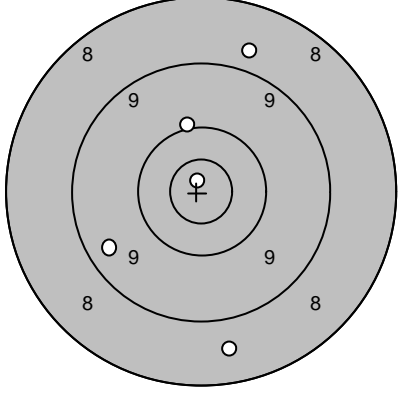
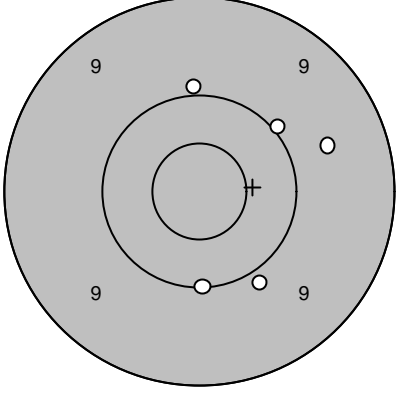
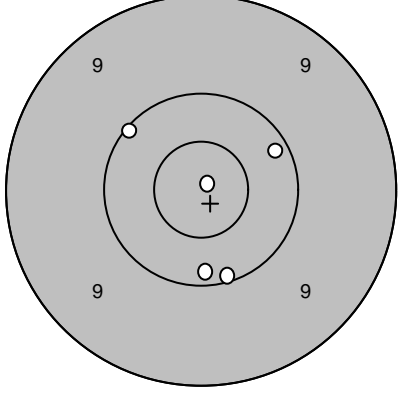
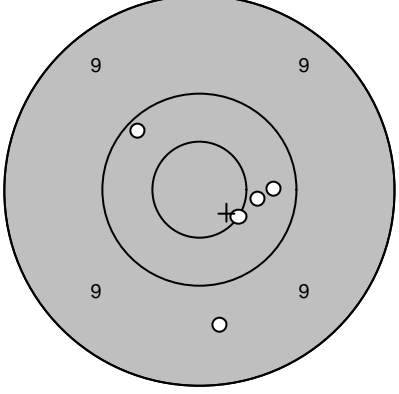
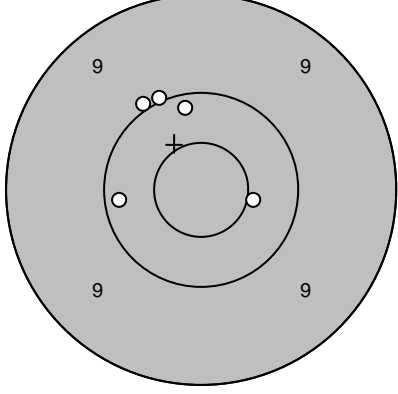
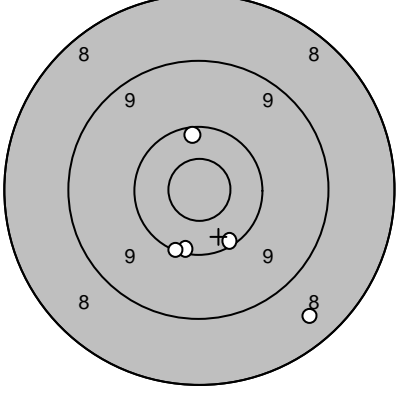
Skjutlag	Tavla	Daniel Wallberg	
3	14		
		Loos	
13.07.2007	Tavelträffen A 2007	Ramselefors SKF	
Provskott 	1: 10,0 ↑ 2: 8,8 ↑ 3: 10,9* ↑ 4: 9,4 ← 5: 8,6 ↓	Serie 1 	1: 9,6 → 2: 10,0 ↗ 3: 10,0 ↑ 4: 9,9 ↓ 5: 10,1 ↓
	Serie 45,0		Serie 48,0
	Totalt 0,0		Totalt 48,0
Serie 2 	1: 10,1 ↖ 2: 10,1 ↓ 3: 10,2 ↓ 4: 10,2 ↗ 5: 10,9* ↗	Serie 3 	1: 10,2 ↗ 2: 10,3 → 3: 10,5* ↓ 4: 10,4 → 5: 9,6 ↓
	Serie 50,0		Serie 49,0
	Totalt 98,0		Totalt 147,0
Extratävling 10 	1: 10,0 ↖ 2: 10,2 ← 3: 10,2 ↑ 4: 10,0 ↑ 5: 10,5* →	Extratävling 10 	6: 10,2 ↑ 7: 10,1 ↓ 8: 10,1 ↓ 9: 8,5 ↓ 10: 10,2 ↓
	Serie 50,0		Serie 48,0
	Totalt 197,0		Totalt 245,0

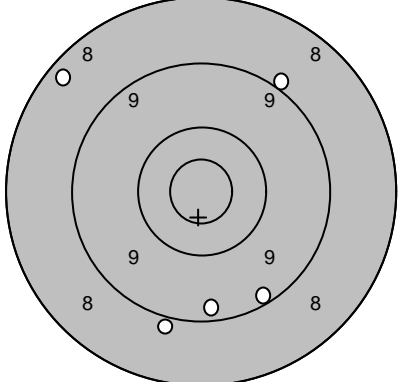
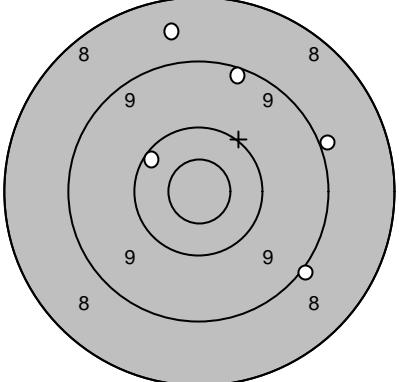
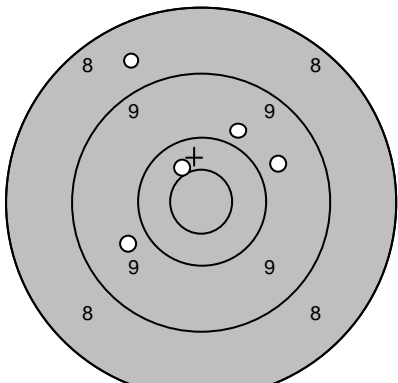
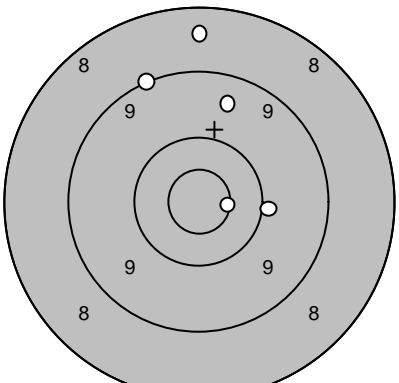
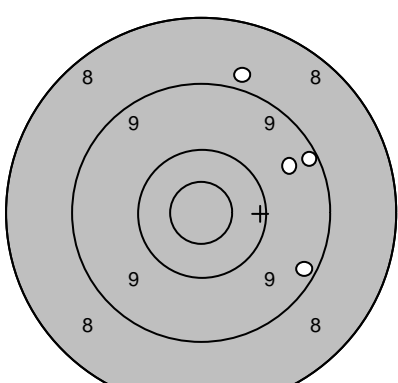
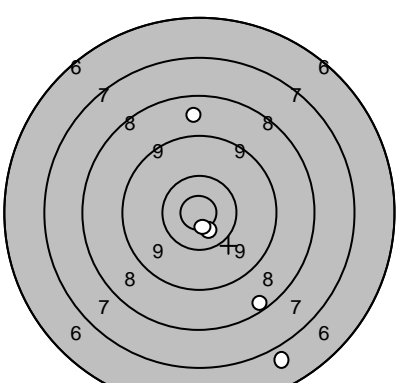
Skjutlag	Tavla	Gustav Karlsson		
3	15	Loos		
13.07.2007	Tavelträffen A 2007	Ramselefors SKF		
Provskott		1: 9,0 ↗ 2: 9,2 ↘ 3: 8,3 ↗ 4: 8,9 ↘ 5: 9,3 ↘	Serie 1 	1: 10,2 ↖ 2: 9,2 ↑ 3: 9,0 → 4: 9,0 ↘ 5: 8,6 ↑
	Serie 43,0		Serie 45,0	
	Totalt 0,0		Totalt 45,0	
Serie 2		1: 9,8 ↗ 2: 10,5* ↖ 3: 9,8 → 4: 8,7 ↖ 5: 9,8 ↙	Serie 3 	1: 10,0 → 2: 9,5 ↑ 3: 10,6* → 4: 8,5 ↑ 5: 9,1 ↖
	Serie 45,0		Serie 46,0	
	Totalt 90,0		Totalt 136,0	
Extratävling 10		1: 9,5 → 2: 9,3 → 3: 9,2 → 4: 8,9 ↑ 5: 8,2 ↘	Extratävling 10 	6: 8,4 ↘ 7: 10,7* ↘ 8: 6,9 ↘ 9: 10,8* ↘ 10: 8,7 ↑
	Serie 43,0		Serie 42,0	
	Totalt 179,0		Totalt 221,0	

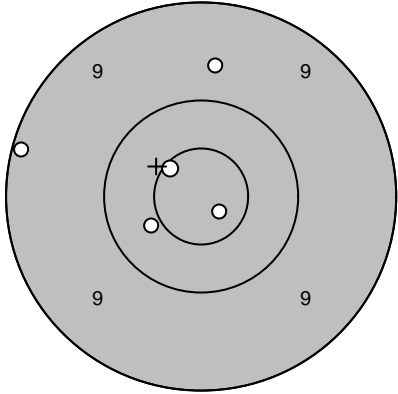
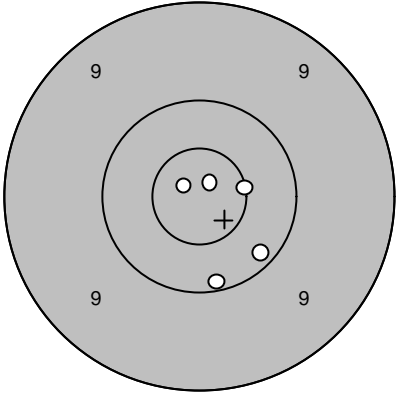
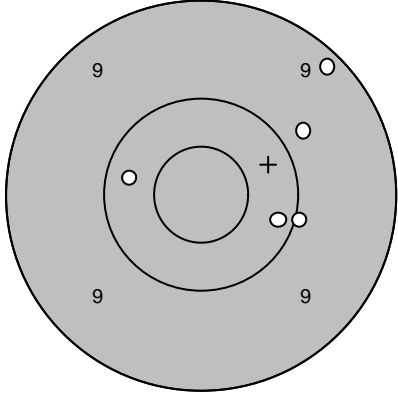
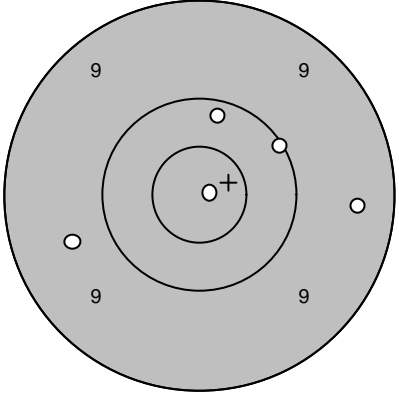
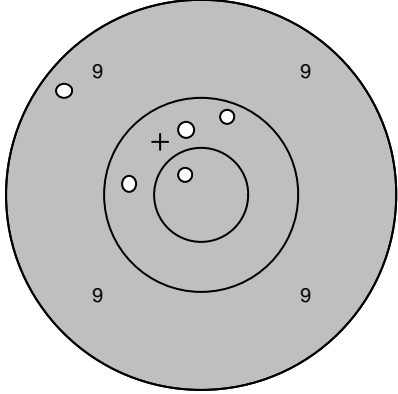
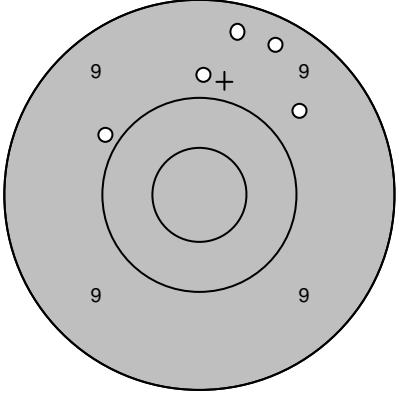
Skjutlag	Tavla	Tommy Lundqvist		
3	17	Ununge		
13.07.2007	Tavelträffen A 2007	Ramselefors SKF		
Provskott		1: 9,7 ↑ 2: 10,4 ← 3: 10,6* ↗ 4: 9,1 ← 5: 10,8* ↘	Serie 1 	1: 10,9* ↖ 2: 10,9* ↗ 3: 10,6* → 4: 10,2 ↘ 5: 10,1 ↓
		Serie 48,0	Serie 50,0	
		Totalt 0,0	Totalt 50,0	
Serie 2		1: 10,0 → 2: 9,8 ↗ 3: 9,2 ↗ 4: 10,2 → 5: 10,3 ←	Serie 3 	1: 10,2 ↑ 2: 10,9* → 3: 9,4 → 4: 10,1 ↗ 5: 9,7 ←
		Serie 48,0	Serie 48,0	
		Totalt 98,0	Totalt 146,0	
Extratävling 10		1: 10,8* ↖ 2: 9,3 ↖ 3: 10,2 ↑ 4: 10,4 ↑ 5: 10,3 ←	Extratävling 10 	6: 9,8 ↑ 7: 9,9 ↖ 8: 9,7 ↗ 9: 9,3 ↗ 10: 9,3 ↑
		Serie 49,0	Serie 45,0	
		Totalt 195,0	Totalt 240,0	

Skjutlag

Tavla

3

18

Peter Lundqvist

Ununge

13.07.2007

Tavelträffen A 2007

Ramselefors SKF

Provskott

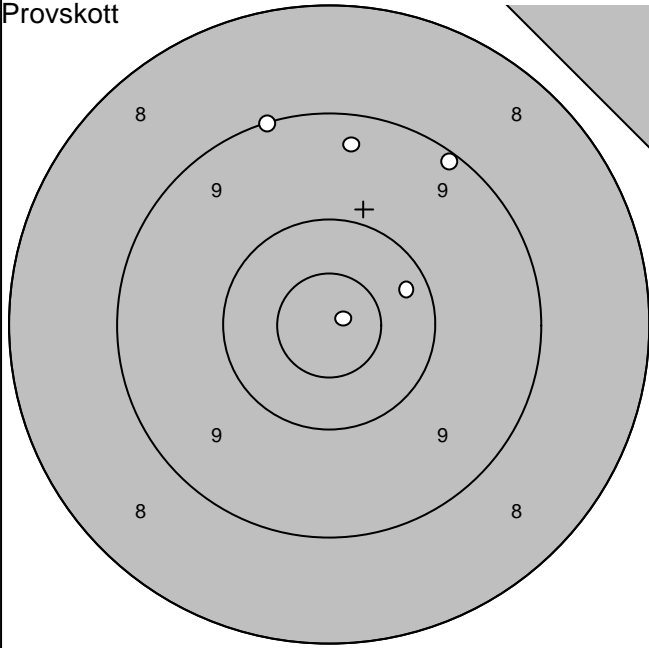

Serie 1

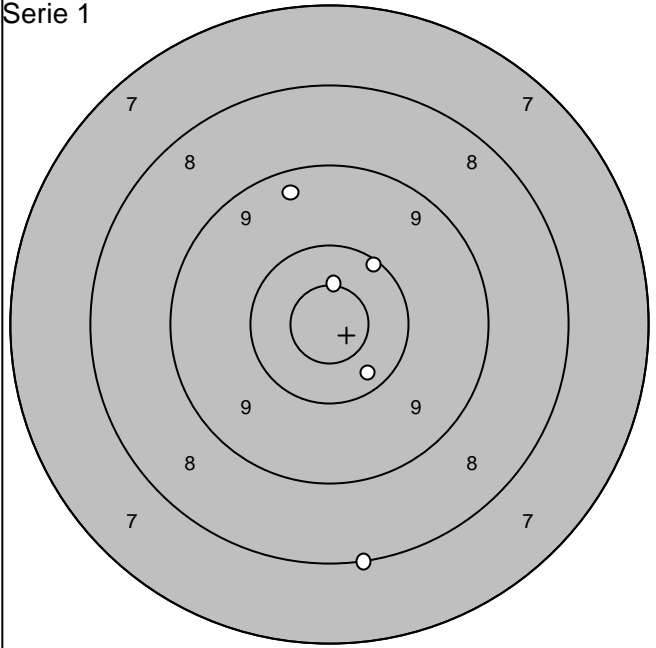

1: 9,3 ↑
 2: 10,9* →
 3: 9,1 ↗
 4: 9,1 ↑
 5: 10,2 →

Serie 47,0
 Totalt 0,0

1: 8,1 ↓
 2: 9,3 ↑
 3: 10,3 ↘
 4: 10,5* ↑
 5: 10,1 ↗

Serie 47,0
 Totalt 47,0

Serie 2

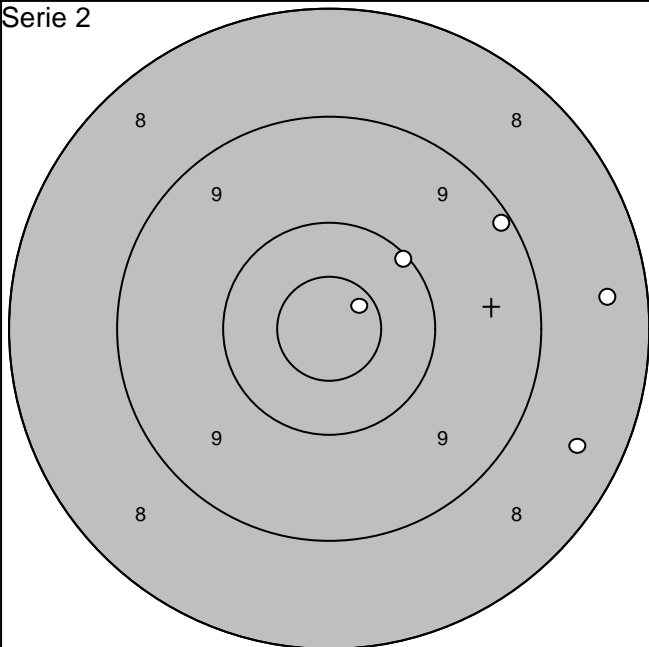

Serie 3

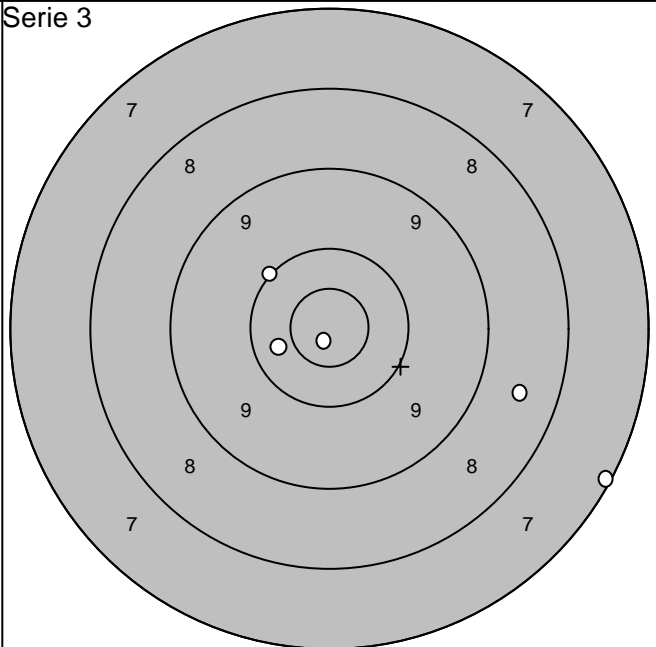

1: 10,1 ↗
 2: 8,5 →
 3: 8,4 →
 4: 9,1 ↗
 5: 10,7* ↗

Serie 45,0
 Totalt 92,0

1: 8,6 →
 2: 7,1 →
 3: 10,4 ←
 4: 10,9* ↘
 5: 10,0 ↖

Serie 45,0
 Totalt 137,0

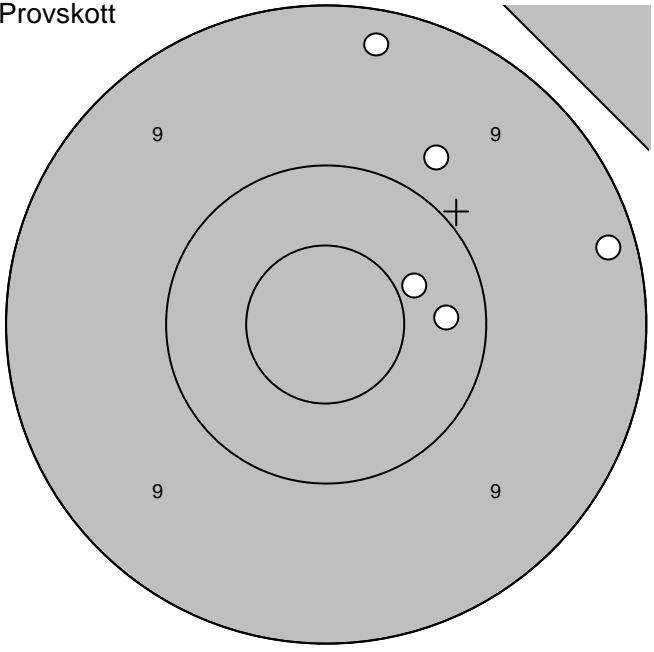
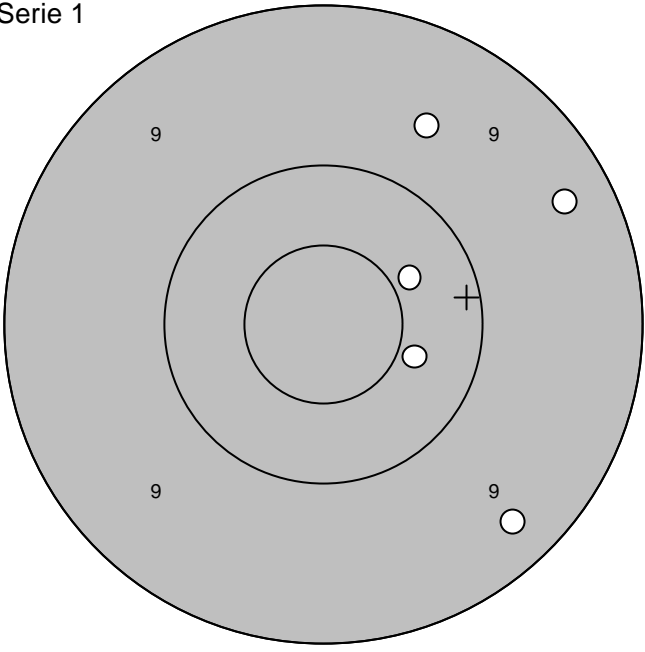
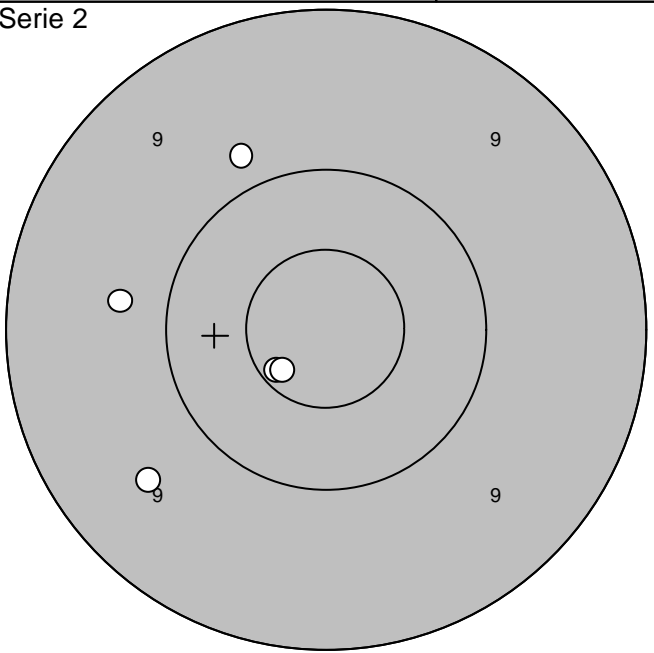
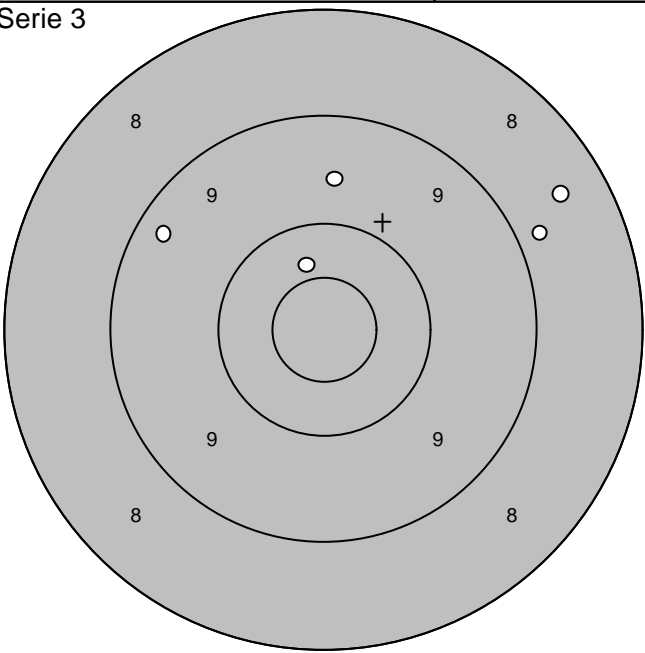
Skjutlag 3	Tavla 19	Markus Andersson	
		Bälinge-Jumkil	
13.07.2007	Tavelträffen A 2007	Ramselefors SKF	
Provskott		Serie 1	
			
1:10,3 →	Serie 47,0	1: 9,3 ↘	Serie 47,0
2: 9,2 →		2:10,4 ↗	
3: 9,3 ↑	Totalt 0,0	3: 9,3 ↗	Totalt 47,0
4: 9,8 ↗		4: 9,6 ↗	
5:10,4 ↗		5:10,4 →	
Serie 2		Serie 3	
			
1:10,6* ↙	Serie 47,0	1:10,4 ↑	Serie 44,0
2:10,7* ↙		2: 8,5 ↗	
3: 9,8 ↗	Totalt 94,0	3: 8,8 ↗	Totalt 138,0
4: 9,7 ←		4: 9,6 ↑	
5: 9,6 ↙		5: 9,3 ↙	

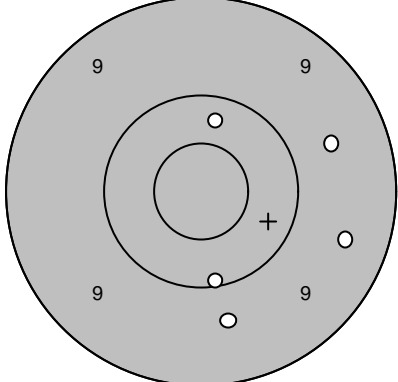
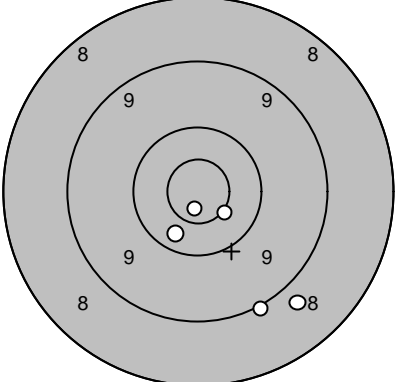
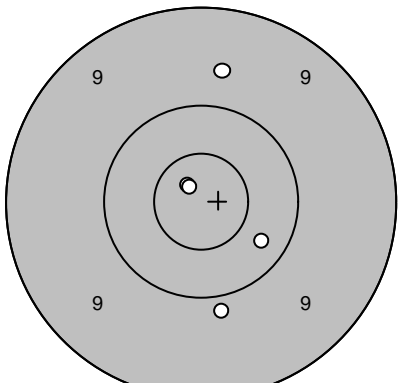
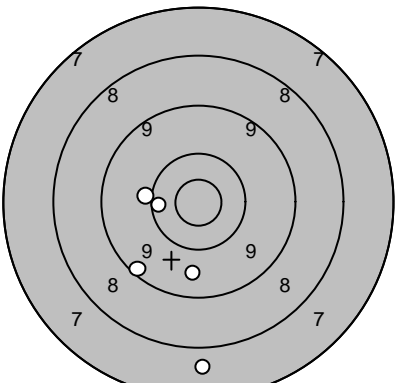
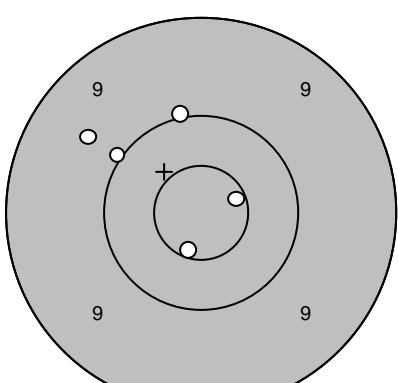
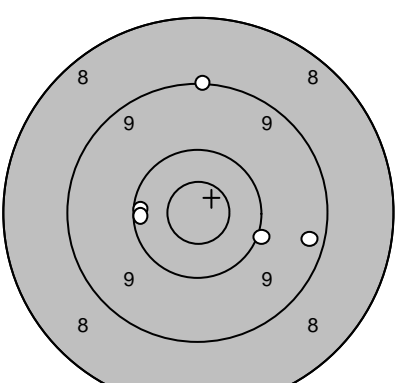
Skjutlag 3	Tavla 21	Elina Högström		
		Ramselefors		
13.07.2007	Tavelträffen A 2007	Ramselefors SKF		
Provskott		1: 9,6 → 2: 9,5 → 3: 10,1 ↓ 4: 9,7 ↓ 5: 10,3 ↑	Serie 1 	1: 8,8 ↓ 2: 9,0 ↓ 3: 10,8* ↓ 4: 10,6* ↓ 5: 10,3 ↓
		Serie 47,0	Serie 47,0	
		Totalt 0,0	Totalt 47,0	
Serie 2		1: 10,8* ↗ 2: 9,7 ↑ 3: 10,8* ↗ 4: 10,3 → 5: 9,9 ↓	Serie 3 	1: 9,3 ↙ 2: 10,0 ← 3: 9,7 ↓ 4: 7,7 ↓ 5: 10,3 ←
		Serie 48,0	Serie 45,0	
		Totalt 95,0	Totalt 140,0	
Extratävling 10		1: 10,7* → 2: 10,6* ↓ 3: 9,6 ↗ 4: 10,0 ↑ 5: 10,0 ↗	Extratävling 10 	6: 9,1 ↑ 7: 10,2 ← 8: 10,0 → 9: 9,3 → 10: 10,2 ←
		Serie 49,0	Serie 48,0	
		Totalt 189,0	Totalt 237,0	

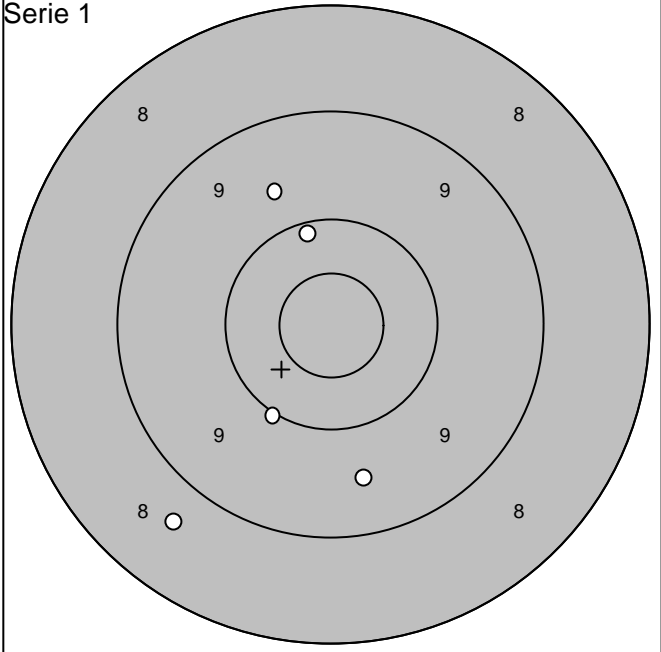
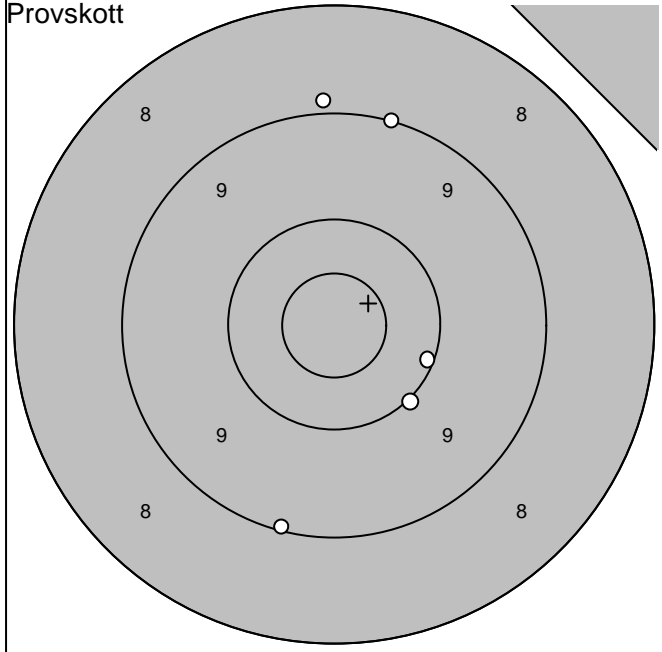

1: 9,0 ↑
2: 8,9 ↑
3:10,1 →
4:10,0 ↘
5: 9,1 ↓

Serie	46,0
Totalt	0,0

1:10,1 ↑
2: 9,7 ↑
3:10,0 ↙
4: 8,7 ↙
5: 9,6 ↓

Serie	46,0
Totalt	46,0

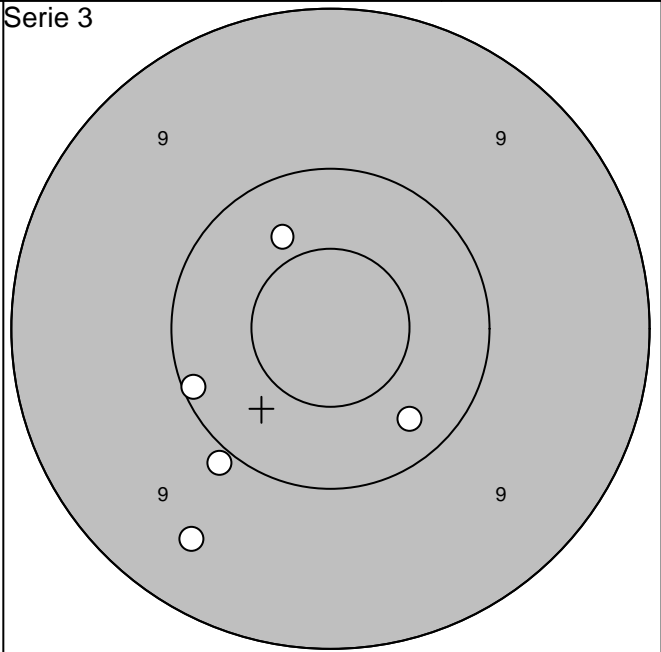
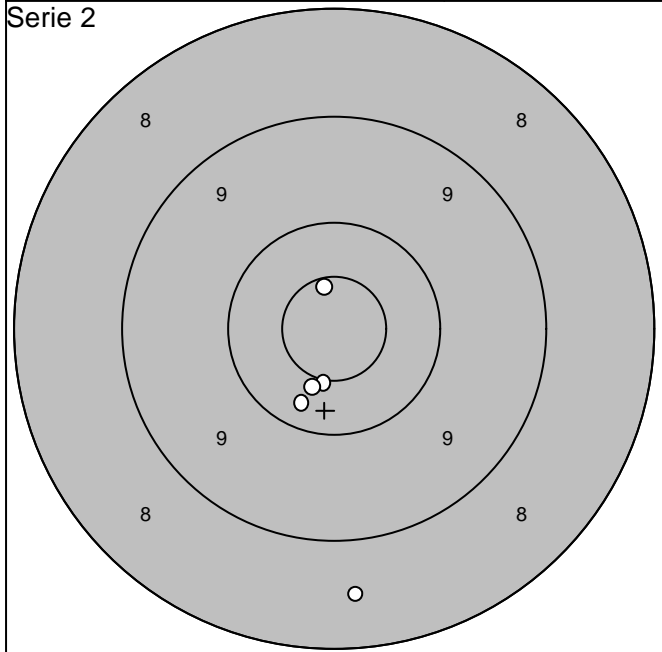

1:10,6* ↑
2:10,3 ↓
3:10,5* ↓
4:10,4 ↓
5: 8,5 ↓

Serie	48,0
Totalt	94,0

1: 9,5 ↙
2:10,4 ↗
3: 9,9 ↙
4:10,3 ↘
5:10,1 ↙

Serie	48,0
Totalt	142,0

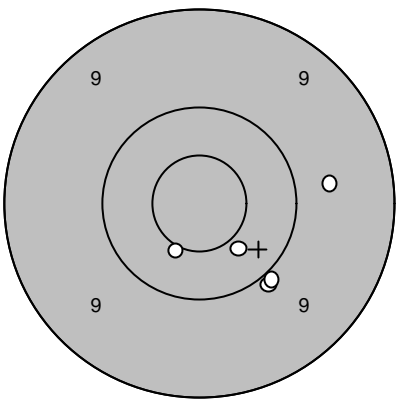
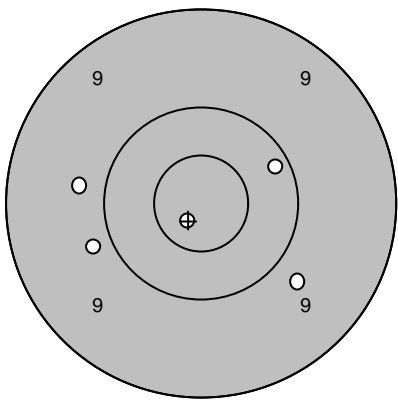
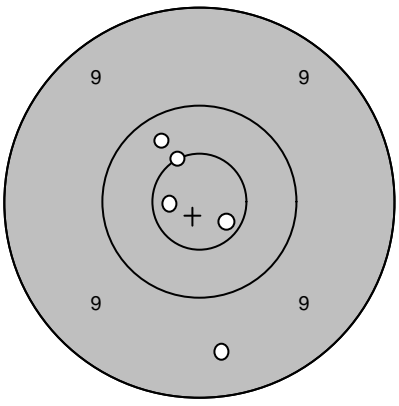
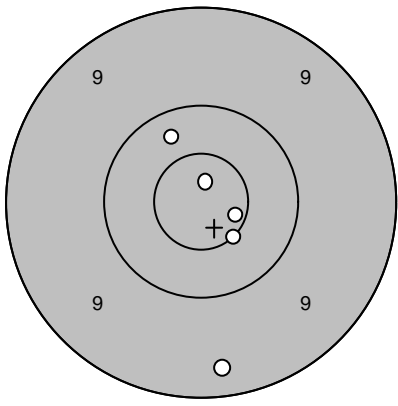
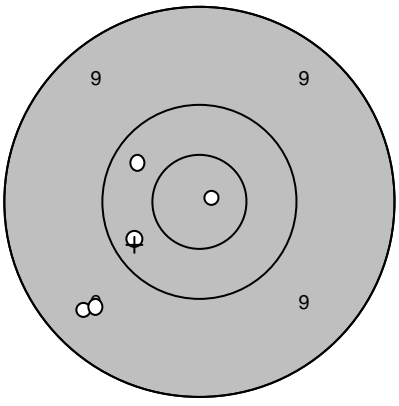
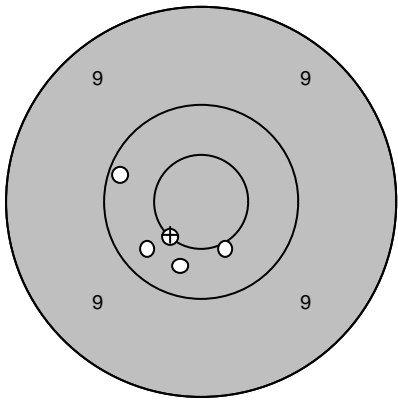
Skjutlag	Tavla	Lars Möllsten	
3	24	Umeå	
13.07.2007	Tavelträffen A 2007	Ramselefors SKF	
Provskott	1: 9,8 ← 2: 9,9 ← 3: 10,2 → 4: 10,8* ↙ 5: 9,8 ↘	Serie 1 	1: 10,5* ↓ 2: 9,9 ↓ 3: 10,0 ↓ 4: 10,4 ↓ 5: 9,7 →
	Serie 47,0 Totalt 0,0	Serie 48,0 Totalt 48,0	
Serie 2	1: 10,3 ↗ 2: 10,8* ↗ 3: 10,5* ↘ 4: 10,7* → 5: 9,3 ↓	Serie 3 	1: 10,3 ↗ 2: 10,6* ↗ 3: 9,5 ↓ 4: 10,7* ← 5: 10,7* ↘
	Serie 49,0 Totalt 97,0	Serie 49,0 Totalt 146,0	
Extratävling 10	1: 10,3 ↓ 2: 10,5* ↓ 3: 10,3 ↙ 4: 10,6* ↙ 5: 10,2 ←	Extratävling 10 	6: 9,4 ↙ 7: 10,9* → 8: 10,3 ↙ 9: 9,5 ↙ 10: 10,3 ↙
	Serie 50,0 Totalt 196,0	Serie 48,0 Totalt 244,0	

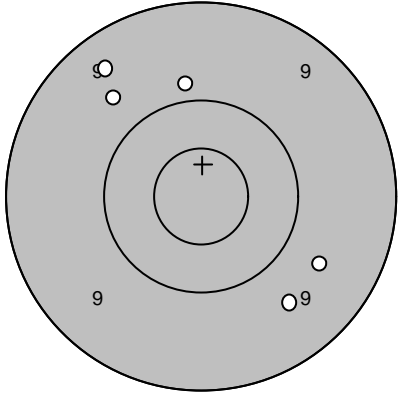
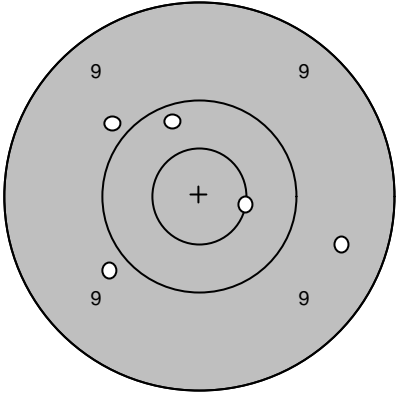
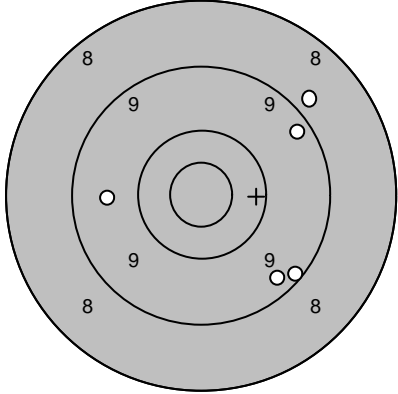
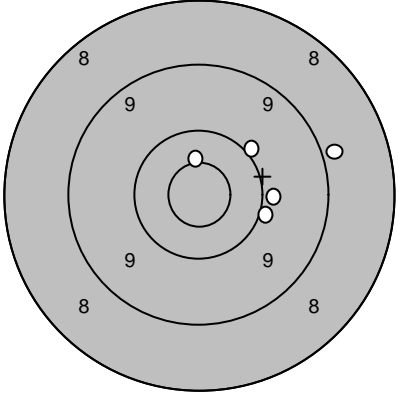
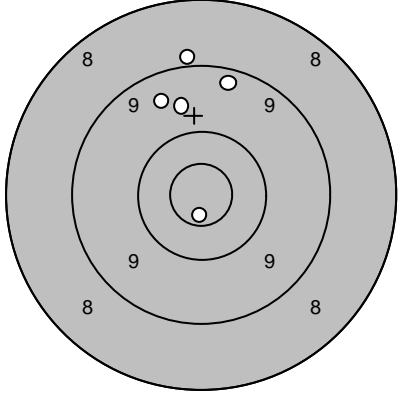
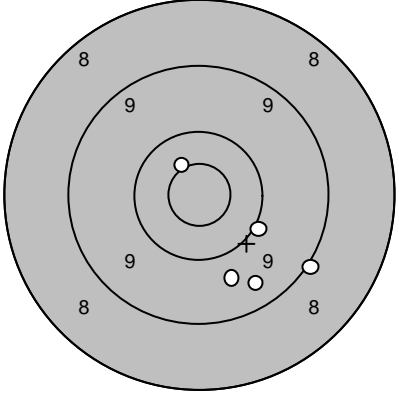
Skjutlag	Tavla	Dan-Ivan Karlsson		
4	1	Ramselefors		
13.07.2007	Tavelträffen A 2007	Ramselefors SKF		
Provskott		1: 9,9 ↗ 2: 9,4 ↗ 3: 9,7 ↗ 4: 9,6 ↘ 5: 9,6 ↘	Serie 1 	1: 10,2 ↗ 2: 9,9 ↗ 3: 9,9 ↘ 4: 9,5 ↘ 5: 10,6* →
		Serie 45,0	Serie 47,0	
		Totalt 0,0	Totalt 47,0	
Serie 2		1: 9,3 ↘ 2: 9,2 ↘ 3: 9,6 ← 4: 9,3 ↗ 5: 8,9 ↗	Serie 3 	1: 10,0 → 2: 10,5* ↑ 3: 9,9 → 4: 10,0 ↗ 5: 8,9 →
		Serie 44,0	Serie 47,0	
		Totalt 91,0	Totalt 138,0	
Extratävling 10		1: 10,8* ↓ 2: 9,5 ↗ 3: 9,0 ↑ 4: 9,3 ↑ 5: 9,7 ↑	Extratävling 10 	6: 10,0 ↘ 7: 9,7 ↘ 8: 10,5* ↗ 9: 9,0 ↘ 10: 9,5 ↘
		Serie 46,0	Serie 47,0	
		Totalt 184,0	Totalt 231,0	

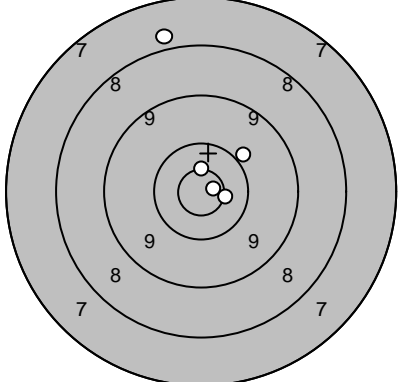
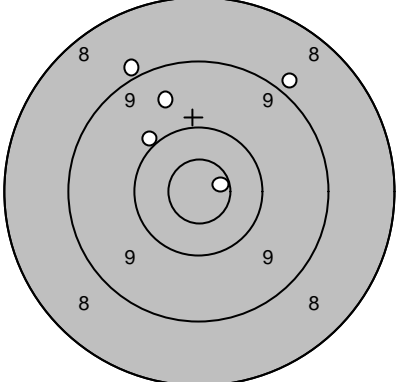
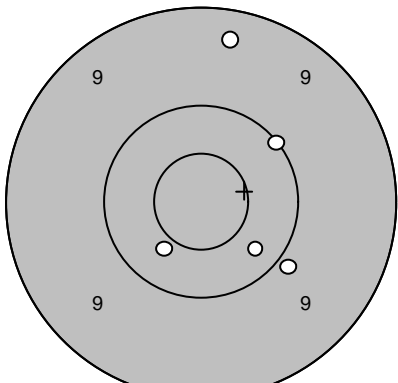
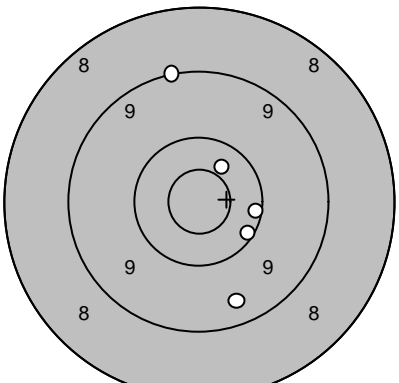
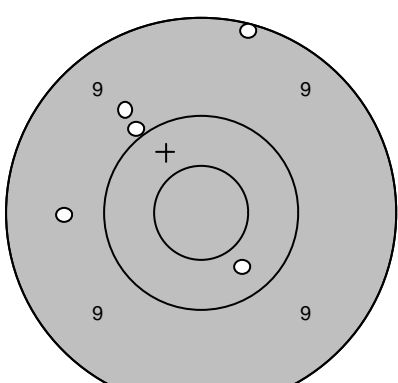
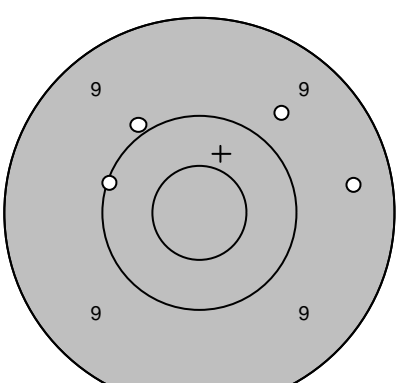
Skjutlag 4	Tavla 2	Jan-Erik Karlsson	
		Ramselefors	
13.07.2007	Tavelträffen A 2007	Ramselefors SKF	
Provskott		1: 7,9 ↑ 2: 10,6* ↑ 3: 10,0 ↗ 4: 10,9* → 5: 10,6* →	Serie 1 
			1: 8,9 ↗ 2: 9,6 ↑ 3: 10,0 ↗ 4: 8,9 ↑ 5: 10,7* →
		Serie 47,0	Serie 45,0
		Totalt 0,0	Totalt 45,0
Serie 2		1: 9,4 ↑ 2: 9,9 ↘ 3: 10,3 ↘ 4: 10,1 ↗ 5: 10,4 ↙	Serie 3 
			1: 9,1 ↑ 2: 10,2 → 3: 10,4 ↗ 4: 9,5 ↘ 5: 10,2 ↘
		Serie 48,0	Serie 48,0
		Totalt 93,0	Totalt 141,0
Extratävling 10		1: 9,6 ← 2: 10,0 ↗ 3: 9,7 ↗ 4: 10,3 ↘ 5: 9,1 ↑	Extratävling 10 
			6: 10,1 ← 7: 9,7 ↗ 8: 9,9 ↗ 9: 9,4 →
		Serie 47,0	Serie 37,0
		Totalt 188,0	Totalt 225,0

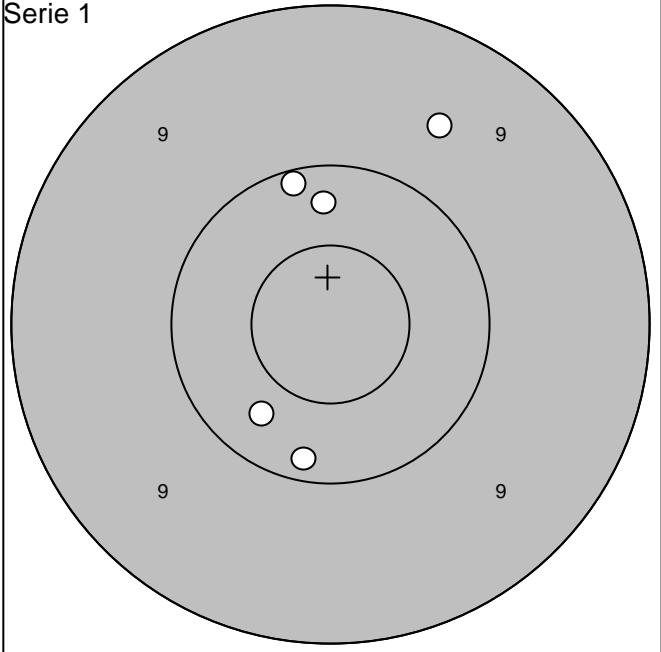
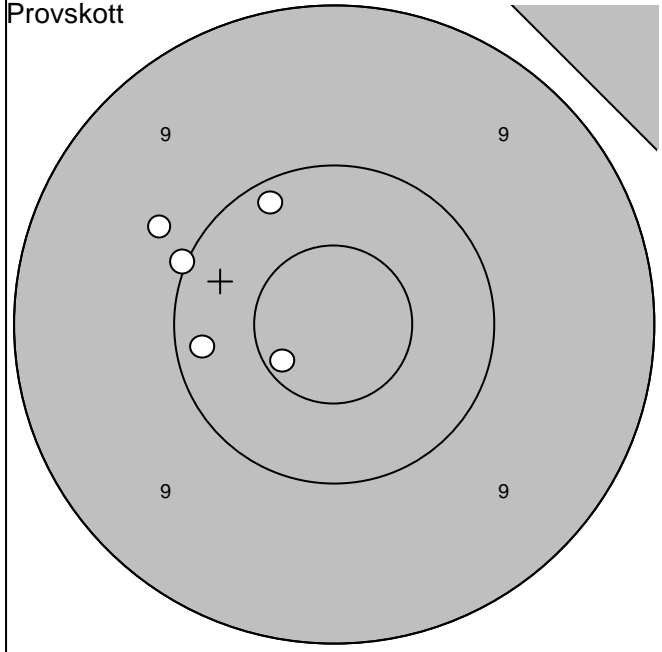

1:10,2 ←	Serie	49,0
2: 9,8 ↖		
3:10,2 ↗	Totalt	0,0
4:10,0 ←		
5:10,6* ↙		

1: 9,6 ↗	Serie	49,0
2:10,3 ↑		
3:10,1 ↑	Totalt	49,0
4:10,2 ↓		
5:10,3 ↘		

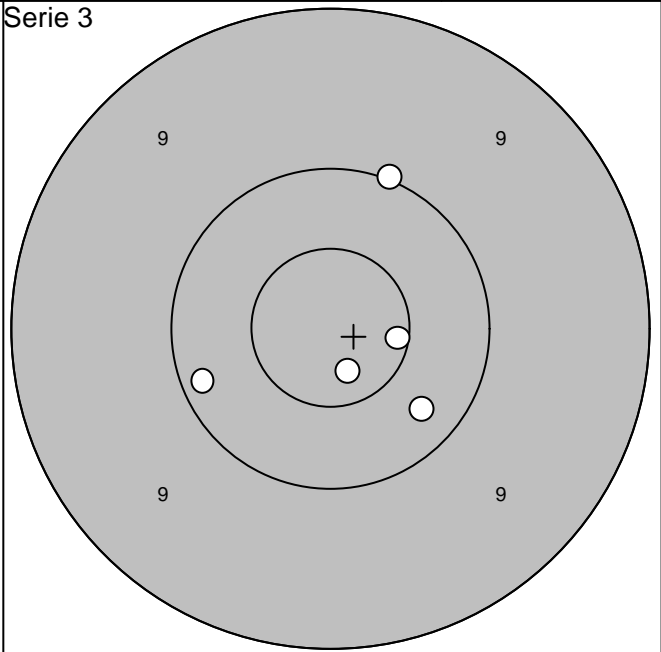
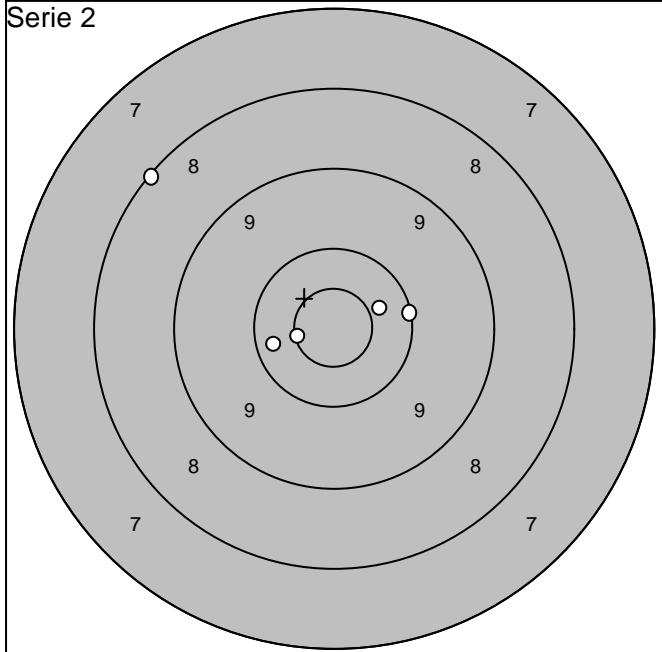

1:10,3 ←	Serie	48,0
2:10,6* ←		
3:10,1 →	Totalt	97,0
4: 8,1 ↖		
5:10,4 ↗		

1:10,6* →	Serie	50,0
2:10,0 ↑		
3:10,2 ←	Totalt	147,0
4:10,3 ↓		
5:10,7* ↓		

Skjutlag 4	Tavla 4	Sture Allansson	
		Stenungsund	
13.07.2007	Tavelträffen A 2007	Ramselefors SKF	
Provskott		Serie 1	
1: 10,1 ↗	Serie 48,0	1: 9,0 ↗	Serie 47,0
2: 9,9 →		2: 10,7* ↓	
3: 10,6* ↓	Totalt 0,0	3: 10,4 ↓	Totalt 47,0
4: 10,2 ↓		4: 9,4 ↗	
5: 9,8 ↙		5: 9,7 →	
Serie 2		Serie 3	
1: 8,9 →	Serie 43,0	1: 9,2 ↗	Serie 46,0
2: 10,3 →		2: 9,7 ↓	
3: 8,6 →	Totalt 90,0	3: 10,8* ↓	Totalt 136,0
4: 8,9 ↗		4: 9,6 →	
5: 9,5 ↙		5: 9,8 ↗	

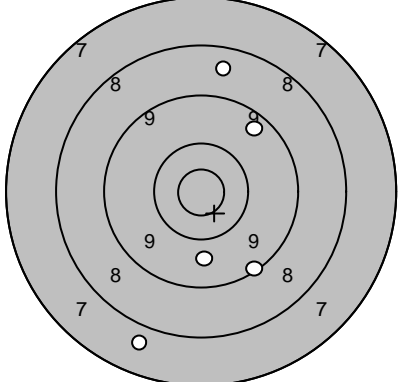
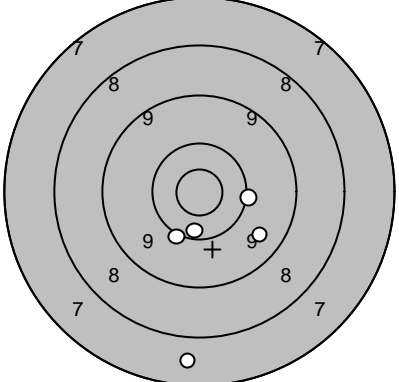
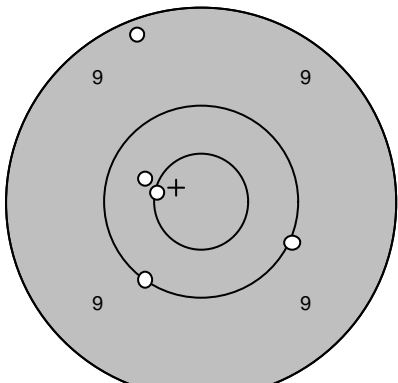
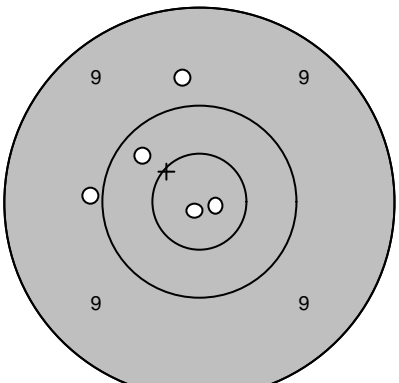
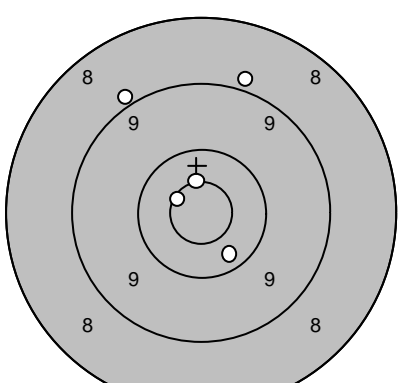
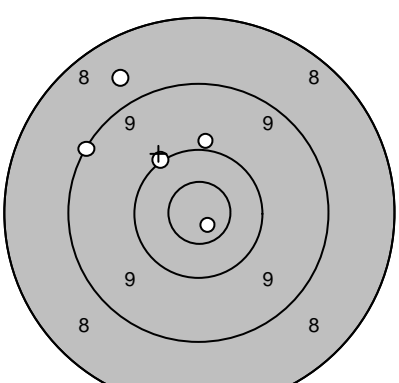
Skjutlag	Tavla	Börje Erlandsson		
4	5	Vikingen		
13.07.2007	Tavelträffen A 2007	Ramselefors SKF		
Provskott		1: 8,6 ↑ 2: 9,7 ↓ 3: 9,4 ↗ 4: 7,8 ↓ 5: 9,2 ↓	Serie 1 	1: 10,1 → 2: 9,6 ↘ 3: 10,1 ↓ 4: 7,7 ↓ 5: 10,3 ↓
		Serie 42,0	Serie 46,0	
		Totalt 0,0	Totalt 46,0	
Serie 2		1: 9,2 ↑ 2: 10,0 → 3: 10,4 ← 4: 10,6* ← 5: 10,0 ↓	Serie 3 	1: 9,9 ← 2: 10,3 ↗ 3: 9,8 ↑ 4: 10,9* ↓ 5: 10,9* →
		Serie 49,0	Serie 48,0	
		Totalt 95,0	Totalt 143,0	
Extratävling 10		1: 9,0 ↖ 2: 8,9 ↑ 3: 10,7* ← 4: 10,3 ↓ 5: 10,6* ↑	Extratävling 10 	6: 10,1 ↗ 7: 10,0 ↑ 8: 9,1 ↗ 9: 10,8* ↓ 10: 8,7 ↗
		Serie 47,0	Serie 47,0	
		Totalt 190,0	Totalt 237,0	

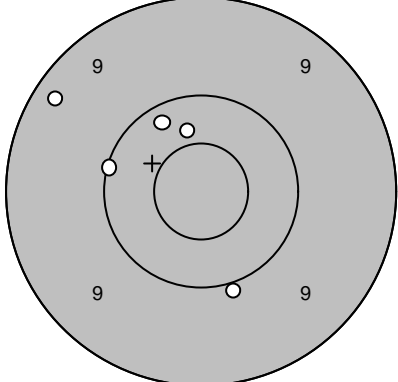
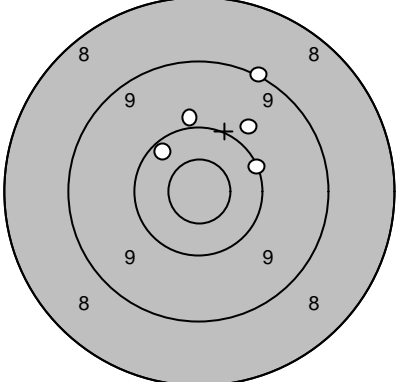
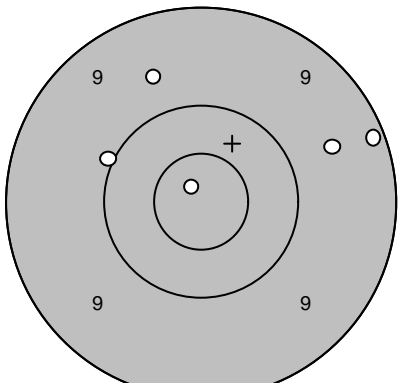
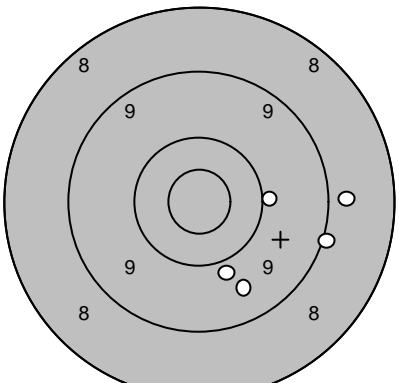
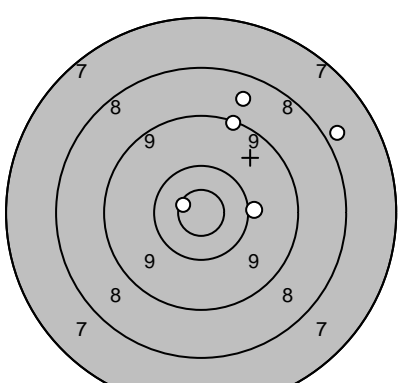
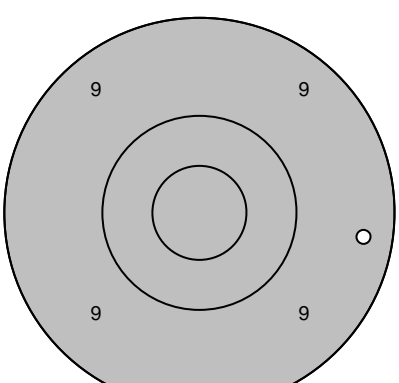
Skjutlag 4	Tavla 6	Owe Gustafsson		
		Solberga		
13.07.2007	Tavelträffen A 2007	Ramselefors SKF		
Provskott		1: 10,0 ↘ 2: 9,3 ↗ 3: 10,4 ↑ 4: 10,2 ↗ 5: 10,1 ↖	Serie 1 	1: 10,1 → 2: 10,3 ↖ 3: 9,9 ↑ 4: 9,8 ↗ 5: 9,1 ↗
	Serie 49,0		Serie 47,0	
	Totalt 0,0		Totalt 47,0	
Serie 2		1: 10,0 ↖ 2: 9,7 ↑ 3: 9,2 → 4: 9,6 → 5: 10,8* ↗	Serie 3 	1: 9,0 → 2: 10,0 → 3: 9,9 ↘ 4: 8,8 → 5: 9,6 ↘
	Serie 47,0		Serie 45,0	
	Totalt 94,0		Totalt 139,0	
Extratävling 10		1: 10,7* ↖ 2: 9,2 ↑ 3: 10,0 → 4: 7,9 ↗ 5: 8,6 ↗	Extratävling 10 	6: 9,3 →
	Serie 44,0		Serie 9,0	
	Totalt 183,0		Totalt 192,0	

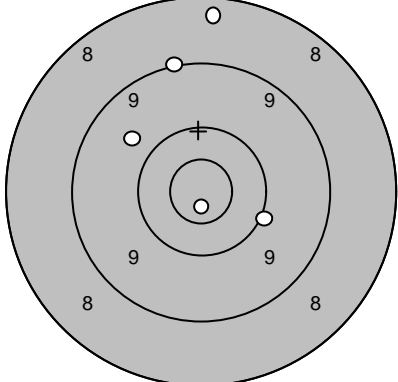
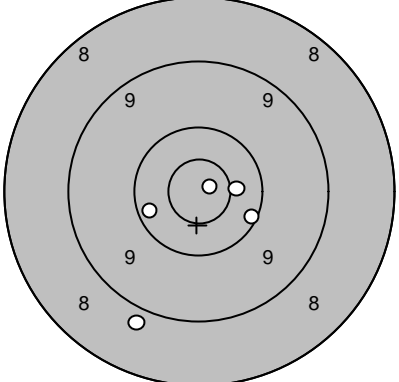
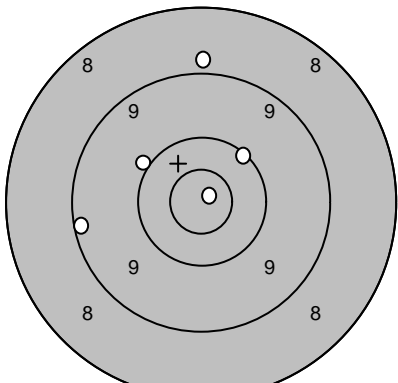
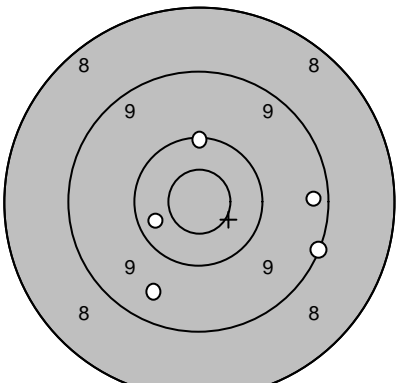
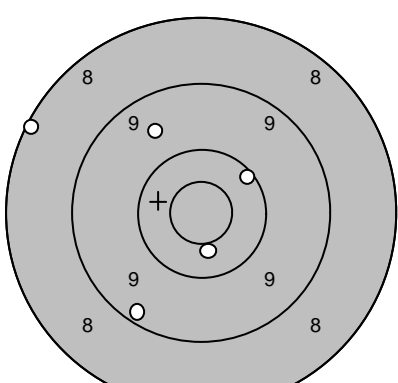
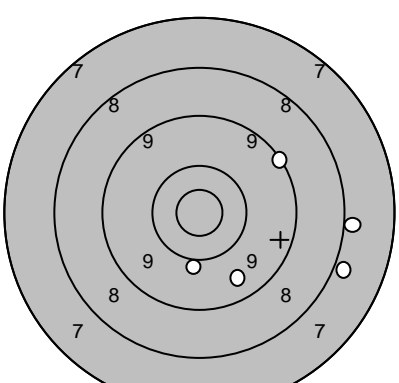
Skjutlag 4	Tavla 7	Lars Wikström	
		Strömsund	
13.07.2007	Tavelträffen A 2007	Ramselefors SKF	
Provskott		1: 9,1 ↗ 2: 10,0 ➤ 3: 8,4 ↗ 4: 10,9* ↘ 5: 9,8 ↖	Serie 1 
			1: 10,9* ➤ 2: 10,2 ➤ 3: 10,5* ➤ 4: 10,3 ← 5: 8,9 ↘
		Serie 46,0	Serie 48,0
		Totalt 0,0	Totalt 48,0
Serie 2		1: 10,1 ↗ 2: 10,9* ↗ 3: 9,2 ← 4: 10,0 ↖ 5: 8,9 ↑	Serie 3 
			1: 9,5 ↘ 2: 10,4 ← 3: 9,1 ➤ 4: 9,3 ➤ 5: 10,1 ↑
		Serie 47,0	Serie 47,0
		Totalt 95,0	Totalt 142,0
Extratävling 10		1: 8,2 ↖ 2: 9,6 ↖ 3: 9,3 ↘ 4: 10,2 ➤ 5: 10,5* ↘	Extratävling 10 
			6: 8,0 ➤ 7: 9,2 ↗ 8: 10,0 ↘ 9: 8,0 ➤ 10: 9,6 ↘
		Serie 46,0	Serie 44,0
		Totalt 188,0	Totalt 232,0

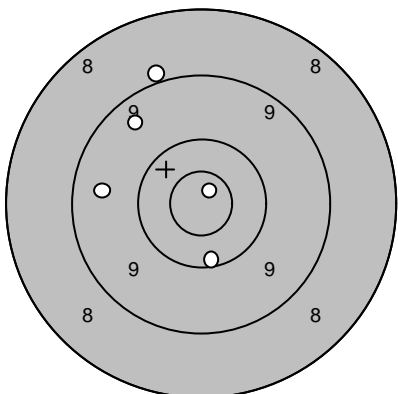
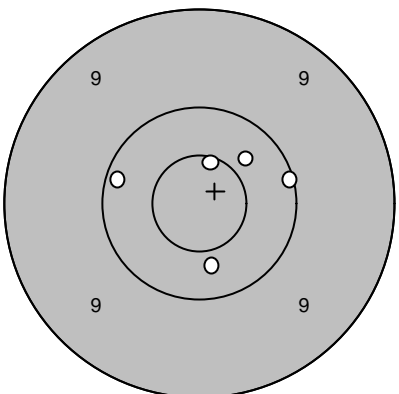
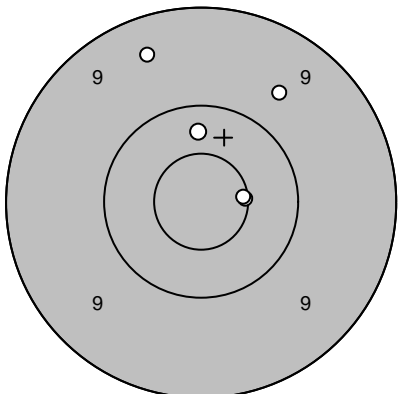
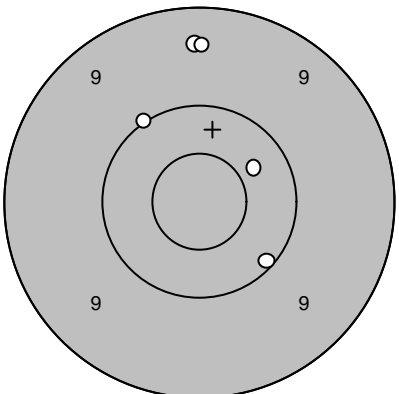
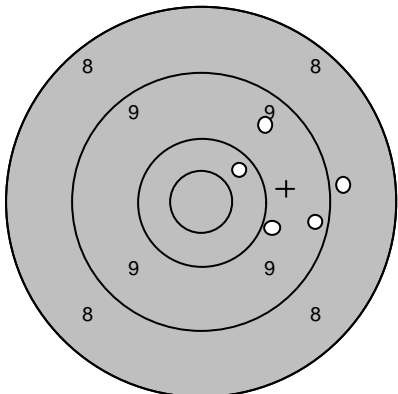
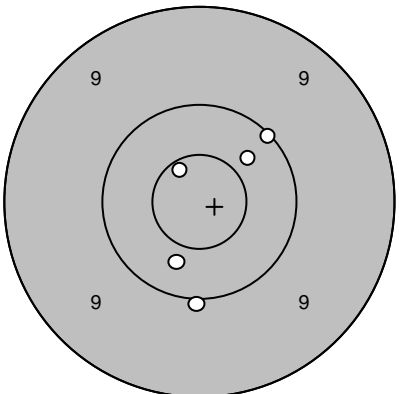
Skjutlag	Tavla	Håkan Lidman		
4	8	Skellefteå		
13.07.2007	Tavelträffen A 2007	Ramselefors SKF		
Provskott		1: 9,0 ↗ 2: 10,8* ↗ 3: 10,2 ↓ 4: 9,6 ← 5: 9,5 ↗	Serie 1 	1: 10,6* ↗ 2: 10,1 → 3: 10,4 ↓ 4: 10,2 ← 5: 10,4 ↗
	Serie 47,0		Serie 50,0	
	Totalt 0,0		Totalt 50,0	
Serie 2		1: 10,6* → 2: 10,6* → 3: 9,7 ↗ 4: 9,4 ↗ 5: 10,3 ↑	Serie 3 	1: 10,0 ↗ 2: 10,1 ↘ 3: 9,4 ↑ 4: 9,4 ↑ 5: 10,4 ↗
	Serie 48,0		Serie 48,0	
	Totalt 98,0		Totalt 146,0	
Extratävling 10		1: 9,9 → 2: 9,3 → 3: 9,5 ↗ 4: 8,9 → 5: 10,3 ↗	Extratävling 10 	6: 10,4 ↓ 7: 10,0 ↓ 8: 10,1 ↗ 9: 10,6* ↗ 10: 10,4 ↗
	Serie 45,0		Serie 50,0	
	Totalt 191,0		Totalt 241,0	

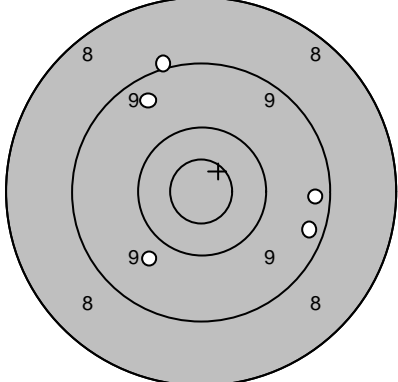
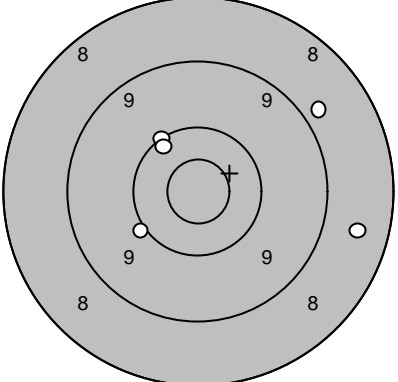
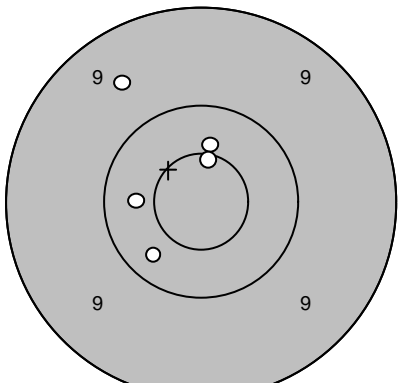
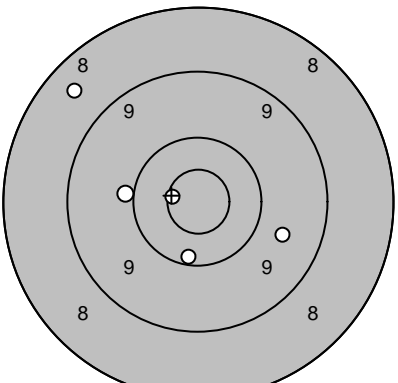
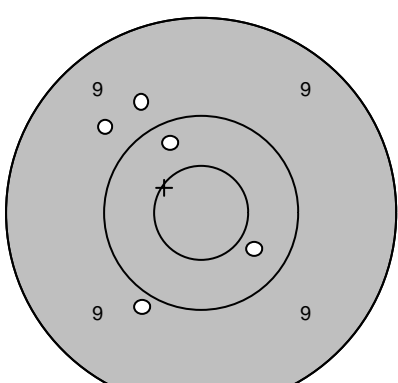
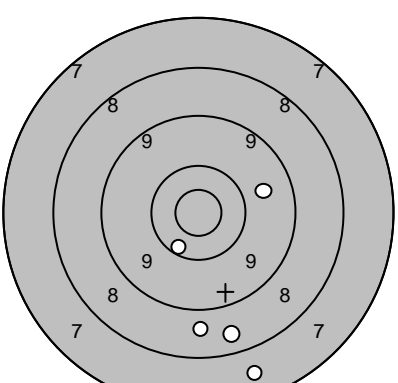
Skjutlag	Tavla	Petter Ivarsson	
4	9	Loos	
13.07.2007	Tavelträffen A 2007	Ramselefors SKF	
Provskott		1: 9,8 ↙ 2: 9,3 → 3: 9,0 ↑ 4: 9,5 ↑ 5: 9,3 →	Serie 1 
			1: 8,6 → 2: 8,8 ↗ 3: 10,0 ↙ 4: 10,1 ↗ 5: 10,2 ↗
		Serie 45,0	Serie 46,0
		Totalt 0,0	Totalt 46,0
Serie 2		1: 10,4 ↑ 2: 10,3 ↙ 3: 10,4 ← 4: 10,6* ↑ 5: 9,6 ↗	Serie 3 
			1: 10,2 ↓ 2: 10,0 ← 3: 8,5 ↗ 4: 10,7* ← 5: 9,7 →
		Serie 49,0	Serie 47,0
		Totalt 95,0	Totalt 142,0
Extratävling 10		1: 9,7 ↗ 2: 10,3 ↑ 3: 10,4 ↘ 4: 9,8 ↑ 5: 9,9 ↙	Extratävling 10 
			6: 10,3 ↙ 7: 8,5 ↓ 8: 9,7 → 9: 7,7 ↓ 10: 8,7 ↓
		Serie 47,0	Serie 42,0
		Totalt 189,0	Totalt 231,0

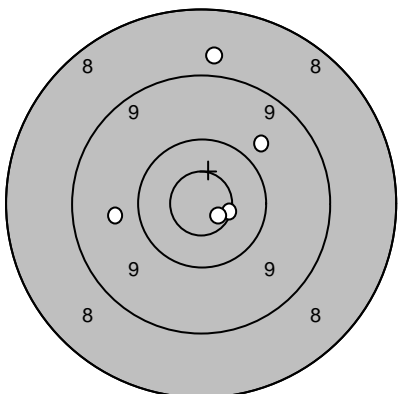
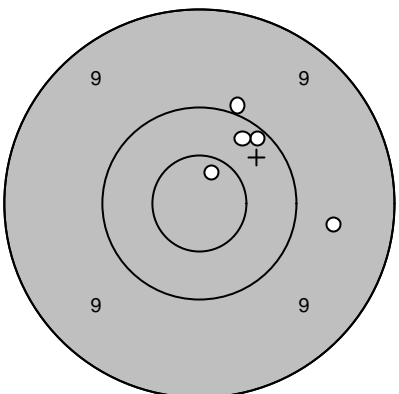
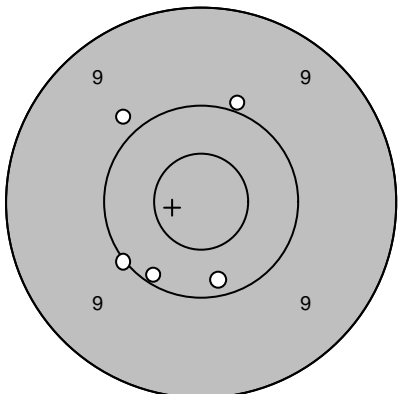
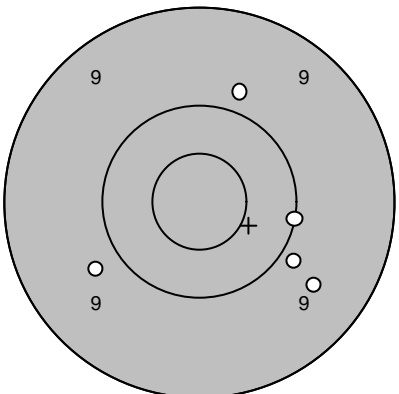
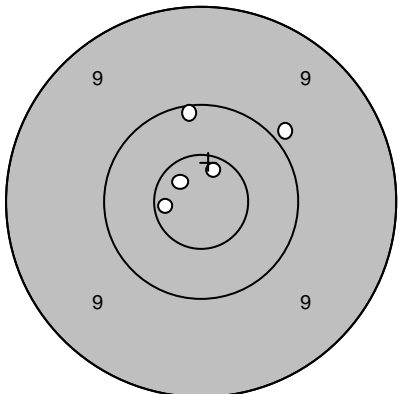
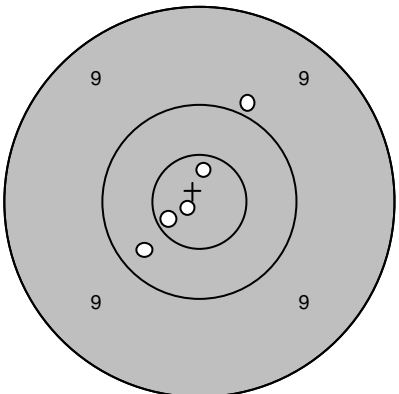
Skjutlag	Tavla	Jennie Ericson	
4	10		
Loos			
13.07.2007	Tavelträffen A 2007	Ramselefors SKF	
Provskott		1: 8,8 ↑ 2: 10,6* → 3: 10,8* ↘ 4: 9,8 ↗ 5: 9,8 ←	Serie 1 
			1: 10,1 ↗ 2: 9,6 → 3: 10,0 ↑ 4: 10,7* ↗ 5: 10,2 ↗
		Serie 46,0	Serie 49,0
		Totalt 0,0	Totalt 49,0
Serie 2		1: 10,1 ↘ 2: 10,2 ↓ 3: 10,0 ↙ 4: 9,9 ↖ 5: 10,0 ↑	Serie 3 
			1: 9,8 ↑ 2: 9,6 ↘ 3: 10,0 → 4: 9,8 ↙ 5: 9,9 ↘
		Serie 49,0	Serie 46,0
		Totalt 98,0	Totalt 144,0
Extratävling 10		1: 10,7* ← 2: 9,9 ↗ 3: 10,1 ↑ 4: 10,7* ↗ 5: 10,7* ↖	Extratävling 10 
			6: 10,9* ↙ 7: 9,9 ↗ 8: 10,7* ↙ 9: 10,3 ↙ 10: 10,7* ↑
		Serie 49,0	Serie 49,0
		Totalt 193,0	Totalt 242,0

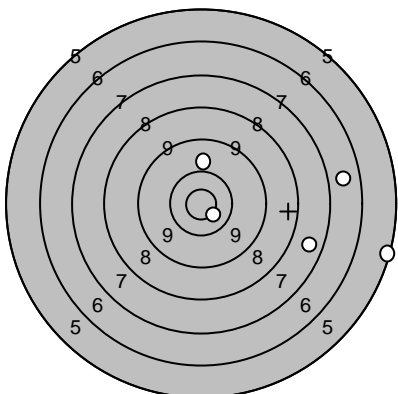
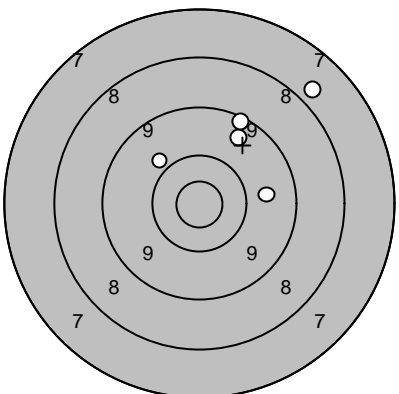
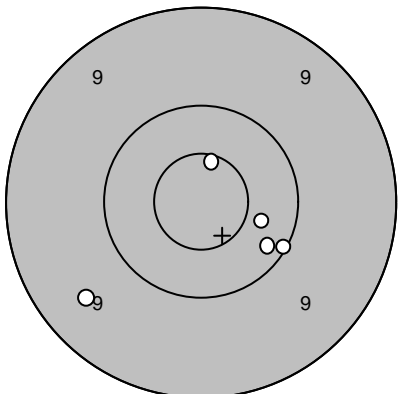
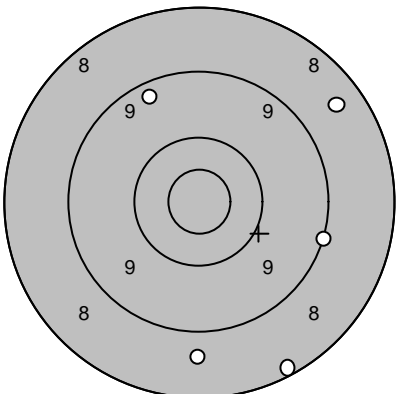
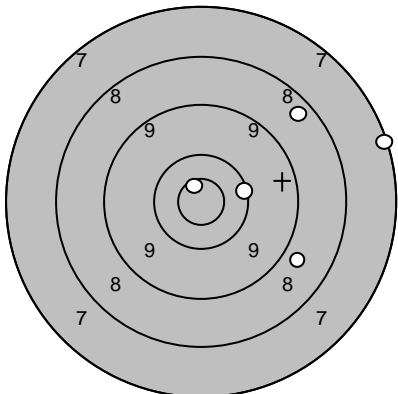
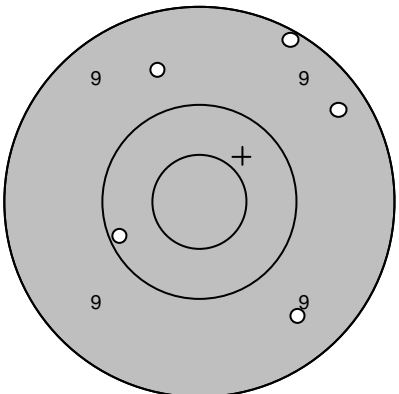
Skjutlag	Tavla	Curt Linerud	
4	11	I 20	
13.07.2007	Tavelträffen A 2007	Ramselefors SKF	
Provskott 	1: 5,3 → 2: 6,8 → 3: 7,7 → 4: 9,9 ↑ 5: 10,7* ↓	Serie 1 	1: 9,9 ↖ 2: 9,7 → 3: 7,8 ↗ 4: 9,5 ↗ 5: 9,2 ↗
	Serie 37,0		Serie 43,0
	Totalt 0,0		Totalt 43,0
Serie 2 	1: 9,5 ↙ 2: 10,6* ↑ 3: 10,2 → 4: 10,1 → 5: 10,4 →	Serie 3 	1: 9,3 ↖ 2: 8,5 ↗ 3: 8,2 ↓ 4: 9,1 → 5: 8,7 ↓
	Serie 49,0		Serie 42,0
	Totalt 92,0		Totalt 134,0
Extratävling 10 	1: 10,2 → 2: 10,8* ↑ 3: 8,8 → 4: 8,4 ↗ 5: 7,2 →	Extratävling 10 	6: 10,2 ↙ 7: 9,3 ↗ 8: 9,1 ↗ 9: 9,5 ↓ 10: 9,6 ↑
	Serie 43,0		Serie 46,0
	Totalt 177,0		Totalt 223,0

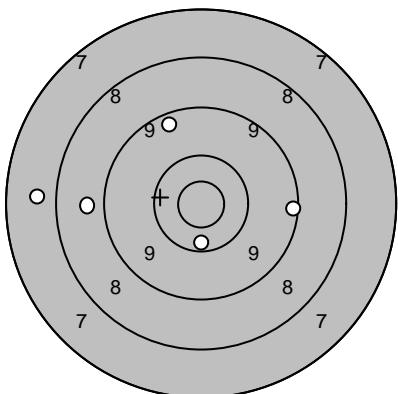
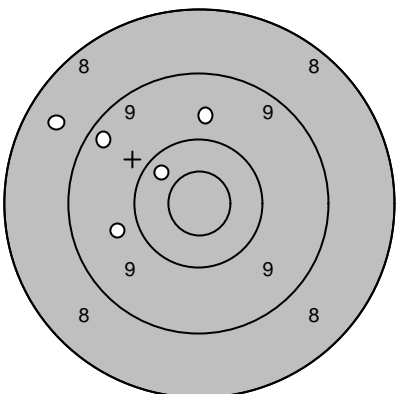
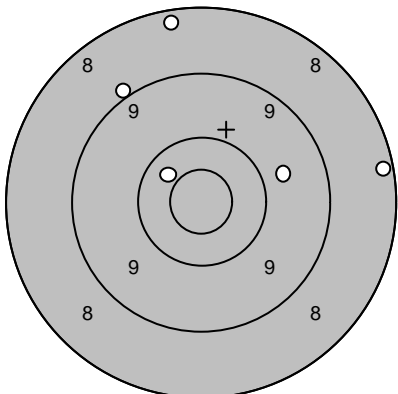
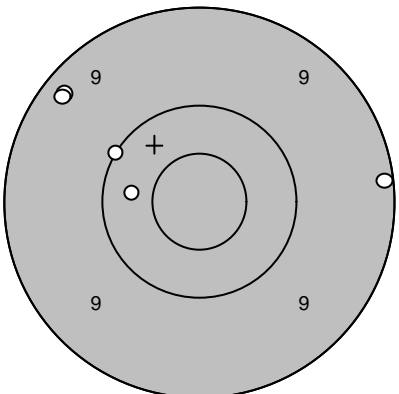
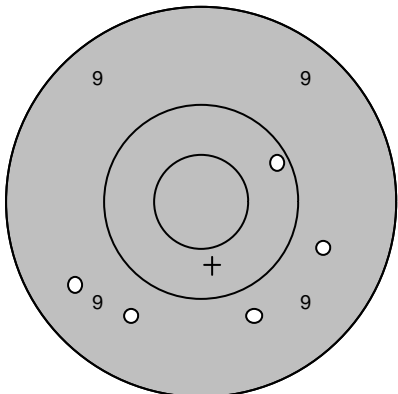
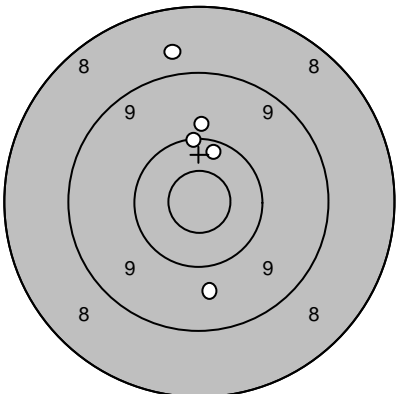
Skjutlag	Tavla			
4	12	Hugo Håkansson		
		Östersund		
13.07.2007	Tavelträffen A 2007	Ramselefors SKF		
Provskott		1: 9,2 → 2: 10,3 ↓ 3: 9,4 ↗ 4: 7,8 ← 5: 8,8 ←	Serie 1 	1: 10,3 ↖ 2: 9,8 ← 3: 8,6 ↖ 4: 9,3 ↗ 5: 9,7 ↑
	Serie 43,0		Serie 45,0	
	Totalt 0,0		Totalt 45,0	
Serie 2		1: 8,2 → 2: 9,7 → 3: 10,4 ↖ 4: 8,3 ↑ 5: 9,0 ↗	Serie 3 	1: 9,1 → 2: 10,3 ← 3: 9,3 ↗ 4: 10,1 ↖ 5: 9,3 ↗
	Serie 44,0		Serie 47,0	
	Totalt 89,0		Totalt 136,0	
Extratävling 10		1: 9,7 → 2: 9,8 ↓ 3: 9,7 ↓ 4: 9,5 ← 5: 10,2 →	Extratävling 10 	6: 8,7 ↑ 7: 9,7 ↓ 8: 10,1 ↑ 9: 10,3 ↗ 10: 9,9 ↑
	Serie 46,0		Serie 46,0	
	Totalt 182,0		Totalt 228,0	

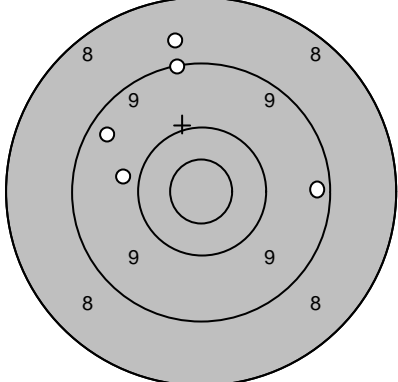
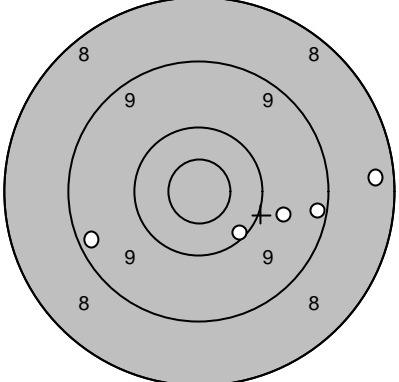
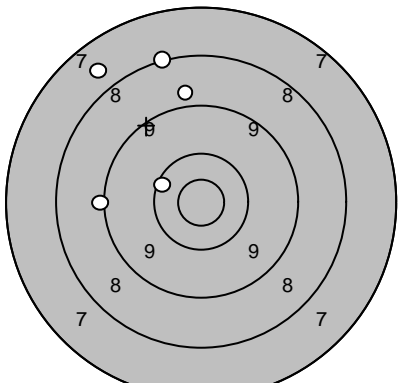
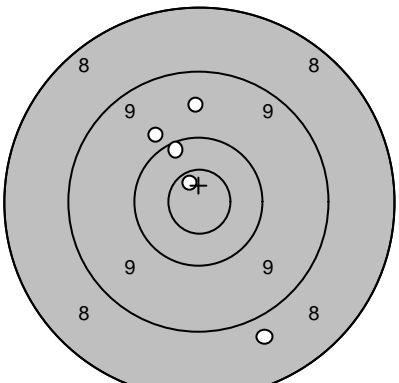
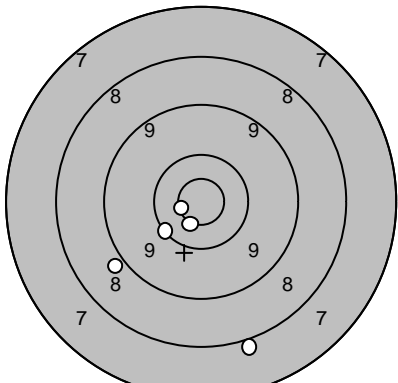
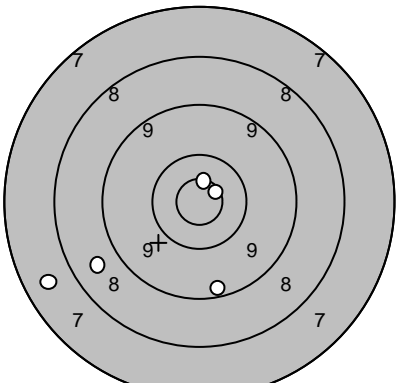
Skjutlag	Tavla	Jonas Bromihh		
4	13	Älmhult		
13.07.2007	Tavelträffen A 2007	Ramselefors SKF		
Provskott		1: 9,3 → 2: 9,9 ← 3: 9,1 ↑ 4: 8,7 ↑ 5: 9,4 ↖	Serie 1 	1: 8,4 → 2: 9,2 → 3: 10,2 ↘ 4: 9,7 → 5: 9,3 ←
	Serie 44,0		Serie 45,0	
	Totalt 0,0		Totalt 45,0	
Serie 2		1: 10,3 ← 2: 8,1 ↑ 3: 9,1 ← 4: 7,7 ↖ 5: 8,9 ↑	Serie 3 	1: 10,2 ↗ 2: 8,8 ↘ 3: 9,9 ↗ 4: 10,8* ↗ 5: 9,6 ↑
	Serie 42,0		Serie 46,0	
	Totalt 87,0		Totalt 133,0	
Extratävling 10		1: 8,0 ↓ 2: 10,2 ↘ 3: 10,7* ← 4: 10,6* ↘ 5: 8,9 ↘	Extratävling 10 	6: 7,7 ← 7: 9,3 ↓ 8: 10,7* ↑ 9: 8,7 ← 10: 10,7* ↗
	Serie 46,0		Serie 44,0	
	Totalt 179,0		Totalt 223,0	

Skjutlag 4	Tavla 14	Josefin Sandberg
----------------------	--------------------	-------------------------

	Kalix	
--	-------	--

13.07.2007	Tavelträffen A 2007	Ramselefors SKF
------------	---------------------	-----------------

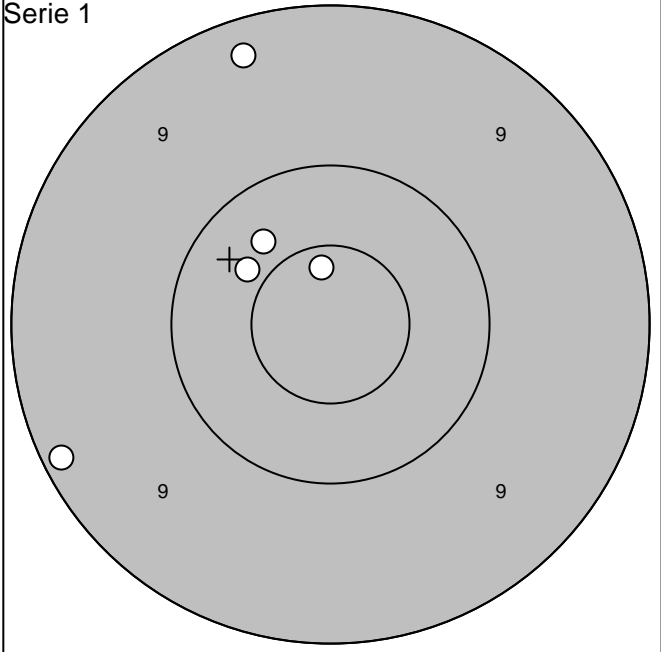
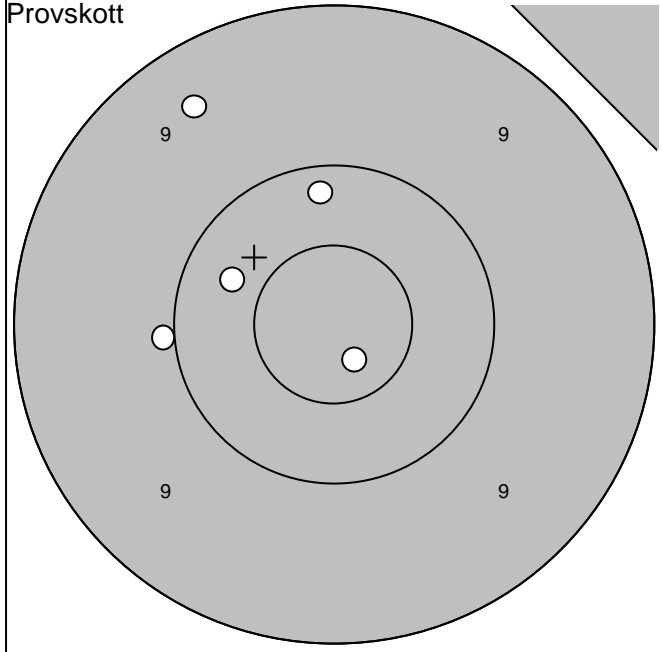

1: 9,4 ↗	Serie	49,0
2: 10,2 ↑		
3: 10,3 ↖	Totalt	0,0
4: 10,0 ←		
5: 10,8* ↘		

1: 10,4 ↗	Serie	48,0
2: 9,2 ↙		
3: 10,7* ↑	Totalt	48,0
4: 9,3 ↑		
5: 10,4 ↘		

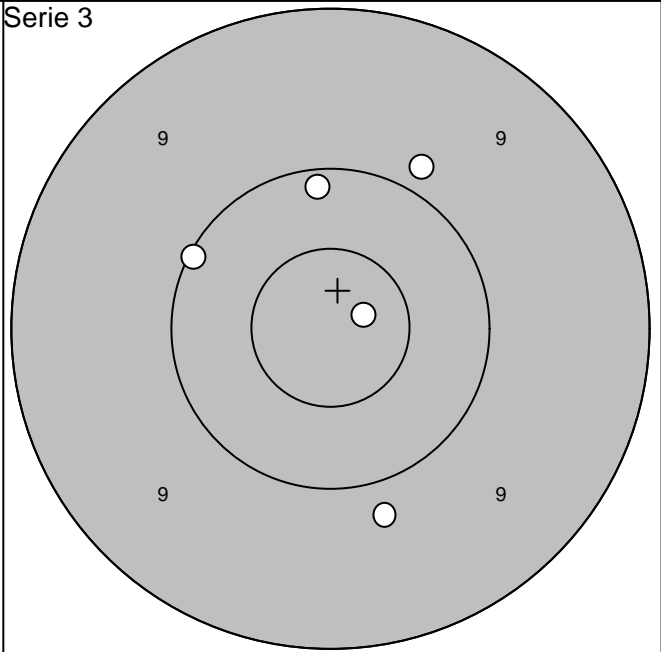
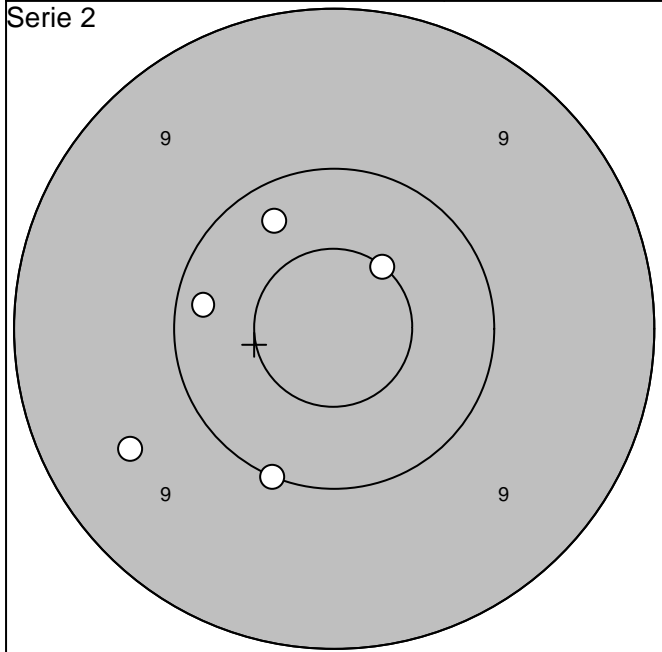

1: 9,6 ↖	Serie	49,0
2: 10,0 ↘		
3: 10,2 ↖	Totalt	97,0
4: 10,5* ↗		
5: 10,3 ↗		

1: 9,9 ↗	Serie	48,0
2: 10,1 ↑		
3: 10,8* →	Totalt	145,0
4: 10,1 ↖		
5: 9,8 ↘		

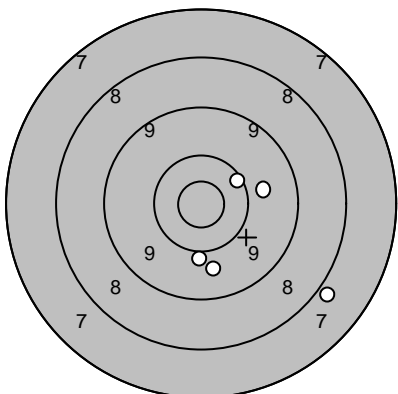
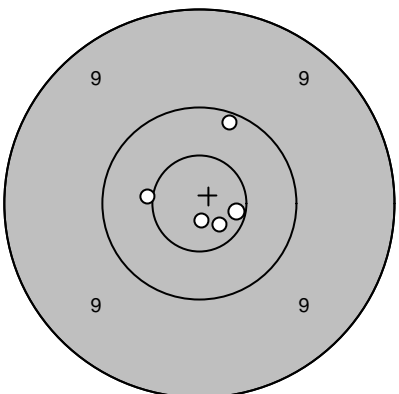
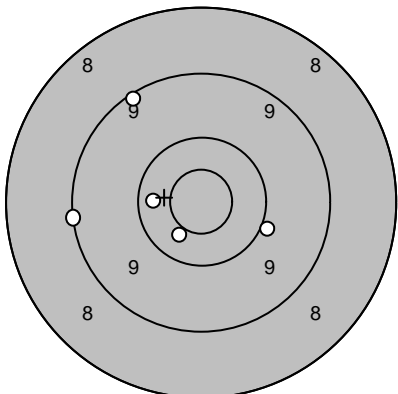
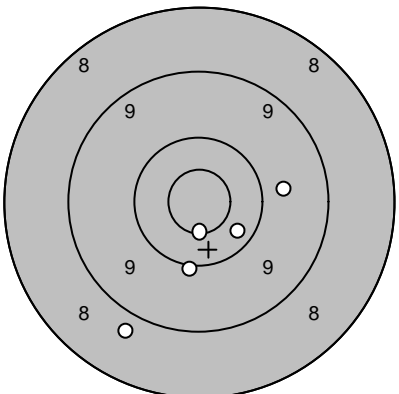
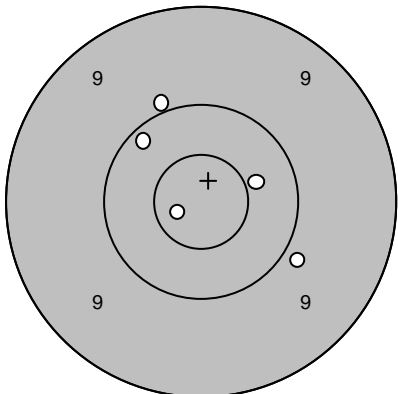
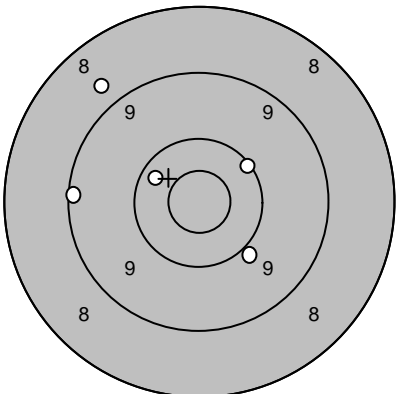
Skjutlag 4	Tavla 15	Sven Magnusson	
		Liden	
13.07.2007	Tavelträffen A 2007	Ramselefors SKF	
Provskott		1: 9,8 ↓ 2: 7,9 ↘ 3: 10,0 ↓ 4: 10,2 ↗ 5: 9,8 →	Serie 1 
			1: 10,9* ↓ 2: 10,7* ↘ 3: 10,2 ↑ 4: 10,6* → 5: 10,5* ←
		Serie 45,0	Serie 50,0
		Totalt 0,0	Totalt 50,0
Serie 2		1: 10,0 → 2: 10,3 ← 3: 9,2 ↗ 4: 9,1 ← 5: 10,5* ↘	Serie 3 
			1: 10,0 ↓ 2: 10,6* ↓ 3: 9,8 → 4: 10,3 ↘ 5: 8,8 ↘
		Serie 48,0	Serie 47,0
		Totalt 98,0	Totalt 145,0
Extratävling 10		1: 10,2 ↖ 2: 9,9 ↑ 3: 10,4 → 4: 9,9 ↘ 5: 10,8* ←	Extratävling 10 
			6: 10,1 ↗ 7: 9,1 ← 8: 10,0 ↘ 9: 8,8 ↗ 10: 10,3 ↖
		Serie 48,0	Serie 47,0
		Totalt 193,0	Totalt 240,0

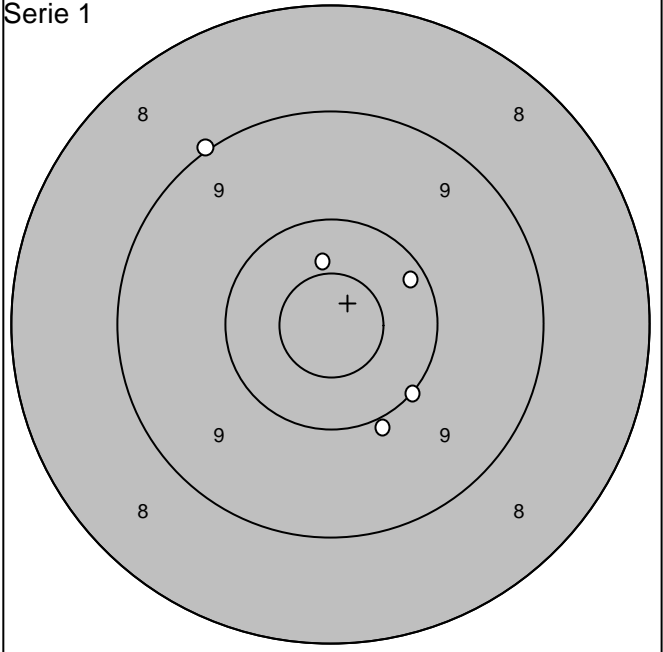
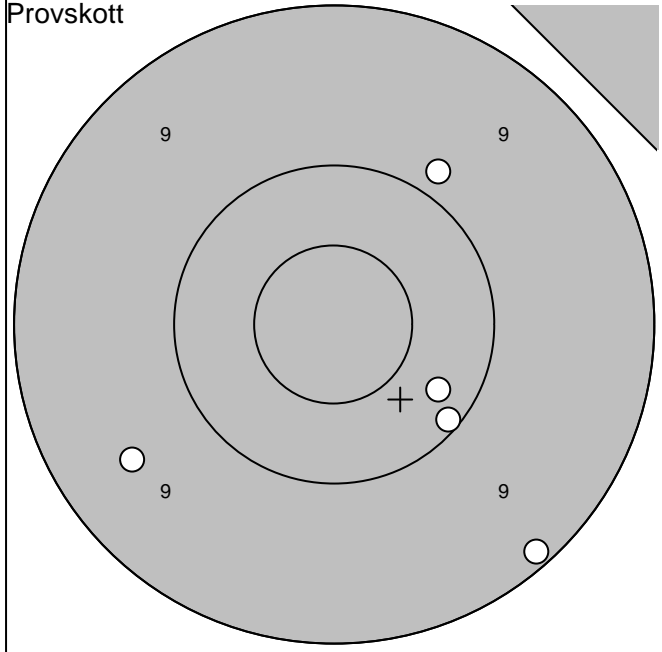

1: 9,9 ↗
2: 10,3 ↘
3: 10,1 ↘
4: 9,5 ↙
5: 9,1 ↘

Serie	47,0
Totalt	0,0

1: 10,0 ↘
2: 10,0 ↘
3: 10,2 ↗
4: 10,4 ↑
5: 9,0 ↖

Serie	49,0
Totalt	49,0

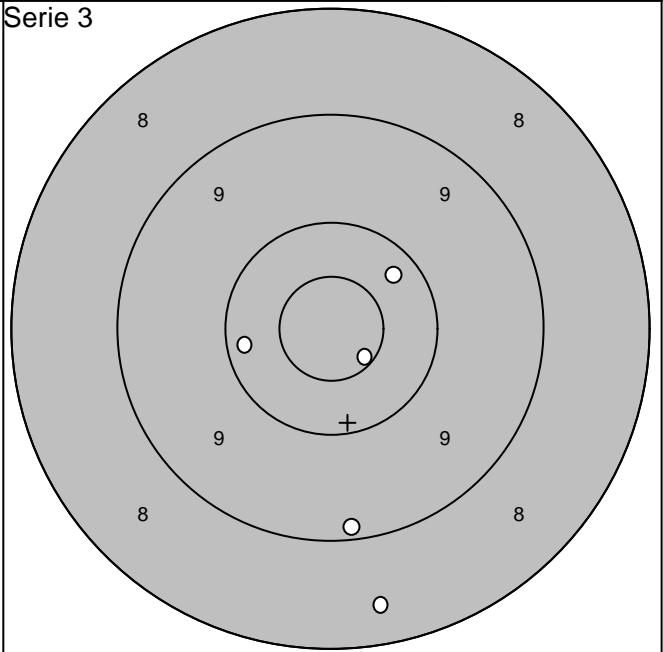
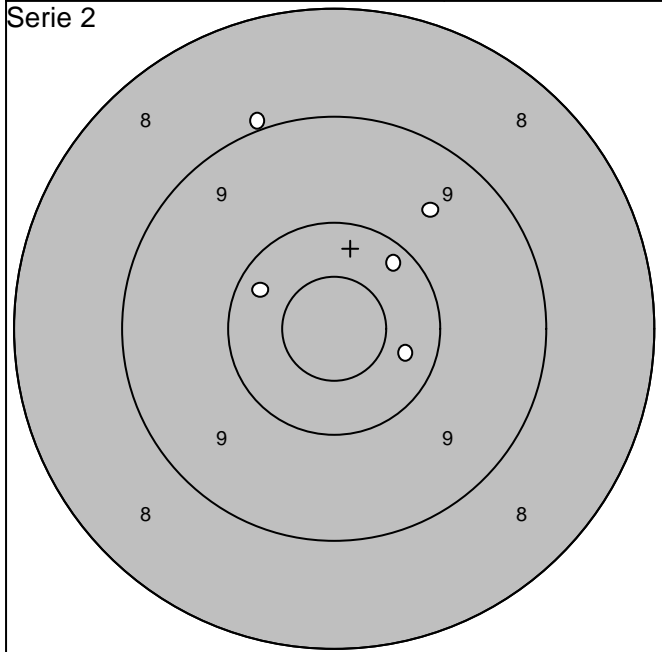

1: 10,3 →
2: 9,0 ↑
3: 10,2 ↗
4: 10,2 ↖
5: 9,6 ↗

Serie	48,0
Totalt	97,0

1: 8,4 ↓
2: 9,2 ↓
3: 10,6* ↘
4: 10,3 ↗
5: 10,2 ←

Serie	47,0
Totalt	144,0

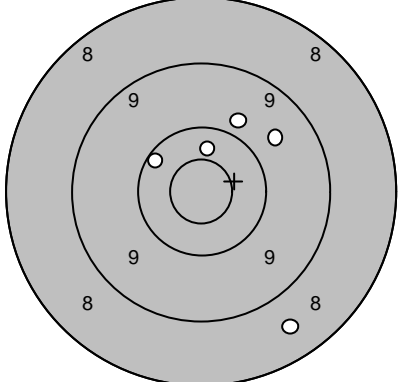
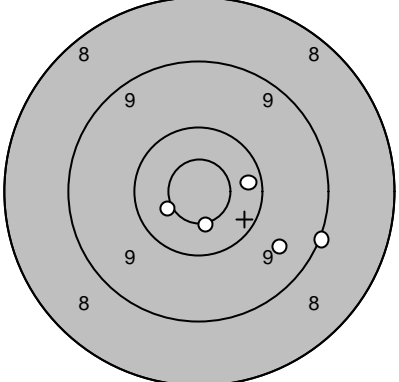
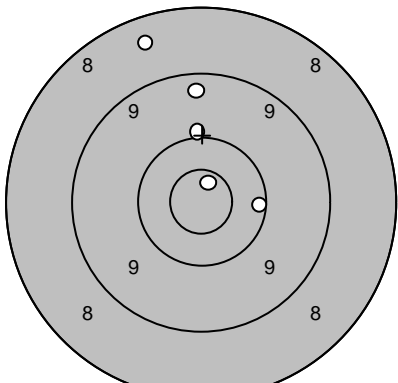
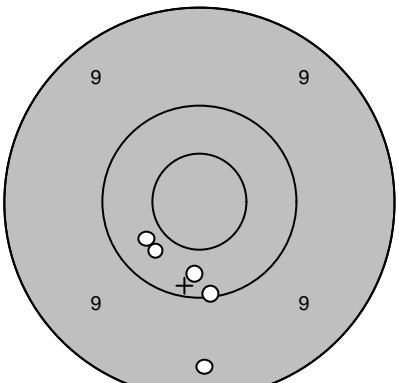
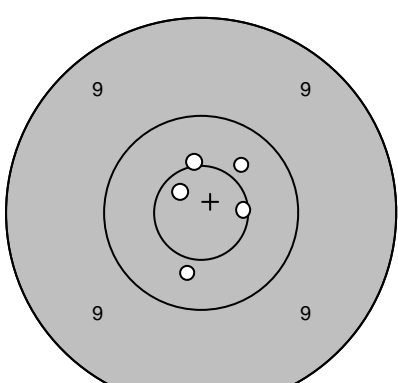
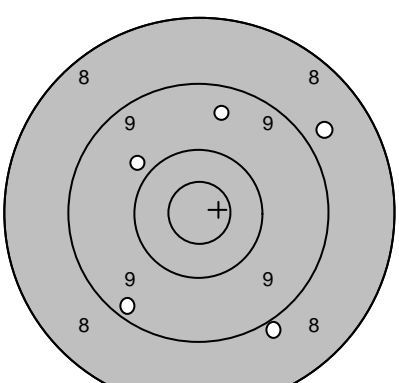
Skjutlag	Tavla	Sture Grahn		
4	17	Piteå		
13.07.2007	Tavelträffen A 2007	Ramselefors SKF		
Provskott		1: 10,4 ↑ 2: 10,2 ↖ 3: 9,7 ↗ 4: 8,6 ↘ 5: 9,9 ↑	Serie 1 	1: 10,3 → 2: 10,6* ↓ 3: 9,1 ↘ 4: 9,6 ↘ 5: 10,5* ←
		Serie 46,0	Serie 48,0	
		Totalt 0,0	Totalt 48,0	
Serie 2		1: 10,8* ↑ 2: 8,5 ↖ 3: 9,4 ↑ 4: 10,0 ↑ 5: 10,2 →	Serie 3 	1: 10,1 ↓ 2: 9,3 ↓ 3: 10,3 ↓ 4: 10,4 ↘ 5: 10,4 ←
		Serie 47,0	Serie 49,0	
		Totalt 95,0	Totalt 144,0	
Extratävling 10		1: 10,6* → 2: 10,7* ↖ 3: 10,4 ↓ 4: 10,5* ↑ 5: 10,4 ↗	Extratävling 10 	6: 9,9 ↖ 7: 9,5 ↑ 8: 8,8 ↗ 9: 9,3 ↘ 10: 8,9 ↓
		Serie 50,0	Serie 43,0	
		Totalt 194,0	Totalt 237,0	

Skjutlag 4	Tavla 18	Peter Östling	
		F 21	
13.07.2007	Tavelträffen A 2007	Ramselefors SKF	
Provskott		Serie 1	
1: 8,9 ↓	Serie 48,0	1:10,2 ↗	Serie 49,0
2:10,2 ↗		2:10,1 ↑	
3:10,5* →	Totalt 0,0	3:10,4 ↓	Totalt 49,0
4:10,0 ↗		4:10,0 ↑	
5:10,3 ↓		5: 9,3 ↓	
Serie 2		Serie 3	
1: 9,9 ↑	Serie 49,0	1:10,3 ←	Serie 48,0
2:10,5* ↖		2:10,6* →	
3:10,2 ←	Totalt 98,0	3: 9,9 ↓	Totalt 146,0
4:10,2 ↙		4:10,7* →	
5:10,7* ↓		5: 9,9 ↘	

Skjutlag	Tavla	Harry Östling	
4	19	F 21	
13.07.2007	Tavelträffen A 2007	Ramselefors SKF	
Provskott 	1: 10,6* ↓ 2: 9,6 ↙ 3: 10,6* ↓ 4: 10,7* ↓ 5: 9,9 ↓	Serie 1 	1: 10,1 ← 2: 10,3 ↗ 3: 10,2 ↖ 4: 9,2 ↑ 5: 10,3 ↖
	Serie 48,0		Serie 49,0
	Totalt 0,0		Totalt 49,0
Serie 2 	1: 9,2 ↑ 2: 10,3 ← 3: 10,1 ← 4: 10,7* ↓ 5: 10,3 ↑	Serie 3 	1: 10,2 ↑ 2: 9,4 ↘ 3: 9,1 → 4: 10,0 ↑ 5: 10,4 →
	Serie 49,0		Serie 48,0
	Totalt 98,0		Totalt 146,0
Extratävling 10 	1: 10,6* → 2: 8,6 ↓ 3: 10,1 ↓ 4: 10,9* ↗ 5: 9,9 →	Extratävling 10 	6: 10,2 ← 7: 9,5 ↗ 8: 10,7* ↘ 9: 10,0 ← 10: 9,8 ↓
	Serie 47,0		Serie 48,0
	Totalt 193,0		Totalt 241,0

Skjutlag **4** Tavla **20** **Per Östling**

F 21

13.07.2007

Tavelträffen A 2007

Ramselefors SKF

Provskott

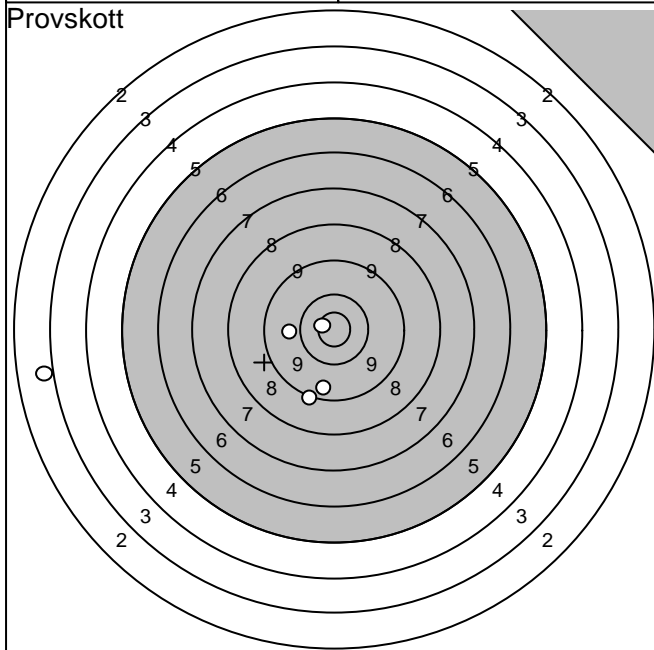

Serie 1

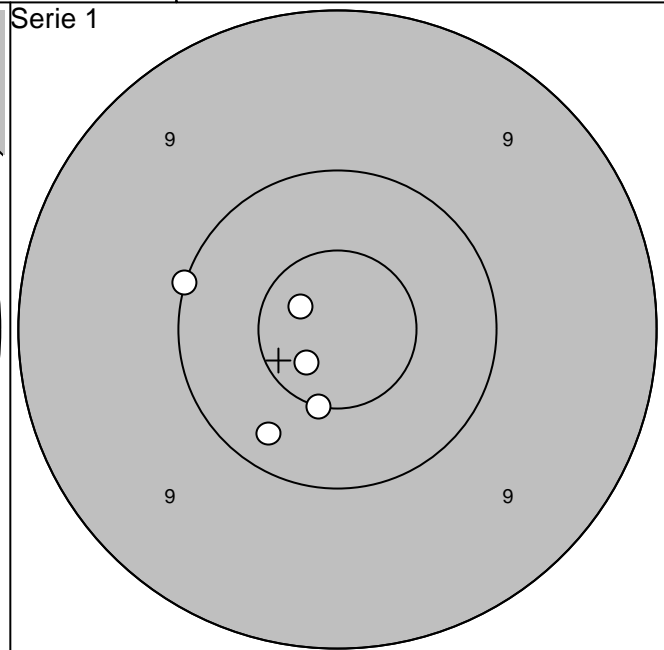

1: 9,1 ↓
2: 3,0 ←
3: 9,5 ↓
4: 9,9 ←
5:10,8* ←

Serie 40,0

Totalt 0,0

1:10,3 ↙
2:10,5* ↓
3:10,8* ↖
4:10,0 ←
5:10,8* ↙

Serie 50,0

Totalt 50,0

Serie 2

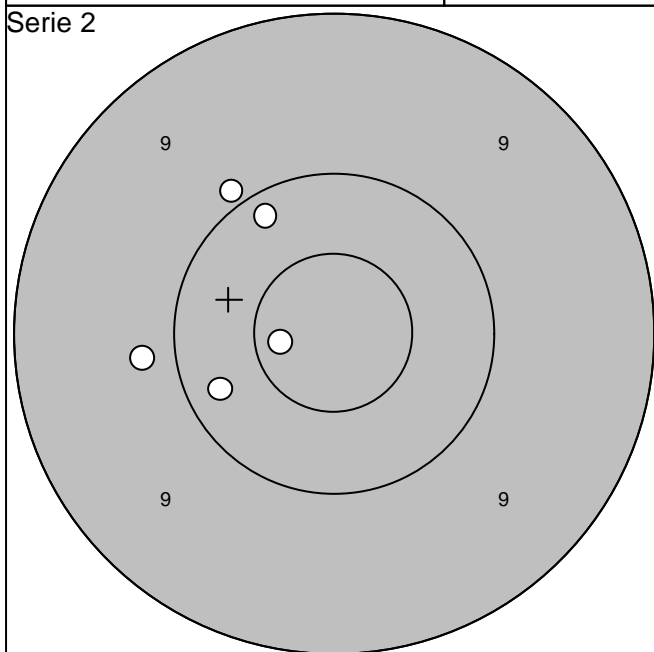

Serie 3

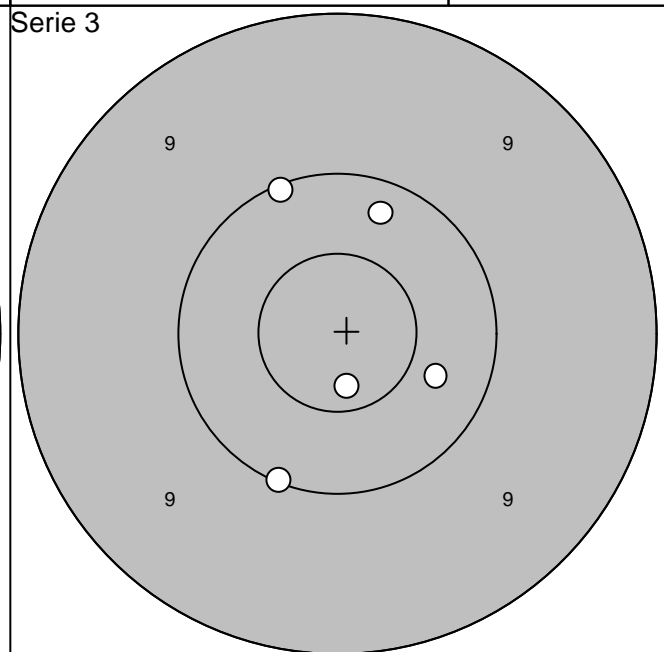

1:10,7* ←
2: 9,8 ←
3: 9,9 ↗
4:10,2 ←
5:10,2 ↗

Serie 48,0

Totalt 98,0

1:10,4 →
2:10,2 ↗
3:10,7* ↓
4:10,1 ↗
5:10,0 ↓

Serie 50,0

Totalt 148,0

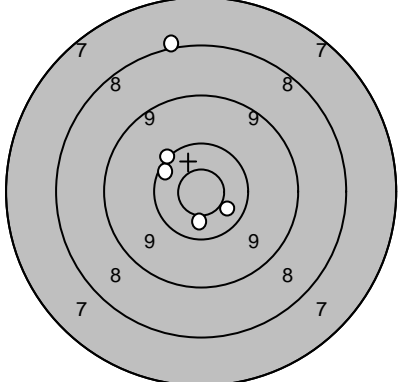
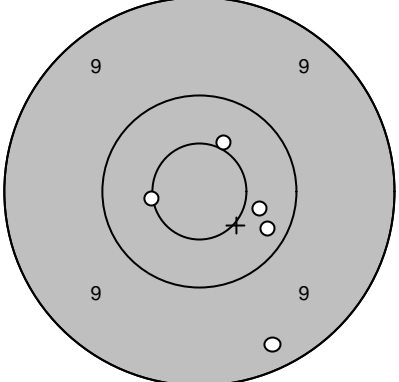
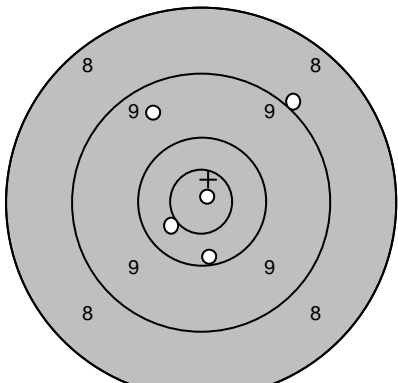
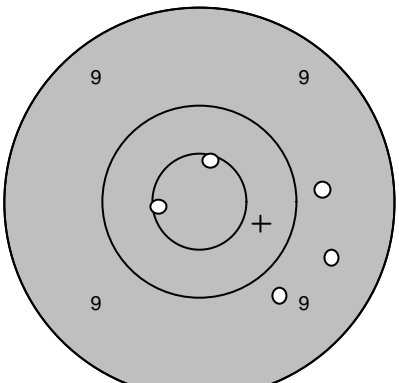
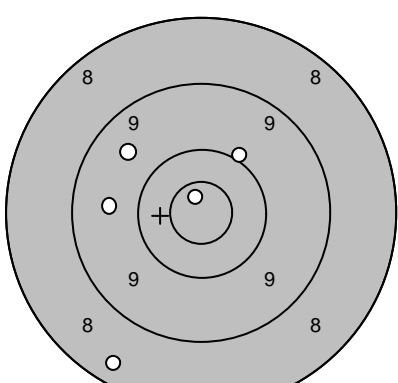
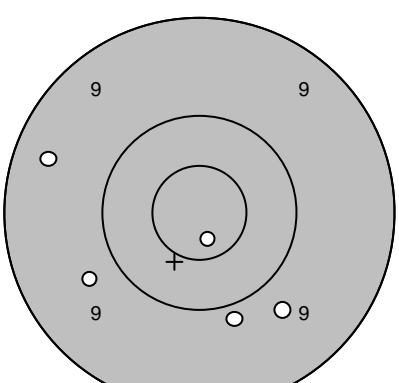
Skjutlag 4	Tavla 21	Fredrik Ågren	
		I 19	
13.07.2007	Tavelträffen A 2007	Ramselefors SKF	
Provskott		1: 8,0 ↗ 2: 10,5* ↓ 3: 10,3 ↗ 4: 10,1 ↗ 5: 10,5* ↘	Serie 1 
			1: 10,5* ← 2: 10,4 → 3: 10,2 ↘ 4: 9,3 ↘ 5: 10,5* ↗
		Serie 48,0	Serie 49,0
		Totalt 0,0	Totalt 49,0
Serie 2		1: 10,9* ↗ 2: 9,0 ↗ 3: 10,2 ↓ 4: 10,5* ↙ 5: 9,5 ↗	Serie 3 
			1: 10,6* ← 2: 9,6 → 3: 9,8 ↘ 4: 9,8 → 5: 10,6* ↗
		Serie 48,0	Serie 47,0
		Totalt 97,0	Totalt 144,0
Extratävling 10		1: 9,6 ↙ 2: 10,0 ↗ 3: 10,8* ↗ 4: 8,4 ↘ 5: 9,7 ←	Extratävling 10 
			6: 9,7 ↙ 7: 9,4 ↙ 8: 9,7 ↘ 9: 10,7* ↘ 10: 9,9 ↘
		Serie 46,0	Serie 46,0
		Totalt 190,0	Totalt 236,0

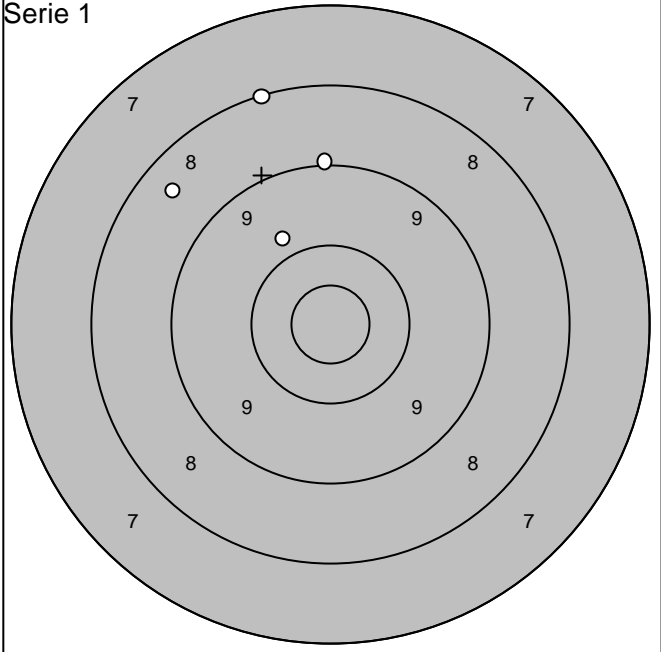
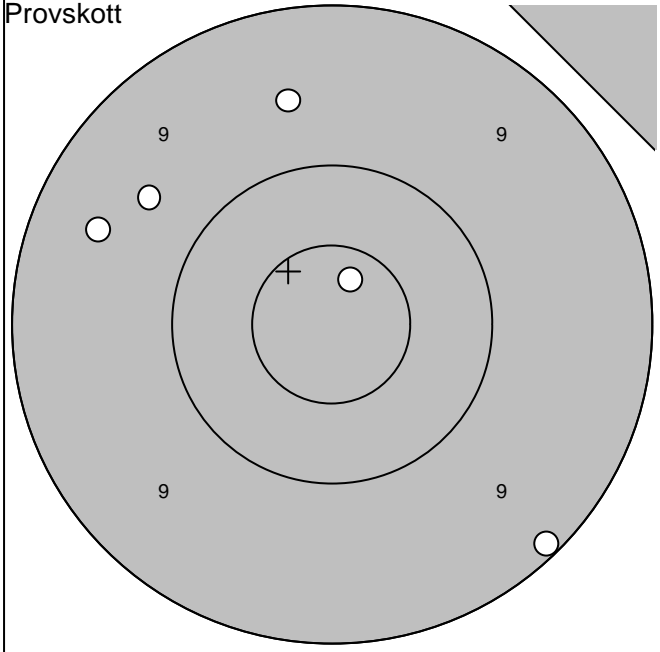

1: 9,5 ←	Serie	46,0
2: 9,6 ↑		
3: 9,6 ↖	Totalt	0,0
4: 10,7* ↑		
5: 9,1 ↘		

1: 8,1 ↑	Serie	34,0
2: 9,0 ↑		
3: 9,8 ↖	Totalt	34,0
4: 8,5 ↖		

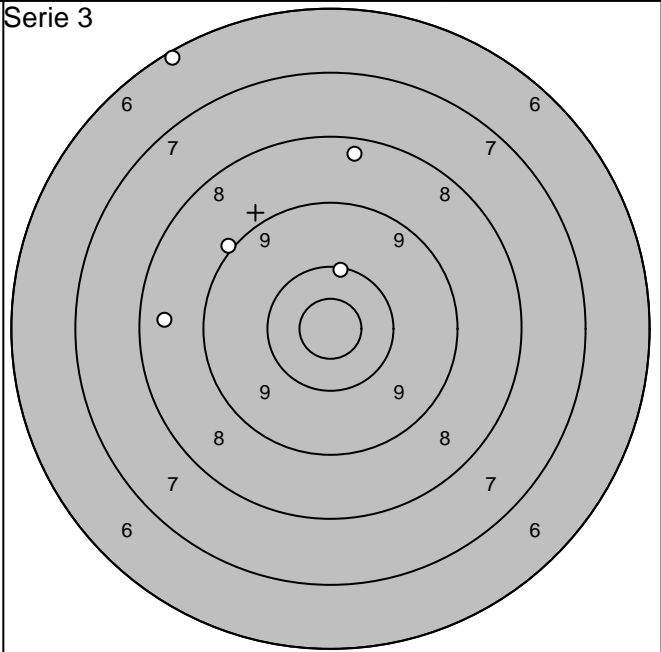
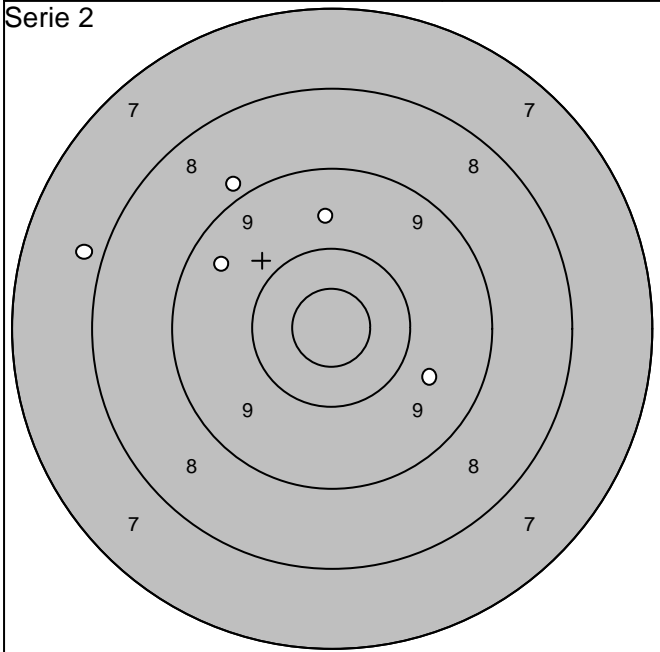

1: 9,7 ↑	Serie	42,0
2: 9,7 ↘		
3: 8,9 ↖	Totalt	76,0
4: 9,5 ↖		
5: 7,8 ←		

1: 6,2 ↖	Serie	41,0
2: 8,5 ←		
3: 8,3 ↑	Totalt	117,0
4: 9,1 ↖		
5: 10,2 ↑		

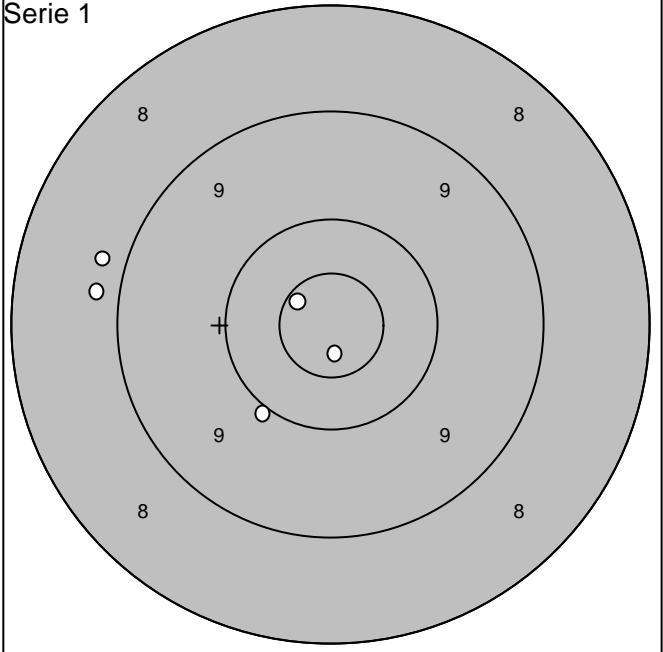
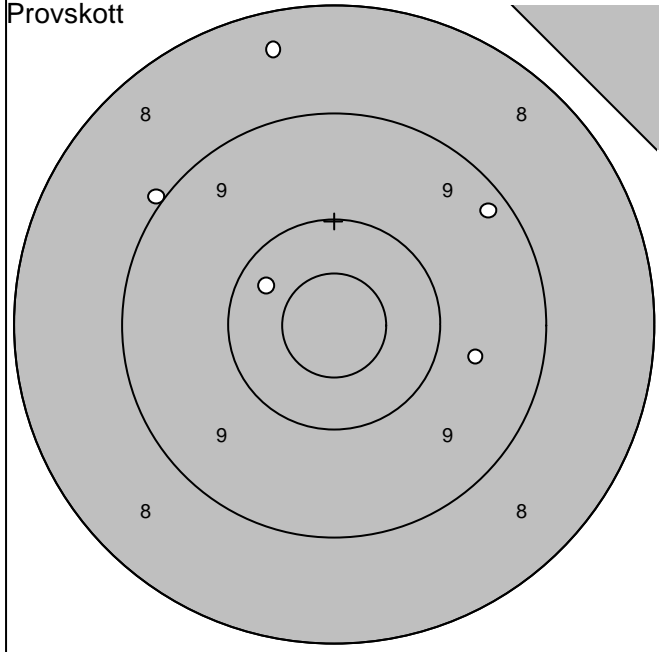

1: 8,4 ↗	Serie	45,0	
2: 9,0 ↗			
3: 10,3 ↖	Totalt	0,0	
4: 9,2 ↗			
5: 9,7 →			

1: 8,8 ←	Serie	46,0	
2: 10,7* ↖			
3: 8,8 ←	Totalt	46,0	
4: 10,8* ↓			
5: 10,0 ↙			

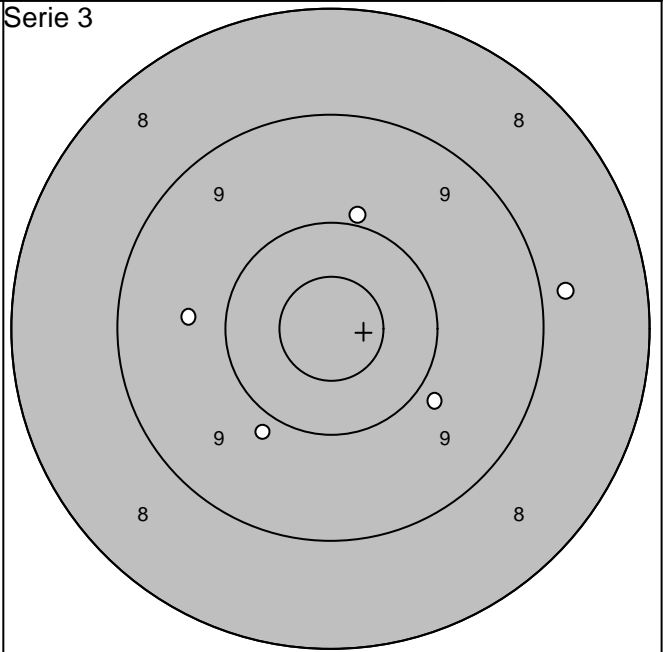
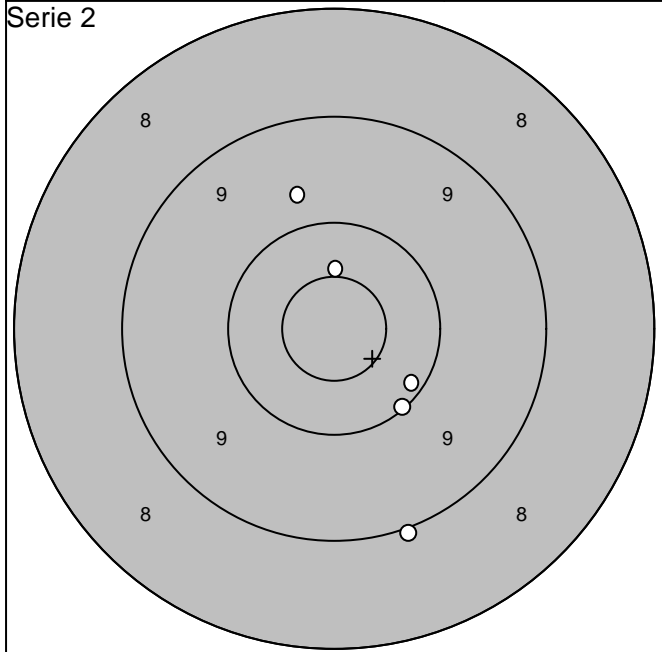

1: 9,0 ↓	Serie	48,0	
2: 10,1 ↓			
3: 9,7 ↗	Totalt	94,0	
4: 10,1 ↓			
5: 10,5* ↗			

1: 8,8 →	Serie	44,0	
2: 9,8 ↘			
3: 9,9 ↙	Totalt	138,0	
4: 9,9 ↗			
5: 9,7 ←			

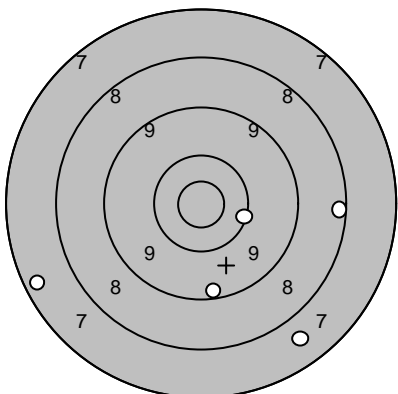
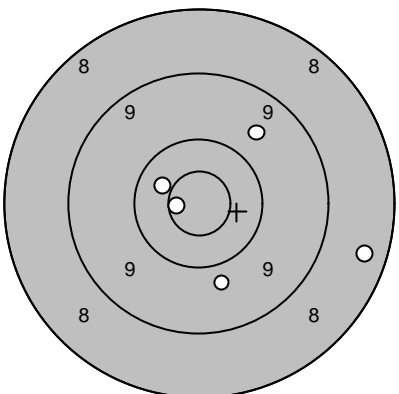
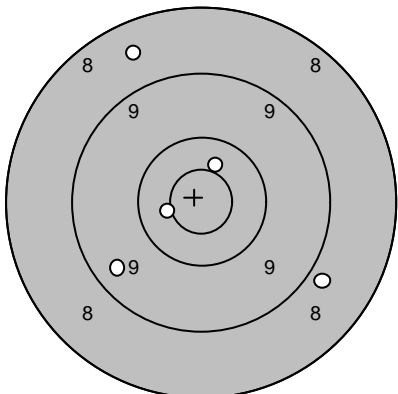
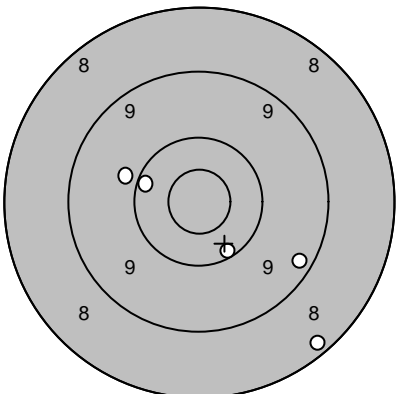
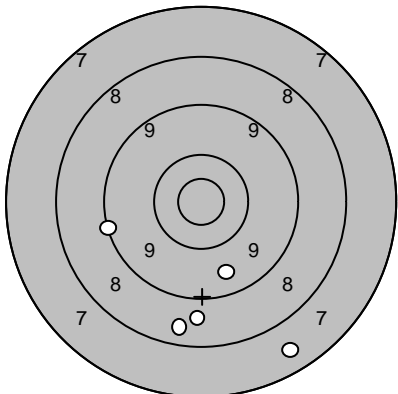
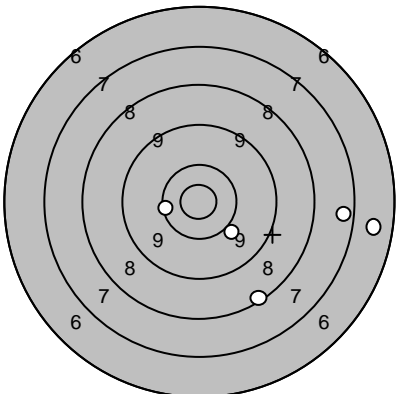
Skjutlag	Tavla	Sven-Olov Olsson		
4	24	Liden		
13.07.2007	Tavelträffen A 2007	Ramselefors SKF		
Provskott		1: 7,4 ↙ 2: 7,7 ↓ 3: 8,3 → 4: 9,3 ↓ 5: 10,2 →	Serie 1 	1: 9,7 ↗ 2: 8,4 → 3: 10,7* ← 4: 10,5* ↖ 5: 9,8 ↓
		Serie 41,0	Serie 46,0	
		Totalt 0,0	Totalt 46,0	
Serie 2		1: 8,6 ↗ 2: 8,9 ↓ 3: 10,5* ← 4: 9,4 ↖ 5: 10,5* ↗	Serie 3 	1: 10,2 ← 2: 9,3 ↓ 3: 8,3 ↓ 4: 10,2 ↓ 5: 9,9 ↖
		Serie 45,0	Serie 46,0	
		Totalt 91,0	Totalt 137,0	
Extratävling 10		1: 8,5 ↓ 2: 9,1 ← 3: 8,7 ↓ 4: 7,6 ↓ 5: 9,6 ↓	Extratävling 10 	6: 7,5 → 7: 6,6 → 8: 10,0 ↓ 9: 10,3 ← 10: 8,3 ↓
		Serie 41,0	Serie 41,0	
		Totalt 178,0	Totalt 219,0	

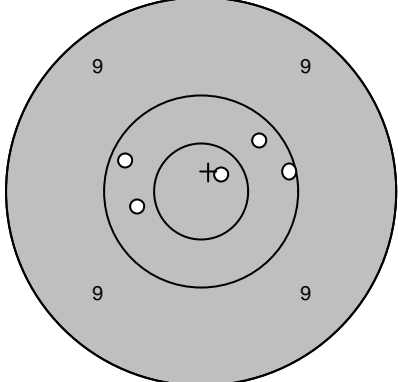
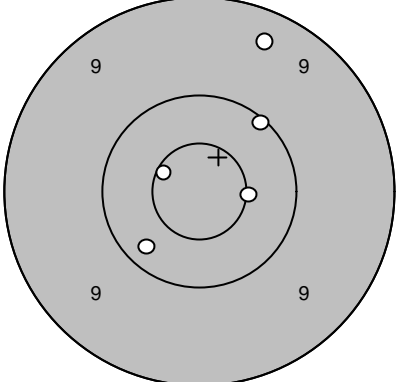
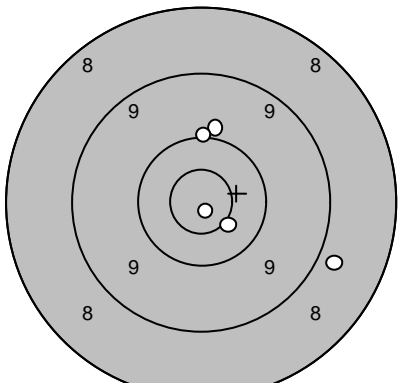
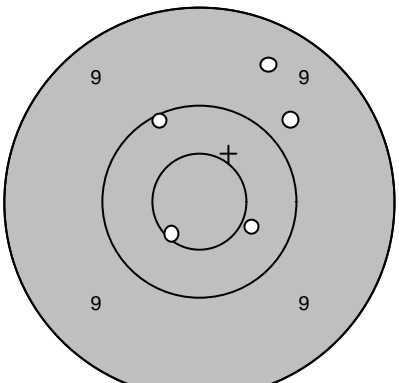
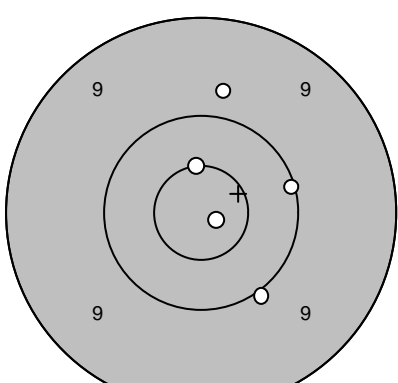
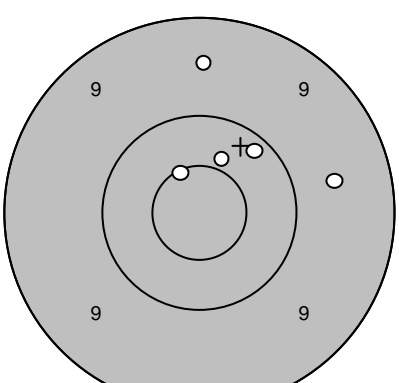
Skjutlag	Tavla	Peder Vahlberg		
5	1	Ramselefors		
13.07.2007	Tavelträffen A 2007	Ramselefors SKF		
Provskott		1: 10,4 ← 2: 10,2 ↙ 3: 10,2 ↗ 4: 10,8* ↗ 5: 10,1 →	Serie 1 	1: 10,1 ↗ 2: 10,6* ↙ 3: 10,5* → 4: 9,4 ↗ 5: 10,3 ↙
		Serie 50,0	Serie 49,0	
		Totalt 0,0	Totalt 49,0	
Serie 2		1: 9,9 ↑ 2: 10,5* ↘ 3: 10,9* ↘ 4: 10,1 ↑ 5: 8,8 ↘	Serie 3 	1: 9,8 ↗ 2: 10,6* ↙ 3: 10,1 ↗ 4: 10,4 ↘ 5: 9,5 ↗
		Serie 47,0	Serie 48,0	
		Totalt 96,0	Totalt 144,0	
Extratävling 10		1: 10,9* ↘ 2: 10,0 ↘ 3: 9,8 ↑ 4: 10,1 → 5: 10,6* ↑	Extratävling 10 	6: 10,6* ↙ 7: 9,5 ↑ 8: 10,2 ↗ 9: 9,6 → 10: 10,4 ↗
		Serie 49,0	Serie 48,0	
		Totalt 193,0	Totalt 241,0	

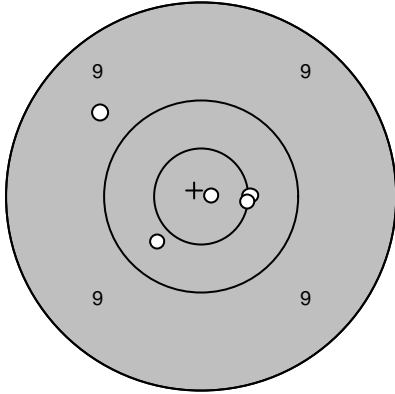
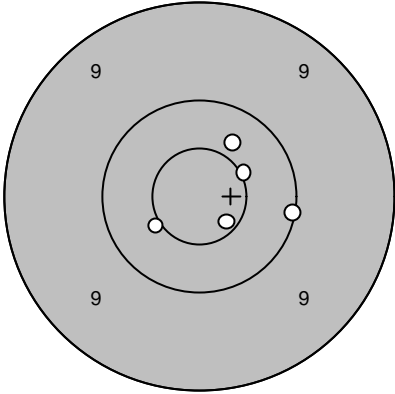
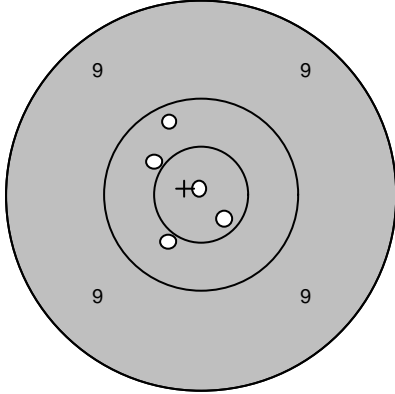
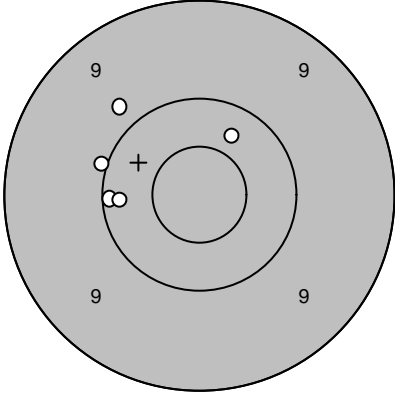
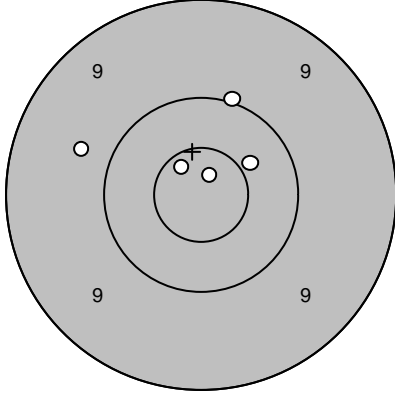
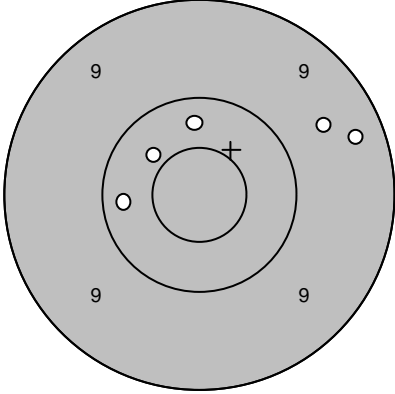
Skjutlag	Tavla	Petter Eriksson	
5	2		
		Moälven/Modo	
13.07.2007	Tavelträffen A 2007	Ramselefors SKF	
Provskott 	1: 9,7 ↖ 2: 10,5* → 3: 10,9* → 4: 10,6* → 5: 10,4 ↙	Serie 1 	1: 10,1 → 2: 10,7* ↘ 3: 10,5* ↗ 4: 10,4 ↗ 5: 10,5* ↙
	Serie 49,0		Serie 50,0
	Totalt 0,0		Totalt 50,0
Serie 2 	1: 10,5* ↖ 2: 10,2 ↗ 3: 10,9* ↗ 4: 10,7* ↘ 5: 10,5* ↙	Serie 3 	1: 9,8 ↖ 2: 10,0 ← 3: 10,4 ↗ 4: 10,1 ← 5: 10,2 ←
	Serie 50,0		Serie 49,0
	Totalt 100,0		Totalt 149,0
Extratävling 10 	1: 10,8* ↗ 2: 9,7 ← 3: 10,0 ↗ 4: 10,7* ↖ 5: 10,4 ↗	Extratävling 10 	6: 10,3 ← 7: 10,4 ↖ 8: 9,3 → 9: 9,6 ↗ 10: 10,3 ↑
	Serie 49,0		Serie 48,0
	Totalt 198,0		Totalt 246,0

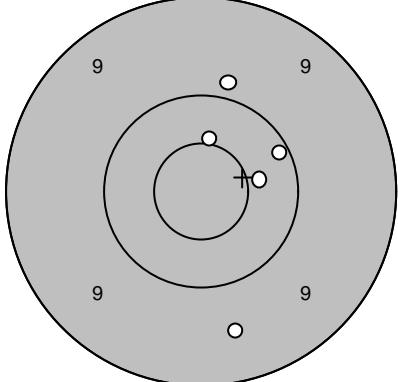
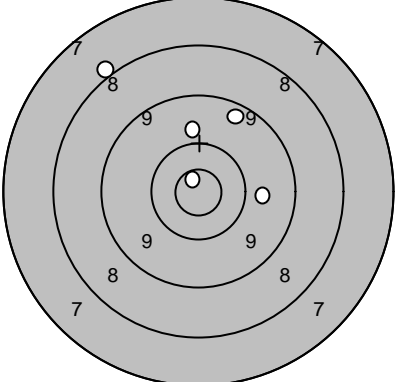
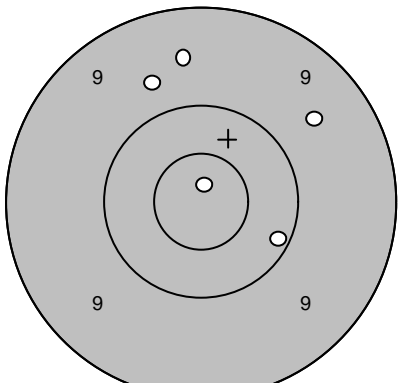
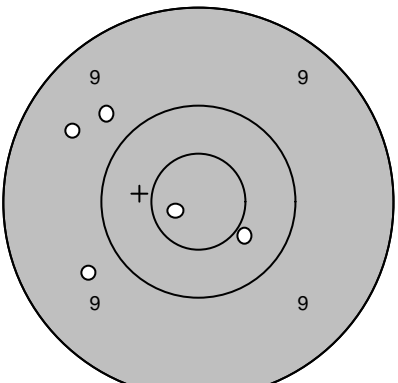
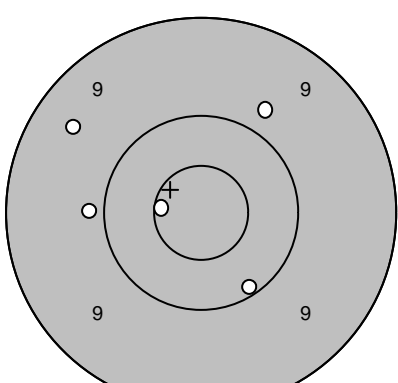
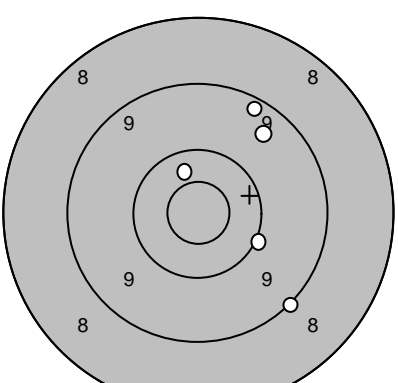
Skjutlag	Tavla	Leif Sandberg		
5	3			
		Kalix		
13.07.2007	Tavelträffen A 2007	Ramselefors SKF		
Provskott		1: 9,9 ↑ 2: 10,4 → 3: 10,1 → 4: 10,5* ↑ 5: 9,6 ↓	Serie 1 	1: 9,8 → 2: 9,4 ↗ 3: 8,0 ↖ 4: 9,9 ↑ 5: 10,9* ↗
		Serie 48,0	Serie 45,0	
		Totalt 0,0	Totalt 45,0	
Serie 2		1: 10,2 → 2: 10,9* ↑ 3: 9,7 ↗ 4: 9,6 ↑ 5: 9,6 ↗	Serie 3 	1: 9,7 ↖ 2: 10,8* ↖ 3: 9,6 ↖ 4: 9,7 ↗ 5: 10,4 ↘
		Serie 47,0	Serie 47,0	
		Totalt 92,0	Totalt 139,0	
Extratävling 10		1: 9,8 ↗ 2: 9,9 ← 3: 10,6* ← 4: 9,5 ↗ 5: 10,1 ↘	Extratävling 10 	6: 9,3 ↗ 7: 9,1 ↘ 8: 9,5 ↗ 9: 10,1 → 10: 10,4 ↑
		Serie 47,0	Serie 47,0	
		Totalt 186,0	Totalt 233,0	

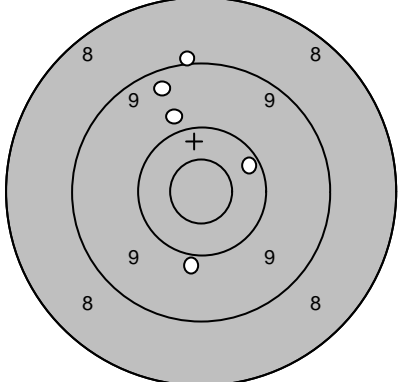
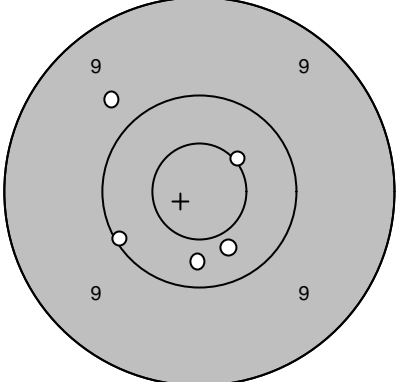
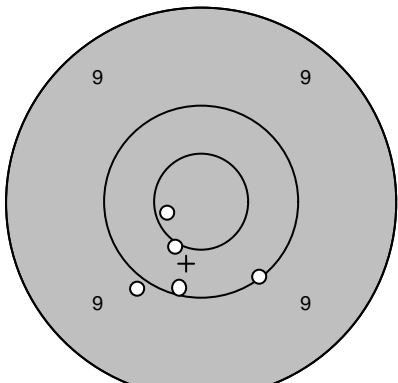
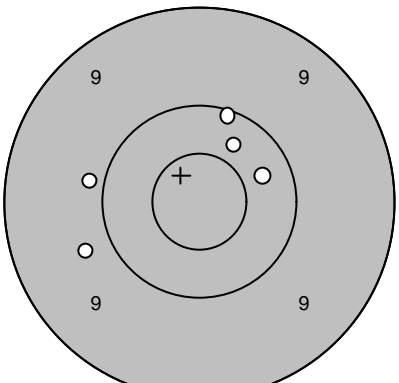
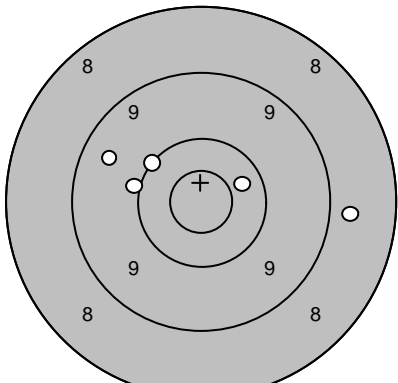
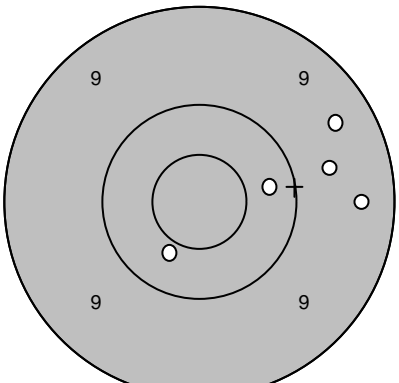
Skjutlag 5	Tavla 4	Helena Jansson	
		Söderala	
13.07.2007	Tavelträffen A 2007	Ramselefors SKF	
Provskott 	1: 9,4 ↗ 2: 9,0 ↑ 3: 9,9 ↗ 4: 9,9 ↓ 5: 10,2 →	Serie 1 	1: 10,5* ↗ 2: 10,4 ↓ 3: 10,1 ← 4: 9,7 ↗ 5: 10,3 ↓
	Serie 46,0		Serie 49,0
	Totalt 0,0		Totalt 49,0
Serie 2 	1: 10,1 ↓ 2: 10,5* ↓ 3: 10,1 ↓ 4: 10,7* ← 5: 9,9 ↘	Serie 3 	1: 9,8 ← 2: 10,1 ↑ 3: 10,3 → 4: 9,9 ← 5: 10,4 ↗
	Serie 49,0		Serie 48,0
	Totalt 98,0		Totalt 146,0
Extratävling 10 	1: 10,0 ← 2: 10,1 ↗ 3: 9,5 ↗ 4: 10,4 → 5: 8,8 →	Extratävling 10 	6: 9,7 → 7: 9,4 ↗ 8: 10,3 → 9: 9,4 → 10: 10,4 ↓
	Serie 47,0		Serie 47,0
	Totalt 193,0		Totalt 240,0

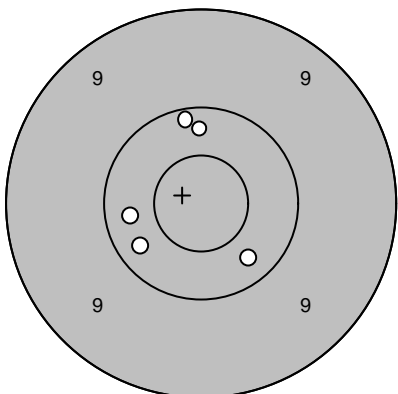
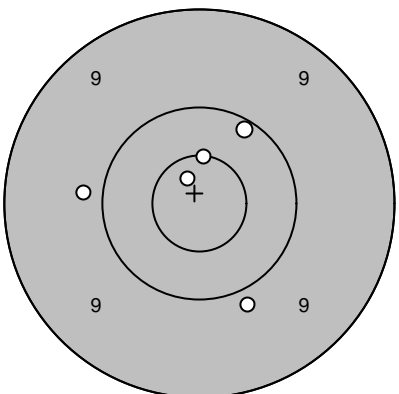
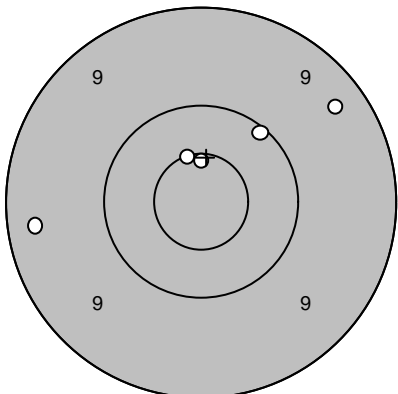
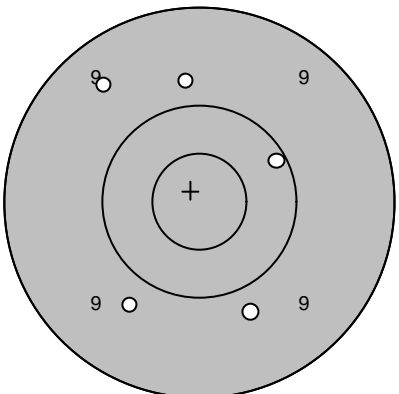
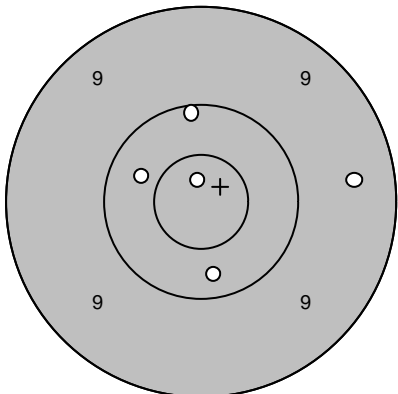
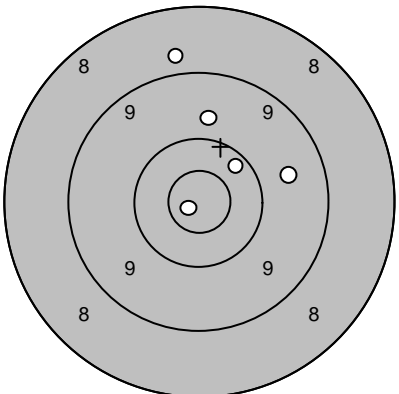
Skjutlag	Tavla	Bengt Jansson		
5	5	Söderala		
13.07.2007	Tavelträffen A 2007	Ramselefors SKF		
Provskott		1: 10,3 ↘ 2: 10,3 ← 3: 10,3 ↑ 4: 10,2 ↑ 5: 10,3 ↙	Serie 1 	1: 10,1 ↗ 2: 10,8* ↖ 3: 9,8 ← 4: 10,6* ↑ 5: 9,9 ↘
		Serie 50,0	Serie 48,0	
		Totalt 0,0	Totalt 48,0	
Serie 2		1: 10,6* ↑ 2: 10,6* ↑ 3: 10,1 ↗ 4: 9,3 ↗ 5: 9,3 ←	Serie 3 	1: 9,5 ↖ 2: 10,1 ↗ 3: 9,8 ↑ 4: 9,8 ↘ 5: 9,8 ↙
		Serie 48,0	Serie 46,0	
		Totalt 96,0	Totalt 142,0	
Extratävling 10		1: 10,4 ↖ 2: 10,3 ↓ 3: 10,8* ↑ 4: 10,1 ↑ 5: 9,5 →	Extratävling 10 	6: 8,8 ↑ 7: 10,3 ↗ 8: 9,8 ↑ 9: 9,6 → 10: 10,9* ↖
		Serie 49,0	Serie 46,0	
		Totalt 191,0	Totalt 237,0	

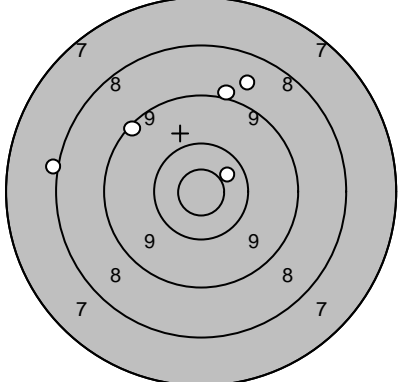
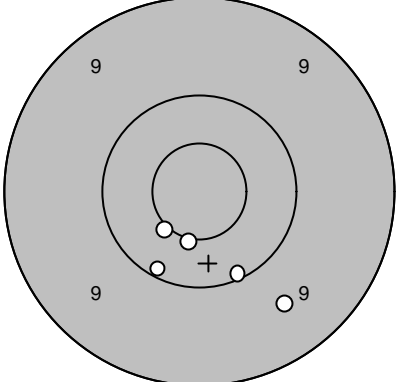
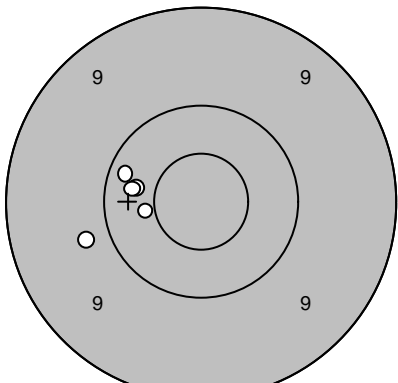
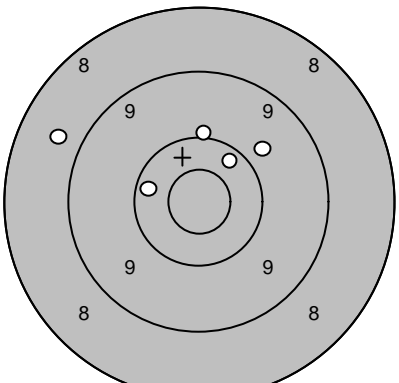
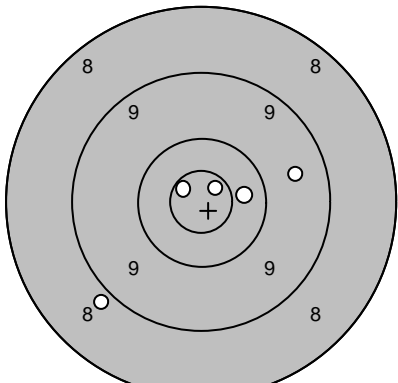
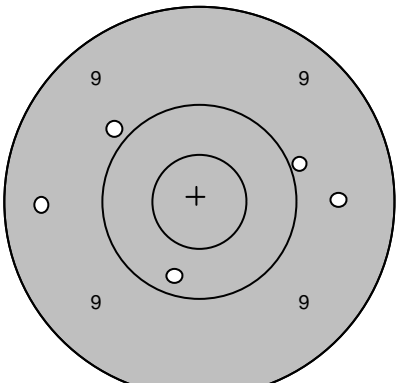
Skjutlag	Tavla	Carina Norling	
5	7		
Söderala			
13.07.2007	Tavelträffen A 2007	Ramselefors SKF	
Provskott 	1: 10,5* ↗	Serie 1 	1: 10,1 ↘
	2: 8,7 ↑		2: 10,5* ↙
	3: 9,0 ↑		3: 10,1 ↘
	4: 8,1 ←		4: 10,5* ↘
	5: 9,2 ↖		5: 9,6 ↘
	Serie 44,0		Serie 49,0
	Totalt 0,0		Totalt 49,0
Serie 2 	1: 10,2 ←	Serie 3 	1: 10,0 ↑
	2: 9,8 ←		2: 10,3 ↗
	3: 10,4 ←		3: 9,8 ↗
	4: 10,5* ←		4: 8,7 ←
	5: 10,3 ←		5: 10,3 ←
	Serie 49,0		Serie 47,0
	Totalt 98,0		Totalt 145,0
Extratävling 10 	1: 8,9 ↙	Extratävling 10 	6: 9,9 ↖
	2: 10,7* ↖		7: 9,9 →
	3: 10,4 →		8: 9,6 →
	4: 10,8* ↗		9: 10,2 ↘
	5: 9,6 →		10: 9,4 ←
	Serie 47,0		Serie 46,0
	Totalt 192,0		Totalt 238,0

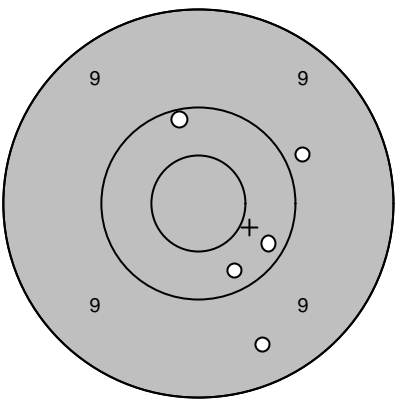
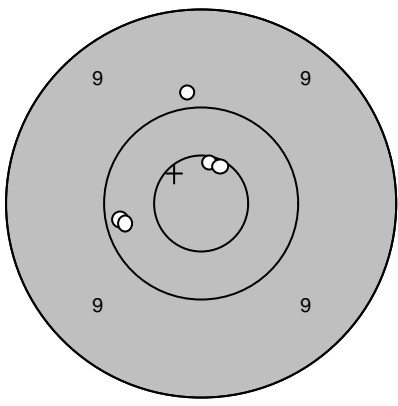
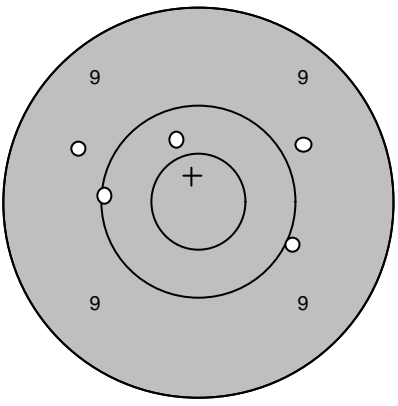
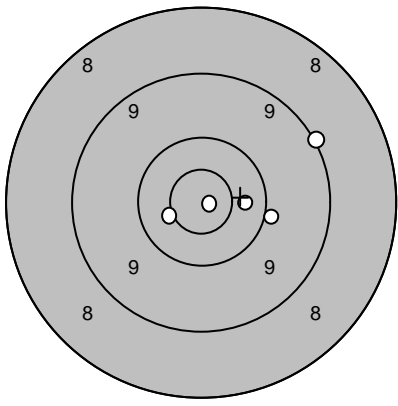
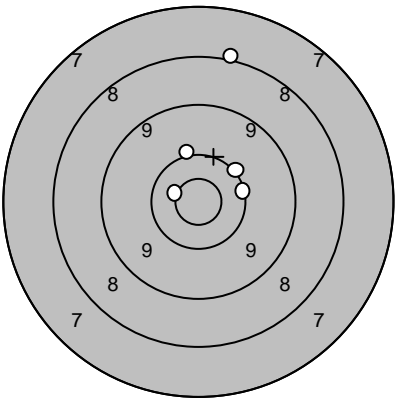
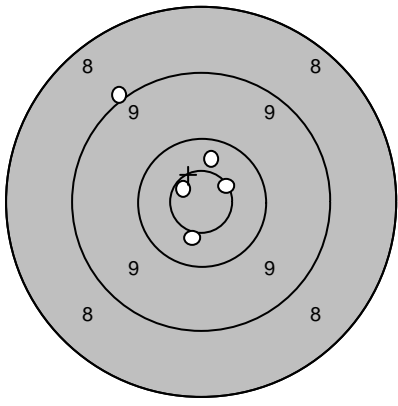
Skjutlag	Tavla	Gustav Lövgren	
5	8		
		Niemisel	
13.07.2007	Tavelträffen A 2007	Ramselefors SKF	
Provskott		1: 10,2 ← 2: 9,9 ↑ 3: 10,6* ↑ 4: 10,6* ↑ 5: 10,2 ←	Serie 1  1: 10,2 ↑ 2: 10,2 ↘ 3: 9,9 ↗ 4: 9,4 ↓ 5: 10,2 ↓
		Serie 49,0 Totalt 0,0	Serie 48,0 Totalt 48,0
Serie 2		1: 10,5* ← 2: 10,9* → 3: 10,4 → 4: 10,0 → 5: 9,1 ↗	Serie 3  1: 9,7 ↖ 2: 10,4 ↑ 3: 10,1 ← 4: 9,8 ↗ 5: 10,0 ↘
		Serie 49,0 Totalt 97,0	Serie 48,0 Totalt 145,0
Extratävling 10		1: 10,4 ↑ 2: 10,5* ↓ 3: 10,6* ↗ 4: 9,0 ↑ 5: 10,7* ↖	Extratävling 10  6: 10,2 → 7: 8,1 ↑ 8: 10,1 ↗ 9: 10,1 ↑ 10: 10,6* ↖
		Serie 49,0 Totalt 194,0	Serie 48,0 Totalt 242,0

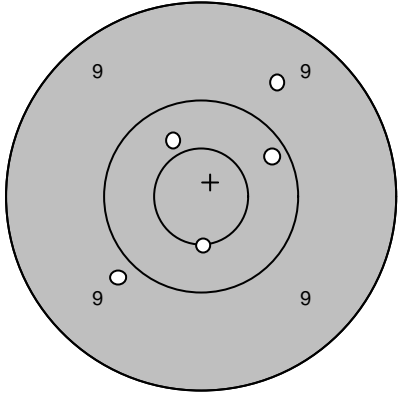
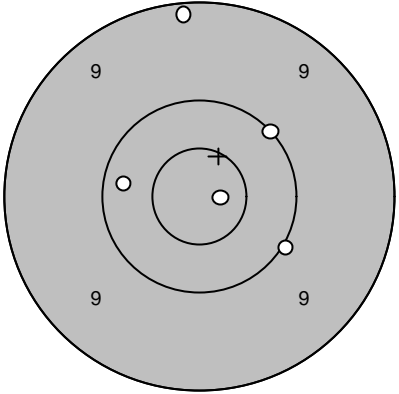
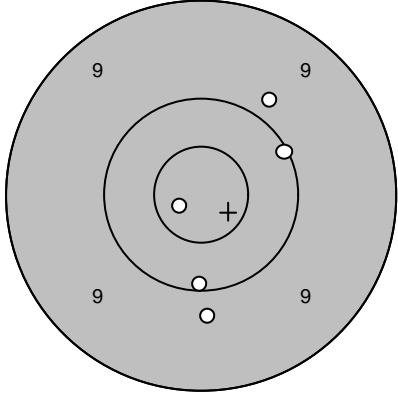
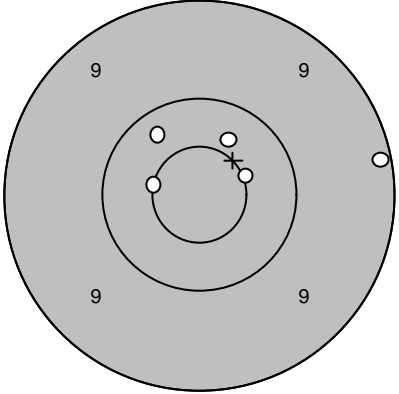
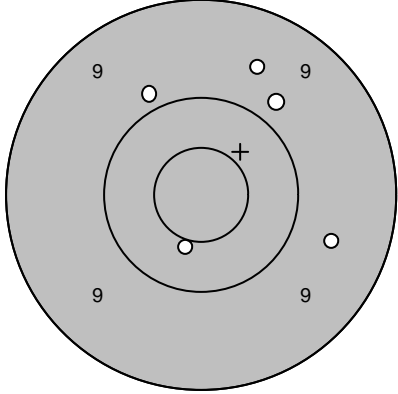
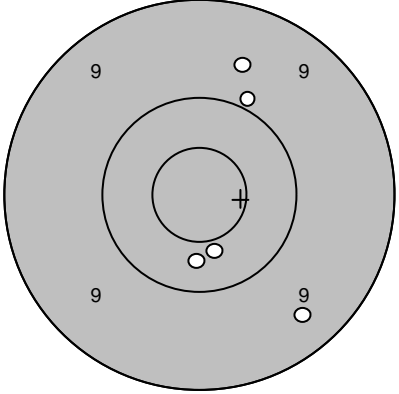
Skjutlag	Tavla	Stefan Håkansson		
5	9	Östersund		
13.07.2007	Tavelträffen A 2007	Ramselefors SKF		
Provskott		1: 9,6 ↗ 2: 10,4 ↖ 3: 10,2 → 4: 10,5* ↓ 5: 9,9 ↙	Serie 1 	1: 9,2 ↑ 2: 10,1 ↗ 3: 10,0 ↘ 4: 10,8* → 5: 10,3 ←
		Serie 48,0	Serie 49,0	
		Totalt 0,0	Totalt 49,0	
Serie 2		1: 10,1 → 2: 9,8 ↗ 3: 10,1 ↓ 4: 10,8* ← 5: 9,8 ↓	Serie 3 	1: 10,3 ↖ 2: 10,6* ← 3: 10,5* → 4: 9,1 → 5: 10,4 ↗
		Serie 48,0	Serie 49,0	
		Totalt 97,0	Totalt 146,0	
Extratävling 10		1: 9,8 ↗ 2: 10,5* ↓ 3: 9,9 ↖ 4: 9,6 ↗ 5: 9,6 →	Extratävling 10 	6: 10,4 ↓ 7: 9,9 ↗ 8: 9,6 ↗ 9: 10,4 ↓ 10: 9,4 ↘
		Serie 46,0	Serie 47,0	
		Totalt 192,0	Totalt 239,0	

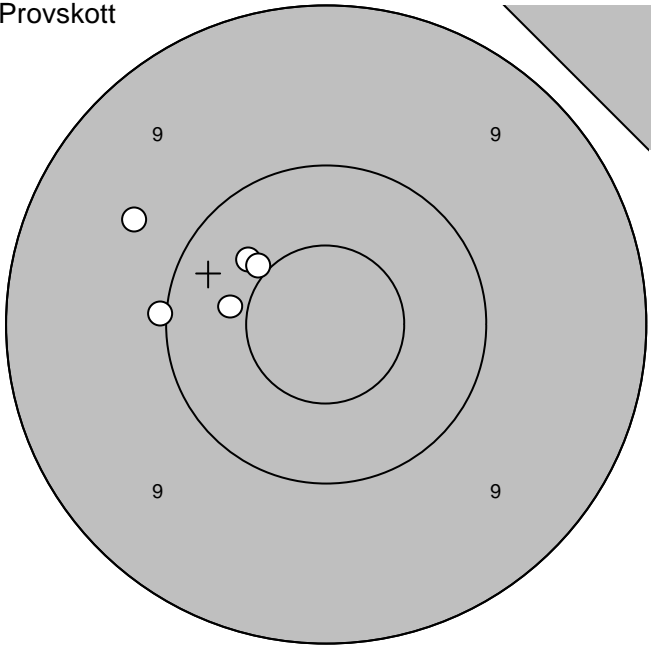
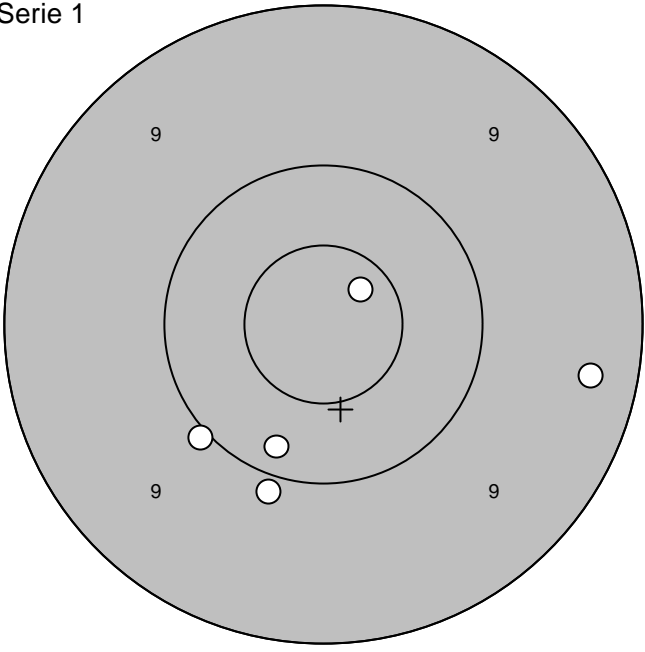
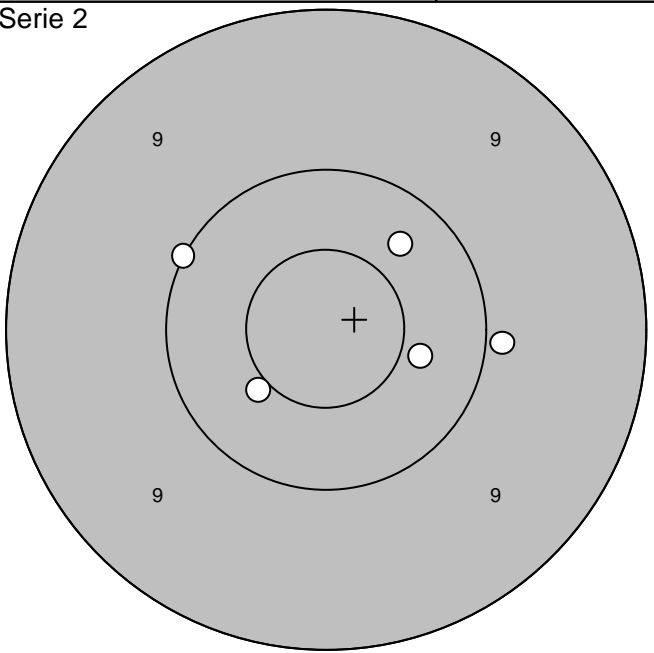
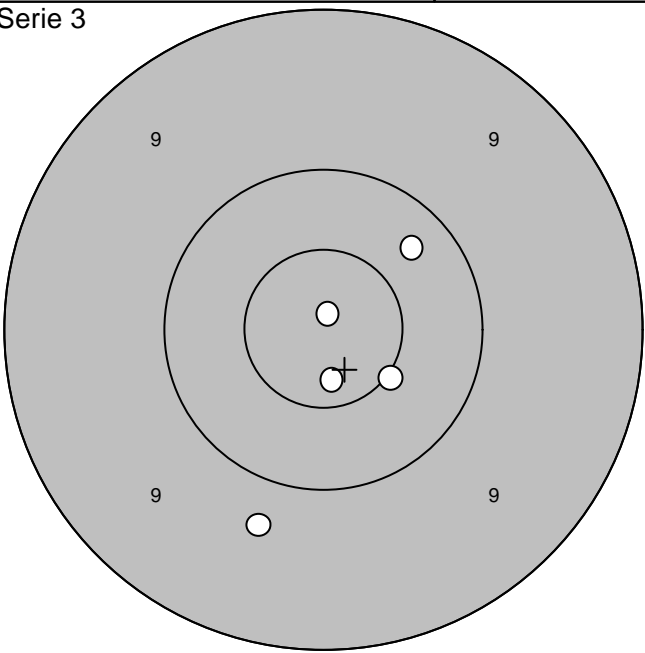
Skjutlag 5	Tavla 10	Stefan Lundqvist	
		Ununge	
13.07.2007	Tavelträffen A 2007	Ramselefors SKF	
Provskott		Serie 1	
			
1:10,0 ←	Serie 49,0	1: 9,3 →	Serie 48,0
2:10,4 ↗		2:10,7* ↗	
3: 9,7 ↖	Totalt 0,0	3:10,2 ↓	Totalt 48,0
4:10,4 ←		4:10,0 ↙	
5:10,5* ↖		5: 9,9 ↓	
Serie 2		Serie 3	
			
1:10,0 ↖	Serie 49,0	1:10,7* ↓	Serie 49,0
2:10,4 →		2: 9,7 ↓	
3:10,3 ↗	Totalt 97,0	3:10,3 ↗	Totalt 146,0
4: 9,9 →		4:10,9* ↑	
5:10,5* ↙		5:10,5* ↘	

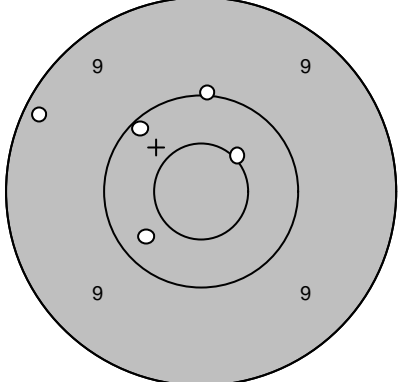
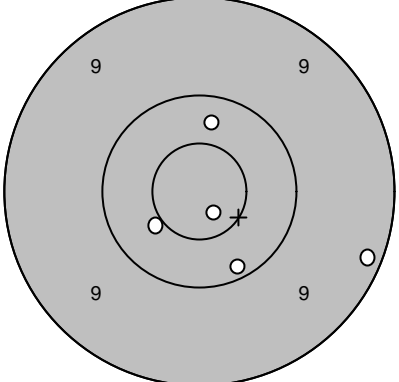
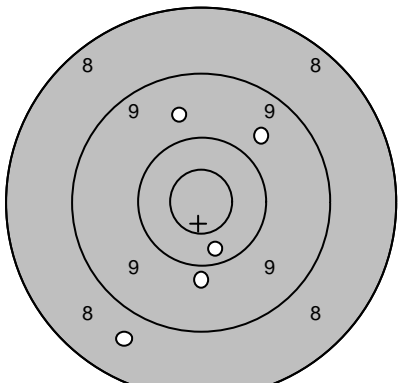
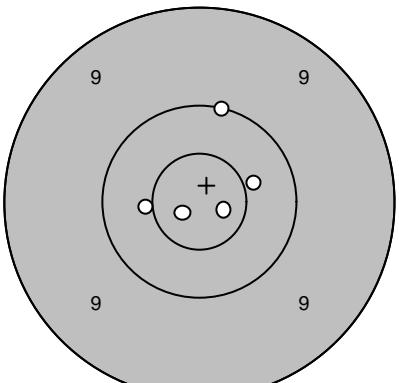
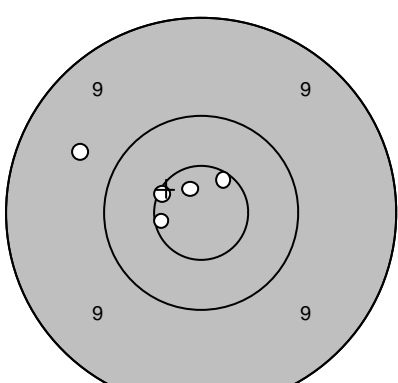
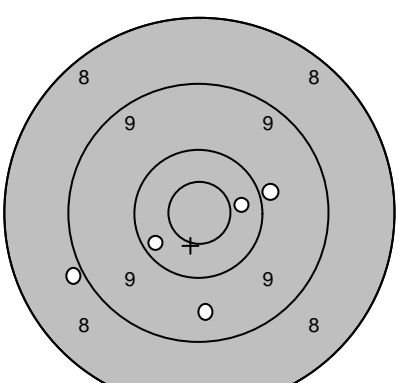
Skjutlag	Tavla	Linda Bergman		
5	11			
		Ununge		
13.07.2007	Tavelträffen A 2007	Ramselefors SKF		
Provskott		1: 9,2 ↖ 2: 10,1 ↖ 3: 10,0 ↑ 4: 10,5* ↗ 5: 10,3 ↙	Serie 1 	1: 9,2 → 2: 10,2 ↓ 3: 10,3 ↑ 4: 10,8* ↓ 5: 10,5* ↙
	Serie 49,0		Serie 49,0	
	Totalt 0,0		Totalt 49,0	
Serie 2		1: 9,7 ↑ 2: 9,7 ↗ 3: 10,3 ↓ 4: 9,9 ↓ 5: 8,7 ↙	Serie 3 	1: 10,8* → 2: 10,1 ↑ 3: 10,8* ↙ 4: 10,4 → 5: 10,5* ←
	Serie 45,0		Serie 50,0	
	Totalt 94,0		Totalt 144,0	
Extratävling 10		1: 9,7 ↖ 2: 10,8* ↖ 3: 10,6* ← 4: 10,6* ↗ 5: 10,6* ↙	Extratävling 10 	6: 9,9 → 7: 10,3 ↙ 8: 10,4 → 9: 9,5 ↓ 10: 8,9 ←
	Serie 49,0		Serie 46,0	
	Totalt 193,0		Totalt 239,0	

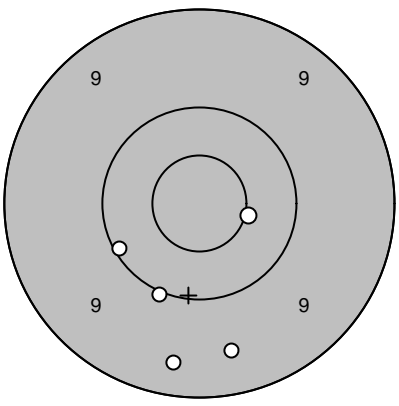
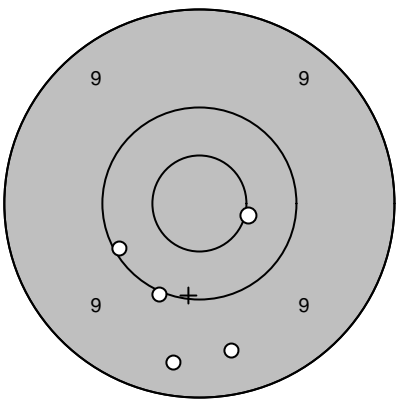
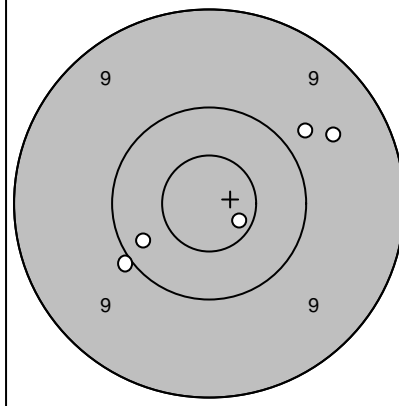
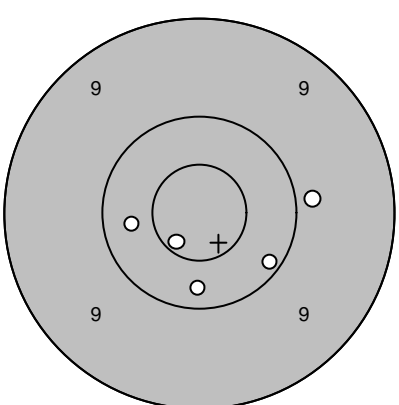
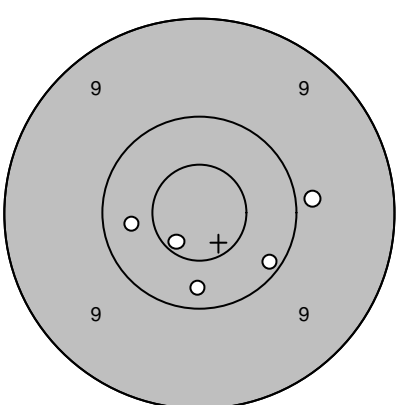
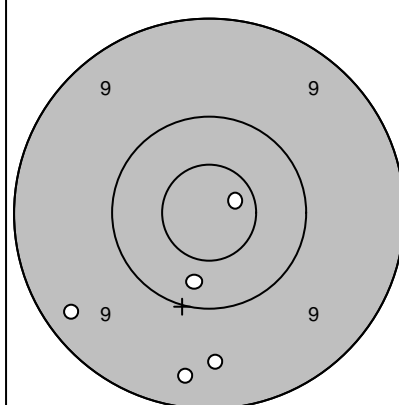
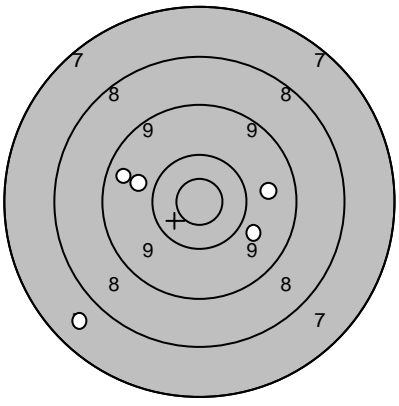
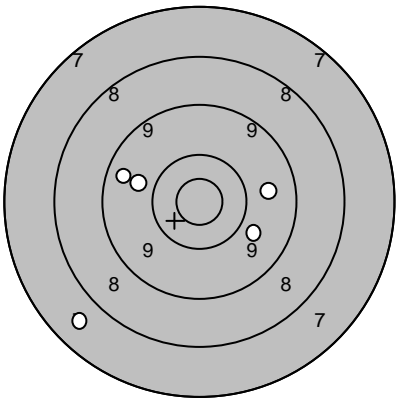
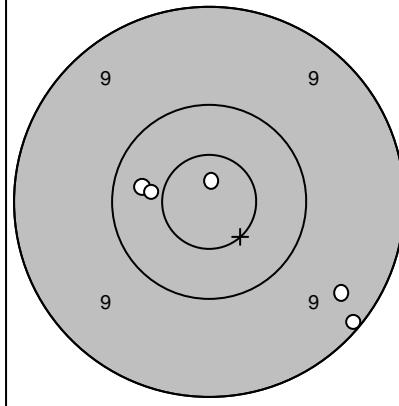
Skjutlag	Tavla	Urban Johansson	
5	13	F 21	
13.07.2007	Tavelträffen A 2007	Ramselefors SKF	
Provskott	1: 9,8 ↗ 2: 9,6 → 3: 10,0 ↙ 4: 10,3 ↙ 5: 10,7* →	Serie 1  1: 9,4 ↓ 2: 9,5 ↓ 3: 10,5* → 4: 10,0 ↓ 5: 10,1 ↙	Serie 1  1: 9,4 ↓ 2: 9,5 ↓ 3: 10,5* → 4: 10,0 ↓ 5: 10,1 ↙
	Serie 48,0 Totalt 0,0	Serie 48,0 Totalt 48,0	Serie 48,0 Totalt 48,0
Serie 2	1: 9,5 ↓ 2: 10,7* → 3: 10,3 ↓ 4: 9,4 ↓ 5: 9,3 ↙	Serie 3  1: 10,2 ↘ 2: 10,3 ↓ 3: 10,7* ↙ 4: 10,3 ← 5: 9,9 →	Serie 3  1: 10,2 ↘ 2: 10,3 ↓ 3: 10,7* ↙ 4: 10,3 ← 5: 9,9 →
	Serie 47,0 Totalt 95,0	Serie 49,0 Totalt 144,0	Serie 49,0 Totalt 144,0
Extratävling 10	1: 9,1 ↘ 2: 10,3 ← 3: 10,4 ← 4: 9,4 ↘ 5: 10,8* ↑	Extratävling 10  6: 9,7 → 7: 9,8 ↘ 8: 9,5 ← 9: 9,8 ← 10: 7,7 ↙	Extratävling 10  6: 9,7 → 7: 9,8 ↘ 8: 9,5 ← 9: 9,8 ← 10: 7,7 ↙
	Serie 48,0 Totalt 192,0	Serie 43,0 Totalt 235,0	Serie 43,0 Totalt 235,0

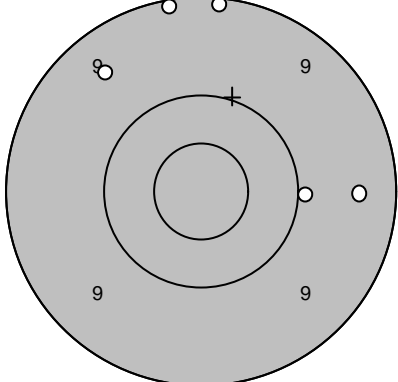
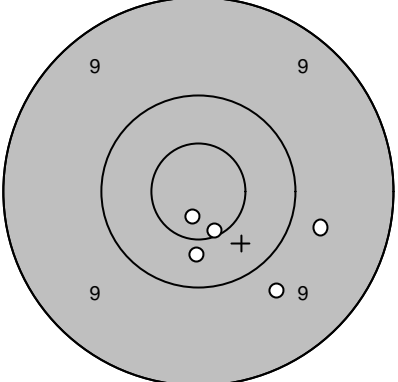
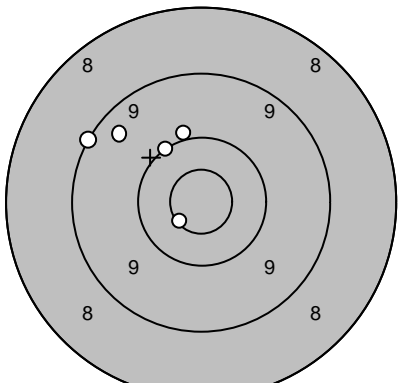
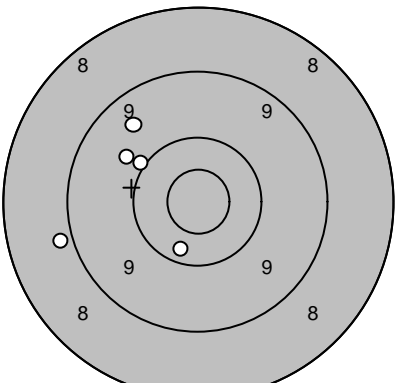
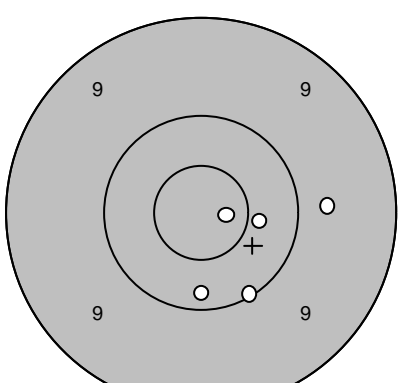
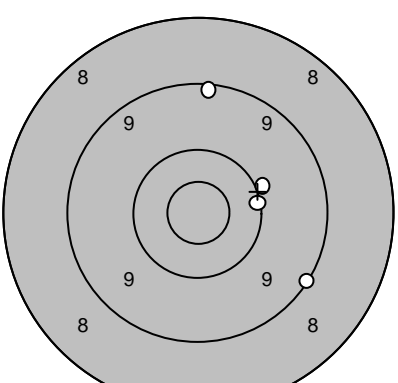
Skjutlag	Tavla	Bo Allansson		
5	15	Stenungsund		
13.07.2007	Tavelträffen A 2007	Ramselefors SKF		
Provskott		1: 10,0 → 2: 9,4 → 3: 9,1 ↑ 4: 9,1 ↑ 5: 9,5 ↖	Serie 1 	1: 9,7 ↘ 2: 9,7 → 3: 10,4 ↓ 4: 10,6* ↓ 5: 10,8* ↓
	Serie 46,0		Serie 48,0	
	Totalt 0,0		Totalt 48,0	
Serie 2		1: 10,1 ↖ 2: 9,1 ↖ 3: 10,0 ↑ 4: 10,6* ↘ 5: 9,5 ↖	Serie 3 	1: 8,9 ← 2: 10,0 ↖ 3: 9,5 ↖ 4: 9,8 ↖ 5: 10,3 ↓
	Serie 48,0		Serie 46,0	
	Totalt 96,0		Totalt 142,0	
Extratävling 10		1: 10,4 → 2: 10,1 ↓ 3: 10,8* → 4: 10,2 ↓ 5: 9,7 →	Extratävling 10 	6: 9,1 ↘ 7: 10,2 → 8: 10,0 → 9: 9,2 ↑
	Serie 49,0		Serie 38,0	
	Totalt 191,0		Totalt 229,0	

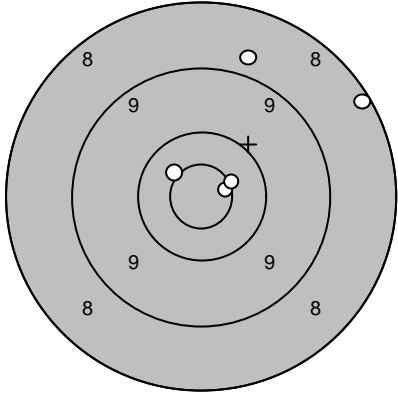
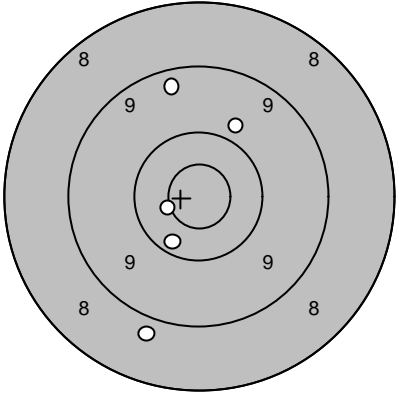
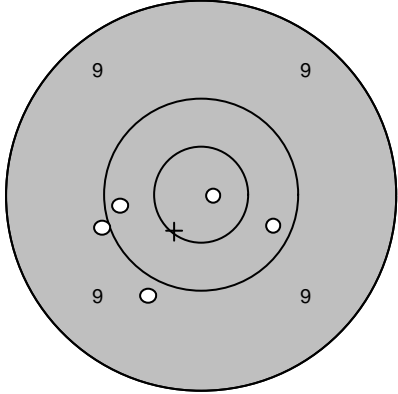
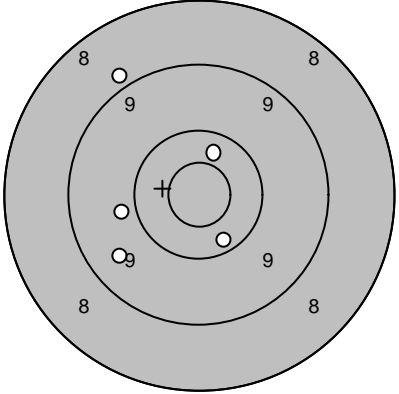
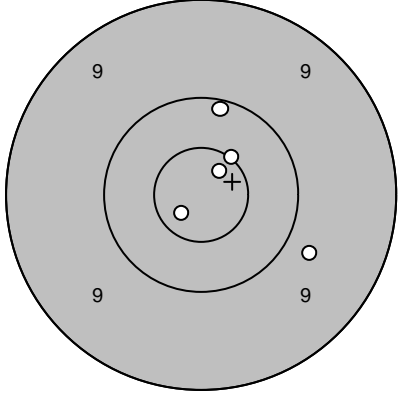
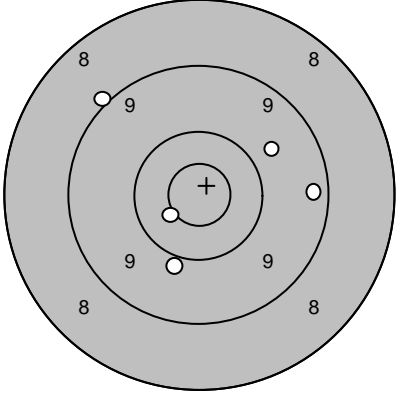
Skjutlag	Tavla		
5	16	Anders Petersson	
		P 7	
13.07.2007	Tavelträffen A 2007	Ramselefors SKF	
Provskott		1: 8,2 → 2: 8,8 ↑ 3: 10,7* → 4: 10,6* → 5: 10,5* ↖	Serie 1 
			1: 10,3 ↘ 2: 9,8 ↗ 3: 9,3 ↑ 4: 8,8 ↘ 5: 10,6* ←
		Serie 46,0	Serie 46,0
		Totalt 0,0	Totalt 46,0
Serie 2		1: 10,9* → 2: 10,2 → 3: 10,0 ← 4: 9,9 ↘ 5: 10,2 ←	Serie 3 
			1: 9,5 ↘ 2: 8,9 ↗ 3: 10,3 ↘ 4: 10,4 ↑ 5: 9,9 ←
		Serie 49,0	Serie 46,0
		Totalt 95,0	Totalt 141,0
Extratävling 10		1: 10,1 ↑ 2: 10,5* ↗ 3: 10,8* ↘ 4: 10,7* ↗ 5: 9,8 →	Extratävling 10 
			6: 9,3 → 7: 9,9 ↘ 8: 9,8 ↗ 9: 10,5* ↘ 10: 9,0 ↖
		Serie 49,0	Serie 46,0
		Totalt 190,0	Totalt 236,0

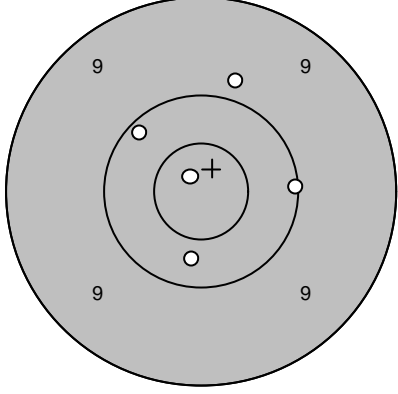
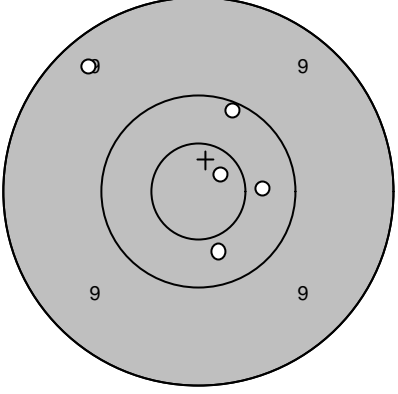
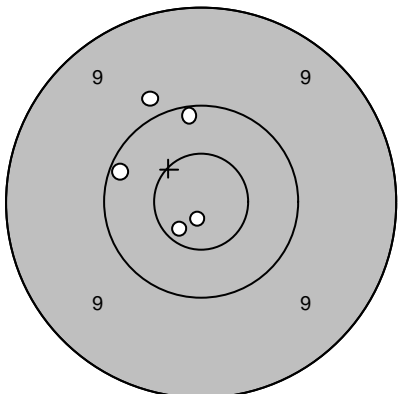
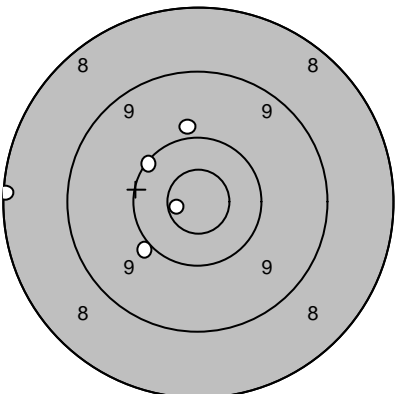
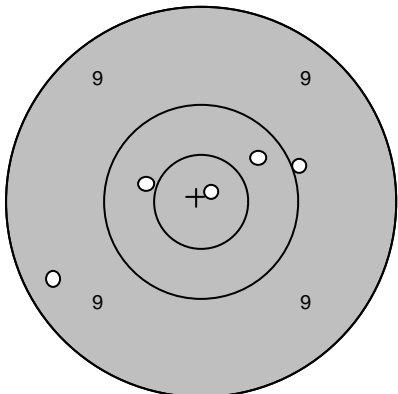
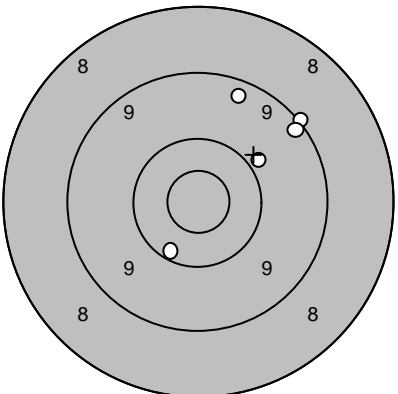
Skjutlag	Tavla	Donald Johansson		
5	17	Ale		
13.07.2007	Tavelträffen A 2007	Ramselefors SKF		
Provskott		1: 10,2 ↖ 2: 10,9* ↖ 3: 10,1 → 4: 10,3 ↓ 5: 9,8 ↑	Serie 1 	1: 9,4 ↖ 2: 10,4 ↓ 3: 10,7* ↗ 4: 10,4 → 5: 10,1 ↗
		Serie 49,0	Serie 49,0	
		Totalt 0,0	Totalt 49,0	
Serie 2		1: 10,2 ↖ 2: 10,7* ↙ 3: 9,9 ↗ 4: 10,2 ↑ 5: 10,9* ↓	Serie 3 	1: 8,1 ← 2: 10,7* ← 3: 9,9 ↑ 4: 10,1 ↖ 5: 10,0 ↙
		Serie 49,0	Serie 47,0	
		Totalt 98,0	Totalt 145,0	
Extratävling 10		1: 10,4 ← 2: 9,3 ↙ 3: 10,0 → 4: 10,3 ↗ 5: 10,9* ↗	Extratävling 10 	6: 9,1 ↗ 7: 9,4 ↑ 8: 9,9 ↗ 9: 9,2 ↗ 10: 10,2 ↓
		Serie 49,0	Serie 46,0	
		Totalt 194,0	Totalt 240,0	

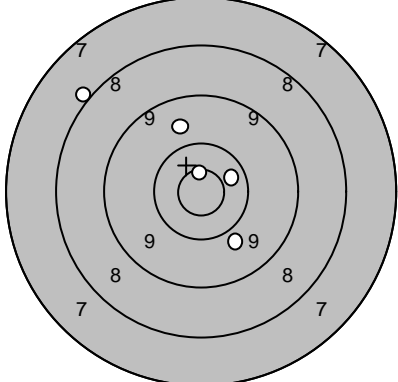
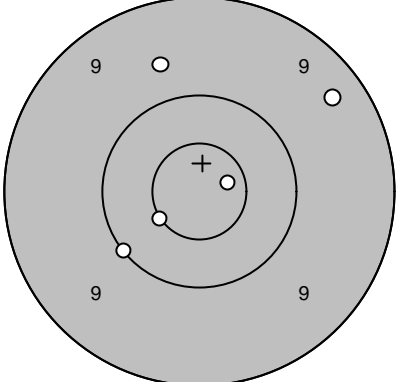
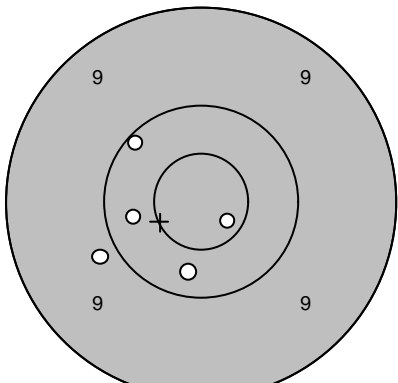
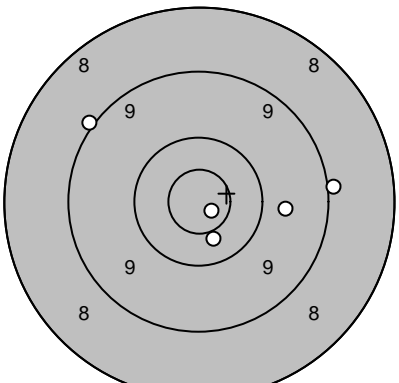
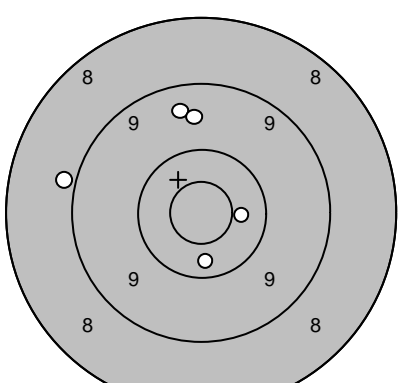
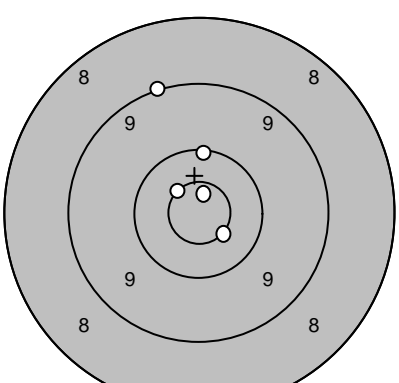
Skjutlag	Tavla	Stefan Thorin	
5	19		
Umeå			
13.07.2007	Tavelträffen A 2007	Ramselefors SKF	
Provskott		1: 8,0 ↖ 2: 9,7 ↑ 3: 10,7* ↑ 4: 10,4 → 5: 9,9 ↓	Serie 1 
	Serie 46,0 Totalt 0,0	1: 9,7 ↑ 2: 10,1 ↙ 3: 10,7* → 4: 9,4 ↗ 5: 10,5* ↖	Serie 48,0 Totalt 48,0
Serie 2		1: 10,3 ↓ 2: 10,7* ↘ 3: 10,1 ↗ 4: 10,3 ← 5: 9,9 ↙	Serie 3 
	Serie 49,0 Totalt 97,0	1: 9,0 ↗ 2: 10,8* ↘ 3: 9,7 → 4: 9,0 → 5: 10,5* ↓	Serie 47,0 Totalt 144,0
Extratävling 10		1: 10,5* → 2: 9,5 ↑ 3: 10,3 ↓ 4: 8,9 ← 5: 9,6 ↑	Extratävling 10 
	Serie 46,0 Totalt 190,0	6: 10,2 ↑ 7: 10,6* ↖ 8: 10,6* ↘ 9: 10,8* ↑ 10: 9,1 ↑	Serie 49,0 Totalt 239,0