

Skjutlag	Tavla	Linnea Jonsson	
1	1	Umeå	
2006-09-02	Höstträffen 2006 Final	Ramselefors SKF	
Provskott		1: 9,6 → 2: 9,2 ↘ 3: 9,0 → 4: 8,3 ↘ 5: 10,7* → 6: 8,8 ↘ 7: 8,9 ↘ 8: 9,4 ↘ 9: 9,7 ↘ 10: 9,9 ↘	Provschott 
	Serie 88,0		11: 10,0 ↗ 12: 9,4 ↗ 13: 10,1 → 14: 9,9 ← 15: 9,2 ← 16: 9,5 ↑ 17: 9,7 ↓ 18: 9,9 →
	Totalt 193,0		Serie 74,0
			Totalt 193,0
10 skott		1: 8,1 ← 2: 10,7* ↑ 3: 10,5* ↗ 4: 9,1 → 5: 9,2 ←	10 skott 
	Serie 46,0		6: 10,0 ↗ 7: 9,3 ↘ 8: 10,7* → 9: 9,4 ←
	Totalt 239,0		10: 9,6 ←
			Serie 47,0
			Totalt 286,0
Enkeltskott		1: 10,4* ↖ 2: 10,3 ← 3: 9,5 ↗ 4: 9,8 ↗ 5: 10,0 →	
	Serie 48,0		
	Totalt 334,0		

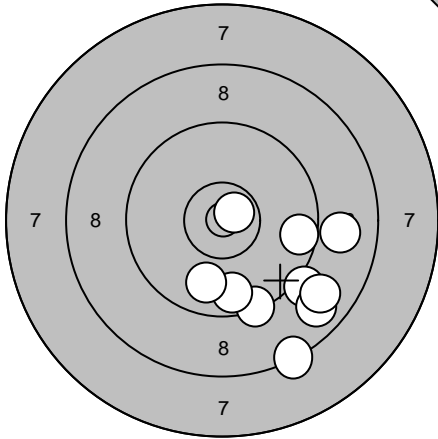

1: 7,6 ↘	6: 9,3 ↘	Serie	91,0
2: 9,5 ↑	7: 9,5 →		
3: 10,7* →	8: 9,9 ↑	Totalt	192,0
4: 10,1 ↗	9: 10,7* ↘		
5: 9,7 →	10: 9,5 ↘		

1: 10,8* ↙	Serie	50,0
2: 10,6* →		
3: 10,4* ↗	Totalt	242,0
4: 10,6* ↙		
5: 10,3* ↘		

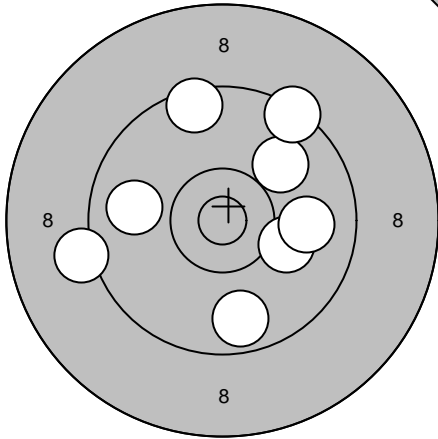
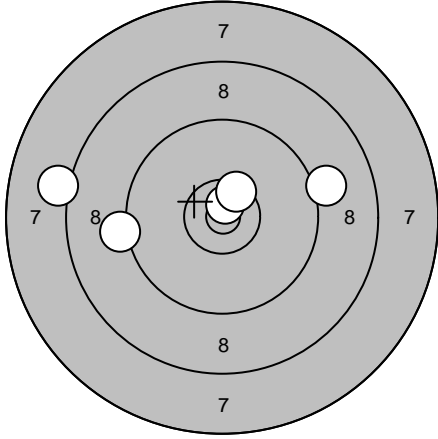
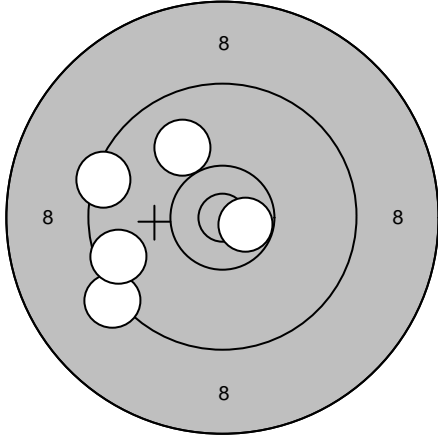
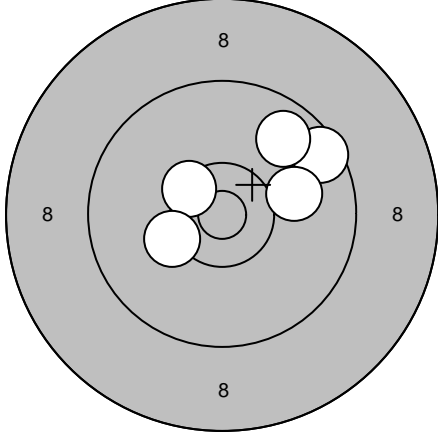
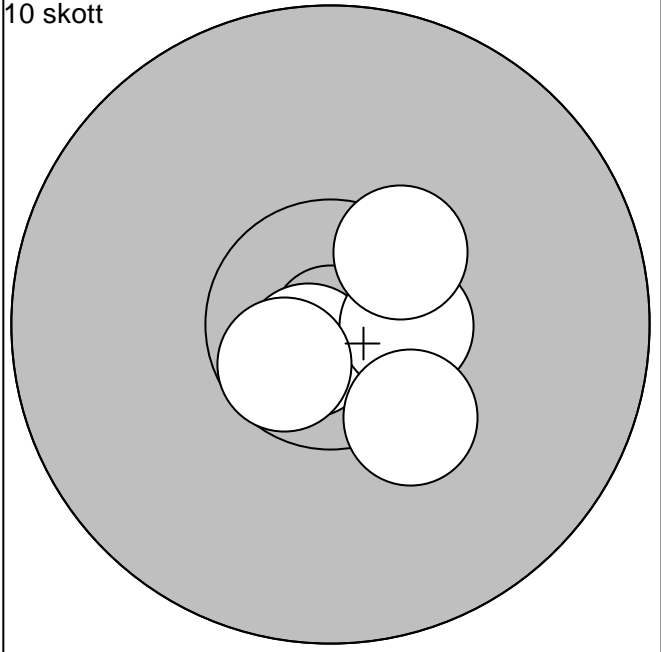
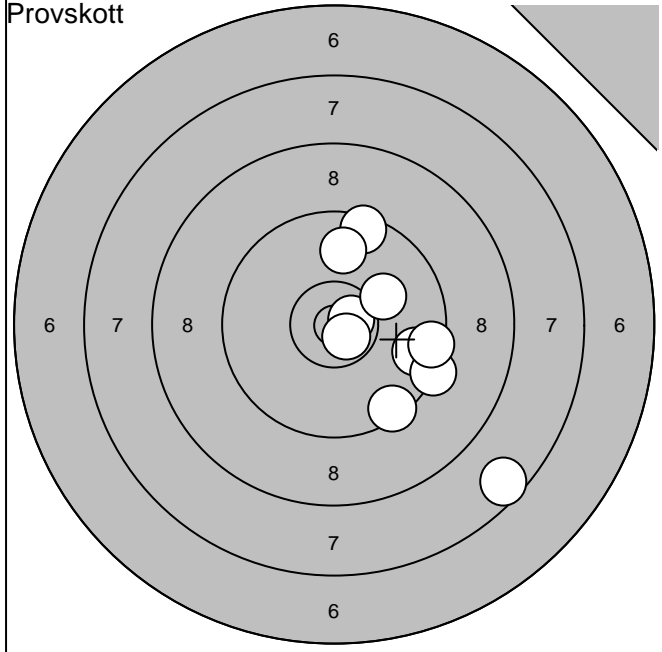
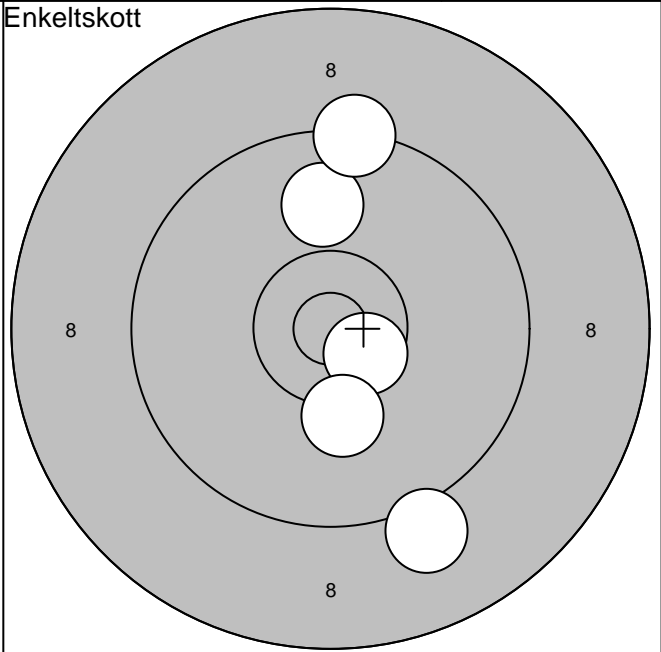
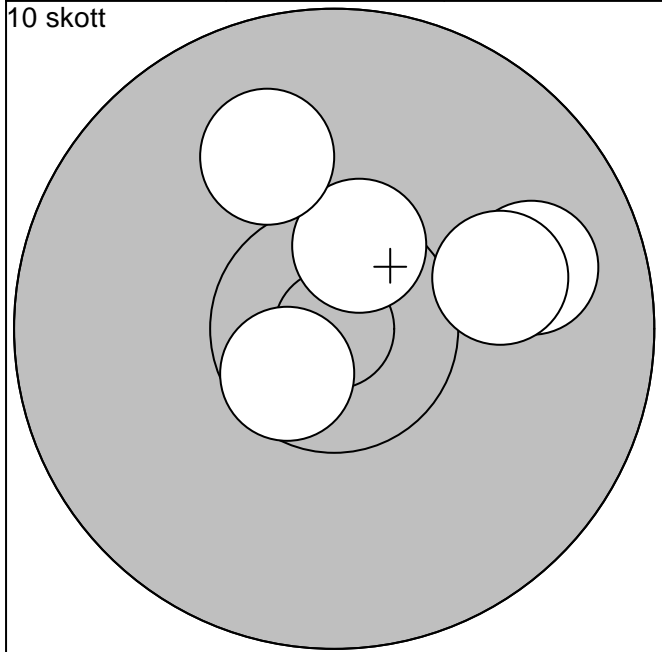

6: 9,9 →	Serie	49,0
7: 10,6* ↙		
8: 10,1 →	Totalt	291,0
9: 10,5* ↑		
10: 10,0 ↑		

1: 9,1 ↘	Serie	47,0
2: 9,9 ↑		
3: 10,6* ↘	Totalt	338,0
4: 9,3 ↑		
5: 10,2 ↘		

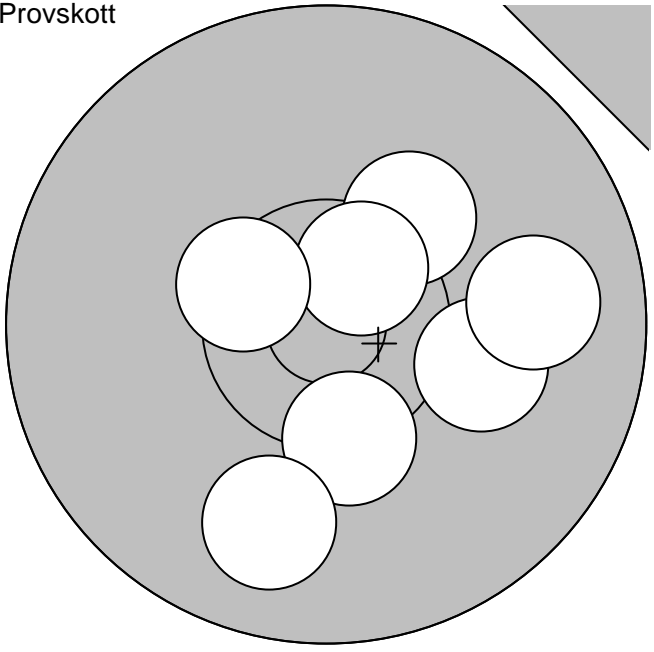
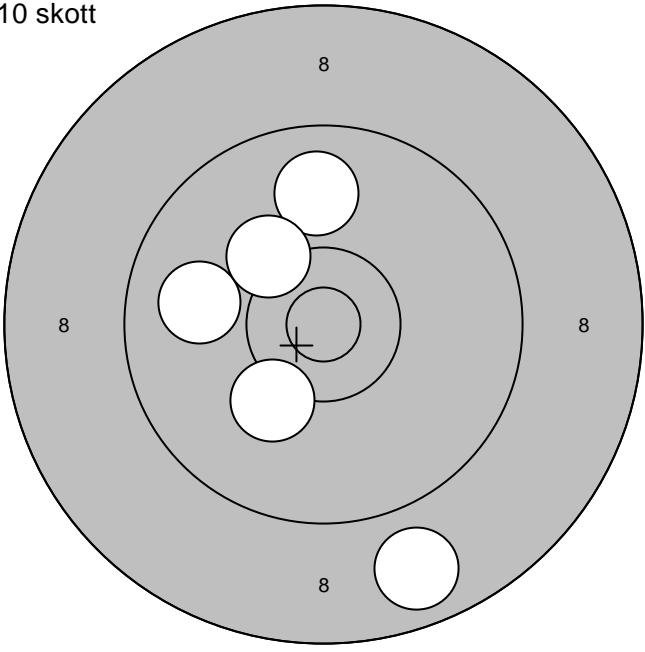
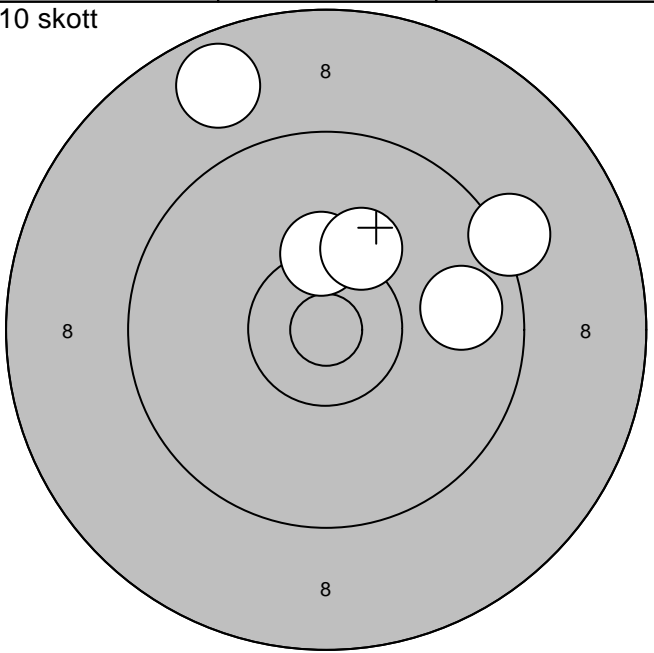
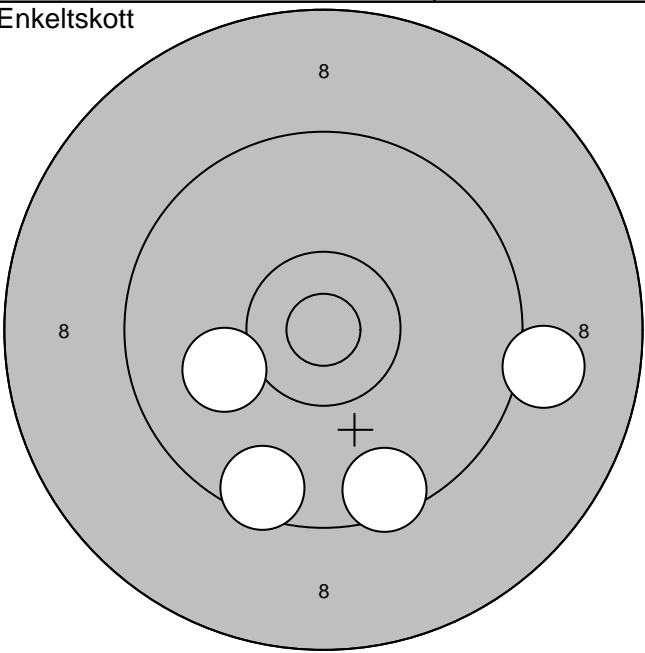
Skjutlag	Tavla	Therese Karlsson	
1	3	Drängsmark	
2006-09-02	Höstträffen 2006 Final	Ramselefors SKF	
Provskott		10 skott	
			
1:10,3 ↗	6: 9,9 ↓	Serie 68,0	Serie 46,0
2:10,1 →	7:10,5* ↖		
3:10,6* ↗		Totalt 189,0	Totalt 235,0
4: 9,9 →			
5:10,3* ↓			
10 skott		Enkeltskott	
			
6: 9,8 →		Serie 46,0	Serie 37,0
7:10,3* ↑			
8:10,2 ↗		Totalt 281,0	Totalt 318,0
9: 8,7 ↗			
10: 9,2 ↗			

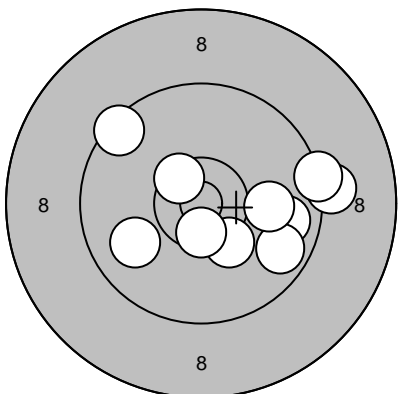
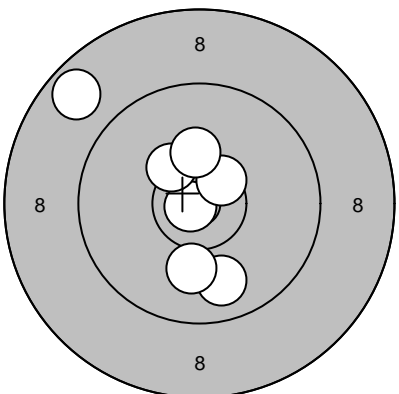
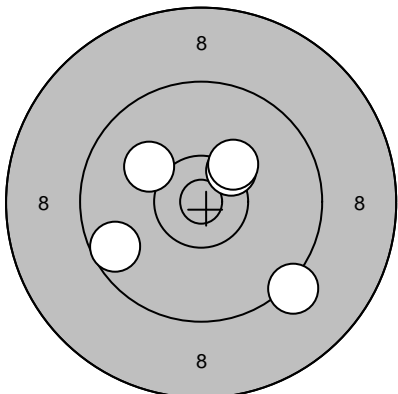
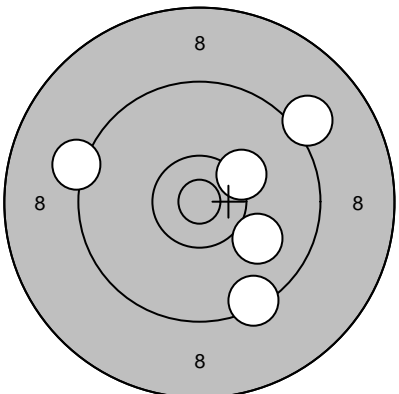
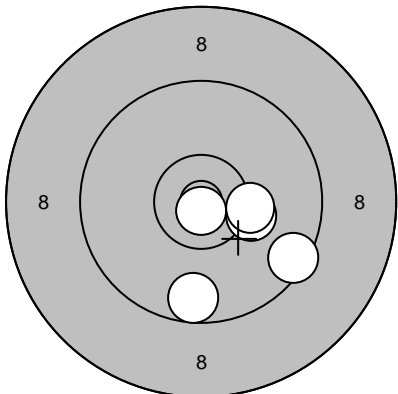
Skjutlag	Tavla	Emil Bergman	
1	4		
		Umeå	
2006-09-02	Höstträffen 2006 Final	Ramselefors SKF	
Provskott		1: 9,8 → 2: 9,2 → 3: 10,5* ↗ 4: 10,3* ↓ 5: 9,7 → 6: 10,6* ↓ 7: 10,0 → 8: 9,3 → 9: 9,9 ← 10: 9,5 ↖	Provskott  11: 9,9 ↓ 12: 8,7 ↗ 13: 10,8* ← 14: 10,3* ↗ 15: 10,1 ↓ 16: 10,5* ↗ 17: 10,3 ↑
		Serie 94,0	Serie 67,0
		Totalt 189,0	Totalt 189,0
10 skott		1: 9,2 ↘ 2: 10,4* ↗ 3: 10,3* ↗ 4: 10,1 ↖ 5: 9,6 ←	10 skott  6: 9,2 ← 7: 9,4 ↓ 8: 9,1 ↗ 9: 10,3 ↗ 10: 10,0 ↘
		Serie 48,0	Serie 47,0
		Totalt 237,0	Totalt 284,0
Enkeltskott		1: 10,2 → 2: 10,8* ↓ 3: 10,3 → 4: 9,7 ↓ 5: 9,5 →	
		Serie 48,0	
		Totalt 332,0	

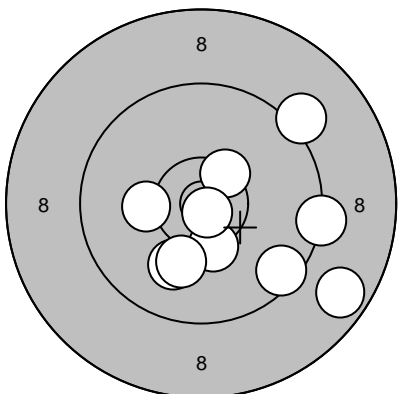
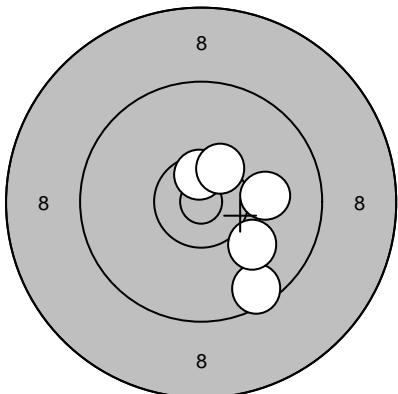
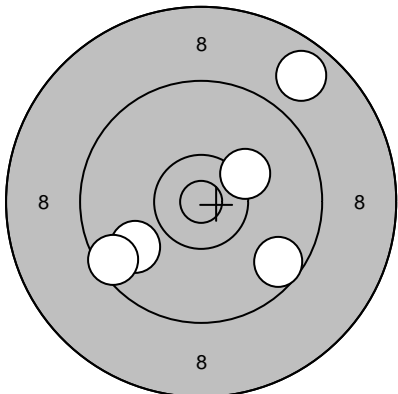
Skjutlag	Tavla	Elina Högström	
1	5	Ramselefors	
2006-09-02	Höstträffen 2006 Final	Ramselefors SKF	
Provskott		1: 8,7 ↘ 2: 9,2 ↗ 3: 10,2 ← 4: 10,0 ↓ 5: 9,3 → 6: 9,5 ↘ 7: 10,4* ↗ 8: 10,4* ↓ 9: 10,1 ↓ 10: 10,8* ↘	11: 9,3 ← 12: 8,6 ← 13: 10,4* ← 14: 10,6* ↘
	Serie 95,0		Serie 37,0
	Totalt 187,0		Totalt 187,0
10 skott		1: 9,6 ↓ 2: 10,6* ↑ 3: 10,4* ↗ 4: 10,0 ↘ 5: 10,1 →	6: 10,0 ← 7: 10,5* ↗ 8: 10,6* ↘ 9: 10,1 ← 10: 8,9 ↗
	Serie 49,0		Serie 48,0
	Totalt 236,0		Totalt 284,0
Enkeltskott		1: 10,2 ↗ 2: 9,6 ↘ 3: 9,9 ← 4: 8,8 ↗ 5: 9,5 ←	
	Serie 45,0		
	Totalt 329,0		

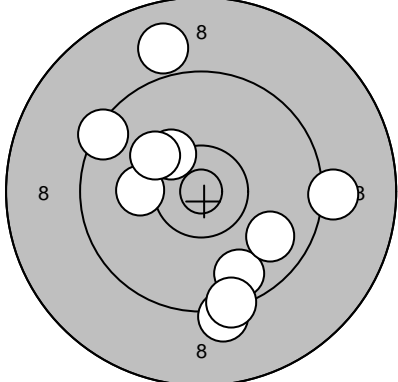
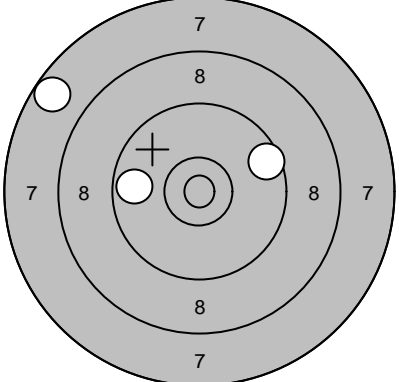
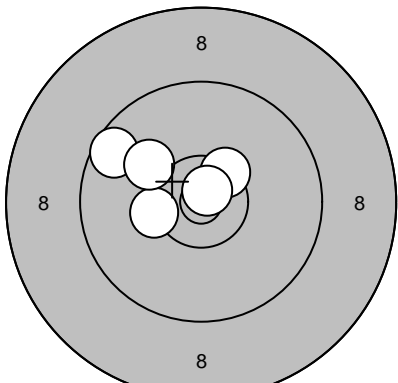
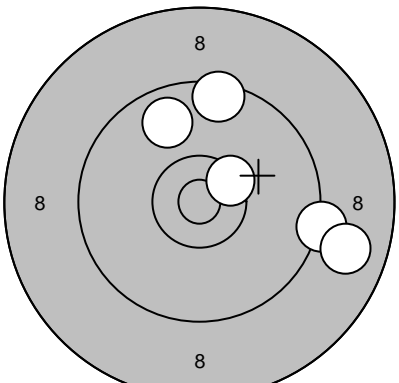
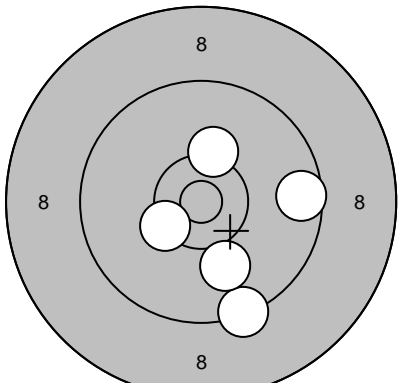
Skjutlag	Tavla	Kevin Yu	
1	6		
Umeå			
2006-09-02	Höstträffen 2006 Final	Ramselefors SKF	
Provskott		1: 9,2 ↓ 2: 9,4 ↗ 3: 9,7 ↓ 4: 9,2 → 5: 10,1 ← 6: 9,4 ↓ 7: 9,8 ↓ 8: 10,3* ↗ 9: 10,2 ↗ 10: 9,0 ↑	Provskott 
	Serie 93,0 Totalt 187,0		11: 7,7 ↖ 12: 9,7 ← 13: 9,6 ↗
			Serie 25,0 Totalt 187,0
10 skott		1: 10,4* ↗ 2: 10,3* ← 3: 9,6 ↖ 4: 10,1 ↗ 5: 10,8* ↗	10 skott 
	Serie 49,0 Totalt 236,0		6: 10,4* ↗ 7: 9,3 → 8: 9,8 ↑ 9: 8,9 → 10: 9,5 ↑
			Serie 45,0 Totalt 281,0
Enkeltskott		1: 10,4* ↖ 2: 9,3 ↓ 3: 10,0 ↓ 4: 10,3 ↑ 5: 9,6 →	
	Serie 48,0 Totalt 329,0		

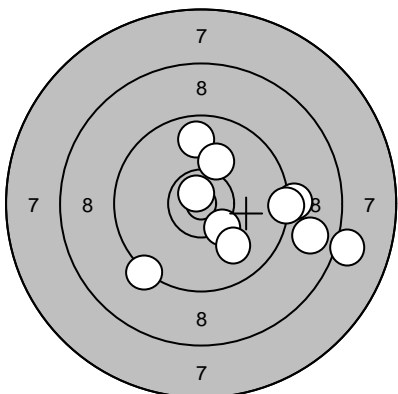
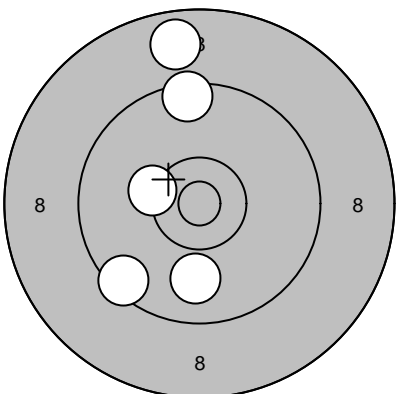
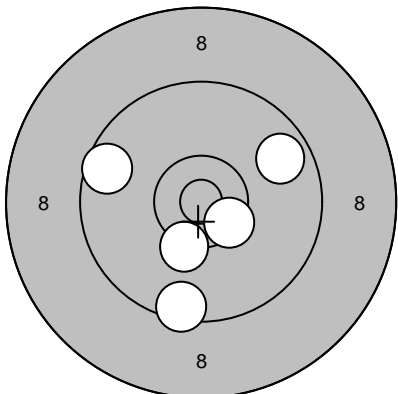
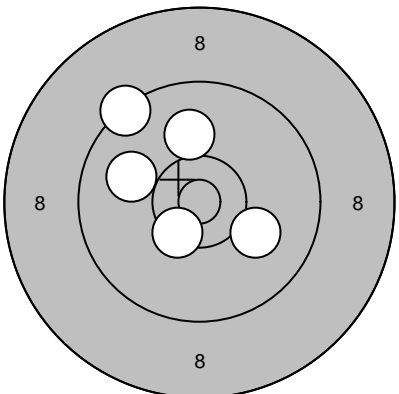
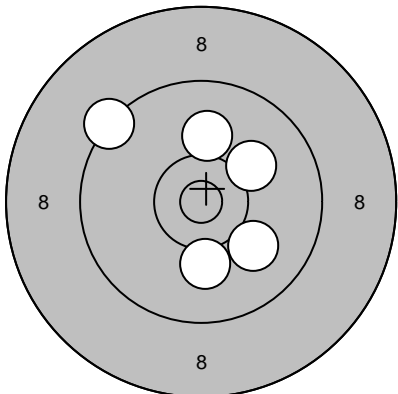
Skjutlag	Tavla	Daniel Evertsson	
1	7	Ramselefors	
2006-09-02	Höstträffen 2006 Final	Ramselefors SKF	
Provskott		1: 9,2 → 2: 8,1 → 3: 8,8 → 4: 9,7 ↑ 5: 9,3 → 6: 10,4* ↓ 7: 10,8* ↗ 8: 10,1 ↑ 9: 9,3 ↙ 10: 10,0 ↓	Provskott 
	Serie 92,0		11: 9,9 ↓
	Totalt 185,0		12: 10,3* ←
			13: 8,8 ↑
			14: 9,5 ↙
			15: 9,5 ↑
	Serie 45,0		
	Totalt 185,0		
10 skott		1: 10,3* ↓ 2: 9,7 → 3: 9,6 ← 4: 9,5 ↓ 5: 10,5* →	10 skott 
	Serie 47,0		6: 10,1 →
	Totalt 232,0		7: 9,4 ↗
			8: 10,4* ↓
			9: 10,0 ←
			10: 10,0 ↑
	Serie 49,0		
	Totalt 281,0		
Enkeltskott		1: 10,1 ↗ 2: 9,3 ↙ 3: 10,0 ↑ 4: 10,1 ↓ 5: 10,0 →	
	Serie 49,0		
	Totalt 330,0		

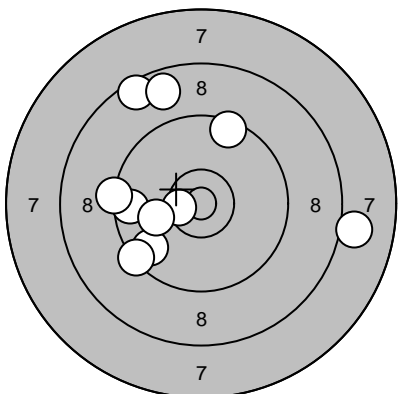
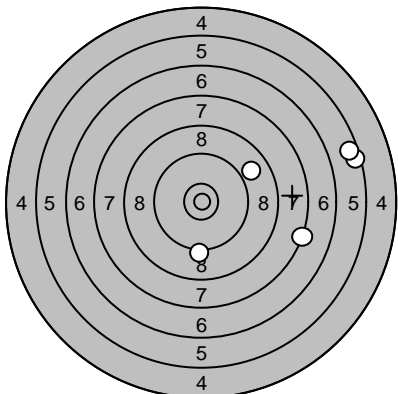
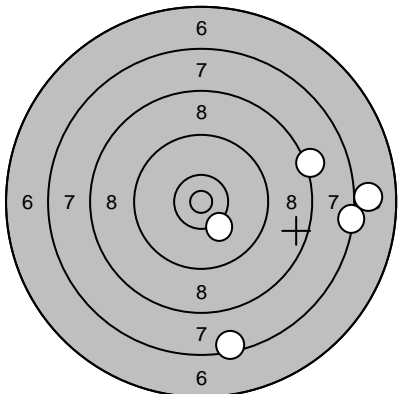
Skjutlag	Tavla		
1	8	Andre Forsberg	
		Umeå	
2006-09-02	Höstträffen 2006 Final	Ramselefors SKF	
Provskott		1: 8,6 ↖ 2: 8,8 ↖ 3: 9,6 ← 4: 9,7 ↙ 5: 10,5* ← 6: 9,3 ← 7: 9,5 ↖ 8: 8,0 → 9: 10,1 ← 10: 9,4 ↙	11: 9,3 ↓ 12: 8,1 ↘ 13: 7,0 ↑ 14: 8,7 ↓ 15: 10,1 ↗
	Serie 89,0		Serie 42,0
	Totalt 174,0		Totalt 174,0
10 skott		1: 5,5 → 2: 9,0 ↗ 3: 9,2 ↓ 4: 7,3 → 5: 5,6 →	6: 8,4 ↘ 7: 5,8 ↘ 8: 9,5 → 9: 9,0 → 10: 8,1 ↗
	Serie 35,0		Serie 39,0
	Totalt 209,0		Totalt 248,0
Enkeltskott		1: 10,2 ↓ 2: 7,5 ↓ 3: 8,2 → 4: 7,4 → 5: 7,0 →	
	Serie 39,0		
	Totalt 287,0		

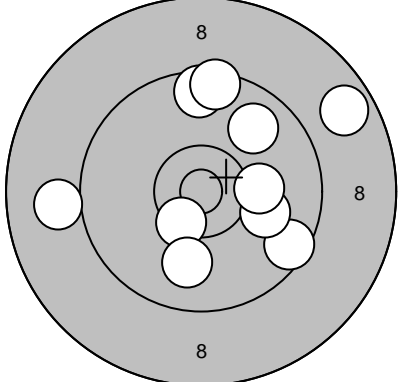
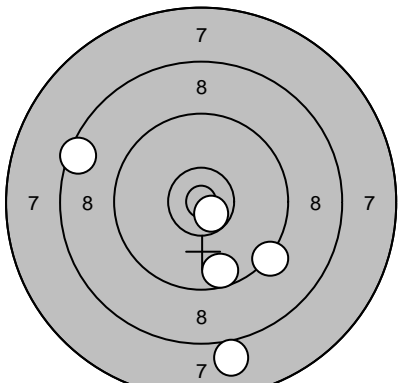
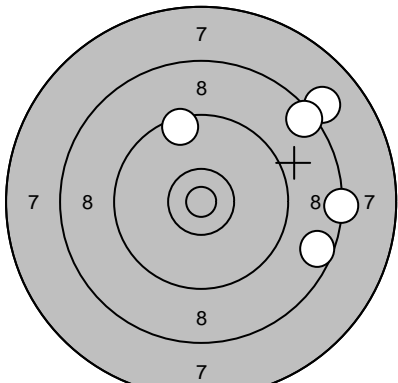
Skjutlag	Tavla	Viktor Strand	
1	9		
		Ramselefors	
2006-09-02	Höstträffen 2006 Final	Ramselefors SKF	
Provskott		1: 9,6 ↘ 2: 10,5* ↓ 3: 8,7 → 4: 9,8 ↗ 5: 9,6 ↑ 6: 9,5 ↑ 7: 9,0 ← 8: 10,0 ↓ 9: 10,0 → 10: 10,2 →	Provskott
		Serie 93,0	11: 9,7 ↖ 12: 9,6 ↑ 13: 9,8 ↗ 14: 10,0 → 15: 10,1 ← 16: 9,3 ↖
		Totalt 172,0	Serie 56,0
			Totalt 172,0
10 skott		1: 9,6 ↓ 2: 10,7* ↓ 3: 8,0 ↓ 4: 9,3 ↓ 5: 8,5 ↖	10 skott
		Serie 44,0	6: 9,3 ↓
		Totalt 216,0	7: 10,1 ←
			8: 9,3 →
			9: 10,0 →
			10: 10,0 ←
			Serie 48,0
			Totalt 264,0
Enkeltskott		1: 8,0 ↗ 2: 9,5 ↑ 3: 8,6 → 4: 8,5 ↗ 5: 8,3 →	
		Serie 41,0	
		Totalt 305,0	

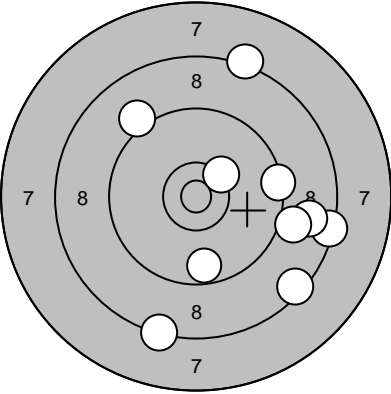
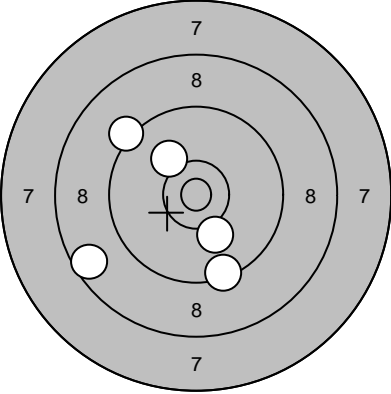
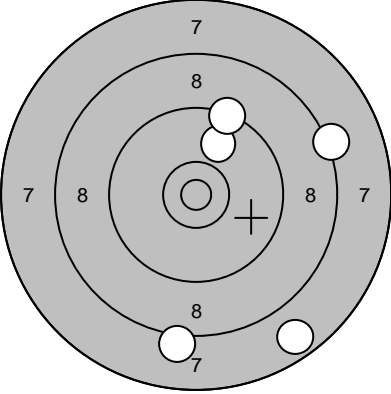
Skjutlag	Tavla	Jasmine Frank	
1	10		
		Ramselefors	
2006-09-02	Höstträffen 2006 Final	Ramselefors SKF	
Provskott		1: 8,4 → 2: 8,3 ↓ 3: 10,3* ↗ 4: 8,8 → 5: 8,3 ↗ 6: 9,4 → 7: 9,1 → 8: 9,7 ↓ 9: 8,5 ↓ 10: 9,1 ↗	Provskott
			11: 9,5 ↙
		Serie 86,0	Serie 9,0
		Totalt 165,0	Totalt 165,0
10 skott		1: 8,6 ↙ 2: 9,4 ↓ 3: 9,2 ↗ 4: 10,1 ↗ 5: 10,1 ↓	10 skott
			6: 10,1 ← 7: 9,5 ↓ 8: 9,8 ↘ 9: 9,9 ↗ 10: 8,6 ↗
		Serie 46,0	Serie 45,0
		Totalt 211,0	Totalt 256,0
Enkeltskott		1: 9,9 ↗ 2: 9,4 ↗ 3: 8,2 → 4: 8,2 ↓ 5: 7,7 ↘	
		Serie 41,0	
		Totalt 297,0	

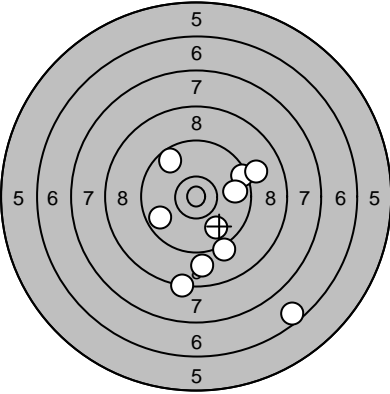
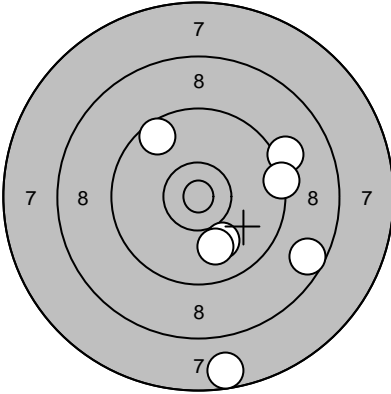
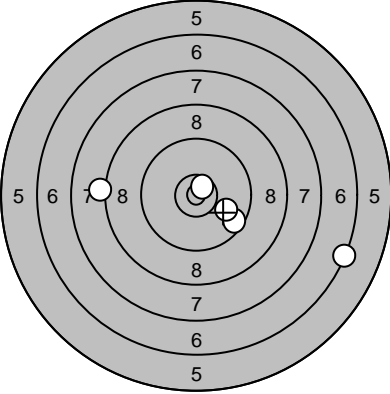
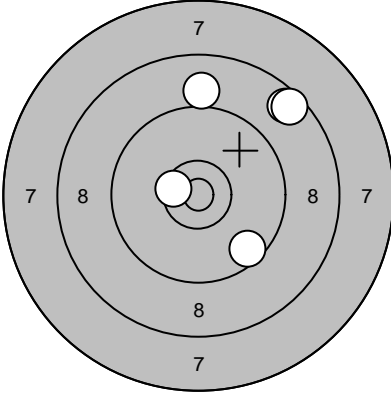
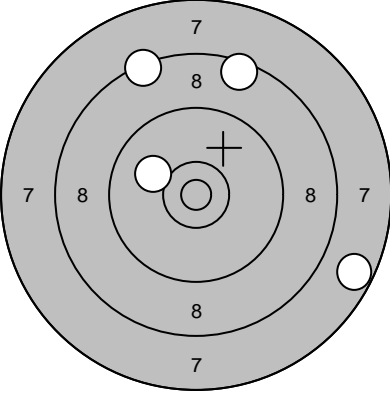
Skjutlag	Tavla		
1	11	Edward Yu	
		Umeå	
2006-09-02	Höstträffen 2006 Final	Ramselefors SKF	
Provskott		1: 9,5 → 2: 9,9 ↓ 3: 9,7 ↗ 4: 9,8 → 5: 9,8 ← 6: 8,9 ↓ 7: 8,3 ↓ 8: 9,2 ↓ 9: 6,6 ↓ 10: 9,0 →	Provskott 
	Serie 85,0		11: 10,0 ↓
	Totalt 159,0		12: 9,1 ↗
			13: 10,0 ↓
			14: 7,7 ↓
			15: 9,4 →
			16: 8,6 ↓
			17: 9,6 ↗
	Serie 85,0		Serie 62,0
	Totalt 159,0		Totalt 159,0
10 skott		1: 10,7* ↗ 2: 6,3 → 3: 9,6 ↓ 4: 10,0 → 5: 8,2 ←	10 skott 
	Serie 43,0		6: 10,5* ←
	Totalt 202,0		7: 8,6 ↗
			8: 8,6 ↗
			9: 9,0 ↑
			10: 9,6 ↓
	Serie 43,0		Serie 44,0
	Totalt 202,0		Totalt 246,0
Enkeltskott		1: 8,5 ↗ 2: 0,0 ↓ 3: 10,1 ↗ 4: 8,4 ↗ 5: 7,7 →	
	Serie 33,0		
	Totalt 279,0		

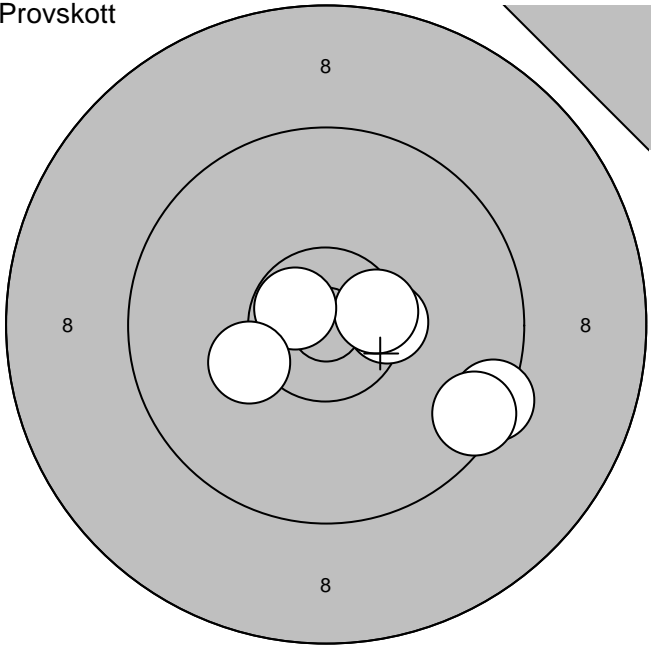
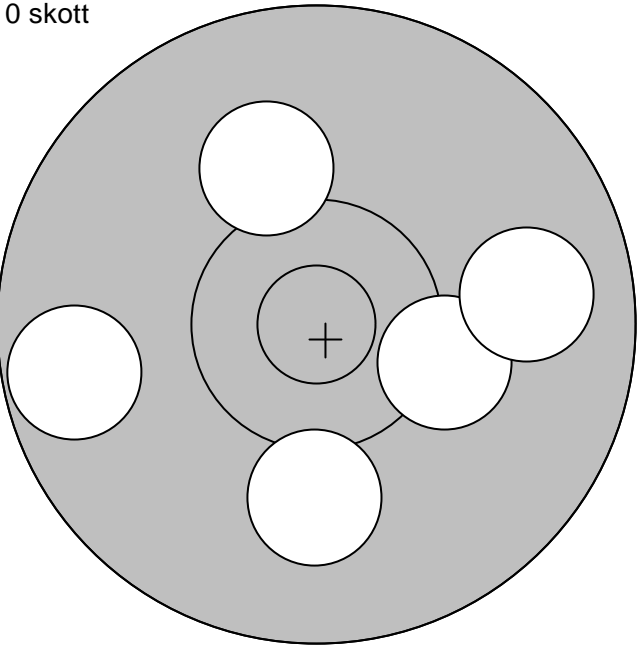
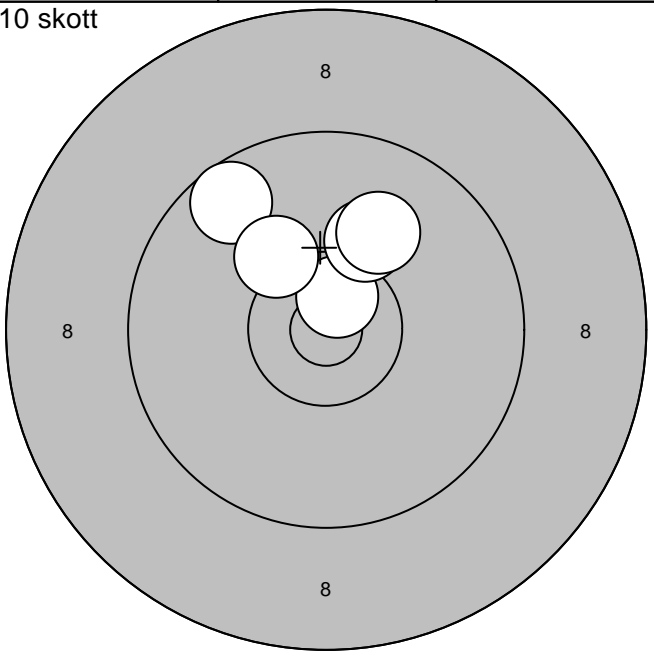
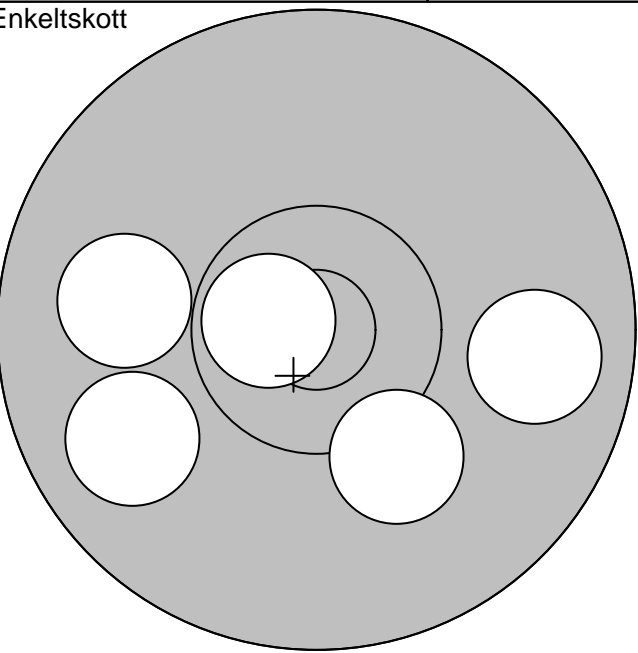
Skjutlag 2	Tavla 1	Fredrik Forsgren						
		Ramselefors						
2006-09-02		Höstträffen 2006 Final		Ramselefors SKF				
Provskott			10 skott					
								
1: 9,4 →	6:10,2 ←	Serie	58,0	1: 9,7 ←	Serie	48,0		
2: 9,5 ↘				2:10,1 ↗				
3:10,4* →		3:10,1 ↓	Totalt	191,0		4:10,3 →	Totalt	239,0
4:10,5* →		5: 9,9 →						
5:10,7* ↖								
10 skott			Enkeltskott					
								
6: 9,6 ↗		Serie	49,0	1:10,7* ←	Serie	47,0		
7:10,7* ↗				2: 9,8 →				
8:10,1 ↗		3:10,2 ↘	Totalt	288,0		4: 9,9 ←	Totalt	335,0
9:10,0 ↗		5: 9,9 ↖						
10:10,2 ↖								

Skjutlag

Tavla

2

2

Niklas Westermark

Drängsmark

2006-09-02

Höstträffen 2006 Final

Ramselefors SKF

Provskott

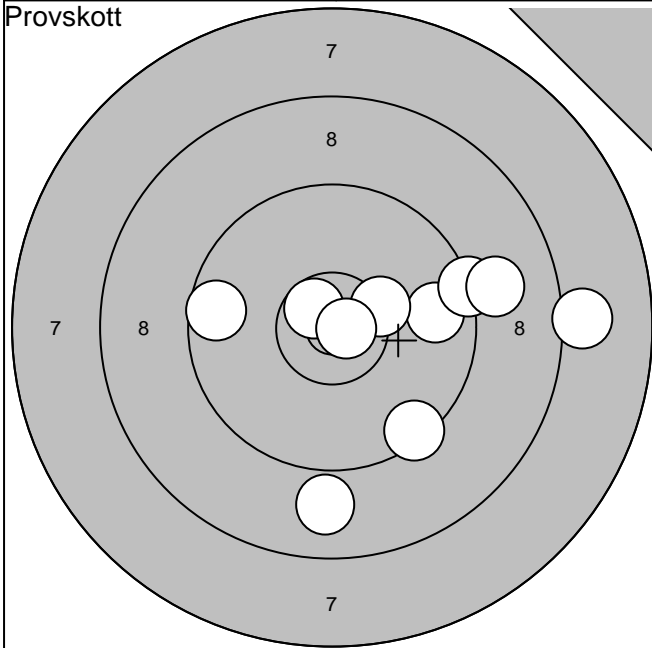

10 skott

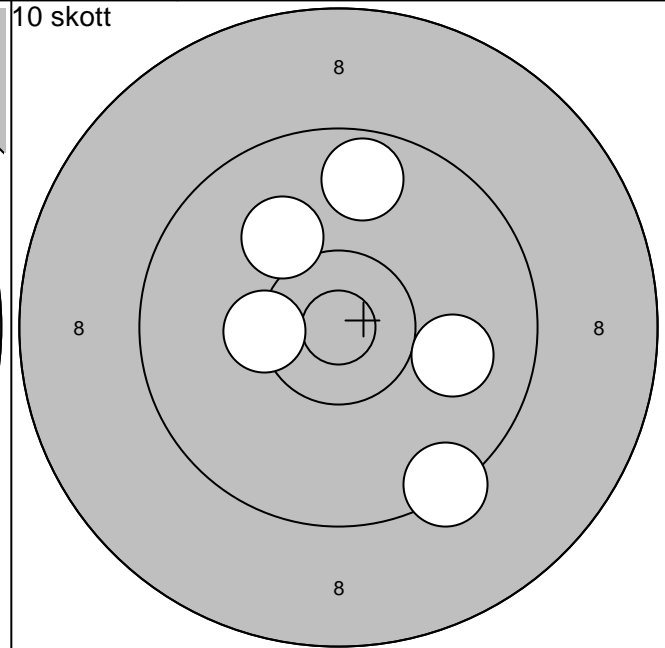

1: 9,8 →

6: 9,6 ←

2: 10,7* ↗

7: 10,8* →

3: 9,4 ↘

8: 9,3 →

4: 8,9 ↓

9: 8,1 →

5: 10,4* ↗

10: 9,0 →

Serie 91,0

Totalt 188,0

1: 9,7 ↑

2: 10,1 ↗

3: 9,4 ↘

4: 10,0 →

5: 10,3* ←

Serie 48,0

Totalt 236,0

10 skott

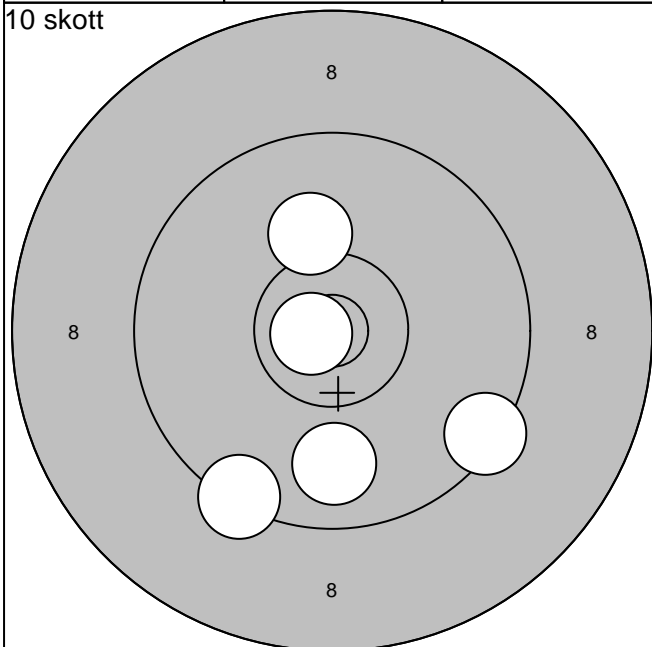

Enkeltskott

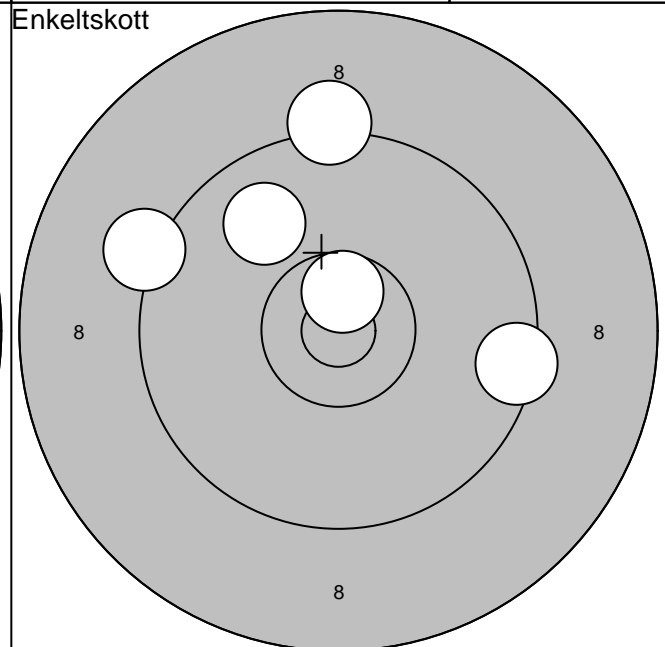

6: 9,4 ↘

7: 10,8* ←

8: 9,8 ↓

9: 9,4 ↘

10: 10,1 ↑

Serie 47,0

Totalt 283,0

1: 10,6* ↑

2: 9,9 ↗

3: 9,2 ←

4: 9,2 ↑

5: 9,5 →

Serie 46,0

Totalt 329,0

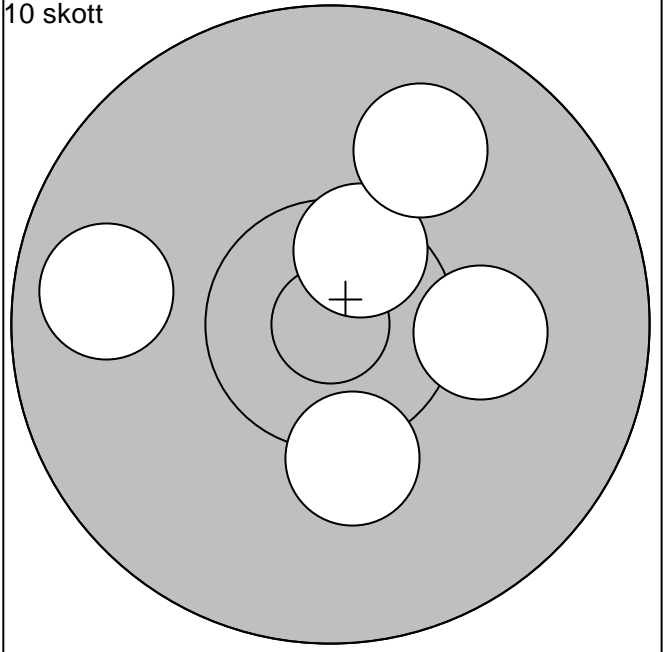
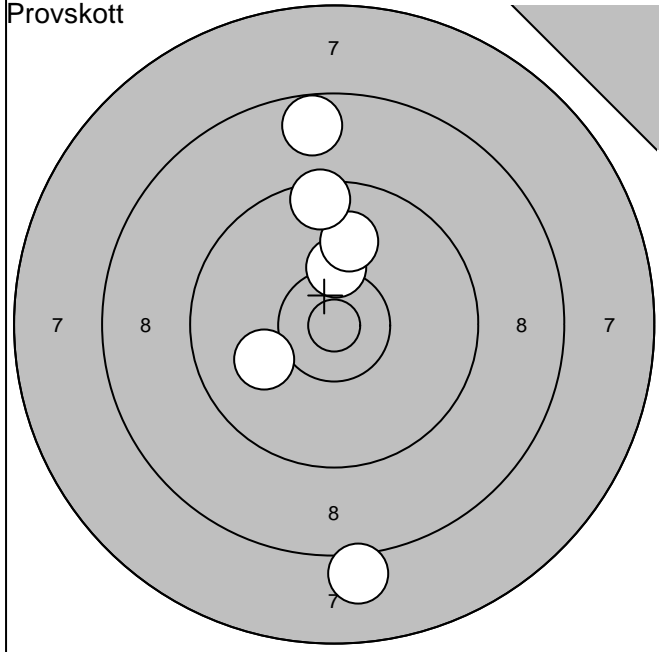

1:10,1 ←	6: 9,5 ↑		
2: 8,1 ↓		Serie	55,0
3:10,3* ↑		Totalt	187,0
4:10,0 ↑			
5: 8,7 ↑			

1:10,5* ↑			
2: 9,9 ↗		Serie	48,0
3:10,2 →		Totalt	235,0
4:10,3 ↓			
5: 9,8 ←			

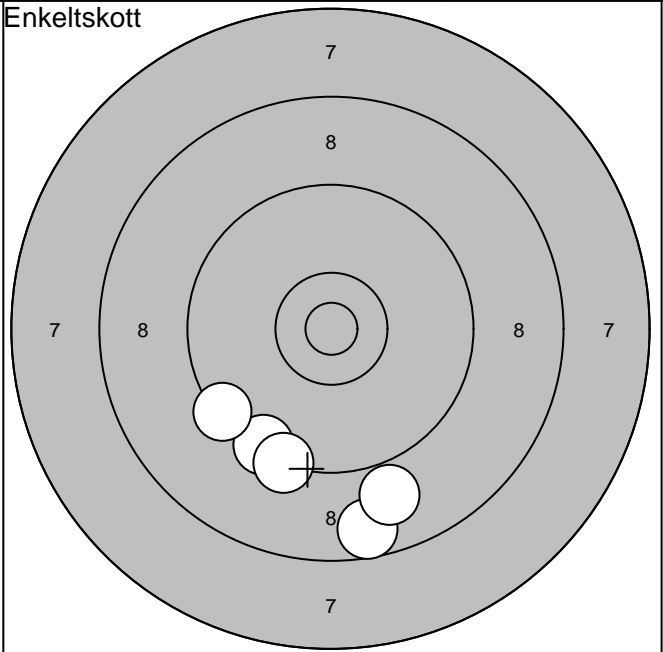
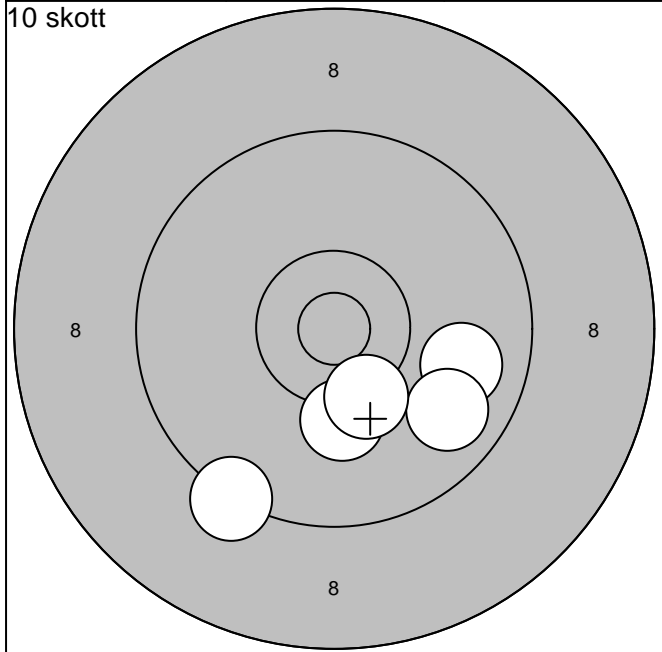

6: 9,3 ↘			
7: 9,9 →		Serie	47,0
8:10,2 ↓		Totalt	282,0
9: 9,8 ↘			
10:10,3* ↘			

1: 9,4 ↘			
2: 8,6 ↓		Serie	43,0
3: 9,4 ↙		Totalt	325,0
4: 9,3 ↓			
5: 8,9 ↓			

Skjutlag	Tavla	Lars Möllsten	
2	5		
		Umeå	
2006-09-02	Höstträffen 2006 Final	Ramselefors SKF	
Provskott		10 skott	
1:10,0 ←	6:10,4* →	Serie 88,0	Serie 49,0
2:10,3 ↗	7:10,7* →		
3: 9,7 ↗	8: 9,8 ↗	Totalt 198,0	Totalt 247,0
4:10,7* →	9:10,2 ↗		
5:10,1 ↗			
10 skott		Enkeltskott	
6:10,2 →		Serie 50,0	Serie 47,0
7:10,6* →			
8:10,5* →		Totalt 297,0	Totalt 344,0
9:10,3* ↗			
10:10,6* →			

Skjutlag 2	Tavla 6	Lars Evaldsson		
		GBG Skyttegille		
2006-09-02		Höstträffen 2006 Final	Ramselefors SKF	
Provskott		10 skott		
1:10,2 ←	6: 9,4 →	Serie 94,0	1:10,1 ↗	Serie 50,0
2: 8,9 ↖	7:10,3 ↘		2:10,2 ↑	
3:10,3 ↗	8: 9,6 ↗	Totalt 193,0	3:10,2 ↑	Totalt 243,0
4: 9,1 ↖	9:10,4* ←		4:10,3* ↓	
5: 9,0 ↖	10:10,1 ↘		5:10,8* ↗	
10 skott		Enkeltskott		
6:10,7* ↓		Serie 49,0	1:10,1 ↗	Serie 49,0
7:10,3* ↘			2:10,1 ↓	
8:10,1 ←		Totalt 292,0	3: 9,8 ←	Totalt 341,0
9: 9,7 →			4:10,0 →	
10:10,1 ←			5:10,5* ↖	

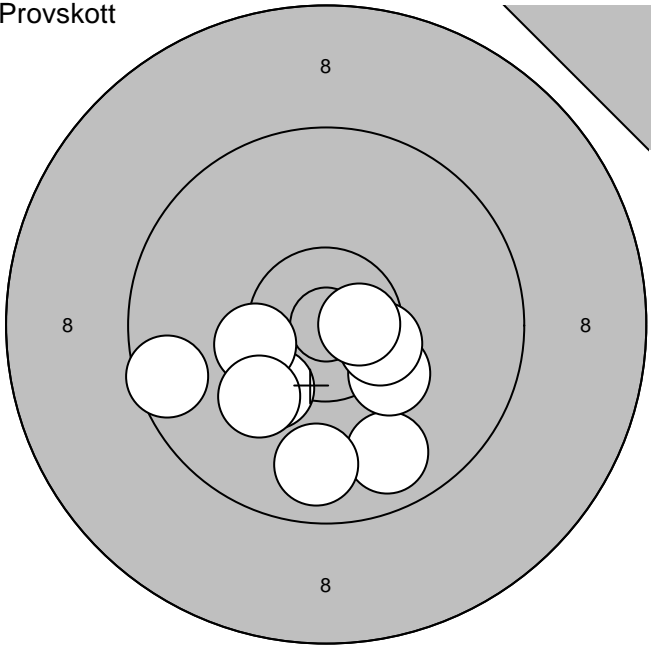
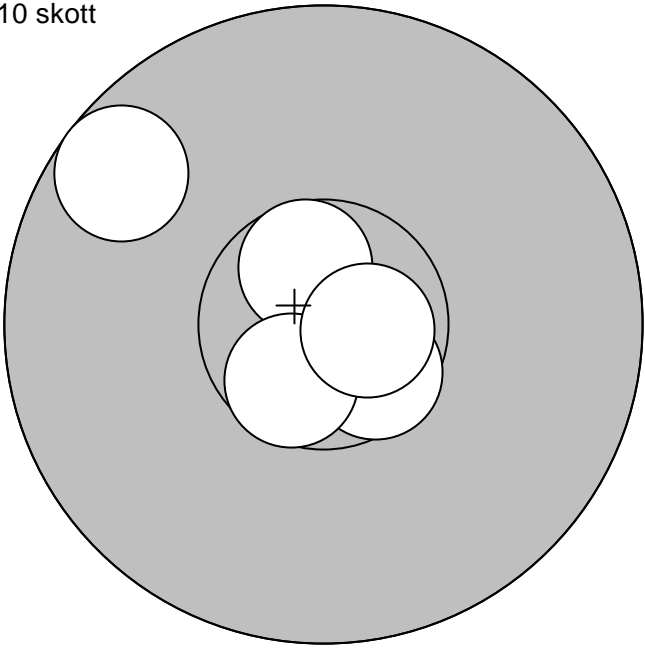
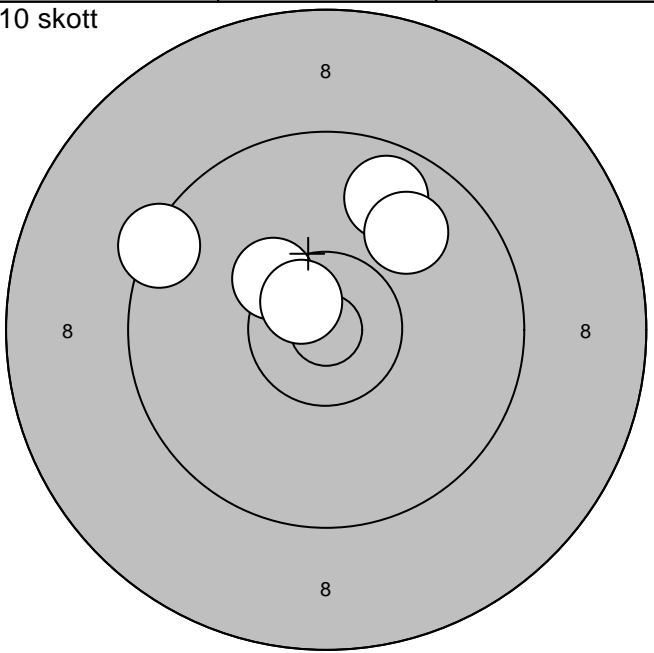
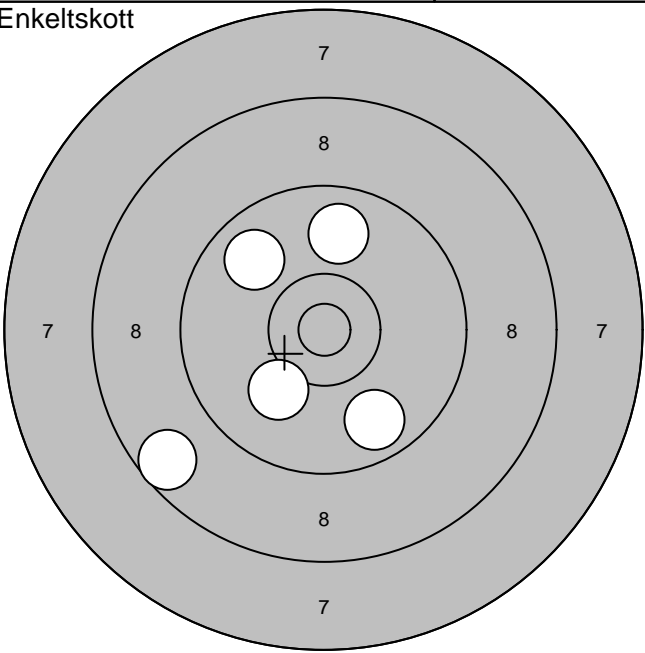
Skjutlag 2	Tavla 7	Magnus Lindkvist			
		Umeå			
2006-09-02		Höstträffen 2006 Final		Ramselefors SKF	
Provskott			10 skott		
					
1: 9,8 ↘	6:10,1 ↙	Serie 87,0	1:10,6* ↘	Serie 49,0	
2:10,3 ↙	7:10,5* →		2:10,6* ↗		
3:10,3* ↘	8: 9,6 ←	Totalt 192,0	3: 9,7 ↖	Totalt 241,0	
4: 9,8 ↓	9:10,7* →		4:10,6* ↙		
5:10,3* ←			5:10,7* →		
10 skott			Enkeltskott		
					
6:10,3* ↗		Serie 47,0	1: 9,8 ↖	Serie 45,0	
7: 9,7 ↗			2: 9,9 ↑		
8: 9,4 ↖		Totalt 288,0	3: 8,6 ↙	Totalt 333,0	
9:10,6* ↗			4:10,1 ↙		
10: 9,9 ↗			5: 9,8 ↓		

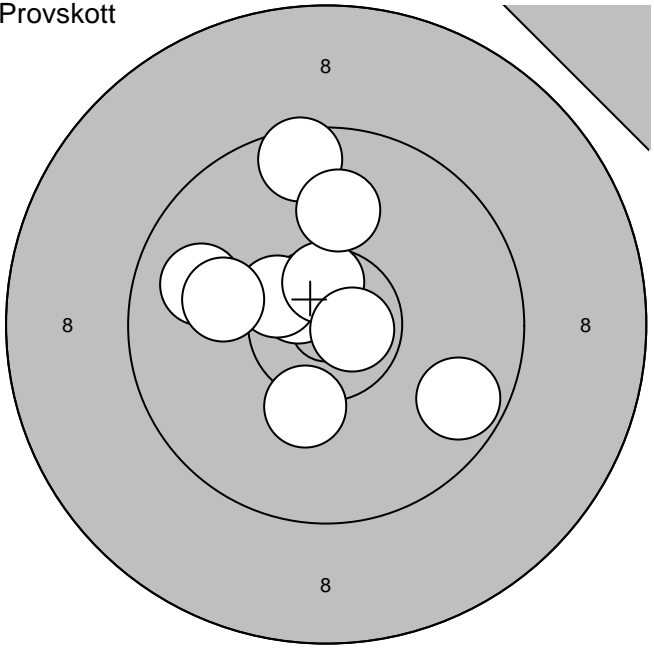
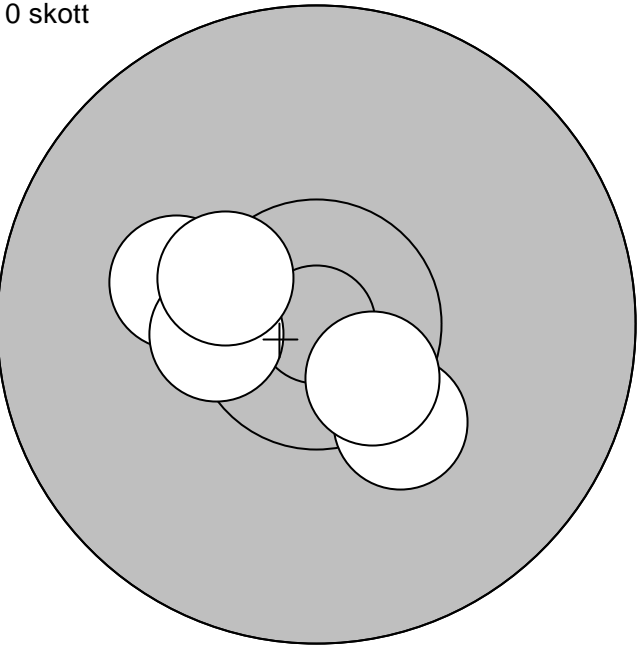
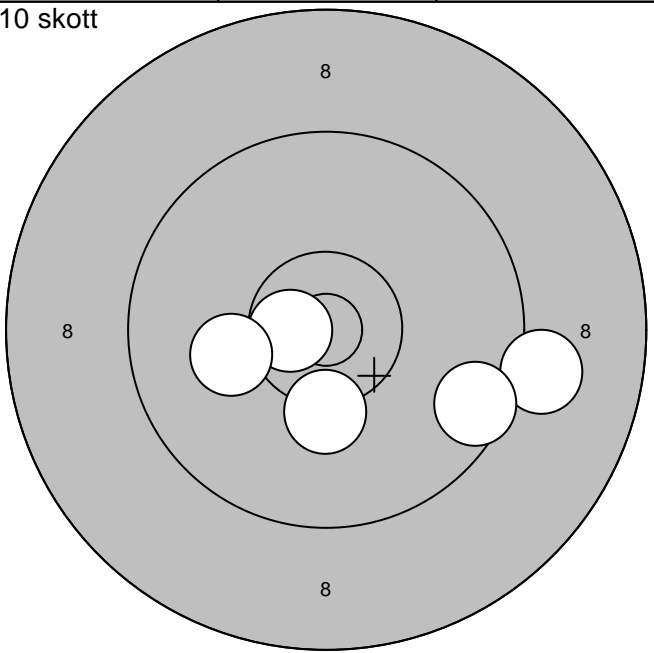
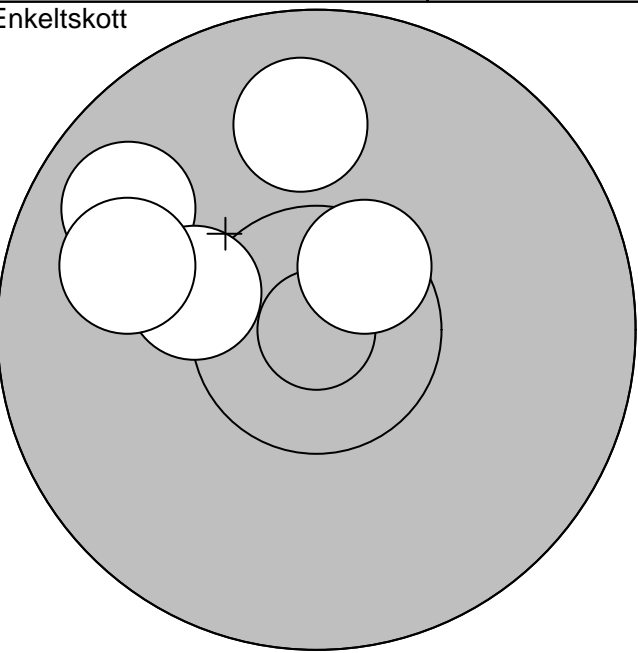
Skjutlag 2	Tavla 9	Stefan Thorin	
		Umeå	
2006-09-02	Höstträffen 2006 Final	Ramselefors SKF	
Provskott		10 skott	
			
1: 9,6 ↑	6:10,1 ←	Serie 97,0	1:10,3 ↘
2:10,7* ↖	7: 9,7 →		2:10,2 ←
3:10,5* ↖	8:10,3 ↓	Totalt 189,0	3:10,4* ←
4:10,6* ↑	9:10,0 ↑		4:10,4* ←
5: 9,9 ←	10:10,7* →		5:10,5* ↘
			Serie 50,0
			Totalt 239,0
10 skott		Enkeltskott	
			
6: 9,1 →		Serie 48,0	1: 9,8 ↖
7: 9,6 →			2: 9,9 ↑
8:10,3 ↓		Totalt 287,0	3:10,3* ←
9:10,7* ←			4: 9,9 ←
10:10,1 ←			5:10,5* ↗
			Serie 47,0
			Totalt 334,0

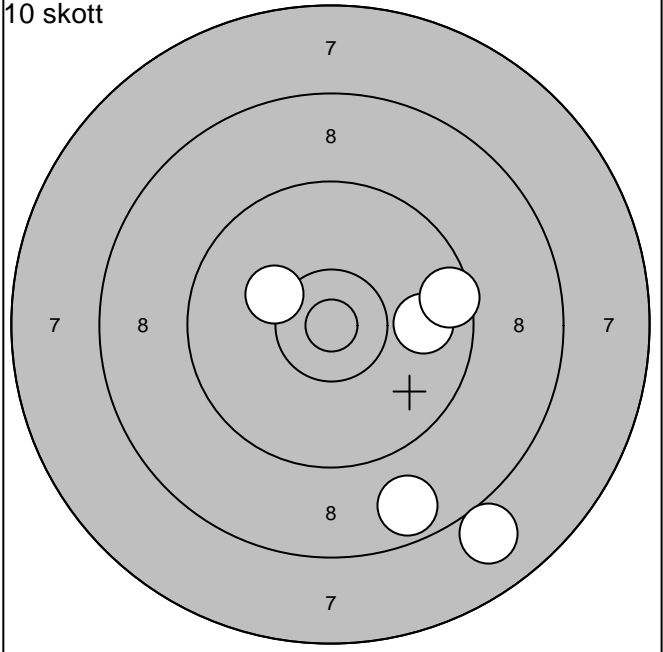
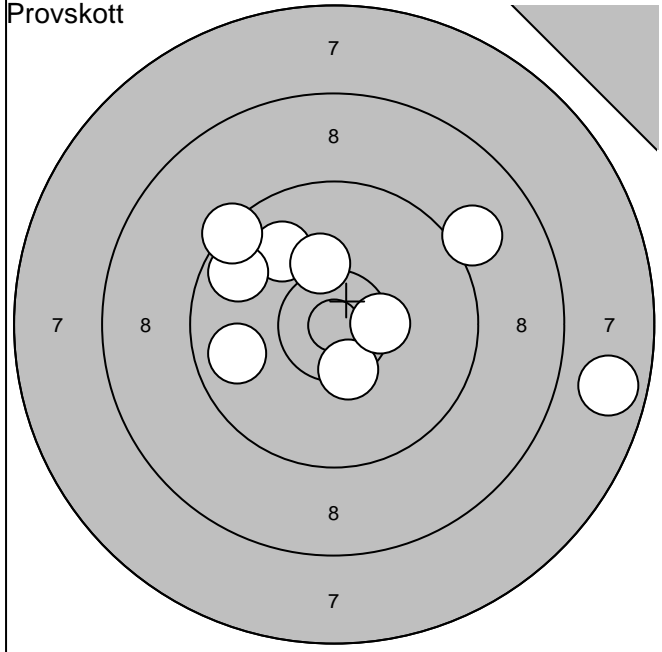

1: 9,9 ↗	6: 9,1 ↗	Serie	82,0
2: 9,8 ←	7: 7,8 →		
3: 9,7 ↖	8:10,4* ↓	Totalt	188,0
4:10,2 ↑	9:10,4* →		
5: 9,4 ↖			

1: 8,7 ↓	Serie	44,0
2:10,2 ↖		
3: 9,9 →	Totalt	232,0
4: 9,6 →		
5: 8,0 ↓		

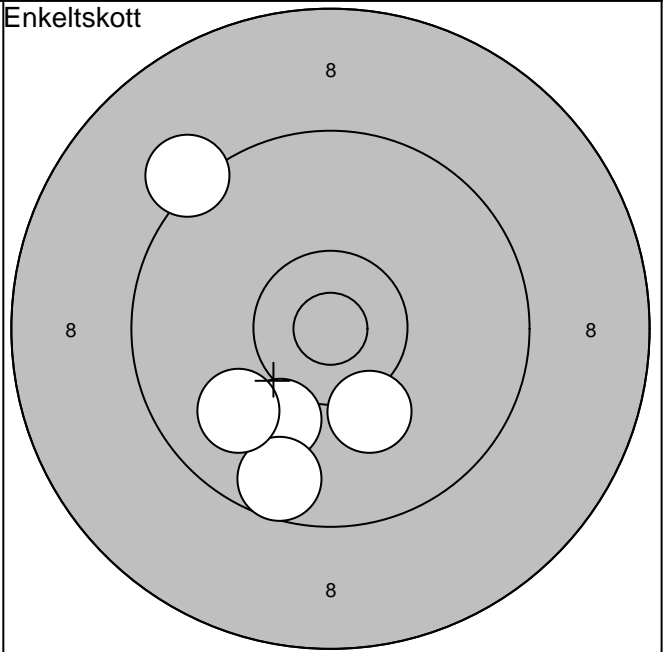
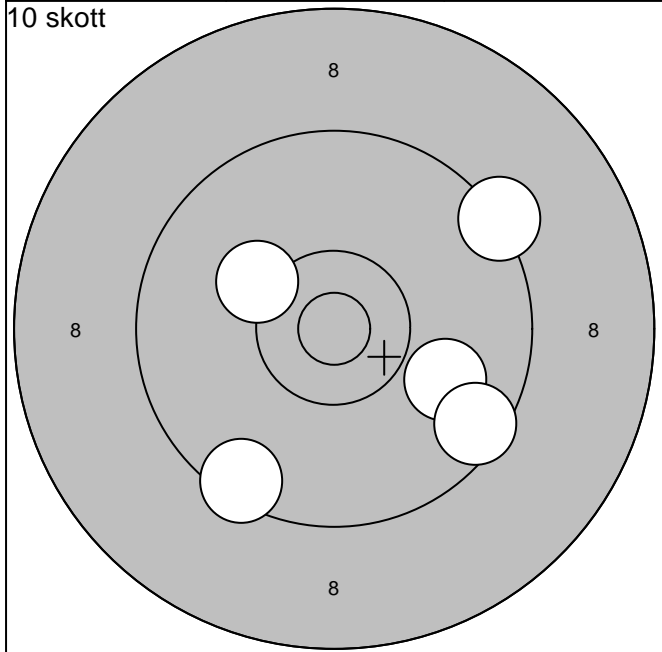

6: 9,9 →	Serie	46,0
7:10,2 ↖		
8: 9,3 ↗	Totalt	278,0
9: 9,5 ↓		
10: 9,5 ↓		

1:10,1 ↓	Serie	47,0
2: 9,6 ↓		
3:10,2 ↓	Totalt	325,0
4: 9,9 ↖		
5: 9,2 ↖		

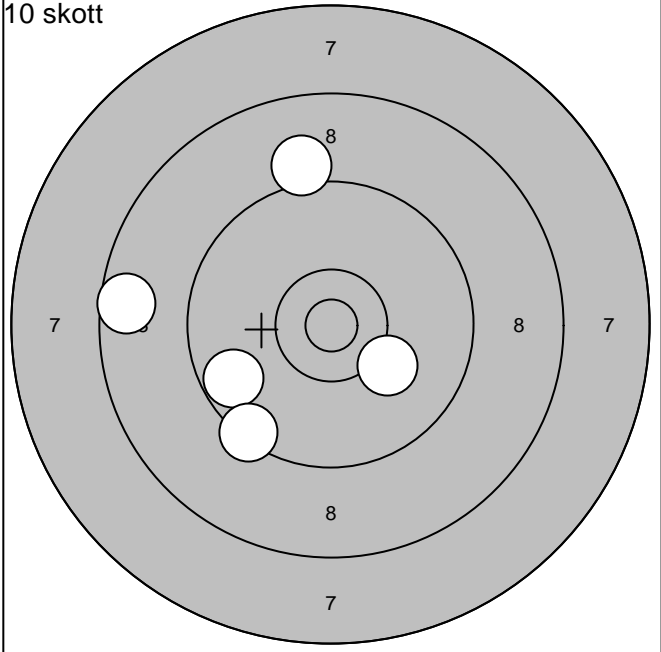
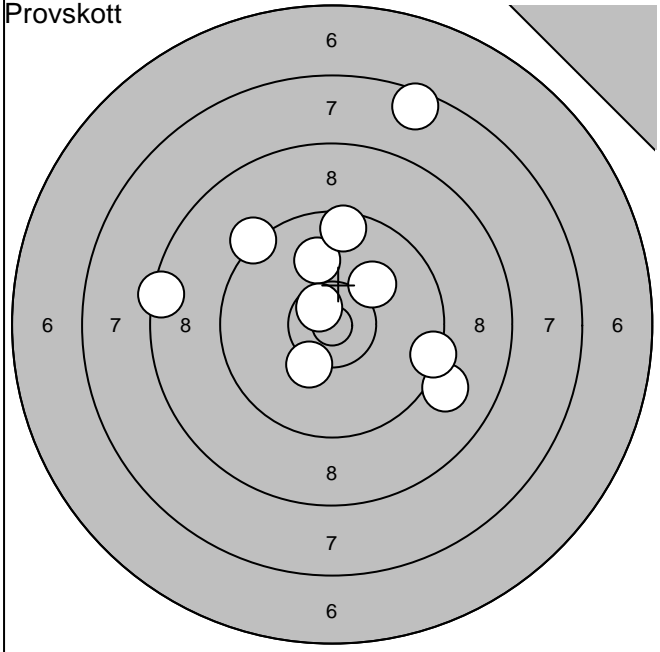

1: 9,1 ↘	6: 7,6 ↗	Serie	91,0
2: 9,4 ↘	7:10,7* ↖		
3: 9,3 ↗	8:10,3* ↘	Totalt	184,0
4:10,1 ↗	9: 8,4 ←		
5:10,0 ↗	10: 9,6 ↗		

1:10,1 ↘	Serie	45,0
2: 8,6 ←		
3: 9,7 ↙	Totalt	229,0
4: 9,4 ↘		
5: 9,1 ↗		

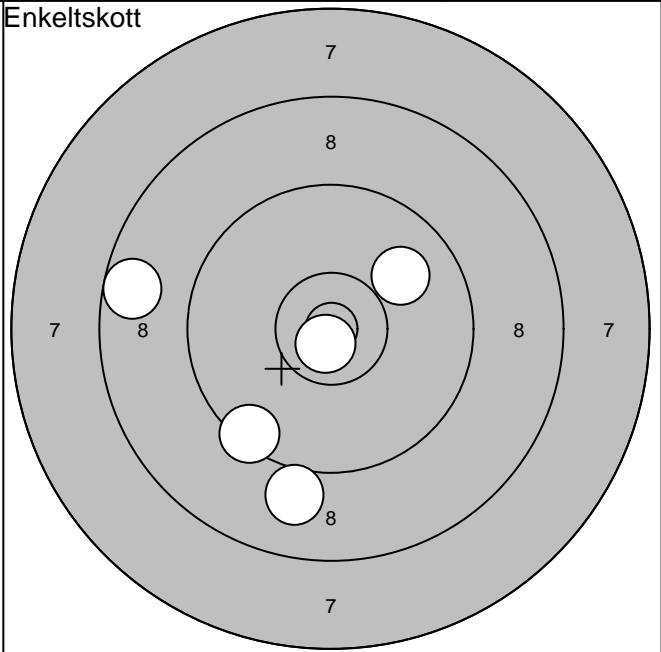
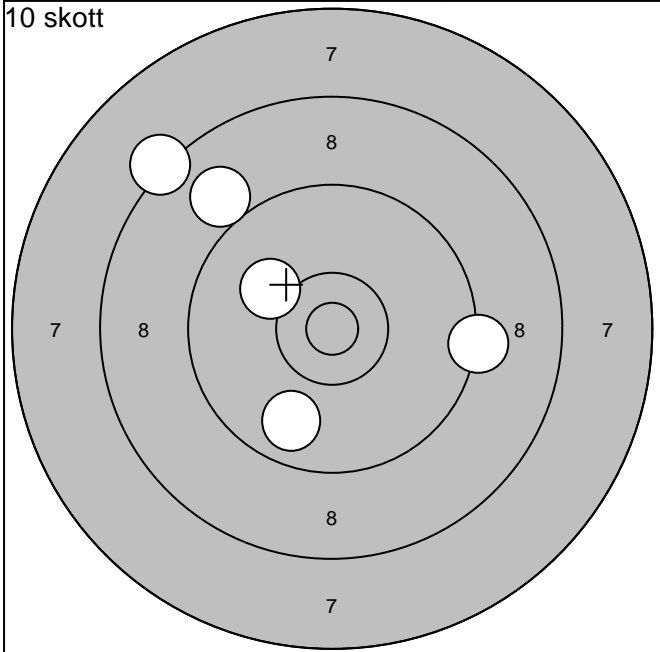

6:10,1 ↗	Serie	45,0
7: 9,3 →		
8: 8,3 ↗	Totalt	274,0
9: 9,8 ↘		
10: 9,0 ↗		

1:10,8* ↘	Serie	46,0
2: 9,4 ↘		
3: 9,0 ↘	Totalt	320,0
4: 8,6 ←		
5:10,0 ↗		

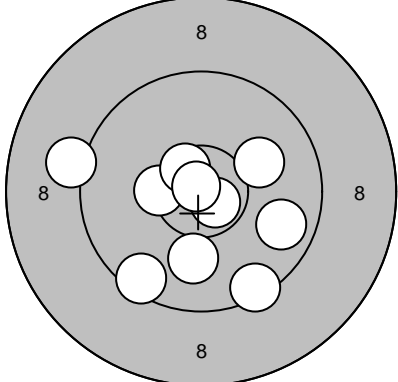
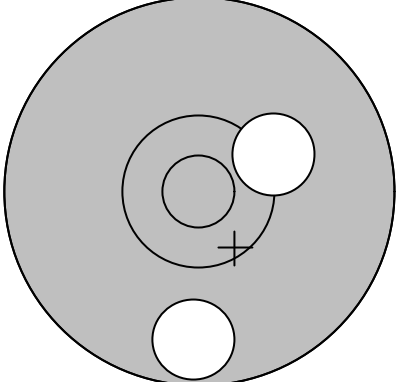
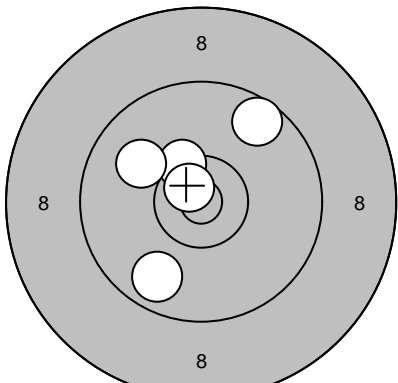
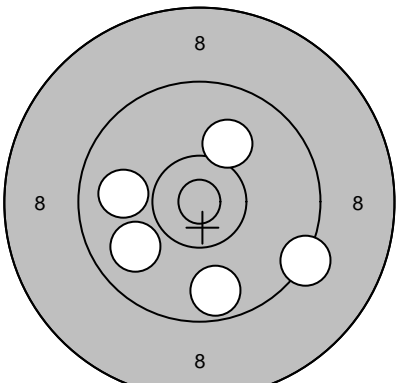
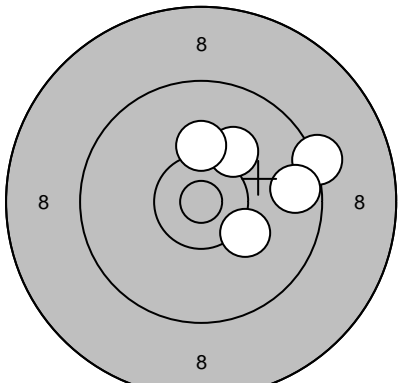
Skjutlag	Tavla	Gunnar Iversen	
2	13	S3	
2006-09-02	Höstträffen 2006 Final	Ramselefors SKF	
Provskott		1: 9,5 ↘ 2: 10,7* ↘ 3: 10,0 ↓ 4: 10,4* ← 5: 10,6* ↗ 6: 9,5 ↘ 7: 10,1 ↗ 8: 10,9* ↗ 9: 9,8 → 10: 9,1 ←	Provskott 
	Serie 96,0		11: 9,7 ↓
	Totalt 194,0		12: 10,3 ↗
			Serie 19,0
			Totalt 194,0
10 skott		1: 9,8 ↘ 2: 9,6 ↗ 3: 10,4* ↗ 4: 10,7* ↗ 5: 10,0 ←	10 skott 
	Serie 48,0		6: 9,7 ↓
	Totalt 242,0		7: 9,9 ←
			8: 9,3 ↘
			9: 10,1 ↗
			10: 9,9 ←
			Serie 46,0
			Totalt 288,0
Enkeltskott		1: 10,2 ↗ 2: 9,3 → 3: 10,2 ↘ 4: 10,2 ↑ 5: 9,7 →	
	Serie 48,0		
	Totalt 336,0		

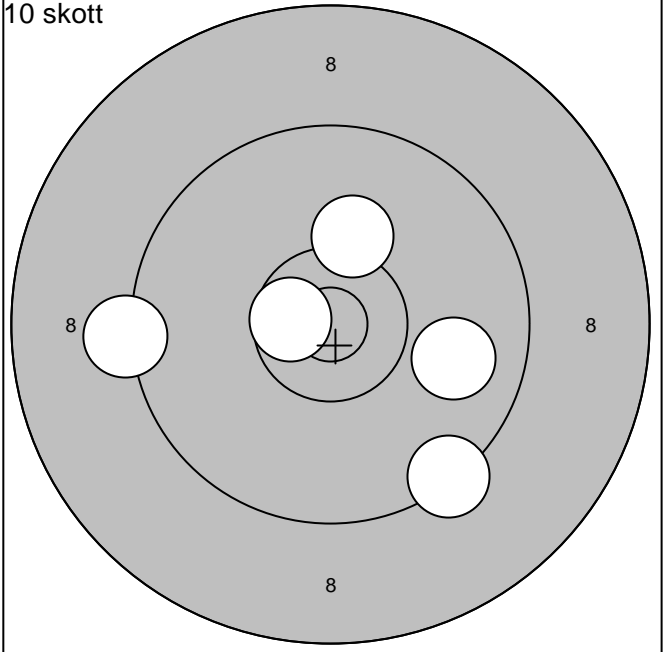
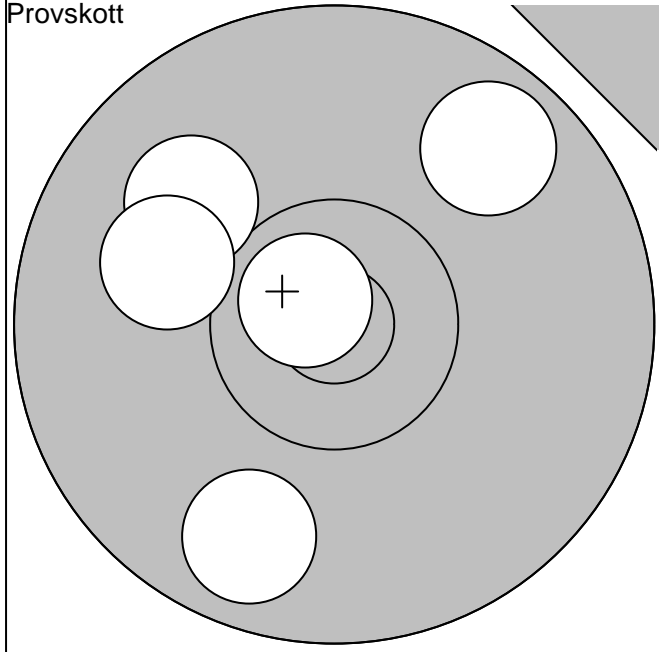

1: 10,0 ↖
2: 9,7 ↗
3: 10,0 ↖
4: 9,8 ↓
5: 10,8* ↖

Serie	48,0
Totalt	193,0

1: 9,9 →
2: 10,6* ←
3: 9,3 ←
4: 10,2 ↑
5: 9,4 ↘

Serie	47,0
Totalt	240,0

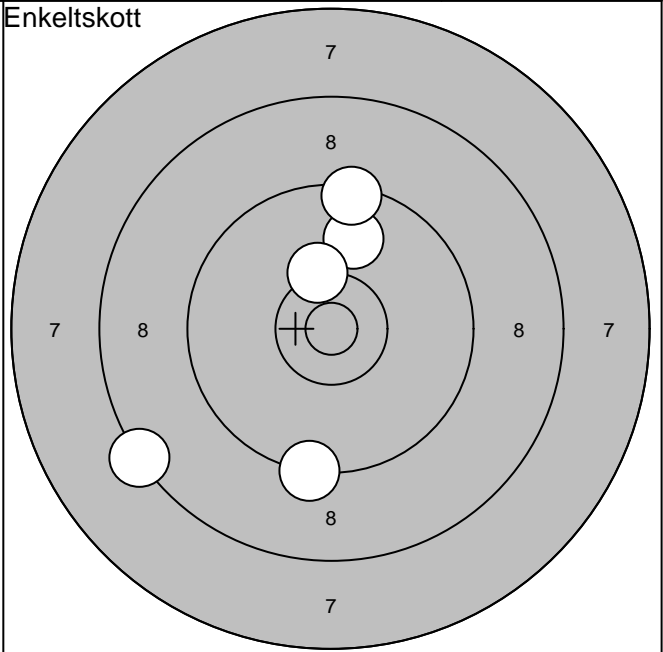
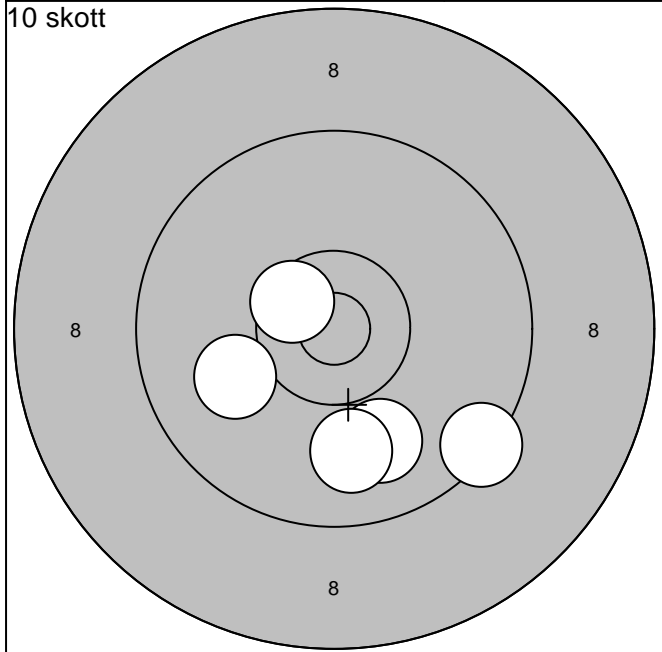

6: 9,4 ↘
7: 10,0 ↖
8: 10,5* ↖
9: 9,9 ↓
10: 9,9 ↓

Serie	47,0
Totalt	287,0

1: 9,9 ↑
2: 9,4 ↑
3: 9,3 ↓
4: 8,3 ↙
5: 10,3* ↑

Serie	45,0
Totalt	332,0

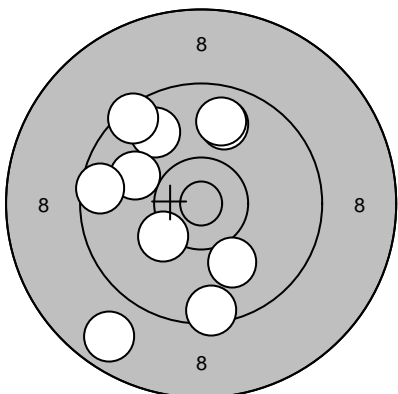
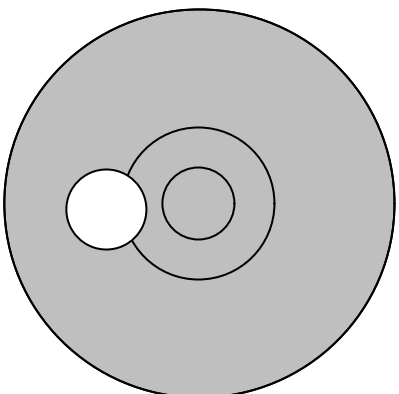
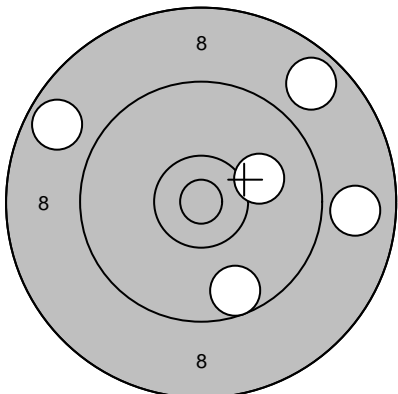
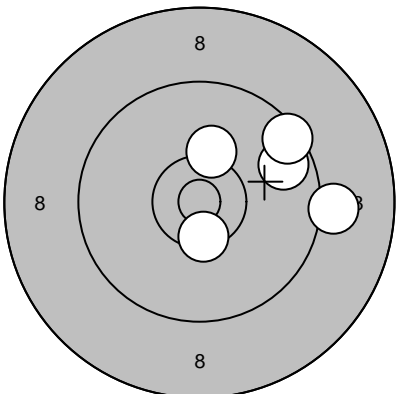
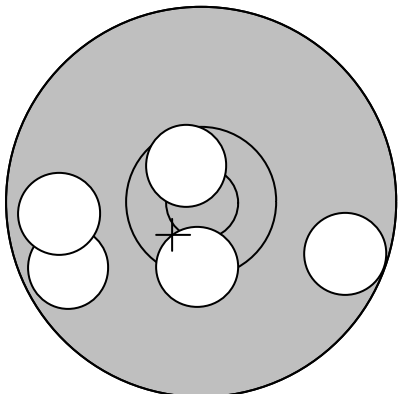
Skjutlag	Tavla	Dan-Ivan Karlsson	
2	15	Ramselefors	
2006-09-02	Höstträffen 2006 Final	Ramselefors SKF	
Provskott	 1: 8,8 ↙ 2: 9,8 ↗ 3: 10,0 ↖ 4: 9,8 ↗ 5: 9,6 ← 6: 10,0 ↓ 7: 10,3 ↙ 8: 9,5 ↗ 9: 9,5 ↓ 10: 9,8 ↗ Serie 92,0 Totalt 191,0	Provskott	 11: 10,2 ← Serie 10,0 Totalt 191,0
10 skott	 1: 8,8 ↗ 2: 10,1 → 3: 8,7 ↖ 4: 8,9 → 5: 9,7 ↓ Serie 43,0 Totalt 234,0	10 skott	 6: 9,7 ↗ 7: 10,3 ↗ 8: 9,5 ↗ 9: 9,1 → 10: 10,5* ↓ Serie 47,0 Totalt 281,0
Enkeltskott	 1: 10,6* ↗ 2: 9,7 → 3: 9,7 ↖ 4: 10,4* ↓ 5: 9,8 ← Serie 47,0 Totalt 328,0		

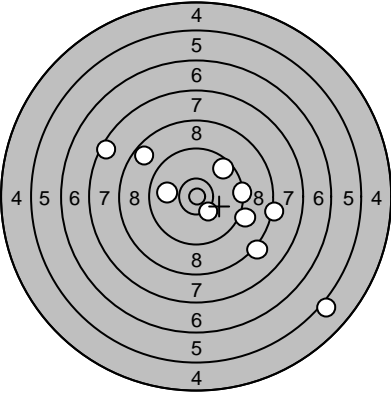
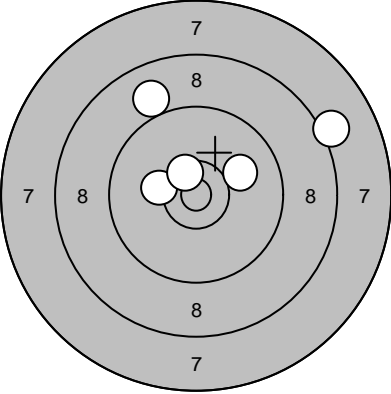
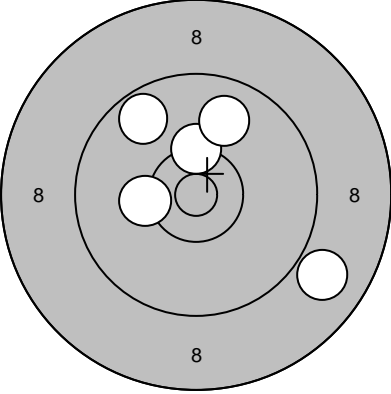
Skjutlag 2	Tavla 17	Lennart Westermark	
		Drängsmark	
2006-09-02		Höstträffen 2006 Final	Ramselefors SKF
Provskott		1: 10,0 ← 2: 9,4 → 3: 7,5 ↗ 4: 8,7 ↗ 5: 10,3 ↘ 6: 9,1 → 7: 8,3 → 8: 5,1 ↘ 9: 8,2 ↘ 10: 9,6 ↗	Provskott
		Serie 83,0	11: 9,4 ←
		Totalt 165,0	12: 8,0 ↑
			13: 9,7 ↓
			14: 8,6 ↑
			Serie 34,0
			Totalt 165,0
10 skott		1: 10,0 → 2: 8,1 → 3: 10,3 ← 4: 9,0 ↑ 5: 10,5* ↑	10 skott
		Serie 47,0	6: 9,6 →
		Totalt 212,0	7: 10,0 ↗
			8: 9,7 ↗
			9: 9,9 ↑
			10: 7,7 ↖
			Serie 44,0
			Totalt 256,0
Enkeltskott		1: 10,3* ↑ 2: 9,9 ↑ 3: 9,7 ↗ 4: 8,9 → 5: 10,3 ←	
		Serie 46,0	
		Totalt 302,0	

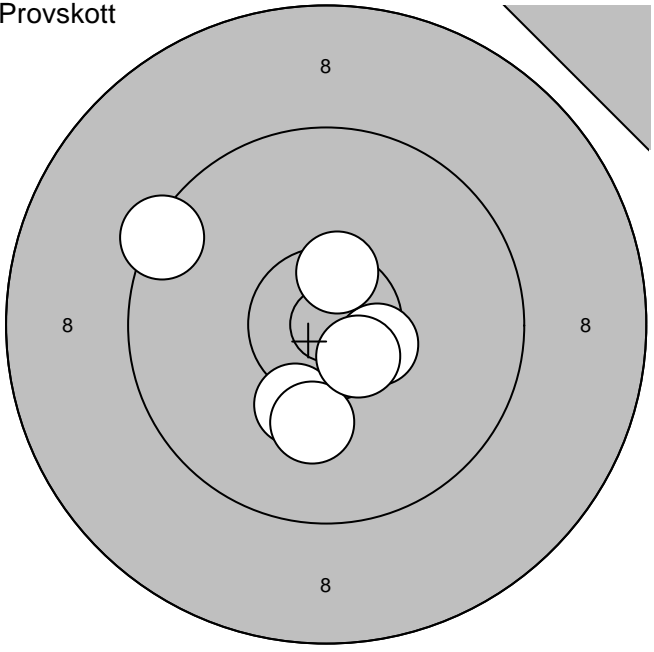
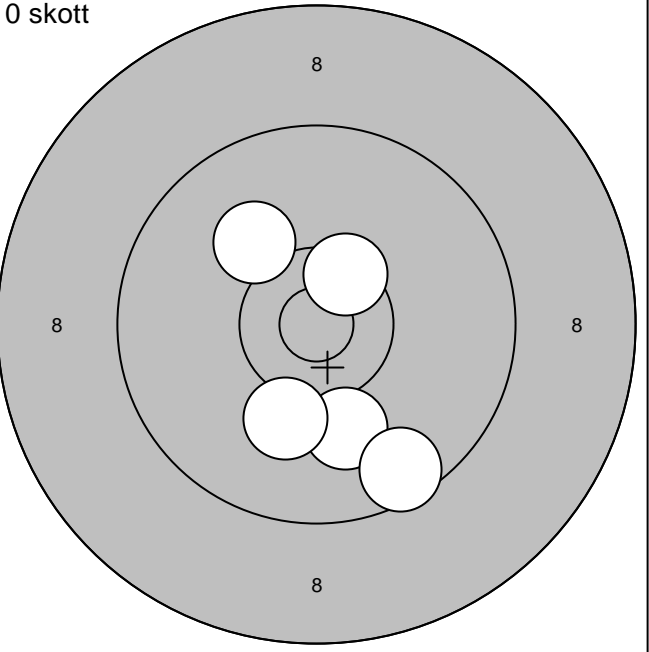
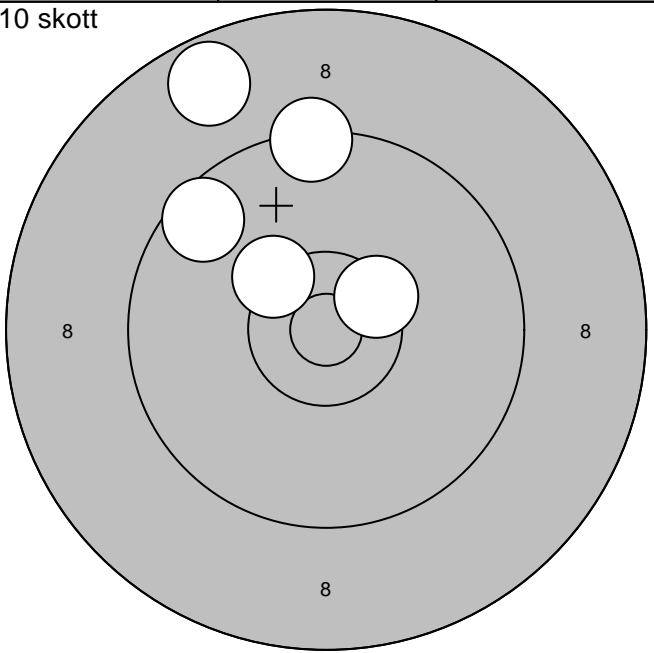
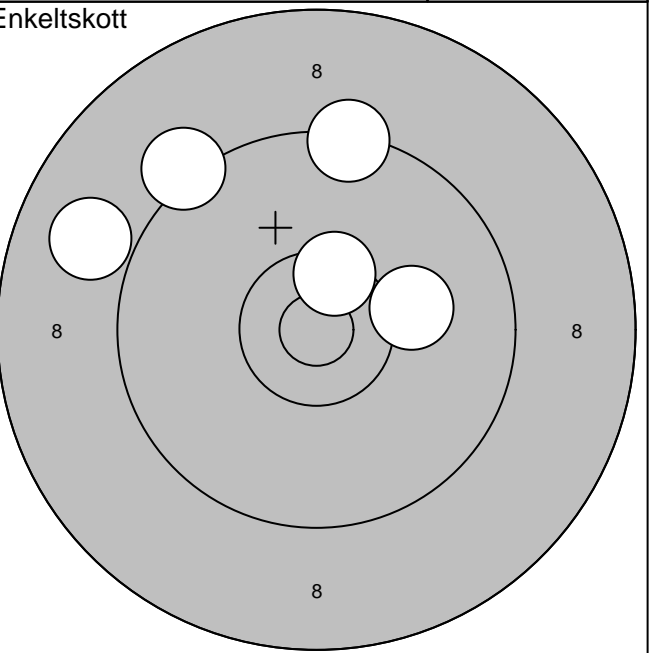
Skjutlag 3	Tavla 1	Fredrik Forsgren	
		Ramselefors	
2006-09-02	Höstträffen 2006 Final	Ramselefors SKF	
Provskott		10 skott	
			
1:10,2 ↓	6:10,6* ↘	Serie 59,0	1:10,5* ↗
2:10,1 ↓		Totalt 188,0	2:10,1 ↗
3: 9,4 ↖	3:10,1 ↓		
4:10,5* →	4: 9,6 ↓		
5:10,5* ↑			5:10,1 ↓
		Serie 49,0	Totalt 237,0
10 skott		Enkeltskott	
			
6: 9,6 ↗	Serie 46,0	1:10,1 →	Serie 46,0
7:10,3* ↖		2: 9,4 ↑	
8: 8,7 ↗	Totalt 283,0	3:10,5* ↗	Totalt 329,0
9: 9,4 ↑		4: 8,9 ↖	
10:10,5* ↗		5: 9,2 ↗	

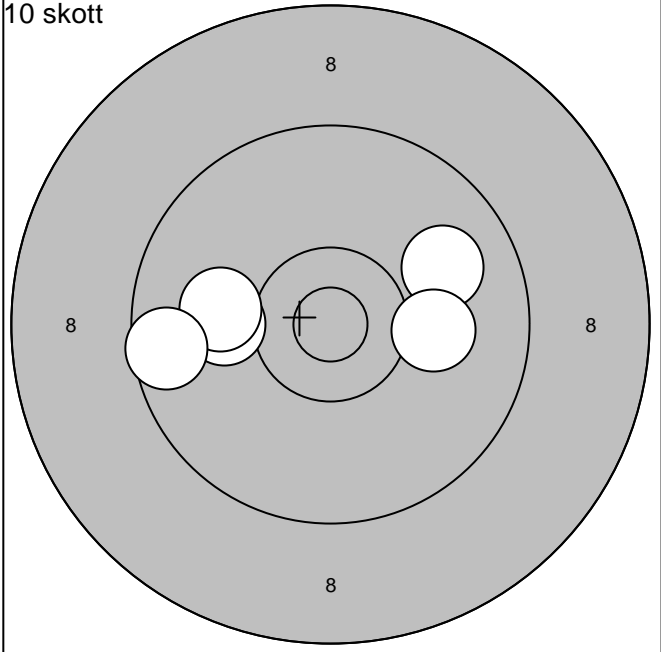
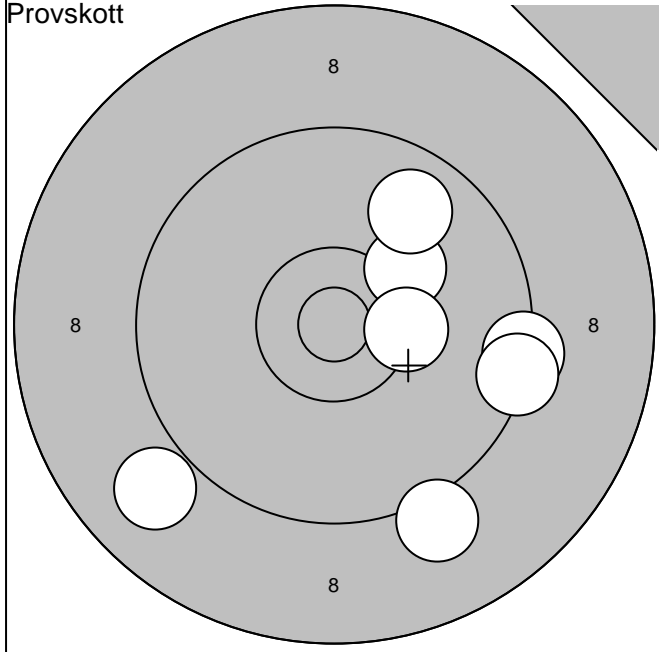

1: 8,9 ↙	6:10,3* →	Serie	64,0
2: 9,1 ↘	7: 9,4 →		Totalt
3:10,2 ↗			
4: 9,8 ↗			
5: 9,4 →			

1: 9,9 ↗	Serie	48,0
2:10,1 ←		Totalt
3:10,0 ←		
4: 9,6 ←		
5:10,1 →		

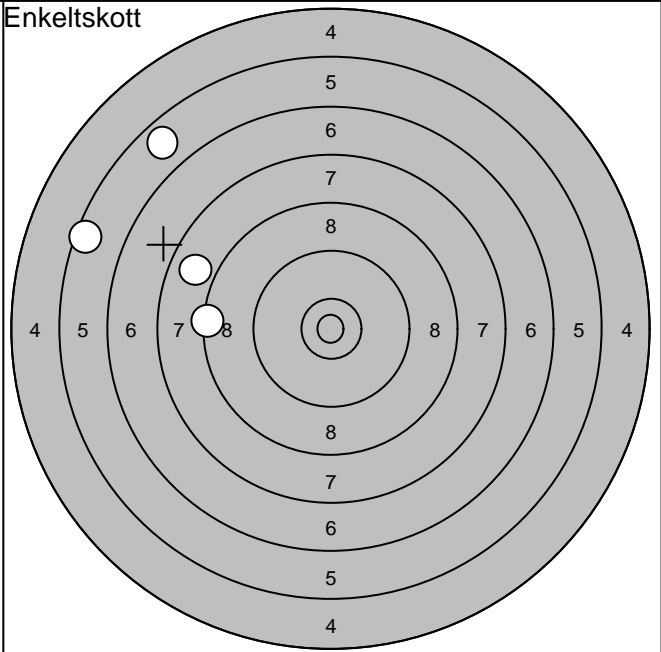
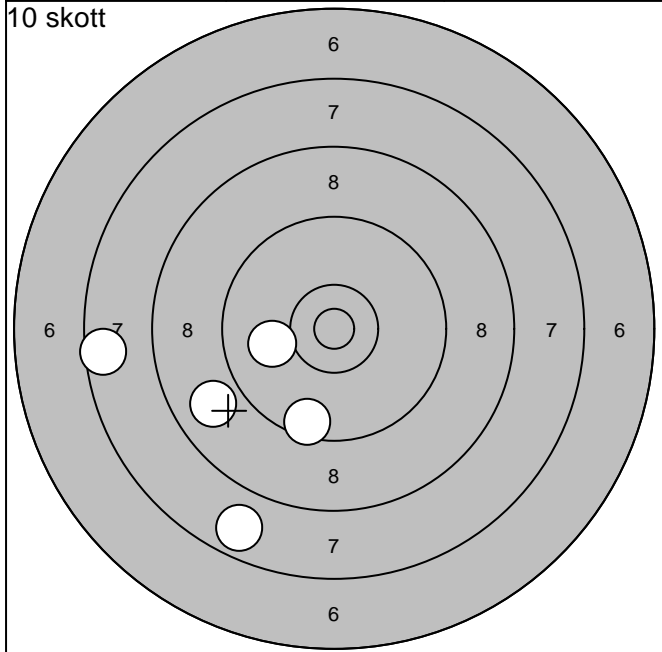

6: 7,6 ←	Serie	41,0
7: 7,8 ↓		Totalt
8:10,0 ←		
9: 8,9 ←		
10: 9,5 ↓		

1: 5,8 ↗	Serie	25,0
2: 5,5 ←		Totalt
3: 8,4 ←		
4: 7,9 ←		
5: 0,0 ↙		

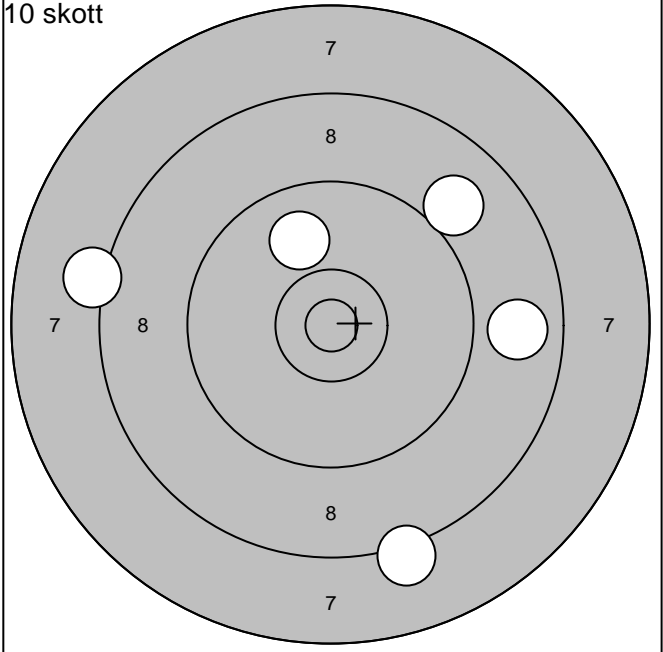
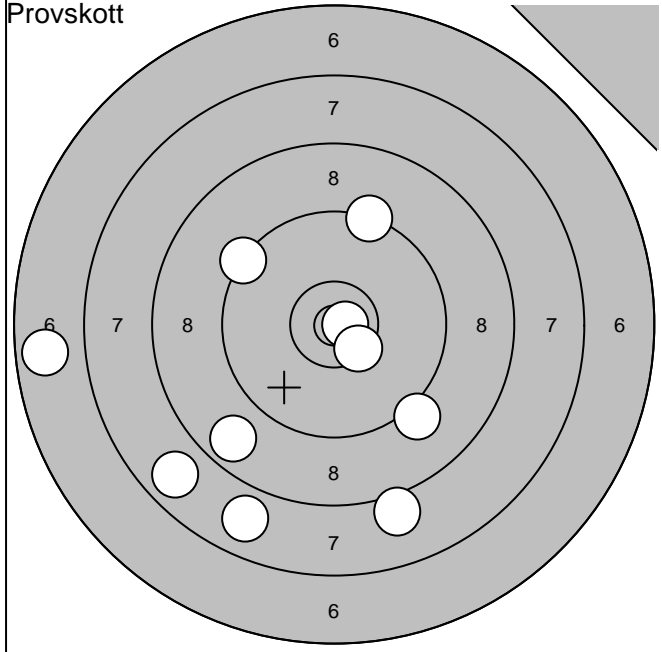

1: 9,3 ↗	6: 9,1 ↘	Serie	83,0
2: 10,8* →	7: 9,3 ↖		
3: 8,7 ↘	8: 7,8 ↘	Totalt	168,0
4: 10,4* ↘	9: 8,1 ↘		
5: 6,7 ←	10: 7,8 ↘		

1: 8,8 →	Serie	42,0
2: 9,0 ↗		
3: 9,9 ↗	Totalt	210,0
4: 8,2 ←		
5: 8,2 ↘		

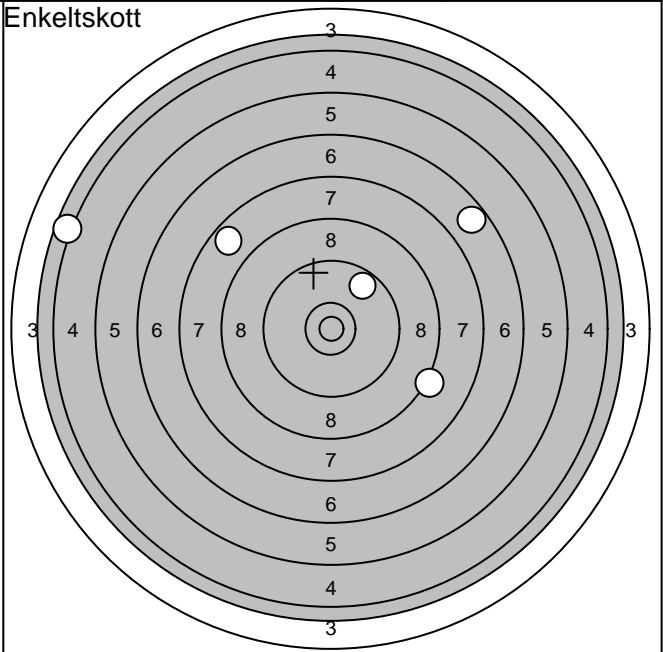
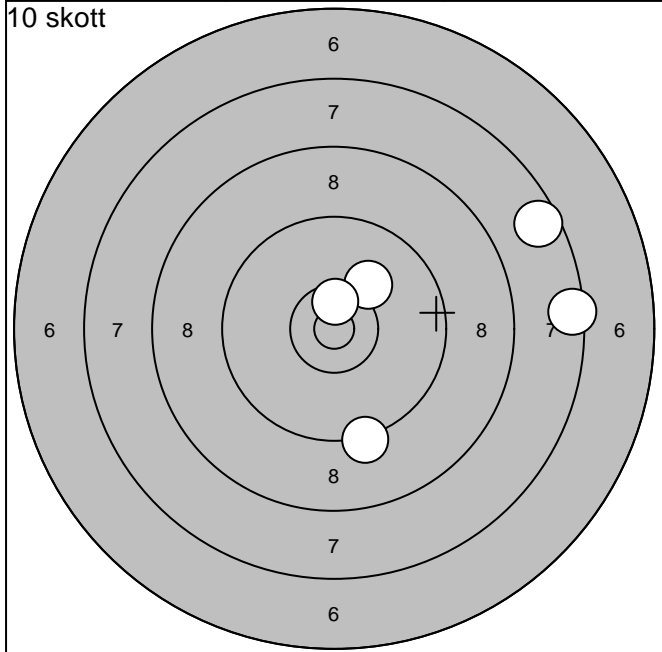

6: 10,1 ↗	Serie	43,0
7: 9,3 ↘		
8: 10,6* ↗	Totalt	253,0
9: 7,6 ↗		
10: 7,5 →		

1: 9,7 ↗	Serie	34,0
2: 6,7 ↗		
3: 4,2 ←	Totalt	287,0
4: 8,2 ↘		
5: 7,7 ↖		

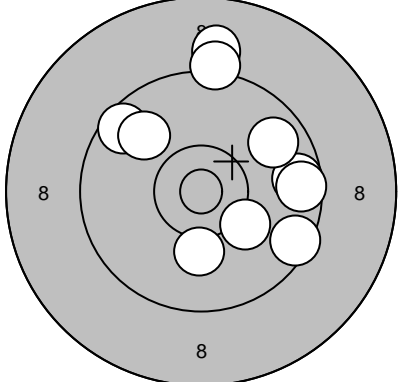
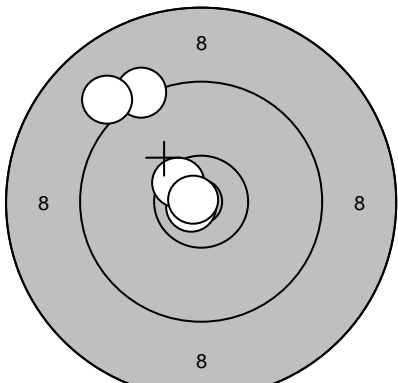
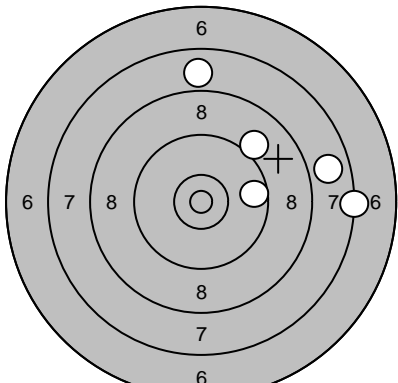
Skjutlag	Tavla	Therese Karlsson	
3	4	Drängsmark	
2006-09-02	Höstträffen 2006 Final	Ramselefors SKF	
Provskott		1: 9,0 ↑ 2: 9,5 → 3: 9,2 ↑ 4: 9,6 → 5: 9,6 → 6: 9,8 ↗ 7: 10,2 ↘ 8: 9,6 ↗ 9: 9,9 ↗ 10: 10,1 ↓	11: 9,8 ↓ 12: 9,8 → 13: 10,0 ↓ 14: 8,1 ← 15: 9,6 ← 16: 10,3 →
	Serie 92,0		Serie 55,0
	Totalt 161,0		Totalt 161,0
10 skott		1: 9,3 ↗ 2: 10,8* ← 3: 10,6* ↗ 4: 9,1 ↗ 5: 10,8* ←	6: 10,3* ↘ 7: 7,0 → 8: 7,6 → 9: 7,8 → 10: 9,5 ↗
	Serie 48,0		Serie 40,0
	Totalt 209,0		Totalt 249,0
Enkeltskott		1: 9,1 ↗ 2: 7,3 → 3: 7,9 ↑ 4: 9,7 → 5: 7,8 →	
	Serie 39,0		
	Totalt 288,0		

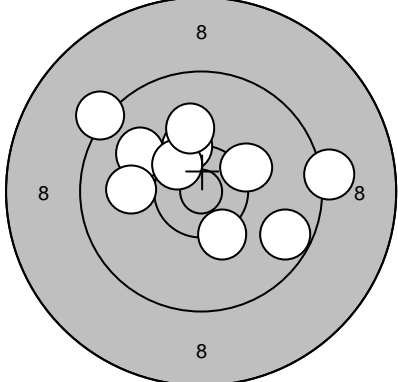
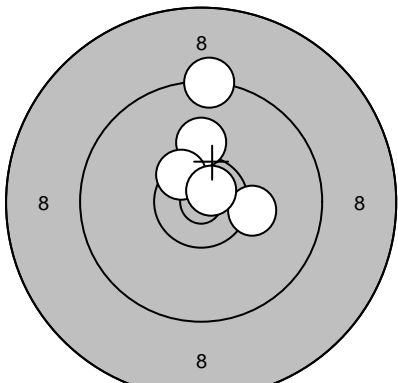
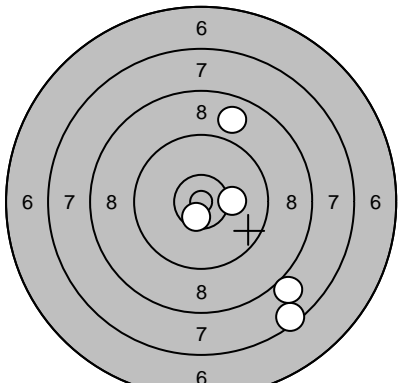
Skjutlag	Tavla	Magnus Lindkvist	
3	6		
		Umeå	
2006-09-02	Höstträffen 2006 Final	Ramselefors SKF	
Provskott		1: 10,3* ↗ 2: 10,3 → 3: 10,0 ↗ 4: 9,2 → 5: 9,2 ↗ 6: 10,0 ← 7: 10,5* ↗ 8: 9,7 ↘ 9: 10,3* ↘ 10: 10,1 ↗	Provskott
			11: 10,8* ↘
		Serie 97,0	Serie 10,0
		Totalt 191,0	Totalt 191,0
10 skott		1: 10,3 → 2: 10,2 ↑ 3: 10,5* ↗ 4: 9,3 ↑ 5: 10,7* ↗	10 skott
			6: 10,0 ↑ 7: 9,9 ↘ 8: 10,4* ↖ 9: 9,7 ↑ 10: 10,2 ←
		Serie 49,0	Serie 48,0
		Totalt 240,0	Totalt 288,0
Enkeltskott		1: 8,9 ↗ 2: 10,2 → 3: 7,5 ↘ 4: 10,6* ↘ 5: 8,0 ↘	
		Serie 43,0	
		Totalt 331,0	

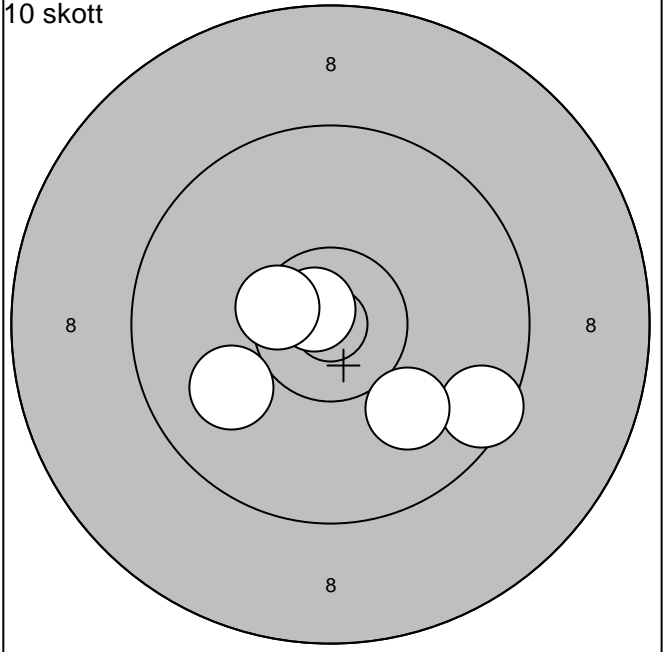
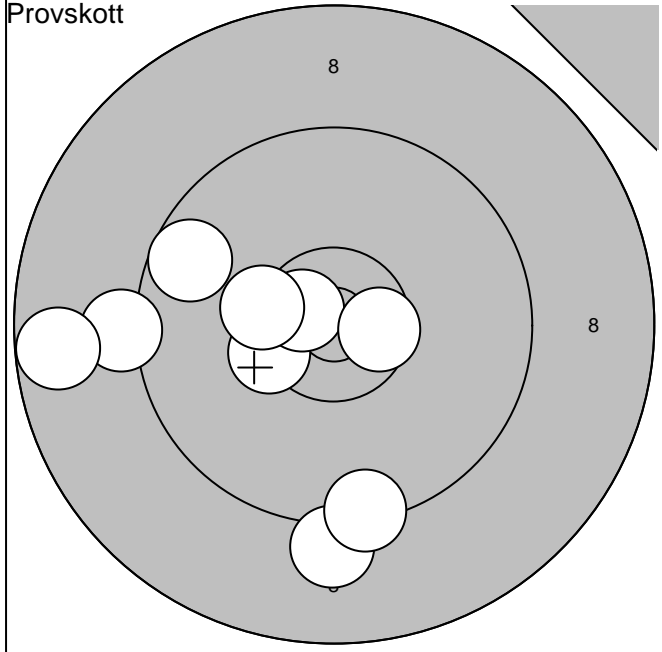

1: 9,2 ←	6:10,7* ↖	Serie	84,0
2: 8,7 ←	7:10,3* ←		
3:10,4* ↙	8: 9,7 ←	Totalt	183,0
4: 9,1 ↓	9:10,6* →		
5: 9,4 ↓			

1: 9,5 ↘	Serie	49,0
2:10,0 ↘		
3:10,8* ↗	Totalt	232,0
4:10,0 ←		
5:10,5* ↖		

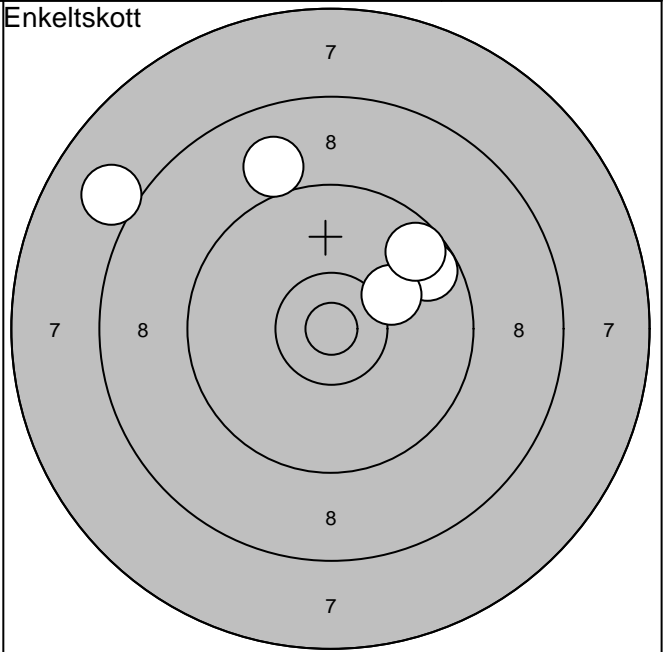
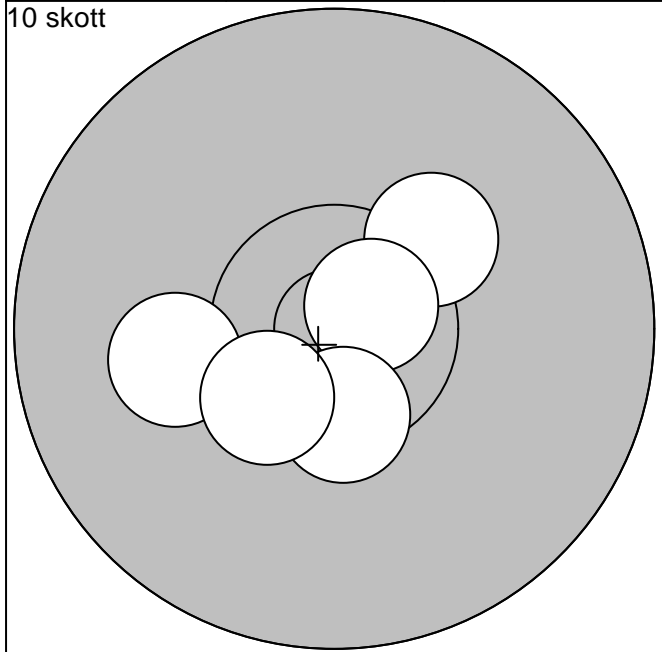

6:10,3 ↗	Serie	50,0
7:10,7* ↗		
8:10,5* ↓	Totalt	282,0
9:10,1 ←		
10:10,4* ↙		

1: 9,7 ↗	Serie	45,0
2:10,2 ↗		
3: 8,0 ↖	Totalt	327,0
4: 9,6 ↗		
5: 9,0 ↕		

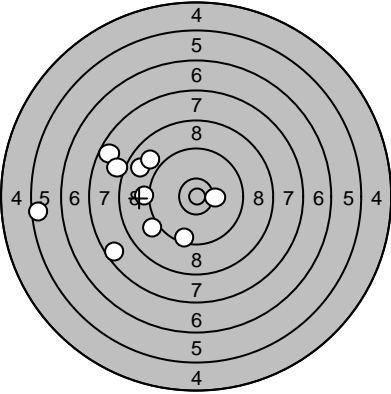
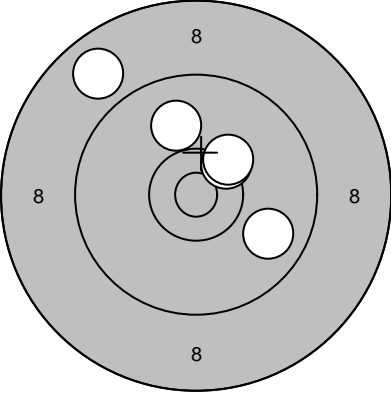
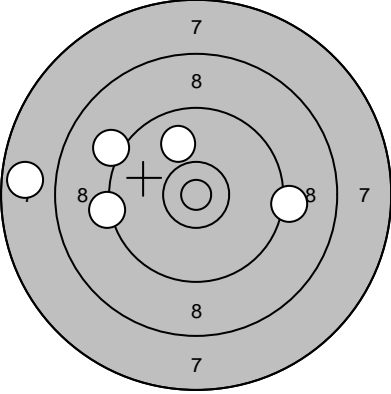
Skjutlag	Tavla	Lars-Gunnar Marklund	
3	8		
		S3	
2006-09-02	Höstträffen 2006 Final	Ramselefors SKF	
Provskott		1: 9,5 ↓ 2: 7,7 ↖ 3: 9,1 ↙ 4: 7,6 ↙ 5: 5,6 ← 6: 10,3* → 7: 8,1 ↖ 8: 8,8 ↗ 9: 9,0 ↗ 10: 9,2 ←	Provskott
		Serie 81,0	11: 10,2 ↗
		Totalt 183,0	Serie 10,0
			Totalt 183,0
10 skott		1: 9,8 → 2: 10,4* ↗ 3: 10,3* ↗ 4: 10,0 ↑ 5: 8,8 ↖	6: 10,1 ← 7: 8,7 ↗ 8: 10,4* ← 9: 8,4 ↓ 10: 9,9 →
		Serie 47,0	Serie 45,0
		Totalt 230,0	Totalt 275,0
Enkeltskott		1: 9,9 ↗ 2: 9,2 ↖ 3: 7,7 ← 4: 9,3 ← 5: 9,2 →	
		Serie 43,0	
		Totalt 318,0	

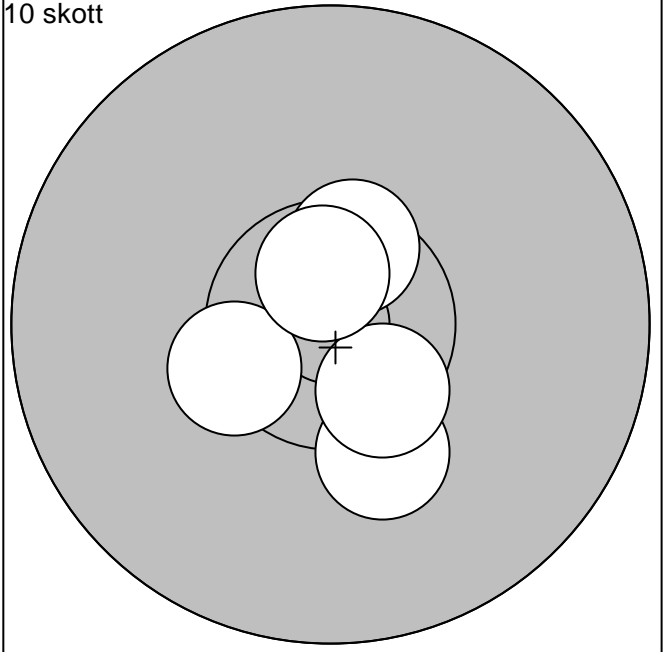
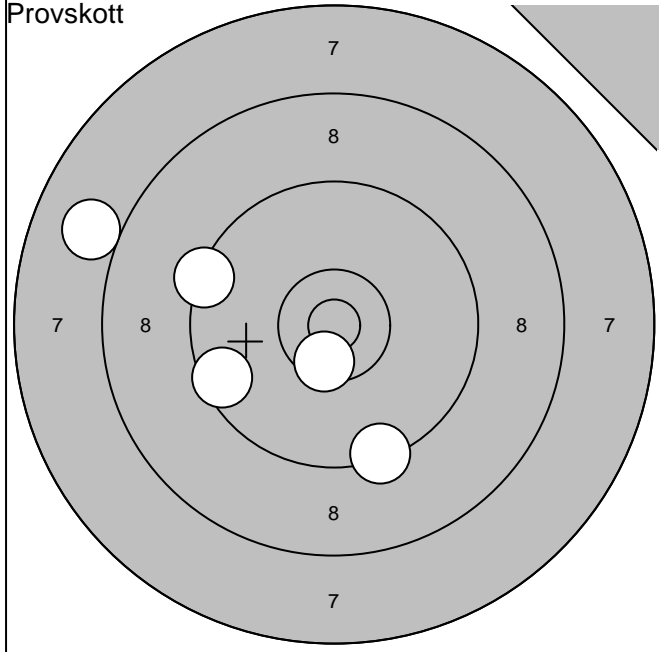

1: 9,5 ←	Serie 45,0
2: 9,4 ↓	
3:10,5* ↓	
4: 8,0 ←	
5: 9,4 ←	
Totalt 182,0	

1:10,2 ↓	Serie 50,0
2:10,5* ↓	
3:10,4* ←	
4:10,5* ↑	
5:10,7* ↑	
Totalt 232,0	

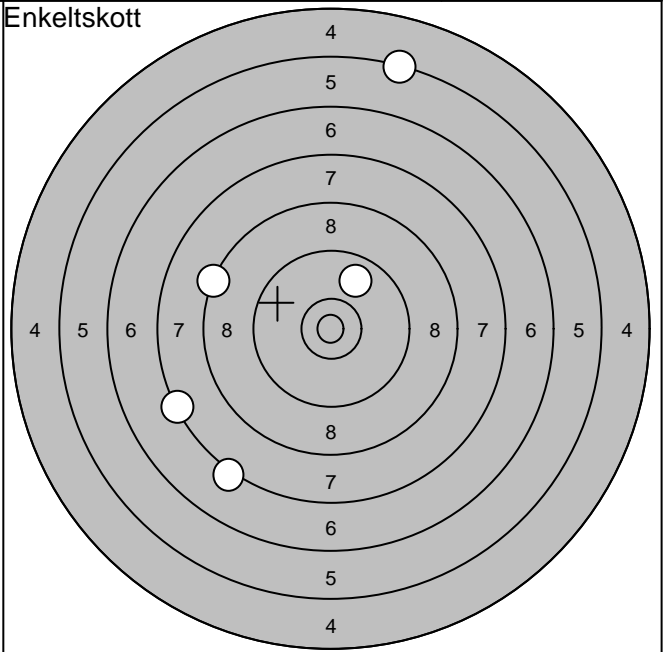
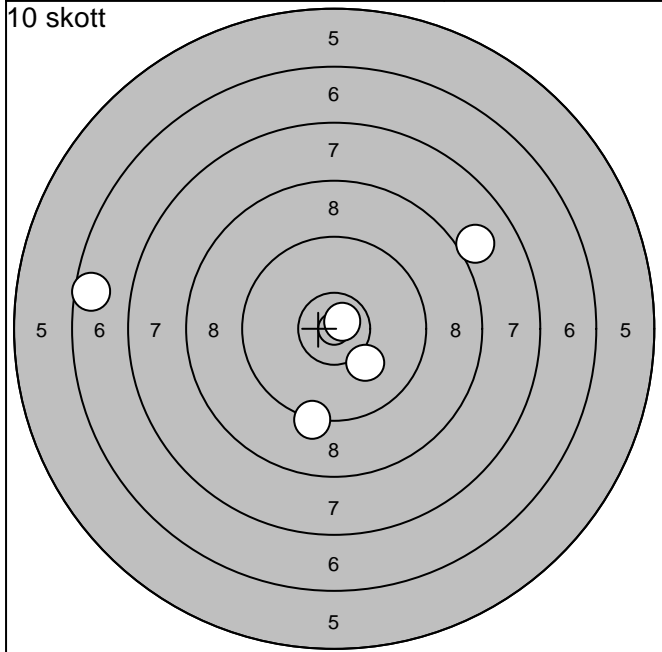

6: 6,6 ←	Serie 43,0
7: 9,3 ↓	
8:10,1 ↓	
9:10,8* ↗	
10: 8,0 ↗	
Totalt 275,0	

1: 9,9 ↗	Serie 36,0
2: 7,4 ←	
3: 5,3 ↑	
4: 7,2 ↓	
5: 8,3 ←	
Totalt 311,0	

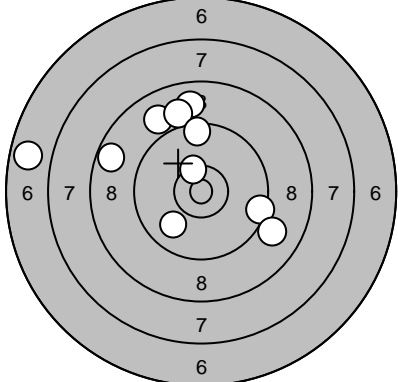
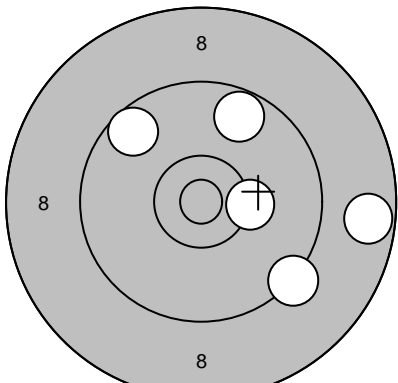
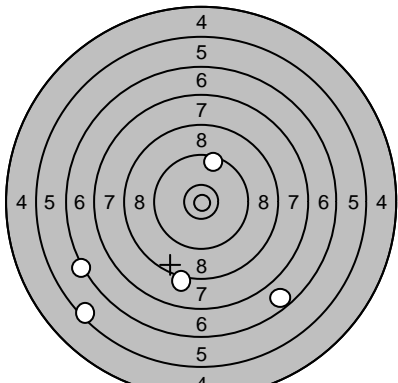
Skjutlag	Tavla		
3	11	Ida Lundmark	
		Drängsmark	
2006-09-02	Höstträffen 2006 Final	Ramselefors SKF	
Provskott		1: 10,4* ↑ 2: 9,9 ↘ 3: 8,7 ← 4: 9,5 → 5: 8,9 ↑ 6: 6,8 ← 7: 9,0 ↑ 8: 9,0 ↑ 9: 9,0 → 10: 9,5 ↑	Provskott
		Serie 86,0	11: 9,2 ↖
		Totalt 162,0	12: 10,1 ↘
			Serie 19,0
			Totalt 162,0
10 skott		1: 9,3 ↘ 2: 8,7 → 3: 9,6 ↗ 4: 9,7 ↑ 5: 10,3 →	10 skott
		Serie 45,0	6: 10,0 ↖
		Totalt 207,0	7: 9,5 ↓
			8: 7,3 →
			9: 9,6 ↓
			10: 10,5* ↖
			Serie 45,0
			Totalt 252,0
Enkeltskott		1: 9,5 ↑ 2: 6,7 ↘ 3: 5,5 ↘ 4: 8,2 ↓ 5: 6,3 ↖	
		Serie 34,0	
		Totalt 286,0	

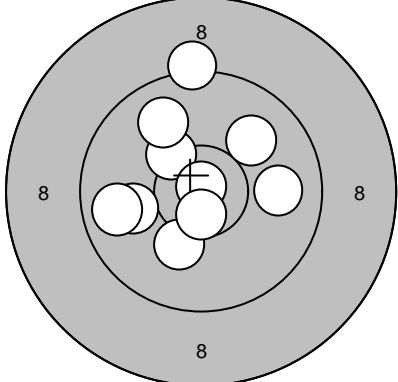
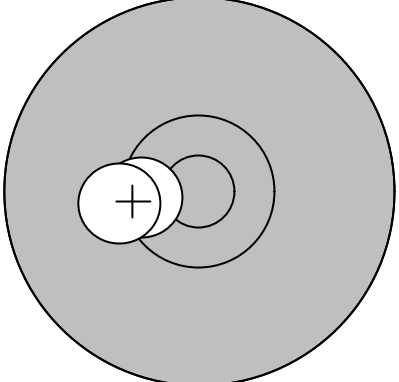
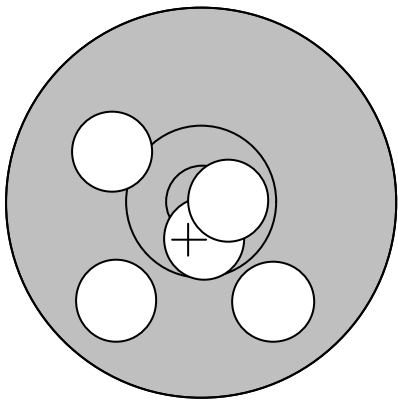
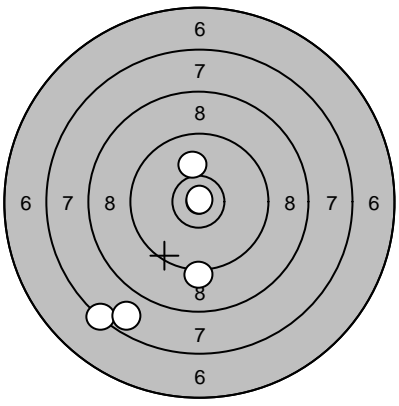
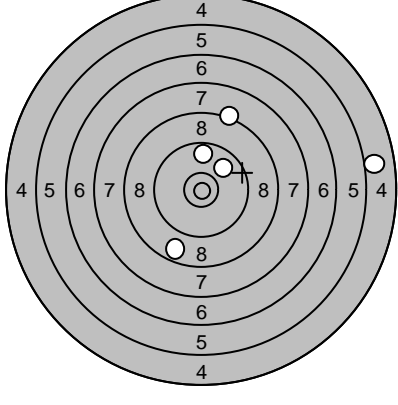
Skjutlag	Tavla	Gunnar Iversen	
3	13	S3	
2006-09-02	Höstträffen 2006 Final	Ramselefors SKF	
Provs-kott		1: 9,9 → 2: 10,0 ↗ 3: 9,2 ↑ 4: 10,3* ↖ 5: 10,9* ↑ 6: 10,0 ← 7: 9,9 ↖ 8: 10,2 ↓ 9: 9,8 ← 10: 10,6* ↓	Provs-kott 
	Serie 96,0		11: 10,5* ←
	Totalt 180,0		12: 10,3 ←
		Serie 20,0	
		Totalt 180,0	
10 skott		1: 9,9 ↓ 2: 10,6* ↓ 3: 9,8 ↙ 4: 10,1 ↖ 5: 10,7* →	10 skott 
	Serie 48,0		6: 7,3 ↙
	Totalt 228,0		7: 7,8 ↙
		Serie 43,0	8: 9,2 ↓
		Totalt 271,0	9: 10,9* ↗
			10: 10,1 ↑
Enkeltskott		1: 5,0 → 2: 8,8 ↓ 3: 9,7 ↑ 4: 8,3 ↗ 5: 9,9 ↗	
	Serie 39,0		
	Totalt 310,0		

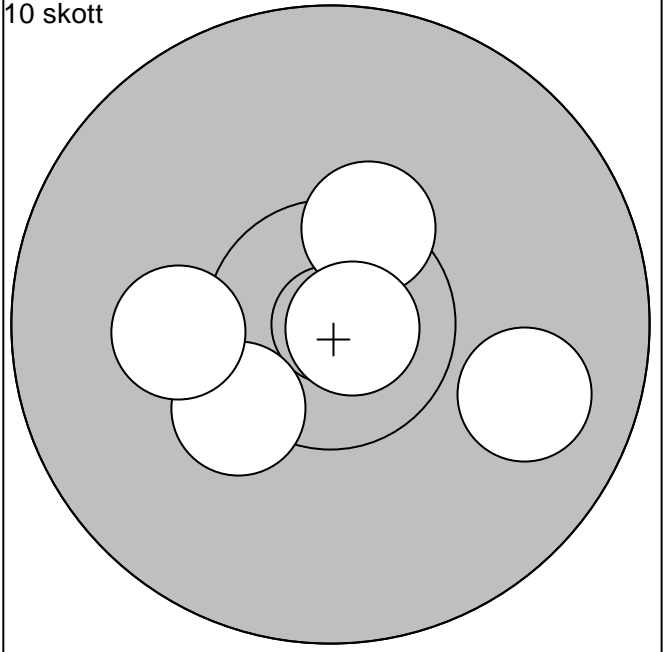
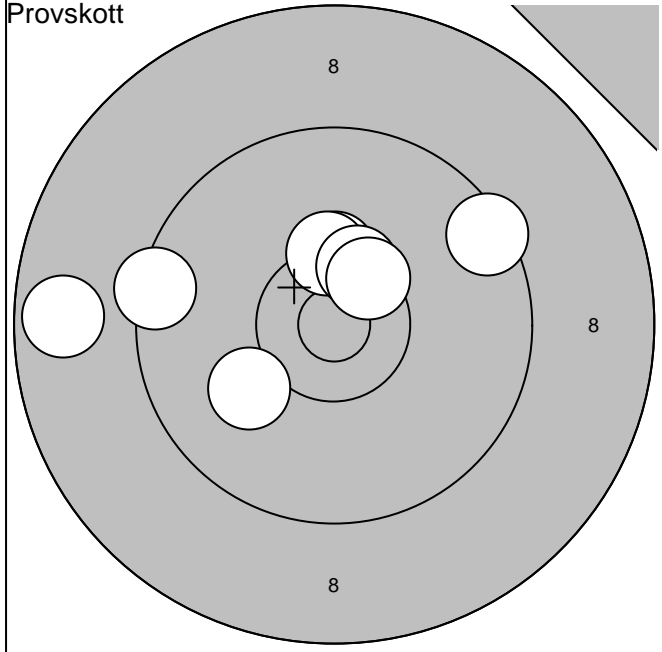

1: 9,5 ↗	6:10,5* ↗	Serie	76,0
2:10,4* ↑	7: 8,7 ←		
3:10,4* ↑	8: 9,4 ←	Totalt	179,0
4:10,1 ↙			
5:10,4* ↗			

1:10,3* ↙	Serie	49,0
2: 9,9 ➔		
3:10,4* ↗	Totalt	228,0
4:10,8* ➔		
5:10,2 ←		

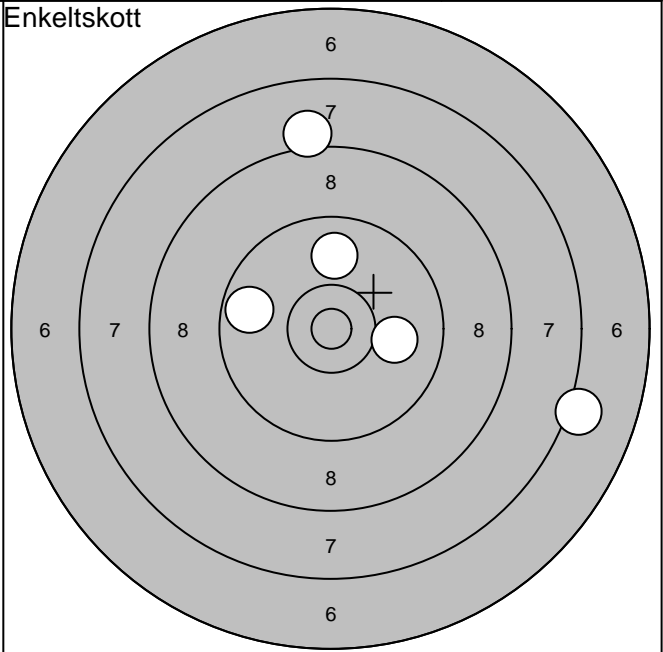
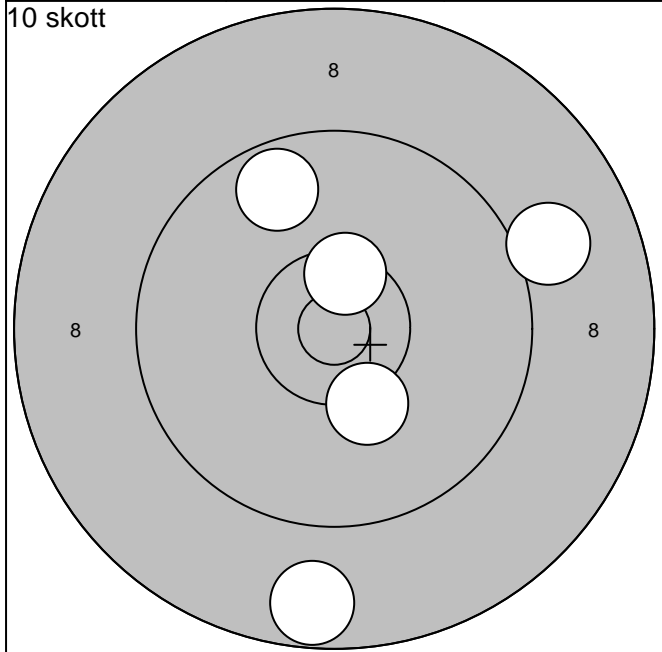

6:10,5* ↑	Serie	46,0
7: 8,7 ↓		
8: 9,7 ↗	Totalt	274,0
9:10,3 ↓		
10: 9,0 ➔		

1: 7,2 ➔	Serie	43,0
2: 9,9 ↑		
3: 9,7 ←	Totalt	317,0
4: 8,1 ↑		
5:10,0 ➔		

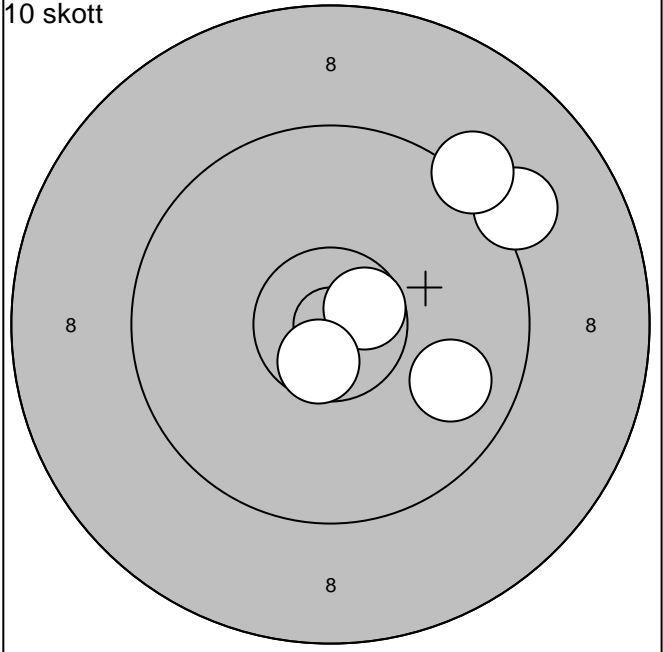
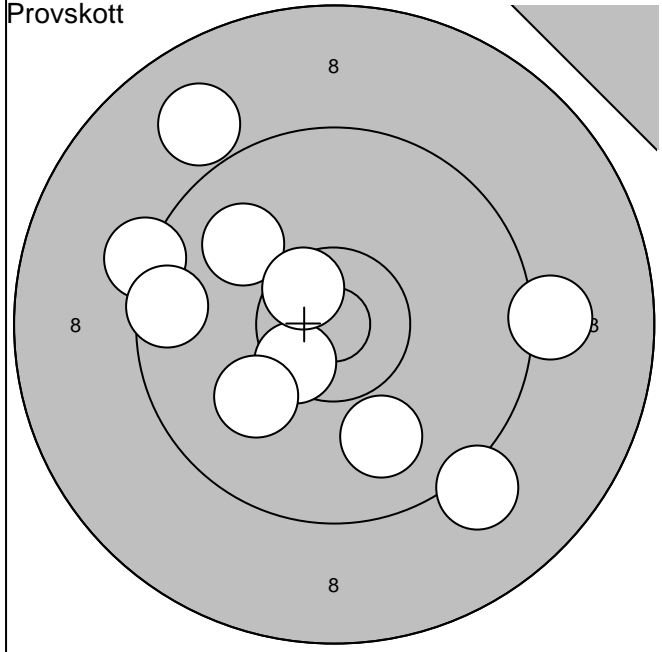

1: 10,0 ↖	6: 9,6 ←	Serie	94,0
2: 9,3 ←	7: 9,2 →		
3: 9,0 ↗	8: 9,2 ↘	Totalt	176,0
4: 10,5* ↙	9: 9,9 ↘		
5: 10,6* ↗	10: 10,1 ↙		

1: 9,1 ↗	Serie	47,0
2: 10,6* ↗		
3: 9,2 ↗	Totalt	223,0
4: 9,9 →		
5: 10,6* ↘		

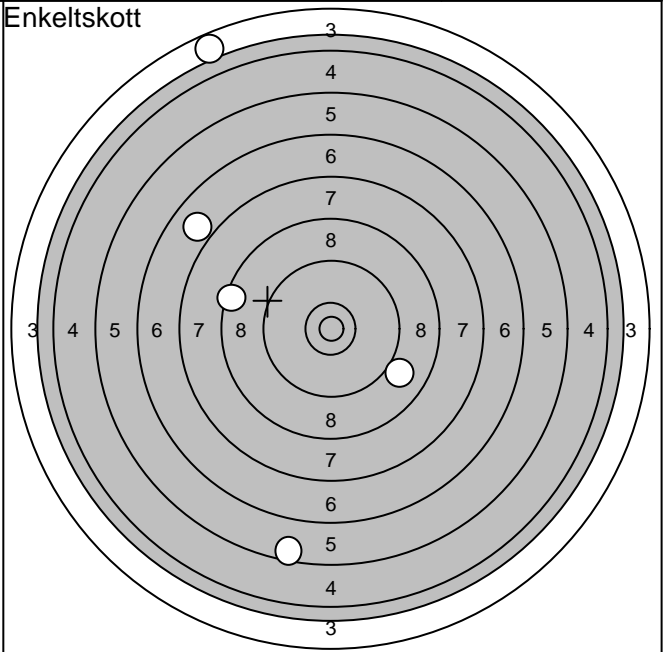
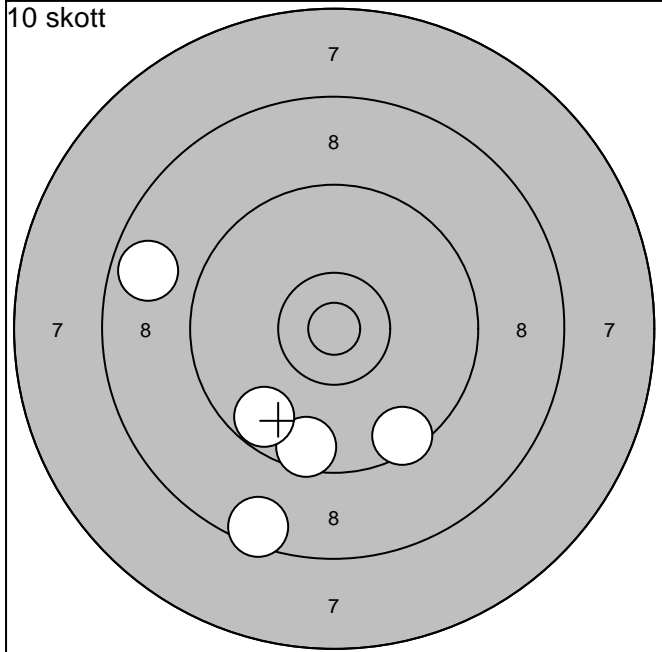

6: 8,5 ↘	Serie	43,0
7: 9,6 ↘		
8: 8,7 ←	Totalt	266,0
9: 9,5 ↘		
10: 9,7 ↙		

1: 3,7 ↗	Serie	32,0
2: 8,5 ←		
3: 5,5 ↘	Totalt	298,0
4: 9,0 →		
5: 7,0 ↗		