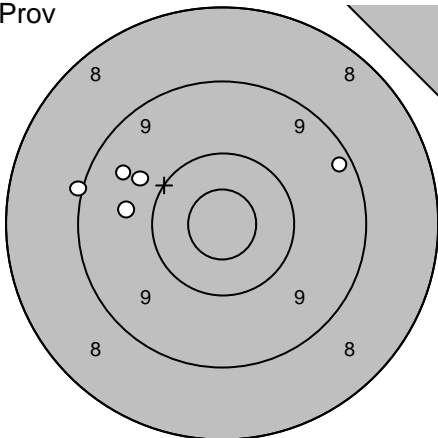
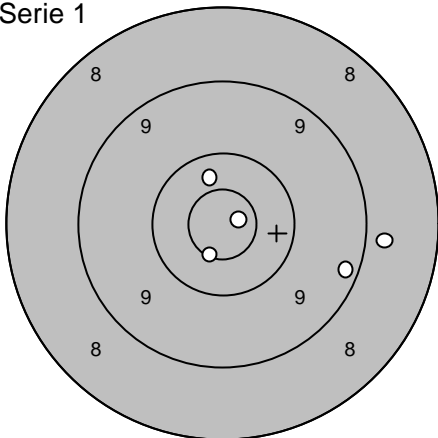
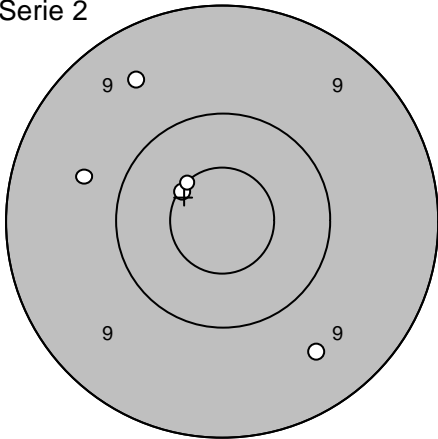
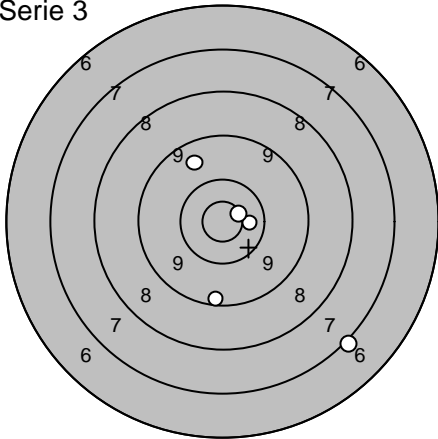
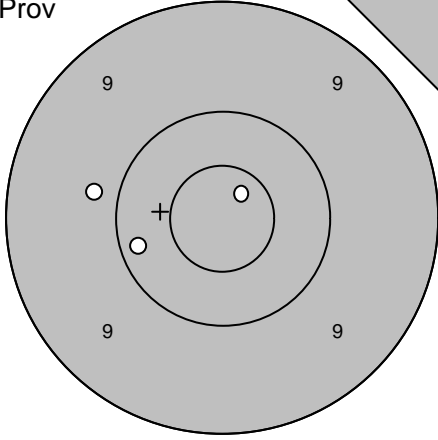
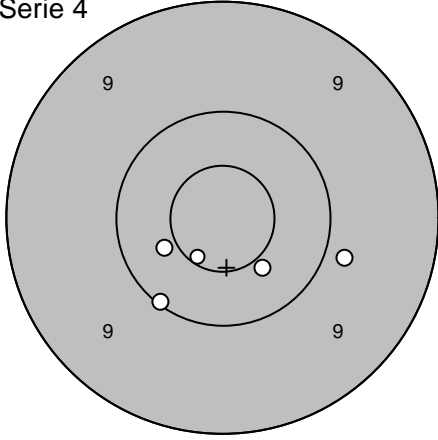
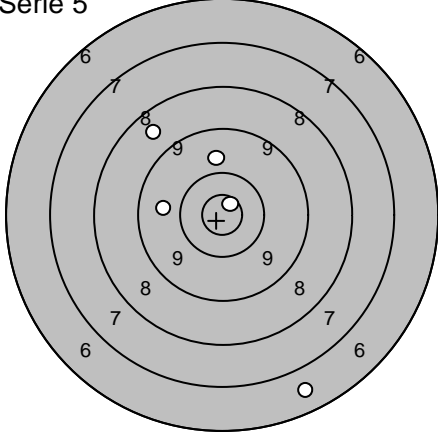
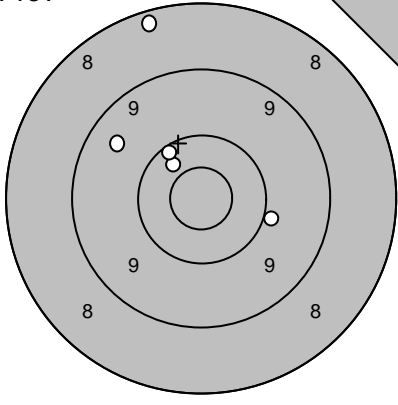
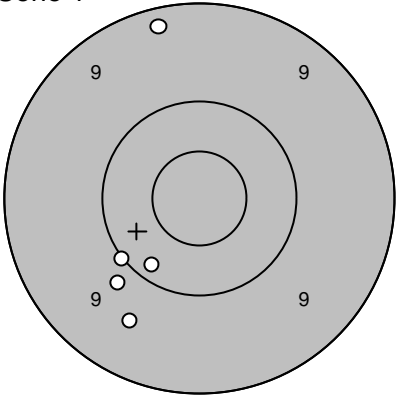
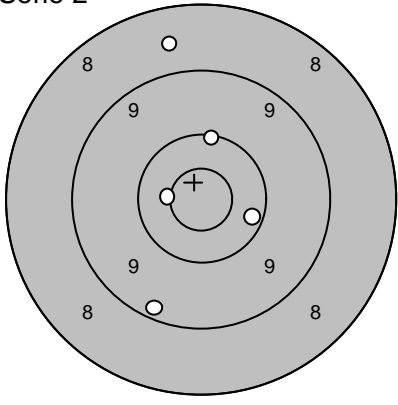
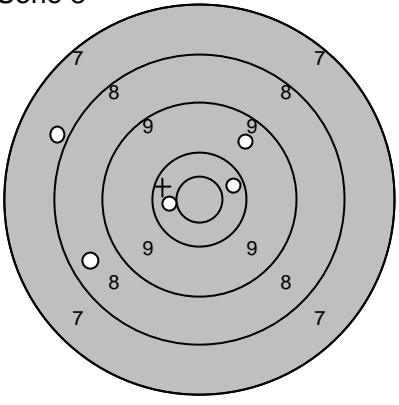
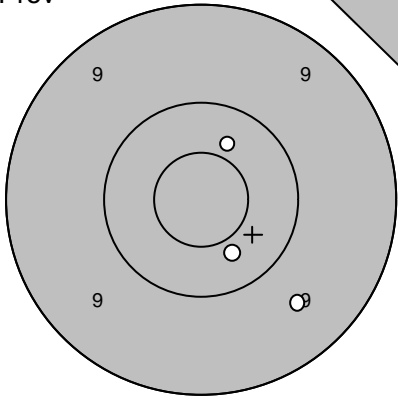
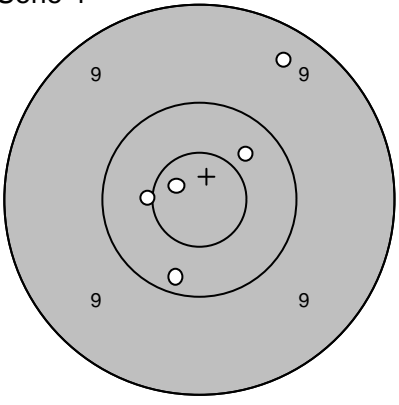
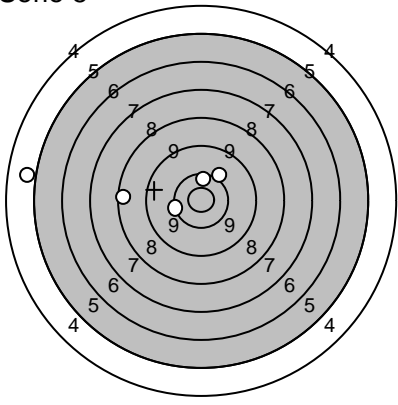
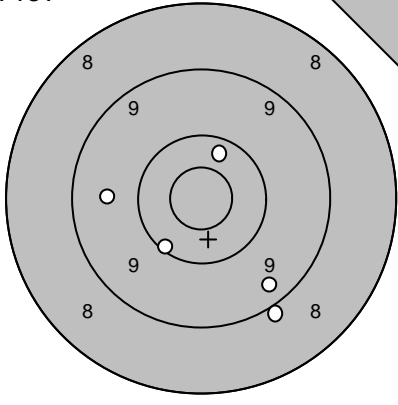
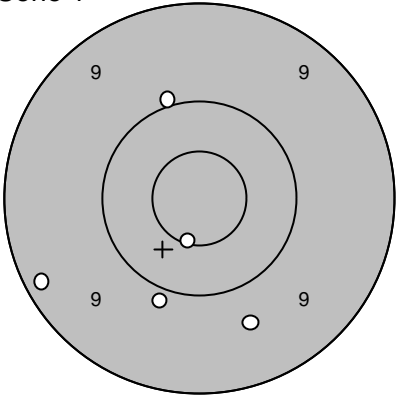
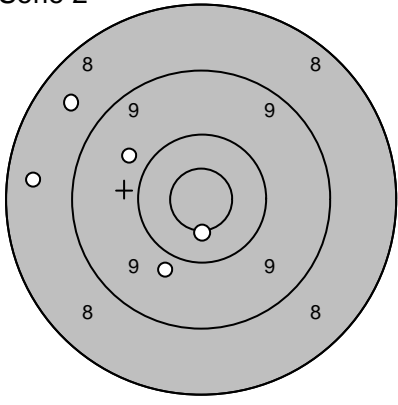
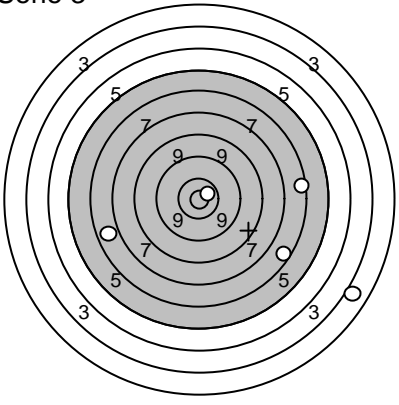
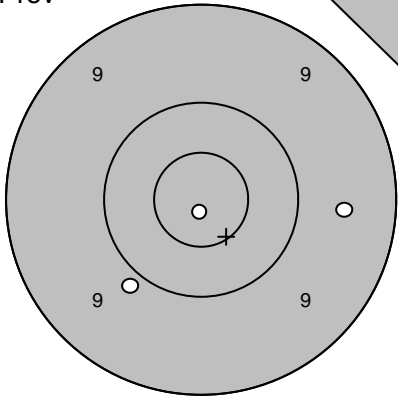
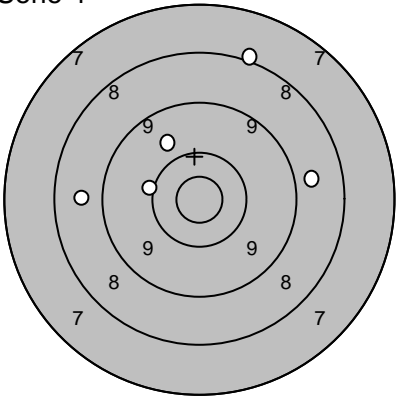
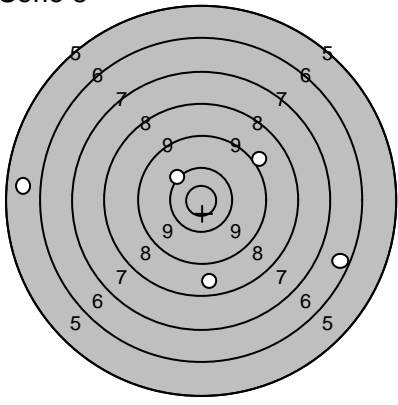
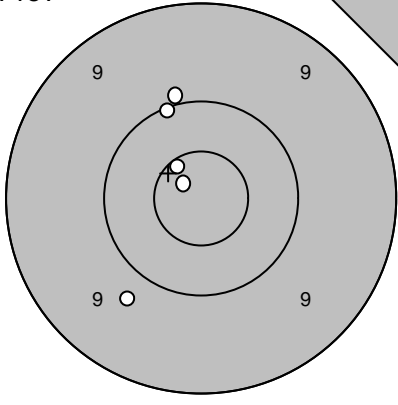
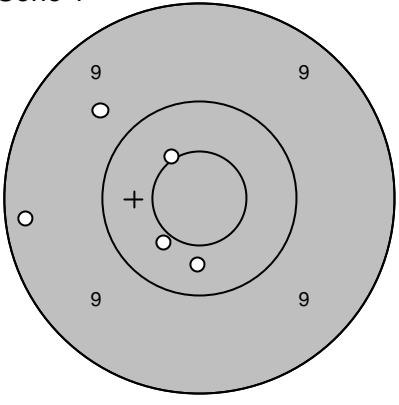
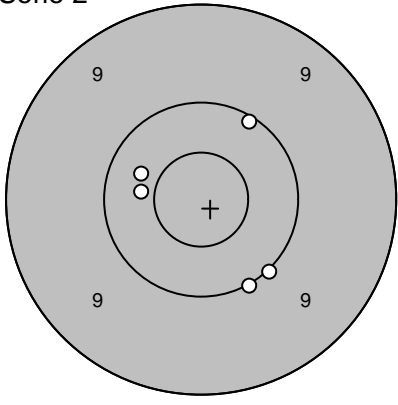
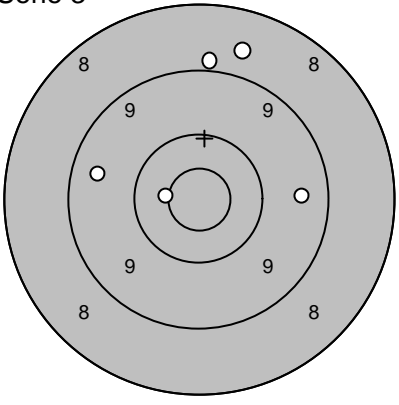
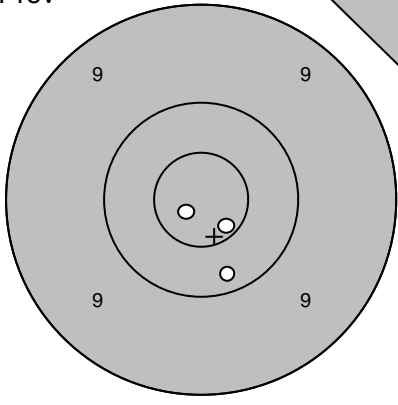
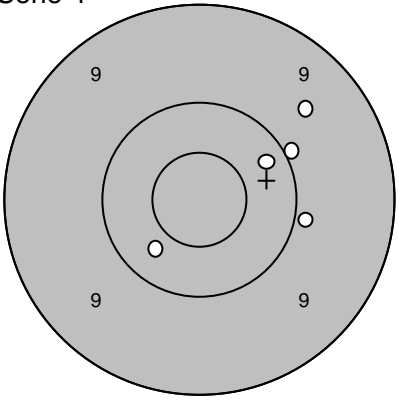
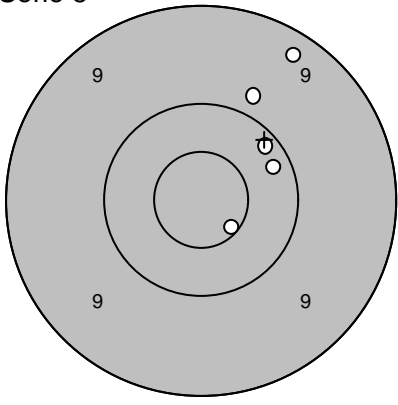
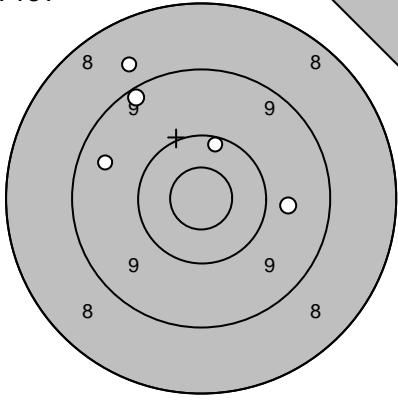
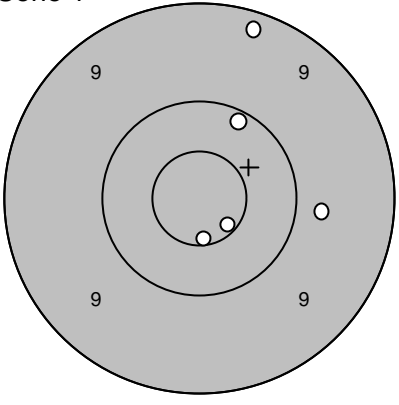
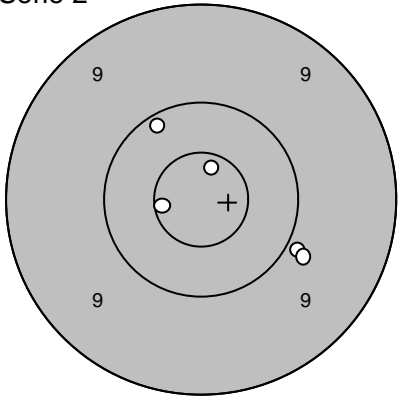
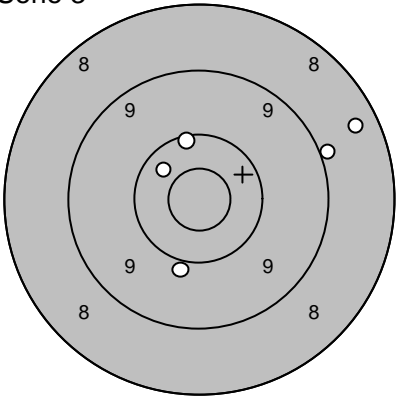
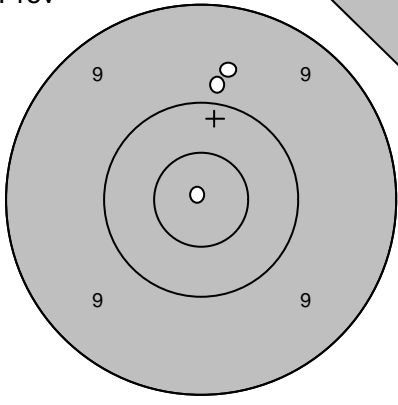
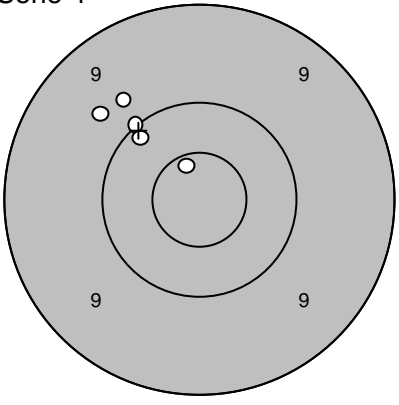
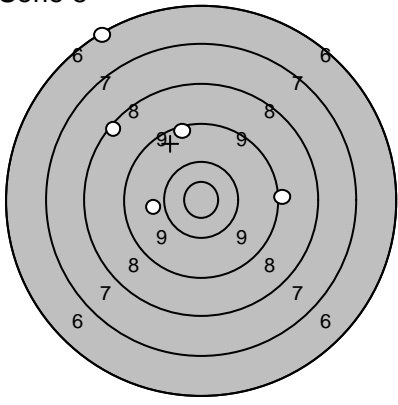

Skjutlag 1	Tavla 1	Dan-Ivan Karlsson	
Ramselefors		Ramselefors	
2006-07-07		Björkskottet 2006	Ramselefors Skytteförening
Prov		1: 9,0 ← 2: 9,5 ↗ 3: 9,8 ↗ 4: 9,7 ← 5: 9,2 ↗ Serie 45,0 Totalt 0,0	Serie 1  1: 9,3 → 2: 10,6* ↓ 3: 8,8 → 4: 10,4 ↑ 5: 10,8* → Serie 47,0 Totalt 47,0
Serie 2		1: 9,5 ↗ 2: 10,6* ↗ 3: 9,7 ← 4: 10,6* ↗ 5: 9,5 ↓ Serie 47,0 Totalt 94,0	Serie 3  1: 10,5* → 2: 10,7* → 3: 9,3 ↓ 4: 7,1 ↓ 5: 9,6 ↑ Serie 45,0 Totalt 139,0
Prov		1: 9,8 ← 2: 10,7* ↗ 3: 10,2 ← Serie 29,0 Totalt 139,0	Serie 4  1: 9,9 → 2: 10,4 ↓ 3: 10,6* ↓ 4: 10,1 ↓ 5: 10,4 ← Serie 49,0 Totalt 188,0
Serie 5		1: 9,8 ← 2: 9,8 ↑ 3: 10,8* ↗ 4: 8,7 ↗ 5: 6,7 ↓ Serie 42,0 Totalt 230,0	

Skjutlag 1	Tavla 2	Jan-Erik Karlsson	
Ramselefors		Ramselefors	
2006-07-07		Björkskottet 2006	Ramselefors Skytteförening
Prov 	1: 8,3 ↗ 2: 10,4 ↗ 3: 9,6 ↗ 4: 10,2 ↗ 5: 10,0 →	Serie 1 	1: 9,2 ↗ 2: 9,8 ↘ 3: 10,2 ↘ 4: 9,6 ↘ 5: 10,0 ↘
	Serie 47,0 Totalt 0,0		Serie 47,0 Totalt 47,0
Serie 2 	1: 8,6 ↗ 2: 9,3 ↘ 3: 10,6* ← 4: 10,2 → 5: 10,1 ↗	Serie 3 	1: 10,5* ← 2: 10,4 → 3: 8,6 ← 4: 7,9 ↖ 5: 9,6 ↗
	Serie 47,0 Totalt 94,0		Serie 44,0 Totalt 138,0
Prov 	1: 10,4 ↘ 2: 10,4 ↗ 3: 9,6 ↘	Serie 4 	1: 9,4 ↗ 2: 10,4 ↗ 3: 10,5* ← 4: 10,8* ↖ 5: 10,2 ↘
	Serie 29,0 Totalt 138,0		Serie 49,0 Totalt 187,0
Serie 5 	1: 10,3 ← 2: 10,2 ↗ 3: 10,5* ↗ 4: 8,5 ← 5: 4,9 ←		
	Serie 42,0 Totalt 229,0		

Skjutlag	Tavla	Leif Sigfridsson		
1	3	Ramselefors	Ramselefors	
2006-07-07	Björkskottet 2006	Ramselefors Skytteförening		
Prov		1: 9,0 ↘ 2: 9,6 ← 3: 9,4 ↘ 4: 10,2 ↘ 5: 10,3 ↑	Serie 1 	1: 10,0 ↑ 2: 9,7 ↓ 3: 10,6* ↓ 4: 9,2 ← 5: 9,9 ↓
		Serie 47,0		Serie 47,0
		Totalt 0,0		Totalt 47,0
Serie 2		1: 9,8 ← 2: 8,6 ↖ 3: 9,9 ↘ 4: 10,6* ↓ 5: 8,5 ←	Serie 3 	1: 6,6 → 2: 6,9 ← 3: 10,9* ↗ 4: 6,7 ↘ 5: 3,0 ↘
		Serie 44,0		Serie 31,0
		Totalt 91,0		Totalt 122,0
Prov		1: 10,9* ↓ 2: 9,6 → 3: 9,9 ↘	Serie 4 	1: 9,8 ↑ 2: 8,8 → 3: 8,0 ↑ 4: 10,1 ← 5: 8,7 ←
		Serie 28,0		Serie 43,0
		Totalt 122,0		Totalt 165,0
Serie 5		1: 10,2 ↖ 2: 9,0 ↗ 3: 6,5 → 4: 5,8 ← 5: 8,7 ↓		
		Serie 38,0		
		Totalt 203,0		

Skjutlag	Tavla	Peder Vahlberg	
1	4		
Ramselefors	Ramselefors		
2006-07-07	Björkskottet 2006	Ramselefors Skytteförening	
Prov		1: 10,0 ↗ 2: 10,1 ↗ 3: 10,8* ↗ 4: 10,6* ↗ 5: 9,8 ↘	Serie 1 
	Serie 49,0 Totalt 0,0	1: 9,7 ↗ 2: 10,5* ↗ 3: 10,5* ↘ 4: 9,3 ← 5: 10,4 ↓	Serie 48,0 Totalt 48,0
Serie 2		1: 10,1 ↗ 2: 10,4 ← 3: 10,4 ↗ 4: 10,0 ↘ 5: 10,0 ↘	Serie 3 
	Serie 50,0 Totalt 98,0	1: 9,5 → 2: 10,6* ← 3: 9,5 ← 4: 9,0 ↑ 5: 8,7 ↑	Serie 45,0 Totalt 143,0
Prov		1: 10,7* ↘ 2: 10,8* ↘ 3: 10,2 ↓	Serie 4 
	Serie 30,0 Totalt 143,0	1: 10,2 ↗ 2: 10,4 ↘ 3: 9,6 ↗ 4: 10,0 ↗ 5: 9,9 →	Serie 48,0 Totalt 191,0
Serie 5		1: 9,3 ↗ 2: 10,2 → 3: 9,8 ↗ 4: 10,6* ↘ 5: 10,2 ↗	
	Serie 48,0 Totalt 239,0		

Skjutlag	Tavla	Lars Sandström	
1	5		
Ramselefors	Ramselefors		
2006-07-07	Björkskottet 2006	Ramselefors Skytteförening	
Prov		1: 8,8 ↗ 2: 9,2 ↗ 3: 9,7 → 4: 9,5 ↖ 5: 10,2 ↑	Serie 1 
	Serie 45,0 Totalt 0,0	1: 9,2 ↗ 2: 10,2 ↗ 3: 9,8 → 4: 10,6* ↘ 5: 10,6* ↓	Serie 48,0 Totalt 48,0
Serie 2		1: 10,6* ← 2: 9,9 ↘ 3: 9,8 ↘ 4: 10,7* ↑ 5: 10,2 ↗	Serie 3 
	Serie 48,0 Totalt 96,0	1: 8,4 → 2: 10,4 ↗ 3: 10,2 ↑ 4: 10,0 ↓ 5: 9,0 →	Serie 47,0 Totalt 143,0
Prov		1: 9,9 ↑ 2: 9,7 ↑ 3: 10,9* ↗	Serie 4 
	Serie 28,0 Totalt 143,0	1: 10,7* ↑ 2: 10,0 ↗ 3: 9,7 ↗ 4: 9,8 ↗ 5: 10,2 ↗	Serie 48,0 Totalt 191,0
Serie 5		1: 9,1 → 2: 9,3 ↑ 3: 8,3 ↗ 4: 6,3 ↗ 5: 9,9 ←	
	Serie 41,0 Totalt 232,0		

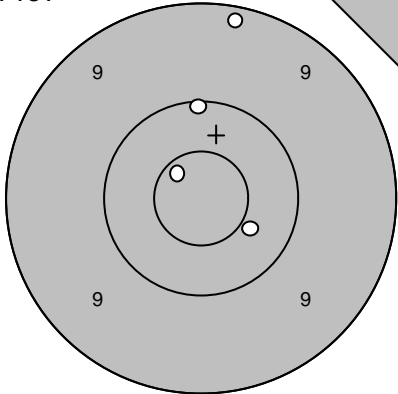
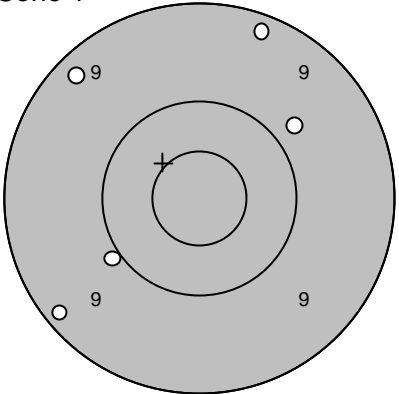
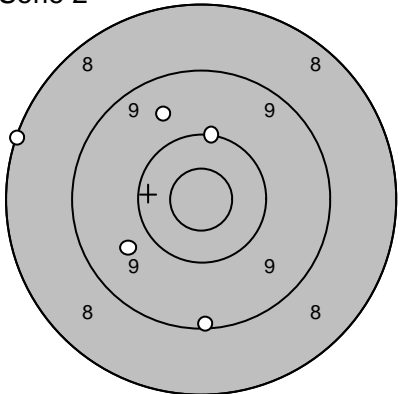
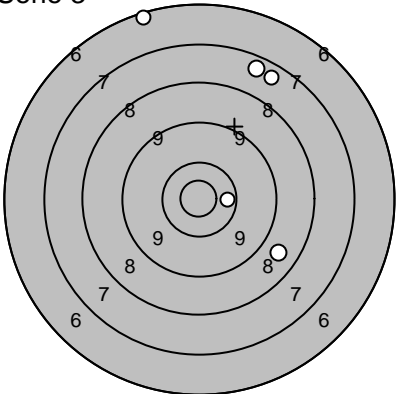
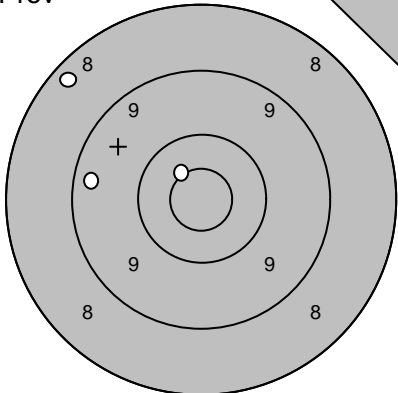
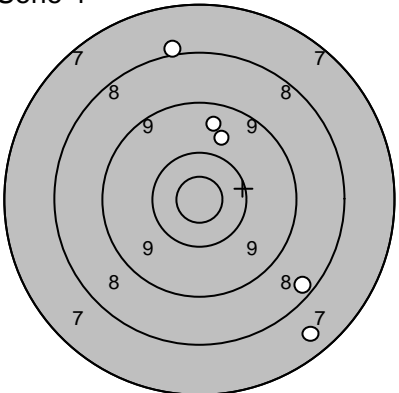
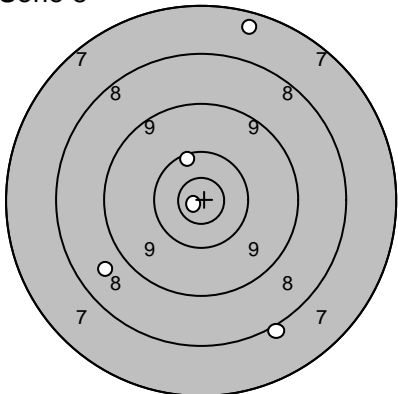
Skjutlag	Tavla	Johnny Wallberg		
1	6			
Ramselefors	Loos			
2006-07-07	Björkskottet 2006	Ramselefors Skytteförening		
Prov		1: 10,4 ↘ 2: 9,2 ↑ 3: 10,1 ↑ 4: 10,7* ↖	Serie 1 	1: 9,2 ↑ 2: 9,8 ↗ 3: 9,3 ↖ 4: 9,2 ↙ 5: 10,0 ↙
	Serie 39,0 Totalt 0,0		Serie 46,0 Totalt 46,0	
Serie 2		1: 8,1 ← 2: 9,7 ↙ 3: 9,2 ↓ 4: 10,1 ↑ 5: 9,7 ↖	Serie 3 	1: 10,4 → 2: 6,3 ↑ 3: 7,5 ↗ 4: 7,5 ↗ 5: 8,7 ↘
	Serie 45,0 Totalt 91,0		Serie 38,0 Totalt 129,0	
Prov		1: 9,4 ← 2: 8,3 ↗ 3: 10,6* ↗	Serie 4 	1: 9,8 ↑ 2: 9,6 ↑ 3: 8,0 ↑ 4: 7,6 ↘ 5: 8,4 ↘
	Serie 27,0 Totalt 129,0		Serie 41,0 Totalt 170,0	
Serie 5		1: 7,5 ↑ 2: 10,9* ↙ 3: 10,3 ↑ 4: 8,0 ↓ 5: 8,7 ↙		
	Serie 43,0 Totalt 213,0			

Skjutlag	Tavla	
1	7	

Ramselefors

2006-07-07 Björkskottet 2006 Ramselefors Skytteförening

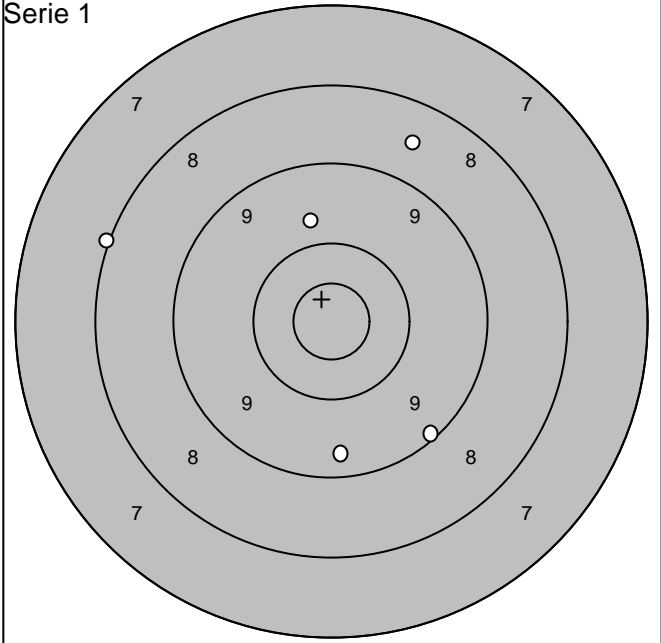
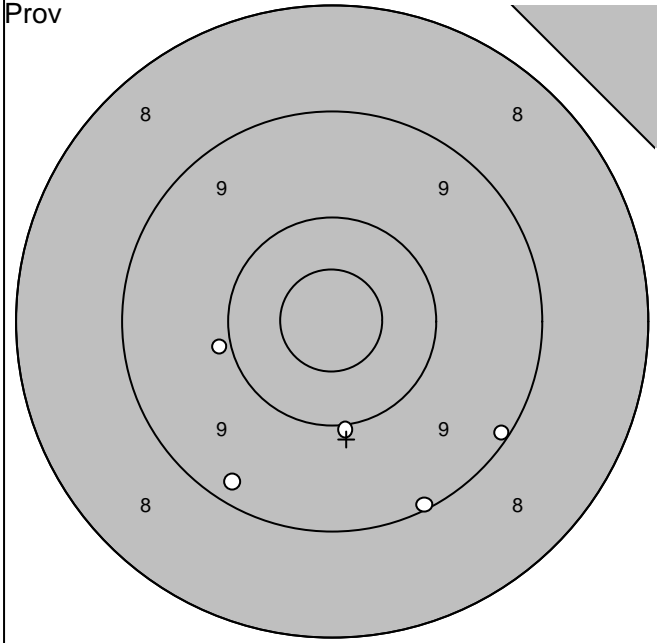

1: 9,1	➔
2: 9,2	➙
3: 10,0	➘
4: 9,1	➙
5: 9,9	➔

Serie	46,0
Totalt	0,0

1: 8,0	➔
2: 9,8	➔
3: 8,6	➔
4: 9,4	➙
5: 9,1	➙

Serie	43,0
Totalt	43,0

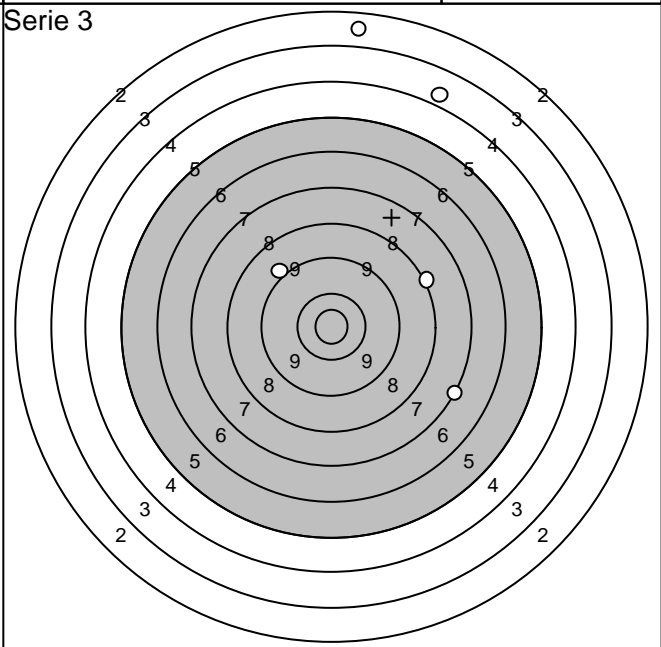
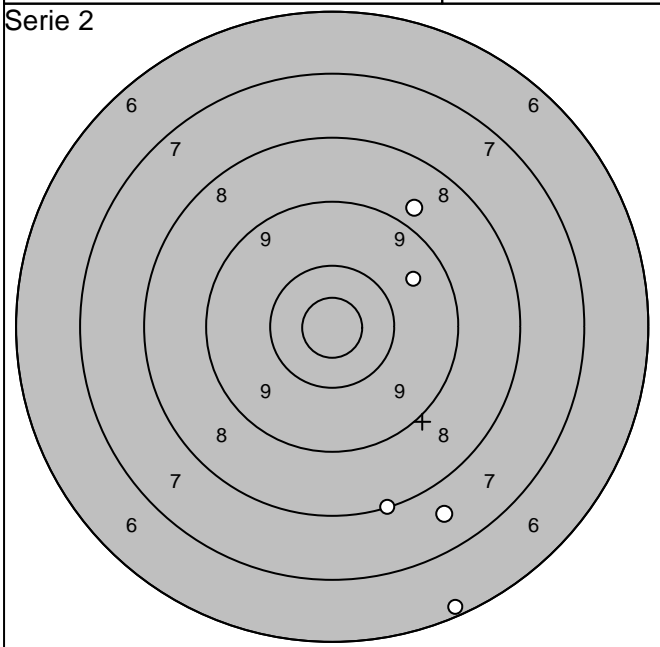

1: 8,8	➔
2: 6,3	➙
3: 7,6	➙
4: 9,6	➔
5: 8,1	➙

Serie	38,0
Totalt	81,0

1: 7,2	➔
2: 9,0	➔
3: 8,2	➔
4: 3,9	➔
5: 2,7	➔

Serie	29,0
Totalt	110,0

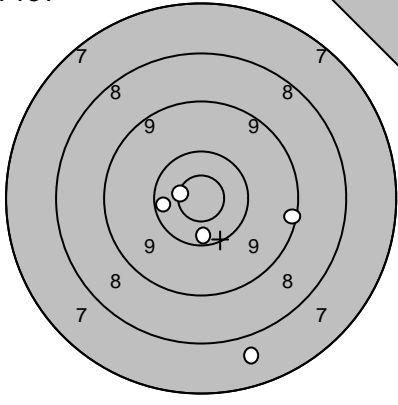
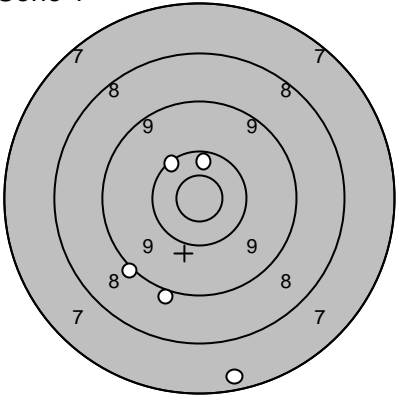
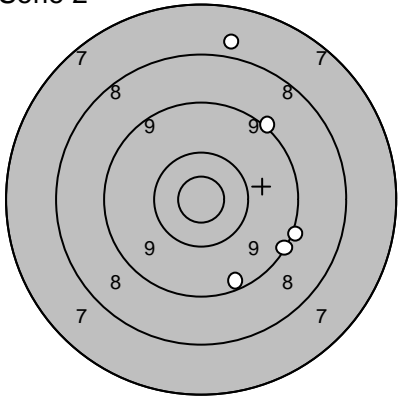
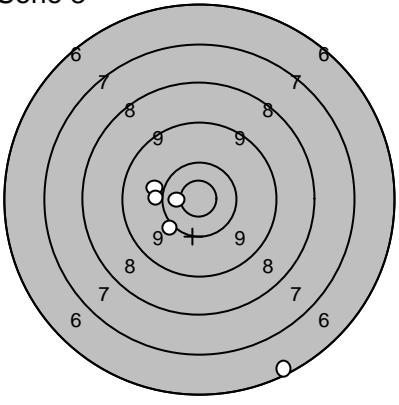
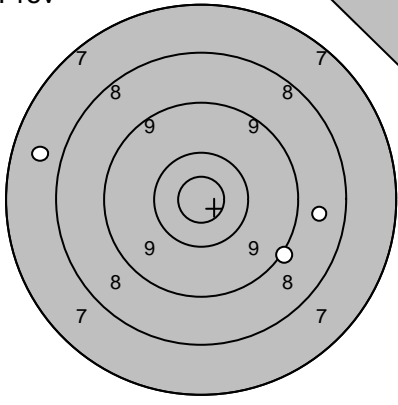
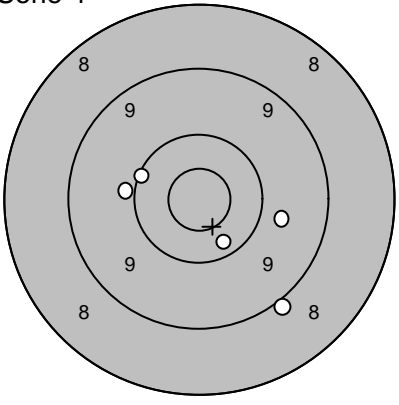
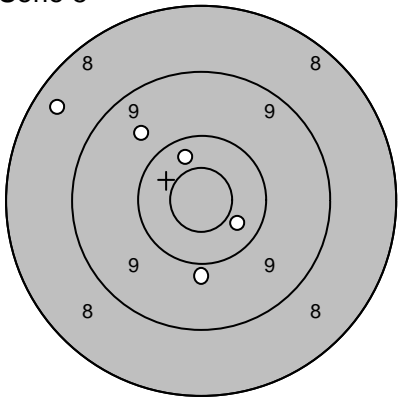
Skjutlag	Tavla	Petter Ivarsson	
1	8		
Ramselefors	Loos		
2006-07-07	Björkskottet 2006	Ramselefors Skytteförening	
Prov		1: 9,2 → 2: 10,3 ← 3: 7,7 ↓ 4: 10,3 ↓ 5: 10,7* ←	Serie 1 
	Serie 46,0 Totalt 0,0		1: 9,0 ↓ 2: 9,1 ↙ 3: 7,4 ↓ 4: 10,4 ↑ 5: 10,2 ↗
			Serie 45,0 Totalt 45,0
Serie 2		1: 9,1 → 2: 9,3 ↓ 3: 9,1 ↗ 4: 7,8 ↑ 5: 9,1 →	Serie 3 
	Serie 43,0 Totalt 88,0		1: 6,3 ↓ 2: 10,6* ← 3: 10,1 ↙ 4: 10,0 ← 5: 10,1 ←
			Serie 46,0 Totalt 134,0
Prov		1: 7,7 ← 2: 9,1 ↓ 3: 8,7 →	Serie 4 
	Serie 24,0 Totalt 134,0		1: 9,0 ↓ 2: 9,8 → 3: 10,1 ↗ 4: 9,9 ← 5: 10,3 ↓
			Serie 47,0 Totalt 181,0
Serie 5		1: 9,9 ↓ 2: 10,4 ↑ 3: 9,7 ↗ 4: 8,5 ↗ 5: 10,4 ↓	
	Serie 46,0 Totalt 227,0		

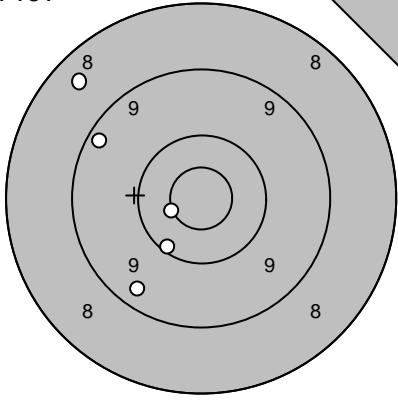
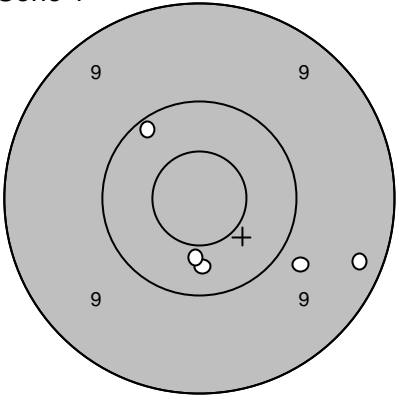
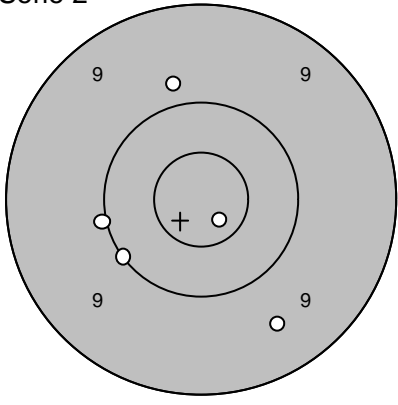
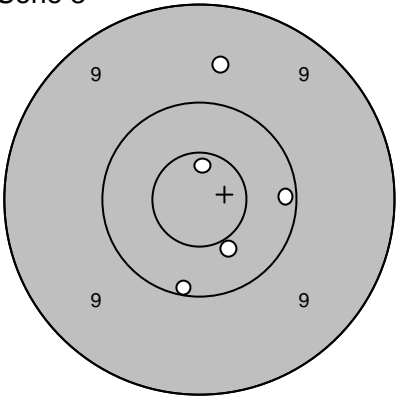
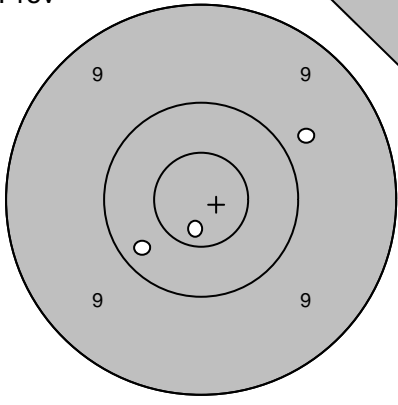
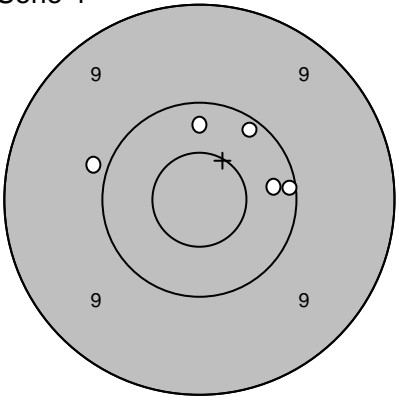
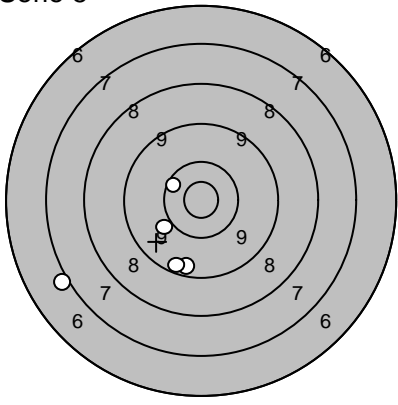
Skjutlag	Tavla	Donald Johansson		
1	10			
Ramselefors	Ale			
2006-07-07	Björkskottet 2006	Ramselefors Skytteförening		
Prov		1: 9,3 ↖ 2: 8,5 ↗ 3: 9,4 ↓ 4: 10,6* ← 5: 10,2 ↓	Serie 1 	1: 9,8 ↘ 2: 10,3 ↓ 3: 9,3 ↗ 4: 10,4 ↓ 5: 10,2 ↗
		Serie 46,0 Totalt 0,0		Serie 48,0 Totalt 48,0
Serie 2		1: 9,5 ↓ 2: 10,0 ← 3: 10,8* ↘ 4: 10,0 ↙ 5: 9,8 ↑	Serie 3 	1: 10,1 ↓ 2: 10,4 ↘ 3: 10,7* ↑ 4: 9,6 ↑ 5: 10,1 →
		Serie 48,0 Totalt 96,0		Serie 49,0 Totalt 145,0
Prov		1: 10,7* ↓ 2: 9,8 ↗ 3: 10,3 ↙	Serie 4 	1: 10,3 ↑ 2: 9,9 ← 3: 10,3 → 4: 10,1 → 5: 10,2 ↗
		Serie 29,0 Totalt 145,0		Serie 49,0 Totalt 194,0
Serie 5		1: 9,4 ↓ 2: 10,0 ← 3: 10,3 ↖ 4: 9,4 ↓ 5: 7,0 ←		
		Serie 45,0 Totalt 239,0		

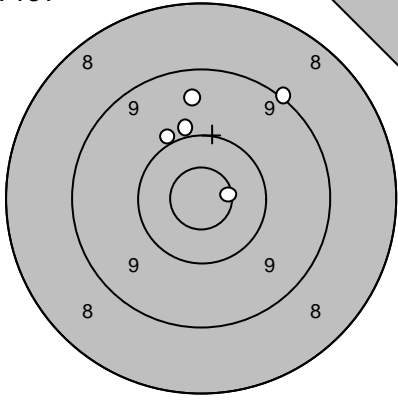
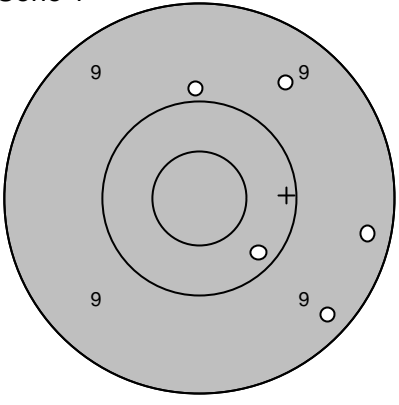
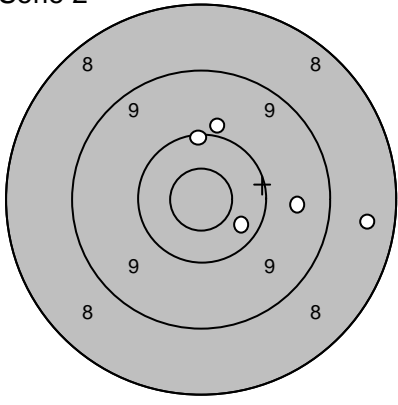
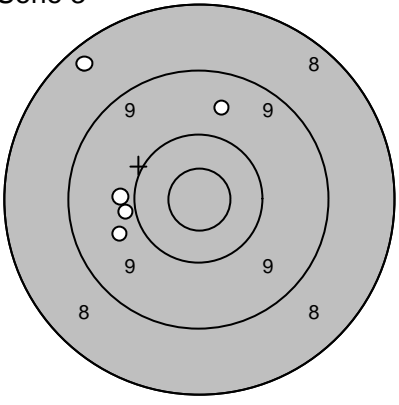
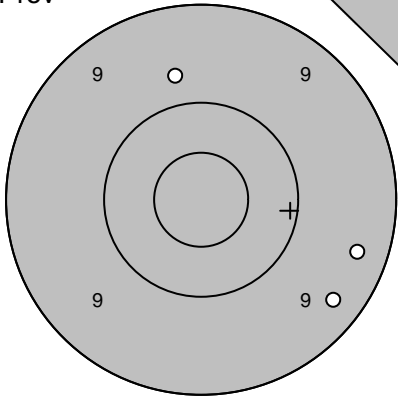
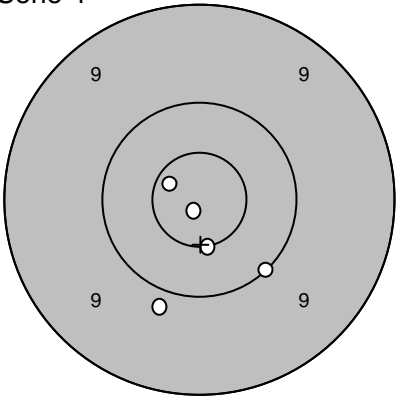
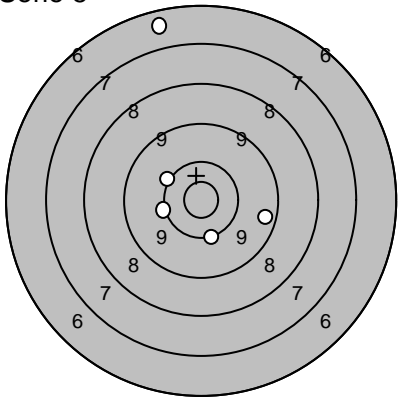
Skjutlag	Tavla	Gunnar Iversen		
1	11			
Ramselefors	S 3			
2006-07-07	Björkskottet 2006	Ramselefors Skytteförening		
Prov		1: 10,0 ↖ 2: 10,0 ↑ 3: 10,7* → 4: 9,5 ↑ 5: 9,1 ↗	Serie 1 	1: 9,3 → 2: 10,2 ↘ 3: 9,3 ↘ 4: 9,9 ↑ 5: 9,6 ↗
		Serie 48,0 Totalt 0,0		Serie 46,0 Totalt 46,0
Serie 2		1: 10,4 ↘ 2: 9,6 → 3: 8,5 → 4: 9,9 ↑ 5: 10,1 ↑	Serie 3 	1: 9,9 ← 2: 9,6 ↑ 3: 9,7 ← 4: 8,4 ↗ 5: 9,9 ←
		Serie 46,0 Totalt 92,0		Serie 44,0 Totalt 136,0
Prov		1: 9,4 → 2: 9,3 ↘ 3: 9,7 ↑	Serie 4 	1: 9,9 ↘ 2: 10,5* ↘ 3: 10,7* ↗ 4: 10,9* ↘ 5: 10,0 ↘
		Serie 27,0 Totalt 136,0		Serie 49,0 Totalt 185,0
Serie 5		1: 10,1 ↗ 2: 10,2 ← 3: 9,5 → 4: 10,2 ↘ 5: 6,6 ↑		
		Serie 45,0 Totalt 230,0		

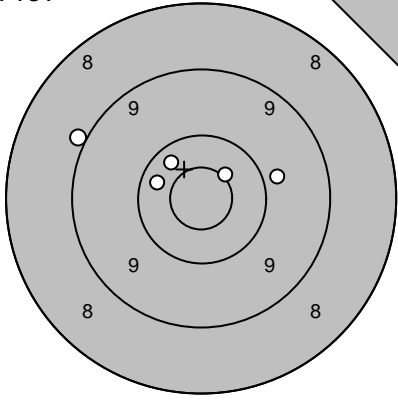
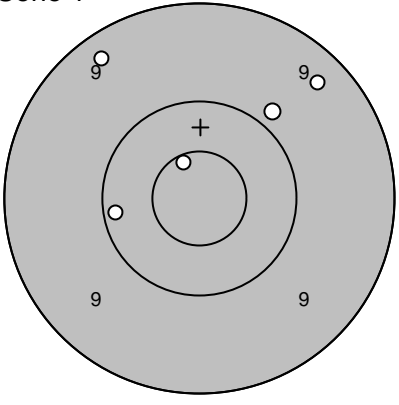
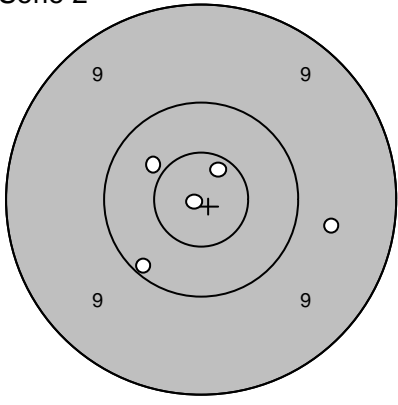
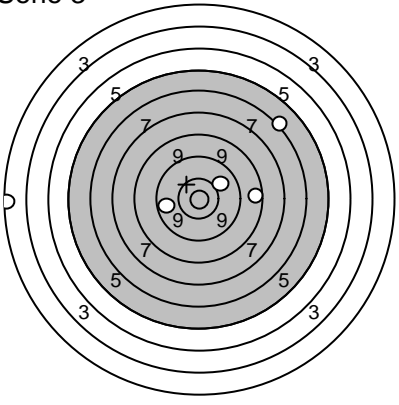
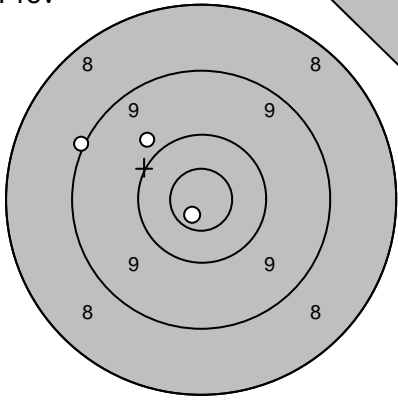
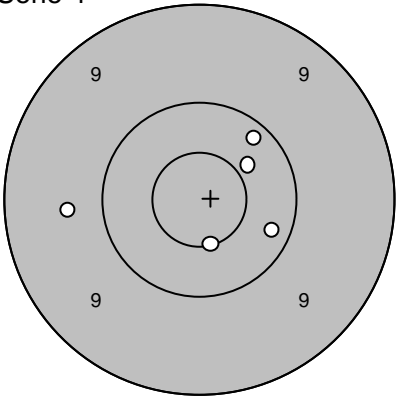
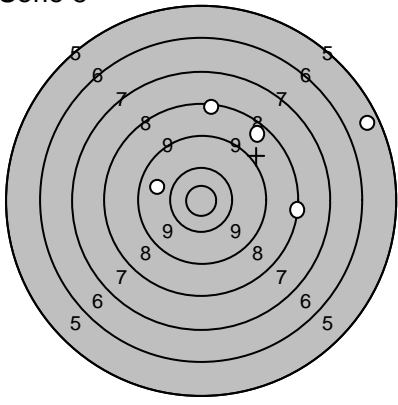
Skjutlag 1	Tavla 12	Tony Jansson	
Ramselefors		Ununge	
2006-07-07		Björkskottet 2006	Ramselefors Skytteförening
Prov 	1: 10,6* ↗ 2: 9,9 → 3: 10,4 ↖ 4: 10,4 ↗ 5: 9,0 ↖ <hr/> Serie 48,0 Totalt 0,0	Serie 1 	1: 10,6* ↗ 2: 9,3 ↖ 3: 9,3 ↗ 4: 9,9 ↗ 5: 10,2 ← <hr/> Serie 47,0 Totalt 47,0
Serie 2 	1: 10,7* ↗ 2: 10,1 ↘ 3: 9,7 → 4: 10,4 ↖ 5: 10,9* ← <hr/> Serie 49,0 Totalt 96,0	Serie 3 	1: 9,8 ← 2: 10,1 ↗ 3: 8,7 → 4: 2,5 ← 5: 6,2 ↗ <hr/> Serie 35,0 Totalt 131,0
Prov 	1: 9,1 ← 2: 10,8* ↘ 3: 9,9 ↖ <hr/> Serie 28,0 Totalt 131,0	Serie 4 	1: 10,6* ↓ 2: 10,2 ↗ 3: 10,4 ↗ 4: 9,7 ← 5: 10,2 → <hr/> Serie 49,0 Totalt 180,0
Serie 5 	1: 8,5 ↗ 2: 9,8 ← 3: 8,2 → 4: 8,3 ↑ 5: 5,6 ↗ <hr/> Serie 38,0 Totalt 218,0		

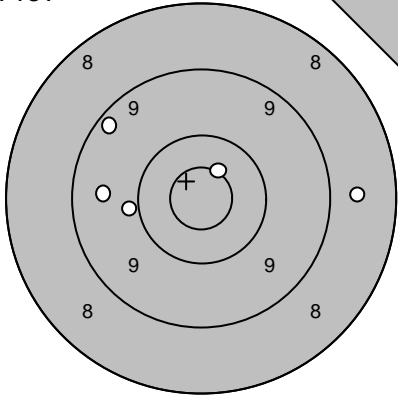
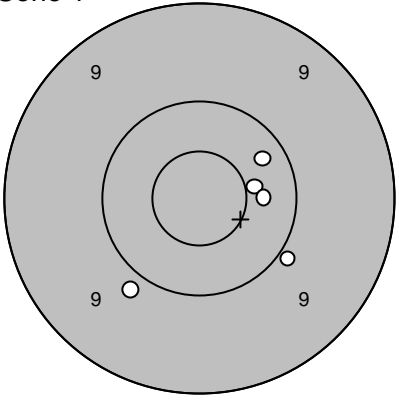
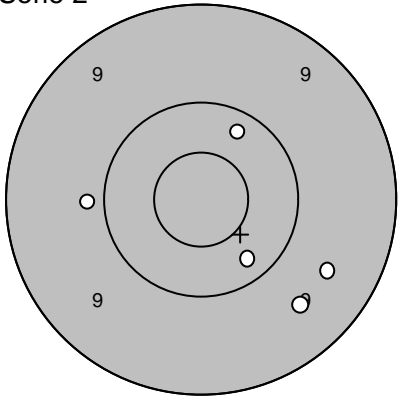
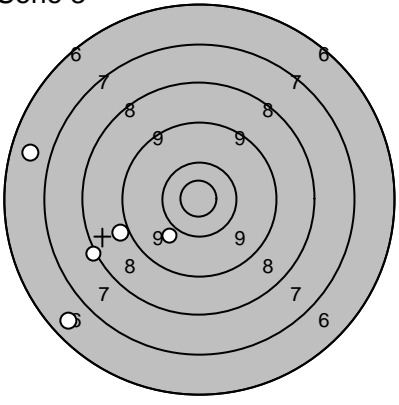
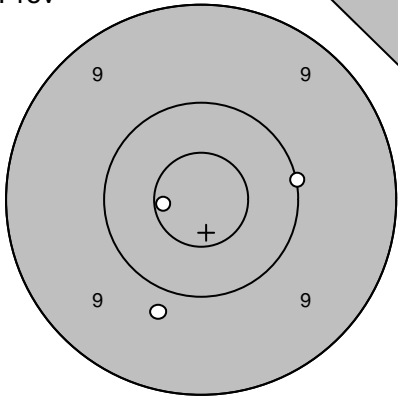
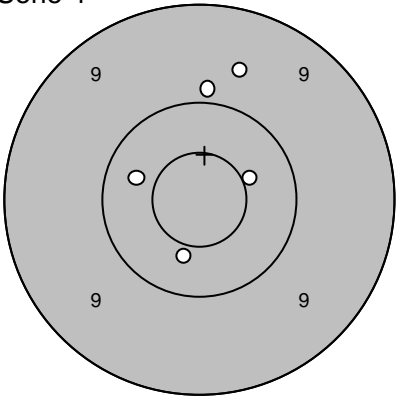
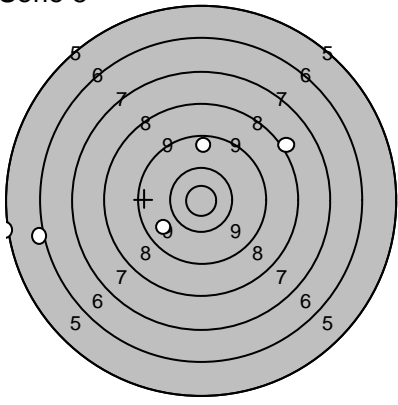
Skjutlag	Tavla	Emil Johansson	
1	13		
Ramselefors	Ale		
2006-07-07	Björkskottet 2006	Ramselefors Skytteförening	
Prov		1: 8,7 → 2: 10,0 ← 3: 9,6 ← 4: 9,3 ↗ 5: 10,6* ↗	Serie 1 
	Serie 46,0 Totalt 0,0	1: 10,5* → 2: 10,4 → 3: 9,9 ↘ 4: 10,3 ↗ 5: 9,9 ↘	Serie 48,0 Totalt 48,0
Serie 2		1: 9,9 ← 2: 10,3 ↗ 3: 9,6 ↘ 4: 10,3 ↘ 5: 9,6 ↘	Serie 3 
	Serie 47,0 Totalt 95,0	1: 8,2 ← 2: 10,0 ↘ 3: 9,0 ← 4: 6,7 ← 5: 6,6 ↘	Serie 39,0 Totalt 134,0
Prov		1: 9,8 ↘ 2: 10,6* ← 3: 10,0 →	Serie 4 
	Serie 29,0 Totalt 134,0	1: 10,5* → 2: 10,4 ↘ 3: 10,4 ← 4: 9,9 ↑ 5: 9,7 ↑	Serie 48,0 Totalt 182,0
Serie 5		1: 8,1 ↗ 2: 9,5 ↑ 3: 9,8 ↘ 4: 6,1 ← 5: 5,1 ←	
	Serie 37,0 Totalt 219,0		

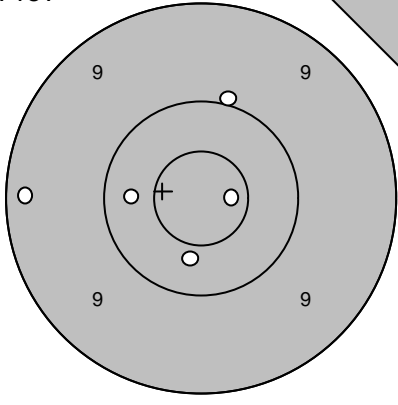
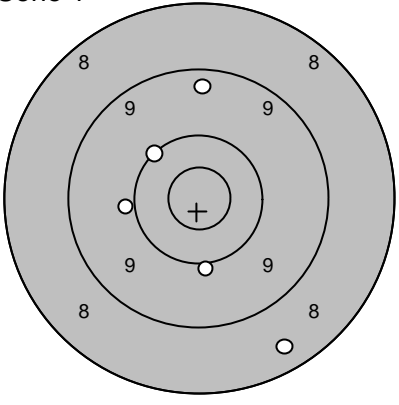
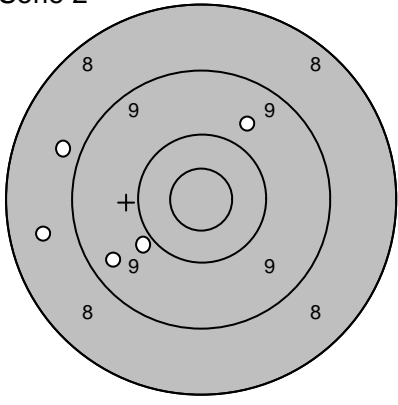
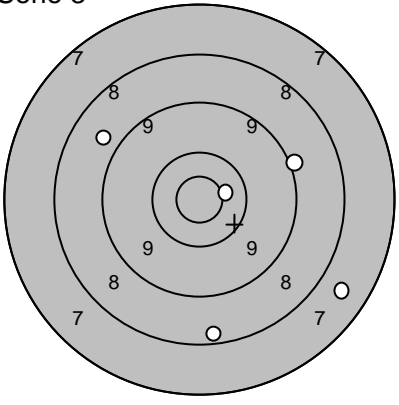
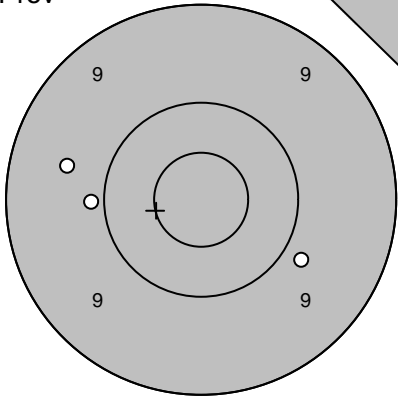
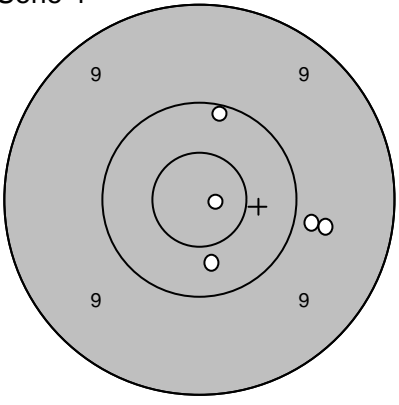
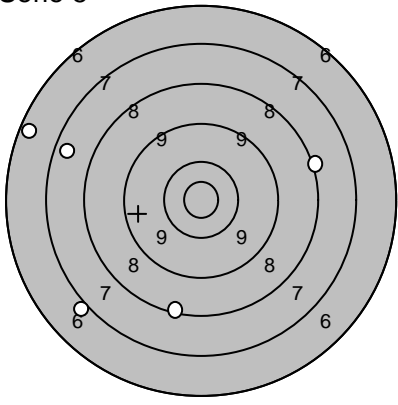
Skjutlag	Tavla	Alf Edin	
1	14		
Ramselefors	Ale		
2006-07-07	Björkskottet 2006	Ramselefors Skytteförening	
Prov		1: 10,0 ↑ 2: 10,4 ↓ 3: 10,7* → 4: 10,3 ← 5: 9,2 ←	Serie 1 
		Serie 49,0 Totalt 0,0	1: 9,4 ↑ 2: 8,5 ↓ 3: 10,1 ↗ 4: 10,0 ↓ 5: 10,0 ←
			Serie 47,0 Totalt 47,0
Serie 2		1: 9,7 ↑ 2: 8,8 ← 3: 8,6 ← 4: 10,0 ↙ 5: 9,5 ↙	Serie 3 
		Serie 44,0 Totalt 91,0	1: 7,7 ↘ 2: 8,4 ↓ 3: 10,6* → 4: 8,8 ↗ 5: 9,0 ↗
			Serie 42,0 Totalt 133,0
Prov		1: 9,6 ← 2: 9,8 ↘ 3: 9,9 ←	Serie 4 
		Serie 27,0 Totalt 133,0	1: 10,1 ↑ 2: 10,9* → 3: 9,9 → 4: 10,4 ↓ 5: 9,7 →
			Serie 48,0 Totalt 181,0
Serie 5		1: 7,5 ← 2: 8,3 ↓ 3: 8,1 → 4: 6,4 ← 5: 7,0 ↙	
		Serie 36,0 Totalt 217,0	

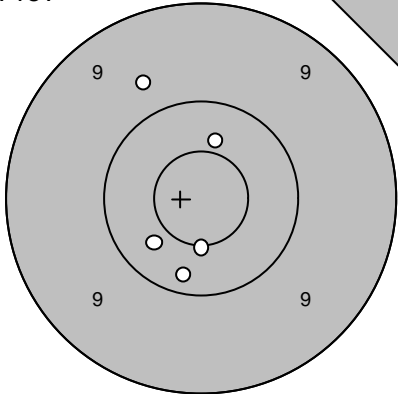
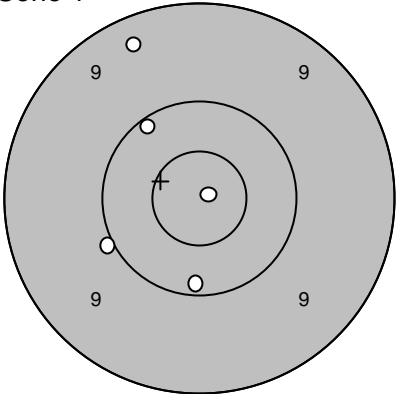
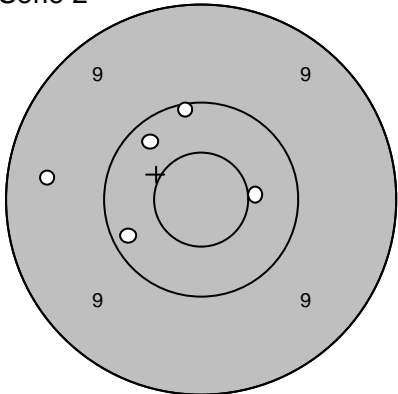
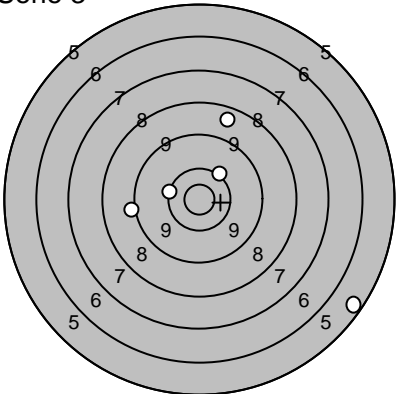
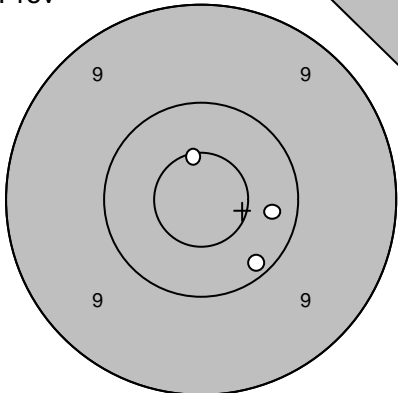
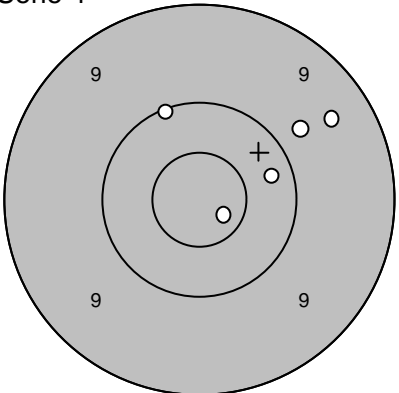
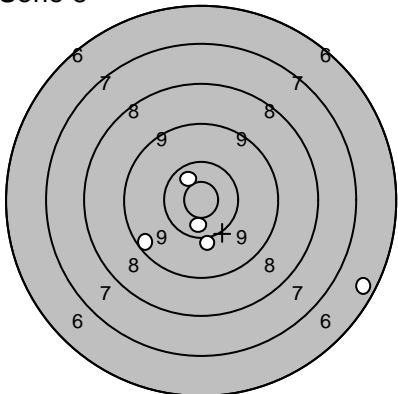
Skjutlag	Tavla	Magnus Lindkvist			
1	17				
Ramselefors	Umeå				
2006-07-07	Björkskottet 2006	Ramselefors Skytteförening			
Prov		1: 10,4 ↑ 2: 9,7 ↖ 3: 10,2 ↓ 4: 10,5* ↓ 5: 10,4 ↙	Serie 1 	1: 9,3 ↑ 2: 10,2 ↓ 3: 10,9* → 4: 10,0 ← 5: 10,1 ↗	
		Serie 49,0		Serie 49,0	
		Totalt 0,0		Totalt 49,0	
Serie 2		1: 10,3 ↖ 2: 9,5 ← 3: 10,5* → 4: 10,2 ← 5: 10,1 ↑	Serie 3		1: 10,2 ↗ 2: 10,3 ← 3: 8,6 ↑ 4: 5,5 ↘ 5: 9,1 ←
		Serie 49,0		Serie 42,0	
		Totalt 98,0		Totalt 140,0	
Prov		1: 10,6* ↑ 2: 10,2 ↘ 3: 10,3 →	Serie 4		1: 10,7* ↘ 2: 10,1 ↑ 3: 9,8 → 4: 9,5 → 5: 10,3 →
		Serie 30,0		Serie 48,0	
		Totalt 140,0		Totalt 188,0	
Serie 5		1: 10,5* ↓ 2: 9,4 ↙ 3: 10,5* ↖ 4: 6,5 ↘ 5: 10,1 ↓			
		Serie 45,0			
		Totalt 233,0			

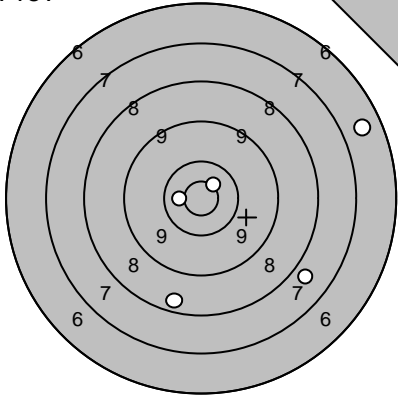
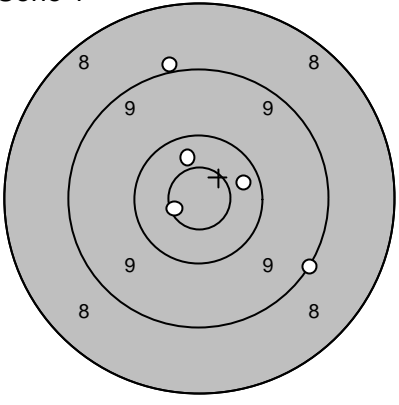
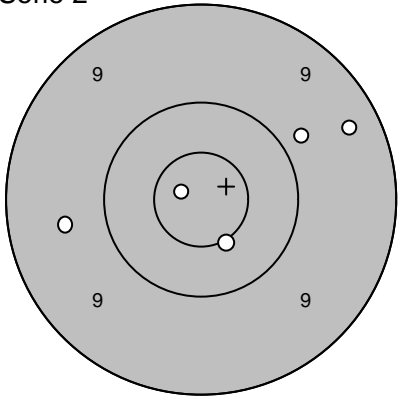
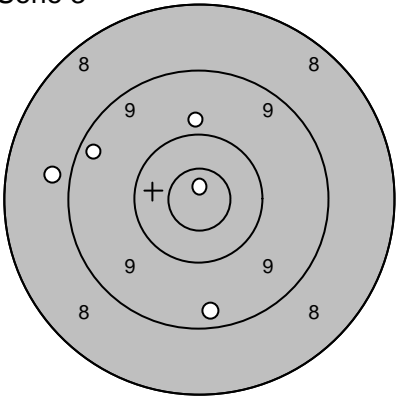
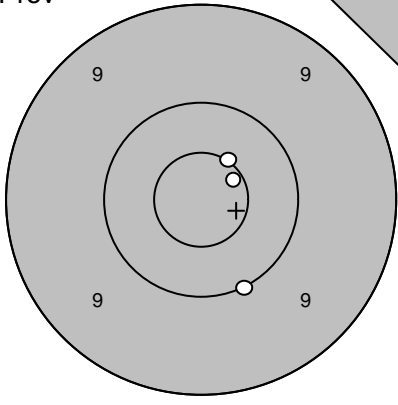
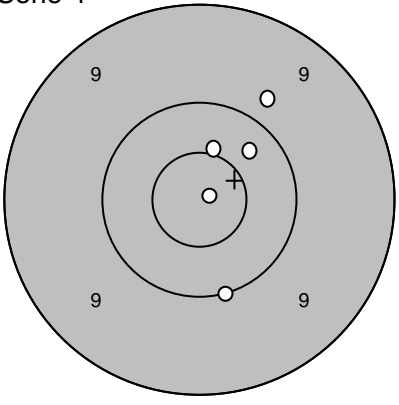
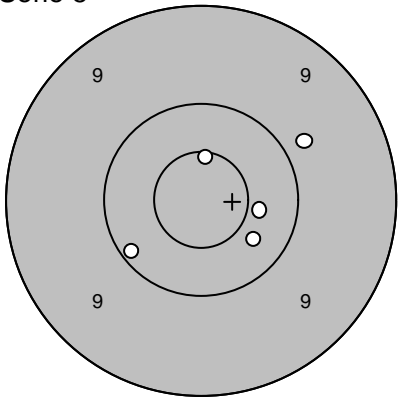
Skjutlag	Tavla	Madelene Johannisson		
1	18			
Ramselefors	Växjö			
2006-07-07	Björkskottet 2006	Ramselefors Skytteförening		
Prov		1: 6,7 → 2: 7,8 ↘ 3: 8,5 ↓ 4: 10,6* ← 5: 10,7* ↗	Serie 1 	1: 9,0 ↑ 2: 10,4 ↑ 3: 10,7* ← 4: 10,4 → 5: 9,1 ↘
		Serie 41,0 Totalt 0,0		Serie 48,0 Totalt 48,0
Serie 2		1: 10,5* ↓ 2: 9,3 → 3: 9,8 ↗ 4: 10,8* ← 5: 9,6 ←	Serie 3 	1: 9,9 ↑ 2: 10,9* ↑ 3: 9,4 ↓ 4: 9,3 ↖ 5: 8,8 ←
		Serie 47,0 Totalt 95,0		Serie 45,0 Totalt 140,0
Prov		1: 10,7* ↗ 2: 10,5* ↗ 3: 10,0 ↓	Serie 4 	1: 10,3 ↗ 2: 10,9* → 3: 9,8 ↗ 4: 10,5* ↑ 5: 10,0 ↓
		Serie 30,0 Totalt 140,0		Serie 49,0 Totalt 189,0
Serie 5		1: 10,6* ↑ 2: 9,8 ↗ 3: 10,4 ↘ 4: 10,2 ↖ 5: 10,4 →		
		Serie 49,0 Totalt 238,0		

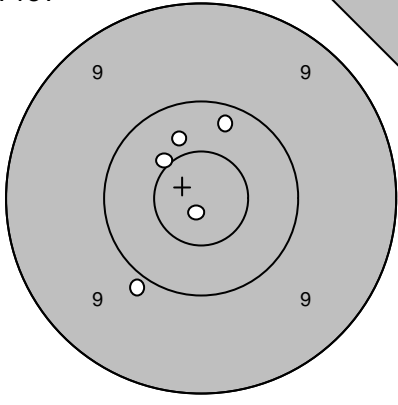
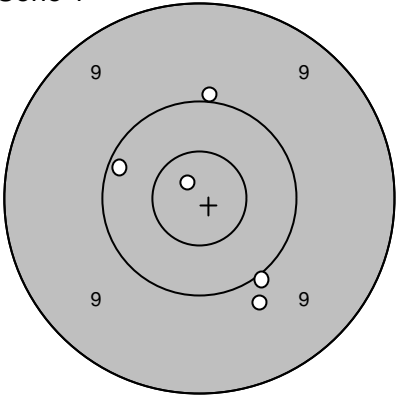
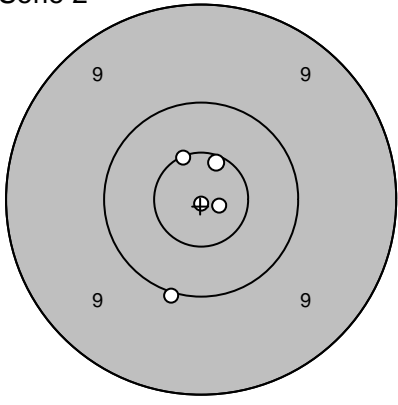
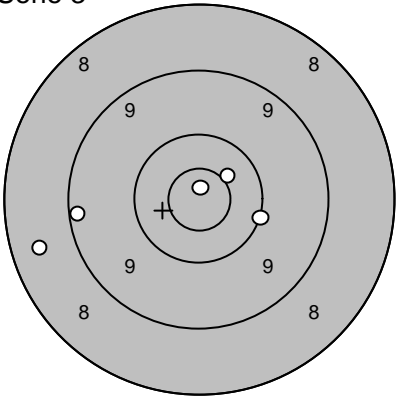
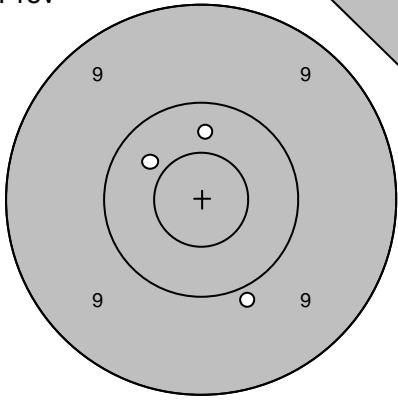
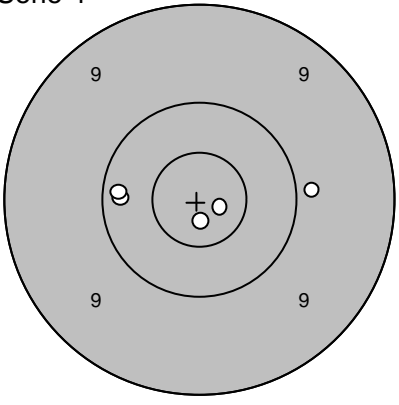
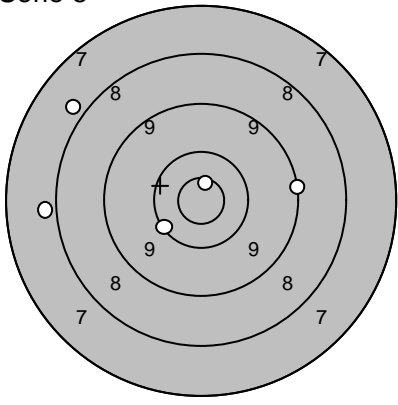
Skjutlag	Tavla	Stefan Håkansson		
1	19			
Ramselefors	Östersund			
2006-07-07	Björkskottet 2006	Ramselefors Skytteförening		
Prov		1: 10,2 ↗ 2: 10,9* ↓ 3: 10,5* ↖ 4: 10,4 ↗ 5: 9,9 ↓	Serie 1 	1: 10,2 ← 2: 10,8* ↗ 3: 10,0 ↑ 4: 10,0 ↓ 5: 9,8 ↓
		Serie 49,0 Totalt 0,0		Serie 49,0 Totalt 49,0
Serie 2		1: 10,8* → 2: 10,6* ↗ 3: 10,6* ↗ 4: 10,9* ↓ 5: 10,0 ↓	Serie 3 	1: 10,1 → 2: 10,9* ↑ 3: 10,5* ↗ 4: 9,2 ← 5: 8,5 ←
		Serie 50,0 Totalt 99,0		Serie 47,0 Totalt 146,0
Prov		1: 10,4 ↖ 2: 10,3 ↑ 3: 9,9 ↓	Serie 4 	1: 9,9 → 2: 10,8* ↓ 3: 10,8* → 4: 10,2 ← 5: 10,2 ←
		Serie 29,0 Totalt 146,0		Serie 49,0 Totalt 195,0
Serie 5		1: 10,8* ↑ 2: 10,2 ← 3: 9,1 → 4: 7,9 ↖ 5: 7,9 ←		
		Serie 43,0 Totalt 238,0		

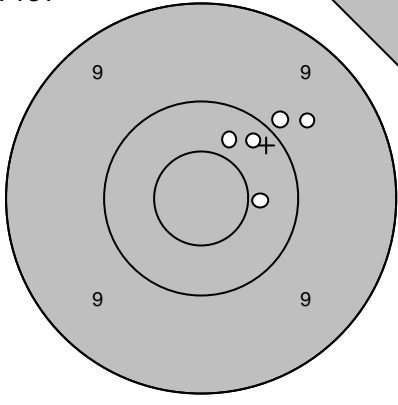
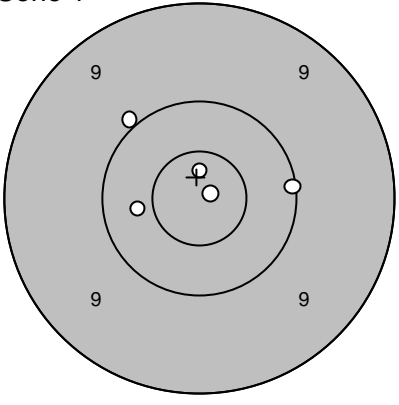
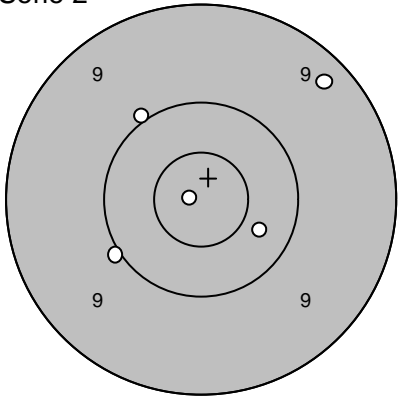
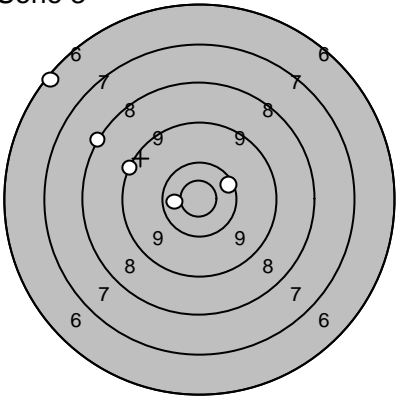
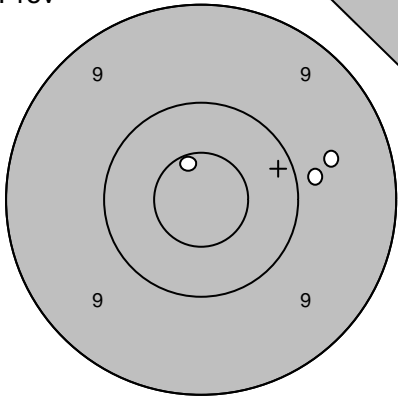
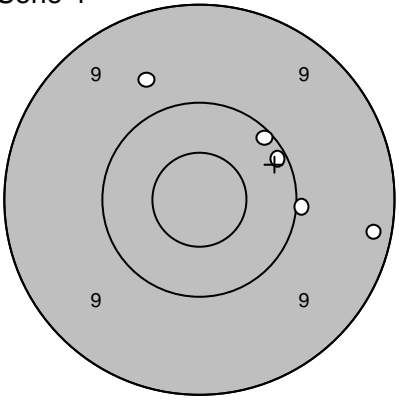
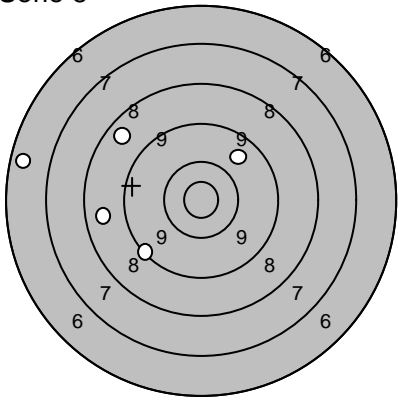
Skjutlag	Tavla	Lars Evaldsson		
1	20			
Ramselefors	Göteborg			
2006-07-07	Björkskottet 2006	Ramselefors Skytteförening		
Prov		1: 9,7 ↗ 2: 10,4 → 3: 10,2 ↗ 4: 10,4 ↑ 5: 9,9 ↗	Serie 1 	1: 10,0 ↖ 2: 10,4 ← 3: 10,1 → 4: 10,8* ↑ 5: 10,9* ↗
		Serie 48,0		Serie 50,0
		Totalt 0,0		Totalt 50,0
Serie 2		1: 9,3 ↗ 2: 10,0 ← 3: 10,0 ↗ 4: 10,4 → 5: 10,9* ←	Serie 3 	1: 10,3 ↗ 2: 8,2 ↖ 3: 9,2 ↗ 4: 6,3 ↗ 5: 10,5* ←
		Serie 49,0		Serie 43,0
		Totalt 99,0		Totalt 142,0
Prov		1: 10,7* ↑ 2: 9,6 → 3: 9,9 →	Serie 4 	1: 9,7 ↖ 2: 10,1 ↗ 3: 9,2 → 4: 10,0 → 5: 10,1 ↗
		Serie 28,0		Serie 48,0
		Totalt 142,0		Totalt 190,0
Serie 5		1: 8,6 ← 2: 9,2 ↙ 3: 8,6 ↗ 4: 6,5 ← 5: 9,7 ↗		
		Serie 40,0		
		Totalt 230,0		

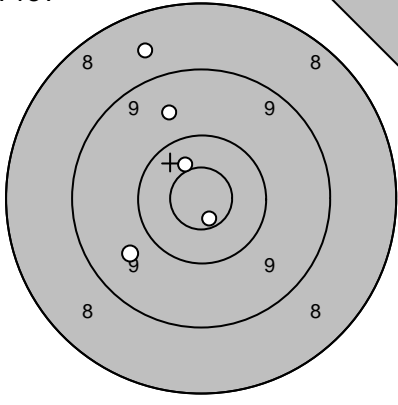
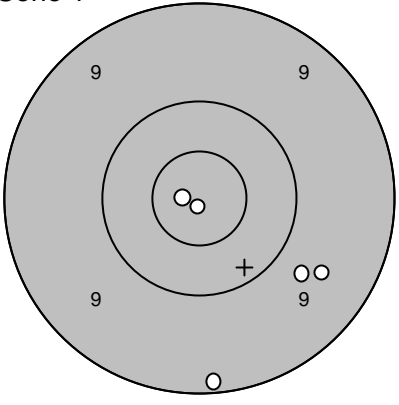
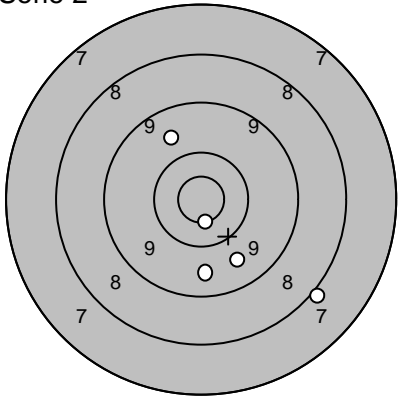
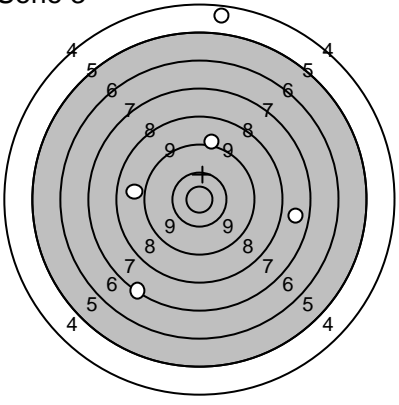
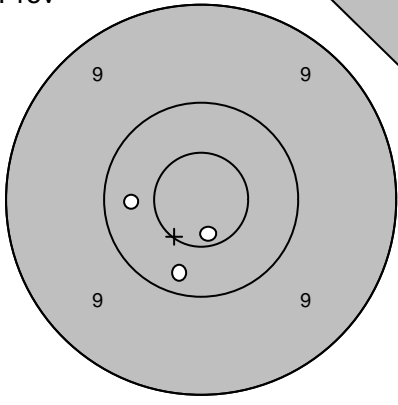
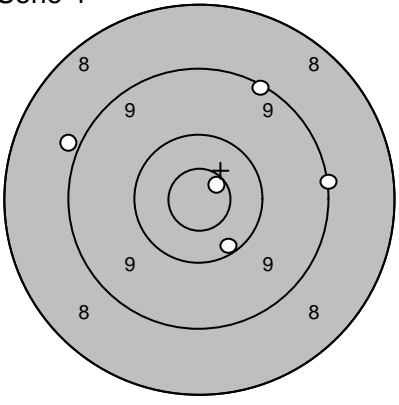
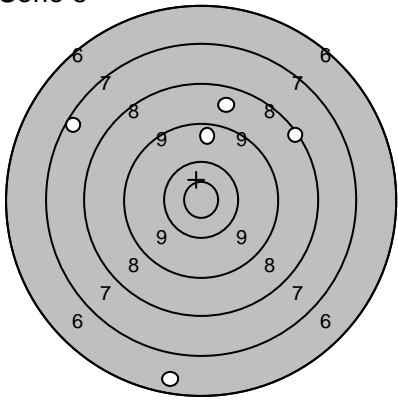
Skjutlag	Tavla	Bengt Heder		
1	24			
Ramselefors	Evertsberg			
2006-07-07	Björkskottet 2006	Ramselefors Skytteförening		
Prov		1: 9,7 ↗ 2: 8,7 ↗ 3: 10,7* ↘ 4: 10,5* ↗ 5: 9,7 ↘	Serie 1 	1: 9,6 ↘ 2: 9,2 ↘ 3: 10,9* ← 4: 9,7 ↘ 5: 10,9* ↘
		Serie 46,0 Totalt 0,0		Serie 47,0 Totalt 47,0
Serie 2		1: 9,6 ↘ 2: 10,6* ↘ 3: 9,7 ↗ 4: 9,7 ↘ 5: 8,0 ↘	Serie 3 	1: 8,9 ← 2: 7,7 → 3: 9,2 ↑ 4: 4,6 ↑ 5: 7,3 ↘
		Serie 45,0 Totalt 92,0		Serie 35,0 Totalt 127,0
Prov		1: 10,3 ↘ 2: 10,3 ← 3: 10,7* ↘	Serie 4 	1: 8,9 ← 2: 9,1 → 3: 10,7* ↗ 4: 9,1 ↗ 5: 10,2 ↘
		Serie 30,0 Totalt 127,0		Serie 46,0 Totalt 173,0
Serie 5		1: 7,4 ↖ 2: 8,7 ↑ 3: 8,2 → 4: 9,5 ↑ 5: 6,5 ↘		
		Serie 38,0 Totalt 211,0		

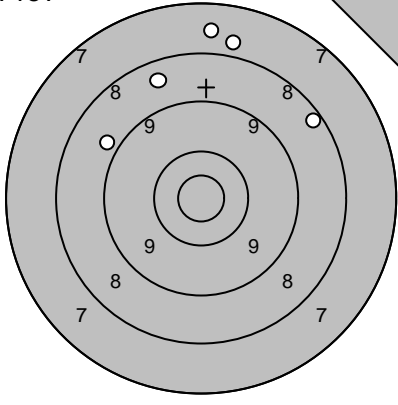
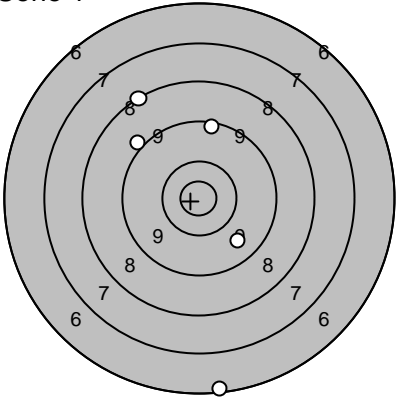
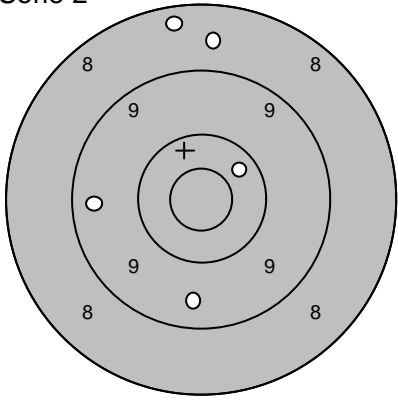
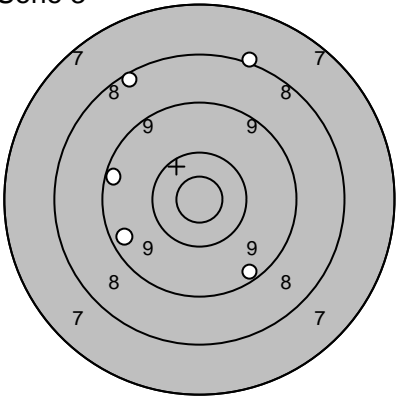
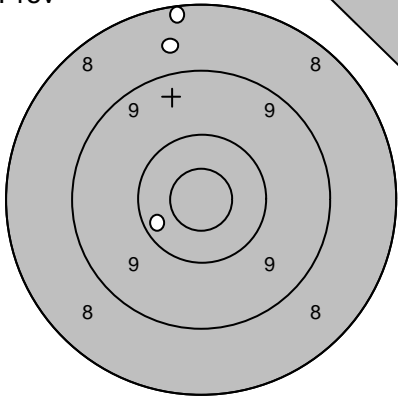
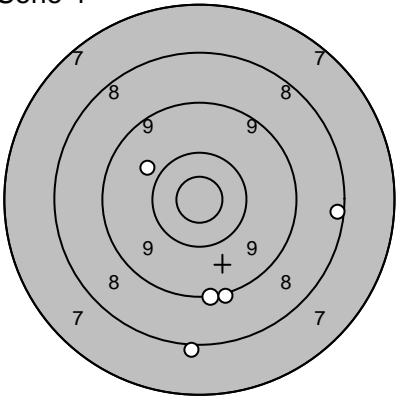
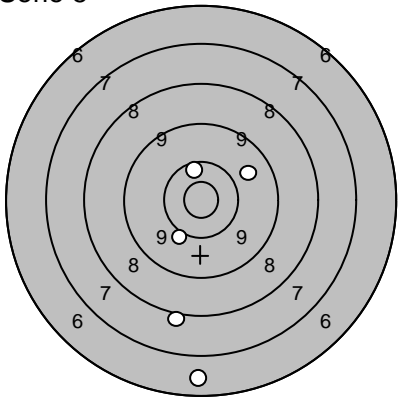
Skjutlag 2	Tavla 1	Daniel Evertsson		
Ramselefors	Ramselefors			
2006-07-07	Björkskottet 2006	Ramselefors Skytteförening		
Prov		1: 7,7 ↑ 2: 7,9 ↑ 3: 8,9 ↖ 4: 8,5 ↑ 5: 8,3 ↗	Serie 1 	1: 9,1 ↖ 2: 9,3 ↑ 3: 8,2 ↖ 4: 6,3 ↓ 5: 9,7 ↓
		Serie 38,0		Serie 41,0
		Totalt 0,0		Totalt 41,0
Serie 2		1: 8,6 ↑ 2: 9,5 ↓ 3: 9,4 ← 4: 10,3 ↗ 5: 8,4 ↑	Serie 3 	1: 8,3 ↖ 2: 9,4 ← 3: 9,3 ← 4: 8,1 ↑ 5: 9,3 ↓
		Serie 44,0		Serie 43,0
		Totalt 85,0		Totalt 128,0
Prov		1: 8,7 ↑ 2: 10,3 ↖ 3: 8,2 ↑	Serie 4 	1: 9,9 ↖ 2: 8,0 ↓ 3: 9,1 ↓ 4: 8,3 → 5: 9,1 ↓
		Serie 26,0		Serie 43,0
		Totalt 128,0		Totalt 171,0
Serie 5		1: 10,4 ↑ 2: 10,1 ↓ 3: 8,1 ↓ 4: 6,6 ↓ 5: 9,8 ↗		
		Serie 43,0		
		Totalt 214,0		

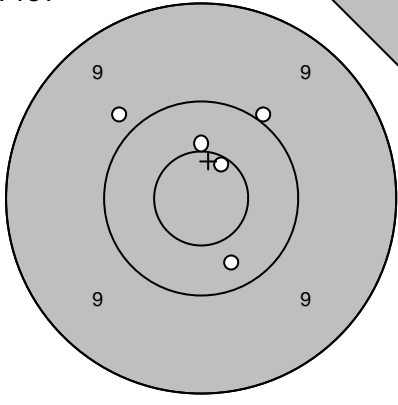
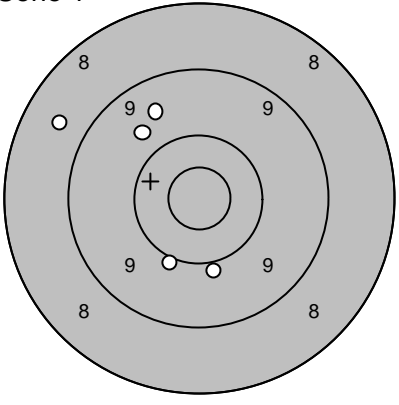
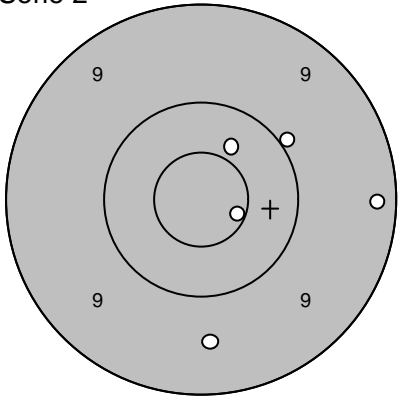
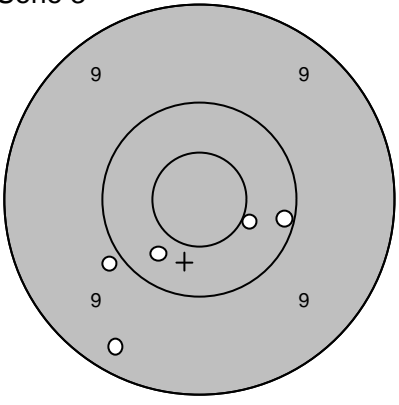
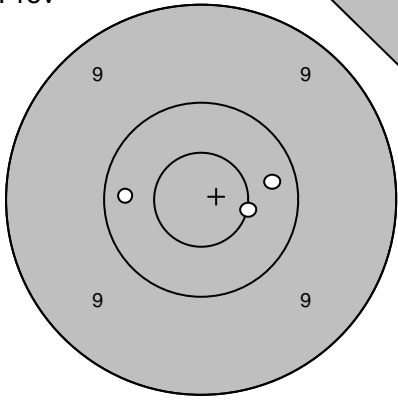
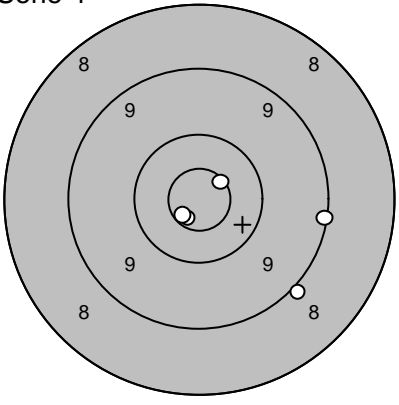
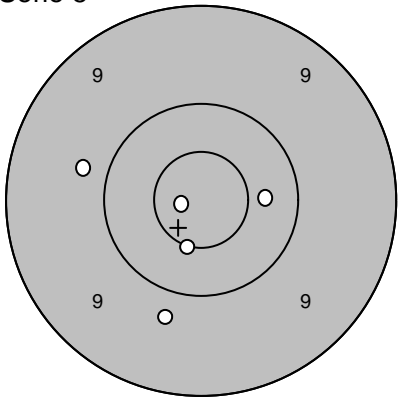
Skjutlag 2	Tavla 2	Elina Högström	
Ramselefors	Ramselefors		
2006-07-07	Björkskottet 2006	Ramselefors Skytteförening	
Prov 	1: 10,5* ↑ 2: 9,8 ↖ 3: 10,0 ↗ 4: 10,3 ↓ 5: 10,6* ↗	Serie 1 	1: 9,9 ↓ 2: 10,0 ↓ 3: 8,7 ↗ 4: 9,8 ↗ 5: 9,6 ↗
	Serie 49,0 Totalt 0,0		Serie 45,0 Totalt 45,0
Serie 2 	1: 10,6* → 2: 10,0 ↗ 3: 9,2 → 4: 9,6 ↓ 5: 10,4 ↗	Serie 3 	1: 10,5* → 2: 10,1 → 3: 9,9 ↖ 4: 10,3 ↖ 5: 9,3 ↖
	Serie 48,0 Totalt 93,0		Serie 48,0 Totalt 141,0
Prov 	1: 10,5* → 2: 10,3 → 3: 10,3 ←	Serie 4 	1: 10,7* ↓ 2: 10,7* ↗ 3: 9,0 ↓ 4: 9,1 → 5: 10,7* ↖
	Serie 30,0 Totalt 141,0		Serie 48,0 Totalt 189,0
Serie 5 	1: 10,5* ↓ 2: 10,8* ← 3: 9,8 ← 4: 9,8 ↓ 5: 10,4 →		
	Serie 48,0 Totalt 237,0		

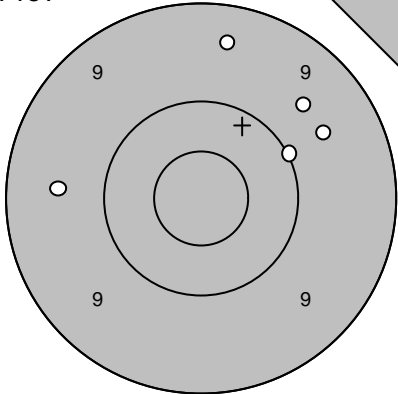
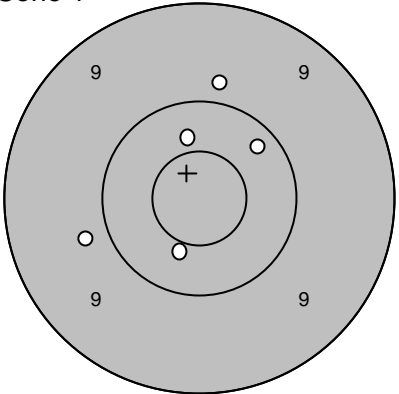
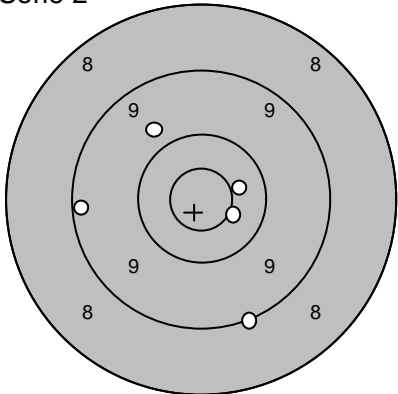
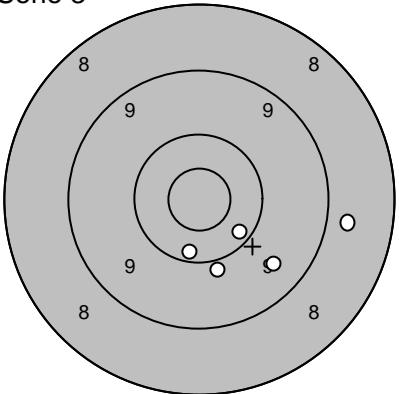
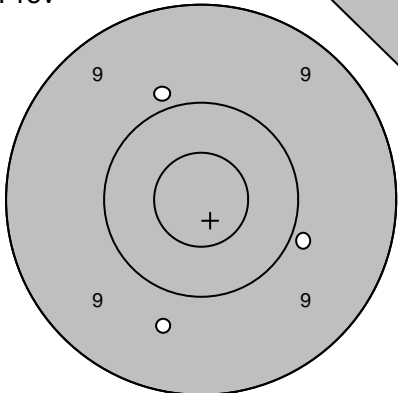
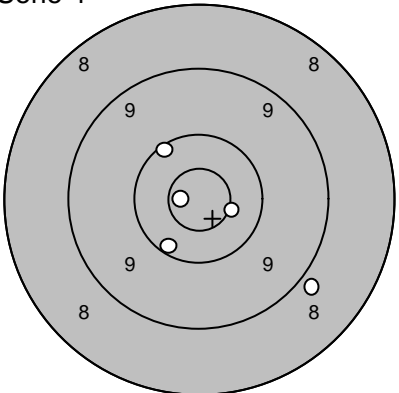
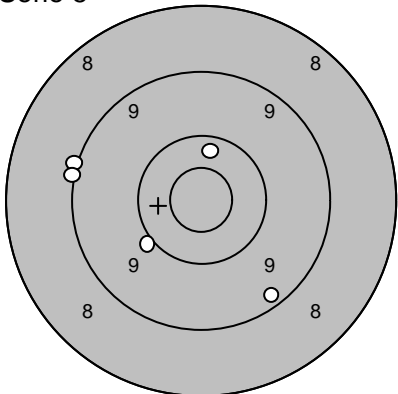
Skjutlag	Tavla	Marlene Forsell	
2	3		
Ramselefors	Ramselefors		
2006-07-07	Björkskottet 2006	Ramselefors Skytteförening	
Prov		1: 9,4 ↑ 2: 9,6 ← 3: 9,6 ↗ 4: 10,0 → 5: 9,6 ↗	Serie 1 
	Serie 46,0 Totalt 0,0		1: 10,2 ↗ 2: 10,4 ↑ 3: 9,8 ← 4: 9,8 ↑ 5: 10,5* ↓
			Serie 48,0 Totalt 48,0
Serie 2		1: 9,1 ↓ 2: 9,2 ← 3: 9,8 ↗ 4: 10,4 → 5: 10,5* ↘	Serie 3 
	Serie 47,0 Totalt 95,0		1: 10,0 ↓ 2: 10,3 ↘ 3: 10,3 ↓ 4: 8,8 → 5: 9,6 ↘
			Serie 47,0 Totalt 142,0
Prov		1: 9,9 ↑ 2: 9,9 → 3: 9,7 ↓	Serie 4 
	Serie 27,0 Totalt 142,0		1: 10,8* ← 2: 10,6* → 3: 8,9 ↘ 4: 10,2 ↙ 5: 10,2 ↗
			Serie 48,0 Totalt 190,0
Serie 5		1: 10,0 ← 2: 9,1 ← 3: 9,1 ← 4: 10,3 ↑ 5: 9,3 ↓	
	Serie 47,0 Totalt 237,0		

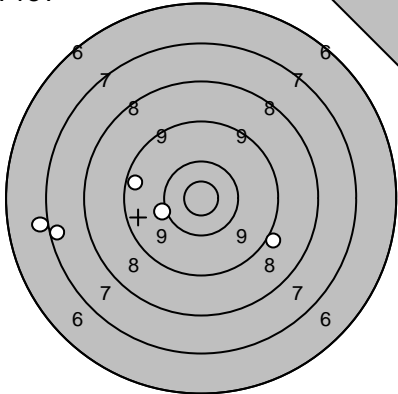
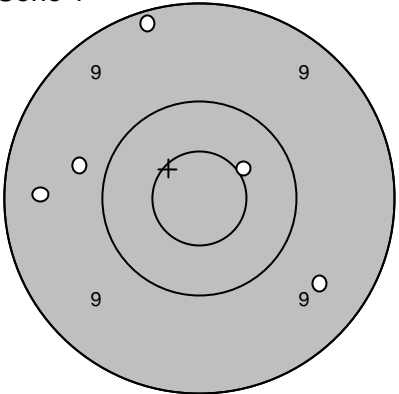
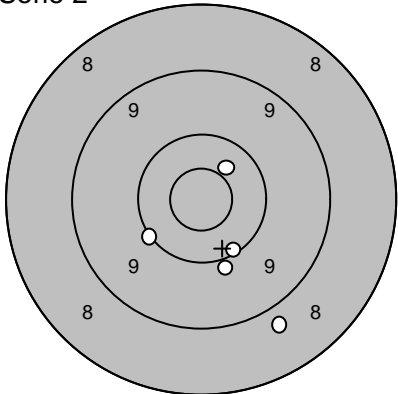
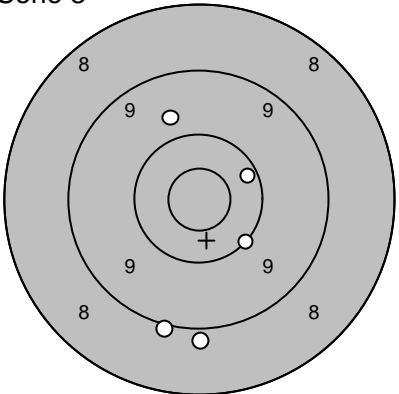
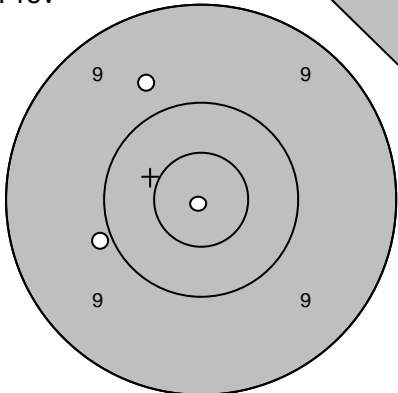
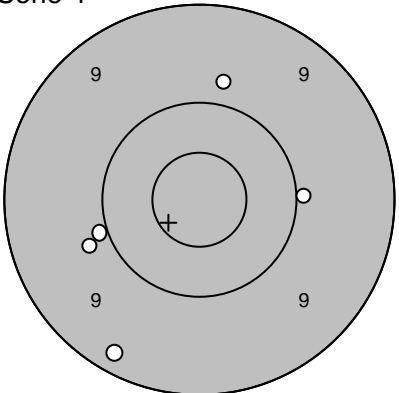
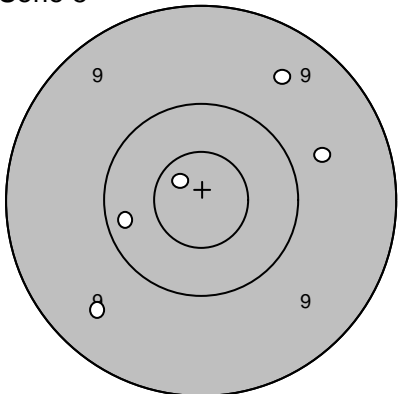
Skjutlag 2	Tavla 5	Hugo Håkansson	
Ramselefors		Östersund	
2006-07-07		Björkskottet 2006	Ramselefors Skytteförening
Prov 	1: 7,0 ← 2: 10,1 ← 3: 7,4 ← 4: 9,4 ← 5: 9,0 ↘ <hr/> Serie 42,0 Totalt 0,0	Serie 1 	1: 9,4 ← 2: 9,5 ↘ 3: 10,5* ↗ 4: 9,8 ← 5: 9,2 ↑ <hr/> Serie 46,0 Totalt 46,0
Serie 2 	1: 10,2 ↘ 2: 8,8 ↘ 3: 10,1 ↙ 4: 10,4 ↗ 5: 10,0 ↘ <hr/> Serie 48,0 Totalt 94,0	Serie 3 	1: 10,1 ↘ 2: 10,2 ↗ 3: 9,0 ↓ 4: 9,8 ↑ 5: 8,9 ↓ <hr/> Serie 46,0 Totalt 140,0
Prov 	1: 9,9 ← 2: 10,9* ↙ 3: 9,7 ↗ <hr/> Serie 28,0 Totalt 140,0	Serie 4 	1: 10,0 → 2: 9,8 ← 3: 9,8 ↑ 4: 10,0 ← 5: 9,2 ↘ <hr/> Serie 47,0 Totalt 187,0
Serie 5 	1: 10,7* ↖ 2: 9,5 ↗ 3: 9,5 ↙ 4: 10,2 ← 5: 9,7 → <hr/> Serie 47,0 Totalt 234,0		

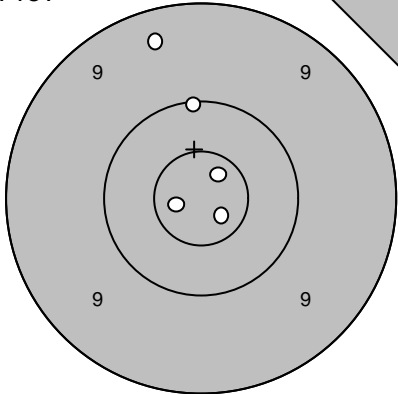
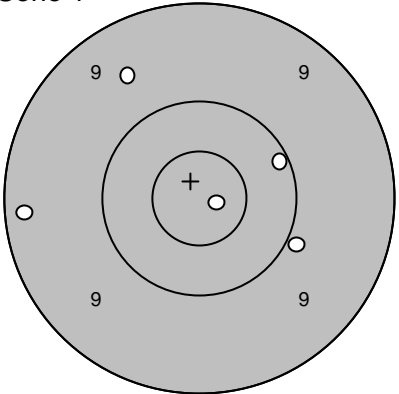
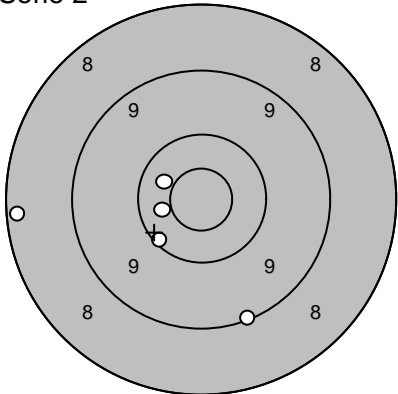
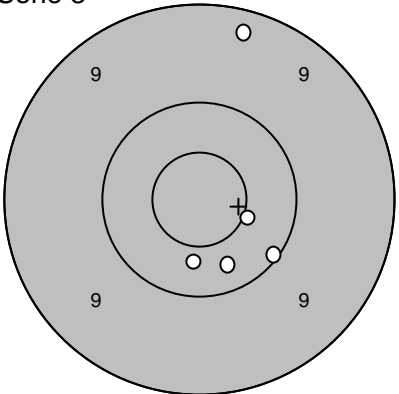
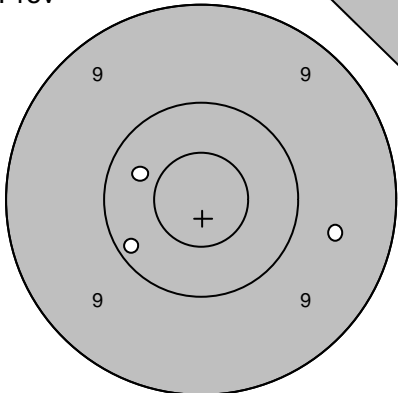
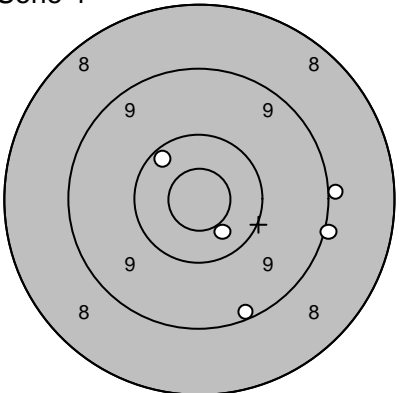
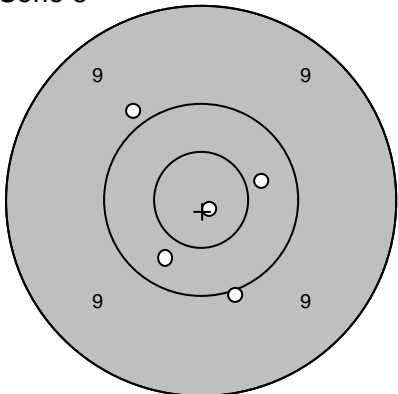
Skjutlag	Tavla	Jennie Ericson		
2	6			
Ramselefors	Loos			
2006-07-07	Björkskottet 2006	Ramselefors Skytteförening		
Prov		1: 10,1 ↑ 2: 9,4 ↑ 3: 10,8* → 4: 10,7* ↗ 5: 10,8* ←	Serie 1 	1: 10,1 → 2: 9,6 ↗ 3: 9,3 ← 4: 10,8* → 5: 9,9 ↘
	Serie 49,0 Totalt 0,0		Serie 47,0 Totalt 47,0	
Serie 2		1: 8,2 ← 2: 10,2 ↙ 3: 10,5* ← 4: 10,5* ↗ 5: 9,1 ↘	Serie 3 	1: 10,5* → 2: 10,1 ↘ 3: 10,3 ↓ 4: 9,3 ↑ 5: 10,4 ↓
	Serie 47,0 Totalt 94,0		Serie 49,0 Totalt 143,0	
Prov		1: 10,2 ↙ 2: 10,4 ← 3: 9,6 →	Serie 4 	1: 9,0 → 2: 10,2 ↗ 3: 10,5* ↘ 4: 9,2 ↘ 5: 9,0 →
	Serie 29,0 Totalt 143,0		Serie 47,0 Totalt 190,0	
Serie 5		1: 10,4 → 2: 9,9 ↗ 3: 10,9* ↘ 4: 10,3 ↘ 5: 10,0 ↓		
	Serie 49,0 Totalt 239,0			

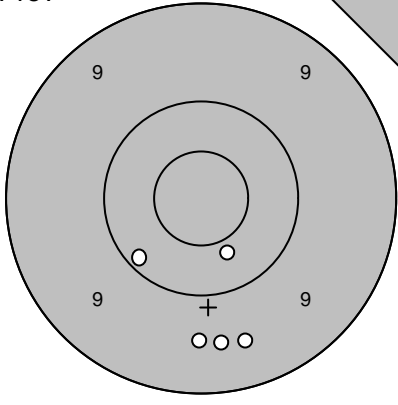
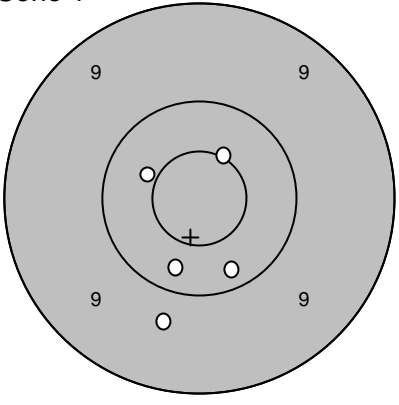
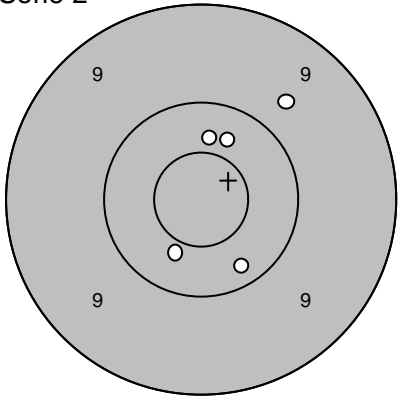
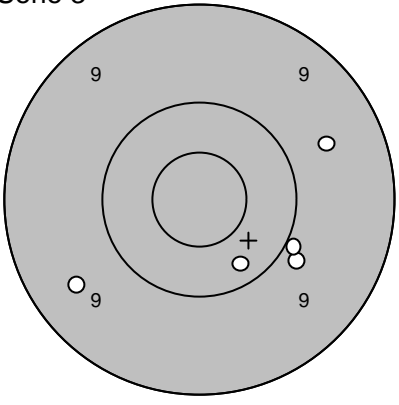
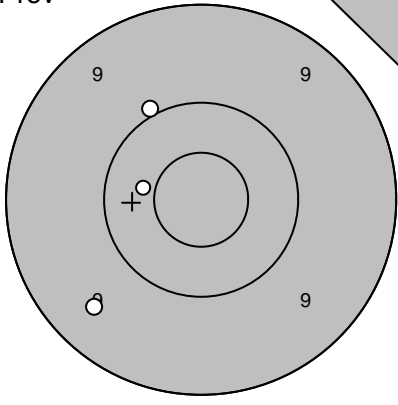
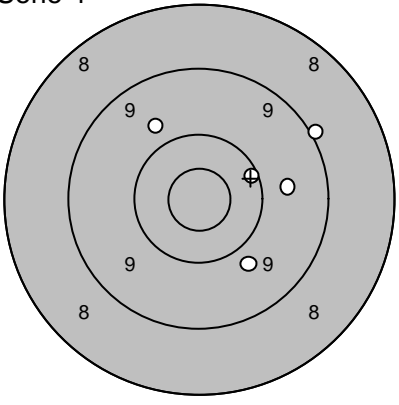
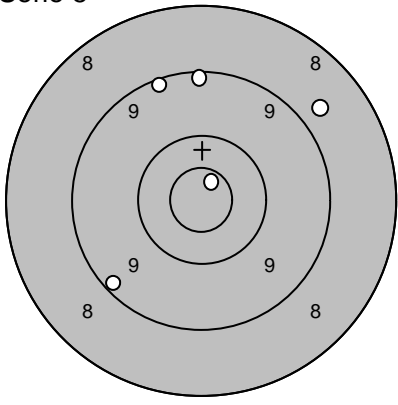
Skjutlag 2	Tavla 7	Daniel Wallberg	
Ramselefors	Loos		
2006-07-07	Björkskottet 2006	Ramselefors Skytteförening	
Prov 	1: 9,5 ↓ 2: 10,4 ↓ 3: 9,5 ↓ 4: 10,2 ↙ 5: 9,6 ↓ <hr/> Serie 47,0 Totalt 0,0	Serie 1 	1: 10,3 ↓ 2: 9,7 ↓ 3: 10,5* ↗ 4: 10,2 ↓ 5: 10,5* ↗ <hr/> Serie 49,0 Totalt 49,0
Serie 2 	1: 10,4 ↑ 2: 10,4 ↑ 3: 9,7 ↗ 4: 10,2 ↓ 5: 10,4 ↓ <hr/> Serie 49,0 Totalt 98,0	Serie 3 	1: 9,9 ↓ 2: 10,3 ↓ 3: 10,0 ↘ 4: 9,6 → 5: 9,5 ↙ <hr/> Serie 47,0 Totalt 145,0
Prov 	1: 10,0 ↗ 2: 9,5 ↙ 3: 10,4 ← <hr/> Serie 29,0 Totalt 145,0	Serie 4 	1: 9,8 ↓ 2: 9,8 ↗ 3: 9,0 ↗ 4: 10,2 ↗ 5: 9,7 → <hr/> Serie 46,0 Totalt 191,0
Serie 5 	1: 9,2 ↑ 2: 9,2 ↙ 3: 10,8* ↗ 4: 9,2 ↑ 5: 8,8 ↗ <hr/> Serie 45,0 Totalt 236,0		

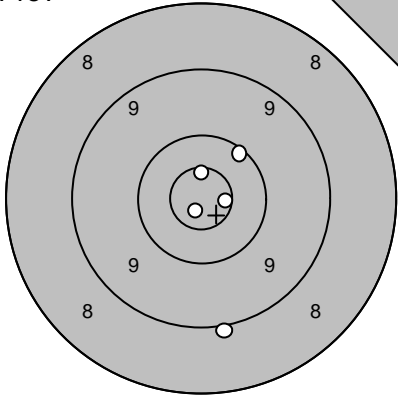
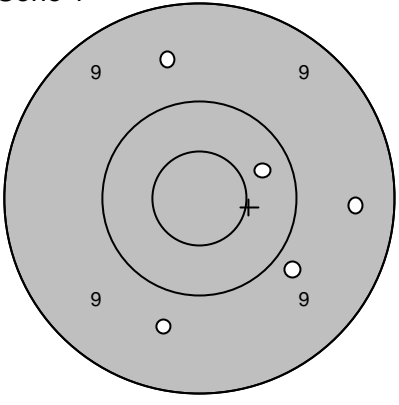
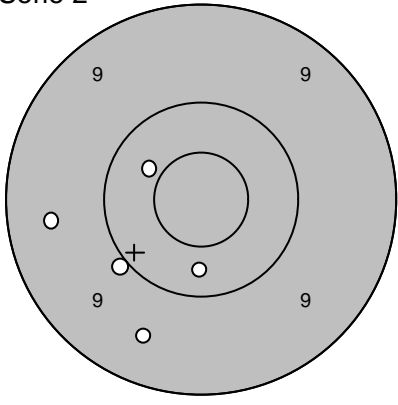
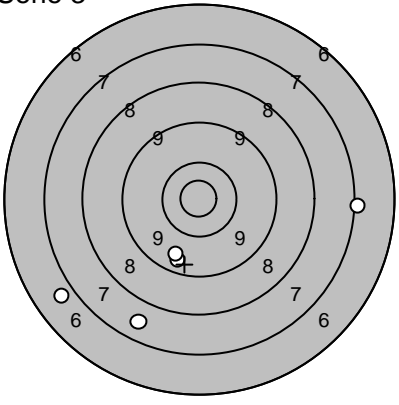
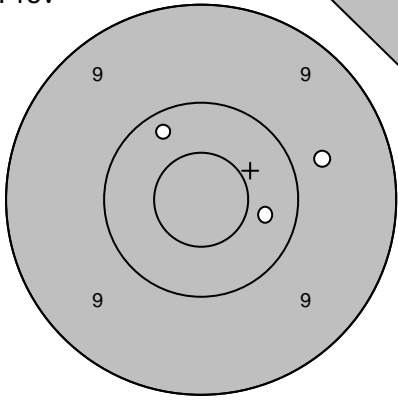
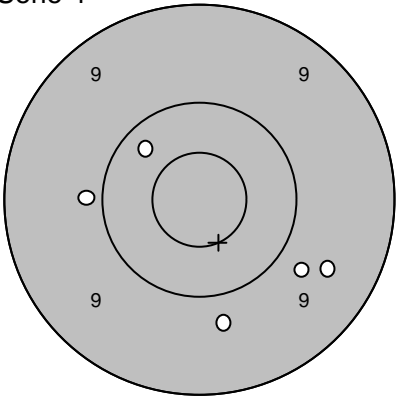
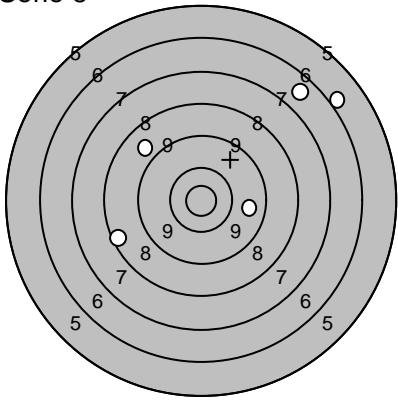
Skjutlag 2	Tavla 11	Daniel Zakrisson	
Ramselefors	Ramselefors		
2006-07-07	Björkskottet 2006	Ramselefors Skytteförening	
Prov 	1: 10,2 ↗ 2: 10,7* → 3: 10,9* ↓ 4: 9,0 ↓ 5: 10,7* ↑ Serie 49,0 Totalt 0,0	Serie 1 	1: 9,6 ↑ 2: 9,7 ↓ 3: 9,8 ↘ 4: 10,3 → 5: 9,4 → Serie 46,0 Totalt 46,0
Serie 2 	1: 10,4 ↖ 2: 10,0 ↙ 3: 9,5 ↓ 4: 9,5 ← 5: 10,3 ↓ Serie 48,0 Totalt 94,0	Serie 3 	1: 6,9 ↙ 2: 9,5 ↓ 3: 7,7 ↙ 4: 9,7 ↓ 5: 7,1 → Serie 38,0 Totalt 132,0
Prov 	1: 9,7 → 2: 10,3 ↗ 3: 10,4 → Serie 29,0 Totalt 132,0	Serie 4 	1: 9,8 ↘ 2: 10,3 ↗ 3: 9,5 ↘ 4: 9,8 ↓ 5: 9,9 ← Serie 46,0 Totalt 178,0
Serie 5 	1: 8,4 ← 2: 8,9 ↖ 3: 9,7 → 4: 6,7 ↗ 5: 6,0 ↗ Serie 37,0 Totalt 215,0		

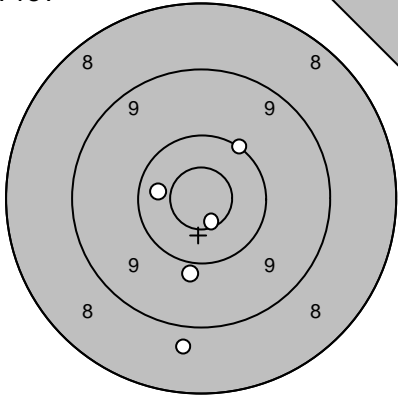
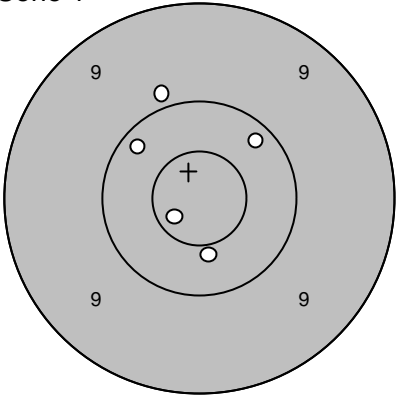
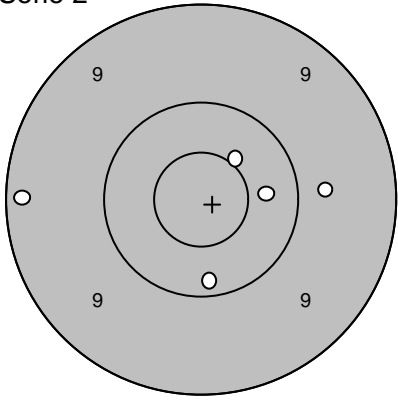
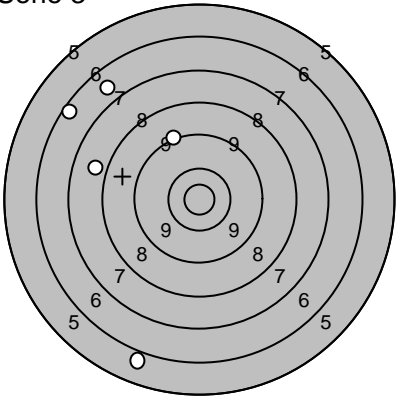
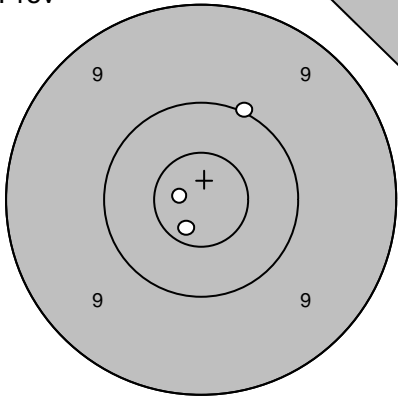
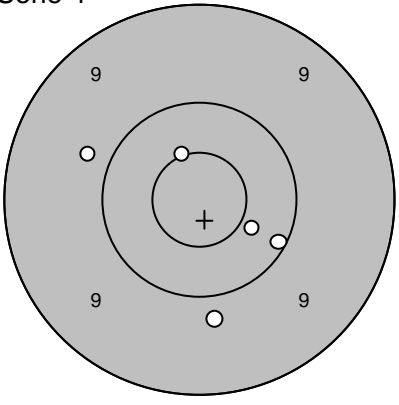
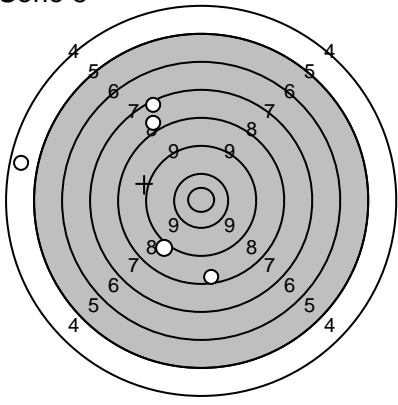
Skjutlag	Tavla	Johan Zakrisson		
2	12			
Ramselefors	Ramselefors			
2006-07-07	Björkskottet 2006	Ramselefors Skytteförening		
Prov		1: 10,1 ↗ 2: 10,4 ← 3: 10,7* ↓ 4: 9,9 ↓ 5: 8,8 ↓	Serie 1 	1: 10,7* ↙ 2: 10,4 ↓ 3: 10,2 ↗ 4: 9,9 ↗ 5: 10,2 ↗
		Serie 47,0 Totalt 0,0		Serie 49,0 Totalt 49,0
Serie 2		1: 10,2 ↓ 2: 10,4 → 3: 9,2 ← 4: 10,5* ↗ 5: 9,8 →	Serie 3 	1: 9,2 ↗ 2: 6,4 ↗ 3: 6,8 ↗ 4: 7,9 ← 5: 5,9 ↓
		Serie 48,0 Totalt 97,0		Serie 33,0 Totalt 130,0
Prov		1: 10,0 ↗ 2: 10,8* ← 3: 10,7* ↓	Serie 4 	1: 10,4 ↘ 2: 9,8 ↓ 3: 10,1 ↘ 4: 10,5* ↗ 5: 9,8 ↗
		Serie 30,0 Totalt 130,0		Serie 48,0 Totalt 178,0
Serie 5		1: 4,7 ← 2: 7,4 ↗ 3: 9,1 ↘ 4: 8,5 ↓ 5: 8,0 ↗		
		Serie 36,0 Totalt 214,0		

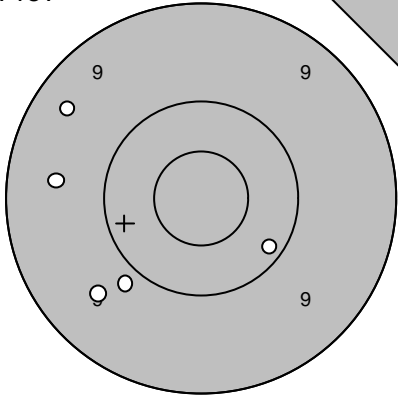
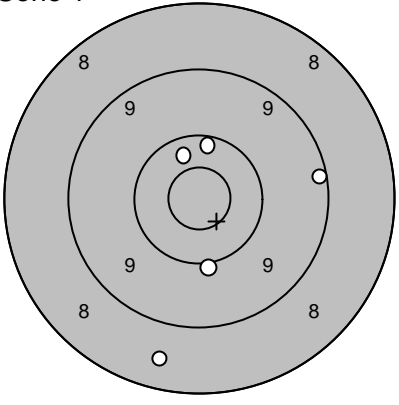
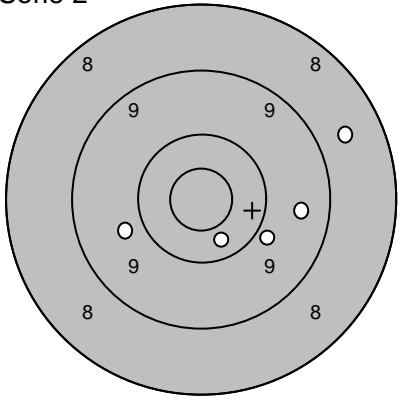
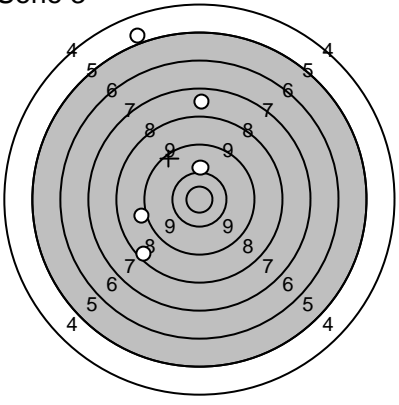
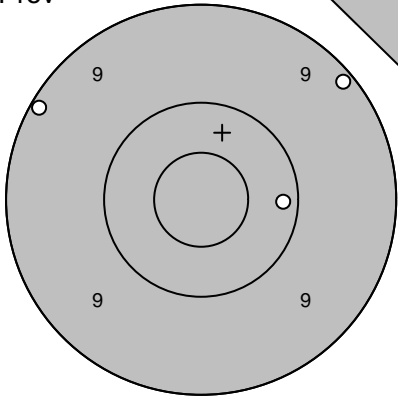
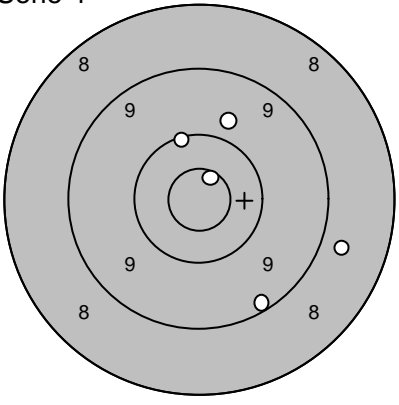
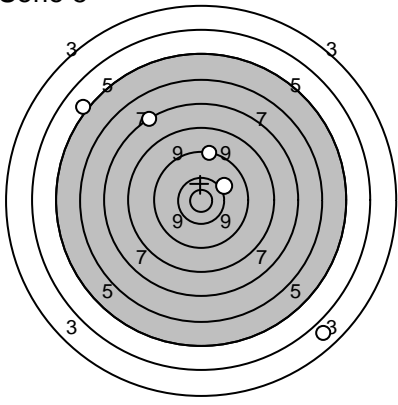
Skjutlag 2	Tavla 13	Matthias Lampinen	
Ramselefors		S 3	
2006-07-07		Björkskottet 2006	Ramselefors Skytteförening
Prov 	1: 9,4 ↖ 2: 9,6 ↙ 3: 9,5 ← 4: 10,2 ↘ 5: 9,9 ↙	Serie 1 	1: 10,3 ↑ 2: 9,2 → 3: 10,4 ↑ 4: 10,0 ↓ 5: 8,6 ↓
	Serie 46,0 Totalt 0,0		Serie 47,0 Totalt 47,0
Serie 2 	1: 9,5 → 2: 8,6 → 3: 9,8 ← 4: 9,9 ↘ 5: 10,4 ↙	Serie 3 	1: 7,8 ↑ 2: 9,1 ← 3: 10,1 ↑ 4: 5,0 ↑ 5: 8,5 ↙
	Serie 45,0 Totalt 92,0		Serie 39,0 Totalt 131,0
Prov 	1: 9,2 ↗ 2: 10,2 → 3: 9,1 ↗	Serie 4 	1: 8,8 → 2: 9,8 ↑ 3: 10,7* ↑ 4: 10,1 ↑ 5: 9,2 ↓
	Serie 28,0 Totalt 131,0		Serie 46,0 Totalt 177,0
Serie 5 	1: 10,2 ↗ 2: 9,3 ↑ 3: 7,4 ↗ 4: 3,9 ↘ 5: 5,2 ↗		
	Serie 34,0 Totalt 211,0		

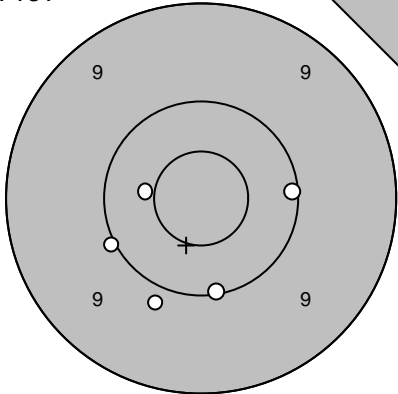
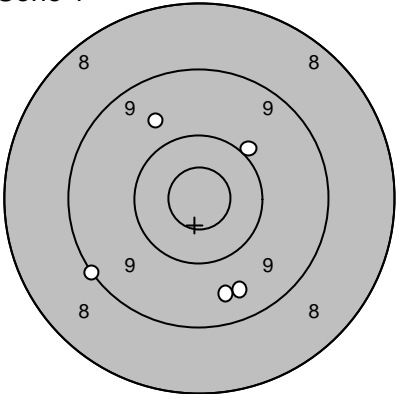
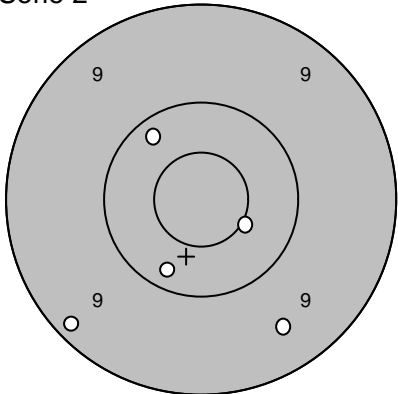
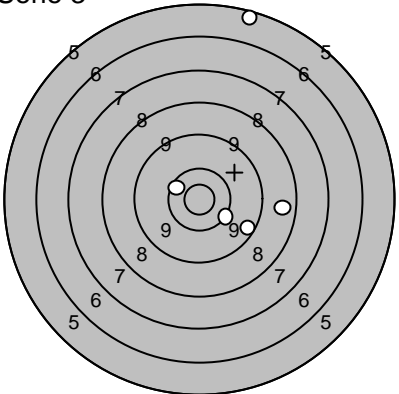
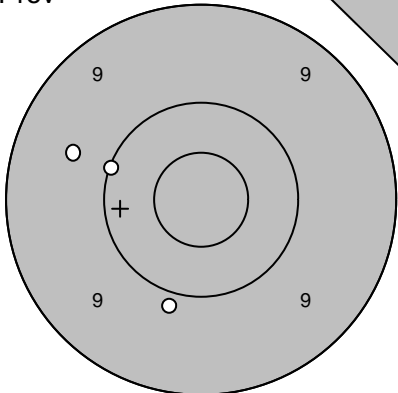
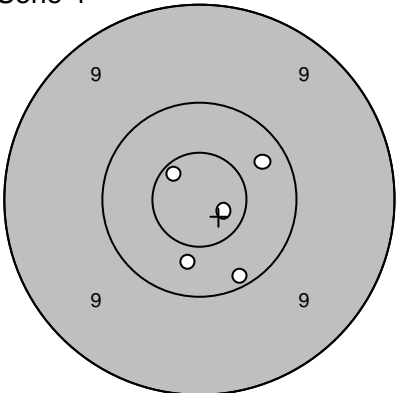
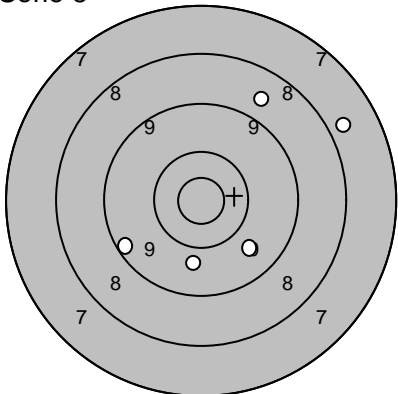
Skjutlag	Tavla	Carina Norling		
2	14			
Ramselefors	Söderala			
2006-07-07	Björkskottet 2006	Ramselefors Skytteförening		
Prov		1: 10,5* ← 2: 10,0 ← 3: 10,1 → 4: 9,9 ↓ 5: 10,1 ↓	Serie 1 	1: 9,7 ↗ 2: 10,0 ↗ 3: 9,5 ↓ 4: 9,1 ↙ 5: 9,6 ↓
	Serie 49,0 Totalt 0,0		Serie 46,0 Totalt 46,0	
Serie 2		1: 10,2 ↗ 2: 9,5 ↓ 3: 9,2 ↙ 4: 10,2 ↓ 5: 10,5* ↘	Serie 3 	1: 10,2 ↘ 2: 9,5 ↘ 3: 10,5* ↗ 4: 8,6 → 5: 5,4 ↑
	Serie 48,0 Totalt 94,0		Serie 42,0 Totalt 136,0	
Prov		1: 9,9 ↓ 2: 10,1 ← 3: 9,6 ←	Serie 4 	1: 10,3 ↗ 2: 10,7* ↗ 3: 10,1 ↓ 4: 10,4 ↓ 5: 10,8* ↘
	Serie 28,0 Totalt 136,0		Serie 50,0 Totalt 186,0	
Serie 5		1: 8,7 ↗ 2: 9,7 ↘ 3: 9,8 ↓ 4: 9,3 ↙ 5: 7,8 ↗		
	Serie 42,0 Totalt 228,0			

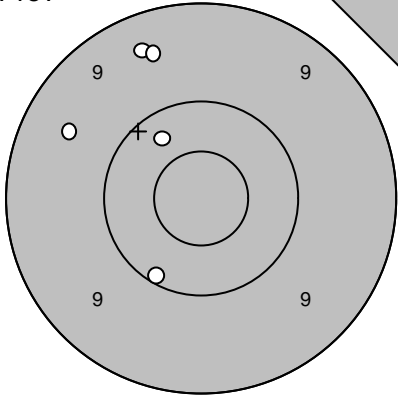
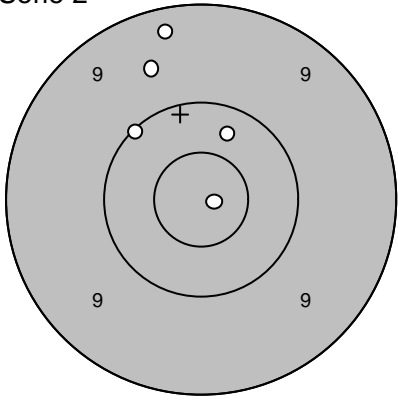
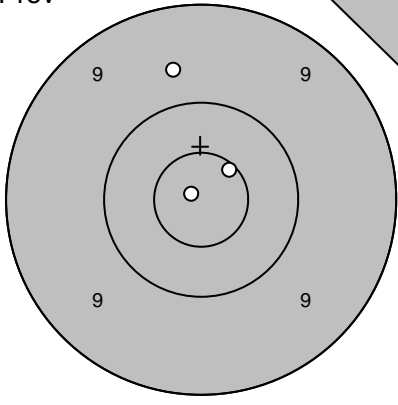
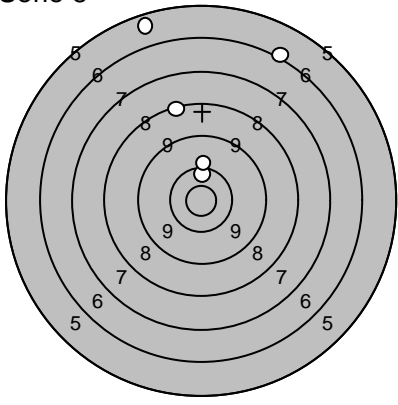
Skjutlag 2	Tavla 17	Kjell Marklund	
Ramselefors		S 3	
2006-07-07		Björkskottet 2006	Ramselefors Skytteförening
Prov		1: 9,5 ↖ 2: 10,3 ↗ 3: 9,4 ↗ 4: 9,5 ↗ 5: 10,1 ↘	Serie 1
		Serie 47,0	1: 10,5* ↓ 2: 10,2 ← 3: 9,1 ← 4: 10,4 ↙ 5: 10,6* ↓
		Totalt 0,0	Serie 49,0
			Totalt 49,0
Serie 2		1: 9,3 ↑ 2: 10,3 ↑ 3: 10,1 ↖ 4: 10,9* → 5: 9,6 ↑	Serie 3
		Serie 48,0	1: 9,7 ↓ 2: 9,6 → 3: 8,1 ↗ 4: 4,1 ↘ 5: 9,4 →
		Totalt 97,0	Serie 39,0
			Totalt 136,0
Prov		1: 10,9* ↖ 2: 10,6* ↗ 3: 9,7 ↑	Serie 4
		Serie 29,0	1: 10,3 ↗ 2: 10,1 ↓ 3: 10,7* ← 4: 9,0 ↓ 5: 10,6* ↖
		Totalt 136,0	Serie 49,0
			Totalt 185,0
Serie 5		1: 10,4 ↑ 2: 8,3 ↑ 3: 10,1 ↑ 4: 5,6 ↑ 5: 6,1 ↗	
		Serie 39,0	
		Totalt 224,0	

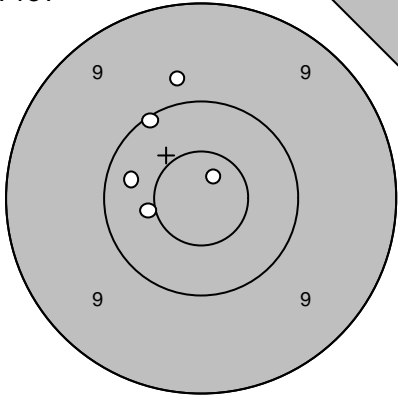
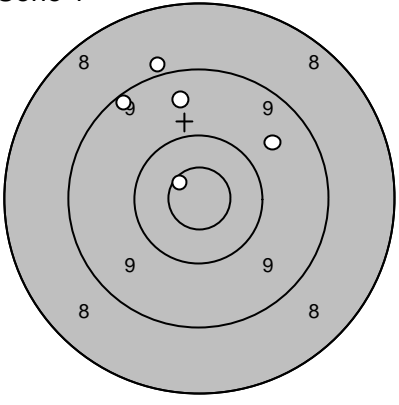
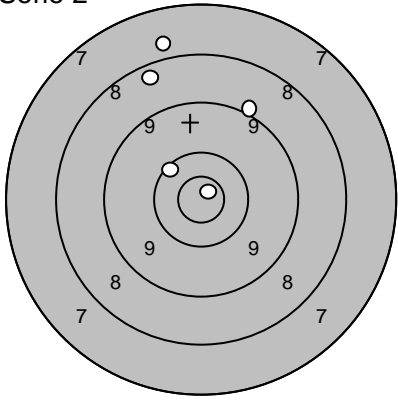
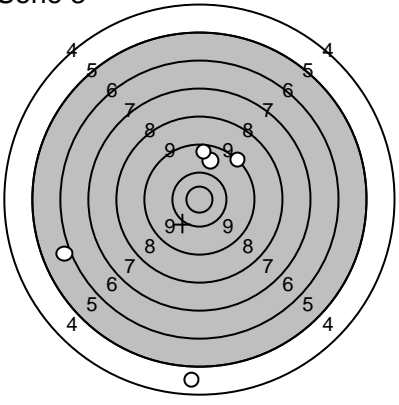
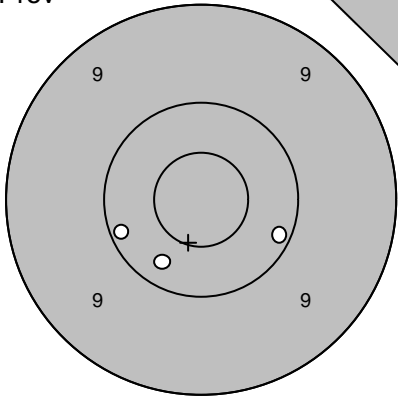
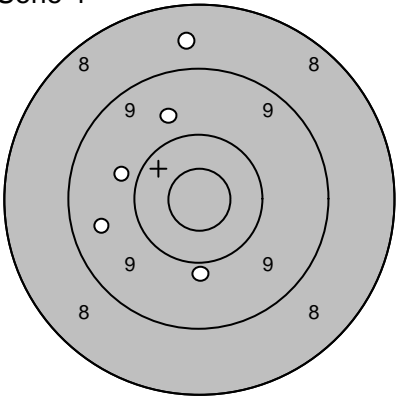
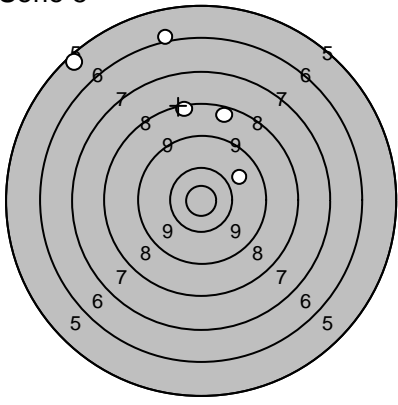
Skjutlag 2	Tavla 18	Håkan Lidman	
Ramselefors		Skellefteå	
2006-07-07		Björkskottet 2006	Ramselefors Skytteförening
Prov 	1: 10,5* ← 2: 10,3 ← 3: 9,8 ↑ 4: 10,8* ↗ 5: 10,1 ↖	Serie 1 	1: 9,7 ↗ 2: 10,7* ↖ 3: 8,9 ↑ 4: 9,2 ↗ 5: 9,5 ↑
	Serie 49,0 Totalt 0,0		Serie 45,0 Totalt 45,0
Serie 2 	1: 9,0 ↗ 2: 7,8 ↑ 3: 10,9* ↗ 4: 10,2 ↖ 5: 8,4 ↑	Serie 3 	1: 9,3 ↗ 2: 9,8 ↑ 3: 9,6 ↑ 4: 6,1 ← 5: 4,8 ↓
	Serie 44,0 Totalt 89,0		Serie 37,0 Totalt 126,0
Prov 	1: 10,2 ← 2: 10,2 → 3: 10,3 ↘	Serie 4 	1: 9,8 ← 2: 9,9 ↓ 3: 8,6 ↑ 4: 9,5 ← 5: 9,7 ↗
	Serie 30,0 Totalt 126,0		Serie 44,0 Totalt 170,0
Serie 5 	1: 8,5 ↑ 2: 6,1 ↑ 3: 8,4 ↑ 4: 5,5 ↖ 5: 9,8 ↗		
	Serie 36,0 Totalt 206,0		

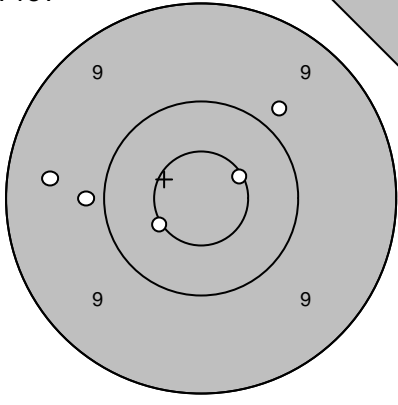
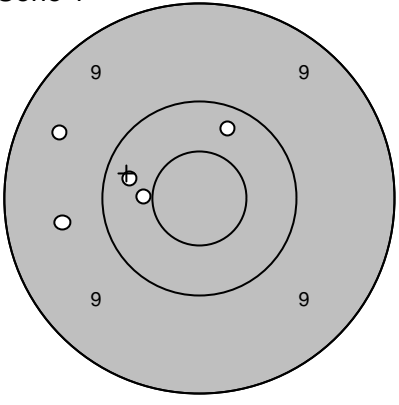
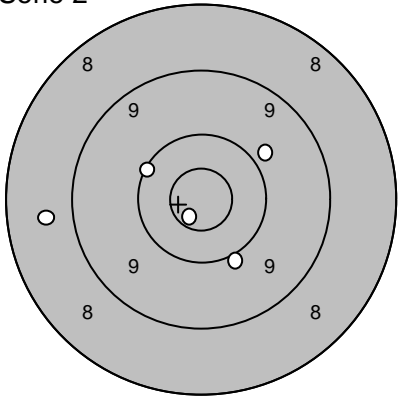
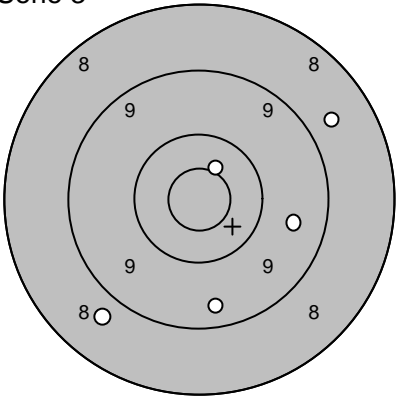
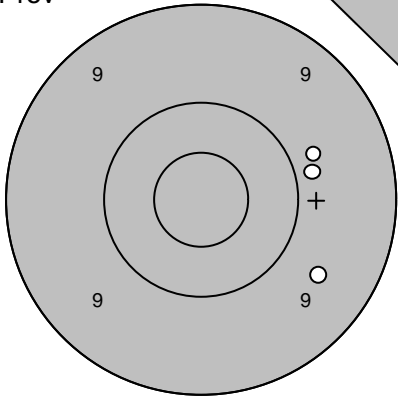
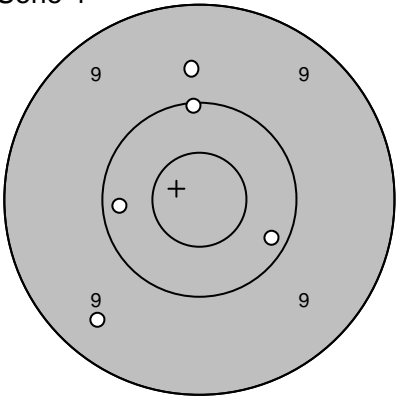
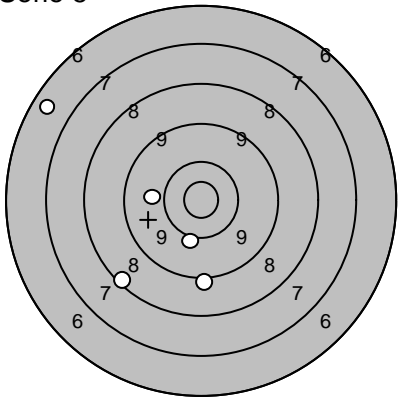
Skjutlag 2	Tavla 19	Torvald Andersson	
Ramselefors		Ununge	
2006-07-07		Björkskottet 2006	Ramselefors Skytteförening
Prov 	1: 9,8 ↗ 2: 9,5 ← 3: 9,9 ← 4: 10,5* ↙ 5: 10,6* →	Serie 1 	1: 10,3 ← 2: 9,6 ← 3: 9,5 ↖ 4: 10,3 ↑ 5: 10,5* ←
	Serie 47,0 Totalt 0,0		Serie 48,0 Totalt 48,0
Serie 2 	1: 9,9 ↗ 2: 10,1 ← 3: 10,0 ↓ 4: 10,7* ↙ 5: 8,7 ←	Serie 3 	1: 8,8 ↙ 2: 9,4 ↓ 3: 9,6 → 4: 10,5* ↑ 5: 8,7 →
	Serie 47,0 Totalt 95,0		Serie 44,0 Totalt 139,0
Prov 	1: 9,9 → 2: 9,6 ↘ 3: 9,8 →	Serie 4 	1: 9,7 ↑ 2: 10,2 ↘ 3: 9,4 ↙ 4: 10,1 ↑ 5: 10,2 ←
	Serie 27,0 Totalt 139,0		Serie 48,0 Totalt 187,0
Serie 5 	1: 9,9 ← 2: 8,3 ↙ 3: 10,1 ↓ 4: 6,6 ↖ 5: 9,1 ↓		
	Serie 42,0 Totalt 229,0		

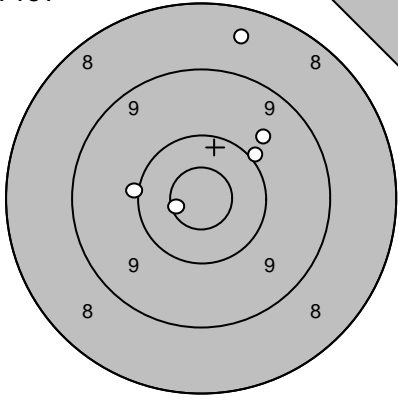
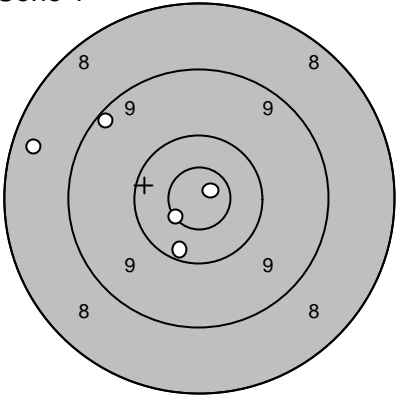
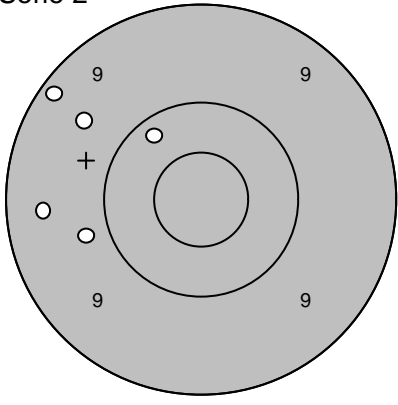
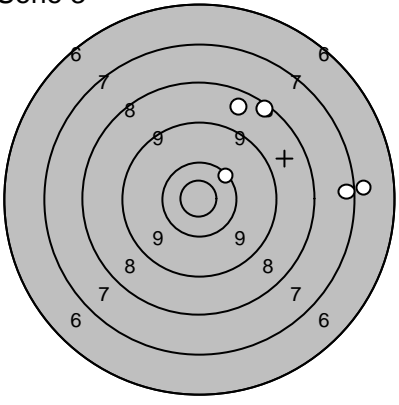
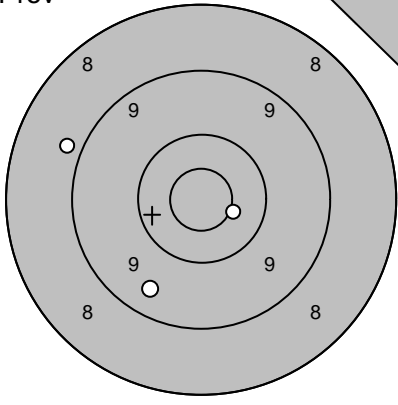
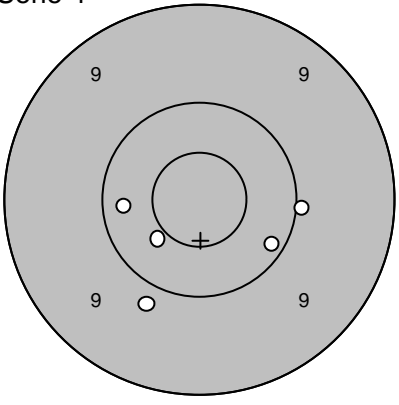
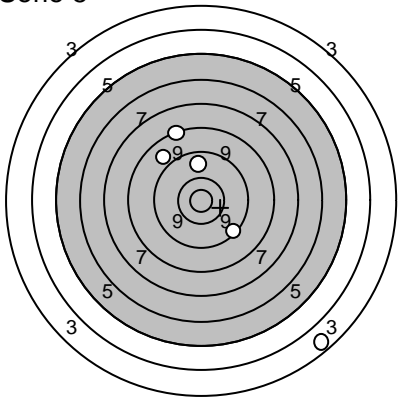
Skjutlag 2	Tavla 20	Martin Olofsson	
Ramselefors		Vännäs	
2006-07-07		Björkskottet 2006	Ramselefors Skytteförening
Prov 	1: 10,7* ← 2: 9,7 ↗ 3: 10,0 ↗ 4: 8,5 ↑ 5: 10,0 ←	Serie 1 	1: 10,2 ↓ 2: 8,4 ← 3: 9,2 ↗ 4: 10,6* ↓ 5: 10,9* ↗
	Serie 47,0 Totalt 0,0		Serie 47,0 Totalt 47,0
Serie 2 	1: 9,8 ← 2: 9,4 ← 3: 9,2 ↗ 4: 10,2 ↗ 5: 9,6 ↗	Serie 3 	1: 7,0 → 2: 8,3 ↗ 3: 8,6 ↑ 4: 7,4 → 5: 10,3 ↗
	Serie 46,0 Totalt 93,0		Serie 40,0 Totalt 133,0
Prov 	1: 8,9 ← 2: 10,5* → 3: 9,5 ↓	Serie 4 	1: 10,2 ↘ 2: 10,0 → 3: 10,5* ↓ 4: 9,8 ↓ 5: 10,3 ←
	Serie 27,0 Totalt 133,0		Serie 49,0 Totalt 182,0
Serie 5 	1: 9,0 ↗ 2: 9,8 ↑ 3: 8,4 ↗ 4: 9,5 ↘ 5: 3,7 ↓		
	Serie 38,0 Totalt 220,0		

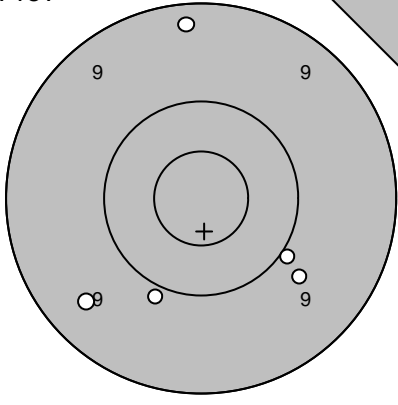
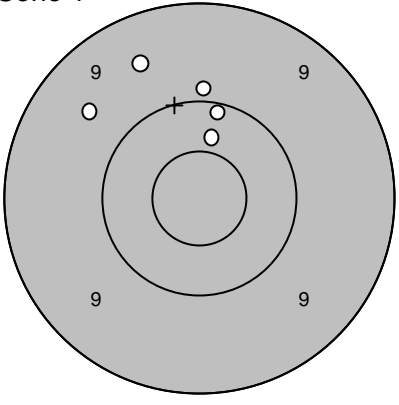
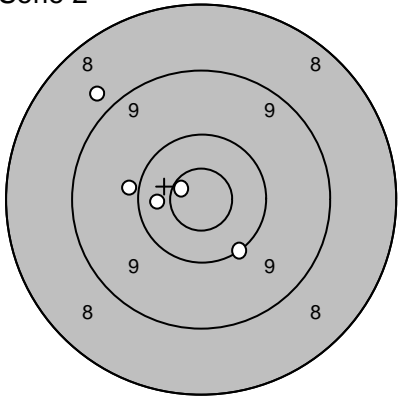
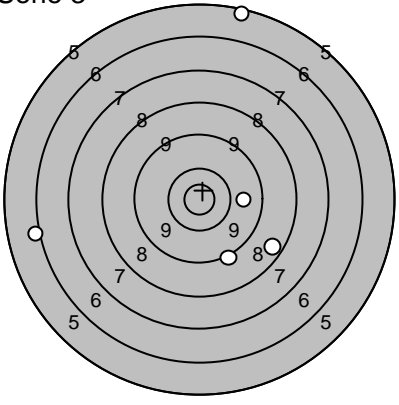
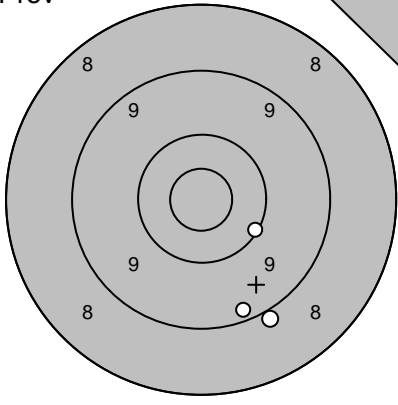
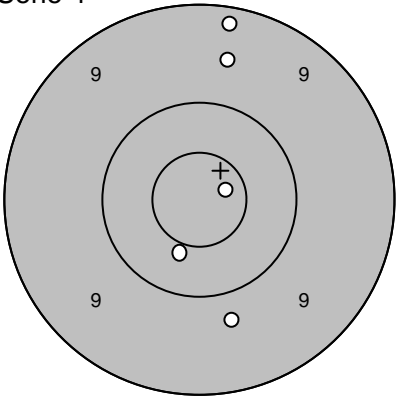
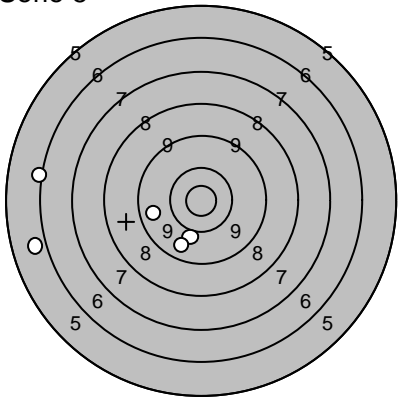
Skjutlag 2	Tavla 21	Jan-Olof Jannesson	
Ramselefors		Falköping	
2006-07-07		Björkskottet 2006	Ramselefors Skytteförening
Prov 	1: 9,5 ↙ 2: 9,9 ↓ 3: 9,7 ↘ 4: 10,0 → 5: 9,3 ↑	Serie 1 	1: 9,9 ↑ 2: 10,1 ↑ 3: 9,5 ↑ 4: 9,6 ↗ 5: 10,4 ↑
	Serie 46,0 Totalt 0,0		Serie 47,0 Totalt 47,0
Serie 2 	1: 10,4 ← 2: 8,8 ↗ 3: 10,1 ↘ 4: 10,7* ↗ 5: 10,0 ←	Serie 3 	1: 8,5 ↘ 2: 9,8 → 3: 9,2 ↓ 4: 5,4 ↑ 5: 6,1 ←
	Serie 48,0 Totalt 95,0		Serie 37,0 Totalt 132,0
Prov 	1: 9,0 ↓ 2: 9,3 ↓ 3: 10,1 ↘	Serie 4 	1: 9,6 ↑ 2: 9,8 ↓ 3: 10,4 ↓ 4: 10,7* → 5: 9,2 ↑
	Serie 28,0 Totalt 132,0		Serie 47,0 Totalt 179,0
Serie 5 	1: 10,0 ↓ 2: 9,7 ↓ 3: 9,7 ← 4: 5,9 ← 5: 6,2 ←		
	Serie 39,0 Totalt 218,0		

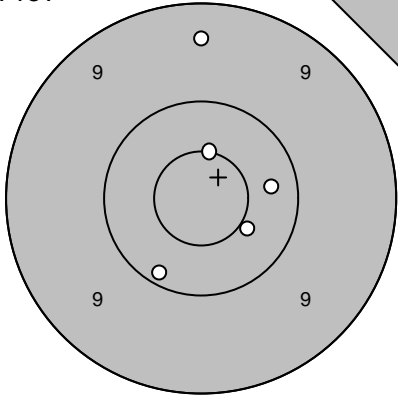
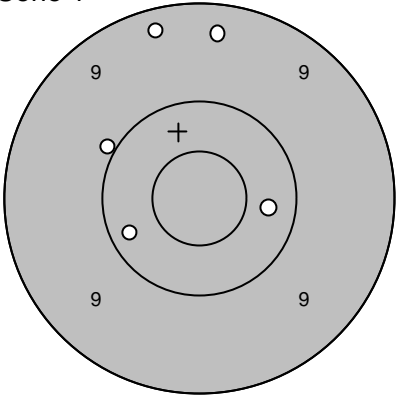
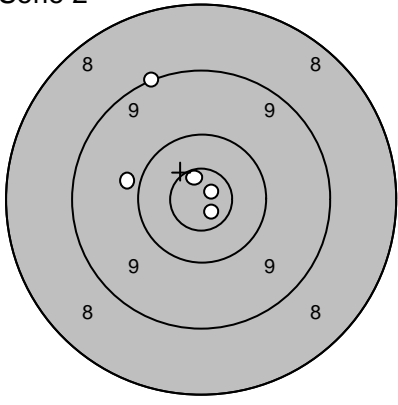
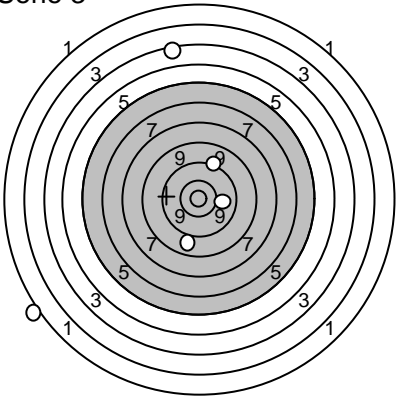
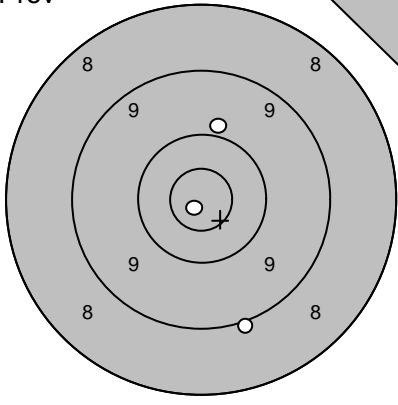
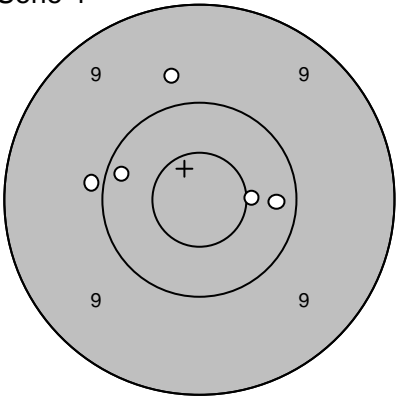
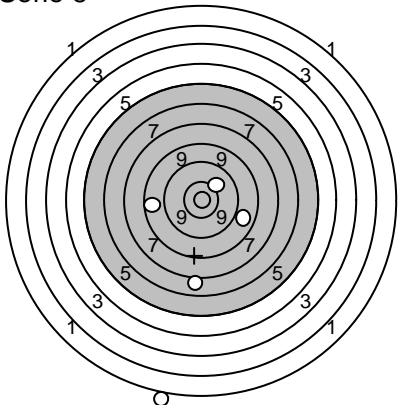
Skjutlag 2	Tavla 22	Håkan Engman	
Ramselefors		Lindesberg	
2006-07-07		Björkskottet 2006	Ramselefors Skytteförening
Prov 	1: 9,4 ↑ 2: 10,5* ↘ 3: 10,3 → 4: 10,2 ↙ 5: 10,6* ↑ <hr/> Serie 49,0 Totalt 0,0	Serie 1 	1: 9,3 ↑ 2: 9,3 ↑ 3: 10,3 → 4: 10,2 ← 5: 10,0 ↙ <hr/> Serie 48,0 Totalt 48,0
Serie 2 	1: 9,1 ↑ 2: 10,8* ↑ 3: 10,9* ↗ 4: 9,9 ← 5: 10,8* ↘ <hr/> Serie 48,0 Totalt 96,0	Serie 3 	1: 9,4 ↑ 2: 9,1 ↓ 3: 10,2 → 4: 1,1 ← 5: 3,7 ↑ <hr/> Serie 32,0 Totalt 128,0
Prov 	1: 9,9 ↑ 2: 10,9* ↙ 3: 9,0 ↓ <hr/> Serie 28,0 Totalt 128,0	Serie 4 	1: 9,7 ↑ 2: 10,5* → 3: 10,2 → 4: 10,2 ← 5: 9,9 ← <hr/> Serie 48,0 Totalt 176,0
Serie 5 	1: 8,9 ← 2: 9,0 → 3: 10,3 ↗ 4: 7,1 ↓ 5: 1,0 ↓ <hr/> Serie 35,0 Totalt 211,0		

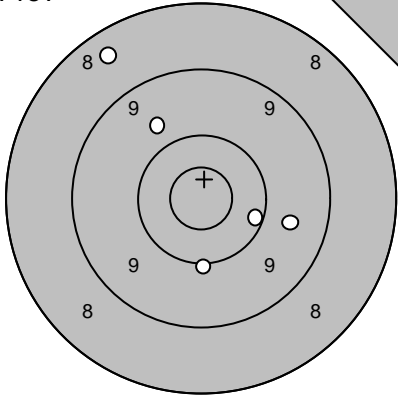
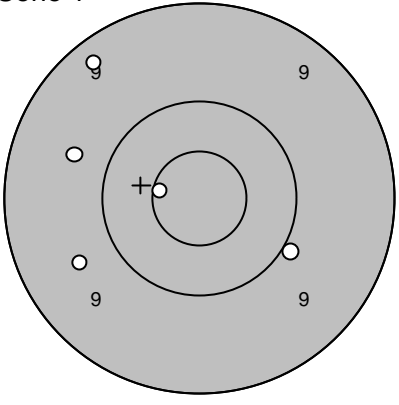
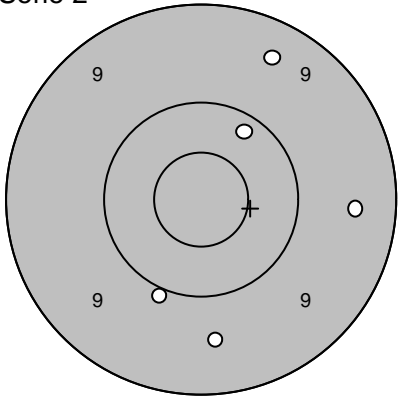
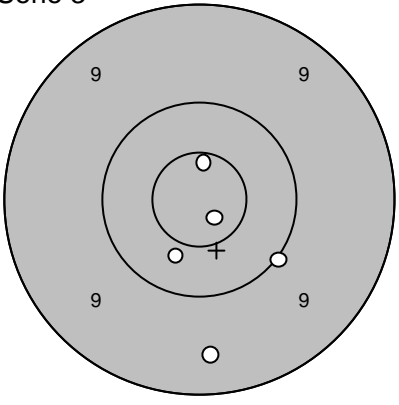
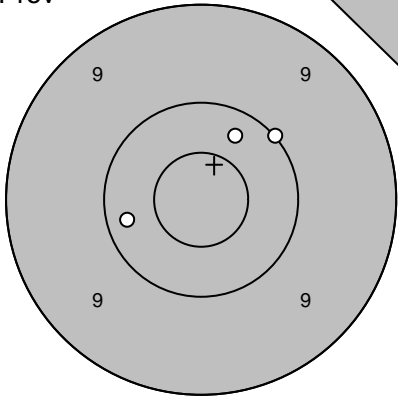
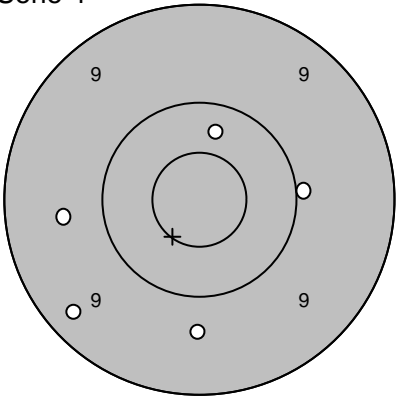
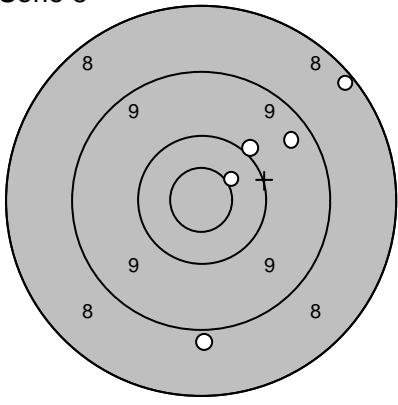
Skjutlag 3	Tavla 1	Rolf Åström	
Ramselefors		Brattby	
2006-07-07		Björkskottet 2006	Ramselefors Skytteförening
Prov 	1: 8,5 ↗ 2: 10,0 ↓ 3: 9,8 ↗ 4: 9,7 → 5: 10,2 → Serie 46,0 Totalt 0,0	Serie 1 	1: 10,0 ↘ 2: 10,6* ← 3: 9,7 ↗ 4: 9,3 ↗ 5: 9,7 ↘ Serie 47,0 Totalt 47,0
Serie 2 	1: 9,5 → 2: 9,4 ↑ 3: 9,6 ↓ 4: 10,2 ↗ 5: 10,0 ↓ Serie 47,0 Totalt 94,0	Serie 3 	1: 10,0 ↘ 2: 10,8* ↘ 3: 9,4 ↓ 4: 10,7* ↑ 5: 10,4 ↓ Serie 49,0 Totalt 143,0
Prov 	1: 10,3 ↑ 2: 10,0 ↗ 3: 10,3 ← Serie 30,0 Totalt 143,0	Serie 4 	1: 9,7 ↓ 2: 10,0 → 3: 9,6 ← 4: 10,3 ↑ 5: 9,3 ↘ Serie 47,0 Totalt 190,0
Serie 5 	1: 8,9 ↓ 2: 8,2 ↗ 3: 9,4 ↗ 4: 10,0 ↗ 5: 10,5* ↗ Serie 45,0 Totalt 235,0		

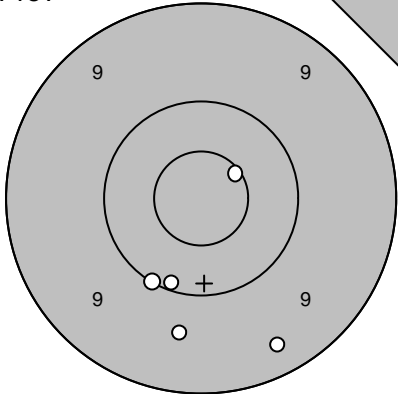
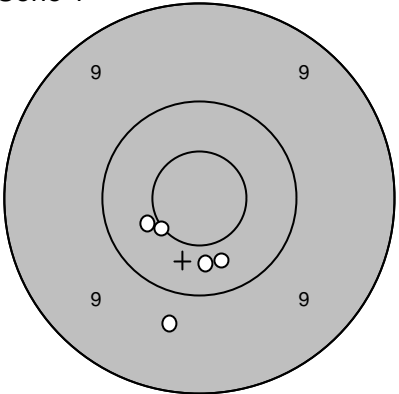
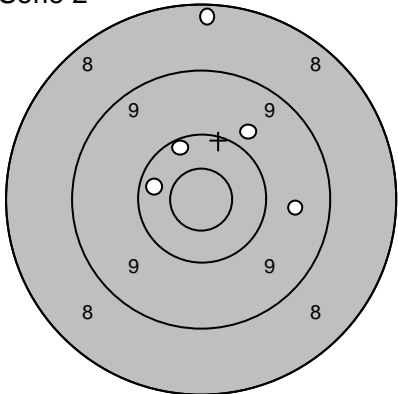
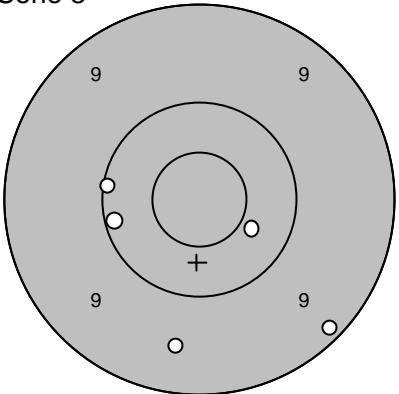
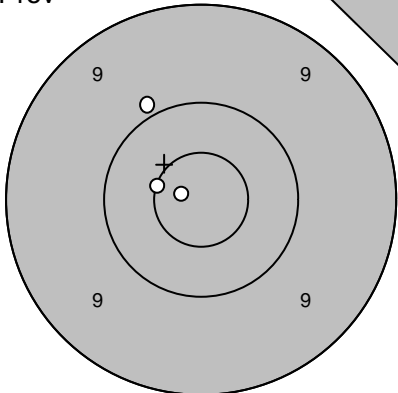
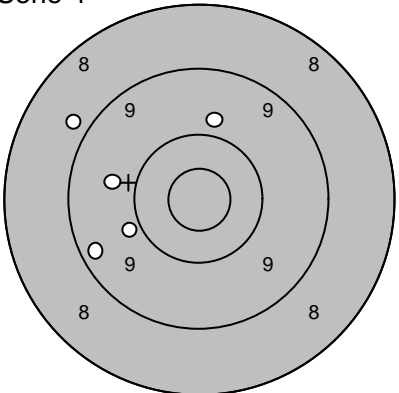
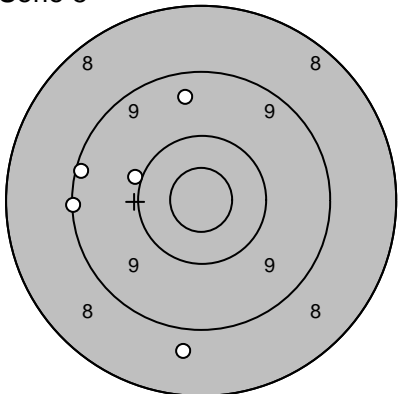
Skjutlag	Tavla	Jörgen Åström		
3	2			
Ramselefors	Brattby			
2006-07-07	Björkskottet 2006	Ramselefors Skytteförening		
Prov		1: 10,0 ↘ 2: 10,6* ↗ 3: 9,6 ↓ 4: 10,1 ↓ 5: 9,3 ↓	Serie 1 	1: 10,5* ← 2: 10,4 ↓ 3: 10,5* ← 4: 9,7 ↓ 5: 10,4 ↓
	Serie 48,0 Totalt 0,0		Serie 49,0 Totalt 49,0	
Serie 2		1: 8,3 ↑ 2: 10,2 ↖ 3: 10,3 ← 4: 9,8 ↗ 5: 9,6 →	Serie 3 	1: 10,1 ← 2: 10,1 ← 3: 10,4 → 4: 9,5 ↓ 5: 9,2 ↘
	Serie 46,0 Totalt 95,0		Serie 48,0 Totalt 143,0	
Prov		1: 9,9 ↖ 2: 10,8* ← 3: 10,6* ←	Serie 4 	1: 9,8 ↑ 2: 9,7 ← 3: 9,9 ← 4: 9,3 ← 5: 8,8 ↖
	Serie 29,0 Totalt 143,0		Serie 44,0 Totalt 187,0	
Serie 5		1: 9,5 ↑ 2: 8,7 ↓ 3: 10,0 ← 4: 9,2 ← 5: 9,1 ←		
	Serie 45,0 Totalt 232,0			

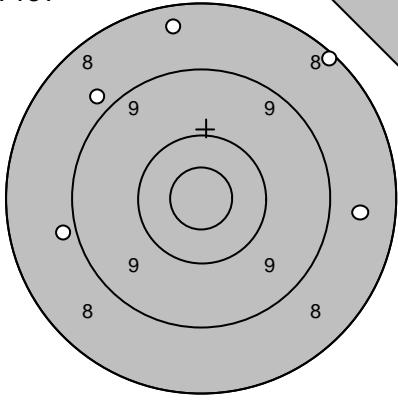
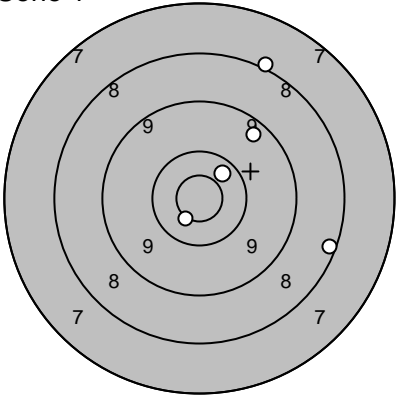
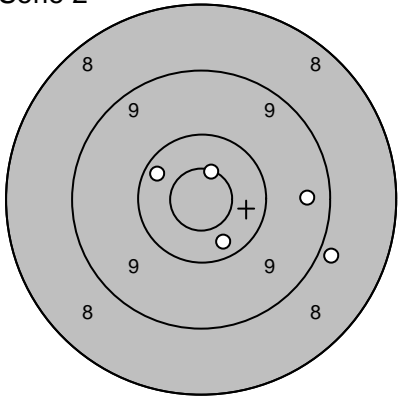
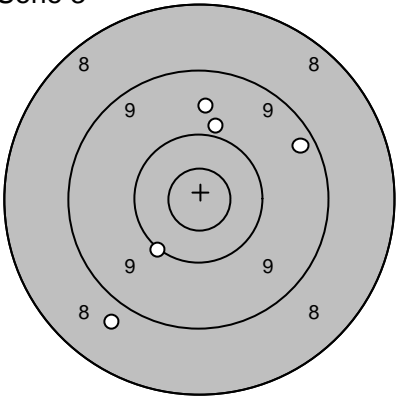
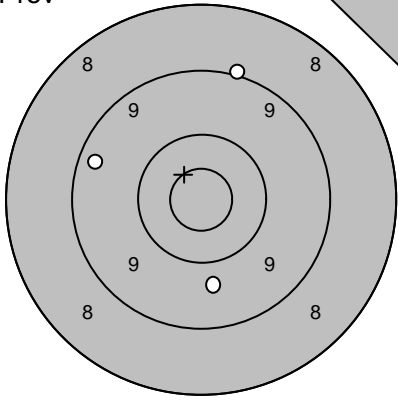
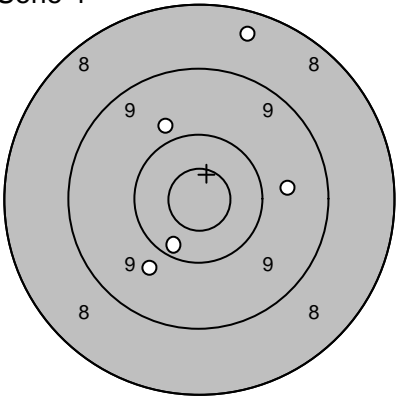
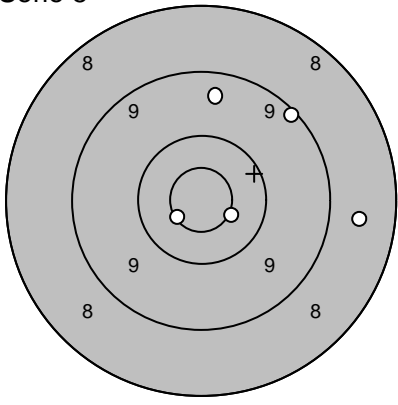
Skjutlag 3	Tavla 3	Gerhard Andersson	
Ramselefors		Ramselefors	
2006-07-07		Björkskottet 2006	Ramselefors Skytteförening
Prov 	1: 8,9 ← 2: 8,8 ↖ 3: 8,6 → 4: 8,2 ↗ 5: 8,4 ↑ Serie 40,0 Totalt 0,0	Serie 1 	1: 10,6* ↘ 2: 10,4 ↗ 3: 8,3 → 4: 8,1 ↗ 5: 9,4 ↗ Serie 45,0 Totalt 45,0
Serie 2 	1: 9,5 → 2: 10,6* ↗ 3: 8,9 → 4: 10,3 ↗ 5: 10,3 ↘ Serie 47,0 Totalt 92,0	Serie 3 	1: 10,1 ↘ 2: 9,9 ↑ 3: 9,6 ↑ 4: 9,3 → 5: 8,8 ↘ Serie 45,0 Totalt 137,0
Prov 	1: 9,3 ← 2: 9,8 ↓ 3: 9,1 ↑ Serie 27,0 Totalt 137,0	Serie 4 	1: 10,3 ↘ 2: 9,8 ↘ 3: 8,4 ↑ 4: 9,9 ↖ 5: 9,7 → Serie 45,0 Totalt 182,0
Serie 5 	1: 10,6* ↖ 2: 10,6* → 3: 9,5 ↑ 4: 9,2 ↗ 5: 8,6 → Serie 46,0 Totalt 228,0		

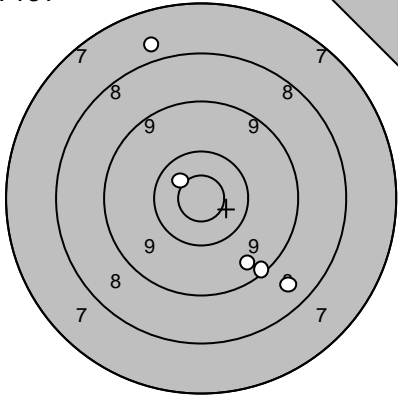
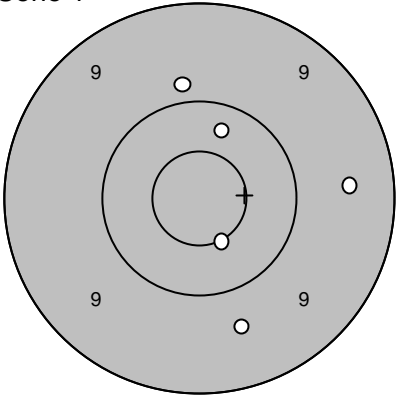
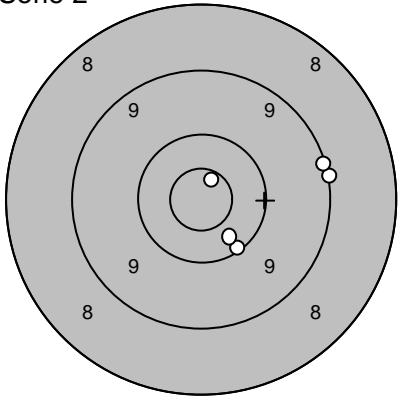
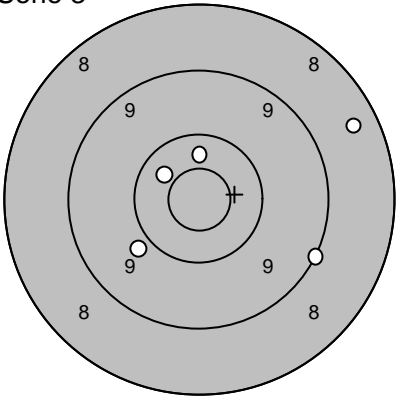
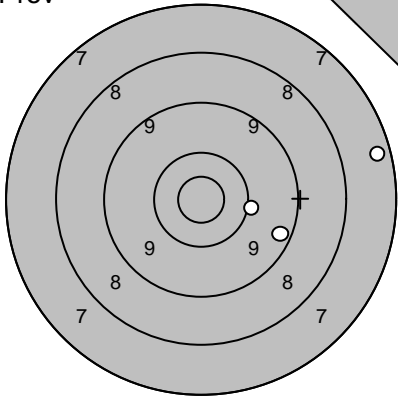
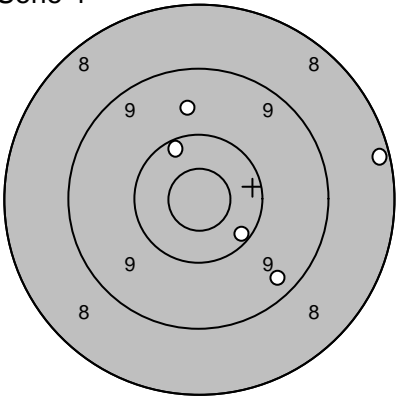
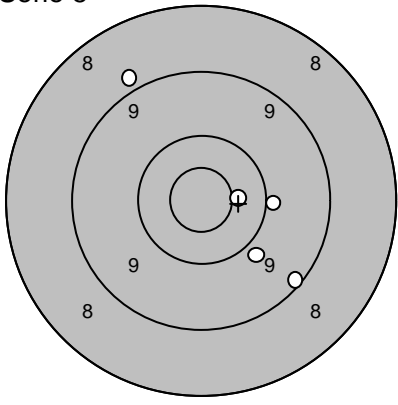
Skjutlag	Tavla	Marcus Mattsson	
3	5		
Ramselefors	Ramselefors		
2006-07-07	Björkskottet 2006	Ramselefors Skytteförening	
Prov		1: 7,8 ↗ 2: 8,6 ↘ 3: 10,6* ↗ 4: 9,5 ↘ 5: 9,2 ↘	Serie 1 
	Serie 43,0 Totalt 0,0	1: 9,5 → 2: 10,3 ↑ 3: 9,9 ↑ 4: 10,5* ↘ 5: 9,6 ↘	Serie 47,0 Totalt 47,0
Serie 2		1: 9,1 → 2: 10,2 ↘ 3: 9,1 → 4: 10,7* ↗ 5: 10,4 ↘	Serie 3 
	Serie 48,0 Totalt 95,0	1: 8,5 ↗ 2: 9,9 ↘ 3: 10,4 ↑ 4: 10,4 ↗ 5: 9,1 ↘	Serie 46,0 Totalt 141,0
Prov		1: 7,4 → 2: 9,4 ↘ 3: 10,1 →	Serie 4 
	Serie 26,0 Totalt 141,0	1: 9,7 ↑ 2: 9,4 ↘ 3: 10,2 ↗ 4: 8,2 → 5: 10,2 ↘	Serie 46,0 Totalt 187,0
Serie 5		1: 8,9 ↗ 2: 9,2 ↘ 3: 10,5* → 4: 10,0 → 5: 9,9 ↘	
	Serie 46,0 Totalt 233,0		

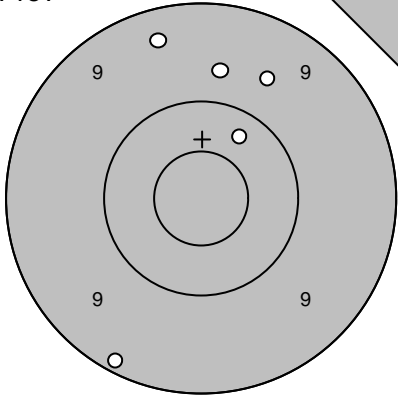
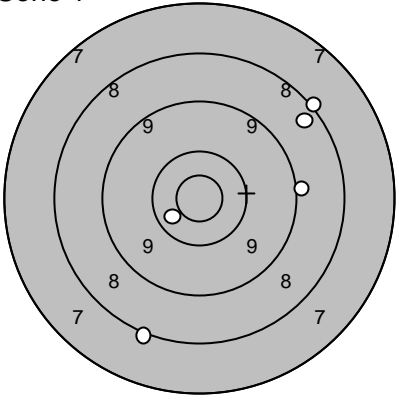
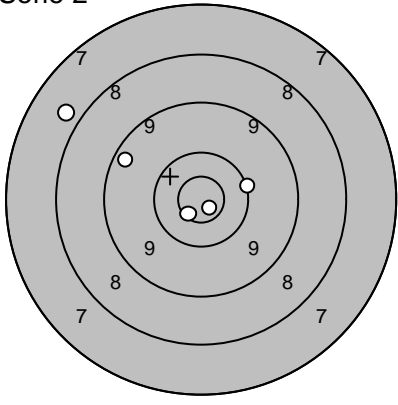
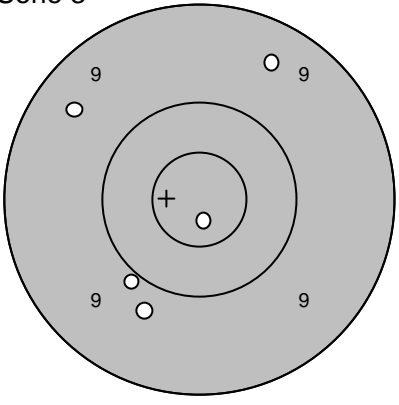
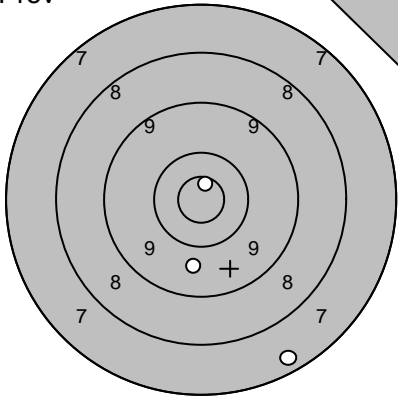
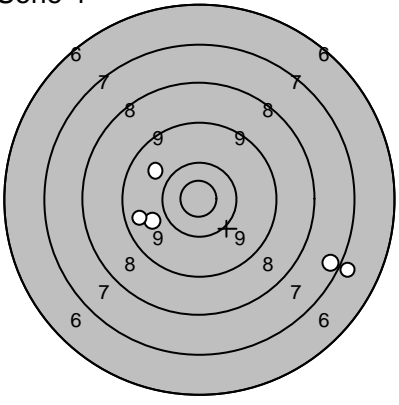
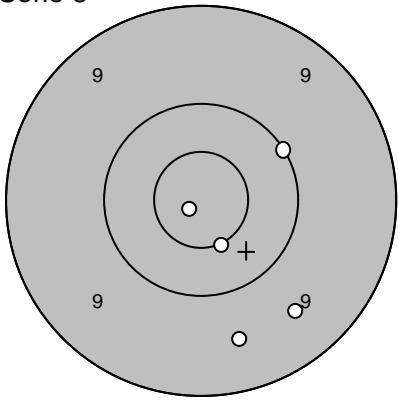
Skjutlag	Tavla	Gustav Karlsson		
3	6			
Ramselefors	Loos			
2006-07-07	Björkskottet 2006	Ramselefors Skytteförening		
Prov		1: 9,7 ↑ 2: 10,3 ↗ 3: 9,4 ↑ 4: 9,2 ↘ 5: 9,6 ↗	Serie 1 	1: 9,0 → 2: 8,4 ↗ 3: 10,5* ↘ 4: 8,1 ↗ 5: 8,1 ↓
		Serie 46,0 Totalt 0,0		Serie 43,0 Totalt 43,0
Serie 2		1: 10,1 → 2: 9,4 ↖ 3: 7,8 ↗ 4: 10,7* ↘ 5: 10,9* ↘	Serie 3 	1: 10,8* ↓ 2: 10,0 ↘ 3: 9,5 ↖ 4: 9,5 ↗ 5: 9,8 ↓
		Serie 46,0 Totalt 89,0		Serie 47,0 Totalt 136,0
Prov		1: 10,8* ↑ 2: 9,7 ↓ 3: 7,4 ↓	Serie 4 	1: 9,8 ↖ 2: 7,4 → 3: 9,9 ↖ 4: 9,6 ← 5: 6,9 →
		Serie 26,0 Totalt 136,0		Serie 40,0 Totalt 176,0
Serie 5		1: 10,5* ↓ 2: 9,6 ↓ 3: 9,5 ↓ 4: 10,9* ↘ 5: 10,1 ↗		
		Serie 48,0 Totalt 224,0		

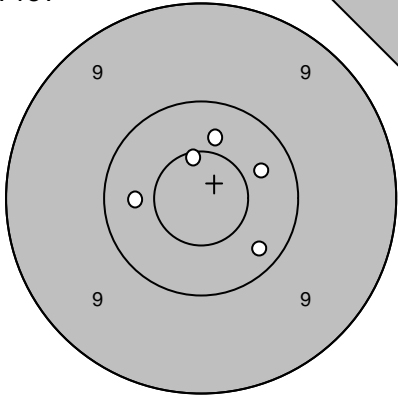
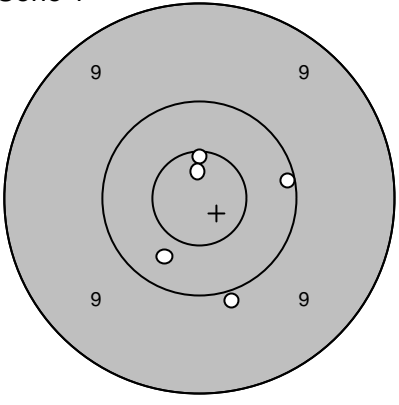
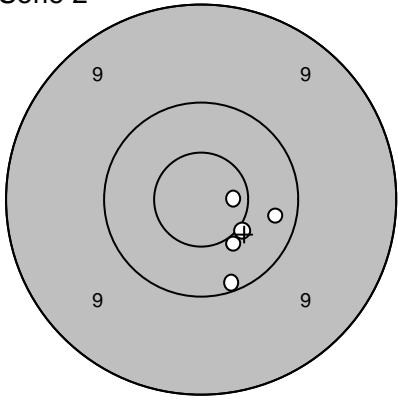
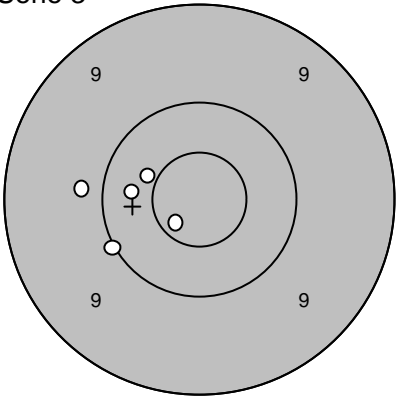
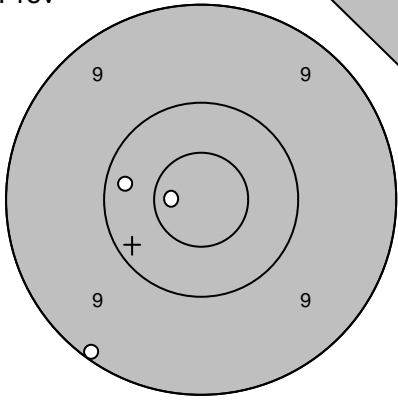
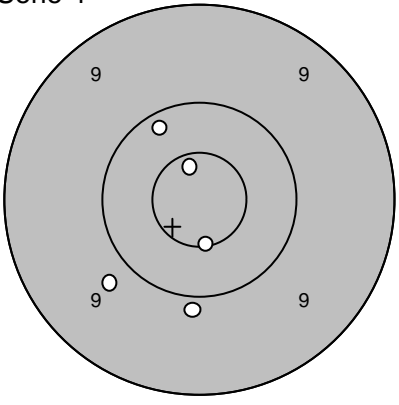
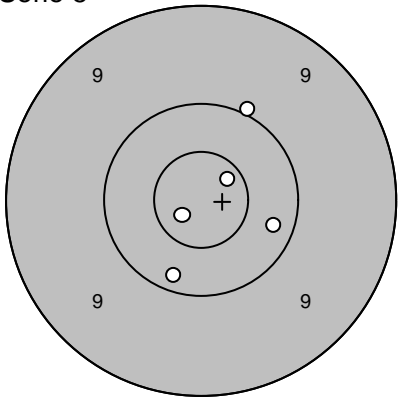
Skjutlag	Tavla	Peter Ericson		
3	7			
Ramselefors	Loos			
2006-07-07	Björkskottet 2006	Ramselefors Skytteförening		
Prov		1: 10,4 ← 2: 10,4 ↑ 3: 10,4 → 4: 10,6* ↑ 5: 10,2 ↓	Serie 1 	1: 10,1 → 2: 9,9 ↓ 3: 10,6* ↑ 4: 10,8* ↑ 5: 10,3 ↓
		Serie 50,0 Totalt 0,0		Serie 49,0 Totalt 49,0
Serie 2		1: 10,1 ↓ 2: 10,5* ↓ 3: 10,3 → 4: 10,7* → 5: 10,5* ↓	Serie 3 	1: 10,7* ↙ 2: 9,8 ← 3: 10,5* ↖ 4: 10,3 ← 5: 10,0 ↙
		Serie 50,0 Totalt 99,0		Serie 49,0 Totalt 148,0
Prov		1: 10,2 ← 2: 9,1 ↓ 3: 10,7* ←	Serie 4 	1: 10,6* ↓ 2: 9,9 ↓ 3: 9,8 ↙ 4: 10,2 ↑ 5: 10,7* ↑
		Serie 29,0 Totalt 148,0		Serie 48,0 Totalt 196,0
Serie 5		1: 10,8* ↙ 2: 10,2 ↓ 3: 10,0 ↑ 4: 10,7* ↗ 5: 10,3 →		
		Serie 50,0 Totalt 246,0		

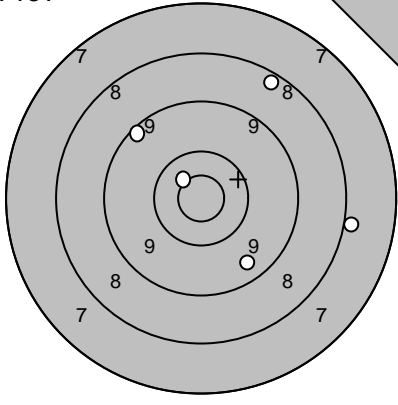
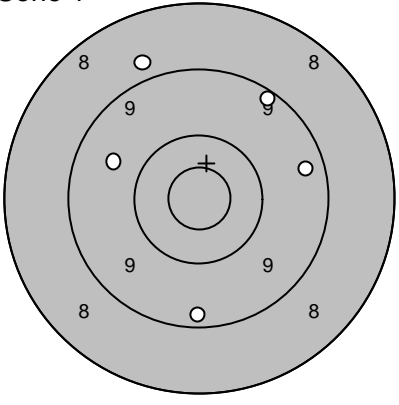
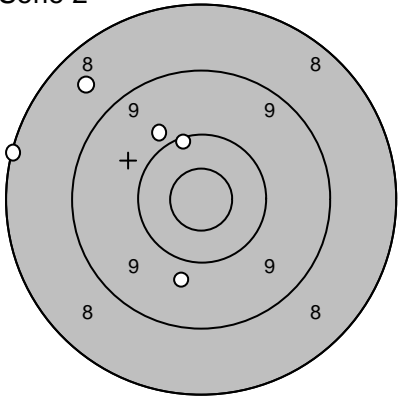
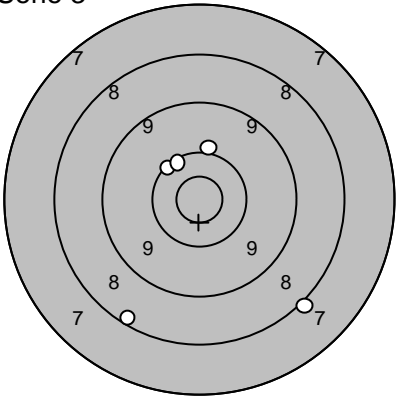
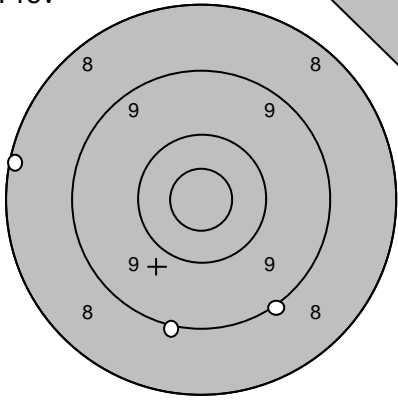
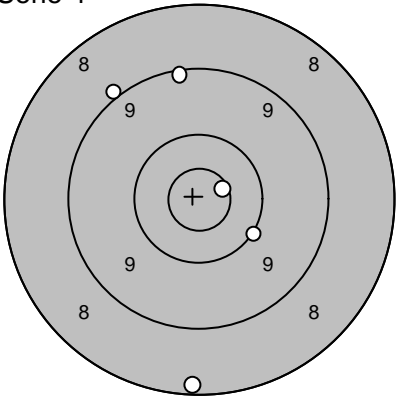
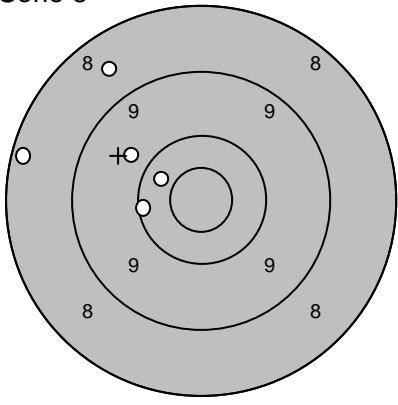
Skjutlag 3	Tavla 8	Peter Lundqvist	
Ramselefors		Ununge	
2006-07-07		Björkskottet 2006	Ramselefors Skytteförening
Prov 	1: 9,3 ↗ 2: 10,6* ↗ 3: 8,4 ↗ 4: 9,5 ↘ 5: 8,0 →	Serie 1 	1: 9,2 ↗ 2: 9,3 ↓ 3: 9,4 → 4: 9,6 ← 5: 8,8 ↗
	Serie 44,0 Totalt 0,0		Serie 44,0 Totalt 44,0
Serie 2 	1: 9,8 ↓ 2: 10,2 ↗ 3: 9,9 ↗ 4: 8,1 ← 5: 8,6 ↗	Serie 3 	1: 10,2 ↗ 2: 8,1 ↘ 3: 10,1 ↗ 4: 10,2 ↗ 5: 8,3 ↓
	Serie 44,0 Totalt 88,0		Serie 46,0 Totalt 134,0
Prov 	1: 9,0 ↘ 2: 9,0 ↓ 3: 8,2 ←	Serie 4 	1: 10,1 ↘ 2: 9,2 ↗ 3: 9,0 ↗ 4: 8,2 ↓ 5: 10,7* →
	Serie 26,0 Totalt 134,0		Serie 46,0 Totalt 180,0
Serie 5 	1: 10,2 ← 2: 8,6 ↗ 3: 10,4 ↗ 4: 8,3 ← 5: 9,8 ↗		
	Serie 45,0 Totalt 225,0		

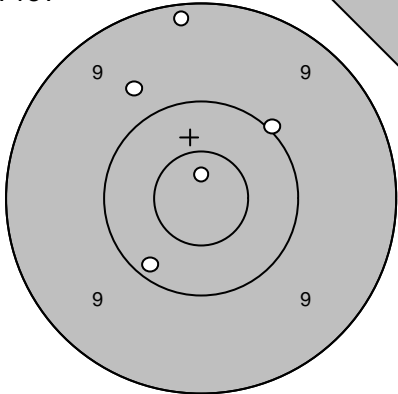
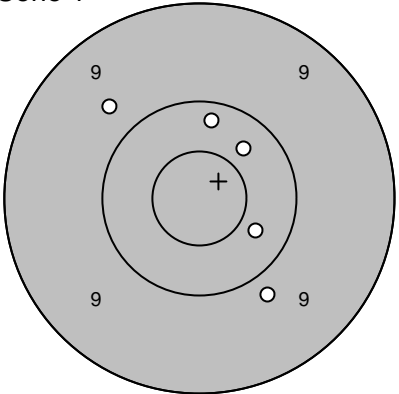
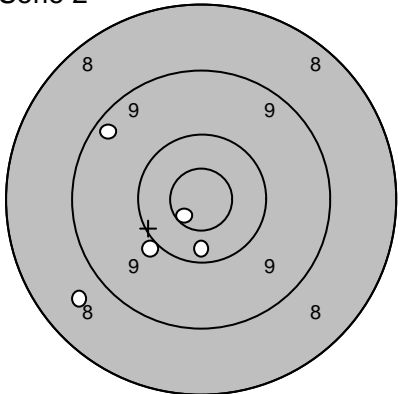
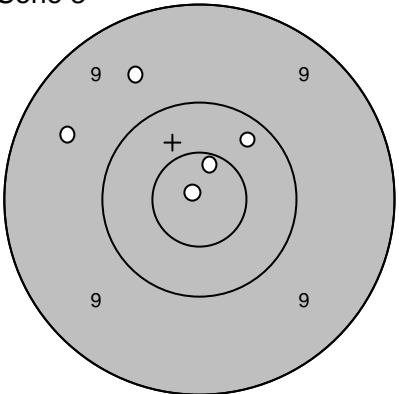
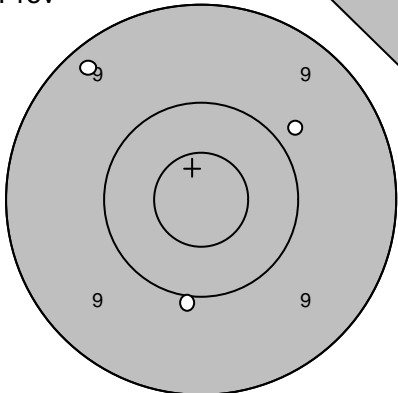
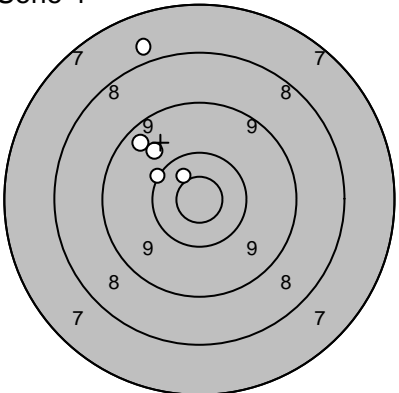
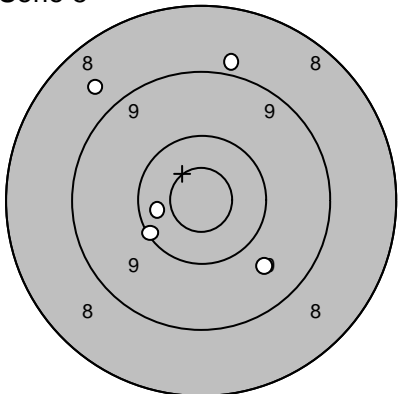
Skjutlag 3	Tavla 9	Simon Dahlberg	
Ramselefors		Bastuträsk	
2006-07-07		Björkskottet 2006	Ramselefors Skytteförening
Prov 	1: 9,2 ↑ 2: 9,7 ↖ 3: 10,8* ↑ 4: 10,0 ↗ 5: 10,2 ↘ Serie 48,0 Totalt 0,0	Serie 1 	1: 10,4 ↘ 2: 10,2 ↑ 3: 9,7 ↗ 4: 9,8 ↘ 5: 10,4 ↗ Serie 48,0 Totalt 48,0
Serie 2 	1: 10,3 ↓ 2: 10,7* ↘ 3: 9,3 ↖ 4: 8,7 ↘ 5: 10,0 ↘ Serie 47,0 Totalt 95,0	Serie 3 	1: 10,7* ↑ 2: 9,6 ↗ 3: 10,9* ↗ 4: 9,5 ↖ 5: 10,2 ↗ Serie 48,0 Totalt 143,0
Prov 	1: 9,3 ↖ 2: 9,8 ↗ 3: 10,0 ↓ Serie 28,0 Totalt 143,0	Serie 4 	1: 7,8 ↑ 2: 10,5* ↗ 3: 10,1 ↗ 4: 9,5 ↗ 5: 9,8 ↗ Serie 45,0 Totalt 188,0
Serie 5 	1: 8,7 ↖ 2: 8,9 ↑ 3: 10,4 ← 4: 9,7 ↘ 5: 10,1 ↘ Serie 45,0 Totalt 233,0		

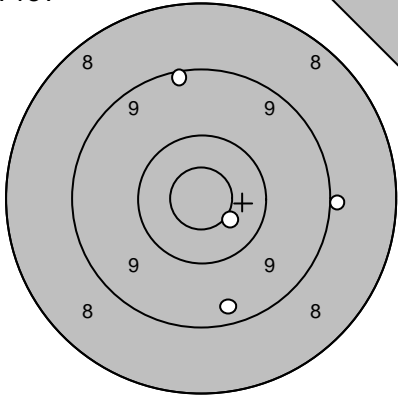
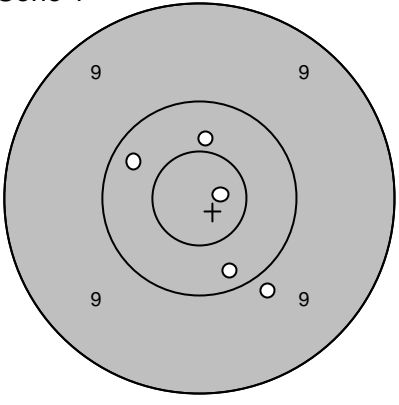
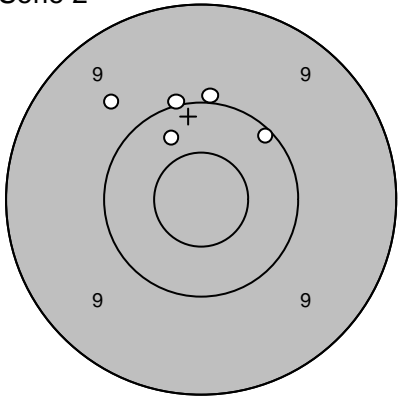
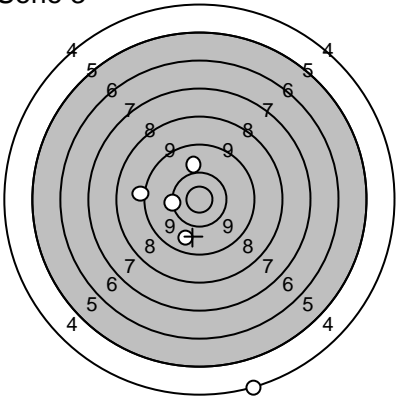
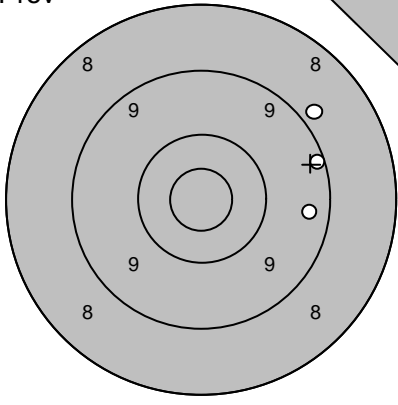
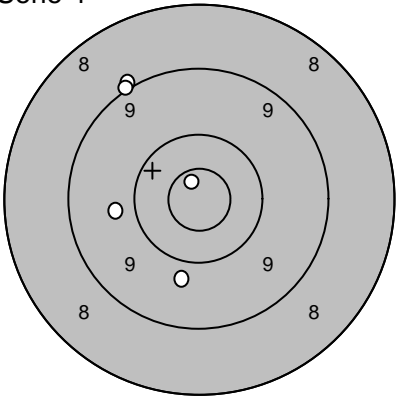
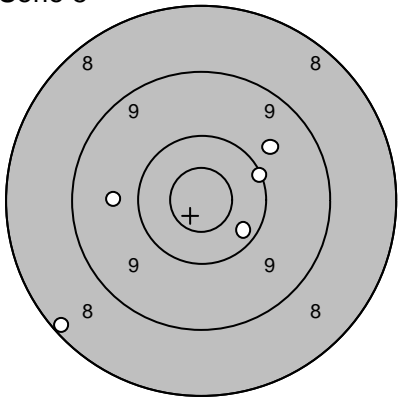
Skjutlag 3	Tavla 11	Therese Danielsson	
Ramselefors		Ununge	
2006-07-07		Björkskottet 2006	Ramselefors Skytteförening
Prov 	1: 10,5* ↘ 2: 9,4 ↓ 3: 9,2 ↑ 4: 9,0 →	Serie 1 	1: 10,4 ↑ 2: 9,9 ↓ 3: 10,2 ↓ 4: 10,3 ↗ 5: 10,8* →
	Serie 37,0 Totalt 0,0		Serie 49,0 Totalt 49,0
Serie 2 	1: 10,1 ↗ 2: 9,7 ↖ 3: 10,3 ↗ 4: 10,0 ↑ 5: 10,0 ↑	Serie 3 	1: 10,3 ← 2: 9,1 ← 3: 9,8 ↓ 4: 10,0 ↑ 5: 4,2 ↓
	Serie 49,0 Totalt 98,0		Serie 42,0 Totalt 140,0
Prov 	1: 8,9 ↗ 2: 9,2 → 3: 9,4 →	Serie 4 	1: 9,0 ↑ 2: 9,8 ← 3: 9,0 ↗ 4: 10,8* ↗ 5: 9,8 ↓
	Serie 26,0 Totalt 140,0		Serie 46,0 Totalt 186,0
Serie 5 	1: 8,2 ↙ 2: 9,7 ← 3: 9,7 ↗ 4: 10,3 ↘ 5: 10,1 →		
	Serie 46,0 Totalt 232,0		

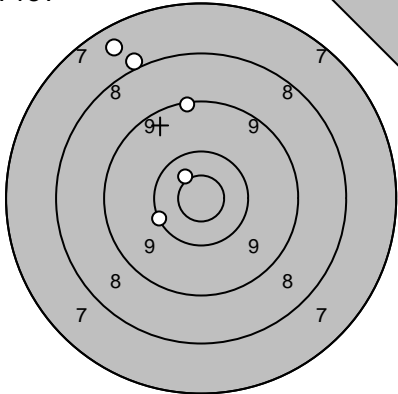
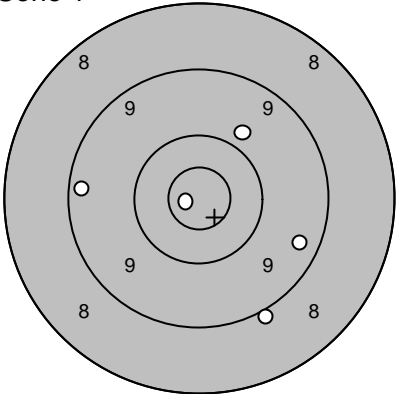
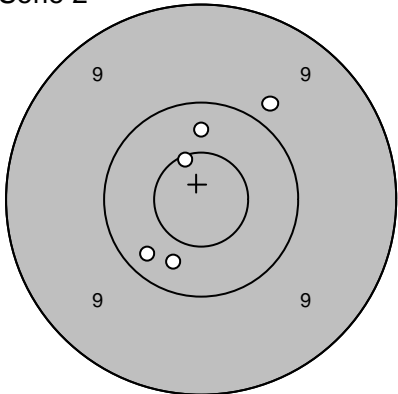
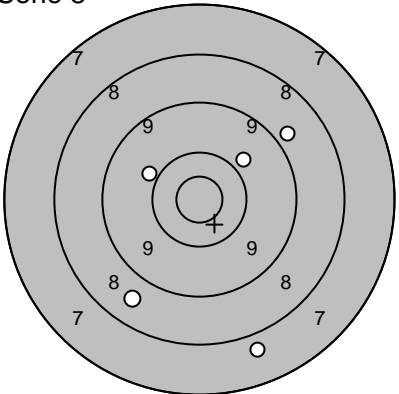
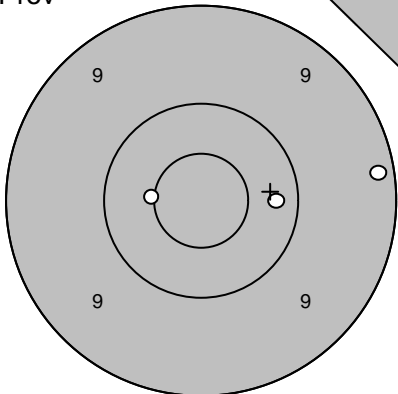
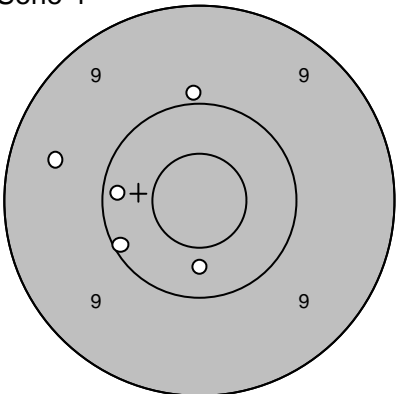
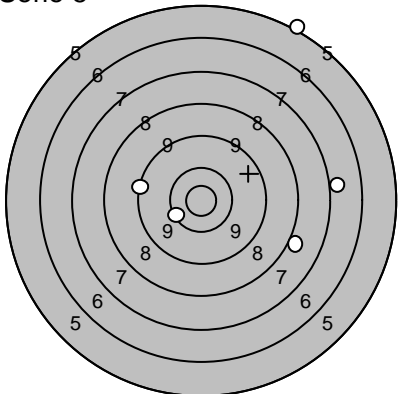
Skjutlag	Tavla	Per Östling		
3	12			
Ramselefors	F 21			
2006-07-07	Björkskottet 2006	Ramselefors Skytteförening		
Prov		1: 7,6 ↗ 2: 9,2 ↑ 3: 8,0 ↗ 4: 10,2 ← 5: 10,6* ↗	Serie 1 	1: 9,9 ↗ 2: 9,4 → 3: 9,0 ↓ 4: 10,9* ← 5: 9,3 ←
		Serie 44,0 Totalt 0,0		Serie 46,0 Totalt 46,0
Serie 2		1: 10,3 ↓ 2: 10,2 ↙ 3: 10,3 ↑ 4: 9,8 ↗ 5: 10,6* ↗	Serie 3 	1: 10,0 ↙ 2: 8,9 ↗ 3: 8,7 ↓ 4: 9,9 ↗ 5: 7,8 ↓
		Serie 49,0 Totalt 95,0		Serie 42,0 Totalt 137,0
Prov		1: 9,2 → 2: 10,3 → 3: 10,5* ←	Serie 4 	1: 9,9 ↑ 2: 9,5 ← 3: 10,4 ↓ 4: 10,2 ← 5: 10,1 ←
		Serie 29,0 Totalt 137,0		Serie 48,0 Totalt 185,0
Serie 5		1: 10,3 ↙ 2: 9,3 ← 3: 7,0 → 4: 8,0 → 5: 5,1 ↗		
		Serie 39,0 Totalt 224,0		

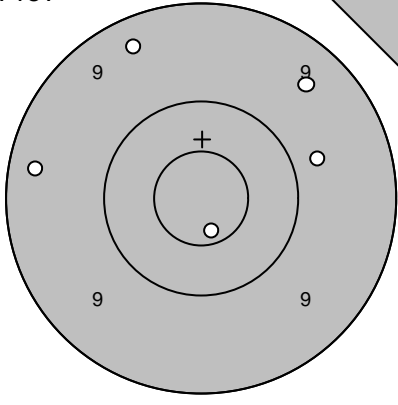
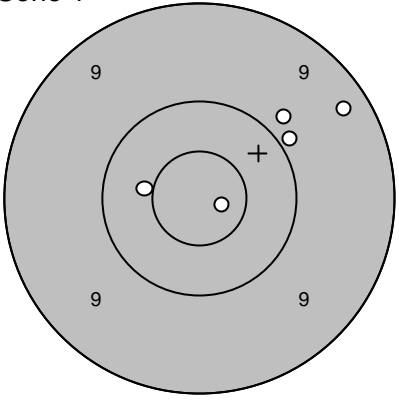
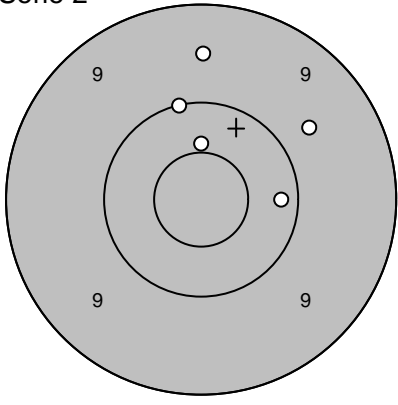
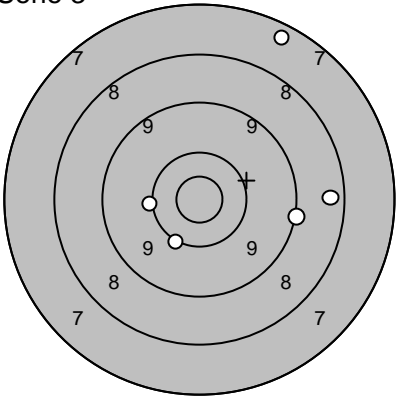
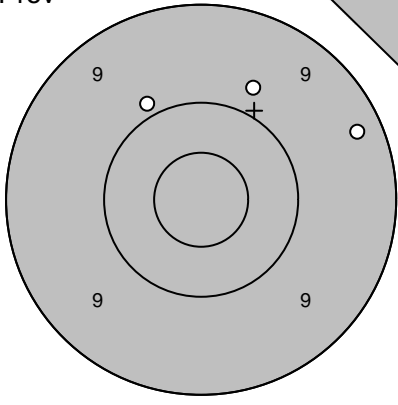
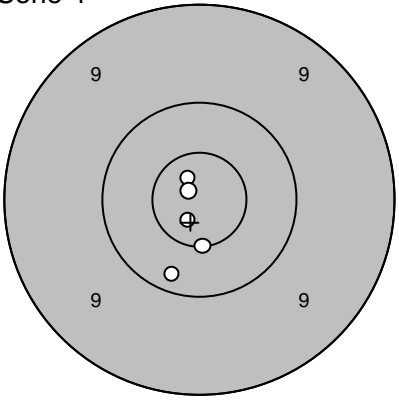
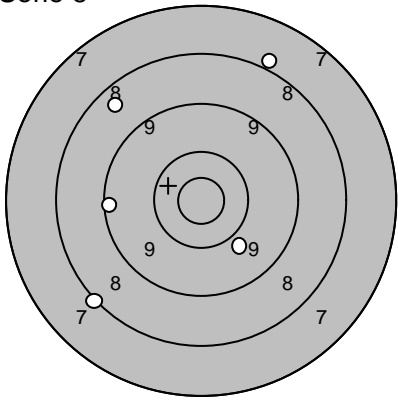
Skjutlag 3	Tavla 13	Fredrik Forsgren	
Ramselefors		Ramselefors	
2006-07-07		Björkskottet 2006	Ramselefors Skytteförening
Prov 	1: 10,7* ↓ 2: 9,5 ↗ 3: 9,8 → 4: 9,3 ↖ 5: 9,3 ←	Serie 1 	1: 10,5* ← 2: 9,9 ↗ 3: 9,8 ↗ 4: 9,3 ↗ 5: 10,8* →
	Serie 46,0 Totalt 0,0		Serie 47,0 Totalt 47,0
Serie 2 	1: 10,0 ↑ 2: 9,5 ↑ 3: 9,7 ↗ 4: 10,5* ↑ 5: 10,2 →	Serie 3 	1: 10,1 ↓ 2: 8,4 → 3: 9,1 → 4: 10,1 ← 5: 7,4 ↗
	Serie 48,0 Totalt 95,0		Serie 44,0 Totalt 139,0
Prov 	1: 9,9 ↖ 2: 9,3 → 3: 9,8 ↗	Serie 4 	1: 10,8* ↖ 2: 10,6* ↓ 3: 10,2 ↓ 4: 10,9* ↗ 5: 10,8* ↓
	Serie 27,0 Totalt 139,0		Serie 50,0 Totalt 189,0
Serie 5 	1: 8,1 ↖ 2: 9,3 ← 3: 9,9 ↖ 4: 8,5 ↗ 5: 8,0 ↗		
	Serie 42,0 Totalt 231,0		

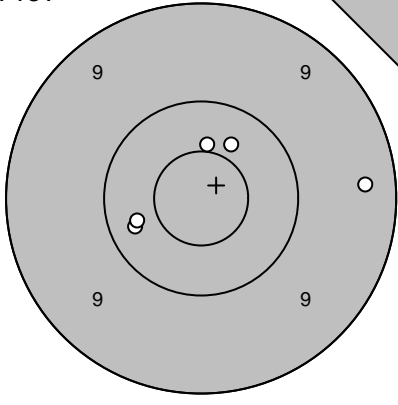
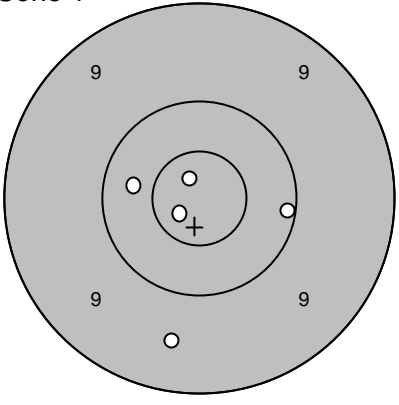
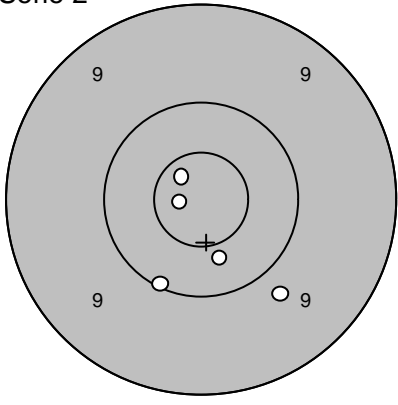
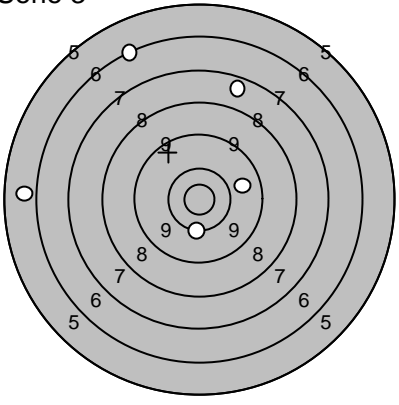
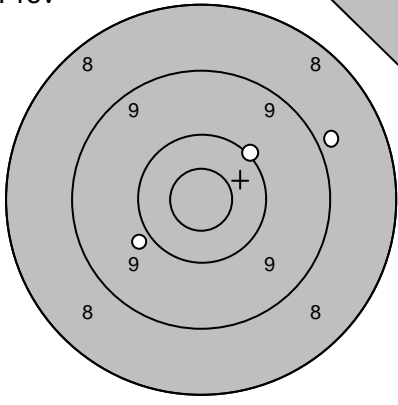
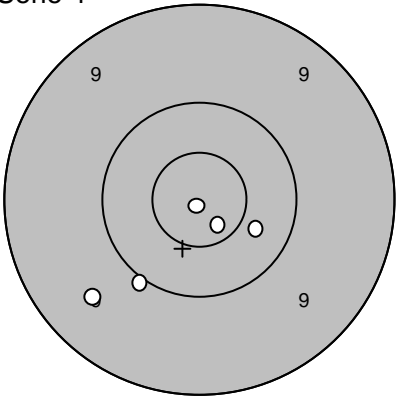
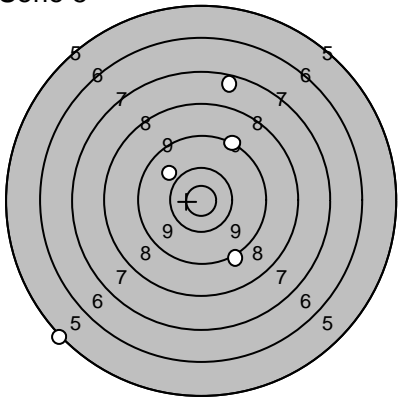
Skjutlag 3	Tavla 14	Johan Nilsson	
Ramselefors		Ramselefors	
2006-07-07		Björkskottet 2006	Ramselefors Skytteförening
Prov 	1: 10,3 ← 2: 10,5* ↑ 3: 10,3 ← 4: 10,4 ↗ 5: 9,3 →	Serie 1 	1: 10,4 ← 2: 9,6 ↓ 3: 10,8* ↙ 4: 10,1 → 5: 10,8* ↗
	Serie 49,0 Totalt 0,0		Serie 49,0 Totalt 49,0
Serie 2 	1: 10,1 ↙ 2: 10,4 ↓ 3: 9,8 ↘ 4: 10,7* ↗ 5: 10,8* ←	Serie 3 	1: 10,2 ↓ 2: 9,8 → 3: 7,6 ↗ 4: 6,3 ↗ 5: 5,9 ←
	Serie 49,0 Totalt 98,0		Serie 37,0 Totalt 135,0
Prov 	1: 9,9 ↙ 2: 8,9 → 3: 10,0 ↗	Serie 4 	1: 9,6 ↙ 2: 10,0 ↙ 3: 10,7* ↘ 4: 10,9* ↘ 5: 10,4 →
	Serie 27,0 Totalt 135,0		Serie 49,0 Totalt 184,0
Serie 5 	1: 7,5 ↑ 2: 9,9 ↖ 3: 9,2 ↗ 4: 9,2 ↓ 5: 5,2 ↙		
	Serie 39,0 Totalt 223,0		

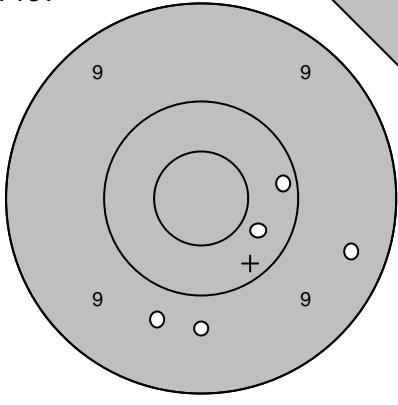
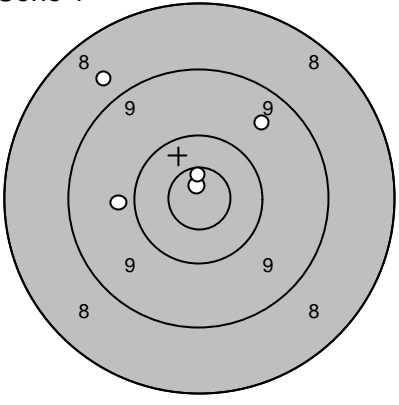
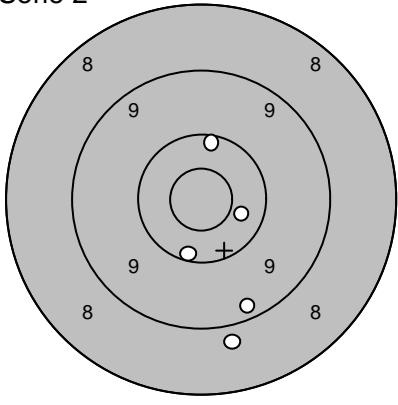
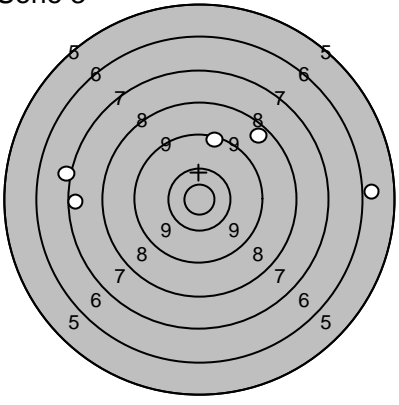
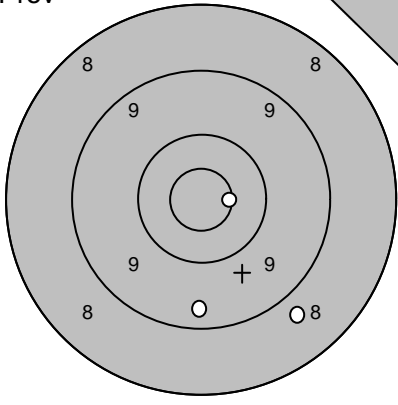
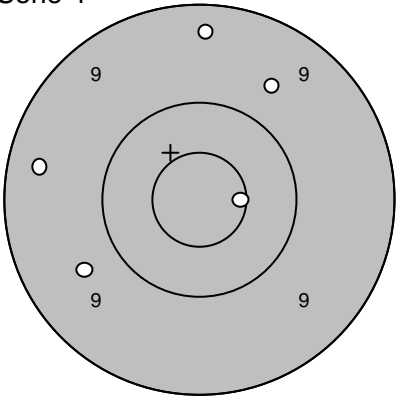
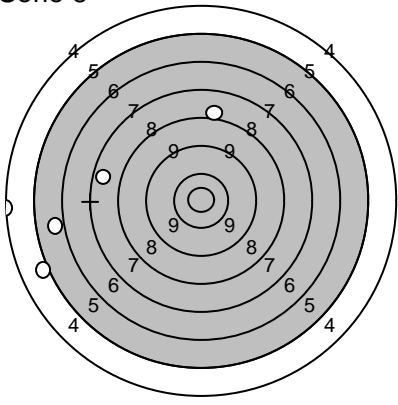
Skjutlag 3	Tavla 15	Marie Fjällström	
Ramselefors		Ramselefors	
2006-07-07		Björkskottet 2006	Ramselefors Skytteförening
Prov 	1: 9,7 ↓ 2: 10,2 → 3: 9,4 → 4: 9,7 ↓ 5: 10,4 ↓	Serie 1 	1: 10,9* ↑ 2: 9,6 ↗ 3: 8,7 ↖ 4: 10,7* ↑ 5: 9,8 ←
	Serie 47,0 Totalt 0,0		Serie 46,0 Totalt 46,0
Serie 2 	1: 10,4 → 2: 10,2 ↓ 3: 10,2 ↑ 4: 9,3 ↓ 5: 8,8 ↓	Serie 3 	1: 7,1 ← 2: 7,4 ← 3: 8,6 ↗ 4: 5,9 → 5: 9,3 ↑
	Serie 47,0 Totalt 93,0		Serie 36,0 Totalt 129,0
Prov 	1: 9,4 ↓ 2: 10,6* → 3: 8,8 ↓	Serie 4 	1: 10,6* → 2: 9,3 ↑ 3: 9,7 ↗ 4: 9,7 ← 5: 9,4 ←
	Serie 27,0 Totalt 129,0		Serie 46,0 Totalt 175,0
Serie 5 	1: 7,7 ← 2: 6,0 ← 3: 4,2 ← 4: 8,1 ↑ 5: 5,1 ←		
	Serie 30,0 Totalt 205,0		

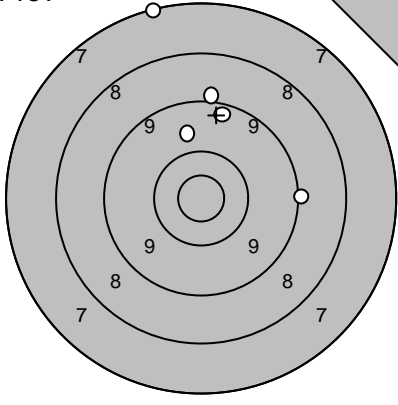
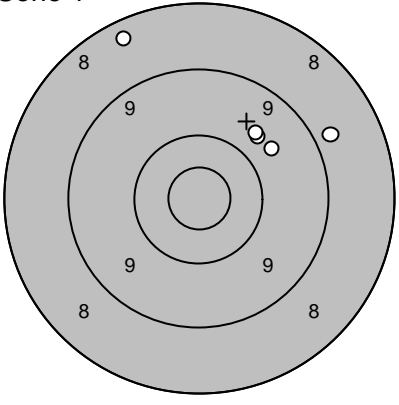
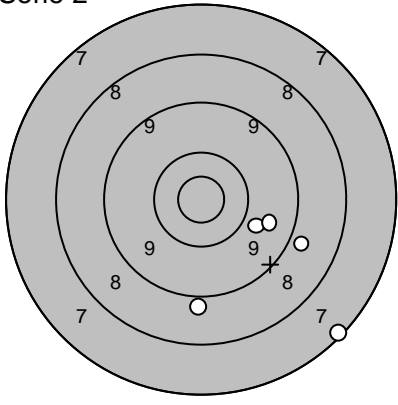
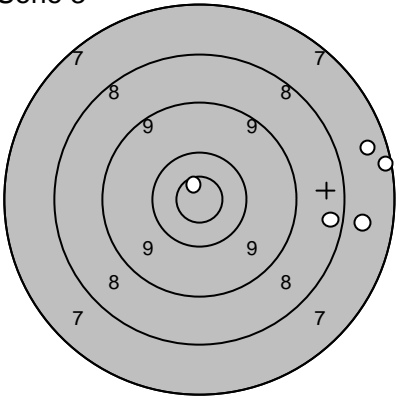
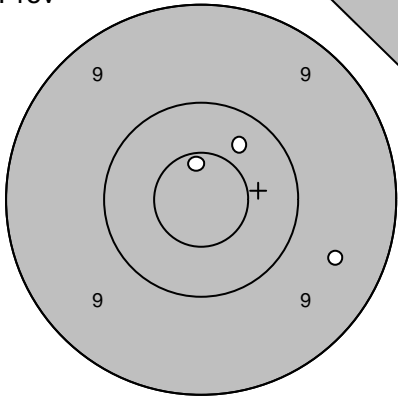
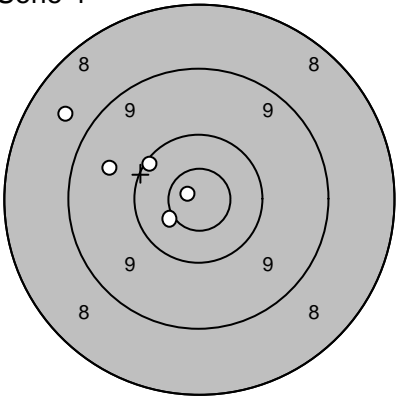
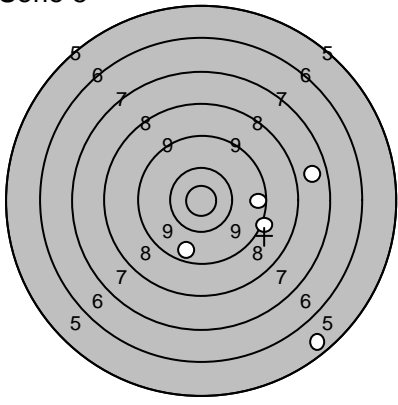
Skjutlag	Tavla	Bror Rantakyrö	
3	17		
Ramselefors	Övertorneå		
2006-07-07	Björkskottet 2006	Ramselefors Skytteförening	
Prov		1: 7,2 ↑ 2: 9,0 ↑ 3: 9,8 ↑ 4: 9,3 ↑ 5: 9,1 →	Serie 1 
		Serie 43,0 Totalt 0,0	1: 9,8 ↗ 2: 9,7 ↗ 3: 8,4 ↖ 4: 8,8 → 5: 9,7 ↗
		Serie 43,0 Totalt 43,0	Serie 43,0 Totalt 43,0
Serie 2		1: 9,9 → 2: 8,9 → 3: 7,2 ↘ 4: 9,6 → 5: 8,9 ↓	Serie 3 
		Serie 41,0 Totalt 84,0	1: 10,8* ↑ 2: 7,7 → 3: 7,5 → 4: 8,4 → 5: 7,2 →
		Serie 39,0 Totalt 123,0	Serie 39,0 Totalt 123,0
Prov		1: 9,5 → 2: 10,4 ↗ 3: 10,7* ↑	Serie 4 
		Serie 29,0 Totalt 123,0	1: 8,6 ↖ 2: 10,5* ↙ 3: 10,9* ↖ 4: 9,6 ↖ 5: 10,2 ↗
		Serie 47,0 Totalt 170,0	Serie 47,0 Totalt 170,0
Serie 5		1: 9,6 ↓ 2: 9,4 → 3: 9,1 → 4: 7,7 → 5: 5,6 ↘	
		Serie 39,0 Totalt 209,0	
		Serie 39,0 Totalt 209,0	

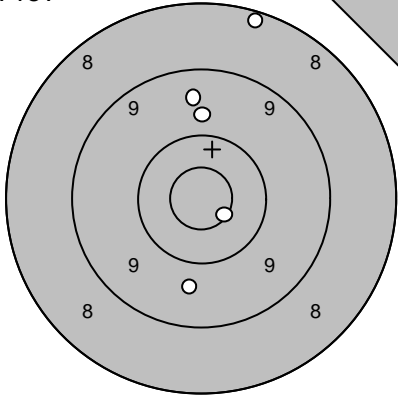
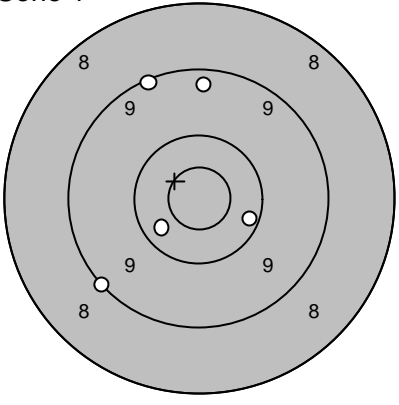
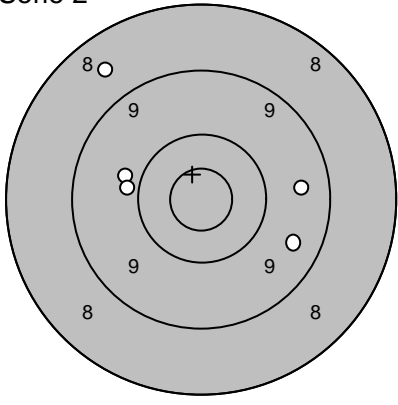
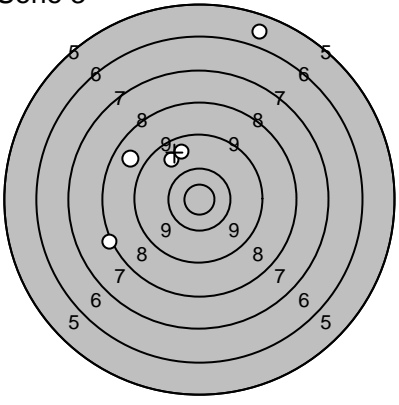
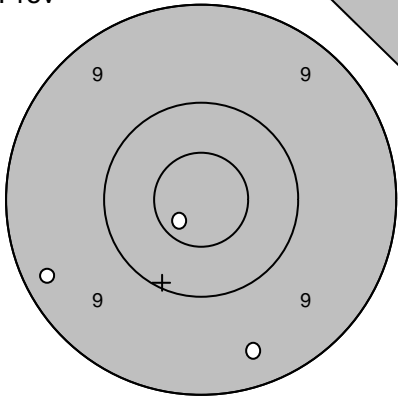
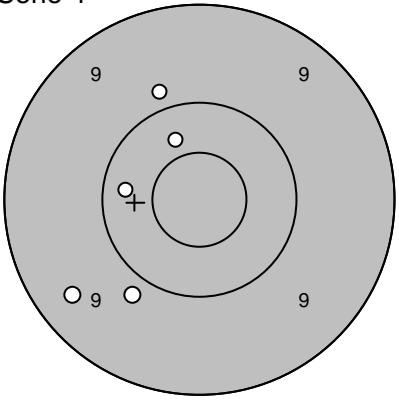
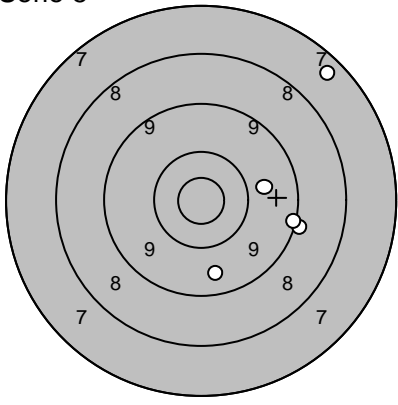
Skjutlag	Tavla	Nisse Ström	
3	18		
Ramselefors	Övertorneå		
2006-07-07	Björkskottet 2006	Ramselefors Skytteförening	
Prov		1: 9,8 ↑ 2: 8,2 ↑ 3: 9,7 ↓ 4: 10,6* ↘ 5: 9,5 ↑	Serie 1 
		Serie 47,0 Totalt 0,0	1: 9,4 ↑ 2: 9,1 ↗ 3: 9,1 ↘ 4: 10,2 → 5: 10,3 ↙
		Serie 45,0 Totalt 0,0	Serie 47,0 Totalt 47,0
Serie 2		1: 9,5 → 2: 9,5 → 3: 9,9 ↖ 4: 8,6 ↗ 5: 9,9 ←	Serie 3 
		Serie 44,0 Totalt 91,0	1: 8,8 ↖ 2: 9,7 ↗ 3: 9,7 ↗ 4: 5,8 ↗ 5: 8,2 ↖
		Serie 44,0 Totalt 91,0	Serie 39,0 Totalt 130,0
Prov		1: 9,4 ↓ 2: 10,7* ↘ 3: 9,3 ←	Serie 4 
		Serie 28,0 Totalt 130,0	1: 9,9 ↑ 2: 10,4 ↑ 3: 10,3 ← 4: 9,9 ↘ 5: 9,4 ↙
		Serie 28,0 Totalt 130,0	Serie 47,0 Totalt 177,0
Serie 5		1: 9,6 ↓ 2: 9,0 → 3: 9,2 → 4: 7,4 ↗ 5: 9,8 →	
		Serie 43,0 Totalt 220,0	
		Serie 43,0 Totalt 220,0	

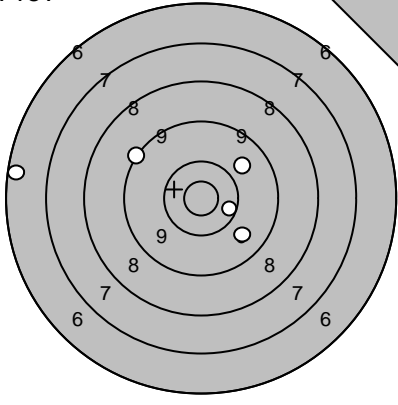
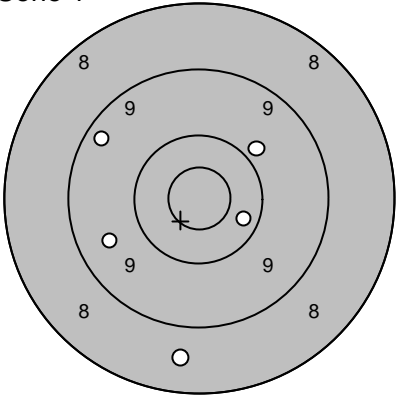
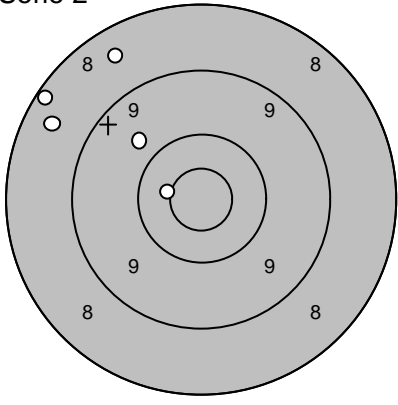
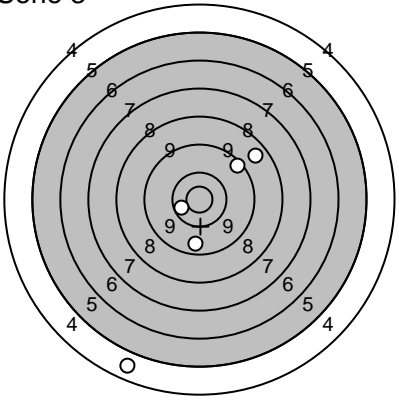
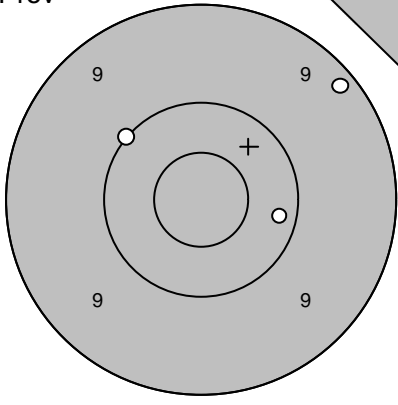
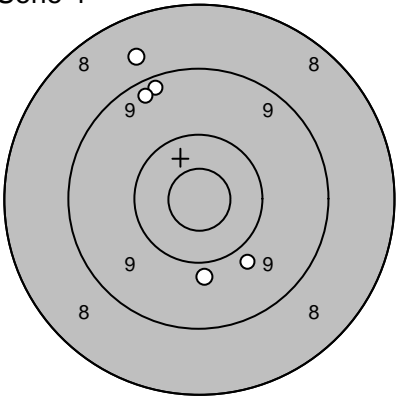
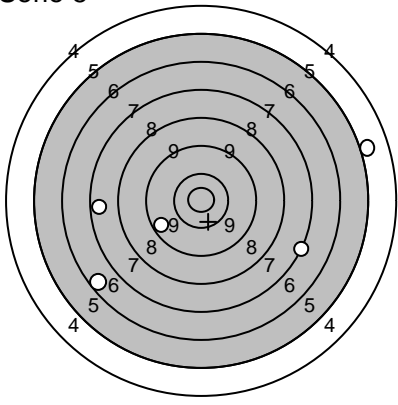
Skjutlag 3	Tavla 19	Ove Lövgren	
Ramselefors		Övertorneå	
2006-07-07		Björkskottet 2006	Ramselefors Skytteförening
Prov 	1: 6,4 ← 2: 9,8 ↗ 3: 9,8 ↘ 4: 9,2 ↗ 5: 10,4 ↘ Serie 43,0 Totalt 0,0	Serie 1 	1: 9,6 ← 2: 9,9 ↗ 3: 10,3 ↘ 4: 9,3 ↗ 5: 8,6 ↓ Serie 45,0 Totalt 45,0
Serie 2 	1: 8,5 ← 2: 10,5* ← 3: 9,8 ↗ 4: 8,2 ↗ 5: 8,5 ↗ Serie 43,0 Totalt 88,0	Serie 3 	1: 9,4 ↗ 2: 10,6* ← 3: 8,7 ↗ 4: 4,8 ↓ 5: 9,7 ↓ Serie 40,0 Totalt 128,0
Prov 	1: 9,2 ↗ 2: 10,2 → 3: 10,0 ↗ Serie 29,0 Totalt 128,0	Serie 4 	1: 9,3 ↗ 2: 9,3 ↗ 3: 8,7 ↗ 4: 9,9 ↓ 5: 9,9 ↓ Serie 44,0 Totalt 172,0
Serie 5 	1: 7,6 ← 2: 7,3 → 3: 9,6 ← 4: 5,0 → 5: 6,6 ← Serie 34,0 Totalt 206,0		

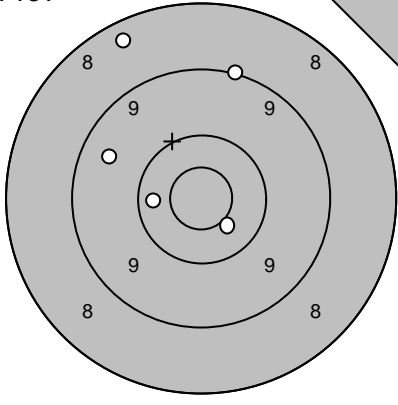
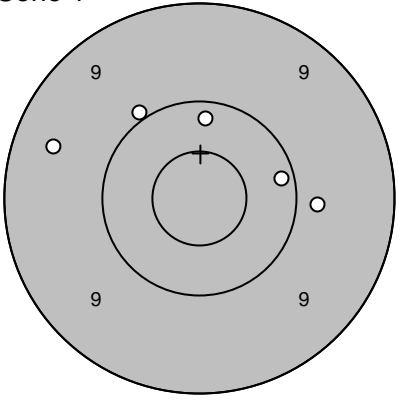
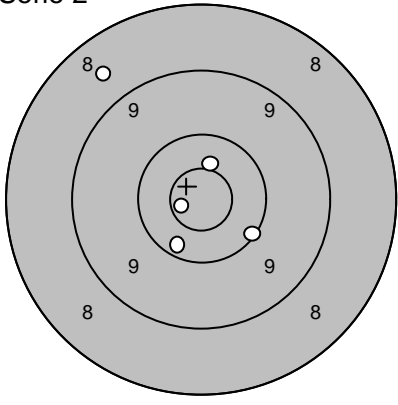
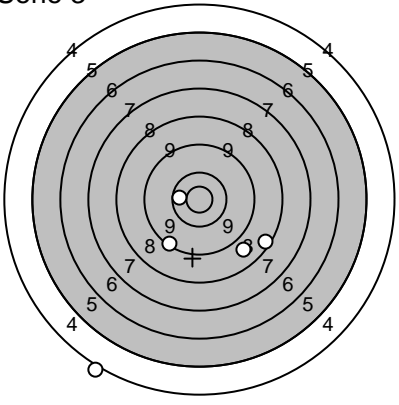
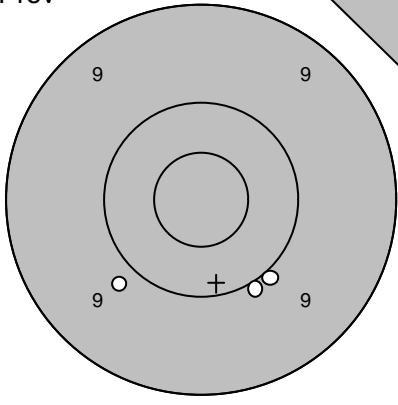
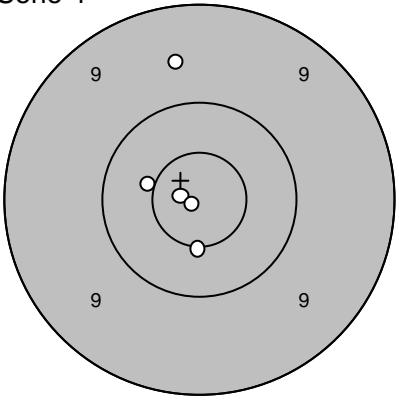
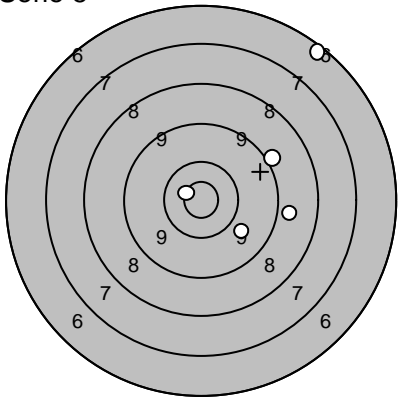
Skjutlag	Tavla	Rune Utterström		
3	20			
Ramselefors	Ale			
2006-07-07	Björkskottet 2006	Ramselefors Skytteförening		
Prov		1: 8,4 ↗ 2: 9,1 ↑ 3: 10,3 ← 4: 9,5 ↗ 5: 10,5* ↘	Serie 1 	1: 9,8 → 2: 10,2 → 3: 10,2 ↑ 4: 10,0 ↗ 5: 9,5 ↖
		Serie 46,0 Totalt 0,0		Serie 48,0 Totalt 48,0
Serie 2		1: 10,8* ← 2: 10,5* ↑ 3: 10,1 ↘ 4: 8,6 ↗ 5: 10,3 ↘	Serie 3 	1: 8,8 ↘ 2: 9,3 ↘ 3: 8,4 ↘ 4: 4,1 ↘ 5: 10,5* ←
		Serie 48,0 Totalt 96,0		Serie 39,0 Totalt 135,0
Prov		1: 10,0 ↘ 2: 10,0 ↘ 3: 9,8 ↘	Serie 4 	1: 9,6 ↑ 2: 10,5* ← 3: 10,5* ↓ 4: 10,8* ← 5: 10,9* ↖
		Serie 29,0 Totalt 135,0		Serie 49,0 Totalt 184,0
Serie 5		1: 6,4 ↗ 2: 9,9 ↘ 3: 8,9 → 4: 10,8* ↗ 5: 9,0 ↗		
		Serie 42,0 Totalt 226,0		

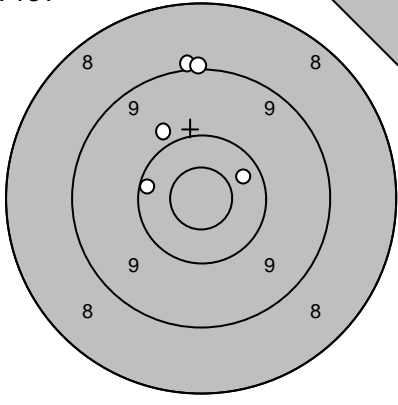
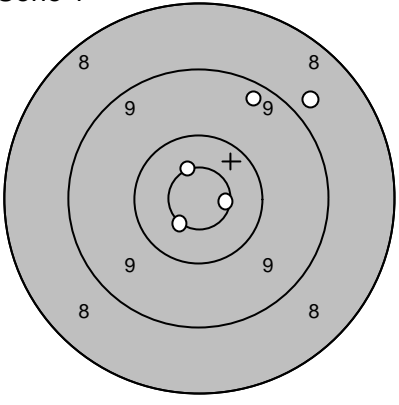
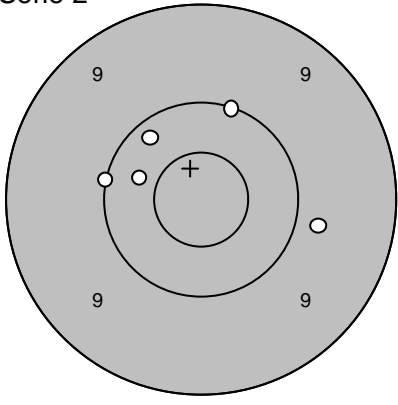
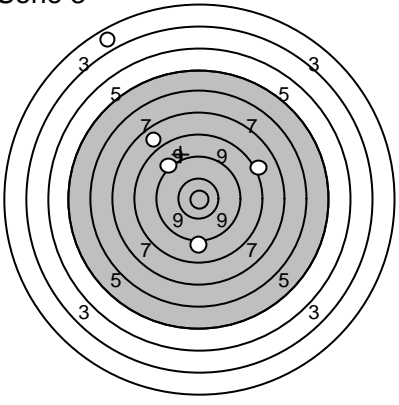
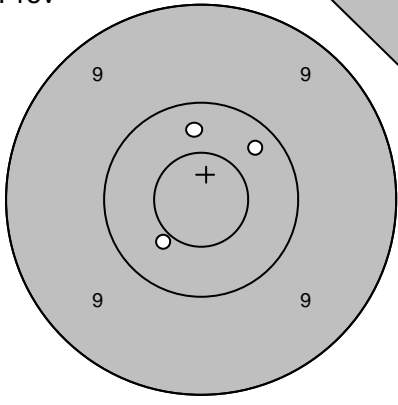
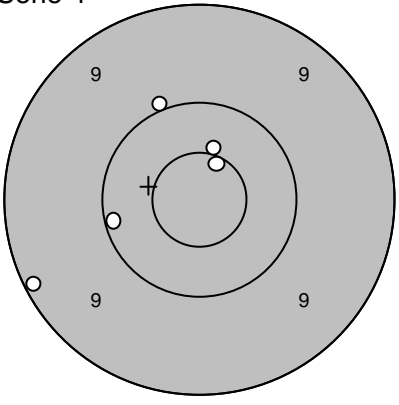
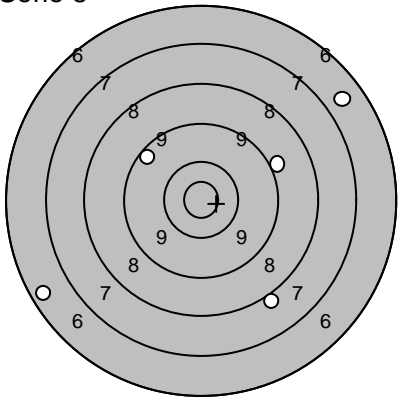
Skjutlag	Tavla	Roland Nilsson	
3	21		
Ramselefors	Piteå		
2006-07-07	Björkskottet 2006	Ramselefors Skytteförening	
Prov		1: 9,9 ↖ 2: 9,0 ↑ 3: 10,3 → 4: 9,0 ↑ 5: 10,2 ←	Serie 1 
	Serie 47,0 Totalt 0,0	1: 10,7* → 2: 10,6* ↖ 3: 9,3 ↗ 4: 8,8 ↗ 5: 10,6* ↘	Serie 47,0 Totalt 47,0
Serie 2		1: 10,1 ↑ 2: 10,2 ↗ 3: 10,0 ← 4: 9,8 → 5: 10,4 ←	Serie 3 
	Serie 49,0 Totalt 96,0	1: 8,2 → 2: 7,9 ↖ 3: 9,2 ↗ 4: 2,9 ↗ 5: 9,2 ↓	Serie 35,0 Totalt 131,0
Prov		1: 10,3 ↑ 2: 10,3 ↗ 3: 10,4 ↘	Serie 4 
	Serie 30,0 Totalt 131,0	1: 10,6* ↗ 2: 10,1 ← 3: 9,1 ← 4: 10,5* ↑ 5: 10,0 ↖	Serie 49,0 Totalt 180,0
Serie 5		1: 9,4 ↖ 2: 9,0 → 3: 6,7 → 4: 6,5 ← 5: 8,0 ↘	
	Serie 38,0 Totalt 218,0		

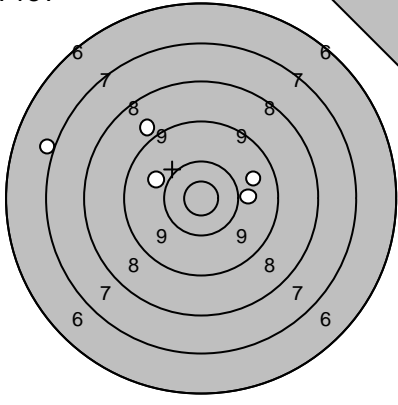
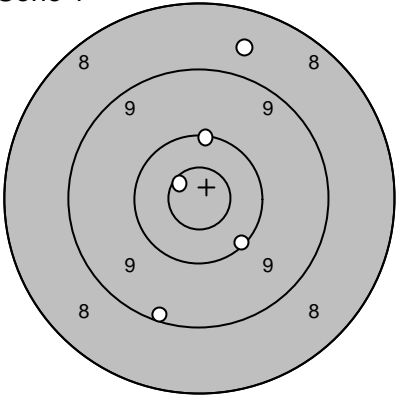
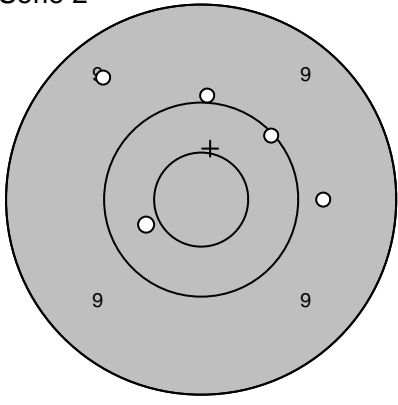
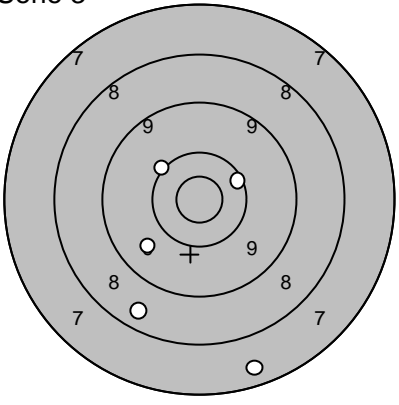
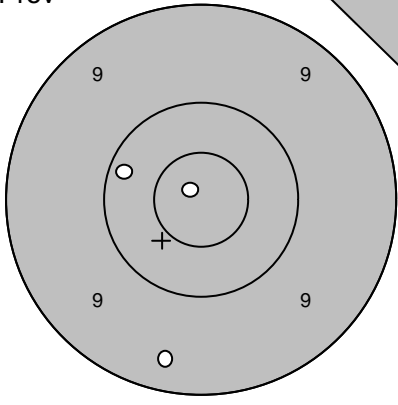
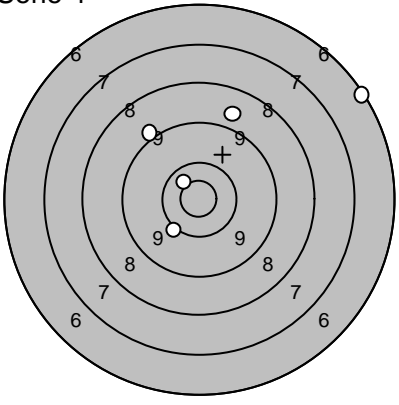
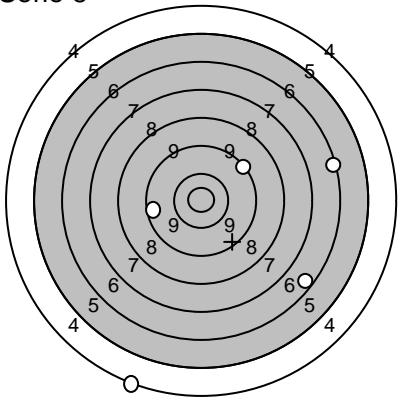
Skjutlag	Tavla	Dennis Sundqvist			
3	22				
Ramselefors	Piteå				
2006-07-07	Björkskottet 2006	Ramselefors Skytteförening			
Prov		1: 7,0 ← 2: 8,9 ↗ 3: 9,7 → 4: 9,9 → 5: 9,9 ↖	Serie 1 	1: 9,2 ↓ 2: 10,1 ↘ 3: 10,7* ↖ 4: 8,7 ↑ 5: 10,1 ↑	
		Serie 42,0		Serie 47,0	
		Totalt 0,0		Totalt 47,0	
Serie 2		1: 9,4 ↖ 2: 10,4 ← 3: 9,8 → 4: 10,0 ↑ 5: 10,1 ↗	Serie 3		1: 10,1 ↖ 2: 9,7 ↙ 3: 10,3 → 4: 8,5 ↓ 5: 7,5 ↓
		Serie 48,0		Serie 44,0	
		Totalt 95,0		Totalt 139,0	
Prov		1: 10,2 ← 2: 9,4 ↓ 3: 10,9* ↖	Serie 4		1: 10,6* ↖ 2: 10,1 ↓ 3: 9,1 ↖ 4: 8,8 ↑ 5: 6,2 ↗
		Serie 29,0		Serie 43,0	
		Totalt 139,0		Totalt 182,0	
Serie 5		1: 9,3 ↗ 2: 9,5 ← 3: 6,4 → 4: 4,2 ↓ 5: 6,5 ↘			
		Serie 34,0			
		Totalt 216,0			

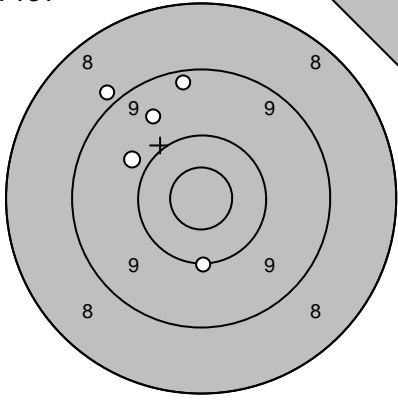
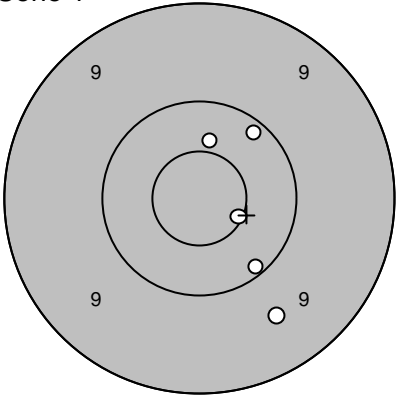
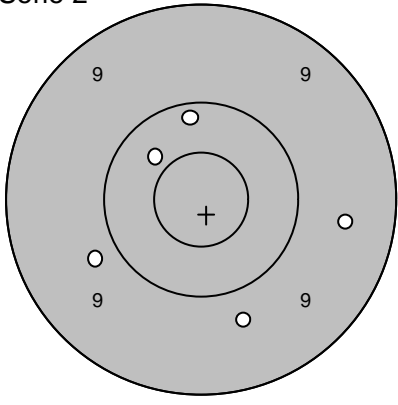
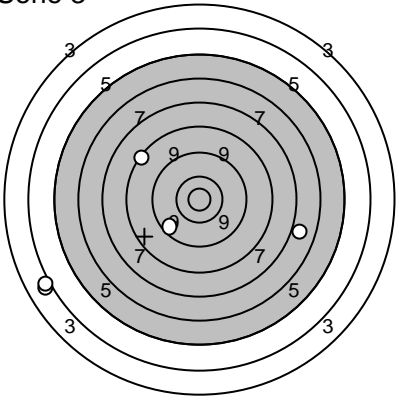
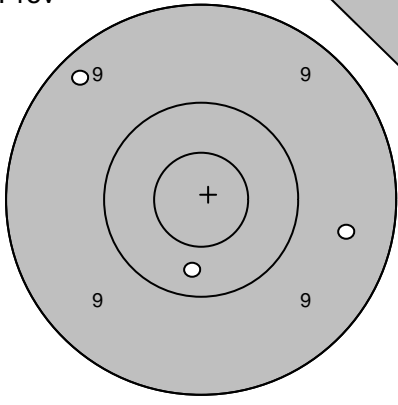
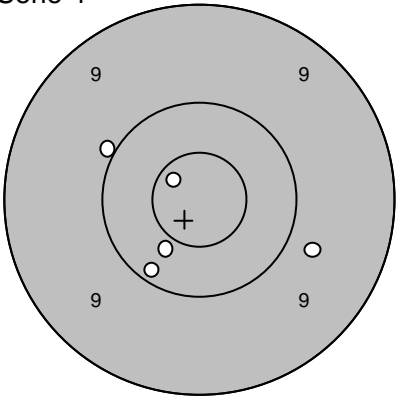
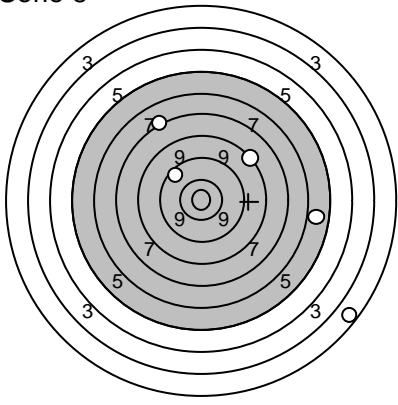
Skjutlag	Tavla	3 23 Sture Grahn		
Ramselefors	Piteå			
2006-07-07	Björkskottet 2006	Ramselefors Skytteförening		
Prov		1: 9,9 ↖ 2: 9,3 ↑ 3: 10,0 ↓ 4: 8,9 ↗ 5: 9,6 ↗	Serie 1 	1: 9,6 ↓ 2: 10,6* → 3: 10,1 ↓ 4: 10,2 ↗ 5: 10,4 ↑
		Serie 45,0 Totalt 0,0		Serie 49,0 Totalt 49,0
Serie 2		1: 10,2 ↑ 2: 9,7 ↓ 3: 9,5 → 4: 10,4 ↗ 5: 9,8 ↙	Serie 3 	1: 7,0 → 2: 9,7 ↙ 3: 8,4 ↗ 4: 4,1 ← 5: 4,2 ↙
		Serie 47,0 Totalt 96,0		Serie 32,0 Totalt 128,0
Prov		1: 10,3 ↓ 2: 9,5 → 3: 9,3 ↗	Serie 4 	1: 9,8 → 2: 10,7* ↗ 3: 10,4 ↓ 4: 10,0 ↗ 5: 10,2 ↓
		Serie 28,0 Totalt 128,0		Serie 49,0 Totalt 177,0
Serie 5		1: 7,3 ↗ 2: 8,4 ↗ 3: 9,7 ↗ 4: 2,7 ↓ 5: 6,0 →		
		Serie 32,0 Totalt 209,0		

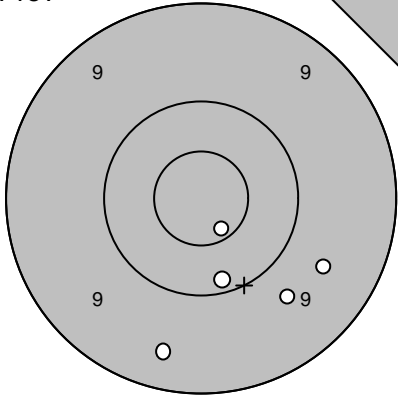
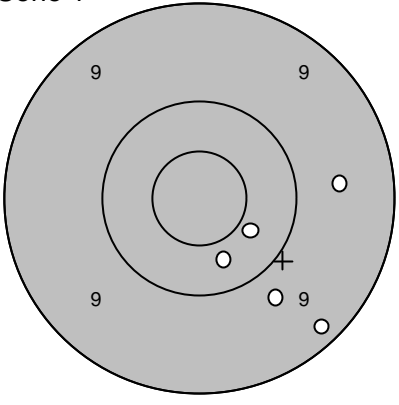
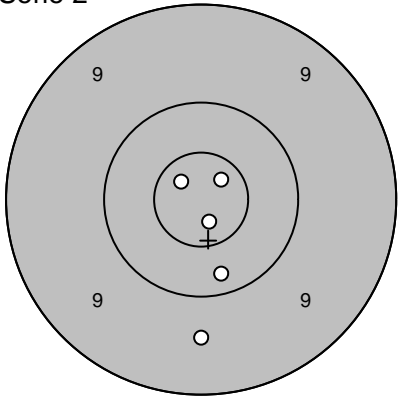
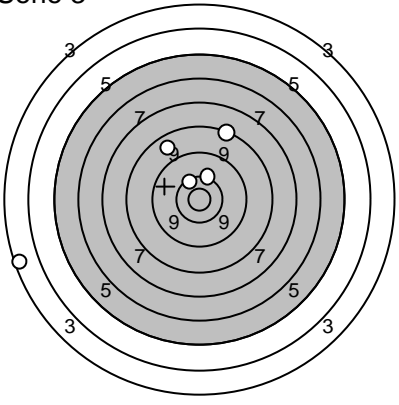
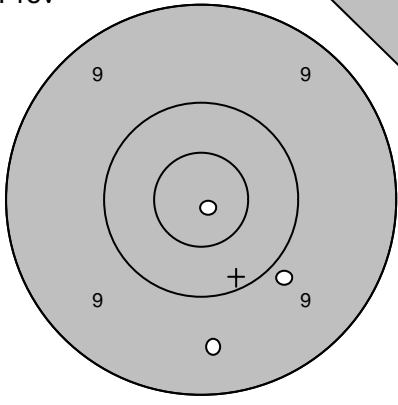
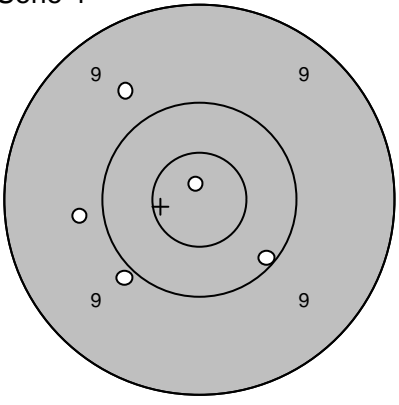
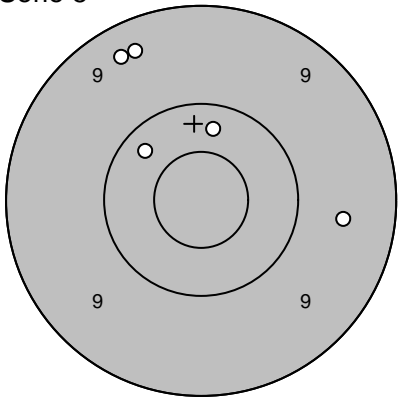
Skjutlag	Tavla	Linda Bergman	
3	24		
Ramselefors	Ununge		
2006-07-07	Björkskottet 2006	Ramselefors Skytteförening	
Prov		1: 9,4 ↘ 2: 10,2 ↘ 3: 10,7* ↘ 4: 9,7 ↘ 5: 9,6 ↘	Serie 1 
	Serie 47,0 Totalt 0,0	1: 9,6 → 2: 9,7 ↘ 3: 9,2 ↘ 4: 10,4 ↘ 5: 10,4 ↘	Serie 47,0 Totalt 47,0
Serie 2		1: 10,8* ↖ 2: 9,6 ↘ 3: 10,7* ↗ 4: 10,8* ↘ 5: 10,2 ↘	Serie 3 
	Serie 49,0 Totalt 96,0	1: 8,4 ↑ 2: 10,3 ↑ 3: 10,5* ↗ 4: 8,9 ↗ 5: 3,5 ←	Serie 39,0 Totalt 135,0
Prov		1: 10,9* ↘ 2: 9,9 ↘ 3: 9,5 ↘	Serie 4 
	Serie 28,0 Totalt 135,0	1: 9,7 ↖ 2: 9,9 ↘ 3: 10,1 ↘ 4: 9,8 ← 5: 10,9* ↑	Serie 47,0 Totalt 182,0
Serie 5		1: 10,3 ↗ 2: 10,3 ↑ 3: 9,6 → 4: 9,4 ↗ 5: 9,4 ↗	
	Serie 47,0 Totalt 229,0		

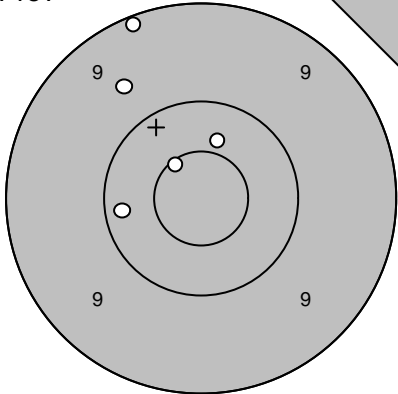
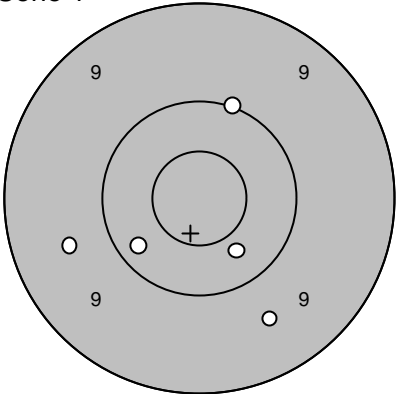
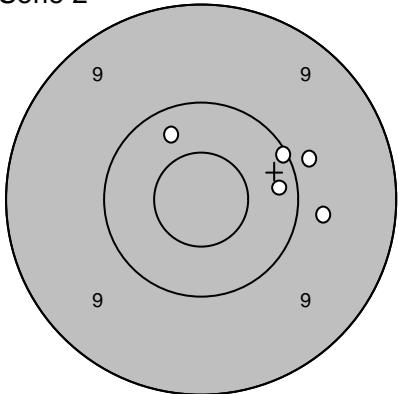
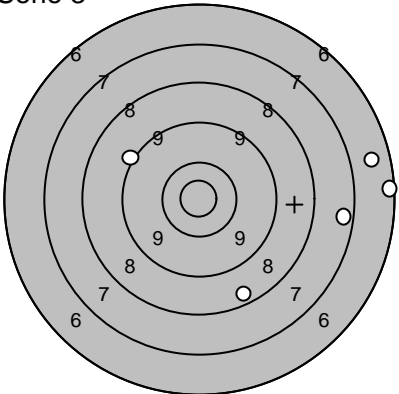
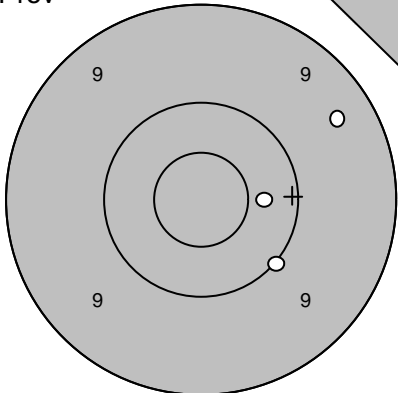
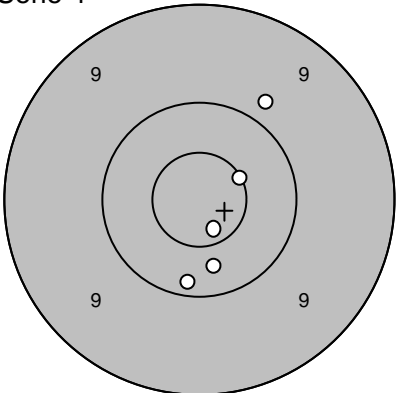
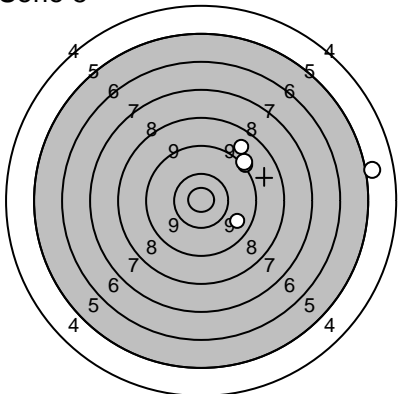
Skjutlag 4	Tavla 1	Helena Arvidsson	
Ramselefors		Moälven-Modo	
2006-07-07		Björkskottet 2006	Ramselefors Skytteförening
Prov 	1: 10,2 ← 2: 10,6* ↗ 3: 9,7 ↗ 4: 10,4 ↑ 5: 9,1 ↗	Serie 1 	1: 9,6 ← 2: 10,3 ↘ 3: 10,0 ↑ 4: 9,6 ↘ 5: 10,4 ↘
	Serie 48,0 Totalt 0,0		Serie 48,0 Totalt 48,0
Serie 2 	1: 10,3 ↗ 2: 10,1 ↗ 3: 10,2 → 4: 9,9 → 5: 9,8 →	Serie 3 	1: 8,5 ↘ 2: 7,5 → 3: 6,6 → 4: 6,3 → 5: 9,1 ↗
	Serie 48,0 Totalt 96,0		Serie 36,0 Totalt 132,0
Prov 	1: 9,4 ↗ 2: 10,4 → 3: 10,0 ↘	Serie 4 	1: 10,3 ↘ 2: 10,2 ↘ 3: 9,8 ↑ 4: 10,6* ↗ 5: 10,7* ↘
	Serie 29,0 Totalt 132,0		Serie 49,0 Totalt 181,0
Serie 5 	1: 9,2 ↗ 2: 5,0 → 3: 9,2 ↗ 4: 8,9 ↗ 5: 9,7 ↘		
	Serie 40,0 Totalt 221,0		

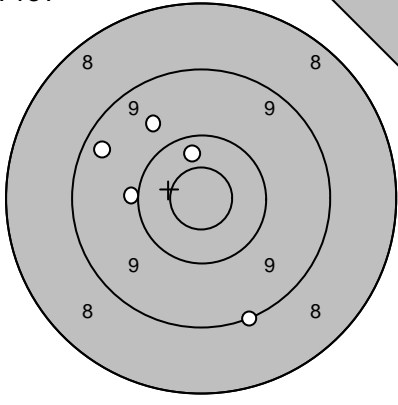
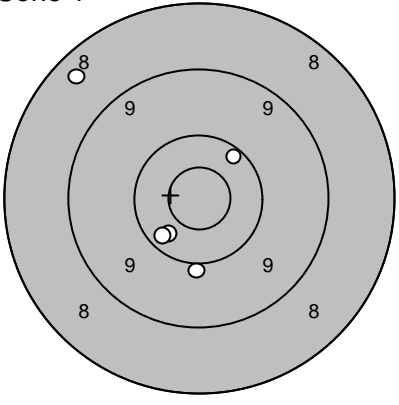
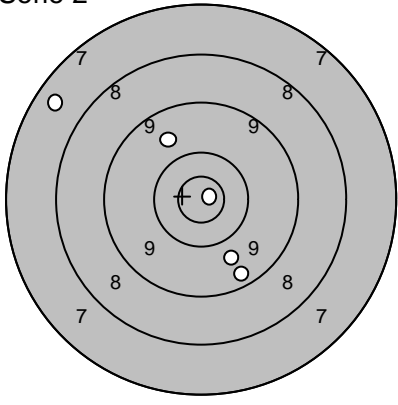
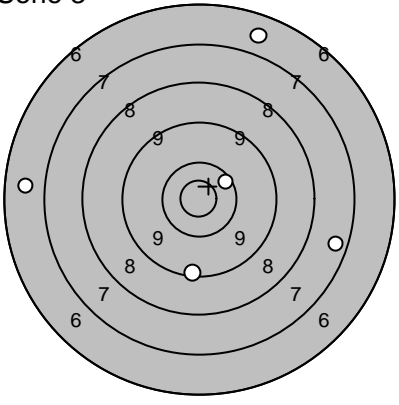
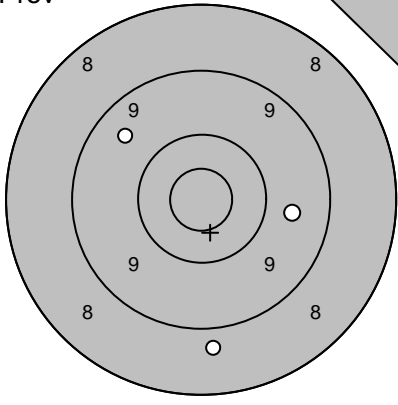
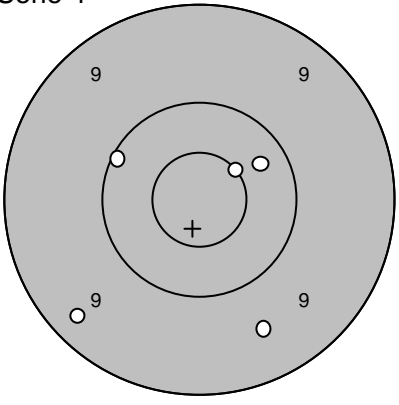
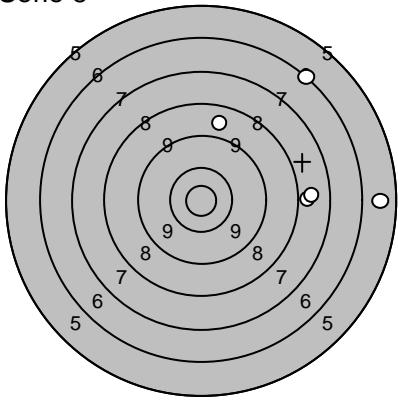
Skjutlag 4	Tavla 2	Tommy Åkerström	
Ramselefors		Niemisel	
2006-07-07		Björkskottet 2006	Ramselefors Skytteförening
Prov 	1: 10,4 ↑ 2: 10,0 ← 3: 9,7 ↗ 4: 9,1 ↓ 5: 9,4 ↖	Serie 1 	1: 10,0 ↓ 2: 10,4 ↙ 3: 8,4 ↗ 4: 10,3 ↙ 5: 10,3 ↗
	Serie 47,0 Totalt 0,0		Serie 48,0 Totalt 48,0
Serie 2 	1: 9,4 ↓ 2: 10,9* → 3: 9,8 ↓ 4: 7,5 ↗ 5: 9,7 ↗	Serie 3 	1: 6,7 ↑ 2: 9,3 ↓ 3: 10,3 ↗ 4: 7,5 → 5: 6,7 ←
	Serie 44,0 Totalt 92,0		Serie 38,0 Totalt 130,0
Prov 	1: 9,7 → 2: 9,6 ↗ 3: 8,8 ↓	Serie 4 	1: 9,6 ↓ 2: 9,3 ↙ 3: 10,6* ↗ 4: 10,1 ↖ 5: 10,3 ↗
	Serie 26,0 Totalt 130,0		Serie 48,0 Totalt 178,0
Serie 5 	1: 7,9 → 2: 6,2 ↗ 3: 8,8 ↑ 4: 7,8 → 5: 5,7 →		
	Serie 33,0 Totalt 211,0		

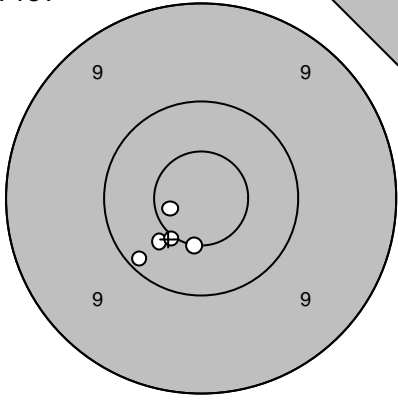
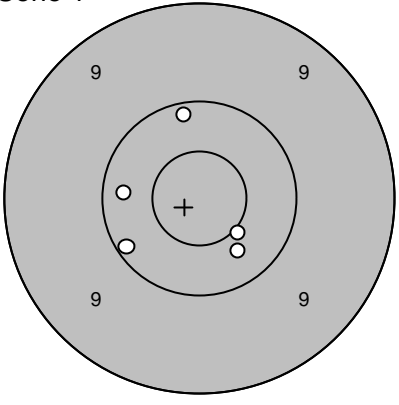
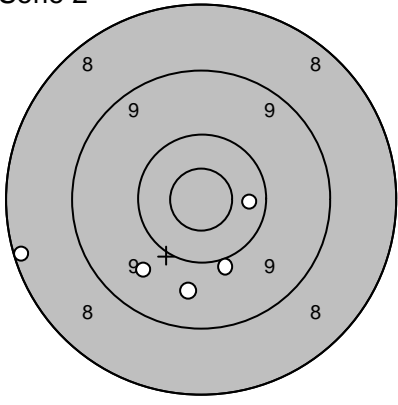
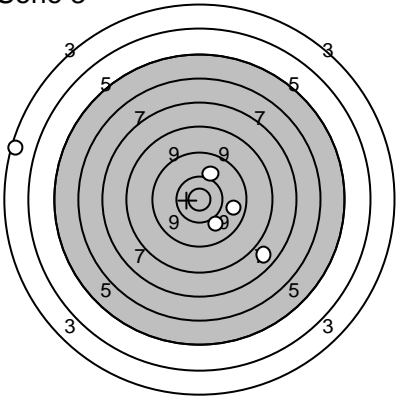
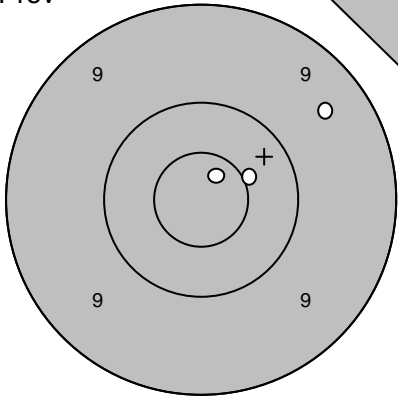
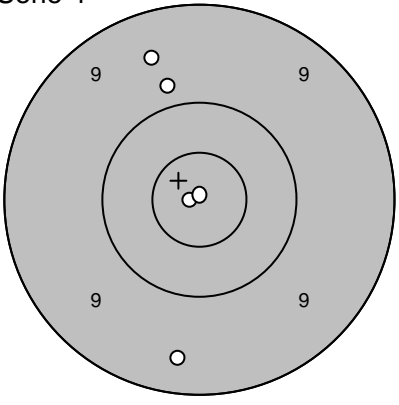
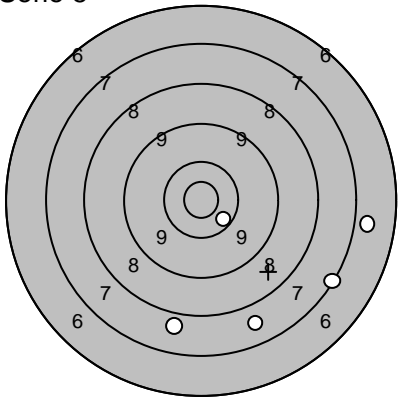
Skjutlag 4	Tavla 3	Lennart Jacobsson	
Ramselefors		Ramselefors	
2006-07-07		Björkskottet 2006	Ramselefors Skytteförening
Prov 	1: 10,1 ↙ 2: 10,7* ← 3: 10,4 ↙ 4: 10,5* ↓ 5: 10,5* ↙ Serie 50,0 Totalt 0,0	Serie 1 	1: 10,2 ↑ 2: 10,3 ← 3: 10,1 ↙ 4: 10,5* ↘ 5: 10,4 ↘ Serie 50,0 Totalt 50,0
Serie 2 	1: 10,0 ↓ 2: 9,7 ↘ 3: 9,7 ↓ 4: 8,2 ← 5: 10,3 → Serie 46,0 Totalt 96,0	Serie 3 	1: 7,8 ↘ 2: 9,8 → 3: 10,1 ↑ 4: 3,5 ← 5: 10,1 ↓ Serie 39,0 Totalt 135,0
Prov 	1: 9,5 ↗ 2: 10,7* ↗ 3: 10,5* ↗ Serie 29,0 Totalt 135,0	Serie 4 	1: 9,5 ↑ 2: 9,8 ↑ 3: 10,9* ← 4: 9,4 ↓ 5: 10,9* ↑ Serie 47,0 Totalt 182,0
Serie 5 	1: 10,4 → 2: 7,9 ↓ 3: 7,2 → 4: 7,7 ↓ 5: 6,9 → Serie 37,0 Totalt 219,0		

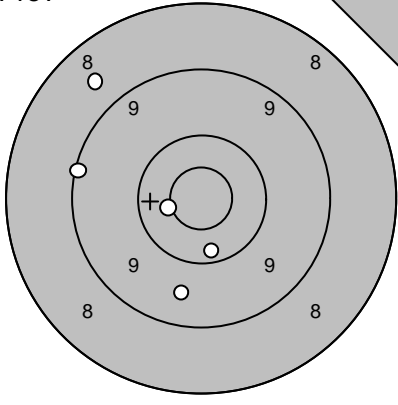
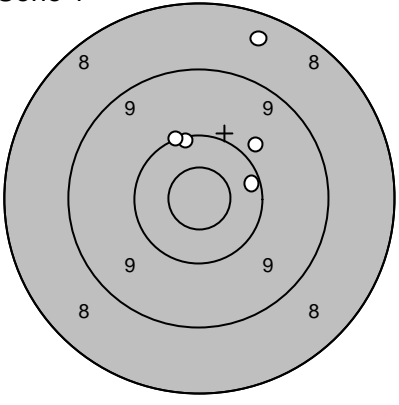
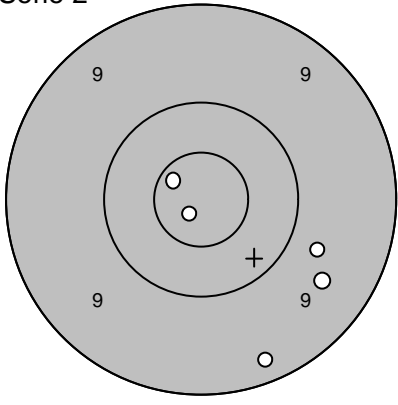
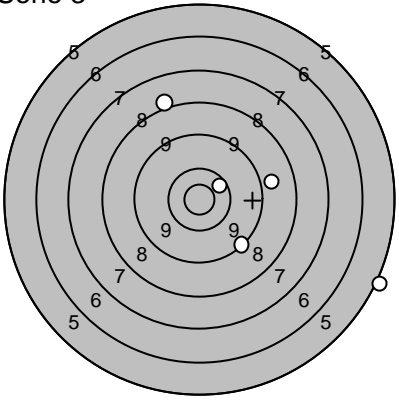
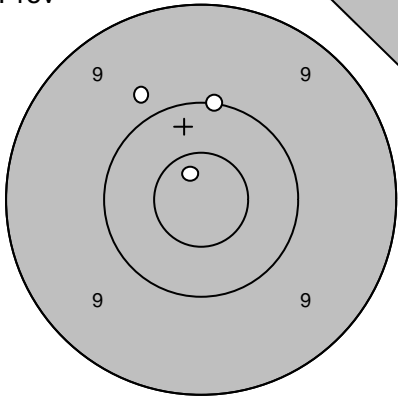
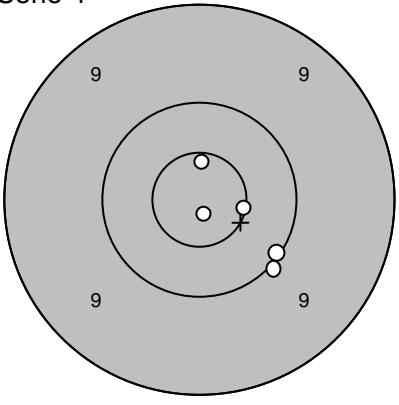
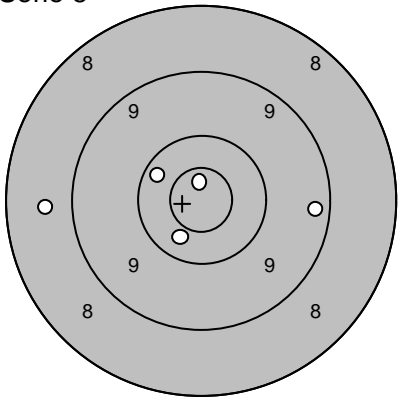
Skjutlag 4	Tavla 4	Stefan Sigfridsson	
Ramselefors		Ramselefors	
2006-07-07		Björkskottet 2006	Ramselefors Skytteförening
Prov 	1: 8,7 ↗ 2: 10,3 ↓ 3: 9,2 ← 4: 9,6 ↓ 5: 10,6* ←	Serie 1 	1: 8,5 ↑ 2: 9,9 ↗ 3: 10,2 ↑ 4: 10,2 → 5: 10,1 ↑
	Serie 46,0 Totalt 0,0		Serie 47,0 Totalt 47,0
Serie 2 	1: 9,7 → 2: 10,8* ↓ 3: 9,3 ↓ 4: 10,7* ↗ 5: 9,5 ↓	Serie 3 	1: 10,5* ↗ 2: 8,9 → 3: 8,1 ↑ 4: 9,3 ↓ 5: 5,1 ↓
	Serie 47,0 Totalt 94,0		Serie 40,0 Totalt 134,0
Prov 	1: 10,0 ↑ 2: 9,8 ↗ 3: 10,8* ↑	Serie 4 	1: 10,7* ↑ 2: 10,6* → 3: 10,9* ↓ 4: 10,1 ↓ 5: 10,0 ↓
	Serie 29,0 Totalt 134,0		Serie 50,0 Totalt 184,0
Serie 5 	1: 10,4 ↓ 2: 9,3 → 3: 10,3 ↗ 4: 10,8* ↑ 5: 8,7 ←		
	Serie 47,0 Totalt 231,0		

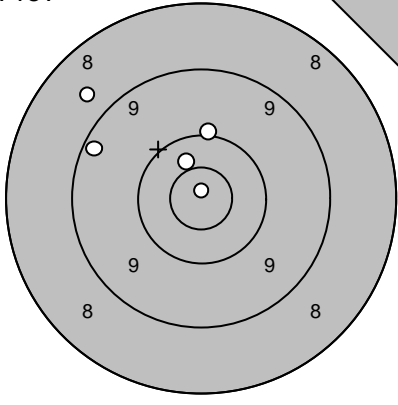
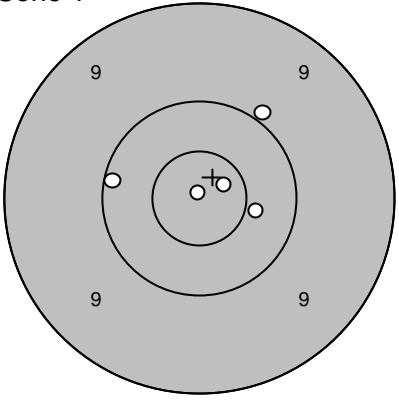
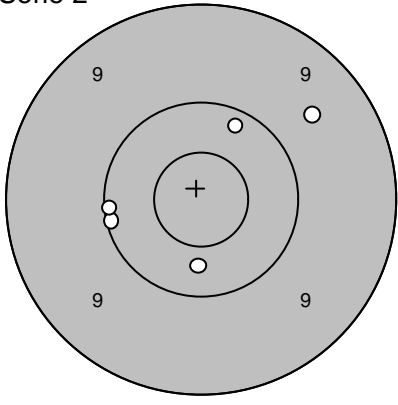
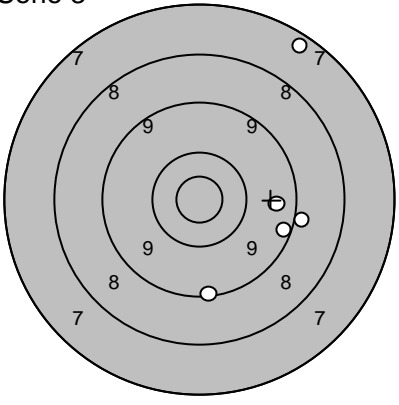
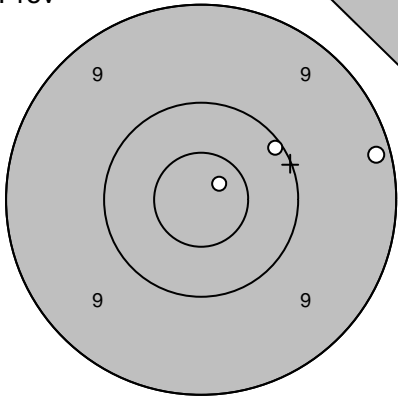
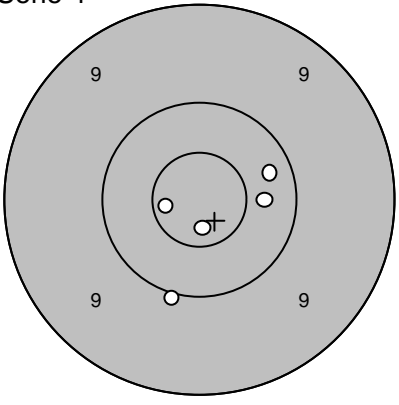
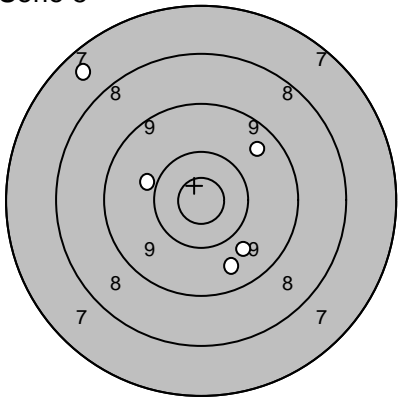
Skjutlag 4	Tavla 5	Sören Olsson		
Ramselefors		Umeå		
2006-07-07		Björkskottet 2006		Ramselefors Skytteförening
Prov 	1: 8,7 ↖ 2: 9,3 ↖ 3: 10,5* ↑ 4: 10,0 ↑ 5: 10,9* ↑	Serie 1 	1: 10,9* ↑ 2: 9,9 ↗ 3: 10,7* ↗ 4: 10,1 ← 5: 10,4 →	
	Serie 47,0 Totalt 0,0		Serie 49,0 Totalt 49,0	
Serie 2 	1: 10,1 ← 2: 10,1 ← 3: 10,4 ↓ 4: 10,2 ↑ 5: 9,6 ↗	Serie 3 	1: 9,2 ↓ 2: 9,0 → 3: 9,3 → 4: 7,4 ↗ 5: 9,5 →	
	Serie 49,0 Totalt 98,0		Serie 43,0 Totalt 141,0	
Prov 	1: 10,1 ↗ 2: 9,2 → 3: 10,8* ↗	Serie 4 	1: 10,7* ← 2: 10,7* ↓ 3: 10,0 ↓ 4: 10,4 → 5: 10,3 →	
	Serie 29,0 Totalt 141,0		Serie 50,0 Totalt 191,0	
Serie 5 	1: 9,8 ↓ 2: 9,6 ↗ 3: 10,0 ↖ 4: 7,6 ↗ 5: 9,6 ↓			
	Serie 44,0 Totalt 235,0			

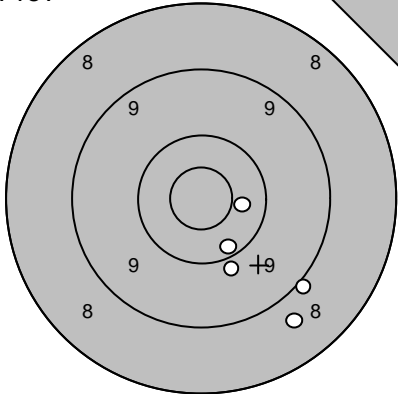
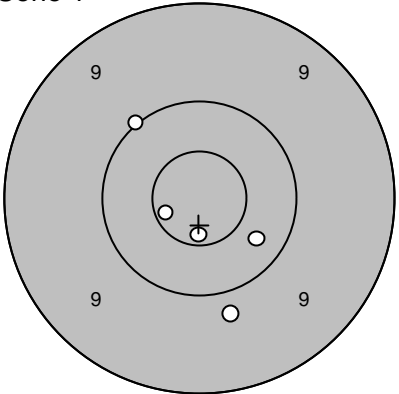
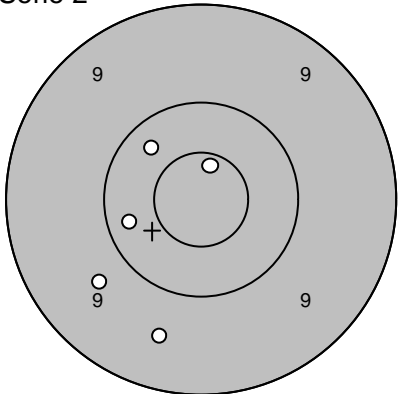
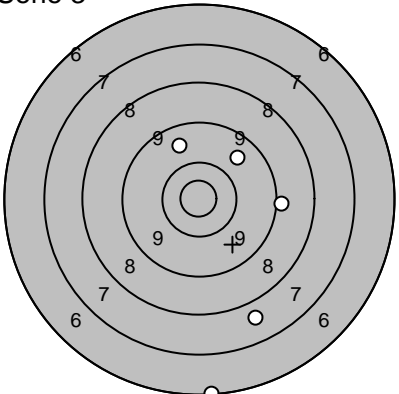
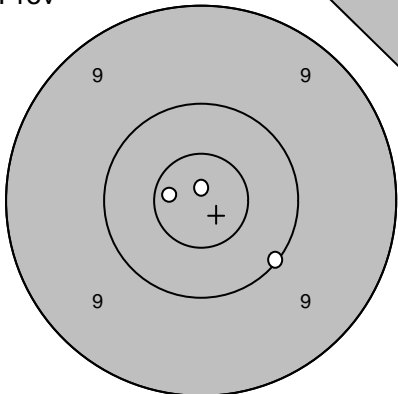
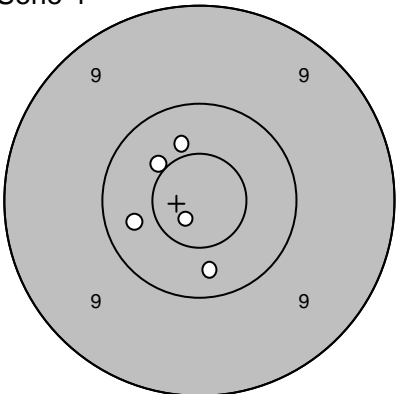
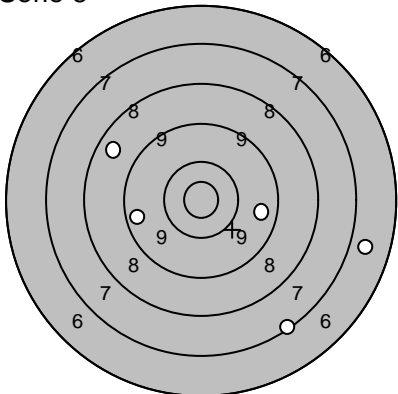
Skjutlag 4	Tavla 6	Curt Lejon	
Ramselefors		Umeå	
2006-07-07		Björkskottet 2006	Ramselefors Skytteförening
Prov 	1: 8,7 ↘ 2: 9,0 ↘ 3: 10,2 ↘ 4: 9,9 ↘ 5: 10,4 →	Serie 1 	1: 10,7* ↓ 2: 10,7* ← 3: 10,0 ↗ 4: 10,3 ↘ 5: 9,8 ↓
	Serie 46,0 Totalt 0,0		Serie 49,0 Totalt 49,0
Serie 2 	1: 10,3 ← 2: 10,7* ↑ 3: 10,3 ↗ 4: 9,7 ↘ 5: 9,6 ↓	Serie 3 	1: 9,7 ↗ 2: 7,8 ↓ 3: 9,0 → 4: 9,7 ↗ 5: 6,2 ↓
	Serie 48,0 Totalt 97,0		Serie 40,0 Totalt 137,0
Prov 	1: 10,9* ↑ 2: 10,7* ← 3: 10,1 ↘	Serie 4 	1: 10,3 ↓ 2: 10,8* ↘ 3: 10,4 ↑ 4: 10,5* ↗ 5: 10,3 ←
	Serie 30,0 Totalt 137,0		Serie 50,0 Totalt 187,0
Serie 5 	1: 9,5 ← 2: 9,6 → 3: 7,2 ↘ 4: 6,8 → 5: 8,6 ↗		
	Serie 39,0 Totalt 226,0		

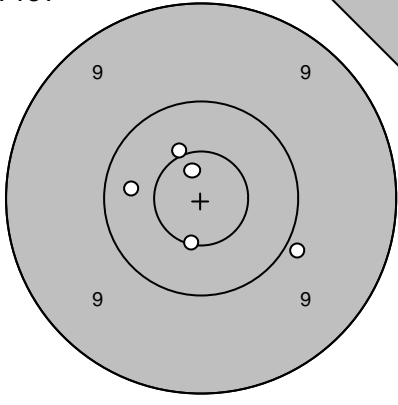
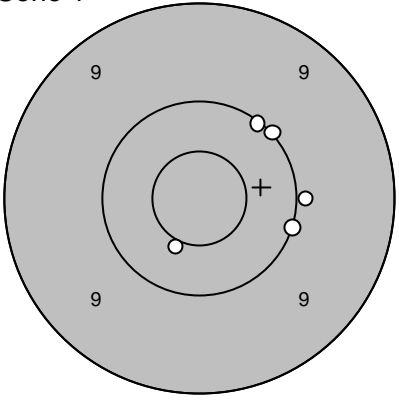
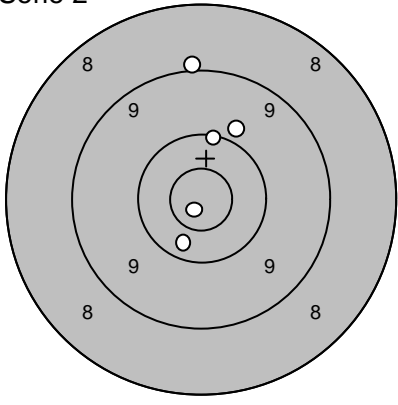
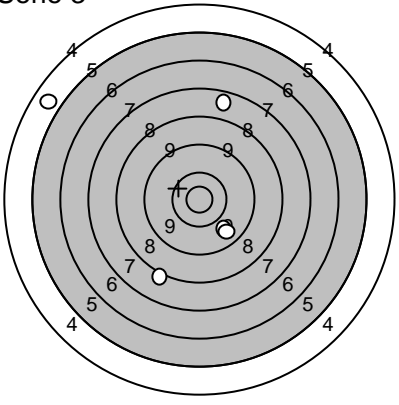
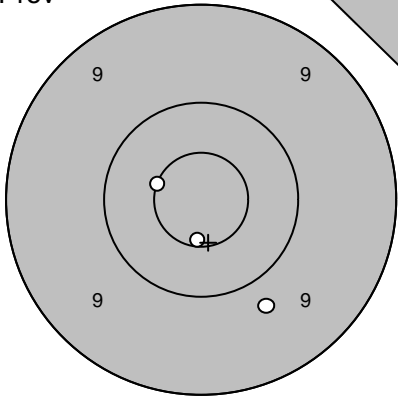
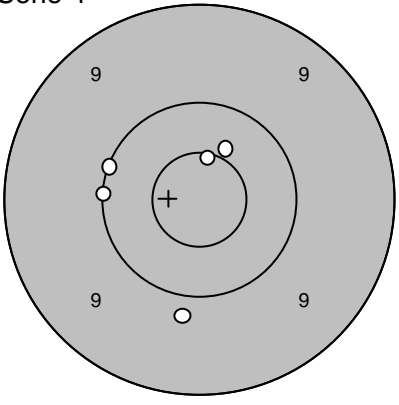
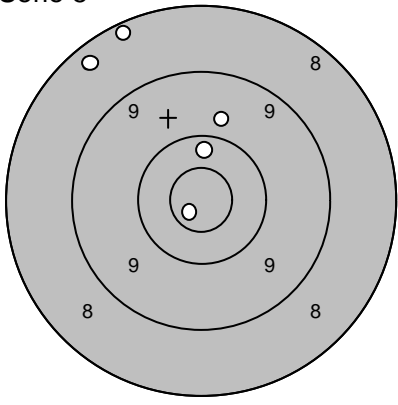
Skjutlag 4	Tavla 7	Jan Wallerström	
Ramselefors		Ununge	
2006-07-07		Björkskottet 2006	Ramselefors Skytteförening
Prov 	1: 9,9 ↘ 2: 10,6* ↓ 3: 10,7* ↑ 4: 10,3 ← 5: 10,5* ↗	Serie 1 	1: 10,5* ↓ 2: 10,1 ↗ 3: 10,0 → 4: 9,9 → 5: 10,0 ↗
	Serie 49,0 Totalt 0,0		Serie 49,0 Totalt 49,0
Serie 2 	1: 10,4 ↓ 2: 10,9* ↓ 3: 9,0 ↑ 4: 10,1 ↑ 5: 9,9 ↗	Serie 3 	1: 8,1 ↓ 2: 9,9 ↓ 3: 9,7 ↓ 4: 7,7 ↑ 5: 4,8 ↖
	Serie 48,0 Totalt 97,0		Serie 37,0 Totalt 134,0
Prov 	1: 10,6* ← 2: 9,8 ↓ 3: 10,6* ↓	Serie 4 	1: 10,6* ↑ 2: 9,8 ↓ 3: 10,1 ← 4: 10,1 ← 5: 10,5* ↗
	Serie 29,0 Totalt 134,0		Serie 49,0 Totalt 183,0
Serie 5 	1: 10,3 ↑ 2: 10,8* ↓ 3: 9,8 ↑ 4: 8,4 ↗ 5: 8,3 ↗		
	Serie 45,0 Totalt 228,0		

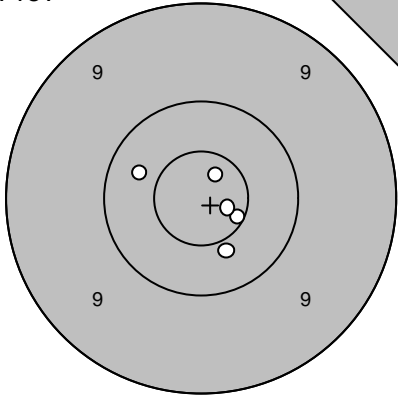
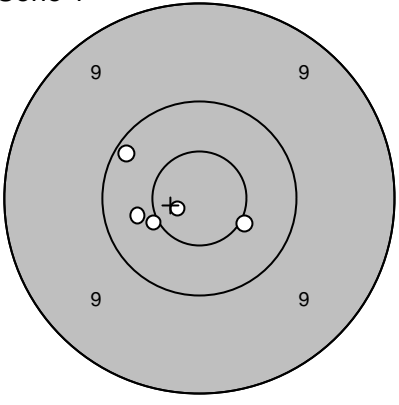
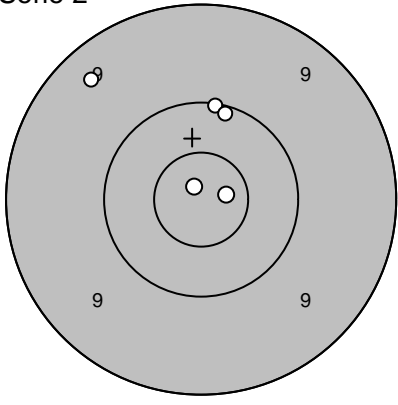
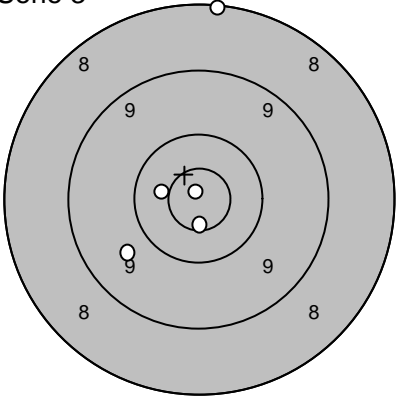
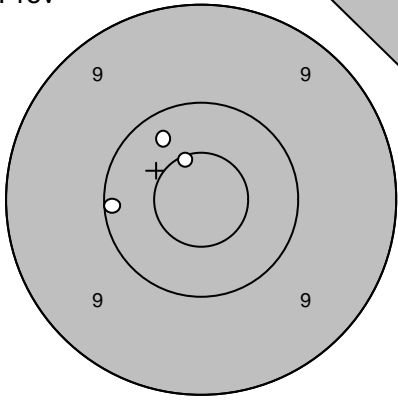
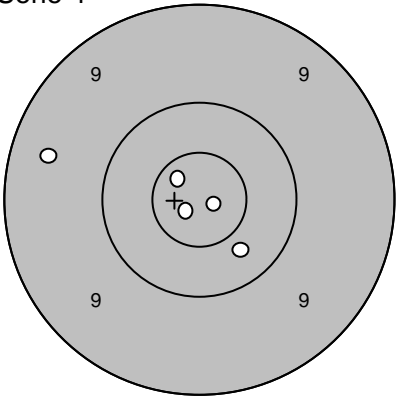
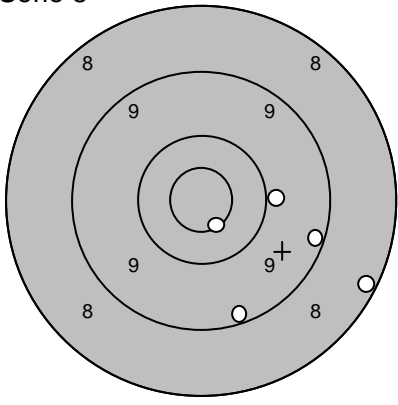
Skjutlag 4	Tavla 8	Lars-Göran Lundqvist	
Ramselefors		Ununge	
2006-07-07		Björkskottet 2006	Ramselefors Skytteförening
Prov 	1: 10,6* → 2: 10,4 ↓ 3: 10,7* → 4: 10,8* ↗ 5: 10,3 ↖ Serie 50,0 Totalt 0,0	Serie 1 	1: 10,5* ↘ 2: 10,2 ↗ 3: 10,4 ← 4: 10,5* ← 5: 10,8* ← Serie 50,0 Totalt 50,0
Serie 2 	1: 10,9* ↗ 2: 10,8* → 3: 10,1 ↑ 4: 9,4 ↗ 5: 10,1 ↑ Serie 49,0 Totalt 99,0	Serie 3 	1: 10,7* ↓ 2: 9,7 ↙ 3: 10,5* ← 4: 8,1 ↑ 5: 10,9* ↗ Serie 47,0 Totalt 146,0
Prov 	1: 10,3 ↗ 2: 10,1 ← 3: 10,6* ↗ Serie 30,0 Totalt 146,0	Serie 4 	1: 10,4 ↘ 2: 10,8* ↙ 3: 10,7* ↗ 4: 10,9* → 5: 9,4 ← Serie 49,0 Totalt 195,0
Serie 5 	1: 9,9 → 2: 9,2 → 3: 10,6* ↘ 4: 9,2 ↘ 5: 8,2 ↘ Serie 45,0 Totalt 240,0		

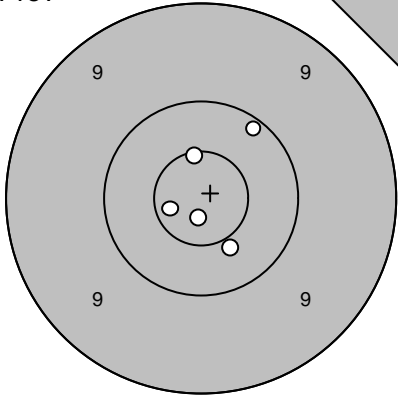
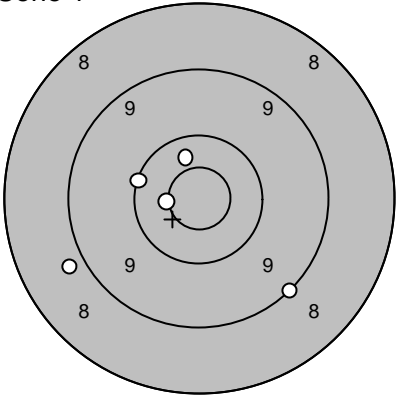
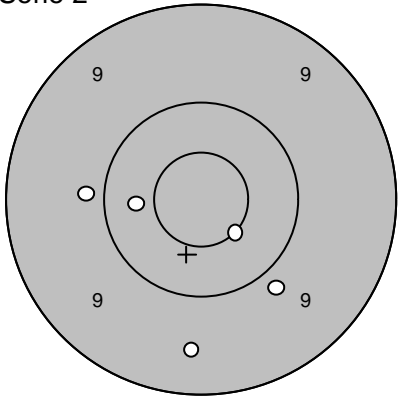
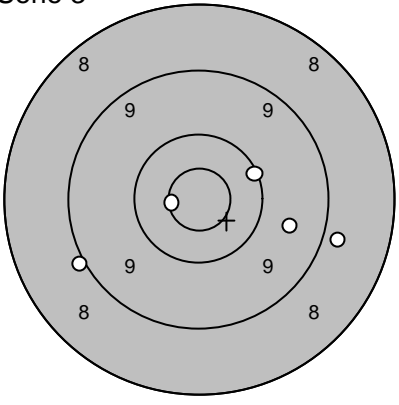
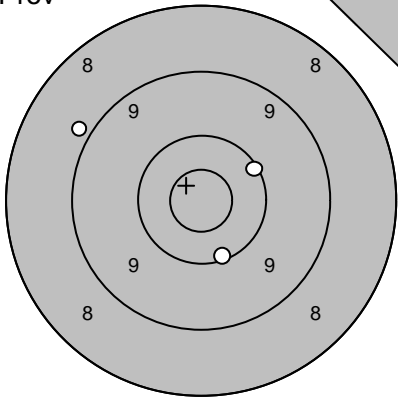
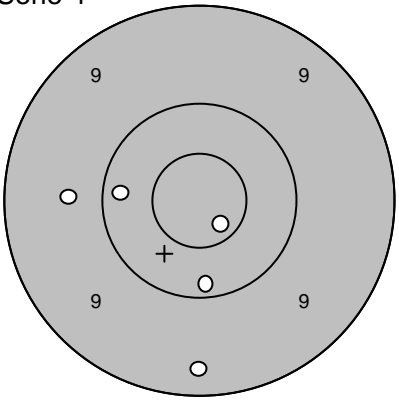
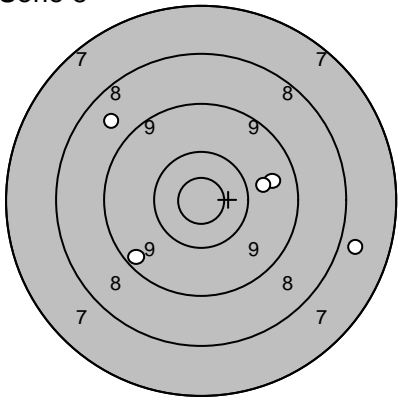
Skjutlag	Tavla	Stefan Lundqvist		
4	9			
Ramselefors	Ununge			
2006-07-07	Björkskottet 2006	Ramselefors Skytteförening		
Prov		1: 10,4 ↘ 2: 10,1 ↗ 3: 10,7* ← 4: 10,8* ↓ 5: 10,6* ↑	Serie 1 	1: 10,6* ← 2: 10,1 ← 3: 10,4 ↗ 4: 9,1 ↓ 5: 8,8 ←
	Serie 50,0 Totalt 0,0		Serie 47,0 Totalt 47,0	
Serie 2		1: 10,4 ← 2: 10,5* ↓ 3: 9,5 ↓ 4: 9,9 ← 5: 9,8 ↓	Serie 3 	1: 9,0 ← 2: 10,7* ← 3: 9,6 → 4: 10,1 ↗ 5: 8,9 →
	Serie 47,0 Totalt 94,0		Serie 46,0 Totalt 140,0	
Prov		1: 10,2 ↓ 2: 10,1 ↗ 3: 8,9 ↖	Serie 4 	1: 10,2 ← 2: 10,2 ↓ 3: 10,7* ↓ 4: 9,3 ↓ 5: 9,7 ←
	Serie 28,0 Totalt 140,0		Serie 48,0 Totalt 188,0	
Serie 5		1: 9,6 → 2: 9,8 → 3: 9,4 ← 4: 7,8 → 5: 8,7 ↗		
	Serie 42,0 Totalt 230,0			

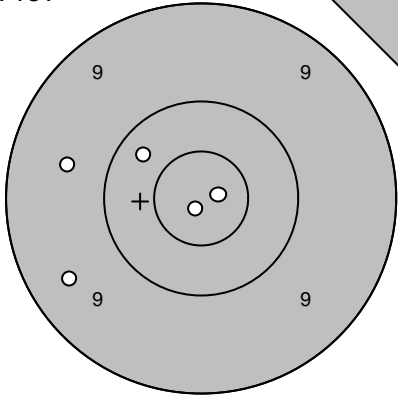
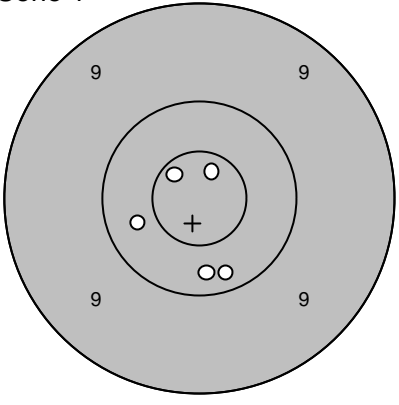
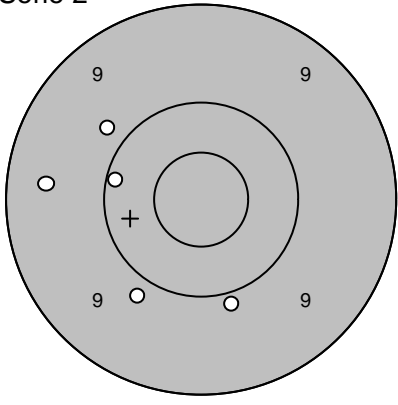
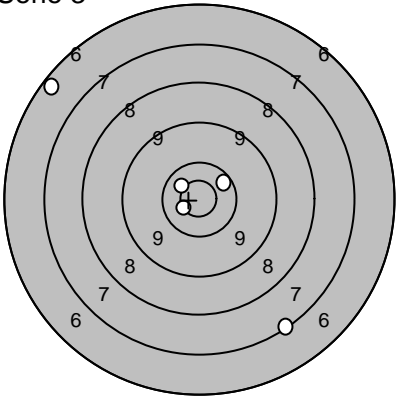
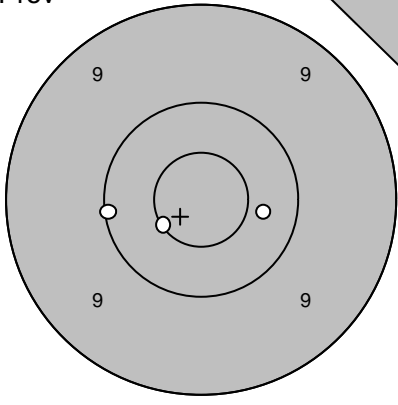
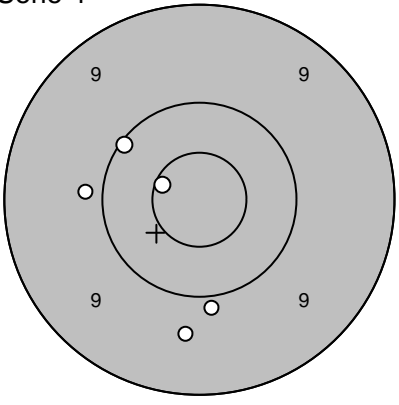
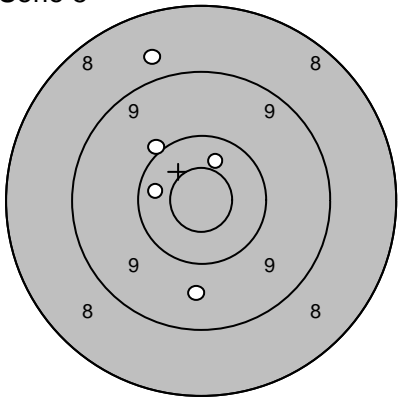
Skjutlag 4	Tavla 10	Jan-Olof Lampinen	
Ramselefors		S 3	
2006-07-07		Björkskottet 2006	Ramselefors Skytteförening
Prov 	1: 10,3 ↖ 2: 9,5 ↙ 3: 9,6 ← 4: 10,9* → 5: 10,9* ↘ <hr/> Serie 48,0 Totalt 0,0	Serie 1 	1: 10,4 ← 2: 10,7* ↖ 3: 10,2 ↓ 4: 10,7* ↗ 5: 10,3 ↓ <hr/> Serie 50,0 Totalt 50,0
Serie 2 	1: 9,8 ↖ 2: 10,1 ← 3: 9,4 ← 4: 9,9 ↓ 5: 9,9 ↘ <hr/> Serie 46,0 Totalt 96,0	Serie 3 	1: 10,6* ↖ 2: 10,7* ↙ 3: 10,4 ↗ 4: 6,4 ↗ 5: 7,2 ↓ <hr/> Serie 43,0 Totalt 139,0
Prov 	1: 10,6* ↙ 2: 10,4 → 3: 10,1 ← <hr/> Serie 30,0 Totalt 139,0	Serie 4 	1: 9,9 ↓ 2: 9,7 ↓ 3: 10,6* ↖ 4: 10,1 ↗ 5: 9,9 ← <hr/> Serie 47,0 Totalt 186,0
Serie 5 	1: 10,4 ← 2: 10,4 ↑ 3: 10,0 ↗ 4: 8,8 ↑ 5: 9,7 ↓ <hr/> Serie 47,0 Totalt 233,0		

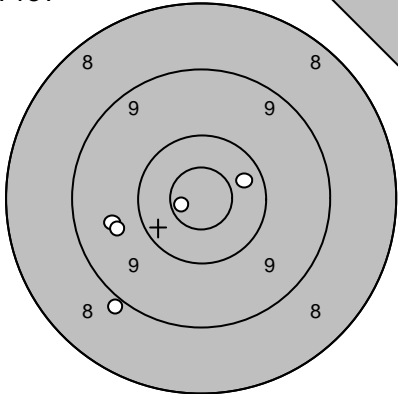
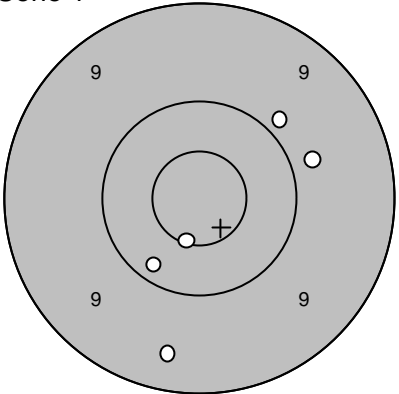
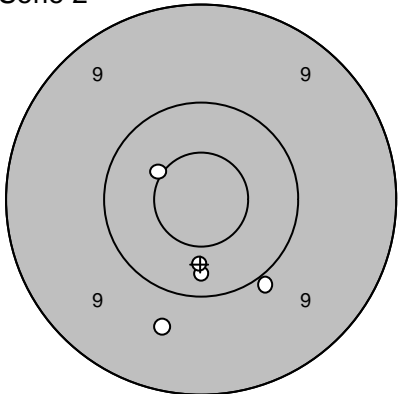
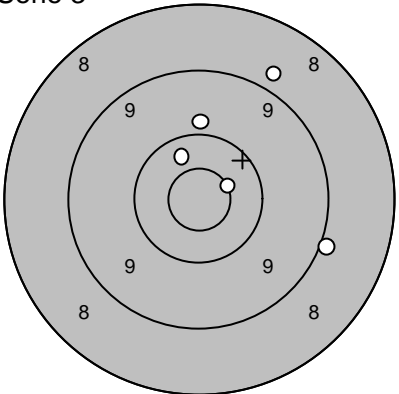
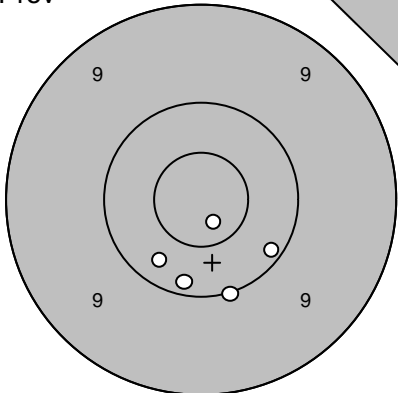
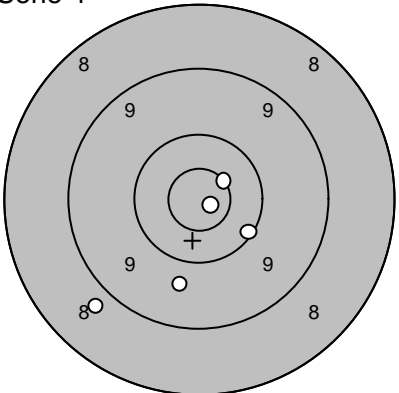
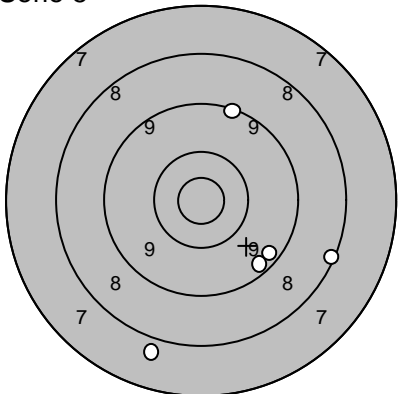
Skjutlag 4	Tavla 11	Bengt Jansson	
Ramselefors		Söderala	
2006-07-07		Björkskottet 2006	Ramselefors Skytteförening
Prov 	1: 9,7 ← 2: 9,7 ← 3: 10,8* ← 4: 10,4 → 5: 9,0 ↘	Serie 1 	1: 10,2 ↘ 2: 9,8 → 3: 10,6* ↘ 4: 9,9 ↗ 5: 9,4 ↘
	Serie 47,0 Totalt 0,0		Serie 47,0 Totalt 47,0
Serie 2 	1: 10,3 ↓ 2: 10,4 ↓ 3: 9,7 ↓ 4: 9,9 ↓ 5: 10,5* ↗	Serie 3 	1: 8,8 ↗ 2: 9,9 ↑ 3: 10,6* → 4: 9,0 → 5: 10,4 ↑
	Serie 48,0 Totalt 95,0		Serie 46,0 Totalt 141,0
Prov 	1: 10,8* ↘ 2: 10,2 ↘ 3: 10,2 ↓ 4: 10,3 ↘ 5: 10,0 ↓	Serie 4 	1: 10,6* ↗ 2: 10,2 ↘ 3: 10,9* → 4: 9,8 ↓ 5: 8,8 ↘
	Serie 50,0 Totalt 141,0		Serie 47,0 Totalt 188,0
Serie 5 	1: 8,2 → 2: 9,4 ↘ 3: 9,4 ↘ 4: 9,2 ↑ 5: 7,8 ↘		
	Serie 42,0 Totalt 230,0		

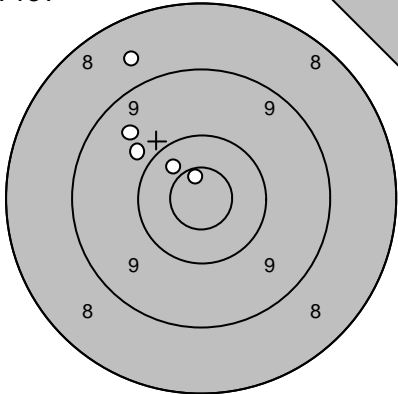
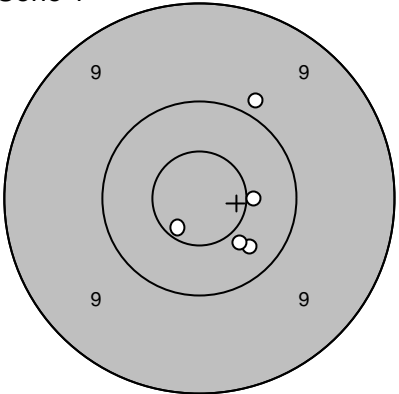
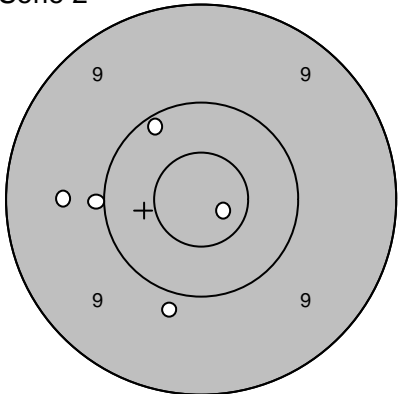
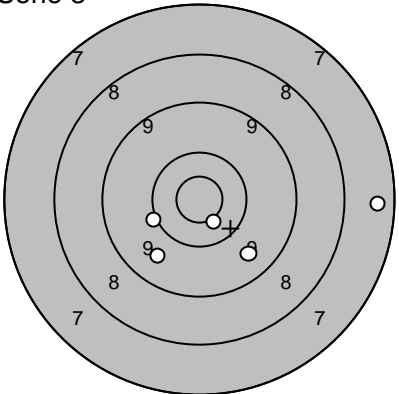
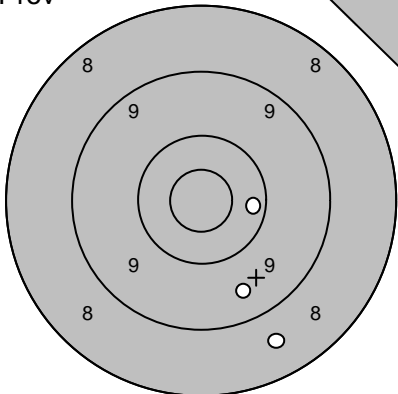
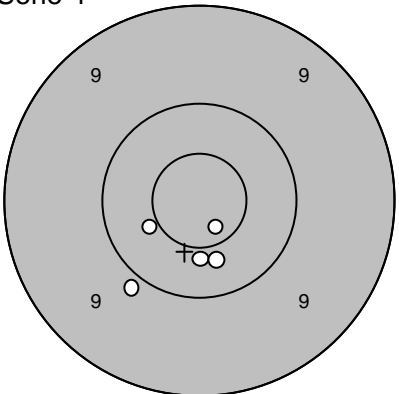
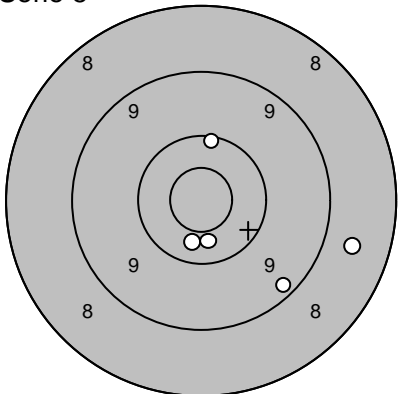
Skjutlag 4	Tavla 12	Helena Jansson	
Ramselefors		Söderala	
2006-07-07		Björkskottet 2006	Ramselefors Skytteförening
Prov 	1: 8,7 ↗ 2: 9,6 ↗ 3: 10,4 ↗ 4: 9,9 ↗ 5: 10,7* ↗	Serie 1 	1: 10,5* → 2: 9,9 ↗ 3: 10,3 ↘ 4: 10,7* ↓ 5: 10,4 ↘
	Serie 46,0 Totalt 0,0		Serie 49,0 Totalt 49,0
Serie 2 	1: 9,9 ↓ 2: 9,6 ← 3: 10,0 ← 4: 10,2 ↗ 5: 10,8* ↘	Serie 3 	1: 9,6 ↘ 2: 9,7 ↓ 3: 10,1 ← 4: 10,6* ↘ 5: 7,5 →
	Serie 48,0 Totalt 97,0		Serie 45,0 Totalt 142,0
Prov 	1: 8,6 ↓ 2: 10,3 → 3: 9,5 ↘	Serie 4 	1: 9,9 ↘ 2: 10,7* ↘ 3: 10,4 ↓ 4: 10,5* ← 5: 10,4 ↓
	Serie 27,0 Totalt 142,0		Serie 49,0 Totalt 191,0
Serie 5 	1: 10,4 ↓ 2: 10,4 ↓ 3: 10,2 ↑ 4: 8,7 → 5: 9,3 ↘		
	Serie 47,0 Totalt 238,0		

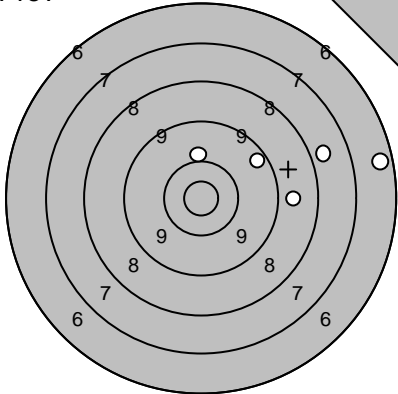
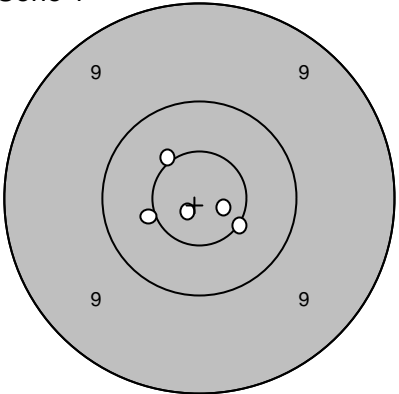
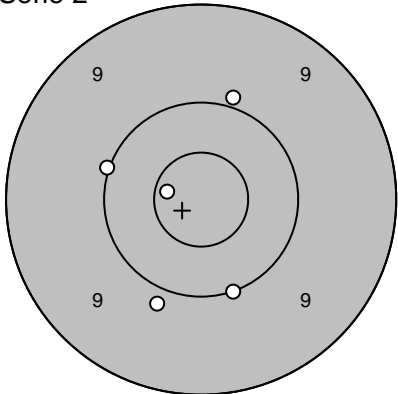
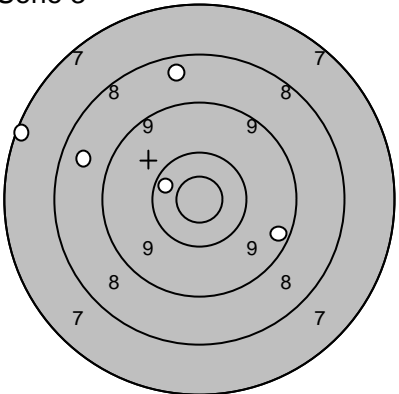
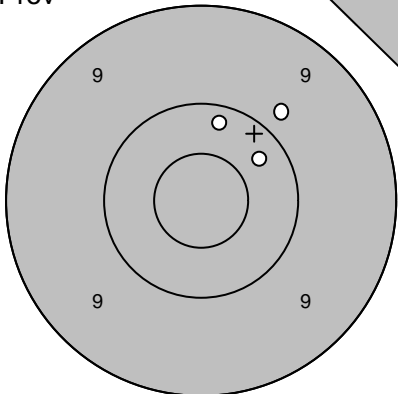
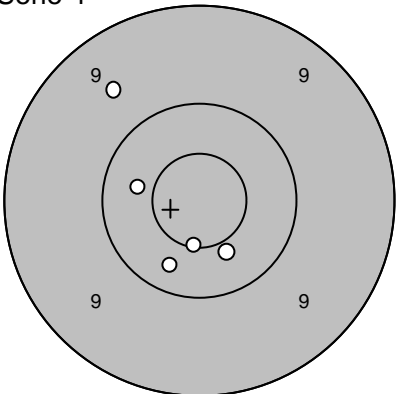
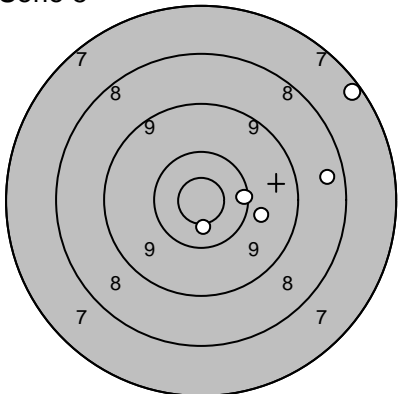
Skjutlag 4	Tavla 13	Linda Gustavsson			
Ramselefors		Moälven-Modo			
2006-07-07		Björkskottet 2006		Ramselefors Skytteförening	
Prov		1: 6,5 → 2: 7,8 → 3: 8,8 → 4: 9,4 ↗ 5: 10,1 ↑	Serie 1		1: 10,8* → 2: 10,9* ↓ 3: 10,5* ↓ 4: 10,5* ← 5: 10,5* ↗
		Serie 40,0		Serie 50,0	
		Totalt 0,0		Totalt 50,0	
Serie 2		1: 9,9 ↓ 2: 10,7* ← 3: 9,9 ↑ 4: 10,0 ← 5: 10,0 ↓	Serie 3		1: 8,5 ↑ 2: 8,6 ← 3: 10,4 ↗ 4: 7,2 ← 5: 9,3 →
		Serie 48,0		Serie 42,0	
		Totalt 98,0		Totalt 140,0	
Prov		1: 9,8 ↗ 2: 10,2 ↑ 3: 10,3 →	Serie 4		1: 10,4 ↓ 2: 10,4 ← 3: 9,6 ↗ 4: 10,6* ↓ 5: 10,3 ↓
		Serie 29,0		Serie 49,0	
		Totalt 140,0		Totalt 189,0	
Serie 5		1: 9,8 → 2: 10,6* ↓ 3: 10,2 → 4: 8,5 → 5: 7,3 ↗			
		Serie 44,0			
		Totalt 233,0			

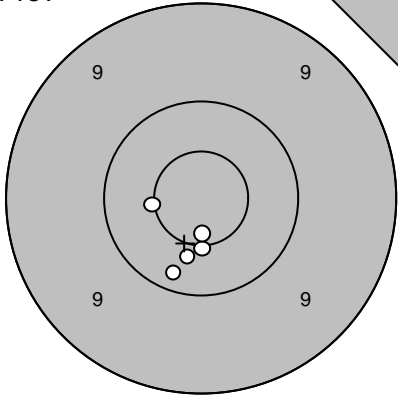
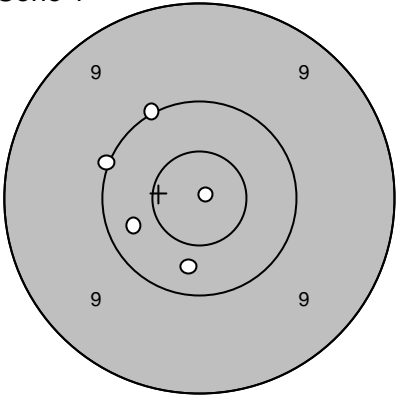
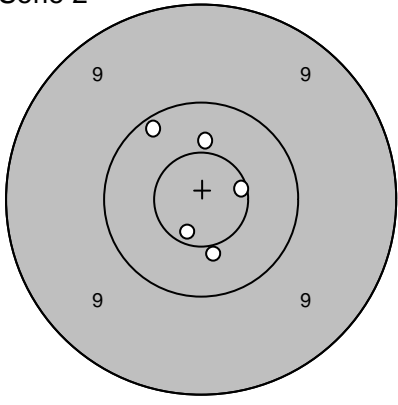
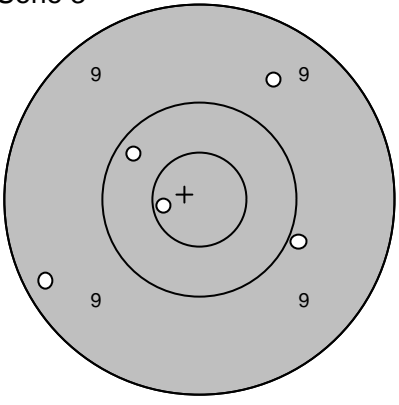
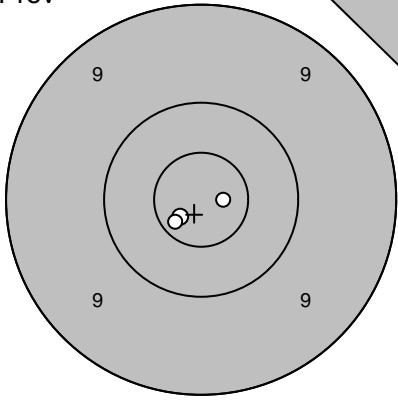
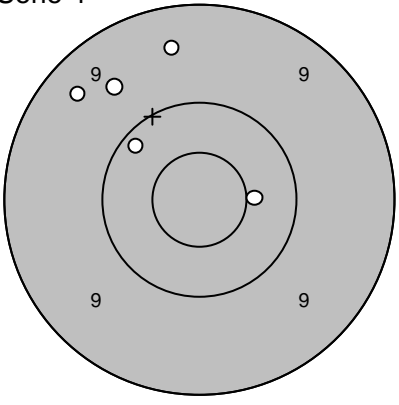
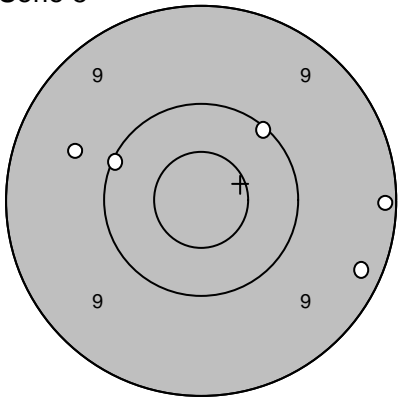
Skjutlag 4	Tavla 14	Maria Falck	
Ramselefors		Moälven-Modo	
2006-07-07		Björkskottet 2006	Ramselefors Skytteförening
Prov 	1: 10,5* ← 2: 10,5* ↓ 3: 10,2 ↓ 4: 10,7* ↓ 5: 10,4 ↓	Serie 1 	1: 10,3 ↓ 2: 10,3 ← 3: 10,0 ↖ 4: 10,9* → 5: 10,0 ↗
	Serie 50,0 Totalt 0,0		Serie 50,0 Totalt 50,0
Serie 2 	1: 10,6* → 2: 10,7* ↓ 3: 10,2 ↗ 4: 10,4 ↑ 5: 10,5* ↓	Serie 3 	1: 10,2 ↖ 2: 10,7* ← 3: 9,3 ← 4: 9,6 ↗ 5: 9,9 →
	Serie 50,0 Totalt 100,0		Serie 47,0 Totalt 147,0
Prov 	1: 10,8* ↖ 2: 10,8* → 3: 10,7* ↖	Serie 4 	1: 10,2 ↖ 2: 10,5* → 3: 9,5 ↑ 4: 9,6 ↗ 5: 9,4 ↗
	Serie 30,0 Totalt 147,0		Serie 47,0 Totalt 194,0
Serie 5 	1: 9,2 → 2: 9,7 ← 3: 10,1 ↖ 4: 10,1 ↗ 5: 9,3 →		
	Serie 47,0 Totalt 241,0		

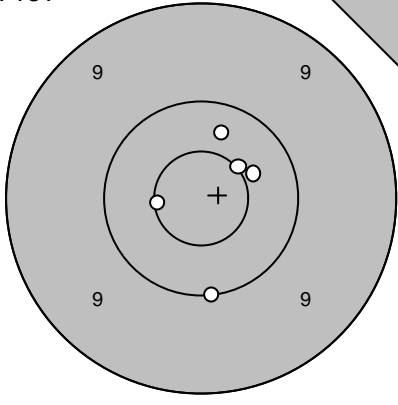
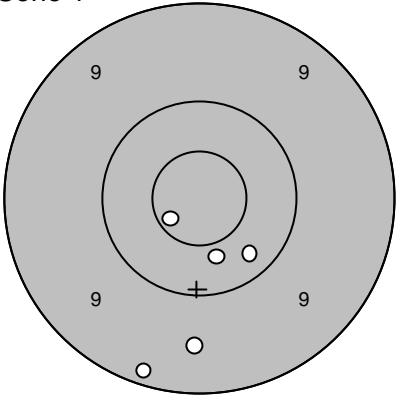
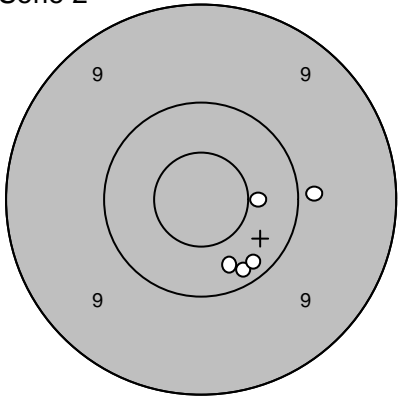
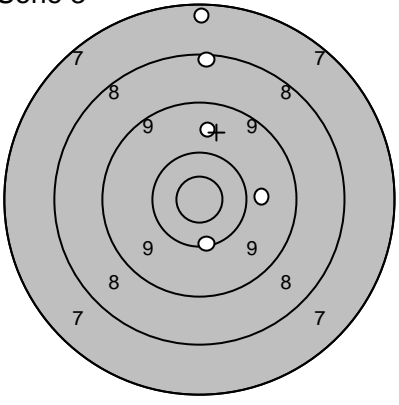
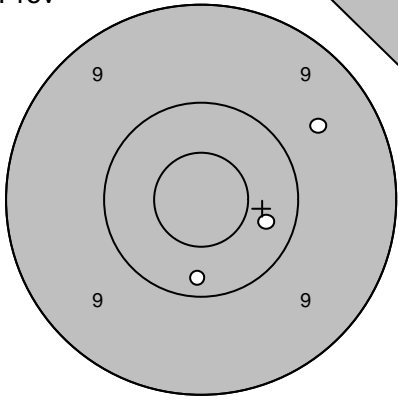
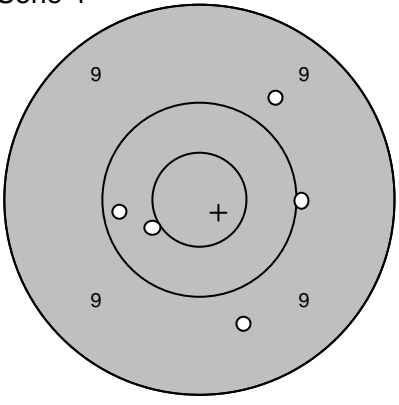
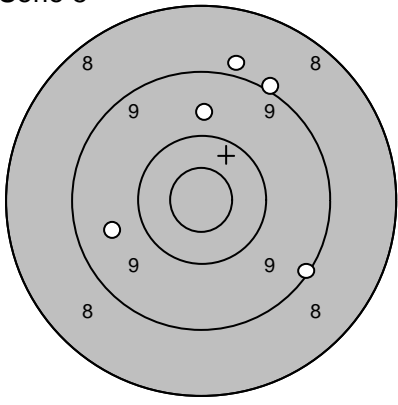
Skjutlag 4	Tavla 15	Petter Eriksson		
Ramselefors		Moälven-Modo		
2006-07-07		Björkskottet 2006		Ramselefors Skytteförening
Prov 	1: 10,5* ↗ 2: 10,6* ← 3: 10,3 ↑ 4: 10,4 → 5: 10,0 ↓	Serie 1 	1: 10,3 ↘ 2: 10,4 ↓ 3: 10,7* ↙ 4: 9,5 ↓ 5: 9,2 ↓	
	Serie 50,0 Totalt 0,0		Serie 48,0 Totalt 48,0	
Serie 2 	1: 10,5* → 2: 10,2 ↘ 3: 10,3 ↘ 4: 10,2 ↘ 5: 9,9 →	Serie 3 	1: 10,2 ↓ 2: 9,9 → 3: 8,3 ↑ 4: 7,4 ↑ 5: 9,7 ↑	
	Serie 49,0 Totalt 97,0		Serie 43,0 Totalt 140,0	
Prov 	1: 10,3 → 2: 9,6 ↗ 3: 10,2 ↓	Serie 4 	1: 10,0 → 2: 9,7 ↗ 3: 10,2 ← 4: 10,5* ↙ 5: 9,7 ↓	
	Serie 29,0 Totalt 140,0		Serie 48,0 Totalt 188,0	
Serie 5 	1: 9,7 ↑ 2: 9,6 ← 3: 9,1 → 4: 9,0 ↗ 5: 8,9 ↑			
	Serie 44,0 Totalt 232,0			

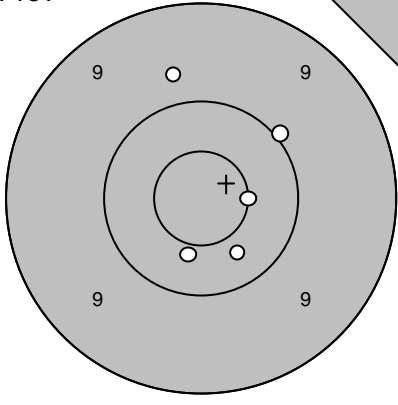
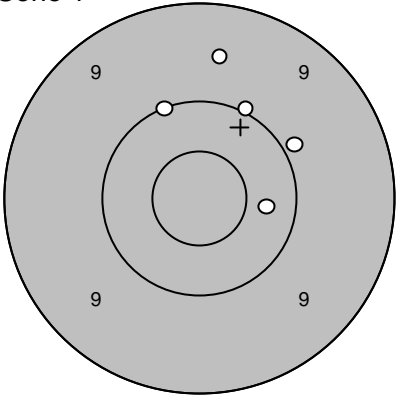
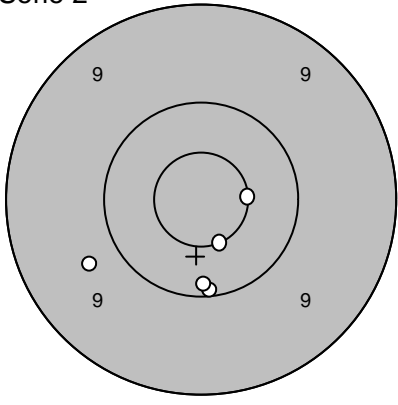
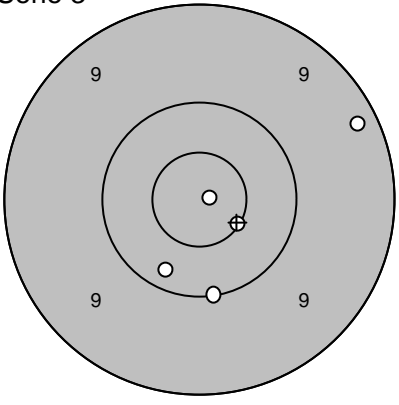
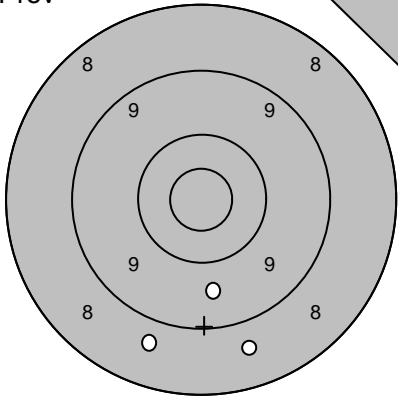
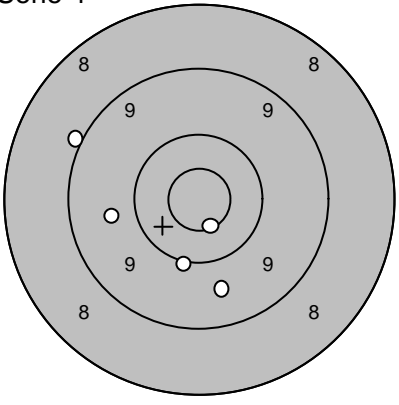
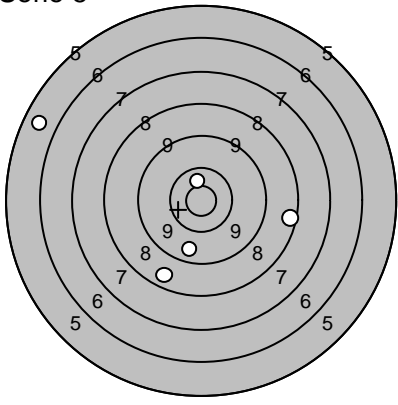
Skjutlag 4	Tavla 16	Marie Arvidsson	
Ramselefors		Lidingö	
2006-07-07		Björkscottet 2006	Ramselefors Skytteförening
Prov 	1: 10,0 ↗ 2: 10,4 ↓ 3: 10,6* → 4: 10,4 ↓ 5: 9,7 ↑	Serie 1 	1: 10,1 ↑ 2: 10,0 ↗ 3: 10,3 → 4: 9,9 ↗ 5: 9,6 ↑
	Serie 49,0 Totalt 0,0		Serie 48,0 Totalt 48,0
Serie 2 	1: 10,1 ↓ 2: 10,2 ↓ 3: 10,6* → 4: 9,7 ← 5: 10,6* ↓	Serie 3 	1: 10,9* → 2: 10,0 ↓ 3: 10,2 ↓ 4: 10,6* ↘ 5: 9,3 ↘
	Serie 49,0 Totalt 97,0		Serie 49,0 Totalt 146,0
Prov 	1: 8,7 ↓ 2: 9,7 ↓ 3: 8,7 ↓	Serie 4 	1: 9,7 ↓ 2: 9,7 ← 3: 9,0 ↖ 4: 10,6* ↓ 5: 10,1 ↓
	Serie 25,0 Totalt 146,0		Serie 47,0 Totalt 193,0
Serie 5 	1: 8,4 → 2: 9,7 ↓ 3: 8,6 ↓ 4: 10,6* ↑ 5: 5,7 ↖		
	Serie 40,0 Totalt 233,0		

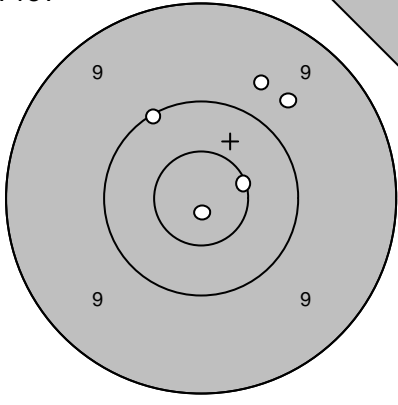
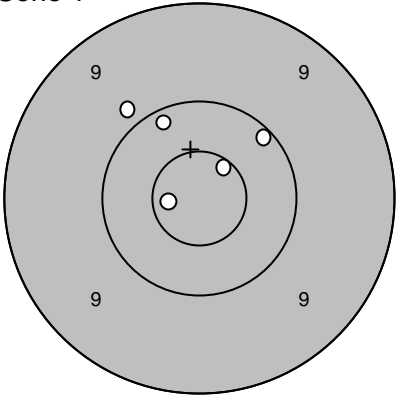
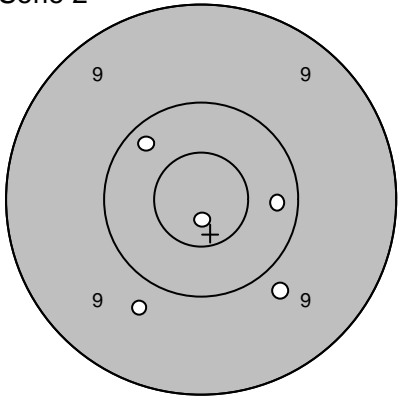
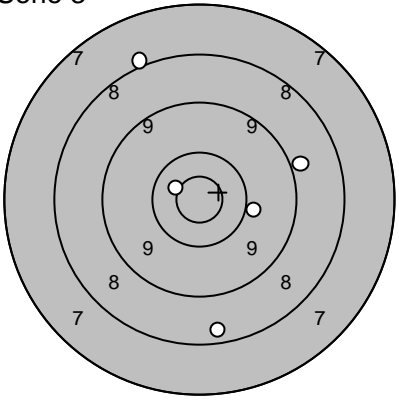
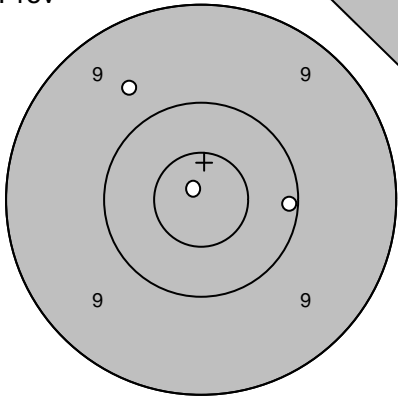
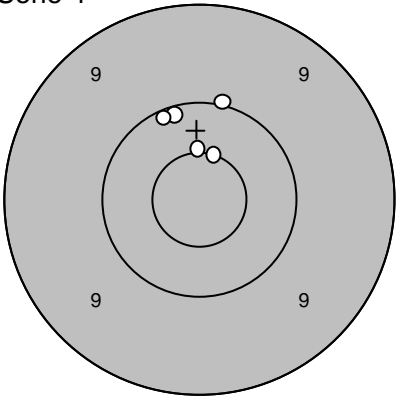
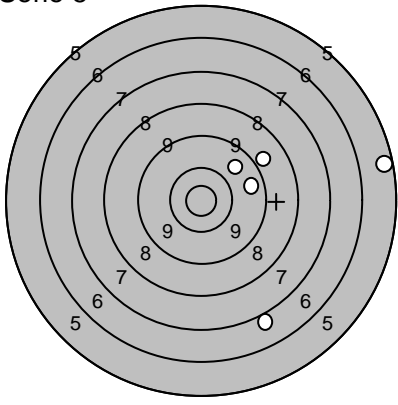
Skjutlag 4	Tavla 17	Gustav Lövgren	
Ramselefors		Niemisel	
2006-07-07		Björkskottet 2006	Ramselefors Skytteförening
Prov 	1: 9,7 ↗ 2: 9,7 ↗ 3: 10,9* ↓ 4: 10,1 ↗ 5: 10,6* →	Serie 1 	1: 10,7* ← 2: 10,2 ↗ 3: 9,9 ↗ 4: 10,6* ↗ 5: 10,1 ↗
	Serie 48,0 Totalt 0,0		Serie 49,0 Totalt 49,0
Serie 2 	1: 9,8 ↓ 2: 10,8* ↓ 3: 10,2 ↗ 4: 9,8 ↓ 5: 10,2 →	Serie 3 	1: 10,0 → 2: 10,6* ↖ 3: 8,0 ↗ 4: 8,4 ↓ 5: 8,9 →
	Serie 48,0 Totalt 97,0		Serie 44,0 Totalt 141,0
Prov 	1: 10,9* ↖ 2: 10,1 → 3: 9,7 ↗	Serie 4 	1: 10,6* ↗ 2: 10,5* ↗ 3: 10,1 ↗ 4: 10,0 ↗ 5: 10,1 ↗
	Serie 29,0 Totalt 141,0		Serie 50,0 Totalt 191,0
Serie 5 	1: 8,9 ↗ 2: 9,6 → 3: 9,7 ↗ 4: 5,5 → 5: 7,0 ↓		
	Serie 38,0 Totalt 229,0		

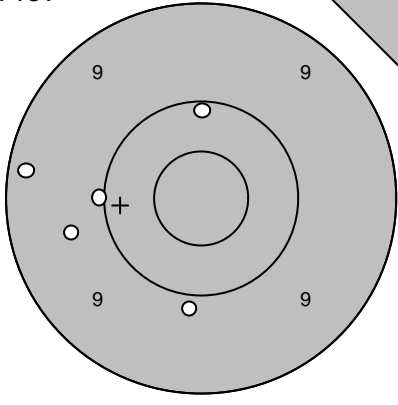
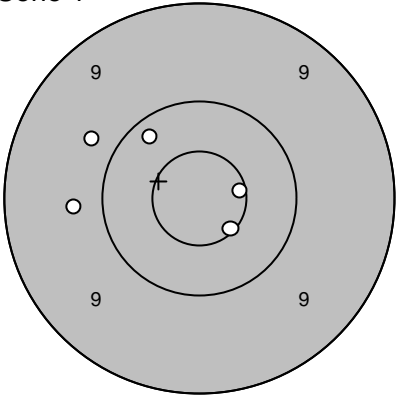
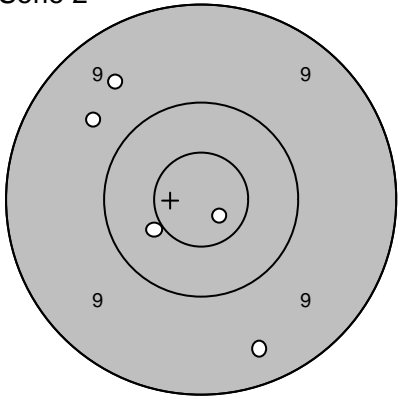
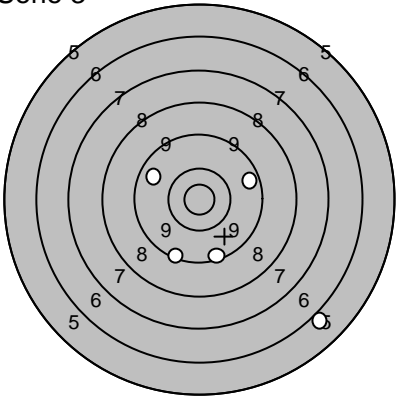
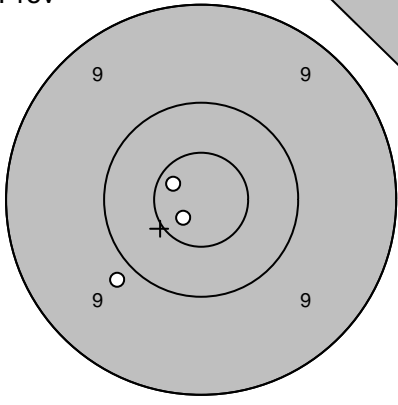
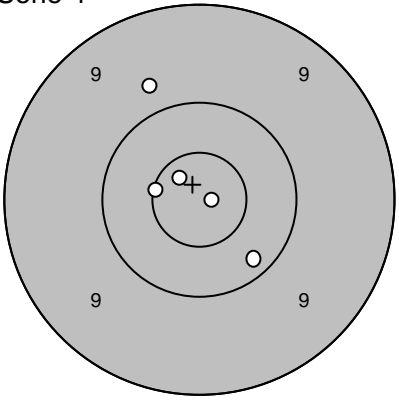
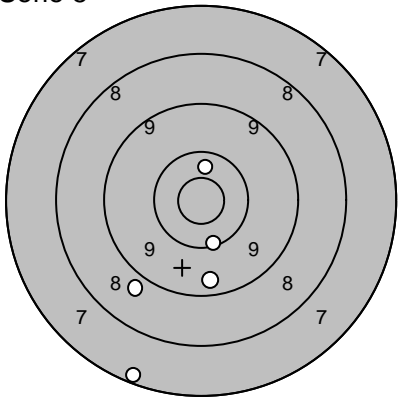
Skjutlag	Tavla	Harry Östling		
4	18			
Ramselefors	F 21			
2006-07-07	Björkskottet 2006	Ramselefors Skytteförening		
Prov		1: 10,0 ← 2: 9,2 ← 3: 9,7 ← 4: 10,1 ↑ 5: 9,9 ↓	Serie 1 	1: 10,2 ↗ 2: 9,8 ↗ 3: 9,8 ← 4: 10,6* → 5: 10,6* ↘
		Serie 47,0		Serie 48,0
		Totalt 0,0		Totalt 48,0
Serie 2		1: 9,6 ↗ 2: 10,8* ↘ 3: 9,7 ↗ 4: 10,5* ← 5: 9,4 ↓	Serie 3 	1: 9,3 ↓ 2: 9,7 ↖ 3: 9,5 → 4: 9,4 ↓ 5: 6,0 ↘
		Serie 47,0		Serie 42,0
		Totalt 95,0		Totalt 137,0
Prov		1: 10,8* ↘ 2: 9,8 ↘ 3: 10,7* ↖	Serie 4 	1: 9,8 ↗ 2: 10,9* → 3: 10,6* ← 4: 10,7* ↗ 5: 10,2 ↘
		Serie 29,0		Serie 49,0
		Totalt 137,0		Totalt 186,0
Serie 5		1: 9,5 ↓ 2: 10,2 ↓ 3: 10,4 ↑ 4: 7,3 ↓ 5: 8,9 ↘		
		Serie 44,0		
		Totalt 230,0		

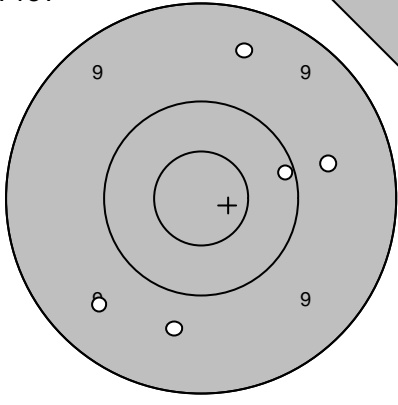
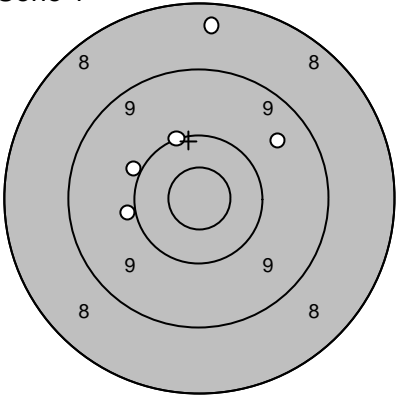
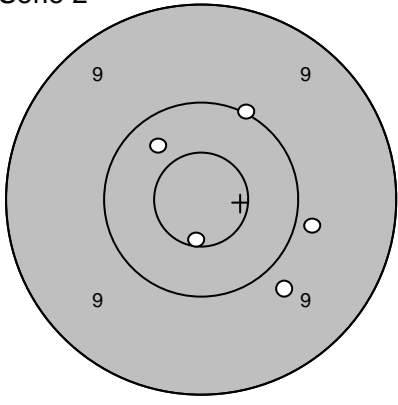
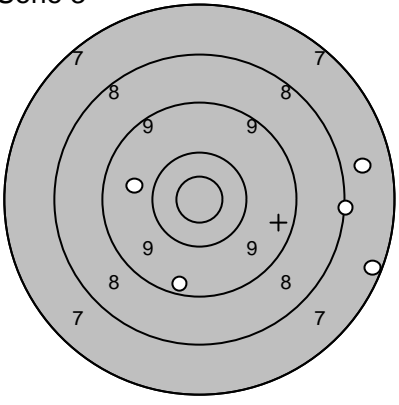
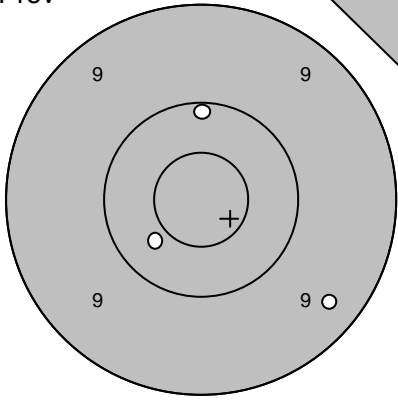
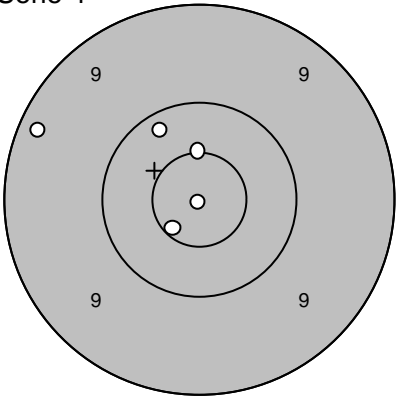
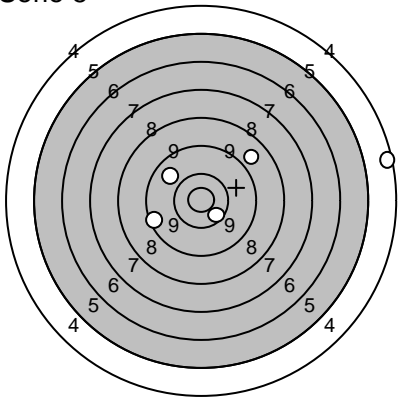
Skjutlag	Tavla	Peter Östling		
4	19			
Ramselefors	F 21			
2006-07-07	Björkskottet 2006	Ramselefors Skytteförening		
Prov		1: 9,5 ↙ 2: 9,7 ↓ 3: 10,1 → 4: 9,7 → 5: 9,5 ↑	Serie 1 	1: 10,0 ↖ 2: 8,4 ↑ 3: 10,0 ← 4: 10,1 ↗ 5: 9,6 ↘
		Serie 46,0		Serie 47,0
		Totalt 0,0		Totalt 47,0
Serie 2		1: 10,6* ↓ 2: 9,8 ↘ 3: 10,3 ↗ 4: 10,0 ↗ 5: 9,9 →	Serie 3 	1: 8,1 → 2: 9,4 ↓ 3: 9,8 ← 4: 7,7 → 5: 7,3 ↘
		Serie 48,0		Serie 40,0
		Totalt 95,0		Totalt 135,0
Prov		1: 9,4 ↘ 2: 10,4 ↙ 3: 10,1 ↑	Serie 4 	1: 10,5* ↑ 2: 10,9* ↓ 3: 10,6* ↙ 4: 9,2 ← 5: 10,2 ↗
		Serie 29,0		Serie 49,0
		Totalt 135,0		Totalt 184,0
Serie 5		1: 10,5* ↘ 2: 8,9 ↗ 3: 9,9 ↗ 4: 9,4 ← 5: 4,4 →		
		Serie 40,0		
		Totalt 224,0		

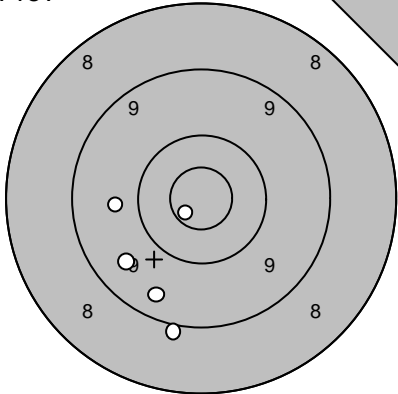
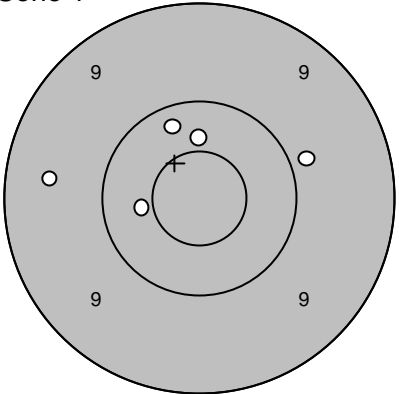
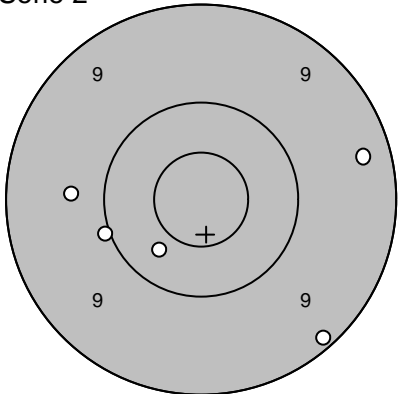
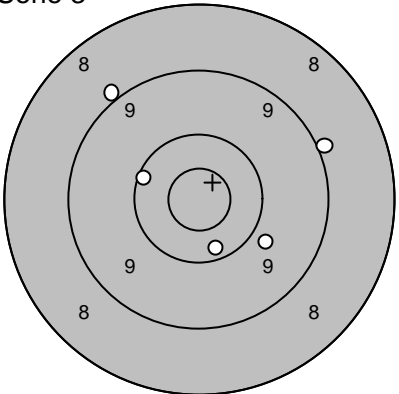
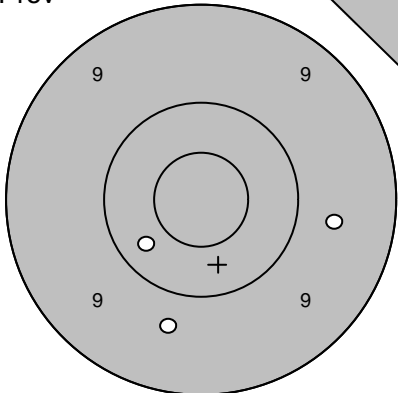
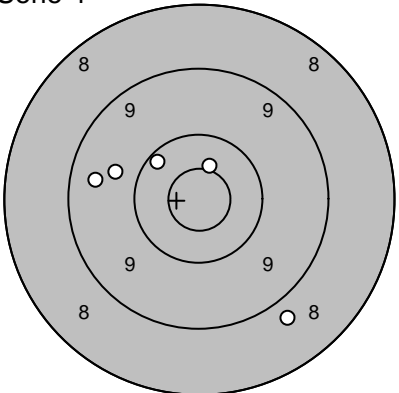
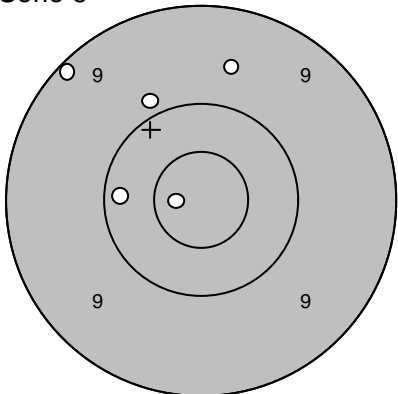
Skjutlag	Tavla	Urban Johansson		
4	20			
Ramselefors	F 21			
2006-07-07	Björkskottet 2006	Ramselefors Skytteförening		
Prov		1: 9,4 ↘ 2: 9,0 ↓ 3: 10,8* ↙ 4: 9,6 ↙ 5: 9,8 ←	Serie 1 	1: 9,9 → 2: 10,4 ↑ 3: 10,3 ↑ 4: 9,5 ← 5: 10,4 ←
		Serie 46,0	Serie 48,0	
		Totalt 0,0	Totalt 48,0	
Serie 2		1: 9,1 ↘ 2: 10,0 ← 3: 9,7 ← 4: 10,4 ↙ 5: 9,3 →	Serie 3 	1: 9,9 ↘ 2: 10,3 ↓ 3: 9,0 ↗ 4: 9,0 → 5: 10,2 ↗
		Serie 47,0	Serie 47,0	
		Totalt 95,0	Totalt 142,0	
Prov		1: 9,7 → 2: 10,3 ↙ 3: 9,7 ↓	Serie 4 	1: 10,6* ↑ 2: 9,7 ← 3: 9,5 ← 4: 10,2 ↗ 5: 8,8 ↓
		Serie 28,0	Serie 46,0	
		Totalt 142,0	Totalt 188,0	
Serie 5		1: 9,9 ↗ 2: 10,8* ← 3: 9,6 ↑ 4: 9,1 ↗ 5: 10,2 ←		
		Serie 47,0		
		Totalt 235,0		

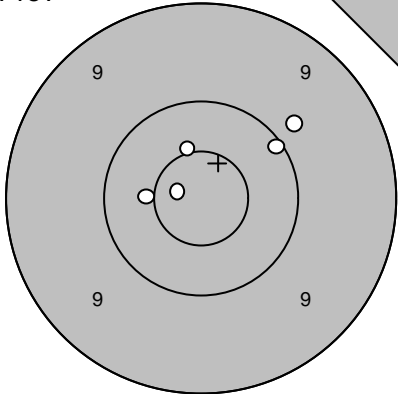
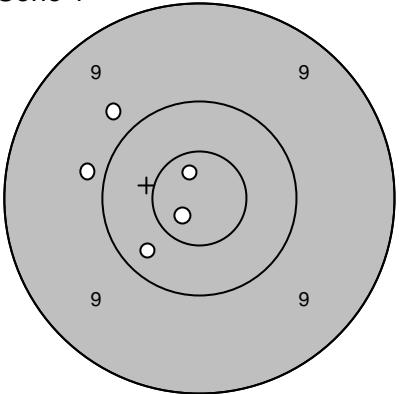
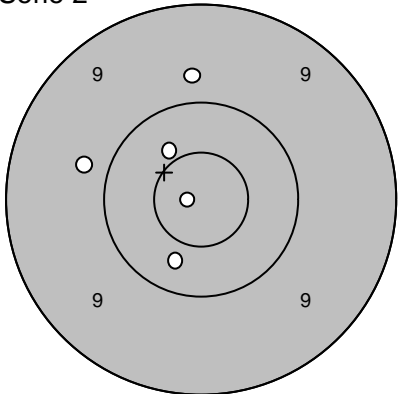
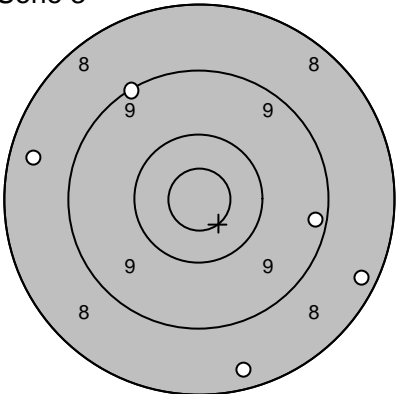
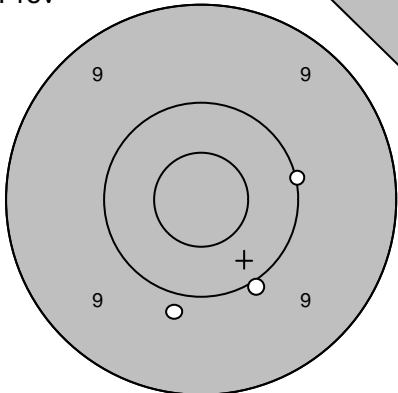
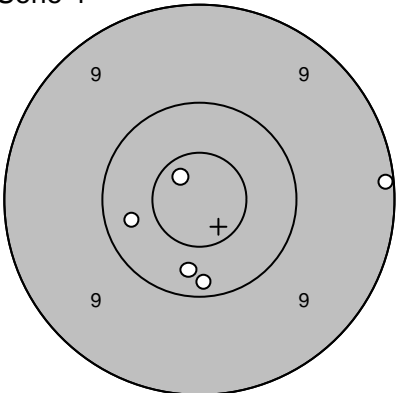
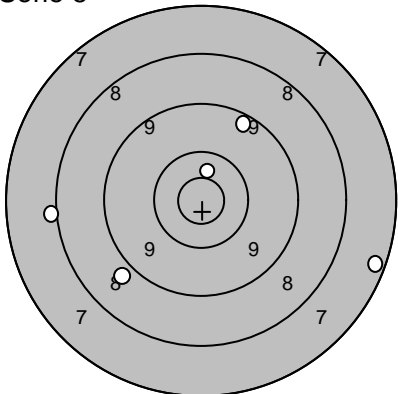
Skjutlag 4	Tavla 21	Patrik Lindfors	
Ramselefors		I 19	
2006-07-07		Björkskottet 2006	Ramselefors Skytteförening
Prov 	1: 10,5* ↑ 2: 10,1 ↗ 3: 9,8 ↗ 4: 10,5* ← 5: 10,8* ←	Serie 1 	1: 9,8 ↗ 2: 10,3 ↘ 3: 9,9 ← 4: 10,8* ↘ 5: 10,8* ↗
	Serie 49,0 Totalt 0,0		Serie 48,0 Totalt 48,0
Serie 2 	1: 9,8 ← 2: 10,4 ↗ 3: 10,9* ← 4: 9,8 ↑ 5: 10,4 ↓	Serie 3 	1: 8,5 ← 2: 9,1 ↗ 3: 9,3 → 4: 8,3 ↘ 5: 8,4 ↓
	Serie 48,0 Totalt 96,0		Serie 42,0 Totalt 138,0
Prov 	1: 10,0 ↓ 2: 10,0 → 3: 9,9 ↓	Serie 4 	1: 10,3 ↓ 2: 10,3 ← 3: 9,1 → 4: 10,2 ↓ 5: 10,7* ↗
	Serie 29,0 Totalt 138,0		Serie 49,0 Totalt 187,0
Serie 5 	1: 8,9 ↘ 2: 10,5* ↑ 3: 9,4 ↗ 4: 8,1 ← 5: 7,3 →		
	Serie 42,0 Totalt 229,0		

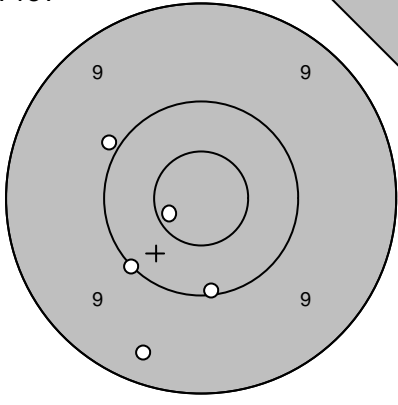
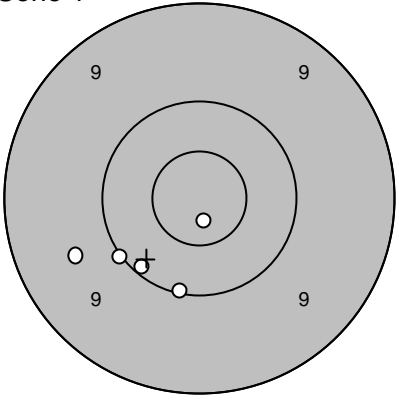
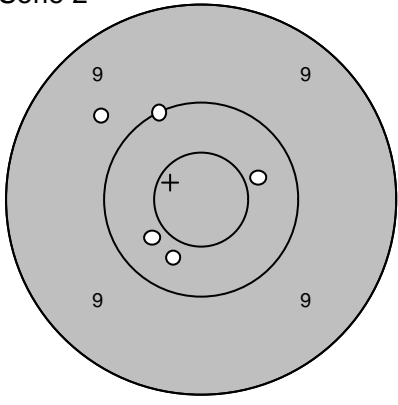
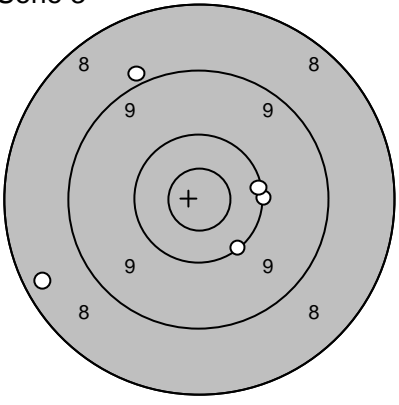
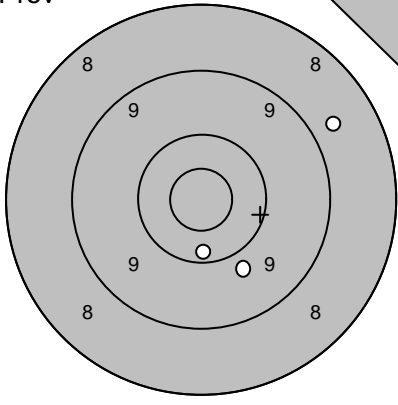
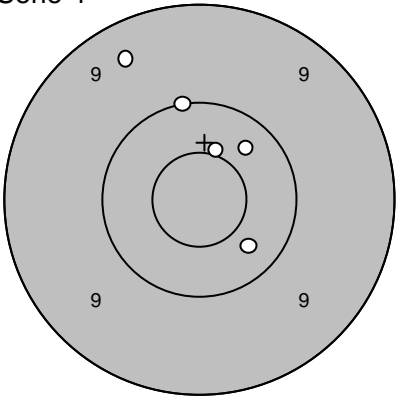
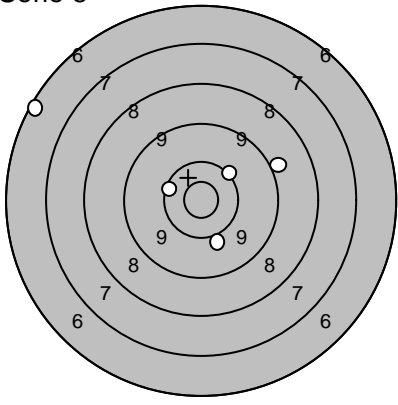
Skjutlag 4	Tavla 22	Linda Lidman	
Ramselefors		Piteå	
2006-07-07		Björkskottet 2006	Ramselefors Skytteförening
Prov 	1: 9,4 ↘ 2: 10,7* ← 3: 10,1 ↓ 4: 10,0 ↙ 5: 9,9 ↖	Serie 1 	1: 10,1 ↘ 2: 10,8* ↓ 3: 9,6 ← 4: 10,0 ↙ 5: 10,1 ↘
	Serie 48,0 Totalt 0,0		Serie 49,0 Totalt 49,0
Serie 2 	1: 9,7 ↖ 2: 10,4 ↙ 3: 10,4 ↓ 4: 10,4 → 5: 10,1 ↗	Serie 3 	1: 10,1 → 2: 8,9 ↗ 3: 8,4 ← 4: 10,1 ↓ 5: 10,2 →
	Serie 49,0 Totalt 98,0		Serie 46,0 Totalt 144,0
Prov 	1: 8,7 ↗ 2: 10,3 ↓ 3: 9,8 ↓	Serie 4 	1: 10,3 ↗ 2: 9,4 ↖ 3: 10,5* ↑ 4: 10,0 ↑ 5: 10,3 ↓
	Serie 27,0 Totalt 144,0		Serie 49,0 Totalt 193,0
Serie 5 	1: 10,3 ← 2: 9,0 → 3: 10,0 ↓ 4: 10,2 ↗ 5: 6,3 ↖		
	Serie 45,0 Totalt 238,0		