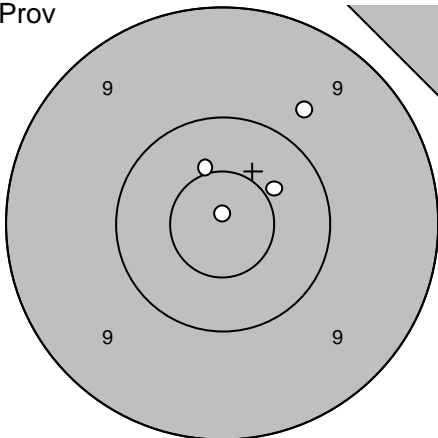
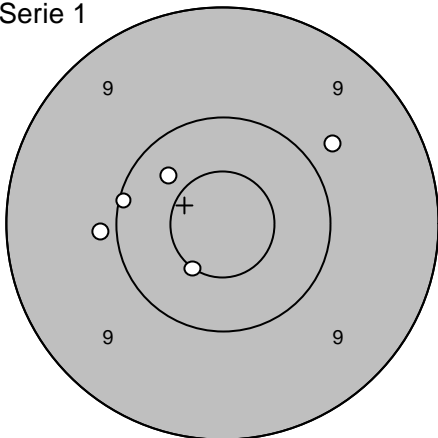
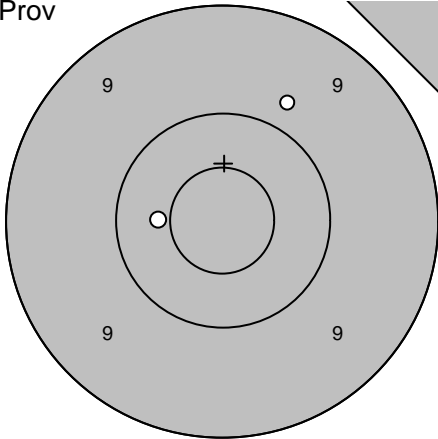
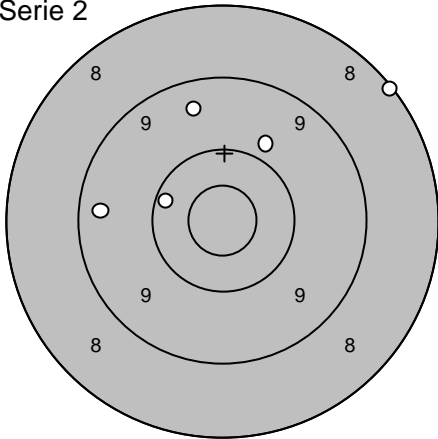
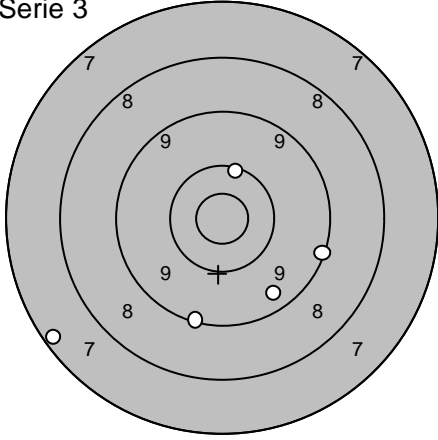
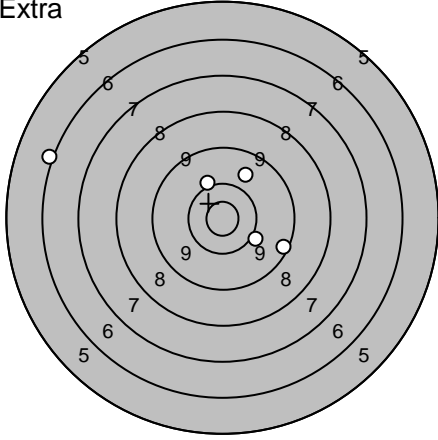
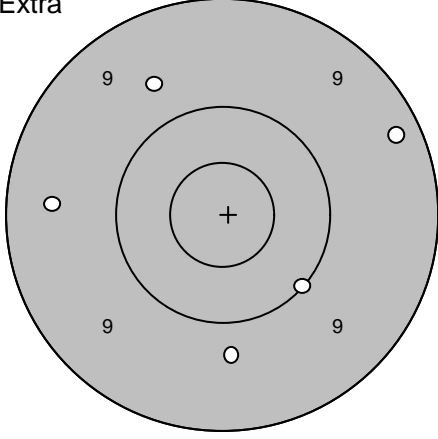
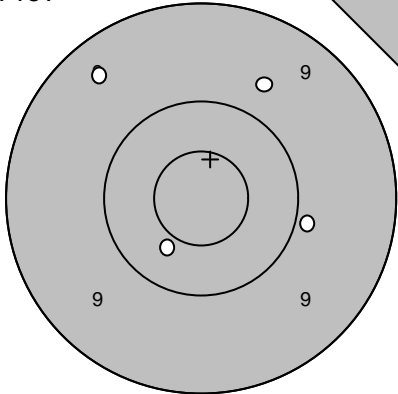
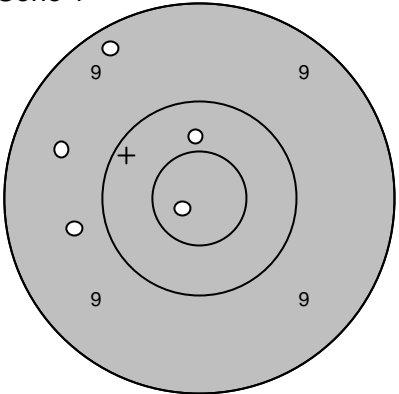
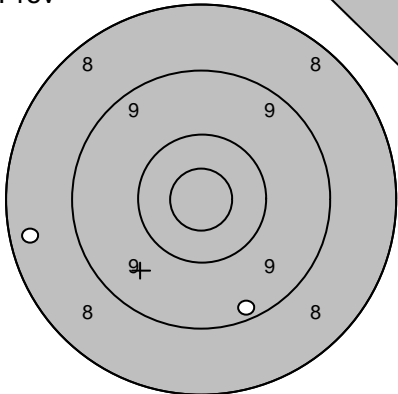
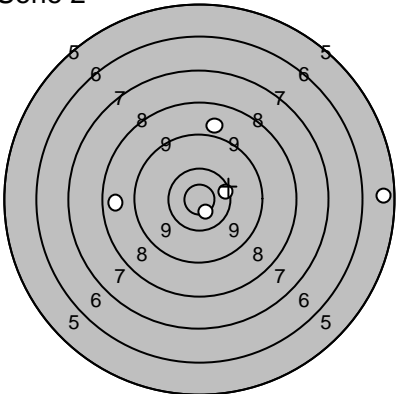
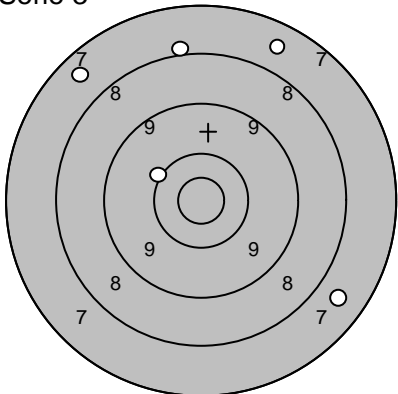
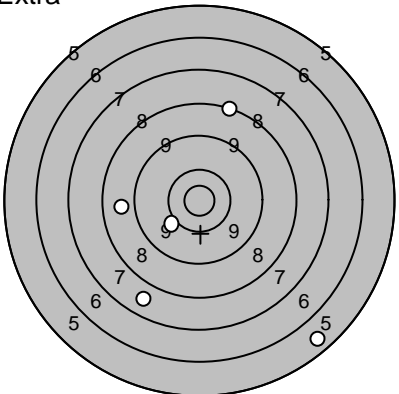
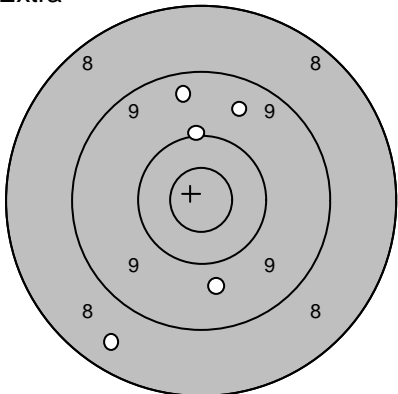
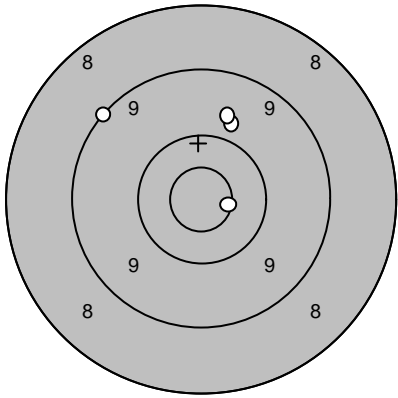
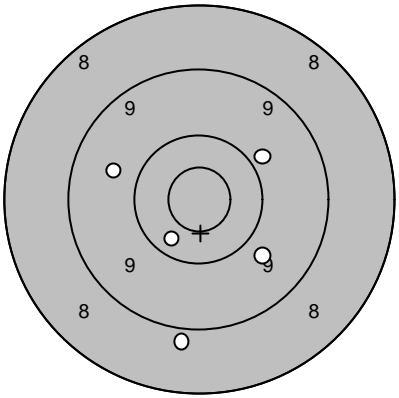
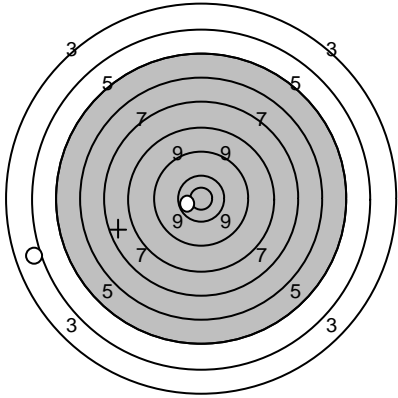
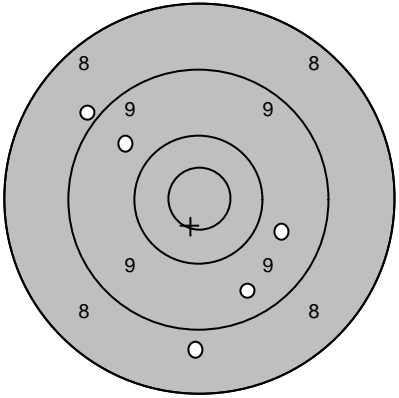
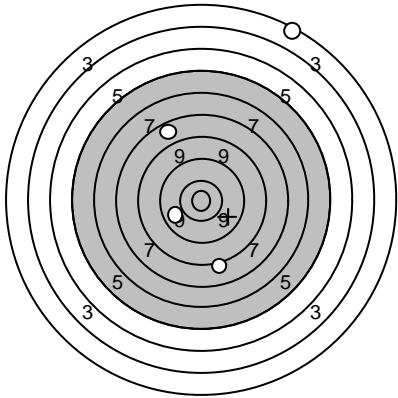
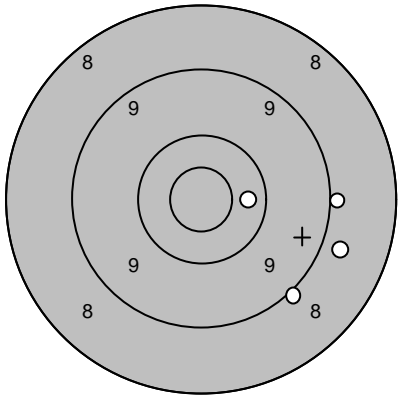
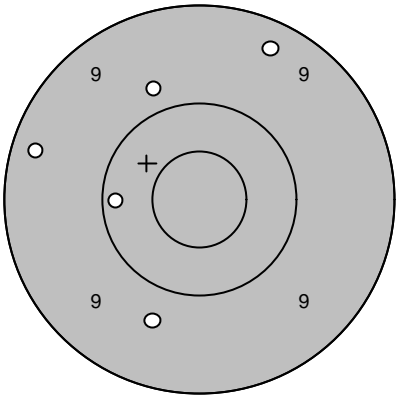
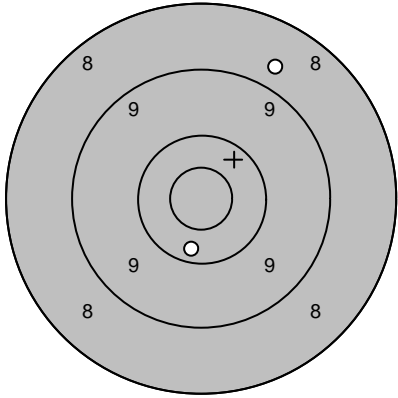
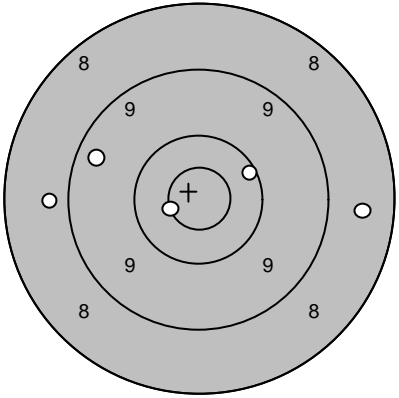
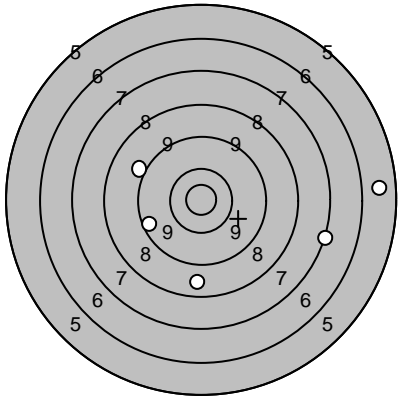
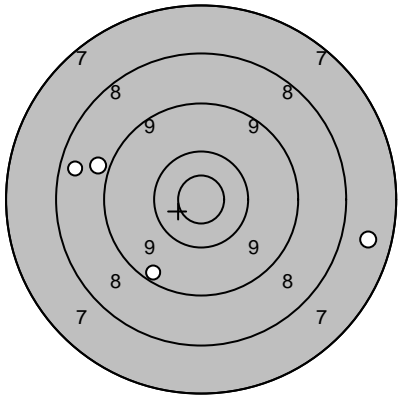
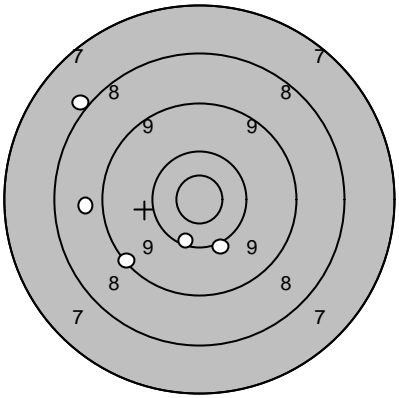
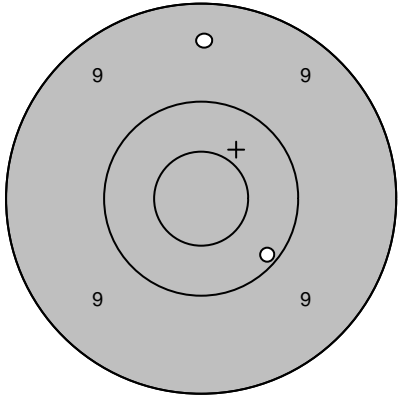
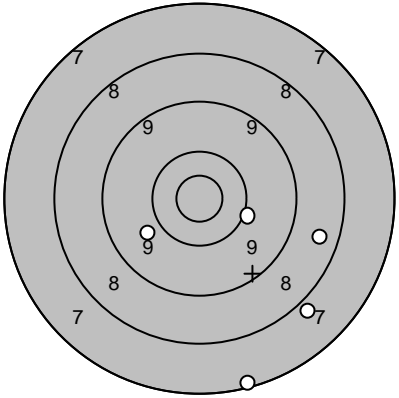
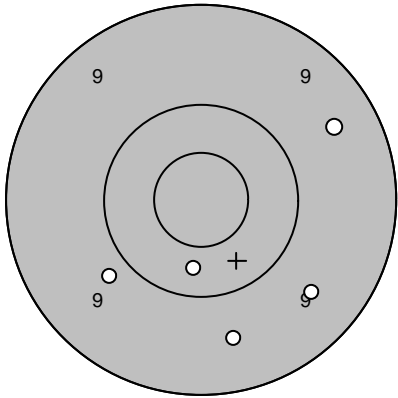

Lag 1	Tavla 1	Jan-Erik Karlsson	
Ramselefors	Ramselefors		
06.07.2006	Tavelträffen B - 2006	Ramselefors Skytteförening	
Prov		1: 9,7 ↗ 2: 10,5* → 3: 10,5* ↑ 4: 10,9* ↑	Serie 1 
	Serie: 39,0 Summa: 142,0	1: 9,8 ↗ 2: 10,4 ↖ 3: 9,9 ← 4: 10,1 ← 5: 10,5* ↘	Serie: 48,0 Summa: 190,0
Prov		1: 10,4 ← 2: 9,8 ↗	Serie 2 
	Serie: 19,0 Summa: 190,0	1: 8,1 ↗ 2: 9,4 ← 3: 9,8 ↗ 4: 10,2 ← 5: 9,5 ↑	Serie: 45,0 Summa: 235,0
Serie 3		1: 10,2 ↑ 2: 9,2 ↓ 3: 7,3 ← 4: 9,1 → 5: 9,4 ↓	Extra 
	Serie: 44,0 Summa: 279,0	1: 9,3 → 2: 10,1 → 3: 6,1 ← 4: 10,1 ↗ 5: 9,8 ↗	Serie: 44,0 Summa: 323,0
Extra		6: 9,3 → 7: 9,7 ↗ 8: 10,0 ↓ 9: 9,7 ↓ 10: 9,5 ←	
	Serie: 46,0 Summa: 369,0		

Lag 1	Tavla 2	Lennart Jacobsson	
Ramselefors	Ramselefors		
06.07.2006	Tavelträffen B - 2006	Ramselefors Skytteförening	
Prov		1: 9,4 ↖ 2: 9,7 ↗ 3: 10,4 ↘ 4: 9,9 →	Serie 1 
		Serie: 37,0 Summa: 142,0	1: 10,4 ↑ 2: 9,3 ↖ 3: 9,7 ← 4: 10,8* ↘ 5: 9,5 ←
			Serie: 47,0 Summa: 189,0
Prov		1: 9,3 ↓ 2: 8,4 ←	Serie 2 
		Serie: 17,0 Summa: 189,0	1: 10,7* ↘ 2: 8,7 ← 3: 8,9 ↑ 4: 10,4 → 5: 5,6 →
			Serie: 41,0 Summa: 230,0
Serie 3		1: 7,6 ↗ 2: 7,6 ↖ 3: 10,1 ↖ 4: 8,0 ↑ 5: 7,7 ↘	Extra 
		Serie: 39,0 Summa: 269,0	1: 7,7 ↘ 2: 5,6 ↘ 3: 10,1 ↘ 4: 8,2 ↑ 5: 8,8 ←
			Serie: 38,0 Summa: 307,0
Extra		6: 8,5 ↘ 7: 9,4 ↑ 8: 9,6 ↑ 9: 10,0 ↑ 10: 9,7 ↓	
		Serie: 45,0 Summa: 352,0	

Lag 1	Tavla 3	Daniel Zakrisson		
Ramselefors	Ramselefors			
06.07.2006	Tavelträffen B - 2006	Ramselefors Skytteförening		
Prov		1: 9,8 ↗ 2: 9,1 ↖ 3: 9,7 ↗ 4: 10,6* →	Serie 1 	1: 9,9 ↗ 2: 8,9 ↓ 3: 10,3 ↘ 4: 9,7 ↖ 5: 9,8 ↘
		Serie: 37,0	Serie: 45,0	
		Summa: 142,0	Summa: 187,0	
Prov		1: 10,7* ← 2: 4,1 ←	Serie 2 	1: 8,9 ↗ 2: 9,7 → 3: 9,7 ↗ 4: 9,5 ↓ 5: 8,8 ↓
		Serie: 14,0	Serie: 43,0	
		Summa: 187,0	Summa: 230,0	
Serie 3		1: 0,0 ↓ 2: 2,5 ↗ 3: 7,9 ↗ 4: 8,2 ↓ 5: 9,9 ↖		
		Serie: 26,0		
		Summa: 256,0		

Lag 1	Tavla 4	Leif Sigfridsson	
Ramselefors		Ramselefors	
06.07.2006		Tavelträffen B - 2006	Ramselefors Skytteförening
Prov		1: 9,0 ↘ 2: 10,3 → 3: 8,8 → 4: 9,0 →	Serie 1 
		Serie: 36,0 Summa: 140,0	1: 9,8 ↖ 2: 9,3 ↗ 3: 9,3 ← 4: 9,7 ↓ 5: 10,2 ←
			Serie: 46,0 Summa: 186,0
Prov		1: 10,3 ↓ 2: 8,8 ↗	Serie 2 
		Serie: 18,0 Summa: 186,0	1: 8,6 → 2: 9,4 ← 3: 8,8 ← 4: 10,6* ← 5: 10,2 ↗
			Serie: 45,0 Summa: 231,0
Serie 3		1: 9,1 ↖ 2: 5,7 → 3: 8,7 ↓ 4: 7,2 → 5: 9,5 ←	
		Serie: 38,0 Summa: 269,0	

Lag 1	Tavla 5	Gunnar Sigfridsson		
Ramselefors	Ramselefors			
06.07.2006	Tavelträffen B - 2006	Ramselefors Skytteförening		
Prov		1: 8,9 ← 2: 8,5 ← 3: 7,6 → 4: 9,3 ↙	Serie 1 	1: 8,0 ↖ 2: 10,2 ↓ 3: 9,2 ↙ 4: 8,8 ← 5: 10,1 ↓
		Serie: 32,0		Serie: 45,0
		Summa: 132,0		Summa: 177,0
Prov		1: 9,4 ↑ 2: 10,1 ↘	Serie 2 	1: 9,9 ↙ 2: 10,1 → 3: 8,5 → 4: 7,9 ↙ 5: 7,2 ↓
		Serie: 19,0		Serie: 41,0
		Summa: 177,0		Summa: 218,0
Serie 3		1: 10,3 ↓ 2: 9,8 ↙ 3: 9,5 ↗ 4: 9,6 ↘ 5: 9,6 ↓		
		Serie: 46,0		
		Summa: 264,0		

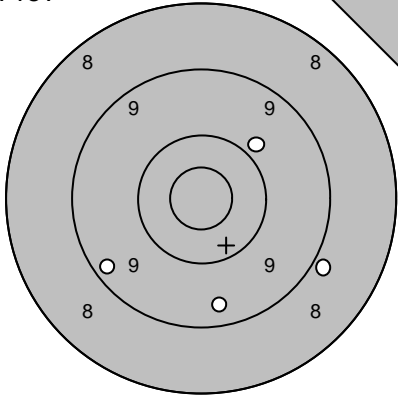
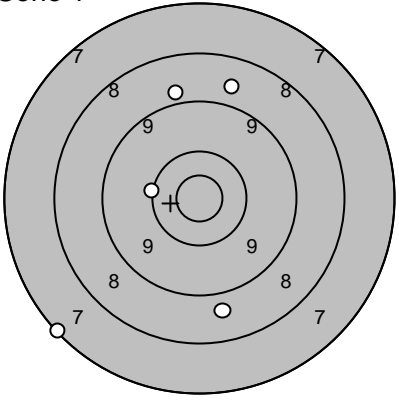
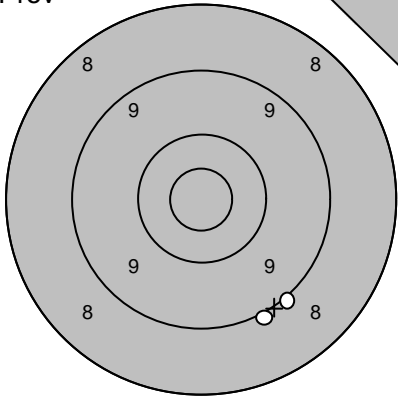
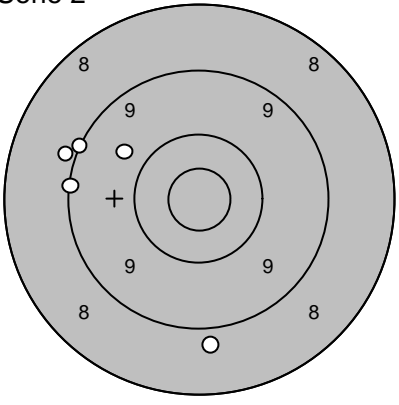
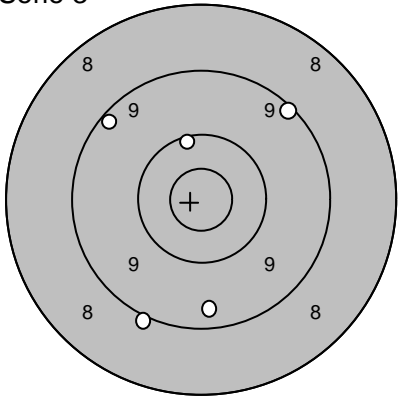
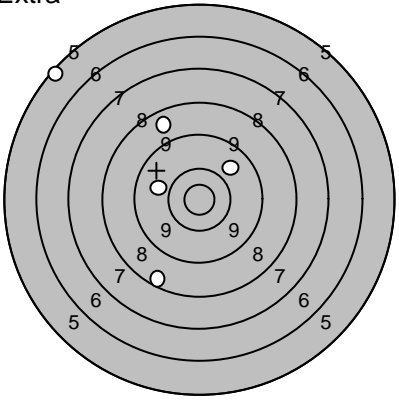
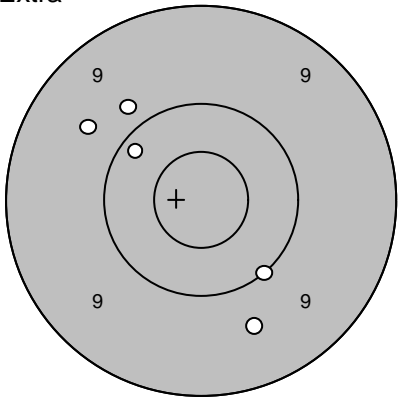
Lag 1	Tavla 6	Petter Ivarsson		
Ramselefors	Loos			
06.07.2006	Tavelträffen B - 2006	Ramselefors Skytteförening		
Prov		1: 8,9 → 2: 9,9 ↗ 3: 9,3 ↖ 4: 9,4 ↓ Serie: 35,0 Summa: 129,0	Serie 1 	1: 8,7 ↑ 2: 8,8 ↓ 3: 7,2 ↖ 4: 8,9 ↑ 5: 10,1 ← Serie: 41,0 Summa: 170,0
Prov		1: 9,0 ↓ 2: 9,0 ↓ Serie: 18,0 Summa: 170,0	Serie 2 	1: 8,8 ↓ 2: 9,7 ↗ 3: 9,1 ↗ 4: 8,9 ← 5: 9,1 ← Serie: 43,0 Summa: 213,0
Serie 3		1: 9,2 ↗ 2: 9,2 ↖ 3: 9,0 ↓ 4: 10,2 ↑ 5: 9,4 ↓ Serie: 46,0 Summa: 259,0	Extra 	1: 8,7 ↑ 2: 5,4 ↖ 3: 9,9 ↗ 4: 9,9 ← 5: 8,5 ↓ Serie: 39,0 Summa: 298,0
Extra		6: 9,8 ↗ 7: 10,0 ↓ 8: 9,7 ↗ 9: 10,2 ↗ 10: 9,6 ↓ Serie: 47,0 Summa: 345,0		

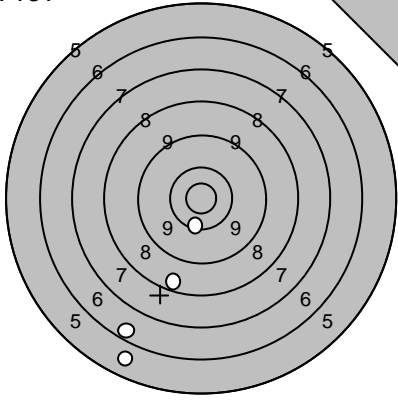
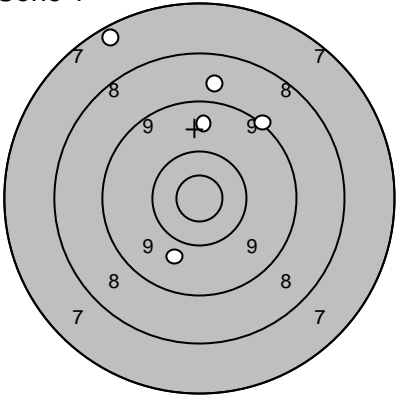
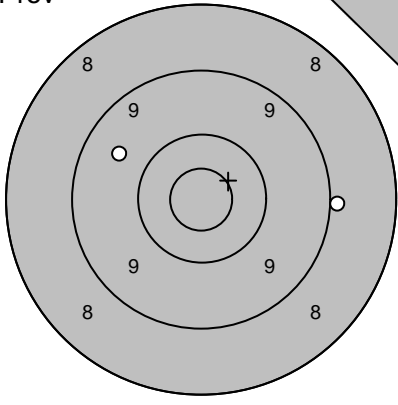
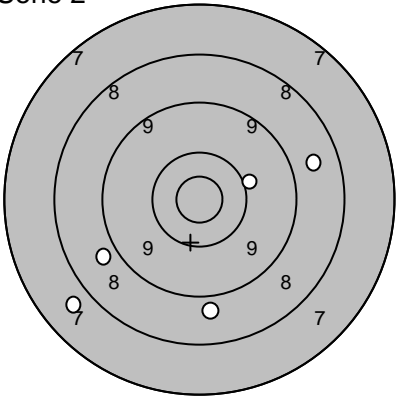
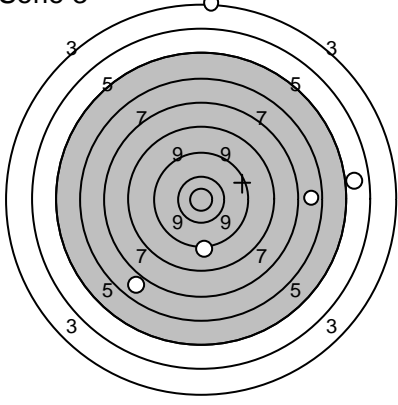
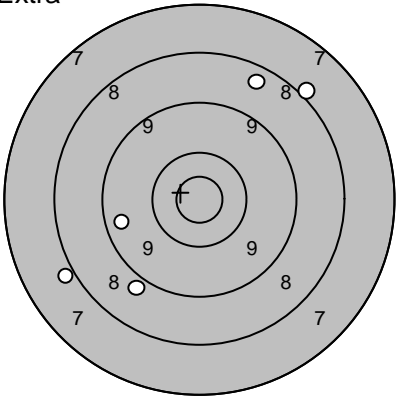
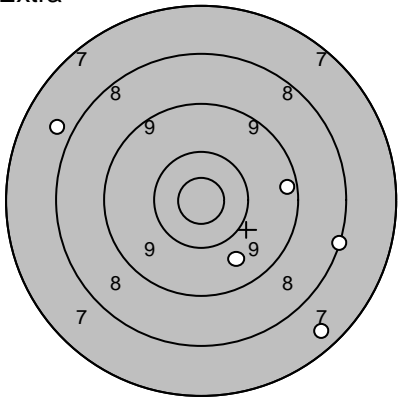
Lag 1	Tavla 7	Tony Ericson		
Ramselefors	Loos			
06.07.2006	Tavelträffen B - 2006	Ramselefors Skytteförening		
Prov		1: 5,8 ↘ 2: 10,3 ↓ 3: 6,5 ↘ 4: 8,5 ↓	Serie 1 	1: 7,4 ↖ 2: 9,8 ↓ 3: 8,8 ↑ 4: 9,1 ↗ 5: 9,6 ↑
		Serie: 29,0		Serie: 42,0
		Summa: 140,0		Summa: 182,0
Prov		1: 9,6 ↖ 2: 9,0 →	Serie 2 	1: 7,8 ↙ 2: 8,8 ↓ 3: 8,8 ↙ 4: 10,0 → 5: 8,7 →
		Serie: 18,0		Serie: 41,0
		Summa: 182,0		Summa: 223,0
Serie 3		1: 6,8 → 2: 5,0 → 3: 3,3 ↑ 4: 6,9 ↘ 5: 9,3 ↓	Extra 	1: 9,5 ↙ 2: 8,0 ↗ 3: 8,0 ↙ 4: 8,5 ↗ 5: 8,9 ↓
		Serie: 29,0		Serie: 41,0
		Summa: 252,0		Summa: 293,0
Extra		6: 7,8 ↖ 7: 7,5 ↘ 8: 9,3 → 9: 9,7 ↘ 10: 8,1 →		
		Serie: 40,0		
		Summa: 333,0		

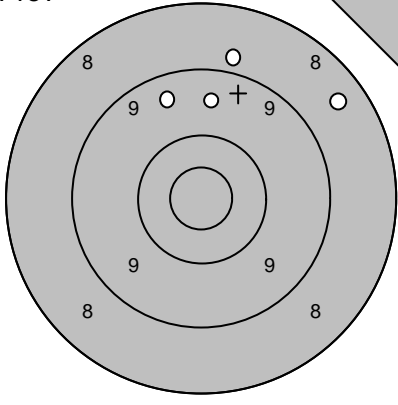
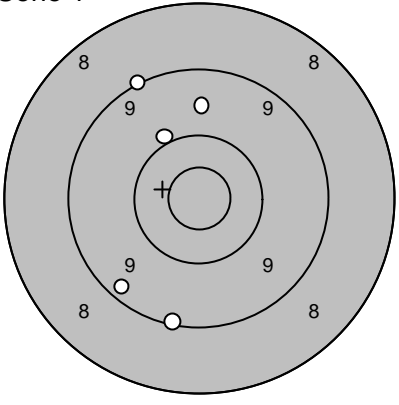
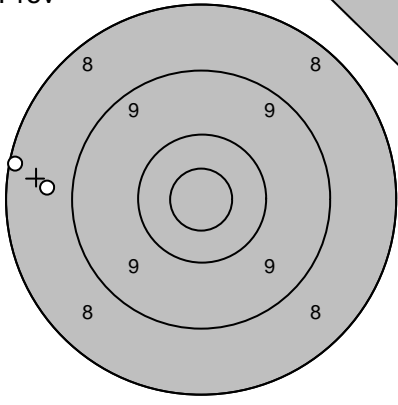
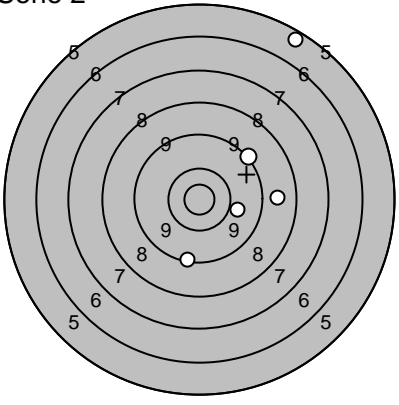
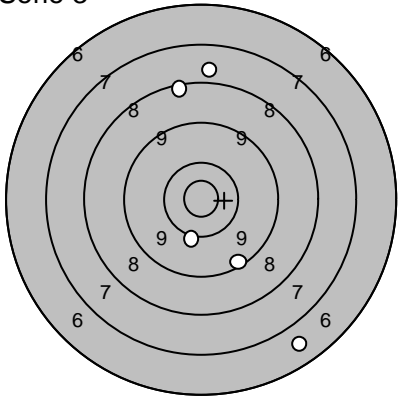
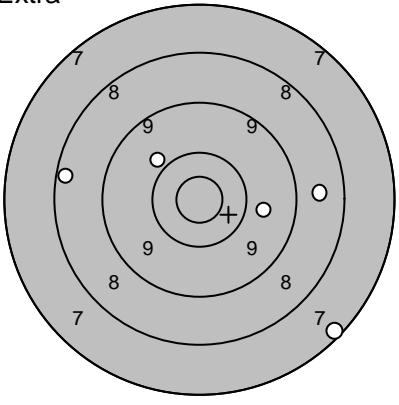
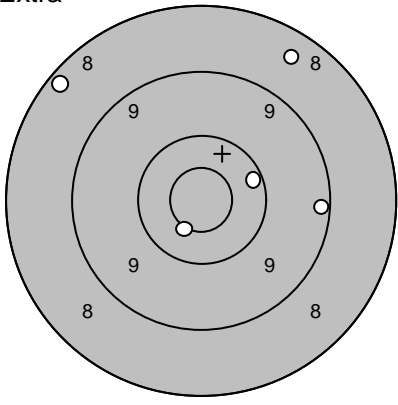
Lag	Tavla	Johnny Wallberg	
1	8		
Ramselefors	Loos		
06.07.2006	Tavelträffen B - 2006	Ramselefors Skytteförening	
Prov		1: 8,9 ↑ 2: 8,5 ↗ 3: 9,6 ↑ 4: 9,5 ↑ Serie: 34,0 Summa: 144,0	Serie 1  1: 9,7 ↑ 2: 9,1 ↓ 3: 10,0 ↗ 4: 9,3 ↘ 5: 9,1 ↗ Serie: 46,0 Summa: 190,0
Prov		1: 8,7 ← 2: 8,2 ← Serie: 16,0 Summa: 190,0	Serie 2  1: 9,3 ↓ 2: 5,5 ↗ 3: 8,8 → 4: 9,2 ↗ 5: 10,0 → Serie: 41,0 Summa: 231,0
Serie 3		1: 9,3 ↓ 2: 6,7 ↓ 3: 10,1 ↓ 4: 7,8 ↑ 5: 8,3 ↑ Serie: 40,0 Summa: 271,0	Extra  1: 8,6 → 2: 8,4 ← 3: 7,3 ↓ 4: 10,0 ↗ 5: 9,8 → Serie: 42,0 Summa: 313,0
Extra		6: 10,2 ↗ 7: 8,3 ↘ 8: 8,5 ↗ 9: 9,2 → 10: 10,6* ↓ Serie: 45,0 Summa: 358,0	

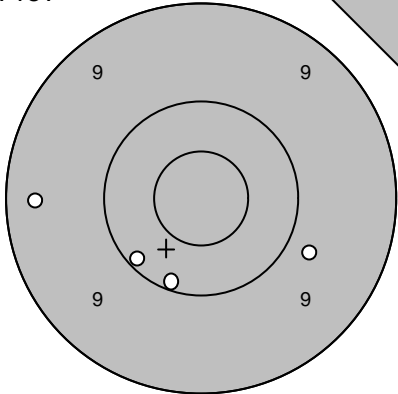
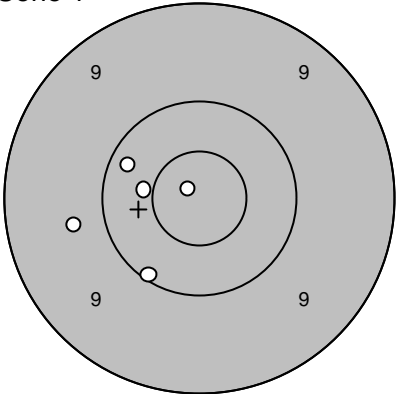
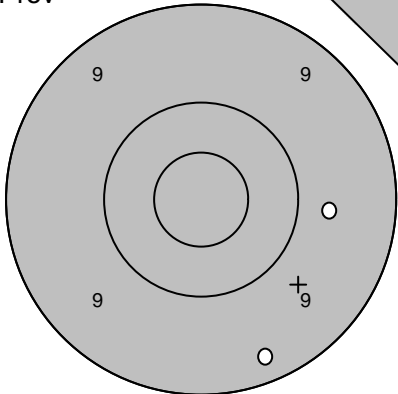
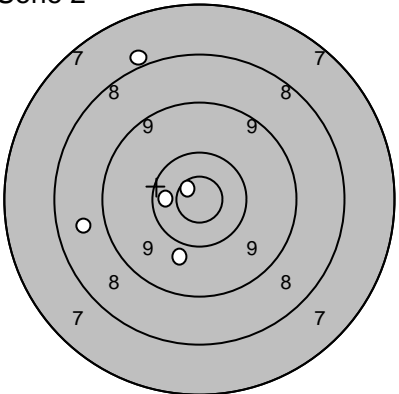
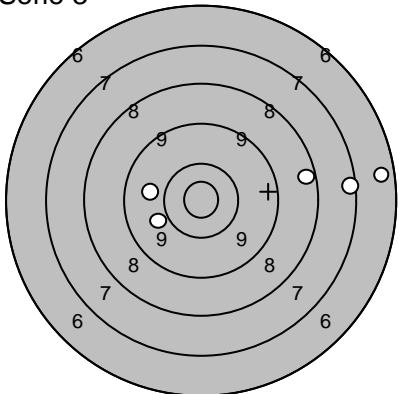
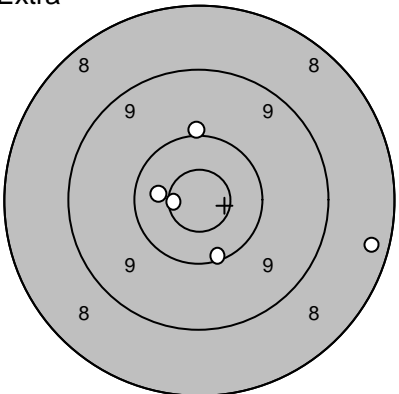
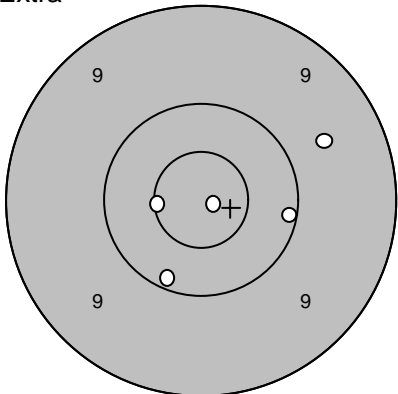
Lag 1	Tavla 9	Magnus Lindkvist		
Ramselefors	Umeå			
06.07.2006	Tavelträffen B - 2006	Ramselefors Skytteförening		
Prov		1: 9,8 → 2: 10,1 ↘ 3: 10,1 ↓ 4: 9,3 ←	Serie 1 	1: 10,9* ↗ 2: 9,7 ← 3: 10,5* ← 4: 10,2 ↗ 5: 10,1 ↓
		Serie: 38,0 Summa: 143,0		Serie: 49,0 Summa: 192,0
Prov		1: 9,7 → 2: 9,3 ↓	Serie 2 	1: 8,0 ↑ 2: 10,8* ↗ 3: 9,9 ↓ 4: 8,7 ← 5: 10,4 ←
		Serie: 18,0 Summa: 192,0		Serie: 45,0 Summa: 237,0
Serie 3		1: 7,3 → 2: 10,0 ← 3: 9,8 ← 4: 8,4 → 5: 6,5 →	Extra 	1: 10,7* ← 2: 10,0 ↑ 3: 8,4 → 4: 10,2 ↓ 5: 10,4 ←
		Serie: 40,0 Summa: 277,0		Serie: 48,0 Summa: 325,0
Extra		6: 10,2 ↓ 7: 10,1 → 8: 9,6 ↗ 9: 10,9* → 10: 10,6* ←		
		Serie: 49,0 Summa: 374,0		

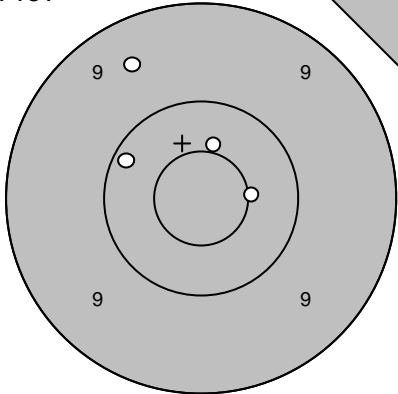
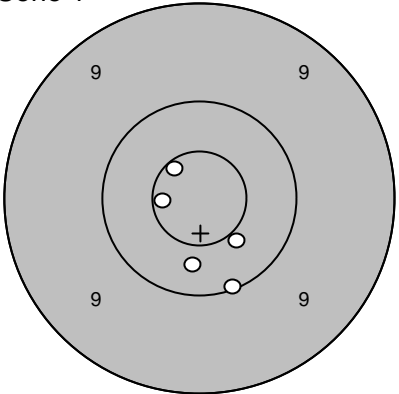
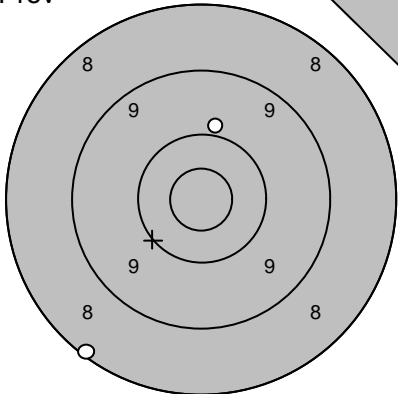
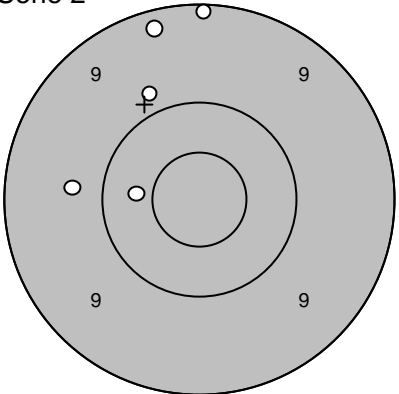
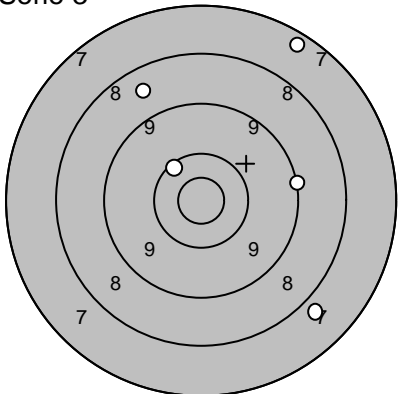
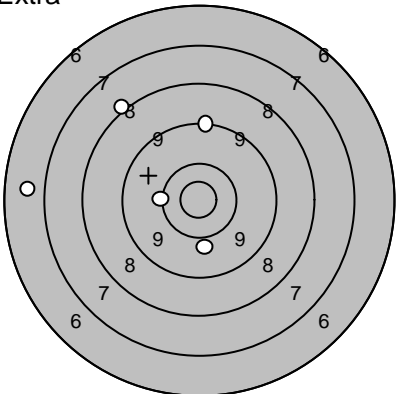
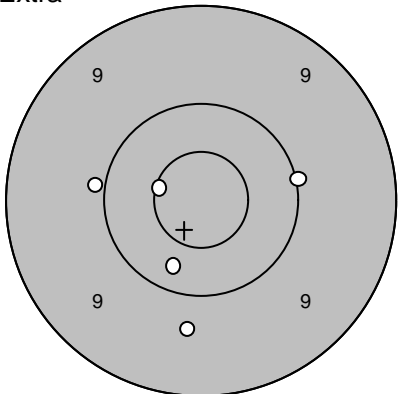
Lag 1	Tavla 10	Lars-Göran Lundqvist		
Ramselefors	Ununge			
06.07.2006	Tavelträffen B - 2006	Ramselefors Skytteförening		
Prov		1: 10,5* ↑ 2: 9,5 ↗ 3: 10,5* → 4: 10,2 ↖	Serie 1 	1: 10,1 ↓ 2: 10,5* ↓ 3: 10,3 ↓ 4: 10,6* ↗ 5: 10,7* ←
	Serie: 39,0 Summa: 141,0		Serie: 50,0 Summa: 191,0	
Prov		1: 9,9 ↑ 2: 8,2 ↓	Serie 2 	1: 9,7 ← 2: 9,2 ↑ 3: 9,1 ↑ 4: 10,4 ← 5: 9,8 ↗
	Serie: 17,0 Summa: 191,0		Serie: 46,0 Summa: 237,0	
Serie 3		1: 8,6 ↖ 2: 10,3 ↗ 3: 7,4 ↗ 4: 7,9 ↓ 5: 9,1 →	Extra 	1: 6,8 ← 2: 10,0 ↓ 3: 8,1 ↗ 4: 9,2 ↑ 5: 10,2 ←
	Serie: 41,0 Summa: 278,0		Serie: 43,0 Summa: 321,0	
Extra		6: 9,9 ← 7: 9,7 ↓ 8: 10,6* ← 9: 10,3 ↓ 10: 10,0 →		
	Serie: 48,0 Summa: 369,0			

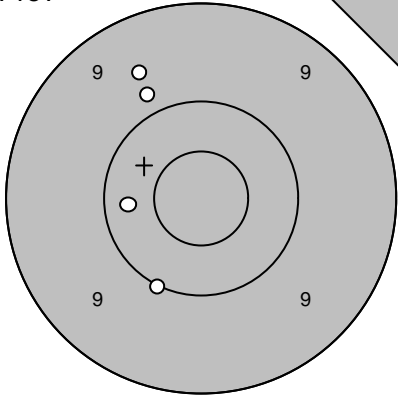
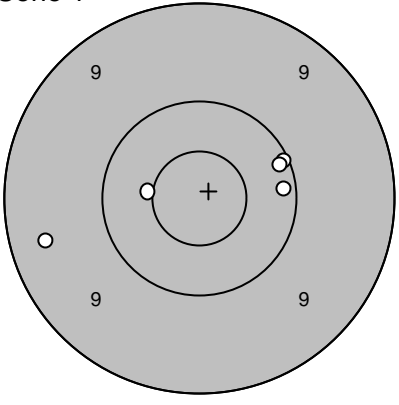
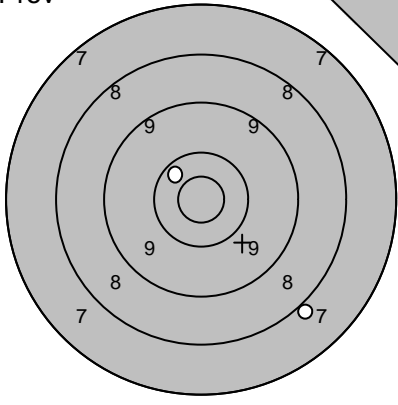
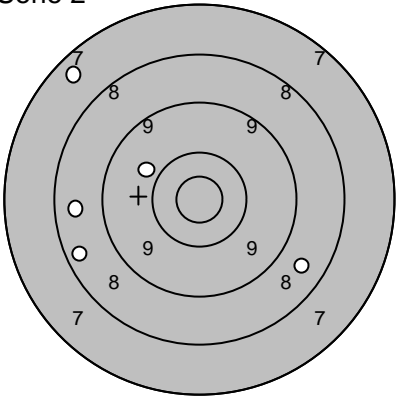
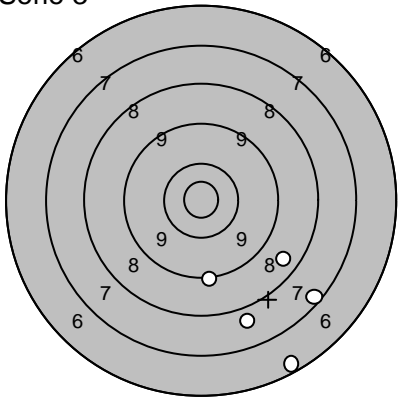
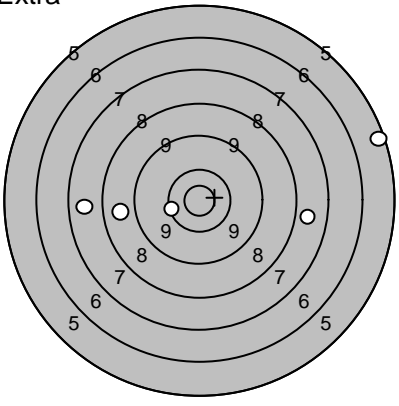
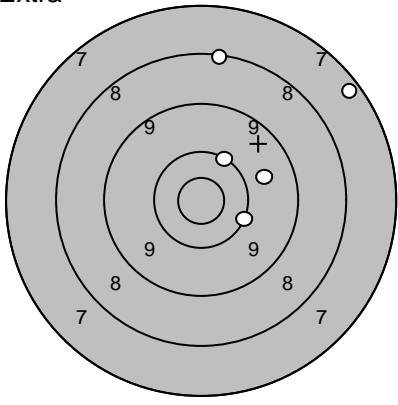
Lag 1	Tavla 11	Curt Lejon	
Ramselefors		Umeå	
06.07.2006		Tavelträffen B - 2006	Ramselefors Skytteförening
Prov 	1: 10,0 ↙ 2: 10,3 ← 3: 9,8 ↗ 4: 9,6 ↗	Serie 1 	1: 10,1 → 2: 10,1 → 3: 9,4 ← 4: 10,5* ← 5: 10,2 →
	Serie: 38,0 Summa: 141,0		Serie: 49,0 Summa: 190,0
Prov 	1: 10,4 ↖ 2: 8,0 ↘	Serie 2 	1: 9,9 ↖ 2: 7,5 ↗ 3: 8,6 ↘ 4: 8,4 ← 5: 8,6 ←
	Serie: 18,0 Summa: 190,0		Serie: 40,0 Summa: 230,0
Serie 3 	1: 9,2 ↓ 2: 6,4 ↓ 3: 7,9 ↓ 4: 7,4 ↓ 5: 8,6 ↓	Extra 	1: 7,8 → 2: 8,8 ← 3: 10,3 ← 4: 5,4 → 5: 7,7 ←
	Serie: 37,0 Summa: 267,0		Serie: 37,0 Summa: 304,0
Extra 	6: 10,2 ↗ 7: 7,4 ↗ 8: 10,1 → 9: 9,8 → 10: 8,2 ↑		
	Serie: 44,0 Summa: 348,0		

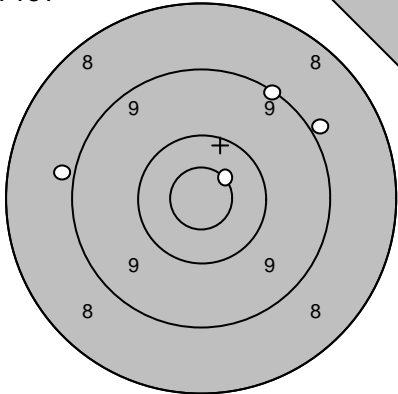
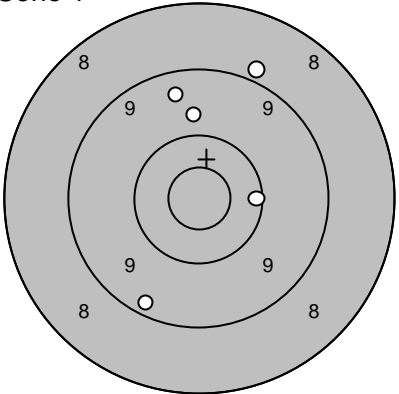
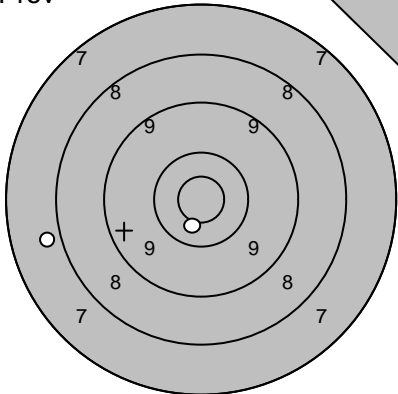
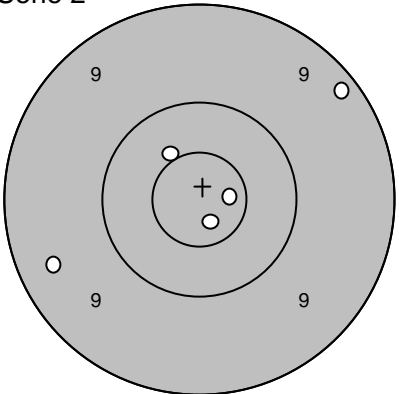
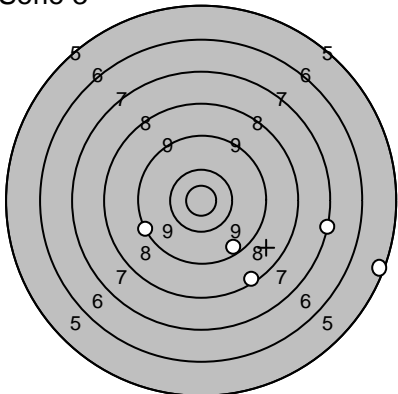
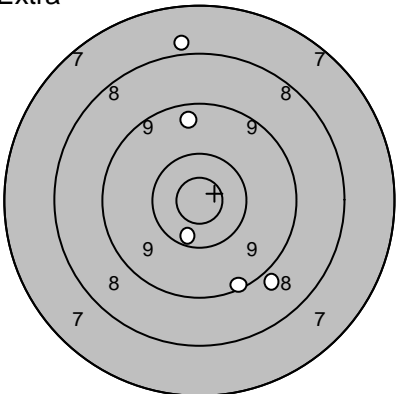
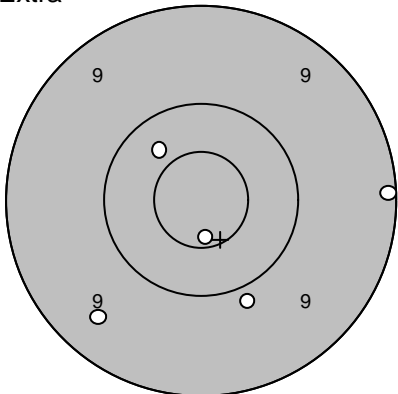
Lag 1	Tavla 12	Torvald Andersson	
Ramselefors		Ununge	
06.07.2006		Tavelträffen B - 2006	Ramselefors Skytteförening
Prov 	1: 8,9 → 2: 10,6* ↗ 3: 9,1 ↗ 4: 8,9 ←	Serie 1 	1: 9,4 ↑ 2: 9,8 ↑ 3: 8,9 ↗ 4: 10,2 → 5: 9,3 ↓
	Serie: 35,0 Summa: 146,0		Serie: 45,0 Summa: 191,0
Prov 	1: 7,9 ← 2: 10,6* ↓	Serie 2 	1: 10,8* ↓ 2: 10,5* ↗ 3: 9,4 ← 4: 9,2 ↗ 5: 10,7* →
	Serie: 17,0 Summa: 191,0		Serie: 48,0 Summa: 239,0
Serie 3 	1: 9,3 ← 2: 5,4 → 3: 8,4 ↓ 4: 9,4 ↓ 5: 7,2 →	Extra 	1: 7,9 ↑ 2: 9,5 ↑ 3: 8,9 ↓ 4: 9,2 ↓ 5: 10,4 ↓
	Serie: 38,0 Summa: 277,0		Serie: 43,0 Summa: 320,0
Extra 	6: 9,1 → 7: 10,4 ↗ 8: 9,4 ↓ 9: 9,9 ↓ 10: 10,7* ↓		
	Serie: 47,0 Summa: 367,0		

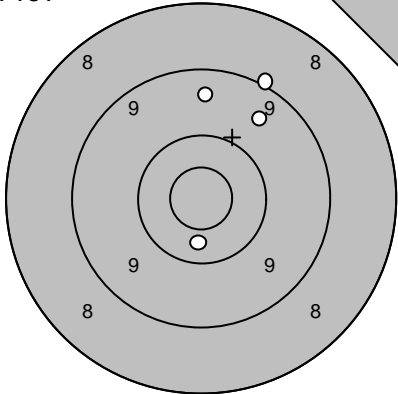
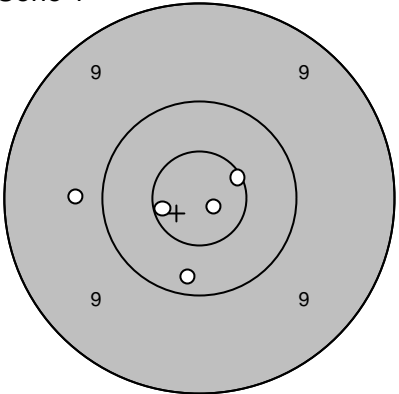
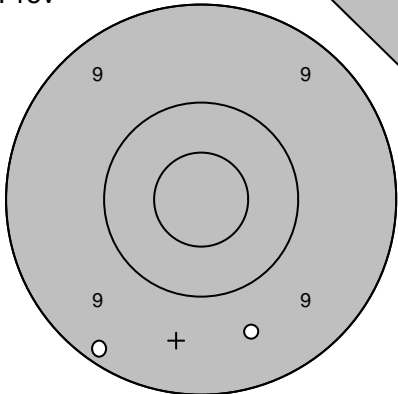
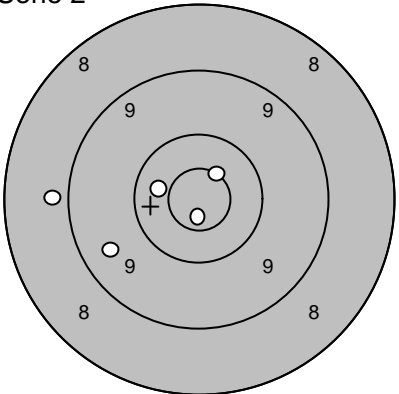
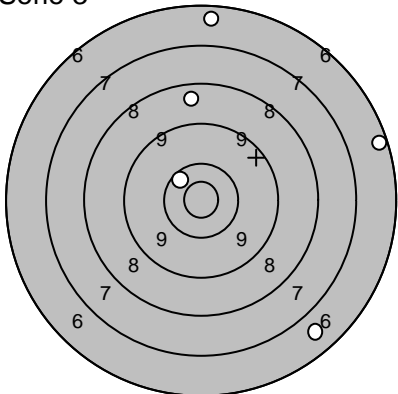
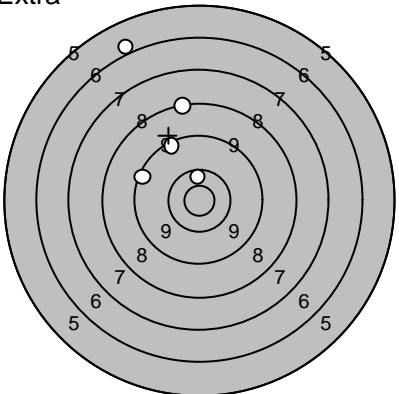
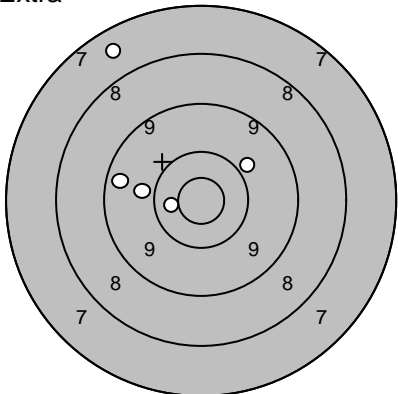
Lag 1	Tavla 14	Jan Wallerström			
Ramselefors		Ununge			
06.07.2006		Tavelträffen B - 2006		Ramselefors Skytteförening	
Prov		1: 10,4 ↓ 2: 9,6 ↗ 3: 9,5 ↑ 4: 9,0 ↗	Serie 1		1: 10,7* ← 2: 9,8 ← 3: 10,6* ↗ 4: 10,9* ↘ 5: 10,2 ↓
		Serie: 37,0 Summa: 143,0			Serie: 49,0 Summa: 192,0
Prov		1: 9,6 ↓ 2: 9,2 ↘	Serie 2		1: 10,8* ↓ 2: 9,5 ↙ 3: 10,4 ← 4: 10,6* ↗ 5: 8,8 ←
		Serie: 18,0 Summa: 192,0			Serie: 47,0 Summa: 239,0
Serie 3		1: 6,4 → 2: 8,6 ↑ 3: 6,5 ↑ 4: 10,4 ↗ 5: 6,7 ↘	Extra		1: 6,0 ↗ 2: 10,5* ↑ 3: 9,3 ← 4: 8,3 ↑ 5: 9,3 ↗
		Serie: 36,0 Summa: 275,0			Serie: 42,0 Summa: 317,0
Extra		6: 7,6 ↗ 7: 9,9 ↗ 8: 10,5* ← 9: 9,9 ← 10: 9,4 ←			
		Serie: 44,0 Summa: 361,0			

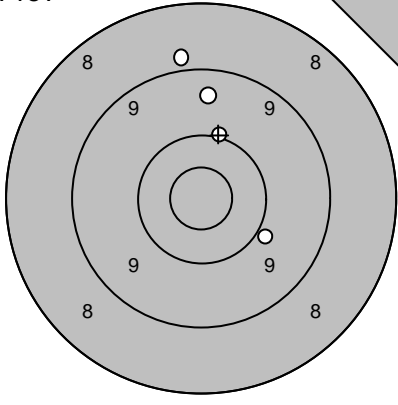
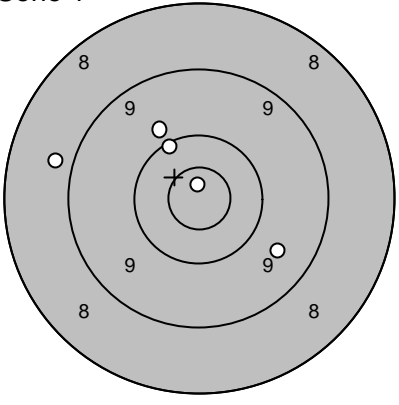
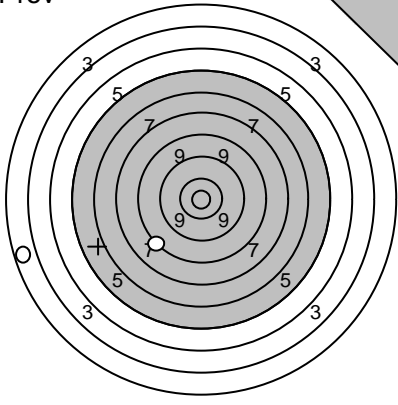
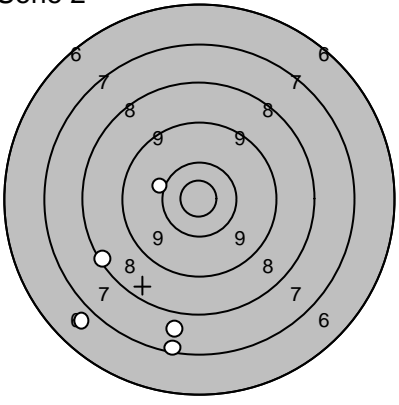
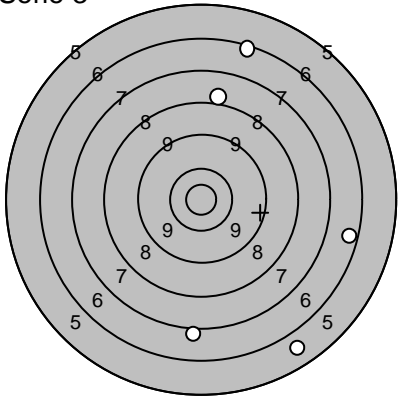
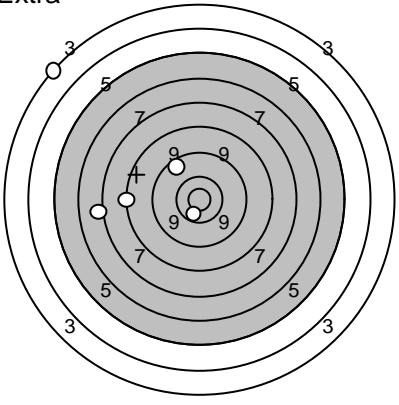
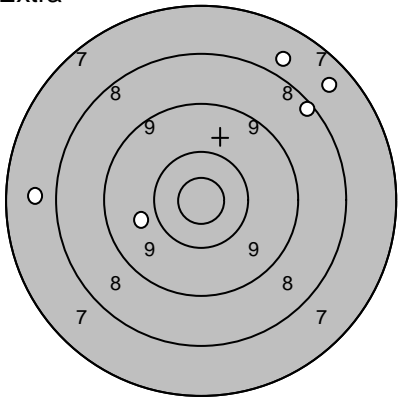
Lag	Tavla	Curt Linerud	
1	15		
Ramselefors	I 20		
06.07.2006	Tavelträffen B - 2006	Ramselefors Skytteförening	
Prov		1: 9,9 → 2: 9,5 ↑ 3: 8,9 ↑ 4: 10,1 ↑ Serie: 36,0 Summa: 135,0	Serie 1  1: 9,6 ↘ 2: 10,2 ↗ 3: 10,9* ↑ 4: 8,8 ← 5: 9,9 ↗ Serie: 46,0 Summa: 181,0
Prov		1: 2,8 ← 2: 8,4 ↙ Serie: 10,0 Summa: 181,0	Serie 2  1: 6,9 ↙ 2: 10,1 ← 3: 7,3 ↓ 4: 8,3 ← 5: 7,8 ↓ Serie: 38,0 Summa: 219,0
Serie 3		1: 6,6 → 2: 6,4 ↑ 3: 5,8 ↘ 4: 8,0 ↑ 5: 7,1 ↓ Serie: 32,0 Summa: 251,0	Extra  1: 10,7* ↓ 2: 8,3 ← 3: 3,4 ↗ 4: 7,2 ← 5: 9,7 ↗ Serie: 37,0 Summa: 288,0
Extra		6: 7,7 ← 7: 9,8 ← 8: 7,6 ↗ 9: 7,8 ↗ 10: 8,3 ↗ Serie: 38,0 Summa: 326,0	

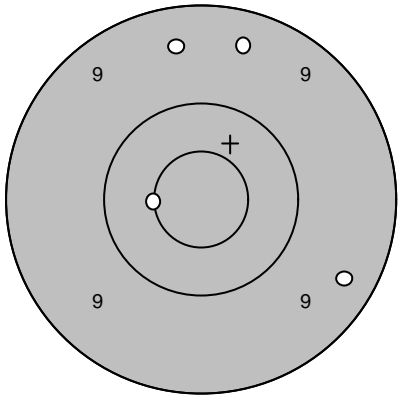
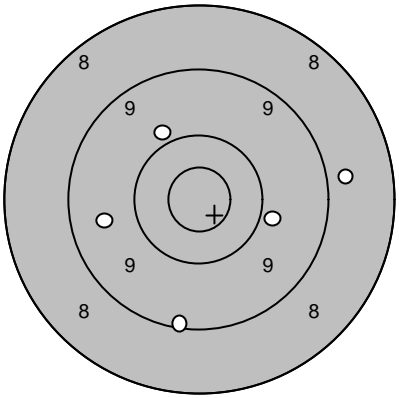
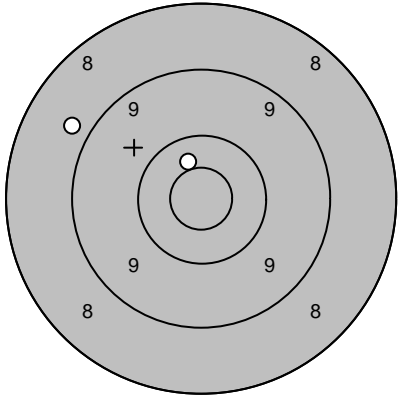
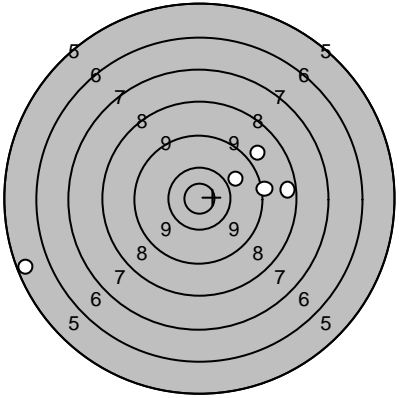
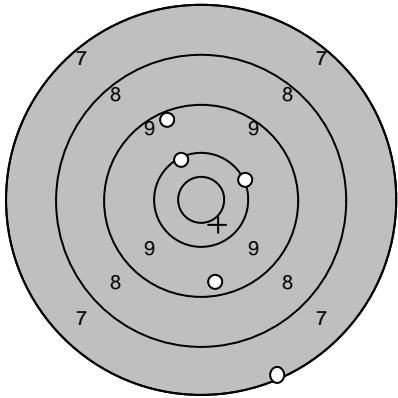
Lag 1	Tavla 16	Martin Olofsson	
Ramselefors		Vännäs	
06.07.2006		Tavelträffen B - 2006	Ramselefors Skytteförening
Prov		1: 9,4 ↗ 2: 9,4 ↑ 3: 10,6* ← 4: 9,4 ↘	Serie 1
			
			1: 9,9 → 2: 9,1 ↓ 3: 9,6 ← 4: 9,9 ↗ 5: 8,8 →
		Serie: 37,0	Serie: 44,0
		Summa: 138,0	Summa: 182,0
Prov		1: 10,5* ↗ 2: 8,8 ↖	Serie 2
			
			1: 5,5 ← 2: 8,9 ↗ 3: 9,9 ↗ 4: 8,5 → 5: 9,2 →
		Serie: 18,0	Serie: 39,0
		Summa: 182,0	Summa: 221,0
Serie 3		1: 10,1 → 2: 7,2 ↓ 3: 9,4 ↓ 4: 9,4 ↗ 5: 10,2 ↗	
		Serie: 45,0	
		Summa: 266,0	

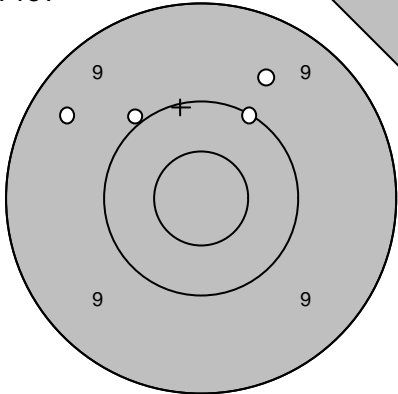
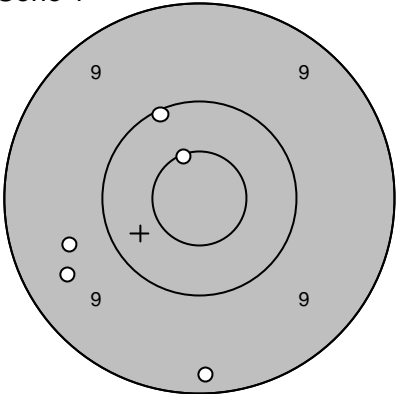
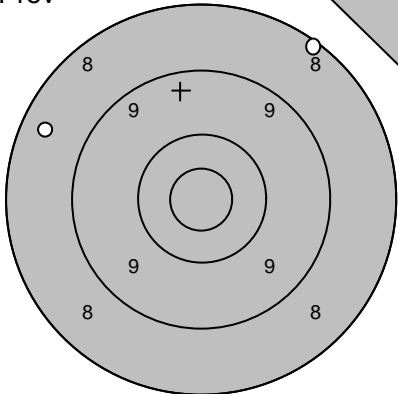
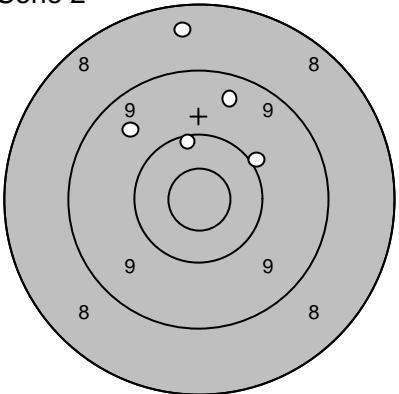
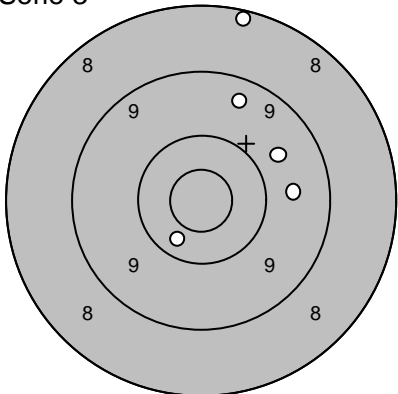
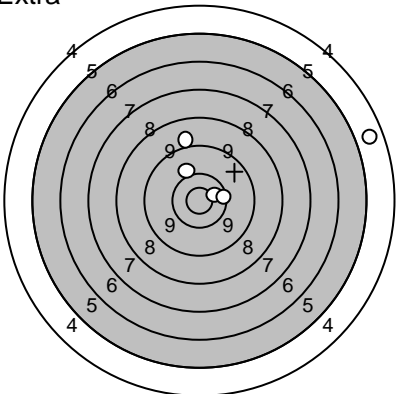
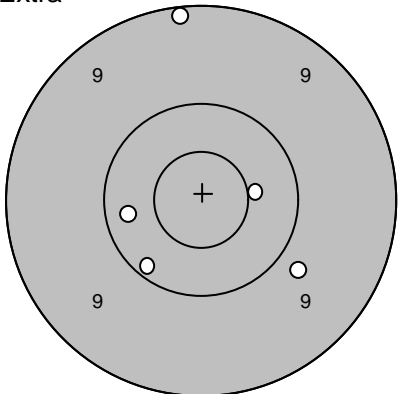
Lag 1	Tavla 19	Urban Johansson		
Ramselefors	F 21			
06.07.2006	Tavelträffen B - 2006	Ramselefors Skytteförening		
Prov		1: 10,1 ↗ 2: 9,4 ↖ 3: 10,0 ↘ 4: 9,6 ↗	Serie 1 	1: 10,6* ↗ 2: 10,1 ↗ 3: 9,6 ↖ 4: 9,5 ↖ 5: 9,2 ↓
		Serie: 38,0 Summa: 143,0		Serie: 47,0 Summa: 190,0
Prov		1: 8,5 ↖ 2: 8,2 ↗	Serie 2 	1: 10,0 ↗ 2: 9,6 ↖ 3: 10,2 ↑ 4: 9,5 ↑ 5: 8,5 ↑
		Serie: 16,0 Summa: 190,0		Serie: 46,0 Summa: 236,0
Serie 3		1: 8,2 ↑ 2: 9,5 ↑ 3: 9,7 → 4: 9,6 → 5: 10,4 ↓	Extra 	1: 9,1 ↑ 2: 10,6* → 3: 4,8 → 4: 10,4 → 5: 10,1 ↗
		Serie: 45,0 Summa: 281,0		Serie: 43,0 Summa: 324,0
Extra		6: 9,1 ↑ 7: 10,5* → 8: 10,2 ↘ 9: 9,8 ↘ 10: 10,3 ←		
		Serie: 48,0 Summa: 372,0		

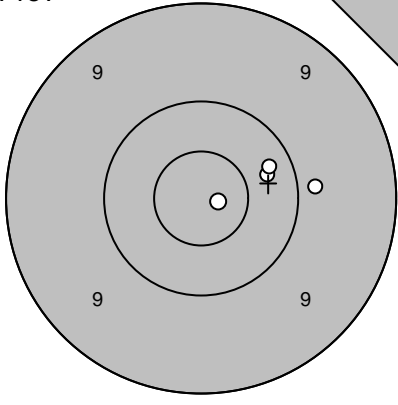
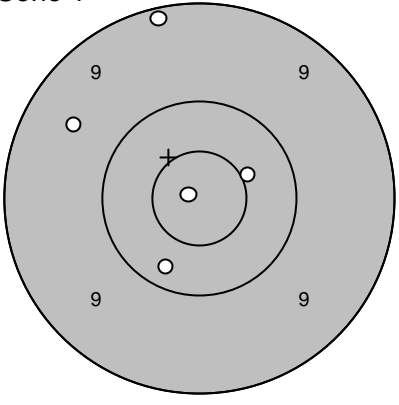
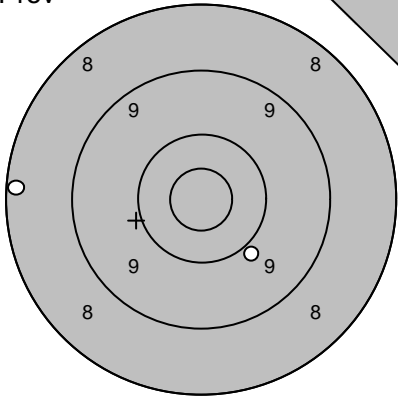
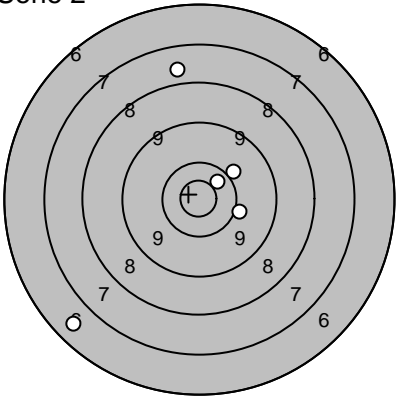
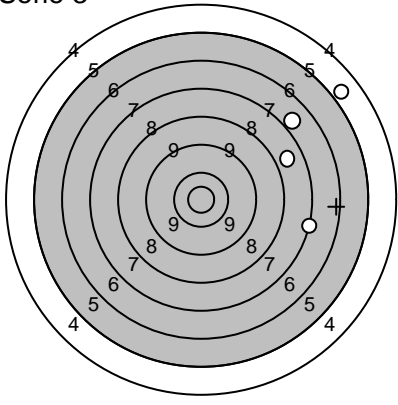
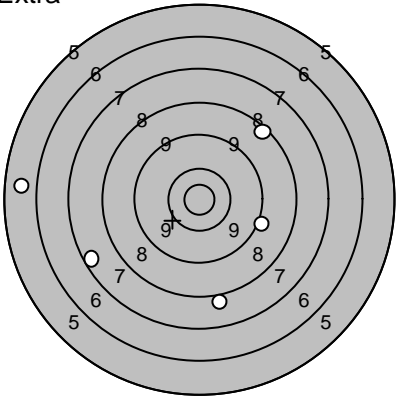
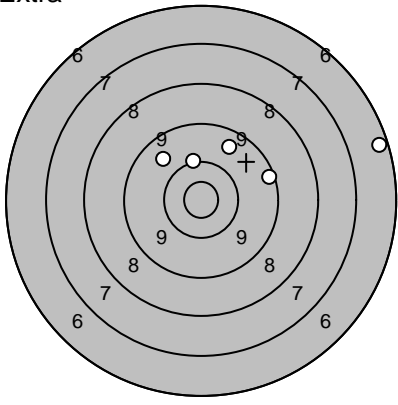
Lag 1	Tavla 20	Roland Nilsson			
Ramselefors		Piteå			
06.07.2006		Tavelträffen B - 2006		Ramselefors Skytteförening	
Prov		1: 9,9 → 2: 10,9* → 3: 10,3 → 4: 10,3 →	Serie 1		1: 9,2 ↑ 2: 10,5* → 3: 10,9* ← 4: 10,3 ↓ 5: 9,6 ←
		Serie: 39,0 Summa: 139,0			Serie: 48,0 Summa: 187,0
Prov		1: 9,9 ↘ 2: 8,2 ←	Serie 2		1: 6,7 ↙ 2: 7,8 ↑ 3: 10,1 → 4: 10,0 ↗ 5: 10,5* ↗
		Serie: 17,0 Summa: 187,0			Serie: 43,0 Summa: 230,0
Serie 3		1: 5,0 ↗ 2: 7,8 → 3: 0,0 ↘ 4: 7,0 ↗ 5: 7,3 →	Extra		1: 9,1 → 2: 8,0 ↓ 3: 7,4 ← 4: 5,8 ← 5: 8,4 ↗
		Serie: 26,0 Summa: 256,0			Serie: 37,0 Summa: 293,0
Extra		6: 10,2 ↑ 7: 6,4 → 8: 9,6 ↗ 9: 9,3 → 10: 9,8 ↖			
		Serie: 43,0 Summa: 336,0			

Lag	Tavla		
1	21	Mikael Gustafsson	

Ramselefors	Umeå		
-------------	------	--	--

06.07.2006	Tavelträffen B - 2006	Ramselefors Skytteförening	
------------	-----------------------	----------------------------	--

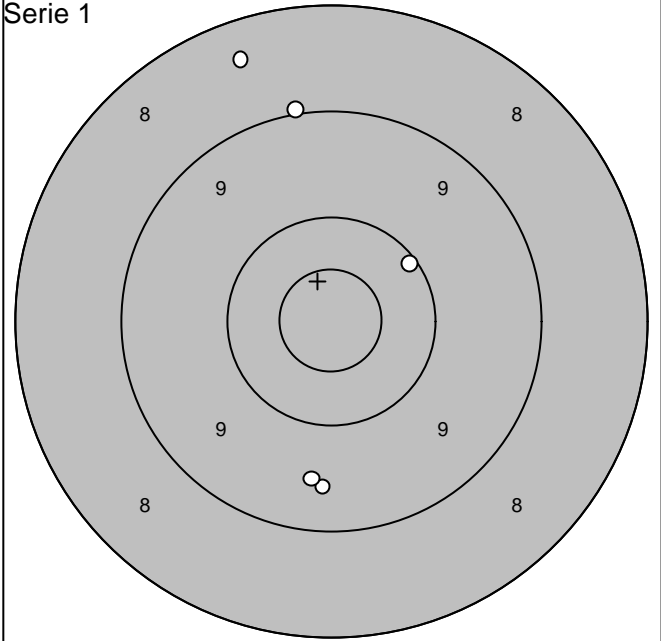
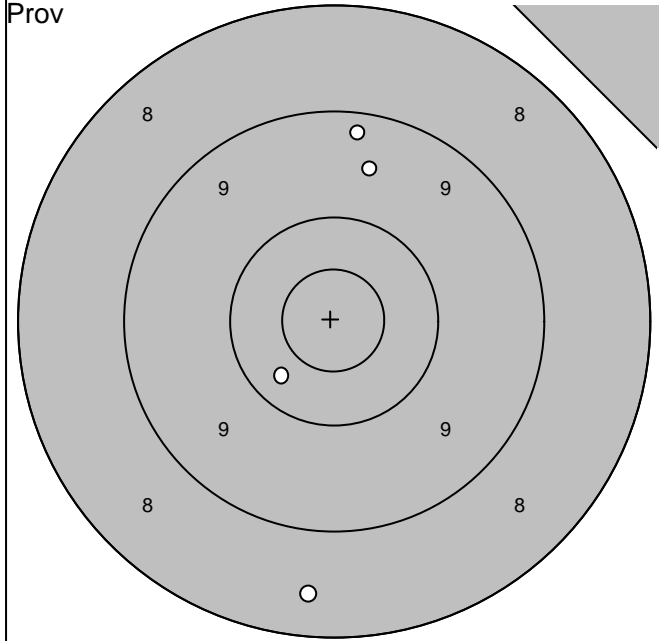

1: 10,3 ↙	Serie: 36,0
2: 9,5 ↑	
3: 9,2 ↑	
4: 8,4 ↓	
Summa: 134,0	

1: 8,4 ↑	Serie: 45,0
2: 9,0 ↑	
3: 10,1 ↗	
4: 9,5 ↓	
5: 9,5 ↓	
Summa: 179,0	

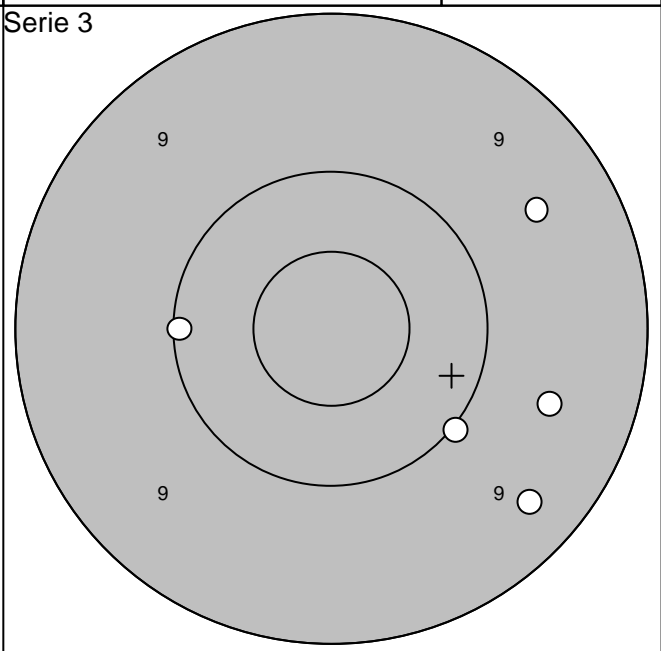
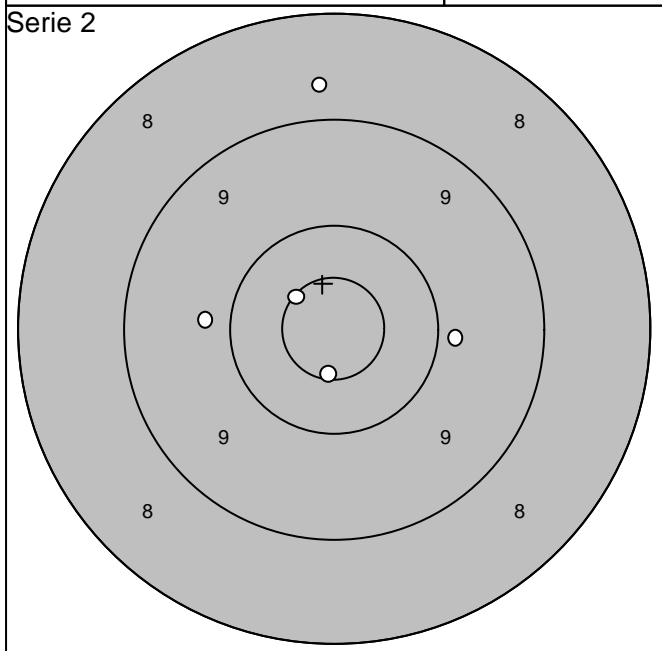

1: 8,7 ↑	Serie: 46,0
2: 9,9 →	
3: 10,6* ↓	
4: 10,6* ↖	
5: 9,8 ←	
Summa: 225,0	

1: 9,5 ↗	Serie: 47,0
2: 10,0 ↘	
3: 9,6 →	
4: 10,1 ←	
5: 9,4 ↘	
Summa: 272,0	

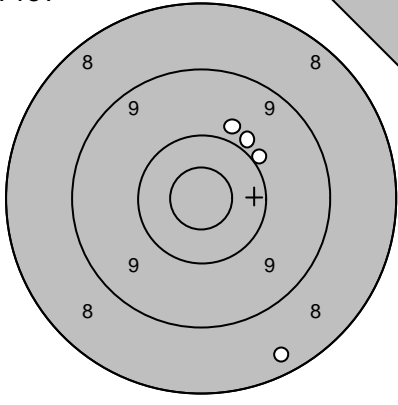
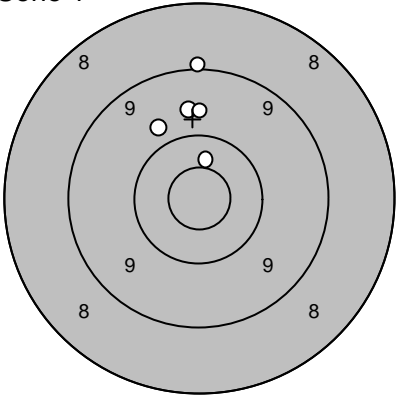
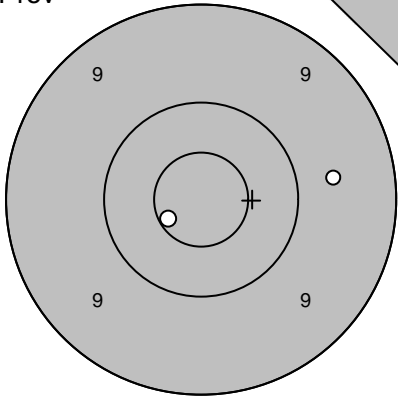
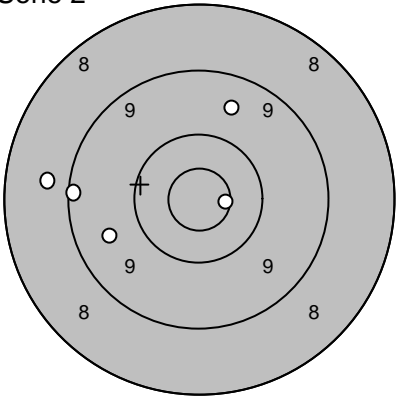
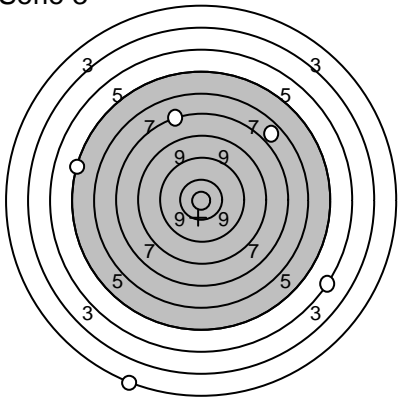
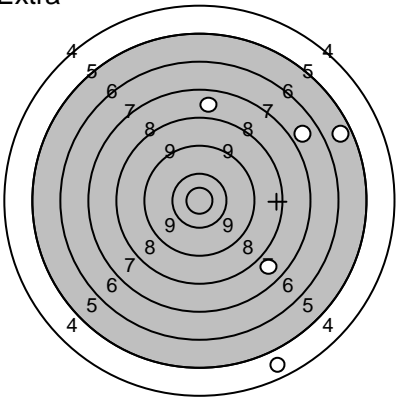
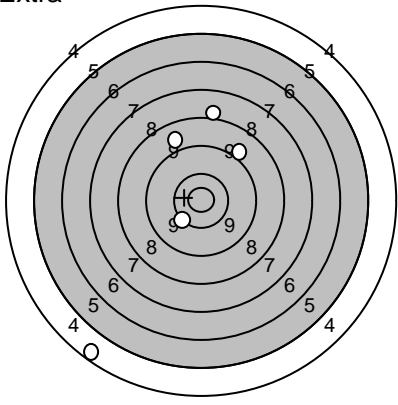
Lag 1	Tavla 22	Bengt Heder	
Ramselefors		Evertsberg	
06.07.2006		Tavelträffen B - 2006	Ramselefors Skytteförening
Prov 	1: 10,0 ↗ 2: 8,4 ↘ 3: 9,9 ↗ 4: 9,9 ↑ Serie: 36,0 Summa: 145,0	Serie 1 	1: 9,7 ↑ 2: 9,8 ↖ 3: 10,5* ↑ 4: 9,7 ↑ 5: 9,0 ↑ Serie: 46,0 Summa: 191,0
Prov 	1: 10,6* ↖ 2: 9,7 → Serie: 19,0 Summa: 191,0	Serie 2 	1: 8,7 ← 2: 9,6 ↖ 3: 9,2 ← 4: 10,7* → 5: 9,6 ↑ Serie: 45,0 Summa: 236,0
Serie 3 	1: 4,4 ↘ 2: 2,3 ↘ 3: 5,4 ← 4: 7,4 ↑ 5: 6,9 ↗ Serie: 24,0 Summa: 260,0	Extra 	1: 4,7 ↘ 2: 7,8 ↘ 3: 7,9 ↑ 4: 6,8 ↗ 5: 5,7 ↗ Serie: 29,0 Summa: 289,0
Extra 	6: 4,5 ↖ 7: 8,9 ↖ 8: 8,1 ↑ 9: 9,1 ↗ 10: 10,3 ↖ Serie: 39,0 Summa: 328,0		

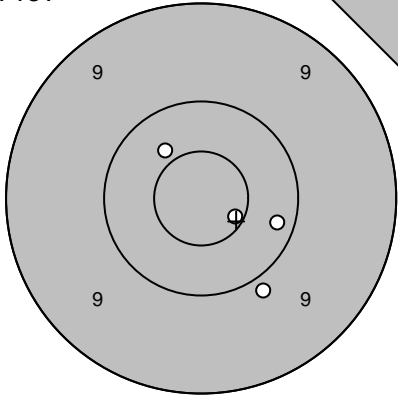
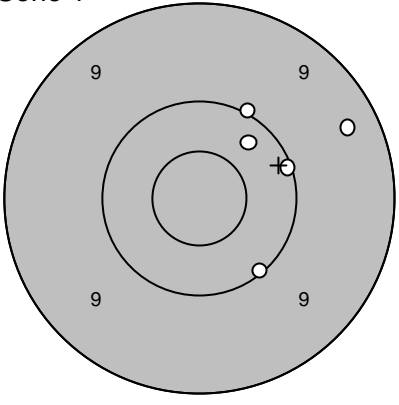
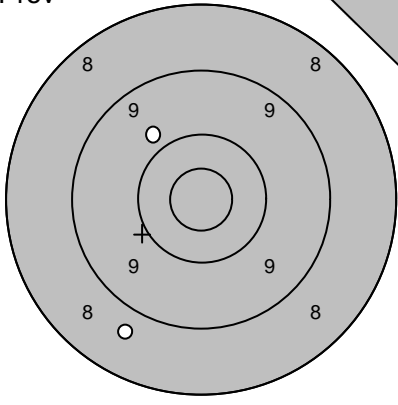
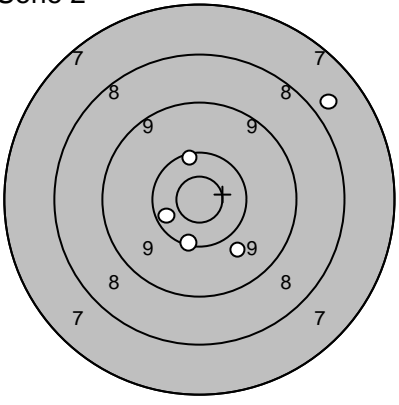
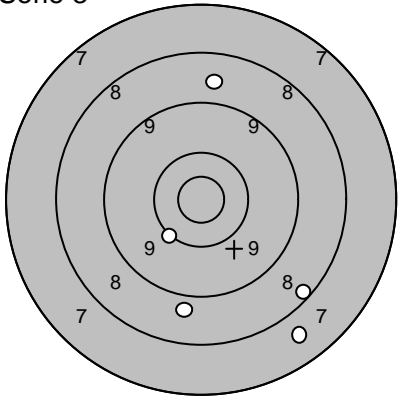
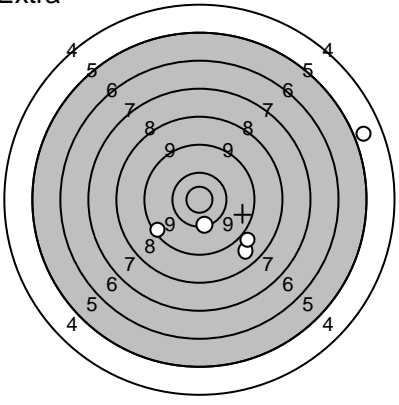
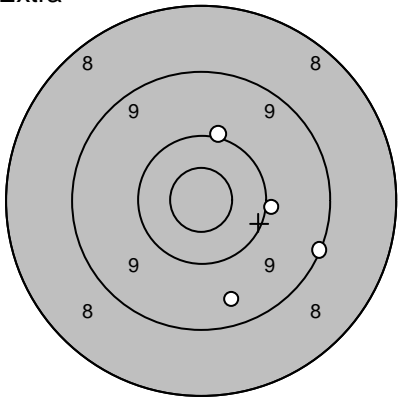
Lag 1	Tavla 23	Gunnar Iversen	
Ramselefors	S 3		
06.07.2006	Tavelträffen B - 2006	Ramselefors Skytteförening	
Prov		1: 9,9 ↘ 2: 10,4 ↗ 3: 10,6* → 4: 10,2 →	Serie 1 
		Serie: 39,0 Summa: 146,0	1: 10,1 ↘ 2: 10,0 ↗ 3: 9,3 → 4: 10,3 ↗ 5: 10,1 →
			Serie: 49,0 Summa: 195,0
Prov		1: 8,7 ↘ 2: 9,8 ↖	Serie 2 
		Serie: 17,0 Summa: 195,0	1: 9,8 ↘ 2: 7,8 ↗ 3: 10,4 ← 4: 10,3 ↑ 5: 10,2 ↓
			Serie: 46,0 Summa: 241,0
Serie 3		1: 8,7 ↑ 2: 7,7 ↘ 3: 10,1 ↘ 4: 8,8 ↘ 5: 8,3 ↘	Extra 
		Serie: 41,0 Summa: 282,0	1: 8,8 ↘ 2: 9,0 ↘ 3: 4,9 → 4: 10,3 ↓ 5: 9,4 ←
			Serie: 40,0 Summa: 322,0
Extra		6: 9,5 ↘ 7: 9,1 → 8: 10,0 ↑ 9: 10,0 →	
		Serie: 38,0 Summa: 360,0	

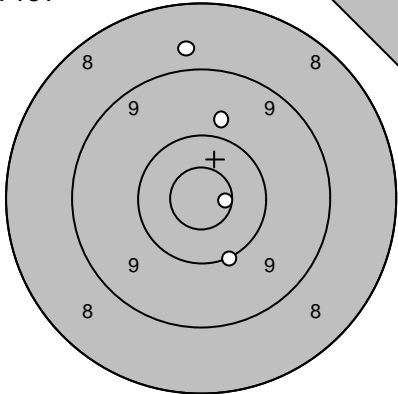
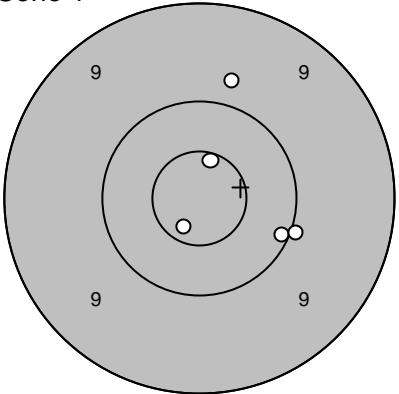
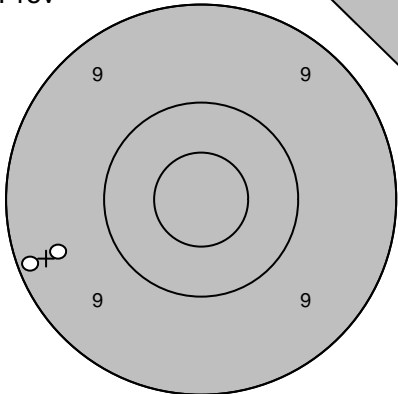
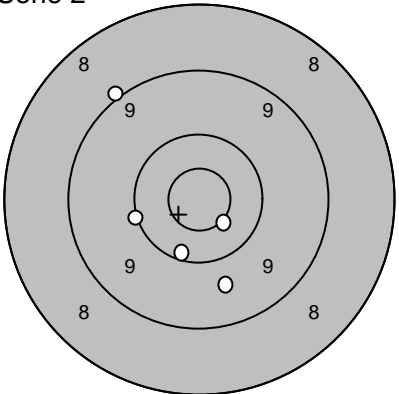
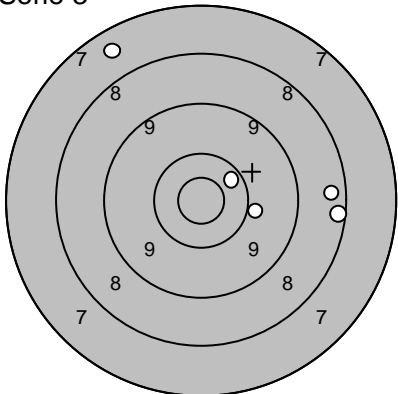
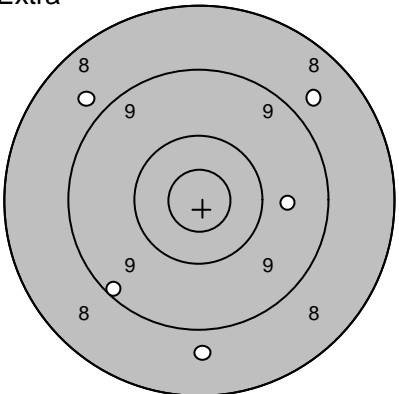
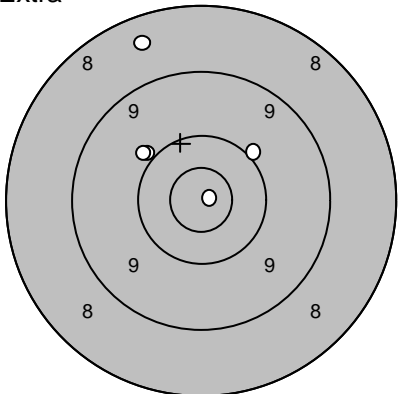
Lag 2	Tavla 1	Helena Jansson	
Ramselefors		Söderala	
06.07.2006		Tavelträffen B - 2006	Ramselefors Skytteförening
Prov 	1: 10,7* → 2: 9,8 ↑ 3: 8,8 ↑ 4: 10,0 ↓	Serie 1 	1: 10,6* ↑ 2: 10,7* ↓ 3: 10,1 → 4: 9,8 ↑ 5: 10,0 →
	Serie: 37,0 Summa: 142,0		Serie: 49,0 Summa: 191,0
Prov 	1: 9,5 ← 2: 9,2 ←	Serie 2 	1: 10,2 ↓ 2: 10,1 ← 3: 9,7 ↓ 4: 9,0 ↗ 5: 10,6* ↓
	Serie: 18,0 Summa: 191,0		Serie: 48,0 Summa: 239,0
Serie 3 	1: 8,5 → 2: 10,0 → 3: 7,6 ↗ 4: 8,3 → 5: 10,4 ↗	Extra 	1: 8,7 ↓ 2: 8,8 ↖ 3: 9,2 ↓ 4: 9,7 → 5: 8,7 ↗
	Serie: 43,0 Summa: 282,0		Serie: 42,0 Summa: 324,0
Extra 	6: 10,0 ↗ 7: 8,5 ↗ 8: 10,0 ↗ 9: 10,9* → 10: 9,9 ↖		
	Serie: 47,0 Summa: 371,0		

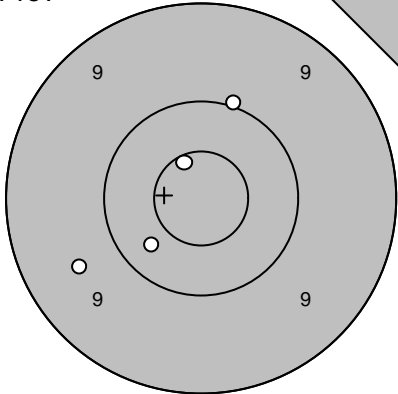
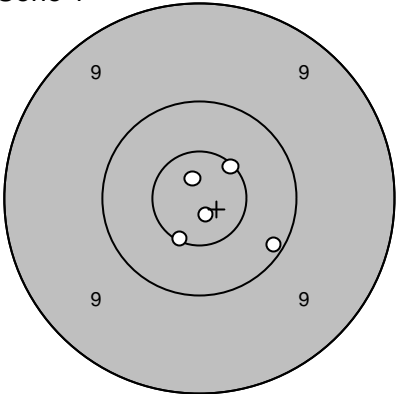
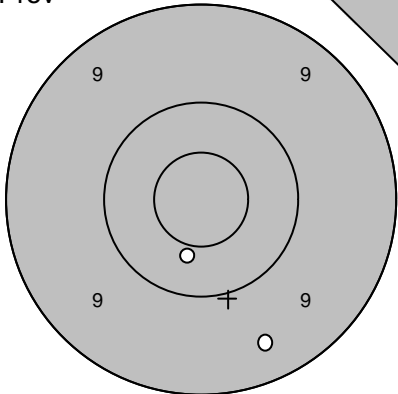
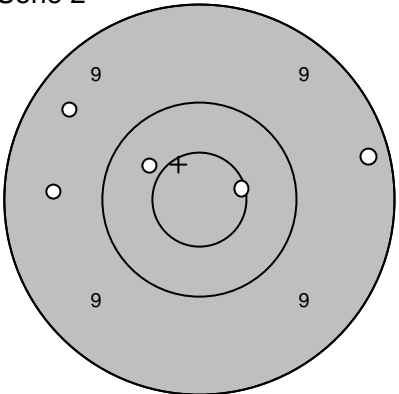
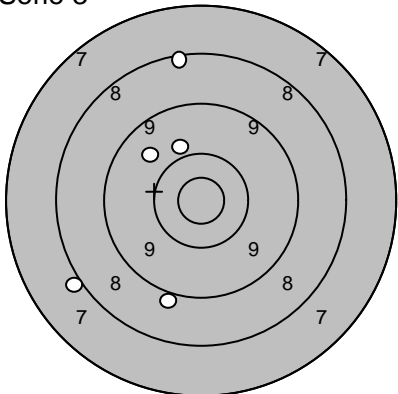
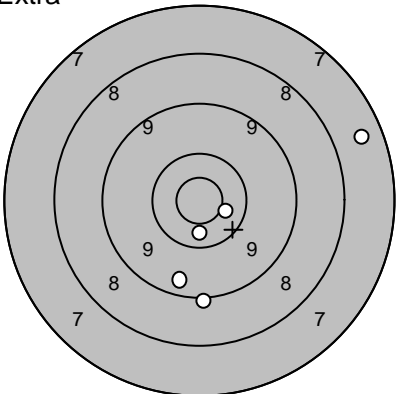
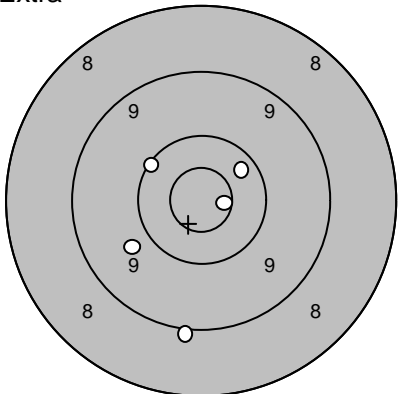
Lag 2	Tavla 2	Bengt Jansson	
Ramselefors		Söderala	
06.07.2006		Tavelträffen B - 2006	Ramselefors Skytteförening
Prov 	1: 9,6 ↙ 2: 10,0 ↑ 3: 10,6* ↗ 4: 10,3 ↙ Serie: 39,0 Summa: 147,0	Serie 1 	1: 10,6* ↙ 2: 10,1 ↘ 3: 10,6* ↗ 4: 10,8* ↗ 5: 10,9* ↘ Serie: 50,0 Summa: 197,0
Prov 	1: 10,4 ↓ 2: 9,4 ↓ Serie: 19,0 Summa: 197,0	Serie 2 	1: 9,4 ↖ 2: 10,6* → 3: 9,5 ← 4: 9,3 → 5: 10,4 ↗ Serie: 47,0 Summa: 244,0
Serie 3 	1: 8,2 ↑ 2: 9,7 ↖ 3: 8,0 ← 4: 10,0 ↑ 5: 9,0 ↓ Serie: 44,0 Summa: 288,0	Extra 	1: 7,6 ↗ 2: 9,1 ↓ 3: 9,4 ↓ 4: 10,5* ↓ 5: 10,6* ↘ Serie: 45,0 Summa: 333,0
Extra 	6: 9,0 ↓ 7: 10,7* → 8: 10,1 ↖ 9: 10,3 ↗ 10: 9,8 ↙ Serie: 48,0 Summa: 381,0		

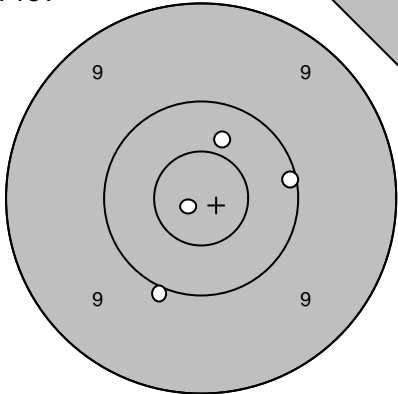
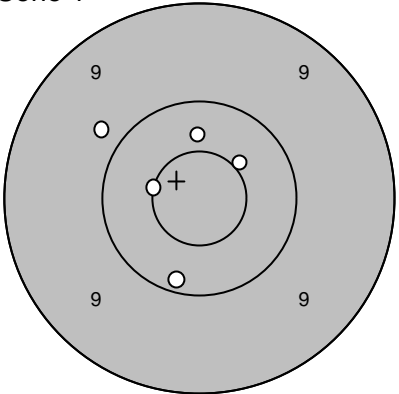
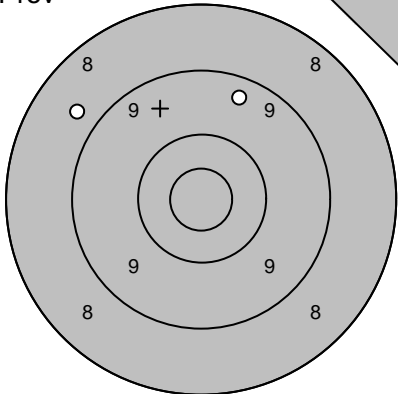
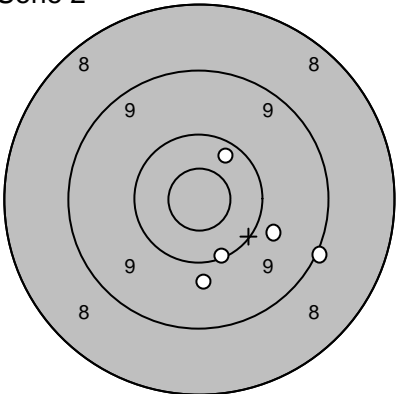
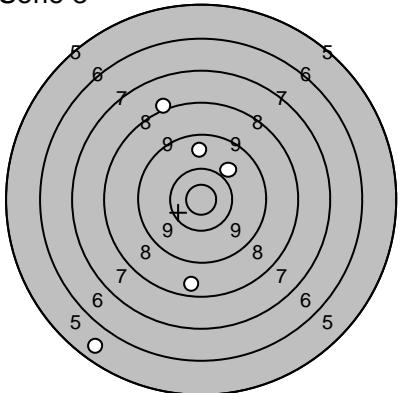
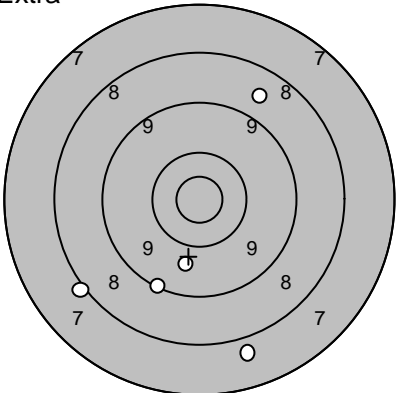
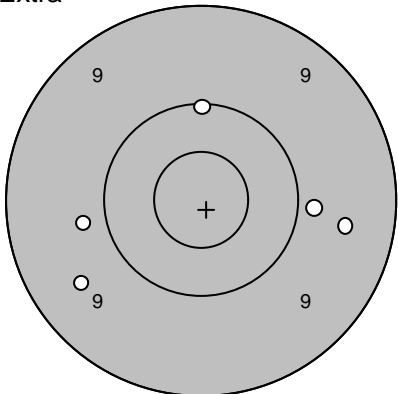
Lag 2	Tavla 3	Carina Norling		
Ramselefors	Söderala			
06.07.2006	Tavelträffen B - 2006	Ramselefors Skytteförening		
Prov		1: 10,1 → 2: 10,9* ↙ 3: 10,0 ↓ 4: 10,4 ↑	Serie 1 	1: 10,6* ← 2: 10,2 ↓ 3: 10,5* ↗ 4: 9,8 ↗ 5: 10,4 ↑
	Serie: 40,0 Summa: 142,0		Serie: 49,0 Summa: 191,0	
Prov		1: 9,4 ↑ 2: 8,8 ↙	Serie 2 	1: 10,3 ↗ 2: 9,8 → 3: 9,0 → 4: 10,1 ↓ 5: 9,8 ↓
	Serie: 17,0 Summa: 191,0		Serie: 47,0 Summa: 238,0	
Serie 3		1: 8,6 ↓ 2: 8,1 ↗ 3: 9,7 ↑ 4: 10,0 ↗ 5: 5,7 ↙	Extra 	1: 7,8 ↓ 2: 8,1 ↙ 3: 8,7 ↗ 4: 9,8 ↓ 5: 9,2 ↙
	Serie: 40,0 Summa: 278,0		Serie: 41,0 Summa: 319,0	
Extra		6: 9,5 → 7: 9,6 ↙ 8: 9,8 ← 9: 10,1 ↑ 10: 9,9 →		
	Serie: 46,0 Summa: 365,0			

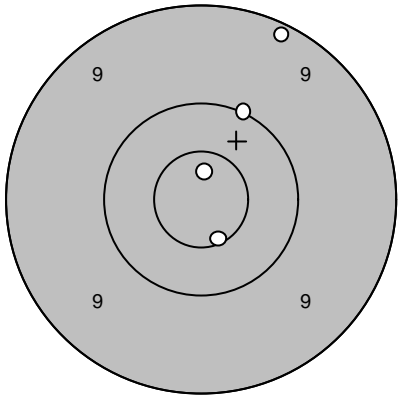
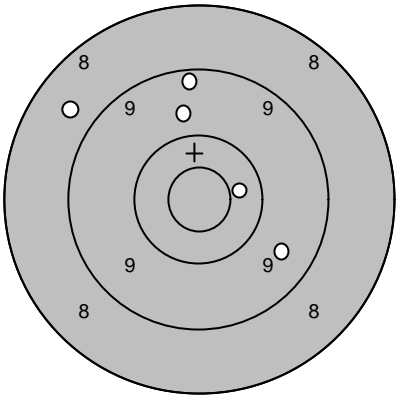
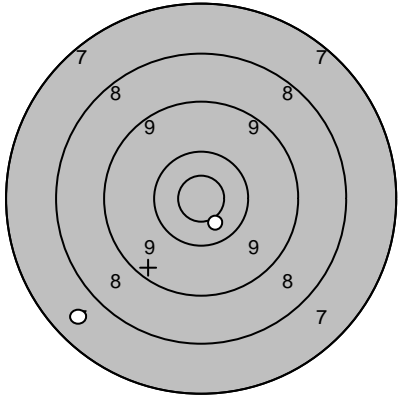
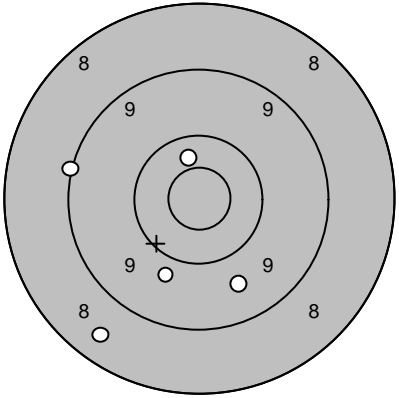
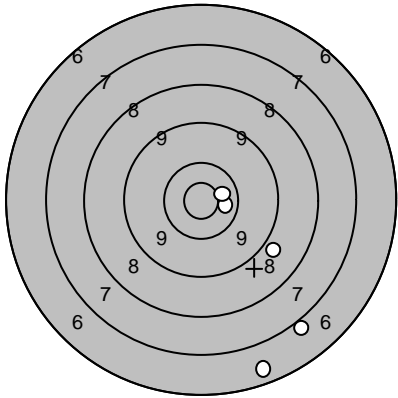
Lag 2	Tavla 4	Jan-Olof Janneson		
Ramselefors		Falköping		
06.07.2006		Tavelträffen B - 2006	Ramselefors Skytteförening	
Prov		1: 9,2 ↗ 2: 10,7* ↑ 3: 10,0 ↗ 4: 10,6* ↘	Serie 1 	1: 8,7 ↖ 2: 9,3 ↑ 3: 9,7 ↑ 4: 10,4 → 5: 9,6 ↘
		Serie: 39,0		Serie: 45,0
		Summa: 140,0		Summa: 185,0
Prov		1: 10,6* ↘ 2: 7,6 ↙	Serie 2 	1: 10,4 ↑ 2: 8,5 ↘ 3: 9,6 ↘ 4: 9,8 ↘ 5: 9,1 ←
		Serie: 17,0		Serie: 45,0
		Summa: 185,0		Summa: 230,0
Serie 3		1: 10,5* → 2: 6,6 ↘ 3: 7,0 ↘ 4: 8,9 ↘ 5: 10,6* →		
		Serie: 41,0		
		Summa: 271,0		

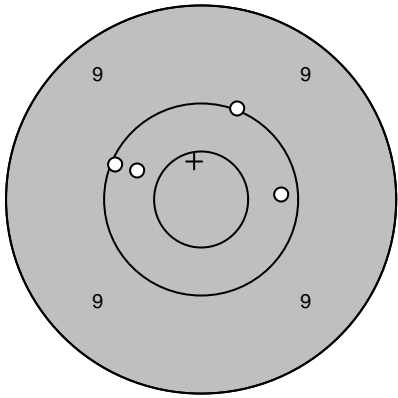
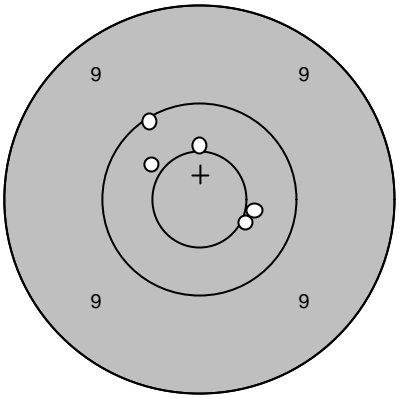
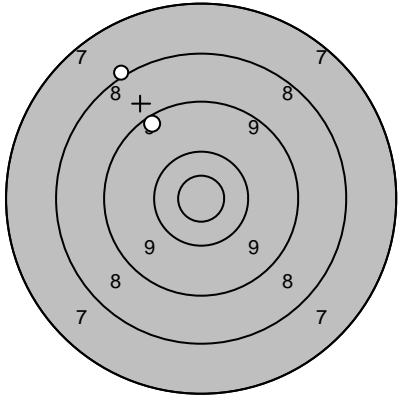
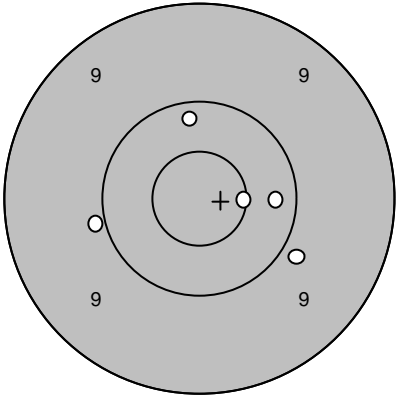
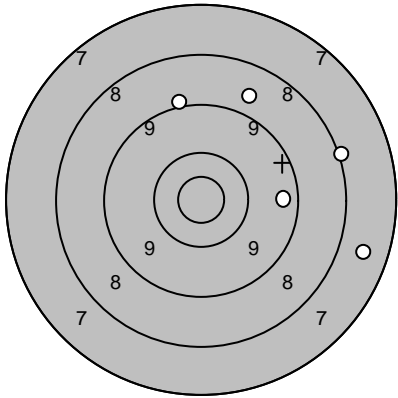
Lag 2	Tavla 5	Stefan Lundqvist		
Ramselefors	Ununge			
06.07.2006	Tavelträffen B - 2006	Ramselefors Skytteförening		
Prov		1: 10,1 ← 2: 10,3 ↙ 3: 10,0 ↑ 4: 10,2 →	Serie 1 	1: 10,5* ↑ 2: 10,5* → 3: 10,4 ↗ 4: 10,1 ↗ 5: 10,5* ↘
		Serie: 40,0	Serie: 50,0	
		Summa: 143,0	Summa: 193,0	
Prov		1: 8,1 ↖ 2: 9,3 ↖	Serie 2 	1: 9,9 ← 2: 10,3 → 3: 10,6* → 4: 9,9 ↘ 5: 10,2 ↑
		Serie: 17,0	Serie: 48,0	
		Summa: 193,0	Summa: 241,0	
Serie 3		1: 8,8 ↗ 2: 7,6 → 3: 8,1 → 4: 9,1 ↑ 5: 9,4 →		
		Serie: 41,0		
		Summa: 282,0		

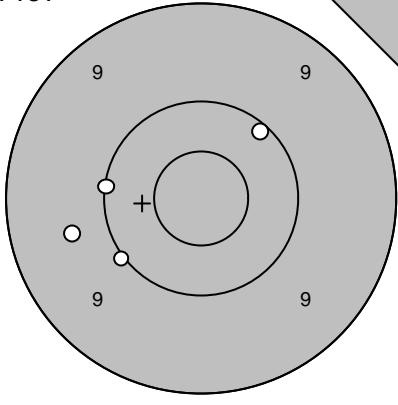
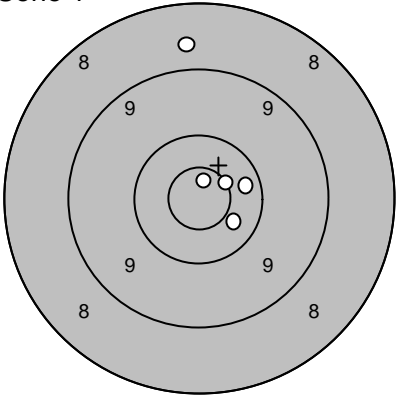
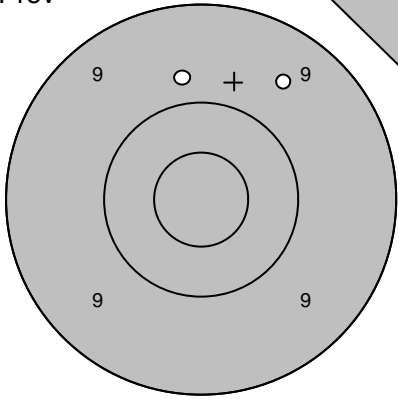
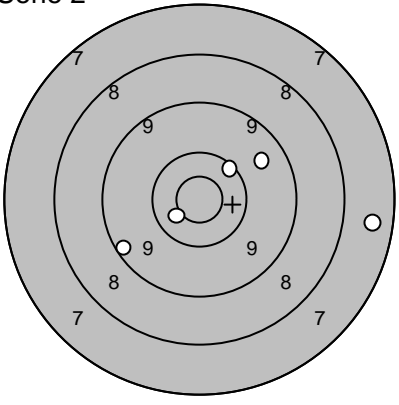
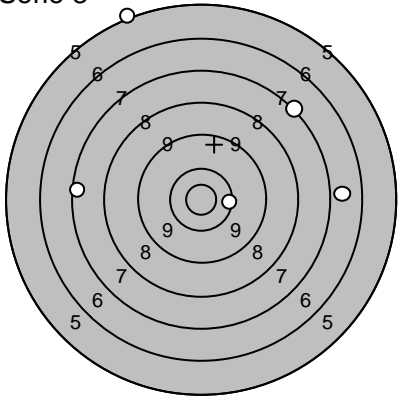
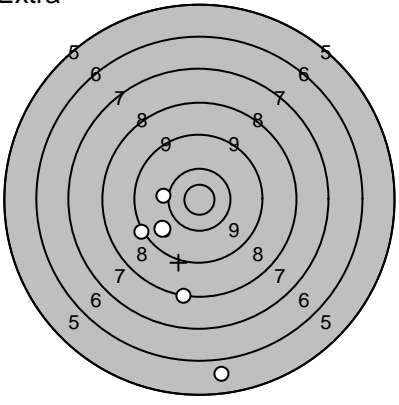
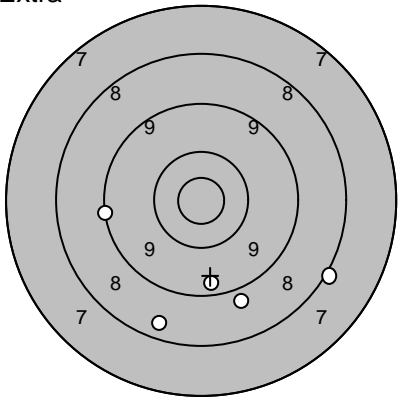
Lag 2	Tavla 6	Linda Bergman	
Ramselefors		Ununge	
06.07.2006		Tavelträffen B - 2006	Ramselefors Skytteförening
Prov 	1: 9,7 ← 2: 10,1 ← 3: 10,1 ↗ 4: 10,0 ↙	Serie 1 	1: 8,7 ↑ 2: 10,8* ↑ 3: 10,4 ↘ 4: 10,3 → 5: 10,6* ↗
	Serie: 39,0 Summa: 144,0		Serie: 48,0 Summa: 192,0
Prov 	1: 9,6 ↗ 2: 9,8 ↑	Serie 2 	1: 9,6 ↗ 2: 7,5 → 3: 10,5* ↙ 4: 9,3 ← 5: 10,2 ↗
	Serie: 18,0 Summa: 192,0		Serie: 45,0 Summa: 237,0
Serie 3 	1: 7,4 ← 2: 5,1 ↑ 3: 7,2 ↗ 4: 6,9 → 5: 10,3 →	Extra 	1: 10,1 ← 2: 9,8 ↙ 3: 9,2 ← 4: 8,2 ↓ 5: 5,8 ↓
	Serie: 35,0 Summa: 272,0		Serie: 41,0 Summa: 313,0
Extra 	6: 8,1 ↘ 7: 9,1 ← 8: 8,5 ↓ 9: 9,4 ↓ 10: 8,9 ↓		
	Serie: 42,0 Summa: 355,0		

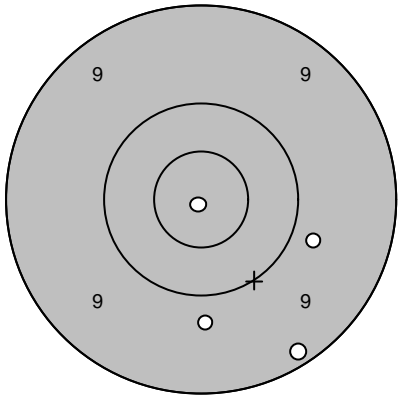
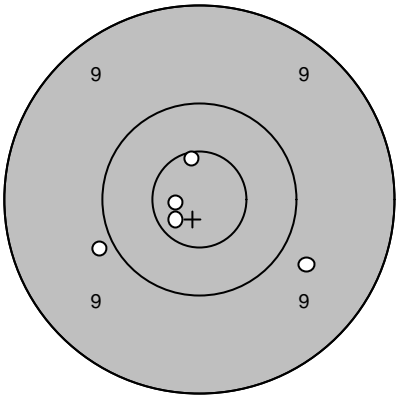
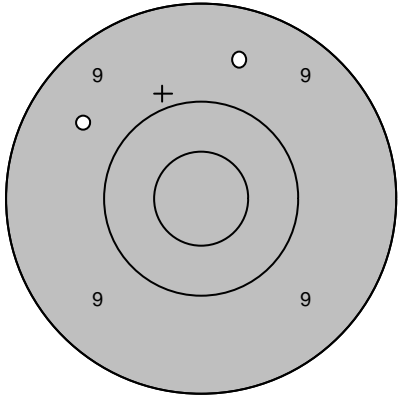
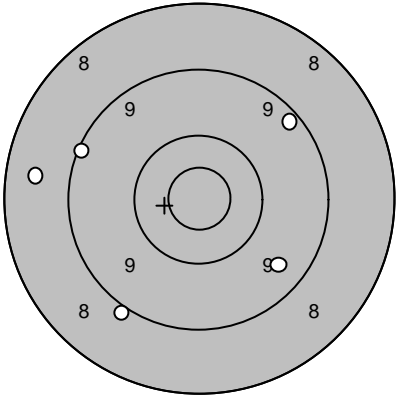
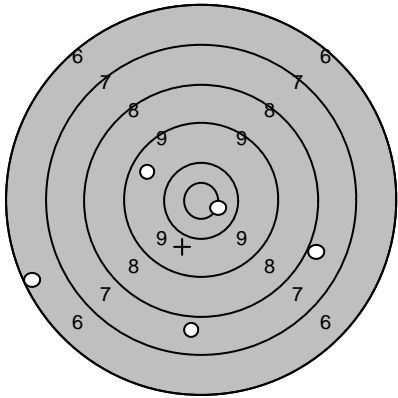
Lag 2	Tavla 7	Therese Danielsson		
Ramselefors	Ununge			
06.07.2006	Tavelträffen B - 2006	Ramselefors Skytteförening		
Prov		1: 9,8 → 2: 10,9* ↓ 3: 9,2 ↓ 4: 9,8 ↓	Serie 1 	1: 10,6* ↑ 2: 9,7 → 3: 10,7* ↓ 4: 10,8* ← 5: 9,9 ←
	Serie: 37,0		Serie: 48,0	
	Summa: 146,0		Summa: 194,0	
Prov		1: 9,6 ↑ 2: 9,6 ↖	Serie 2 	1: 9,3 ↗ 2: 9,1 ← 3: 9,0 ↓ 4: 8,6 ← 5: 9,5 ↓
	Serie: 18,0		Serie: 44,0	
	Summa: 194,0		Summa: 238,0	
Serie 3		1: 10,7* → 2: 6,4 ← 3: 7,8 ↓ 4: 9,6 ↖ 5: 7,9 →		
	Serie: 39,0			
	Summa: 277,0			

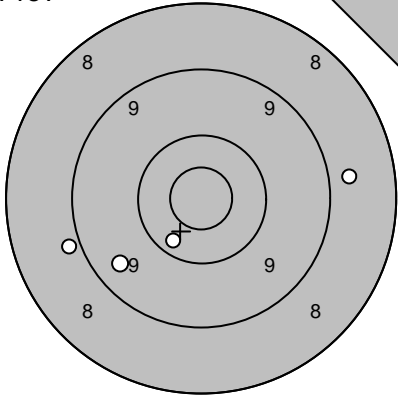
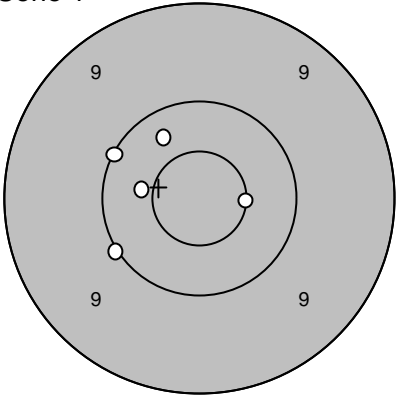
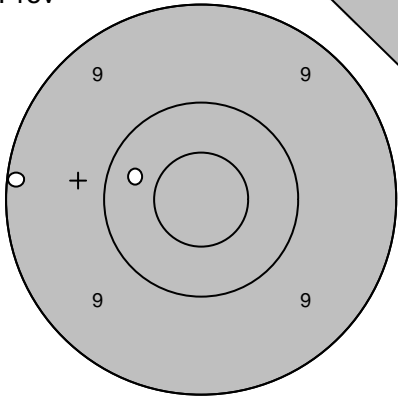
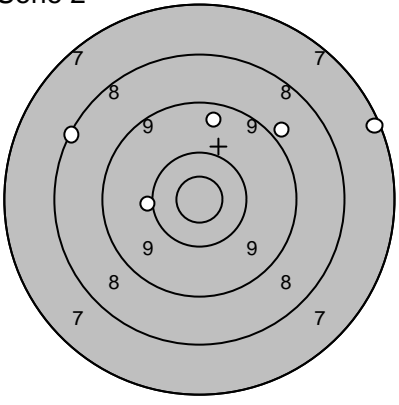
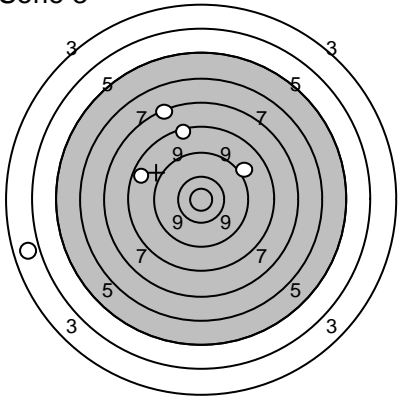
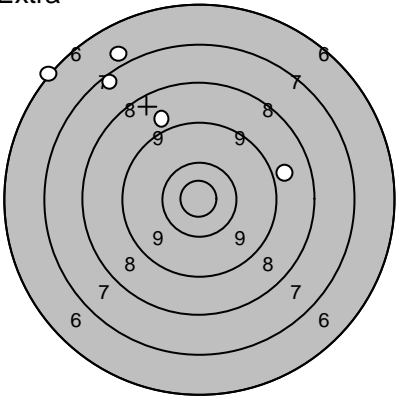
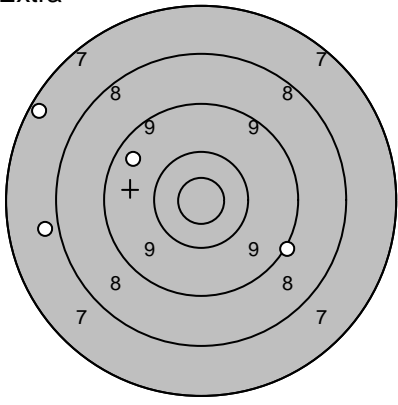
Lag 2	Tavla 8	Tony Jansson	
Ramselefors		Ununge	
06.07.2006		Tavelträffen B - 2006	
Prov		Ramselefors Skytteförening	
	1: 8,9 ← 2: 9,5 ↙ 3: 8,8 → 4: 10,3 ↘	Serie 1 	1: 10,0 ↙ 2: 10,1 ↖ 3: 10,6* → 4: 10,3 ↗ 5: 10,4 ←
	Serie: 35,0		Serie: 50,0
	Summa: 138,0		Summa: 188,0
	1: 9,1 ← 2: 10,3 ←	Serie 2 	1: 8,2 ↖ 2: 9,5 ↑ 3: 8,9 ↗ 4: 10,1 ← 5: 7,2 ↘
	Serie: 19,0		Serie: 42,0
	Summa: 188,0		Summa: 230,0
	1: 9,2 ↗ 2: 8,6 ↖ 3: 3,9 ← 4: 8,5 ↑ 5: 7,4 ↗	Extra 	1: 7,4 ↗ 2: 6,9 ↗ 3: 6,2 ↗ 4: 8,9 ↗ 5: 8,9 →
	Serie: 35,0		Serie: 35,0
	Summa: 265,0		Summa: 300,0
	6: 9,1 ↘ 7: 9,5 ↗ 8: 7,9 ← 9: 7,4 ↗		
	Serie: 32,0		
	Summa: 332,0		

Lag 2	Tavla 9	Jan-Olof Lampinen	
Ramselefors		S 3	
06.07.2006		Tavelträffen B - 2006	
Prov		Ramselefors Skytteförening	
	1: 9,8 ↑ 2: 10,6* ↑ 3: 10,1 ← 4: 10,2 ↗	Serie 1 	1: 10,4 ↗ 2: 10,2 ↑ 3: 10,4 ↗ 4: 9,1 ↑ 5: 10,2 ↑
	Serie: 39,0	Serie: 49,0	
	Summa: 142,0	Summa: 191,0	
	1: 9,9 ↑ 2: 9,6 ↗	Serie 2 	1: 9,8 ↗ 2: 10,0 ↘ 3: 10,3 ↘ 4: 8,3 ↓ 5: 10,5* ↗
	Serie: 18,0	Serie: 47,0	
	Summa: 191,0	Summa: 238,0	
	1: 9,6 ↙ 2: 8,7 ← 3: 8,1 → 4: 9,4 ↑ 5: 5,6 ↓	Extra 	1: 8,2 ← 2: 8,5 ↗ 3: 8,6 ↗ 4: 9,2 ↗ 5: 10,5* ↗
	Serie: 39,0	Serie: 43,0	
	Summa: 277,0	Summa: 320,0	
	6: 10,0 ↘ 7: 9,9 ↑ 8: 10,5* ↗ 9: 10,3 ↑ 10: 9,0 ↗		
	Serie: 48,0		
	Summa: 368,0		

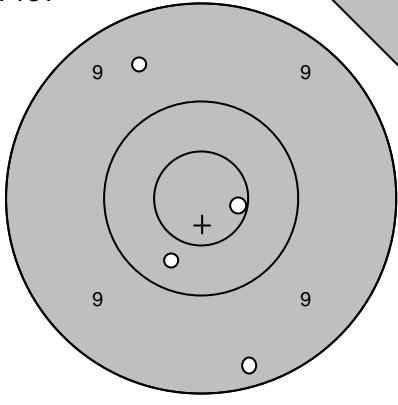
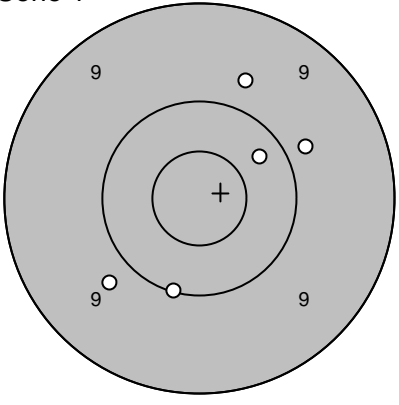
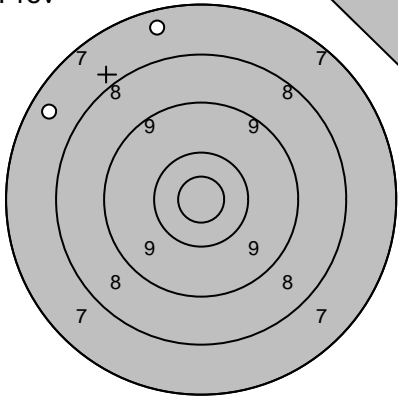
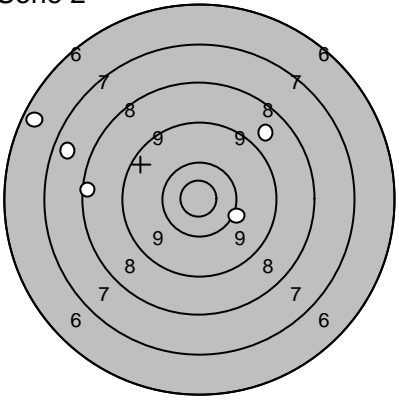
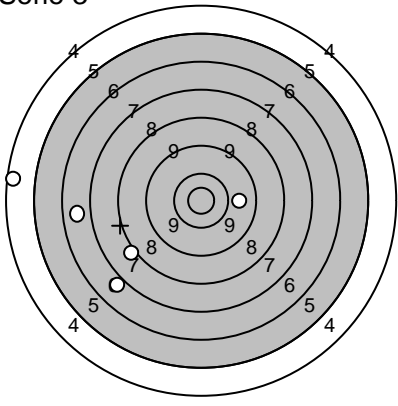
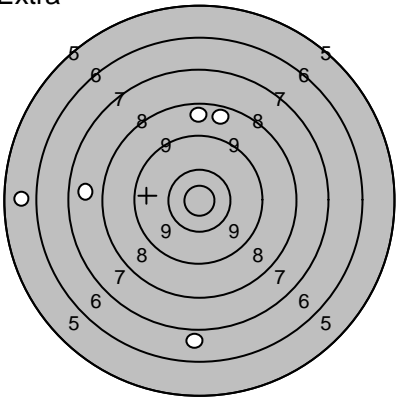
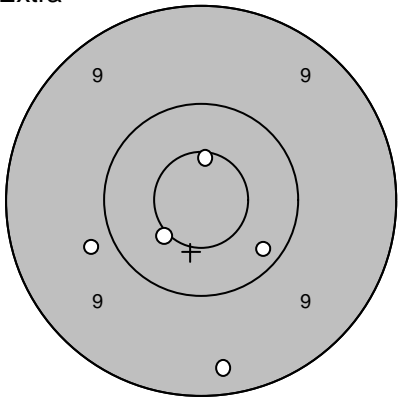
Lag 2	Tavla 10	Matthias Lampinen	
Ramselefors	S 3		
06.07.2006	Tavelträffen B - 2006	Ramselefors Skytteförening	
Prov		1: 9,5 ↖ 2: 10,6* → 3: 9,3 ↓ 4: 10,3 ↙	Serie 1 
		Serie: 38,0 Summa: 142,0	1: 10,1 ↓ 2: 9,7 ↑ 3: 9,8 → 4: 10,3 ↗ 5: 9,8 ↘
			Serie: 47,0 Summa: 189,0
Prov		1: 7,5 ↑ 2: 7,5 ↖	Serie 2 
		Serie: 14,0 Summa: 189,0	1: 6,5 ↖ 2: 8,8 ↗ 3: 7,6 ↖ 4: 10,1 → 5: 8,3 ←
			Serie: 39,0 Summa: 228,0
Serie 3		1: 6,8 ← 2: 4,5 ← 3: 9,9 → 4: 8,2 ↙ 5: 7,0 ↘	Extra 
		Serie: 34,0 Summa: 262,0	1: 8,6 ↑ 2: 6,9 ↓ 3: 7,7 ← 4: 5,8 ← 5: 8,6 ↑
			Serie: 34,0 Summa: 296,0
Extra		6: 9,3 ↓ 7: 10,5* ↙ 8: 10,6* ↑ 9: 10,2 ↘ 10: 9,8 ←	
		Serie: 48,0 Summa: 344,0	

Lag 2	Tavla 11	Kjell Marklund	
Ramselefors		S 3	
06.07.2006		Tavelträffen B - 2006	Ramselefors Skytteförening
Prov		1: 9,5 ↗ 2: 9,9 ↗ 3: 10,2 ↖ 4: 10,9* ↗	Serie 1
		Serie: 38,0	1: 9,3 ↖ 2: 10,7* ↓ 3: 10,5* ↗ 4: 10,6* ↖ 5: 10,2 →
		Summa: 144,0	Serie: 49,0
			Summa: 193,0
Prov		1: 10,1 ↘ 2: 9,8 ↗	Serie 2
		Serie: 19,0	1: 9,2 → 2: 10,4 ↖ 3: 9,0 ↘ 4: 7,6 ↗ 5: 9,0 ↗
		Summa: 193,0	Serie: 44,0
			Summa: 237,0
Serie 3		1: 8,5 ↗ 2: 5,6 ↗ 3: 3,4 ↓ 4: 9,2 ↖ 5: 9,0 ↗	
		Serie: 34,0	
		Summa: 271,0	

Lag 2	Tavla 12	Liselott Danielsson	
Ramselefors		Växjö	
06.07.2006		Tavelträffen B - 2006	Ramselefors Skytteförening
Prov		1: 9,8 ↑ 2: 10,6* ↓ 3: 10,6* ↑ 4: 10,1 ↘ Serie: 39,0 Summa: 146,0	Serie 1 1: 10,5* ↑ 2: 10,1 ← 3: 10,4 ↑ 4: 10,6* ↗ 5: 10,5* ↖ Serie: 50,0 Summa: 196,0
Prov		1: 10,0 ← 2: 10,0 → Serie: 20,0 Summa: 196,0	Serie 2 1: 10,1 ↖ 2: 10,6* ↗ 3: 9,5 ← 4: 8,2 ↑ 5: 10,3 → Serie: 47,0 Summa: 243,0
Serie 3		1: 9,3 ↖ 2: 9,8 ↑ 3: 8,5 ↗ 4: 9,3 ↗ 5: 7,7 ↖ Serie: 42,0 Summa: 285,0	Extra 1: 8,5 ↑ 2: 9,5 ↑ 3: 9,3 ↖ 4: 7,3 ↑ 5: 9,3 ↖ Serie: 42,0 Summa: 327,0
Extra		6: 9,3 ↘ 7: 9,8 → 8: 10,3 ↘ 9: 10,3 → 10: 10,4 ← Serie: 48,0 Summa: 375,0	

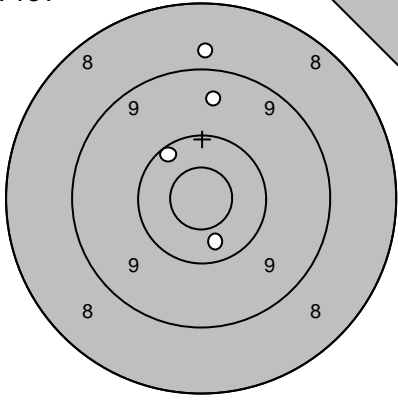
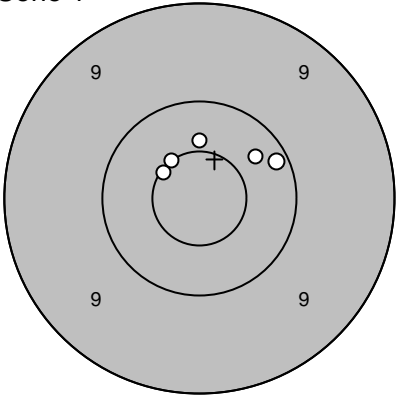
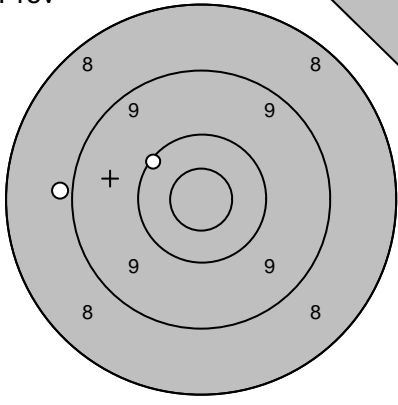
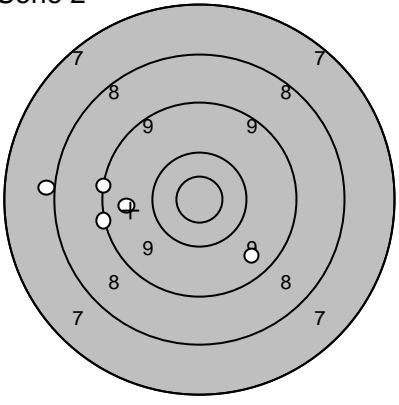
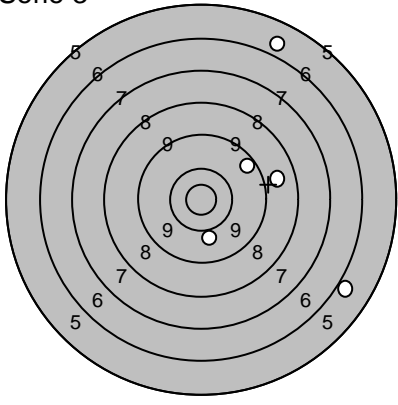
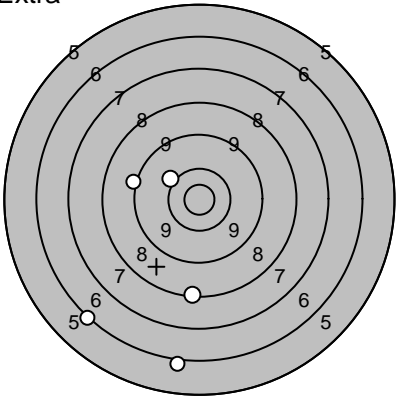
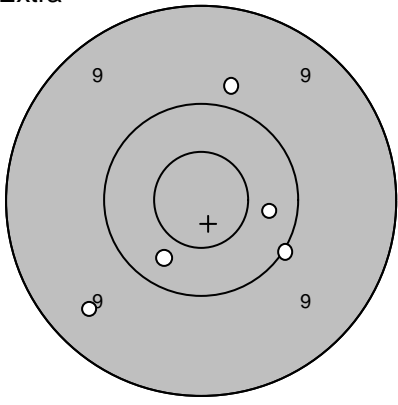
Lag 2	Tavla 14	Lars Evaldsson	
Ramselefors		Göteborg	
06.07.2006		Tavelträffen B - 2006	Ramselefors Skytteförening
Prov 	1: 9,5 ↑ 2: 8,8 ↑ 3: 10,2 ↖ 4: 10,4 ↓	Serie 1 	1: 10,6* ↖ 2: 10,2 → 3: 10,6* ↖ 4: 10,4 ↑ 5: 10,3 ↗
	Serie: 37,0 Summa: 140,0		Serie: 50,0 Summa: 190,0
Prov 	1: 10,2 ↖ 2: 8,9 ←	Serie 2 	1: 8,0 ← 2: 9,1 ← 3: 9,1 ← 4: 9,6 ← 5: 9,5 ↘
	Serie: 18,0 Summa: 190,0		Serie: 44,0 Summa: 234,0
Serie 3 	1: 8,8 → 2: 10,0 ↓ 3: 6,0 → 4: 9,5 ↗ 5: 5,9 ↑	Extra 	1: 6,2 ↖ 2: 8,3 ↓ 3: 6,1 ↓ 4: 9,1 ← 5: 10,1 ↖
	Serie: 38,0 Summa: 272,0		Serie: 39,0 Summa: 311,0
Extra 	6: 9,4 ↖ 7: 10,3 → 8: 9,8 ↑ 9: 10,3 ↖ 10: 10,0 →		
	Serie: 48,0 Summa: 359,0		

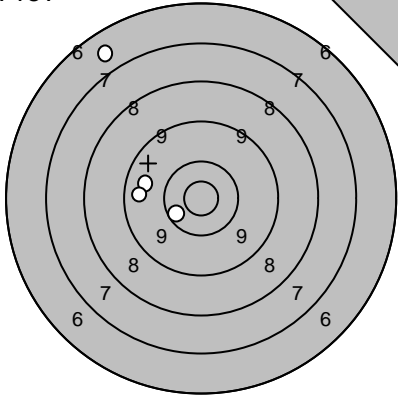
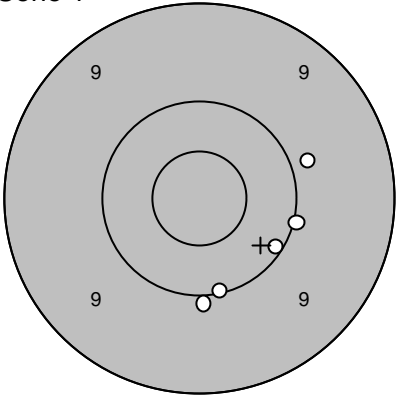
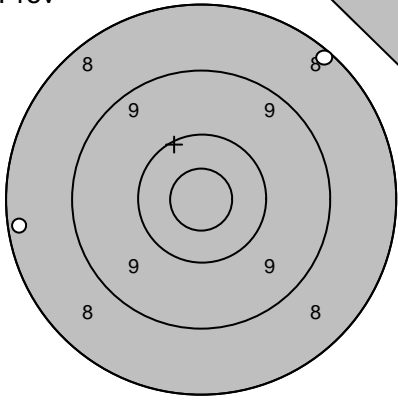
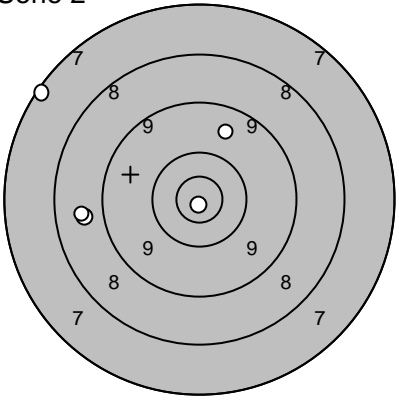
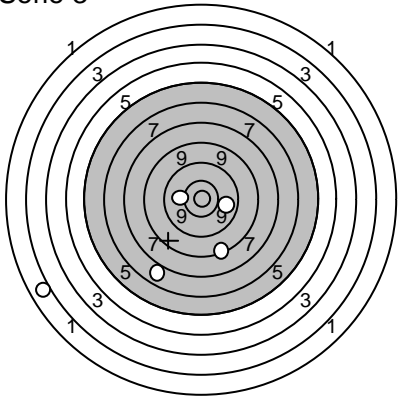
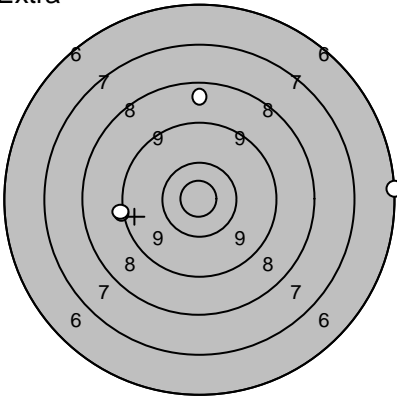
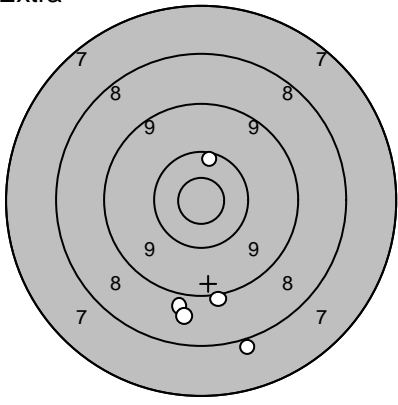
Lag 2	Tavla 15	Håkan Engman	
Ramselefors	Lindesberg		
06.07.2006	Tavelträffen B - 2006	Ramselefors Skytteförening	
Prov 	1: 6,7 ↖ 2: 9,7 ← 3: 10,4 ↙ 4: 9,6 ← Serie: 34,0 Summa: 138,0	Serie 1 	1: 10,1 ↘ 2: 9,9 → 3: 10,0 → 4: 10,0 ↓ 5: 10,1 ↓ Serie: 49,0 Summa: 187,0
Prov 	1: 8,3 ← 2: 8,2 ↗ Serie: 16,0 Summa: 187,0	Serie 2 	1: 9,7 ↑ 2: 7,2 ↖ 3: 8,8 ← 4: 10,9* ↓ 5: 8,7 ← Serie: 42,0 Summa: 229,0
Serie 3 	1: 7,0 ↓ 2: 8,5 ↓ 3: 10,0 → 4: 10,3 ← 5: 2,1 ↙ Serie: 37,0 Summa: 266,0	Extra 	1: 8,5 ↑ 2: 0,0 ← 3: 6,2 → 4: 9,2 ← 5: 9,1 ← Serie: 32,0 Summa: 298,0
Extra 	6: 8,0 ↓ 7: 10,3 ↑ 8: 8,9 ↓ 9: 8,7 ↓ 10: 9,1 ↓ Serie: 43,0 Summa: 341,0		

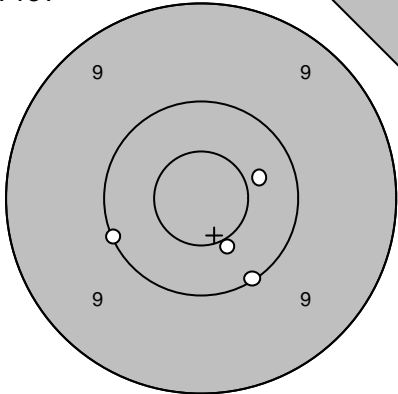
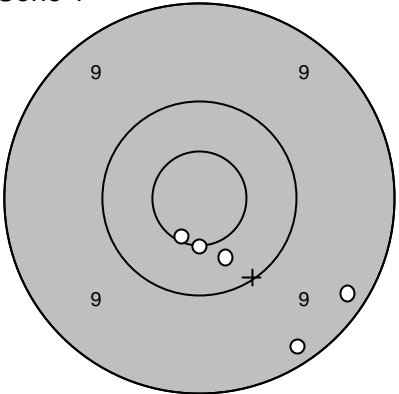
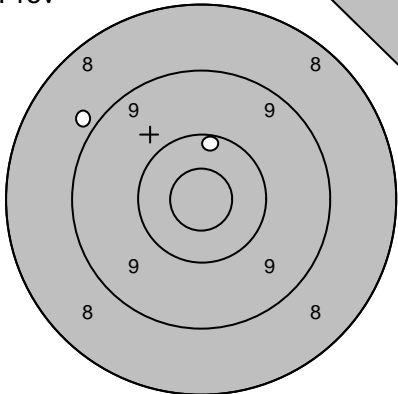
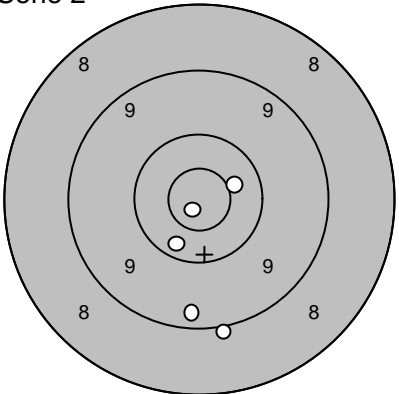
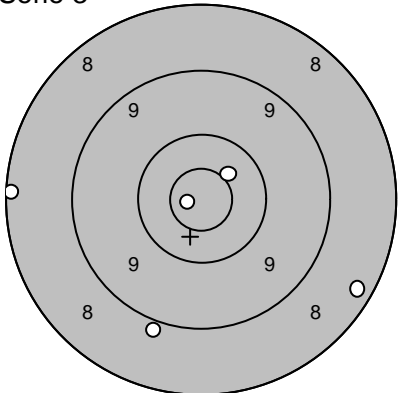
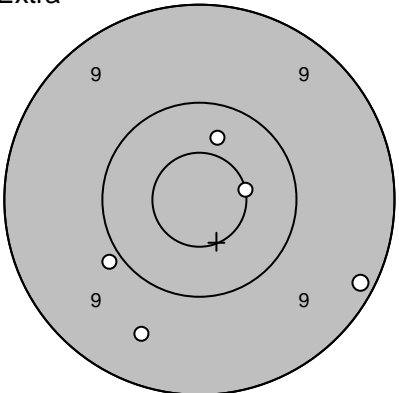
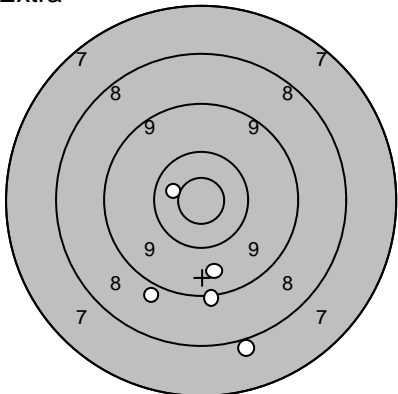
Lag 2	Tavla 16	Jane Jönsson	
Ramselefors	Skurup		
06.07.2006	Tavelträffen B - 2006	Ramselefors Skytteförening	
Prov		1: 10,4 → 2: 10,5* ↓ 3: 10,1 ↓ 4: 10,1 ←	Serie 1 
			1: 10,5* ↓ 2: 10,6* ↓ 3: 9,2 ↓ 4: 10,4 ↓ 5: 9,2 ↓
		Serie: 40,0	Serie: 48,0
		Summa: 142,0	Summa: 190,0
Prov		1: 8,9 ↖ 2: 10,2 ↑	Serie 2 
			1: 10,3 ↓ 2: 10,9* ↓ 3: 10,5* → 4: 9,0 ↓ 5: 9,3 ↓
		Serie: 18,0	Serie: 48,0
		Summa: 190,0	Summa: 238,0
Serie 3		1: 8,2 ← 2: 8,3 ↓ 3: 8,9 ↓ 4: 10,5* ↗ 5: 10,9* ←	Extra 
			1: 10,5* → 2: 9,2 ↘ 3: 9,5 ↓ 4: 9,9 ← 5: 10,4 ↑
		Serie: 44,0	Serie: 47,0
		Summa: 282,0	Summa: 329,0
Extra		6: 9,1 ↓ 7: 10,5* ← 8: 8,0 ↓ 9: 9,6 ↓ 10: 8,9 ↓	
		Serie: 44,0	
		Summa: 373,0	

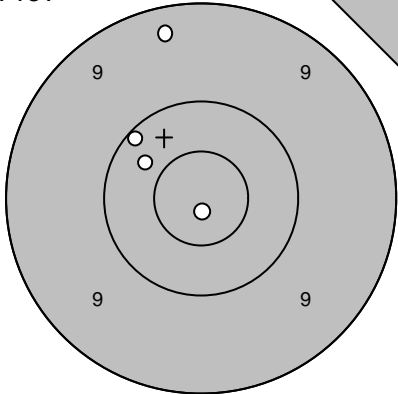
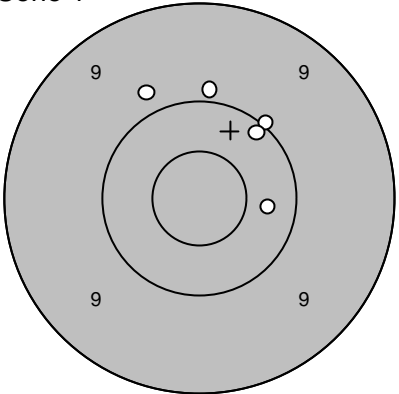
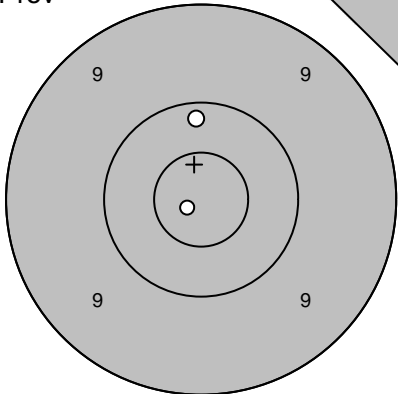
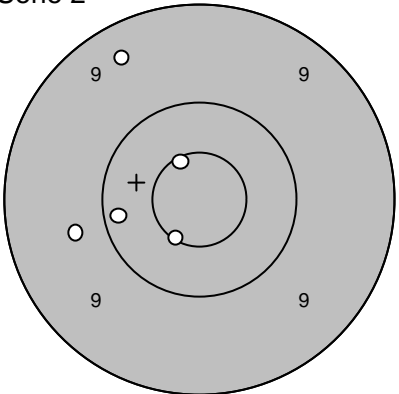
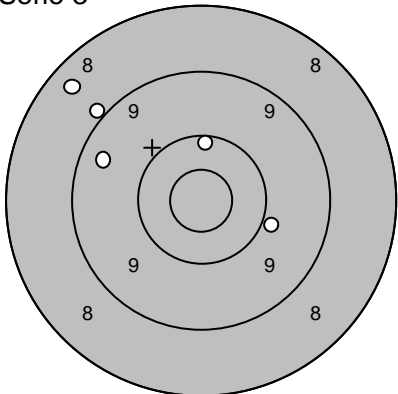
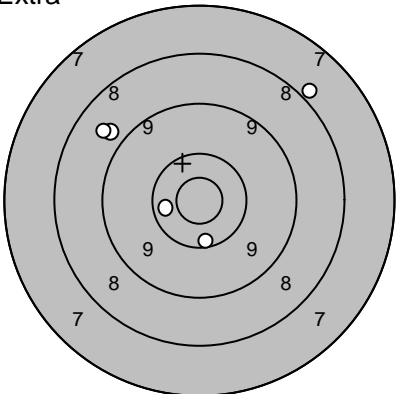
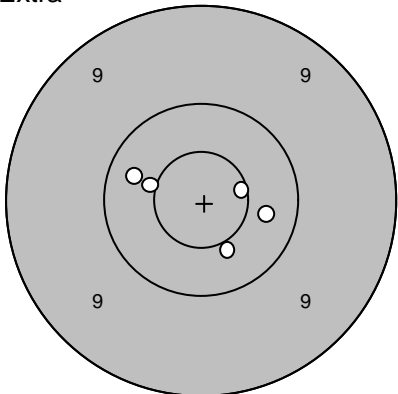
Lag 2	Tavla 19	Donald Johansson	
Ramselefors		Ale	
06.07.2006		Tavelträffen B - 2006	Ramselefors Skytteförening
Prov		1: 9,3 ↑ 2: 10,4 ↖ 3: 10,9* ↓ 4: 10,1 ↗ <hr/> Serie: 39,0 Summa: 144,0	Serie 1  1: 10,0 ↗ 2: 10,1 ↗ 3: 9,9 ↑ 4: 9,8 ↖ 5: 10,3 → <hr/> Serie: 48,0 Summa: 192,0
Prov		1: 10,9* ↖ 2: 10,2 ↑ <hr/> Serie: 20,0 Summa: 192,0	Serie 2  1: 10,2 ← 2: 9,7 ← 3: 10,6* ↗ 4: 10,6* ↖ 5: 9,4 ↗ <hr/> Serie: 48,0 Summa: 240,0
Serie 3		1: 9,9 → 2: 9,5 ↖ 3: 8,4 ↗ 4: 10,2 ↑ 5: 9,0 ↗ <hr/> Serie: 45,0 Summa: 285,0	Extra  1: 8,8 ↖ 2: 8,0 ↗ 3: 8,7 ↗ 4: 10,4 ← 5: 10,3 ↓ <hr/> Serie: 44,0 Summa: 329,0
Extra		6: 10,3 ← 7: 10,6* → 8: 10,5* ↓ 9: 10,4 → 10: 10,5* ← <hr/> Serie: 50,0 Summa: 379,0	

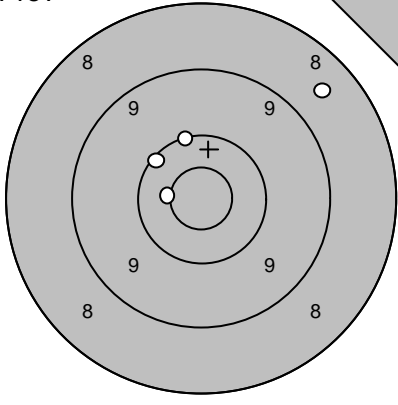
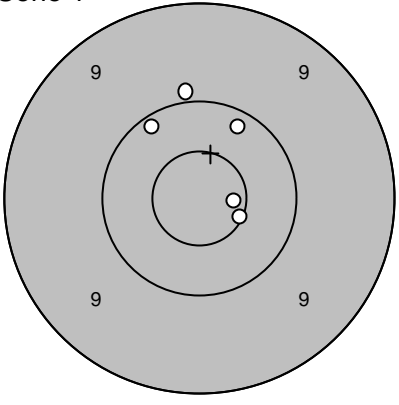
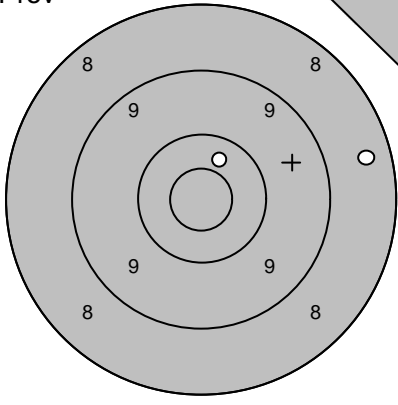
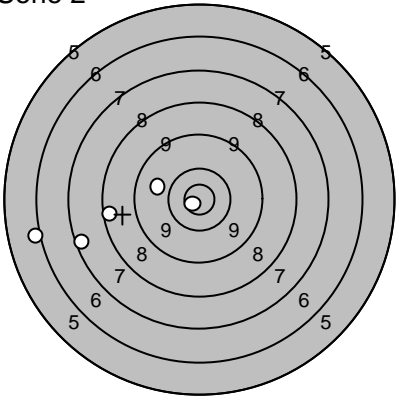
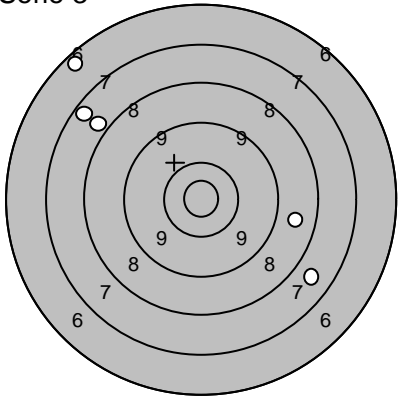
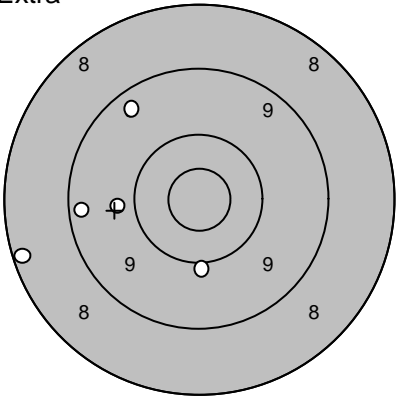
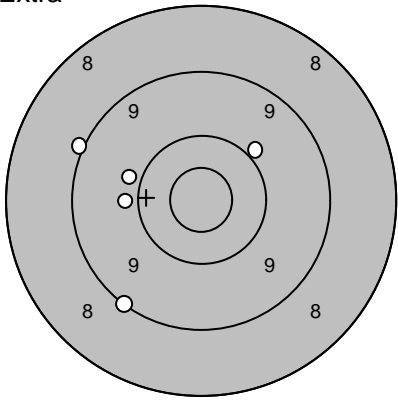
Lag 2	Tavla 21	Alf Edin	
Ramselefors		Ale	
06.07.2006		Tavelträffen B - 2006	
Prov		Ramselefors Skytteförening	
	1: 8,6 ↗ 2: 10,2 ↖ 3: 10,6* ← 4: 10,1 ↑	Serie 1 	1: 10,2 ↗ 2: 10,2 ↖ 3: 10,7* → 4: 9,9 ↑ 5: 10,6* ↘
	Serie: 38,0		Serie: 49,0
	Summa: 131,0		Summa: 180,0
	1: 8,5 → 2: 10,4 ↑	Serie 2 	1: 8,4 ← 2: 10,9* ↙ 3: 6,1 ← 4: 7,4 ← 5: 9,9 ←
	Serie: 18,0		Serie: 40,0
	Summa: 180,0		Summa: 220,0
	1: 7,9 ↖ 2: 7,7 ↘ 3: 7,5 ↗ 4: 6,4 ↗ 5: 8,7 →	Extra 	1: 10,0 ↓ 2: 9,4 ↗ 3: 9,8 ← 4: 9,3 ← 5: 8,2 ←
	Serie: 35,0		Serie: 45,0
	Summa: 255,0		Summa: 300,0
	6: 10,0 ↗ 7: 9,1 ↘ 8: 9,9 ← 9: 9,9 ← 10: 9,0 ↖		
	Serie: 46,0		
	Summa: 346,0		

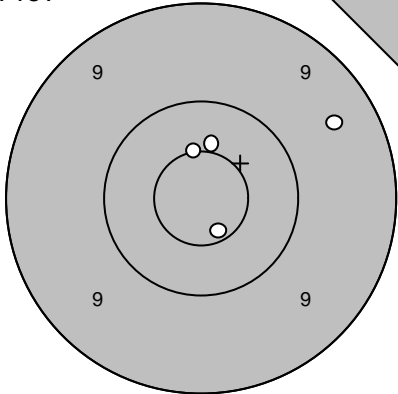
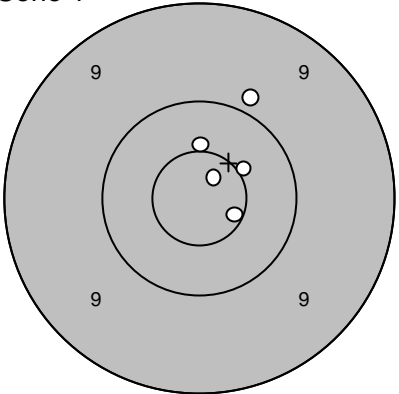
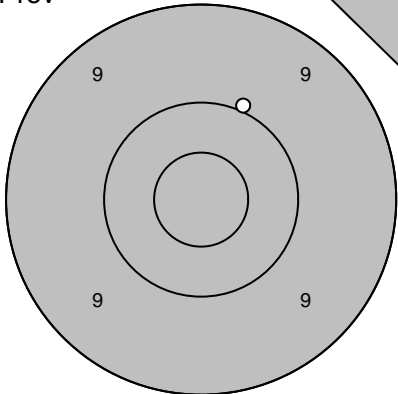
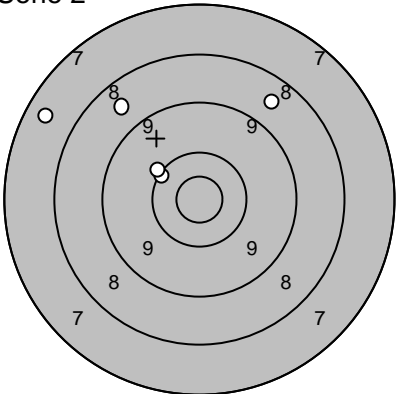
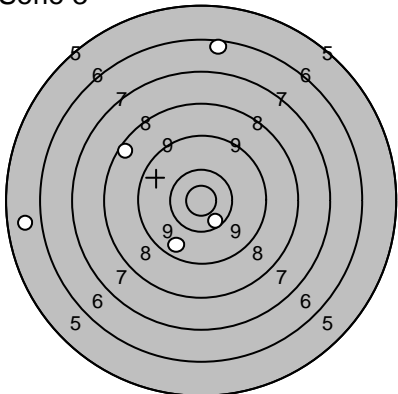
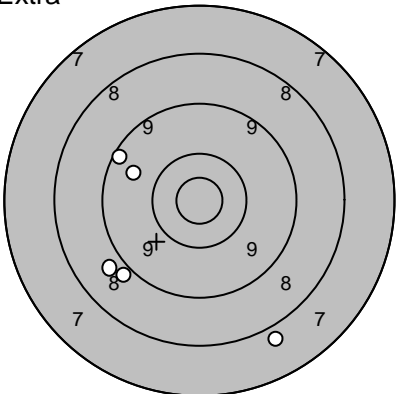
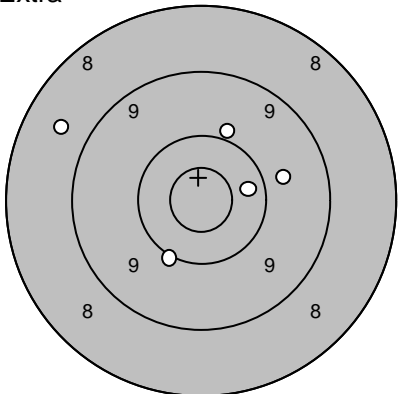
Lag 2	Tavla 22	Joakim Nordlund		
Ramselefors	S 3			
06.07.2006	Tavelträffen B - 2006	Ramselefors Skytteförening		
Prov		1: 9,5 → 2: 10,7* ↘ 3: 10,5* ↑ 4: 10,5* ↑	Serie 1 	1: 10,5* ↗ 2: 9,9 ↗ 3: 10,6* ↘ 4: 10,5* ↑ 5: 10,8* ↗
	Serie: 39,0 Summa: 144,0		Serie: 49,0 Summa: 193,0	
Prov		1: 10,0 ↑	Serie 2 	1: 8,7 ↗ 2: 10,2 ↗ 3: 10,1 ↗ 4: 7,6 ↗ 5: 8,6 ↗
	Serie: 10,0 Summa: 193,0		Serie: 43,0 Summa: 236,0	
Serie 3		1: 9,6 ↘ 2: 8,4 ↖ 3: 6,5 ↑ 4: 5,8 ← 5: 10,4 ↘	Extra 	1: 8,8 ↖ 2: 7,9 ↘ 3: 9,0 ↘ 4: 9,3 ↗ 5: 9,7 ↗
	Serie: 38,0 Summa: 274,0		Serie: 42,0 Summa: 316,0	
Extra		6: 8,7 ↖ 7: 9,8 → 8: 10,3 → 9: 10,1 ↘ 10: 9,9 ↑		
	Serie: 46,0 Summa: 362,0			

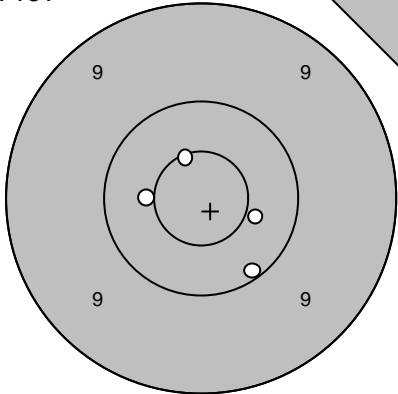
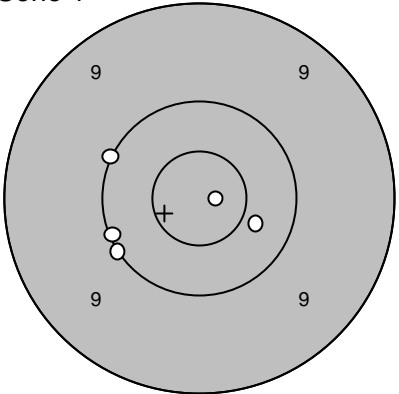
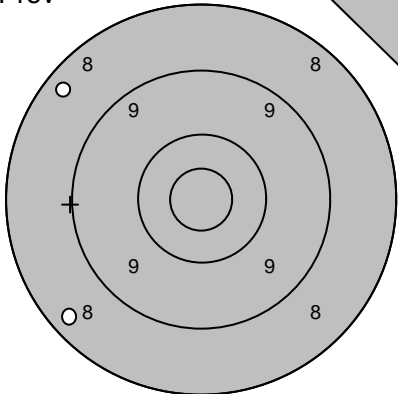
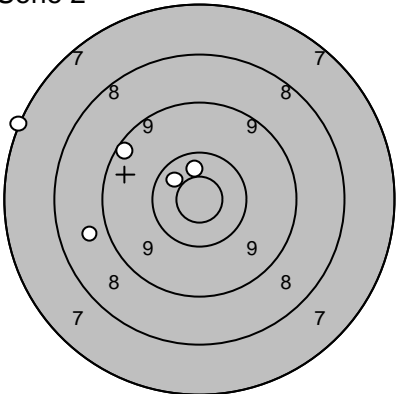
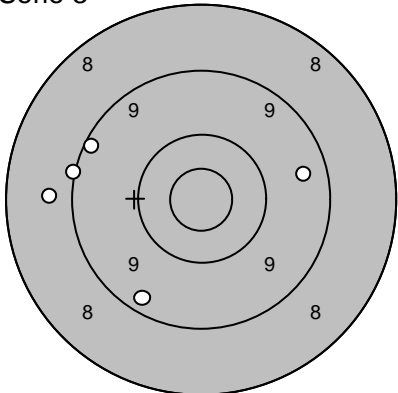
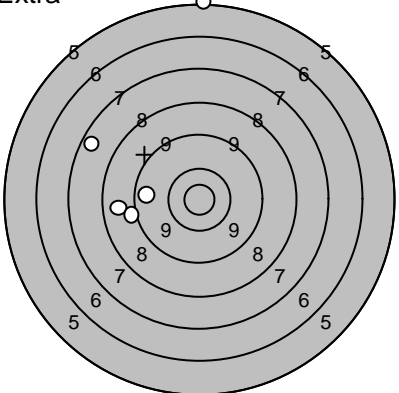
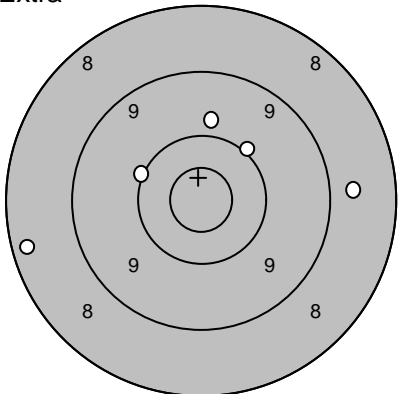
Lag 3	Tavla 1	Lars Sandström	
Ramselefors	Ramselefors		
06.07.2006	Tavelträffen B - 2006	Ramselefors Skytteförening	
Prov		1: 10,1 ↘ 2: 10,4 → 3: 10,6* ↑ 4: 10,5* ←	Serie 1 
	Serie: 41,6 Summa: 141,0		1: 10,9* → 2: 10,0 ↖ 3: 10,4 ↗ 4: 10,1 ← 5: 10,0 ↙
			Serie: 51,4 Summa: 192,4
Prov		1: 8,4 ↖ 2: 8,4 ↙	Serie 2 
	Serie: 16,8 Summa: 192,4		1: 10,5* ↑ 2: 9,3 ↗ 3: 10,5* ↗ 4: 8,8 ← 5: 7,1 ↖
			Serie: 46,2 Summa: 238,6
Serie 3		1: 9,3 ↙ 2: 9,1 ← 3: 9,2 ↖ 4: 8,8 ← 5: 9,5 →	Extra 
	Serie: 45,9 Summa: 284,5		1: 9,6 ← 2: 5,2 ↑ 3: 8,7 ← 4: 7,5 ↖ 5: 9,1 ←
			Serie: 40,1 Summa: 324,6
Extra		6: 8,7 → 7: 9,8 ↑ 8: 8,3 ← 9: 10,0 ↗ 10: 10,1 ↖	
	Serie: 46,9 Summa: 371,5		

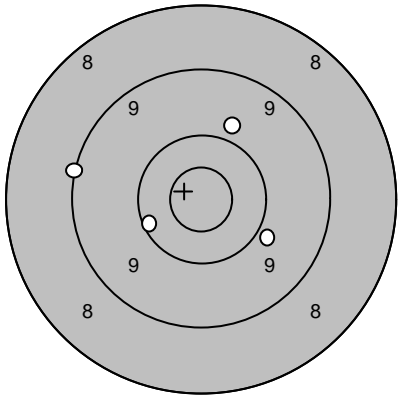
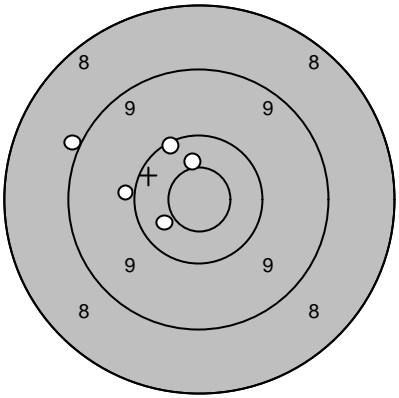
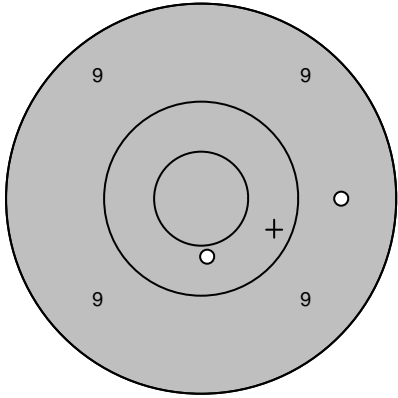
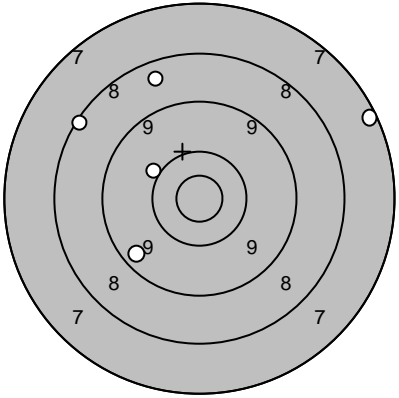
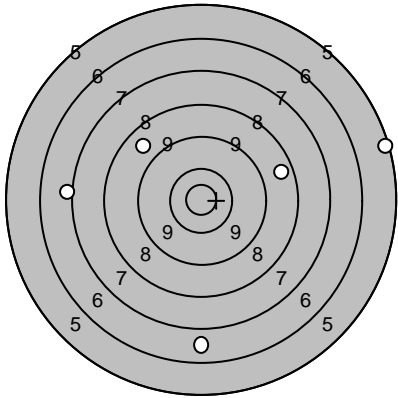
Lag 3	Tavla 2	Ove Lövgren		
Ramselefors		Övertorneå		
06.07.2006		Tavelträffen B - 2006	Ramselefors Skytteförening	
Prov		1: 9,9 ↗ 2: 9,1 ← 3: 10,2 ↙ 4: 9,9 →	Serie 1 	1: 10,0 ← 2: 10,5* ↑ 3: 9,0 ↙ 4: 10,2 ↗ 5: 10,4 ↙
		Serie: 39,1	Serie: 50,1	
		Summa: 140,0	Summa: 190,1	
Prov		1: 10,4 ↓ 2: 9,6 →	Serie 2 	1: 8,5 ↗ 2: 8,2 ↙ 3: 10,0 ↙ 4: 9,4 ↙ 5: 7,3 →
		Serie: 20,0	Serie: 43,4	
		Summa: 190,1	Summa: 233,5	
Serie 3		1: 8,8 ↖ 2: 8,6 → 3: 7,1 ← 4: 6,8 ↓ 5: 5,3 →		
		Serie: 36,6		
		Summa: 270,1		

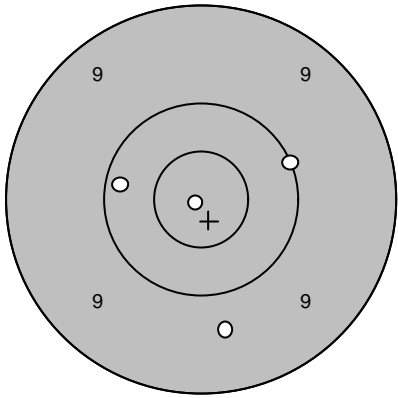
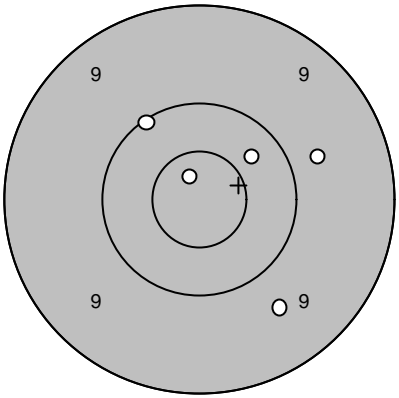
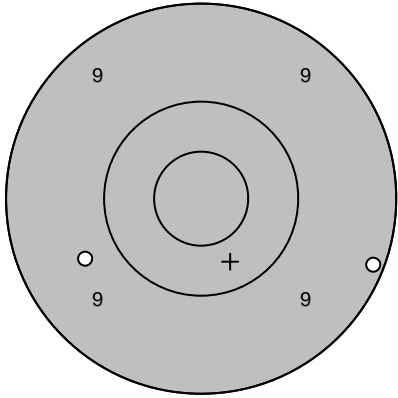
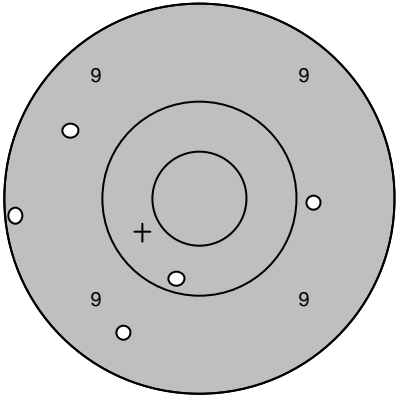
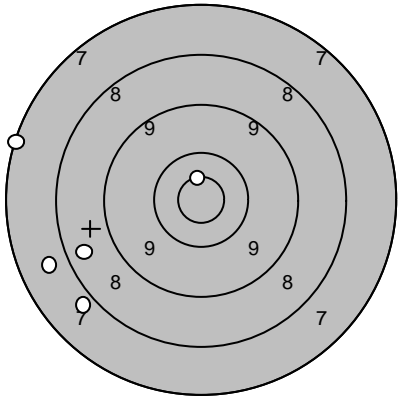
Lag 3	Tavla 3	Ulf Ohlsson		
Ramselefors		Umeå		
06.07.2006		Tavelträffen B - 2006	Ramselefors Skytteförening	
Prov		1: 10,2 ← 2: 10,9* ↙ 3: 9,7 ↓ 4: 10,0 →	Serie 1 	1: 9,8 → 2: 9,7 ↘ 3: 10,3 ↗ 4: 10,1 ↗ 5: 10,8* ↑
		Serie: 40,8		Serie: 50,7
		Summa: 147,0		Summa: 197,7
Prov		1: 9,2 → 2: 9,7 ↙	Serie 2 	1: 9,2 ← 2: 9,5 ↘ 3: 9,9 → 4: 10,2 ↘ 5: 9,6 ↖
		Serie: 18,9		Serie: 48,4
		Summa: 197,7		Summa: 246,1
Serie 3		1: 7,9 ↙ 2: 8,5 ↙ 3: 7,8 ↙ 4: 7,2 ↖ 5: 10,7* ↑		
		Serie: 42,1		
		Summa: 288,2		

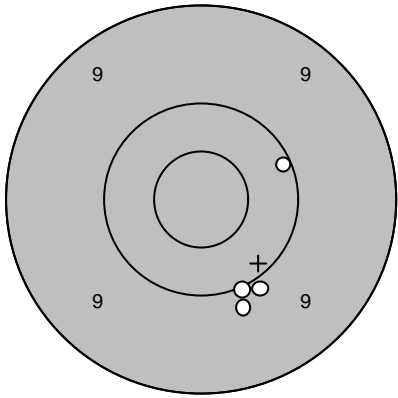
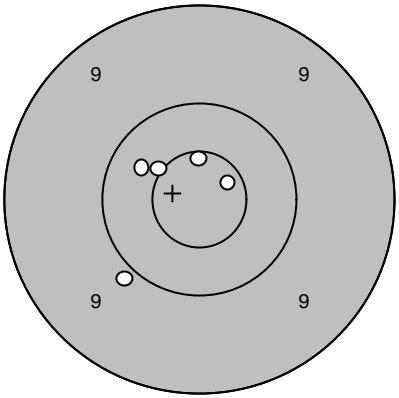
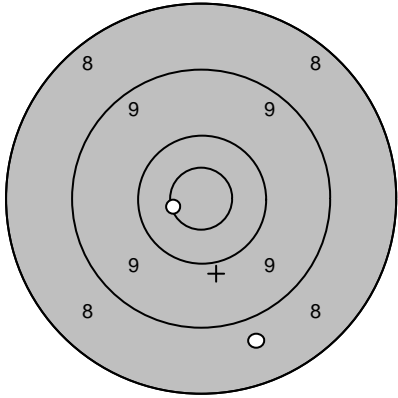
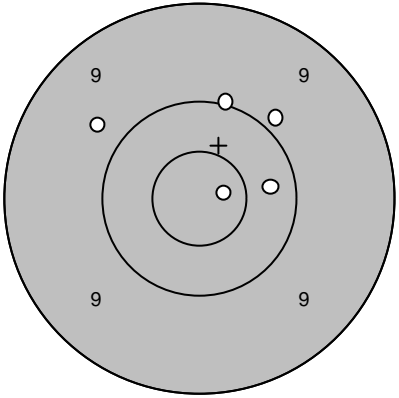
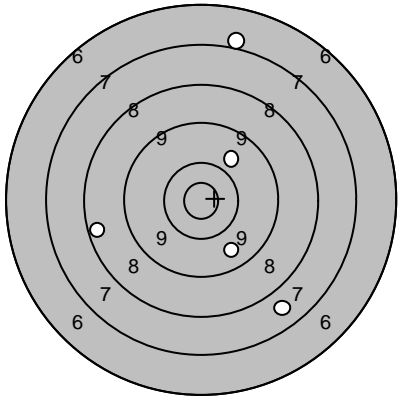
Lag 3	Tavla 4	Sören Olsson		
Ramselefors		Umeå		
06.07.2006		Tavelträffen B - 2006	Ramselefors Skytteförening	
Prov		1: 9,8 ↘ 2: 10,1 → 3: 9,9 ↘ 4: 10,0 ↘	Serie 1 	1: 10,6* ↑ 2: 10,5* ↖ 3: 10,4 ↖ 4: 9,9 ↙ 5: 10,7* →
		Serie: 39,8	Serie: 52,1	
		Summa: 144,0	Summa: 196,1	
Prov		1: 10,6* ← 2: 8,7 ↘	Serie 2 	1: 9,9 ↗ 2: 10,8* → 3: 9,8 ↖ 4: 10,0 ↑ 5: 10,3 →
		Serie: 19,3	Serie: 50,8	
		Summa: 196,1	Summa: 246,9	
Serie 3		1: 7,0 ↑ 2: 9,9 ↗ 3: 7,7 ↘ 4: 9,7 ↘ 5: 8,4 ←		
		Serie: 42,7		
		Summa: 289,6		

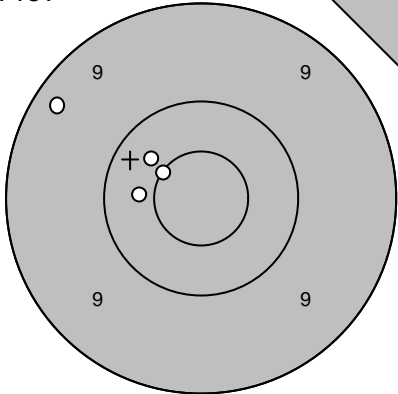
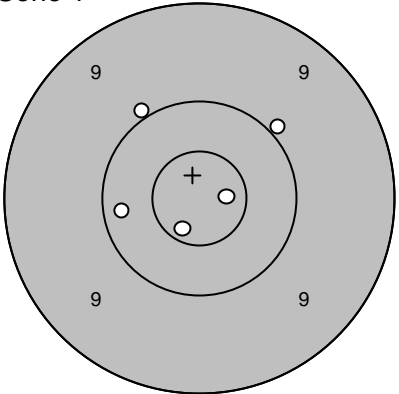
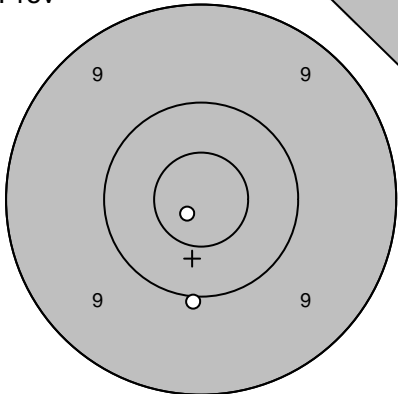
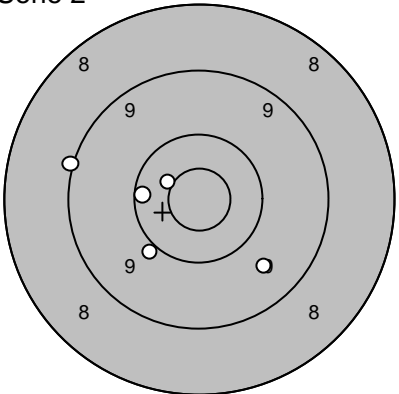
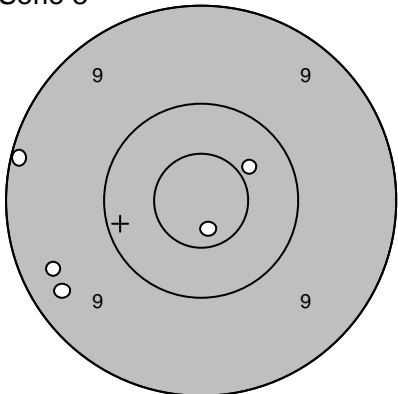
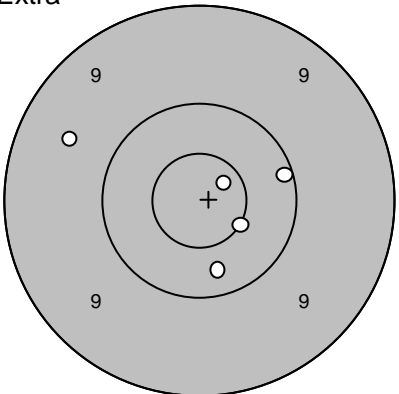
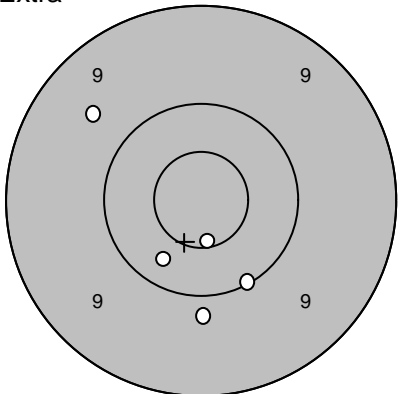
Lag 3	Tavla 6	Maria Falck	
Ramselefors		Moälven-Modo	
06.07.2006		Tavelträffen B - 2006	Ramselefors Skytteförening
Prov 	1: 9,3 ↗ 2: 10,4 ↗ 3: 10,4 ← 4: 10,6* ↗	Serie 1 	1: 9,9 ↗ 2: 10,0 ↗ 3: 10,2 ← 4: 10,8* → 5: 10,7* ↓
	Serie: 40,7 Summa: 141,0		Serie: 51,6 Summa: 192,6
Prov 	1: 10,0 ↓ 2: 10,8* ↓	Serie 2 	1: 9,0 ← 2: 10,5* ↗ 3: 10,2 ← 4: 10,0 ↓ 5: 9,7 ↓
	Serie: 20,8 Summa: 192,6		Serie: 49,4 Summa: 242,0
Serie 3 	1: 10,4 ↗ 2: 9,1 ← 3: 9,3 ← 4: 10,7* ↓ 5: 9,4 ←	Extra 	1: 10,3 ↓ 2: 10,1 → 3: 10,7* ↗ 4: 10,5* ↓ 5: 9,6 ↗
	Serie: 48,9 Summa: 290,9		Serie: 51,2 Summa: 342,1
Extra 	6: 10,3 ↓ 7: 10,6* ↓ 8: 10,1 ↓ 9: 9,6 ↗ 10: 9,9 ↓		
	Serie: 50,5 Summa: 392,6		

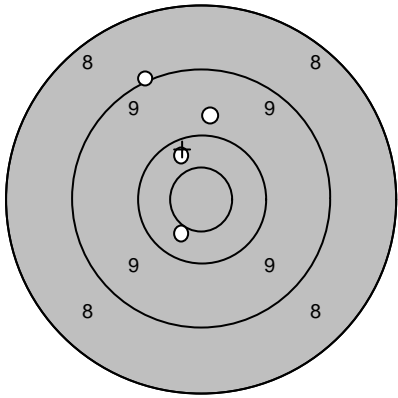
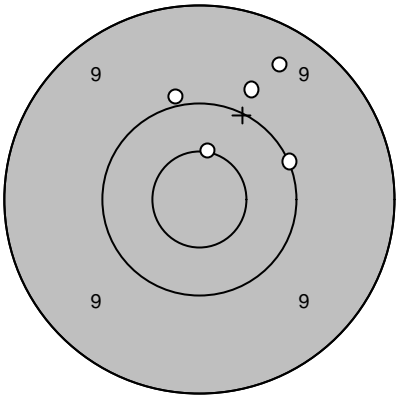
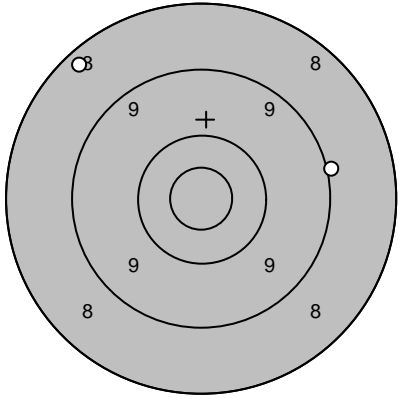
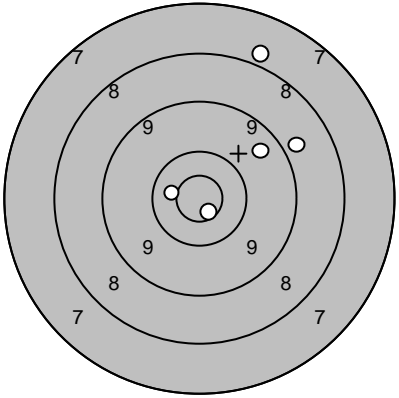
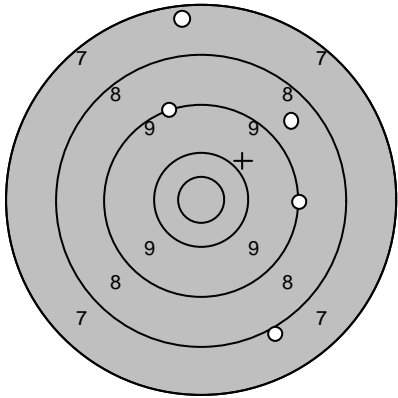
Lag 3	Tavla 7	Helena Arvidsson		
Ramselefors		Moälven-Modo		
06.07.2006		Tavelträffen B - 2006	Ramselefors Skytteförening	
Prov		1: 10,5* ↙ 2: 10,3 ↖ 3: 9,0 ↖ 4: 9,8 ↑	Serie 1 	1: 10,0 ↑ 2: 10,5* ↑ 3: 9,8 ↗ 4: 9,4 ↗ 5: 10,0 →
		Serie: 39,6	Serie: 49,7	
		Summa: 142,0	Summa: 191,7	
Prov		1: 9,0 → 2: 8,3 ↖	Serie 2 	1: 10,8* ↘ 2: 7,9 ↑ 3: 9,5 ↗ 4: 10,5* ← 5: 8,8 ↗
		Serie: 17,3	Serie: 47,5	
		Summa: 191,7	Summa: 239,2	
Serie 3		1: 8,0 ↘ 2: 9,2 ↖ 3: 7,4 ↑ 4: 9,1 → 5: 8,7 ↗		
		Serie: 42,4		
		Summa: 281,6		

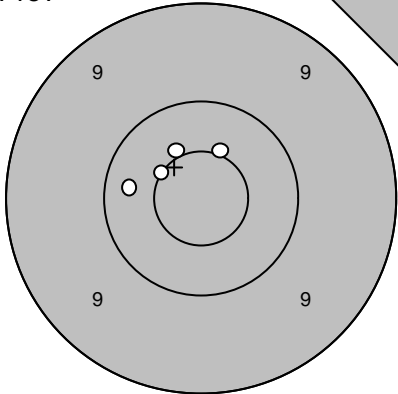
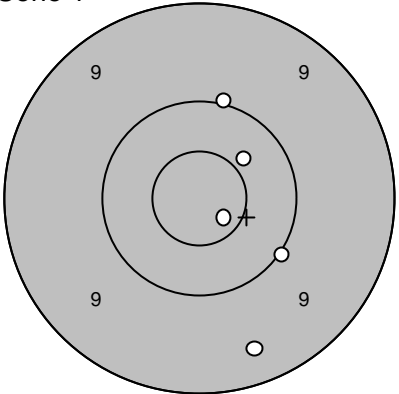
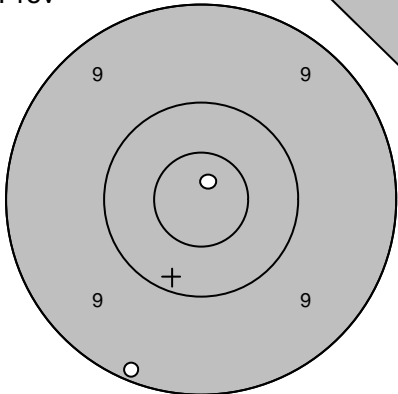
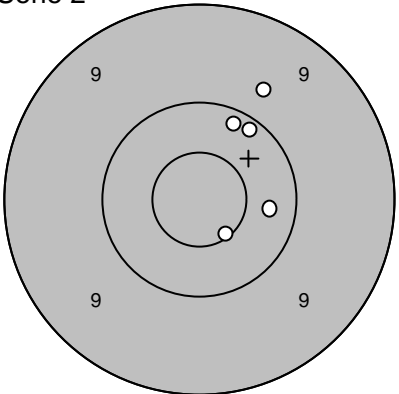
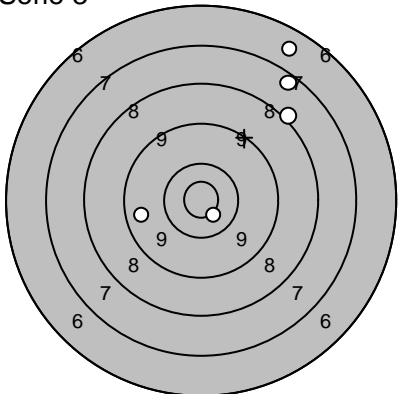
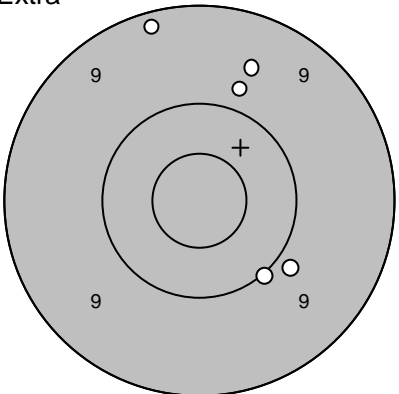
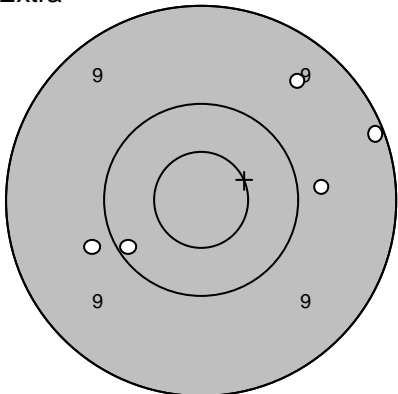
Lag 3	Tavla 8	Petter Eriksson	
Ramselefors		Moälven-Modo	
06.07.2006		Tavelträffen B - 2006	Ramselefors Skytteförening
Prov		1: 10,6* ↖ 2: 10,3 ← 3: 10,5* ↑ 4: 10,5* ↗ Serie: 41,9 Summa: 144,0	Serie 1  1: 10,4 ↗ 2: 10,0 ↑ 3: 10,0 ↘ 4: 10,7* ↘ 5: 9,4 ↓ Serie: 50,5 Summa: 194,5
Prov		1: 9,1 ↓ 2: 10,8* ↑ Serie: 19,9 Summa: 194,5	Serie 2  1: 10,2 ↑ 2: 10,3 → 3: 9,7 ↑ 4: 10,6* ↘ 5: 10,2 ↗ Serie: 51,0 Summa: 245,5
Serie 3		1: 9,6 ← 2: 6,7 ↑ 3: 10,7* ↘ 4: 8,1 ↗ 5: 7,4 ↗ Serie: 42,5 Summa: 288,0	Extra  1: 9,9 ↘ 2: 9,2 ↑ 3: 9,6 ↑ 4: 10,0 ↘ 5: 9,8 ↑ Serie: 48,5 Summa: 336,5
Extra		6: 9,1 → 7: 9,5 ↗ 8: 9,8 → 9: 10,2 ← 10: 9,8 ← Serie: 48,4 Summa: 384,9	

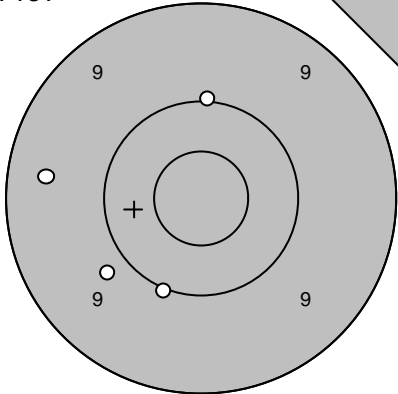
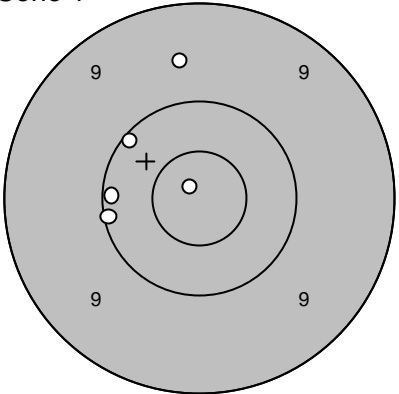
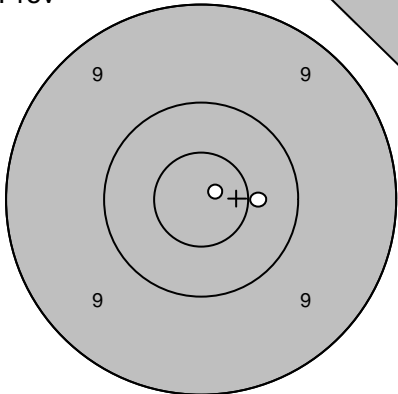
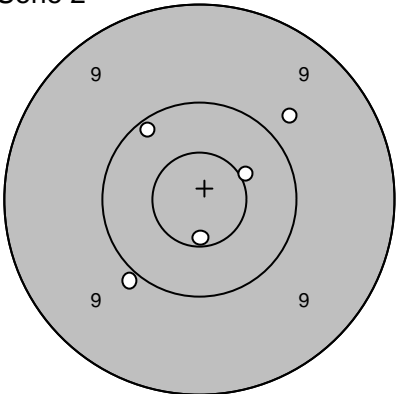
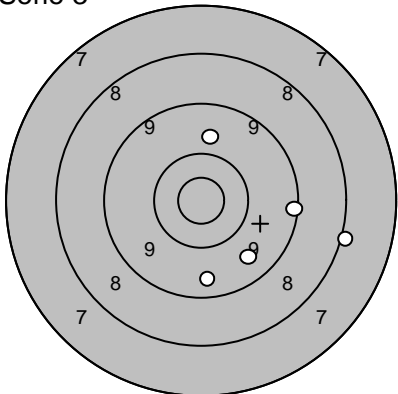
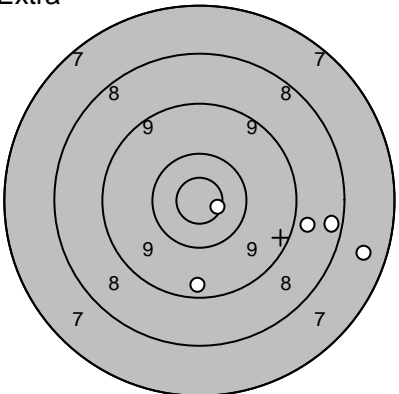
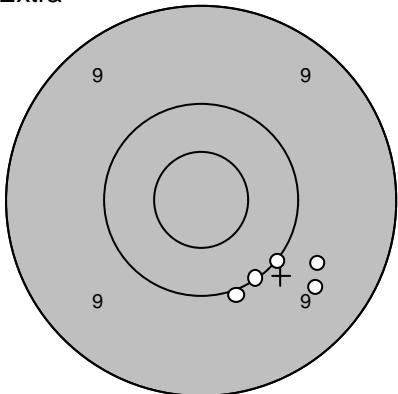
Lag 3	Tavla 9	Marie Arvidsson		
Ramselefors	Lidingö			
06.07.2006	Tavelträffen B - 2006	Ramselefors Skytteförening		
Prov		1: 10,0 ↘ 2: 9,8 ↙ 3: 10,0 ↑ 4: 9,4 ←	Serie 1 	1: 10,9* ↗ 2: 10,1 ↗ 3: 9,6 ↑ 4: 10,1 ← 5: 10,1 ←
		Serie: 39,2 Summa: 144,0		Serie: 50,8 Summa: 194,8
Prov		1: 10,9* ↗ 2: 10,5* →	Serie 2 	1: 9,8 ↗ 2: 10,5* ↗ 3: 10,2 ↗ 4: 9,9 ↙ 5: 10,6* ↓
		Serie: 21,4 Summa: 194,8		Serie: 51,0 Summa: 245,8
Serie 3		1: 9,5 ↓ 2: 9,2 → 3: 8,1 → 4: 9,6 ↘ 5: 9,8 ↑	Extra 	1: 8,8 → 2: 7,6 → 3: 9,4 ↓ 4: 10,7* → 5: 8,4 →
		Serie: 46,2 Summa: 292,0		Serie: 44,9 Summa: 336,9
Extra		6: 10,1 ↘ 7: 9,6 ↘ 8: 9,7 ↘ 9: 10,0 ↘ 10: 10,0 ↘		
		Serie: 49,4 Summa: 386,3		

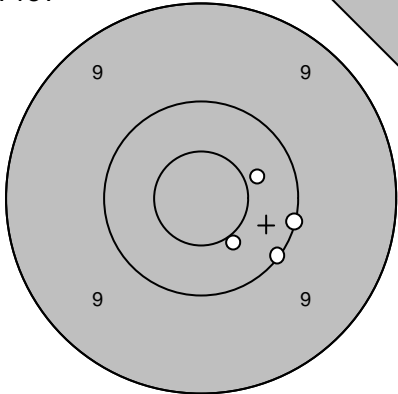
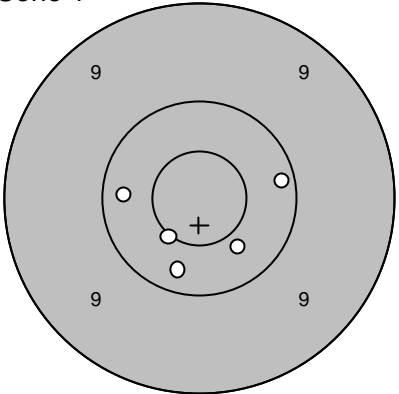
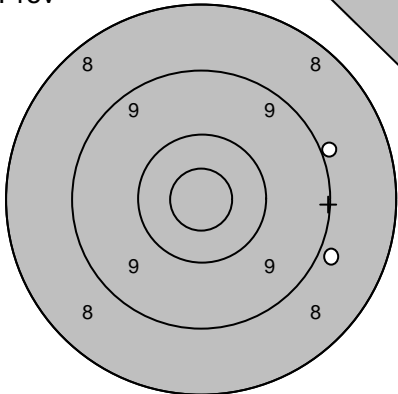
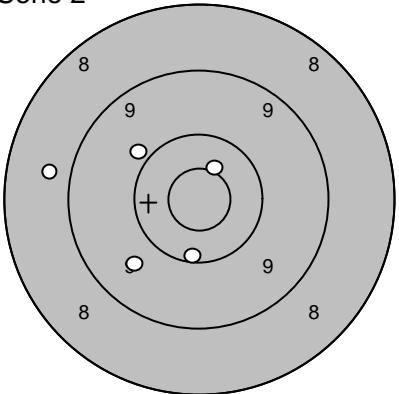
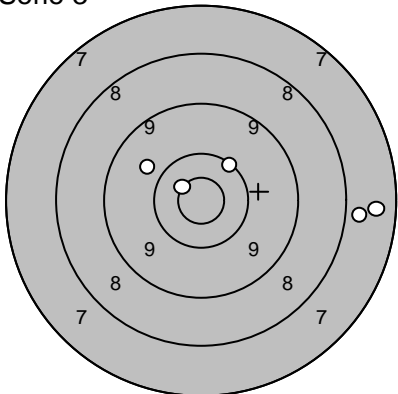
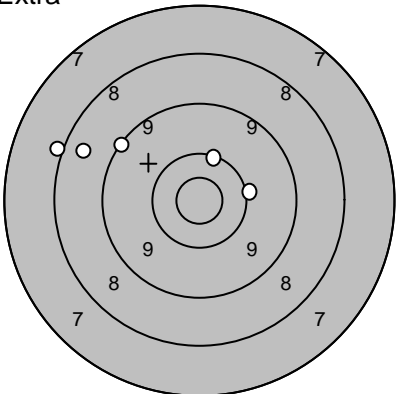
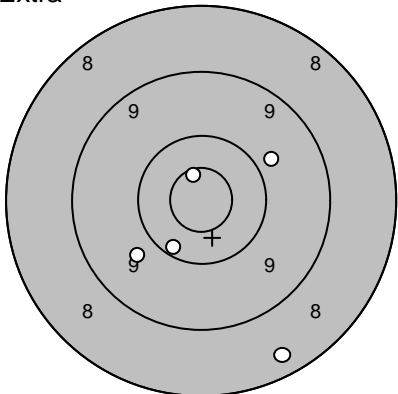
Lag 3	Tavla 10	Stefan Håkansson	
Ramselefors		Östersund	
06.07.2006		Tavelträffen B - 2006	Ramselefors Skytteförening
Prov		1: 10,1 → 2: 10,5* ↘ 3: 10,1 ↘ 4: 10,4 → Serie: 41,1 Summa: 147,0	Serie 1  1: 10,2 → 2: 10,5* ↘ 3: 10,3 ↘ 4: 10,3 ← 5: 10,4 ↘ Serie: 51,7 Summa: 198,7
Prov		1: 9,0 → 2: 8,9 → Serie: 17,9 Summa: 198,7	Serie 2  1: 10,2 ↓ 2: 9,9 ↖ 3: 8,8 ← 4: 9,7 ↘ 5: 10,5* ↗ Serie: 49,1 Summa: 247,8
Serie 3		1: 10,7* ↖ 2: 9,8 ↖ 3: 10,2 ↗ 4: 7,9 → 5: 7,5 → Serie: 46,1 Summa: 293,9	Extra  1: 8,6 ← 2: 8,0 ← 3: 10,1 → 4: 9,2 ↖ 5: 10,2 ↗ Serie: 46,1 Summa: 340,0
Extra		6: 9,8 ↗ 7: 9,8 ↘ 8: 10,7* ↑ 9: 10,2 ↘ 10: 8,4 ↘ Serie: 48,9 Summa: 388,9	

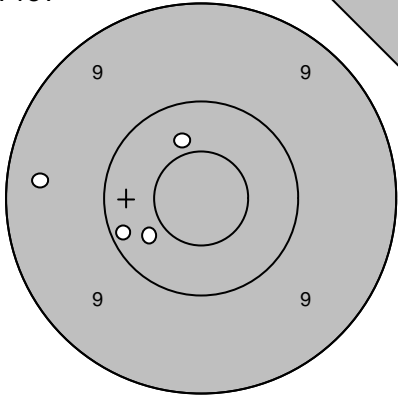
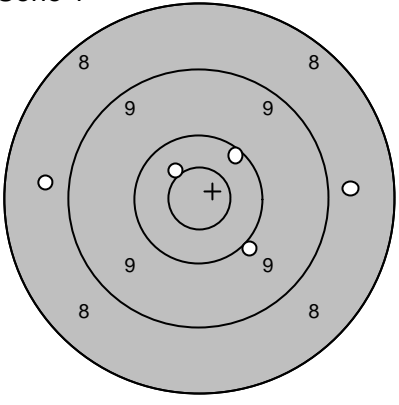
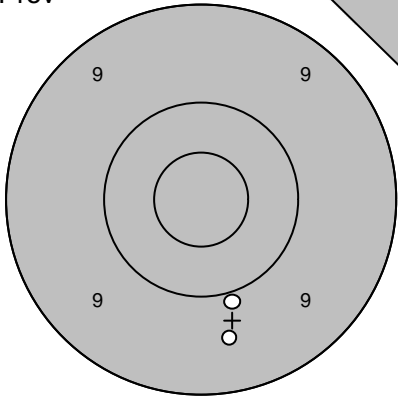
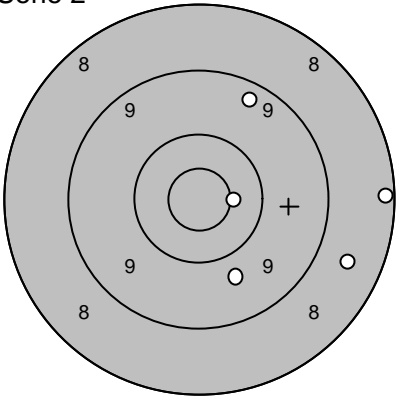
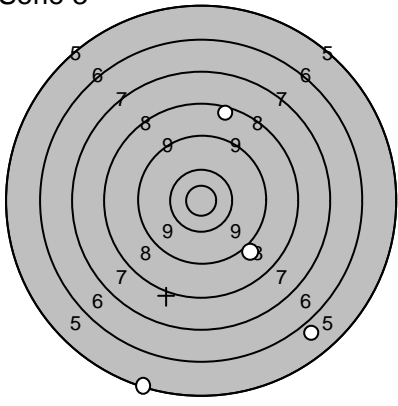
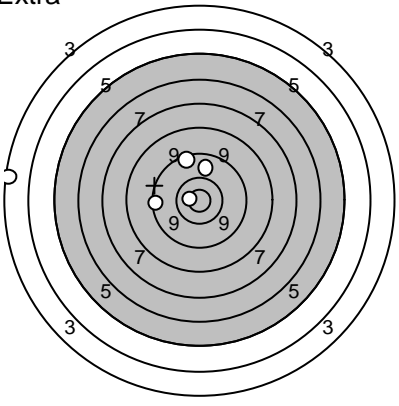
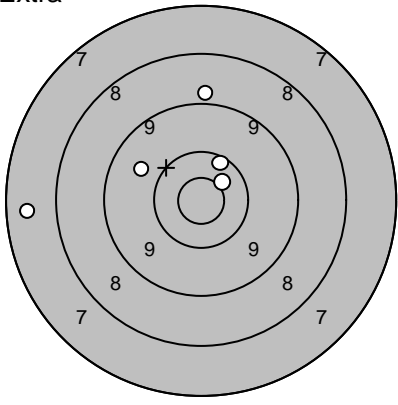
Lag 3	Tavla 11	Bror Rantakyrö	
Ramselefors		Övertorneå	
06.07.2006		Tavelträffen B - 2006	Ramselefors Skytteförening
Prov 	1: 9,4 ← 2: 10,4 ↑ 3: 10,4 ↙ 4: 10,2 ←	Serie 1 	1: 8,8 → 2: 10,2 ↗ 3: 8,7 ← 4: 10,5* ↗ 5: 10,0 ↘
	Serie: 40,4 Summa: 143,0		Serie: 48,2 Summa: 191,2
Prov 	1: 9,6 ↓ 2: 9,9 ↓	Serie 2 	1: 8,6 ⇒ 2: 8,2 → 3: 9,4 ↗ 4: 10,5* → 5: 9,8 ↘
	Serie: 19,5 Summa: 191,2		Serie: 46,5 Summa: 237,7
Serie 3 	1: 0,0 ← 2: 9,0 ↘ 3: 8,4 ↑ 4: 5,2 ↘ 5: 5,9 ↘	Extra 	1: 9,5 ← 2: 9,6 ↑ 3: 3,5 ← 4: 10,9* ← 5: 10,0 ↑
	Serie: 28,5 Summa: 266,2		Serie: 43,5 Summa: 309,7
Extra 	6: 7,6 ← 7: 10,3 ↗ 8: 10,5* ↗ 9: 8,9 ↑ 10: 9,8 ←		
	Serie: 47,1 Summa: 356,8		

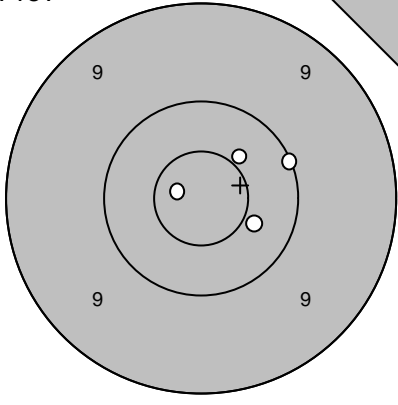
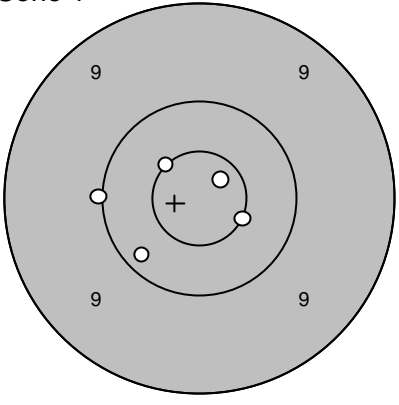
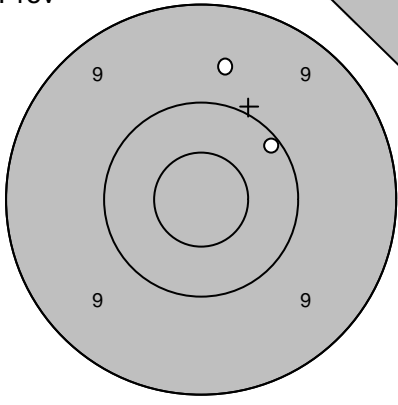
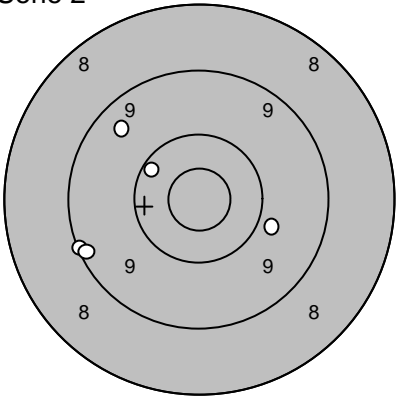
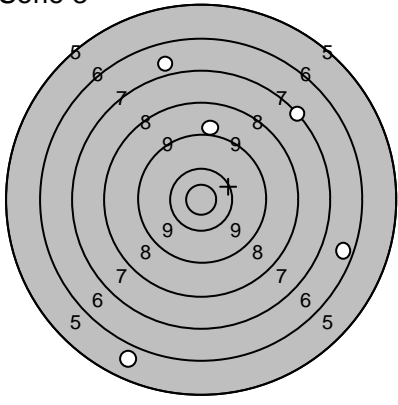
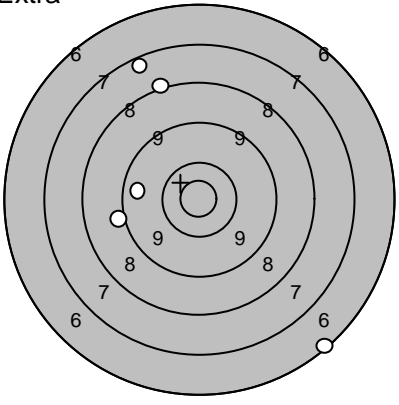
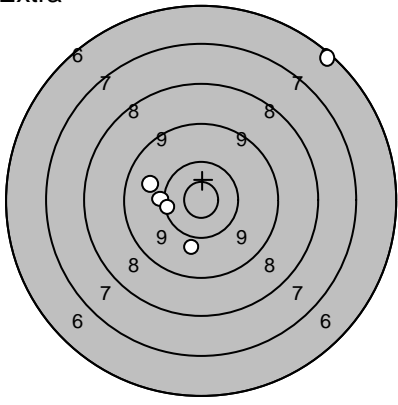
Lag 3	Tavla 12	Nisse Ström	
Ramselefors		Övertorneå	
06.07.2006		Tavelträffen B - 2006	Ramselefors Skytteförening
Prov		1: 10,4 → 2: 10,8* ← 3: 10,5* ↗ 4: 10,1 →	Serie 1 
		Serie: 41,8 Summa: 147,0	1: 10,5* → 2: 10,6* ↗ 3: 10,7* ↗ 4: 10,0 ← 5: 10,2 ↘
			Serie: 52,0 Summa: 199,0
Prov		1: 10,1 ↗ 2: 9,7 ↑	Serie 2 
		Serie: 19,8 Summa: 199,0	1: 9,5 ↗ 2: 10,2 ↗ 3: 9,9 → 4: 9,1 ← 5: 9,2 ←
			Serie: 47,9 Summa: 246,9
Serie 3		1: 6,9 ↑ 2: 9,0 ↑ 3: 7,3 ↗ 4: 5,8 ↘ 5: 6,6 →	Extra 
		Serie: 35,6 Summa: 282,5	1: 9,1 ← 2: 6,3 ↘ 3: 8,1 ↗ 4: 7,4 ↗ 5: 9,6 ←
			Serie: 40,5 Summa: 323,0
Extra		6: 6,3 ↗ 7: 10,1 ← 8: 10,3 ← 9: 9,8 ← 10: 9,9 ↓	
		Serie: 46,4 Summa: 369,4	

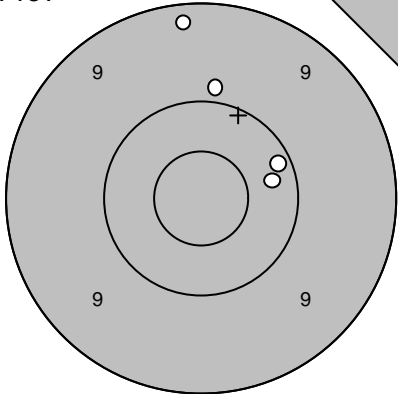
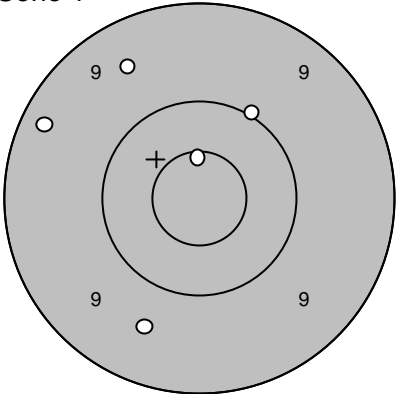
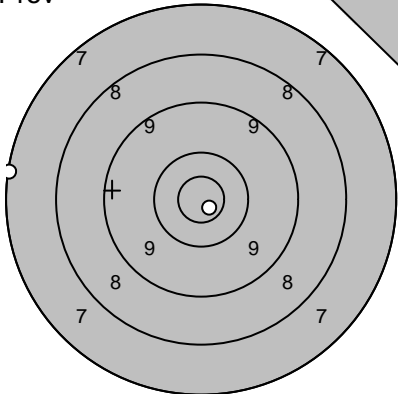
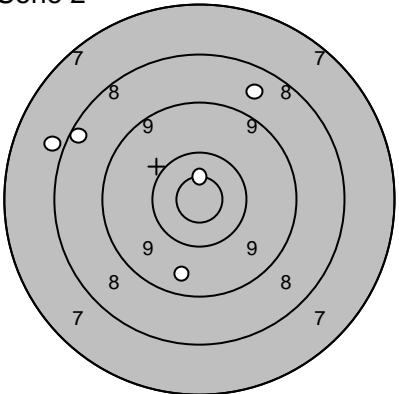
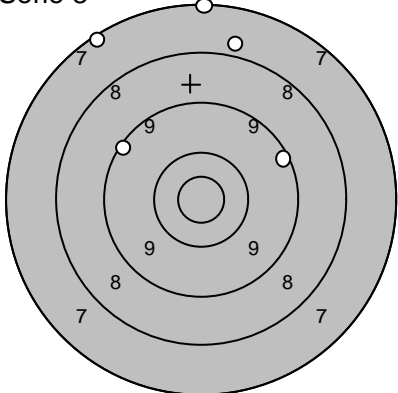
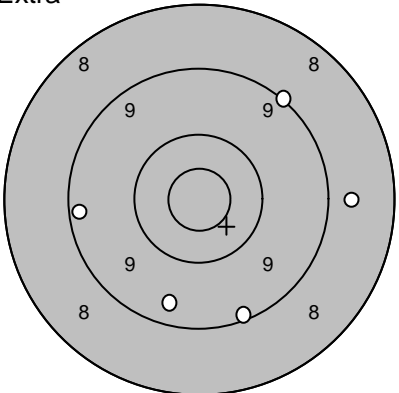
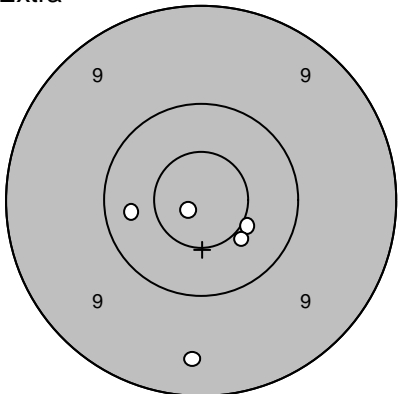
Lag 3	Tavla 13	Stefan Sigfridsson	
Ramselefors		Ramselefors	
06.07.2006		Tavelträffen B - 2006	Ramselefors Skytteförening
Prov		1: 9,2 ↑ 2: 9,9 ↑ 3: 10,3 → 4: 10,2 → Serie: 39,6 Summa: 138,0	Serie 1  1: 9,5 ↖ 2: 10,6* ↑ 3: 10,0 ↗ 4: 9,3 ↖ 5: 9,6 ↓ Serie: 49,0 Summa: 187,0
Prov		1: 7,2 ← 2: 10,9* ↘ Serie: 18,1 Summa: 187,0	Serie 2  1: 7,9 ↖ 2: 10,7* ↑ 3: 8,7 ↗ 4: 8,3 ↖ 5: 9,6 ↓ Serie: 45,2 Summa: 232,2
Serie 3		1: 7,2 ↖ 2: 7,2 ↑ 3: 7,9 ↑ 4: 9,2 ↗ 5: 9,2 ↖ Serie: 40,7 Summa: 272,9	Extra  1: 9,1 ↗ 2: 9,2 ← 3: 8,8 → 4: 9,2 ↓ 5: 9,4 ↓ Serie: 45,7 Summa: 318,6
Extra		6: 10,5* → 7: 10,3 ← 8: 10,5* ↘ 9: 9,4 ↓ 10: 10,9* ↖ Serie: 51,6 Summa: 370,2	

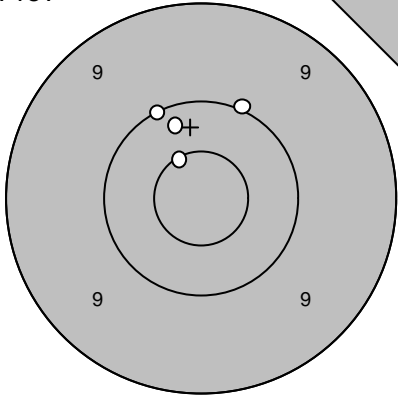
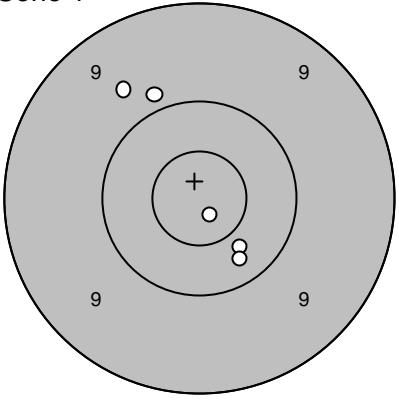
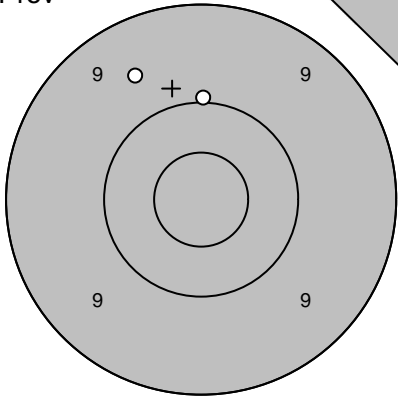
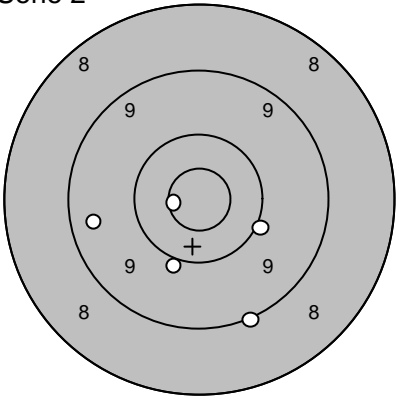
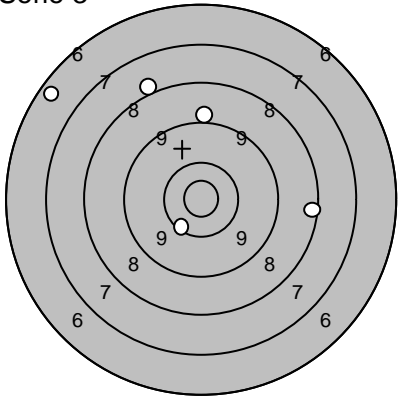
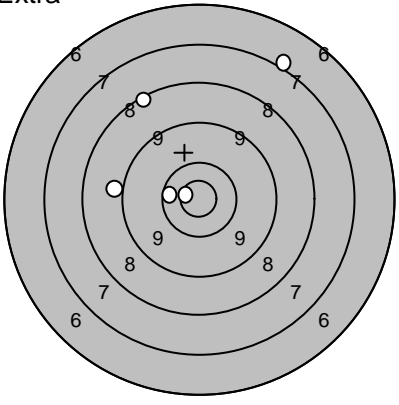
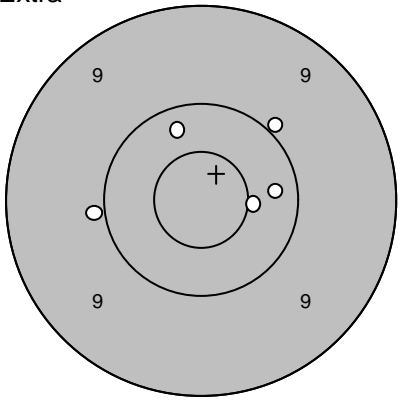
Lag 3	Tavla 14	Gustav Lövgren	
Ramselefors		Niemisel	
06.07.2006		Tavelträffen B - 2006	Ramselefors Skytteförening
Prov 	1: 10,0 ↗ 2: 10,2 ↑ 3: 10,6* ↘ 4: 10,1 ↖	Serie 1 	1: 9,7 ↗ 2: 9,9 ↗ 3: 10,4 ↘ 4: 10,8* ↘ 5: 10,3 ↘
	Serie: 40,9 Summa: 147,0		Serie: 51,1 Summa: 198,1
Prov 	1: 9,6 ↖ 2: 10,0 ↑	Serie 2 	1: 10,0 ↘ 2: 9,4 ← 3: 10,7* ← 4: 10,0 ↘ 5: 9,1 ↘
	Serie: 19,6 Summa: 198,1		Serie: 49,2 Summa: 247,3
Serie 3 	1: 8,3 → 2: 8,0 ↖ 3: 10,3 ↘ 4: 9,0 ↑ 5: 6,5 ↖	Extra 	1: 8,3 ↖ 2: 10,8* ← 3: 7,1 ↗ 4: 9,0 ← 5: 10,4 ←
	Serie: 42,1 Summa: 289,4		Serie: 45,6 Summa: 335,0
Extra 	6: 10,3 → 7: 10,3 ↑ 8: 9,9 ← 9: 10,0 ↗ 10: 10,5* →		
	Serie: 51,0 Summa: 386,0		

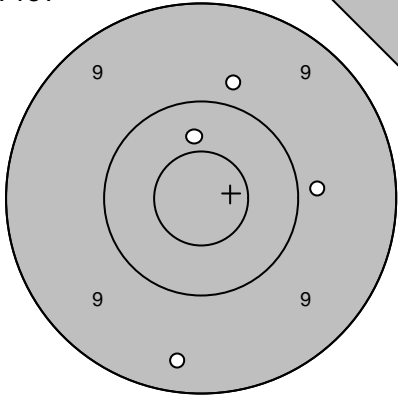
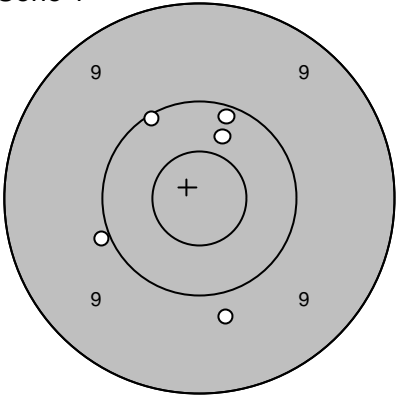
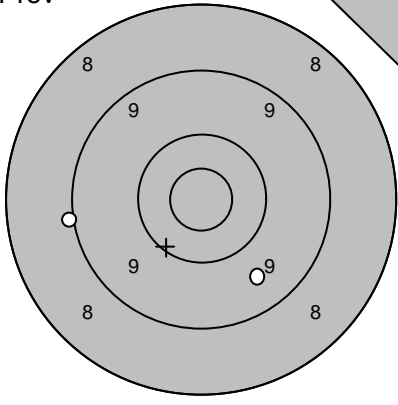
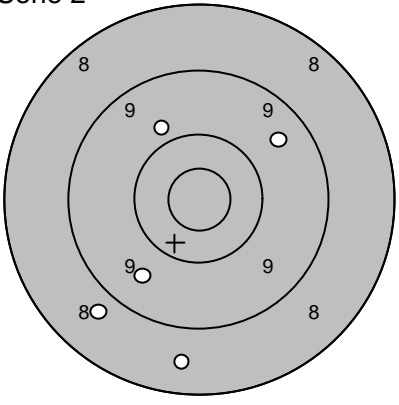
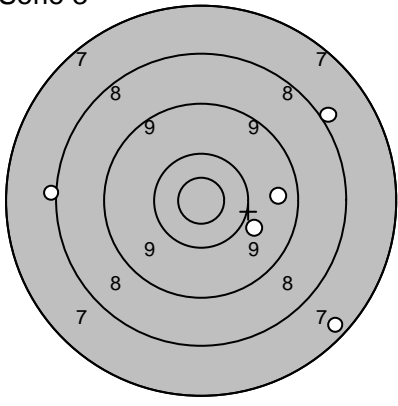
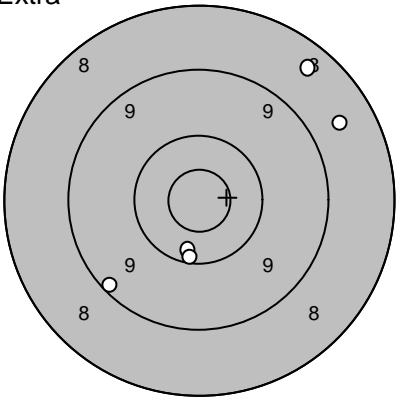
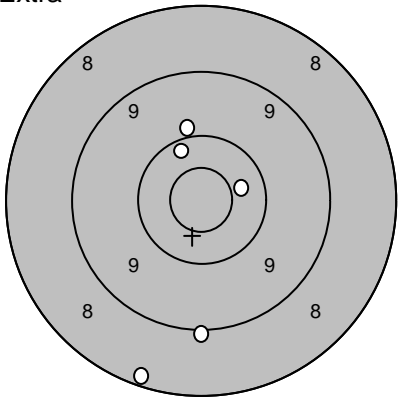
Lag 3	Tavla 15	Peter Östling	
Ramselefors		F 21	
06.07.2006		Tavelträffen B - 2006	
Prov		Ramselefors Skytteförening	
	1: 10,4 ↑ 2: 9,8 → 3: 9,8 ↑ 4: 9,4 ↓	Serie 1 	1: 10,1 ↖ 2: 10,2 ↑ 3: 10,0 ← 4: 9,8 ↓ 5: 10,4 ↑
	Serie: 39,4		Serie: 50,5
	Summa: 144,0		Summa: 194,5
	1: 9,6 ↘ 2: 9,0 ←	Serie 2 	1: 9,8 ↖ 2: 8,8 ↘ 3: 8,6 ↓ 4: 9,6 ↗ 5: 9,6 ↘
	Serie: 18,6		Serie: 46,4
	Summa: 194,5		Summa: 240,9
	1: 8,1 ← 2: 9,9 ↘ 3: 9,5 → 4: 8,0 ↗ 5: 7,4 ↘	Extra 	1: 10,3 ↓ 2: 8,5 ↗ 3: 8,6 ↗ 4: 10,2 ↓ 5: 9,2 ↘
	Serie: 42,9		Serie: 46,8
	Summa: 283,8		Summa: 330,6
	6: 10,4 → 7: 10,0 ↑ 8: 9,0 ↓ 9: 10,3 ↑ 10: 8,2 ↓		
	Serie: 47,9		
	Summa: 378,5		

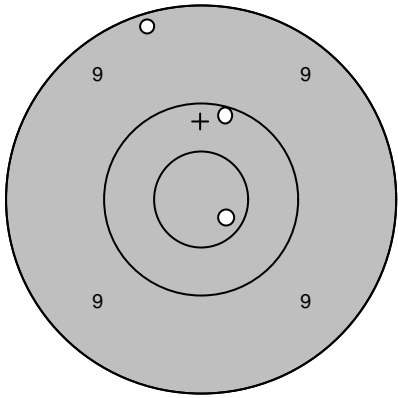
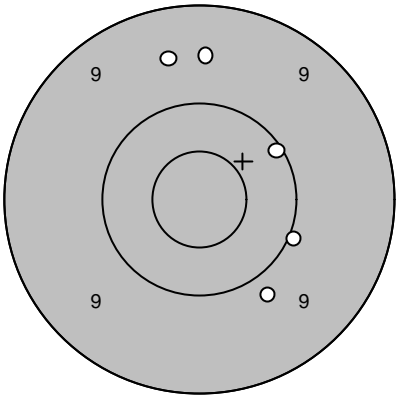
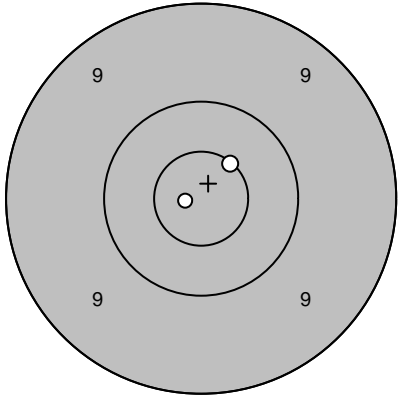
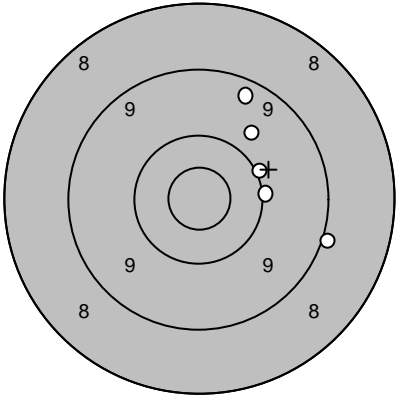
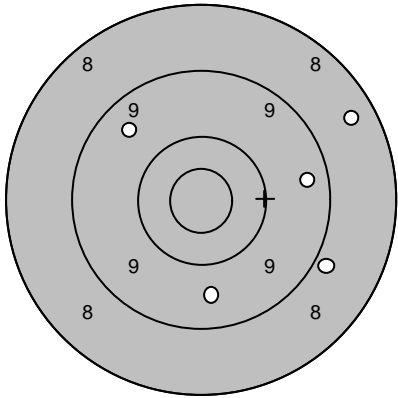
Lag 3	Tavla 16	Harry Östling		
Ramselefors	F 21			
06.07.2006	Tavelträffen B - 2006	Ramselefors Skytteförening		
Prov		1: 9,2 ↗ 2: 10,7* → 3: 10,1 ↗	Serie 1 	1: 9,6 ↗ 2: 9,6 ↗ 3: 10,1 ↗ 4: 9,8 ↘ 5: 10,0 →
	Serie: 30,0	Serie: 49,1		
	Summa: 143,0	Summa: 192,1		
Prov		1: 10,9* ← 2: 10,6* ↗	Serie 2 	1: 9,3 ↗ 2: 10,1 → 3: 9,8 ↗ 4: 10,1 ↗ 5: 9,0 →
	Serie: 21,5	Serie: 48,3		
	Summa: 192,1	Summa: 240,4		
Serie 3		1: 9,6 ↓ 2: 9,4 → 3: 8,9 → 4: 8,4 ↗ 5: 9,5 ↗		
	Serie: 45,8			
	Summa: 286,2			

Lag	Tavla	Peter Lundqvist
3	17	

Ramselefors	Ununge		
-------------	--------	--	--

06.07.2006	Tavelträffen B - 2006	Ramselefors Skytteförening
------------	-----------------------	----------------------------

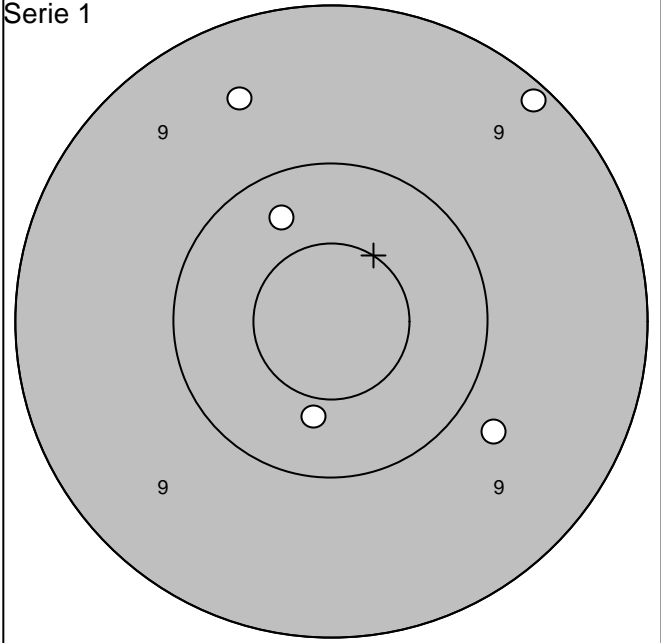
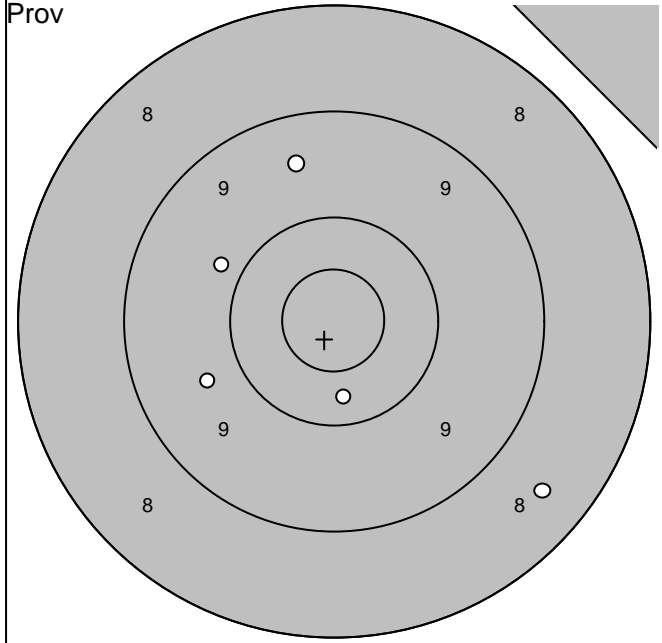

1: 10,3 ↓	Serie: 47,8
2: 9,5 ↑	
3: 9,8 ↖	
4: 9,7 ←	
5: 8,5 ↘	
Summa: 129,0	

1: 10,3 ↗	Serie: 49,1
2: 10,4 ↓	
3: 9,5 ↑	
4: 9,1 ↗	
5: 9,8 ↘	
Summa: 178,1	

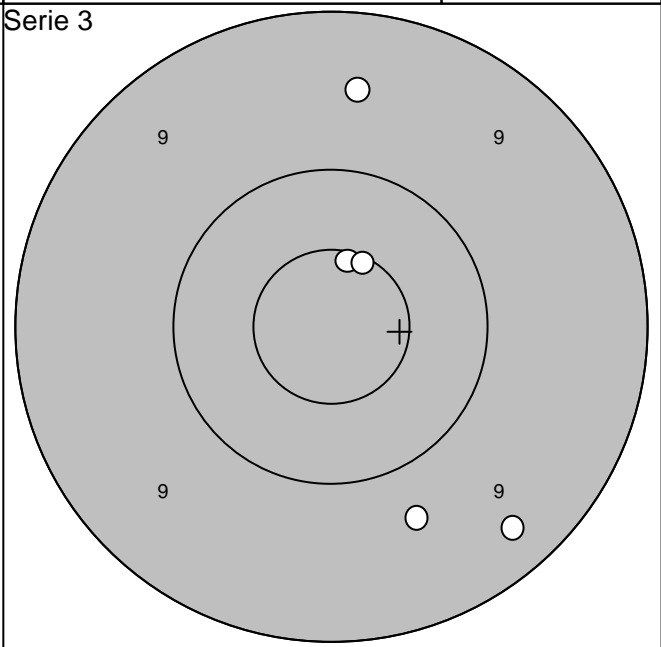
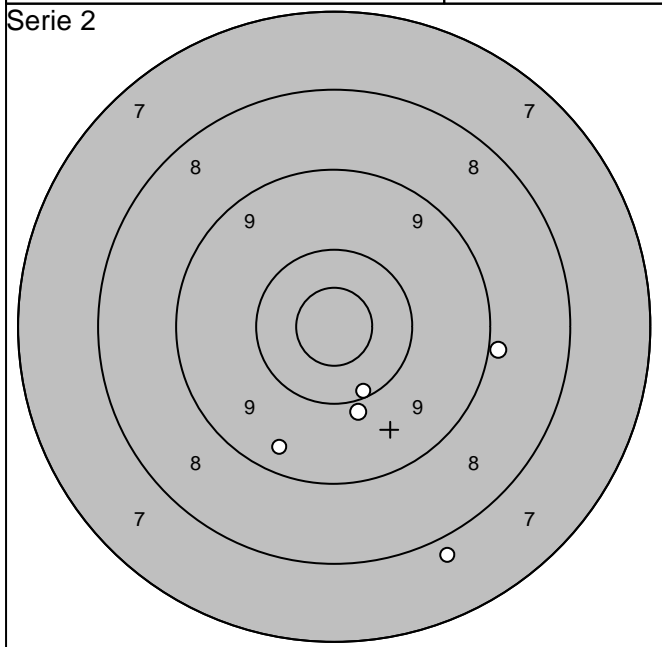

1: 9,9 ↓	Serie: 46,3
2: 9,0 →	
3: 7,8 ↓	
4: 10,2 ↓	
5: 9,4 ↓	
Summa: 224,4	

1: 10,6* ↑	Serie: 49,7
2: 9,3 ↘	
3: 10,6* ↗	
4: 9,7 ↓	
5: 9,5 ↑	
Summa: 274,1	

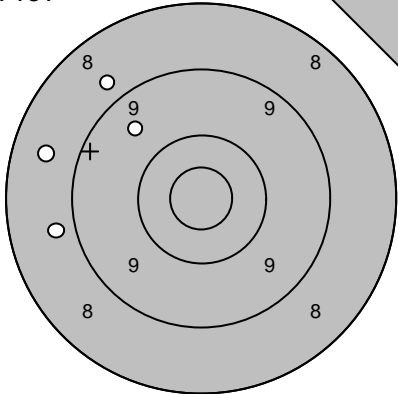
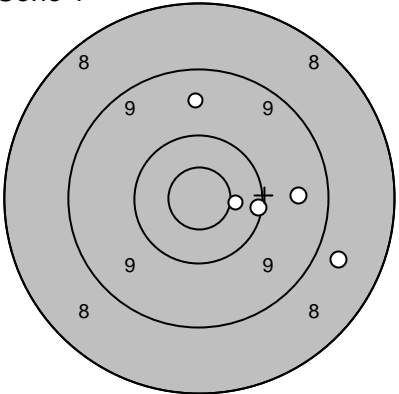
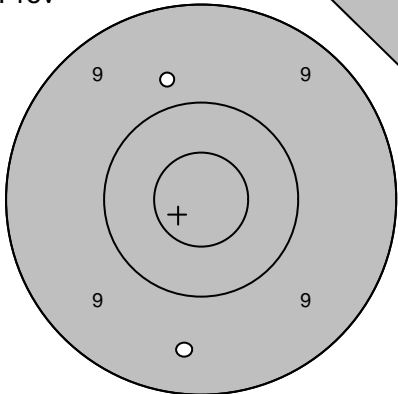
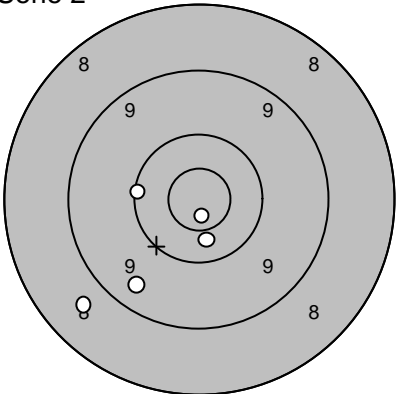
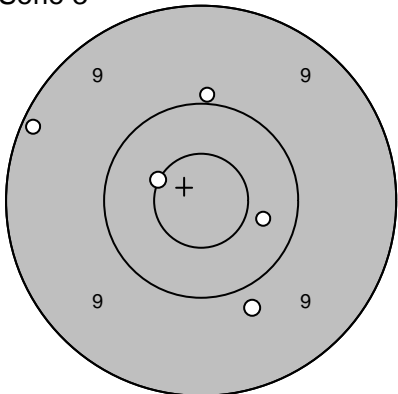
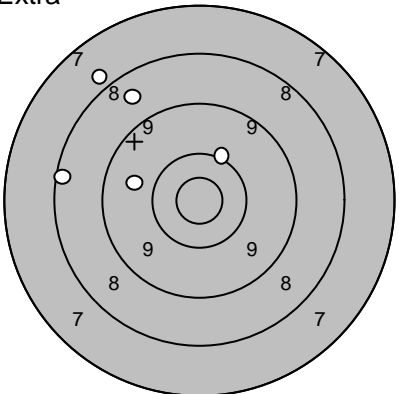
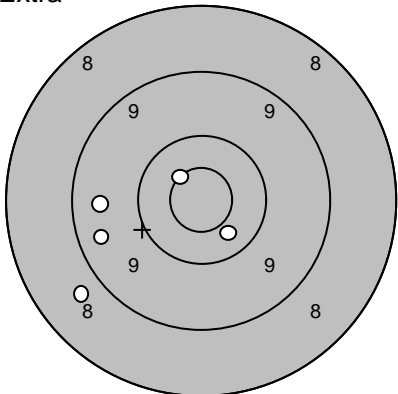
Lag 3	Tavla 18	Hugo Håkansson	
Ramselefors		Östersund	
06.07.2006		Tavelträffen B - 2006	Ramselefors Skytteförening
Prov		1: 8,8 ← 2: 9,6 ↗ 3: 8,6 ↖ 4: 8,8 ↗ Serie: 35,8 Summa: 138,0	Serie 1  1: 8,8 → 2: 9,6 ↑ 3: 9,6 → 4: 10,5* → 5: 10,2 → Serie: 48,7 Summa: 186,7
Prov		1: 9,5 ↓ 2: 9,8 ↑ Serie: 19,3 Summa: 186,7	Serie 2  1: 10,8* ↓ 2: 10,4 ↓ 3: 8,7 ↙ 4: 9,5 ↙ 5: 10,1 ← Serie: 49,5 Summa: 236,2
Serie 3		1: 10,0 ↑ 2: 10,6* ↖ 3: 9,2 ↖ 4: 9,8 ↘ 5: 10,4 → Serie: 50,0 Summa: 286,2	Extra  1: 10,1 ↗ 2: 8,3 ← 3: 8,6 ↗ 4: 9,7 ← 5: 7,9 ↗ Serie: 44,6 Summa: 330,8
Extra		6: 10,4 ↘ 7: 8,7 ↙ 8: 10,6* ↗ 9: 9,4 ← 10: 9,5 ← Serie: 48,6 Summa: 379,4	

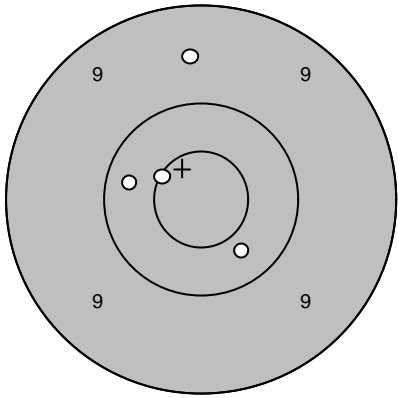
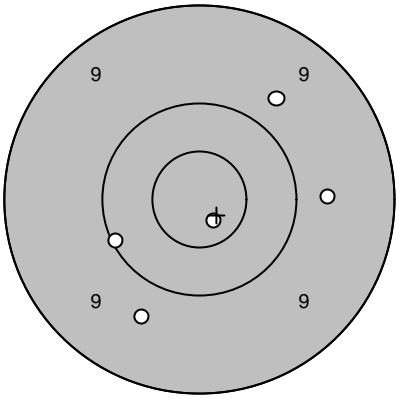
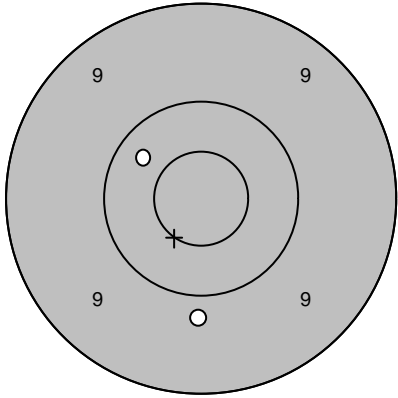
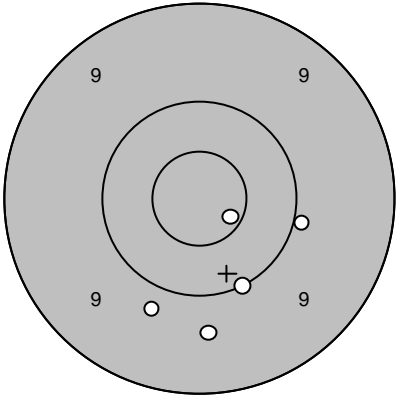
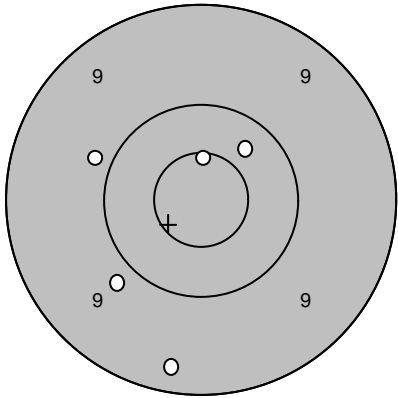
Lag 3	Tavla 19	Rolf Åström	
Ramselefors		Brattby	
06.07.2006		Tavelträffen B - 2006	Ramselefors Skytteförening
Prov 	1: 9,6 ↑	Serie 1 	1: 9,7 ↗
	2: 10,3 ←		2: 10,8* ↓
	3: 10,4 ↓		3: 9,7 ↓
	4: 10,6* ↑		4: 10,1 ←
			5: 9,7 →
	Serie: 40,9		Serie: 50,0
	Summa: 137,0		Summa: 187,0
Prov 	1: 10,3 ↖	Serie 2 	1: 9,7 ↓
	2: 9,8 ↓		2: 10,0 →
			3: 10,7* ↓
			4: 9,8 ↓
			5: 10,0 ↓
	Serie: 20,1		Serie: 50,2
	Summa: 187,0		Summa: 237,2
Serie 3 	1: 10,6* ↑		
	2: 9,8 ↙		
	3: 9,9 ↖		
	4: 10,3 ↗		
	5: 9,3 ↓		
	Serie: 49,9		
	Summa: 287,1		

Lag 3	Tavla 21	Jennie Ericson		
Ramselefors		Loos		
06.07.2006		Tavelträffen B - 2006		Ramselefors Skytteförening
Prov		1: 10,5* ← 2: 9,9 ← 3: 10,5* ↗ 4: 10,3 ↘	Serie 1	 1: 10,0 ↑ 2: 9,7 ← 3: 10,5* ↓ 4: 9,5 ← 5: 9,6 ↘
		Serie: 41,2 Summa: 143,0		Serie: 49,3 Summa: 192,3
Prov		1: 10,4 ↓ 2: 9,8 ↘	Serie 2	 1: 10,1 ↘ 2: 10,4 ↗ 3: 10,1 ↑ 4: 10,8* ↑ 5: 10,5* ↑
		Serie: 20,2 Summa: 192,3		Serie: 51,9 Summa: 244,2
Serie 3		1: 9,7 ↗ 2: 10,7* ↘ 3: 10,1 ↑ 4: 10,2 → 5: 10,1 ↘	Extra	 1: 10,4 ↓ 2: 9,8 ← 3: 0,0 ↑ 4: 9,8 → 5: 10,5* ↗
		Serie: 50,8 Summa: 295,0		Serie: 40,5 Summa: 335,5
Extra		6: 10,0 ↗ 7: 10,5* ↑ 8: 9,8 ↑ 9: 10,4 ↓ 10: 8,4 →		
		Serie: 49,1 Summa: 384,6		

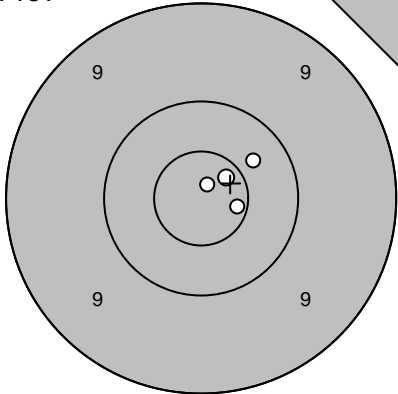
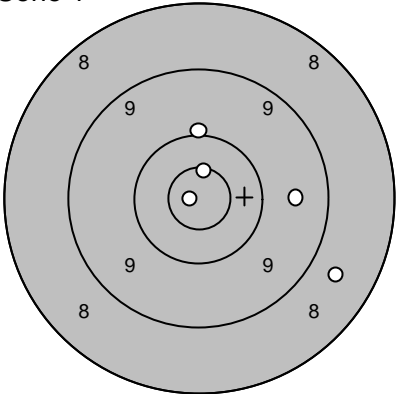
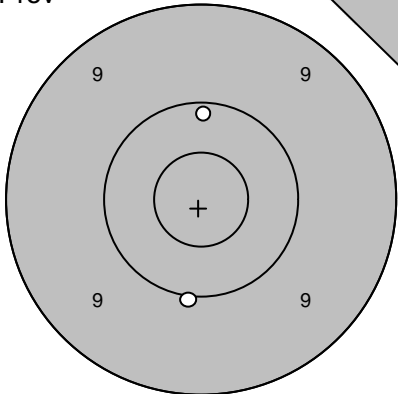
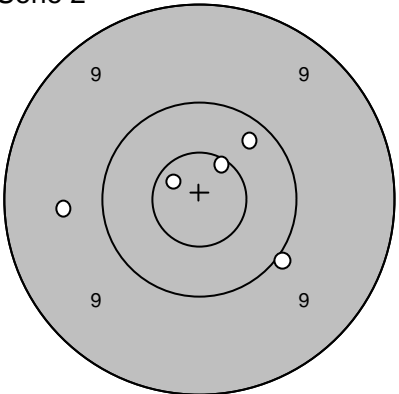
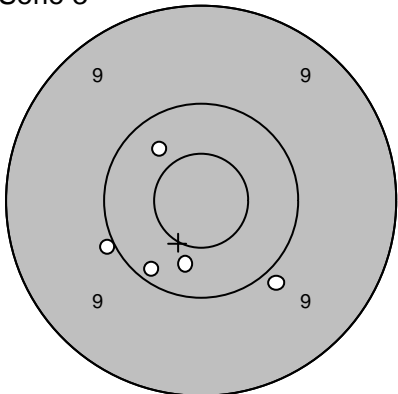
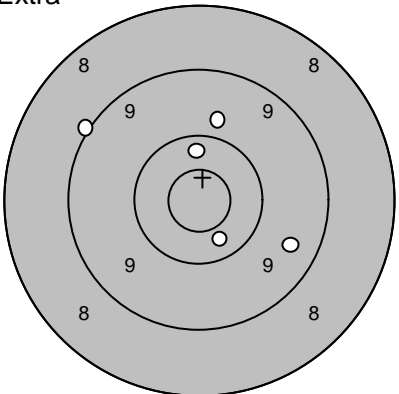
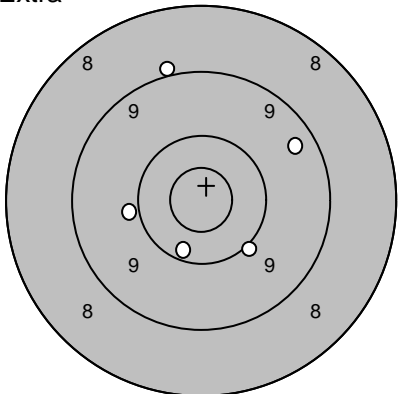
Lag 3	Tavla 22	Daniel Wallberg			
Ramselefors	Loos				
06.07.2006	Tavelträffen B - 2006	Ramselefors Skytteförening			
Prov		1: 10,7* → 2: 10,7* ↗ 3: 10,9* ↑ 4: 10,4 ↗	Serie 1		1: 10,0 ↑ 2: 10,9* ← 3: 8,7 ↘ 4: 10,6* ↑ 5: 9,6 →
		Serie: 42,7 Summa: 145,0			Serie: 49,8 Summa: 194,8
Prov		1: 10,2 ↑ 2: 10,0 ↓	Serie 2		1: 10,2 ↗ 2: 10,0 ↘ 3: 9,7 ← 4: 10,7* ↗ 5: 10,6* ↑
		Serie: 20,2 Summa: 194,8			Serie: 51,2 Summa: 246,0
Serie 3		1: 10,4 ↓ 2: 10,4 ↘ 3: 10,0 ← 4: 10,2 ↓ 5: 9,9 ↘	Extra		1: 9,0 ↖ 2: 10,4 ↓ 3: 9,8 ↑ 4: 10,3 ↑ 5: 9,5 ↘
		Serie: 50,9 Summa: 296,9			Serie: 49,0 Summa: 345,9
Extra		6: 10,0 ↘ 7: 9,4 ↗ 8: 9,0 ↑ 9: 10,0 ← 10: 10,3 ↓			
		Serie: 48,7 Summa: 394,6			

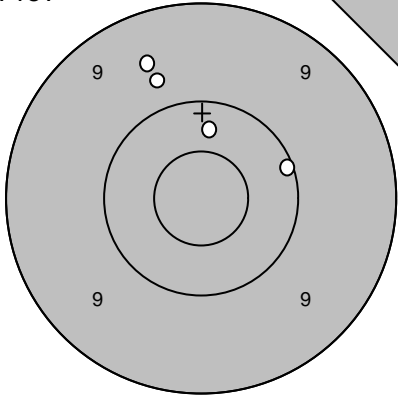
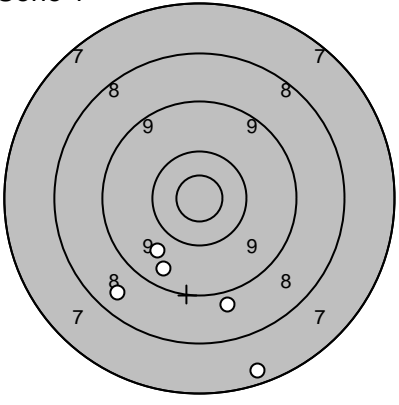
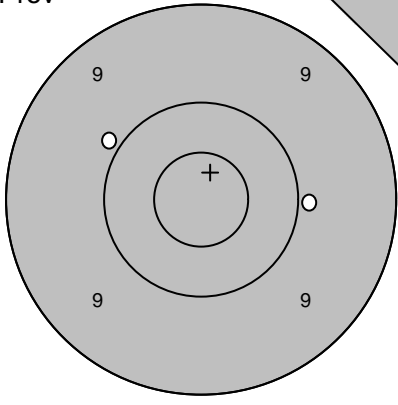
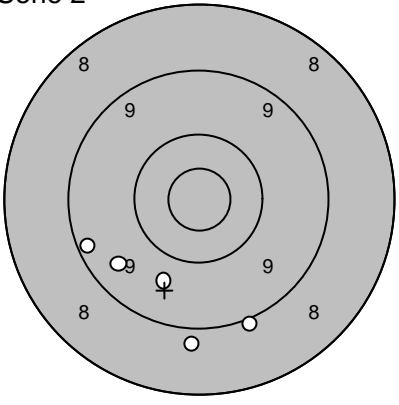
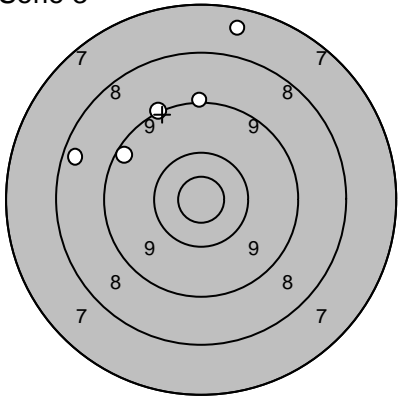
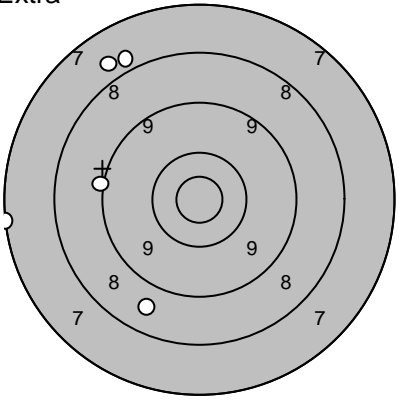
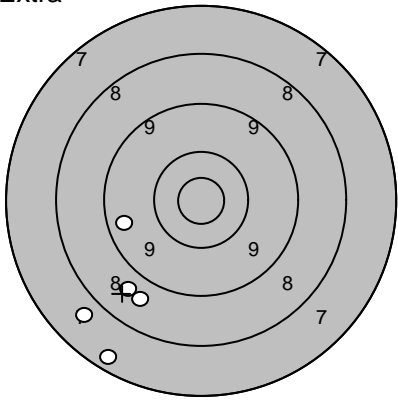
Lag 3	Tavla 23	Karl-Magnus Sundberg		
Ramselefors	Ramselefors			
06.07.2006	Tavelträffen B - 2006	Ramselefors Skytteförening		
Prov		1: 9,8 ↑ 2: 10,3 ↑ 3: 9,6 ↑ 4: 10,1 → Serie: 39,8 Summa: 139,0	Serie 1 	1: 8,6 ↙ 2: 8,9 ↓ 3: 7,4 ↓ 4: 9,8 ↙ 5: 9,5 ↙ Serie: 44,2 Summa: 183,2
Prov		1: 9,9 → 2: 9,9 ↙ Serie: 19,8 Summa: 183,2	Serie 2 	1: 9,2 ↙ 2: 9,5 ↙ 3: 9,7 ↓ 4: 8,9 ↓ 5: 9,0 ↓ Serie: 46,3 Summa: 229,5
Serie 3		1: 9,1 ↑ 2: 7,6 ↑ 3: 8,4 ↙ 4: 9,3 ↙ 5: 9,1 ↗ Serie: 43,5 Summa: 273,0	Extra 	1: 7,8 ↗ 2: 7,9 ↗ 3: 7,1 ← 4: 9,1 ← 5: 8,7 ↓ Serie: 40,6 Summa: 313,6
Extra		6: 8,7 ↙ 7: 9,5 ← 8: 7,4 ↙ 9: 7,8 ↙ 10: 8,8 ↙ Serie: 42,2 Summa: 355,8		

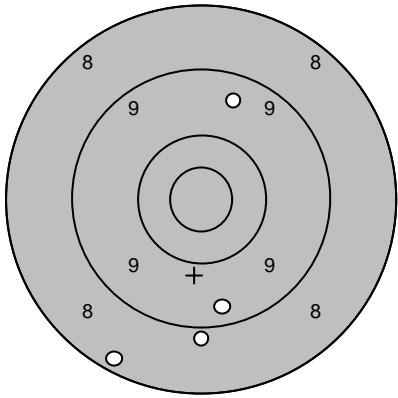
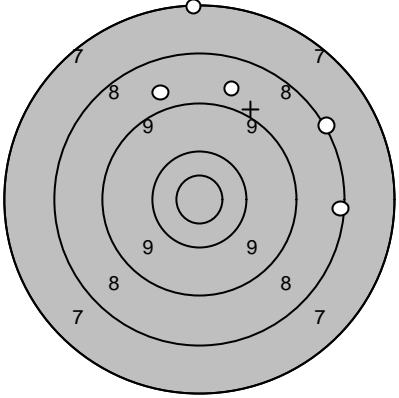
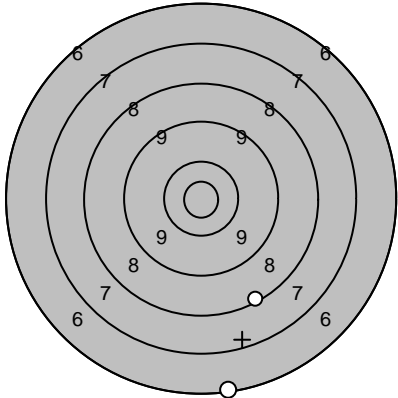
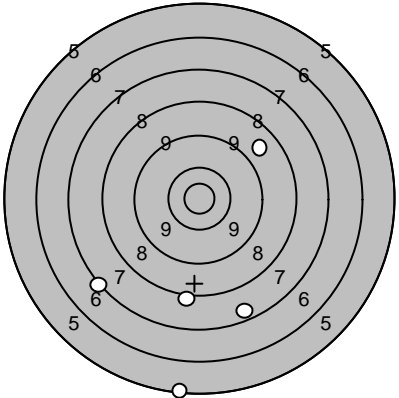
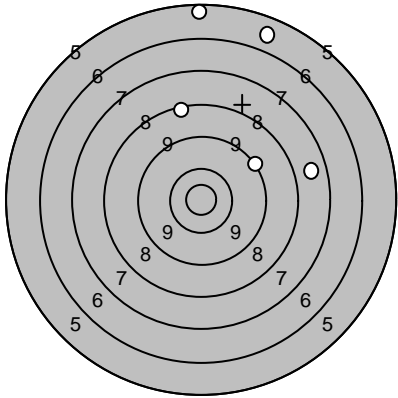
Lag 3	Tavla 24	Daniel Evertsson		
Ramselefors	Ramselefors			
06.07.2006	Tavelträffen B - 2006	Ramselefors Skytteförening		
Prov		1: 8,9 ↓ 2: 8,3 ↓ 3: 9,4 ↓ 4: 9,5 ↑	Serie 1 	1: 8,8 ↑ 2: 8,1 ↗ 3: 8,8 ↑ 4: 7,2 ↑ 5: 8,2 →
	Serie: 36,1 Summa: 126,0	Serie: 41,1 Summa: 167,1		
Prov		1: 6,2 ↓ 2: 8,3 ↓	Serie 2 	1: 7,2 ↙ 2: 8,1 ↓ 3: 5,3 ↓ 4: 8,8 ↗ 5: 7,5 ↓
	Serie: 14,5 Summa: 167,1	Serie: 36,9 Summa: 204,0		
Serie 3		1: 7,7 → 2: 5,5 ↑ 3: 9,2 ↗ 4: 8,4 ↑ 5: 5,7 ↑		
	Serie: 36,5 Summa: 240,5			

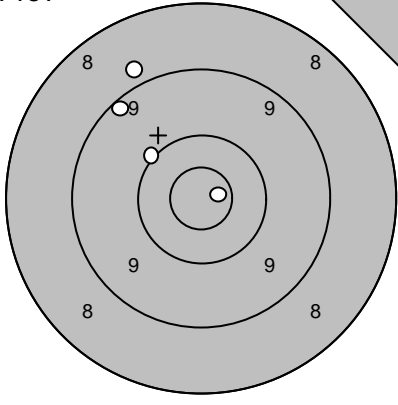
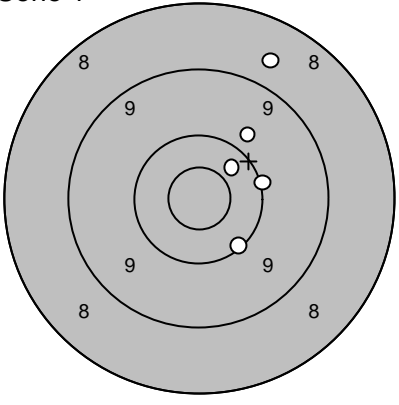
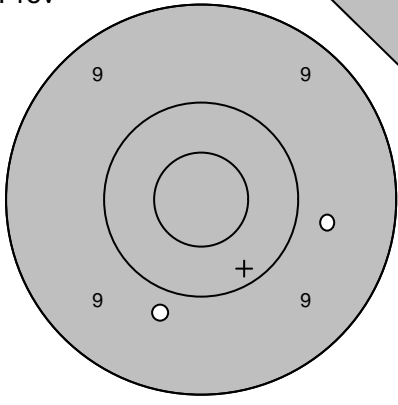
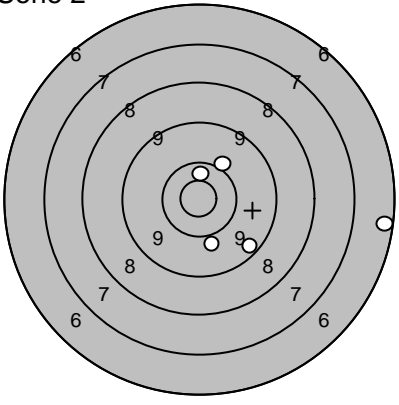
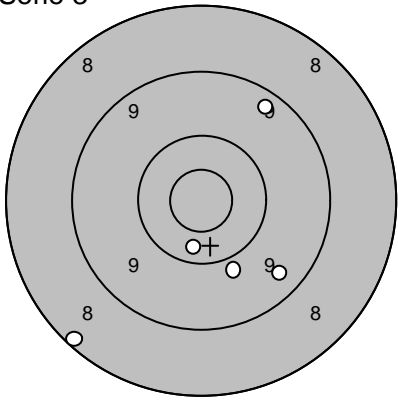
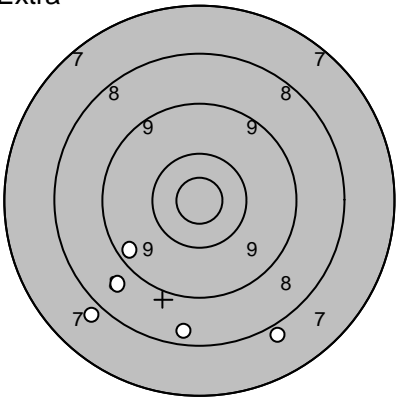
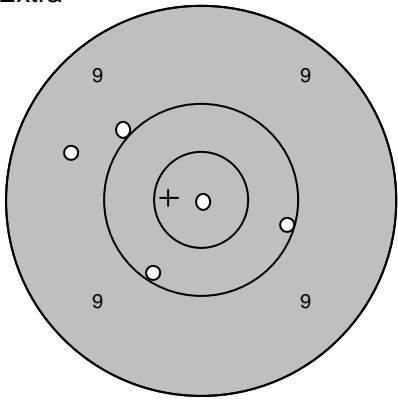
Lag 4	Tavla 1	Dan-Ivan Karlsson		
Ramselefors	Ramselefors			
06.07.2006	Tavelträffen B - 2006	Ramselefors Skytteförening		
Prov		1: 8,9 ↖ 2: 9,2 ↖ 3: 10,8* → 4: 10,1 ↖	Serie 1 	1: 10,1 → 2: 9,9 ↗ 3: 8,7 ↗ 4: 10,4 ↗ 5: 10,1 ↘
		Serie: 37,0 Summa: 142,0		Serie: 47,0 Summa: 189,0
Prov		1: 9,7 → 2: 9,8 ↓	Serie 2 	1: 10,0 ↓ 2: 9,4 ↓ 3: 10,1 ↗ 4: 6,4 → 5: 10,5* ↑
		Serie: 18,0 Summa: 189,0		Serie: 45,0 Summa: 234,0
Serie 3		1: 9,4 ↘ 2: 10,3 ↓ 3: 8,2 ↙ 4: 9,9 ↓ 5: 9,3 ↗	Extra 	1: 8,4 ↓ 2: 7,9 ↙ 3: 7,9 ↘ 4: 9,4 ↙ 5: 8,7 ↙
		Serie: 45,0 Summa: 279,0		Serie: 39,0 Summa: 318,0
Extra		6: 10,1 → 7: 10,1 ↘ 8: 9,6 ↗ 9: 10,0 ↗ 10: 10,9* ↘		
		Serie: 49,0 Summa: 367,0		

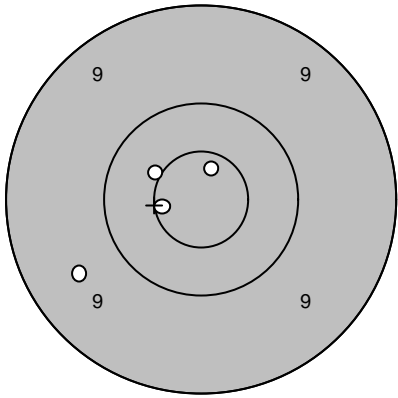
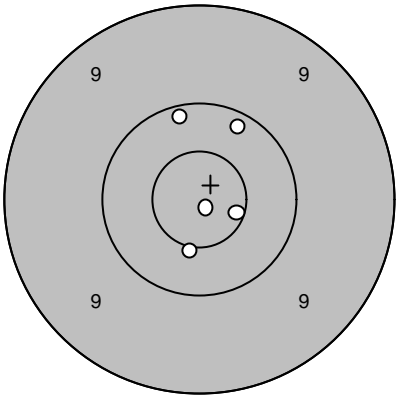
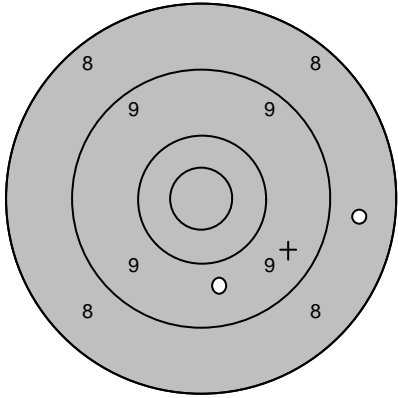
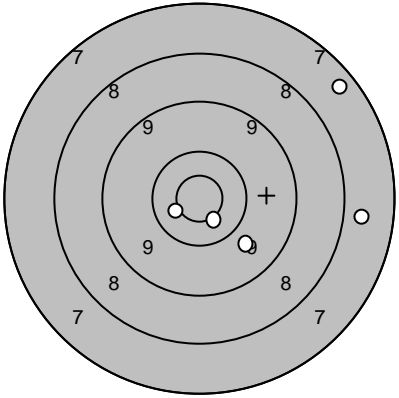
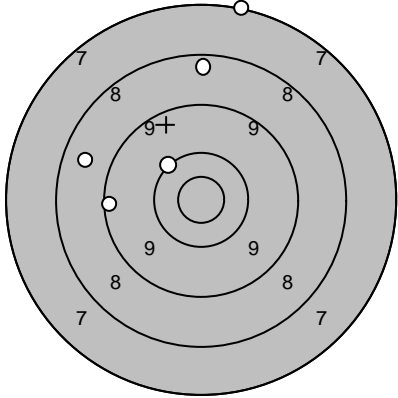
Lag 4	Tavla 3	Fredrik Forsgren		
Ramselefors	Ramselefors			
06.07.2006	Tavelträffen B - 2006	Ramselefors Skytteförening		
Prov		1: 10,7* ↗ 2: 10,6* ← 3: 10,5* ↖ 4: 9,6 ↙	Serie 1 	1: 10,2 ↗ 2: 10,5* ↓ 3: 10,2 ↗ 4: 10,9* ↓ 5: 10,6* ↘
	Serie: 39,0		Serie: 50,0	
	Summa: 142,0		Summa: 192,0	
Prov		1: 9,7 ↓ 2: 8,6 →	Serie 2 	1: 10,6* ← 2: 9,8 ↓ 3: 10,6* ↓ 4: 7,8 → 5: 7,5 ↗
	Serie: 17,0		Serie: 43,0	
	Summa: 192,0		Summa: 235,0	
Serie 3		1: 7,1 ↗ 2: 10,1 ↖ 3: 8,4 ↗ 4: 9,3 ← 5: 8,6 ←		
	Serie: 42,0			
	Summa: 277,0			

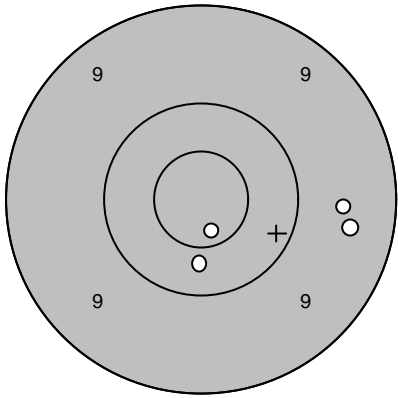
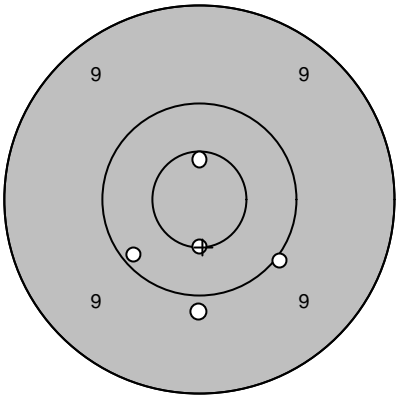
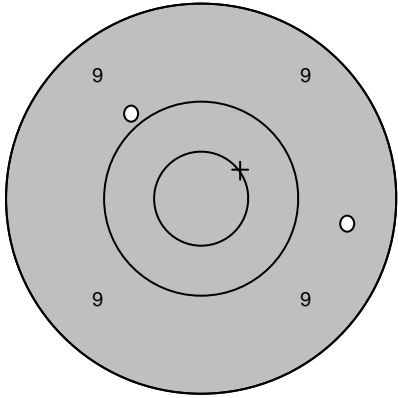
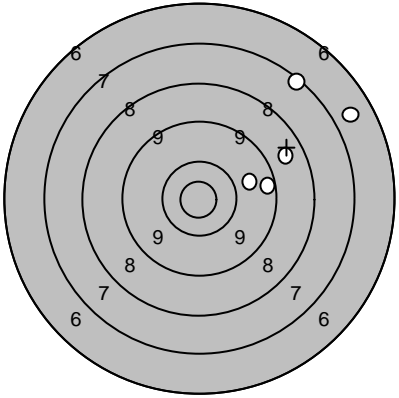
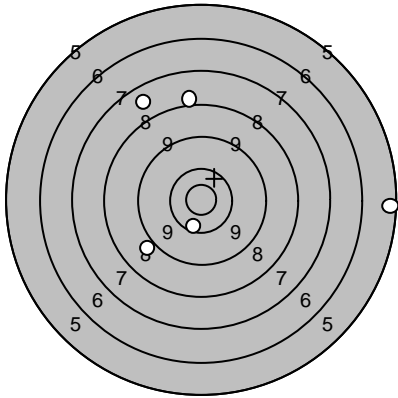
Lag 4	Tavla 4	Johan Nilsson		
Ramselefors		Ramselefors		
06.07.2006		Tavelträffen B - 2006	Ramselefors Skytteförening	
Prov		1: 10,7* ↓ 2: 9,6 → 3: 9,5 → 4: 10,4 ↓	Serie 1 	1: 10,2 ↙ 2: 10,6* ↓ 3: 9,9 ↓ 4: 10,0 ↘ 5: 10,6* ↑
		Serie: 38,0		Serie: 49,0
		Summa: 139,0		Summa: 188,0
Prov		1: 9,5 → 2: 9,9 ↗	Serie 2 	1: 9,8 → 2: 7,3 ↗ 3: 8,7 → 4: 9,4 → 5: 6,8 →
		Serie: 18,0		Serie: 39,0
		Summa: 188,0		Summa: 227,0
Serie 3		1: 5,4 → 2: 8,1 ↑ 3: 7,7 ↗ 4: 10,4 ↓ 5: 9,0 ↙		
		Serie: 39,0		
		Summa: 266,0		

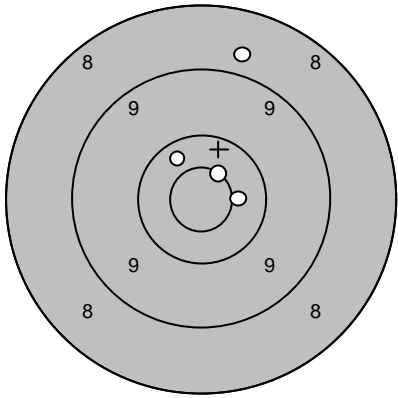
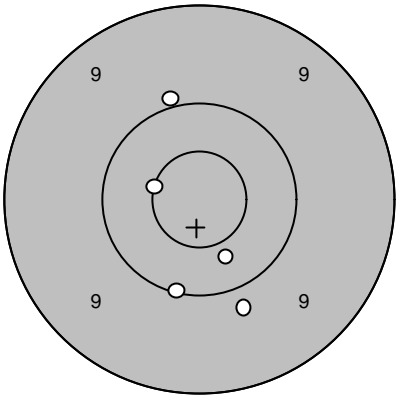
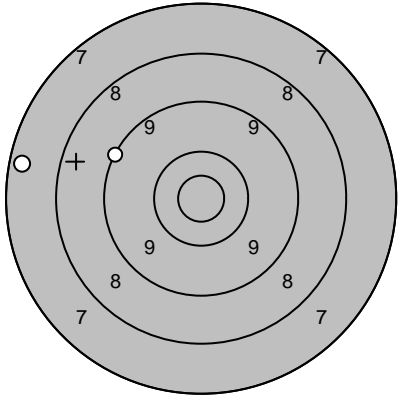
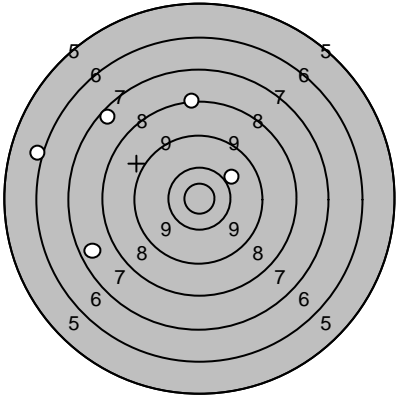
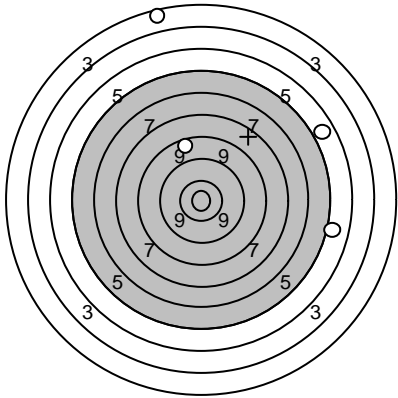
Lag 4	Tavla 5	Marie Fjällström		
Ramselefors	Ramselefors			
06.07.2006	Tavelträffen B - 2006	Ramselefors Skytteförening		
Prov		1: 8,8 ↗ 2: 10,4 ↖ 3: 10,6* ↗ 4: 10,5* →	Serie 1 	1: 10,1 ↓ 2: 10,6* ← 3: 10,4 ↓ 4: 10,0 ↗ 5: 9,8 ↓
	Serie: 38,0		Serie: 49,0	
	Summa: 146,0		Summa: 195,0	
Prov		1: 7,4 ← 2: 9,2 ↖	Serie 2 	1: 7,6 ← 2: 8,2 ↑ 3: 10,0 ↗ 4: 7,4 ↖ 5: 6,1 ←
	Serie: 16,0		Serie: 38,0	
	Summa: 195,0		Summa: 233,0	
Serie 3		1: 2,7 ↑ 2: 8,7 ↑ 3: 5,1 → 4: 4,9 ↗		
	Serie: 19,0			
	Summa: 252,0			

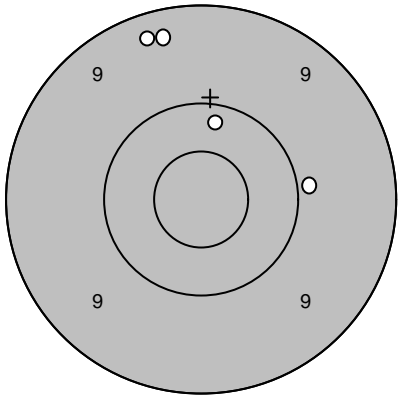
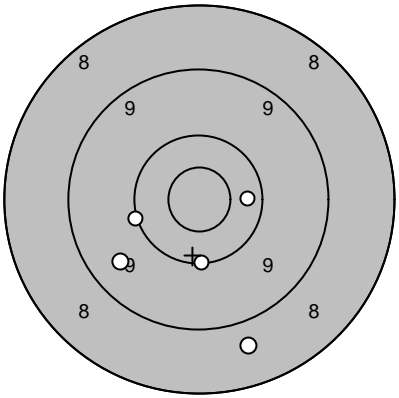
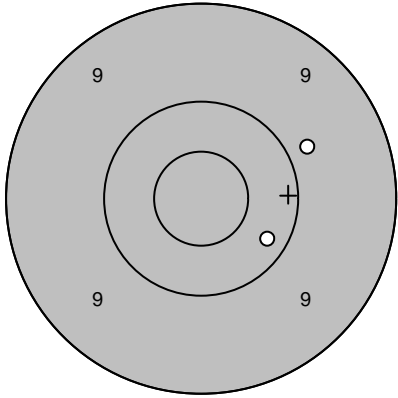
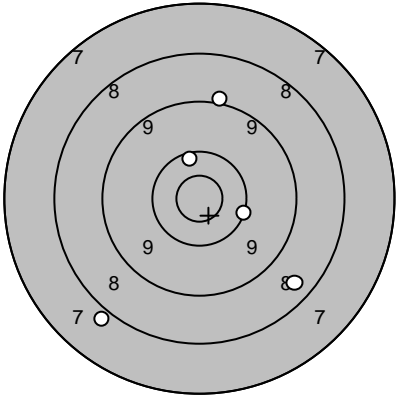
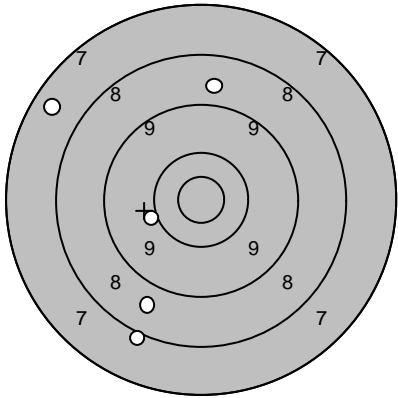
Lag 4	Tavla 6	Anna-Karin Wretell		
Ramselefors	Ramselefors			
06.07.2006	Tavelträffen B - 2006	Ramselefors Skytteförening		
Prov		1: 9,3 ↑ 2: 9,3 ↑↑ 3: 10,2 ↑ 4: 9,9 →	Serie 1 	1: 10,1 ← 2: 9,5 ↙ 3: 8,7 ↓ 4: 10,1 ↓ 5: 10,3 →
		Serie: 37,0		Serie: 47,0
		Summa: 0,0		Summa: 47,0
Prov		1: 9,8 → 2: 10,2 →	Serie 2 	1: 9,1 ↑ 2: 10,3 ↑ 3: 8,5 ↘ 4: 7,9 ↙ 5: 10,2 →
		Serie: 19,0		Serie: 44,0
		Summa: 47,0		Summa: 91,0
Serie 3		1: 8,8 ↑ 2: 8,0 ↓ 3: 10,0 ← 4: 7,5 ↖ 5: 8,7 ↓		
		Serie: 41,0		
		Summa: 132,0		

Lag 4	Tavla 7	Linda Lidman	
Ramselefors		Piteå	
06.07.2006		Tavelträffen B - 2006	Ramselefors Skytteförening
Prov		1: 9,9 ↗ 2: 10,2 ← 3: 10,2 ↖ 4: 9,3 ↗	Serie 1
			1: 9,8 ↗ 2: 10,3 ↘ 3: 9,5 ↘ 4: 10,4 ↗ 5: 10,1 ↘
		Serie: 38,0	Serie: 48,0
		Summa: 140,0	Summa: 188,0
Prov		1: 9,4 ↑ 2: 8,7 →	Serie 2
			1: 8,6 → 2: 8,7 ↑ 3: 8,9 → 4: 9,4 ↖ 5: 9,5 ←
		Serie: 17,0	Serie: 42,0
		Summa: 188,0	Summa: 230,0
Serie 3		1: 10,4 → 2: 5,6 ↖ 3: 4,7 ↑ 4: 6,1 ← 5: 10,7* →	
		Serie: 35,0	
		Summa: 265,0	

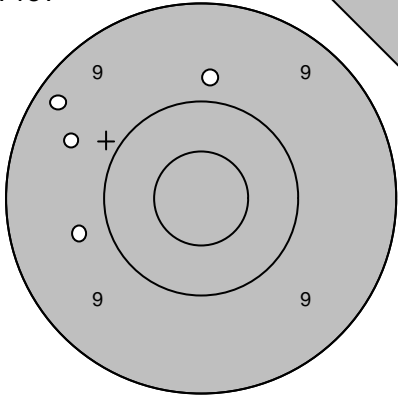
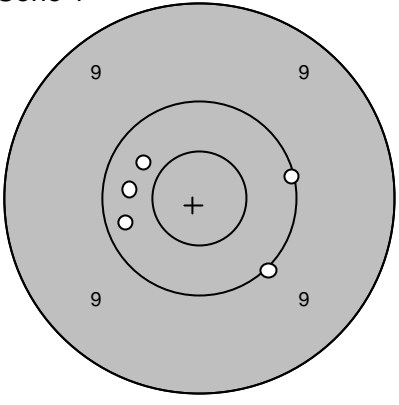
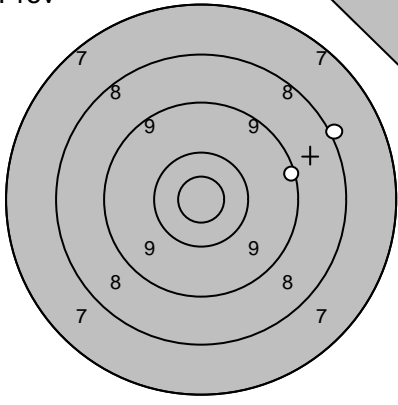
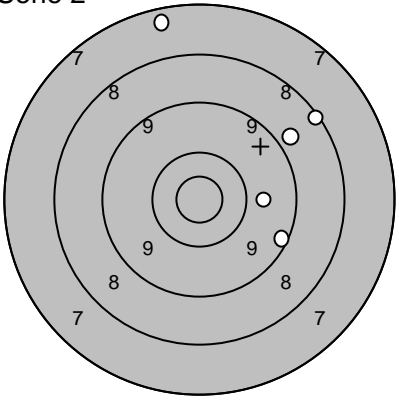
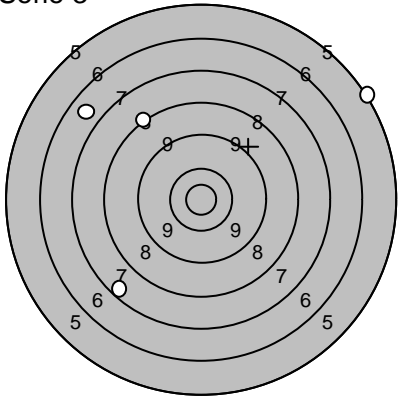
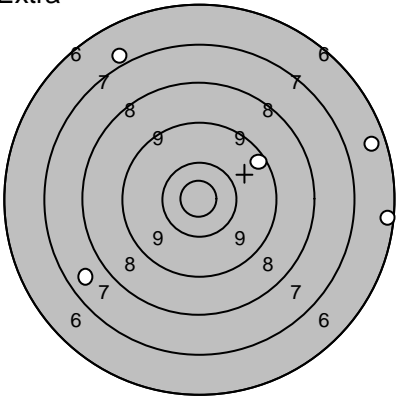
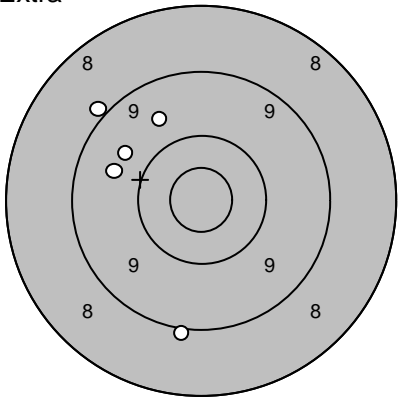
Lag 4	Tavla 8	Sture Grahn	
Ramselefors		Piteå	
06.07.2006		Tavelträffen B - 2006	Ramselefors Skytteförening
Prov		1: 9,8 ↑ 2: 9,7 ← 3: 9,3 ↗ 4: 9,6 ↖	Serie 1
			
		Serie: 36,0	1: 10,0 ↘
		Summa: 143,0	2: 10,1 →
			3: 10,4 ↗
			4: 10,2 ←
			5: 10,3 ←
			Serie: 50,0
			Summa: 193,0
Prov		1: 9,2 → 2: 8,1 →	Serie 2
			
		Serie: 17,0	1: 8,2 ↗
		Summa: 193,0	2: 7,4 ↑
			3: 9,3 ⇒
			4: 8,9 →
			5: 9,8 →
			Serie: 41,0
			Summa: 234,0
Serie 3		1: 8,2 ↖ 2: 5,2 ↗ 3: 7,5 ↘ 4: 6,8 ↗ 5: 0,0 →	Extra
			
		Serie: 26,0	1: 6,3 →
		Summa: 260,0	2: 6,6 →
			3: 7,0 ↗
			4: 7,7 ←
			5: 9,4 ↗
			Serie: 35,0
			Summa: 295,0
Extra		6: 9,0 ↓ 7: 9,7 ↗ 8: 9,0 ↗ 9: 9,7 ← 10: 9,7 ↗	
		Serie: 45,0	
		Summa: 340,0	

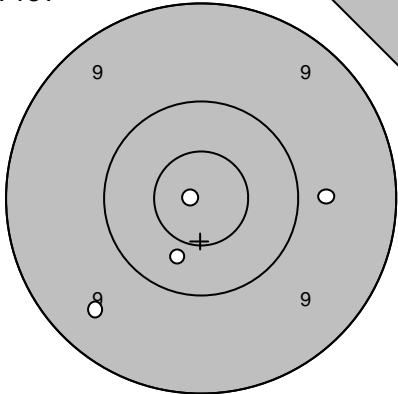
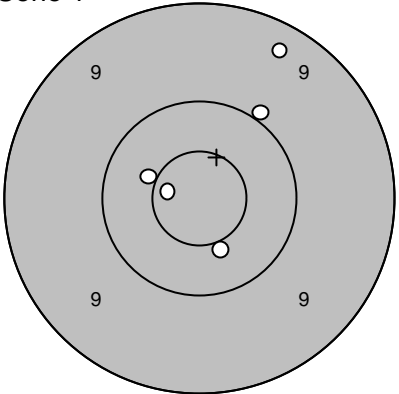
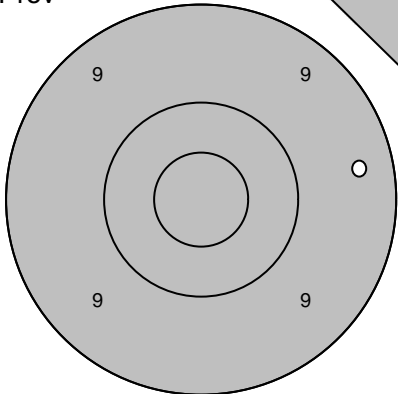
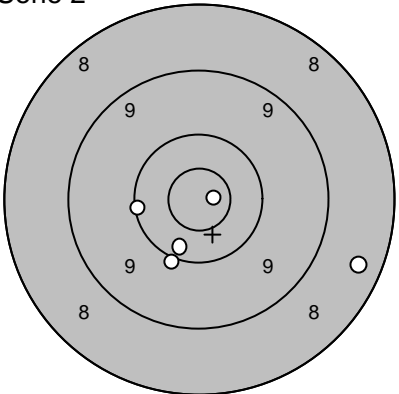
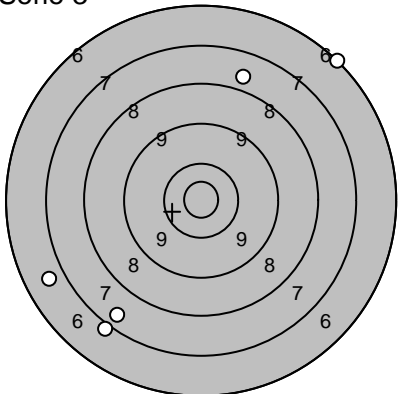
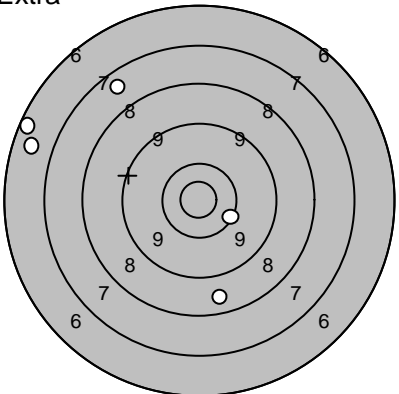
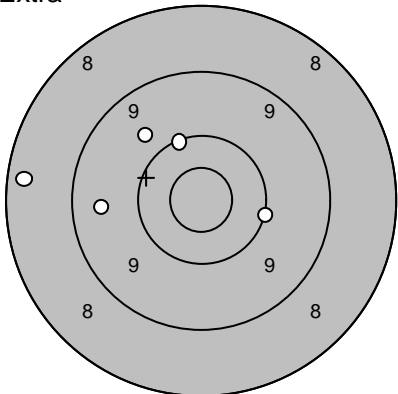
Lag 4	Tavla 9	Håkan Lidman	
Ramselefors		Skellefteå	
06.07.2006		Tavelträffen B - 2006	Ramselefors Skytteförening
Prov		1: 10,4 ↘ 2: 9,8 → 3: 10,9* ← 4: 9,5 ↙ <hr/> Serie: 38,0 Summa: 142,0	Serie 1  1: 10,7* ← 2: 10,5* ↓ 3: 9,3 ↑ 4: 10,5* ← 5: 10,0 ↗ <hr/> Serie: 49,0 Summa: 191,0
Prov		1: 9,4 → <hr/> Serie: 9,0 Summa: 191,0	Serie 2  1: 10,1 ← 2: 8,4 → 3: 10,3 ↓ 4: 10,0 ↓ 5: 10,8* → <hr/> Serie: 48,0 Summa: 239,0
Serie 3		1: 6,8 ← 2: 7,5 ↓ 3: 6,2 ↗ 4: 7,8 ↑ 5: 7,0 ↙ <hr/> Serie: 33,0 Summa: 272,0	Extra  1: 7,6 ↗ 2: 6,4 ↖ 3: 10,3 → 4: 8,7 ↓ 5: 6,7 ← <hr/> Serie: 37,0 Summa: 309,0
Extra		6: 8,4 ← 7: 9,5 ← 8: 10,1 → 9: 10,1 ↗ 10: 9,8 ↗ <hr/> Serie: 46,0 Summa: 355,0	

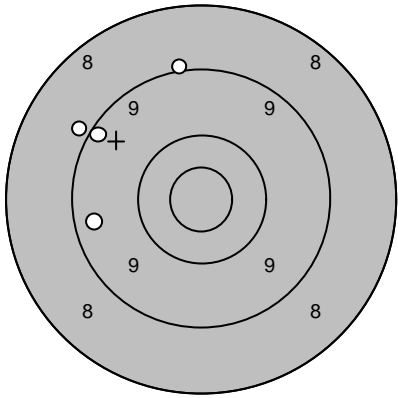
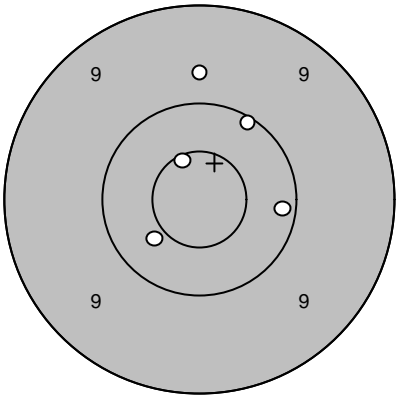
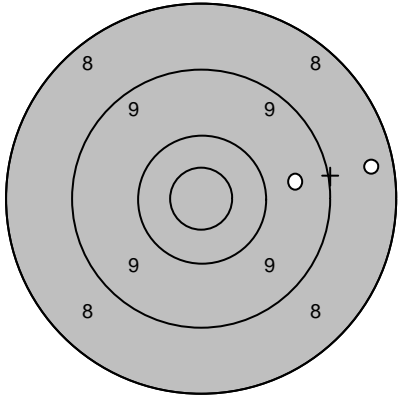
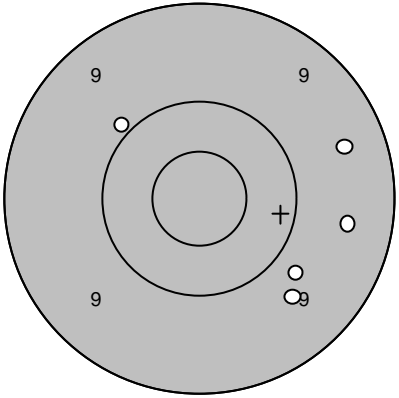
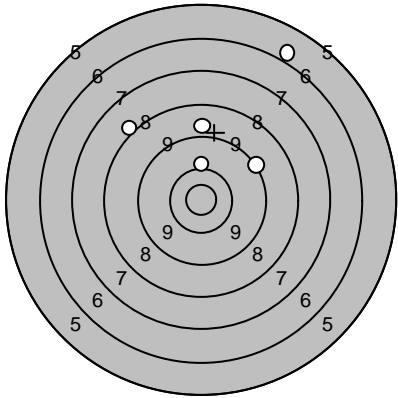
Lag 4	Tavla 11	Anton Lindfors	
Ramselefors		I 19	
06.07.2006		Tavelträffen B - 2006	Ramselefors Skytteförening
Prov		1: 8,9 ↖ 2: 9,4 ← 3: 9,2 ↖ 4: 9,0 ↑	Serie 1
		Serie: 35,0	
		Summa: 145,0	1: 9,7 ↑ 2: 10,4 ↙ 3: 10,6* ↑ 4: 10,2 → 5: 10,1 ↗
			Serie: 49,0
			Summa: 194,0
Prov		1: 8,4 → 2: 9,6 →	Serie 2
		Serie: 17,0	
		Summa: 194,0	1: 9,8 ↘ 2: 9,5 → 3: 9,9 ↗ 4: 9,5 → 5: 9,6 ↘
			Serie: 45,0
			Summa: 239,0
Serie 3		1: 6,0 ↗ 2: 10,1 ↑ 3: 9,0 ↑ 4: 9,2 ↗ 5: 8,1 ↖	
		Serie: 42,0	
		Summa: 281,0	

Lag 4	Tavla 12	Patrik Lindfors	
Ramselefors		I 19	
06.07.2006		Tavelträffen B - 2006	Ramselefors Skytteförening
Prov		1: 9,3 ↙ 2: 10,6* ↘ 3: 9,0 ← 4: 9,8 ↘	Serie 1 1: 10,8* ↑ 2: 9,6 → 3: 10,5* → 4: 10,6* ↓ 5: 10,0 →
		Serie: 37,0 Summa: 142,0	Serie: 49,0 Summa: 191,0
Prov		1: 7,8 → 2: 7,9 ↗	Serie 2 1: 10,3 ↓ 2: 9,2 ↓ 3: 10,2 ↓ 4: 9,3 ↗ 5: 9,9 ←
		Serie: 14,0 Summa: 191,0	Serie: 47,0 Summa: 238,0
Serie 3		1: 7,5 ↑ 2: 7,5 ↘ 3: 8,5 ← 4: 8,7 ← 5: 10,3 ↑	Extra 1: 10,7* ← 2: 9,5 ↑ 3: 9,2 → 4: 10,0 → 5: 9,0 ↓
		Serie: 40,0 Summa: 278,0	Serie: 47,0 Summa: 325,0
Extra		6: 9,0 ↓ 7: 9,7 ↘ 8: 9,6 ↘ 9: 9,7 ↓ 10: 10,1 ↘	
		Serie: 46,0 Summa: 371,0	

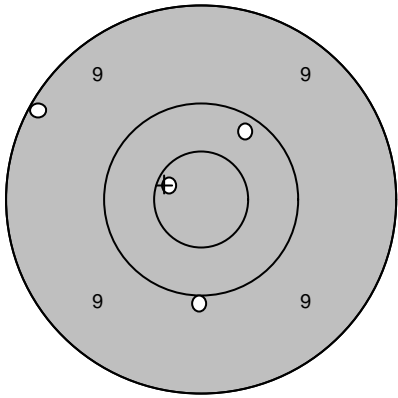
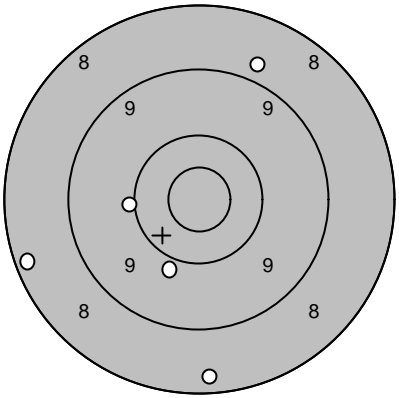
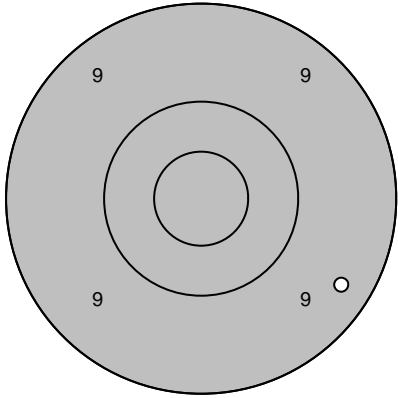
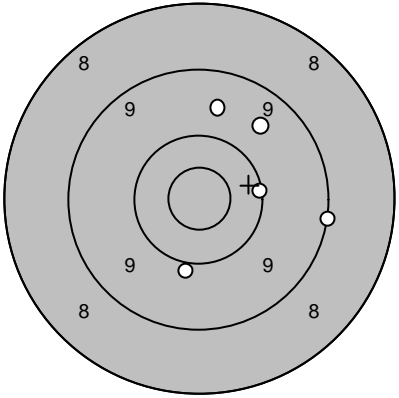
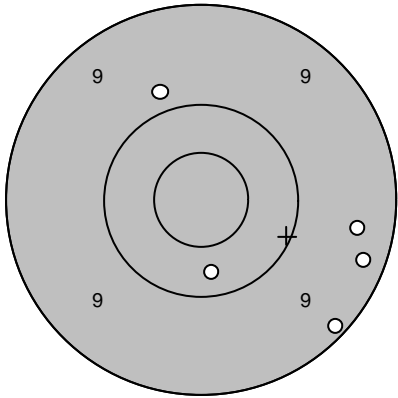
Lag 4	Tavla 13	Gerhard Andersson		
Ramselefors		Ramselefors		
06.07.2006		Tavelträffen B - 2006	Ramselefors Skytteförening	
Prov		1: 10,2 ↗ 2: 10,0 ↓ 3: 9,1 ↖ 4: 10,7* ←	Serie 1 	1: 8,3 ← 2: 9,9 ↓ 3: 8,3 ↓ 4: 10,0 ← 5: 8,8 ↗
		Serie: 39,0	Serie: 43,0	
		Summa: 135,0	Summa: 178,0	
Prov		1: 9,4 ↘	Serie 2 	1: 9,6 ↗ 2: 10,1 → 3: 9,7 ↑ 4: 9,1 → 5: 10,0 ↓
		Serie: 9,0	Serie: 47,0	
		Summa: 178,0	Summa: 225,0	
Serie 3		1: 9,9 ↗ 2: 9,1 ↓ 3: 9,3 → 4: 10,3 ↓ 5: 9,4 →		
		Serie: 46,0		
		Summa: 271,0		

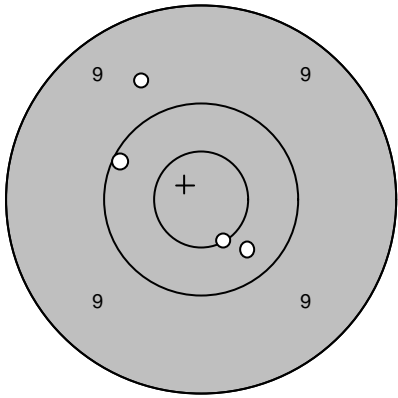
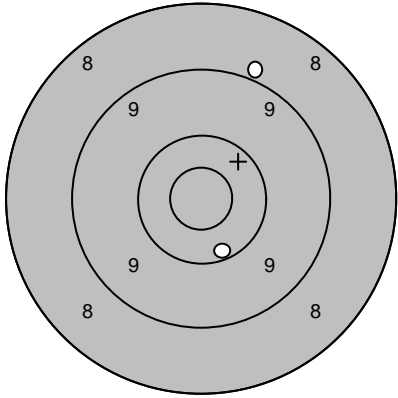
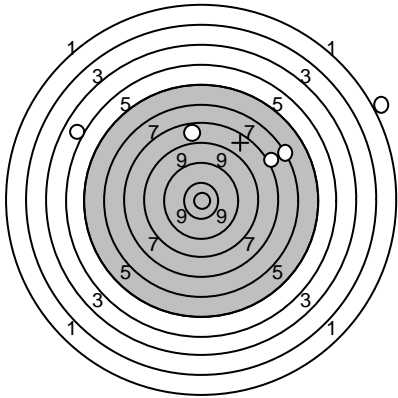
Lag 4	Tavla 14	Torgny Lindfors		
Ramselefors		I 19		
06.07.2006		Tavelträffen B - 2006		Ramselefors Skytteförening
Prov		1: 10,1 ↙ 2: 9,7 ↗ 3: 10,6* ↘ 4: 10,3 ↘	Serie 1	1: 10,8* ↘ 2: 9,5 ↘ 3: 10,0 → 4: 9,0 → 5: 9,0 ↘
		Serie: 39,0		Serie: 47,0
		Summa: 138,0		Summa: 185,0
Prov		1: 10,2 ↘ 2: 8,9 ↗	Serie 2	1: 9,8 → 2: 8,8 → 3: 9,6 ↗ 4: 9,3 ↑ 5: 9,3 ↗
		Serie: 18,0		Serie: 44,0
		Summa: 185,0		Summa: 229,0
Serie 3		1: 4,2 ↙ 2: 7,9 ↑ 3: 7,3 ↗ 4: 6,5 ↗ 5: 1,0 →		
		Serie: 25,0		
		Summa: 254,0		

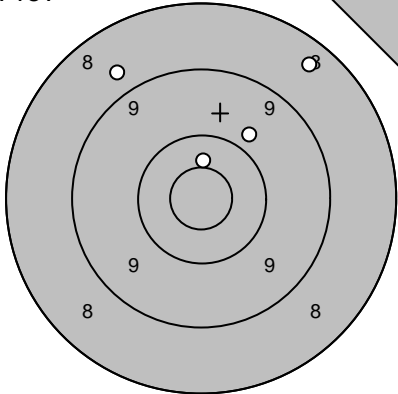
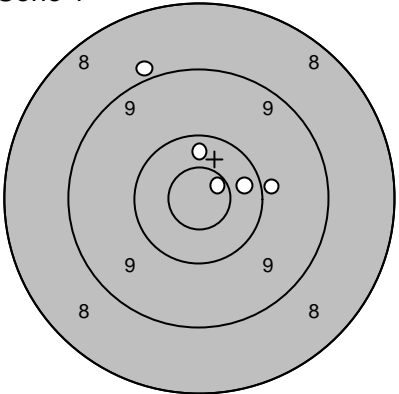
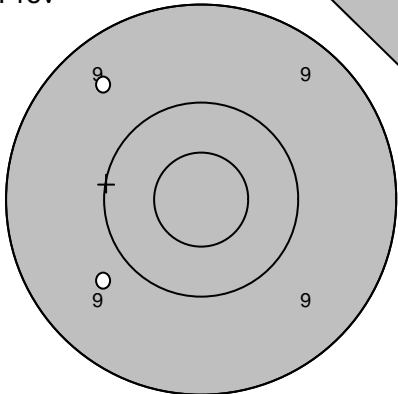
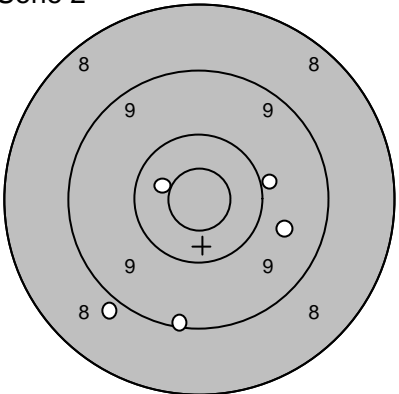
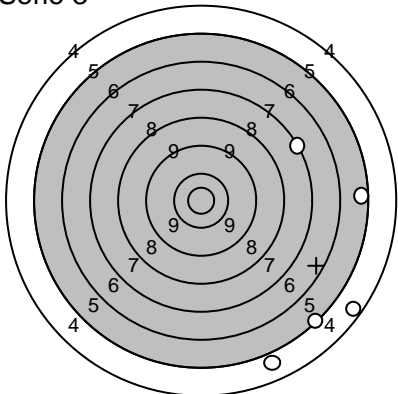
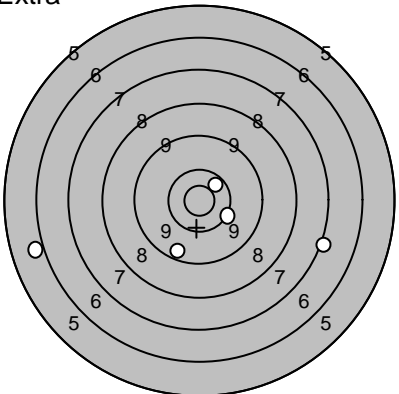
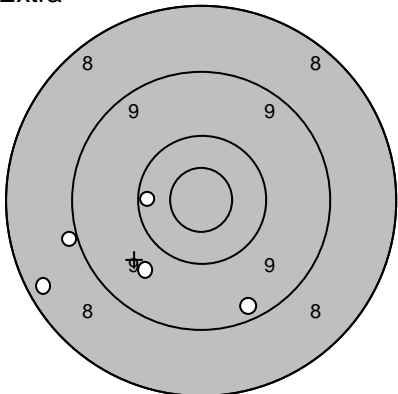
Lag 4	Tavla 15	Rune Utterström	
Ramselefors		Ale	
06.07.2006		Tavelträffen B - 2006	Ramselefors Skytteförening
Prov 	1: 8,8 ↖ 2: 10,5* ↑ 3: 8,4 ↗ 4: 9,8 ↗ Serie: 35,0 Summa: 144,0	Serie 1 	1: 10,4 → 2: 10,7* ↗ 3: 8,9 ↑ 4: 10,4 ↑ 5: 10,0 → Serie: 48,0 Summa: 192,0
Prov 	1: 9,5 ↖ 2: 9,7 ↙ Serie: 18,0 Summa: 192,0	Serie 2 	1: 10,5* ← 2: 9,7 → 3: 9,2 ↓ 4: 8,9 ↙ 5: 10,0 → Serie: 46,0 Summa: 238,0
Serie 3 	1: 5,5 → 2: 7,3 ↗ 3: 4,9 ↓ 4: 4,6 ↘ 5: 5,3 ↓ Serie: 25,0 Summa: 263,0	Extra 	1: 7,2 → 2: 10,5* ↗ 3: 6,0 ← 4: 9,5 ↓ 5: 10,2 → Serie: 42,0 Summa: 305,0
Extra 	6: 10,3 ← 7: 9,3 ↓ 8: 8,3 ← 9: 9,7 ↙ 10: 9,0 ← Serie: 45,0 Summa: 350,0		

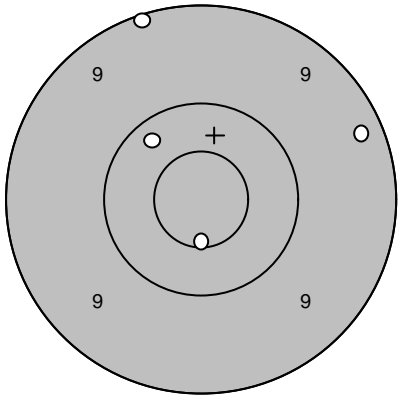
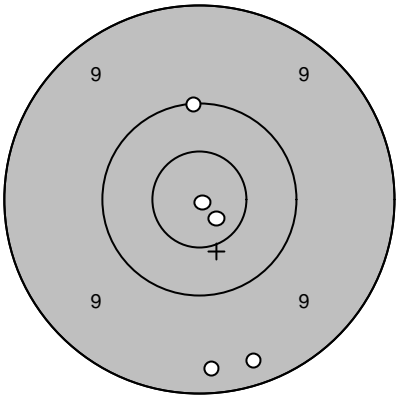
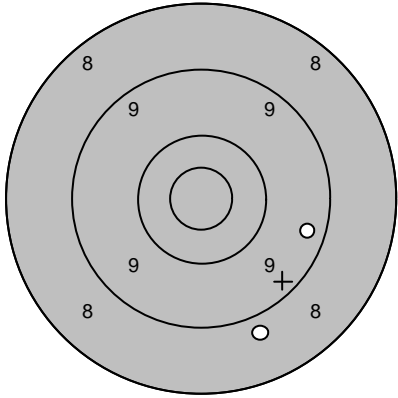
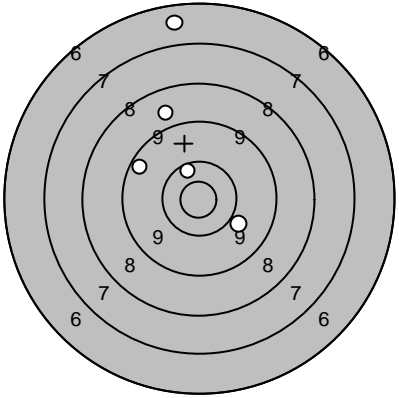
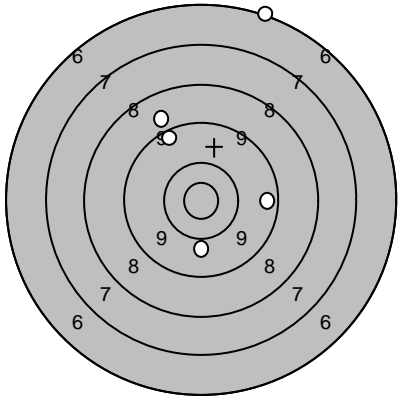
Lag 4	Tavla 16	Dennis Sundqvist		
Ramselefors	Piteå			
06.07.2006	Tavelträffen B - 2006	Ramselefors Skytteförening		
Prov		1: 9,1 ↗ 2: 10,6* ↓ 3: 9,3 → 4: 10,3 ↖	Serie 1 	1: 10,1 ↑ 2: 9,3 ↓ 3: 10,8* ↘ 4: 10,9* ↘ 5: 9,3 ↓
	Serie: 38,0		Serie: 48,0	
	Summa: 139,0		Summa: 187,0	
Prov		1: 8,8 ↓ 2: 9,4 →	Serie 2 	1: 10,4 ↗ 2: 10,0 ↘ 3: 8,8 ↗ 4: 9,4 ↖ 5: 6,6 ↑
	Serie: 17,0		Serie: 43,0	
	Summa: 187,0		Summa: 230,0	
Serie 3		1: 9,9 ↓ 2: 6,1 ↑ 3: 8,9 ↗ 4: 9,5 → 5: 9,4 ↗		
	Serie: 41,0			
	Summa: 271,0			

Lag 4	Tavla 17	Per Östling	
Ramselefors		F 21	
06.07.2006		Tavelträffen B - 2006	Ramselefors Skytteförening
Prov		1: 9,8 ↗ 2: 9,3 → 3: 10,4 ↑ 4: 8,5 → Serie: 36,0 Summa: 144,0	Serie 1 1: 9,4 ↗ 2: 9,2 ↗ 3: 10,6* ↑ 4: 10,1 ↘ 5: 10,9* ↗ Serie: 48,0 Summa: 192,0
Prov		1: 9,1 → 2: 8,7 ↘ Serie: 17,0 Summa: 192,0	Serie 2 1: 8,9 ← 2: 8,2 ← 3: 8,2 → 4: 9,9 ↓ 5: 10,4 ↖ Serie: 43,0 Summa: 235,0
Serie 3		1: 8,7 ↑ 2: 8,8 → 3: 7,8 ↗ 4: 7,3 ↓ 5: 9,5 ↑ Serie: 39,0 Summa: 274,0	Extra 1: 7,9 ↓ 2: 7,3 ↓ 3: 5,6 ← 4: 10,3 ↖ 5: 9,1 ↓ Serie: 38,0 Summa: 312,0
Extra		6: 9,7 ← 7: 10,3 → 8: 10,1 → 9: 10,3 ↗ 10: 10,1 ↖ Serie: 49,0 Summa: 361,0	

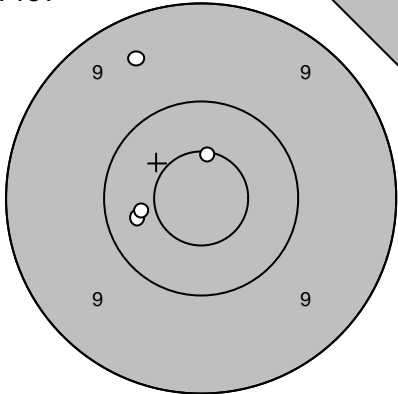
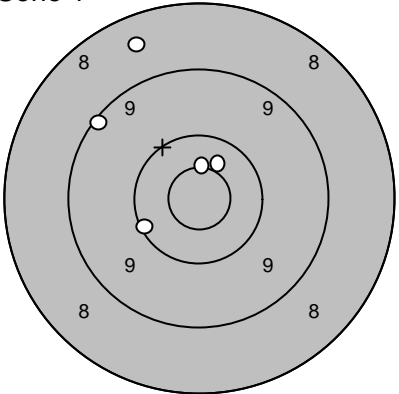
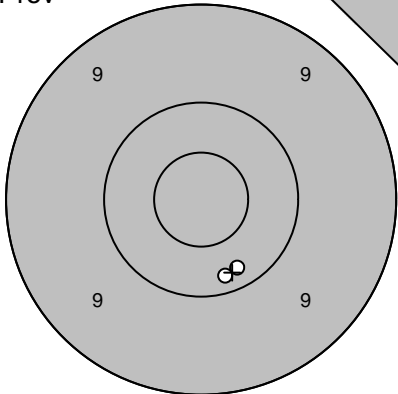
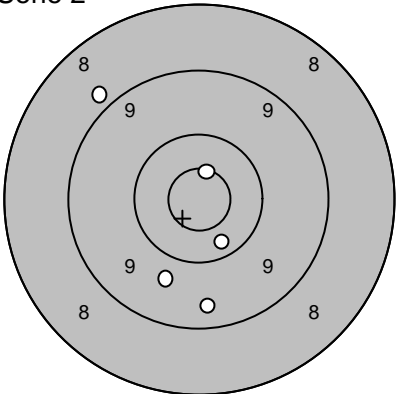
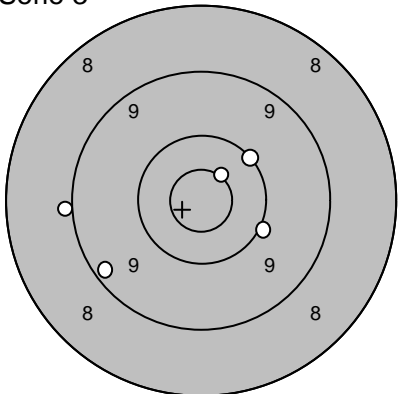
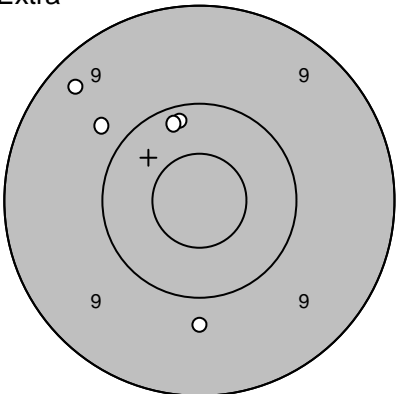
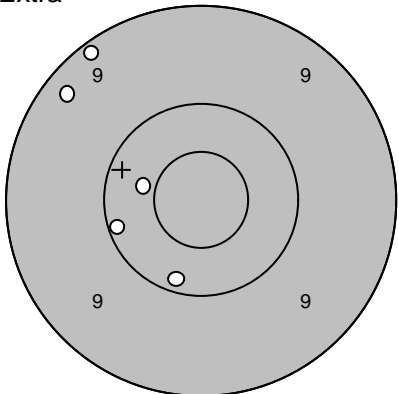
Lag 4	Tavla 19	Marlene Forsell	
Ramselefors		Ramselefors	
06.07.2006		Tavelträffen B - 2006	Ramselefors Skytteförening
Prov 	1: 9,5 ↗ 2: 10,6* ↑ 3: 10,4 ← 4: 10,4 ←	Serie 1 	1: 8,5 ↗ 2: 10,5* ↗ 3: 10,1 ← 4: 9,2 ↗ 5: 10,6* ↑
	Serie: 39,0 Summa: 140,0		Serie: 47,0 Summa: 187,0
Prov 	1: 10,2 ↓ 2: 10,2 ↓	Serie 2 	1: 8,9 ↗ 2: 10,3 ↓ 3: 9,8 ↓ 4: 9,4 ↓ 5: 10,6* ↑
	Serie: 20,0 Summa: 187,0		Serie: 46,0 Summa: 233,0
Serie 3 	1: 10,6* ↗ 2: 9,3 ← 3: 9,0 ← 4: 10,0 → 5: 10,1 ↗	Extra 	1: 10,2 ↑ 2: 9,3 ↗ 3: 10,2 ↑ 4: 9,8 ↓ 5: 9,8 ↗
	Serie: 48,0 Summa: 281,0		Serie: 47,0 Summa: 328,0
Extra 	6: 9,2 ↗ 7: 10,4 ← 8: 10,2 ↓ 9: 9,3 ↗ 10: 10,1 ←		
	Serie: 48,0 Summa: 376,0		

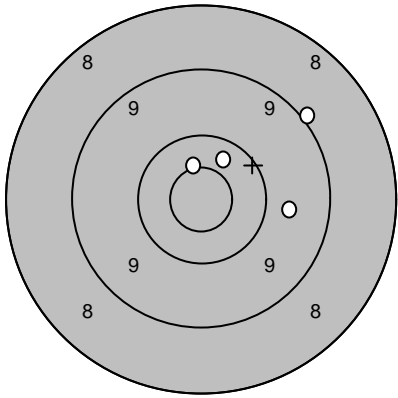
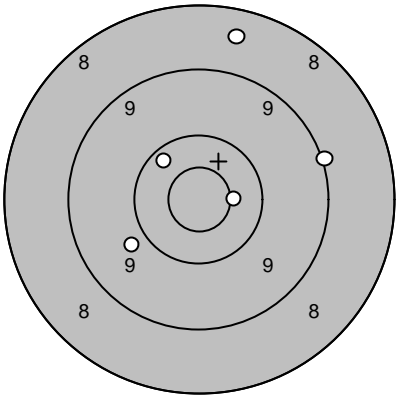
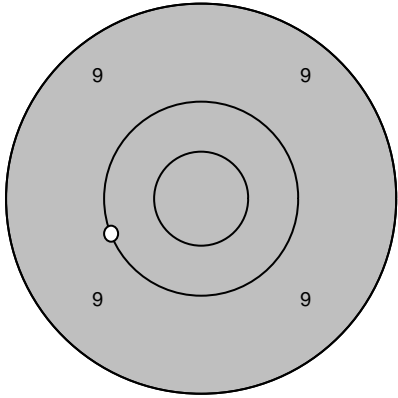
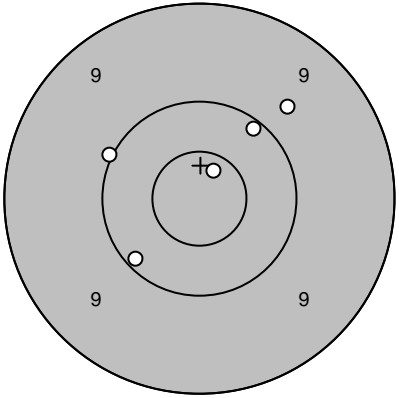
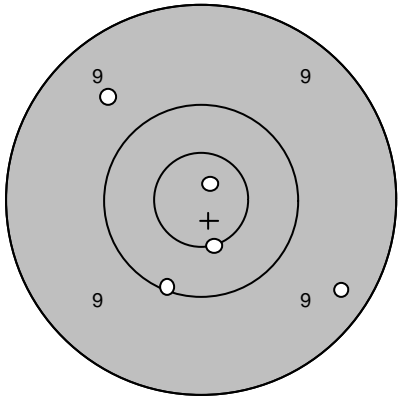
Lag 4	Tavla 20	Elina Johansson		
Ramselefors	Ale			
06.07.2006	Tavelträffen B - 2006	Ramselefors Skytteförening		
Prov		1: 9,7 → 2: 9,0 ↗ 3: 10,5* ↑ 4: 10,4 ↗	Serie 1 	1: 10,5* → 2: 8,5 ↑ 3: 9,1 → 4: 10,3 ↖ 5: 9,8 ↙
		Serie: 38,0		Serie: 46,0
		Summa: 144,0		Summa: 190,0
Prov		1: 10,0 ←	Serie 2 	1: 10,1 ↗ 2: 9,7 ↗ 3: 10,7* ↑ 4: 10,0 ↖ 5: 10,1 ↙
		Serie: 10,0		Serie: 49,0
		Summa: 190,0		Summa: 239,0
Serie 3		1: 10,8* ↗ 2: 10,6* ↓ 3: 10,1 ↓ 4: 9,3 → 5: 9,6 ↗		
		Serie: 48,0		
		Summa: 287,0		

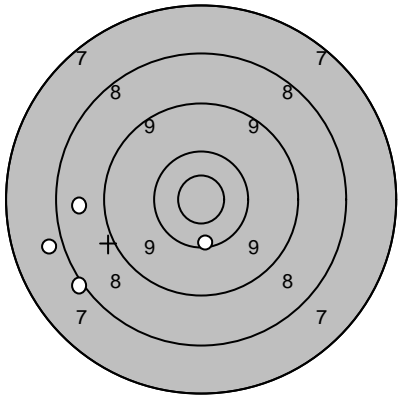
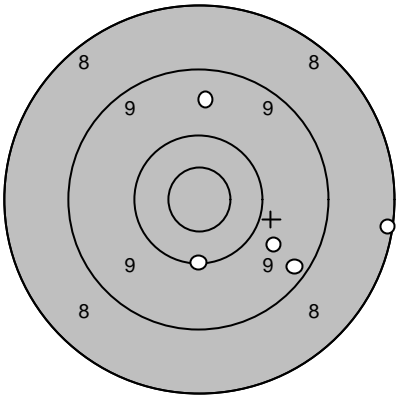
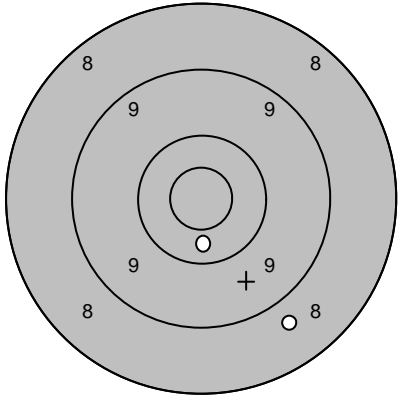
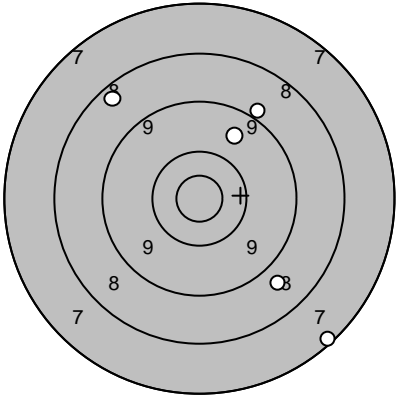
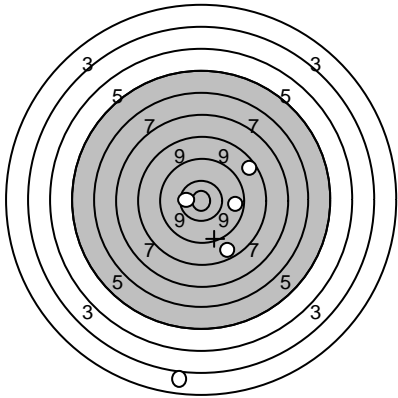
Lag 4	Tavla 21	Gustav Karlsson		
Ramselefors	Loos			
06.07.2006	Tavelträffen B - 2006	Ramselefors Skytteförening		
Prov		1: 10,2 ↓ 2: 8,6 ← 3: 8,1 ↙ 4: 7,9 ←	Serie 1 	1: 10,1 ↓ 2: 9,7 ↘ 3: 9,3 ↘ 4: 9,6 ↑ 5: 8,2 →
	Serie: 33,0		Serie: 45,0	
	Summa: 124,0		Summa: 169,0	
Prov		1: 10,4 ↓ 2: 8,8 ↘	Serie 2 	1: 9,6 ↗ 2: 9,0 ↗ 3: 7,3 ↘ 4: 8,8 ↘ 5: 8,4 ↗
	Serie: 18,0		Serie: 41,0	
	Summa: 169,0		Summa: 210,0	
Serie 3		1: 3,1 ↓ 2: 8,7 ↗ 3: 8,7 ↓ 4: 9,7 → 5: 10,7* ←		
	Serie: 38,0			
	Summa: 248,0			

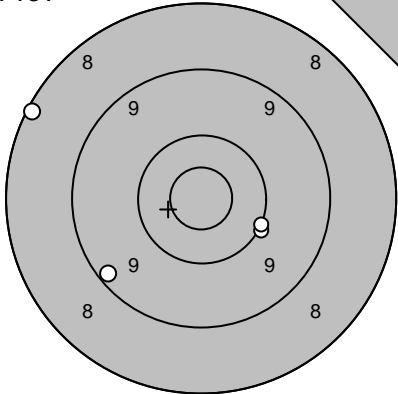
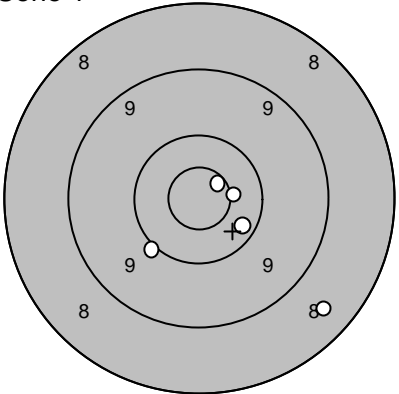
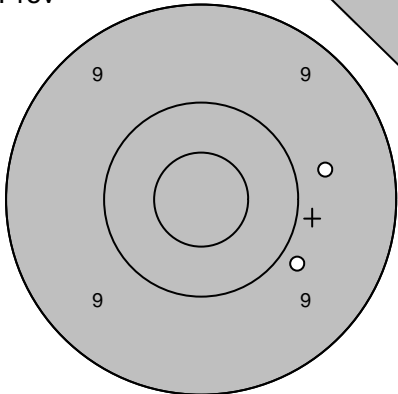
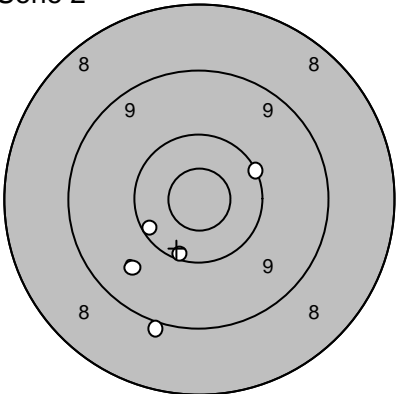
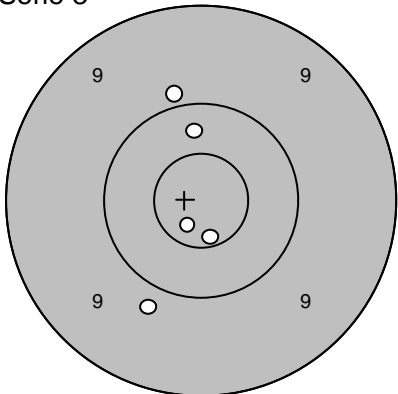
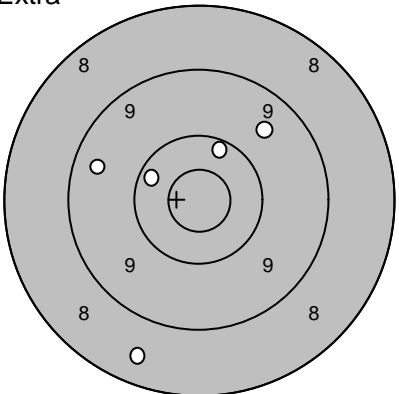
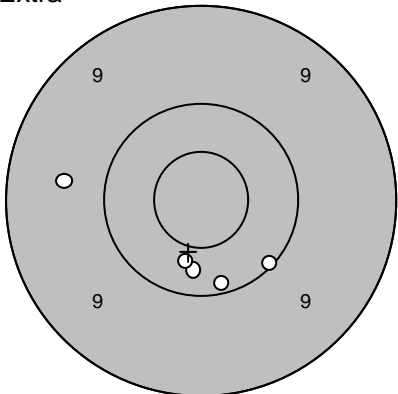
Lag 4	Tavla 22	Peter Ericson		
Ramselefors	Loos			
06.07.2006	Tavelträffen B - 2006	Ramselefors Skytteförening		
Prov		1: 8,2 ↖ 2: 9,2 ↙ 3: 10,0 → 4: 10,1 →	Serie 1 	1: 10,7* ↗ 2: 10,3 ↘ 3: 10,6* → 4: 10,0 ↙ 5: 8,5 ↘
		Serie: 37,0 Summa: 146,0		Serie: 48,0 Summa: 194,0
Prov		1: 9,7 → 2: 9,9 ↘	Serie 2 	1: 10,1 ↗ 2: 10,2 ↘ 3: 9,0 ↘ 4: 9,6 ↙ 5: 10,2 ↙
		Serie: 18,0 Summa: 194,0		Serie: 48,0 Summa: 242,0
Serie 3		1: 9,8 ↙ 2: 10,3 ↑ 3: 9,9 ↑ 4: 10,6* ↘ 5: 10,7* ↘	Extra 	1: 9,4 ↖ 2: 10,3 ↖ 3: 9,6 ↗ 4: 10,3 ↑ 5: 8,5 ↘
		Serie: 48,0 Summa: 290,0		Serie: 46,0 Summa: 336,0
Extra		6: 10,1 ↘ 7: 10,3 ↘ 8: 10,4 ↘ 9: 9,6 ← 10: 10,2 ↘		
		Serie: 49,0 Summa: 385,0		

Lag 4	Tavla 23	Elina Högström
-----------------	--------------------	-----------------------

Ramselefors	Ramselefors		
-------------	-------------	--	--

06.07.2006	Tavelträffen B - 2006	Ramselefors Skytteförening	
------------	-----------------------	----------------------------	--

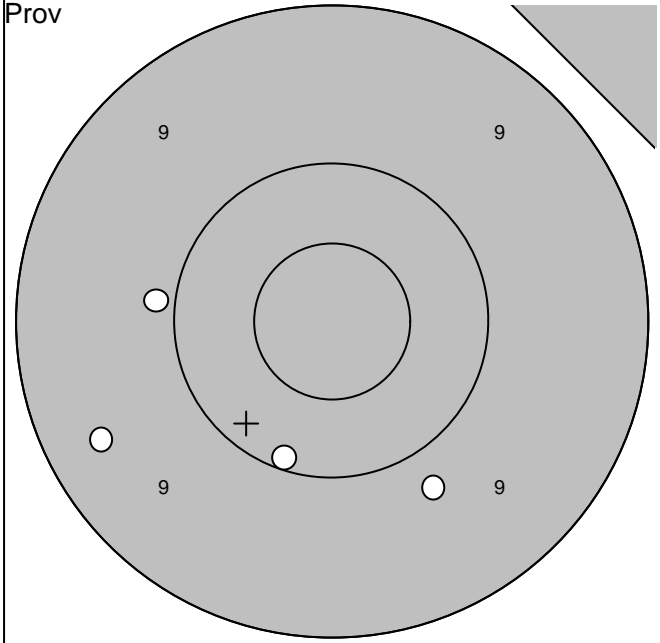

1: 9,4 ←	Serie: 37,0
2: 10,1 ↓	
3: 9,8 ↓	Summa: 144,0
4: 9,9 ←	

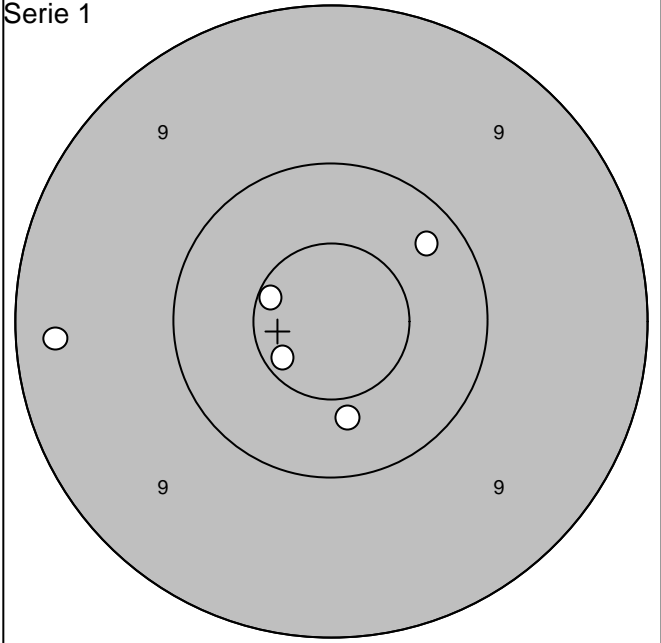

1: 10,3 ↗	Serie: 49,0
2: 10,4 ↓	
3: 10,6* ↙	Summa: 193,0
4: 10,6* ↙	
5: 9,3 ←	

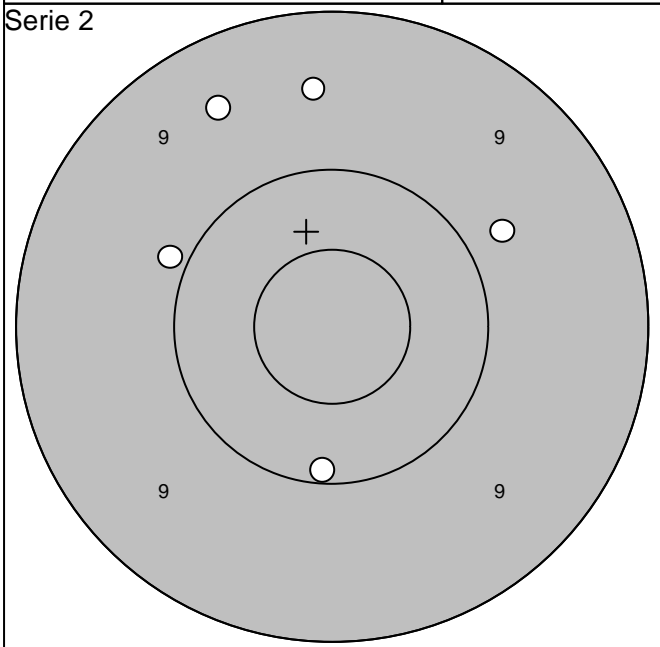

1: 10,1 ↓	Serie: 46,0
2: 9,8 ↗	
3: 9,5 ↑	Summa: 239,0
4: 9,9 ↙	
5: 9,5 ↗	

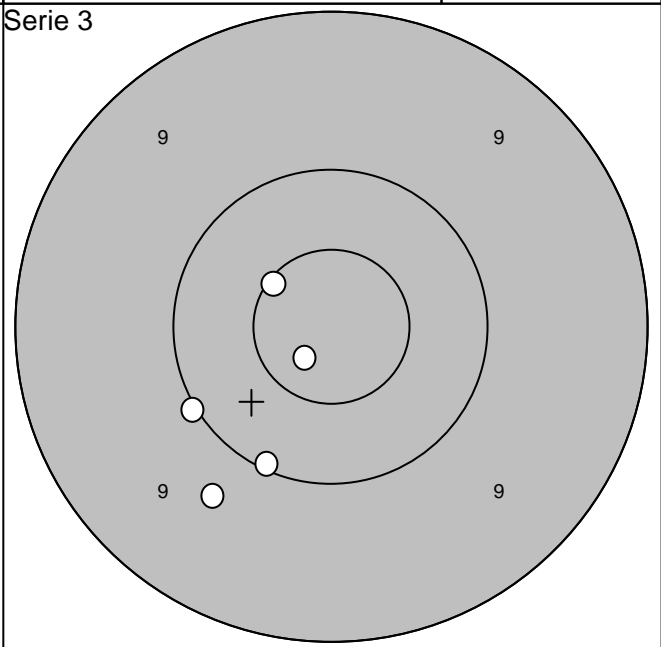

1: 10,8* ↙	Serie: 49,0
2: 10,1 ↓	
3: 9,7 ↙	Summa: 288,0
4: 10,0 ↙	
5: 10,6* ↙	

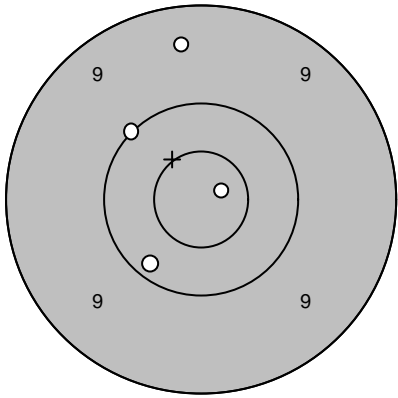
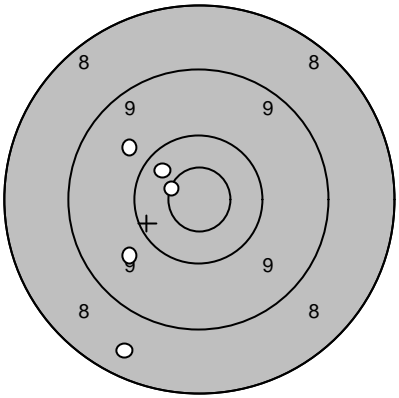
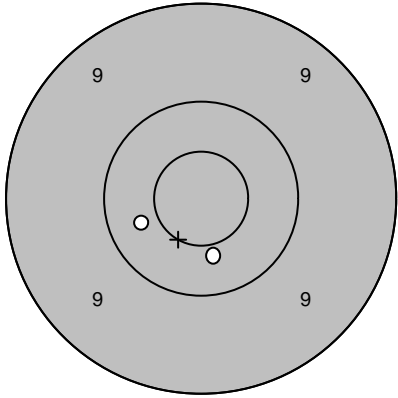
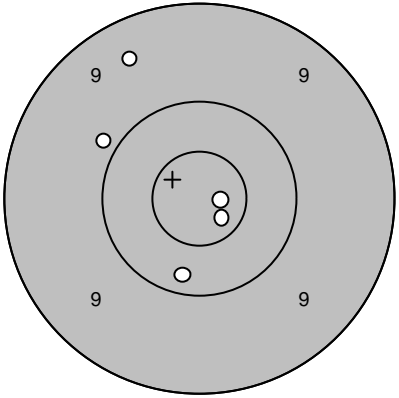
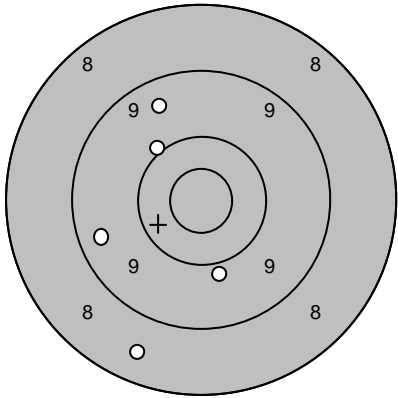
Lag 4	Tavla 24	Marcus Mattsson		
Ramselefors	Ramselefors			
06.07.2006	Tavelträffen B - 2006	Ramselefors Skytteförening		
Prov		1: 10,0 ↙ 2: 9,4 ↑ 3: 10,8* → 4: 10,2 ↘	Serie 1 	1: 10,6* ← 2: 10,4 ↙ 3: 9,7 ↘ 4: 8,5 ↓ 5: 9,7 ↙
		Serie: 39,0		Serie: 46,0
		Summa: 136,0		Summa: 182,0
Prov		1: 10,4 ← 2: 10,4 ↓	Serie 2 	1: 10,8* → 2: 9,9 ↙ 3: 9,4 ↑ 4: 10,2 ↓ 5: 10,7* ↘
		Serie: 20,0		Serie: 48,0
		Summa: 182,0		Summa: 230,0
Serie 3		1: 10,0 ↙ 2: 9,9 ↓ 3: 8,6 ↓ 4: 9,4 ← 5: 9,5 ↑		
		Serie: 45,0		
		Summa: 275,0		