

Skjutlag 1	Tavla 1	Jan-Erik Karlsson		
Ramselefors		Ramselefors		
05.07.2006		Tavelträffen A - 2006	Ramselefors Skytteförening	
Prov		1: 8,9 ↗ 2: 9,1 ↘ 3: 10,4 ↓ 4: 10,6* ↓ 5: 10,1 →	Serie 1 	1: 10,5* ← 2: 10,7* ↓ 3: 9,2 ↙ 4: 9,0 ↓ 5: 10,1 ↙
		Serie 47,0	Serie 48,0	
		Totalt 0,0	Totalt 48,0	
Serie 2		1: 9,8 → 2: 9,7 ↖ 3: 10,8* ↓ 4: 9,7 ← 5: 10,2 ↙	Serie 3 	1: 9,8 → 2: 10,3 ↑ 3: 10,2 ↓ 4: 9,7 ↘ 5: 9,9 ↑
		Serie 47,0	Serie 47,0	
		Totalt 95,0	Totalt 142,0	
Extratävling		1: 9,8 ↖ 2: 10,5* ↗ 3: 10,1 ← 4: 9,8 ← 5: 10,9* ← 6: 10,2 ↓ 7: 9,4 ↖ 8: 10,4 → 9: 10,1 ↑ 10: 10,4 →		
		Serie 97,0		
		Totalt 239,0		

Skjutlag 1	Tavla 2	Lennart Jacobsson		
Ramselefors	Ramselefors			
05.07.2006	Tavelträffen A - 2006	Ramselefors Skytteförening		
Prov		1: 10,3 ← 2: 10,2 ↗ 3: 10,0 ↗ 4: 10,8* ↘ 5: 9,8 →	Serie 1 	1: 10,0 ← 2: 10,3 ↖ 3: 9,4 ↖ 4: 9,3 ← 5: 10,4 ←
		Serie 51,1	Serie 49,4	
		Totalt 0,0	Totalt 49,4	
Serie 2		1: 10,2 ↘ 2: 10,1 ↓ 3: 8,7 ↓ 4: 9,7 ↓ 5: 10,2 →	Serie 3 	1: 10,7* → 2: 10,1 ↓ 3: 9,2 ↗ 4: 9,4 ↘ 5: 9,4 ↗
		Serie 48,9	Serie 48,8	
		Totalt 98,3	Totalt 147,1	
Extratävling		1: 9,3 ↗ 2: 10,4 ↗ 3: 9,3 ↓ 4: 8,8 ← 5: 10,4 ↖ 6: 10,0 ↓ 7: 9,8 ↓ 8: 9,3 ↓ 9: 10,4 → 10: 9,9 ↓		
		Serie 97,6		
		Totalt 244,7		

Skjutlag 1	Tavla 3	Daniel Zakrisson	
Ramselefors		Ramselefors	
05.07.2006		Tavelträffen A - 2006	Ramselefors Skytteförening
Prov 	1: 10,0 ↓ 2: 10,7* ← 3: 9,7 ↓ 4: 10,0 ↓ 5: 9,1 →	Serie 1 	1: 9,5 ← 2: 10,3 ↑ 3: 9,4 ↗ 4: 9,6 ↓ 5: 9,7 ↓
	Serie 49,5		Serie 48,5
	Totalt 0,0		Totalt 48,5
Serie 2 	1: 10,5* ↗ 2: 10,6* ↓ 3: 9,6 ← 4: 9,4 ↓ 5: 10,3 ↓	Serie 3 	1: 10,6* ↓ 2: 10,7* ← 3: 10,1 ↗ 4: 9,3 ↓ 5: 9,1 →
	Serie 50,4		Serie 49,8
	Totalt 98,9		Totalt 148,7
Extratävling 	1: 8,5 ↗ 2: 9,5 ↓ 3: 9,4 ↑ 4: 10,6* ← 5: 10,6* ↓ 6: 9,8 ↓ 7: 10,6* ↑ 8: 10,4 ↗ 9: 9,1 ↓ 10: 10,7* ↗		
	Serie 99,2		
	Totalt 247,9		

Skjutlag 1	Tavla 4	Leif Sigfridsson	
Ramselefors		Ramselefors	
05.07.2006		Tavelträffen A - 2006	Ramselefors Skytteförening
Prov		Serie 1	
1:10,4 ↙	Serie 48,7	1: 9,4 ↗	Serie 49,1
2: 8,7 ↗		2:10,5* ↖	
3: 8,7 ↗	Totalt 0,0	3: 9,1 ↑	Totalt 49,1
4:10,2 →		4: 9,7 ↖	
5:10,7* ↘		5:10,4 ↘	
Serie 2		Serie 3	
1: 8,8 ↗	Serie 48,3	1:10,1 ↗	Serie 50,1
2: 8,7 ←		2:10,6* ↘	
3:10,1 ↖	Totalt 97,4	3: 9,8 ↗	Totalt 147,5
4:10,5* ↘		4: 9,9 ↘	
5:10,2 →		5: 9,7 ↘	

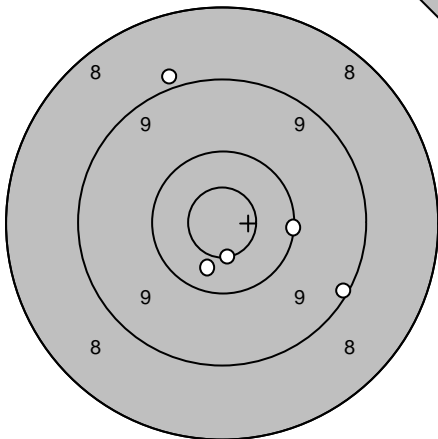
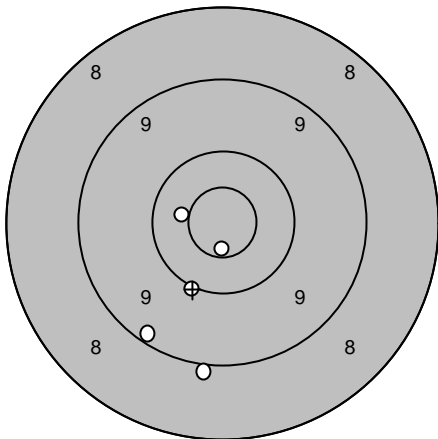
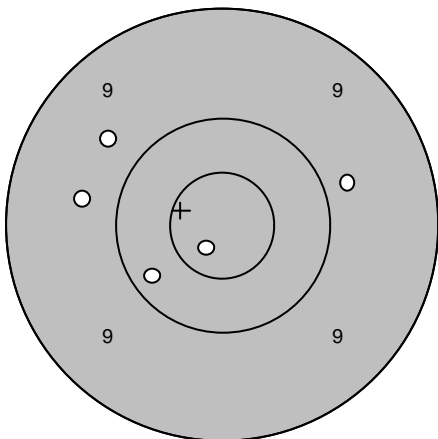
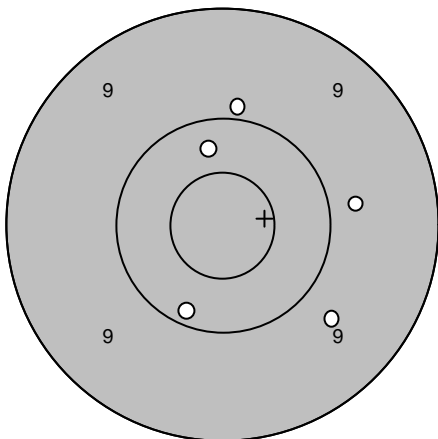
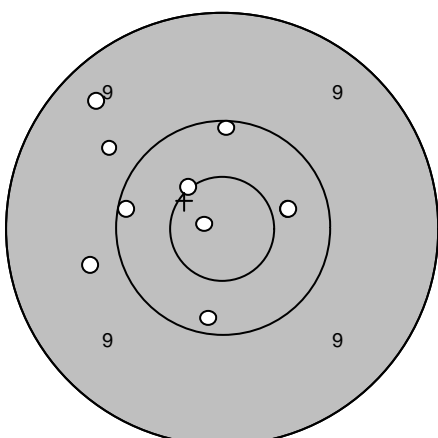
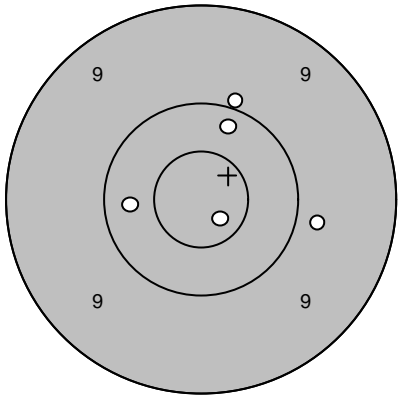
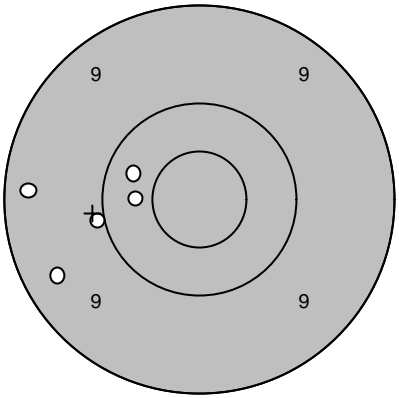
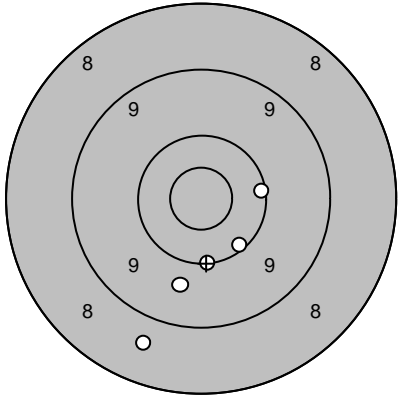
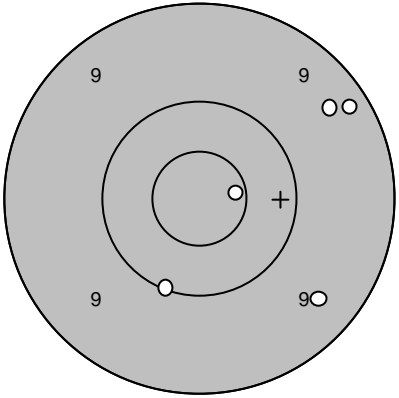
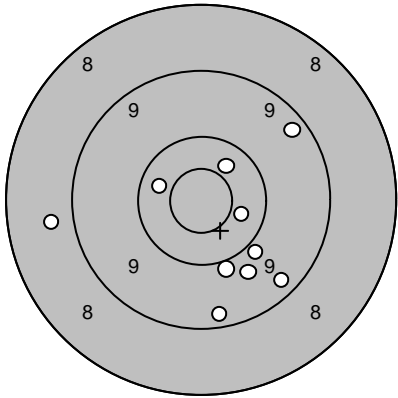
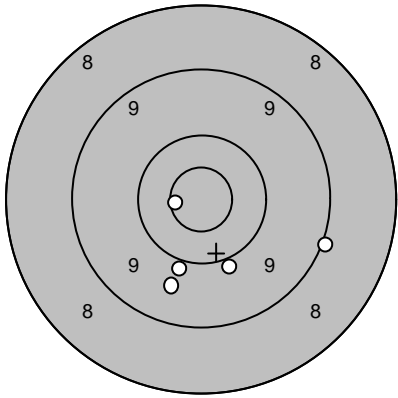
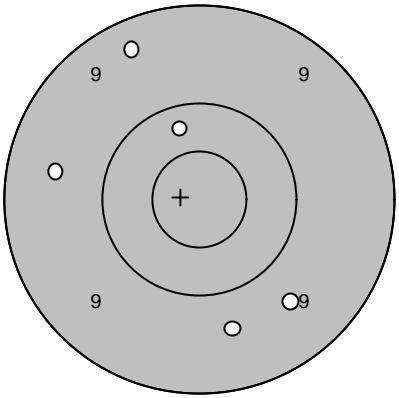
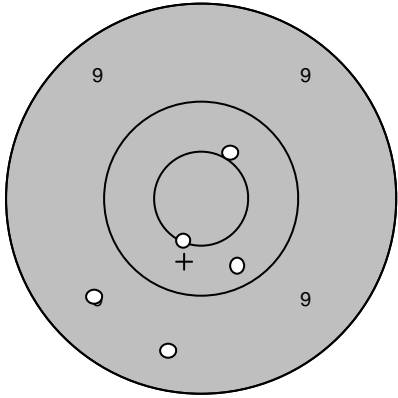
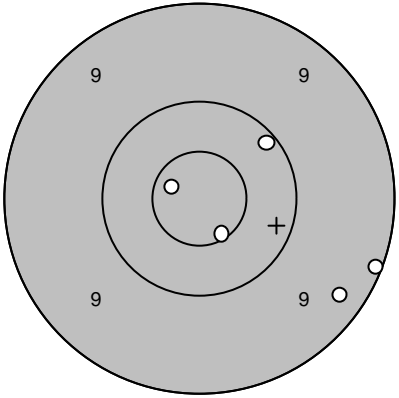
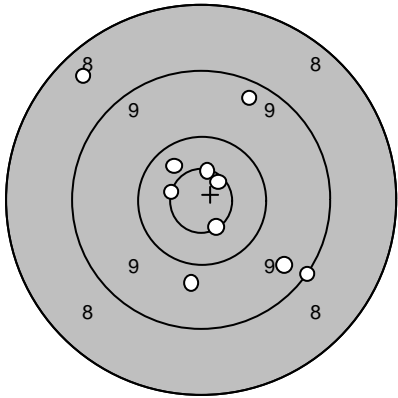
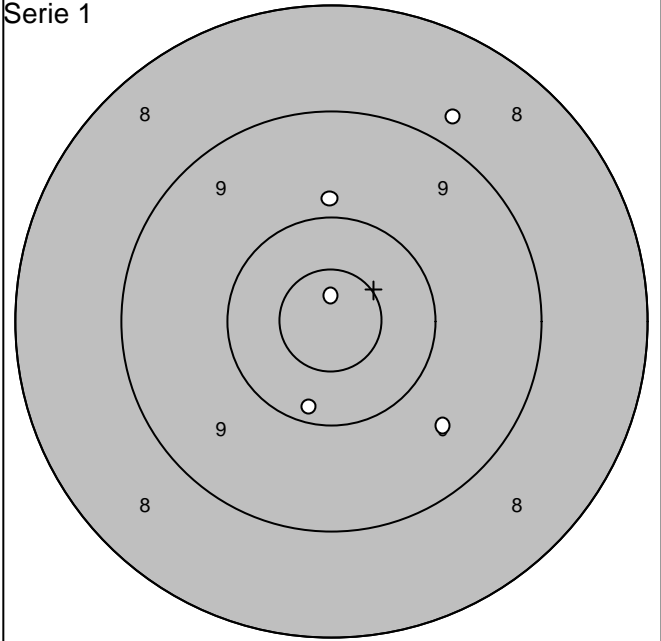
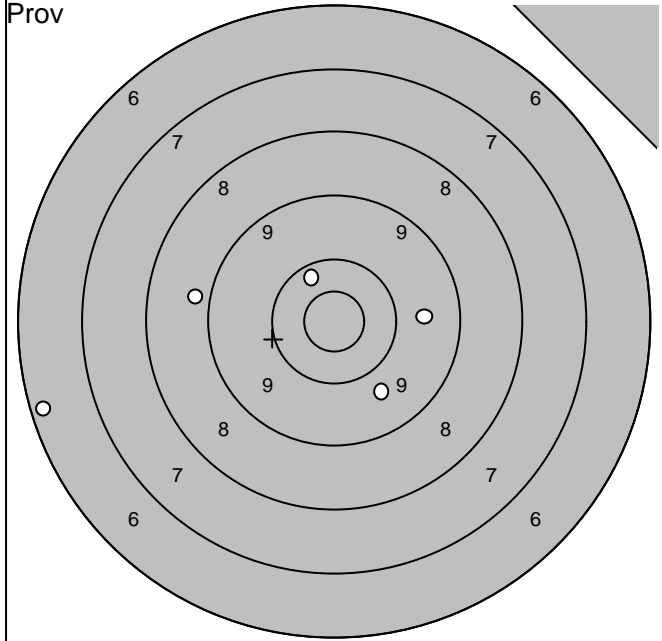

1: 6,3 ←	Serie	44,9	
2: 8,9 ←			
3: 9,7 →	Totalt	0,0	
4: 9,7 ↘			
5: 10,3 ↗			

1: 9,9 ↑	Serie	49,3	
2: 10,8* ↑			
3: 8,8 ↗	Totalt	49,3	
4: 10,2 ↘			
5: 9,6 ↘			

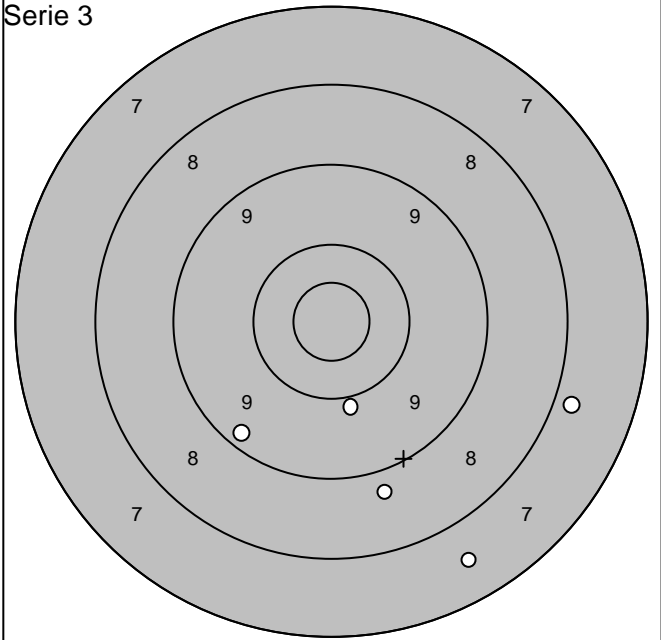
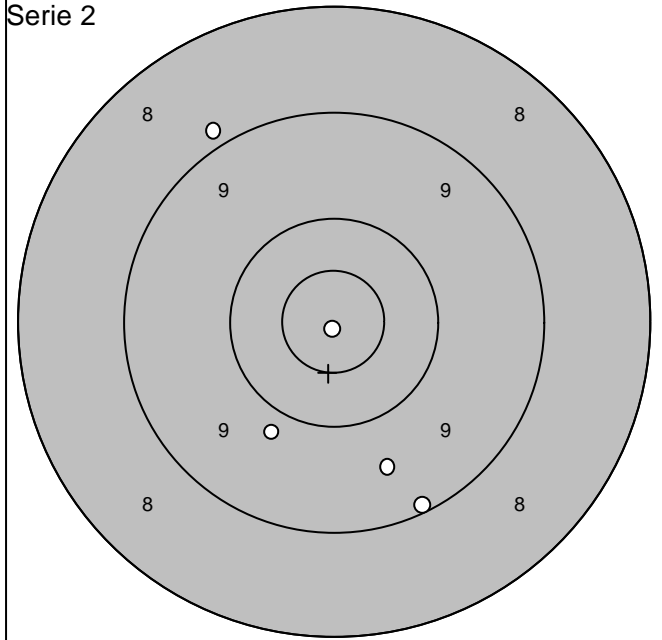

1: 8,9 ↗	Serie	48,3	
2: 9,8 ↘			
3: 9,1 ↘	Totalt	97,6	
4: 10,9* ↘			
5: 9,6 ↘			

1: 8,8 ↘	Serie	43,5	
2: 9,3 ↙			
3: 10,0 ↘	Totalt	141,1	
4: 7,8 →			
5: 7,6 ↘			

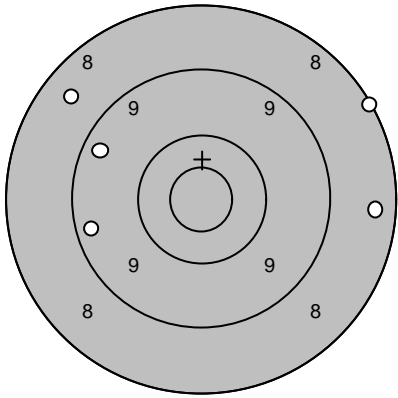
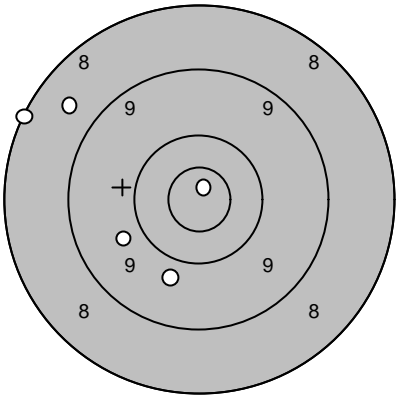
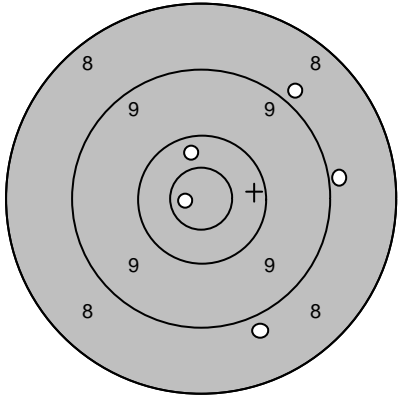
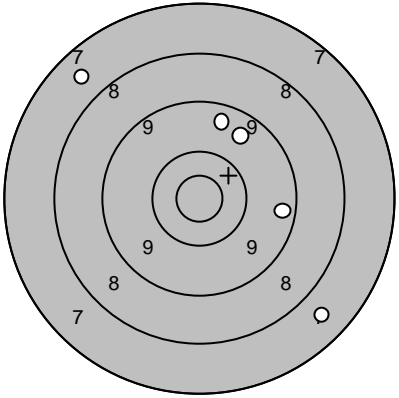
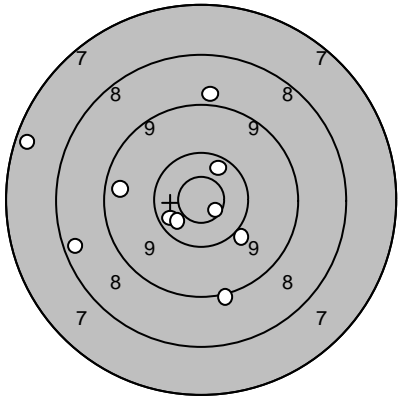
Skjutlag 1	Tavla 6	Petter Ivarsson	
Ramselefors		Loos	
05.07.2006		Tavelträffen A - 2006	Ramselefors Skytteförening
Prov 	1: 8,4 →	Serie 1 	1: 8,1 ↖
	2: 8,1 ↗		2: 8,6 ↖
	3: 8,5 ↖		3: 9,8 ↙
	4: 9,3 ←		4: 10,9* ↑
	5: 9,4 ↖		5: 9,8 ↓
	Serie 43,7		Serie 47,2
	Totalt 0,0		Totalt 47,2
Serie 2 	1: 8,9 →	Serie 3 	1: 7,7 ↘
	2: 10,3 ↑		2: 9,6 ↗
	3: 10,8* ←		3: 9,4 →
	4: 8,9 ↓		4: 7,7 ↖
	5: 8,9 ↗		5: 9,5 ↑
	Serie 47,8		Serie 43,9
	Totalt 95,0		Totalt 138,9
Extratävling 	1: 9,5 ←		
	2: 10,0 ↘		
	3: 8,9 ↑		
	4: 10,8* ↘		
	5: 7,4 ←		
	6: 10,4 ↙		
	7: 10,4 ↗		
	8: 10,5* ↙		
	9: 8,4 ←		
	10: 9,1 ↓		
	Serie 95,4		
	Totalt 234,3		

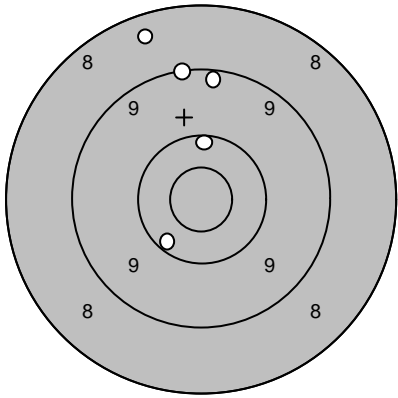
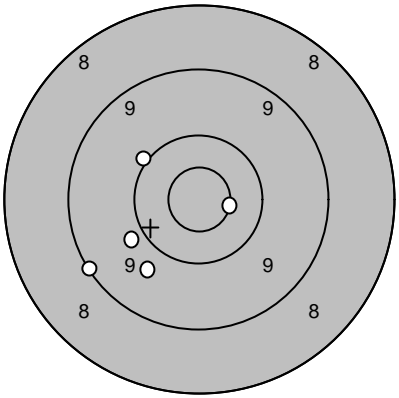
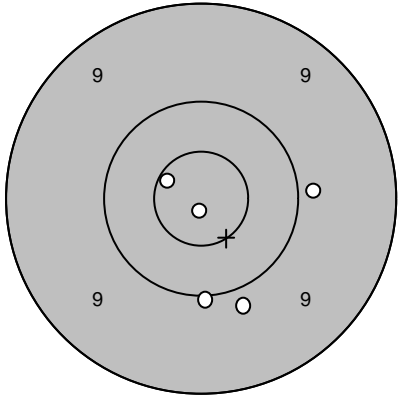
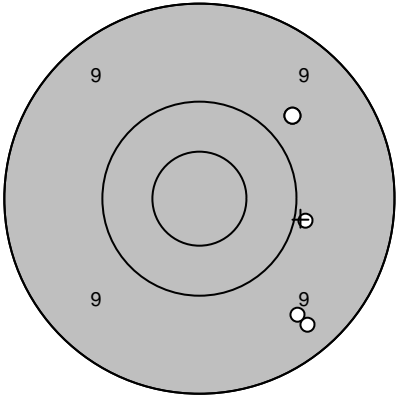
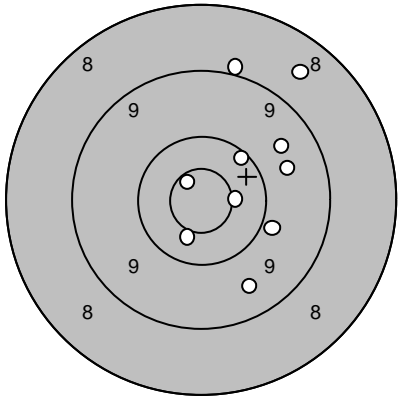
Skjutlag 1	Tavla 7	Tony Ericson	
Ramselefors	Loos		
05.07.2006	Tavelträffen A - 2006	Ramselefors Skytteförening	
Prov		1: 9,2 ↑ 2: 10,2 ↑ 3: 9,1 ↑ 4: 8,4 ↑ 5: 10,2 ↘	Serie 1 
			1: 10,0 ↖ 2: 9,9 ← 3: 9,7 ↙ 4: 10,6* → 5: 9,1 ↙
		Serie 47,1	Serie 49,3
		Totalt 0,0	Totalt 49,3
Serie 2		1: 9,9 ↓ 2: 10,0 ↓ 3: 10,6* ↖ 4: 9,9 → 5: 10,9* ↓	Serie 3 
			1: 9,8 ↗ 2: 9,3 ↓ 3: 9,9 → 4: 9,8 ↗ 5: 9,5 ↓
		Serie 51,3	Serie 48,3
		Totalt 100,6	Totalt 148,9
Extratävling		1: 9,0 ↑ 2: 10,5* ↓ 3: 8,6 ↗ 4: 10,7* ↖ 5: 9,7 → 6: 9,6 ↗ 7: 9,9 → 8: 9,6 ↓ 9: 10,6* → 10: 10,2 ↗	
		Serie 98,4	
		Totalt 247,3	

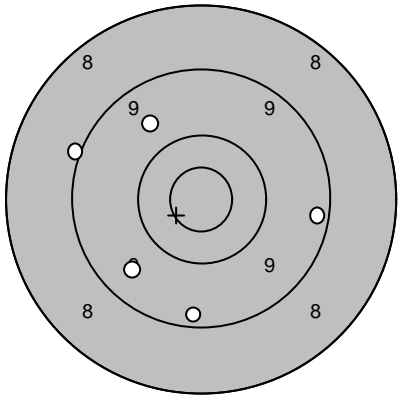
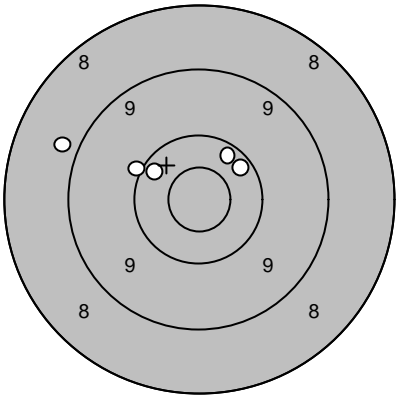
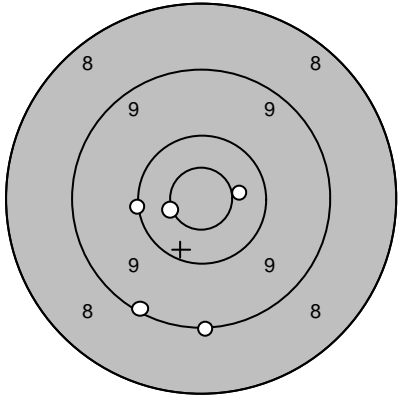
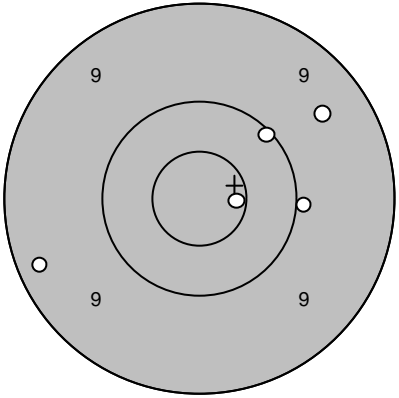
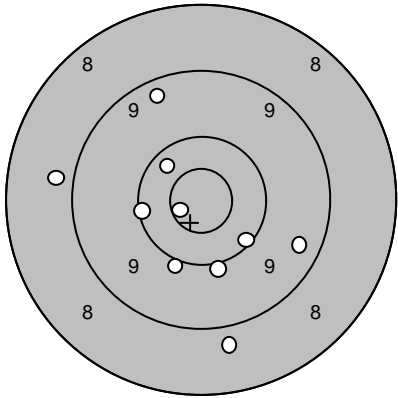
Skjutlag 1	Tavla 8	Johnny Wallberg	
Ramselefors	Loos		
05.07.2006	Tavelträffen A - 2006	Ramselefors Skytteförening	
Prov		1: 9,6 ↙ 2: 9,3 ↓ 3: 9,7 ↗ 4: 9,0 ↖ 5: 9,3 →	Serie 1 
			1: 10,0 ↖ 2: 8,8 ↖ 3: 10,3 ↗ 4: 10,3 ↗ 5: 10,3 ↖
		Serie 46,9	Serie 49,7
		Totalt 0,0	Totalt 49,7
Serie 2		1: 10,5* → 2: 9,1 ↙ 3: 9,1 ↓ 4: 10,6* ← 5: 10,1 ←	Serie 3 
			1: 10,0 → 2: 9,5 ↗ 3: 10,7* → 4: 9,3 ← 5: 10,1 ↗
		Serie 49,4	Serie 49,6
		Totalt 99,1	Totalt 148,7
Extratävling		1: 9,3 ↗ 2: 8,8 ← 3: 10,2 ← 4: 10,3 ↗ 5: 10,7* ← 6: 9,4 → 7: 10,0 ↙ 8: 10,0 ↓ 9: 10,2 ↓ 10: 8,8 ↓	
		Serie 97,7	
		Totalt 246,4	

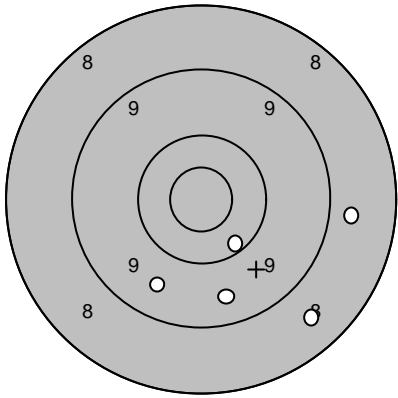
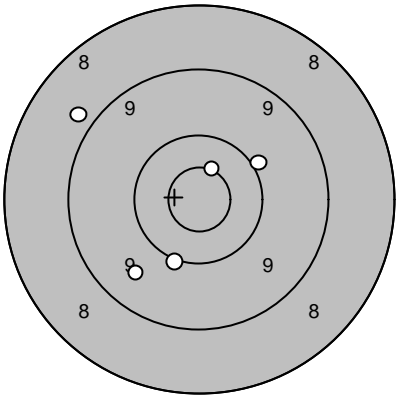
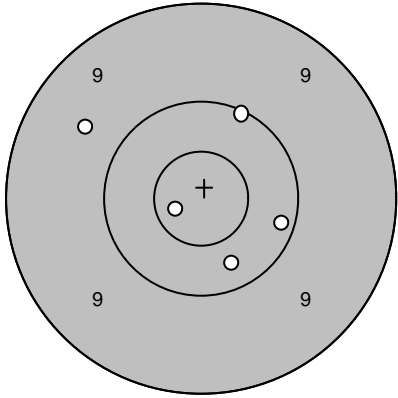
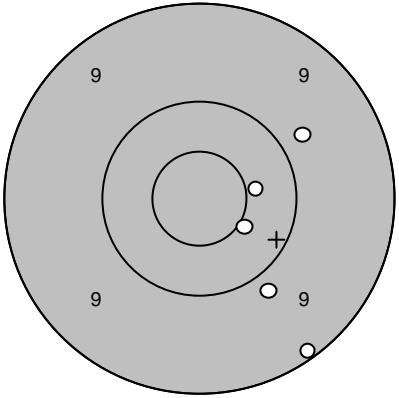
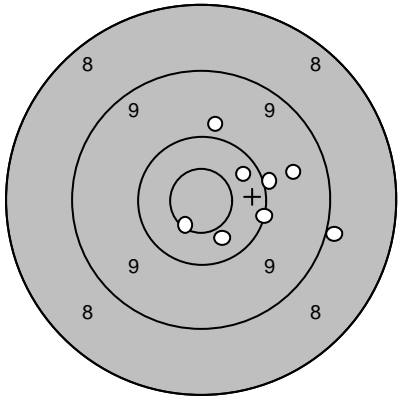
Skjutlag 1	Tavla 9	Magnus Lindkvist		
Ramselefors	Umeå			
05.07.2006	Tavelträffen A - 2006	Ramselefors Skytteförening		
Prov		1: 8,8 → 2: 9,5 ↓ 3: 8,6 ↓ 4: 9,6 ↓ 5: 10,2 ↓	Serie 1 	1: 8,8 ↖ 2: 9,6 ↙ 3: 10,6* ↗ 4: 10,1 ↓ 5: 10,0 →
	Serie 46,7		Serie 49,1	
	Totalt 0,0		Totalt 49,1	
Serie 2		1: 10,1 ↗ 2: 9,6 ↗ 3: 10,8* ← 4: 10,2 → 5: 10,3 ↓	Serie 3 	1: 9,8 ↗ 2: 9,9 ↓ 3: 9,1 ↓ 4: 10,5* ↓ 5: 10,4 →
	Serie 51,0		Serie 49,7	
	Totalt 100,1		Totalt 149,8	
Extratävling		1: 10,4 ↓ 2: 9,9 ↑ 3: 10,0 → 4: 10,3 ↗ 5: 9,0 → 6: 10,6* ↓ 7: 9,6 → 8: 10,1 →		
	Serie 79,9			
	Totalt 229,7			

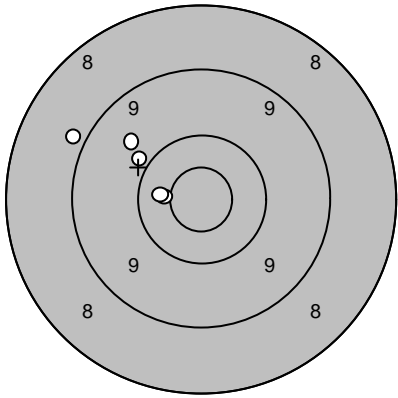
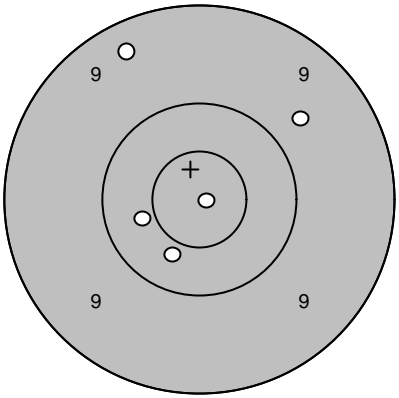
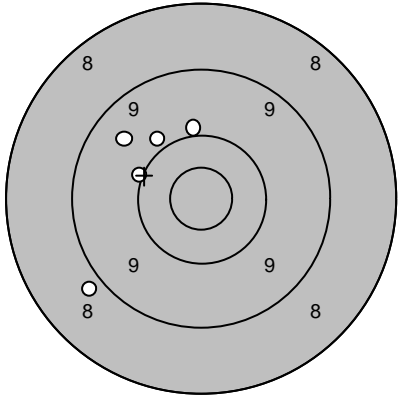
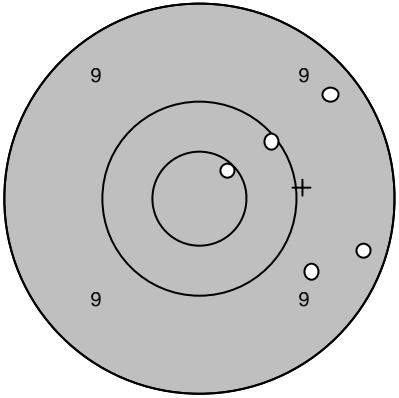
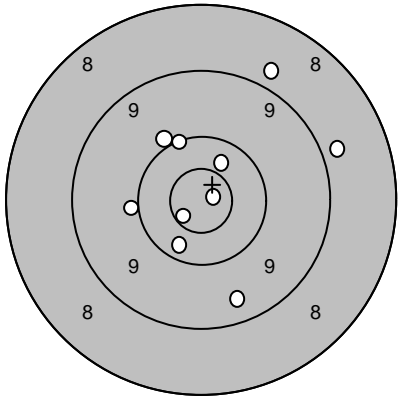
Skjutlag 1	Tavla 11	Curt Lejon		
Ramselefors		Umeå		
05.07.2006		Tavelträffen A - 2006	Ramselefors Skytteförening	
Prov		1: 10,5* ← 2: 9,7 ↗ 3: 8,9 ↗ 4: 9,9 ↗ 5: 10,5* ←	Serie 1 	1: 9,4 ↖ 2: 10,9* → 3: 10,4 ← 4: 9,7 ↗ 5: 10,4 ↘
		Serie 49,5	Serie 50,8	
		Totalt 0,0	Totalt 50,8	
Serie 2		1: 8,9 ↖ 2: 9,6 ↗ 3: 9,9 ↗ 4: 10,1 ← 5: 10,0 ↑	Serie 3 	1: 9,3 → 2: 10,1 ↗ 3: 9,3 ↗ 4: 10,6* ↗ 5: 9,7 ↘
		Serie 48,5	Serie 49,0	
		Totalt 99,3	Totalt 148,3	
Extratävling		1: 10,7* ↖ 2: 10,0 ↖ 3: 10,4 ↗ 4: 10,1 ↗ 5: 10,9* → 6: 10,0 ← 7: 10,3 ↘ 8: 9,5 ↘ 9: 8,8 ↗ 10: 8,9 →		
		Serie 99,6		
		Totalt 247,9		

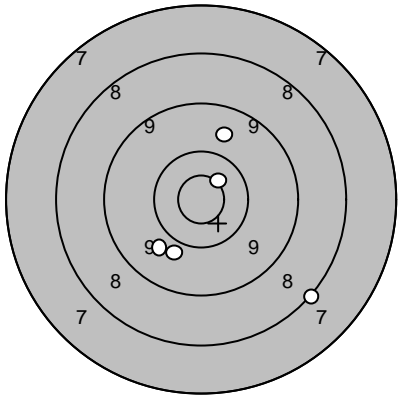
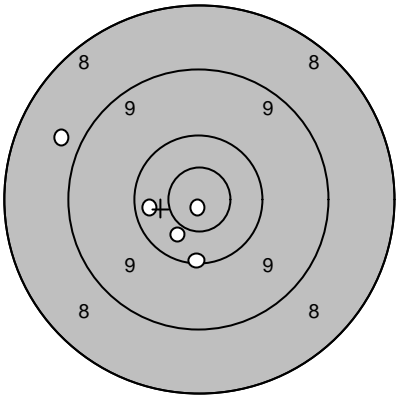
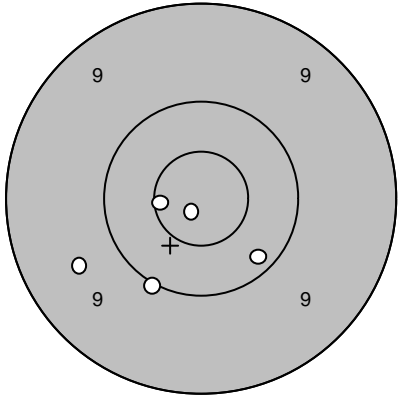
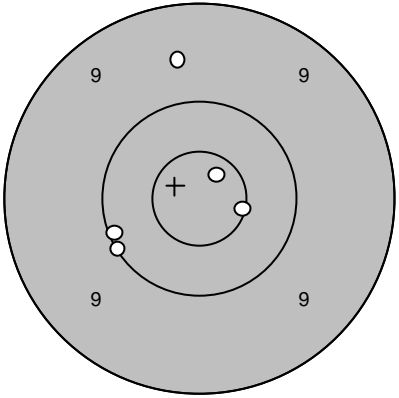
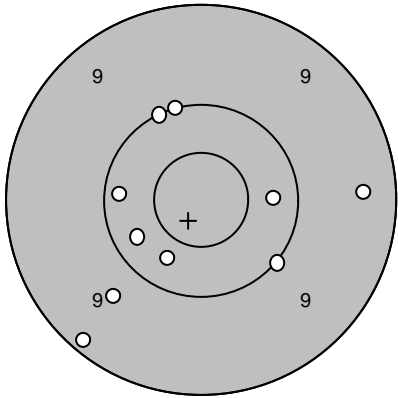
Skjutlag 1	Tavla 12	Torvald Andersson	
Ramselefors		Ununge	
05.07.2006		Tavelträffen A - 2006	Ramselefors Skytteförening
Prov 	1: 8,1 ↘ 2: 10,6* ↗ 3: 9,9 ↓ 4: 9,7 ↑ 5: 9,8 ↙	Serie 1 	1: 10,9* ↓ 2: 10,3 ← 3: 8,8 ↖ 4: 10,5* ↘ 5: 10,1 ↓
	Serie 48,1		Serie 50,6
	Totalt 0,0		Totalt 50,6
Serie 2 	1: 9,6 ← 2: 10,6* ← 3: 10,2 ↘ 4: 10,0 ↓ 5: 10,9* ↙	Serie 3 	1: 10,6* → 2: 9,6 ↑ 3: 10,1 ← 4: 10,1 ↙ 5: 10,7* ↗
	Serie 51,3		Serie 51,1
	Totalt 101,9		Totalt 153,0
Extratävling 	1: 10,1 ↗ 2: 10,3 ↓ 3: 10,2 ← 4: 9,2 ↓ 5: 9,7 ↘ 6: 9,4 → 7: 10,3 ↖ 8: 10,1 ↑ 9: 10,3 → 10: 10,0 ↘		
	Serie 99,6		
	Totalt 252,6		

Skjutlag 1	Tavla 14	Jan Wallerström
----------------------	--------------------	------------------------

Ramselefors	Ununge		
-------------	--------	--	--

05.07.2006	Tavelträffen A - 2006	Ramselefors Skytteförening
------------	-----------------------	----------------------------

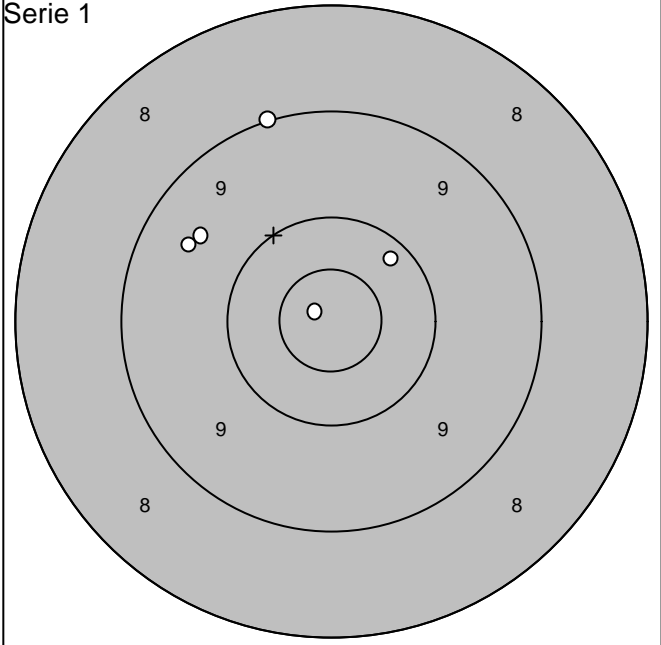
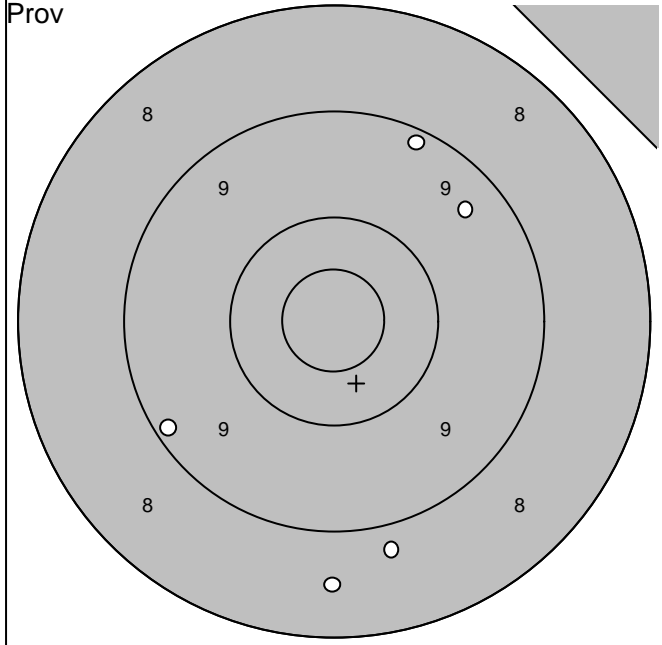

1: 8,5 ↓	Serie	45,1
2: 8,8 ↓		
3: 9,2 ↑		
4: 9,4 ↗		
5: 9,2 ↙		
Totalt		0,0

1:10,9* ↗	Serie	49,2
2: 9,6 ↗		
3: 9,5 ↖		
4:10,2 ↗		
5: 9,0 ↑		
Totalt		49,2

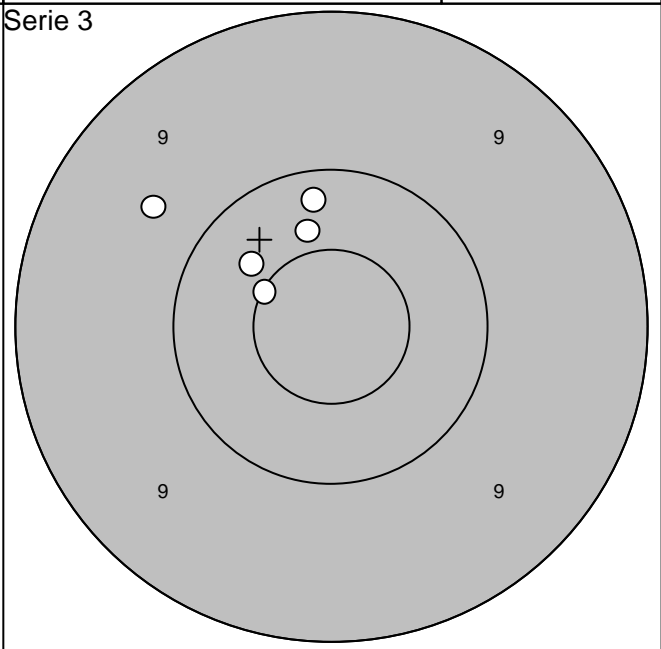
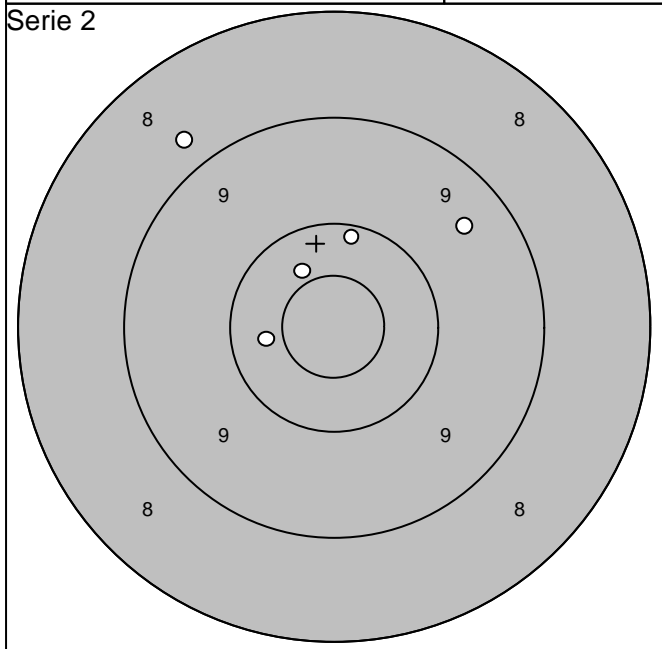

1:10,4 ←	Serie	49,3
2:10,2 ↑		
3: 8,8 ↖		
4: 9,5 ↗		
5:10,4 ↖		
Totalt		98,5

1:10,4 ↗	Serie	51,3
2:10,2 ↑		
3: 9,7 ↖		
4:10,6* ↖		
5:10,4 ↑		
Totalt		149,8

www.AC-Skytte.com

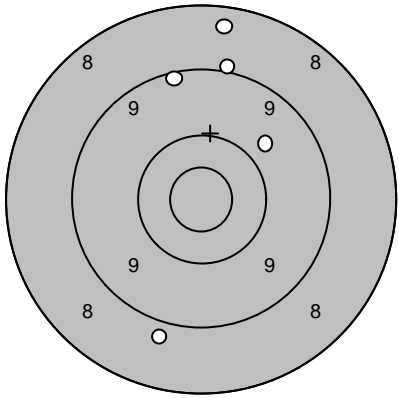
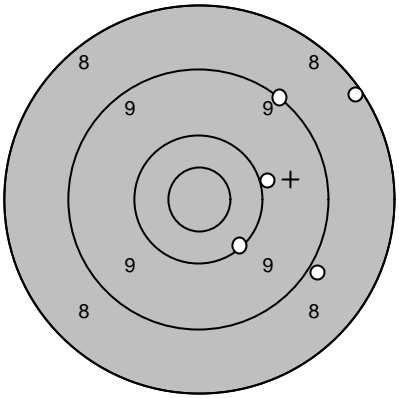
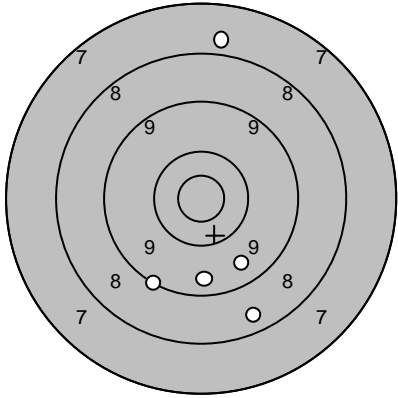
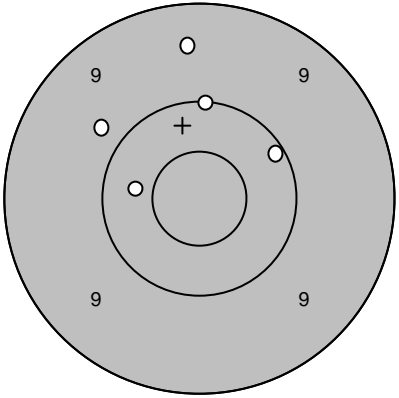
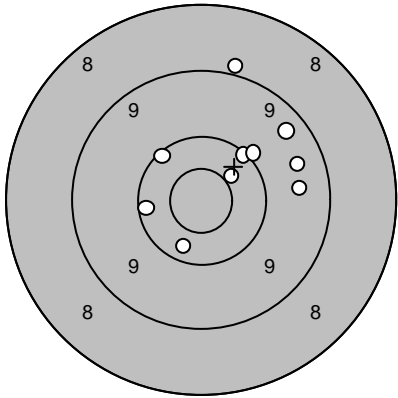
Skjutlag	Tavla	Curt Linerud	
1	15		
Ramselefors	I 20		
05.07.2006	Tavelträffen A - 2006	Ramselefors Skytteförening	
Prov		1: 8,9 ↓ 2: 9,0 ↑ 3: 8,4 ↑ 4: 9,2 ↑ 5: 9,8 ↗	Serie 1 
		Serie 45,3 Totalt 0,0	1: 8,9 ↘ 2: 10,1 ↘ 3: 8,2 ↗ 4: 9,1 ↗ 5: 10,0 →
			Serie 46,3 Totalt 46,3
Serie 2		1: 8,5 ↓ 2: 9,6 ↓ 3: 9,1 ↘ 4: 9,5 ↓ 5: 7,8 ↑	Serie 3 
		Serie 44,5 Totalt 90,8	1: 10,4 ← 2: 10,1 ↑ 3: 9,5 ↑ 4: 9,8 ↖ 5: 10,1 ↗
			Serie 49,9 Totalt 140,7
Extratävling		1: 10,3 ↓ 2: 10,2 ← 3: 10,1 ↗ 4: 10,0 ↗ 5: 10,2 ↖ 6: 9,0 ↑ 7: 10,5* ↗ 8: 9,5 → 9: 9,6 → 10: 9,4 ↗	
		Serie 98,8 Totalt 239,5	

Skjutlag	Tavla		
1	16	Martin Olofsson	

Ramselefors	Vännäs		
-------------	--------	--	--

05.07.2006	Tavelträffen A - 2006	Ramselefors Skytteförening	
------------	-----------------------	----------------------------	--

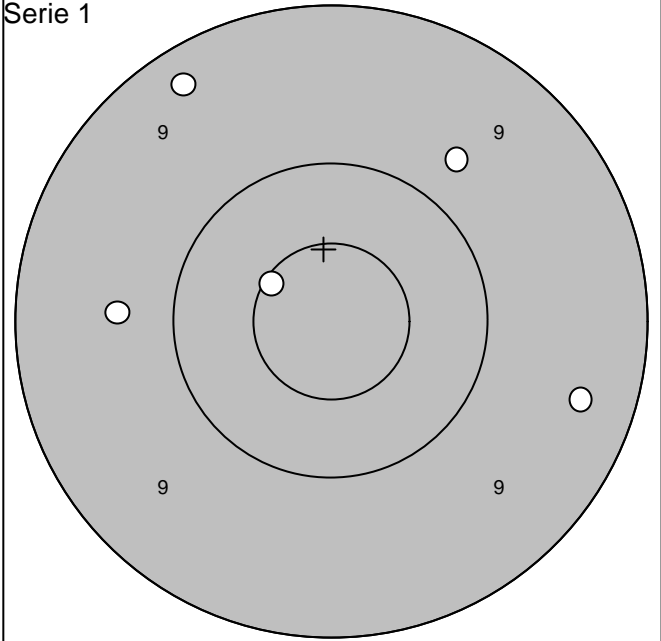
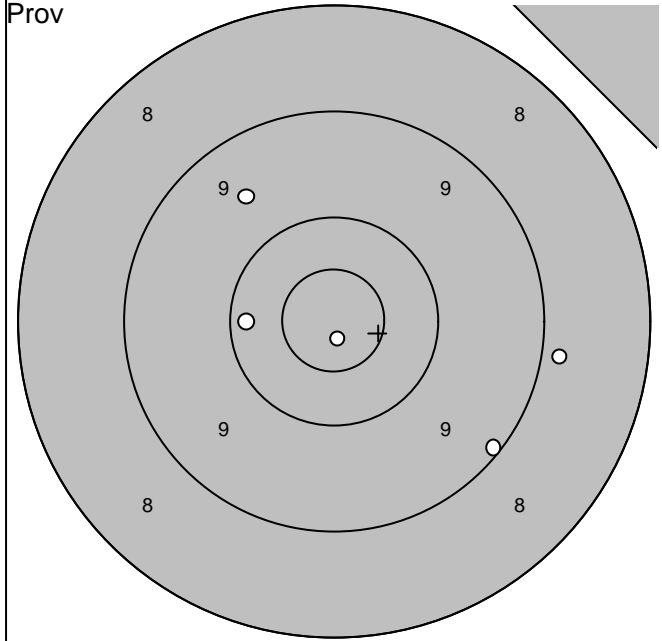

1: 10,9* ↓	Serie	48,7
2: 8,9 →		
3: 9,1 ↘	Totalt	0,0
4: 9,6 ↗		
5: 10,2 ←		

1: 9,3 ↗	Serie	48,7
2: 9,7 ←		
3: 9,4 →	Totalt	48,7
4: 10,6* ↖		
5: 9,7 ↗		

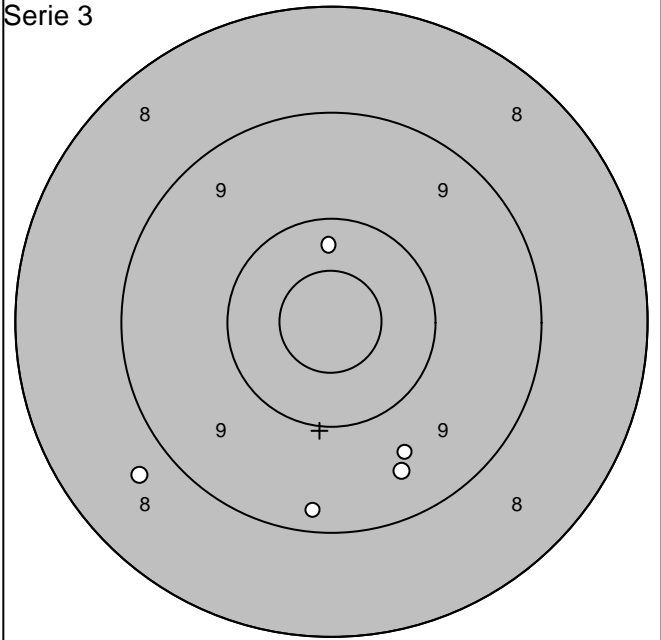
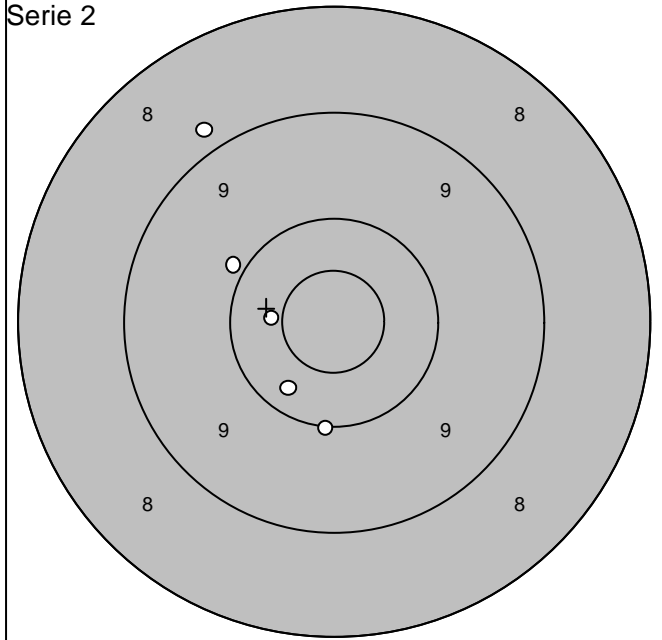

1: 9,9 ↖	Serie	49,4
2: 10,3 ↘		
3: 10,0 ↓	Totalt	98,1
4: 8,8 ↗		
5: 10,4 ←		

1: 8,7 ↖	Serie	47,3
2: 9,2 ↓		
3: 9,6 ↘	Totalt	145,4
4: 9,5 ↘		
5: 10,3 ↑		

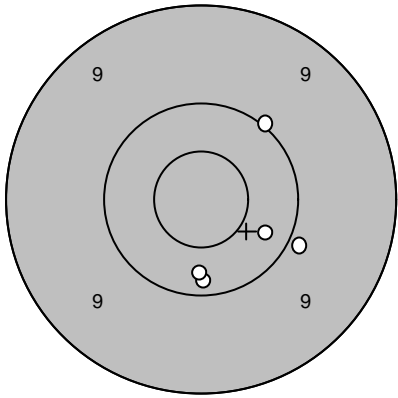
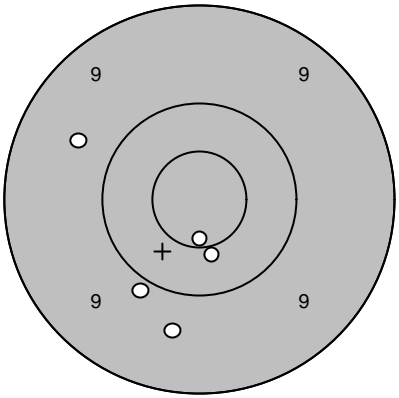
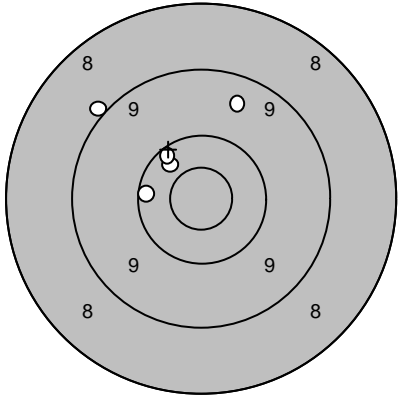
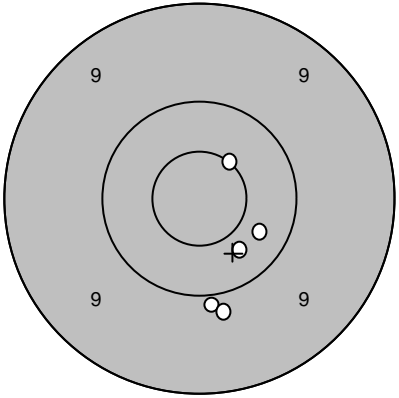
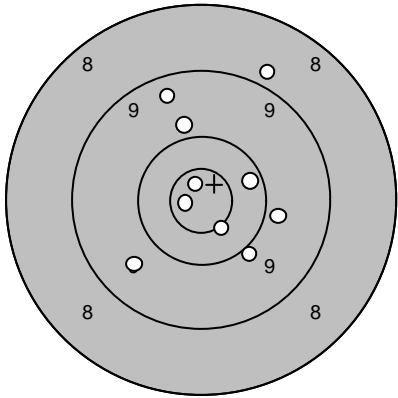
Skjutlag 1	Tavla 19	Urban Johansson	
Ramselefors	F 21		
05.07.2006	Tavelträffen A - 2006	Ramselefors Skytteförening	
Prov		1: 10,0 ↗ 2: 9,9 → 3: 10,2 ↓ 4: 10,3 ↓ 5: 10,3 →	Serie 1 
			1: 9,7 ↖ 2: 10,5* ↓ 3: 9,9 ↙ 4: 9,7 ↓ 5: 10,6* ↓
		Serie 50,7	Serie 50,4
		Totalt 0,0	Totalt 50,4
Serie 2		1: 10,2 ← 2: 9,5 ↗ 3: 9,0 ↗ 4: 10,4 ↗ 5: 10,3 ↗	Serie 3 
			1: 9,9 ↓ 2: 10,3 → 3: 9,9 ↓ 4: 10,4 ↘ 5: 10,5* ↗
		Serie 49,4	Serie 51,0
		Totalt 99,8	Totalt 150,8
Extratävling		1: 9,9 → 2: 10,3 → 3: 8,9 ↗ 4: 10,0 ↓ 5: 10,8* ← 6: 9,9 ↗ 7: 9,4 ↗ 8: 10,8* ↗ 9: 9,7 ↖ 10: 10,5* ↓	
		Serie 100,2	
		Totalt 251,0	

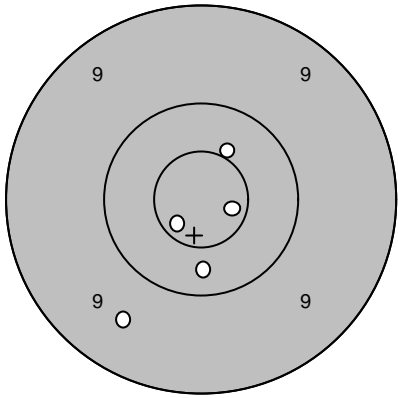
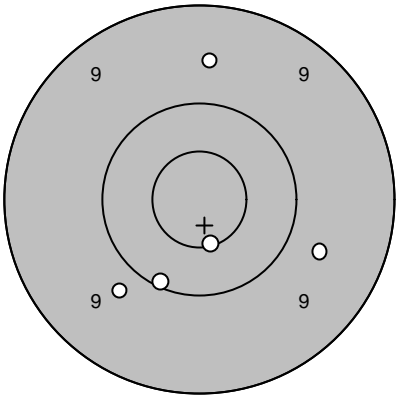
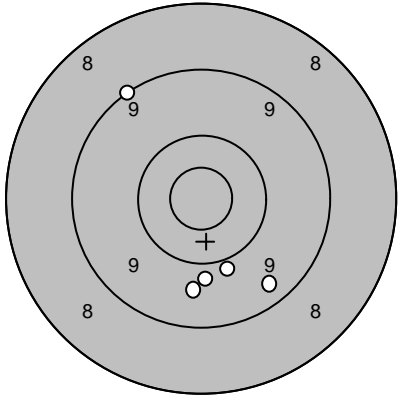
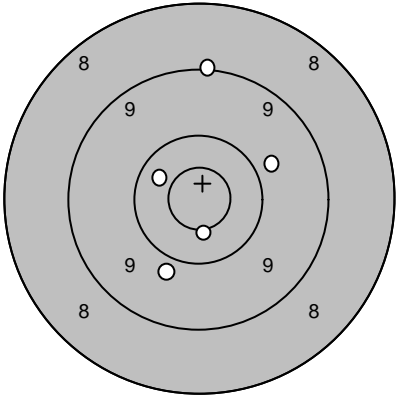
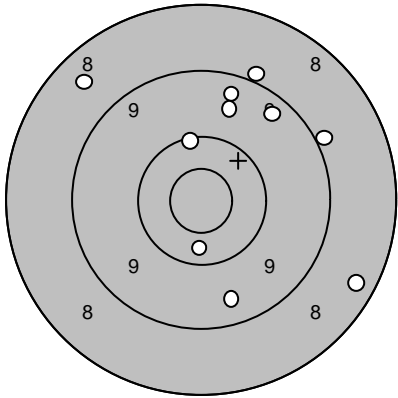
Skjutlag	Tavla	Roland Nilsson	
1	20		
Ramselefors	Piteå		
05.07.2006	Tavelträffen A - 2006	Ramselefors Skytteförening	
Prov 	1: 10,3 ↓	Serie 1 	1: 10,1 ↓
	2: 10,7* →		2: 9,6 ↑
	3: 9,6 ↓		3: 10,6* ↓
	4: 10,7* ↓		4: 9,7 →
	5: 10,5* ↗		5: 9,8 ↓
	Serie 51,8		Serie 49,8
	Totalt 0,0		Totalt 49,8
Serie 2 	1: 9,8 ↓	Serie 3 	1: 9,9 ↓
	2: 9,9 ↓		2: 9,1 ↑
	3: 9,4 ↓		3: 9,8 ↗
	4: 9,7 ↓		4: 10,4 ↖
	5: 9,1 ↗		5: 10,6* ↓
	Serie 47,9		Serie 49,8
	Totalt 97,7		Totalt 147,5
Extratävling 	1: 9,4 ↑		
	2: 8,5 ↖		
	3: 9,5 ↓		
	4: 8,4 →		
	5: 9,4 ↗		
	6: 10,3 ↓		
	7: 9,0 ↗		
	8: 10,2 ↑		
	9: 9,0 ↗		
	10: 9,6 ↑		
	Serie 93,3		
	Totalt 240,8		

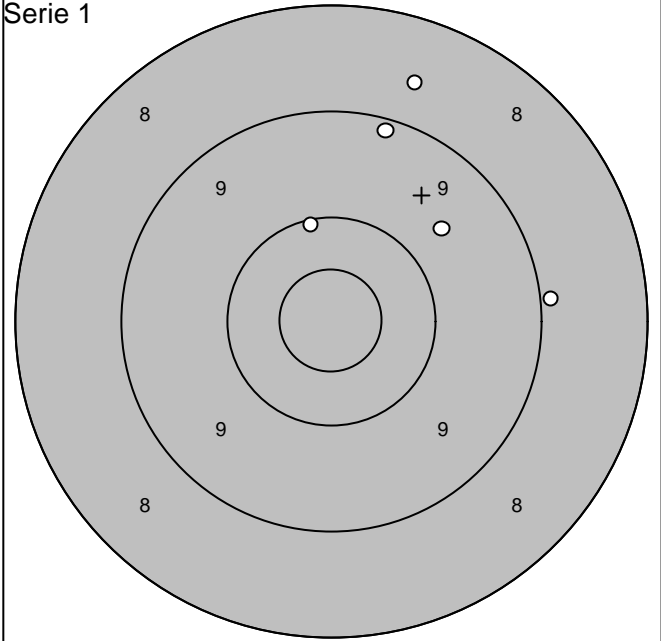
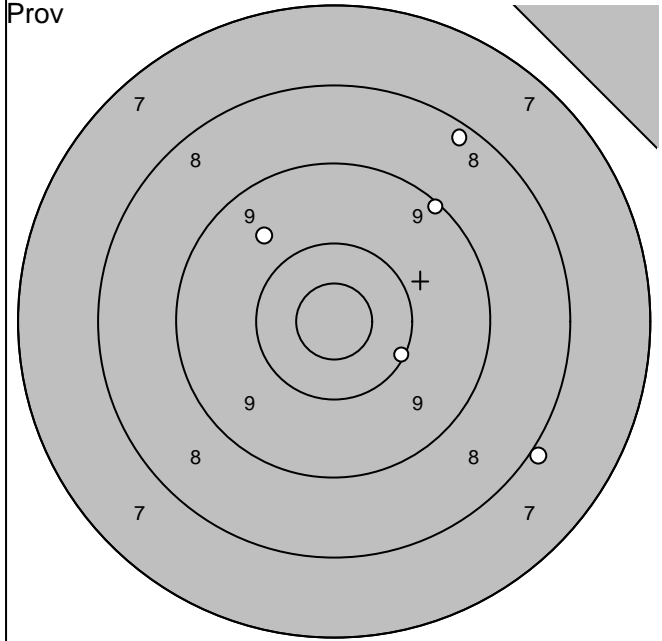

1: 8,2 ↗
2: 9,7 ↖
3: 9,1 ↗
4: 8,0 ↘
5: 10,1 ↘

Serie	45,1
Totalt	0,0

1: 8,6 ↗
2: 10,1 ↖
3: 9,7 ↗
4: 8,9 →
5: 9,2 ↗

Serie	46,5
Totalt	46,5

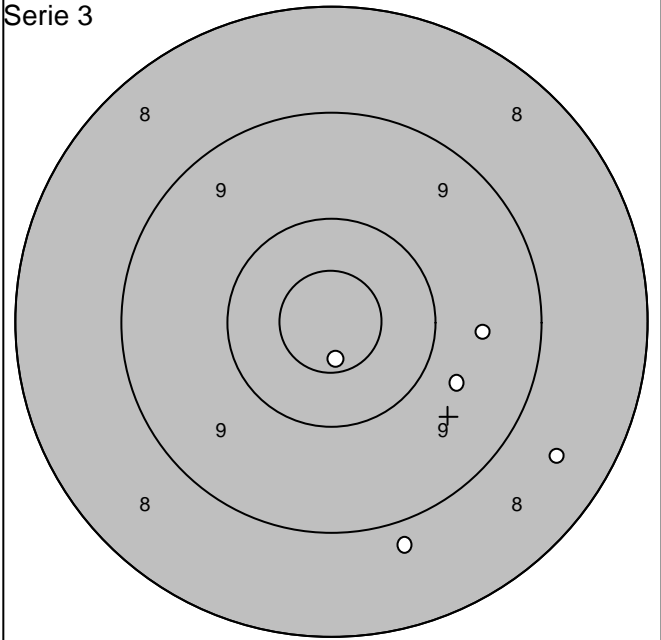
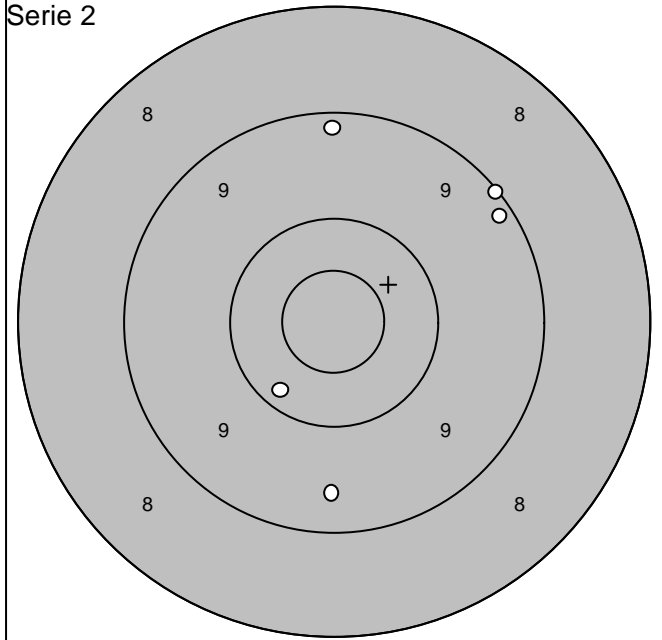

1: 10,2 ↘
2: 9,1 ↗
3: 9,2 ↗
4: 9,2 ↗
5: 9,4 ↓

Serie	47,1
Totalt	93,6

1: 10,7* ↓
2: 8,8 ↓
3: 9,7 ↘
4: 9,6 →
5: 8,5 ↘

Serie	47,3
Totalt	140,9

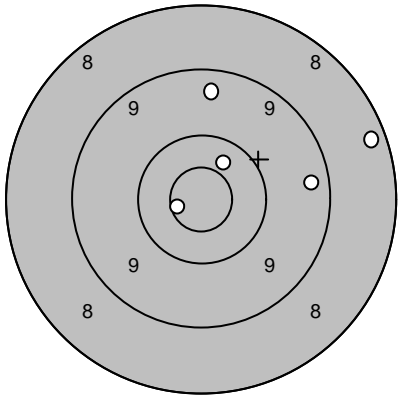
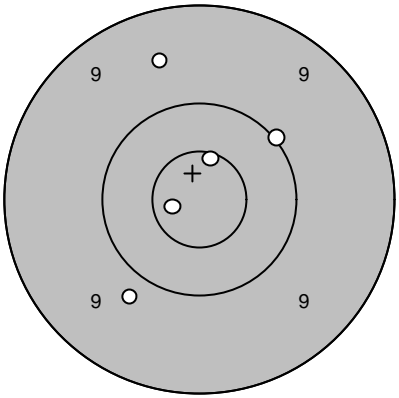
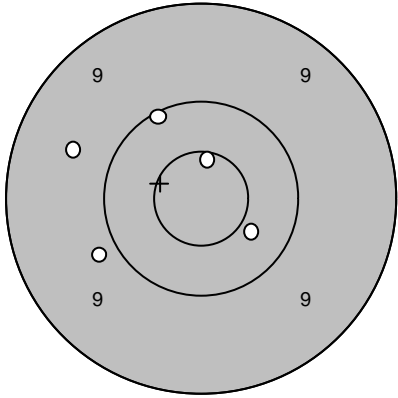
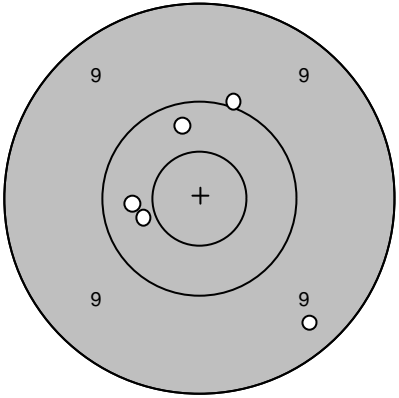
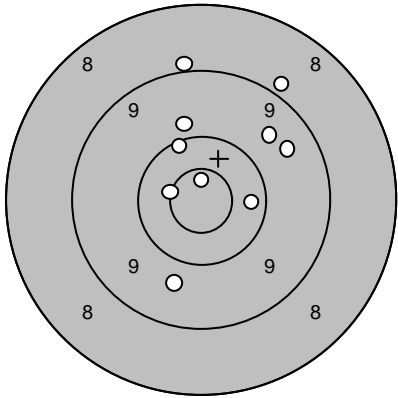
Skjutlag 1	Tavla 22	Bengt Heder	
Ramselefors		Evertsberg	
05.07.2006		Tavelträffen A - 2006	Ramselefors Skytteförening
Prov 	1: 8,3 →	Serie 1 	1: 10,0 ↗
	2: 10,7* ←		2: 10,6* ↑
	3: 10,4 ↗		3: 9,6 ↑
	4: 9,4 →		4: 10,8* ←
	5: 9,4 ↑		5: 9,8 ↘
	Serie 48,2		Serie 50,8
	Totalt 0,0		Totalt 50,8
Serie 2 	1: 9,9 ←	Serie 3 	1: 10,4 ←
	2: 10,4 →		2: 9,3 ↘
	3: 9,6 ←		3: 10,0 ↑
	4: 10,6* ↑		4: 10,3 ↑
	5: 10,1 ↗		5: 10,4 ←
	Serie 50,6		Serie 50,4
	Totalt 101,4		Totalt 151,8
Extratävling 	1: 9,7 ↓		
	2: 9,6 ↗		
	3: 10,6* ←		
	4: 10,3 →		
	5: 10,8* ↑		
	6: 9,0 ↑		
	7: 8,9 ↗		
	8: 10,2 ↗		
	9: 9,5 ↗		
	10: 9,9 ↑		
	Serie 98,5		
	Totalt 250,3		

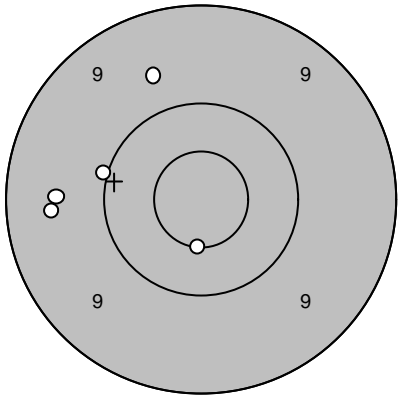
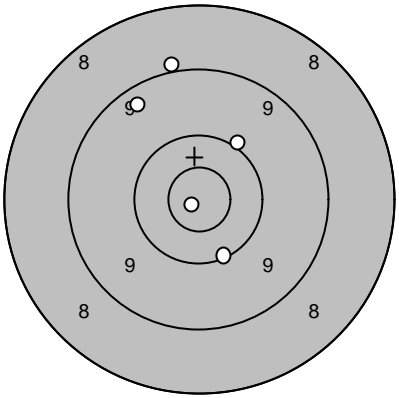
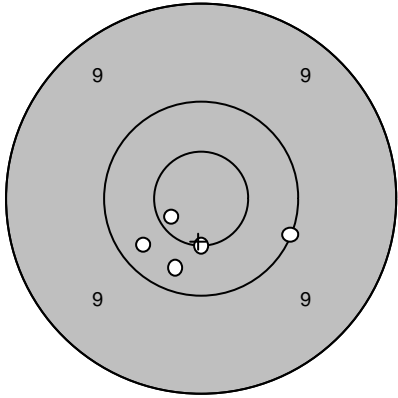
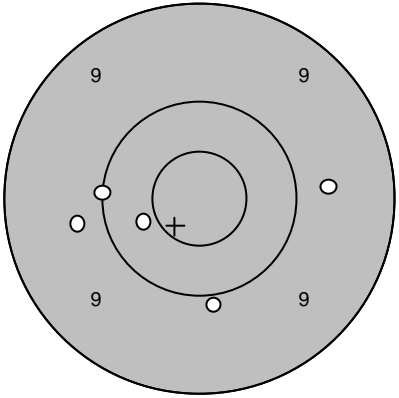
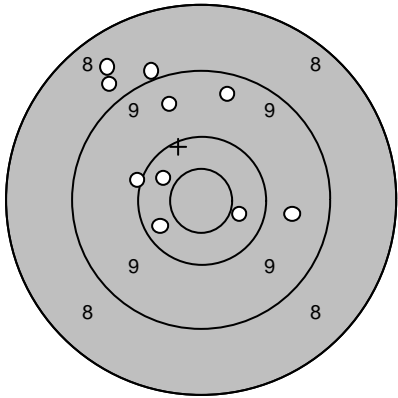
Skjutlag 1	Tavla 23	Gunnar Iversen	
Ramselefors		S 3	
05.07.2006		Tavelträffen A - 2006	Ramselefors Skytteförening
Prov 	1: 10,0 ←	Serie 1 	1: 9,4 ↗
	2: 9,6 ←		2: 10,9* ←
	3: 10,5* ↓		3: 10,0 ↗
	4: 9,5 ←		4: 9,0 ↑
	5: 9,7 ↗		5: 10,1 ↓
	Serie 49,3		Serie 49,4
	Totalt 0,0		Totalt 49,4
Serie 2 	1: 10,3 ↙	Serie 3 	1: 9,8 ←
	2: 10,6* ↓		2: 10,0 ↓
	3: 10,0 →		3: 10,4 ←
	4: 10,3 ↓		4: 9,7 →
	5: 10,7* ↙		5: 10,0 ←
	Serie 51,9		Serie 49,9
	Totalt 101,3		Totalt 151,2
Extratävling 	1: 10,3 ↙		
	2: 8,8 ↗		
	3: 9,4 ↑		
	4: 10,4 ↙		
	5: 9,0 ↗		
	6: 8,6 ↗		
	7: 10,0 ↙		
	8: 9,7 →		
	9: 10,4 →		
	10: 9,5 ↗		
	Serie 96,1		
	Totalt 247,3		

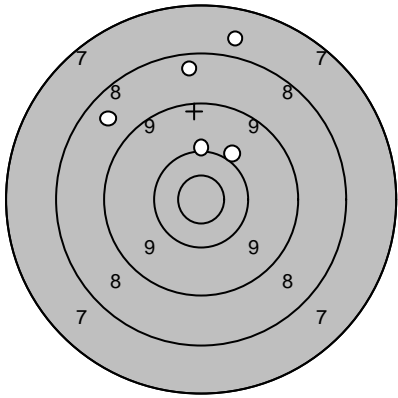
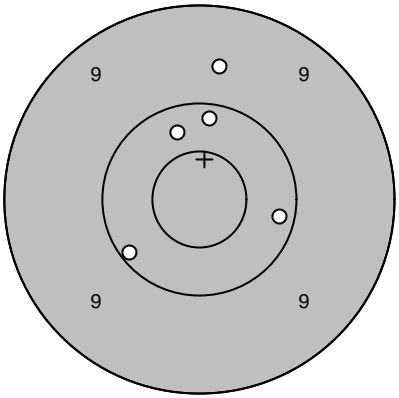
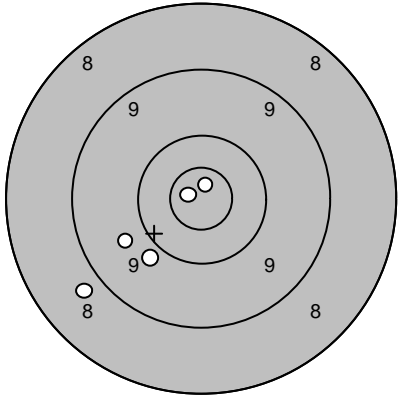
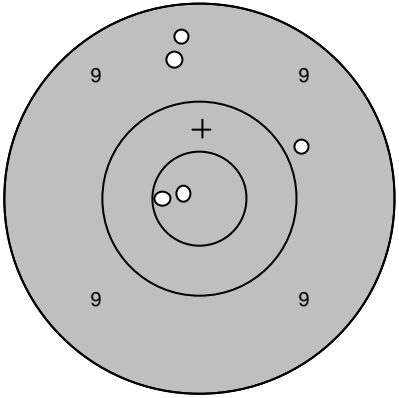
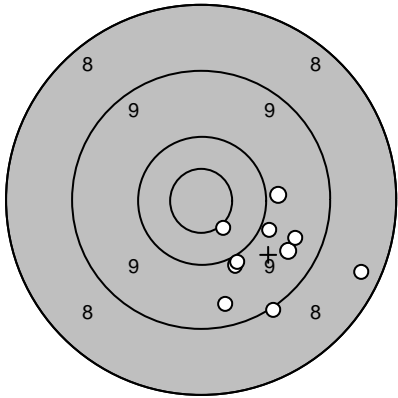
Skjutlag 2	Tavla 1	Helena Jansson	
Ramselefors		Söderala	
05.07.2006		Tavelträffen A - 2006	Ramselefors Skytteförening
Prov 	1: 10,1 ↑ 2: 7,8 ↑ 3: 8,6 ↖ 4: 8,4 ↑ 5: 10,0 ↗	Serie 1 	1: 9,7 ↑ 2: 10,2 ↑ 3: 10,2 → 4: 10,3 ↑ 5: 10,1 ↙
	Serie 43,0		Serie 49,0
	Totalt 0,0		Totalt 49,0
Serie 2 	1: 10,9* ← 2: 8,8 ↙ 3: 9,9 ↙ 4: 9,7 ↙ 5: 10,9* ↑	Serie 3 	1: 9,4 ↑ 2: 10,9* ← 3: 9,6 ↑ 4: 9,9 ↗ 5: 10,7* ←
	Serie 46,0		Serie 47,0
	Totalt 95,0		Totalt 142,0
Extratävling 	1: 10,5* ↘ 2: 9,9 → 3: 9,9 → 4: 10,0 ↘ 5: 9,4 ↘ 6: 10,0 ↘ 7: 9,5 ↘ 8: 9,5 → 9: 9,1 ↘ 10: 8,4 →		
	Serie 92,0		
	Totalt 234,0		

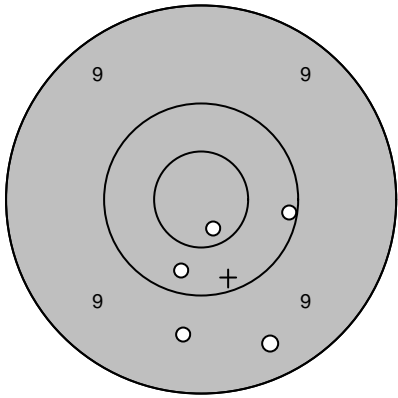
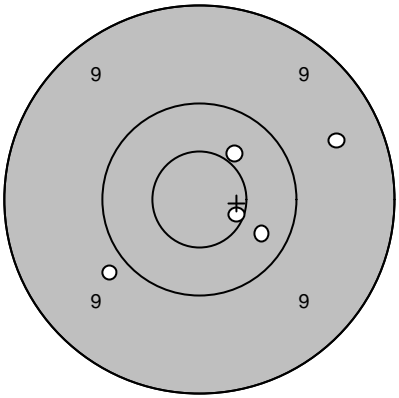
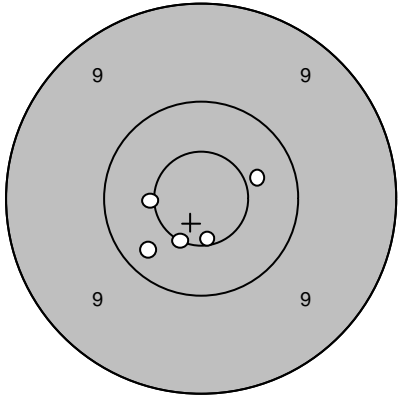
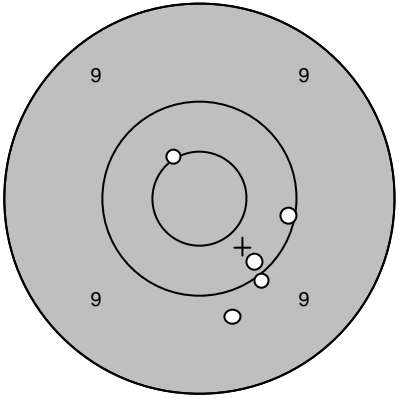
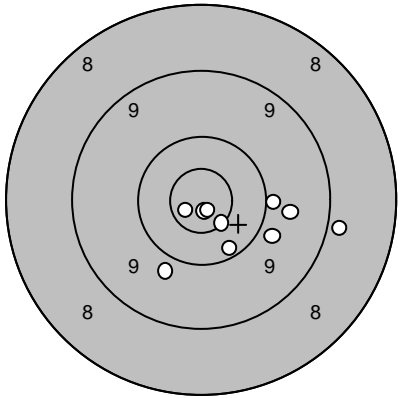
Skjutlag 2	Tavla 2	Bengt Jansson	
Ramselefors		Söderala	
05.07.2006		Tavelträffen A - 2006	Ramselefors Skytteförening
Prov 	1: 10,1 → 2: 9,6 ↓ 3: 10,7* ↓ 4: 10,3 ↓ 5: 9,4 ↓	Serie 1 	1: 9,5 → 2: 10,6* → 3: 10,4 ↗ 4: 10,3 → 5: 9,9 ↙
	Serie 48,0		Serie 48,0
	Totalt 0,0		Totalt 48,0
Serie 2 	1: 10,4 → 2: 10,3 ↙ 3: 10,6* ↓ 4: 10,5* ← 5: 10,6* ↓	Serie 3 	1: 10,1 → 2: 9,8 ↓ 3: 10,5* ↗ 4: 10,2 ↙ 5: 10,0 ↙
	Serie 50,0		Serie 49,0
	Totalt 98,0		Totalt 147,0
Extratävling 	1: 10,8* ↙ 2: 10,0 → 3: 10,2 ↓ 4: 10,9* ↓ 5: 9,9 ↓ 6: 10,6* ↓ 7: 8,9 → 8: 10,9* ↓ 9: 9,7 → 10: 9,9 →		
	Serie 95,0		
	Totalt 242,0		

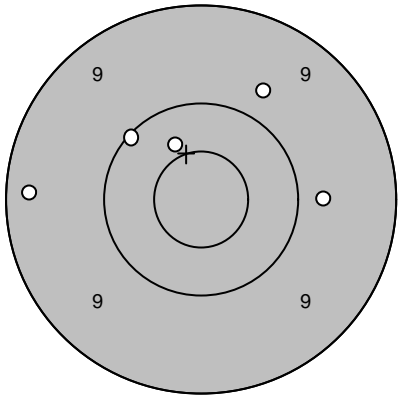
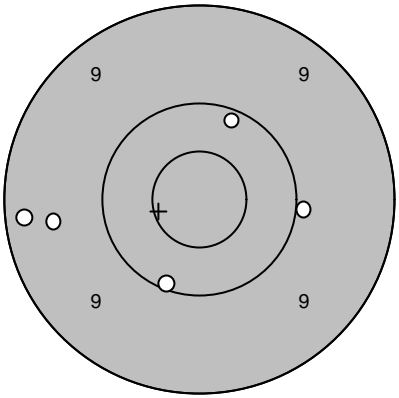
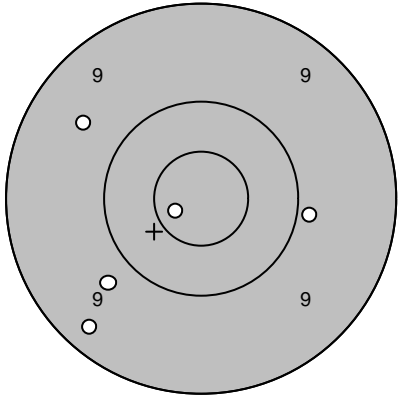
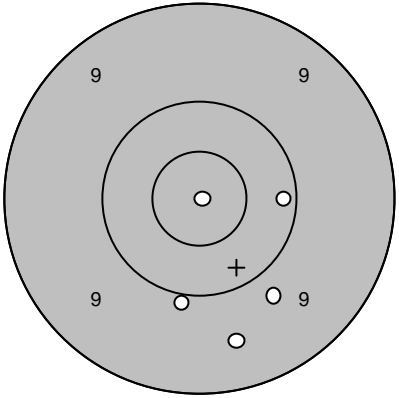
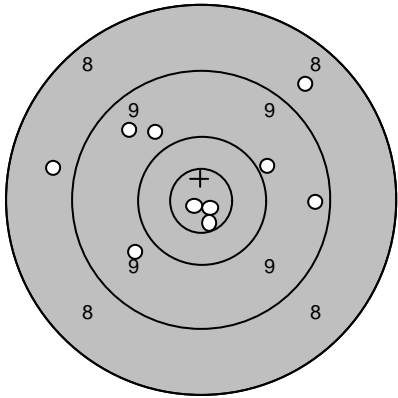
Skjutlag 2	Tavla 3	Carina Norling	
Ramselefors		Söderala	
05.07.2006		Tavelträffen A - 2006	Ramselefors Skytteförening
Prov 	1: 9,8 ↗ 2: 10,4 ↗ 3: 9,3 ← 4: 10,1 ↗ 5: 9,8 →	Serie 1 	1: 10,2 ↗ 2: 10,0 → 3: 10,1 ↓ 4: 9,2 ← 5: 9,5 ←
	Serie 47,0		Serie 48,0
	Totalt 0,0		Totalt 48,0
Serie 2 	1: 10,8* ← 2: 9,9 → 3: 9,6 ↗ 4: 9,3 ↓ 5: 9,8 ↙	Serie 3 	1: 10,2 → 2: 9,5 ↓ 3: 10,0 ↓ 4: 9,8 ↘ 5: 10,9* →
	Serie 46,0		Serie 48,0
	Totalt 94,0		Totalt 142,0
Extratävling 	1: 8,7 ↗ 2: 9,9 → 3: 9,8 ↙ 4: 10,9* ↘ 5: 10,9* ↙ 6: 8,8 ← 7: 9,3 → 8: 9,5 ↗ 9: 10,7* ↓ 10: 9,8 ↗		
	Serie 91,0		
	Totalt 233,0		

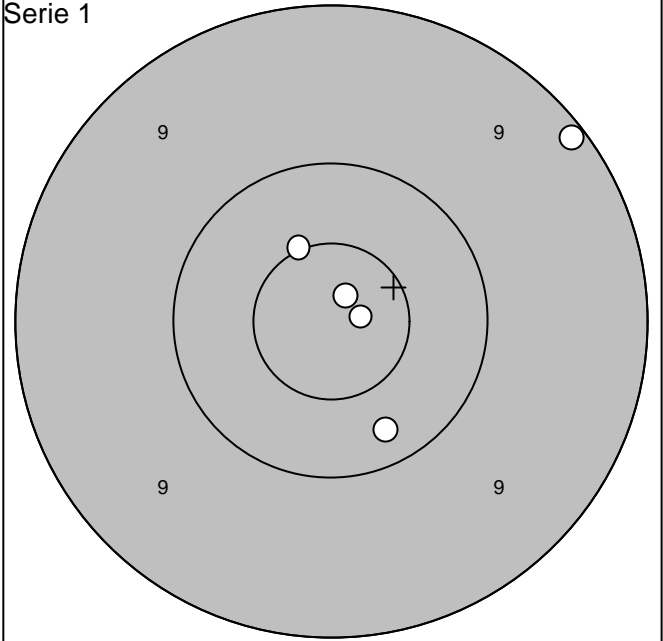
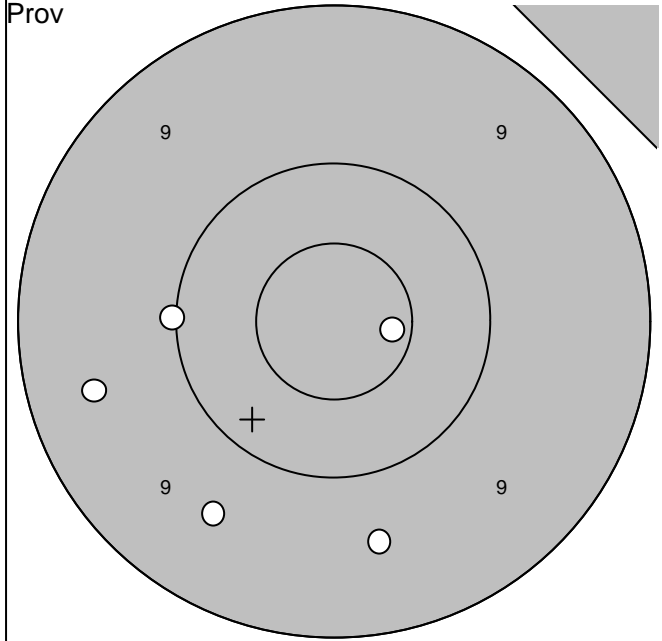

1:10,0 ←		Serie	47,0
2: 9,5 ←		Totalt	0,0
3:10,7* →			
4: 9,6 ↘			
5: 9,6 ↓			

1: 9,1 ↗		Serie	49,0
2:10,3 ↘		Totalt	49,0
3:10,8* →			
4:10,5* ↗			
5:10,8* ↗			

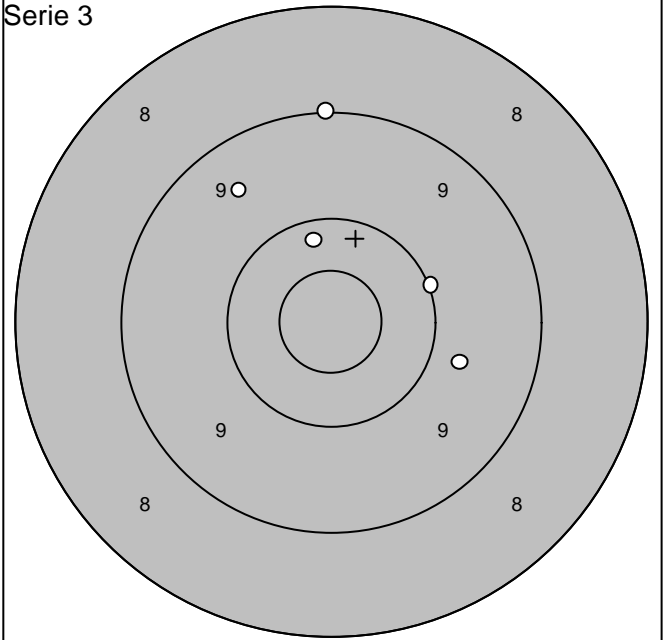
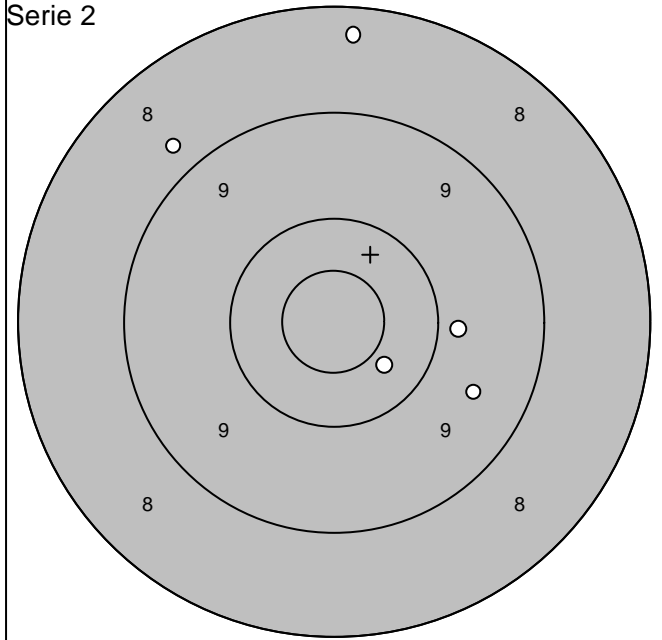

1: 8,3 ↑		Serie	44,0
2:10,4 ↘		Totalt	93,0
3: 9,8 →			
4: 8,8 ↗			
5: 9,5 ↘			

1: 9,5 ↗		Serie	47,0
2: 9,7 →		Totalt	140,0
3:10,0 →			
4:10,2 ↑			
5: 9,0 ↑			

Skjutlag 2	Tavla 5	Stefan Lundqvist
----------------------	-------------------	-------------------------

Ramselefors	Ununge	
-------------	--------	--

05.07.2006	Tavelträffen A - 2006	Ramselefors Skytteförening
------------	-----------------------	----------------------------

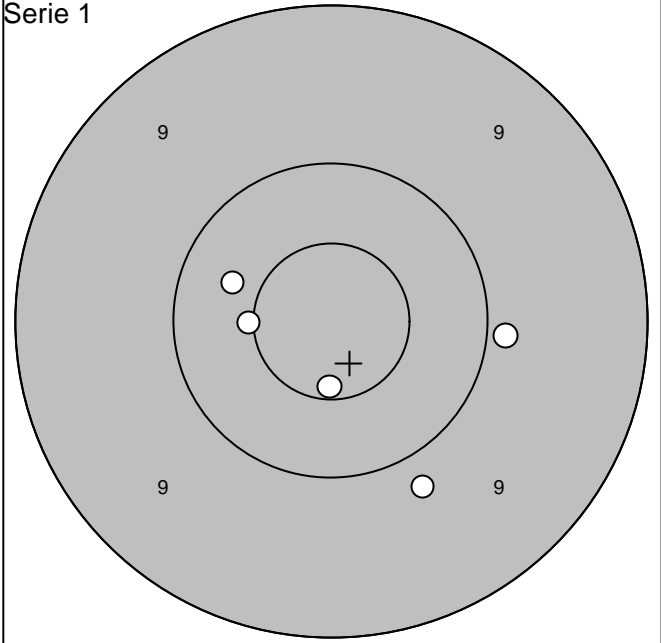
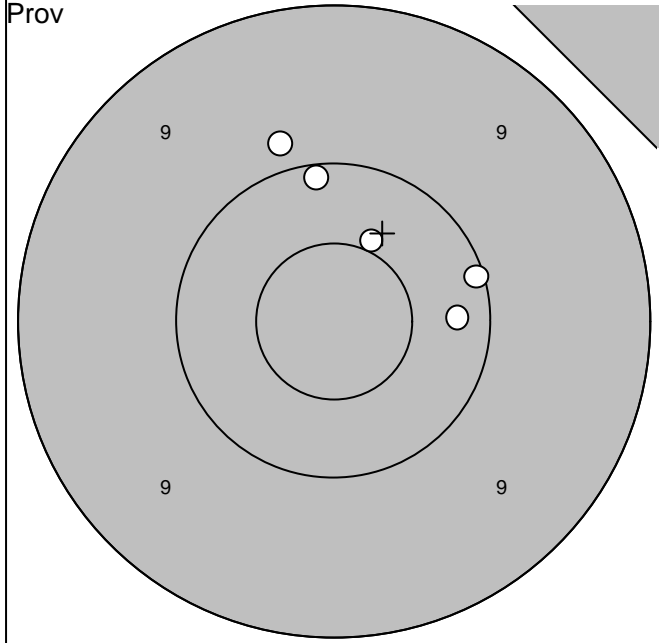

1:10,1	➔
2:10,2	➔
3:10,5*	↗
4: 9,9	↗
5:10,1	↗

Serie	49,0
Totalt	0,0

1: 9,9	➔
2:10,5*	↖
3:10,4	↖
4:10,6*	↘
5: 9,8	↘

Serie	48,0
Totalt	48,0

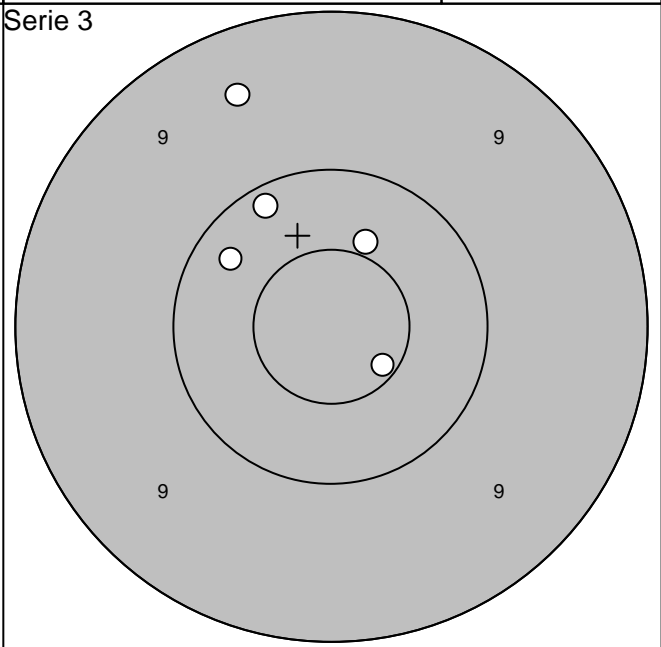
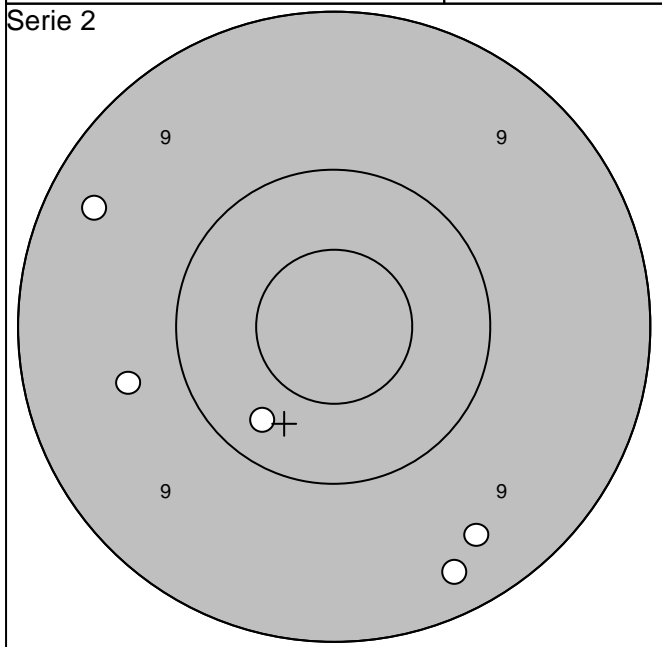

1: 9,4	↘
2: 9,3	↖
3: 9,7	↖
4:10,3	↘
5: 9,3	↘

Serie	46,0
Totalt	94,0

1:10,3	↗
2: 9,5	↗
3:10,5*	↗
4:10,6*	↘
5:10,2	↗

Serie	49,0
Totalt	143,0

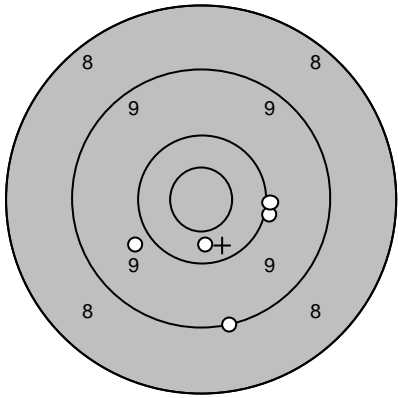
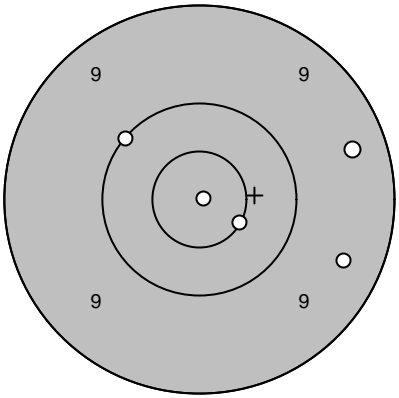
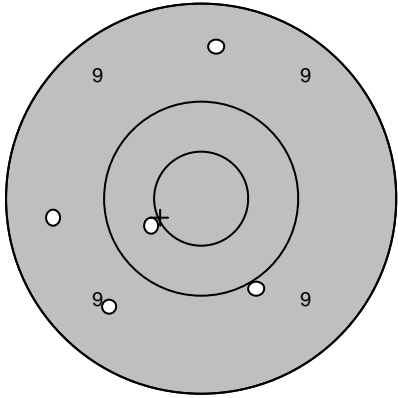
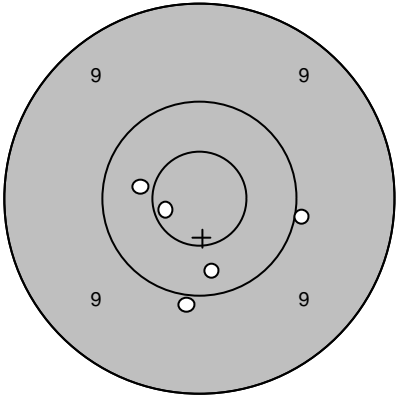
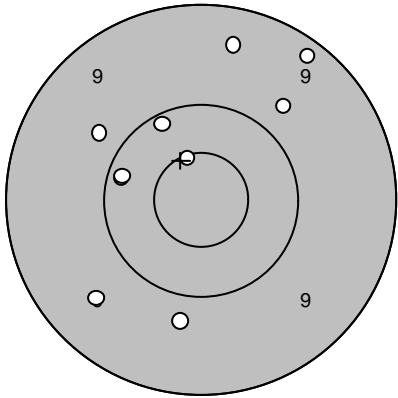
Skjutlag 2	Tavla 6	Linda Bergman	
Ramselefors		Ununge	
05.07.2006		Tavelträffen A - 2006	Ramselefors Skytteförening
Prov 	1: 9,1 ↓	Serie 1 	1: 9,4 →
	2: 10,4 ↓		2: 10,6* ↘
	3: 9,9 ↙		3: 10,9* →
	4: 10,0 →		4: 10,1 ↗
	5: 10,0 →		5: 9,4 ↘
	Serie 48,0		Serie 48,0
	Totalt 0,0		Totalt 48,0
Serie 2 	1: 9,5 ↑	Serie 3 	1: 10,0 →
	2: 9,5 ←		2: 10,3 ↓
	3: 10,5* ←		3: 10,7* ←
	4: 9,6 ↙		4: 9,9 ↓
	5: 10,0 ↘		5: 10,4 ←
	Serie 47,0		Serie 49,0
	Totalt 95,0		Totalt 144,0
Extratävling 	1: 9,4 ↑		
	2: 9,2 ↗		
	3: 9,8 ↓		
	4: 9,6 ↙		
	5: 10,2 ↗		
	6: 10,2 ←		
	7: 9,8 ↗		
	8: 10,2 ↙		
	9: 10,6* ↑		
	10: 9,8 ↗		
	Serie 94,0		
	Totalt 238,0		

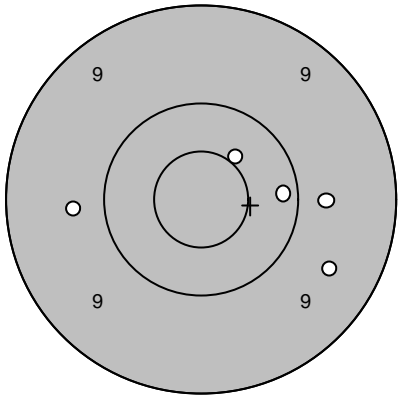
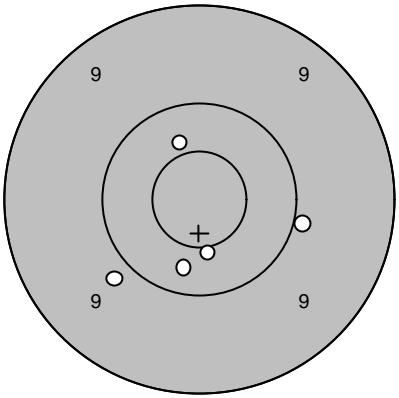
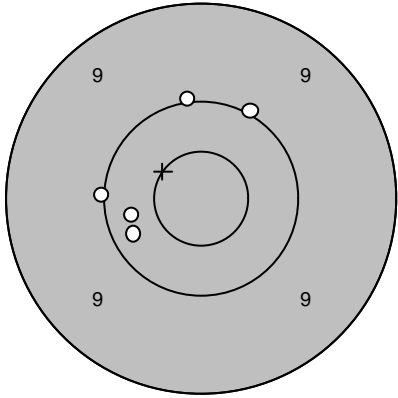
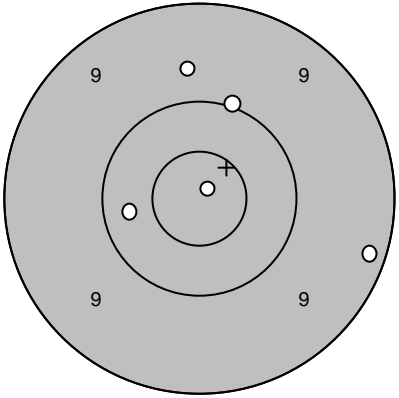
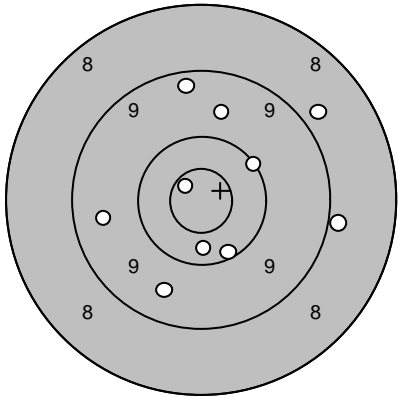
Skjutlag 2	Tavla 7	Therese Danielsson	
Ramselefors		Ununge	
05.07.2006		Tavelträffen A - 2006	Ramselefors Skytteförening
Prov 	1: 10,2 → 2: 9,5 → 3: 10,5* ↗ 4: 9,8 → 5: 9,7 ←	Serie 1 	1: 10,4 ↑ 2: 9,9 ↙ 3: 10,5* ↓ 4: 9,9 → 5: 10,3 ↓
	Serie 47,0		Serie 48,0
	Totalt 0,0		Totalt 48,0
Serie 2 	1: 10,0 ↗ 2: 10,3 ← 3: 10,0 ↑ 4: 10,0 ← 5: 10,3 ↙	Serie 3 	1: 10,0 ↑ 2: 10,3 ← 3: 10,9* ↗ 4: 9,7 ↑ 5: 9,2 →
	Serie 50,0		Serie 48,0
	Totalt 98,0		Totalt 146,0
Extratävling 	1: 9,7 ↑ 2: 8,9 → 3: 10,8* ↗ 4: 9,6 ← 5: 10,2 ↓ 6: 9,6 ↓ 7: 10,3 ↓ 8: 9,3 ↑ 9: 10,1 ↗ 10: 8,8 ↗		
	Serie 92,0		
	Totalt 238,0		

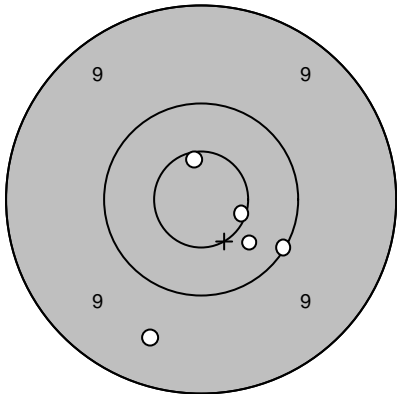
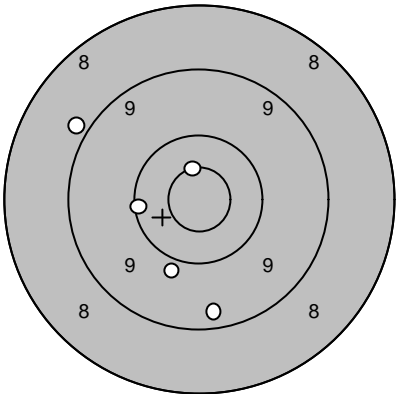
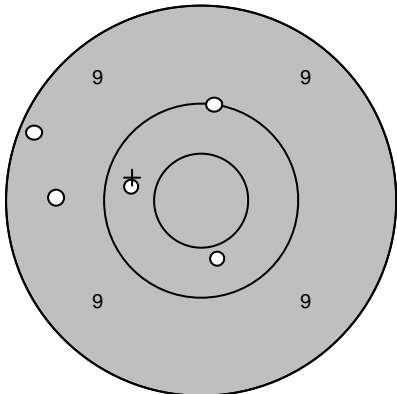
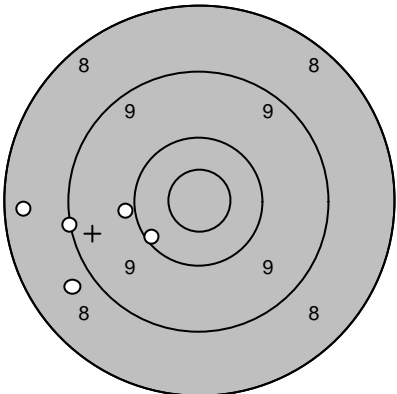
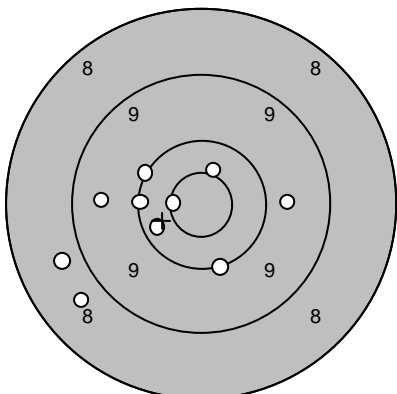
Skjutlag	Tavla	Tony Jansson		
2	8			
Ramselefors	Ununge			
05.07.2006	Tavelträffen A - 2006	Ramselefors Skytteförening		
Prov		Serie 1 1: 10,1 ↘ 2: 10,4 ↘ 3: 10,6* ↑ 4: 9,5 ↘ 5: 10,6* →		1: 9,3 ↓ 2: 9,9 ↓ 3: 10,6* ↑ 4: 10,2 ← 5: 8,9 ↖
	Serie 49,0 Totalt 0,0	Serie 46,0 Totalt 46,0		
Serie 2		Serie 3 1: 9,6 ← 2: 9,2 ↖ 3: 10,3 ← 4: 10,0 ↑ 5: 10,4 ↘		1: 8,7 ↖ 2: 10,2 ↖ 3: 9,9 ← 4: 9,1 ← 5: 8,4 ←
	Serie 48,0 Totalt 94,0	Serie 44,0 Totalt 138,0		
Extratävling		1: 10,3 ↖ 2: 10,1 ↓ 3: 9,8 → 4: 10,1 ↖ 5: 10,1 ← 6: 10,6* ← 7: 10,5* ↑ 8: 8,7 ↖ 9: 9,5 ← 10: 8,8 ↖		
	Serie 94,0 Totalt 232,0			

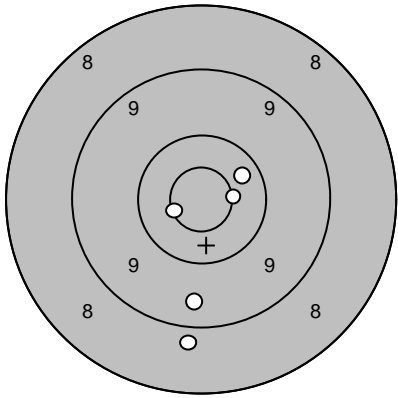
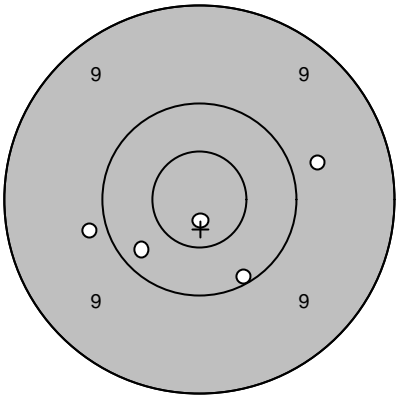
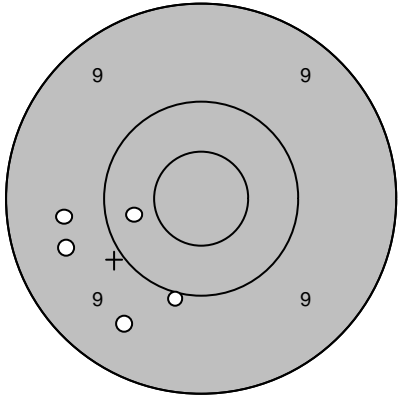
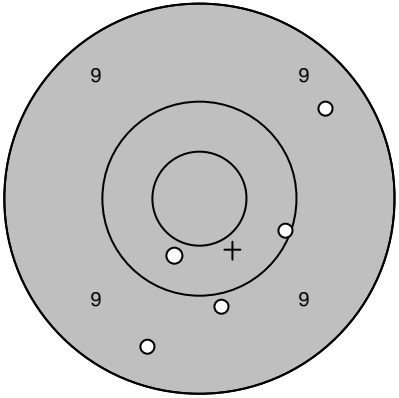
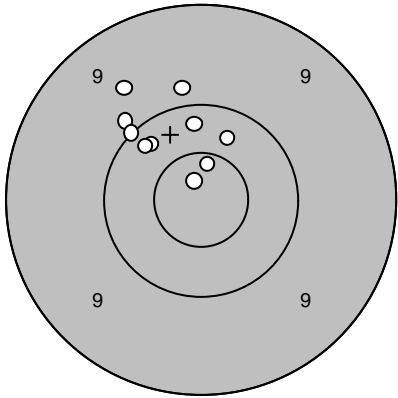
Skjutlag 2	Tavla 9	Jan-Olof Lampinen		
Ramselefors		S 3		
05.07.2006		Tavelträffen A - 2006	Ramselefors Skytteförening	
Prov		1: 8,9 ↓ 2: 9,5 ↓ 3: 10,6* ← 4: 10,6* → 5: 10,4 ↗	Serie 1 	1: 9,8 → 2: 10,3 ↙ 3: 10,8* ↓ 4: 9,9 ← 5: 10,1 ↓
		Serie 47,0	Serie 48,0	
		Totalt 0,0	Totalt 48,0	
Serie 2		1: 10,3 ← 2: 10,0 ↓ 3: 9,5 ↙ 4: 9,6 ← 5: 9,6 ←	Serie 3 	1: 9,5 ↗ 2: 9,4 ↓ 3: 9,9 ↓ 4: 10,1 → 5: 10,4 ↓
		Serie 47,0	Serie 47,0	
		Totalt 95,0	Totalt 142,0	
Extratävling		1: 10,3 ↗ 2: 10,3 ↑ 3: 9,9 ↑ 4: 10,7* ↑ 5: 9,9 ↗ 6: 10,3 ↑ 7: 10,0 ↗ 8: 10,8* ↑ 9: 9,7 ↗ 10: 10,2 ↗		
		Serie 97,0		
		Totalt 239,0		

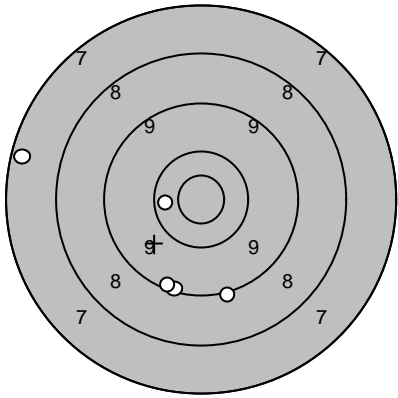
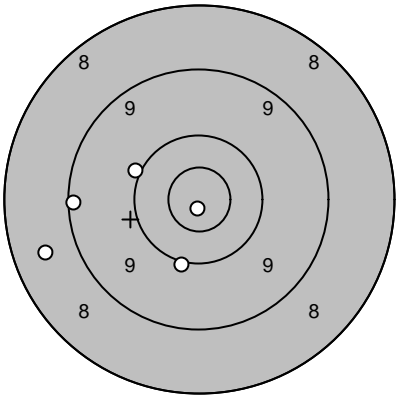
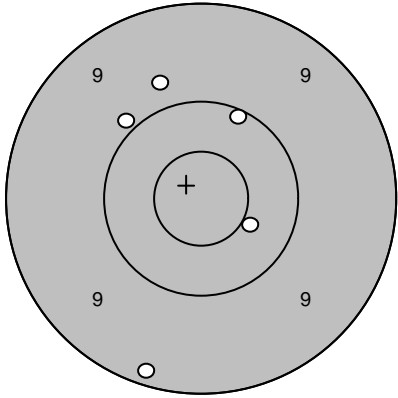
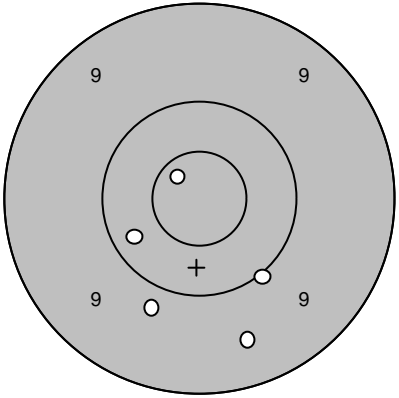
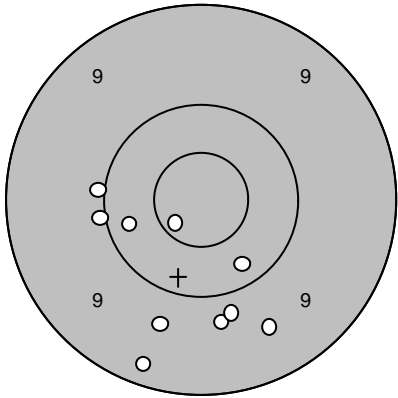
Skjutlag 2	Tavla 10	Matthias Lampinen	
Ramselefors		S 3	
05.07.2006		Tavelträffen A - 2006	Ramselefors Skytteförening
Prov		1: 9,2 ↓ 2: 9,1 ↓ 3: 7,4 ← 4: 9,2 ↓ 5: 10,4 ←	Serie 1  1: 10,0 ↖ 2: 8,6 ← 3: 9,2 ← 4: 10,9* ↓ 5: 10,0 ↓
		Serie 44,0	Serie 47,0
		Totalt 0,0	Totalt 47,0
Serie 2		1: 9,2 ↓ 2: 10,1 ↗ 3: 10,5* → 4: 9,8 ↗ 5: 9,9 ↗	Serie 3  1: 9,5 ↓ 2: 10,7* ↗ 3: 10,0 ↓ 4: 9,8 ↓ 5: 10,3 ←
		Serie 47,0	Serie 48,0
		Totalt 94,0	Totalt 142,0
Extratävling		1: 9,8 ↓ 2: 10,7* ← 3: 10,3 ↓ 4: 9,7 ↓ 5: 10,0 ← 6: 9,6 ↓ 7: 10,0 ← 8: 10,3 ← 9: 9,8 ↓ 10: 9,3 ↓	
		Serie 95,0	
		Totalt 237,0	

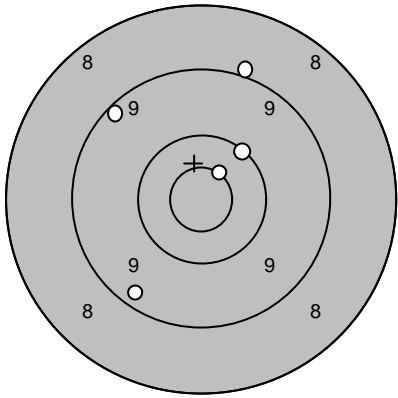
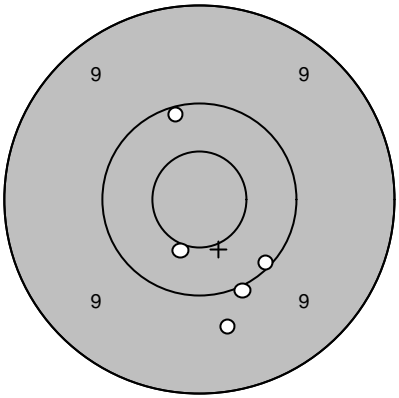
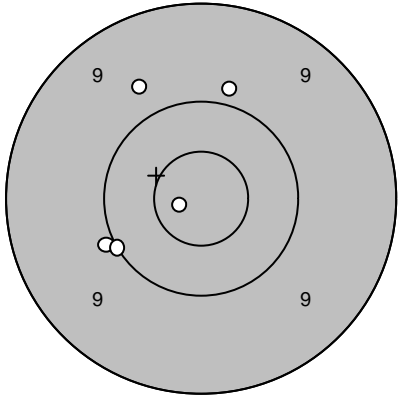
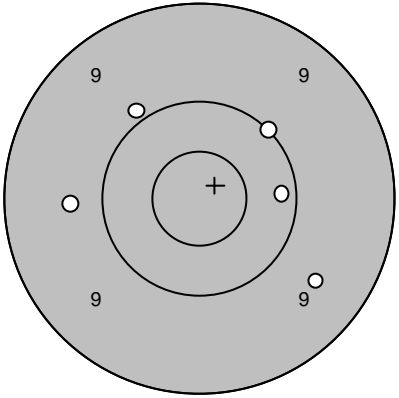
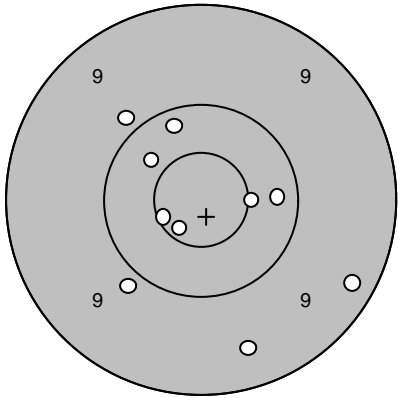
Skjutlag 2	Tavla 11	Kjell Marklund		
Ramselefors		S 3		
05.07.2006		Tavelträffen A - 2006	Ramselefors Skytteförening	
Prov		1: 9,0 ↗ 2: 10,6* ↗ 3: 9,2 ↖ 4: 9,3 ↓ 5: 10,1 ↗	Serie 1 	1: 10,1 ↘ 2: 10,1 ↗ 3: 9,7 ↓ 4: 10,5* ↓ 5: 10,0 ↓
		Serie 47,0	Serie 49,0	
		Totalt 0,0	Totalt 49,0	
Serie 2		1: 9,7 ↖ 2: 10,0 ← 3: 10,0 ← 4: 9,9 ↑ 5: 10,8* ←	Serie 3 	1: 10,0 ↗ 2: 9,9 ↗ 3: 10,2 → 4: 9,6 ↓ 5: 9,7 ←
		Serie 48,0	Serie 47,0	
		Totalt 97,0	Totalt 144,0	
Extratävling		1: 9,9 ↓ 2: 10,5* → 3: 9,3 → 4: 10,4 ↖ 5: 10,7* ↓ 6: 10,3 → 7: 9,9 ↗ 8: 9,5 ↓ 9: 10,6* ← 10: 10,2 ↗		
		Serie 96,0		
		Totalt 240,0		

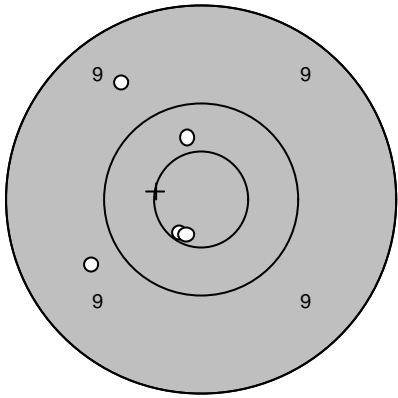
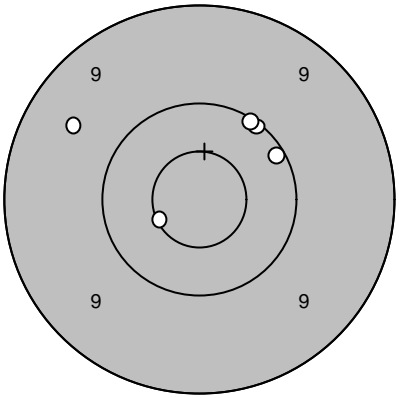
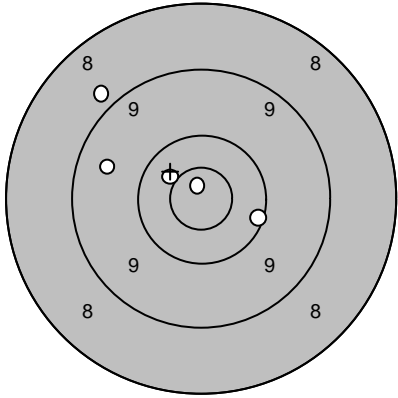
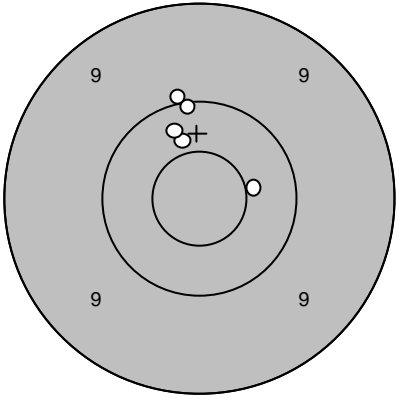
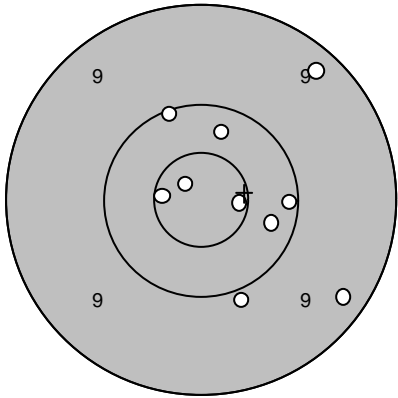
Skjutlag 2	Tavla 12	Liselott Danielsson	
Ramselefors	Växjö		
05.07.2006	Tavelträffen A - 2006	Ramselefors Skytteförening	
Prov		1: 10,6* ↘ 2: 10,6* ↘ 3: 10,4 ↑ 4: 9,7 ↙ 5: 9,6 ↗	Serie 1 
			1: 10,1 ↗ 2: 10,1 ↗ 3: 10,1 ↗ 4: 9,6 ↙ 5: 10,6* ↙
		Serie 48,0	Serie 49,0
		Totalt 0,0	Totalt 49,0
Serie 2		1: 10,2 → 2: 8,9 ↗ 3: 10,9* ↑ 4: 9,6 ↙ 5: 10,5* ↗	Serie 3 
			1: 10,1 ↑ 2: 10,0 ↑ 3: 10,4 ↑ 4: 10,3 ↑ 5: 10,5* →
		Serie 47,0	Serie 50,0
		Totalt 96,0	Totalt 146,0
Extratävling		1: 10,8* ↗ 2: 10,6* → 3: 9,3 ↘ 4: 10,3 → 5: 10,3 ↑ 6: 9,9 ↘ 7: 10,6* ↙ 8: 10,1 ↑ 9: 9,3 ↗ 10: 10,1 →	
		Serie 97,0	
		Totalt 243,0	

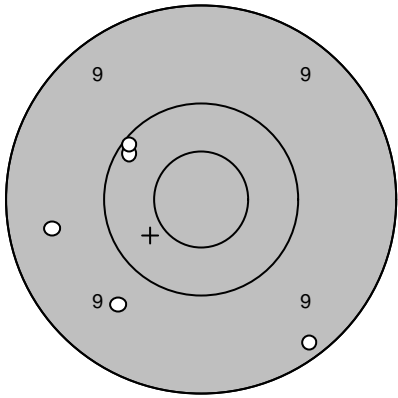
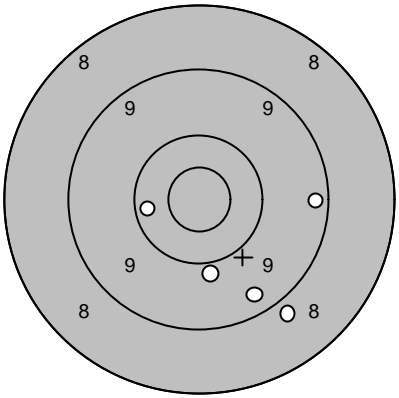
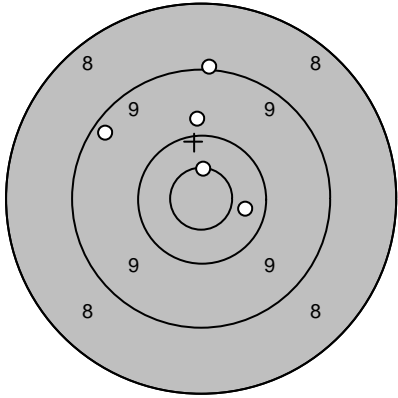
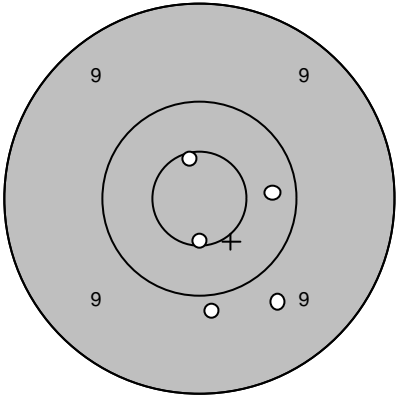
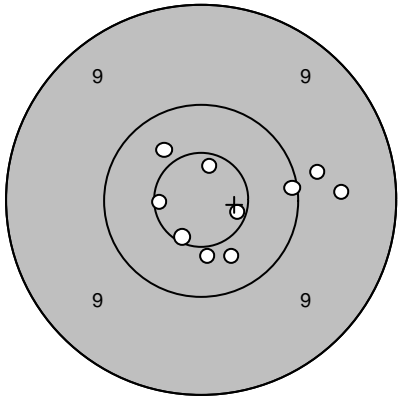
Skjutlag 2	Tavla 14	Lars Evaldsson	
Ramselefors		Göteborg	
05.07.2006		Tavelträffen A - 2006	Ramselefors Skytteförening
Prov 	1: 10,2 ↖ 2: 9,7 ↙ 3: 9,5 ← 4: 10,1 ↗ 5: 9,2 ↘	Serie 1 	1: 8,9 ↘ 2: 9,3 → 3: 9,9 ↙ 4: 10,3 ← 5: 9,4 ↘
	Serie 47,0 Totalt 0,0		Serie 45,0 Totalt 45,0
Serie 2 	1: 9,3 ↖ 2: 9,8 ↑ 3: 10,6* ↑ 4: 10,4 → 5: 9,1 ↑	Serie 3 	1: 10,6* ↑ 2: 10,3 → 3: 9,9 ↙ 4: 10,6* ↘ 5: 9,7 ↘
	Serie 47,0 Totalt 92,0		Serie 48,0 Totalt 140,0
Extratävling 	1: 9,8 → 2: 10,1 → 3: 10,7* ↑ 4: 10,5* ↓ 5: 10,4 ↗ 6: 10,6* ← 7: 9,6 → 8: 10,6* → 9: 10,6* ↘ 10: 10,4 ↘		
	Serie 98,0 Totalt 238,0		

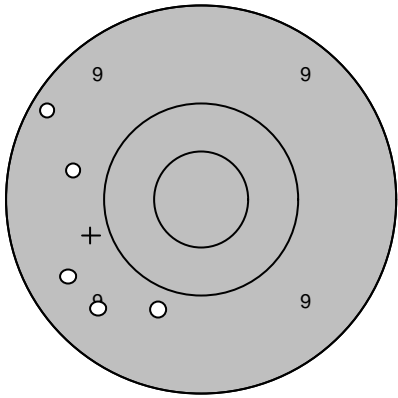
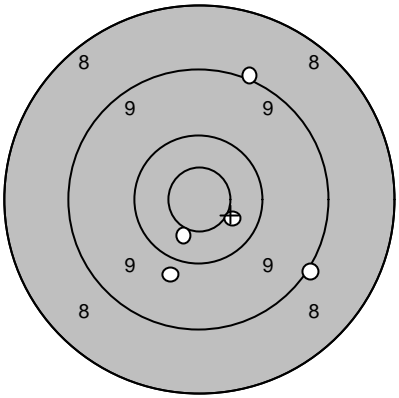
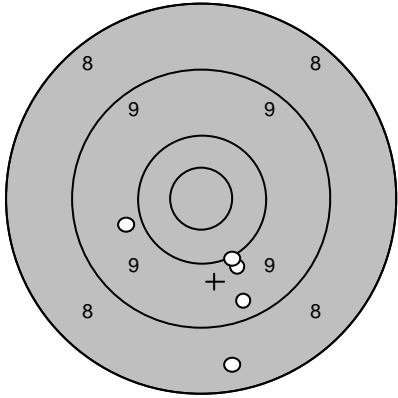
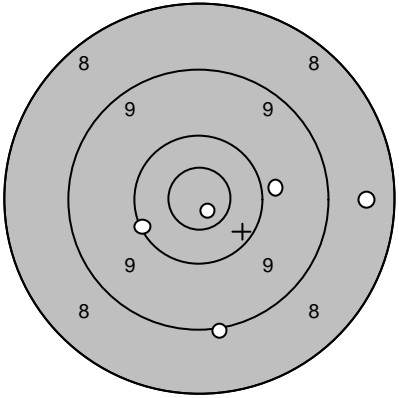
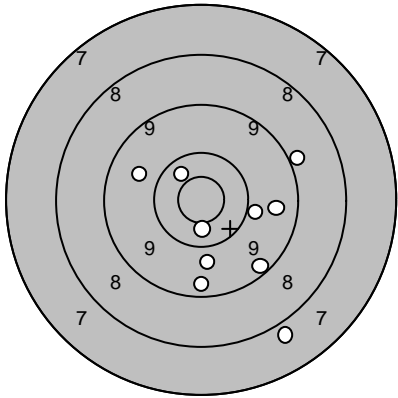
Skjutlag 2	Tavla 15	Håkan Engman	
Ramselefors		Lindesberg	
05.07.2006		Tavelträffen A - 2006	Ramselefors Skytteförening
Prov 	1: 9,8 ↓ 2: 9,5 ↓ 3: 9,5 ← 4: 9,2 ↗ 5: 9,7 ←	Serie 1 	1: 9,0 ↗ 2: 10,5* ↓ 3: 9,0 ↘ 4: 9,8 ↓ 5: 10,5* ↘
	Serie 45,0		Serie 47,0
	Totalt 0,0		Totalt 47,0
Serie 2 	1: 9,9 ↓ 2: 8,5 ↓ 3: 10,0 ↓ 4: 9,9 ← 5: 9,4 ↓	Serie 3 	1: 10,1 ← 2: 10,9* ↓ 3: 8,5 → 4: 9,9 → 5: 9,0 ↓
	Serie 45,0		Serie 46,0
	Totalt 92,0		Totalt 138,0
Extratävling 	1: 9,9 ↓ 2: 9,3 ↓ 3: 7,9 ↓ 4: 10,0 → 5: 9,7 ↗ 6: 10,5* ↓ 7: 9,0 ↗ 8: 9,4 ↓ 9: 10,5* ↗ 10: 9,6 →		
	Serie 91,0		
	Totalt 229,0		

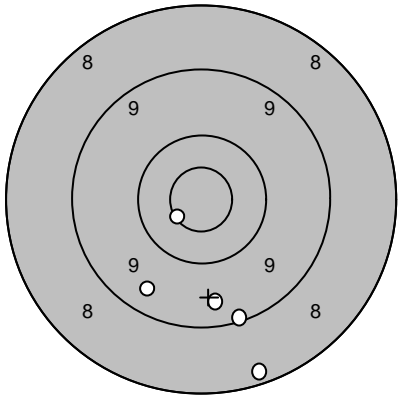
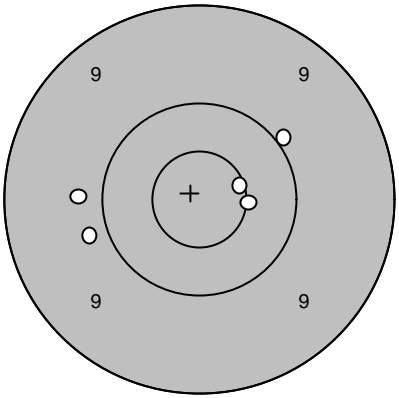
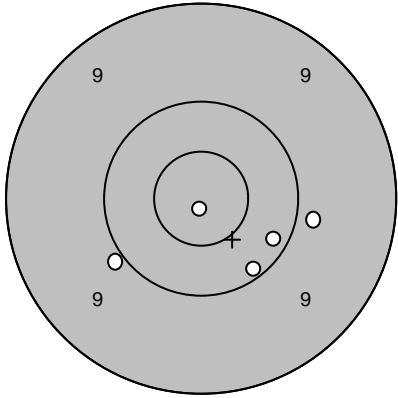
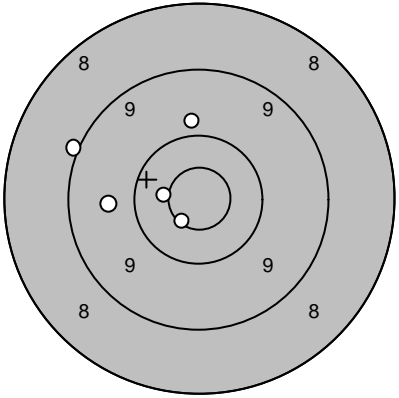
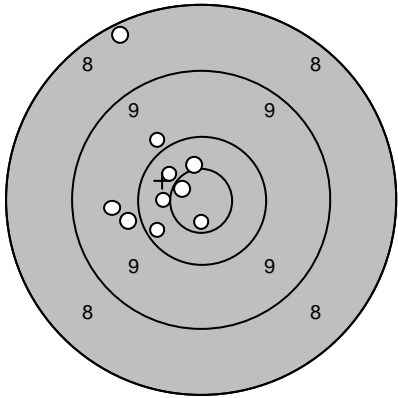
Skjutlag 2	Tavla 19	Donald Johansson	
Ramselefors		Ale	
05.07.2006		Tavelträffen A - 2006	Ramselefors Skytteförening
Prov		1: 8,3 ↓ 2: 9,2 ↓ 3: 10,6* ← 4: 9,5 ↓ 5: 9,5 ↓	Serie 1 
		Serie 45,0 Totalt 0,0	1: 10,6* → 2: 10,5* → 3: 9,8 ← 4: 10,0 ↗ 5: 9,9 ←
			Serie 48,0 Totalt 48,0
Serie 2		1: 10,0 ← 2: 10,1 ↓ 3: 10,9* ↓ 4: 9,9 → 5: 10,2 →	Serie 3 
		Serie 49,0 Totalt 97,0	1: 9,0 ← 2: 9,9 ↑ 3: 10,5* ← 4: 9,7 ← 5: 10,7* ↘
			Serie 47,0 Totalt 144,0
Extratävling		1: 8,3 ↗ 2: 9,9 ↗ 3: 10,3 ← 4: 9,7 ← 5: 10,8* ↗ 6: 10,5* ↗ 7: 10,5* ← 8: 10,5* ↑ 9: 10,7* ↓ 10: 9,9 ←	
		Serie 95,0 Totalt 239,0	

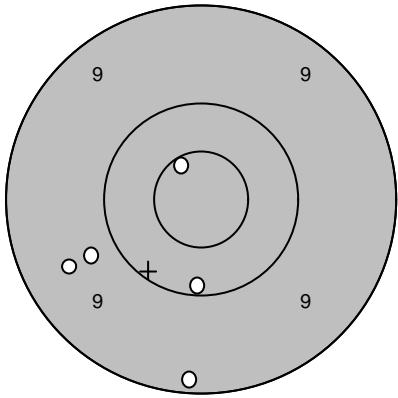
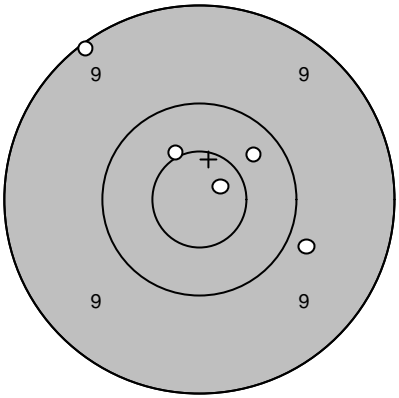
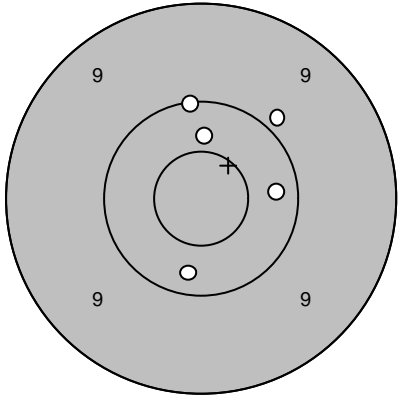
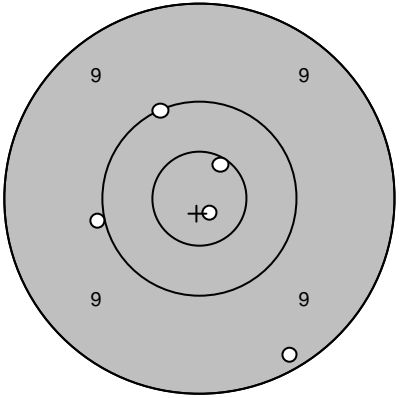
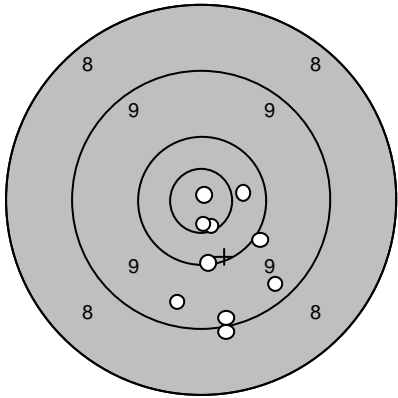
Skjutlag 2	Tavla 20	Emil Johansson		
Ramselefors		Ale		
05.07.2006		Tavelträffen A - 2006	Ramselefors Skytteförening	
Prov		1: 9,8 ← 2: 10,6* ↖ 3: 9,5 ← 4: 10,2 ↓ 5: 9,2 ↓	Serie 1 	1: 10,8* ↗ 2: 9,1 ↖ 3: 9,8 ↘ 4: 10,3 ↗ 5: 10,5* ↖
		Serie 47,0	Serie 48,0	
		Totalt 0,0	Totalt 48,0	
Serie 2		1: 10,3 → 2: 10,3 ↓ 3: 10,1 ↑ 4: 10,4 ↑ 5: 9,9 ↗	Serie 3 	1: 10,6* ↗ 2: 9,2 ↓ 3: 10,0 ← 4: 10,1 ↗ 5: 10,9* ↘
		Serie 49,0	Serie 49,0	
		Totalt 97,0	Totalt 146,0	
Extratävling		1: 9,2 ↓ 2: 10,7* ↓ 3: 9,0 ↓ 4: 10,7* ↓ 5: 9,4 ↘ 6: 10,1 ↓ 7: 9,5 ↓ 8: 10,4 → 9: 10,9* ↗ 10: 10,0 ↘		
		Serie 96,0		
		Totalt 242,0		

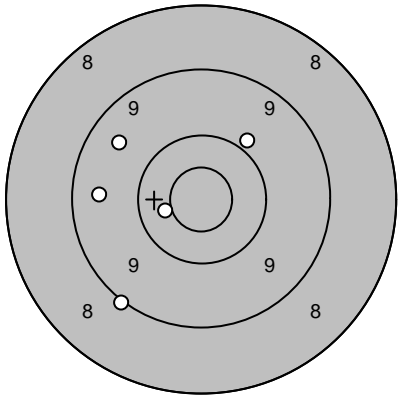
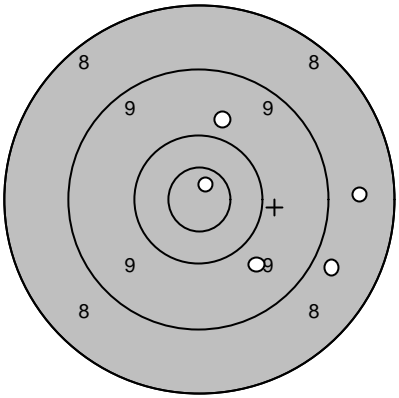
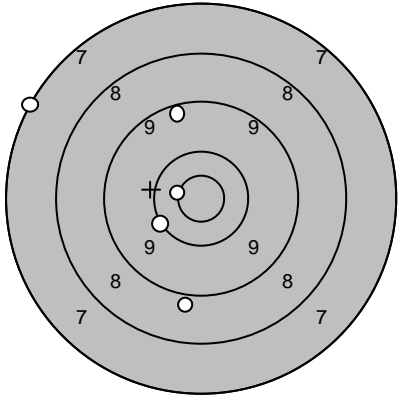
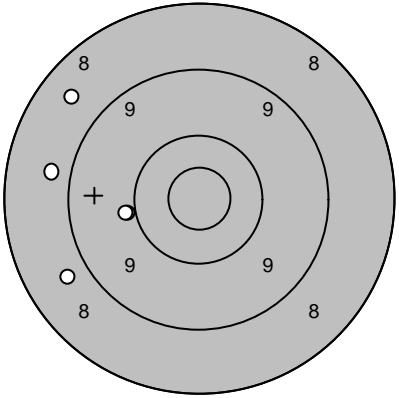
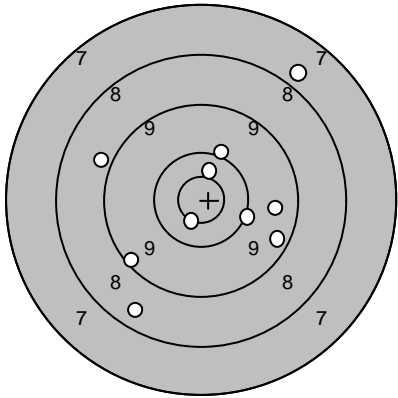
Skjutlag 2	Tavla 21	Alf Edin	
Ramselefors		Ale	
05.07.2006		Tavelträffen A - 2006	Ramselefors Skytteförening
Prov		1: 9,1 ↘ 2: 9,5 ← 3: 10,5* ← 4: 9,6 ↖ 5: 9,9 ↗	Serie 1 
		Serie 46,0 Totalt 0,0	1: 9,8 ↗ 2: 9,7 ↘ 3: 8,6 → 4: 8,8 ↘ 5: 10,8* ↗
			Serie 44,0 Totalt 44,0
Serie 2		1: 10,6* ← 2: 7,1 ↖ 3: 9,3 ↗ 4: 8,9 ↓ 5: 10,1 ↖	Serie 3 
		Serie 44,0 Totalt 88,0	1: 8,6 ↖ 2: 8,8 ← 3: 10,0 ← 4: 9,9 ← 5: 8,7 ↖
			Serie 43,0 Totalt 131,0
Extratävling		1: 10,6* ↘ 2: 7,9 ↗ 3: 9,6 → 4: 9,4 → 5: 10,1 → 6: 10,5* ↗ 7: 9,3 ↖ 8: 10,0 ↗ 9: 8,9 ↖ 10: 8,5 ↘	
		Serie 90,0 Totalt 221,0	

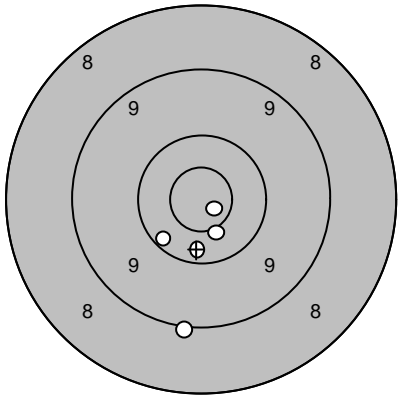
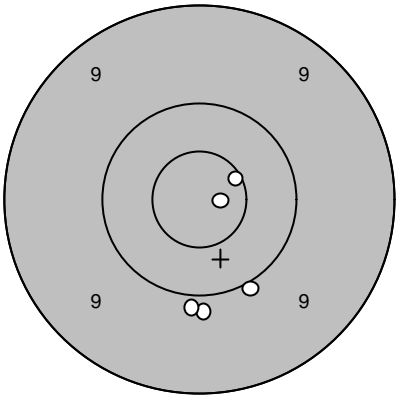
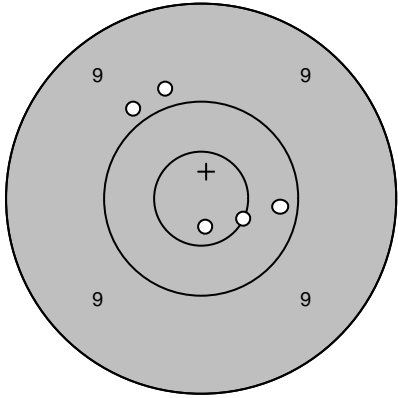
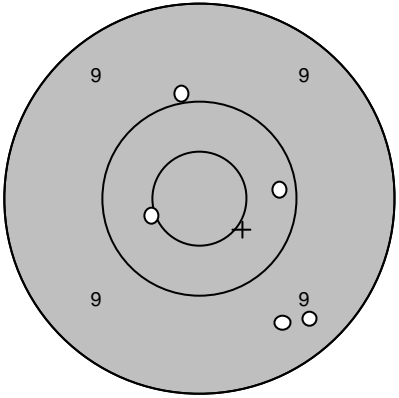
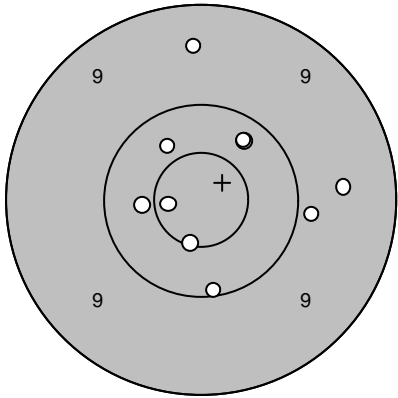
Skjutlag 2	Tavla 22	Joakim Nordlund	
Ramselefors		S 3	
05.07.2006		Tavelträffen A - 2006	Ramselefors Skytteförening
Prov		1: 10,8* ↘ 2: 10,5* ↓ 3: 9,1 ↓ 4: 10,2 ↙ 5: 10,3 ↓	Serie 1 
		Serie 49,0 Totalt 0,0	1: 10,6* ↗ 2: 9,9 ↓ 3: 10,0 ↘ 4: 10,8* → 5: 9,9 ↓
			Serie 48,0 Totalt 48,0
Serie 2		1: 9,9 ↗ 2: 9,9 ↗ 3: 10,7* ↓ 4: 10,2 → 5: 10,5* →	Serie 3 
		Serie 48,0 Totalt 96,0	1: 10,0 ↑ 2: 10,5* ← 3: 10,2 → 4: 9,4 ↘ 5: 9,5 ↘
			Serie 48,0 Totalt 144,0
Extratävling		1: 10,3 ↗ 2: 9,5 ↑ 3: 10,4 ↗ 4: 10,3 ↗ 5: 10,7* ← 6: 9,6 → 7: 10,4 ← 8: 10,6* ↓ 9: 10,1 ↓ 10: 9,9 →	
		Serie 97,0 Totalt 241,0	

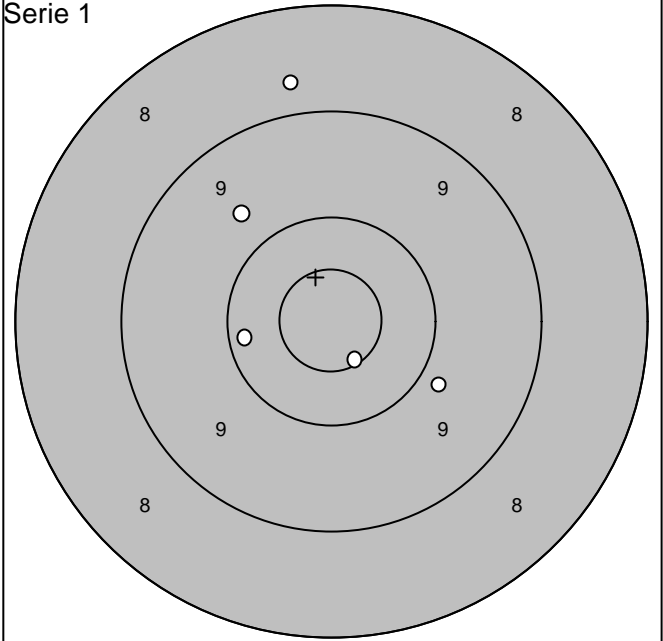
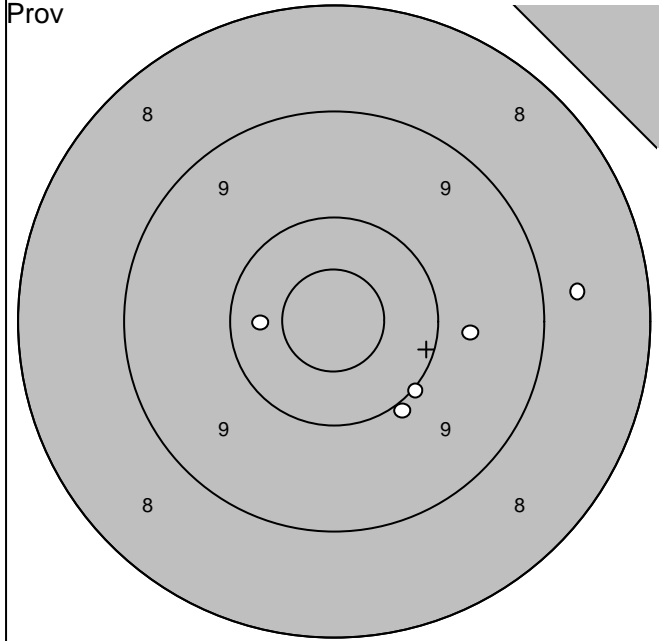

1: 9,7 →		Serie	47,0
2: 8,7 →		Totalt	0,0
3: 10,0 ↘			
4: 10,0 ↘			
5: 10,3 ←			

1: 8,7 ↑		Serie	46,0
2: 9,7 ↗		Totalt	46,0
3: 9,8 ↘			
4: 10,2 ←			
5: 10,6* ↘			

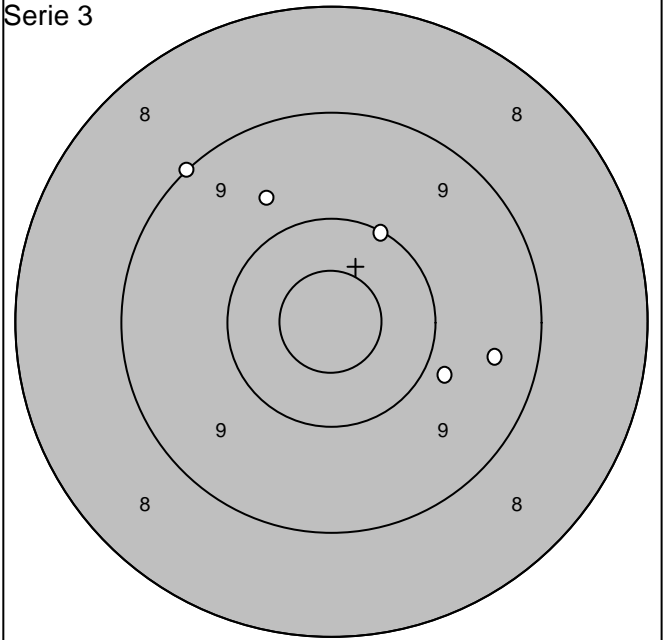
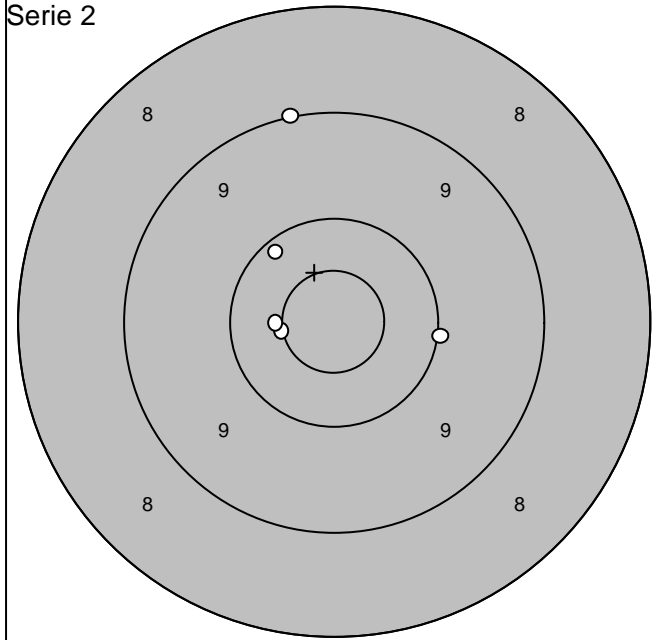

1: 10,0 →		Serie	49,0
2: 9,0 ↑		Totalt	95,0
3: 10,5* ←			
4: 10,2 ↗			
5: 10,5* ←			

1: 9,4 →		Serie	46,0
2: 9,8 →		Totalt	141,0
3: 10,1 ↗			
4: 9,7 ↗			
5: 9,0 ↗			

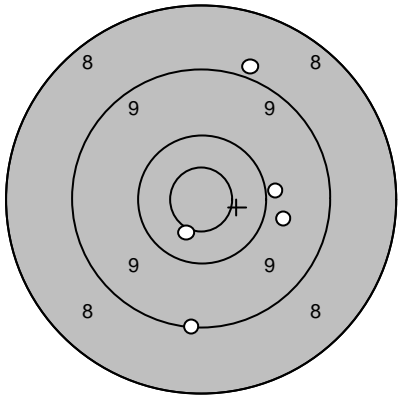
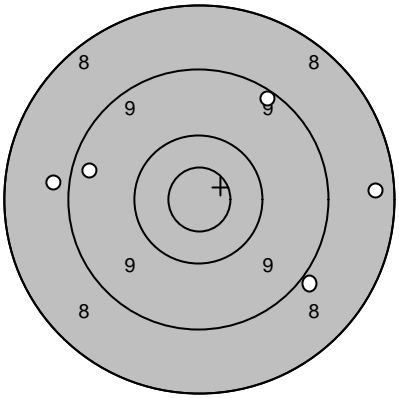
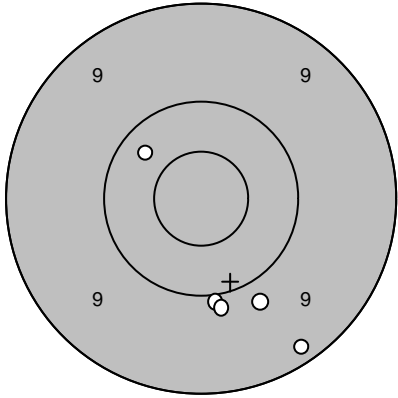
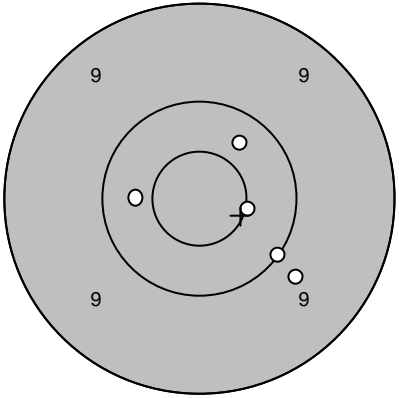
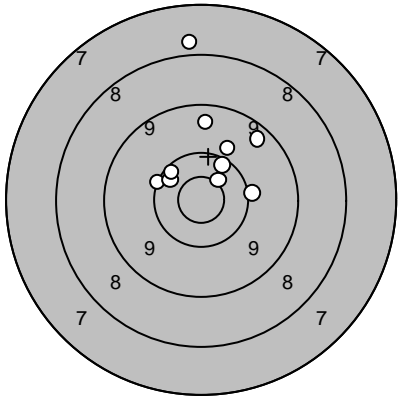
Skjutlag 3	Tavla 2	Stefan Sigfridsson	
Ramselefors		Ramselefors	
05.07.2006		Tavelträffen A - 2006	Ramselefors Skytteförening
Prov		1: 8,9 ↗ 2: 10,5* ↓ 3: 9,9 → 4: 9,8 → 5: 9,1 ↓	Serie 1 
		Serie 45,0 Totalt 0,0	1: 8,8 ← 2: 9,3 ← 3: 8,9 ↘ 4: 9,2 ↗ 5: 8,4 →
			Serie 42,0 Totalt 42,0
Serie 2		1: 10,3 ↗ 2: 9,8 ↓ 3: 9,2 ↓ 4: 10,0 ↓ 5: 9,9 ↓	Serie 3 
		Serie 47,0 Totalt 89,0	1: 9,8 ↘ 2: 10,0 ↓ 3: 10,3 ↗ 4: 10,5* → 5: 10,4 ←
			Serie 49,0 Totalt 138,0
Extratävling		1: 10,1 ← 2: 10,4 ↖ 3: 10,3 ↖ 4: 9,5 ↑ 5: 10,6* ↗ 6: 9,4 ↗ 7: 10,1 → 8: 10,3 ↗ 9: 7,9 ↑ 10: 9,9 ↗	
		Serie 94,0 Totalt 232,0	

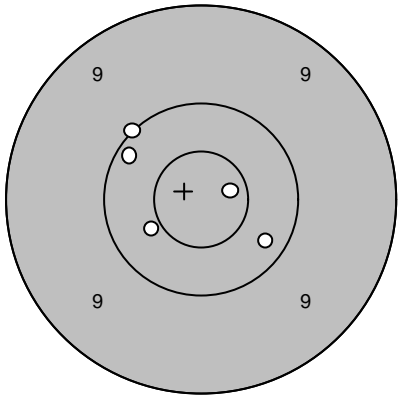
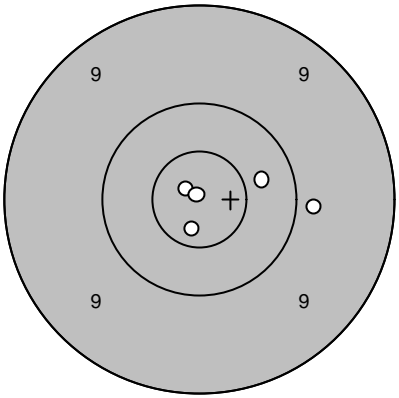
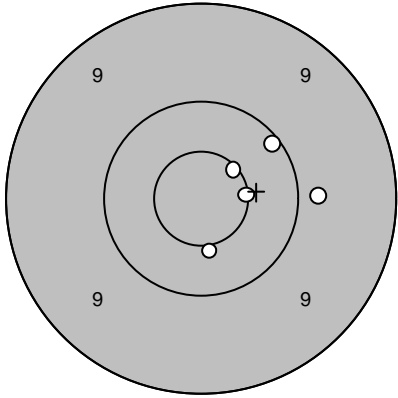
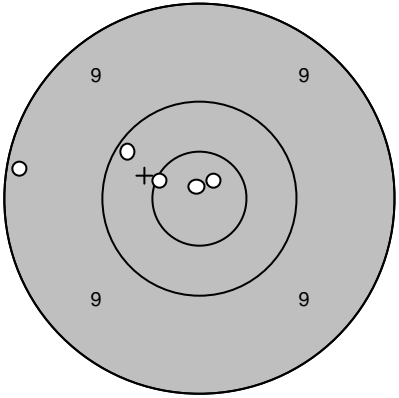
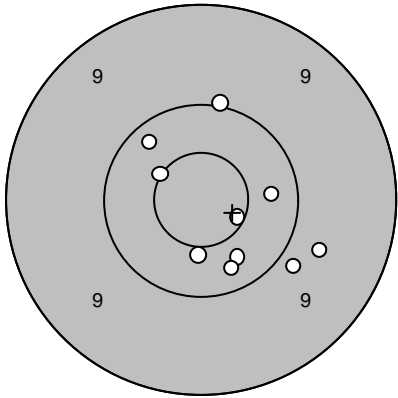
Skjutlag 3	Tavla 3	Ulf Ohlsson		
Ramselefors		Umeå		
05.07.2006		Tavelträffen A - 2006	Ramselefors Skytteförening	
Prov		1: 10,2 ↖ 2: 10,4 ← 3: 10,7* → 4: 10,0 ↗ 5: 10,2 ↘	Serie 1 	1: 10,7* ↓ 2: 10,9* ↖ 3: 9,9 → 4: 10,4 → 5: 10,9* ↗
		Serie 50,0	Serie 49,0	
		Totalt 0,0	Totalt 49,0	
Serie 2		1: 10,5* ↓ 2: 10,6* → 3: 10,6* ↗ 4: 9,8 → 5: 10,1 ↗	Serie 3 	1: 9,2 ← 2: 10,6* ↖ 3: 10,8* ↗ 4: 10,9* ↑ 5: 10,2 ↖
		Serie 49,0	Serie 49,0	
		Totalt 98,0	Totalt 147,0	
Extratävling		1: 9,7 → 2: 10,3 → 3: 10,0 ↑ 4: 9,9 ↘ 5: 10,3 ↘ 6: 10,5* ↓ 7: 10,5* ↗ 8: 10,6* ↘ 9: 10,3 ↘ 10: 10,2 ↗		
		Serie 98,0		
		Totalt 245,0		

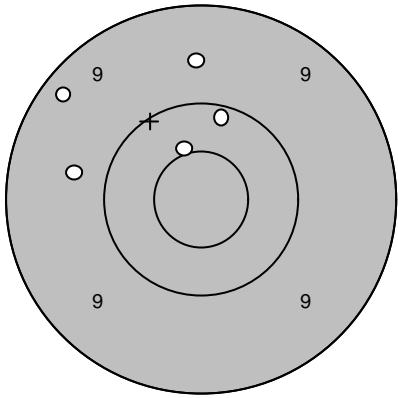
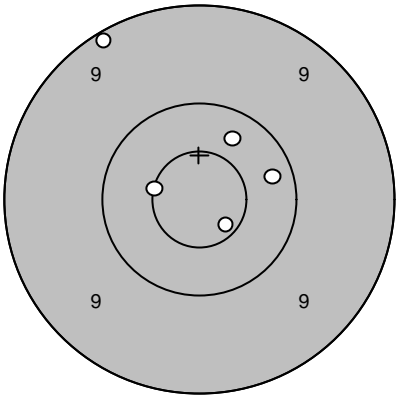
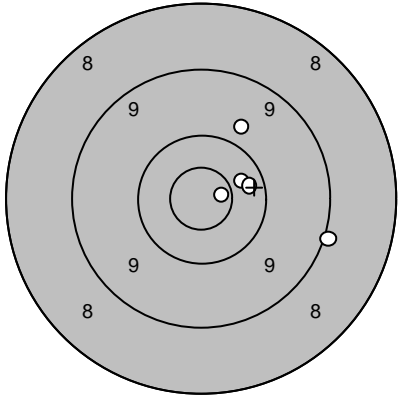
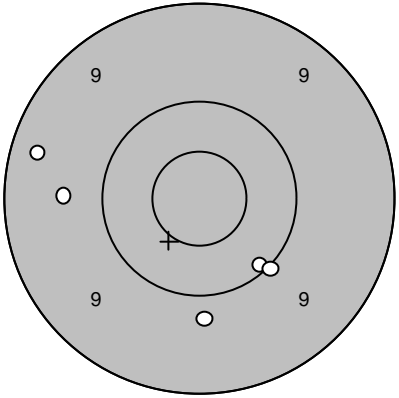
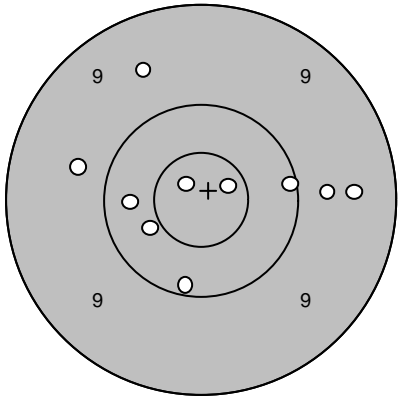
Skjutlag 3	Tavla 4	Sören Olsson	
Ramselefors		Umeå	
05.07.2006		Tavelträffen A - 2006	Ramselefors Skytteförening
Prov 	1: 9,6 ↑ 2: 10,5* ↑ 3: 9,7 ← 4: 10,2 ↑ 5: 9,3 ↖ Serie 47,0 Totalt 0,0	Serie 1 	1: 10,6* ← 2: 9,2 ↗ 3: 10,7* ↘ 4: 10,3 ↗ 5: 10,3 → Serie 49,0 Totalt 49,0
Serie 2 	1: 9,8 ↗ 2: 10,8* → 3: 10,4 → 4: 10,3 → 5: 9,0 → Serie 48,0 Totalt 97,0	Serie 3 	1: 9,3 ← 2: 9,7 ← 3: 9,8 ↓ 4: 10,1 ↘ 5: 10,0 ↘ Serie 47,0 Totalt 144,0
Extratävling 	1: 10,4 ← 2: 10,3 ← 3: 9,7 ← 4: 9,6 ↑ 5: 10,1 ↓ 6: 9,5 → 7: 10,7* ↗ 8: 9,7 → 9: 10,1 → 10: 10,8* ↖ Serie 96,0 Totalt 240,0		

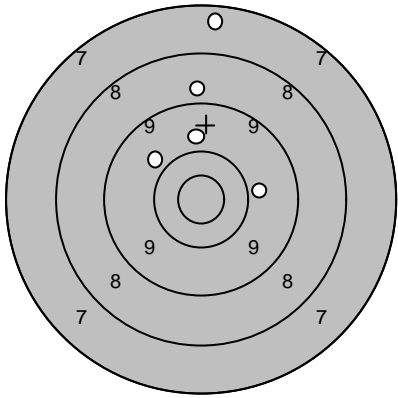
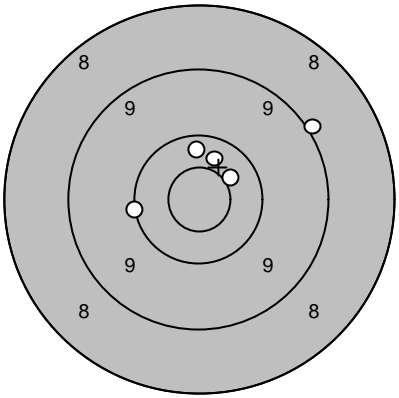
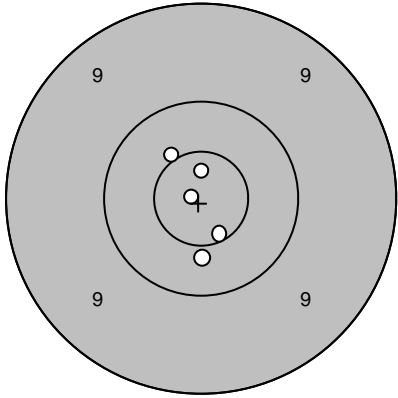
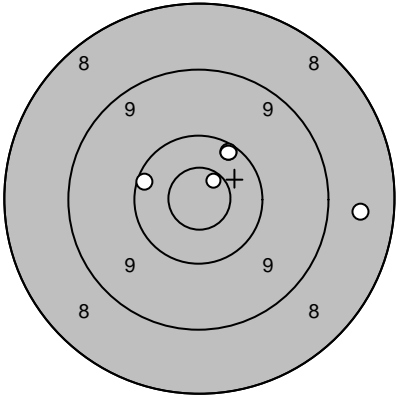
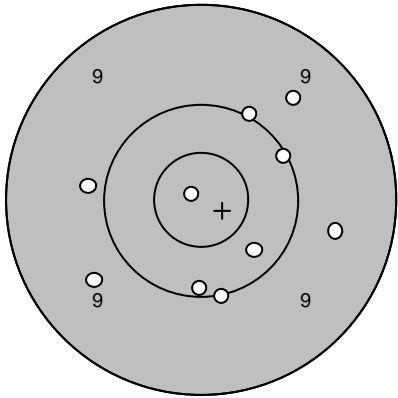
Skjutlag 3	Tavla 5	Stefan Thorin	
Ramselefors		Umeå	
05.07.2006		Tavelträffen A - 2006	Ramselefors Skytteförening
Prov		1: 7,5 ↑ 2: 8,9 ↑ 3: 9,9 → 4: 9,8 ↑ 5: 9,9 ↖	Serie 1  1: 10,5* ↗ 2: 10,4 ↑ 3: 10,1 ← 4: 10,3 ↑ 5: 9,0 ↗
		Serie 42,0	Serie 49,0
		Totalt 0,0	Totalt 49,0
Serie 2		1: 10,6* ↓ 2: 10,8* ↑ 3: 10,9* ← 4: 10,5* ↗ 5: 10,4 ↓	Serie 3  1: 10,2 ← 2: 10,2 ↑ 3: 10,7* ↗ 4: 8,6 → 5: 10,2 ↑
		Serie 50,0	Serie 48,0
		Totalt 99,0	Totalt 147,0
Extratävling		1: 10,1 ↓ 2: 10,0 ↓ 3: 9,6 → 4: 9,9 ← 5: 10,9* ↖ 6: 9,7 ↖ 7: 10,3 ↘ 8: 10,0 ↗ 9: 9,6 ↗ 10: 10,1 ↗	
		Serie 96,0	
		Totalt 243,0	

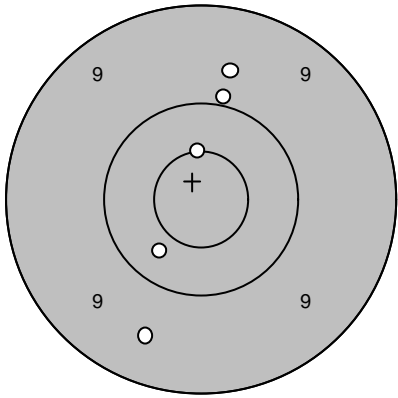
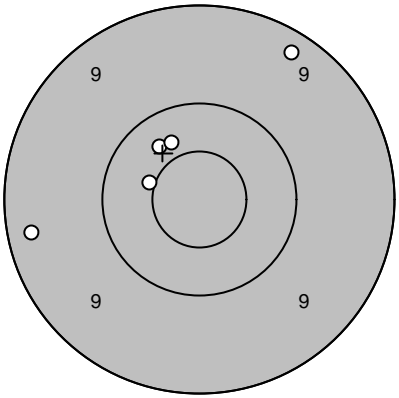
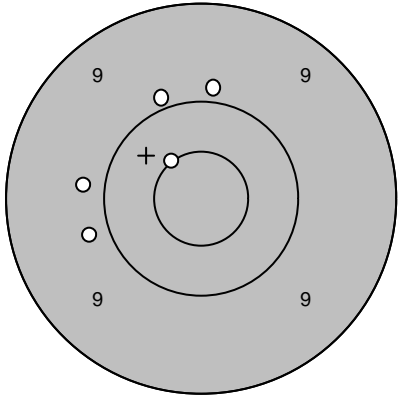
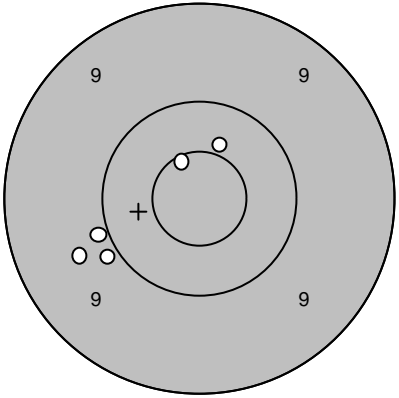
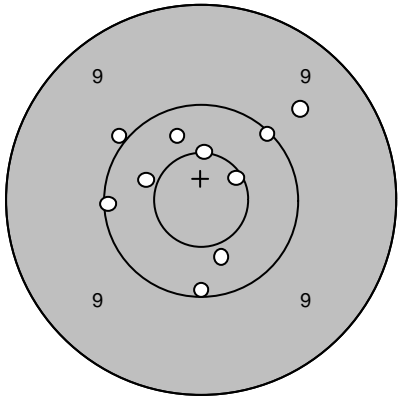
Skjutlag 3	Tavla 6	Maria Falck	
Ramselefors		Moälven-Modo	
05.07.2006		Tavelträffen A - 2006	Ramselefors Skytteförening
Prov		1: 9,7 ↑ 2: 9,5 ↓ 3: 10,0 ↑ 4: 10,5* ↑ 5: 10,4 ↓	Serie 1 
		Serie 48,0 Totalt 0,0	1: 10,4 ↖ 2: 9,3 ← 3: 10,5* ↖ 4: 9,3 ↗ 5: 10,4 ↖
			Serie 48,0 Totalt 48,0
Serie 2		1: 9,8 ← 2: 10,5* ↗ 3: 9,8 ← 4: 9,9 ↑ 5: 9,9 ↗	Serie 3 
		Serie 46,0 Totalt 94,0	1: 9,9 ← 2: 10,6* ↗ 3: 10,4 ↗ 4: 9,9 ← 5: 9,7 ←
			Serie 47,0 Totalt 141,0
Extratävling		1: 10,1 ↓ 2: 10,1 ← 3: 10,0 ↖ 4: 10,3 ↑ 5: 10,4 ↓ 6: 10,5* ↑ 7: 9,7 ↗ 8: 10,6* ↗ 9: 10,1 ↗ 10: 10,4 ←	
		Serie 99,0 Totalt 240,0	

Skjutlag

Tavla

3

7

Helena Arvidsson

Ramselefors

Moälven-Modo

05.07.2006

Tavelträffen A - 2006

Ramselefors Skytteförening

Prov

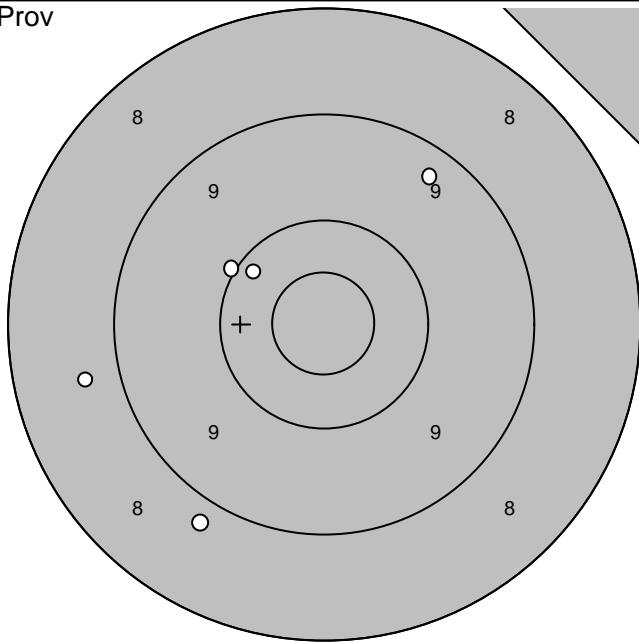

1: 8,8 ↘
2: 8,7 ←
3: 10,2 ↖
4: 9,3 ↗
5: 10,0 ↙

Serie 45,0

Totalt 0,0

Serie 1

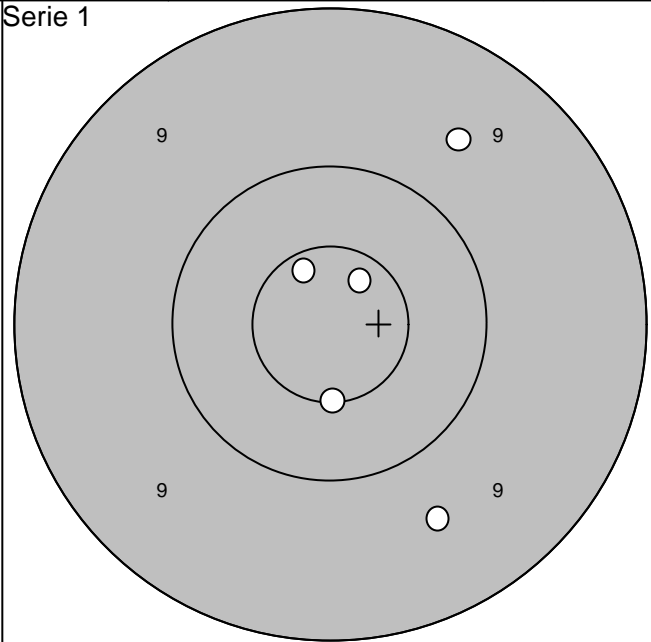

1: 10,7* ↗
2: 10,5* ↓
3: 9,6 ↘
4: 9,6 ↗
5: 10,7* ↗

Serie 48,0

Totalt 48,0

Serie 2

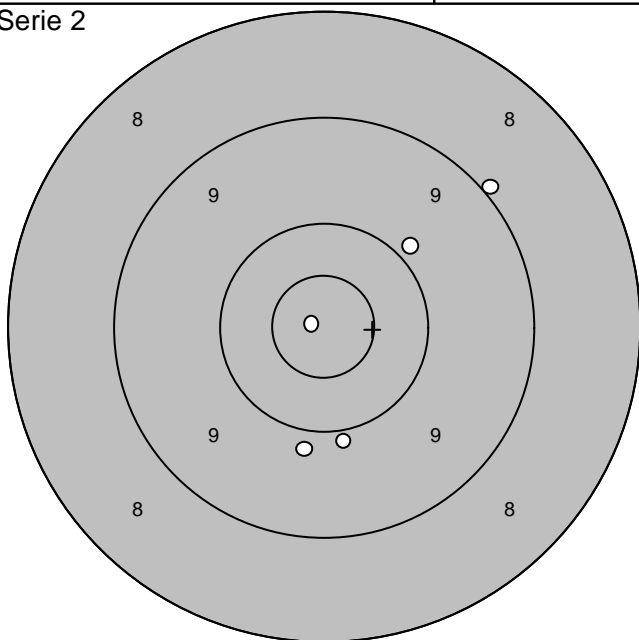

1: 9,9 ↓
2: 9,9 ↓
3: 10,9* ←
4: 9,9 ↗
5: 9,0 ↗

Serie 46,0

Totalt 94,0

Serie 3

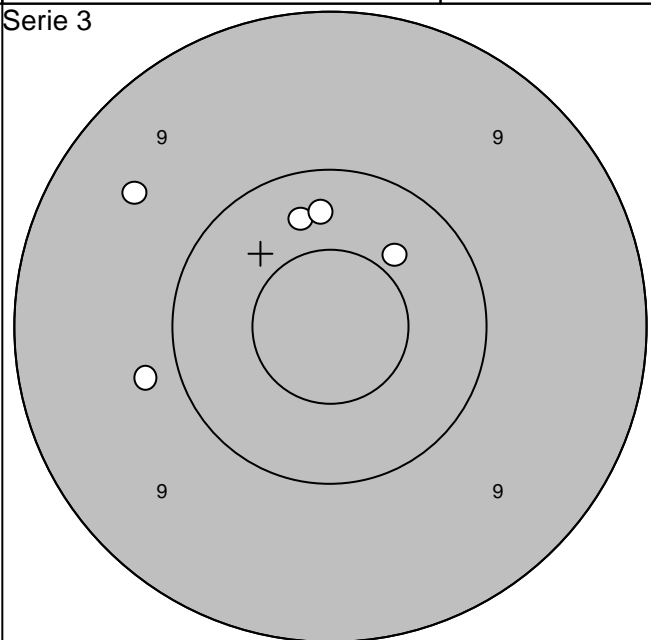

1: 9,8 ←
2: 10,3 ↑
3: 9,5 ↖
4: 10,4 ↗
5: 10,3 ↑

Serie 48,0

Totalt 142,0

www.AC-Skytte.com

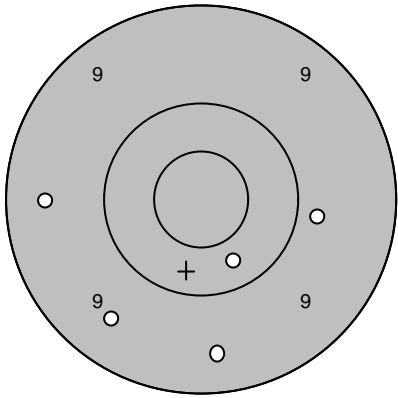
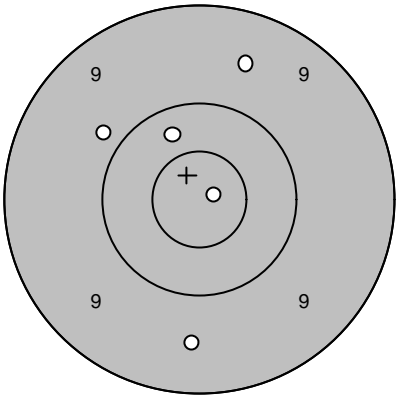
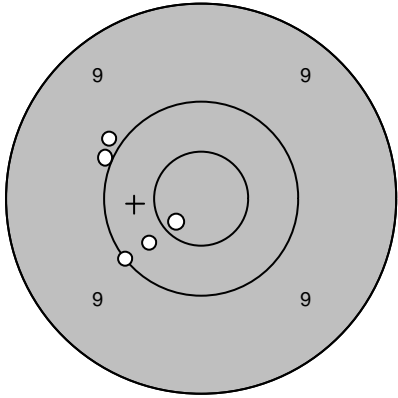
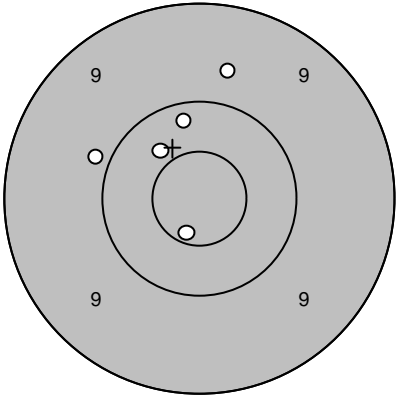
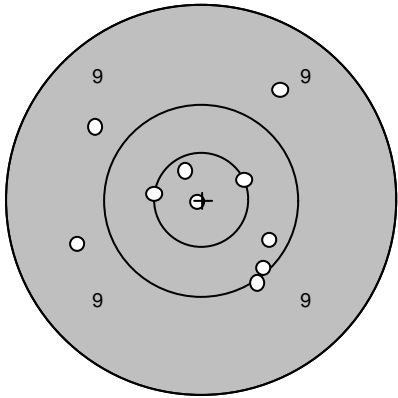
Skjutlag 3	Tavla 8	Petter Eriksson	
Ramselefors		Moälven-Modo	
05.07.2006		Tavelträffen A - 2006	Ramselefors Skytteförening
Prov		1: 9,8 → 2: 10,3 ↓ 3: 9,4 ← 4: 9,5 ↓ 5: 9,4 ↓	Serie 1  1: 9,8 ↖ 2: 9,6 ↓ 3: 9,6 ↑ 4: 10,9* → 5: 10,3 ↑
		Serie 46,0	Serie 47,0
		Totalt 0,0	Totalt 47,0
Serie 2		1: 10,7* ↙ 2: 10,3 ↙ 3: 10,0 ↖ 4: 10,0 ↙ 5: 9,9 ↖	Serie 3  1: 10,2 ↑ 2: 9,9 ↖ 3: 10,4 ↖ 4: 9,7 ↑ 5: 10,7* ↓
		Serie 49,0	Serie 48,0
		Totalt 96,0	Totalt 144,0
Extratävling		1: 10,2 → 2: 10,1 ↓ 3: 9,7 ↗ 4: 10,7* ↗ 5: 9,7 ← 6: 10,6* ← 7: 10,9* ← 8: 9,7 ↗ 9: 10,5* → 10: 10,0 ↓	
		Serie 97,0	
		Totalt 241,0	

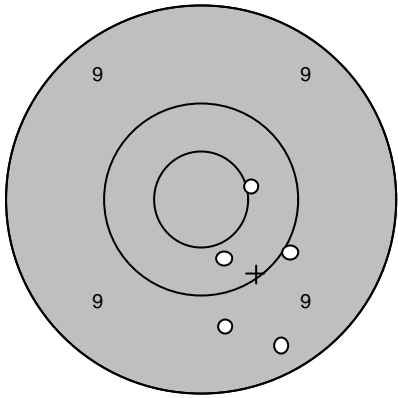
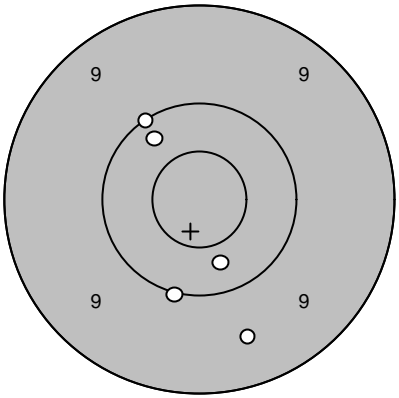
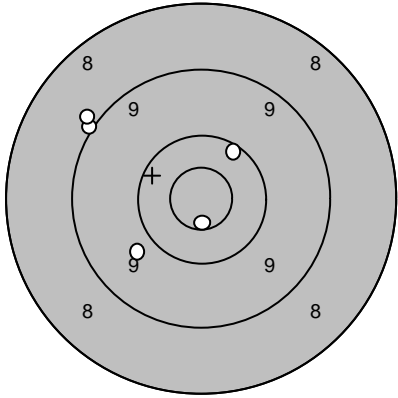
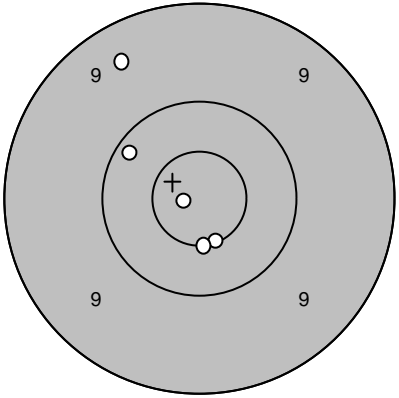
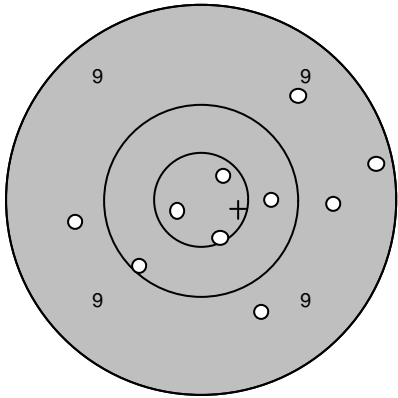
Skjutlag 3	Tavla 9	Marie Arvidsson	
Ramselefors		Lidingö	
05.07.2006		Tavelträffen A - 2006	Ramselefors Skytteförening
Prov 	1: 10,5* → 2: 9,7 ↓ 3: 9,3 ↓ 4: 10,4 ↓ 5: 10,0 →	Serie 1 	1: 10,4 ↓ 2: 10,1 ↗ 3: 10,0 ↓ 4: 9,5 ↓ 5: 10,3 ↗
	Serie 48,0		Serie 49,0
	Totalt 0,0		Totalt 49,0
Serie 2 	1: 10,7* ↓ 2: 9,8 ↙ 3: 10,2 ↗ 4: 9,0 ↖ 5: 8,9 ↖	Serie 3 	1: 10,6* ↓ 2: 10,6* ↓ 3: 10,2 ↗ 4: 9,4 ↗ 5: 10,9* ←
	Serie 46,0		Serie 49,0
	Totalt 95,0		Totalt 144,0
Extratävling 	1: 10,1 ↙ 2: 9,7 ← 3: 10,8* ← 4: 9,7 → 5: 10,6* ↓ 6: 9,6 ↗ 7: 9,2 → 8: 9,7 ↓ 9: 10,3 → 10: 10,7* ↗		
	Serie 95,0		
	Totalt 239,0		

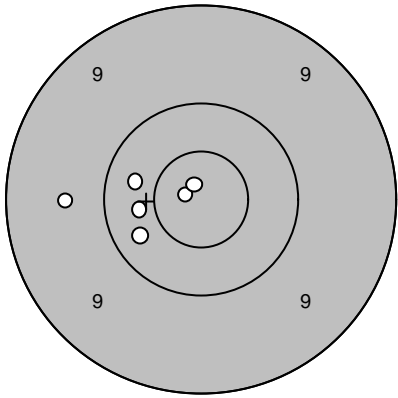
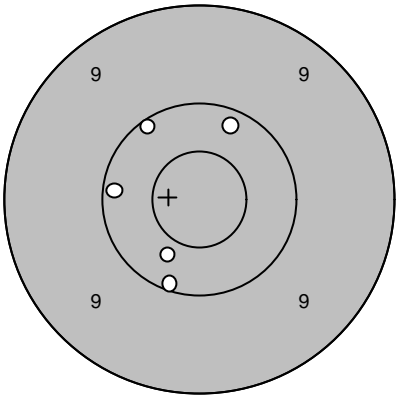
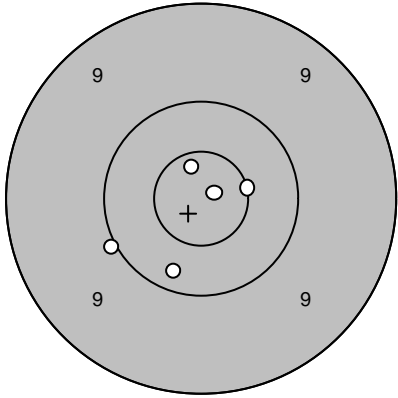
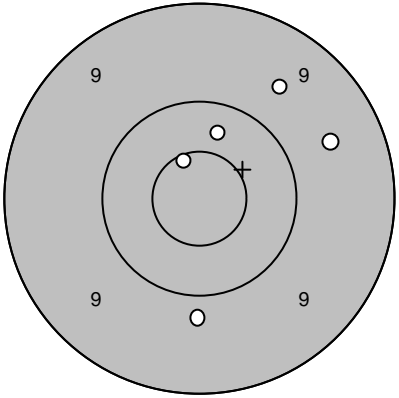
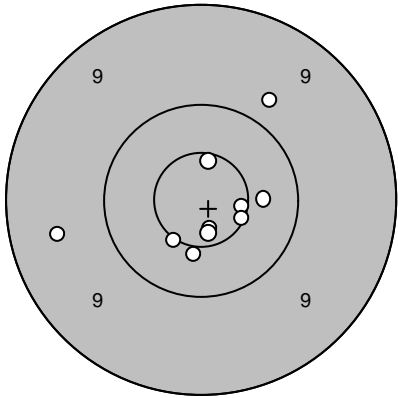
Skjutlag 3	Tavla 10	Stefan Håkansson	
Ramselefors		Östersund	
05.07.2006		Tavelträffen A - 2006	Ramselefors Skytteförening
Prov 	1: 9,6 ← 2: 10,9* ← 3: 10,9* ↗ 4: 10,3 ← 5: 10,4 ← 6: 10,3 ←	Serie 1 	1: 10,2 ← 2: 10,4 ↘ 3: 10,1 ↖ 4: 10,2 ↗ 5: 10,1 ↘
	Serie 59,0 Totalt 0,0		Serie 50,0 Totalt 50,0
Serie 2 	1: 10,0 ← 2: 10,2 ↘ 3: 10,9* ↗ 4: 10,7* ↗ 5: 10,5* →	Serie 3 	1: 9,6 → 2: 10,6* ↗ 3: 9,6 ↗ 4: 10,3 ↗ 5: 9,8 ↓
	Serie 50,0 Totalt 100,0		Serie 47,0 Totalt 147,0
Extratävling 	1: 9,5 ← 2: 10,5* ↘ 3: 10,6* ↗ 4: 10,7* ↘ 5: 10,5* ↘ 6: 9,8 ↗ 7: 10,6* → 8: 10,4 → 9: 10,6* → 10: 10,7* ↘		
	Serie 98,0 Totalt 245,0		

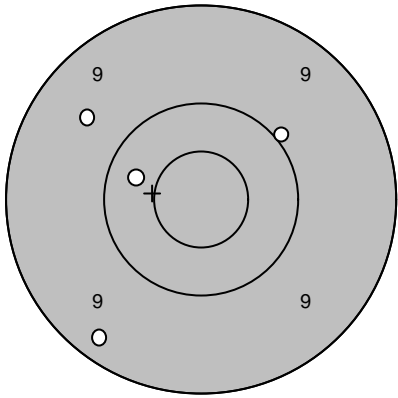
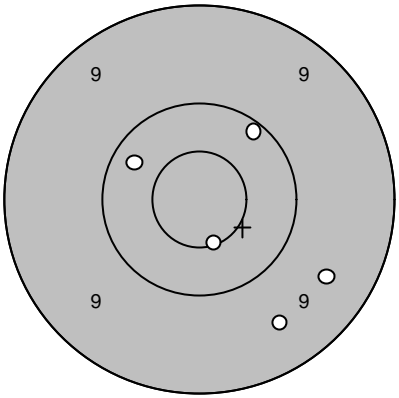
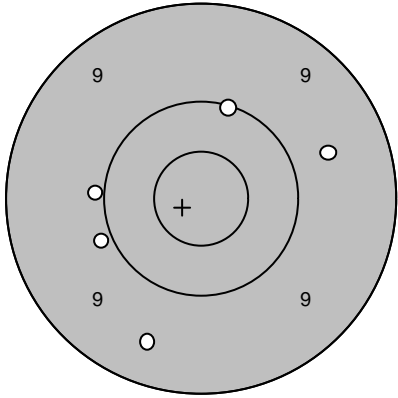
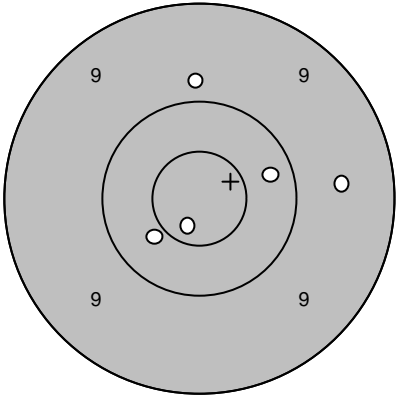
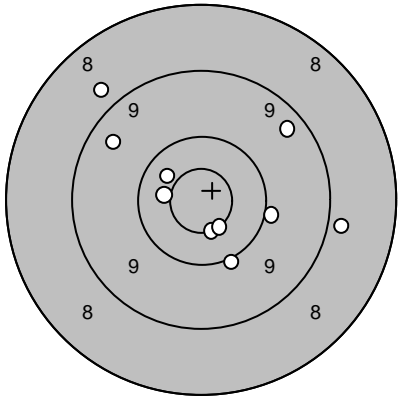
Skjutlag 3	Tavla 11	Bror Rantakyrö	
Ramselefors		Övertorneå	
05.07.2006		Tavelträffen A - 2006	Ramselefors Skytteförening
Prov 	1: 10,3 ← 2: 10,0 ↗ 3: 9,3 ↓ 4: 9,6 ↖	Serie 1 	1: 9,5 ↓ 2: 10,3 ↖ 3: 10,6* ↓ 4: 10,2 ↗ 5: 9,5 ↓
	Serie 38,0		Serie 48,0
	Totalt 0,0		Totalt 48,0
Serie 2 	1: 10,1 ↑ 2: 9,7 → 3: 9,5 ↓ 4: 9,9 ← 5: 10,0 ←	Serie 3 	1: 10,3 → 2: 9,6 → 3: 9,8 ↑ 4: 10,7* ↓ 5: 10,4 ↖
	Serie 47,0		Serie 48,0
	Totalt 95,0		Totalt 143,0
Extratävling 	1: 8,9 → 2: 10,4 ↗ 3: 8,8 ↗ 4: 9,5 ↗ 5: 10,5* ← 6: 9,4 ↗ 7: 10,6* ↓ 8: 10,0 → 9: 10,0 ↓ 10: 10,6* ↓		
	Serie 94,0		
	Totalt 237,0		

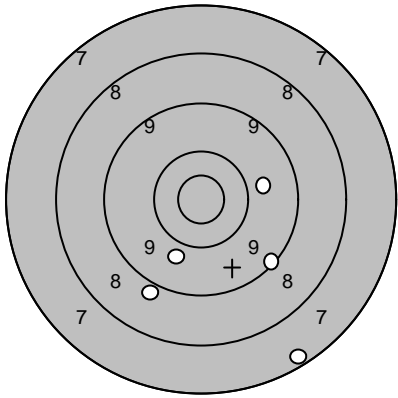
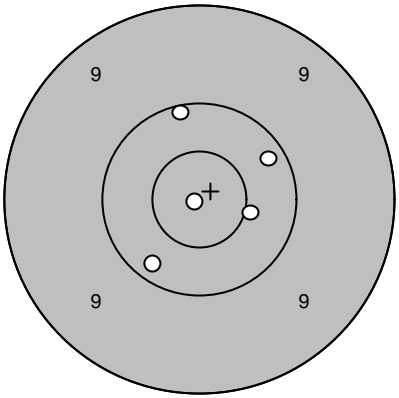
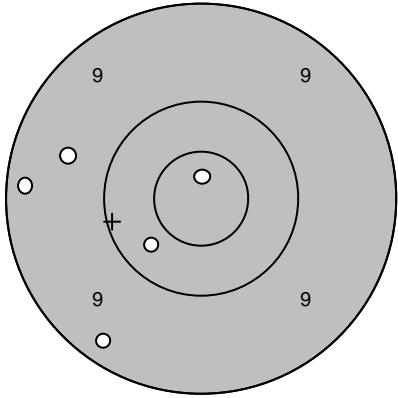
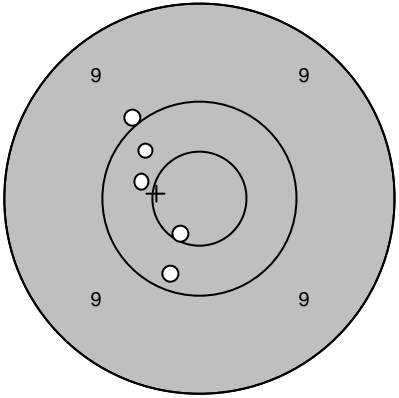
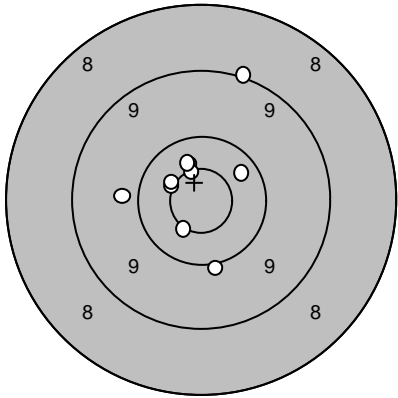
Skjutlag	Tavla	Nisse Ström	
3	12		
Ramselefors	Övertorneå		
05.07.2006	Tavelträffen A - 2006	Ramselefors Skytteförening	
Prov		1: 7,3 ↘ 2: 9,2 ↘ 3: 9,8 → 4: 8,9 ↘ 5: 9,9 ↘	Serie 1 
		1: 10,5* → 2: 10,1 ↑ 3: 10,2 ↗ 4: 10,9* ↙ 5: 10,2 ↘	
		Serie 42,0	Serie 50,0
		Totalt 0,0	Totalt 50,0
Serie 2		1: 10,8* ↑ 2: 9,6 ↙ 3: 9,3 ↘ 4: 9,2 ← 5: 10,3 ↙	Serie 3 
		1: 10,4 ← 2: 10,3 ↗ 3: 10,0 ↗ 4: 10,2 ↘ 5: 10,6* ↘	
		Serie 47,0	Serie 50,0
		Totalt 97,0	Totalt 147,0
Extratävling		1: 9,1 ↑ 2: 9,9 ← 3: 10,6* ↘ 4: 10,3 ↗ 5: 10,6* ↙ 6: 10,5* ↑ 7: 10,0 ↘ 8: 10,6* ↑ 9: 10,5* ↑ 10: 10,5* ↙	
		Serie 98,0	
		Totalt 245,0	

Skjutlag

Tavla

3

13

Ove Lövgren

Ramselefors

Övertorneå

05.07.2006

Tavelträffen A - 2006

Ramselefors Skytteförening

Prov

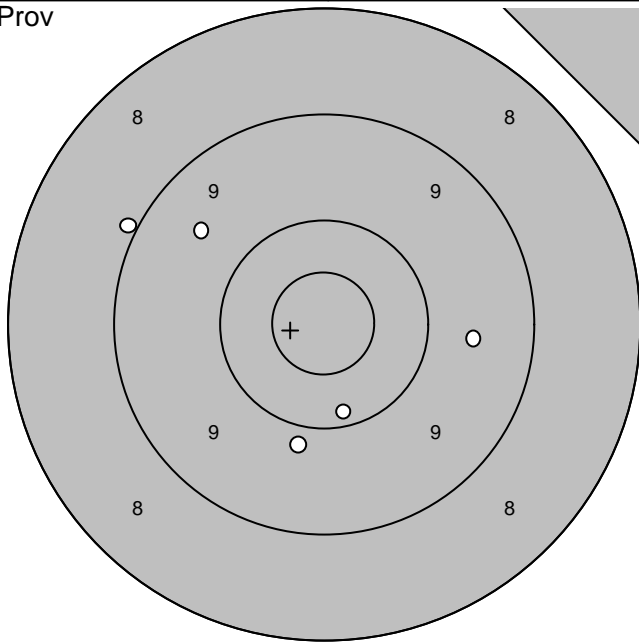

Serie 1

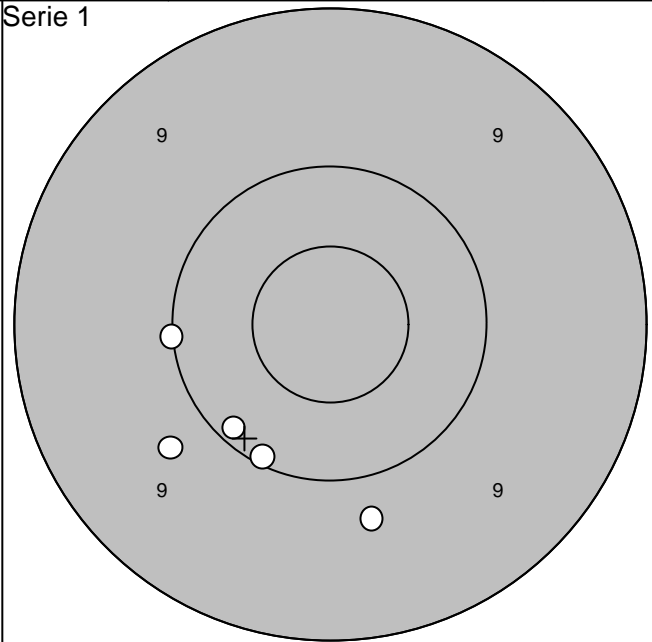

1: 9,6 →
 2: 10,2 ↓
 3: 9,0 ↖
 4: 9,6 ↗
 5: 9,9 ↓

Serie 46,0

Totalt 0,0

1: 9,8 ↙
 2: 10,1 ↙
 3: 9,8 ↓
 4: 10,1 ↓
 5: 10,0 ←

Serie 48,0

Totalt 48,0

Serie 2

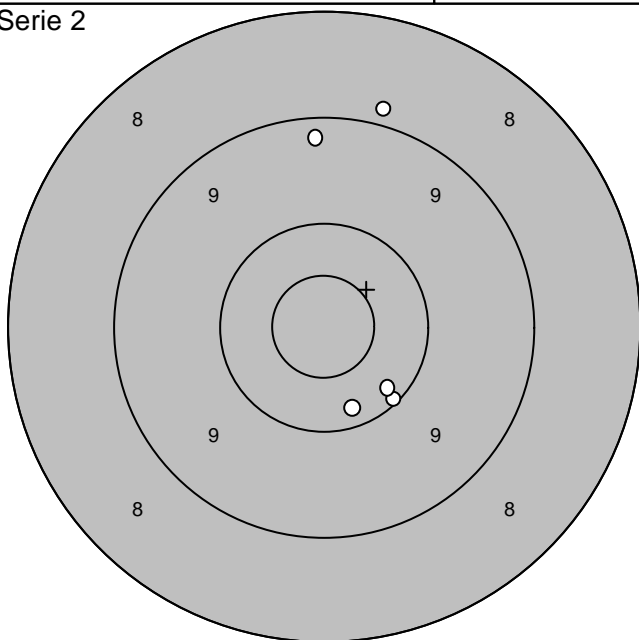

Serie 3

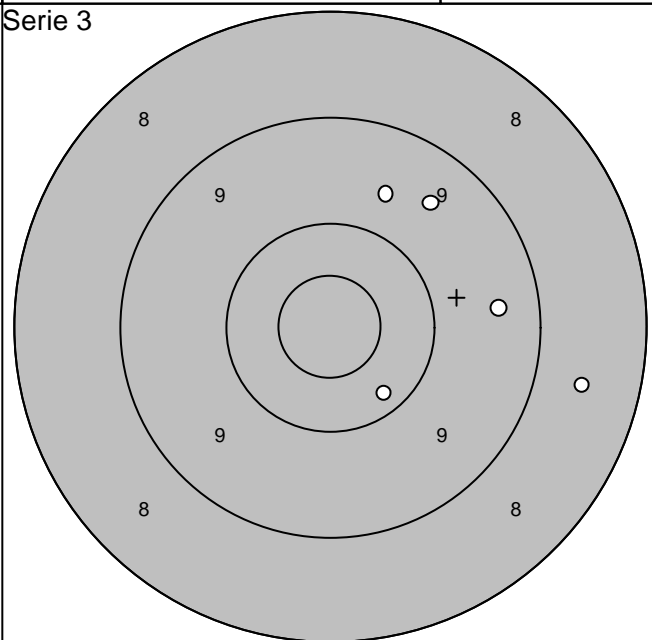

1: 10,2 ↓
 2: 10,1 ↓
 3: 8,9 ↑
 4: 9,2 ↑
 5: 10,2 ↓

Serie 47,0

Totalt 95,0

1: 8,6 →
 2: 9,4 →
 3: 9,7 ↑
 4: 10,2 ↓
 5: 9,5 ↗

Serie 45,0

Totalt 140,0

www.AC-Skytte.com

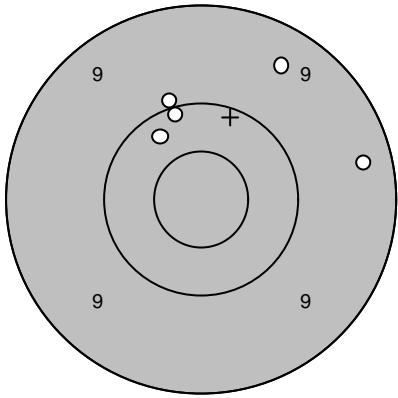
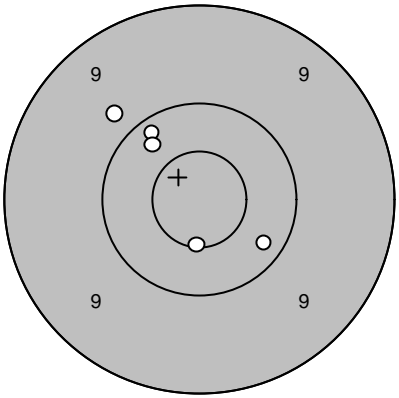
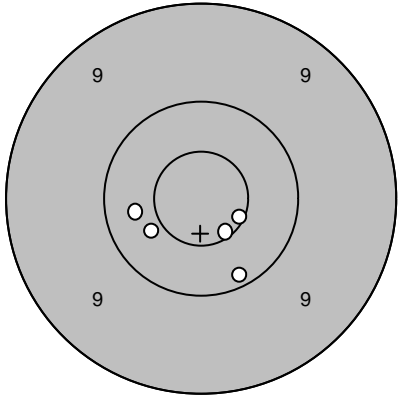
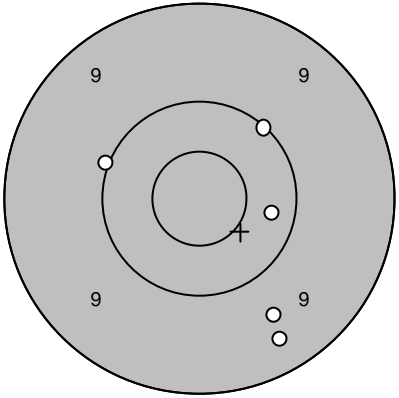
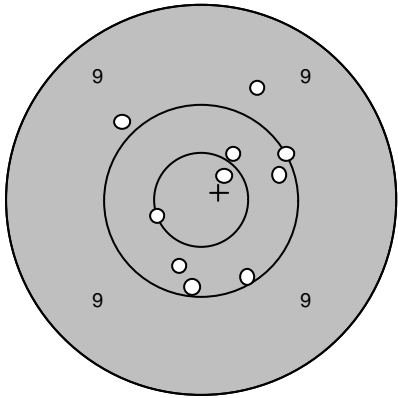
Skjutlag 3	Tavla 14	Gustav Lövgren	
Ramselefors		Niemisel	
05.07.2006		Tavelträffen A - 2006	Ramselefors Skytteförening
Prov		1: 9,3 → 2: 9,4 ↗ 3: 10,3 ↖ 4: 10,0 ↗ 5: 10,1 ↗	Serie 1 
		Serie 48,0 Totalt 0,0	1: 10,2 ↗ 2: 9,8 ↗ 3: 10,6* ↓ 4: 10,3 ↗ 5: 10,2 ↓
			Serie 49,0 Totalt 49,0
Serie 2		1: 10,2 ↓ 2: 10,6* → 3: 10,4 ← 4: 10,6* ↓ 5: 10,4 ←	Serie 3 
		Serie 50,0 Totalt 99,0	1: 10,0 ← 2: 10,1 ↗ 3: 10,3 → 4: 9,6 ↓ 5: 9,4 ↓
			Serie 48,0 Totalt 147,0
Extratävling		1: 10,7* ↗ 2: 9,8 ↗ 3: 10,1 → 4: 9,9 ↖ 5: 10,1 ↓ 6: 10,3 ↓ 7: 10,6* ← 8: 10,5* ↗ 9: 10,1 ↓ 10: 10,2 →	
		Serie 98,0 Totalt 245,0	

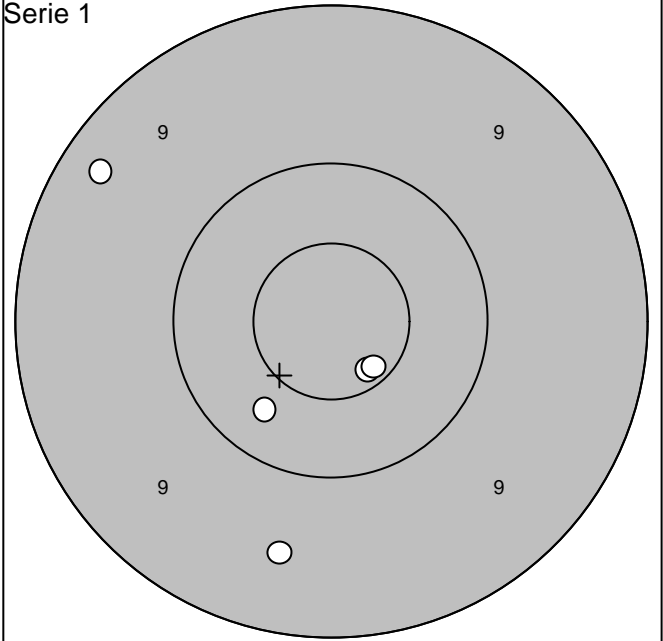
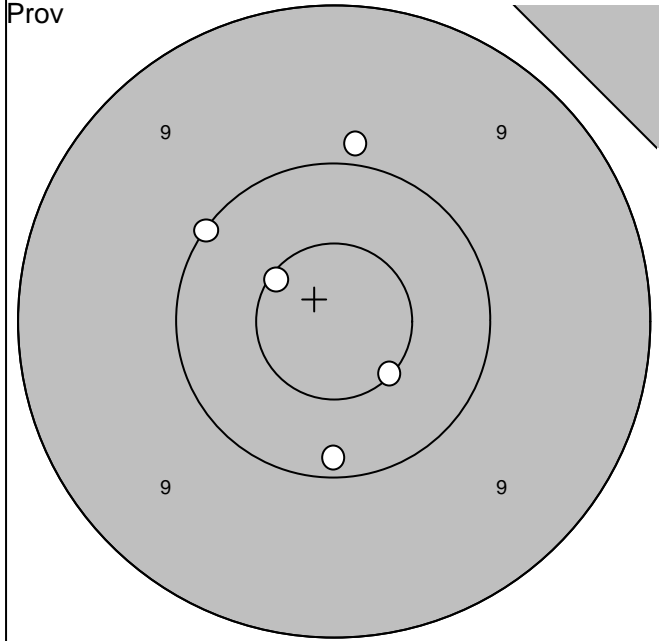

1:10,5* ↘	Serie	49,0	
2: 9,9 ↑			
3:10,6* ↗	Totalt	0,0	
4:10,2 ↓			
5:10,0 ↖			

1:10,3 ↙	Serie	48,0	
2: 9,3 ↗			
3: 9,5 ↓	Totalt	48,0	
4:10,6* ↓			
5:10,6* ↓			

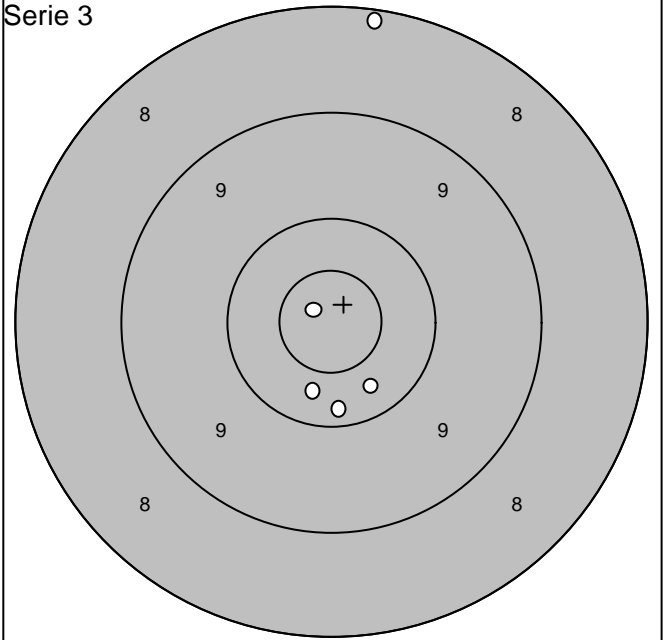
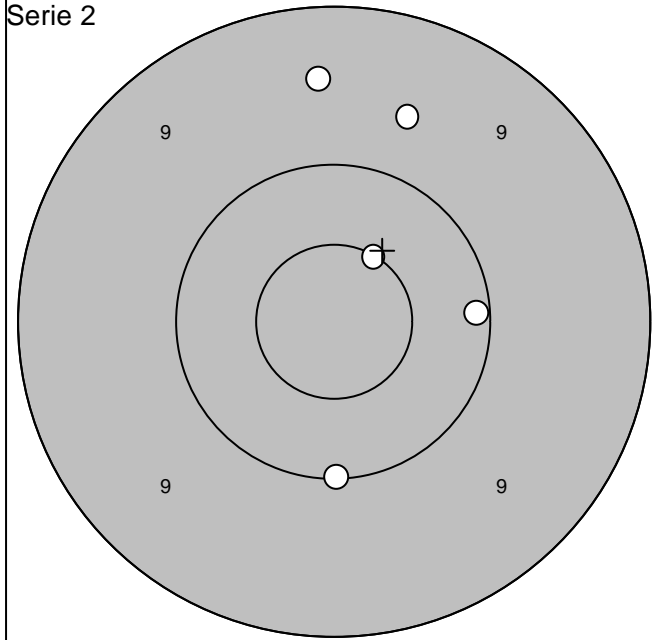

1:10,1 ↓	Serie	48,0	
2: 9,5 ↑			
3:10,5* ↗	Totalt	96,0	
4: 9,7 ↗			
5:10,1 →			

1:10,2 ↓	Serie	48,0	
2:10,4 ↓			
3: 8,2 ↑	Totalt	144,0	
4:10,3 ↓			
5:10,8* ↖			

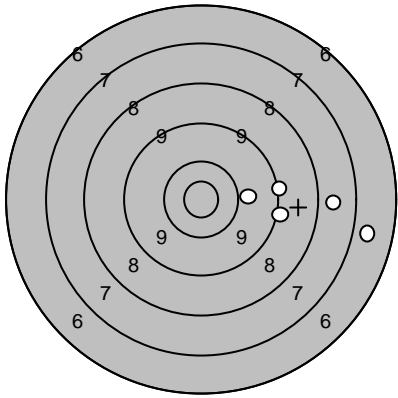
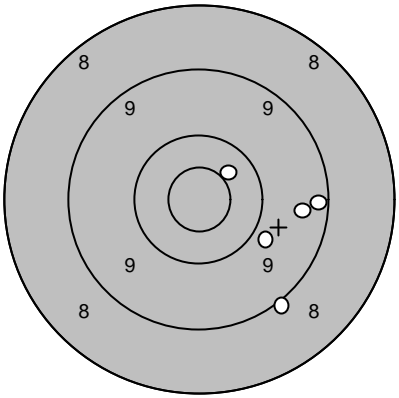
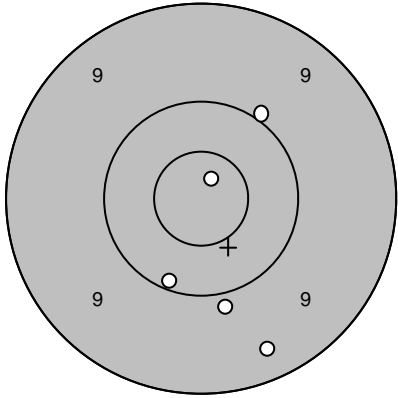
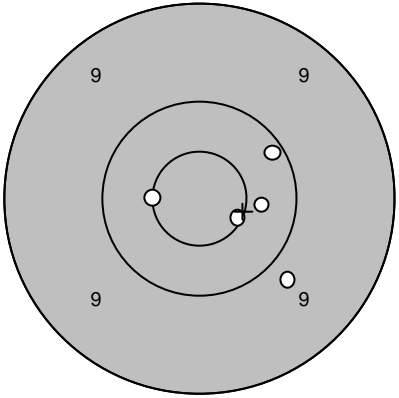
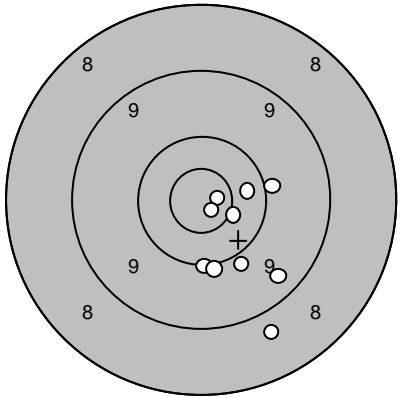
Skjutlag 3	Tavla 16	Harry Östling	
Ramselefors	F 21		
05.07.2006	Tavelträffen A - 2006	Ramselefors Skytteförening	
Prov		1: 7,8 → 2: 6,8 → 3: 9,1 → 4: 10,0 → 5: 9,1 →	Serie 1 
	Serie 41,0 Totalt 0,0	1: 10,5* ↗ 2: 9,9 ↘ 3: 9,0 ↘ 4: 9,5 → 5: 9,2 →	Serie 46,0 Totalt 46,0
Serie 2		1: 10,0 ↗ 2: 10,8* ↗ 3: 10,1 ↘ 4: 9,9 ↘ 5: 9,4 ↘	Serie 3 
	Serie 48,0 Totalt 94,0	1: 10,6* ← 2: 10,6* ↘ 3: 10,1 ↗ 4: 9,8 ↘ 5: 10,4 →	Serie 49,0 Totalt 143,0
Extratävling		1: 10,1 ↓ 2: 10,5* → 3: 10,8* → 4: 9,9 ↘ 5: 10,9* ↘ 6: 8,8 ↘ 7: 10,0 → 8: 10,0 ↓ 9: 10,3 → 10: 9,4 ↘	
	Serie 96,0 Totalt 239,0		

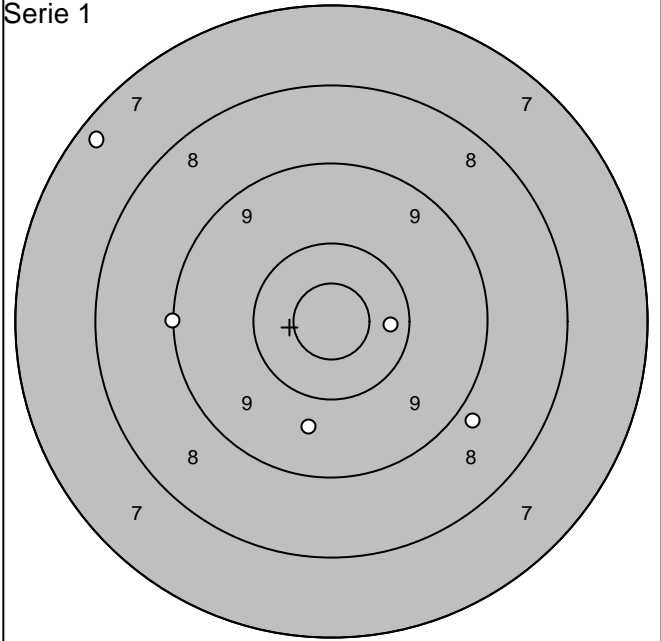
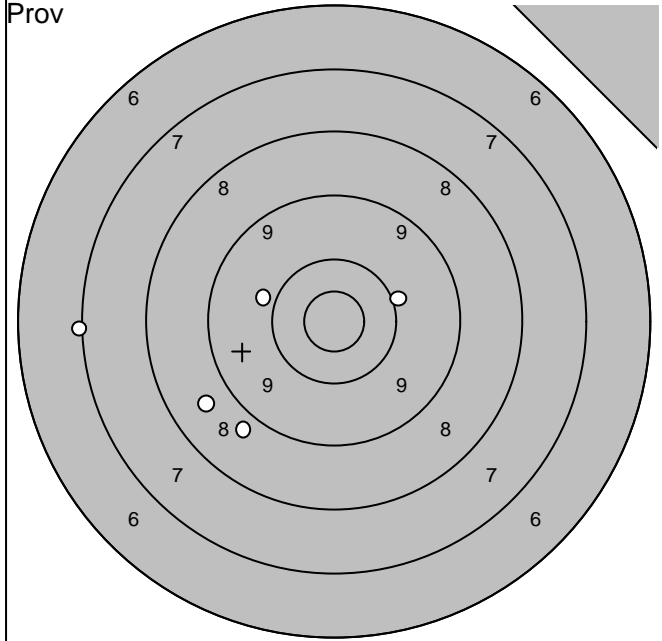

1: 7,1 ←
2: 8,7 ↙
3: 8,9 ↘
4: 9,9 ↖
5:10,0 →

Serie	42,0
Totalt	0,0

1: 7,3 ↗
2: 9,7 ↓
3:10,3 →
4: 8,9 ↘
5: 9,1 ←

Serie	43,0
Totalt	43,0

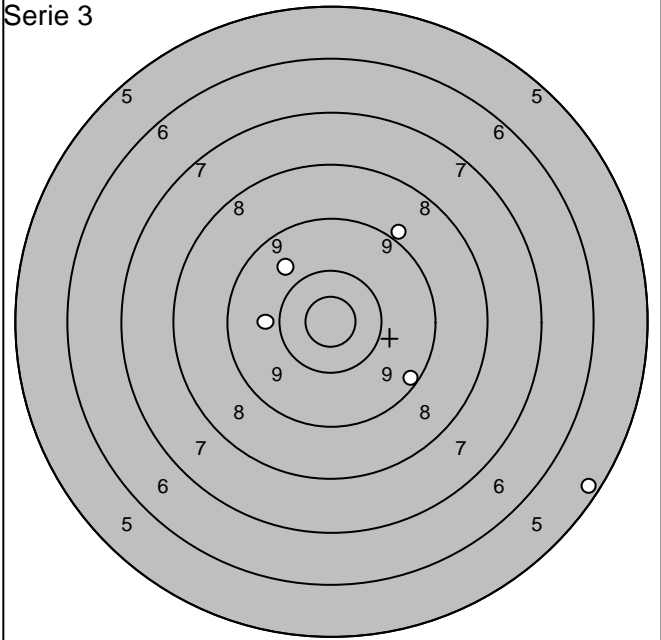
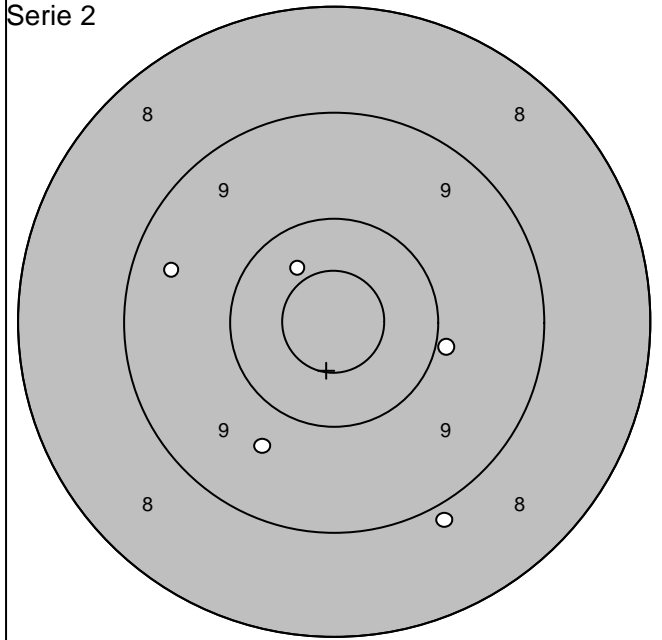

1: 9,4 ↖
2: 8,9 ↘
3:10,4 ↗
4: 9,7 ↘
5: 9,9 →

Serie	45,0
Totalt	88,0

1: 9,9 ←
2: 9,8 ↗
3: 9,2 ↘
4: 5,3 ↘
5: 9,0 ↗

Serie	41,0
Totalt	129,0

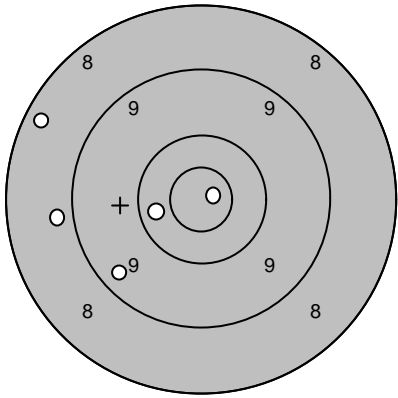
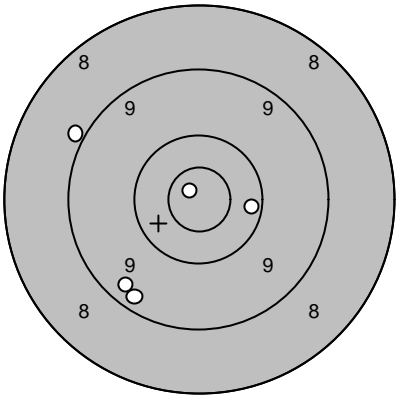
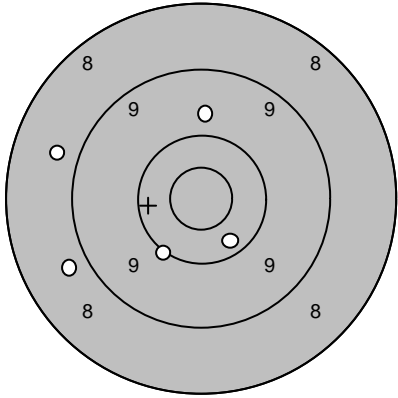
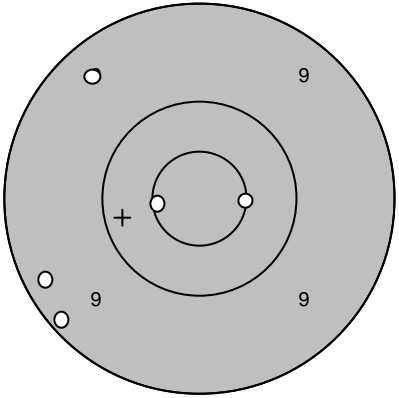
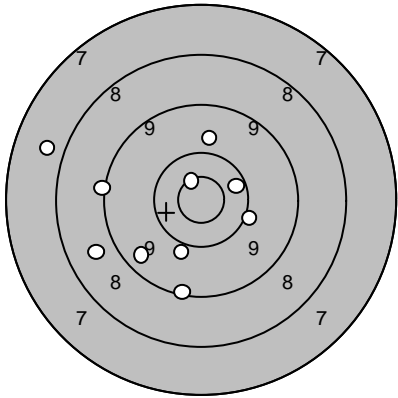
Skjutlag	Tavla		
3	18	Hugo Håkansson	
Ramselefors	Östersund		
05.07.2006	Tavelträffen A - 2006	Ramselefors Skytteförening	
Prov		Serie 1	
	1: 8,4 ↖ 2: 10,4 ← 3: 9,4 ↘ 4: 10,9* → 5: 8,9 ←		1: 9,3 ↘ 2: 10,2 → 3: 9,4 ↘ 4: 10,9* ↗ 5: 8,9 ↖
	Serie 45,0		Serie 46,0
	Totalt 0,0		Totalt 46,0
Serie 2		Serie 3	
	1: 9,8 ↑ 2: 10,1 ↘ 3: 10,3 ↘ 4: 8,8 ← 5: 8,8 ←		1: 9,4 ↖ 2: 9,3 ← 3: 10,6* ← 4: 9,2 ↘ 5: 10,6* →
	Serie 45,0		Serie 47,0
	Totalt 91,0		Totalt 138,0
Extratävling			
	1: 9,8 ↑ 2: 9,2 ↘ 3: 9,1 ← 4: 8,7 ← 5: 10,0 ↘ 6: 10,7* ↗ 7: 10,3 → 8: 10,1 → 9: 7,8 ← 10: 9,5 ↘		
	Serie 91,0		
	Totalt 229,0		

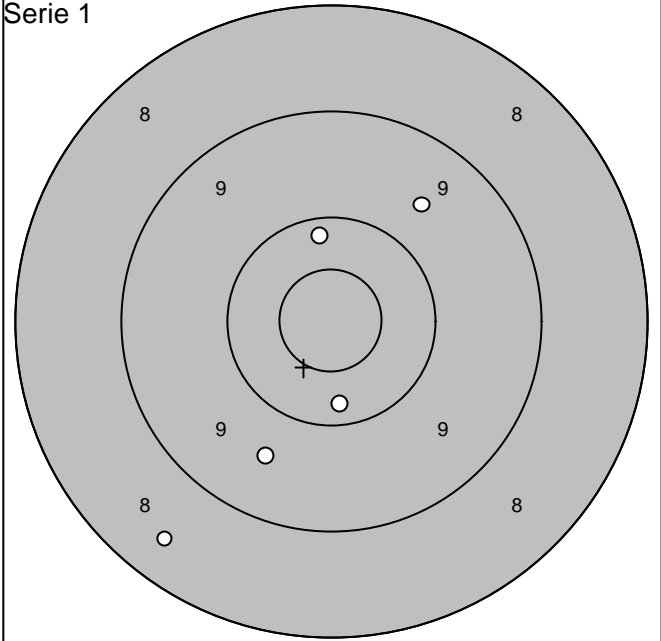
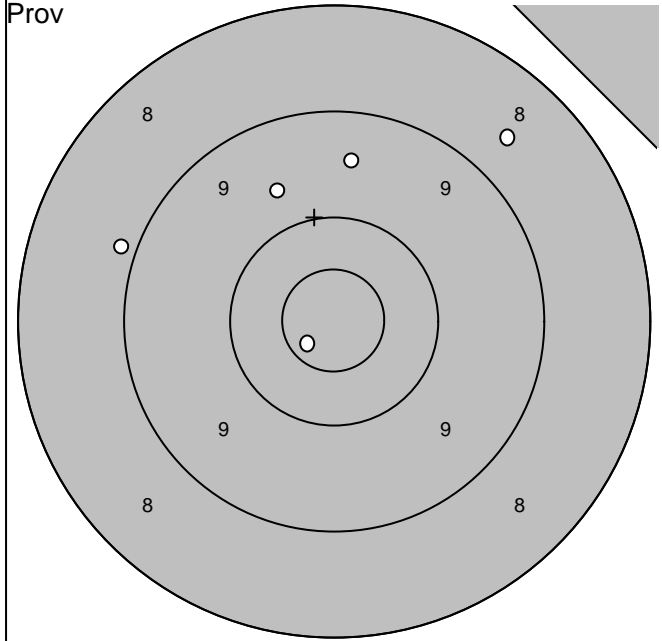

1: 9,7 ↗		Serie	44,0
2: 8,6 ↗		Totalt	0,0
3: 8,9 ↖			
4: 9,5 ↗			
5: 10,7* ↘			

1: 10,2 ↗		Serie	46,0
2: 9,6 ↗		Totalt	46,0
3: 9,6 ↘			
4: 10,2 ↘			
5: 8,4 ↘			

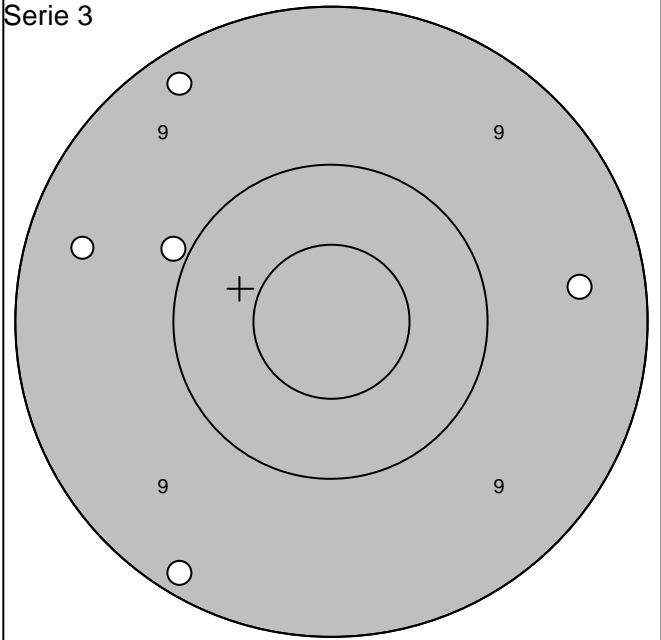
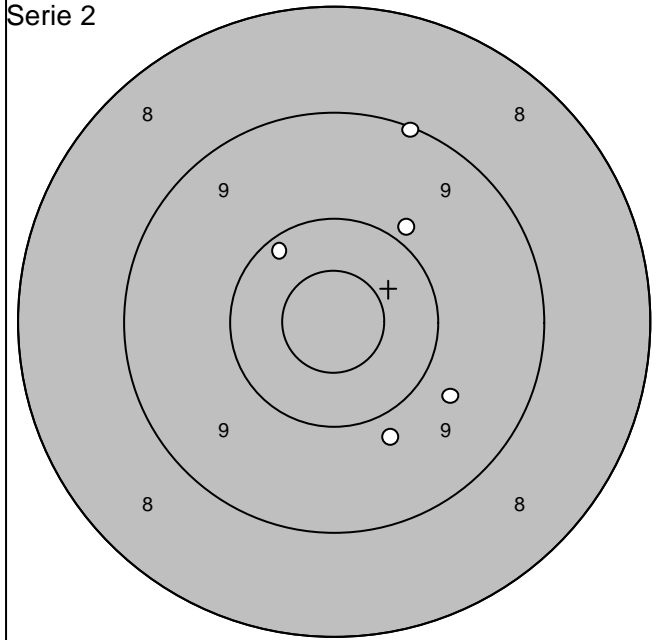

1: 9,7 ↘		Serie	46,0
2: 9,1 ↗		Totalt	92,0
3: 9,9 ↗			
4: 9,8 ↘			
5: 10,2 ↗			

1: 9,4 →		Serie	45,0
2: 9,9 ↖		Totalt	137,0
3: 9,4 ↖			
4: 9,2 ↘			
5: 9,2 ↗			

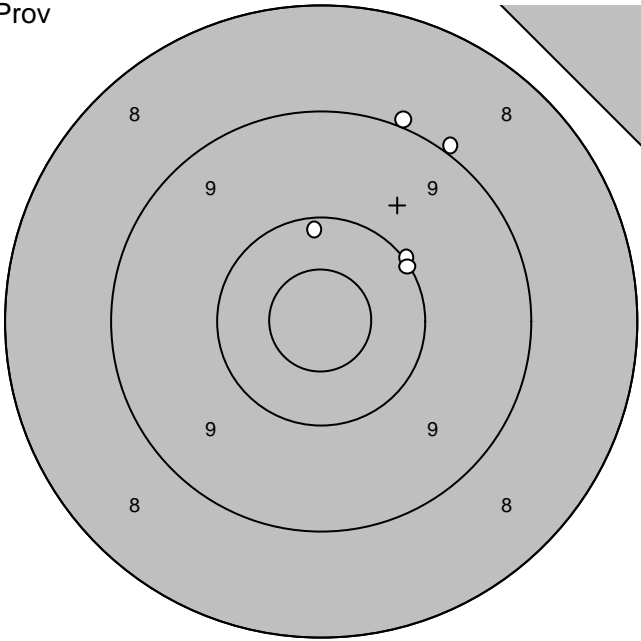
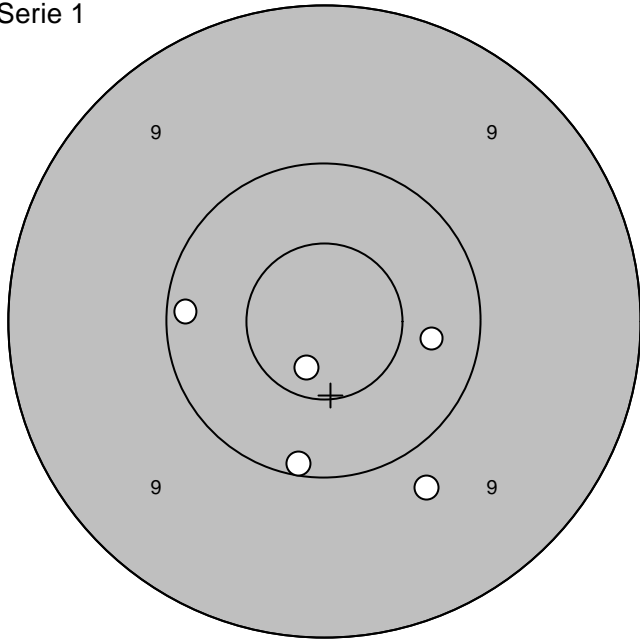
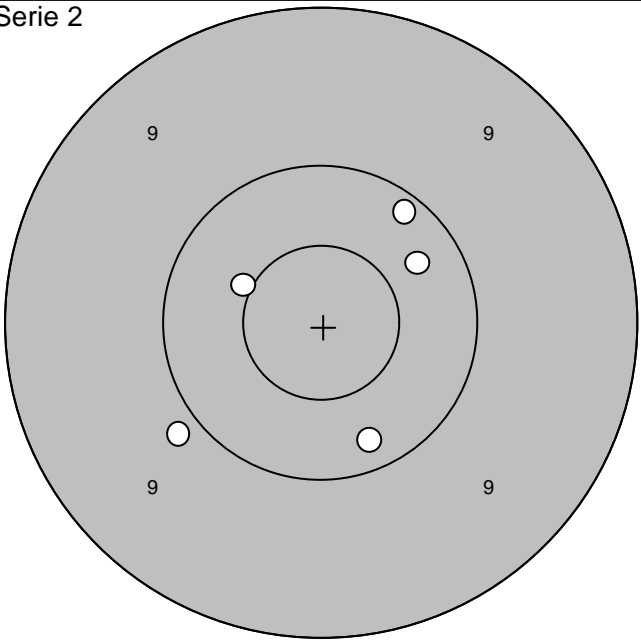
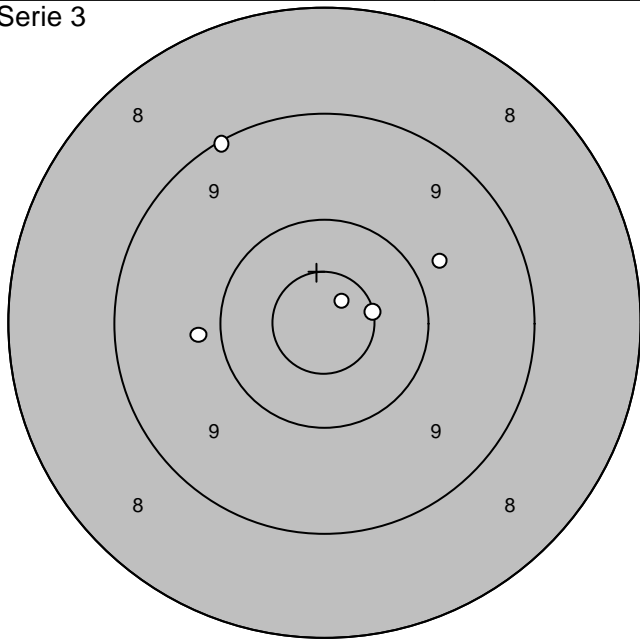
Skjutlag 3	Tavla 20	Jörgen Åström	
Ramselefors		Brattby	
05.07.2006		Tavelträffen A - 2006	Ramselefors Skytteförening
Prov		Serie 1	
			
1: 9,0 ↗ 2: 9,0 ↗ 3: 10,0 ↗ 4: 10,2 ↑ 5: 10,1 ↗	Serie 48,0 Totalt 0,0	1: 10,7* ↓ 2: 9,8 ↓ 3: 10,2 ← 4: 10,3 → 5: 10,1 ↓	Serie 49,0 Totalt 49,0
Serie 2		Serie 3	
			
1: 10,5* ↖ 2: 10,2 ↓ 3: 9,9 ↖ 4: 10,2 ↗ 5: 10,3 ↗	Serie 49,0 Totalt 98,0	1: 10,8* ↗ 2: 9,1 ↖ 3: 9,8 ← 4: 9,8 ↗ 5: 10,6* →	Serie 47,0 Totalt 145,0

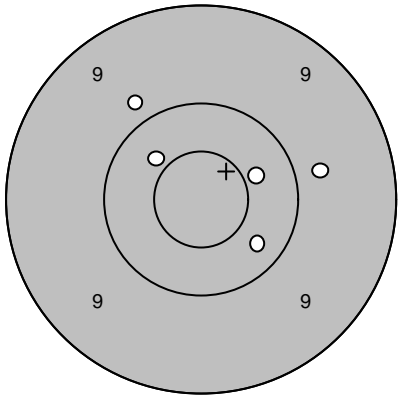
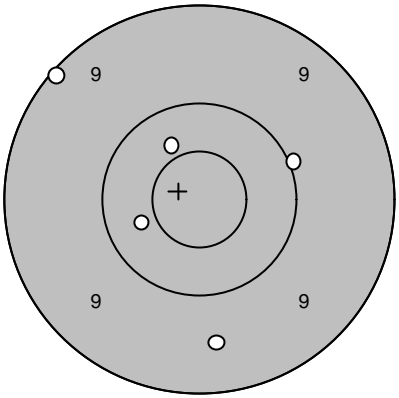
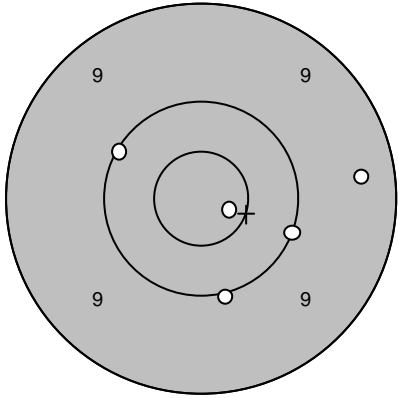
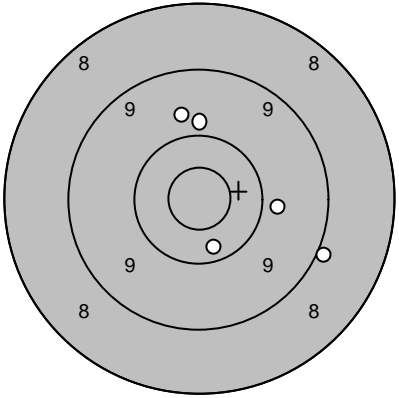
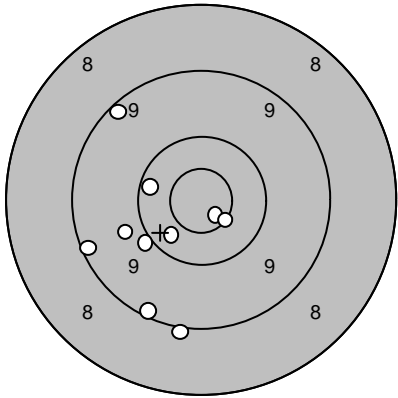
Skjutlag 3	Tavla 21	Jennie Ericson		
Ramselefors	Loos			
05.07.2006	Tavelträffen A - 2006	Ramselefors Skytteförening		
Prov		1: 10,4 ↖ 2: 9,8 ↗ 3: 10,4 → 4: 9,8 → 5: 10,3 ↘	Serie 1 	1: 10,0 → 2: 10,4 ↗ 3: 9,6 ↓ 4: 10,4 ← 5: 9,1 ↖
	Serie 48,0		Serie 48,0	
	Totalt 0,0		Totalt 48,0	
Serie 2		1: 10,1 ↖ 2: 10,0 ↓ 3: 10,7* → 4: 9,4 → 5: 10,0 →	Serie 3 	1: 10,3 ↓ 2: 9,0 → 3: 9,8 ↑ 4: 9,9 → 5: 9,9 ↑
	Serie 49,0		Serie 46,0	
	Totalt 97,0		Totalt 143,0	
Extratävling		1: 9,2 ↖ 2: 10,3 ← 3: 10,8* ↘ 4: 9,2 ↓ 5: 10,4 ↘ 6: 10,6* ↘ 7: 9,0 ↓ 8: 9,2 ← 9: 10,0 ↘ 10: 9,8 ↙		
	Serie 95,0			
	Totalt 238,0			

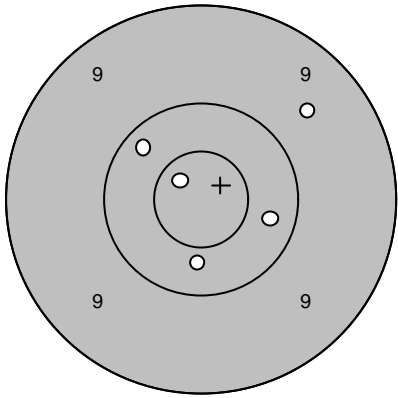
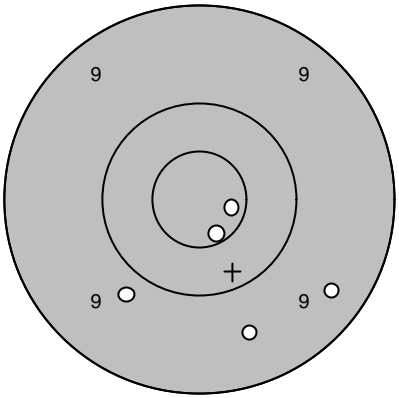
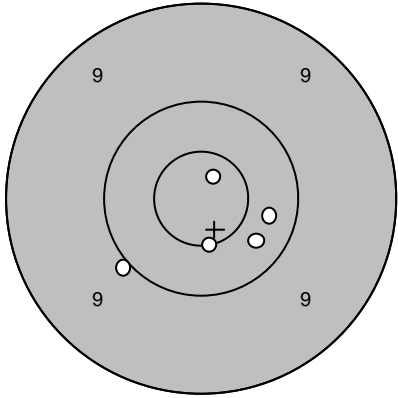
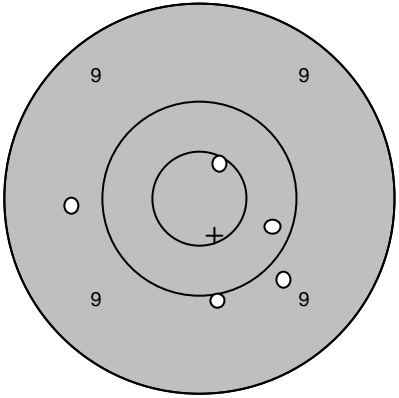
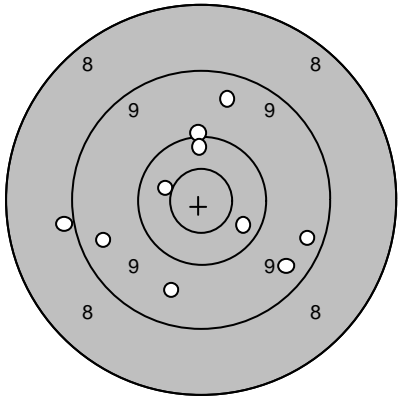
Skjutlag 3	Tavla 22	Daniel Wallberg	
Ramselefors	Loos		
05.07.2006	Tavelträffen A - 2006	Ramselefors Skytteförening	
Prov		1: 9,6 ↗ 2: 10,8* ↗ 3: 10,2 ↗ 4: 10,4 ↓ 5: 10,3 →	Serie 1 
	Serie 49,0 Totalt 0,0	1: 10,7* → 2: 9,8 ↓ 3: 10,6* ↓ 4: 9,6 ↓ 5: 9,4 ↓	Serie 47,0 Totalt 47,0
Serie 2		1: 10,0 ↙ 2: 10,3 → 3: 10,8* ↗ 4: 10,3 ↓ 5: 10,6* ↓	Serie 3 
	Serie 50,0 Totalt 97,0	1: 10,6* ↗ 2: 9,7 ← 3: 9,8 ↓ 4: 10,2 → 5: 10,0 ↓	Serie 48,0 Totalt 145,0
Extratävling		1: 9,0 ← 2: 10,5* ← 3: 10,0 ↑ 4: 10,3 ↑ 5: 9,4 ↓ 6: 9,3 → 7: 9,5 ↑ 8: 9,5 ← 9: 10,3 → 10: 9,6 ↓	
	Serie 94,0 Totalt 239,0		

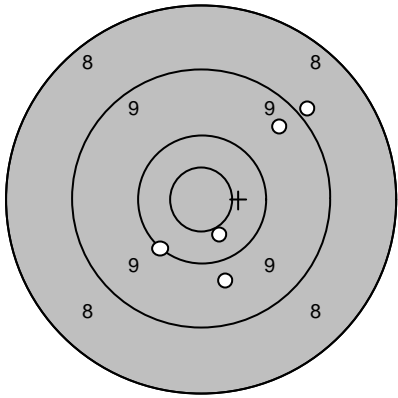
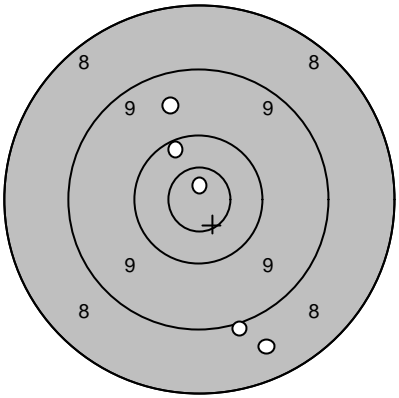
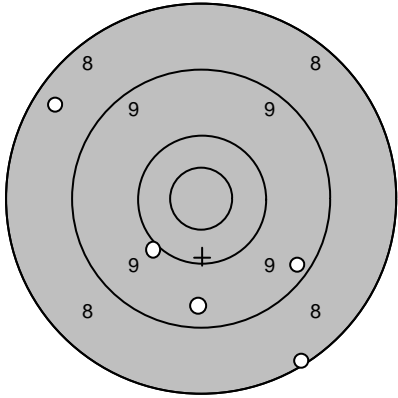
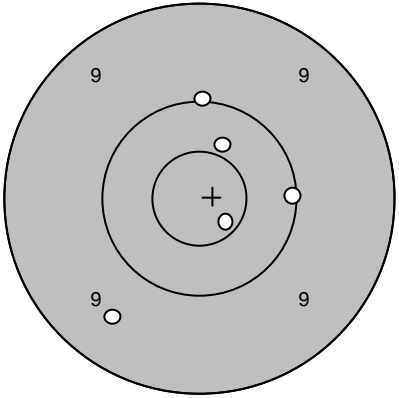
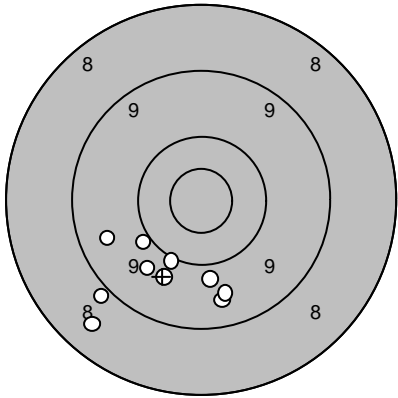
Skjutlag	Tavla	Karl-Magnus Sundberg	
3	23		
Ramselefors	Ramselefors		
05.07.2006	Tavelträffen A - 2006	Ramselefors Skytteförening	
Prov 	1: 9,4 ↗	Serie 1 	1: 9,0 ↓
	2: 10,1 ↙		2: 8,6 ↓
	3: 8,9 ↗		3: 10,2 ↗
	4: 10,5* ↓		4: 10,9* ↑
	5: 9,8 ↓		5: 9,6 ↑
	Serie 46,0		Serie 46,0
	Totalt 0,0		Totalt 46,0
Serie 2 	1: 9,3 ↘	Serie 3 	1: 9,5 ↙
	2: 8,4 ↗		2: 10,4 ↗
	3: 9,4 ↓		3: 10,0 ↑
	4: 8,1 ↓		4: 10,7* ↘
	5: 10,0 ↙		5: 10,1 →
	Serie 44,0		Serie 49,0
	Totalt 90,0		Totalt 139,0
Extratävling 	1: 9,7 ↙		
	2: 9,5 ↙		
	3: 8,6 ↙		
	4: 9,5 ↓		
	5: 9,6 ↓		
	6: 9,8 ↓		
	7: 10,0 ↙		
	8: 10,0 ↙		
	9: 9,9 ↓		
	10: 9,0 ↙		
	Serie 91,0		
	Totalt 230,0		

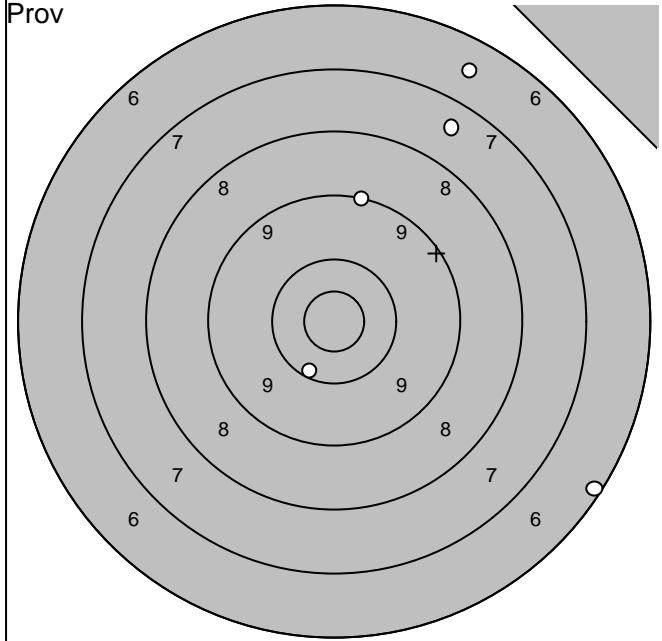

1: 6,6 ↗
2: 7,5 ↗
3: 6,2 ↘
4: 9,1 ↑
5: 10,2 ↙

Serie	38,0
Totalt	0,0

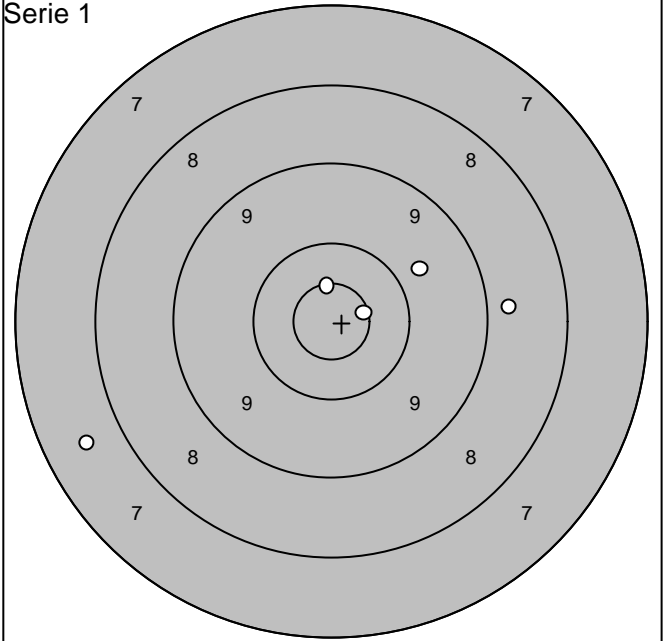

1: 10,6* →
2: 10,6* ↑
3: 8,8 →
4: 7,6 ↙
5: 9,8 ↗

Serie	44,0
Totalt	44,0

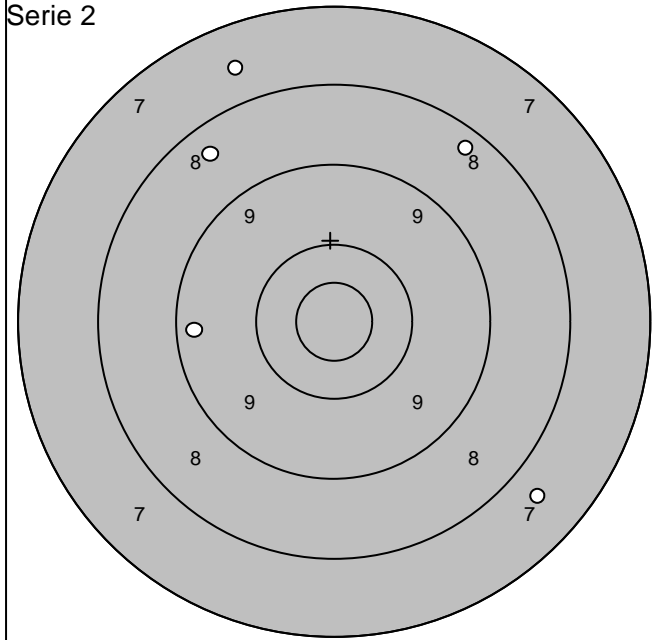

1: 9,3 ←
2: 8,3 ↗
3: 8,4 ↗
4: 7,7 ↘
5: 7,6 ↗

Serie	39,0
Totalt	83,0

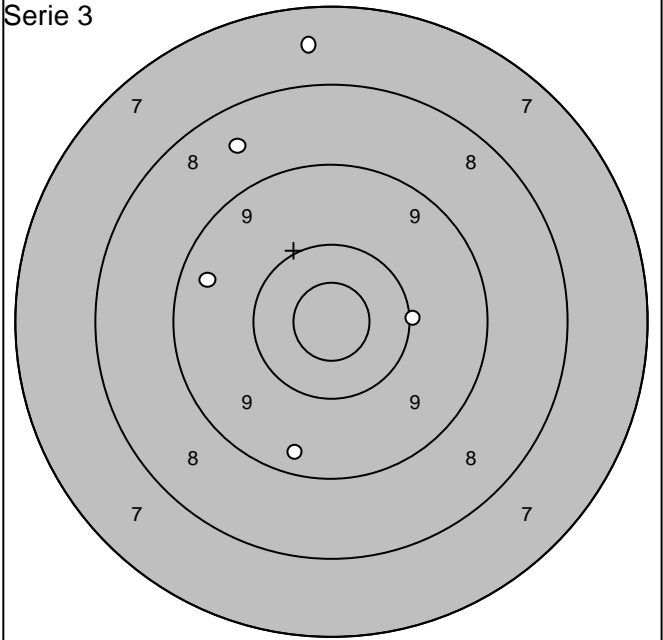

1: 10,0 →
2: 7,5 ↑
3: 9,4 ↙
4: 9,4 ↙
5: 8,5 ↗

Serie	43,0
Totalt	126,0

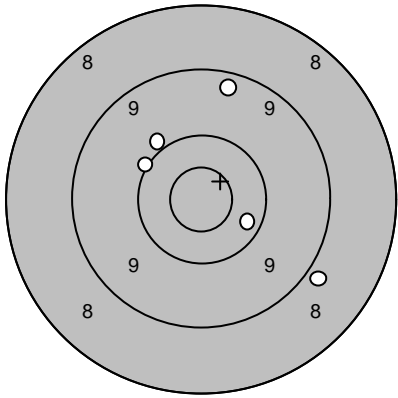
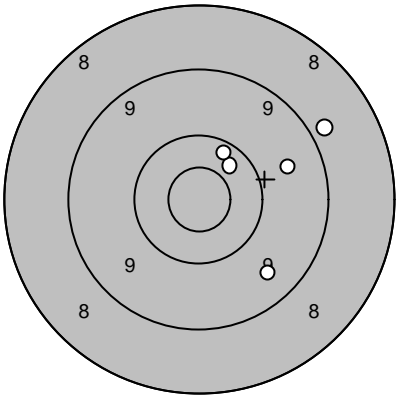
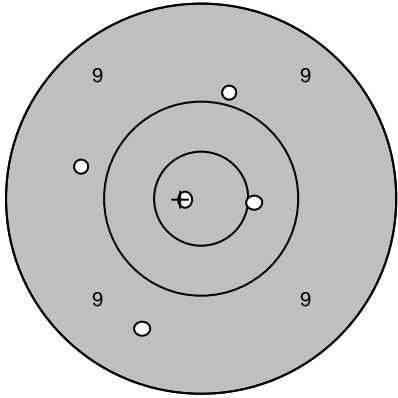
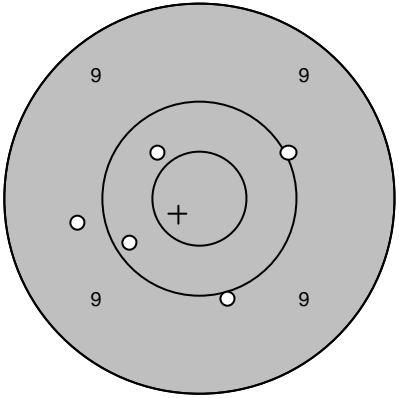
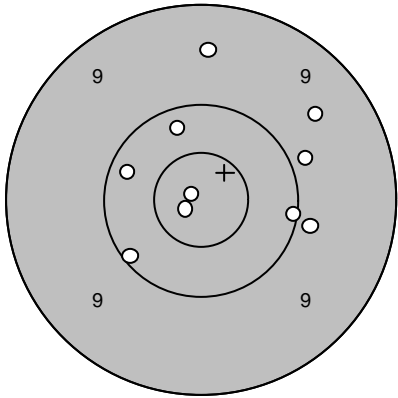
Skjutlag 4	Tavla 1	Dan-Ivan Karlsson	
Ramselefors		Ramselefors	
05.07.2006		Tavelträffen A - 2006	Ramselefors Skytteförening
Prov 	1: 10,1 ↖	Serie 1 	1: 9,5 ↘
	2: 10,0 ↗		2: 9,6 →
	3: 9,3 ↑		3: 10,4 ↗
	4: 10,3 →		4: 8,9 ↗
	5: 8,9 ↘		5: 10,3 ↗
	Serie 48,6		Serie 48,7
	Totalt 0,0		Totalt 48,7
Serie 2 	1: 9,6 ↘	Serie 3 	1: 9,8 ←
	2: 10,9* ←		2: 10,2 ←
	3: 9,9 ↑		3: 10,4 ↗
	4: 10,5* →		4: 10,0 ↘
	5: 9,8 ←		5: 10,0 ↗
	Serie 50,7		Serie 50,4
	Totalt 99,4		Totalt 149,8
Extratävling 	1: 10,9* ↖		
	2: 10,2 ←		
	3: 9,9 →		
	4: 9,6 ↗		
	5: 10,8* ←		
	6: 10,1 →		
	7: 9,5 ↑		
	8: 10,3 ↑		
	9: 10,1 ↘		
	10: 9,9 →		
	Serie 101,3		
	Totalt 251,1		

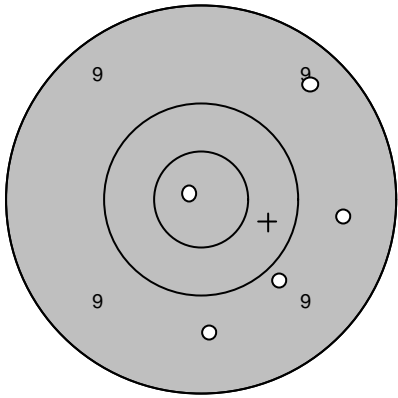
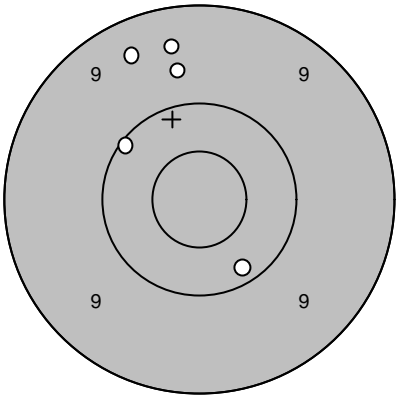
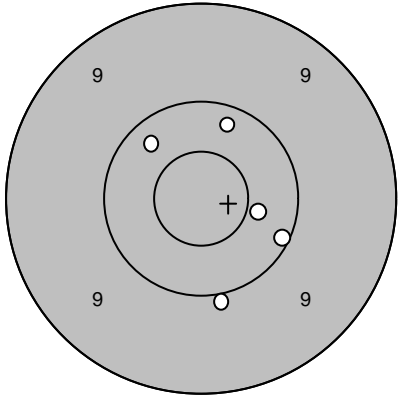
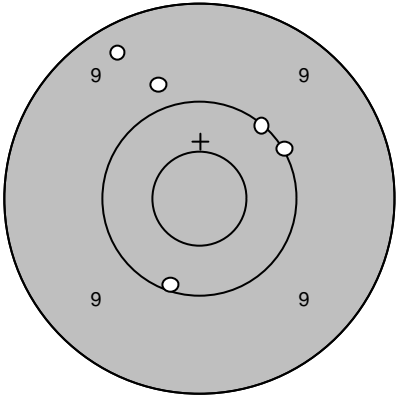
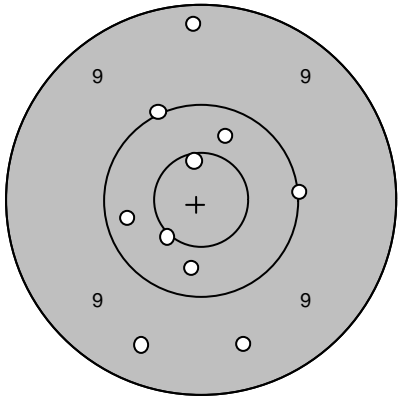
Skjutlag 4	Tavla 2	Johan Zakrisson	
Ramselefors	Ramselefors		
05.07.2006	Tavelträffen A - 2006	Ramselefors Skytteförening	
Prov		1: 9,7 ↓ 2: 10,9* ↖ 3: 9,6 → 4: 9,9 ↘ 5: 9,4 ↗	Serie 1 
			1: 9,5 ↑ 2: 9,4 ↗ 3: 9,7 ↑ 4: 10,1 ↗ 5: 10,2 ↘
		Serie 49,5	Serie 48,9
		Totalt 0,0	Totalt 48,9
Serie 2		1: 10,0 ↓ 2: 10,2 ↑ 3: 10,1 → 4: 10,4 → 5: 10,3 ↗	Serie 3 
			1: 9,8 ↑ 2: 10,1 ↓ 3: 9,3 ↖ 4: 10,0 ↗ 5: 10,1 ↗
		Serie 51,0	Serie 49,3
		Totalt 99,9	Totalt 149,2
Extratävling		1: 10,3 ← 2: 10,5* ↘ 3: 9,4 ↓ 4: 10,0 → 5: 9,5 ↓ 6: 10,6* ↑ 7: 10,3 ↓ 8: 9,2 ↑ 9: 10,3 ↑ 10: 10,0 ↖	
		Serie 100,1	
		Totalt 249,3	

Skjutlag	Tavla	<h1 style="margin: 0;">Fredrik Forsgren</h1>
4	3	

Ramselefors	Ramselefors		
-------------	-------------	--	--

05.07.2006	Tavelträffen A - 2006	Ramselefors Skytteförening
------------	-----------------------	----------------------------

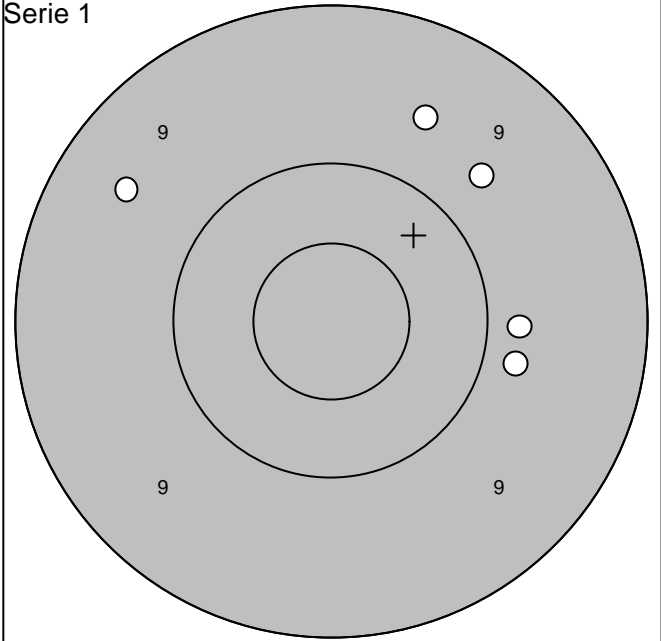
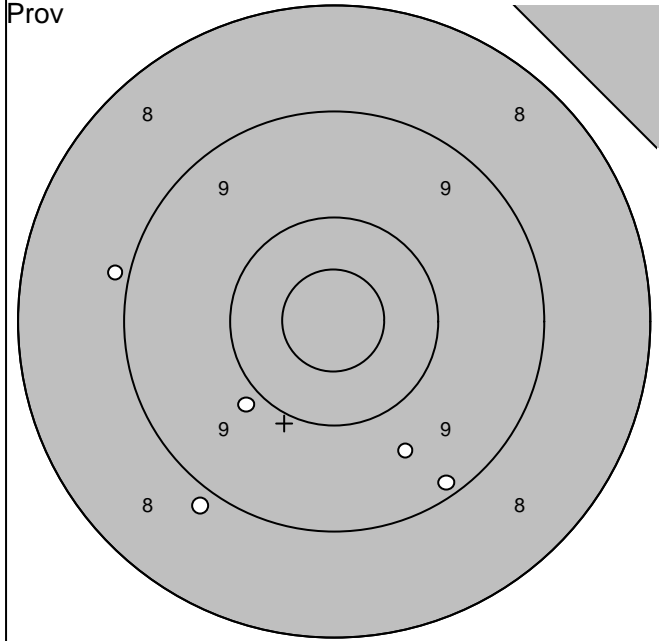

1: 9,9 ↙	Serie	46,5
2: 8,9 ↘		
3: 8,9 ←	Totalt	0,0
4: 9,6 ↘		
5: 9,2 ↘		

1: 9,8 →	Serie	48,4
2: 9,7 ↗		
3: 9,6 ↗	Totalt	48,4
4: 9,8 →		
5: 9,5 ↖		

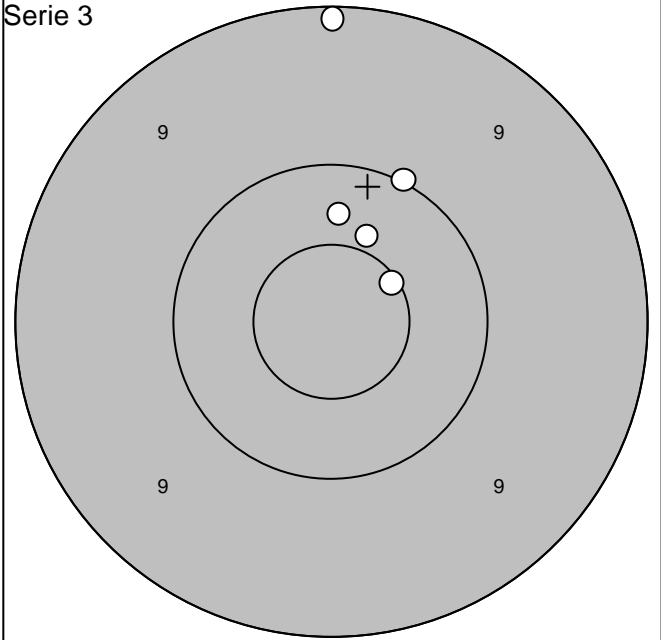
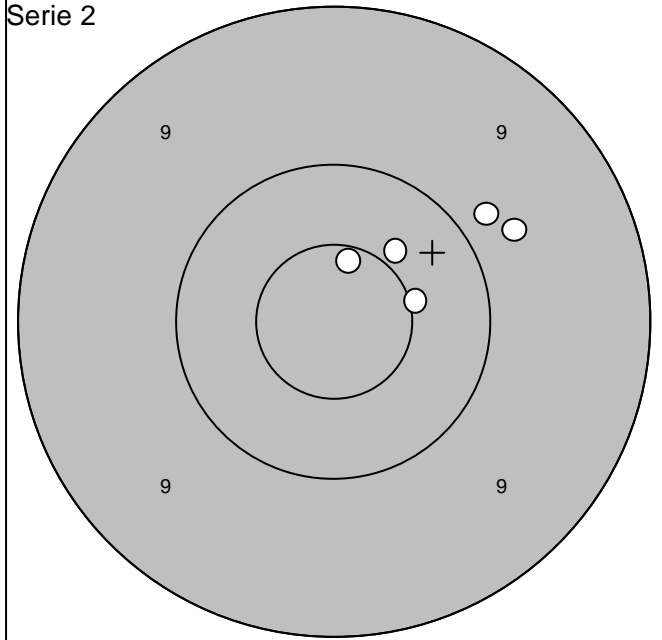

1: 10,5* →	Serie	51,1
2: 10,4 ↗		
3: 9,8 ↗	Totalt	99,5
4: 9,8 ↗		
5: 10,6* ↑		

1: 10,6* ↗	Serie	50,4
2: 9,1 ↑		
3: 10,0 ↗	Totalt	149,9
4: 10,3 ↑		
5: 10,4 ↗		

www.AC-Skytte.com

Skjutlag	Tavla	<h1>Johan Nilsson</h1>
4	4	

Ramselefors	Ramselefors		
-------------	-------------	--	--

05.07.2006	Tavelträffen A - 2006	Ramselefors Skytteförening
------------	-----------------------	----------------------------

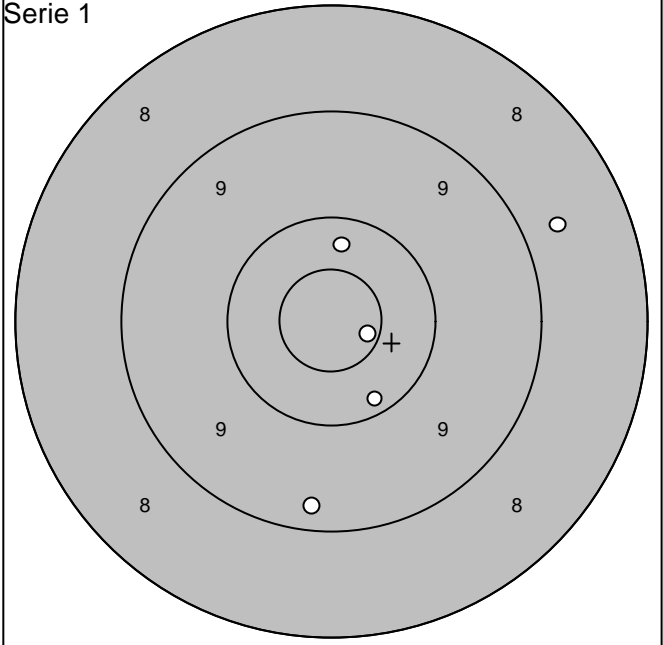
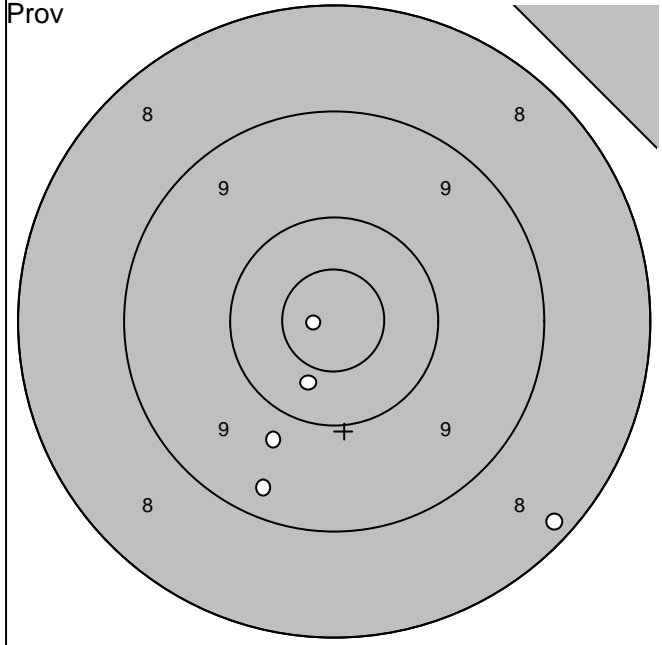

1:10,8* ←
2:10,4 ↓
3: 9,3 ↓
4: 9,8 ↓
5: 8,2 ↘

Serie	48,5
Totalt	0,0

1:10,3 ↑
2: 8,7 →
3:10,2 ↓
4:10,7* →
5: 9,3 ↓

Serie	49,2
Totalt	49,2

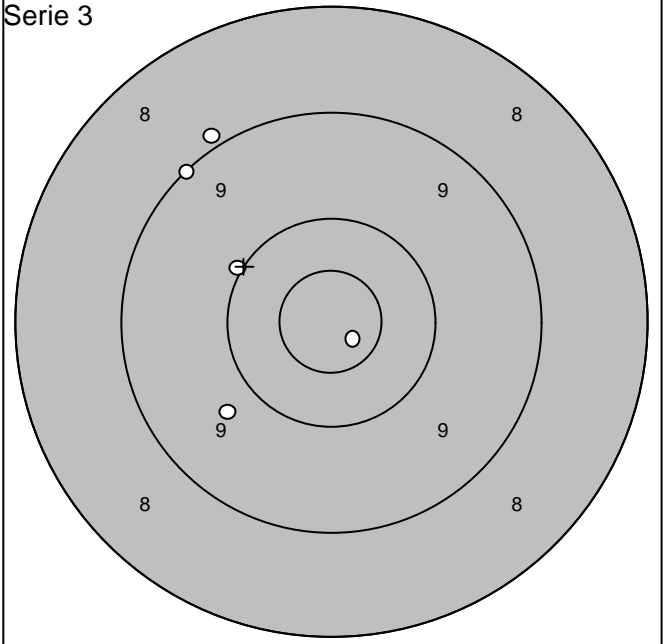
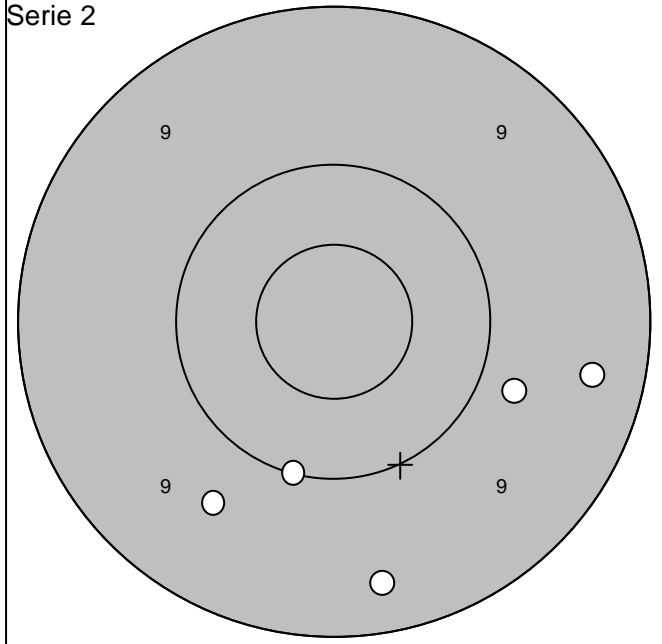

1: 9,8 →
2: 9,4 →
3: 9,4 ↓
4:10,0 ↓
5: 9,7 ↘

Serie	48,3
Totalt	97,5

1:10,0 ↗
2: 8,9 ↗
3: 9,1 ↗
4: 9,7 ↙
5:10,8* ↘

Serie	48,5
Totalt	146,0

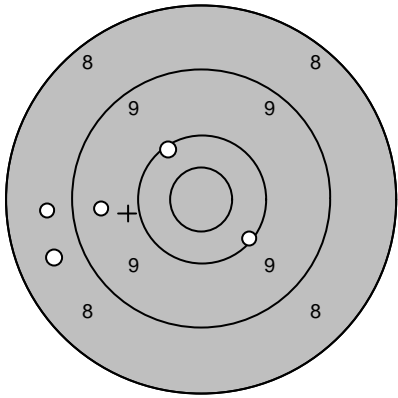
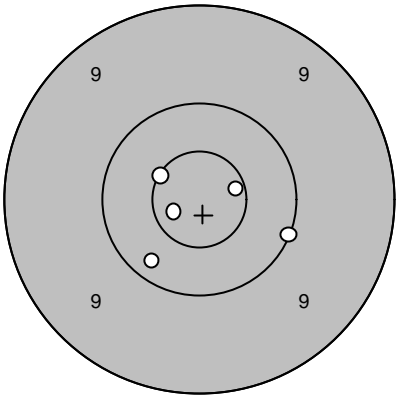
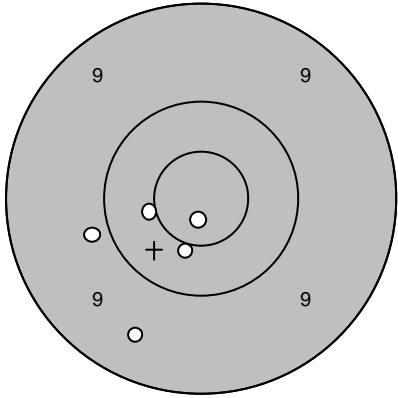
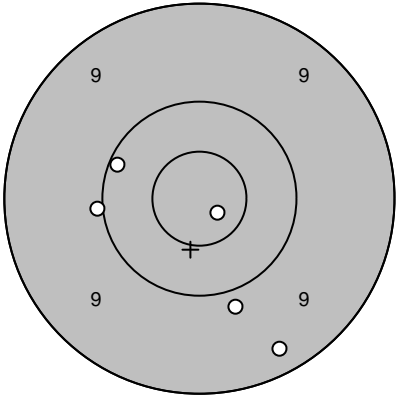
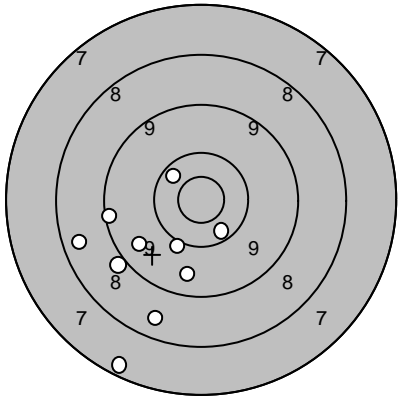
Skjutlag	Tavla	Marie Fjällström	
4	5		
Ramselefors	Ramselefors		
05.07.2006	Tavelträffen A - 2006	Ramselefors Skytteförening	
Prov 	1: 8,7 ←	Serie 1 	1: 10,6* →
	2: 10,2 ↗		2: 10,6* ↖
	3: 8,7 ←		3: 10,2 ↘
	4: 9,5 ←		4: 10,7* ←
	5: 10,1 ↘		5: 10,1 →
	Serie 47,2		Serie 52,2
	Totalt 0,0		Totalt 52,2
Serie 2 	1: 9,5 ↘	Serie 3 	1: 10,8* ↘
	2: 10,8* ↘		2: 9,9 ↘
	3: 10,5* ↘		3: 9,3 ↘
	4: 9,9 ←		4: 10,0 ←
	5: 10,5* ←		5: 10,1 ↖
	Serie 51,2		Serie 50,1
	Totalt 103,4		Totalt 153,5
Extratävling 	1: 10,1 ↘		
	2: 10,4 ↖		
	3: 9,0 ↖		
	4: 10,4 ↘		
	5: 9,6 ←		
	6: 7,4 ↘		
	7: 8,5 ←		
	8: 8,5 ↘		
	9: 9,6 ↘		
	10: 9,2 ←		
	Serie 92,7		
	Totalt 246,2		

Skjutlag

Tavla

4

7

Linda Lidman

Ramselefors

Piteå

05.07.2006

Tavelträffen A - 2006

Ramselefors Skytteförening

Prov

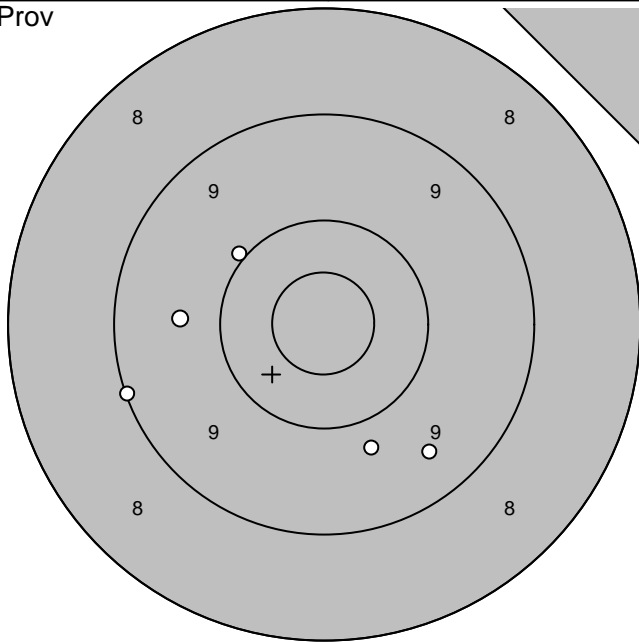

Serie 1

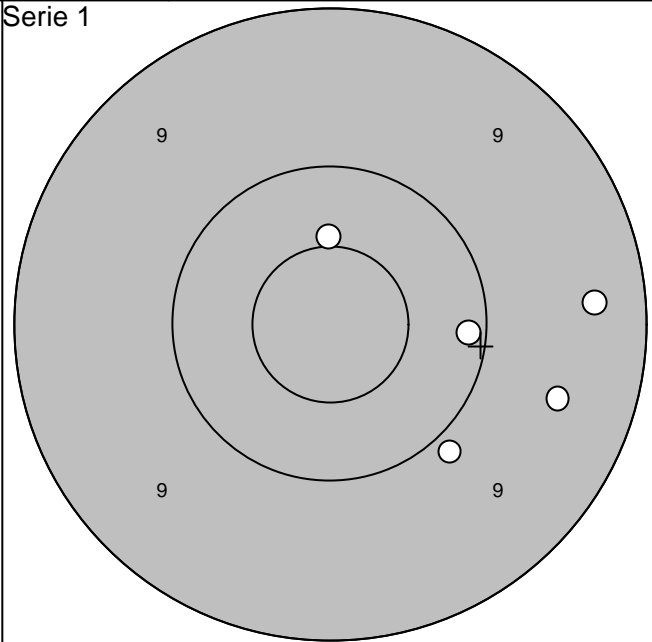

1: 9,1 ←
 2: 9,7 ←
 3: 10,0 ↗
 4: 9,8 ↓
 5: 9,5 ↓

Serie 48,1

Totalt 0,0

1: 9,9 ↘
 2: 10,2 →
 3: 10,5* ↑
 4: 9,5 ↘
 5: 9,4 →

Serie 49,5

Totalt 49,5

Serie 2

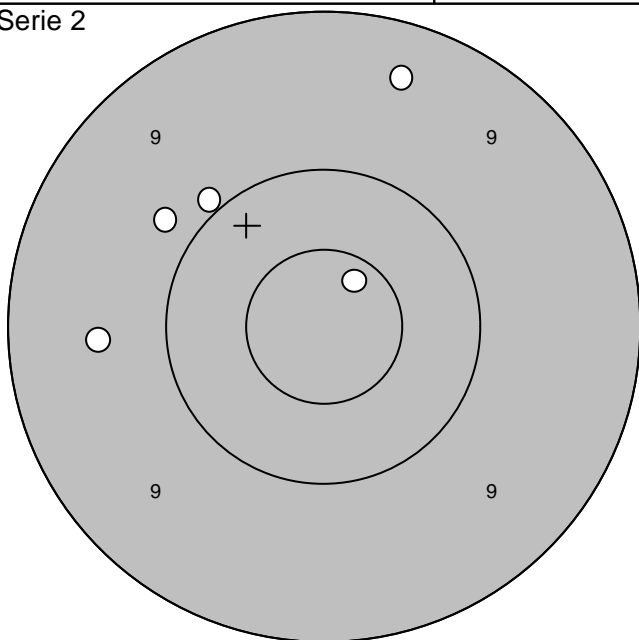

Serie 3

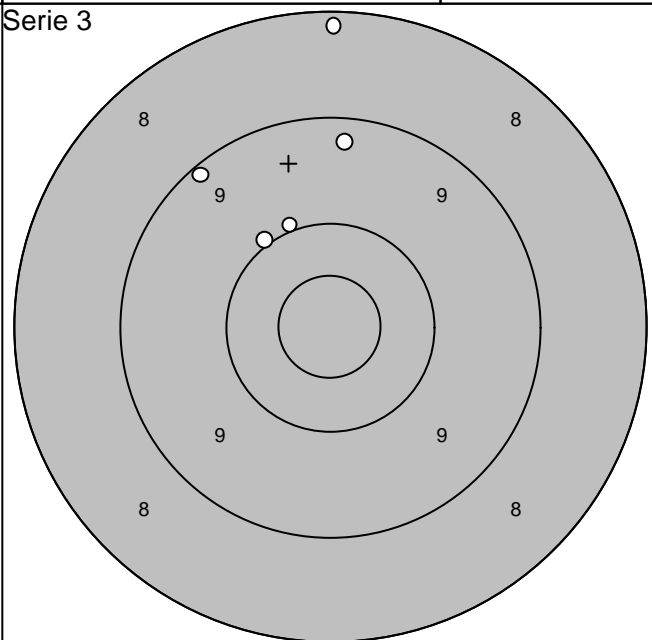

1: 9,6 ←
 2: 10,7* ↗
 3: 10,0 ↗
 4: 9,8 ↖
 5: 9,4 ↑

Serie 49,5

Totalt 99,0

1: 8,2 ↑
 2: 10,0 ↖
 3: 9,3 ↑
 4: 10,0 ↖
 5: 9,1 ↖

Serie 46,6

Totalt 145,6

www.AC-Skytte.com

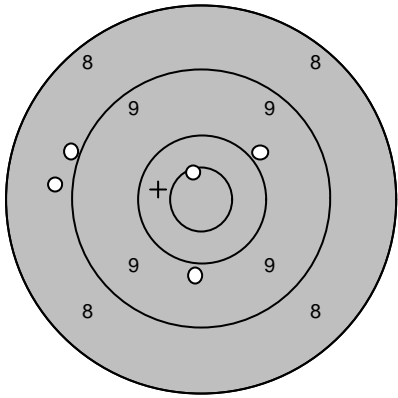
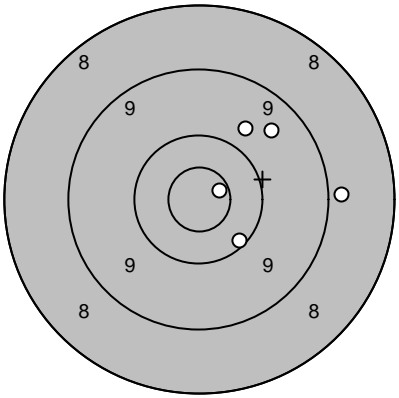
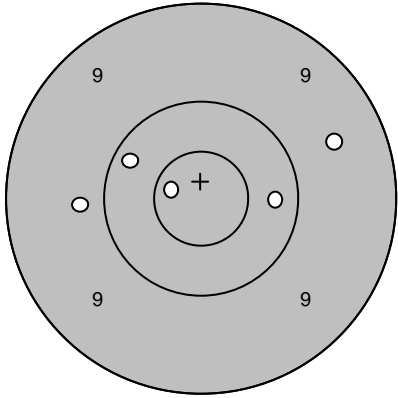
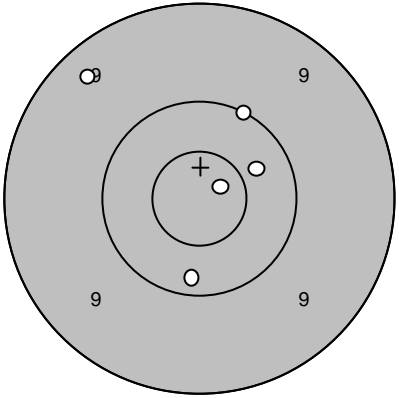
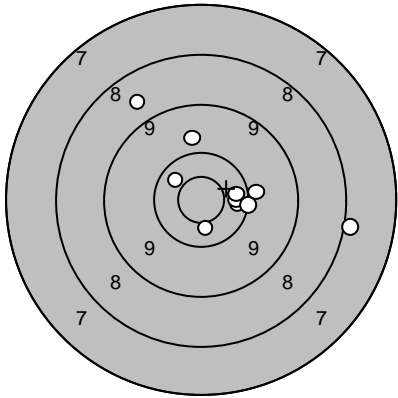
Skjutlag 4	Tavla 8	Sture Grahn	
Ramselefors		Piteå	
05.07.2006		Tavelträffen A - 2006	Ramselefors Skytteförening
Prov 	1: 8,8 ← 2: 8,9 ← 3: 10,7* ↑ 4: 9,9 ↗ 5: 9,9 ↓	Serie 1 	1: 9,6 ↗ 2: 10,7* ↗ 3: 9,8 ↗ 4: 8,9 → 5: 10,2 ↘
	Serie 48,2		Serie 49,2
	Totalt 0,0		Totalt 49,2
Serie 2 	1: 9,6 → 2: 10,2 ↖ 3: 10,7* ← 4: 10,3 → 5: 9,8 ←	Serie 3 	1: 10,8* ↗ 2: 10,2 ↓ 3: 10,4 ↗ 4: 9,4 ↖ 5: 10,1 ↗
	Serie 50,6		Serie 50,9
	Totalt 99,8		Totalt 150,7
Extratävling 	1: 10,4 → 2: 10,4 → 3: 10,4 → 4: 10,5* ↖ 5: 8,7 ↖ 6: 10,2 → 7: 10,0 → 8: 10,5* ↓ 9: 9,8 ↑ 10: 8,0 →		
	Serie 98,9		
	Totalt 249,6		

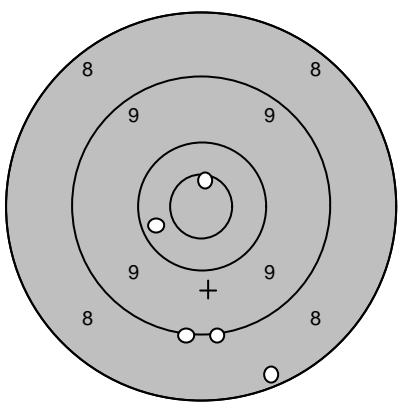
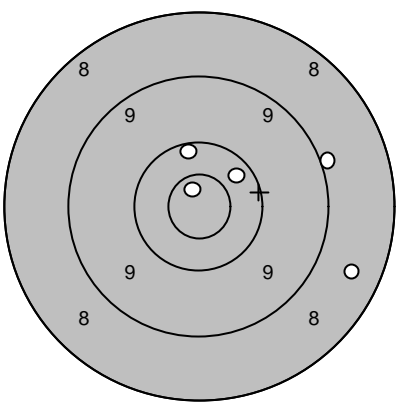
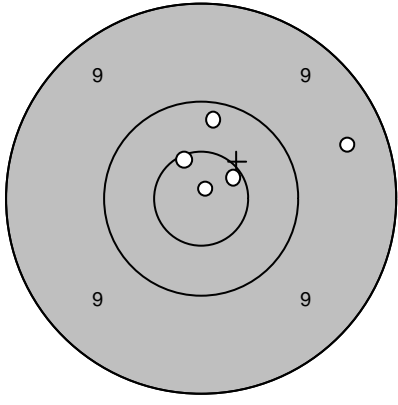
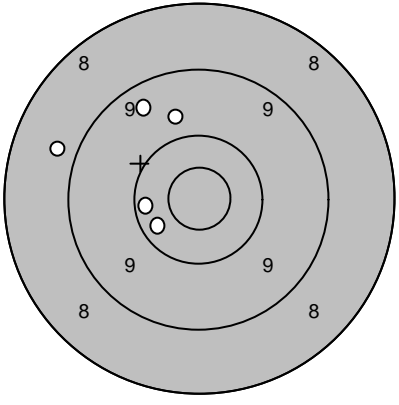
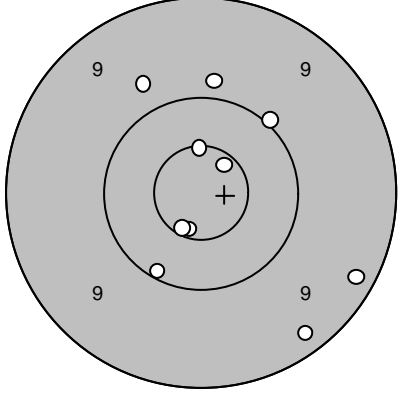
Skjutlag 4	Tavla 9	Håkan Lidman		
Ramselefors		Skellefteå		
05.07.2006		Tavelträffen A - 2006		Ramselefors Skytteförening
Prov 	1: 9,1 ↓	Serie 1 	1: 9,0 →	
	2: 9,1 ↓		2: 8,5 ↘	
	3: 8,3 ↓		3: 10,2 ↑	
	4: 10,7* ↑		4: 10,8* ↑	
	5: 10,3 ←		5: 10,3 ↗	
	Serie 47,5		Serie 48,8	
	Totalt 0,0		Totalt 48,8	
Serie 2 	1: 10,6* ↗	Serie 3 	1: 10,3 ←	
	2: 9,4 →		2: 10,3 ←	
	3: 10,6* ↖		3: 9,8 ↑	
	4: 10,2 ↑		4: 8,8 ←	
	5: 10,9* ↑		5: 9,5 ↖	
	Serie 51,7		Serie 48,7	
	Totalt 100,5		Totalt 149,2	
Extratävling 	1: 9,9 ↑			
	2: 10,6* ↑			
	3: 9,3 ↓			
	4: 10,1 ↓			
	5: 10,6* ↓			
	6: 10,6* ↓			
	7: 10,7* ↗			
	8: 9,2 ↘			
	9: 9,8 ↖			
	10: 10,0 ↗			
	Serie 100,8			
	Totalt 250,0			

Skjutlag	Tavla	<h1>Anders Carlqvist</h1>
4	10	

Ramselefors	Skyllberg		
-------------	-----------	--	--

05.07.2006	Tavelträffen A - 2006	Ramselefors Skytteförening
------------	-----------------------	----------------------------

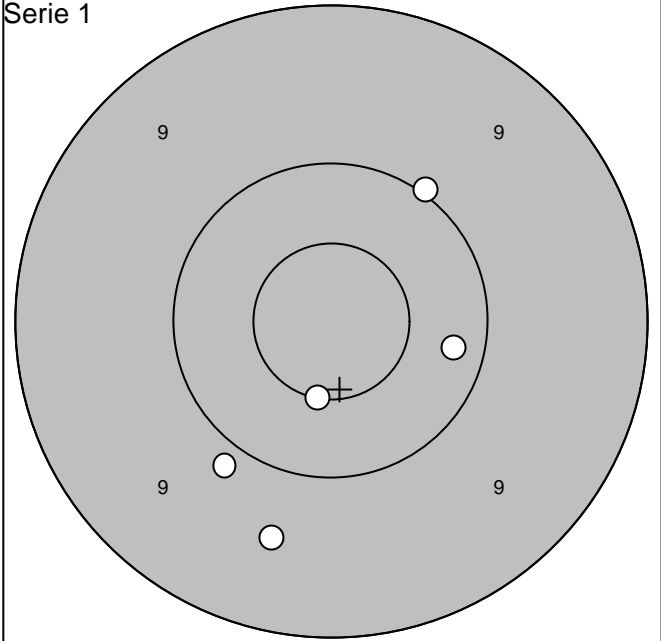
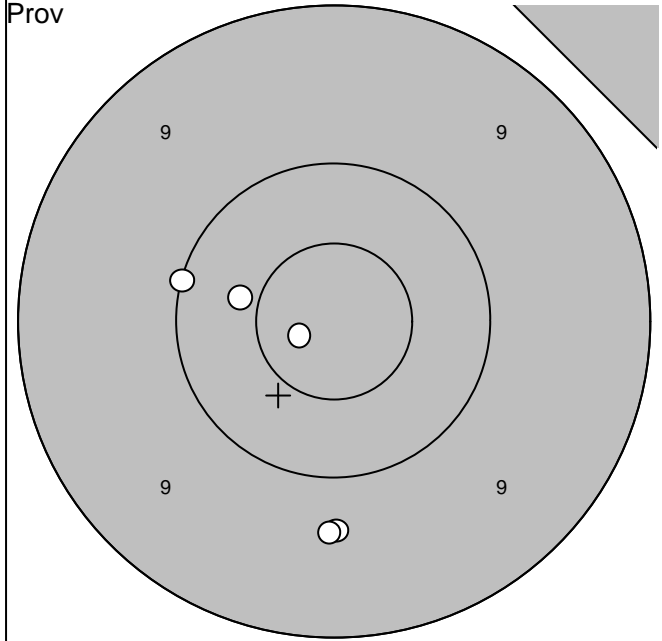

1:10,8* ←
2: 9,7 ↓
3:10,0 ←
4:10,4 ←
5: 9,7 ↓

Serie	50,6
Totalt	0,0

1:10,2 →
2: 9,9 ↙
3:10,5* ↓
4:10,0 ↗
5: 9,6 ↓

Serie	50,2
Totalt	50,2

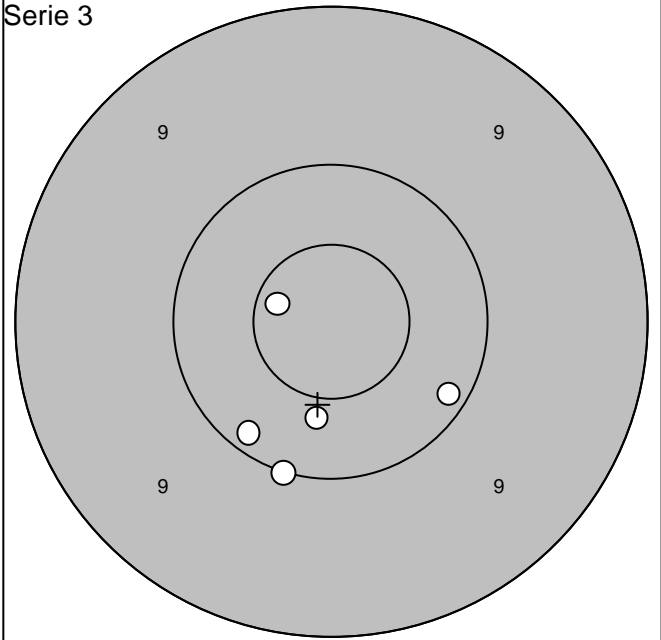
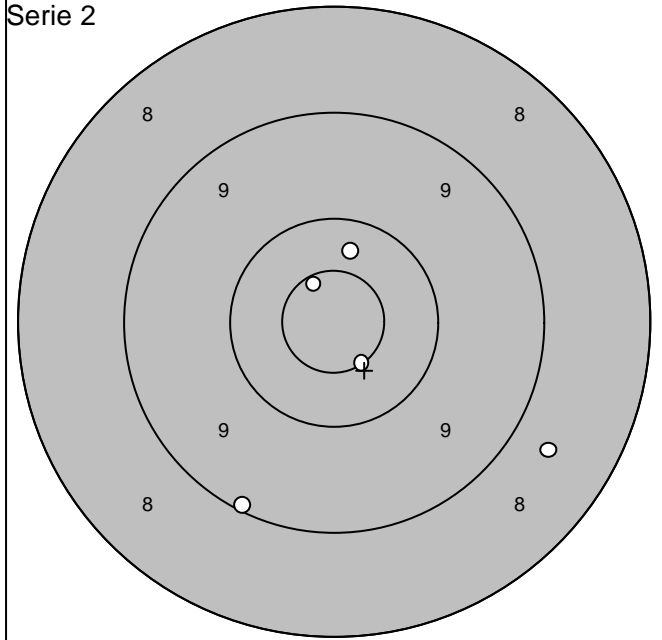

1:10,6* ↗
2: 8,7 ↘
3:10,6* ↘
4: 9,1 ↘
5:10,3 ↑

Serie	49,3
Totalt	99,5

1:10,7* ↖
2:10,2 ↘
3:10,0 ↓
4:10,2 ↙
5:10,4 ↓

Serie	51,5
Totalt	151,0

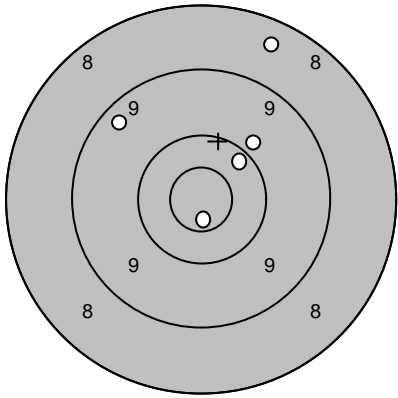
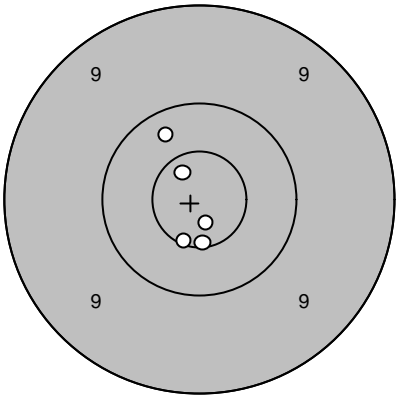
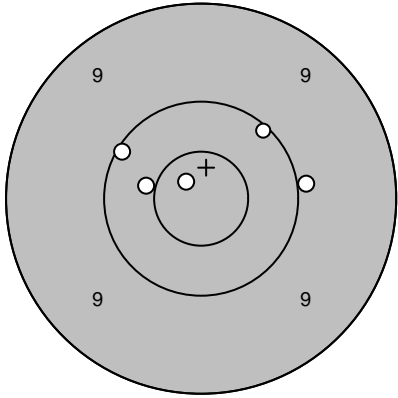
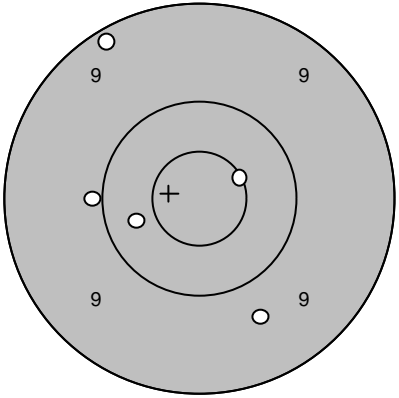
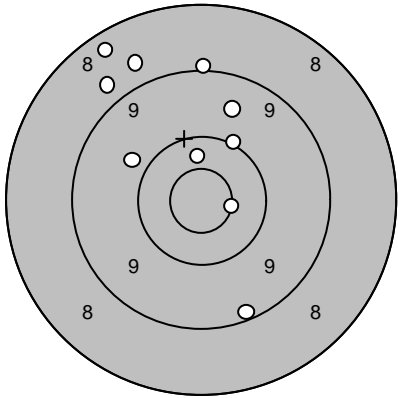
Skjutlag 4	Tavla 11	Krister Pettersson	
Ramselefors		Bastuträsk	
05.07.2006		Tavelträffen A - 2006	Ramselefors Skytteförening
Prov		1: 10,8* ↓ 2: 8,5 ↑ 3: 9,9 ↗ 4: 10,3 ↗ 5: 9,4 ↖	Serie 1 
		Serie 48,9 Totalt 0,0	1: 10,7* ↖ 2: 10,6* ↓ 3: 10,3 ↖ 4: 10,6* ↓ 5: 10,8* ↓ Serie 53,0 Totalt 53,0
Serie 2		1: 10,1 ↗ 2: 10,0 → 3: 10,8* ↗ 4: 10,5* ← 5: 10,1 ↖	Serie 3 
		Serie 51,5 Totalt 104,5	1: 10,4 ← 2: 9,2 ↖ 3: 10,6* ↗ 4: 9,7 ↓ 5: 10,0 ← Serie 49,9 Totalt 154,4
Extratävling		1: 9,0 ↑ 2: 10,4 ↑ 3: 10,1 ↗ 4: 9,2 ↓ 5: 10,6* → 6: 8,3 ↗ 7: 8,8 ↗ 8: 9,6 ↑ 9: 9,9 ↖ 10: 8,7 ↗	
		Serie 94,6 Totalt 249,0	

Skjutlag	Tavla	Patrik Lindfors	
4	12		
Ramselefors	I 19		
05.07.2006	Tavelträffen A - 2006	Ramselefors Skytteförening	
Prov		1: 9,2 ← 2: 9,7 ↗ 3: 10,9* ↘ 4: 10,0 ↑ 5: 9,8 ↗ Serie 49,6 Totalt 0,0	Serie 1 1: 9,4 ↗ 2: 10,0 → 3: 9,9 ↘ 4: 10,9* ↑ 5: 10,2 → Serie 50,4 Totalt 50,4
Serie 2		1: 9,8 ← 2: 10,7* ↘ 3: 10,4 ↘ 4: 10,7* ↘ 5: 10,2 ↘ Serie 51,8 Totalt 102,2	Serie 3 1: 9,8 ↖ 2: 9,3 ↑ 3: 9,8 ↗ 4: 9,7 ↓ 5: 9,9 ↙ Serie 48,5 Totalt 150,7
Extratävling		1: 10,4 ← 2: 10,1 ↓ 3: 10,5* ↘ 4: 10,2 ↙ 5: 9,8 ← 6: 10,2 ↑ 7: 10,4 ← 8: 10,4 ← 9: 8,9 ↗ Serie 90,9 Totalt 241,6	

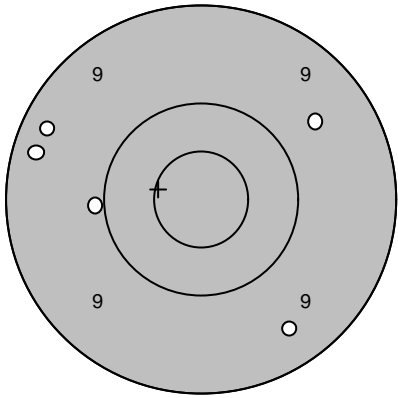
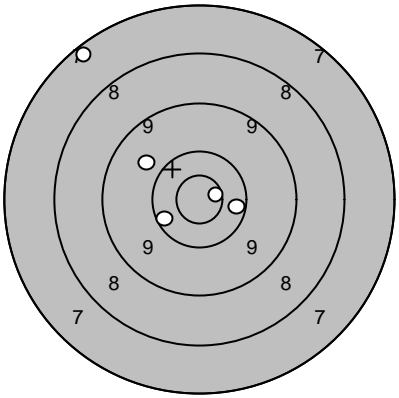
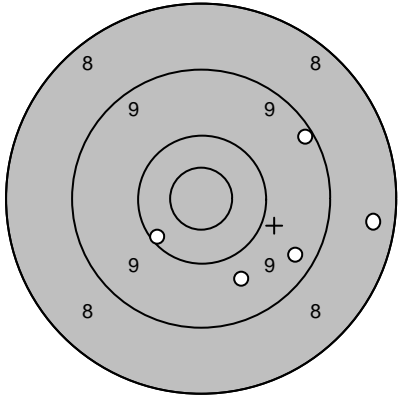
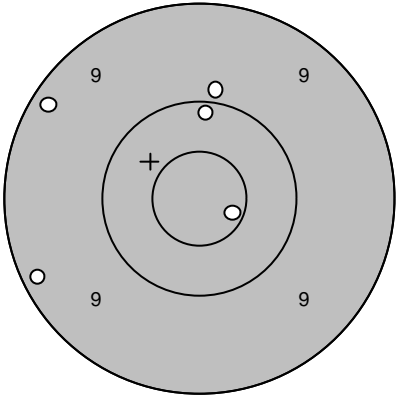
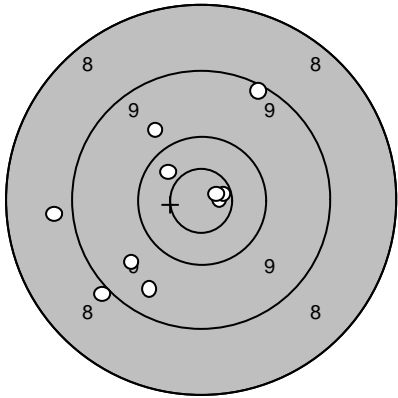
Skjutlag 4	Tavla 14	Torgny Lindfors	
Ramselefors		I 19	
05.07.2006		Tavelträffen A - 2006	Ramselefors Skytteförening
Prov 	1: 9,4 ↘ 2: 9,6 ↗ 3: 9,3 ↖ 4: 9,3 ↖ 5: 10,0 ←	Serie 1 	1: 9,8 ↖ 2: 10,3 → 3: 10,8* → 4: 7,3 ↖ 5: 10,3 ↖
	Serie 47,6		Serie 48,5
	Totalt 0,0		Totalt 48,5
Serie 2 	1: 9,4 → 2: 9,7 ↓ 3: 9,2 ↗ 4: 10,2 ↖ 5: 8,4 →	Serie 3 	1: 9,2 ↖ 2: 9,2 ↖ 3: 10,2 ↑ 4: 10,7* → 5: 9,9 ↑
	Serie 46,9		Serie 49,2
	Totalt 95,4		Totalt 144,6
Extratävling 	1: 9,0 ↖ 2: 10,8* → 3: 10,7* → 4: 9,5 ↓ 5: 9,7 ↖ 6: 10,8* → 7: 9,2 ↗ 8: 8,8 ← 9: 9,8 ↗ 10: 10,4 ↖		
	Serie 98,7		
	Totalt 243,3		

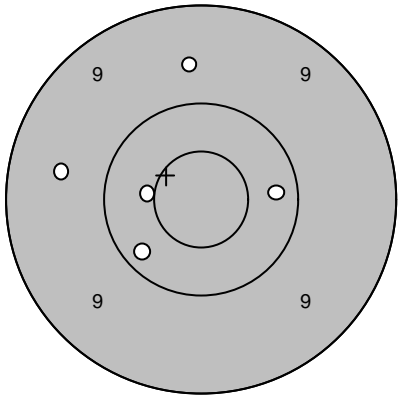
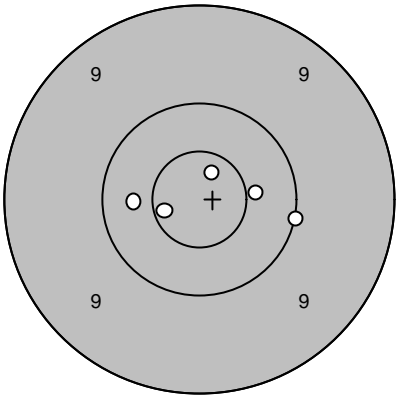
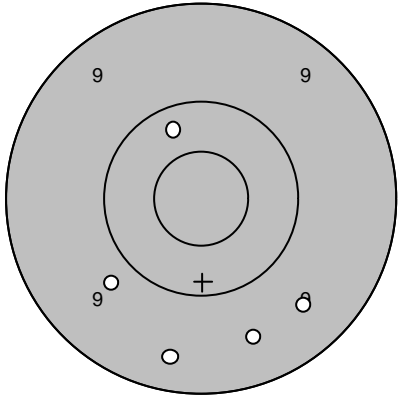
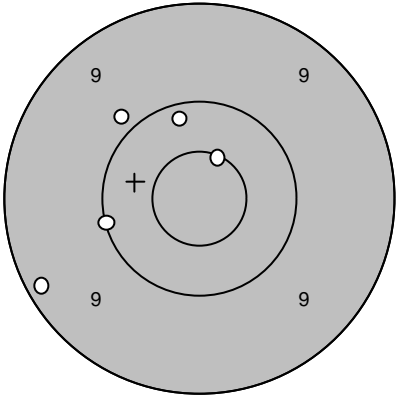
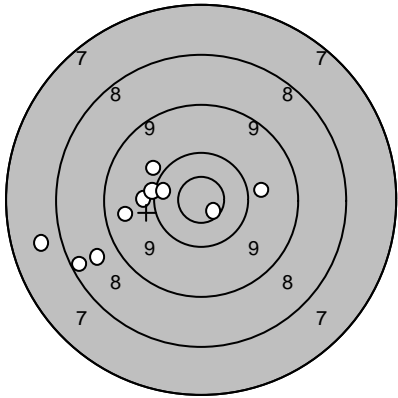
Skjutlag 4	Tavla 15	Rune Utterström	
Ramselefors		Ale	
05.07.2006		Tavelträffen A - 2006	Ramselefors Skytteförening
Prov		1: 10,2 ↙ 2: 10,3 → 3: 9,7 ↑ 4: 10,5* ← 5: 9,6 ←	Serie 1 
		Serie 50,3 Totalt 0,0	1: 10,0 → 2: 10,4 ← 3: 10,7* ← 4: 10,4 → 5: 10,7* ↗
			Serie 52,2 Totalt 52,2
Serie 2		1: 9,5 ↓ 2: 10,3 ↑ 3: 9,8 ↙ 4: 9,4 ↓ 5: 9,5 ↘	Serie 3 
		Serie 48,5 Totalt 100,7	1: 9,2 ← 2: 10,2 ↑ 3: 10,1 ← 4: 9,9 ↖ 5: 10,6* ↗
			Serie 50,0 Totalt 150,7
Extratävling		1: 10,8* ↘ 2: 10,0 ← 3: 10,1 ← 4: 9,9 ↖ 5: 9,5 ← 6: 10,3 ← 7: 8,3 ← 8: 9,9 → 9: 8,7 ↙ 10: 7,8 ←	
		Serie 95,3 Totalt 246,0	

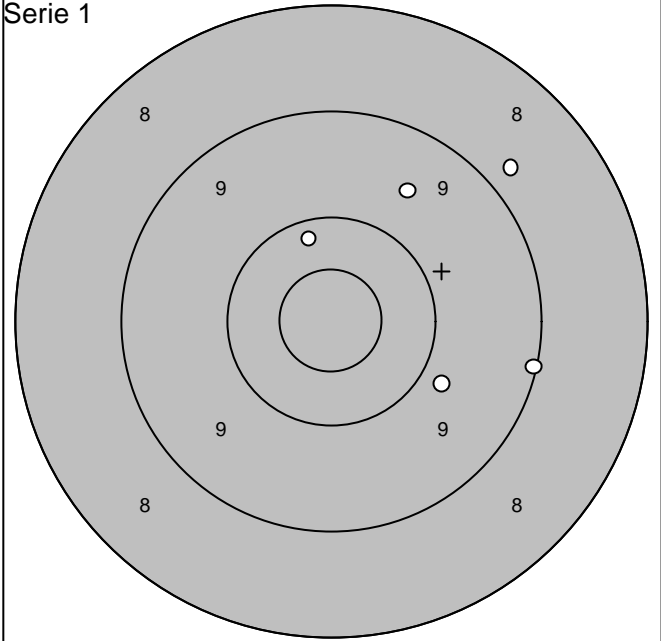
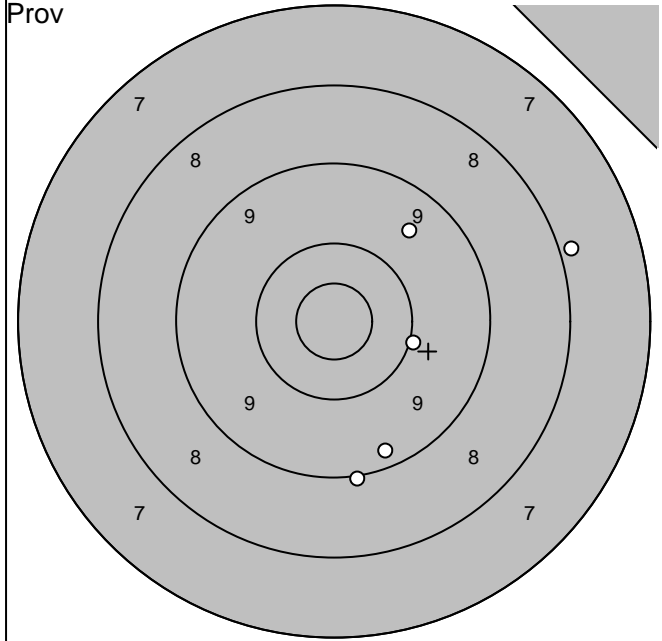

1: 7,9 →		Serie	45,8
2: 9,6 ↗		Totalt	0,0
3: 9,3 ↓			
4: 10,0 →			
5: 9,0 ↓			

1: 10,2 ↑		Serie	47,5
2: 9,1 →		Totalt	47,5
3: 9,6 ↗			
4: 8,8 ↗			
5: 9,8 ↘			

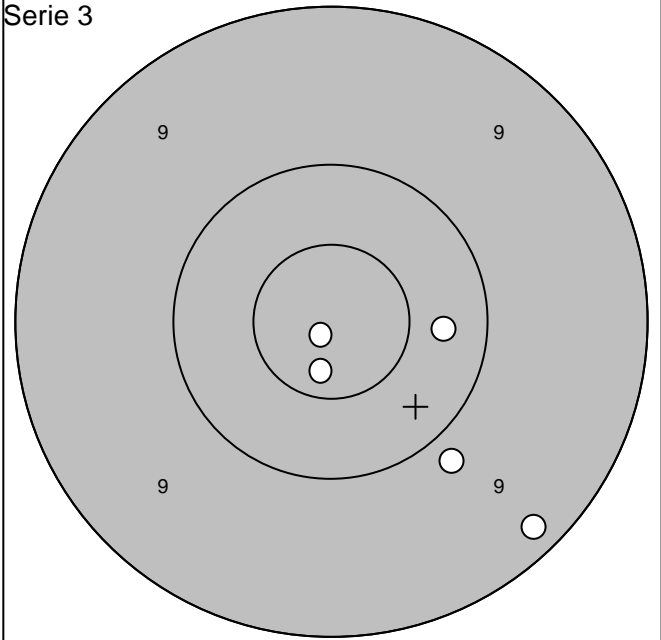
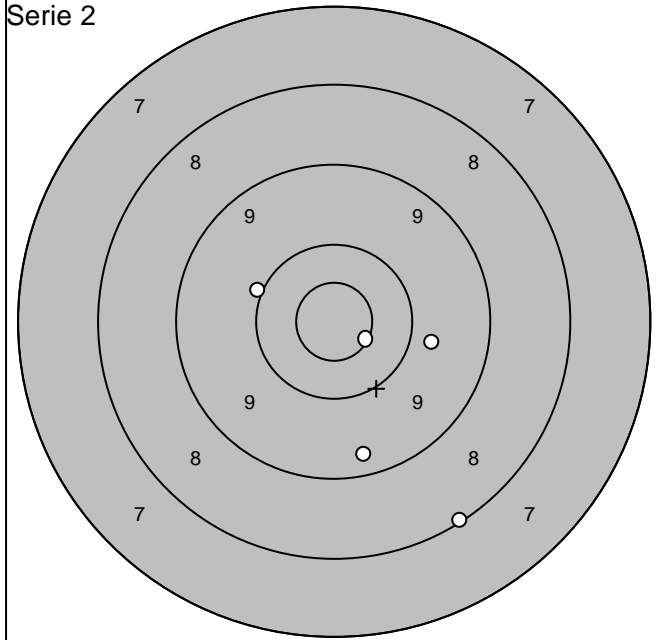

1: 9,4 ↓		Serie	47,9
2: 10,6* ↘		Totalt	95,4
3: 8,1 ↓			
4: 9,8 →			
5: 10,0 ←			

1: 10,7* ↓		Serie	51,0
2: 10,9* ↘		Totalt	146,4
3: 10,3 →			
4: 9,2 ↓			
5: 9,9 ↘			

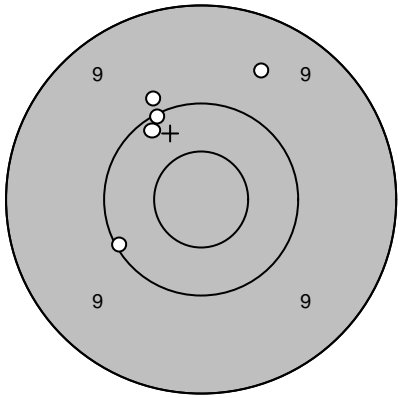
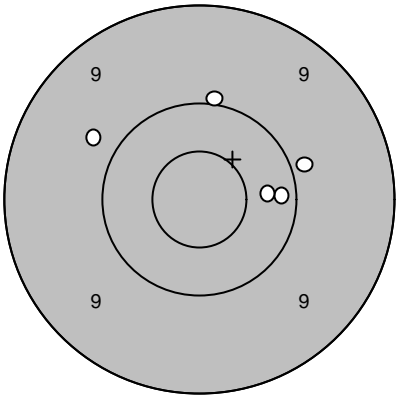
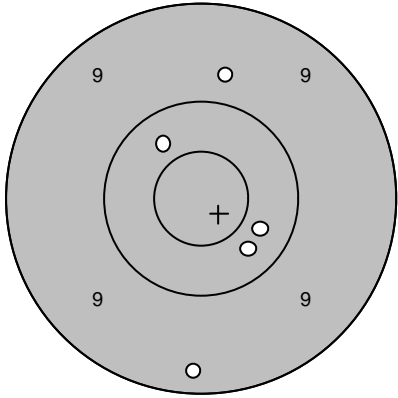
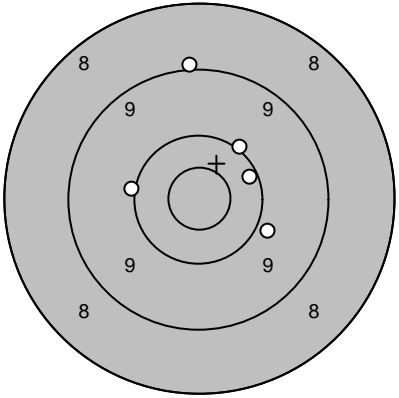
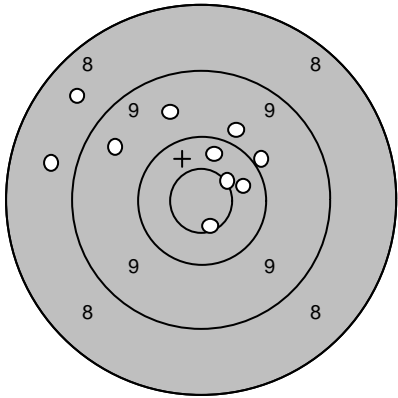
Skjutlag 4	Tavla 17	Per Östling	
Ramselefors		F 21	
05.07.2006		Tavelträffen A - 2006	Ramselefors Skytteförening
Prov 	1: 10,1 ↗ 2: 10,1 ↖ 3: 9,9 ↗ 4: 9,6 ↗ 5: 10,2 ↗	Serie 1 	1: 10,0 ↑ 2: 9,9 → 3: 10,2 → 4: 10,3 → 5: 9,8 ↖
	Serie 49,9 Totalt 0,0		Serie 50,2 Totalt 50,2
Serie 2 	1: 10,3 ↘ 2: 9,3 ↓ 3: 10,4 ↗ 4: 9,8 ↑ 5: 10,4 ↘	Serie 3 	1: 9,0 ↑ 2: 9,9 → 3: 10,2 ↗ 4: 10,1 ↗ 5: 10,0 ←
	Serie 50,2 Totalt 100,4		Serie 49,2 Totalt 149,6
Extratävling 	1: 8,6 ↗ 2: 9,5 ↗ 3: 10,4 → 4: 8,7 ← 5: 10,7* ↓ 6: 9,6 ↗ 7: 9,9 ↗ 8: 10,3 ↗ 9: 10,0 ↗ 10: 10,6* ↗		
	Serie 98,3 Totalt 247,9		

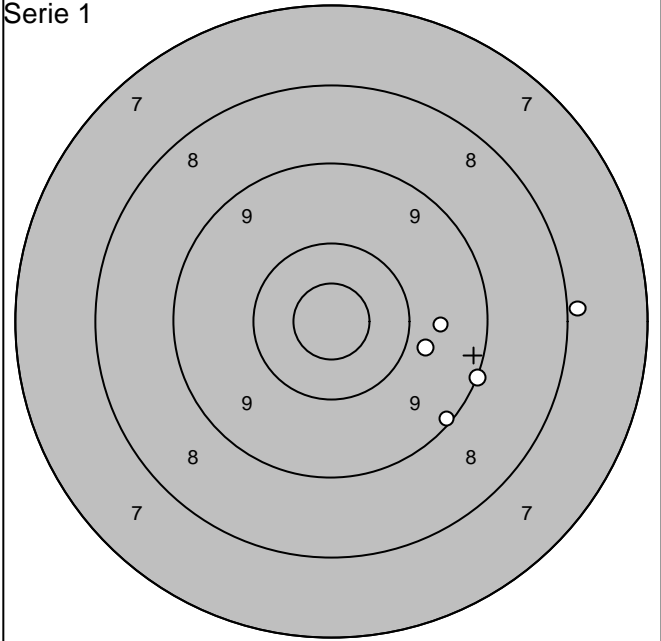
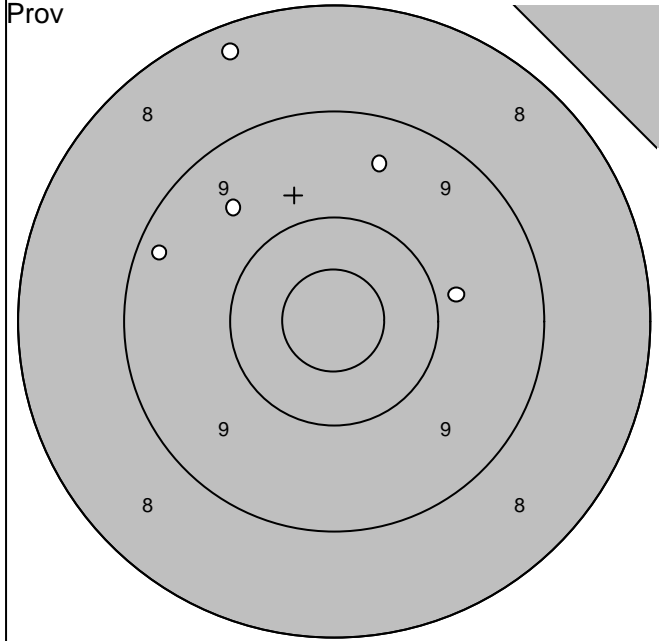

1: 9,8 →	Serie	46,5
2: 9,3 ←		
3: 9,6 ↗	Totalt	0,0
4: 8,3 ↗		
5: 9,5 ↑		

1: 7,9 →	Serie	45,6
2: 9,8 →		
3: 9,1 →	Totalt	45,6
4: 9,7 →		
5: 9,1 ↘		

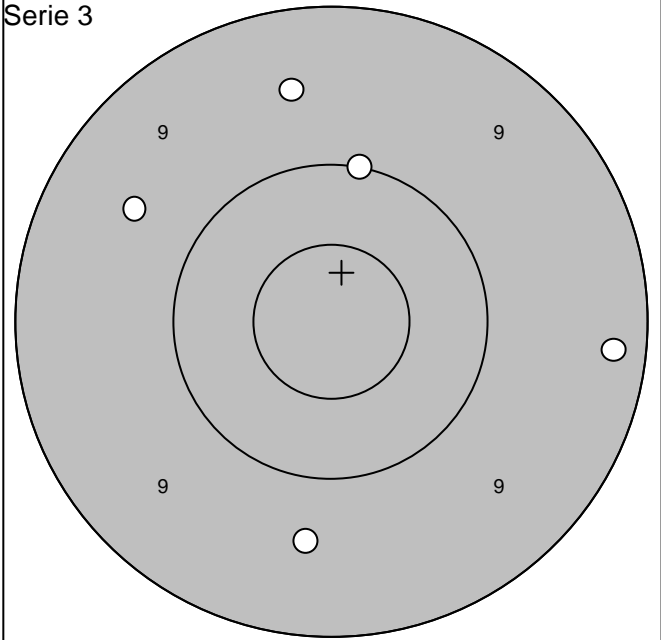
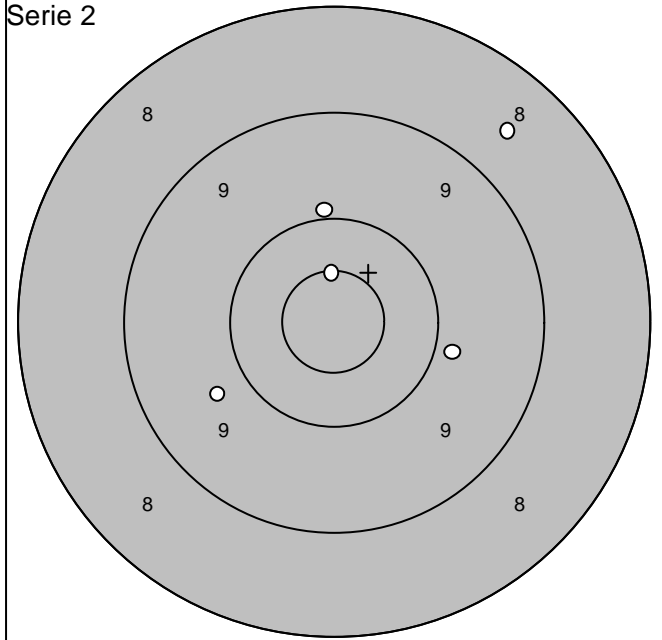

1: 8,6 ↗	Serie	48,8
2: 9,9 →		
3: 10,6* ↑	Totalt	94,4
4: 9,7 ↙		
5: 10,0 ↑		

1: 9,6 ↓	Serie	47,9
2: 9,6 ↙		
3: 9,2 →	Totalt	142,3
4: 9,5 ↑		
5: 10,0 ↑		

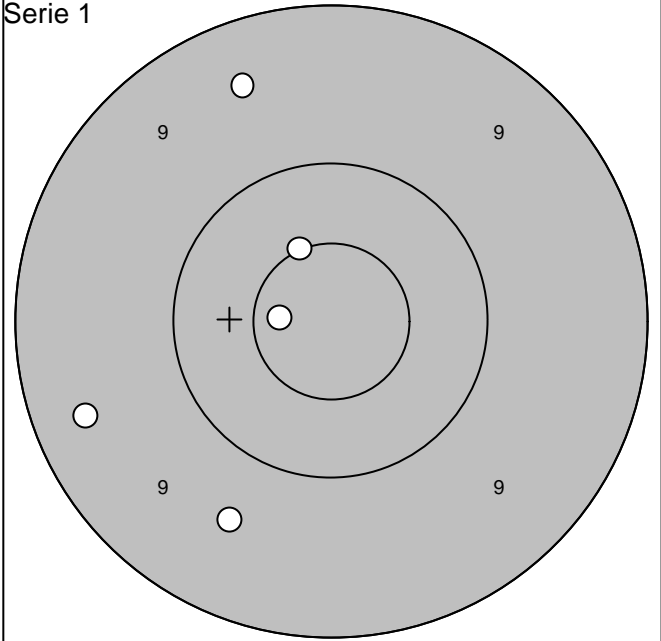
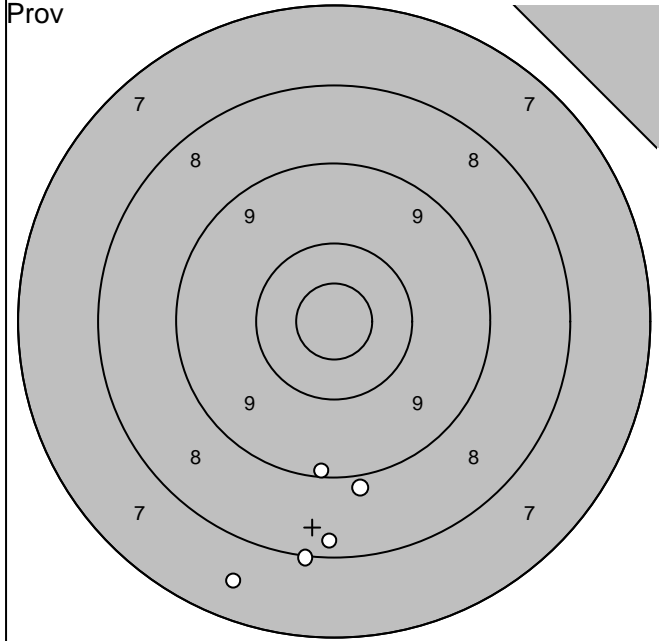

1: 7,5 ↓		Serie	41,9
2: 8,3 ↓		Totalt	0,0
3: 8,0 ↓			
4: 9,2 ↓			
5: 8,9 ↓			

1: 10,5* ↗		Serie	49,6
2: 10,7* ←		Totalt	49,6
3: 9,6 ↓			
4: 9,4 ←			
5: 9,4 ↗			

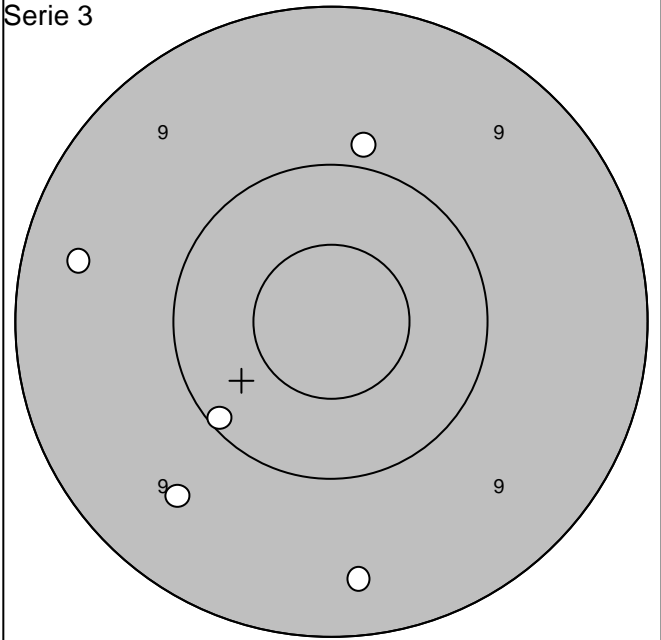
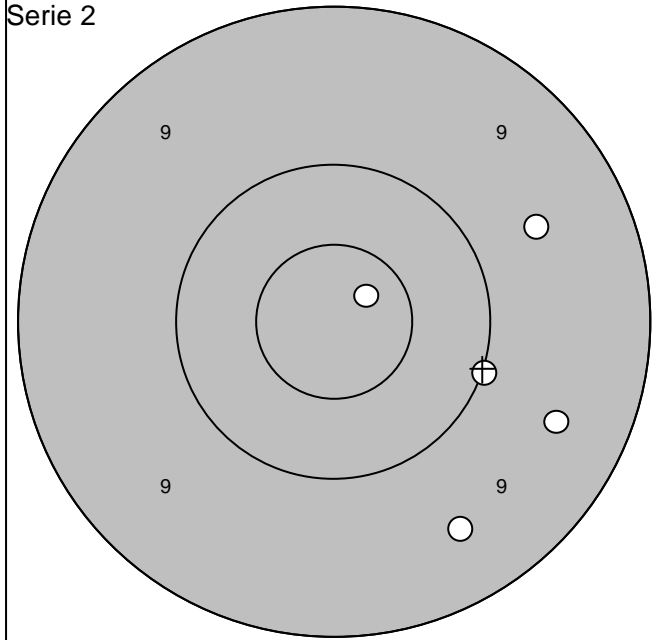

1: 10,8* ↗		Serie	49,4
2: 9,6 →		Totalt	99,0
3: 10,0 →			
4: 9,5 →			
5: 9,5 ↓			

1: 9,9 ↗		Serie	48,4
2: 10,1 ↖		Totalt	147,4
3: 9,4 ↓			
4: 9,6 ↖			
5: 9,4 ←			

Skjutlag 4	Tavla 20	Elina Johansson
----------------------	--------------------	------------------------

Ramselefors	Ale		
-------------	-----	--	--

05.07.2006	Tavelträffen A - 2006	Ramselefors Skytteförening
------------	-----------------------	----------------------------

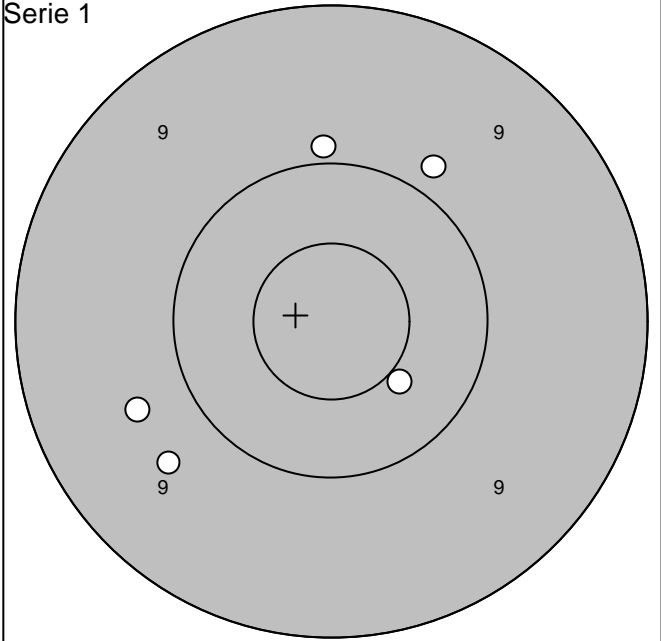
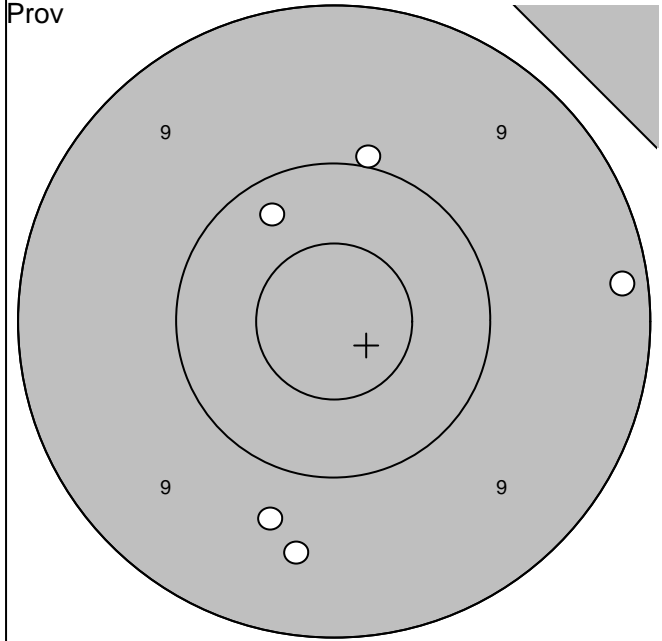

1: 9,7 ↓	Serie	48,8
2: 9,6 ↓		
3: 9,2 →	Totalt	0,0
4:10,3 ↗		
5:10,0 ↑		

1: 9,7 ↙	Serie	49,7
2: 9,9 ↑		
3: 9,9 ↗	Totalt	49,7
4:10,5* ↘		
5: 9,7 ←		

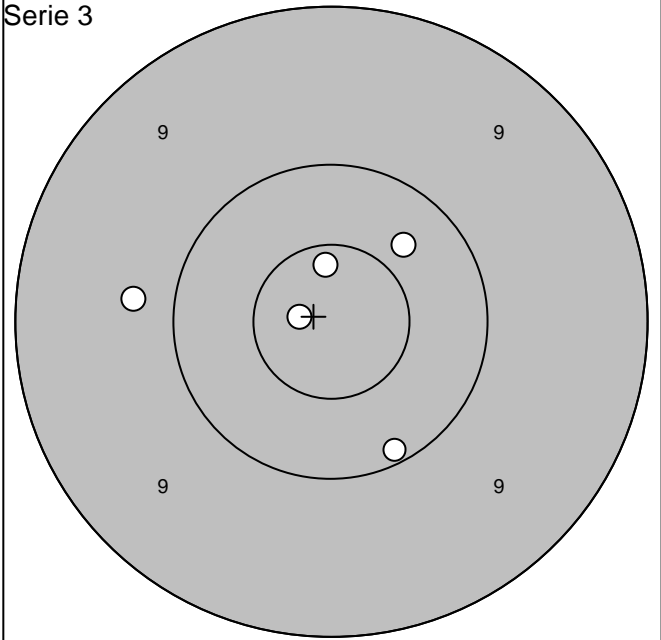
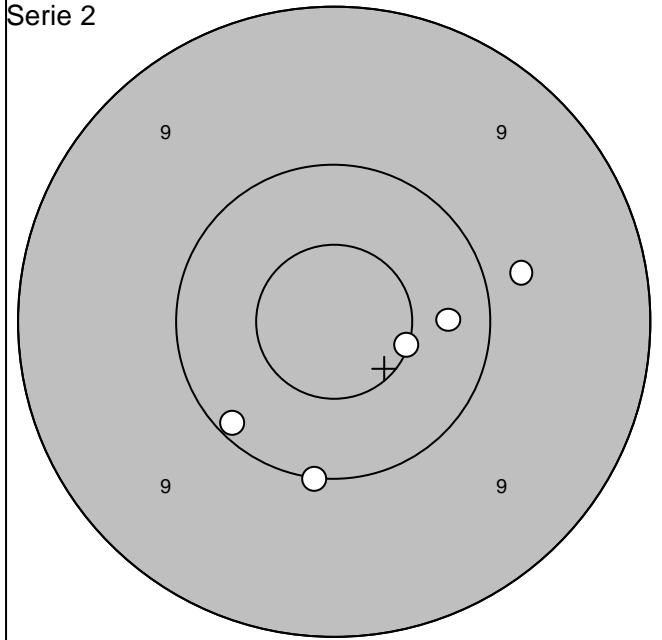

1:10,5* →	Serie	50,7
2: 9,8 →		
3:10,0 ↓	Totalt	100,4
4:10,3 →		
5:10,1 ↙		

1: 9,8 ←	Serie	51,8
2:10,7* ↑		
3:10,4 ↗	Totalt	152,2
4:10,1 ↘		
5:10,8* ←		

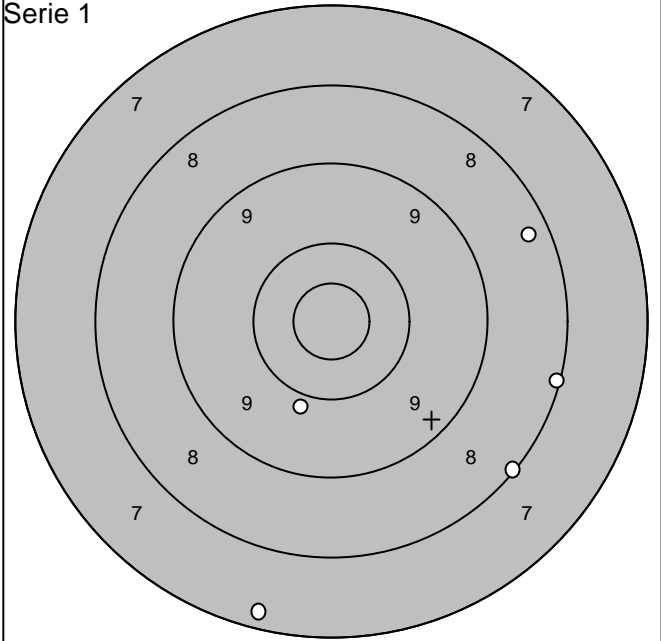
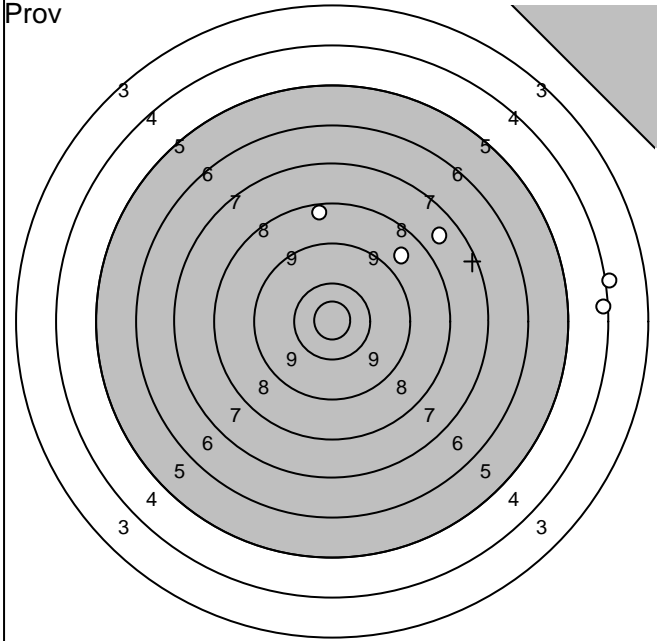

1: 4,1 →	Serie	33,2
2: 4,3 →		
3: 7,7 ↗	Totalt	0,0
4: 8,4 ↑		
5: 8,7 ↗		

1: 8,1 →	Serie	41,7
2: 8,1 ↘		
3: 9,9 ↓	Totalt	41,7
4: 8,3 →		
5: 7,3 ↓		

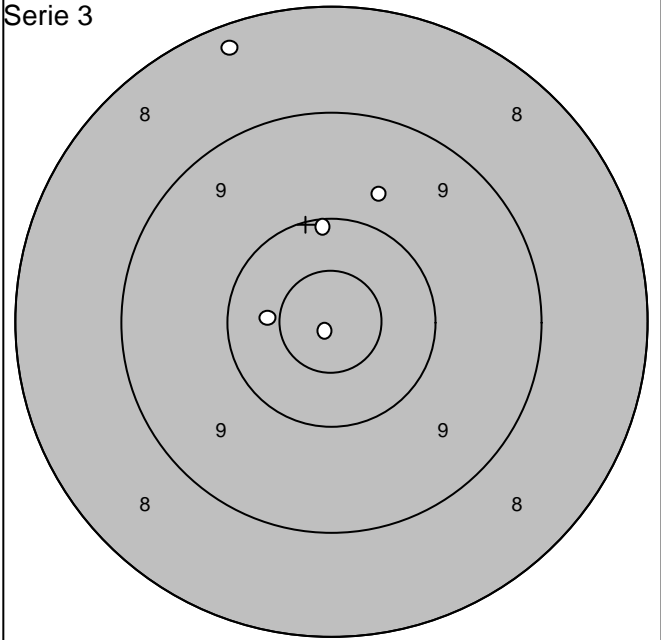
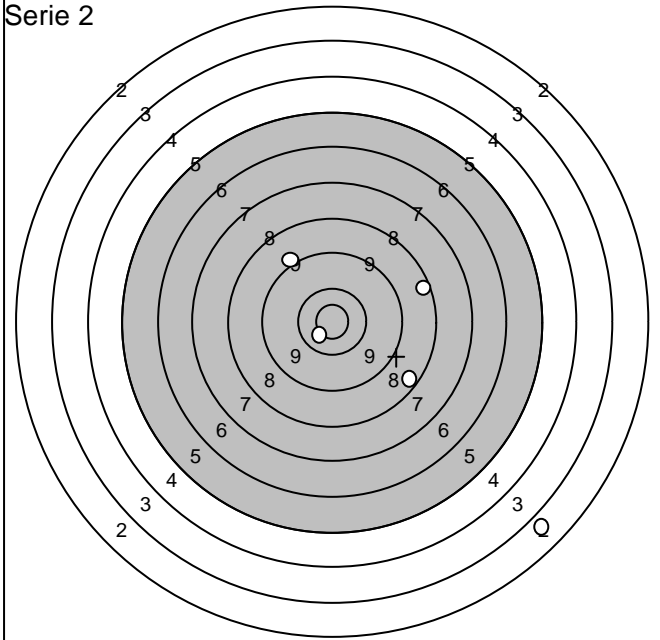

1: 9,1 ↗	Serie	39,5
2: 2,9 ↘		
3: 10,7* ↙	Totalt	81,2
4: 8,4 ↘		
5: 8,4 →		

1: 10,4 ←	Serie	49,4
2: 10,9* ↘		
3: 9,7 ↗	Totalt	130,6
4: 8,3 ↗		
5: 10,1 ↑		

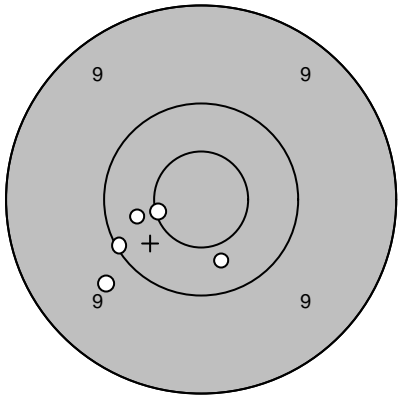
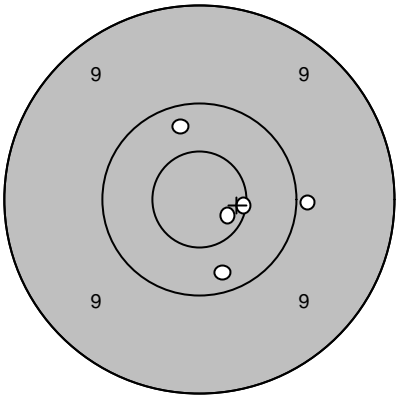
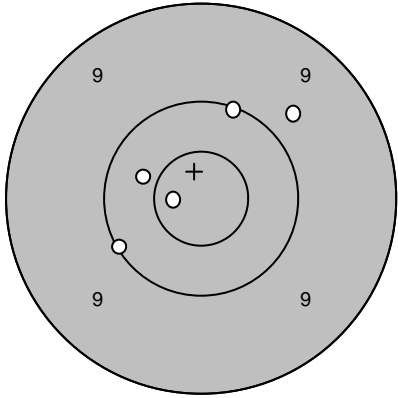
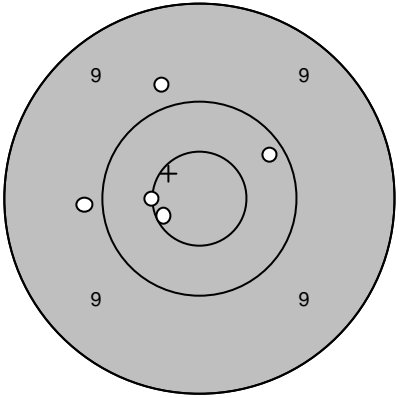
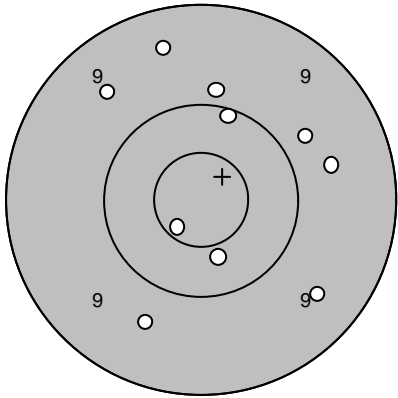
Skjutlag 4	Tavla 22	Peter Ericson	
Ramselefors		Loos	
05.07.2006		Tavelträffen A - 2006	Ramselefors Skytteförening
Prov		1: 10,1 ← 2: 10,4 ↓ 3: 10,4 ← 4: 9,7 ↙ 5: 10,6* ←	Serie 1  1: 10,6* → 2: 9,9 → 3: 10,7* ↘ 4: 10,3 ↓ 5: 10,3 ↑
		Serie 51,2	Serie 51,8
		Totalt 0,0	Totalt 51,8
Serie 2		1: 10,1 ← 2: 10,1 ↑ 3: 9,8 ↗ 4: 10,4 ← 5: 10,7* ←	Serie 3  1: 9,8 ↑ 2: 9,9 ← 3: 10,6* ← 4: 10,6* ← 5: 10,2 ↗
		Serie 51,1	Serie 51,1
		Totalt 102,9	Totalt 154,0
Extratävling		1: 9,9 ↑ 2: 10,7* ↙ 3: 9,6 ↖ 4: 9,4 ↑ 5: 10,1 ↑ 6: 9,8 ↗ 7: 9,5 ↘ 8: 9,7 → 9: 9,7 ↓ 10: 10,4 ↓	
		Serie 98,8	
		Totalt 252,8	

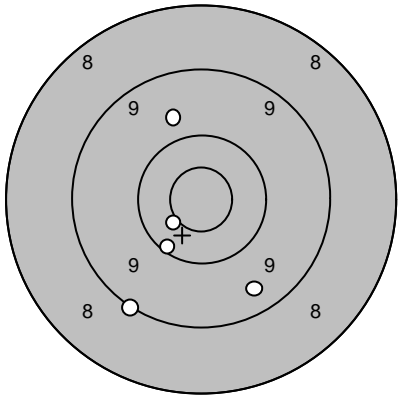
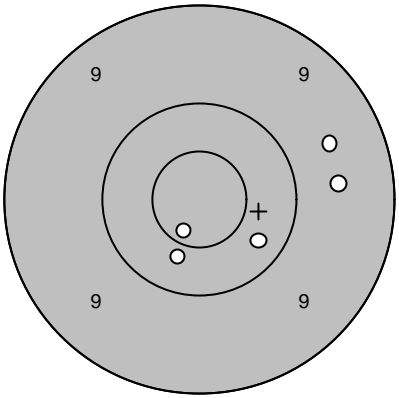
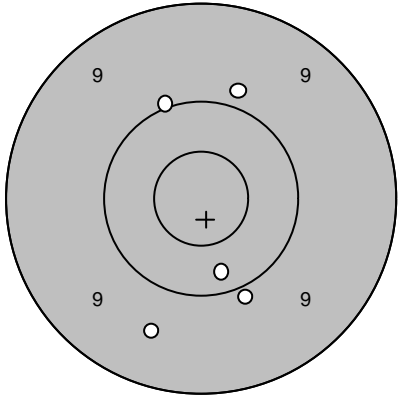
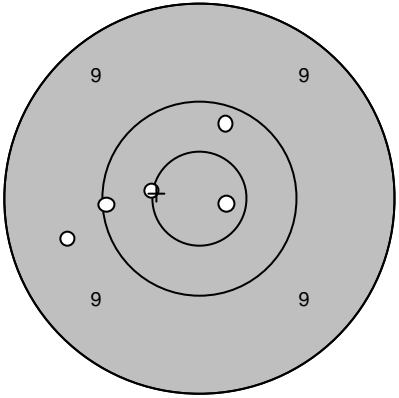
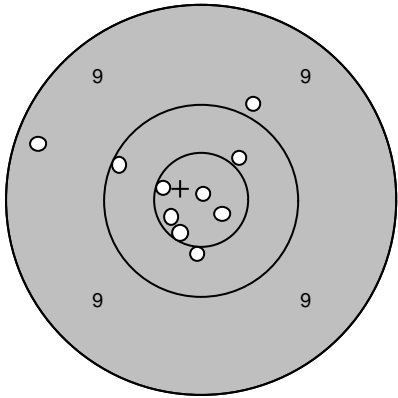
Skjutlag 4	Tavla 23	Elina Högström	
Ramselefors	Ramselefors		
05.07.2006	Tavelträffen A - 2006	Ramselefors Skytteförening	
Prov		1: 9,5 ↘ 2: 10,5* ← 3: 9,1 ↘ 4: 9,8 ↗ 5: 10,2 ↘	Serie 1 
			1: 9,6 → 2: 9,6 ↗ 3: 10,3 ↘ 4: 10,4 ↓ 5: 10,7* ↓
		Serie 49,1	Serie 50,6
		Totalt 0,0	Totalt 50,6
Serie 2		1: 9,9 ↘ 2: 9,9 ↗ 3: 10,3 ↘ 4: 9,6 ↘ 5: 10,0 ↗	Serie 3 
			1: 10,1 ← 2: 10,2 ↗ 3: 10,5* ← 4: 10,8* → 5: 9,6 ←
		Serie 49,7	Serie 51,2
		Totalt 100,3	Totalt 151,5
Extratävling		1: 9,9 ↗ 2: 10,1 ← 3: 9,3 ← 4: 10,9* ↗ 5: 10,8* ↘ 6: 10,5* ↓ 7: 10,5* ↗ 8: 10,6* ↘ 9: 10,6* ← 10: 10,7* ↘	
		Serie 103,9	
		Totalt 255,4	

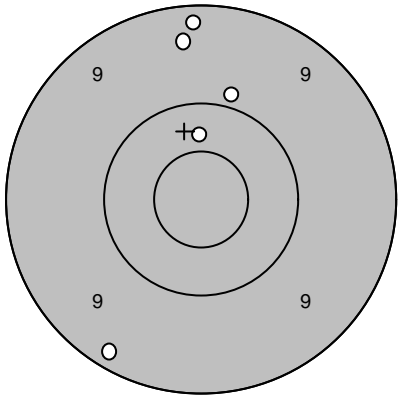
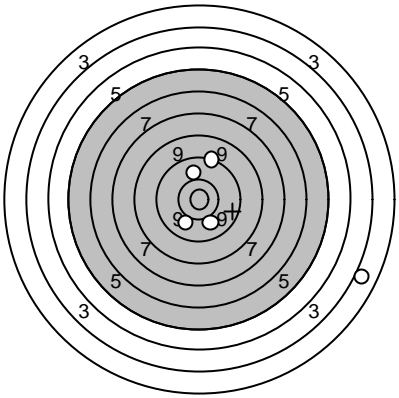
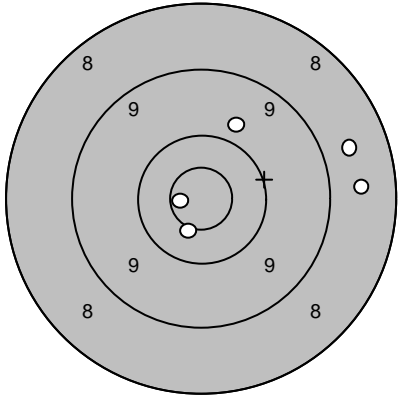
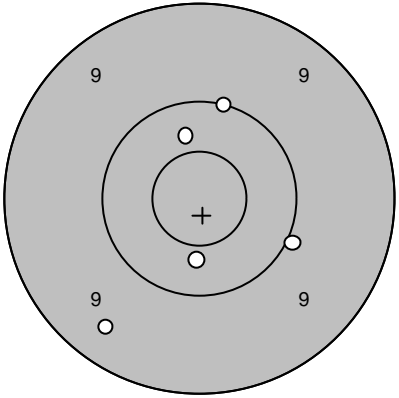
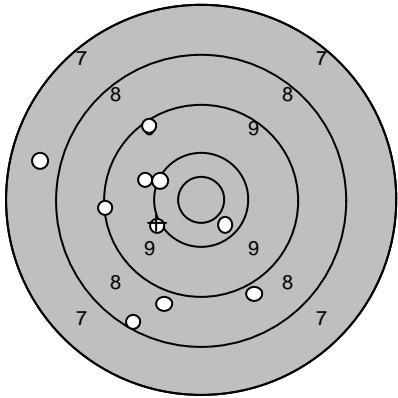
Skjutlag 4	Tavla 24	Marcus Mattsson	
Ramselefors	Ramselefors		
05.07.2006	Tavelträffen A - 2006	Ramselefors Skytteförening	
Prov		1: 9,2 ↑ 2: 9,9 ↑ 3: 9,4 ↑ 4: 9,2 ↓ 5: 10,4 ↑	Serie 1 
			1: 10,1 ↑ 2: 3,0 → 3: 10,1 ↓ 4: 10,1 ↓ 5: 9,4 ↑
		Serie 48,1	Serie 42,7
		Totalt 0,0	Totalt 42,7
Serie 2		1: 8,6 → 2: 10,8* ← 3: 8,7 → 4: 9,8 ↑ 5: 10,6* ↓	Serie 3 
			1: 9,4 ↓ 2: 10,4 ↑ 3: 10,4 ↓ 4: 10,0 ↑ 5: 10,0 →
		Serie 48,5	Serie 50,2
		Totalt 91,2	Totalt 141,4
Extratävling		1: 9,2 ← 2: 8,3 ↓ 3: 8,9 ↓ 4: 9,9 ↖ 5: 10,2 ↖ 6: 8,9 ↓ 7: 7,7 ← 8: 10,1 ← 9: 10,4 ↓ 10: 9,3 ↑	
		Serie 92,9	
		Totalt 234,3	

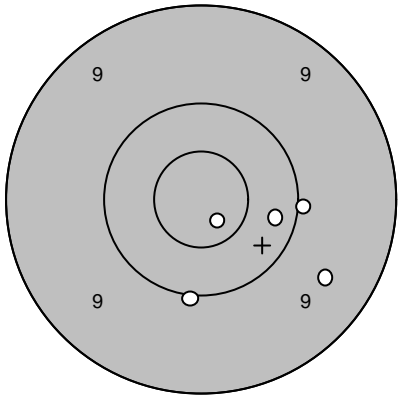
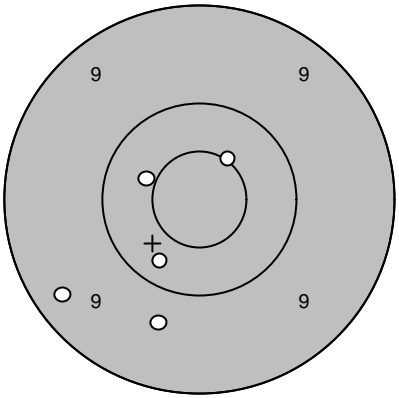
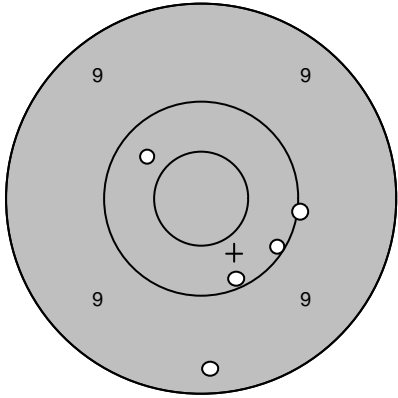
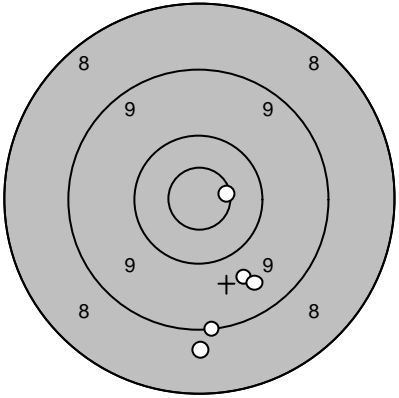
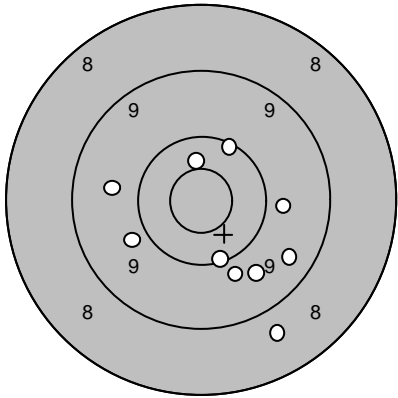
Skjutlag 5	Tavla 1	Jane Jönsson	
Ramselefors		Skurup	
05.07.2006		Tavelträffen A - 2006	Ramselefors Skytteförening
Prov 	1: 10,8* ↘ 2: 10,3 → 3: 9,5 ↘ 4: 10,0 → 5: 10,0 ↓	Serie 1 	1: 9,7 ↓ 2: 9,3 ↙ 3: 10,5* ↗ 4: 10,3 ↓ 5: 10,5* ↖
	Serie 49,0		Serie 48,0
	Totalt 0,0		Totalt 48,0
Serie 2 	1: 10,0 → 2: 10,3 ↗ 3: 9,3 ↓ 4: 10,1 ↓ 5: 10,1 ↓	Serie 3 	1: 8,8 ↓ 2: 10,7* → 3: 9,1 ↓ 4: 9,7 ↓ 5: 9,5 ↓
	Serie 49,0		Serie 45,0
	Totalt 97,0		Totalt 142,0
Extratävling 	1: 9,5 ↘ 2: 9,7 ↓ 3: 10,2 ↗ 4: 8,7 ↓ 5: 9,8 ↓ 6: 10,5* ↑ 7: 9,9 ↙ 8: 10,1 ↓ 9: 9,7 ↖ 10: 9,8 →		
	Serie 92,0		
	Totalt 234,0		

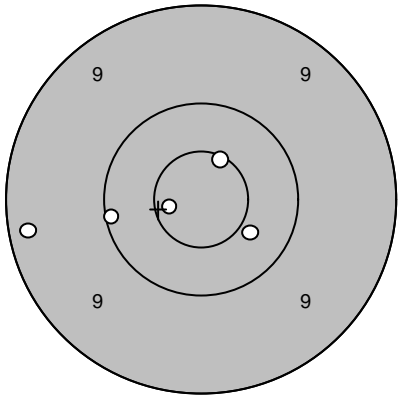
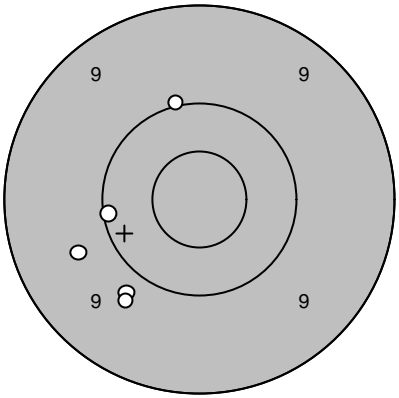
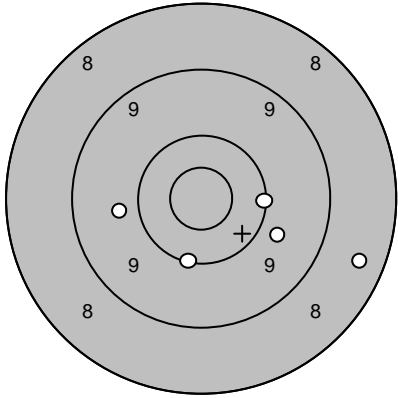
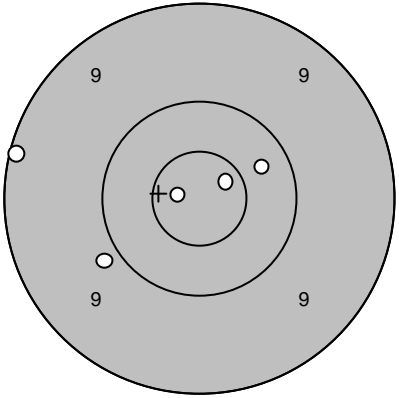
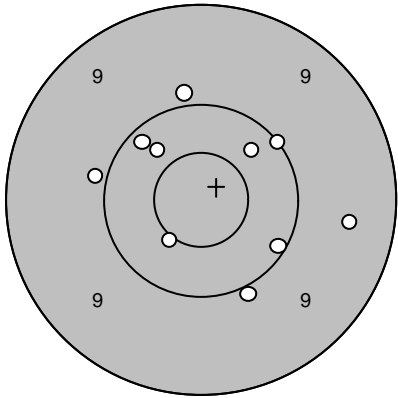
Skjutlag 5	Tavla 2	Lars-Göran Lundqvist	
Ramselefors	Ununge		
05.07.2006	Tavelträffen A - 2006	Ramselefors Skytteförening	
Prov		Serie 1 1: 10,1 ← 2: 9,2 ← 3: 10,4 → 4: 10,6* ↑ 5: 10,7* ←	Serie 1 
			1: 10,0 ↑ 2: 9,7 ← 3: 10,1 ← 4: 9,8 ↘ 5: 9,8 ↘
		Serie 49,0	Serie 47,0
		Totalt 0,0	Totalt 47,0
Serie 2		Serie 3 1: 8,5 → 2: 9,8 → 3: 10,1 → 4: 10,1 ↓ 5: 9,8 ←	Serie 3 
			1: 10,8* ← 2: 9,1 ← 3: 9,9 ← 4: 10,3 ↗ 5: 10,7* ↗
		Serie 46,0	Serie 48,0
		Totalt 93,0	Totalt 141,0
Extratävling		1: 9,5 → 2: 10,1 ↗ 3: 10,2 ↗ 4: 10,4 ↗ 5: 9,9 ← 6: 10,1 → 7: 10,3 ↗ 8: 9,9 ↑ 9: 10,0 ↓ 10: 10,5* ↘	
		Serie 97,0	
		Totalt 238,0	

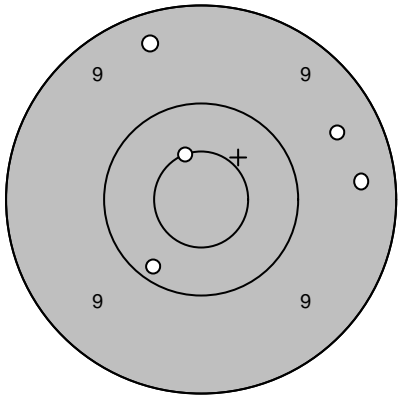
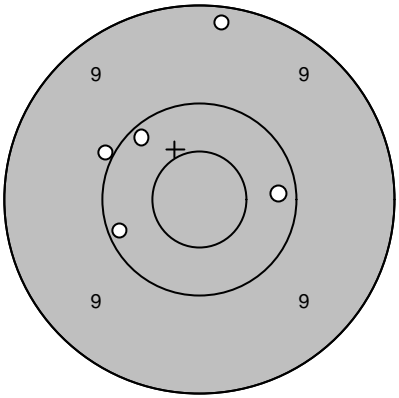
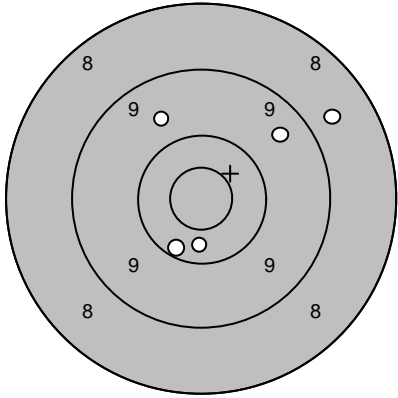
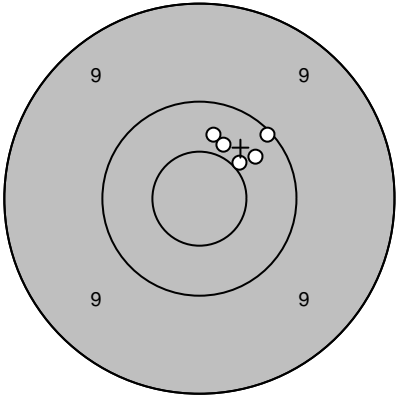
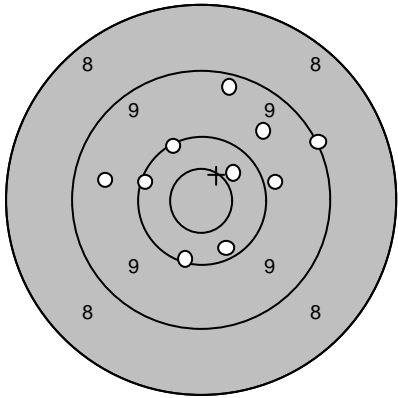
Skjutlag 5	Tavla 3	Anton Lindfors	
Ramselefors		I 19	
05.07.2006		Tavelträffen A - 2006	Ramselefors Skytteförening
Prov		1: 9,4 ↗ 2: 9,5 → 3: 10,2 ↓ 4: 10,5* ↗ 5: 9,4 →	Serie 1 
		Serie 47,0 Totalt 0,0	1: 9,2 ↑ 2: 10,0 ↖ 3: 10,2 ← 4: 10,2 → 5: 10,2 ↗
			Serie 49,0 Totalt 49,0
Serie 2		1: 8,7 → 2: 10,4 ↓ 3: 10,2 ↓ 4: 9,7 ↗ 5: 9,5 ↗	Serie 3 
		Serie 46,0 Totalt 95,0	1: 10,1 ↗ 2: 10,5* ↗ 3: 10,3 ↗ 4: 10,4 ↑ 5: 10,4 ↗
			Serie 50,0 Totalt 145,0
Extratävling		1: 9,1 → 2: 10,3 ↓ 3: 10,1 ↓ 4: 10,2 ← 5: 9,6 ← 6: 10,4 ↗ 7: 9,3 ↑ 8: 10,1 ↗ 9: 9,9 → 10: 9,7 ↗	
		Serie 95,0 Totalt 240,0	