

Lag	Skive	Christoffer Wulff
1	11	

2005-12-20	Föreningsmästerskap	Umeå skytteallians
------------	---------------------	--------------------

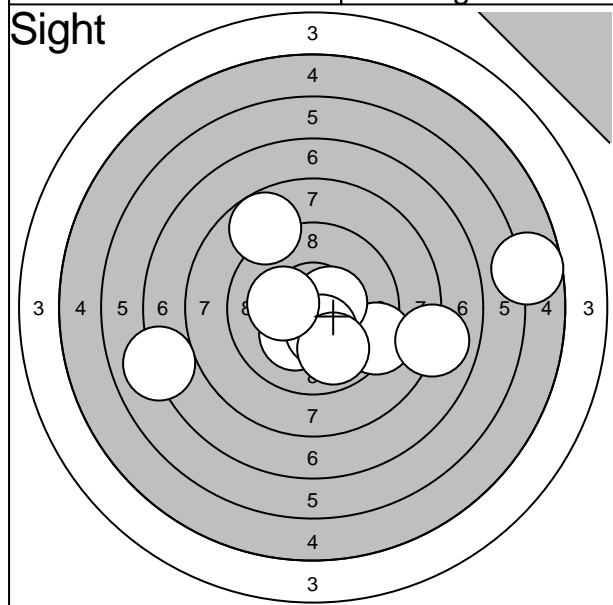

1:	9,3	↘
2:	10,5*	→
3:	8,8	↗
4:	8,0	→
5:	10,2*	↘
6:	10,4*	↓
7:	7,0	←
8:	9,8	↓
9:	5,7	→
10:	10,2*	←

Serie	86,0
Total	0,0

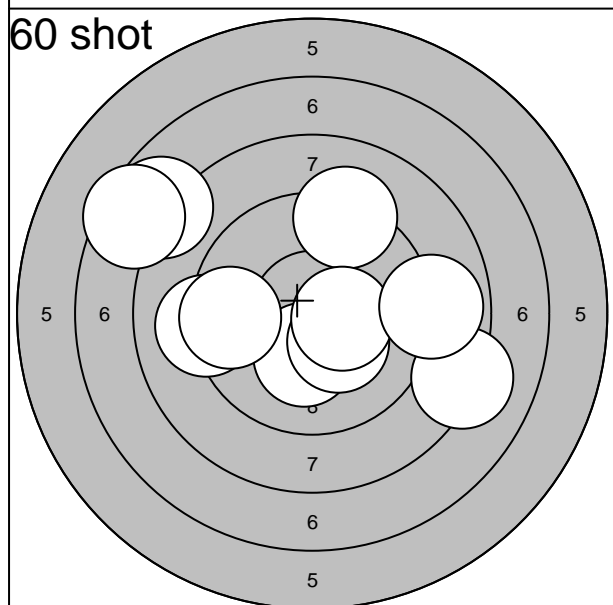

1:	7,8	↗
2:	9,1	←
3:	8,2	→
4:	10,2*	↓
5:	7,5	↗
6:	9,2	↑
7:	10,3*	↘
8:	10,4*	→
9:	9,5	←
10:	8,9	→

Serie	87,0
Total	87,0

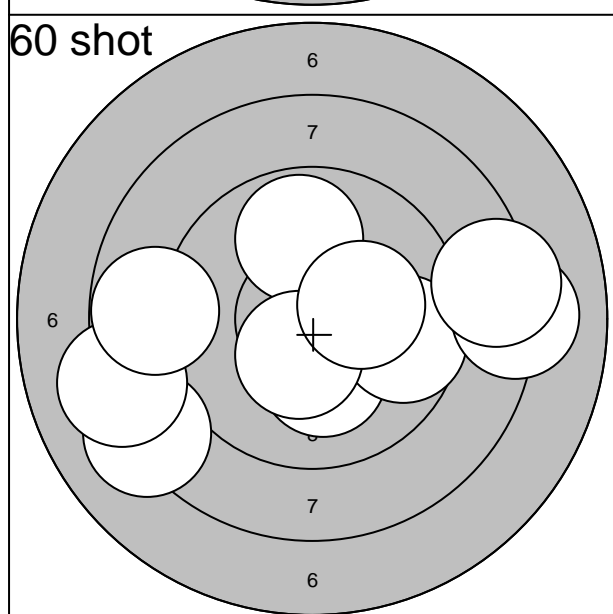

11:	8,2	←
12:	10,2*	↓
13:	8,2	←
14:	9,7	→
15:	8,1	→
16:	9,8	↑
17:	10,4*	↓
18:	8,4	→
19:	10,2*	→
20:	8,8	←

Serie	88,0
Total	175,0

Umeå skytteallians

Lag	Skive		
<b>1</b>	<b>12</b>	<b>Linus Edlund</b>	
2005-12-20		Föreningsmästerskap	Umeå skytteallians
Sight		1: 9,8	↘
		2: 10,3*	↓
		3: 9,0	↑
		4: 9,7	↑
		5: 9,5	→
		6: 9,3	→
		7: 10,4*	↘
		8: 8,7	→
		9: 9,9	↘
		10: 10,1	←
		<b>Serie</b>	
<b>Total</b>		<b>0,0</b>	
60 shot		1: 7,4	→
		2: 10,6*	↓
		3: 9,8	→
		4: 9,7	↑
		5: 9,7	↑
		6: 8,8	↑
		7: 10,8*	↘
		8: 8,8	↘
		9: 9,8	↑
		10: 10,6*	↘
		<b>Serie</b>	
<b>Total</b>		<b>89,0</b>	
60 shot		11: 9,5	→
		12: 9,9	←
		13: 8,3	↑
		14: 9,2	→
		15: 10,2*	→
		16: 9,5	↑
		17: 9,3	↑
		18: 10,1	←
		19: 10,4*	↑
		20: 10,1	↑
		<b>Serie</b>	
<b>Total</b>		<b>182,0</b>	
<b>Umeå skytteallians</b>			

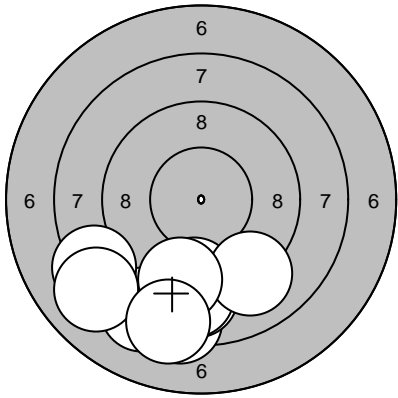
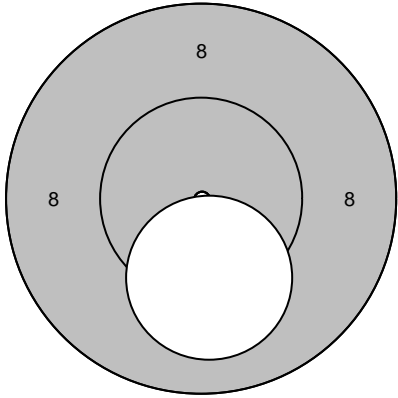
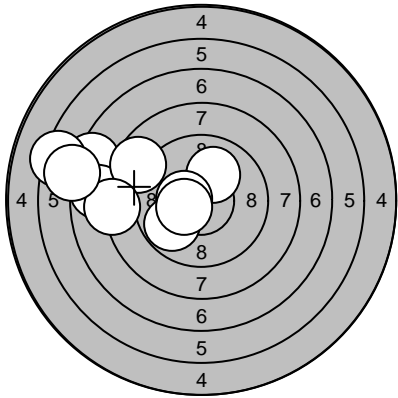
Lag	Skive		
1	13	Jessica Wikström	
2005-12-20		Föreningsmästerskap	Umeå skytteallians
Sight		1: 8,3 ↓ 2: 8,3 ↙ 3: 8,1 ↙ 4: 8,4 ↓ 5: 9,0 ↓ 6: 9,2 ↓ 7: 8,9 ↓ 8: 9,1 ↓ 9: 9,2 ↓ 10: 8,3 ↓ Serie 84,0 Total 0,0	Sight
			11: 8,6 ← 12: 8,5 ↙ 13: 8,5 ← 14: 10,5* ↓ 15: 6,7 ← 16: 10,3* ↓ 17: 10,1 ↗ 18: 8,0 ← 19: 8,3 ← 20: 9,1 ↓ Serie 85,0 Total 0,0
Sight		21: 10,1 ↓	60 shot
		Serie 10,0 Total 0,0	1: 8,6 ↗ 2: 9,7 → 3: 8,1 ← 4: 10,6* ↓ 5: 10,7* ← 6: 9,9 ↙ 7: 6,1 ← 8: 8,7 ← 9: 9,5 → 10: 9,8 → Serie 86,0 Total 86,0
60 shot		11: 10,1 ↗ 12: 10,4* ← 13: 9,8 ↙ 14: 7,3 ← 15: 7,8 ← 16: 8,7 ↗ 17: 8,2 ← 18: 10,4* ← 19: 6,3 ← 20: 6,9 ← Serie 81,0 Total 167,0	
Umeå skytteallians			

Lag	Skive		
<b>1</b>	<b>14</b>	<b>Oskar Åström</b>	

2005-12-20	Föreningsmästerskap	Umeå skytteallians
------------	---------------------	--------------------

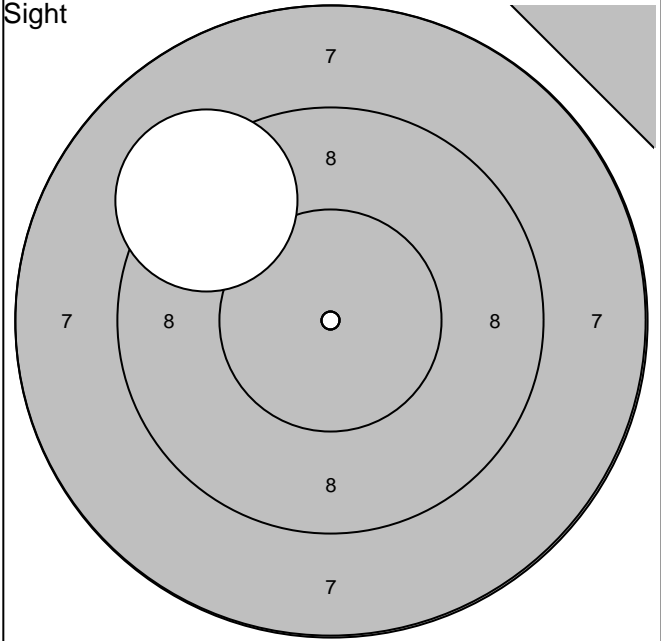
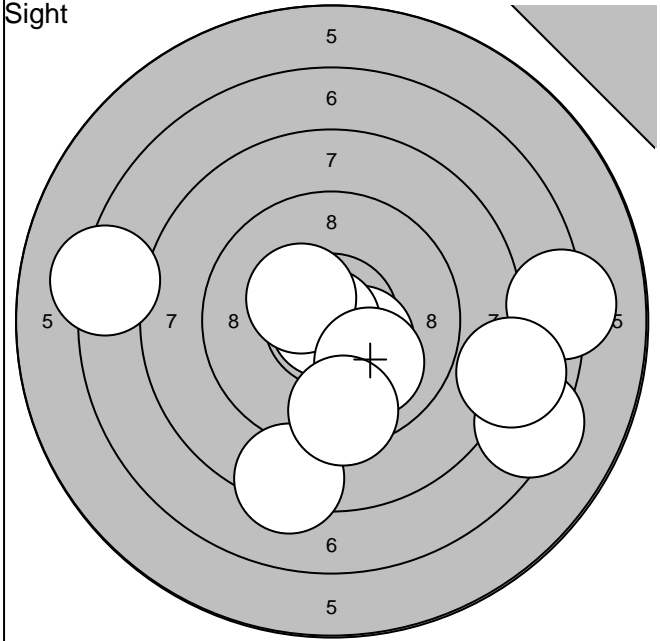

1: 10,4* →	6: 7,2 →	Serie	86,0	11: 9,3 ↖	Serie	9,0
2: 8,3 ↓	7: 8,0 →			Total		
3: 7,2 ←	8: 10,3* ↗					
4: 10,8* ←	9: 10,1 ↓					
5: 7,4 →	10: 9,5 ↓					

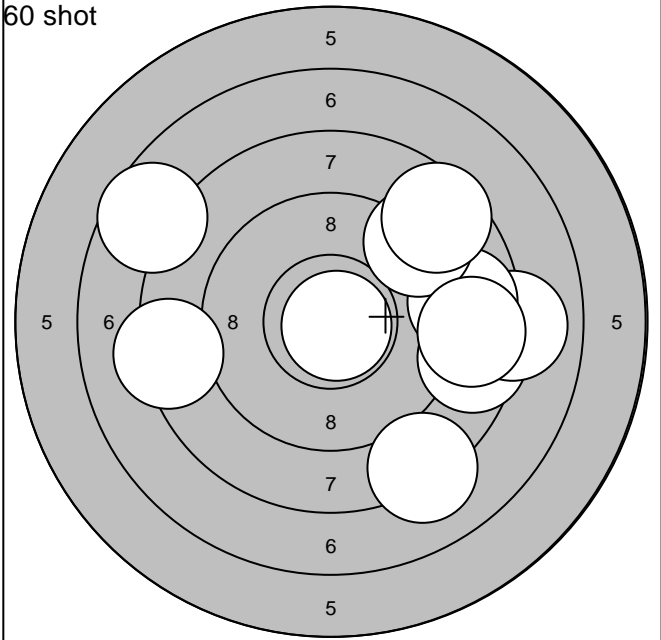
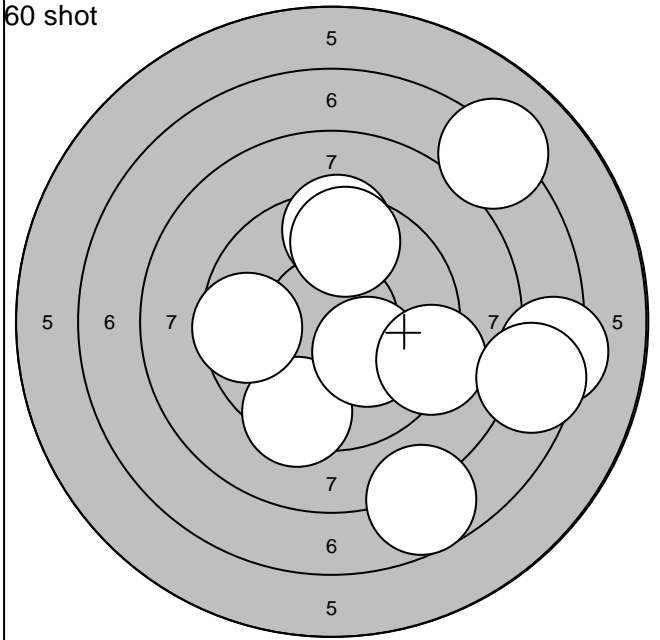

1: 9,4 ↓	6: 7,7 ↓	Serie	83,0	11: 8,6 →	16: 8,7 →	Serie	82,0
2: 10,2* →	7: 7,4 →			Total	83,0		
3: 9,5 ↑	8: 9,2 →					13: 8,8 →	18: 8,6 ↗
4: 9,7 ↑	9: 7,6 →			14: 7,6 ↖	19: 8,3 ←		
5: 9,6 ←	10: 7,2 ↗			15: 9,0 ↗	20: 10,8* ↓		

Umeå skytteallians

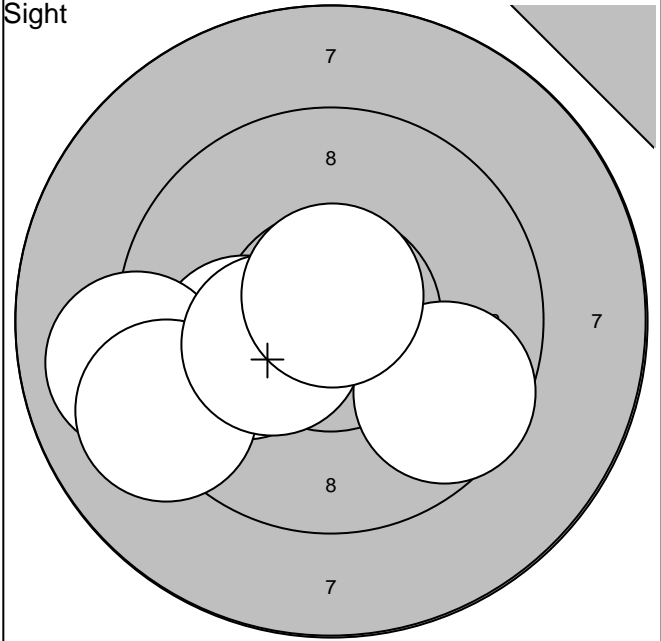
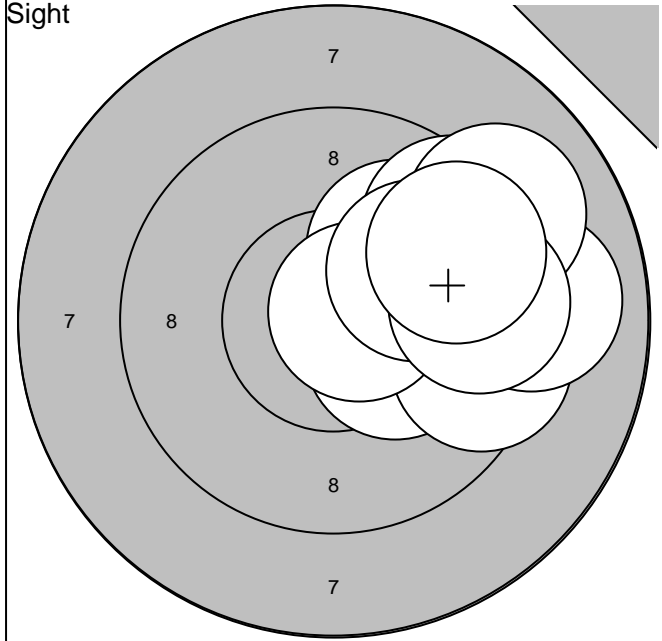

1:10,0 ↗	6: 9,0 →	Serie	94,0	11: 9,6 ↘	16:10,7* ↑	Serie	57,0
2: 9,5 ↗	7:10,0 ↗			12:10,1 ←			
3:10,3* ↘	8: 9,1 ↗	Total	0,0	13: 9,0 ←	Total	0,0	
4: 9,5 →	9: 9,5 →			14: 9,1 ←			
5:10,7* →	10: 9,6 ↗			15:10,3* ←			

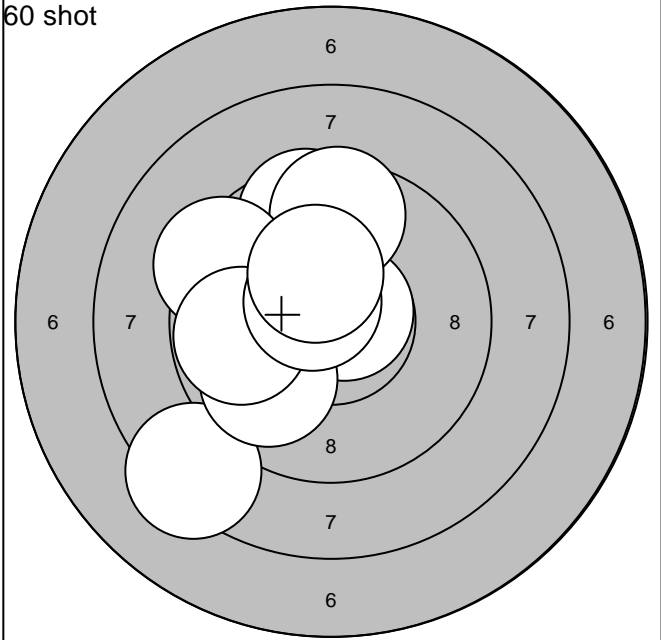
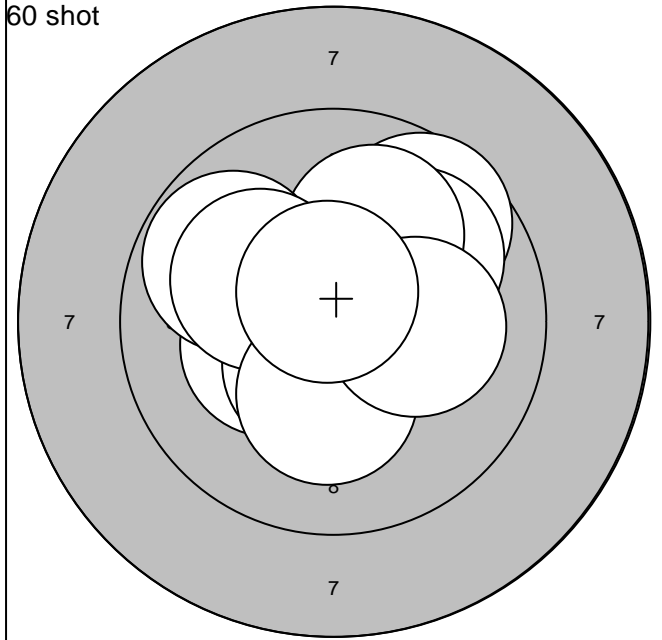

1: 9,7 ↗	6:10,5* ↓	Serie	98,0	11:10,7* ↗	16: 9,9 ↘	Serie	92,0
2:10,0 ↗	7:10,1 ↖			12: 9,9 ←			
3:10,0 ↗	8:10,3* ↓	Total	98,0	13: 8,3 ↘	Total	190,0	
4:10,3* ↖	9:10,2* →			14: 9,6 ↑			18: 9,8 ←
5: 9,8 ↖	10:10,7* ↑			15: 9,6 ↑			
				20:10,3* ↑			

Lag	Skive	<b>Kalle Moritz</b>
<b>1</b>	<b>20</b>	

2005-12-20	Föreningsmästerskap	Umeå skytteallians
------------	---------------------	--------------------

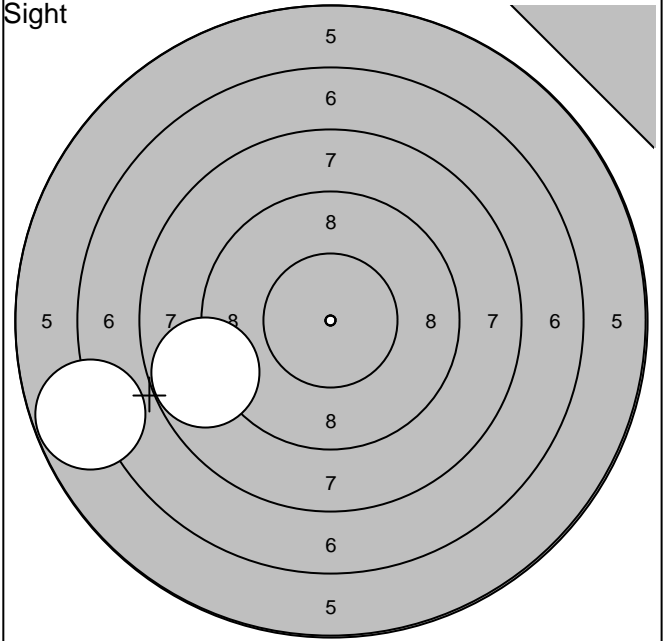
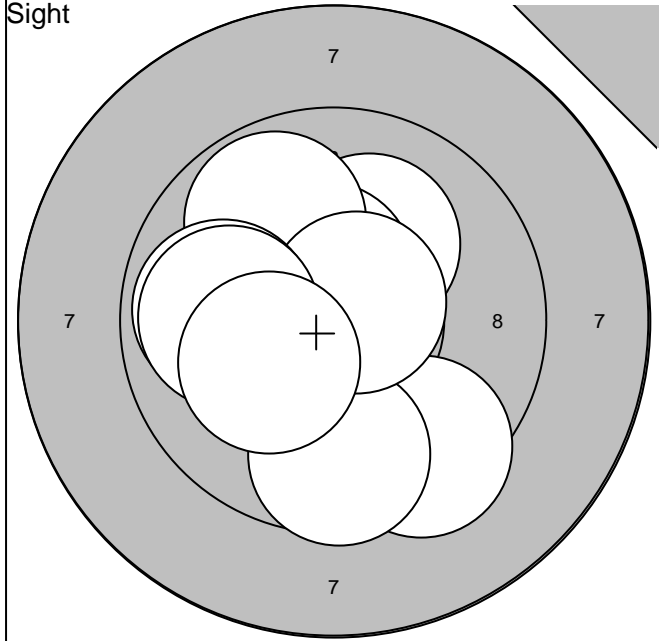

1:10,1 ↗	6: 9,6 ↓	Serie	95,0	11: 8,8 ←	Serie	14,0
2:10,5* ↑	7:10,7* ↗			12: 6,8 ←		
3: 9,8 ↗	8: 9,9 ←	Total	0,0		Total	0,0
4:10,3* ↓	9: 9,9 ←					
5: 9,5 ↓	10:10,2* ↙					

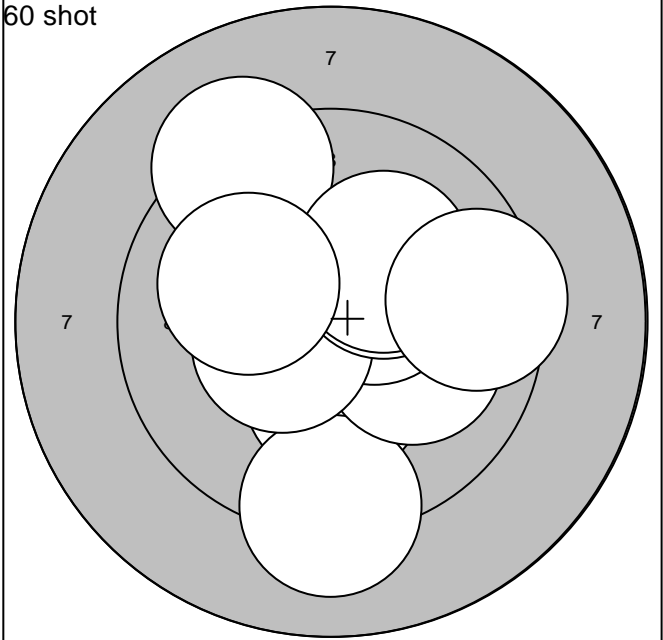
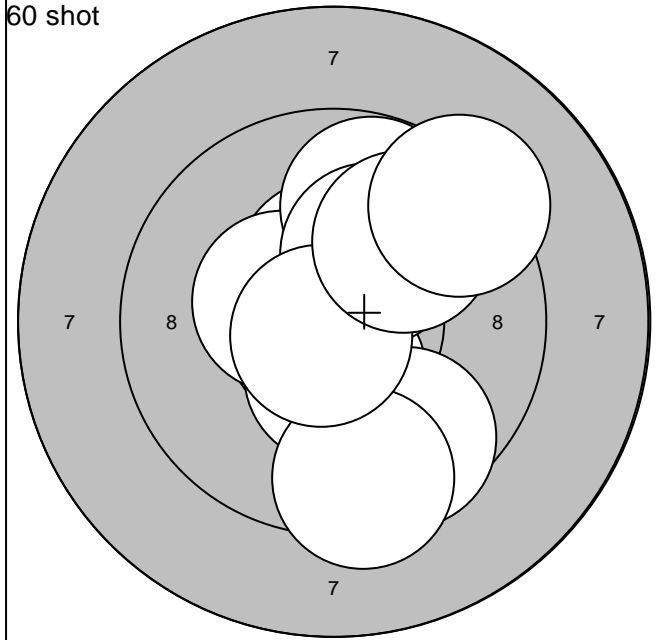

1:10,4* ↓	6: 9,4 ↓	Serie	95,0	11:10,3* ↓	16:10,2* ↗	Serie	97,0
2:10,4* ↑	7:10,2* ↗			12: 9,1 ↓	17: 9,2 ↖		
3:10,4* ↖	8:10,8* ↙	Total	95,0	13:10,1 ➡	18:10,2* ↗	Total	192,0
4: 9,6 ↓	9: 9,9 ↗			14:10,4* ↗	19:10,1 ↖		
5: 9,8 ↗	10: 9,3 ↗			15:10,4* ←	20: 9,5 ➡		

Umeå skytteallians

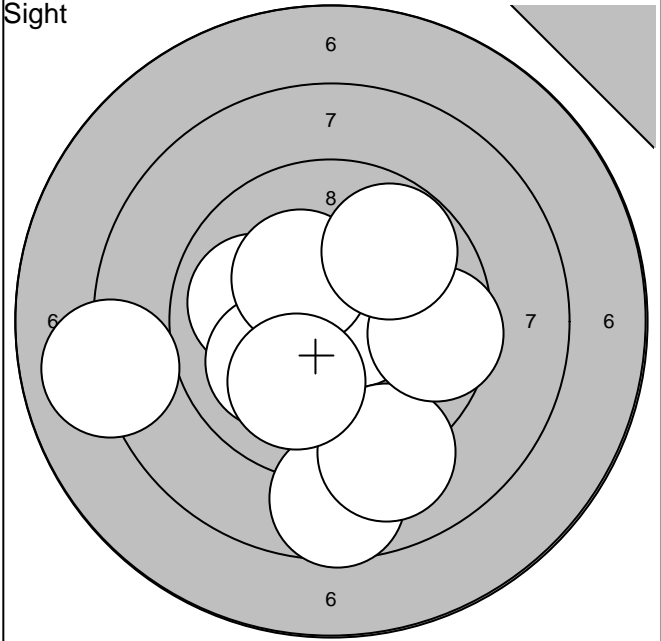
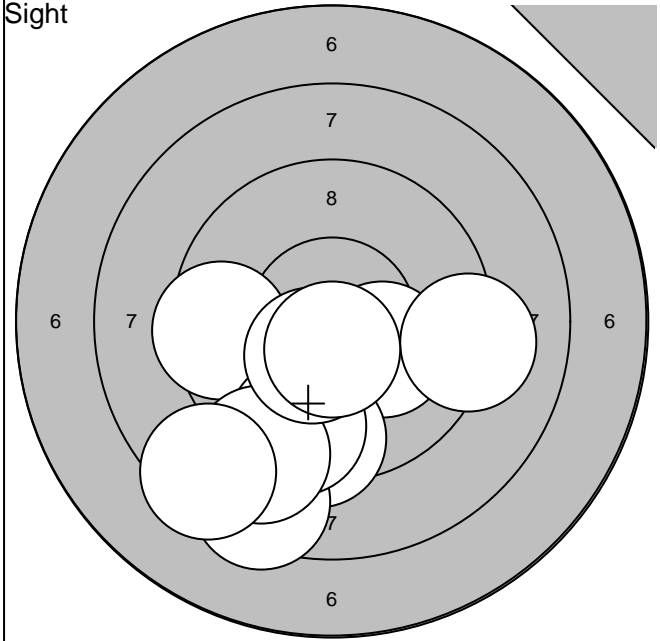

1:10,2* →	6: 9,0 ↓	Serie	91,0
2: 9,5 ←	7: 9,2 →		
3: 9,4 ↓	8:10,5* ↓	Total	0,0
4: 8,4 ↓	9:10,6* ↓		
5: 9,5 ↓	10: 8,4 ↙		

11:10,0 ←	16: 9,6 →	Serie	93,0
12:10,6* →	17:10,3* ↗		
13:10,1 ↙	18:10,1 ↓	Total	0,0
14: 8,6 ↓	19: 8,0 ←		
15: 9,1 ↓	20: 9,8 ↗		

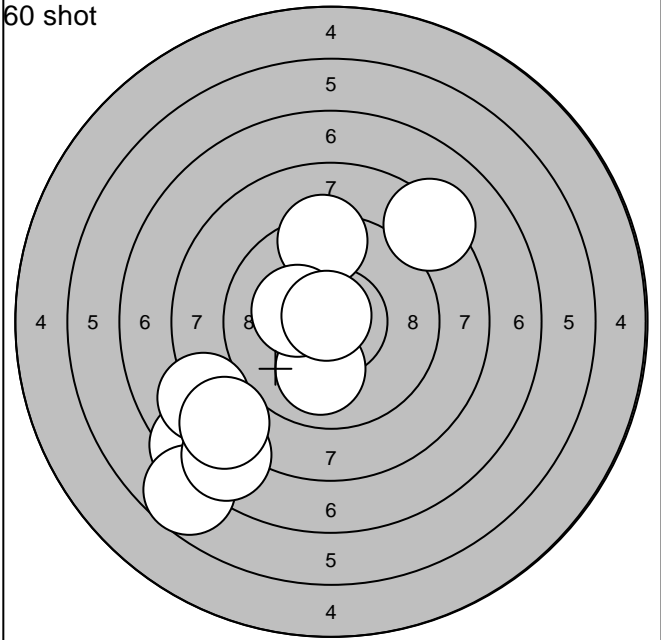
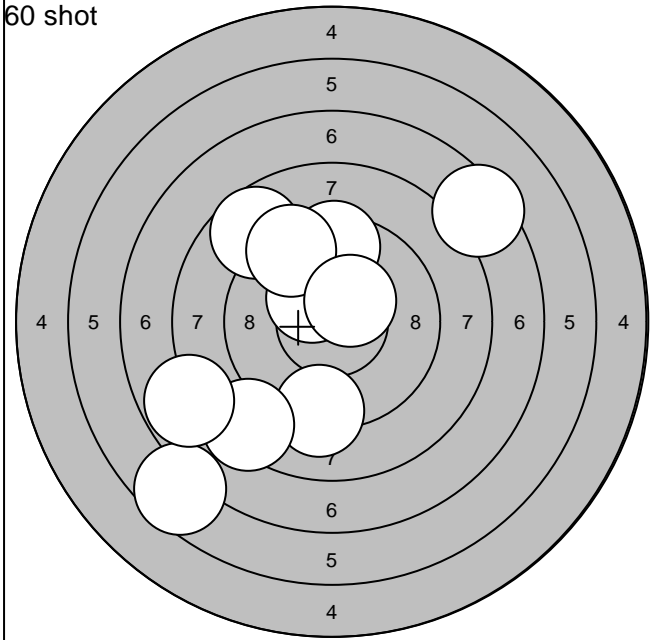

1: 8,7 ↗	6: 9,5 ↑	Serie	83,0
2: 6,6 ↙	7: 9,4 ↗		
3: 9,2 ↓	8: 7,8 ↙	Total	83,0
4: 8,4 ↙	9: 7,4 ↗		
5:10,4* ↗	10:10,4* ↗		

11: 9,4 ↑	16:10,8* ↗	Serie	83,0
12: 8,3 ↗	17: 8,1 ↙		
13:10,0 ↓	18: 6,7 ↙	Total	166,0
14: 7,4 ↙	19: 7,7 ↙		
15:10,3* ←	20: 8,1 ↙		

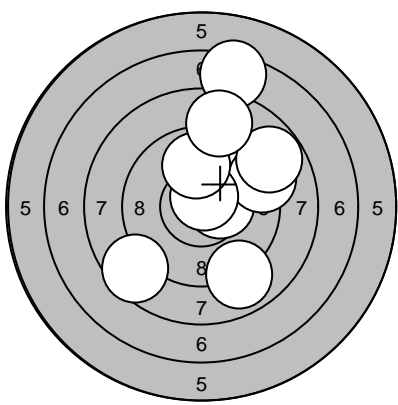
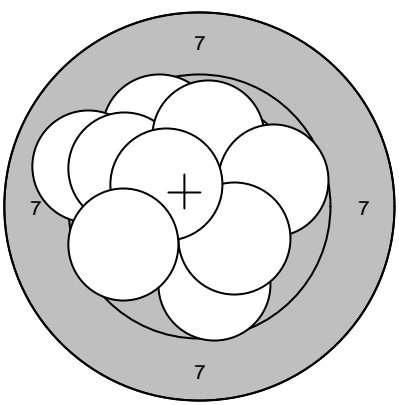
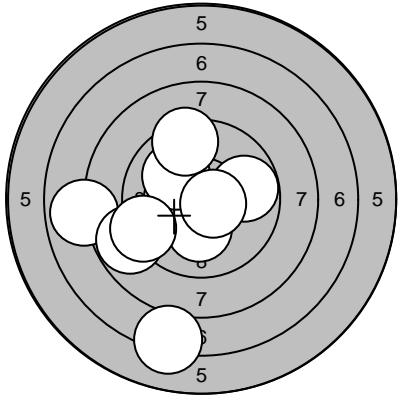
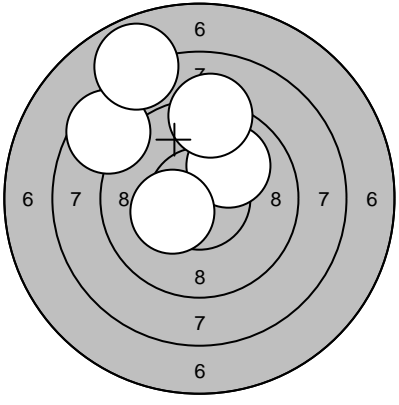
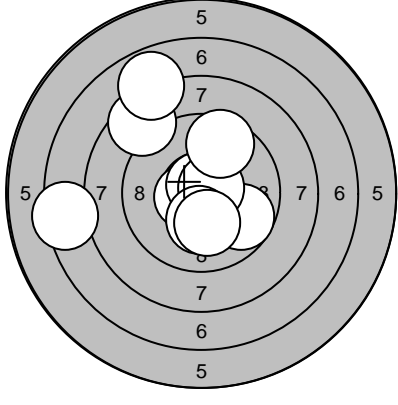
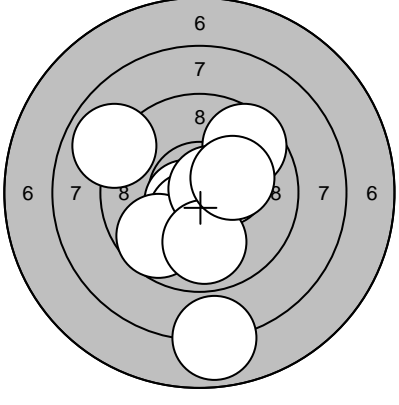
Lag	Skive		
1	22	Joar Wikström	
2005-12-20		Föreningsmästerskap	Umeå skytteallians
Sight		1: 10,4* → 2: 10,0 ↑ 3: 7,4 ↑ 4: 8,9 ↓ 5: 9,2 → 6: 10,7* ↑ 7: 8,6 ↙ 8: 9,9 ↑ 9: 8,8 ↗ 10: 8,8 ↑ Serie 87,0 Total 0,0	Sight  11: 9,6 ↗ 12: 9,1 ↖ 13: 10,1 ↗ 14: 9,6 ↖ 15: 9,8 ↑ 16: 9,7 ↓ 17: 9,7 → 18: 10,2* ↓ 19: 10,3* ↖ 20: 9,6 ↖ Serie 93,0 Total 0,0
Sight		21: 9,8 → 22: 10,4* ← 23: 10,2* ↓ 24: 7,9 ← 25: 8,8 ↙ 26: 7,2 ↓ 27: 10,1 ↗ 28: 9,3 ↙ 29: 10,6* → 30: 9,4 ↑ Serie 89,0 Total 0,0	Sight  31: 8,6 ↖ 32: 10,0 ↗ 33: 9,2 ↑ 34: 10,4* ↖ 35: 7,9 ↗ Serie 44,0 Total 0,0
60 shot		1: 8,6 ↖ 2: 10,6* ← 3: 7,4 ← 4: 9,7 → 5: 7,9 ↑ 6: 10,7* ↑ 7: 10,7* → 8: 10,2* ↓ 9: 10,2* ↓ 10: 9,6 ↑ Serie 90,0 Total 90,0	60 shot  11: 10,4* → 12: 10,6* ↖ 13: 8,9 ↖ 14: 10,5* ↓ 15: 9,8 ↖ 16: 9,6 ↗ 17: 10,7* → 18: 7,9 ↓ 19: 9,9 ↓ 20: 10,2* → Serie 92,0 Total 182,0
Umeå skytteallians			

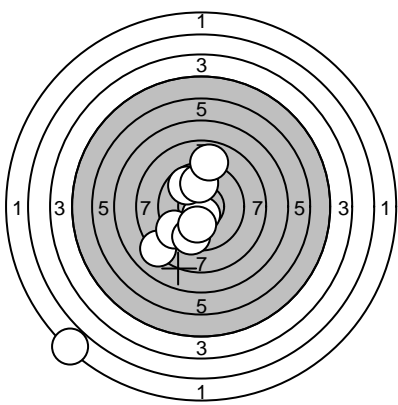
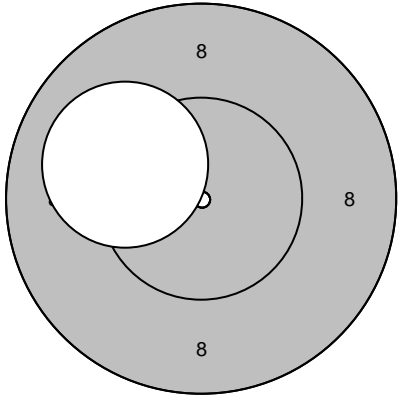
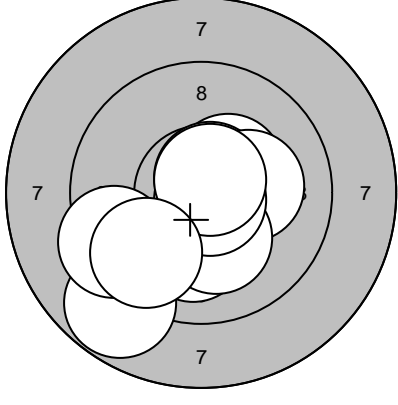

Lag	Skive	Fredrik Bäcklund	
1	24		
2005-12-20		Föreningsmästerskap	Umeå skytteallians
Sight		1: 8,2 ↙ 2: 2,0 ↙ 3: 9,3 ↙ 4: 10,5* ↓ 5: 9,5 ↓ 6: 0,0 ↓ 7: 9,8 ↗ 8: 9,9 ↑ 9: 8,9 ↑ 10: 10,1 ↓	Sight
		Serie 74,0	11: 10,8* ↗
		Total 0,0	12: 5,7 ↓
			13: 3,4 ↓
			14: 10,5* ↓
			15: 10,1 ←
			16: 10,1 ←
			17: 10,4* ↓
			18: 9,9 ↗
			19: 9,0 ↓
			20: 10,3* ↗
		Serie 86,0	
		Total 0,0	
Sight		21: 10,1 ←	60 shot
		Serie 10,0	1: 10,2* ↙
		Total 0,0	2: 9,9 ↙
			3: 10,2* ↖
			4: 9,8 ↓
			5: 10,1 →
			6: 10,9* ←
			7: 9,4 ←
			8: 9,4 ↙
			9: 9,5 ←
			10: 9,7 ↖
		Serie 94,0	
		Total 94,0	
60 shot		11: 10,4* ↗ 12: 10,7* ↗ 13: 10,2* → 14: 10,1 ↓ 15: 10,2* ↓ 16: 10,8* ↘ 17: 8,8 ↙ 18: 10,7* ↗ 19: 9,4 ↙ 20: 9,7 ↙	
		Serie 96,0	
		Total 190,0	
Umeå skytteallians			

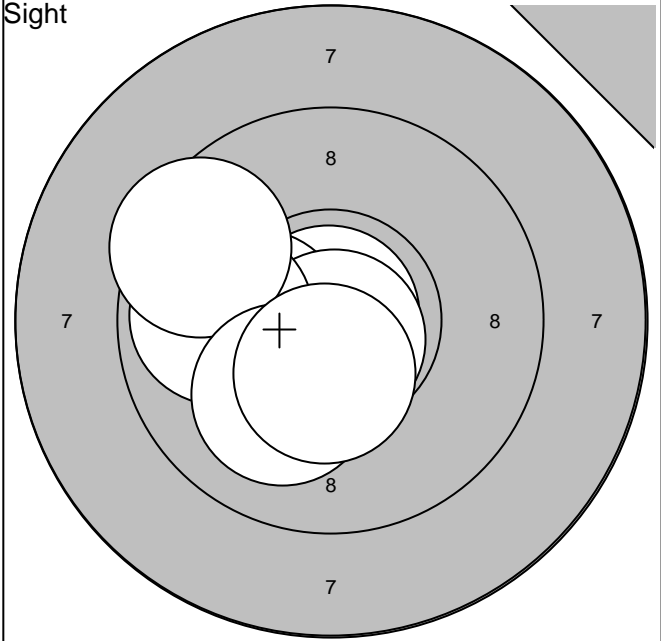
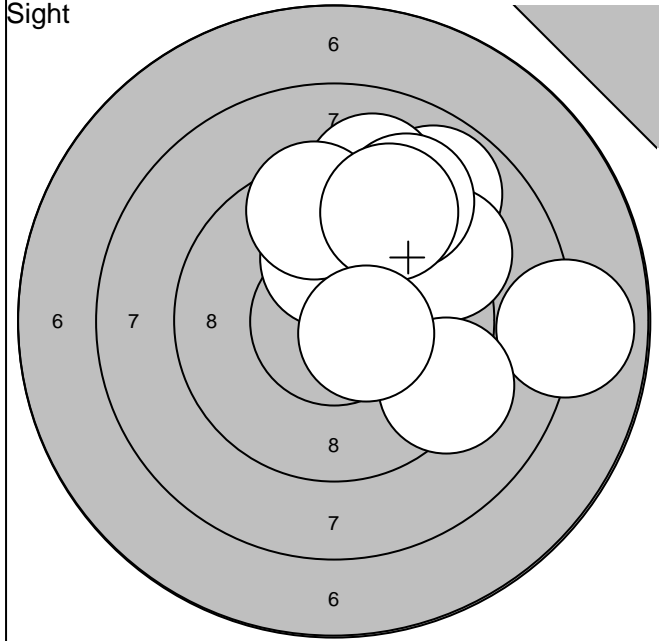

1: 8,9 ↗	6: 9,2 ↗	Serie	90,0	11:10,9* ↗	16:10,1 ↘	Serie	68,0
2: 9,1 ↑	7: 9,4 ↗			12:10,2* ←	17:10,4* ↓		
3:10,1 ↑	8: 8,0 →	Total	0,0	13:10,8* ↓		Total	0,0
4: 9,5 ↑	9: 9,3 ↘			14: 9,9 ←	15: 9,5 ↖		
5: 9,3 ↗	10:10,5* →						

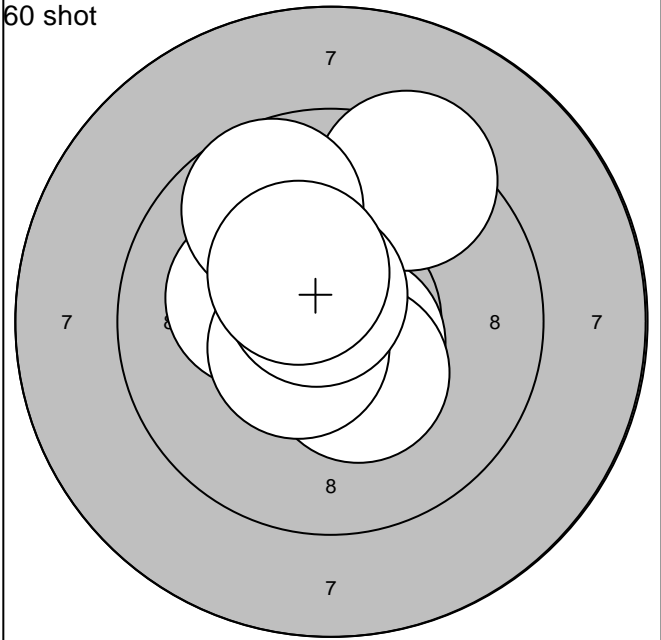
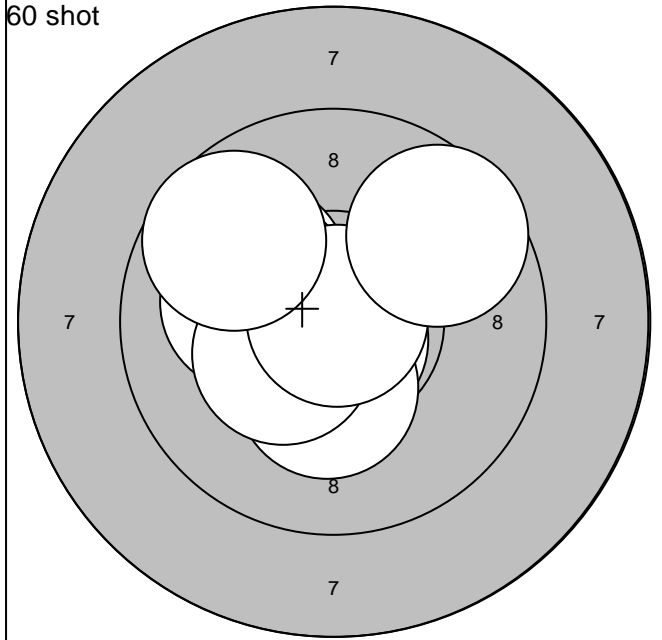

1:10,8* ↓	6:10,1 ←	Serie	98,0	11:10,6* ↘	16:10,4* ↓	Serie	98,0
2:10,5* ↖	7:10,4* ↖			12:10,4* ↖	17: 9,7 ↗		
3:10,1 ↖	8:10,9* ↗	Total	98,0	13:10,6* ←	18:10,5* ↖	Total	196,0
4:10,2* ↖	9: 9,7 ↖			14: 9,4 ↗	19:10,7* ↗		
5:10,3* ↓	10: 9,6 ↗			15:10,2* ↖	20:10,4* ↗		

Lag	Skive	
<b>1</b>	<b>26</b>	<b>Edward Yu</b>

2005-12-20	Föreningsmästerskap	Umeå skytteallians
------------	---------------------	--------------------

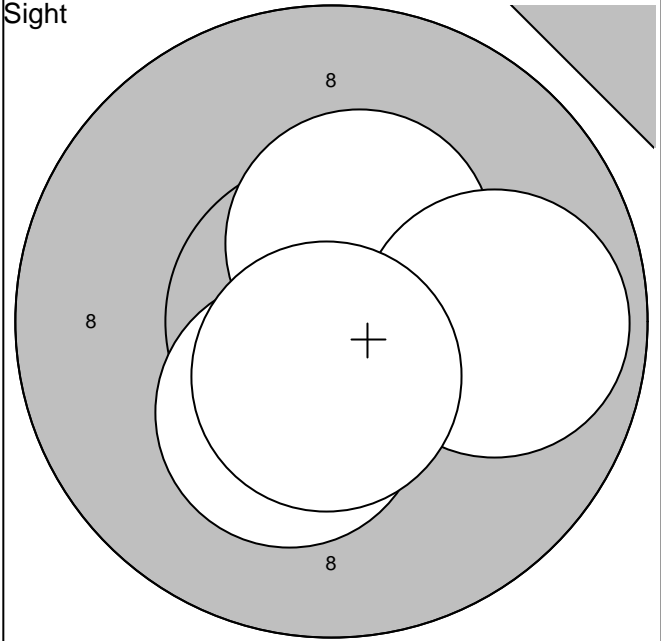
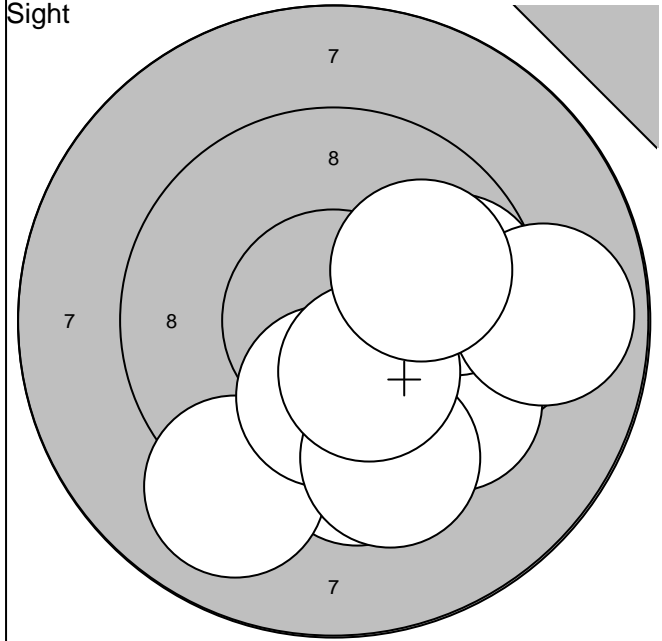

1: 9,6 ↓	6: 8,9 →	Serie	92,0	11:10,4* ↑	Serie	39,0
2: 9,4 →	7:10,2* ↓			12: 9,9 →		
3: 9,6 ↘	8: 9,5 ↓	Total	0,0	13:10,3* ↓	Total	0,0
4: 9,1 ↓	9:10,3* ↓			14:10,6* ↓		
5: 9,7 →	10:10,0 ↗					

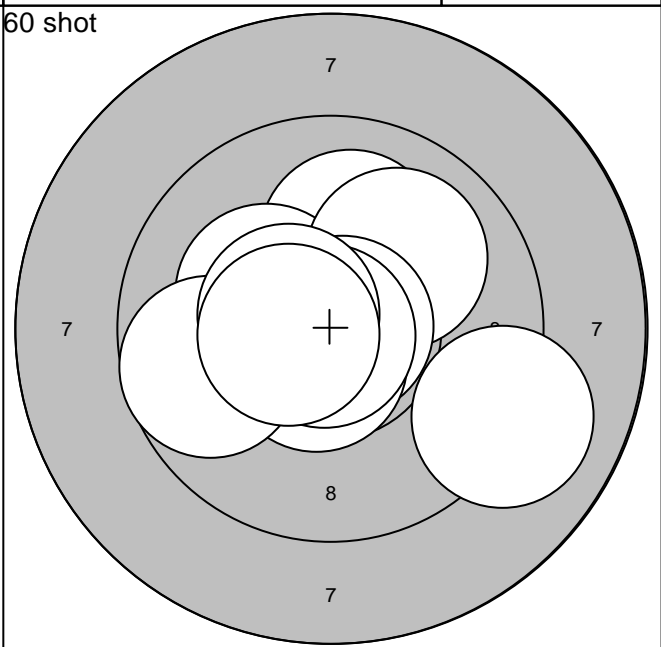
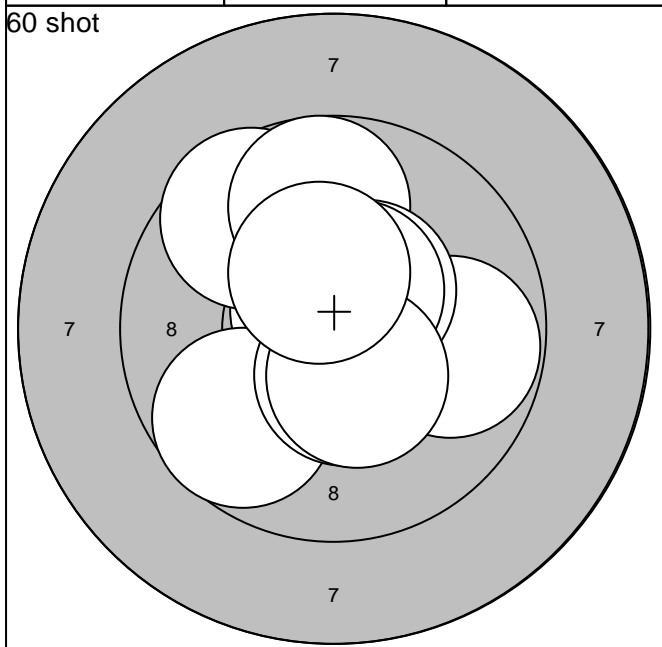

1:10,7* ↗	6:10,5* ↗	Serie	96,0	11:10,1 ↑	16: 9,1 →	Serie	98,0
2: 9,8 →	7:10,5* ↓			12:10,2* ↖	17:10,9* ↓		
3: 9,6 ↗	8:10,5* ↗	Total	96,0	13:10,0 ↗	18: 9,7 ←	Total	194,0
4: 9,8 ↑	9:10,4* ↓			14:10,8* →	19:10,5* ↖		
5: 9,7 ↙	10:10,4* ↑			15:10,6* ↓	20:10,5* ←		

Umeå skytteallians

Lag	Skive	
<b>1</b>	<b>28</b>	<b>Malin Adolfsson</b>

2005-12-20	Föreningsmästerskap	Umeå skytteallians
------------	---------------------	--------------------

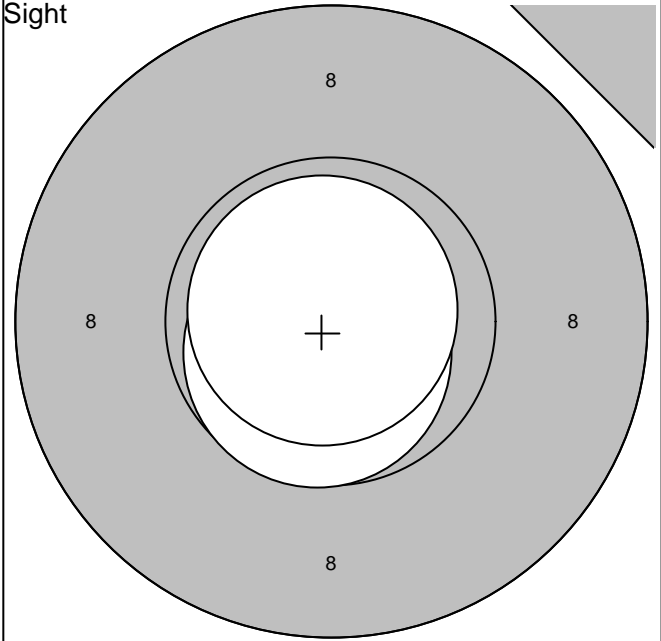
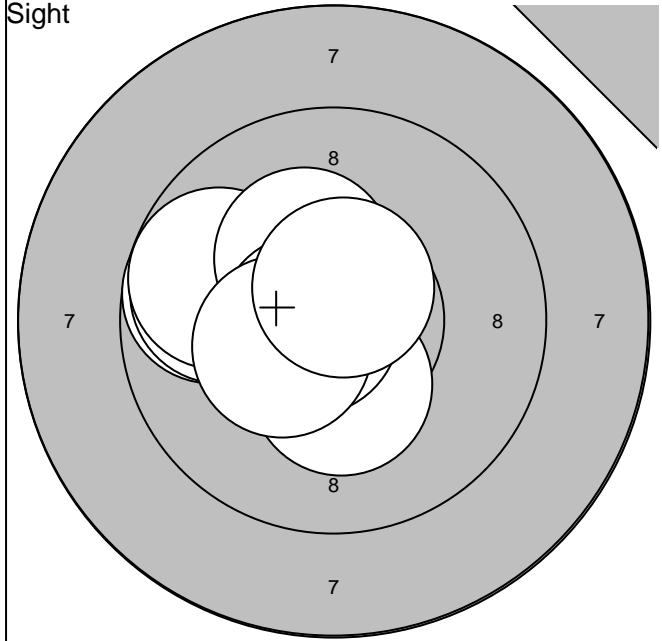

1:10,5* ←	6:10,3* ↗	Serie	96,0
2: 9,9 ←	7:10,3* ↓		
3: 9,7 ←	8:10,7* ←	Total	0,0
4: 9,8 ←	9:10,4* ↙		
5: 9,8 ←	10:10,6* ↗		

11:10,7* ↘	Serie	20,0
12:10,9* ↖		
	Total	0,0

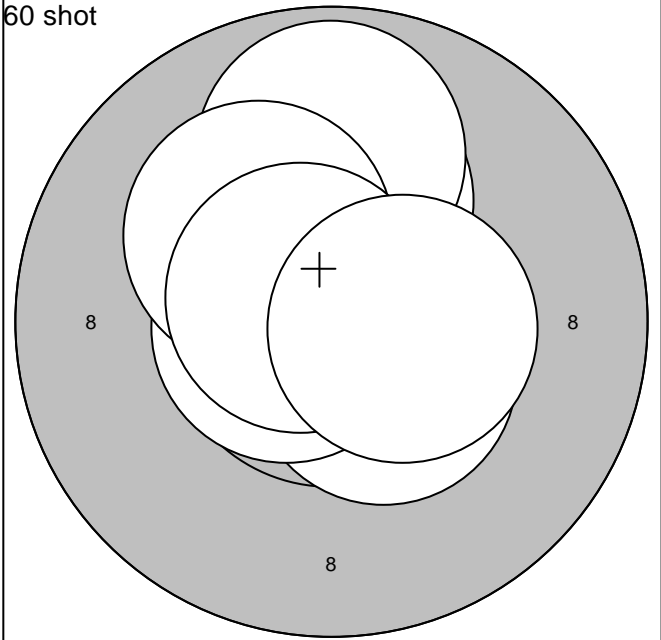
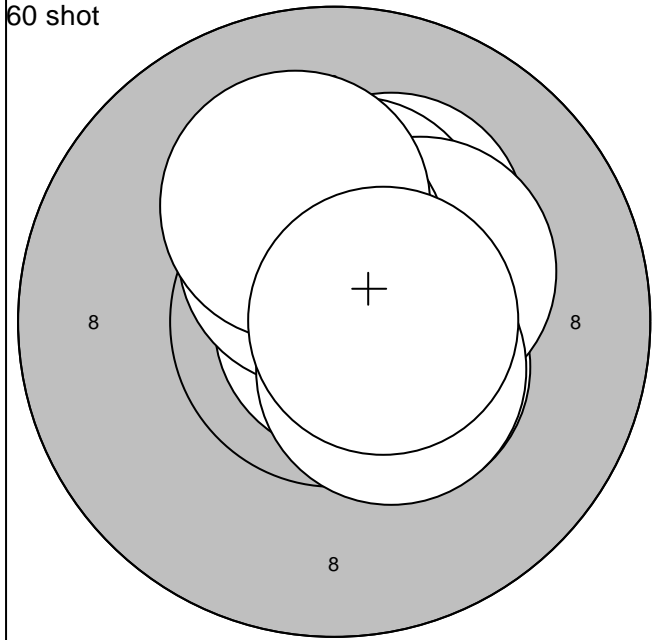

1:10,9* →	6:10,3* ↗	Serie	100,0
2:10,2* ↗	7:10,5* ↗		
3:10,5* ↘	8:10,1 ↗	Total	100,0
4:10,6* ↗	9:10,5* ↘		
5:10,3* ↗	10:10,6* →		

11:10,3* ↖	16:10,7* ←	Serie	99,0
12:10,4* ↖	17: 9,9 ↗		
13:10,2* ↗	18:10,2* ↖	Total	199,0
14:10,6* ↗	19:10,7* ↖		
15:10,5* ↘	20:10,5* →		

Umeå skytteallians

Lag	Skive	
<b>1</b>	<b>29</b>	<b>Robert Wahlin</b>

2005-12-20	Föreningsmästerskap	Umeå skytteallians
------------	---------------------	--------------------

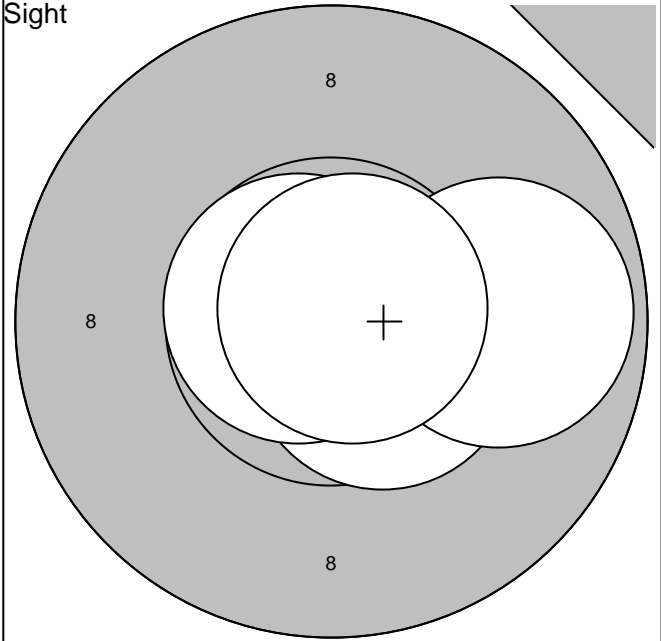
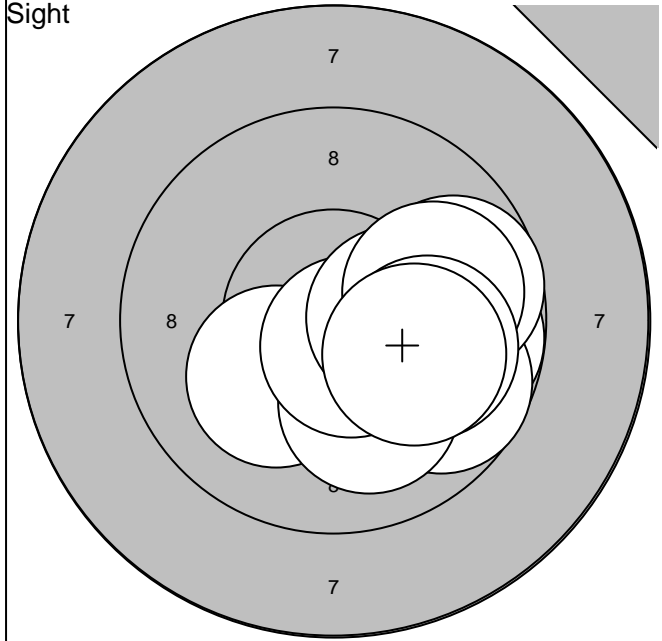

1: 9,8 →	6:10,3* →	Serie	96,0	11:10,5* ↘	Serie	39,0
2: 9,7 ↘	7: 9,7 →			12: 9,8 →		
3:10,2* ↙	8: 9,9 →	Total	0,0	13:10,7* ↖	Total	0,0
4:10,1 ↘	9:10,0 →			14:10,8* ↗		
5:10,7* ↘	10:10,1 →					

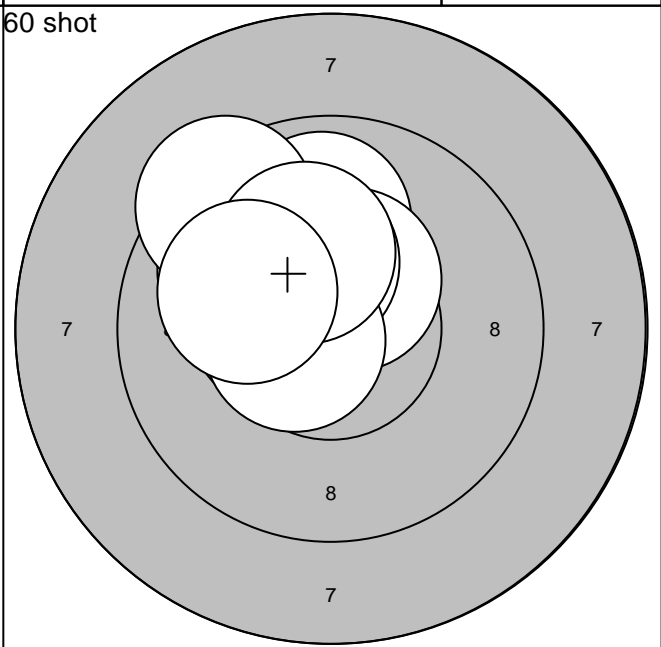
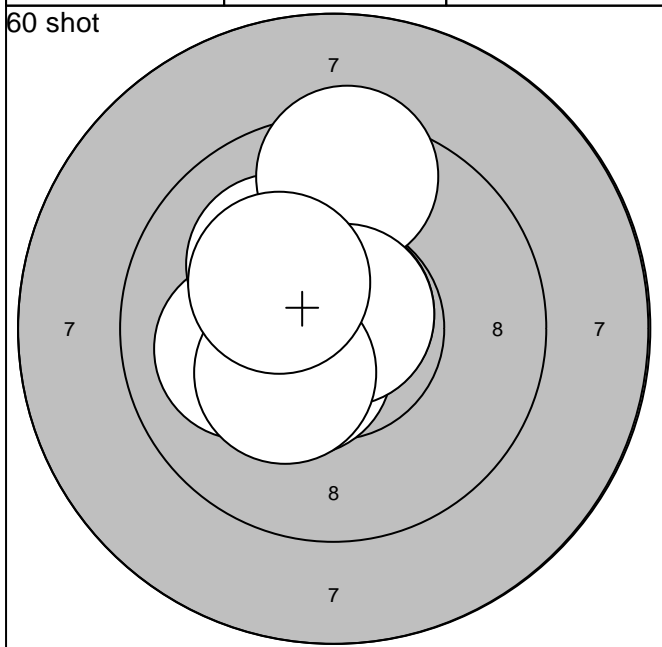

1:10,6* ↖	6:10,3* ↖	Serie	99,0	11:10,0 ↖	16:10,3* ↗	Serie	98,0
2:10,8* ↗	7: 9,5 ↑			12: 9,9 ↑	17:10,6* ↖		
3:10,1 ↖	8:10,8* ↗	Total	99,0	13:10,4* ↑	18: 9,4 ↖	Total	197,0
4:10,1 ↖	9:10,3* ↙			14:10,5* ↖	19:10,2* ↗		
5:10,5* ↘	10:10,3* ↖			15:10,3* ↖	20:10,1 ↖		

Umeå skytteallians

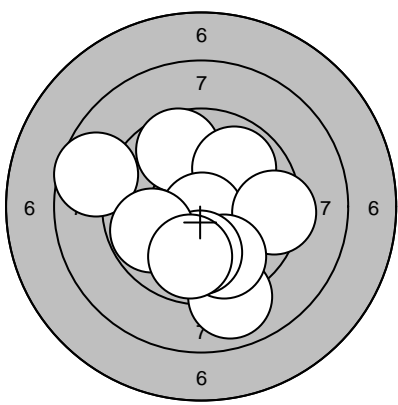
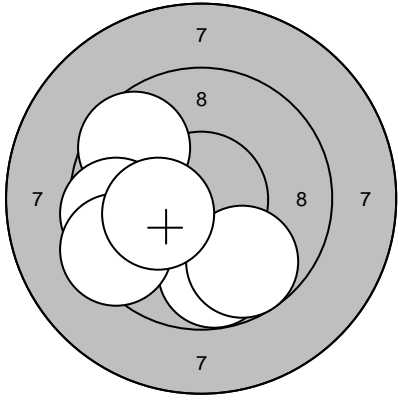
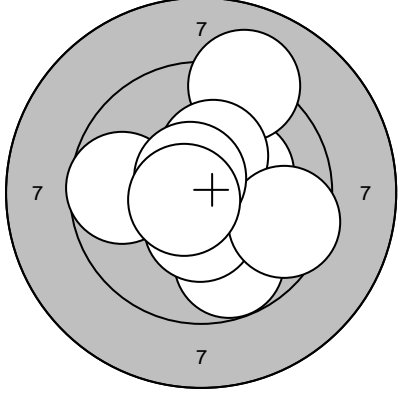
Lag	Skive	Pontus Homgren	
1	30		
2005-12-20		Föreningsmästerskap	Umeå skytteallians
Sight		1: 9,7 ↕ 2: 9,9 ↗ 3: 10,8* ↓ 4: 9,0 ↓ 5: 9,4 → 6: 9,8 ↓ 7: 10,0 ↓ 8: 8,7 ← 9: 9,8 ← 10: 9,9 ↓ Serie 91,0 Total 0,0	Sight
			11: 10,3* ↓ 12: 8,7 ← 13: 10,2* ↖ 14: 7,8 ← 15: 10,0 ← 16: 8,6 ↖ 17: 9,2 ← 18: 10,0 ← 19: 9,4 ← 20: 9,8 ↗ Serie 90,0 Total 0,0
Sight		21: 9,6 ↖ 22: 9,8 ↓ 23: 9,8 ↓ 24: 9,6 ← 25: 9,4 ← 26: 10,2* ← Serie 55,0 Total 0,0	60 shot
			1: 10,2* ↖ 2: 9,3 ↗ 3: 9,9 ↑ 4: 9,8 ↓ 5: 9,8 ↓ 6: 10,0 ← 7: 9,2 ← 8: 9,7 ← 9: 9,4 ← 10: 10,3* ↑ Serie 93,0 Total 93,0
60 shot		11: 9,8 ↓ 12: 10,3* ↗ 13: 10,9* ↗ 14: 9,1 ↑ 15: 10,4* ↓ 16: 10,3* ↑ 17: 9,7 ← 18: 9,6 → 19: 10,6* ↗ 20: 10,7* ← Serie 96,0 Total 189,0	
Umeå skytteallians			

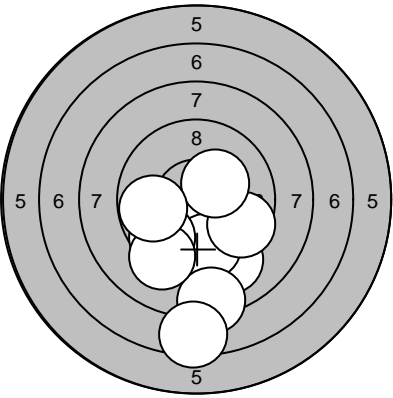
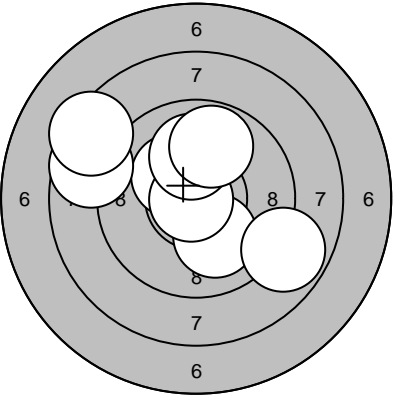
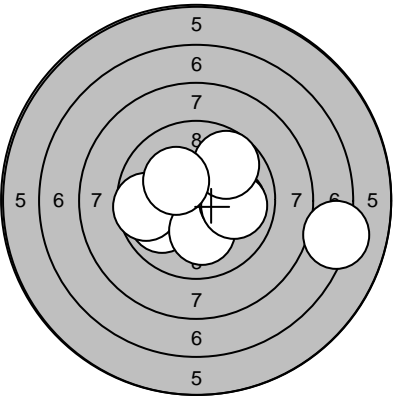
Lag <b>2</b>	Skive <b>8</b>	<b>Linda Jönsson</b>		
2005-12-20		Föreningsmästerskap	Umeå skytteallians	
Sight		1: 9,1 ↘ 2: 10,1 ↓ 3: 9,7 ↓ 4: 9,6 ↙ 5: 8,3 ↓ 6: 9,2 ↙ 7: 9,6 → 8: 7,4 ↓ 9: 10,3* ↗ 10: 9,8 ← Serie 89,0 Total 0,0	Sight	11: 7,9 → 12: 8,8 ↙ 13: 10,1 ↘ 14: 9,2 ← 15: 7,8 ← 16: 9,0 ↙ 17: 9,1 ↘ 18: 10,0 ↘ 19: 8,5 ← 20: 7,6 ↘ Serie 84,0 Total 0,0
Sight		21: 10,1 ↘ 22: 10,3* ↗ 23: 8,6 ← 24: 8,4 ↗ 25: 10,9* ← 26: 10,1 ↑ 27: 9,8 ↑ 28: 8,8 ↘ Serie 73,0 Total 0,0	60 shot	1: 9,7 → 2: 8,9 ← 3: 10,3* ↘ 4: 8,4 ↘ 5: 9,7 ↗ 6: 8,2 → 7: 8,7 ↗ 8: 8,5 ← 9: 10,2* ↘ 10: 10,0 → Serie 88,0 Total 88,0
60 shot		11: 10,9* ← 12: 10,8* ↘ 13: 10,0 ↙ 14: 9,7 ← 15: 7,2 → 16: 10,1 ↓ 17: 10,0 → 18: 9,9 → 19: 9,7 ↗ 20: 10,3* ↖ Serie 94,0 Total 182,0		
<b>Umeå skytteallians</b>				

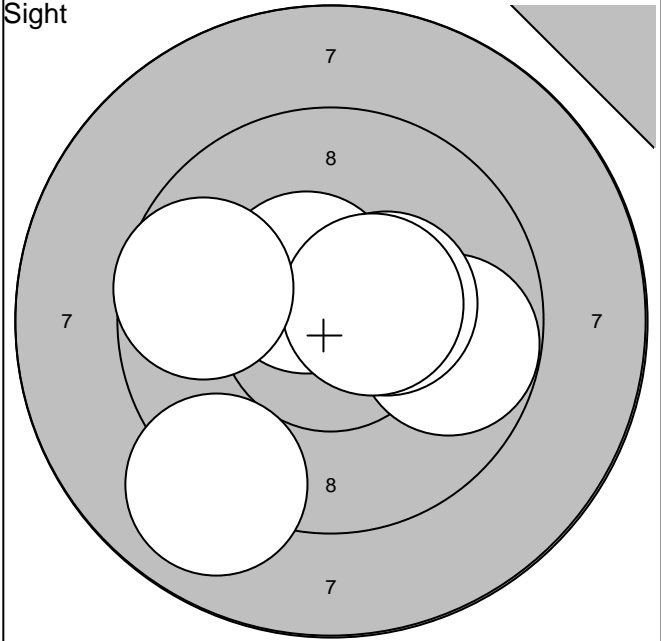
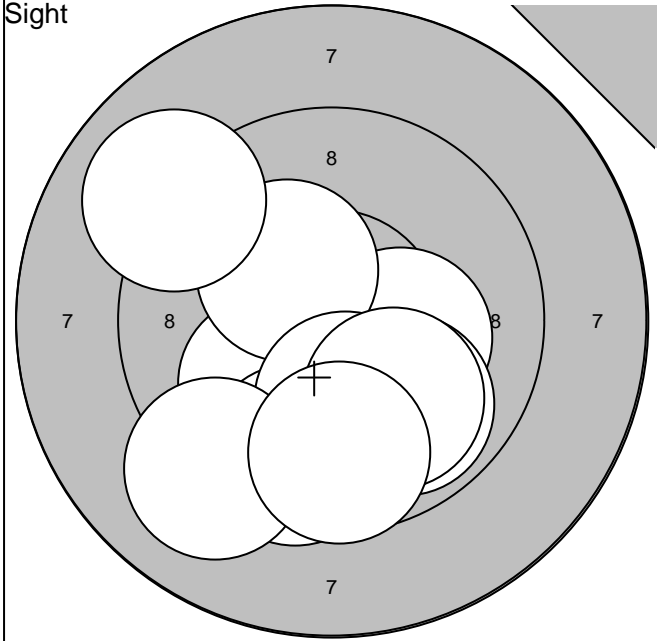

1:10,1 ↙	6: 9,9 ↘	Serie	95,0
2:10,3* →	7: 9,0 ↗		
3: 9,6 ↓	8: 9,1 ↘	Total	0,0
4:10,3* ↗	9:10,0 ↓		
5:10,1 ↓	10: 9,7 ↓		

11: 9,0 ↙	16: 9,7 ←	Serie	57,0
12: 9,8 →			
13:10,4* →		Total	0,0
14:10,5* ↗			
15:10,5* →			

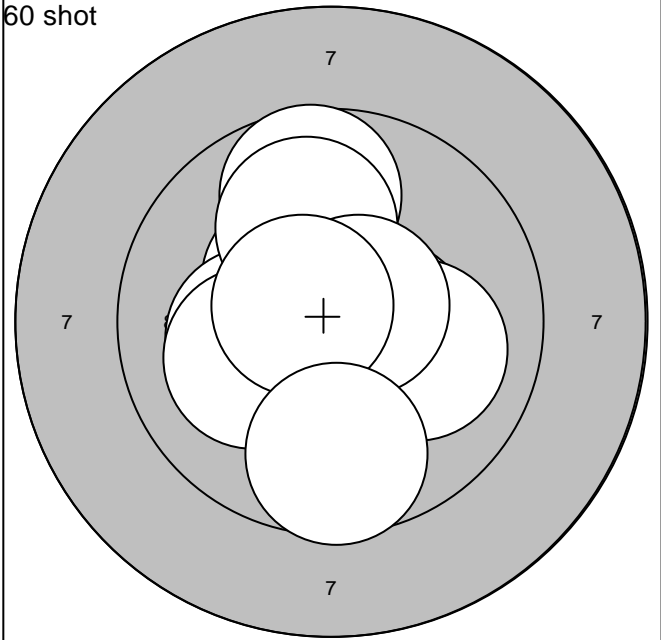
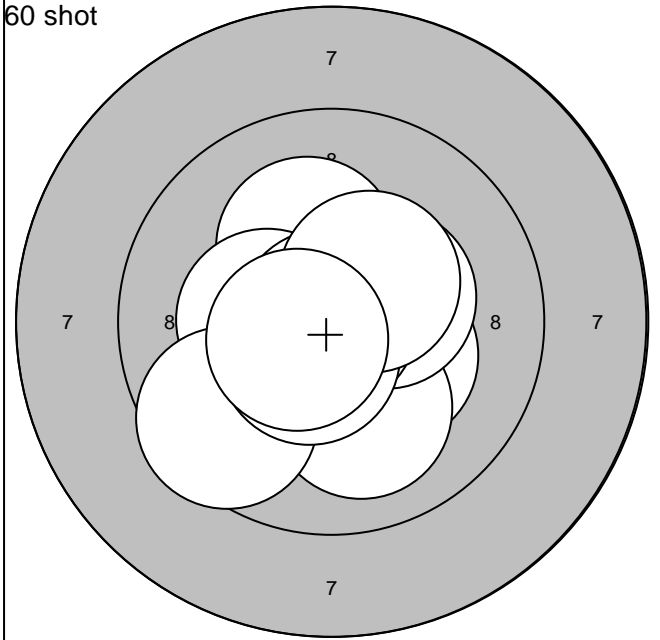

1:10,3* →	6: 9,6 ↙	Serie	99,0
2:10,2* ↗	7:10,9* ↖		
3:10,1 ↓	8:10,6* ↘	Total	99,0
4:10,3* ←	9:10,4* ↗		
5:10,4* ↗	10:10,6* ↖		

11: 9,7 ↑	16:10,0 ↑	Serie	98,0
12:10,4* ↖	17:10,1 ←		
13:10,4* →	18:10,6* ↗	Total	197,0
14:10,1 →	19:10,6* ↖		
15:10,2* ←	20: 9,7 ↓		



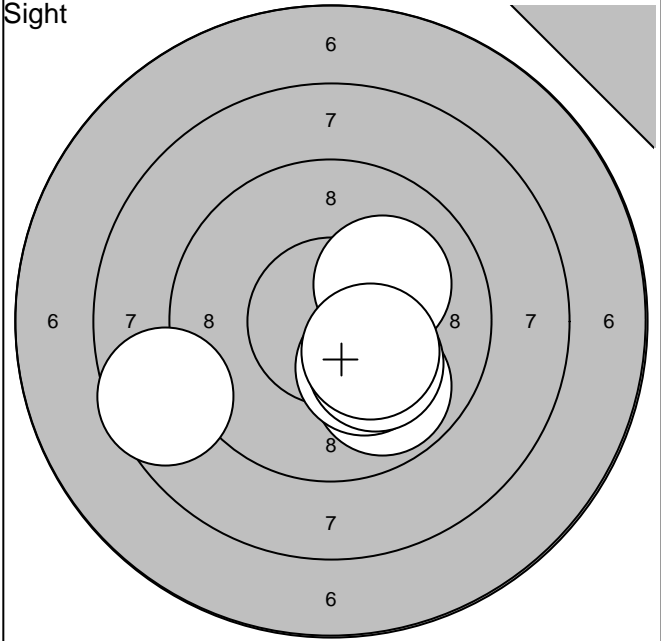
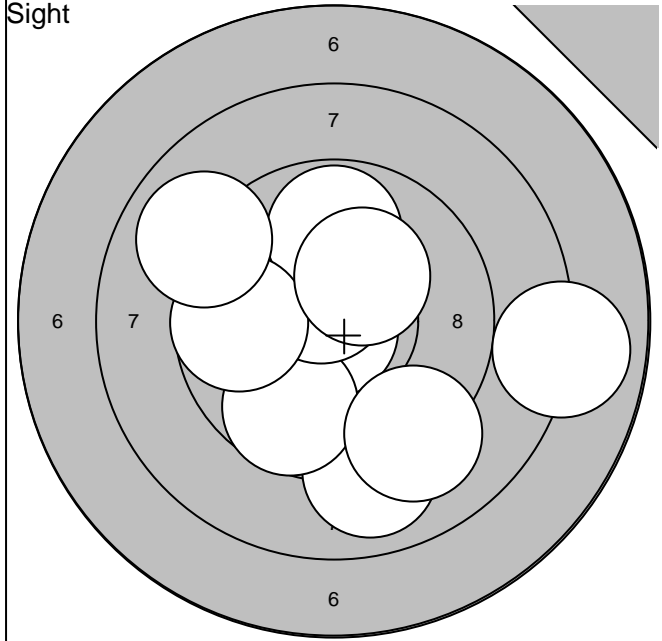

1:10,8* ↓	6: 9,8 ↑	Serie 92,0
2: 9,0 ↓	7: 9,7 ←	
3: 9,7 ↓	8: 9,0 ↖	Total 0,0
4: 8,0 →	9: 9,2 ↓	
5:10,6* ↗	10:10,3* ↗	

11: 8,6 ←	16:10,3* ↓	Serie 57,0
12:10,1 ↗		
13: 9,9 ↓		Total 0,0
14:10,2* ↓		
15:10,2* ↓		

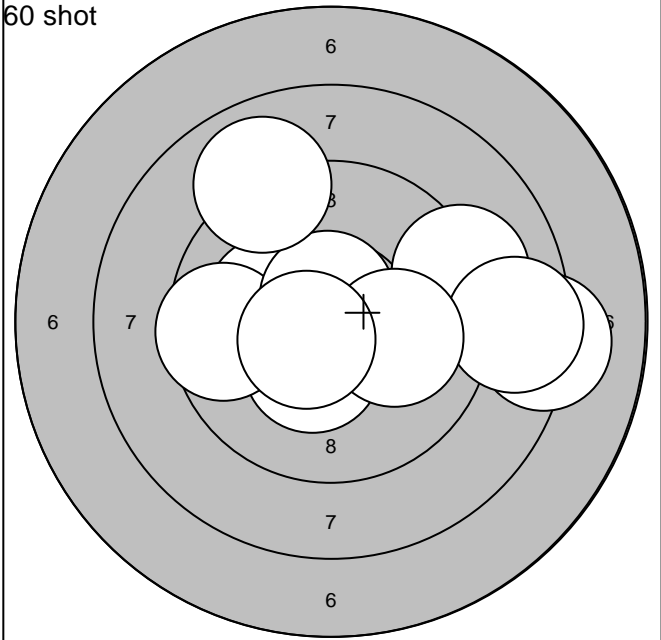
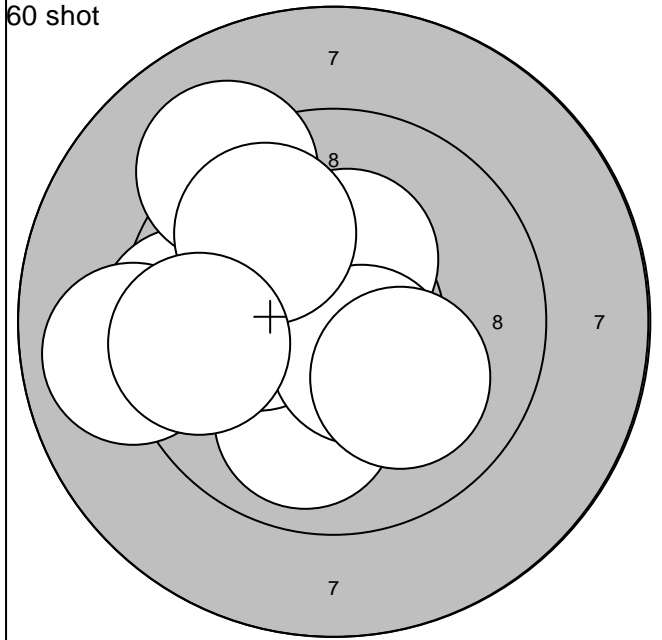

1: 9,5 ←	6:10,5* ↓	Serie 95,0
2: 9,1 ↗	7: 9,0 ←	
3:10,3* ↑	8:10,1 ↓	Total 95,0
4:10,0 ↓	9: 9,9 ↗	
5:10,2* ←	10: 9,6 ←	

11: 9,2 →	16:10,7* ↑	Serie 93,0
12:10,2* ←	17: 8,6 →	
13:10,3* ↓	18:10,1 →	Total 188,0
14: 9,6 ←	19: 9,0 ↗	
15: 8,2 →	20:10,6* ←	

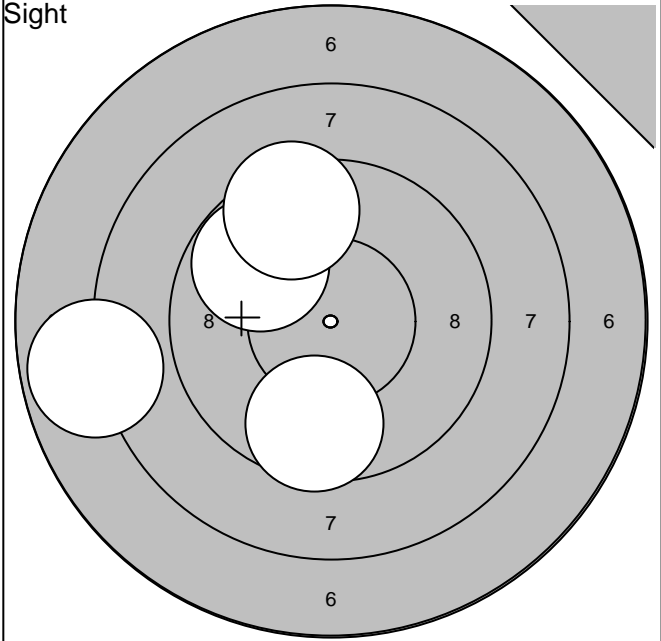
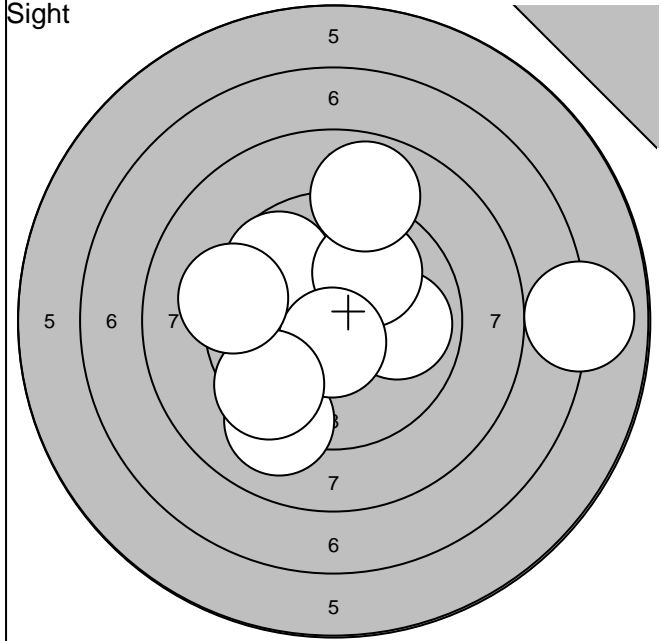

1:10,1 ↗	6: 9,1 ↘	Serie	90,0	11: 9,6 ↓	Serie	34,0
2: 9,9 →	7:10,6* ↓			12: 9,8 ↗		
3: 9,7 ↖	8: 9,5 ↙	Total	0,0	13: 7,8 ←	Total	0,0
4: 7,0 →	9: 8,9 ↑			14: 9,5 ↗		
5:10,0 ↗	10: 9,3 ←					

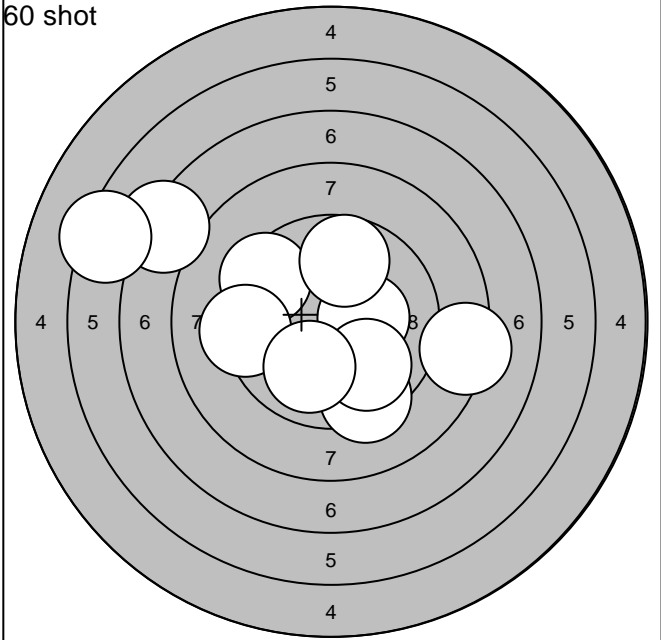
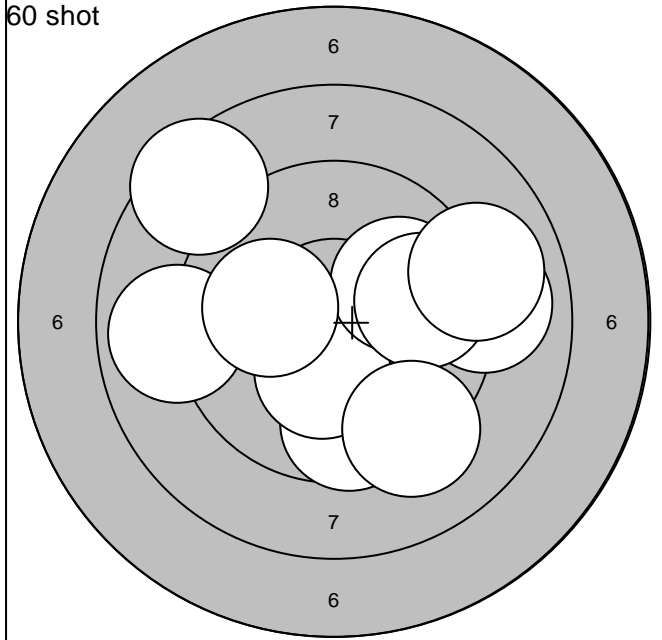

1: 9,0 →	6: 8,9 ←	Serie	91,0	11: 9,4 ↓	16: 9,3 ←	Serie	86,0
2: 9,6 ↓	7: 9,2 ↓			12: 8,3 →	17:10,0 ↓		
3:10,3* ↓	8: 9,0 →	Total	91,0	13: 9,5 ↗	18: 9,7 ↑	Total	177,0
4:10,0 ↗	9: 8,5 ↖			14:10,3* →	19: 7,3 ↖		
5: 9,8 →	10:10,1 ←						
				15: 9,9 ↓	20: 6,3 ←		

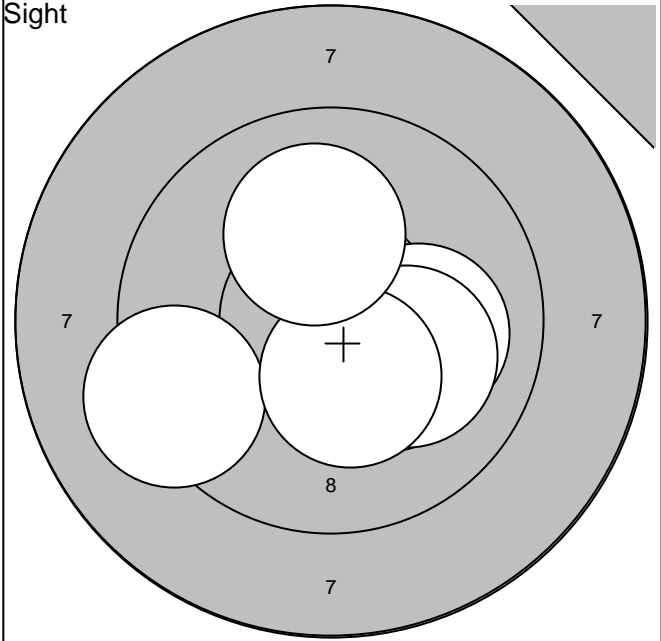
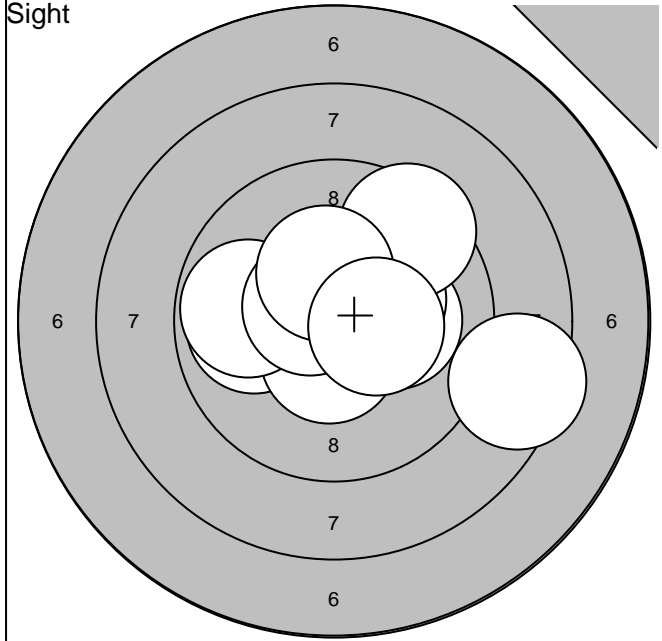

1:10,2* →	6: 9,5 ↗	Serie	95,0	11: 9,3 ←	16:10,1 ↑	Serie	59,0
2: 9,9 ←	7:10,6* ↖			12:10,1 →			
3:10,3* ↗	8:10,3* ↑	Total	0,0	13:10,3* ↘		Total	0,0
4:10,5* ↓	9: 8,5 →			14:10,1 →			
5: 9,8 ←	10:10,4* →			15:10,4* ↓			

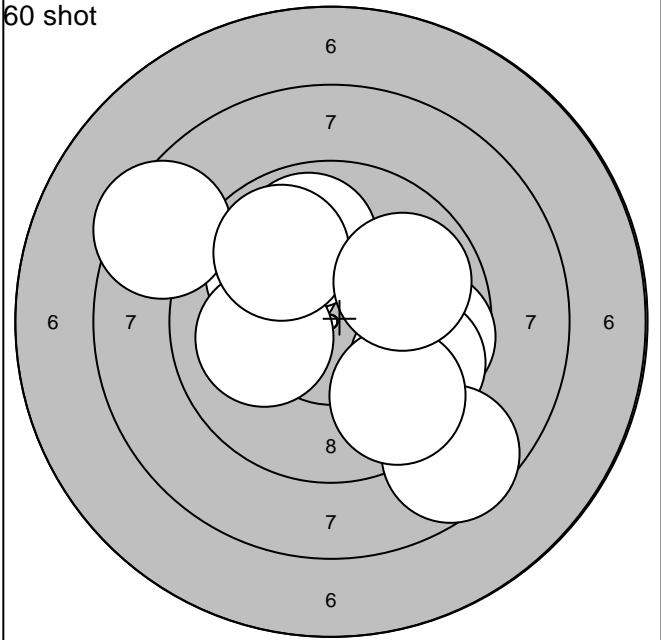
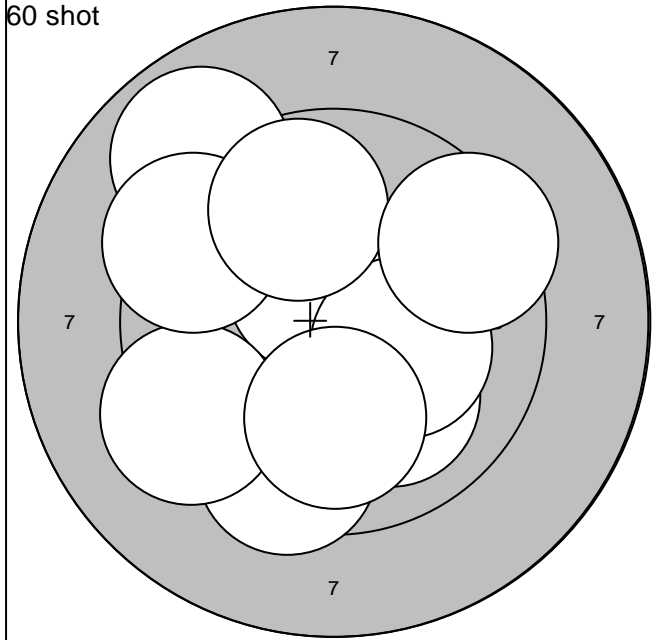

1:10,0 ↓	6: 8,9 ↗	Serie	93,0	11:10,0 ↗	16: 9,7 ↓	Serie	90,0
2:10,5* ↗	7: 9,4 ↖			12: 9,7 →	17:10,1 ←		
3: 9,5 ↓	8:10,0 ↓	Total	93,0	13: 9,7 →	18: 8,5 ↖	Total	183,0
4:10,2* →	9: 9,8 ↑			14: 8,6 ↓	19: 9,9 ↗		
5: 9,3 ←	10: 9,4 ↗			15: 9,9 ↑	20: 9,9 ↗		

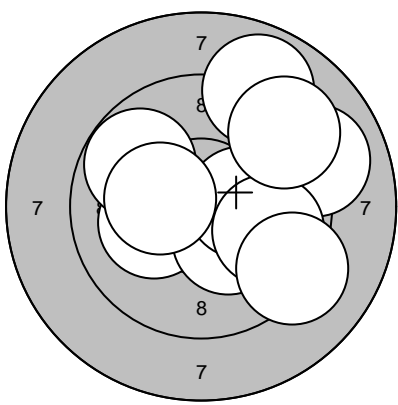
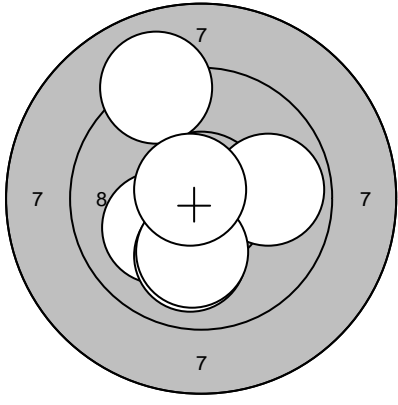
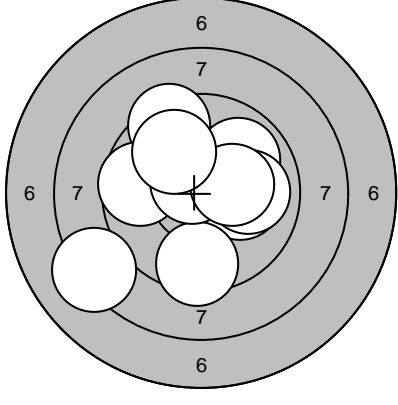
Lag <b>2</b>	Skive <b>13</b>	<b>Lisa Sandgren</b>	
2005-12-20		Föreningsmästerskap	Umeå skytteallians
Sight		1: 9,0 → 2: 10,2* ← 3: 10,3* ↓ 4: 10,3* → 5: 9,8 → 6: 9,2 ↓ 7: 9,8 ↗ 8: 8,9 ↗ 9: 10,3* ← 10: 9,2 ↗	Sight
		Serie 93,0	11: 10,3* →
		Total 0,0	12: 9,1 →
			13: 9,8 →
			14: 10,3* →
			15: 8,9 ↓
			16: 10,0 ↑
			17: 9,1 →
			18: 10,2* →
			19: 9,2 →
			20: 10,5* ↗
			Serie 94,0
			Total 0,0
Sight		21: 10,4* ↓ 22: 10,1 ← 23: 9,9 → 24: 10,0 ↓ 25: 10,1 ↓ 26: 9,1 ↗ 27: 10,7* ↗	60 shot
		Serie 68,0	1: 9,0 ←
		Total 0,0	2: 10,5* ↑
			3: 9,3 ↗
			4: 10,1 ↓
			5: 9,9 →
			6: 10,4* ↓
			7: 9,9 ↓
			8: 9,6 →
			9: 10,5* ↑
			10: 9,3 ←
			Serie 94,0
			Total 94,0
60 shot		11: 10,1 → 12: 9,9 ↗ 13: 9,4 ↗ 14: 9,5 ↓ 15: 9,6 ← 16: 10,7* ↗ 17: 10,0 → 18: 8,2 ← 19: 10,3* → 20: 9,9 ↗	
		Serie 93,0	
		Total 187,0	
<b>Umeå skytteallians</b>			

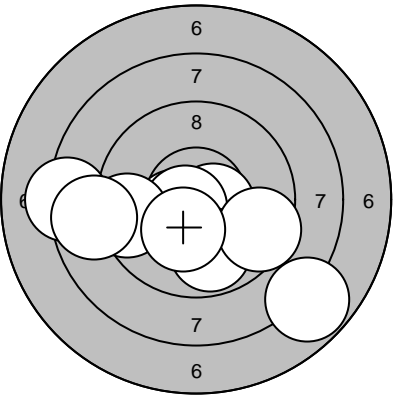
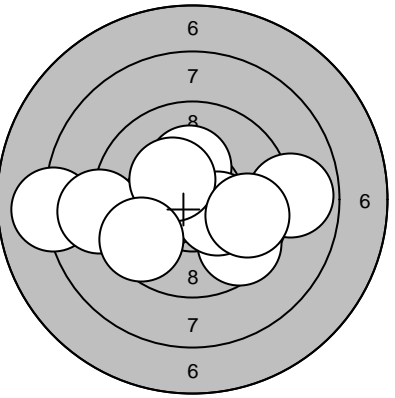
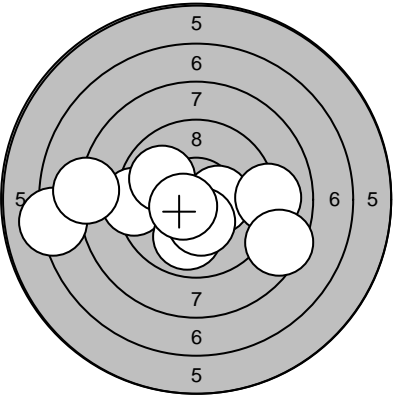
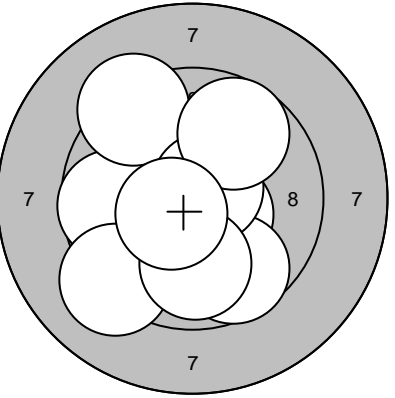
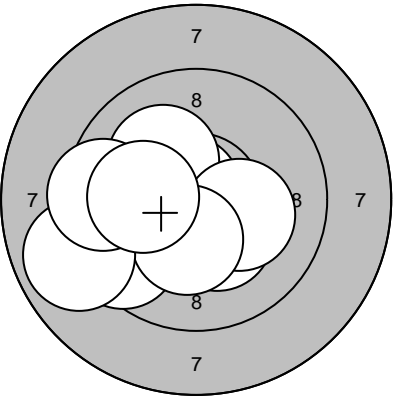
Lag <b>2</b>	Skive <b>14</b>	<b>Sara Bengtsson</b>			
2005-12-20		Föreningsmästerskap	Umeå skytteallians		
Sight		1: 8,3 ← 2: 10,4* ← 3: 7,8 ↘ 4: 10,6* → 5: 10,7* ← 6: 9,9 ↓ 7: 9,5 ← 8: 8,8 ← 9: 9,5 → 10: 10,3* ↓ Serie 90,0 Total 0,0	Sight		11: 10,3* ↑ 12: 9,6 ↘ 13: 8,1 ← 14: 8,9 → 15: 10,3* ← 16: 9,0 ← 17: 10,3* ↘ 18: 10,4* ↗ 19: 9,6 ↘ 20: 9,7 → Serie 92,0 Total 0,0
Sight		21: 9,3 ← 22: 10,0 ↗ 23: 10,4* → 24: 7,2 ← 25: 8,1 ← 26: 9,9 ↓ 27: 9,1 → 28: 10,3* ↓ 29: 8,5 → 30: 10,6* ← Serie 90,0 Total 0,0	60 shot		1: 9,7 ← 2: 10,5* ↘ 3: 9,3 ↗ 4: 10,4* ↓ 5: 9,2 ↘ 6: 9,7 ↓ 7: 10,7* ↗ 8: 9,7 ↗ 9: 9,9 ↓ 10: 10,6* ← Serie 94,0 Total 94,0
60 shot		11: 10,7* ↗ 12: 10,1 ← 13: 10,3* ↘ 14: 10,2* ↗ 15: 9,5 ← 16: 10,2* → 17: 10,3* ↓ 18: 8,9 ← 19: 9,5 ← 20: 10,1 ← Serie 96,0 Total 190,0			
<b>Umeå skytteallians</b>					

Lag	Skive	Matilda Åberg
2	15	

2005-12-20	Föreningsmästerskap	Umeå skytteallians
------------	---------------------	--------------------

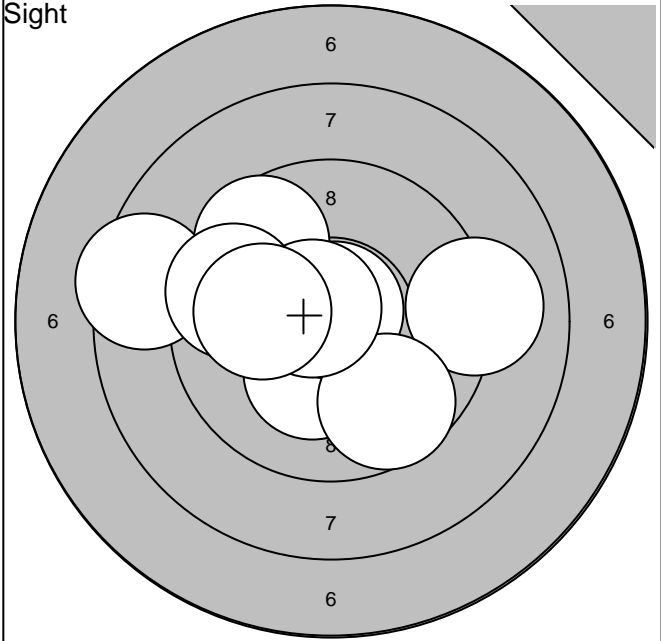
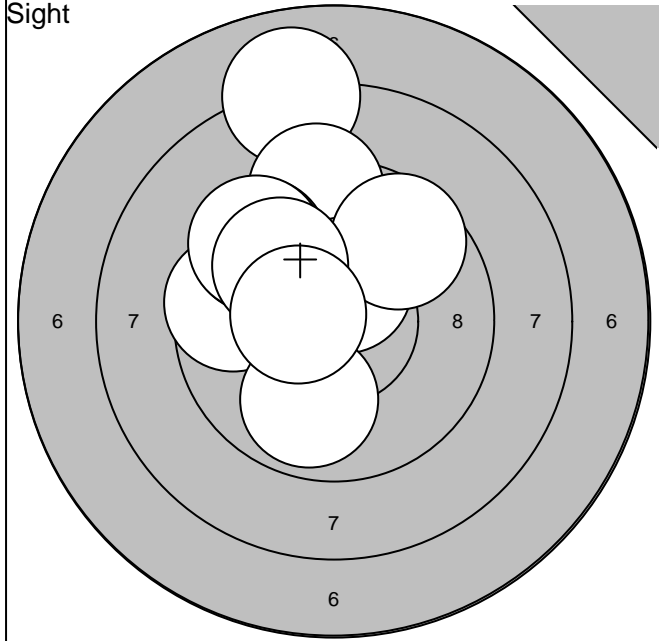

1: 8,0 ↑	6: 9,6 ↖	Serie	92,0
2: 9,3 ↑	7: 9,6 ↗		
3: 9,6 ←	8: 9,5 ↗	Total	0,0
4: 10,5* ↑	9: 10,0 ↗		
5: 9,9 ↓	10: 10,5* ←		

11: 9,6 ↖	16: 9,7 ↓	Serie	84,0
12: 10,3* ↓	17: 10,7* ↖		
13: 10,8* ↑	18: 9,6 ←	Total	0,0
14: 9,1 →	19: 10,1 ←		
15: 8,5 ←			

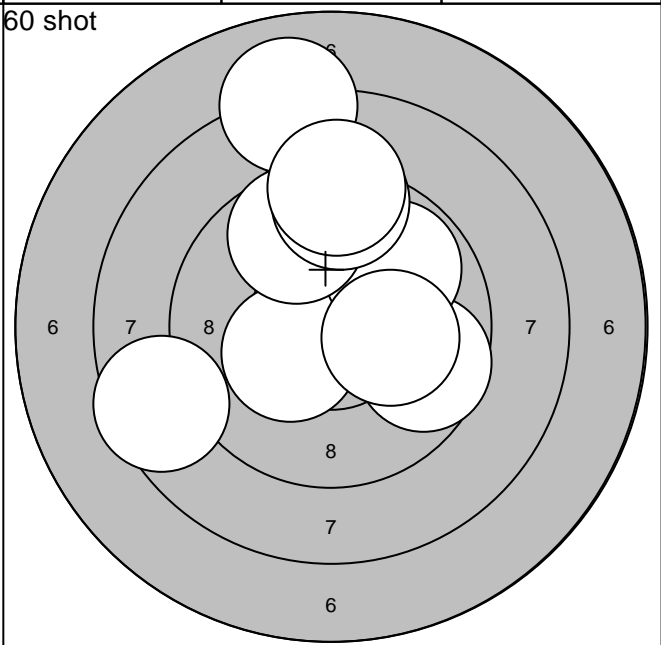
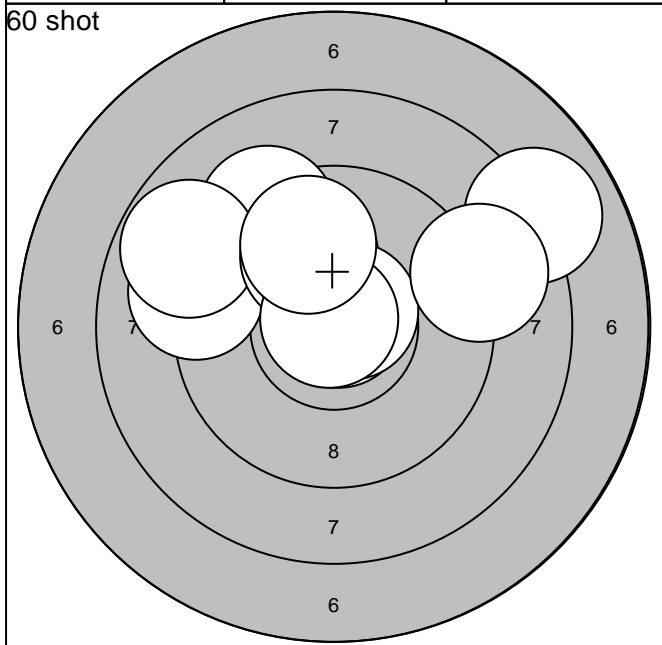

1: 9,1 ←	6: 10,8* ↗	Serie	91,0
2: 9,3 ↗	7: 10,7* ↗		
3: 8,8 ↖	8: 10,8* ↗	Total	91,0
4: 10,0 ↑	9: 8,9 →		
5: 8,0 ↗	10: 9,8 ↑		

11: 10,3* ↖	16: 9,7 ↗	Serie	90,0
12: 9,5 ↑	17: 8,0 ↑		
13: 9,7 →	18: 8,5 ←	Total	181,0
14: 9,9 ↗	19: 9,3 ↑		
15: 10,2* →	20: 9,2 ↑		

Umeå skytteallians

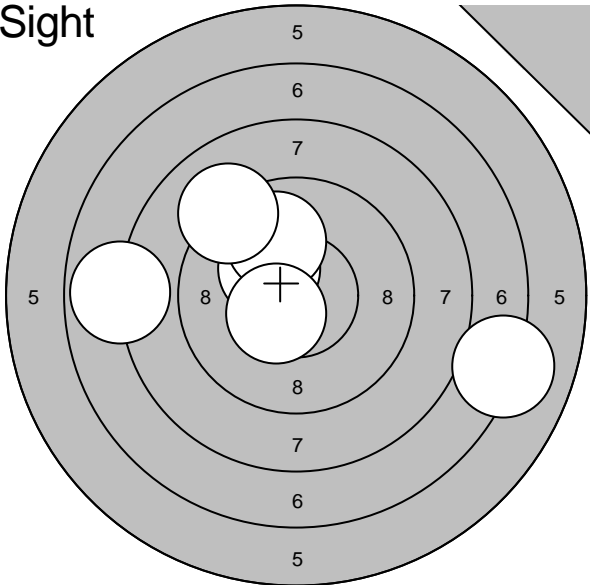
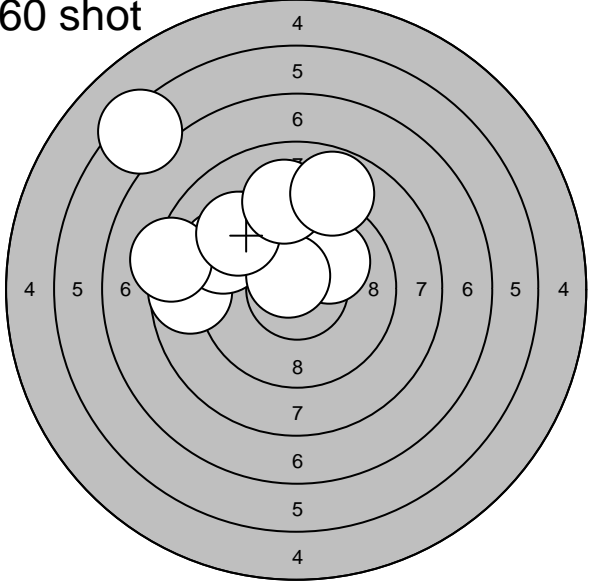
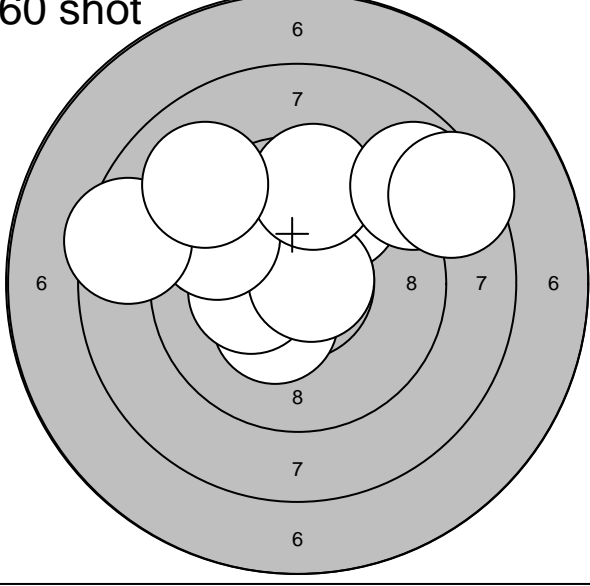
Lag	Skive		
<b>2</b>	<b>17</b>	<b>Henrik Ågren</b>	
2005-12-20		Föreningsmästerskap	Umeå skytteallians
Sight		1: 10,3* ↗ 2: 7,1 → 3: 10,0 ↑ 4: 10,5* ↙ 5: 9,1 ↗ 6: 7,9 ←	
		<b>Serie 53,0</b> <b>Total 0,0</b>	
60 shot		1: 10,1 ↗ 2: 8,7 ← 3: 9,4 ↗ 4: 9,2 ↗ 5: 10,6* ↗ 6: 8,3 ← 7: 9,3 ↗ 8: 9,1 ↑ 9: 8,8 ↗ 10: 6,3 ↗	
		<b>Serie 86,0</b> <b>Total 86,0</b>	
60 shot		11: 9,8 ↑ 12: 10,4* ↙ 13: 10,3* ← 14: 10,8* → 15: 9,7 ↗ 16: 9,6 ↑ 17: 8,5 ← 18: 8,8 ↗ 19: 9,1 ↗ 20: 8,5 ↗	
		<b>Serie 90,0</b> <b>Total 176,0</b>	
Umeå skytteallians			

2005-12-20	Föreningsmästerskap	Umeå skytteallians
------------	---------------------	--------------------

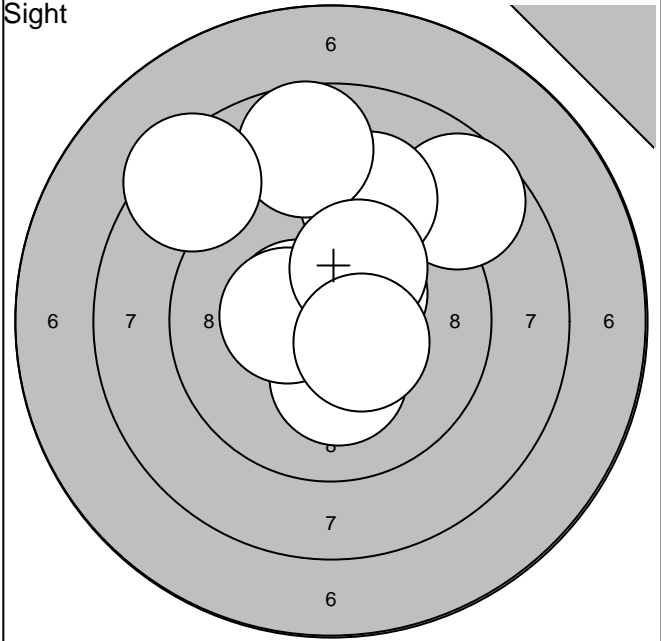
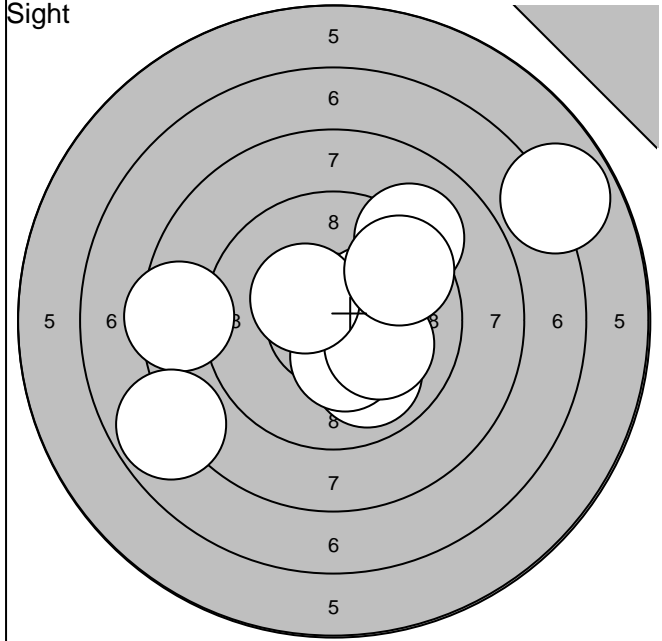

1: 9,9 ↘	6: 10,3* ↗	Serie	88,0
2: 8,5 ←	7: 10,1 →		
3: 10,3* ↘	8: 10,4* ↖	Total	0,0
4: 7,9 ↙	9: 9,2 ↗		
5: 6,9 ↗	10: 9,6 ↗		

11: 10,5* ↗	16: 8,7 ↑	Serie	93,0
12: 10,2* ↘	17: 10,4* ←		
13: 8,7 ↗	18: 10,2* ↗	Total	0,0
14: 10,5* ↙	19: 10,5* ↘		
15: 9,3 ↑	20: 8,4 ↖		

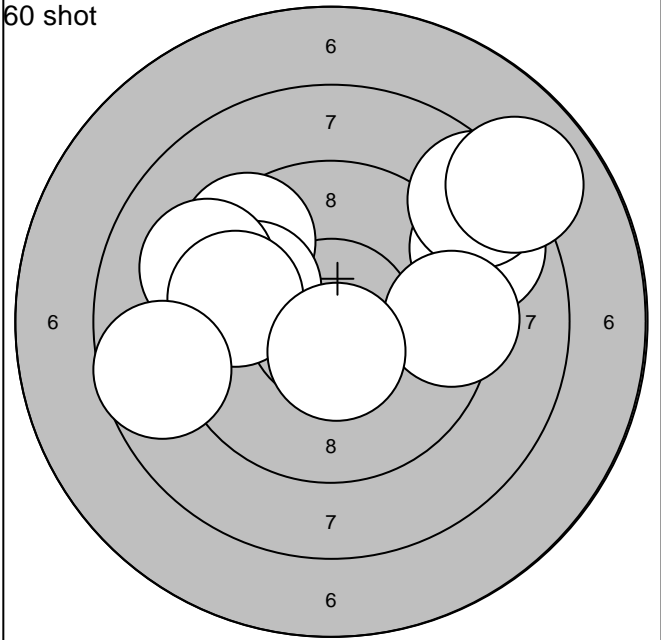
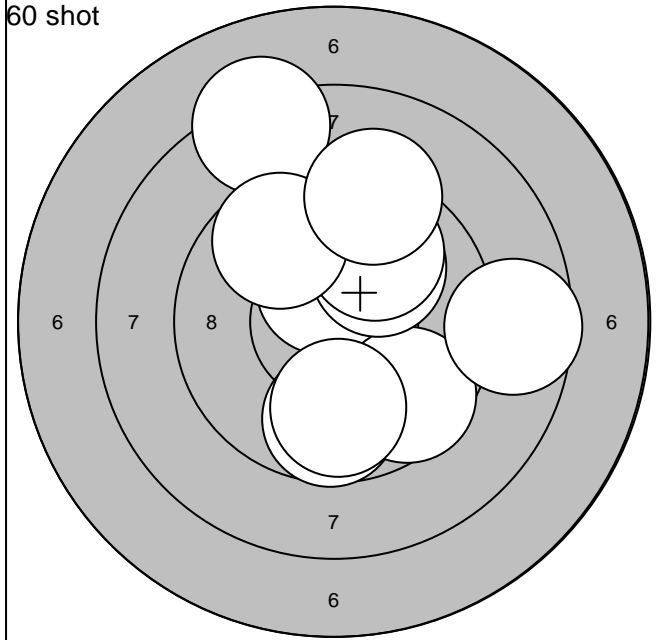

1: 10,5* ↑	6: 9,8 ↓	Serie	90,0
2: 9,7 ↓	7: 8,3 ↑		
3: 9,6 ↘	8: 9,7 ↗	Total	90,0
4: 10,1 ↗	9: 8,6 →		
5: 9,9 ↗	10: 9,3 ↑		

11: 8,8 ↗	16: 9,2 ↙	Serie	87,0
12: 9,5 ↖	17: 9,4 →		
13: 8,5 ↗	18: 9,7 ←	Total	177,0
14: 9,9 ↙	19: 10,6* ↓		
15: 8,0 ↗	20: 8,7 ←		



Lag	Skive	Joachim Lundgren
2	20	

2005-12-20	Föreningsmästerskap	Umeå skytteallians
------------	---------------------	--------------------

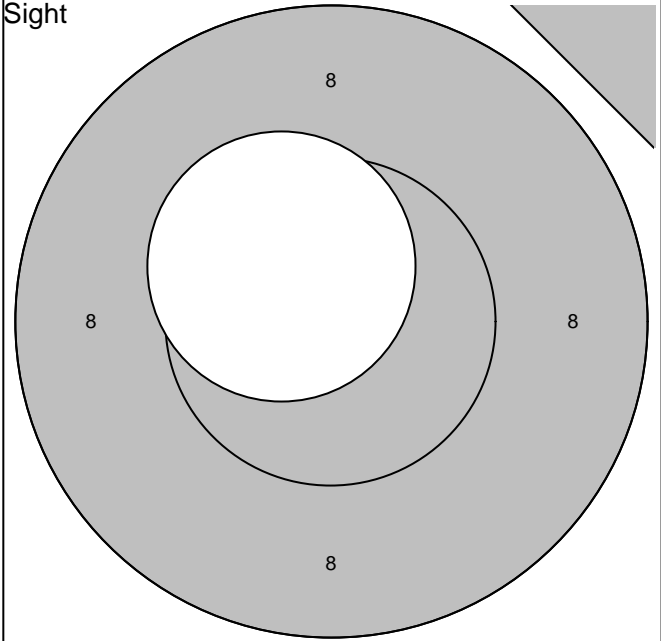
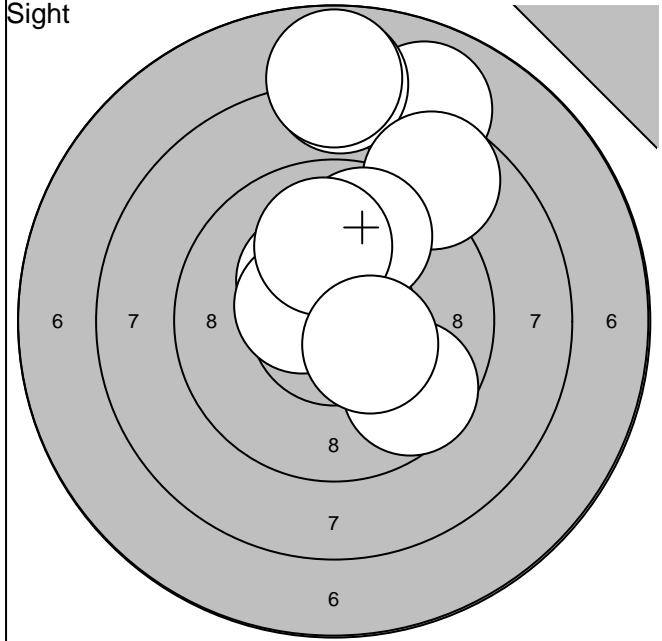

1: 8,0 ↗	6:10,3* ↗	Serie	88,0	11:10,5* ↖	Serie	10,0
2: 7,9 ↑	7:10,5* ↖					
3: 7,8 ↑	8:10,0 ↑	Total	0,0	Total	0,0	
4: 8,8 ↗	9: 9,6 ↘					
5: 9,8 ↑	10:10,4* ↘					

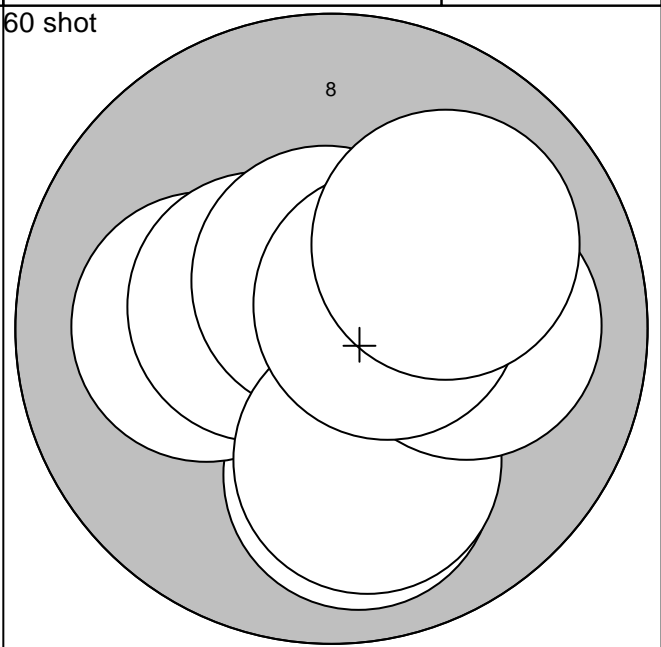
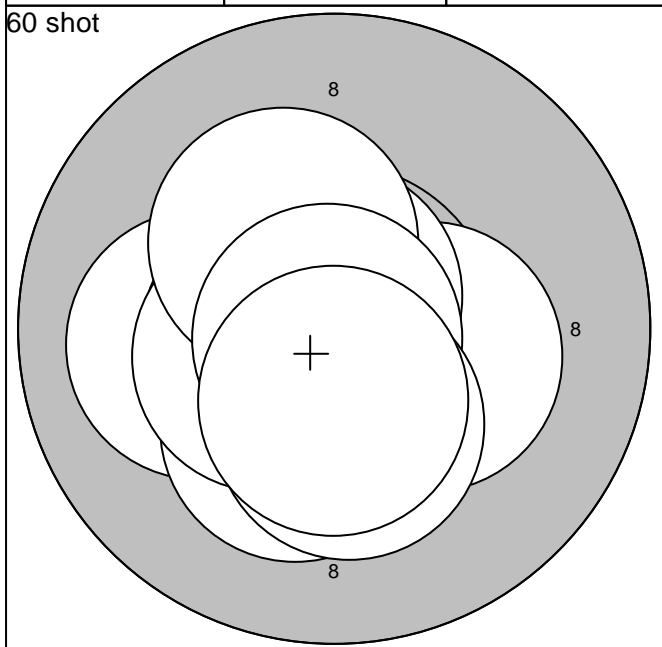

1:10,3* →	6:10,7* ↑	Serie	100,0	11:10,6* ↓	16:10,6* ↑	Serie	100,0
2:10,1 ←	7:10,3* ↗			12:10,0 ↓	17:10,1 ↓		
3:10,3* ↓	8:10,9* ↘	Total	100,0	13:10,1 ←	18:10,1 →	Total	200,0
4:10,6* ←	9:10,3* ↓			14:10,3* →	19:10,5* ↗		
5:10,5* ←	10:10,5* ↓			15:10,5* ←	20:10,0 ↗		

Umeå skytteallians

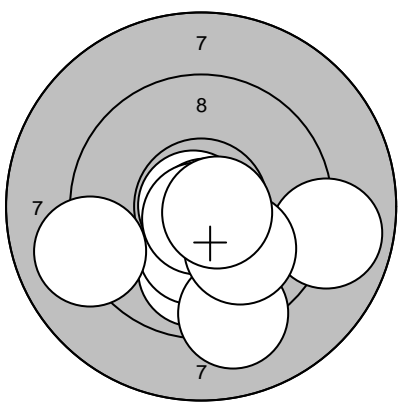
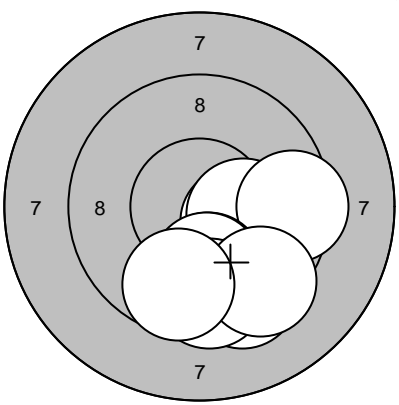
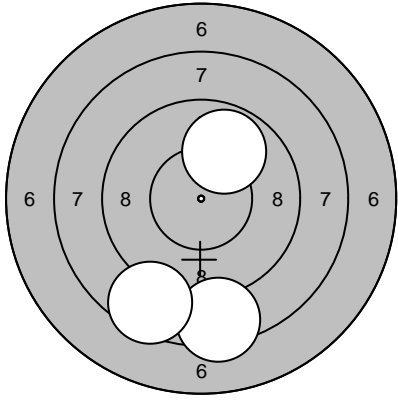
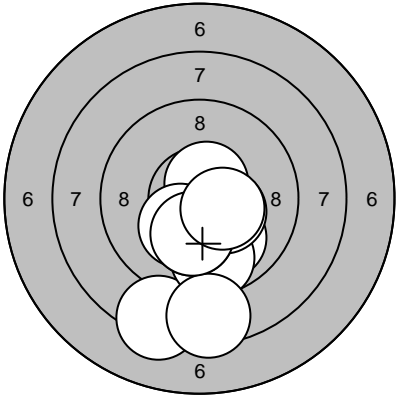
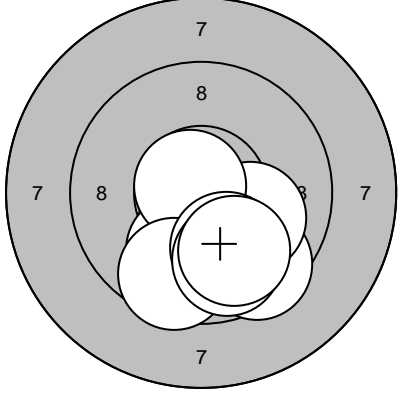
Lag	Skive	Kjell Oscarsson	
2	21		
2005-12-20		Föreningsmästerskap	Umeå skytteallians
Sight		1: 10,8* ← 2: 8,9 → 3: 9,9 ↓ 4: 10,8* ↓ 5: 10,3* ↓ 6: 10,8* ↓ 7: 9,2 ↓ 8: 10,1 ↓ 9: 9,1 ← 10: 10,7* → Serie 95,0 Total 0,0	Sight  11: 9,8 ↓ 12: 10,3* → 13: 10,2* → 14: 9,5 → 15: 9,9 ↓ 16: 9,9 ↓ 17: 9,4 ↓ 18: 9,6 ↓ 19: 9,4 ↓ 20: 9,7 ↓ Serie 92,0 Total 0,0
Sight		21: 8,4 ↓ 22: 8,5 ↓ 23: 9,9 ↑ Serie 25,0 Total 0,0	60 shot  1: 10,6* ↗ 2: 10,0 ↓ 3: 8,3 ↓ 4: 9,7 ↓ 5: 10,2* ↓ 6: 10,3* ↓ 7: 10,4* → 8: 8,5 ↓ 9: 10,2* ↓ 10: 10,4* → Serie 95,0 Total 95,0
60 shot		11: 10,4* ↓ 12: 10,0 ↓ 13: 9,8 ↓ 14: 9,5 ↓ 15: 10,1 → 16: 10,7* ↗ 17: 9,6 ↓ 18: 10,0 ↓ 19: 9,8 ↓ 20: 9,9 ↓ Serie 95,0 Total 190,0	

Umeå skytteallians

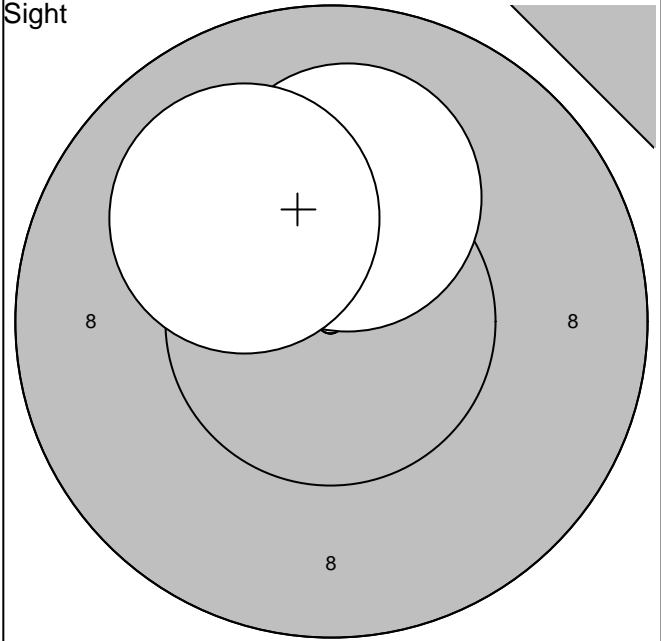
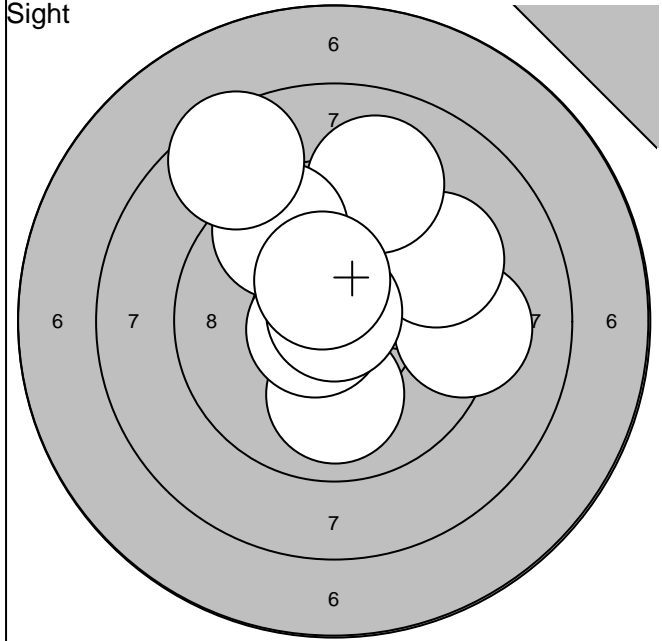

1: 9,9 ↗	6: 9,6 ↖	Serie	93,0	11:10,1 ↑	Serie	20,0
2: 9,3 →	7: 8,5 ↖			12:10,1 ↖		
3: 9,4 ↗	8:10,7* ↙	Total	0,0		Total	0,0
4:10,0 ↓	9:10,9* ↑			10:10,4* ↑		
5: 9,1 ↑						

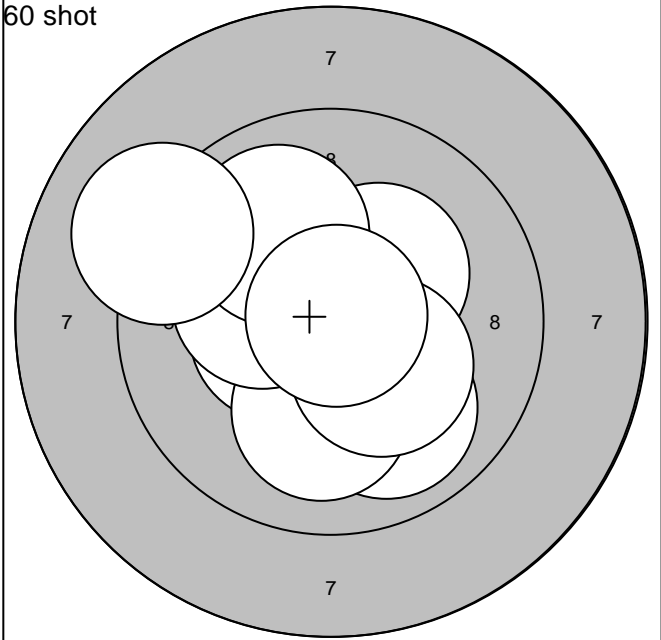
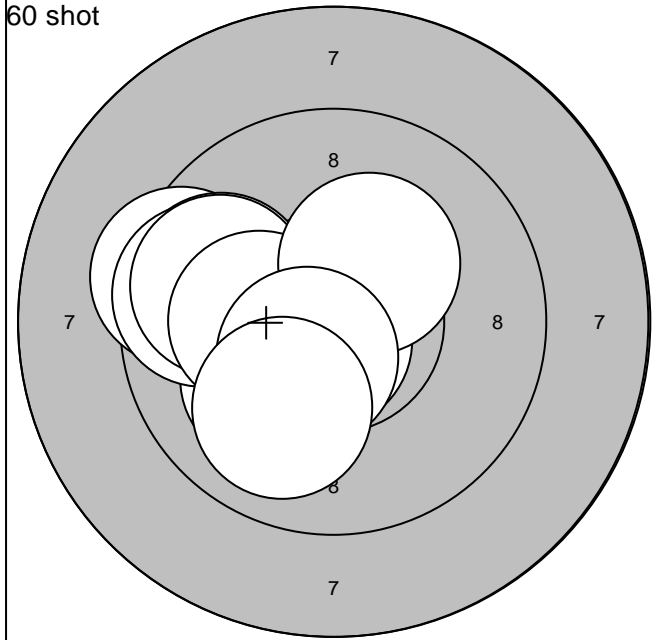

1: 9,4 ←	6: 9,8 ←	Serie	96,0	11:10,3* ↗	16:10,3* ↙	Serie	99,0
2:10,1 ↙	7:10,2* ←			12:10,5* ←	17:10,0 ↖		
3: 9,8 ←	8:10,3* ↗	Total	96,0	13:10,4* ↖	18:10,3* ↘	Total	195,0
4: 9,7 ←	9:10,5* ↘			14:10,0 ↓	19:10,9* ↗		
5:10,7* ↘	10:10,0 ↘			15:10,1 ↓	20: 9,1 ←		

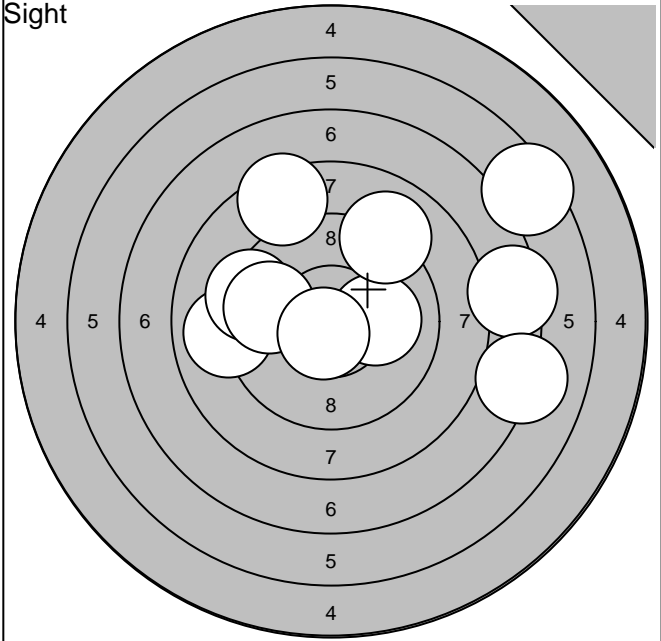
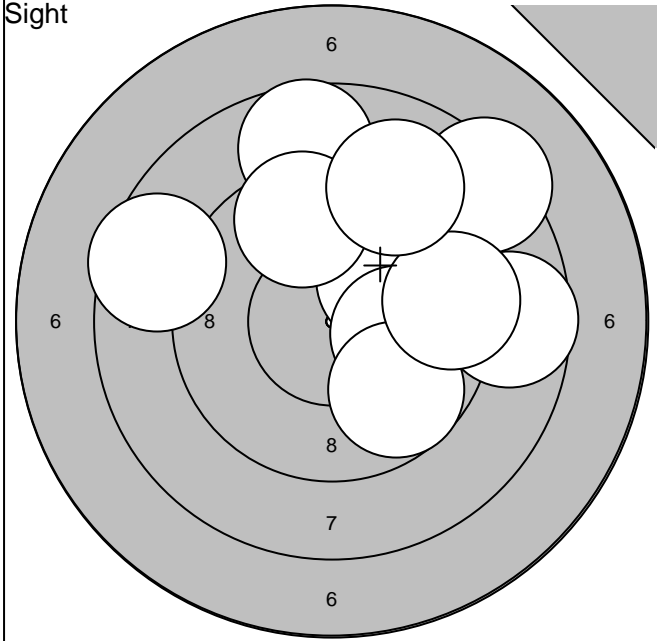

1: 10,1 ↗	6: 8,6 →	Serie	88,0
2: 8,7 ↑	7: 10,1 →		
3: 8,3 ↗	8: 9,7 ↘	Total	0,0
4: 8,6 ←	9: 9,4 →		
5: 9,6 ↑	10: 9,0 ↑		

11: 9,0 ←	16: 10,1 →	Serie	84,0
12: 6,4 ↗	17: 10,7* ↙		
13: 9,3 ←	18: 7,4 →	Total	0,0
14: 9,7 ←	19: 9,0 ↗		
15: 8,4 ↑	20: 7,1 →		

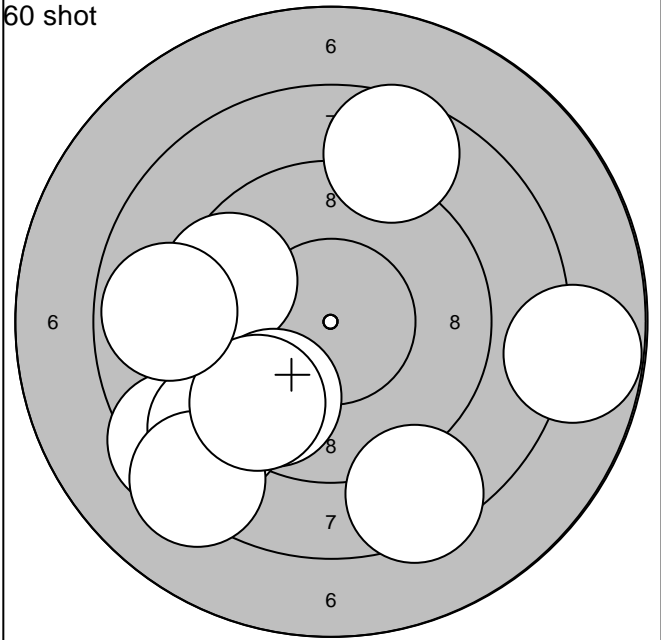
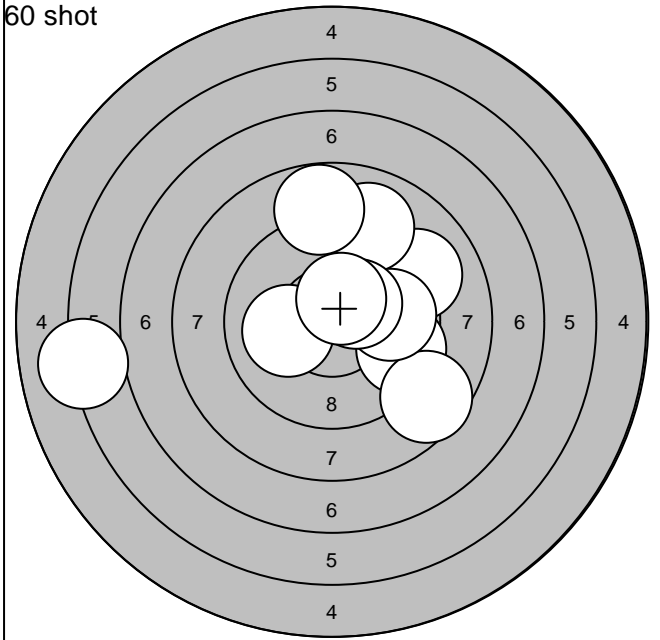

1: 9,1 ↗	6: 10,1 ←	Serie	88,0
2: 9,0 ↑	7: 8,6 ↘		
3: 8,8 ↑	8: 9,8 →	Total	88,0
4: 6,1 ←	9: 10,4* ↗		
5: 9,5 →	10: 10,5* ↑		

11: 8,4 ←	16: 8,5 ↘	Serie	82,0
12: 8,9 ←	17: 9,7 ↘		
13: 7,8 →	18: 8,3 ↘	Total	170,0
14: 8,6 ↑	19: 9,5 ↘		
15: 9,5 ←	20: 8,9 ←		

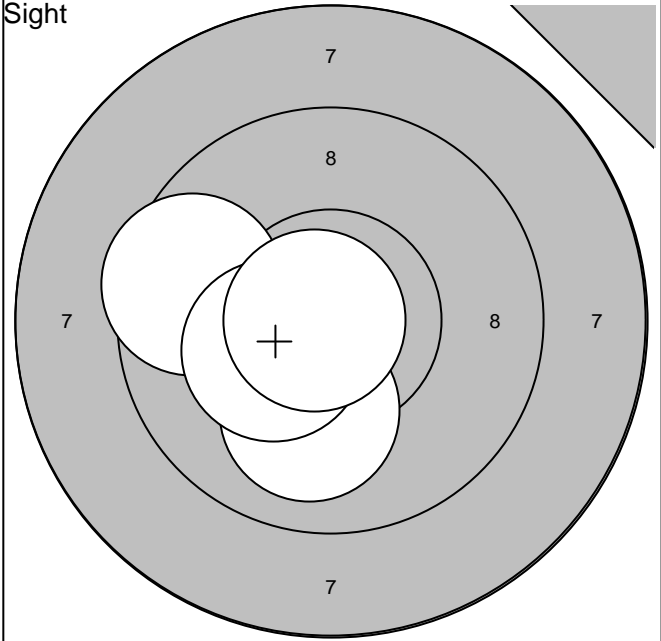
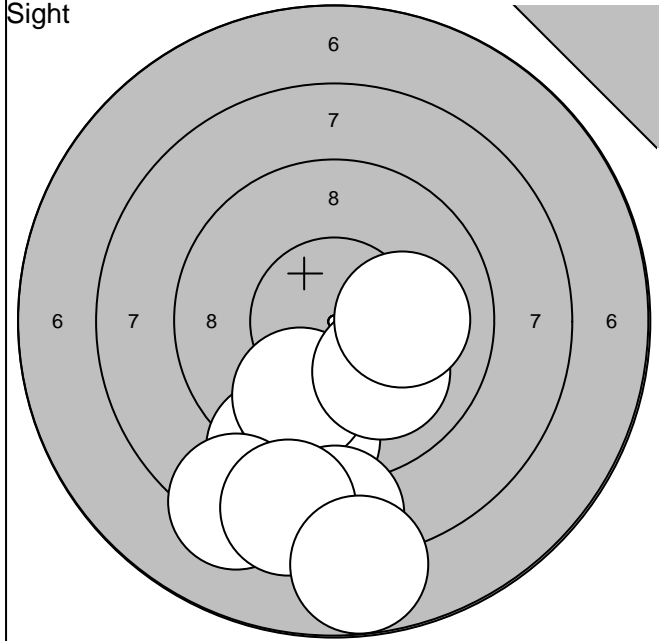

1: 9,1 ↓	6: 0,0 ↑	Serie 78,0
2: 9,4 ↓	7: 8,3 ↓	
3: 9,9 ↓	8: 8,5 ↓	Total 0,0
4: 8,4 ↓	9: 7,8 ↓	
5:10,1 ↘	10:10,1 →	

11: 9,6 ←	Serie 39,0
12:10,1 ↓	
13:10,3* ←	Total 0,0
14:10,8* ←	

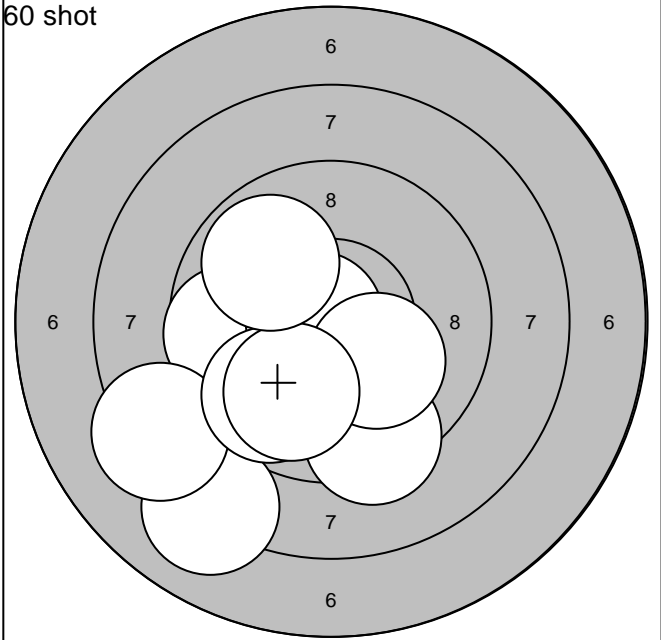
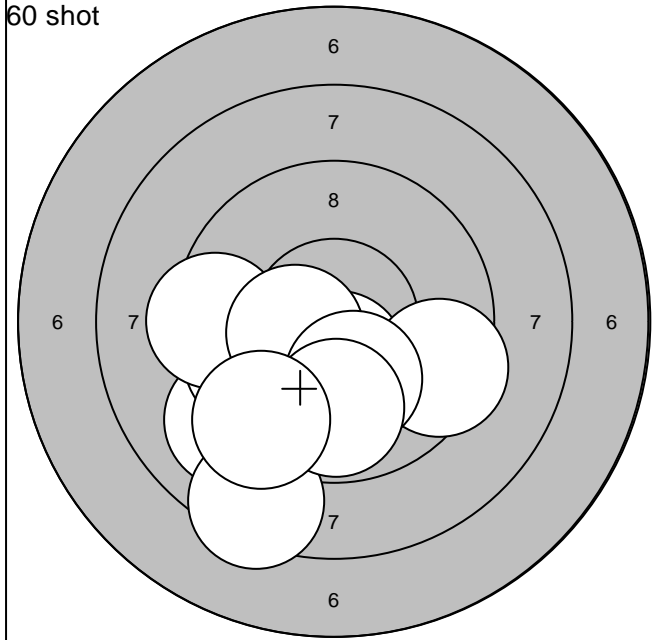

1:10,5* ↓	6: 8,4 ↓	Serie 92,0
2: 9,5 →	7:10,4* ←	
3: 9,1 ←	8:10,2* ↓	Total 92,0
4: 9,8 ←	9: 9,8 ↓	
5: 9,4 ←	10: 9,4 ↓	

11: 8,1 ↓	16:10,7* ←	Serie 91,0
12:10,0 ←	17: 9,7 ↓	
13: 9,7 ←	18:10,2* ↓	Total 183,0
14: 8,3 ←	19: 9,9 ↓	
15: 9,4 ↓	20: 9,9 ↖	

Lag	Skive	Josefin Adolfsson
2	26	

--	--	--

2005-12-20	Föreningsmästerskap	Umeå skytteallians
------------	---------------------	--------------------

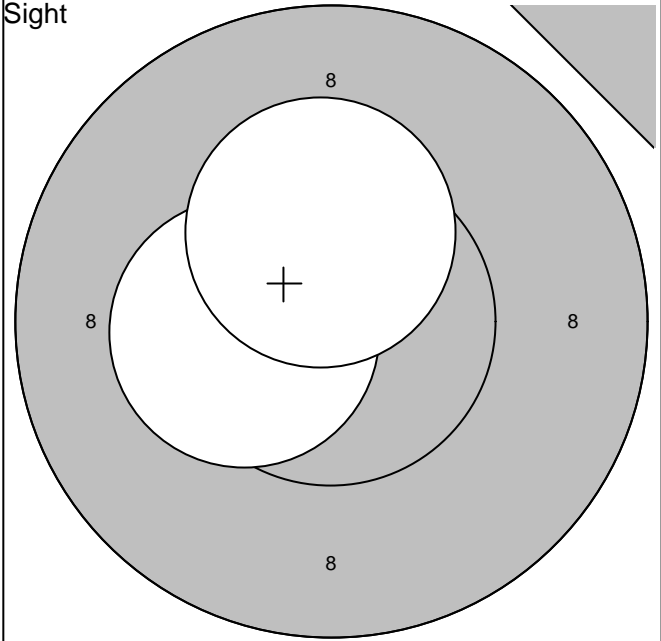
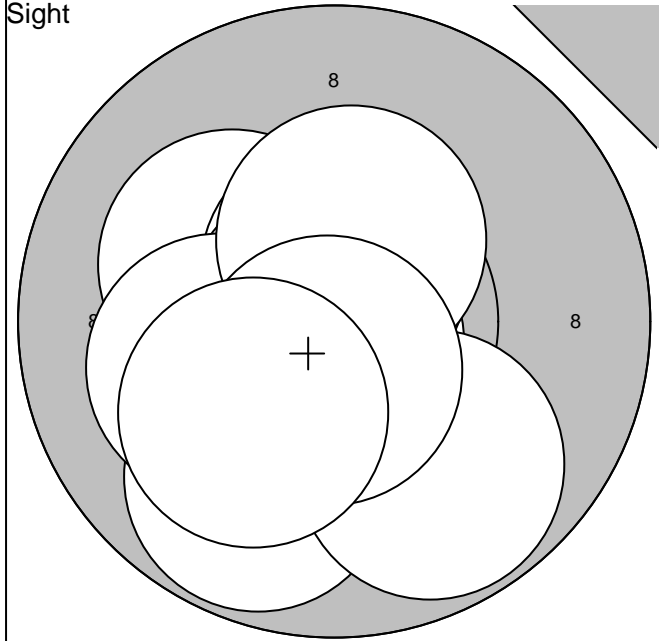

1: 9,8 ↘	6:10,9* ↖	Serie	98,0	11:10,4* ←	Serie	20,0
2:10,8* ↓	7:10,2* ←			12:10,4* ↑		
3: 9,8 ↘	8:10,4* ↑	Total	0,0		Total	0,0
4:10,2* ↖	9:10,6* ↓			10:10,1 ↙		
5:10,6* ↑						

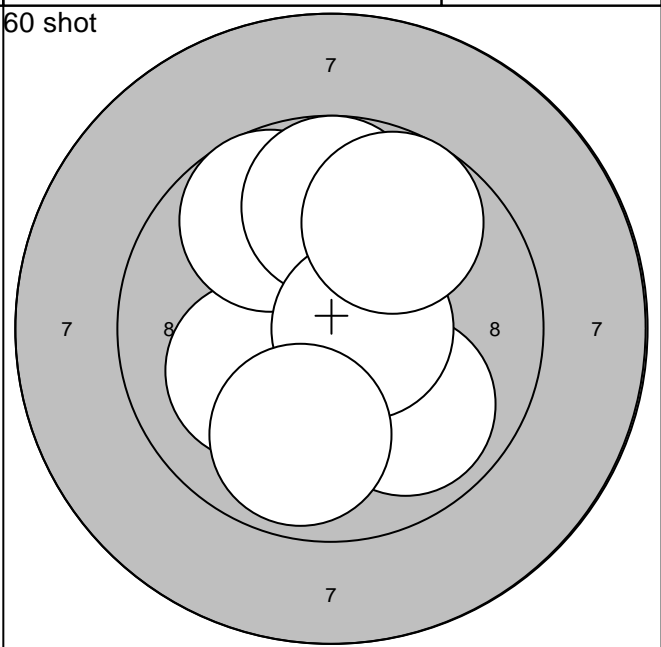
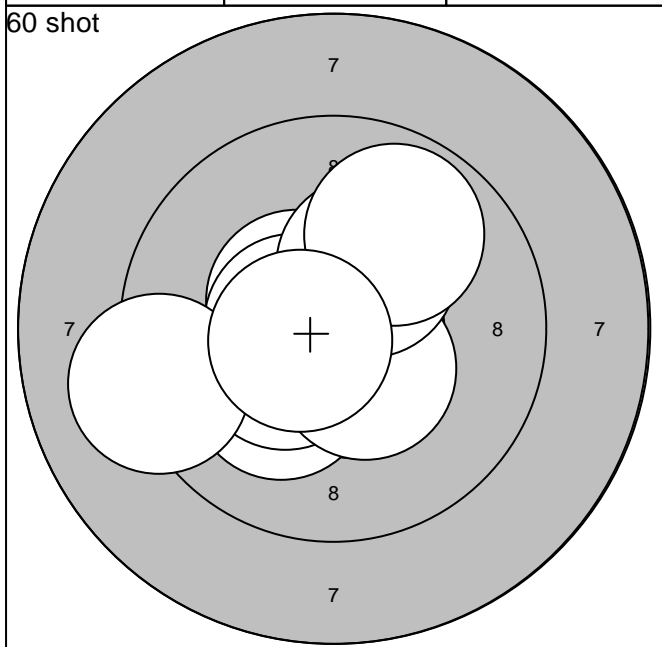

1:10,6* ↓	6:10,6* ←	Serie	98,0	11:10,7* ↖	16: 9,8 ↗	Serie	95,0
2:10,5* ↖	7:10,3* ↗			12:10,4* ↓	17: 9,8 ↑		
3:10,2* ↙	8: 9,9 ↗	Total	98,0	13:10,1 ←	18:10,6* →	Total	193,0
4:10,4* ←	9: 9,2 ←			14: 9,9 ↘	19: 9,9 ↓		
5:10,5* ↓	10:10,6* ←			15:10,2* ↑	20: 9,7 ↗		

Umeå skytteallians

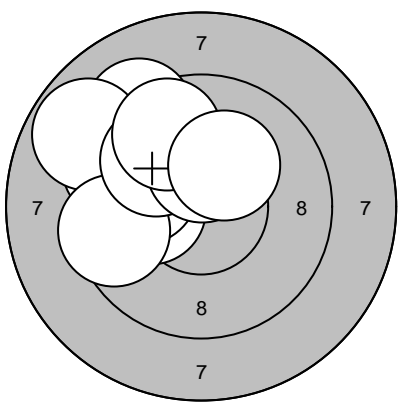
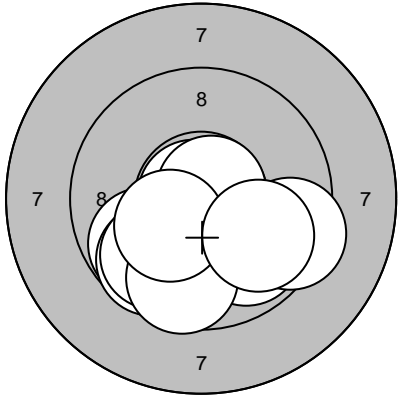
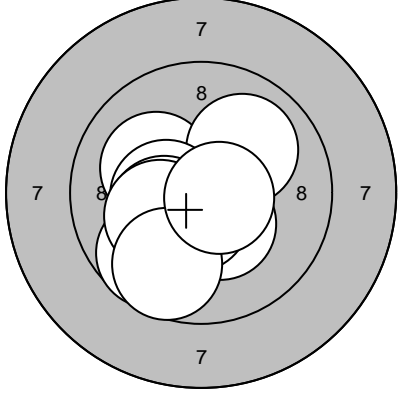
Lag	Skive	Ebba Åberg	
2	28		
2005-12-20		Föreningsmästerskap	Umeå skytteallians
Sight		1: 10,1 ← 2: 9,5 ↖ 3: 9,2 ↗ 4: 10,0 ↖ 5: 8,8 ↗ 6: 9,5 ← 7: 9,9 ↗ 8: 10,3* ↑ 9: 9,7 ↗ 10: 10,2* ↗	Sight
		Serie 93,0	11: 10,0 ↑
		Total 0,0	12: 9,7 ↖
			13: 10,2* ↘
			14: 9,1 ↘
			15: 10,4* ←
			16: 10,3* ↘
			17: 10,3* ↘
			18: 9,9 ↘
			19: 10,1 ↘
			20: 10,6* ←
			Serie 97,0
			Total 0,0
Sight		21: 9,8 ↖ 22: 9,7 ↘ 23: 9,9 ↘ 24: 10,8* ↗ 25: 9,8 ↘ 26: 10,8* ↗ 27: 9,7 ↘ 28: 9,4 ↗ 29: 10,3* ↖ 30: 9,9 ↘	Sight
		Serie 93,0	31: 10,5* →
		Total 0,0	32: 9,6 ←
			33: 9,5 ↘
			34: 9,5 ↘
			35: 10,4* ←
			Serie 47,0
			Total 0,0
60 shot		1: 10,4* ↘ 2: 10,2* ↖ 3: 10,0 ↗ 4: 10,4* ← 5: 9,7 ↘ 6: 10,3* ← 7: 10,6* ↘ 8: 10,2* ← 9: 9,7 ↘ 10: 10,7* →	60 shot
		Serie 98,0	11: 9,9 ↘
		Total 98,0	12: 10,0 →
			13: 10,4* ↑
			14: 10,0 ←
			15: 9,8 ↖
			16: 10,4* ←
			17: 10,3* ↘
			18: 10,0 ←
			19: 10,0 ←
			20: 10,6* ↘
			Serie 98,0
			Total 196,0
Umeå skytteallians			

Lag	Skive	
<b>2</b>	<b>29</b>	<b>Kevin Yu</b>

2005-12-20	Föreningsmästerskap	Umeå skytteallians
------------	---------------------	--------------------

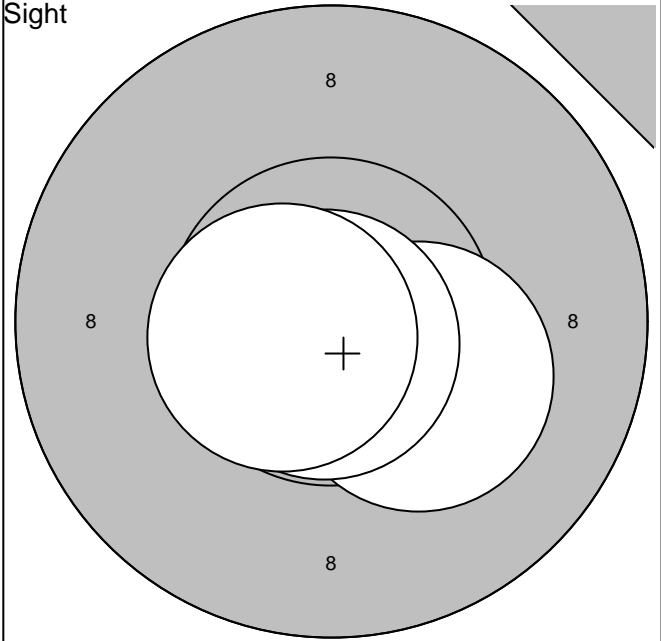
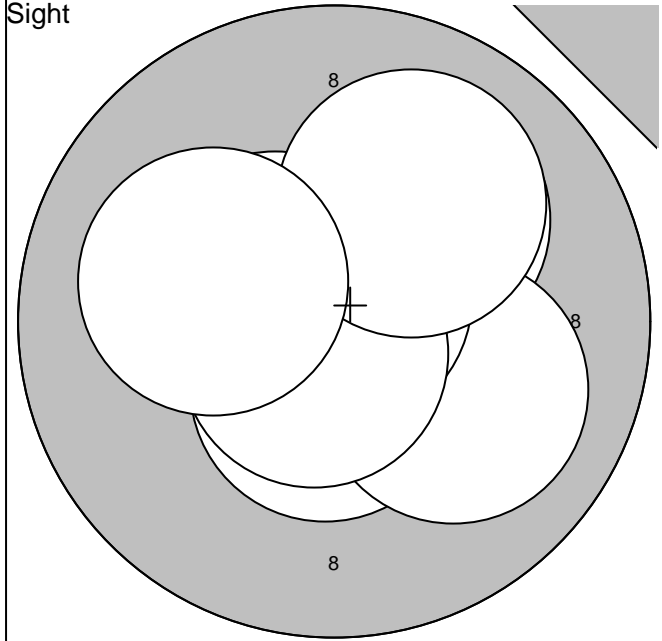

1:10,1 ↗	6:10,8* ↑	Serie	100,0	11:10,3* ➤	Serie	30,0
2:10,6* ↗	7:10,5* ↖			12:10,8* ↓		
3:10,7* ➔	8:10,7* ↘	Total	0,0	13:10,6* ↙	Total	0,0
4:10,5* ↓	9:10,0 ↗			10:10,1 ↖		
5:10,0 ➤						

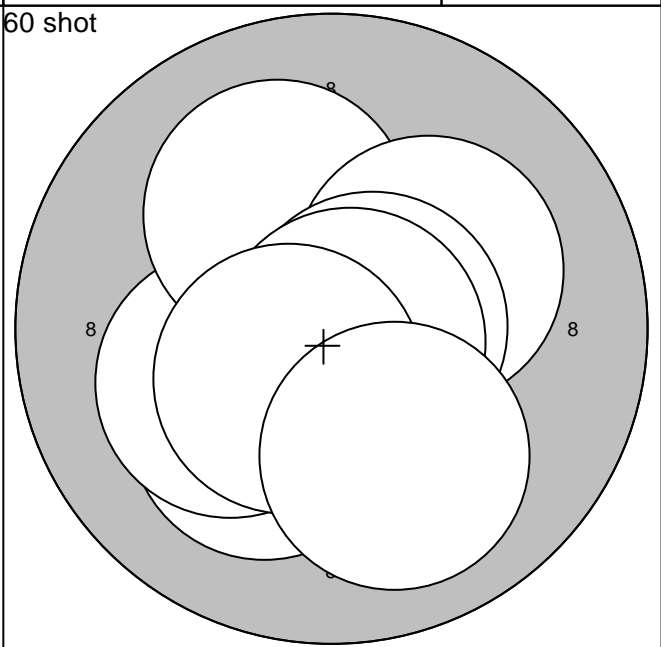
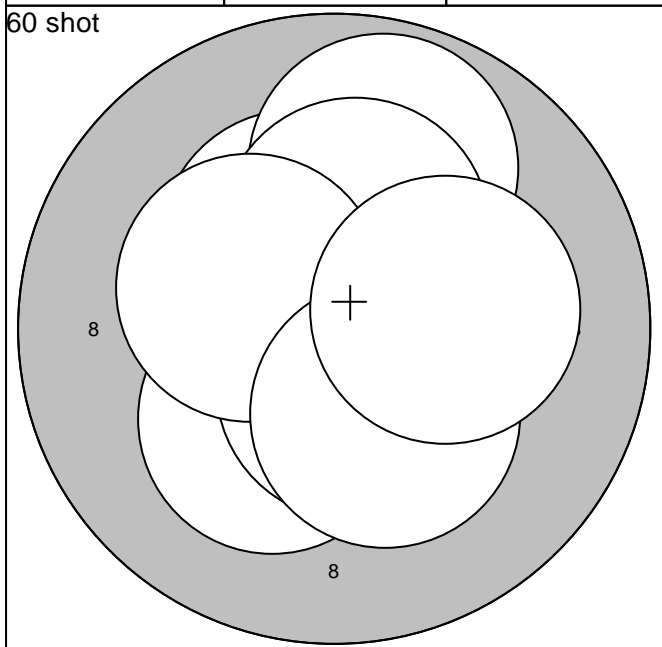

1:10,2* ↘	6:10,7* ↗	Serie	99,0	11:10,5* ↖	16:10,7* ➔	Serie	100,0
2:10,3* ↗	7:10,3* ↑			12:10,2* ↓	17:10,6* ↓		
3:10,6* ↓	8:10,3* ↖	Total	99,0	13:10,2* ↙	18:10,8* ➤	Total	199,0
4:10,3* ↗	9:10,3* ↓			14:10,1 ↗	19:10,5* ↘		
5:9,8 ↑	10:10,2* ➔			15:10,2* ↗	20:10,0 ↓		

Umeå skytteallians



Lag	Skive	Tobias Gissberg Knutsson
2	30	

2005-12-20	Föreningsmästerskap	Umeå skytteallians
------------	---------------------	--------------------

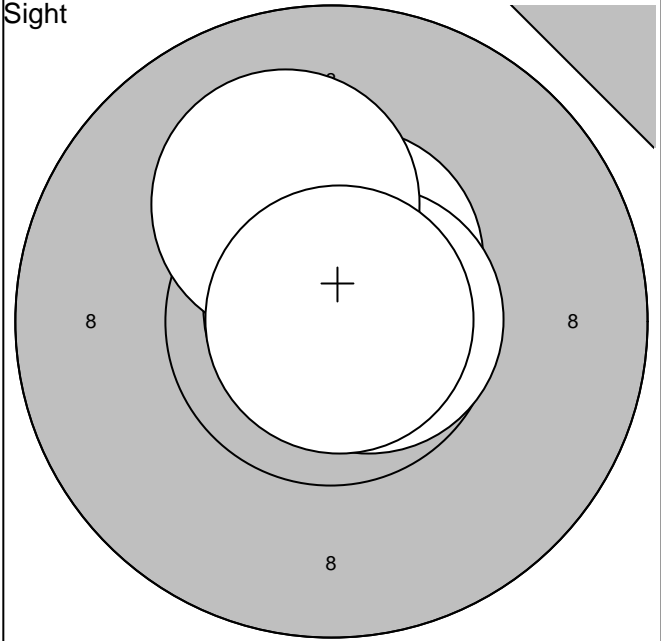
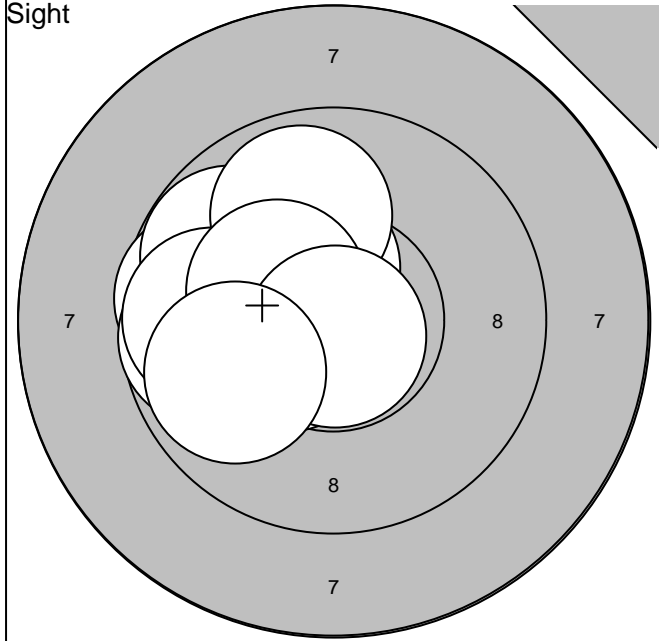

1: 9,7 ←	6:10,4* ↗	Serie	94,0	11:10,9* ↗	Serie	50,0
2: 9,7 ←	7: 9,9 ↗		Total	0,0		12:10,5* ↗
3: 9,8 ↖	8:10,3* ↖	13:10,7* →				
4:10,5* ↙	9:10,8* ↓	14:10,1 ↗				
5: 9,8 ←	10: 9,9 ←			15:10,9* →		

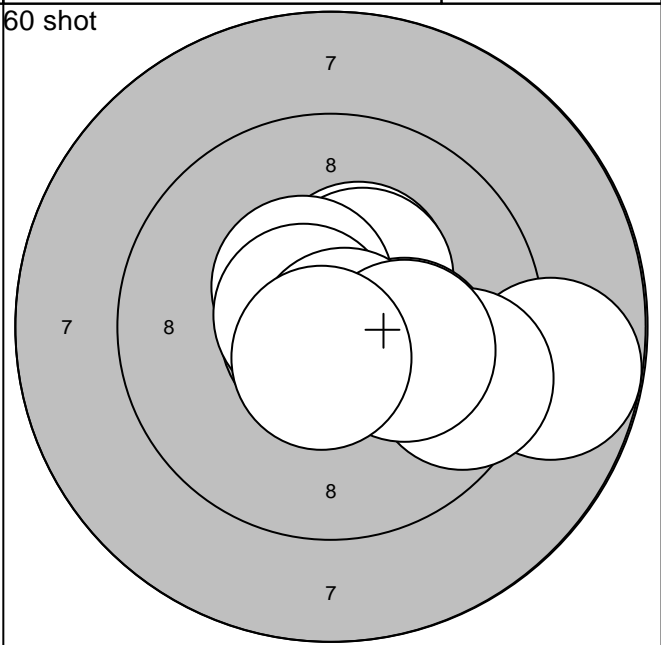
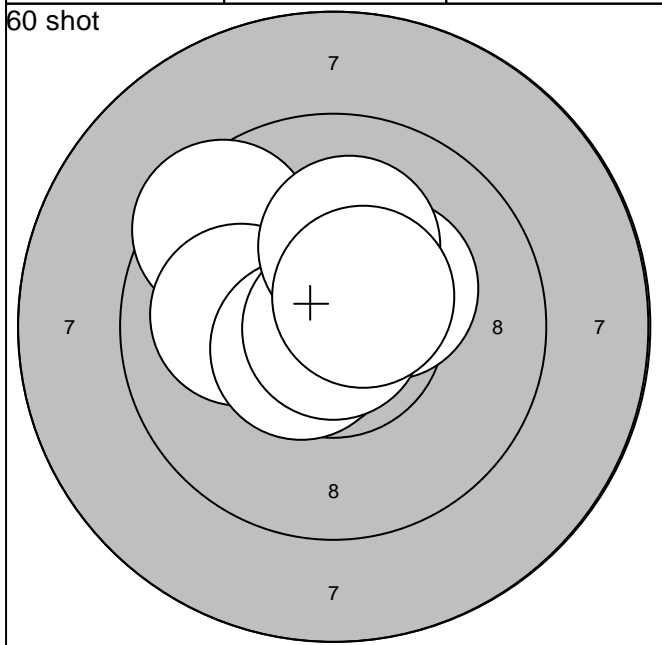

1:10,7* ↙	6:10,3* ↗	Serie	99,0	11:10,4* ↗	16:10,7* ↖	Serie	97,0
2:10,6* ←	7:10,6* ↖		Total	99,0	12:10,4* ↗		17:10,8* ↘
3:10,4* ↗	8:10,9* ↘	13:10,2* →		18: 9,6 →			
4: 9,5 ↖	9:10,2* ↗	14:10,5* ↗		19:10,2* ↘			
5:10,0 ←	10:10,5* ↗			15: 8,8 →	20:10,6* ↓		

Umeå skytteallians