

1:	10.7x	→
2:	10.6x	↓
3:	10.3x	↓
4:	10.6x	→
5:	10.5x	→
6:	10.6x	↓
7:	10.5x	↗
8:	10.5x	↑
9:	10.5x	↗
10:	10.8x	↙

Serie	105.6
-------	-------

Total	400.0
-------	-------

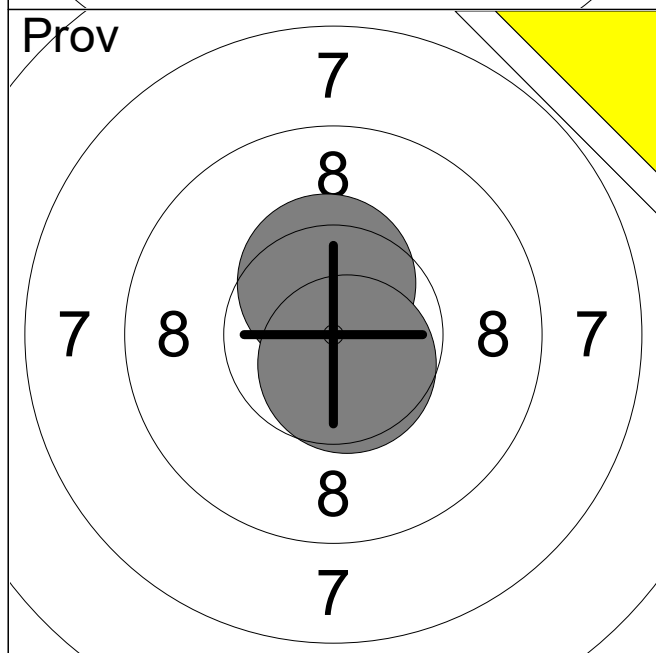

11:	10.4x	↑
12:	10.6x	↓

Serie	21.0
-------	------

Total	400.0
-------	-------

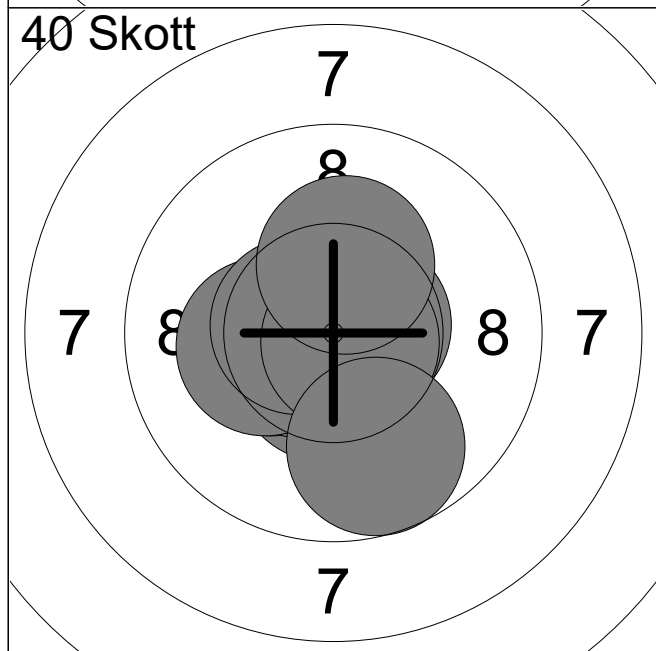

1:	10.9x	↙
2:	10.5x	↓
3:	10.3x	←
4:	10.6x	←
5:	10.7x	→
6:	10.3x	←
7:	10.6x	←
8:	10.8x	↘
9:	9.7	↓
10:	10.3x	↑

Serie	104.7
-------	-------

Total	504.7
-------	-------

Skjutlag

3

Tavla

2

Melker Häggström

Umeå

Ramselefors Skf

25.01.2025

Förbundsmästerskap 2025 Final

Umeå skytteallians

Prov

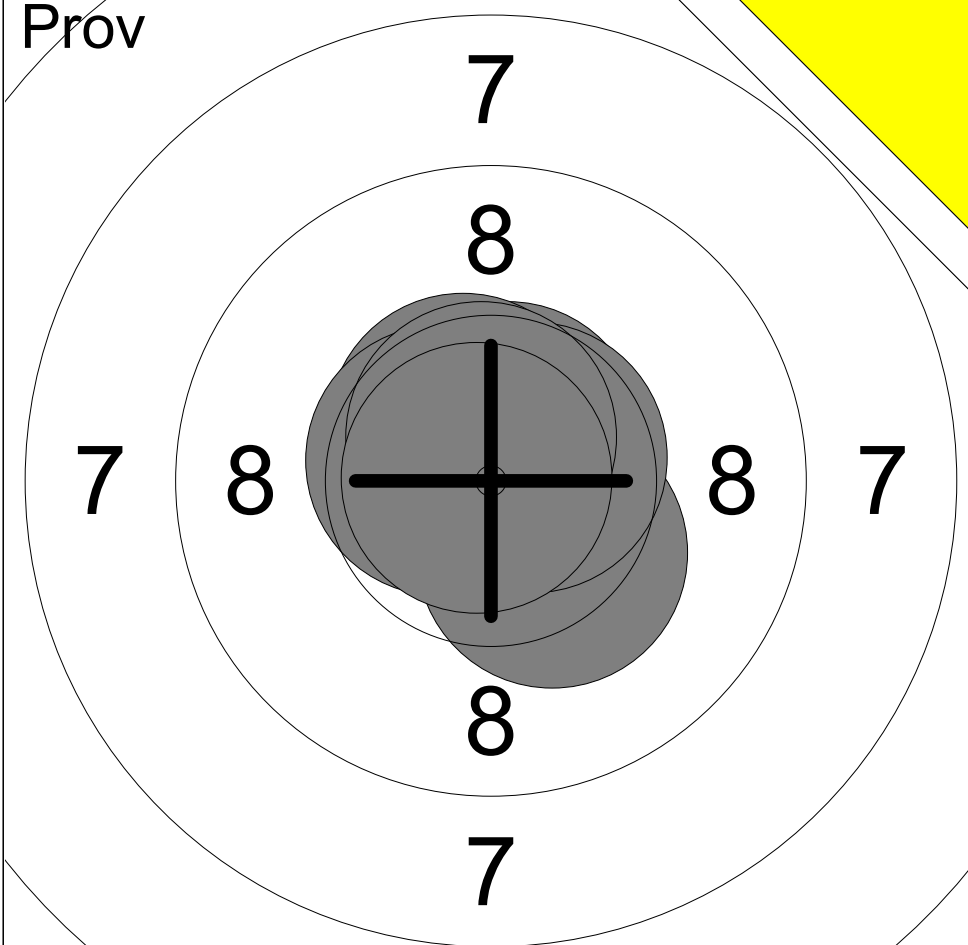

1:	10.6x	↗
2:	10.6x	↗
3:	10.8x	↗
4:	10.3x	↘
5:	10.6x	↗
6:	10.6x	↖
7:	10.7x	↗
8:	10.9x	↖

Serie 85.1

Total 400.0

40 Skott

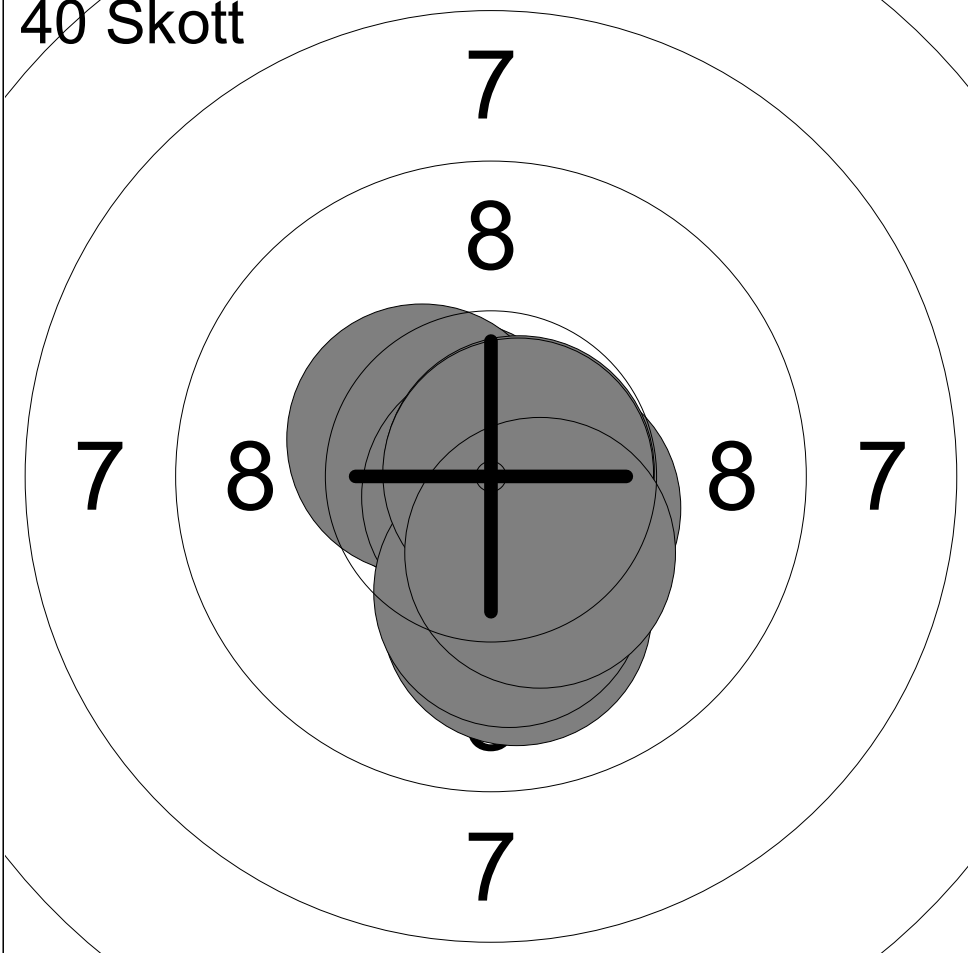

1:	10.7x	↖
2:	10.4x	↖
3:	10.0	↘
4:	10.5x	↘
5:	10.5x	↘
6:	10.8x	↘
7:	10.8x	↗
8:	10.2x	↘
9:	10.8x	↗
10:	10.3x	↘

Serie 105.0

Total 505.0

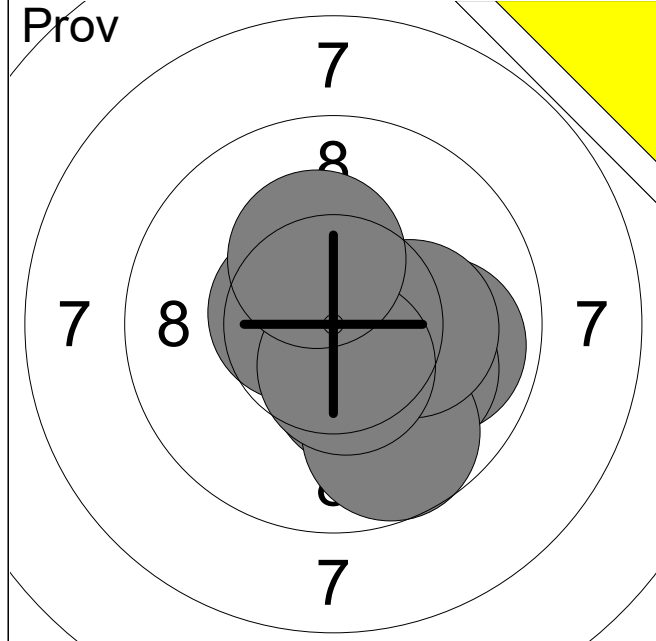

1:	10.3x	↘
2:	10.5x	↘
3:	9.9	→
4:	10.1	↘
5:	9.7	↘
6:	10.6x	→
7:	10.2x	→
8:	10.6x	←
9:	10.5x	↘
10:	10.3x	↑
<b>Serie</b>		<b>102.7</b>
<b>Total</b>		<b>400.0</b>

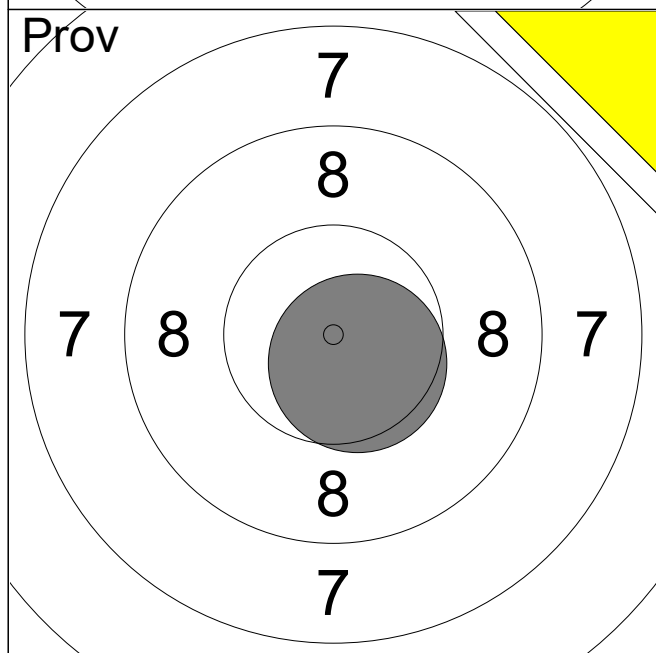

11:	10.6x	↘
<b>Serie</b>		<b>10.6</b>
<b>Total</b>		<b>400.0</b>

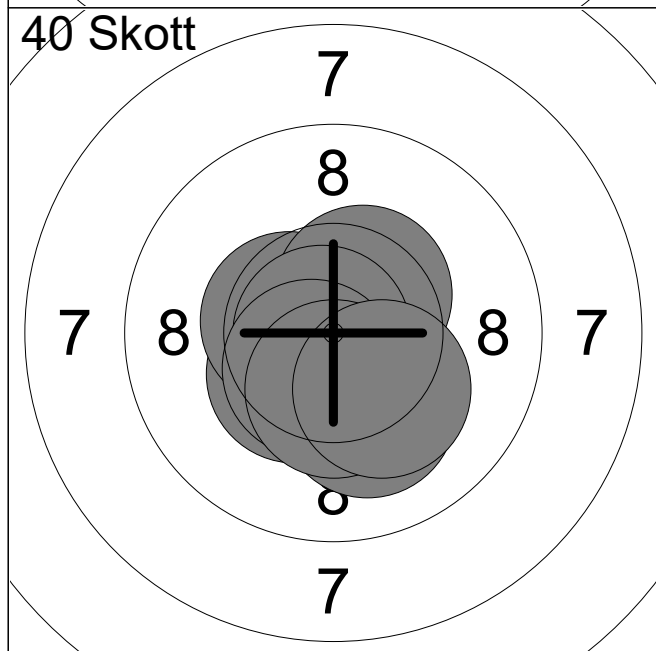

1:	10.8x	↗
2:	10.4x	↘
3:	10.6x	↘
4:	10.5x	←
5:	10.1	↘
6:	10.5x	↗
7:	10.8x	←
8:	10.5x	↘
9:	10.4x	↘
10:	10.2x	↘
<b>Serie</b>		<b>104.8</b>
<b>Total</b>		<b>504.8</b>

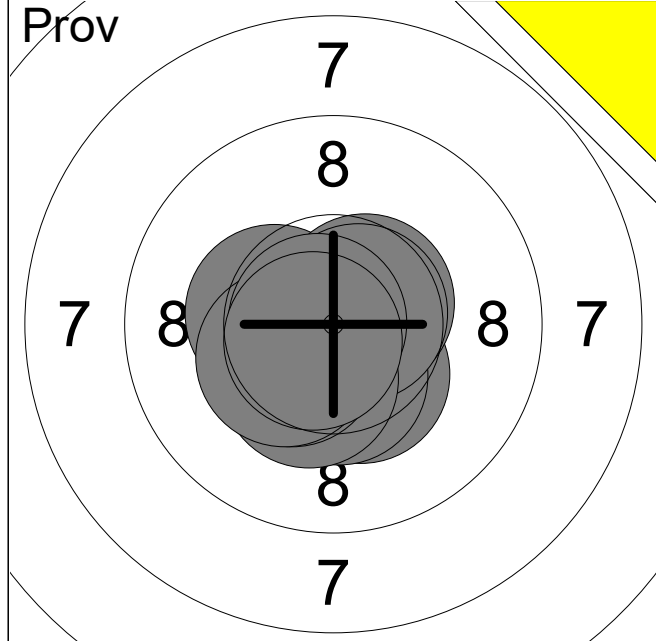

1:	10.4x	↘
2:	10.3x	←
3:	10.4x	↓
4:	10.6x	↗
5:	10.7x	↗
6:	10.4x	↓
7:	10.4x	↙
8:	10.4x	↙
9:	10.8x	←
10:	10.7x	↙
<b>Serie</b>		<b>105.1</b>
<b>Total</b>		<b>400.0</b>

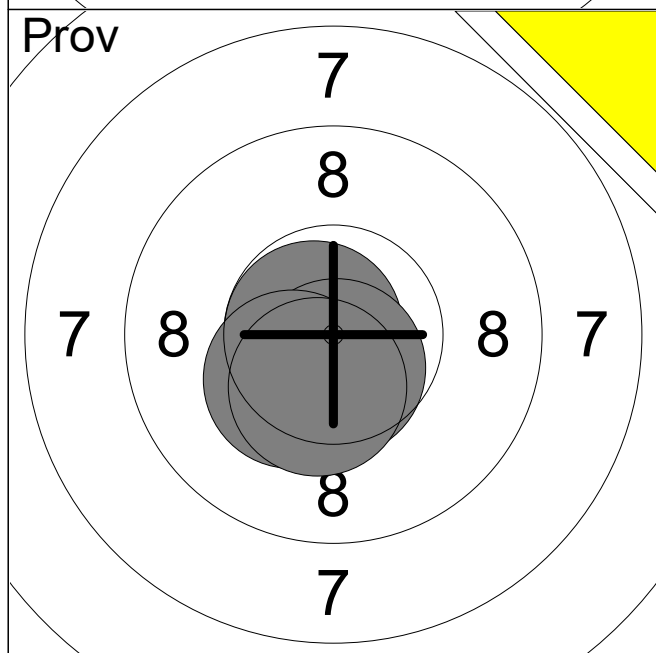

11:	10.8x	↘
12:	10.7x	←
13:	10.6x	↓
14:	10.3x	↙
15:	10.4x	↓
<b>Serie</b>		<b>52.8</b>
<b>Total</b>		<b>400.0</b>

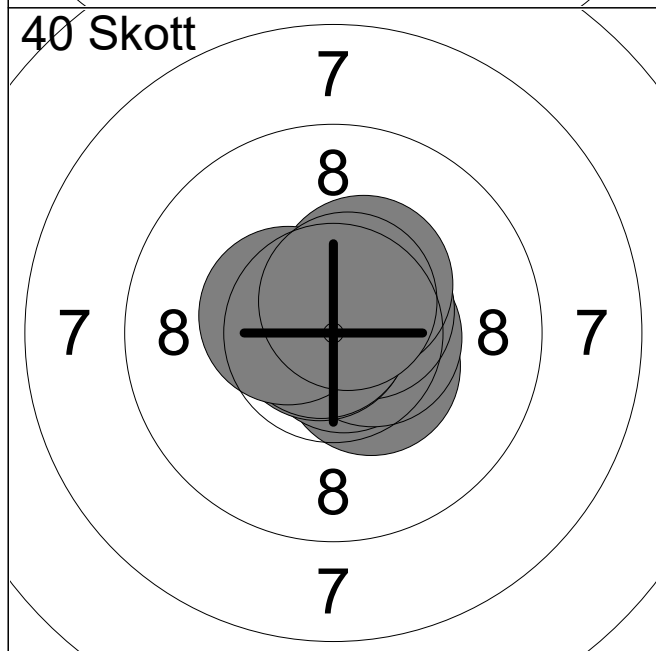

1:	10.9x	↑
2:	10.4x	↘
3:	10.8x	↘
4:	10.6x	→
5:	10.6x	↗
6:	10.4x	↗
7:	10.8x	←
8:	10.8x	←
9:	10.5x	↙
10:	10.6x	↑
<b>Serie</b>		<b>106.4</b>
<b>Total</b>		<b>506.4</b>

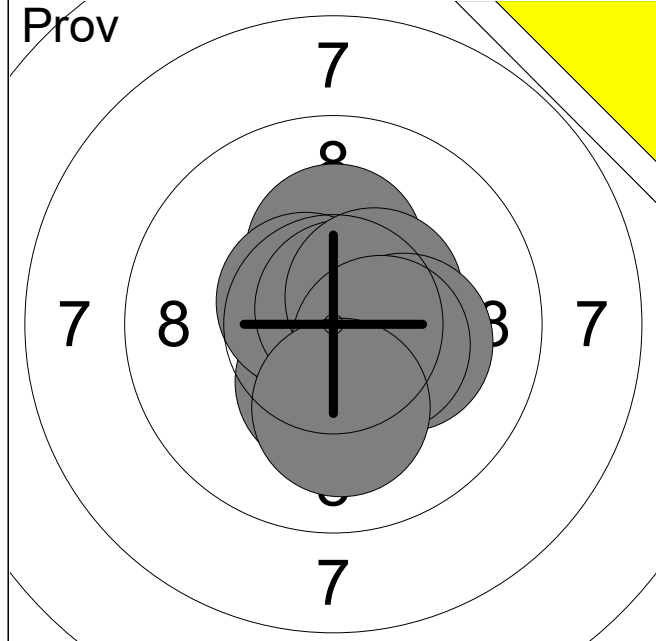

1:	10.5x	→
2:	10.2x	↑
3:	10.4x	↓
4:	10.8x	↗
5:	10.6x	↗
6:	10.8x	↗
7:	10.5x	↗
8:	10.2x	→
9:	10.4x	→
10:	10.1	↓

Serie	104.5
-------	-------

Total	399.0
-------	-------

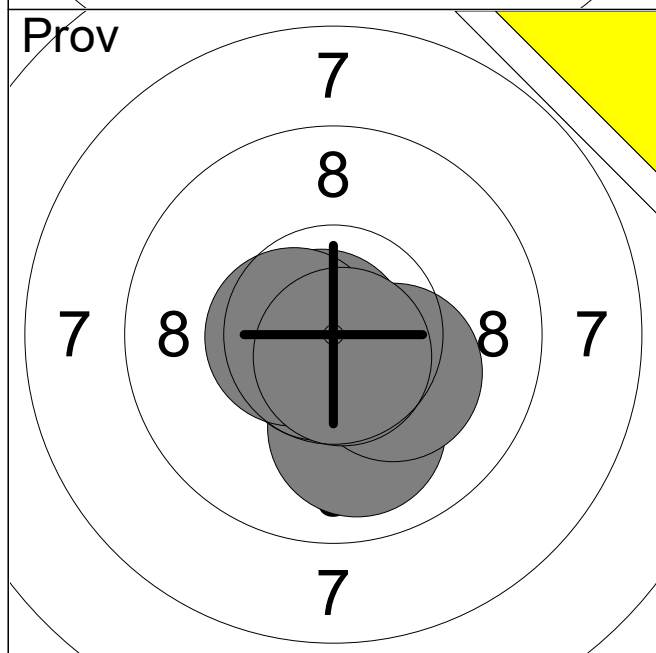

11:	10.0	↓
12:	10.7x	↓
13:	10.8x	←
14:	10.2x	↘
15:	10.6x	←
16:	10.7x	↓

Serie	63.0
-------	------

Total	399.0
-------	-------

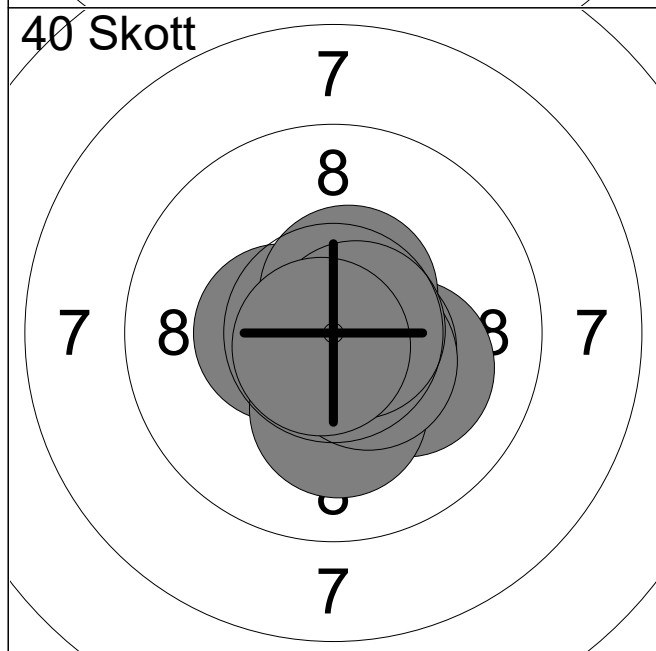

1:	10.3x	↘
2:	10.1	↘
3:	10.4x	←
4:	10.6x	↘
5:	10.5x	↗
6:	10.2x	↓
7:	10.6x	↘
8:	10.5x	↘
9:	10.7x	→
10:	10.8x	↘

Serie	104.7
-------	-------

Total	503.7
-------	-------

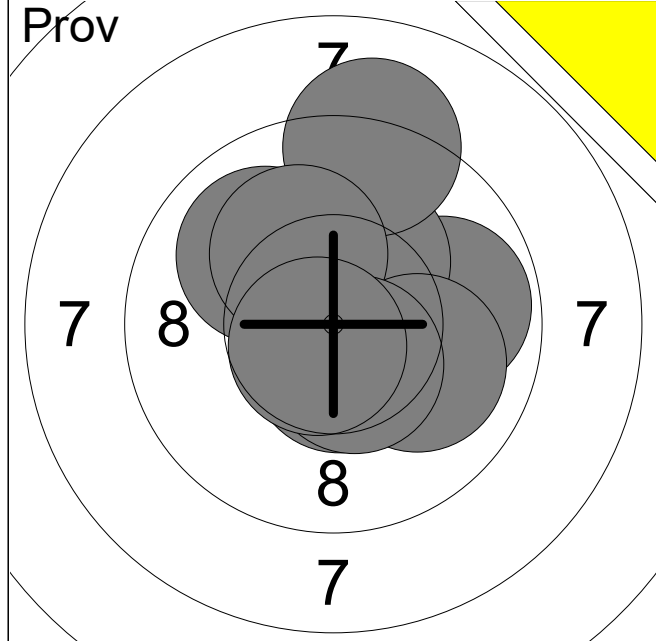

1:	9.8	→
2:	10.4x	↑
3:	10.0	↗
4:	10.3x	↗
5:	9.1	↑
6:	10.6x	↓
7:	10.0	→
8:	10.2x	↗
9:	10.5x	↓
10:	10.7x	↘
<b>Serie</b>		<b>101.6</b>
<b>Total</b>		<b>396.0</b>

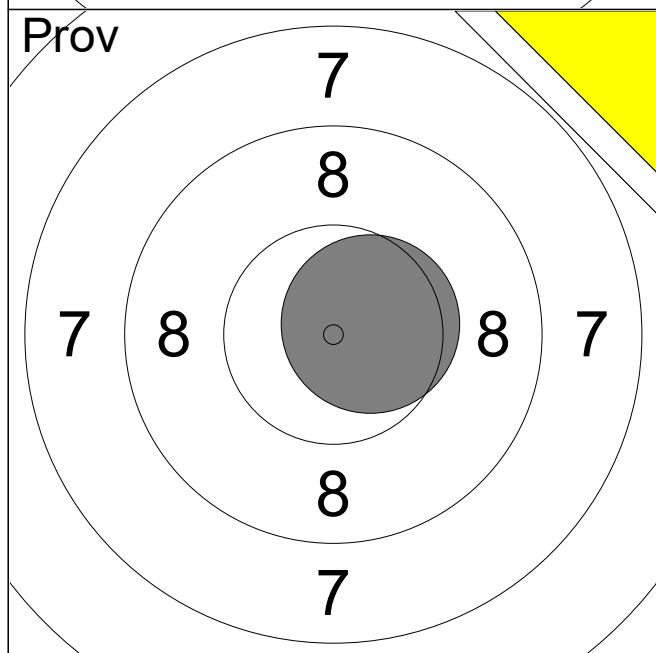

11:	10.6x	→
<b>Serie</b>		<b>10.6</b>
<b>Total</b>		<b>396.0</b>

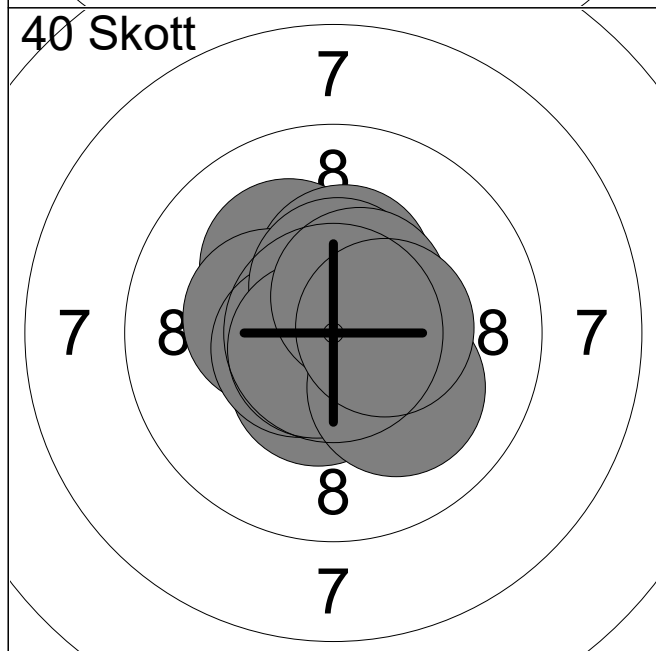

1:	10.2x	↖
2:	10.3x	↑
3:	10.5x	↓
4:	10.3x	←
5:	10.6x	←
6:	10.5x	↑
7:	10.7x	↘
8:	10.5x	↗
9:	10.1	↘
10:	10.4x	→
<b>Serie</b>		<b>104.1</b>
<b>Total</b>		<b>500.1</b>

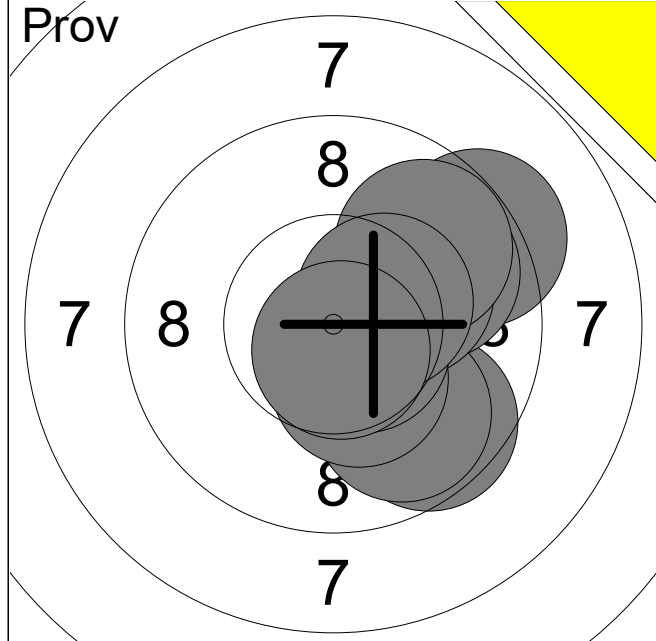

1:	9.3	↗
2:	9.6	↘
3:	9.8	↘
4:	9.8	↗
5:	10.4x	↘
6:	10.1	↗
7:	9.8	↗
8:	10.6x	↘
9:	10.4x	↗
10:	10.7x	↘
<b>Serie</b>		<b>100.5</b>
<b>Total</b>		<b>394.0</b>

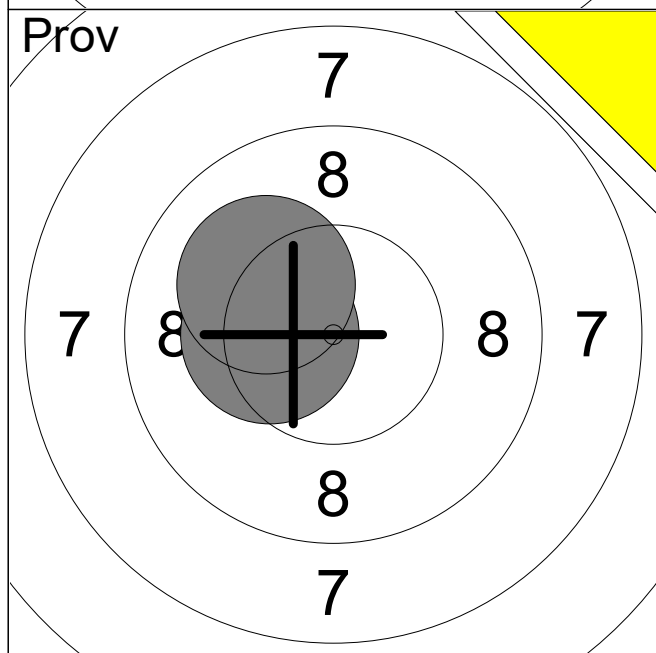

11:	10.3x	←
12:	10.1	↗
<b>Serie</b>		<b>20.4</b>
<b>Total</b>		<b>394.0</b>

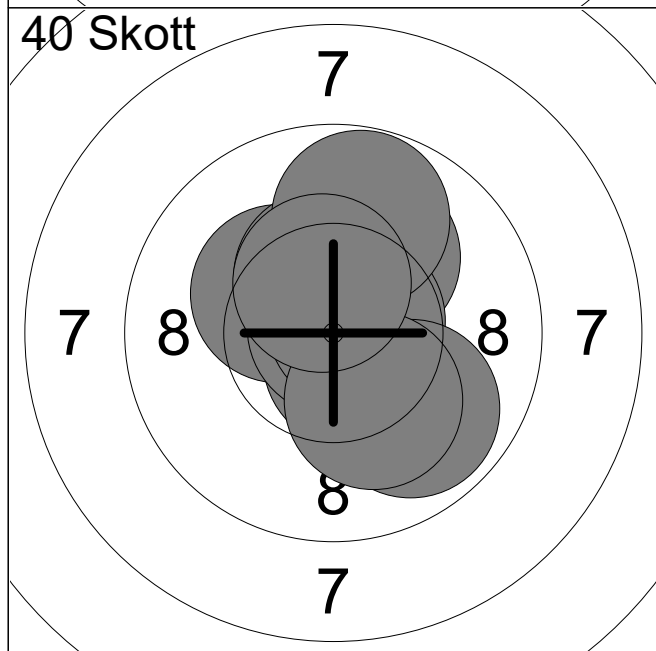

1:	10.3x	↖
2:	10.1	↗
3:	10.4x	↑
4:	10.6x	↘
5:	10.9x	↗
6:	10.7x	↗
7:	9.8	↑
8:	9.9	↘
9:	10.2x	↘
10:	10.4x	↑
<b>Serie</b>		<b>103.3</b>
<b>Total</b>		<b>497.3</b>

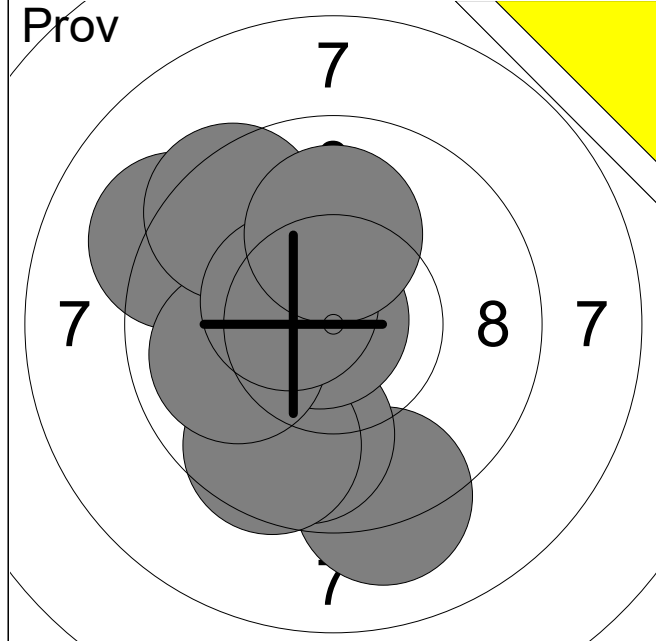

1:	10.1	←
2:	9.2	↓
3:	9.8	↓
4:	9.6	↓
5:	9.2	↖
6:	10.8x	←
7:	9.9	←
8:	9.4	↗
9:	10.5x	↖
10:	10.0	↑

Serie 98.5

Total 394.0

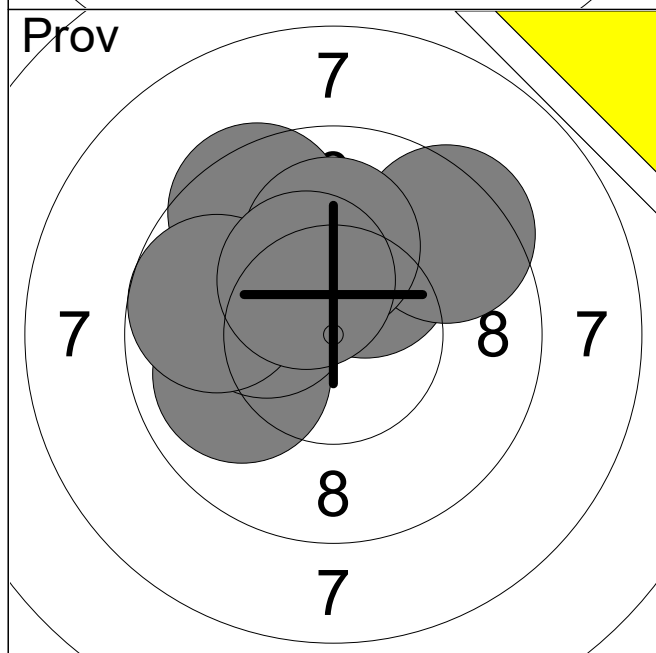

11:	10.0	↖
12:	10.0	←
13:	10.2x	↗
14:	9.5	↖
15:	9.4	↗
16:	10.1	↑
17:	10.2x	←
18:	9.7	←
19:	10.3x	↗

Serie 89.4

Total 394.0

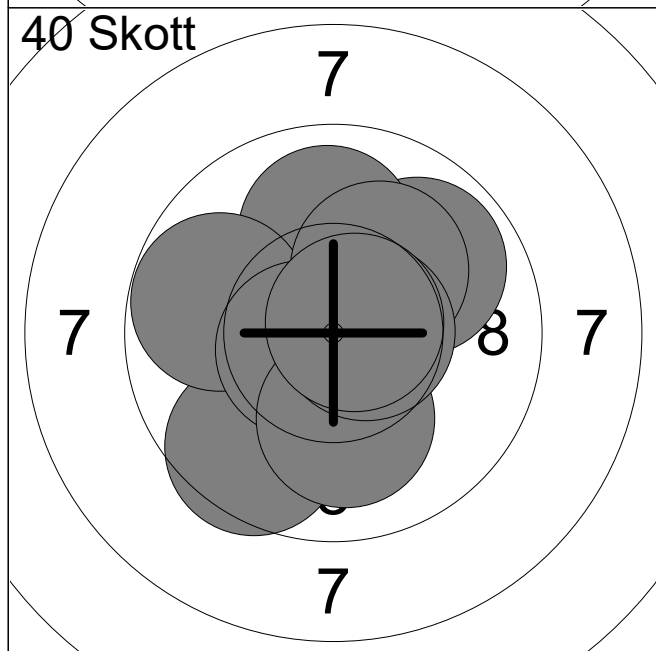

1:	10.4x	↖
2:	9.9	↗
3:	10.0	↑
4:	9.6	↓
5:	9.8	←
6:	10.6x	←
7:	10.1	↓
8:	10.2x	↗
9:	10.6x	→
10:	10.7x	↗

Serie 101.9

Total 495.9



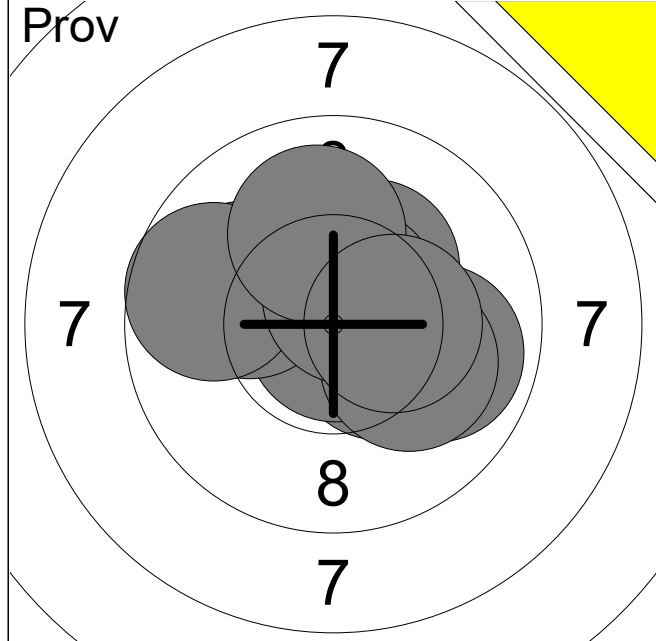

1:	10.4x	↘
2:	10.9x	↓
3:	9.9	→
4:	10.1	↘
5:	10.0	↖
6:	9.7	←
7:	10.3x	↗
8:	10.6x	↗
9:	10.0	↑
10:	10.3x	→

Serie	102.2
-------	-------

Total	392.0
-------	-------

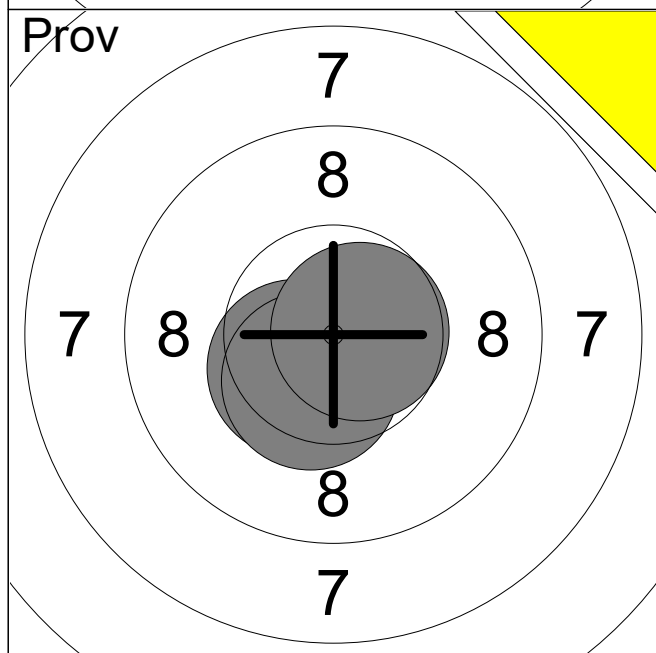

11:	10.4x	↙
12:	10.4x	↓
13:	10.7x	→

Serie	31.5
-------	------

Total	392.0
-------	-------

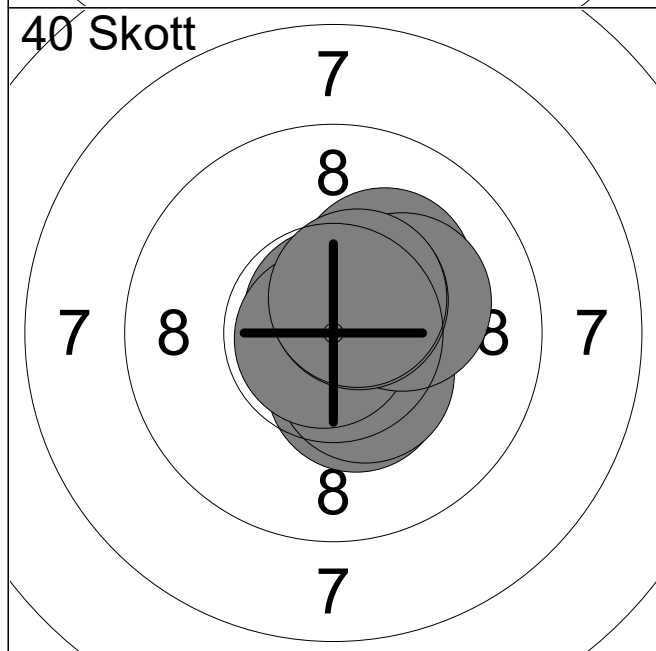

1:	10.8x	↓
2:	10.5x	→
3:	10.8x	↑
4:	10.4x	↓
5:	10.4x	↓
6:	10.2x	↗
7:	10.8x	↙
8:	10.2x	→
9:	10.5x	↗
10:	10.5x	↗

Serie	105.1
-------	-------

Total	497.1
-------	-------

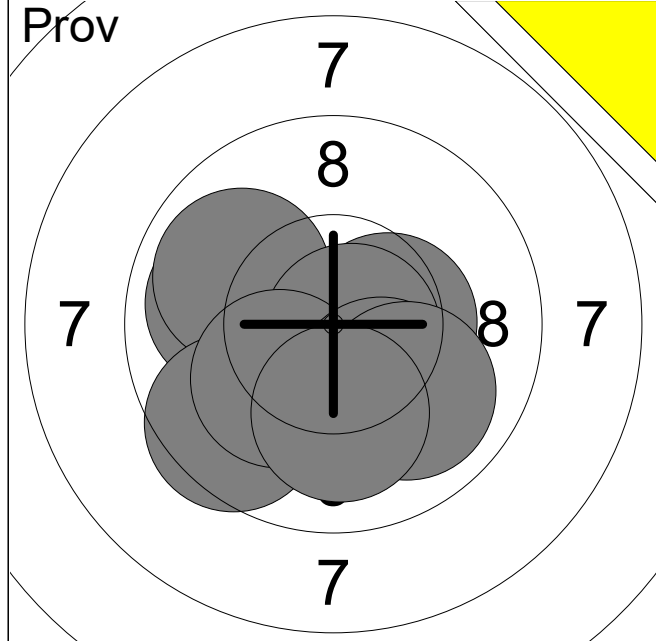

1:	10.1	↙
2:	9.9	←
3:	9.9	↗
4:	9.5	↘
5:	10.4x	→
6:	10.8x	↘
7:	10.2x	↙
8:	10.2x	↘
9:	10.0	↘
10:	10.1	↓
<b>Serie</b>		<b>101.1</b>
<b>Total</b>		<b>391.0</b>

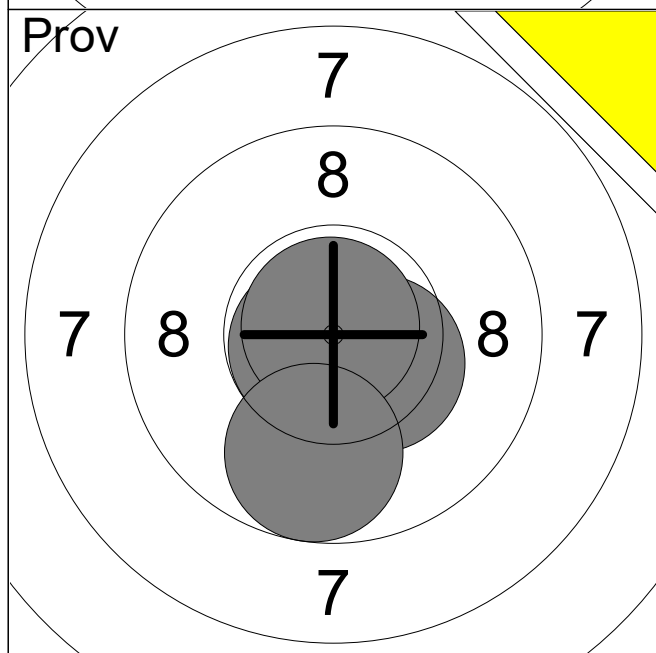

11:	10.7x	↙
12:	10.4x	↘
13:	10.9x	↗
14:	9.7	↓
<b>Serie</b>		<b>41.7</b>
<b>Total</b>		<b>391.0</b>

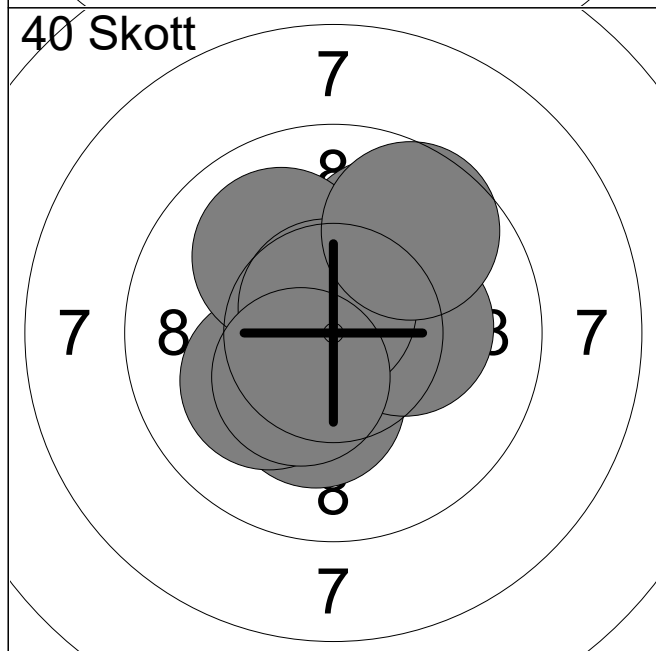

1:	9.9	↗
2:	10.5x	→
3:	10.7x	↗
4:	10.3x	↘
5:	10.1	↙
6:	10.0	↗
7:	10.2x	→
8:	10.7x	↗
9:	10.4x	↘
10:	9.7	↗
<b>Serie</b>		<b>102.5</b>
<b>Total</b>		<b>493.5</b>

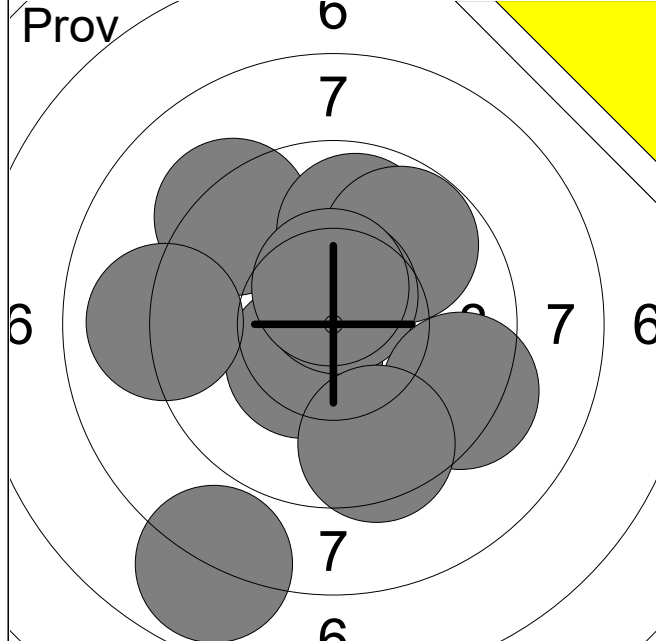

1:	9.3	↖
2:	10.4x	↙
3:	9.0	←
4:	9.9	↑
5:	9.8	↗
6:	10.6x	↑
7:	7.9	↘
8:	9.3	↘
9:	9.5	↘
10:	10.5x	↑
<b>Serie</b>		<b>96.2</b>
<b>Total</b>		<b>385.0</b>

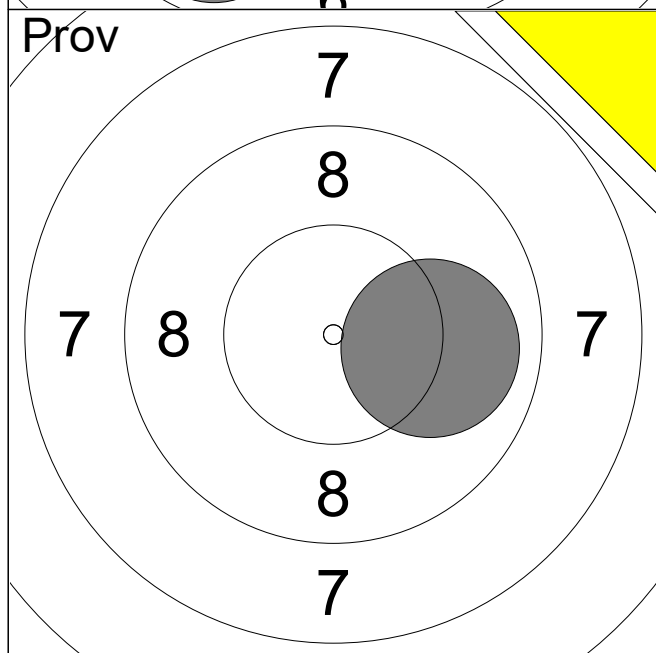

11:	10.0	→
<b>Serie</b>		<b>10.0</b>
<b>Total</b>		<b>385.0</b>

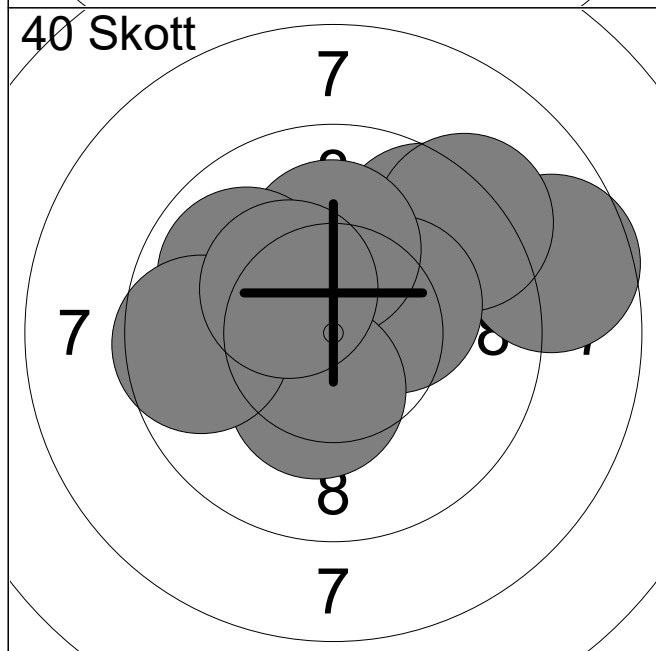

1:	10.5x	↑
2:	8.6	→
3:	9.6	↗
4:	9.2	↗
5:	10.3x	→
6:	10.1	↑
7:	9.9	↖
8:	10.4x	↘
9:	9.6	←
10:	10.3x	↖
<b>Serie</b>		<b>98.5</b>
<b>Total</b>		<b>483.5</b>

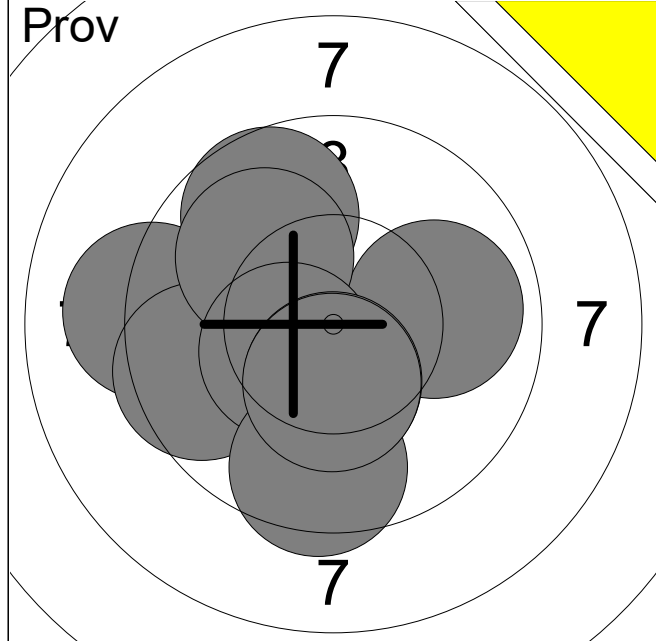

1:	9.7	←
2:	9.1	←
3:	9.5	←
4:	9.7	↗
5:	9.9	→
6:	10.0	↗
7:	10.4x	←
8:	9.5	↓
9:	10.4x	↓
10:	10.4x	↓
<b>Serie</b>		<b>98.6</b>
<b>Total</b>		<b>368.0</b>

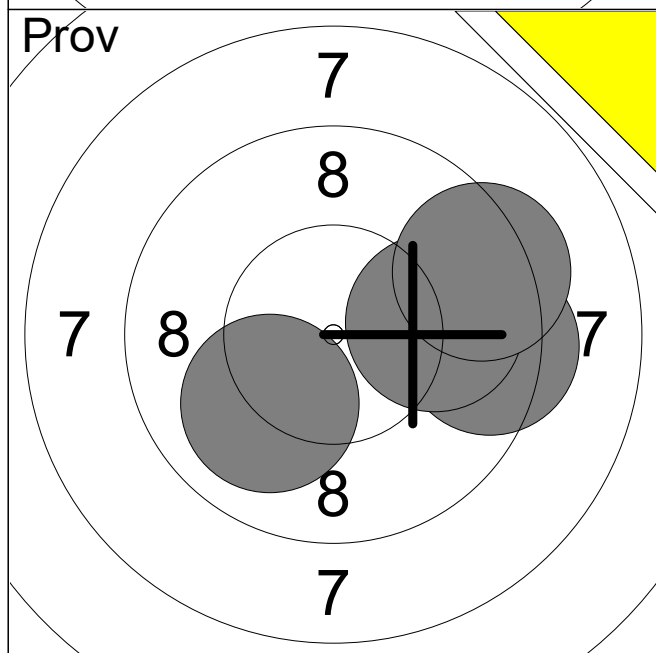

11:	10.0	↙
12:	9.4	→
13:	9.9	→
14:	9.3	→
<b>Serie</b>		<b>38.6</b>
<b>Total</b>		<b>368.0</b>

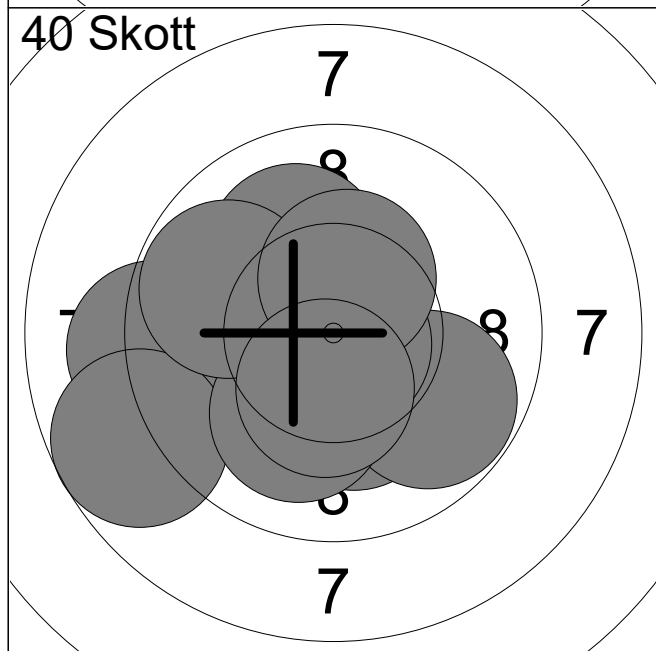

1:	9.2	←
2:	10.1	↗
3:	10.2x	↓
4:	9.8	↘
5:	8.7	←
6:	10.8x	↘
7:	10.1	↓
8:	9.8	↖
9:	10.4x	↗
10:	10.4x	↓
<b>Serie</b>		<b>99.5</b>
<b>Total</b>		<b>467.5</b>

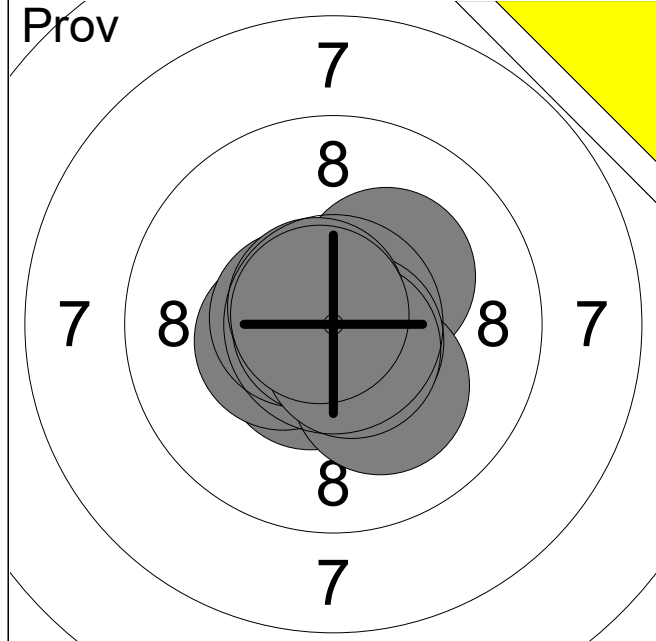

1:	10.5x	↘
2:	10.4x	←
3:	10.2x	↗
4:	10.6x	←
5:	10.2x	↘
6:	10.7x	↘
7:	10.8x	←
8:	10.6x	↘
9:	10.7x	↗
10:	10.8x	↗
<b>Serie</b>		<b>105.5</b>
<b>Total</b>		<b>400.0</b>

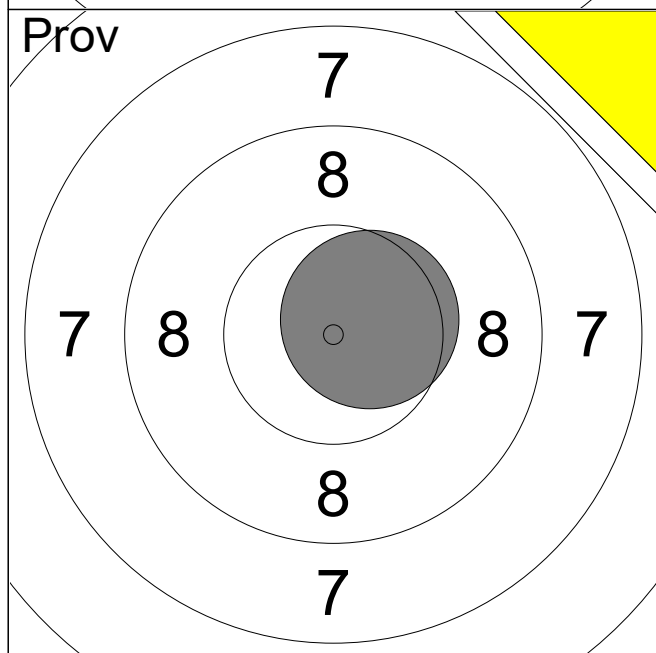

11:	10.6x	→
<b>Serie</b>		<b>10.6</b>
<b>Total</b>		<b>400.0</b>

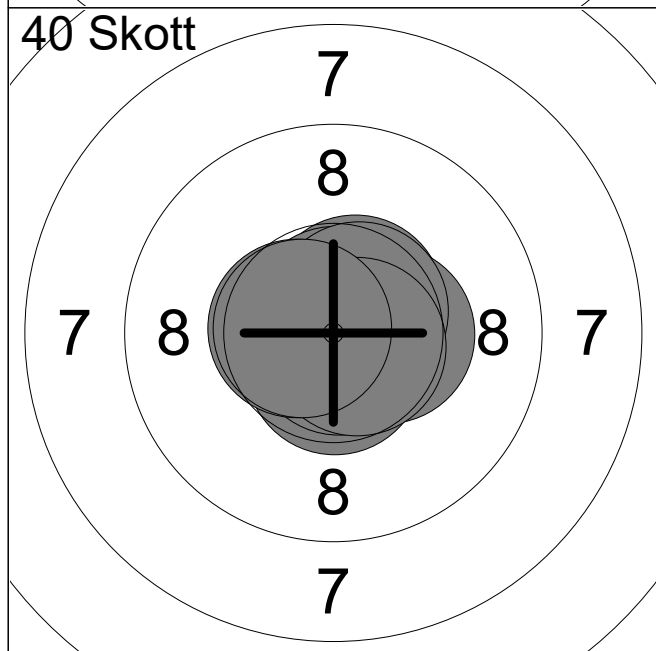

1:	10.6x	↗
2:	10.7x	→
3:	10.4x	→
4:	10.8x	↑
5:	10.6x	↗
6:	10.6x	↓
7:	10.8x	↓
8:	10.6x	←
9:	10.7x	↘
10:	10.6x	←
<b>Serie</b>		<b>106.4</b>
<b>Total</b>		<b>506.4</b>

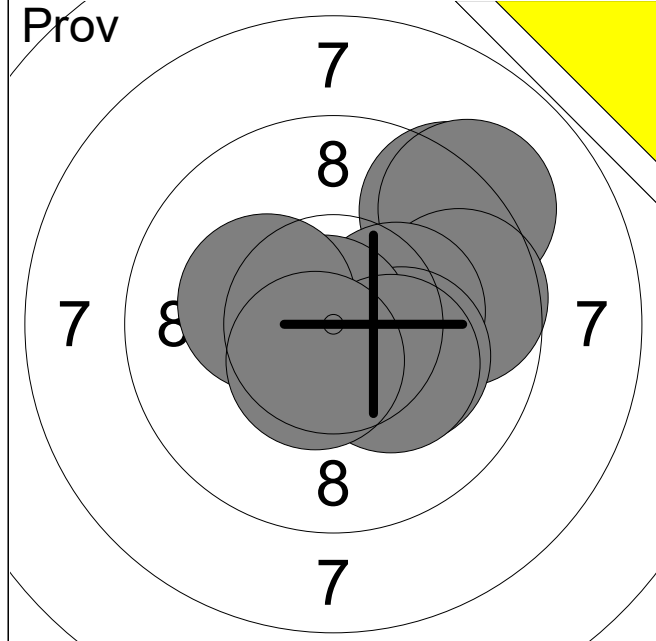

1:	9.3	↗
2:	9.2	↗
3:	9.7	→
4:	10.3x	→
5:	10.6x	↙
6:	10.2x	→
7:	10.8x	←
8:	10.2x	←
9:	10.3x	↘
10:	10.5x	↘
<b>Serie</b>		<b>101.1</b>
<b>Total</b>		<b>400.0</b>

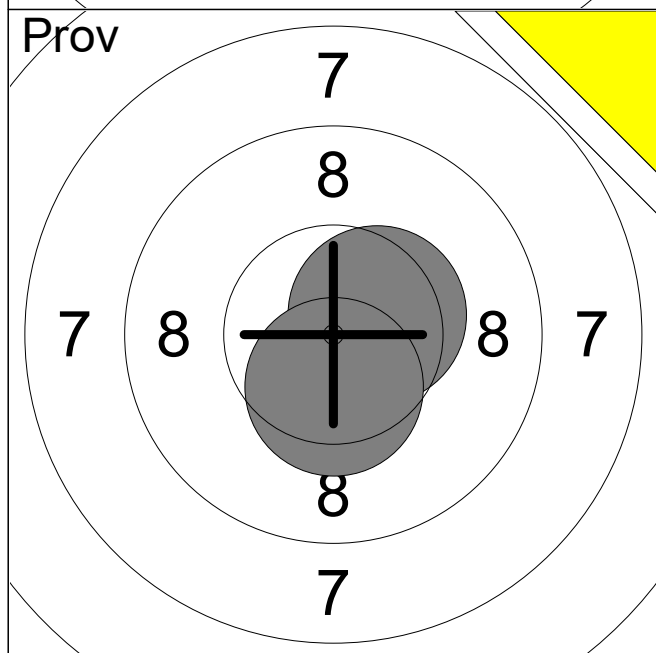

11:	10.5x	↗
12:	10.4x	↓
<b>Serie</b>		<b>20.9</b>
<b>Total</b>		<b>400.0</b>

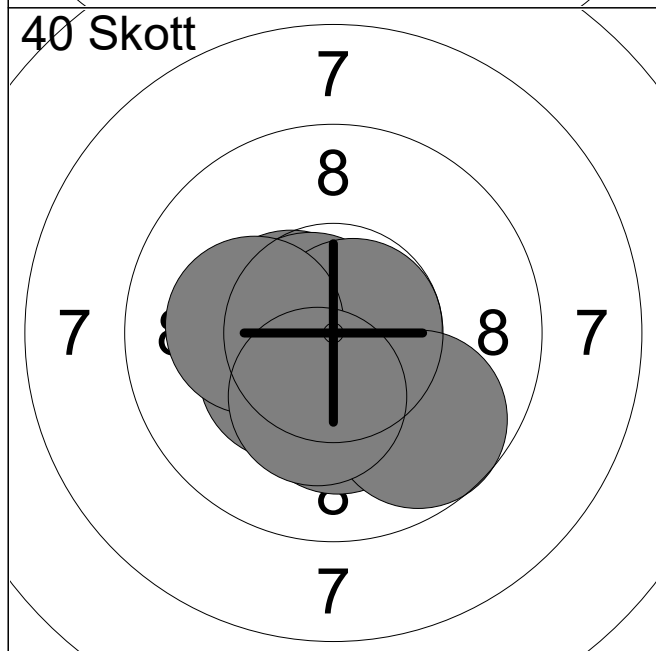

1:	10.7x	↘
2:	10.4x	↙
3:	10.7x	↘
4:	10.5x	←
5:	10.7x	↖
6:	10.2x	↓
7:	10.7x	→
8:	9.7	↘
9:	10.2x	←
10:	10.3x	↘
<b>Serie</b>		<b>104.1</b>
<b>Total</b>		<b>504.1</b>

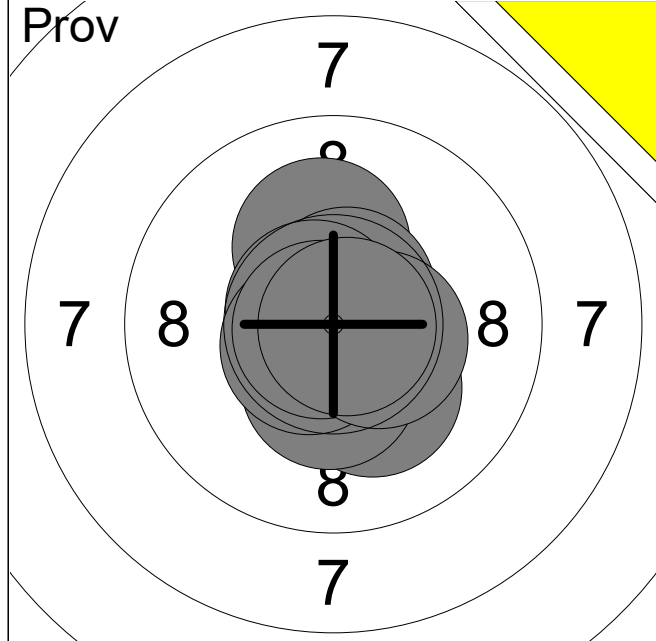

1:	10.2x	↘
2:	10.4x	↓
3:	10.2x	↑
4:	10.6x	↗
5:	10.9x	↓
6:	10.7x	↖
7:	10.6x	↙
8:	10.8x	←
9:	10.5x	→
10:	10.8x	→
<b>Serie</b>		<b>105.7</b>
<b>Total</b>		<b>400.0</b>

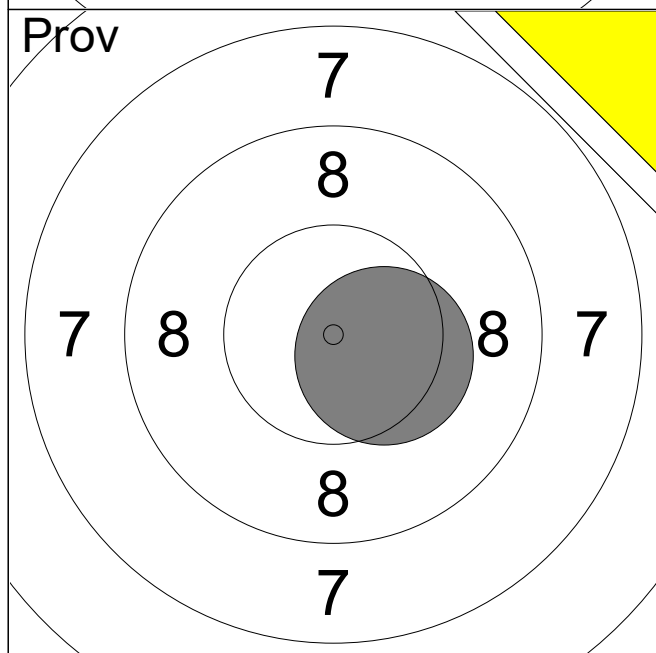

11:	10.4x	→
<b>Serie</b>		<b>10.4</b>
<b>Total</b>		<b>400.0</b>

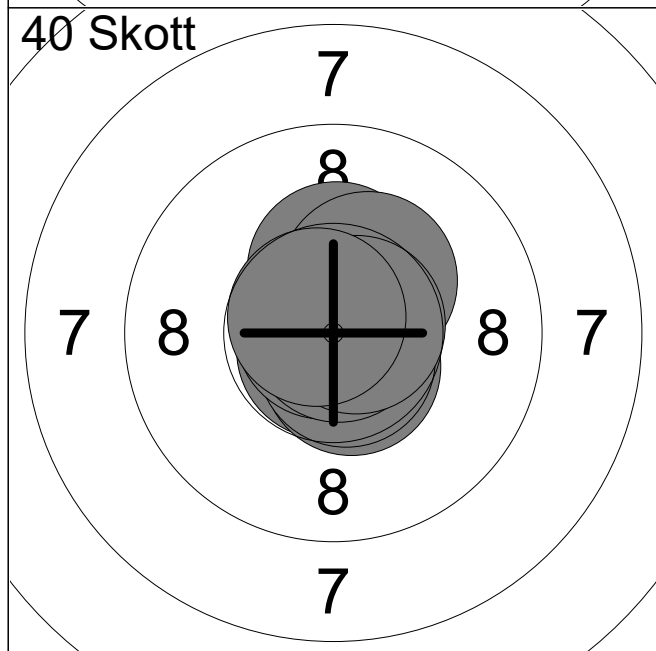

1:	10.8x	↘
2:	10.6x	↓
3:	10.7x	↘
4:	10.9x	↖
5:	10.3x	↑
6:	10.7x	↗
7:	10.9x	→
8:	10.3x	↗
9:	10.7x	→
10:	10.7x	↖
<b>Serie</b>		<b>106.6</b>
<b>Total</b>		<b>506.6</b>

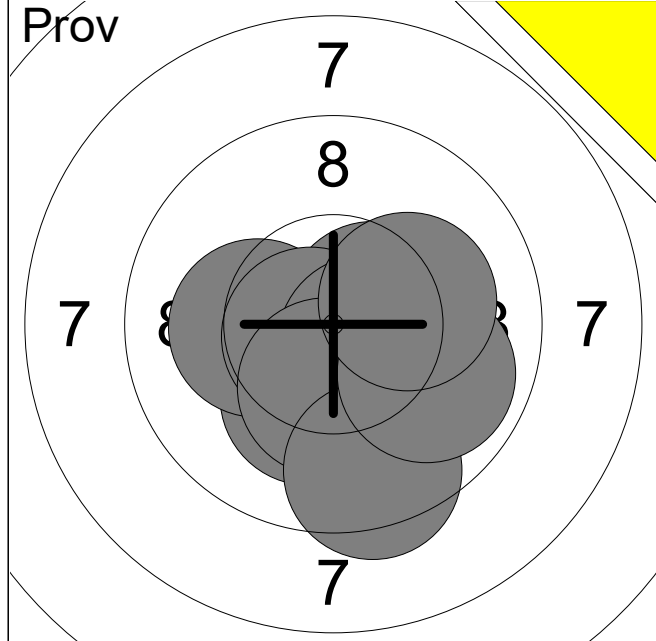

1:	10.2x	↓
2:	10.5x	→
3:	10.6x	↙
4:	10.2x	←
5:	10.7x	↙
6:	10.6x	↘
7:	10.3x	↓
8:	9.4	↓
9:	9.9	↘
10:	10.2x	→
<b>Serie</b>		<b>102.6</b>
<b>Total</b>		<b>399.0</b>

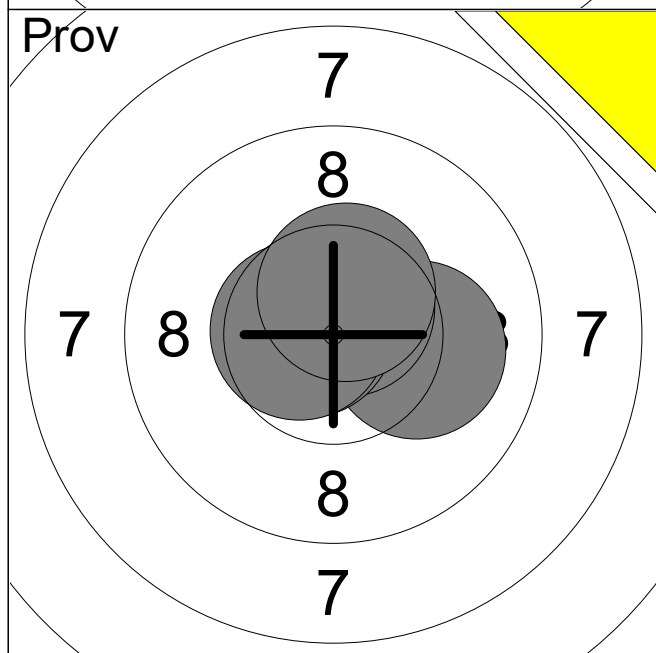

11:	10.1	→
12:	10.6x	↑
13:	10.7x	←
14:	10.6x	←
15:	10.5x	↑
<b>Serie</b>		<b>52.5</b>
<b>Total</b>		<b>399.0</b>

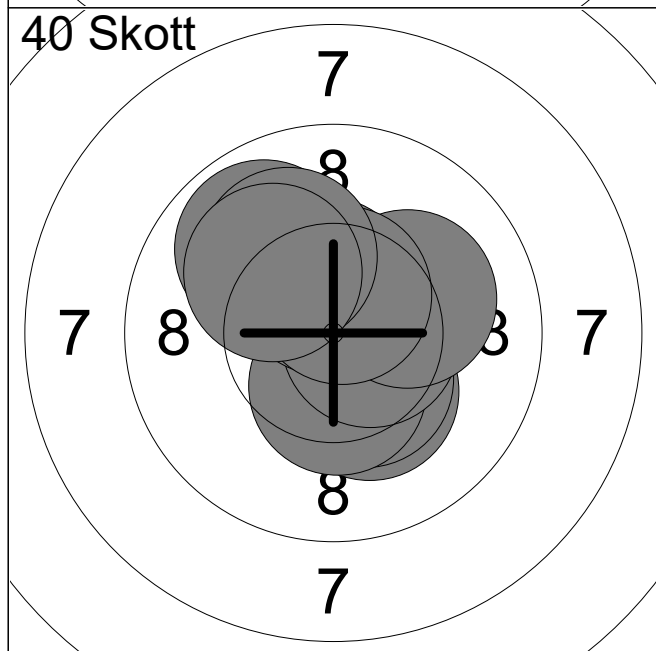

1:	9.9	↗
2:	10.3x	↓
3:	10.4x	↓
4:	10.4x	↓
5:	10.6x	→
6:	10.1	→
7:	10.5x	↑
8:	10.6x	↑
9:	10.1	↗
10:	10.1	↗
<b>Serie</b>		<b>103.0</b>
<b>Total</b>		<b>502.0</b>



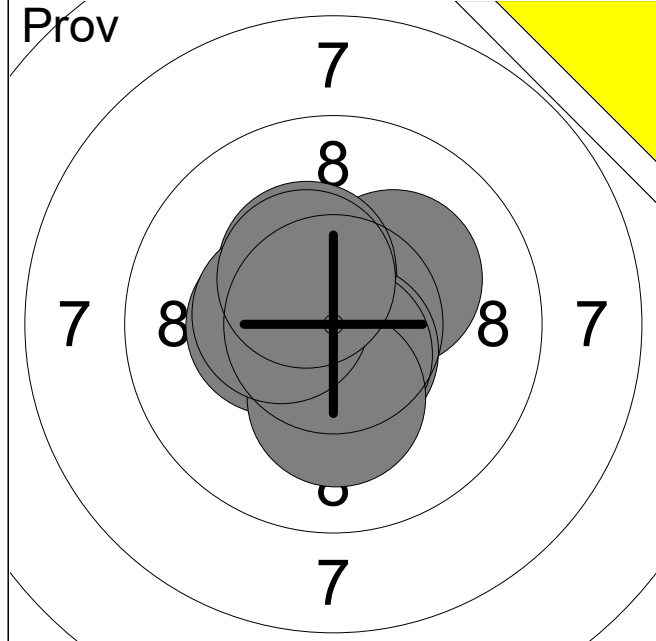

1:	10.2x	↗
2:	10.4x	↗
3:	10.4x	←
4:	10.8x	↙
5:	10.6x	↘
6:	10.4x	↗
7:	10.6x	↘
8:	10.2x	↘
9:	10.4x	←
10:	10.4x	↗
<b>Serie</b>		<b>104.4</b>
<b>Total</b>		<b>399.0</b>

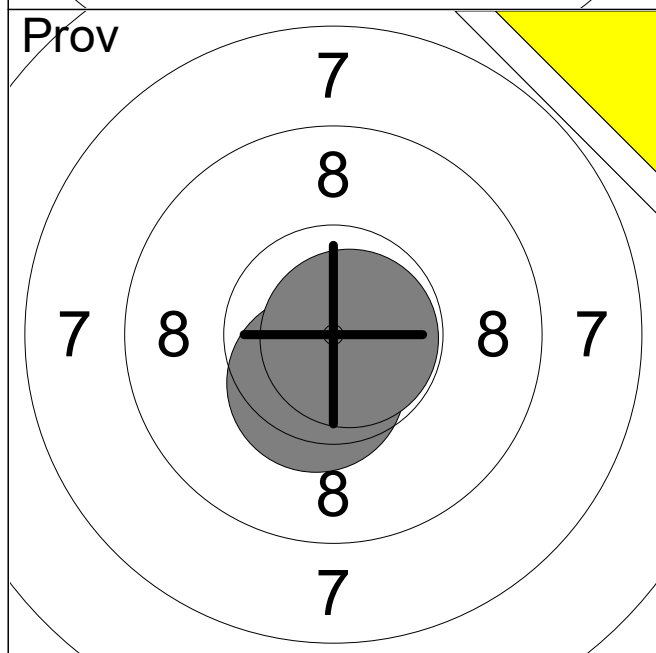

11:	10.4x	↘
12:	10.8x	→
<b>Serie</b>		<b>21.2</b>
<b>Total</b>		<b>399.0</b>

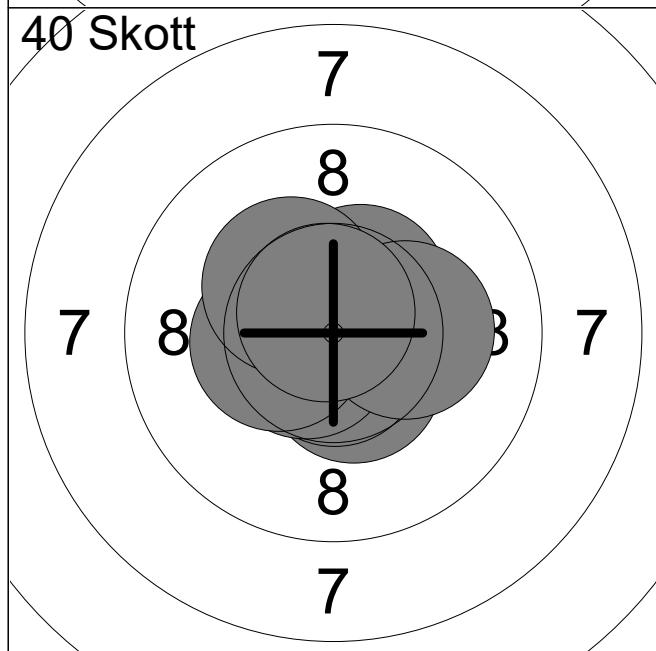

1:	10.5x	↘
2:	10.7x	↘
3:	10.6x	←
4:	10.5x	↗
5:	10.6x	←
6:	10.4x	←
7:	10.5x	↗
8:	10.3x	↗
9:	10.2x	→
10:	10.7x	↗
<b>Serie</b>		<b>105.0</b>
<b>Total</b>		<b>504.0</b>

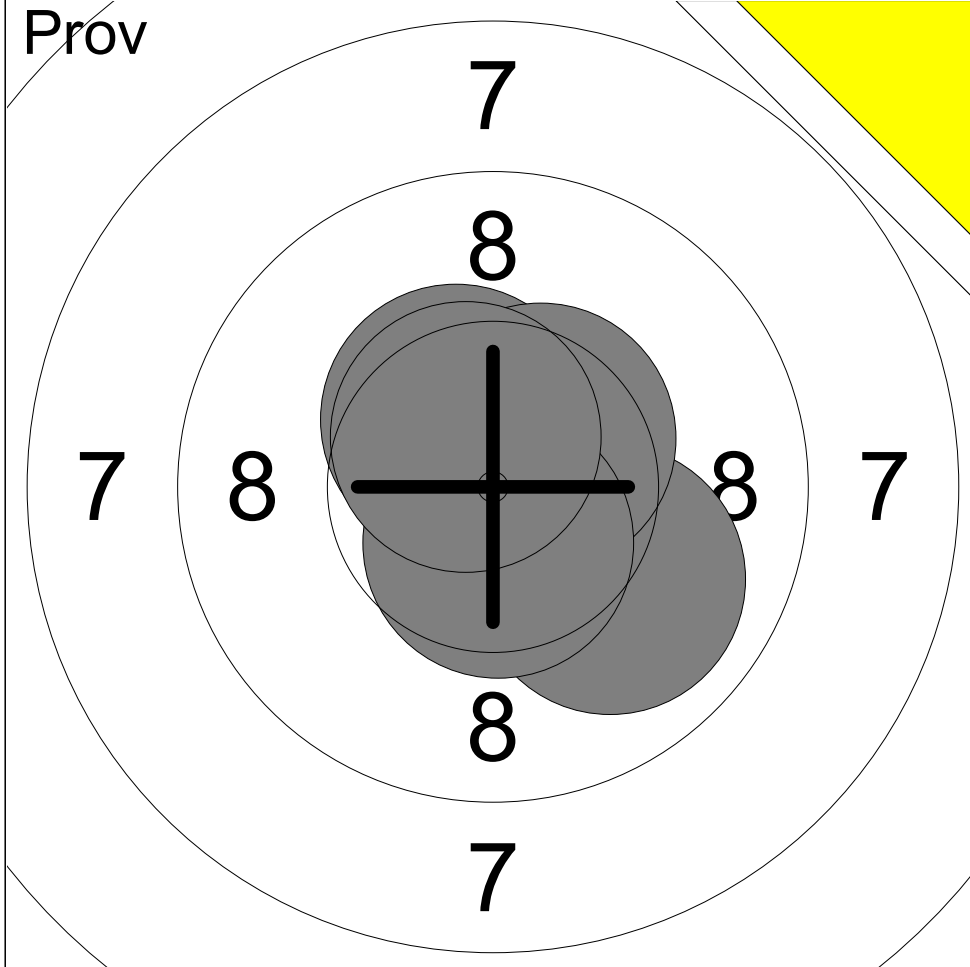

1:	10.8x	↘
2:	10.6x	↘
3:	10.4x	↗
4:	10.0	↘
5:	10.5x	↗
6:	10.6x	↘
7:	10.6x	↗
<b>Serie</b>		<b>73.5</b>
<b>Total</b>		<b>398.0</b>

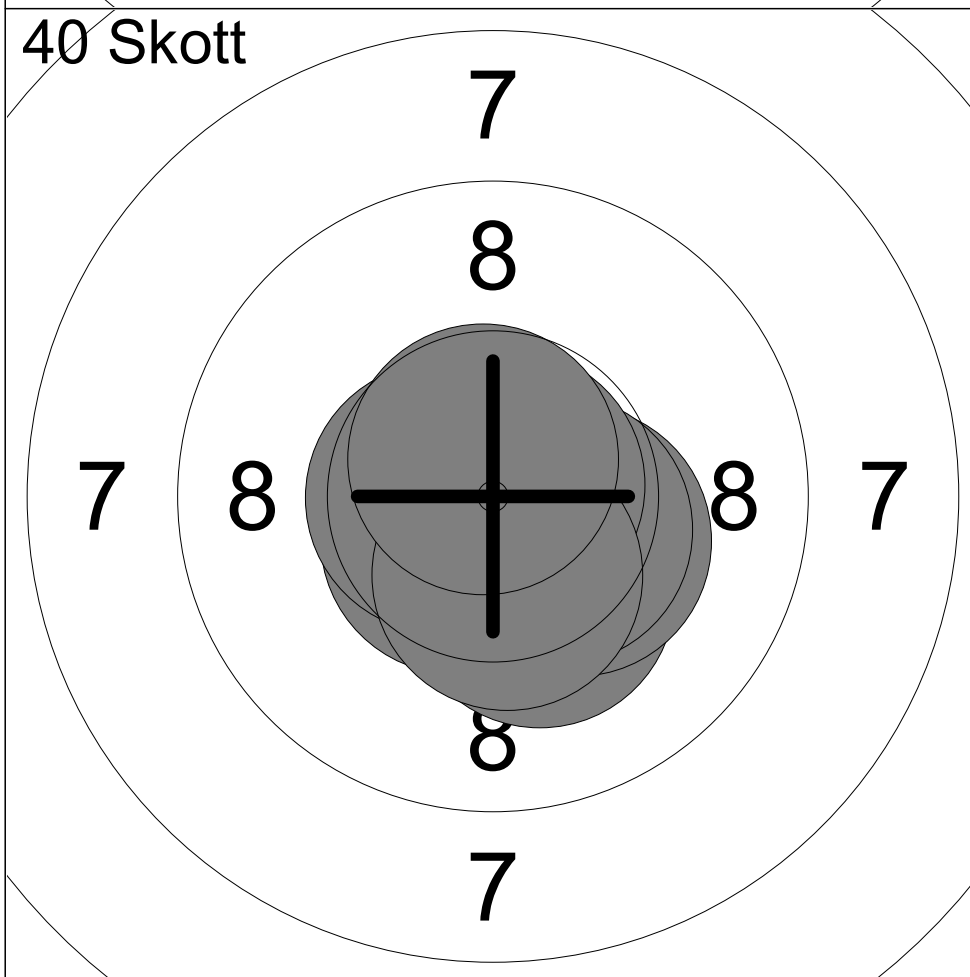

1:	10.6x	↘
2:	10.6x	↘
3:	10.2x	↘
4:	10.3x	↘
5:	10.9x	↗
6:	10.5x	↘
7:	10.8x	↗
8:	10.6x	←
9:	10.4x	↘
10:	10.7x	↗
<b>Serie</b>		<b>105.6</b>
<b>Total</b>		<b>503.6</b>

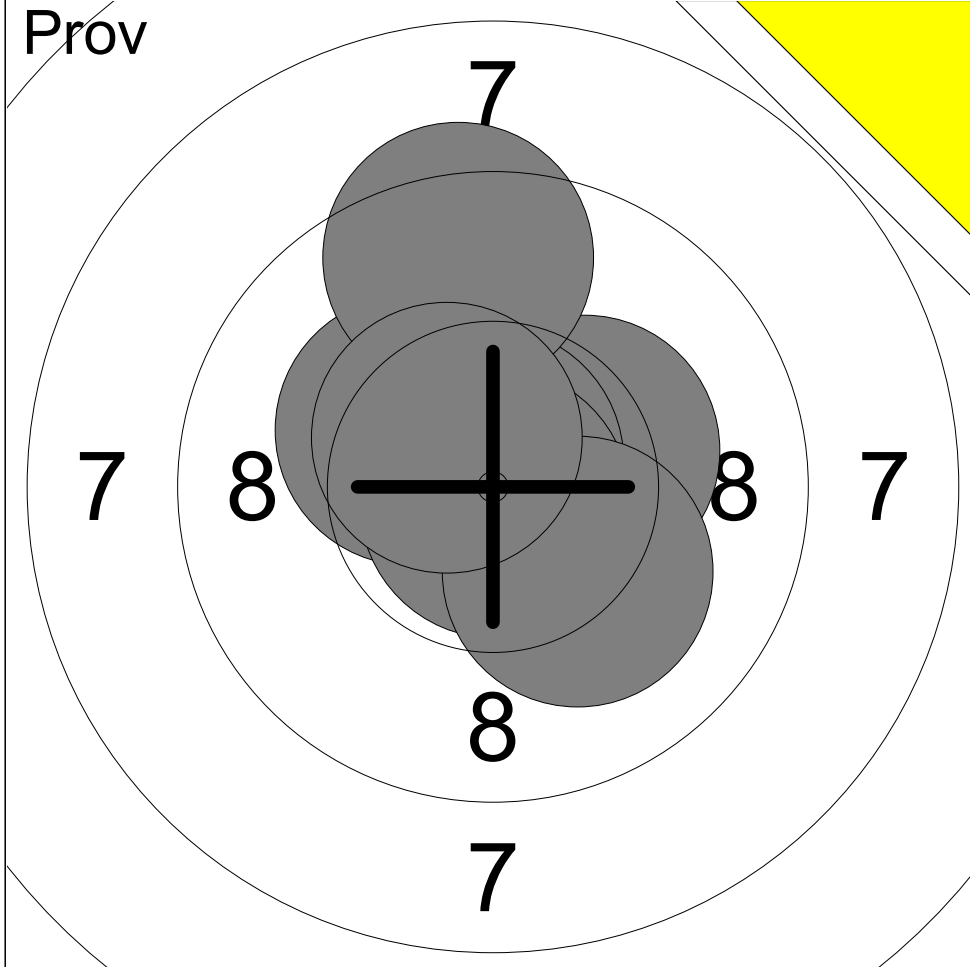

1:	10.3x	↗
2:	10.3x	↖
3:	10.8x	↑
4:	10.8x	↓
5:	10.2x	↘
6:	9.4	↑
7:	10.5x	↖
<b>Serie</b>		<b>72.3</b>
<b>Total</b>		<b>396.0</b>

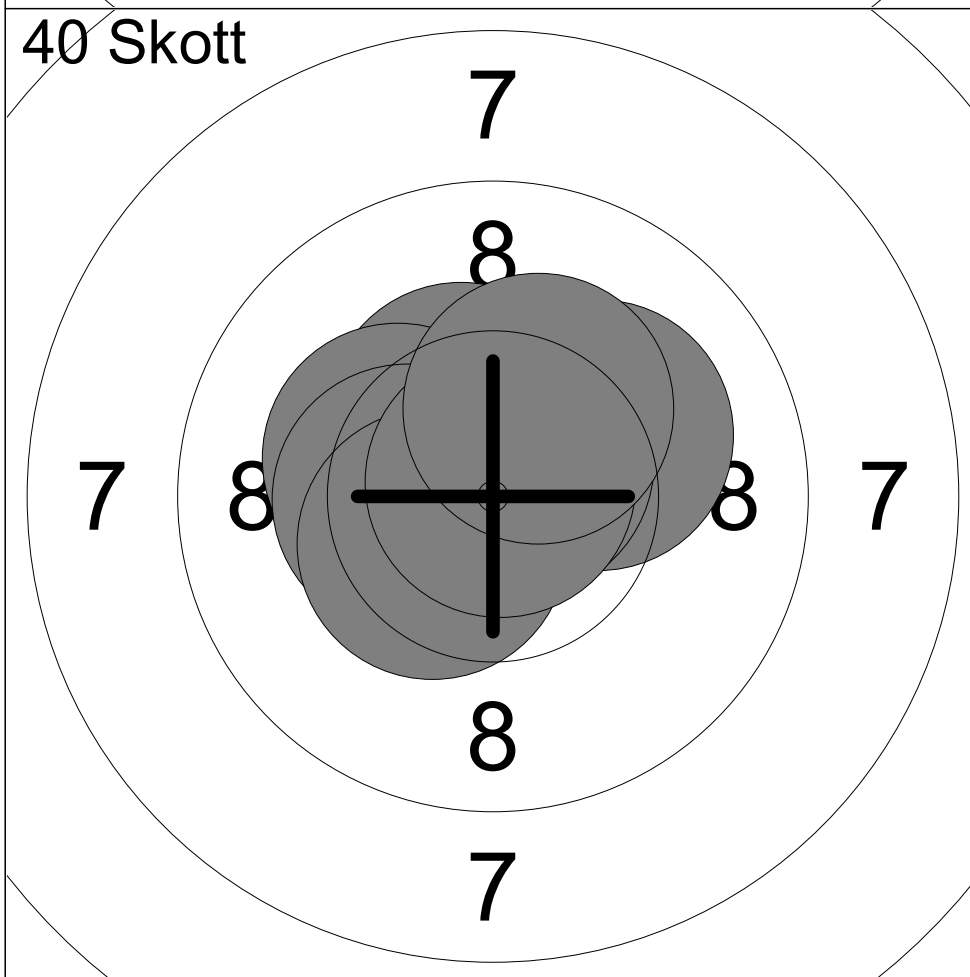

1:	10.4x	↖
2:	10.8x	↖
3:	10.1	↗
4:	10.3x	↖
5:	10.7x	←
6:	10.4x	←
7:	10.7x	↗
8:	10.4x	↖
9:	10.8x	↗
10:	10.3x	↗
<b>Serie</b>		<b>104.9</b>
<b>Total</b>		<b>500.9</b>

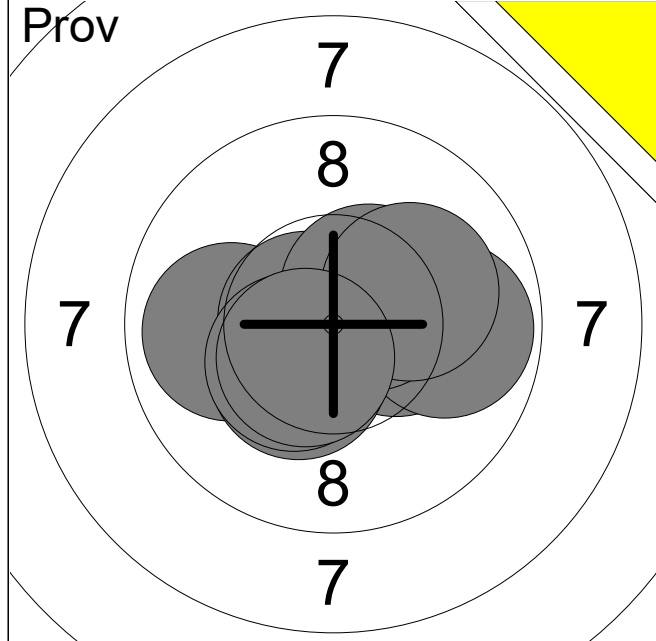

1:	9.9	←
2:	10.3x	→
3:	10.4x	↙
4:	10.7x	←
5:	9.8	→
6:	10.5x	↗
7:	10.5x	↗
8:	10.4x	↙
9:	10.1	↗
10:	10.5x	↙
<b>Serie</b>		<b>103.1</b>
<b>Total</b>		<b>396.0</b>

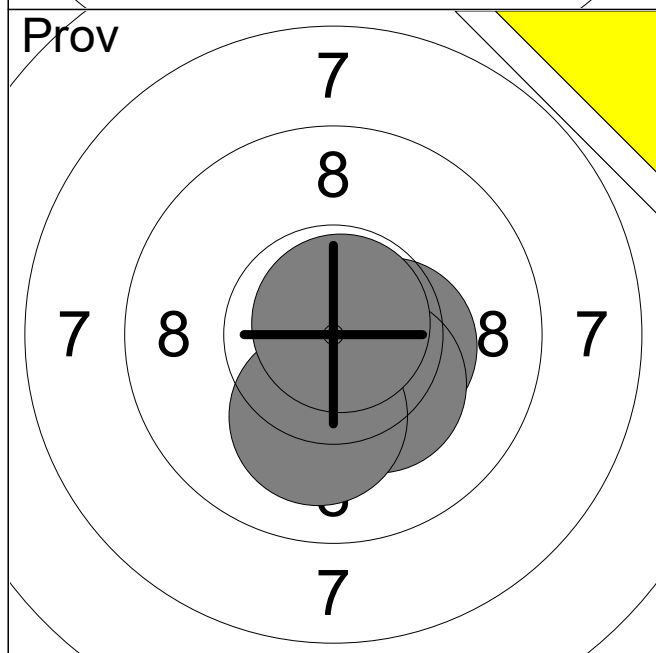

11:	10.4x	→
12:	10.3x	↙
13:	10.1	↙
14:	10.8x	↗
<b>Serie</b>		<b>41.6</b>
<b>Total</b>		<b>396.0</b>

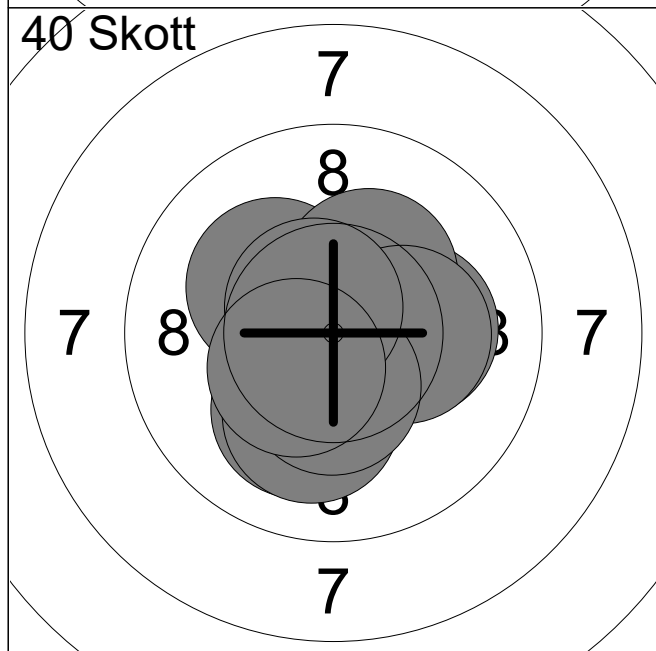

1:	10.2x	→
2:	10.1	↙
3:	10.6x	↑
4:	10.2x	↖
5:	10.1	↙
6:	10.3x	↗
7:	10.3x	→
8:	10.4x	↙
9:	10.6x	↗
10:	10.4x	↙
<b>Serie</b>		<b>103.2</b>
<b>Total</b>		<b>499.2</b>

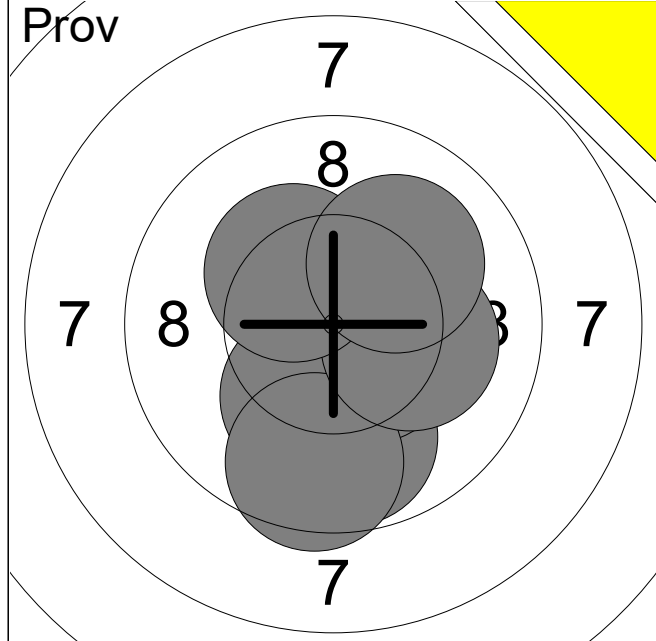

1:	10.2x	→
2:	10.7x	↗
3:	9.8	↓
4:	10.5x	↘
5:	10.5x	→
6:	10.2x	↓
7:	9.6	↓
8:	10.2x	→
9:	10.3x	↗
10:	10.1	↗
<b>Serie</b>		<b>102.1</b>
<b>Total</b>		<b>393.0</b>

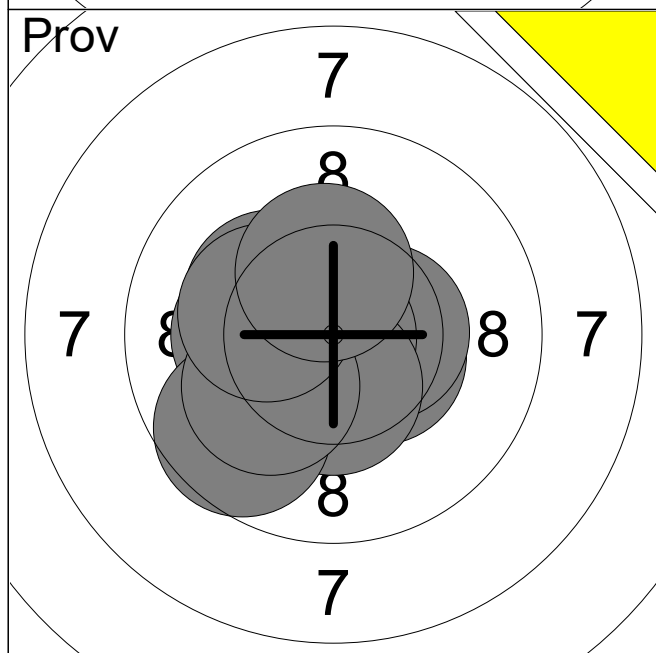

11:	10.2x	←
12:	10.5x	→
13:	10.5x	→
14:	10.9x	←
15:	10.4x	↓
16:	9.6	↘
17:	10.1	↘
18:	10.2x	↖
19:	10.2x	←
20:	10.3x	↑
<b>Serie</b>		<b>102.9</b>
<b>Total</b>		<b>393.0</b>

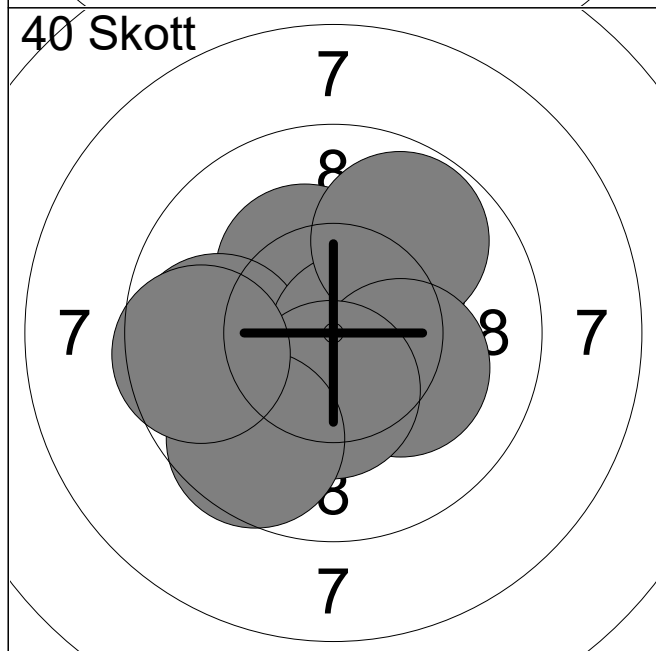

1:	10.3x	↗
2:	10.3x	↑
3:	9.9	←
4:	9.8	←
5:	10.7x	→
6:	9.8	↗
7:	10.2x	→
8:	10.4x	↓
9:	9.6	↘
10:	9.6	←
<b>Serie</b>		<b>100.6</b>
<b>Total</b>		<b>493.6</b>

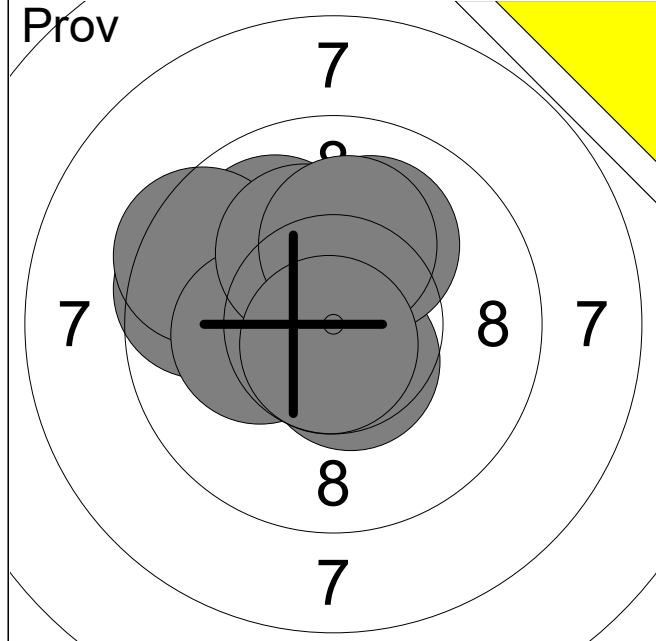

1:	10.0	↗
2:	9.6	↖
3:	10.2x	↖
4:	9.5	↗
5:	10.5x	↘
6:	10.1	↗
7:	10.2x	↖
8:	10.2x	↗
9:	10.1	↗
10:	10.7x	↘
<b>Serie</b>		<b>101.1</b>
<b>Total</b>		<b>393.0</b>

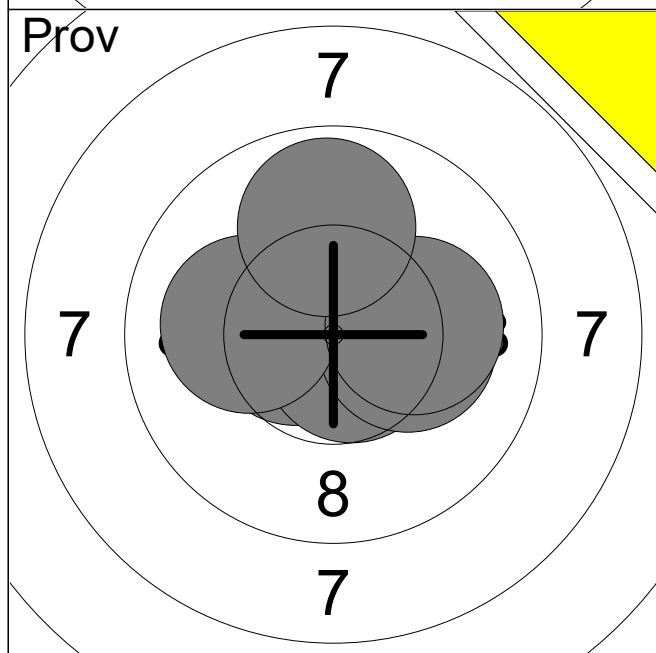

11:	10.6x	↖
12:	10.7x	↘
13:	10.2x	→
14:	10.1	↖
15:	10.1	→
16:	9.9	↗
<b>Serie</b>		<b>61.6</b>
<b>Total</b>		<b>393.0</b>

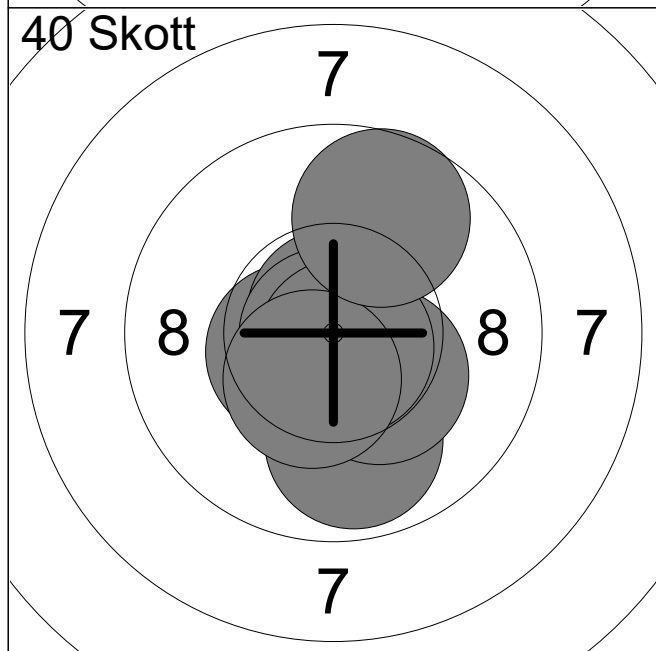

1:	10.2x	↘
2:	10.5x	↖
3:	10.8x	↗
4:	10.9x	↖
5:	10.6x	↘
6:	9.9	↘
7:	10.3x	↘
8:	10.8x	↘
9:	10.4x	↘
10:	9.7	↗
<b>Serie</b>		<b>104.1</b>
<b>Total</b>		<b>497.1</b>

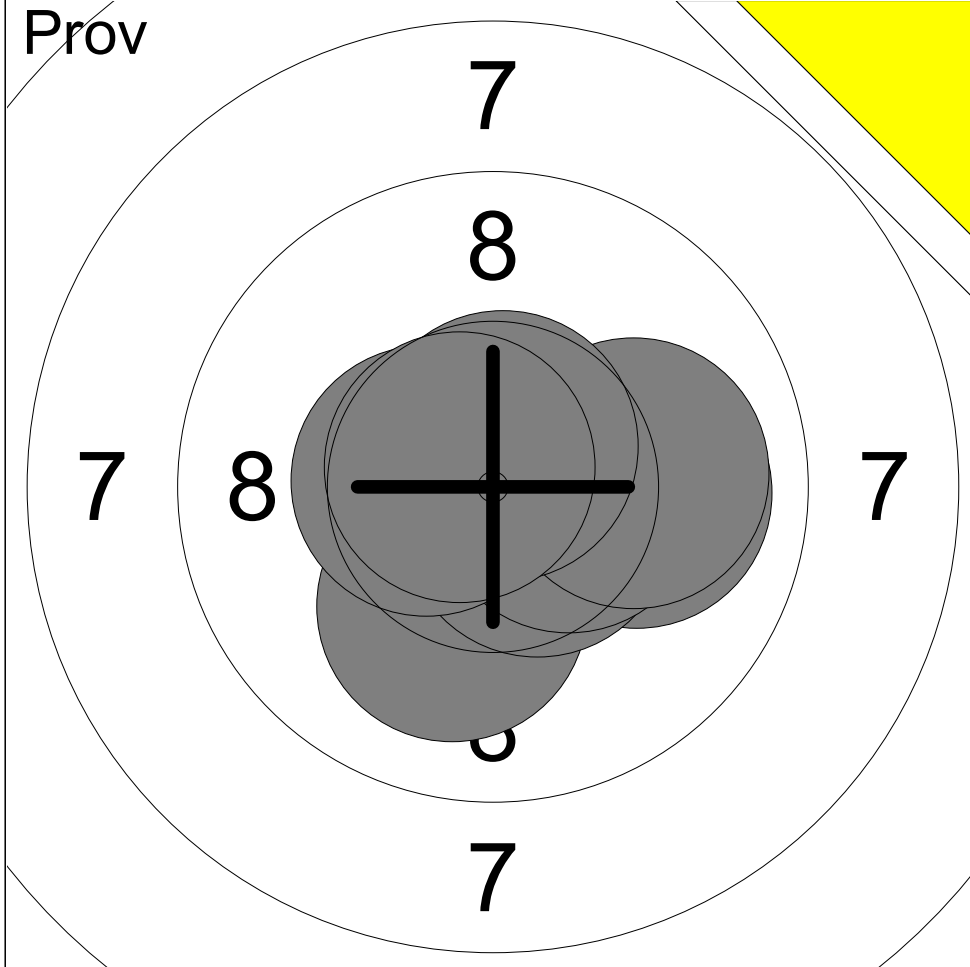

1:	10.0	→
3:	10.1	↘
4:	10.6x	↘
5:	10.4x	→
6:	10.0	→
7:	10.7x	↑
8:	10.5x	←
9:	10.7x	↖

Serie	83.0
Total	391.0

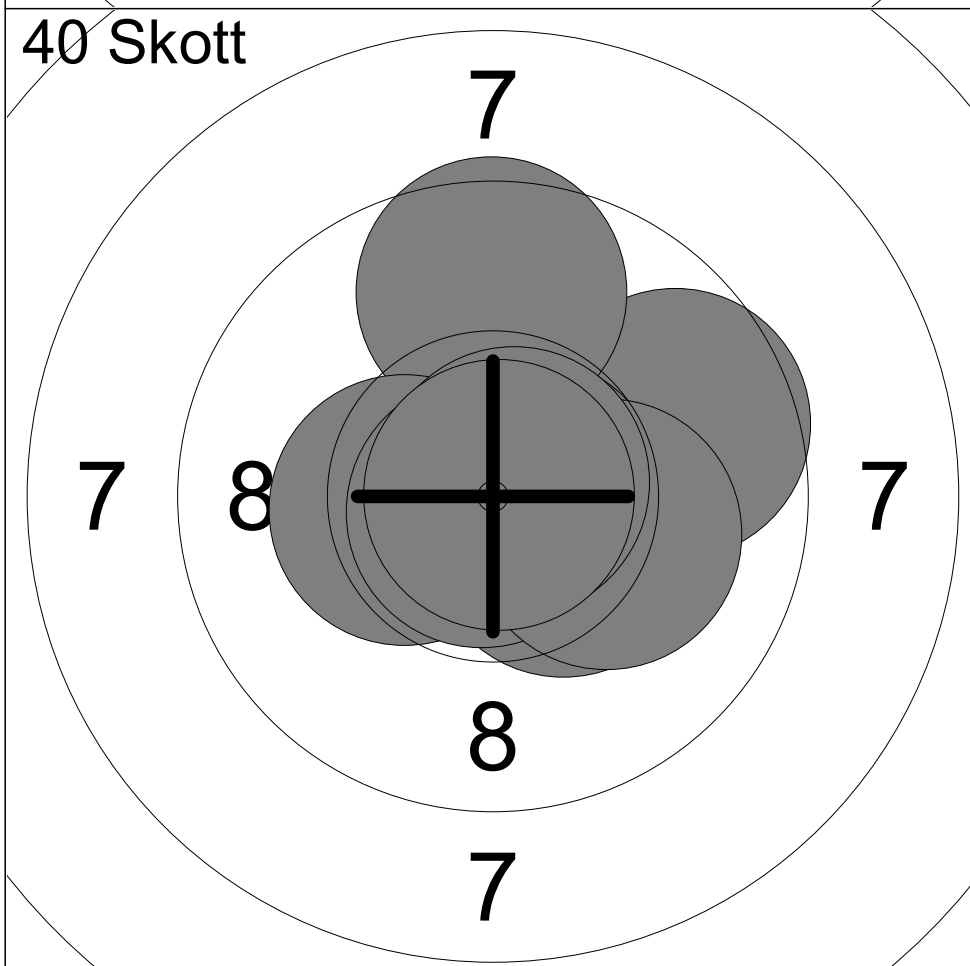

1:	10.4x	→
2:	9.6	→
3:	9.6	↑
4:	10.4x	↘
5:	10.4x	←
6:	10.7x	→
7:	10.8x	↘
8:	10.2x	→
9:	10.8x	↗
10:	10.9x	→

Serie	103.8
Total	494.8

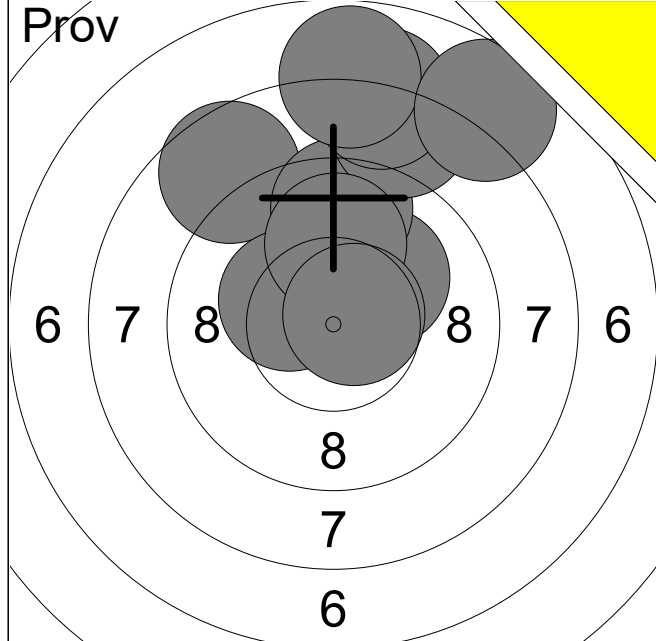

1:	8.6	↖
2:	10.3x	↖
3:	10.1	↗
4:	9.5	↑
5:	8.3	↗
6:	9.9	↑
7:	8.0	↑
8:	7.8	↑
9:	10.7x	↗
10:	7.6	↗
<b>Serie</b>		<b>90.8</b>
<b>Total</b>		<b>362.0</b>

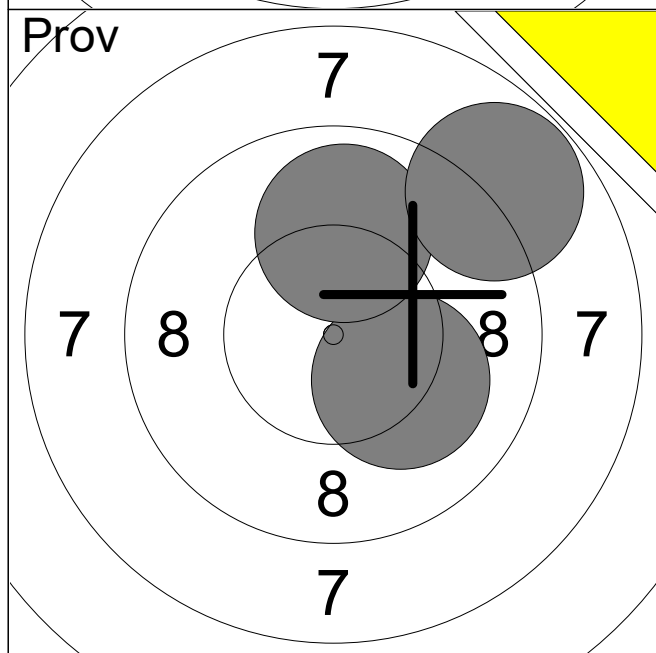

11:	10.1	↘
12:	9.9	↑
13:	8.8	↗
<b>Serie</b>		<b>28.8</b>
<b>Total</b>		<b>362.0</b>

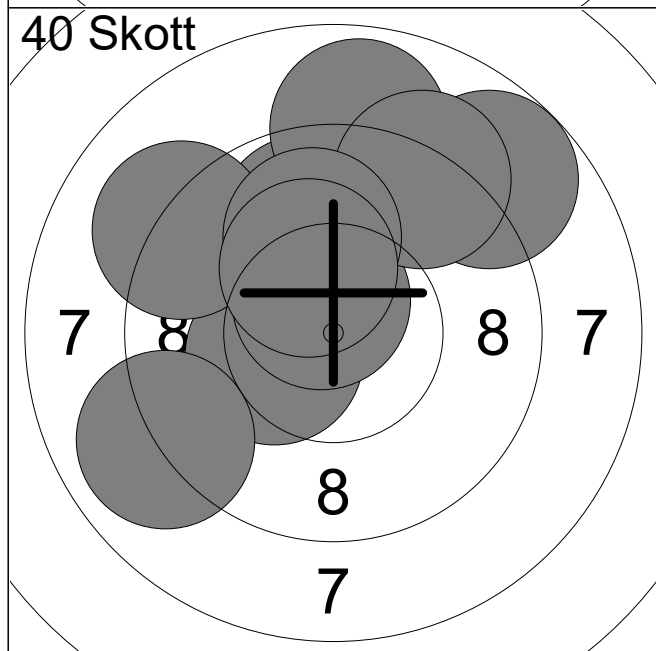

1:	9.8	↑
2:	8.9	↑
3:	10.3x	↖
4:	10.6x	↑
5:	8.7	↗
6:	9.0	↖
7:	9.1	↖
8:	9.2	↗
9:	10.0	↑
10:	10.3x	↑
<b>Serie</b>		<b>95.9</b>
<b>Total</b>		<b>457.9</b>



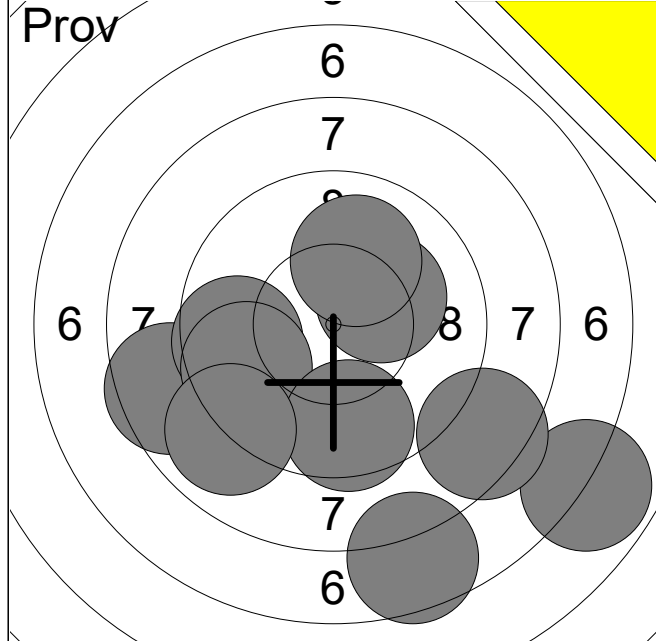

1:	8.5	←
2:	7.6	↓
3:	9.6	←
4:	9.6	←
5:	10.2x	↗
6:	6.9	↘
7:	9.6	↓
8:	8.9	↙
9:	8.4	↘
10:	10.0	↑
<b>Serie</b>		<b>89.3</b>
<b>Total</b>		<b>345.0</b>

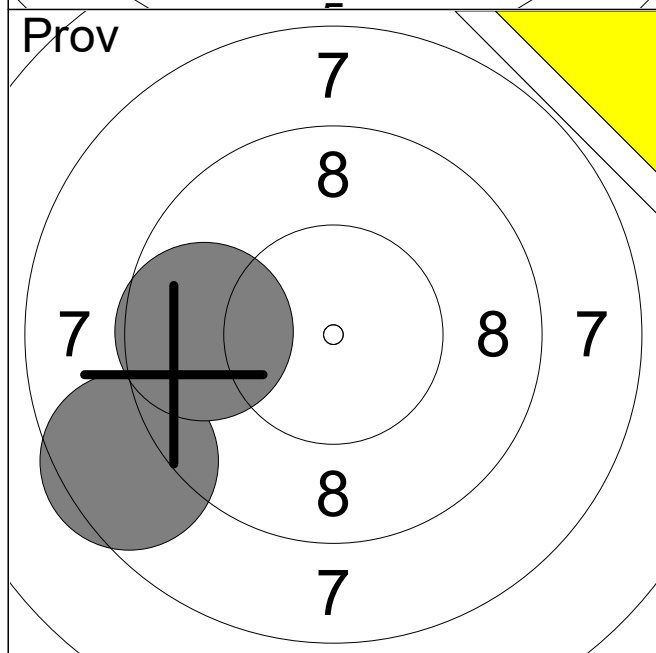

11:	8.5	←
12:	9.7	←
<b>Serie</b>		<b>18.2</b>
<b>Total</b>		<b>345.0</b>

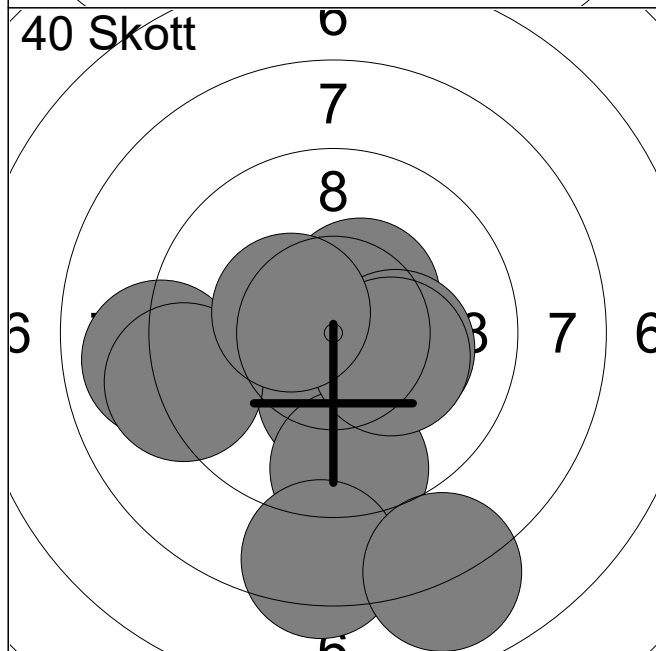

1:	9.0	←
2:	10.4x	↗
3:	10.3x	↓
4:	9.2	←
5:	10.2x	↘
6:	9.4	↓
7:	10.2x	↘
8:	8.4	↓
9:	10.4x	↖
10:	8.0	↓
<b>Serie</b>		<b>95.5</b>
<b>Total</b>		<b>440.5</b>

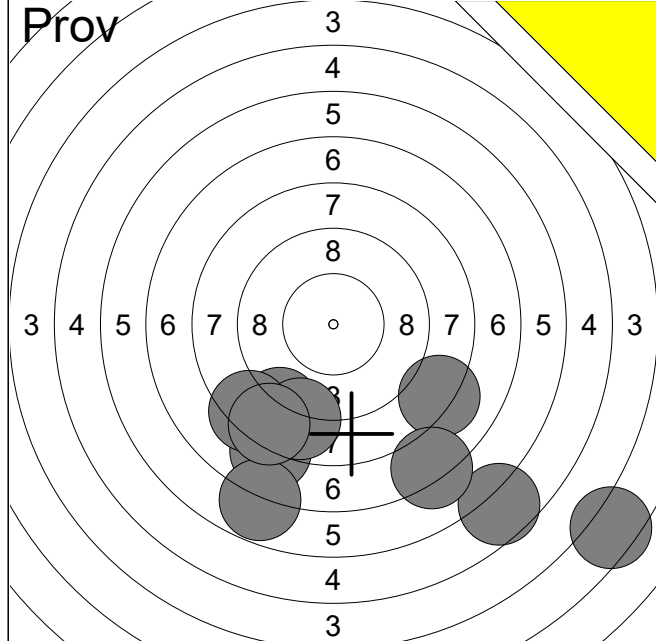

1:	5.6	↘
2:	8.8	↘
3:	7.9	↘
4:	8.2	↘
5:	8.8	↘
6:	8.3	↘
7:	6.8	↘
8:	3.4	↘
9:	8.4	↘
10:	7.1	↘

Serie	<b>73.3</b>
-------	-------------

Total	<b>327.0</b>
-------	--------------

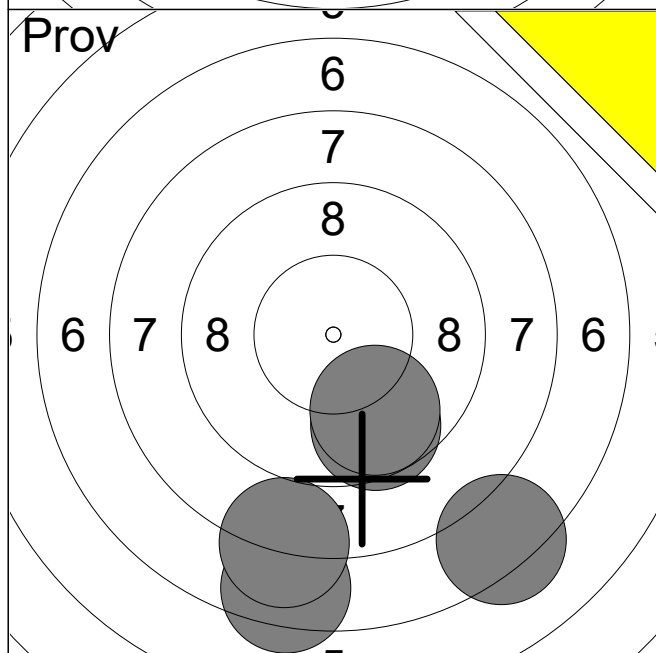

11:	9.6	↘
12:	7.4	↘
13:	8.0	↘
14:	7.3	↘
15:	9.8	↘

Serie	<b>42.1</b>
-------	-------------

Total	<b>327.0</b>
-------	--------------

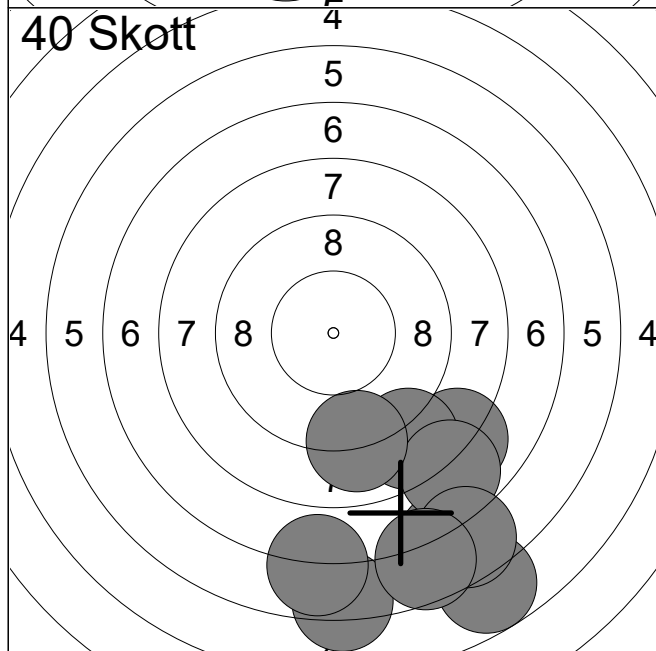

1:	8.1	↘
2:	8.7	↘
3:	6.7	↘
4:	6.2	↘
5:	6.8	↘
6:	5.8	↘
7:	7.7	↘
8:	6.6	↘
9:	9.0	↘
10:	6.6	↘

Serie	<b>72.2</b>
-------	-------------

Total	<b>399.2</b>
-------	--------------

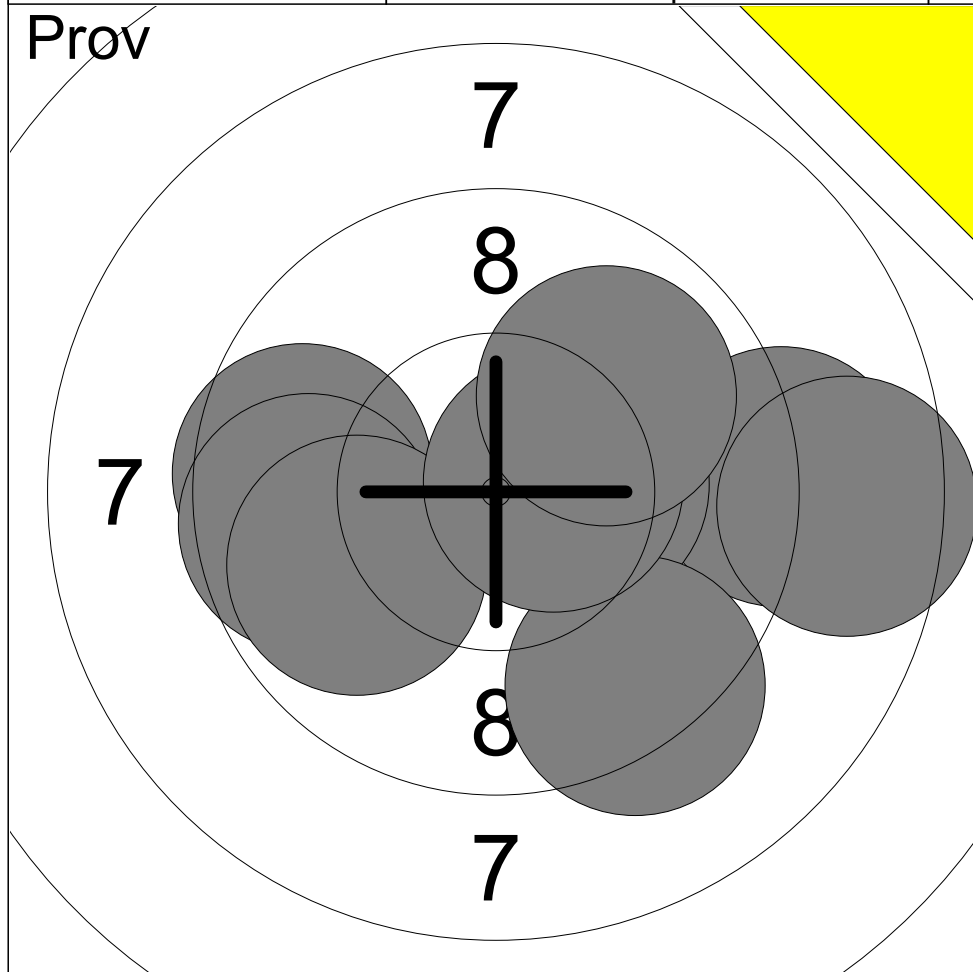

1:	9.0	→
2:	10.4x	→
3:	9.3	↘
4:	8.5	→
5:	9.6	←
6:	9.6	←
7:	9.9	↙
8:	10.5x	→
9:	9.9	↗

Serie	86.7
Total	378.0

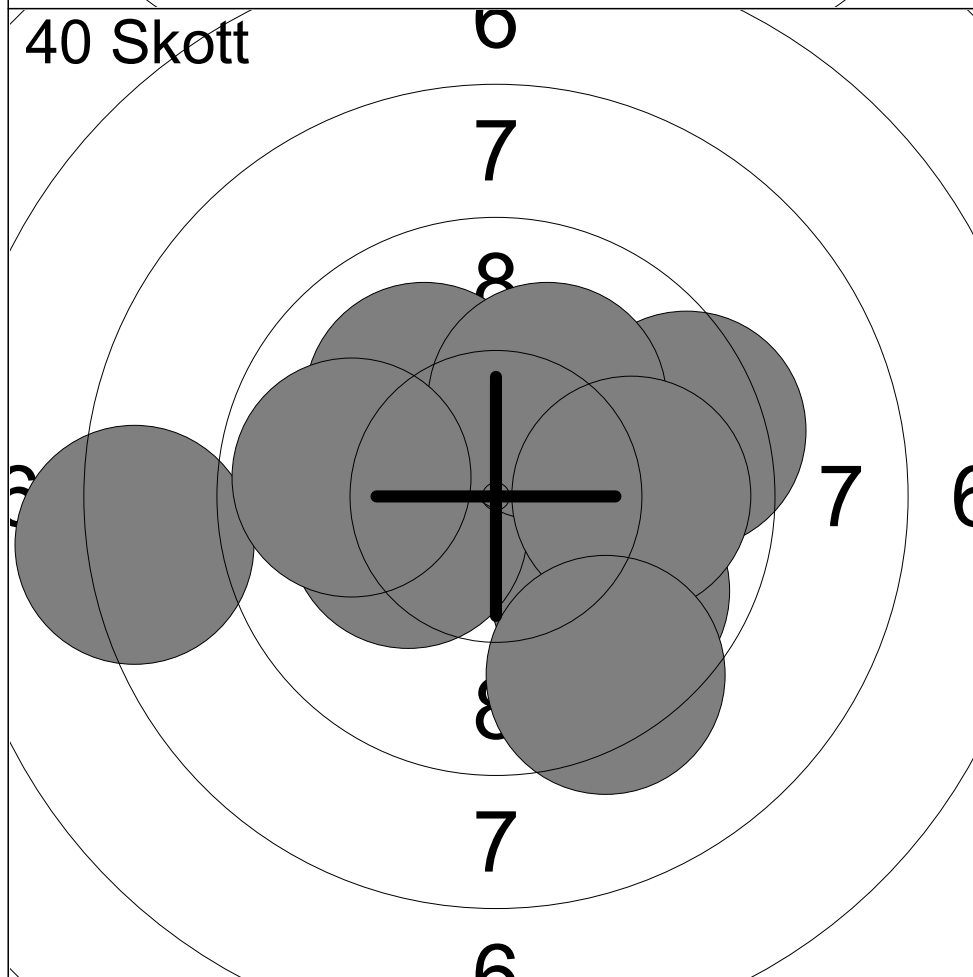

1:	8.2	←
2:	10.4x	↖
3:	10.1	↗
4:	9.8	↘
5:	9.4	→
6:	10.2x	←
7:	10.1	↗
8:	9.9	←
9:	9.9	→
10:	9.4	↘

Serie	97.4
Total	475.4

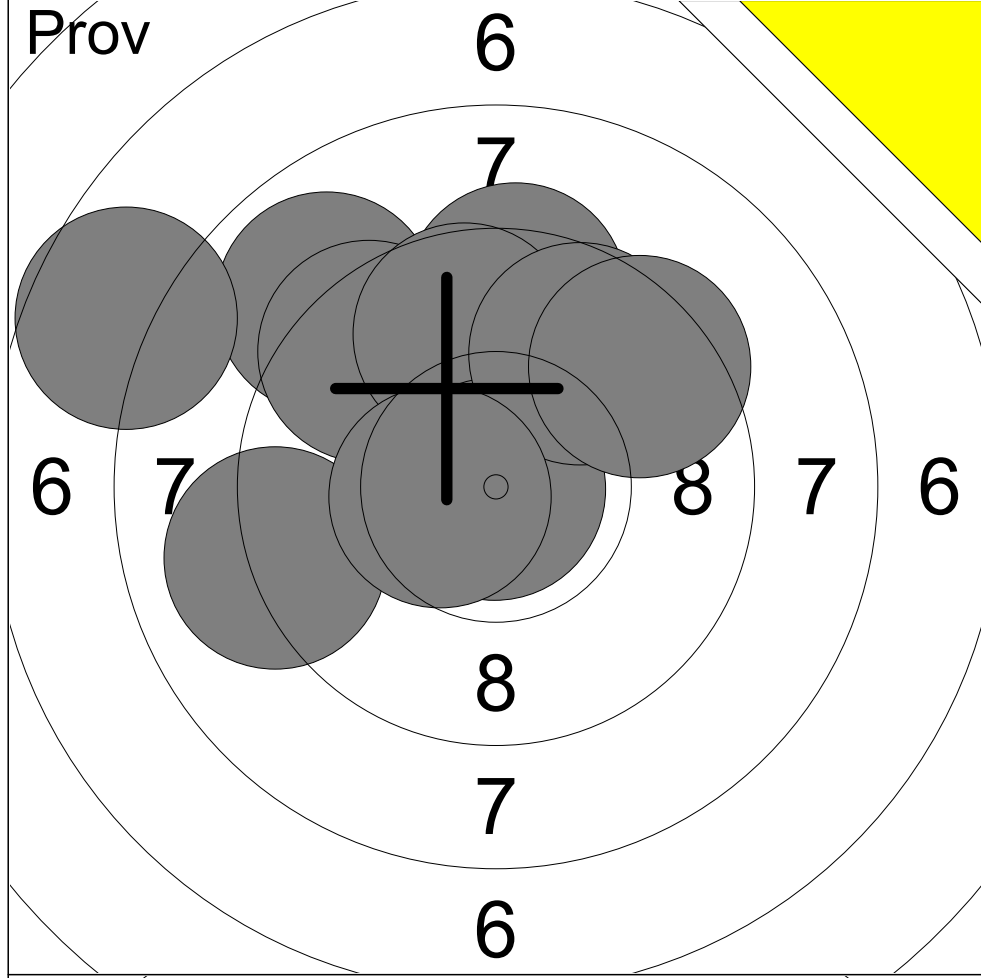

1:	8.9	↗
2:	7.7	↖
3:	9.4	↑
4:	9.4	↗
5:	9.7	↑
6:	10.9x	↘
7:	9.1	↖
8:	9.7	↗
9:	10.5x	↖
10:	9.4	↗

Serie	94.7
Total	368.0

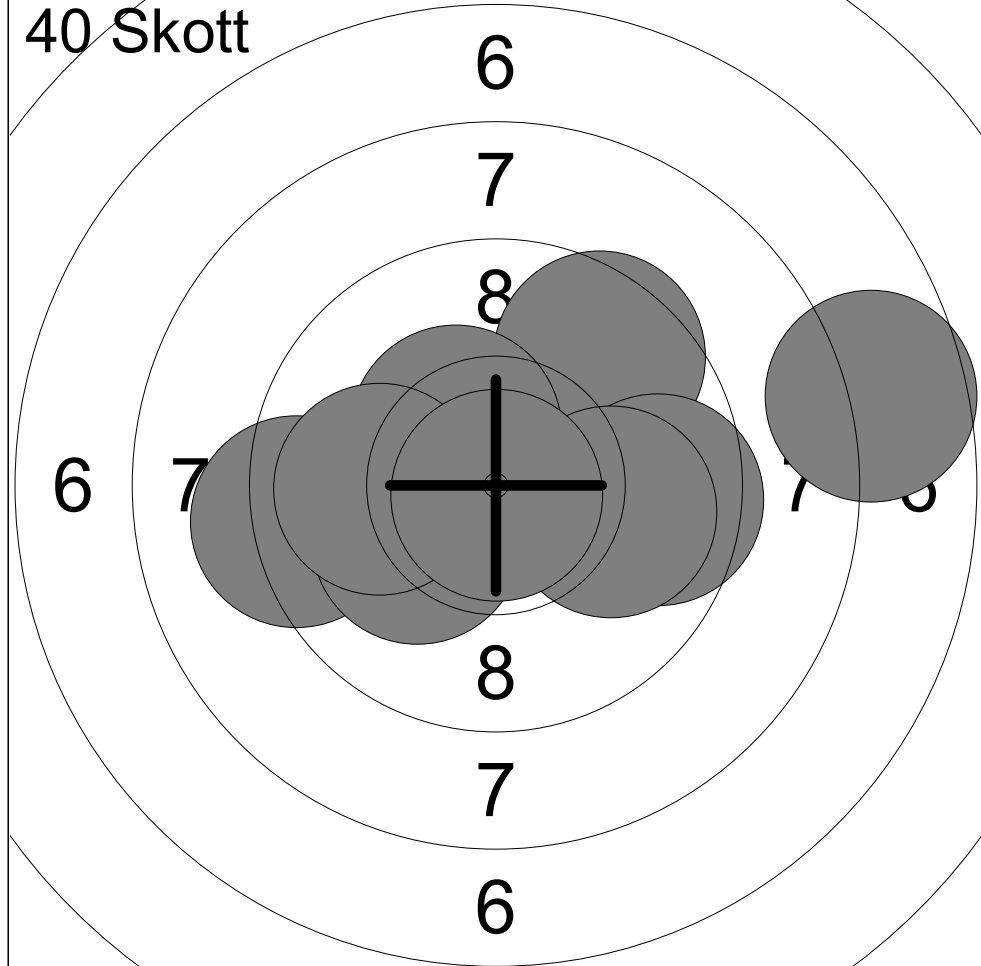

1:	10.4x	→
2:	9.2	↖
3:	9.5	↗
4:	10.4x	↗
5:	7.7	→
6:	10.1	↖
7:	9.6	→
8:	9.9	→
9:	10.0	↖
10:	10.9x	↓

Serie	97.7
Total	465.7

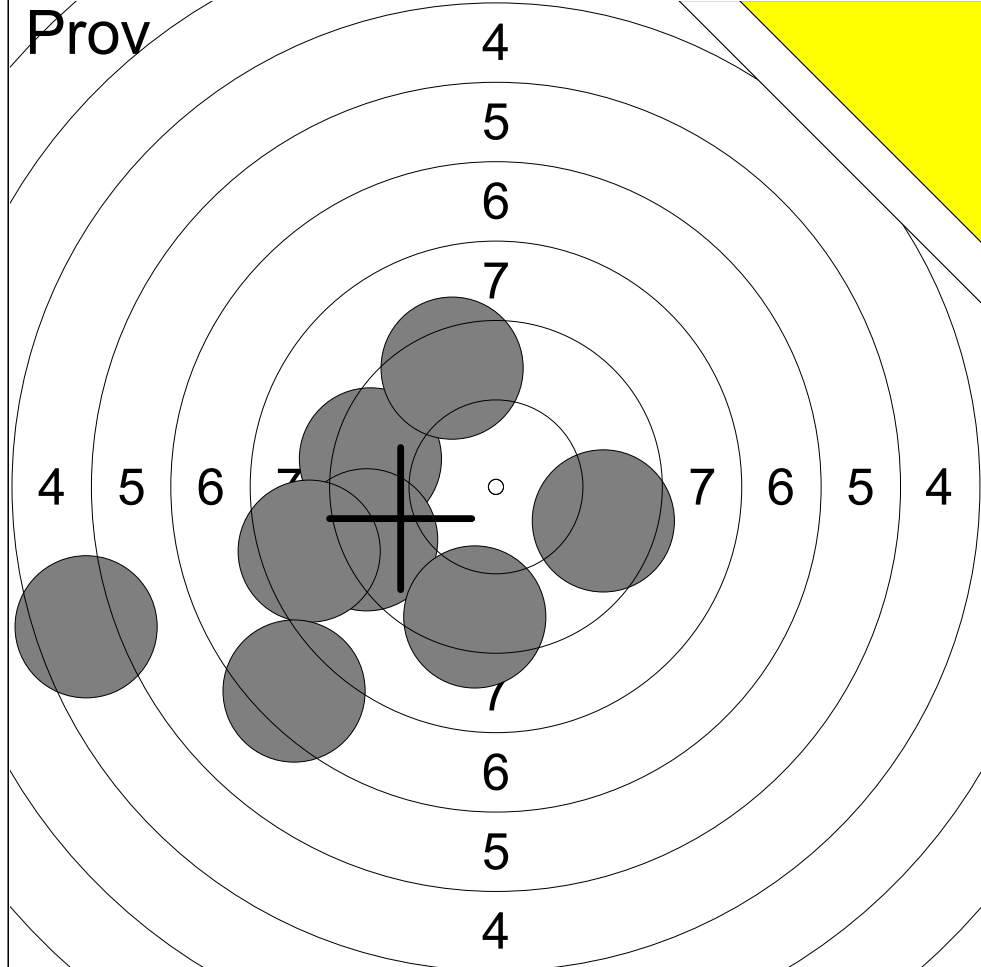

1:	9.3	←
2:	9.2	←
3:	9.3	↓
4:	9.5	→
5:	9.4	↑
6:	8.5	←
7:	7.3	↙
8:	5.5	←

Serie	68.0
Total	363.0

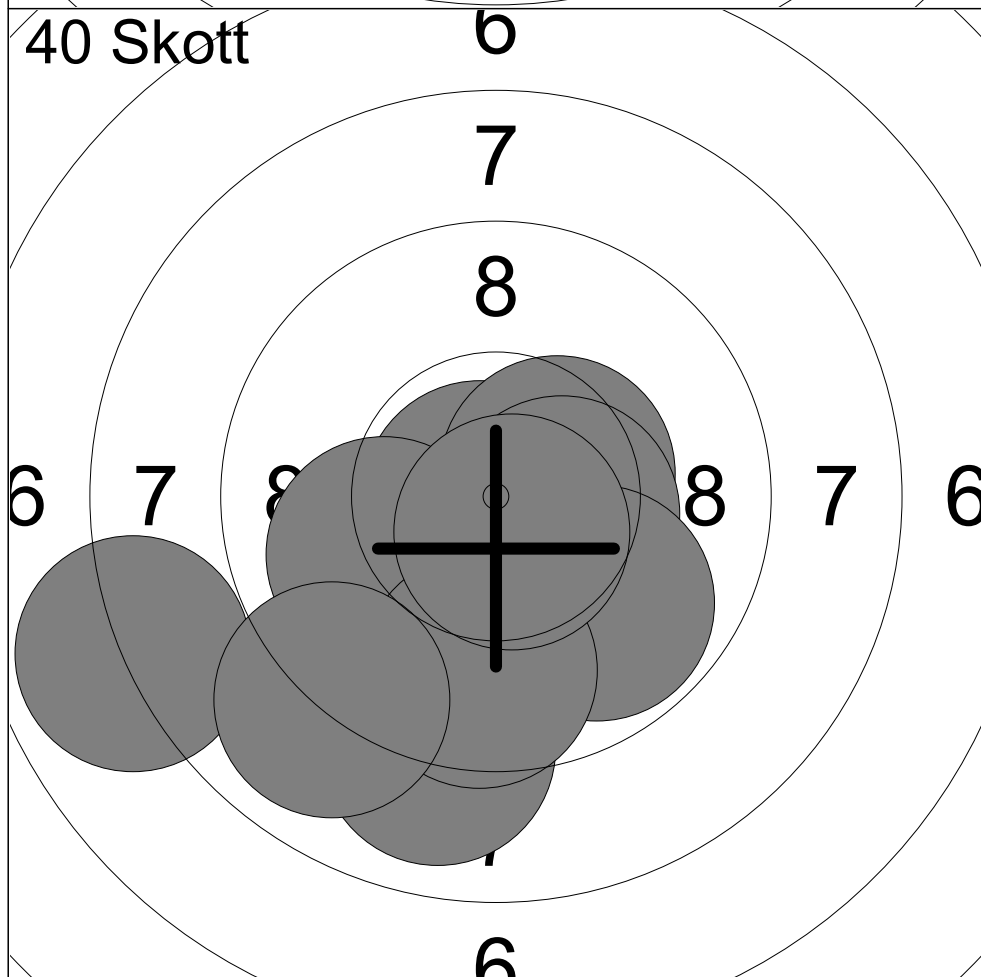

1:	7.9	←
2:	10.8x	←
3:	10.5x	→
4:	9.0	↓
5:	10.4x	→
6:	9.8	↘
7:	10.0	←
8:	9.6	↓
9:	10.7x	↘
10:	9.0	↙

Serie	97.7
Total	460.7

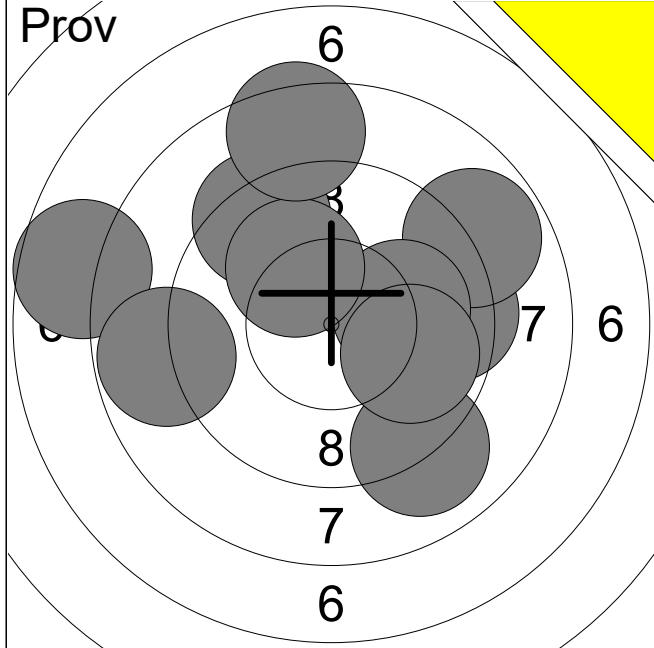

1:	9.0	↘
2:	9.4	→
3:	8.8	↗
4:	7.7	←
5:	10.0	→
6:	9.3	↗
7:	10.1	↗
8:	9.9	↘
9:	8.4	↑
10:	8.8	←
<b>Serie</b>		<b>91.4</b>
<b>Total</b>		<b>362.0</b>

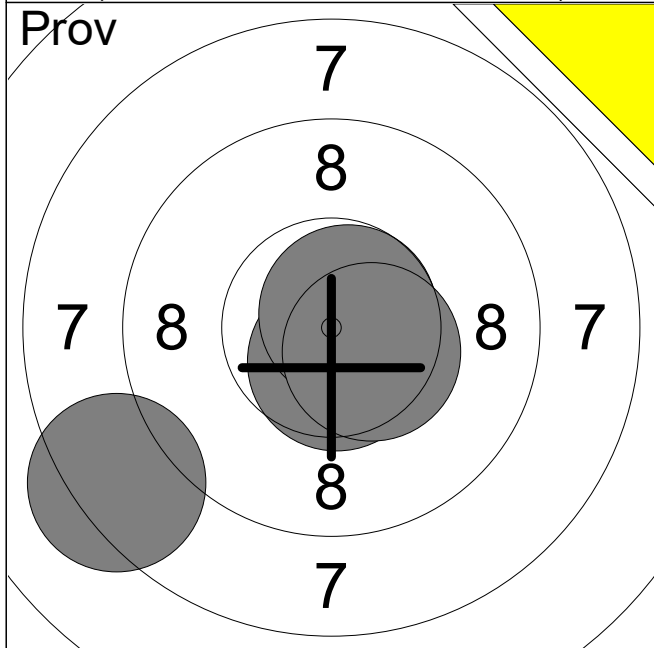

11:	10.6x	↓
12:	10.7x	↗
13:	8.3	←
14:	10.5x	↘
<b>Serie</b>		<b>40.1</b>
<b>Total</b>		<b>362.0</b>

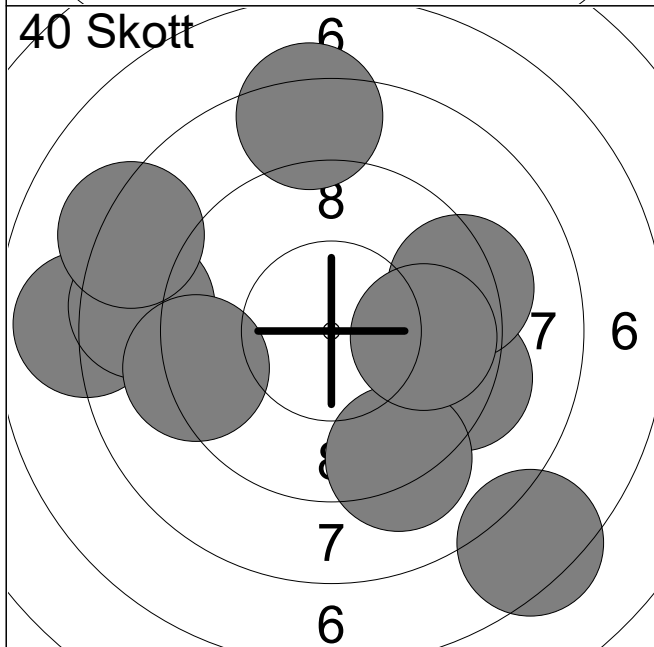

1:	9.3	→
2:	7.4	↘
3:	7.9	←
4:	8.6	←
5:	8.3	↑
6:	9.2	←
7:	9.2	↘
8:	9.3	→
9:	9.8	→
10:	8.2	←
<b>Serie</b>		<b>87.2</b>
<b>Total</b>		<b>449.2</b>