

<p style="font-size: 1.5em; margin:0;">Prov</p> 	<table style="width:100%; border-collapse: collapse;"> <tr> <td style="width:10%; text-align: right;">1:</td> <td style="width:10%;">10.1</td> <td style="width:10%; text-align: right;">↗</td> </tr> <tr> <td style="text-align: right;">2:</td> <td>9.5</td> <td style="text-align: right;">↘</td> </tr> <tr> <td style="text-align: right;">3:</td> <td>9.5</td> <td style="text-align: right;">↘</td> </tr> </table>	1:	10.1	↗	2:	9.5	↘	3:	9.5	↘
1:	10.1	↗								
2:	9.5	↘								
3:	9.5	↘								
<table style="width:100%; border-collapse: collapse;"> <tr> <td style="width:10%;">Serie</td> <td style="width:10%;"></td> <td style="width:10%; text-align: right;">28.0</td> </tr> </table>		Serie		28.0						
Serie		28.0								
<table style="width:100%; border-collapse: collapse;"> <tr> <td style="width:10%;">Total</td> <td style="width:10%;"></td> <td style="width:10%; text-align: right;">237.0</td> </tr> </table>		Total		237.0						
Total		237.0								

<p style="font-size: 1.5em; margin:0;">10 Skott</p> 	<table style="width:100%; border-collapse: collapse;"> <tr> <td style="width:10%; text-align: right;">1:</td> <td style="width:10%;">10.1</td> <td style="width:10%; text-align: right;">↗</td> </tr> <tr> <td style="text-align: right;">2:</td> <td>8.5</td> <td style="text-align: right;">↘</td> </tr> <tr> <td style="text-align: right;">3:</td> <td>9.2</td> <td style="text-align: right;">↘</td> </tr> <tr> <td style="text-align: right;">4:</td> <td>10.0</td> <td style="text-align: right;">→</td> </tr> <tr> <td style="text-align: right;">5:</td> <td>9.5</td> <td style="text-align: right;">↗</td> </tr> </table>	1:	10.1	↗	2:	8.5	↘	3:	9.2	↘	4:	10.0	→	5:	9.5	↗
1:	10.1	↗														
2:	8.5	↘														
3:	9.2	↘														
4:	10.0	→														
5:	9.5	↗														
<table style="width:100%; border-collapse: collapse;"> <tr> <td style="width:10%;">Serie</td> <td style="width:10%;"></td> <td style="width:10%; text-align: right;">46.0</td> </tr> </table>		Serie		46.0												
Serie		46.0														
<table style="width:100%; border-collapse: collapse;"> <tr> <td style="width:10%;">Total</td> <td style="width:10%;"></td> <td style="width:10%; text-align: right;">283.0</td> </tr> </table>		Total		283.0												
Total		283.0														

<p style="font-size: 1.5em; margin:0;">10 Skott</p> 	<table style="width:100%; border-collapse: collapse;"> <tr> <td style="width:10%; text-align: right;">6:</td> <td style="width:10%;">9.3</td> <td style="width:10%; text-align: right;">↘</td> </tr> <tr> <td style="text-align: right;">7:</td> <td>10.2</td> <td style="text-align: right;">→</td> </tr> <tr> <td style="text-align: right;">8:</td> <td>9.2</td> <td style="text-align: right;">↘</td> </tr> <tr> <td style="text-align: right;">9:</td> <td>10.0</td> <td style="text-align: right;">←</td> </tr> <tr> <td style="text-align: right;">10:</td> <td>10.3</td> <td style="text-align: right;">↘</td> </tr> </table>	6:	9.3	↘	7:	10.2	→	8:	9.2	↘	9:	10.0	←	10:	10.3	↘
6:	9.3	↘														
7:	10.2	→														
8:	9.2	↘														
9:	10.0	←														
10:	10.3	↘														
<table style="width:100%; border-collapse: collapse;"> <tr> <td style="width:10%;">Serie</td> <td style="width:10%;"></td> <td style="width:10%; text-align: right;">48.0</td> </tr> </table>		Serie		48.0												
Serie		48.0														
<table style="width:100%; border-collapse: collapse;"> <tr> <td style="width:10%;">Total</td> <td style="width:10%;"></td> <td style="width:10%; text-align: right;">331.0</td> </tr> </table>		Total		331.0												
Total		331.0														

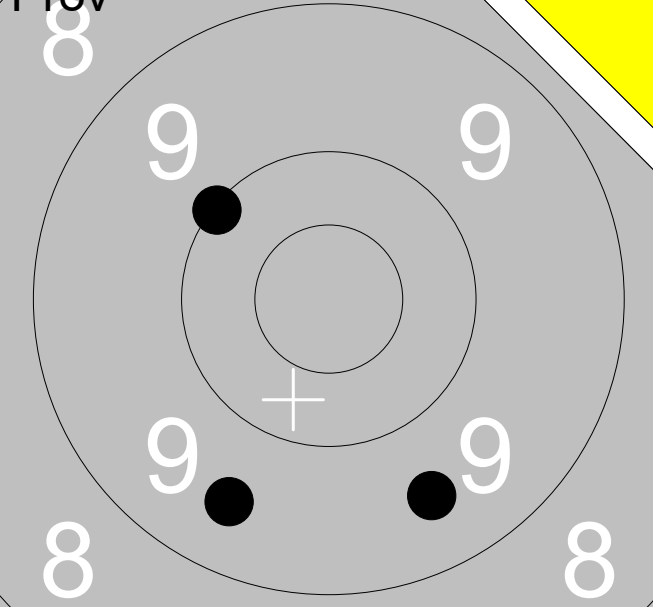
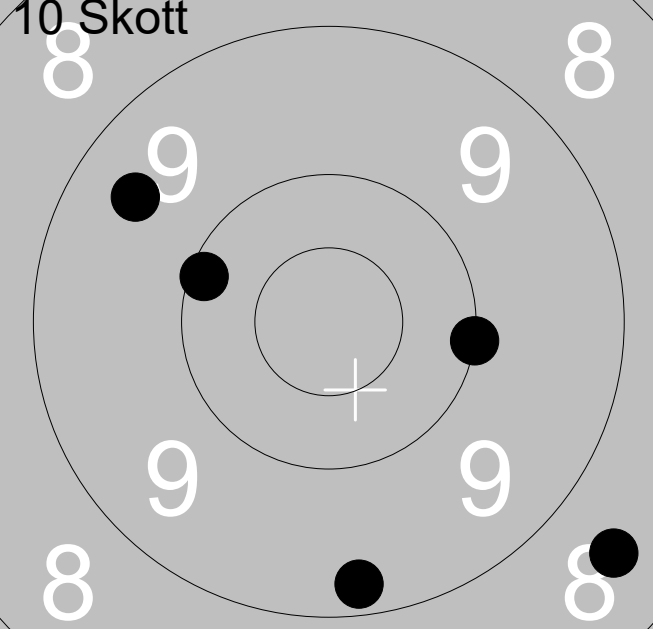
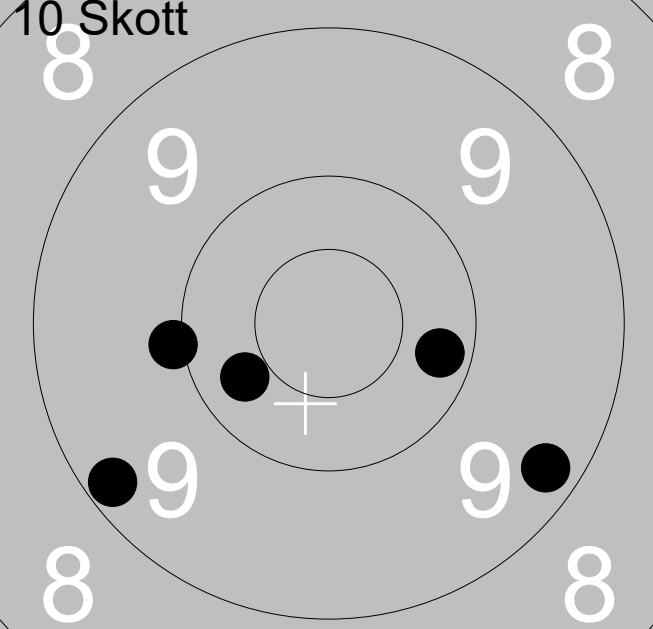
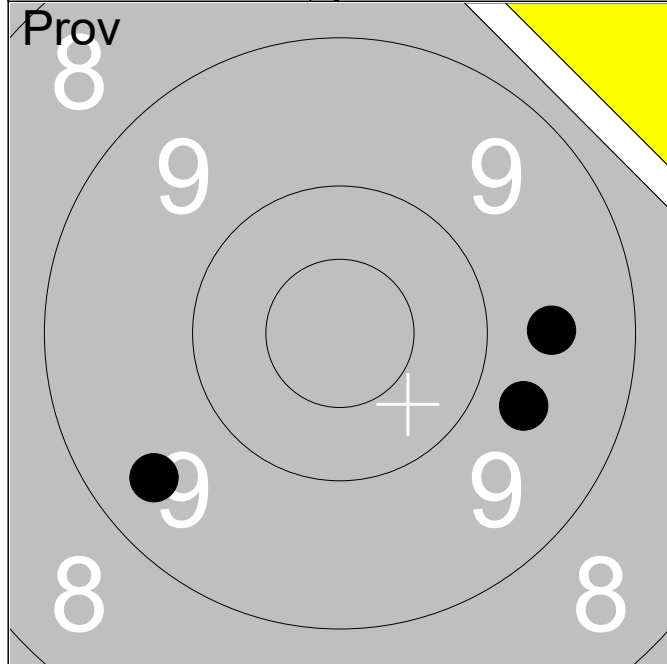

1:	9.7	→
2:	9.6	→
3:	9.4	↙

Serie	27.0
Total	234.0

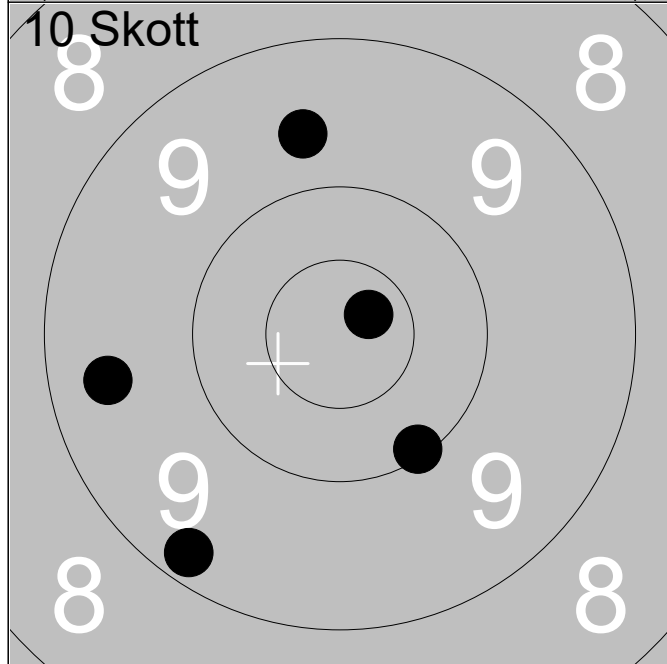

1:	9.7	↑
2:	9.4	←
3:	10.7x	↗
4:	9.2	↙
5:	10.1	↘

Serie	47.0
Total	281.0

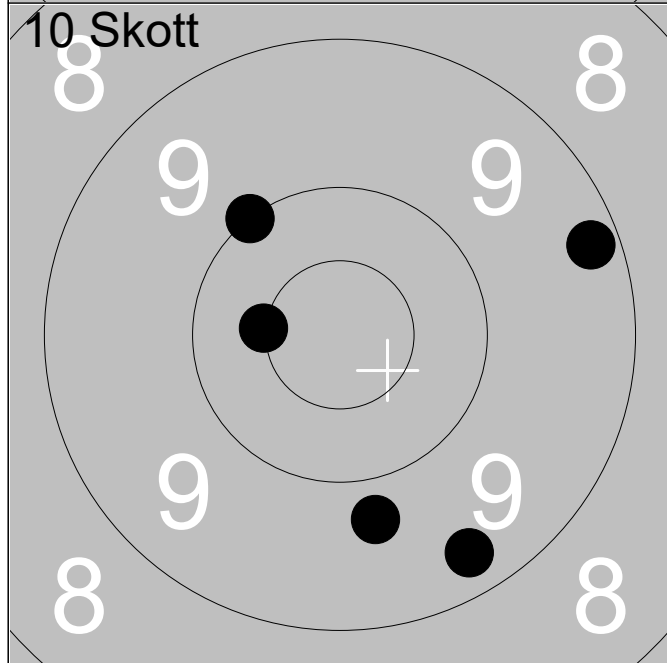

6:	9.2	→
7:	10.0	↗
8:	9.8	↘
9:	9.3	↙
10:	10.5x	←

Serie	47.0
Total	328.0

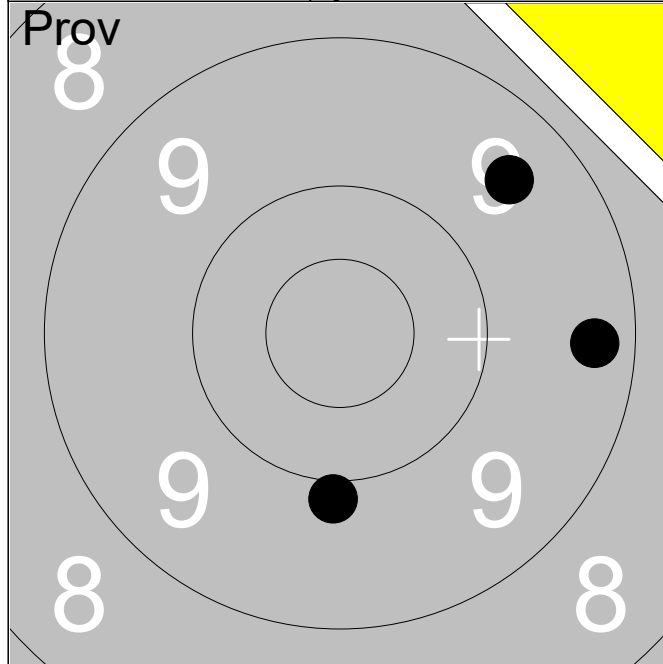

	1:	9.9			↓
	2:	9.3			→
	3:	9.5			↗
Serie					27.0
Total					233.0

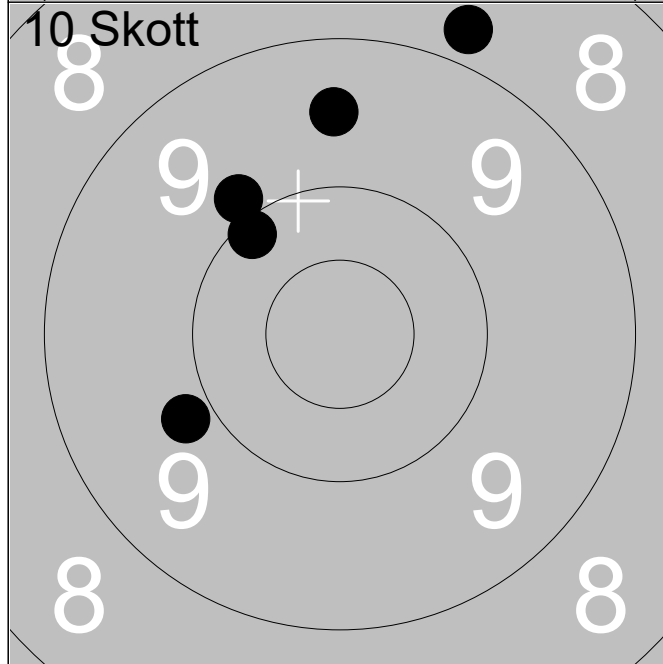

	1:	10.1			↖
	2:	9.9			↖
	3:	8.8			↗
	4:	9.5			↑
	5:	9.8			↙
Serie					45.0
Total					278.0

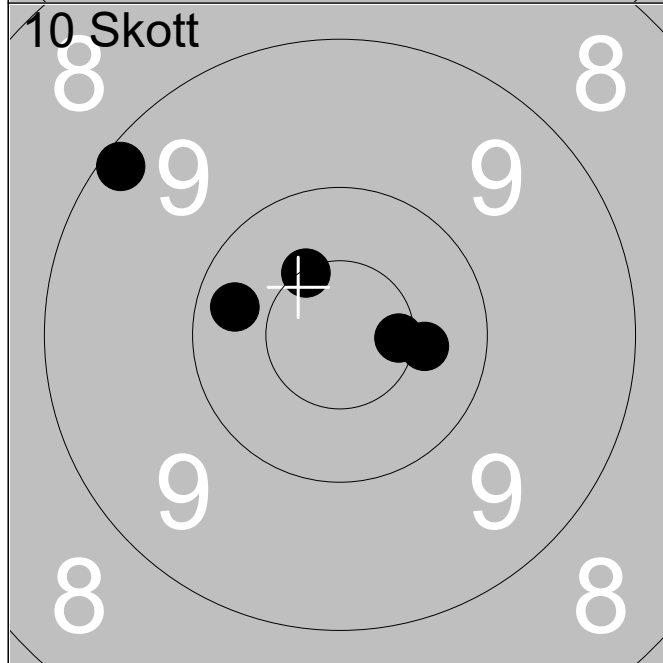

	6:	9.2			↖
	7:	10.4x			→
	8:	10.6x			→
	9:	10.5x			↗
	10:	10.3			↙
Serie					49.0
Total					327.0

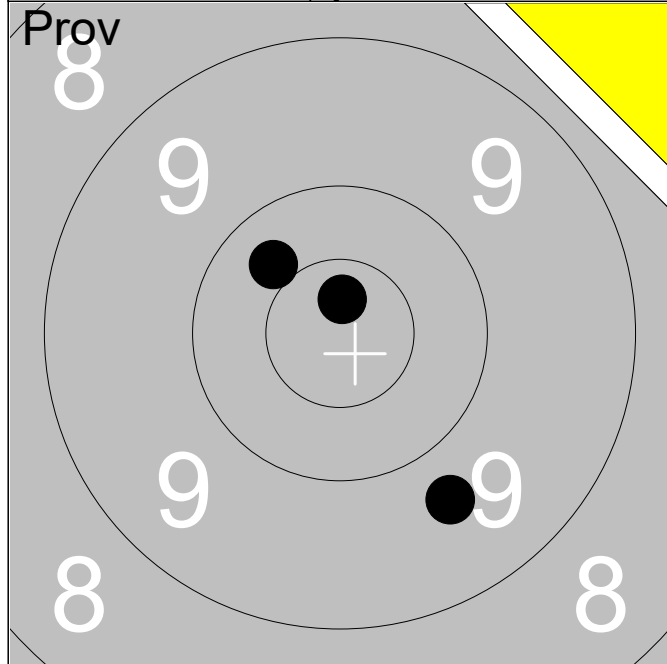

1:	9.7	↘
2:	10.7x	↑
3:	10.4	↗
Serie		29.0
Total		229.0

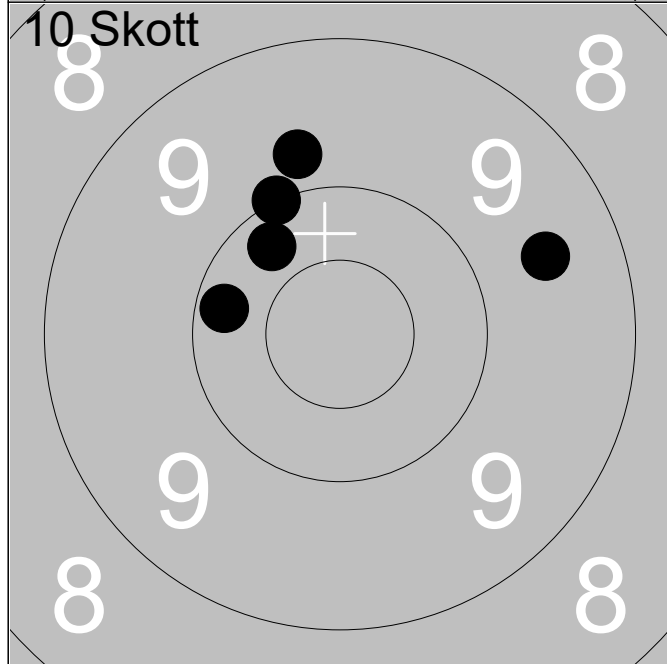

1:	10.2	←
2:	9.8	↑
3:	9.5	→
4:	10.3	↗
5:	10.0	↗
Serie		48.0
Total		277.0

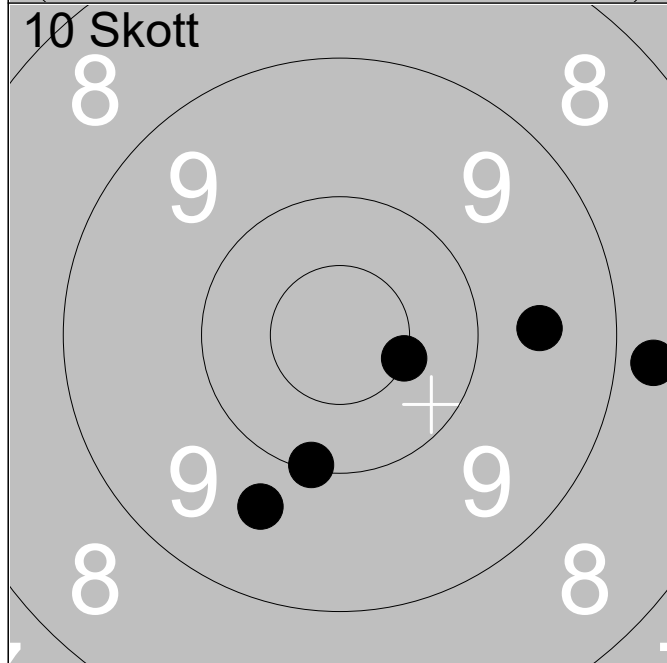

6:	8.8	→
7:	9.6	→
8:	10.1	↘
9:	9.7	↘
10:	10.5x	→
Serie		46.0
Total		323.0

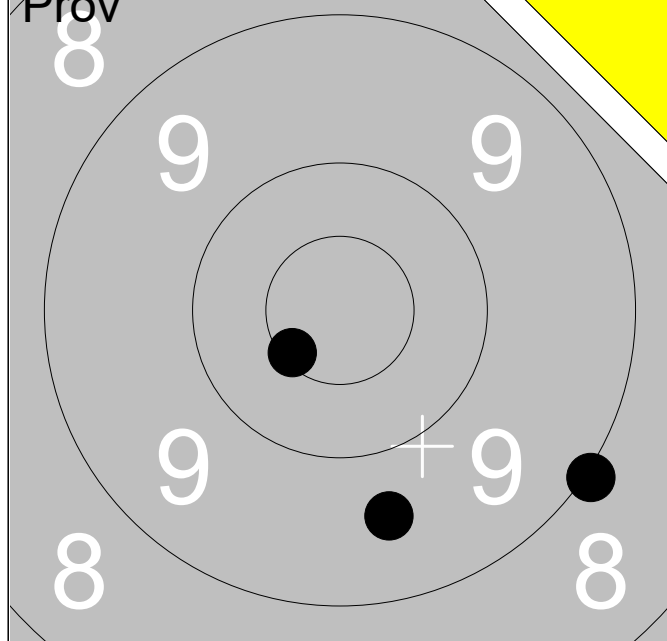

1:	10.6x	↙
2:	9.0	↘
3:	9.6	↓
Serie		28.0
Total		226.0

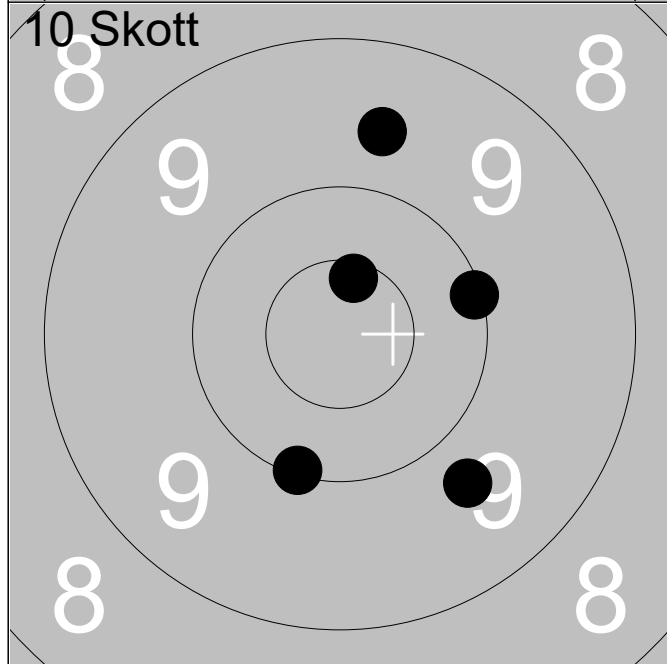

1:	9.6	↑
2:	10.1	→
3:	10.6x	↑
4:	10.1	↓
5:	9.7	↘
Serie		48.0
Total		274.0

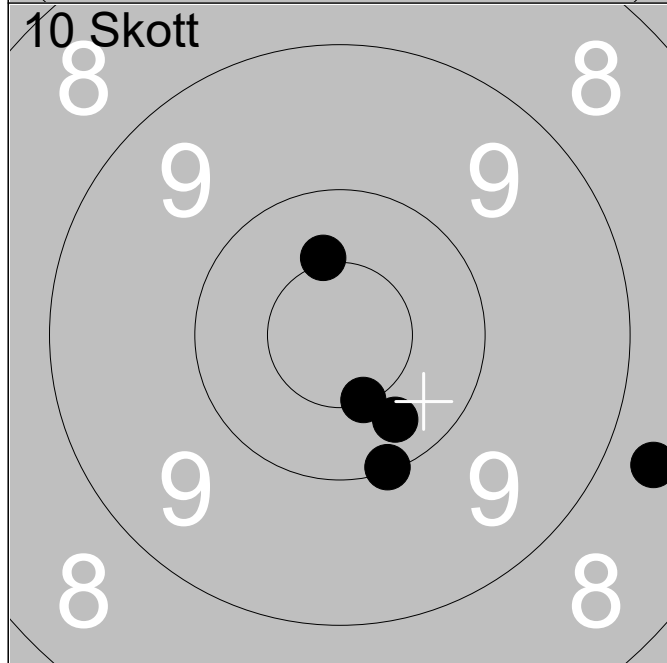

6:	8.7	↘
7:	10.3	↓
8:	10.4x	↑
9:	10.5x	↓
10:	10.1	↓
Serie		48.0
Total		322.0

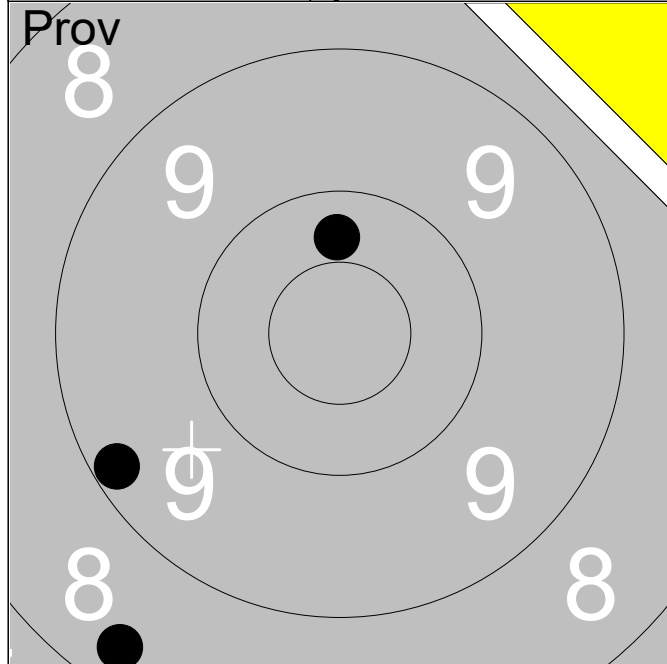

	1:	10.3			↑
	2:	8.3			↙
	3:	9.2			↘
Serie					27.0
Total					225.0

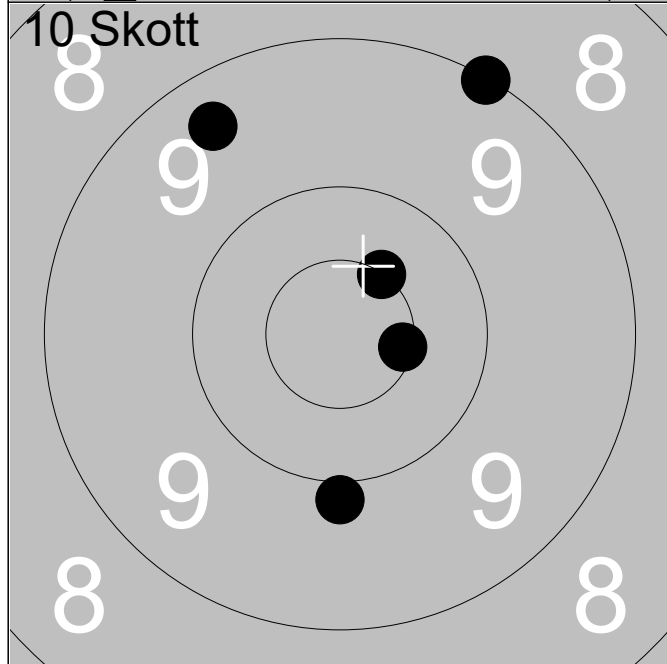

	1:	9.4			↖
	2:	9.0			↗
	3:	10.5x			↗
	4:	10.5x			→
	5:	9.9			↓
Serie					47.0
Total					272.0

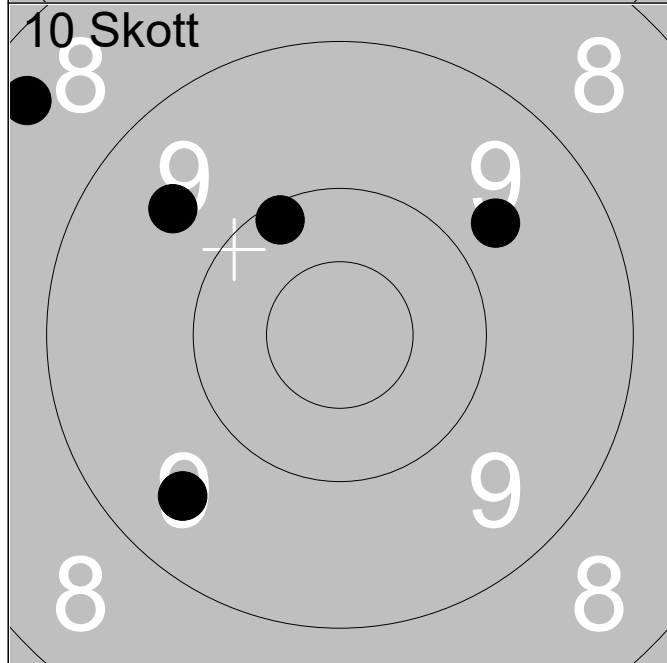

	6:	10.1			↖
	7:	9.6			↖
	8:	8.4			↖
	9:	9.5			↙
	10:	9.7			↗
Serie					45.0
Total					317.0

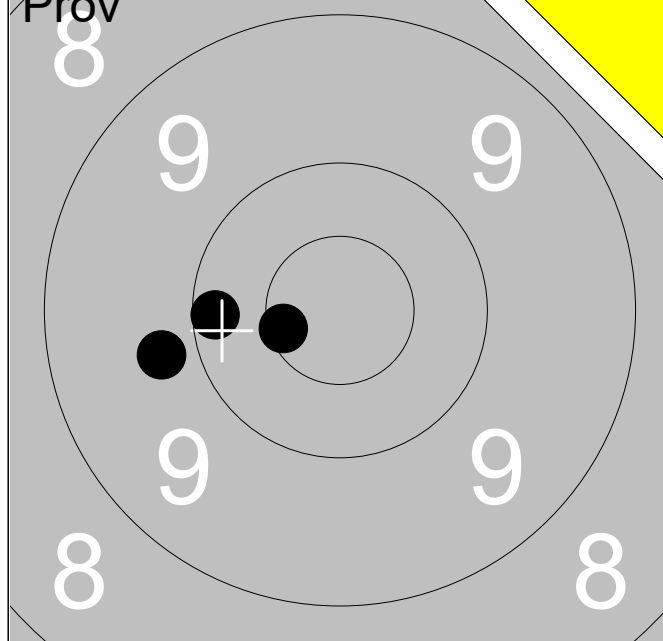

	1:	9.8	←
	2:	10.2	←
	3:	10.6x	←
Serie			29.0
Total			224.0

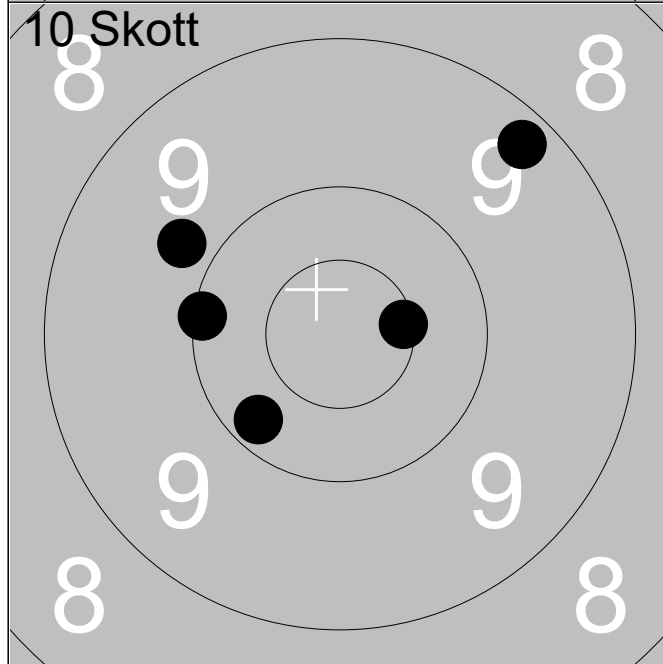

	1:	9.8	↖
	2:	9.3	↗
	3:	10.2	↙
	4:	10.1	←
	5:	10.5x	→
Serie			48.0
Total			272.0

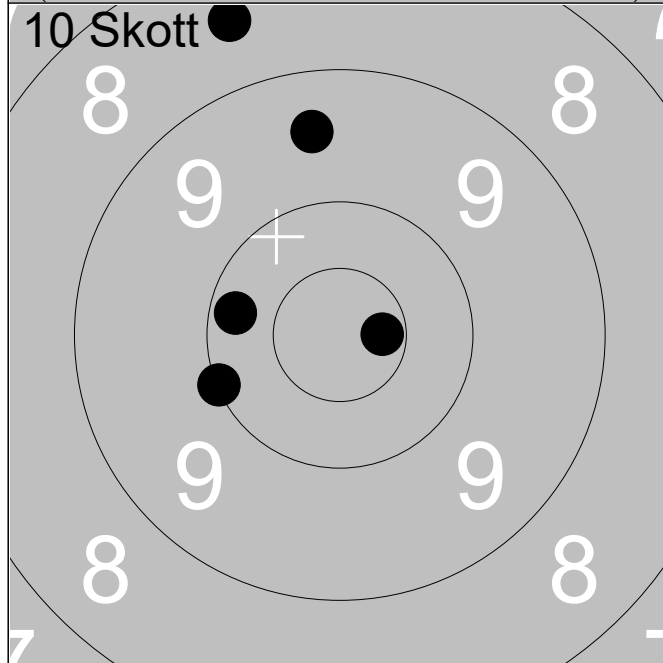

	6:	8.5	↗
	7:	10.0	←
	8:	10.2	←
	9:	10.7x	→
	10:	9.5	↗
Serie			47.0
Total			319.0

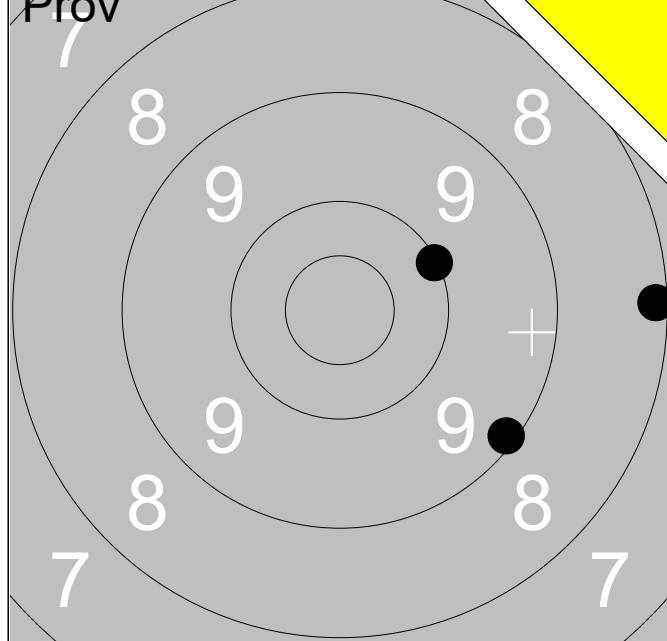

1:	9.1	↘
2:	10.1	↗
3:	8.1	→
Serie		27.0
Total		214.0

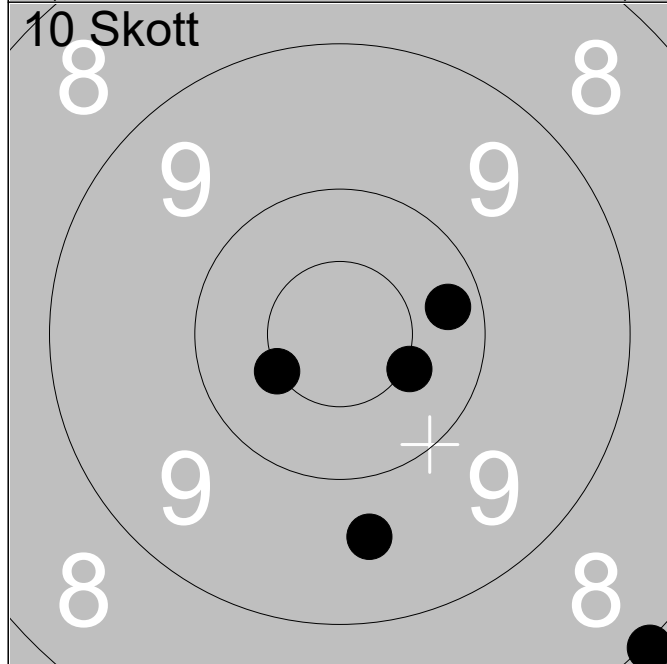

1:	8.0	↘
2:	10.5x	↙
3:	9.6	↓
4:	10.5x	↗
5:	10.2	→
Serie		47.0
Total		261.0

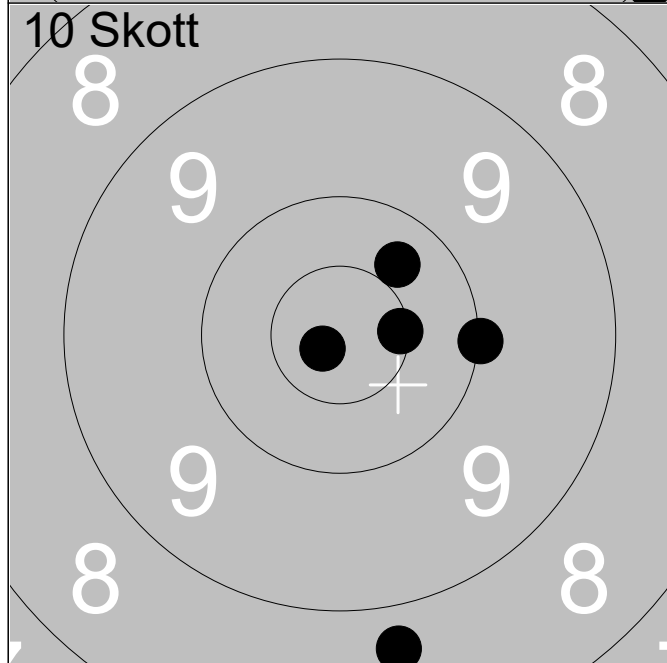

6:	10.0	→
7:	10.3	↗
8:	10.5x	→
9:	10.8x	↙
10:	8.7	↓
Serie		48.0
Total		309.0

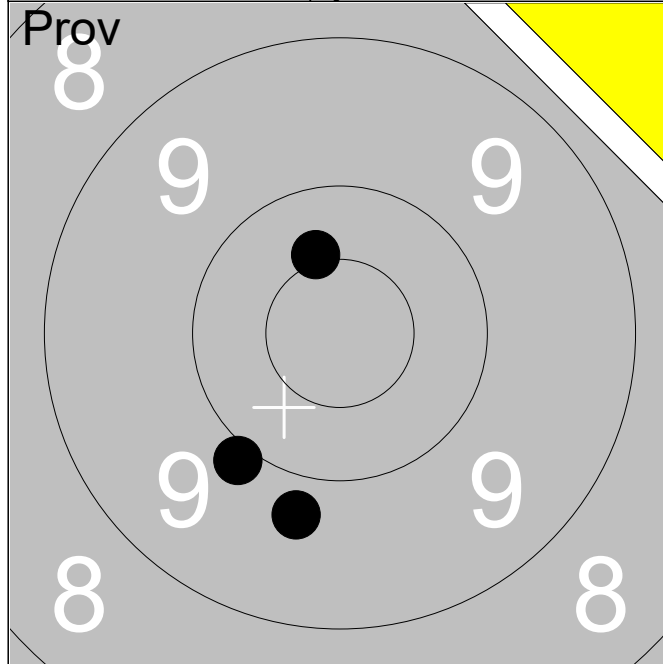

	1:	10.4x	↑
	2:	9.9	↘
	3:	9.8	↘
Serie			28.0
Total			214.0

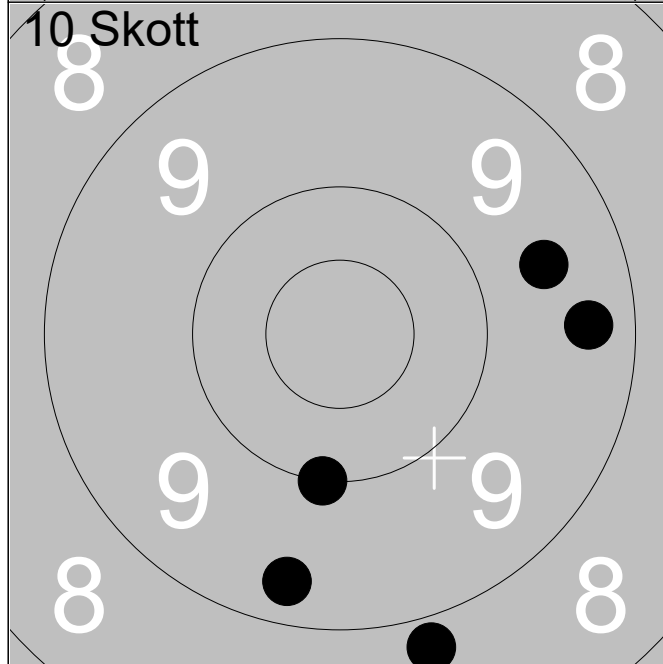

	1:	8.8	↘
	2:	9.6	→
	3:	10.0	↘
	4:	9.3	↘
	5:	9.3	→
Serie			45.0
Total			259.0

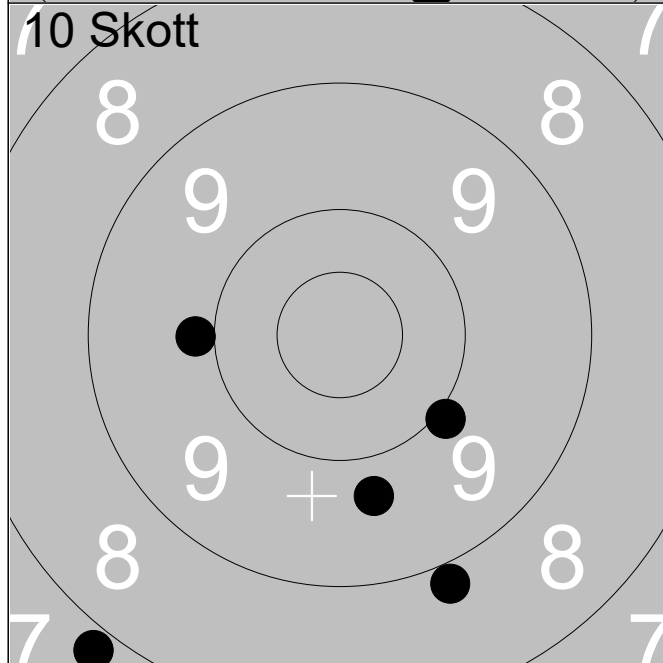

	6:	9.7	↘
	7:	9.9	←
	8:	10.0	↘
	9:	8.9	↘
	10:	7.9	↘
Serie			43.0
Total			302.0

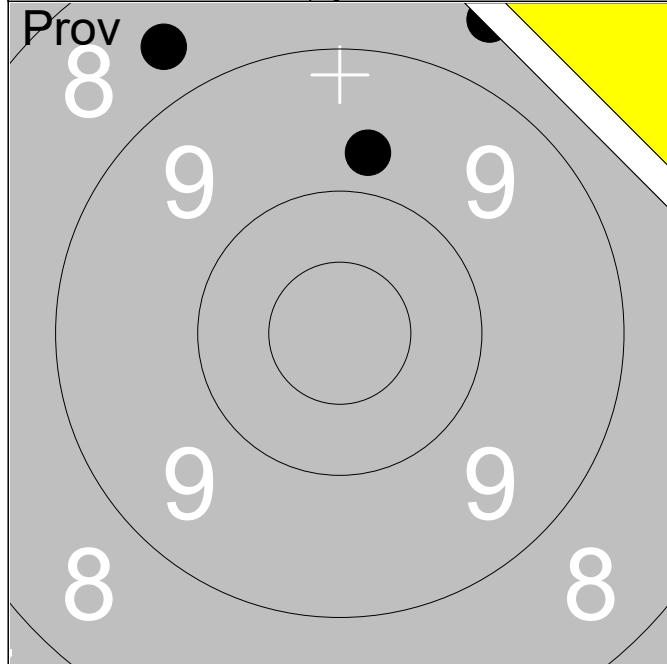

	1:	9.7			↑
	2:	8.6			↗
	3:	8.7			↖
Serie					25.0
Total					210.0

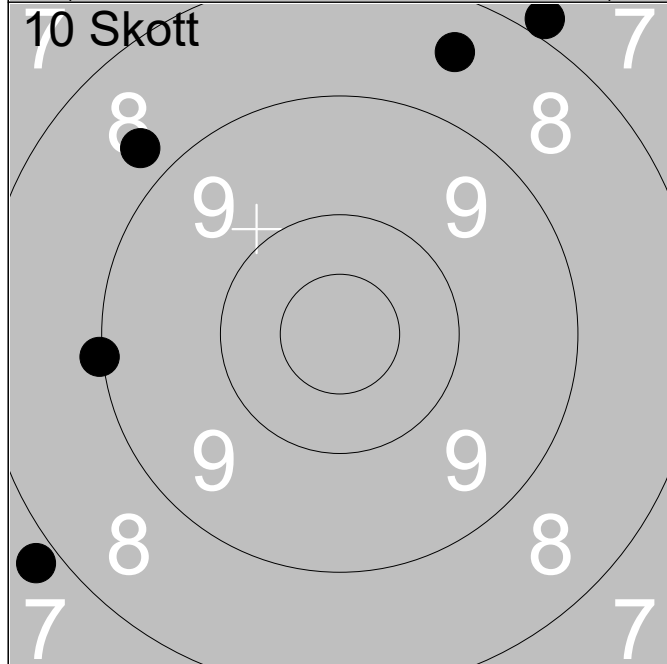

	1:	7.8			↙
	2:	9.0			←
	3:	8.7			↖
	4:	7.9			↗
	5:	8.5			↗
Serie					39.0
Total					249.0

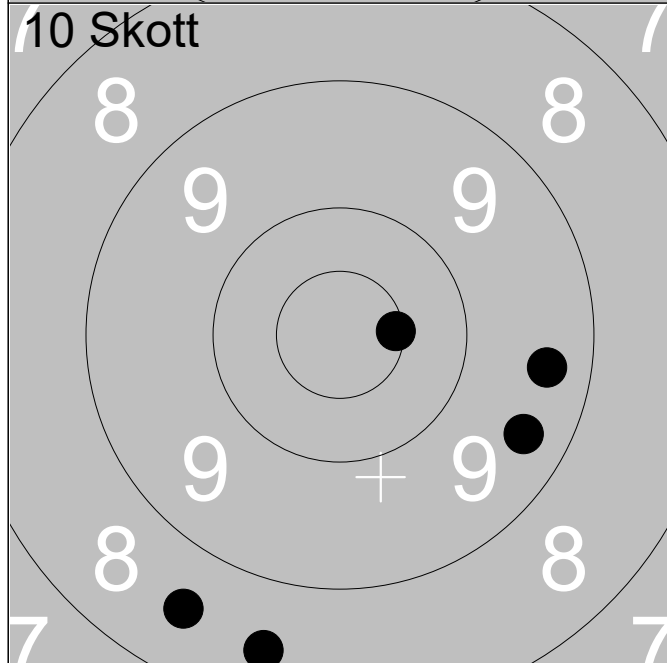

	6:	9.4			→
	7:	8.5			↙
	8:	8.5			↓
	9:	10.5x			→
	10:	9.4			↘
Serie					44.0
Total					293.0

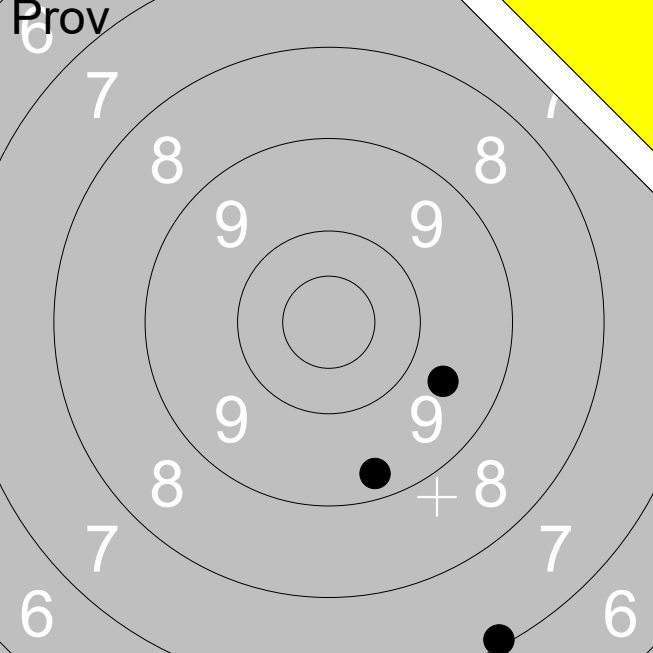
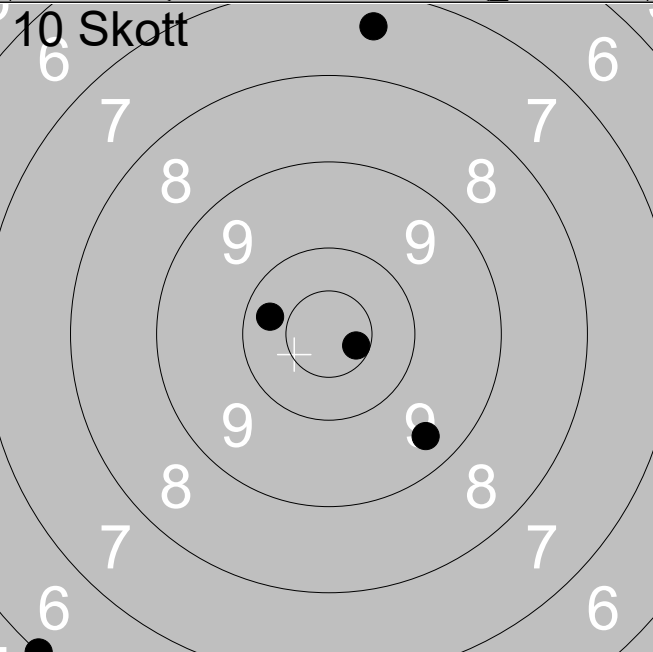
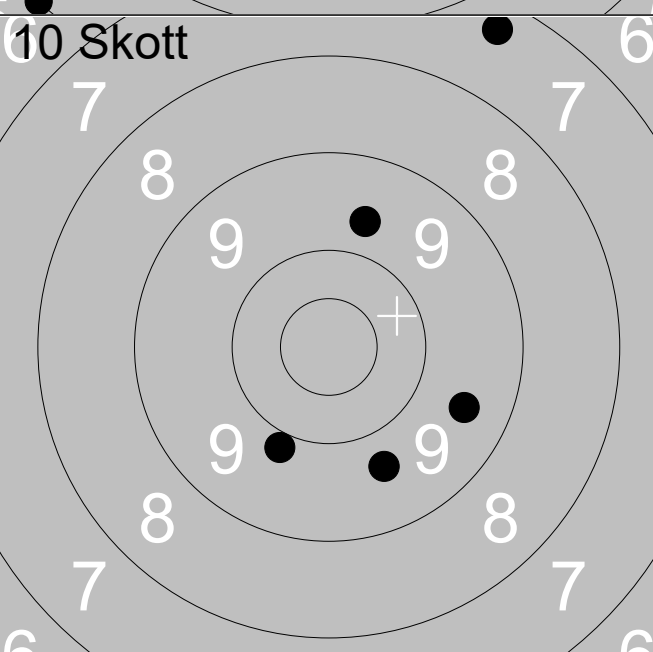
06.07.2024	Björkskottet 2024	Ramselefors SKF	
<div style="display: flex; align-items: center;"> <div style="width: 45%;"> <p>Prov</p>  </div> <div style="width: 55%; text-align: right;"> <p>1: 9.3 ↘</p> <p>2: 7.1 ↘</p> <p>3: 9.6 ↘</p> </div> </div>			
		Serie	25.0
		Total	207.0
<div style="display: flex; align-items: center;"> <div style="width: 45%;"> <p>10 Skott</p>  </div> <div style="width: 55%; text-align: right;"> <p>1: 6.0 ↙</p> <p>2: 10.6x →</p> <p>3: 9.4 ↘</p> <p>4: 7.4 ↑</p> <p>5: 10.3 ←</p> </div> </div>			
		Serie	42.0
		Total	249.0
<div style="display: flex; align-items: center;"> <div style="width: 45%;"> <p>10 Skott</p>  </div> <div style="width: 55%; text-align: right;"> <p>6: 9.7 ↑</p> <p>7: 9.5 →</p> <p>8: 9.7 ↘</p> <p>9: 9.9 ↘</p> <p>10: 7.3 ↑</p> </div> </div>			
		Serie	43.0
		Total	292.0

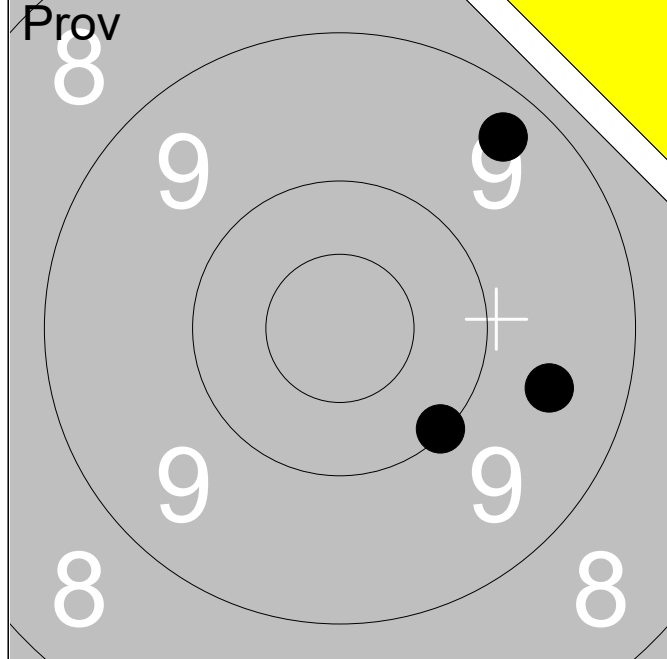

1:	9.6	→
2:	9.3	↗
3:	10.1	↘
Serie		28.0
Total		207.0

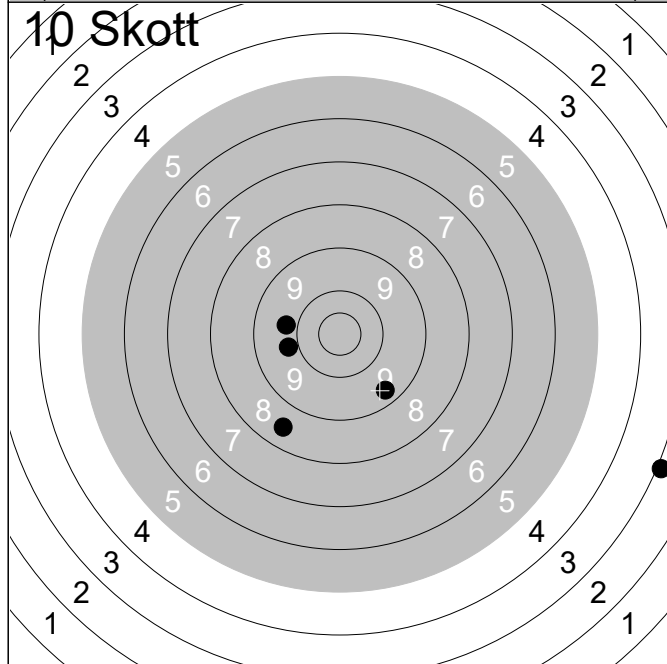

1:	2.9	→
2:	9.8	←
3:	9.8	←
4:	8.5	↘
5:	9.4	↘
Serie		37.0
Total		244.0

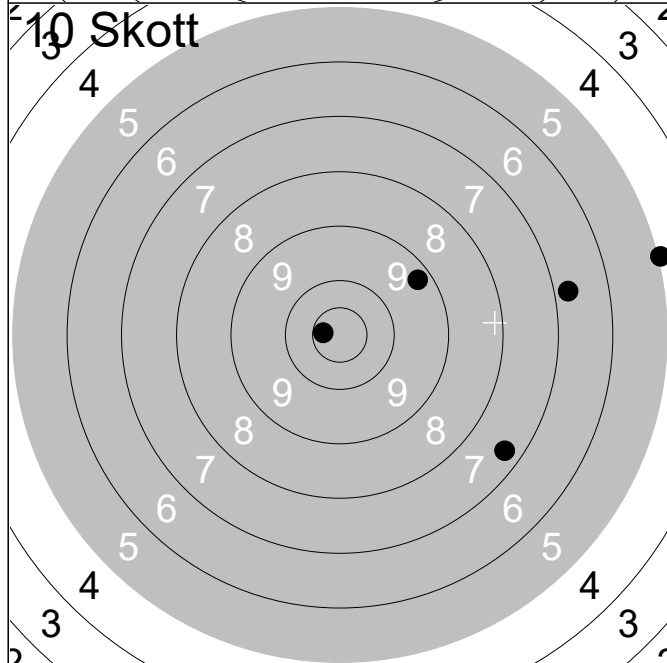

6:	5.0	→
7:	9.3	↗
8:	7.3	↘
9:	6.8	→
10:	10.7x	←
Serie		37.0
Total		281.0

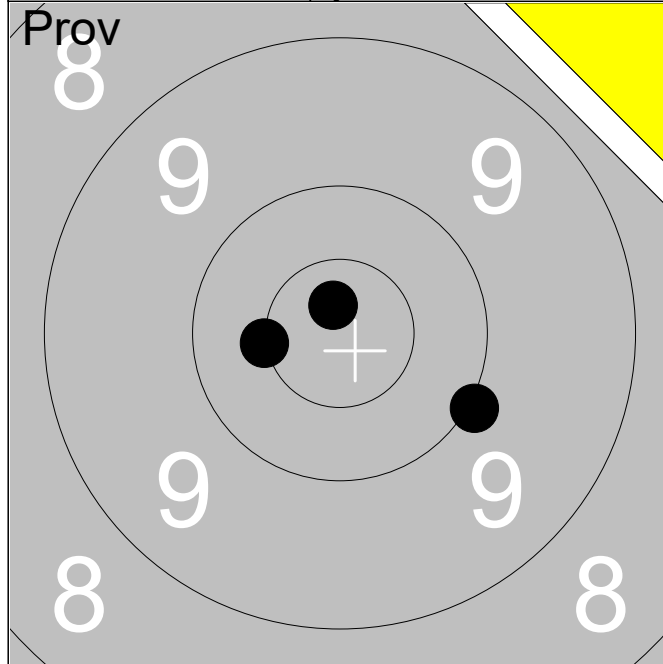

	1:	10.0	↘
	2:	10.8x	↑
	3:	10.5x	←
<hr/>			
Serie			30.0
Total			236.0

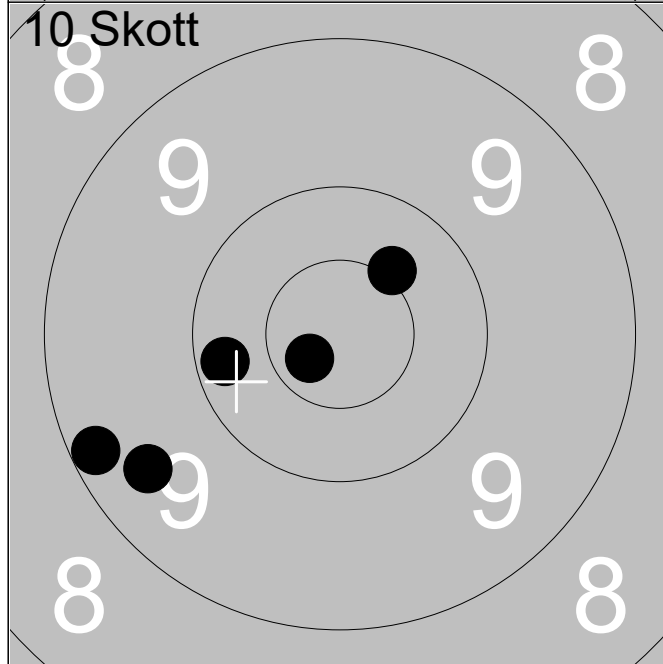

	1:	10.7x	↙
	2:	10.4x	↗
	3:	9.2	↙
	4:	9.4	↙
	5:	10.2	←
<hr/>			
Serie			48.0
Total			284.0

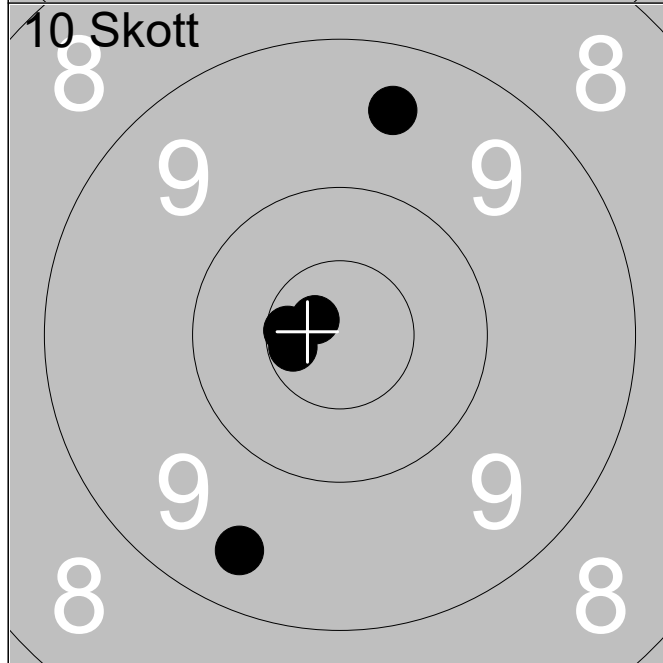

	6:	10.6x	←
	7:	10.8x	↖
	8:	10.6x	←
	9:	9.5	↑
	10:	9.4	↙
<hr/>			
Serie			48.0
Total			332.0

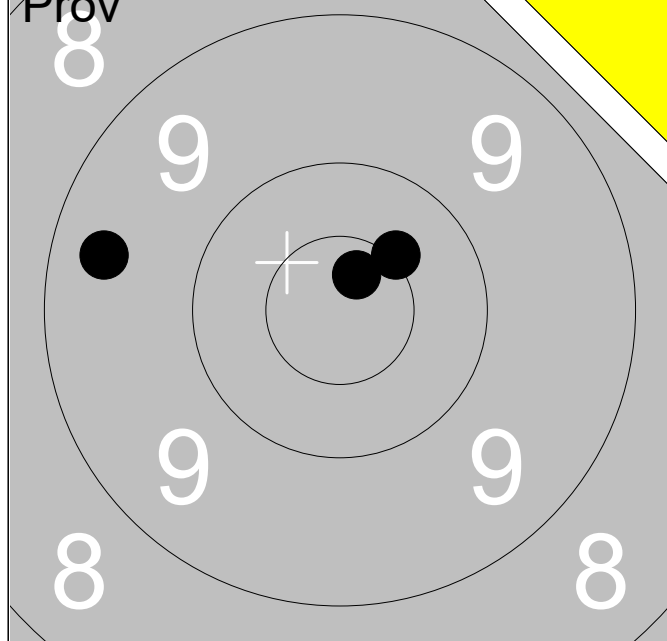

	1:	10.7x	↗
	2:	9.4	↖
	3:	10.5x	↗
Serie			29.0
Total			211.0

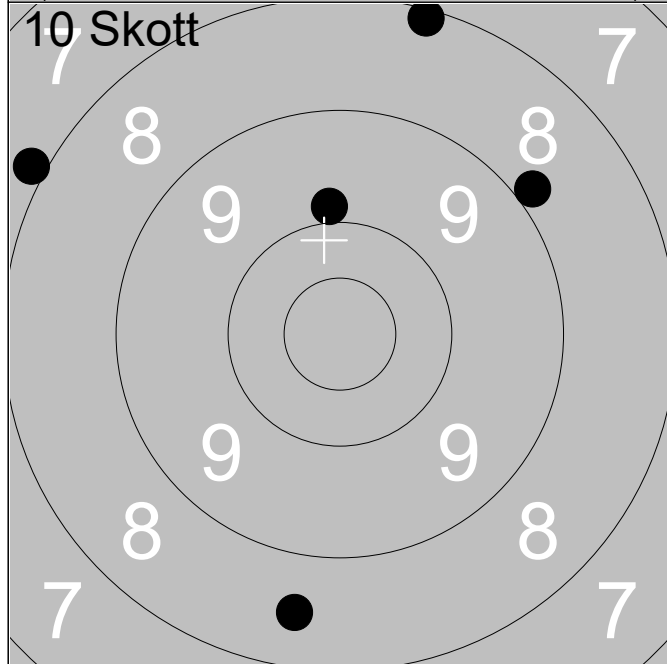

	1:	9.9	↗
	2:	8.9	↗
	3:	8.1	↗
	4:	7.9	↖
	5:	8.5	↘
Serie			40.0
Total			251.0

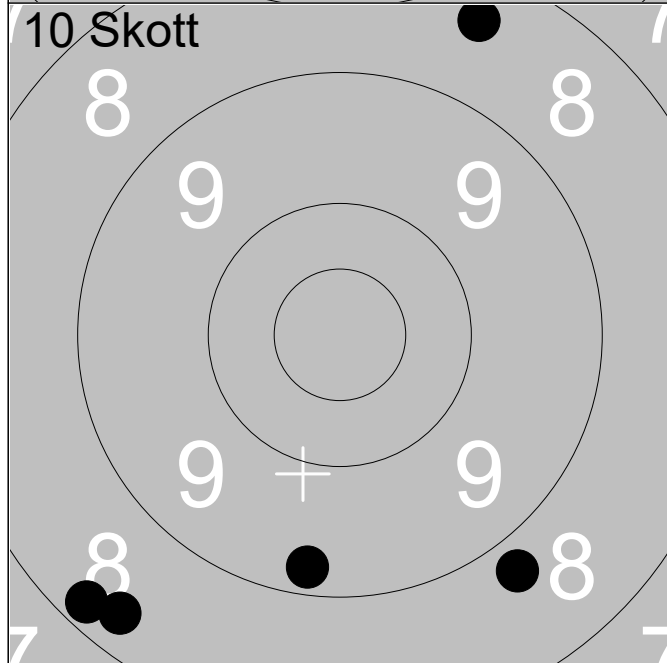

	6:	8.4	↗
	7:	8.3	↖
	8:	9.2	↘
	9:	8.2	↖
	10:	8.8	↘
Serie			41.0
Total			292.0

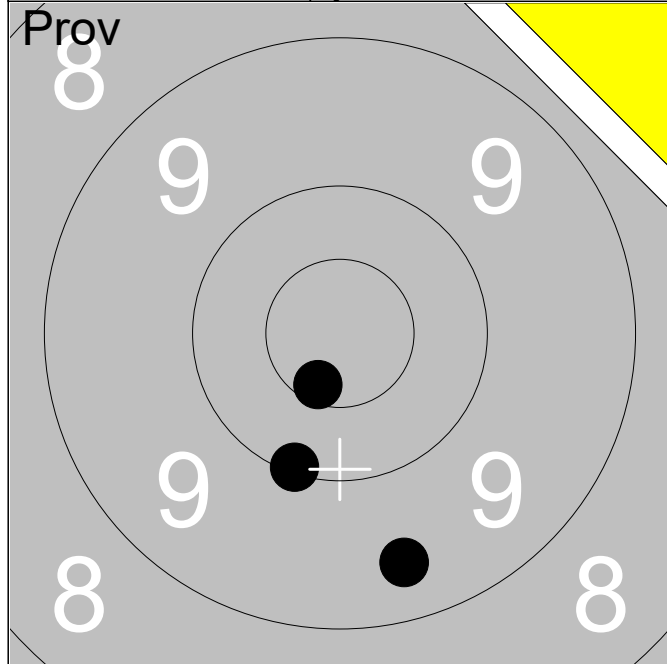

1:	10.6x	↙
2:	9.4	↘
3:	10.1	↙
Serie		29.0
Total		234.0

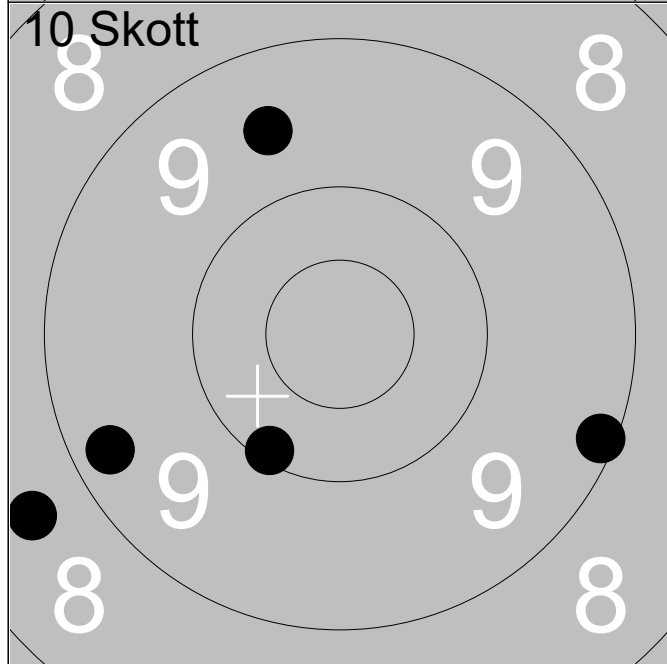

1:	9.3	↙
2:	9.6	↗
3:	9.1	→
4:	10.1	↙
5:	8.6	↙
Serie		45.0
Total		279.0

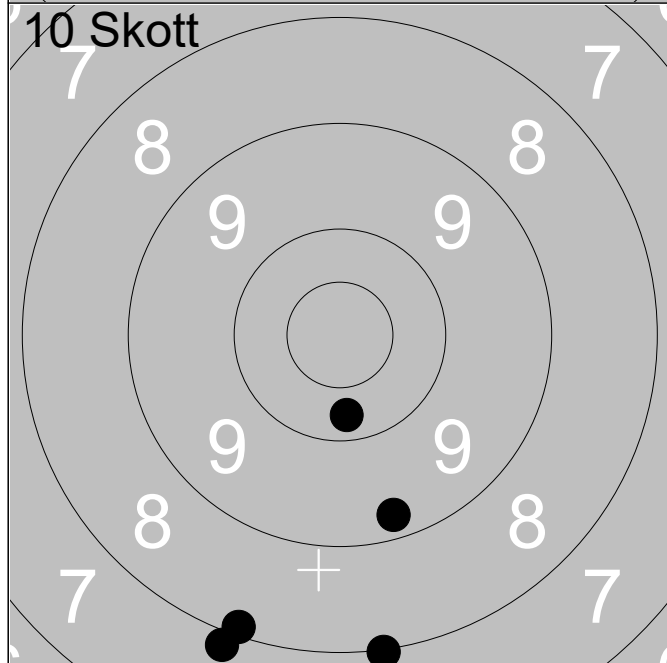

6:	10.2	↓
7:	7.9	↙
8:	8.0	↘
9:	9.3	↘
10:	8.1	↘
Serie		42.0
Total		321.0

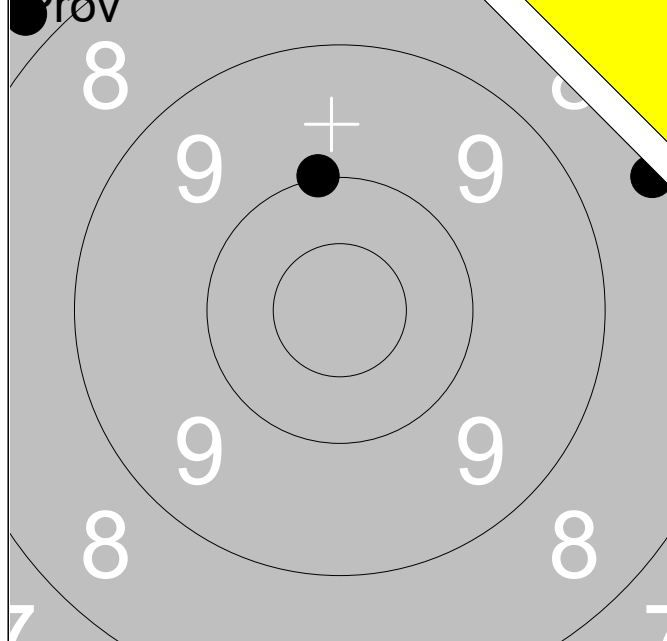

	1:	8.5	→
	2:	7.8	↖
	3:	10.0	↑
Serie			25.0
Total			233.0

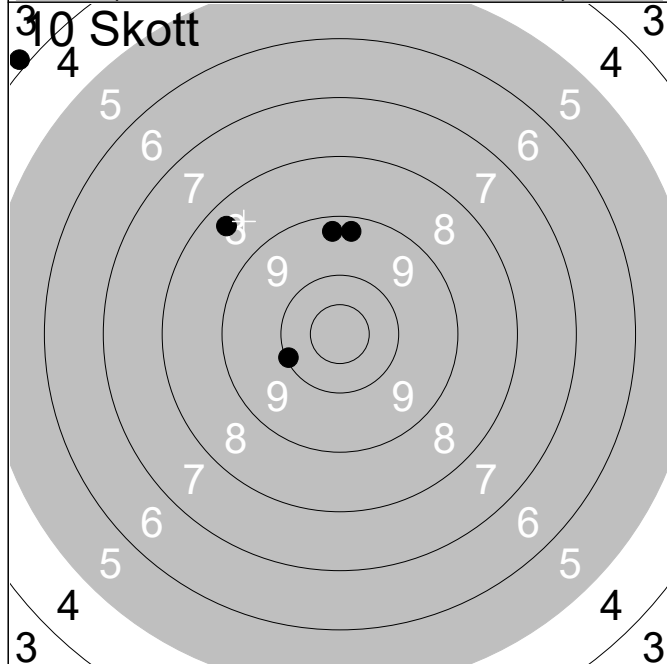

	1:	3.9	↖
	2:	10.1	↙
	3:	8.4	↖
	4:	9.3	↑
	5:	9.3	↑
Serie			39.0
Total			272.0

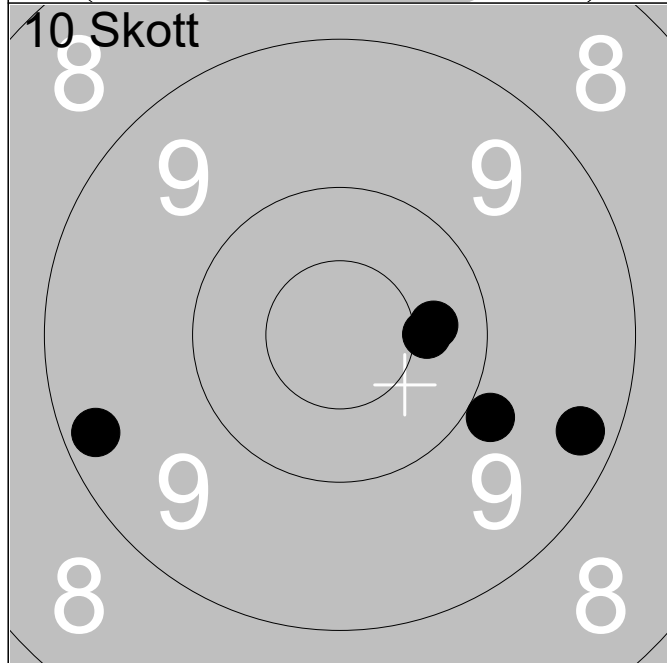

	6:	10.4	→
	7:	9.3	→
	8:	9.9	↘
	9:	10.4	→
	10:	9.3	↙
Serie			47.0
Total			319.0

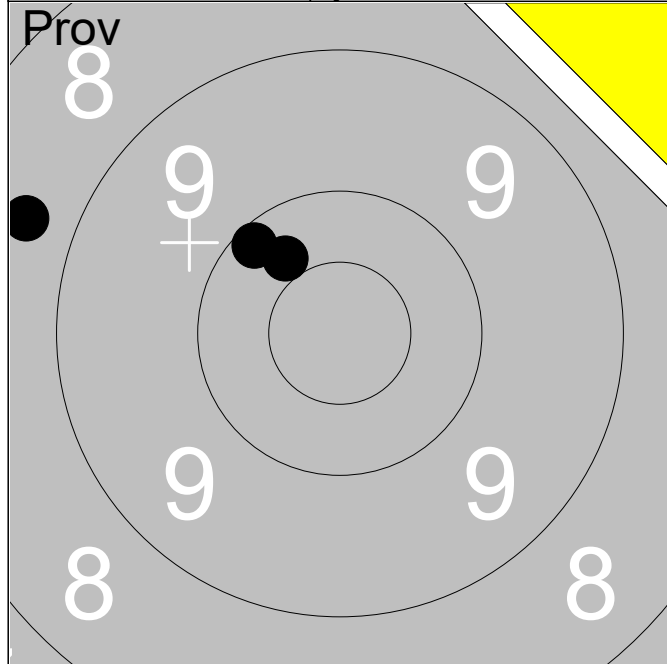

	1:	8.7			↗
	2:	10.2			↗
	3:	10.3			↗
Serie					28.0
Total					232.0

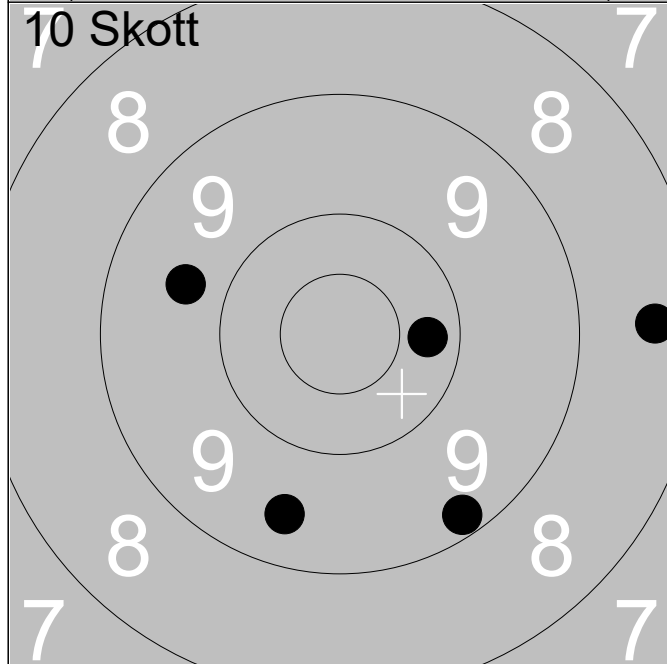

	1:	10.3			→
	2:	8.4			→
	3:	9.2			↘
	4:	9.5			↘
	5:	9.7			↖
Serie					45.0
Total					277.0

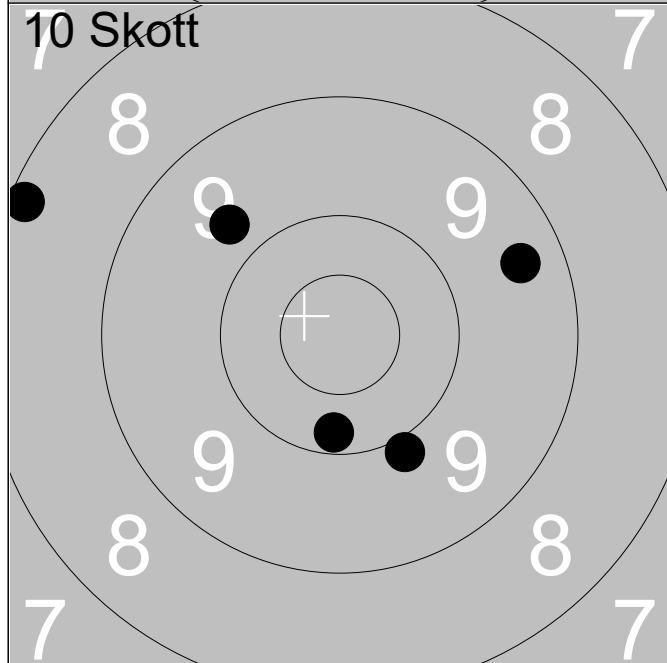

	6:	9.7			↗
	7:	9.4			→
	8:	9.9			↘
	9:	10.2			↘
	10:	8.2			↖
Serie					45.0
Total					322.0

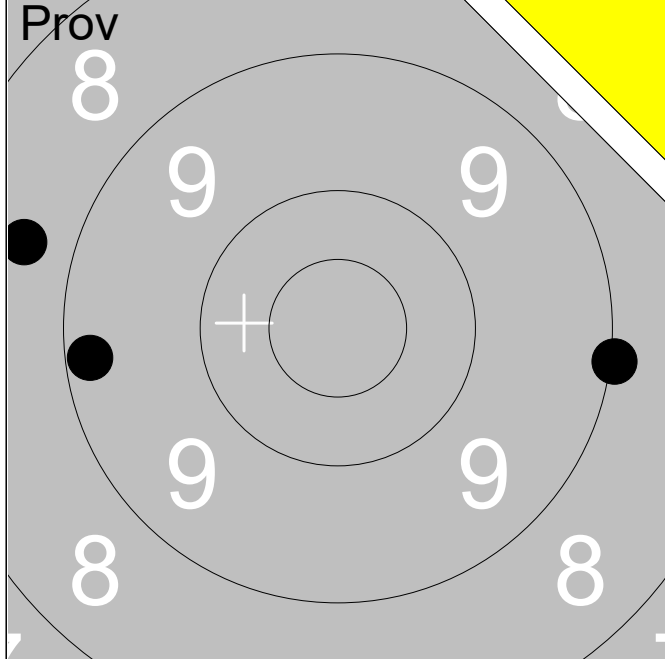

	1:	9.2	←
	2:	8.7	←
	3:	9.0	→
Serie			26.0
Total			232.0

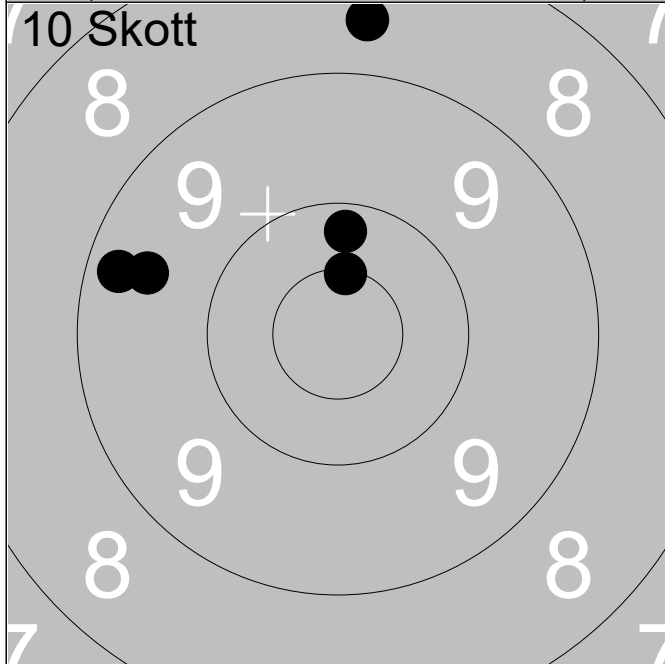

	1:	10.5x	↑
	2:	9.3	←
	3:	10.2	↑
	4:	8.6	↑
	5:	9.5	←
Serie			46.0
Total			278.0

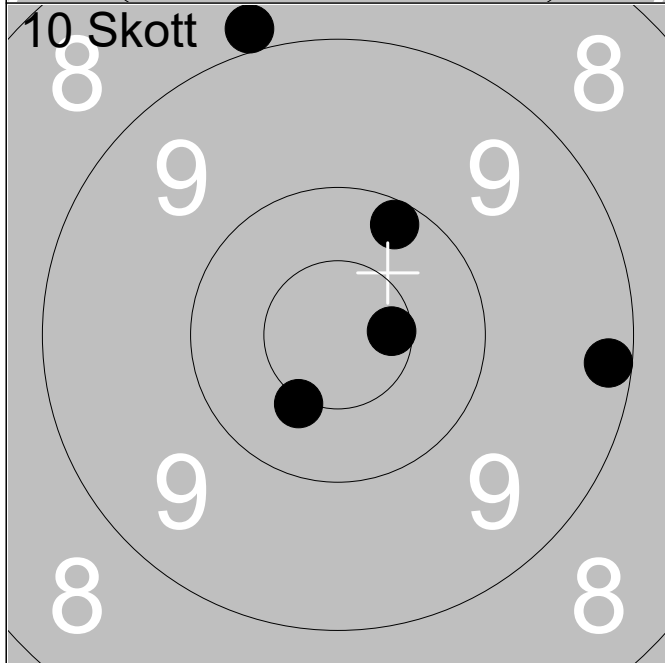

	6:	9.2	→
	7:	10.2	↑
	8:	8.9	↑
	9:	10.6x	→
	10:	10.5x	↙
Serie			47.0
Total			325.0

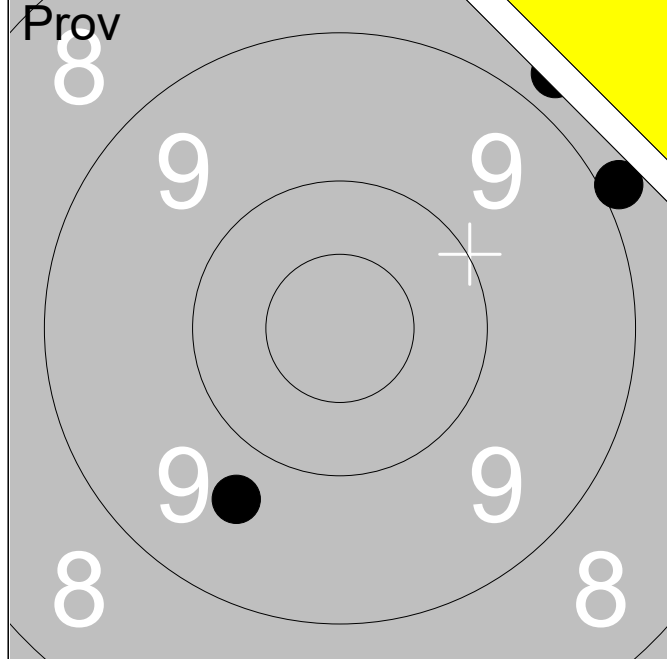

	1:	8.8	↗
	2:	9.7	↘
	3:	8.9	↗
Serie			25.0
Total			226.0

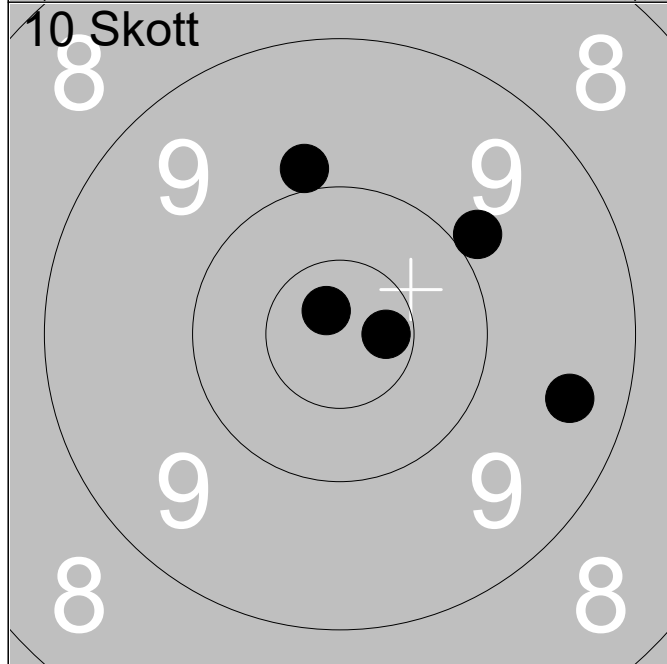

	1:	9.9	↑
	2:	9.4	→
	3:	9.9	↗
	4:	10.8x	↑
	5:	10.7x	→
Serie			47.0
Total			273.0

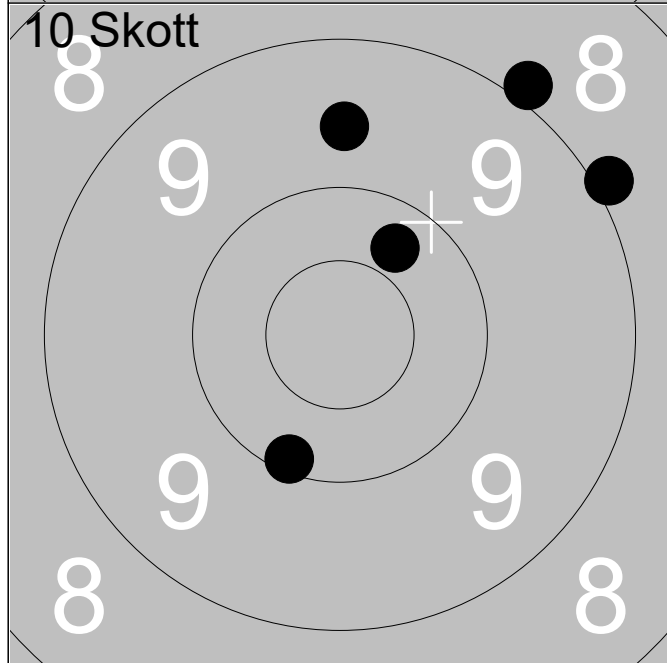

	6:	10.3	↗
	7:	8.9	↗
	8:	9.6	↑
	9:	8.9	↗
	10:	10.1	↘
Serie			45.0
Total			318.0

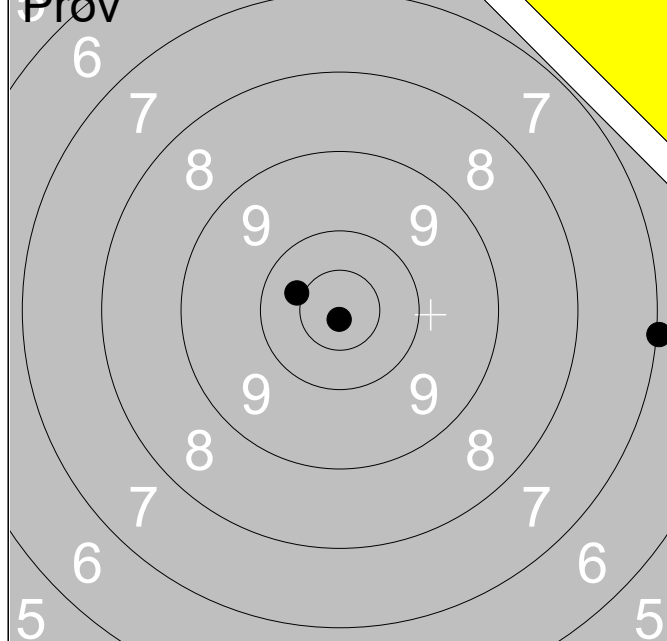

	1:	10.4	↖
	2:	7.0	→
	3:	10.8x	↓
Serie			27.0
Total			225.0

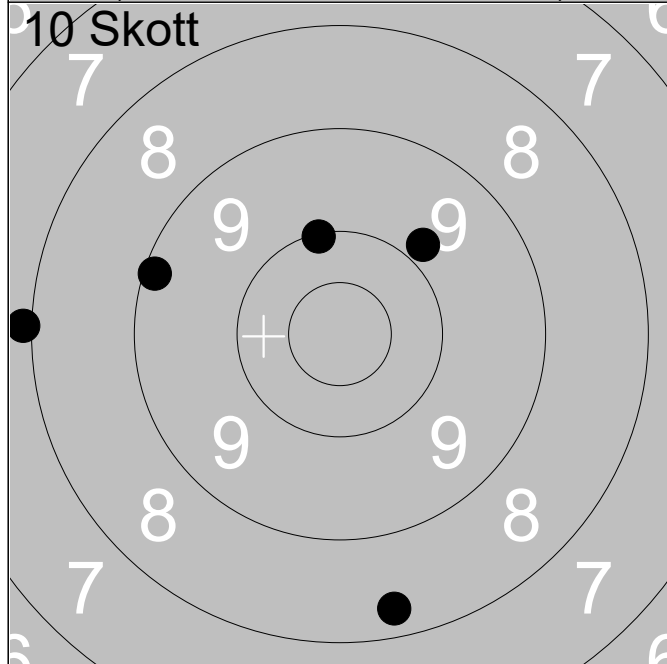

	1:	10.1	↑
	2:	9.8	↗
	3:	8.3	↓
	4:	9.1	↖
	5:	7.9	←
Serie			43.0
Total			268.0

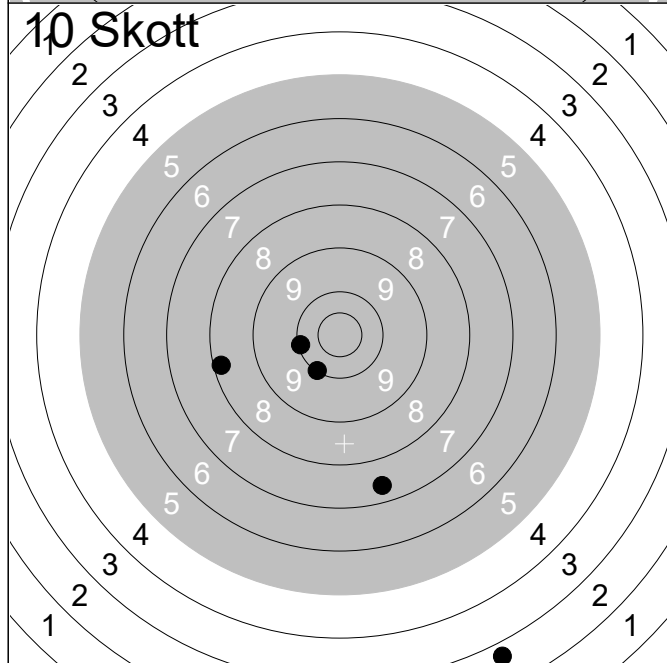

	6:	7.4	↓
	7:	10.0	↖
	8:	10.1	←
	9:	8.2	←
	10:	2.7	↓
Serie			37.0
Total			305.0

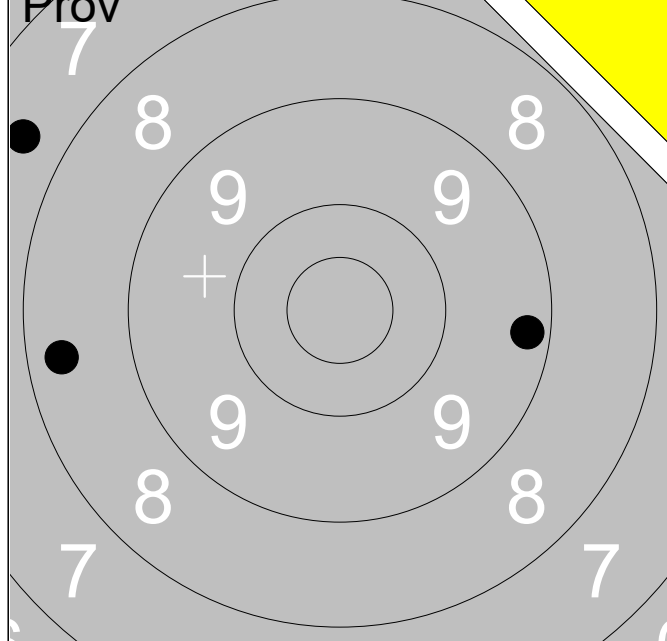

	1:	9.2	→
	2:	7.6	↗
	3:	8.4	←
Serie		24.0	
Total		222.0	

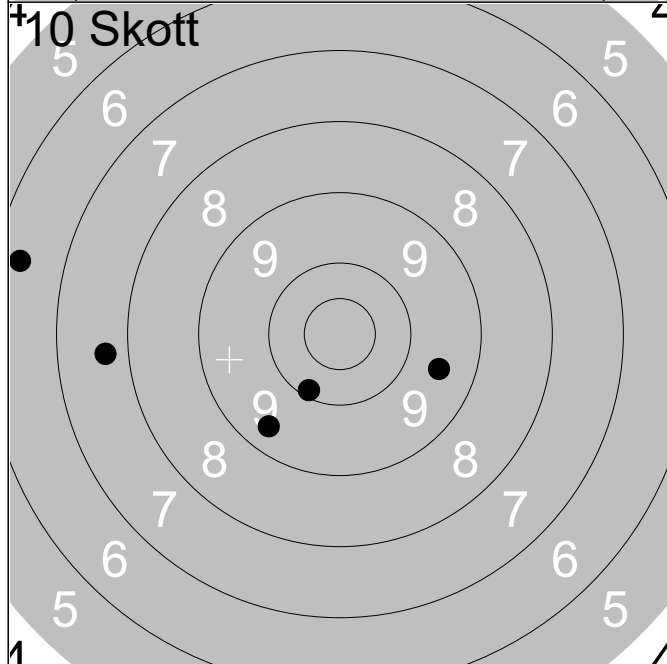

	1:	10.1	↙
	2:	9.6	→
	3:	7.7	←
	4:	9.4	↙
	5:	6.4	←
Serie		41.0	
Total		263.0	

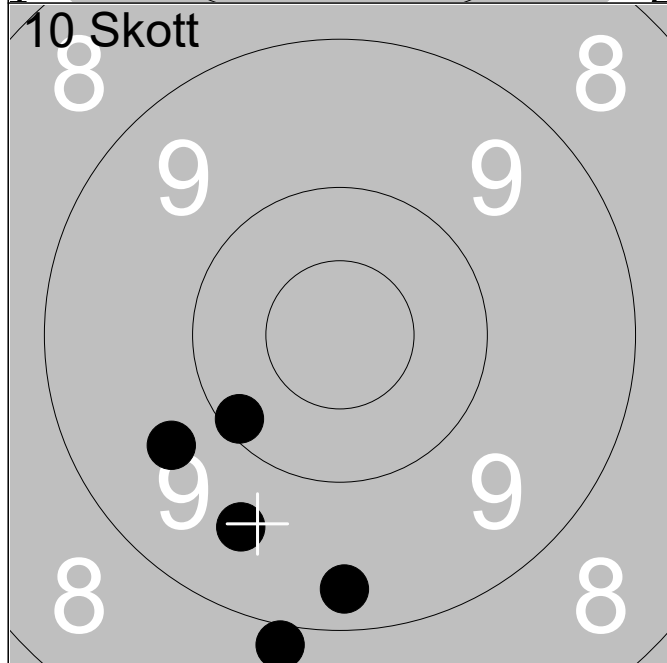

	6:	9.3	↓
	7:	10.1	↙
	8:	9.7	←
	9:	8.9	↙
	10:	9.6	↙
Serie		45.0	
Total		308.0	

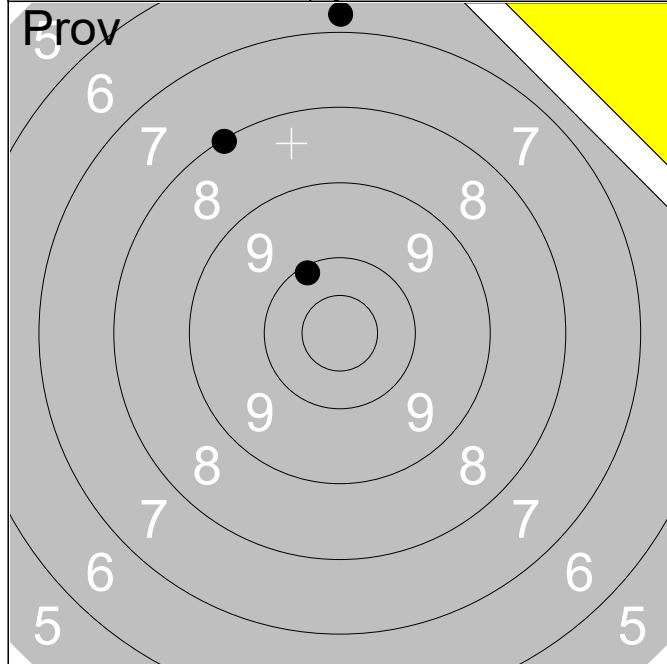

	1:	6.8			↑
	2:	8.0			↖
	3:	10.1			↖
Serie					24.0
Total					221.0

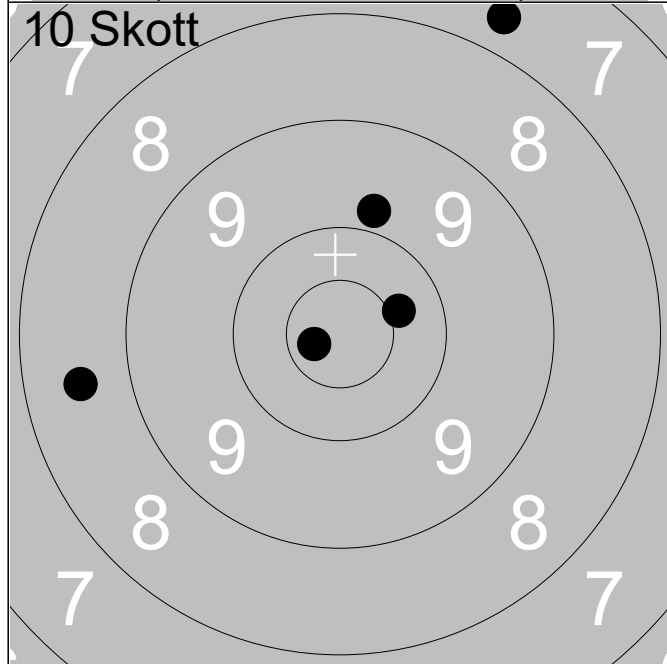

	1:	7.7			↗
	2:	9.8			↑
	3:	8.6			←
	4:	10.4			→
	5:	10.7x			←
Serie					44.0
Total					265.0

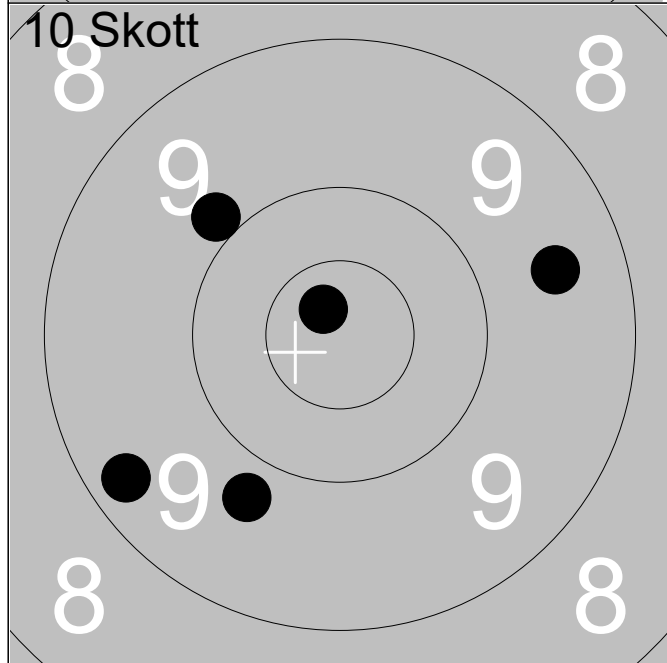

	6:	10.8x			↖
	7:	9.5			→
	8:	9.8			↘
	9:	9.3			↙
	10:	9.9			↖
Serie					46.0
Total					311.0

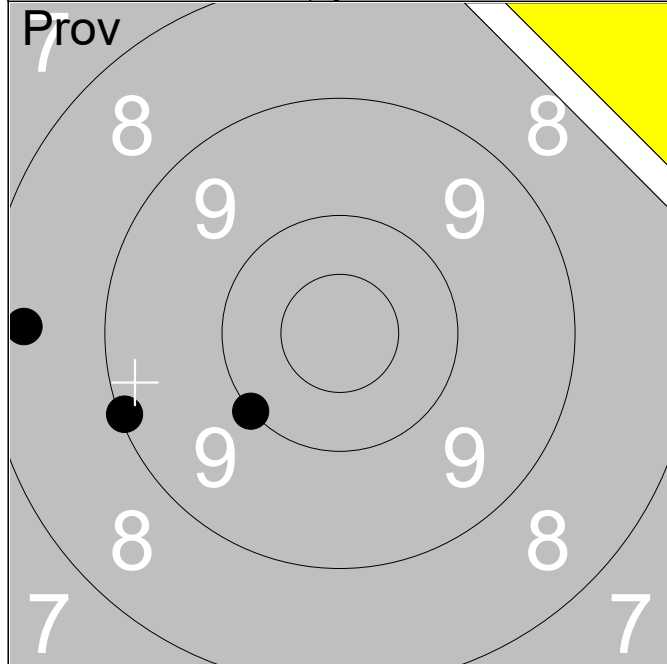

1:	8.3	←
2:	10.0	↙
3:	9.1	←
Serie		27.0
Total		219.0

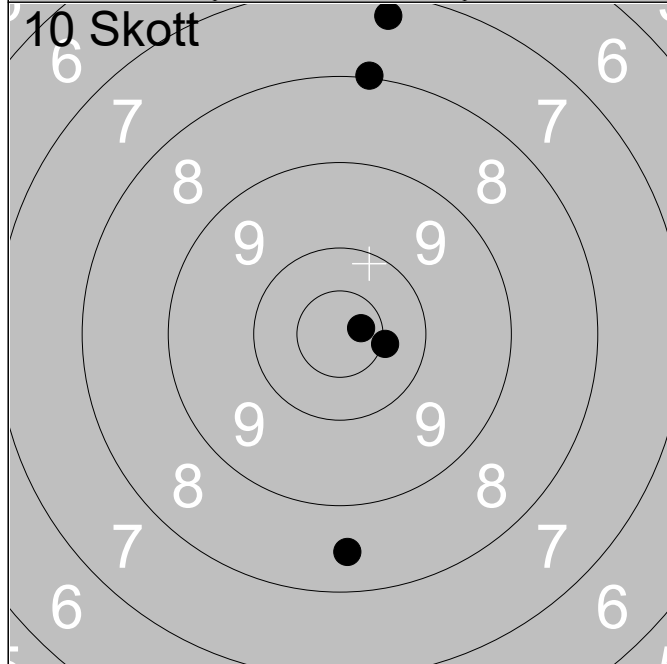

1:	7.3	↑
2:	8.0	↑
3:	10.7x	→
4:	10.4x	→
5:	8.5	↓
Serie		43.0
Total		262.0

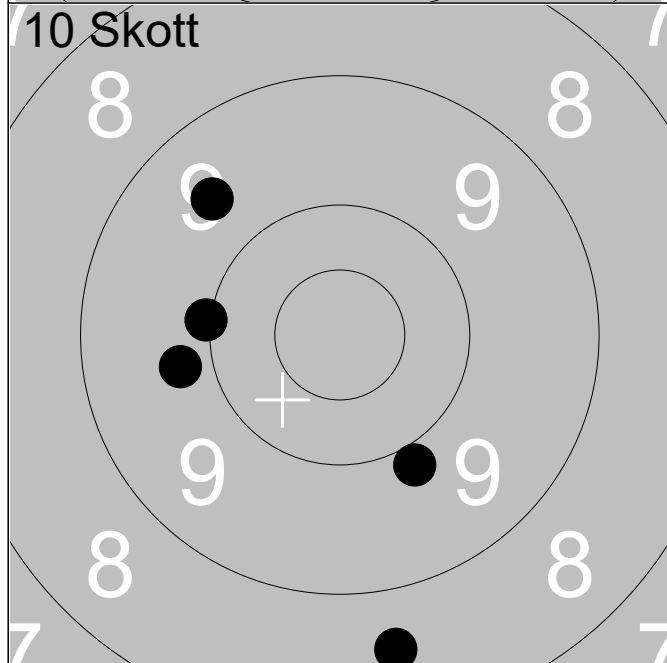

6:	8.6	↓
7:	9.8	←
8:	9.9	↙
9:	10.0	←
10:	9.6	↗
Serie		45.0
Total		307.0

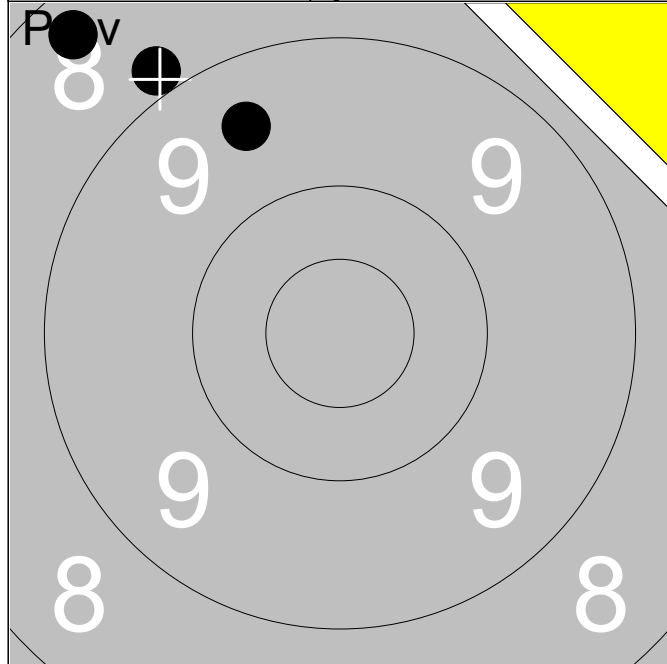

	1:	8.3	↗
	2:	9.5	↗
	3:	8.9	↗
Serie			25.0
Total			217.0

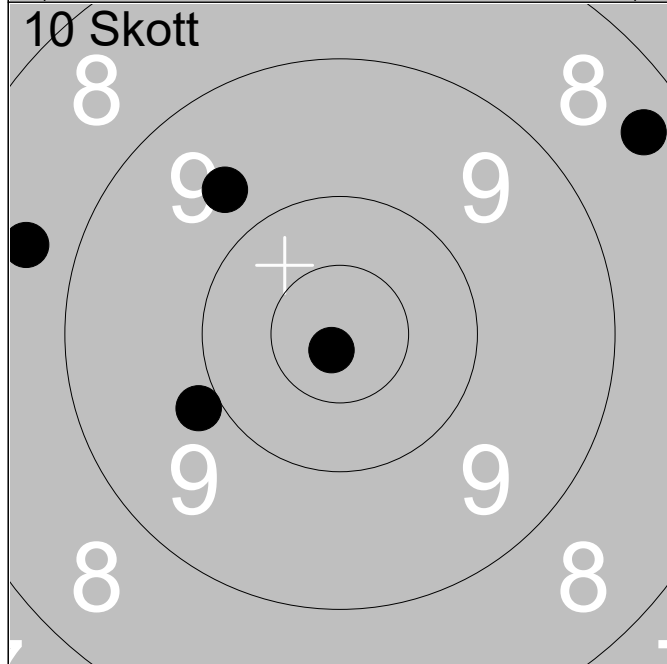

	1:	8.7	↖
	2:	10.8x	↘
	3:	8.4	↗
	4:	9.7	↗
	5:	9.9	↖
Serie			44.0
Total			261.0

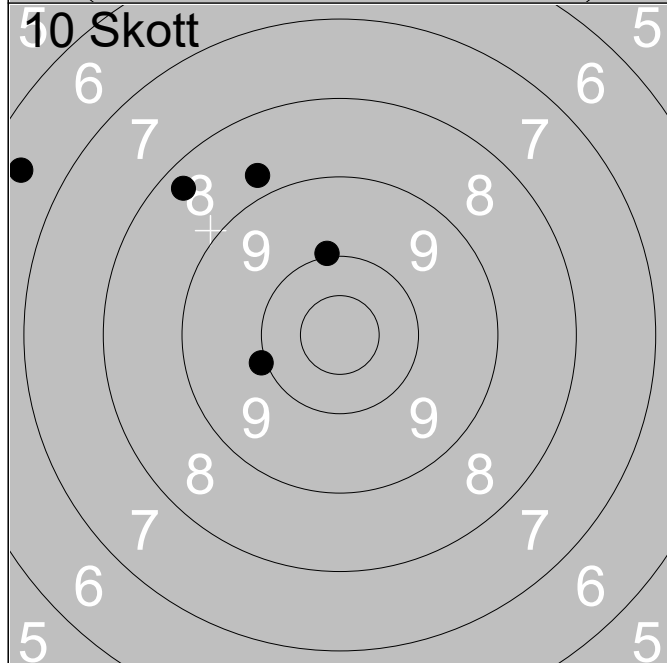

	6:	6.5	↗
	7:	10.0	↗
	8:	8.8	↗
	9:	8.3	↗
	10:	10.0	↖
Serie			42.0
Total			303.0

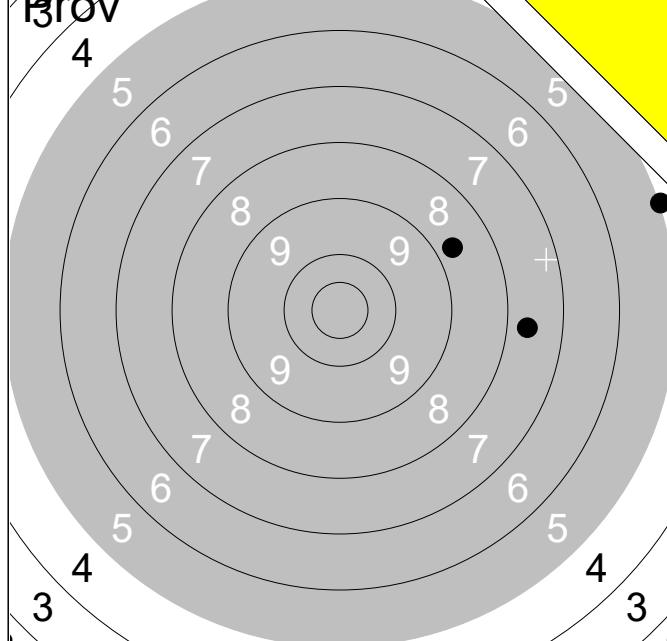

1:	7.7	→
2:	5.0	→
3:	8.7	→
Serie		20.0
Total		213.0

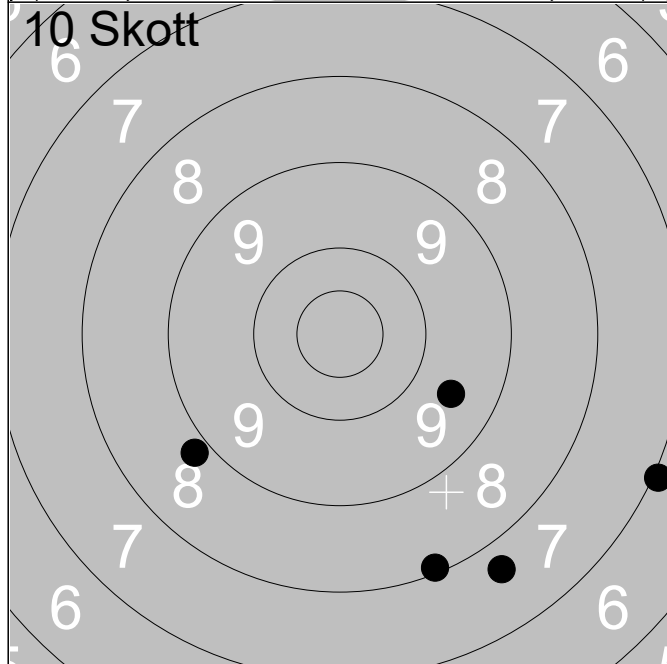

1:	7.7	↘
2:	8.1	↘
3:	7.0	→
4:	8.8	↙
5:	9.6	↘
Serie		39.0
Total		252.0

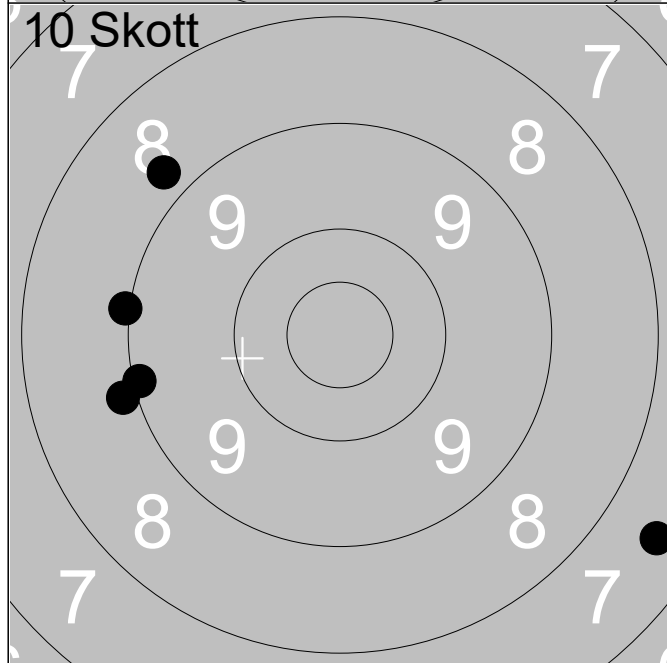

6:	8.9	←
7:	9.0	←
8:	9.1	←
9:	8.8	↗
10:	7.5	↘
Serie		41.0
Total		293.0

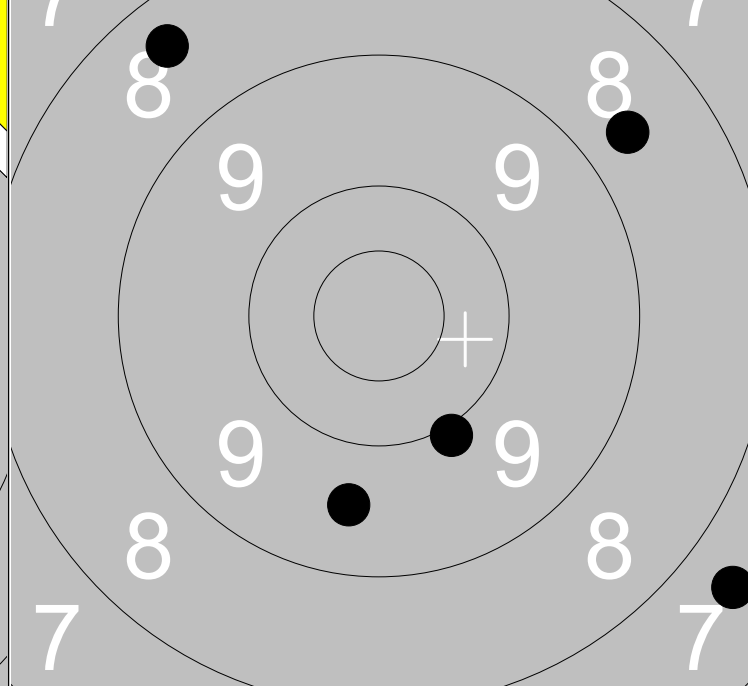
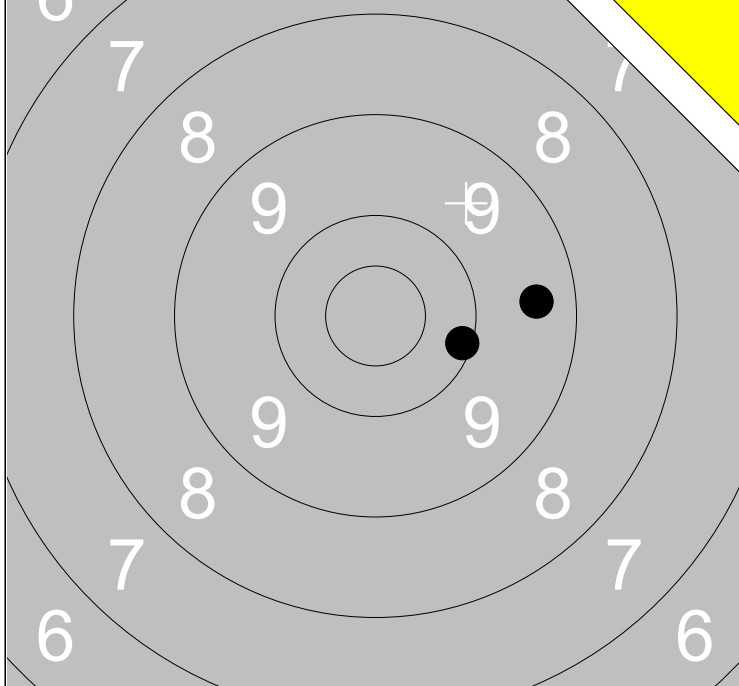

1: 10.1 →	Serie 26
2: 9.4 →	
3: 7.5 ↑	
Total 241	

1: 8.7 ↗	Serie 42
2: 7.6 ↘	
3: 9.6 ↓	
4: 8.4 ↗	
5: 10.0 ↓	
Total 283	

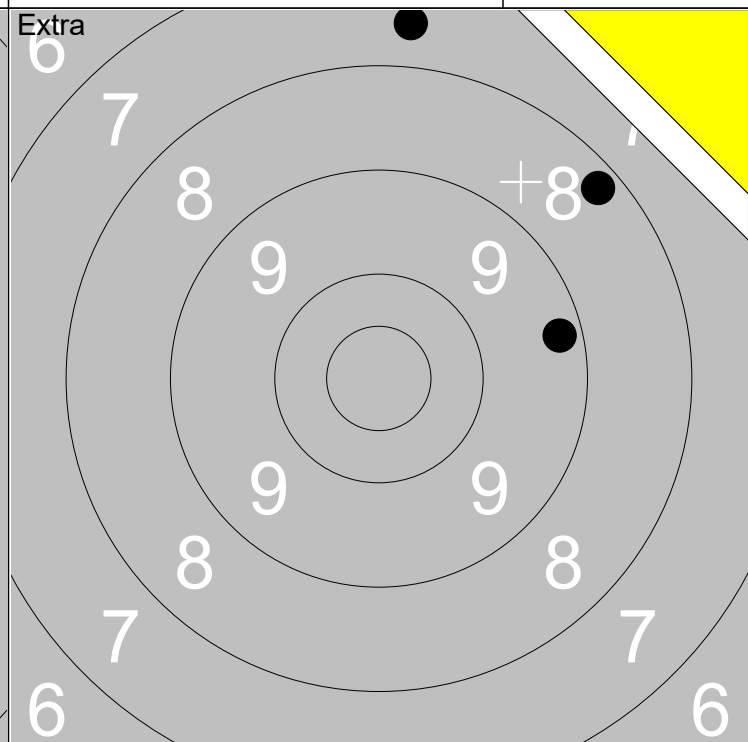
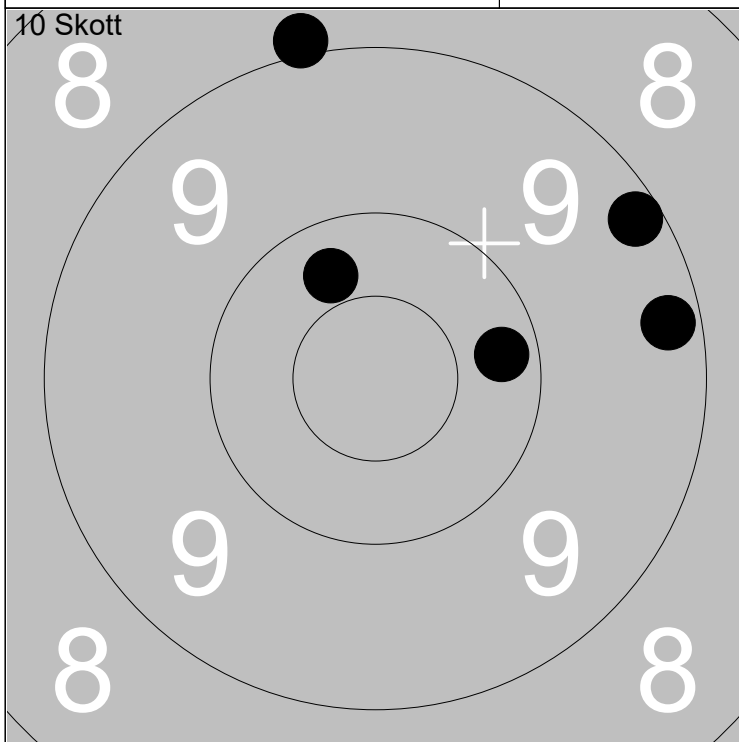

6: 9.2 →	Serie 46
7: 10.3 ↗	
8: 10.2 →	
9: 8.9 ↑	
10: 9.2 ↗	
Total 329	

1: 9.2 →	Serie 24
2: 7.6 ↑	
3: 8.2 ↗	
Total 329	

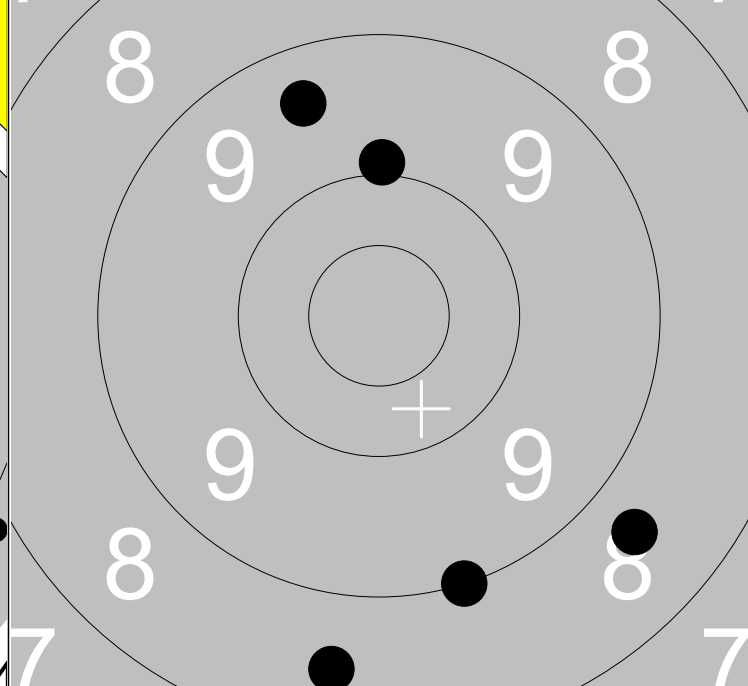
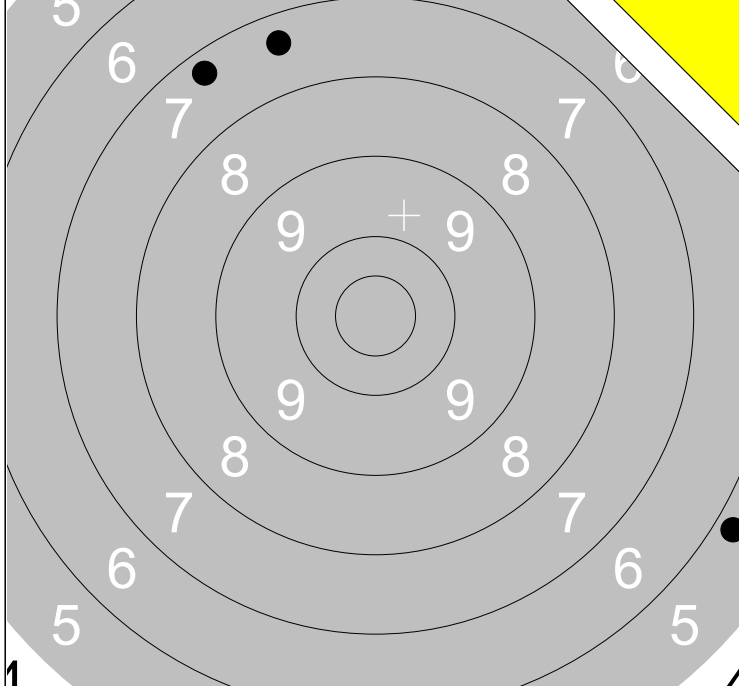

1: 7.4 ↑	Serie 19
2: 7.3 ↗	
3: 5.8 ↘	
Total 240	

1: 9.9 ↑	Serie 43
2: 9.4 ↗	
3: 8.7 ↘	
4: 8.5 ↘	
5: 9.0 ↘	
Total 283	

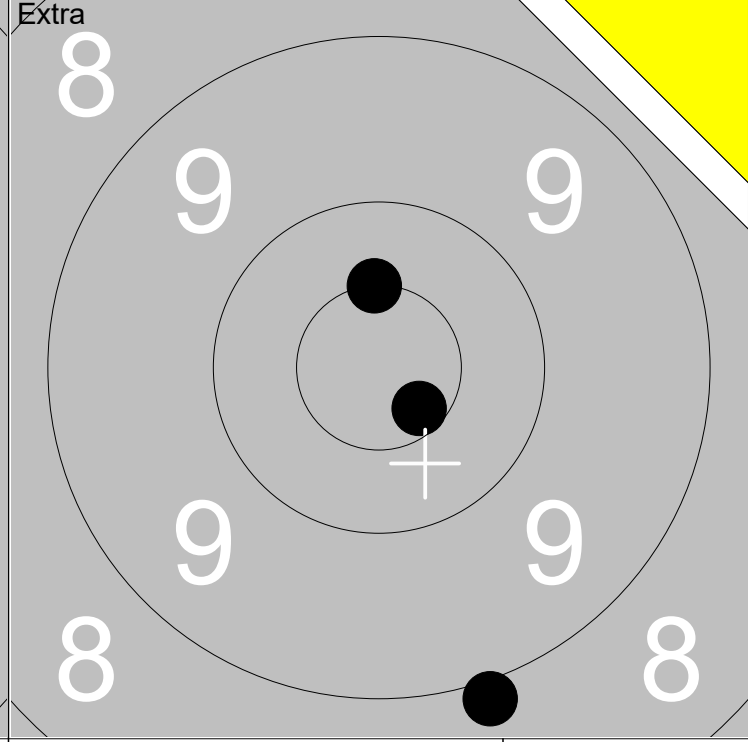
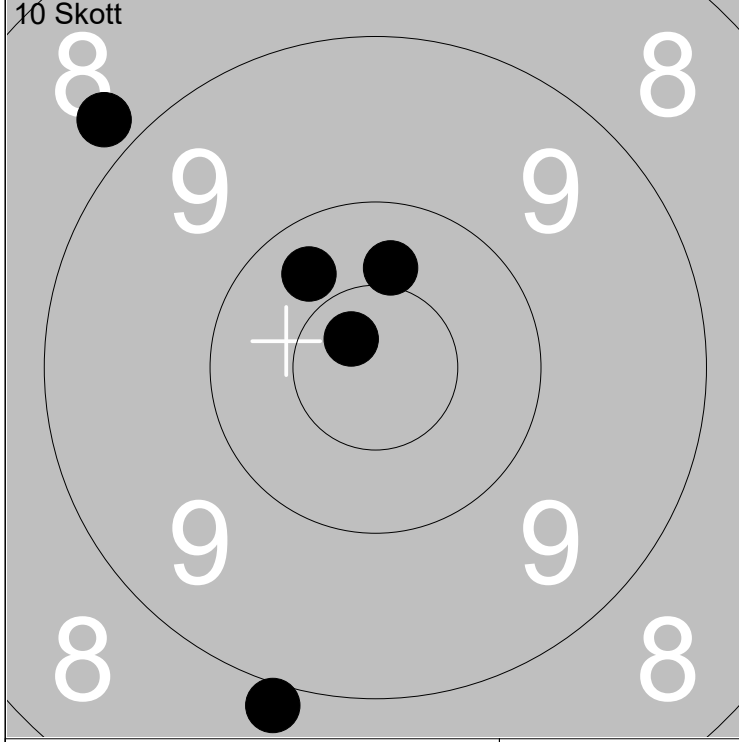

6: 8.9 ↘	Serie 46
7: 8.8 ↗	
8: 10.3 ↗	
9: 10.4 ↑	
10: 10.7x ↗	
Total 329	

1: 10.5x ↑	Serie 28
2: 10.6x ↘	
3: 8.9 ↘	
Total 329	

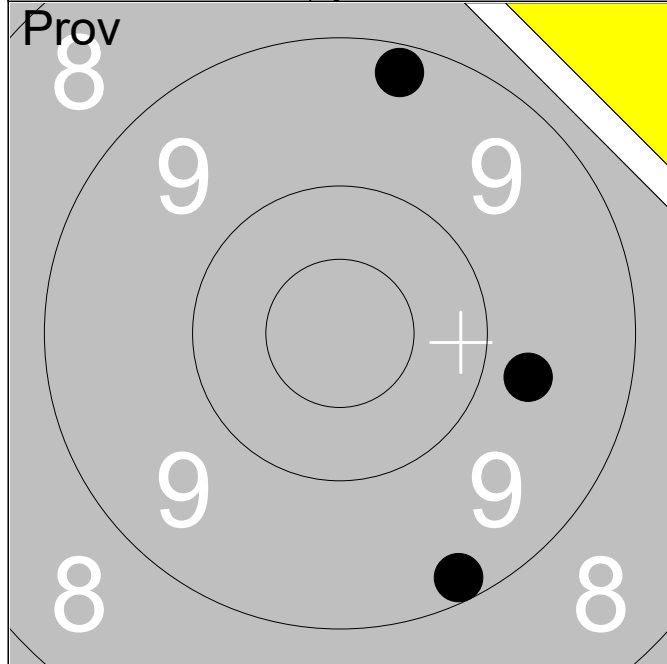

	1:	9.2	↑
	2:	9.7	→
	3:	9.2	↓
Serie			27.0
Total			231.0

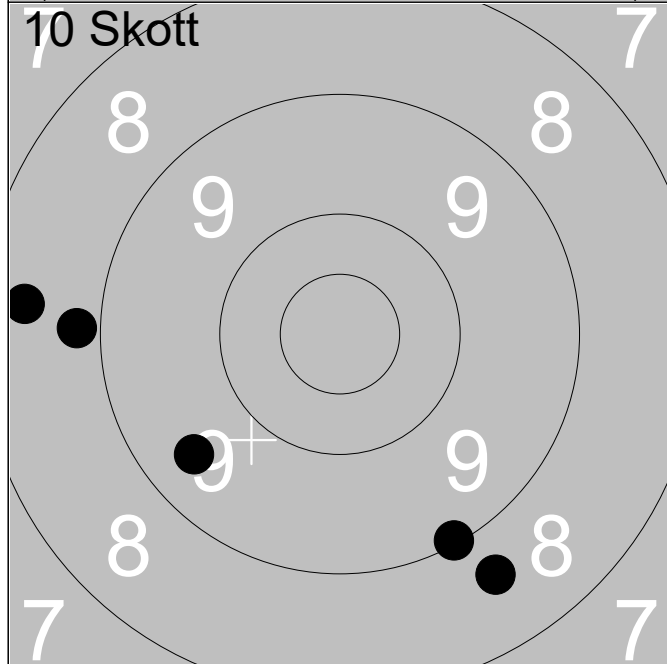

	1:	9.1	↓
	2:	8.6	↓
	3:	8.8	←
	4:	9.5	↙
	5:	8.4	←
Serie			42.0
Total			273.0

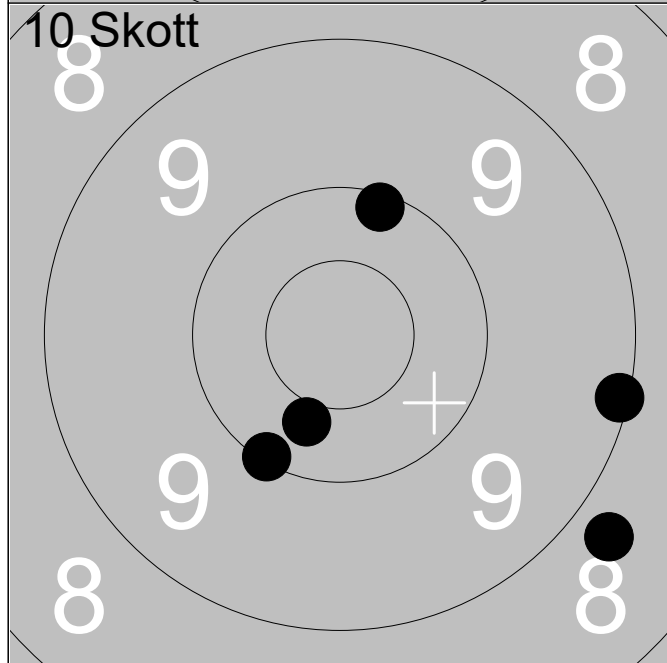

	6:	10.1	↑
	7:	10.4	↓
	8:	9.1	→
	9:	10.1	↙
	10:	8.8	↘
Serie			47.0
Total			320.0

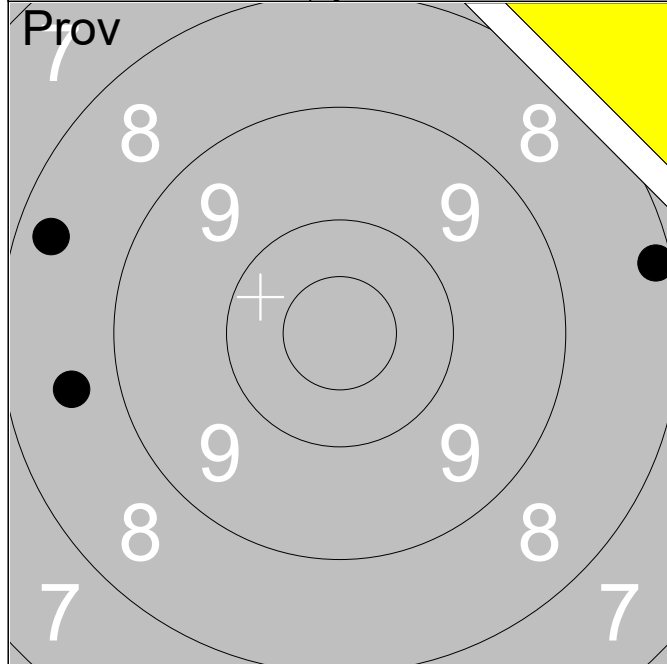

1:	8.6	←
2:	8.3	←
3:	8.2	→
Serie		24.0
Total		231.0

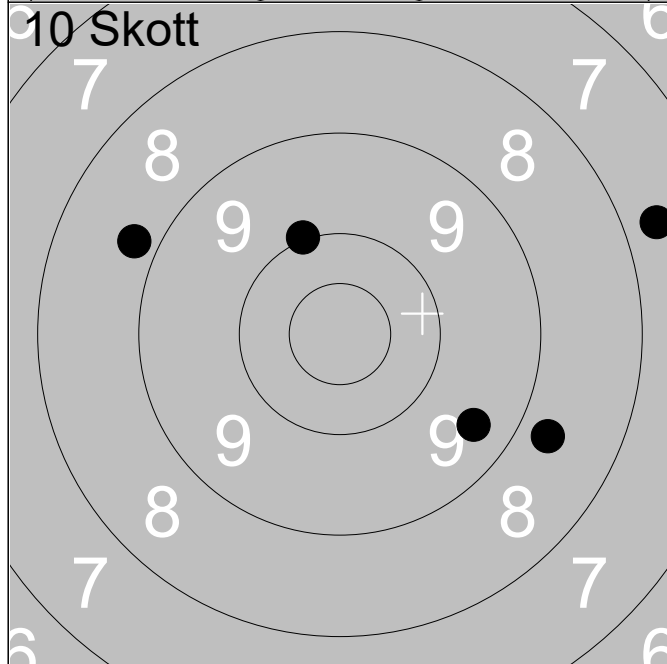

1:	7.7	→
2:	9.4	↘
3:	10.0	↗
4:	8.8	↖
5:	8.7	↙
Serie		42.0
Total		273.0

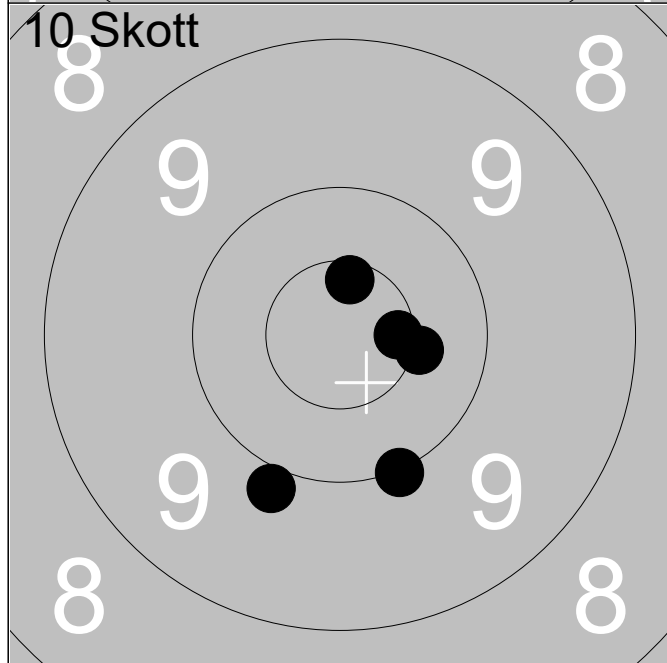

6:	9.9	↙
7:	10.6x	↗
8:	10.4x	→
9:	10.6x	→
10:	10.0	↙
Serie		49.0
Total		322.0

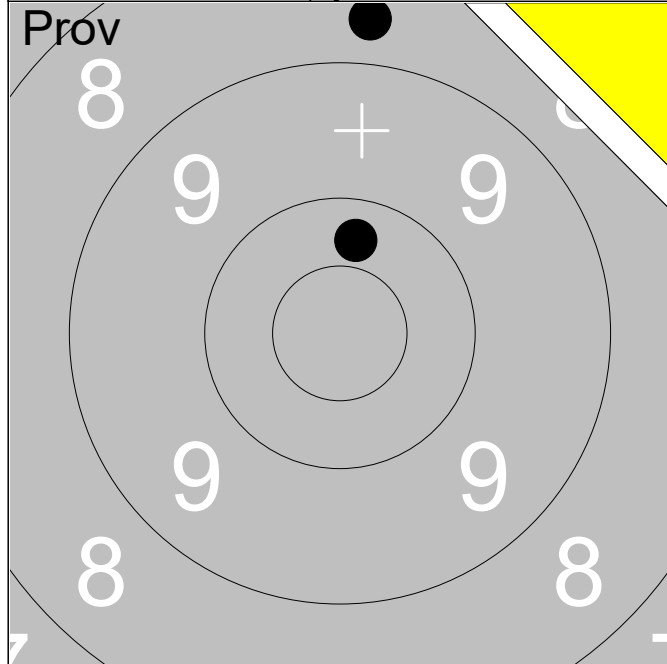

	1:	8.7	↑
	2:	10.3	↑

Serie	18.0
Total	230.0

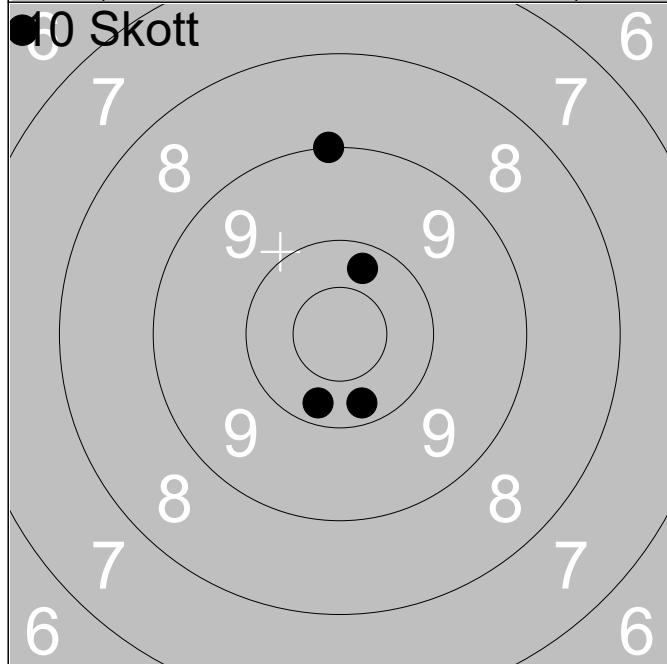

	1:	9.0	↑
	2:	10.3	↑
	3:	6.3	↖
	4:	10.2	↓
	5:	10.2	↓

Serie	45.0
Total	275.0

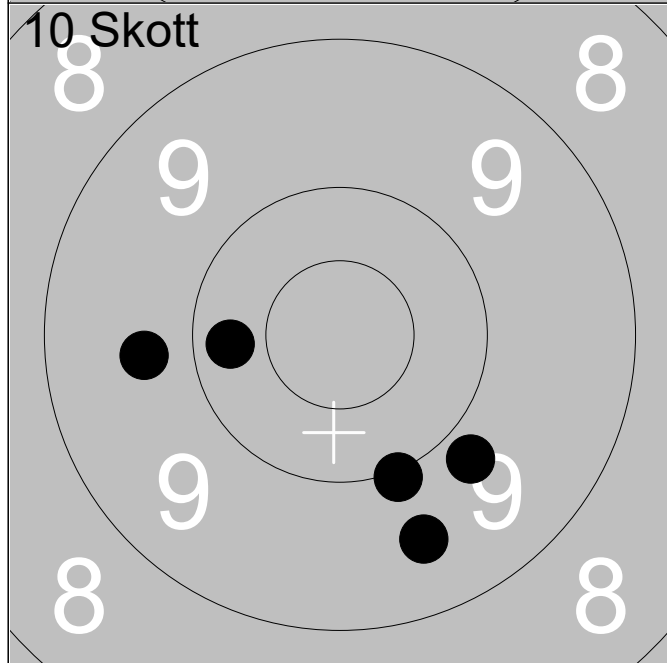

	6:	9.7	←
	7:	10.0	↓
	8:	9.5	↓
	9:	10.3	←
	10:	9.8	↓

Serie	47.0
Total	322.0

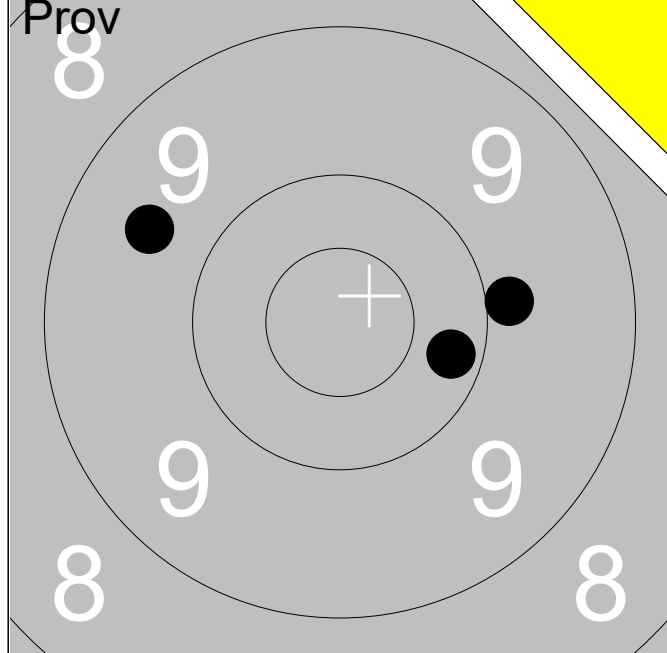

1:	9.6	↖
2:	10.2	→
3:	9.9	→
Serie		28.0
Total		226.0

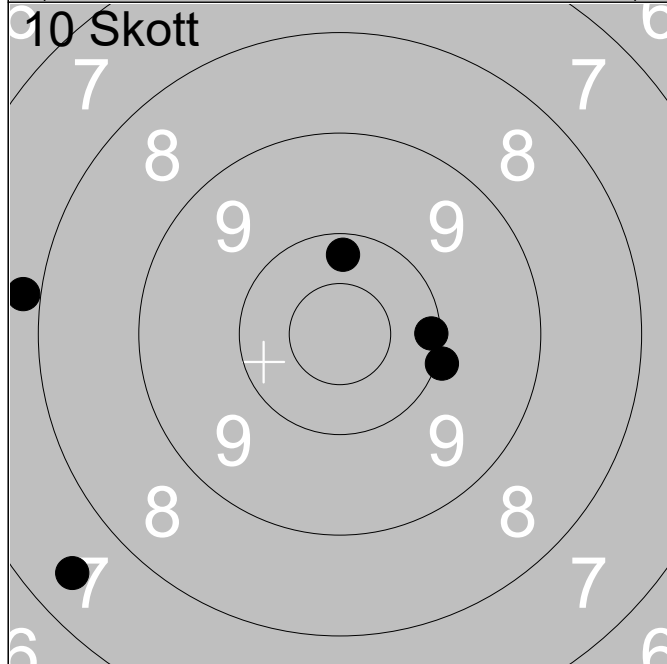

1:	10.0	→
2:	7.5	↙
3:	7.9	←
4:	10.1	→
5:	10.2	↑
Serie		44.0
Total		270.0

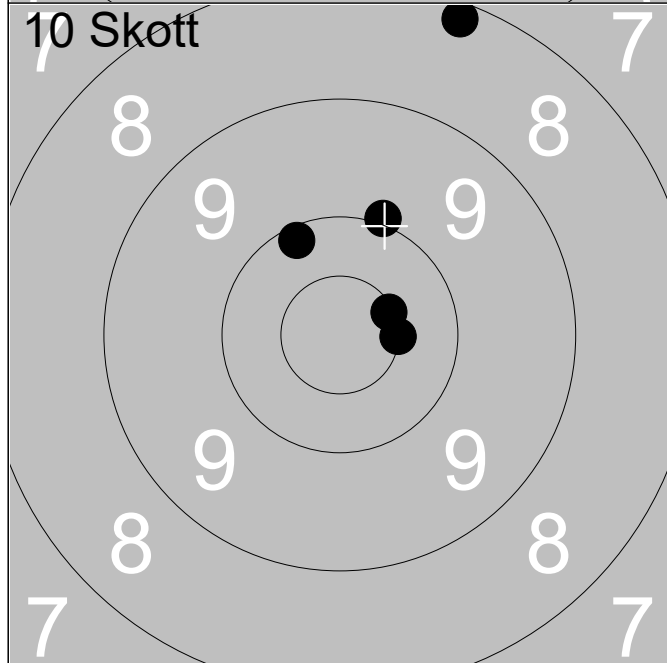

6:	8.2	↑
7:	10.1	↖
8:	10.5x	→
9:	10.5x	→
10:	10.0	↑
Serie		48.0
Total		318.0

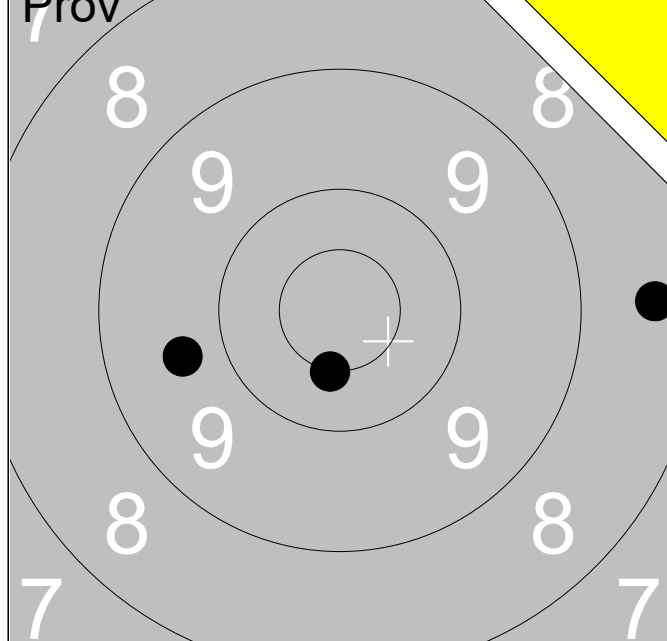

	1:	10.5x	↓
	2:	9.7	←
	3:	8.4	→
Serie			27.0
Total			225.0

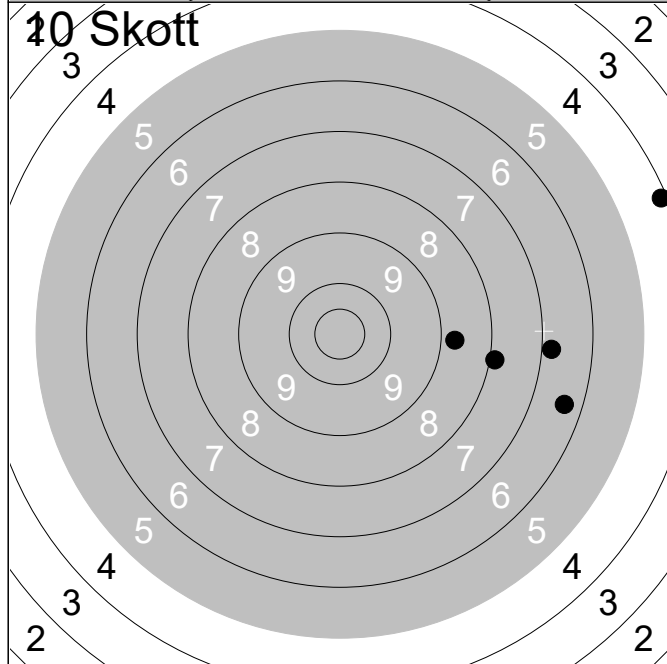

	1:	4.1	→
	2:	6.4	→
	3:	7.9	→
	4:	8.8	→
	5:	6.8	→
Serie			31.0
Total			256.0

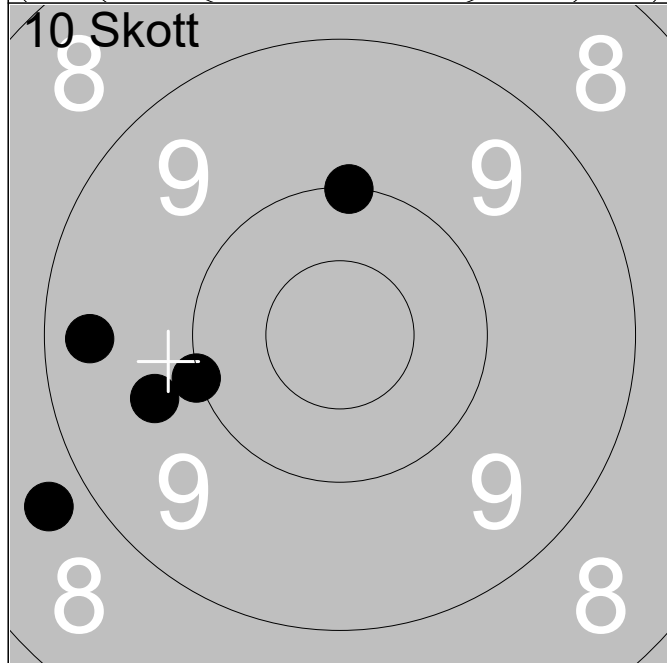

	6:	10.0	↑
	7:	9.3	←
	8:	8.7	←
	9:	9.7	←
	10:	10.0	←
Serie			46.0
Total			302.0

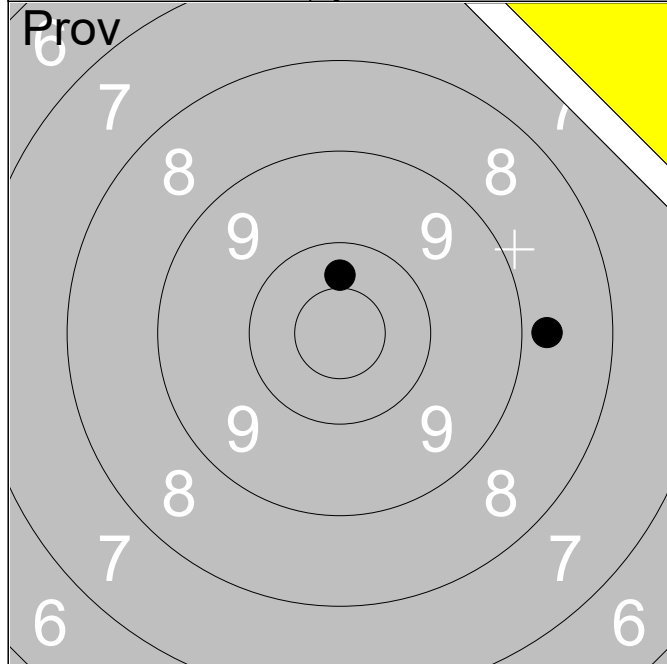

	1:	10.4	↑
	2:	6.9	↗
	3:	8.8	→
Serie			24.0
Total			223.0

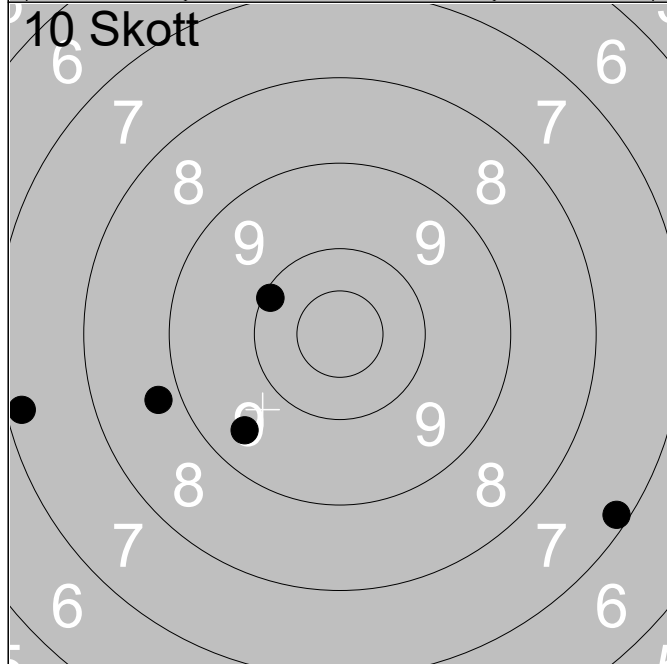

	1:	7.2	↘
	2:	10.1	↖
	3:	9.4	↙
	4:	7.2	←
	5:	8.8	←
Serie			41.0
Total			264.0

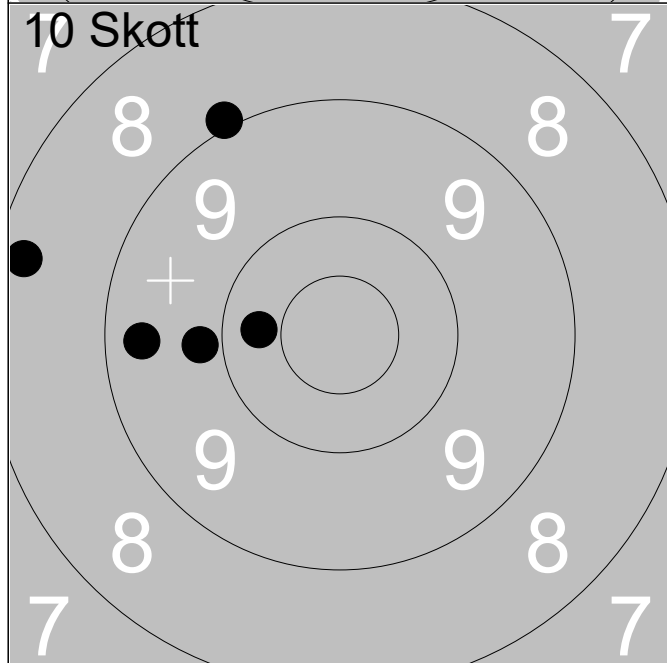

	6:	9.3	←
	7:	10.3	←
	8:	9.8	←
	9:	8.3	↖
	10:	9.0	↗
Serie			45.0
Total			309.0

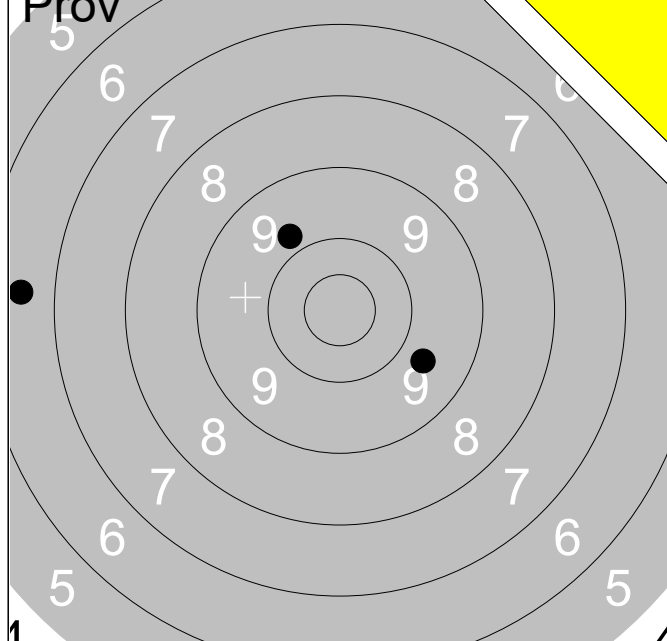

	1:	6.6	←
	2:	9.8	↗
	3:	9.7	↘
Serie			24.0
Total			219.0

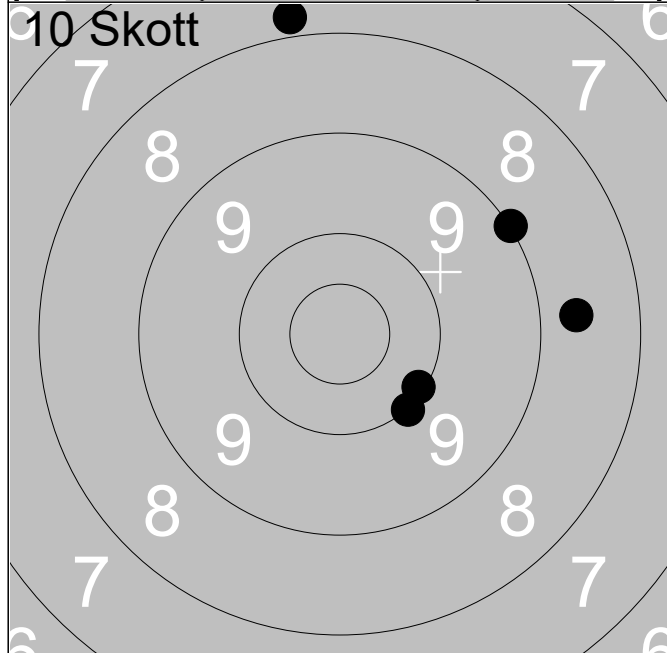

	1:	9.0	↗
	2:	10.1	↘
	3:	7.8	↑
	4:	10.0	↘
	5:	8.7	→
Serie			44.0
Total			263.0

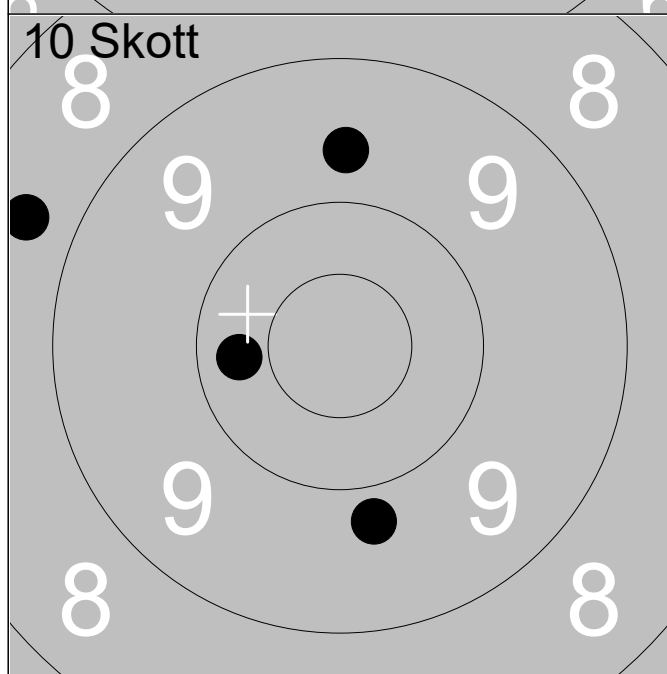

	6:	10.3	←
	7:	8.7	↖
	8:	9.7	↑
	9:	9.8	↘
	10:	0.0	
Serie			36.0
Total			299.0

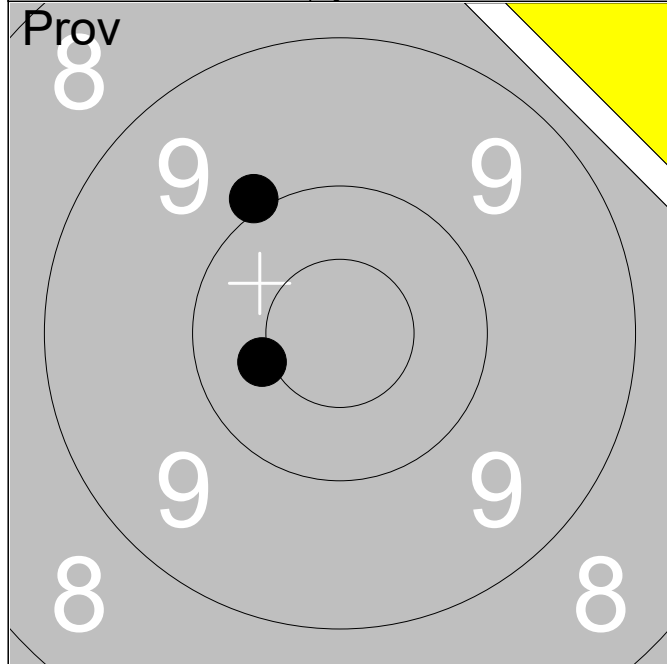

	1:	10.4x	←
	2:	9.9	↑
Serie			19.0
Total			217.0

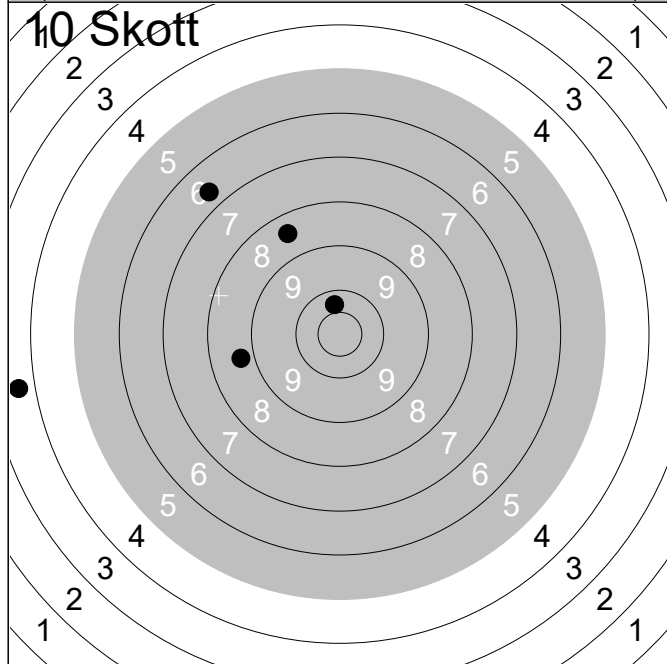

	1:	3.6	←
	2:	10.3	↑
	3:	6.7	↗
	4:	8.7	←
	5:	8.5	↑
Serie			35.0
Total			252.0

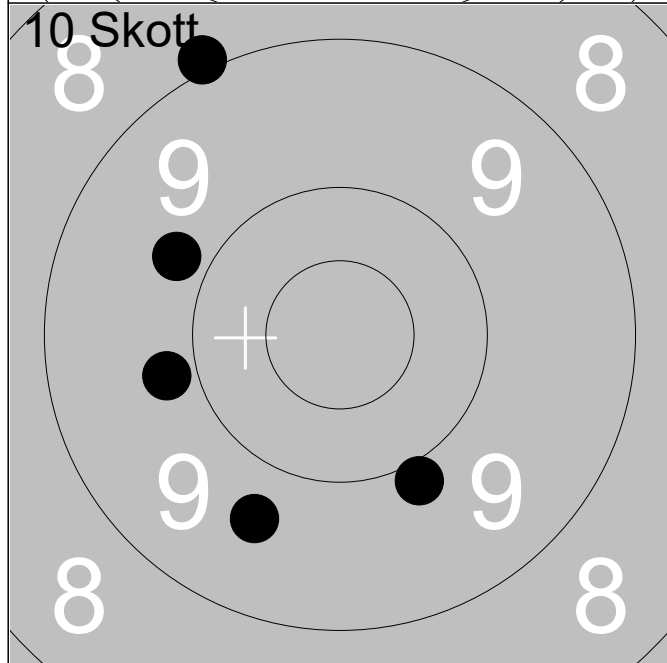

	6:	8.9	↑
	7:	9.8	←
	8:	9.7	↘
	9:	9.8	↗
	10:	9.9	↘
Serie			44.0
Total			296.0

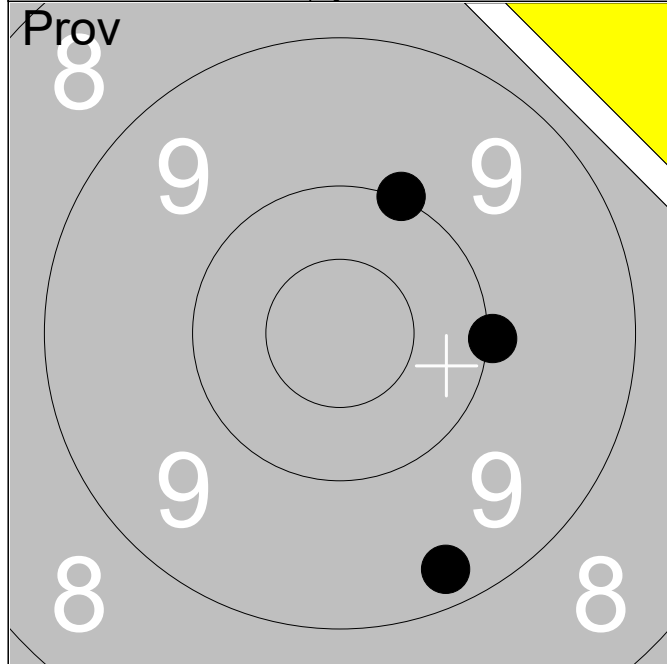

	1:	10.0	→
	2:	9.3	↓
	3:	10.0	↑
Serie			29.0
Total			217.0

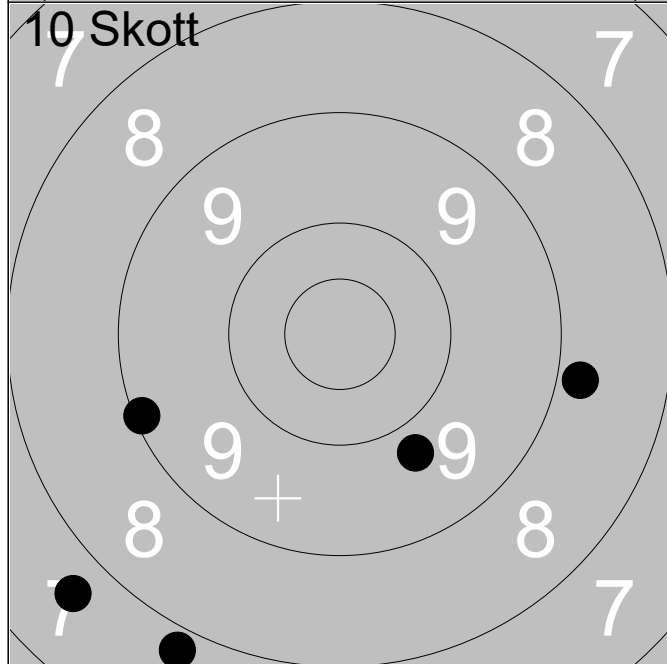

	1:	7.8	↓
	2:	9.8	↓
	3:	8.8	→
	4:	9.1	←
	5:	7.7	↓
Serie			40.0
Total			257.0

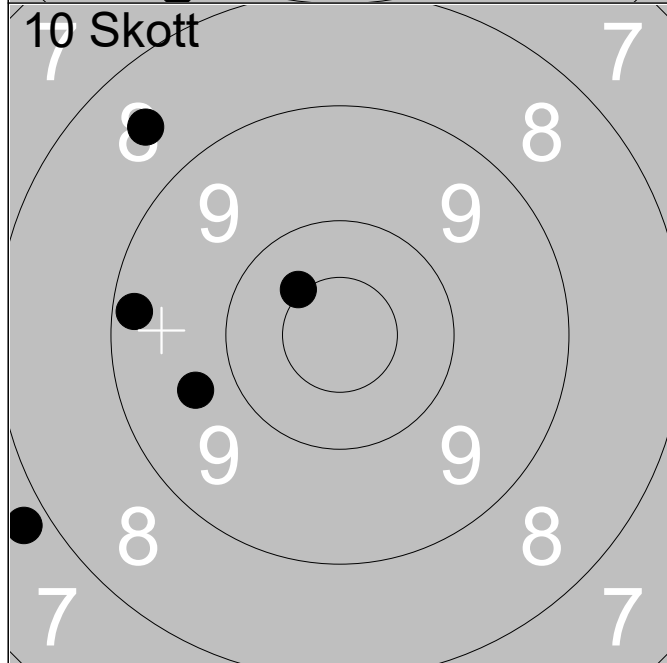

	6:	7.8	←
	7:	9.7	←
	8:	10.5x	↑
	9:	8.5	↑
	10:	9.2	←
Serie			43.0
Total			300.0

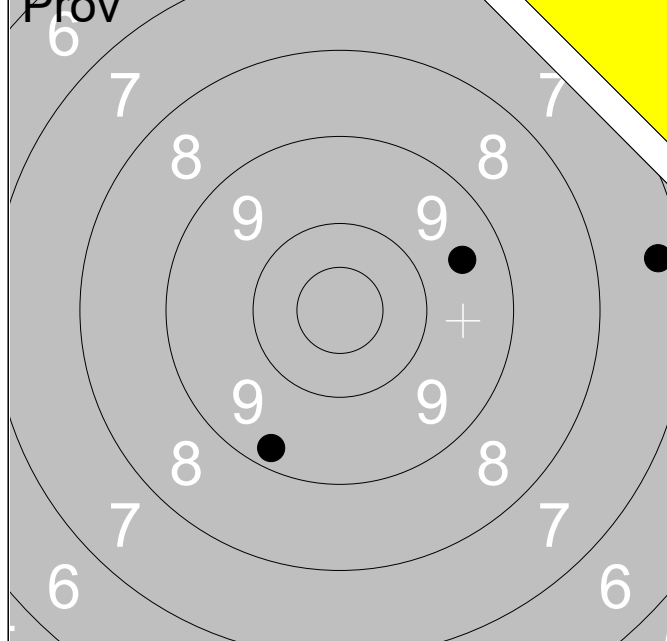

1:	7.3	→
2:	9.5	→
3:	9.3	↙
Serie		25.0
Total		211.0

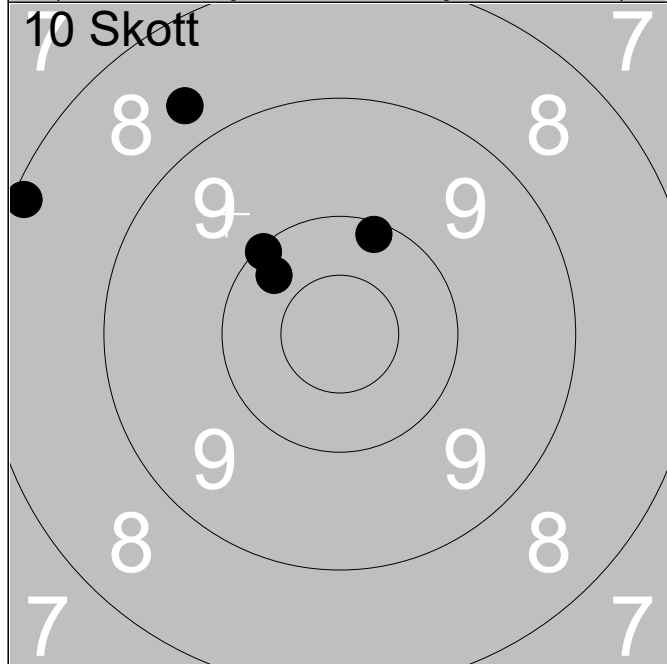

1:	10.1	↗
2:	10.3	↗
3:	8.1	↗
4:	10.1	↗
5:	8.7	↗
Serie		46.0
Total		257.0

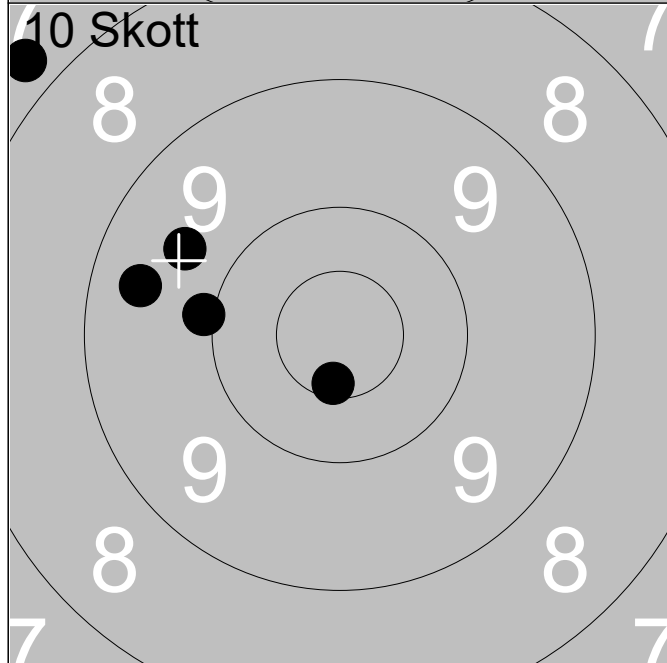

6:	9.6	↗
7:	7.8	↗
8:	9.4	↖
9:	10.6x	↘
10:	10.0	↖
Serie		45.0
Total		302.0

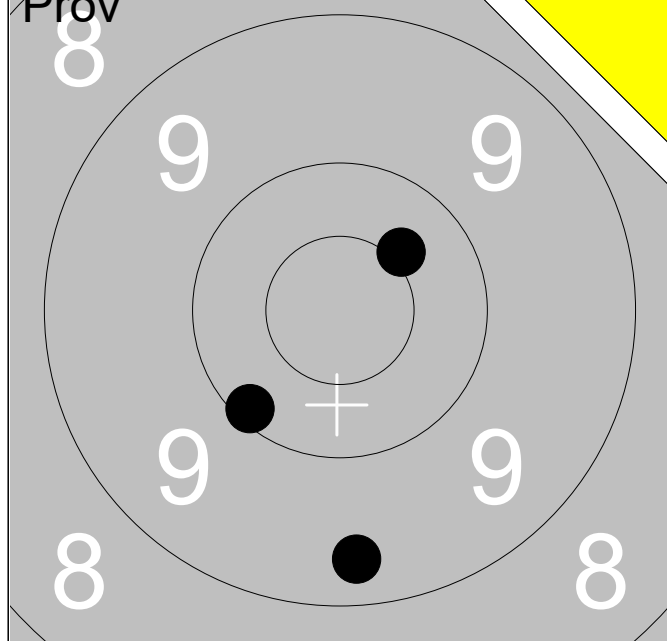

1:	9.3	↓
2:	10.4x	↗
3:	10.1	↘
Serie		29.0
Total		207.0

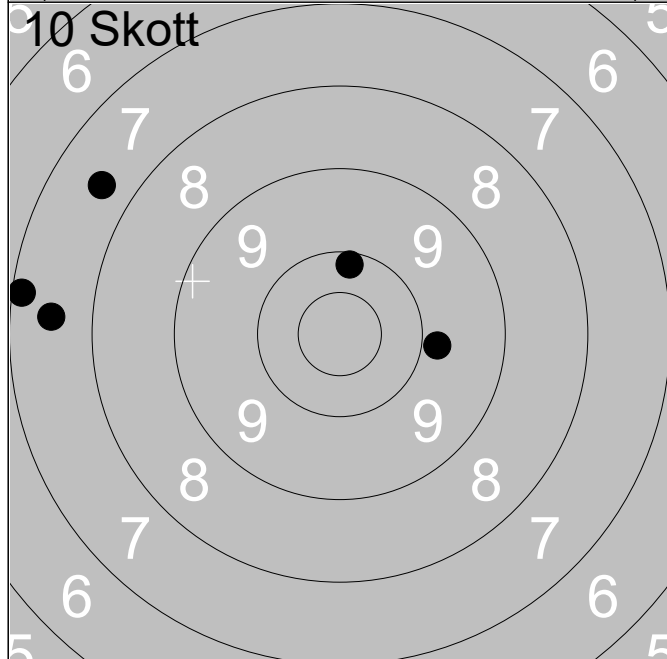

1:	7.6	↖
2:	9.8	→
3:	10.2	↑
4:	7.5	←
5:	7.1	←
Serie		40.0
Total		247.0

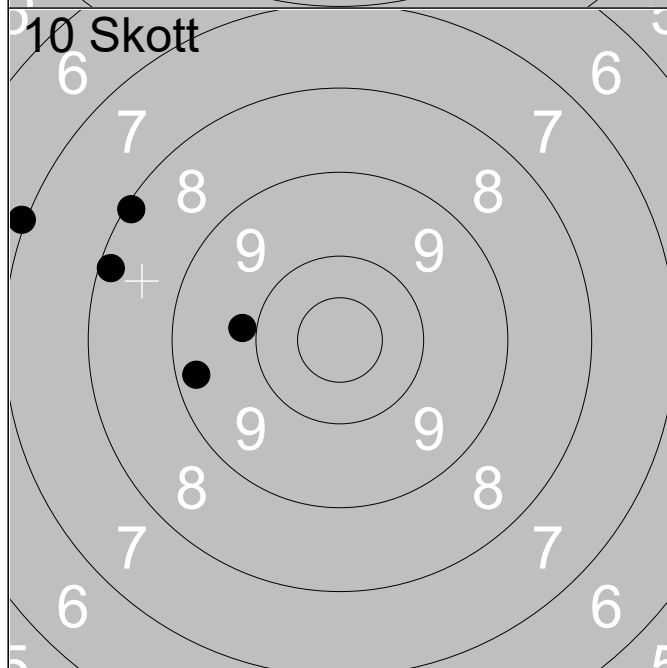

6:	7.0	↖
7:	8.1	↗
8:	8.2	↖
9:	9.3	←
10:	9.9	←
Serie		41.0
Total		288.0

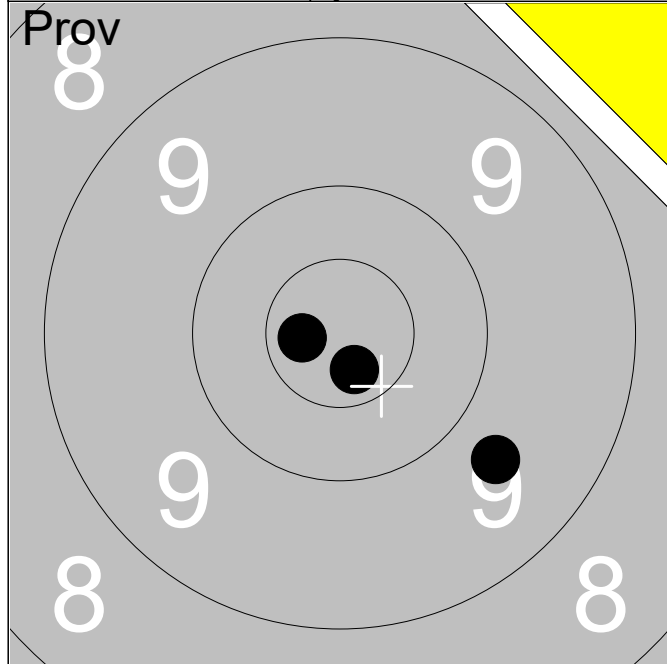

1:	9.7	↘
2:	10.7x	←
3:	10.7x	↘
Serie		29.0
Total		215.0

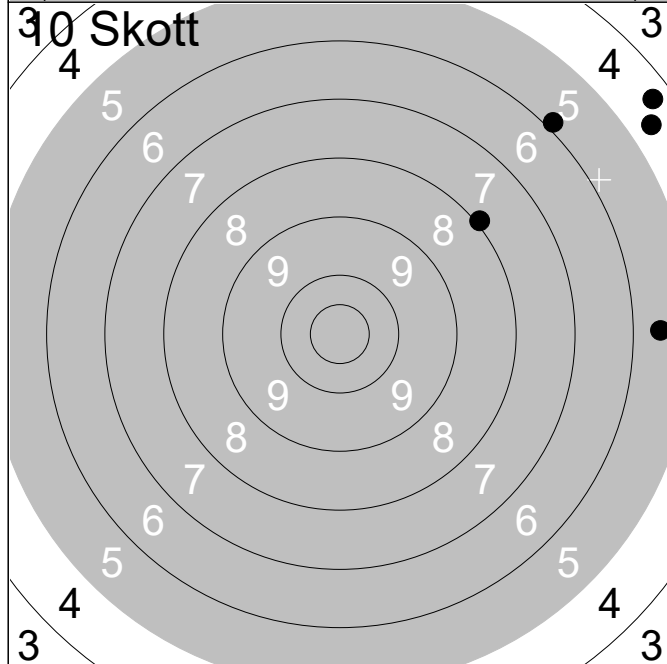

1:	5.6	→
2:	4.6	↗
3:	4.4	↗
4:	8.0	↗
5:	5.9	↗
Serie		26.0
Total		241.0

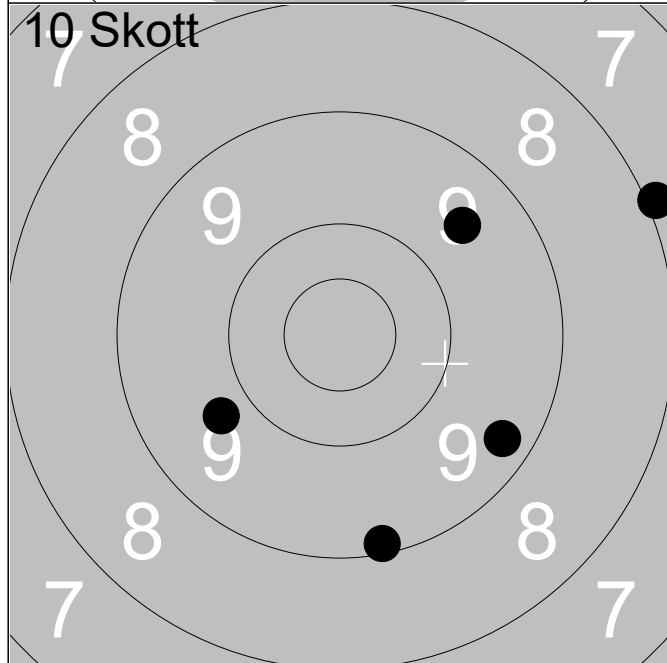

6:	7.9	↗
7:	9.6	↗
8:	9.1	↘
9:	9.3	↘
10:	9.7	↙
Serie		43.0
Total		284.0

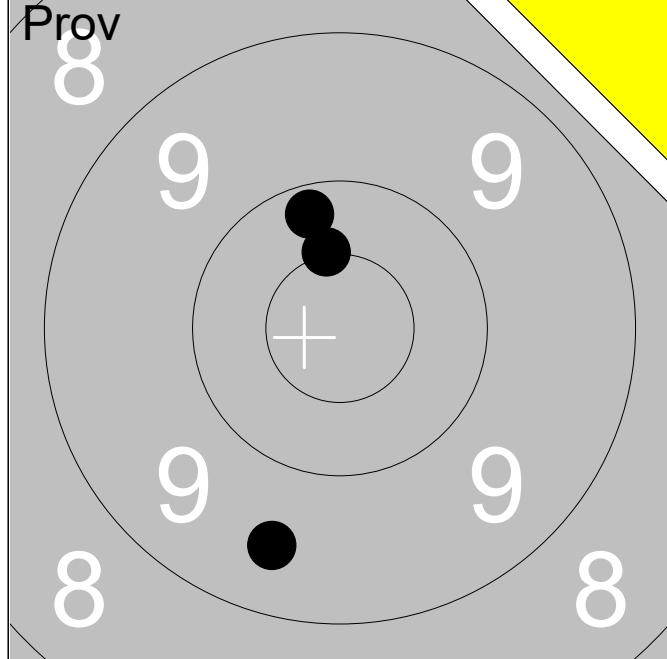

1:	9.5	↘
2:	10.2	↑
3:	10.5x	↑
Serie		29.0
Total		203.0

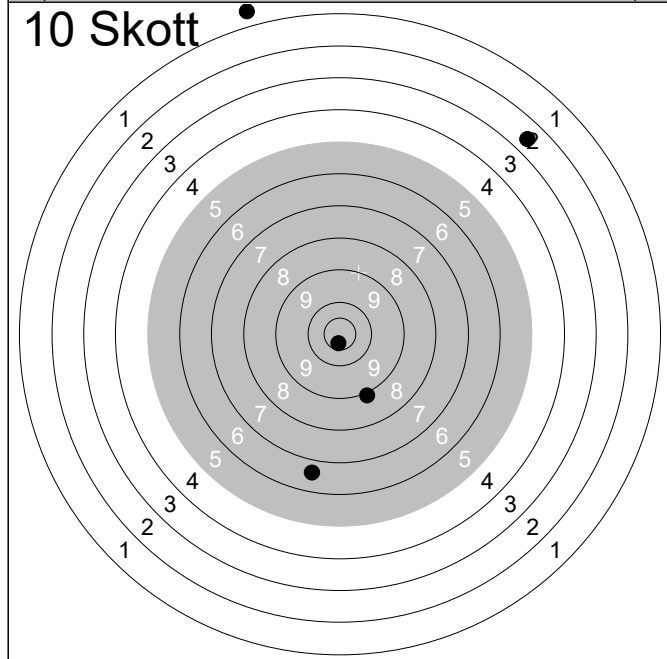

1:	0.0	↖
2:	2.6	↗
3:	6.6	↘
4:	8.9	↘
5:	10.7x	↘
Serie		26.0
Total		229.0

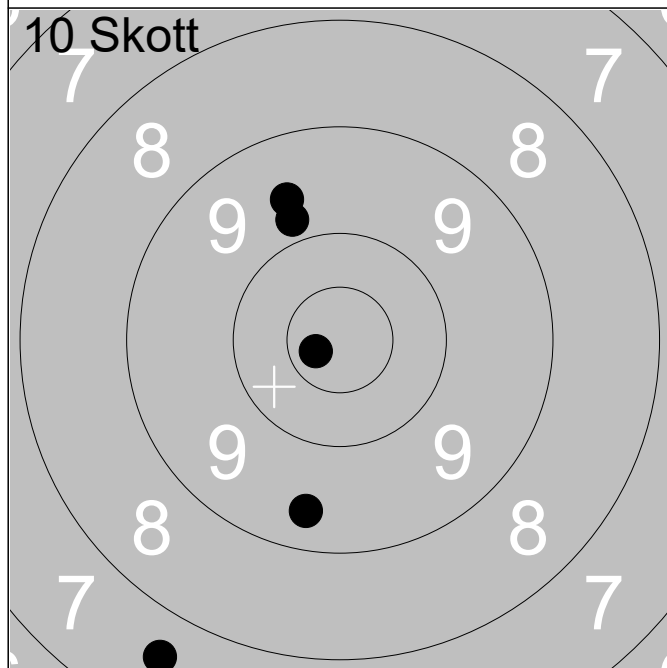

6:	7.6	↘
7:	9.4	↘
8:	9.8	↑
9:	10.7x	↖
10:	9.6	↑
Serie		44.0
Total		273.0

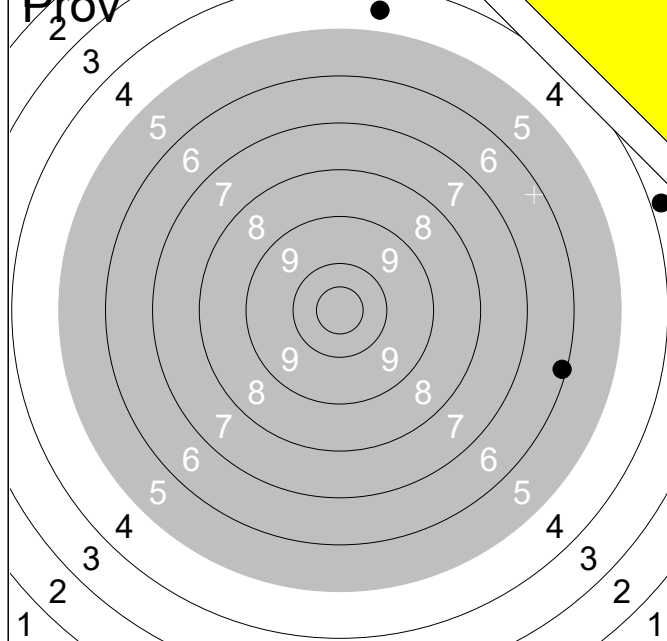

	1:	6.1	→
	2:	4.6	↑
	3:	3.8	→
Serie			13.0
Total			192.0

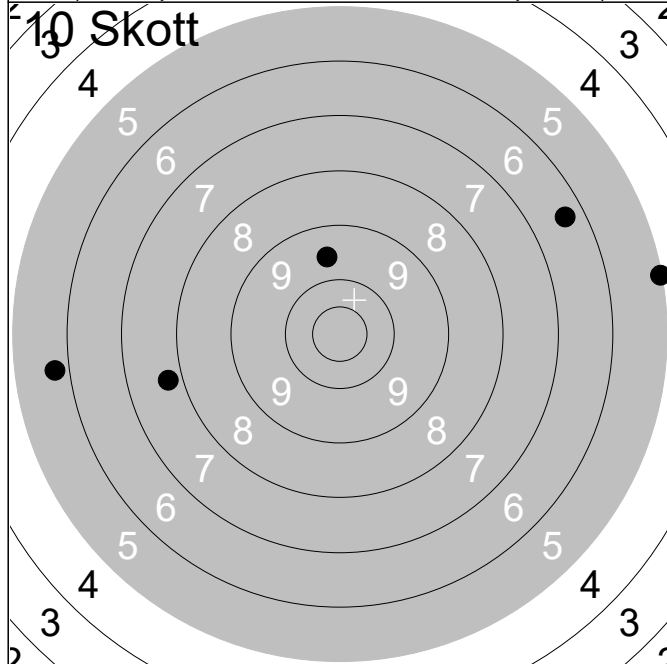

	1:	5.1	→
	2:	6.4	↗
	3:	5.8	←
	4:	7.8	←
	5:	9.6	↑
Serie			32.0
Total			224.0

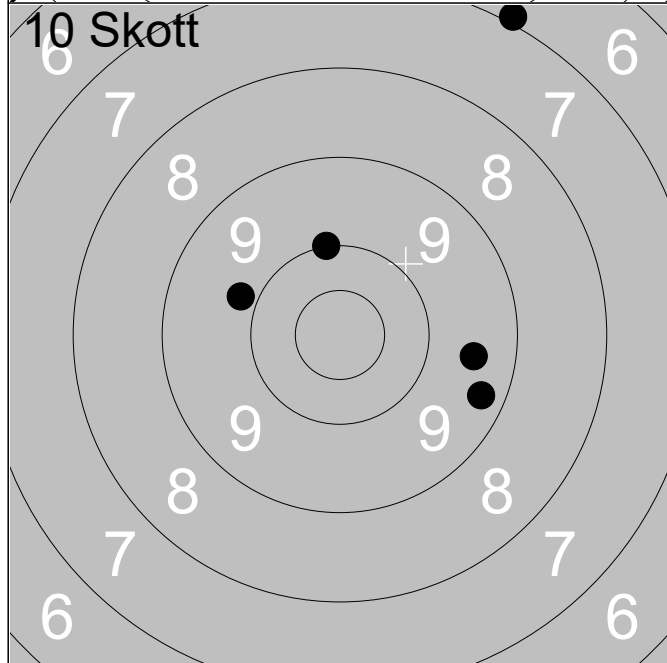

	6:	7.0	↗
	7:	9.3	→
	8:	9.5	→
	9:	9.8	←
	10:	10.0	↑
Serie			44.0
Total			268.0