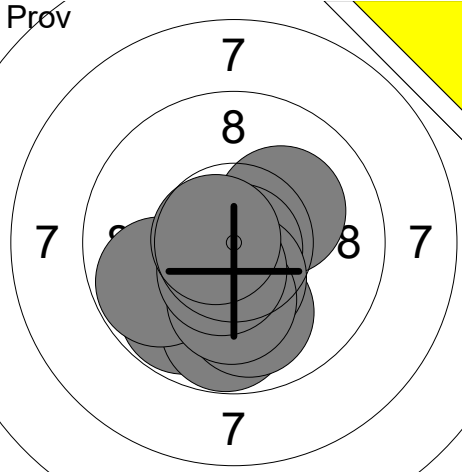
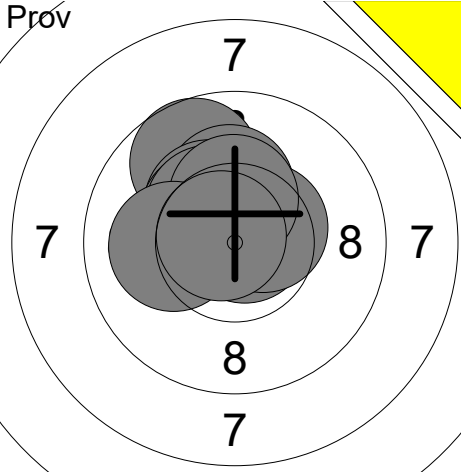
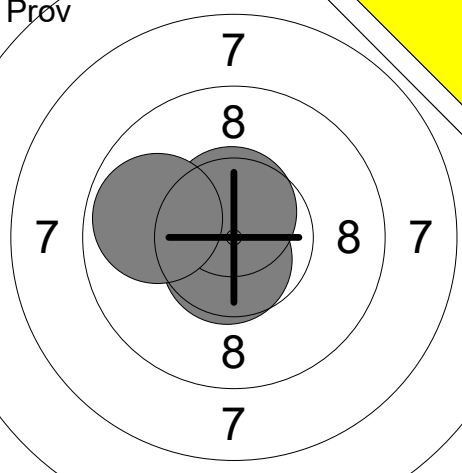
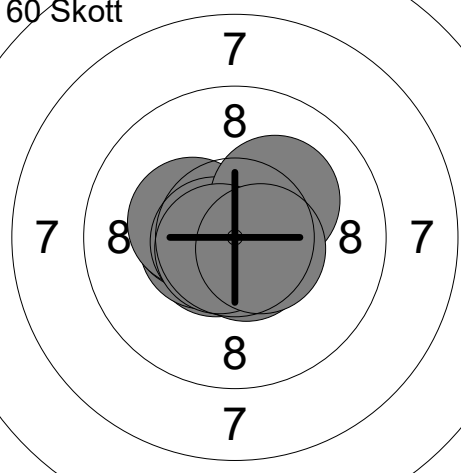
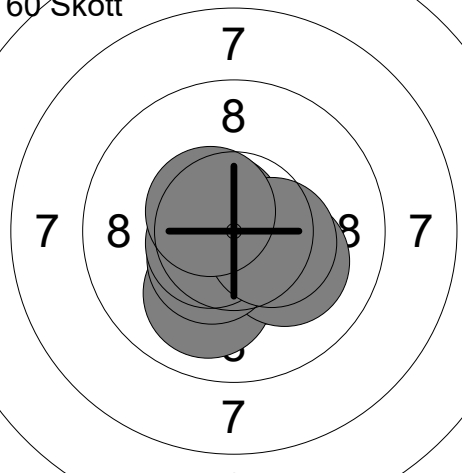
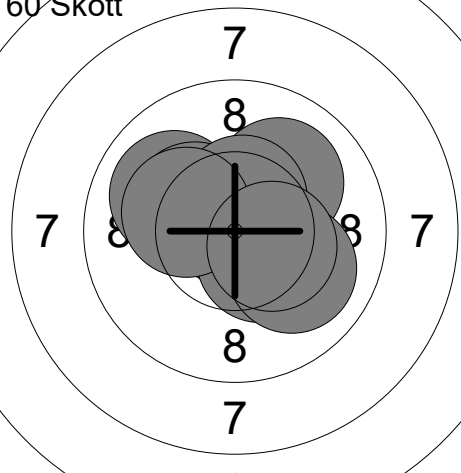
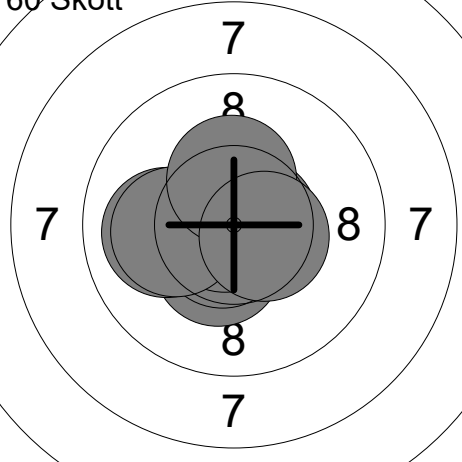
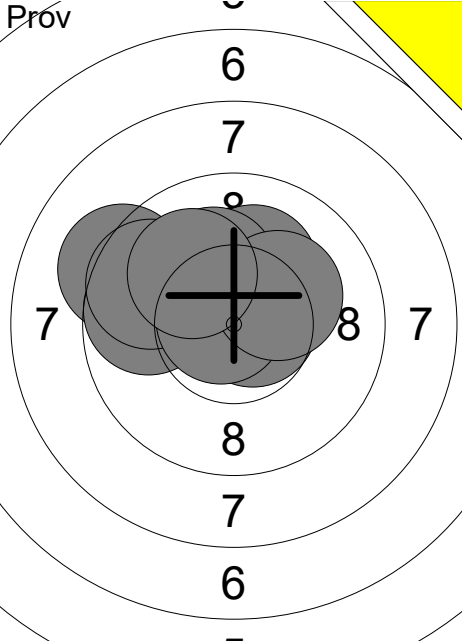
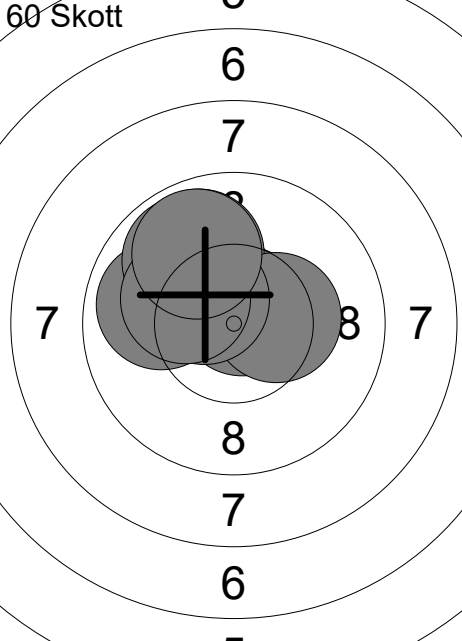
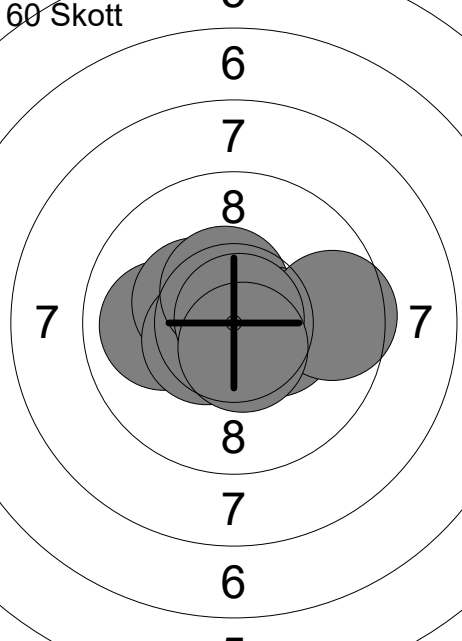
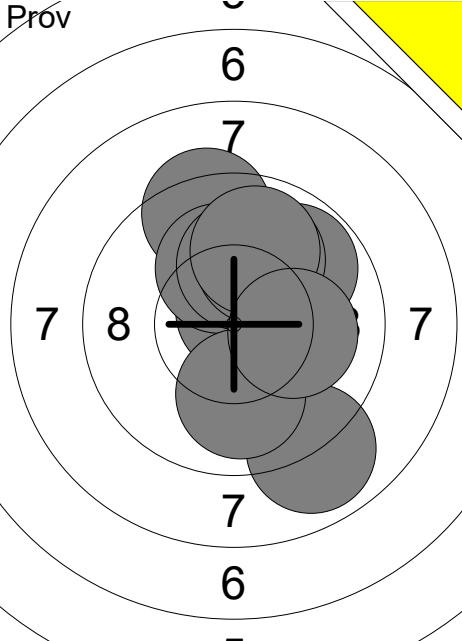
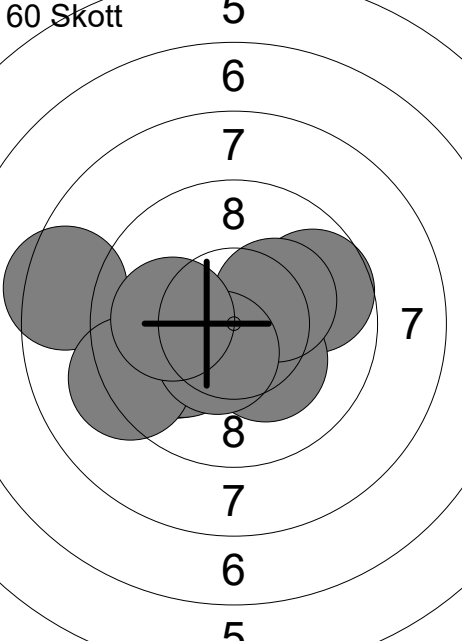
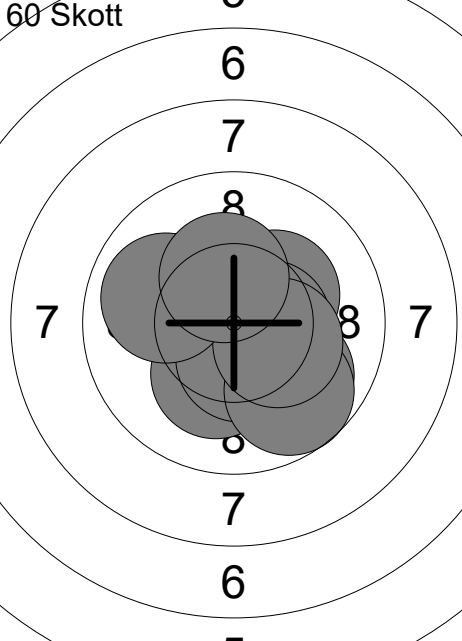
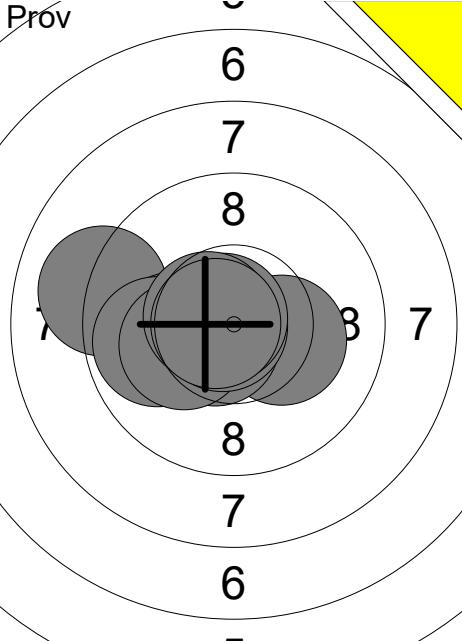
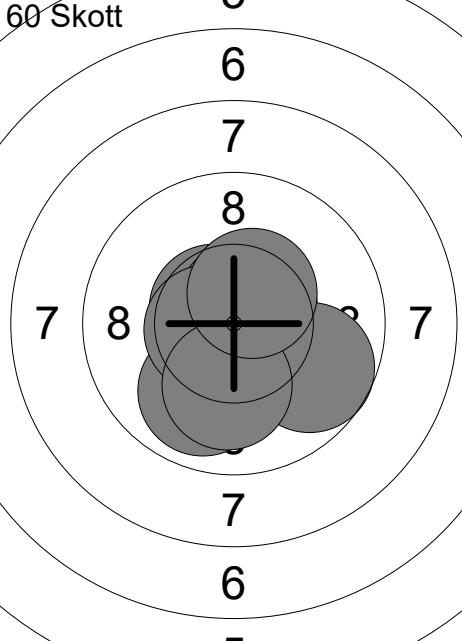
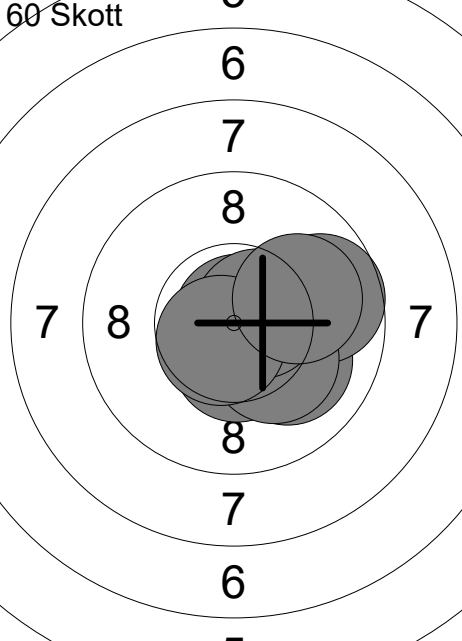
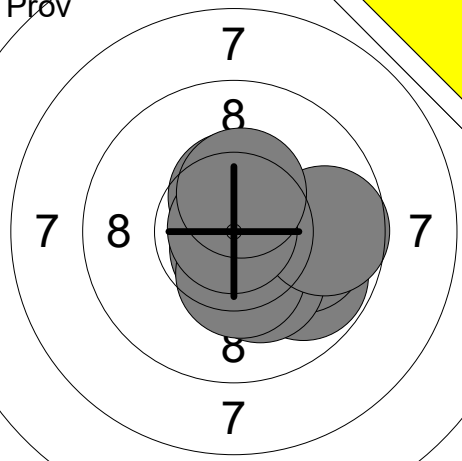
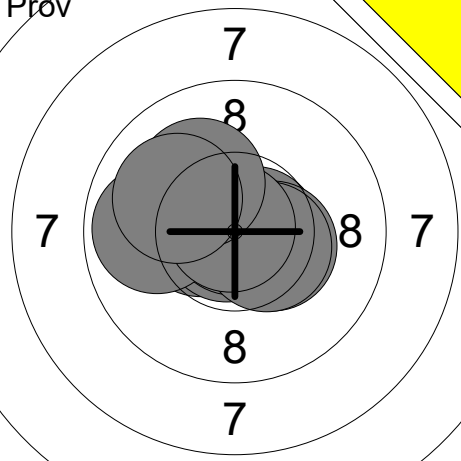
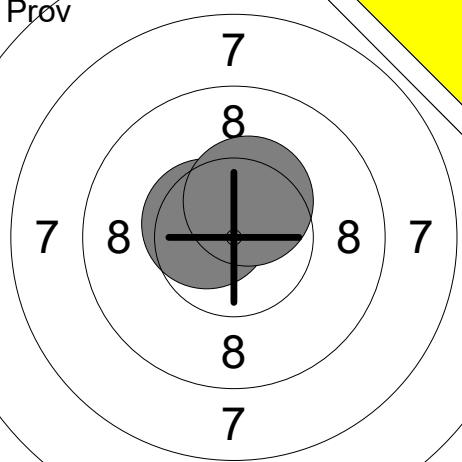
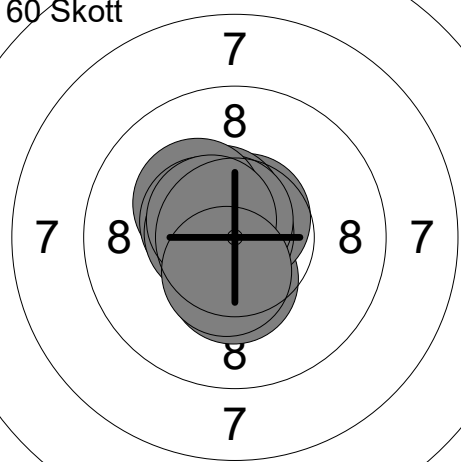
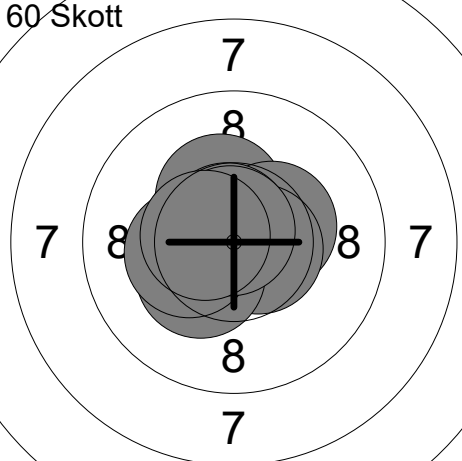
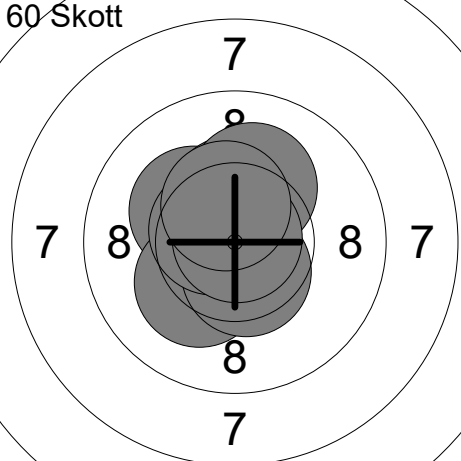
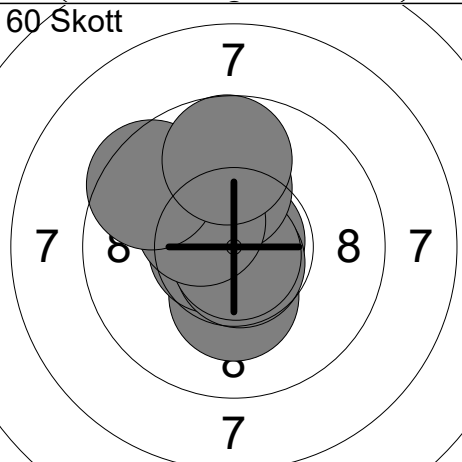

Skjutlag 1	Tavla 16	Bengt Lindberg			
Umeå		Bjurholm/Balsö Skf	Lsitt		
13.04.2024		UME-Kulan 2024	Umeå skytteallians		
Prov		1: 9.8 ↙ 2: 9.8 ↓ 3: 9.8 ↙ 4: 10.2x ↗ 5: 10.0 ↓ 6: 10.8x ↙ 7: 10.5x ↙ 8: 10.2x ↓ 9: 10.5x ↙ 10: 10.7x ←	Prov		11: 10.8x ↗ 12: 9.7 ↗ 13: 10.2x ↑ 14: 10.3x ↗ 15: 10.4x ↗ 16: 10.4x ↗ 17: 10.5x ↗ 18: 10.4x ↑ 19: 10.1 ← 20: 10.7x ↙
Serie 102.3		Total 0.0	Serie 103.5		Total 0.0
Prov		21: 10.6x ↓ 22: 10.6x ↑ 23: 9.9 ←	60 Skott		1: 10.6x ↙ 2: 10.9x ↙ 3: 10.5x ← 4: 10.4x ← 5: 10.3x ↙ 6: 10.6x ↙ 7: 10.7x ← 8: 10.2x ↗ 9: 10.7x ↙ 10: 10.6x ↘
Serie 31.1		Total 0.0	Serie 105.5		Total 105.5
60 Skott		11: 10.4x ↘ 12: 10.5x ↓ 13: 10.0 ↙ 14: 10.7x ↙ 15: 10.1 ↘ 16: 10.7x ↗ 17: 10.5x ↙ 18: 10.6x ← 19: 10.4x ↘ 20: 10.5x ↗	60 Skott		21: 10.7x ↗ 22: 10.8x ↑ 23: 10.0 ↙ 24: 10.3x ↙ 25: 10.0 ↗ 26: 10.5x ↑ 27: 10.4x ↘ 28: 10.2x ← 29: 10.0 ↘ 30: 10.4x ↘
Serie 104.4		Total 209.9	Serie 103.3		Total 313.2
60 Skott		31: 10.7x → 32: 10.4x ↓ 33: 10.6x ← 34: 10.9x ↑ 35: 10.0 ← 36: 10.6x ↙ 37: 10.8x ← 38: 10.1 ← 39: 10.3x ↑ 40: 10.5x ↘			
Serie 104.9		Total 418.1			

Skjutlag	Tavla	Fredrik Byström	
1	17	Umeå Skf	Lsitt
13.04.2024	UME-Kulan 2024	Umeå skytteallians	
Prov		1: 10.3x ↑ 2: 10.2x ↑ 3: 10.2x ↗ 4: 9.2 ↖ 5: 9.7 ↖ 6: 9.7 ↖ 7: 10.7x → 8: 10.8x ↖ 9: 10.2x ↗ 10: 10.0 ↖	11: 9.7 ↖ 12: 10.5x ↖ 13: 9.8 ↘ 14: 9.9 ↖ 15: 10.3x ↖ 16: 10.4x ↘ 17: 10.8x ↖ 18: 10.4x ↗ 19: 10.5x ↖
		Serie 101.0	Serie 92.3
		Total 0.0	Total 0.0
60 Skott		1: 10.4x ↖ 2: 10.7x ↗ 3: 10.1 ↖ 4: 9.9 ↖ 5: 9.9 ↗ 6: 9.9 ↗ 7: 10.4x → 8: 10.4x ↖ 9: 10.2x ↖ 10: 9.9 ↖	11: 10.4x ↖ 12: 10.3x ↖ 13: 10.4x → 14: 10.0 ↘ 15: 10.6x ↖ 16: 10.6x ↗ 17: 10.5x → 18: 10.3x ↘ 19: 10.4x ↖ 20: 10.7x ↗
		Serie 101.8	Serie 104.2
		Total 101.8	Total 206.0
60 Skott		21: 10.0 ↖ 22: 10.8x ↗ 23: 10.5x ↖ 24: 10.4x ↖ 25: 10.5x ↖ 26: 10.5x ↗ 27: 10.4x → 28: 9.6 → 29: 10.8x ↗ 30: 10.6x ↘	31: 10.2x ↗ 32: 10.5x → 33: 10.7x → 34: 10.0 ↗ 35: 10.6x ↘ 36: 10.5x ↘ 37: 10.7x ↗ 38: 10.6x ↗ 39: 10.0 → 40: 10.5x →
		Serie 104.1	Serie 104.3
		Total 310.1	Total 414.4

Skjutlag	Tavla	Ivar Byström	
1	18	Umeå Skf	L11
13.04.2024	UME-Kulan 2024	Umeå skytteallians	
Prov		1: 9.8 ↗ 2: 10.7x ↗ 3: 8.9 ↘ 4: 9.4 ↑ 5: 10.2x ↑ 6: 10.1 ↑ 7: 10.0 ↗ 8: 9.9 ↑ 9: 10.0 ↓ 10: 10.1 →	11: 10.4x ↗ 12: 9.9 ↖ 13: 10.1 ↗ 14: 10.4x ↗ 15: 10.2x ↖ 16: 9.7 ← 17: 9.2 ↓ 18: 9.5 → 19: 9.0 → 20: 9.9 ↘
		Serie 99.1	Serie 98.3
		Total 0.0	Total 0.0
60 Skott		1: 9.7 → 2: 10.2x ↘ 3: 10.0 ← 4: 10.1 ← 5: 8.4 ← 6: 10.6x ↘ 7: 9.2 ← 8: 10.3x ↗ 9: 10.5x ↘ 10: 10.1 ←	11: 9.3 ↘ 12: 10.6x ↗ 13: 9.4 ← 14: 9.3 ← 15: 9.9 ↗ 16: 10.0 ↘ 17: 10.2x ↘ 18: 10.8x ↗ 19: 10.1 ↘ 20: 9.5 ↘
		Serie 99.1	Serie 99.1
		Total 99.1	Total 198.2
60 Skott		21: 10.3x ↗ 22: 9.9 ↘ 23: 10.5x → 24: 10.7x ↘ 25: 10.2x ↘ 26: 10.5x ↘ 27: 9.7 ↘ 28: 10.3x → 29: 9.9 ← 30: 10.3x ↑	31: 10.6x ↗ 32: 10.3x ↖ 33: 9.5 → 34: 9.8 ↗ 35: 10.1 ↓ 36: 9.9 ↖ 37: 9.6 ↗ 38: 10.2x ↖ 39: 10.6x ↘ 40: 10.2x ↑
		Serie 102.3	Serie 100.8
		Total 300.5	Total 401.3

Skjutlag	Tavla	Nils Fredriksson	
1	19	Umeå Skf	Lsitt
13.04.2024	UME-Kulan 2024	Umeå skytteallians	
Prov		1: 9.1 ← 2: 10.3x → 3: 10.1 ← 4: 10.6x ↙ 5: 9.9 ← 6: 10.2x ↙ 7: 10.8x ← 8: 10.8x ↖ 9: 10.6x ↙ 10: 10.7x ←	Prov
		Serie 103.1	11: 10.0 ↗ 12: 9.9 ↓ 13: 10.6x ↙ 14: 10.2x ↑
		Total 0.0	Serie 40.7
			Total 0.0
60 Skott		1: 10.6x ↖ 2: 10.6x ↗ 3: 10.7x ↙ 4: 10.7x ↗ 5: 9.9 ↓ 6: 10.3x ↘ 7: 10.6x ← 8: 9.7 ↘ 9: 10.1 ↓ 10: 10.5x ↗	60 Skott
		Serie 103.7	11: 10.4x ↑ 12: 10.7x ↑ 13: 9.7 ↗ 14: 10.8x ↓ 15: 10.7x → 16: 10.4x → 17: 10.2x ↑ 18: 10.7x → 19: 10.2x ↓ 20: 10.6x →
		Total 103.7	Serie 104.4
			Total 208.1
60 Skott		21: 10.4x → 22: 10.1 ↘ 23: 10.9x ↗ 24: 9.7 → 25: 10.6x ↓ 26: 10.5x ↓ 27: 10.2x ↘ 28: 10.6x → 29: 10.6x ↙ 30: 10.0 →	60 Skott
		Serie 103.6	31: 10.5x → 32: 10.5x → 33: 10.2x ↙ 34: 9.8 → 35: 10.0 ↗ 36: 10.0 ↑ 37: 10.5x ← 38: 10.1 ↗ 39: 10.3x → 40: 10.2x ↖
		Total 311.7	Serie 102.1
			Total 413.8

Skjutlag 1	Tavla 21	Ylva Lundstedt	
Umeå		Ramselefors Skf	L13
13.04.2024		UME-Kulan 2024	Umeå skytteallians
Prov 	1: 10.7x ↓ 2: 10.6x ↘ 3: 9.8 ↘ 4: 10.0 → 5: 10.2x ↘ 6: 10.4x ↓ 7: 9.7 → 8: 10.5x ↑ 9: 10.9x ↗ 10: 10.4x ↑ Serie 103.2 Total 0.0	Prov 	11: 10.7x → 12: 10.4x → 13: 10.5x ← 14: 10.8x ↙ 15: 10.9x ↗ 16: 10.5x ↘ 17: 9.9 ← 18: 10.9x ↗ 19: 10.1 ↗ 20: 10.0 ↖ Serie 104.7 Total 0.0
Prov 	21: 10.5x ↖ 22: 10.4x ↗ Serie 20.9 Total 0.0	60 Skott 	1: 10.4x ↓ 2: 10.7x ↗ 3: 10.5x ↗ 4: 10.9x ↗ 5: 10.7x ↗ 6: 10.3x ↗ 7: 10.5x ↗ 8: 10.6x ← 9: 10.5x ↗ 10: 10.5x ↓ Serie 105.6 Total 105.6
60 Skott 	11: 10.7x ↖ 12: 10.6x ↗ 13: 10.3x ↗ 14: 10.4x → 15: 10.6x ↘ 16: 10.3x ↙ 17: 10.7x ↗ 18: 10.3x ← 19: 10.8x ↗ 20: 10.5x ↖ Serie 105.2 Total 210.8	60 Skott 	21: 10.2x ↖ 22: 10.4x ↑ 23: 10.8x ↖ 24: 10.2x ↘ 25: 10.5x ↓ 26: 10.6x ↖ 27: 10.4x ↑ 28: 10.2x ↑ 29: 10.9x ↗ 30: 10.4x ↑ Serie 104.6 Total 315.4
60 Skott 	31: 10.3x ↓ 32: 10.4x ↗ 33: 10.7x ← 34: 10.8x ↗ 35: 10.7x ↓ 36: 10.8x ↓ 37: 10.1 ↑ 38: 10.4x ↗ 39: 9.5 ↗ 40: 9.7 ↑ Serie 103.4 Total 418.8		

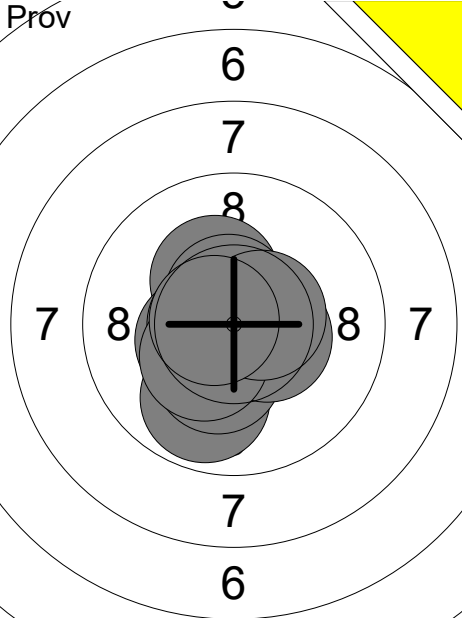
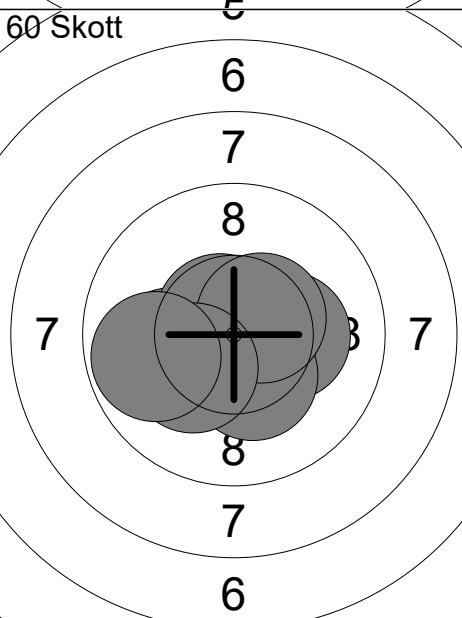
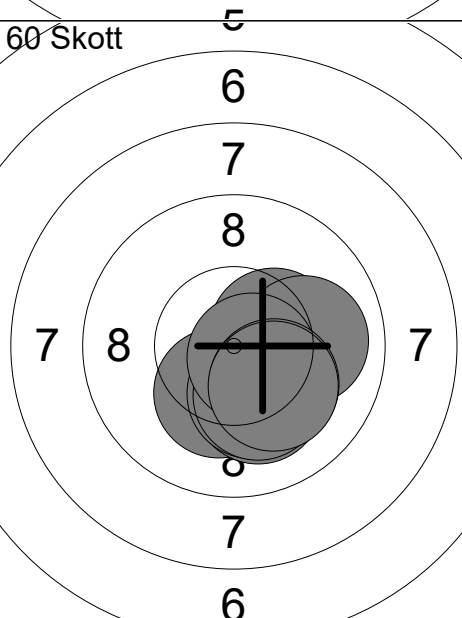
Skjutlag 1	Tavla 22	Alexander Lindahl	
Umeå	Vännäs Skf	L13	
13.04.2024	UME-Kulan 2024	Umeå skytteallians	
Prov		1: 10.3x ↗ 2: 9.9 ↓ 3: 10.3x ↓ 4: 10.4x ↙ 5: 10.5x → 6: 10.6x ↑ 7: 10.6x ← 8: 10.3x ↓ 9: 10.5x → 10: 10.7x ←	11: 10.6x ↓ 12: 10.0 → 13: 9.9 → 14: 10.2x ↓ 15: 10.8x ↗ 16: 10.2x → 17: 10.2x ↗ 18: 10.1 ↓
	Serie 104.1		Serie 82.0
	Total 0.0		Total 0.0
60 Skott		1: 10.6x ↘ 2: 10.5x → 3: 10.2x → 4: 10.7x → 5: 10.1 ← 6: 10.3x ↓ 7: 10.7x ↗ 8: 10.5x ↗ 9: 10.2x ↙ 10: 9.8 ←	11: 10.6x ↖ 12: 9.7 → 13: 10.7x ↘ 14: 10.4x ↓ 15: 10.6x ↓ 16: 10.2x → 17: 10.4x ↗ 18: 10.5x ← 19: 10.5x ↖ 20: 10.6x →
	Serie 103.6		Serie 104.2
	Total 103.6		Total 207.8
60 Skott		21: 10.3x ↓ 22: 10.4x → 23: 10.1 ↓ 24: 10.2x ↓ 25: 10.4x → 26: 10.0 → 27: 10.2x ↓ 28: 10.7x ↘ 29: 10.2x ↓ 30: 10.2x ↘	31: 10.3x → 32: 10.1 ↓ 33: 10.6x ↗ 34: 10.5x ↘ 35: 10.4x ↑ 36: 10.5x ↙ 37: 10.5x ↗ 38: 10.3x → 39: 10.5x ↓ 40: 10.5x ↙
	Serie 102.7		Serie 104.2
	Total 310.5		Total 414.7

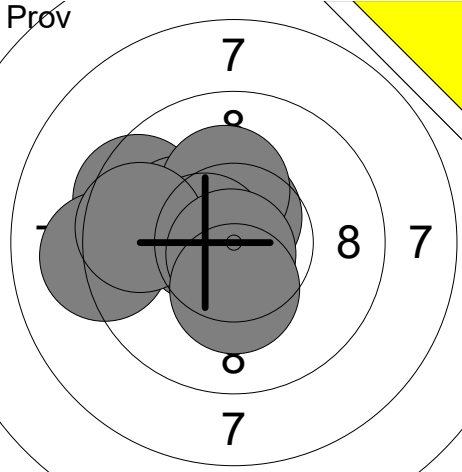
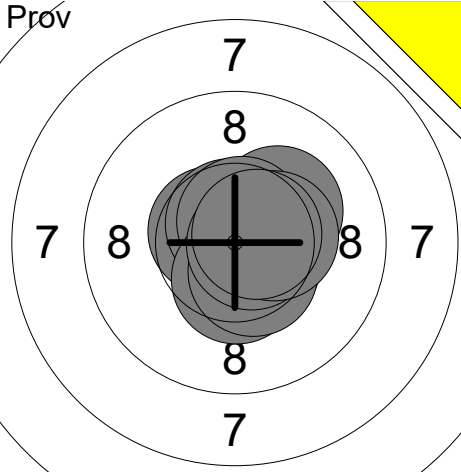
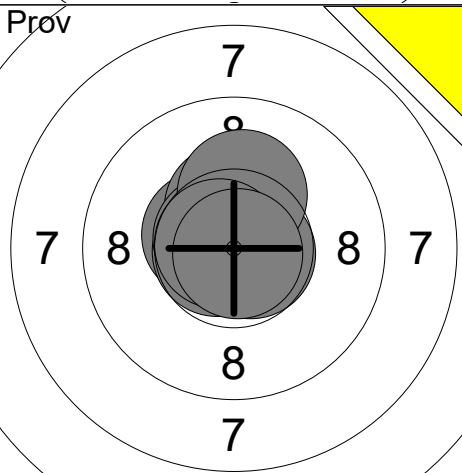
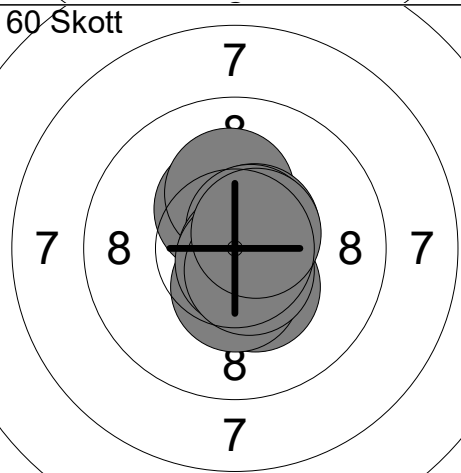
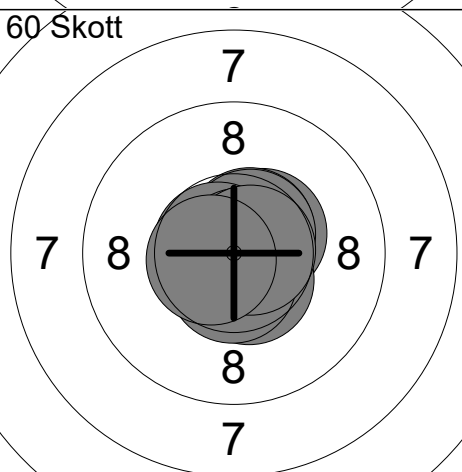
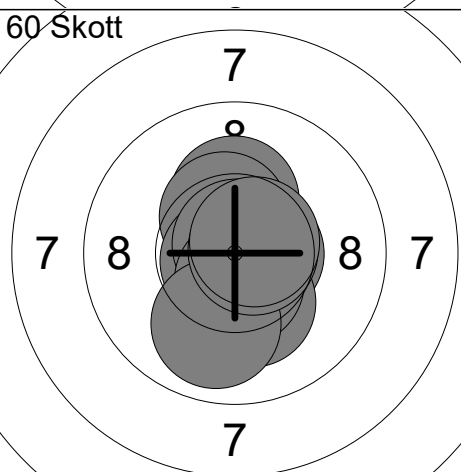
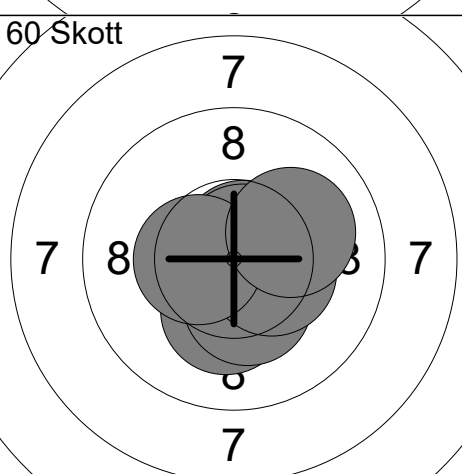
Skjutlag 1	Tavla 23	Milly Burström	
Umeå		Bjurholm/Balsö Skf	L13
13.04.2024		UME-Kulan 2024	Umeå skytteallians
Prov 	1: 9.5 ↖ 2: 9.1 ← 3: 10.2x ↗ 4: 10.6x ↑ 5: 10.5x ↖ 6: 10.2x ↑ 7: 10.5x ↖ 8: 9.6 ← 9: 10.8x ↓ 10: 10.3x ↓ Serie 101.3 Total 0.0	Prov 	11: 10.6x ↖ 12: 10.2x ↗ 13: 10.7x ↑ 14: 10.6x ↑ 15: 10.4x ↓ 16: 10.5x ↘ 17: 10.5x ↘ 18: 10.7x → 19: 10.4x → 20: 10.6x ↗ Serie 105.2 Total 0.0
Prov 	21: 10.5x ↖ 22: 10.7x ← 23: 10.4x ↑ 24: 10.7x ↗ 25: 10.7x → 26: 10.2x ↑ 27: 10.7x ↖ 28: 10.9x ↘ Serie 84.8 Total 0.0	60 Skott 	1: 10.4x ↑ 2: 10.2x ↑ 3: 10.6x ↗ 4: 10.6x ↗ 5: 10.3x ↘ 6: 10.4x ↓ 7: 10.8x ↘ 8: 10.7x ↘ 9: 10.6x ↘ 10: 10.6x ↗ Serie 105.2 Total 105.2
60 Skott 	11: 10.7x → 12: 10.5x ↗ 13: 10.5x ↘ 14: 10.6x ↗ 15: 10.6x ↗ 16: 10.7x ↖ 17: 10.9x → 18: 10.6x ↓ 19: 10.7x → 20: 10.6x ← Serie 106.4 Total 211.6	60 Skott 	21: 10.6x → 22: 10.2x ↓ 23: 10.2x ↑ 24: 10.4x ↑ 25: 10.8x ↖ 26: 10.8x ↑ 27: 10.6x ↓ 28: 9.9 ↓ 29: 10.7x → 30: 10.6x ↗ Serie 104.8 Total 316.4
60 Skott 	31: 10.7x ↗ 32: 10.5x ↓ 33: 10.8x ↗ 34: 10.2x ↓ 35: 10.8x ↓ 36: 10.3x ↓ 37: 10.8x ↗ 38: 10.4x → 39: 10.5x ↖ 40: 10.1 ↗ Serie 105.1 Total 421.5		

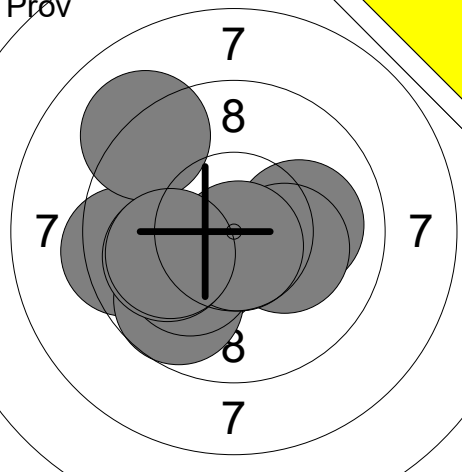
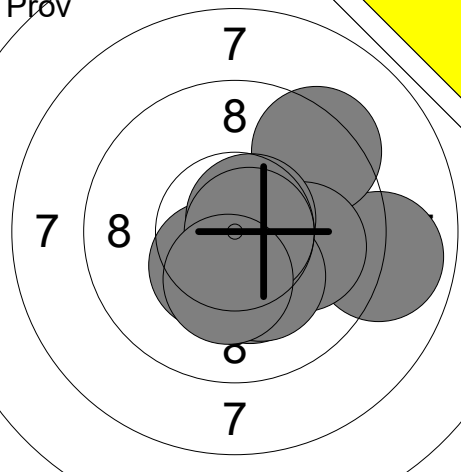
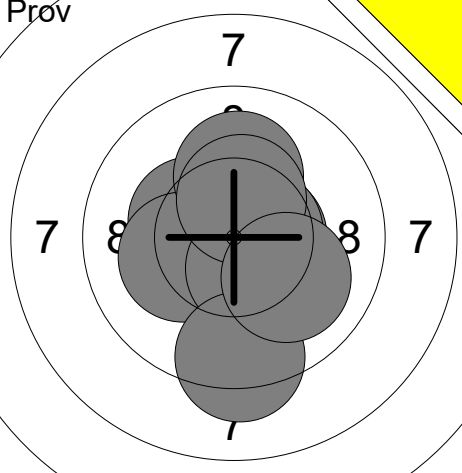
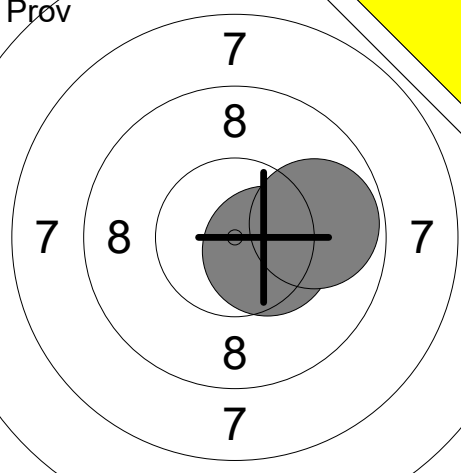
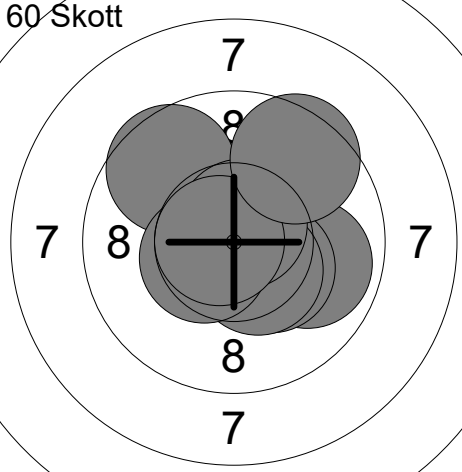
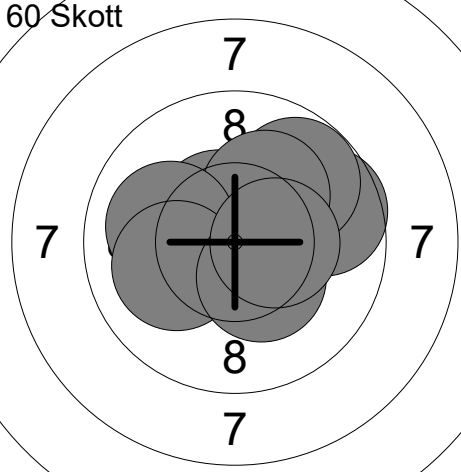
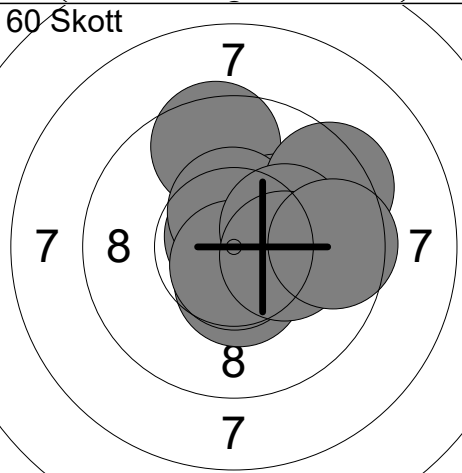
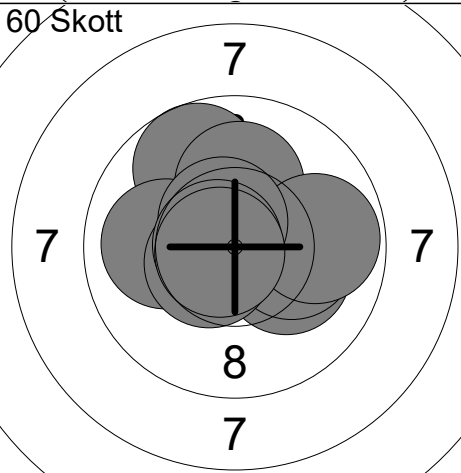
Skjutlag	Tavla	Emma Söderlund	
1	24	Umeå	Vännäs Skf
13.04.2024		UME-Kulan 2024	Umeå skytteallians
Prov 	1: 9.4 ← 2: 10.3x ↙ 3: 9.1 ↗ 4: 10.0 → 5: 9.7 ↙ 6: 10.2x → 7: 10.1 ↙ 8: 10.7x ↘ 9: 10.0 ← 10: 10.0 ← Serie 99.5 Total 0.0	Prov 	11: 8.9 → 12: 10.4x ↘ 13: 9.4 ↗ 14: 10.3x ↘ 15: 10.4x ↘ 16: 10.0 → 17: 10.7x ↗ 18: 10.2x ↘ 19: 10.7x → 20: 10.3x ↘ Serie 101.3 Total 0.0
Prov 	21: 10.3x ← 23: 10.2x ← 24: 10.6x → 25: 10.1 ↑ 26: 10.6x → 27: 10.5x ↘ 28: 10.4x ↑ 29: 9.3 ↘ 30: 10.0 ↘ Serie 92.0 Total 0.0	Prov 	31: 10.5x → 32: 9.8 → Serie 20.3 Total 0.0
60 Skott 	1: 10.4x ↗ 2: 10.2x → 3: 9.9 → 4: 10.3x ↘ 5: 10.4x ↘ 6: 9.6 ↗ 7: 10.5x ↙ 8: 10.7x ↑ 9: 10.7x ← 10: 9.5 ↗ Serie 102.2 Total 102.2	60 Skott 	11: 9.7 → 12: 10.5x ↗ 13: 10.5x → 14: 9.8 ↗ 15: 10.6x ↑ 16: 10.2x ↑ 17: 10.0 ← 18: 10.1 ← 19: 10.3x ↘ 20: 10.4x → Serie 102.1 Total 204.3
60 Skott 	21: 10.8x ↑ 22: 9.5 ↑ 23: 10.2x ↗ 24: 10.5x ↑ 25: 10.5x ↘ 26: 9.4 ↗ 27: 10.7x ↘ 28: 10.2x → 29: 10.2x → 30: 9.6 → Serie 101.6 Total 305.9	60 Skott 	31: 10.2x → 32: 9.7 ↗ 33: 10.1 ↑ 34: 10.2x → 35: 10.0 ← 36: 9.8 → 37: 10.6x ↗ 38: 10.5x ↙ 39: 10.7x ← 40: 10.7x ← Serie 102.5 Total 408.4

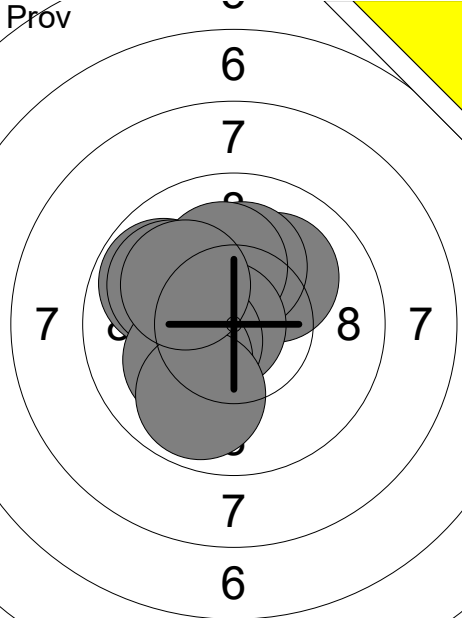
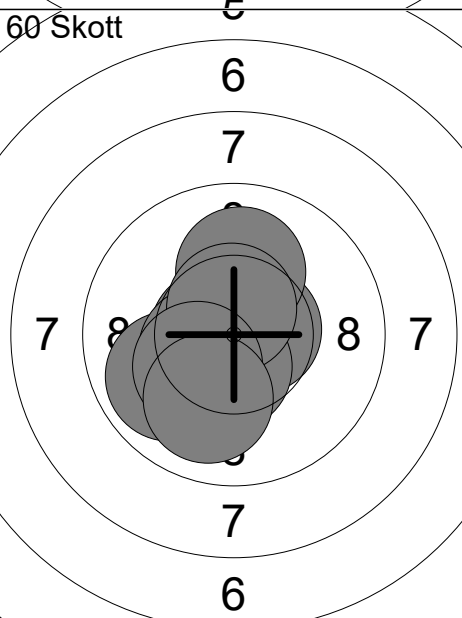
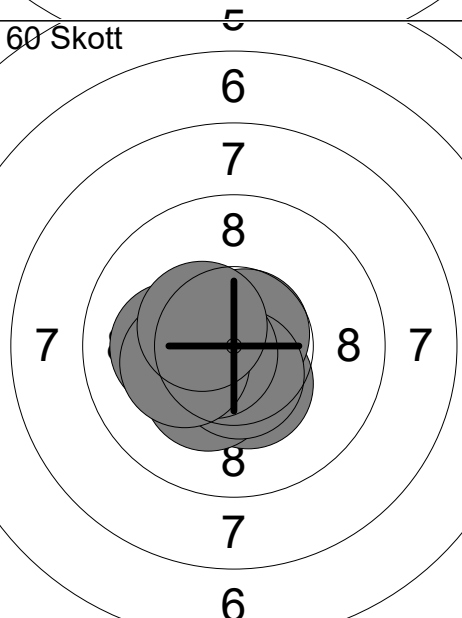
Skjutlag 1	Tavla 25	Dennis Alenius	
Umeå		Ramselefors Skf	L13
13.04.2024		UME-Kulan 2024	Umeå skytteallians
Prov		1: 10.1 ↗ 2: 10.1 ↑ 3: 9.8 ↖ 4: 9.9 ↖ 5: 10.1 ↑ 6: 10.8x ← 7: 10.4x ← 8: 10.1 ↙ 9: 9.9 ↘ 10: 10.1 ↖	11: 10.9x ↘ 12: 10.0 ↓ 13: 10.3x ↘ 14: 10.3x ↙ 15: 9.9 ↘ 16: 10.0 ↖ 17: 9.9 ← 18: 10.3x ↘ 19: 10.8x ↘
		Serie 101.3	Serie 92.4
		Total 0.0	Total 0.0
60 Skott		1: 10.7x ← 2: 10.6x ↙ 3: 10.6x → 4: 10.1 ↑ 5: 9.9 ↖ 6: 10.5x ← 7: 10.5x ↓ 8: 10.6x ↑ 9: 10.3x ↙ 10: 10.0 ↓	11: 10.5x ↖ 12: 10.0 ← 13: 10.5x ← 14: 10.3x → 15: 10.6x ← 16: 10.7x ← 17: 10.6x ↘ 18: 10.9x ← 19: 10.8x ← 20: 10.4x ↘
		Serie 103.8	Serie 105.3
		Total 103.8	Total 209.1
60 Skott		21: 10.1 ← 22: 10.4x ↘ 23: 10.8x ↘ 24: 10.5x ← 25: 10.3x ↘ 26: 10.7x ↗ 27: 10.6x ↓ 28: 10.6x ← 29: 10.2x ← 30: 10.4x ↖	31: 10.3x ↗ 32: 10.8x ← 33: 10.4x ↘ 34: 10.2x ↖ 35: 10.5x ↑ 36: 10.5x ↖ 37: 10.7x ← 38: 10.5x ↖ 39: 10.7x ↘ 40: 10.6x ←
		Serie 104.6	Serie 105.2
		Total 313.7	Total 418.9

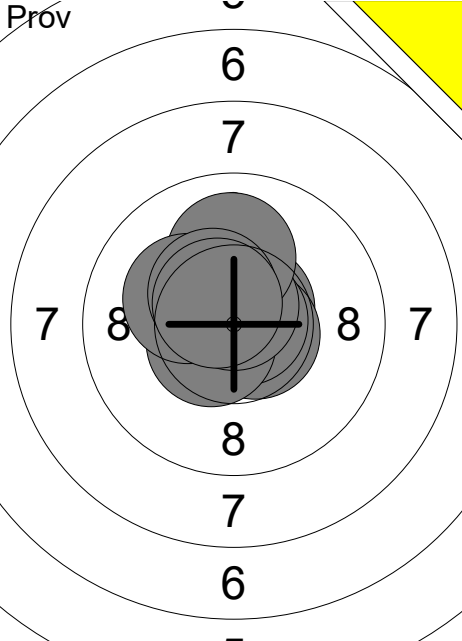
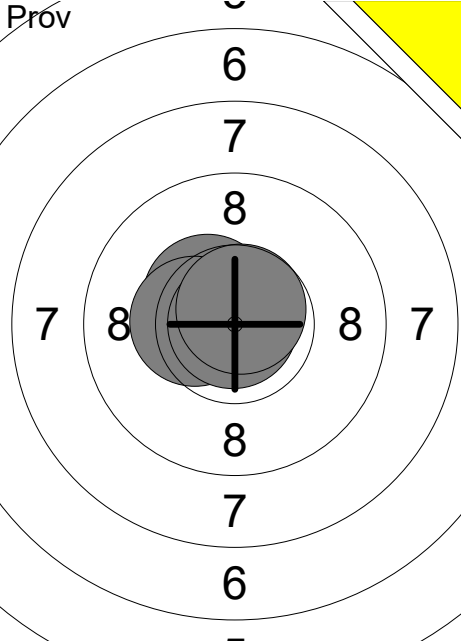
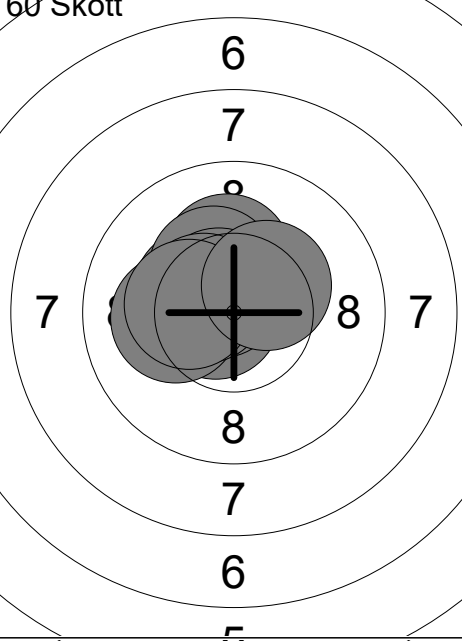
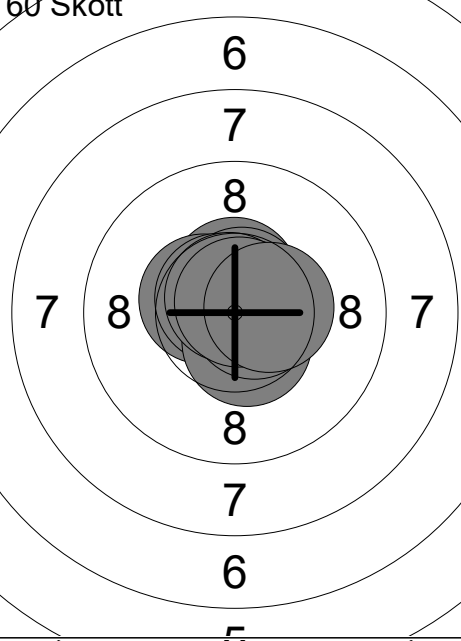
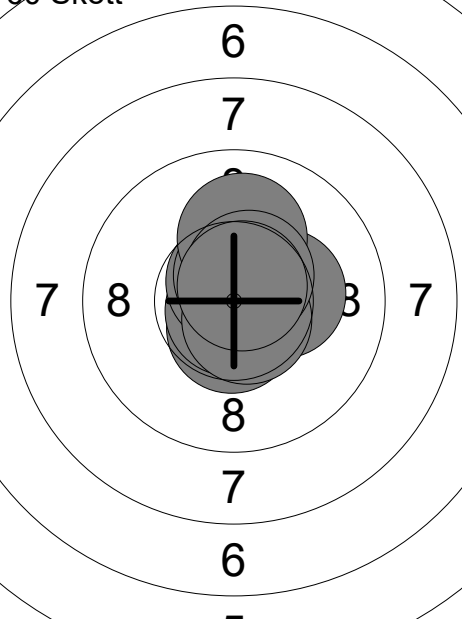
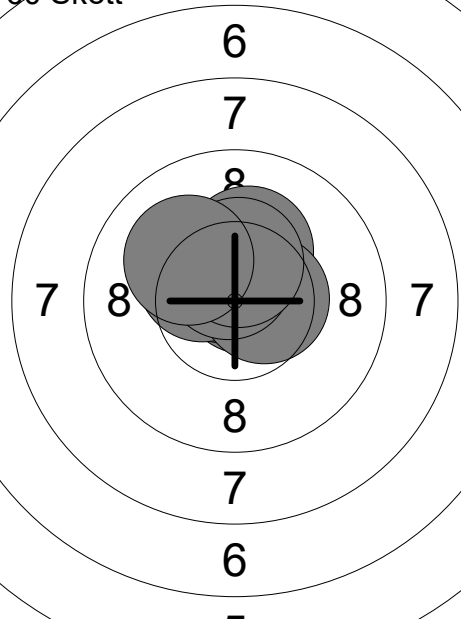
Skjutlag	Tavla	Melker Häggström	
1	26	Ramselefors Skf	L11
13.04.2024	UME-Kulan 2024	Umeå skytteallians	
Prov		1: 10.6x ↗ 2: 10.6x ➤ 3: 10.8x ➤ 4: 10.6x ↙ 5: 10.3x ↖ 6: 10.7x ↑ 7: 10.0 ↑ 8: 10.2x ↖ 9: 10.4x ↖ 10: 10.6x ↖ Serie 104.8 Total 0.0	Prov  11: 10.6x ↖ 12: 10.4x ↖ 13: 10.4x ← 14: 10.9x ↖ 15: 10.7x ↑ Serie 53.0 Total 0.0
60 Skott		1: 10.7x ← 2: 10.1 ← 3: 10.4x ↖ 4: 10.4x ↗ 5: 10.2x ↑ 6: 10.3x ↗ 7: 10.6x ↖ 8: 10.5x ↖ 9: 10.3x ← 10: 10.4x ↗ Serie 103.9 Total 103.9	60 Skott  11: 10.5x ↑ 12: 10.5x ↖ 13: 10.7x ↑ 14: 10.7x ↖ 15: 10.5x ↓ 16: 10.7x ↑ 17: 10.7x ↗ 18: 10.7x ➔ 19: 10.8x ↑ 20: 10.5x ➔ Serie 106.3 Total 210.2
60 Skott		21: 10.6x ↓ 22: 10.6x ↗ 23: 10.8x ↓ 24: 10.7x ↑ 25: 10.3x ➔ 26: 10.6x ↓ 27: 10.6x ↑ 28: 10.1 ↑ 29: 10.5x ↗ 30: 10.7x ↗ Serie 105.5 Total 315.7	60 Skott  31: 10.7x ↗ 32: 10.6x ↖ 33: 10.6x ↗ 34: 10.6x ↗ 35: 10.4x ↖ 36: 10.2x ↑ 37: 10.5x ➔ 38: 10.6x ↑ 39: 10.4x ↑ 40: 10.1 ↖ Serie 104.7 Total 420.4

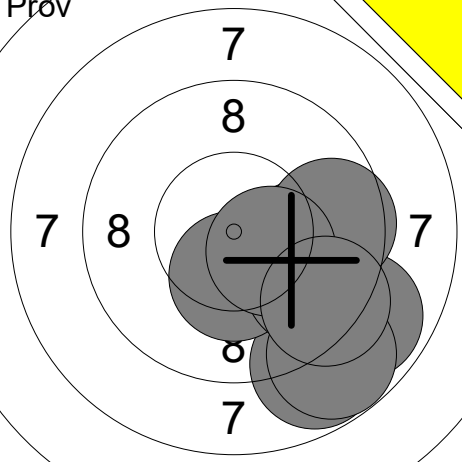
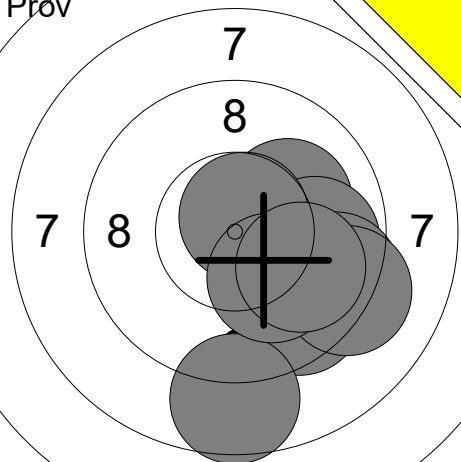
<p>Prov</p> 	<table border="1" style="width:100%; border-collapse: collapse;"> <tr><td>1:</td><td>8.8</td><td>↘</td></tr> <tr><td>2:</td><td>8.9</td><td>↘</td></tr> <tr><td>3:</td><td>10.0</td><td>→</td></tr> <tr><td>4:</td><td>10.1</td><td>↘</td></tr> <tr><td>5:</td><td>10.3x</td><td>↘</td></tr> <tr><td>6:</td><td>9.7</td><td>↘</td></tr> <tr><td>7:</td><td>9.6</td><td>→</td></tr> <tr><td>8:</td><td>8.8</td><td>↘</td></tr> <tr><td>9:</td><td>10.4x</td><td>↘</td></tr> <tr><td>10:</td><td>9.4</td><td>↘</td></tr> <tr><td colspan="2">Serie</td><td>96.0</td></tr> <tr><td colspan="2">Total</td><td>0.0</td></tr> </table>	1:	8.8	↘	2:	8.9	↘	3:	10.0	→	4:	10.1	↘	5:	10.3x	↘	6:	9.7	↘	7:	9.6	→	8:	8.8	↘	9:	10.4x	↘	10:	9.4	↘	Serie		96.0	Total		0.0	<p>Prov</p> 	<table border="1" style="width:100%; border-collapse: collapse;"> <tr><td>11:</td><td>9.5</td><td>↘</td></tr> <tr><td>12:</td><td>10.5x</td><td>→</td></tr> <tr><td>13:</td><td>10.1</td><td>→</td></tr> <tr><td>14:</td><td>9.8</td><td>→</td></tr> <tr><td>15:</td><td>9.4</td><td>↘</td></tr> <tr><td>16:</td><td>8.6</td><td>↘</td></tr> <tr><td>17:</td><td>10.7x</td><td>↗</td></tr> <tr><td>18:</td><td>9.2</td><td>↘</td></tr> <tr><td>19:</td><td>10.1</td><td>↘</td></tr> <tr><td>20:</td><td>9.9</td><td>↘</td></tr> <tr><td colspan="2">Serie</td><td>97.8</td></tr> <tr><td colspan="2">Total</td><td>0.0</td></tr> </table>	11:	9.5	↘	12:	10.5x	→	13:	10.1	→	14:	9.8	→	15:	9.4	↘	16:	8.6	↘	17:	10.7x	↗	18:	9.2	↘	19:	10.1	↘	20:	9.9	↘	Serie		97.8	Total		0.0
1:	8.8	↘																																																																									
2:	8.9	↘																																																																									
3:	10.0	→																																																																									
4:	10.1	↘																																																																									
5:	10.3x	↘																																																																									
6:	9.7	↘																																																																									
7:	9.6	→																																																																									
8:	8.8	↘																																																																									
9:	10.4x	↘																																																																									
10:	9.4	↘																																																																									
Serie		96.0																																																																									
Total		0.0																																																																									
11:	9.5	↘																																																																									
12:	10.5x	→																																																																									
13:	10.1	→																																																																									
14:	9.8	→																																																																									
15:	9.4	↘																																																																									
16:	8.6	↘																																																																									
17:	10.7x	↗																																																																									
18:	9.2	↘																																																																									
19:	10.1	↘																																																																									
20:	9.9	↘																																																																									
Serie		97.8																																																																									
Total		0.0																																																																									

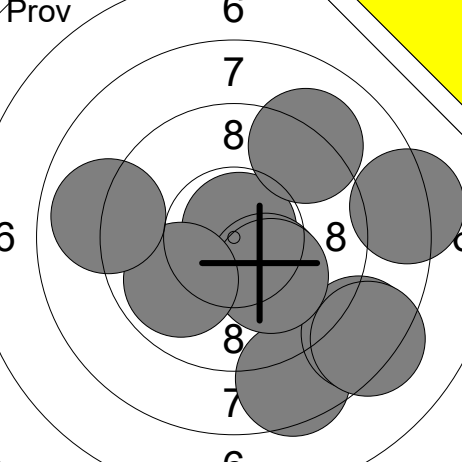
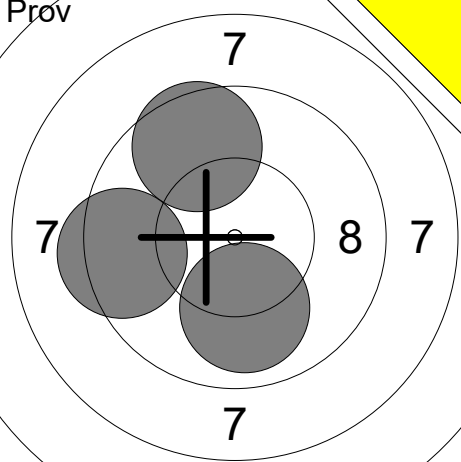
<p>Prov</p> 	<table border="1" style="width:100%; border-collapse: collapse;"> <tr><td>21:</td><td>8.5</td><td>↘</td></tr> <tr><td>22:</td><td>10.8x</td><td>↗</td></tr> <tr><td>23:</td><td>8.5</td><td>↘</td></tr> <tr><td>24:</td><td>9.1</td><td>↗</td></tr> <tr><td>25:</td><td>10.2x</td><td>↘</td></tr> <tr><td>26:</td><td>10.1</td><td>↘</td></tr> <tr><td>27:</td><td>8.2</td><td>→</td></tr> <tr><td>28:</td><td>8.3</td><td>↘</td></tr> <tr><td>29:</td><td>9.9</td><td>↙</td></tr> <tr><td>30:</td><td>9.0</td><td>↙</td></tr> <tr><td colspan="2">Serie</td><td>92.6</td></tr> <tr><td colspan="2">Total</td><td>0.0</td></tr> </table>	21:	8.5	↘	22:	10.8x	↗	23:	8.5	↘	24:	9.1	↗	25:	10.2x	↘	26:	10.1	↘	27:	8.2	→	28:	8.3	↘	29:	9.9	↙	30:	9.0	↙	Serie		92.6	Total		0.0	<p>Prov</p> 	<table border="1" style="width:100%; border-collapse: collapse;"> <tr><td>31:</td><td>9.6</td><td>↗</td></tr> <tr><td>32:</td><td>9.4</td><td>←</td></tr> <tr><td>33:</td><td>10.0</td><td>↘</td></tr> <tr><td colspan="2">Serie</td><td>29.0</td></tr> <tr><td colspan="2">Total</td><td>0.0</td></tr> </table>	31:	9.6	↗	32:	9.4	←	33:	10.0	↘	Serie		29.0	Total		0.0
21:	8.5	↘																																																				
22:	10.8x	↗																																																				
23:	8.5	↘																																																				
24:	9.1	↗																																																				
25:	10.2x	↘																																																				
26:	10.1	↘																																																				
27:	8.2	→																																																				
28:	8.3	↘																																																				
29:	9.9	↙																																																				
30:	9.0	↙																																																				
Serie		92.6																																																				
Total		0.0																																																				
31:	9.6	↗																																																				
32:	9.4	←																																																				
33:	10.0	↘																																																				
Serie		29.0																																																				
Total		0.0																																																				

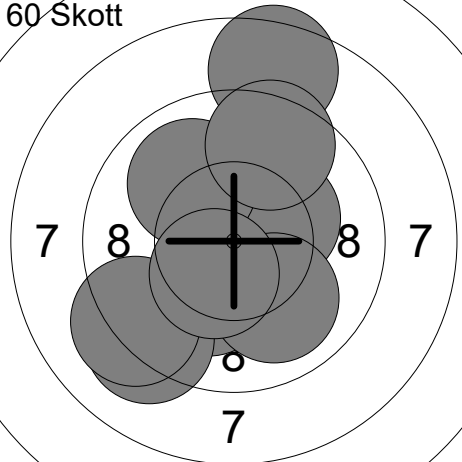
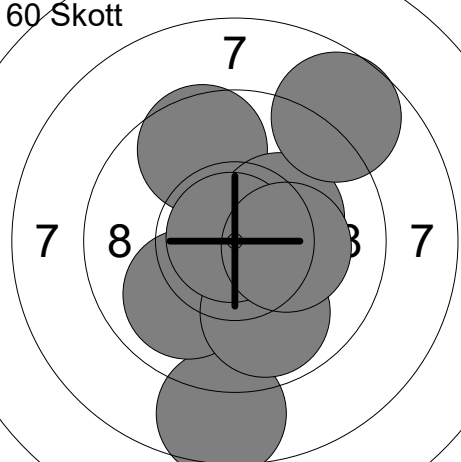
<p>60 Skott</p> 	<table border="1" style="width:100%; border-collapse: collapse;"> <tr><td>1:</td><td>10.2x</td><td>↘</td></tr> <tr><td>2:</td><td>10.8x</td><td>↗</td></tr> <tr><td>3:</td><td>9.2</td><td>↘</td></tr> <tr><td>4:</td><td>10.3x</td><td>→</td></tr> <tr><td>5:</td><td>10.0</td><td>↘</td></tr> <tr><td>6:</td><td>9.2</td><td>↙</td></tr> <tr><td>7:</td><td>8.5</td><td>↗</td></tr> <tr><td>8:</td><td>10.0</td><td>↗</td></tr> <tr><td>9:</td><td>10.4x</td><td>↘</td></tr> <tr><td>10:</td><td>9.5</td><td>↗</td></tr> <tr><td colspan="2">Serie</td><td>98.1</td></tr> <tr><td colspan="2">Total</td><td>98.1</td></tr> </table>	1:	10.2x	↘	2:	10.8x	↗	3:	9.2	↘	4:	10.3x	→	5:	10.0	↘	6:	9.2	↙	7:	8.5	↗	8:	10.0	↗	9:	10.4x	↘	10:	9.5	↗	Serie		98.1	Total		98.1	<p>60 Skott</p> 	<table border="1" style="width:100%; border-collapse: collapse;"> <tr><td>11:</td><td>9.6</td><td>↗</td></tr> <tr><td>12:</td><td>10.4x</td><td>→</td></tr> <tr><td>13:</td><td>8.6</td><td>↘</td></tr> <tr><td>14:</td><td>10.4x</td><td>→</td></tr> <tr><td>15:</td><td>10.0</td><td>↘</td></tr> <tr><td>16:</td><td>10.2x</td><td>→</td></tr> <tr><td>17:</td><td>9.9</td><td>↘</td></tr> <tr><td>18:</td><td>10.9x</td><td>↗</td></tr> <tr><td>19:</td><td>10.2x</td><td>→</td></tr> <tr><td>20:</td><td>8.7</td><td>↗</td></tr> <tr><td colspan="2">Serie</td><td>98.9</td></tr> <tr><td colspan="2">Total</td><td>197.0</td></tr> </table>	11:	9.6	↗	12:	10.4x	→	13:	8.6	↘	14:	10.4x	→	15:	10.0	↘	16:	10.2x	→	17:	9.9	↘	18:	10.9x	↗	19:	10.2x	→	20:	8.7	↗	Serie		98.9	Total		197.0
1:	10.2x	↘																																																																									
2:	10.8x	↗																																																																									
3:	9.2	↘																																																																									
4:	10.3x	→																																																																									
5:	10.0	↘																																																																									
6:	9.2	↙																																																																									
7:	8.5	↗																																																																									
8:	10.0	↗																																																																									
9:	10.4x	↘																																																																									
10:	9.5	↗																																																																									
Serie		98.1																																																																									
Total		98.1																																																																									
11:	9.6	↗																																																																									
12:	10.4x	→																																																																									
13:	8.6	↘																																																																									
14:	10.4x	→																																																																									
15:	10.0	↘																																																																									
16:	10.2x	→																																																																									
17:	9.9	↘																																																																									
18:	10.9x	↗																																																																									
19:	10.2x	→																																																																									
20:	8.7	↗																																																																									
Serie		98.9																																																																									
Total		197.0																																																																									

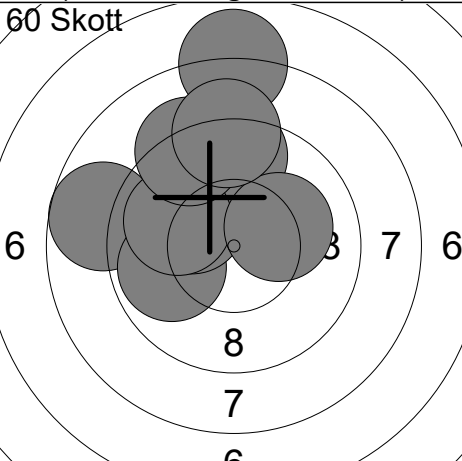
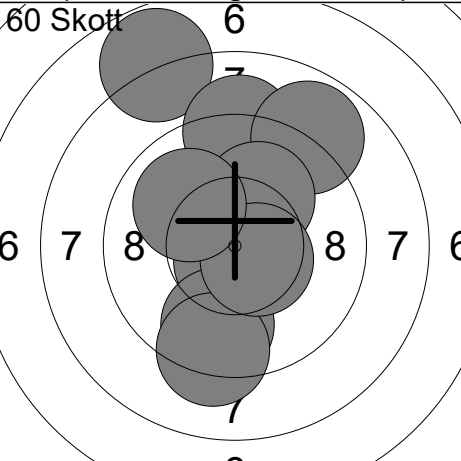
<p>60 Skott</p> 	<table border="1" style="width:100%; border-collapse: collapse;"> <tr><td>21:</td><td>10.1</td><td>↗</td></tr> <tr><td>22:</td><td>8.7</td><td>←</td></tr> <tr><td>23:</td><td>9.9</td><td>←</td></tr> <tr><td>24:</td><td>10.1</td><td>↗</td></tr> <tr><td>25:</td><td>9.5</td><td>↗</td></tr> <tr><td>26:</td><td>7.9</td><td>↗</td></tr> <tr><td>27:</td><td>9.9</td><td>↙</td></tr> <tr><td>28:</td><td>10.2x</td><td>→</td></tr> <tr><td>29:</td><td>9.2</td><td>↗</td></tr> <tr><td>30:</td><td>9.1</td><td>↗</td></tr> <tr><td colspan="2">Serie</td><td>94.6</td></tr> <tr><td colspan="2">Total</td><td>291.6</td></tr> </table>	21:	10.1	↗	22:	8.7	←	23:	9.9	←	24:	10.1	↗	25:	9.5	↗	26:	7.9	↗	27:	9.9	↙	28:	10.2x	→	29:	9.2	↗	30:	9.1	↗	Serie		94.6	Total		291.6	<p>60 Skott</p> 	<table border="1" style="width:100%; border-collapse: collapse;"> <tr><td>31:</td><td>7.8</td><td>↗</td></tr> <tr><td>32:</td><td>9.1</td><td>↗</td></tr> <tr><td>33:</td><td>10.6x</td><td>↘</td></tr> <tr><td>34:</td><td>10.7x</td><td>↘</td></tr> <tr><td>35:</td><td>8.9</td><td>↗</td></tr> <tr><td>36:</td><td>9.7</td><td>↘</td></tr> <tr><td>37:</td><td>9.3</td><td>↘</td></tr> <tr><td>38:</td><td>10.1</td><td>↗</td></tr> <tr><td>39:</td><td>10.5x</td><td>↘</td></tr> <tr><td>40:</td><td>10.0</td><td>↗</td></tr> <tr><td colspan="2">Serie</td><td>96.7</td></tr> <tr><td colspan="2">Total</td><td>388.3</td></tr> </table>	31:	7.8	↗	32:	9.1	↗	33:	10.6x	↘	34:	10.7x	↘	35:	8.9	↗	36:	9.7	↘	37:	9.3	↘	38:	10.1	↗	39:	10.5x	↘	40:	10.0	↗	Serie		96.7	Total		388.3
21:	10.1	↗																																																																									
22:	8.7	←																																																																									
23:	9.9	←																																																																									
24:	10.1	↗																																																																									
25:	9.5	↗																																																																									
26:	7.9	↗																																																																									
27:	9.9	↙																																																																									
28:	10.2x	→																																																																									
29:	9.2	↗																																																																									
30:	9.1	↗																																																																									
Serie		94.6																																																																									
Total		291.6																																																																									
31:	7.8	↗																																																																									
32:	9.1	↗																																																																									
33:	10.6x	↘																																																																									
34:	10.7x	↘																																																																									
35:	8.9	↗																																																																									
36:	9.7	↘																																																																									
37:	9.3	↘																																																																									
38:	10.1	↗																																																																									
39:	10.5x	↘																																																																									
40:	10.0	↗																																																																									
Serie		96.7																																																																									
Total		388.3																																																																									

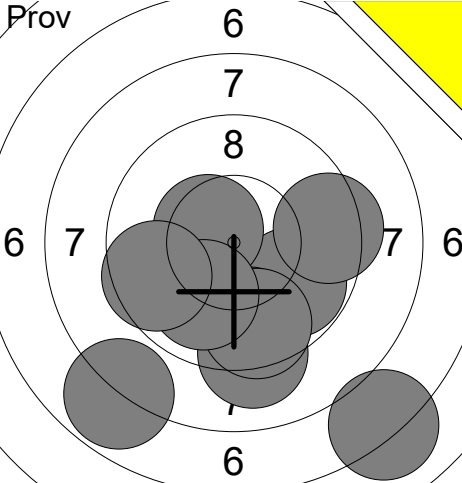
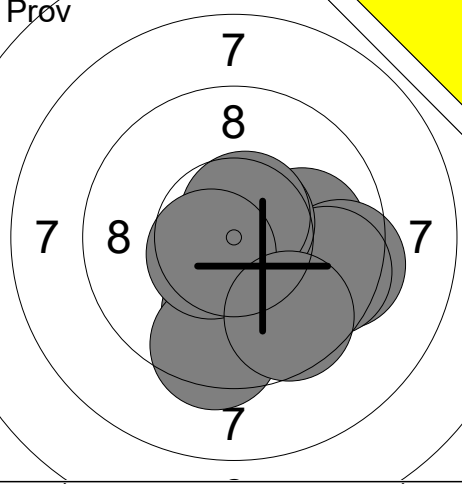
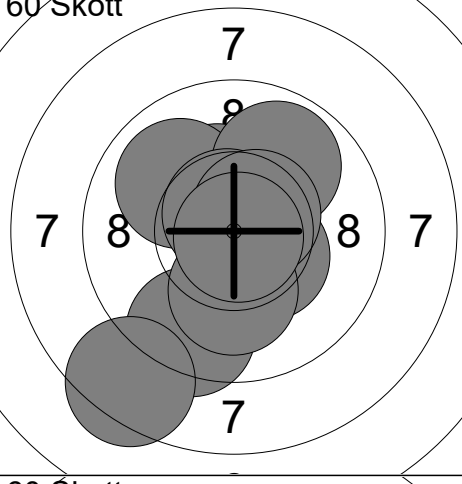
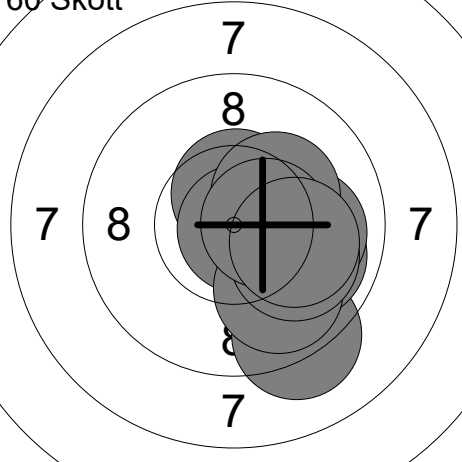
Skjutlag	Tavla	Elin Söderlund	
1	28	Umeå	Vännäs Skf
13.04.2024		UME-Kulan 2024	Umeå skytteallians
Prov		1: 9.8 ↘ 2: 7.1 ↘ 3: 9.4 → 4: 9.6 ↘ 5: 9.1 ↘ 6: 9.6 ↘ 7: 7.8 ↘ 8: 10.5x ↗ 9: 10.0 ↘ 10: 9.6 ↙ Serie 92.5 Total 0.0	11: 9.8 ↘ 12: 10.0 ↘ 13: 9.9 ↘ 14: 10.0 ↘ 15: 9.9 ↘ 16: 8.5 → 17: 10.5x ↗ 18: 10.5x ↗ 19: 9.4 ↘ 20: 9.8 ↘ Serie 98.3 Total 0.0
Prov		21: 10.0 → 22: 9.4 → 23: 9.6 → 24: 9.9 ↘ 25: 9.9 ↘ 26: 9.4 ↘ 27: 10.7x ↗ 28: 10.6x ↗ 29: 10.6x ↙ 30: 9.6 ↘ Serie 99.7 Total 0.0	31: 9.8 → 32: 9.4 ↘ 33: 9.6 ↘ Serie 28.8 Total 0.0
60 Skott		1: 10.3x ↗ 2: 10.0 ↗ 3: 10.4x ↘ 4: 9.9 ↗ 5: 10.7x ↗ 6: 9.4 ↘ 7: 10.1 ↘ 8: 8.4 ↘ 9: 10.6x ↗ 10: 10.8x ↘ Serie 100.6 Total 100.6	11: 10.0 ↗ 12: 9.7 → 13: 10.3x ↗ 14: 10.5x ↗ 15: 9.3 ↗ 16: 10.3x ↗ 17: 9.1 → 18: 10.8x ↘ 19: 9.6 → 20: 10.5x ↗ Serie 100.1 Total 200.7
60 Skott		21: 9.2 ↘ 22: 10.5x ↗ 23: 10.8x ↘ 24: 9.9 ↘ 25: 10.0 → 26: 9.9 ↘ 27: 10.3x ↗ 28: 10.0 ↘ 29: 10.5x → 30: 10.1 ↘ Serie 101.2 Total 301.9	31: 9.8 → 32: 10.3x ↘ 33: 10.0 → 34: 9.6 ↗ 35: 9.9 ↘ 36: 9.3 ↗ 37: 10.0 → 38: 9.9 ↗ 39: 10.0 ↘ 40: 10.4x ↘ Serie 99.2 Total 401.1

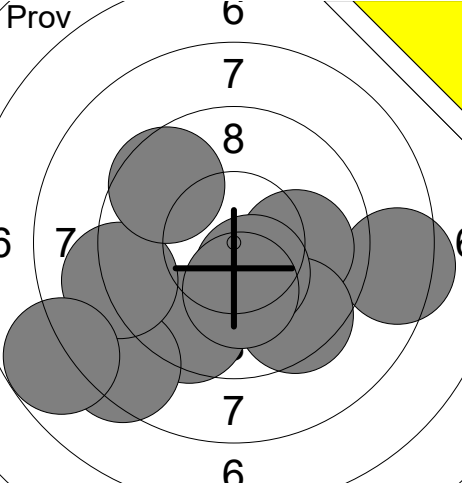
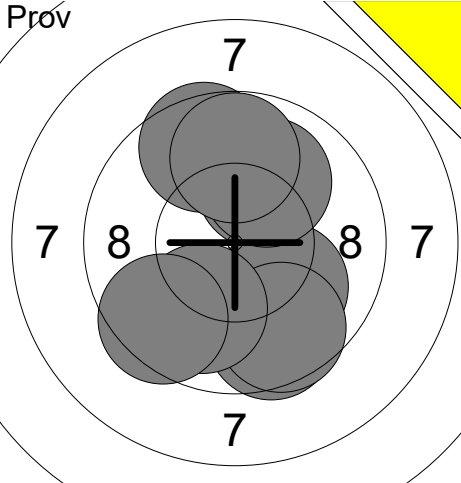
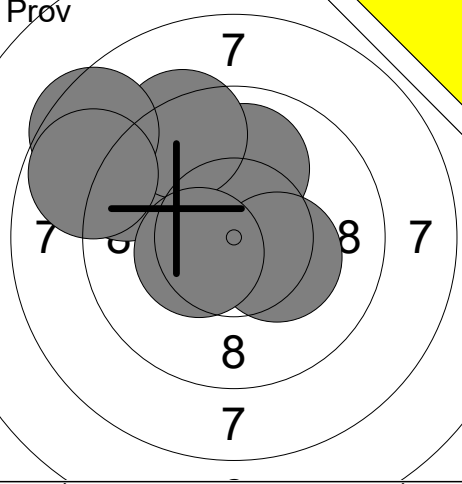
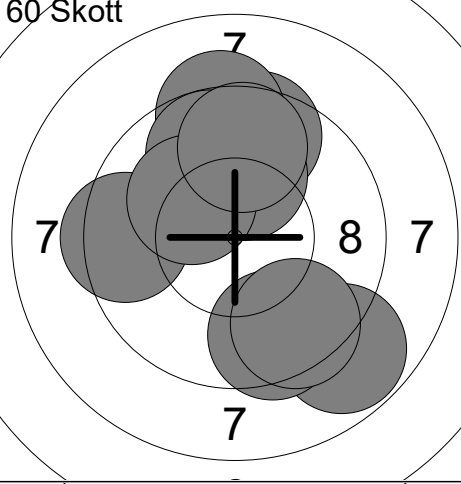
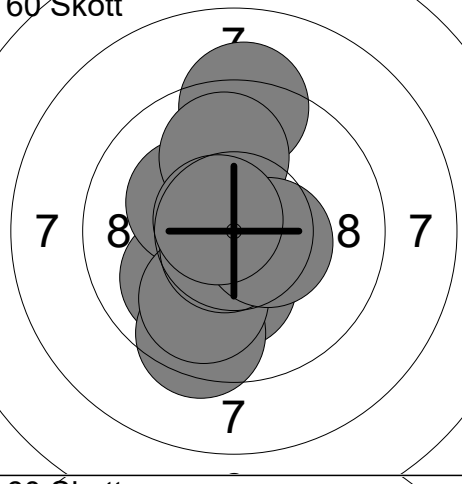
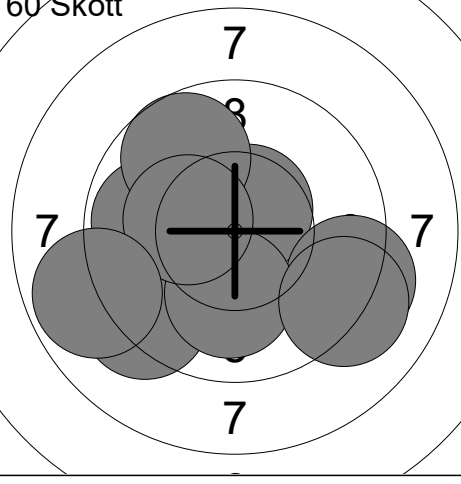
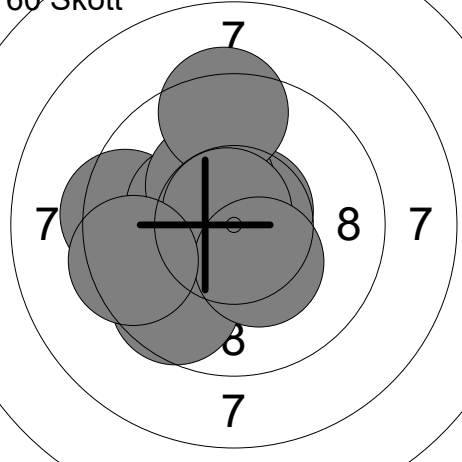
Skjutlag 1	Tavla 30	Nova Burman			
Umeå		Vännäs Skf		L11	
13.04.2024		UME-Kulan 2024		Umeå skytteallians	
Prov		1: 9.5 ↘ 2: 8.4 → 3: 8.4 ↘ 4: 9.1 ← 5: 9.6 ↗ 6: 7.8 ← 7: 10.0 → 8: 9.5 ↘ 9: 10.4x ↘ 10: 10.2x ↘	Prov		11: 9.7 ↘ 12: 9.6 ↘ 13: 9.6 ↗ 14: 10.1 ↗ 15: 10.0 ↘ 16: 9.6 ↘ 17: 9.9 ↘ 18: 9.5 ↘ 19: 10.0 ↗ 20: 9.8 ↗
	Serie 92.9 Total 0.0			Serie 97.8 Total 0.0	
Prov		21: 10.0 ↗ 22: 10.3x ↘ 23: 9.2 ↗ 24: 9.3 ↗ 25: 8.5 ↗ 26: 8.8 ↗ 27: 10.4x ←	60 Skott		1: 9.5 ↗ 2: 9.2 ↗ 3: 9.8 ↗ 4: 10.1 ↗ 5: 9.4 ← 6: 10.2x ↗ 7: 8.8 ↘ 8: 9.7 ↗ 9: 9.5 ↘ 10: 9.5 ↘
	Serie 66.5 Total 0.0			Serie 95.7 Total 95.7	
60 Skott		11: 10.2x ↘ 12: 10.0 ↘ 13: 9.5 ↘ 14: 10.2x ↗ 15: 9.2 ↗ 16: 9.9 ↗ 17: 9.9 ↘ 18: 10.7x ↘ 19: 10.4x → 20: 10.7x ↗	60 Skott		21: 10.6x ↗ 22: 10.3x ← 23: 9.2 → 24: 9.8 ← 25: 9.3 ↘ 26: 10.1 ↘ 27: 9.7 ↗ 28: 10.3x ← 29: 9.1 → 30: 8.9 ←
	Serie 100.7 Total 196.4			Serie 97.3 Total 293.7	
60 Skott		31: 9.4 ← 32: 10.7x ↗ 33: 10.3x ← 34: 9.6 ↘ 35: 10.3x ← 36: 10.3x ↗ 37: 9.4 ↗ 38: 10.8x ↗ 39: 10.3x ↘ 40: 9.5 ←			
	Serie 100.6 Total 394.3				

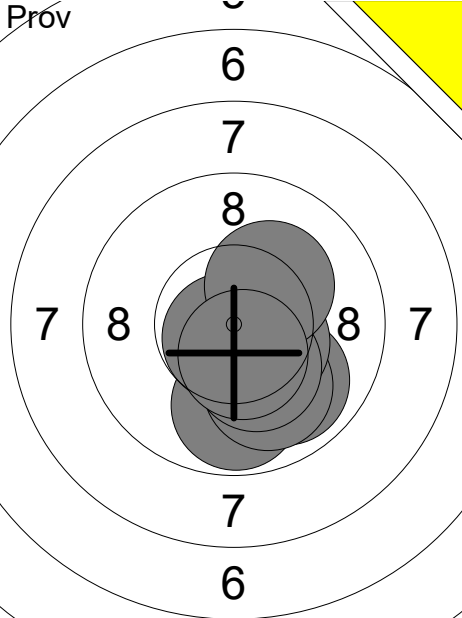
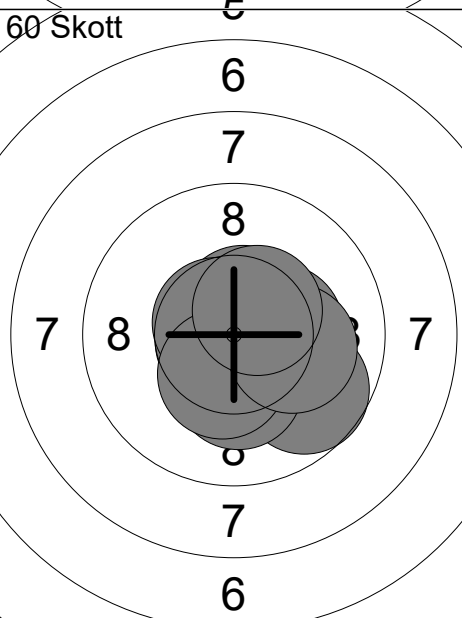
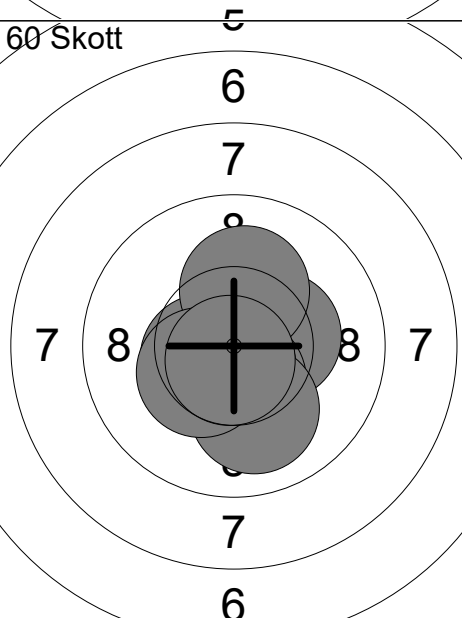
Skjutlag	Tavla	Alex Hansson	
1	32	Umeå	Vännäs Skf
13.04.2024		UME-Kulan 2024	Umeå skytteallians
Umeå	Vännäs Skf	L11	
13.04.2024	UME-Kulan 2024	Umeå skytteallians	
Prov		1: 10.0 ↘ 2: 9.9 ↘ 3: 10.6x ↘ 4: 9.8 ↓ 5: 10.0 ↘ 6: 10.7x ↘ 7: 10.5x ↘ 8: 10.3x ↘ 9: 10.2x ↗ 10: 10.5x ↘	Prov
		Serie 102.5	11: 10.2x ↓ 12: 10.4x ↗ 13: 10.3x ↗ 14: 10.3x → 15: 10.3x ↗ 16: 10.2x ↗ 17: 10.5x ← 18: 10.5x ↗ 19: 10.4x → 20: 10.7x ↗
		Total 0.0	Serie 103.8
			Total 0.0
60 Skott		1: 10.6x ↗ 2: 10.7x ↙ 3: 10.8x → 4: 9.7 ↘ 5: 10.3x ↓ 6: 10.7x ↙ 7: 10.3x → 8: 10.4x ↓ 9: 10.1 → 10: 10.5x ↗	60 Skott
		Serie 104.1	11: 10.9x ↗ 12: 10.4x → 13: 10.3x ↖ 14: 10.4x → 15: 10.5x ↗ 16: 10.6x ↓ 17: 10.4x → 18: 10.5x → 19: 10.7x ↗ 20: 10.2x ↓
		Total 104.1	Serie 104.9
			Total 209.0
60 Skott		21: 10.5x ↙ 22: 10.5x → 23: 10.6x → 24: 10.4x → 25: 10.5x ↓ 26: 10.2x ↗ 27: 10.7x ↓ 28: 10.0 ↓ 29: 10.4x ↙ 30: 10.7x ↓	60 Skott
		Serie 104.5	31: 10.9x ↓ 32: 10.5x ↖ 33: 10.5x ↓ 34: 10.7x ← 35: 10.2x ↓ 36: 10.4x ↗ 37: 10.7x ↓ 38: 10.7x ← 39: 10.7x → 40: 10.5x ↙
		Total 313.5	Serie 105.8
			Total 419.3

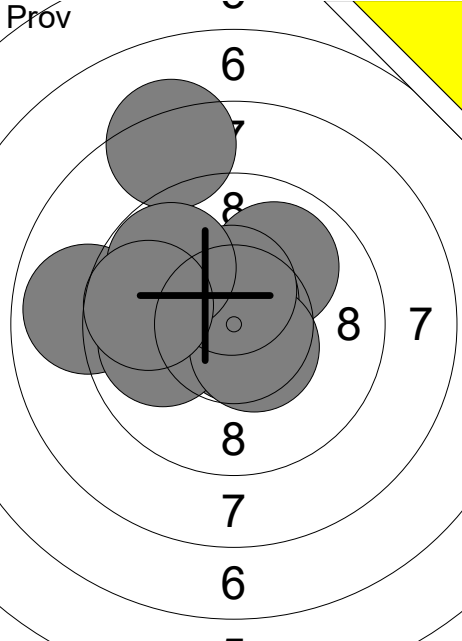
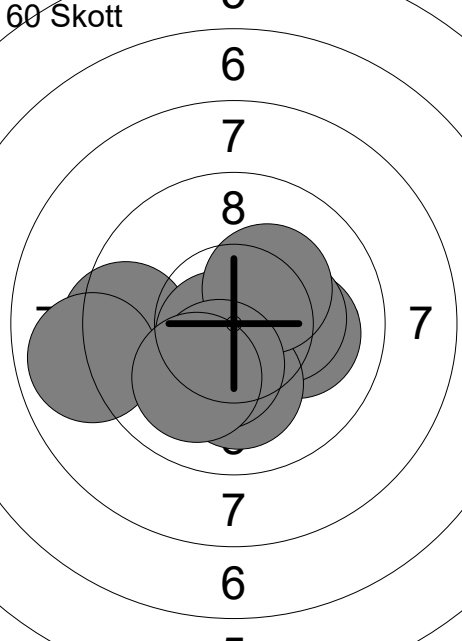
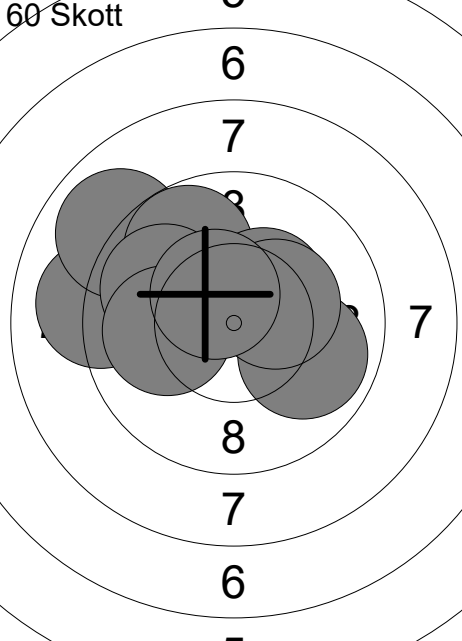
Skjutlag	Tavla	Tilly Forsman	
1	34	Umeå Skf	L9
13.04.2024	UME-Kulan 2024	Umeå skytteallians	
Prov		1: 8.9 ← 2: 10.7x ↓ 3: 9.9 ← 4: 10.0 ↗ 5: 10.6x ↑ 6: 8.3 ↑ 7: 10.5x ↓ 8: 10.5x ↑ 9: 9.8 ↖ 10: 9.7 ←	11: 10.3x ↗ 12: 9.9 ↗ 13: 9.7 ↗ 14: 9.8 ↓ 15: 10.1 ↓ 16: 10.5x ← 17: 10.5x ↓
	Serie 98.9	Serie 70.8	
	Total 0.0	Total 0.0	
60 Skott		1: 9.4 ← 2: 8.9 ← 3: 10.5x → 4: 10.1 → 5: 10.7x ↙ 6: 10.3x → 7: 10.1 ↓ 8: 10.3x ↗ 9: 10.4x ↓ 10: 10.0 ↓	11: 10.3x ↙ 12: 9.8 ↓ 13: 10.1 ↗ 14: 10.3x → 15: 9.9 ↓ 16: 9.9 ↖ 17: 10.6x ↗ 18: 10.7x ↙ 19: 9.9 ↖ 20: 10.0 ↑
	Serie 100.7	Serie 101.5	
	Total 100.7	Total 202.2	
60 Skott		21: 9.1 ← 22: 10.3x ↖ 23: 8.9 ↖ 24: 9.9 → 25: 9.8 ↗ 26: 9.9 ← 27: 10.4x ↗ 28: 10.0 ← 29: 10.3x → 30: 10.5x ↖	31: 9.6 ↑ 32: 9.9 ↗ 33: 8.9 ↗ 34: 10.6x ← 35: 10.0 ← 36: 10.4x → 37: 9.7 ↖ 38: 9.5 ↑ 39: 9.7 ↗ 40: 10.1 ↗
	Serie 99.1	Serie 98.4	
	Total 301.3	Total 399.7	

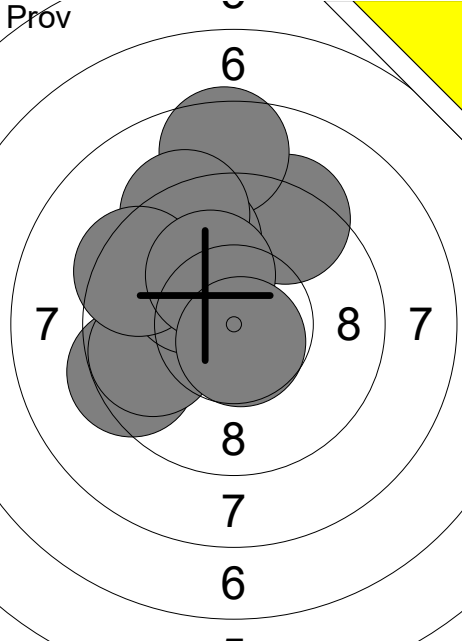
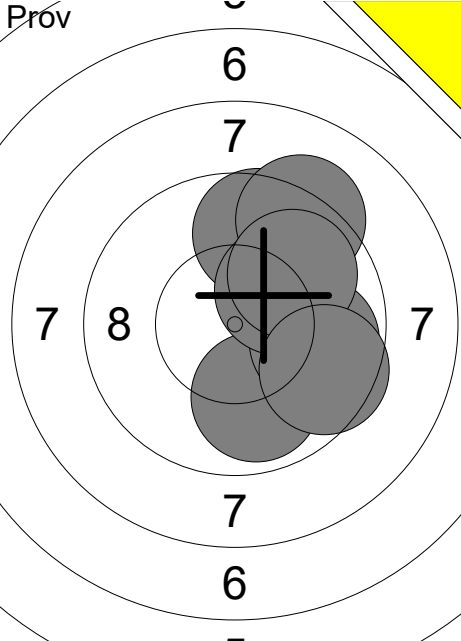
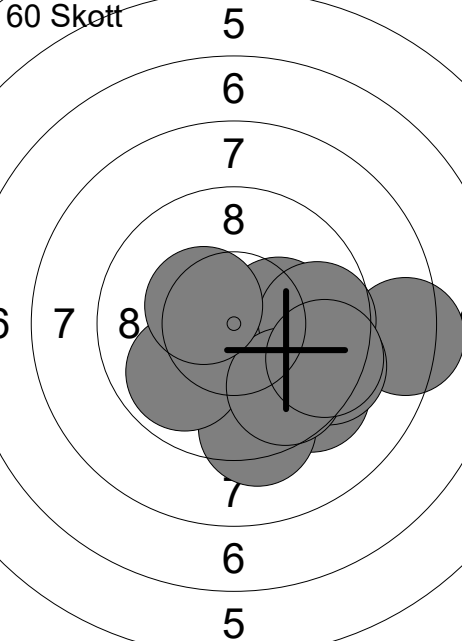
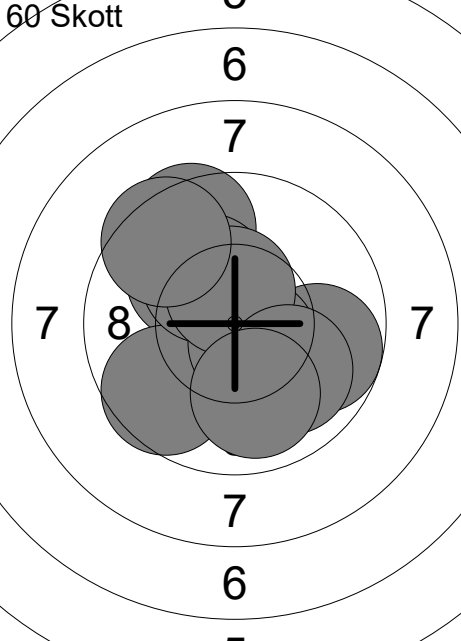
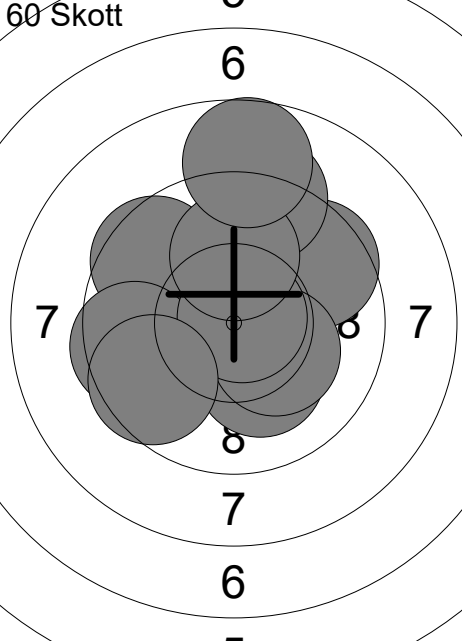
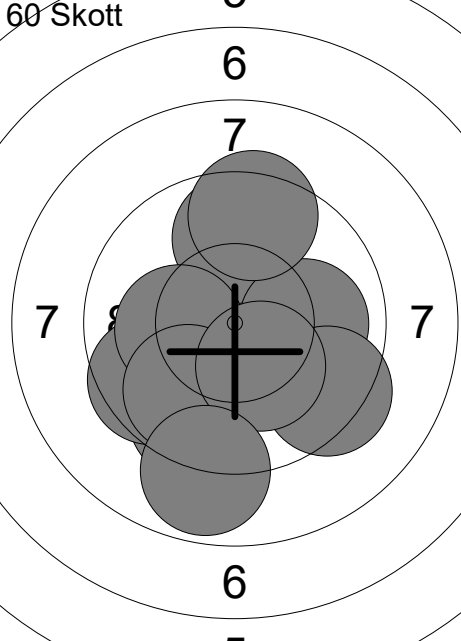
Skjutlag	Tavla	Oskar Nilsson	
1	36	Ramselefors Skf	L7
13.04.2024	UME-Kulan 2024	Umeå skytteallians	
Prov		1: 9.3 ↗ 2: 8.6 ↑ 3: 9.7 ↗ 4: 9.4 ↙ 5: 9.3 ↗ 6: 9.8 ↙ 7: 10.2x ↗ 8: 9.4 ↙ 9: 10.2x ↗ 10: 10.7x ↘ Serie 96.6 Total 0.0	Prov  11: 9.6 ↗ 12: 9.9 ↘ 13: 9.7 ↗ 14: 9.2 ↗ 15: 9.8 → 16: 10.2x ↗ 17: 9.9 ↗ 18: 9.6 ↘ Serie 77.9 Total 0.0
60 Skott		1: 9.4 ↘ 2: 8.3 → 3: 9.3 ↘ 4: 9.4 ↘ 5: 10.3x → 6: 9.9 ↙ 7: 9.7 → 8: 9.7 ↘ 9: 9.5 → 10: 10.4x ↗ Serie 95.9 Total 95.9	60 Skott  11: 10.1 ↗ 12: 9.5 ↗ 13: 9.8 → 14: 9.6 ↙ 15: 10.2x ↗ 16: 10.6x ↘ 17: 10.5x ↑ 18: 10.0 ↘ 19: 9.9 ↘ 20: 9.5 ↗ Serie 99.7 Total 195.6
60 Skott		21: 10.2x ↘ 22: 9.6 ↗ 23: 9.6 ↗ 24: 9.2 ↑ 25: 9.5 ↙ 26: 10.3x ↘ 27: 10.8x ↗ 28: 10.0 ↑ 29: 8.7 ↑ 30: 9.6 ↙ Serie 97.5 Total 293.1	60 Skott  31: 9.8 ↑ 32: 9.5 ↘ 33: 10.0 → 34: 9.4 ↑ 35: 9.6 ↙ 36: 10.2x ↙ 37: 9.4 ↘ 38: 9.8 ↘ 39: 10.3x ↘ 40: 8.9 ↘ Serie 96.9 Total 390.0

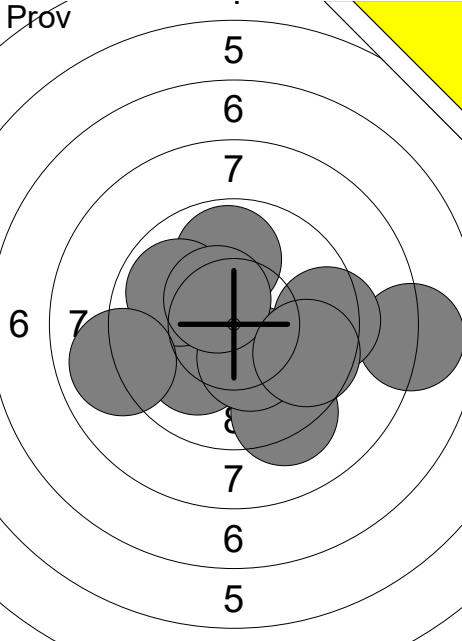
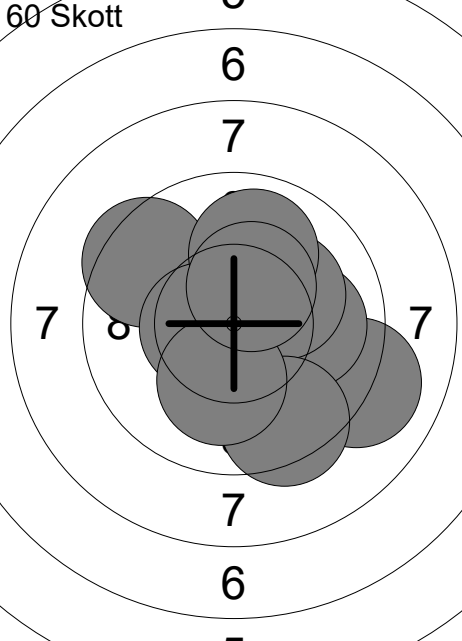
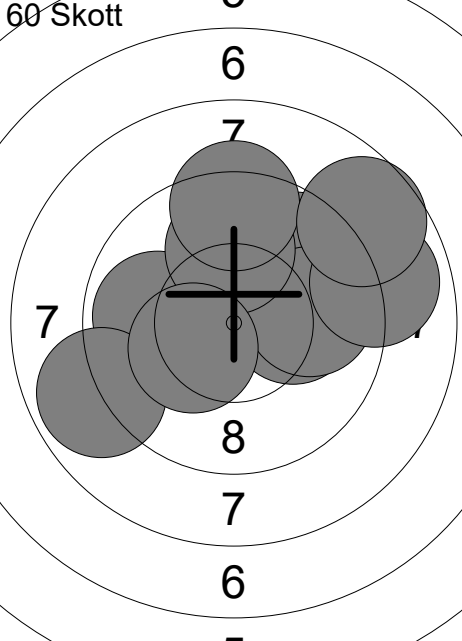
Skjutlag	Tavla	Olivia Leosson	
1	38	Umeå Skf	L9
13.04.2024	UME-Kulan 2024	Umeå skytteallians	
Prov		1: 8.0 → 2: 10.1 ↙ 3: 9.9 ↑ 4: 9.2 ↘ 5: 10.3x ↘ 6: 9.9 ↖ 7: 9.0 ← 8: 10.4x ↗ 9: 9.4 → 10: 9.6 →	11: 10.0 → 12: 9.9 ↗ 13: 10.8x ↖ 14: 10.7x ↙ 15: 10.1 ↓ 16: 10.4x ↗ 17: 8.9 → 18: 9.2 ↑ 19: 9.7 ← 20: 10.3x ↙
		Serie 95.8	Serie 100.0
		Total 0.0	Total 0.0
60 Skott		1: 9.5 ↖ 2: 9.1 → 3: 10.7x ↘ 4: 10.0 → 5: 10.5x ← 6: 10.2x ↗ 7: 9.9 ↑ 8: 9.4 ↘ 9: 10.1 ↓ 10: 10.4x ↗	11: 9.7 ↙ 12: 7.5 ↙ 13: 10.5x ↘ 14: 9.5 ↙ 15: 9.5 ↑ 16: 9.7 ↗ 17: 8.8 ← 18: 10.2x ← 19: 10.6x ↘ 20: 8.1 →
		Serie 99.8	Serie 94.1
		Total 99.8	Total 193.9
60 Skott		21: 10.1 → 22: 9.9 ← 23: 9.7 ↗ 24: 8.9 ↙ 25: 9.9 → 26: 9.9 ↑ 27: 10.3x ↙ 28: 9.3 ↑ 29: 8.9 → 30: 8.7 ↗	31: 9.7 ↗ 32: 10.5x ↙ 33: 10.3x ↘ 34: 9.9 ↑ 35: 9.7 ↘ 36: 8.6 ↗ 37: 9.7 ↗ 38: 10.2x ↗ 39: 10.1 ↗ 40: 10.7x ↘
		Serie 95.6	Serie 99.4
		Total 289.5	Total 388.9

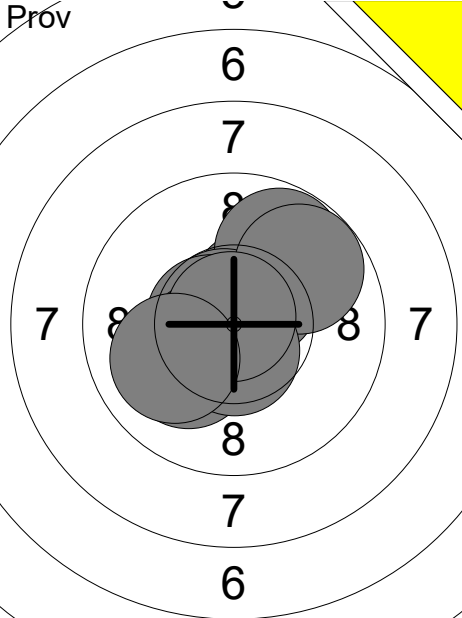
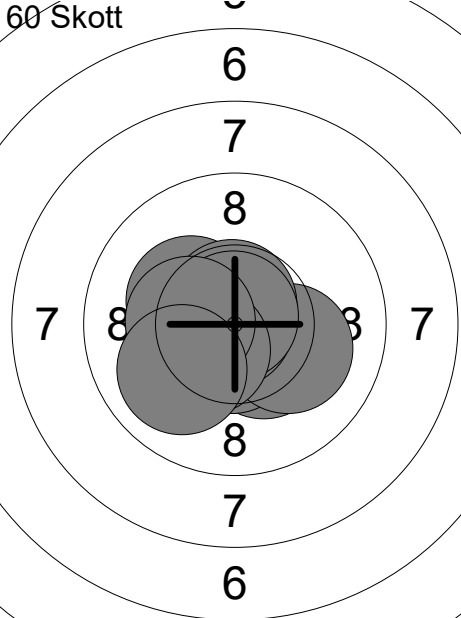
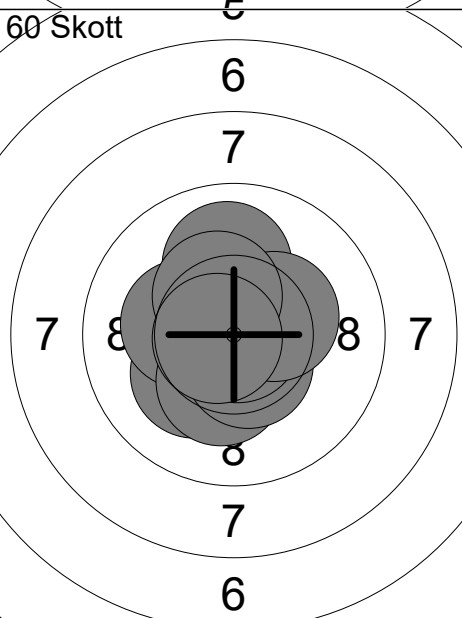
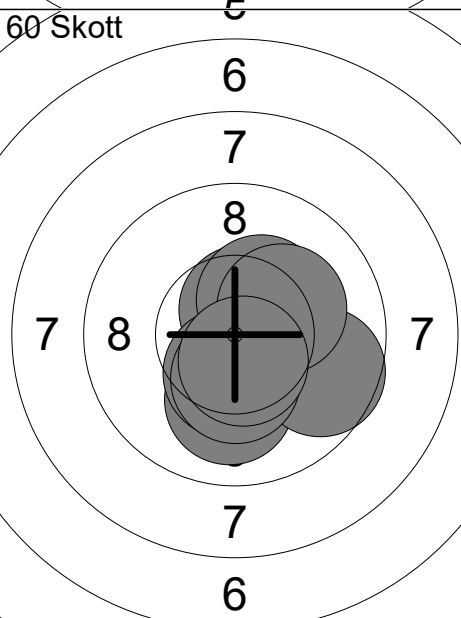
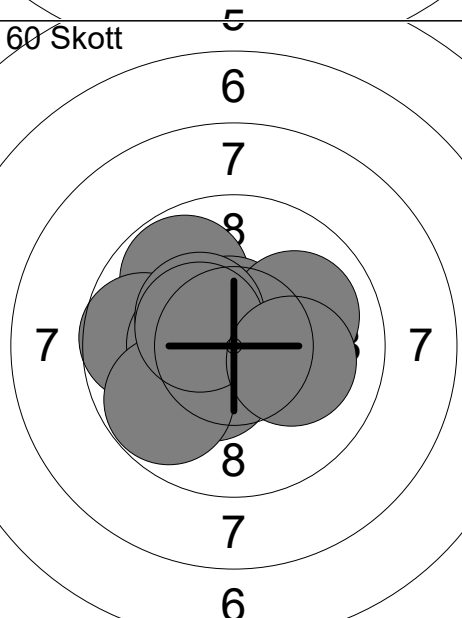
Skjutlag 1	Tavla 40	Oskar Lindgren	
Umeå	Umeå Skf	Lfunk	
13.04.2024	UME-Kulan 2024	Umeå skytteallians	
Prov		60 Skott	
	1: 10.4x ↗ 2: 9.8 ↗ 3: 10.7x ↘ 4: 9.8 ↗ 5: 10.6x ← 6: 10.5x ↙ 7: 10.1 ↙ 8: 10.6x ↓ 9: 10.8x ↗ 10: 10.0 ↙		1: 10.4x ↘ 2: 10.3x ↙ 3: 10.6x ↓ 4: 10.1 → 5: 10.9x ← 6: 10.7x ↑ 7: 10.8x ↑ 8: 10.4x ↙ 9: 10.3x ← 10: 10.0 ↙
	Serie 103.3		Serie 104.5
	Total 0.0		Total 104.5
60 Skott		60 Skott	
	11: 10.2x ↙ 12: 10.3x ← 13: 10.3x ↓ 14: 10.0 ↑ 15: 10.6x → 16: 10.5x ↓ 17: 10.9x ↘ 18: 10.3x → 19: 10.4x ↗ 20: 10.7x ←		21: 10.6x ↘ 22: 10.6x ↑ 23: 10.3x ↗ 24: 10.4x ↓ 25: 10.0 ↓ 26: 10.4x ↓ 27: 9.7 → 28: 10.3x ↓ 29: 10.2x ↗ 30: 10.6x ↓
	Serie 104.2		Serie 103.1
	Total 208.7		Total 311.8
60 Skott			
	31: 10.4x ↙ 32: 9.8 ↘ 33: 9.7 ← 34: 10.6x ↑ 35: 10.4x ← 36: 10.0 → 37: 9.8 ↙ 38: 10.3x ↘ 39: 10.4x ↙ 40: 10.1 →		
	Serie 101.5		
	Total 413.3		

Skjutlag 2	Tavla 2	Emma Eriksson	
Umeå		Ramselefors Skf	Lsen
13.04.2024		UME-Kulan 2024	Umeå skytteallians
Prov 	1: 3.3 ↗ 2: 8.2 ← 3: 10.0 ← 4: 6.5 ↗ 5: 8.1 ↗ 6: 9.2 ↗ 7: 10.2x ↗ 8: 10.0 ↗ 9: 10.5x ↗ 10: 8.9 → Serie 84.9 Total 0.0	Prov 	11: 9.8 ↗ 12: 8.5 ↗ 13: 9.4 ← 14: 9.5 ↘ 15: 9.3 → 16: 9.3 → 17: 9.2 ↑ 18: 10.0 ↑ 19: 10.0 ↓ 20: 9.8 ↗ Serie 94.8 Total 0.0
Prov 	21: 9.4 ↗ 22: 7.7 ↑ 23: 9.7 ↗ 24: 10.2x → 25: 9.7 ← 26: 9.5 ↑ 27: 10.2x → 28: 7.1 ← 29: 8.5 ↑ Serie 82.0 Total 0.0	60 Skott 	1: 9.5 ↗ 2: 10.3x ↑ 3: 10.6x ↘ 4: 6.0 → 5: 8.6 → 6: 10.2x ↑ 7: 9.9 ↗ 8: 10.0 ↑ 9: 8.9 → 10: 10.3x ↗ Serie 94.3 Total 94.3
60 Skott 	11: 9.0 ↗ 12: 9.8 ← 13: 10.8x ← 14: 9.1 ↗ 15: 10.1 → 16: 9.6 ← 17: 9.9 ↘ 18: 9.2 ↑ 19: 9.2 ← 20: 10.4x ↗ Serie 97.1 Total 191.4	60 Skott 	21: 8.8 ↑ 22: 8.3 ↗ 23: 8.2 → 24: 9.5 ↓ 25: 9.0 ↗ 26: 8.2 → 27: 8.8 ↑ 28: 8.4 → 29: 9.5 ↗ 30: 10.1 → Serie 88.8 Total 280.2
60 Skott 	31: 9.1 ↑ 32: 8.7 → 33: 9.7 ← 34: 9.3 ↗ 35: 10.4x ↗ 36: 8.9 → 37: 9.2 ↑ 38: 10.2x ↘ 39: 10.0 ↗ 40: 9.2 → Serie 94.7 Total 374.9		

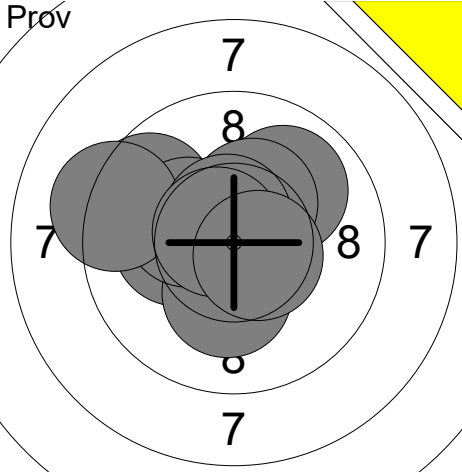
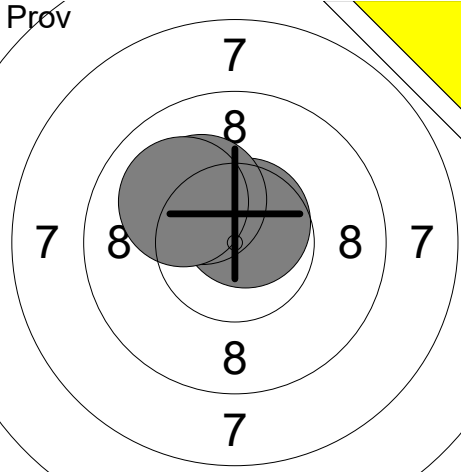
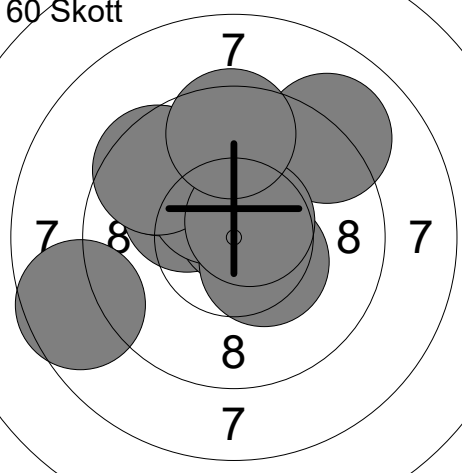
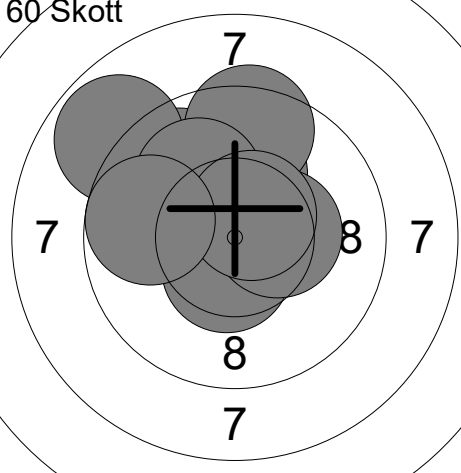
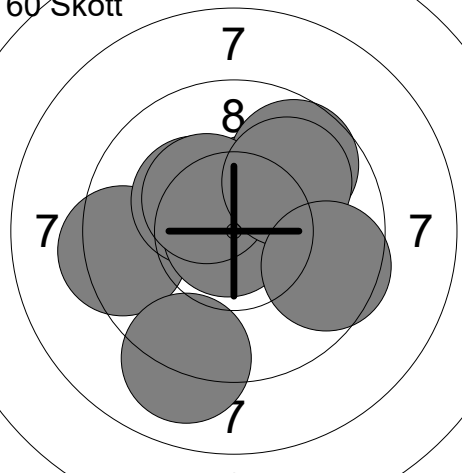
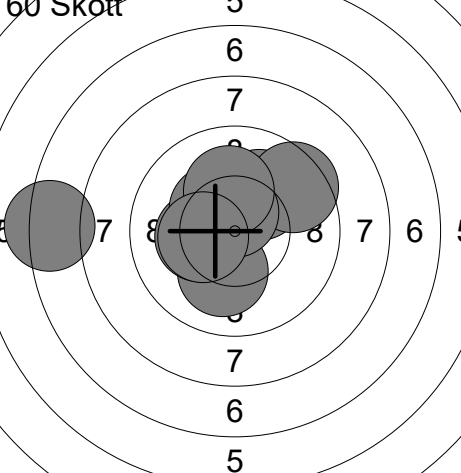
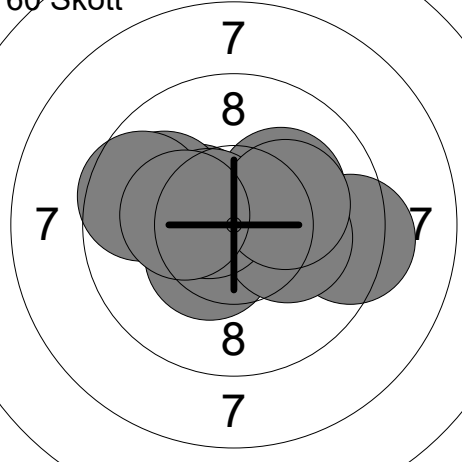
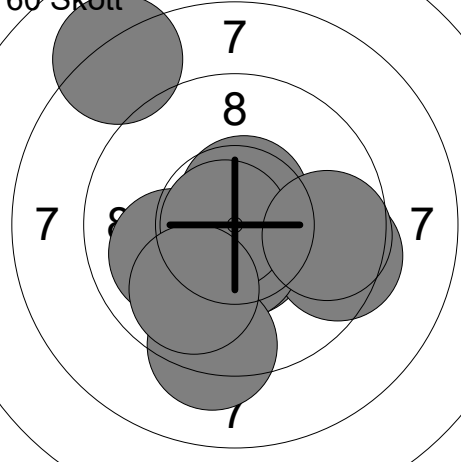
Skjutlag	Tavla	Caroline Rannebo Eklund		
2	4	Umeå	Gällivare Skf	L17s
13.04.2024		UME-Kulan 2024		Umeå skytteallians
Prov 	1: 10.2x ←	Prov 	11: 10.6x ↗	
	2: 10.0 ↗		12: 10.2x ↗	
	3: 10.3x ↗		13: 10.0 ↗	
	4: 10.3x ↓			
	5: 9.6 ↗			
	6: 10.3x ↗			
	7: 9.2 ↗			
	8: 10.6x ↗			
	9: 10.7x ↗			
	10: 10.6x ↓			
	Serie 101.8		Serie 30.8	
	Total 0.0		Total 0.0	
60 Skott 	1: 10.2x ↗	60 Skott 	11: 10.1 ↗	
	2: 9.1 ↗		12: 9.8 ↗	
	3: 10.7x ↗		13: 10.5x ↓	
	4: 9.6 ↗		14: 8.9 ↗	
	5: 10.4x ↓		15: 10.1 ↗	
	6: 10.4x ↗		16: 10.4x →	
	7: 9.5 ↗		17: 9.4 ↗	
	8: 8.6 ←		18: 10.0 ↗	
	9: 10.6x ↗		19: 10.6x ↗	
	10: 9.5 ↑		20: 9.7 ←	
	Serie 98.6		Serie 99.5	
	Total 98.6		Total 198.1	
60 Skott 	21: 10.5x ↗	60 Skott 	31: 10.1 ↓	
	22: 9.4 ←		32: 10.3x ←	
	23: 10.5x ↗		33: 10.1 ↗	
	24: 10.3x ↗		34: 10.3x ↑	
	25: 9.7 ↗		35: 9.5 ↗	
	26: 10.9x ←		36: 7.2 ←	
	27: 9.1 ↓		37: 10.4x ↗	
	28: 10.4x ↗		38: 10.6x ↑	
	29: 9.9 ↗		39: 10.1 ↑	
	30: 9.6 →		40: 10.3x ←	
	Serie 100.3		Serie 98.9	
	Total 298.4		Total 397.3	
60 Skott 	41: 10.4x ↗	60 Skott 	51: 10.6x ↗	
	42: 9.3 →		52: 10.6x ↓	
	43: 10.4x ↓		53: 9.5 →	
	44: 10.2x ↗		54: 10.0 ←	
	45: 9.9 ↗		55: 10.5x ↓	
	46: 10.2x →		56: 9.3 ↓	
	47: 10.6x ↗		57: 8.1 ↗	
	48: 9.6 ↗		58: 10.8x ←	
	49: 10.2x →		59: 9.7 →	
	50: 10.3x ←		60: 9.9 ↓	
	Serie 101.1		Serie 99.0	
	Total 498.4		Total 597.4	

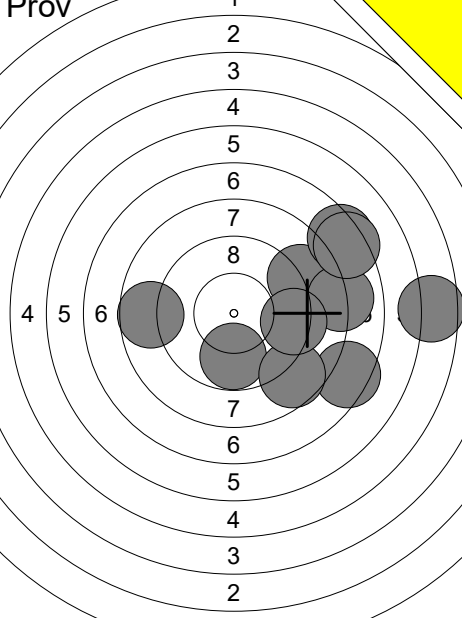
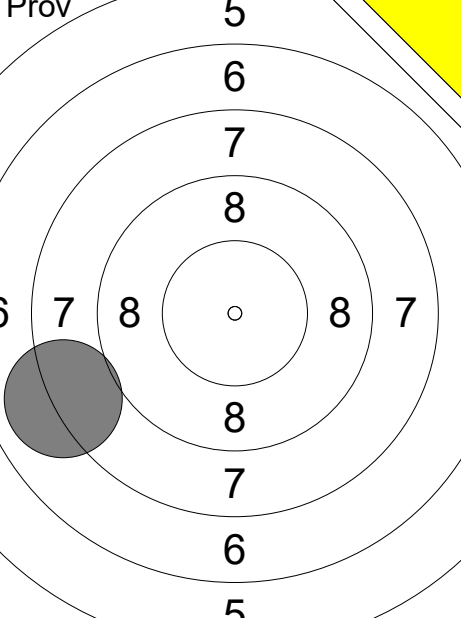
<p>Prov</p> 	<p>1: 9.8 ↓ 2: 8.9 → 3: 7.4 → 4: 8.7 ↓ 5: 7.4 → 6: 8.0 → 7: 5.6 → 8: 8.7 ← 9: 9.3 → 10: 7.4 →</p> <p>Serie 81.2 Total 0.0</p>	<p>Prov</p> 	<p>11: 8.0 ↙</p> <p>Serie 8.0 Total 0.0</p>
--	---	--	---

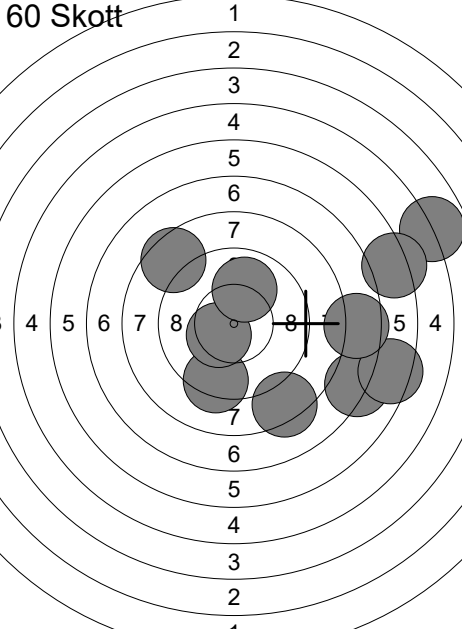
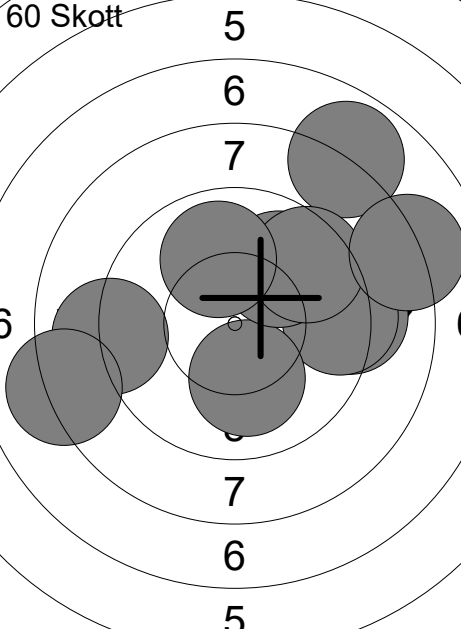
<p>60 Skott</p> 	<p>1: 9.3 ↓ 2: 4.9 → 3: 8.5 ↗ 4: 8.3 ↓ 5: 7.1 → 6: 10.4x ↙ 7: 6.2 → 8: 6.4 → 9: 10.0 ↑ 10: 7.5 →</p> <p>Serie 78.6 Total 78.6</p>	<p>60 Skott</p> 	<p>11: 9.2 → 12: 9.3 → 13: 10.1 ↓ 14: 9.9 ↗ 15: 7.9 ↗ 16: 9.5 ↗ 17: 9.9 ↑ 18: 9.0 ← 19: 8.1 ← 20: 8.1 →</p> <p>Serie 91.0 Total 169.6</p>
---	---	---	---

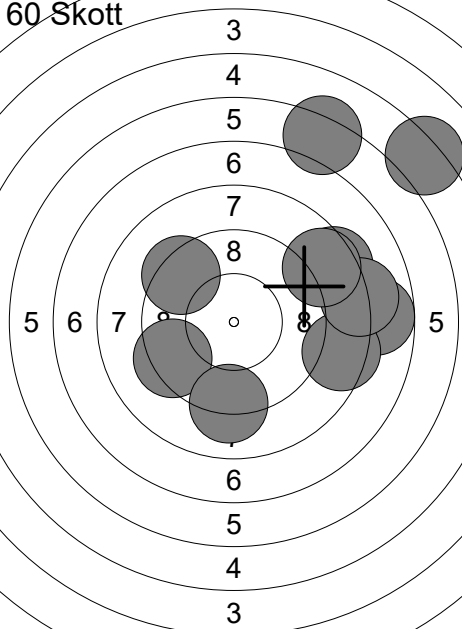
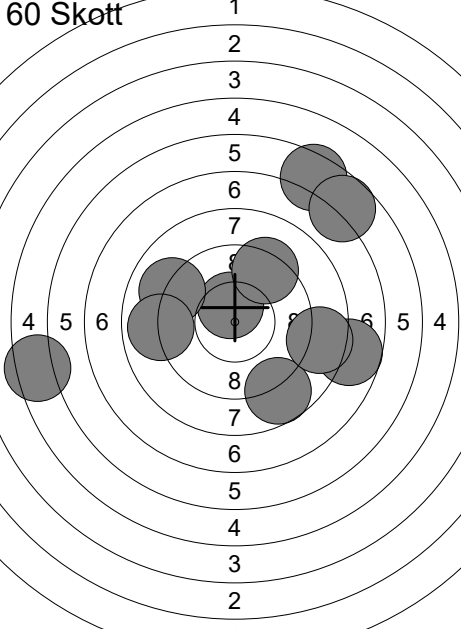
<p>60 Skott</p> 	<p>21: 7.7 → 22: 8.3 → 23: 9.3 ↙ 24: 9.1 ↓ 25: 6.3 ↗ 26: 8.4 → 27: 8.0 → 28: 8.6 ↗ 29: 9.3 ↗ 30: 5.2 ↗</p> <p>Serie 80.2 Total 249.8</p>	<p>60 Skott</p> 	<p>31: 10.5x ↑ 32: 6.5 ↗ 33: 7.7 → 34: 8.7 ↓ 35: 6.7 ↗ 36: 9.0 ↙ 37: 9.3 ↗ 38: 8.9 ← 39: 5.4 ← 40: 8.6 →</p> <p>Serie 81.3 Total 331.1</p>
--	--	--	--

Skjutlag 2	Tavla 10	Mats Österlund	
Umeå		Ramselefors Skf	Lvet
13.04.2024		UME-Kulan 2024	Umeå skytteallians
Prov 	1: 9.7 ↘ 2: 10.3x ← 3: 9.3 → 4: 9.1 → 5: 10.1 → 6: 10.1 ↘ 7: 9.5 ↘ 8: 9.8 ↘ 9: 10.0 → Serie 87.9 Total 0.0	60 Skott 	1: 8.9 → 2: 7.7 → 3: 7.7 → 4: 10.0 ← 5: 9.7 ↑ 6: 6.0 → 7: 7.6 → 8: 7.8 → 9: 5.0 → 10: 9.0 → Serie 79.4 Total 79.4
60 Skott 	11: 10.4x ↘ 12: 8.2 → 13: 10.4x ↘ 14: 10.2x ↘ 15: 9.8 ← 16: 9.9 → 17: 9.9 ← 18: 10.4x ↘ 19: 9.9 → 20: 9.6 ↘ Serie 98.7 Total 178.1	60 Skott 	21: 10.3x ← 22: 6.9 → 23: 9.9 ↑ 24: 9.6 ← 25: 8.8 → 26: 9.7 ↘ 27: 10.1 ← 28: 10.0 ↑ 29: 9.6 ↑ 30: 9.6 ← Serie 94.5 Total 272.6
60 Skott 	31: 9.7 ↑ 32: 9.4 ↗ 33: 10.2x ↗ 34: 10.8x ↘ 35: 10.4x → 36: 9.2 ↘ 37: 8.6 → 38: 9.8 → 39: 10.2x ↑ 40: 9.0 ↘ Serie 97.3 Total 369.9	60 Skott 	41: 10.6x ← 42: 10.7x ← 43: 10.5x ← 44: 10.4x ← 45: 8.7 → 46: 10.2x ↓ 47: 8.9 ↘ 48: 9.0 ↑ 49: 10.0 → 50: 10.2x ← Serie 99.2 Total 469.1
60 Skott 	51: 10.5x ↑ 52: 6.5 → 53: 8.9 ← 54: 7.7 ↘ 55: 10.6x ↘ 56: 9.5 → 57: 9.6 ↘ 58: 10.0 ← 59: 9.8 ↘ 60: 10.3x ↗ Serie 93.4 Total 562.5		

Skjutlag	Tavla	Klas Eklund	
2	11		
Umeå	Gällivare Skf	Lvet	
13.04.2024	UME-Kulan 2024	Umeå skytteallians	
Prov		1: 9.0 ↖ 2: 9.0 ↗ 3: 9.7 ← 4: 10.2x ↗ 5: 8.4 ↗ 6: 8.8 ↘ 7: 10.3x ↗ 8: 8.6 → 9: 9.2 → 10: 8.7 → Serie 91.9 Total 0.0	11: 8.2 → 12: 8.7 ↗ 13: 8.9 ↗ 14: 8.0 ↗ 15: 9.0 ↘ 16: 8.2 ↘ 17: 10.3x ↗ Serie 61.3 Total 0.0
60 Skott		1: 10.7x ↖ 2: 9.5 → 3: 6.8 → 4: 9.7 ↖ 5: 8.6 ↗ 6: 9.0 ↗ 7: 8.5 ↘ 8: 9.8 → 9: 9.1 ↗ 10: 9.1 ↘ Serie 90.8 Total 90.8	11: 9.7 → 12: 9.9 → 13: 9.9 ↘ 14: 9.4 ← 15: 9.9 ↘ 16: 8.9 ↘ 17: 9.9 → 18: 9.4 ↗ 19: 9.6 ↗ 20: 10.4x → Serie 97.0 Total 187.8
60 Skott		21: 10.0 ← 22: 9.7 ← 23: 9.8 ↘ 24: 9.3 ↗ 25: 9.9 ↗ 26: 8.4 ↘ 27: 10.0 ↘ 28: 10.7x ← 29: 10.1 ↗ 30: 9.7 ← Serie 97.6 Total 285.4	31: 10.3x ↘ 32: 8.6 ↘ 33: 10.1 ← 34: 10.1 ↗ 35: 9.7 ↖ 36: 10.8x → 37: 10.4x ↗ 38: 8.9 ↗ 39: 9.8 → 40: 10.2x ↗ Serie 98.9 Total 384.3
60 Skott		41: 9.4 ↘ 42: 9.4 → 43: 9.9 ↗ 44: 9.5 ↗ 45: 9.9 ↗ 46: 9.2 → 47: 9.5 ↗ 48: 9.7 ↖ 49: 8.4 ← 50: 8.5 ↘ Serie 93.4 Total 477.7	51: 10.2x ↗ 52: 9.5 ← 53: 9.6 ← 54: 10.8x ↗ 55: 10.2x ← 56: 9.0 ← 57: 9.4 → 58: 8.8 ↘ 59: 8.1 ← 60: 9.6 ↘ Serie 95.2 Total 572.9

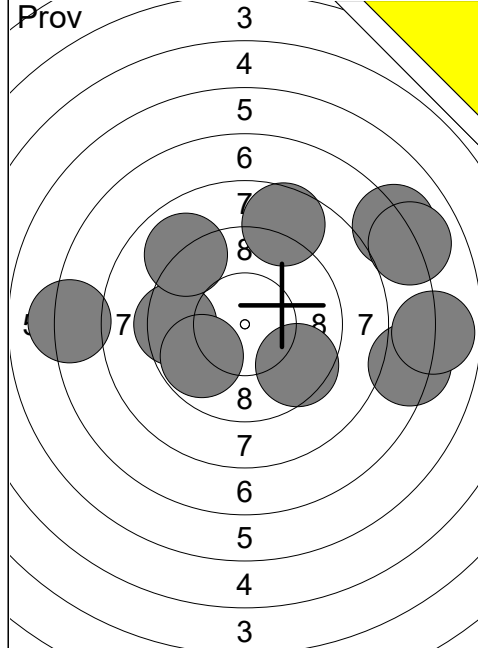

1:	7.1	↗
2:	9.5	↘
3:	8.6	↗
4:	7.2	←
5:	9.5	←
6:	9.8	↙
7:	7.0	↗
8:	7.3	→
9:	9.0	↗
10:	6.9	→
Serie	81.9	
Total	0.0	

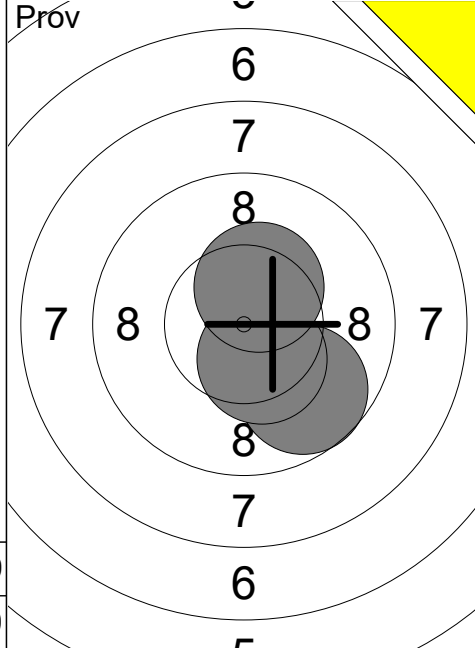

11:	9.7	↘
12:	10.4x	↘
13:	10.4x	↗
Serie	30.5	
Total	0.0	

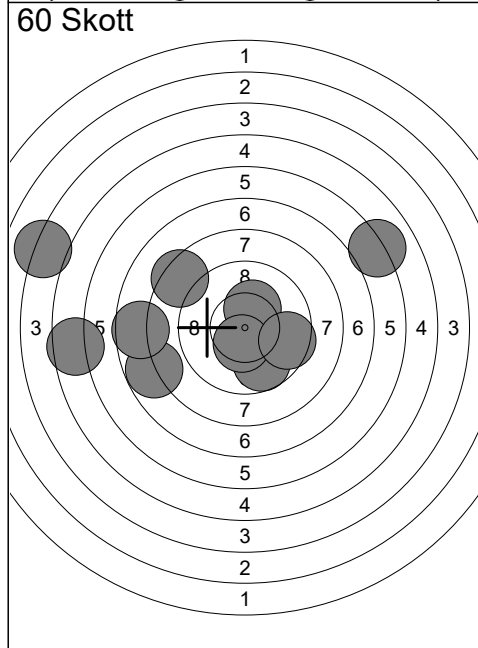

1:	9.7	↘
2:	4.1	←
3:	7.8	←
4:	10.3x	↗
5:	6.1	↗
6:	10.4x	↘
7:	8.4	↗
8:	9.6	→
9:	7.6	←
10:	5.6	←
Serie	79.6	
Total	79.6	

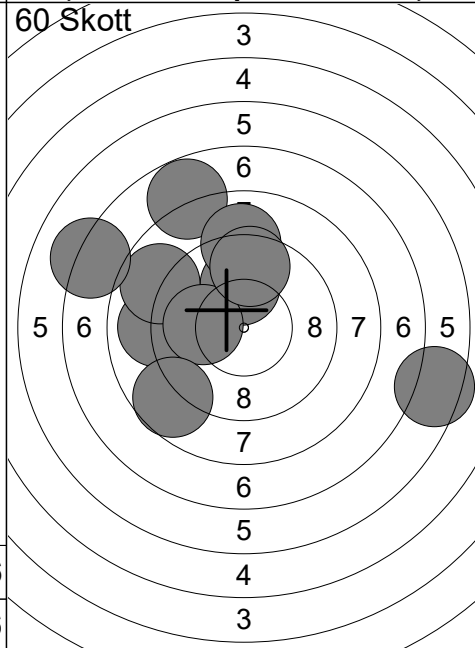

11:	7.8	↗
12:	9.0	←
13:	6.4	→
14:	10.0	↑
15:	9.0	↑
16:	8.8	←
17:	7.1	←
18:	10.0	←
19:	8.7	↙
20:	9.6	↑
Serie	86.4	
Total	166.0	

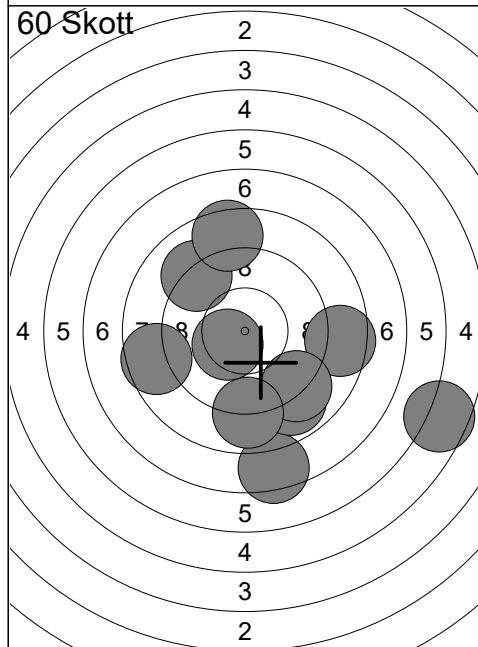

21:	7.4	↘
22:	8.5	→
23:	9.1	↗
24:	8.9	↘
25:	9.0	↘
26:	8.9	↘
27:	5.6	→
28:	10.4x	↙
29:	8.6	←
30:	8.5	↑
Serie	84.9	
Total	250.9	

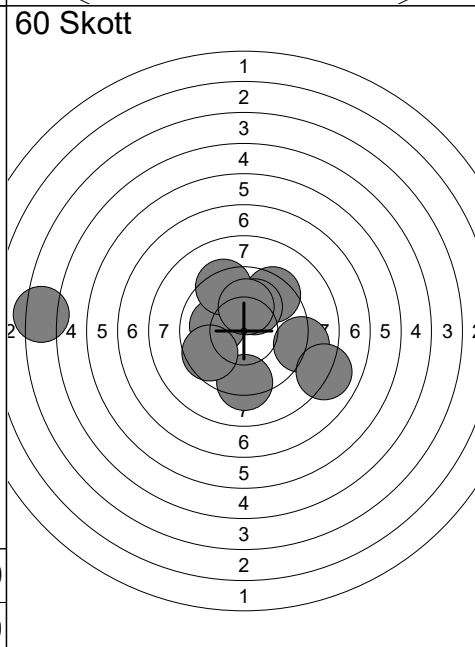

31:	9.4	↗
32:	9.3	↘
33:	9.0	→
34:	10.1	←
35:	9.4	↗
36:	4.3	←
37:	10.1	↗
38:	10.2x	↑
39:	8.0	→
40:	9.6	↙
Serie	89.4	
Total	340.3	

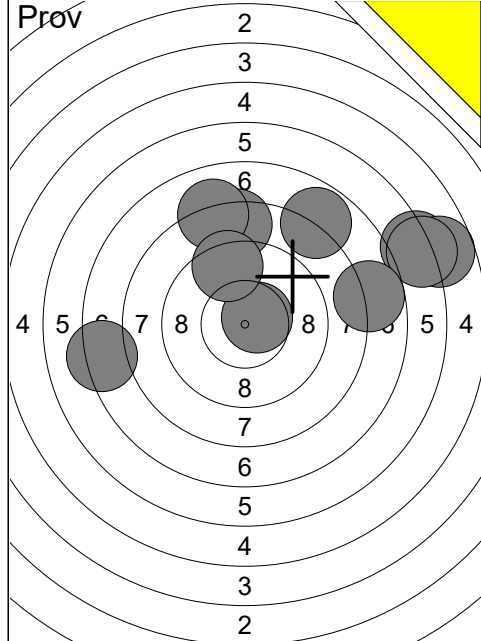

1:	6.2	➔
2:	8.4	↑
3:	5.7	➔
4:	6.1	➔
5:	7.7	➔
6:	7.8	↗
7:	10.6x	➔
8:	7.2	←
9:	8.1	↑
10:	9.4	↑
Serie		77.2
Total		0.0

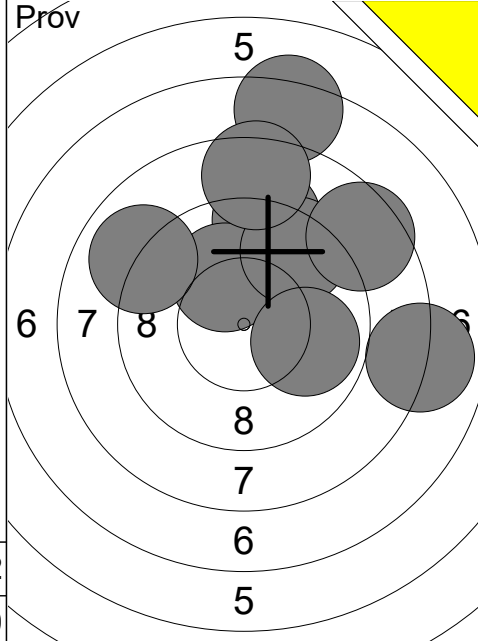

11:	7.3	↑
12:	9.2	↑
13:	10.1	↖
14:	9.5	↗
15:	9.0	↖
16:	8.5	↑
17:	8.0	➔
18:	9.9	➔
19:	8.5	↗
Serie		80.0
Total		0.0

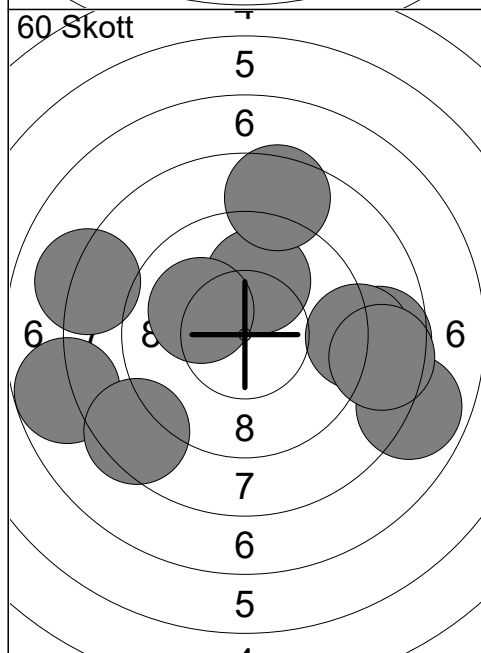

1:	7.9	➔
2:	8.7	➔
3:	10.0	↑
4:	8.5	↑
5:	10.1	↖
6:	9.0	➔
7:	8.6	➔
8:	7.8	←
9:	8.1	←
10:	8.5	↙
Serie		87.2
Total		87.2

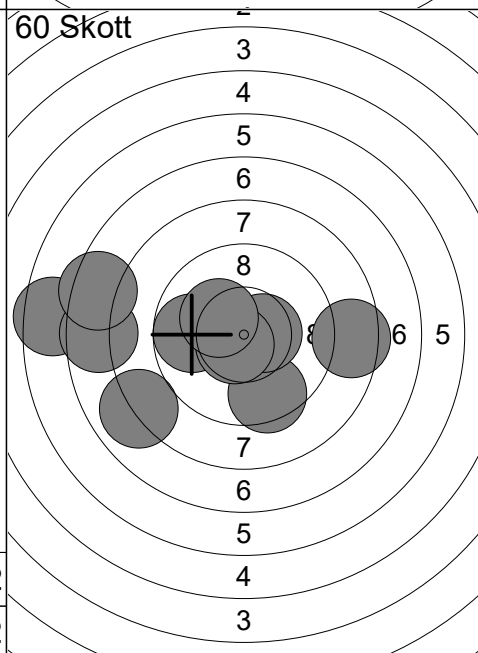

11:	9.5	↓
12:	9.8	←
13:	10.5x	➔
14:	6.5	←
15:	8.0	↙
16:	7.6	←
17:	10.6x	↙
18:	7.4	←
19:	10.3x	↖
20:	8.5	➔
Serie		88.7
Total		175.9

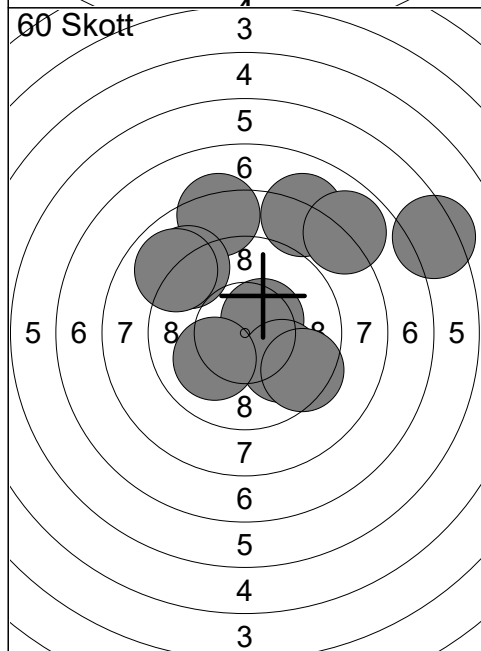

21:	8.1	↑
22:	6.3	➔
23:	10.5x	↗
24:	10.0	↘
25:	7.9	↗
26:	8.3	↑
27:	9.1	↖
28:	10.1	↙
29:	9.5	↘
30:	8.9	↖
Serie		88.7
Total		264.6

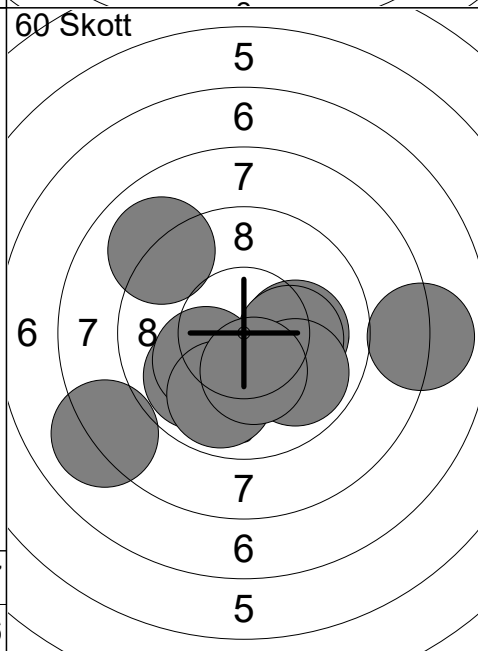

31:	9.0	↖
32:	10.1	➔
33:	10.2x	➔
34:	9.9	↘
35:	8.0	➔
36:	8.1	↙
37:	9.9	↙
38:	10.2x	↙
39:	9.9	↓
40:	10.3x	↓
Serie		95.6
Total		360.2

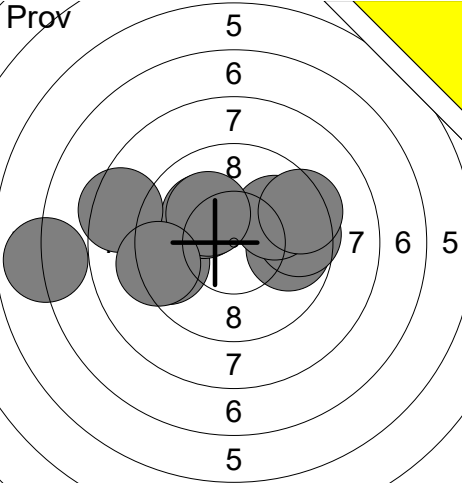
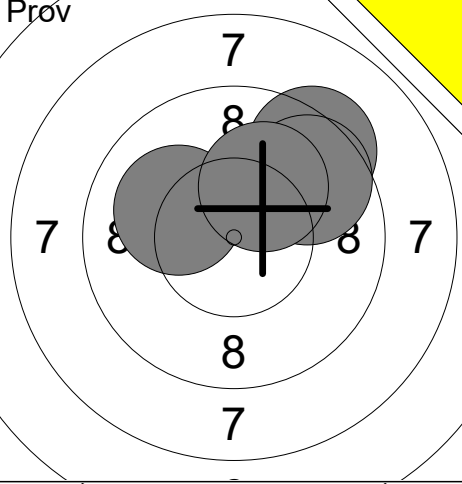
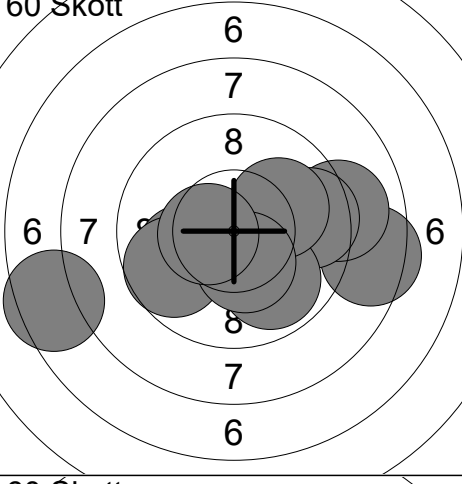
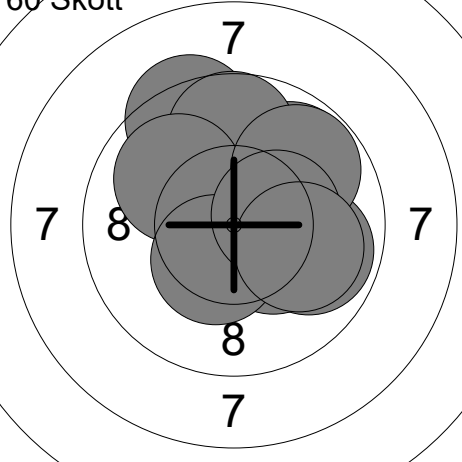
Skjutlag 2	Tavla 14	Milly Burström	
Umeå		Bjurholm/Balsö Skf	L13s
13.04.2024		UME-Kulan 2024	Umeå skytteallians
Prov		1: 9.5 ← 2: 9.8 → 3: 9.5 → 4: 10.1 ↗ 5: 8.4 ← 6: 6.9 ← 7: 9.9 → 8: 10.1 ↗ 9: 9.4 → 10: 9.3 ←	Prov
		Serie 92.9 Total 0.0	11: 9.9 → 12: 10.2x ↗ 13: 8.4 → 14: 9.8 ← 15: 10.5x ↗ 16: 10.2x ↗ 17: 9.1 ↗ 18: 10.4x → 19: 10.1 ↗
Prov		21: 9.3 ↗ 22: 9.7 ↗ 23: 10.1 ← 24: 10.1 ↗	60 Skott
		Serie 39.2 Total 0.0	1: 9.8 ↗ 2: 10.6x ↘ 3: 9.4 ← 4: 10.8x ↘ 5: 8.9 ← 6: 10.5x ← 7: 8.7 ↘ 8: 10.0 ← 9: 9.4 ← 10: 10.0 ←
60 Skott		11: 10.0 ← 12: 8.5 → 13: 9.1 → 14: 9.6 → 15: 7.5 ← 16: 9.9 ↘ 17: 10.1 → 18: 9.7 ← 19: 10.4x ↘ 20: 10.5x ←	60 Skott
		Serie 95.3 Total 193.4	21: 9.0 ↗ 22: 8.5 ← 23: 10.8x → 24: 9.1 ↗ 25: 10.1 ↗ 26: 9.1 → 27: 10.2x ↗ 28: 9.2 ↗ 29: 8.9 ↗ 30: 10.5x ←
60 Skott		31: 9.8 ↗ 32: 9.9 → 33: 9.4 ↗ 34: 9.7 ↗ 35: 10.0 ↗ 36: 9.8 ↗ 37: 10.3x ↘ 38: 10.4x ↘ 39: 10.3x → 40: 10.0 →	
		Serie 99.6 Total 388.4	

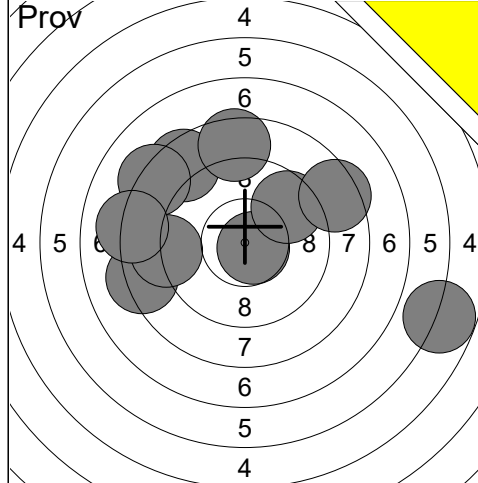

1:	8.2	←
2:	8.5	↗
3:	9.0	←
4:	5.8	↘
5:	8.2	↗
6:	10.7x	↘
7:	9.6	↗
8:	8.1	←
9:	8.4	↗
10:	8.5	↑
Serie		85.0
Total		0.0

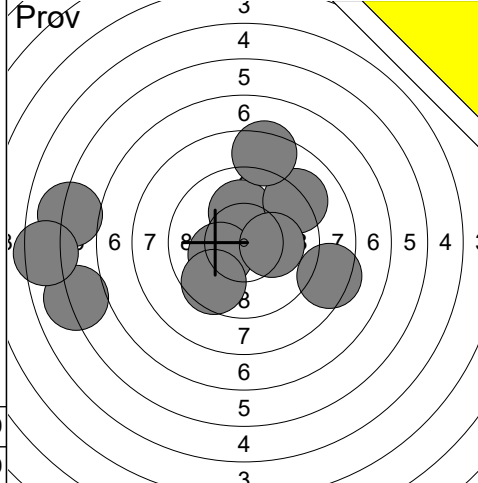

11:	10.1	↑
12:	9.1	↗
13:	8.4	→
14:	6.1	←
15:	8.4	↑
16:	6.0	←
17:	10.2x	←
18:	10.2x	→
19:	9.6	↘
20:	5.4	←
Serie		83.5
Total		0.0

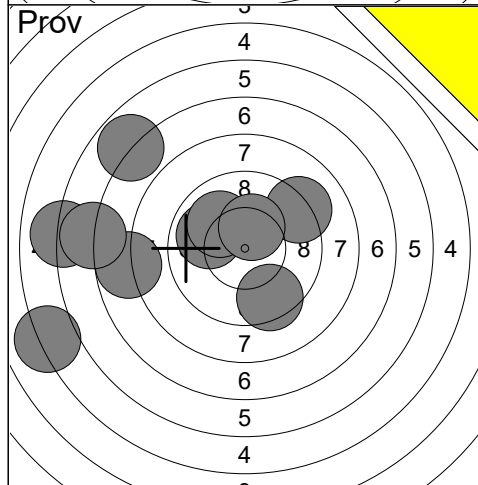

21:	6.0	←
22:	5.1	←
23:	7.8	←
24:	6.8	←
25:	9.2	↗
26:	9.9	↗
27:	10.0	↗
28:	6.8	↗
29:	10.4x	↑
30:	9.5	↘
Serie		81.5
Total		0.0

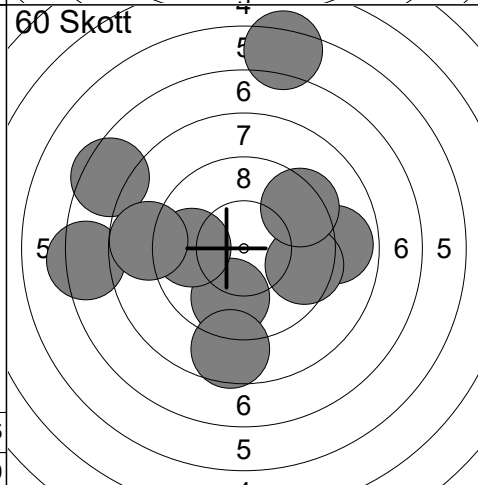

1:	9.8	↘
2:	9.8	←
3:	8.9	→
4:	8.6	↘
5:	9.5	→
6:	7.5	↖
7:	7.3	←
8:	9.4	↗
9:	8.8	←
10:	6.3	↑
Serie		85.9
Total		85.9

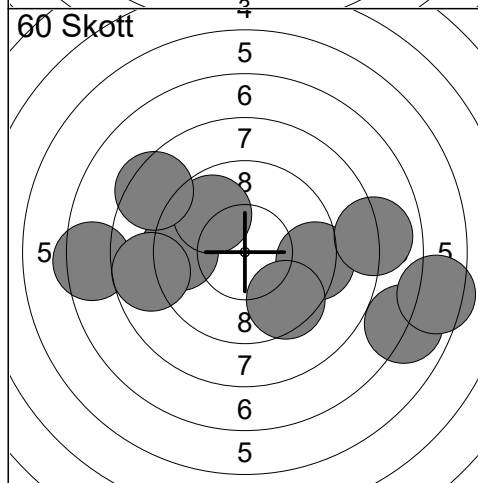

11:	9.3	→
12:	7.0	↘
13:	9.5	↘
14:	8.0	→
15:	9.4	←
16:	6.5	→
17:	7.4	←
18:	8.7	←
19:	9.8	↗
20:	8.4	↗
Serie		84.0
Total		169.9

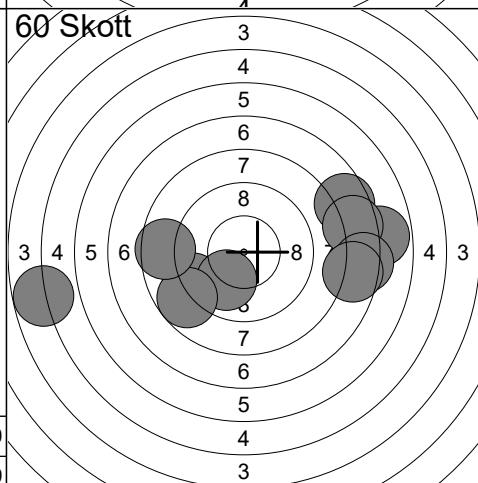

21:	4.8	←
22:	9.1	←
23:	6.8	→
24:	7.6	↗
25:	10.0	↘
26:	8.8	↖
27:	8.6	←
28:	7.6	→
29:	7.3	→
30:	7.6	→
Serie		78.2
Total		248.1

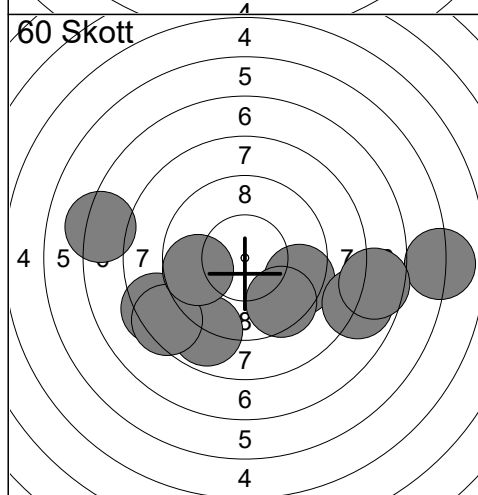

31:	6.0	→
32:	9.5	↘
33:	7.9	↘
34:	7.6	→
35:	8.4	←
36:	7.2	←
37:	8.9	↘
38:	8.4	↖
39:	9.7	←
40:	9.5	↘
Serie		83.1
Total		331.2

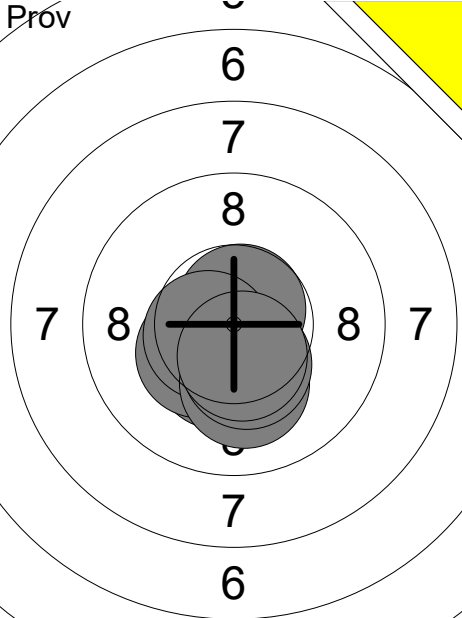
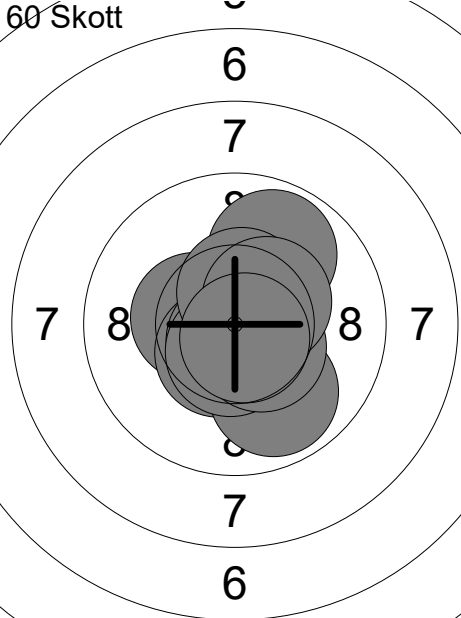
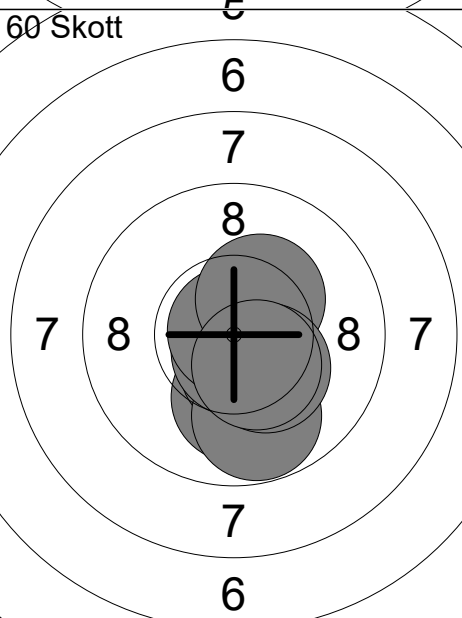
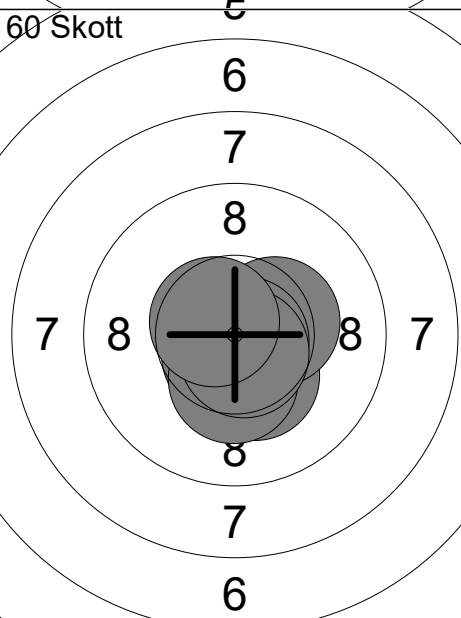
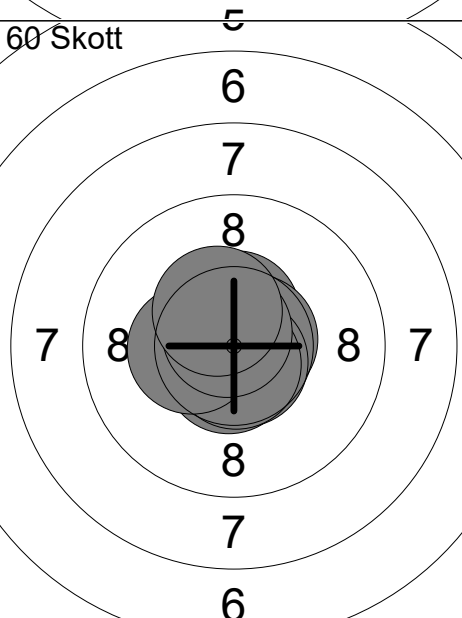
Skjutlag 2	Tavla 16	Anders Hansson	
Umeå	Vännäs Skf	Umeå skytteallians	Umeå skytteallians
13.04.2024	UME-Kulan 2024	Umeå skytteallians	
Prov		60 Skott	
	1: 10.4x ↓ 2: 10.3x ↙ 3: 10.7x ↗ 4: 10.6x ↙ 5: 10.1 ↓ 6: 10.4x ↓ 7: 10.5x ↓		1: 10.4x ← 2: 9.9 ↗ 3: 10.5x ↙ 4: 10.7x ↓ 5: 9.9 ↓ 6: 10.6x ↓ 7: 10.5x ↘ 8: 10.5x ↗ 9: 10.4x ↗ 10: 10.7x ↘
	Serie 73.0		Serie 104.1
	Total 0.0		Total 104.1
60 Skott		60 Skott	
	11: 10.1 ↓ 12: 10.5x ↓ 13: 9.8 ↓ 14: 10.7x ↓ 15: 10.5x ↘ 16: 10.6x ↘ 17: 10.9x ↗ 18: 10.3x ↗ 19: 10.3x ↘ 20: 10.4x ↘		21: 10.8x ↗ 22: 10.6x ↓ 23: 10.3x ↘ 24: 10.8x ↙ 25: 10.7x ↓ 26: 10.4x → 27: 10.8x ↘ 28: 10.3x ↓ 29: 10.7x ↘ 30: 10.6x ↙
	Serie 104.1		Serie 106.0
	Total 208.2		Total 314.2
60 Skott			
	31: 10.6x ← 32: 10.6x ↓ 33: 10.5x ↗ 34: 10.8x ← 35: 10.7x → 36: 10.7x ↓ 37: 10.7x ↓ 38: 10.4x ← 39: 10.7x ↗ 40: 10.4x ↗		
	Serie 106.1		
	Total 420.3		

Skjutlag	Tavla	Filip Hansson	
2	17	Umeå	Vännäs Skf
13.04.2024	UME-Kulan 2024	Umeå skytteallians	Lsitt
Prov		1: 10.0 ↗ 2: 10.2x ↖ 3: 10.4x ↘ 4: 10.6x ➔ 5: 10.5x ↙ 6: 10.0 ➔ 7: 10.7x ↖ 8: 10.7x ↘ 9: 10.7x ➔ 10: 10.5x ↘	11: 10.5x ↘ 12: 10.4x ↙ 13: 10.6x ↘ 14: 10.3x ← 15: 10.5x ↙ 16: 10.2x ↘ 17: 10.6x ↙ 18: 10.5x ↙
	Serie 104.3	Serie 83.6	
	Total 0.0	Total 0.0	
60 Skott		1: 10.3x ↘ 2: 10.4x ➔ 3: 10.4x ↖ 4: 10.6x ↙ 5: 10.1 ← 6: 10.3x ↙ 7: 10.8x ↘ 8: 10.8x ↘ 9: 10.7x ↖ 10: 10.8x ↗	11: 10.2x ↙ 12: 10.0 ← 13: 10.7x ➔ 14: 10.5x ➔ 15: 10.1 ↗ 16: 10.5x ↗ 17: 10.7x ↘ 18: 10.2x ➔ 19: 10.4x ↗ 20: 10.7x ➔
	Serie 105.2	Serie 104.0	
	Total 105.2	Total 209.2	
60 Skott		21: 10.6x ↗ 22: 10.6x ➔ 23: 10.1 ➔ 24: 10.6x ↙ 25: 10.1 ↗ 26: 10.2x ➔ 27: 10.2x ↙ 28: 9.9 ↗ 29: 10.8x ➔ 30: 10.8x ↙	31: 10.6x ↖ 32: 10.4x ➔ 33: 10.4x ➔ 34: 10.5x ↙ 35: 10.3x ↙ 36: 10.3x ↗ 37: 10.3x ↗ 38: 10.4x ↗ 39: 10.7x ↗ 40: 10.3x ↖
	Serie 103.9	Serie 104.2	
	Total 313.1	Total 417.3	

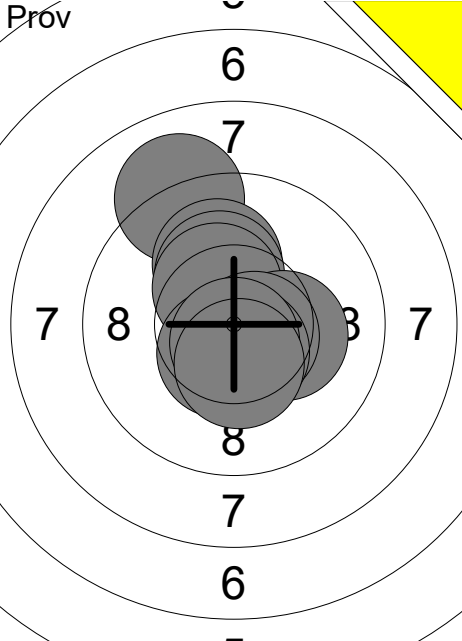
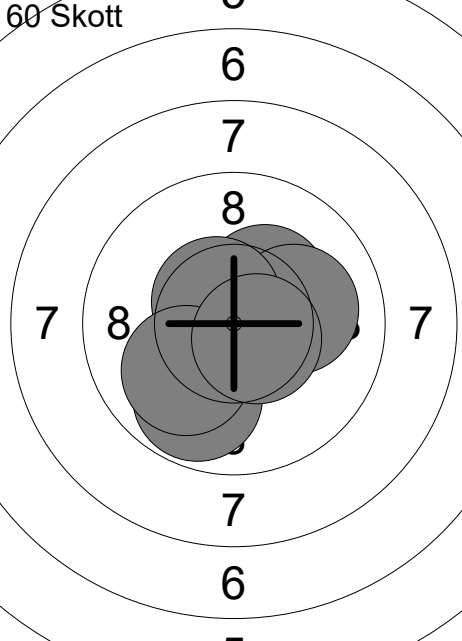
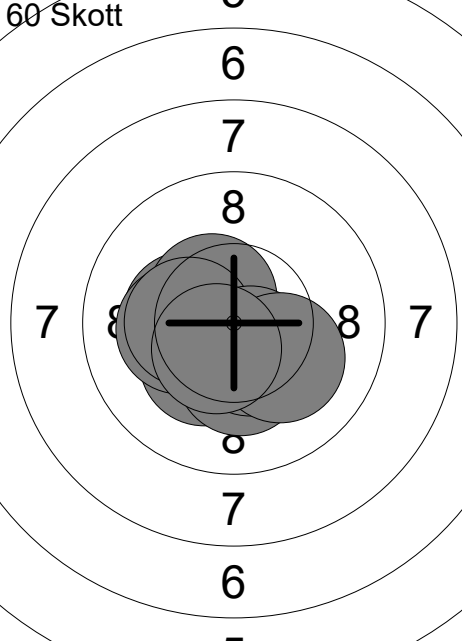
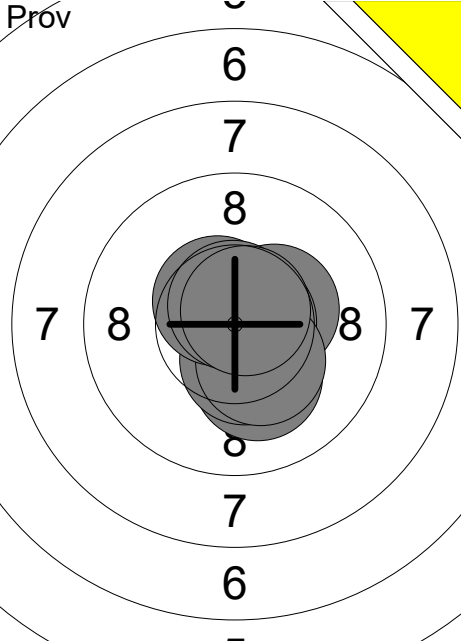
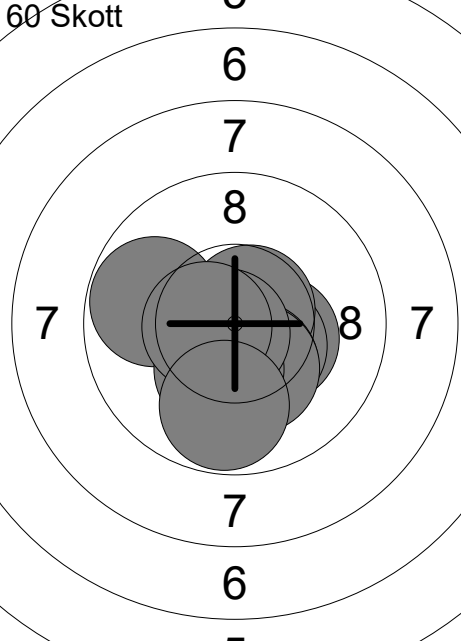
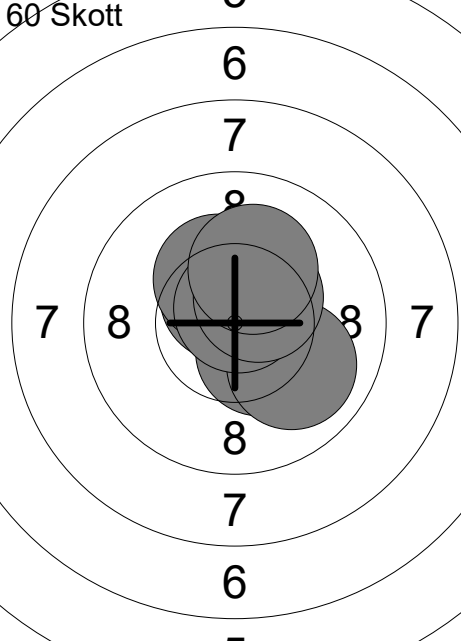
Skjutlag	Tavla	Monica Häggström	
2	18	Ramselefors Skf	Lsitt
13.04.2024	UME-Kulan 2024	Umeå skytteallians	
Prov		1: 9.0 ↗ 2: 10.1 ↗ 3: 10.2x ↗ 4: 10.4x ↗ 5: 10.5x ↘ 6: 10.3x → 7: 10.6x → 8: 10.5x ↘ 9: 10.7x ↘ 10: 10.4x ↘	Prov
	Serie 102.7 Total 0.0		11: 10.2x ↘ 12: 10.4x ↘ 13: 10.4x → 14: 10.7x → 15: 10.3x ↘ 16: 10.5x ↖ 17: 10.7x ↗ 18: 10.7x ↗
60 Skott		1: 10.5x ↘ 2: 10.8x → 3: 10.3x ↗ 4: 10.9x ↗ 5: 10.1 → 6: 10.7x ↘ 7: 10.6x ↖ 8: 9.8 ↘ 9: 10.0 ↘ 10: 10.6x →	Serie 83.9 Total 0.0
60 Skott		11: 10.4x → 12: 10.5x ↘ 13: 10.7x ↗ 14: 10.3x ↘ 15: 10.3x ↘ 16: 9.8 ← 17: 10.3x ↘ 18: 10.8x ↙ 19: 10.6x ← 20: 9.8 ↘	Serie 104.3 Total 104.3
60 Skott		21: 10.3x ← 22: 10.4x ↙ 23: 10.3x ↘ 24: 10.3x ↘ 25: 10.5x ↖ 26: 10.2x ← 27: 10.3x ← 28: 10.5x ↘ 29: 10.2x ↘ 30: 10.5x ↘	Serie 103.5 Total 207.8
60 Skott		31: 10.4x ↘ 32: 10.5x ↗ 33: 10.6x ↗ 34: 10.4x ↗ 35: 10.6x ↗ 36: 10.3x ↗ 37: 10.0 ↘ 38: 10.7x ↗ 39: 10.5x ↗ 40: 10.2x ↗	Serie 103.5 Total 311.3
60 Skott		41: 10.3x ↙ 42: 10.4x ↙ 43: 10.3x ↘ 44: 10.3x ↘ 45: 10.5x ↖ 46: 10.2x ← 47: 10.3x ← 48: 10.5x ↘ 49: 10.2x ↘ 50: 10.5x ↘	Serie 104.2 Total 415.5

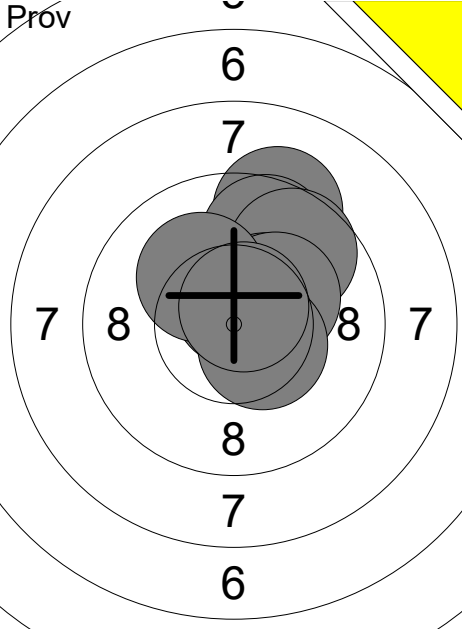
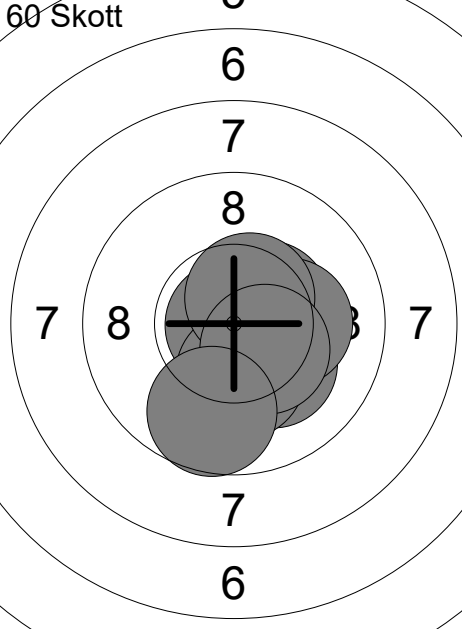
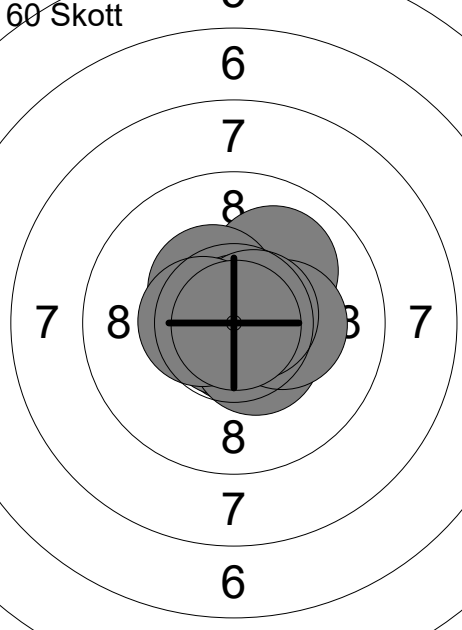
Skjutlag	Tavla	Jimmy Söderlund	
2	19		
Umeå	Vännäs Skf	Umeå skytteallians	Lsitt
13.04.2024	UME-Kulan 2024		
Prov		1: 10.6x ↗ 2: 9.3 ↗ 3: 9.7 ↗ 4: 10.7x ↗ 5: 9.7 ↗ 6: 10.4x ↗ 7: 10.3x ↗ 8: 10.2x ↖ 9: 10.5x ↘ 10: 10.7x ↗	11: 10.0 ↗ 12: 10.6x → 13: 10.4x → 14: 10.5x ↓ 15: 10.7x → 16: 10.4x → 17: 10.7x ↑ 18: 10.5x ↓ 19: 10.8x →
		Serie 102.1	Serie 94.6
		Total 0.0	Total 0.0
60 Skott		1: 10.5x ↓ 2: 10.7x ↗ 3: 10.4x → 4: 10.2x ↘ 5: 10.9x ↙ 6: 10.2x → 7: 10.2x ↓ 8: 10.5x ↗ 9: 10.4x ↘ 10: 9.7 ↓	11: 10.4x → 12: 10.5x → 13: 10.3x → 14: 10.9x ↙ 15: 10.3x → 16: 10.6x ↙ 17: 10.8x ↗ 18: 10.6x ↙ 19: 10.6x ↙ 20: 10.4x ↓
		Serie 103.7	Serie 105.4
		Total 103.7	Total 209.1
60 Skott		21: 10.0 ↗ 22: 10.7x ↓ 23: 10.4x ↖ 24: 10.8x ↙ 25: 10.9x ↗ 26: 10.5x ↘ 27: 10.3x → 28: 10.7x → 29: 10.5x ↙ 30: 10.9x ↘	31: 10.5x → 32: 10.4x ↙ 33: 10.2x ↗ 34: 10.7x ↘ 35: 10.5x ↓ 36: 10.1 ↓ 37: 10.4x ↙ 38: 10.2x ↓ 39: 10.6x ↗ 40: 10.8x ↙
		Serie 105.7	Serie 104.4
		Total 314.8	Total 419.2

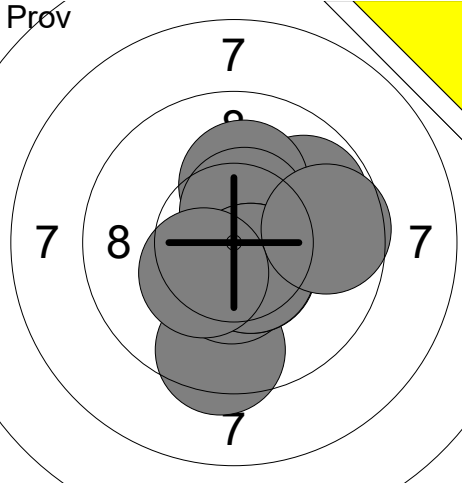
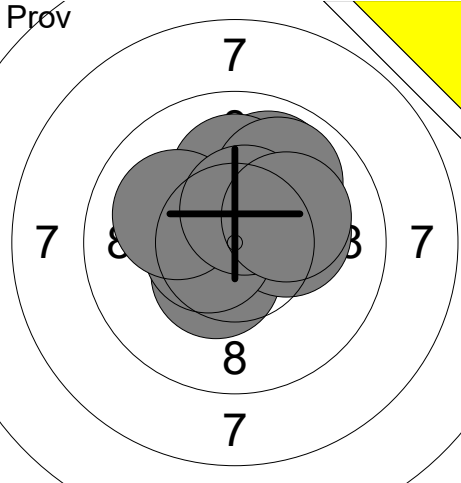
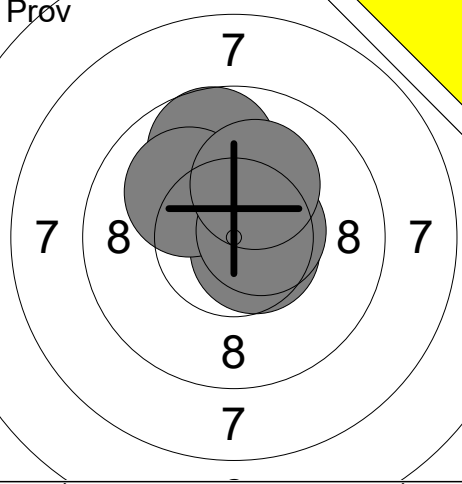
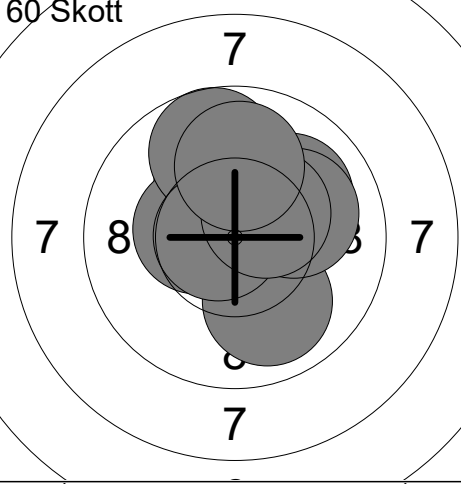
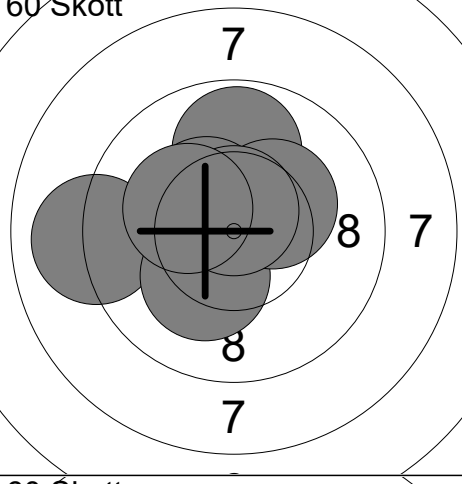
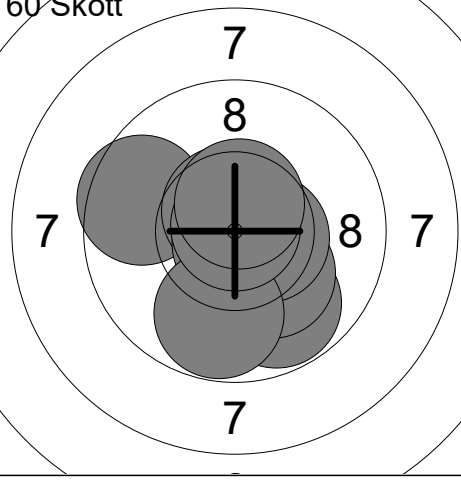
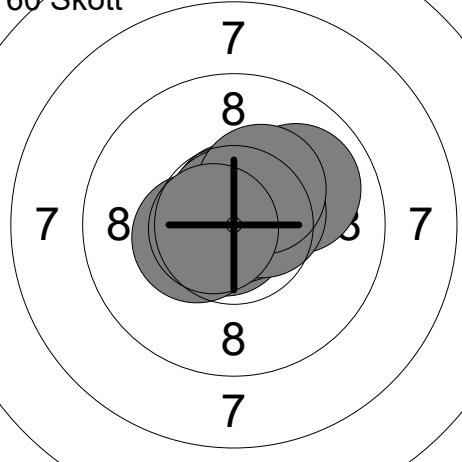
Skjutlag 2	Tavla 20	Maria Söderlund			
Umeå		Vännäs Skf			Lsitt
13.04.2024		UME-Kulan 2024		Umeå skytteallians	
Prov		1: 9.4 ↓ 2: 9.8 → 3: 10.4x → 4: 10.1 ↑ 5: 10.5x ↑ 6: 10.4x ↓ 7: 10.5x ↓ 8: 10.5x ↓ 9: 9.7 → 10: 10.4x ↙	Prov		11: 10.2x ↑ 12: 10.4x ↓ 13: 10.2x → 14: 10.6x ← 15: 9.9 ↑ 16: 10.1 ↑ 17: 9.9 ↑ 18: 10.1 ↖ 19: 10.5x ↑ 20: 10.2x →
		Serie 101.7 Total 0.0			Serie 102.1 Total 0.0
Prov		21: 9.7 ↑ 22: 10.6x → 23: 10.1 ↗ 24: 10.6x → 25: 10.2x ↑	60 Skott		1: 10.5x ↖ 2: 10.0 ↓ 3: 10.1 ↑ 4: 10.0 → 5: 10.1 → 6: 10.4x ← 7: 9.7 ↑ 8: 10.7x ← 9: 10.4x ↗ 10: 10.0 ↑
		Serie 51.2 Total 0.0			Serie 101.9 Total 101.9
60 Skott		11: 10.5x ← 12: 10.4x ↖ 13: 10.4x ← 14: 9.0 ← 15: 10.2x ↓ 16: 9.8 ↑ 17: 10.4x ↗ 18: 10.3x → 19: 10.7x ↑ 20: 10.2x ↖	60 Skott		21: 9.8 ↓ 22: 9.6 ← 23: 10.6x ↑ 24: 10.8x ↓ 25: 10.7x → 26: 10.2x ↓ 27: 10.5x → 28: 9.8 ↓ 29: 10.9x ↑ 30: 10.6x ↑
		Serie 101.9 Total 203.8			Serie 103.5 Total 307.3
60 Skott		31: 10.7x ↑ 32: 9.9 → 33: 10.8x ↖ 34: 10.6x → 35: 10.8x ↑ 36: 10.4x ← 37: 10.8x ↑ 38: 10.5x → 39: 10.3x ↗ 40: 10.7x ←			
		Serie 105.5 Total 412.8			

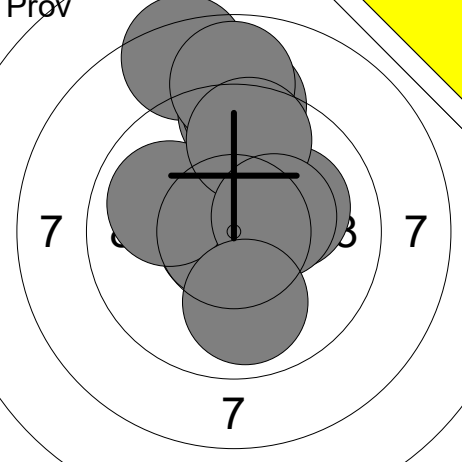
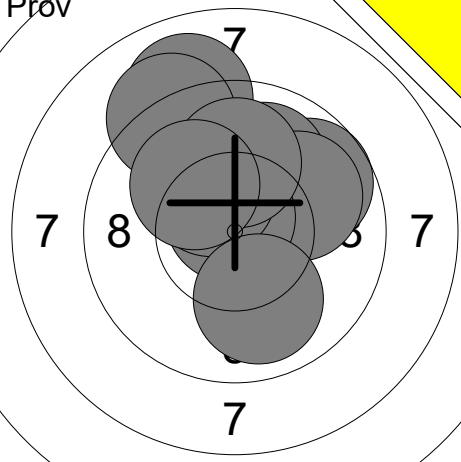
<p>Prov</p>  <p style="text-align: center;">7</p>	<table border="1" style="width:100%; border-collapse: collapse;"> <tr><td>1:</td><td>8.4</td><td>↑</td></tr> <tr><td>2:</td><td>9.3</td><td>↑</td></tr> <tr><td>3:</td><td>9.1</td><td>↑</td></tr> <tr><td>4:</td><td>8.8</td><td>↑</td></tr> <tr><td>5:</td><td>10.7x</td><td>←</td></tr> <tr><td>6:</td><td>10.1</td><td>→</td></tr> <tr><td>7:</td><td>10.0</td><td>←</td></tr> <tr><td>8:</td><td>9.6</td><td>↑</td></tr> <tr><td>9:</td><td>10.3x</td><td>→</td></tr> <tr><td>10:</td><td>9.9</td><td>↓</td></tr> <tr><td colspan="2">Serie</td><td>96.2</td></tr> <tr><td colspan="2">Total</td><td>0.0</td></tr> </table>	1:	8.4	↑	2:	9.3	↑	3:	9.1	↑	4:	8.8	↑	5:	10.7x	←	6:	10.1	→	7:	10.0	←	8:	9.6	↑	9:	10.3x	→	10:	9.9	↓	Serie		96.2	Total		0.0	<p>Prov</p>  <p style="text-align: center;">7</p>	<table border="1" style="width:100%; border-collapse: collapse;"> <tr><td>11:</td><td>9.0</td><td>↑</td></tr> <tr><td>12:</td><td>9.7</td><td>→</td></tr> <tr><td>13:</td><td>9.2</td><td>↑</td></tr> <tr><td>14:</td><td>10.0</td><td>↑</td></tr> <tr><td>15:</td><td>10.0</td><td>→</td></tr> <tr><td>16:</td><td>10.7x</td><td>↑</td></tr> <tr><td>17:</td><td>10.3x</td><td>↑</td></tr> <tr><td>18:</td><td>10.0</td><td>↓</td></tr> <tr><td>19:</td><td>10.0</td><td>↑</td></tr> <tr><td>20:</td><td>10.1</td><td>↖</td></tr> <tr><td colspan="2">Serie</td><td>99.0</td></tr> <tr><td colspan="2">Total</td><td>0.0</td></tr> </table>	11:	9.0	↑	12:	9.7	→	13:	9.2	↑	14:	10.0	↑	15:	10.0	→	16:	10.7x	↑	17:	10.3x	↑	18:	10.0	↓	19:	10.0	↑	20:	10.1	↖	Serie		99.0	Total		0.0
1:	8.4	↑																																																																									
2:	9.3	↑																																																																									
3:	9.1	↑																																																																									
4:	8.8	↑																																																																									
5:	10.7x	←																																																																									
6:	10.1	→																																																																									
7:	10.0	←																																																																									
8:	9.6	↑																																																																									
9:	10.3x	→																																																																									
10:	9.9	↓																																																																									
Serie		96.2																																																																									
Total		0.0																																																																									
11:	9.0	↑																																																																									
12:	9.7	→																																																																									
13:	9.2	↑																																																																									
14:	10.0	↑																																																																									
15:	10.0	→																																																																									
16:	10.7x	↑																																																																									
17:	10.3x	↑																																																																									
18:	10.0	↓																																																																									
19:	10.0	↑																																																																									
20:	10.1	↖																																																																									
Serie		99.0																																																																									
Total		0.0																																																																									

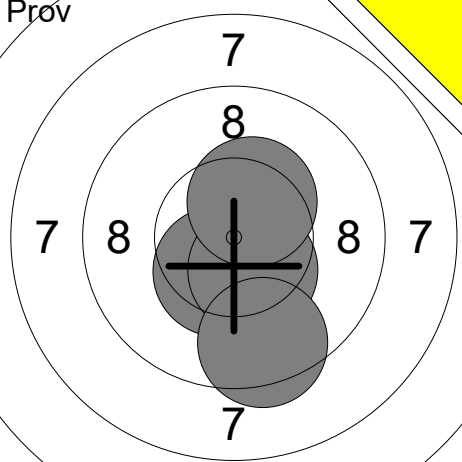
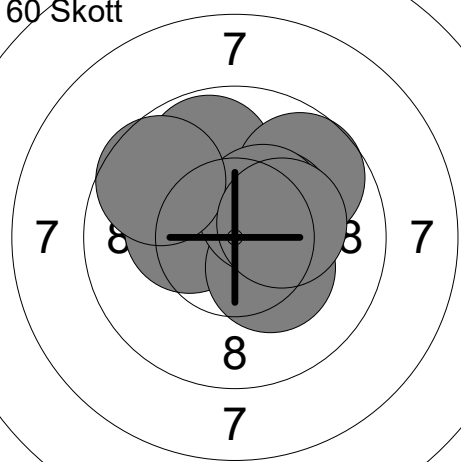
<p>Prov</p>  <p style="text-align: center;">7</p>	<table border="1" style="width:100%; border-collapse: collapse;"> <tr><td>21:</td><td>10.4x</td><td>↓</td></tr> <tr><td>22:</td><td>10.4x</td><td>↓</td></tr> <tr><td>23:</td><td>9.4</td><td>↓</td></tr> <tr><td>24:</td><td>10.4x</td><td>↑</td></tr> <tr><td colspan="2">Serie</td><td>40.6</td></tr> <tr><td colspan="2">Total</td><td>0.0</td></tr> </table>	21:	10.4x	↓	22:	10.4x	↓	23:	9.4	↓	24:	10.4x	↑	Serie		40.6	Total		0.0	<p>60 Skott</p>  <p style="text-align: center;">7</p>	<table border="1" style="width:100%; border-collapse: collapse;"> <tr><td>1:</td><td>9.8</td><td>↑</td></tr> <tr><td>2:</td><td>10.6x</td><td>→</td></tr> <tr><td>3:</td><td>10.1</td><td>↗</td></tr> <tr><td>4:</td><td>10.3x</td><td>←</td></tr> <tr><td>5:</td><td>9.7</td><td>↗</td></tr> <tr><td>6:</td><td>10.3x</td><td>↓</td></tr> <tr><td>7:</td><td>10.4x</td><td>↗</td></tr> <tr><td>8:</td><td>10.4x</td><td>↗</td></tr> <tr><td>9:</td><td>9.7</td><td>↖</td></tr> <tr><td>10:</td><td>10.3x</td><td>→</td></tr> <tr><td colspan="2">Serie</td><td>101.6</td></tr> <tr><td colspan="2">Total</td><td>101.6</td></tr> </table>	1:	9.8	↑	2:	10.6x	→	3:	10.1	↗	4:	10.3x	←	5:	9.7	↗	6:	10.3x	↓	7:	10.4x	↗	8:	10.4x	↗	9:	9.7	↖	10:	10.3x	→	Serie		101.6	Total		101.6
21:	10.4x	↓																																																							
22:	10.4x	↓																																																							
23:	9.4	↓																																																							
24:	10.4x	↑																																																							
Serie		40.6																																																							
Total		0.0																																																							
1:	9.8	↑																																																							
2:	10.6x	→																																																							
3:	10.1	↗																																																							
4:	10.3x	←																																																							
5:	9.7	↗																																																							
6:	10.3x	↓																																																							
7:	10.4x	↗																																																							
8:	10.4x	↗																																																							
9:	9.7	↖																																																							
10:	10.3x	→																																																							
Serie		101.6																																																							
Total		101.6																																																							

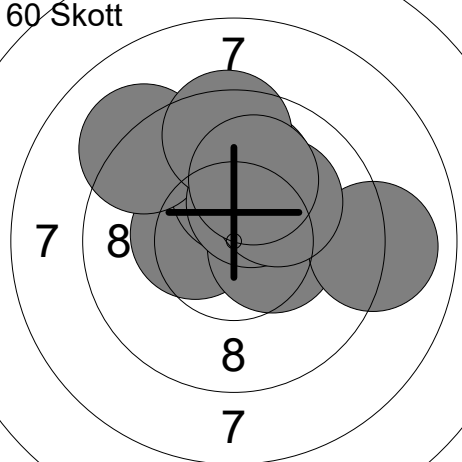
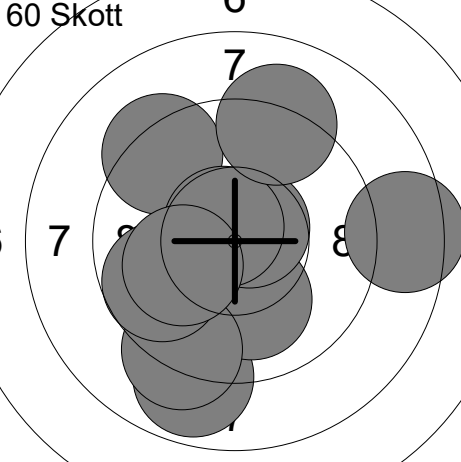
<p>60 Skott</p>  <p style="text-align: center;">7</p>	<table border="1" style="width:100%; border-collapse: collapse;"> <tr><td>11:</td><td>10.4x</td><td>←</td></tr> <tr><td>12:</td><td>10.0</td><td>↑</td></tr> <tr><td>13:</td><td>10.2x</td><td>↑</td></tr> <tr><td>14:</td><td>10.4x</td><td>→</td></tr> <tr><td>15:</td><td>9.2</td><td>↗</td></tr> <tr><td>16:</td><td>10.4x</td><td>↑</td></tr> <tr><td>17:</td><td>9.0</td><td>→</td></tr> <tr><td>18:</td><td>9.5</td><td>↑</td></tr> <tr><td>19:</td><td>10.1</td><td>↗</td></tr> <tr><td>20:</td><td>10.1</td><td>↑</td></tr> <tr><td colspan="2">Serie</td><td>99.3</td></tr> <tr><td colspan="2">Total</td><td>200.9</td></tr> </table>	11:	10.4x	←	12:	10.0	↑	13:	10.2x	↑	14:	10.4x	→	15:	9.2	↗	16:	10.4x	↑	17:	9.0	→	18:	9.5	↑	19:	10.1	↗	20:	10.1	↑	Serie		99.3	Total		200.9	<p>60 Skott</p>  <p style="text-align: center;">7</p>	<table border="1" style="width:100%; border-collapse: collapse;"> <tr><td>21:</td><td>8.9</td><td>↓</td></tr> <tr><td>22:</td><td>10.1</td><td>↓</td></tr> <tr><td>23:</td><td>9.2</td><td>↓</td></tr> <tr><td>24:</td><td>8.4</td><td>→</td></tr> <tr><td>25:</td><td>9.7</td><td>←</td></tr> <tr><td>26:</td><td>10.7x</td><td>↗</td></tr> <tr><td>27:</td><td>9.3</td><td>↑</td></tr> <tr><td>28:</td><td>10.7x</td><td>↖</td></tr> <tr><td>29:</td><td>10.1</td><td>←</td></tr> <tr><td>30:</td><td>9.1</td><td>↑</td></tr> <tr><td colspan="2">Serie</td><td>96.2</td></tr> <tr><td colspan="2">Total</td><td>297.1</td></tr> </table>	21:	8.9	↓	22:	10.1	↓	23:	9.2	↓	24:	8.4	→	25:	9.7	←	26:	10.7x	↗	27:	9.3	↑	28:	10.7x	↖	29:	10.1	←	30:	9.1	↑	Serie		96.2	Total		297.1
11:	10.4x	←																																																																									
12:	10.0	↑																																																																									
13:	10.2x	↑																																																																									
14:	10.4x	→																																																																									
15:	9.2	↗																																																																									
16:	10.4x	↑																																																																									
17:	9.0	→																																																																									
18:	9.5	↑																																																																									
19:	10.1	↗																																																																									
20:	10.1	↑																																																																									
Serie		99.3																																																																									
Total		200.9																																																																									
21:	8.9	↓																																																																									
22:	10.1	↓																																																																									
23:	9.2	↓																																																																									
24:	8.4	→																																																																									
25:	9.7	←																																																																									
26:	10.7x	↗																																																																									
27:	9.3	↑																																																																									
28:	10.7x	↖																																																																									
29:	10.1	←																																																																									
30:	9.1	↑																																																																									
Serie		96.2																																																																									
Total		297.1																																																																									

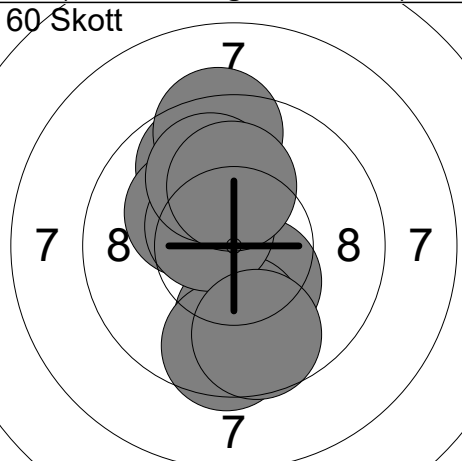
<p>60 Skott</p>  <p style="text-align: center;">7</p>	<table border="1" style="width:100%; border-collapse: collapse;"> <tr><td>31:</td><td>10.4x</td><td>↓</td></tr> <tr><td>32:</td><td>9.8</td><td>↗</td></tr> <tr><td>33:</td><td>10.2x</td><td>↗</td></tr> <tr><td>34:</td><td>9.9</td><td>↓</td></tr> <tr><td>35:</td><td>9.4</td><td>↑</td></tr> <tr><td>36:</td><td>9.6</td><td>↓</td></tr> <tr><td>37:</td><td>10.5x</td><td>↗</td></tr> <tr><td>38:</td><td>9.7</td><td>↓</td></tr> <tr><td>39:</td><td>9.9</td><td>↑</td></tr> <tr><td>40:</td><td>10.1</td><td>↑</td></tr> <tr><td colspan="2">Serie</td><td>99.5</td></tr> <tr><td colspan="2">Total</td><td>396.6</td></tr> </table>	31:	10.4x	↓	32:	9.8	↗	33:	10.2x	↗	34:	9.9	↓	35:	9.4	↑	36:	9.6	↓	37:	10.5x	↗	38:	9.7	↓	39:	9.9	↑	40:	10.1	↑	Serie		99.5	Total		396.6		
31:	10.4x	↓																																					
32:	9.8	↗																																					
33:	10.2x	↗																																					
34:	9.9	↓																																					
35:	9.4	↑																																					
36:	9.6	↓																																					
37:	10.5x	↗																																					
38:	9.7	↓																																					
39:	9.9	↑																																					
40:	10.1	↑																																					
Serie		99.5																																					
Total		396.6																																					

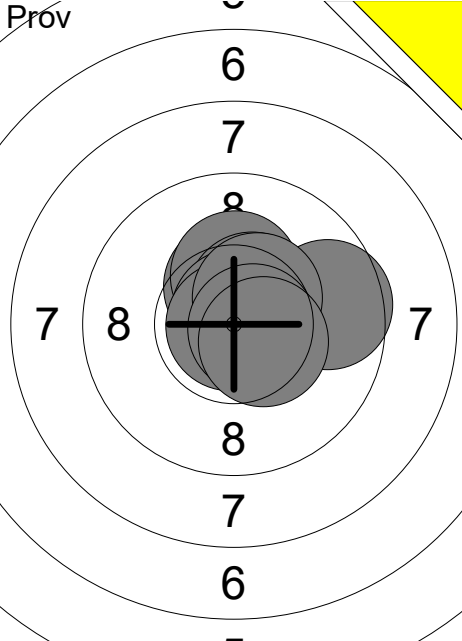
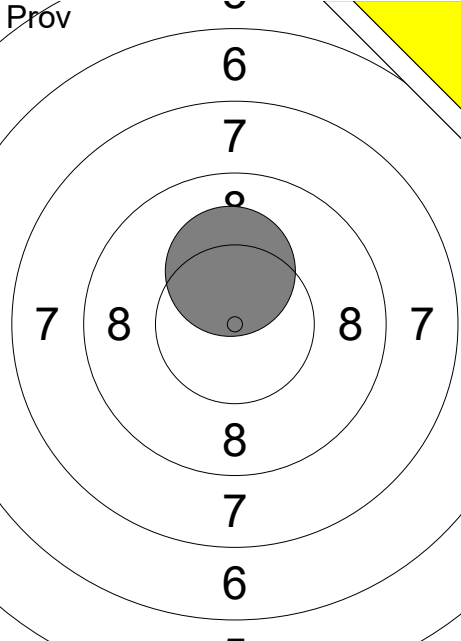
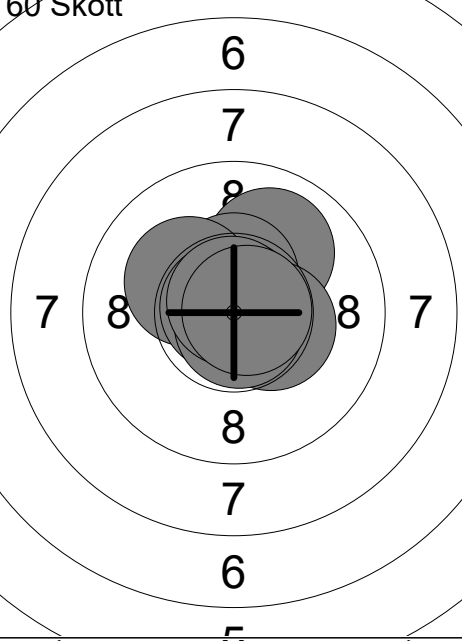
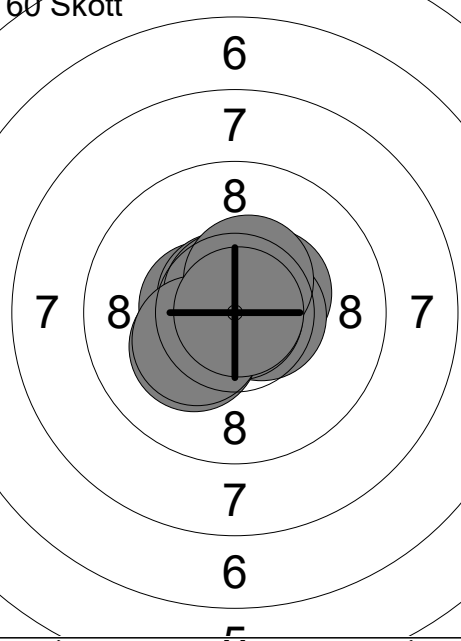
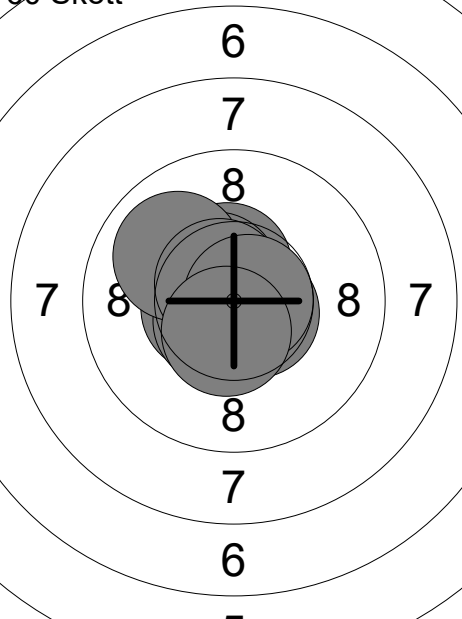
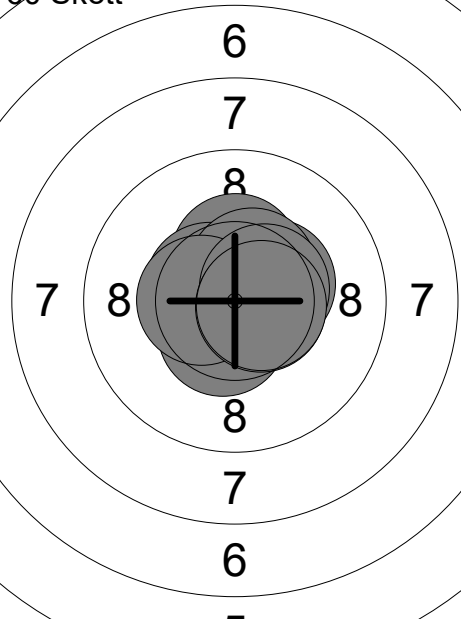
Skjutlag	Tavla	Marlene Forsell	
2	24	Ramselefors Skf	Lsitt
13.04.2024	UME-Kulan 2024	Umeå skytteallians	
Prov		1: 10.4x ↑ 2: 9.6 → 3: 10.3x ↑ 4: 10.5x ↗ 5: 10.5x ↗ 6: 10.8x ↑ 7: 10.9x ← 8: 10.5x ↗ 9: 10.7x → 10: 10.5x ↘	Prov  11: 10.2x ↑
		Serie 104.7	Serie 10.2
		Total 0.0	Total 0.0
60 Skott		1: 10.0 ↗ 2: 10.5x ↑ 3: 10.8x ↗ 4: 10.4x → 5: 10.9x ↑ 6: 10.2x ↖ 7: 10.8x ↖ 8: 10.8x ↓ 9: 10.8x ↑ 10: 10.8x →	60 Skott  11: 10.4x ↗ 12: 10.5x ← 13: 10.7x ↖ 14: 10.6x → 15: 10.9x ↘ 16: 10.7x ↑ 17: 10.2x ↙ 18: 10.3x ↙ 19: 10.5x ↑ 20: 10.9x →
		Serie 106.0	Serie 105.7
		Total 106.0	Total 211.7
60 Skott		21: 10.4x ↖ 22: 10.5x ← 23: 10.6x → 24: 10.6x ↙ 25: 10.5x ↑ 26: 10.5x ↖ 27: 10.0 ↖ 28: 10.6x ↖ 29: 10.7x → 30: 10.5x ↓	60 Skott  31: 10.4x ↗ 32: 10.9x ↓ 33: 10.4x ↑ 34: 10.5x ↓ 35: 10.6x ↖ 36: 10.5x ↗ 37: 10.5x ← 38: 10.5x → 39: 10.6x → 40: 10.6x →
		Serie 104.9	Serie 105.5
		Total 316.6	Total 422.1

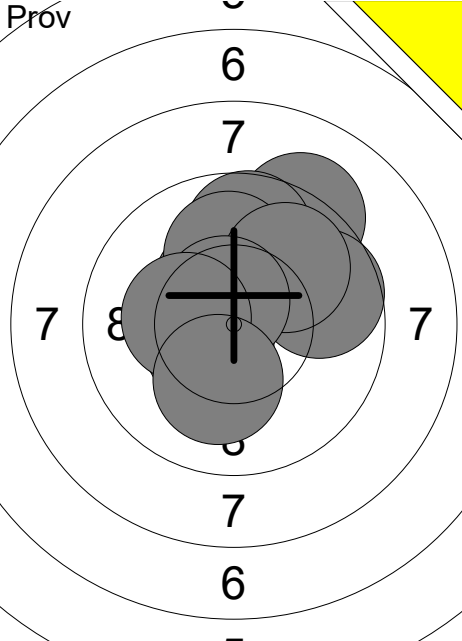
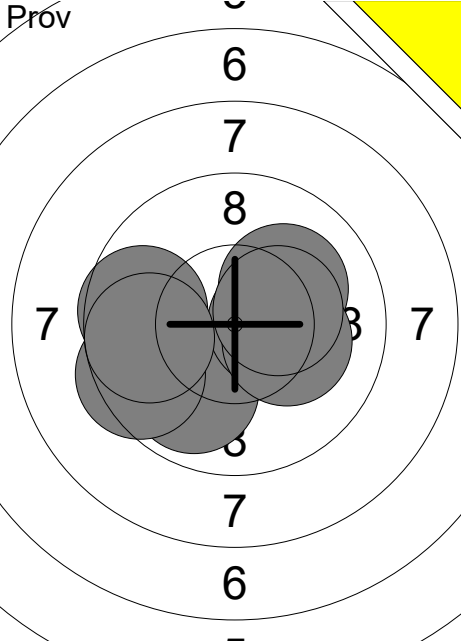
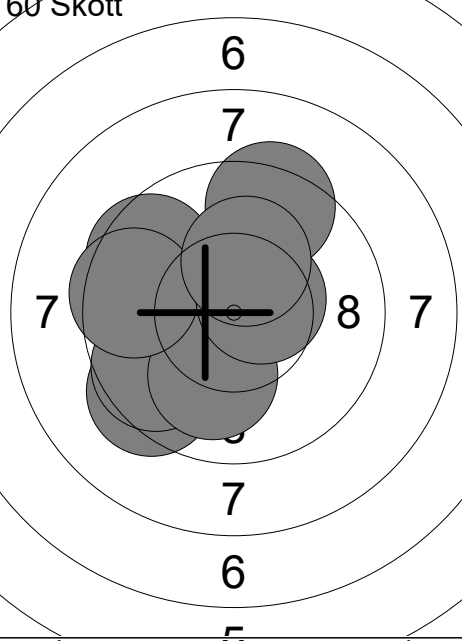
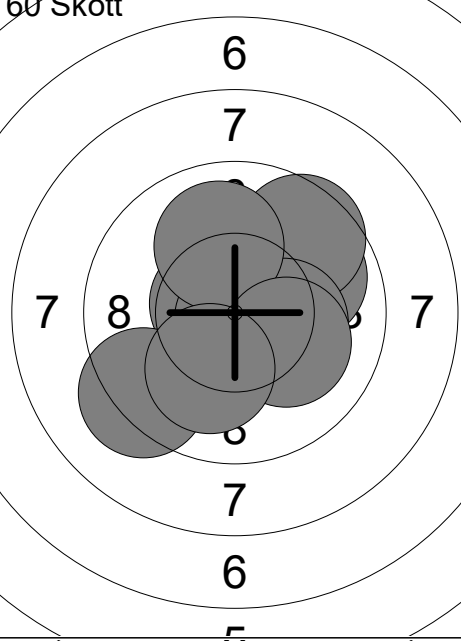
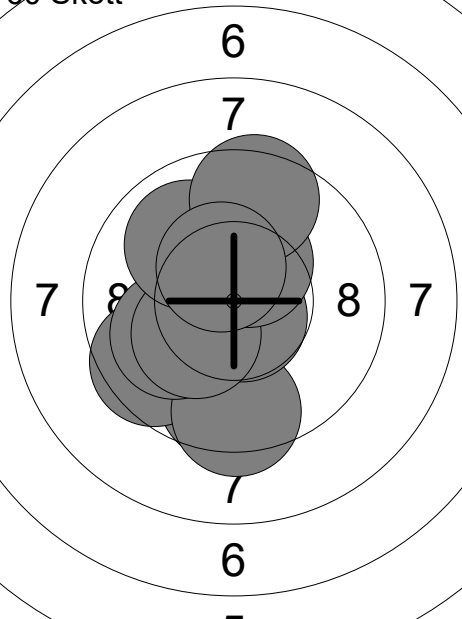
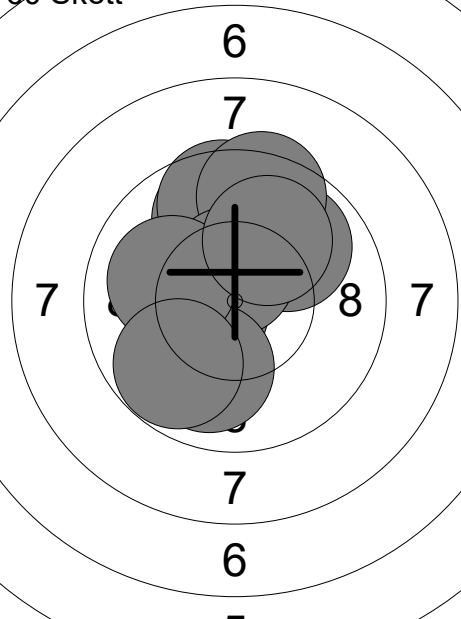
Skjutlag 2	Tavla 25	Alfred Wernflo	
Umeå	Gideå Skf	L13	
13.04.2024	UME-Kulan 2024	Umeå skytteallians	
Prov		1: 9.2 ↗ 2: 10.4x ↖ 3: 9.7 ↑ 4: 10.0 ↑ 5: 10.5x ↙ 6: 9.7 → 7: 9.9 ↗ 8: 10.6x ↖ 9: 10.3x ← 10: 10.2x ↓ Serie 100.5 Total 0.0	Prov  11: 9.9 ↘ 12: 9.7 ← 13: 10.4x → 14: 9.5 ↙ 15: 10.1 ↗ 16: 10.2x → 17: 10.3x → 18: 9.7 ← Serie 79.8 Total 0.0
60 Skott		1: 10.4x ← 2: 10.5x ↑ 3: 9.4 ↘ 4: 9.6 ↙ 5: 10.0 ↓ 6: 9.4 ↑ 7: 9.6 ↙ 8: 9.5 ← 9: 10.5x → 10: 10.2x ↑ Serie 99.1 Total 99.1	60 Skott  11: 9.9 ↗ 12: 10.6x ↘ 13: 10.6x ↙ 14: 9.6 ↗ 15: 10.8x ↘ 16: 10.3x → 17: 10.0 ↑ 18: 9.3 ↘ 19: 10.1 → 20: 10.1 ↓ Serie 101.3 Total 200.4
60 Skott		21: 9.6 ↓ 22: 9.6 ↙ 23: 9.4 ↓ 24: 10.7x ↘ 25: 10.0 ↙ 26: 10.3x ↙ 27: 10.0 ↖ 28: 10.4x ↗ 29: 9.5 ↑ 30: 10.4x ↖ Serie 99.9 Total 300.3	60 Skott  31: 9.8 ↑ 32: 9.6 ↑ 33: 9.9 ↗ 34: 10.5x ← 35: 9.5 ↑ 36: 10.5x ↑ 37: 10.0 ↓ 38: 10.0 ← 39: 10.0 ↗ 40: 9.8 ↘ Serie 99.6 Total 399.9

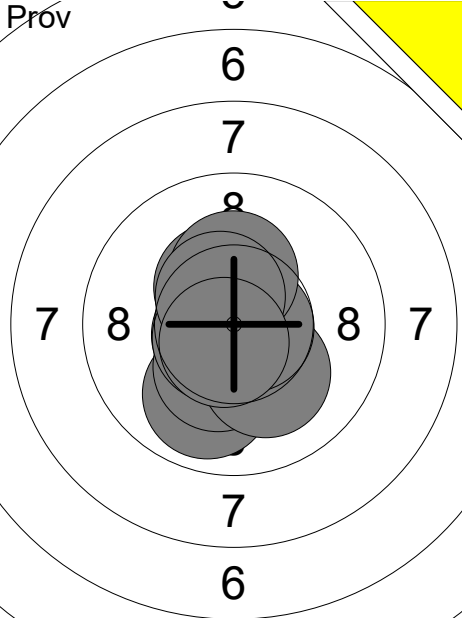
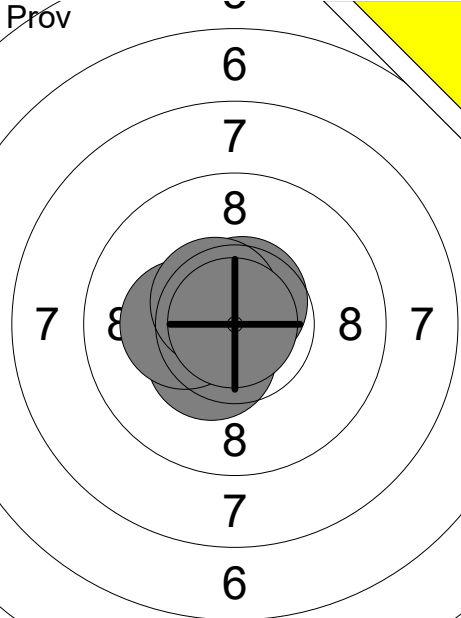
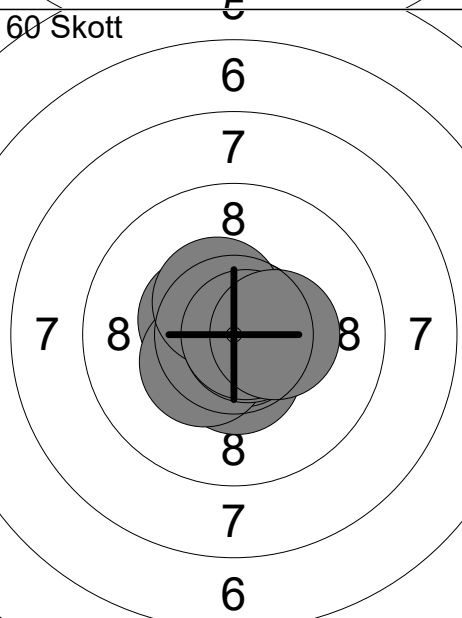
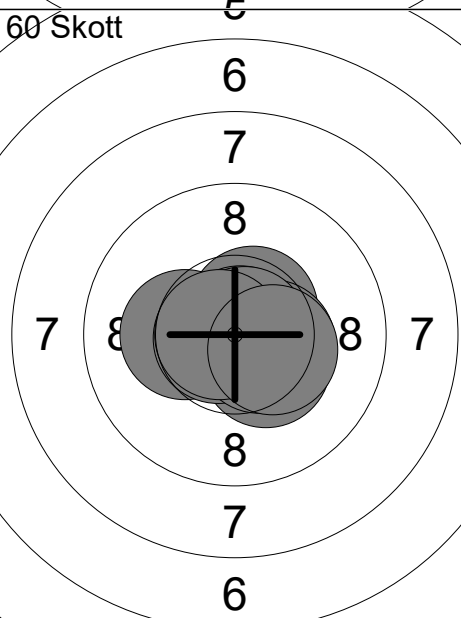
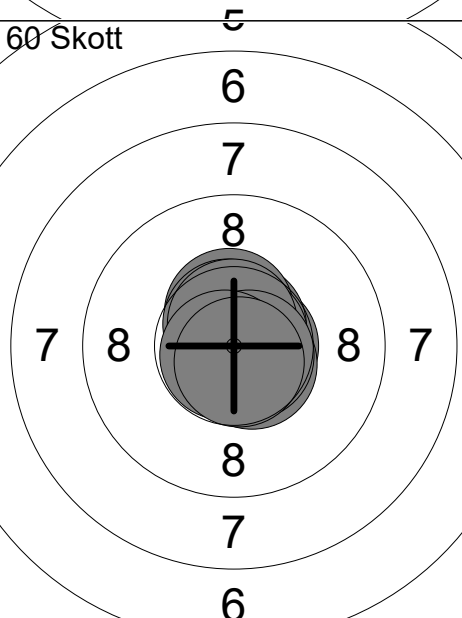
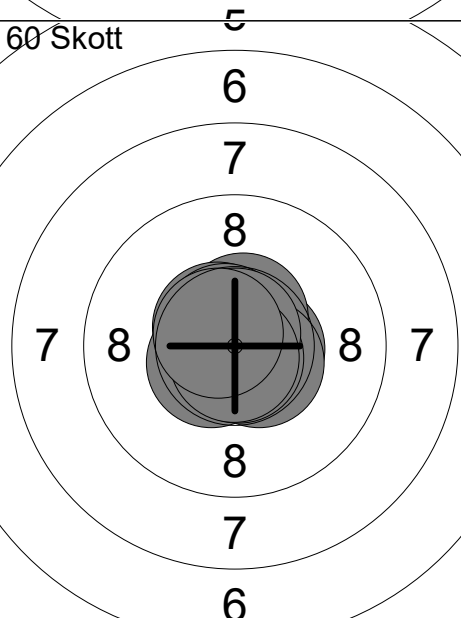
Skjutlag	Tavla	Idun Lindgren	
2	26		
Umeå	Bastuträsk Skf	L9	
13.04.2024	UME-Kulan 2024	Umeå skytteallians	
Prov		Prov	
	1: 9.9 ↓ 2: 10.3x ↓ 3: 10.1 ↓ 4: 10.7x ↙ 5: 10.7x ↙ 6: 10.4x ↗ 7: 10.7x → 8: 10.3x ↑ 9: 10.5x ↗ 10: 10.7x ↓		11: 10.4x ↘ 12: 10.3x ← 13: 10.6x ↗ 14: 10.5x ↖ 15: 10.9x ↖
Serie	104.3	Serie	52.7
Total	0.0	Total	0.0
60 Skott		60 Skott	
	1: 10.5x ↓ 2: 10.5x ↖ 3: 10.8x ↘ 4: 10.4x ↙ 5: 10.7x ↗ 6: 10.8x → 7: 10.4x ↖ 8: 10.8x → 9: 10.8x → 10: 10.4x →		11: 10.4x ↘ 12: 10.5x ↗ 13: 10.3x ← 14: 10.7x ← 15: 10.4x → 16: 10.6x → 17: 10.9x ↗ 18: 10.8x → 19: 10.7x ← 20: 10.4x →
Serie	106.1	Serie	105.7
Total	106.1	Total	211.8
60 Skott		60 Skott	
	21: 10.7x → 22: 10.7x ↗ 23: 10.5x ↑ 24: 10.8x ↗ 25: 10.6x ↘ 26: 10.6x ↑ 27: 10.6x ↑ 28: 10.7x → 29: 10.8x ↙ 30: 10.7x ↓		31: 10.6x → 32: 10.5x ↑ 33: 10.6x ↖ 34: 10.5x ↘ 35: 10.6x ↙ 36: 10.7x ↖ 37: 10.8x ↓ 38: 10.8x ↑ 39: 10.8x ↓ 40: 10.7x ↖
Serie	106.7	Serie	106.6
Total	318.5	Total	425.1

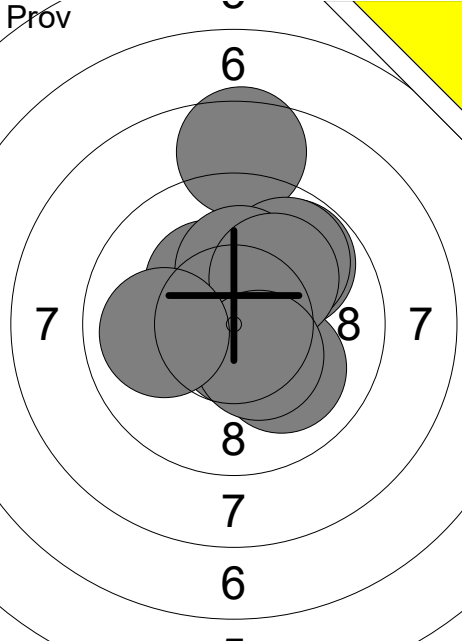
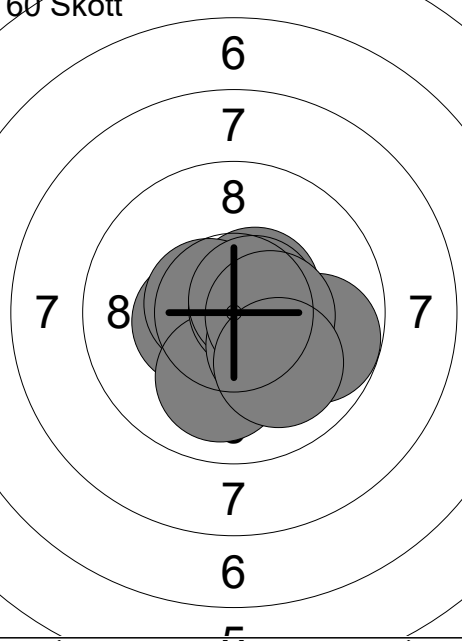
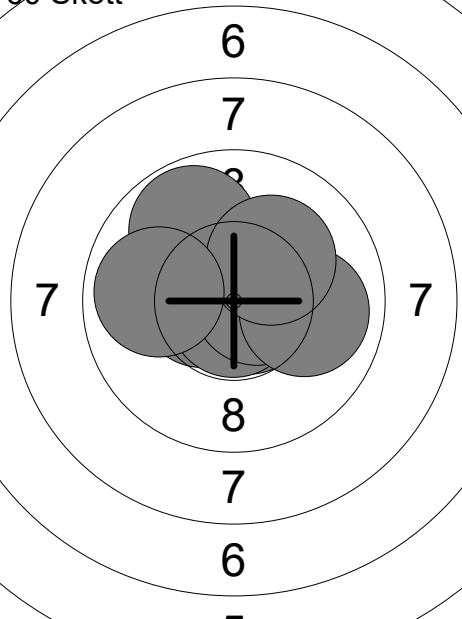
Skjutlag	Tavla	Melker Wernflo	
2	27		
Umeå	Gideå Skf	L9	
13.04.2024	UME-Kulan 2024	Umeå skytteallians	
Prov		1: 8.6 ↑ 2: 9.8 ↗ 3: 9.8 ↗ 4: 10.7x ↓ 5: 10.3x ↗ 6: 10.2x ↑ 7: 10.0 ↘ 8: 10.1 ↗ 9: 10.4x ↓ 10: 10.0 ←	11: 10.1 ↘ 12: 10.6x ↓ 13: 10.0 ↘ 14: 10.4x ↗ 15: 10.8x ↓
	Serie 99.9	Serie 51.9	
	Total 0.0	Total 0.0	
60 Skott		1: 10.4x ← 2: 10.5x ↗ 3: 10.6x ← 4: 9.8 → 5: 10.0 ↓ 6: 10.7x → 7: 10.6x ↗ 8: 10.3x ↓ 9: 10.4x → 10: 10.0 ↓	11: 10.7x ↘ 12: 10.3x → 13: 9.9 ↗ 14: 9.9 ← 15: 10.3x ↓ 16: 10.0 ↓ 17: 10.4x ↗ 18: 10.7x ← 19: 10.4x ↓ 20: 10.8x ←
	Serie 103.3	Serie 103.4	
	Total 103.3	Total 206.7	
60 Skott		21: 10.7x ↘ 22: 10.5x ← 23: 10.4x → 24: 10.4x → 25: 10.8x ↓ 26: 10.6x → 27: 9.8 ↗ 28: 10.0 → 29: 10.2x ↗ 30: 9.9 ←	31: 10.2x ↑ 32: 9.7 ↗ 33: 10.1 ↓ 34: 10.6x ← 35: 10.2x ↘ 36: 10.5x ↗ 37: 10.5x ↓ 38: 10.7x ↓ 39: 10.7x ↗ 40: 10.2x ↓
	Serie 103.3	Serie 103.4	
	Total 310.0	Total 413.4	

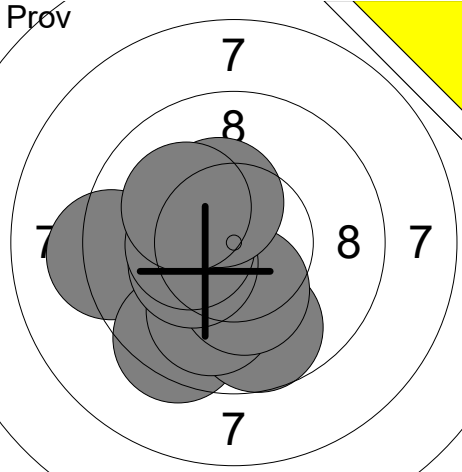
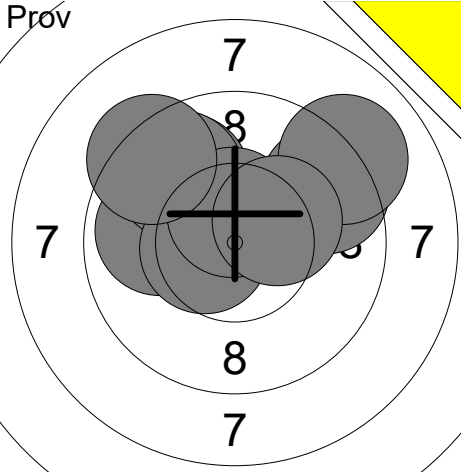
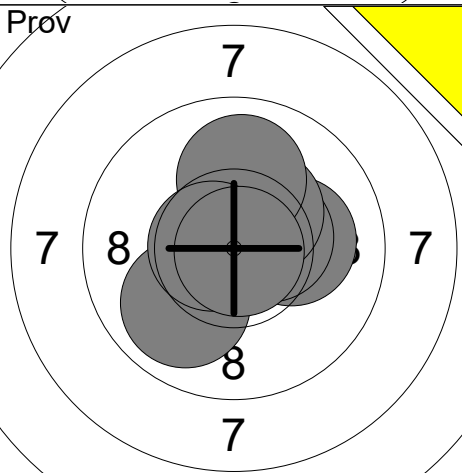
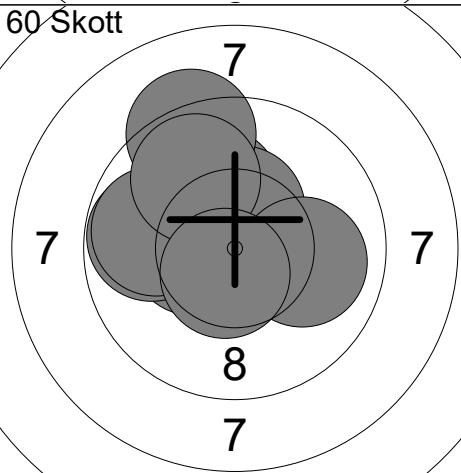
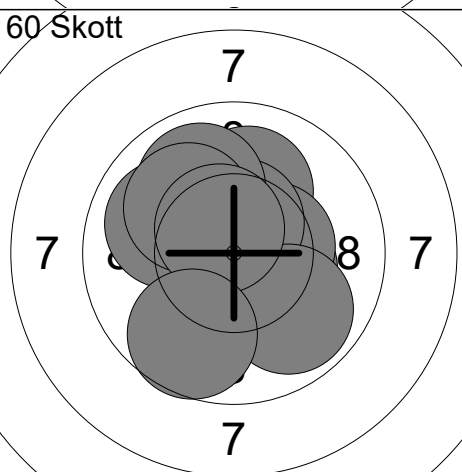
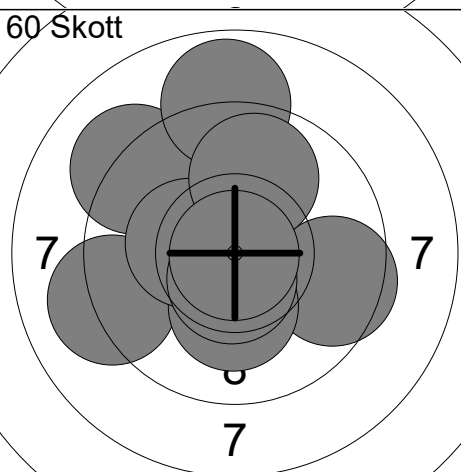
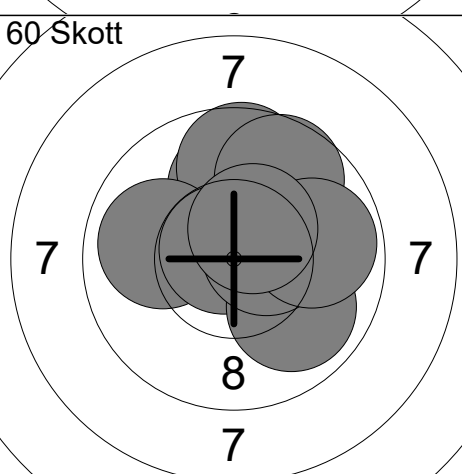
Skjutlag 2	Tavla 28	Kevin Eriksson-Lindberg	
Umeå		Bjurholm/Balsö Skf	L7
13.04.2024		UME-Kulan 2024	Umeå skytteallians
Prov 	1: 9.2 ← 2: 9.4 ↓ 3: 10.2x ↓ 4: 9.7 ↓ 5: 10.0 ↓ 6: 10.3x ↓ 7: 10.3x ← 8: 10.3x ← 9: 10.4x ↑ 10: 10.1 ↗ Serie 99.9 Total 0.0	Prov 	11: 9.7 ↗ 12: 9.8 ↗ 13: 9.9 ← 14: 9.5 ↗ 15: 9.7 ↗ 16: 10.5x ← 17: 10.5x ↑ 18: 9.1 ↗ 19: 9.3 ↗ 20: 10.3x ↗ Serie 98.3 Total 0.0
Prov 	21: 10.1 → 22: 9.9 ↓ 23: 10.4x → 24: 10.3x ↗ 25: 10.0 ↑ 26: 10.7x ← 27: 10.9x ↘ Serie 72.3 Total 0.0	60 Skott 	1: 10.1 ↑ 2: 10.3x ↗ 3: 10.4x ↑ 4: 10.4x ← 5: 9.8 ← 6: 9.3 ↗ 7: 9.8 ← 8: 9.8 ↗ 9: 10.0 → 10: 10.6x ↓ Serie 100.5 Total 100.5
60 Skott 	11: 10.4x → 12: 10.1 ↑ 13: 10.0 ← 14: 10.4x → 15: 10.5x ↑ 16: 9.9 ↗ 17: 9.9 ↓ 18: 10.1 ↗ 19: 10.6x ↗ 20: 9.7 ↓ Serie 101.6 Total 202.1	60 Skott 	21: 9.1 ← 22: 9.5 → 23: 9.1 ↗ 24: 10.2x ↓ 25: 8.9 ↑ 26: 10.7x ↓ 27: 10.3x ← 28: 10.6x ↓ 29: 9.9 ↑ 30: 10.9x ↓ Serie 99.2 Total 301.3
60 Skott 	31: 10.0 ↑ 32: 9.7 ↑ 33: 9.9 ← 34: 10.6x → 35: 10.8x ↗ 36: 9.9 ↓ 37: 10.5x → 38: 9.7 ↗ 39: 9.8 → 40: 10.5x ↗ Serie 101.4 Total 402.7		

Skjutlag	Tavla	Ellie Östman Göransson	
2	29	Gideå Skf	L9
13.04.2024	UME-Kulan 2024	Umeå skytteallians	
Prov		Prov	
60 Skott		60 Skott	
60 Skott		60 Skott	

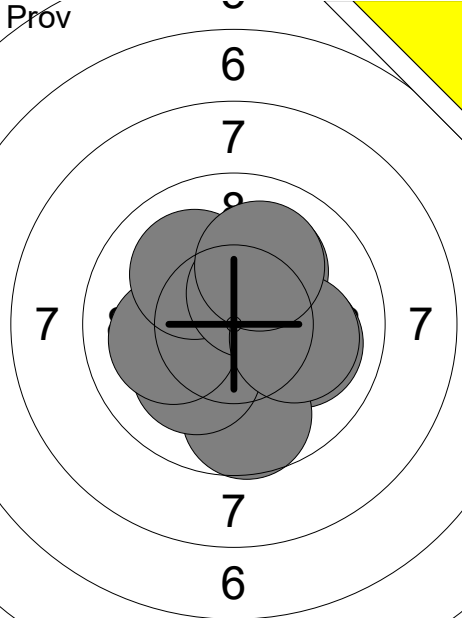
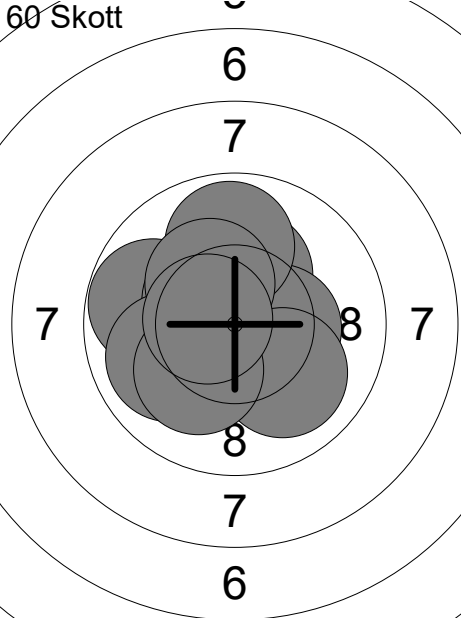
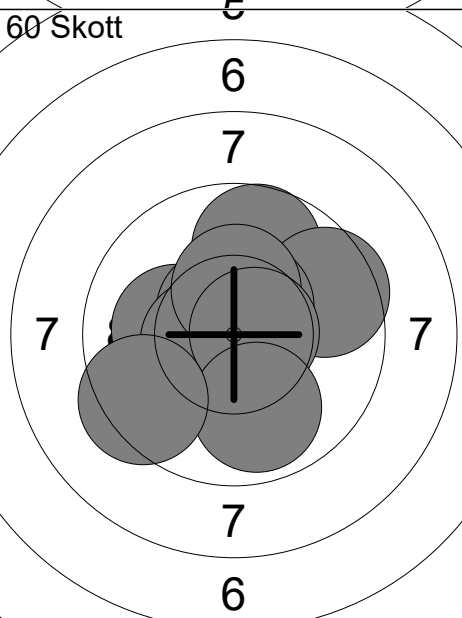
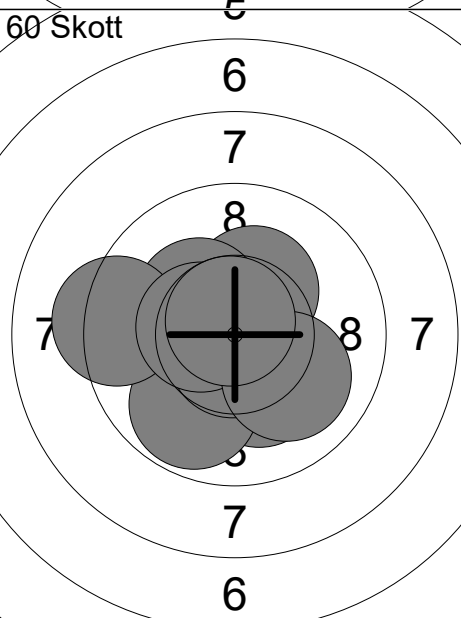
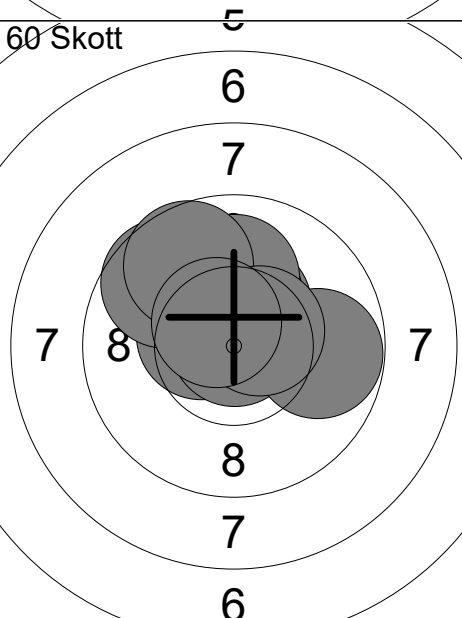
Skjutlag	Tavla	Py Wiksten-Signarsson	
2	30		
Umeå	Bastuträsk Skf	L7	
13.04.2024	UME-Kulan 2024	Umeå skytteallians	
Prov		60 Skott	
	1: 10.0 → 2: 9.7 ↓ 3: 10.3x ↑ 4: 10.1 ↓ 5: 10.1 ← 6: 10.1 ↖ 7: 10.1 ↗ 8: 10.5x ↗ 9: 10.1 → 10: 10.1 ↗		1: 9.8 ← 2: 10.4x ↖ 3: 10.0 ← 4: 10.2x ↑ 5: 10.4x → 6: 10.0 ↓ 7: 9.9 ↑ 8: 10.1 ↓ 9: 10.3x ↖ 10: 10.6x ←
	Serie 101.1		Serie 101.7
	Total 0.0		Total 101.7
60 Skott		60 Skott	
	11: 9.7 ↑ 12: 9.6 → 13: 10.2x ← 14: 10.6x ↖ 15: 10.5x ↗ 16: 10.5x ← 17: 10.3x ↑ 18: 10.7x → 19: 9.9 ↓ 20: 9.4 ←		21: 10.4x ← 22: 10.3x ↗ 23: 10.2x ↓ 24: 9.8 ↓ 25: 10.3x ↖ 26: 10.7x ↓ 27: 9.3 ← 28: 10.5x ← 29: 10.0 ↓ 30: 10.7x ↗
	Serie 101.4		Serie 102.2
	Total 203.1		Total 305.3
60 Skott			
	31: 10.4x ↗ 32: 10.5x ← 33: 10.9x ↑ 34: 10.3x ↑ 35: 9.7 ↖ 36: 9.8 → 37: 10.0 ↑ 38: 9.7 ↖ 39: 10.5x ↗ 40: 10.5x ↖		
	Serie 102.3		
	Total 407.6		

Skjutlag	Tavla	Inez Bergström	
2	32	Umeå	Bastuträsk Skf
13.04.2024		UME-Kulan 2024	Umeå skytteallians
Prov	6	1: 8.8 ↘	Prov
	7	2: 9.0 ↘	
	8	3: 8.2 ↘	
6 7 8	8 7 6	4: 10.9x ↙	11: 9.0 ↗
		5: 9.9 ↘	12: 10.1 →
		6: 8.0 ↘	13: 7.8 ↘
		7: 8.2 ↘	14: 9.9 ↘
		8: 9.8 ↘	15: 9.4 →
		9: 8.8 ↘	16: 8.9 →
		10: 9.1 ↘	17: 9.6 ↘
			18: 9.3 ↘
			19: 9.1 ↘
			20: 9.7 ↘
		Serie 90.7	Serie 92.8
		Total 0.0	Total 0.0
Prov	7	21: 8.3 ↘	60 Skott
	8	22: 9.5 ↗	
7 7	7	23: 9.3 ↗	
		24: 9.7 ↙	1: 9.5 ↗
		25: 10.1 ↗	2: 9.1 →
		26: 10.0 →	3: 9.0 →
		27: 9.7 →	4: 10.4x ↗
			5: 9.6 ↙
			6: 9.2 ↗
			7: 9.6 →
			8: 8.8 ↗
			9: 9.2 ↗
			10: 9.4 ↘
		Serie 66.6	Serie 93.8
		Total 0.0	Total 93.8
60 Skott	3	11: 8.6 ↗	60 Skott
	4	12: 9.0 ↗	
	5	13: 10.2x ↗	
	6	14: 9.7 ↗	21: 9.5 →
3 4 5 6 7 8	8 7 6 5 4 3	15: 10.0 ↗	22: 8.3 ↘
		16: 9.4 ↗	23: 9.9 ↗
		17: 10.2x ↘	24: 10.1 ↗
		18: 8.8 ↘	25: 9.8 ↗
		19: 4.9 ↘	26: 9.4 →
		20: 8.9 ↗	27: 9.2 ↗
			28: 8.6 →
			29: 9.4 →
			30: 8.7 →
		Serie 89.7	Serie 92.9
		Total 183.5	Total 276.4
60 Skott	7	31: 9.0 ↘	
	8	32: 9.2 ↘	
7 8	7	33: 9.7 →	
		34: 9.5 ↗	
		35: 10.3x ↙	
		36: 8.7 ↗	
		37: 10.7x ↗	
		38: 10.3x ↗	
		39: 10.4x ↗	
		40: 10.5x ↘	
		Serie 98.3	
		Total 374.7	

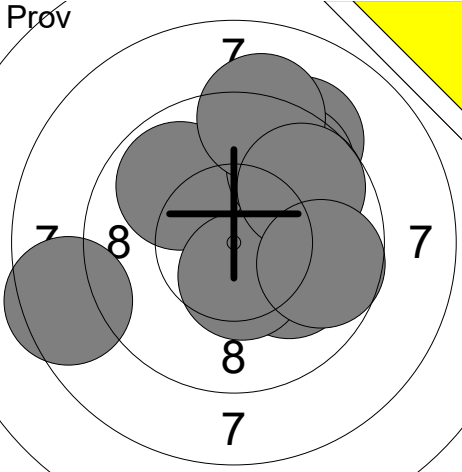
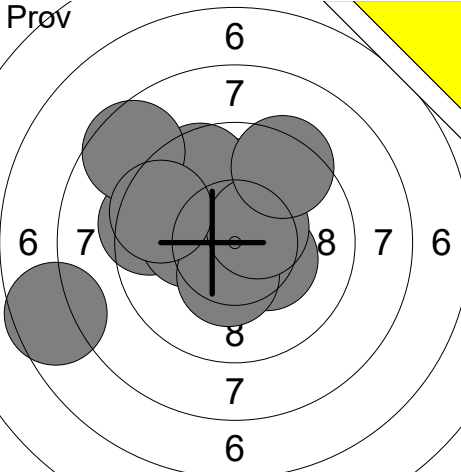
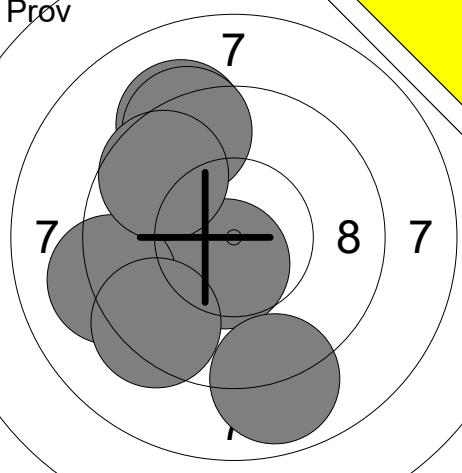
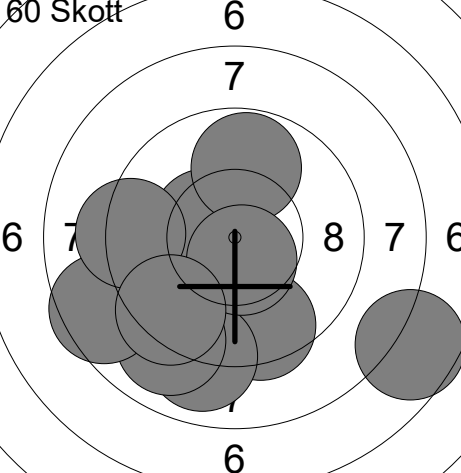
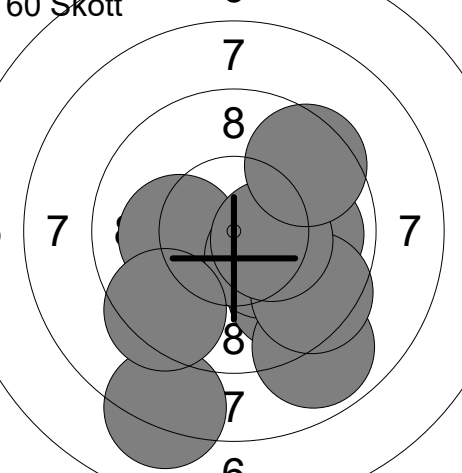
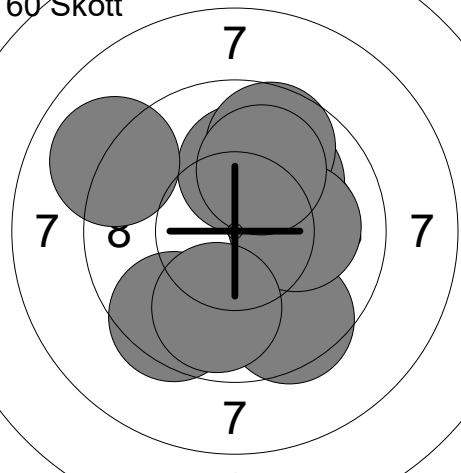
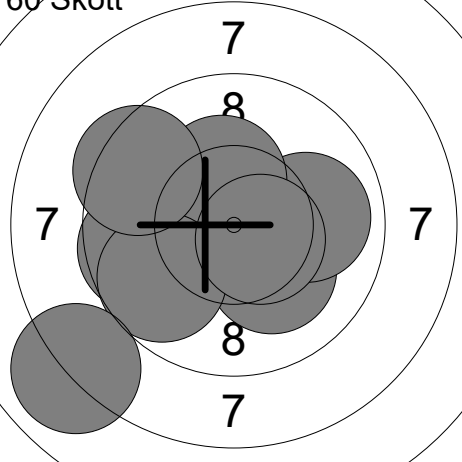
Skjutlag 2	Tavla 34	Matias Malinen	
Umeå	Gideå Skf	Lfunk	
13.04.2024	UME-Kulan 2024	Umeå skytteallians	
Pröv 	1: 10.1 → 2: 10.2x ↗ 3: 9.9 ↗ 4: 9.3 ↗ 5: 9.6 ↗ 6: 9.2 ↗ 7: 10.5x ↓ 8: 8.5 ← 9: 9.7 ↗ 10: 9.7 → Serie 96.7 Total 0.0	Pröv 	11: 9.4 ← 12: 10.2x ← 13: 10.3x → 14: 10.4x ↓ 15: 9.6 ↗ 16: 10.5x ↗ 17: 8.6 ↗ 18: 9.6 ← 19: 7.6 ← 20: 9.4 ↗ Serie 95.6 Total 0.0
Pröv 	21: 10.3x ← 22: 9.2 ↗ 23: 9.3 ↗ 24: 10.6x ↓ 25: 9.2 ← 26: 9.3 ← 27: 9.6 ↗ 28: 8.9 ↓ Serie 76.4 Total 0.0	60 Skott 	1: 7.6 → 2: 9.5 ↓ 3: 10.4x ← 4: 8.9 ↓ 5: 9.8 ↗ 6: 9.0 ↓ 7: 10.6x ↓ 8: 8.5 ← 9: 9.3 ← 10: 9.4 ↓ Serie 93.0 Total 93.0
60 Skott 	11: 9.9 → 12: 10.1 ← 13: 9.8 ↓ 14: 8.2 ↓ 15: 8.9 ↓ 16: 10.3x ↓ 17: 9.5 ↓ 18: 9.4 ↓ 19: 10.4x → 20: 9.5 ↗ Serie 96.0 Total 189.0	60 Skott 	21: 9.5 ↓ 22: 9.5 ↓ 23: 10.1 → 24: 10.1 ↑ 25: 10.0 ↗ 26: 9.7 ↗ 27: 10.1 → 28: 9.0 ← 29: 10.0 ↗ 30: 9.9 ↓ Serie 97.9 Total 286.9
60 Skott 	31: 10.6x ↗ 32: 10.1 ↓ 33: 10.8x → 34: 9.6 ← 35: 9.9 → 36: 10.3x ↗ 37: 9.7 ← 38: 9.4 ↗ 39: 10.5x → 40: 8.0 ↓ Serie 98.9 Total 385.8		

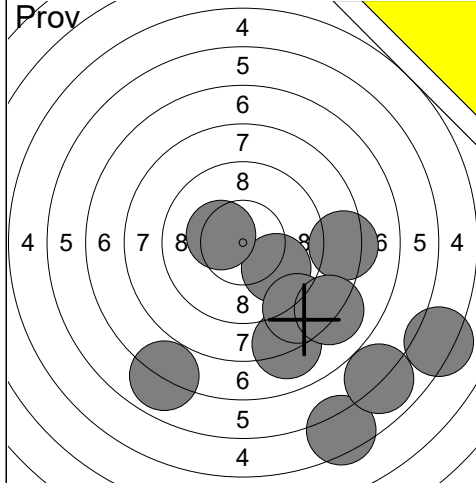

1:	5.2	↘
2:	5.4	↘
3:	5.9	↘
4:	8.1	↘
5:	9.9	↘
6:	8.3	→
7:	6.9	↘
8:	8.7	↘
9:	8.1	↘
10:	10.4x	↗
Serie		76.9
Total		0.0

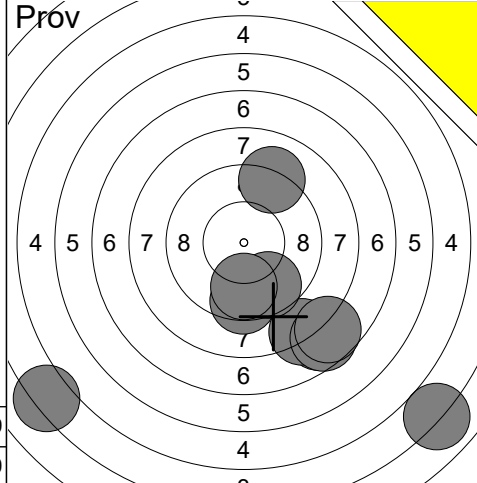

11:	4.0	↘
12:	7.7	↘
13:	9.1	↗
14:	4.2	↖
15:	8.1	↘
16:	7.6	↘
17:	9.4	↘
18:	9.6	↘
19:	9.8	↘
20:	7.7	↘
Serie		77.2
Total		0.0

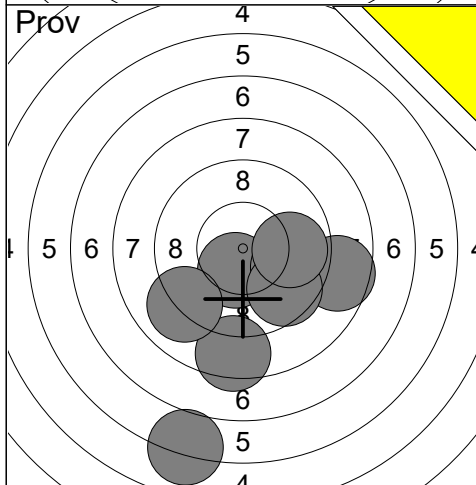

21:	10.4x	↘
22:	9.8	↘
23:	8.6	→
24:	6.0	↘
25:	9.6	↘
26:	9.8	→
27:	8.4	↘
28:	9.0	↘
Serie		71.6
Total		0.0

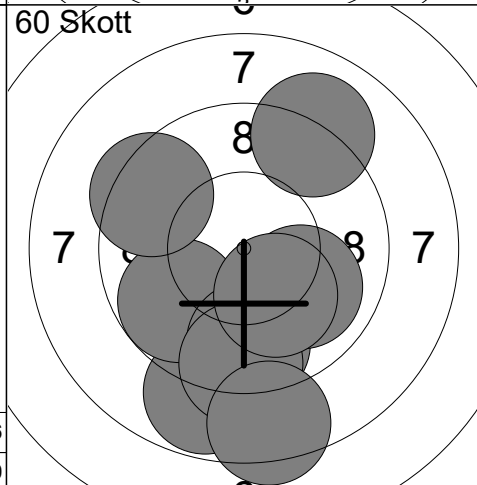

1:	9.8	↘
2:	8.8	↘
3:	9.8	↖
4:	9.6	↘
5:	9.3	↘
6:	8.4	↘
7:	9.0	↗
8:	10.0	↘
9:	10.1	↘
10:	9.4	↗
Serie		94.2
Total		94.2

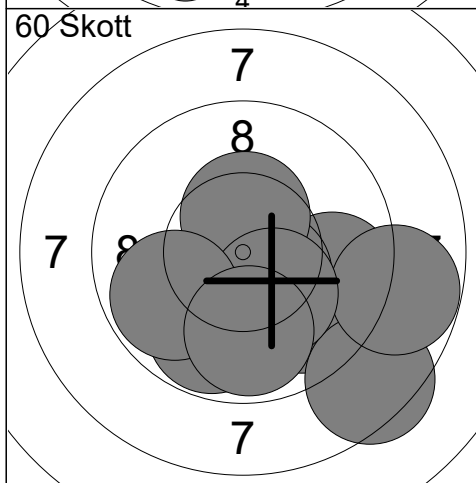

11:	9.8	↘
12:	9.7	→
13:	8.4	↘
14:	10.5x	↘
15:	10.4x	↗
16:	8.8	→
17:	10.2x	↘
18:	9.8	↘
19:	9.8	↖
20:	9.9	↘
Serie		97.3
Total		191.5

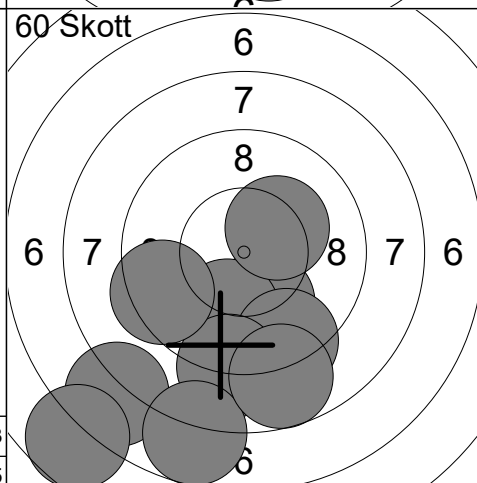

21:	7.7	↖
22:	10.0	↘
23:	9.9	↘
24:	9.3	↘
25:	10.2x	↗
26:	9.0	↘
27:	7.7	↘
28:	6.7	↖
29:	9.4	↖
30:	8.7	↘
Serie		88.6
Total		280.1

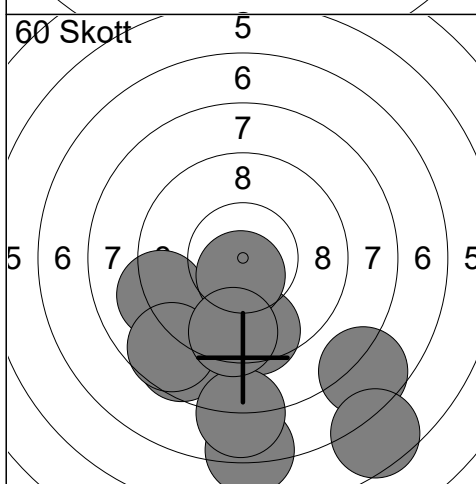

31:	8.6	↘
32:	7.6	↘
33:	7.1	↘
34:	9.5	↘
35:	6.6	↘
36:	7.8	↘
37:	9.2	↖
38:	8.7	↖
39:	10.6x	↘
40:	9.5	↘
Serie		85.2
Total		365.3

Skjutlag	Tavla	Maria Olsson			
2	38	Umeå Skf	Lfunk		
13.04.2024	UME-Kulan 2024	Umeå skytteallians			
Prov 	4 5 6 7 8 8 7 6 7 6 5 4	1: 7.5 ← 2: 8.0 ← 3: 9.7 ↓ 4: 10.3x ↘ 5: 10.5x ←← 6: 10.2x ←← 7: 8.9 ←	60 Skott 	1: 8.4 ↓ 2: 9.3 ↓ 3: 10.7x ↗ 4: 10.4x ↓ 5: 8.6 ↘ 6: 7.2 → 7: 5.3 → 8: 8.9 ↗ 9: 10.0 ↗ 10: 9.6 ↘	
	Serie	65.1	Serie	88.4	
	Total	0.0	Total	88.4	
60 Skott 	6 7 8 8 7 6 7 6	11: 10.8x ↓ 12: 9.8 ↘ 13: 8.9 → 14: 10.2x ↑ 15: 9.7 ← 16: 8.8 → 17: 9.3 → 18: 10.2x → 19: 9.5 → 20: 10.7x ↑	60 Skott 	21: 10.2x → 22: 9.8 ← 23: 10.4x ←← 24: 9.9 → 25: 10.3x ↓ 26: 10.4x ↗ 27: 10.5x ↗ 28: 10.7x → 29: 10.1 ↗ 30: 9.7 ↗	
	Serie	97.9		Serie	102.0
	Total	186.3		Total	288.3
60 Skott 	3 4 5 6 7 7 5 6 7 8 7 6 5 4 3	31: 9.7 → 32: 9.8 ← 33: 10.1 ↑ 34: 10.1 ↗ 35: 6.9 → 36: 10.5x ↗ 37: 9.6 ↘ 38: 10.3x ↗ 39: 10.0 ↑ 40: 10.1 ↑			
	Serie	97.1			
	Total	385.4			

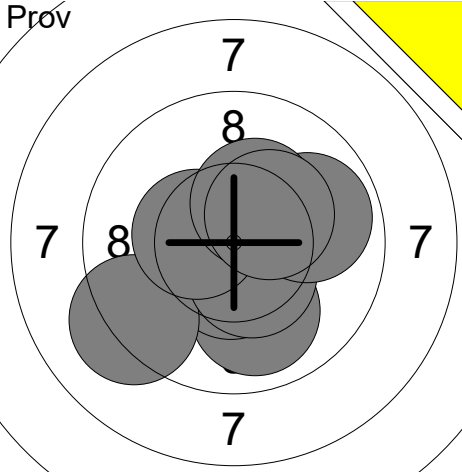
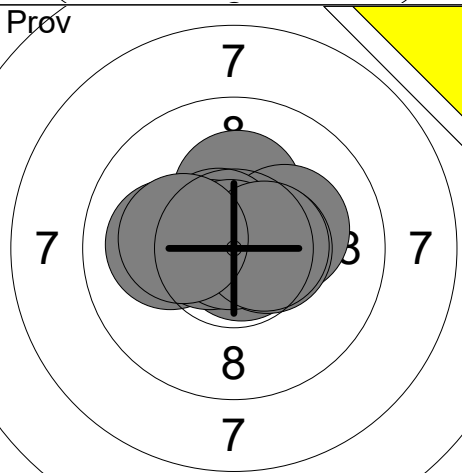
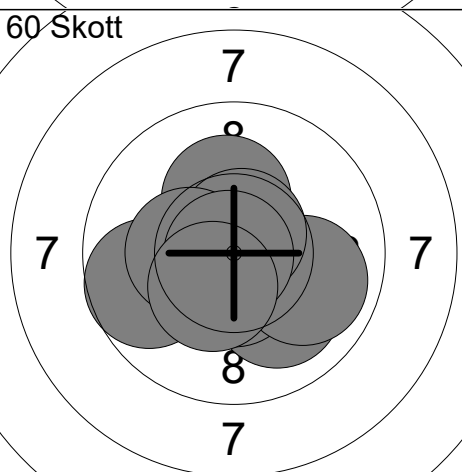
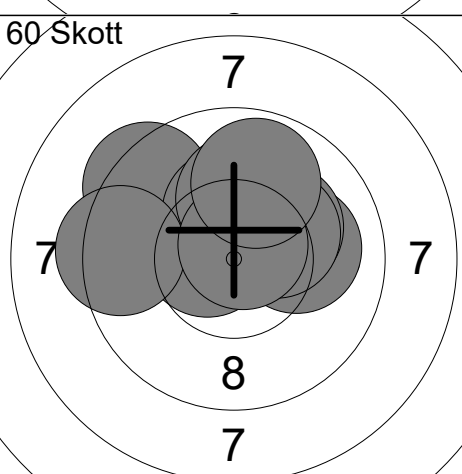
Skjutlag	Tavla	Sture Lönnefjord	
2	40	Ramselefors Skf	Lfunk
13.04.2024	UME-Kulan 2024	Umeå skytteallians	
Prov		1: 10.0 ↓ 2: 10.8x ↓ 3: 10.7x → 4: 10.5x ↓ 5: 9.2 ↓ 6: 10.5x ↓ 7: 10.4x ← 8: 9.9 → 9: 10.3x ↑ 10: 10.3x ↗ Serie 102.6 Total 0.0	11: 10.4x ↓ 12: 10.5x ↗ 13: 10.5x ↑ 14: 10.8x ↙ 15: 10.3x → 16: 10.6x ↗ 17: 9.8 ↗ 18: 10.2x ↗ 19: 10.4x → 20: 10.2x ← Serie 103.7 Total 0.0
Prov		21: 10.2x ↑ 22: 10.2x → 23: 10.8x ↓ 24: 10.5x → 25: 10.1 ← 26: 10.7x ↗ 27: 10.6x ← 28: 10.9x ↗ 29: 10.5x → 30: 10.2x ← Serie 104.7 Total 0.0	31: 10.1 ↓ 32: 10.2x ← Serie 20.3 Total 0.0
60 Skott		1: 10.8x ↙ 2: 10.0 ↓ 3: 10.6x ↓ 4: 9.9 → 5: 10.2x ↑ 6: 10.7x ↑ 7: 9.7 ← 8: 10.3x ← 9: 10.9x ← 10: 10.4x ↓ Serie 103.5 Total 103.5	11: 10.2x ↙ 12: 10.8x ↓ 13: 10.2x ↑ 14: 9.5 ← 15: 10.4x ↑ 16: 10.3x ↑ 17: 10.7x ↗ 18: 10.3x ↓ 19: 10.0 ↗ 20: 10.4x ← Serie 102.8 Total 206.3
60 Skott		21: 10.6x ← 22: 9.4 ↗ 23: 10.1 → 24: 10.2x ↗ 25: 10.3x ↗ 26: 10.3x ↑ 27: 9.4 ← 28: 10.1 ↑ 29: 10.7x ↗ 30: 9.9 ↑ Serie 101.0 Total 307.3	31: 10.5x ↑ 32: 10.4x ↙ 33: 10.6x ↗ 34: 10.2x ↙ 35: 10.1 → 36: 9.6 ← 37: 10.5x ↑ 38: 9.7 ↑ 39: 9.8 ↑ 40: 10.5x ↑ Serie 101.9 Total 409.2