

1: 10.2x ↖	6: 10.1 →		
2: 9.6 ←		Serie	60.6
3: 10.6x ↖			
4: 9.9 ↘		Total	0.0
5: 10.2x ↓			

1: 9.8 ↖			
2: 8.4 ↖		Serie	47.5
3: 9.8 ↓			
4: 9.7 ↖		Total	47.5
5: 9.8 ↓			

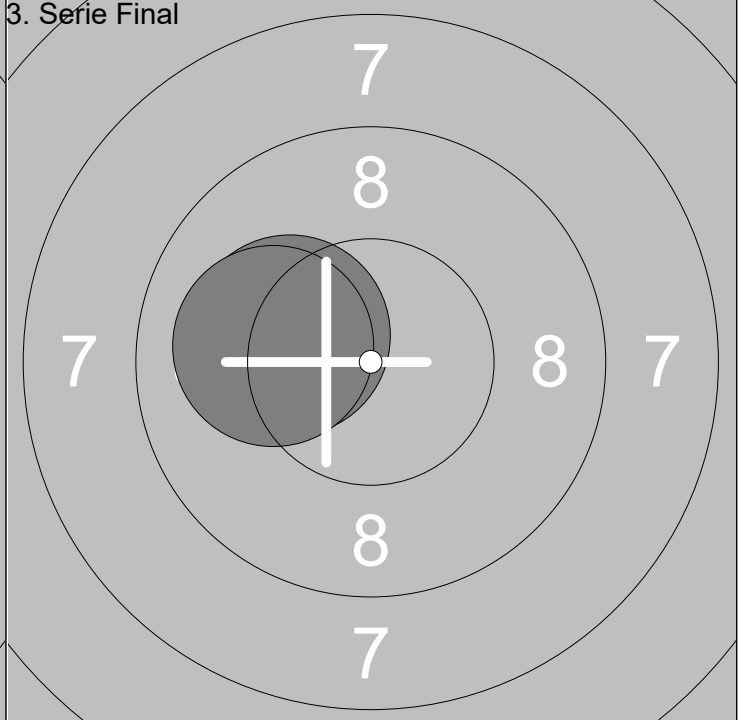

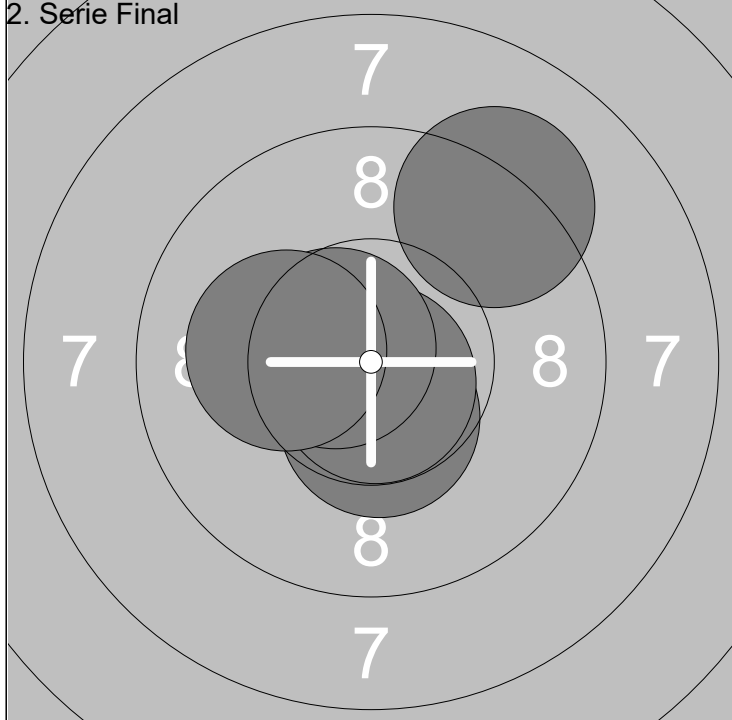





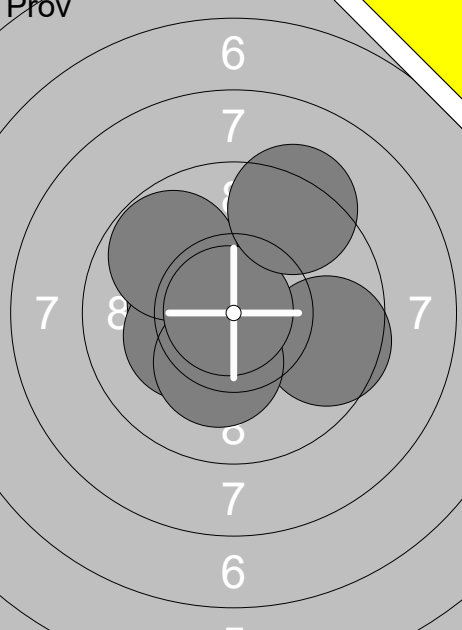
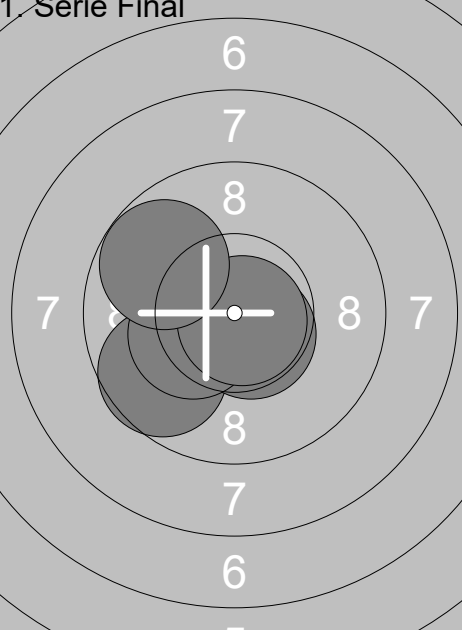
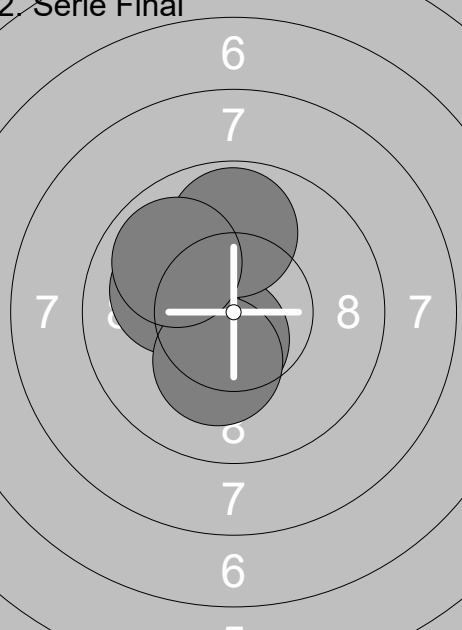
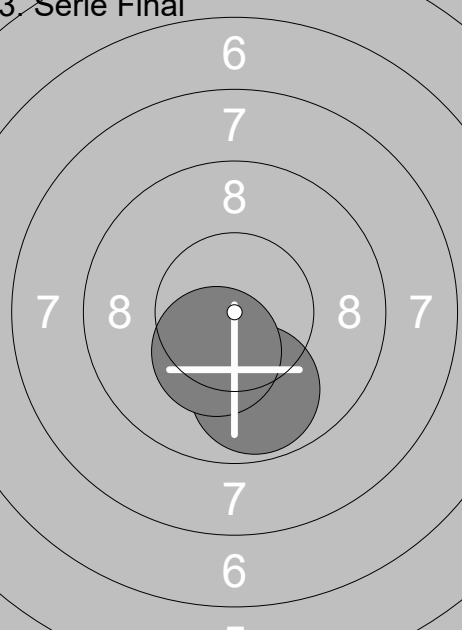
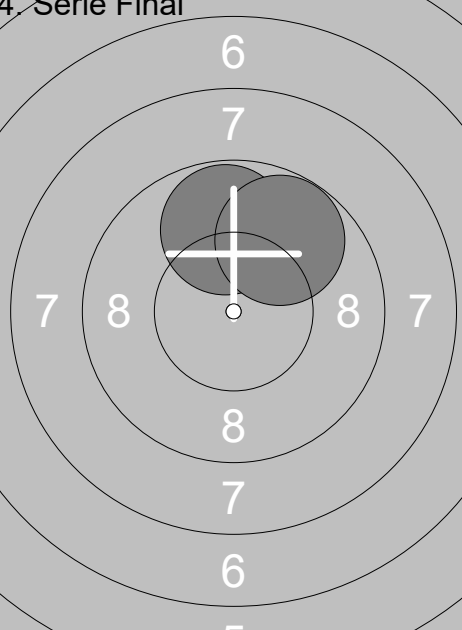
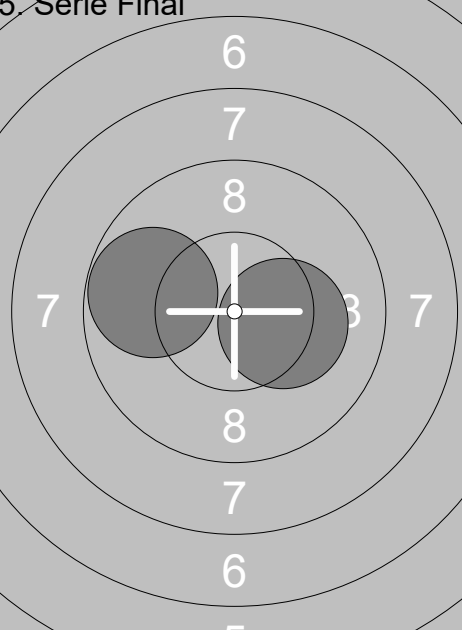

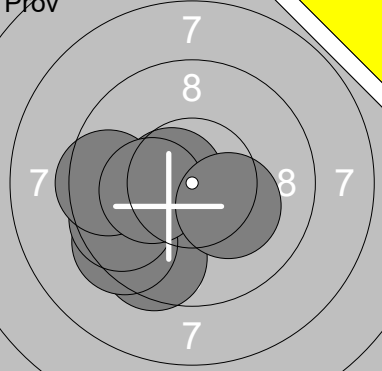

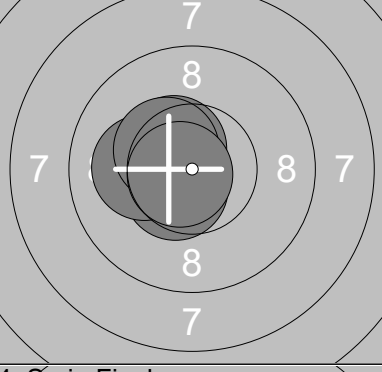
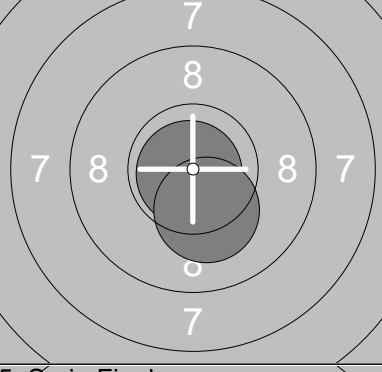
1: 10.4x ↓			
2: 10.8x ↓		Serie	51.2
3: 10.6x ↖			
4: 10.2x ←		Total	98.7
5: 9.2 ↗			

1: 10.2x ↖			
2: 10.1 ↖		Serie	20.3
		Total	119.0

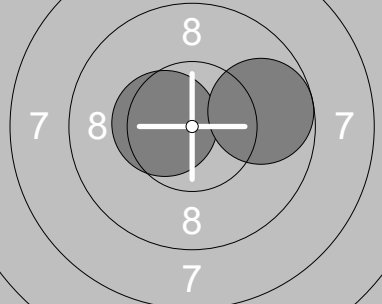
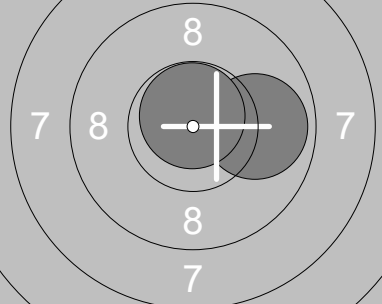

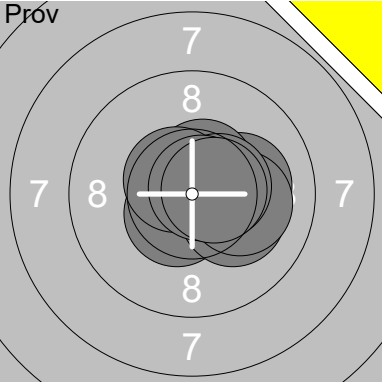
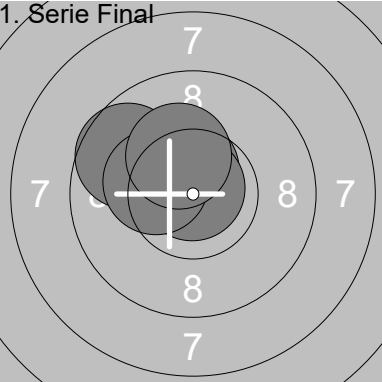
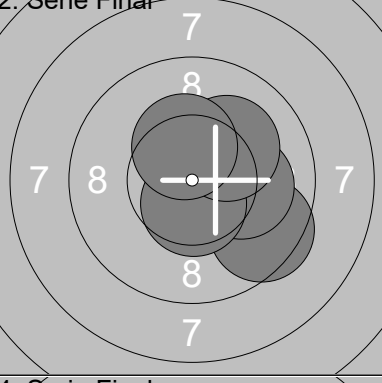
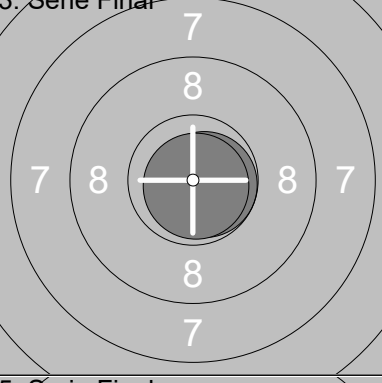
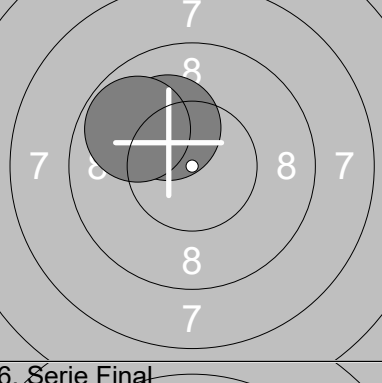
<p>Prov</p> 	<p>1: 10.4x ↙                  2: 10.2x ↙                  3: 9.6 →                  4: 9.8 ↗                  5: 10.2x ↓                  6: 10.9x ↙                  7: 9.3 ↗</p> <p>Serie 70.4 Total 0.0</p>	<p>1. Serie Final</p> 		<p>1: 9.7 ↙                  2: 10.6x ↘                  3: 10.3x ↙                  4: 10.8x ↘                  5: 9.8 ↖</p> <p>Serie 51.2 Total 51.2</p>
<p>2. Serie Final</p> 	<p>1: 10.6x ↓                  2: 10.1 ↖                  3: 10.2x ↓                  4: 9.9 ↗                  5: 9.9 ↖</p> <p>Serie 50.7 Total 101.9</p>	<p>3. Serie Final</p> 		<p>1: 9.8 ↓                  2: 10.3x ↘</p> <p>Serie 20.1 Total 122.0</p>
<p>4. Serie Final</p> 	<p>1: 9.8 ↗                  2: 9.8 ↗</p> <p>Serie 19.6 Total 141.6</p>	<p>5. Serie Final</p> 		<p>1: 9.8 ↖                  2: 10.3x →</p> <p>Serie 20.1 Total 161.7</p>

Pröv 	1: 10.6x ← 2: 9.5 ↓ 3: 9.4 ↙ 4: 9.6 ← 5: 9.5 ← 6: 10.3x ← 7: 10.2x ↘	1. Serie Final 	1: 10.3x ↑ 2: 10.5x ↗ 3: 10.6x → 4: 10.3x ↗ 5: 10.3x ↘
	Serie 69.1		Serie 52.0
	Total 0.0		Total 52.0
2. Serie Final 	1: 10.5x ↗ 2: 10.5x ↓ 3: 10.1 ← 4: 10.4x ↗ 5: 10.7x ←	3. Serie Final 	1: 10.9x ↙ 2: 10.2x ↓
	Serie 52.2		Serie 21.1
	Total 104.2		Total 125.3
4. Serie Final 	1: 10.4x ← 2: 10.3x ←	5. Serie Final 	1: 10.2x → 2: 9.9 ↙
	Serie 20.7		Serie 20.1
	Total 146.0		Total 166.1
6. Serie Final 	1: 10.6x ↘ 2: 10.2x ↑	7. Serie Final 	1: 10.8x ↑ 2: 10.4x →
	Serie 20.8		Serie 21.2
	Total 186.9		Total 208.1
8. Serie Final 	1: 10.5x ← 2: 9.8 →	9. Serie Final 	1: 9.9 → 2: 10.8x ↑
	Serie 20.3		Serie 20.7
	Total 228.4		Total 249.1

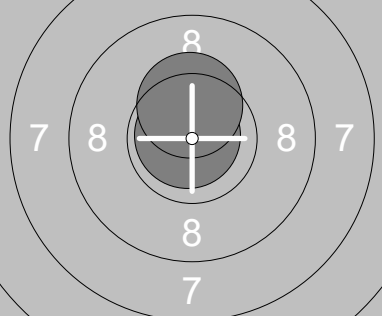
Skjuttag <b>1</b>	Tavla <b>25</b>	<b>Amanda Carlsson</b>			
Ramselefors		Gullabo		DJ	Sm
09.04.2022		SM Luftgevär 2022 - Finaler		Ramselefors SKF	
Pröv 	1: 10.1 → 2: 10.5x ↙ 3: 10.2x → 4: 10.5x ↑ 5: 10.1 → 6: 10.5x → 7: 10.6x ↗ 8: 10.8x ↗ 9: 10.6x →	1. Serie Final 	1: 10.5x ↑ 2: 9.7 ↖ 3: 10.8x ↑ 4: 10.3x ↖ 5: 10.3x ↑	Serie 93.9 Total 0.0	Serie 51.6 Total 51.6
2. Serie Final 	1: 9.5 ↘ 2: 10.1 → 3: 10.5x ↓ 4: 10.2x ↗ 5: 10.4x ↑	3. Serie Final 	1: 10.7x → 2: 10.8x ↓	Serie 50.7 Total 102.3	Serie 21.5 Total 123.8
4. Serie Final 	1: 10.2x ↗ 2: 9.8 ↖	5. Serie Final 	1: 10.6x ↙ 2: 10.5x ↓	Serie 20.0 Total 143.8	Serie 21.1 Total 164.9
6. Serie Final 	1: 10.4x ↑ 2: 10.6x ←	7. Serie Final 	1: 10.2x → 2: 10.3x ↓	Serie 21.0 Total 185.9	Serie 20.5 Total 206.4
8. Serie Final 	1: 10.9x ↖ 2: 10.4x ↑				
		Serie 21.3 Total 227.7			

Skjutlag	Tavla	Julia Johansson		
1	26	Ramselefors	I16/Lv6	DJ Ha
09.04.2022	SM Luftgevär 2022 - Finaler	Ramselefors SKF		
<b>Prov</b> 	1: 9.8 ↗ 2: 9.9 ← 3: 10.3x ↓ 4: 10.6x ↗ 5: 10.0 ↘ 6: 10.6x ↗ 7: 10.6x →	<b>1. Serie Final</b> 	1: 10.3x ↗ 2: 9.2 ↘ 3: 10.9x ↓ 4: 10.5x ↓ 5: 9.9 ←	
	Serie 71.8		Serie 50.8	
	Total 0.0		Total 50.8	
<b>2. Serie Final</b> 	1: 10.3x ↓ 2: 10.6x → 3: 10.5x ↓ 4: 10.2x ← 5: 10.5x ←	<b>3. Serie Final</b> 	1: 10.3x ↓ 2: 10.6x ↓	
	Serie 52.1		Serie 20.9	
	Total 102.9		Total 123.8	
<b>4. Serie Final</b> 	1: 10.2x ↓ 2: 9.6 ←	<b>5. Serie Final</b> 	1: 9.8 ↗ 2: 10.2x ↗	
	Serie 19.8		Serie 20.0	
	Total 143.6		Total 163.6	
<b>6. Serie Final</b> 	1: 10.0 → 2: 10.6x ↗	<b>Extra Final</b> 	1: 9.9 →	
	Serie 20.6		Serie 9.9	
	Total 184.2		Total 184.2	

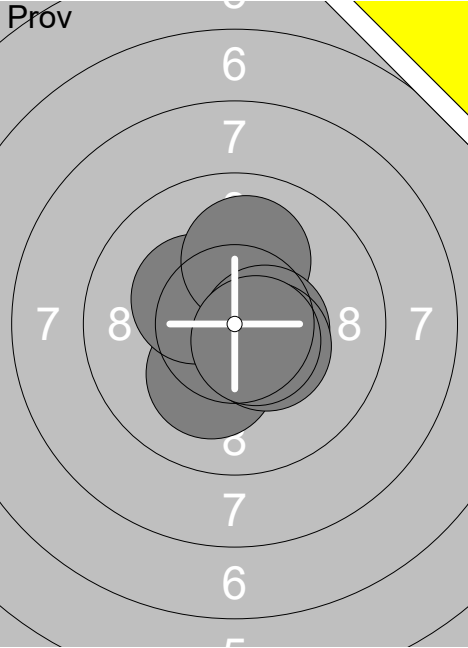
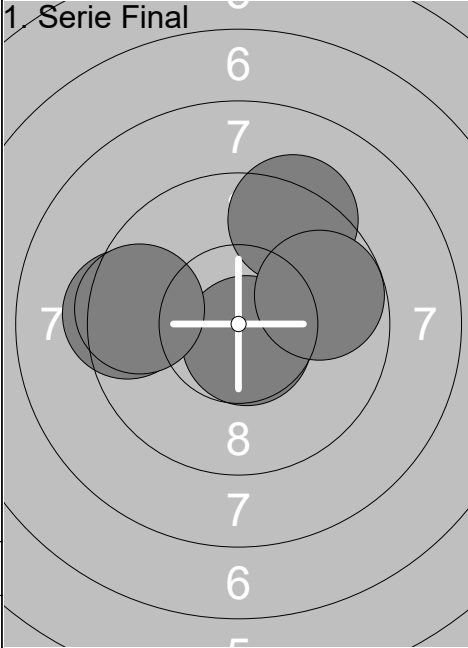
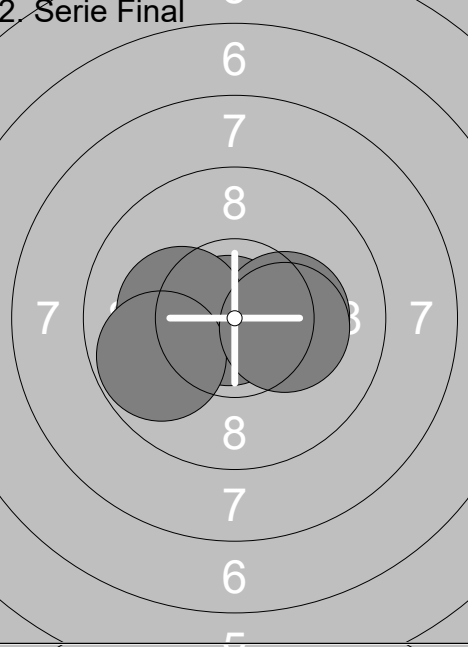
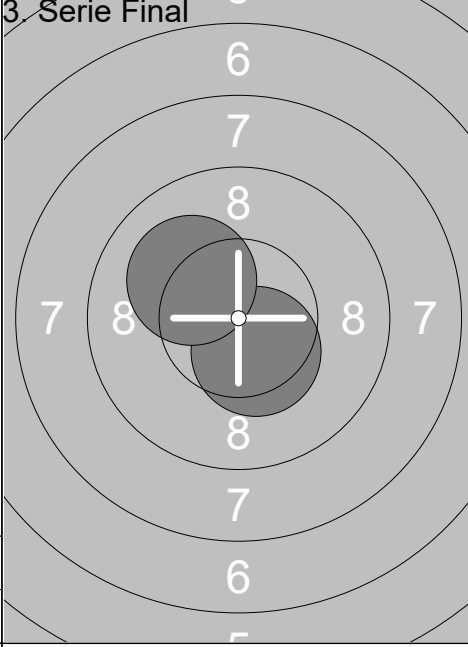
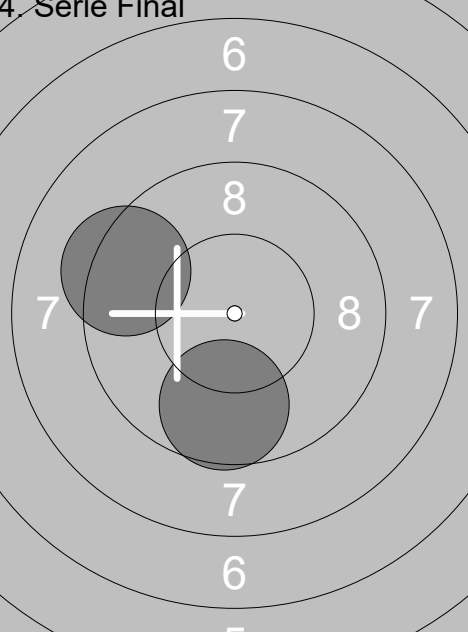
Skjutlag <b>1</b>	Tavla <b>27</b>	<b>Maja Bucher</b>	
Ramselefors	Skabersjö	DJ	Sk
09.04.2022	SM Luftgevär 2022 - Finaler	Ramselefors SKF	
<b>Prov</b> 	1: 10.8x ↗ 2: 10.2x ↓ 3: 10.3x ↗ 4: 10.1 ↑ 5: 10.5x → 6: 10.4x ↓ 7: 10.6x ↓	<b>1. Serie Final</b> 	1: 9.4 ← 2: 10.7x ↓ 3: 9.6 ← 4: 9.3 ↑ 5: 9.8 →
	Serie 72.9		Serie 48.8
	Total 0.0		Total 48.8
<b>2. Serie Final</b> 	1: 10.9x ← 2: 10.3x → 3: 10.2x ← 4: 9.8 ← 5: 10.2x →	<b>3. Serie Final</b> 	1: 10.4x ↓ 2: 10.1 ↗
	Serie 51.4		Serie 20.5
	Total 100.2		Total 120.7
<b>4. Serie Final</b> 	1: 9.7 ↓ 2: 9.3 ←		
	Serie 19.0		
	Total 139.7		



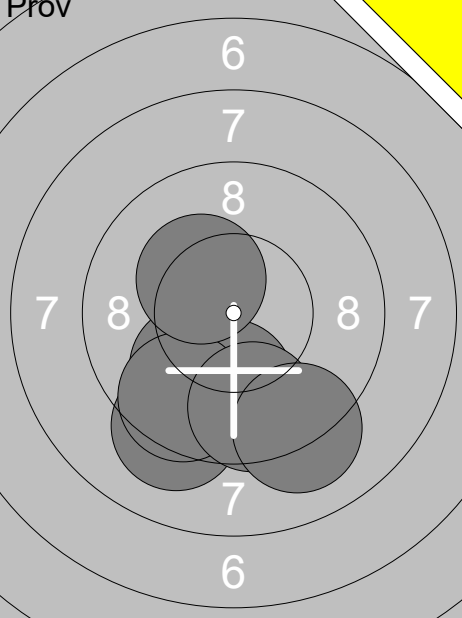
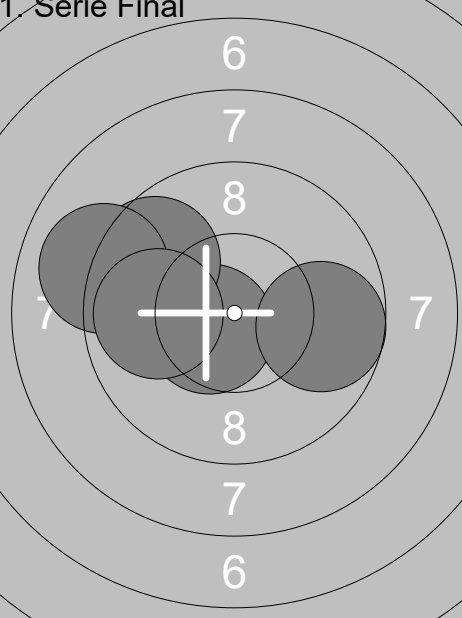

<p>Prov</p> 	<p>1. Serie Final</p> 	<p>1: 9.2 ↘ 2: 10.0 ↘ 3: 10.0 ↓ 4: 9.6 ↘ 5: 9.6 ↘ 6: 10.3x ↗ 7: 9.1 ↘</p> <p>Serie 67.8 Total 0.0</p>	<p>1: 10.5x ↙ 2: 9.7 → 3: 9.6 ↗ 4: 9.0 ← 5: 9.9 ←</p> <p>Serie 48.7 Total 48.7</p>
--	--	---	--

<p>2. Serie Final</p> 	<p>3. Serie Final</p> 	<p>1: 10.3x ↗ 2: 10.2x ← 3: 8.4 → 4: 10.6x ↗ 5: 9.9 ↘</p> <p>Serie 49.4 Total 98.1</p>	<p>1: 10.1 → 2: 9.7 ↗</p> <p>Serie 19.8 Total 117.9</p>
---	---	--	---

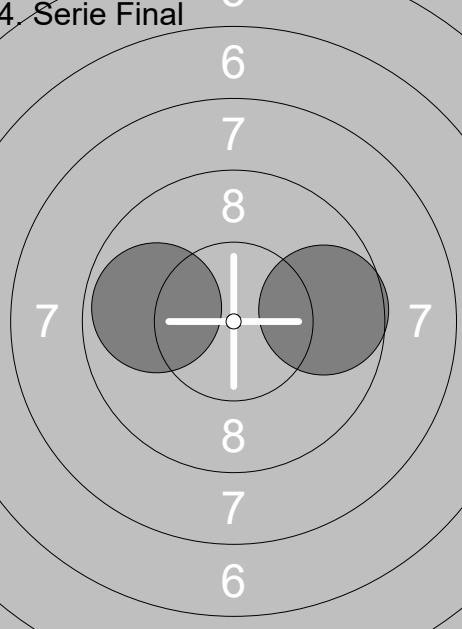
<p>4. Serie Final</p> 		<p>1: 9.7 → 2: 9.9 ←</p> <p>Serie 19.6 Total 137.5</p>	
--	--	--	--

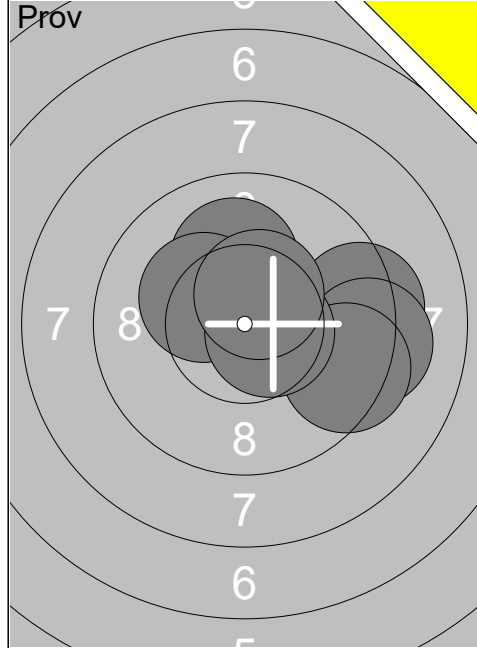

1:	9.3	→
2:	10.1	↑
3:	9.2	→
4:	9.4	→
5:	10.3x	↖
6:	10.6x	→
7:	10.5x	↗
Serie		69.4
Total		0.0

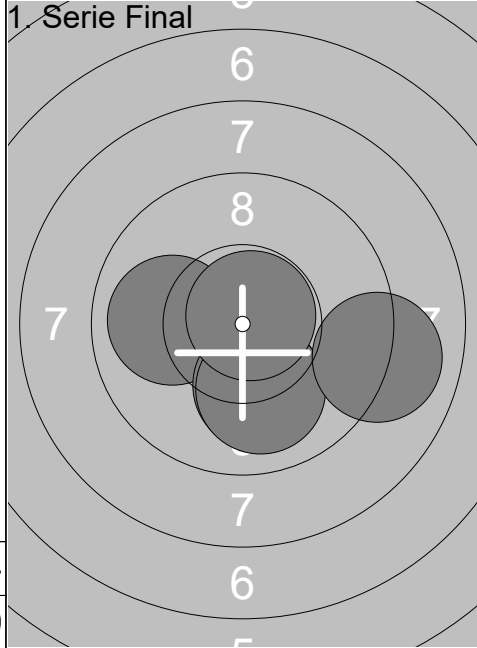

1:	10.0	←
2:	10.1	↓
3:	10.0	↓
4:	9.0	→
5:	10.8x	↗
Serie		49.9
Total		49.9

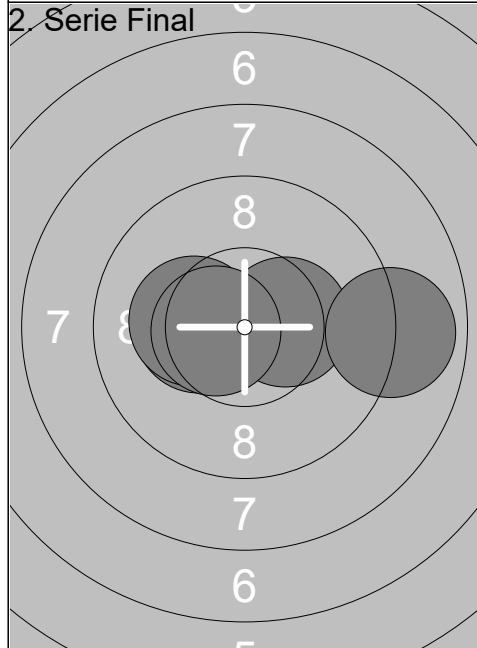

1:	10.4x	→
2:	8.9	→
3:	10.3x	←
4:	10.2x	←
5:	10.5x	←
Serie		50.3
Total		100.2

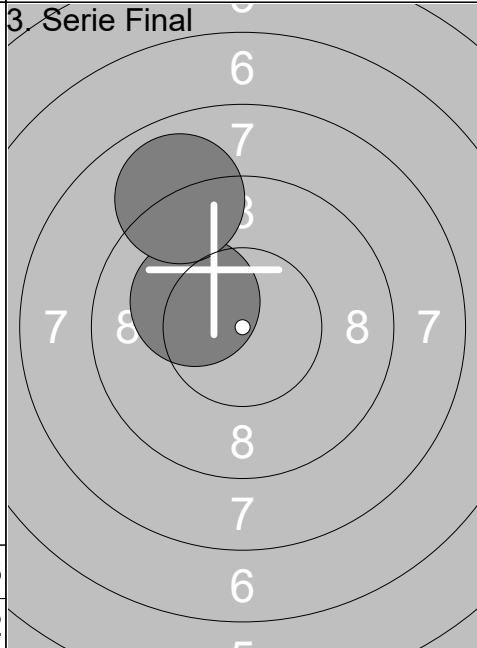

1:	10.2x	↖
2:	9.0	↗
Serie		19.2
Total		119.4

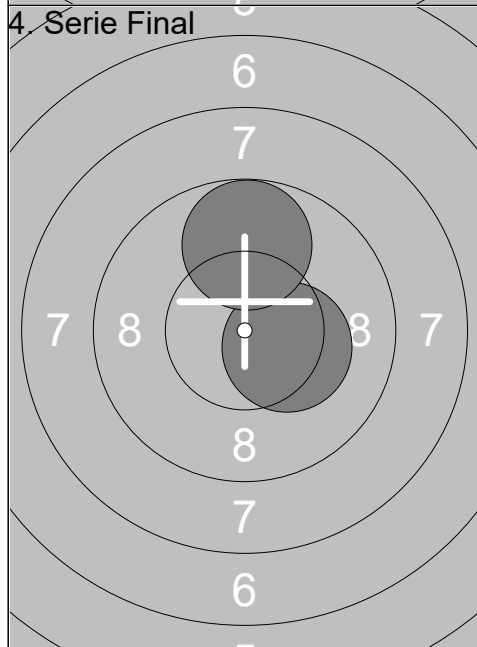



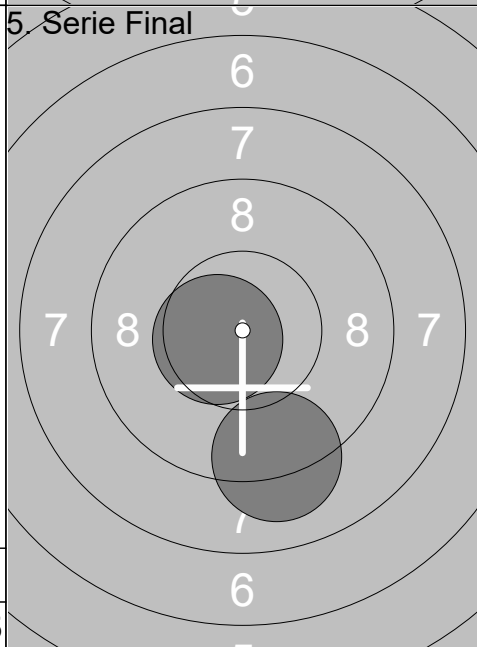



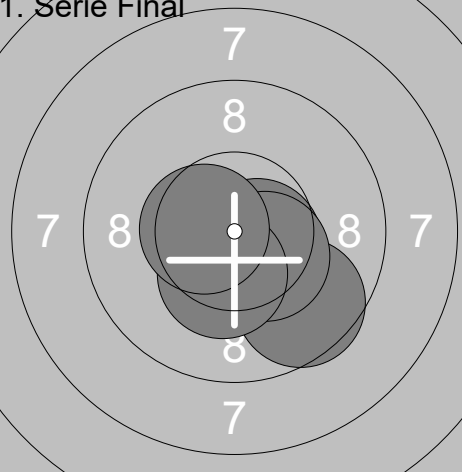
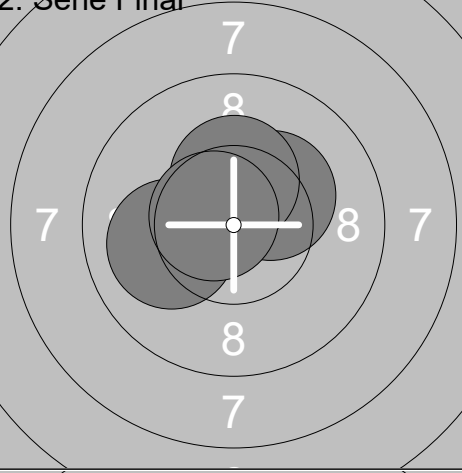
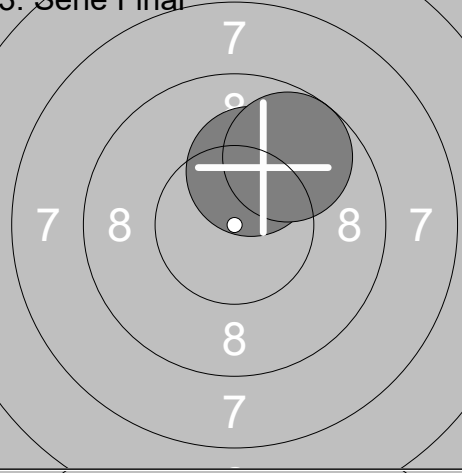
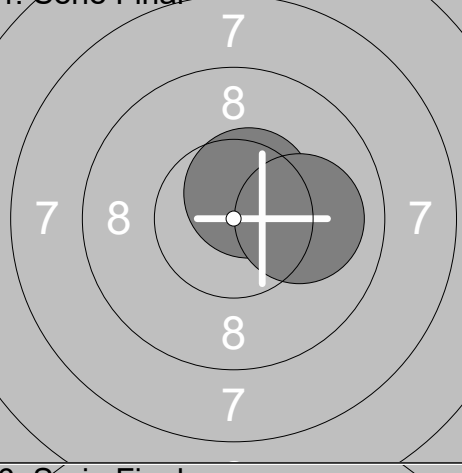
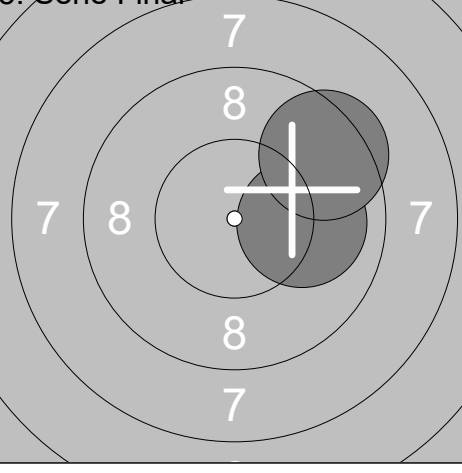
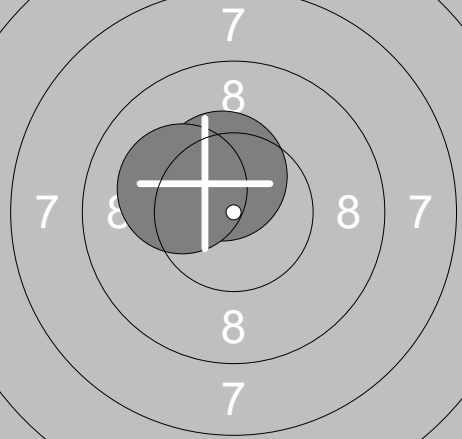

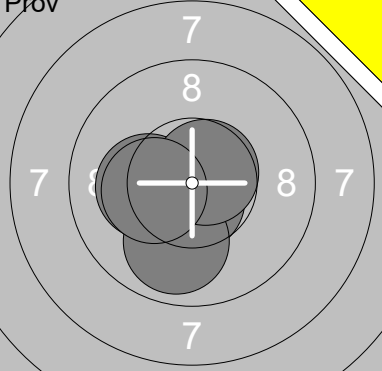
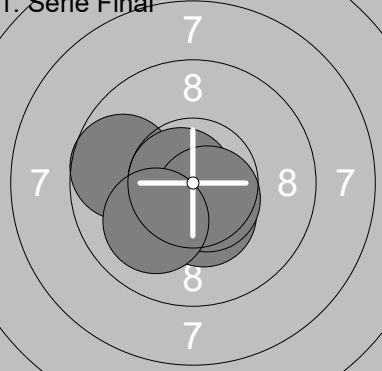
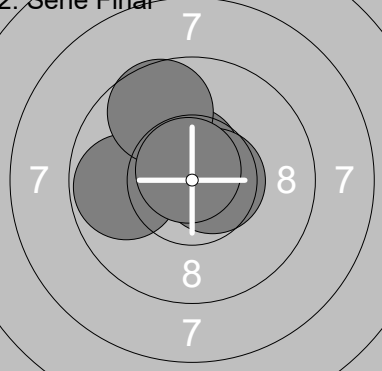
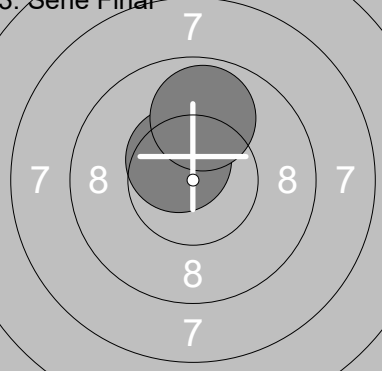
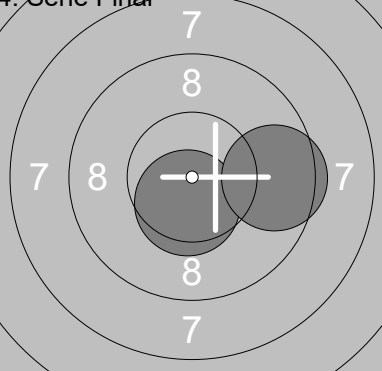
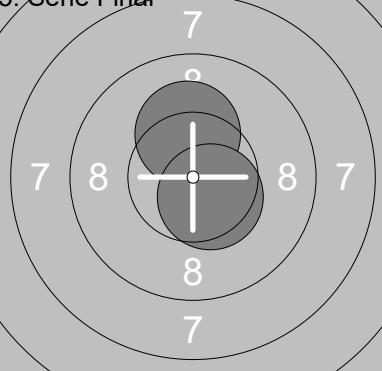
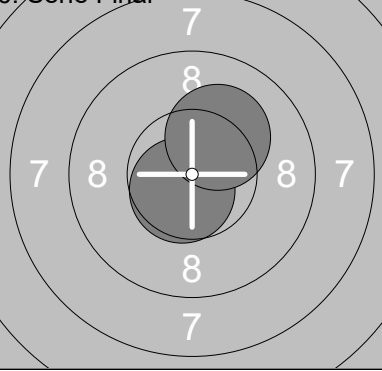
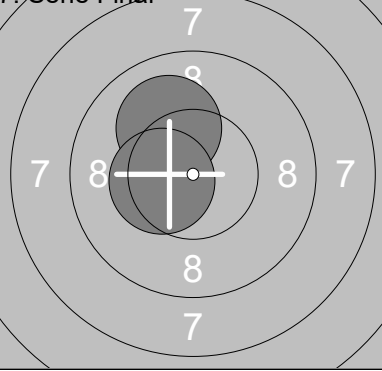

1:	10.3x	→
2:	9.8	↑
Serie		20.1
Total		139.5

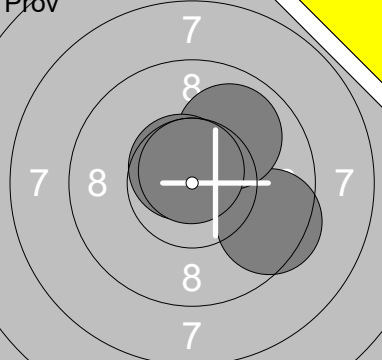
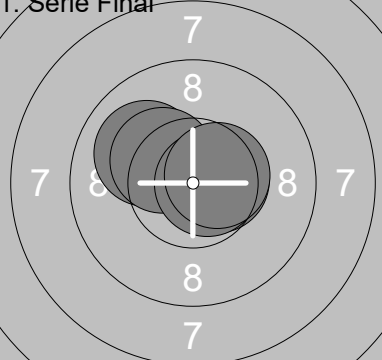



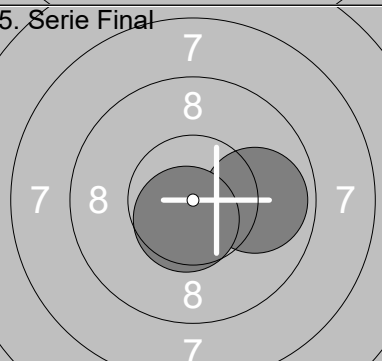



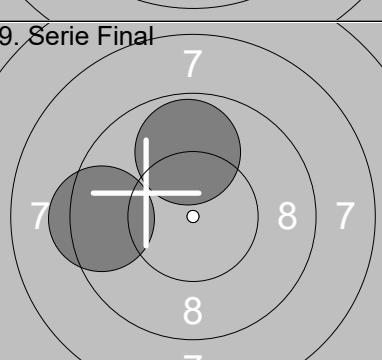

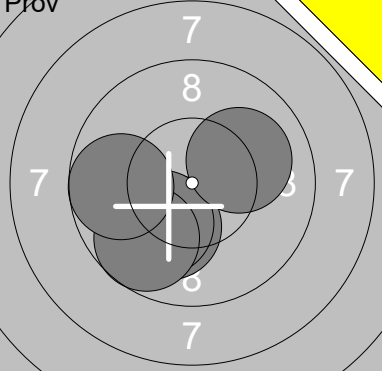
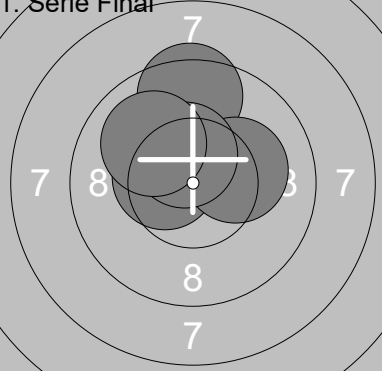
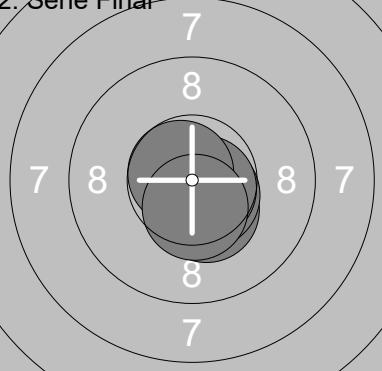
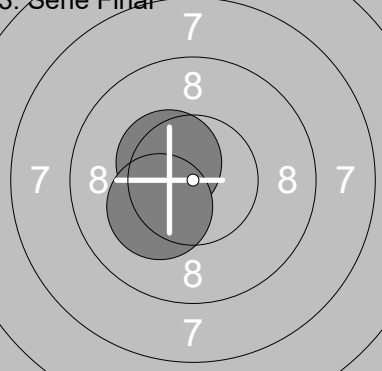
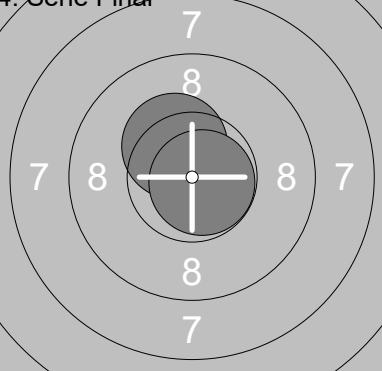
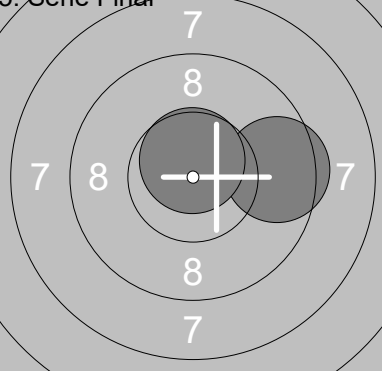
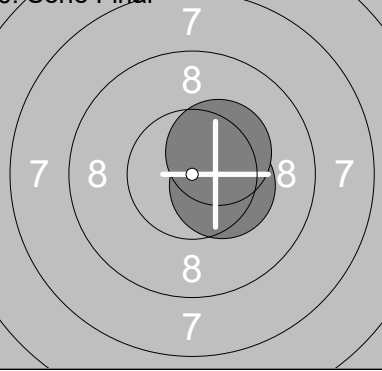
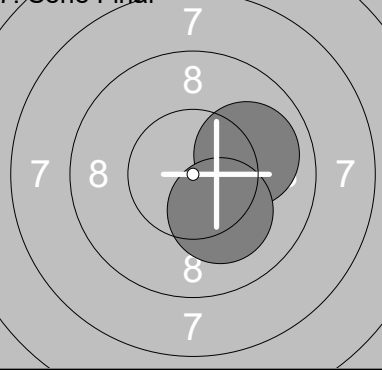
1:	10.6x	↖
2:	9.1	↓
Serie		19.7
Total		159.2

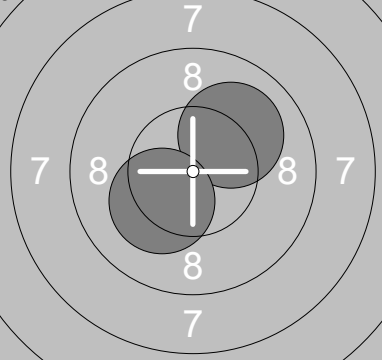
<b>Prov</b> 	1: 10.1 ↙ 2: 10.3x ↓ 3: 10.2x ↘ 4: 10.7x ↗	<b>1. Serie Final</b> 	1: 10.6x → 2: 9.6 ↓ 3: 10.4x ↘ 4: 10.3x ↓ 5: 10.5x ←
Serie 41.3		Serie 51.4	
Total 0.0		Total 51.4	
<b>2. Serie Final</b> 	1: 10.4x ↗ 2: 10.0 ← 3: 10.3x ↗ 4: 10.3x ↑ 5: 10.7x ←	<b>3. Serie Final</b> 	1: 10.2x ↑ 2: 9.8 ↗
Serie 51.7		Serie 20.0	
Total 103.1		Total 123.1	
<b>4. Serie Final</b> 	1: 10.5x ↗ 2: 10.0 →	<b>5. Serie Final</b> 	1: 10.0 → 2: 9.4 ↗
Serie 20.5		Serie 19.4	
Total 143.6		Total 163.0	
<b>6. Serie Final</b> 	1: 10.4x ↗ 2: 10.2x ←		
Serie 20.6			
Total 183.6			

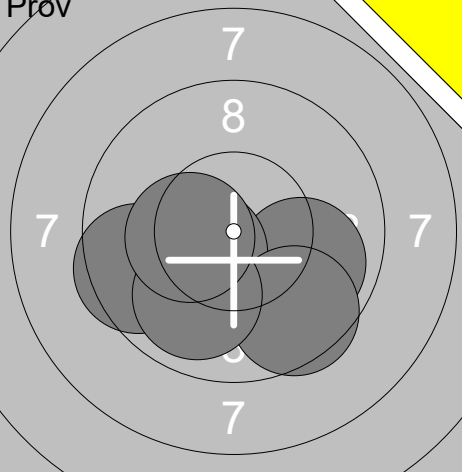
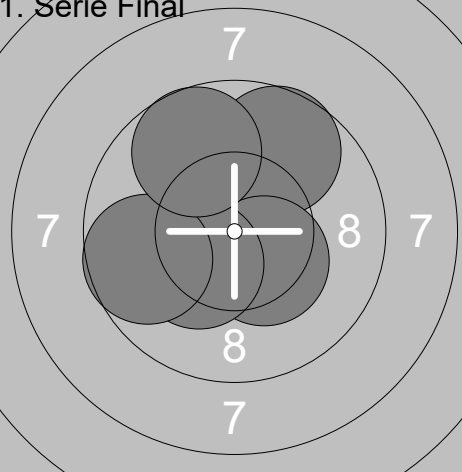
Pröv 	1: 10.7x ↓ 2: 9.9 ↓ 3: 10.2x ← 4: 10.7x ↗ 5: 10.3x ← Serie 51.8 Total 0.0	1. Serie Final 	1: 10.4x ↓ 2: 9.7 ← 3: 10.7x ← 4: 10.6x ↓ 5: 10.1 ↙ Serie 51.5 Total 51.5
2. Serie Final 	1: 10.6x ↑ 2: 10.6x → 3: 9.8 ← 4: 9.7 ↖ 5: 10.8x ↗ Serie 51.5 Total 103.0	3. Serie Final 	1: 10.5x ↖ 2: 9.9 ↑ Serie 20.4 Total 123.4
4. Serie Final 	1: 10.5x ↓ 2: 9.5 → Serie 20.0 Total 143.4	5. Serie Final 	1: 10.2x ↑ 2: 10.5x ↘ Serie 20.7 Total 164.1
6. Serie Final 	1: 10.6x ↘ 2: 10.2x ↗ Serie 20.8 Total 184.9	7. Serie Final 	1: 10.1 ↖ 2: 10.4x ← Serie 20.5 Total 205.4
8. Serie Final 	1: 9.9 ↑ 2: 10.5x ↑ Serie 20.4 Total 225.8		

Pröv 	1: 9.5 → 2: 9.9 ↗ 3: 10.6x ↖ 4: 10.7x ↑	1. Serie Final 	1: 10.0 ↖ 2: 10.3x ↖ 3: 10.5x → 4: 10.7x → 5: 10.5x →
	Serie 40.7		Serie 52.0
	Total 0.0		Total 52.0
2. Serie Final 	1: 10.5x ← 2: 10.0 → 3: 10.5x ↖ 4: 10.5x ↗ 5: 10.1 →	3. Serie Final 	1: 10.3x ↖ 2: 10.4x ↖
	Serie 51.6		Serie 20.7
	Total 103.6		Total 124.3
4. Serie Final 	1: 10.8x ← 2: 10.6x →	5. Serie Final 	1: 9.9 → 2: 10.6x ↓
	Serie 21.4		Serie 20.5
	Total 145.7		Total 166.2
6. Serie Final 	1: 10.9x ↖ 2: 9.9 ↖	7. Serie Final 	1: 10.8x ↓ 2: 10.7x ↓
	Serie 20.8		Serie 21.5
	Total 187.0		Total 208.5
8. Serie Final 	1: 10.6x ↖ 2: 10.1 ↖	9. Serie Final 	1: 9.9 ↑ 2: 9.4 ←
	Serie 20.7		Serie 19.3
	Total 229.2		Total 248.5

Pröv 	1: 10.1 ↘ 2: 10.1 ↘ 3: 9.7 ↘ 4: 9.7 ← 5: 10.1 →	1. Serie Final 	1: 9.5 ↑ 2: 10.5x ← 3: 10.2x → 4: 10.5x ↑ 5: 10.0 ↖
	Serie 49.7		Serie 50.7
	Total 0.0		Total 50.7
2. Serie Final 	1: 10.4x ↘ 2: 10.6x ↘ 3: 10.7x ↘ 4: 10.7x ↗ 5: 10.5x ↓	3. Serie Final 	1: 10.4x ↖ 2: 10.2x ↘
	Serie 52.9		Serie 20.6
	Total 103.6		Total 124.2
4. Serie Final 	1: 10.3x ↗ 2: 10.8x →	5. Serie Final 	1: 9.5 → 2: 10.7x ↑
	Serie 21.1		Serie 20.2
	Total 145.3		Total 165.5
6. Serie Final 	1: 10.4x → 2: 10.4x ↗	7. Serie Final 	1: 10.0 → 2: 10.2x ↘
	Serie 20.8		Serie 20.2
	Total 186.3		Total 206.5
8. Serie Final 	1: 9.9 ← 2: 10.6x ←	9. Serie Final 	1: 10.1 ↗ 2: 10.2x ↘
	Serie 20.5		Serie 20.3
	Total 227.0		Total 247.3

<b>Prov</b> 	1: 9.9 → 2: 9.5 ← 3: 10.4x ← 4: 9.6 ↓ 5: 9.9 ↓ 6: 10.3x ←	<b>1. Serie Final</b> 	1: 9.7 ↗ 2: 10.4x ↘ 3: 10.3x ← 4: 9.7 ← 5: 9.7 ↗
Serie 59.6	Total 0.0	Serie 49.8	Total 49.8
<b>2. Serie Final</b> 	1: 10.7x ↑ 2: 9.9 ↓ 3: 10.7x → 4: 10.3x ↗ 5: 10.6x ↖	<b>3. Serie Final</b> 	1: 9.7 → 2: 10.0 ↗
Serie 52.2	Total 102.0	Serie 19.7	Total 121.7
<b>4. Serie Final</b> 	1: 10.3x ↖ 2: 10.4x ↗	<b>5. Serie Final</b> 	1: 10.2x ↓ 2: 9.8 ↖
Serie 20.7	Total 142.4	Serie 20.0	Total 162.4
<b>6. Serie Final</b> 	1: 10.6x ← 2: 10.7x ↑	<b>7. Serie Final</b> 	1: 9.9 → 2: 10.0 ↑
Serie 21.3	Total 183.7	Serie 19.9	Total 203.6

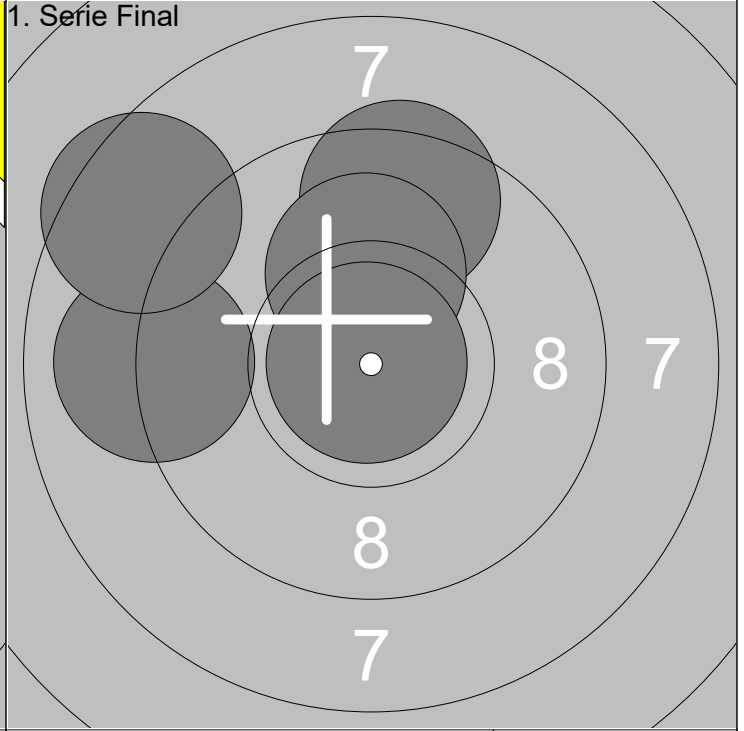
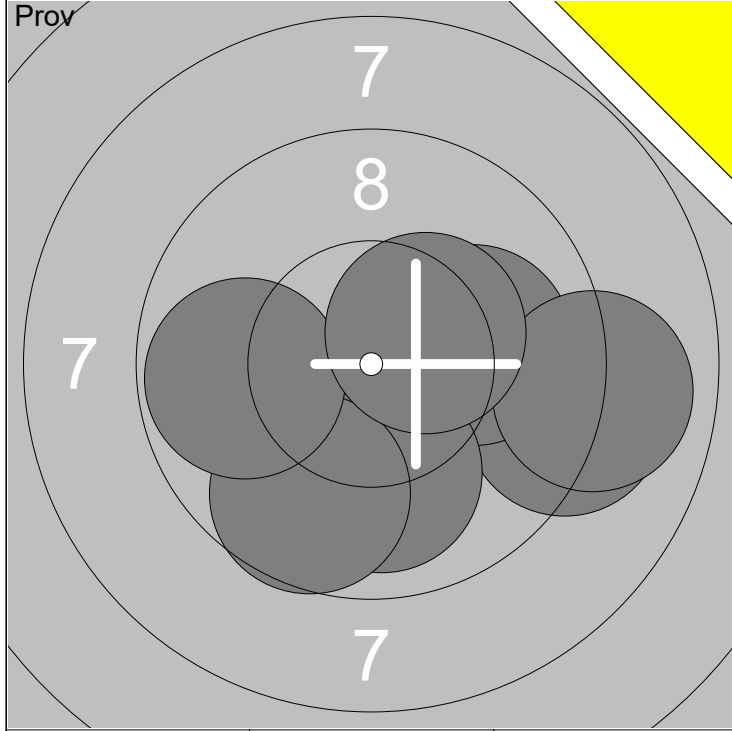

1: 9.2 →	6: 9.8 ←		Serie	68.1
2: 10.0 →	7: 10.4x ↗		Total	0.0
3: 9.0 →				
4: 10.0 ↓				
5: 9.7 ↓				

1: 9.5 ↑		Serie	48.0
2: 9.0 ←		Total	48.0
3: 10.1 ↑			
4: 8.5 ↖			
5: 10.9x ↖			

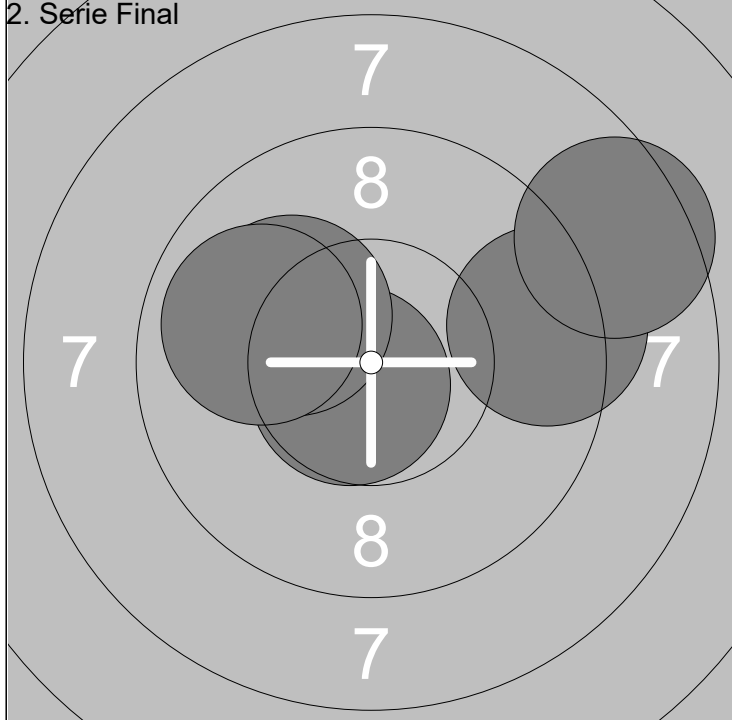

1: 10.7x ↙		Serie	48.5
2: 10.1 ↖		Total	96.5
3: 9.3 →			
4: 9.9 ↖			
5: 8.5 ↗			

1: 10.8x ↘		Serie	21.0
2: 10.2x ↘		Total	117.5