

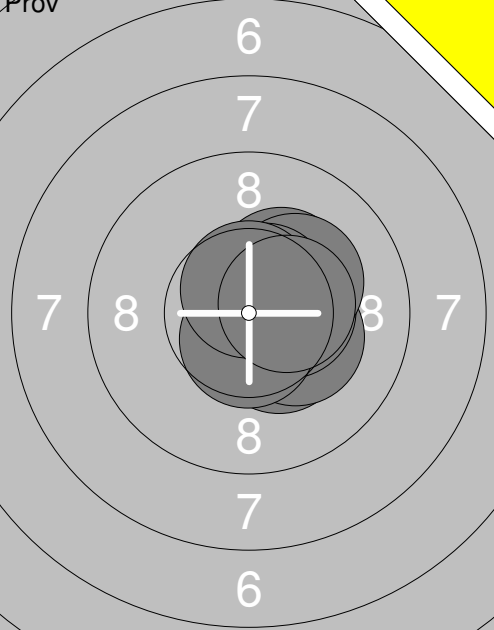

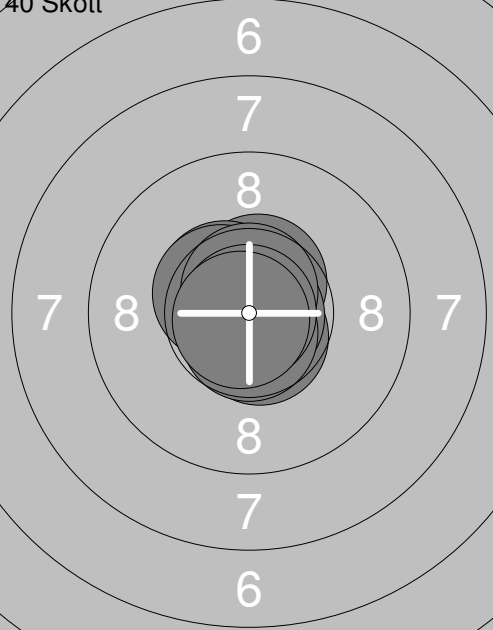

Skjuttag	Tavla	Emma Eriksson	
S		Ramselefors	
11.01.2020		Skyttiaden Distriktsfinal	Umeå skytteallians
Prov		1: 10.4x➤ 2: 9.3↙ 3: 9.7↙ 4: 9.0↓ 5: 9.1↙ 6: 9.1↓ 7: 9.7➤ 8: 9.2↙ 9: 10.2x↓ 10: 8.6↘ Serie 94.3 Total 0.0	11: 9.9➔ 12: 9.4↖ 13: 10.4x↙ 14: 9.3↖ 15: 8.7↙ 16: 9.3➔ 17: 10.1↖ Serie 67.1 Total 0.0
40 Skott		1: 10.6x↗ 2: 10.5x➤ 3: 10.3x↘ 4: 10.2x➤ 5: 9.2➤ 6: 10.3x↙ 7: 8.1➤ 8: 10.2x↗ 9: 9.9➤ 10: 10.1↙ Serie 99.4 Total 99.4	11: 9.7↙ 12: 10.1➤ 13: 9.5↙ 14: 10.1↓ 15: 10.6x↓ 16: 10.1↙ 17: 10.6x↗ 18: 8.5↙ 19: 9.8↘ 20: 9.7↓ Serie 98.7 Total 198.1
40 Skott		21: 10.5x↓ 22: 10.2x↙ 23: 8.4↓ 24: 9.6➤ 25: 10.6x↓ 26: 10.2x↙ 27: 10.4x↗ 28: 10.2x↙ 29: 9.5↙ 30: 10.7x↗ Serie 100.3 Total 298.4	31: 10.0↖ 32: 9.8➔ 33: 9.9↗ 34: 9.3➤ 35: 10.2x↙ 36: 9.2↖ 37: 10.2x➤ 38: 7.9↙ 39: 10.7x➤ 40: 10.1➤ Serie 97.3 Total 395.7

<p>Prov</p> 	<p>40 Skott</p> <p>1: 10.3x↗ 2: 10.4x↘ 3: 10.3x↘ 4: 10.8x↗ 5: 10.4x→ 6: 10.2x↗ 7: 10.6x↓ 8: 10.6x↗ 9: 10.6x↑ 10: 10.4x→</p> <p>Serie 104.6 Total 0.0</p>	<p>40 Skott</p>  <p>1: 10.6x↓ 2: 10.5x↑ 3: 10.9x↘ 4: 10.7x↗ 5: 10.5x↘ 6: 10.5x↘ 7: 10.7x↑ 8: 10.7x↓ 9: 10.9x↘ 10: 10.8x↘</p> <p>Serie 106.8 Total 106.8</p>
<p>40 Skott</p> 	<p>40 Skott</p> <p>11: 10.7x↓ 12: 10.7x→ 13: 10.6x↗ 14: 10.6x↘ 15: 10.7x↗ 16: 10.5x↓ 17: 10.8x↗ 18: 10.7x↘ 19: 10.6x→ 20: 10.7x↓</p> <p>Serie 106.6 Total 213.4</p>	<p>40 Skott</p>  <p>21: 10.3x↔ 22: 10.6x→ 23: 10.8x↔ 24: 10.8x↘ 25: 10.6x↗ 26: 9.8 ↓ 27: 10.4x↔ 28: 10.8x→ 29: 10.3x↓ 30: 10.5x↓</p> <p>Serie 104.9 Total 318.3</p>
<p>40 Skott</p> 	<p>31: 10.7x→ 32: 10.2x↑ 33: 10.2x↓ 34: 10.6x↓ 35: 10.8x→ 36: 10.2x↓ 37: 10.7x↘ 38: 10.7x→ 39: 10.7x↔ 40: 10.5x↗</p> <p>Serie 105.3 Total 423.6</p>	

<p>Prov</p>	<p>1: 10.1 ↘ 2: 10.0 ↓ 3: 9.9 → 4: 10.2x↘ 5: 10.6x→ 6: 10.1 ↓ 7: 10.1 → 8: 10.1 ↓ 9: 10.5x↘ 10: 10.1 →</p> <p>Serie 101.7 Total 0.0</p>	<p>Prov</p>	<p>11: 10.3x↘ 12: 10.5x↘ 13: 10.7x↗ 14: 10.4x↑ 15: 10.7x→ 16: 10.8x↘ 17: 10.3x↘</p> <p>Serie 73.7 Total 0.0</p>
<p>40 Skott</p>	<p>1: 10.3x↘ 2: 10.7x← 3: 10.3x↘ 4: 10.9x↘ 5: 10.6x↘ 6: 10.7x← 7: 10.6x← 8: 10.7x→ 9: 10.6x← 10: 10.8x←</p> <p>Serie 106.2 Total 106.2</p>	<p>40 Skott</p>	<p>11: 10.6x← 12: 10.5x↗ 13: 10.8x↘ 14: 10.2x← 15: 10.4x← 16: 10.6x← 17: 10.2x↑ 18: 10.6x↘ 19: 10.0 ↑ 20: 10.1 ↖</p> <p>Serie 104.0 Total 210.2</p>
<p>40 Skott</p>	<p>21: 10.4x↑ 22: 10.4x↘ 23: 10.5x↑ 24: 10.4x↘ 25: 10.5x↘ 26: 10.4x↑ 27: 10.7x← 28: 10.5x↘ 29: 10.4x← 30: 10.5x←</p> <p>Serie 104.7 Total 314.9</p>	<p>40 Skott</p>	<p>31: 10.4x↘ 32: 10.8x← 33: 10.3x↘ 34: 10.2x← 35: 10.4x↘ 36: 10.6x← 37: 10.7x↘ 38: 10.7x↘ 39: 10.9x↘ 40: 10.4x↗</p> <p>Serie 105.4 Total 420.3</p>

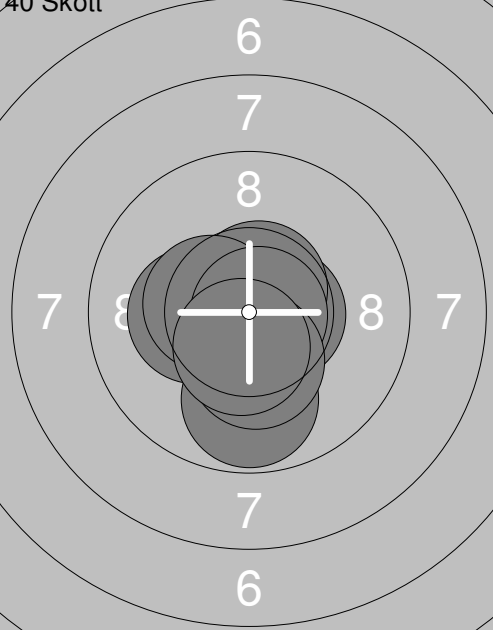
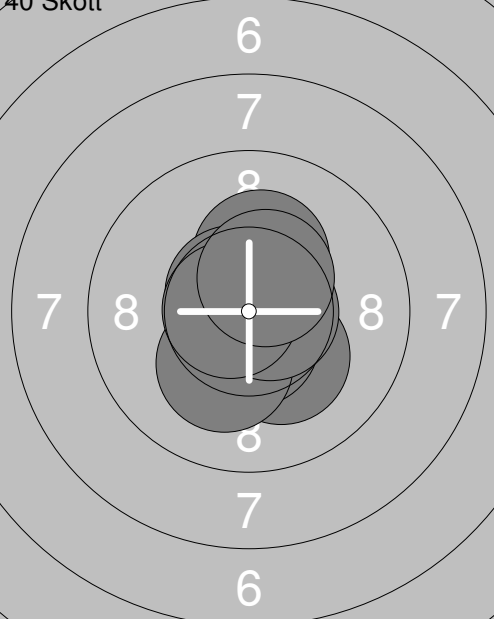
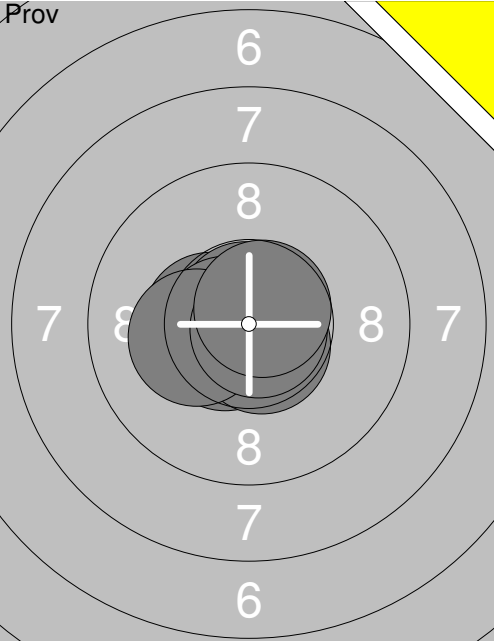
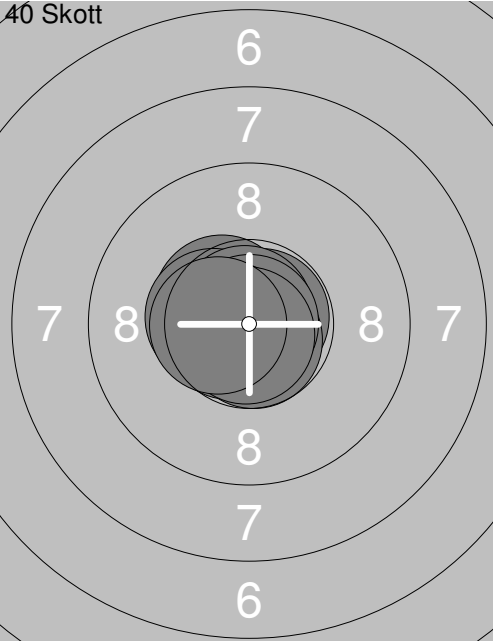
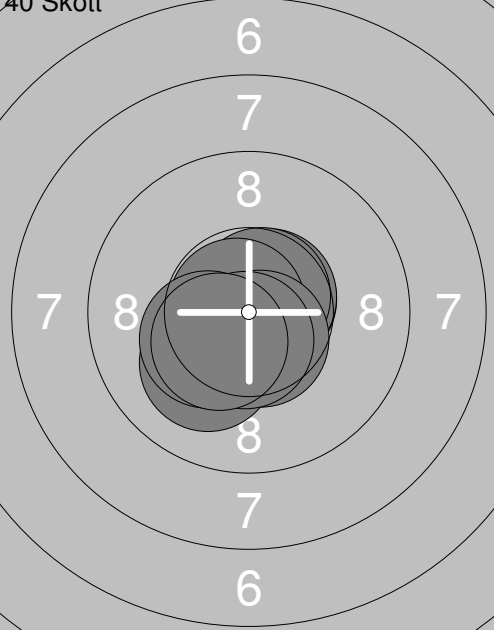
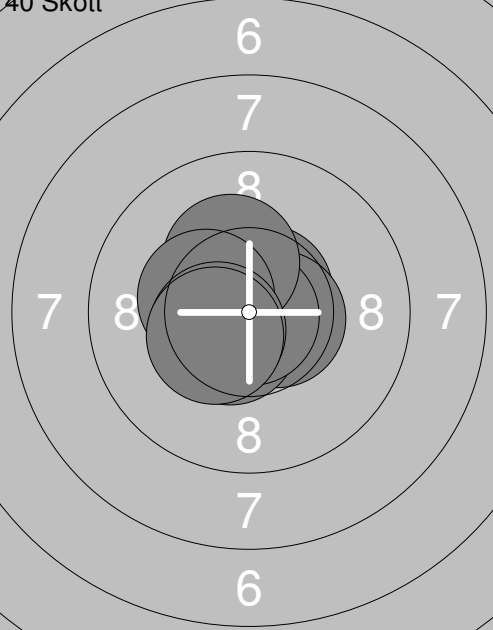
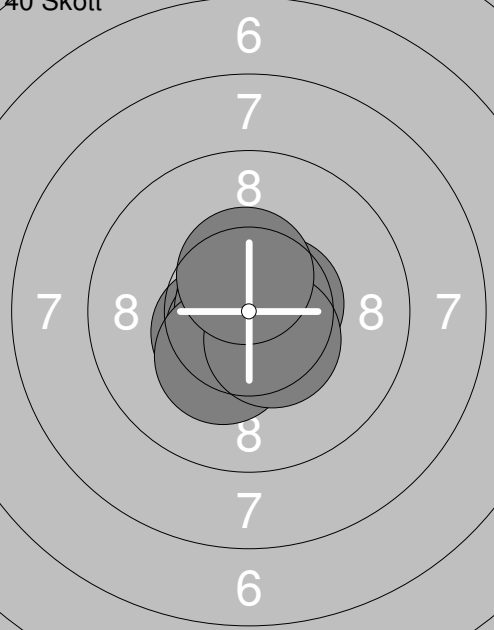
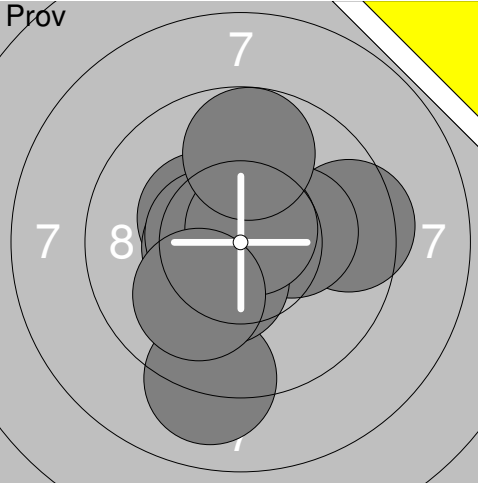
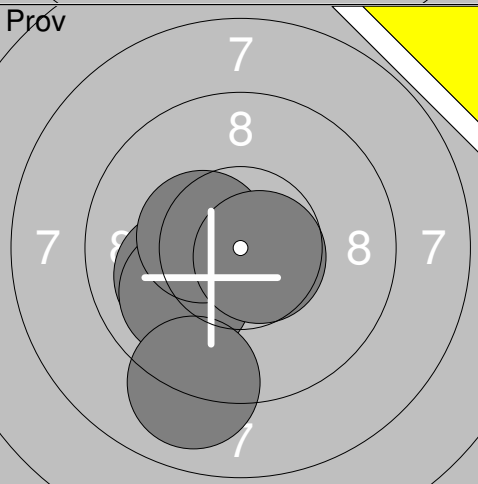
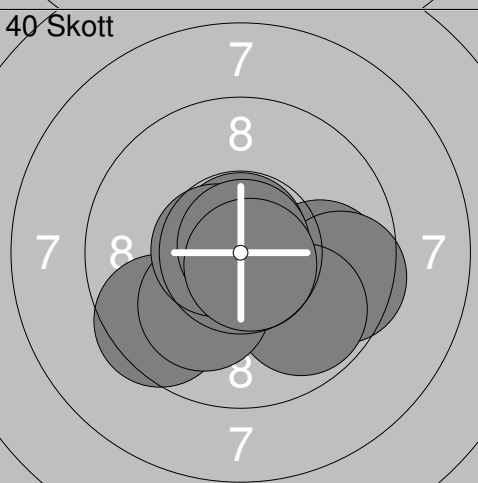
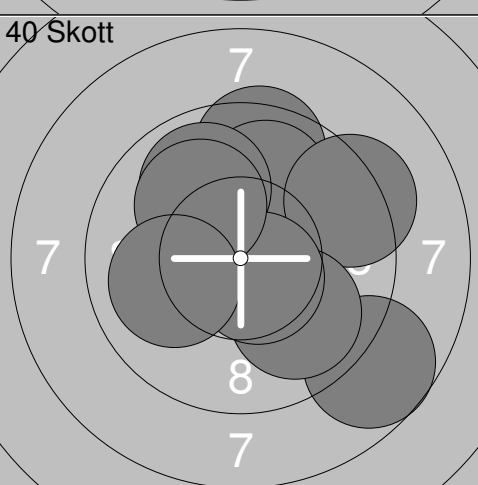
Skjutlag	Tavla	Hanna Augustsson	
S	Vännäs		
11.01.2020	Skyttiaden Distriktsfinal	Umeå skytteallians	
Prov 	1: 10.6x↙ 2: 10.5x↙ 3: 10.6x↙ 4: 10.6x↘ 5: 10.8x↗ 6: 10.7x↙ 7: 10.2x↙ 8: 10.8x↘ 9: 10.7x↗ Serie 95.5 Total 0.0	40 Skott 	1: 10.9x↗ 2: 10.5x↙ 3: 10.8x↗ 4: 10.7x↘ 5: 10.5x↙ 6: 10.8x↗ 7: 10.9x↗ 8: 10.7x↙ 9: 10.8x↘ 10: 10.5x↙ Serie 107.1 Total 107.1
40 Skott 	11: 10.6x↗ 12: 10.1 ↘ 13: 10.6x↗ 14: 10.7x↗ 15: 10.6x↙ 16: 10.8x↙ 17: 10.6x↘ 18: 10.6x↘ 19: 10.3x↙ 20: 10.4x↘ Serie 105.3 Total 212.4	40 Skott 	21: 10.8x↘ 22: 10.6x↗ 23: 10.6x↘ 24: 10.6x↙ 25: 10.5x↘ 26: 10.9x↘ 27: 10.3x↗ 28: 10.4x↙ 29: 10.5x↙ 30: 10.4x↙ Serie 105.6 Total 318.0
40 Skott 	31: 10.5x↙ 32: 10.8x↗ 33: 10.8x↗ 34: 10.6x↘ 35: 10.9x↙ 36: 10.6x↘ 37: 10.6x↗ 38: 10.3x↘ 39: 10.5x↘ 40: 10.5x↗ Serie 106.1 Total 424.1		

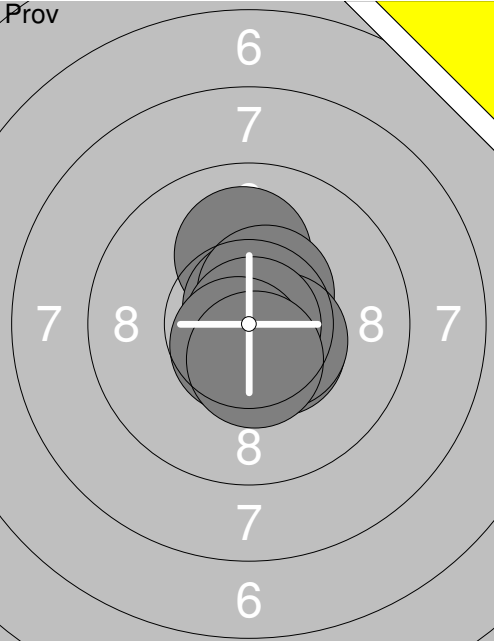
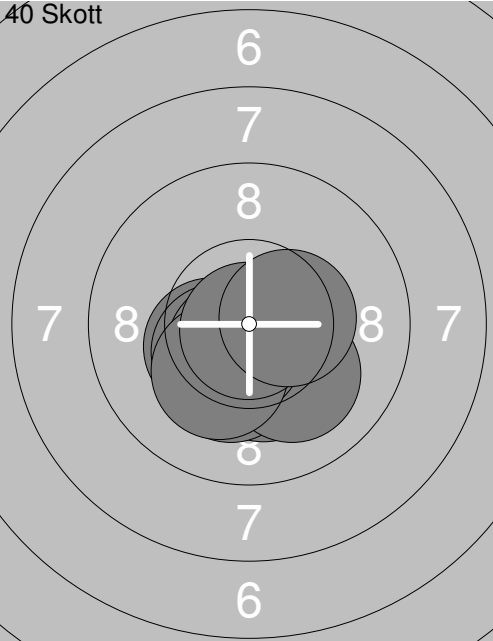
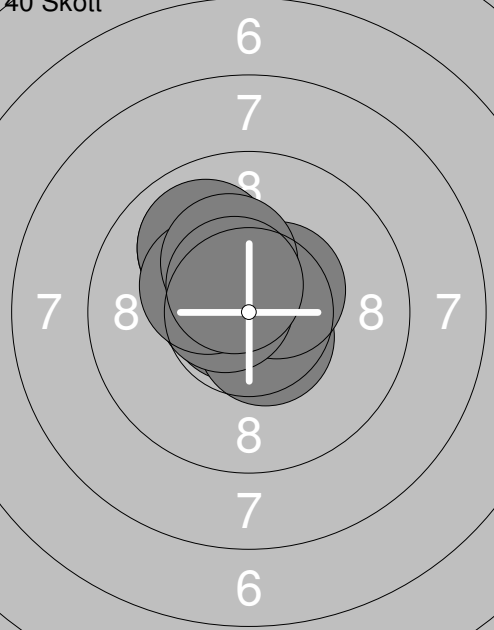
Skjutlag	Tavla	Henrik Albihn	
1	24		
S	Vännäs		
11.01.2020	Skyttiaden Distriktsfinal	Umeå skytteallians	
Prov		1: 10.4x ↖ 2: 9.1 ↓ 3: 10.5x ← 4: 9.5 → 5: 10.2x → 6: 10.4x ↓ 7: 10.5x ← 8: 10.7x ↗ 9: 9.7 ↑ 10: 10.0 ↓	11: 10.8x ↓ 12: 9.1 ↓ 13: 9.9 ↗ 14: 10.0 → 15: 9.8 ↗ 16: 10.1 ↗ 17: 9.7 ↓ 18: 10.1 ↓ 19: 10.2x ← 20: 10.2x ↗
		Serie 101.0	Serie 99.9
		Total 0.0	Total 0.0
Prov		21: 10.0 ← 22: 10.0 ← 23: 10.4x ← 24: 9.0 ↓ 25: 10.7x →	1: 10.1 ↑ 2: 9.7 ← 3: 9.4 ↓ 4: 10.1 ↗ 5: 10.2x → 6: 10.6x ↑ 7: 10.4x ↓ 8: 10.1 ↓ 9: 10.0 ↑ 10: 10.6x ↗
		Serie 50.1	Serie 101.2
		Total 0.0	Total 101.2
40 Skott		11: 9.5 ↓ 12: 9.9 → 13: 9.6 → 14: 10.8x ↑ 15: 9.8 ↓ 16: 10.9x ↓ 17: 10.1 ↓ 18: 10.6x ← 19: 10.9x ↗ 20: 10.7x ↓	21: 10.7x ↖ 22: 10.6x ← 23: 10.7x → 24: 10.1 ↗ 25: 10.7x ↓ 26: 5.8 ↗ 27: 10.3x ↗ 28: 10.6x ↓ 29: 9.1 ↓ 30: 10.2x ↗
		Serie 102.8	Serie 98.8
		Total 204.0	Total 302.8
40 Skott		31: 9.5 ↑ 32: 10.4x ← 33: 9.9 ↗ 34: 9.3 → 35: 9.9 ↗ 36: 8.7 ↓ 37: 9.9 ↓ 38: 10.6x ↓ 39: 10.1 ↗ 40: 10.0 ←	
		Serie 98.3	
		Total 401.1	

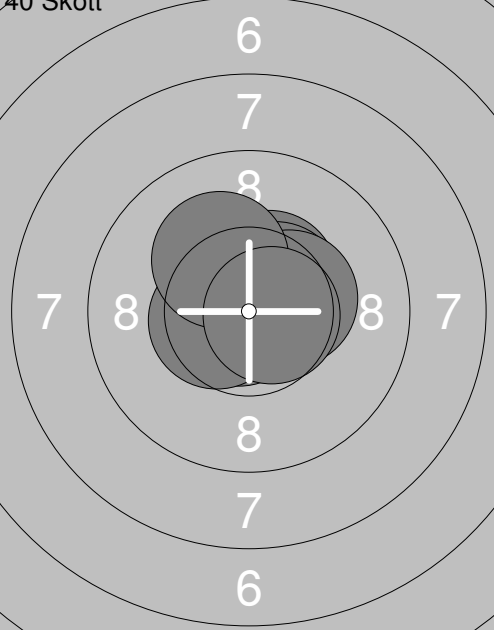
Skjutlag	Tavla	Beatrice Andersson	
1	25		
S	Ramselefors		
11.01.2020	Skyttiaden Distriktsfinal	Umeå skytteallians	
Prov		40 Skott	
	1: 10.1 ↑ 2: 10.7x↑ 3: 10.5x↗ 4: 10.5x↘ 5: 10.5x↘ 6: 10.9x→ 7: 10.6x↘ 8: 10.5x↘	1: 10.3x↘ 2: 10.8x↘ 3: 10.3x↘ 4: 10.1 ↘ 5: 10.4x↘ 6: 10.4x↘ 7: 10.6x↘ 8: 10.2x↘ 9: 10.9x↘ 10: 10.4x→	
	Serie 84.3		Serie 104.4
	Total 0.0		Total 104.4
40 Skott		40 Skott	
	11: 10.8x← 12: 10.6x↘ 13: 10.0 ↘ 14: 10.6x↘ 15: 10.5x↗ 16: 10.6x↘ 17: 9.9 ↘ 18: 10.3x↘ 19: 10.3x↗ 20: 10.5x↘	21: 10.8x→ 22: 10.8x↑ 23: 10.7x↘ 24: 10.0 ↘ 25: 10.5x↗ 26: 10.4x↘ 27: 10.0 ↘ 28: 10.7x↑ 29: 10.3x↘ 30: 10.7x→	
	Serie 104.1		Serie 104.9
	Total 208.5		Total 313.4
40 Skott			
	31: 10.9x← 32: 10.5x↗ 33: 10.8x↘ 34: 10.7x→ 35: 10.4x↘ 36: 10.5x↗ 37: 10.4x→ 38: 10.5x↘ 39: 10.2x↘ 40: 10.7x→		
	Serie 105.6		
	Total 419.0		

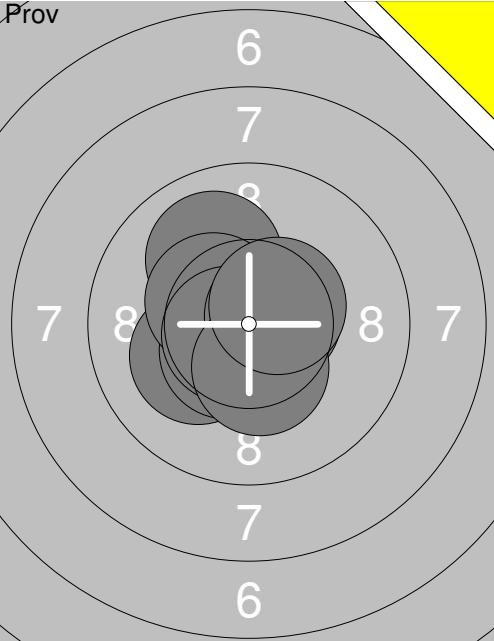
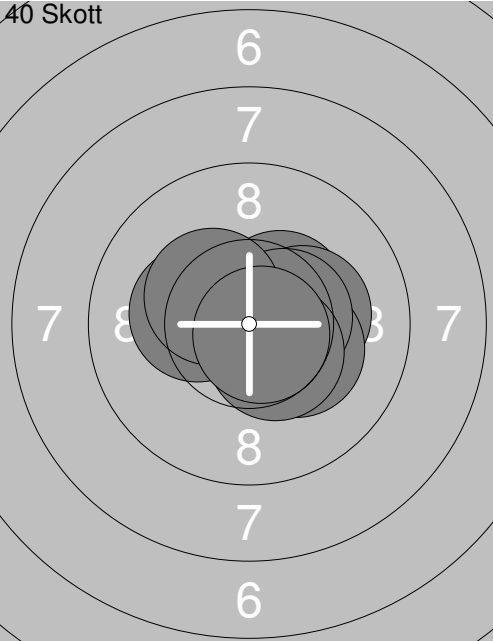
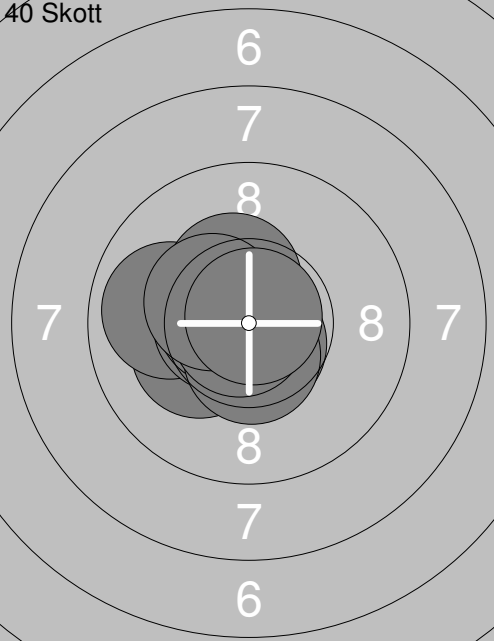
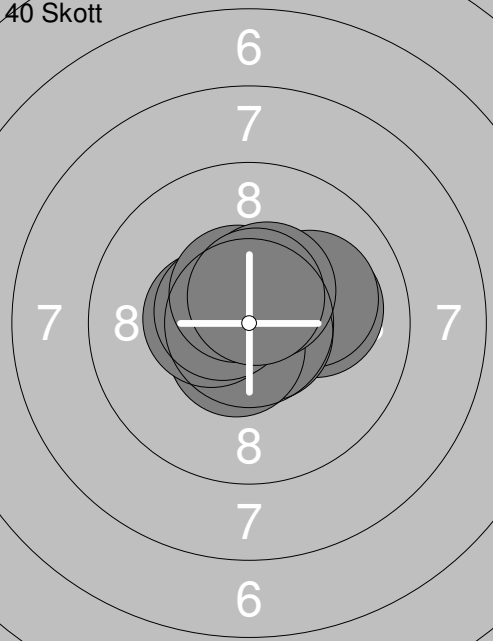
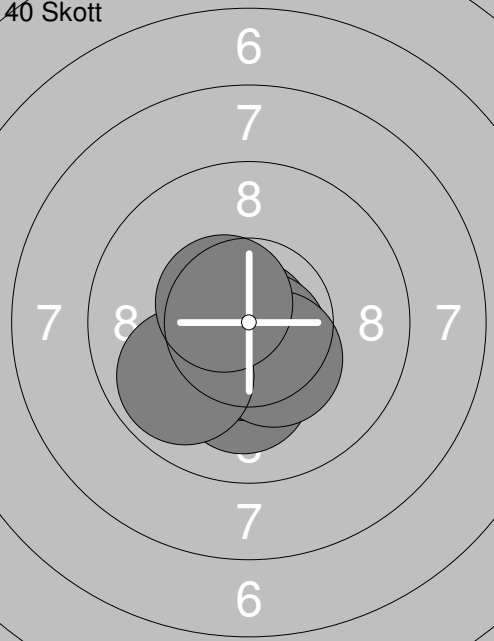
Skjutlag 1	Tavla 26	Jacob Hedman	
S		Umeå	
11.01.2020		Skyttiaden Distriktsfinal	Umeå skytteallians
Prov		1: 10.3x ↘ 2: 10.0 ↖ 3: 10.8x ↘ 4: 10.2x ↘ 5: 10.5x ↘ 6: 10.4x ↘ 7: 10.7x ↘ 8: 10.6x ➔ 9: 10.4x ↘ 10: 10.5x ↗ Serie 104.4 Total 0.0	40 Skott  1: 10.5x ➔ 2: 10.4x ↗ 3: 10.2x ➔ 4: 10.9x ↘ 5: 10.3x ↘ 6: 10.5x ➔ 7: 10.4x ↘ 8: 10.3x ↘ 9: 10.4x ↘ 10: 10.7x ↘ Serie 104.6 Total 104.6
40 Skott		11: 10.2x ↘ 12: 10.7x ↘ 13: 9.9 ← 14: 10.6x ↘ 15: 10.6x ↘ 16: 10.5x ↘ 17: 10.8x ↘ 18: 10.4x ↗ 19: 10.4x ↘ 20: 10.8x ↗ Serie 104.9 Total 209.5	40 Skott  21: 10.1 ➔ 22: 10.1 ➔ 23: 10.7x ↘ 24: 10.7x ↘ 25: 10.6x ↘ 26: 10.5x ↘ 27: 10.6x ↘ 28: 10.5x ↗ 29: 10.5x ↗ 30: 10.6x ↗ Serie 104.9 Total 314.4
40 Skott		31: 10.1 ↓ 32: 10.8x ↘ 33: 10.6x ↘ 34: 10.5x ↘ 35: 10.9x ↘ 36: 10.7x ↘ 37: 10.7x ↘ 38: 10.4x ↘ 39: 9.9 ↙ 40: 10.5x ↘ Serie 105.1 Total 419.5	

Skjutlag 1	Tavla 27	Filip Hansson	
S		Vännäs	
11.01.2020		Skyttiaden Distriktsfinal	Umeå skytteallians
Prov 	1: 9.6 → 2: 9.5 → 3: 10.0 → 4: 10.3x ↗ 5: 10.3x ↗ 6: 9.6 ↗ 7: 9.9 → 8: 9.7 → 9: 9.5 → 10: 9.8 → Serie 98.2 Total 0.0	Prov 	11: 10.0 → 12: 9.2 → 13: 8.0 → 14: 9.6 → 15: 9.6 → 16: 10.3x → 17: 10.0 → 18: 10.2x ↓ 19: 10.6x → 20: 10.3x ↗ Serie 97.8 Total 0.0
Prov 	21: 10.5x → 22: 10.4x ↗ 23: 9.9 ↗ 24: 10.4x ↗ 25: 10.3x ↗ 26: 10.2x ↗ Serie 61.7 Total 0.0	40 Skott 	1: 10.8x ↑ 2: 10.6x ↑ 3: 10.6x → 4: 10.5x ↗ 5: 10.7x ↗ 6: 10.7x ↗ 7: 10.2x ↗ 8: 10.3x ↗ 9: 10.5x ↗ 10: 10.6x ↗ Serie 105.5 Total 105.5
40 Skott 	11: 10.5x ↗ 12: 10.5x ↗ 13: 10.6x ↗ 14: 10.7x ↗ 15: 10.2x ↑ 16: 10.4x ↑ 17: 10.6x → 18: 10.8x ↗ 19: 10.2x ↑ 20: 10.3x ↑ Serie 104.8 Total 210.3	40 Skott 	21: 10.6x ↗ 22: 10.4x ↗ 23: 10.3x ↗ 24: 10.5x ← 25: 10.0 ↑ 26: 10.1 ↑ 27: 10.6x ↑ 28: 10.7x ↗ 29: 10.5x ↗ 30: 10.7x ↗ Serie 104.4 Total 314.7
40 Skott 	31: 10.3x ↗ 32: 10.3x ↗ 33: 10.4x ↗ 34: 10.4x ↑ 35: 10.6x ↑ 36: 10.7x ↗ 37: 10.4x ↗ 38: 10.6x ↗ 39: 10.2x ← 40: 10.1 ↗ Serie 104.0 Total 418.7		

Skjutlag 1	Tavla 28	Isak Bäckström	
S		Ramselefors	
11.01.2020		Skyttiaden Distriktsfinal	Umeå skytteallians
Pröv 	1: 7.7 ↓ 2: 8.1 ↓ 3: 8.6 ↓ 4: 9.9 ↓ 5: 9.6 ↓ 6: 10.3x ↓ 7: 10.2x ↓ 8: 9.4 ← 9: 9.9 ← 10: 9.7 ← Serie 93.4 Total 0.0	Pröv 	11: 9.8 ↖ 12: 9.3 ← 13: 9.9 ↖ 14: 9.7 ↖ 15: 10.6x ↓ 16: 10.8x ← 17: 9.7 ↑ 18: 10.4x ↘ 19: 10.5x ← 20: 10.7x ↗ Serie 101.4 Total 0.0
Pröv 	21: 10.6x → Serie 10.6 Total 0.0	40 Skott 	1: 10.6x ↑ 2: 9.9 ↓ 3: 10.0 → 4: 10.3x ← 5: 10.3x ← 6: 10.5x ↗ 7: 10.4x ↑ 8: 10.5x ↑ 9: 10.5x ↓ 10: 9.8 ↑ Serie 102.8 Total 102.8
40 Skott 	11: 10.4x → 12: 10.6x ↑ 13: 10.5x ↗ 14: 10.6x → 15: 10.6x ↑ 16: 10.5x ↑ 17: 10.5x ← 18: 10.2x → 19: 9.8 ↑ 20: 10.1 ↑ Serie 103.8 Total 206.6	40 Skott 	21: 10.6x ↗ 22: 10.8x → 23: 9.1 ↘ 24: 9.8 ↘ 25: 10.2x ↖ 26: 10.1 ← 27: 10.0 ↗ 28: 10.7x ↖ 29: 10.4x ↗ 30: 10.3x ↑ Serie 102.0 Total 308.6
40 Skott 	31: 10.8x ↑ 32: 9.8 ↑ 33: 10.5x ↗ 34: 10.6x ↖ 35: 9.8 ↑ 36: 10.2x ↑ 37: 9.8 ↑ 38: 10.5x ↖ 39: 9.5 ↑ 40: 9.4 ↗ Serie 100.9 Total 409.5		

Skjutlag 1	Tavla 29	Emelie Albihn	
S		Vännäs	
11.01.2020		Skyttiaden Distriktsfinal	Umeå skytteallians
Pröv 	1: 10.4x ↗ 2: 9.9 → 3: 9.5 ↓ 4: 10.2x ↙ 5: 9.7 → 6: 10.4x ↓ 7: 8.5 ↗ 8: 8.6 ← 9: 8.9 → 10: 10.2x →	Pröv 	11: 10.5x ↖ 12: 9.5 → 13: 10.0 → 14: 10.0 ↓ 15: 9.6 ↓ 16: 10.0 → 17: 9.9 ↑ 18: 9.3 → 19: 10.6x ↖ 20: 9.3 ↓
Serie 96.3		Serie 98.7	
Total 0.0		Total 0.0	
Pröv 	21: 9.6 ↓ 22: 10.2x ↓ 23: 10.8x ↓	40 Skott 	1: 10.3x ↑ 2: 9.5 ↙ 3: 10.5x ↙ 4: 10.3x ↑ 5: 10.1 → 6: 10.0 ↓ 7: 8.8 ↓ 8: 9.1 ↗ 9: 10.2x ↓ 10: 10.2x ↖
Serie 30.6		Serie 99.0	
Total 0.0		Total 99.0	
40 Skott 	11: 10.5x ↓ 12: 10.2x → 13: 10.3x ↑ 14: 9.8 ↓ 15: 10.6x → 16: 10.2x ← 17: 10.7x ↗ 18: 10.2x ↖ 19: 10.7x → 20: 10.5x ↖	40 Skott 	21: 10.6x ↖ 22: 8.1 ↑ 23: 10.4x ↓ 24: 9.8 ↖ 25: 9.0 ↓ 26: 10.6x ↗ 27: 10.7x ↓ 28: 10.5x → 29: 10.0 ↓ 30: 10.1 ↖
Serie 103.7		Serie 99.8	
Total 202.7		Total 302.5	
40 Skott 	31: 9.7 ↑ 32: 10.5x ↓ 33: 9.6 ↓ 34: 10.4x ← 35: 10.5x ↑ 36: 10.5x → 37: 9.7 ↗ 38: 10.3x ← 39: 10.1 ← 40: 9.6 ↓		
Serie 100.9			
Total 403.4			

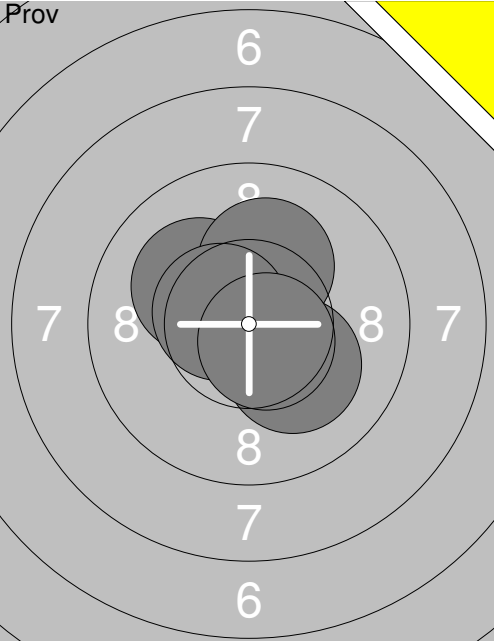
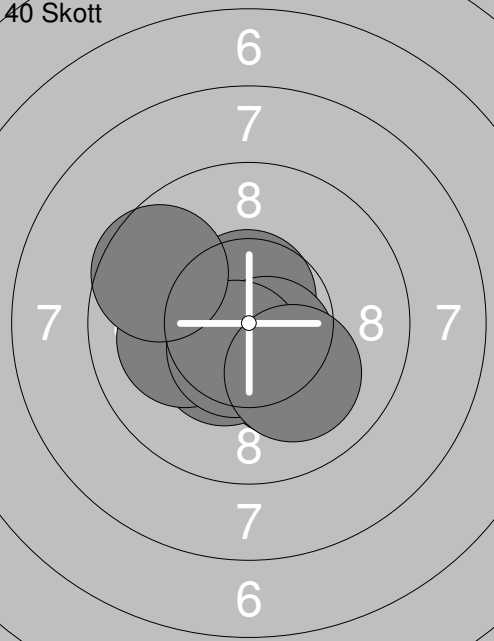
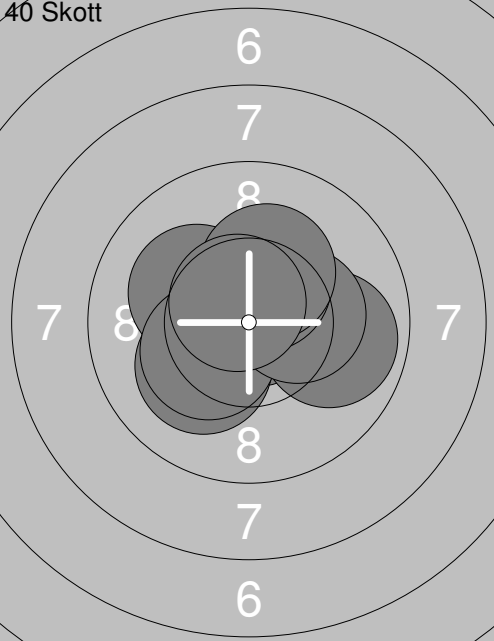
Skjutlag	Tavla	Ylva Lundstedt	
S		Ramselefors	
11.01.2020		Skyttiaden Distriktsfinal	Umeå skytteallians
Prov		40 Skott	40 Skott
		1: 10.1 ↖ 2: 10.2 ↗ 3: 10.6 ↘ 4: 10.2 ↘ 5: 10.6 ↘	1: 10.8x ➤ 2: 10.4x ↘ 3: 10.5x ↗ 4: 10.4x ↗ 5: 10.8x ↘ 6: 10.7x ➤ 7: 10.2x ➤ 8: 10.5x ↗ 9: 10.2x ↗ 10: 10.5x ↗
		Serie 51.7	Serie 105.0
		Total 0.0	Total 105.0
40 Skott		40 Skott	40 Skott
		11: 10.2x ↘ 12: 10.4x ↘ 13: 10.3x ↘ 14: 10.9x ➤ 15: 10.6x ↗ 16: 10.6x ↘ 17: 10.1 ← 18: 10.6x ↘ 19: 10.1 ↘ 20: 9.6 ↖	21: 10.7x ↘ 22: 10.7x ➤ 23: 10.7x ↘ 24: 10.2x ↘ 25: 10.3x ➤ 26: 10.5x ↘ 27: 10.7x ➤ 28: 10.5x ↘ 29: 10.8x ➤ 30: 9.9 ↘
		Serie 103.4	Serie 105.0
		Total 208.4	Total 313.4
40 Skott			
		31: 10.8x ↗ 32: 10.7x ↗ 33: 9.9 ➤ 34: 10.2x ↘ 35: 10.1 ↘ 36: 10.3x ↘ 37: 10.3x ➤ 38: 10.4x ↗ 39: 10.3x ↗ 40: 10.7x ↘	
		Serie 103.7	
		Total 417.1	

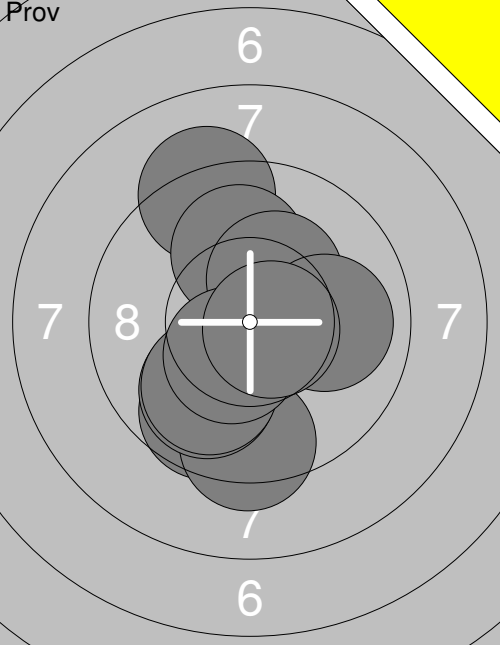
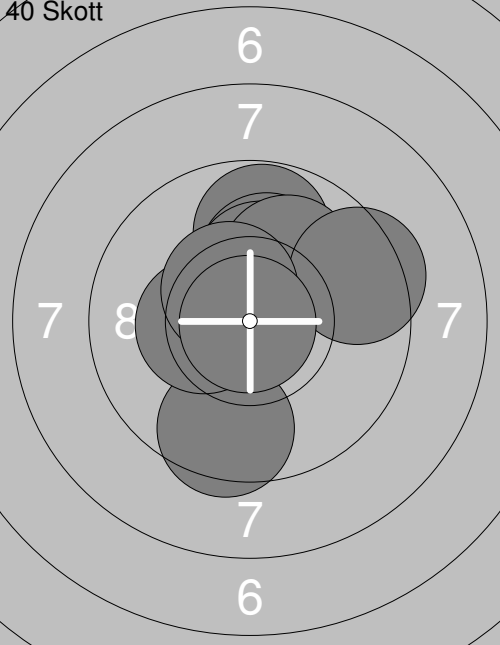
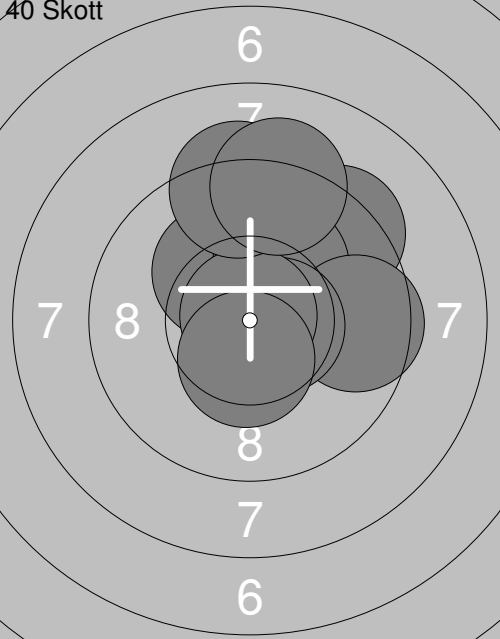
Skjutlag	Tavla	Olivia Mikaelsson	
1	32		
S	Ramselefors		
11.01.2020	Skyttiaden Distriktsfinal	Umeå skytteallians	
Prov		1: 9.7 ↓ 2: 9.4 ↓ 3: 9.9 ↓ 4: 10.0 ↓ 5: 9.2 ↑ 6: 10.0 ↑ 7: 10.3x ↗ 8: 10.0 → 9: 10.5x ↓ 10: 10.7x →	11: 10.1 ↓ Serie 10.1 Total 0.0
40 Skott		1: 9.8 ↑ 2: 10.1 ↑ 3: 10.6x ↑ 4: 10.3x ↑ 5: 9.5 ↓ 6: 10.0 ↗ 7: 10.3x ← 8: 9.4 → 9: 10.5x ↘ 10: 10.9x ↘	11: 10.3x ↘ 12: 10.5x ↘ 13: 9.9 ↓ 14: 9.9 ↗ 15: 10.6x ↓ 16: 10.2x ← 17: 9.8 ↓ 18: 10.1 ↓ 19: 10.2x ↓ 20: 9.5 ↑
40 Skott		21: 10.3x ↗ 22: 10.2x ↘ 23: 9.3 ↗ 24: 10.2x ↗ 25: 9.6 → 26: 10.6x → 27: 10.9x ↗ 28: 9.2 ↑ 29: 10.4x ↓ 30: 9.2 ↑	31: 10.1 ↓ 32: 9.9 ← 33: 10.4x ↗ 34: 9.7 ↑ 35: 9.6 ↓ 36: 9.7 ↓ 37: 8.9 ← 38: 8.3 ↓ 39: 10.5x ↗ 40: 9.1 ↓
		Serie 99.7 Total 0.0	Serie 101.4 Total 101.4
		Serie 99.9 Total 302.3	Serie 101.0 Total 202.4
		Serie 99.9 Total 302.3	Serie 96.2 Total 398.5

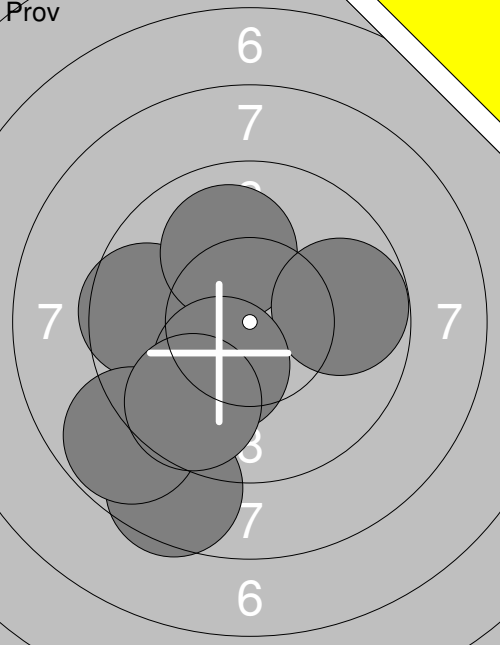
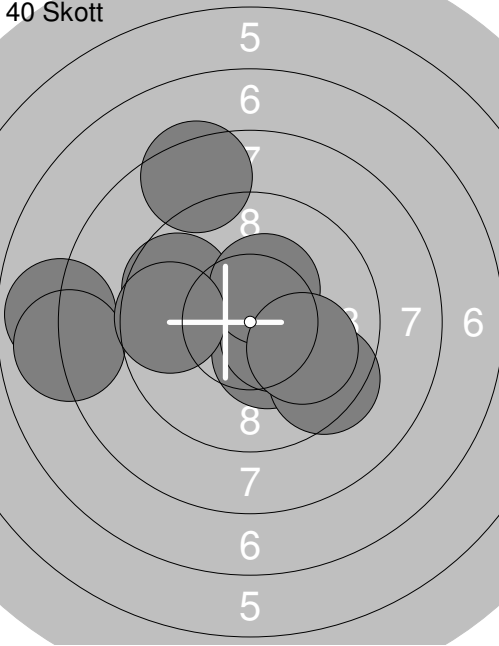
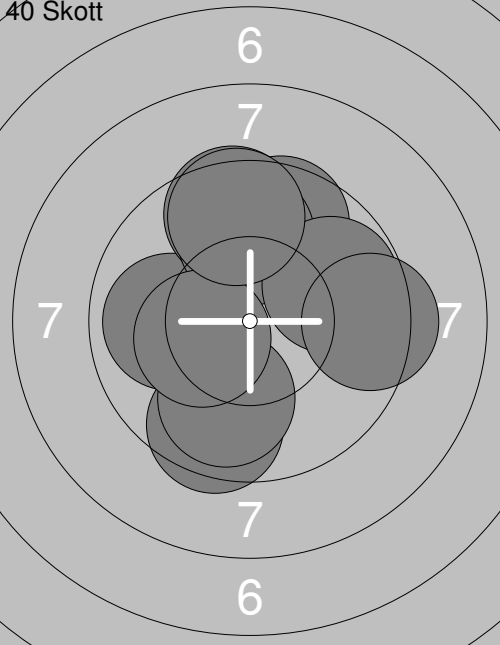
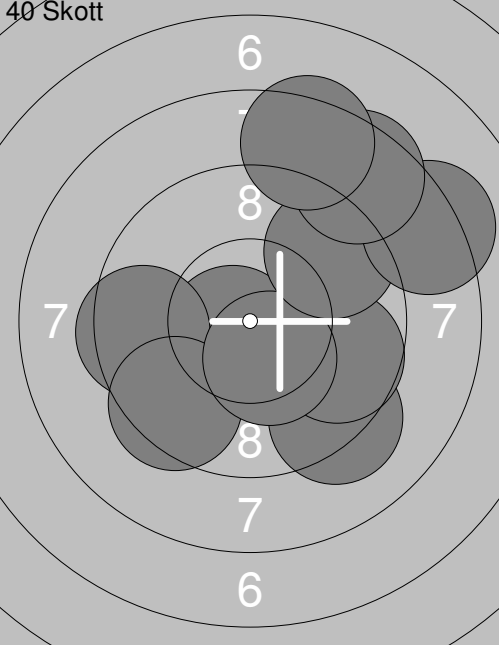
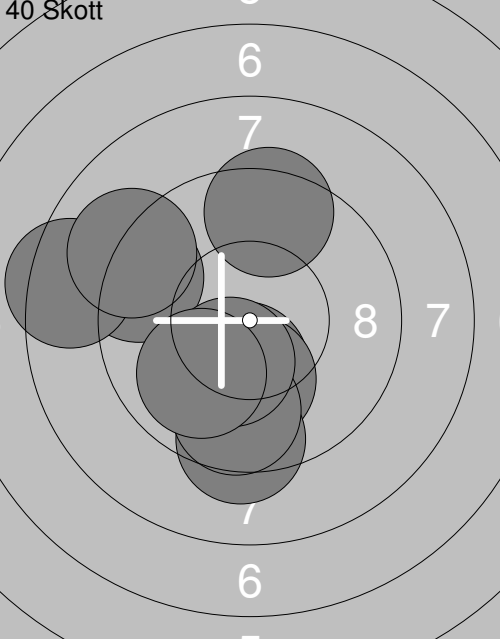
Skjutlag	Tavla	Melker Häggström	
1	33		
S	Ramselefors		
11.01.2020	Skyttiaden Distriktsfinal	Umeå skytteallians	
Prov		40 Skott	
	1: 9.6 ← 2: 8.6 ↓ 3: 10.0 ↑ 4: 9.8 → 5: 10.3x↓ 6: 8.8 ↙ 7: 9.7 ↓		1: 10.4x↘ 2: 7.9 ← 3: 9.7 ↙ 4: 10.5x↘ 5: 10.4x↗ 6: 8.4 ↑ 7: 9.4 ↘ 8: 10.0 ↘ 9: 8.0 ← 10: 9.7 ←
	Serie 66.8		Serie 94.4
	Total 0.0		Total 94.4
40 Skott		40 Skott	
	11: 9.9 ← 12: 9.5 ↑ 13: 9.6 ↑ 14: 9.5 ↓ 15: 9.9 ↑ 16: 9.9 ↓ 17: 10.3x↙ 18: 9.8 → 19: 9.6 ↑ 20: 9.4 →		21: 10.7x↙ 22: 9.2 ↓ 23: 9.5 ← 24: 9.7 → 25: 9.5 ↙ 26: 10.4x↘ 27: 9.5 ↗ 28: 8.3 → 29: 8.5 ↗ 30: 8.4 ↑
	Serie 97.4		Serie 93.7
	Total 191.8		Total 285.5
40 Skott			
	31: 9.3 ↙ 32: 10.3x↓ 33: 10.1 ↓ 34: 9.3 ↓ 35: 9.7 ↓ 36: 10.3x↓ 37: 10.0 ↙ 38: 8.4 ← 39: 9.4 ↑ 40: 9.1 ↙		
	Serie 95.9		
	Total 381.4		

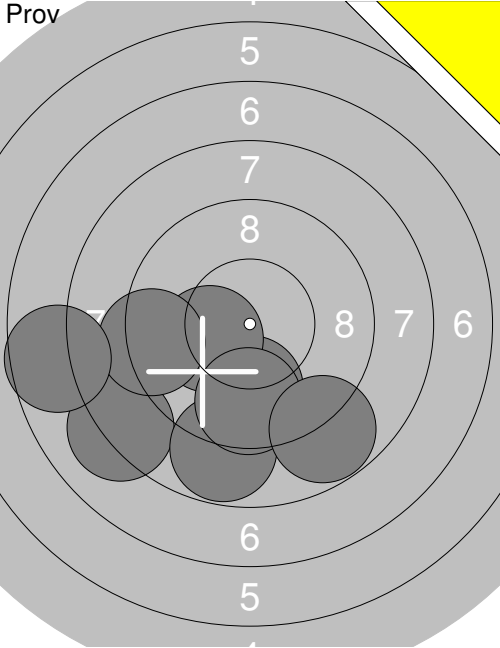
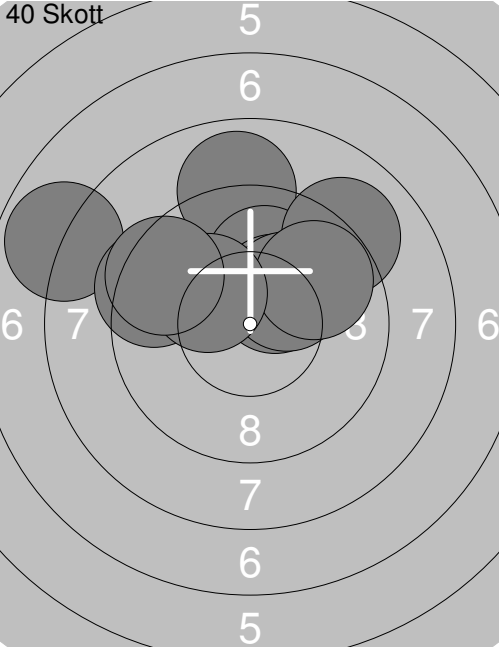
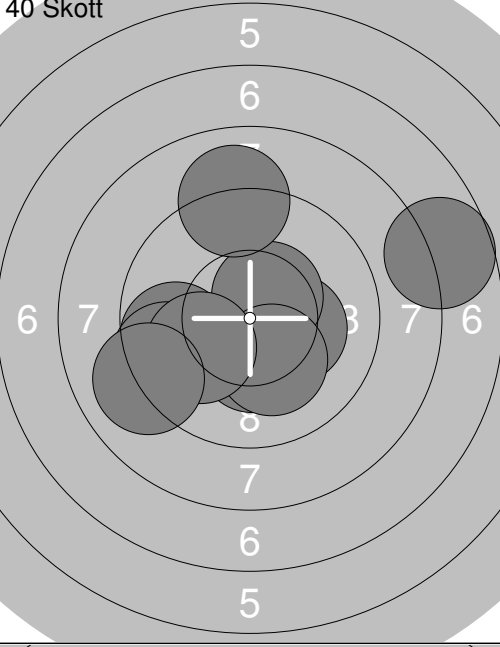
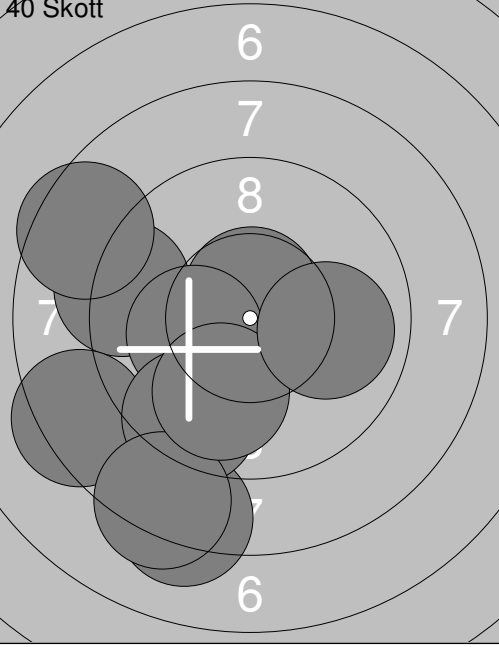
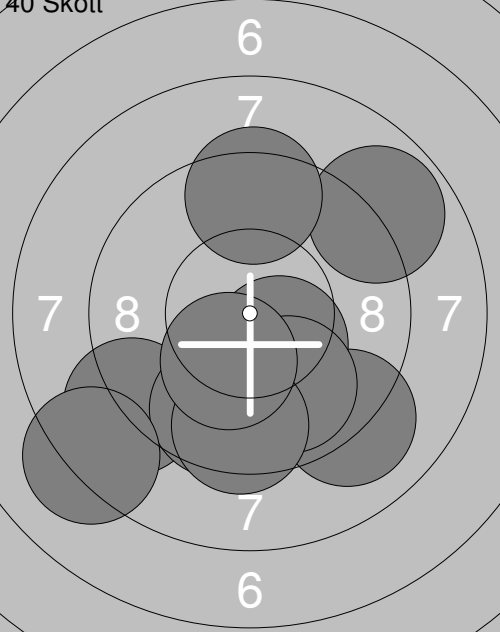
Skjutlag	Tavla	Emma Hermansson	
S		Ramselefors	
11.01.2020		Skyttiaden Distriktsfinal	Umeå skytteallians
Prov		1: 8.2 ↙ 2: 9.9 ↓ 3: 8.8 ↓ 4: 10.2x↙ 5: 9.6 ↓ 6: 9.3 ← 7: 8.8 ↘ 8: 7.7 ←	40 Skott  1: 8.9 ↑ 2: 7.9 ↖ 3: 10.0 ↑ 4: 10.4x↗ 5: 10.2x↗ 6: 9.1 ↗ 7: 9.4 ↖ 8: 9.8 ↗ 9: 10.2x↘ 10: 9.5 ↖
		Serie 72.5	Serie 95.4
		Total 0.0	Total 95.4
40 Skott		11: 9.7 ← 12: 10.3x→ 13: 10.3x↓ 14: 9.5 ← 15: 10.5x↗ 16: 10.2x↓ 17: 10.0↙ 18: 7.7 → 19: 9.0 ↑ 20: 9.0 ↙	40 Skott  21: 9.2 ↖ 22: 8.5 ↖ 23: 10.6x↑ 24: 10.2x↙ 25: 8.2 ↓ 26: 8.4 ↖ 27: 9.4 ↓ 28: 8.3 ↓ 29: 9.9 ↓ 30: 10.0→
		Serie 96.2	Serie 92.7
		Total 191.6	Total 284.3
40 Skott		31: 9.1 ↘ 32: 8.9 ↗ 33: 10.4x↘ 34: 9.0 ↖ 35: 9.6 ↓ 36: 9.9 ↓ 37: 8.2 ↖ 38: 9.5 ↓ 39: 10.3x↘ 40: 9.4 ↑	
		Serie 94.3	
		Total 378.6	

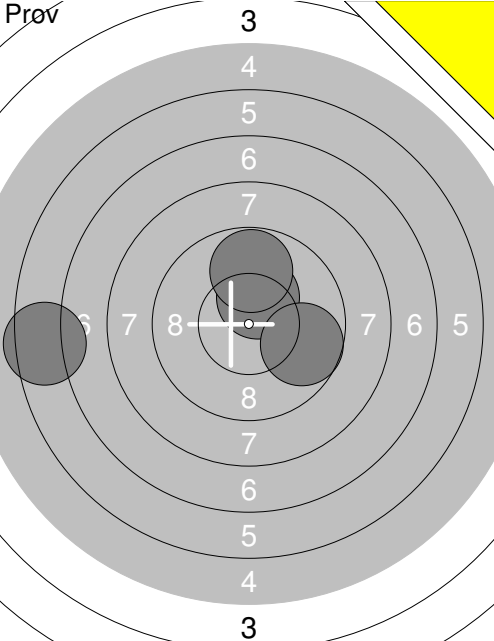
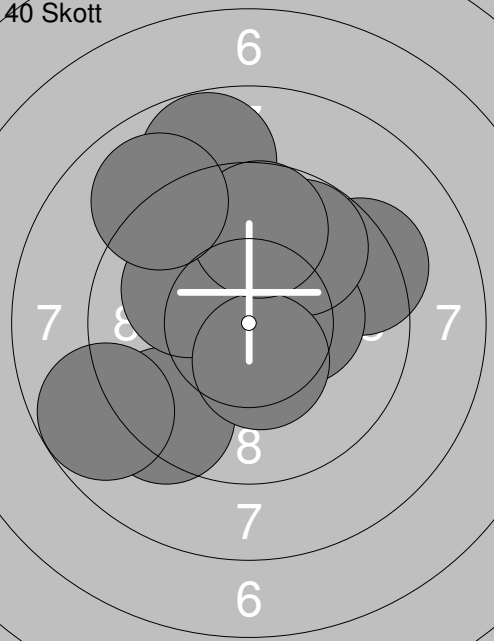
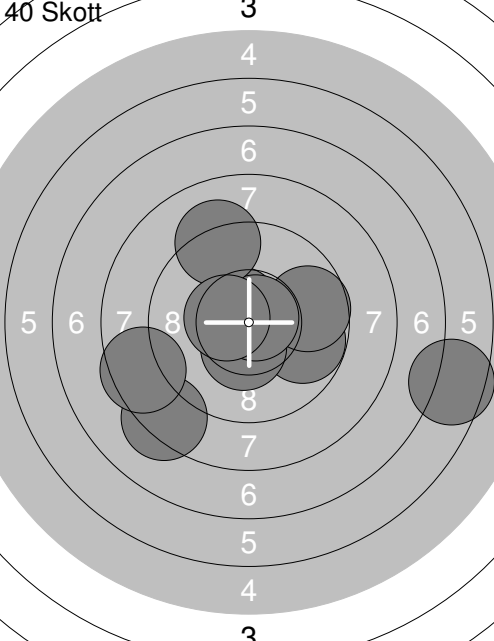
Skjutlag 1	Tavla 35	Alex Hansson	
S		Vännäs	
11.01.2020		Skyttiaden Distriktsfinal	Umeå skytteallians
Pröv		1: 6.5 ← 2: 10.3x ↗ 3: 9.8 ↑ 4: 9.7 →	1: 9.8 ↑ 2: 9.0 ← 3: 9.9 ↖ 4: 10.6x ↗ 5: 10.6x ↗ 6: 10.2x ↘ 7: 10.1 ↓ 8: 10.2x ↗ 9: 10.1 ← 10: 8.7 ↑
		Serie 36.3	Serie 99.2
		Total 0.0	Total 99.2
40 Skott		11: 9.3 ↗ 12: 9.3 ↘ 13: 10.3x → 14: 9.8 ↗ 15: 8.8 ↑ 16: 10.1 ← 17: 10.4x ↓ 18: 9.7 ↑ 19: 8.8 ← 20: 9.0 ↖	21: 8.4 ← 22: 8.2 ↖ 23: 8.7 ← 24: 7.5 → 25: 9.0 ↘ 26: 9.3 ↗ 27: 7.9 → 28: 10.5x ↘ 29: 9.2 ↖ 30: 9.8 ←
		Serie 95.5	Serie 88.5
		Total 194.7	Total 283.2
40 Skott		31: 9.8 → 32: 8.3 ↘ 33: 8.5 ← 34: 10.6x ↘ 35: 10.4x ↓ 36: 9.7 → 37: 10.8x ↗ 38: 6.5 → 39: 9.2 ↖ 40: 10.5x ↘	
		Serie 94.3	
		Total 377.5	

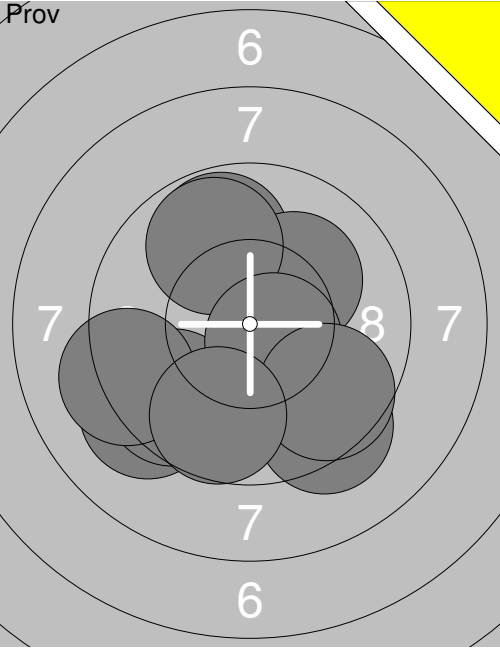
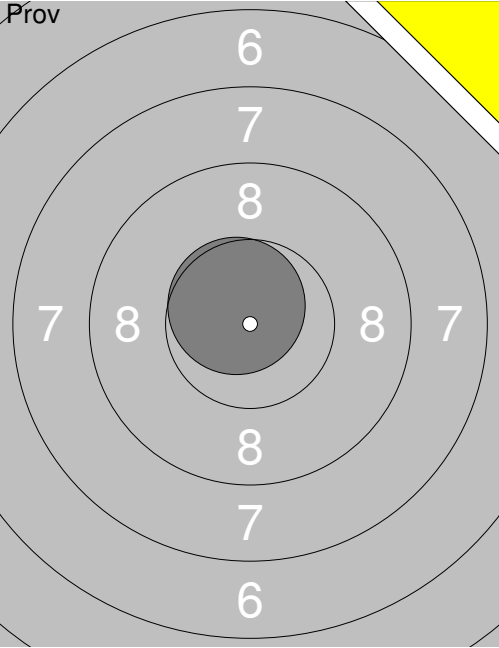
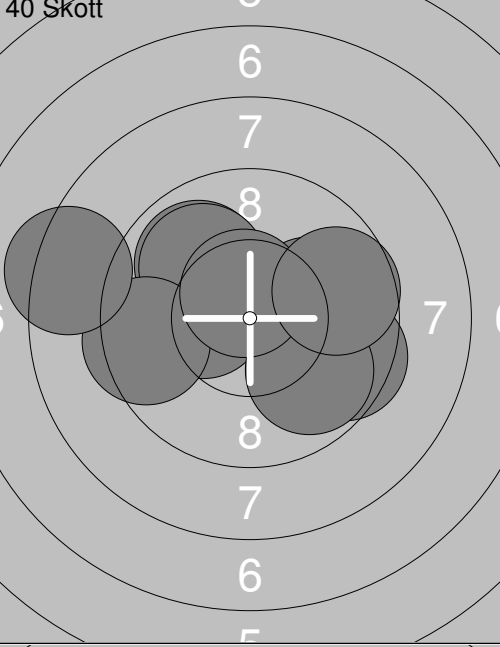
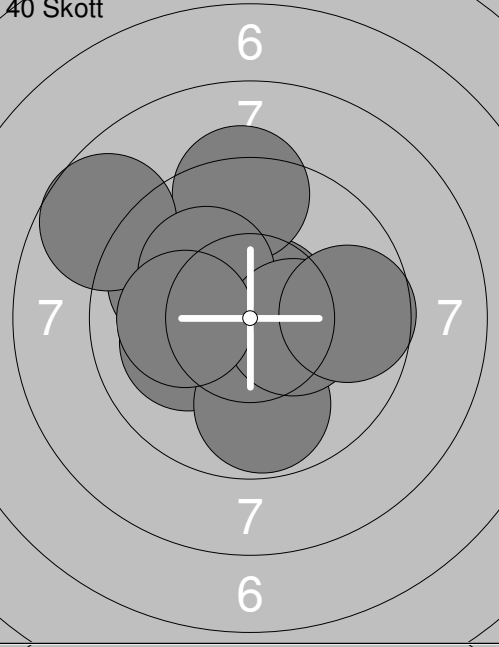
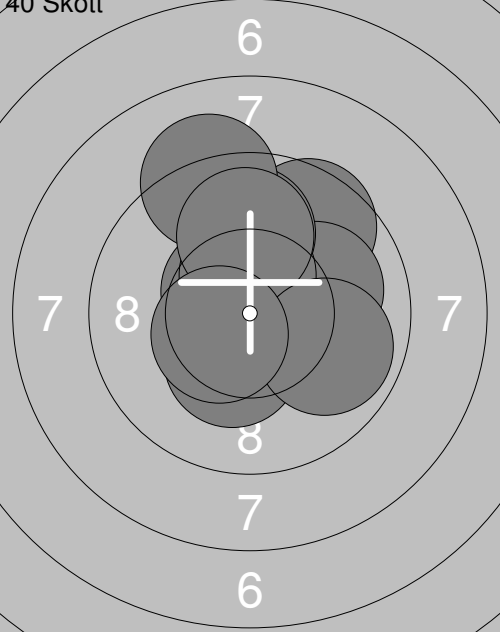
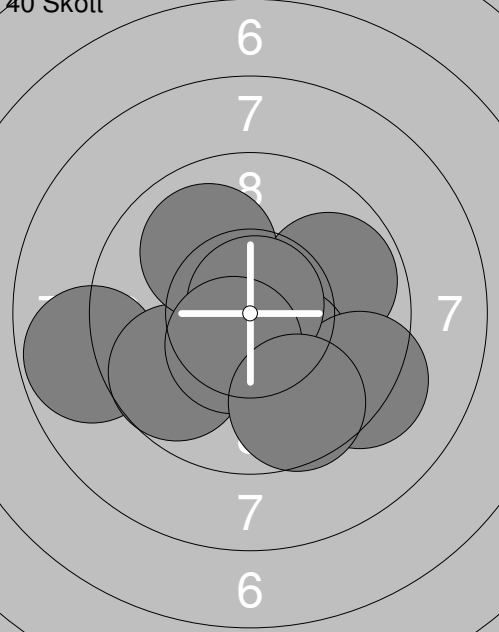
Skjutlag	Tavla	Emma Johansson	
S		Ramselefors	
11.01.2020	Skyttiaden Distriktsfinal	Umeå skytteallians	
Prov		Prov	11: 10.7x
	1: 9.3 ↘ 2: 9.2 ↙ 3: 9.6 ↙ 4: 9.8 ↗ 5: 10.1 ↗ 6: 9.8 ↗ 7: 9.2 ↖ 8: 10.6x ↘ 9: 9.6 ↘ 10: 9.7 ↘		11: 10.7x
	Serie 96.9 Total 0.0		Serie 10.7 Total 0.0
40 Skott		40 Skott	11: 9.9 ↖ 12: 10.1 ↖ 13: 10.7x ↗ 14: 9.8 ↓ 15: 9.3 ↑ 16: 8.7 ↖ 17: 10.1 ↖ 18: 10.4x → 19: 9.7 → 20: 10.1 ↖
	1: 9.5 → 2: 9.9 ↗ 3: 10.3x ← 4: 10.0 ↖ 5: 9.5 ← 6: 10.1 → 7: 9.8 ↘ 8: 10.6x ↗ 9: 9.7 → 10: 8.3 ←		11: 9.9 ↖ 12: 10.1 ↖ 13: 10.7x ↗ 14: 9.8 ↓ 15: 9.3 ↑ 16: 8.7 ↖ 17: 10.1 ↖ 18: 10.4x → 19: 9.7 → 20: 10.1 ↖
	Serie 97.7 Total 97.7		Serie 98.8 Total 196.5
40 Skott		40 Skott	31: 8.8 ↖ 32: 10.7x ← 33: 9.7 ↙ 34: 9.8 → 35: 10.0 ↖ 36: 10.3x ↘ 37: 9.3 ↘ 38: 10.8x ↗ 39: 10.5x ↘ 40: 9.6 ↓
	21: 9.6 ↗ 22: 10.0 → 23: 10.6x ↘ 24: 9.9 ↑ 25: 9.2 ↗ 26: 10.3x ↘ 27: 10.5x ↗ 28: 9.9 ↑ 29: 9.9 → 30: 10.5x ↘		31: 8.8 ↖ 32: 10.7x ← 33: 9.7 ↙ 34: 9.8 → 35: 10.0 ↖ 36: 10.3x ↘ 37: 9.3 ↘ 38: 10.8x ↗ 39: 10.5x ↘ 40: 9.6 ↓
	Serie 100.4 Total 296.9		Serie 99.5 Total 396.4

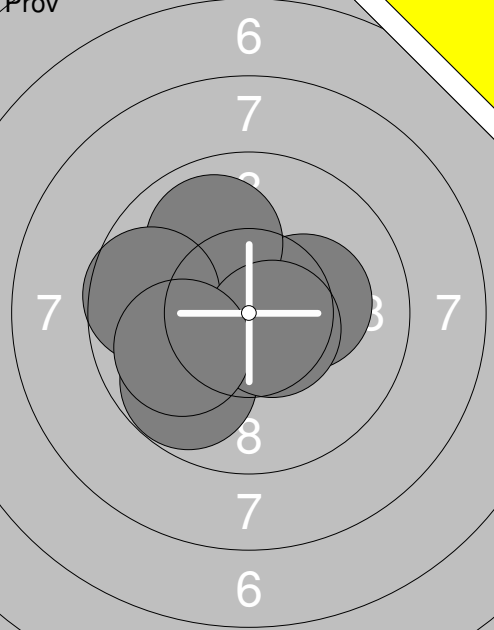
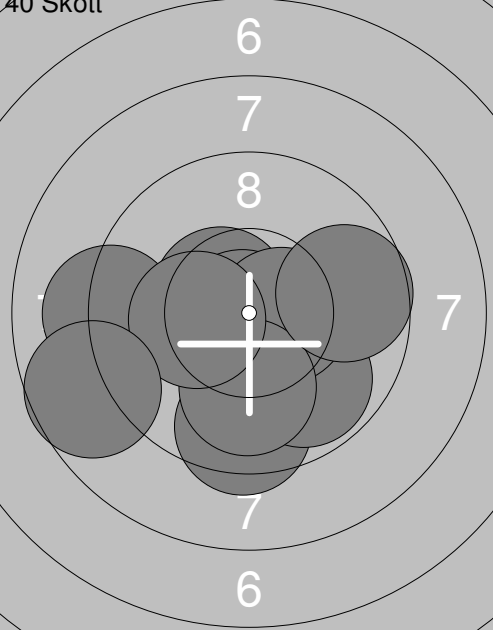
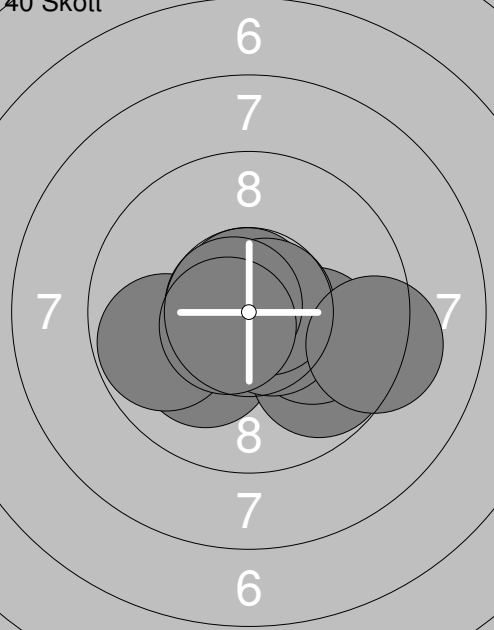
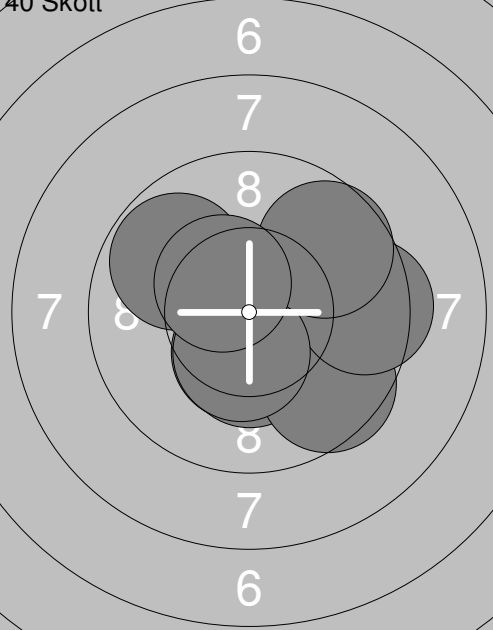
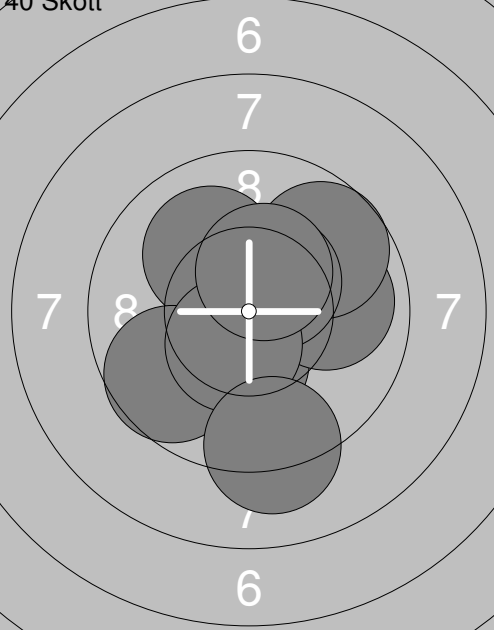
<p>Prov</p>  <p style="text-align: center;">6 7 8 7 6</p>	<p>1: 10.2x➤</p> <p>2: 9.9 ↖</p> <p>3: 9.8 ↙</p> <p>4: 9.7 ←</p> <p>5: 10.6x↘</p> <p>6: 10.0↙</p> <p>Serie 60.2</p> <p>Total 0.0</p>	<p>40 Skott</p>  <p style="text-align: center;">6 7 8 7 6</p> <p>7: 10.5x↖</p> <p>8: 9.1 ←</p> <p>9: 10.8x↙</p> <p>10: 9.5 ↓</p> <p>11: 9.8 ↙</p> <p>12: 10.5x➤</p> <p>13: 10.0 ↓</p> <p>14: 9.7 ➔</p> <p>15: 10.3x↖</p> <p>16: 8.7 ←</p> <p>Serie 98.9</p> <p>Total 98.9</p>
<p>40 Skott</p>  <p style="text-align: center;">6 7 8 7 6</p>	<p>11: 10.1 ↙</p> <p>12: 10.7x↗</p> <p>13: 9.8 ↙</p> <p>14: 10.1 ➔</p> <p>15: 10.6x↘</p> <p>16: 9.8 ←</p> <p>17: 10.7x➤</p> <p>18: 10.7x↖</p> <p>19: 10.6x↙</p> <p>20: 9.3 ➔</p> <p>Serie 102.4</p> <p>Total 201.3</p>	<p>40 Skott</p>  <p style="text-align: center;">6 7 8 7 6</p> <p>21: 10.4x↙</p> <p>22: 10.6x➤</p> <p>23: 10.3x↙</p> <p>24: 10.4x↘</p> <p>25: 9.6 ↙</p> <p>26: 9.4 ➔</p> <p>27: 10.4x↙</p> <p>28: 9.7 ↗</p> <p>29: 9.8 ↖</p> <p>30: 10.4x↖</p> <p>Serie 101.0</p> <p>Total 302.3</p>
<p>40 Skott</p>  <p style="text-align: center;">6 7 8 7 6</p>	<p>31: 10.3x↙</p> <p>32: 10.1 ↙</p> <p>33: 9.9 ➔</p> <p>34: 10.1 ↖</p> <p>35: 9.7 ↗</p> <p>36: 9.7 ↙</p> <p>37: 10.5x↗</p> <p>38: 10.5x↙</p> <p>39: 10.4x↗</p> <p>40: 9.2 ↓</p> <p>Serie 100.4</p> <p>Total 402.7</p>	

	1: 10.4x		11: 8.9
	2: 9.0		12: 8.6
	3: 10.8x		13: 9.6
	4: 9.3		
	5: 9.6		
	6: 10.0		
	7: 9.7		
	8: 10.4x		
	9: 10.9x		
	10: 9.5		
Serie 99.6		Serie 27.1	
Total 0.0		Total 0.0	

	1: 10.3x		11: 9.1
	2: 10.1		12: 9.0
	3: 9.8		13: 10.0
	4: 9.6		14: 10.4x
	5: 9.2		15: 8.3
	6: 8.7		16: 9.9
	7: 10.0		17: 10.1
	8: 10.4x		18: 8.6
	9: 10.0		19: 10.2x
	10: 8.8		20: 10.4x
Serie 96.9		Serie 96.0	
Total 96.9		Total 192.9	

	21: 9.8		31: 10.6x
	22: 9.5		32: 9.5
	23: 9.2		33: 8.7
	24: 9.8		34: 7.2
	25: 9.9		35: 10.1
	26: 10.3x		36: 10.0
	27: 10.2x		37: 10.6x
	28: 10.0		38: 10.3x
	29: 9.5		39: 9.6
	30: 8.9		40: 9.9
Serie 97.1		Serie 96.5	
Total 290.0		Total 386.5	

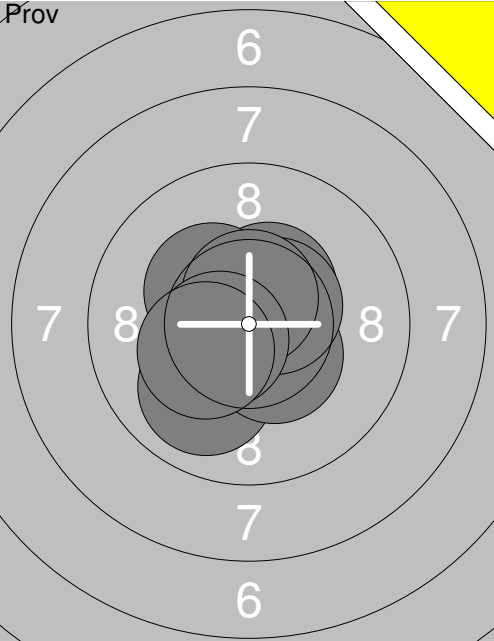
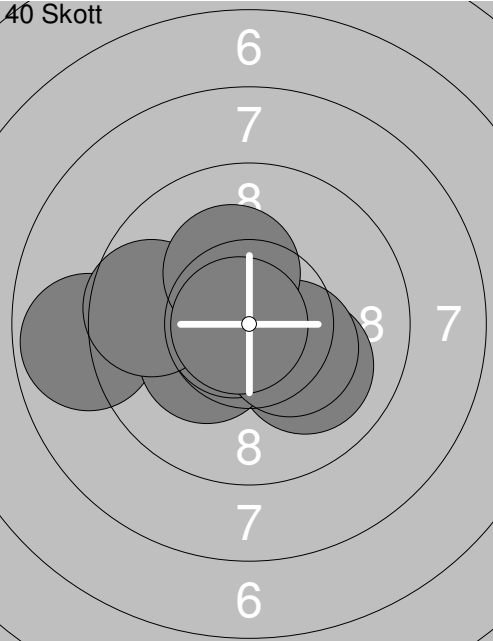
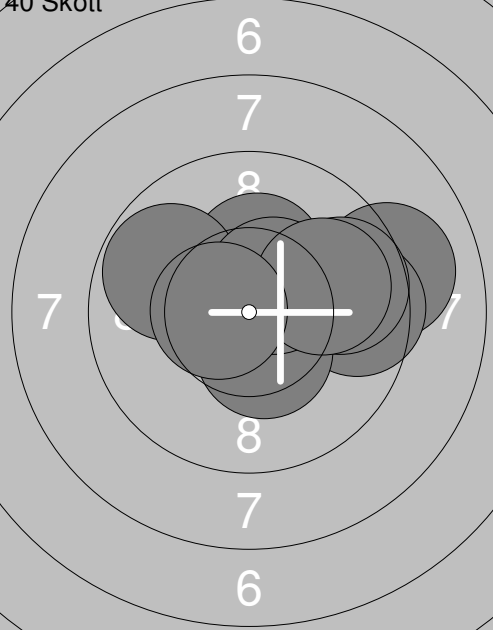
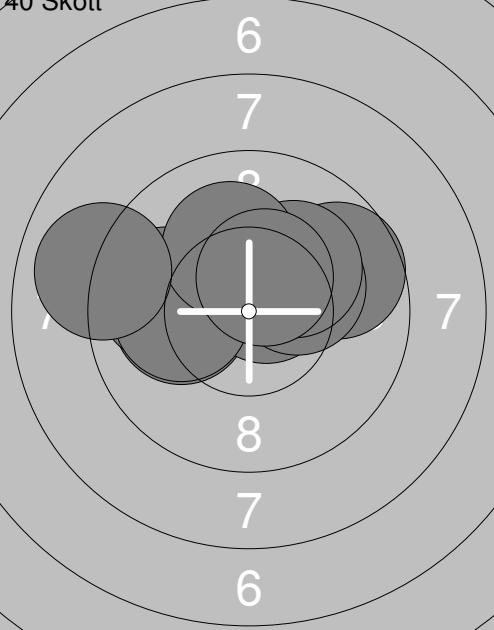
Skjutlag 2	Tavla 15	Hanna Lundin	
S		Umeå	
11.01.2020		Skyttiäden Distriktsfinal	Umeå skytteallians
Prov		1: 10.0 ↘ 2: 10.4x↘ 3: 10.4x↗ 4: 10.5x↗ 5: 10.3x↘ 6: 10.6x↗ 7: 10.5x↘ 8: 10.3x↘	40 Skott 
		Serie 83.0 Total 0.0	1: 10.0 ↘ 2: 10.9x↘ 3: 8.8 ← 4: 10.6x↘ 5: 10.3x↘ 6: 10.7x↘ 7: 10.3x↘ 8: 9.7 ← 9: 10.2x↗ 10: 10.8x↘
		Serie 102.3 Total 102.3	
40 Skott		11: 10.2x↘ 12: 10.5x↗ 13: 10.9x↘ 14: 10.0 → 15: 10.2x↘ 16: 10.6x→ 17: 9.9 ↖ 18: 10.2x← 19: 10.6x↗ 20: 10.4x↗	40 Skott 
		Serie 103.5 Total 205.8	21: 9.1 → 22: 9.5 → 23: 10.3x↗ 24: 10.7x↘ 25: 10.4x↘ 26: 9.7 → 27: 9.8 ↖ 28: 10.5x↗ 29: 9.9 → 30: 10.5x←
		Serie 100.4 Total 306.2	
40 Skott		31: 10.1← 32: 10.6x↗ 33: 9.7 → 34: 10.2x↗ 35: 10.1 ↗ 36: 9.9 ← 37: 10.1← 38: 10.1 ↗ 39: 10.5x↗ 40: 9.0 ←	
		Serie 100.3 Total 406.5	

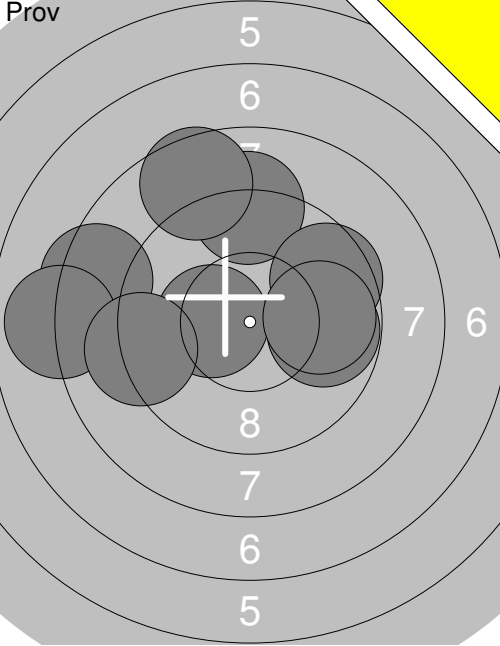
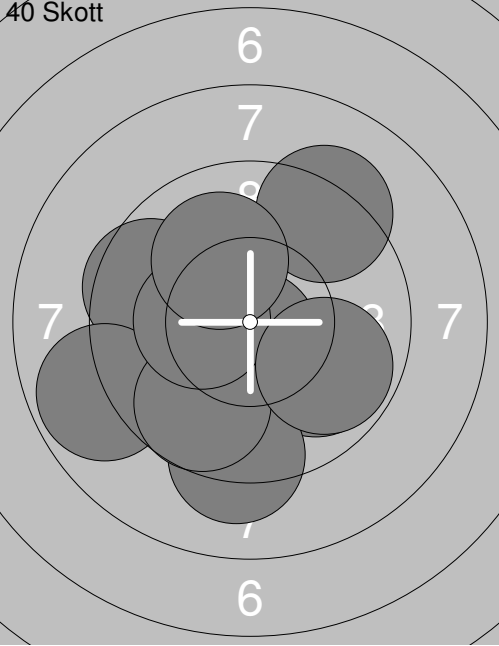
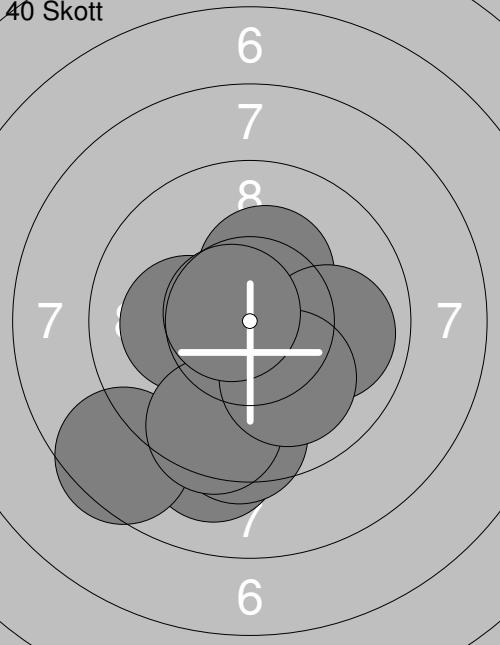
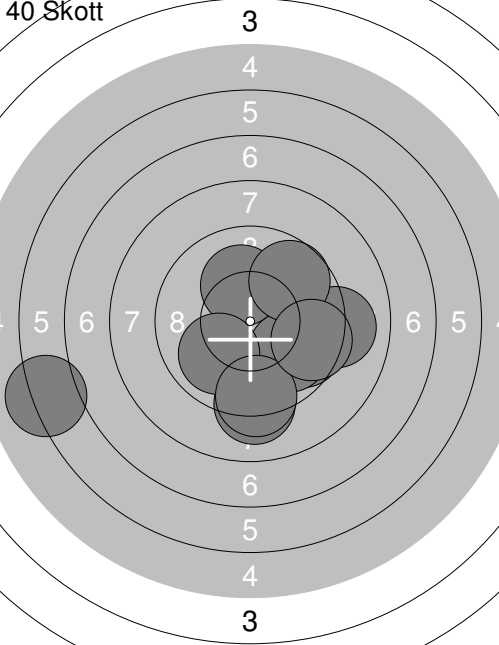
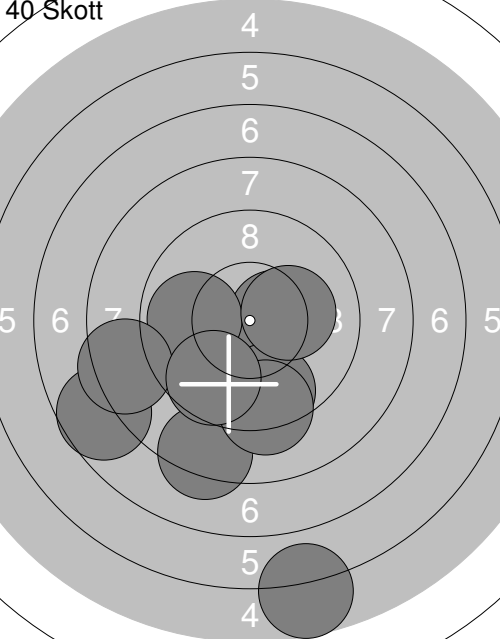
Skjutlag	Tavla	Ebba Lundstedt	
S	Ramselefors		
11.01.2020	Skyttiaden Distriktsfinal	Umeå skytteallians	
Prov		1: 9.1 ↑ 2: 8.4 ← 3: 10.3x ← 4: 8.0 ← 5: 9.2 ← 6: 9.6 ↗ 7: 9.8 → 8: 8.6 ↑ 9: 9.8 →	40 Skott  1: 9.9 ↘ 2: 9.2 ↓ 3: 9.6 ← 4: 8.8 ← 5: 10.7x ↓ 6: 9.7 ↓ 7: 10.3x ← 8: 9.2 ↗ 9: 9.8 ↘ 10: 10.1 ↖
	Serie 82.8	Serie 97.3	
	Total 0.0	Total 97.3	
40 Skott		11: 9.2 ↓ 12: 8.5 ↙ 13: 10.2x ↓ 14: 9.5 ↓ 15: 10.3x ↗ 16: 10.2x ← 17: 9.9 → 18: 9.5 ↓ 19: 10.1 ↓ 20: 10.7x ←	40 Skott  21: 9.7 ↘ 22: 9.9 ↘ 23: 10.1 ↑ 24: 9.1 ↓ 25: 10.0 ↙ 26: 9.3 ↓ 27: 6.2 ← 28: 9.1 → 29: 9.7 ↗ 30: 9.5 ↘
	Serie 98.1	Serie 92.6	
	Total 195.4	Total 288.0	
40 Skott		31: 8.3 ↓ 32: 10.4x → 33: 5.7 ↓ 34: 7.7 ← 35: 9.6 ↓ 36: 9.9 ← 37: 8.4 ← 38: 9.3 ↓ 39: 9.7 ↓ 40: 10.2x →	
	Serie 89.2		
	Total 377.2		

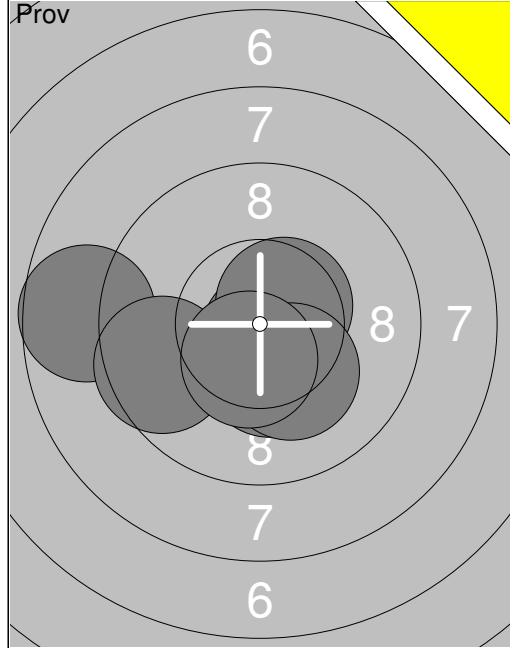

1:	10.3x↓
2:	10.8x↓
3:	10.6x↗
4:	8.7 ←
5:	9.6 ←
6:	10.2x↓
7:	10.5x↓
Serie 70.7	
Total 0.0	

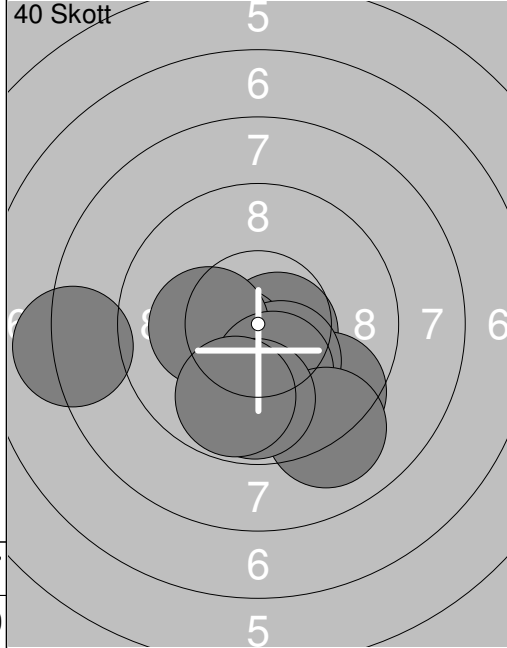

1:	10.6x⇒
2:	8.2 ←
3:	9.5 ↓
4:	10.4x↘
5:	10.3x↓
6:	10.2x←
7:	10.2x↓
8:	9.1 ↓
9:	9.8 ↓
10:	9.8 ↓
Serie 98.1	
Total 98.1	

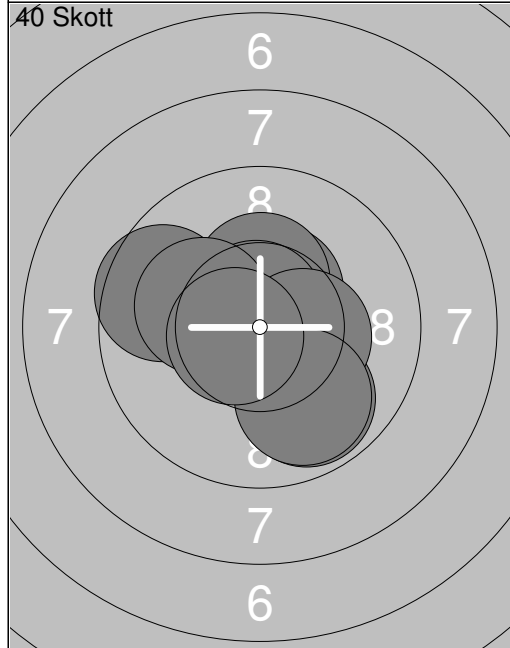

11:	9.8 ↓
12:	10.4x↘
13:	10.5x↗
14:	10.3x↗
15:	9.6 ←
16:	10.7x↗
17:	10.4x⇒
18:	9.9 ↓
19:	10.2x↘
20:	10.6x↘
Serie 102.4	
Total 200.5	

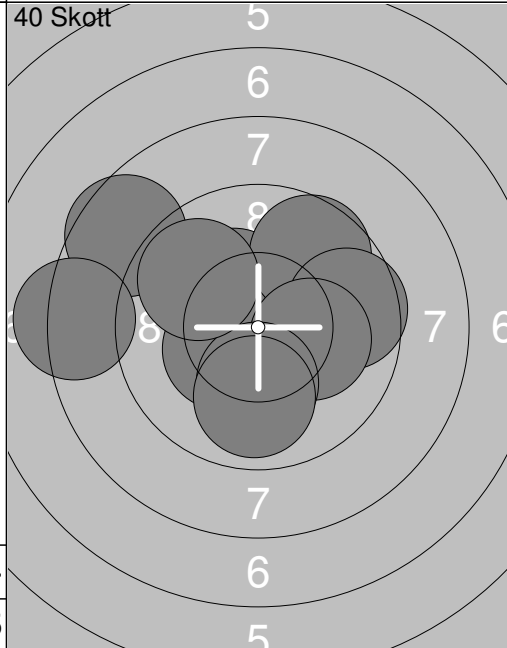

21:	8.6 ↖
22:	10.3x↘
23:	10.3x↘
24:	9.7 ↗
25:	9.6 →
26:	8.2 ←
27:	10.2x⇒
28:	10.1 ↓
29:	9.8 ↖
30:	9.9 ↓
Serie 96.7	
Total 297.2	

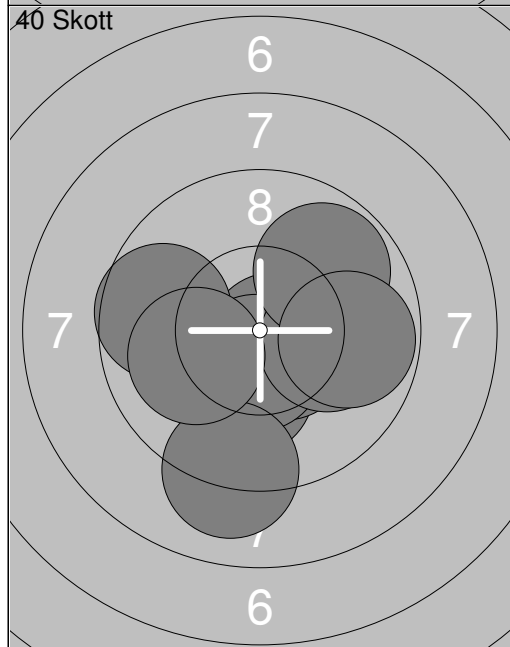

31:	10.2x↓
32:	10.5x↘
33:	10.7x↘
34:	10.5x↓
35:	10.1 →
36:	9.7 ←
37:	9.1 ↓
38:	10.1←
39:	9.8 ↗
40:	9.8 →
Serie 100.5	
Total 397.7	

Prov 	Prov
1: 8.1 ← 2: 8.7 ↖ 3: 8.9 ↑ 4: 9.4 ← 5: 10.5x ↗ 6: 8.5 ↓ 7: 8.4 → 8: 7.8 ← 9: 9.7 ↗ 10: 9.9 ↑ Serie 89.9 Total 0.0	11: 8.5 → 12: 10.1 ↑ 13: 10.8x → 14: 7.9 → 15: 10.4x ↖ 16: 9.8 ↘ 17: 8.8 ↗ 18: 8.5 → 19: 8.3 → 20: 10.4x ↗ Serie 93.5 Total 0.0

40 Skott 	40 Skott
1: 9.5 ↓ 2: 8.9 → 3: 6.9 ↑ 4: 6.1 → 5: 10.6x → 6: 7.0 → 7: 7.4 → 8: 10.3x ↗ 9: 9.3 ← 10: 10.2x ↗ Serie 86.2 Total 86.2	11: 10.6x ↘ 12: 9.4 → 13: 9.7 ← 14: 8.2 → 15: 9.4 → 16: 10.3x ↗ 17: 8.5 ↑ 18: 6.2 ↑ 19: 10.5x → 20: 10.1 ↓ Serie 92.9 Total 179.1

40 Skott 	40 Skott
21: 8.6 → 22: 9.5 → 23: 8.8 ↑ 24: 7.9 → 25: 9.9 → 26: 9.0 → 27: 10.7x ↗ 28: 9.6 → 29: 9.4 → 30: 9.7 ↗ Serie 93.1 Total 272.2	31: 10.3x → 32: 8.4 ← 33: 9.0 ← 34: 10.4x ↖ 35: 9.8 → 36: 10.0 ← 37: 7.1 ← 38: 9.8 → 39: 9.2 ↗ 40: 9.3 ← Serie 93.3 Total 365.5

	1: 8.7 ← 2: 10.1 ← 3: 9.8 ↖ 4: 8.9 ↗ 5: 7.3 → 6: 9.2 → 7: 10.7x ↘ 8: 9.1 → 9: 9.5 ← 10: 10.0 ← Serie 93.3 Total 0.0		11: 8.1 → Serie 8.1 Total 0.0
--	--	--	-------------------------------------

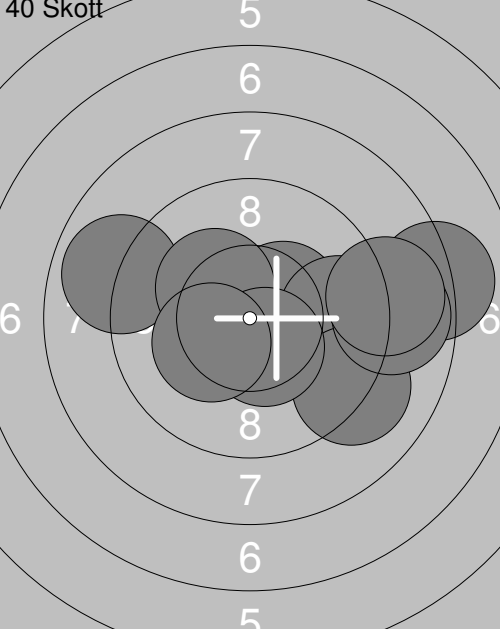
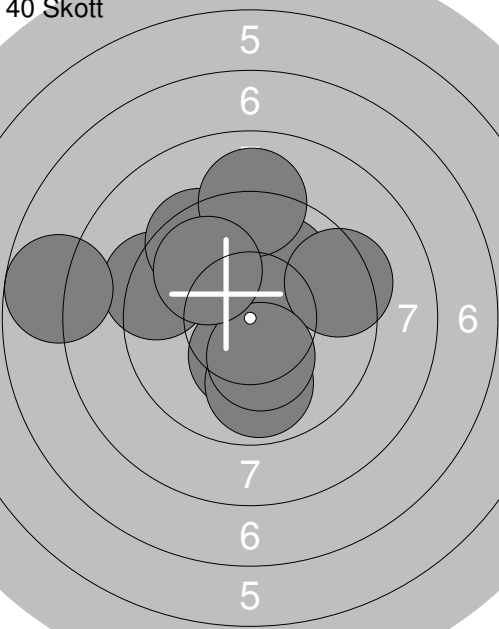
	1: 8.1 → 2: 10.4x ↗ 3: 9.6 → 4: 9.1 ↘ 5: 8.9 ← 6: 8.8 → 7: 8.9 → 8: 10.3x ↘ 9: 10.5x ↘ 10: 10.3x ↘ Serie 94.9 Total 94.9		11: 10.3x ↘ 12: 9.9 ↓ 13: 10.0 ↗ 14: 9.4 ↗ 15: 9.3 ← 16: 9.4 ↖ 17: 10.3x ↘ 18: 7.8 ← 19: 9.0 ↑ 20: 9.9 ↖ Serie 95.3 Total 190.2
---	---	---	--

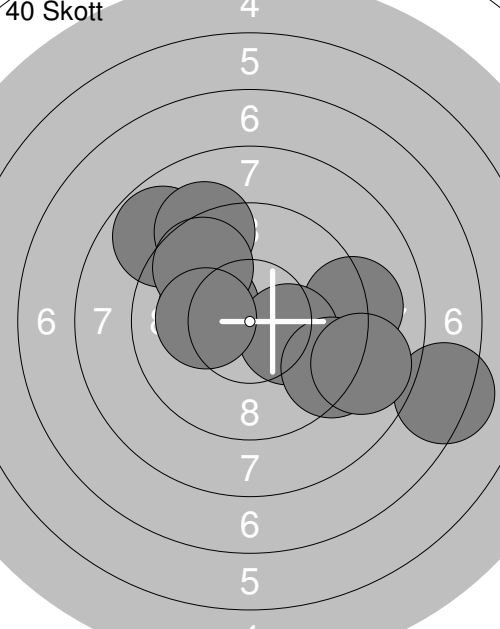
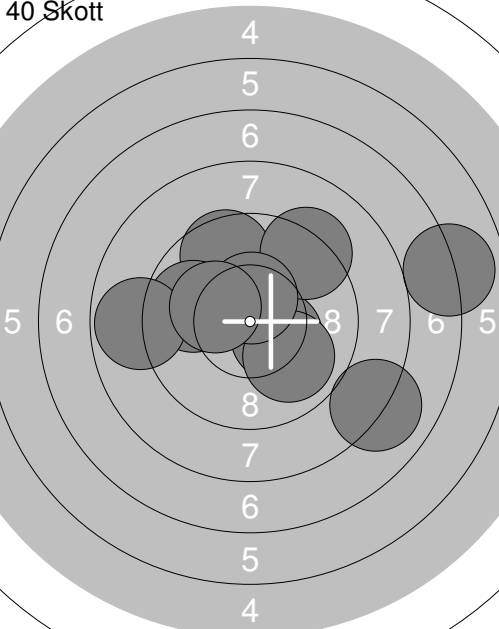
	21: 7.3 → 22: 8.8 ↖ 23: 9.2 ↗ 24: 10.2x ↘ 25: 9.1 → 26: 9.7 ↗ 27: 10.2x ↘ 28: 9.3 ↘ 29: 8.8 → 30: 10.2x ← Serie 92.8 Total 283.0		31: 10.4x ↘ 32: 9.9 ↘ 33: 9.6 ↑ 34: 9.2 ↗ 35: 9.8 ← 36: 10.5x ↗ 37: 7.0 → 38: 8.8 ← 39: 10.2x ↘ 40: 8.0 ↘ Serie 93.4 Total 376.4
--	---	--	---

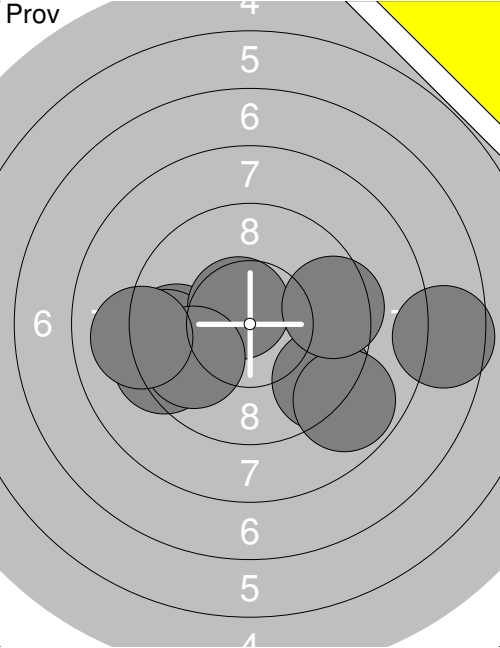
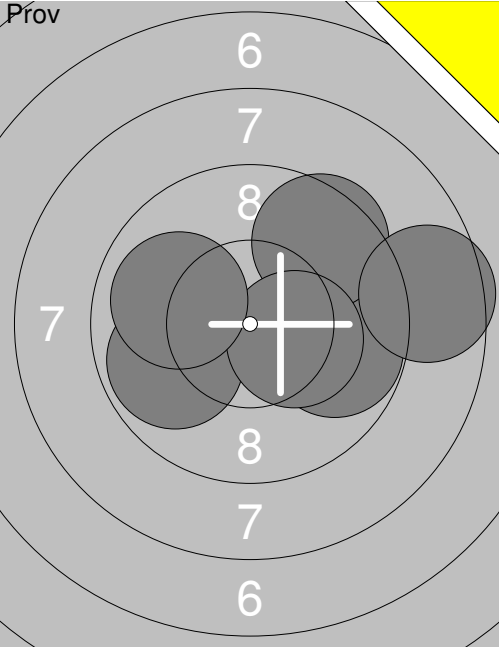
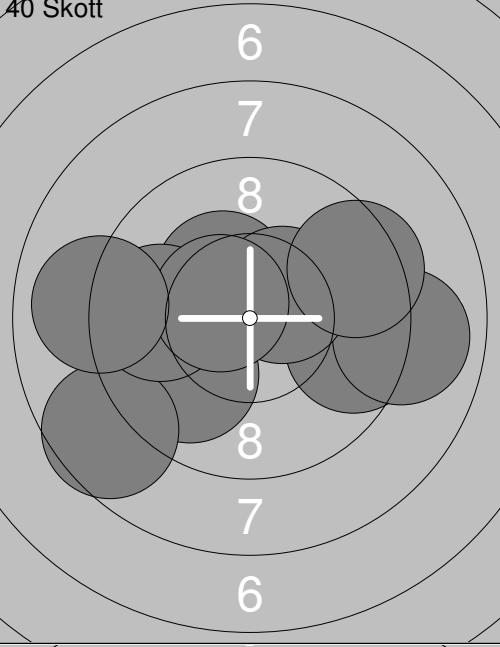
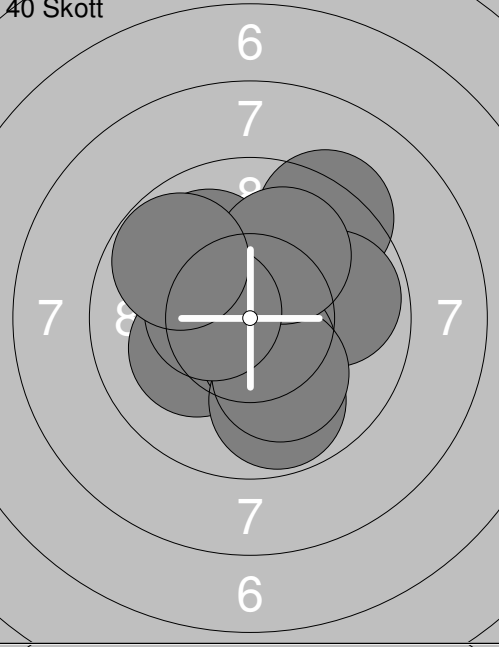
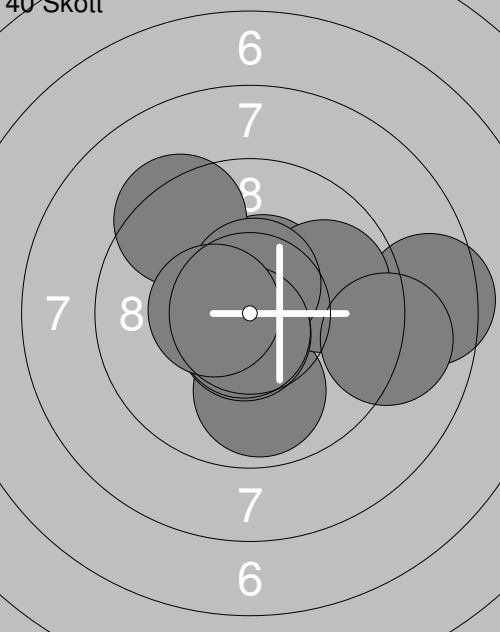
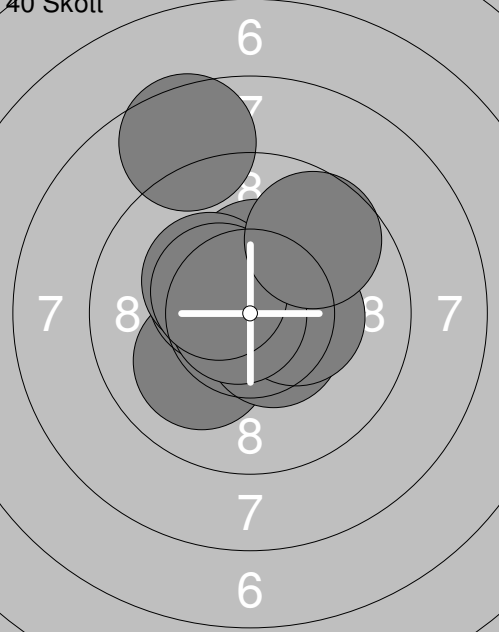
Skjutlag	Tavla	Hanna Johansson	
S	Vännäs		
11.01.2020	Skyttiaden Distriktsfinal	Umeå skytteallians	
Prov		Prov	
	1: 9.7 ←		11: 9.8 →
	2: 9.3 ↘		12: 9.9 ←
	3: 9.5 ←		13: 9.5 ↗
	4: 9.3 ←		14: 10.3x↘
	5: 10.6x↘		15: 8.6 →
	6: 9.8 ←		16: 10.0 ←
	7: 8.8 ↘		
	8: 7.6 →		
	9: 9.5 →		
	10: 9.1 ←		
	Serie 93.2		Serie 58.1
	Total 0.0		Total 0.0
40 Skott		40 Skott	
	1: 9.9 ←		11: 9.3 ↗
	2: 9.6 →		12: 9.8 →
	3: 9.0 →		13: 10.2x↘
	4: 8.6 ←		14: 10.5x↘
	5: 10.3x↘		15: 9.8 ↓
	6: 10.4x↗		16: 10.1 ↓
	7: 9.4 ↗		17: 10.0 ↗
	8: 9.8 ←		18: 10.0 ↗
	9: 10.5x↘		19: 10.5x↘
	10: 9.0 ←		20: 9.8 ↗
	Serie 96.5		Serie 100.0
	Total 96.5		Total 196.5
40 Skott		40 Skott	
	21: 10.5x↗		31: 10.1 ↘
	22: 8.5 →		32: 10.5x↘
	23: 9.9 ↓		33: 10.4x↗
	24: 9.9 →		34: 8.6 ↗
	25: 9.4 ↗		35: 10.5x↘
	26: 10.6x↗		36: 10.3x↘
	27: 9.1 →		37: 10.3x↘
	28: 10.7x↓		38: 10.8x↘
	29: 10.7x↓		39: 10.5x↘
	30: 10.5x↘		40: 9.7 ↗
	Serie 99.8		Serie 101.7
	Total 296.3		Total 398.0

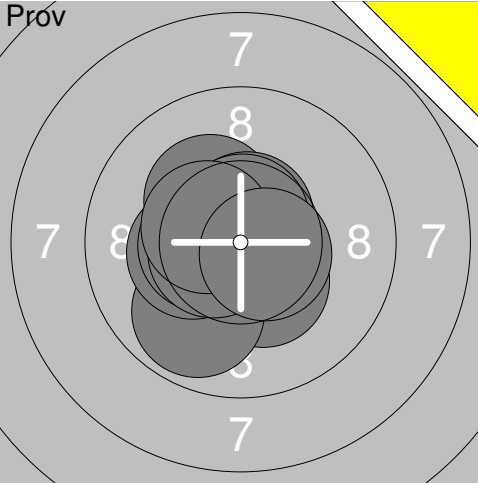
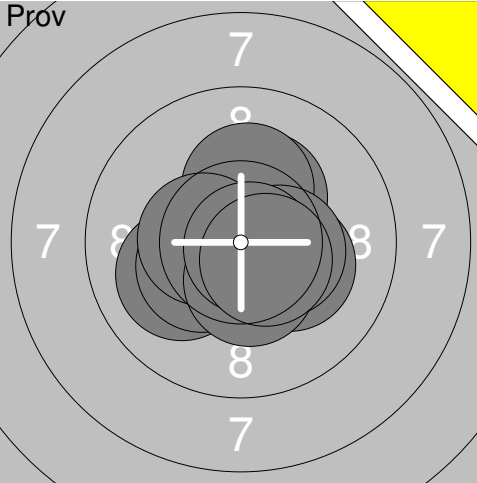
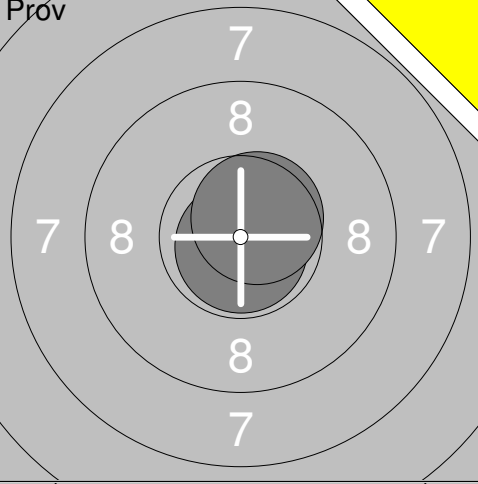
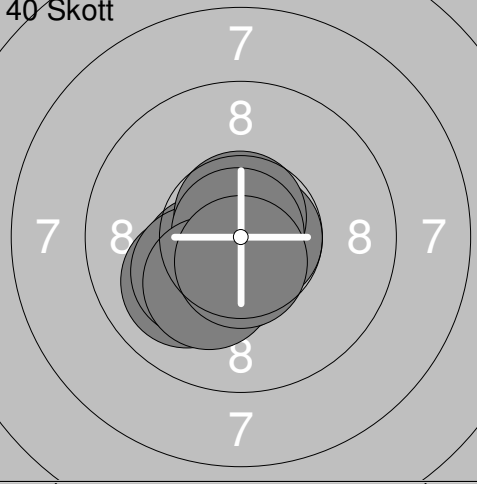
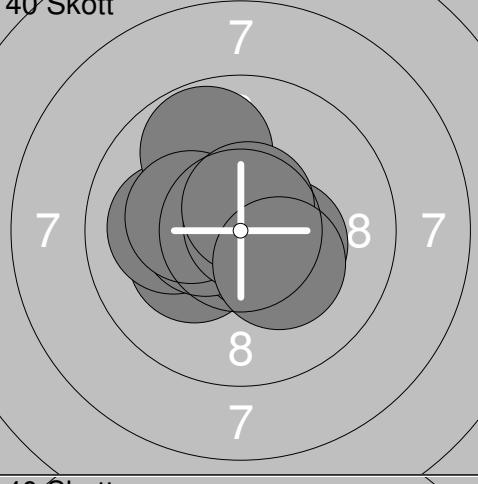
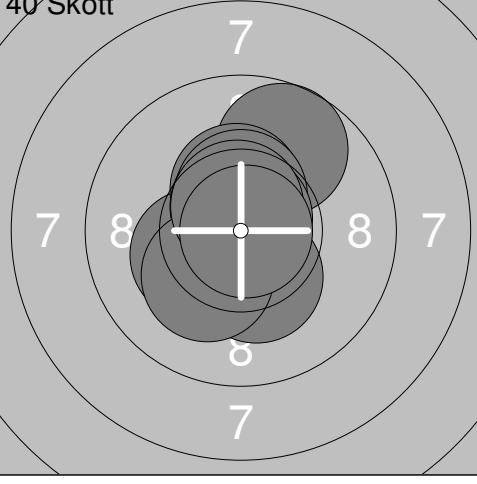
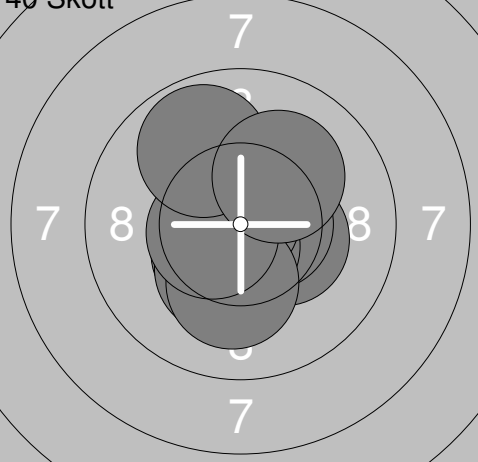
Skjutlag	Tavla	Rasmus Alfredsson	
2	21		
S	Umeå		
11.01.2020	Skyttiaden Distriktsfinal	Umeå skytteallians	
Prov		1: 10.3x ↗ 2: 10.6x ↑ 3: 10.4x ↓ 4: 10.6x ↑ 5: 9.9 ↓ 6: 10.3x ← 7: 10.5x ← 8: 10.6x ← 9: 10.5x ↖ 10: 10.6x ↘ Serie 104.3 Total 0.0	Prov  11: 10.3x ↗ 12: 10.2x ↑ 13: 10.1 ← 14: 10.3x ← 15: 10.4x ← 16: 10.2x → 17: 10.4x → 18: 10.4x ↓ 19: 10.8x ↘ 20: 10.5x ↘ Serie 103.6 Total 0.0
Prov		21: 10.8x ↓ 22: 10.6x ↗ Serie 21.4 Total 0.0	40 Skott  1: 10.5x ↓ 2: 10.7x → 3: 10.4x ← 4: 10.0 ← 5: 10.9x ← 6: 10.2x ← 7: 10.7x ↑ 8: 10.9x ↗ 9: 10.2x ↓ 10: 10.6x ↓ Serie 105.1 Total 105.1
40 Skott		11: 10.2x ← 12: 10.6x ↘ 13: 10.0 ← 14: 10.5x ← 15: 9.8 ↗ 16: 10.4x → 17: 10.3x ↖ 18: 10.8x → 19: 10.6x ↑ 20: 10.3x ↘ Serie 103.5 Total 208.6	40 Skott  21: 10.3x ↓ 22: 10.3x ← 23: 9.7 ↗ 24: 10.4x ↑ 25: 10.6x ↑ 26: 10.5x ↑ 27: 10.2x ↓ 28: 10.8x ↗ 29: 10.6x ↑ 30: 10.9x → Serie 104.3 Total 312.9
40 Skott		31: 10.5x ↓ 32: 10.3x → 33: 10.6x → 34: 10.3x ↓ 35: 10.6x ↓ 36: 10.8x ↗ 37: 10.2x ↓ 38: 10.6x ← 39: 9.8 ↗ 40: 10.1 ↗ Serie 103.8 Total 416.7	

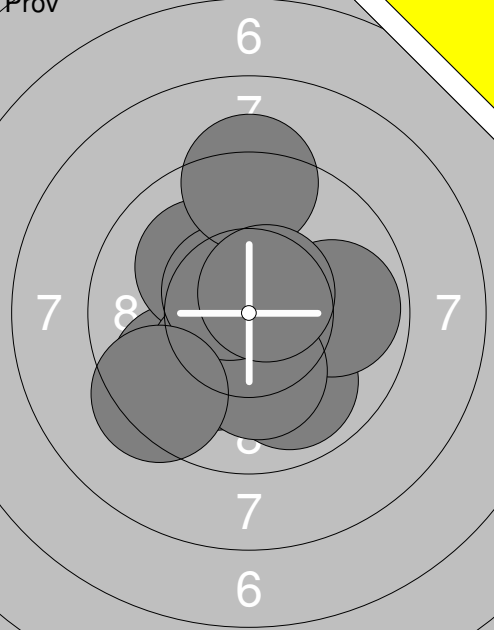
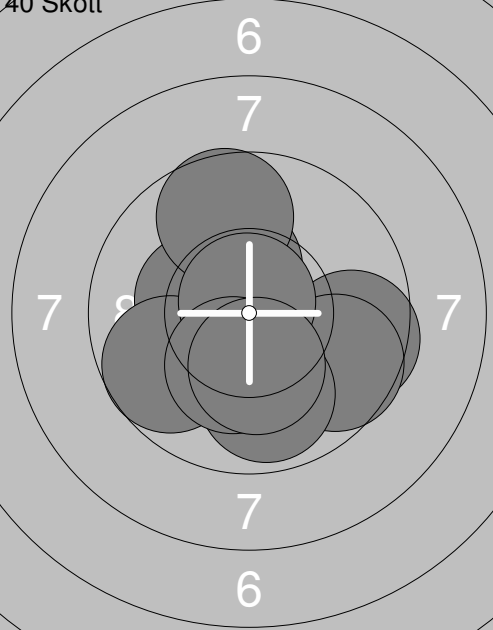
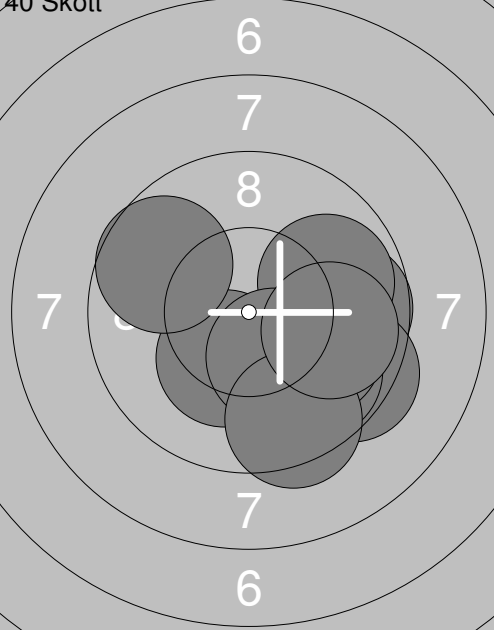
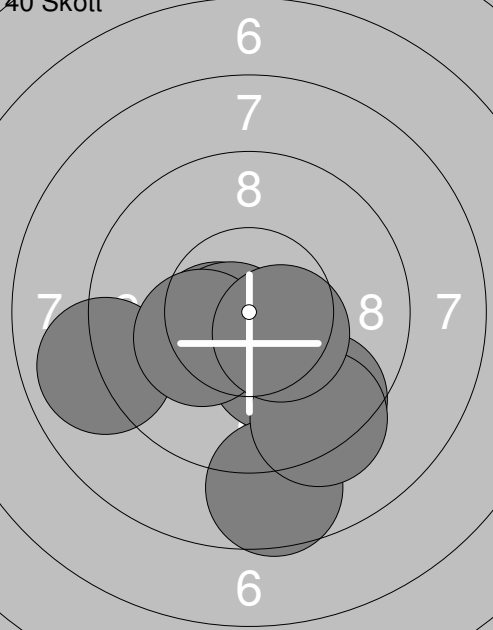
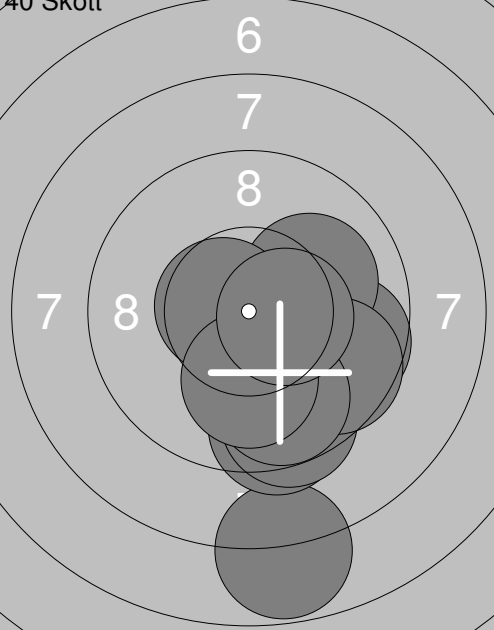
<p>Prov</p>  <p style="text-align: center;">6 7 7 8 7 7 6</p>	<p>40 Skott</p>  <p style="text-align: center;">6 7 7 8 7 7 6</p>	<table style="width:100%; border-collapse: collapse;"> <tr><td>1:</td><td>9.9</td><td>↘</td></tr> <tr><td>2:</td><td>9.9</td><td>→</td></tr> <tr><td>3:</td><td>9.8</td><td>↙</td></tr> <tr><td>4:</td><td>10.1</td><td>↖</td></tr> <tr><td>5:</td><td>10.2</td><td>↘</td></tr> <tr><td>6:</td><td>10.2</td><td>↘</td></tr> <tr><td>7:</td><td>10.6</td><td>↖</td></tr> <tr><td>8:</td><td>9.3</td><td>↑</td></tr> <tr><td>9:</td><td>9.4</td><td>↙</td></tr> <tr><td>10:</td><td>10.6</td><td>↗</td></tr> <tr><td colspan="2">Serie</td><td>100.0</td></tr> <tr><td colspan="2">Total</td><td>0.0</td></tr> </table>	1:	9.9	↘	2:	9.9	→	3:	9.8	↙	4:	10.1	↖	5:	10.2	↘	6:	10.2	↘	7:	10.6	↖	8:	9.3	↑	9:	9.4	↙	10:	10.6	↗	Serie		100.0	Total		0.0																																				
1:	9.9	↘																																																																								
2:	9.9	→																																																																								
3:	9.8	↙																																																																								
4:	10.1	↖																																																																								
5:	10.2	↘																																																																								
6:	10.2	↘																																																																								
7:	10.6	↖																																																																								
8:	9.3	↑																																																																								
9:	9.4	↙																																																																								
10:	10.6	↗																																																																								
Serie		100.0																																																																								
Total		0.0																																																																								
<p>40 Skott</p>  <p style="text-align: center;">6 7 8 7 6</p>	<p>40 Skott</p>  <p style="text-align: center;">6 7 8 7 6</p>	<table style="width:100%; border-collapse: collapse;"> <tr><td>11:</td><td>10.3</td><td>↘</td></tr> <tr><td>12:</td><td>9.7</td><td>→</td></tr> <tr><td>13:</td><td>9.7</td><td>↖</td></tr> <tr><td>14:</td><td>9.9</td><td>→</td></tr> <tr><td>15:</td><td>9.4</td><td>↘</td></tr> <tr><td>16:</td><td>9.8</td><td>↘</td></tr> <tr><td>17:</td><td>10.0</td><td>↘</td></tr> <tr><td>18:</td><td>10.3</td><td>↘</td></tr> <tr><td>19:</td><td>9.4</td><td>↘</td></tr> <tr><td>20:</td><td>9.9</td><td>→</td></tr> <tr><td colspan="2">Serie</td><td>98.4</td></tr> <tr><td colspan="2">Total</td><td>198.9</td></tr> </table>	11:	10.3	↘	12:	9.7	→	13:	9.7	↖	14:	9.9	→	15:	9.4	↘	16:	9.8	↘	17:	10.0	↘	18:	10.3	↘	19:	9.4	↘	20:	9.9	→	Serie		98.4	Total		198.9																																				
11:	10.3	↘																																																																								
12:	9.7	→																																																																								
13:	9.7	↖																																																																								
14:	9.9	→																																																																								
15:	9.4	↘																																																																								
16:	9.8	↘																																																																								
17:	10.0	↘																																																																								
18:	10.3	↘																																																																								
19:	9.4	↘																																																																								
20:	9.9	→																																																																								
Serie		98.4																																																																								
Total		198.9																																																																								
<p>40 Skott</p>  <p style="text-align: center;">6 7 8 7 6</p>	<table style="width:100%; border-collapse: collapse;"> <tr><td>21:</td><td>10.5</td><td>↘</td></tr> <tr><td>22:</td><td>9.5</td><td>↘</td></tr> <tr><td>23:</td><td>10.5</td><td>↘</td></tr> <tr><td>24:</td><td>8.9</td><td>←</td></tr> <tr><td>25:</td><td>10.6</td><td>↘</td></tr> <tr><td>26:</td><td>10.2</td><td>↘</td></tr> <tr><td>27:</td><td>8.6</td><td>↓</td></tr> <tr><td>28:</td><td>10.3</td><td>↘</td></tr> <tr><td>29:</td><td>9.3</td><td>↘</td></tr> <tr><td>30:</td><td>10.5</td><td>↘</td></tr> <tr><td colspan="2">Serie</td><td>98.9</td></tr> <tr><td colspan="2">Total</td><td>297.8</td></tr> </table>	21:	10.5	↘	22:	9.5	↘	23:	10.5	↘	24:	8.9	←	25:	10.6	↘	26:	10.2	↘	27:	8.6	↓	28:	10.3	↘	29:	9.3	↘	30:	10.5	↘	Serie		98.9	Total		297.8	<table style="width:100%; border-collapse: collapse;"> <tr><td>31:</td><td>7.8</td><td>↓</td></tr> <tr><td>32:</td><td>9.4</td><td>↓</td></tr> <tr><td>33:</td><td>9.5</td><td>↓</td></tr> <tr><td>34:</td><td>9.7</td><td>→</td></tr> <tr><td>35:</td><td>10.1</td><td>↗</td></tr> <tr><td>36:</td><td>9.6</td><td>↘</td></tr> <tr><td>37:</td><td>10.6</td><td>↖</td></tr> <tr><td>38:</td><td>9.8</td><td>↓</td></tr> <tr><td>39:</td><td>10.1</td><td>↓</td></tr> <tr><td>40:</td><td>10.5</td><td>→</td></tr> <tr><td colspan="2">Serie</td><td>97.1</td></tr> <tr><td colspan="2">Total</td><td>394.9</td></tr> </table>	31:	7.8	↓	32:	9.4	↓	33:	9.5	↓	34:	9.7	→	35:	10.1	↗	36:	9.6	↘	37:	10.6	↖	38:	9.8	↓	39:	10.1	↓	40:	10.5	→	Serie		97.1	Total		394.9
21:	10.5	↘																																																																								
22:	9.5	↘																																																																								
23:	10.5	↘																																																																								
24:	8.9	←																																																																								
25:	10.6	↘																																																																								
26:	10.2	↘																																																																								
27:	8.6	↓																																																																								
28:	10.3	↘																																																																								
29:	9.3	↘																																																																								
30:	10.5	↘																																																																								
Serie		98.9																																																																								
Total		297.8																																																																								
31:	7.8	↓																																																																								
32:	9.4	↓																																																																								
33:	9.5	↓																																																																								
34:	9.7	→																																																																								
35:	10.1	↗																																																																								
36:	9.6	↘																																																																								
37:	10.6	↖																																																																								
38:	9.8	↓																																																																								
39:	10.1	↓																																																																								
40:	10.5	→																																																																								
Serie		97.1																																																																								
Total		394.9																																																																								

Prov 	1: 10.3x↓ 3: 9.9 → 4: 10.0 ↓ 5: 10.6x↓ 6: 9.7 ↘ 7: 9.6 ↑ 8: 10.6x↗ 9: 10.3x↖ 10: 10.0 ←	Prov 	11: 10.1 ↗ 12: 7.9 ← 13: 9.3 ↑ 14: 10.5x↗ 15: 10.2x↓ 16: 10.5x→
Serie	91.0	Serie	58.5
Total	0.0	Total	0.0

40 Skott 	1: 10.2x→ 2: 9.8 ← 3: 10.5x↑ 4: 10.8x↓ 5: 9.3 ↖ 6: 9.1 ↖ 7: 10.2x→ 8: 10.1 ↑ 9: 9.7 ↓ 10: 10.6x↖	40 Skott 	11: 10.1 ↖ 12: 9.5 ← 13: 10.4x↖ 14: 10.2x↖ 15: 9.7 ↗ 16: 10.4x→ 17: 9.5 ↖ 18: 10.7x↑ 19: 9.1 ↑ 20: 9.5 ↖
Serie	100.3	Serie	99.1
Total	100.3	Total	199.4

40 Skott 	21: 10.2x↖ 22: 10.0 ← 23: 10.5x↖ 24: 10.3x↖ 25: 10.5x↖ 26: 9.6 ← 27: 10.5x↓ 28: 9.2 ↗ 29: 9.9 ↑ 30: 10.1 ←	40 Skott 	31: 9.8 ← 32: 9.5 ← 33: 10.3x↓ 34: 9.4 ↖ 35: 10.1 ← 36: 10.2x↑ 37: 9.8 → 38: 10.2x↗ 39: 10.2x↑ 40: 10.1 ↓
Serie	100.8	Serie	99.6
Total	300.2	Total	399.8

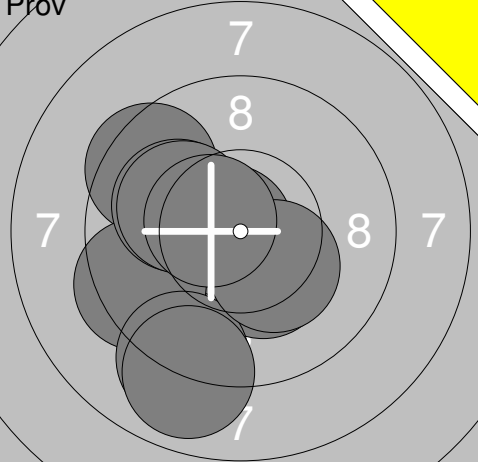
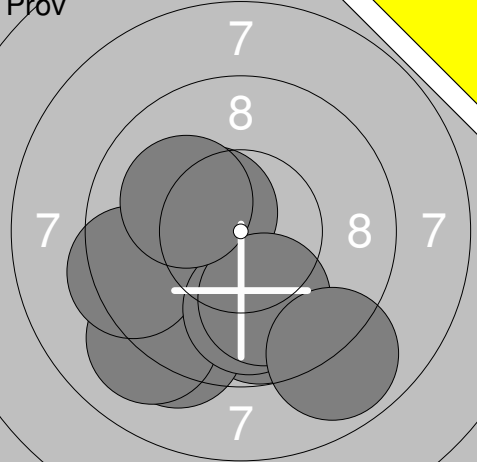
<p>Pröv</p> 	<table border="1" style="width:100%; border-collapse: collapse;"> <tr><td>1:</td><td>10.3x</td><td>↘</td></tr> <tr><td>2:</td><td>10.8x</td><td>←</td></tr> <tr><td>3:</td><td>9.5</td><td>↗</td></tr> <tr><td>4:</td><td>9.4</td><td>←</td></tr> <tr><td>5:</td><td>9.1</td><td>↘</td></tr> <tr><td>6:</td><td>10.3x</td><td>↘</td></tr> <tr><td>7:</td><td>8.9</td><td>↘</td></tr> <tr><td>8:</td><td>10.0</td><td>↗</td></tr> <tr><td>9:</td><td>10.1</td><td>↗</td></tr> <tr><td>10:</td><td>10.5x</td><td>↖</td></tr> <tr><td colspan="2">Serie</td><td>98.9</td></tr> <tr><td colspan="2">Total</td><td>0.0</td></tr> </table>	1:	10.3x	↘	2:	10.8x	←	3:	9.5	↗	4:	9.4	←	5:	9.1	↘	6:	10.3x	↘	7:	8.9	↘	8:	10.0	↗	9:	10.1	↗	10:	10.5x	↖	Serie		98.9	Total		0.0	<p>Pröv</p> 	<table border="1" style="width:100%; border-collapse: collapse;"> <tr><td>11:</td><td>10.5x</td><td>↖</td></tr> <tr><td>12:</td><td>9.8</td><td>↘</td></tr> <tr><td>13:</td><td>9.2</td><td>↘</td></tr> <tr><td>14:</td><td>9.7</td><td>←</td></tr> <tr><td>15:</td><td>9.1</td><td>↘</td></tr> <tr><td>16:</td><td>9.4</td><td>←</td></tr> <tr><td>17:</td><td>9.9</td><td>↘</td></tr> <tr><td>18:</td><td>10.0</td><td>↘</td></tr> <tr><td>19:</td><td>8.9</td><td>↘</td></tr> <tr><td>20:</td><td>10.1</td><td>↖</td></tr> <tr><td colspan="2">Serie</td><td>96.6</td></tr> <tr><td colspan="2">Total</td><td>0.0</td></tr> </table>	11:	10.5x	↖	12:	9.8	↘	13:	9.2	↘	14:	9.7	←	15:	9.1	↘	16:	9.4	←	17:	9.9	↘	18:	10.0	↘	19:	8.9	↘	20:	10.1	↖	Serie		96.6	Total		0.0
1:	10.3x	↘																																																																									
2:	10.8x	←																																																																									
3:	9.5	↗																																																																									
4:	9.4	←																																																																									
5:	9.1	↘																																																																									
6:	10.3x	↘																																																																									
7:	8.9	↘																																																																									
8:	10.0	↗																																																																									
9:	10.1	↗																																																																									
10:	10.5x	↖																																																																									
Serie		98.9																																																																									
Total		0.0																																																																									
11:	10.5x	↖																																																																									
12:	9.8	↘																																																																									
13:	9.2	↘																																																																									
14:	9.7	←																																																																									
15:	9.1	↘																																																																									
16:	9.4	←																																																																									
17:	9.9	↘																																																																									
18:	10.0	↘																																																																									
19:	8.9	↘																																																																									
20:	10.1	↖																																																																									
Serie		96.6																																																																									
Total		0.0																																																																									

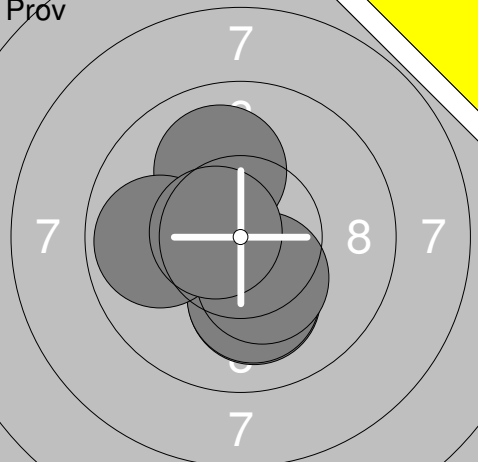
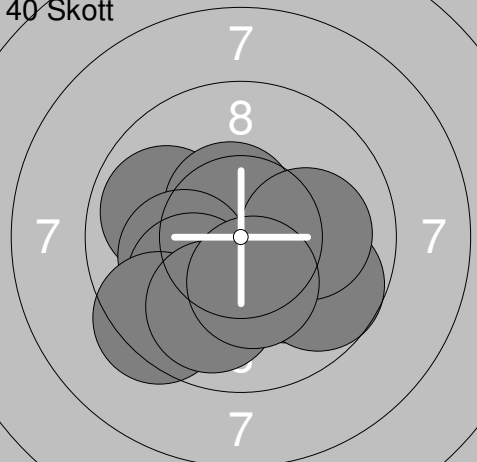
<p>Pröv</p> 	<table border="1" style="width:100%; border-collapse: collapse;"> <tr><td>21:</td><td>10.1</td><td>↘</td></tr> <tr><td>22:</td><td>10.1</td><td>↘</td></tr> <tr><td>23:</td><td>10.0</td><td>↗</td></tr> <tr><td>24:</td><td>9.9</td><td>←</td></tr> <tr><td>25:</td><td>10.3x</td><td>↘</td></tr> <tr><td>26:</td><td>10.6x</td><td>↖</td></tr> <tr><td colspan="2">Serie</td><td>61.0</td></tr> <tr><td colspan="2">Total</td><td>0.0</td></tr> </table>	21:	10.1	↘	22:	10.1	↘	23:	10.0	↗	24:	9.9	←	25:	10.3x	↘	26:	10.6x	↖	Serie		61.0	Total		0.0	<p>40 Skott</p> 	<table border="1" style="width:100%; border-collapse: collapse;"> <tr><td>1:</td><td>9.9</td><td>←</td></tr> <tr><td>2:</td><td>10.5x</td><td>↗</td></tr> <tr><td>3:</td><td>10.1</td><td>←</td></tr> <tr><td>4:</td><td>10.1</td><td>↘</td></tr> <tr><td>5:</td><td>9.4</td><td>↘</td></tr> <tr><td>6:</td><td>10.1</td><td>↘</td></tr> <tr><td>7:</td><td>9.9</td><td>↘</td></tr> <tr><td>8:</td><td>9.7</td><td>↘</td></tr> <tr><td>9:</td><td>10.1</td><td>→</td></tr> <tr><td>10:</td><td>10.3x</td><td>↘</td></tr> <tr><td colspan="2">Serie</td><td>100.1</td></tr> <tr><td colspan="2">Total</td><td>100.1</td></tr> </table>	1:	9.9	←	2:	10.5x	↗	3:	10.1	←	4:	10.1	↘	5:	9.4	↘	6:	10.1	↘	7:	9.9	↘	8:	9.7	↘	9:	10.1	→	10:	10.3x	↘	Serie		100.1	Total		100.1
21:	10.1	↘																																																													
22:	10.1	↘																																																													
23:	10.0	↗																																																													
24:	9.9	←																																																													
25:	10.3x	↘																																																													
26:	10.6x	↖																																																													
Serie		61.0																																																													
Total		0.0																																																													
1:	9.9	←																																																													
2:	10.5x	↗																																																													
3:	10.1	←																																																													
4:	10.1	↘																																																													
5:	9.4	↘																																																													
6:	10.1	↘																																																													
7:	9.9	↘																																																													
8:	9.7	↘																																																													
9:	10.1	→																																																													
10:	10.3x	↘																																																													
Serie		100.1																																																													
Total		100.1																																																													

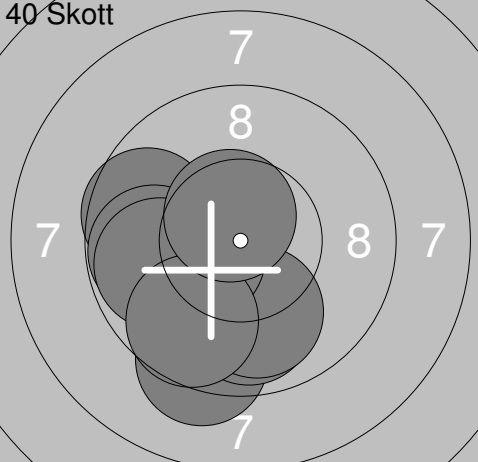
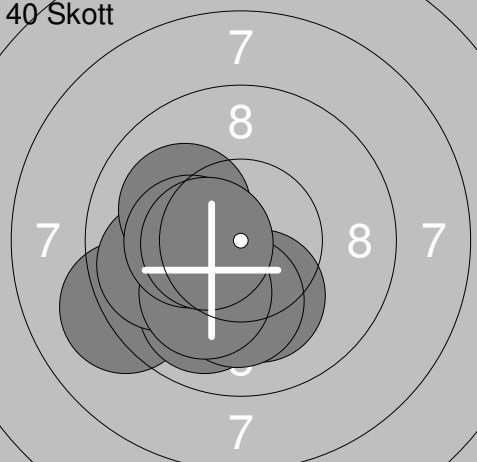
<p>40 Skott</p> 	<table border="1" style="width:100%; border-collapse: collapse;"> <tr><td>11:</td><td>9.3</td><td>↘</td></tr> <tr><td>12:</td><td>9.9</td><td>↘</td></tr> <tr><td>13:</td><td>9.8</td><td>←</td></tr> <tr><td>14:</td><td>10.0</td><td>↘</td></tr> <tr><td>15:</td><td>9.6</td><td>↗</td></tr> <tr><td>16:</td><td>9.8</td><td>←</td></tr> <tr><td>17:</td><td>10.4x</td><td>←</td></tr> <tr><td>18:</td><td>9.8</td><td>←</td></tr> <tr><td>19:</td><td>9.7</td><td>↘</td></tr> <tr><td>20:</td><td>10.6x</td><td>↗</td></tr> <tr><td colspan="2">Serie</td><td>98.9</td></tr> <tr><td colspan="2">Total</td><td>199.0</td></tr> </table>	11:	9.3	↘	12:	9.9	↘	13:	9.8	←	14:	10.0	↘	15:	9.6	↗	16:	9.8	←	17:	10.4x	←	18:	9.8	←	19:	9.7	↘	20:	10.6x	↗	Serie		98.9	Total		199.0	<p>40 Skott</p> 	<table border="1" style="width:100%; border-collapse: collapse;"> <tr><td>21:</td><td>10.3x</td><td>↘</td></tr> <tr><td>22:</td><td>9.2</td><td>←</td></tr> <tr><td>23:</td><td>9.9</td><td>↘</td></tr> <tr><td>24:</td><td>10.2x</td><td>↘</td></tr> <tr><td>25:</td><td>9.8</td><td>←</td></tr> <tr><td>26:</td><td>10.1</td><td>↘</td></tr> <tr><td>27:</td><td>10.1</td><td>↘</td></tr> <tr><td>28:</td><td>10.1</td><td>↖</td></tr> <tr><td>29:</td><td>10.3x</td><td>←</td></tr> <tr><td>30:</td><td>10.5x</td><td>←</td></tr> <tr><td colspan="2">Serie</td><td>100.5</td></tr> <tr><td colspan="2">Total</td><td>299.5</td></tr> </table>	21:	10.3x	↘	22:	9.2	←	23:	9.9	↘	24:	10.2x	↘	25:	9.8	←	26:	10.1	↘	27:	10.1	↘	28:	10.1	↖	29:	10.3x	←	30:	10.5x	←	Serie		100.5	Total		299.5
11:	9.3	↘																																																																									
12:	9.9	↘																																																																									
13:	9.8	←																																																																									
14:	10.0	↘																																																																									
15:	9.6	↗																																																																									
16:	9.8	←																																																																									
17:	10.4x	←																																																																									
18:	9.8	←																																																																									
19:	9.7	↘																																																																									
20:	10.6x	↗																																																																									
Serie		98.9																																																																									
Total		199.0																																																																									
21:	10.3x	↘																																																																									
22:	9.2	←																																																																									
23:	9.9	↘																																																																									
24:	10.2x	↘																																																																									
25:	9.8	←																																																																									
26:	10.1	↘																																																																									
27:	10.1	↘																																																																									
28:	10.1	↖																																																																									
29:	10.3x	←																																																																									
30:	10.5x	←																																																																									
Serie		100.5																																																																									
Total		299.5																																																																									

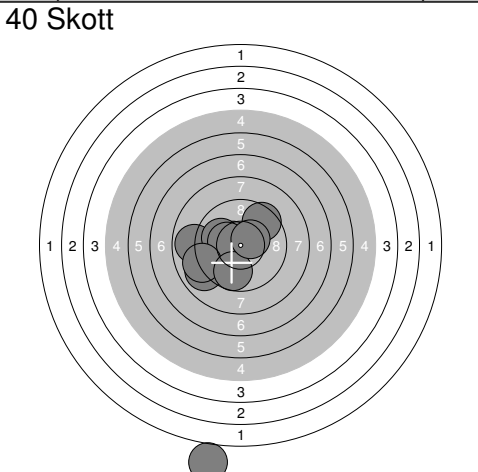
<p>40 Skott</p> 	<table border="1" style="width:100%; border-collapse: collapse;"> <tr><td>31:</td><td>10.6x</td><td>↗</td></tr> <tr><td>32:</td><td>1.0</td><td>↘</td></tr> <tr><td>33:</td><td>8.9</td><td>←</td></tr> <tr><td>34:</td><td>10.0</td><td>↖</td></tr> <tr><td>35:</td><td>9.0</td><td>←</td></tr> <tr><td>36:</td><td>10.3x</td><td>↖</td></tr> <tr><td>37:</td><td>9.5</td><td>↗</td></tr> <tr><td>38:</td><td>9.0</td><td>←</td></tr> <tr><td>39:</td><td>9.7</td><td>↘</td></tr> <tr><td>40:</td><td>10.4x</td><td>↗</td></tr> <tr><td colspan="2">Serie</td><td>88.4</td></tr> <tr><td colspan="2">Total</td><td>387.9</td></tr> </table>	31:	10.6x	↗	32:	1.0	↘	33:	8.9	←	34:	10.0	↖	35:	9.0	←	36:	10.3x	↖	37:	9.5	↗	38:	9.0	←	39:	9.7	↘	40:	10.4x	↗	Serie		88.4	Total		387.9		
31:	10.6x	↗																																					
32:	1.0	↘																																					
33:	8.9	←																																					
34:	10.0	↖																																					
35:	9.0	←																																					
36:	10.3x	↖																																					
37:	9.5	↗																																					
38:	9.0	←																																					
39:	9.7	↘																																					
40:	10.4x	↗																																					
Serie		88.4																																					
Total		387.9																																					

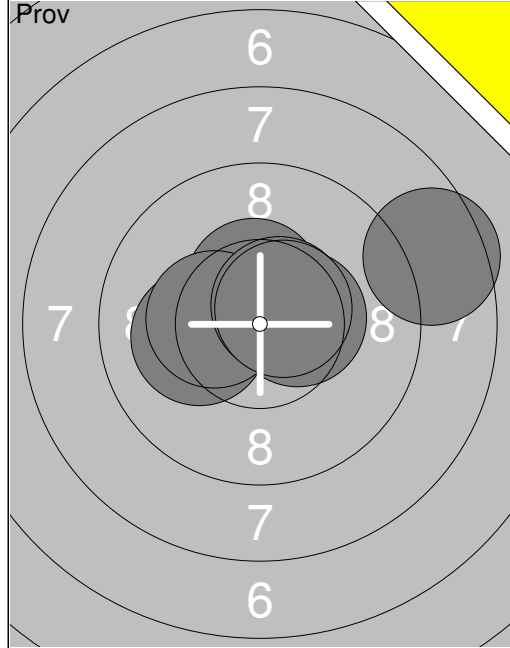

1:	10.1	←
2:	10.5	↗
3:	10.5	→
4:	8.5	→
5:	10.4	↖
6:	10.6	↗
7:	10.6	↗
Serie		71.2
Total		0.0

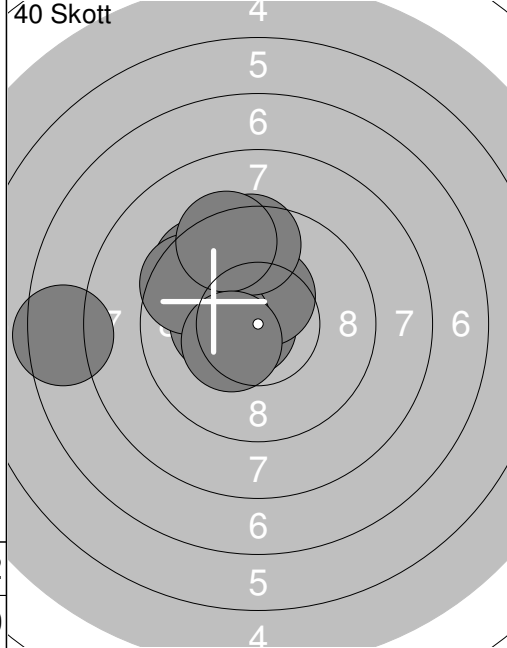

1:	10.7	↖
2:	7.5	←
3:	10.2	↖
4:	10.4	↗
5:	10.3	↖
6:	9.6	↖
7:	9.5	←
8:	9.5	↑
9:	9.4	↖
10:	10.4	↖
Serie		97.5
Total		97.5

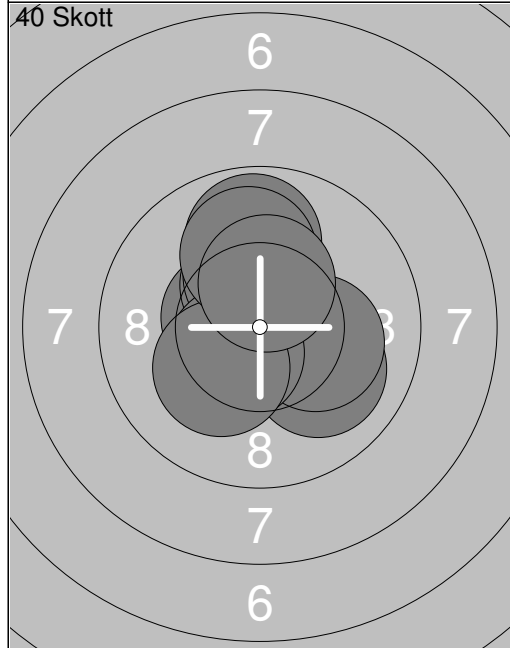

11:	10.5	↖
12:	10.4	↗
13:	10.3	↗
14:	10.0	↘
15:	10.2	→
16:	10.5	↖
17:	9.8	↑
18:	10.2	↖
19:	10.0	↑
20:	10.4	↗
Serie		102.3
Total		199.8

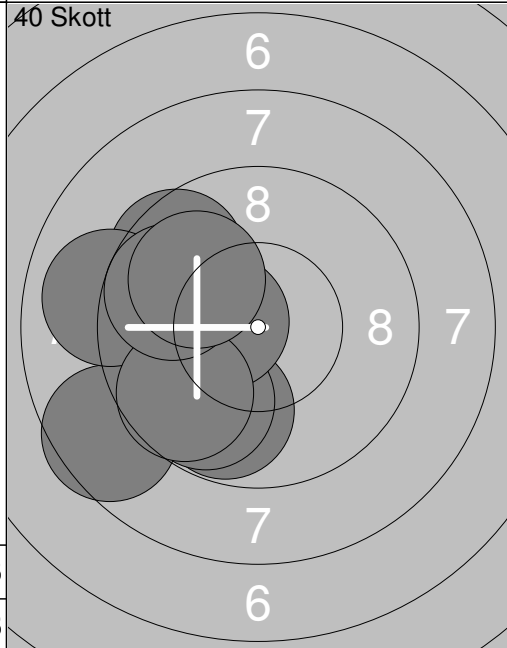

21:	9.9	←
22:	9.8	↘
23:	9.8	↘
24:	8.6	←
25:	9.5	↖
26:	9.0	←
27:	10.5	↖
28:	9.7	↘
29:	9.7	←
30:	9.9	↖
Serie		96.4
Total		296.2

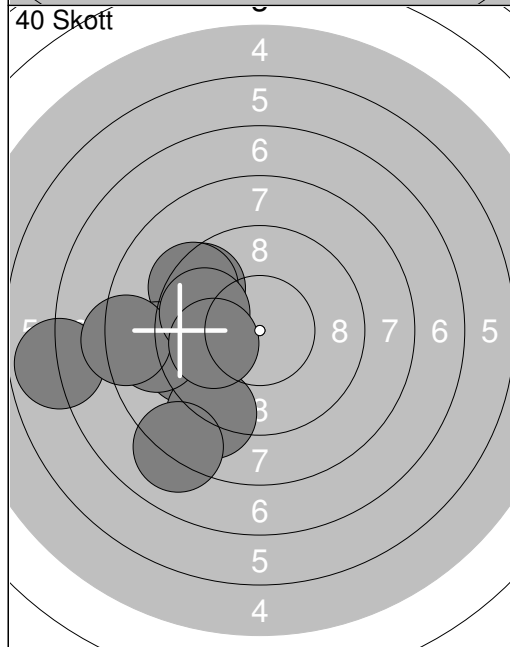

31:	9.4	←
32:	9.0	↘
33:	9.5	↖
34:	9.4	↖
35:	6.9	←
36:	8.9	←
37:	8.3	←
38:	9.8	←
39:	10.0	←
40:	8.1	↘
Serie		89.3
Total		385.5

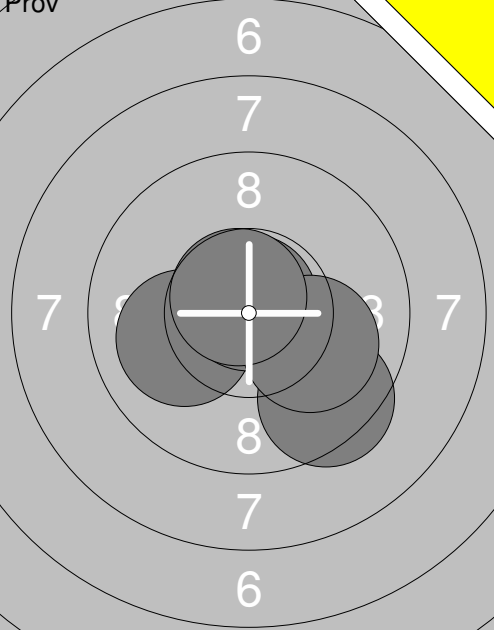
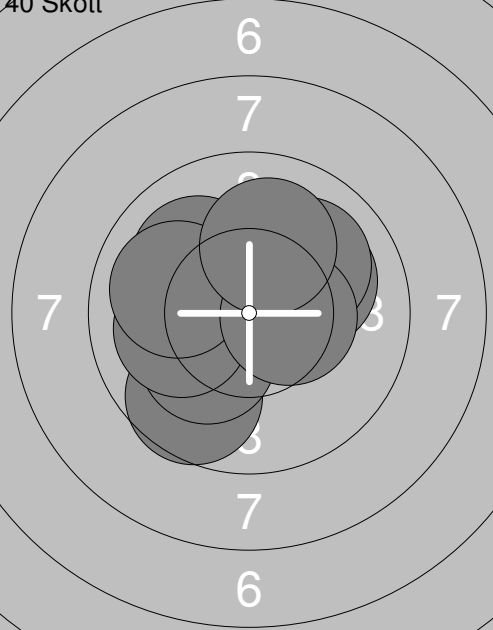
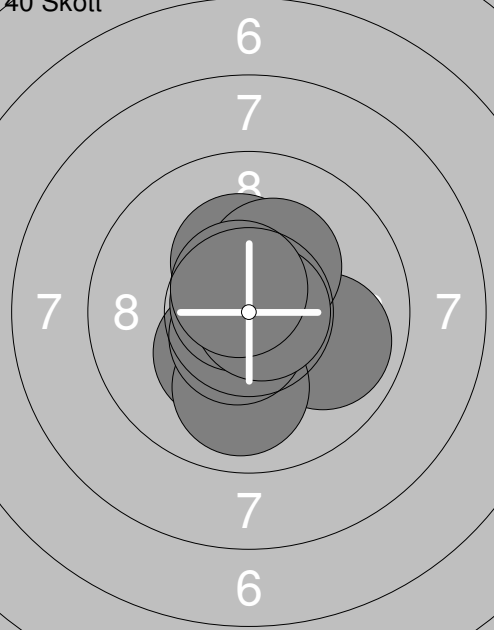
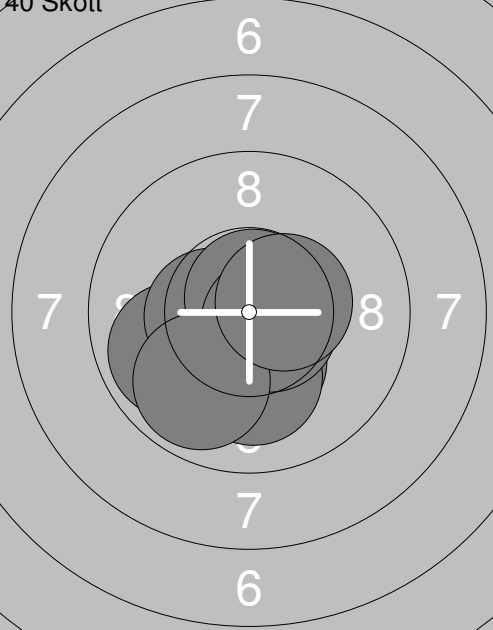
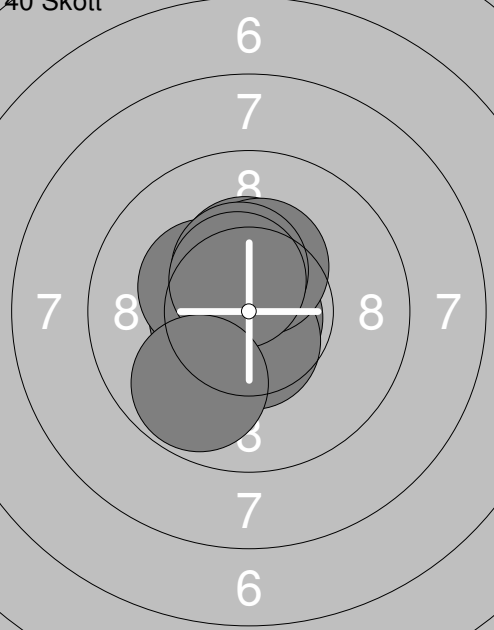
<p>Prov</p>  <p style="text-align: center;">6 7 8 7 6</p>	<p>1: 9.5 ↘ 2: 10.0 ← 3: 10.8x ↑ 4: 10.1 → 5: 10.7x ↘</p> <p>Serie 51.1 Total 0.0</p>	<p>40 Skott</p>  <p style="text-align: center;">6 7 8 7 6</p>	<p>1: 9.6 ↘ 2: 10.2x ↘ 3: 10.1 → 4: 10.0 ↗ 5: 10.0 ← 6: 10.0 ↘ 7: 10.4x ↑ 8: 10.0 ← 9: 10.4x → 10: 10.1 ↑</p> <p>Serie 100.8 Total 100.8</p>
<p>40 Skott</p>  <p style="text-align: center;">6 7 8 7 6</p>	<p>11: 10.6x ↑ 12: 10.3x ↑ 13: 9.9 → 14: 10.3x ↘ 15: 10.0 ↓ 16: 10.6x ↘ 17: 10.3x ↑ 18: 10.8x ↘ 19: 10.8x → 20: 10.6x ↑</p> <p>Serie 104.2 Total 205.0</p>	<p>40 Skott</p>  <p style="text-align: center;">6 7 8 7 6</p>	<p>21: 10.5x ↘ 22: 9.9 ← 23: 10.6x ← 24: 10.5x ← 25: 10.8x ↑ 26: 10.3x ↓ 27: 10.1 ↓ 28: 10.6x ↘ 29: 9.9 ↘ 30: 10.5x →</p> <p>Serie 103.7 Total 308.7</p>
<p>40 Skott</p>  <p style="text-align: center;">6 7 8 7 6</p>	<p>31: 10.4x ↑ 32: 10.8x ↘ 33: 10.5x ← 34: 10.7x ↘ 35: 10.6x ↓ 36: 10.4x ↑ 37: 10.3x ↘ 38: 10.4x ↑ 39: 10.5x ↑ 40: 9.8 ↘</p> <p>Serie 104.4 Total 413.1</p>		

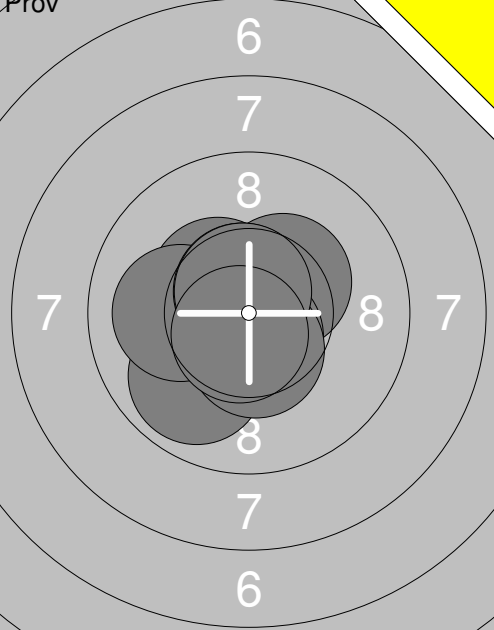
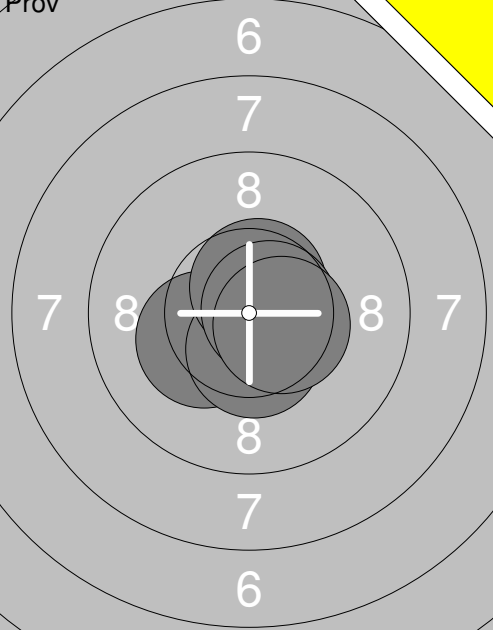
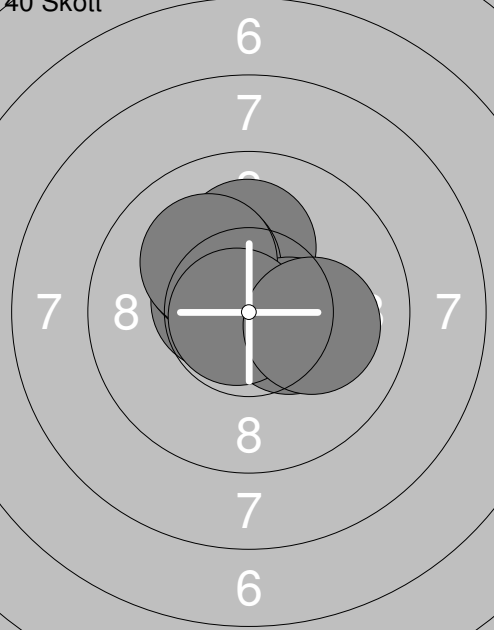
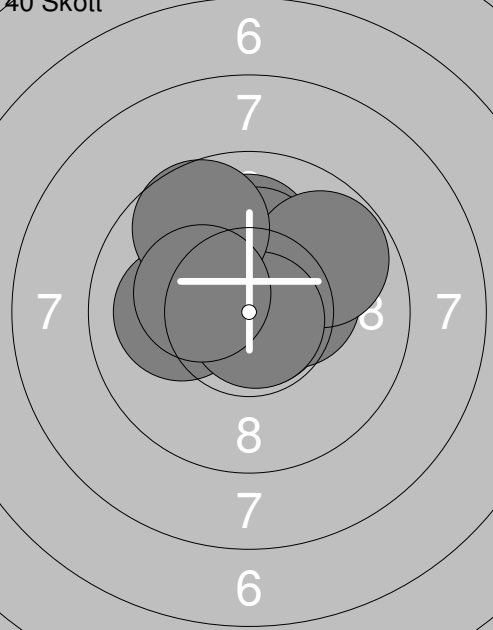
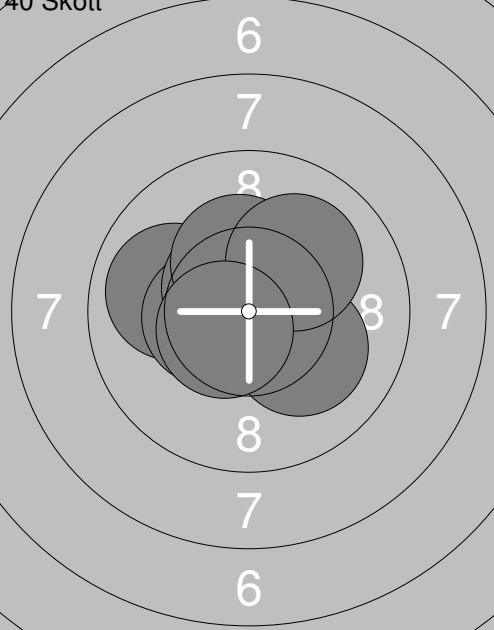
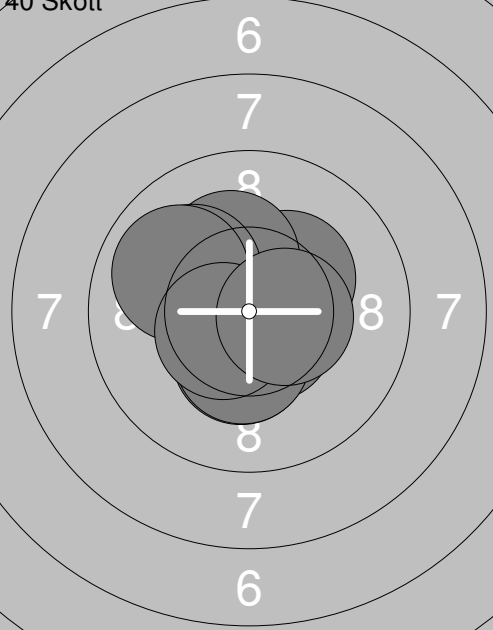
<p>Prov</p> 	<p>1: 10.3x↘ 2: 10.6x↓ 3: 9.9 ↙ 4: 10.5x↓ 5: 10.6x↔ 6: 10.4x↘ 7: 10.1← 8: 10.7x↗ 9: 10.7x↗ 10: 10.6x↓</p> <p>Serie 104.4 Total 0.0</p>	<p>Prov</p> 	<p>11: 10.3x↘ 12: 10.5x↓ 13: 10.6x↗ 14: 10.7x→ 15: 10.5x→</p> <p>Serie 52.6 Total 0.0</p>
<p>40 Skott</p> 	<p>1: 10.3x↘ 2: 10.2x↗ 3: 10.9x↗ 4: 10.5x↔ 5: 10.1 ↑ 6: 10.2x↘ 7: 10.4x→ 8: 10.1 ↖ 9: 10.8x↙ 10: 10.1 →</p> <p>Serie 103.6 Total 103.6</p>	<p>40 Skott</p> 	<p>11: 10.8x↘ 12: 10.4x→ 13: 10.1← 14: 10.3x↘ 15: 10.0 ↑ 16: 10.2x↗ 17: 9.8 ↗ 18: 10.8x↘ 19: 9.7 ↖ 20: 10.3x↔</p> <p>Serie 102.4 Total 206.0</p>
<p>40 Skott</p> 	<p>21: 10.3x↔ 22: 9.9 ← 23: 10.7x↔ 24: 10.4x↔ 25: 10.6x↘ 26: 10.9x↘ 27: 10.1 ↘ 28: 10.3x↗ 29: 10.1 ↗ 30: 10.6x↙</p> <p>Serie 103.9 Total 309.9</p>	<p>40 Skott</p> 	<p>31: 10.5x↗ 32: 10.3x↗ 33: 10.2x↗ 34: 10.1 ↖ 35: 10.4x↓ 36: 10.6x↘ 37: 9.9 ← 38: 10.4x↓ 39: 10.5x↙ 40: 10.5x→</p> <p>Serie 103.4 Total 413.3</p>

<p>Prov</p>	<p>1: 9.0 ↓ 2: 9.5 ↙ 3: 10.3 ✕ 4: 10.7x ➔ 5: 10.7x ↓ 6: 9.7 ↙ 7: 9.9 ↓ 8: 10.2x ↓ 9: 10.3x ✕ 10: 9.8 ↓</p> <p>Serie 100.1 Total 0.0</p>	<p>Prov</p>	<p>11: 10.3x ✕ 12: 9.3 ↓ 13: 8.6 ↙ 14: 10.0 ↙ 15: 10.0 ↓ 16: 8.8 ↙ 17: 10.8x ↗ 18: 10.8x ↗</p> <p>Serie 78.6 Total 0.0</p>
<p>40 Skott</p>	<p>1: 10.3x ✕ 2: 10.1 ↙ 3: 10.8x ↓ 4: 9.2 ↗ 5: 10.3x ✕ 6: 10.1 ↓ 7: 9.3 ↑ 8: 9.2 ↗ 9: 10.2x ✕ 10: 10.2x ✕</p> <p>Serie 99.7 Total 99.7</p>	<p>40 Skott</p>	<p>11: 10.4x ✕ 12: 10.6x ➔ 13: 10.1 ↑ 14: 9.9 ↙ 15: 10.6x ✕ 16: 10.6x ✕ 17: 9.3 ➔ 18: 10.8x ✕ 19: 9.4 ↙ 20: 10.3x ↗</p> <p>Serie 102.0 Total 201.7</p>
<p>40 Skott</p>	<p>21: 10.7x ➔ 22: 10.2x ➔ 23: 10.8x ↓ 24: 10.6x ➔ 25: 10.5x ✕ 26: 9.8 ↗ 27: 9.8 ↙ 28: 10.7x ✕ 29: 10.3x ↓ 30: 10.0 ↙</p> <p>Serie 103.4 Total 305.1</p>	<p>40 Skott</p>	<p>31: 10.4x ↓ 32: 10.6x ↓ 33: 10.4x ✕ 34: 10.8x ✕ 35: 9.5 ↑ 36: 10.5x ➔ 37: 10.5x ✕ 38: 9.5 ➔ 39: 10.4x ✕ 40: 9.9 ↗</p> <p>Serie 102.5 Total 407.6</p>

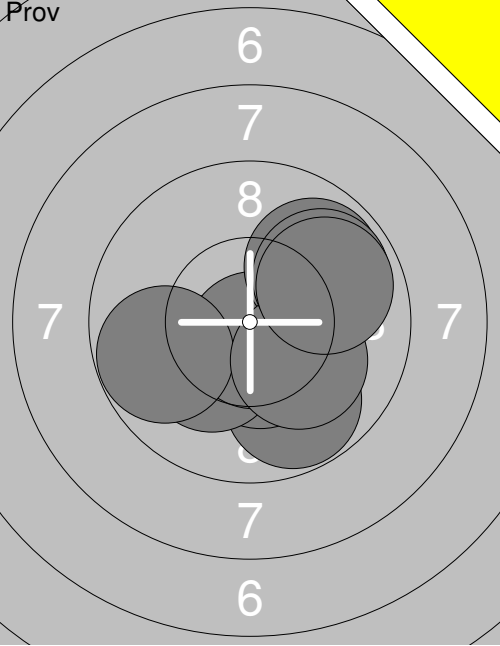
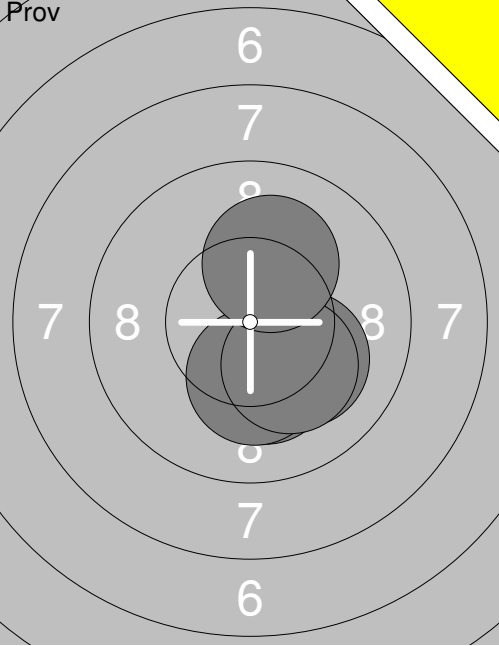
Skjuttlag	Tavla	Linus Holmlund	
S	Umeå		
11.01.2020	Skyttiäden Distriktsfinal	Umeå skytteallians	
Prov		Prov	
	1: 9.8 ↘ 2: 10.5x↘ 3: 10.4x↘ 4: 10.2x↘ 5: 10.7x↘ 6: 9.9 ↗ 7: 9.8 ← 8: 10.1 ↘ 9: 9.9 ↗ 10: 9.9 ↗ Serie 101.2 Total 0.0		11: 10.2x↘ 12: 10.1 ↘ 13: 10.2x↘ 14: 10.2x↘ 15: 10.1 ↗ Serie 50.8 Total 0.0
40 Skott	1: 8.8 ← 2: 10.4x↘ 3: 10.2x↗ 4: 10.6x→ 5: 10.1← 6: 10.4x↘ 7: 9.6 ↗ 8: 10.8x→ 9: 9.7 ← 10: 9.2 ← Serie 99.8 Total 99.8	40 Skott	11: 10.5x↘ 12: 9.8 → 13: 9.4 ↗ 14: 8.7 → 15: 10.3x↘ 16: 10.7x↘ 17: 10.3x↗ 18: 9.6 ← 19: 9.6 ← 20: 10.4x↘ Serie 99.3 Total 199.1
40 Skott	21: 9.6 ← 22: 10.3x↘ 23: 10.1← 24: 9.6 → 25: 10.5x→ 26: 9.5 ← 27: 10.1 ↗ 28: 10.9x→ 29: 9.9 ↘ 30: 9.8 ← Serie 100.3 Total 299.4	40 Skott	31: 10.2x↘ 32: 10.0↘ 33: 10.2x↘ 34: 9.9 ↘ 35: 10.5x↗ 36: 10.5x↘ 37: 10.5x↘ 38: 10.7x↘ 39: 10.0 ↗ 40: 10.2x↗ Serie 102.7 Total 402.1

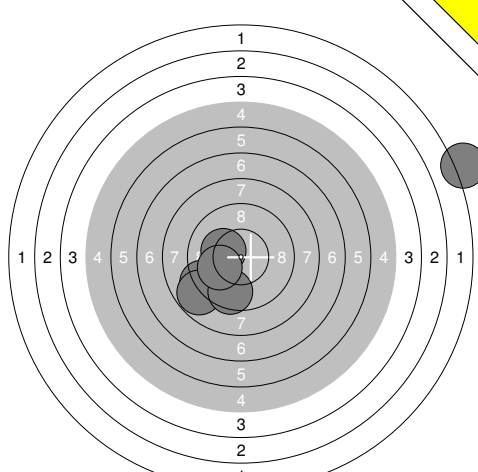
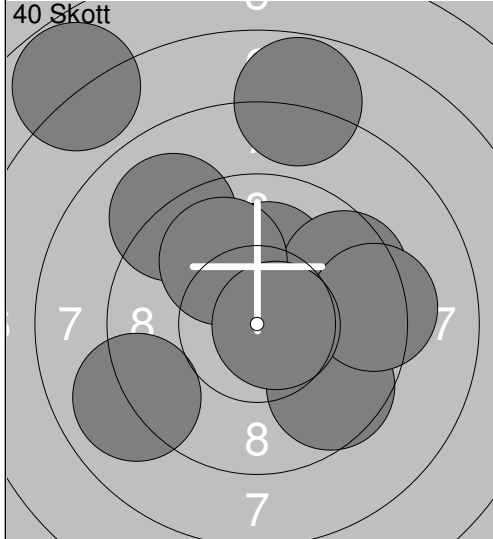
Prov 	1: 9.6 ↘ 2: 9.1 ↘ 3: 1.5 → 4: 8.8 ↘ 5: 9.5 ↓ 6: 10.2x ↘ 7: 10.0 ↙	40 Skott 	1: 10.1 ↑ 2: 9.6 ↘ 3: 9.6 ↗ 4: 9.3 → 5: 7.8 ↑ 6: 9.1 ↖ 7: 10.0 ↖ 8: 6.8 ↖ 9: 9.0 ↙ 10: 10.7x →
	Serie 58.7		Serie 92.0
	Total 0.0		Total 92.0

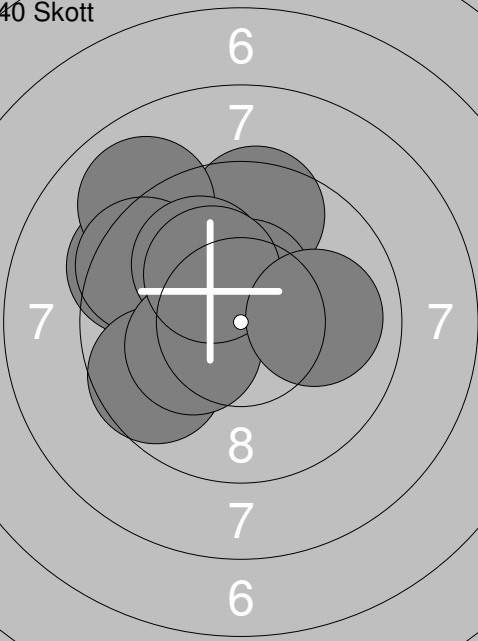
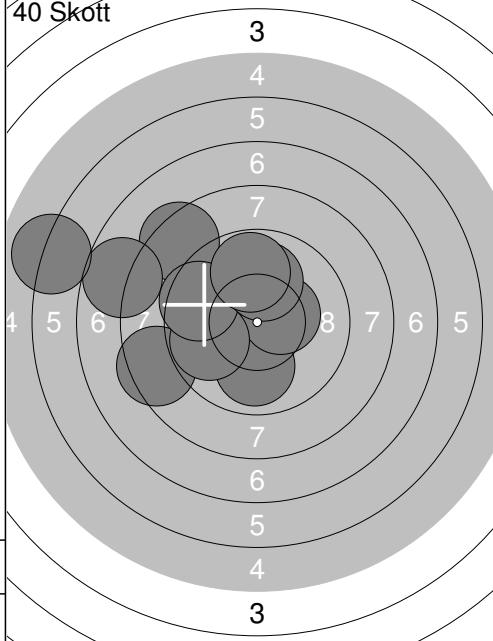
40 Skott 	11: 9.5 ↑ 12: 9.4 ↙ 13: 9.0 ↖ 14: 9.5 ↙ 15: 10.5x ↑ 16: 10.0 ↖ 17: 9.6 ↙ 18: 10.3x ↙ 19: 10.2x ↘ 20: 10.0 →	40 Skott 	21: 10.0 ↓ 22: 10.4x → 23: 8.5 ↙ 24: 8.4 ↖ 25: 7.7 ↙ 26: 9.8 ↙ 27: 9.5 ↙ 28: 6.0 ↙ 29: 10.0 ↑ 30: 9.8 ↑
	Serie 98.0		Serie 90.1
	Total 190.0		Total 280.1

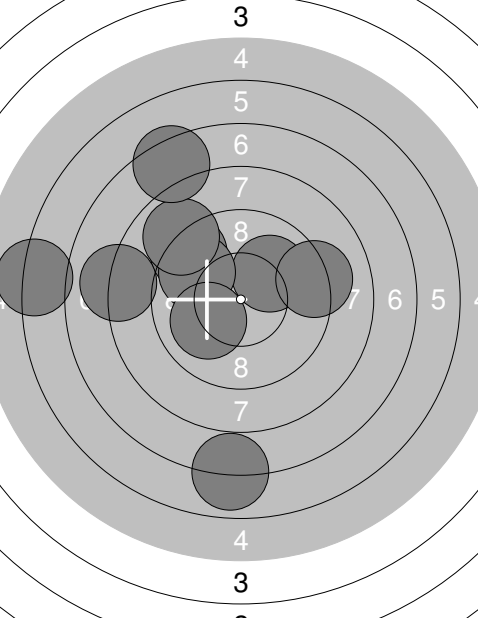
40 Skott 	31: 9.3 ↖ 32: 8.1 ← 33: 10.1 ↗ 34: 9.7 ↖ 35: 8.9 ↖ 36: 9.2 → 37: 10.0 ↙ 38: 6.1 ← 39: 7.4 ↖ 40: 6.9 ↓	
	Serie 85.7	
	Total 365.8	