

1: 10.2x ↙	6: 10.2x ↓	Serie	94 (4x)
2: 9.7 ↓	7: 10.0 ↓		
3: 9.6 ↗	8: 10.4x →	Total	94 (4x)
4: 9.6 ↖	9: 10.2x ↓		
5: 8.5 ↓	10: 9.2 ↓		

1: 10.6x ↗	6: 10.7x ↓	Serie	98 (6x)
2: 10.4x →	7: 10.6x →		
3: 9.7 →	8: 10.2x ↙	Total	192 (10x)
4: 10.0 →	9: 10.5x ↓		
5: 10.1 ↓	10: 9.9 ↙		

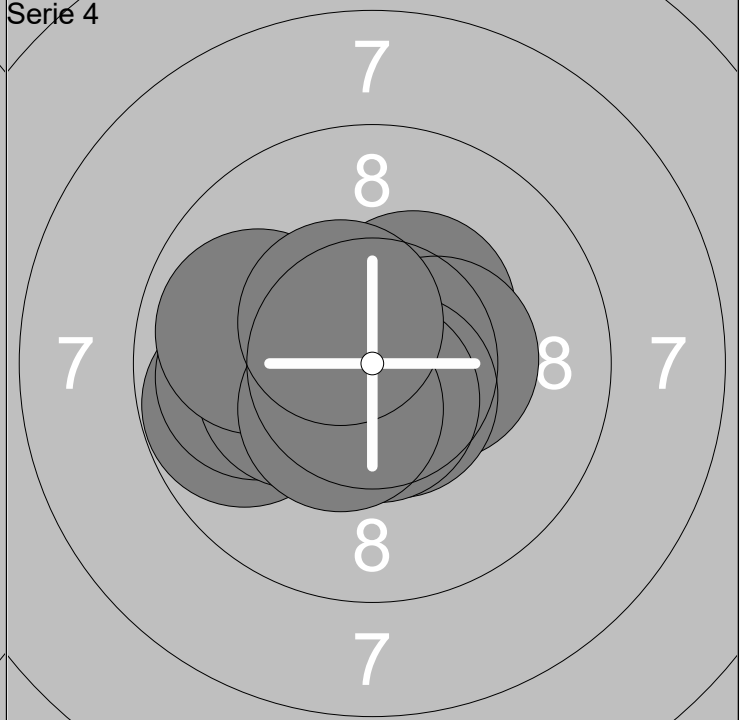
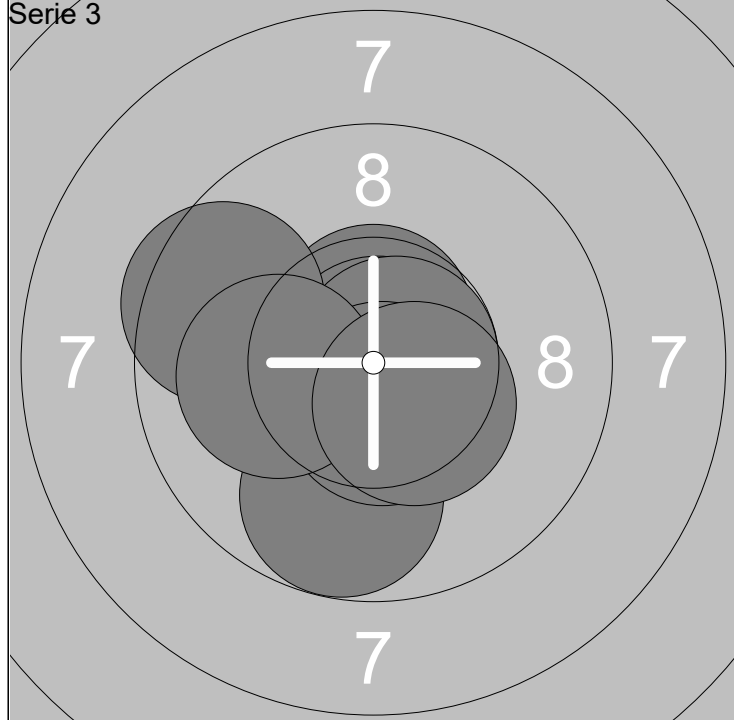

1: 10.6x ↗	6: 9.7 ↓	Serie	98 (7x)
2: 10.9x ↗	7: 10.7x →		
3: 9.5 ↖	8: 10.5x ↓	Total	290 (17x)
4: 10.6x ↓	9: 10.1 ←		
5: 10.4x ↙	10: 10.4x ↘		

1: 9.7 ↖	6: 10.6x ↘	Serie	97 (7x)
2: 10.3x ↗	7: 9.9 ↖		
3: 9.9 ↖	8: 10.6x ↓	Total	387 (24x)
4: 10.2x ↖	9: 10.4x ↙		
5: 10.4x →	10: 10.5x ↗		

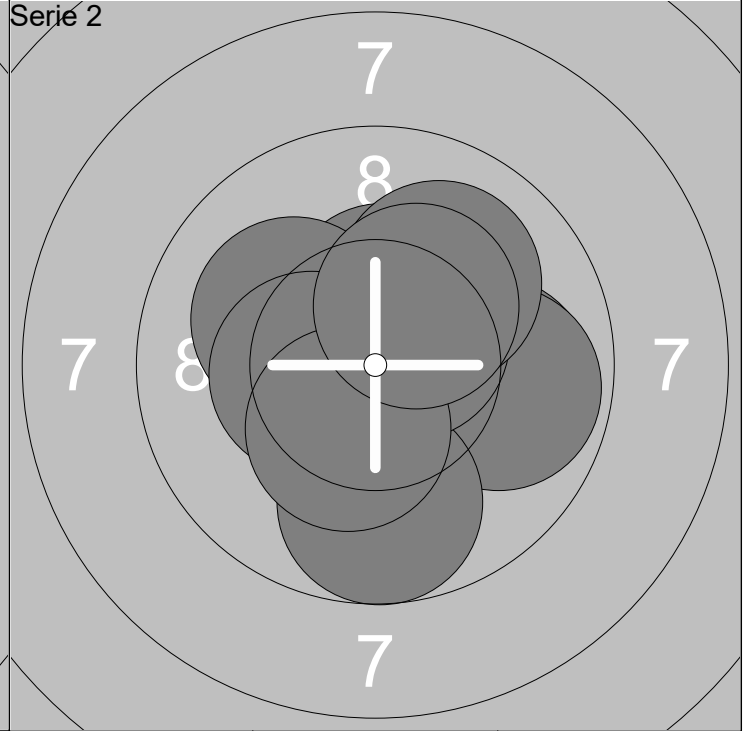
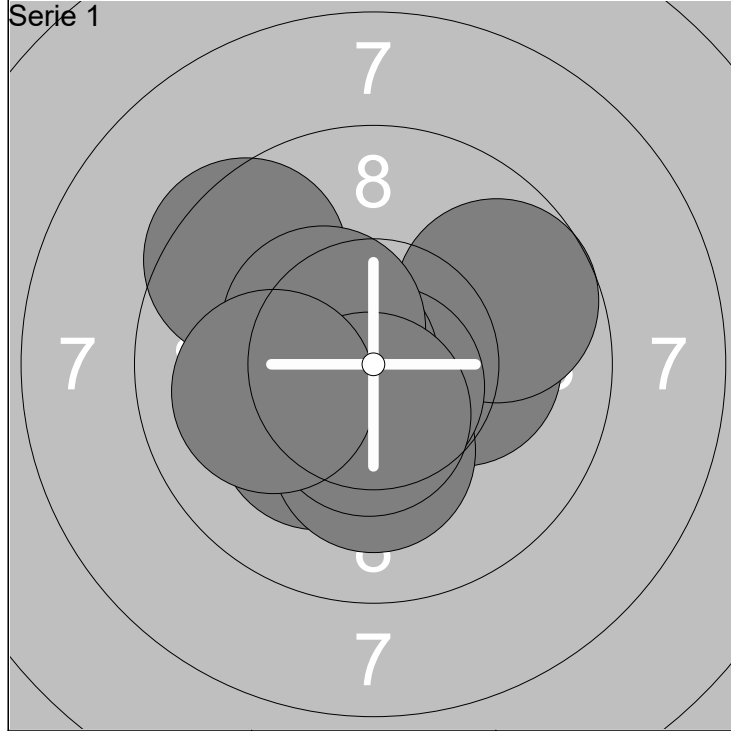

1: 10.2x →	6: 10.7x ↓	Serie	98 (7x)
2: 10.2x ↙	7: 10.6x ←		
3: 9.5 ↖	8: 10.4x ↖	Total	98 (7x)
4: 10.2x ↓	9: 10.5x ↓		
5: 9.7 ↗	10: 10.0 ←		

1: 10.4x ↑	6: 10.6x ↗	Serie	97 (5x)
2: 9.9 →	7: 10.3x ←		
3: 10.1 ↖	8: 10.3x ↓	Total	195 (12x)
4: 9.8 →	9: 10.0 ↗		
5: 9.7 ↓	10: 10.3x ↗		

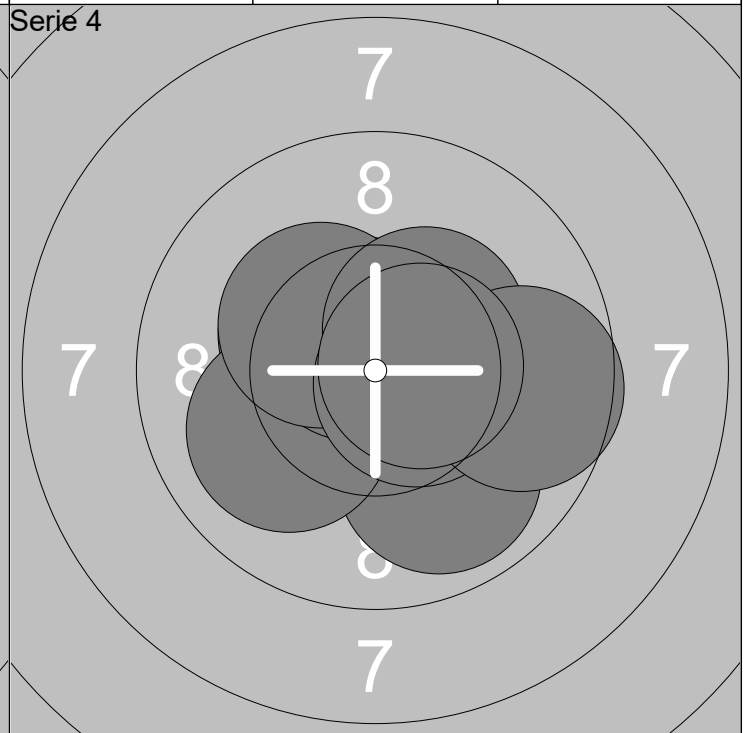
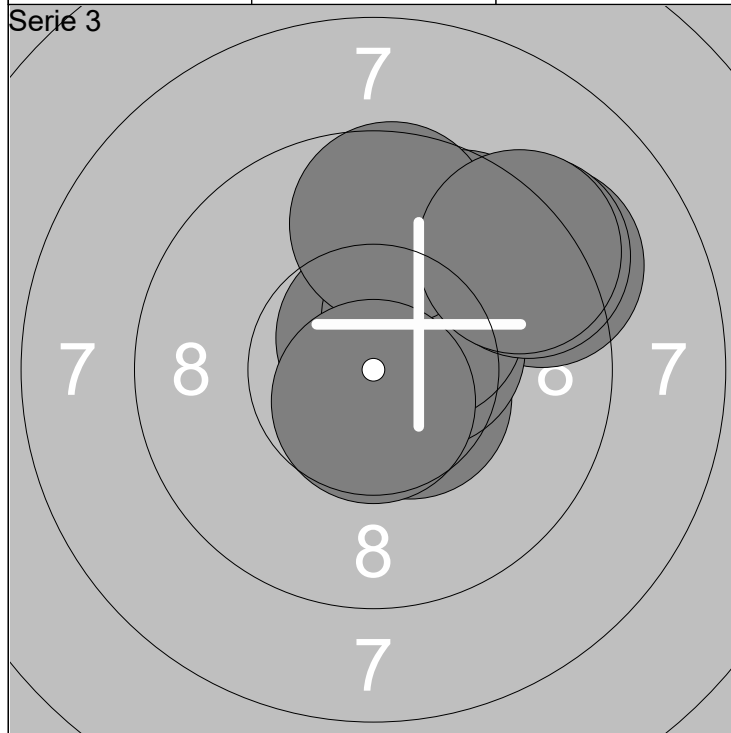

1: 9.6 ↗	6: 10.3x ↗	Serie	95 (5x)
2: 9.2 ↗	7: 9.7 ↑		
3: 10.5x ↘	8: 10.7x ↓	Total	290 (17x)
4: 10.6x ↑	9: 9.2 ↗		
5: 10.4x ↗	10: 9.3 ↗		

1: 10.1 →	6: 10.3x ↖	Serie	98 (6x)
2: 10.3x ↖	7: 10.5x →		
3: 9.9 ↓	8: 10.3x ↗	Total	388 (23x)
4: 10.0 ↖	9: 9.6 →		
5: 10.6x ↖	10: 10.5x →		

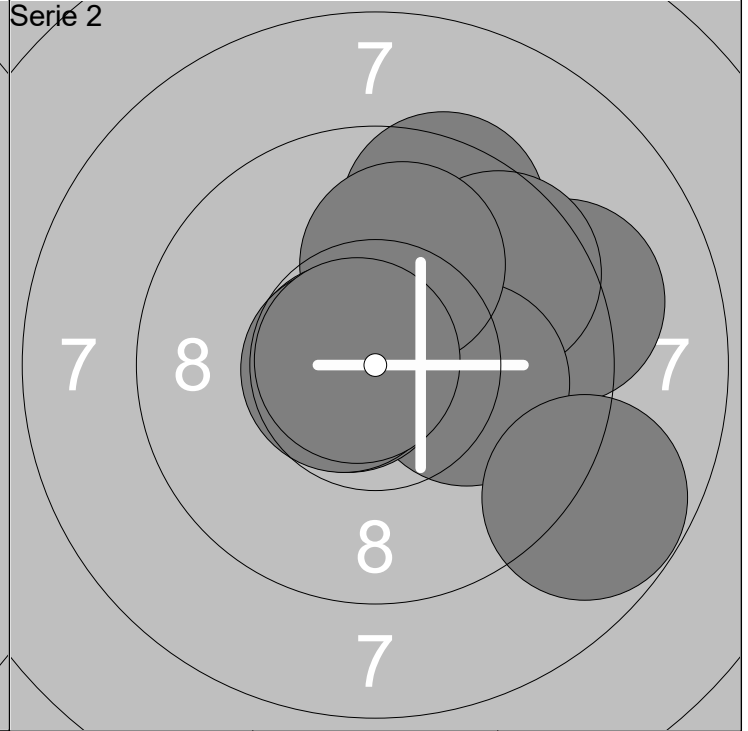
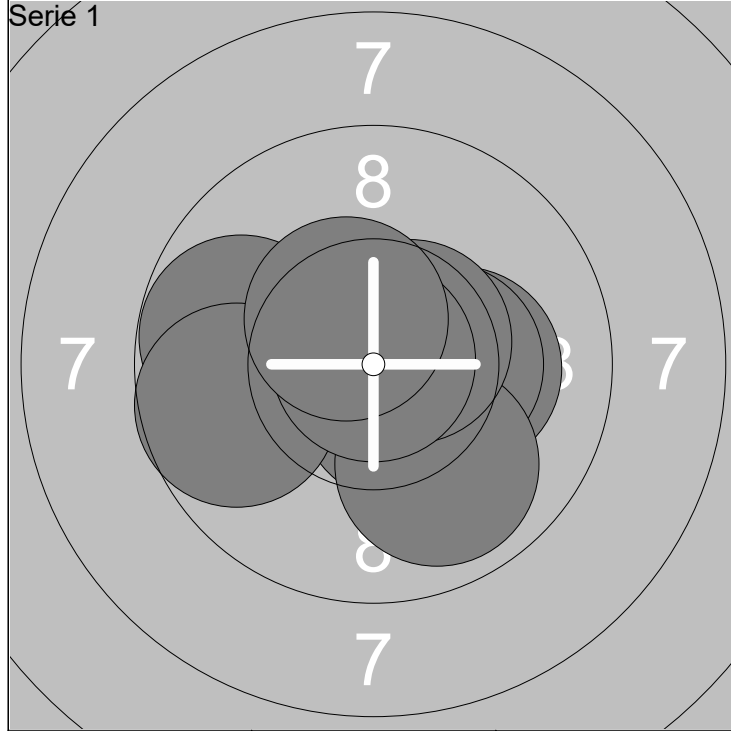

1: 10.5x ↘	6: 10.3x →	Serie	97 (7x)
2: 9.7 ←	7: 9.9 ↘		
3: 10.3x ↘	8: 10.5x ↗	Total	97 (7x)
4: 9.7 ←	9: 10.9x ↑		
5: 10.2x →	10: 10.5x ↖		

1: 9.2 →	6: 10.7x ←	Serie	95 (4x)
2: 9.5 ↗	7: 10.7x ←		
3: 9.6 ↗	8: 8.7 ↘	Total	192 (11x)
4: 10.1 →	9: 10.7x ←		
5: 10.0 ↑	10: 10.8x ←		

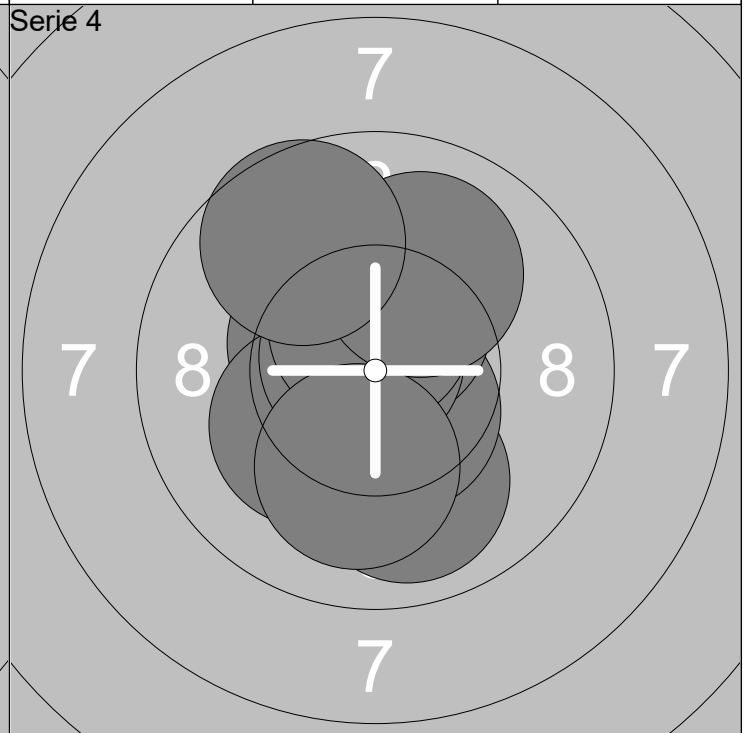
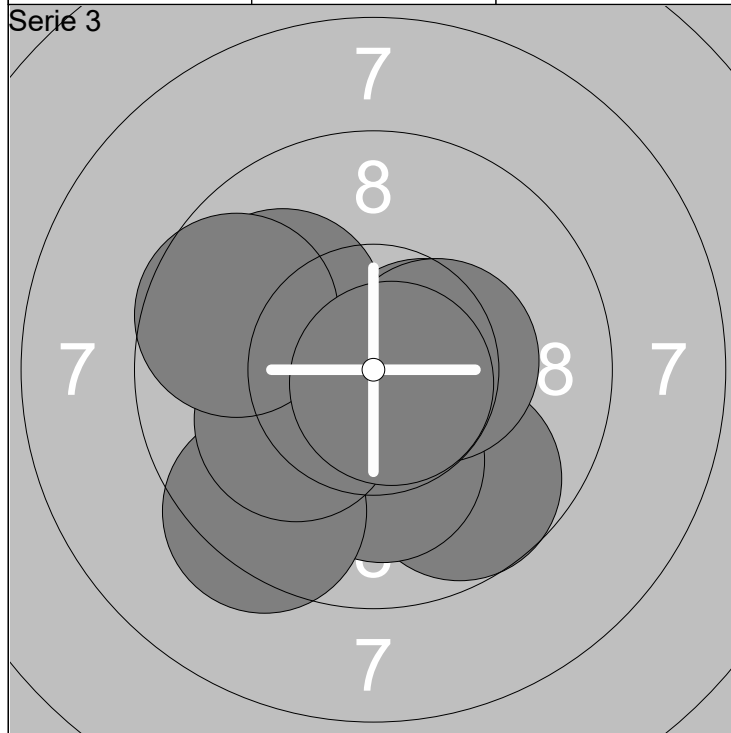

1: 10.5x →	6: 10.0 ↖	Serie	97 (4x)
2: 9.7 ↘	7: 10.1 ←		
3: 10.4x ←	8: 9.6 ←	Total	289 (15x)
4: 10.1 ↘	9: 10.4x →		
5: 9.3 ↙	10: 10.7x ↘		

1: 10.4x ↖	6: 10.7x ↖	Serie	98 (6x)
2: 9.9 ↘	7: 10.5x ↑		
3: 10.2x ↙	8: 10.0 ↗	Total	387 (21x)
4: 10.5x ↘	9: 9.6 ↖		
5: 10.5x ↑	10: 10.1 ↘		

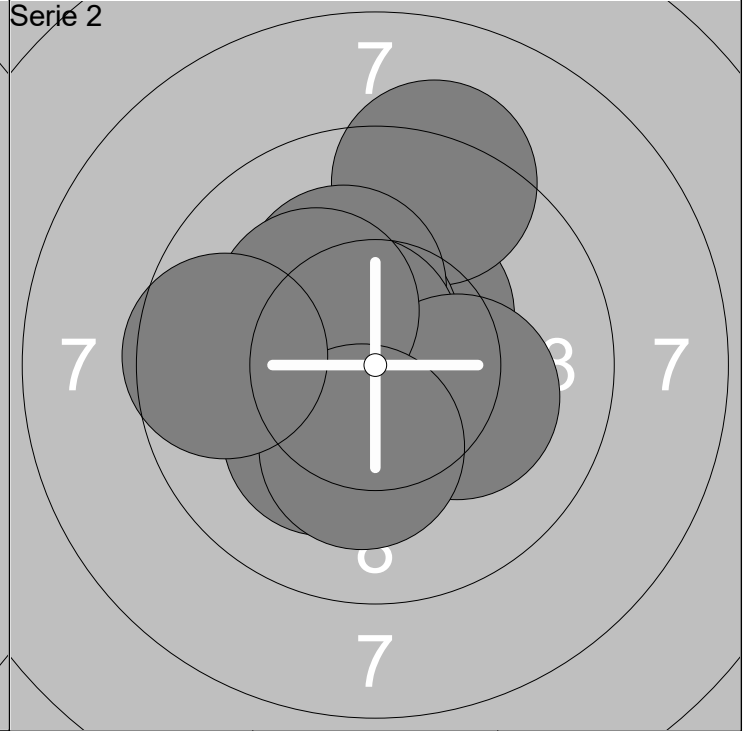
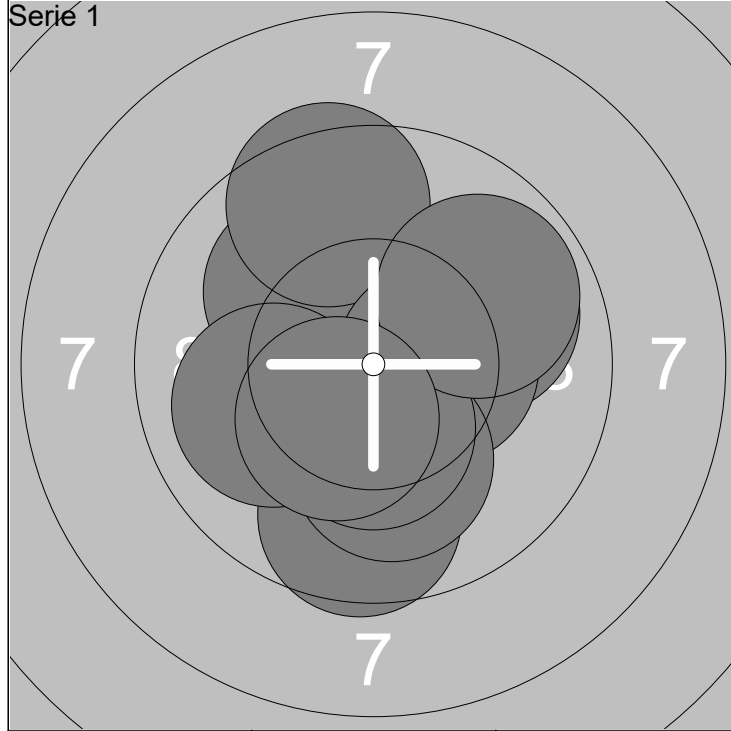

1: 10.1 ↖	6: 10.1 ↓	Serie 96 (3x)
2: 9.6 ↓	7: 10.0 ←	
3: 9.5 ↗	8: 10.4x ↓	Total 96 (3x)
4: 9.9 ↗	9: 9.8 ↗	
5: 10.4x →	10: 10.3x ↘	

1: 10.4x ↗	6: 10.6x ↗	Serie 98 (7x)
2: 10.2x ↘	7: 10.1 →	
3: 9.2 ↗	8: 10.2x ↖	Total 194 (10x)
4: 10.6x ↖	9: 10.2x ↓	
5: 10.2x ↖	10: 9.6 ←	

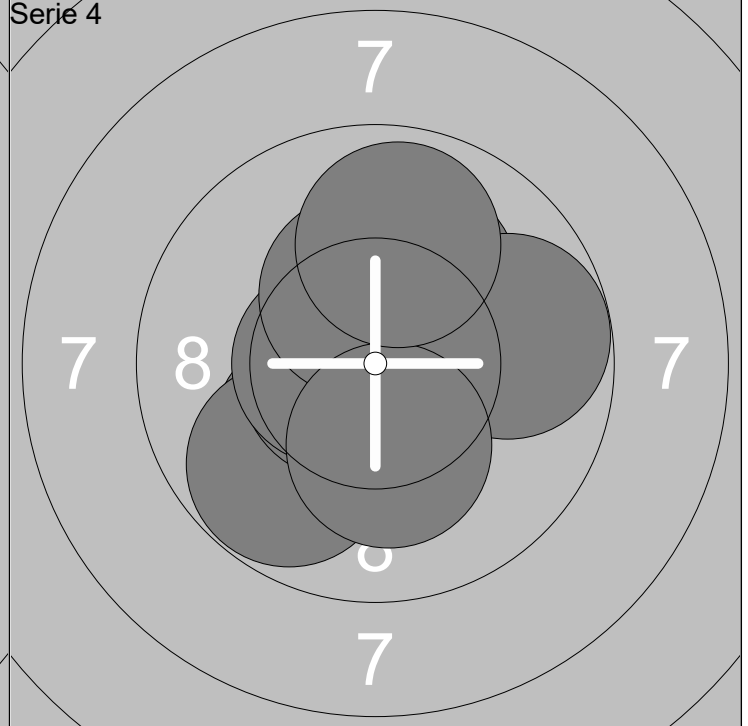
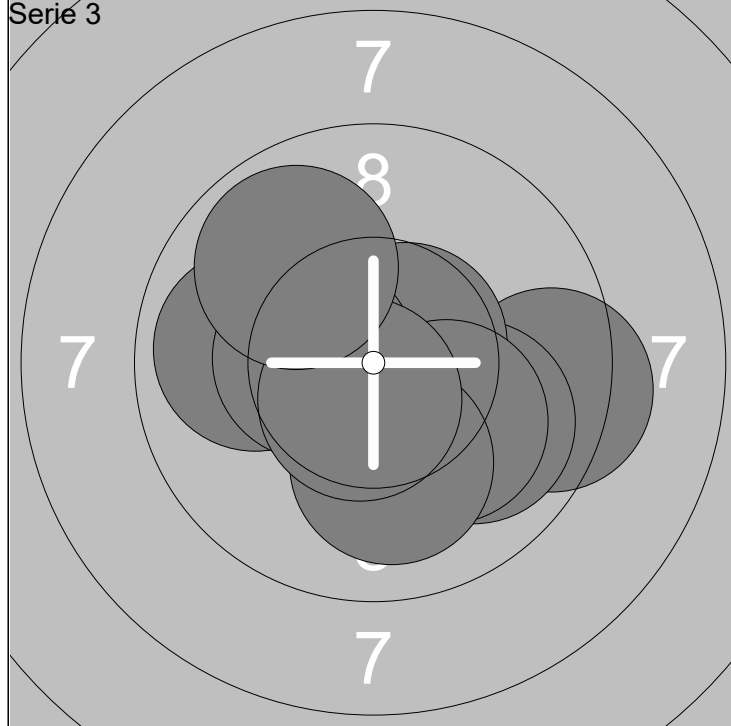

1: 10.4x ↖	6: 10.1 ↘	Serie 96 (4x)
2: 9.4 →	7: 10.0 ↓	
3: 9.9 ↘	8: 10.4x ←	Total 290 (14x)
4: 9.9 ←	9: 10.6x ↓	
5: 10.6x ↗	10: 9.9 ↖	

1: 10.1 ↘	6: 10.1 ↗	Serie 97 (5x)
2: 9.8 ↘	7: 10.3x ↗	
3: 10.7x ↖	8: 9.7 →	Total 387 (19x)
4: 10.6x ←	9: 10.2x ↓	
5: 10.6x ←	10: 9.9 ↗	

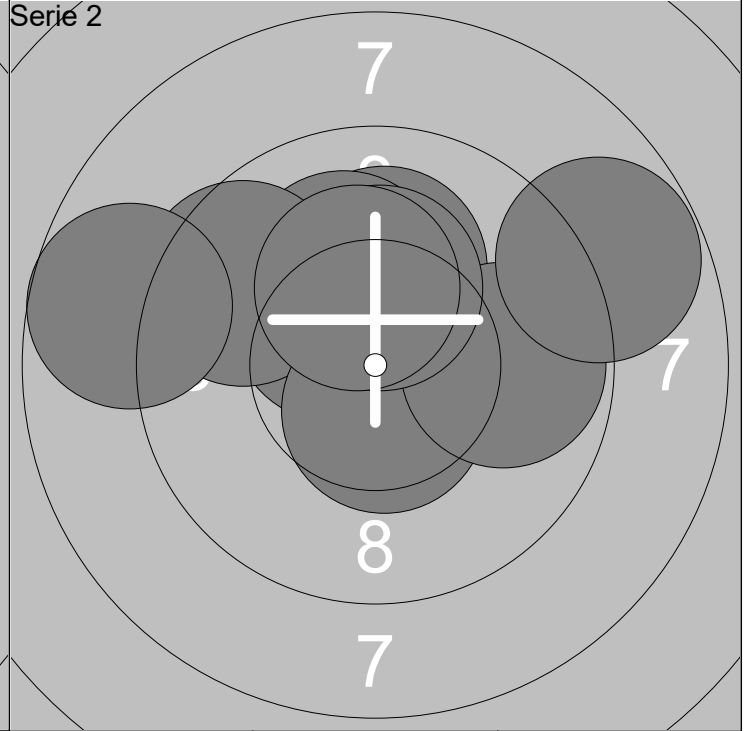
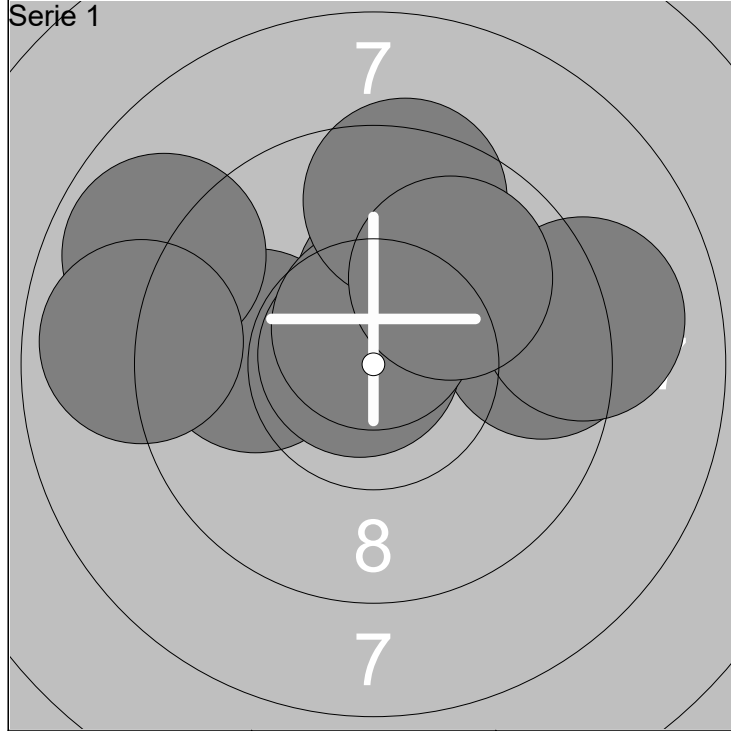

1: 9.5 →	6: 10.6x ↑	Serie	91 (3x)
2: 9.9 ←	7: 9.0 →		
3: 10.3x ↑	8: 9.5 ↑	Total	91 (3x)
4: 8.8 ↖	9: 9.9 ↗		
5: 10.8x ↖	10: 8.9 ←		

1: 10.1 ↑	6: 9.8 →	Serie	94 (4x)
2: 10.4x ↖	7: 8.8 →		
3: 10.1 ↑	8: 10.3x ↑	Total	185 (7x)
4: 9.5 ↖	9: 10.2x ↑		
5: 10.5x ↓	10: 8.7 ←		

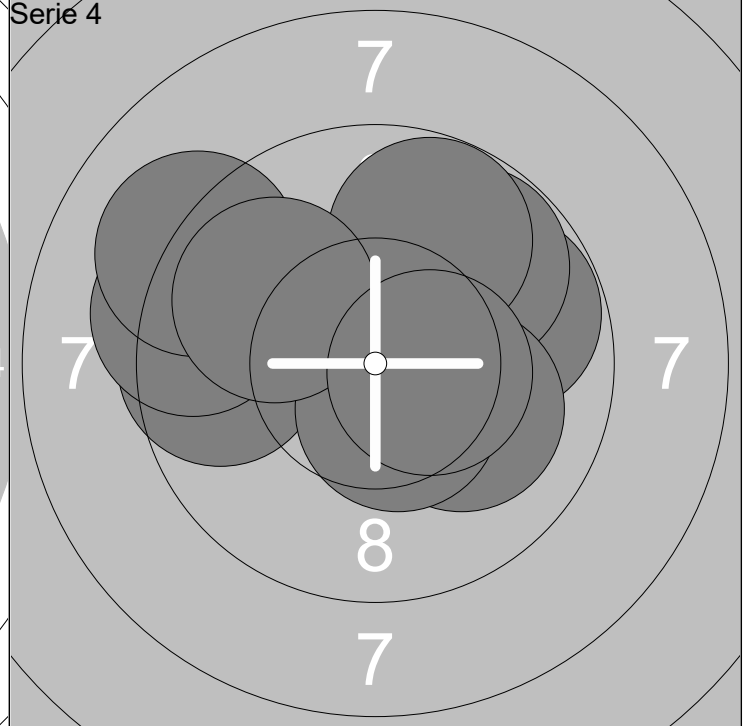
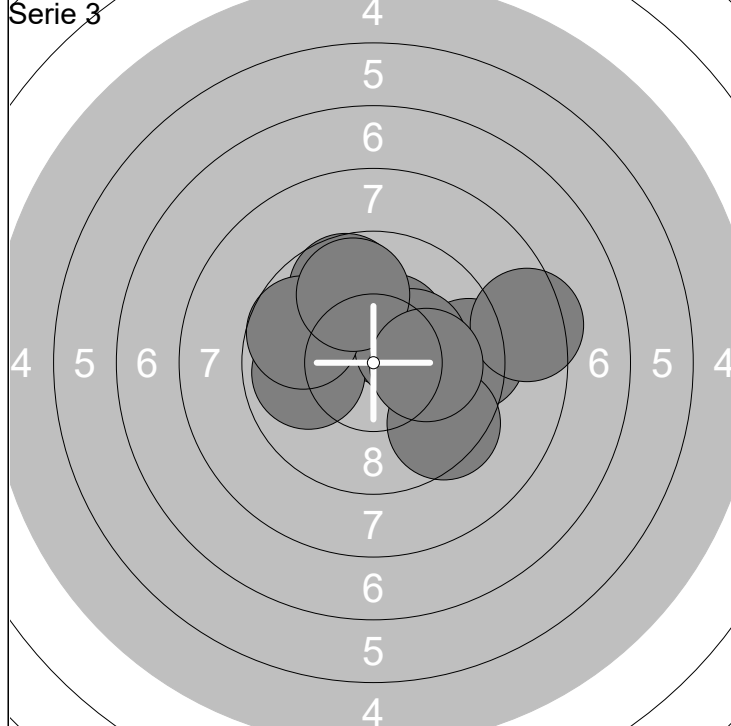

1: 10.3x ↗	6: 9.9 ←	Serie	92 (2x)
2: 9.4 →	7: 10.3x →		
3: 9.5 ↘	8: 9.7 ←	Total	277 (9x)
4: 9.7 ↑	9: 9.8 ↑		
5: 8.4 →	10: 10.1 →		

1: 9.6 ←	6: 9.1 ↖	Serie	93 (2x)
2: 9.8 →	7: 9.7 ↗		
3: 9.7 ↗	8: 10.5x ↓	Total	370 (11x)
4: 9.3 ←	9: 9.9 ↖		
5: 10.1 ↘	10: 10.5x →		

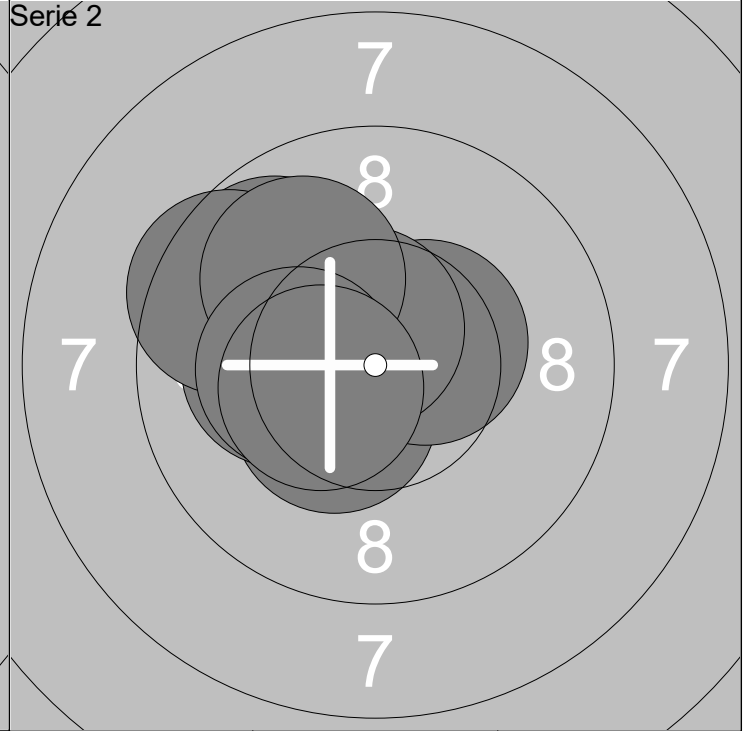
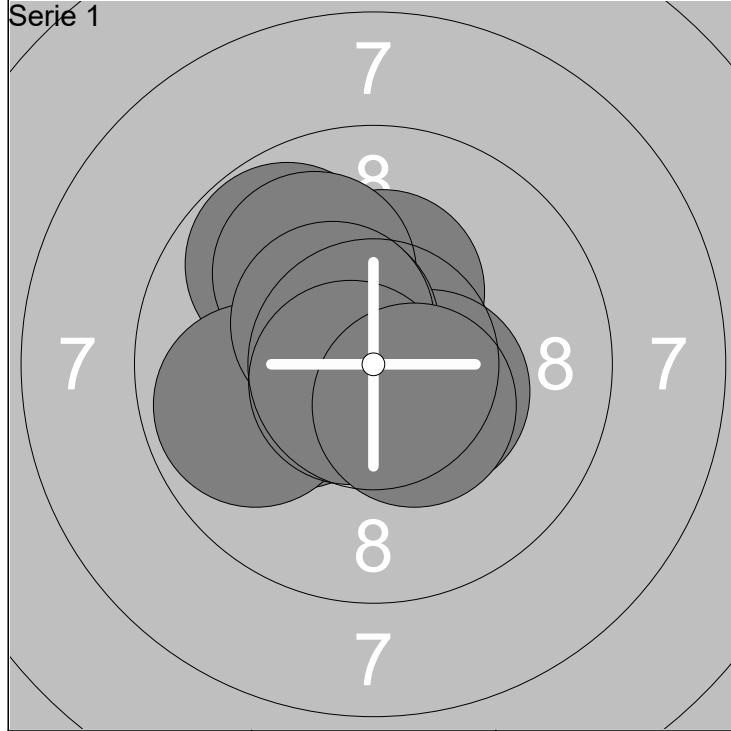

1: 10.3x ↑	6: 10.5x ↘	Serie	98 (7x)
2: 10.2x ←	7: 9.8 ←		
3: 9.8 ↗	8: 10.4x ↗	Total	98 (7x)
4: 10.0 ↗	9: 10.7x ↙		
5: 10.4x ↘	10: 10.4x ↘		

1: 10.4x ↙	6: 10.6x ↑	Serie	97 (6x)
2: 10.5x →	7: 9.5 ↖		
3: 10.1 ←	8: 9.9 ↗	Total	195 (13x)
4: 10.5x ←	9: 10.2x ←		
5: 9.8 ↖	10: 10.4x ←		

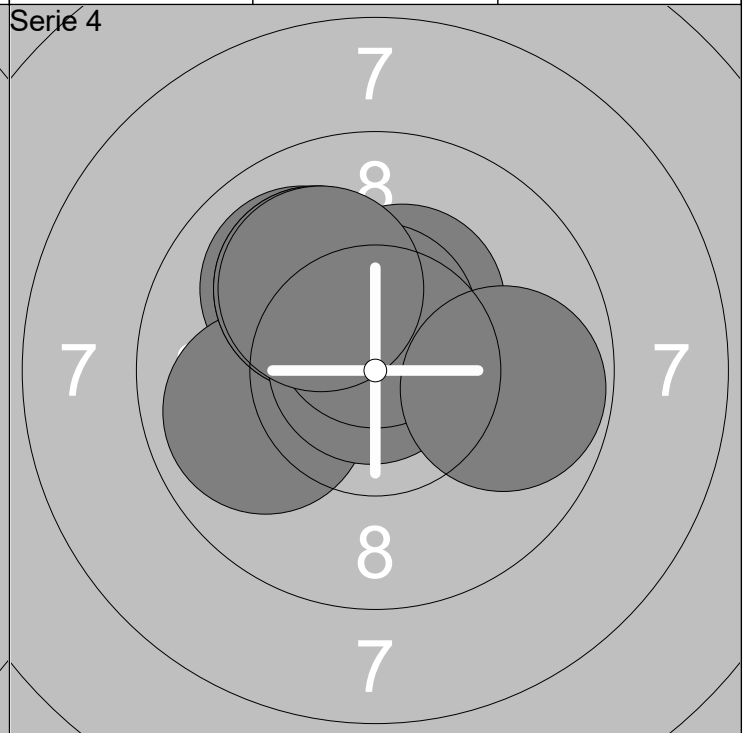
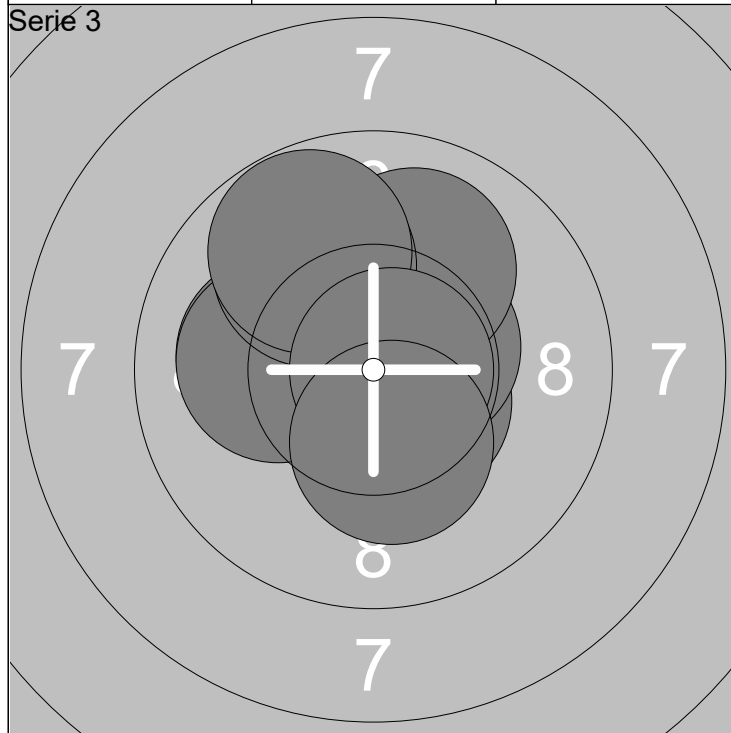

1: 10.5x ↑	6: 10.0 ↑	Serie	98 (5x)
2: 10.5x ↘	7: 9.9 ↗		
3: 10.1 ←	8: 9.8 ↗	Total	293 (18x)
4: 10.1 ←	9: 10.8x →		
5: 10.5x ↗	10: 10.3x ↓		

1: 10.0 ↖	6: 10.3x ↑	Serie	98 (4x)
2: 10.2x ↗	7: 10.8x ↖		
3: 9.9 ←	8: 10.5x ↑	Total	391 (22x)
4: 10.1 ↗	9: 10.1 ↖		
5: 10.0 ↖	10: 9.8 →		

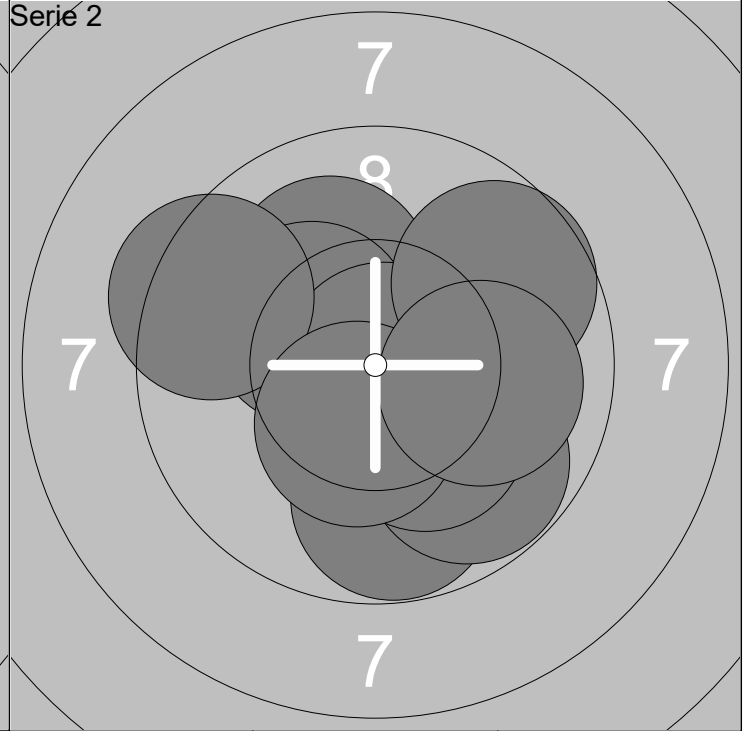
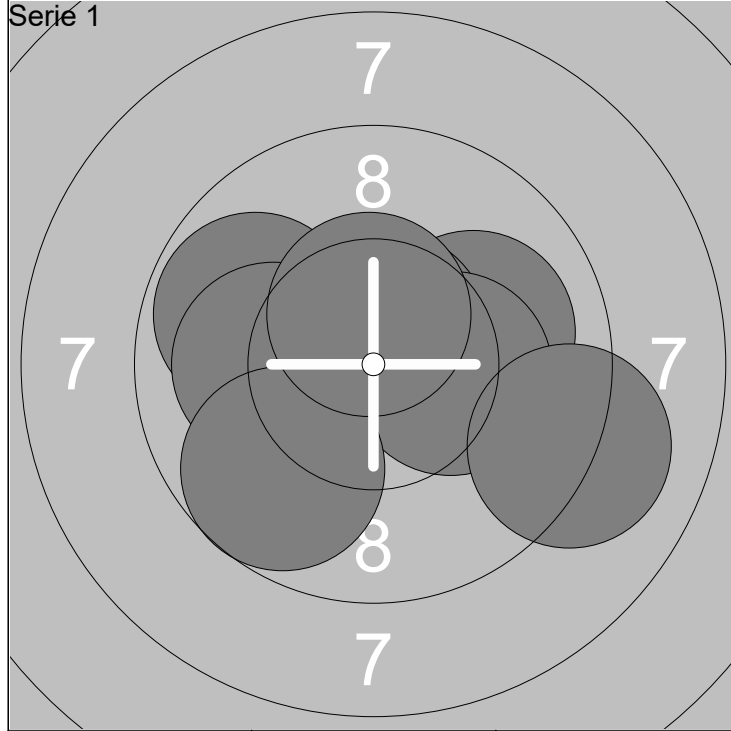

1: 10.7x ↗	6: 10.1 ←	Serie 97 (5x)
2: 10.0 →	7: 10.2x →	
3: 9.8 ↖	8: 9.7 ↙	Total 97 (5x)
4: 10.6x ↗	9: 9.1 ↘	
5: 10.6x ↗	10: 10.5x ↗	

1: 9.8 ↓	6: 10.8x →	Serie 96 (4x)
2: 9.8 ↘	7: 9.4 ↖	
3: 10.2x ↘	8: 9.7 ↗	Total 193 (9x)
4: 10.0 ↗	9: 10.4x ↓	
5: 10.3x ↖	10: 10.0 →	

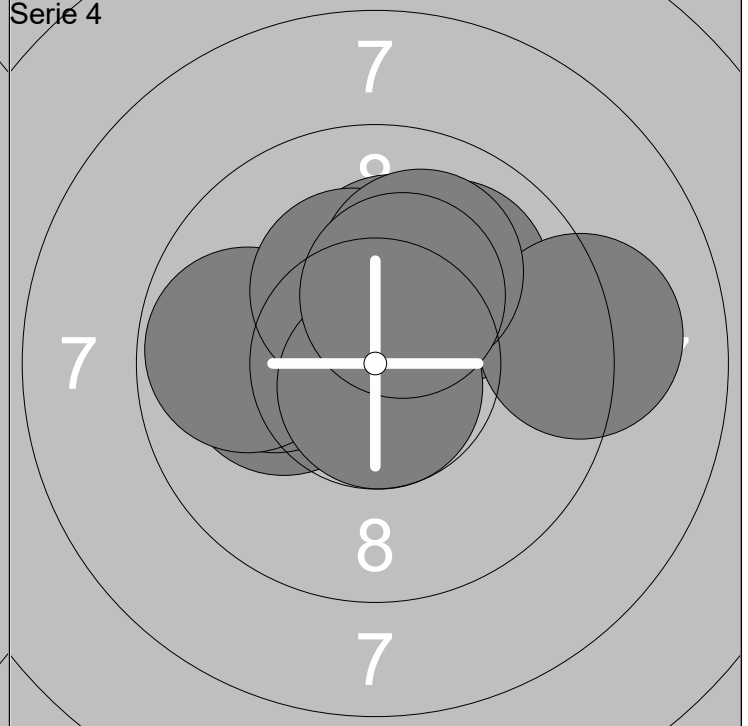
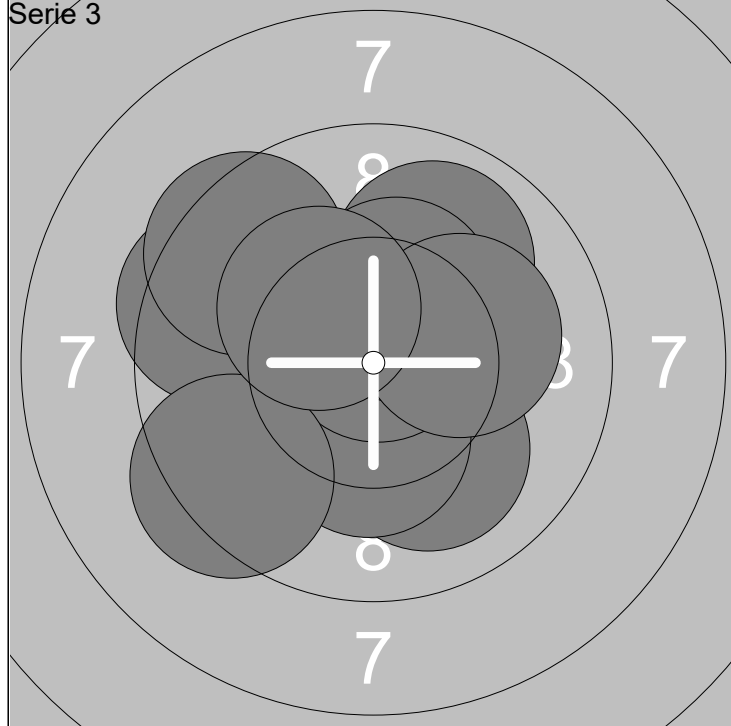

1: 10.0 ↘	6: 10.3x ↗	Serie 96 (4x)
2: 10.3x ↓	7: 10.1 →	
3: 10.7x ↗	8: 9.4 ↖	Total 289 (13x)
4: 9.9 ↗	9: 9.3 ↙	
5: 9.5 ↖	10: 10.3x ↖	

1: 10.1 ←	6: 9.1 →	Serie 97 (3x)
2: 10.0 ↖	7: 10.3x ↗	
3: 9.9 ↗	8: 10.7x ↓	Total 386 (16x)
4: 9.8 ↖	9: 10.0 ↗	
5: 10.1 ↗	10: 10.3x ↗	

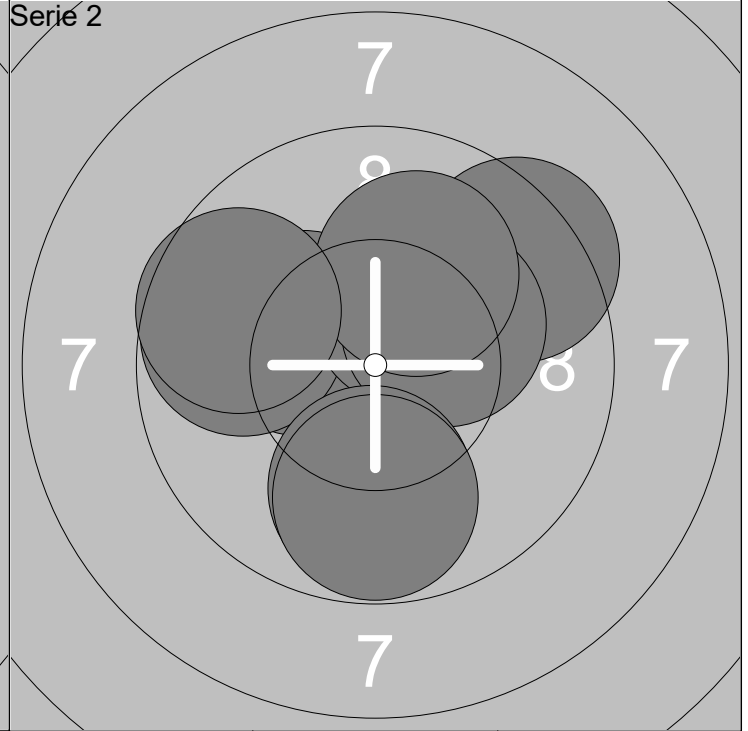
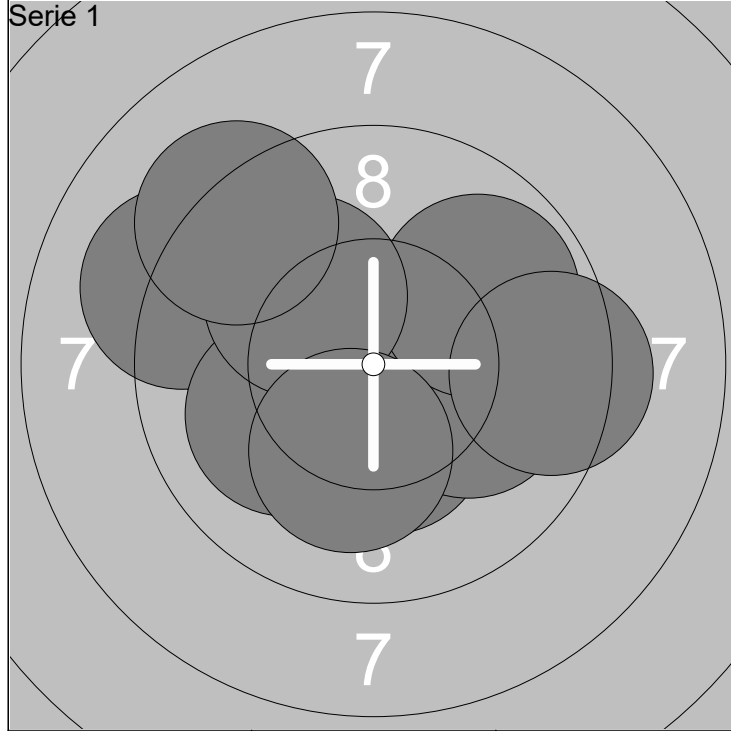

1: 9.7 ↖	6: 9.8 ↗	Serie 95 (2x)
2: 10.3x ↓	7: 10.1 ↖	
3: 9.1 ↖	8: 10.2x ↓	Total 95 (2x)
4: 10.0 ↙	9: 9.2 ↗	
5: 10.1 →	10: 9.4 →	

1: 10.2x ↖	6: 10.2x ↗	Serie 95 (4x)
2: 10.5x ↗	7: 9.9 ↓	
3: 9.7 ↖	8: 9.8 ↓	Total 190 (6x)
4: 10.3x ↗	9: 10.0 ↗	
5: 9.4 ↗	10: 9.6 ↖	

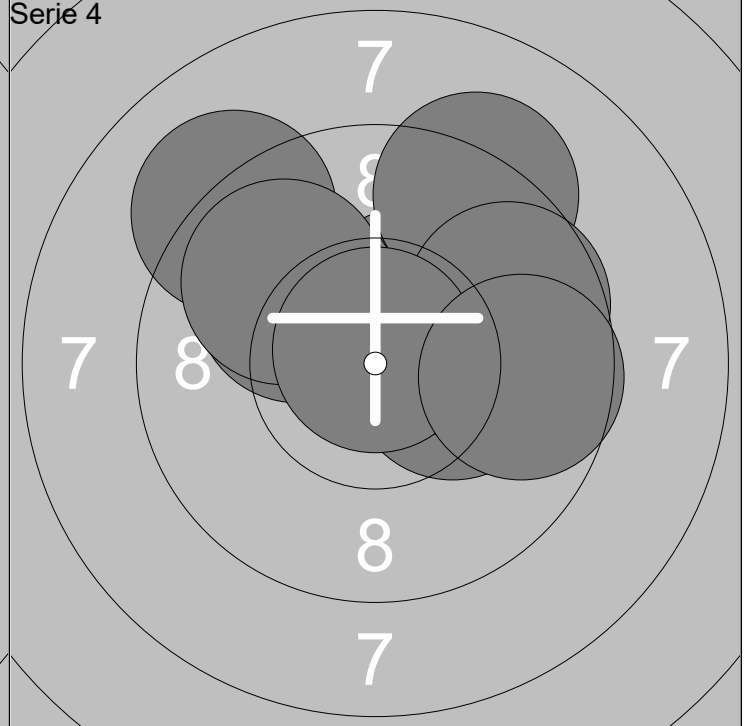
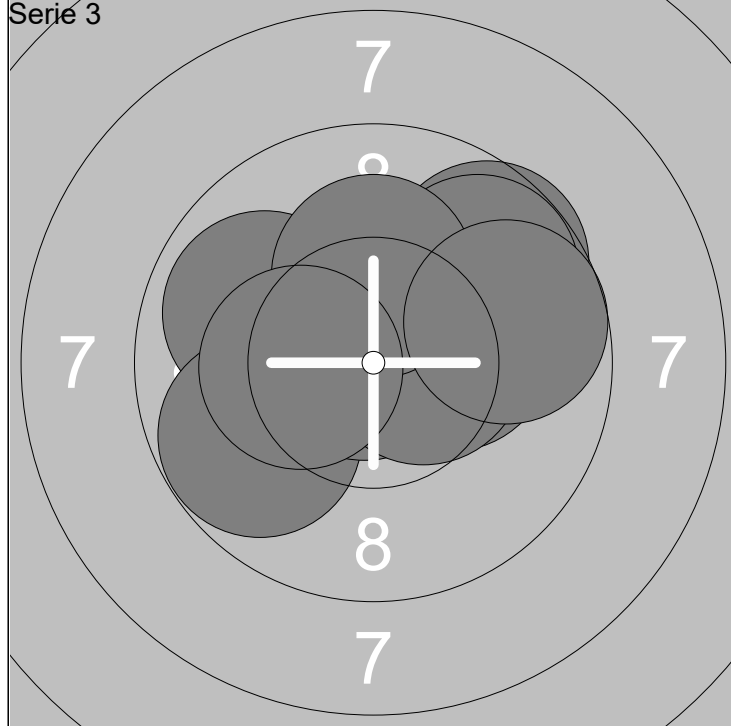

1: 9.9 ↖	6: 9.7 ↗	Serie 95 (5x)
2: 9.8 ↙	7: 10.5x →	
3: 9.6 ↗	8: 10.2x ↑	Total 285 (11x)
4: 10.3x →	9: 10.3x ←	
5: 10.8x ↖	10: 9.7 →	

1: 10.2x →	6: 9.7 ↗	Serie 94 (3x)
2: 10.3x ↗	7: 9.1 ↖	
3: 10.0 ↖	8: 9.9 ↖	Total 379 (14x)
4: 9.2 ↗	9: 10.8x ↑	
5: 9.9 →	10: 9.6 →	

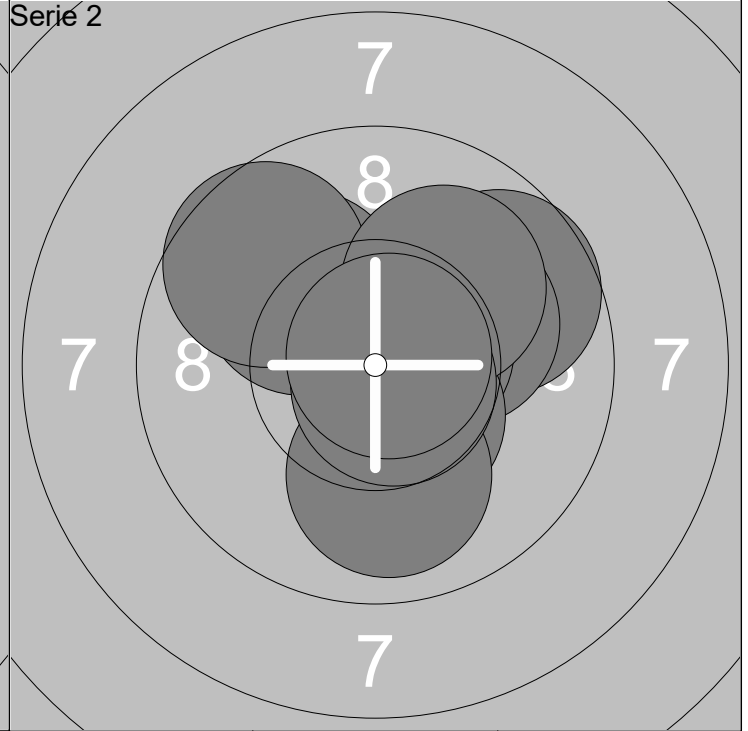
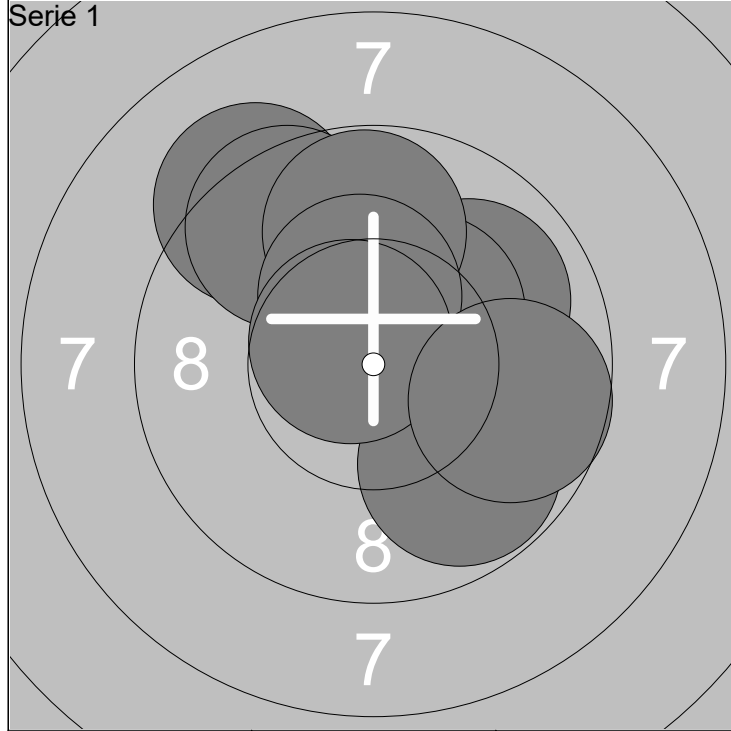

1: 10.5x ↖	6: 9.8 ↘	Serie	94 (4x)
2: 9.2 ↖	7: 9.8 ↑		
3: 9.5 ↖	8: 10.3x ↑	Total	94 (4x)
4: 9.9 ↗	9: 10.7x ↖		
5: 10.3x ↗	10: 9.7 →		

1: 9.6 ↗	6: 10.4x ↘	Serie	98 (4x)
2: 10.1 ↗	7: 10.0 ↗		
3: 10.0 ↖	8: 10.0 ↓	Total	192 (8x)
4: 10.6x ↗	9: 10.7x ↘		
5: 9.6 ↖	10: 10.8x ↗		

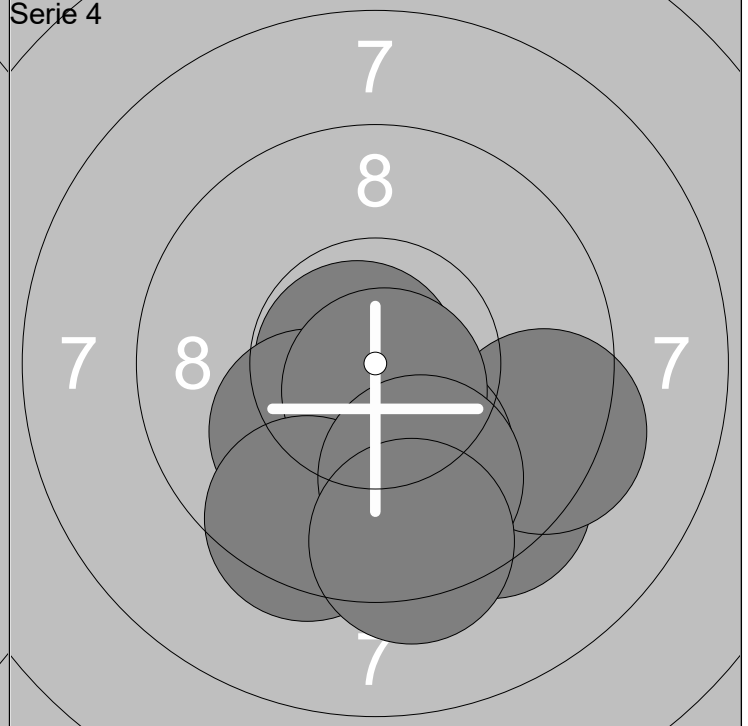
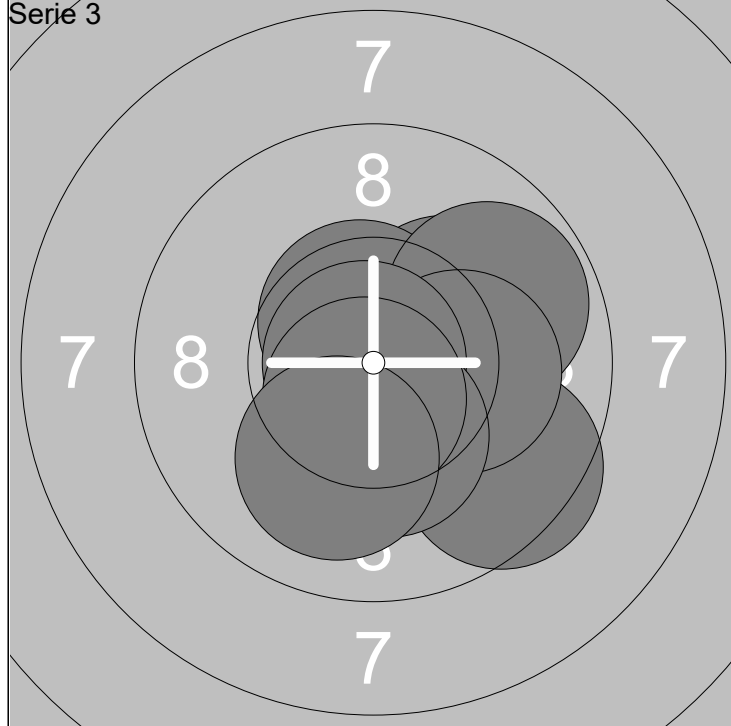

1: 10.2x ↗	6: 10.2x →	Serie	98 (7x)
2: 10.7x →	7: 10.9x ←		
3: 9.5 ↘	8: 10.3x ↓	Total	290 (15x)
4: 10.6x ↑	9: 10.6x ↓		
5: 9.8 ↗	10: 10.0 ↓		

1: 9.4 ↘	6: 10.1 ↓	Serie	95 (3x)
2: 10.2x ↘	7: 10.7x ↓		
3: 10.8x ←	8: 9.5 ↓	Total	385 (18x)
4: 10.1 ↘	9: 9.9 ↓		
5: 9.3 →	10: 9.3 ↓		

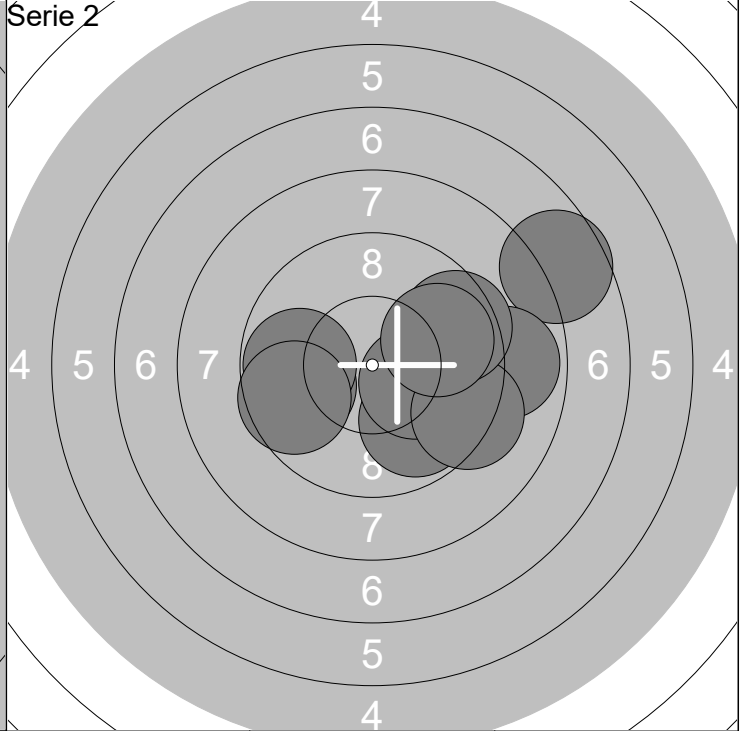
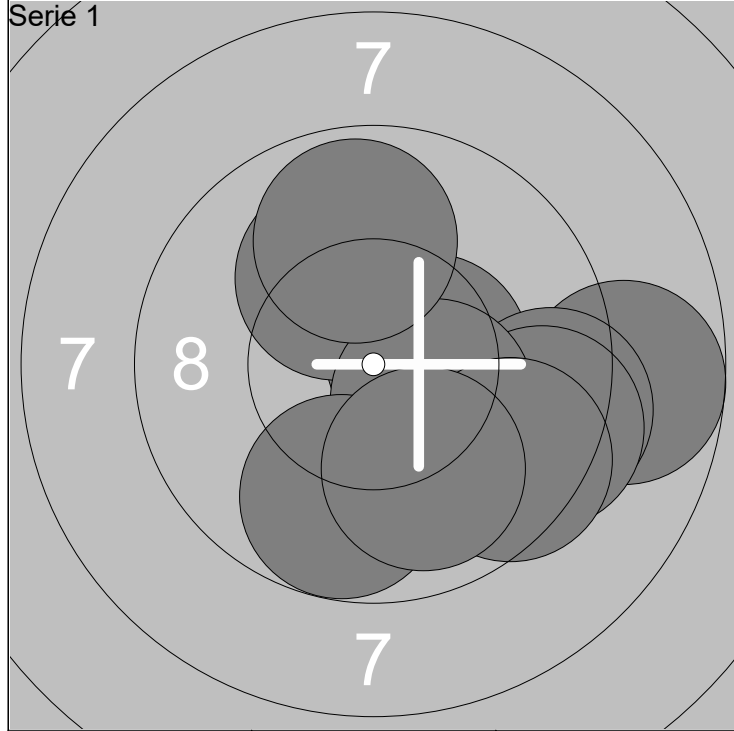

1: 8.7 →	6: 10.3x ↘	Serie 92 (2x)
2: 10.5x →	7: 9.7 ↓	
3: 10.1 ↗	8: 9.4 ↘	Total 92 (2x)
4: 9.3 →	9: 9.9 ↓	
5: 9.4 →	10: 9.8 ↑	

1: 7.6 ↗	6: 8.9 →	Serie 88 (1x)
2: 9.8 ↘	7: 9.2 ↘	
3: 9.7 ←	8: 9.5 ↗	Total 180 (3x)
4: 9.8 ←	9: 9.8 ↗	
5: 10.2x →	10: 9.6 ←	

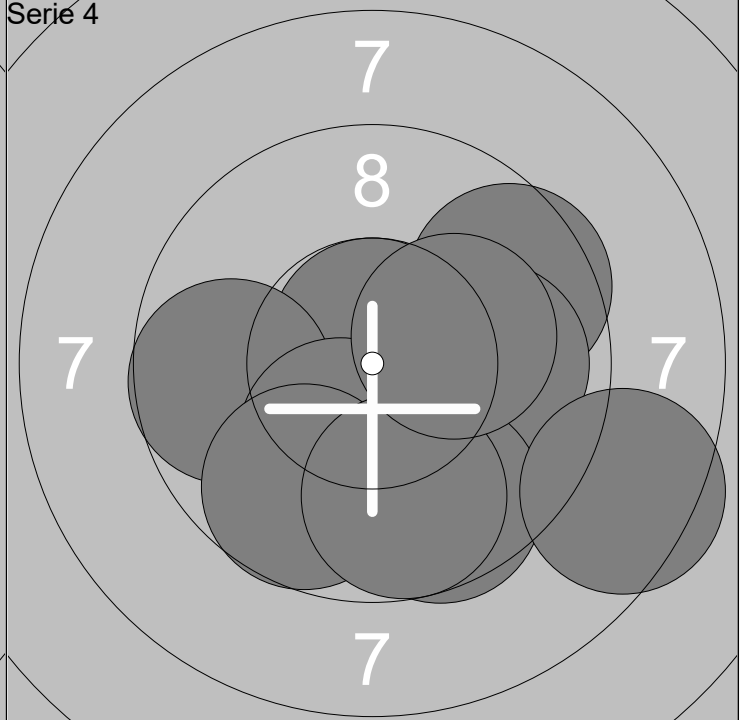
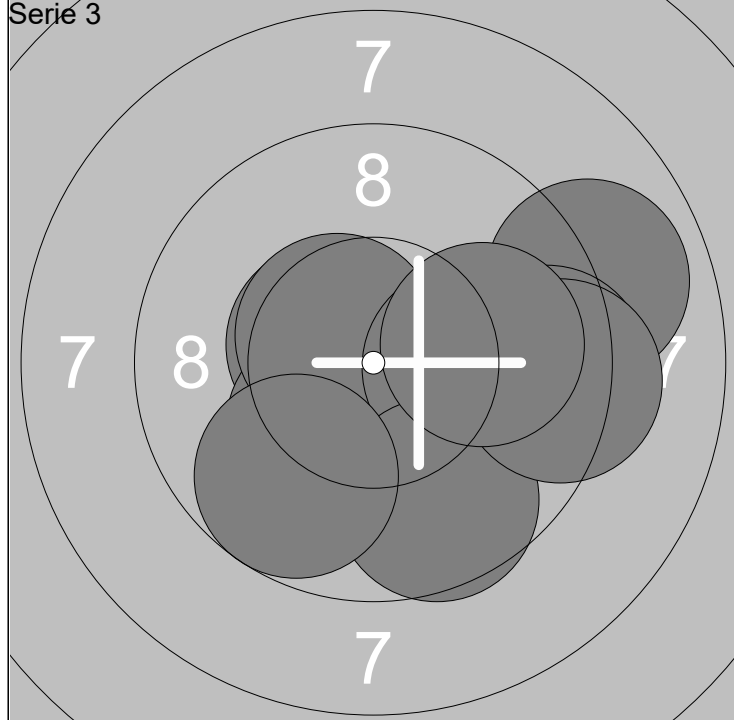

1: 8.9 ↗	6: 10.1 →	Serie 94 (3x)
2: 10.5x ↖	7: 9.6 ↓	
3: 9.4 →	8: 9.7 ↘	Total 274 (6x)
4: 10.2x ↘	9: 9.3 →	
5: 10.5x ↖	10: 10.0 →	

1: 9.6 ↗	6: 10.2x ↓	Serie 92 (3x)
2: 9.9 →	7: 9.7 ↓	
3: 9.6 ↘	8: 8.5 →	Total 366 (9x)
4: 10.7x ↑	9: 9.8 ↓	
5: 9.7 ←	10: 10.2x →	

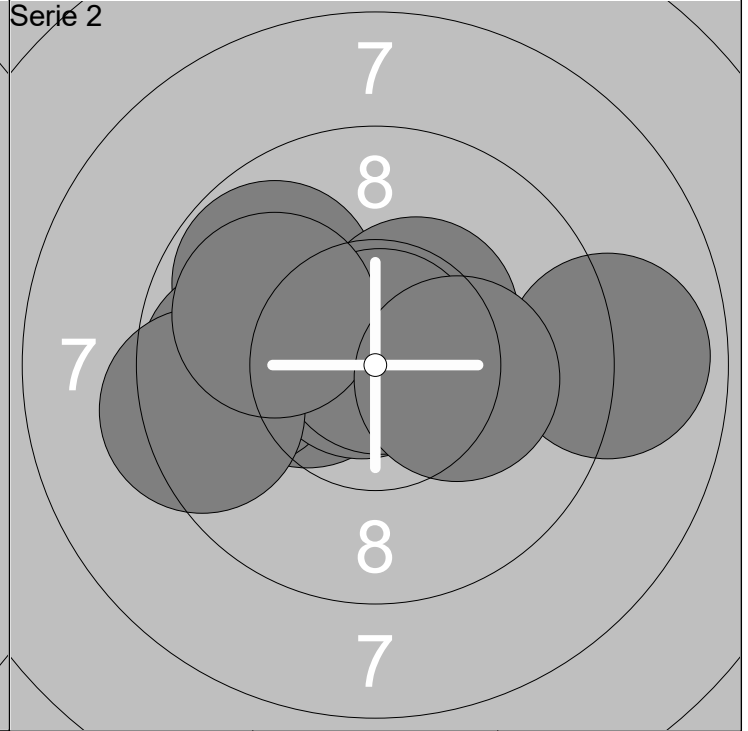
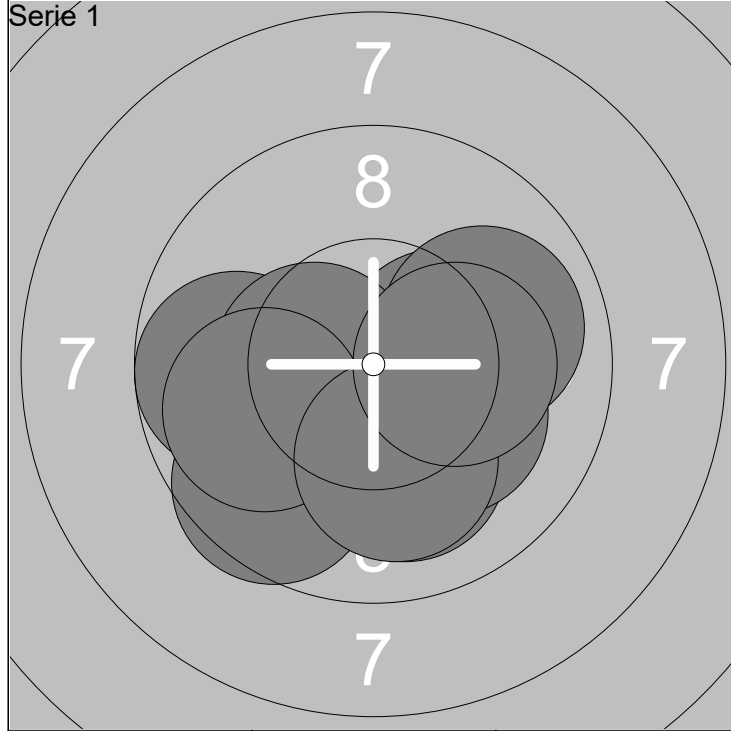

1: 10.3x →	6: 10.4x ←	Serie	96 (4x)
2: 9.7 ←	7: 10.2x ↘		
3: 9.5 ↙	8: 9.9 ←	Total	96 (4x)
4: 9.9 →	9: 10.1 ↓		
5: 10.1 ↓	10: 10.2x →		

1: 9.8 ↖	6: 10.8x ↗	Serie	95 (5x)
2: 10.3x ←	7: 9.4 ←		
3: 10.4x ↗	8: 10.0 ↖	Total	191 (9x)
4: 9.8 ←	9: 8.9 →		
5: 10.8x ↖	10: 10.2x →		

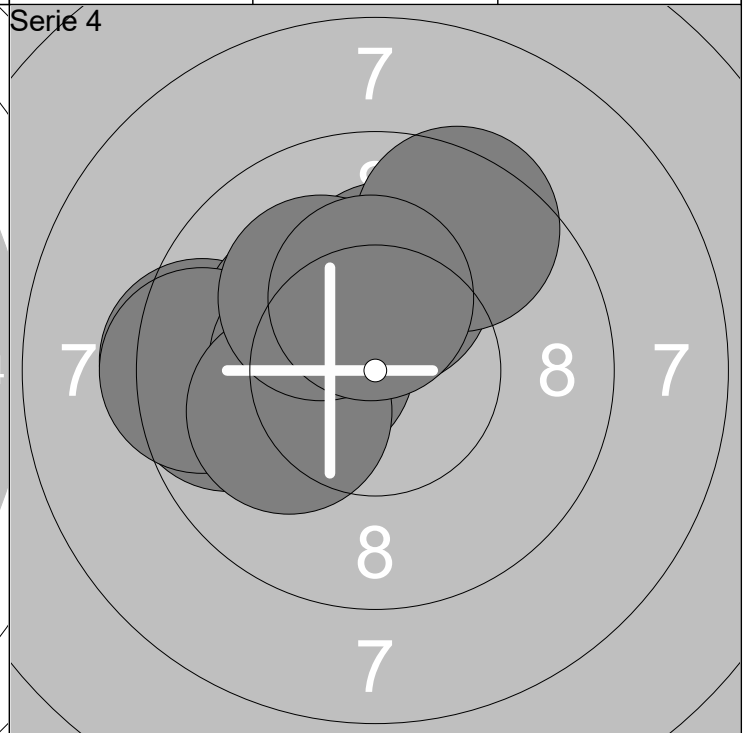
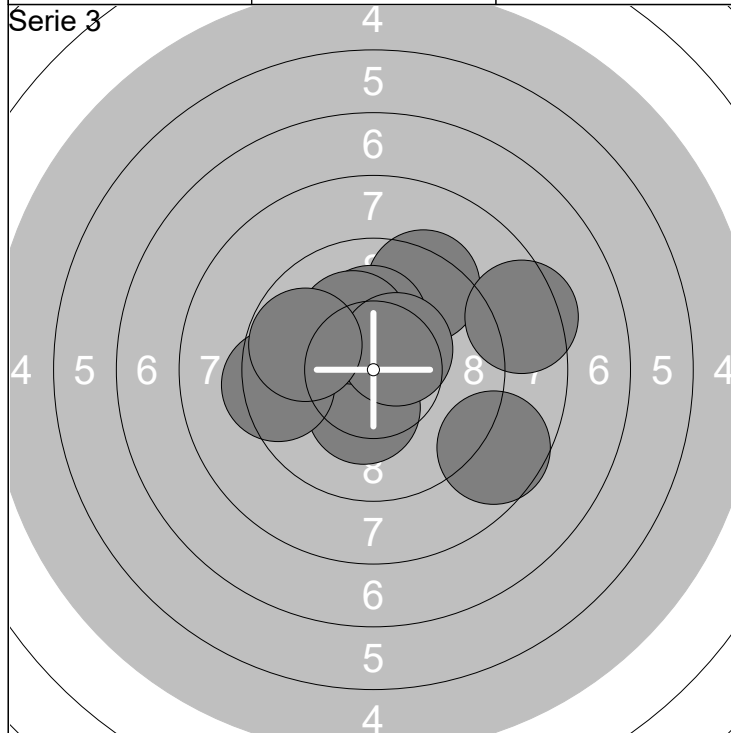

1: 9.9 ←	6: 10.2x ↗	Serie	92 (4x)
2: 9.4 ↗	7: 9.4 ←		
3: 8.4 →	8: 8.6 ↘	Total	283 (13x)
4: 10.3x ↓	9: 10.4x ↗		
5: 10.2x ↑	10: 9.8 ←		

1: 9.4 ←	6: 10.3x ←	Serie	96 (4x)
2: 10.2x ↖	7: 10.1 ←		
3: 9.6 ←	8: 9.5 ↗	Total	379 (17x)
4: 9.4 ←	9: 10.1 ↖		
5: 10.2x ↑	10: 10.3x ↑		

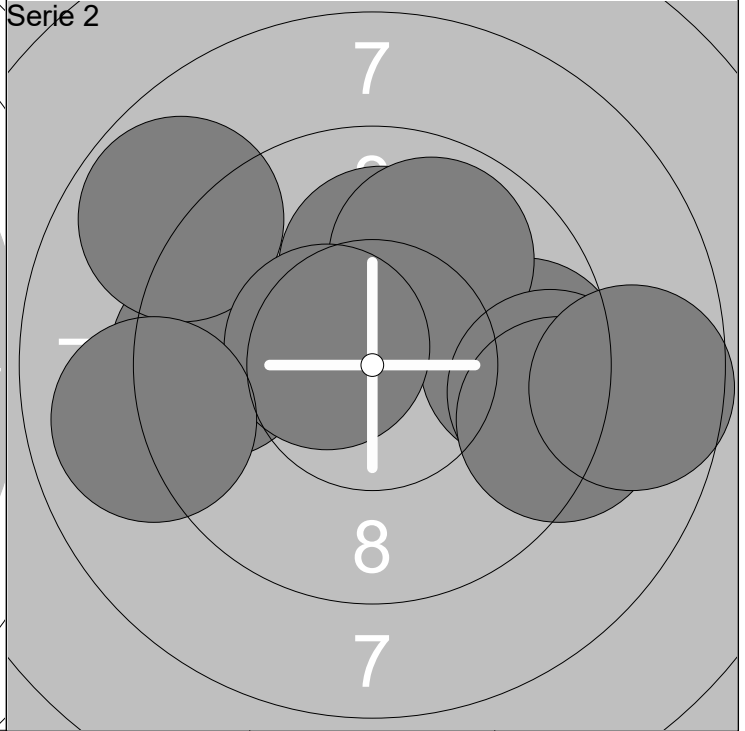
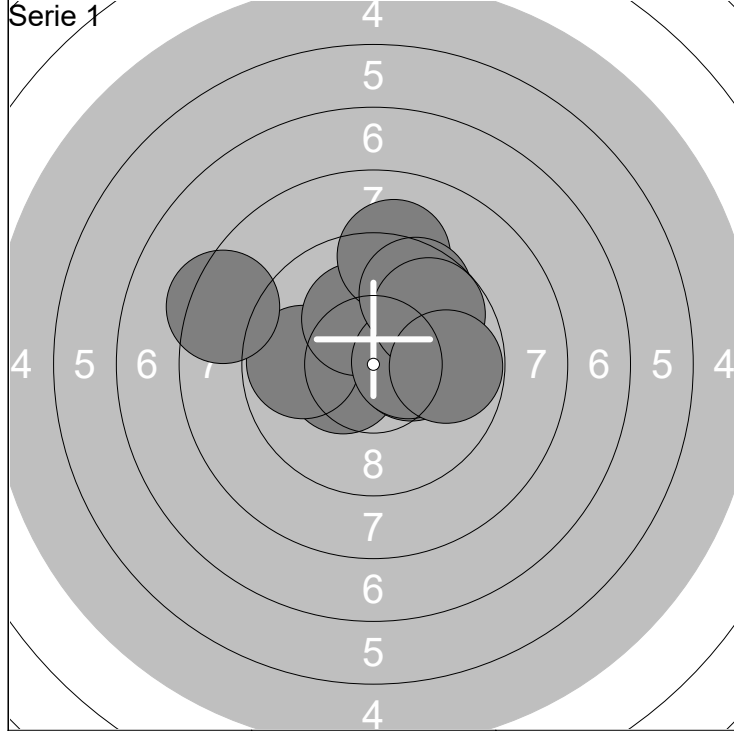

1: 10.4x ←	6: 9.2 ↑	Serie	93 (4x)
2: 9.8 ←	7: 9.6 ↗		
3: 10.3x →	8: 8.4 ←	Total	93 (4x)
4: 10.2x ↗	9: 9.8 ↗		
5: 10.4x →	10: 9.8 →		

1: 9.6 →	6: 10.5x ←	Serie	89 (1x)
2: 9.5 ←	7: 9.4 →		
3: 10.1 ↑	8: 9.2 →	Total	182 (5x)
4: 8.8 ↖	9: 8.9 ←		
5: 9.9 ↗	10: 8.6 →		

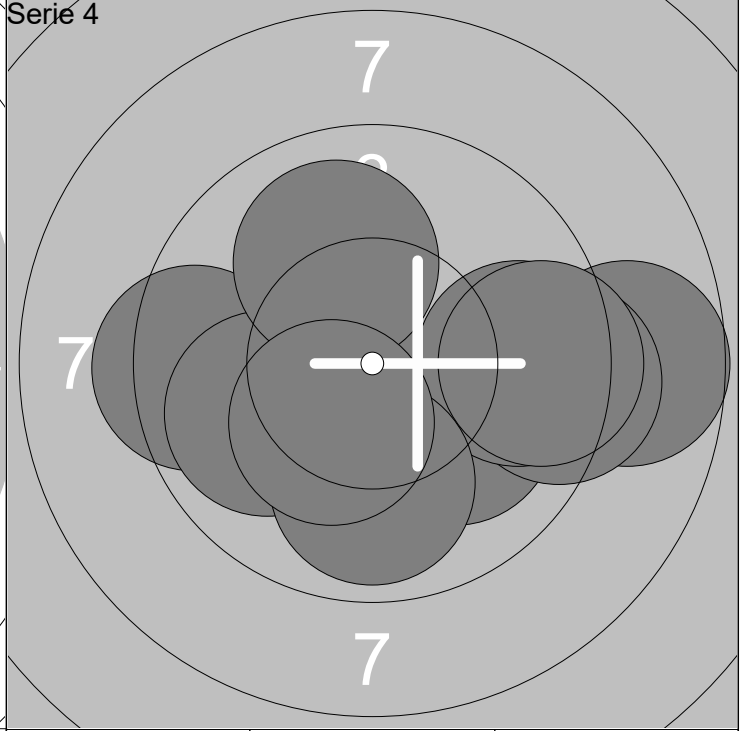
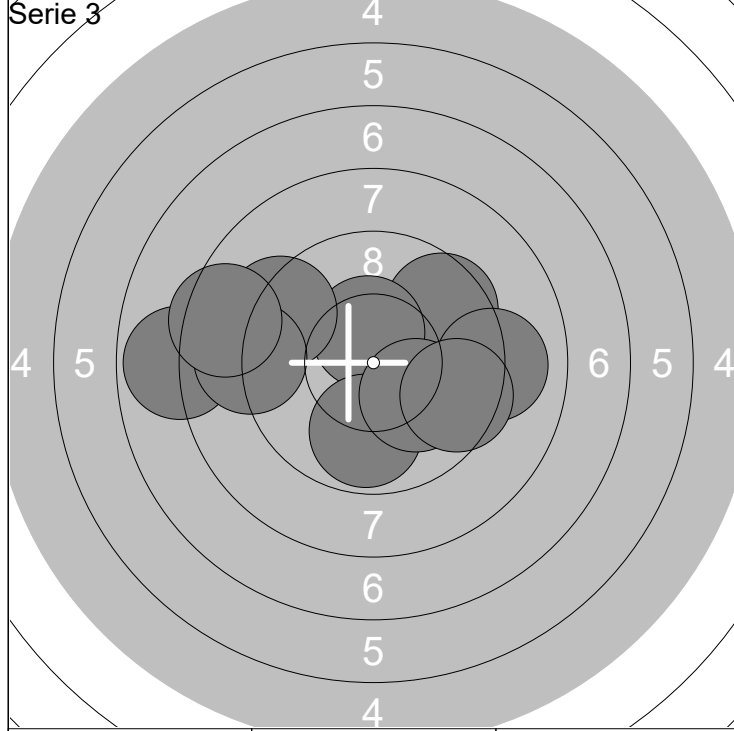

1: 9.6 ↗	6: 9.0 ←	Serie	89 (1x)
2: 10.4x ↑	7: 8.5 ←		
3: 7.9 ←	8: 9.1 →	Total	271 (6x)
4: 9.9 ↓	9: 10.1 ↘		
5: 9.2 ↖	10: 9.5 →		

1: 10.0 ↘	6: 9.9 ←	Serie	92 (1x)
2: 8.7 →	7: 10.0 ↗		
3: 9.3 →	8: 9.9 ↓	Total	363 (7x)
4: 9.4 ←	9: 9.4 →		
5: 9.7 →	10: 10.3x ↘		

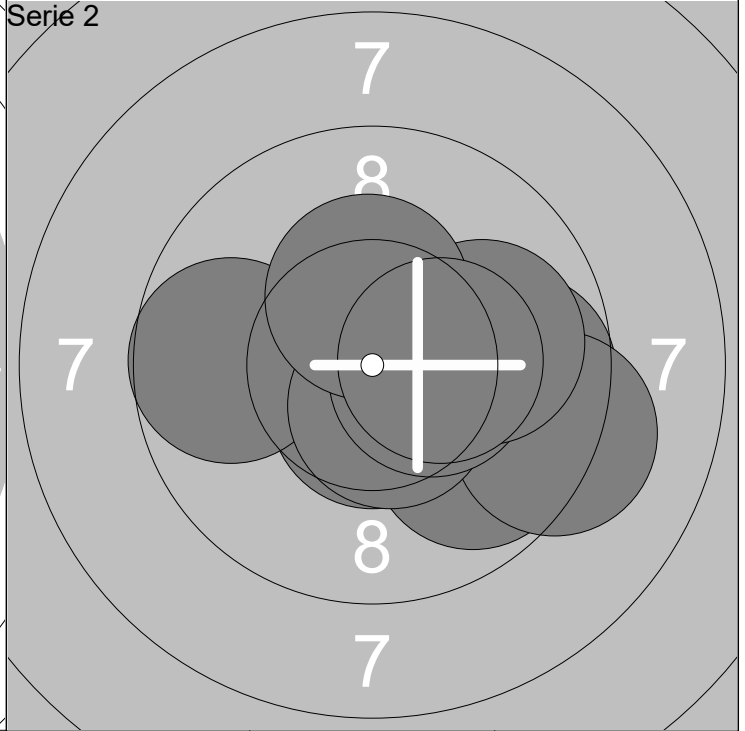
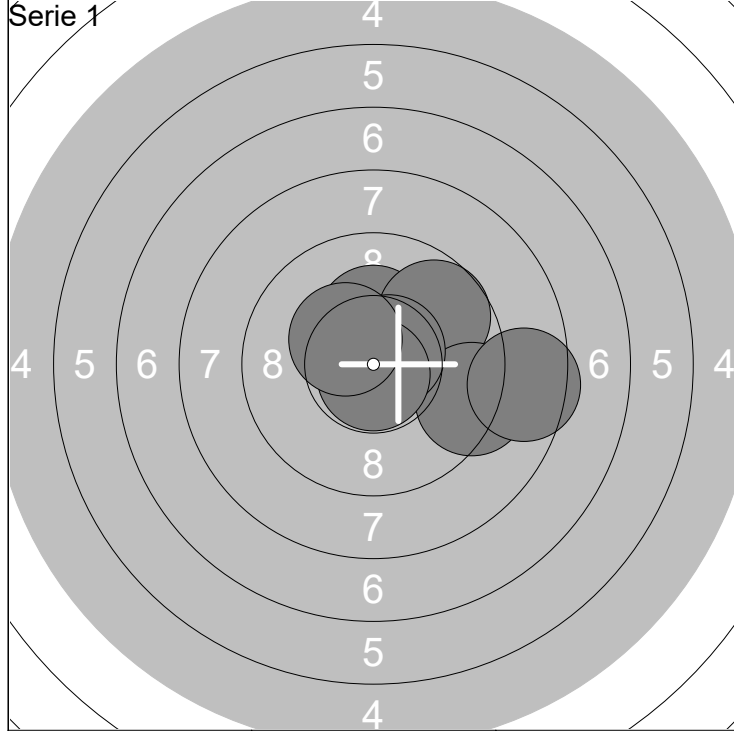

1: 10.3x ↗	6: 9.3 →	Serie	96 (7x)
2: 10.2x ↑	7: 8.5 →		
3: 9.7 ↗	8: 10.6x ↗	Total	96 (7x)
4: 10.9x ←	9: 10.8x ↓		
5: 10.8x ↑	10: 10.3x ↖		

1: 10.6x ↓	6: 10.6x ↓	Serie	95 (5x)
2: 9.8 ↘	7: 10.4x →		
3: 9.7 ←	8: 9.9 →	Total	191 (12x)
4: 9.7 →	9: 10.3x ↑		
5: 9.2 →	10: 10.3x →		

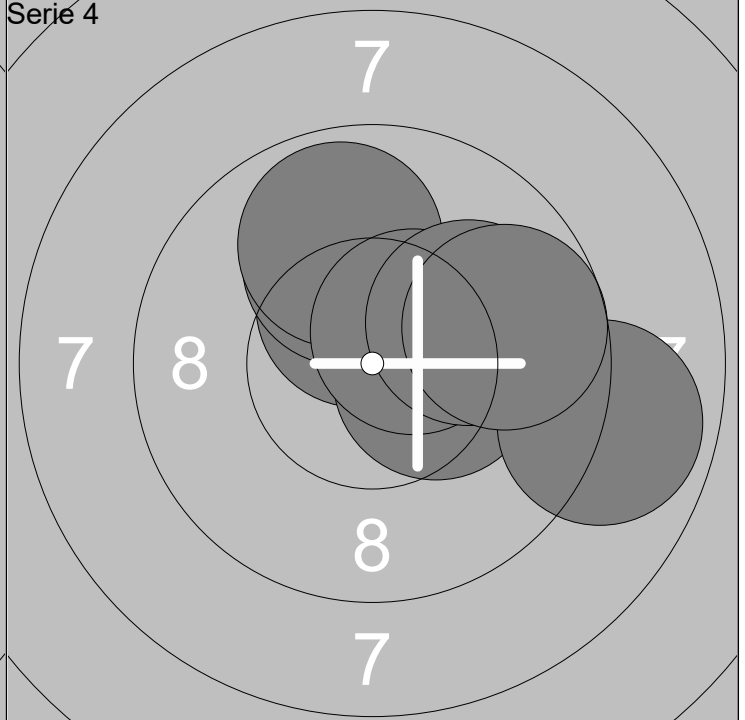
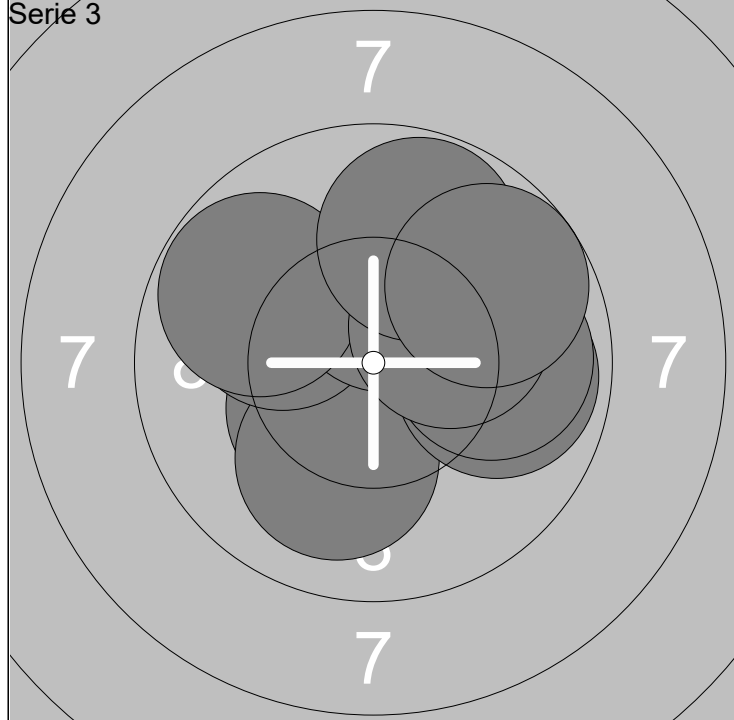

1: 10.4x ↙	6: 9.9 →	Serie	95 (3x)
2: 10.0 ↓	7: 9.7 ↖		
3: 10.0 ↖	8: 10.2x ↗	Total	286 (15x)
4: 10.3x ↑	9: 9.8 ↑		
5: 9.9 →	10: 9.7 ↗		

1: 10.3x →	6: 10.4x →	Serie	96 (5x)
2: 10.5x ↗	7: 10.5x ↗		
3: 10.4x ↑	8: 10.0 →	Total	382 (20x)
4: 10.0 ↑	9: 8.9 →		
5: 9.8 ↑	10: 9.7 →		

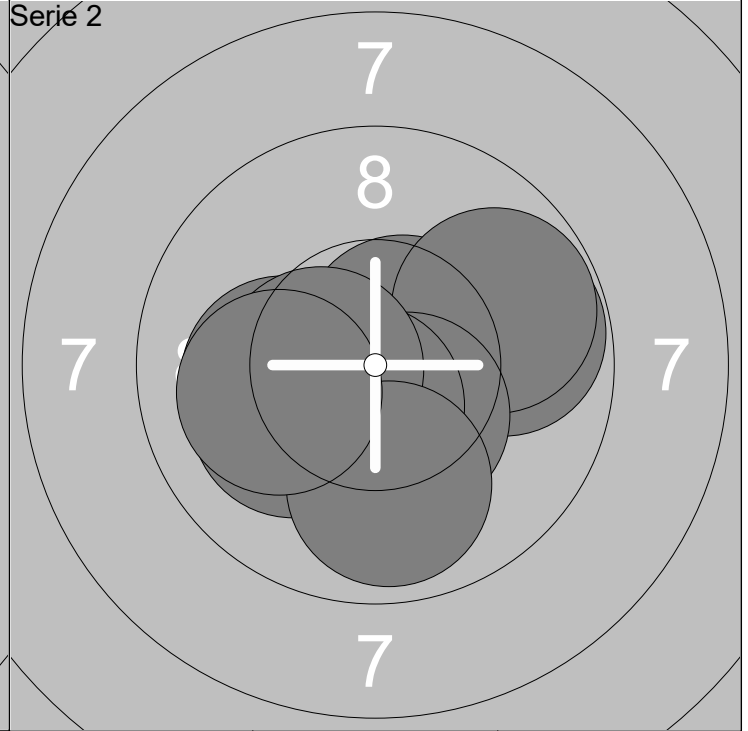
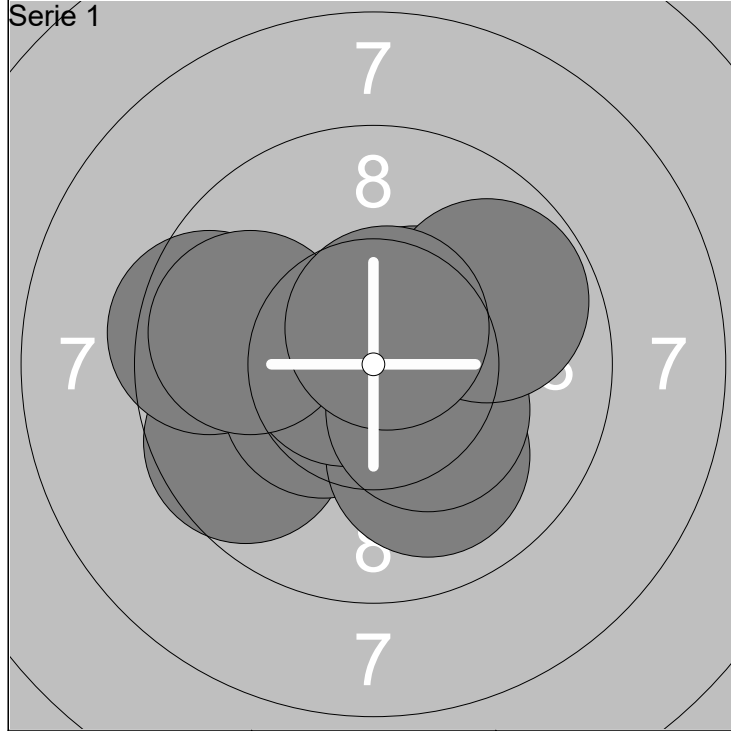

1: 9.6 ↙	6: 10.7x ←	Serie	96 (5x)
2: 10.5x ↗	7: 9.8 ←		
3: 9.5 ←	8: 10.3x ↘	Total	96 (5x)
4: 10.4x ↙	9: 9.8 ↗		
5: 10.0 ↘	10: 10.6x ↗		

1: 10.6x ↗	6: 10.4x ↘	Serie	97 (4x)
2: 9.8 →	7: 10.6x ↓		
3: 10.1 ←	8: 10.5x ←	Total	193 (9x)
4: 9.8 ↗	9: 9.9 ↓		
5: 10.1 ←	10: 10.0 ←		

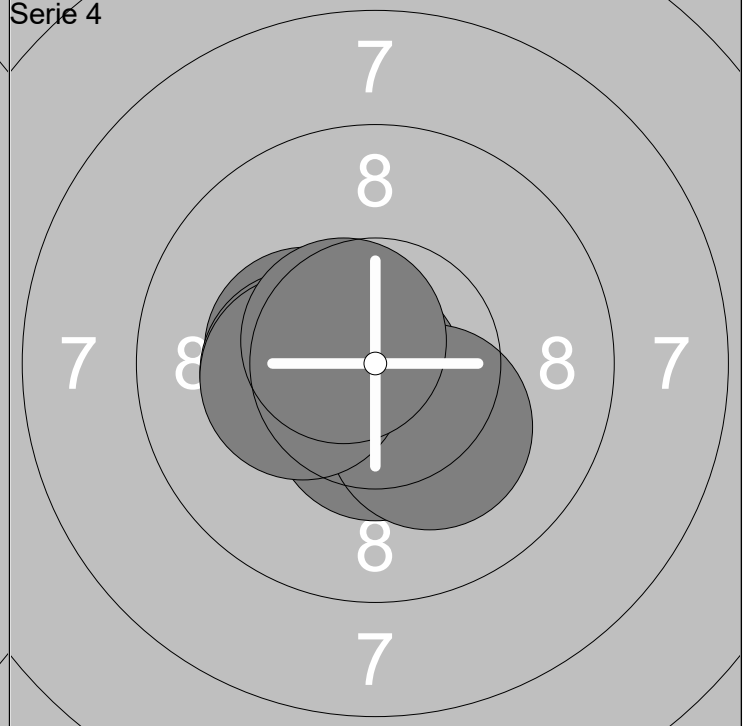
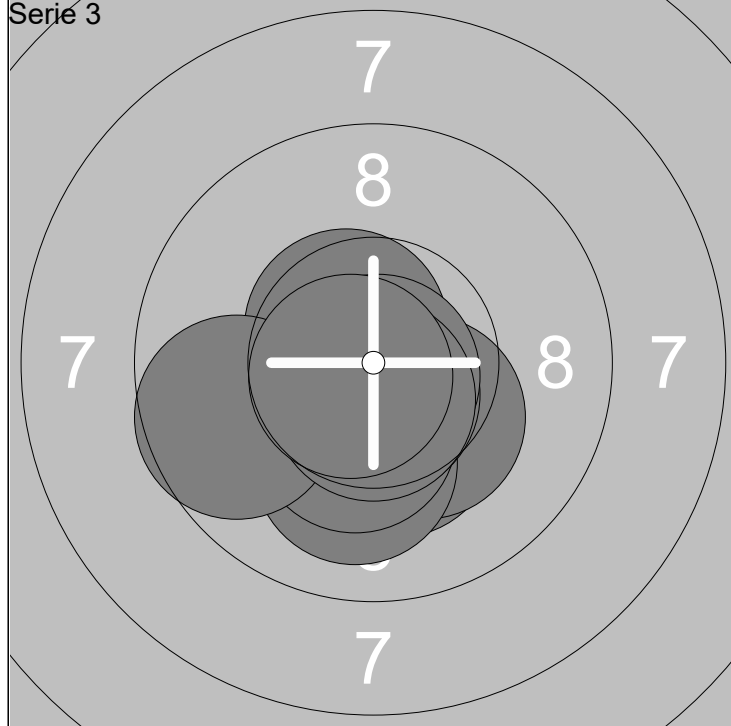

1: 10.3x ↓	6: 10.5x ↗	Serie	99 (8x)
2: 10.3x ↓	7: 9.6 ←		
3: 10.0 ↓	8: 10.8x ↓	Total	292 (17x)
4: 10.3x ↓	9: 10.6x ↓		
5: 10.6x ↓	10: 10.7x ↙		

1: 10.6x ←	6: 10.6x ←	Serie	100 (10x)
2: 10.5x ↓	7: 10.3x ←		
3: 10.3x ←	8: 10.2x ↓	Total	392 (27x)
4: 10.8x ↙	9: 10.3x ←		
5: 10.5x ↓	10: 10.6x ↙		

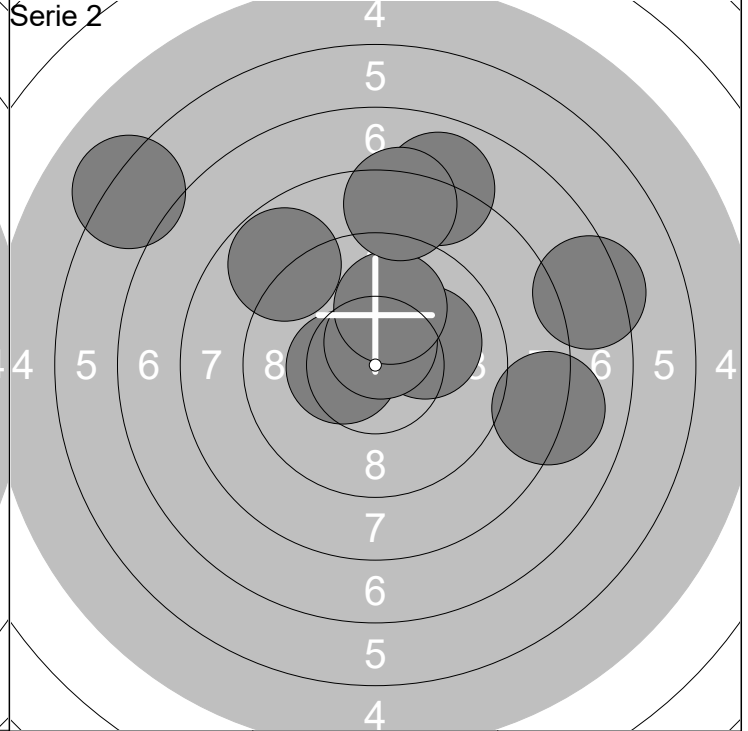
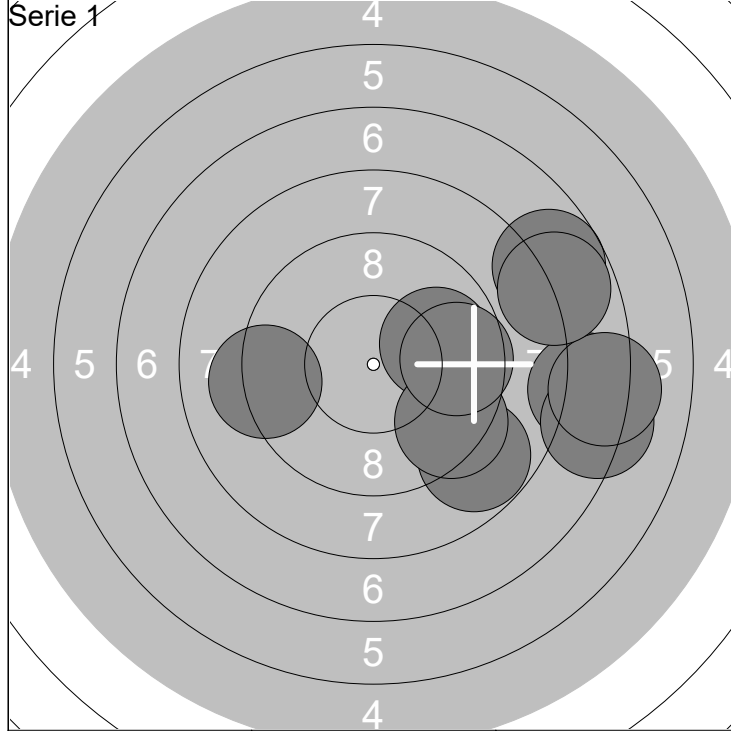

1: 7.6 →	6: 9.4 ↘	Serie	79 (0x)
2: 7.2 →	7: 7.7 ↗		
3: 8.8 ↘	8: 9.2 ←	Total	79 (0x)
4: 7.2 →	9: 9.6 →		
5: 9.9 →	10: 7.8 ↗		

1: 10.0 ↗	6: 10.0 ↑	Serie	84 (2x)
2: 10.4x ←	7: 8.8 ↖		
3: 7.3 →	8: 8.4 ↑	Total	163 (2x)
4: 10.6x ↑	9: 6.1 ↖		
5: 7.9 ↑	10: 8.1 →		

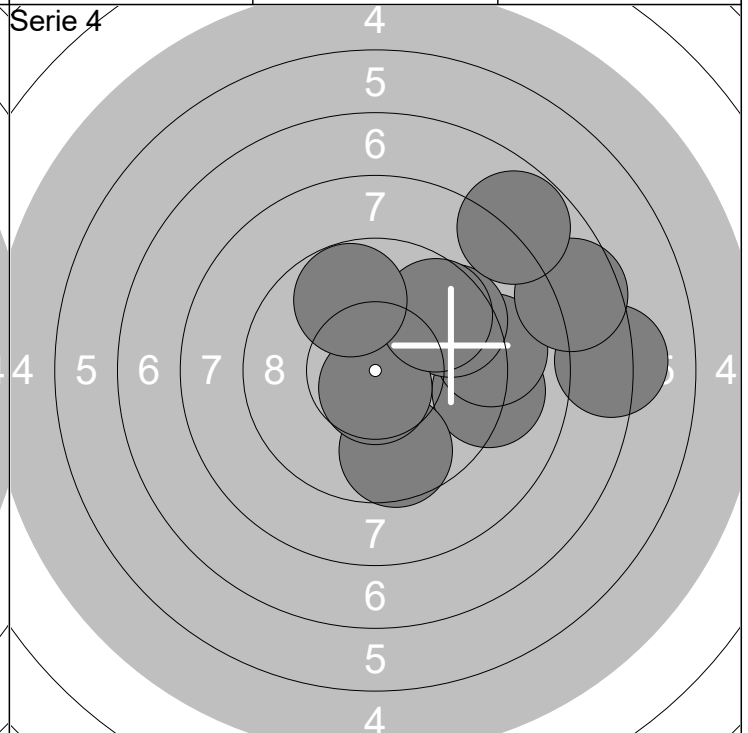
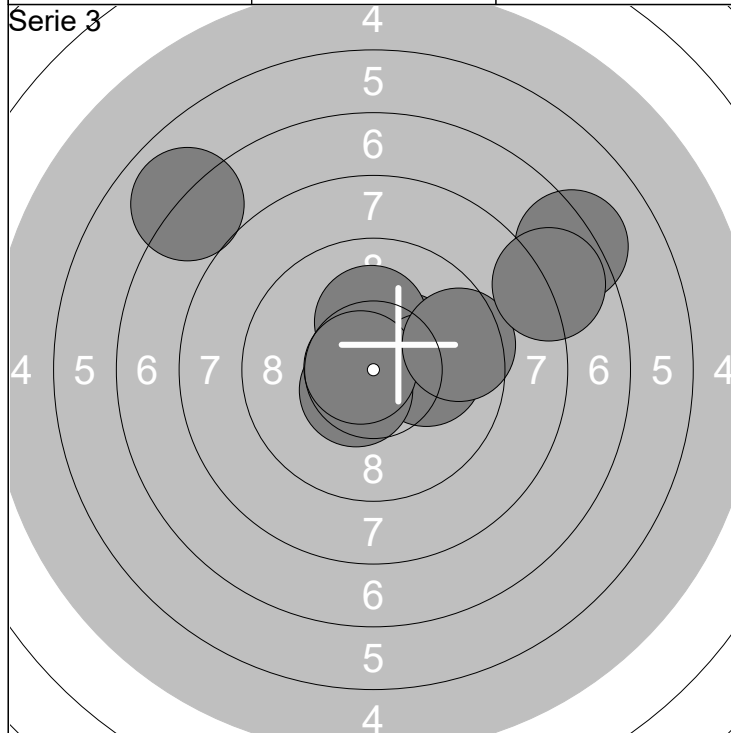

1: 7.2 ↗	6: 10.5x ↘	Serie	90 (4x)
2: 10.4x ↗	7: 7.0 ↖		
3: 10.0 →	8: 10.7x ←	Total	253 (6x)
4: 10.2x ↑	9: 9.5 →		
5: 10.1 →	10: 7.8 ↗		

1: 7.1 →	6: 7.6 ↗	Serie	85 (1x)
2: 9.1 →	7: 10.7x ↓		
3: 9.6 ↓	8: 9.6 ↗	Total	338 (7x)
4: 9.1 →	9: 7.7 ↗		
5: 9.5 ↗	10: 9.7 ↑		

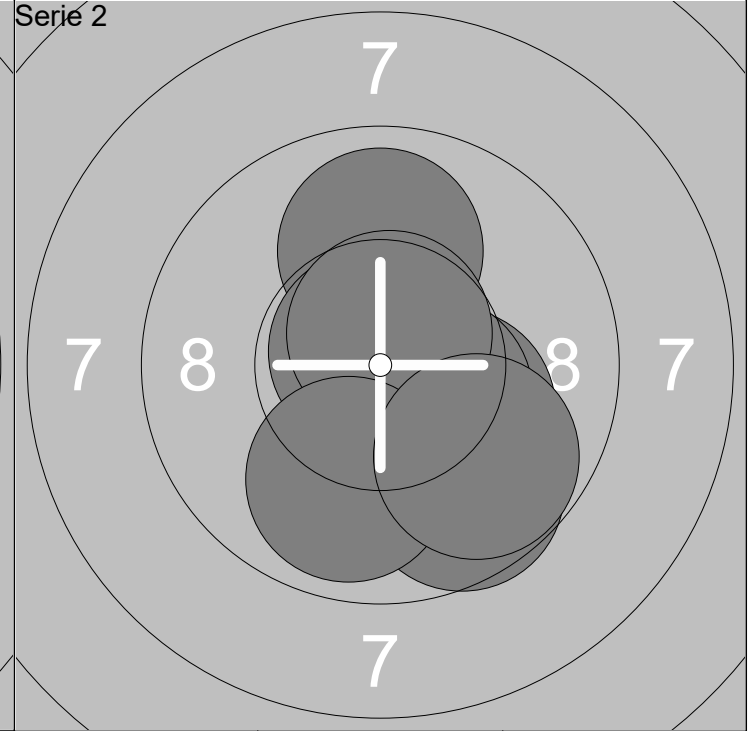
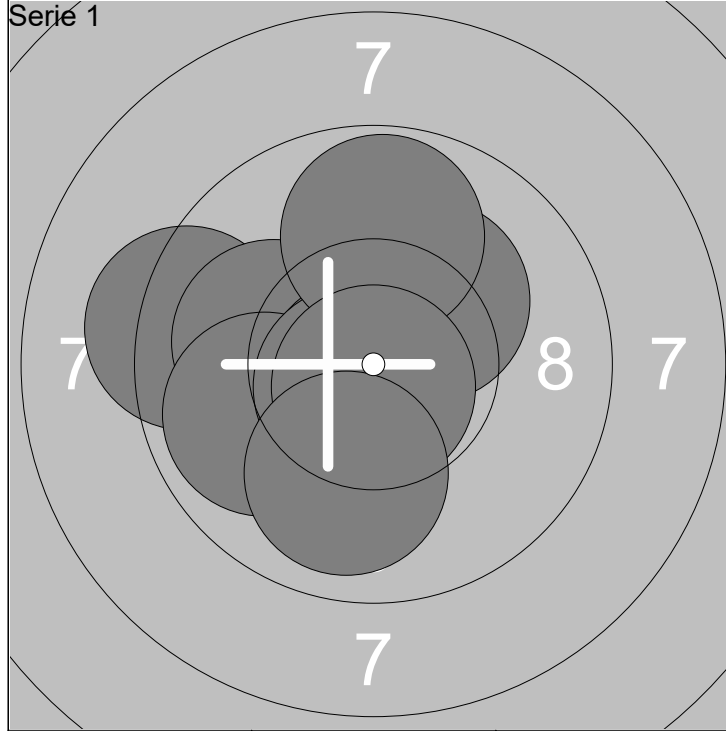

1: 10.1 ↙	6: 10.8x ↘	Serie	96 (4x)
2: 10.2x ↗	7: 10.7x ↘		
3: 9.3 ↙	8: 9.8 ↑	Total	96 (4x)
4: 10.0 ↙	9: 10.7x ↓		
5: 9.9 ↙	10: 9.9 ↓		

1: 9.9 ↑	6: 10.2x ↘	Serie	96 (6x)
2: 10.2x ↘	7: 10.4x ↘		
3: 10.4x ↘	8: 10.6x ↑	Total	192 (10x)
4: 9.6 ↘	9: 9.9 ↓		
5: 10.8x ↗	10: 9.8 ↘		

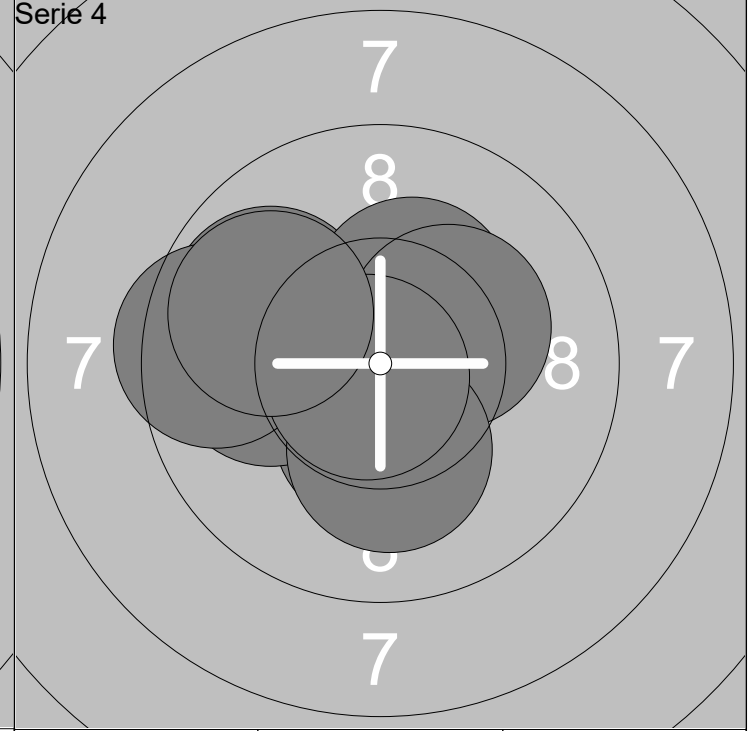
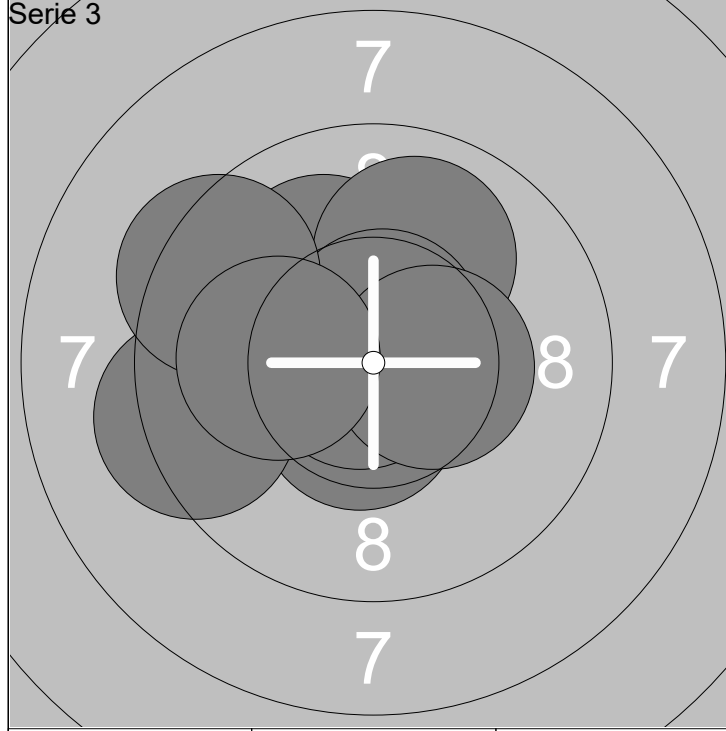

1: 10.5x ↗	6: 10.8x ↙	Serie	97 (5x)
2: 10.0 ↗	7: 10.6x ↑		
3: 10.5x ↓	8: 10.4x →	Total	289 (15x)
4: 9.3 ↙	9: 9.4 ↙		
5: 9.9 ↑	10: 10.1 ↙		

1: 10.4x ↓	6: 10.0 ↙	Serie	97 (6x)
2: 10.5x ↙	7: 10.2x ↓		
3: 9.9 ↙	8: 9.5 ↙	Total	386 (21x)
4: 10.3x ↑	9: 10.8x ↘		
5: 10.2x ↗	10: 9.9 ↙		

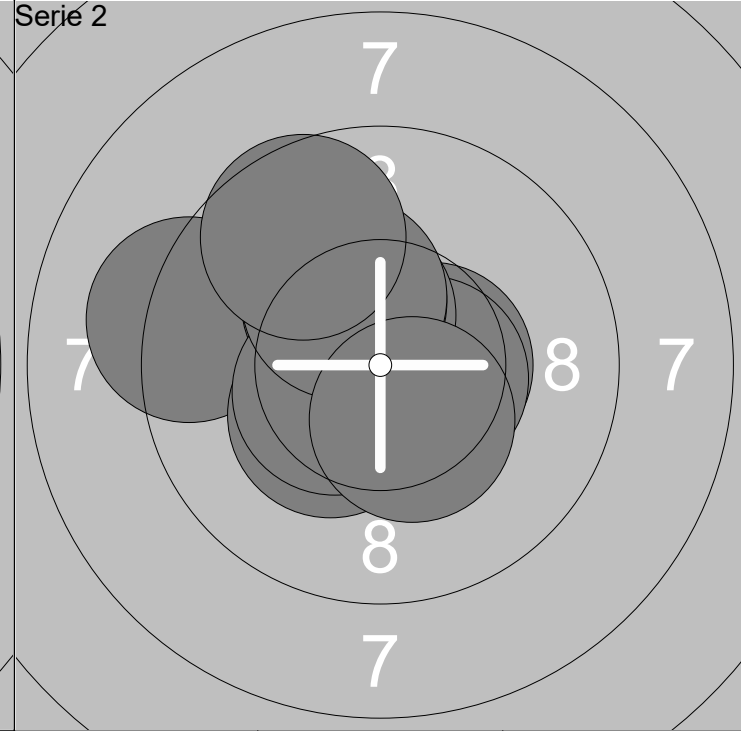
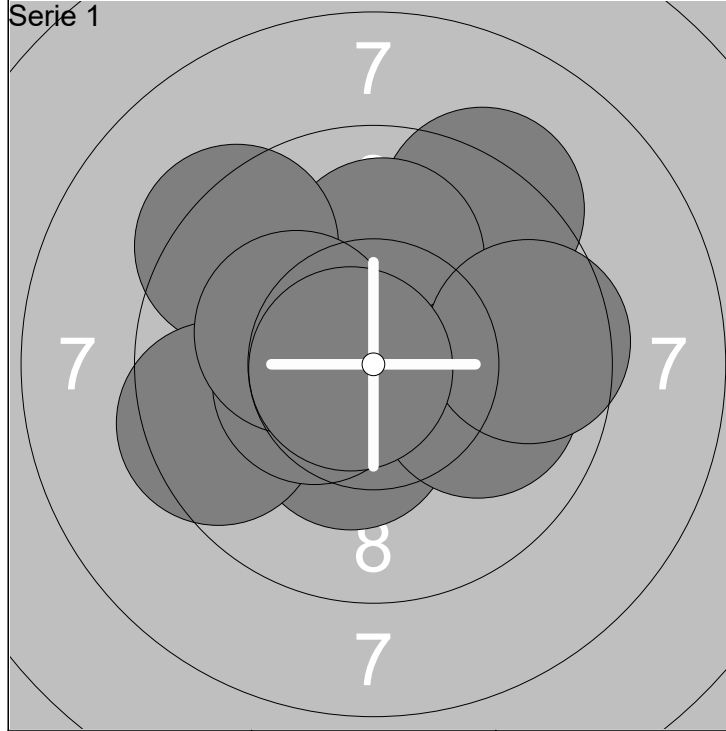

1: 9.3 ↗	6: 10.4x ←	Serie	96 (4x)
2: 10.0 ↑	7: 10.0 →		
3: 10.3x ↓	8: 9.6 →	Total	96 (4x)
4: 9.3 ↖	9: 10.2x ←		
5: 9.5 ←	10: 10.7x ←		

1: 9.2 ←	6: 10.3x ↗	Serie	98 (8x)
2: 10.3x ↙	7: 10.5x ↖		
3: 10.5x →	8: 10.3x ↗	Total	194 (12x)
4: 10.5x →	9: 9.6 ↗		
5: 10.4x ↗	10: 10.4x ↓		

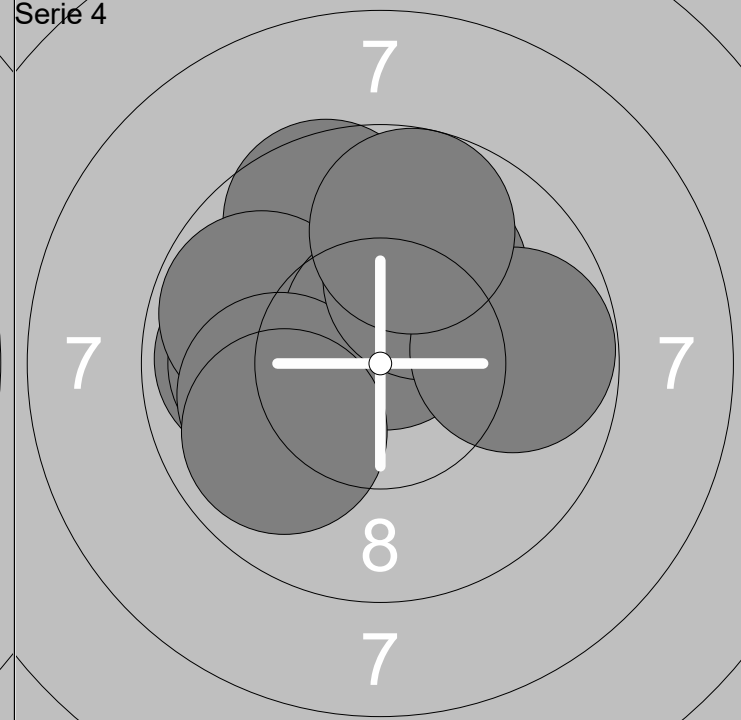
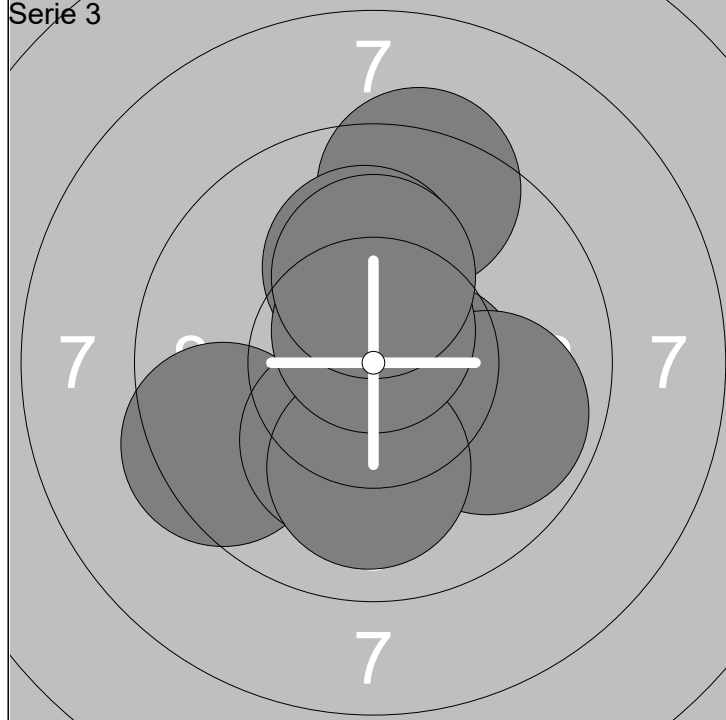

1: 10.5x →	6: 9.4 ←	Serie	97 (5x)
2: 10.6x ↓	7: 10.2x ↓		
3: 9.8 →	8: 10.0 ↓	Total	291 (17x)
4: 9.4 ↑	9: 10.6x ↑		
5: 10.1 ↑	10: 10.2x ↑		

1: 9.8 ←	6: 10.0 ←	Serie	94 (1x)
2: 10.0 ←	7: 10.1 ↗		
3: 9.6 ↗	8: 9.9 ↖	Total	385 (18x)
4: 9.8 ↖	9: 9.8 →		
5: 10.6x ↑	10: 9.7 ↑		

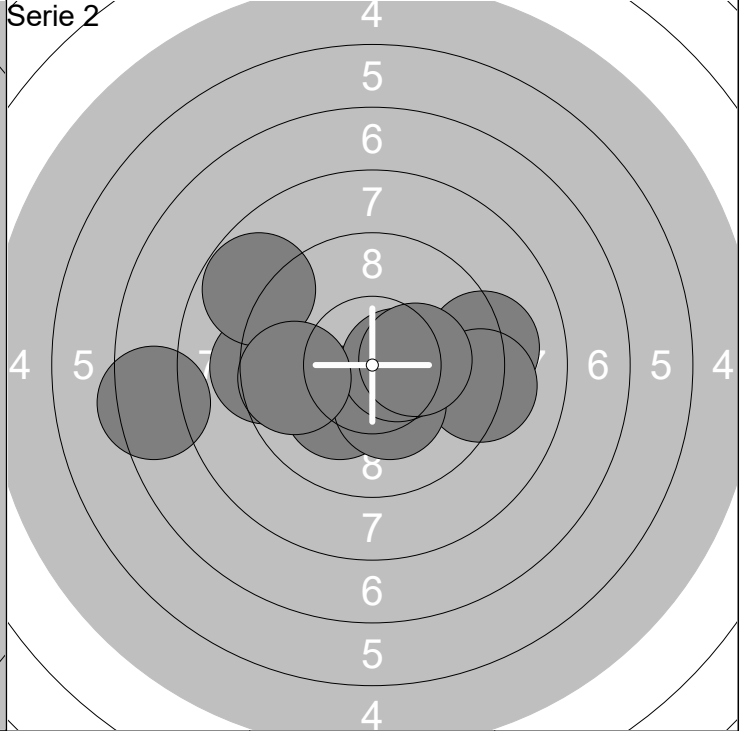
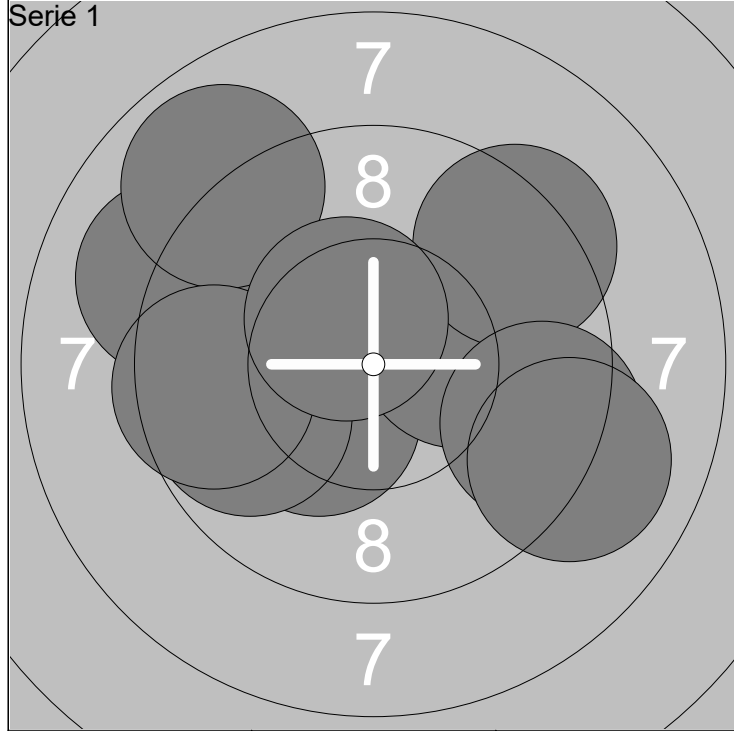

1: 9.0 ↖	6: 9.3 ↗	Serie 92 (2x)
2: 10.3x ↙	7: 9.5 ←	
3: 9.8 ←	8: 10.5x ↗	Total 92 (2x)
4: 8.9 ↗	9: 9.4 →	
5: 10.1 →	10: 9.0 →	

1: 9.2 →	6: 9.3 ←	Serie 91 (3x)
2: 10.1 ↙	7: 7.4 ←	
3: 9.2 →	8: 8.8 ↖	Total 183 (5x)
4: 10.3x ↙	9: 9.7 ←	
5: 10.5x →	10: 10.2x →	

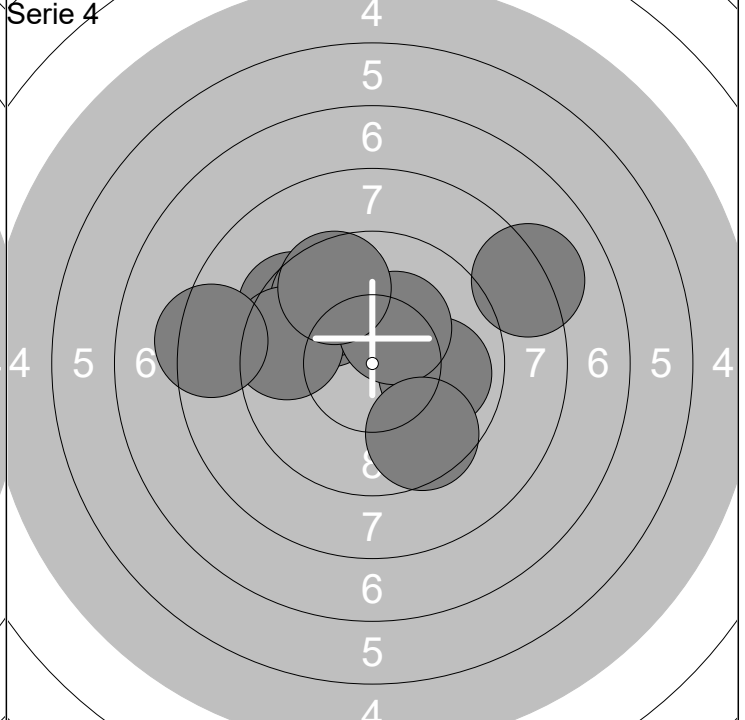
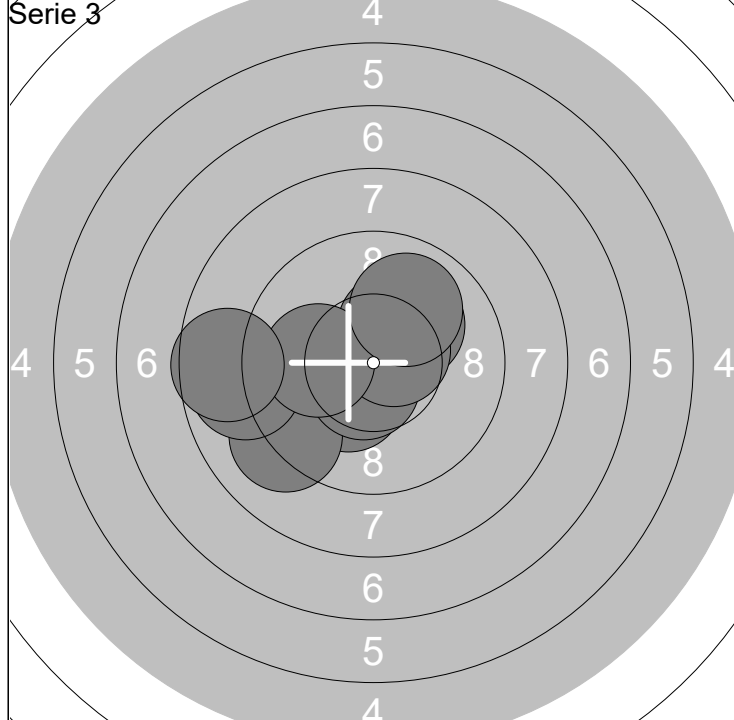

1: 10.1 ↗	6: 8.8 ←	Serie 94 (4x)
2: 10.3x ↗	7: 10.6x ↗	
3: 10.3x ↙	8: 10.1 ←	Total 277 (9x)
4: 9.1 ↙	9: 8.6 ←	
5: 10.6x ↙	10: 9.9 ↗	

1: 9.4 ↖	6: 10.3x ↗	Serie 89 (1x)
2: 9.8 ↗	7: 8.3 ←	
3: 9.9 →	8: 9.6 ↙	Total 366 (10x)
4: 9.7 ↗	9: 8.1 ↗	
5: 9.6 ←	10: 9.6 ↗	

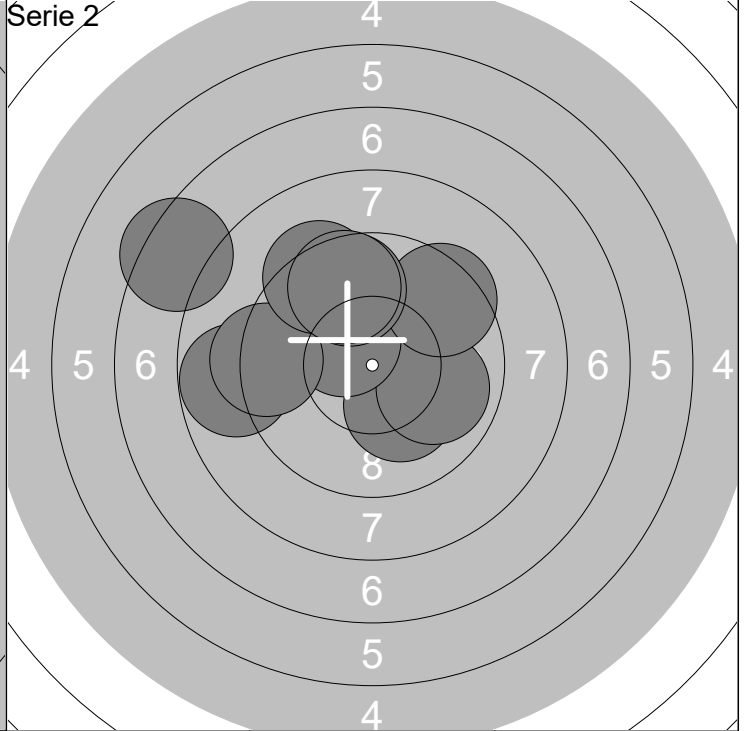
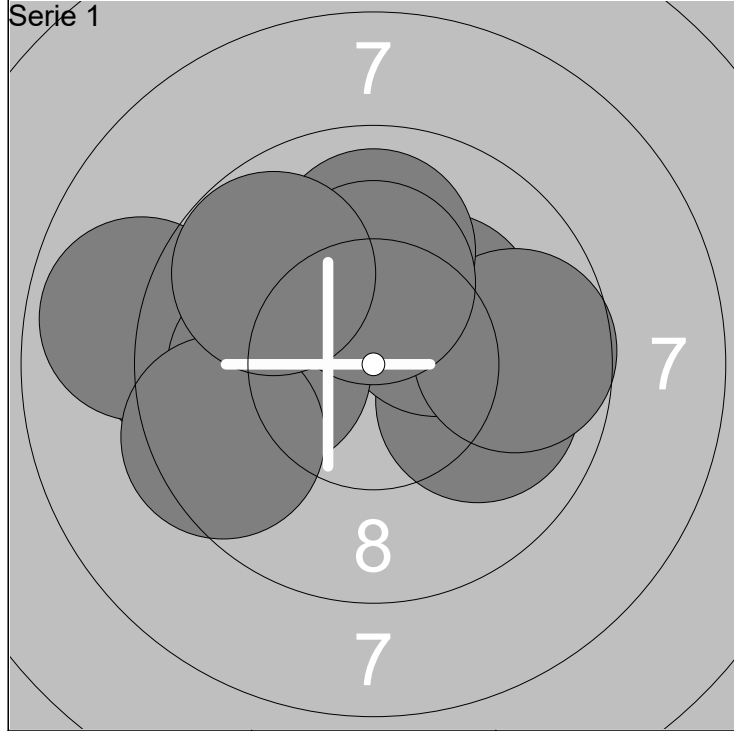

1: 9.3 ←	6: 10.0 ←	Serie	92 (2x)
2: 8.8 ←	7: 9.9 ↑		
3: 9.9 →	8: 9.5 ←	Total	92 (2x)
4: 10.2x ↗	9: 10.2x ↑		
5: 9.7 →	10: 9.7 ↙		

1: 10.1 ↘	6: 9.3 ←	Serie	89 (1x)
2: 8.8 ←	7: 9.4 ↗		
3: 9.9 →	8: 9.3 ↗	Total	181 (3x)
4: 7.4 ↗	9: 9.7 ↑		
5: 10.3x ↗	10: 9.6 ↑		

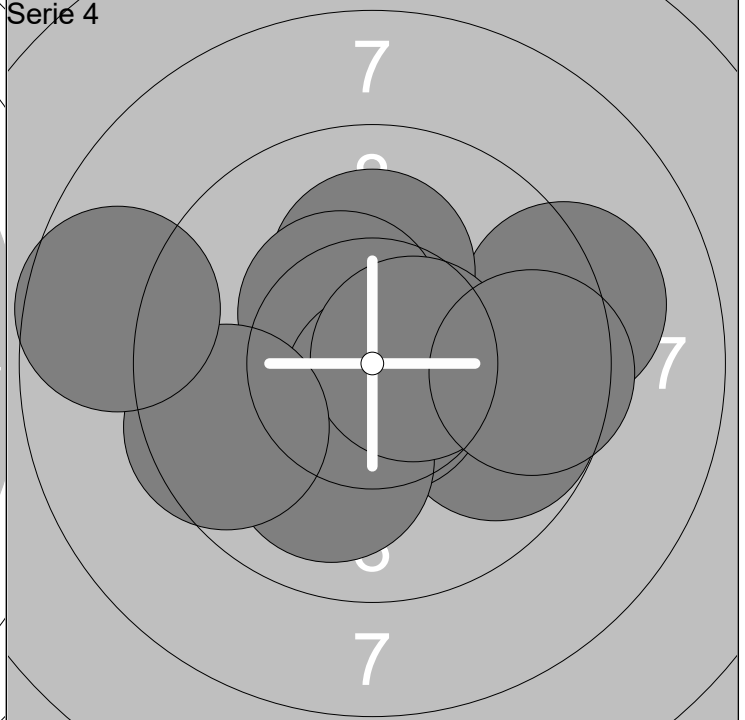
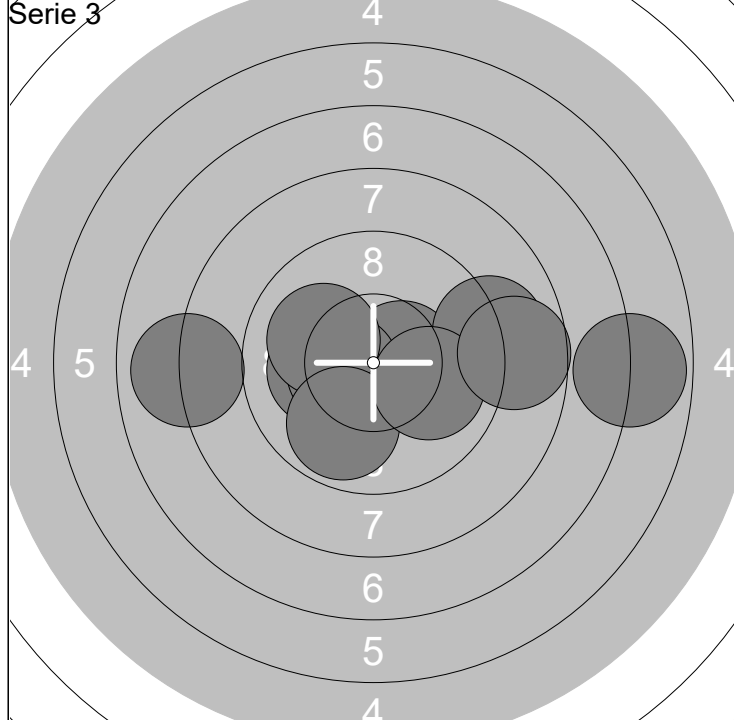

1: 10.5x →	6: 6.8 →	Serie	90 (2x)
2: 10.1 ←	7: 10.0 ←		
3: 8.0 ←	8: 9.9 ↘	Total	271 (5x)
4: 9.0 →	9: 10.0 →		
5: 10.4x ←	10: 8.7 →		

1: 9.7 →	6: 10.0 ↘	Serie	94 (3x)
2: 9.2 →	7: 10.6x →		
3: 10.1 ↑	8: 9.5 →	Total	365 (8x)
4: 10.4x ↗	9: 9.5 ←		
5: 10.6x ↘	10: 8.6 ←		

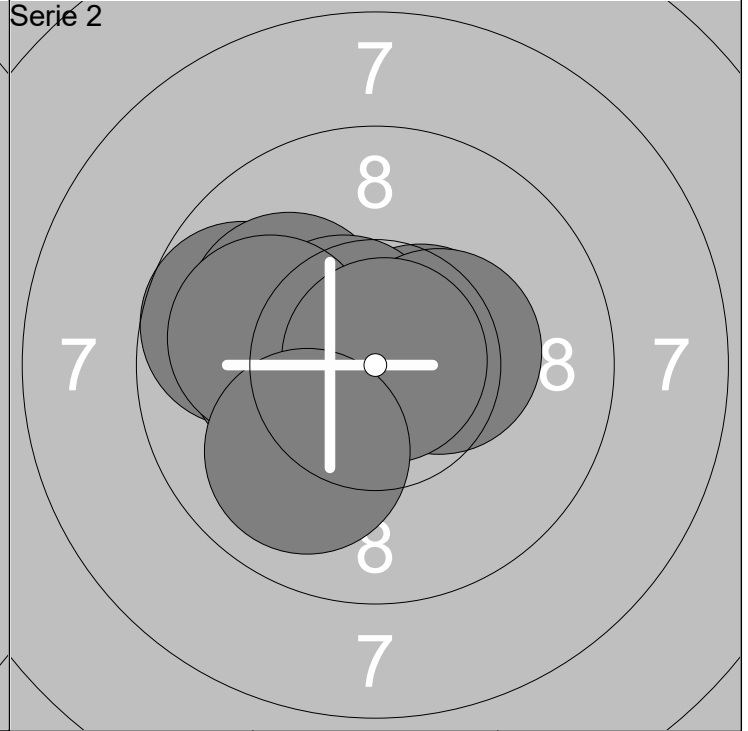
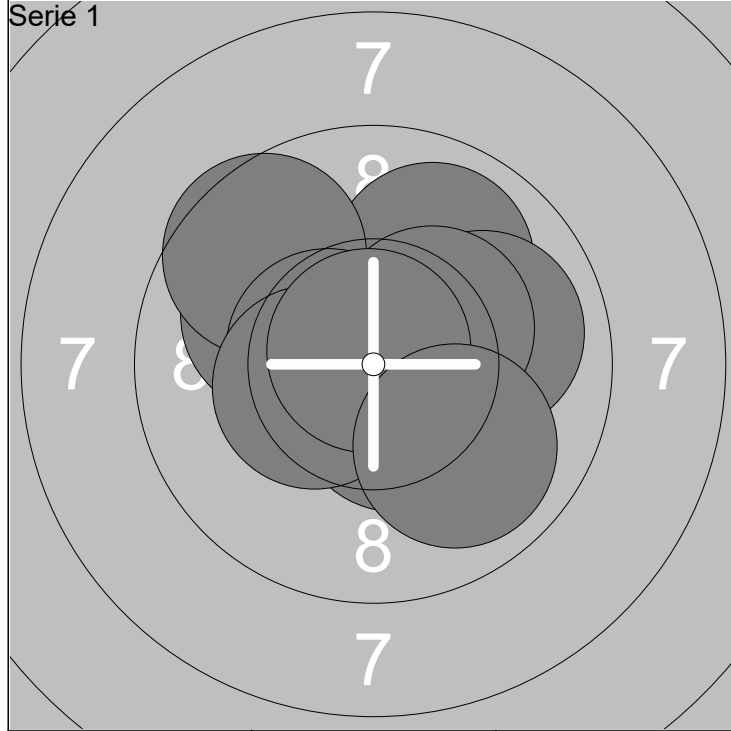

1: 9.9 ↗	6: 10.5x ←	Serie	96 (5x)
2: 10.0 ↖	7: 10.4x ←		
3: 9.6 ↗	8: 10.3x ↗	Total	96 (5x)
4: 9.9 →	9: 10.8x ↗		
5: 10.5x ↓	10: 9.9 ↓		

1: 10.0 ←	6: 10.3x →	Serie	99 (5x)
2: 10.5x ↗	7: 10.2x ←		
3: 9.7 ←	8: 10.0 ←	Total	195 (10x)
4: 10.1 ↖	9: 10.8x ↗		
5: 10.5x ↖	10: 10.0 ↓		

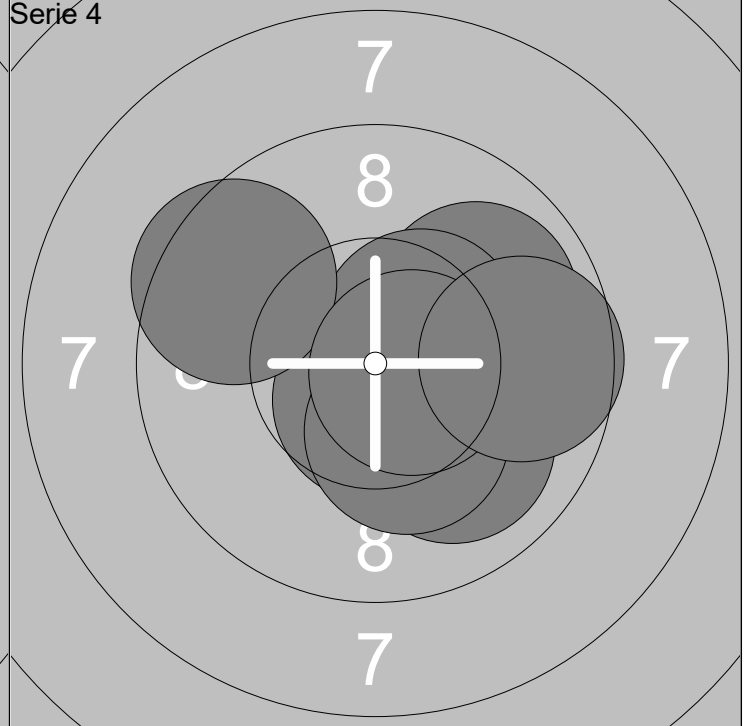
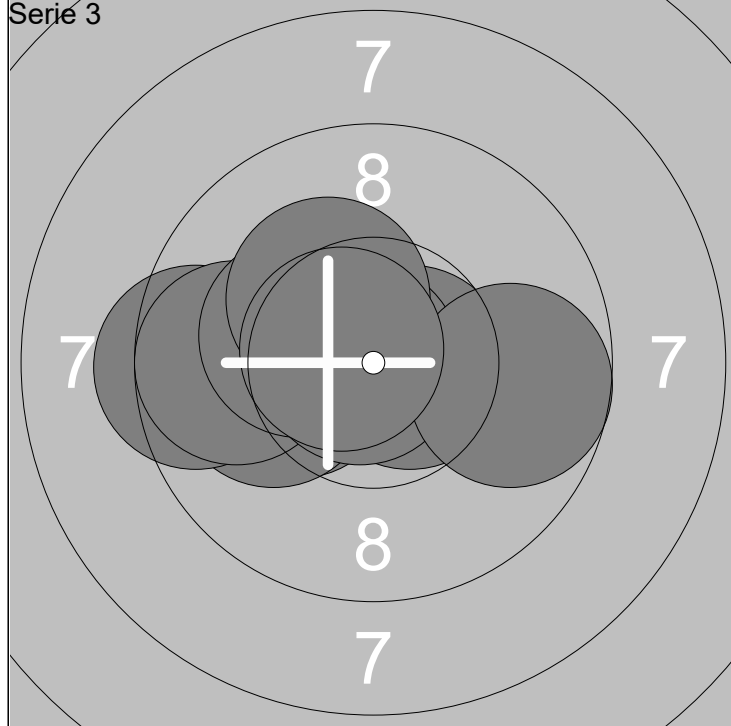

1: 10.2x ←	6: 10.8x ←	Serie	97 (6x)
2: 10.0 ←	7: 10.2x ←		
3: 9.4 ←	8: 10.2x ↗	Total	292 (16x)
4: 10.6x →	9: 9.7 →		
5: 9.8 ←	10: 10.6x ↖		

1: 9.9 ↗	6: 9.5 ↖	Serie	97 (6x)
2: 10.8x ↓	7: 10.0 ↓		
3: 10.6x →	8: 10.2x ↓	Total	389 (22x)
4: 10.4x ↗	9: 10.6x →		
5: 10.6x ↓	10: 9.6 →		

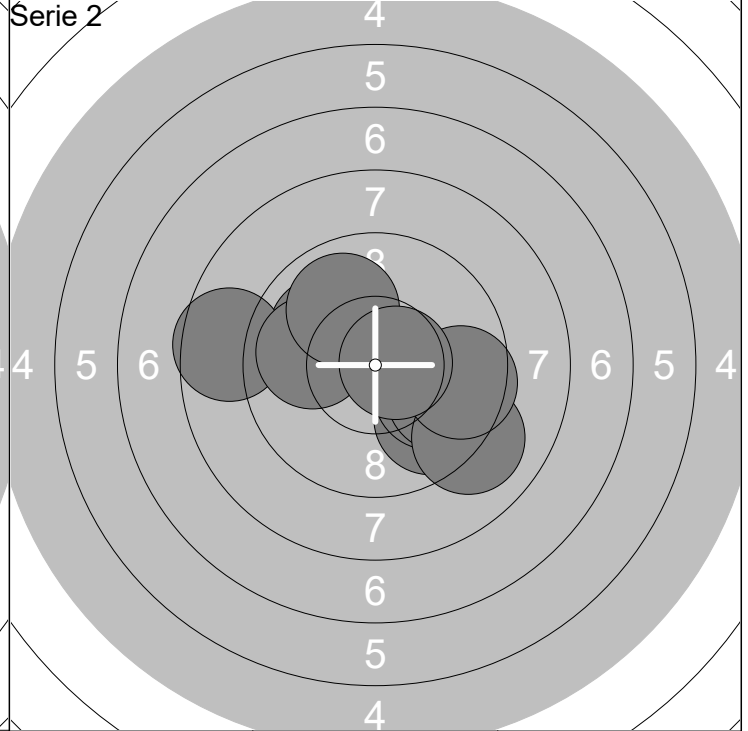
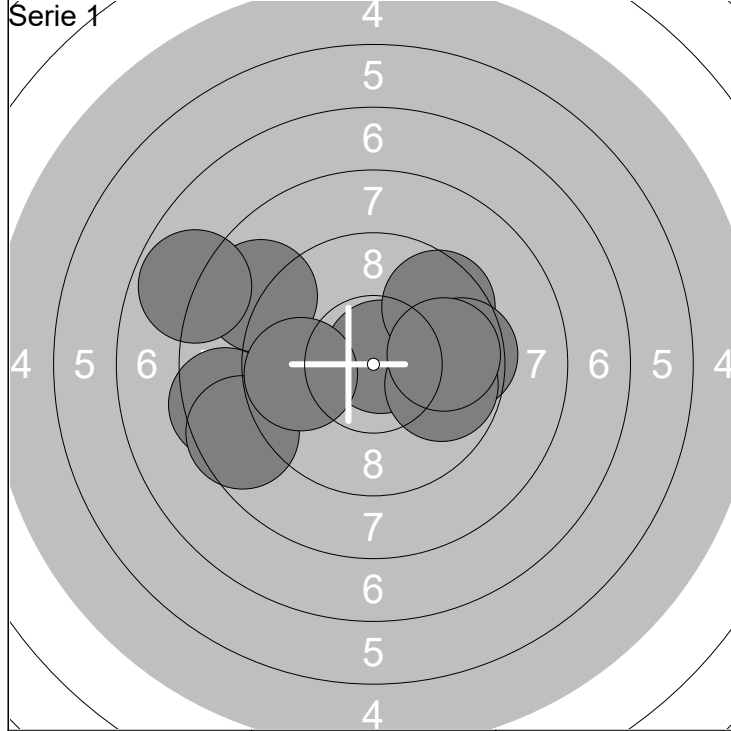

1: 8.8 ↖	6: 7.8 ←	Serie 86 (1x)
2: 10.8x ↗	7: 8.5 ←	
3: 9.5 ↗	8: 8.6 ←	Total 86 (1x)
4: 9.5 →	9: 9.7 ←	
5: 9.8 →	10: 9.8 →	

1: 10.0 ↖	6: 9.9 ↗	Serie 91 (1x)
2: 8.6 ←	7: 9.7 ↘	
3: 9.7 ↘	8: 9.0 ↘	Total 177 (2x)
4: 9.9 ↘	9: 9.5 →	
5: 9.9 ←	10: 10.6x →	

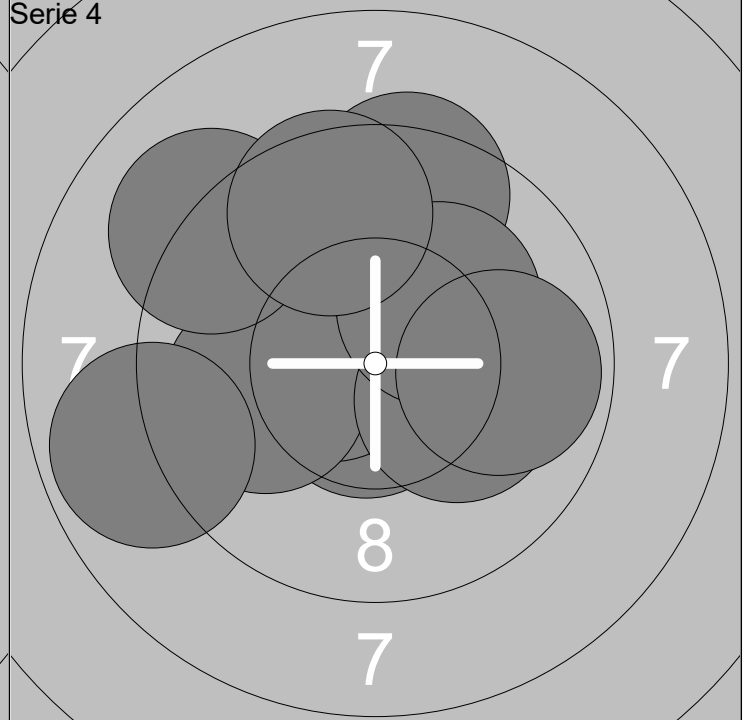
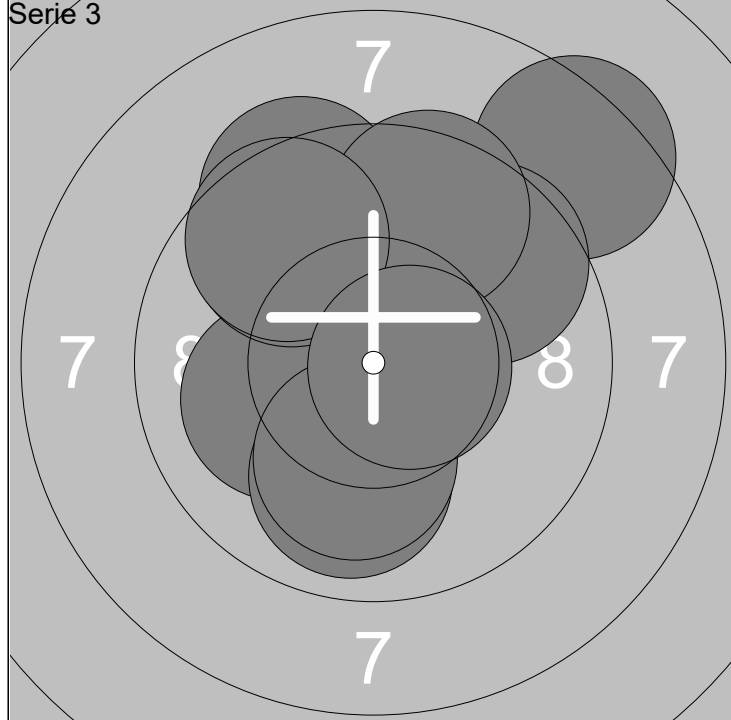

1: 9.3 ↖	6: 9.9 ↓	Serie 92 (1x)
2: 10.1 ←	7: 9.5 ↗	
3: 9.7 ↖	8: 10.1 ↓	Total 269 (3x)
4: 8.4 ↗	9: 9.6 ↖	
5: 9.6 ↗	10: 10.6x →	

1: 10.6x ↓	6: 10.1 →	Serie 94 (3x)
2: 10.5x ←	7: 8.9 ←	
3: 10.0 ←	8: 10.2x ↗	Total 363 (6x)
4: 9.1 ↖	9: 9.5 ↗	
5: 9.4 ↗	10: 9.9 →	

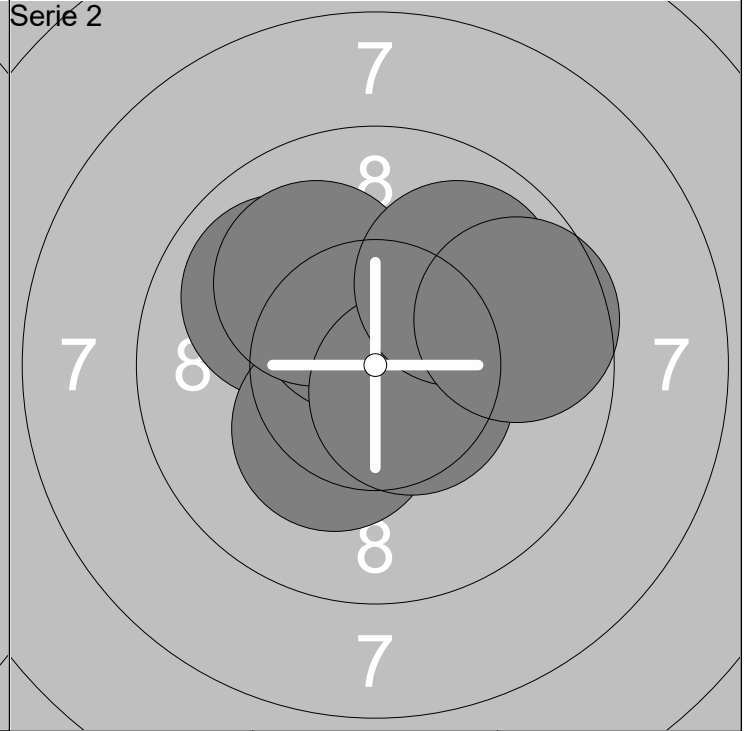
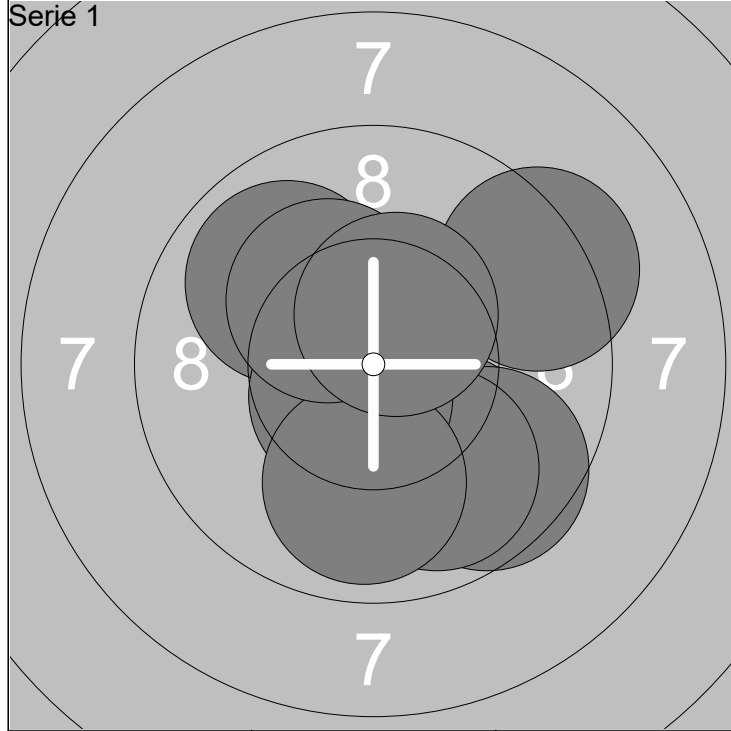

1: 9.9 ↘	6: 10.6x ↗	Serie	94 (4x)
2: 9.3 ↗	7: 10.6x ↘		
3: 9.6 ↘	8: 9.9 ↓	Total	94 (4x)
4: 9.9 ↗	9: 10.2x ↗		
5: 9.8 ↘	10: 10.4x ↗		

1: 9.9 ↖	6: 10.5x ↗	Serie	97 (6x)
2: 10.5x ↗	7: 10.1 ↖		
3: 10.3x ↘	8: 10.5x ↘	Total	191 (10x)
4: 10.2x ↗	9: 9.9 ↗		
5: 10.4x ↗	10: 9.6 →		

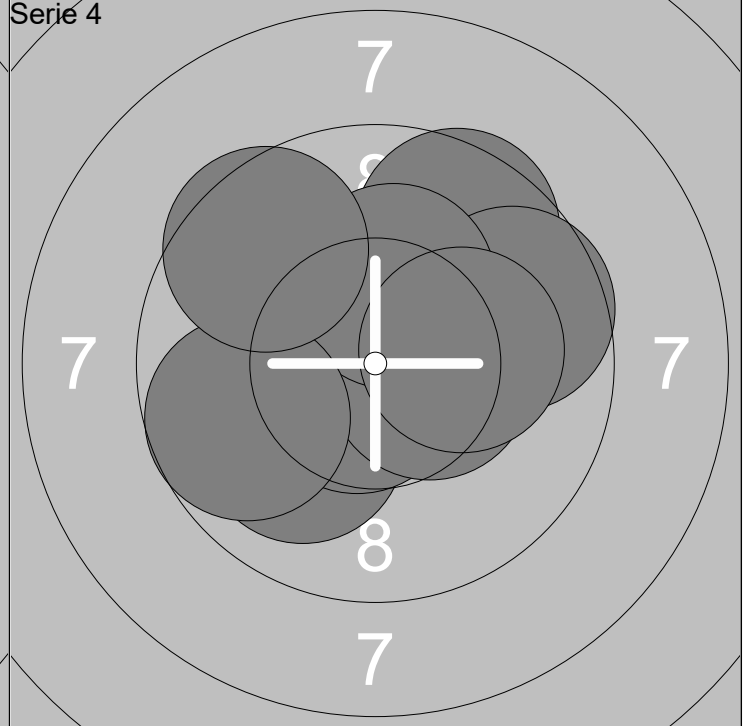
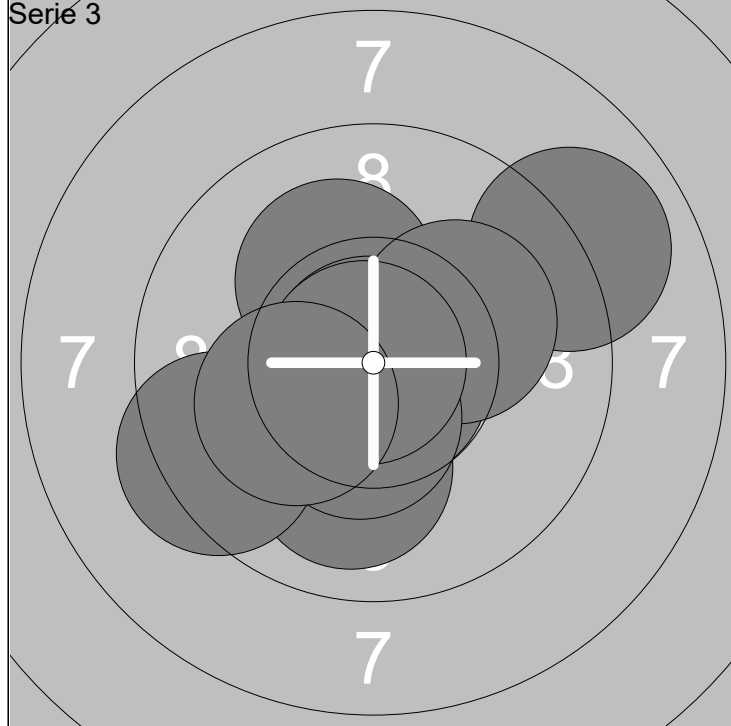

1: 10.1 ↗	6: 10.7x ↘	Serie	97 (5x)
2: 8.9 ↗	7: 10.1 ↗		
3: 10.0 ↓	8: 10.4x ↘	Total	288 (15x)
4: 9.4 ↖	9: 10.8x ←		
5: 10.9x ↖	10: 10.2x ←		

1: 9.9 ↗	6: 9.6 ↗	Serie	95 (4x)
2: 9.6 ↗	7: 10.2x ↗		
3: 10.0 ↘	8: 10.2x →	Total	383 (19x)
4: 10.6x ↘	9: 9.7 ←		
5: 10.4x →	10: 9.5 ↖		

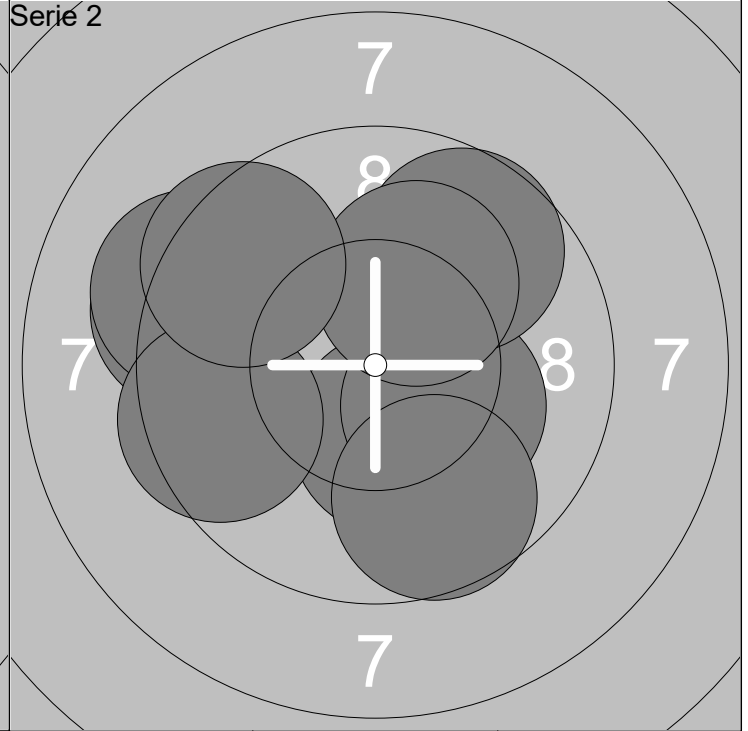
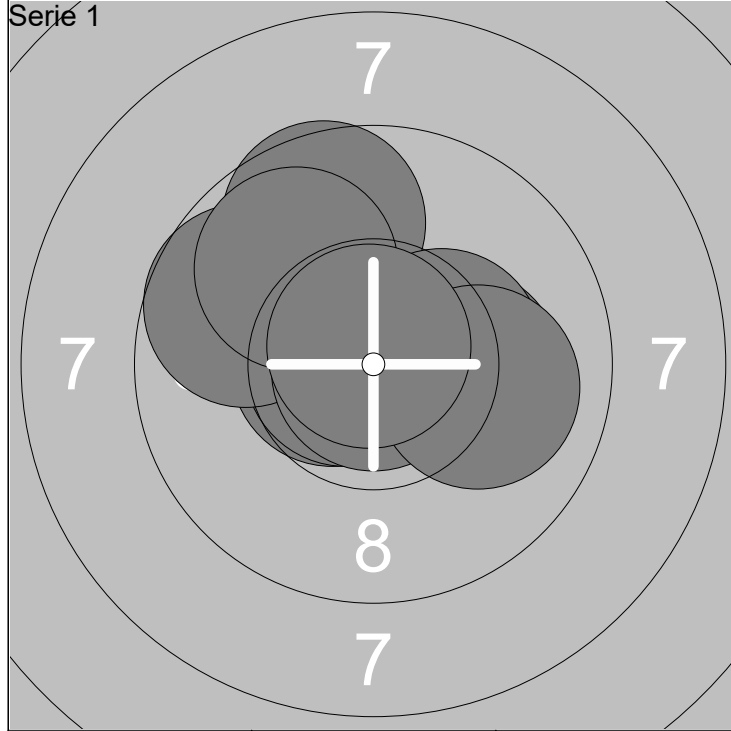

1: 10.6x ←	6: 9.7 ↙	Serie 97 (6x)
2: 9.6 ↗	7: 10.9x ↓	
3: 10.2x →	8: 9.8 ↗	Total 97 (6x)
4: 10.7x ←	9: 10.0 →	
5: 10.3x →	10: 10.8x ↗	

1: 9.3 ↙	6: 10.2x ↘	Serie 94 (3x)
2: 9.2 ↖	7: 9.7 ↗	
3: 10.2x ↓	8: 9.7 ↓	Total 191 (9x)
4: 10.3x ↓	9: 10.1 ↗	
5: 9.5 ←	10: 9.5 ↖	

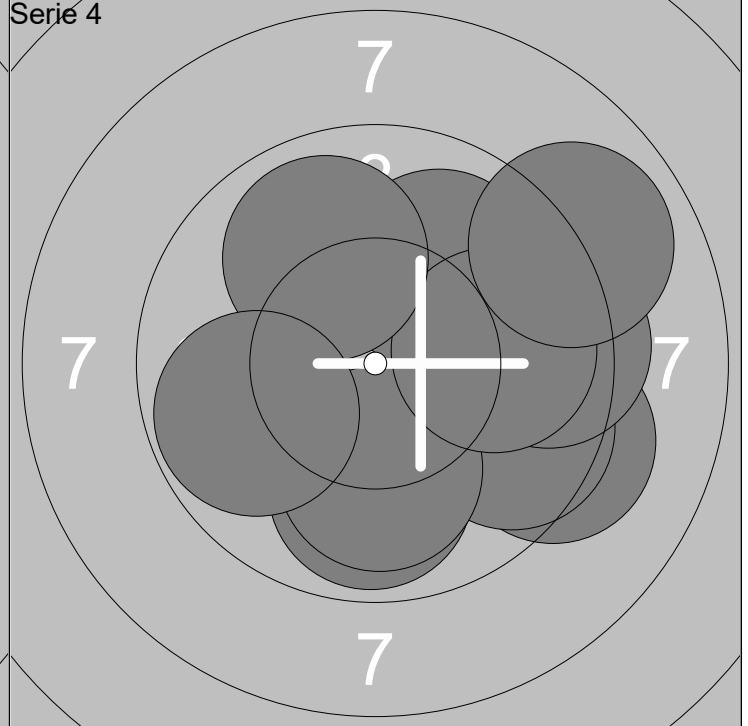
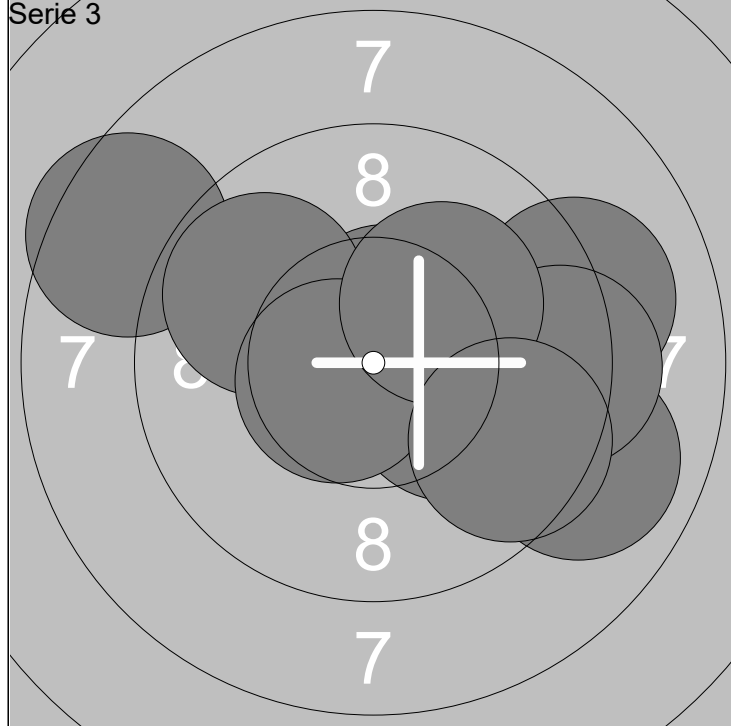

1: 10.6x ↗	6: 9.3 →	Serie 92 (3x)
2: 8.5 ↖	7: 9.8 ↖	
3: 10.2x ↘	8: 10.6x ←	Total 283 (12x)
4: 9.1 →	9: 10.1 ↗	
5: 8.9 ↘	10: 9.5 ↘	

1: 9.2 →	6: 9.9 ↗	Serie 90 (0x)
2: 9.6 →	7: 9.9 →	
3: 9.8 ↓	8: 9.9 ↗	Total 373 (12x)
4: 9.4 →	9: 8.9 ↗	
5: 10.0 ↓	10: 9.8 ←	

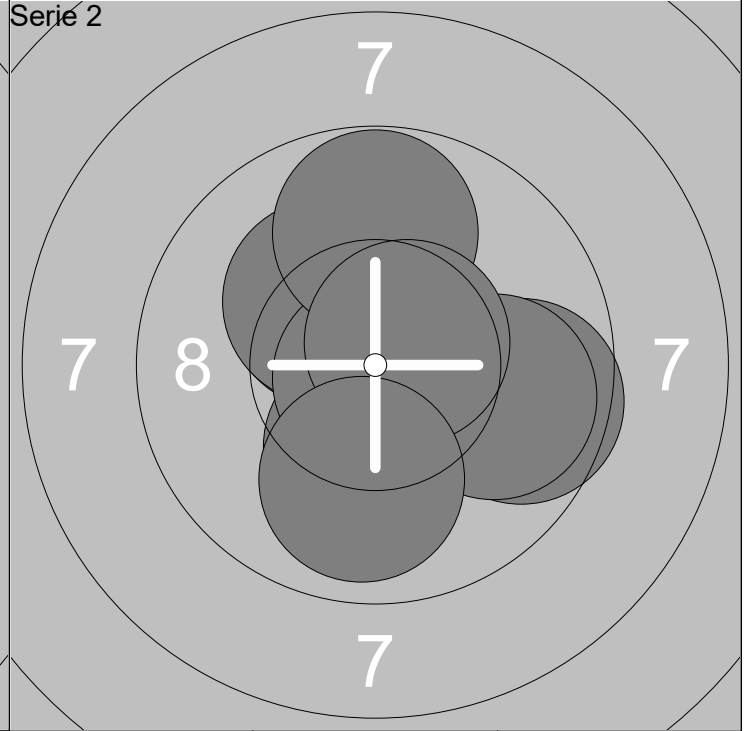
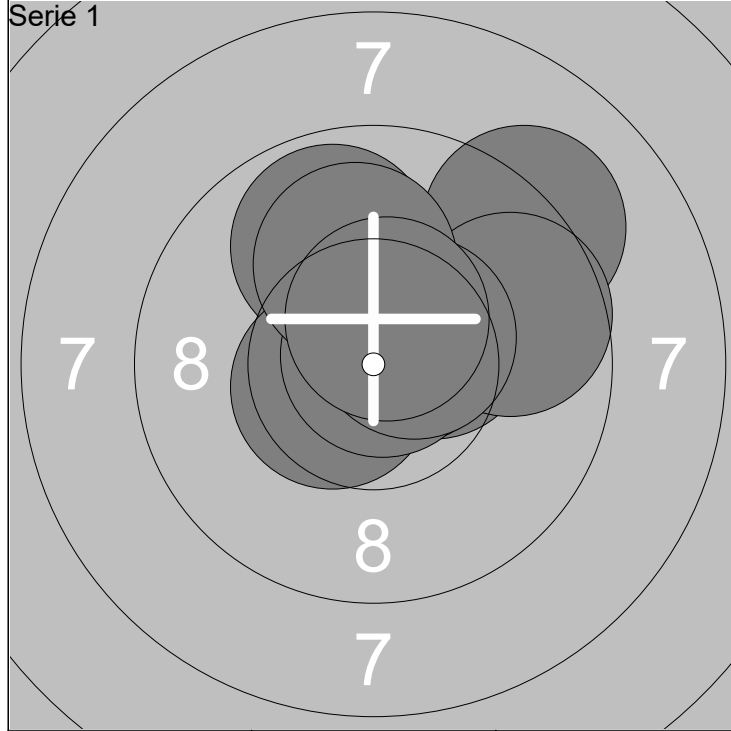

1: 9.8 ↖	6: 10.8x ↗	Serie 97 (6x)
2: 10.5x ↙	7: 9.6 →	
3: 10.4x →	8: 10.5x ↗	Total 97 (6x)
4: 10.6x ↗	9: 10.0 ↑	
5: 9.2 ↗	10: 10.5x ↑	

1: 10.2x ↓	6: 10.8x ↓	Serie 96 (6x)
2: 10.8x ↗	7: 9.8 ↑	
3: 10.2x ↖	8: 9.8 →	Total 193 (12x)
4: 10.2x ↖	9: 10.6x ↗	
5: 9.6 →	10: 9.9 ↓	

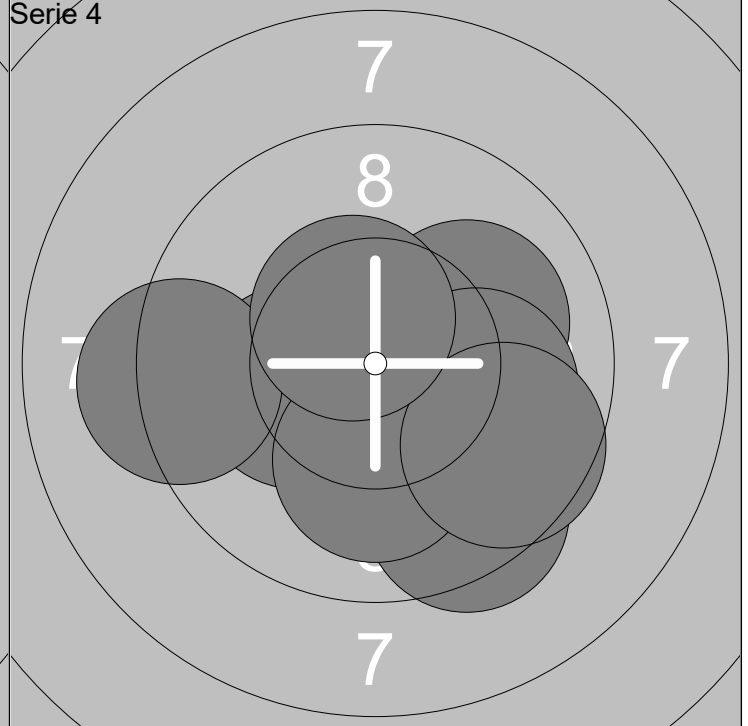
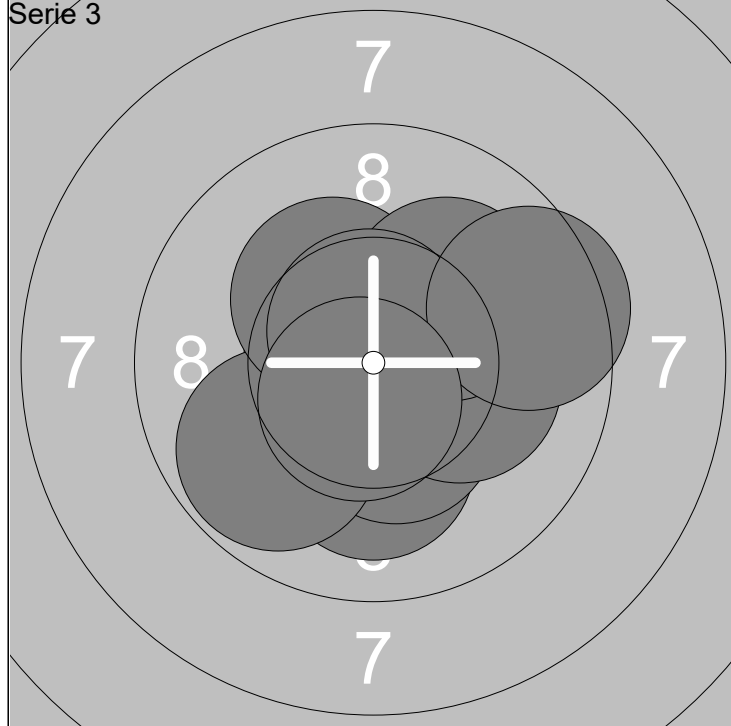

1: 10.1 ↓	6: 10.2x ↖	Serie 98 (5x)
2: 10.7x ↙	7: 10.1 ↗	
3: 10.4x ↓	8: 10.6x ↑	Total 291 (17x)
4: 9.8 ↙	9: 9.5 →	
5: 10.1 →	10: 10.6x ↓	

1: 10.7x ↓	6: 10.5x ↘	Serie 97 (4x)
2: 10.0 →	7: 10.0 →	
3: 10.2x ←	8: 10.1 ↓	Total 388 (21x)
4: 9.2 ←	9: 9.6 ↘	
5: 9.4 ↓	10: 10.5x ↖	

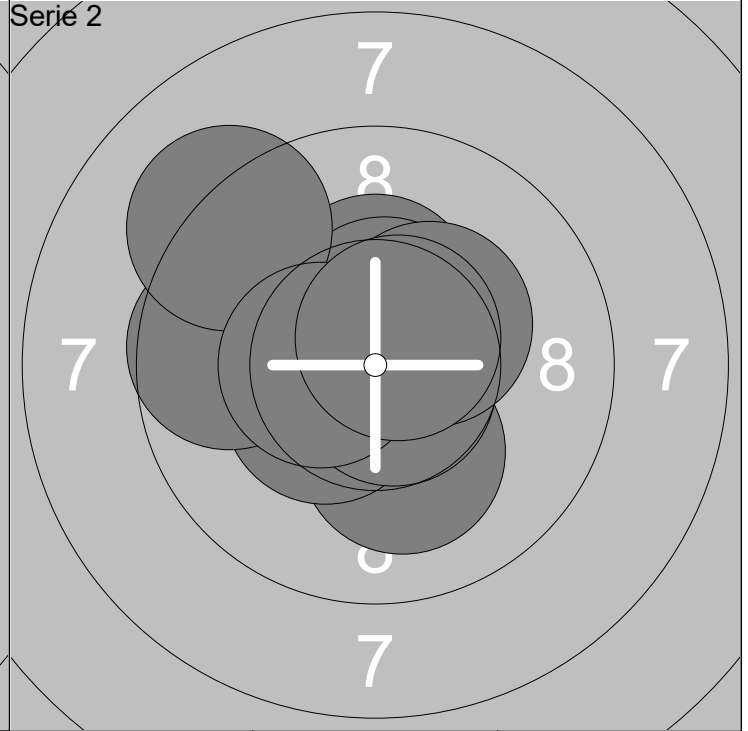
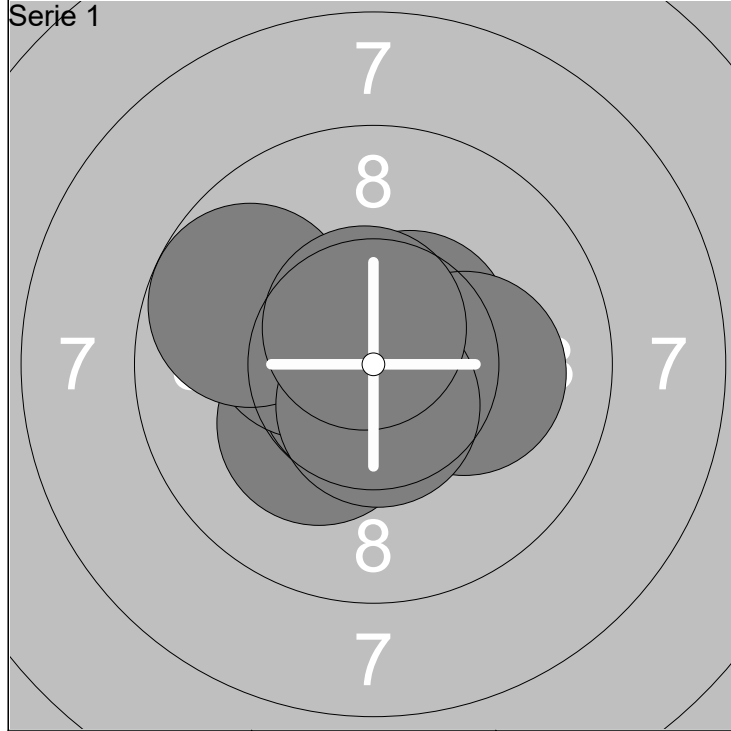

1: 10.2x ↙	6: 10.1 →	Serie 99 (8x)
2: 10.8x →	7: 10.3x ↖	
3: 10.8x ↙	8: 9.7 ↖	Total 99 (8x)
4: 10.5x ↗	9: 10.6x ↓	
5: 10.8x ↑	10: 10.6x ↑	

1: 10.1 ↓	6: 10.5x ↑	Serie 98 (7x)
2: 10.4x ↙	7: 10.3x ↗	
3: 10.7x ↘	8: 9.2 ↖	Total 197 (15x)
4: 10.3x ↑	9: 10.4x ←	
5: 9.6 ←	10: 10.6x ↗	

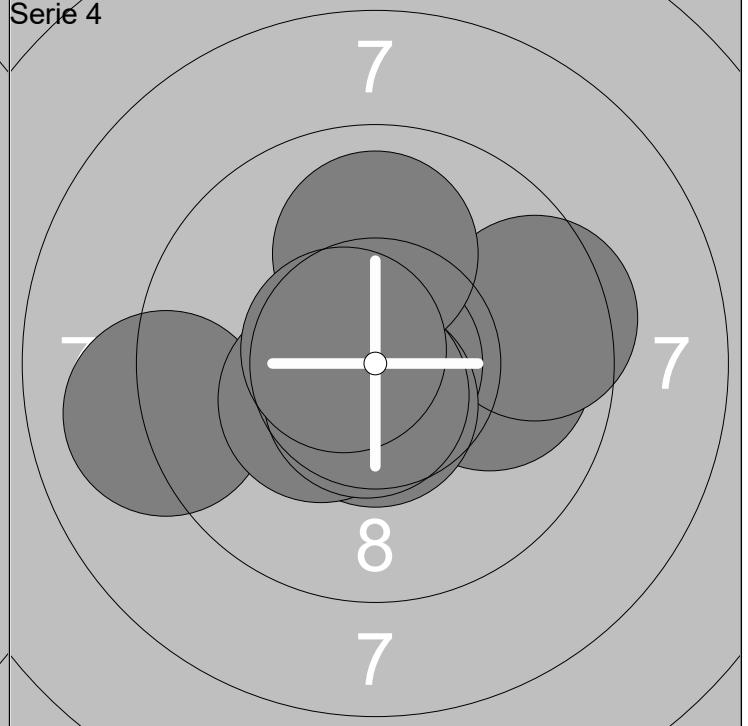
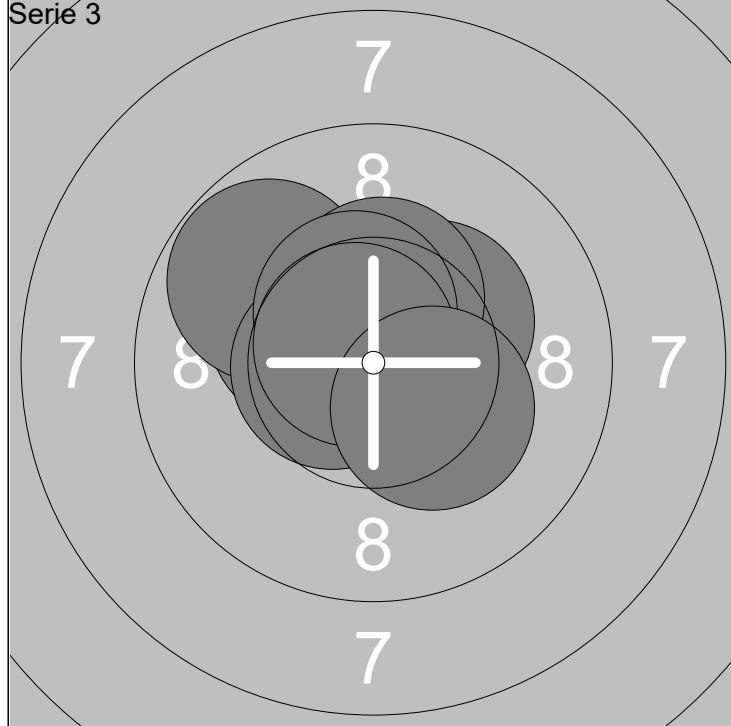

1: 10.3x ↖	6: 10.6x ←	Serie 99 (9x)
2: 10.6x ←	7: 10.4x ↑	
3: 10.3x ↗	8: 10.4x ↑	Total 296 (24x)
4: 10.7x ↗	9: 10.7x ↖	
5: 9.8 ↖	10: 10.3x ↘	

1: 10.8x ↘	6: 10.6x ↓	Serie 97 (6x)
2: 9.9 →	7: 10.4x ↙	
3: 9.5 →	8: 10.6x ↓	Total 393 (30x)
4: 9.0 ←	9: 10.0 ↑	
5: 10.9x →	10: 10.6x ↖	

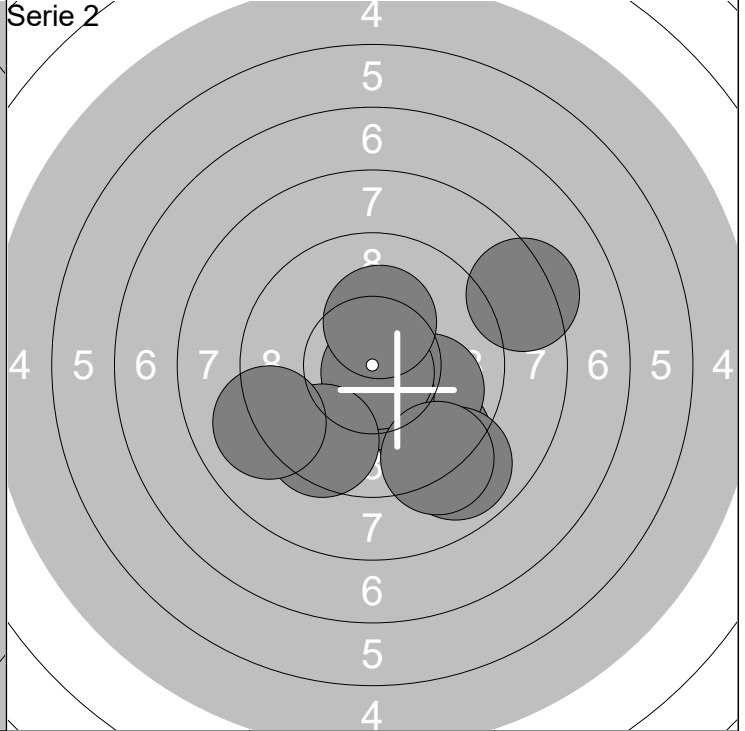
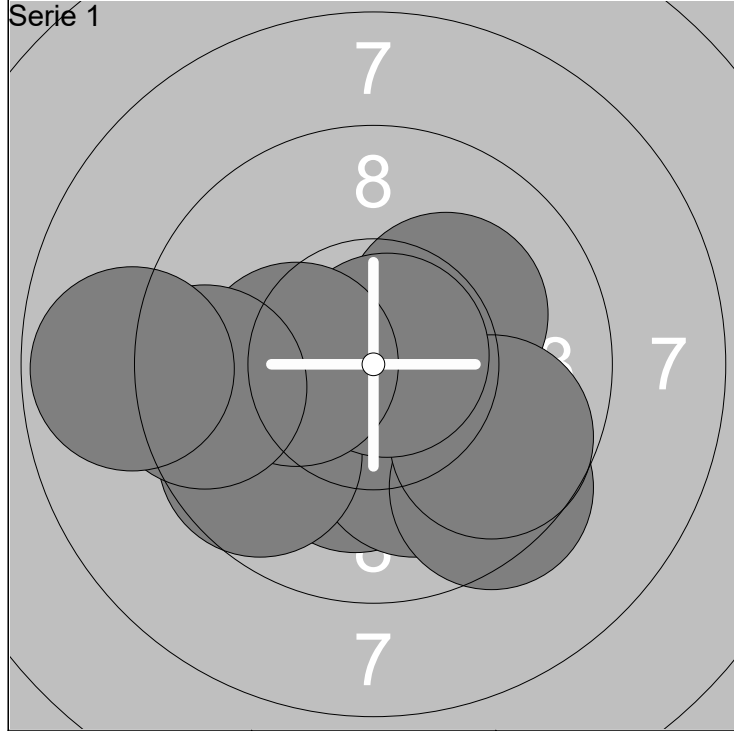

1: 10.2x ↓	6: 9.6 ↙	Serie	94 (3x)
2: 10.1 ↓	7: 10.8x ↗		
3: 10.1 ↗	8: 10.3x ←	Total	94 (3x)
4: 9.4 ↓	9: 9.4 ←		
5: 9.7 ↓	10: 8.8 ←		

1: 9.4 ↓	6: 9.5 ↓	Serie	92 (3x)
2: 10.0 →	7: 8.9 ↓		
3: 10.5x ↓	8: 10.2x ↑	Total	186 (6x)
4: 8.3 →	9: 9.1 ↓		
5: 10.8x ↓	10: 9.0 ↙		

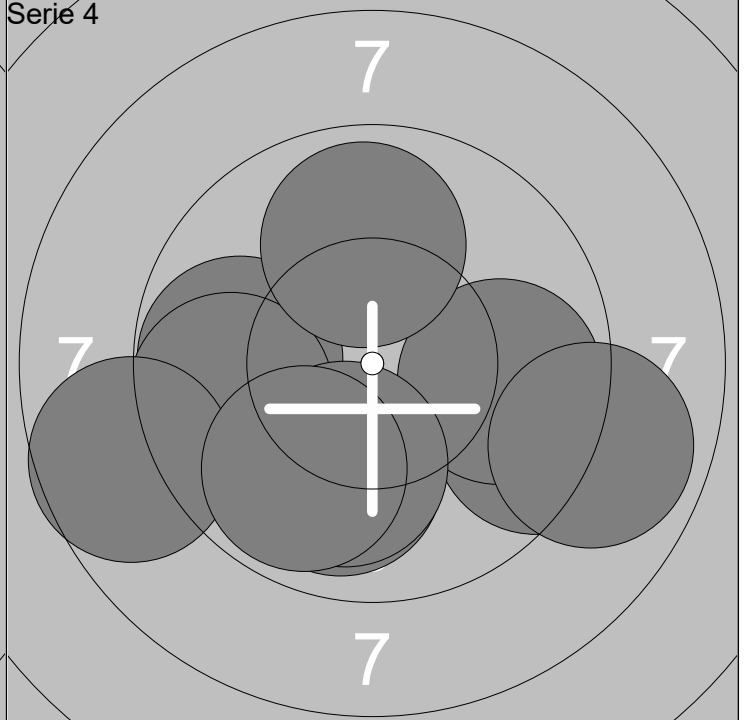
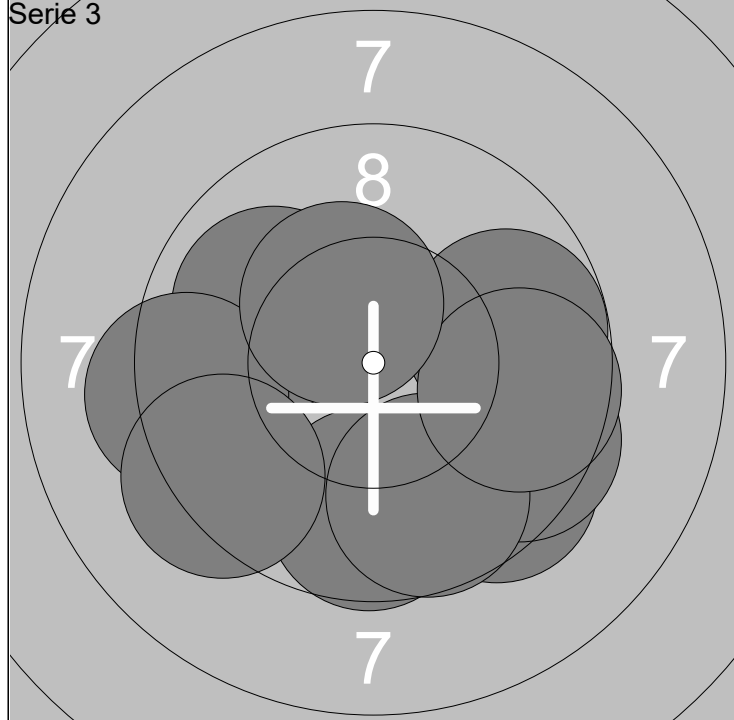

1: 9.4 ↓	6: 9.8 →	Serie	91 (1x)
2: 9.5 ↓	7: 9.7 ↓		
3: 9.9 ↗	8: 9.6 →	Total	277 (7x)
4: 9.3 ←	9: 9.3 ↙		
5: 9.6 ↓	10: 10.3x ↗		

1: 9.8 ←	6: 10.0 ↓	Serie	89 (0x)
2: 9.9 ↓	7: 8.6 ←		
3: 9.4 →	8: 8.9 →	Total	366 (7x)
4: 9.6 ←	9: 9.8 ↓		
5: 9.8 →	10: 9.9 ↑		

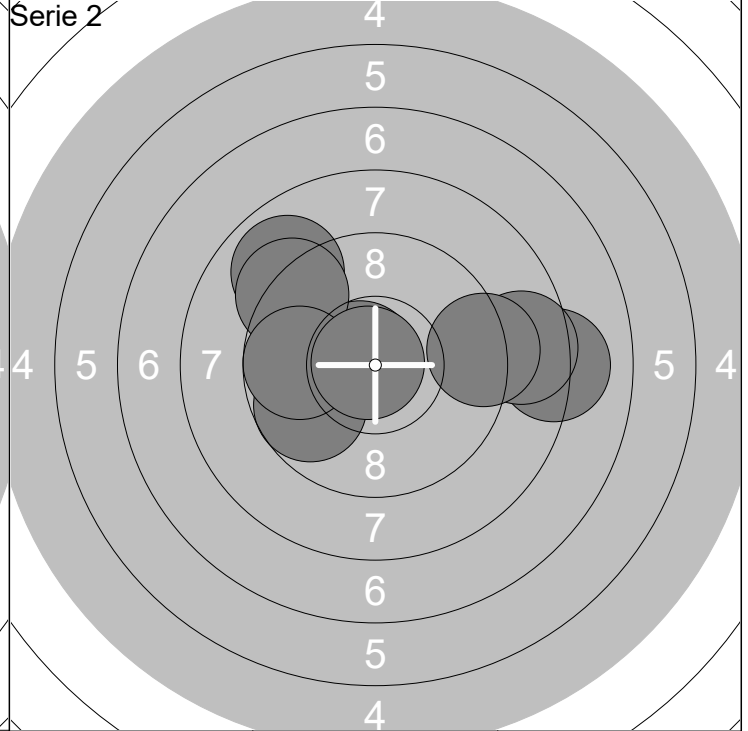
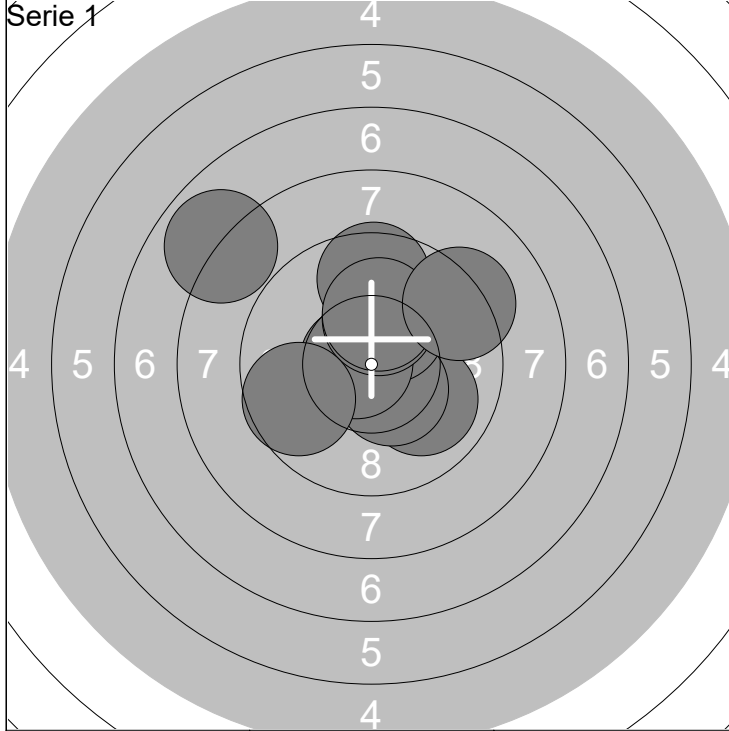

1: 9.9 ↘	6: 9.6 ←	Serie 93 (4x)
2: 10.4x ↘	7: 9.6 ↑	
3: 10.3x ↗	8: 10.1 ↑	Total 93 (4x)
4: 10.7x ←	9: 9.2 ↗	
5: 10.2x ↑	10: 7.9 ↖	

1: 8.1 →	6: 10.7x ↖	Serie 90 (3x)
2: 10.5x ←	7: 9.2 ↖	
3: 8.6 →	8: 9.7 ←	Total 183 (7x)
4: 9.7 ↖	9: 9.2 →	
5: 8.9 ↖	10: 10.8x ←	

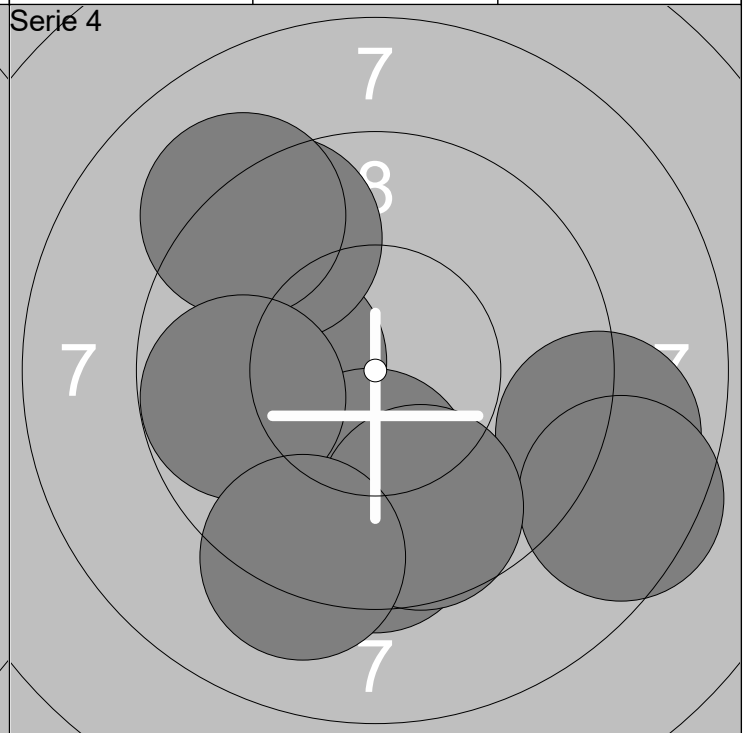
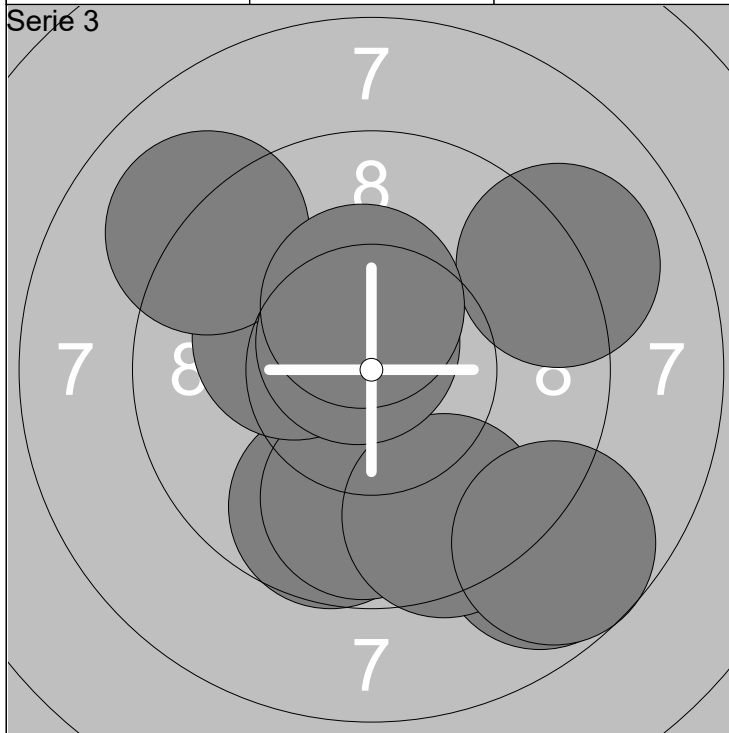

1: 9.7 ↓	6: 9.5 ↓	Serie 91 (3x)
2: 9.8 ↓	7: 10.7x ↗	
3: 10.2x ↖	8: 9.0 ↗	Total 274 (10x)
4: 8.8 ↓	9: 10.4x ↑	
5: 9.0 ↗	10: 8.7 ↓	

1: 10.1 ←	6: 8.9 →	Serie 90 (0x)
2: 9.5 ↗	7: 8.5 ↘	
3: 9.5 ↓	8: 9.7 ↓	Total 364 (10x)
4: 9.1 ↗	9: 9.8 ←	
5: 10.1 ↓	10: 9.2 ↓	

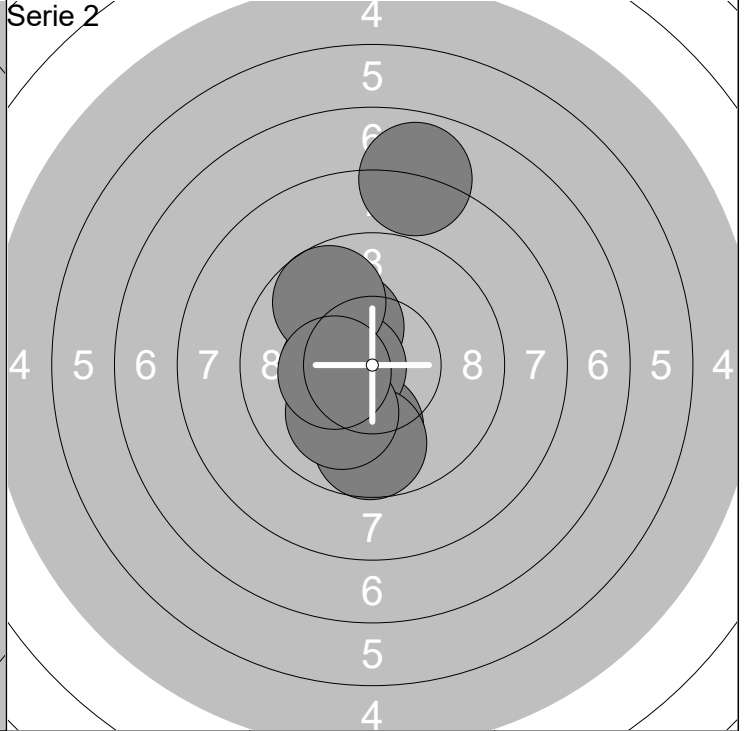
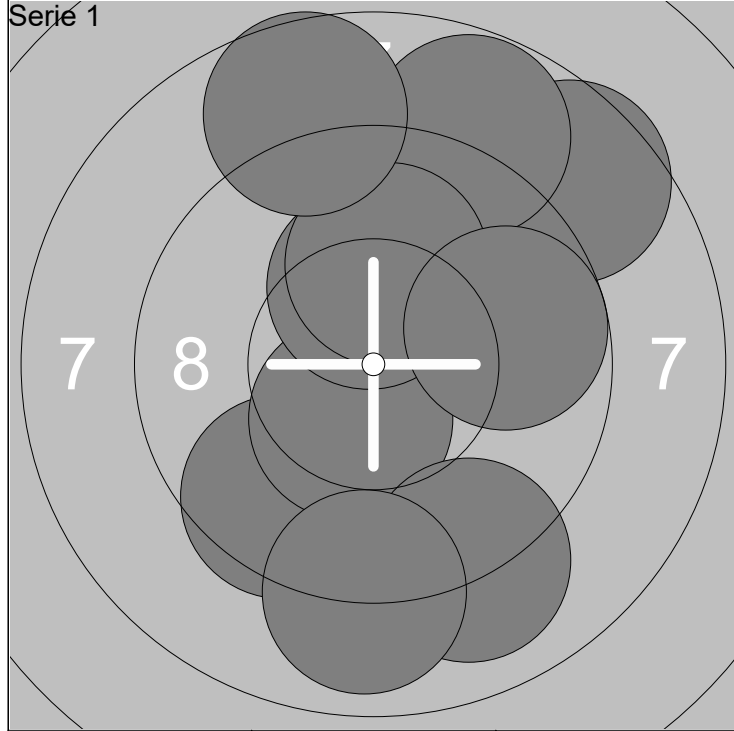

1: 8.6 ↗	6: 10.2x ↑	Serie	89 (2x)
2: 9.5 ↘	7: 10.1 ↑		
3: 8.8 ↑	8: 8.7 ↑	Total	89 (2x)
4: 10.4x ↘	9: 8.9 ↓		
5: 9.0 ↘	10: 9.7 →		

1: 10.4x ←	6: 7.9 ↑	Serie	94 (5x)
2: 10.4x ←	7: 9.7 ↓		
3: 9.9 ↓	8: 9.7 ↗	Total	183 (7x)
4: 10.2x ↗	9: 10.0 ↘		
5: 10.6x ←	10: 10.3x ←		

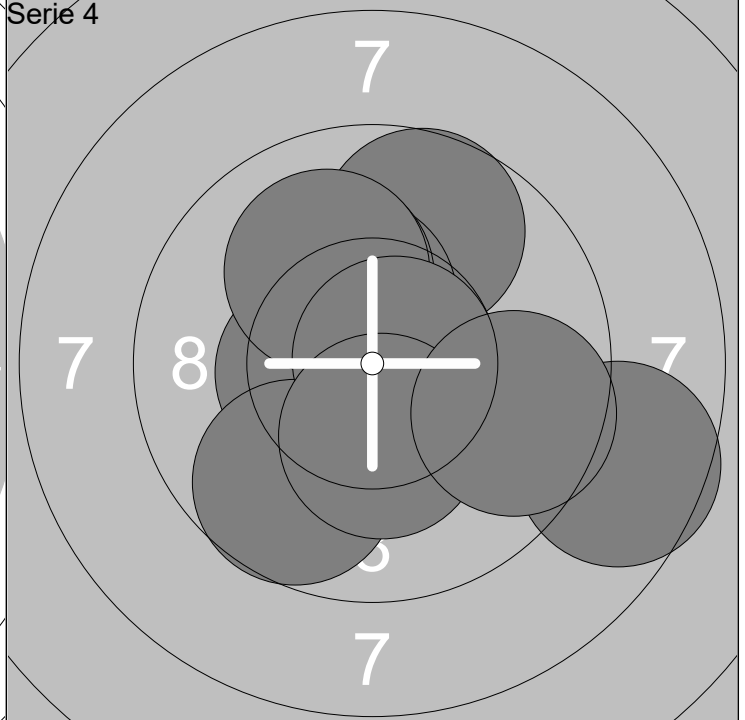
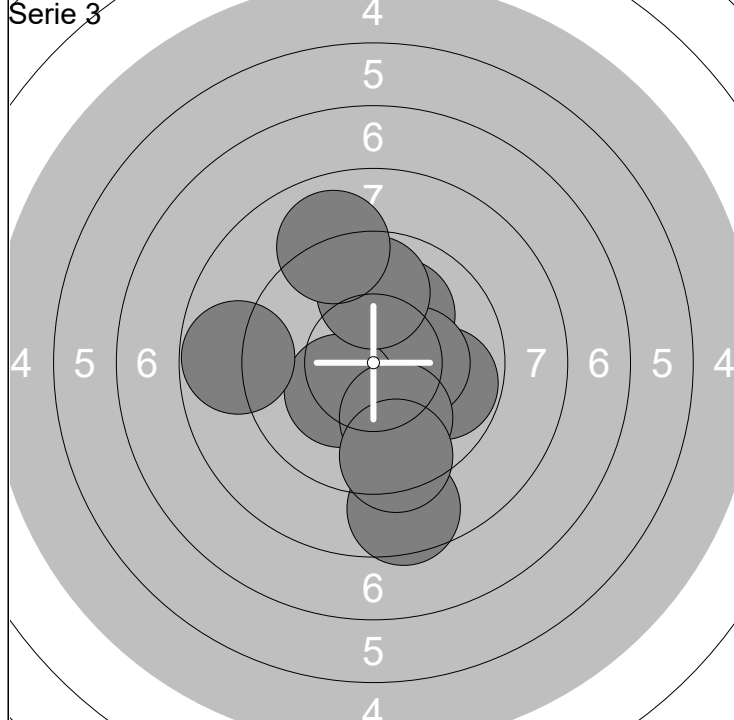

1: 10.1 ↗	6: 10.0 ↓	Serie	92 (2x)
2: 9.8 →	7: 9.8 ↑		
3: 10.3x →	8: 9.4 ↓	Total	275 (9x)
4: 10.2x ↘	9: 8.8 ←		
5: 8.5 ↓	10: 9.0 ↑		

1: 9.7 ↑	6: 9.7 ↘	Serie	95 (4x)
2: 8.6 →	7: 10.0 ↗		
3: 10.4x ↑	8: 10.7x →	Total	370 (13x)
4: 10.1 ↗	9: 10.3x ↓		
5: 10.4x ←	10: 9.6 →		

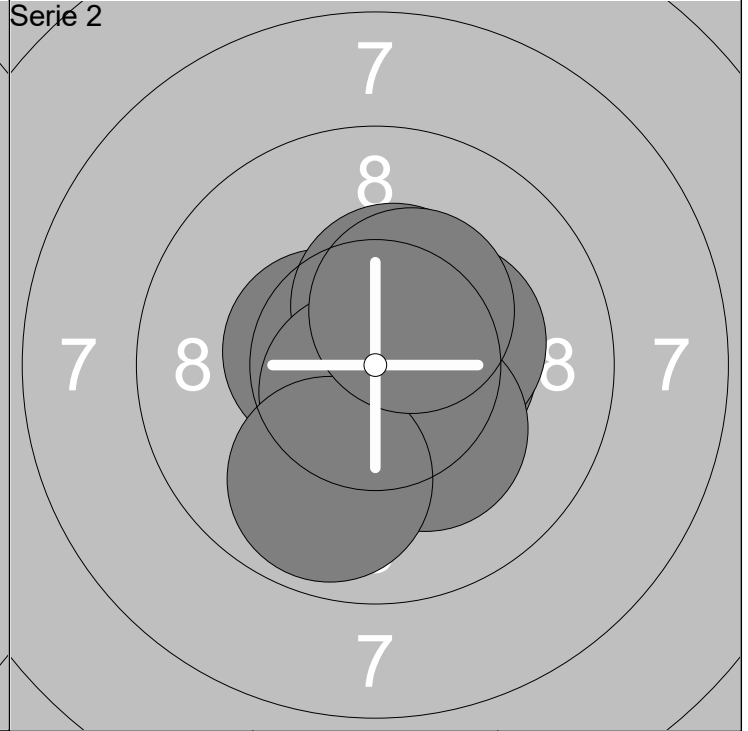
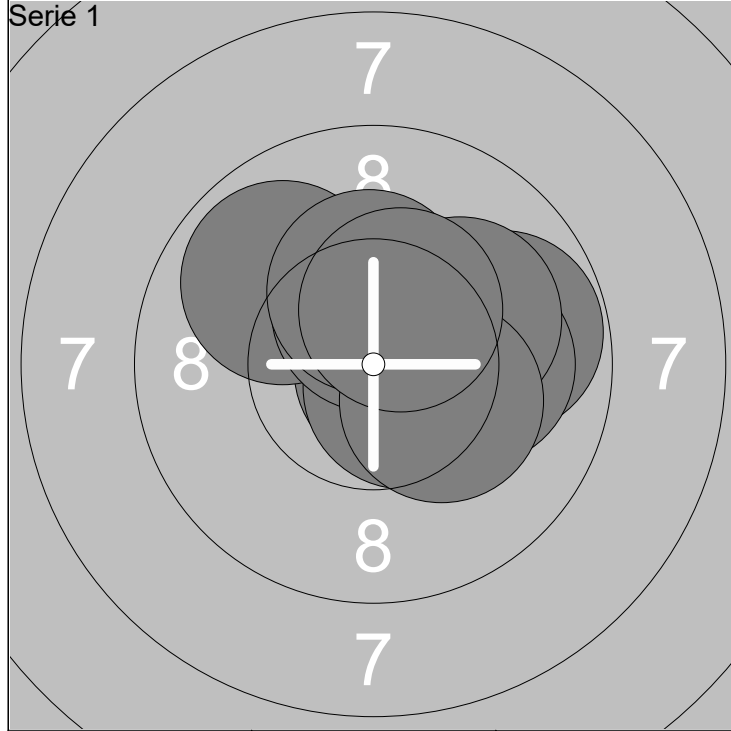

1: 9.8 →	6: 10.4x ↑	Serie 98 (6x)
2: 10.7x →	7: 10.1 ↗	
3: 9.8 ↗	8: 10.2x ↘	Total 98 (6x)
4: 10.0 →	9: 10.3x ↑	
5: 10.6x ↘	10: 10.4x ↗	

1: 10.6x ↙	6: 10.7x ↘	Serie 99 (9x)
2: 10.5x ←	7: 10.3x →	
3: 10.4x →	8: 10.2x ↘	Total 197 (15x)
4: 10.4x ↑	9: 9.9 ↘	
5: 10.7x →	10: 10.4x ↗	

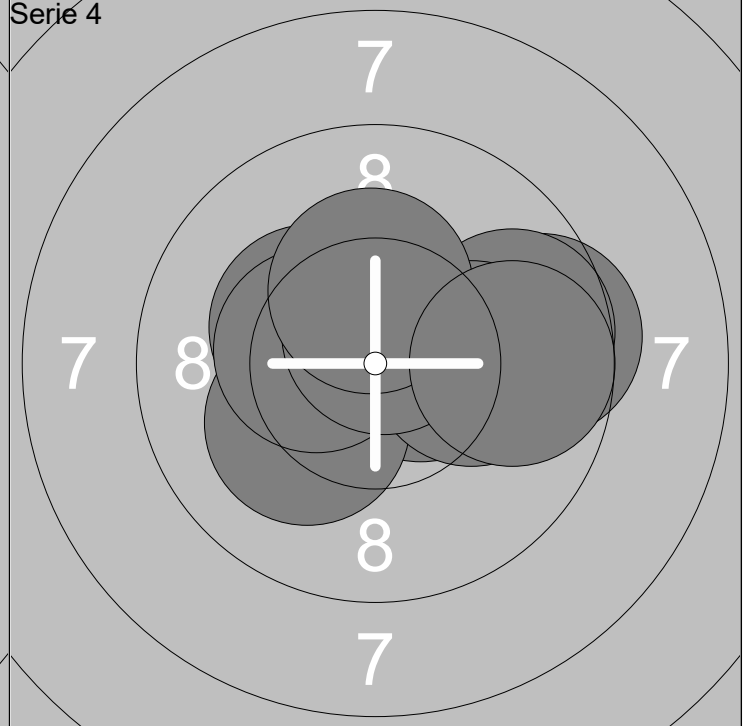
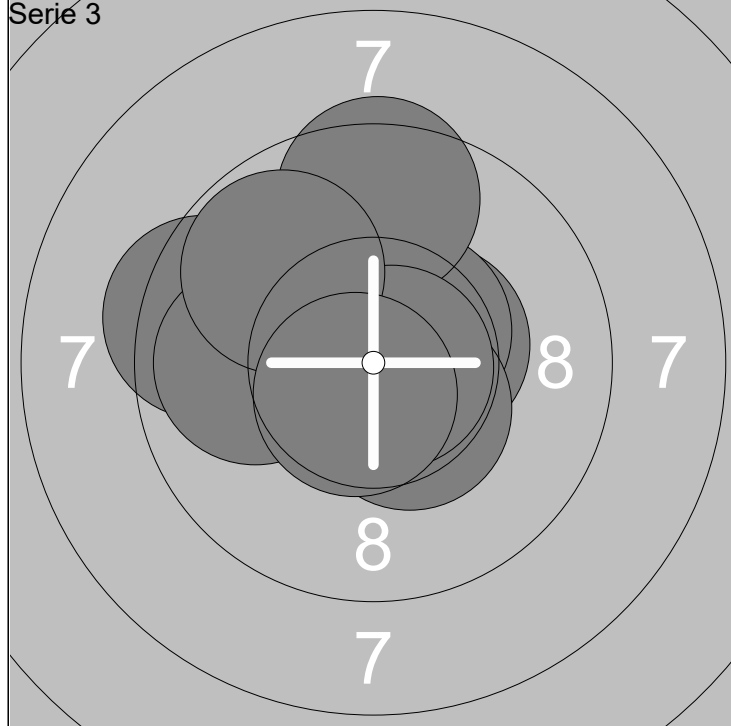

1: 10.4x →	6: 10.4x ↘	Serie 96 (6x)
2: 10.3x ←	7: 9.5 ↑	
3: 9.4 ←	8: 10.8x →	Total 293 (21x)
4: 10.5x ↗	9: 9.8 ↖	
5: 9.9 ←	10: 10.6x ↘	

1: 10.5x →	6: 10.3x ↖	Serie 97 (5x)
2: 10.1 ↙	7: 10.4x ←	
3: 9.4 →	8: 10.6x ↑	Total 390 (26x)
4: 9.7 →	9: 10.3x ↑	
5: 10.1 →	10: 9.7 →	

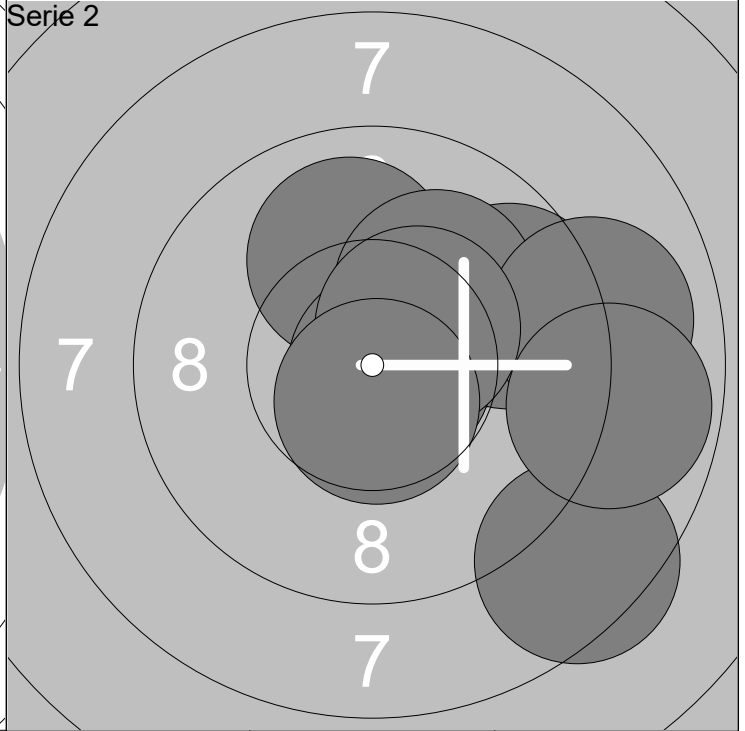
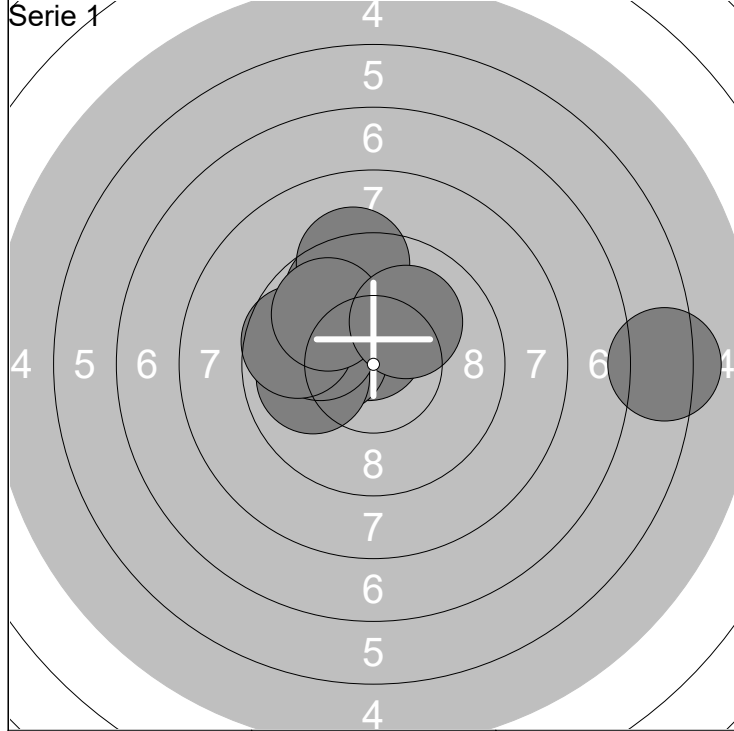

1: 10.6x ↗	6: 9.7 ↗	Serie	92 (2x)
2: 10.2x ↖	7: 9.3 ↗		
3: 10.0 ↖	8: 6.3 →	Total	92 (2x)
4: 10.0 ↖	9: 9.8 ↖		
5: 9.7 ↖	10: 10.1 ↗		

1: 10.0 ↗	6: 9.0 →	Serie	94 (4x)
2: 10.2x ↗	7: 10.8x →		
3: 9.6 ↗	8: 10.4x ↗	Total	186 (6x)
4: 10.1 ↗	9: 8.8 →		
5: 8.4 ↘	10: 10.6x ↓		

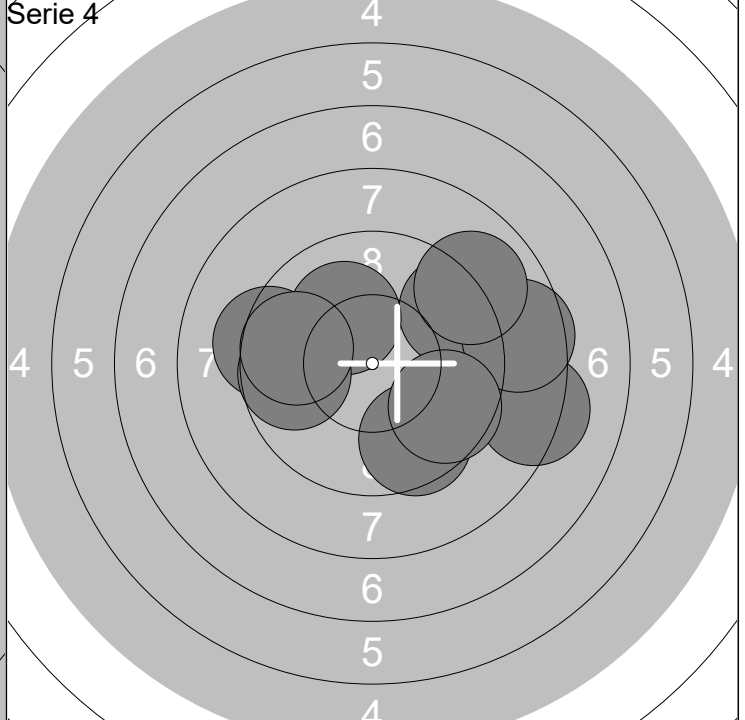
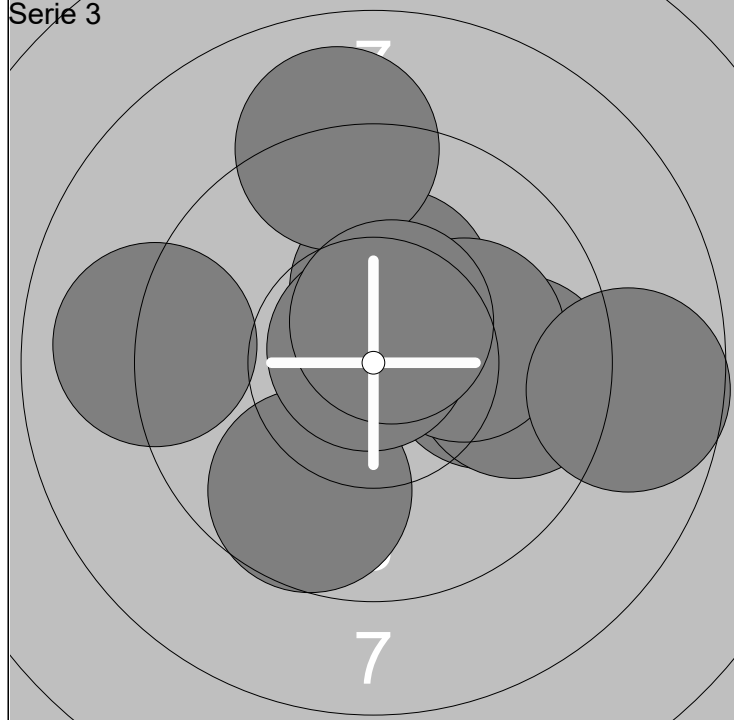

1: 10.3x ↗	6: 9.0 ↗	Serie	93 (3x)
2: 9.0 ↖	7: 9.7 ↘		
3: 9.9 →	8: 10.8x ↗	Total	279 (9x)
4: 9.7 →	9: 10.5x ↗		
5: 10.1 →	10: 8.7 →		

1: 9.2 ↖	6: 9.6 ↘	Serie	89 (0x)
2: 8.3 →	7: 8.6 →		
3: 9.3 ↗	8: 9.7 ↖	Total	368 (9x)
4: 10.1 ↖	9: 9.0 ↗		
5: 9.7 ↖	10: 9.6 ↘		

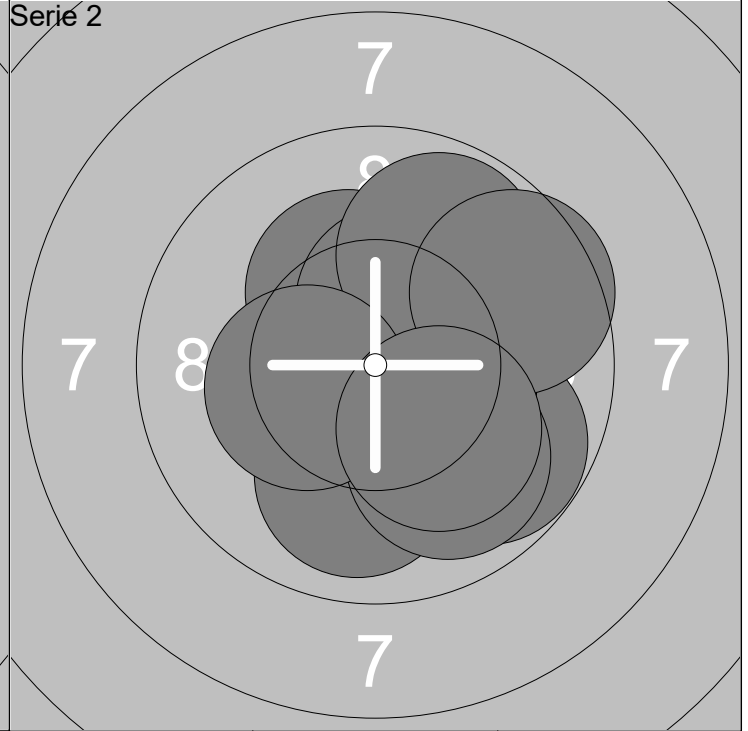
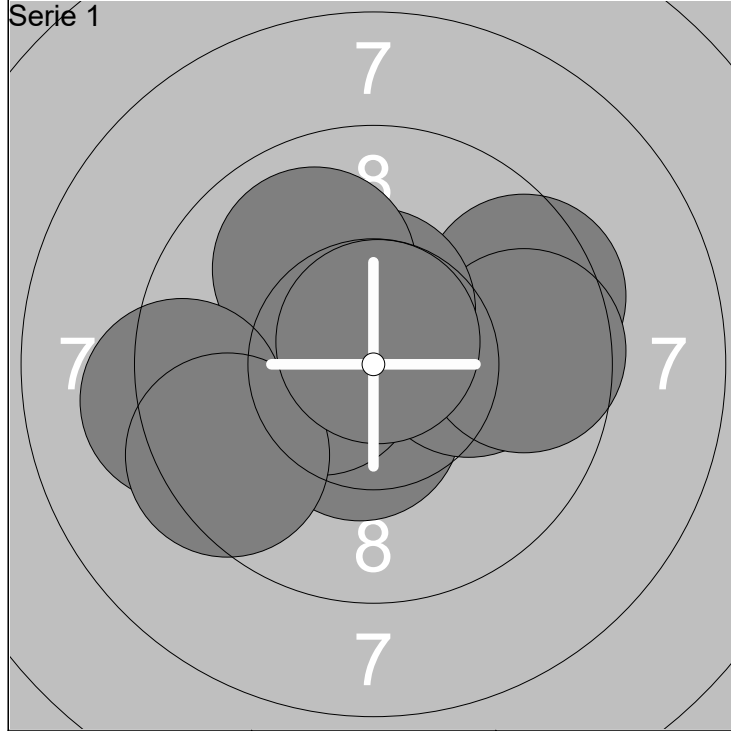

1: 10.4x ↓	6: 10.5x ↑	Serie	96 (4x)
2: 10.5x ←	7: 10.0 ↖		
3: 10.1 →	8: 9.2 ←	Total	96 (4x)
4: 9.5 ↗	9: 9.4 ↙		
5: 9.6 →	10: 10.7x ↑		

1: 9.8 ↘	6: 9.8 ↗	Serie	95 (4x)
2: 10.2x ↗	7: 9.9 ↘		
3: 10.4x ↗	8: 9.6 ↗	Total	191 (8x)
4: 10.4x →	9: 10.3x ←		
5: 9.9 ↓	10: 10.1 ↘		

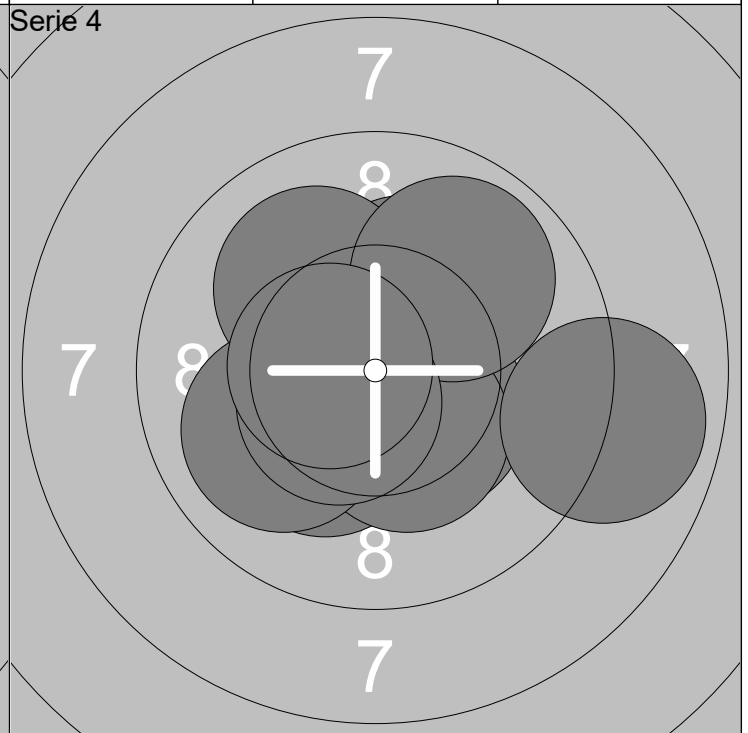
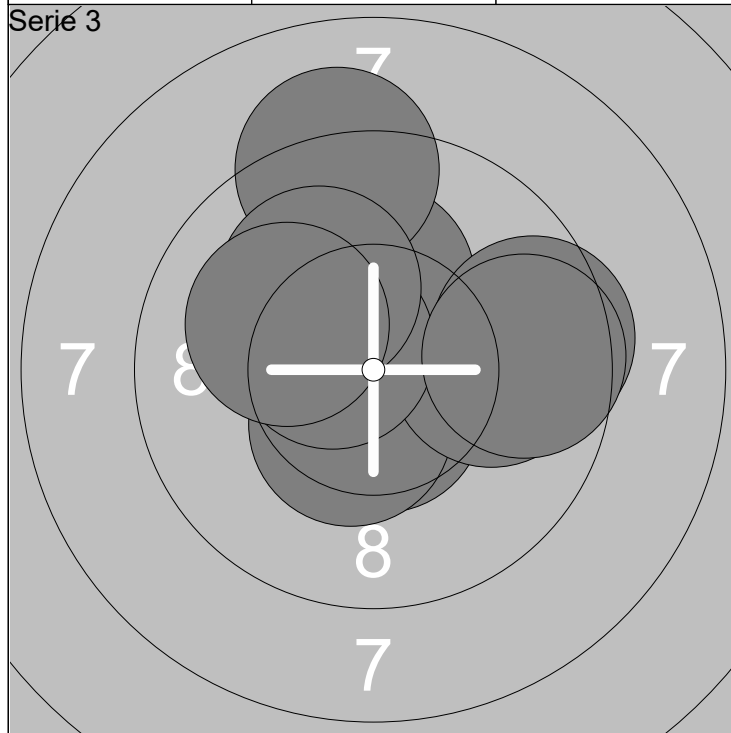

1: 10.6x ↓	6: 9.5 →	Serie	96 (4x)
2: 10.4x ↓	7: 10.5x ↖		
3: 9.9 →	8: 10.1 ↗	Total	287 (12x)
4: 10.2x ↑	9: 9.6 →		
5: 9.2 ↑	10: 10.1 ↖		

1: 10.2x ↙	6: 9.9 ↗	Serie	97 (6x)
2: 10.2x ↗	7: 10.0 ↙		
3: 10.4x ↘	8: 10.5x ↙	Total	384 (18x)
4: 10.0 ↗	9: 8.9 →		
5: 10.4x ↓	10: 10.5x ←		

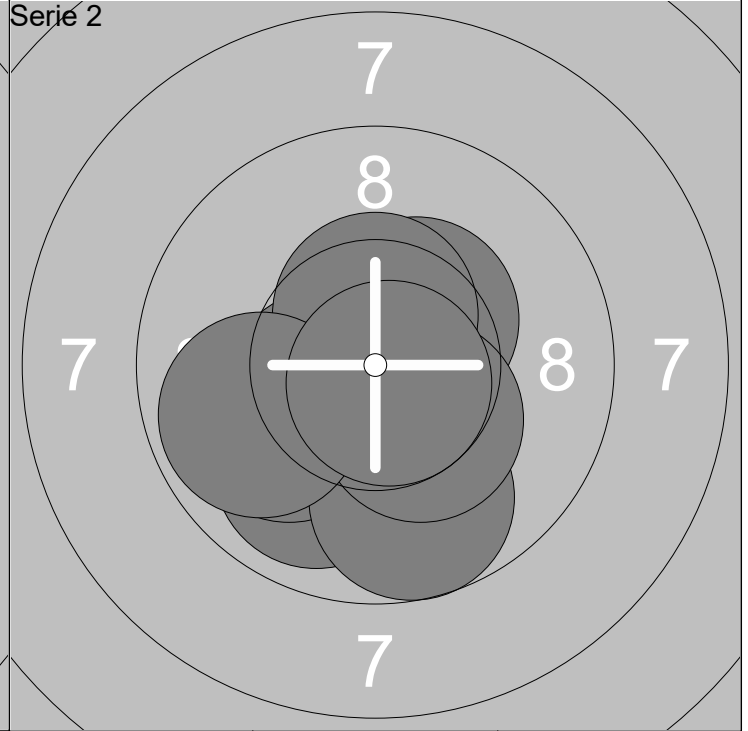
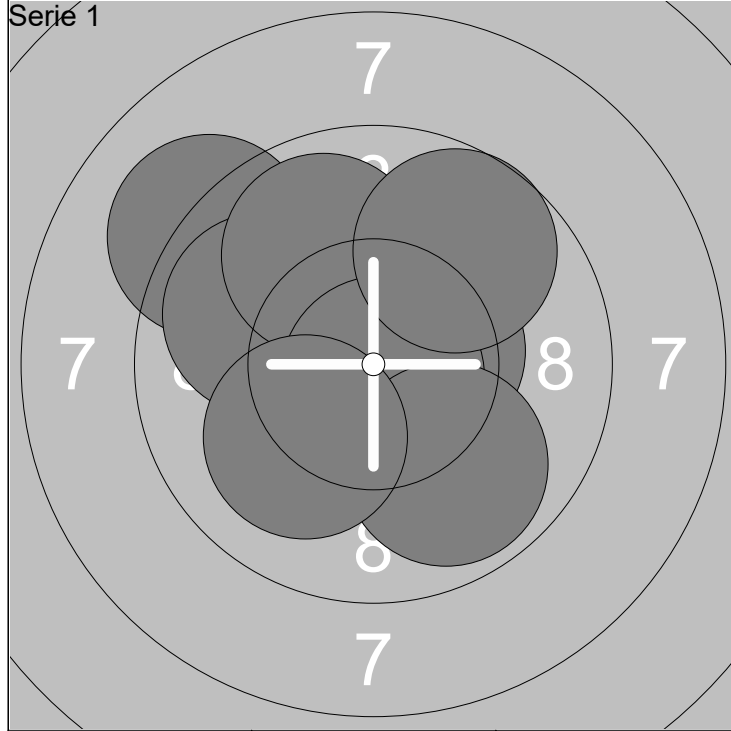

1: 10.3x ↖	6: 9.9 ↗	Serie	95 (4x)
2: 10.5x →	7: 10.8x ↓		
3: 9.1 ↗	8: 9.8 ↓	Total	95 (4x)
4: 10.8x ↓	9: 10.1 ↙		
5: 9.9 ↖	10: 9.7 ↗		

1: 9.9 ↓	6: 9.7 ↓	Serie	97 (6x)
2: 10.0 ↖	7: 10.5x ↑		
3: 10.4x ↖	8: 10.3x ↓	Total	192 (10x)
4: 10.4x ↗	9: 9.8 ↖		
5: 10.8x ↓	10: 10.7x ↓		

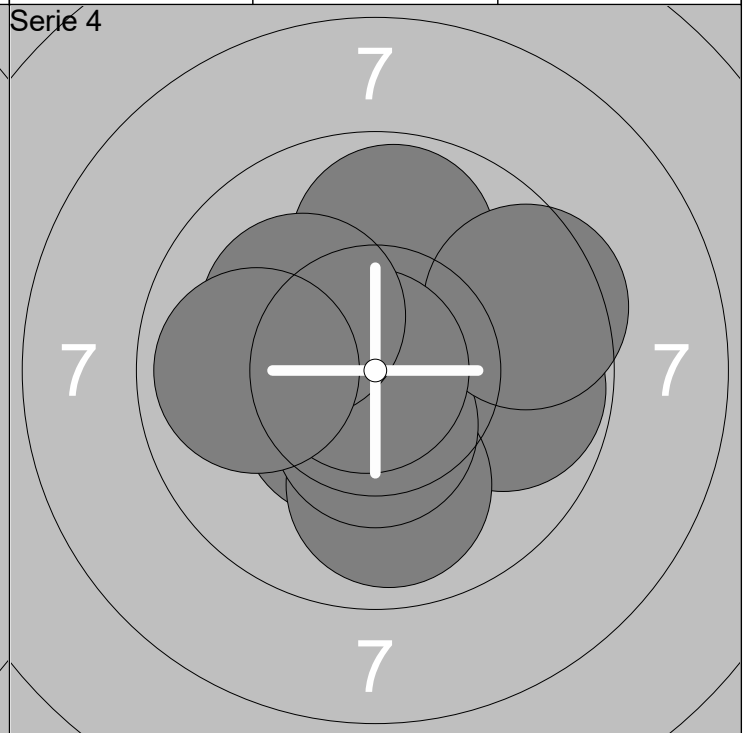
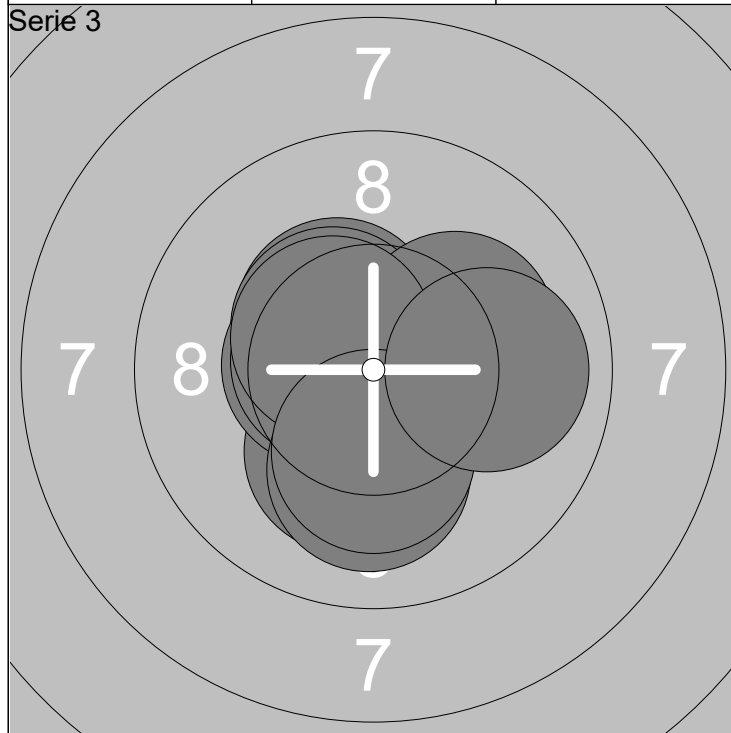

1: 10.4x ↗	6: 10.5x ↖	Serie	99 (7x)
2: 10.4x ↖	7: 10.5x ↖		
3: 10.1 →	8: 10.0 ↓	Total	291 (17x)
4: 10.2x ↓	9: 10.2x ↓		
5: 10.5x ↖	10: 9.9 →		

1: 10.4x ↓	6: 9.5 →	Serie	95 (4x)
2: 9.8 →	7: 10.4x ↖		
3: 9.9 ↓	8: 10.8x ↖	Total	386 (21x)
4: 10.4x ↓	9: 10.1 ↖		
5: 9.8 ↑	10: 9.9 ↖		

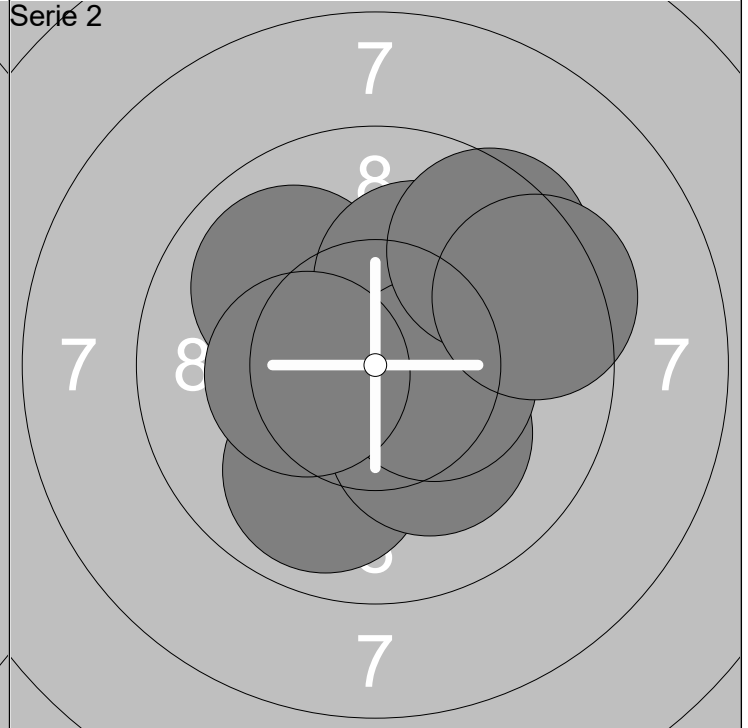
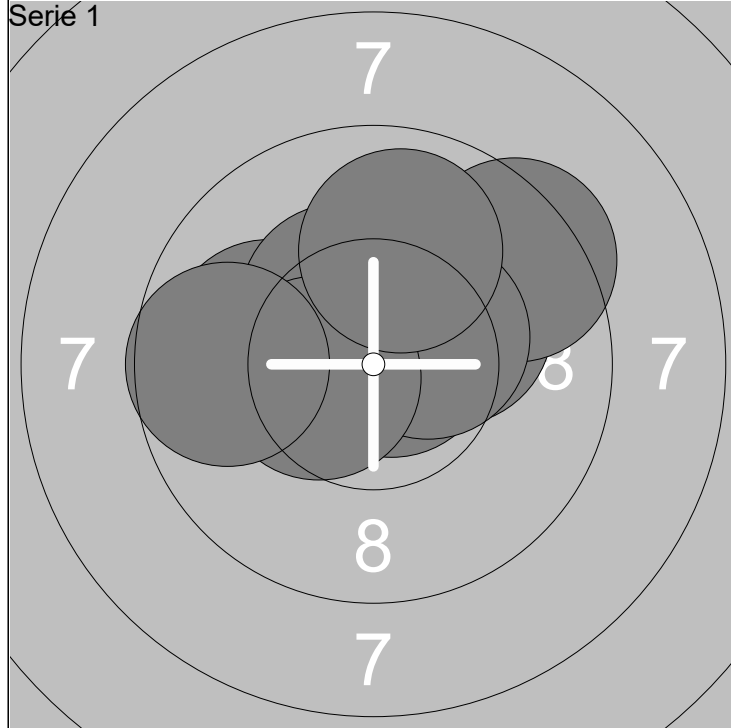

1: 10.3x ←	6: 10.3x ↗	Serie	97 (6x)
2: 10.2x ↗	7: 10.4x ↗		
3: 10.7x ↗	8: 10.4x ←	Total	97 (6x)
4: 9.4 ↗	9: 9.7 ←		
5: 10.0 ←	10: 9.9 ↑		

1: 9.9 ↖	6: 10.2x ↘	Serie	96 (5x)
2: 10.7x ↓	7: 10.4x →		
3: 10.7x ↓	8: 10.3x ←	Total	193 (11x)
4: 10.1 ↑	9: 9.5 ↗		
5: 9.9 ↓	10: 9.4 →		

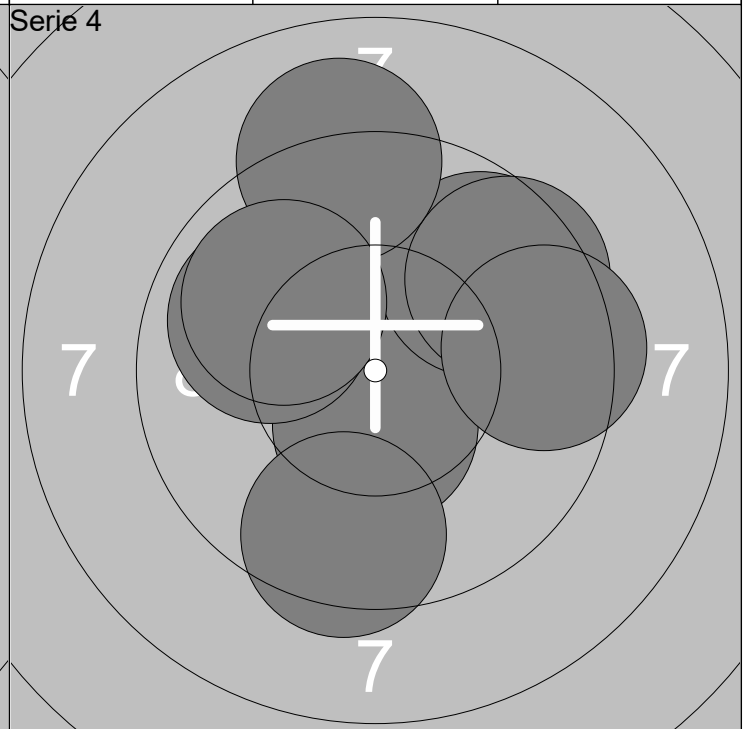
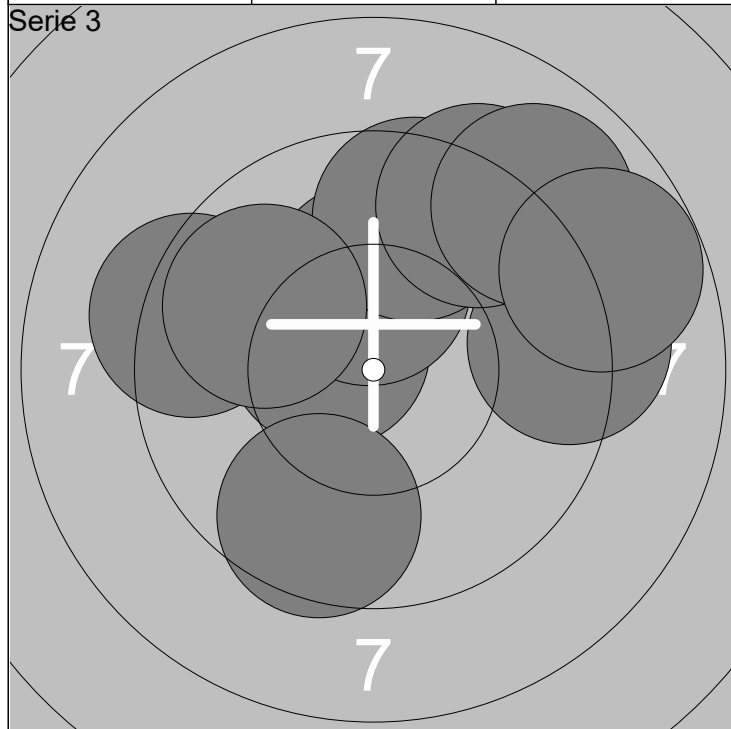

1: 10.5x ↖	6: 9.6 ↑	Serie	90 (2x)
2: 10.2x ↑	7: 9.2 ↗		
3: 9.2 ←	8: 9.8 ↖	Total	283 (13x)
4: 9.2 →	9: 8.9 ↗		
5: 9.6 ↓	10: 8.7 ↗		

1: 10.4x ↖	6: 9.9 ↖	Serie	93 (2x)
2: 10.0 ↑	7: 9.5 ↗		
3: 10.5x ↓	8: 9.0 ↑	Total	376 (15x)
4: 9.7 ↗	9: 9.9 ↖		
5: 9.5 ↓	10: 9.5 →		

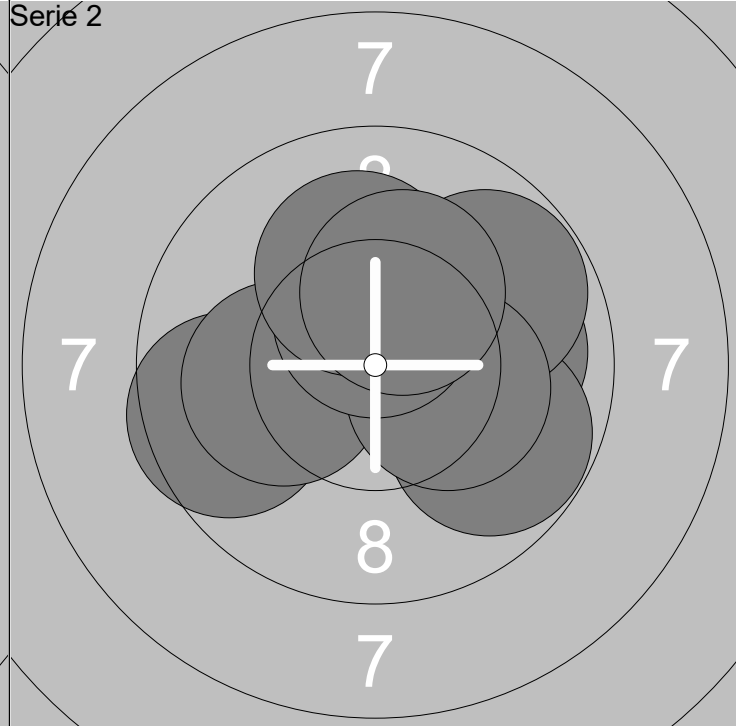
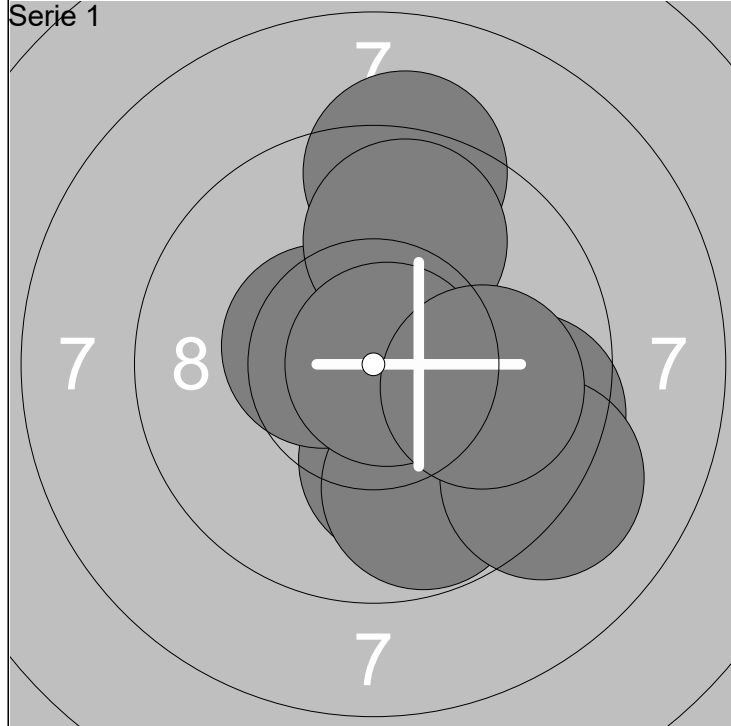

1: 10.7x ↗	6: 9.2 ↘	Serie 95 (3x)
2: 10.1 ↓	7: 9.2 ↑	
3: 9.5 →	8: 9.8 ↑	Total 95 (3x)
4: 10.4x ↖	9: 10.8x →	
5: 9.8 ↓	10: 10.0 →	

1: 10.5x →	6: 9.8 ↗	Serie 97 (4x)
2: 10.0 →	7: 10.3x →	
3: 9.6 ←	8: 10.5x ↑	Total 192 (7x)
4: 9.8 ↘	9: 10.1 ↑	
5: 10.1 ←	10: 10.3x ↑	

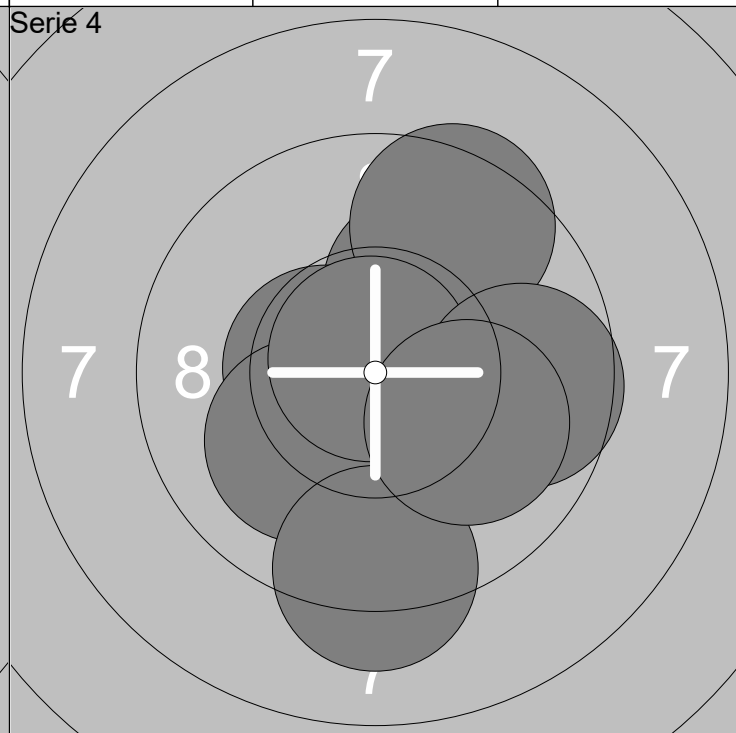
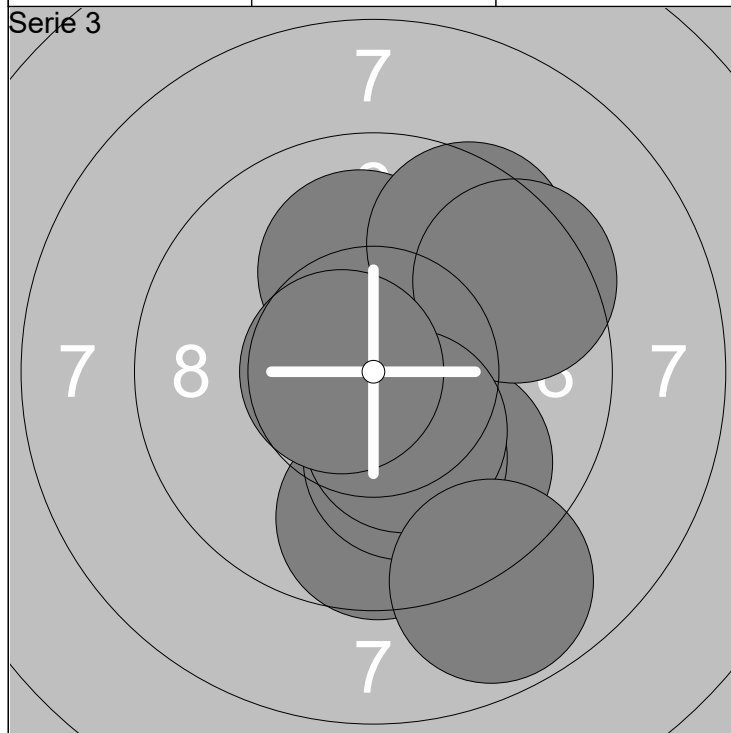

1: 9.9 ↓	6: 9.5 ↗	Serie 94 (3x)
2: 10.6x ↑	7: 9.5 ↗	
3: 9.7 ↓	8: 10.3x ↓	Total 286 (10x)
4: 10.1 ↓	9: 10.6x ←	
5: 10.0 ↑	10: 8.8 ↓	

1: 10.3x →	6: 9.5 ↗	Serie 97 (4x)
2: 10.1 ↑	7: 10.8x ↖	
3: 10.5x ←	8: 9.2 ↓	Total 383 (14x)
4: 10.1 ↙	9: 9.6 →	
5: 10.2x →	10: 10.0 ↘	

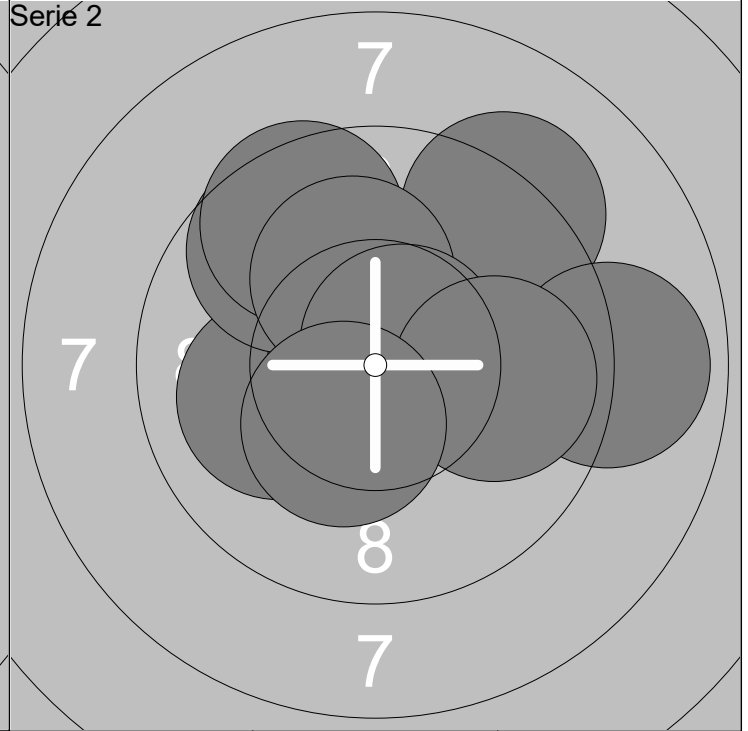
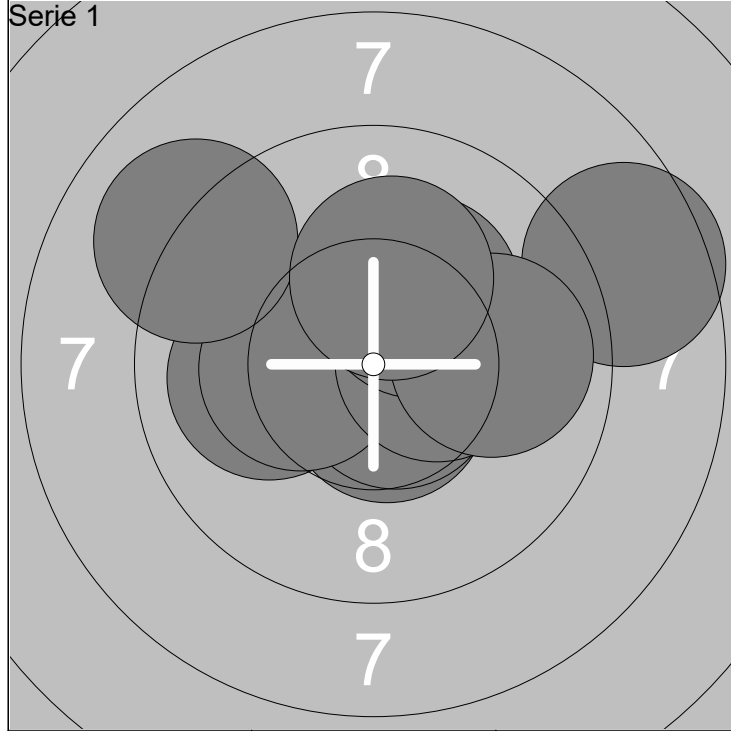

1: 10.0 ←	6: 10.4x →	Serie	96 (5x)
2: 10.6x ↓	7: 10.2x ↗		
3: 8.6 →	8: 9.9 →	Total	96 (5x)
4: 10.6x ↓	9: 9.0 ↖		
5: 10.3x ←	10: 10.1 ↑		

1: 10.1 ←	6: 9.5 ↖	Serie	94 (3x)
2: 9.2 ↗	7: 10.1 ↑		
3: 10.8x ↖	8: 10.6x ↗	Total	190 (8x)
4: 8.9 →	9: 9.9 →		
5: 9.7 ↖	10: 10.4x ↓		

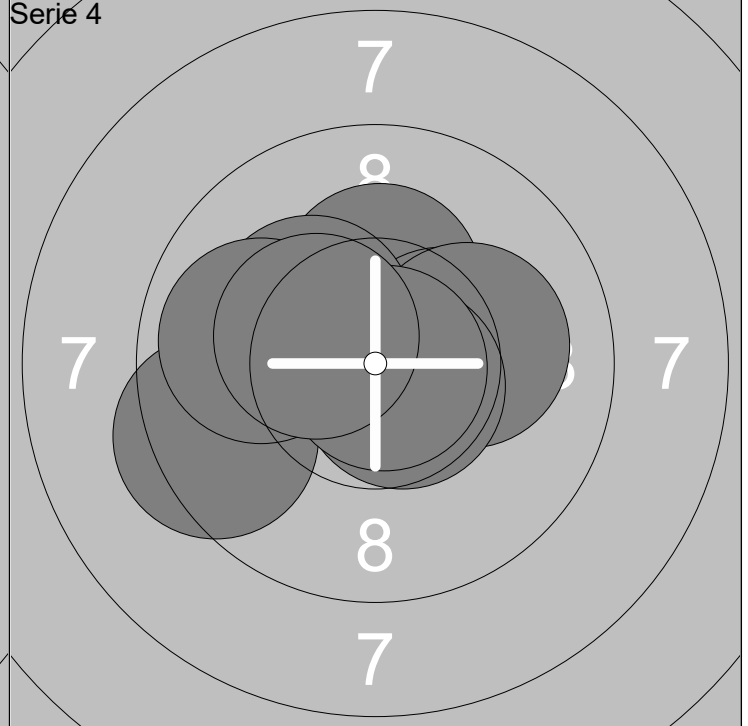
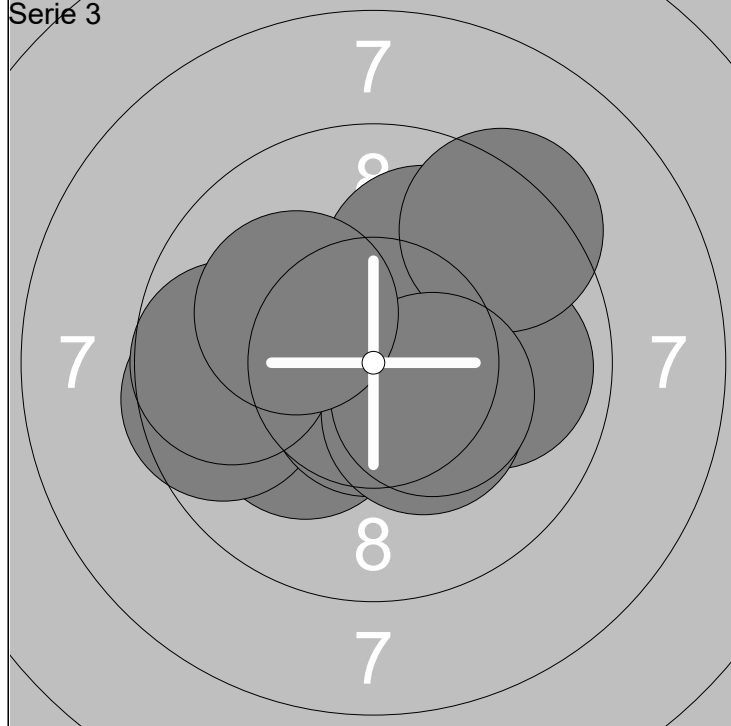

1: 10.1 ↖	6: 10.3x ↓	Serie	96 (3x)
2: 9.9 →	7: 10.0 ↗		
3: 9.6 ←	8: 9.3 ↗	Total	286 (11x)
4: 10.6x ↓	9: 10.3x ↓		
5: 9.7 ←	10: 10.1 ↖		

1: 10.7x ↗	6: 9.4 ←	Serie	98 (7x)
2: 10.3x ↑	7: 9.9 ←		
3: 10.3x →	8: 10.6x ↓	Total	384 (18x)
4: 10.1 →	9: 10.8x ↓		
5: 10.2x ↖	10: 10.4x ↖		

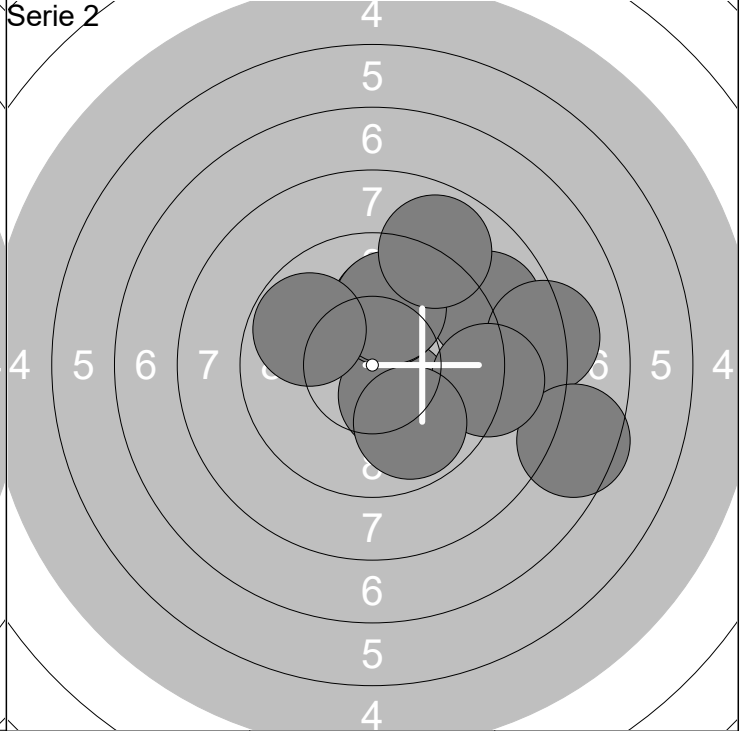
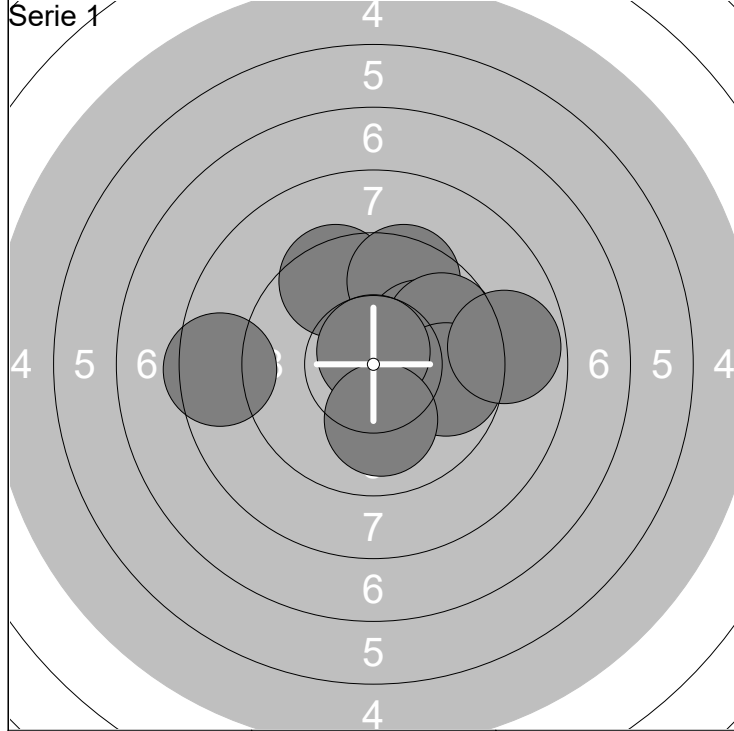

1: 9.5 ↖	6: 9.7 ↗	Serie	92 (2x)
2: 10.5x →	7: 9.7 →		
3: 8.5 ←	8: 10.7x ↑	Total	92 (2x)
4: 9.5 ↑	9: 10.0 ↓		
5: 10.0 ↗	10: 8.8 →		

1: 8.9 ↗	6: 10.0 ↑	Serie	88 (1x)
2: 8.2 →	7: 10.0 ↑		
3: 10.3x ↘	8: 9.8 ↖	Total	180 (3x)
4: 7.5 →	9: 8.9 ↗		
5: 9.1 →	10: 9.8 ↘		

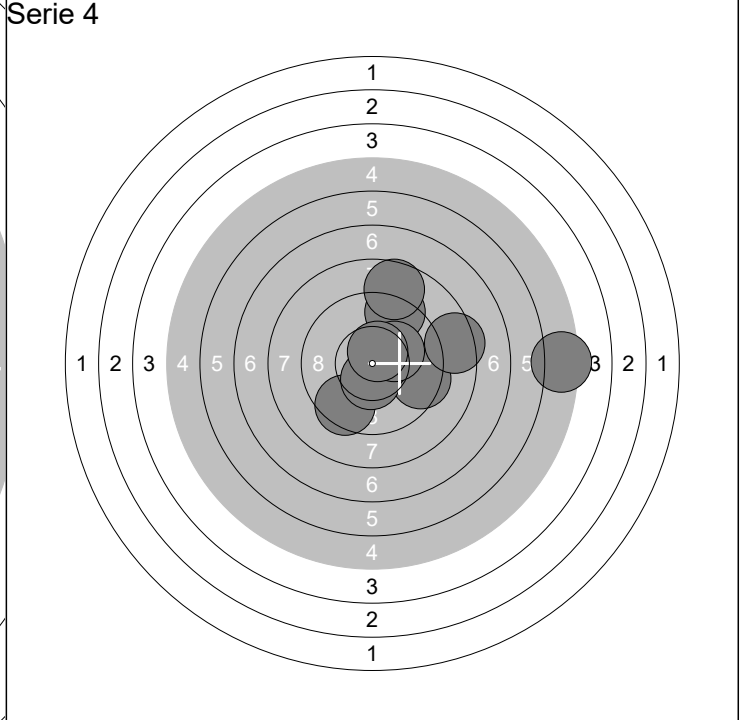
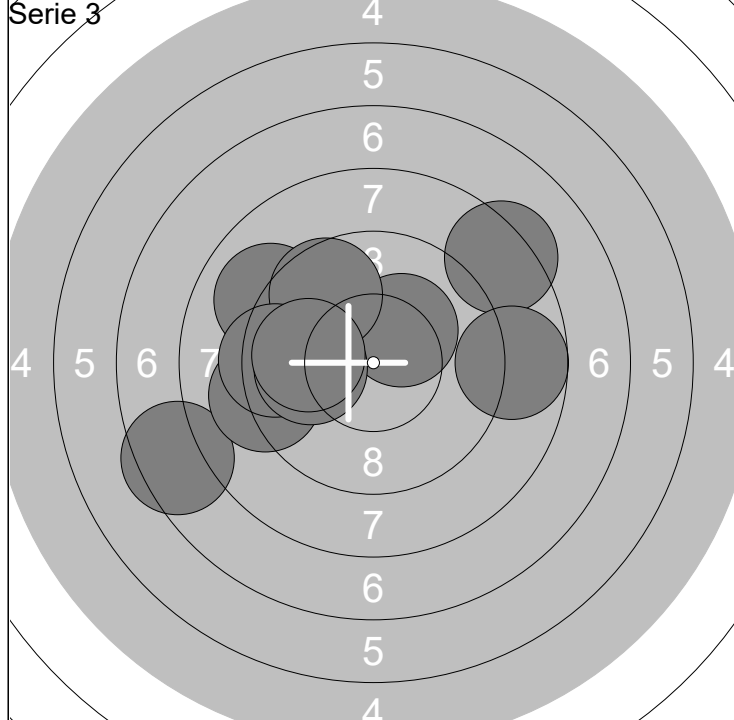

1: 8.3 ↗	6: 7.5 ←	Serie	87 (1x)
2: 10.3x ↗	7: 9.1 ←		
3: 9.0 ↖	8: 9.4 ←	Total	267 (4x)
4: 9.6 ↗	9: 9.9 ←		
5: 8.7 →	10: 9.9 ←		

1: 9.4 →	6: 5.3 →	Serie	88 (4x)
2: 9.5 ↘	7: 10.4x ↓		
3: 8.4 →	8: 8.6 ↑	Total	355 (8x)
4: 10.6x ↗	9: 10.2x ↗		
5: 9.2 ↑	10: 10.6x ↗		

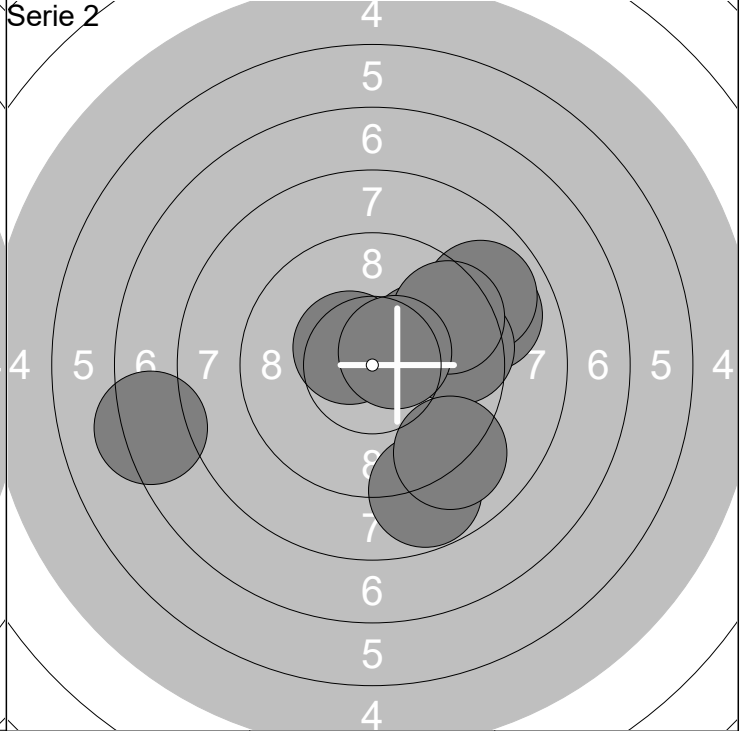
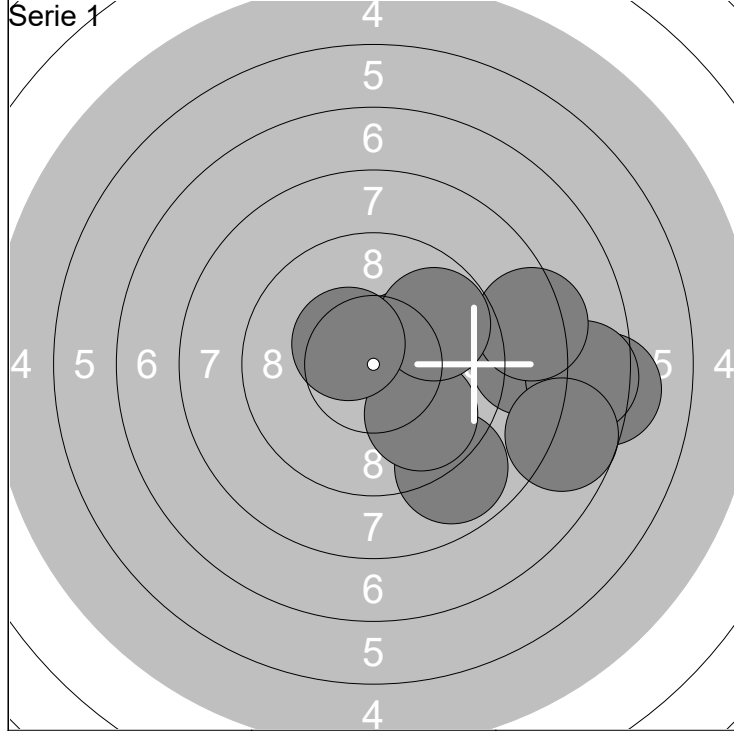

1: 7.2 →	6: 9.8 ↘	Serie	83 (2x)
2: 8.5 →	7: 8.3 →		
3: 8.9 ↘	8: 9.8 ↗	Total	83 (2x)
4: 7.6 →	9: 7.7 ↘		
5: 10.3x ↗	10: 10.4x ↖		

1: 9.0 ↗	6: 9.5 ↗	Serie	89 (2x)
2: 10.0 ↗	7: 10.5x ↖		
3: 8.9 ↗	8: 10.5x ↗	Total	172 (4x)
4: 9.5 →	9: 9.0 ↘		
5: 8.8 ↘	10: 7.3 ←		

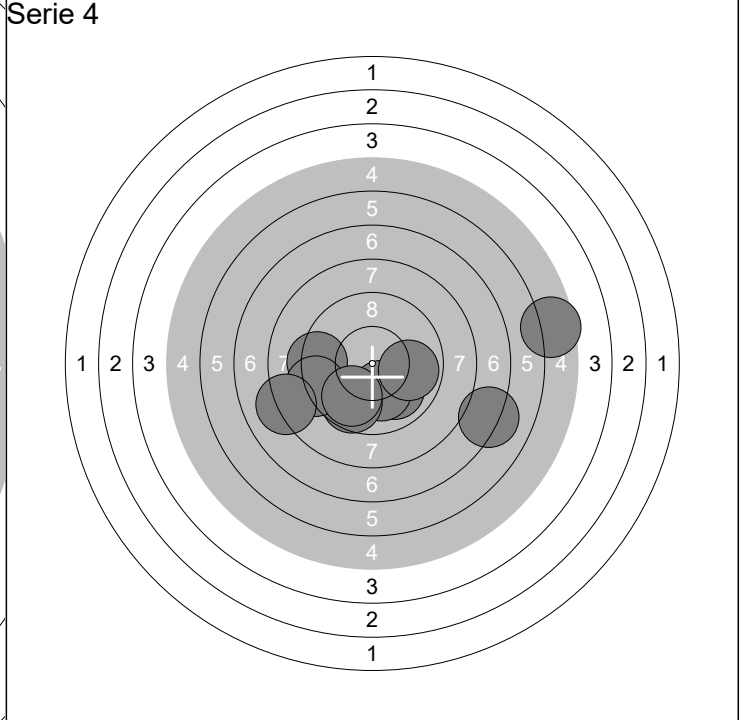
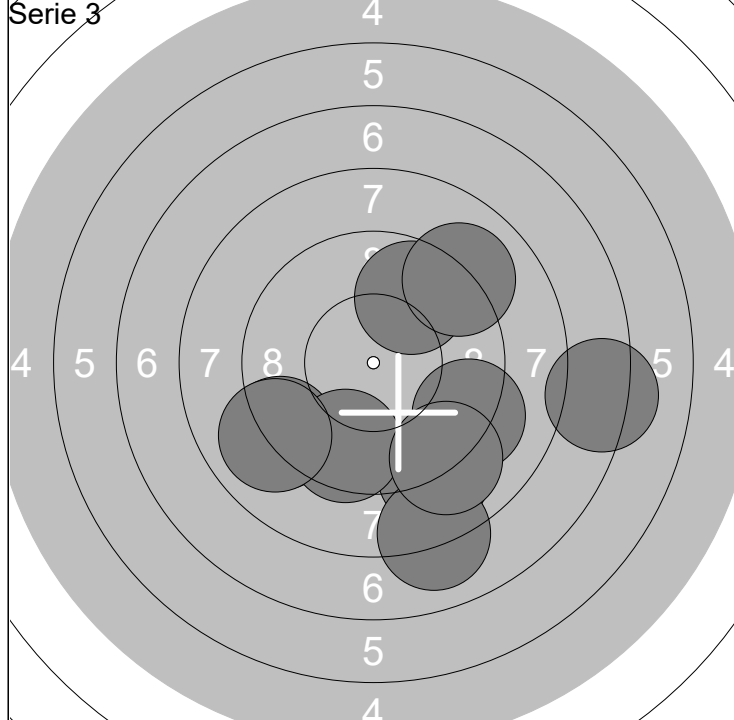

1: 9.7 ↗	6: 9.0 ↗	Serie	86 (0x)
2: 8.9 ↘	7: 7.3 →		
3: 8.1 ↘	8: 9.2 ↘	Total	258 (4x)
4: 9.1 ↖	9: 9.0 ↖		
5: 9.5 ↘	10: 9.0 ↘		

1: 9.9 ↘	6: 9.1 ←	Serie	84 (0x)
2: 7.1 →	7: 8.1 ←		
3: 9.3 ←	8: 5.6 →	Total	342 (4x)
4: 10.1 ↘	9: 9.8 →		
5: 9.6 ↘	10: 9.8 ↘		

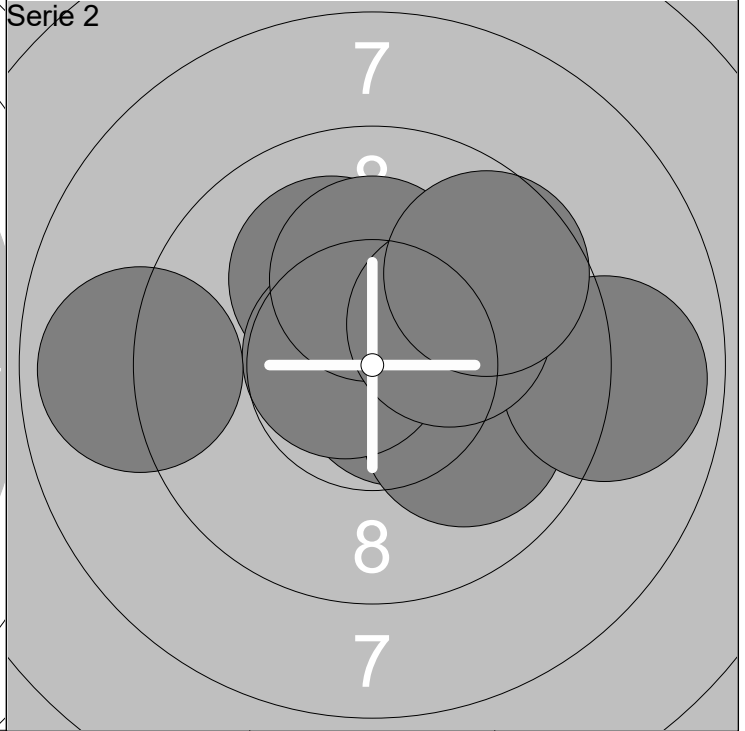
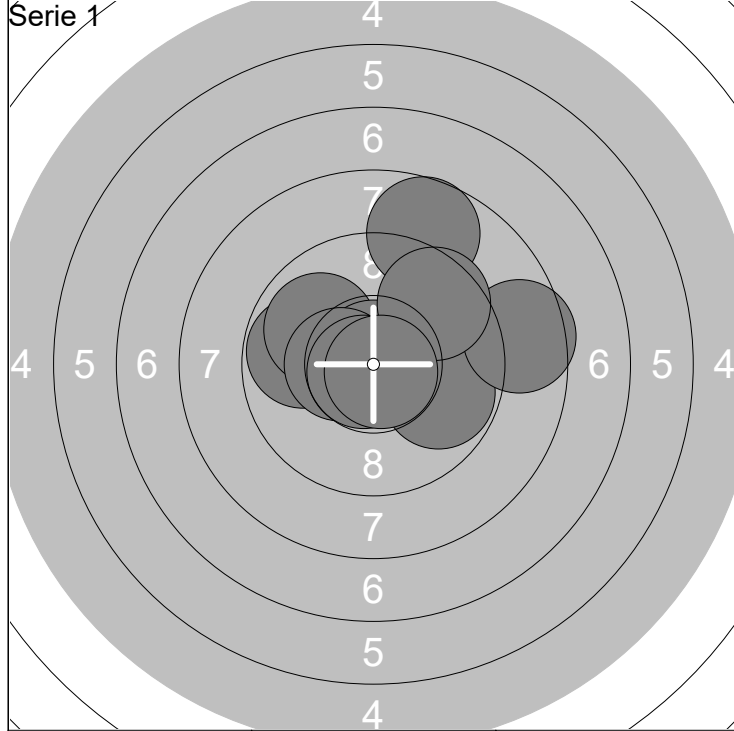

1: 9.8 ←	6: 8.6 →	Serie	92 (4x)
2: 9.8 →	7: 10.7x ↙		
3: 9.9 ↖	8: 8.7 ↗	Total	92 (4x)
4: 10.8x ↑	9: 9.6 ↗		
5: 10.4x ←	10: 10.7x ↘		

1: 10.4x →	6: 10.7x ←	Serie	95 (4x)
2: 10.6x ↘	7: 10.2x ↑		
3: 10.0 ↘	8: 8.9 ←	Total	187 (8x)
4: 8.9 →	9: 10.1 ↗		
5: 10.1 ↗	10: 9.6 ↗		

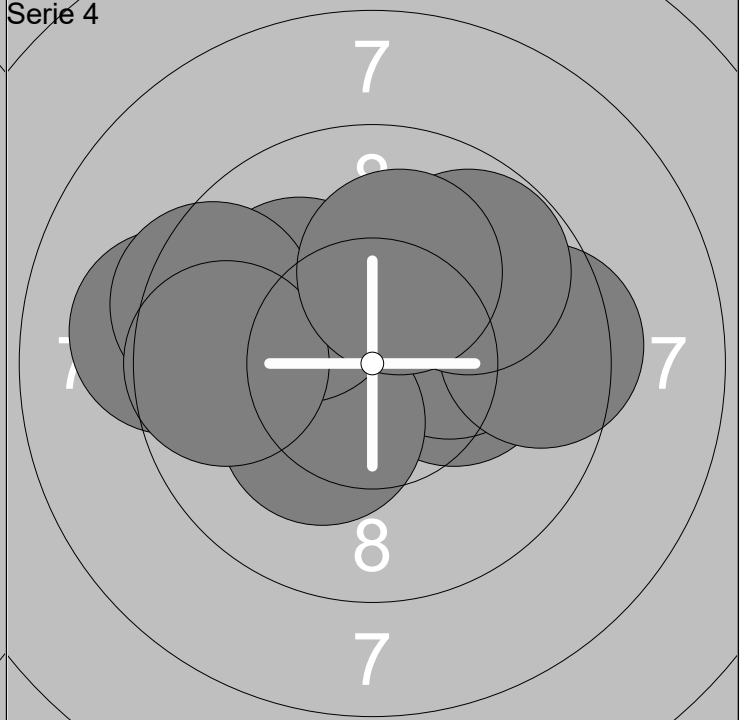
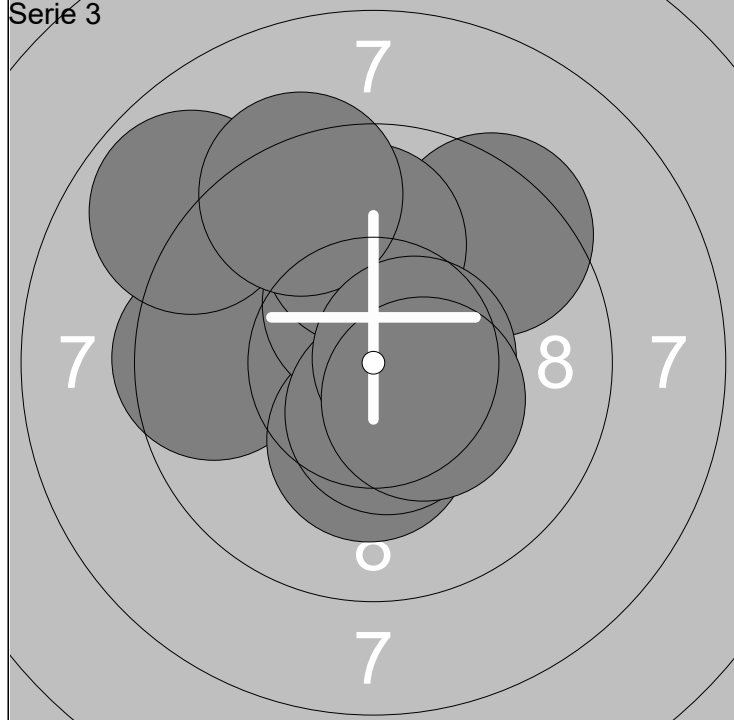

1: 9.5 ←	6: 9.9 ↑	Serie	94 (5x)
2: 9.4 ↗	7: 10.5x ↓		
3: 10.2x ↓	8: 9.3 ↗	Total	281 (13x)
4: 10.4x ↑	9: 10.6x →		
5: 8.8 ↖	10: 10.4x ↘		

1: 10.2x →	6: 9.4 →	Serie	95 (3x)
2: 9.1 ←	7: 9.4 ↙		
3: 10.2x →	8: 9.6 ←	Total	376 (16x)
4: 10.2x ↙	9: 9.8 ↗		
5: 10.1 ↖	10: 10.1 ↑		

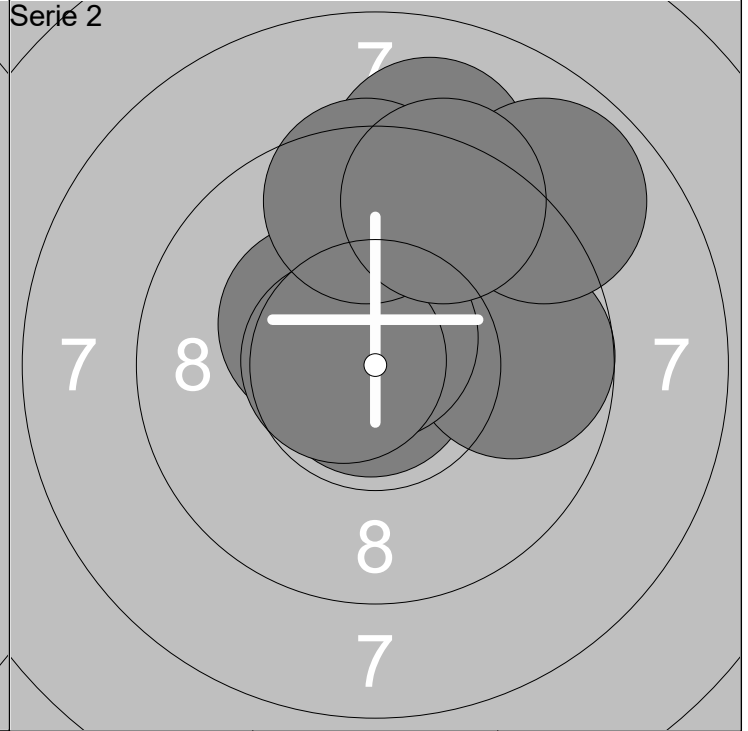
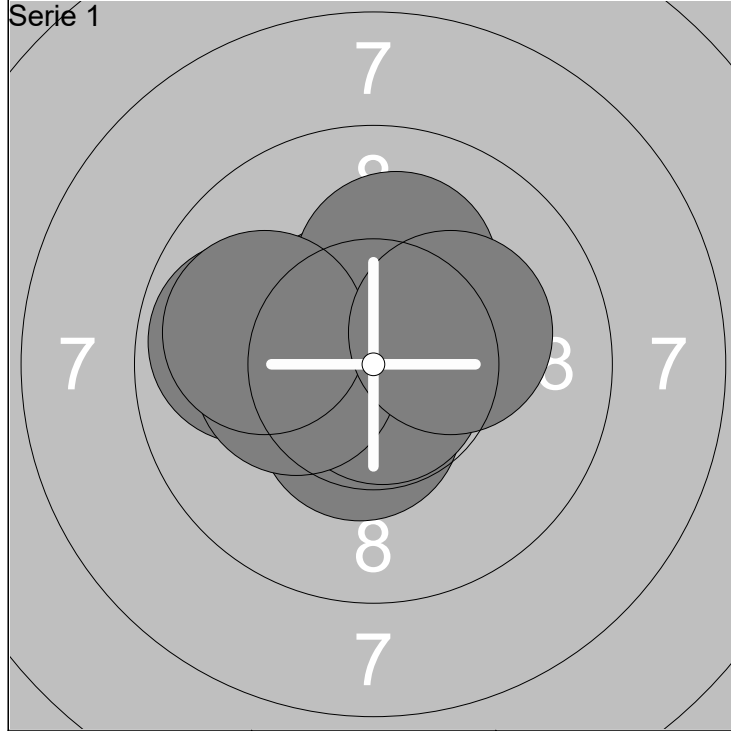

1: 9.8 ←	6: 10.7x ↓	Serie	98 (7x)
2: 10.4x ↓	7: 10.3x ←		
3: 10.5x ↖	8: 10.1 ↑	Total	98 (7x)
4: 10.5x ↗	9: 9.9 ←		
5: 10.6x ↗	10: 10.2x →		

1: 10.8x ↓	6: 10.7x ↑	Serie	94 (4x)
2: 10.0 ↗	7: 10.6x ←		
3: 10.3x ↖	8: 8.8 ↗	Total	192 (11x)
4: 9.1 ↑	9: 9.5 ↑		
5: 9.7 →	10: 9.4 ↗		

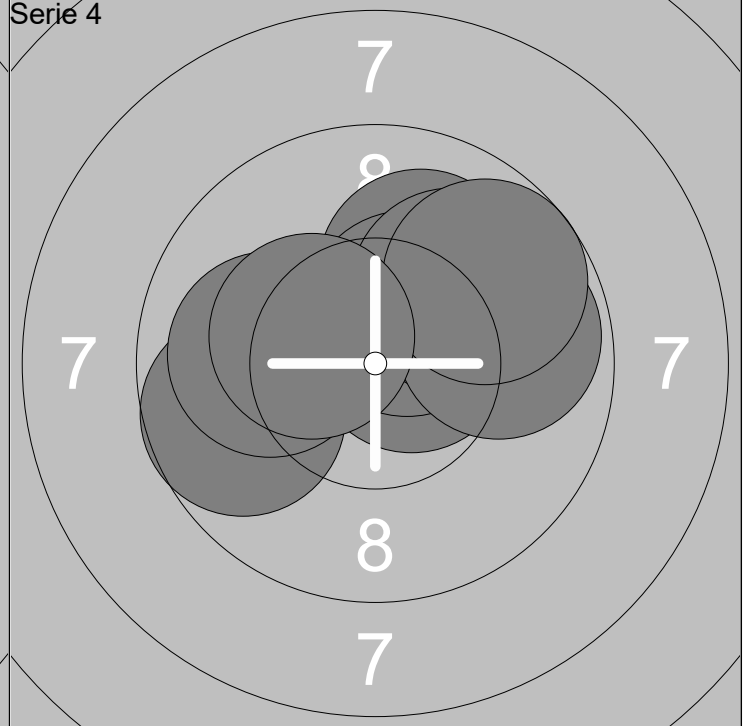
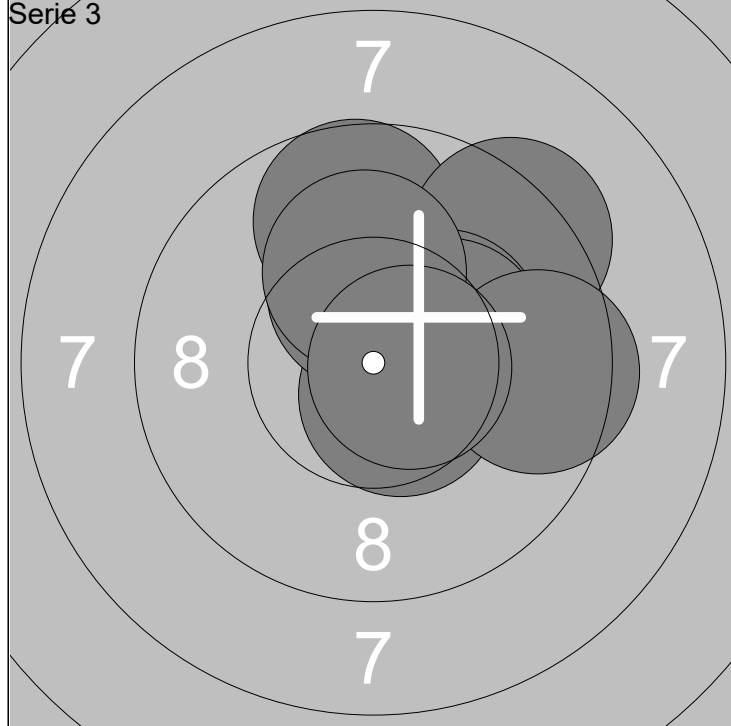

1: 10.1 →	6: 10.3x ↑	Serie	97 (5x)
2: 9.7 ↑	7: 10.3x →		
3: 9.3 ↗	8: 9.5 →	Total	289 (16x)
4: 10.3x →	9: 10.1 ↑		
5: 10.5x ↓	10: 10.6x →		

1: 9.7 ←	6: 10.4x ↗	Serie	97 (4x)
2: 10.0 ←	7: 10.0 ↗		
3: 10.0 ↗	8: 9.8 →	Total	386 (20x)
4: 10.2x ↗	9: 9.7 ↗		
5: 10.6x →	10: 10.3x ←		

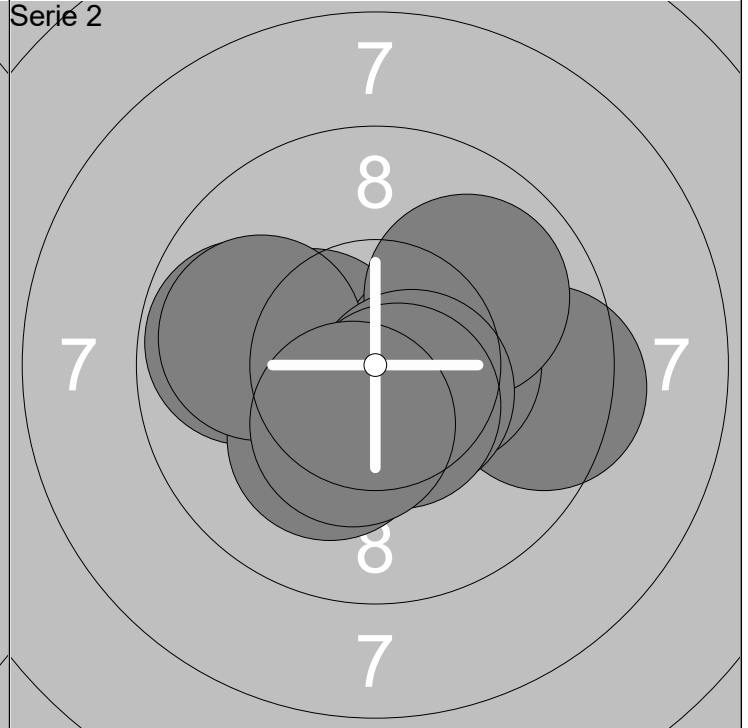
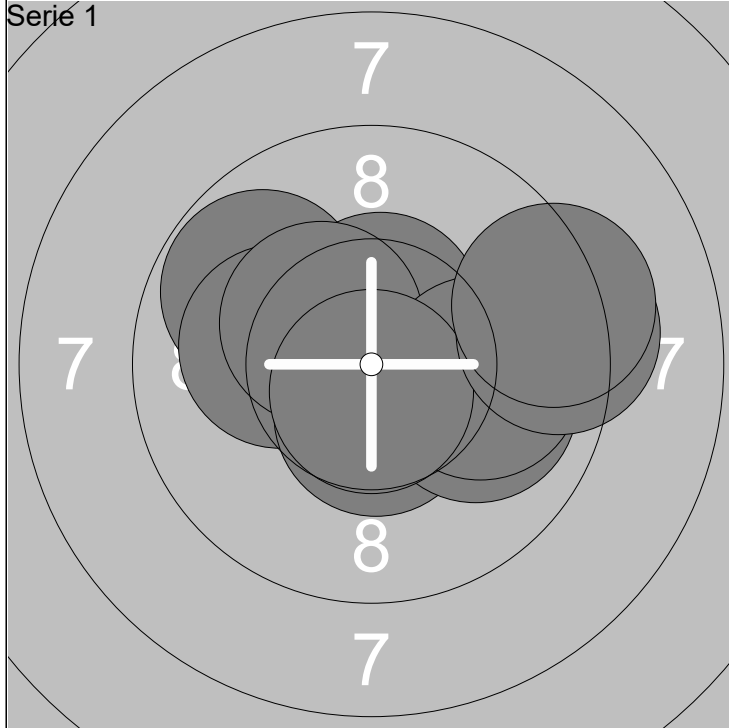

1: 10.5x ↑	6: 10.3x ↖	Serie 97 (4x)
2: 9.8 ↖	7: 10.0 →	
3: 10.1 ←	8: 10.7x ↓	Total 97 (4x)
4: 10.5x ↓	9: 9.3 →	
5: 10.0 →	10: 9.2 →	

1: 9.4 →	6: 10.2x ↘	Serie 96 (6x)
2: 10.3x ←	7: 9.9 ←	
3: 10.4x →	8: 10.5x ↘	Total 193 (10x)
4: 9.9 ↗	9: 10.5x ↓	
5: 9.8 ←	10: 10.4x ↘	

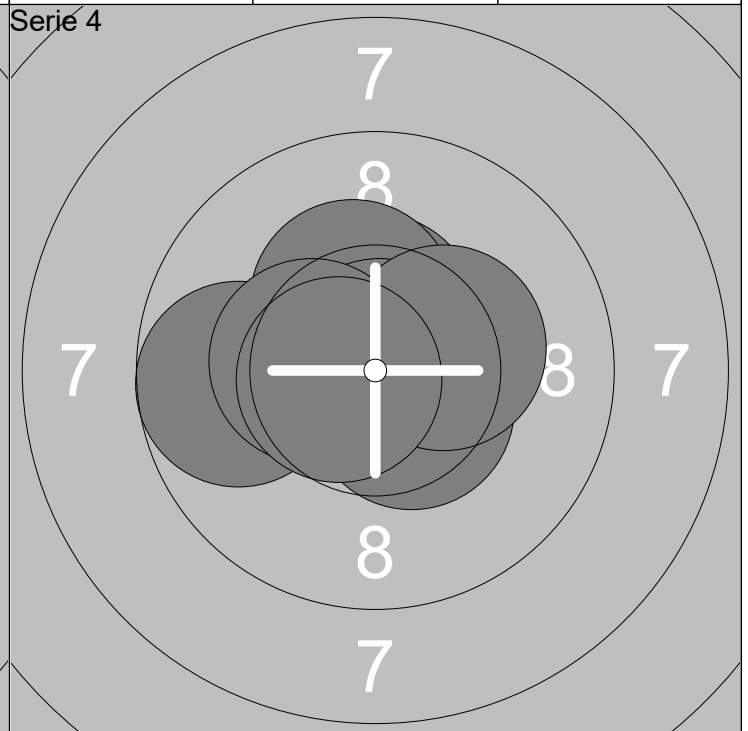
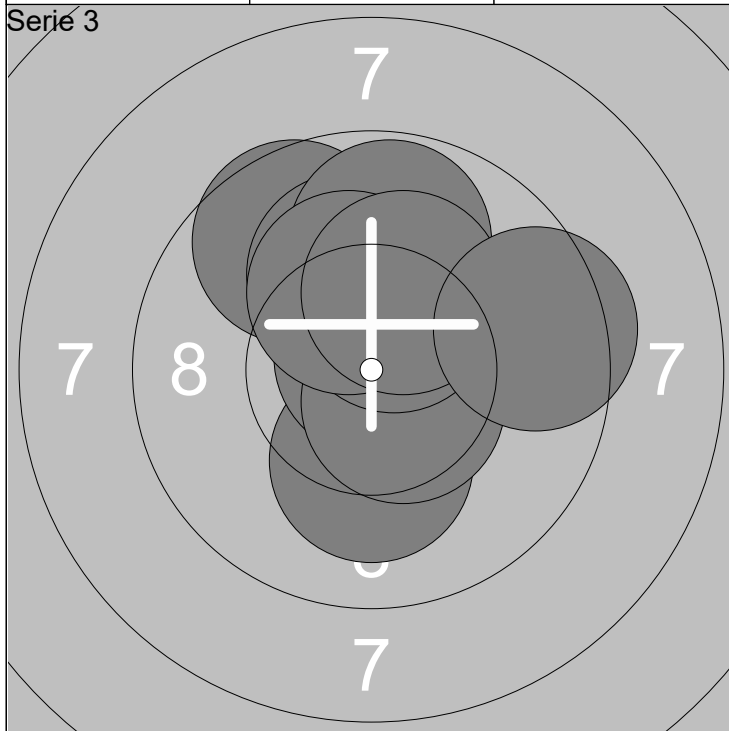

1: 9.6 ↖	6: 10.4x ↑	Serie 97 (5x)
2: 10.1 ↓	7: 9.8 ↑	
3: 10.8x ↑	8: 10.2x ↑	Total 290 (15x)
4: 10.1 ↑	9: 10.2x ↑	
5: 10.5x ↘	10: 9.4 →	

1: 9.7 ←	6: 10.8x ↑	Serie 99 (9x)
2: 10.4x ↑	7: 10.5x ↘	
3: 10.7x ↘	8: 10.3x →	Total 389 (24x)
4: 10.3x ↑	9: 10.4x ←	
5: 10.5x ↘	10: 10.6x ←	

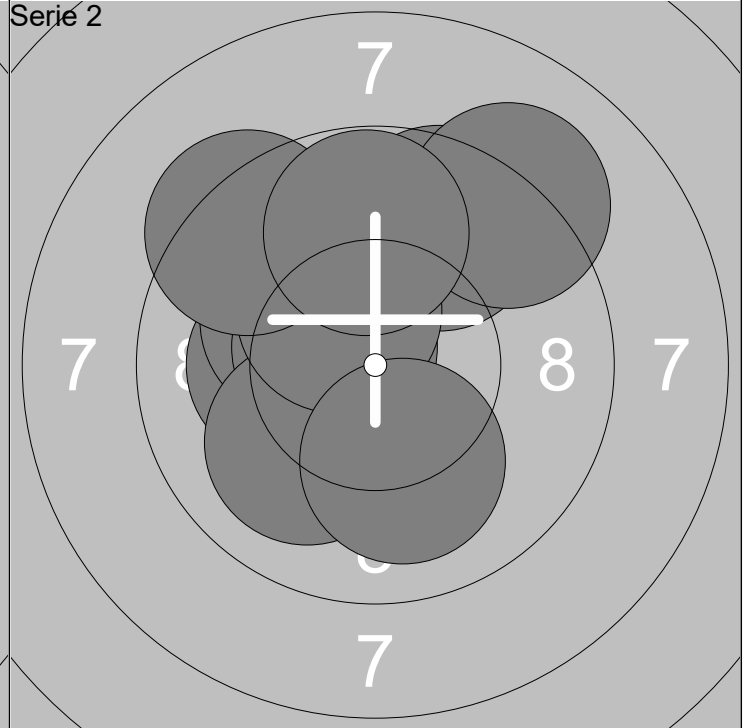
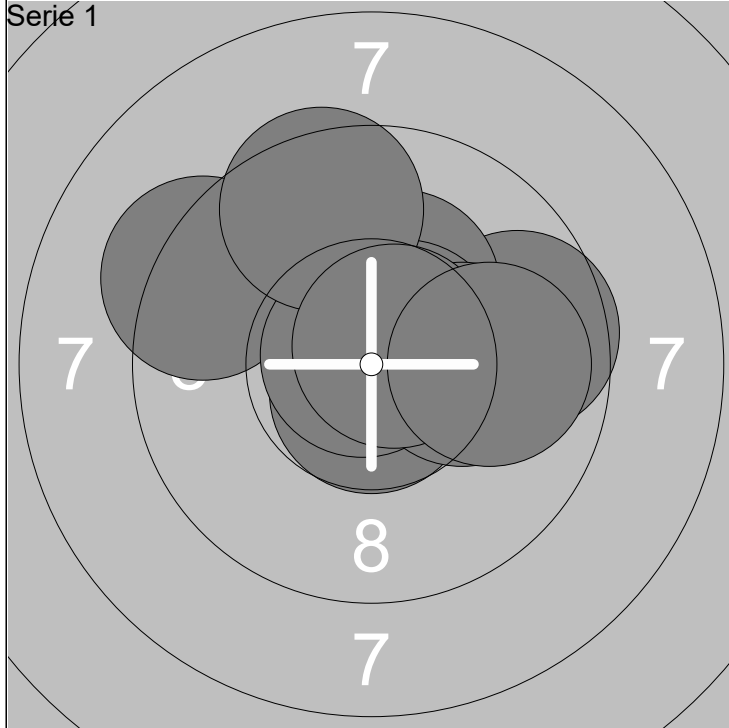

1: 9.3 ↖	6: 10.6x ↗	Serie 96 (5x)
2: 10.7x ↓	7: 10.1 →	
3: 9.6 →	8: 9.5 ↑	Total 96 (5x)
4: 10.2x ↑	9: 10.7x ↗	
5: 10.8x ↖	10: 9.9 →	

1: 10.2x ←	6: 10.3x ↗	Serie 96 (4x)
2: 10.2x ↖	7: 9.3 ↖	
3: 10.5x ↖	8: 9.1 ↗	Total 192 (9x)
4: 10.0 ↙	9: 9.8 ↑	
5: 9.6 ↑	10: 10.1 ↓	

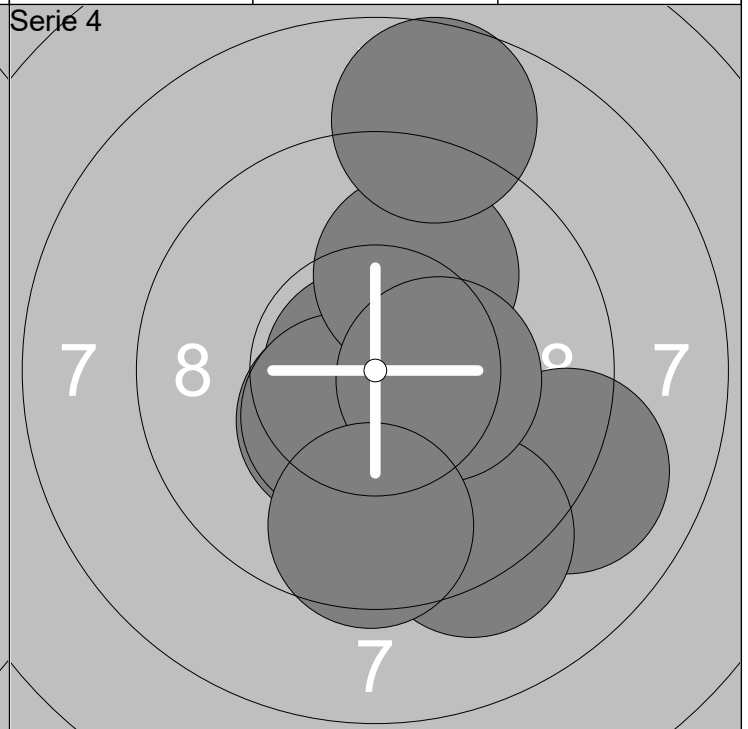
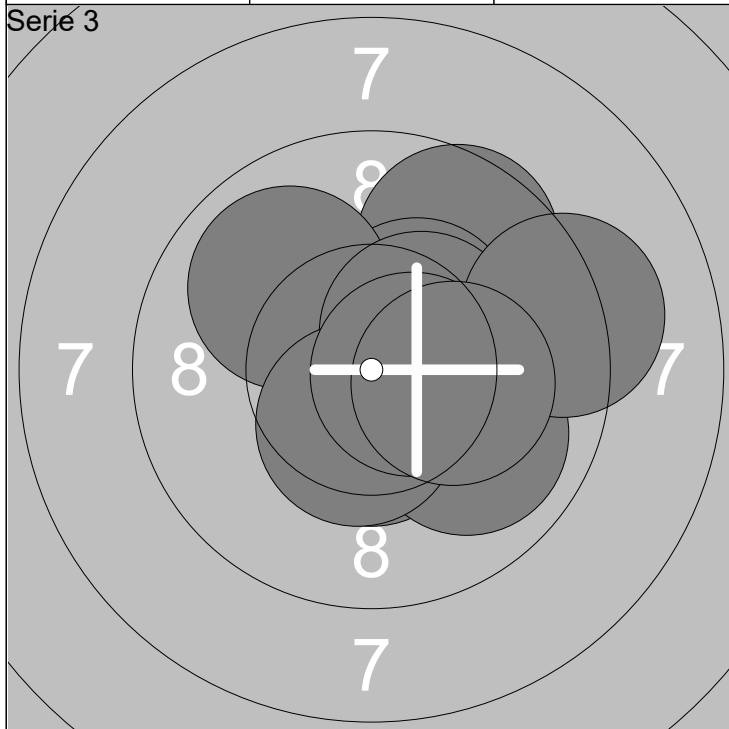

1: 9.6 ↗	6: 9.9 ↘	Serie 96 (6x)
2: 10.3x ↗	7: 10.4x ↓	
3: 9.9 ↖	8: 10.6x →	Total 288 (15x)
4: 10.4x ↗	9: 9.2 →	
5: 10.5x ↓	10: 10.2x →	

1: 10.7x ↓	6: 10.0 ↑	Serie 95 (5x)
2: 10.4x ↙	7: 9.3 ↓	
3: 9.0 →	8: 10.4x →	Total 383 (20x)
4: 10.9x ←	9: 9.6 ↓	
5: 10.4x ↙	10: 8.7 ↑	

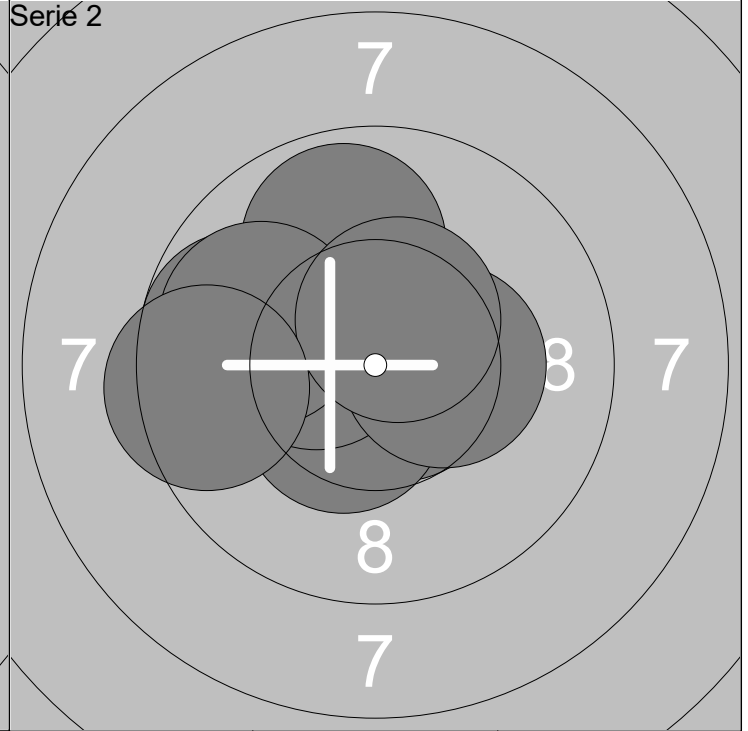
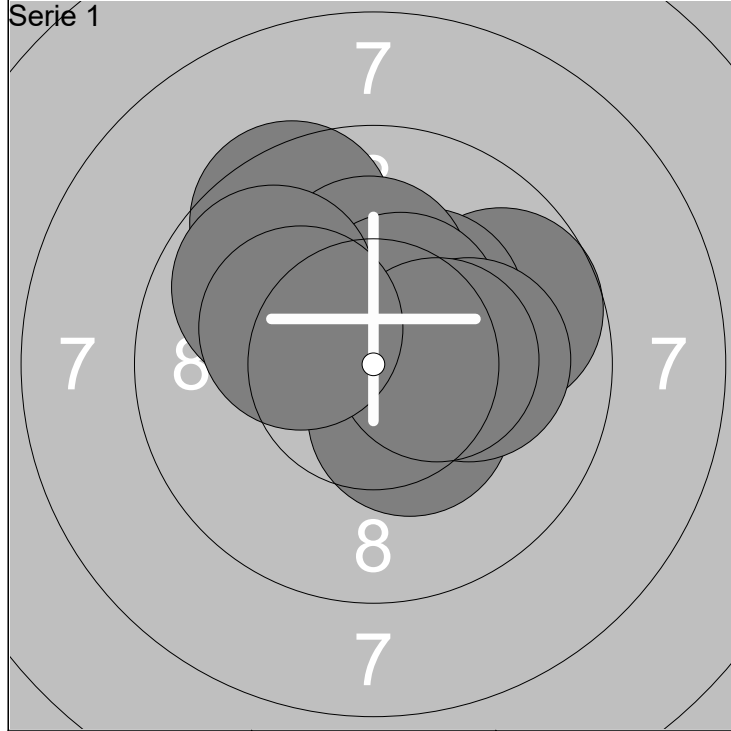

1: 9.7 →	6: 10.4x ↗	Serie 97 (6x)
2: 9.5 ↗	7: 10.1 →	
3: 10.4x ↘	8: 9.8 ↖	Total 97 (6x)
4: 10.3x ↗	9: 10.4x →	
5: 10.2x ↑	10: 10.2x ↖	

1: 10.7x ↘	6: 10.2x ↗	Serie 96 (6x)
2: 10.4x ↘	7: 9.9 ↗	
3: 10.4x ↖	8: 9.9 ↖	Total 193 (12x)
4: 9.7 ↖	9: 10.5x ↗	
5: 10.3x →	10: 9.4 ↖	

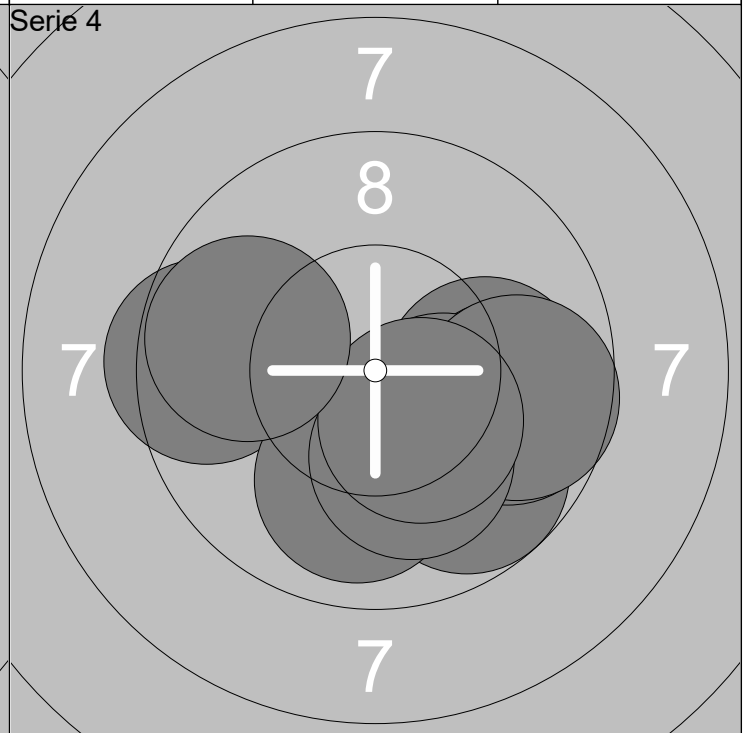
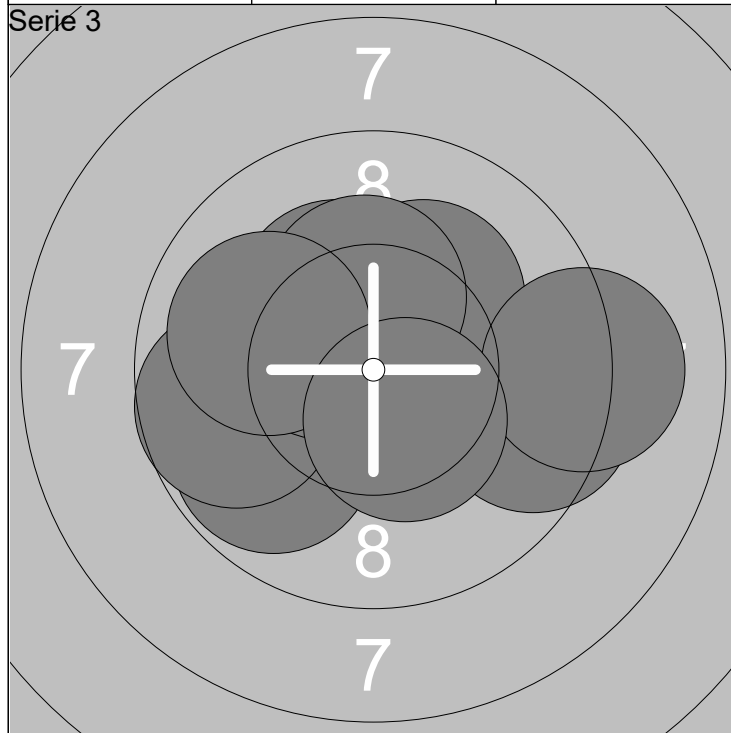

1: 9.8 ↖	6: 10.2x ↗	Serie 95 (5x)
2: 9.7 ↖	7: 10.3x ↑	
3: 9.5 →	8: 9.1 →	Total 288 (17x)
4: 10.2x ↗	9: 9.9 ↖	
5: 10.4x ↖	10: 10.4x ↘	

1: 9.5 ↖	6: 9.7 →	Serie 95 (2x)
2: 9.7 ↘	7: 10.0 ↘	
3: 10.0 →	8: 10.1 ↘	Total 383 (19x)
4: 9.7 →	9: 10.3x ↘	
5: 10.2x ↘	10: 9.8 ↖	

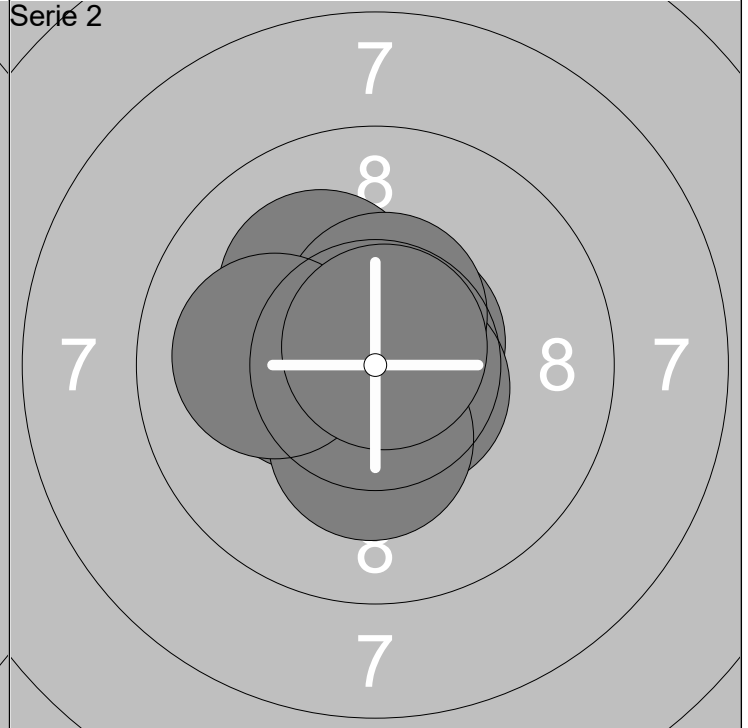
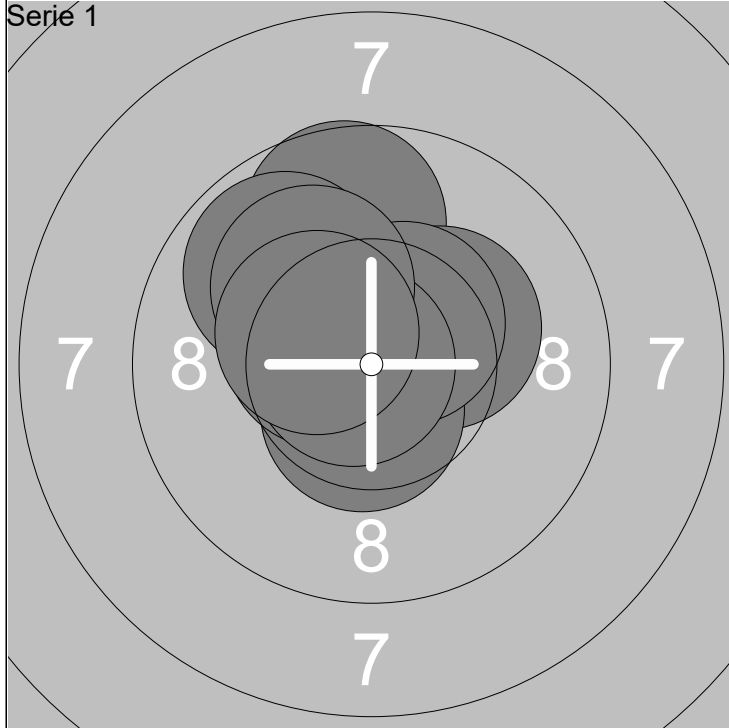

1: 9.7 ↑	6: 10.5x ↗	Serie 98 (7x)
2: 10.3x ↗	7: 10.5x ↖	
3: 10.7x ↑	8: 10.8x ←	Total 98 (7x)
4: 10.5x ↓	9: 10.1 ↗	
5: 9.8 ↖	10: 10.4x ↖	

1: 10.1 ↖	6: 10.6x ←	Serie 100 (8x)
2: 10.6x ↗	7: 10.3x ↓	
3: 10.6x ↓	8: 10.5x ↑	Total 198 (15x)
4: 10.6x ↘	9: 10.0 ←	
5: 10.4x ←	10: 10.7x ↗	

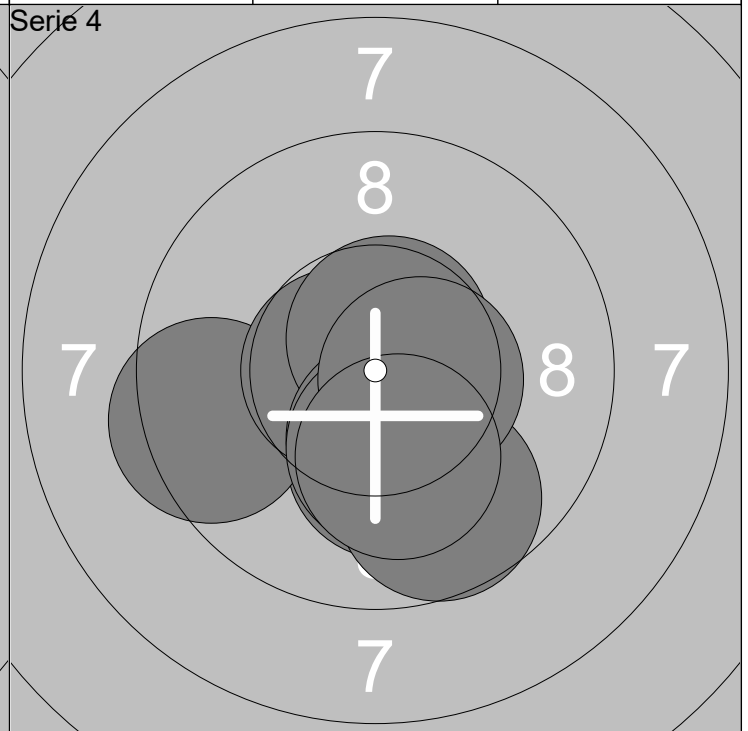
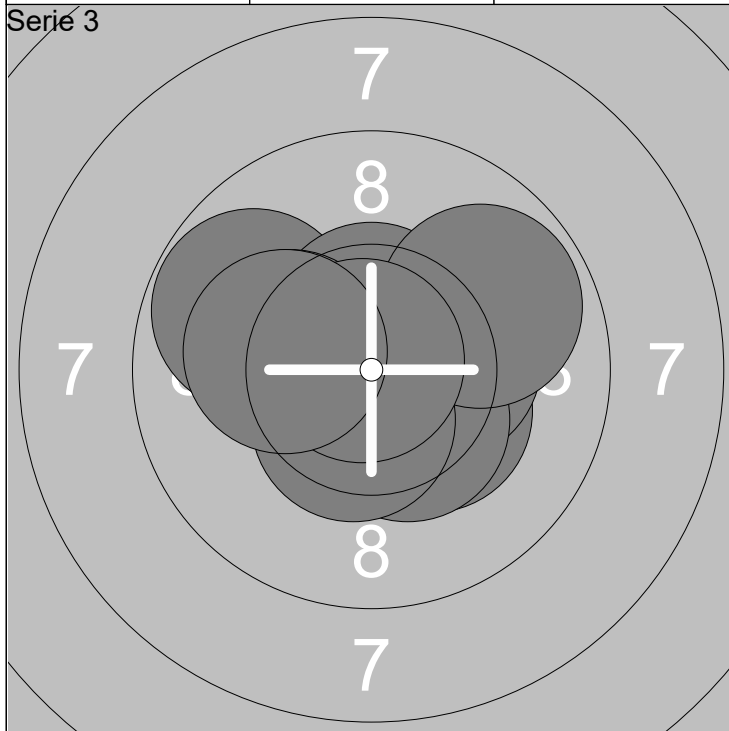

1: 9.7 ↖	6: 9.8 ↗	Serie 98 (8x)
2: 10.3x ↘	7: 10.2x ←	
3: 10.3x →	8: 10.5x ↓	Total 296 (23x)
4: 10.4x ↓	9: 10.8x ↗	
5: 10.5x ↑	10: 10.2x ←	

1: 10.8x ↓	6: 10.3x ↓	Serie 98 (7x)
2: 10.2x ↓	7: 10.2x ↓	
3: 9.4 ←	8: 9.7 ↓	Total 394 (30x)
4: 10.7x ←	9: 10.5x →	
5: 10.6x ↗	10: 10.1 ↓	

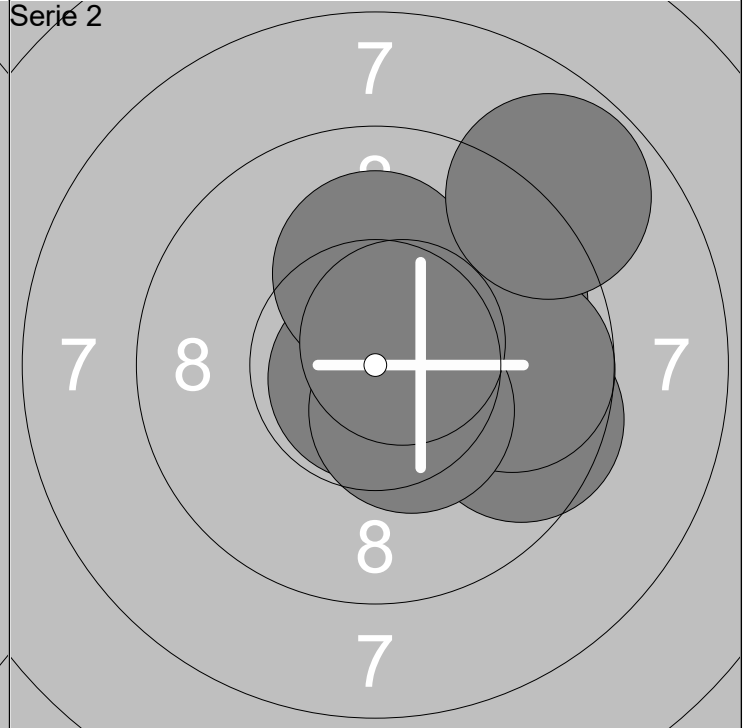
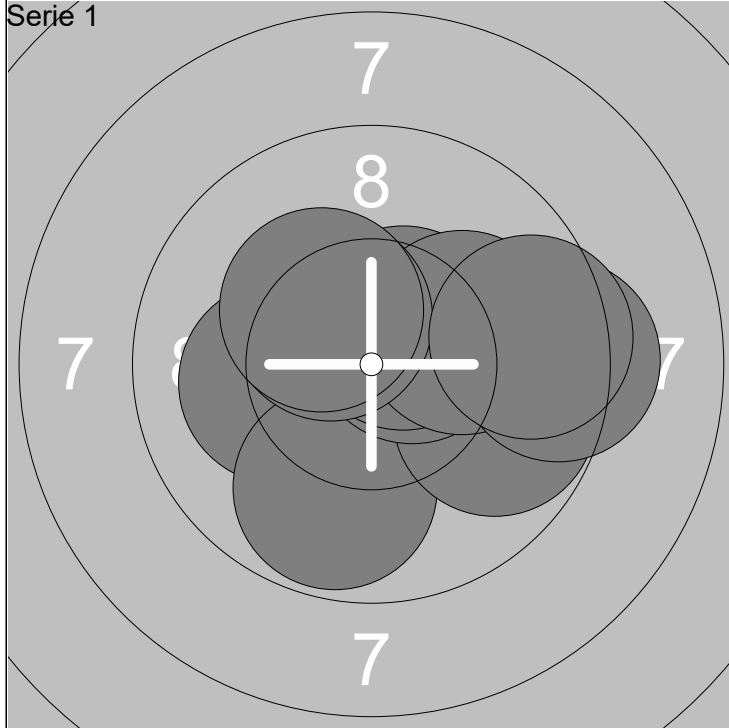

1: 10.1 ←	6: 10.1 →	Serie	96 (4x)
2: 9.8 ↓	7: 10.4x ↖		
3: 9.8 →	8: 10.3x ↖	Total	96 (4x)
4: 10.5x ↗	9: 9.3 →		
5: 10.5x ↗	10: 9.5 →		

1: 10.5x ↗	6: 10.1 ↑	Serie	95 (5x)
2: 10.8x ↓	7: 9.7 →		
3: 9.8 ↗	8: 10.4x ↘	Total	191 (9x)
4: 10.5x ↗	9: 8.8 ↗		
5: 9.6 →	10: 10.6x ↗		

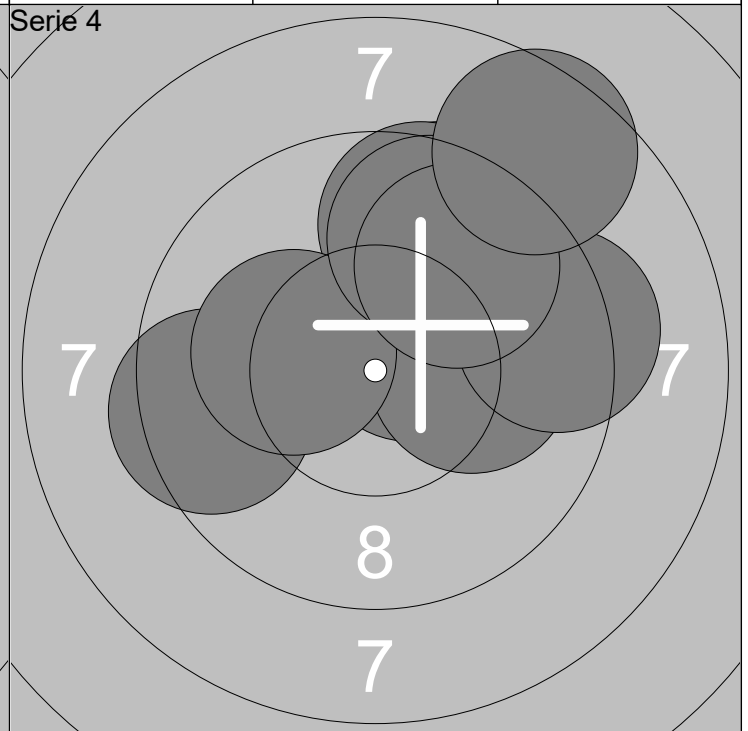
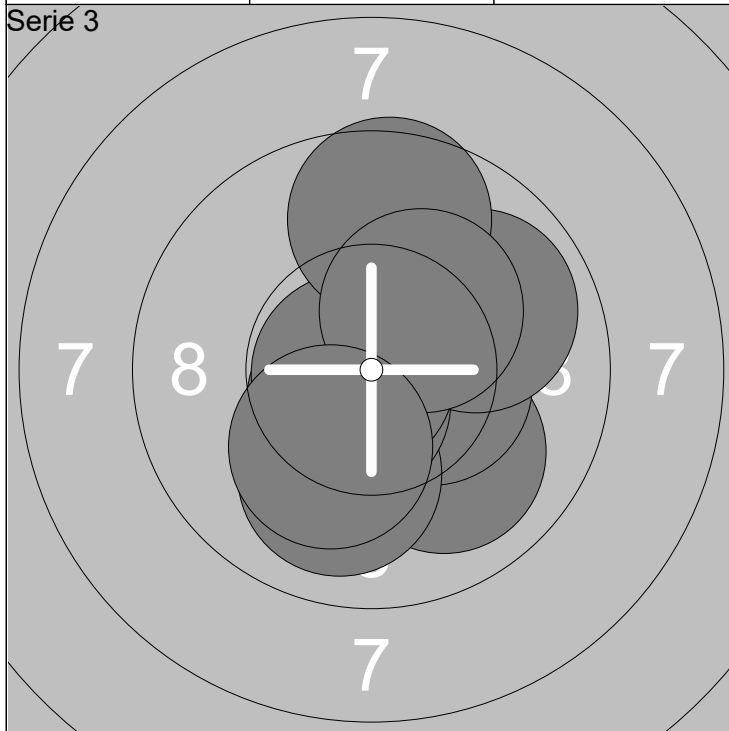

1: 10.0 ↘	6: 10.2x ↗	Serie	98 (6x)
2: 10.4x →	7: 10.8x ←		
3: 10.0 ↓	8: 9.6 ↑	Total	289 (15x)
4: 10.6x ↙	9: 10.3x ↗		
5: 9.9 ↗	10: 10.2x ↓		

1: 10.5x ↗	6: 10.2x ←	Serie	92 (2x)
2: 10.1 →	7: 9.7 ↑		
3: 9.5 ↑	8: 9.3 →	Total	381 (17x)
4: 9.4 ←	9: 9.8 ↗		
5: 9.6 ↑	10: 8.5 ↗		

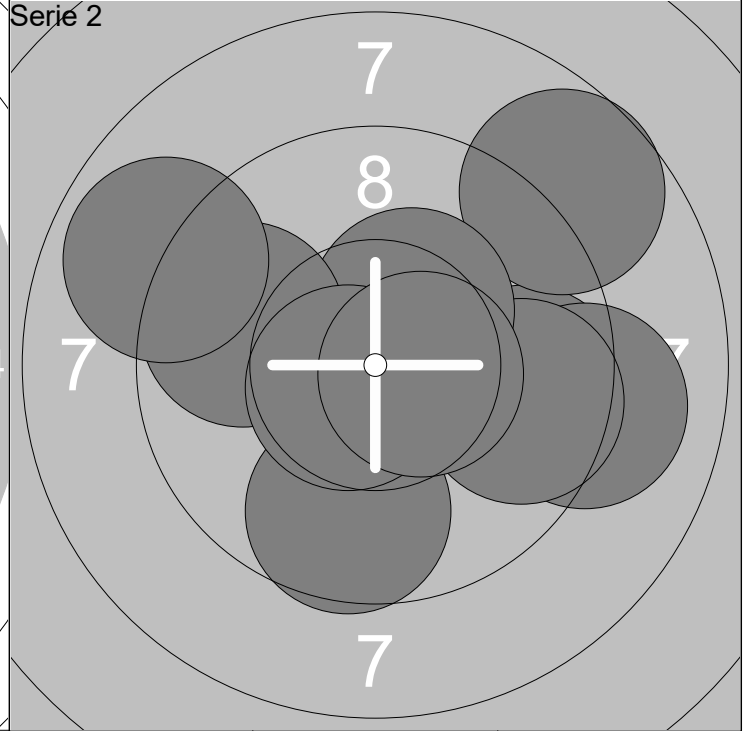
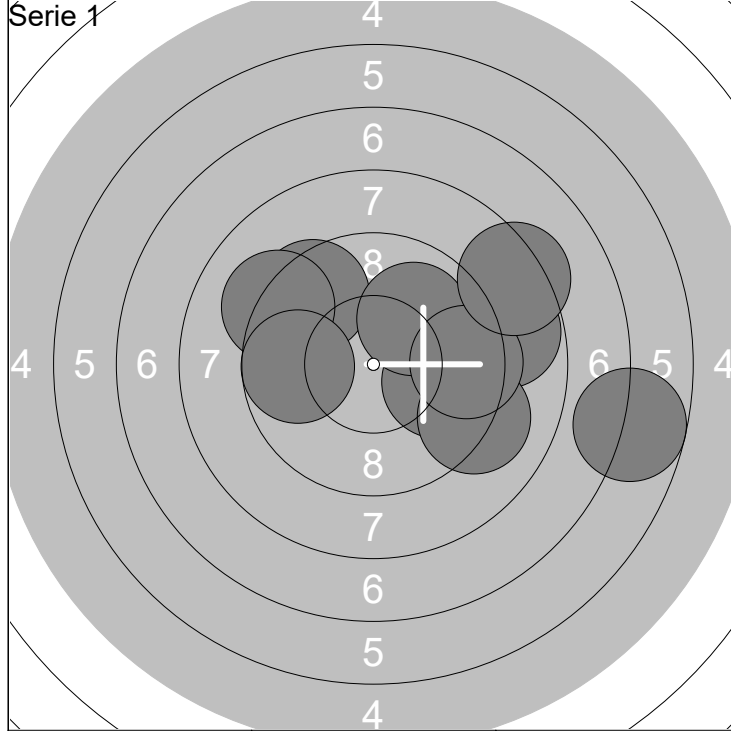

1: 9.9 →	6: 10.0 ↗	Serie	86 (0x)
2: 9.5 ↗	7: 9.1 →		
3: 8.8 →	8: 9.7 ←	Total	86 (0x)
4: 9.2 ↗	9: 9.4 →		
5: 6.7 →	10: 8.3 ↗		

1: 9.6 →	6: 10.3x ↗	Serie	91 (3x)
2: 9.1 →	7: 9.7 ←		
3: 9.6 →	8: 10.6x ↙	Total	177 (3x)
4: 8.7 ↗	9: 10.5x →		
5: 9.6 ↓	10: 8.9 ←		

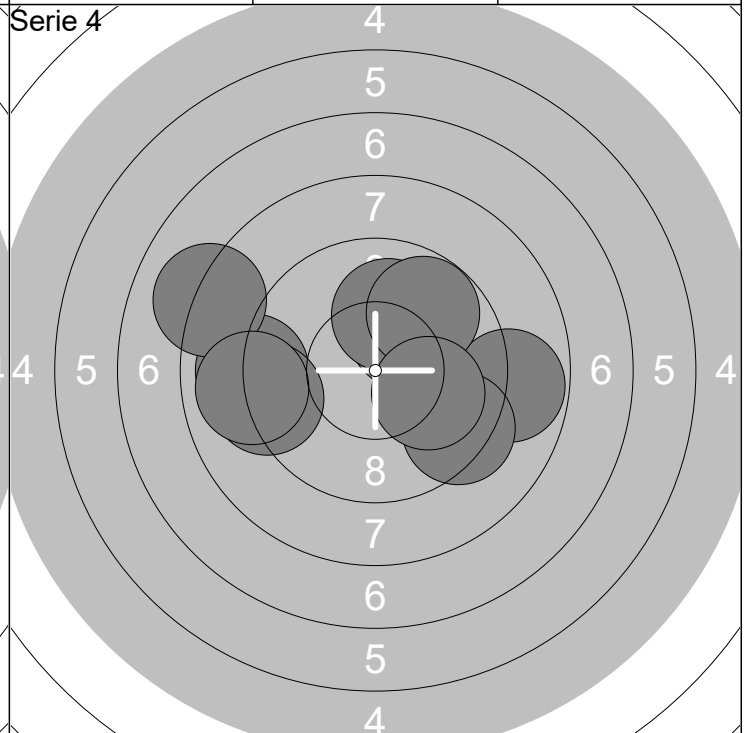
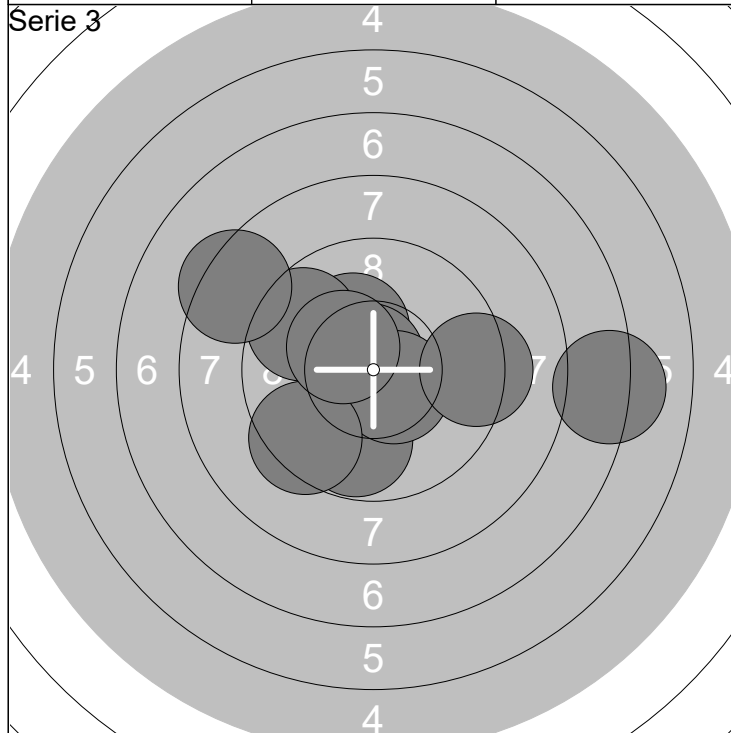

1: 10.2x ↗	6: 10.5x ↘	Serie	91 (4x)
2: 10.8x ↗	7: 9.4 ↙		
3: 7.2 →	8: 10.3x ↙	Total	268 (7x)
4: 9.8 ↓	9: 8.3 ↙		
5: 9.6 ↗	10: 9.3 →		

1: 8.8 →	6: 8.1 ←	Serie	90 (1x)
2: 10.2x ↗	7: 9.1 ←		
3: 9.0 ←	8: 9.7 ↗	Total	358 (8x)
4: 9.3 ↘	9: 8.9 ←		
5: 10.0 ↑	10: 10.0 →		

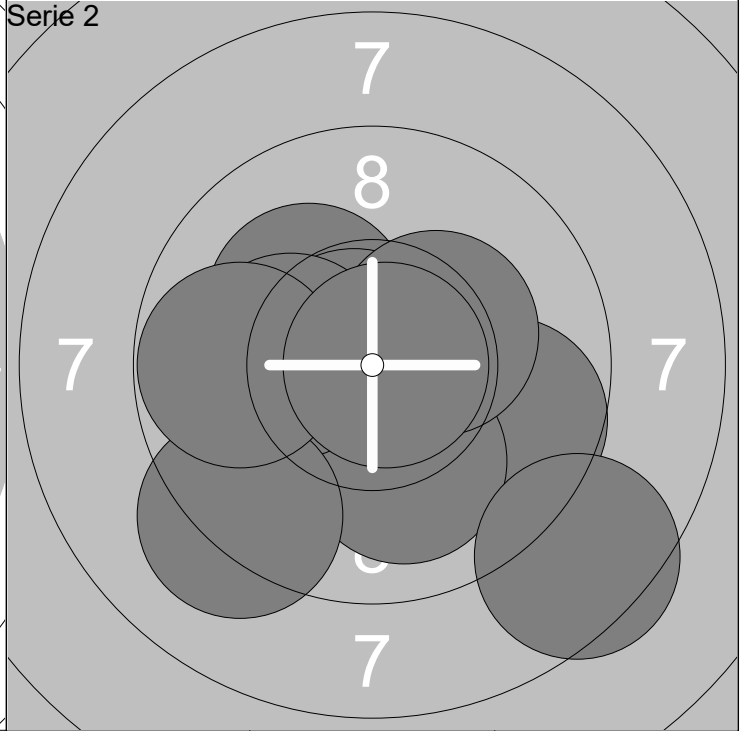
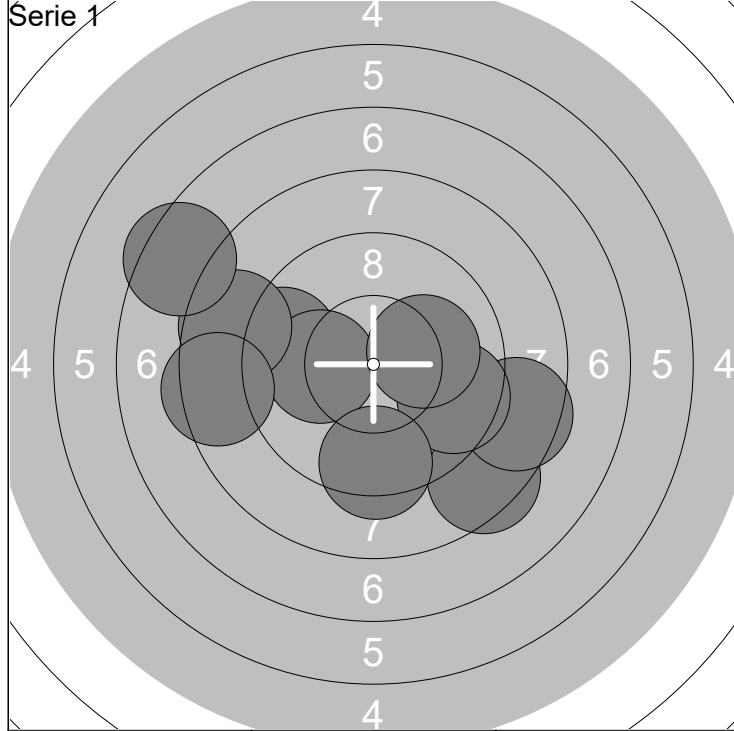

1: 8.4 ↘	6: 8.6 ←	Serie	86 (0x)
2: 8.5 →	7: 9.4 ↓		
3: 9.6 →	8: 7.4 ↖	Total	86 (0x)
4: 9.4 ←	9: 10.1 →		
5: 10.1 ←	10: 8.4 ←		

1: 10.2x ↗	6: 10.2x ←	Serie	95 (5x)
2: 10.8x ↗	7: 10.3x ↗		
3: 9.7 →	8: 9.2 ↓	Total	181 (5x)
4: 10.0 ↓	9: 9.8 ←		
5: 8.5 ↓	10: 10.8x →		

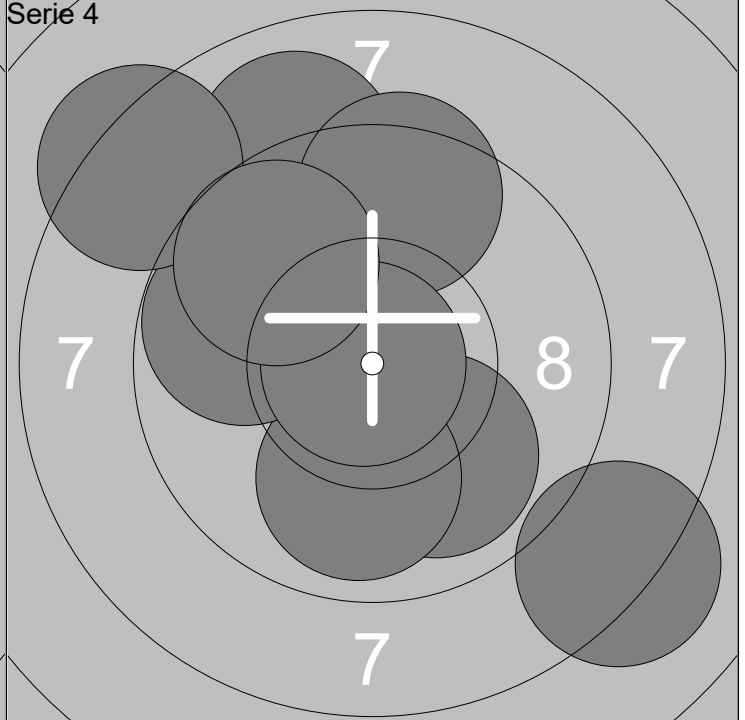
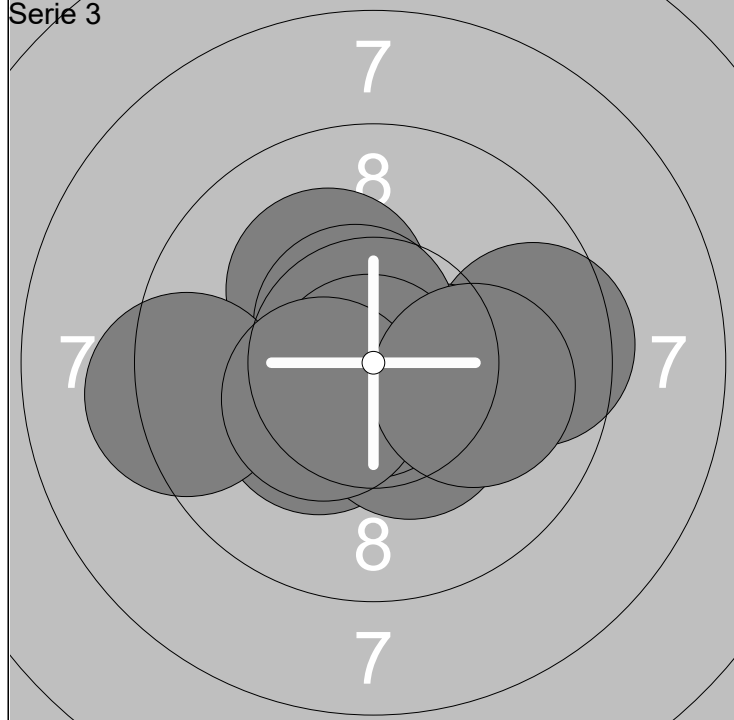

1: 10.2x ↗	6: 9.3 ←	Serie	98 (7x)
2: 9.5 →	7: 10.3x ↓		
3: 10.3x →	8: 10.8x ↓	Total	279 (12x)
4: 10.3x ↖	9: 10.4x ↖		
5: 10.6x ↗	10: 10.0 →		

1: 9.9 ↓	6: 9.8 ←	Serie	89 (1x)
2: 8.1 ↓	7: 9.4 ↑		
3: 9.5 ↑	8: 10.8x ←	Total	368 (13x)
4: 9.9 ↓	9: 8.3 ↖		
5: 9.0 ↗	10: 9.7 ↖		

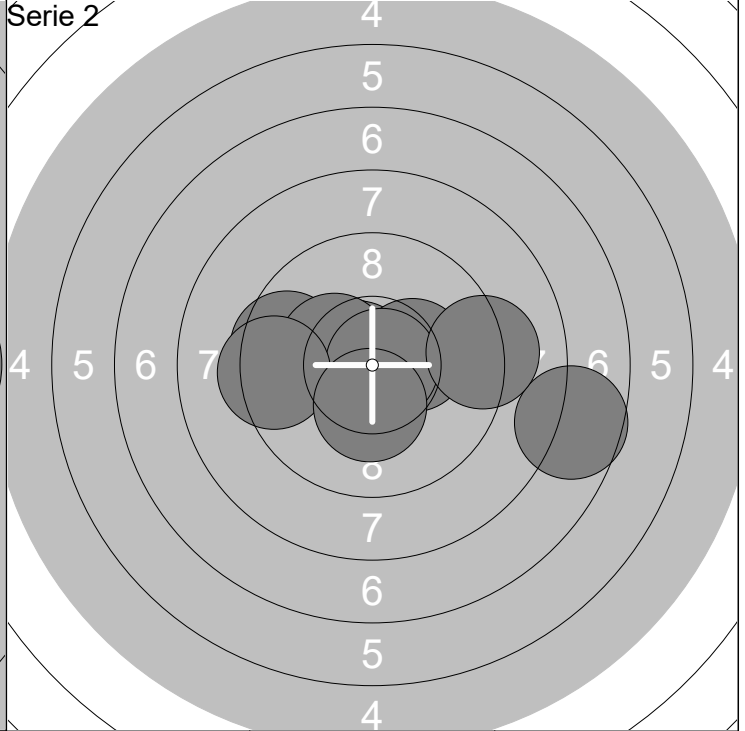
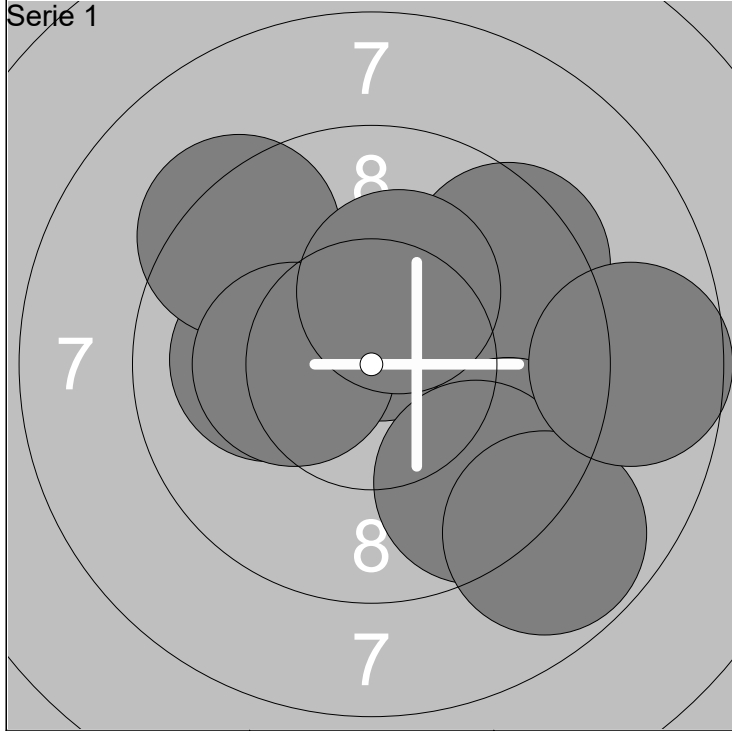

1: 10.5x ↑	6: 10.3x ←	Serie	92 (3x)
2: 9.5 ↗	7: 9.5 ↘		
3: 9.5 ↘	8: 10.2x ↑	Total	92 (3x)
4: 10.1 ←	9: 8.8 ↘		
5: 9.3 ↖	10: 8.6 →		

1: 10.5x ←	6: 10.3x →	Serie	94 (6x)
2: 9.5 ←	7: 10.8x →		
3: 7.6 →	8: 9.3 ←	Total	186 (9x)
4: 10.7x ↖	9: 10.3x ↓		
5: 10.3x ←	10: 9.1 →		

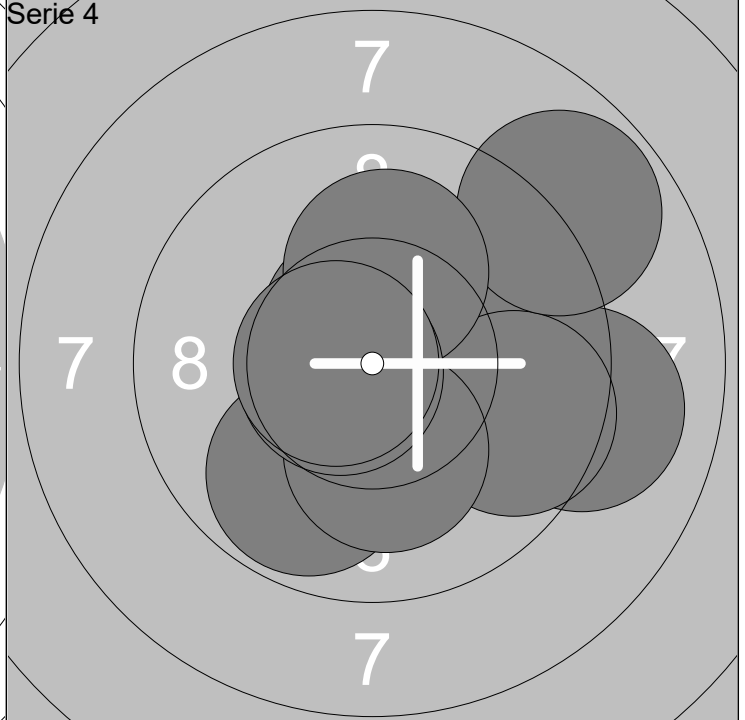
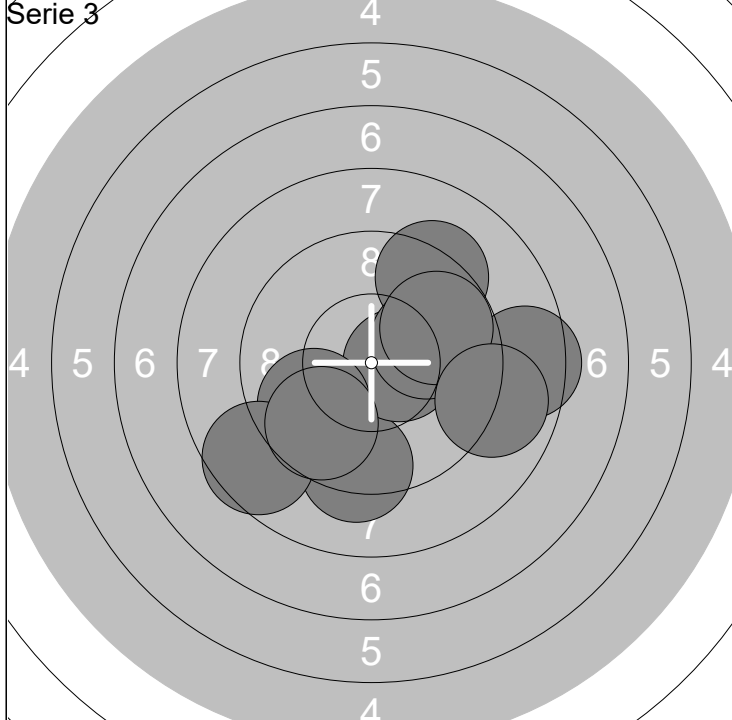

1: 9.3 ↓	6: 8.6 ↙	Serie	89 (1x)
2: 10.5x →	7: 10.0 →		
3: 9.8 ↙	8: 9.7 ↗	Total	275 (10x)
4: 9.3 ↗	9: 8.9 →		
5: 8.5 →	10: 9.7 ↘		

1: 9.1 →	6: 8.8 ↗	Serie	95 (4x)
2: 10.2x ↗	7: 10.1 ↓		
3: 9.8 ↙	8: 10.1 ↑	Total	370 (14x)
4: 10.6x ↑	9: 10.6x ←		
5: 9.6 →	10: 10.6x ←		

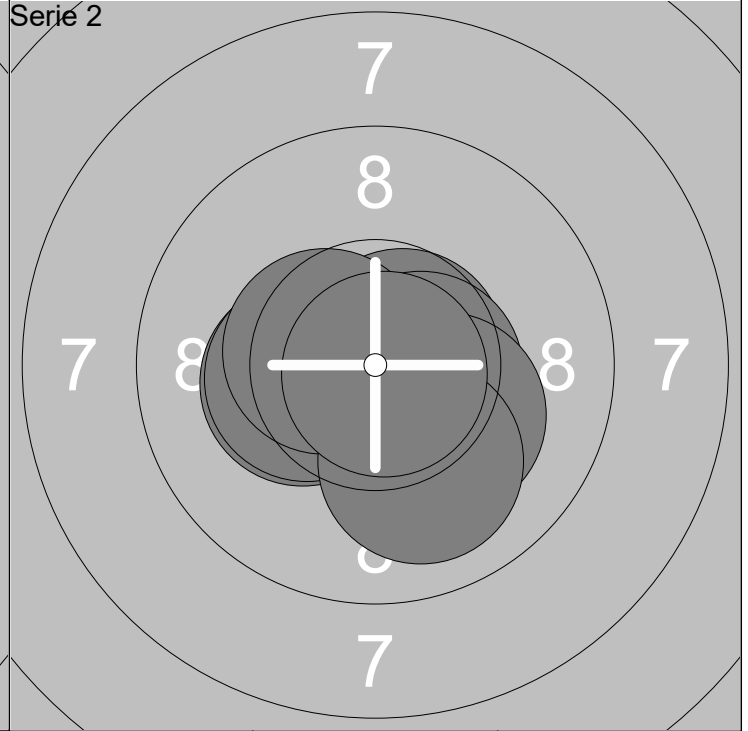
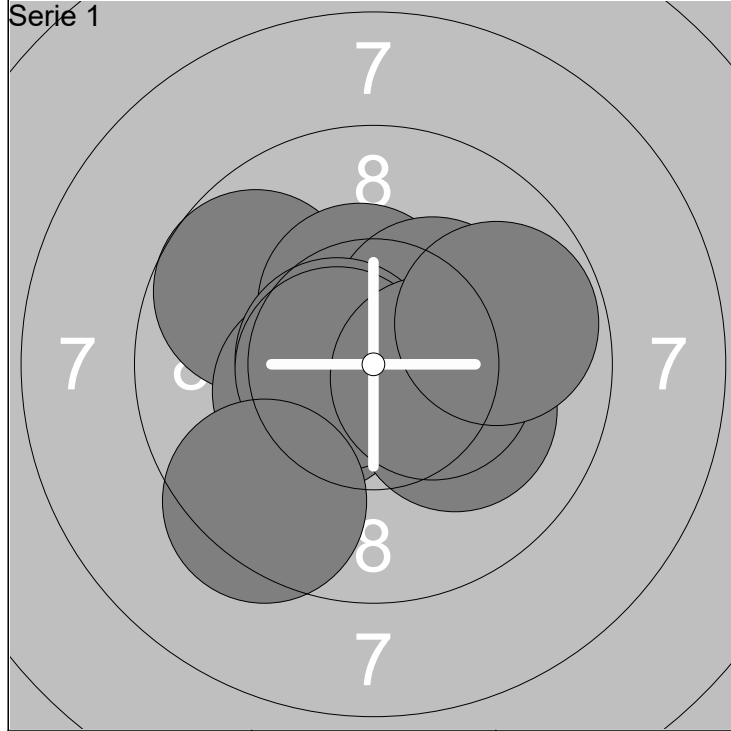

1: 9.7 ↖	6: 10.6x ←	Serie 97 (6x)
2: 10.4x ↑	7: 10.6x ←	
3: 10.3x ↙	8: 9.4 ↘	Total 97 (6x)
4: 10.3x ↗	9: 10.4x →	
5: 10.1 ↘	10: 9.8 →	

1: 10.9x	6: 10.5x →	Serie 100 (9x)
2: 10.3x ←	7: 10.2x ↘	
3: 10.3x ←	8: 10.5x ←	Total 197 (15x)
4: 10.6x →	9: 10.0 ↘	
5: 10.7x ↗	10: 10.8x ↘	

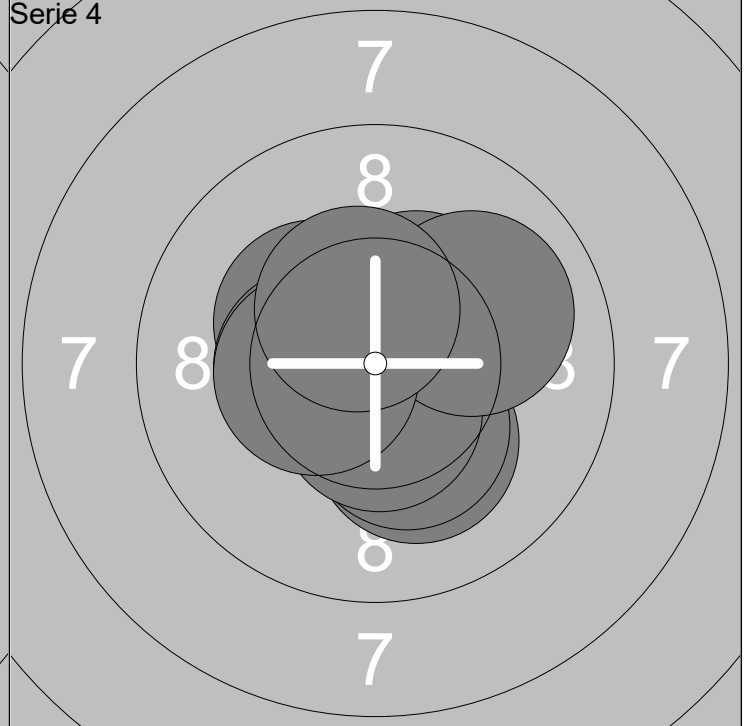
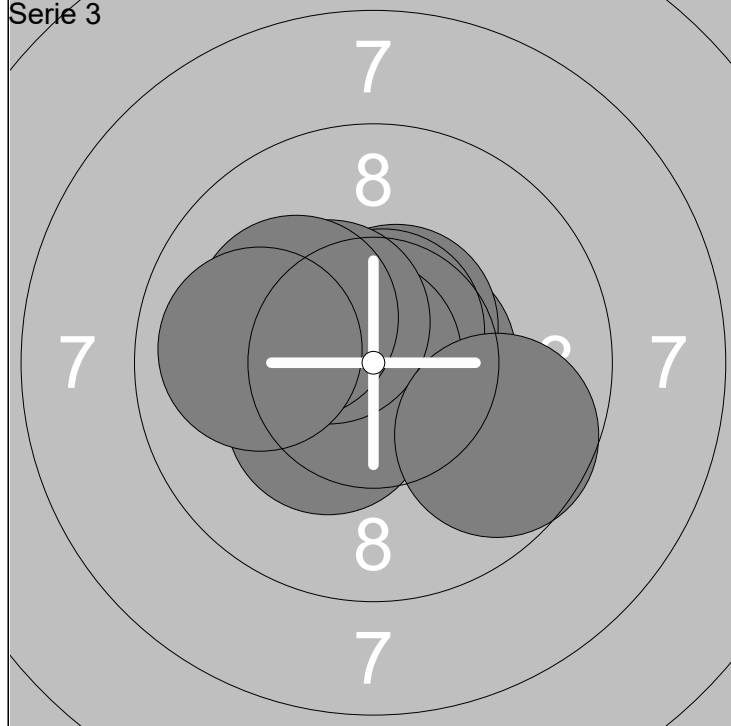

1: 10.6x ←	6: 10.3x ↘	Serie 98 (7x)
2: 10.6x →	7: 10.4x ↖	
3: 10.5x ↗	8: 10.1 ↖	Total 295 (22x)
4: 10.6x ↑	9: 9.9 ←	
5: 10.8x ↖	10: 9.7 ↘	

1: 10.4x ↗	6: 10.4x ←	Serie 100 (9x)
2: 10.2x ↘	7: 10.5x ↓	
3: 10.8x ↗	8: 10.0 ↗	Total 395 (31x)
4: 10.3x ↘	9: 10.4x ←	
5: 10.3x ↖	10: 10.4x ↑	

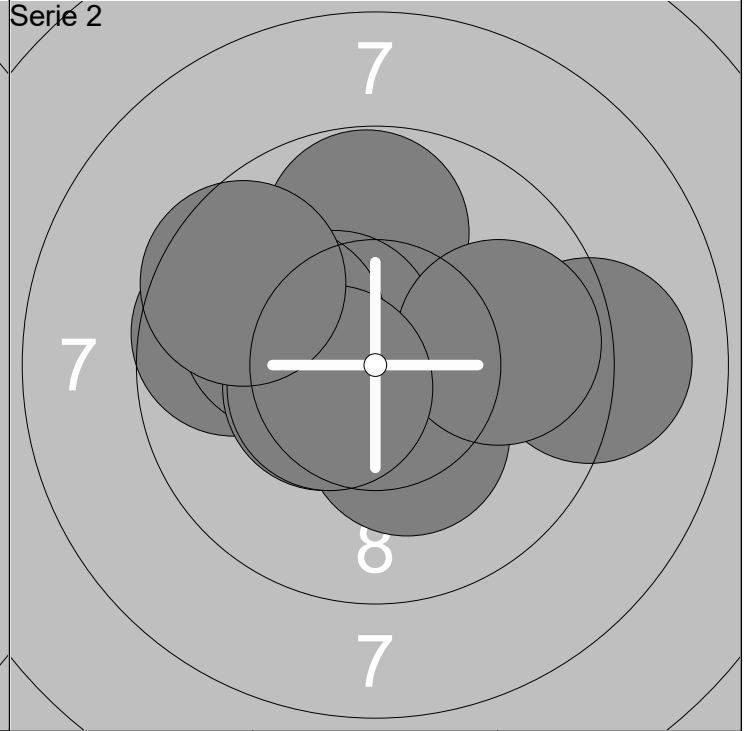
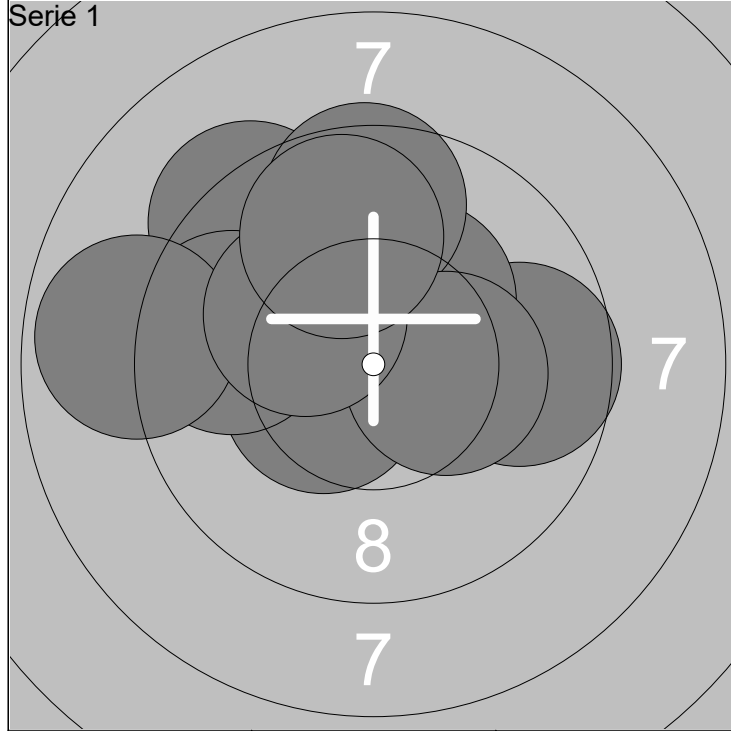

1: 10.4x ↙	6: 9.5 ↑	Serie	93 (4x)
2: 9.3 ↗	7: 8.8 ←		
3: 9.7 ←	8: 10.3x →	Total	93 (4x)
4: 9.7 →	9: 10.2x ↖		
5: 10.3x ↗	10: 9.8 ↑		

1: 9.8 ↑	6: 9.1 →	Serie	95 (4x)
2: 10.3x ↘	7: 9.8 →		
3: 9.6 ←	8: 10.4x ↙	Total	188 (8x)
4: 10.5x ↗	9: 10.5x ↖		
5: 10.1 ←	10: 9.6 ↖		

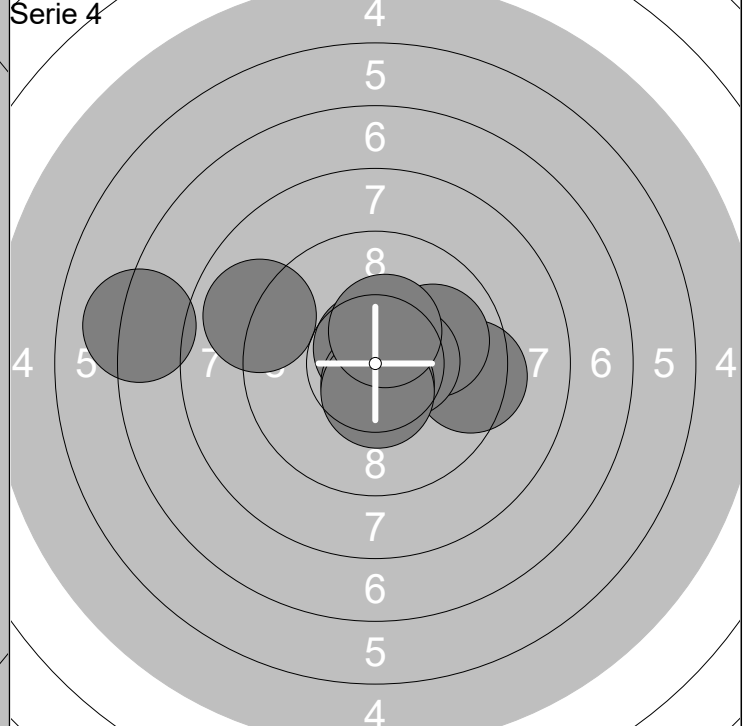
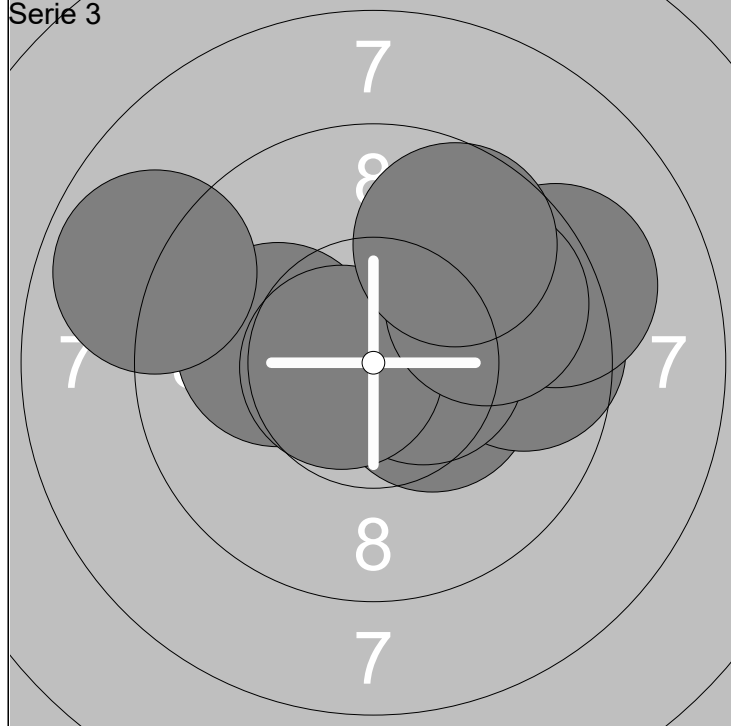

1: 10.4x →	6: 10.6x ←	Serie	94 (4x)
2: 9.6 →	7: 8.8 ←		
3: 10.4x ↗	8: 9.2 →	Total	282 (12x)
4: 10.1 ←	9: 9.8 →		
5: 10.5x →	10: 9.7 ↗		

1: 10.6x →	6: 10.5x →	Serie	94 (6x)
2: 7.1 ←	7: 9.0 ↖		
3: 9.4 →	8: 10.6x ↘	Total	376 (18x)
4: 10.7x ↗	9: 10.5x ↘		
5: 9.9 →	10: 10.4x ↗		

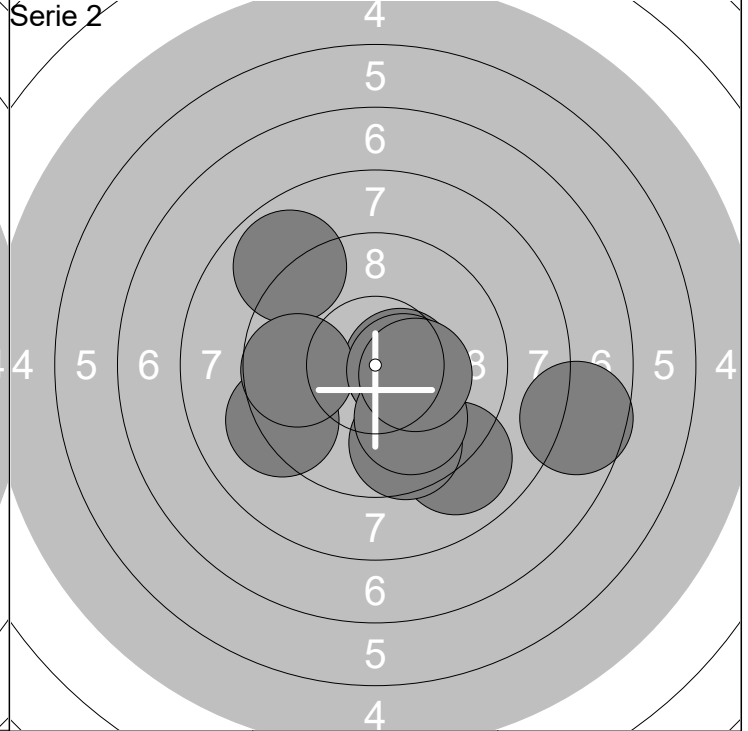
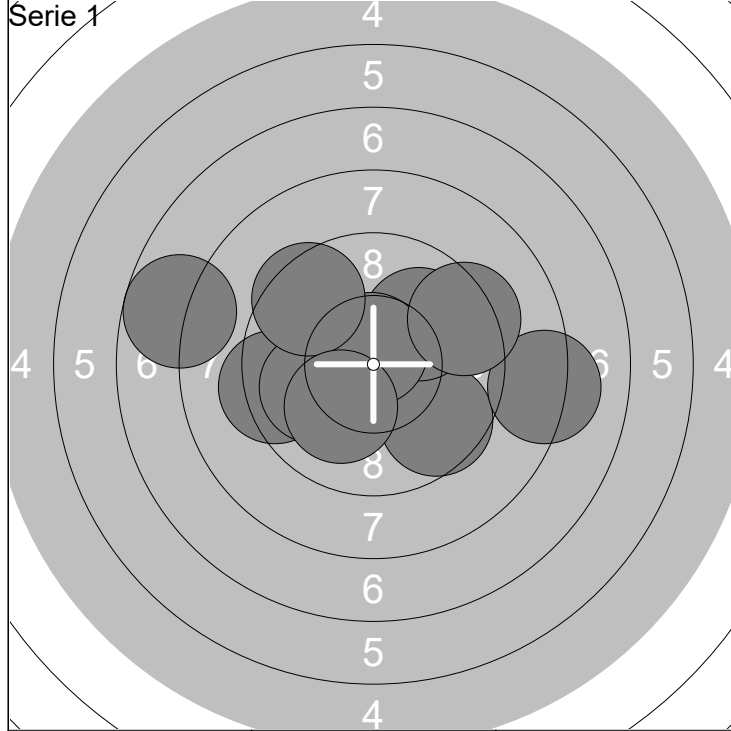

1: 9.6 ↘	6: 9.5 ↖	Serie 90 (1x)
2: 10.0 ↗	7: 8.2 →	
3: 9.3 ←	8: 10.1 ↙	Total 90 (1x)
4: 9.9 ←	9: 7.7 ←	
5: 10.7x ↑	10: 9.3 ↗	

1: 10.5x →	6: 10.5x →	Serie 90 (3x)
2: 8.8 ↖	7: 9.0 ↘	
3: 7.6 →	8: 9.6 ↙	Total 180 (4x)
4: 9.2 ←	9: 9.9 ↘	
5: 9.7 ←	10: 10.3x →	

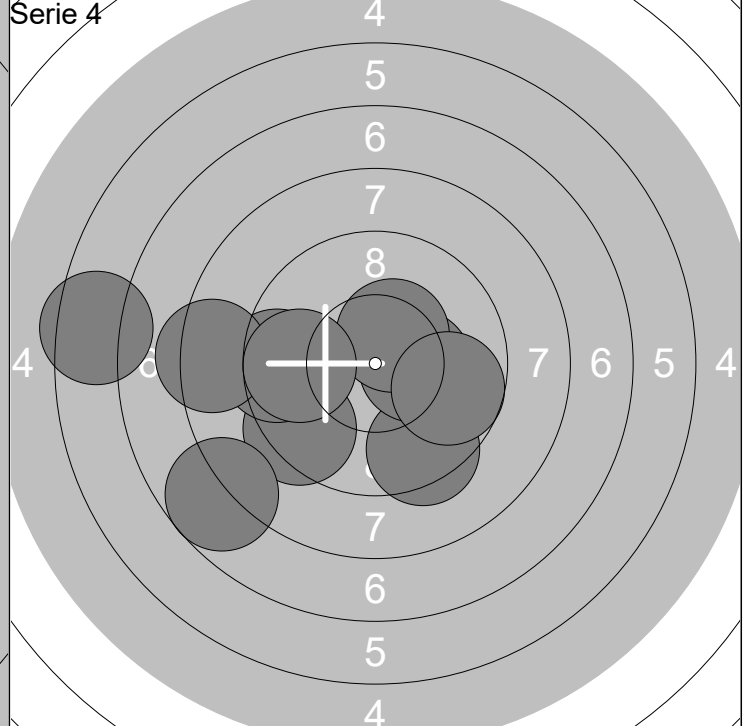
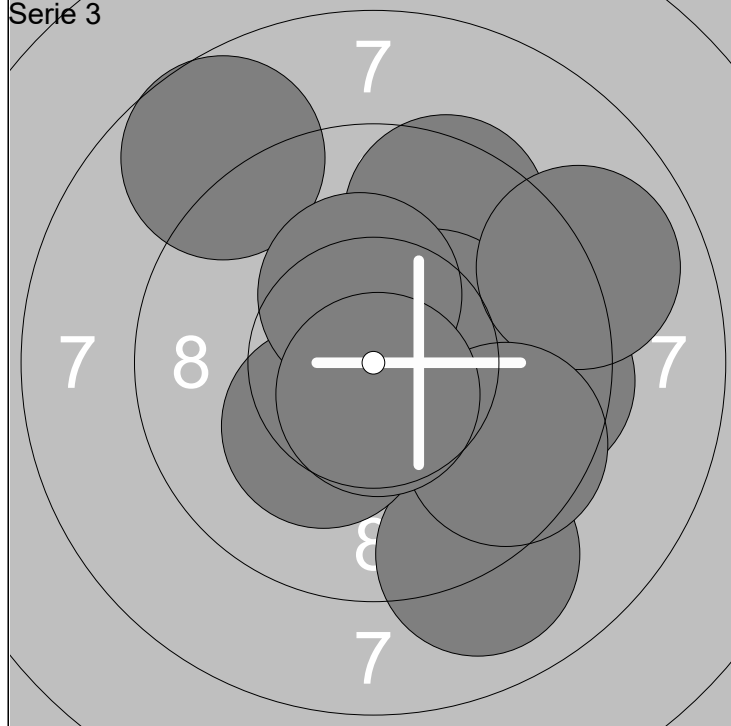

1: 9.0 ↘	6: 10.2x ↙	Serie 92 (4x)
2: 9.5 ↗	7: 9.6 →	
3: 9.5 →	8: 8.7 ↖	Total 272 (8x)
4: 10.3x ↗	9: 10.3x ↑	
5: 8.9 ↗	10: 10.7x ↘	

1: 9.4 ↘	6: 10.4x ↗	Serie 86 (2x)
2: 10.3x →	7: 8.3 ←	
3: 9.4 ↙	8: 9.7 ←	Total 358 (10x)
4: 9.4 ←	9: 7.7 ↙	
5: 6.5 ←	10: 9.7 →	

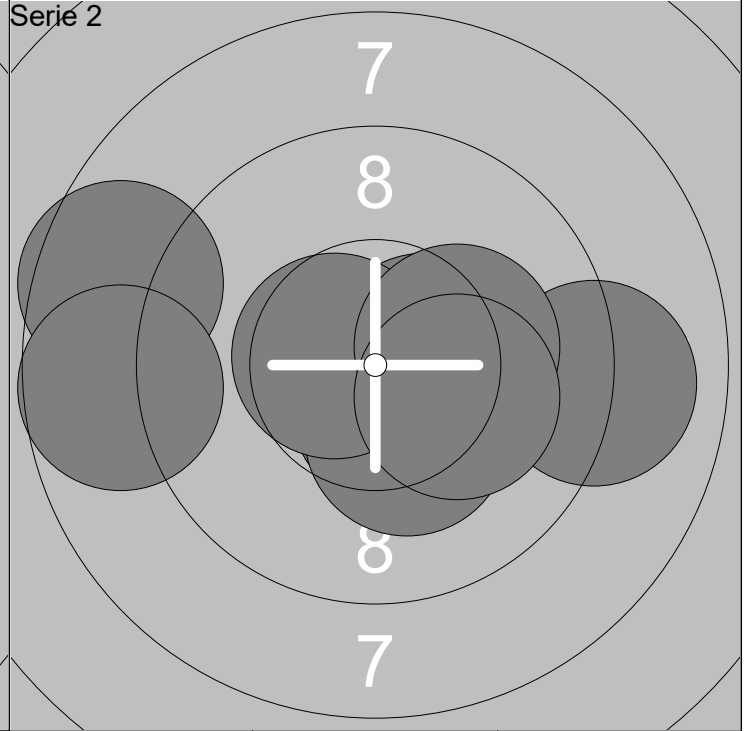
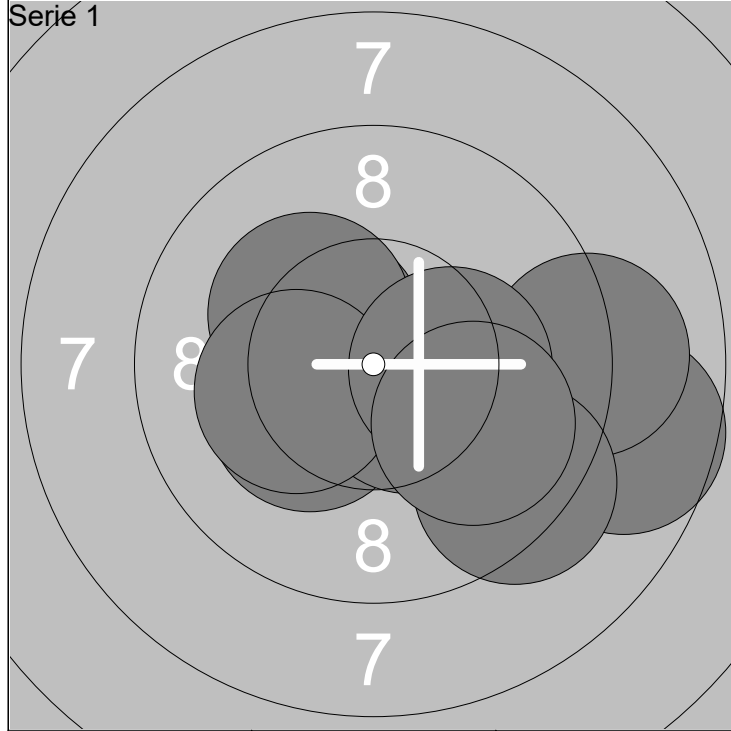

1: 10.4x ↖	6: 9.3 ↘	Serie 95 (6x)
2: 10.3x ↙	7: 10.2x ↗	
3: 8.6 →	8: 10.2x ←	Total 95 (6x)
4: 10.5x ↘	9: 10.3x →	
5: 9.1 →	10: 9.9 ↘	

1: 9.0 →	6: 10.5x →	Serie 95 (7x)
2: 10.5x ↘	7: 10.6x ←	
3: 8.6 ←	8: 10.2x →	Total 190 (13x)
4: 10.8x ↓	9: 8.7 ←	
5: 10.3x ↘	10: 10.2x ↘	

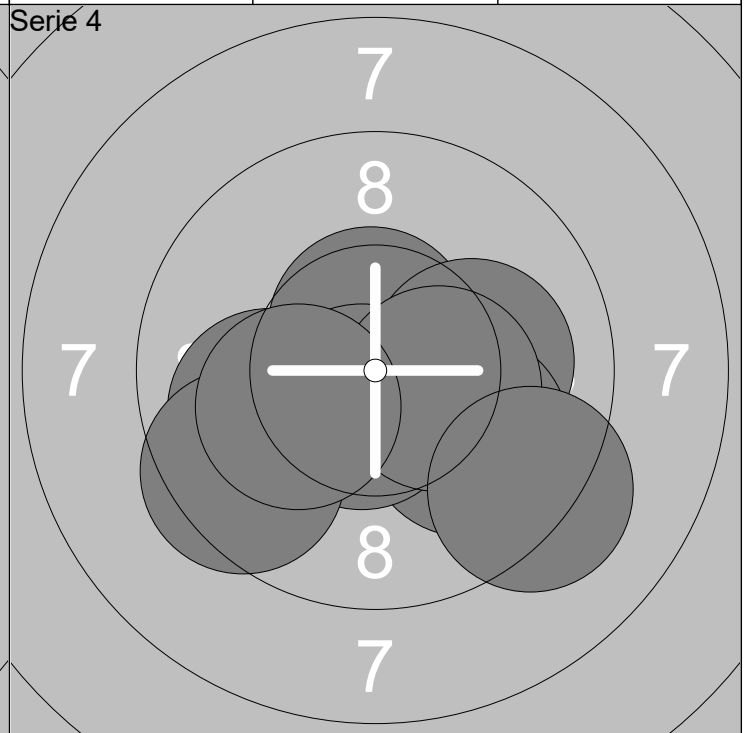
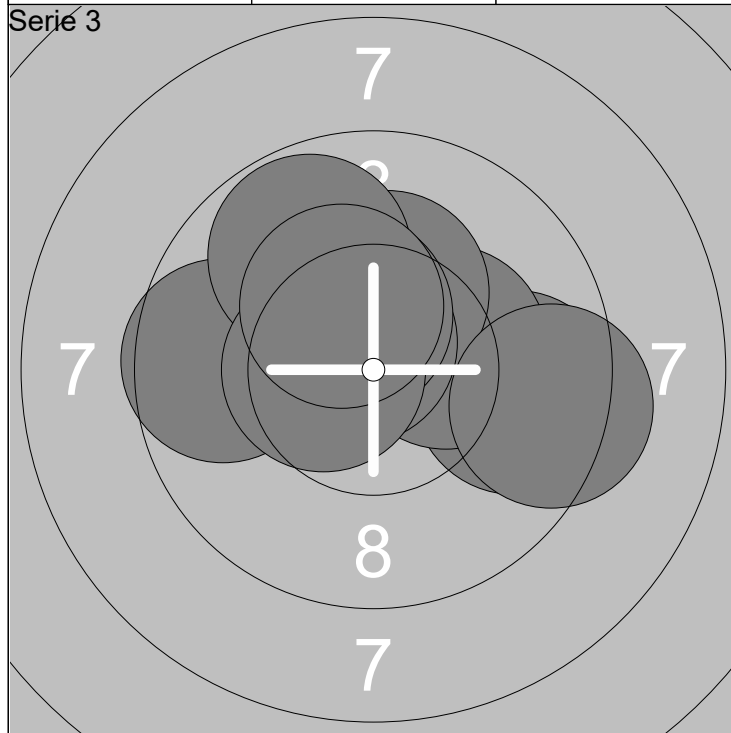

1: 9.7 →	6: 10.4x ↗	Serie 96 (6x)
2: 10.3x →	7: 9.8 ↗	
3: 10.2x ↑	8: 10.5x ←	Total 286 (19x)
4: 9.6 ←	9: 9.3 →	
5: 10.6x ↗	10: 10.3x ↗	

1: 10.7x ↙	6: 10.3x →	Serie 97 (5x)
2: 10.6x ↑	7: 9.2 ↘	
3: 10.1 →	8: 9.9 ←	Total 383 (24x)
4: 10.0 ↘	9: 9.5 ↙	
5: 10.6x ↘	10: 10.2x ←	

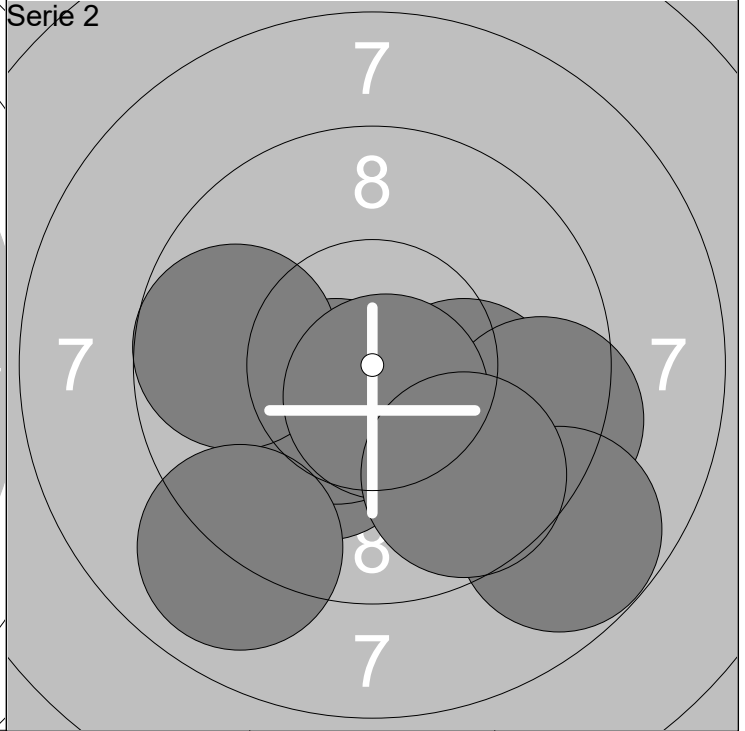
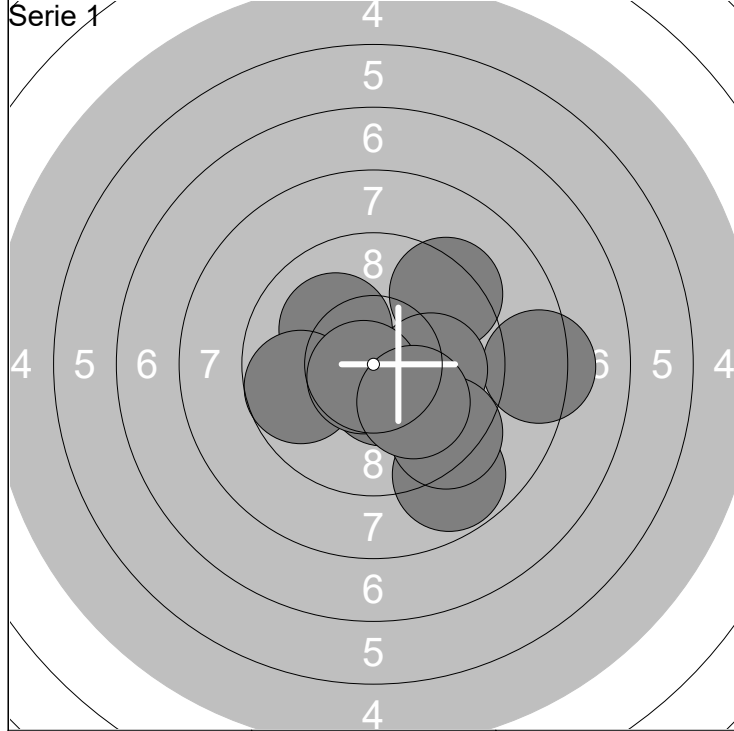

1: 8.8 ↘	6: 10.0 →	Serie	93 (2x)
2: 8.3 →	7: 9.7 ←		
3: 10.1 ↗	8: 9.4 ↘	Total	93 (2x)
4: 9.3 ↗	9: 10.7x ↘		
5: 10.5x ↘	10: 10.0 ↘		

1: 10.1 ↘	6: 9.4 →	Serie	93 (2x)
2: 10.5x ↘	7: 8.8 ↘		
3: 9.7 →	8: 10.6x ↘	Total	186 (4x)
4: 10.1 →	9: 9.7 ↘		
5: 9.7 ←	10: 9.0 ↘		

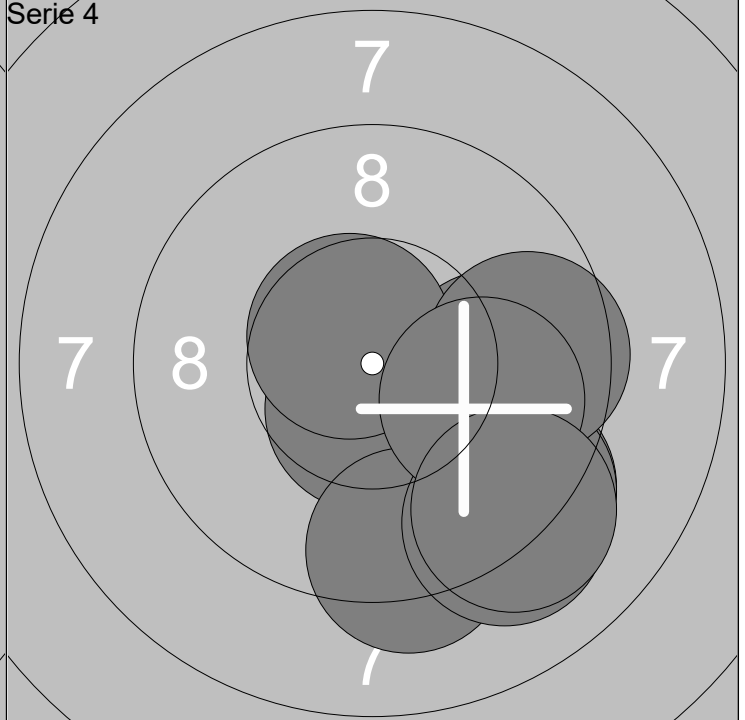
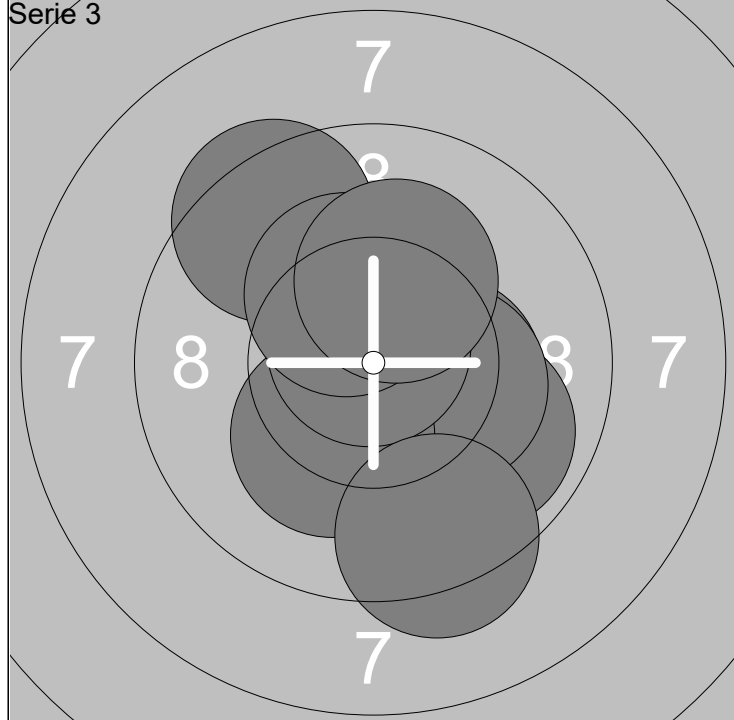

1: 10.3x →	6: 10.2x ↘	Serie	97 (7x)
2: 10.9x	7: 10.7x ↗		
3: 9.9 ↘	8: 10.3x ↗	Total	283 (11x)
4: 9.4 ↗	9: 10.2x ↗		
5: 10.3x →	10: 9.3 ↘		

1: 10.5x ↘	6: 9.2 ↘	Serie	92 (2x)
2: 9.3 ↘	7: 9.1 ↘		
3: 9.8 →	8: 9.6 →	Total	375 (13x)
4: 10.6x ↗	9: 9.9 ↘		
5: 9.3 ↘	10: 9.1 ↘		

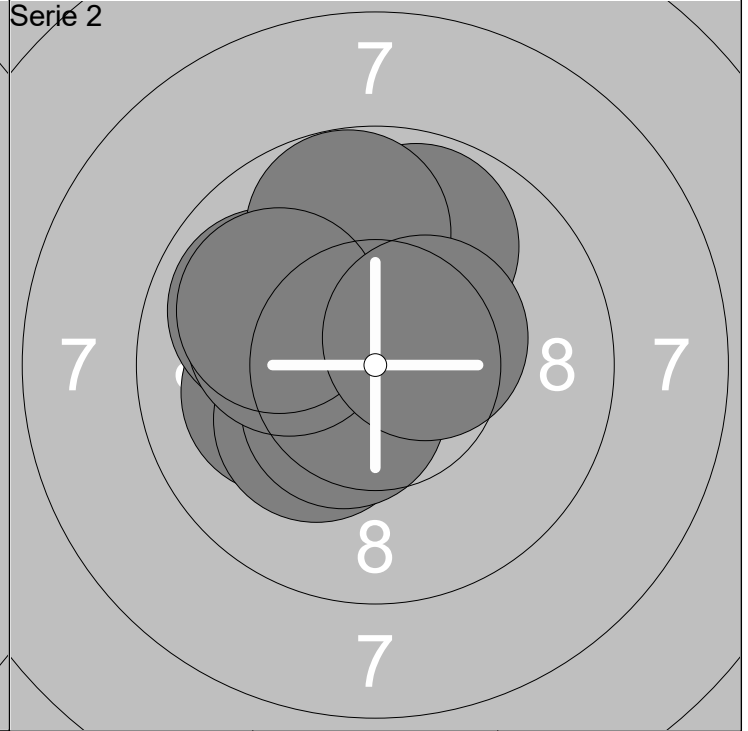
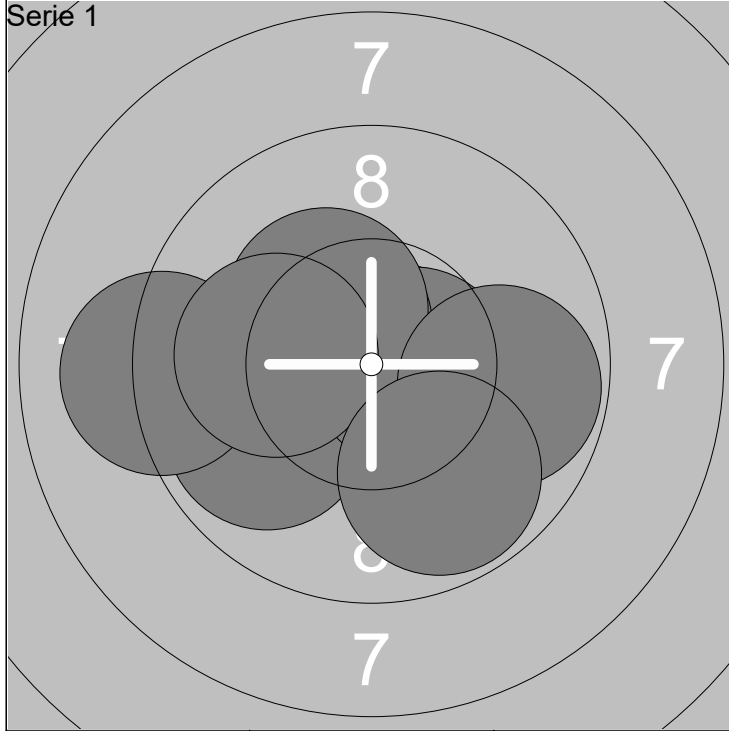

1: 10.8x →	6: 10.3x ↗	Serie	96 (5x)
2: 10.5x ←	7: 9.1 ←		
3: 9.9 ←	8: 10.1 ←	Total	96 (5x)
4: 10.6x →	9: 9.8 →		
5: 10.4x ↖	10: 9.8 ↘		

1: 10.0 ↑	6: 10.1 ←	Serie	97 (3x)
2: 10.1 ←	7: 9.8 ↑		
3: 10.2x ↙	8: 9.8 ↑	Total	193 (8x)
4: 10.5x ↘	9: 10.0 ↖		
5: 9.9 ←	10: 10.4x ↗		

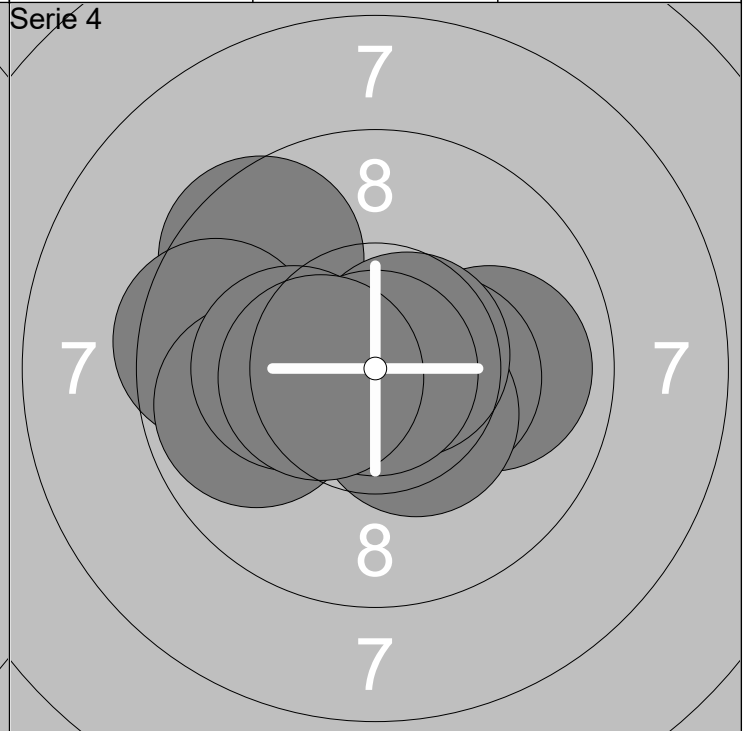
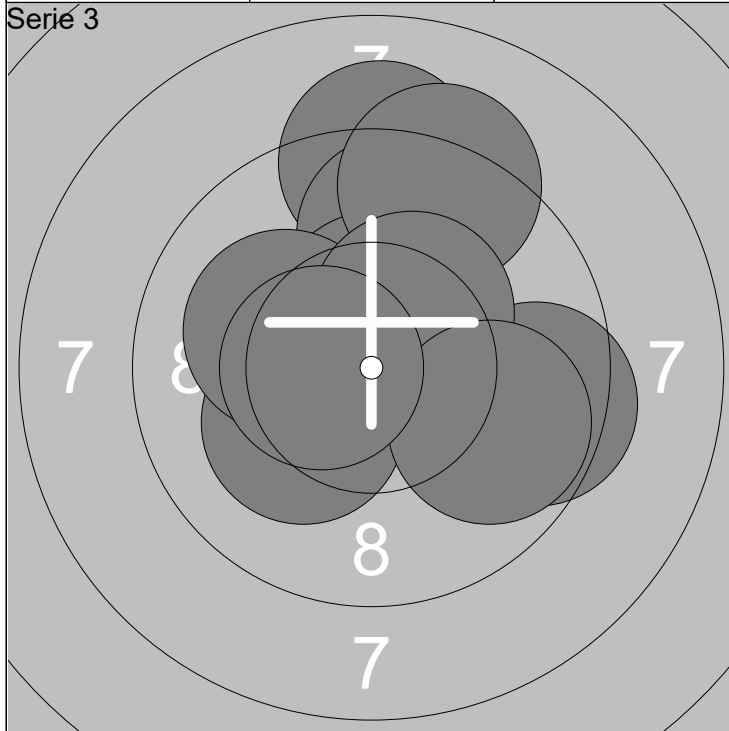

1: 10.2x ↙	6: 10.1 ←	Serie	95 (4x)
2: 9.1 ↑	7: 9.5 →		
3: 9.7 ↑	8: 10.3x ↗	Total	288 (12x)
4: 10.4x ↑	9: 9.8 →		
5: 9.2 ↑	10: 10.5x ←		

1: 9.9 →	6: 10.4x ↘	Serie	96 (6x)
2: 10.4x →	7: 10.2x ←		
3: 9.5 ↖	8: 10.6x ↗	Total	384 (18x)
4: 9.5 ←	9: 10.9x ↓		
5: 9.8 ←	10: 10.5x ←		

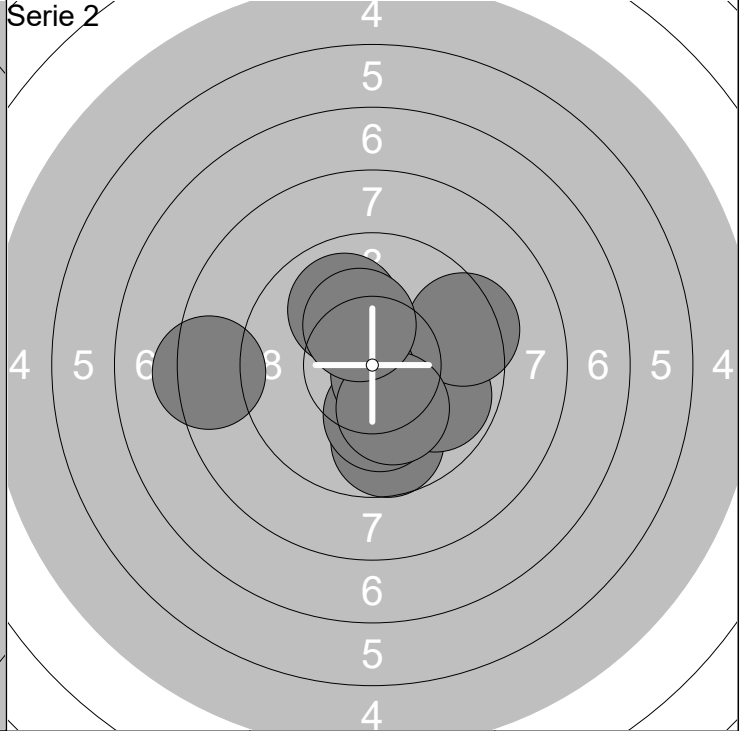
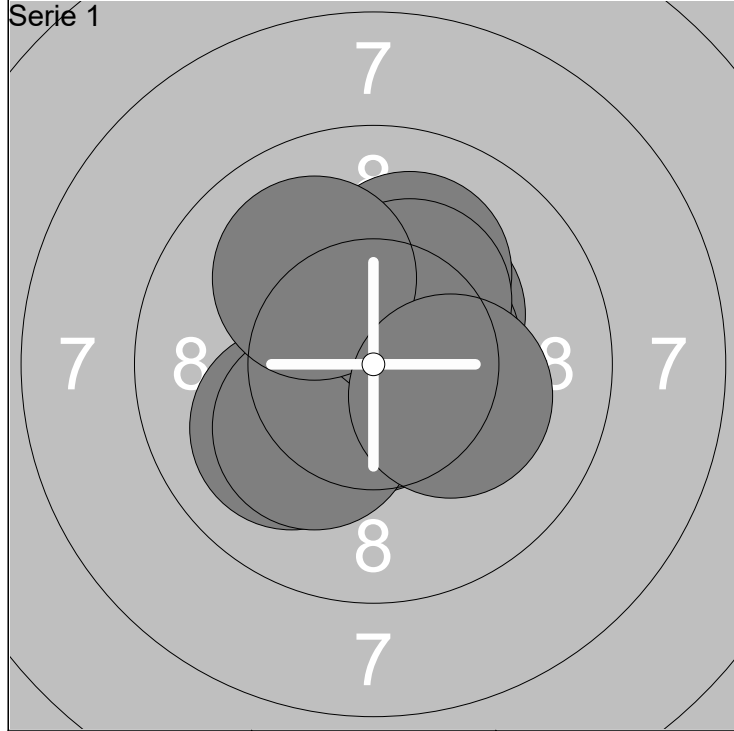

1: 10.7x ↑	6: 10.7x ↓	Serie 100 (7x)
2: 10.3x ↗	7: 10.2x ↘	
3: 10.5x →	8: 10.3x ↗	Total 100 (7x)
4: 10.1 ↑	9: 10.0 ↖	
5: 10.0 ↙	10: 10.2x →	

1: 9.7 ↓	6: 8.3 ←	Serie 95 (3x)
2: 10.1 ↓	7: 10.0 ↗	
3: 10.1 →	8: 9.4 →	Total 195 (10x)
4: 9.8 →	9: 10.2x ↓	
5: 10.6x ↘	10: 10.3x ↑	

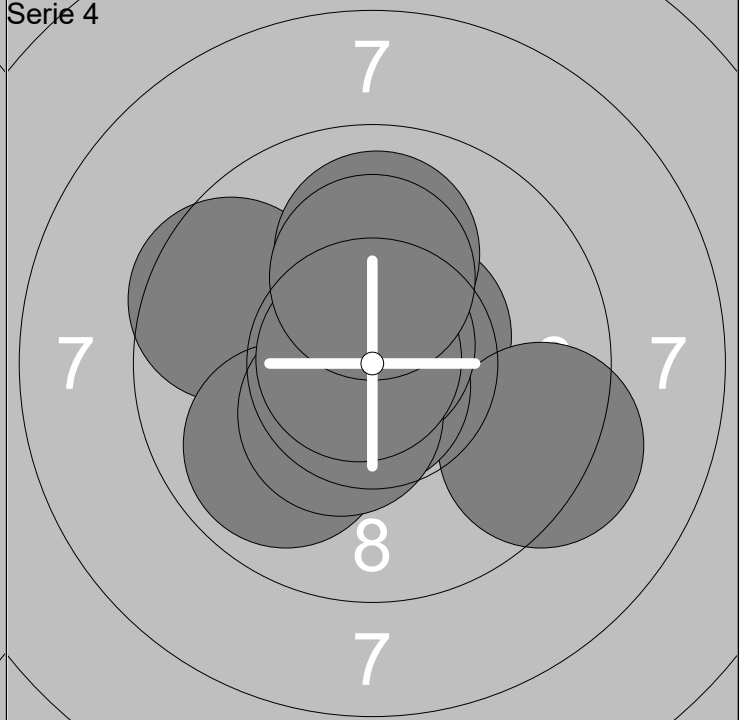
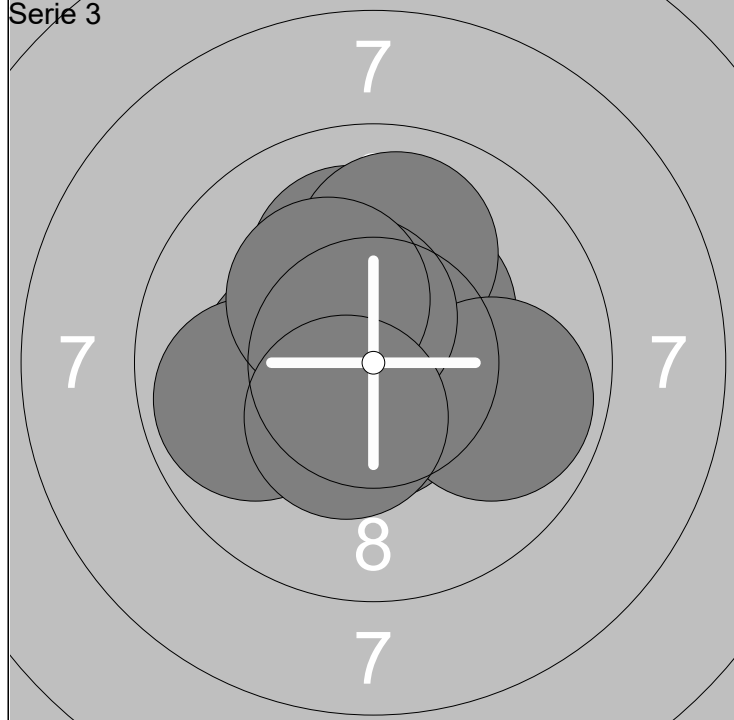

1: 10.1 ↑	6: 9.8 →	Serie 97 (6x)
2: 10.3x ←	7: 9.8 ←	
3: 10.4x ↗	8: 10.5x ↗	Total 292 (16x)
4: 10.6x ↓	9: 10.2x ↖	
5: 9.9 ↑	10: 10.4x ↓	

1: 9.6 ↖	6: 10.8x ↑	Serie 97 (6x)
2: 10.5x ↗	7: 10.0 ↑	
3: 9.9 ↘	8: 10.4x ↓	Total 389 (22x)
4: 9.3 →	9: 10.8x ↖	
5: 10.7x ↓	10: 10.2x ↑	

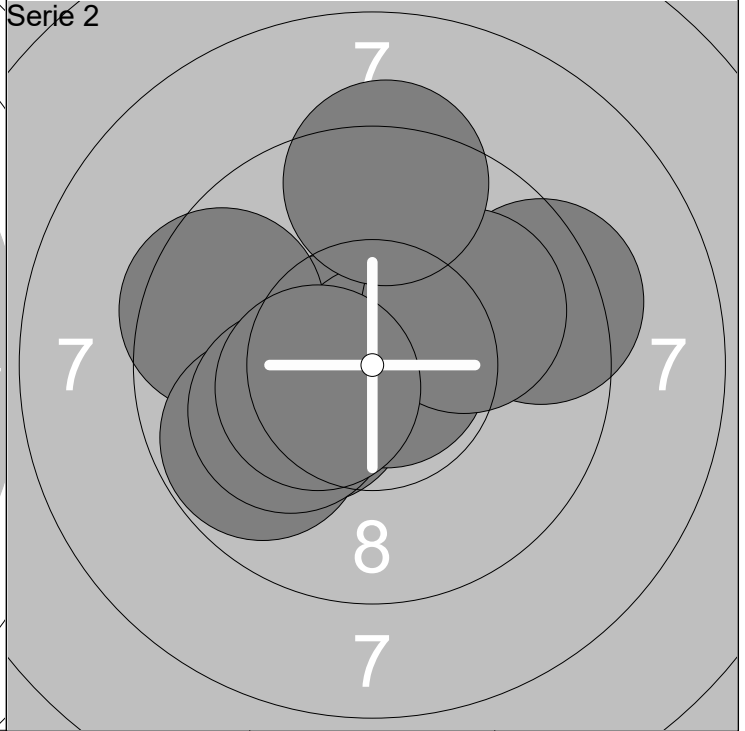
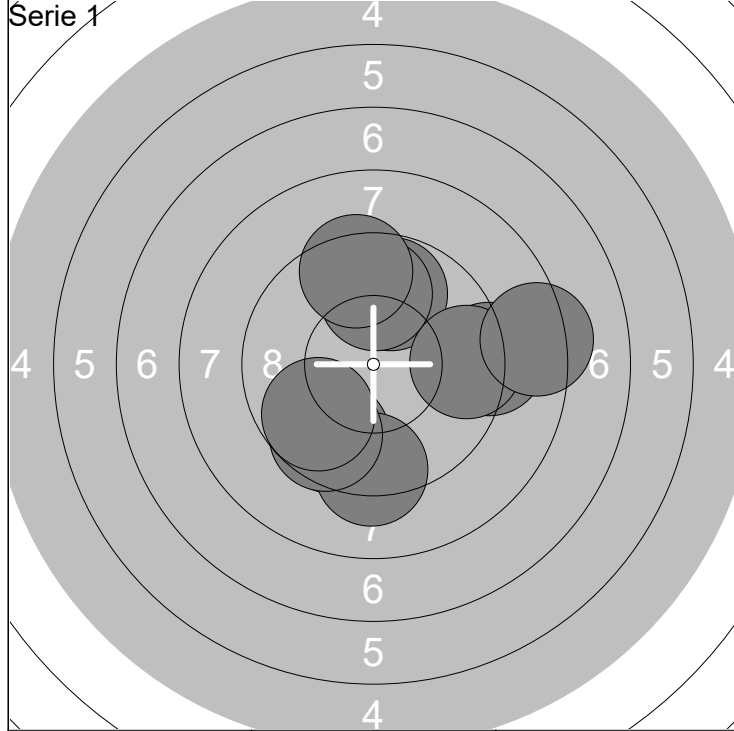

1: 9.8 ↑	6: 9.6 ↓	Serie	89 (0x)
2: 9.6 ↓	7: 9.7 ↙		
3: 9.1 →	8: 8.3 →	Total	89 (0x)
4: 9.3 ↓	9: 9.8 ↑		
5: 9.5 →	10: 9.4 ↑		

1: 10.3x ↙	6: 9.5 ↙	Serie	96 (4x)
2: 10.6x ↖	7: 9.3 ↑		
3: 9.3 →	8: 9.8 ↙	Total	185 (4x)
4: 10.8x →	9: 10.1 ↙		
5: 10.0 ↗	10: 10.4x ↖		

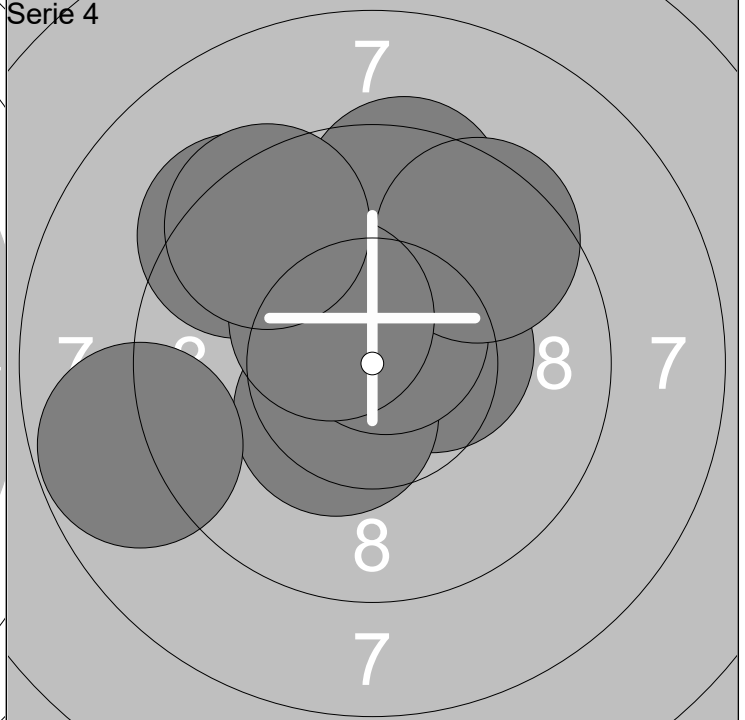
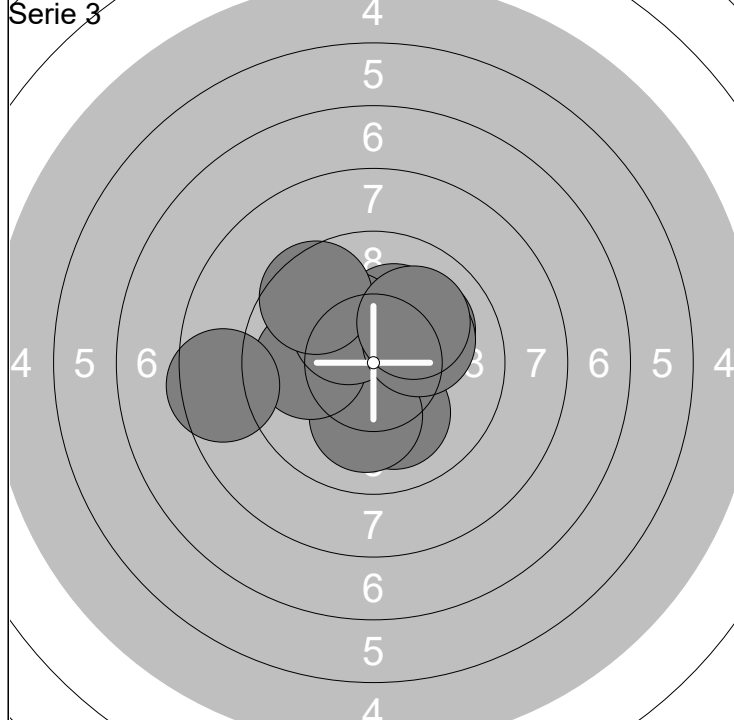

1: 10.2x ↗	6: 10.3x ↖	Serie	96 (2x)
2: 10.0 ↗	7: 9.6 ↖		
3: 10.1 ↓	8: 8.5 ↖	Total	281 (6x)
4: 10.1 ↓	9: 10.1 ↗		
5: 9.9 ↖	10: 10.0 ↗		

1: 10.4x →	6: 9.5 ↑	Serie	94 (5x)
2: 9.3 ↖	7: 9.5 ↗		
3: 10.5x ↑	8: 10.4x ↖	Total	375 (11x)
4: 10.4x ↙	9: 8.8 ↖		
5: 10.6x ↑	10: 9.4 ↖		

Skjutlag

3

Tavla

7

Jacob Andersson

Stående

Nässjö Skyttegille (SM)

L SJ

23.10.2019

SM Luft 2019

SM2019

Serié 1

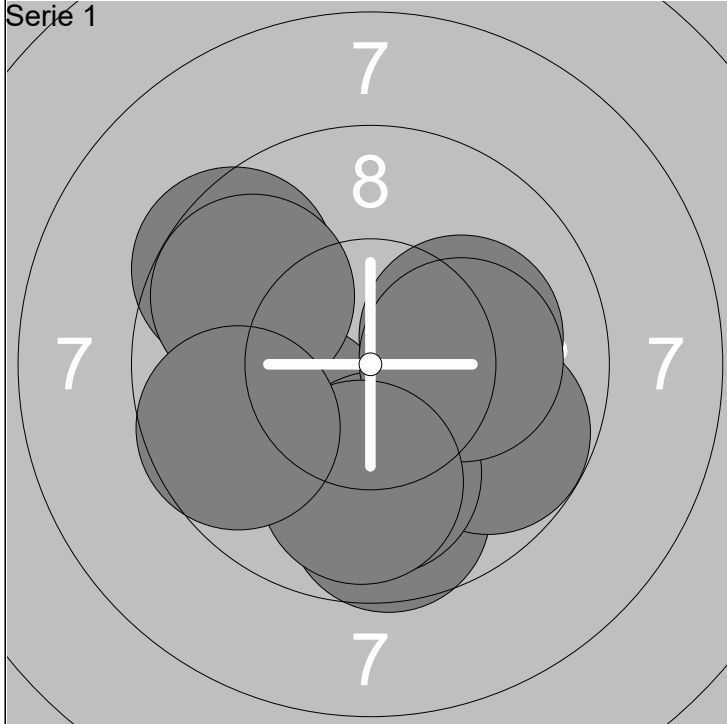

Serié 2

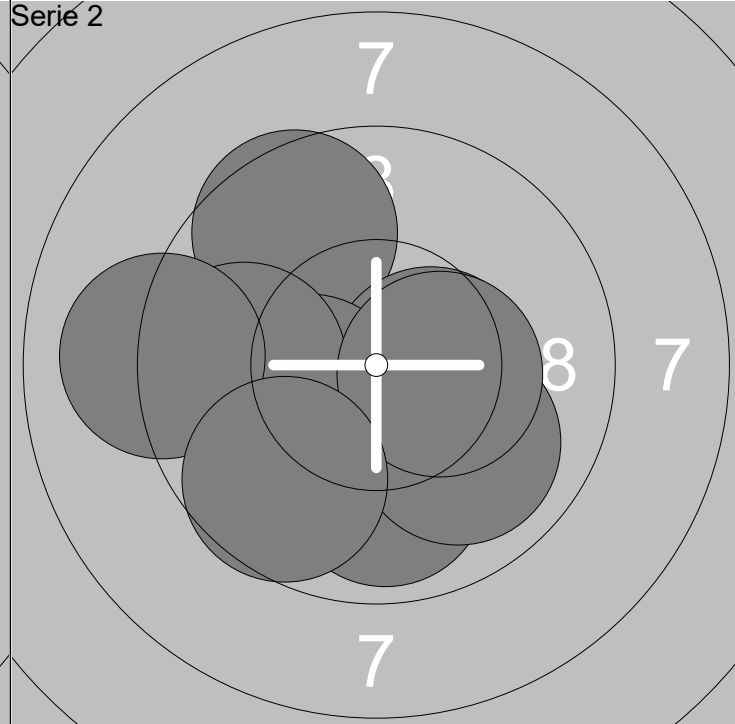

1:	9.6	↓	6:	10.0	↓	Serie	94 (0x)
2:	9.7	↘	7:	10.1	→		
3:	9.5	↗	8:	10.1	→	Total	94 (0x)
4:	10.1	↙	9:	9.9	↓		
5:	9.7	↖	10:	9.6	↙		

1:	9.5	↖	6:	9.9	↘	Serie	94 (3x)
2:	10.5x	→	7:	9.8	←		
3:	9.9	↓	8:	10.4x	→	Total	188 (3x)
4:	10.1	↘	9:	9.1	←		
5:	10.3x	↙	10:	9.6	↘		

Serié 3

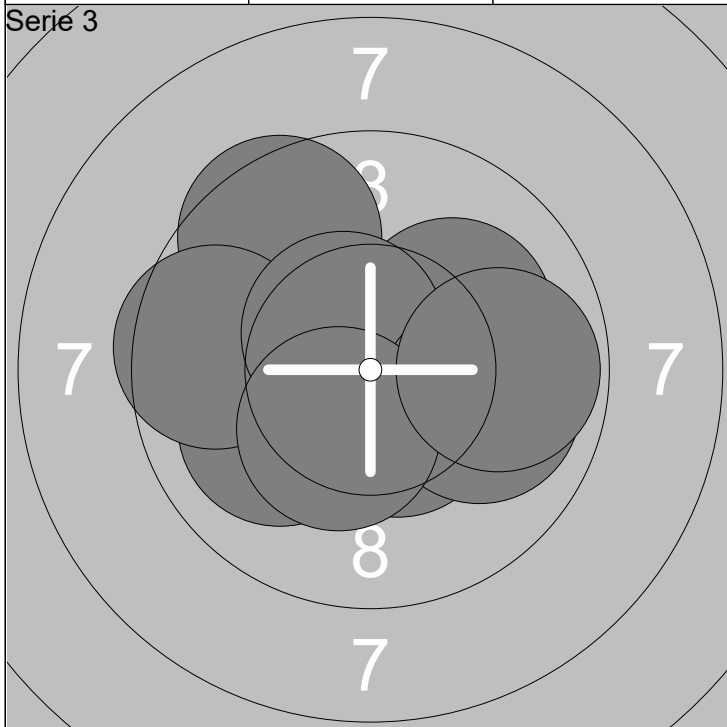

Serié 4

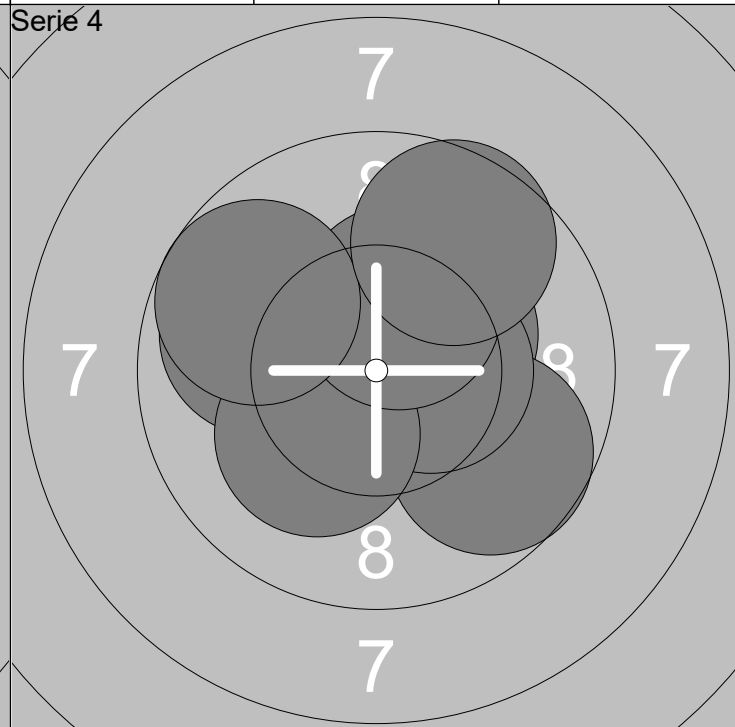

1:	9.5	↖	6:	10.1	↗	Serie	96 (4x)
2:	10.0	↙	7:	10.5x	↖		
3:	9.6	←	8:	9.9	→	Total	284 (7x)
4:	10.5x	↘	9:	10.4x	↘		
5:	10.5x	→	10:	9.8	→		

1:	10.3x	↗	6:	9.9	←	Serie	96 (6x)
2:	10.9x	↙	7:	10.2x	↘		
3:	10.8x	↘	8:	10.3x	↗	Total	380 (13x)
4:	9.7	↘	9:	9.7	↖		
5:	10.5x	→	10:	9.6	↗		

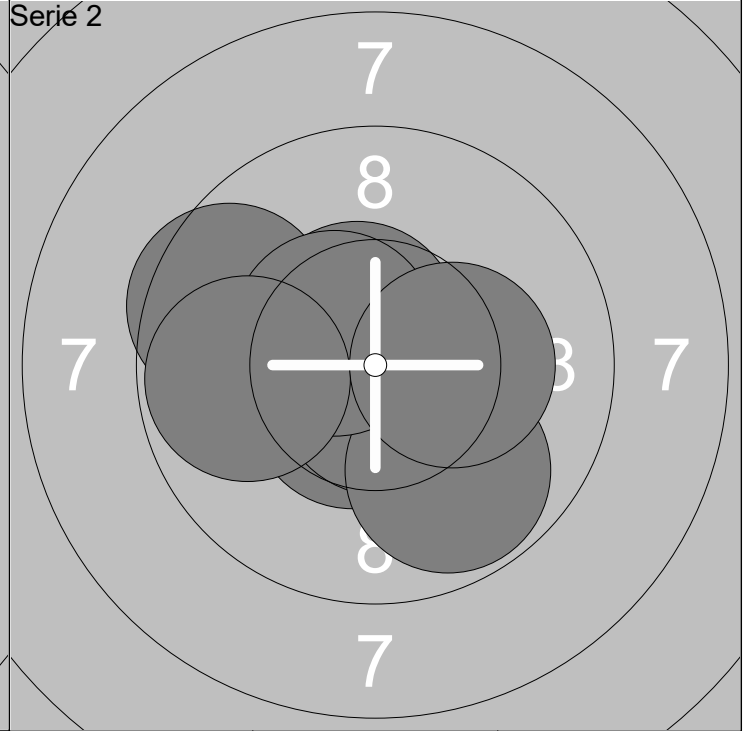
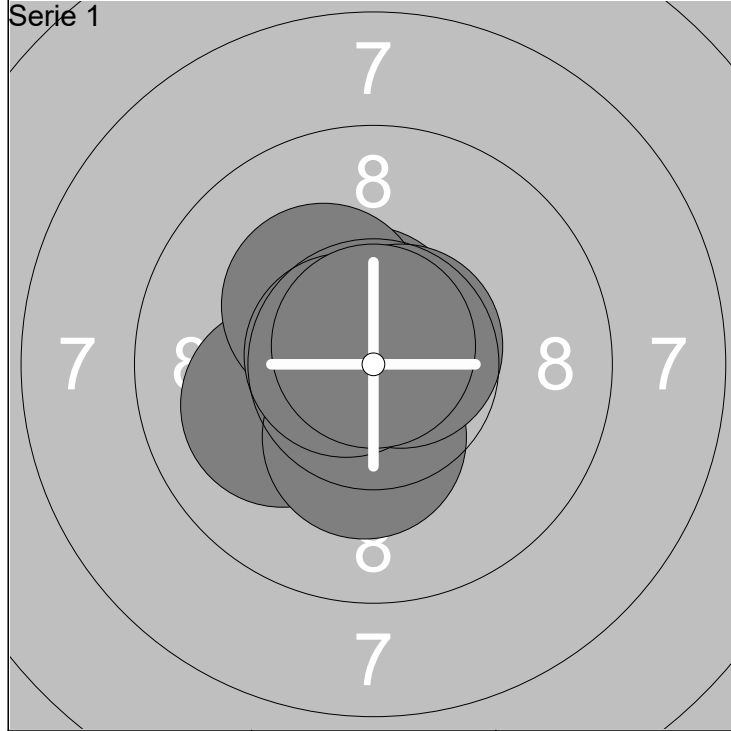

1: 10.6x ↖	6: 10.3x ↖	Serie	100 (9x)
2: 10.2x ↙	7: 10.3x ↓		
3: 10.6x ↑	8: 10.6x ↗	Total	100 (9x)
4: 10.0 ↙	9: 10.7x ↖		
5: 10.8x ↘	10: 10.8x ↑		

1: 10.5x →	6: 10.7x ↓	Serie	97 (7x)
2: 10.5x ↖	7: 9.8 ↓		
3: 9.5 ↙	8: 10.5x ↖	Total	197 (16x)
4: 10.6x ↓	9: 9.8 ↖		
5: 10.5x ↘	10: 10.2x →		

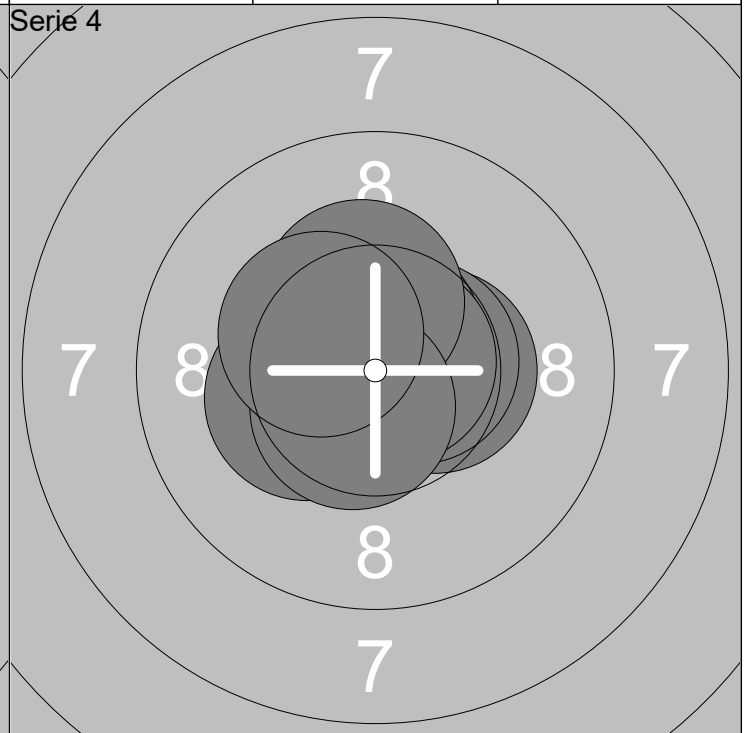
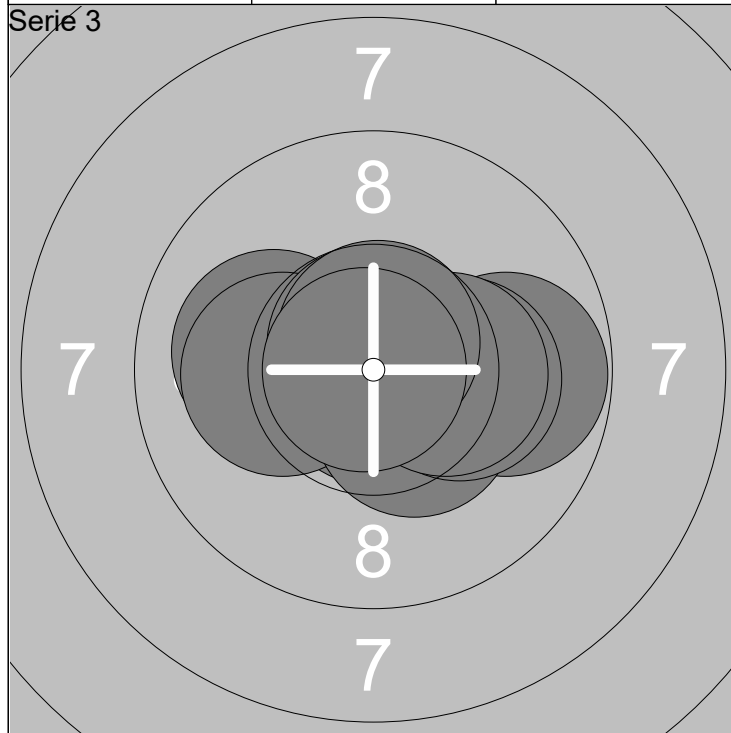

1: 10.0 ↖	6: 10.2x →	Serie	99 (7x)
2: 10.8x ↓	7: 10.3x →		
3: 10.1 ↖	8: 10.7x ↑	Total	296 (23x)
4: 9.8 →	9: 10.7x ↑		
5: 10.4x ↘	10: 10.9x ↖		

1: 10.4x →	6: 10.7x ↗	Serie	100 (10x)
2: 10.6x →	7: 10.3x ↑		
3: 10.8x ↘	8: 10.3x ↖	Total	396 (33x)
4: 10.7x ↖	9: 10.6x ↘		
5: 10.6x ↑	10: 10.4x ↖		

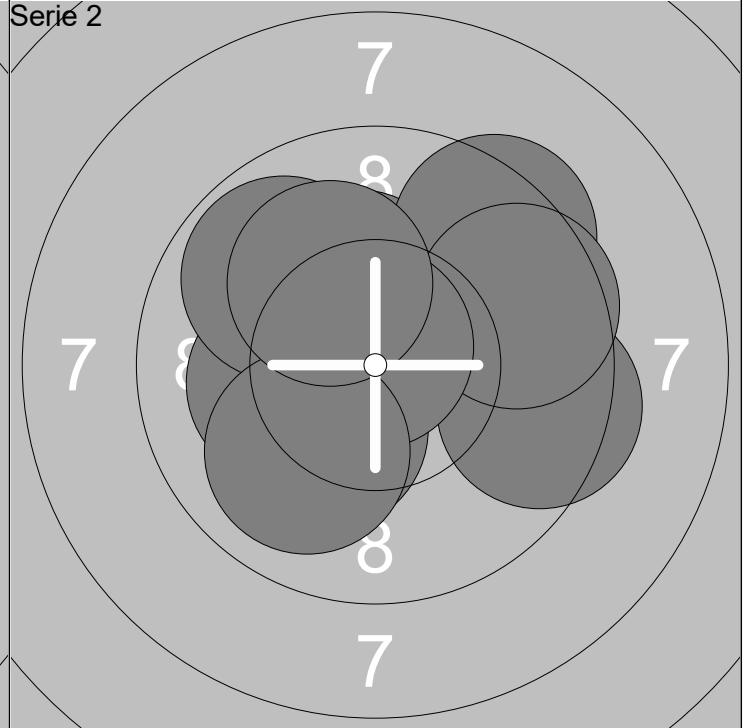
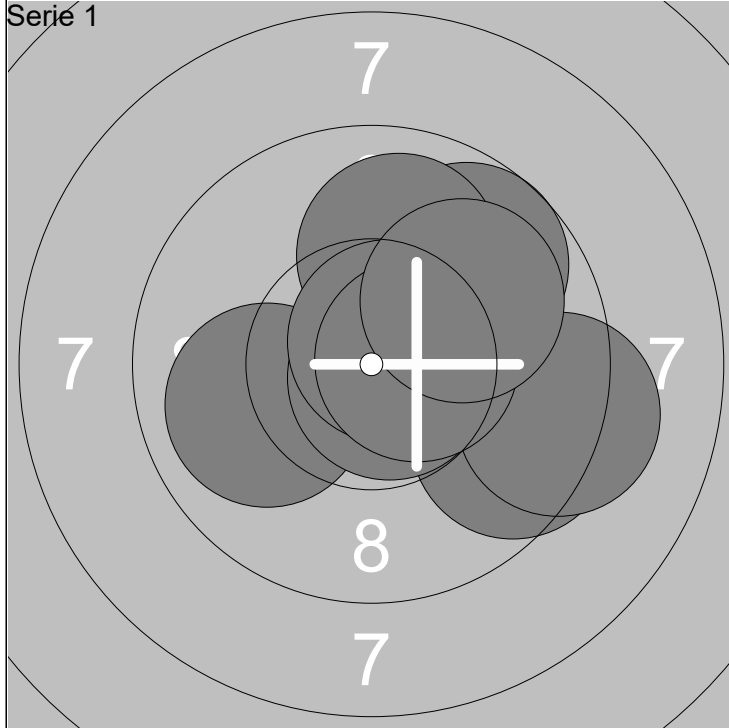

1: 9.5 →	6: 10.0 ↑	Serie	96 (4x)
2: 9.9 ←	7: 9.2 →		
3: 10.3x ↗	8: 10.7x ↗	Total	96 (4x)
4: 10.7x ↘	9: 10.5x →		
5: 9.7 ↗	10: 10.0 ↗		

1: 9.4 →	6: 10.1 ←	Serie	96 (3x)
2: 10.3x ↑	7: 9.8 ↖		
3: 10.2x ↘	8: 10.8x ↑	Total	192 (7x)
4: 9.4 ↗	9: 10.0 ↘		
5: 9.6 →	10: 10.1 ↖		

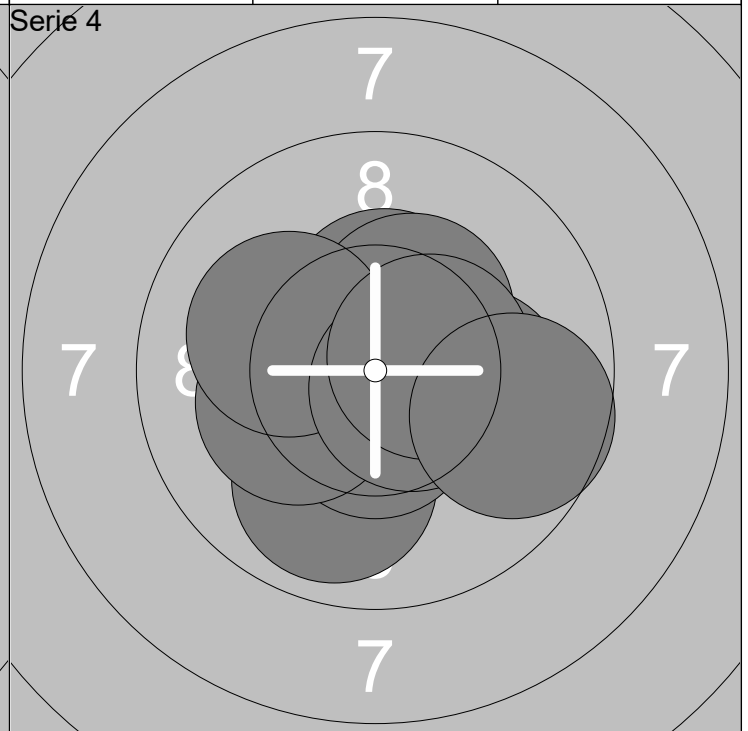
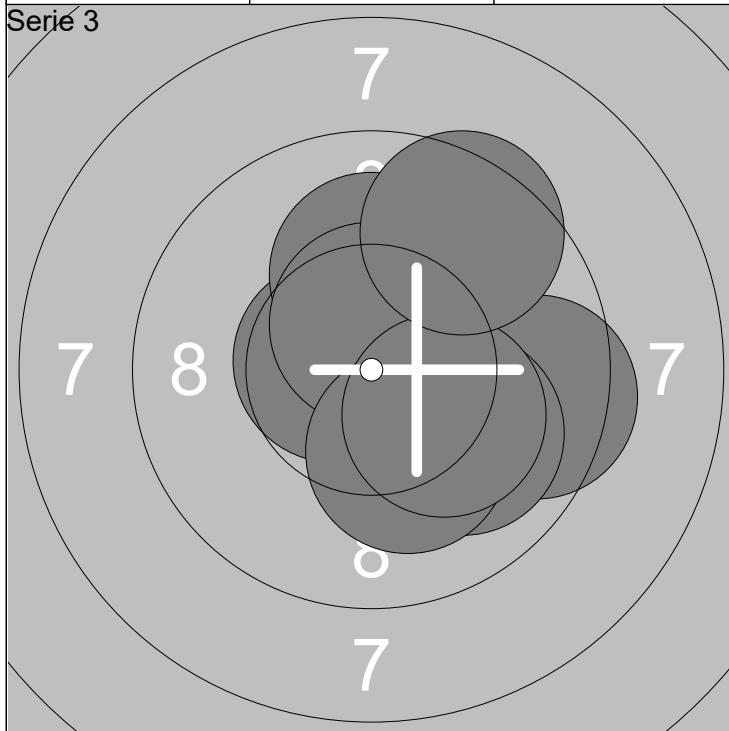

1: 10.6x ←	6: 10.0 ↘	Serie	98 (6x)
2: 10.4x ↘	7: 10.5x ↑		
3: 10.1 ↑	8: 10.2x ↘	Total	290 (13x)
4: 10.4x ↗	9: 10.2x ↘		
5: 9.5 →	10: 9.5 ↗		

1: 9.9 ↘	6: 10.4x ↗	Serie	98 (6x)
2: 10.1 →	7: 10.1 ←		
3: 10.4x ↑	8: 10.6x ↘	Total	388 (19x)
4: 10.5x ↘	9: 10.5x →		
5: 10.2x ←	10: 9.7 →		

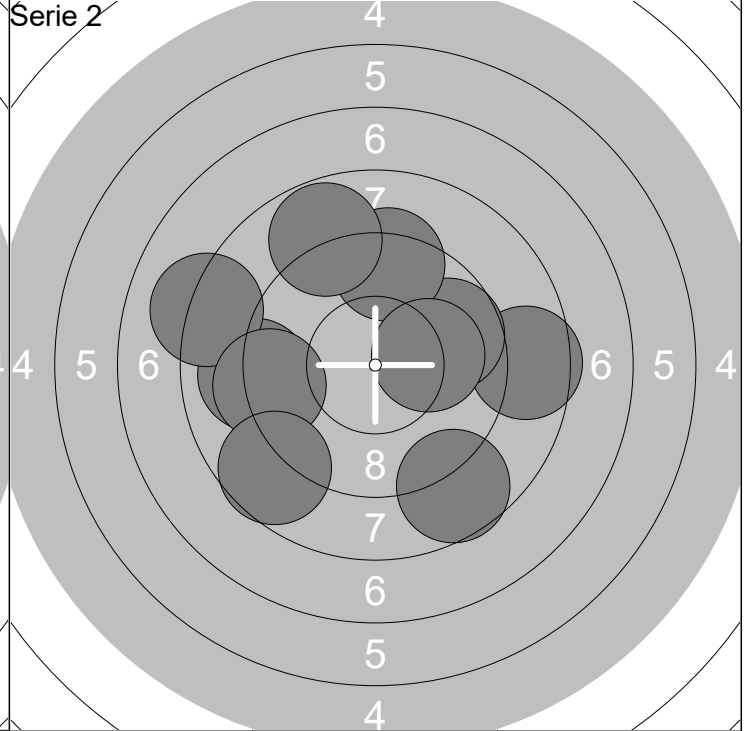
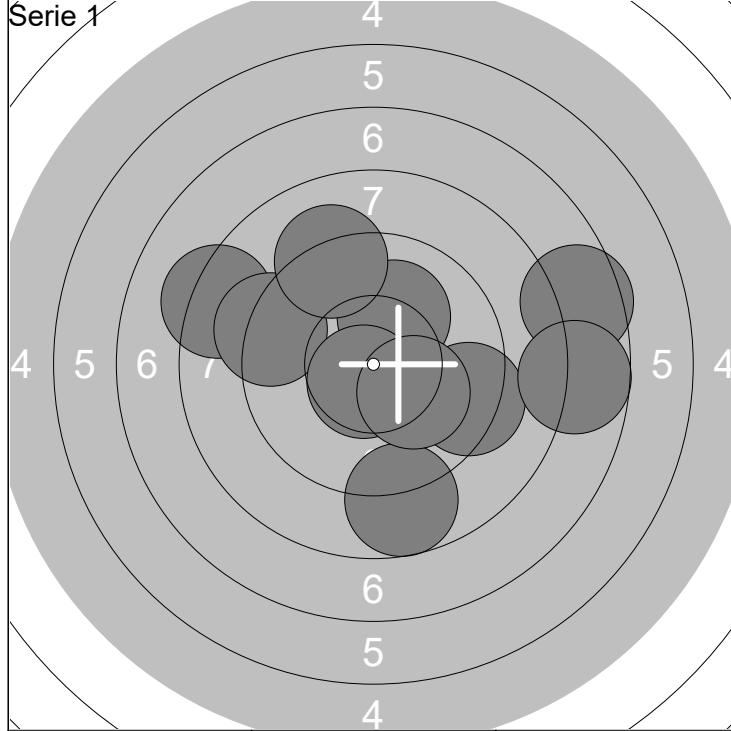

1: 8.2 ←	6: 8.7 ↓	Serie	87 (2x)
2: 9.3 →	7: 10.6x ↓		
3: 9.2 ←	8: 10.2x →	Total	87 (2x)
4: 10.1 ↗	9: 7.5 →		
5: 9.2 ↗	10: 7.7 →		

1: 8.6 ↓	6: 9.0 ←	Serie	86 (0x)
2: 8.5 →	7: 8.1 ←		
3: 9.7 →	8: 9.2 ←	Total	173 (2x)
4: 9.3 ↗	9: 8.8 ↗		
5: 10.1 →	10: 8.6 ↓		

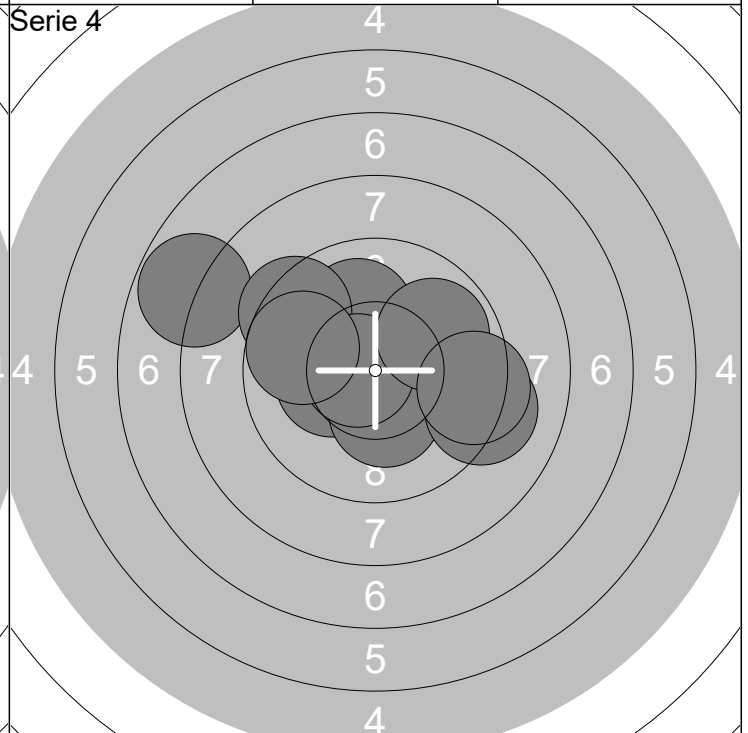
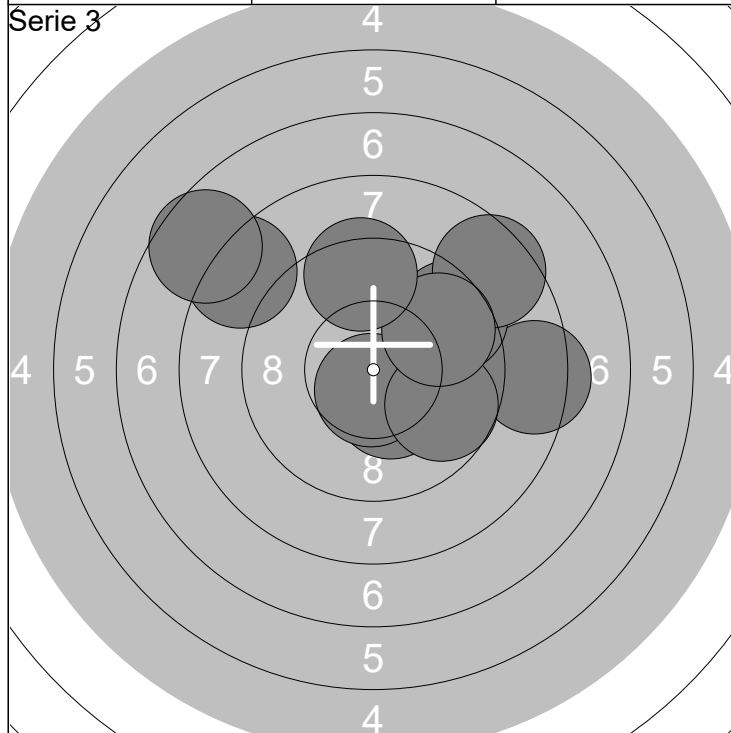

1: 8.4 →	6: 10.6x ↓	Serie	87 (2x)
2: 10.3x ↓	7: 9.7 →		
3: 9.4 ↗	8: 9.7 ↗	Total	260 (4x)
4: 8.5 ↗	9: 7.6 ←		
5: 8.3 ←	10: 9.4 ↗		

1: 10.2x ←	6: 9.1 →	Serie	92 (3x)
2: 7.8 ←	7: 10.6x ←		
3: 10.0 ↗	8: 9.8 ↗	Total	352 (7x)
4: 10.3x ↓	9: 9.3 →		
5: 9.3 ←	10: 9.7 ←		

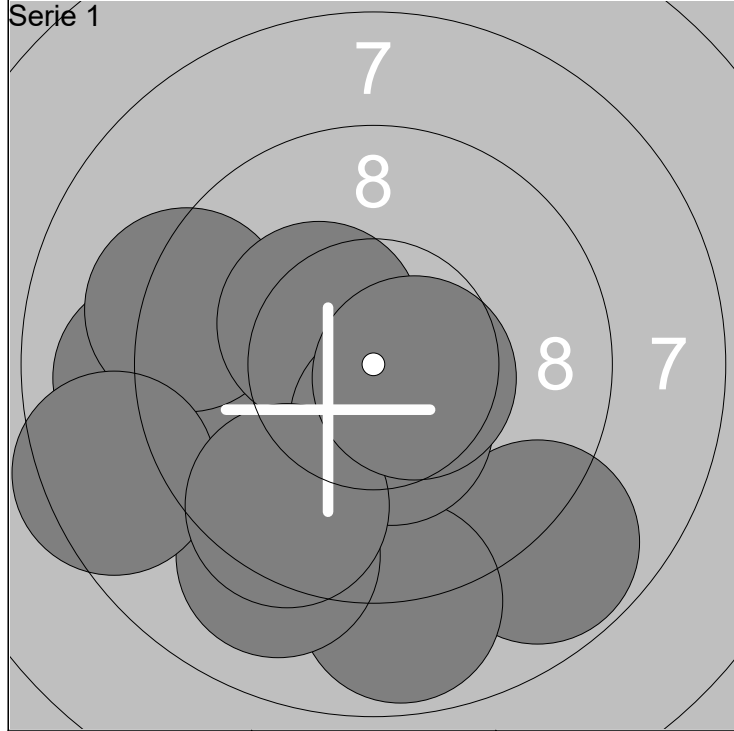

1: 8.8 ↘	6: 10.4x ↓	Serie	90 (3x)
2: 9.0 ←	7: 9.1 ↓		
3: 9.2 ↙	8: 8.5 ←	Total	90 (3x)
4: 8.8 ↓	9: 9.4 ↓		
5: 10.3x ↗	10: 10.5x →		

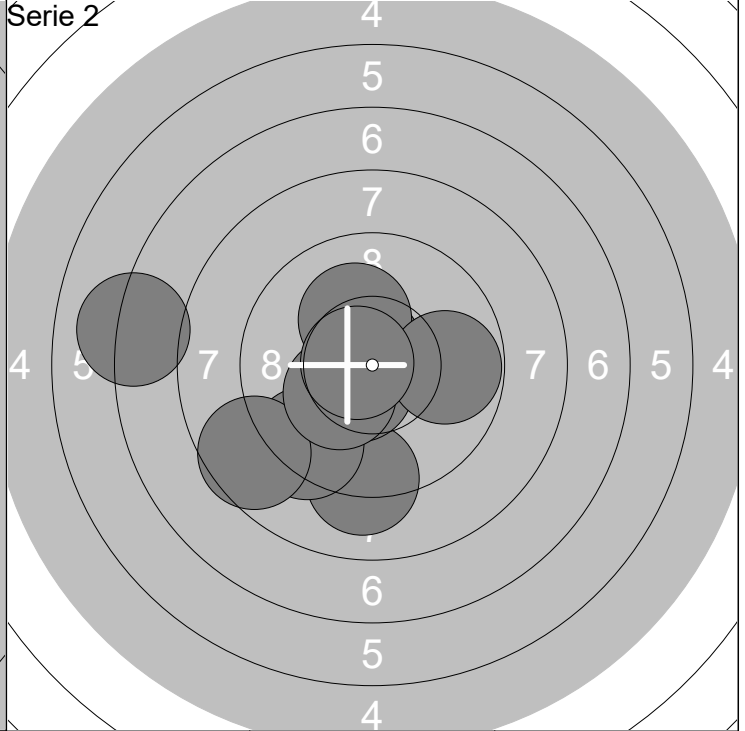

1: 9.1 ↓	6: 8.6 ↙	Serie	92 (5x)
2: 10.6x ↗	7: 10.3x ↙		
3: 9.3 ↘	8: 9.8 →	Total	182 (8x)
4: 10.5x ↘	9: 10.7x ←		
5: 10.2x ↗	10: 7.1 ←		

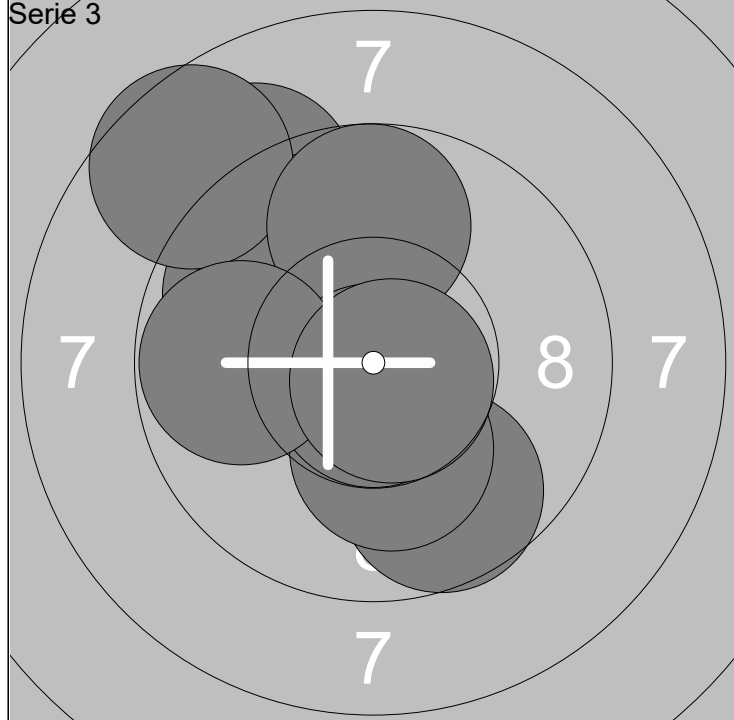

1: 9.8 ↗	6: 10.2x ↓	Serie	92 (3x)
2: 9.0 ↗	7: 9.7 ↑		
3: 9.9 ↗	8: 10.7x ↓	Total	274 (11x)
4: 9.7 ↘	9: 9.8 ←		
5: 8.6 ↗	10: 10.7x ↓		

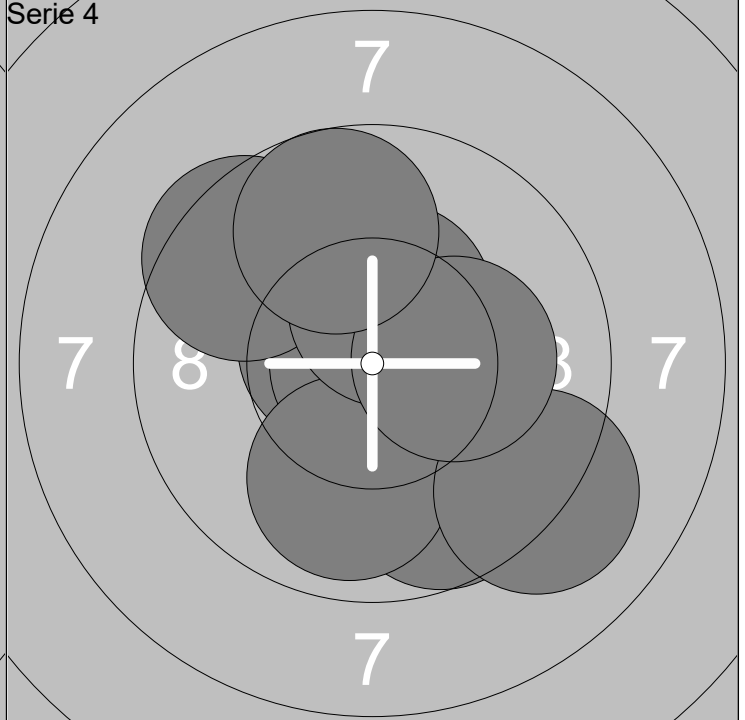

1: 10.6x ↙	6: 9.1 ↓	Serie	95 (5x)
2: 9.7 ↓	7: 9.5 ↙		
3: 10.2x ↘	8: 10.4x ↑	Total	369 (16x)
4: 10.9x	9: 10.2x →		
5: 9.9 ↓	10: 9.7 ↑		

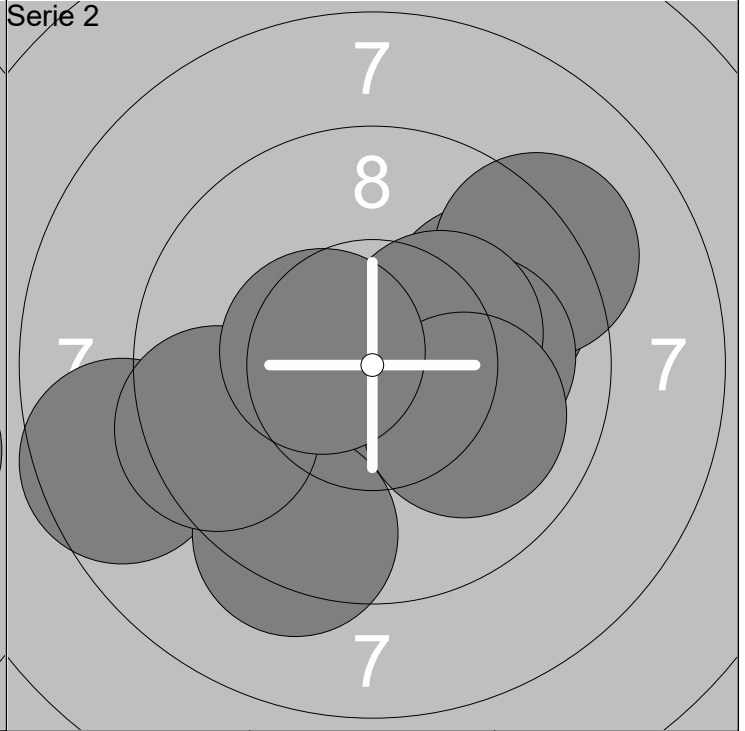
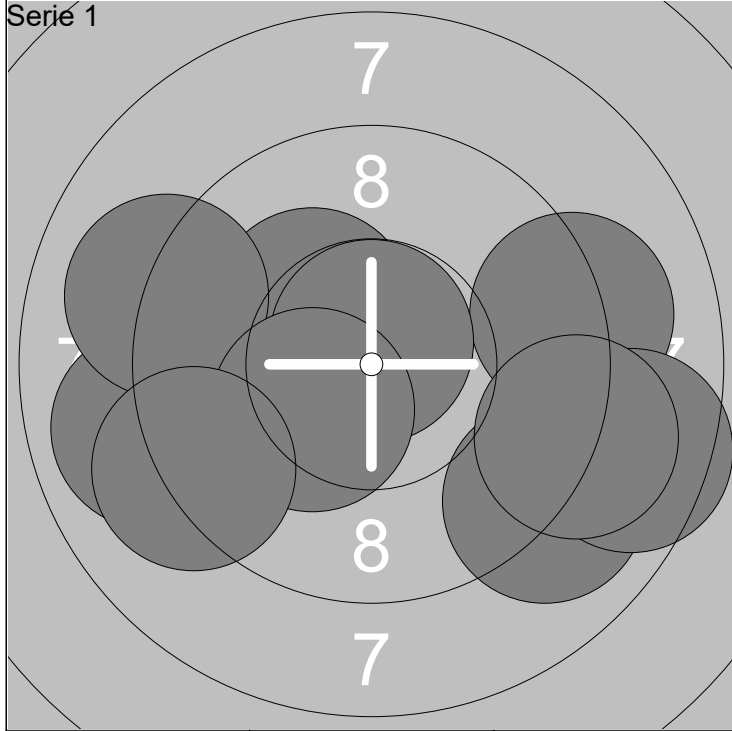

1: 10.2x ↖	6: 9.0 ←	Serie	91 (3x)
2: 8.9 ←	7: 10.3x ↙		
3: 9.1 →	8: 8.5 →	Total	91 (3x)
4: 10.7x ↑	9: 9.1 ←		
5: 9.0 ↘	10: 9.0 →		

1: 9.8 ↗	6: 10.0 →	Serie	94 (3x)
2: 8.6 ←	7: 9.5 ←		
3: 10.8x →	8: 10.3x ↗	Total	185 (6x)
4: 9.3 ↘	9: 10.0 ↘		
5: 9.2 ↗	10: 10.5x ←		

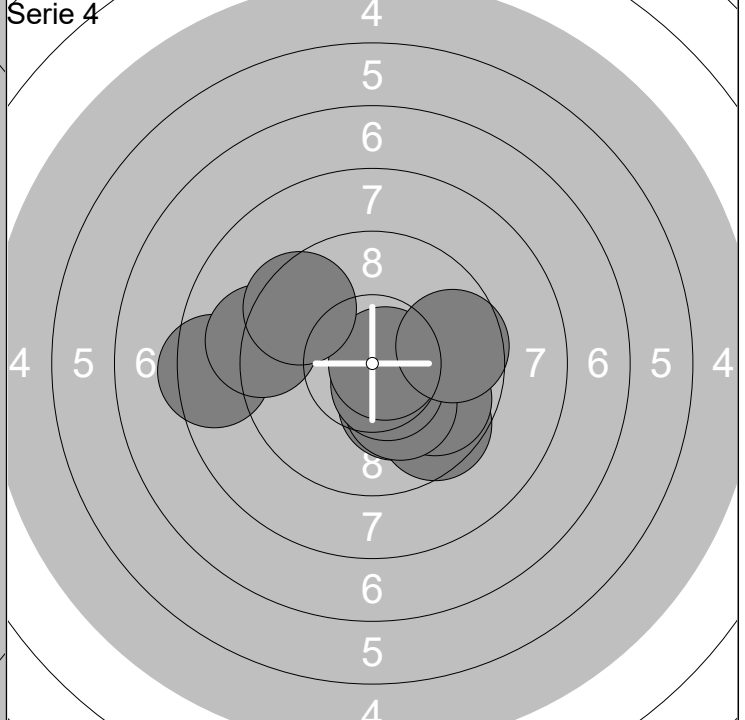
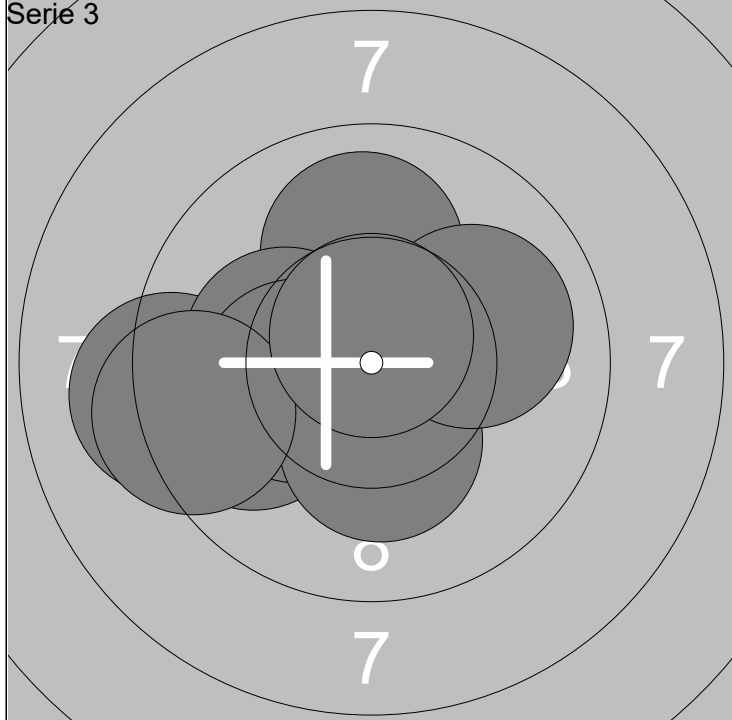

1: 9.1 ←	6: 10.9x →	Serie	97 (4x)
2: 10.0 ↑	7: 10.3x ↓		
3: 9.8 ←	8: 10.0 →	Total	282 (10x)
4: 10.1 ←	9: 9.3 ←		
5: 10.3x ←	10: 10.7x ↑		

1: 10.2x ↘	6: 10.5x ↘	Serie	93 (3x)
2: 9.5 ↘	7: 10.7x →		
3: 9.8 ↘	8: 9.1 ←	Total	375 (13x)
4: 8.4 ←	9: 9.6 →		
5: 10.1 ↘	10: 9.5 ↖		

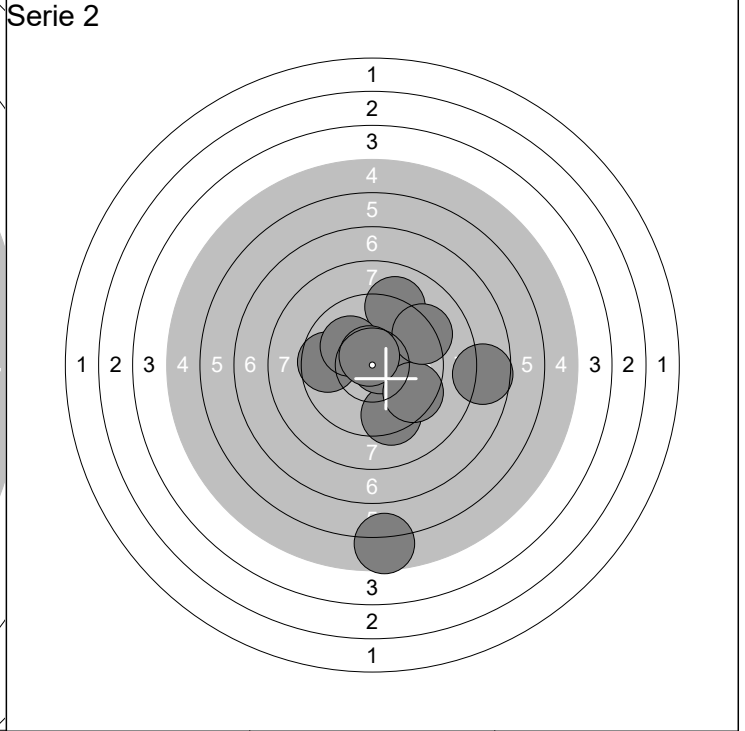
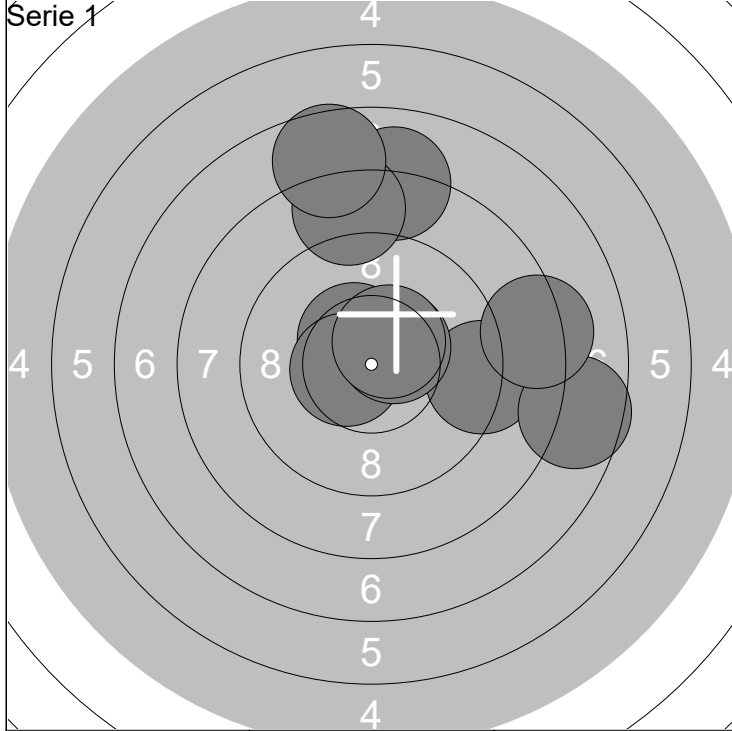

1: 8.0 ↑	6: 7.6 ↑	Serie	87 (4x)
2: 9.2 →	7: 10.5x ←		
3: 7.6 →	8: 10.5x ↗	Total	87 (4x)
4: 10.4x ↖	9: 8.3 →		
5: 8.4 ↑	10: 10.5x ↗		

1: 7.6 →	6: 10.7x →	Serie	87 (2x)
2: 9.4 ↓	7: 9.5 ↘		
3: 5.6 ↓	8: 10.1 ↖	Total	174 (6x)
4: 9.1 ↑	9: 9.2 ↗		
5: 9.6 ←	10: 10.6x ↑		

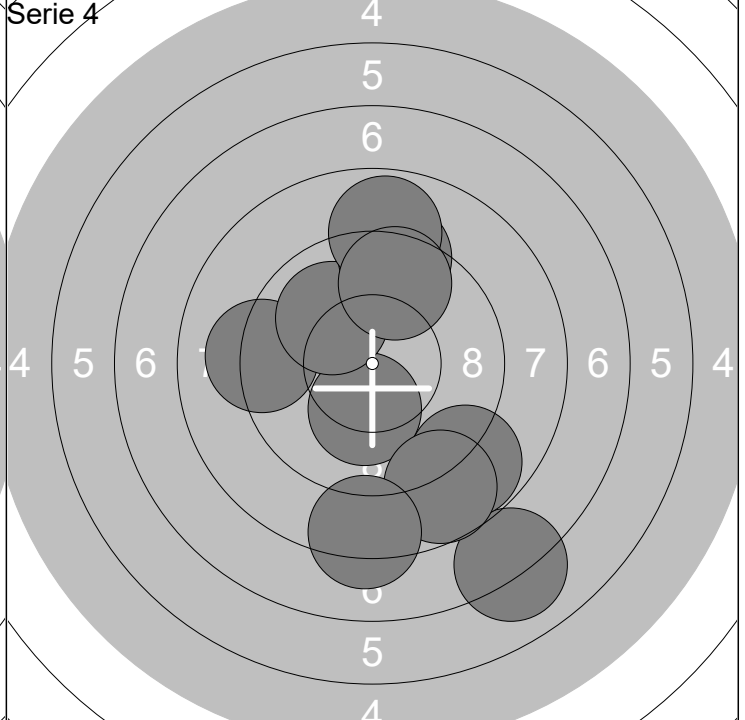
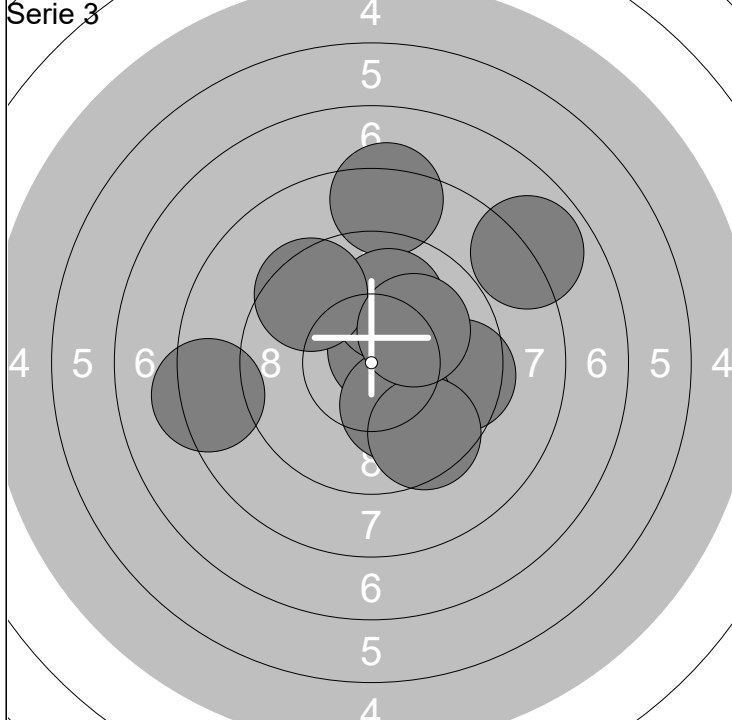

1: 7.9 ↗	6: 9.5 ↖	Serie	90 (1x)
2: 8.3 ↑	7: 10.1 ↓		
3: 10.7x ↗	8: 9.5 ↓	Total	264 (7x)
4: 9.5 →	9: 10.1 ↗		
5: 10.0 ↑	10: 8.3 ←		

1: 10.2x ↓	6: 8.7 ↓	Serie	86 (1x)
2: 9.2 ←	7: 8.3 ↓		
3: 7.0 ↓	8: 9.2 ↑	Total	350 (8x)
4: 8.8 ↓	9: 8.8 ↑		
5: 10.0 ↖	10: 9.6 ↑		

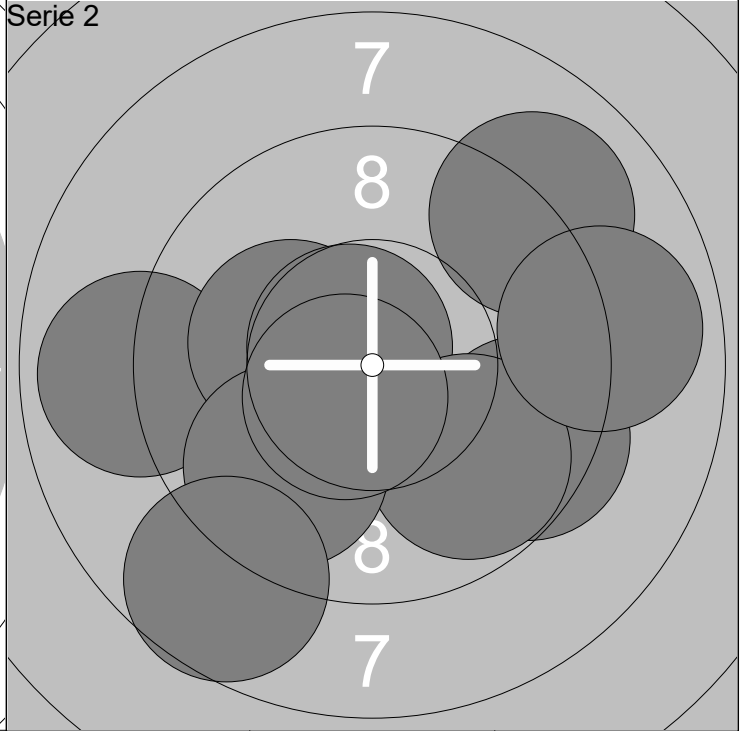
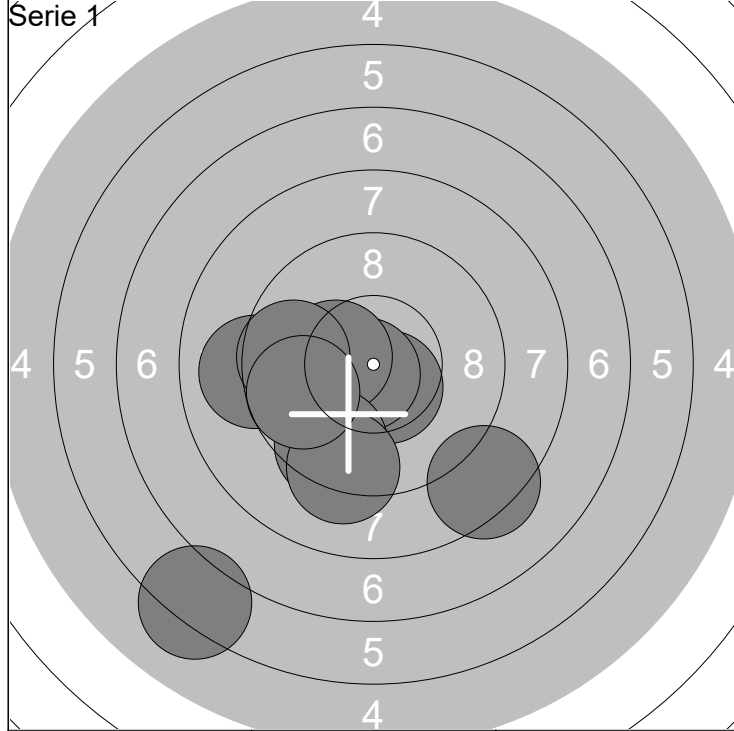

1: 6.2 ↙	6: 10.3x ←	Serie 89 (3x)
2: 10.5x ↓	7: 9.5 ↓	
3: 8.3 ↓	8: 9.2 ↓	Total 89 (3x)
4: 9.1 ←	9: 9.7 ←	
5: 10.7x ↙	10: 9.7 ←	

1: 8.9 ←	6: 9.0 ↗	Serie 90 (3x)
2: 9.4 →	7: 8.9 →	
3: 10.2x ←	8: 9.7 ↓	Total 179 (6x)
4: 10.7x ↗	9: 8.7 ↓	
5: 9.8 ↓	10: 10.6x ↙	

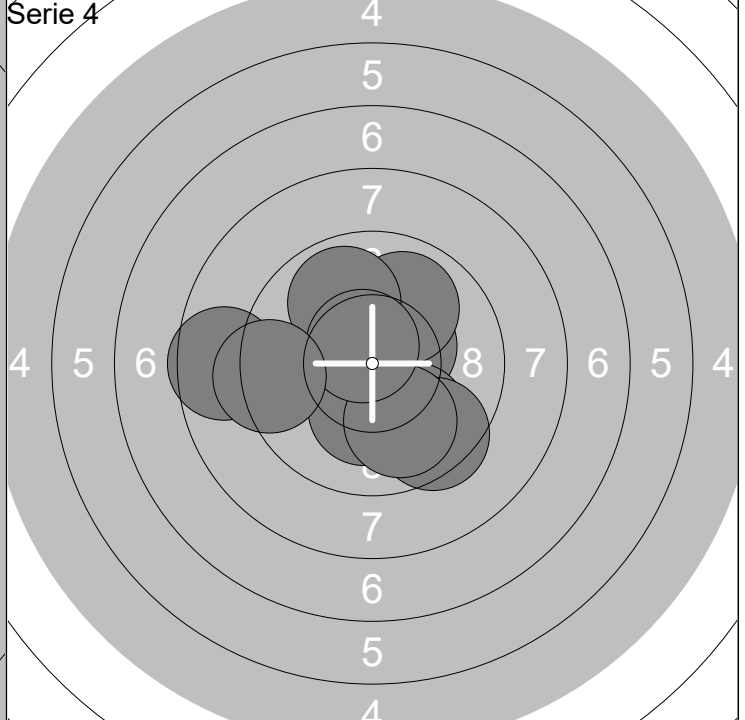
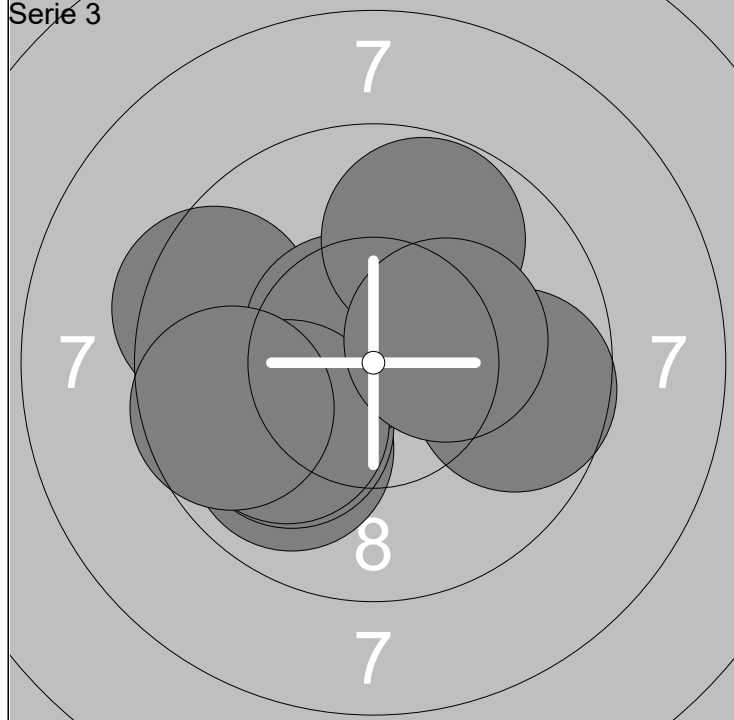

1: 9.9 ↙	6: 10.6x ↖	Serie 95 (2x)
2: 9.7 →	7: 10.0 ←	
3: 10.0 ←	8: 9.8 ↗	Total 274 (8x)
4: 10.0 ↙	9: 10.3x →	
5: 9.4 ←	10: 9.6 ←	

1: 8.6 ←	6: 9.5 ↓	Serie 92 (3x)
2: 10.2x ↓	7: 9.9 ↓	
3: 10.4x ↗	8: 9.9 ↗	Total 366 (11x)
4: 9.9 ↗	9: 10.6x ↖	
5: 9.8 ↓	10: 9.3 ←	

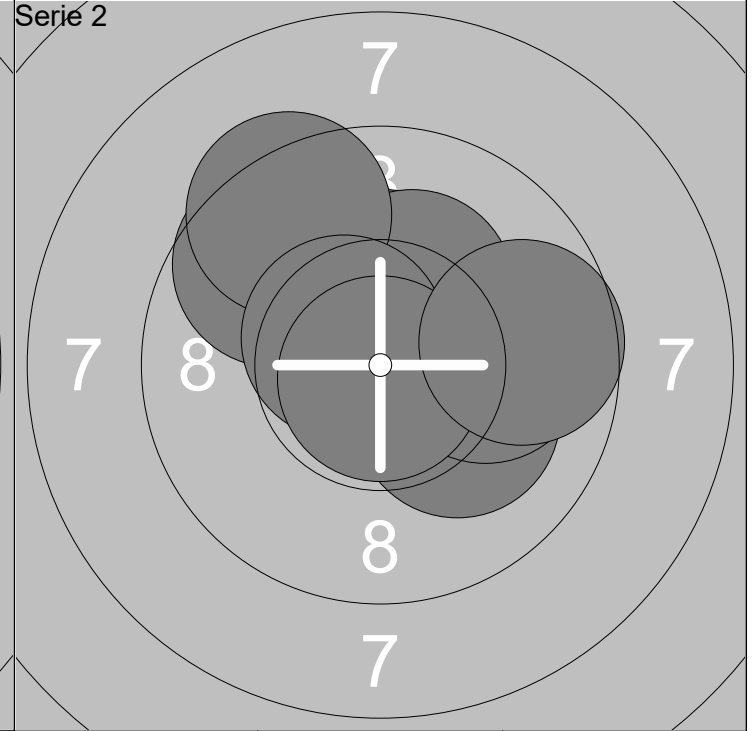
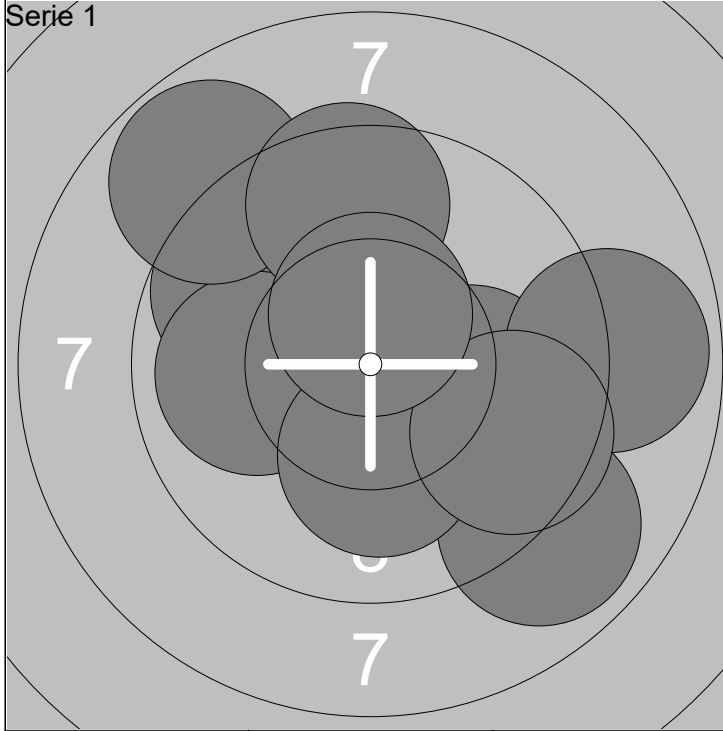

1: 9.7 ↖	6: 8.9 ↘	Serie 90 (1x)
2: 9.9 ←	7: 8.8 →	
3: 8.8 ↗	8: 10.1 ↓	Total 90 (1x)
4: 10.0 →	9: 9.6 ↘	
5: 9.5 ↑	10: 10.5x ↑	

1: 10.1 ↘	6: 10.2x ↗	Serie 97 (5x)
2: 10.3x ↑	7: 9.4 ↖	
3: 10.0 →	8: 10.5x ↖	Total 187 (6x)
4: 10.7x ↑	9: 10.8x ↓	
5: 9.7 ↖	10: 9.7 →	

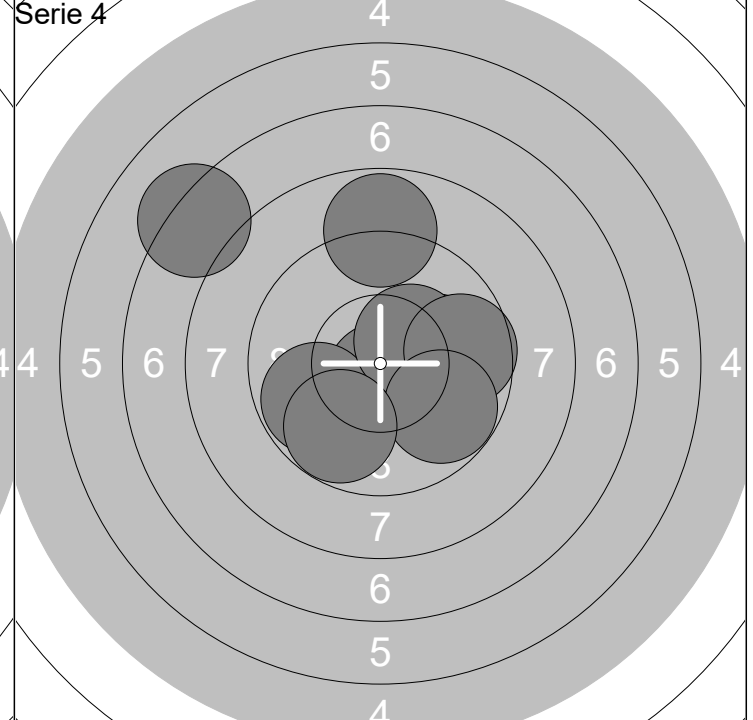
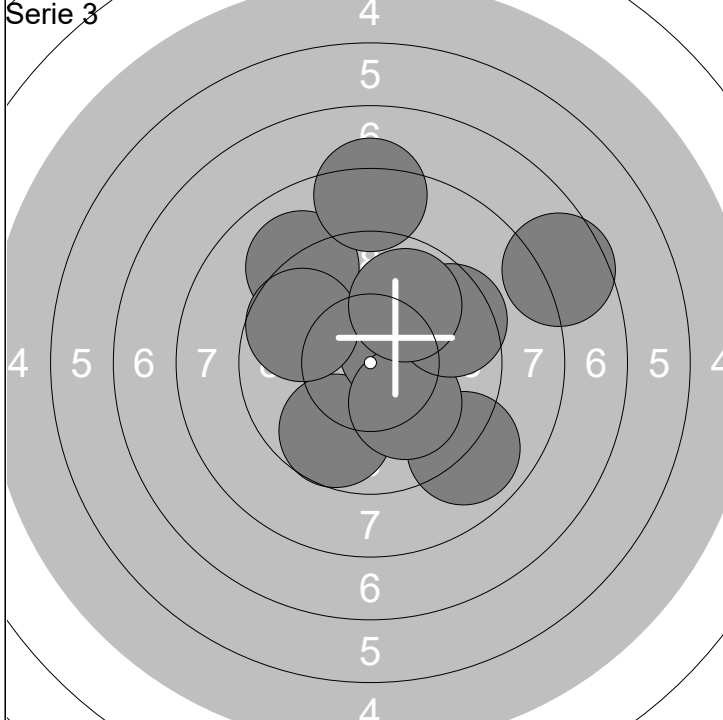

1: 9.1 ↖	6: 9.5 ↗	Serie 88 (1x)
2: 8.9 ↘	7: 7.6 ↗	
3: 9.7 ↘	8: 9.7 ↖	Total 275 (7x)
4: 10.5x ↗	9: 9.9 ↗	
5: 10.1 ↘	10: 8.3 ↑	

1: 10.1 ↘	6: 10.3x ↗	Serie 91 (2x)
2: 10.7x ↓	7: 9.6 →	
3: 8.8 ↑	8: 7.2 ↖	Total 366 (9x)
4: 9.8 ↖	9: 9.7 ↘	
5: 10.0 →	10: 9.7 ↘	

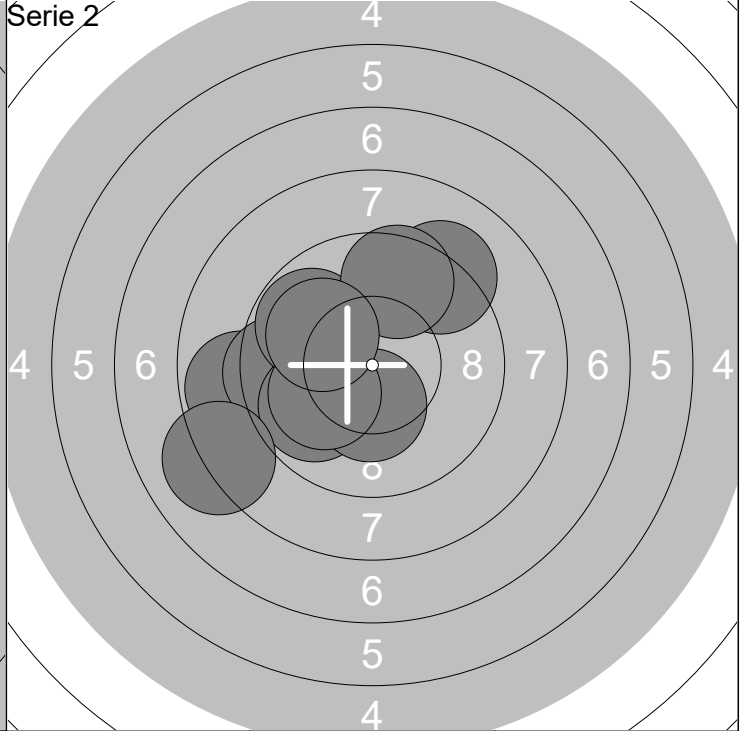
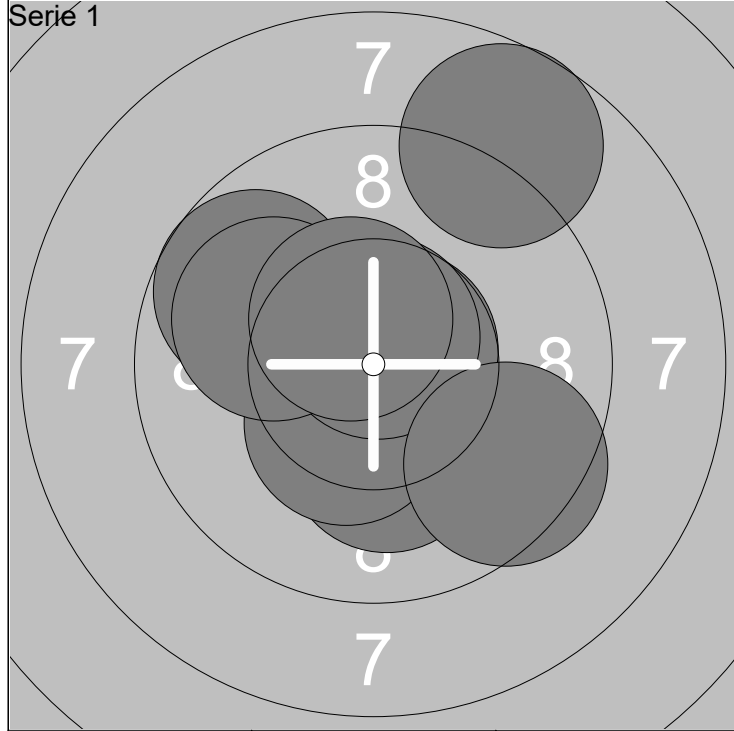

1: 10.7x ↓	6: 10.7x ↑	Serie	96 (6x)
2: 10.2x ↓	7: 9.5 ↘		
3: 10.7x ↗	8: 10.0 ←	Total	96 (6x)
4: 9.7 ↖	9: 8.7 ↗		
5: 10.4x ↓	10: 10.5x ↗		

1: 8.8 ←	6: 8.1 ↙	Serie	91 (1x)
2: 9.4 ←	7: 9.6 ↑		
3: 9.8 ↙	8: 10.3x ↓	Total	187 (7x)
4: 9.8 ↖	9: 10.0 ↙		
5: 9.2 ↗	10: 10.0 ↖		

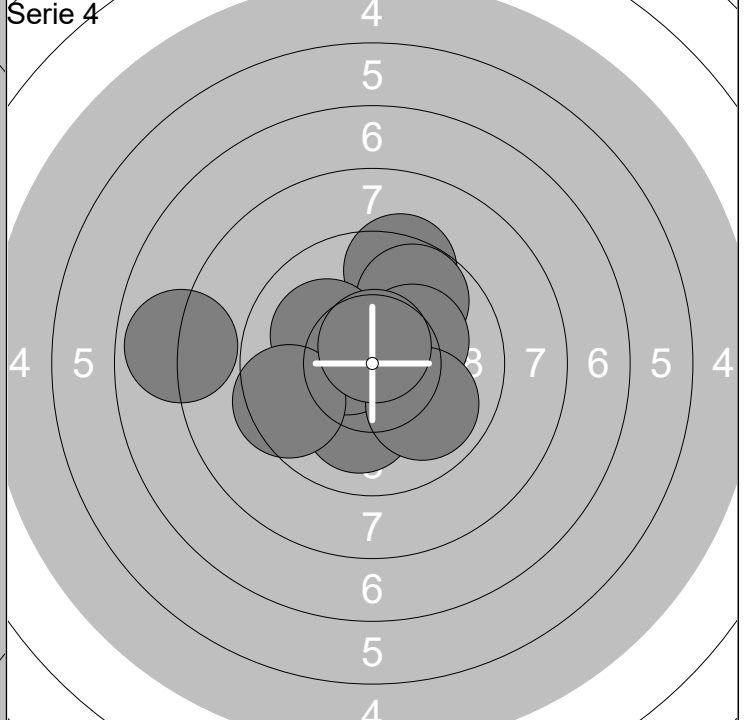
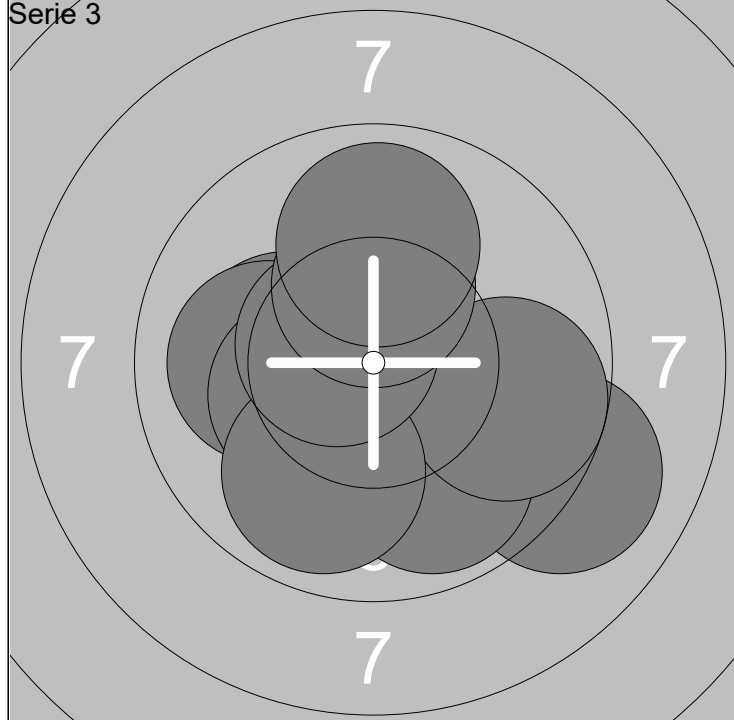

1: 10.2x ←	6: 10.3x ↙	Serie	95 (4x)
2: 9.0 ↘	7: 9.9 ↓		
3: 9.9 ↓	8: 10.6x ↙	Total	282 (11x)
4: 10.0 ←	9: 10.2x ↑		
5: 9.7 ↘	10: 9.9 ↑		

1: 10.0 ↓	6: 10.1 ↖	Serie	93 (3x)
2: 9.4 ↑	7: 7.9 ←		
3: 9.7 ↗	8: 9.9 ↘	Total	375 (14x)
4: 10.2x ↗	9: 9.5 ↙		
5: 10.5x ←	10: 10.7x ↑		

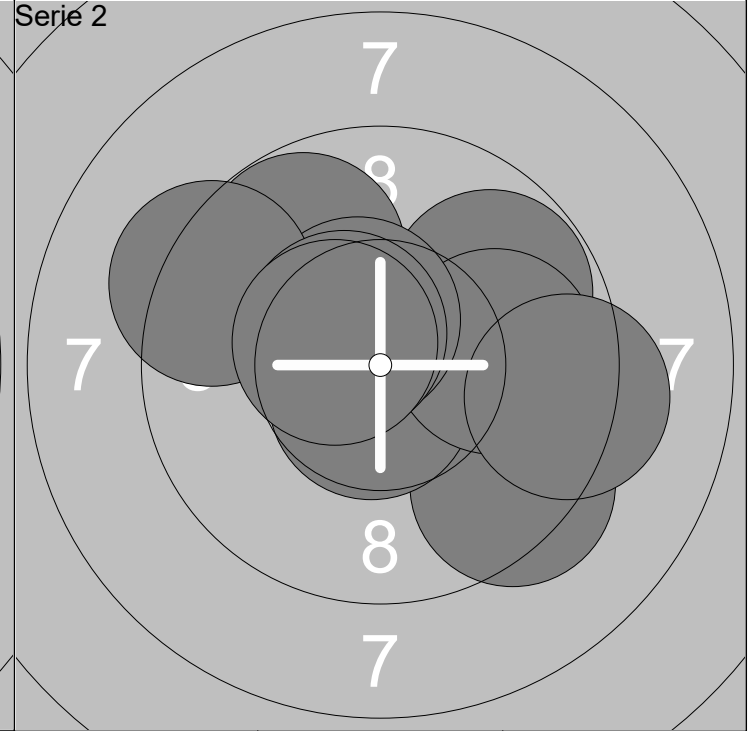
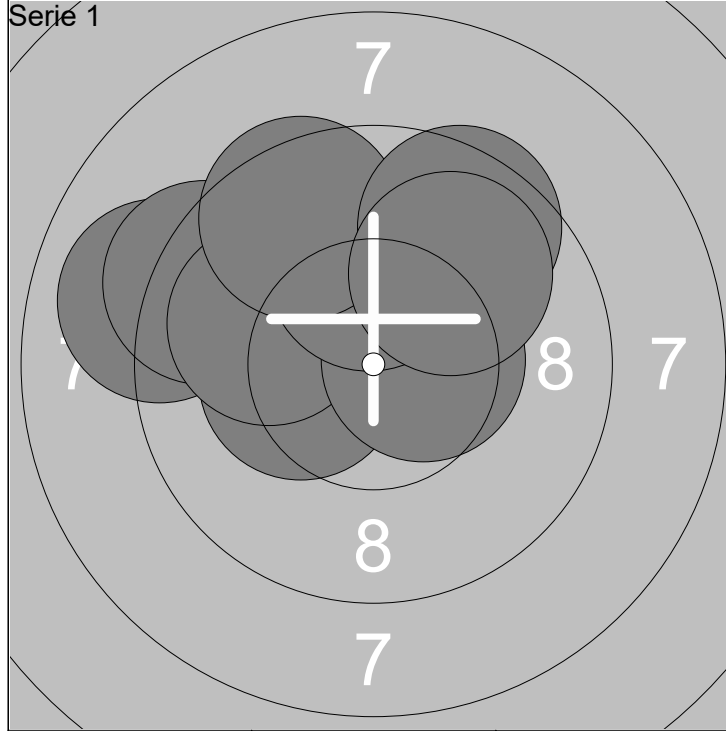

1: 9.0 ↙	6: 10.5x →	Serie	94 (2x)
2: 10.3x ←	7: 10.1 ↑		
3: 9.3 ↙	8: 9.5 ↗	Total	94 (2x)
4: 10.1 ↗	9: 9.5 ↗		
5: 9.9 ↙	10: 9.9 ↗		

1: 9.4 ↘	6: 10.5x ↗	Serie	94 (4x)
2: 9.8 ↗	7: 9.3 →		
3: 10.6x ↓	8: 9.3 ↙	Total	188 (6x)
4: 9.9 →	9: 10.5x ↗		
5: 9.7 ↙	10: 10.5x ↙		

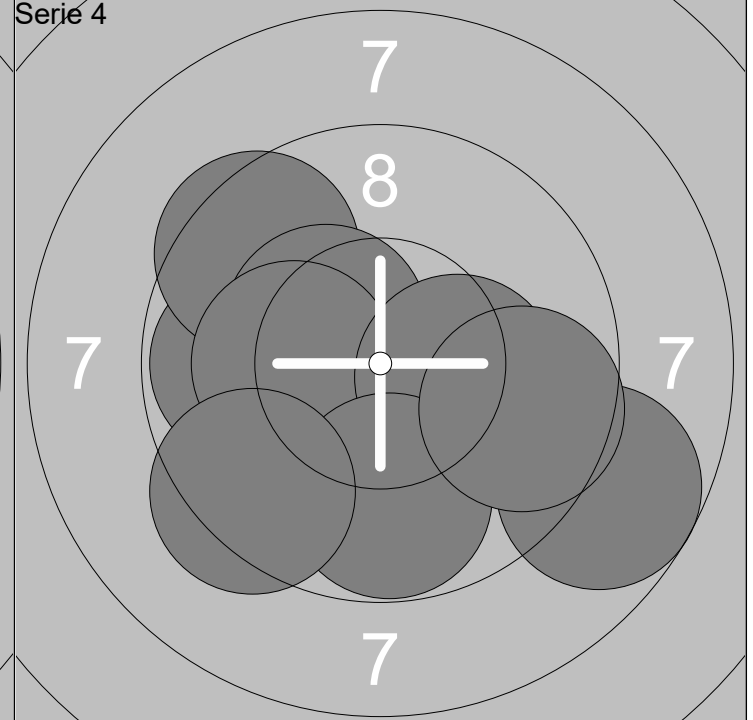
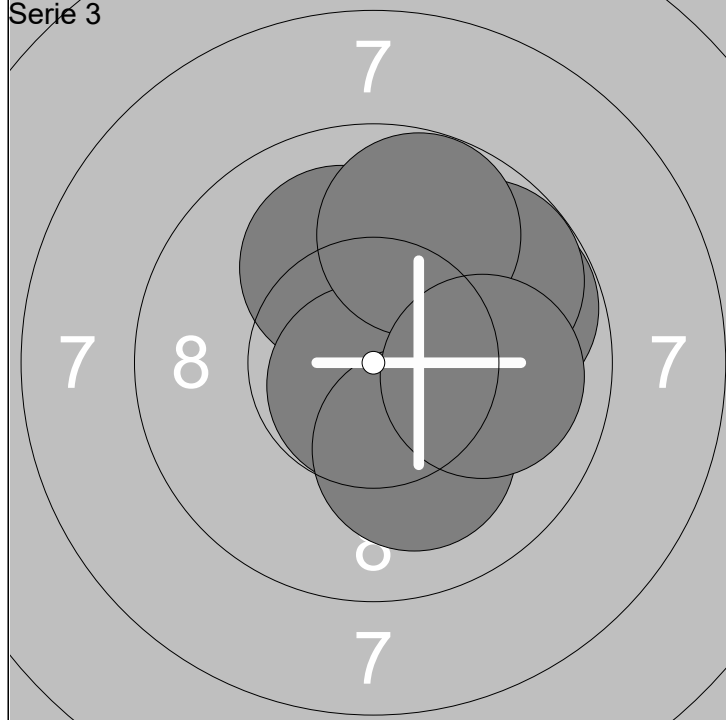

1: 10.7x ↗	6: 10.6x ↓	Serie	97 (4x)
2: 10.5x →	7: 10.7x ↓		
3: 9.7 ↗	8: 10.1 ↓	Total	285 (10x)
4: 9.7 ↗	9: 9.7 ↑		
5: 10.0 ↗	10: 10.0 →		

1: 9.8 ←	6: 10.3x →	Serie	93 (4x)
2: 10.5x ↓	7: 9.8 ↓		
3: 9.5 ↙	8: 9.3 ↙	Total	378 (14x)
4: 10.3x ↙	9: 8.7 ↘		
5: 10.2x ←	10: 9.6 →		

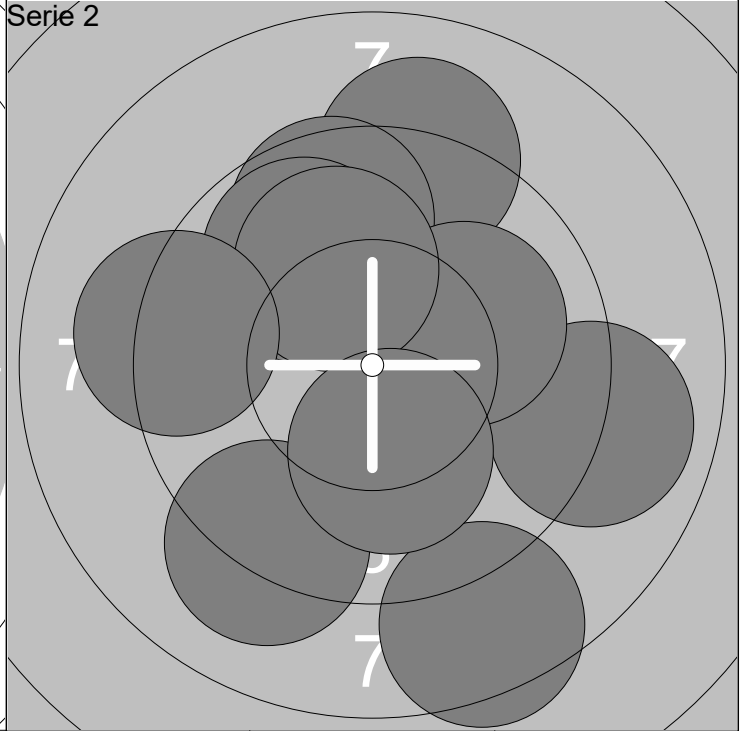
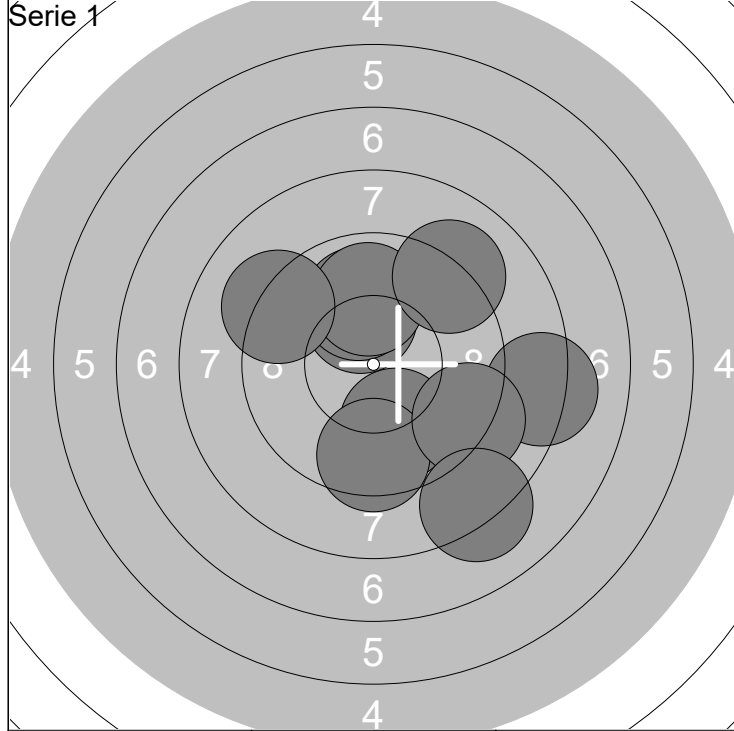

1: 10.1	↑	6: 9.9	↑	Serie	89 (0x)
2: 9.9	↓	7: 9.1	↗		
3: 9.5	↓	8: 9.2	↘	Total	89 (0x)
4: 9.9	↑	9: 9.2	↖		
5: 8.2	→	10: 8.1	↙		

1: 9.1	↑	6: 9.8	↖	Serie	91 (1x)
2: 8.4	↓	7: 10.1	↗		
3: 9.6	↑	8: 10.0	↑	Total	180 (1x)
4: 9.1	↓	9: 10.2x	↓		
5: 8.9	→	10: 9.2	←		

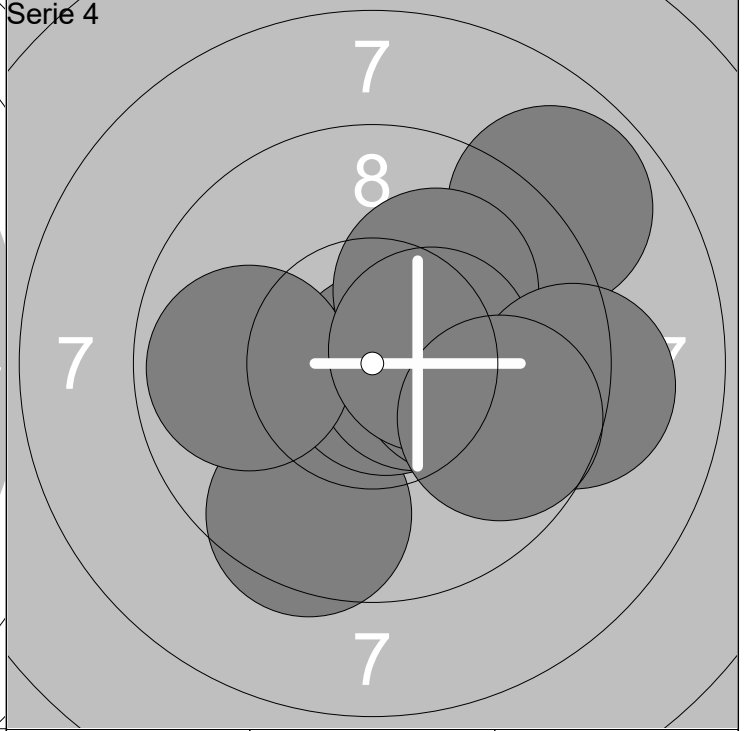
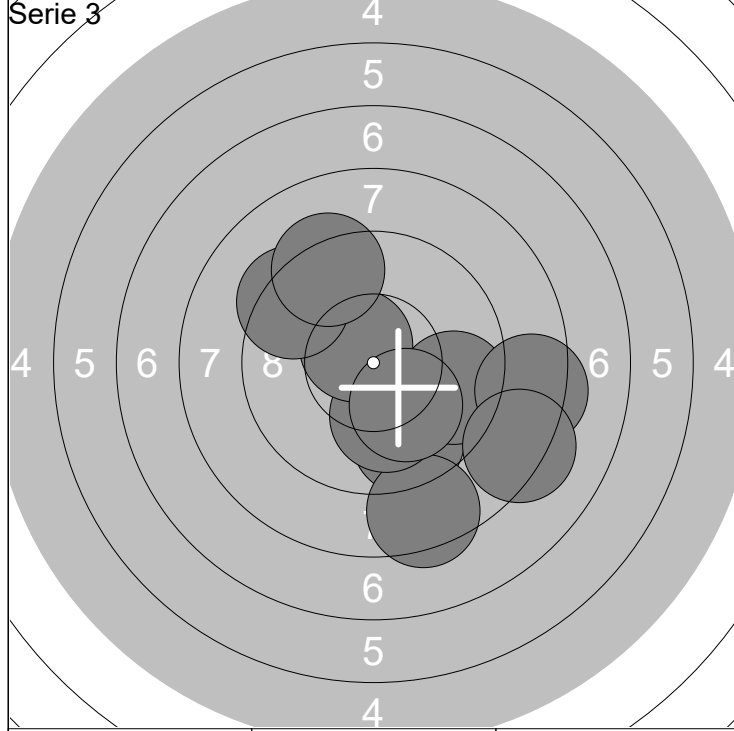

1: 9.6	↓	6: 8.4	→	Serie	90 (1x)
2: 8.4	↓	7: 8.3	↓		
3: 9.6	→	8: 9.3	↗	Total	270 (2x)
4: 10.0	↓	9: 9.3	↖		
5: 10.5x	↖	10: 10.1	↓		

1: 8.9	↗	6: 10.2x	→	Serie	94 (4x)
2: 9.5	↓	7: 10.1	↗		
3: 10.8x	↘	8: 10.4x	→	Total	364 (6x)
4: 10.5x	→	9: 9.1	→		
5: 9.8	←	10: 9.7	↘		

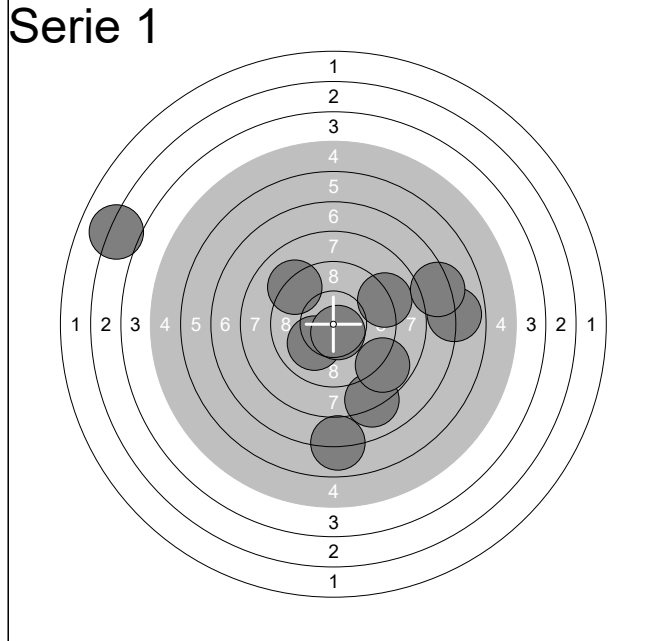

1:	9.0	➔
2:	6.9	➔
3:	10.0	↙
4:	8.1	↘
5:	7.0	↘
6:	3.1	↖
7:	7.3	➔
8:	8.8	↘
9:	9.1	↗
10:	10.6x	↘
Serie		77 (1x)
Total		77 (1x)

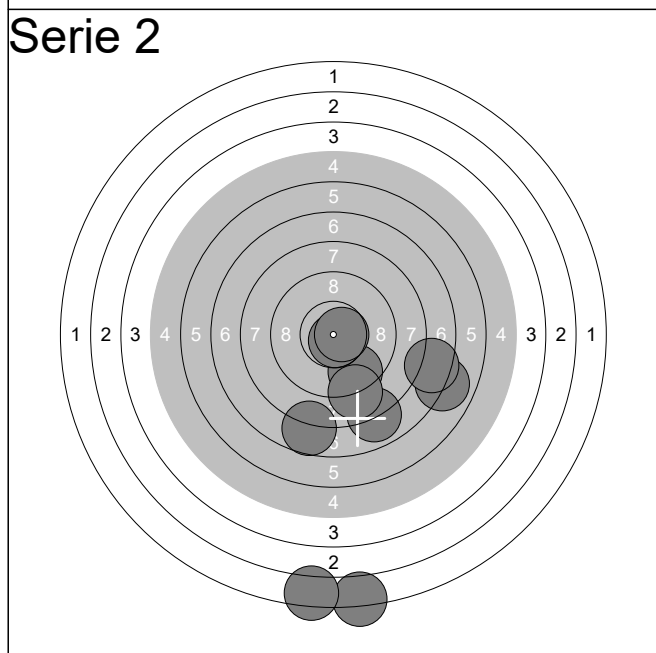

1:	2.0	↘
2:	2.3	↘
3:	9.5	↘
4:	6.9	↘
5:	7.9	↘
6:	8.9	↘
7:	7.7	↘
8:	10.7x	↘
9:	10.6x	➔
10:	7.5	➔
Serie		68 (2x)
Total		145 (3x)



1:	7.8	↘
2:	10.2x	↘
Serie		17 (1x)
Total		162 (4x)

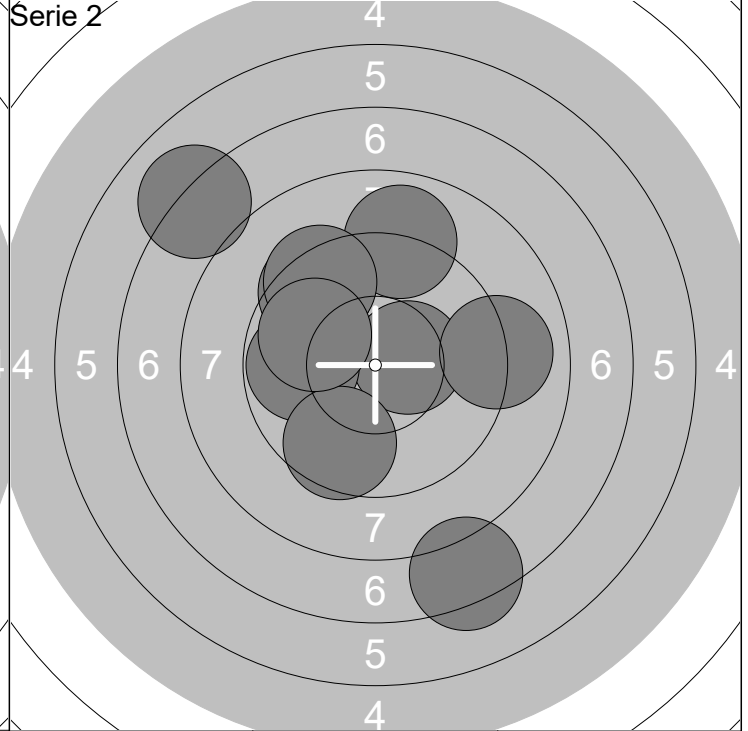
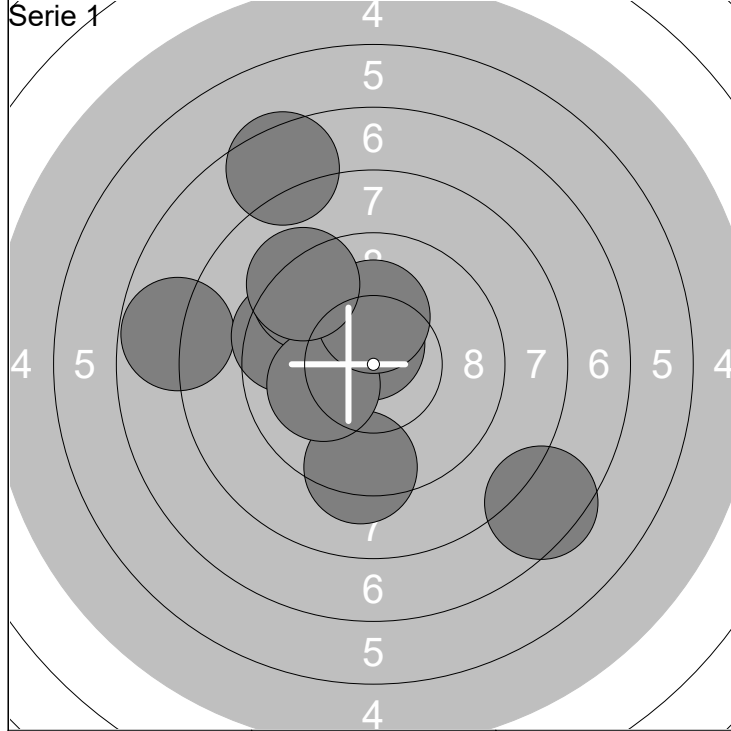

1: 10.6x ↗	6: 9.4 ↘	Serie	87 (2x)
2: 7.8 ←	7: 10.1 ←		
3: 9.5 ←	8: 10.2x ↑	Total	87 (2x)
4: 9.3 ↓	9: 9.2 ↗		
5: 7.5 ↗	10: 7.5 ↘		

1: 8.9 ↑	6: 9.0 →	Serie	86 (1x)
2: 10.4x →	7: 9.3 ↘		
3: 7.3 ↓	8: 9.5 ↓	Total	173 (3x)
4: 9.8 ←	9: 7.0 ↘		
5: 9.4 ↗	10: 9.9 ←		

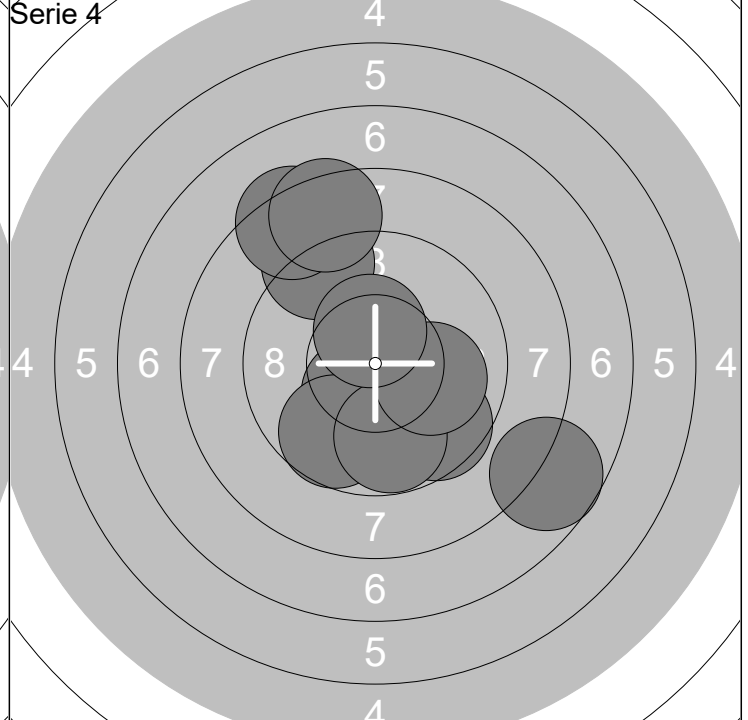
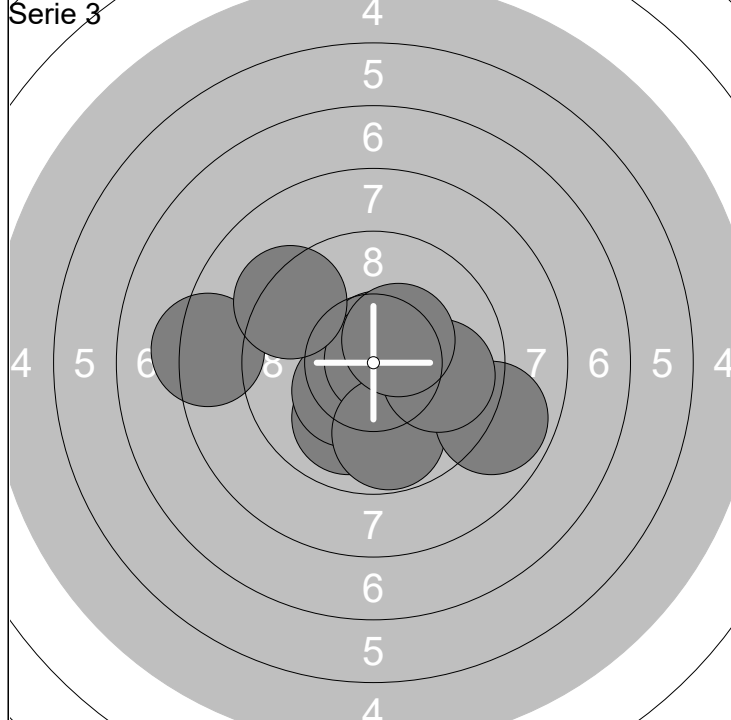

1: 10.7x ↗	6: 8.8 →	Serie	93 (4x)
2: 10.0 ↓	7: 8.3 ←		
3: 10.3x ↘	8: 9.9 →	Total	266 (7x)
4: 10.8x →	9: 9.3 ↘		
5: 9.8 ↓	10: 10.4x ↗		

1: 10.4x ↘	6: 9.1 ↗	Serie	89 (2x)
2: 7.7 →	7: 8.3 ↗		
3: 9.7 ↘	8: 8.4 ↗	Total	355 (9x)
4: 9.6 ↘	9: 10.0 →		
5: 9.8 ↓	10: 10.4x ↑		

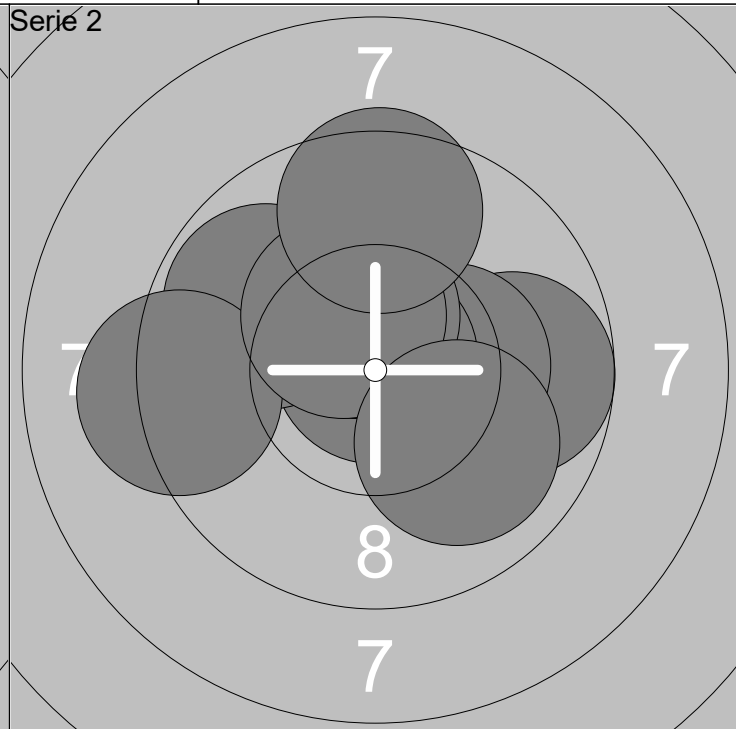
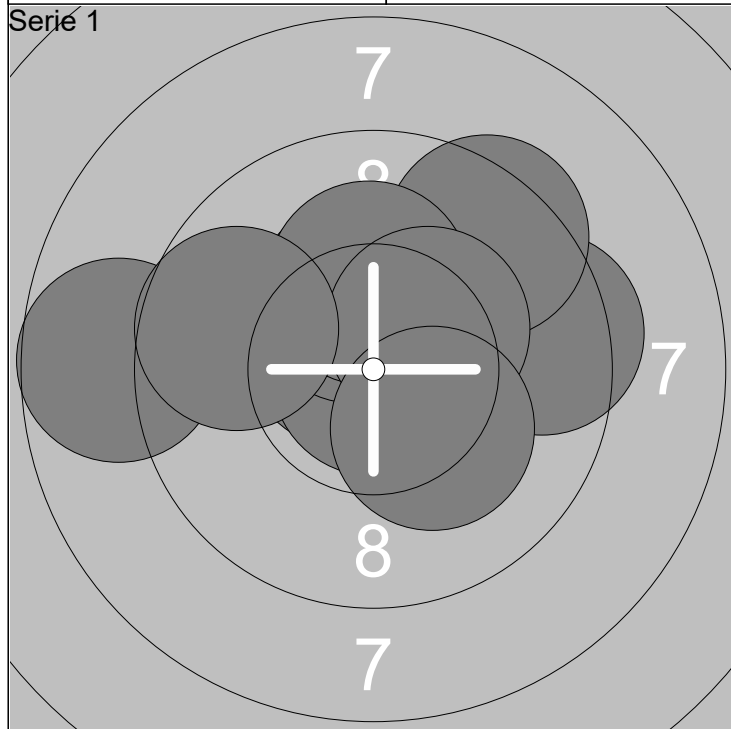

1: 8.7 ←	6: 10.3x ↑	Serie	95 (6x)
2: 9.4 →	7: 10.2x ↑		
3: 10.6x ↖	8: 10.3x ↗	Total	95 (6x)
4: 9.4 ↗	9: 10.2x ↘		
5: 10.9x ↓	10: 9.7 ←		

1: 10.0 →	6: 9.2 ←	Serie	96 (4x)
2: 9.7 →	7: 10.4x ↑		
3: 10.3x →	8: 10.4x ↗	Total	191 (10x)
4: 10.8x ↑	9: 9.5 ↑		
5: 9.8 ↖	10: 10.0 ↘		

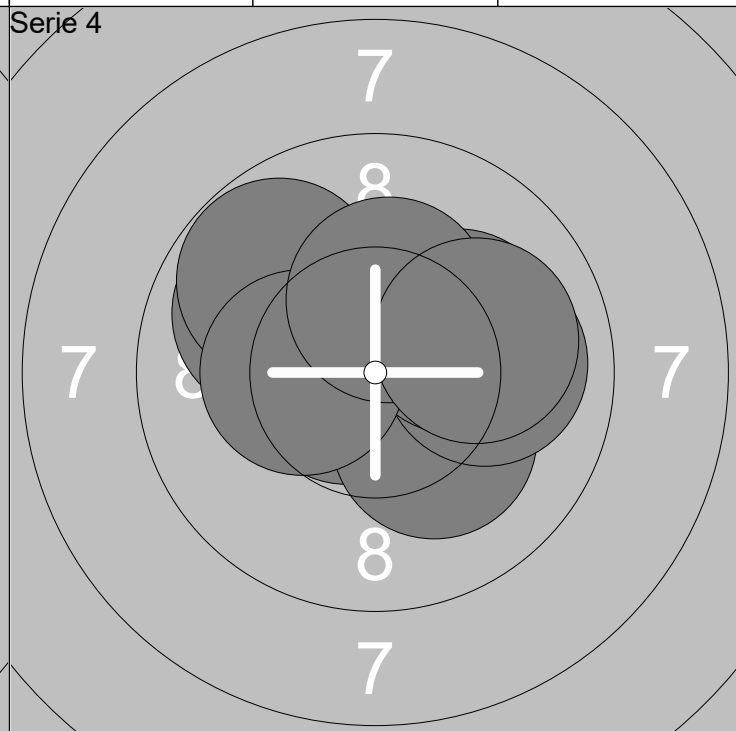
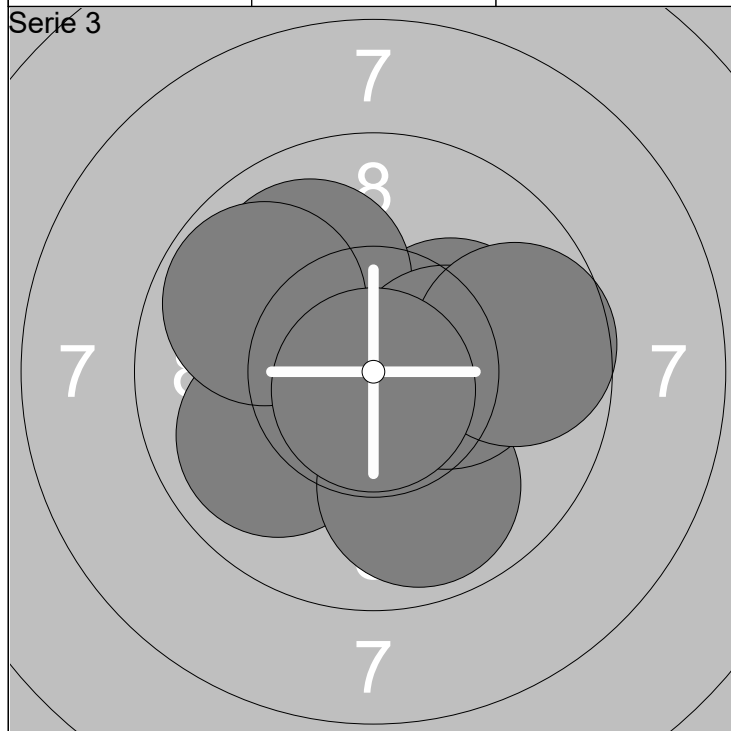

1: 10.7x ↗	6: 9.9 ↖	Serie	95 (5x)
2: 9.9 ↖	7: 9.8 ↖		
3: 9.9 ↓	8: 10.3x →	Total	286 (15x)
4: 10.7x ↗	9: 9.7 →		
5: 10.2x ↗	10: 10.8x ↓		

1: 10.7x ←	6: 9.9 →	Serie	97 (5x)
2: 9.9 ↖	7: 10.1 ↗		
3: 10.4x ↑	8: 10.3x ←	Total	383 (20x)
4: 9.8 ↖	9: 10.3x ↑		
5: 10.2x ↘	10: 10.0 →		

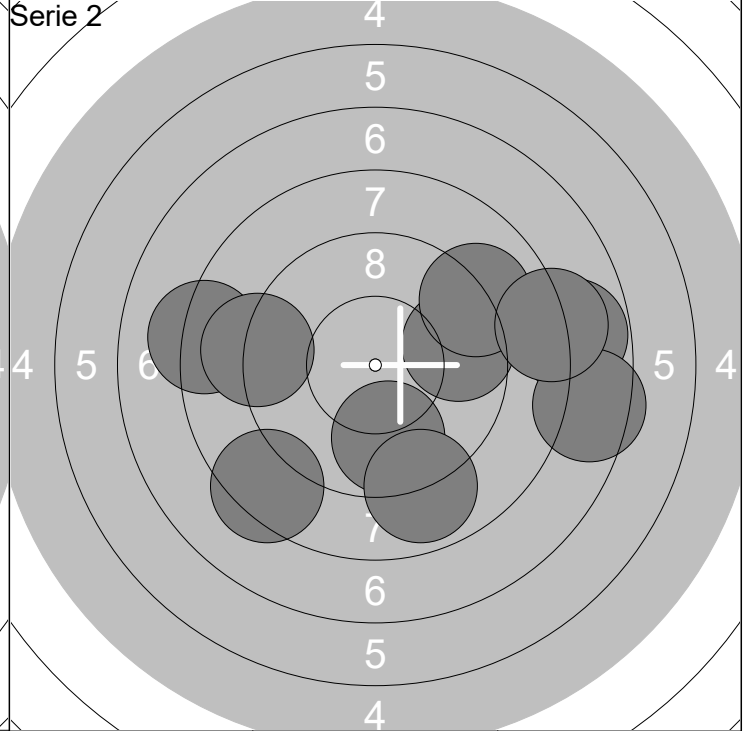
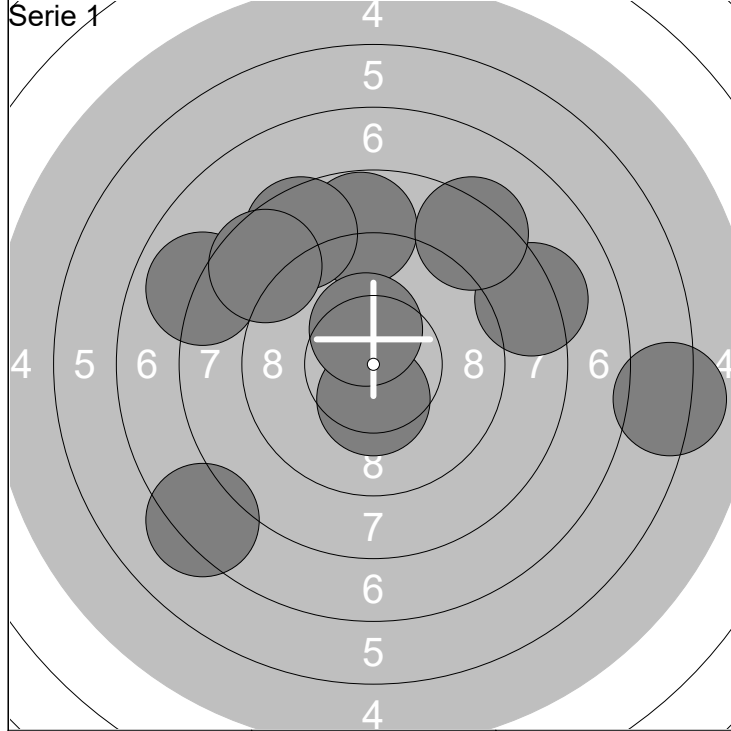

1: 8.8 ↑	6: 7.2 ↙	Serie	80 (2x)
2: 6.2 →	7: 10.4x ↓		
3: 7.9 ↖	8: 10.3x ↑	Total	80 (2x)
4: 8.6 ↗	9: 8.6 ↘		
5: 8.2 →	10: 8.3 ↗		

1: 9.6 →	6: 9.0 ←	Serie	82 (0x)
2: 9.7 ↓	7: 7.8 →		
3: 9.0 ↗	8: 8.4 ↙	Total	162 (2x)
4: 8.2 ←	9: 7.5 →		
5: 8.9 ↓	10: 8.1 →		

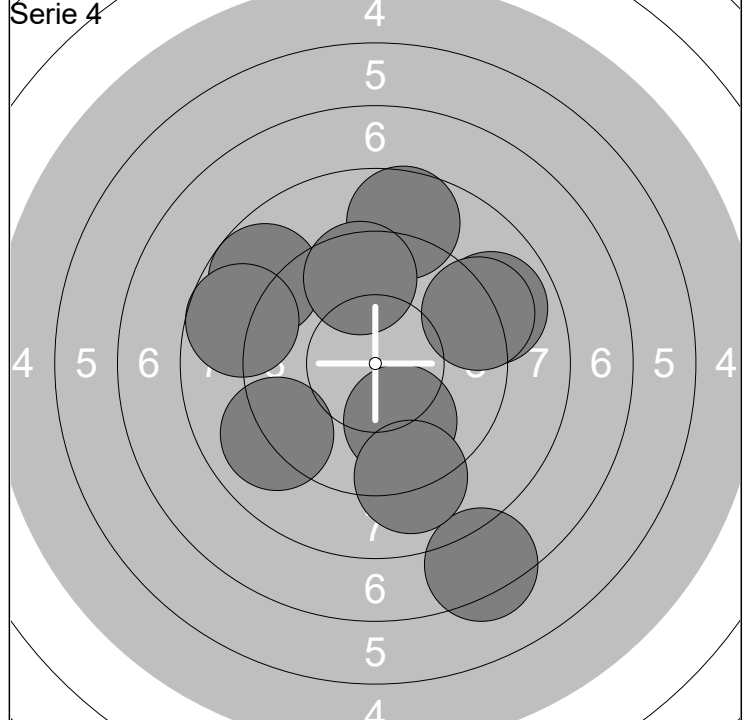
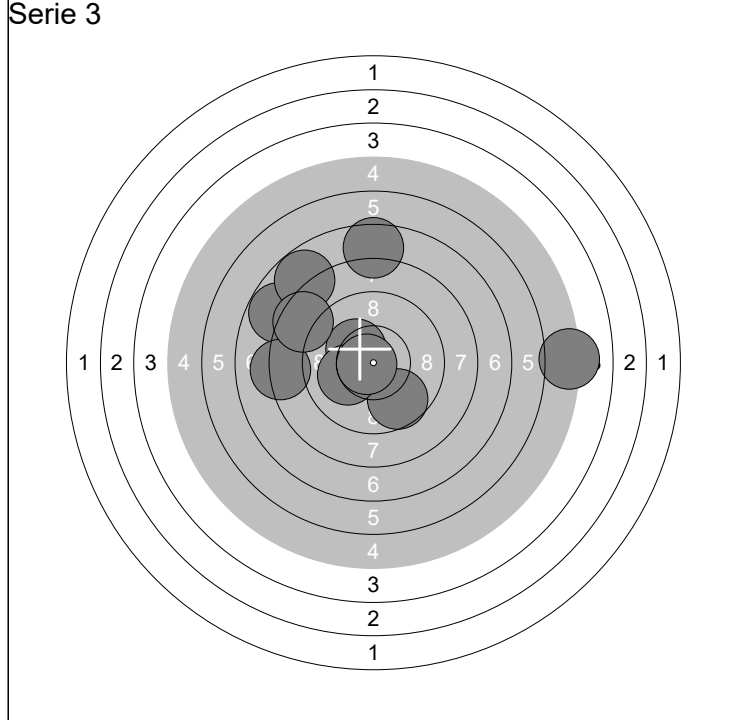

1: 7.8 ↖	6: 9.6 ↙	Serie	81 (2x)
2: 10.3x ↖	7: 10.1 ←		
3: 8.2 ←	8: 7.8 ↗	Total	243 (4x)
4: 5.1 →	9: 10.7x ←		
5: 7.5 ↑	10: 8.5 ↖		

1: 8.7 ↖	6: 8.9 ↗	Serie	84 (0x)
2: 8.7 ↖	7: 9.1 ↗		
3: 8.6 ↑	8: 9.0 ↓	Total	327 (4x)
4: 7.3 ↓	9: 9.0 ↙		
5: 9.9 ↓	10: 9.6 ↑		

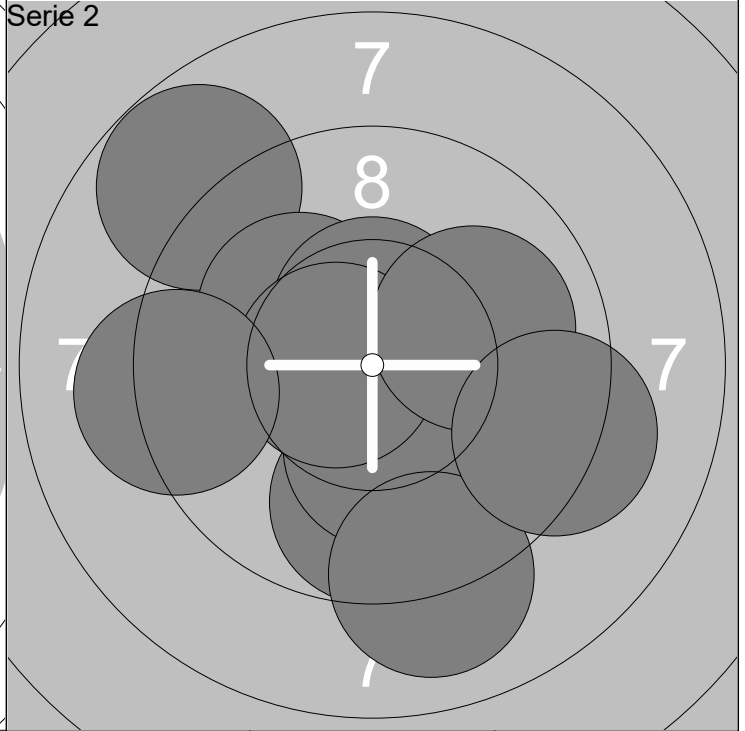
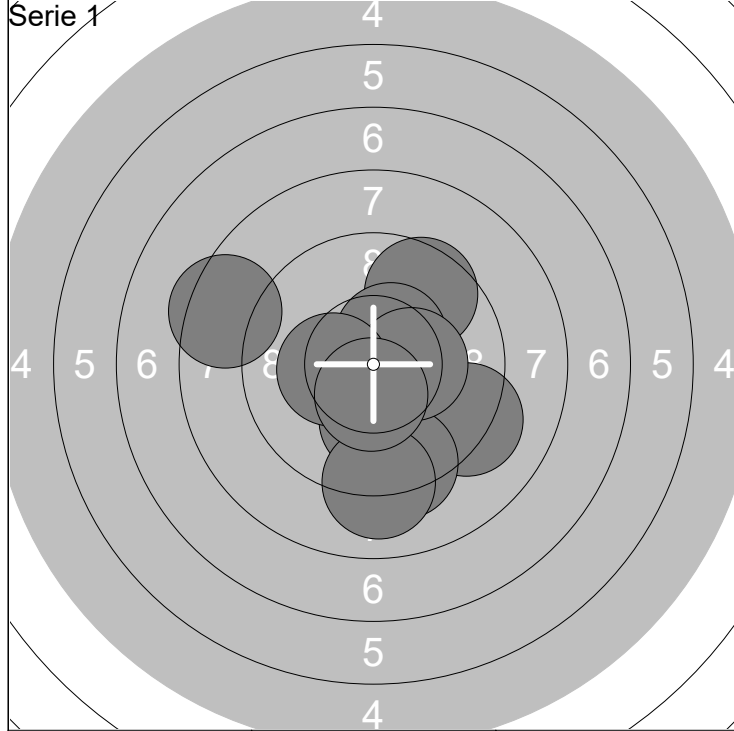

1: 10.0 ↓	6: 10.4x ↗	Serie	94 (4x)
2: 8.4 ←	7: 10.3x →		
3: 9.2 ↘	8: 10.3x ←	Total	94 (4x)
4: 9.3 ↓	9: 9.0 ↓		
5: 9.6 ↗	10: 10.4x ↓		

1: 8.8 ↖	6: 10.6x ←	Serie	94 (3x)
2: 10.1 ↖	7: 9.0 ↓		
3: 9.7 ↓	8: 9.2 ←	Total	188 (7x)
4: 10.2x ↓	9: 10.0 →		
5: 10.5x ↑	10: 9.2 ↘		

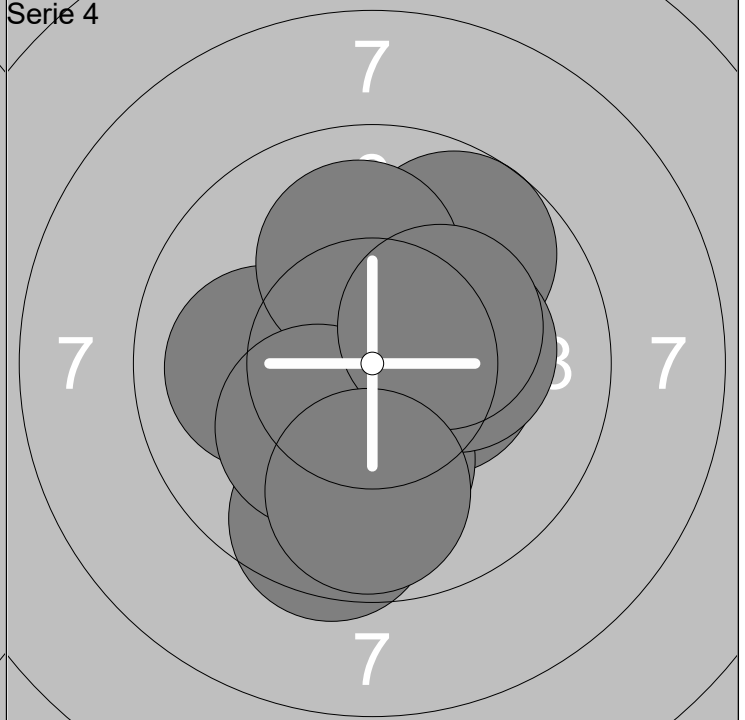
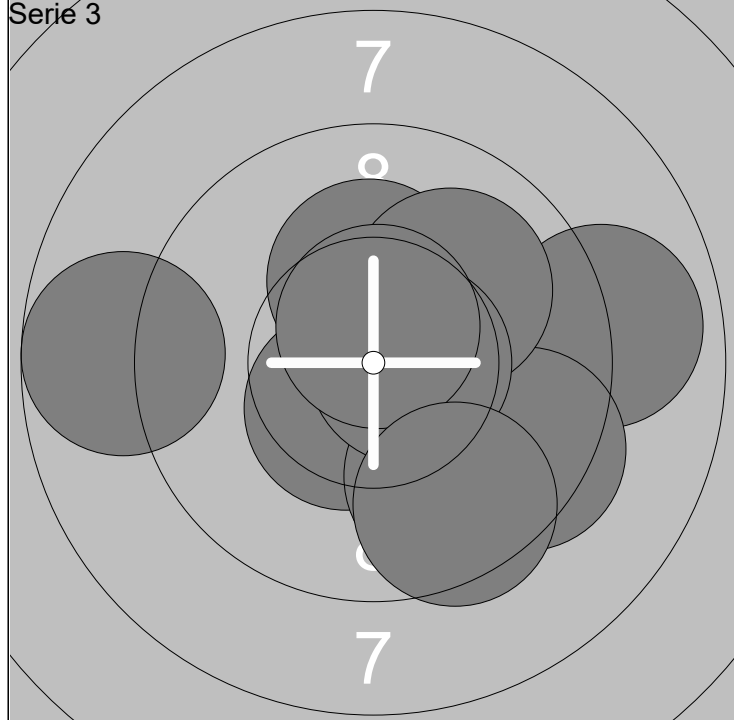

1: 10.5x ↘	6: 10.0 ↗	Serie	93 (4x)
2: 8.9 →	7: 10.6x →		
3: 10.2x ↑	8: 8.7 ←	Total	281 (11x)
4: 9.8 ↓	9: 10.6x ↑		
5: 9.4 ↘	10: 9.5 ↓		

1: 9.5 ↓	6: 10.0 ←	Serie	97 (4x)
2: 10.3x →	7: 10.1 ↑		
3: 9.7 ↗	8: 10.2x ↘	Total	378 (15x)
4: 10.1 ↓	9: 10.2x ↗		
5: 10.2x →	10: 9.8 ↓		

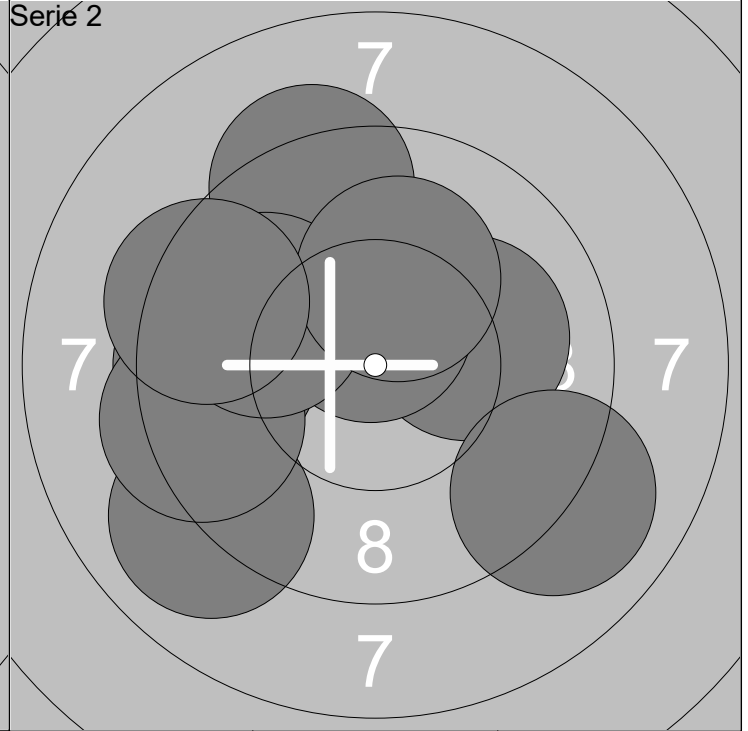
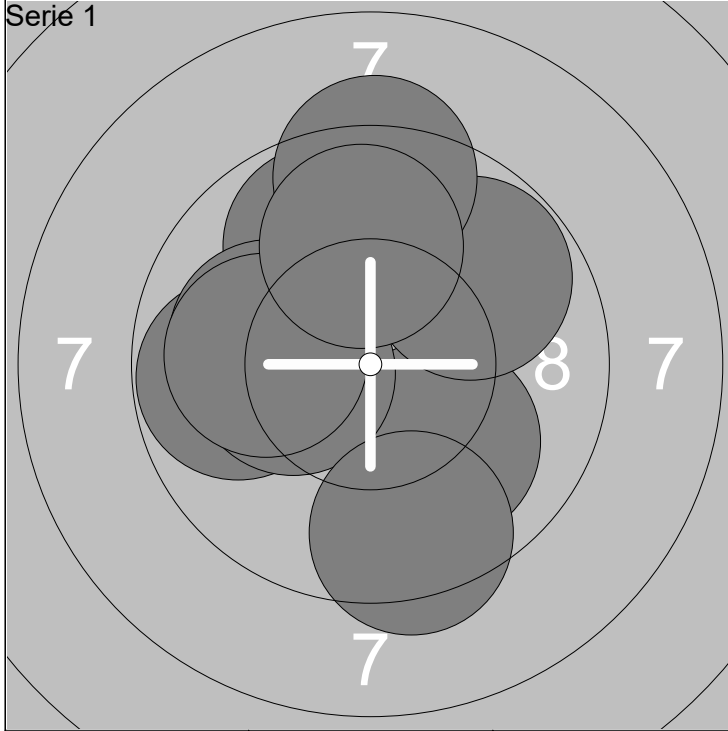

1: 10.0 ↘	6: 10.0 ←	Serie	94 (1x)
2: 9.8 ↗	7: 9.3 ↑		
3: 9.8 ←	8: 10.0 ←	Total	94 (1x)
4: 10.2x ←	9: 9.9 ↑		
5: 9.8 ↗	10: 9.4 ↓		

1: 9.0 ↙	6: 9.3 ←	Serie	93 (2x)
2: 9.3 ↗	7: 9.9 ↙		
3: 10.1 →	8: 10.2x ↑	Total	187 (3x)
4: 9.5 ←	9: 9.4 ↙		
5: 10.5x ↑	10: 9.0 ↘		

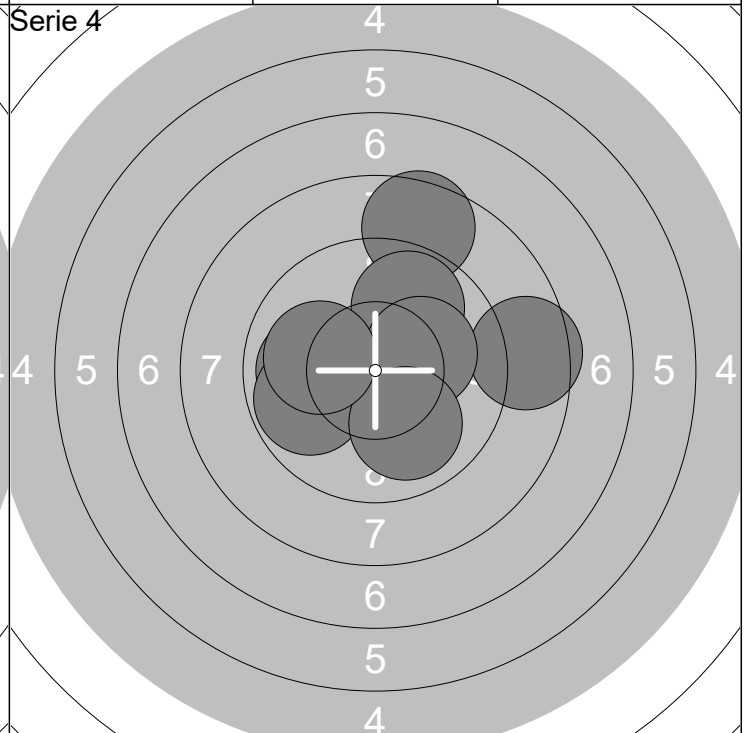
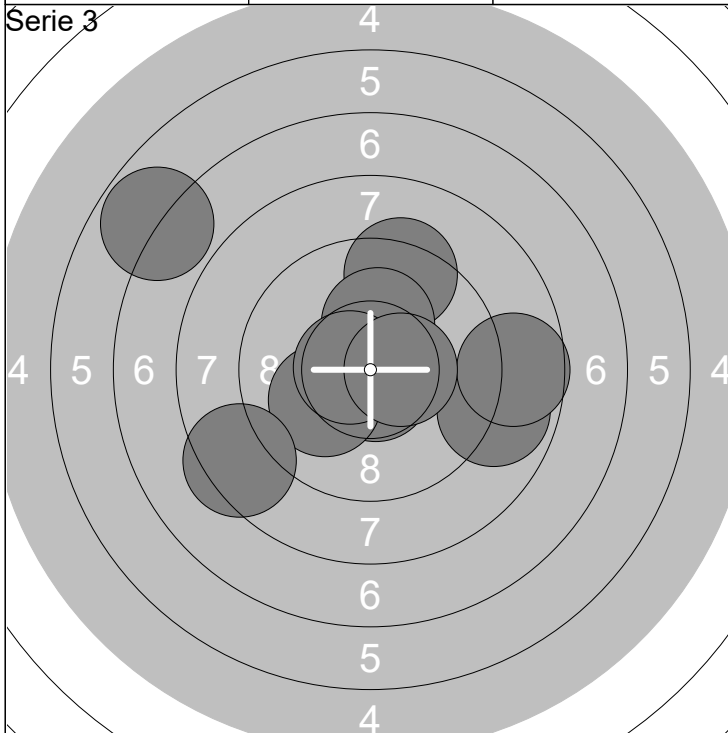

1: 9.3 ↑	6: 10.2x ↑	Serie	89 (4x)
2: 6.8 ↙	7: 10.0 ↙		
3: 8.9 →	8: 8.4 ↙	Total	276 (7x)
4: 10.7x ↓	9: 10.6x ←		
5: 8.7 →	10: 10.5x →		

1: 10.8x ↘	6: 9.8 ↑	Serie	93 (2x)
2: 8.6 ↑	7: 10.1 →		
3: 10.4x →	8: 9.8 ↙	Total	369 (9x)
4: 9.9 ←	9: 10.0 ↓		
5: 8.5 →	10: 10.0 ↙		

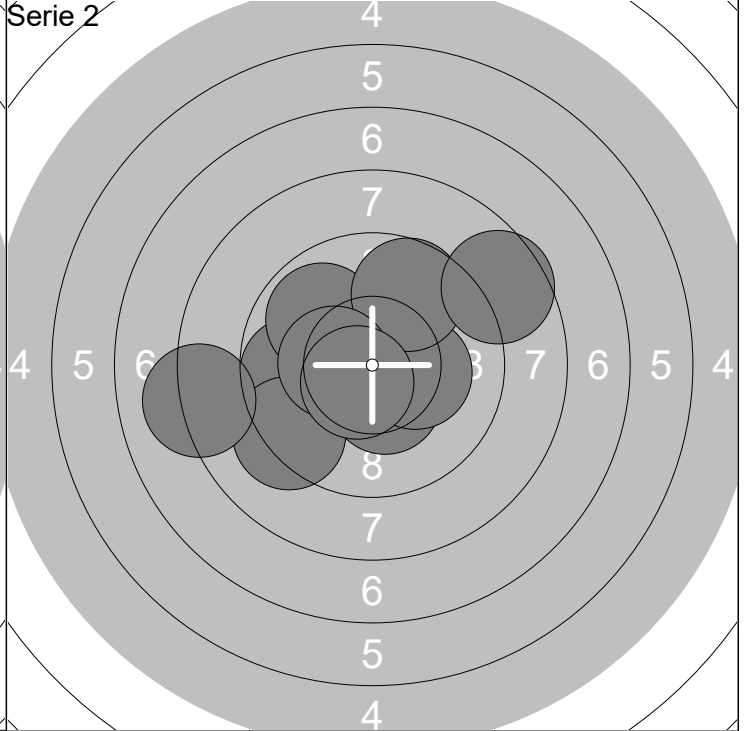
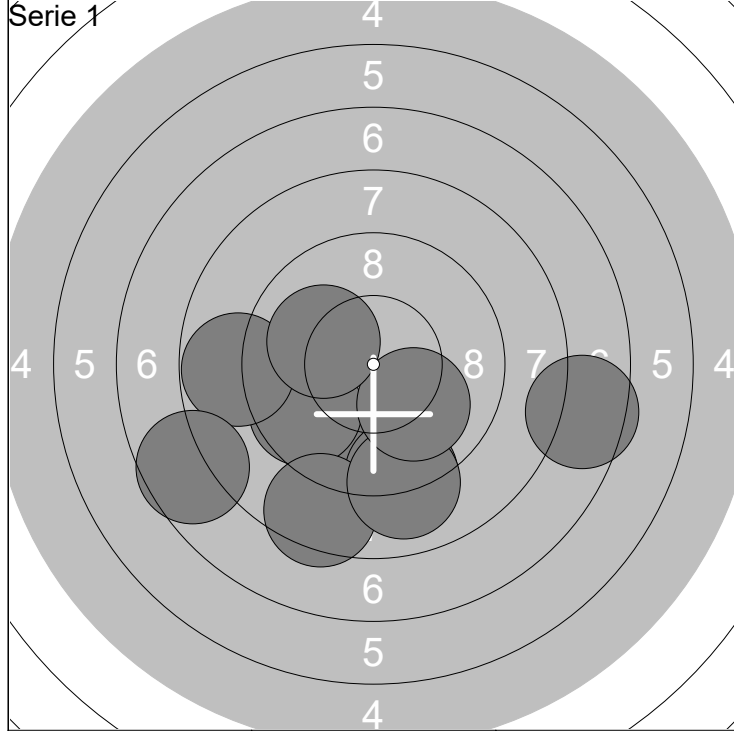

1: 9.6 ↓	6: 8.8 ←	Serie	86 (0x)
2: 7.5 →	7: 9.0 ↓		
3: 9.1 ↓	8: 10.0 ↓	Total	86 (0x)
4: 9.6 ←	9: 7.6 ←		
5: 8.5 ↓	10: 10.1 ←		

1: 9.7 ←	6: 9.7 ↗	Serie	92 (4x)
2: 9.2 ↙	7: 8.1 ←		
3: 10.4x ↓	8: 10.3x ←	Total	178 (4x)
4: 10.3x →	9: 8.6 ↗		
5: 9.8 ↖	10: 10.5x ↓		

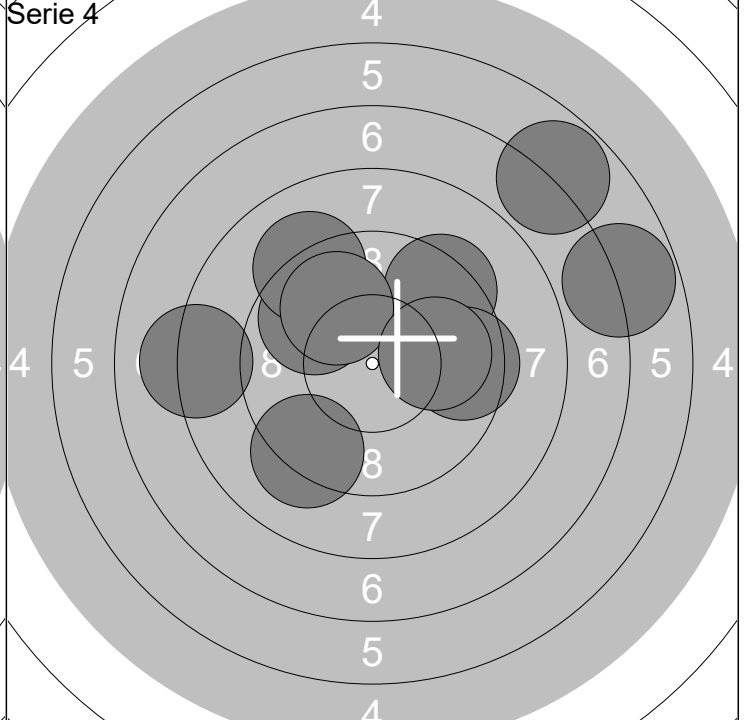
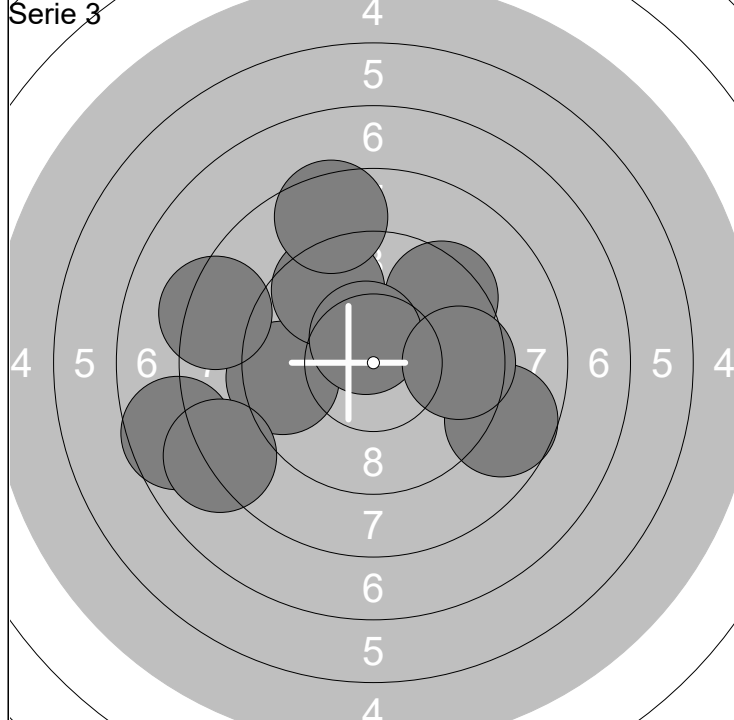

1: 9.4 ↗	6: 8.7 →	Serie	85 (1x)
2: 9.5 ←	7: 10.5x ↗		
3: 7.6 ←	8: 9.6 →	Total	263 (5x)
4: 8.1 ←	9: 8.5 ↗		
5: 9.6 ↖	10: 8.3 ←		

1: 9.7 ↖	6: 9.9 ↖	Serie	83 (0x)
2: 6.8 ↗	7: 9.5 →		
3: 9.1 ↖	8: 9.2 ↓	Total	346 (5x)
4: 9.3 ↗	9: 9.9 →		
5: 6.8 →	10: 8.1 ←		

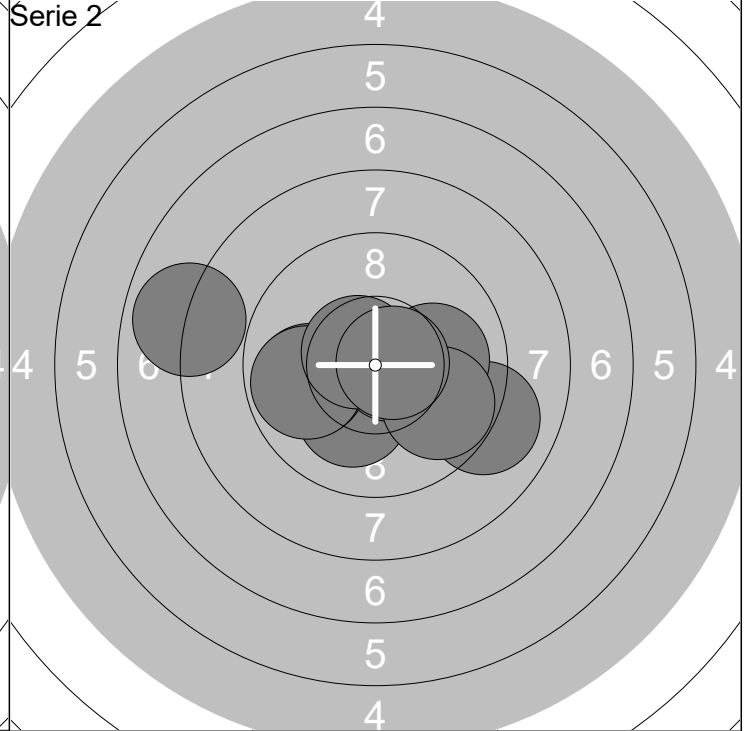
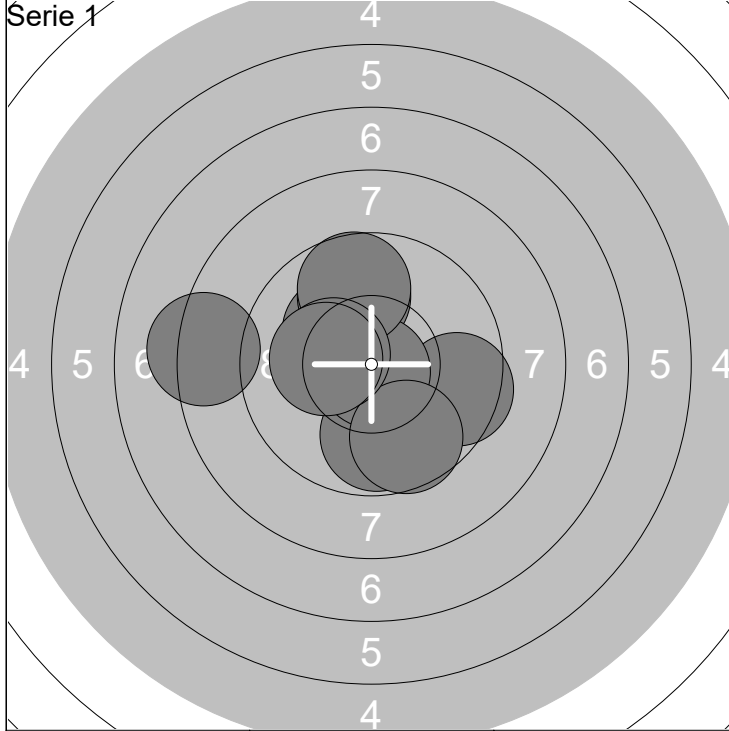

1: 10.2x ↖	6: 9.6 ↓	Serie 93 (4x)
2: 9.5 →	7: 8.2 ←	
3: 9.8 ↑	8: 9.7 ↑	Total 93 (4x)
4: 9.8 ↓	9: 10.3x ←	
5: 10.8x ↓	10: 10.2x ←	

1: 9.0 →	6: 10.7x →	Serie 93 (3x)
2: 10.1 ↓	7: 7.9 ←	
3: 9.9 ←	8: 9.8 ↓	Total 186 (7x)
4: 9.8 ←	9: 10.6x ↖	
5: 10.0 →	10: 10.7x →	

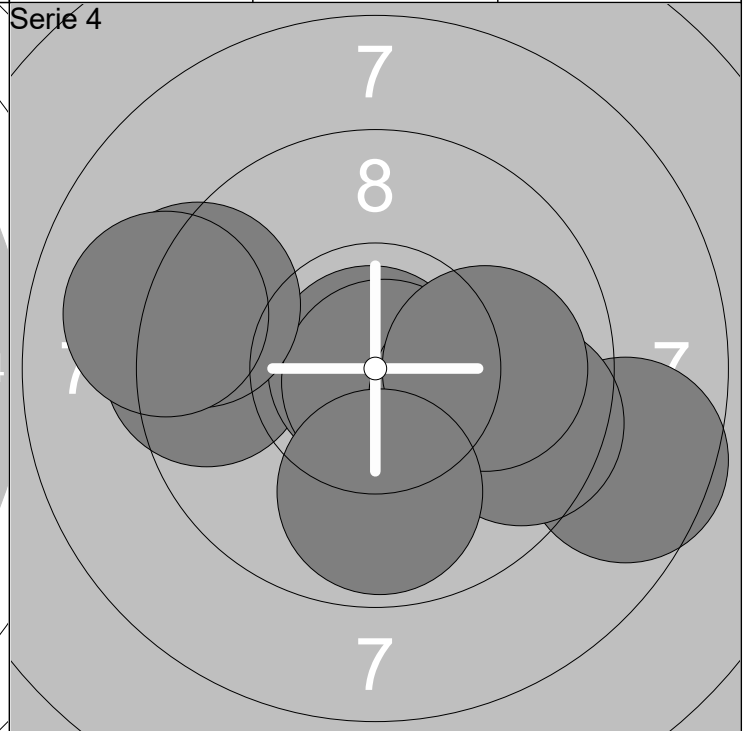
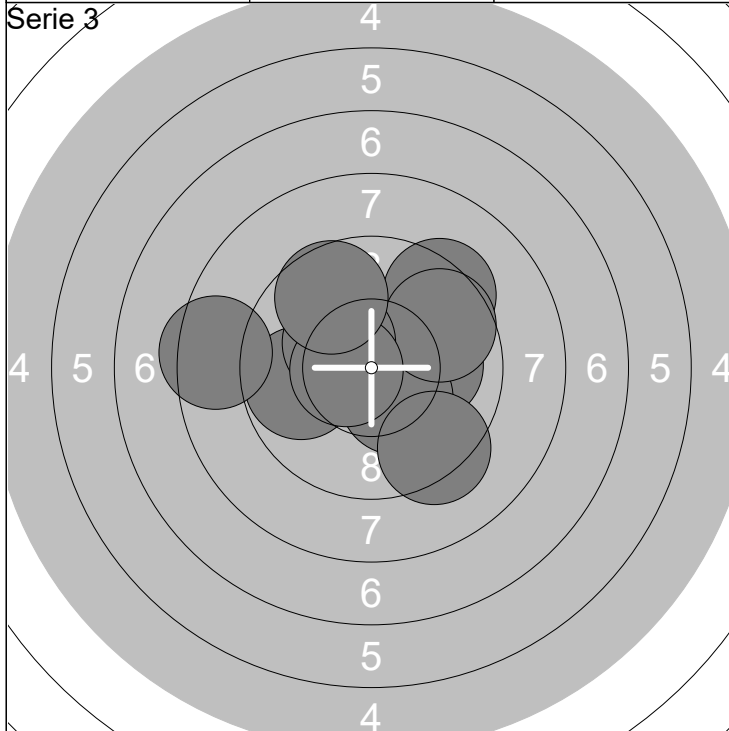

1: 9.8 ←	6: 10.3x ↖	Serie 93 (3x)
2: 9.4 ↗	7: 8.4 ←	
3: 10.1 →	8: 10.5x ←	Total 279 (10x)
4: 10.3x ↓	9: 9.3 ↓	
5: 9.6 ↗	10: 9.6 ↗	

1: 9.5 ←	6: 8.6 →	Serie 93 (2x)
2: 10.9x ←	7: 9.6 →	
3: 10.8x ↓	8: 9.0 ←	Total 372 (12x)
4: 9.3 ←	9: 10.0 →	
5: 10.0 →	10: 9.9 ↓	

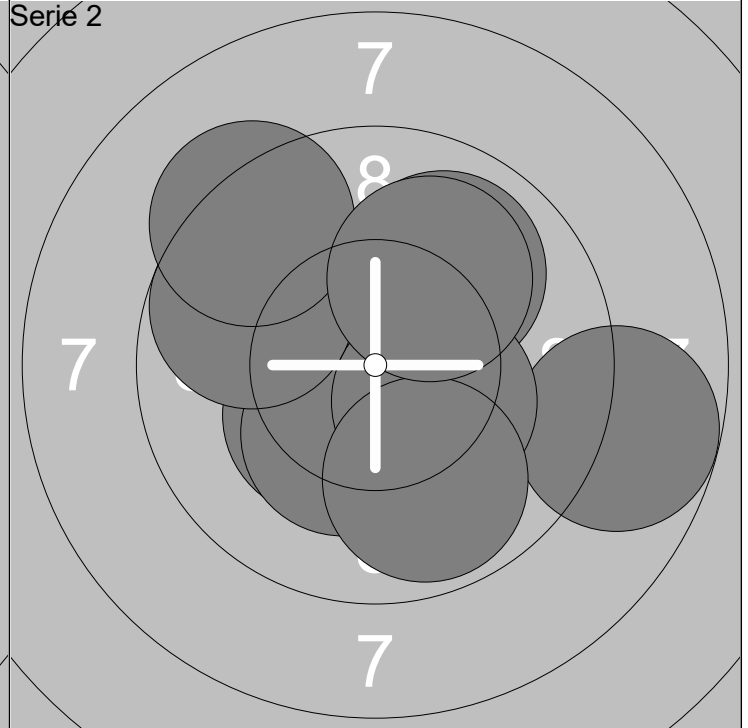
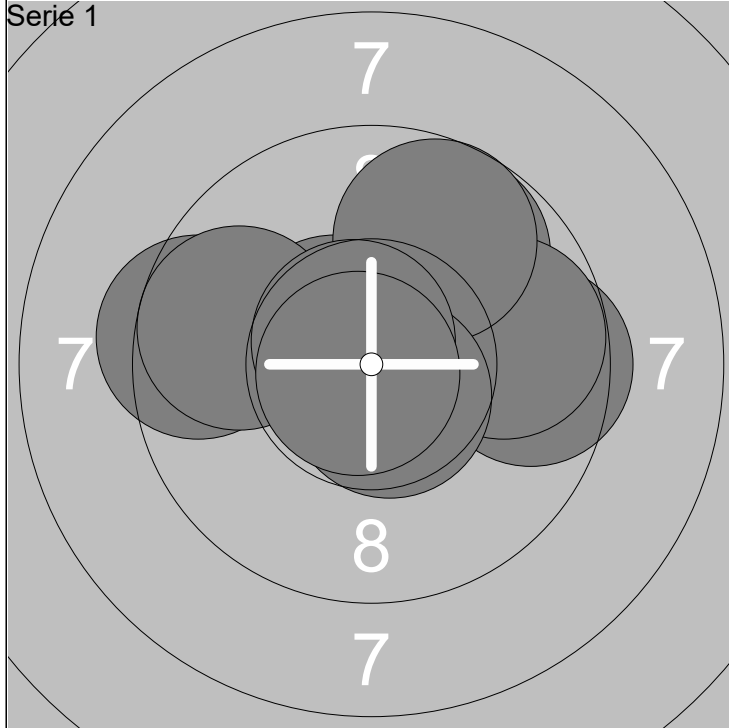

1: 9.7 ↗	6: 9.7 ↗	Serie	94 (4x)
2: 9.5 →	7: 10.6x ↓		
3: 9.8 →	8: 9.7 ←	Total	94 (4x)
4: 9.4 ←	9: 10.7x ↗		
5: 10.5x ↖	10: 10.8x ↙		

1: 10.3x ↙	6: 9.3 ↗	Serie	94 (4x)
2: 10.4x ↓	7: 9.9 ↗		
3: 10.3x ↓	8: 10.3x ↘	Total	188 (8x)
4: 8.7 →	9: 9.8 ↓		
5: 9.7 ←	10: 10.0 ↗		

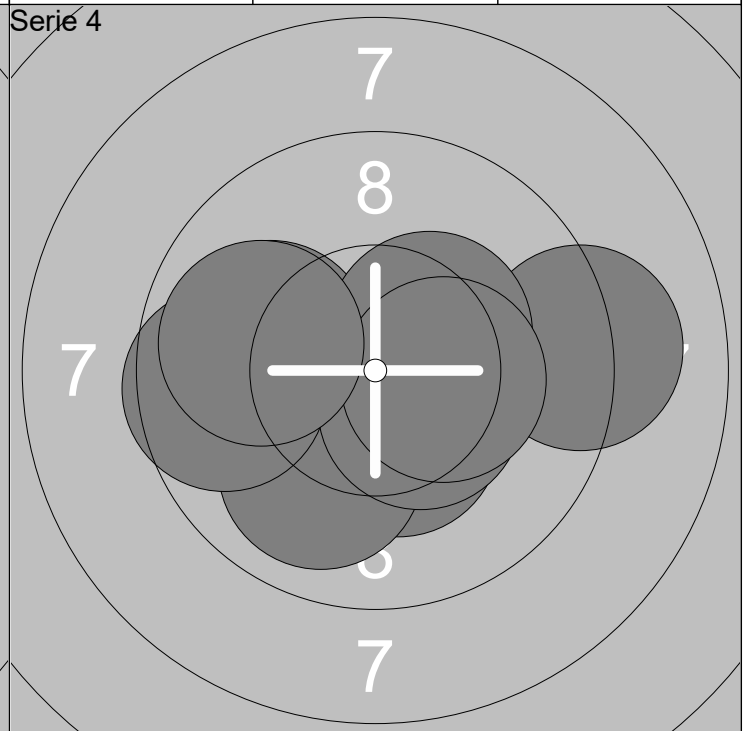
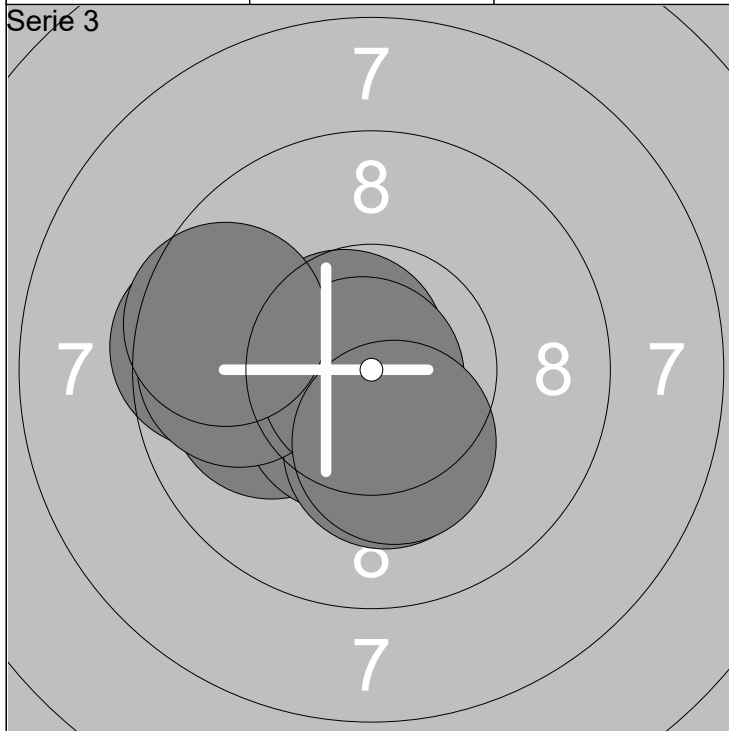

1: 10.6x ←	6: 10.3x ↓	Serie	97 (6x)
2: 10.0 ←	7: 9.8 ←		
3: 9.5 ←	8: 10.8x ↙	Total	285 (14x)
4: 10.5x ↙	9: 9.6 ←		
5: 10.6x ↖	10: 10.3x ↓		

1: 10.3x ↓	6: 10.4x ↘	Serie	96 (5x)
2: 9.1 →	7: 10.3x ↗		
3: 10.8x →	8: 10.3x →	Total	381 (19x)
4: 10.0 ←	9: 9.6 ←		
5: 9.9 ↙	10: 9.9 ←		

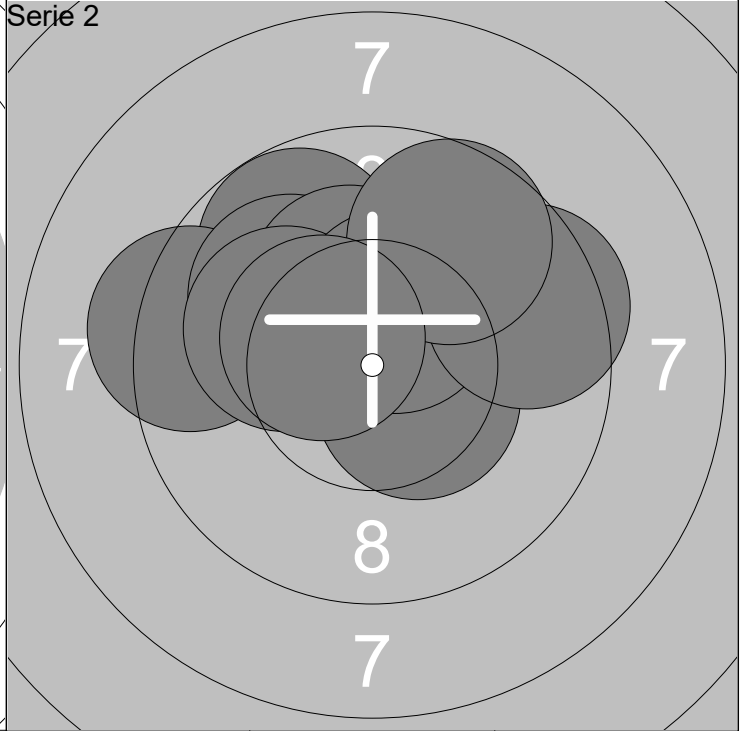
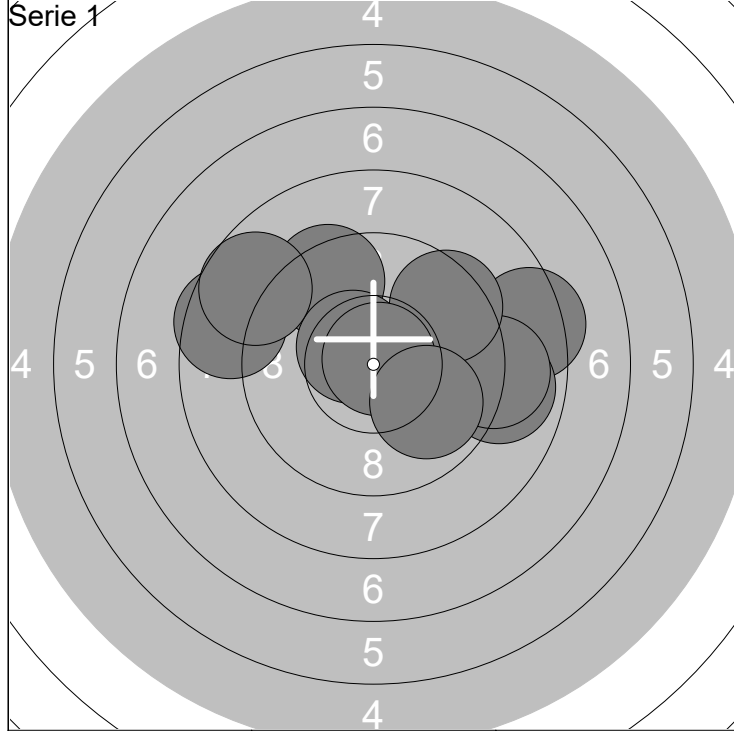

1: 8.4 →	6: 10.5x ↖	Serie	88 (2x)
2: 8.9 →	7: 8.5 ←		
3: 9.0 →	8: 10.8x ↗	Total	88 (2x)
4: 9.4 ↗	9: 9.9 ↘		
5: 9.4 ↖	10: 8.7 ↖		

1: 9.7 ↖	6: 10.1 ↖	Serie	96 (4x)
2: 9.3 ←	7: 10.4x ↗		
3: 10.0 ↖	8: 9.5 →	Total	184 (6x)
4: 10.4x ↘	9: 9.6 ↗		
5: 10.2x ↖	10: 10.4x ↖		

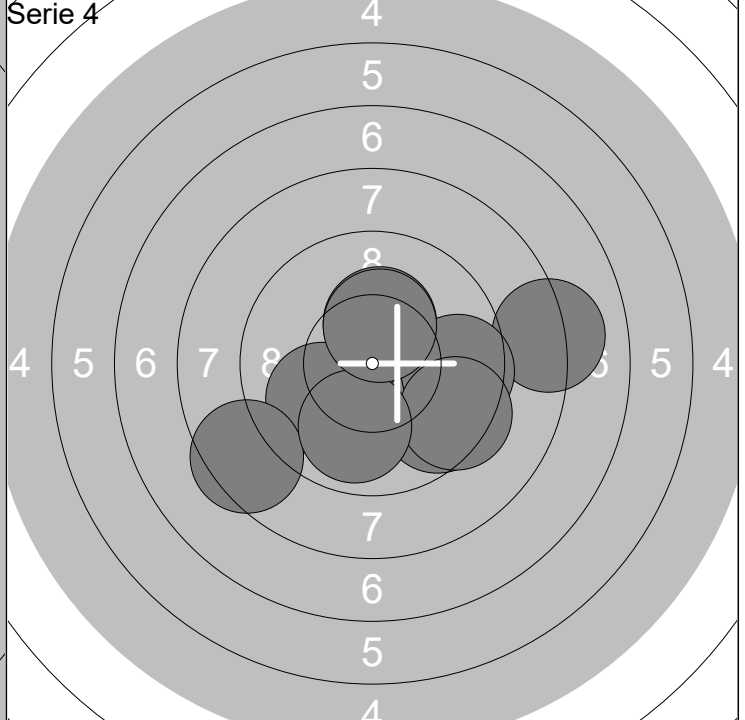
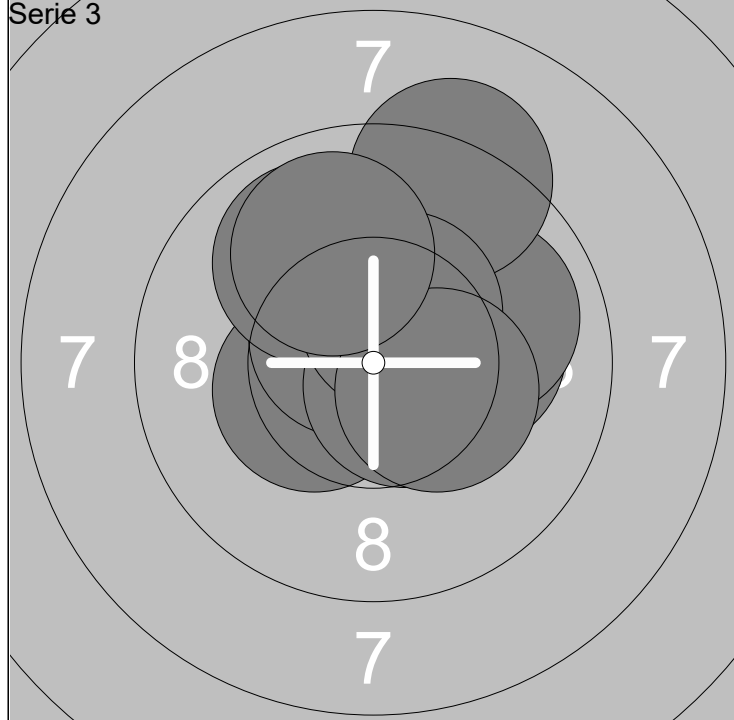

1: 10.3x ↖	6: 9.9 →	Serie	96 (5x)
2: 10.6x ↖	7: 9.2 ↗		
3: 10.6x ↘	8: 10.4x ↗	Total	280 (11x)
4: 10.1 →	9: 10.3x →		
5: 9.9 ↖	10: 9.9 ↖		

1: 9.6 →	6: 9.6 →	Serie	90 (2x)
2: 10.3x ↗	7: 9.4 ↘		
3: 9.9 ↖	8: 8.4 ↖	Total	370 (13x)
4: 8.1 →	9: 9.9 ↘		
5: 9.6 ↘	10: 10.3x ↗		

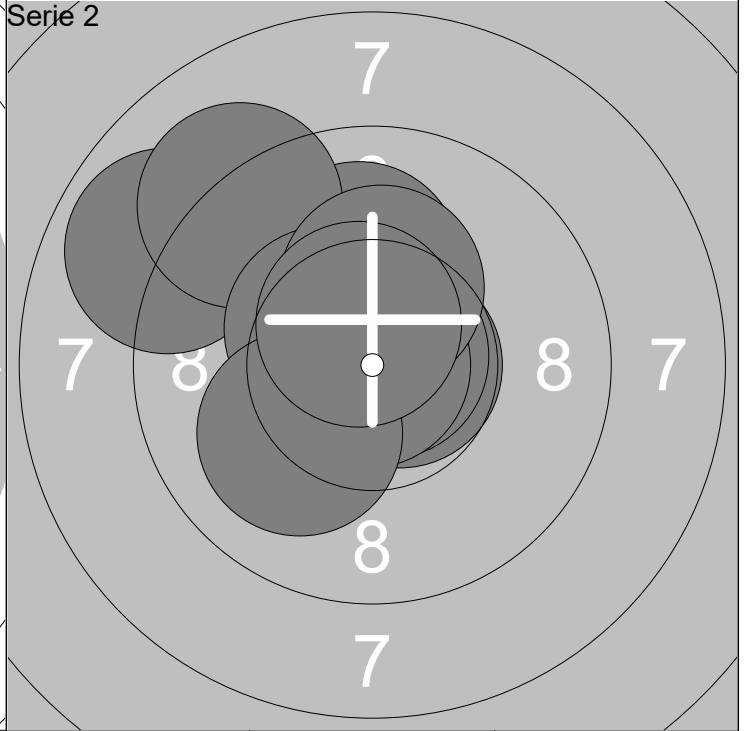
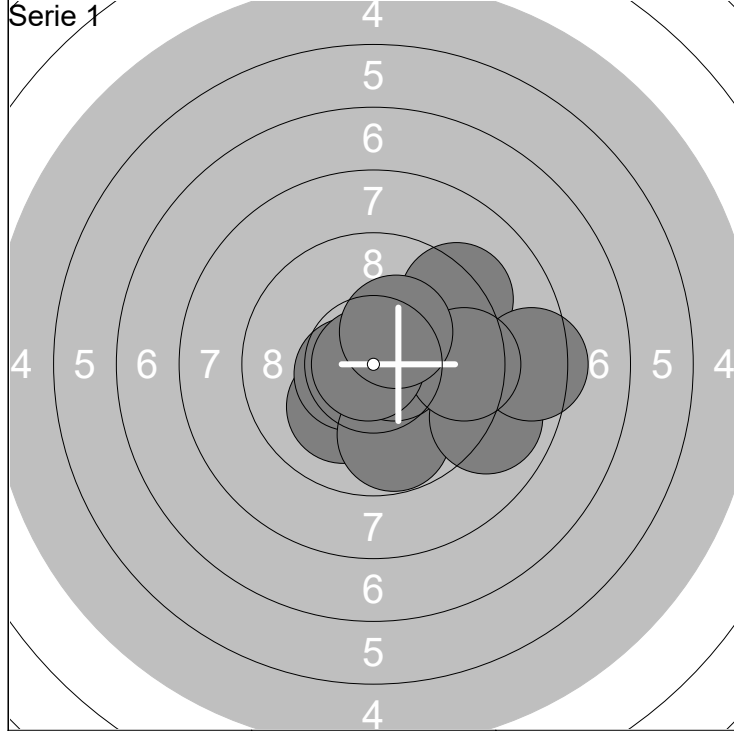

1: 10.1 ↙	6: 10.6x →	Serie	93 (4x)
2: 10.5x ←	7: 8.4 →		
3: 9.8 ↓	8: 9.5 →	Total	93 (4x)
4: 9.2 ↗	9: 10.8x ←		
5: 8.9 ↘	10: 10.3x ↗		

1: 8.9 ↖	6: 9.1 ↗	Serie	97 (6x)
2: 10.7x →	7: 10.4x ↖		
3: 10.8x ↗	8: 10.2x ↑	Total	190 (10x)
4: 10.1 ↑	9: 10.1 ↙		
5: 10.9x ←	10: 10.5x ↗		

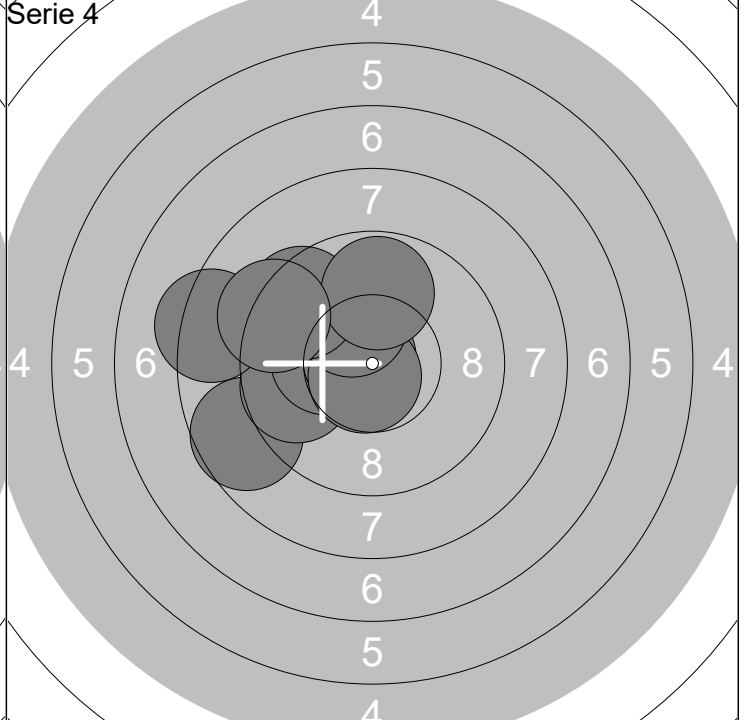
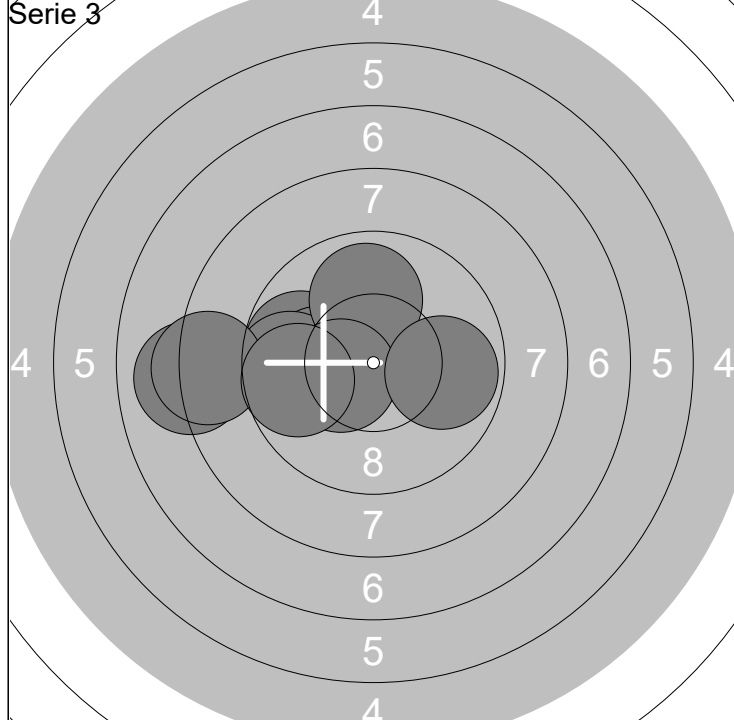

1: 9.8 ←	6: 9.9 ↑	Serie	91 (2x)
2: 8.0 ←	7: 10.4x ←		
3: 10.1 ←	8: 8.3 ←	Total	281 (12x)
4: 10.7x ↗	9: 9.8 →		
5: 9.6 ←	10: 9.7 ←		

1: 8.6 ↖	6: 10.2x ↗	Serie	92 (4x)
2: 9.7 ←	7: 9.5 ↖		
3: 10.2x ←	8: 9.8 ↑	Total	373 (16x)
4: 10.7x ↖	9: 8.3 ←		
5: 10.7x ↙	10: 9.2 ↖		

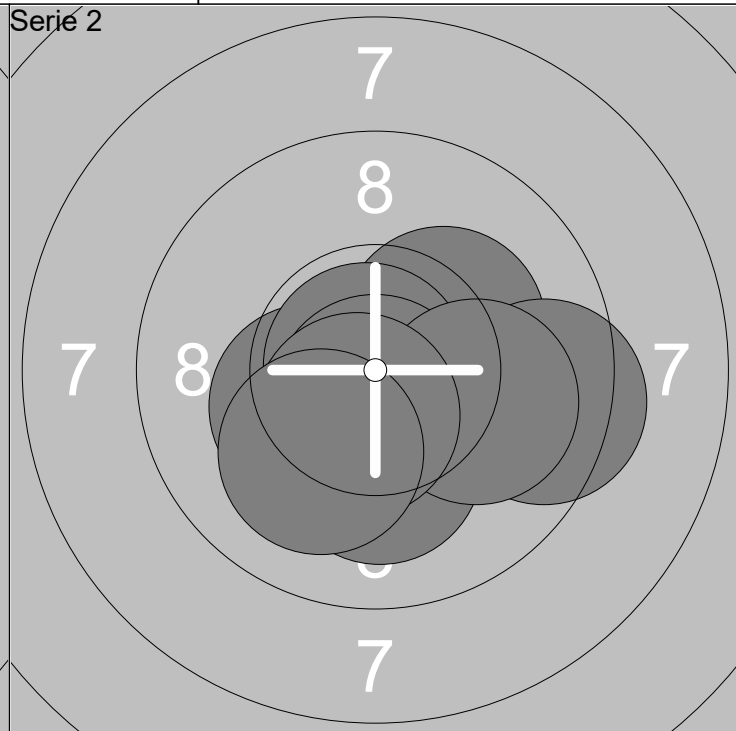
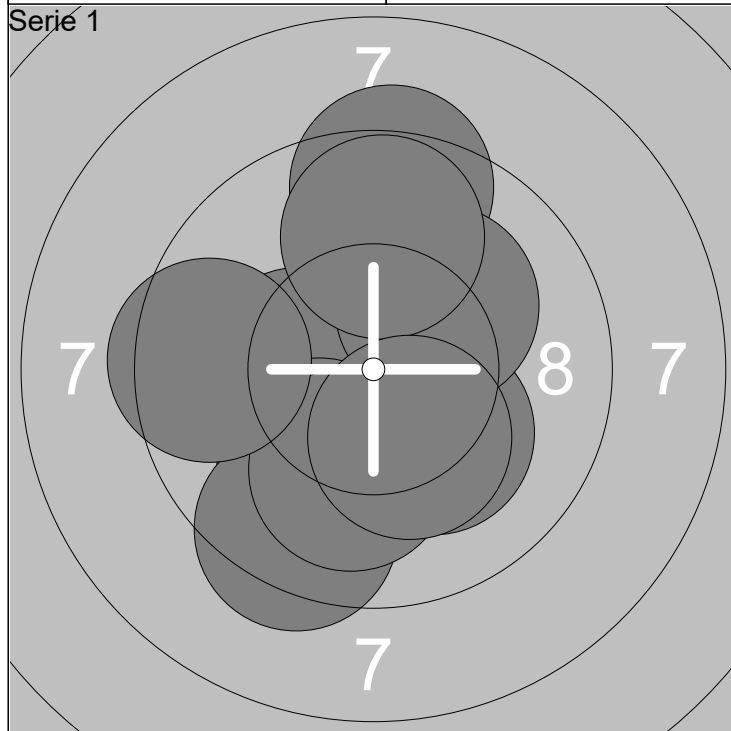

1: 10.3x ←	6: 9.8 ↑	Serie	96 (3x)
2: 10.0 ↙	7: 9.4 ↘		
3: 9.3 ↑	8: 10.0 ↓	Total	96 (3x)
4: 10.2x ↘	9: 9.5 ←		
5: 10.1 ↗	10: 10.3x ↘		

1: 10.1 ↓	6: 9.4 →	Serie	99 (6x)
2: 10.7x ↘	7: 10.7x ↓		
3: 10.2x ↗	8: 10.0 →	Total	195 (9x)
4: 10.3x ←	9: 10.5x ↓		
5: 10.8x ←	10: 10.1 ↓		

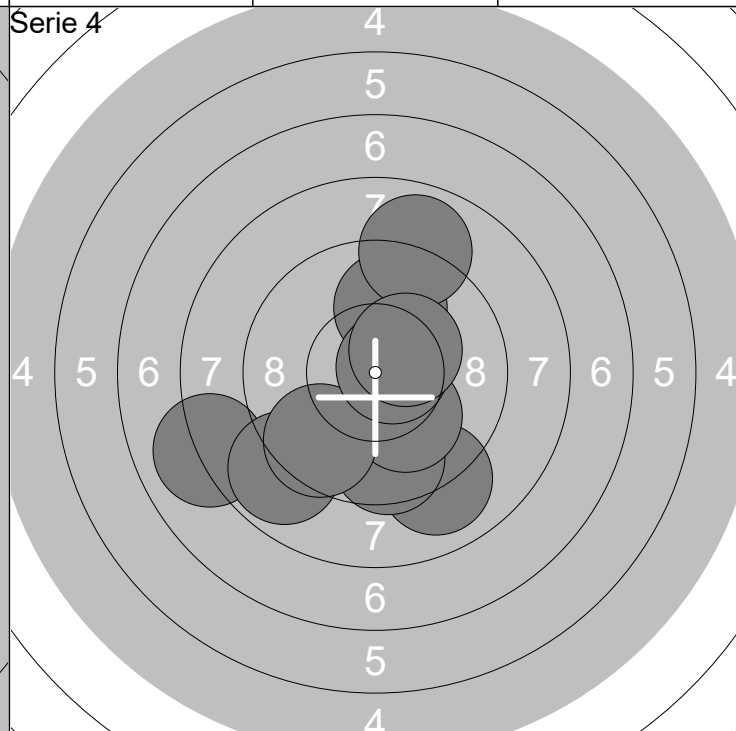
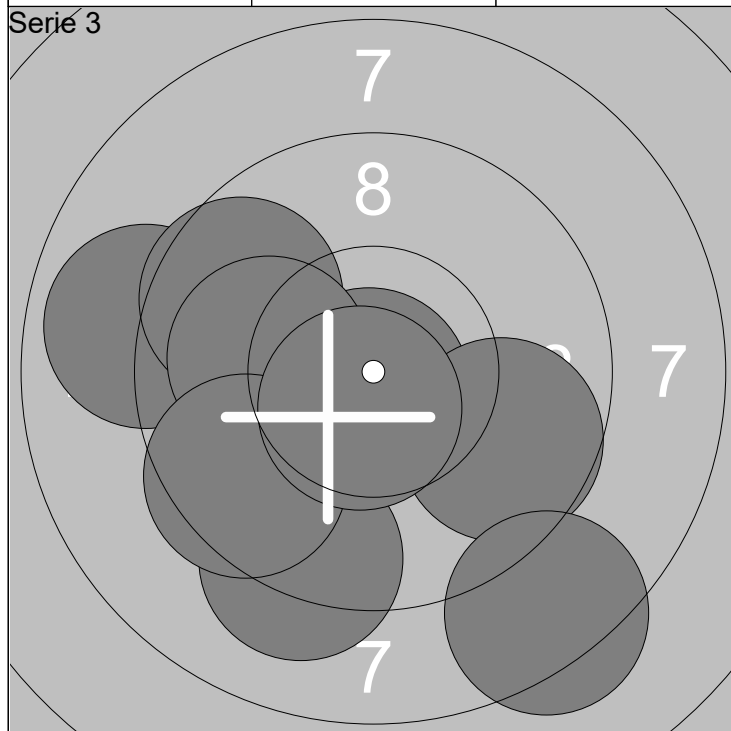

1: 10.8x ↓	6: 8.3 ↘	Serie	92 (2x)
2: 8.9 ←	7: 10.0 ←		
3: 10.1 ↙	8: 9.1 ↓	Total	287 (11x)
4: 9.6 ↗	9: 9.5 ↙		
5: 9.6 ↘	10: 10.6x ↓		

1: 9.0 ↓	6: 10.1 ↓	Serie	90 (2x)
2: 9.9 ↑	7: 9.5 ↘		
3: 9.5 ↓	8: 10.6x →	Total	377 (13x)
4: 8.0 ←	9: 8.9 ↑		
5: 8.8 ↙	10: 10.3x ↗		

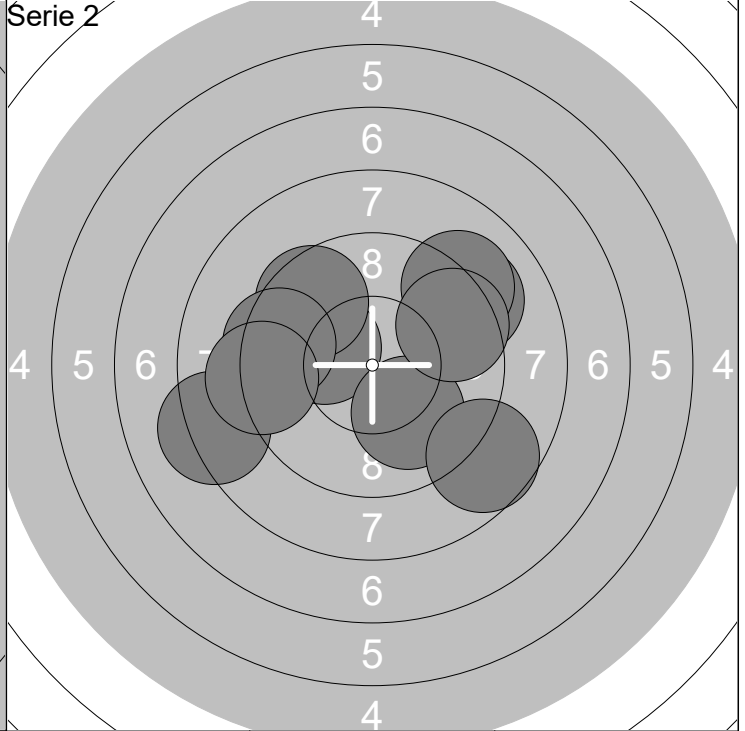
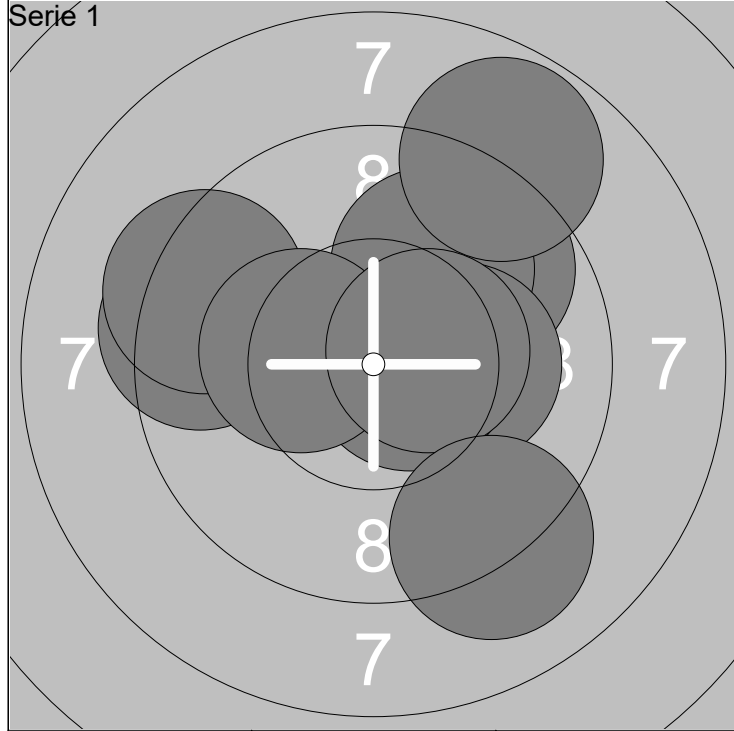

1: 9.7 ↗	6: 10.6x →	Serie	93 (4x)
2: 9.4 ←	7: 10.3x ←		
3: 9.9 ↗	8: 10.4x →	Total	93 (4x)
4: 9.3 ←	9: 8.8 ↗		
5: 10.2x →	10: 9.1 ↘		

1: 10.1 ←	6: 9.1 ↗	Serie	90 (0x)
2: 9.5 ↗	7: 8.2 ←		
3: 9.4 ←	8: 9.1 ←	Total	183 (4x)
4: 9.1 ↗	9: 8.7 ↘		
5: 10.0 ↘	10: 9.5 ↗		

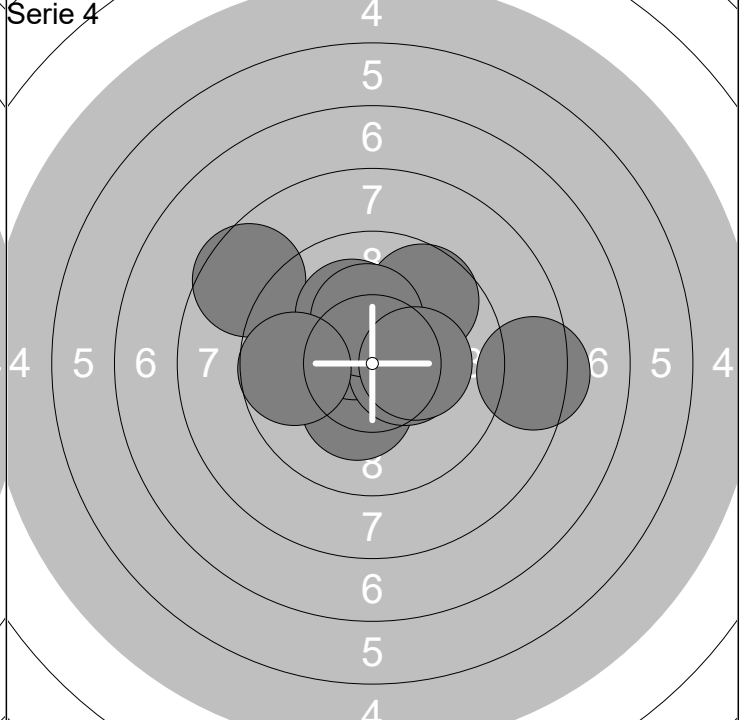
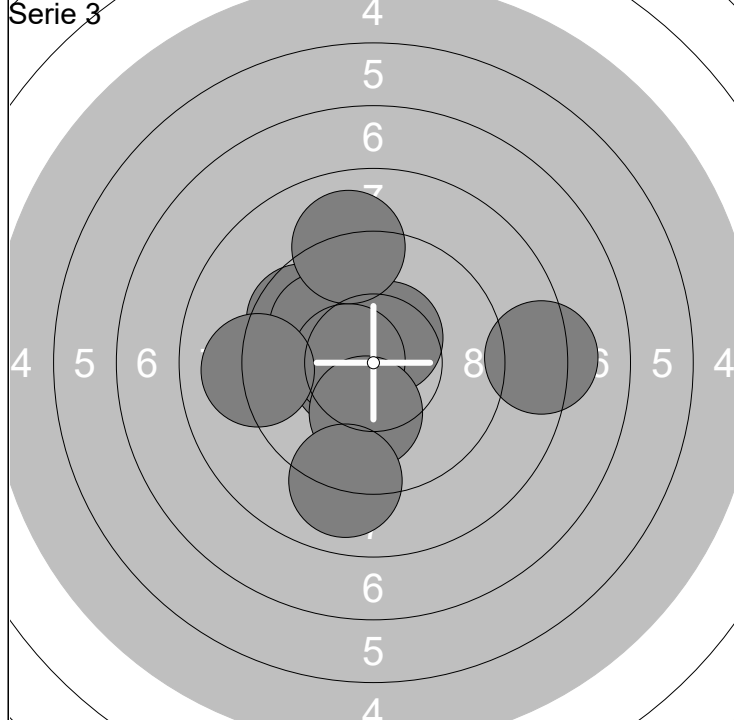

1: 9.6 ←	6: 9.1 ←	Serie	94 (3x)
2: 10.0 ←	7: 9.0 ↑		
3: 10.5x ←	8: 10.1 ↓	Total	277 (7x)
4: 10.5x ↗	9: 9.0 ↓		
5: 10.5x ←	10: 8.2 →		

1: 8.6 ←	6: 10.4x →	Serie	94 (5x)
2: 10.2x ↓	7: 9.6 ↗		
3: 8.3 →	8: 10.2x ↑	Total	371 (12x)
4: 10.5x ↗	9: 10.3x →		
5: 10.1 ↗	10: 9.7 ←		

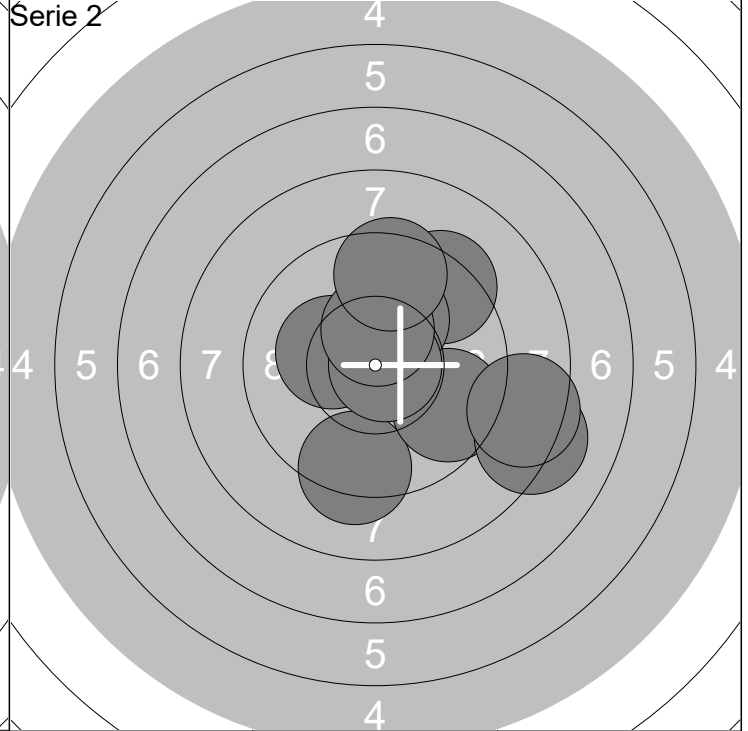
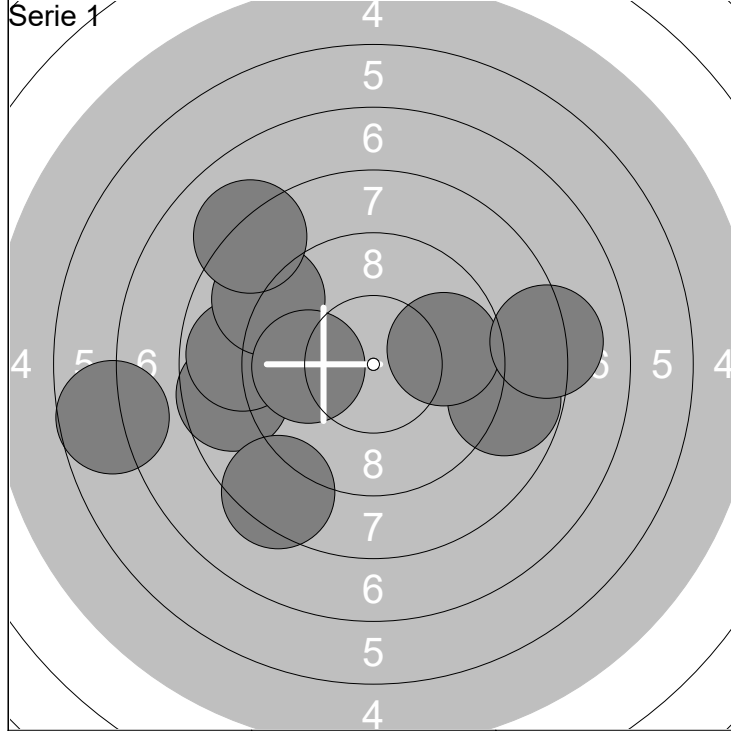

1: 8.6 ←	6: 9.9 ←	Serie 81 (0x)
2: 8.9 ←	7: 8.4 ↙	
3: 8.8 →	8: 8.2 →	Total 81 (0x)
4: 9.0 ↗	9: 6.7 ←	
5: 9.8 →	10: 8.1 ↖	

1: 9.3 ↓	6: 10.8x →	Serie 92 (3x)
2: 10.2x ←	7: 8.2 →	
3: 9.3 ↗	8: 10.4x ↑	Total 173 (3x)
4: 9.6 →	9: 9.5 ↑	
5: 10.1 ↗	10: 8.5 →	

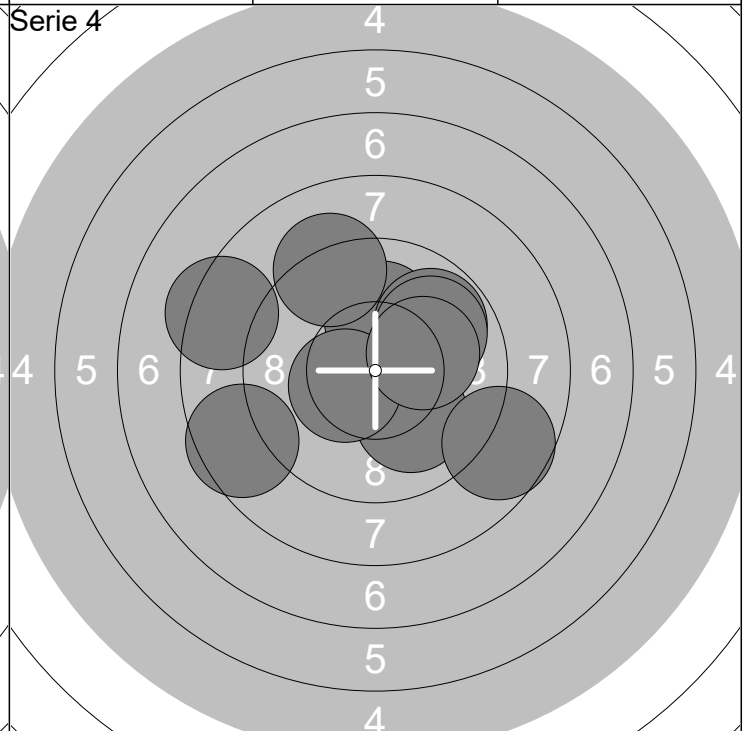
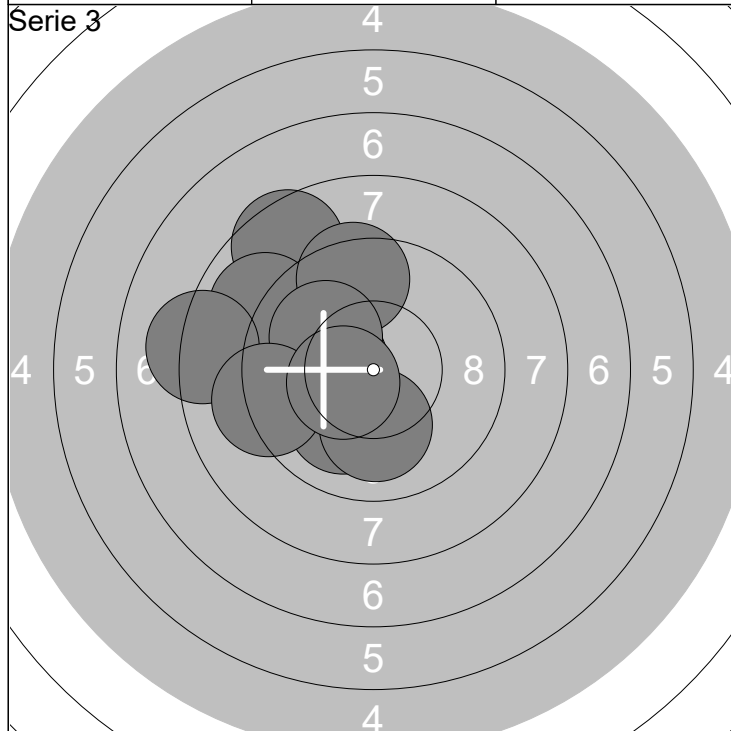

1: 8.5 ↗	6: 10.0 ↖	Serie 93 (2x)
2: 9.0 ↗	7: 10.1 ↓	
3: 10.0 ↙	8: 8.2 ←	Total 266 (5x)
4: 10.2x ←	9: 9.2 ←	
5: 9.4 ↑	10: 10.4x ←	

1: 10.1 ↑	6: 8.3 ←	Serie 91 (1x)
2: 10.0 ↙	7: 9.9 ↗	
3: 9.8 ↗	8: 10.4x ←	Total 357 (6x)
4: 9.1 ↖	9: 8.6 →	
5: 8.5 ←	10: 10.1 →	

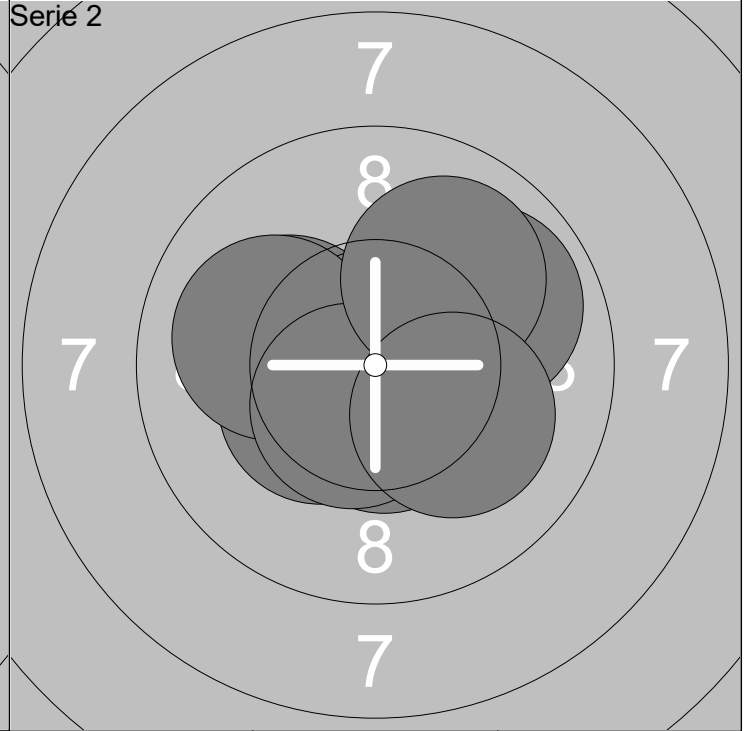
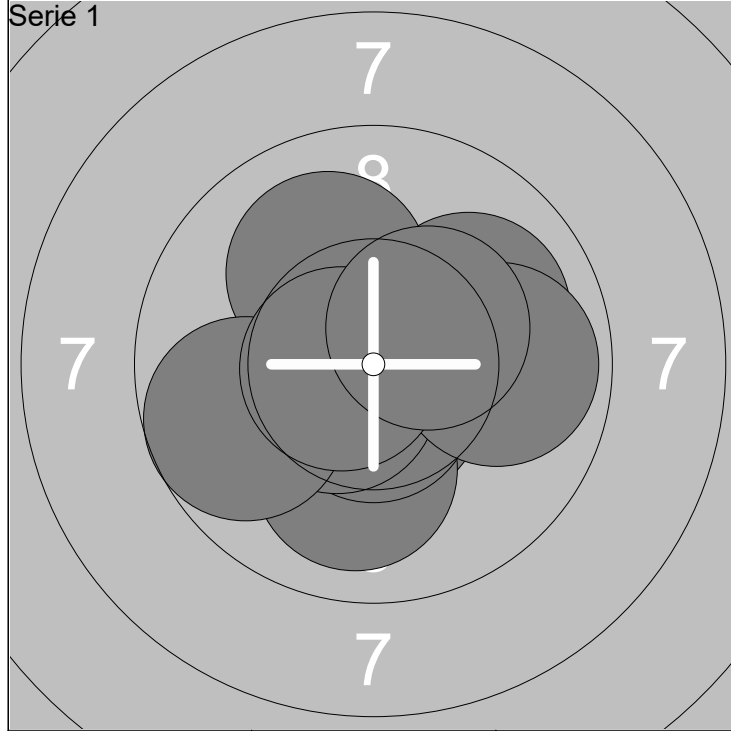

1: 10.6x ↓	6: 10.5x ↙	Serie 98 (5x)
2: 10.0 →	7: 9.9 →	
3: 10.0 ↖	8: 9.7 ↙	Total 98 (5x)
4: 10.0 ↓	9: 10.7x ←	
5: 10.6x ↓	10: 10.4x ↗	

1: 10.5x ↓	6: 10.4x ↙	Serie 99 (5x)
2: 10.5x →	7: 10.0 ←	
3: 9.9 ↗	8: 10.5x ↘	Total 197 (10x)
4: 10.1 ←	9: 10.0 ↗	
5: 10.8x ↑	10: 10.1 ↘	

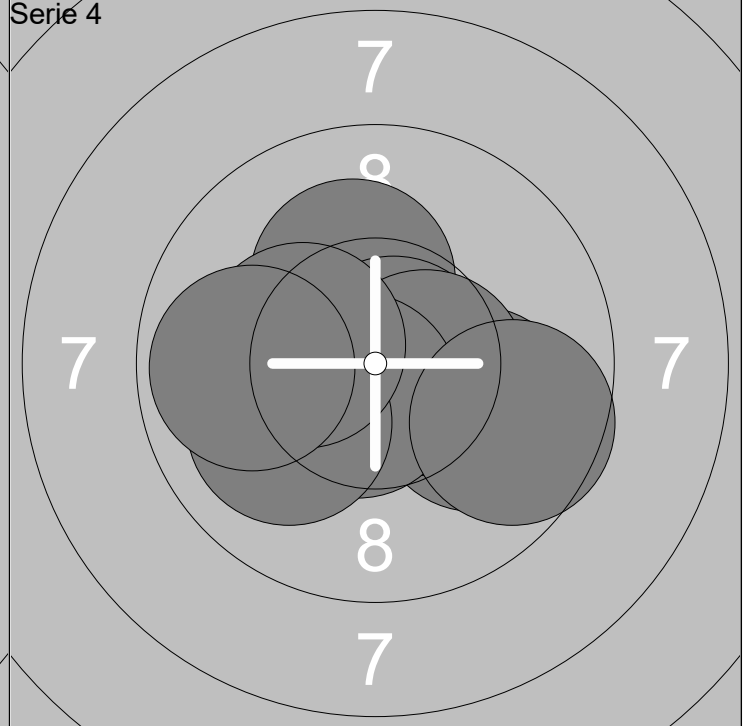
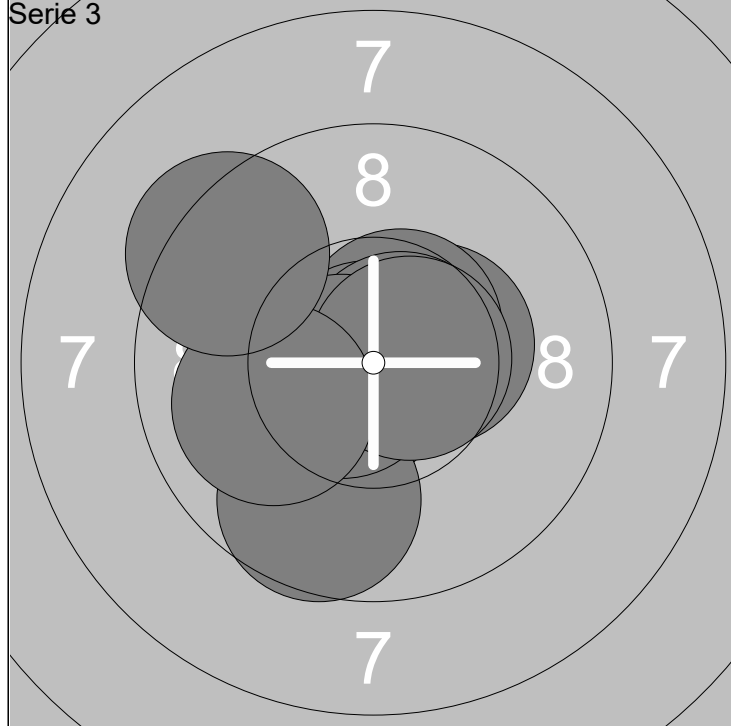

1: 10.6x ↙	6: 9.6 ↓	Serie 98 (7x)
2: 10.4x →	7: 10.6x ↙	
3: 10.5x ↗	8: 10.6x →	Total 295 (17x)
4: 10.9x ←	9: 10.0 ←	
5: 10.7x ↗	10: 9.3 ↖	

1: 10.2x ↖	6: 10.6x ↘	Serie 98 (6x)
2: 10.8x →	7: 10.0 ↙	
3: 10.2x ←	8: 9.6 ↘	Total 393 (23x)
4: 10.0 ↘	9: 10.3x ←	
5: 10.5x →	10: 9.9 ←	

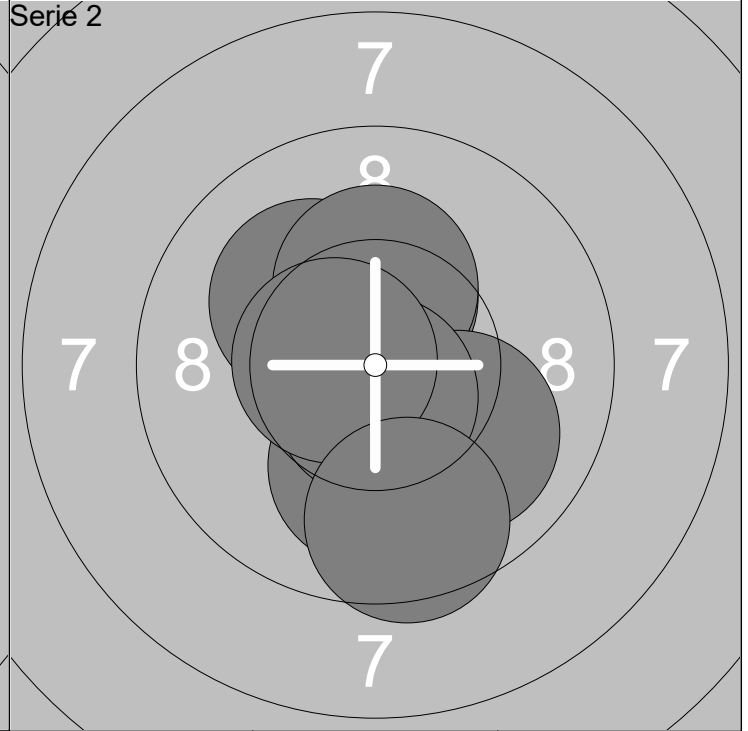
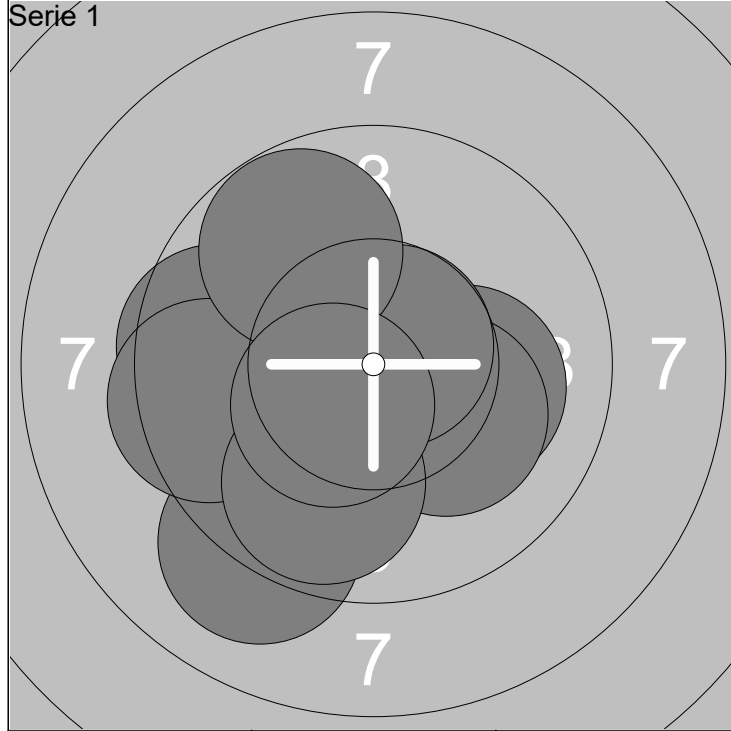

1: 9.1 ↙	6: 9.4 ←	Serie	95 (4x)
2: 10.1 →	7: 10.7x ↗		
3: 10.2x ↘	8: 9.7 ↖	Total	95 (4x)
4: 9.6 ←	9: 9.8 ↓		
5: 10.5x ↗	10: 10.4x ↘		

1: 10.1 ↖	6: 10.0 ↓	Serie	99 (6x)
2: 10.8x ↖	7: 10.0 ↘		
3: 10.3x ↑	8: 10.7x ↓	Total	194 (10x)
4: 10.9x ↖	9: 10.6x ←		
5: 10.2x ↑	10: 9.6 ↓		

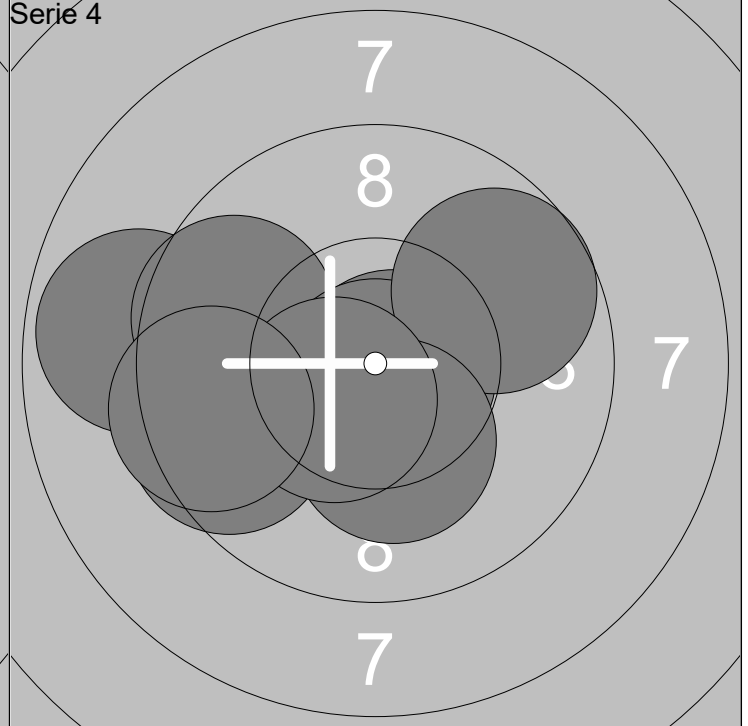
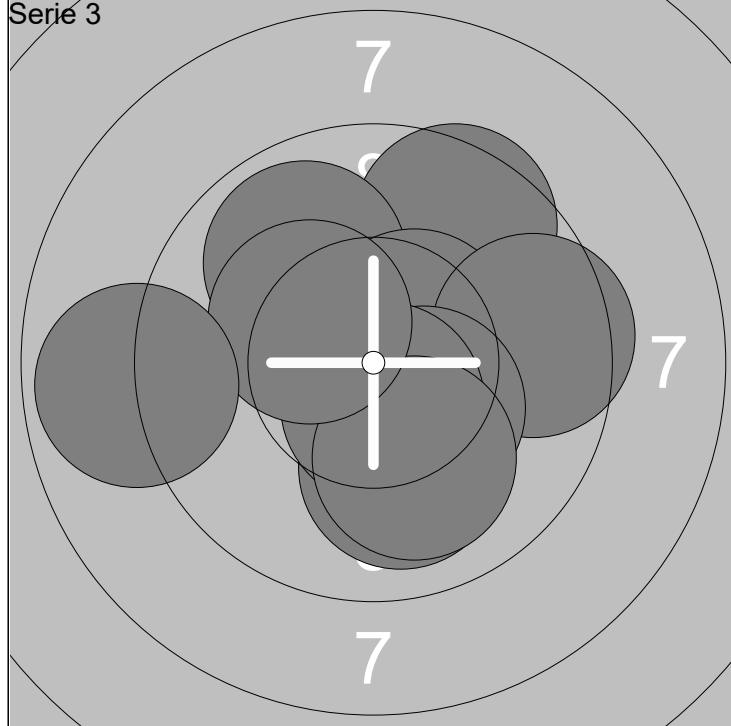

1: 10.0 ↓	6: 10.3x ↘	Serie	95 (4x)
2: 9.5 ↗	7: 10.6x ↓		
3: 9.9 ↖	8: 10.0 ↓	Total	289 (14x)
4: 10.5x ↗	9: 10.3x ↖		
5: 9.5 →	10: 8.8 ←		

1: 10.7x ↓	6: 10.8x ↓	Serie	94 (5x)
2: 10.8x →	7: 9.7 ↗		
3: 9.5 ←	8: 10.2x ↓	Total	383 (19x)
4: 8.8 ←	9: 10.5x ↘		
5: 9.6 ←	10: 9.4 ←		

Skjutlag

3

Tavla

37

Oscar Wässman

Stående

Björksta Ungdomsskyttefö (VM)

L S

23.10.2019

SM Luft 2019

SM2019

Serié 1

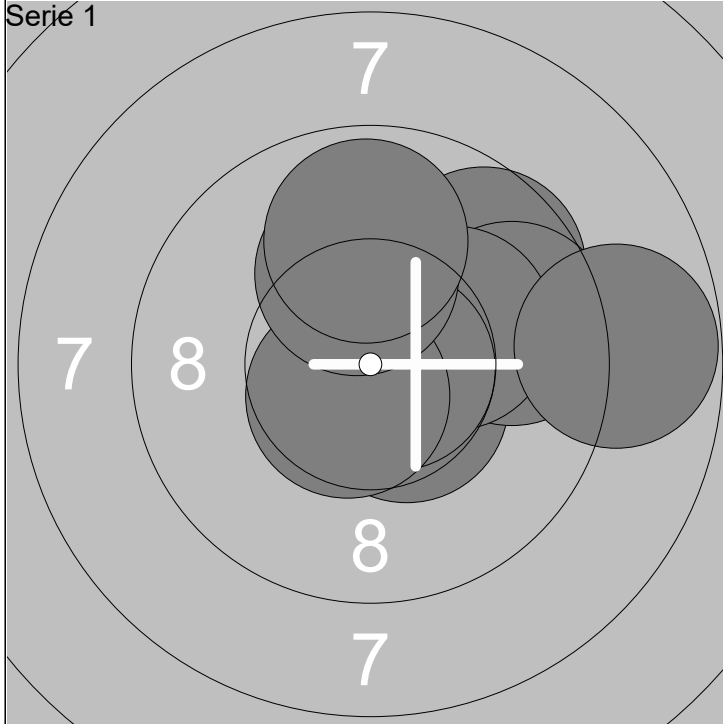

Serié 2

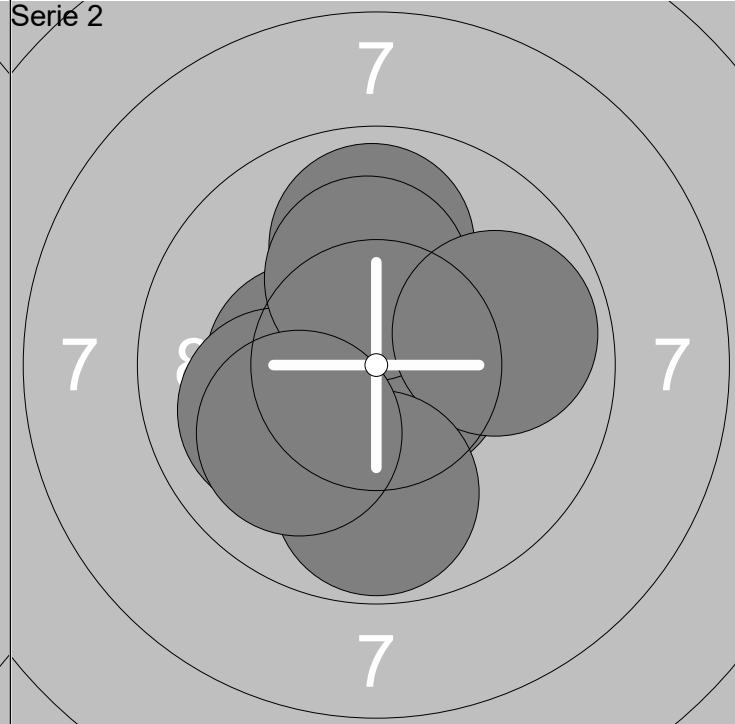

1:	9.6	↗	6:	8.8	→
2:	10.3x	↑	7:	10.7x	→
3:	10.5x	↘	8:	10.6x	↙
4:	9.7	→	9:	10.1	↑
5:	10.1	→	10:	9.9	↑

Serie 95 (4x)

Total 95 (4x)

1:	9.9	↑	6:	10.0	←
2:	10.3x	←	7:	10.2x	↑
3:	10.7x	→	8:	9.8	→
4:	10.6x	←	9:	9.8	↓
5:	10.3x	↙	10:	10.0	↙

Serie 97 (5x)

Total 192 (9x)

Serié 3

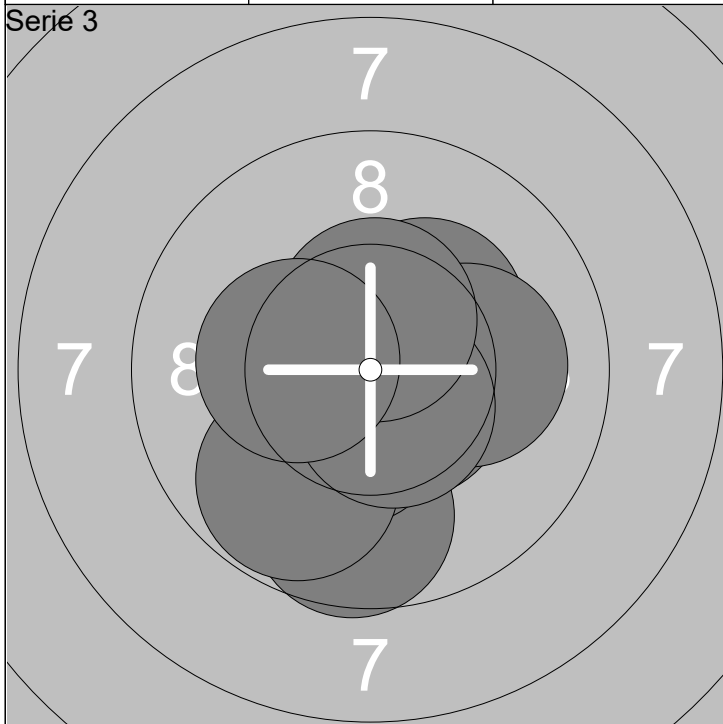

Serié 4

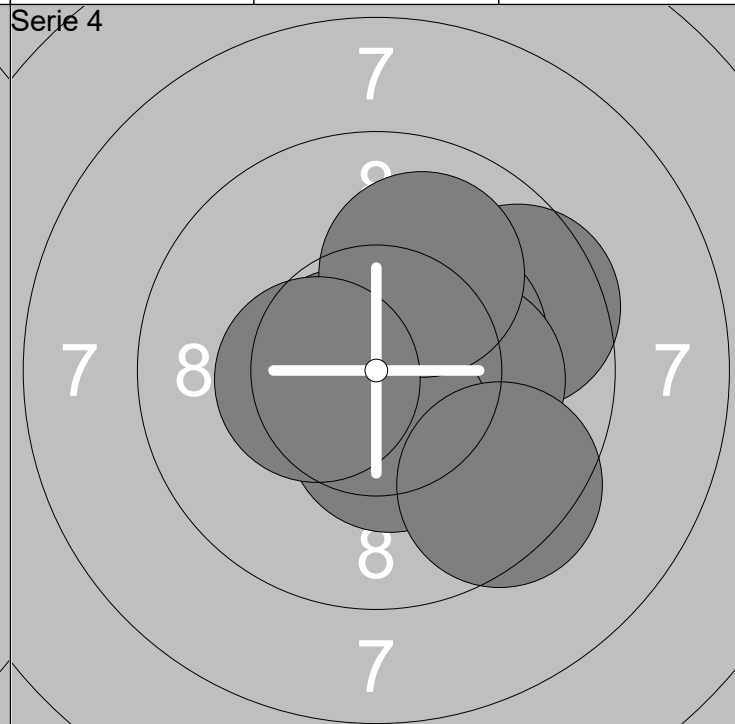

1:	9.7	↓	6:	10.1	→
2:	10.4x	↓	7:	9.8	↙
3:	10.5x	↘	8:	10.6x	↘
4:	10.3x	↗	9:	10.5x	↑
5:	10.7x	↘	10:	10.3x	←

Serie 98 (7x)

Total 290 (16x)

1:	10.7x	←	6:	10.1	→
2:	10.7x	←	7:	10.4x	↓
3:	10.9x		8:	10.0	↑
4:	9.6	↗	9:	10.4x	←
5:	10.3x	↗	10:	9.5	↘

Serie 98 (6x)

Total 388 (22x)

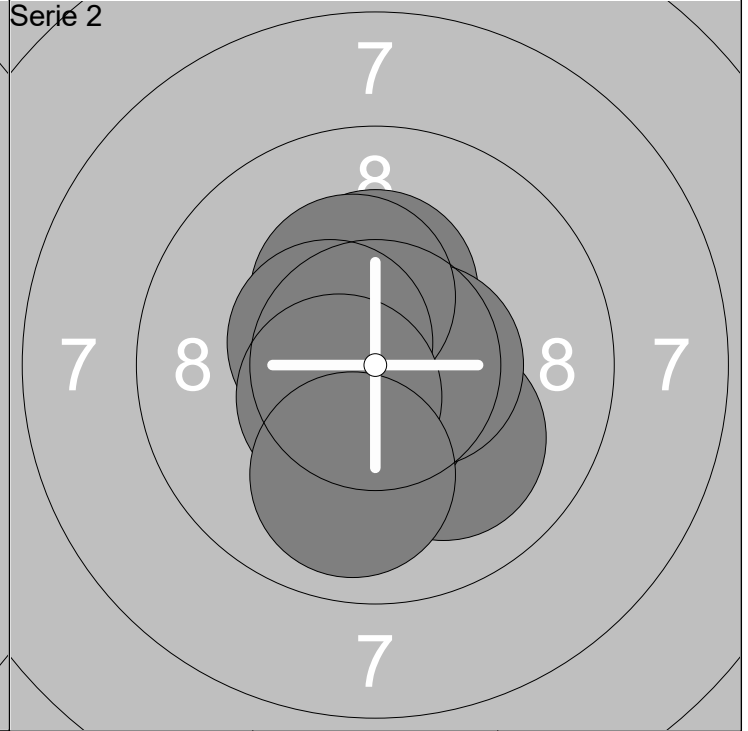
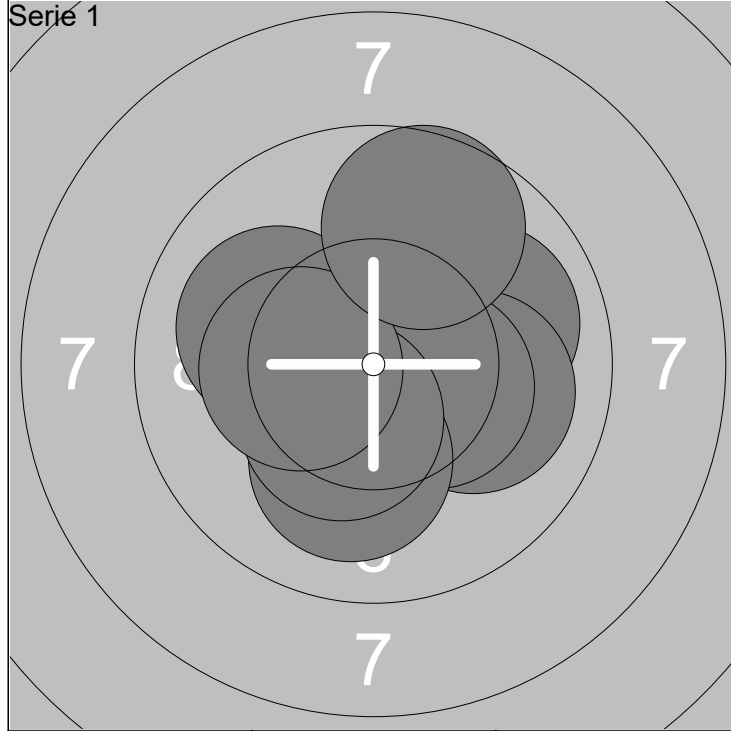

1: 10.6x ↙	6: 10.1 ↓	Serie 98 (5x)
2: 9.9 →	7: 10.0 ↖	
3: 10.0 →	8: 10.4x ↘	Total 98 (5x)
4: 10.7x →	9: 10.3x ↖	
5: 10.4x →	10: 9.6 ↗	

1: 10.3x ↓	6: 10.5x →	Serie 100 (8x)
2: 10.3x ↑	7: 10.3x ↗	
3: 10.0 ↓	8: 10.5x ↖	Total 198 (13x)
4: 10.7x ↖	9: 10.5x ↙	
5: 10.6x ↓	10: 10.0 ↓	

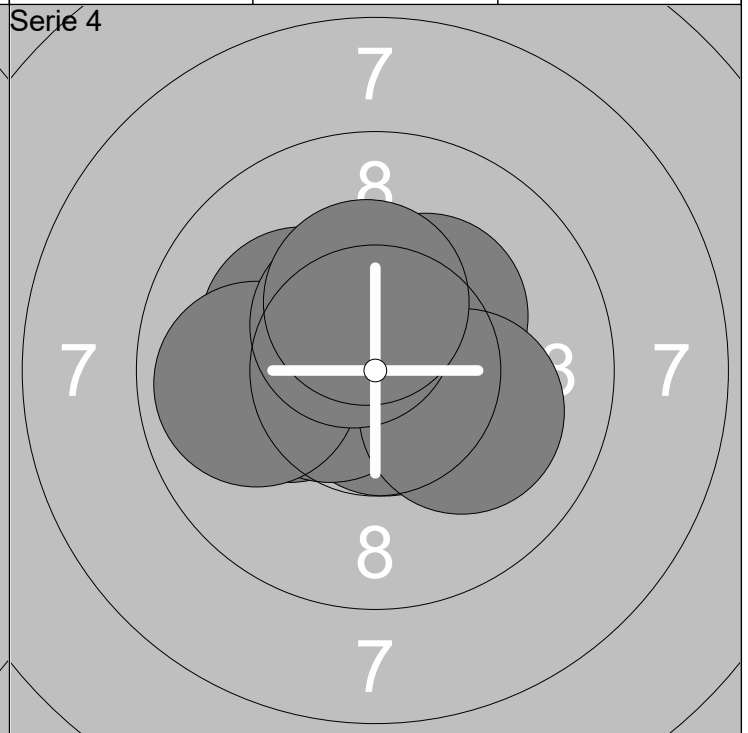
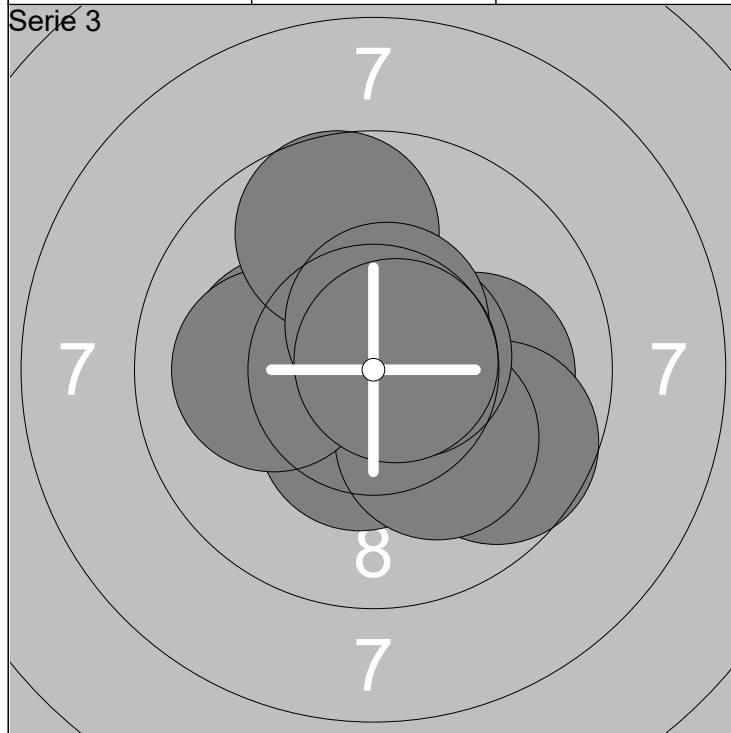

1: 10.2x ↖	6: 10.0 ↖	Serie 98 (5x)
2: 10.4x ↓	7: 9.7 ↗	
3: 10.0 →	8: 10.6x →	Total 296 (18x)
4: 9.7 ↓	9: 10.5x ↗	
5: 10.1 ↓	10: 10.7x →	

1: 10.2x ↖	6: 10.5x ↖	Serie 99 (8x)
2: 10.3x ↗	7: 10.1 →	
3: 10.8x ↖	8: 9.9 ↖	Total 395 (26x)
4: 10.2x ↖	9: 10.5x ↗	
5: 10.7x ↓	10: 10.3x ↗	

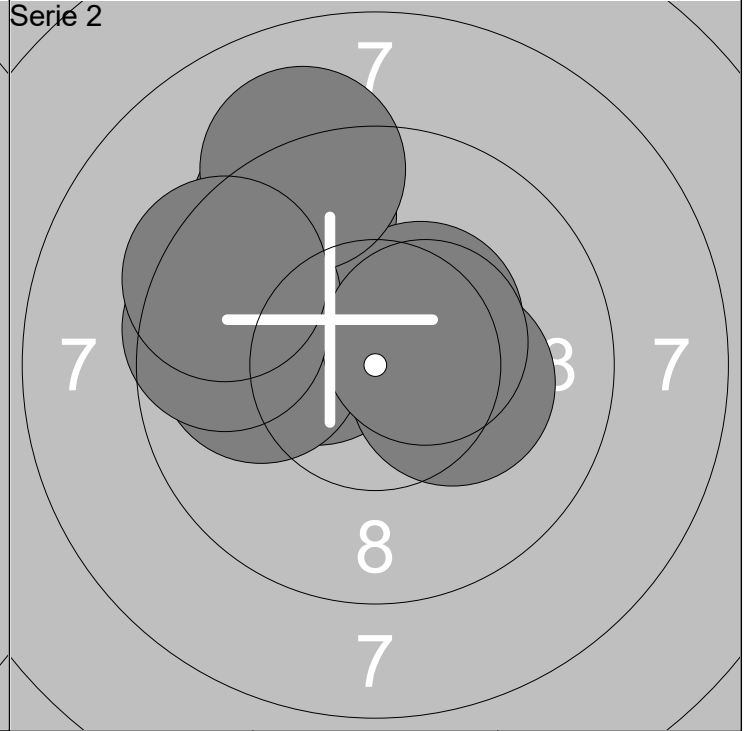
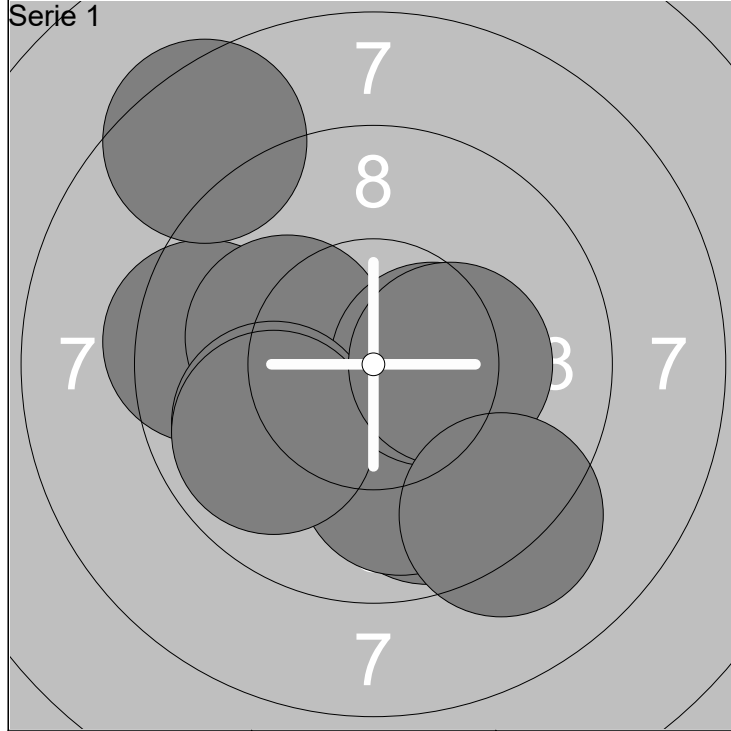

1: 9.4 ←	6: 10.4x →	Serie	92 (2x)
2: 9.8 ↓	7: 9.9 ←		
3: 9.9 ↓	8: 9.9 ←	Total	92 (2x)
4: 10.1 ←	9: 10.2x →		
5: 8.5 ↗	10: 9.2 ↓		

1: 10.4x ↖	6: 9.6 ↖	Serie	94 (4x)
2: 9.4 ↗	7: 10.4x ↗		
3: 9.9 ←	8: 9.6 ←	Total	186 (6x)
4: 10.2x →	9: 9.1 ↗		
5: 10.4x ↗	10: 9.4 ↖		

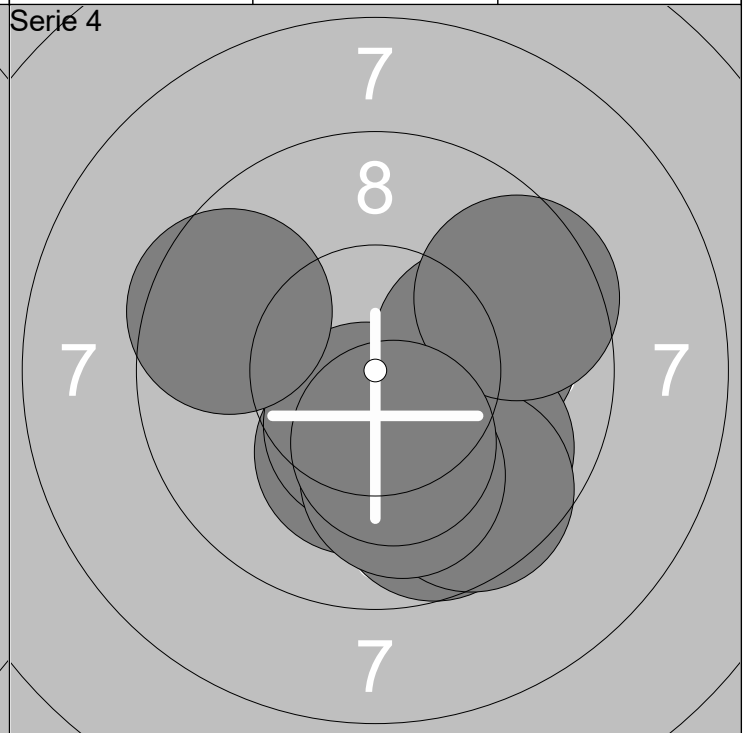
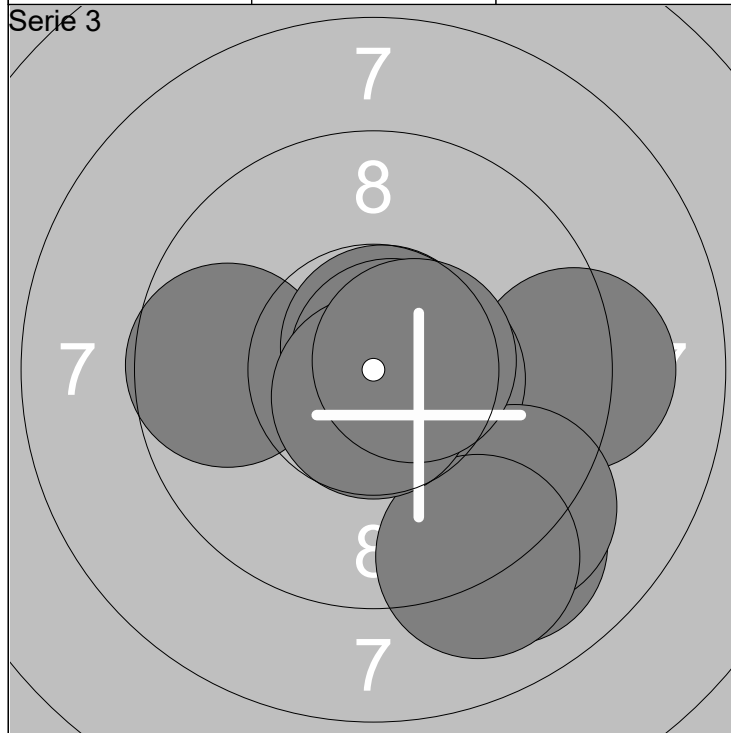

1: 9.7 ←	6: 10.7x ↗	Serie	95 (5x)
2: 9.0 ↓	7: 9.2 ↓		
3: 9.2 →	8: 9.1 ↓	Total	281 (11x)
4: 10.5x →	9: 10.7x ↓		
5: 10.7x ↗	10: 10.6x →		

1: 10.2x ↓	6: 9.8 ↓	Serie	95 (3x)
2: 9.7 ↓	7: 9.6 ↓		
3: 10.4x ↓	8: 9.5 ↗	Total	376 (14x)
4: 9.5 ↖	9: 10.0 ↓		
5: 10.0 →	10: 10.3x ↓		

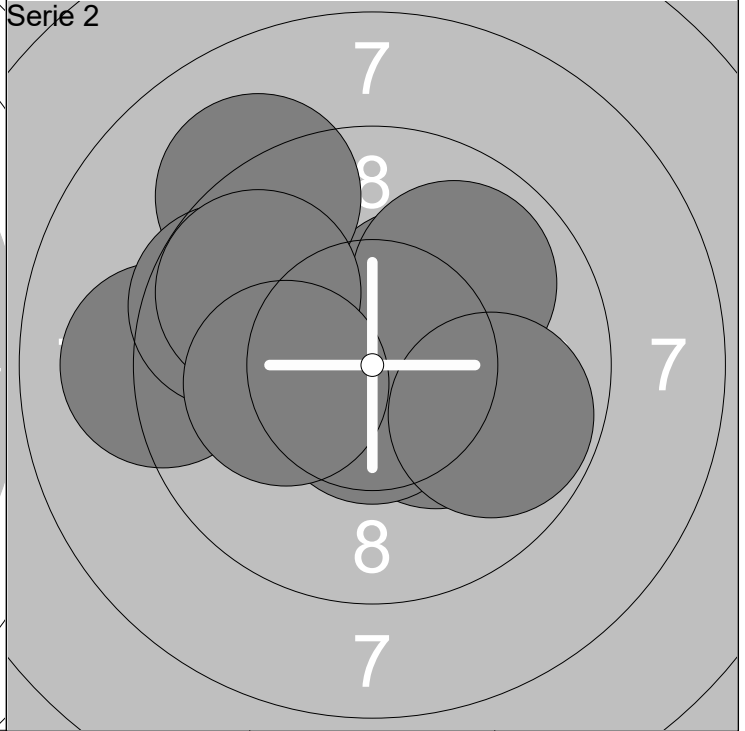
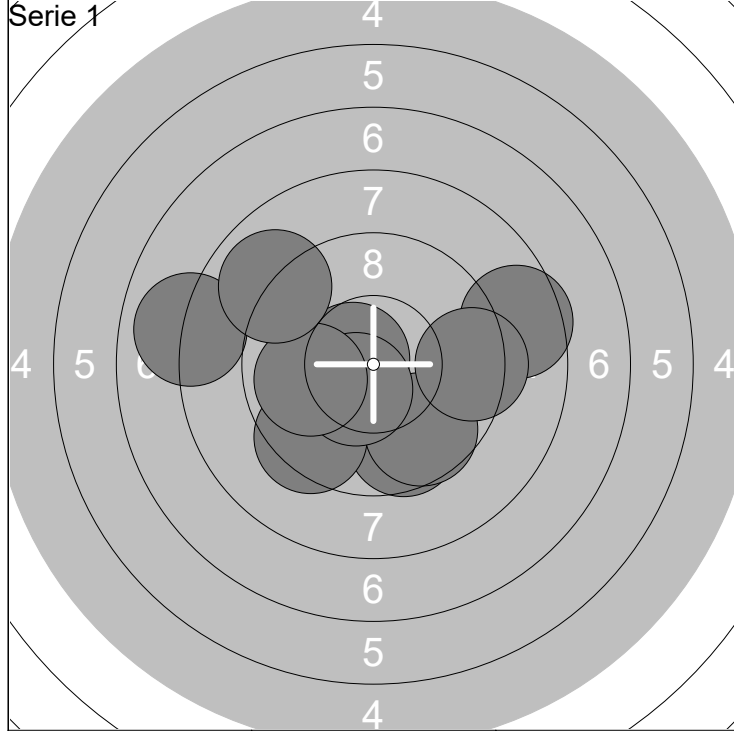

1: 9.6 ↓	6: 10.4x ↙	Serie 89 (2x)
2: 9.4 ↙	7: 8.6 →	
3: 9.6 ↓	8: 9.9 ←	Total 89 (2x)
4: 8.0 ←	9: 8.9 ↗	
5: 10.6x ←	10: 9.4 →	

1: 9.1 ←	6: 10.6x ↓	Serie 94 (3x)
2: 10.3x ↘	7: 9.9 ↗	
3: 10.3x ↗	8: 9.8 ↖	Total 183 (5x)
4: 9.2 ↗	9: 10.1 ←	
5: 9.6 ←	10: 9.8 ↘	

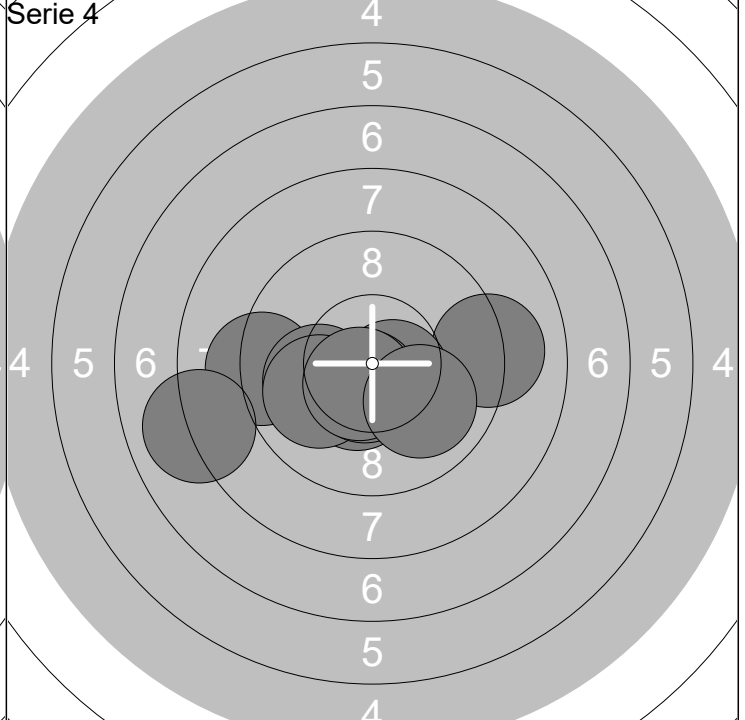
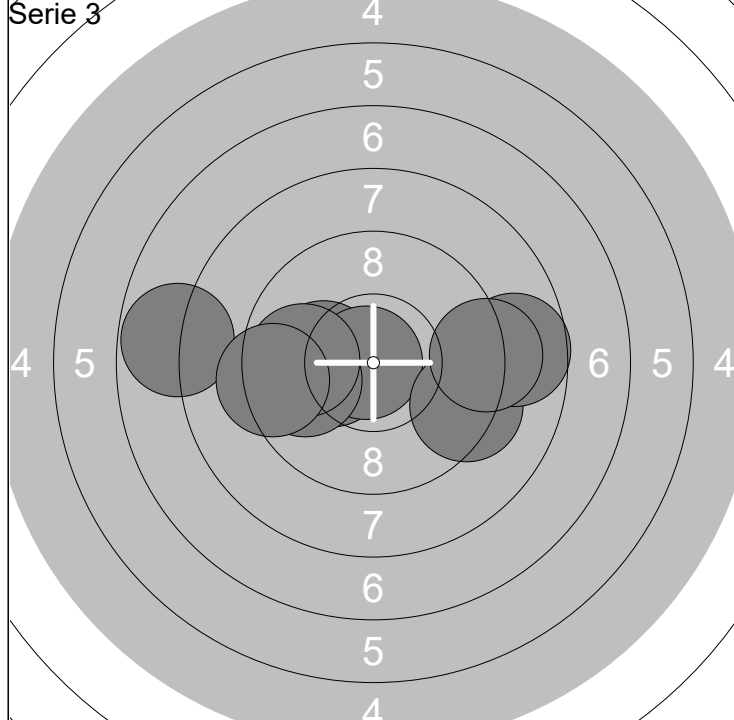

1: 10.3x ←	6: 7.8 ←	Serie 90 (2x)
2: 10.1 ←	7: 9.8 ←	
3: 10.8x ←	8: 8.7 →	Total 273 (7x)
4: 9.8 ←	9: 9.3 ←	
5: 9.3 ↘	10: 9.1 →	

1: 10.4x ↙	6: 10.0 ←	Serie 95 (4x)
2: 9.1 →	7: 10.5x ↓	
3: 10.6x ↘	8: 10.6x ↓	Total 368 (11x)
4: 9.2 ←	9: 8.0 ←	
5: 10.0 ←	10: 9.9 ↘	

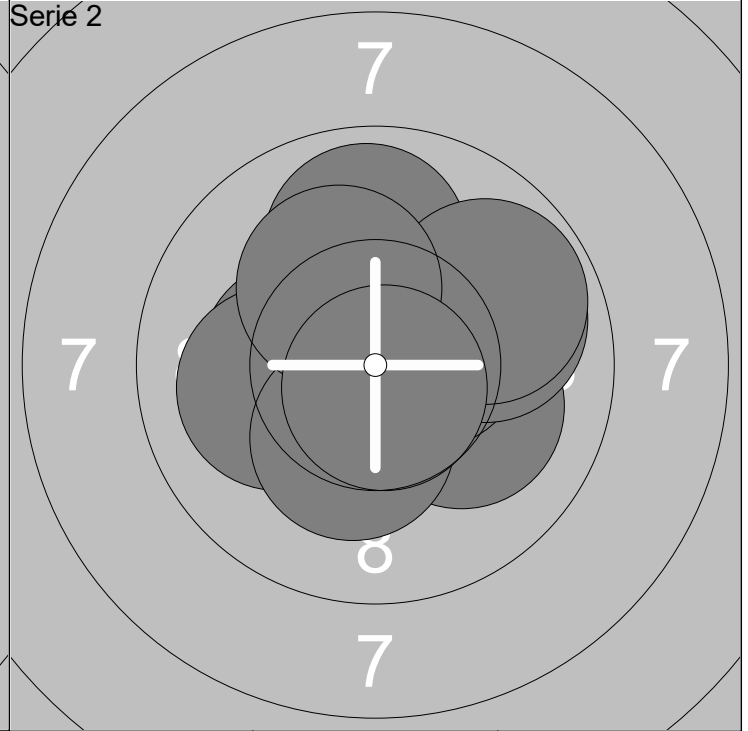
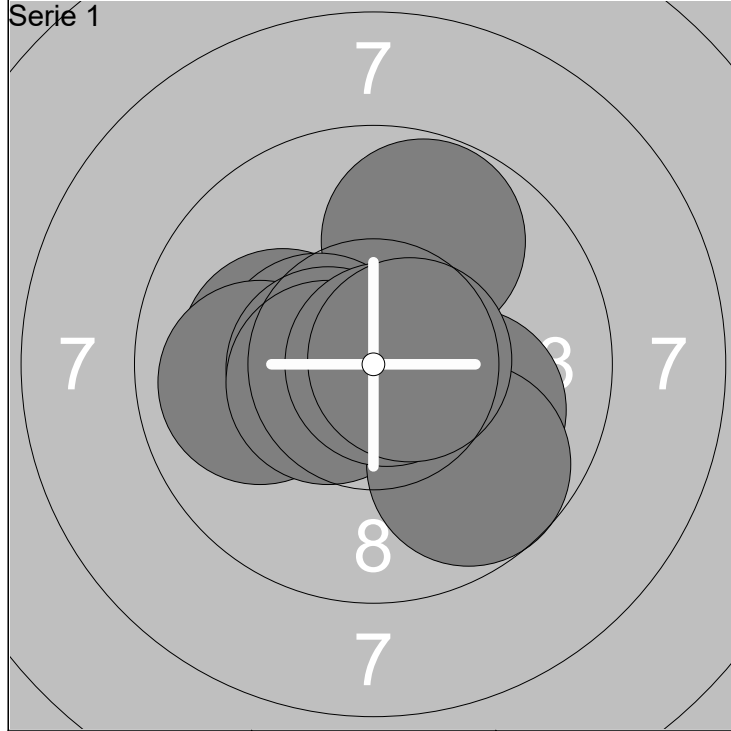

1: 10.1 ←	6: 10.0 →	Serie 97 (5x)
2: 9.7 ↗	7: 10.5x ←	
3: 10.4x ←	8: 9.7 ↘	Total 97 (5x)
4: 9.9 ←	9: 10.8x →	
5: 10.5x ←	10: 10.6x →	

1: 10.1 →	6: 9.9 ↑	Serie 97 (5x)
2: 10.3x ←	7: 9.8 ↗	
3: 10.4x →	8: 10.2x ↓	Total 194 (10x)
4: 10.1 ←	9: 10.2x ↖	
5: 9.9 →	10: 10.7x ↓	

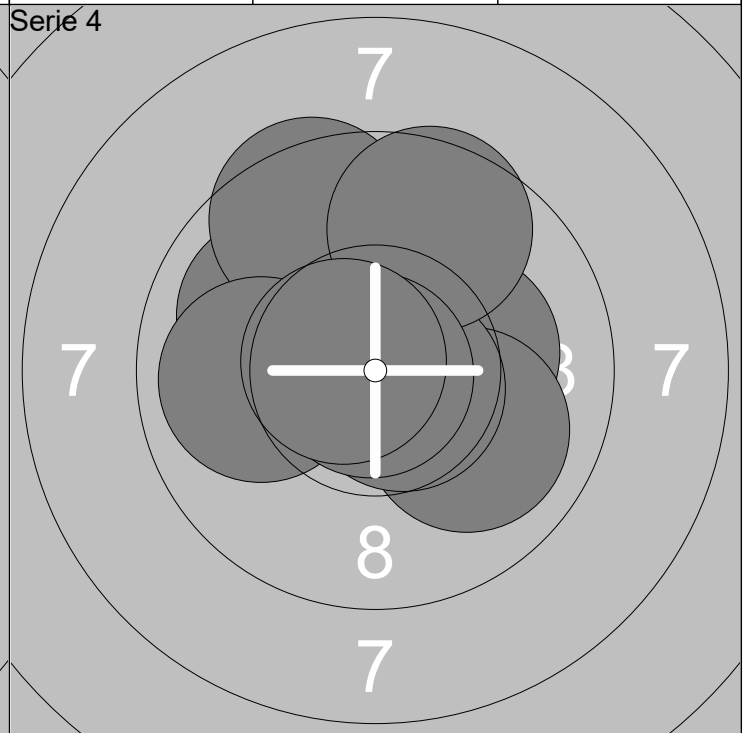
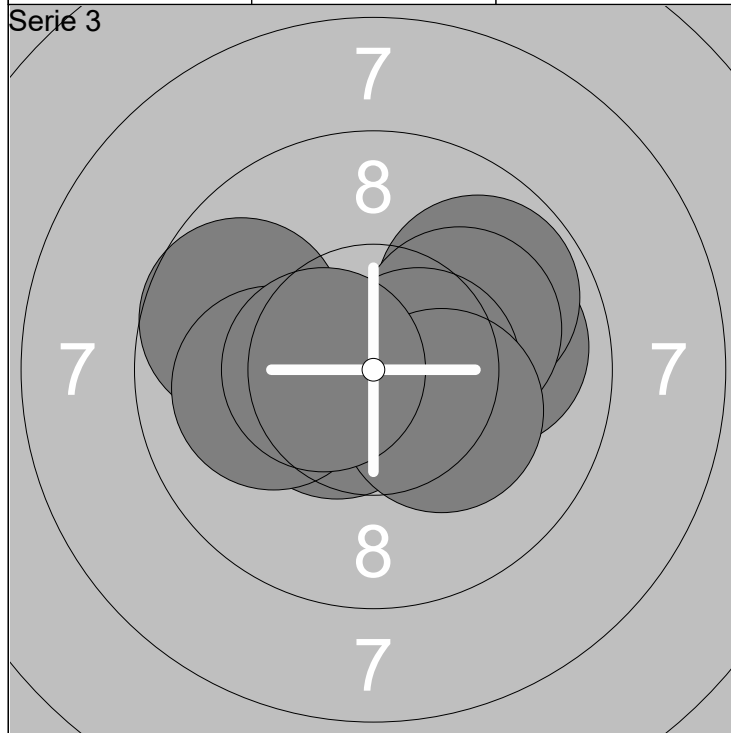

1: 10.5x ↙	6: 10.5x →	Serie 97 (4x)
2: 10.1 →	7: 9.7 ←	
3: 9.9 →	8: 10.2x ↘	Total 291 (14x)
4: 9.8 ↗	9: 10.0 ←	
5: 10.1 ↗	10: 10.5x ←	

1: 10.2x →	6: 9.9 ←	Serie 97 (4x)
2: 10.1 ↗	7: 10.6x ↘	
3: 10.0 ↘	8: 9.6 ↗	Total 388 (18x)
4: 10.0 ↖	9: 10.9x ↙	
5: 9.5 ↗	10: 10.6x ←	

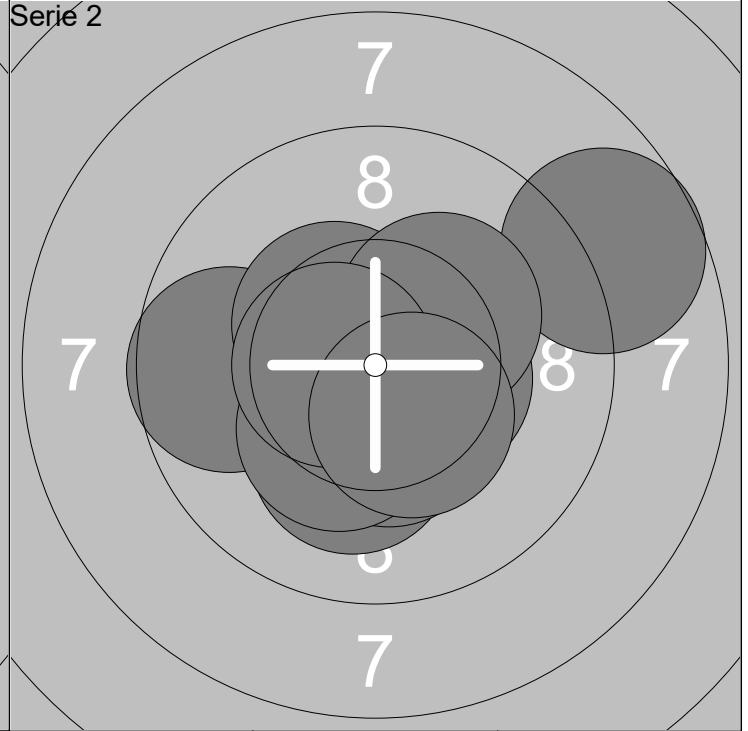
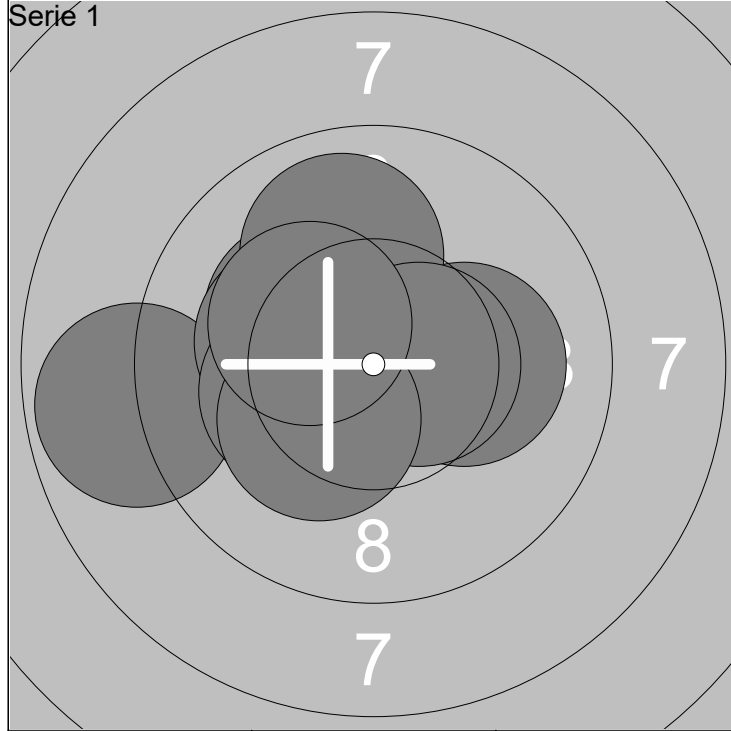

1: 10.2x ↖	6: 10.2x ←	Serie 98 (7x)
2: 10.3x ←	7: 10.2x ←	
3: 8.8 ←	8: 10.5x →	Total 98 (7x)
4: 10.1 →	9: 10.2x ↙	
5: 10.0 ↑	10: 10.3x ↖	

1: 10.1 ↓	6: 10.3x ↘	Serie 97 (7x)
2: 9.7 ←	7: 8.7 →	
3: 10.4x →	8: 10.2x ↗	Total 195 (14x)
4: 10.4x ↓	9: 10.6x ←	
5: 10.4x ↖	10: 10.4x ↘	

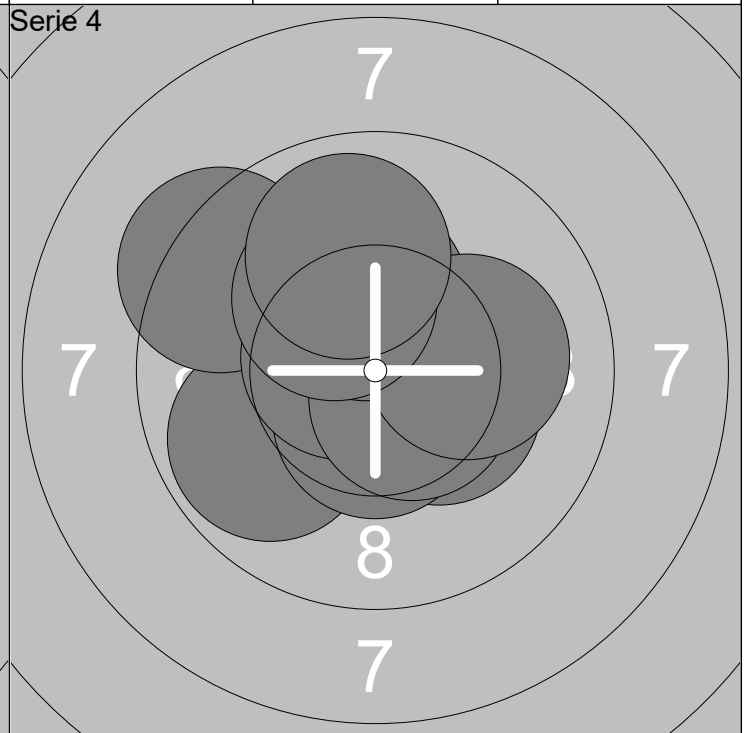
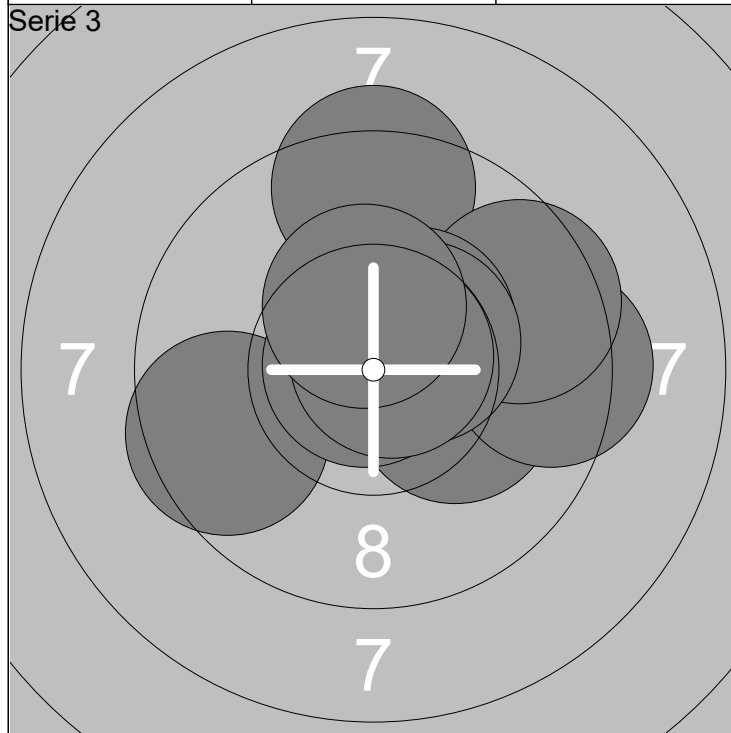

1: 9.3 ↑	6: 10.4x ↗	Serie 96 (6x)
2: 10.2x →	7: 10.8x ↖	
3: 9.4 →	8: 10.5x ↗	Total 291 (20x)
4: 9.5 ←	9: 10.7x ↗	
5: 9.5 →	10: 10.4x ↑	

1: 9.8 ↖	6: 10.5x ↘	Serie 97 (6x)
2: 10.3x →	7: 10.3x ↑	
3: 10.5x ↓	8: 10.1 →	Total 388 (26x)
4: 9.3 ↖	9: 10.2x ↗	
5: 10.6x ←	10: 9.9 ↑	

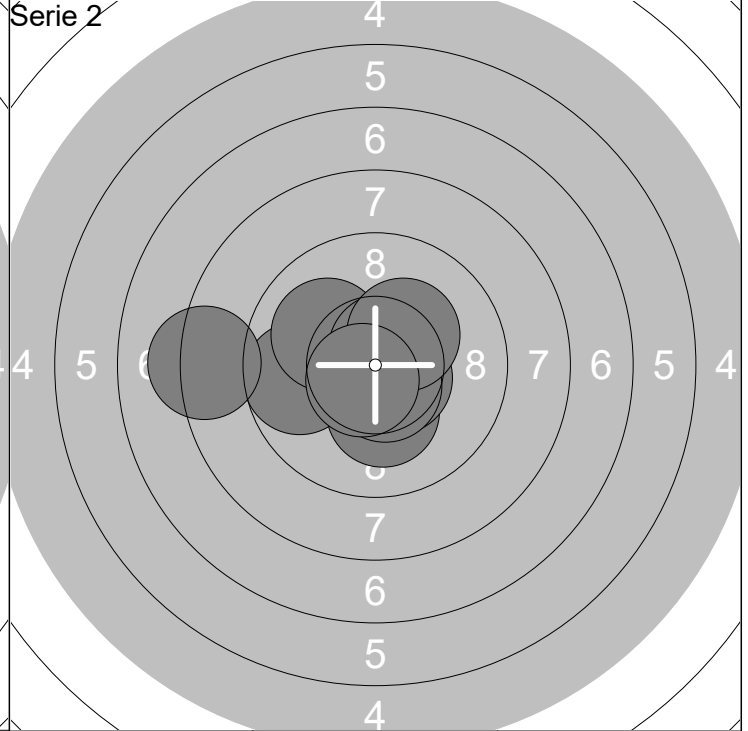
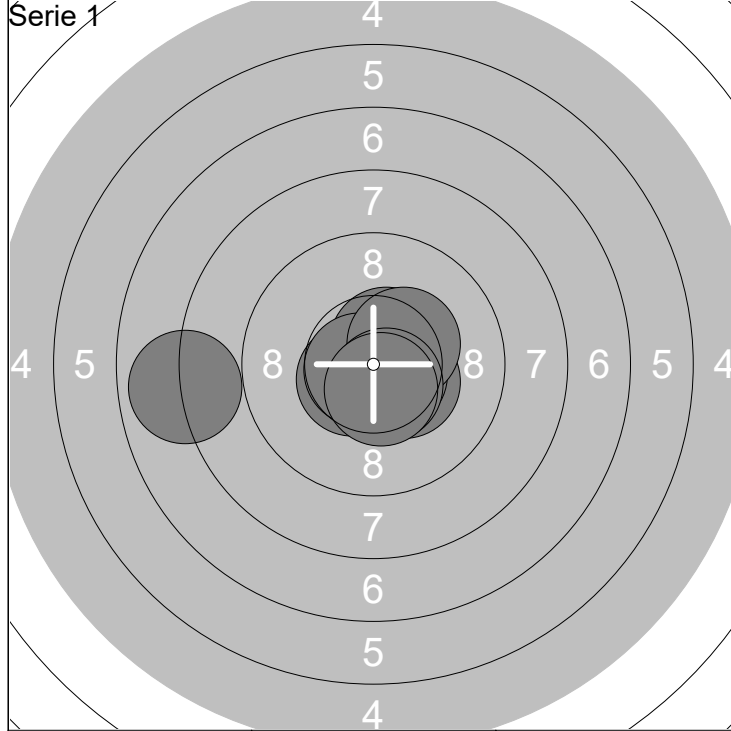

1: 7.9 ←	6: 10.5x ↗	Serie	97 (9x)
2: 10.4x →	7: 10.7x ←		
3: 10.6x ↓	8: 10.3x ↗	Total	97 (9x)
4: 10.5x ↙	9: 10.6x ↓		
5: 10.6x →	10: 10.5x ↓		

1: 10.8x ↘	6: 8.2 ←	Serie	97 (7x)
2: 10.2x ↓	7: 10.6x ↗		
3: 9.7 ←	8: 10.6x ↓	Total	194 (16x)
4: 10.6x →	9: 10.3x ↗		
5: 10.0 ↖	10: 10.6x ↘		

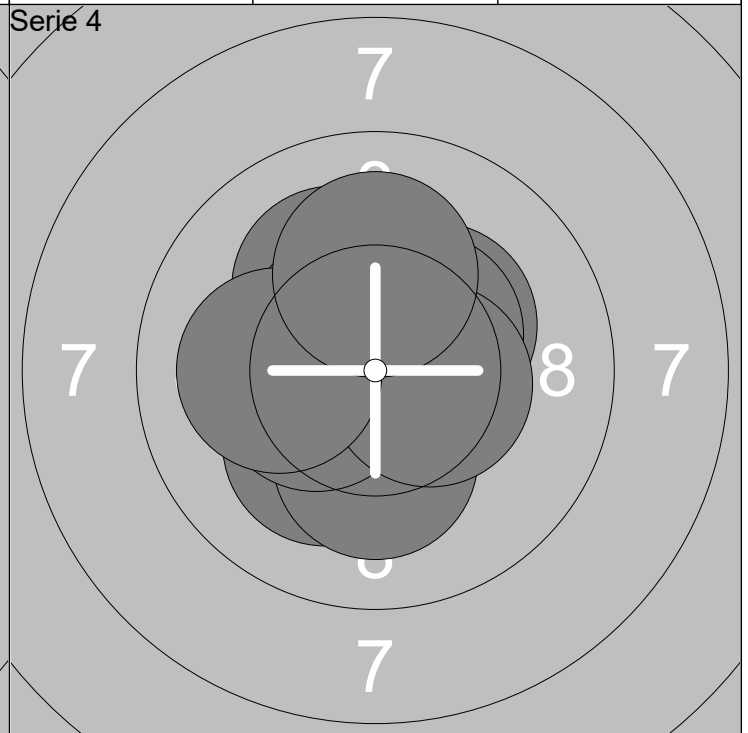
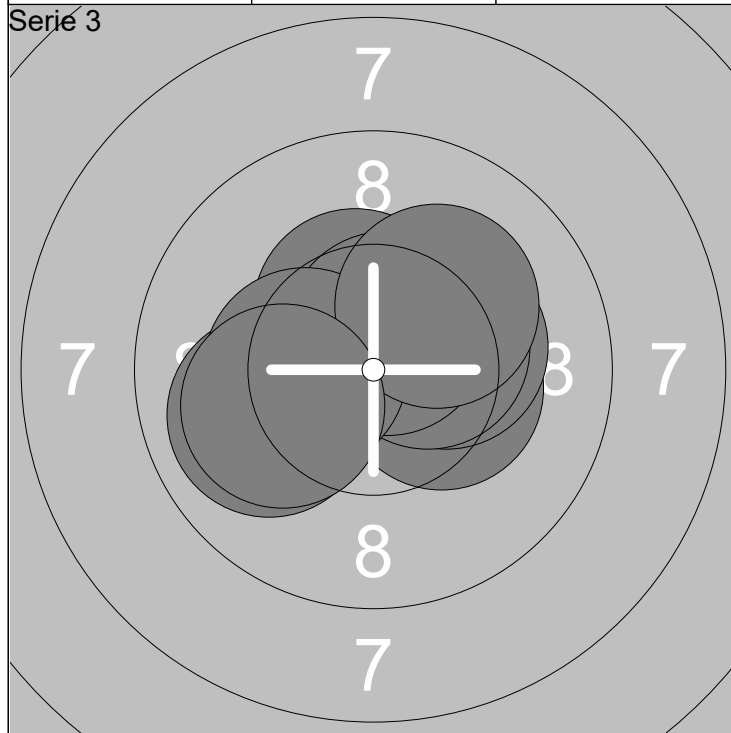

1: 10.6x ↗	6: 9.9 ←	Serie	99 (7x)
2: 10.3x →	7: 10.6x ↗		
3: 10.4x ↖	8: 10.3x ←	Total	293 (23x)
4: 10.2x →	9: 10.1 ↗		
5: 10.4x →	10: 10.1 ←		

1: 10.3x ↗	6: 10.4x ←	Serie	100 (6x)
2: 10.1 ↘	7: 10.5x ↖		
3: 10.1 ↖	8: 10.4x →	Total	393 (29x)
4: 10.4x ↗	9: 10.1 ←		
5: 10.2x ↓	10: 10.1 ↑		

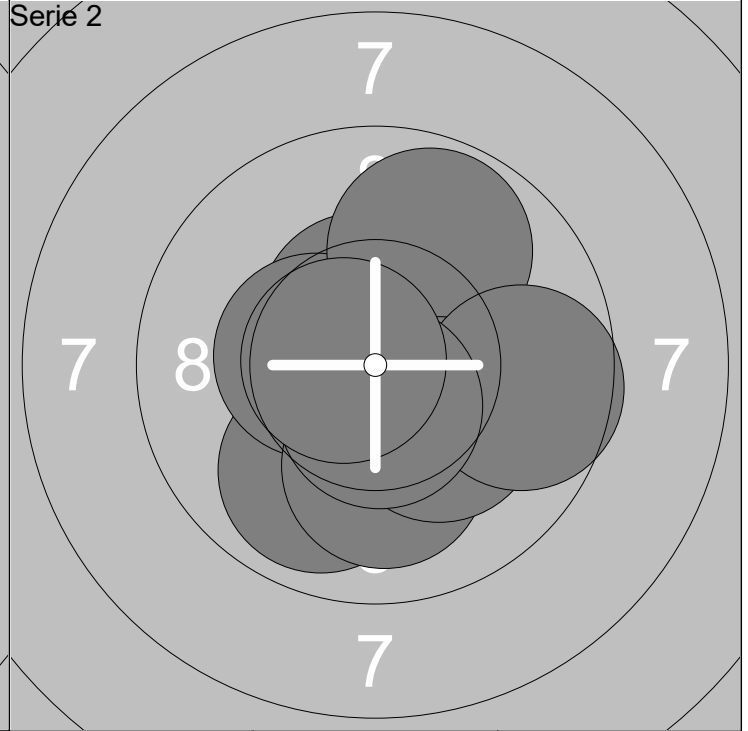
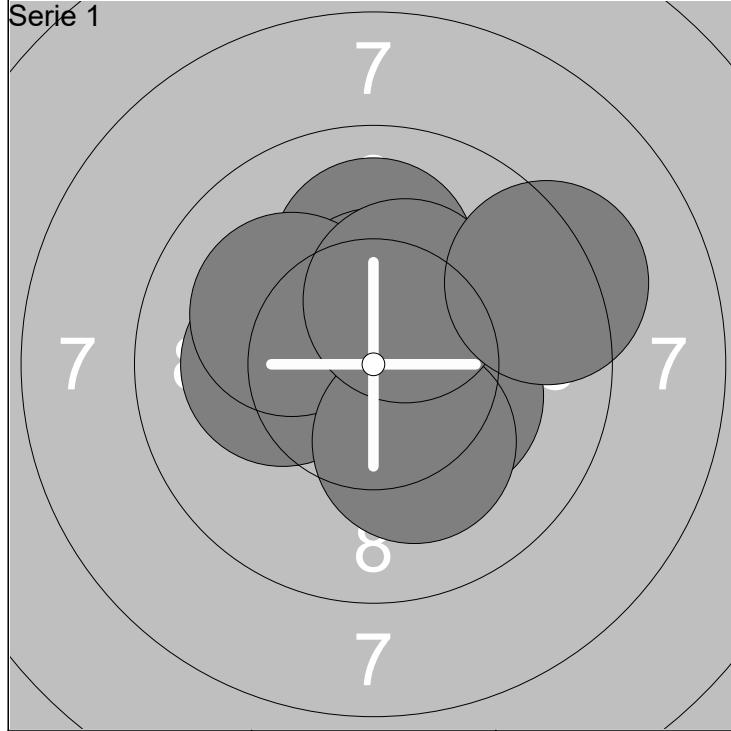

1: 10.3x ↘	6: 10.2x ↗	Serie	99 (6x)
2: 10.0 ↑	7: 10.3x →		
3: 10.1 ←	8: 10.2x ↘	Total	99 (6x)
4: 10.4x ↑	9: 10.3x ↗		
5: 10.1 ↖	10: 9.2 ↗		

1: 9.9 ↙	6: 10.1 ↓	Serie	97 (6x)
2: 10.5x ↑	7: 10.2x ↘		
3: 10.4x ←	8: 9.6 →	Total	196 (12x)
4: 10.6x ↗	9: 10.6x ↓		
5: 9.8 ↑	10: 10.7x ←		

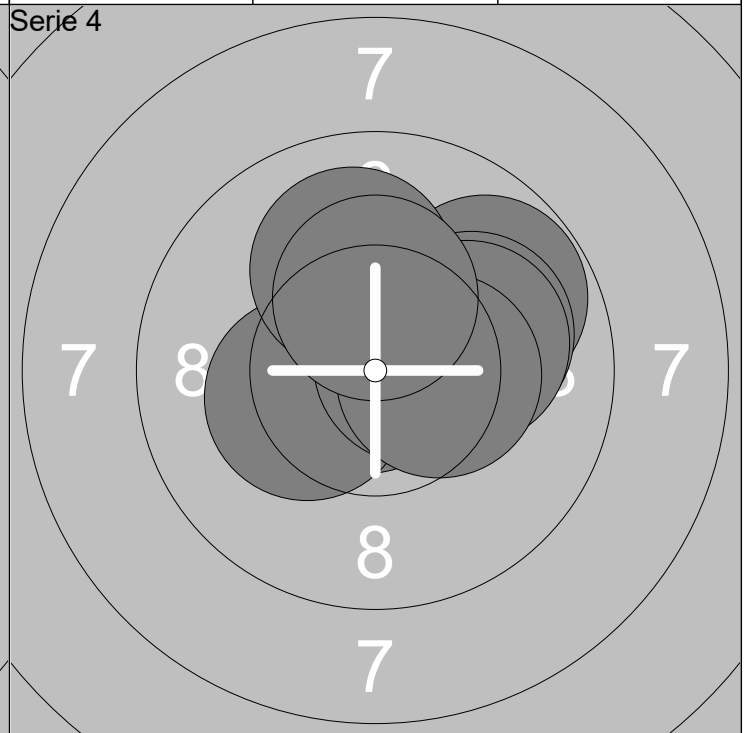
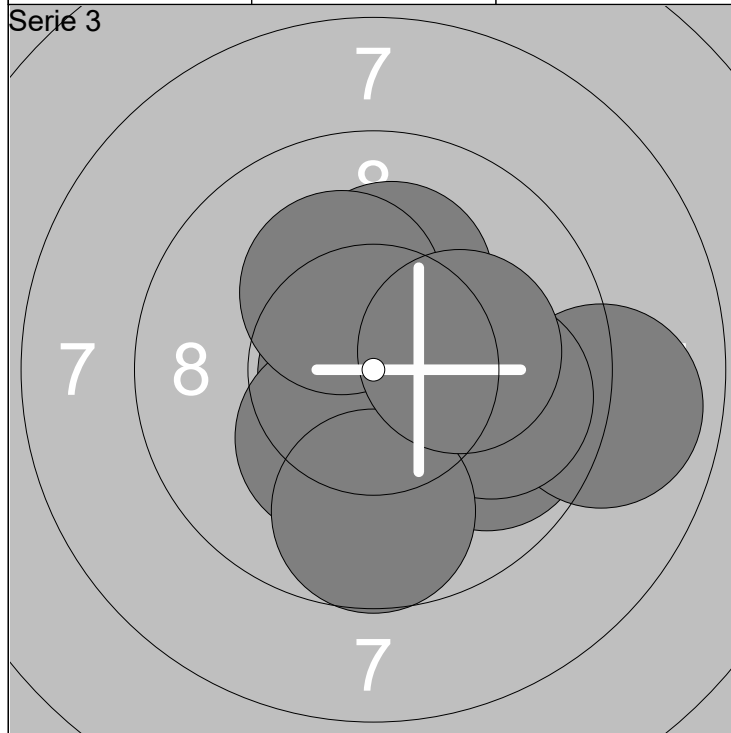

1: 10.2x ↑	6: 10.3x ↘	Serie	95 (5x)
2: 10.8x ←	7: 10.2x ↗		
3: 9.8 →	8: 9.9 →	Total	291 (17x)
4: 10.6x →	9: 9.7 ↓		
5: 8.9 →	10: 10.1 →		

1: 10.4x →	6: 10.6x →	Serie	99 (6x)
2: 10.9x ←	7: 10.0 ↑		
3: 10.3x ←	8: 10.1 →	Total	390 (23x)
4: 9.8 ↗	9: 10.4x →		
5: 10.0 →	10: 10.3x ↑		

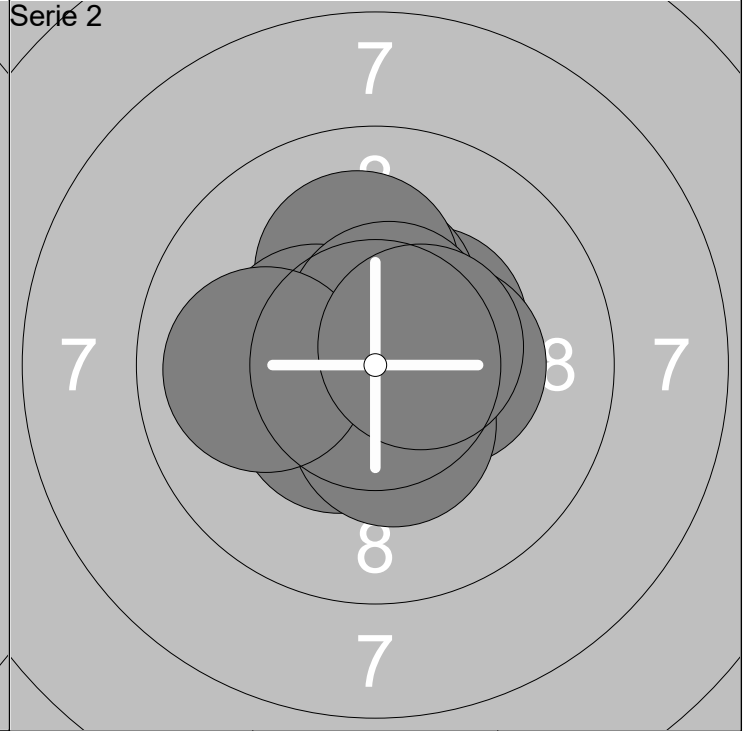
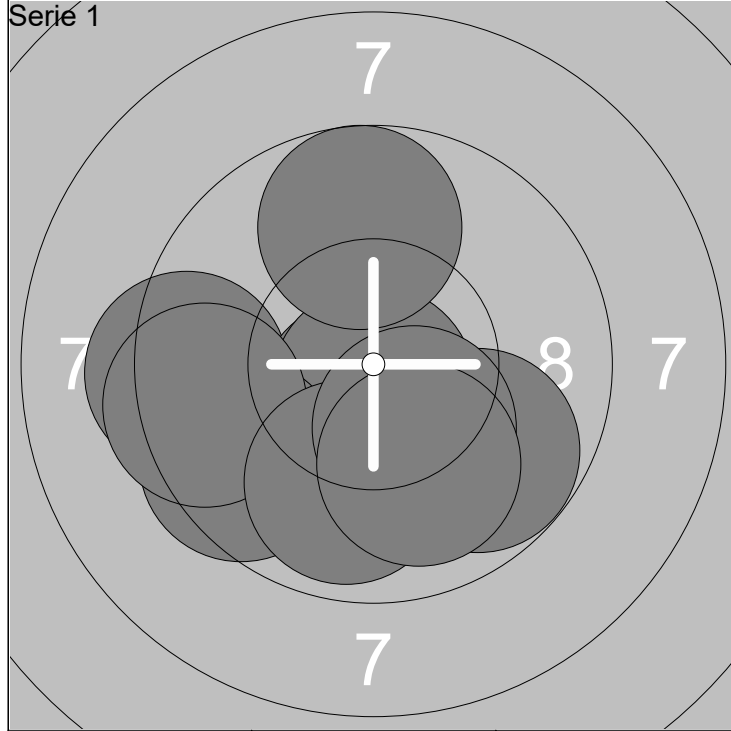

1: 9.3 ←	6: 9.4 ←	Serie 93 (3x)
2: 10.6x ↓	7: 9.8 ↓	
3: 10.7x ↓	8: 9.7 ↓	Total 93 (3x)
4: 9.5 ↙	9: 10.3x ↓	
5: 9.7 ↑	10: 9.9 ↓	

1: 10.4x ↗	6: 10.4x ←	Serie 100 (8x)
2: 10.4x ↙	7: 10.4x ↓	
3: 10.3x →	8: 10.5x ↑	Total 193 (11x)
4: 10.3x ↑	9: 10.0 ←	
5: 10.1 ↑	10: 10.5x ↗	

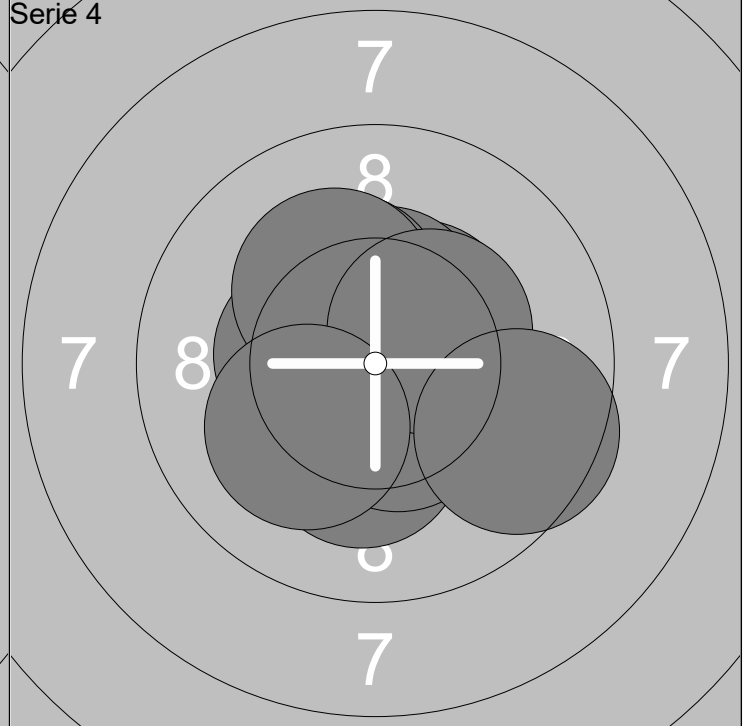
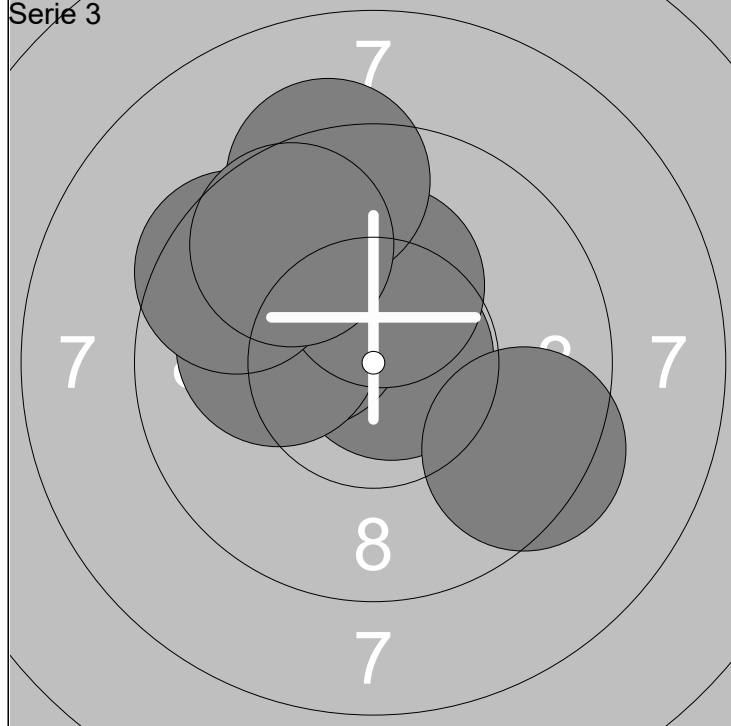

1: 10.8x →	6: 10.1 ←	Serie 95 (4x)
2: 10.2x ↙	7: 10.2x ↑	
3: 9.8 ↗	8: 9.3 ↑	Total 288 (15x)
4: 10.2x ↑	9: 9.5 ↙	
5: 9.4 ↘	10: 9.6 ↗	

1: 10.4x ↗	6: 10.3x ↗	Serie 99 (8x)
2: 10.4x ↑	7: 10.2x ↙	
3: 10.2x ↓	8: 10.4x ↗	Total 387 (23x)
4: 10.4x ←	9: 9.6 →	
5: 10.5x ↓	10: 10.1 ↙	

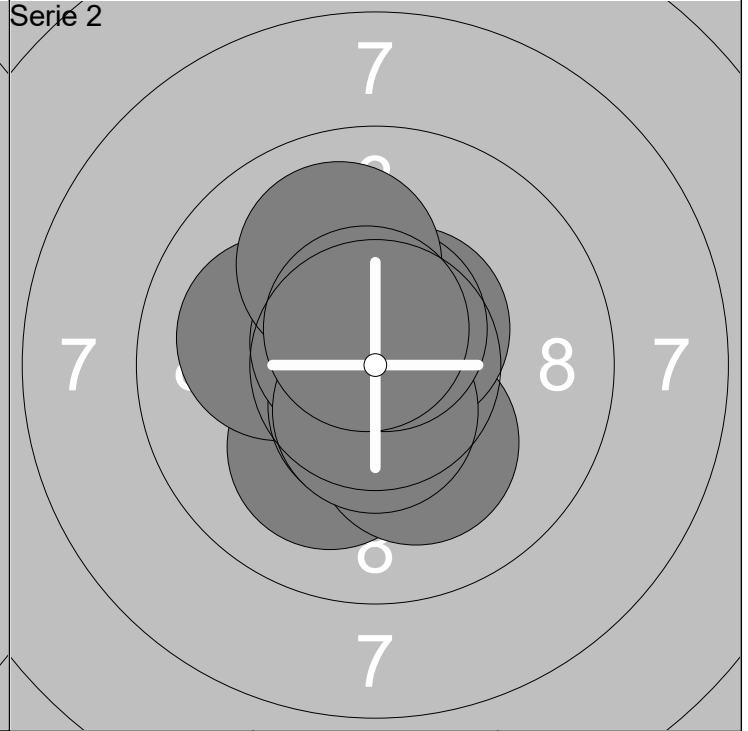
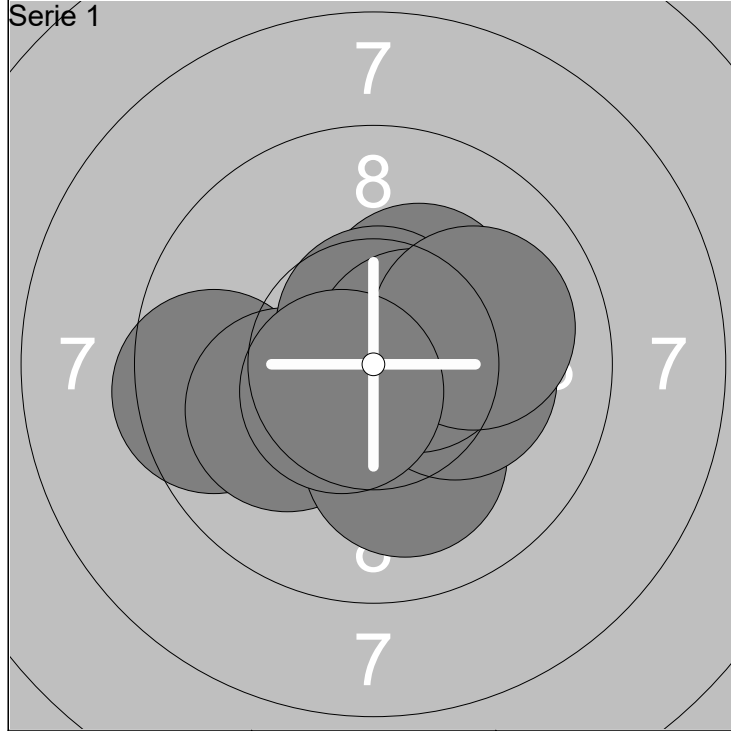

1: 9.5 ←	6: 10.2x →	Serie	99 (6x)
2: 10.6x →	7: 10.6x ↑		
3: 10.1 ←	8: 10.5x →	Total	99 (6x)
4: 10.1 ↓	9: 10.0 →		
5: 10.3x ↗	10: 10.5x ↙		

1: 10.1 ↙	6: 10.6x ↖	Serie	100 (7x)
2: 10.2x ↘	7: 10.5x ↓		
3: 10.5x ↗	8: 10.6x ↑	Total	199 (13x)
4: 10.0 ←	9: 10.0 ↑		
5: 10.6x ↓	10: 10.6x ↑		

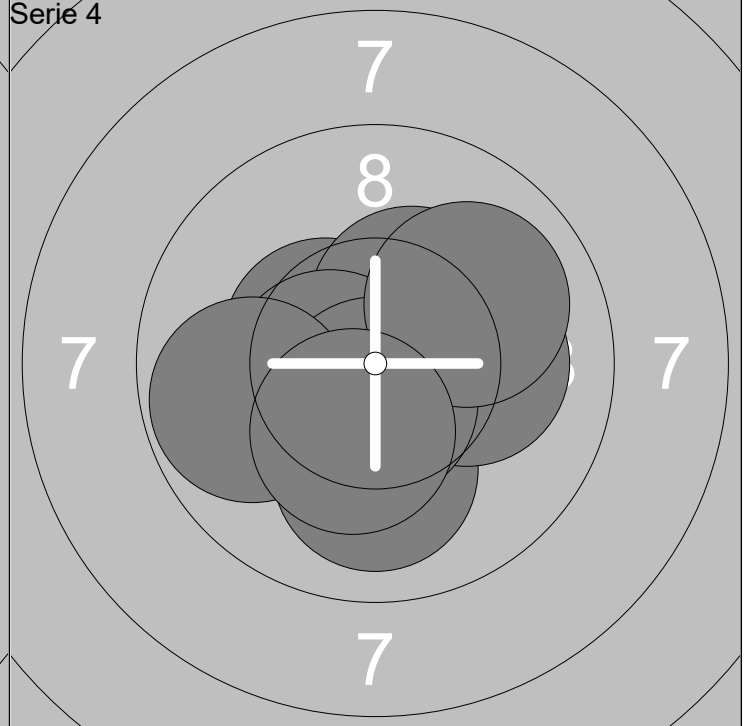
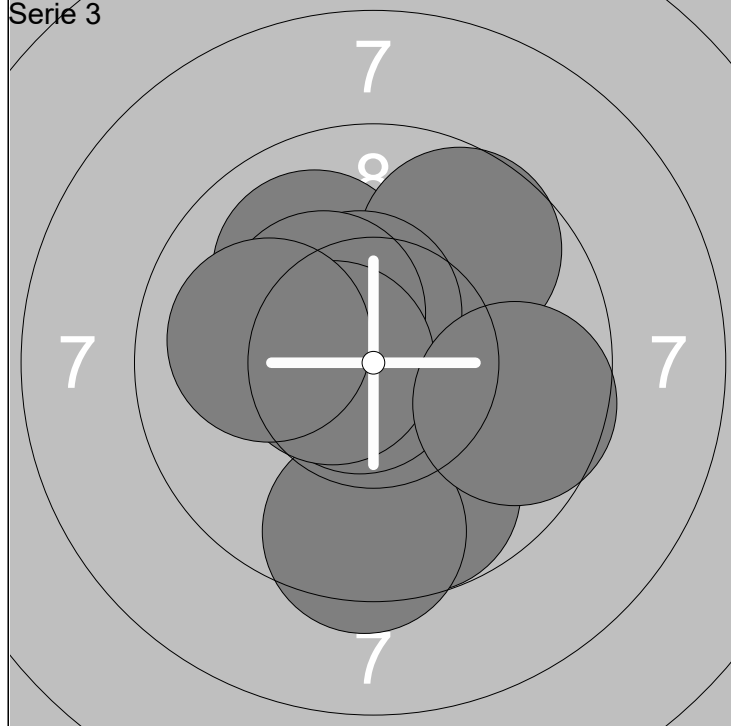

1: 9.7 ↓	6: 10.5x ↑	Serie	95 (4x)
2: 9.4 ↓	7: 10.3x ↖		
3: 10.8x ↙	8: 10.6x ←	Total	294 (17x)
4: 9.9 ↗	9: 9.6 →		
5: 9.7 ↗	10: 10.0 ←		

1: 10.0 ↓	6: 10.5x ←	Serie	99 (6x)
2: 10.5x ↖	7: 10.6x ↓		
3: 10.3x →	8: 9.8 ←	Total	393 (23x)
4: 10.1 →	9: 10.0 ↗		
5: 10.4x ↗	10: 10.3x ↓		

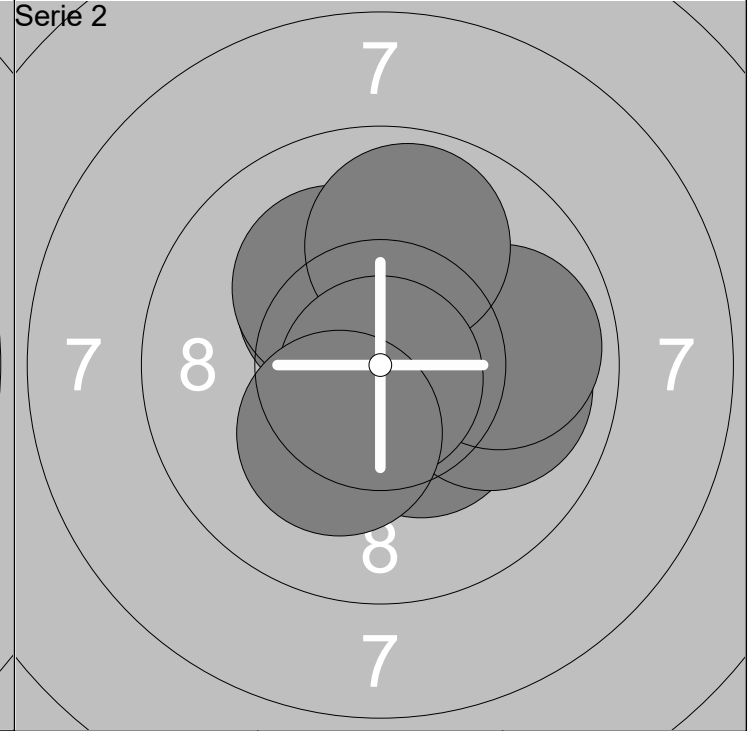
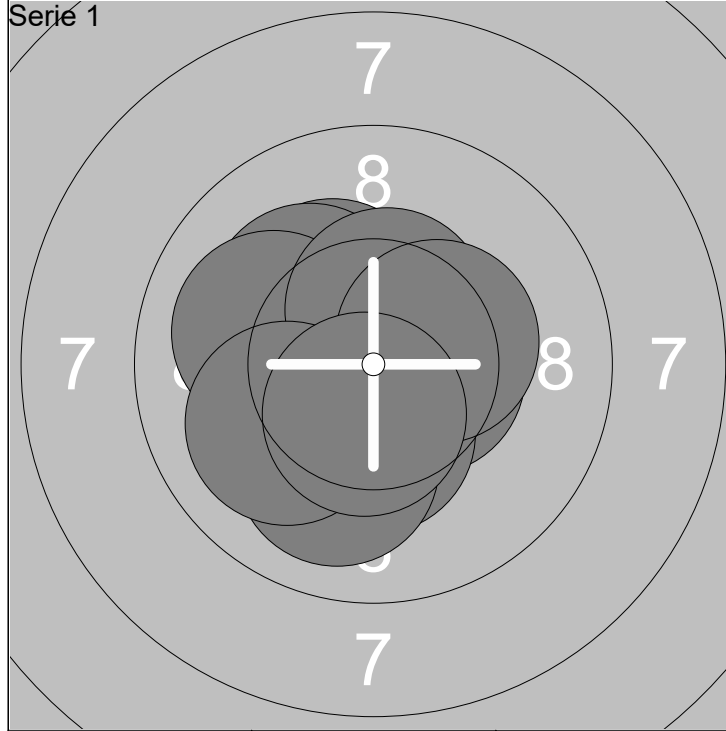

1: 10.2x ↗	6: 10.0 ↓	Serie 100 (7x)
2: 10.5x →	7: 10.4x ↑	
3: 10.3x ↓	8: 10.0 ←	Total 100 (7x)
4: 10.2x ↗	9: 10.3x →	
5: 10.0 ←	10: 10.5x ↓	

1: 10.4x →	6: 9.9 →	Serie 97 (6x)
2: 10.3x ↘	7: 10.1 ↖	
3: 9.9 →	8: 9.8 ↑	Total 197 (13x)
4: 10.8x ↑	9: 10.8x ↓	
5: 10.3x ↖	10: 10.2x ↙	

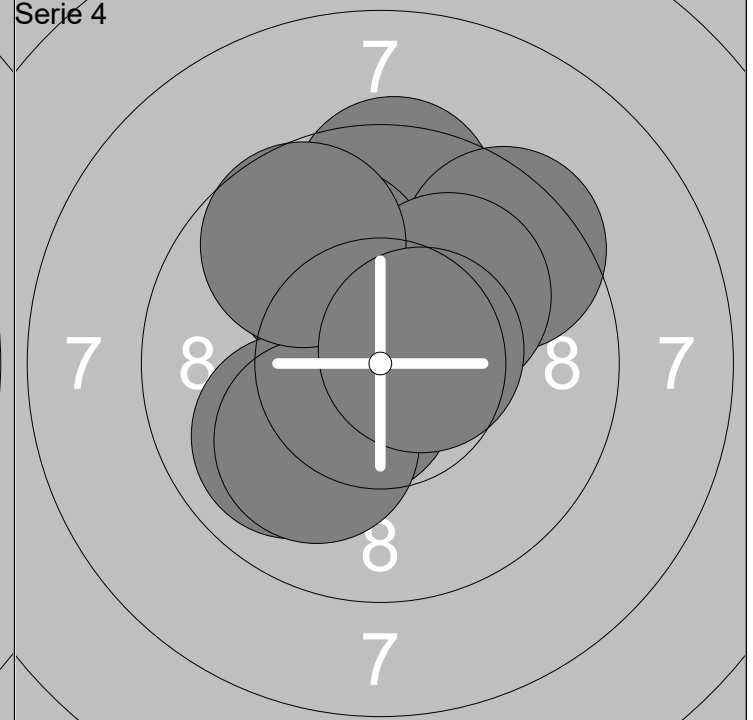
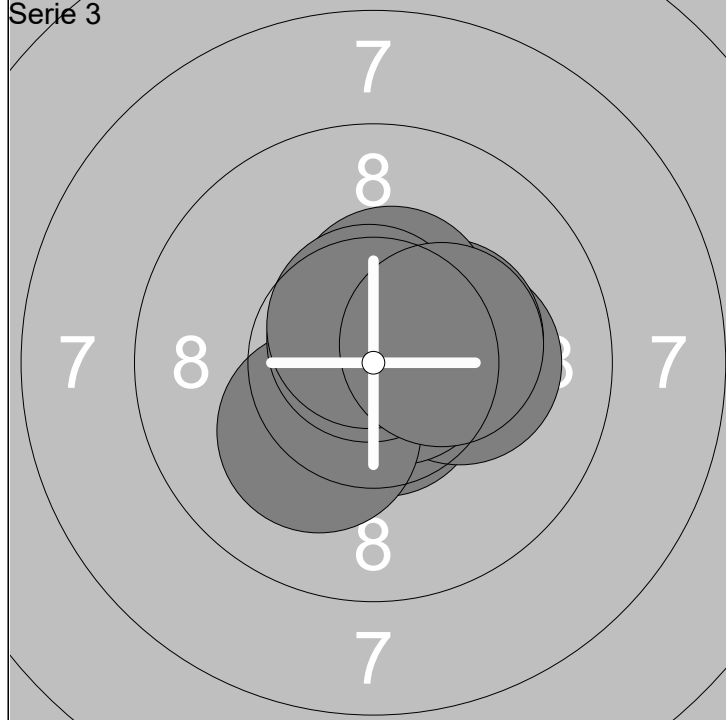

1: 10.9x ↓	6: 10.7x ↑	Serie 100 (10x)
2: 10.6x ↓	7: 10.3x →	
3: 10.2x →	8: 10.4x ↑	Total 297 (23x)
4: 10.7x →	9: 10.6x ↑	
5: 10.2x ↙	10: 10.3x →	

1: 9.5 ↑	6: 9.9 ↙	Serie 96 (3x)
2: 10.7x ↖	7: 10.0 ↙	
3: 9.5 ↗	8: 10.1 ↗	Total 393 (26x)
4: 10.5x ↙	9: 9.7 ↖	
5: 10.0 ↖	10: 10.6x →	

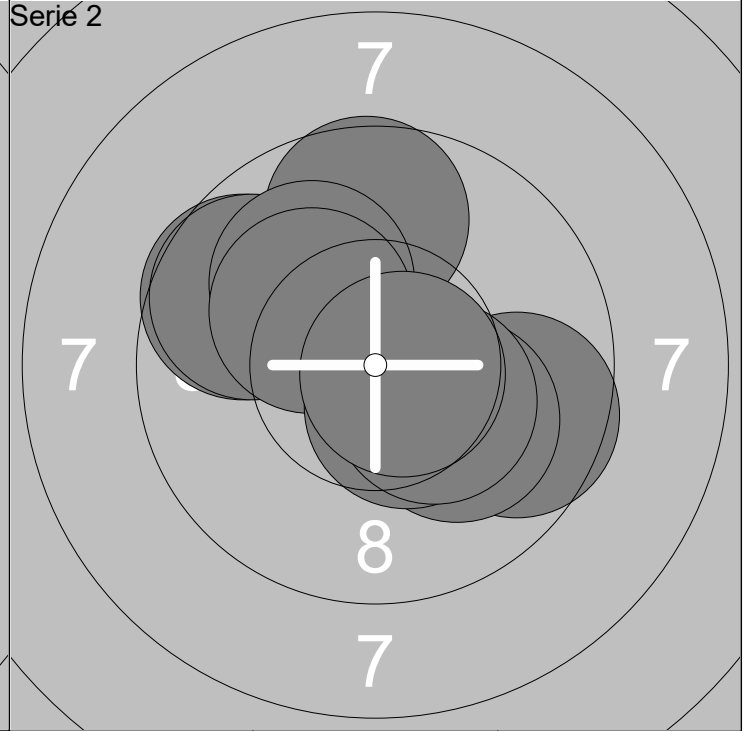
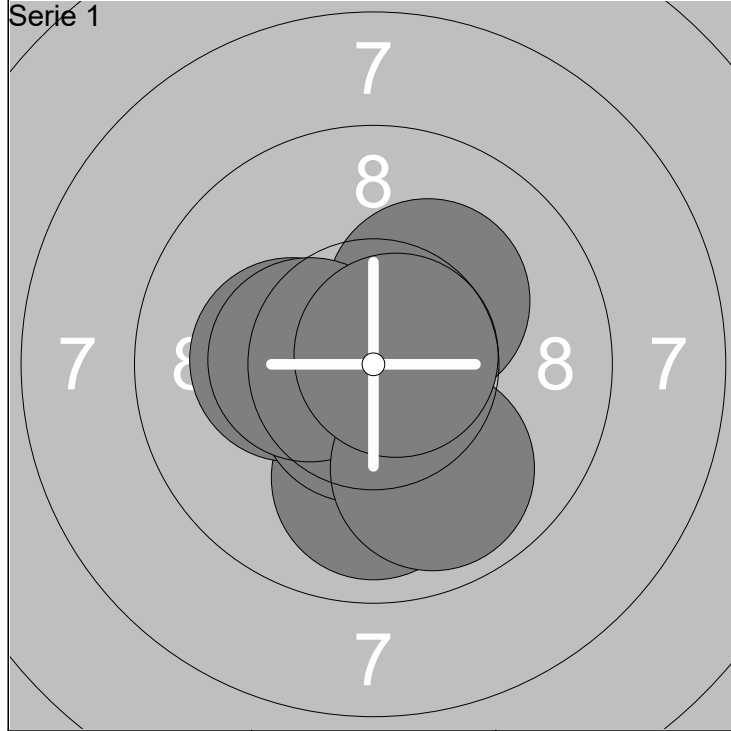

1: 10.8x ↗	6: 10.6x ↓	Serie	98 (8x)
2: 10.8x ←	7: 10.6x ↓		
3: 10.2x ↗	8: 10.4x ←	Total	98 (8x)
4: 9.9 ↓	9: 9.9 ↓		
5: 10.2x ←	10: 10.7x ↗		

1: 9.6 ↖	6: 10.0 ↗	Serie	96 (4x)
2: 9.6 →	7: 10.2x ↗		
3: 10.1 ↘	8: 10.5x ↓	Total	194 (12x)
4: 9.7 ↗	9: 10.3x ↓		
5: 9.7 ↑	10: 10.7x ↘		

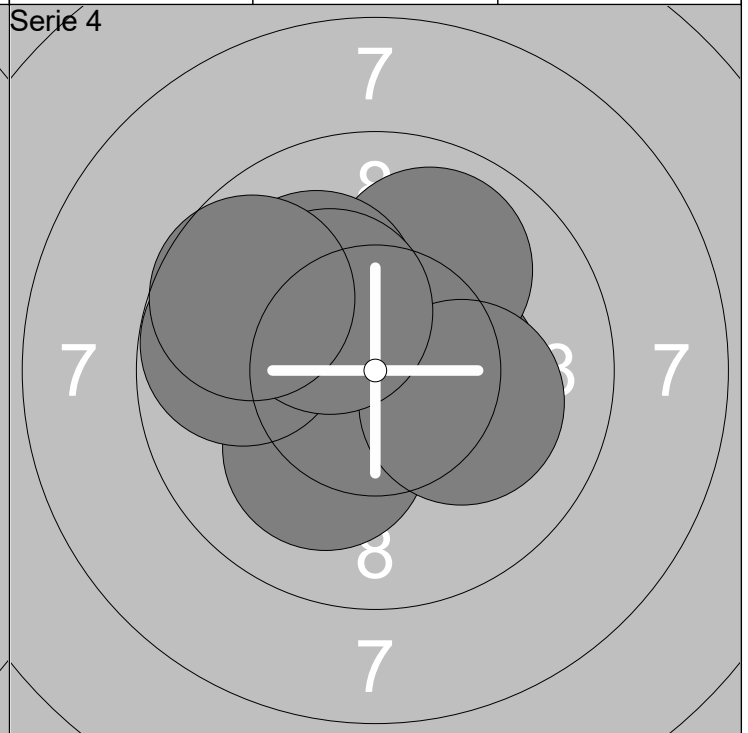
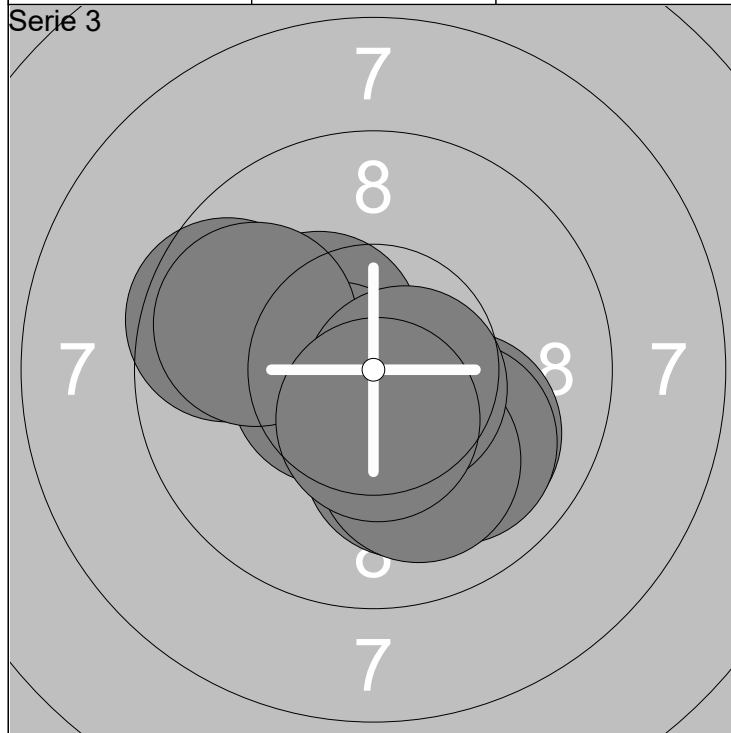

1: 9.6 ↖	6: 10.0 ↓	Serie	98 (4x)
2: 10.0 ↓	7: 10.5x ←		
3: 10.0 ↓	8: 9.8 ↖	Total	292 (16x)
4: 10.4x ↗	9: 10.6x ↘		
5: 10.1 ↓	10: 10.5x ↓		

1: 10.6x ↗	6: 9.8 ↖	Serie	97 (4x)
2: 10.4x →	7: 10.1 ↗		
3: 9.9 ↗	8: 10.1 →	Total	389 (20x)
4: 10.7x ↓	9: 10.3x ↗		
5: 10.1 ↘	10: 9.7 ↖		

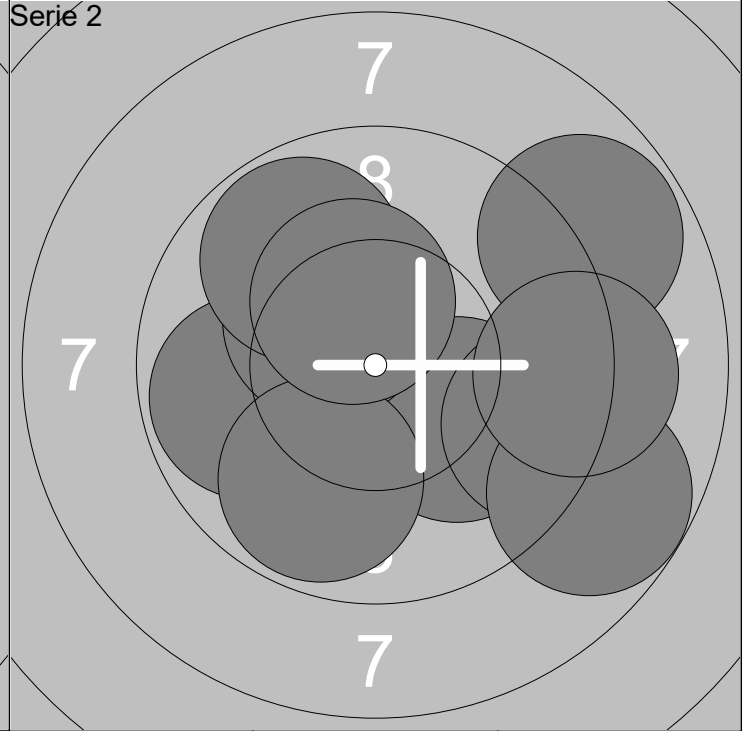
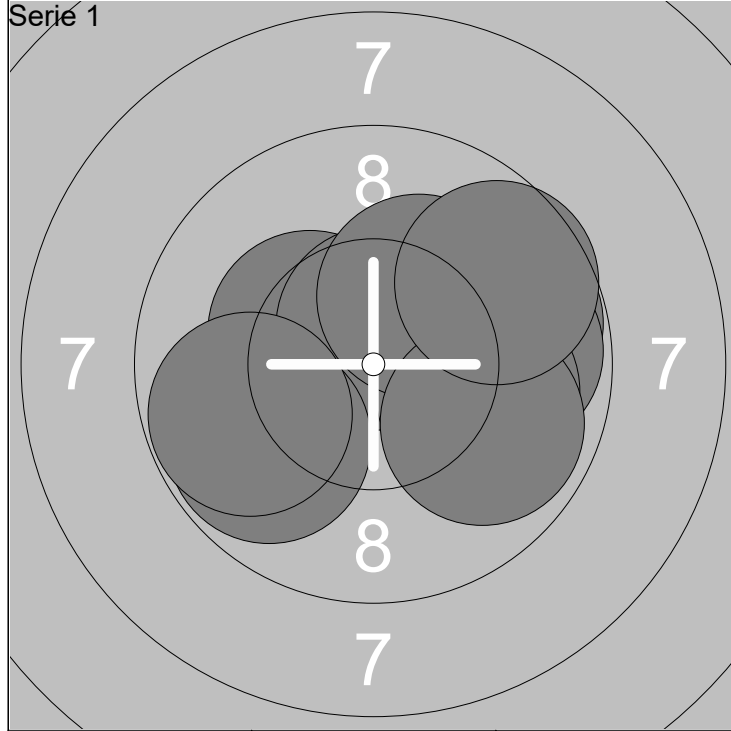

1: 9.7 →	6: 10.0 →	Serie	94 (3x)
2: 10.3x ↖	7: 10.2x ↗		
3: 10.6x ↑	8: 9.8 ←	Total	94 (3x)
4: 9.8 ↙	9: 9.8 →		
5: 9.8 →	10: 9.6 ↗		

1: 10.1 ↘	6: 9.8 ↓	Serie	91 (2x)
2: 8.8 ↗	7: 8.7 ↘		
3: 9.4 →	8: 9.8 ↗	Total	185 (5x)
4: 9.8 ←	9: 10.3x ↑		
5: 10.3x ↖	10: 9.2 →		

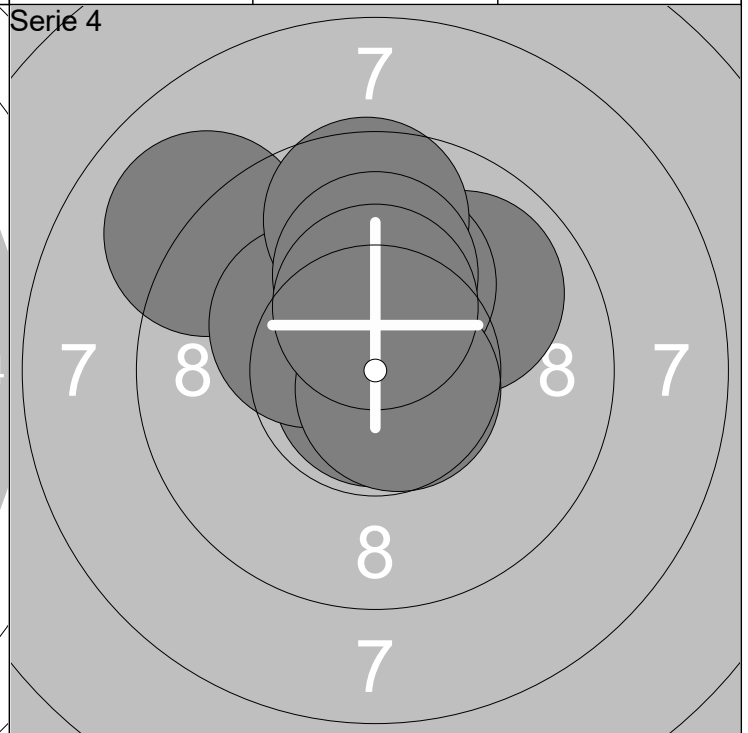
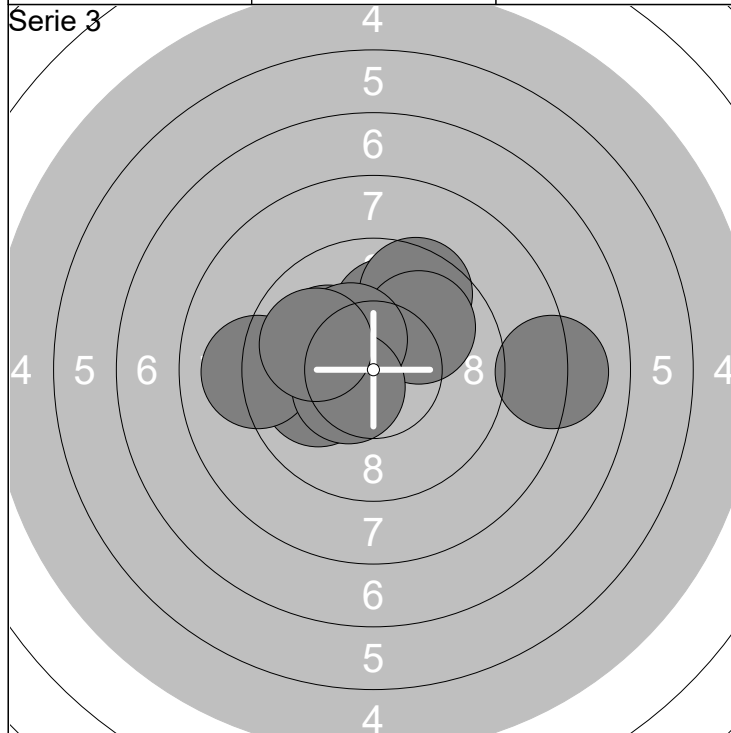

1: 10.0 ↑	6: 8.1 →	Serie	94 (2x)
2: 10.0 ←	7: 9.9 ↗		
3: 9.5 ↗	8: 10.3x ↖	Total	279 (7x)
4: 9.1 ←	9: 10.4x ↙		
5: 10.1 ↖	10: 9.9 ←		

1: 10.8x ↓	6: 10.2x ↖	Serie	97 (5x)
2: 10.3x ↖	7: 9.6 ↑		
3: 9.9 ↗	8: 10.7x ↘	Total	376 (12x)
4: 9.0 ↖	9: 10.1 ↑		
5: 10.1 ↑	10: 10.4x ↑		

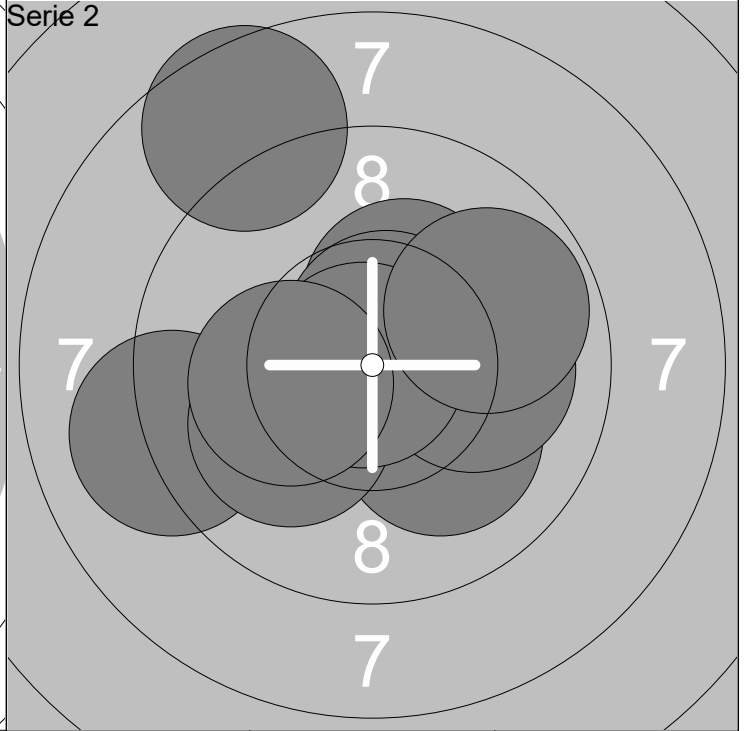
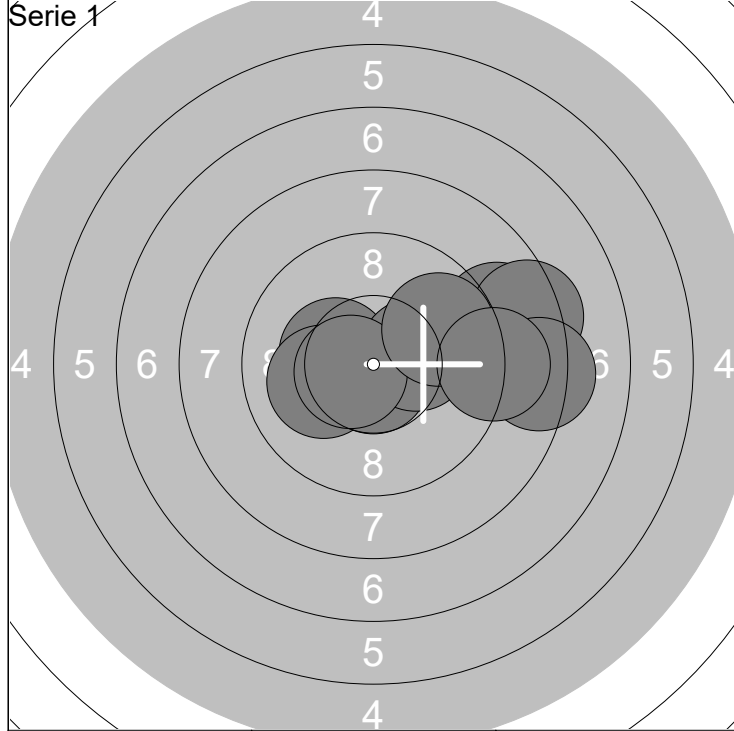

1: 8.8 →	6: 8.4 →	Serie	92 (4x)
2: 10.3x ←	7: 10.5x ←		
3: 10.1 ←	8: 9.7 →	Total	92 (4x)
4: 10.7x ↓	9: 8.3 →		
5: 10.2x →	10: 9.0 →		

1: 10.1 ↘	6: 10.0 ↙	Serie	96 (4x)
2: 9.1 ←	7: 10.9x ←		
3: 10.3x ↗	8: 10.2x ←	Total	188 (8x)
4: 10.6x ↗	9: 8.6 ↗		
5: 10.1 →	10: 9.8 →		

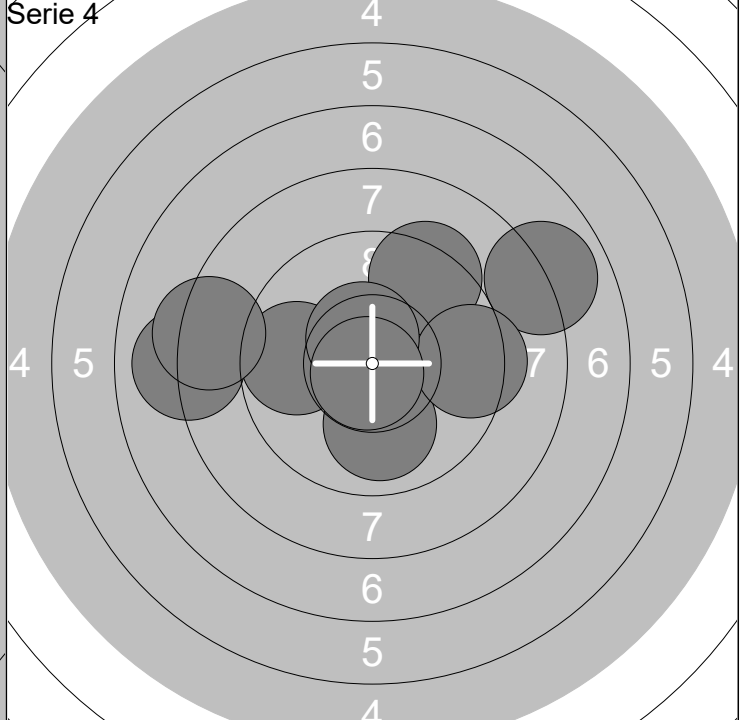
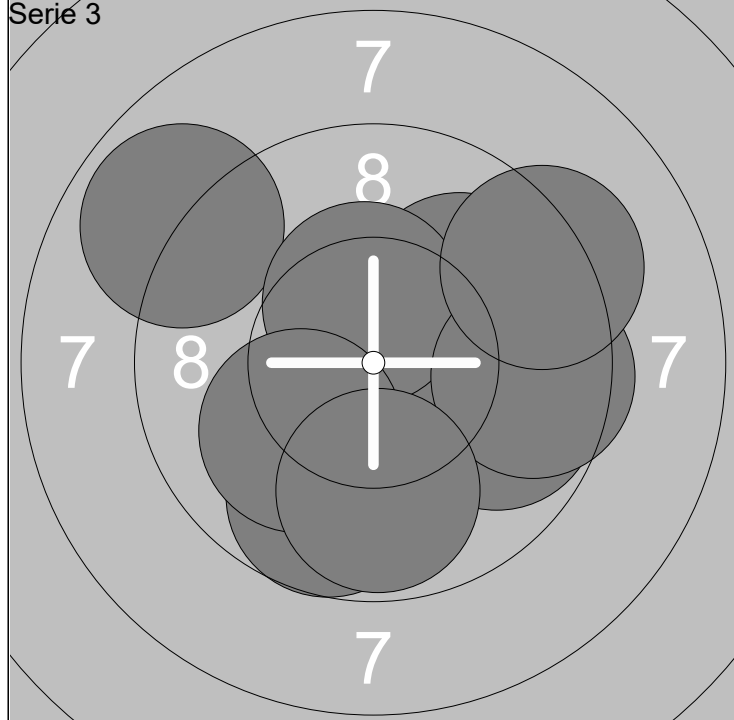

1: 8.8 ↖	6: 9.7 ↓	Serie	93 (2x)
2: 10.0 ↗	7: 9.5 →		
3: 9.8 →	8: 10.0 ↙	Total	281 (10x)
4: 10.7x →	9: 9.8 ↓		
5: 10.4x ↗	10: 9.2 ↗		

1: 10.1 →	6: 8.0 ←	Serie	90 (2x)
2: 7.9 ↗	7: 9.4 →		
3: 10.0 ↓	8: 10.5x ↗	Total	371 (12x)
4: 9.7 ←	9: 10.8x ↙		
5: 9.3 ↗	10: 8.3 ←		

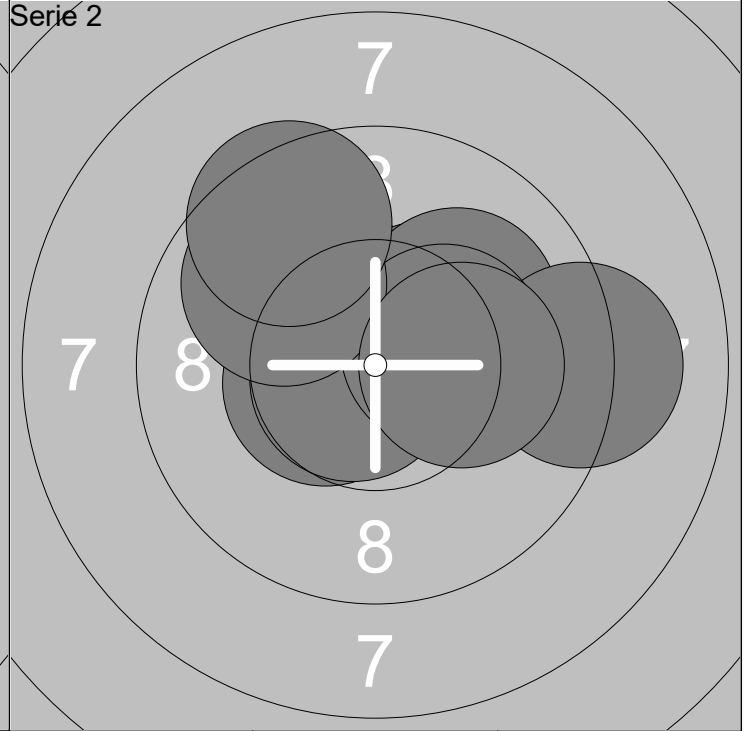
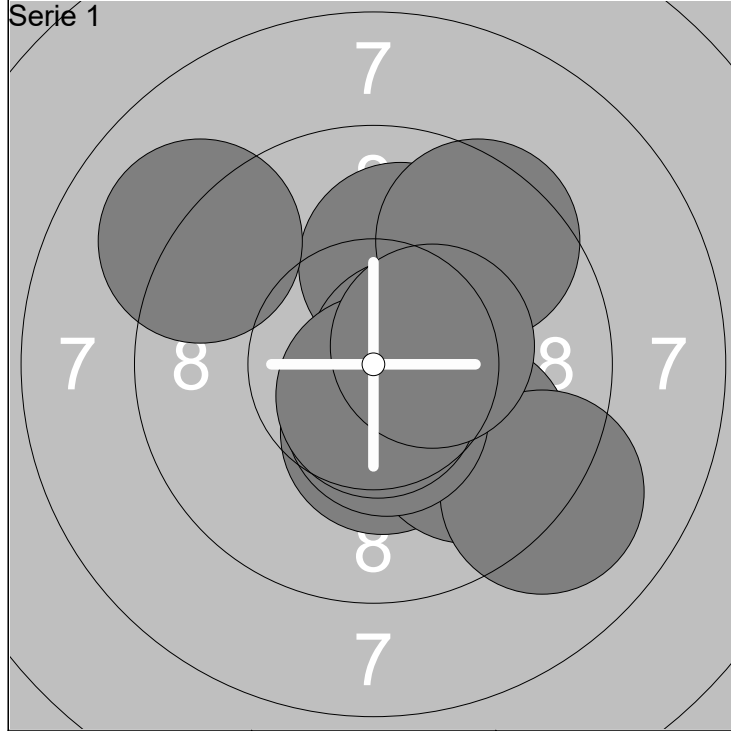

1: 10.0 ↗	6: 9.8 ↘	Serie 96 (5x)
2: 10.3x ↘	7: 9.1 ↘	
3: 9.5 ↗	8: 10.5x ↘	Total 96 (5x)
4: 10.6x →	9: 10.6x ↘	
5: 9.1 ↖	10: 10.4x →	

1: 10.5x ←	6: 10.7x ←	Serie 97 (6x)
2: 10.5x ↗	7: 10.3x →	
3: 10.3x ↗	8: 9.8 ↖	Total 193 (11x)
4: 10.1 ↗	9: 10.2x →	
5: 9.1 →	10: 9.5 ↗	

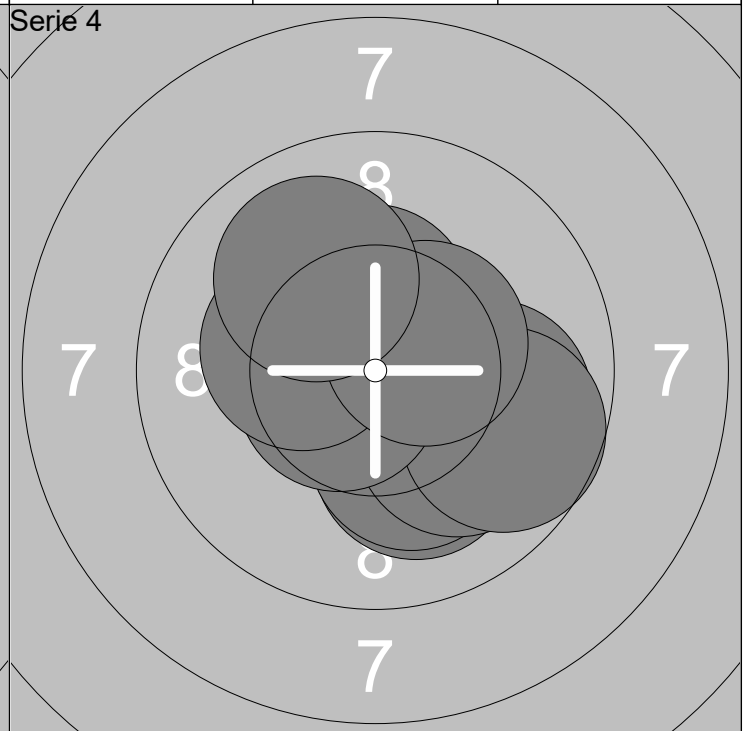
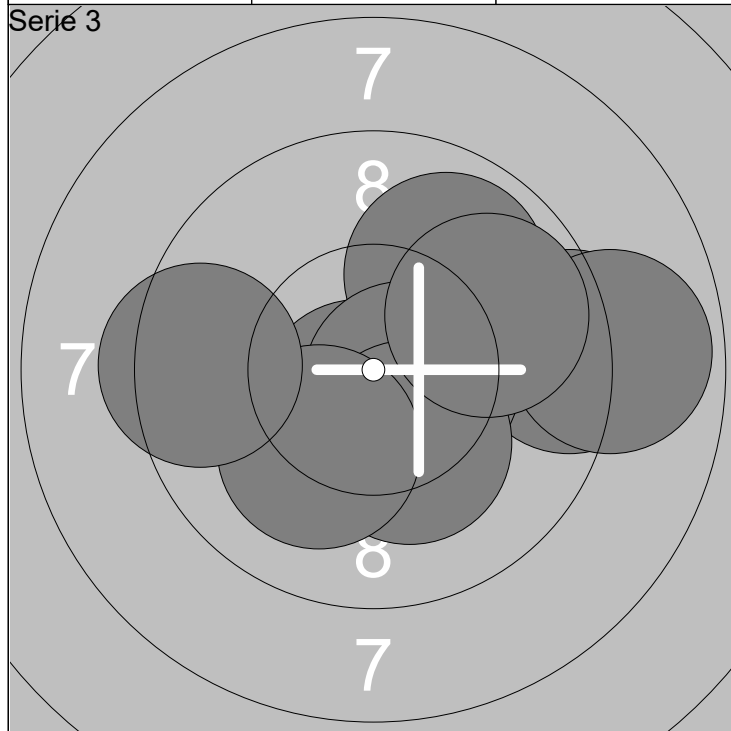

1: 9.2 →	6: 10.6x →	Serie 94 (4x)
2: 10.5x →	7: 10.2x ↘	
3: 9.9 ↗	8: 9.8 →	Total 287 (15x)
4: 8.8 →	9: 10.1 ↘	
5: 10.6x ↘	10: 9.4 ←	

1: 10.3x ↗	6: 9.7 ↘	Serie 98 (5x)
2: 10.1 ↘	7: 10.6x ←	
3: 9.9 →	8: 10.2x ←	Total 385 (20x)
4: 10.2x ↘	9: 10.4x ↗	
5: 10.0 ↘	10: 10.0 ↗	

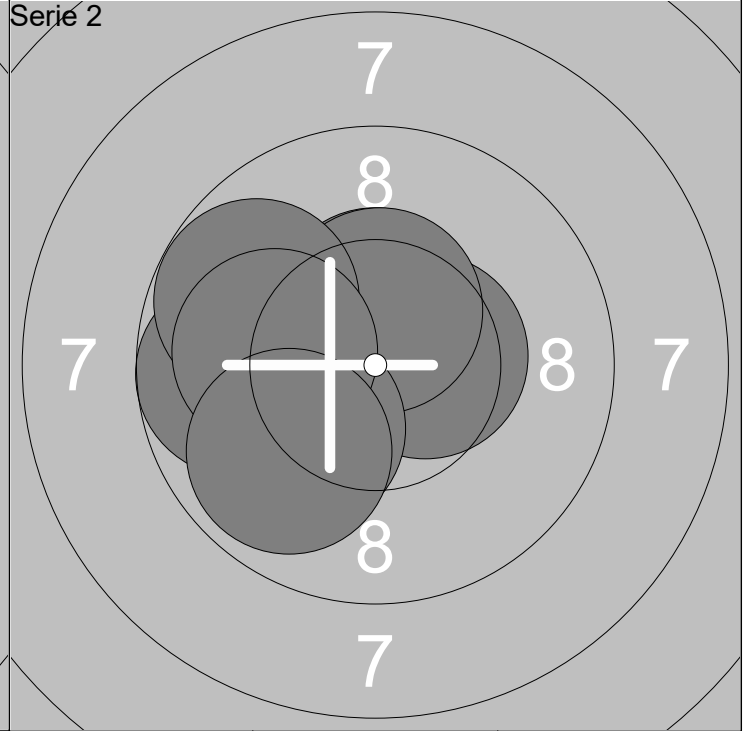
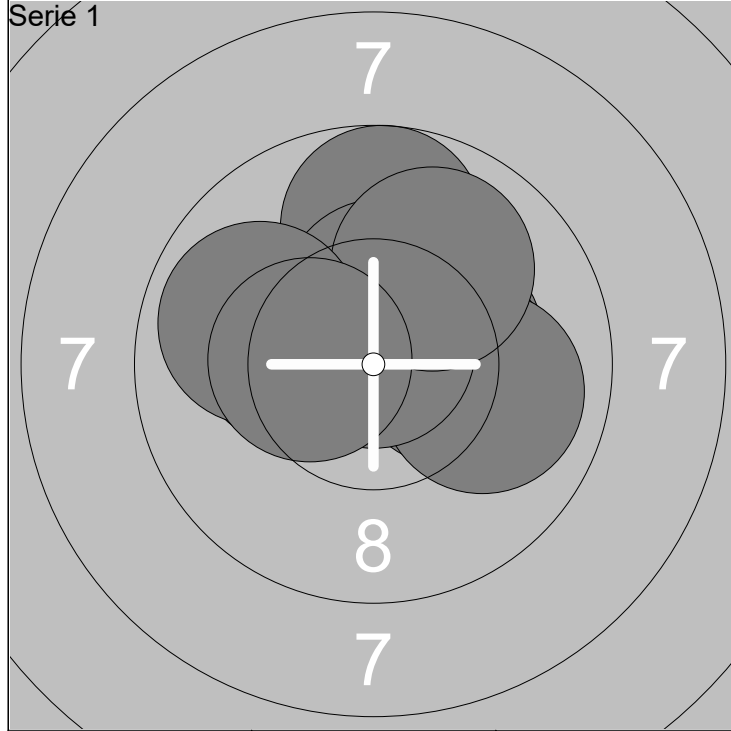

1: 10.3x →	6: 10.4x ↑	Serie	96 (6x)
2: 10.3x →	7: 10.8x ↑		
3: 9.9 →	8: 9.9 ↗	Total	96 (6x)
4: 9.7 ↑	9: 9.9 ←		
5: 10.2x ←	10: 10.4x ←		

1: 10.4x ←	6: 10.4x ↑	Serie	97 (5x)
2: 10.3x ←	7: 9.7 ↖		
3: 10.5x →	8: 10.1 ↙	Total	193 (11x)
4: 9.7 ←	9: 10.1 ←		
5: 10.5x ↑	10: 9.8 ↘		

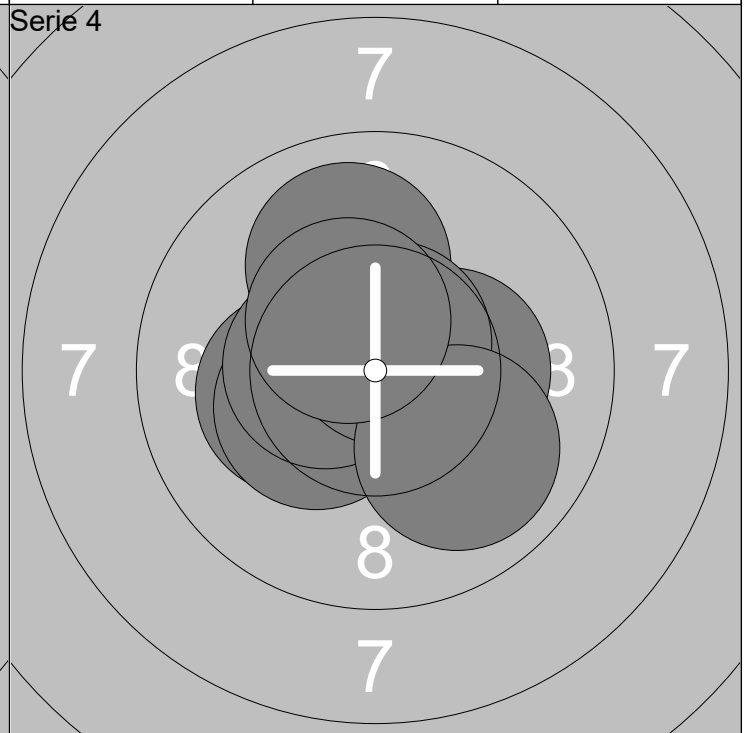
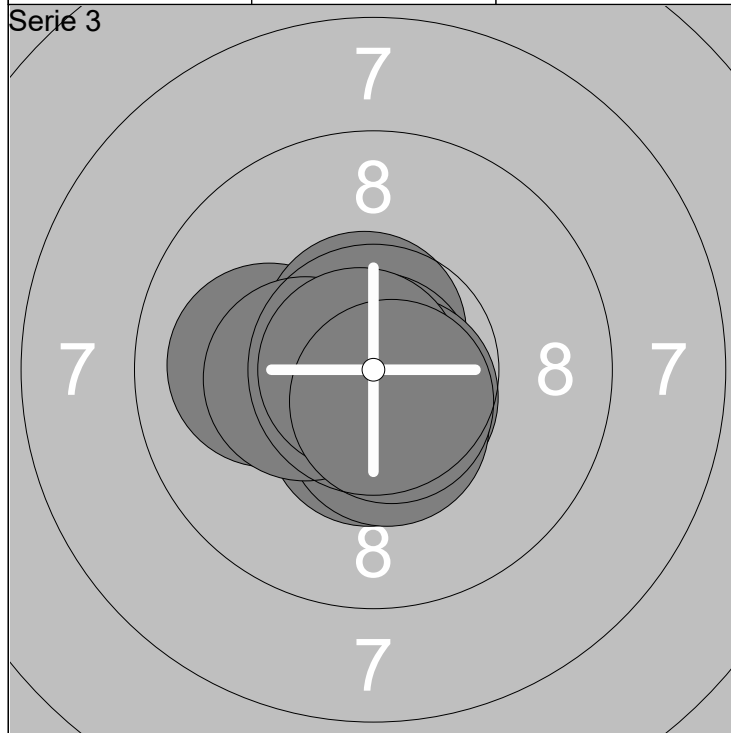

1: 10.5x ↓	6: 10.6x ↘	Serie	100 (9x)
2: 10.7x ↖	7: 10.4x ↓		
3: 10.0 ←	8: 10.3x ←	Total	293 (20x)
4: 10.6x ↑	9: 10.8x ←		
5: 10.9x ↓	10: 10.6x ↘		

1: 10.8x ↗	6: 10.5x ←	Serie	99 (8x)
2: 10.3x →	7: 10.0 ↑		
3: 10.2x ←	8: 10.6x ↗	Total	392 (28x)
4: 10.3x ↙	9: 9.9 ↘		
5: 10.8x ↗	10: 10.4x ↖		

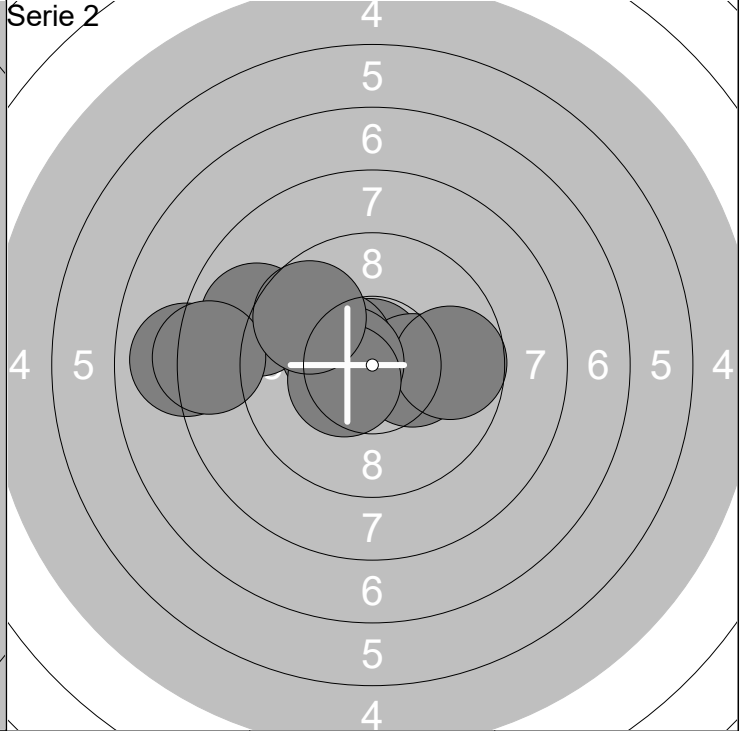
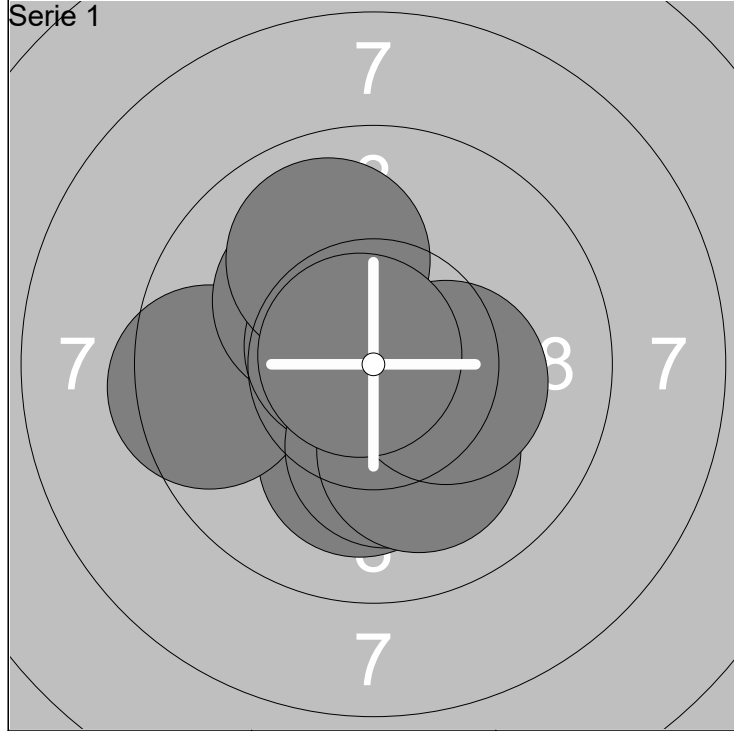

1: 10.1 ↓	6: 10.2x ↓	Serie 98 (6x)
2: 10.4x ↘	7: 9.9 ↗	
3: 9.5 ←	8: 10.1 ↓	Total 98 (6x)
4: 10.2x ↗	9: 10.3x →	
5: 10.6x ↗	10: 10.8x ↗	

1: 8.0 ←	6: 10.3x ↖	Serie 93 (5x)
2: 10.8x ↗	7: 10.5x ←	
3: 9.0 ↖	8: 10.4x ↖	Total 191 (11x)
4: 10.3x →	9: 8.3 ←	
5: 9.7 →	10: 9.7 ↖	

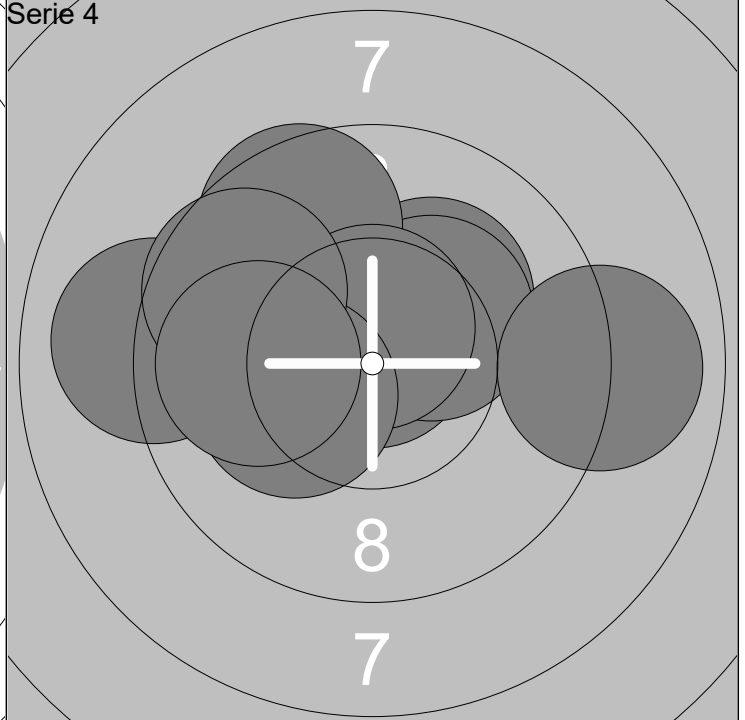
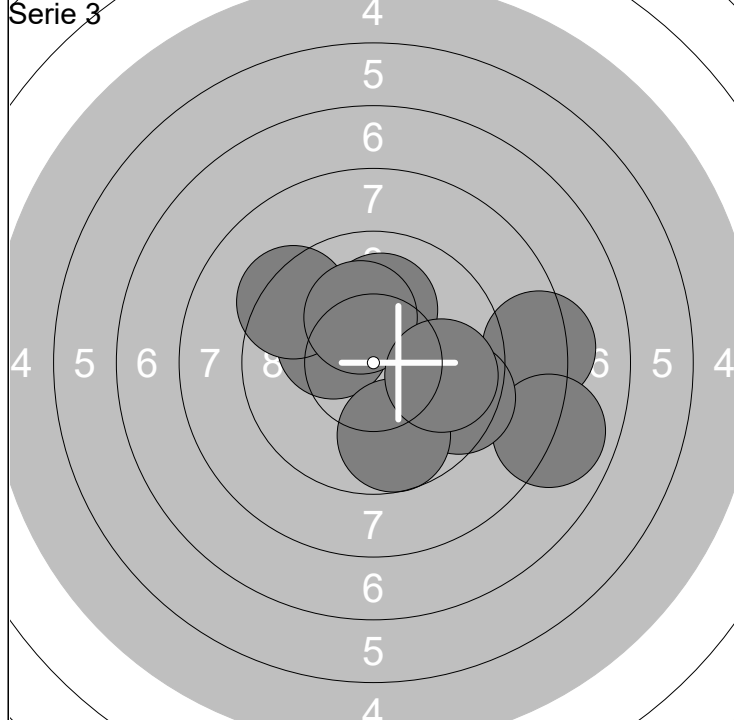

1: 8.3 →	6: 10.2x ↗	Serie 90 (2x)
2: 10.2x ↖	7: 7.9 →	
3: 9.7 →	8: 9.5 →	Total 281 (13x)
4: 9.3 ↖	9: 9.7 ↓	
5: 10.1 ↗	10: 9.8 →	

1: 10.2x ↗	6: 10.6x ↗	Serie 94 (5x)
2: 10.8x ↗	7: 10.2x ↖	
3: 10.3x ↗	8: 9.0 ←	Total 375 (18x)
4: 8.9 →	9: 9.6 ↖	
5: 9.6 ↖	10: 9.9 ←	

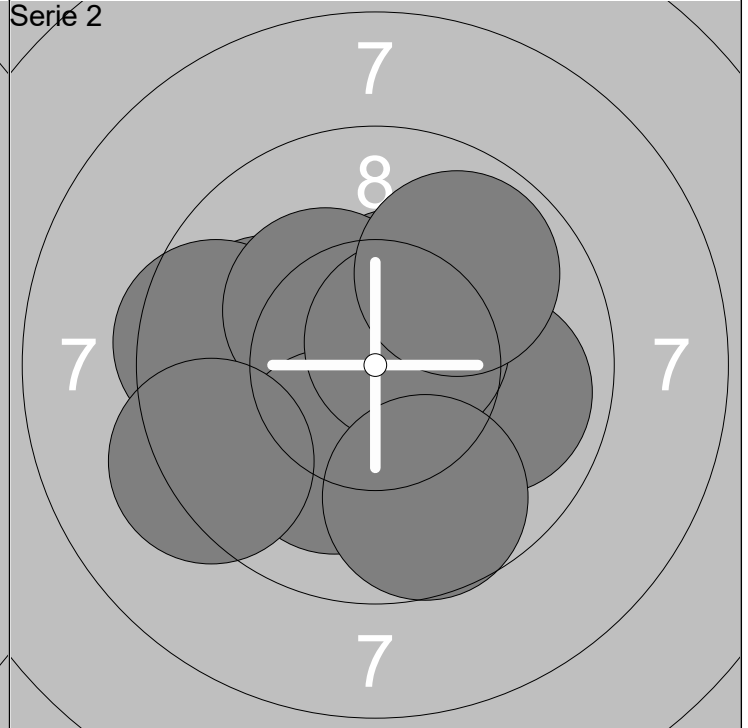
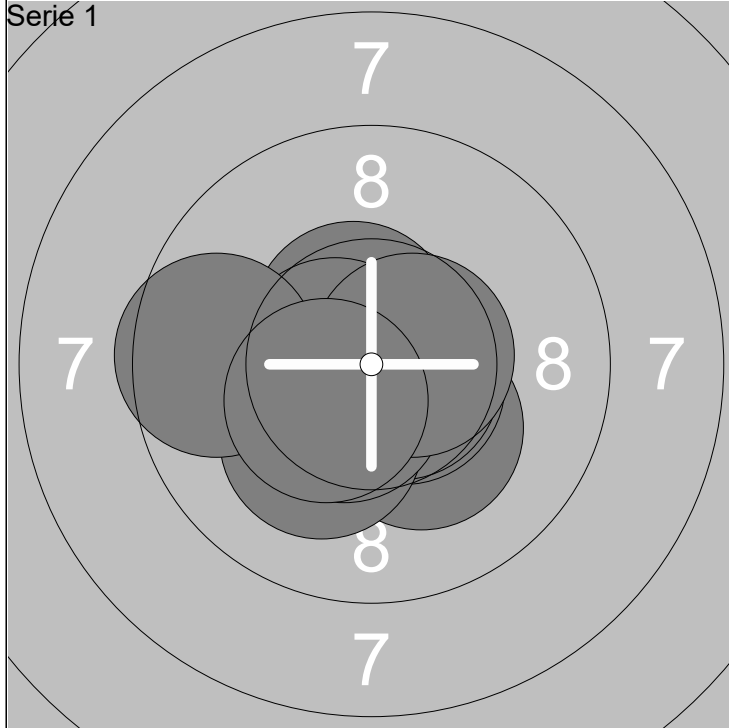

1: 10.5x ↗	6: 10.6x ←	Serie 99 (8x)
2: 10.2x ↘	7: 9.6 ←	
3: 10.6x ↘	8: 10.5x ↘	Total 99 (8x)
4: 10.7x ↘	9: 10.6x →	
5: 10.1 ↘	10: 10.4x ↙	

1: 10.0 ←	6: 10.1 ↘	Serie 95 (3x)
2: 9.5 ←	7: 10.6x ↗	
3: 9.9 →	8: 9.2 ←	Total 194 (11x)
4: 10.4x ↗	9: 9.7 ↘	
5: 10.3x ↖	10: 9.8 ↗	

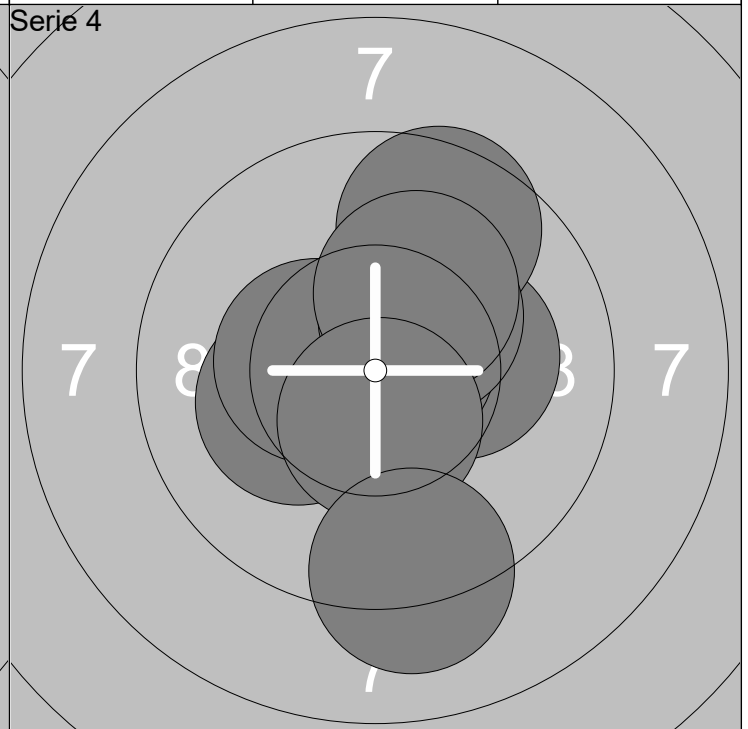
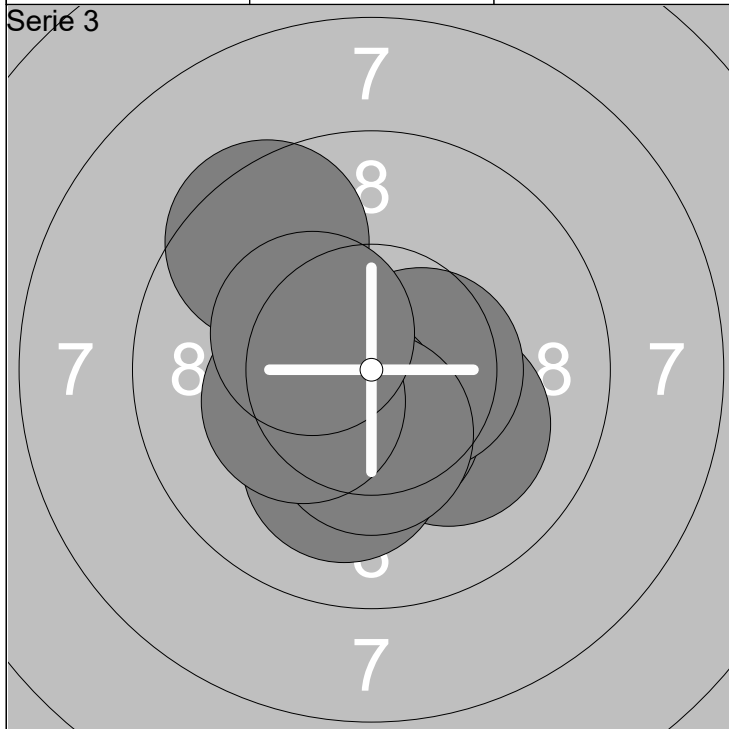

1: 9.5 ↗	6: 10.5x →	Serie 99 (7x)
2: 10.4x ↘	7: 10.5x ↘	
3: 10.1 ↘	8: 10.4x ↘	Total 293 (18x)
4: 10.5x ↘	9: 10.3x ←	
5: 10.1 ↘	10: 10.3x ↖	

1: 10.2x →	6: 10.4x ←	Serie 98 (8x)
2: 10.2x ←	7: 10.3x ↗	
3: 10.6x ↗	8: 10.2x ↗	Total 391 (26x)
4: 10.7x ↗	9: 10.5x ↘	
5: 9.6 ↗	10: 9.1 ↘	

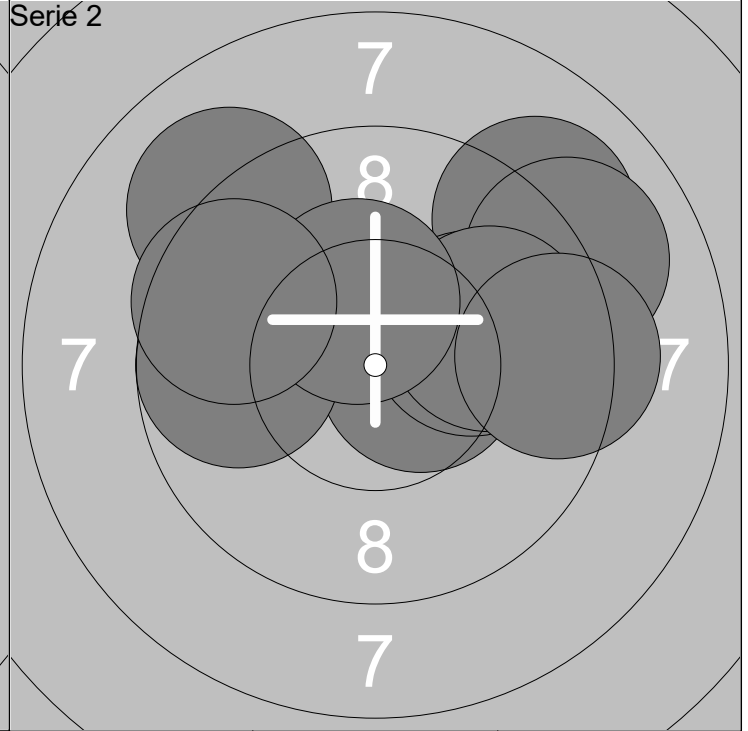
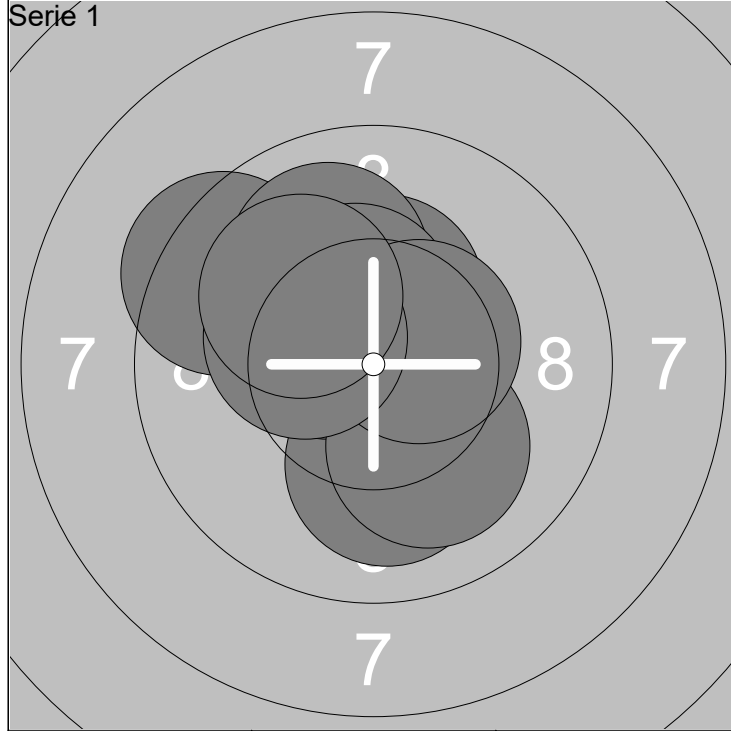

1: 10.0 ↓	6: 9.9 ↗	Serie 98 (5x)
2: 10.4x ↖	7: 10.4x ↗	
3: 10.3x ↑	8: 10.5x ↗	Total 98 (5x)
4: 10.1 ↓	9: 10.3x ↖	
5: 9.4 ↖	10: 10.1 ↖	

1: 9.0 ↗	6: 9.9 →	Serie 93 (2x)
2: 10.5x →	7: 9.7 ←	
3: 10.1 →	8: 9.3 →	Total 191 (7x)
4: 9.0 ↖	9: 10.3x ↑	
5: 9.0 →	10: 9.6 ↖	

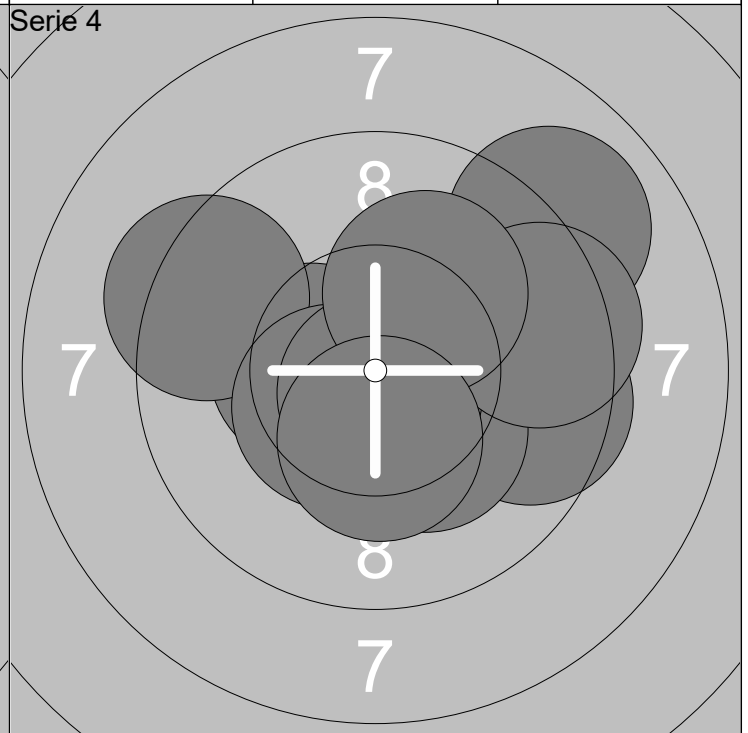
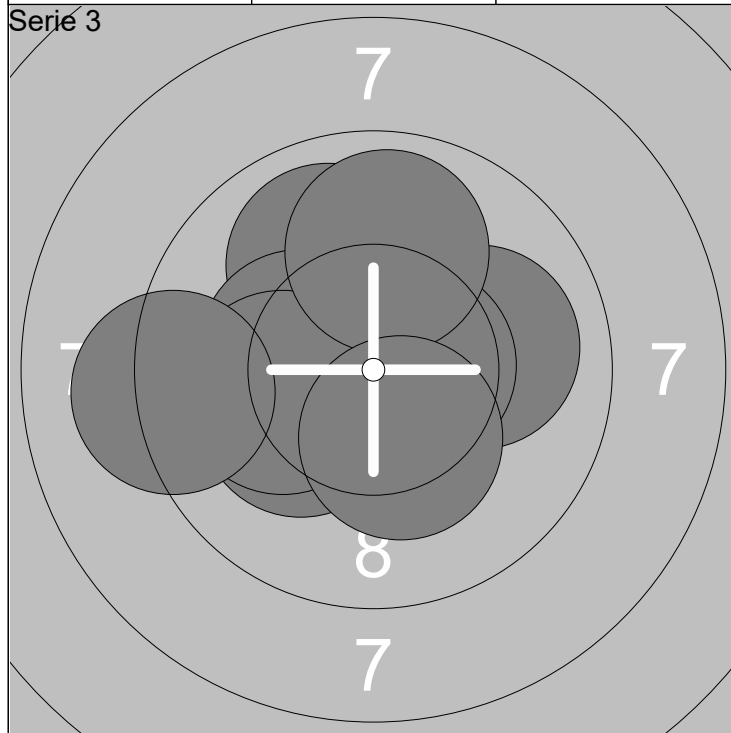

1: 10.2x ↖	6: 10.6x →	Serie 97 (5x)
2: 9.9 ↗	7: 10.1 ←	
3: 10.0 →	8: 9.9 ↑	Total 288 (12x)
4: 10.7x →	9: 10.3x ↓	
5: 10.3x ↖	10: 9.1 ←	

1: 10.4x ←	6: 10.4x ↖	Serie 96 (5x)
2: 9.5 →	7: 10.7x ↓	
3: 9.0 ↗	8: 9.4 →	Total 384 (17x)
4: 10.2x ↓	9: 10.1 ↗	
5: 9.3 ↖	10: 10.3x ↓	

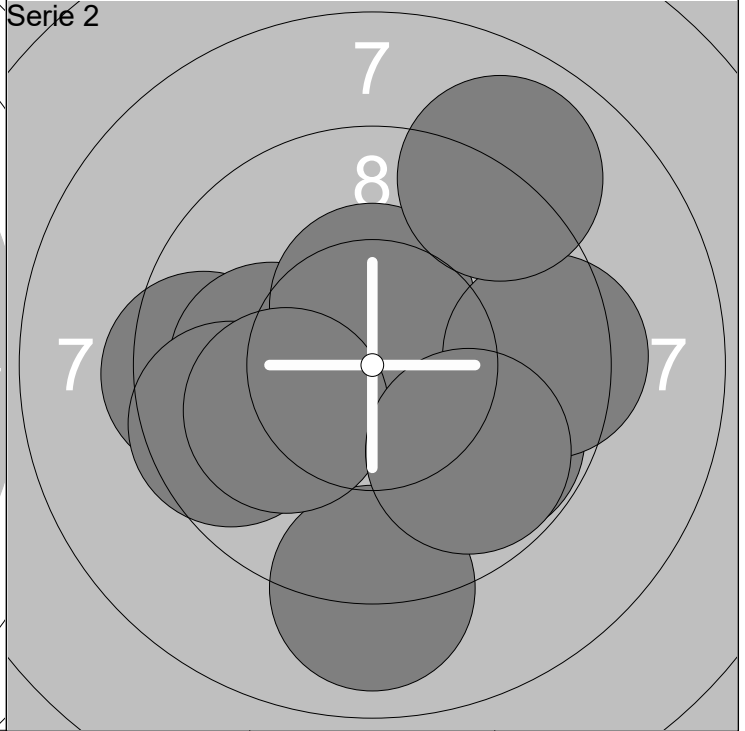
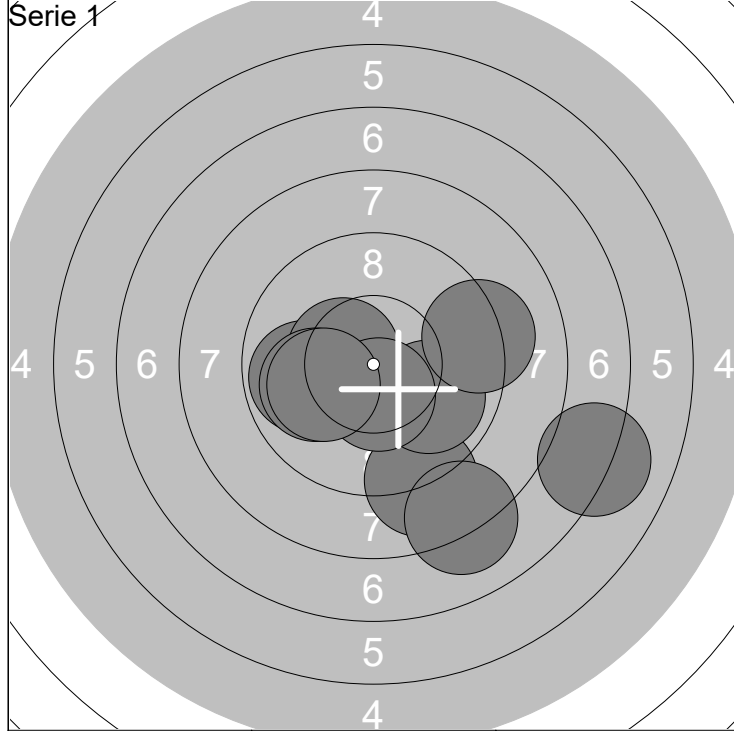

1: 9.8 ←	6: 9.2 →	Serie	90 (2x)
2: 8.9 ↓	7: 8.1 ↓		
3: 10.4x ←	8: 7.1 →	Total	90 (2x)
4: 9.9 →	9: 10.0 ←		
5: 10.5x ↓	10: 10.1 ←		

1: 9.5 ←	6: 9.4 →	Serie	93 (1x)
2: 10.0 ←	7: 9.0 ↗		
3: 9.8 ↘	8: 9.6 ←	Total	183 (3x)
4: 9.0 ↓	9: 10.1 ←		
5: 10.4x ↑	10: 9.8 ↘		

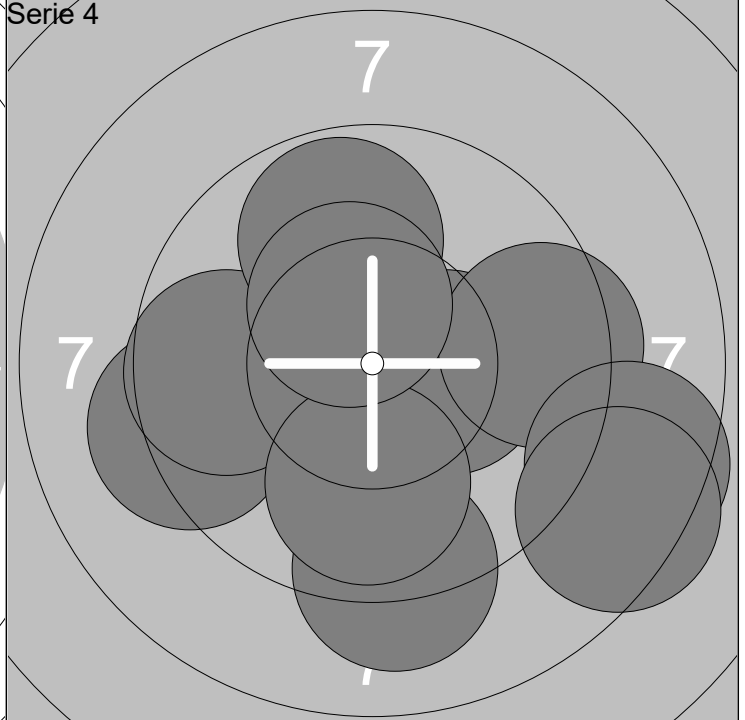
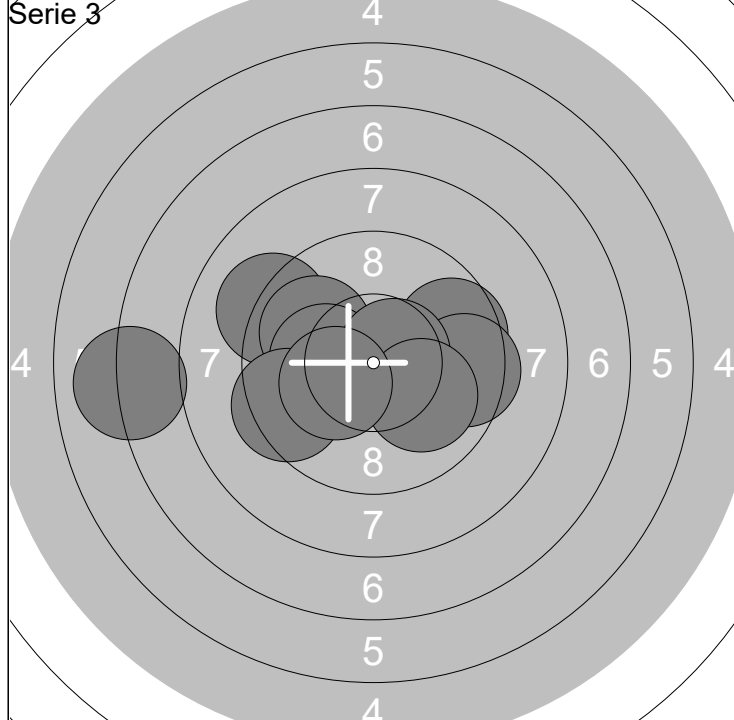

1: 7.0 ←	6: 9.4 ←	Serie	92 (3x)
2: 9.1 ↖	7: 9.5 →		
3: 9.9 ↖	8: 10.6x →	Total	275 (6x)
4: 9.6 →	9: 10.0 ↘		
5: 10.2x ←	10: 10.3x ←		

1: 9.2 ←	6: 9.5 →	Serie	90 (2x)
2: 9.1 ↓	7: 9.9 ↓		
3: 10.3x →	8: 8.5 →	Total	365 (8x)
4: 9.7 ←	9: 10.4x ↗		
5: 9.8 ↑	10: 8.4 ↘		

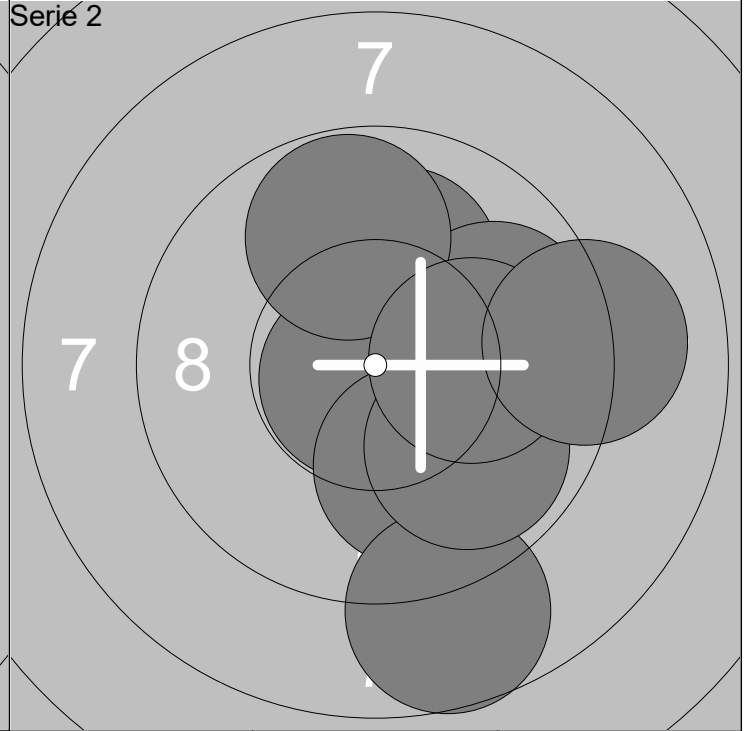
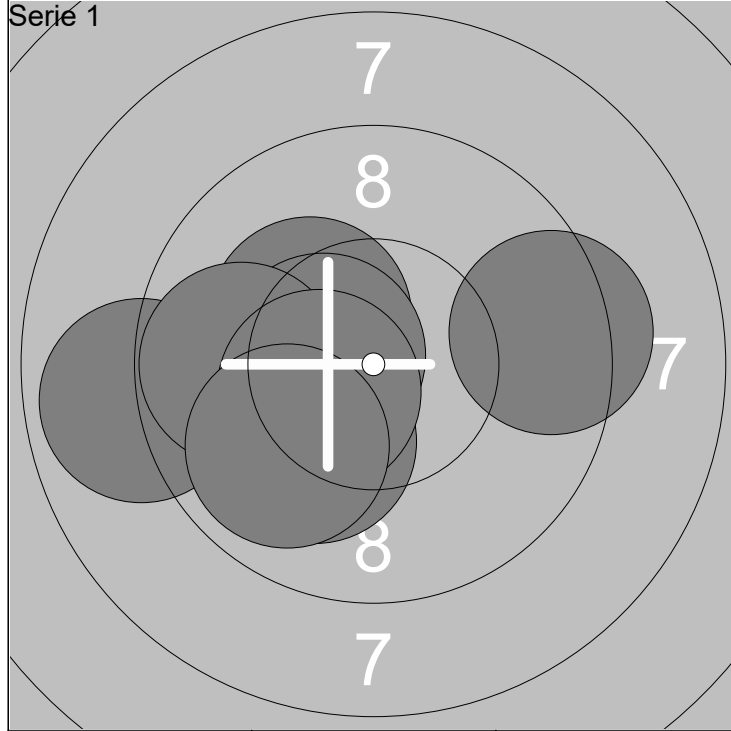

1: 10.3x ←	6: 10.5x ←	Serie	95 (5x)
2: 10.4x ←	7: 8.9 ←		
3: 10.1 ↙	8: 9.8 ←	Total	95 (5x)
4: 9.4 →	9: 10.4x ←		
5: 10.3x ↖	10: 9.9 ↙		

1: 10.1 ↑	6: 9.8 ↑	Serie	94 (2x)
2: 10.2x →	7: 8.7 ↓		
3: 10.8x ↙	8: 9.8 ↘	Total	189 (7x)
4: 9.8 →	9: 10.1 →		
5: 10.0 ↓	10: 9.1 →		

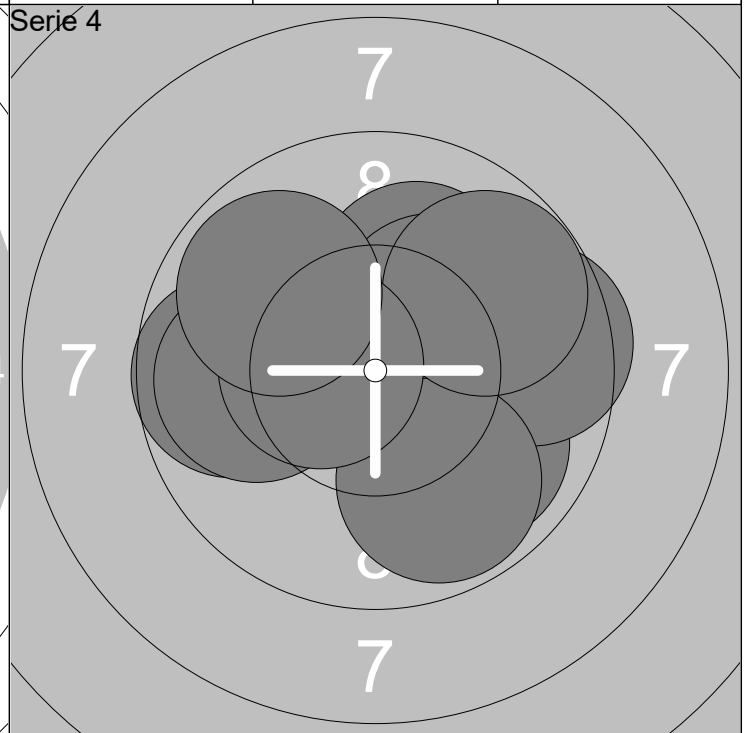
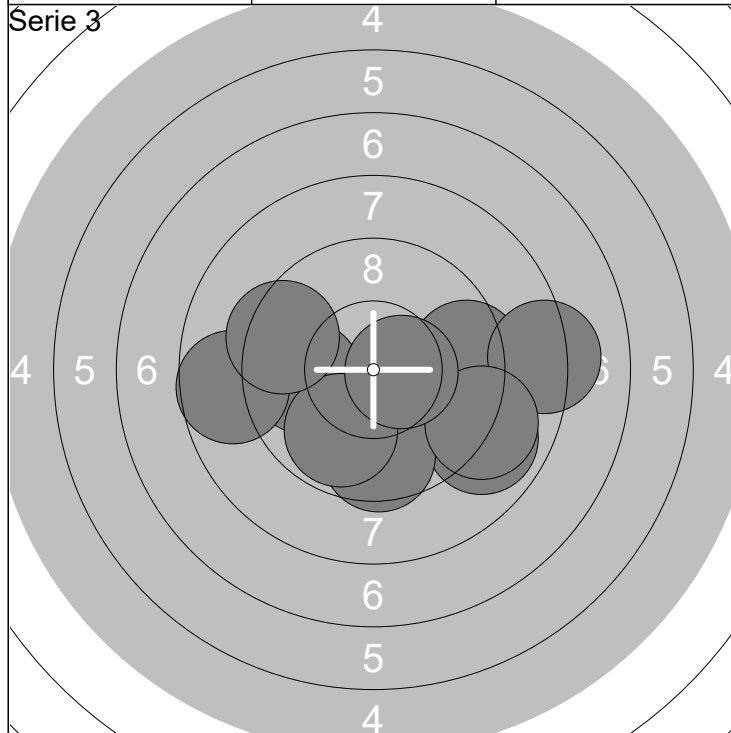

1: 8.9 ↘	6: 8.2 →	Serie	88 (1x)
2: 9.8 ←	7: 8.7 ←		
3: 9.6 ↓	8: 9.0 ↘	Total	277 (8x)
4: 9.8 ↙	9: 10.5x →		
5: 9.4 →	10: 9.4 ←		

1: 10.1 ↑	6: 9.8 ↓	Serie	93 (2x)
2: 9.7 ←	7: 9.7 ↗		
3: 9.9 ↘	8: 9.9 ←	Total	370 (10x)
4: 10.2x ↗	9: 10.5x ←		
5: 9.5 →	10: 9.8 ↖		

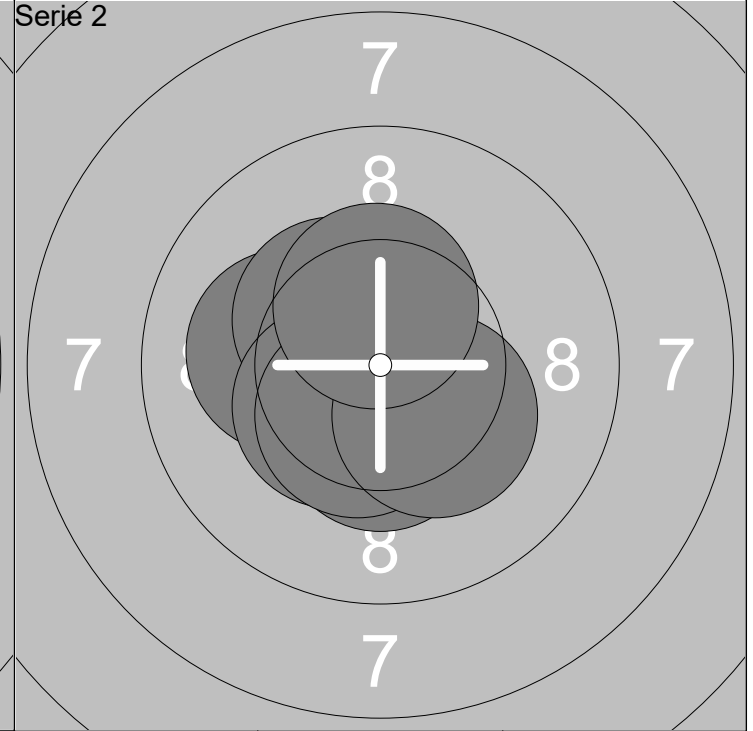
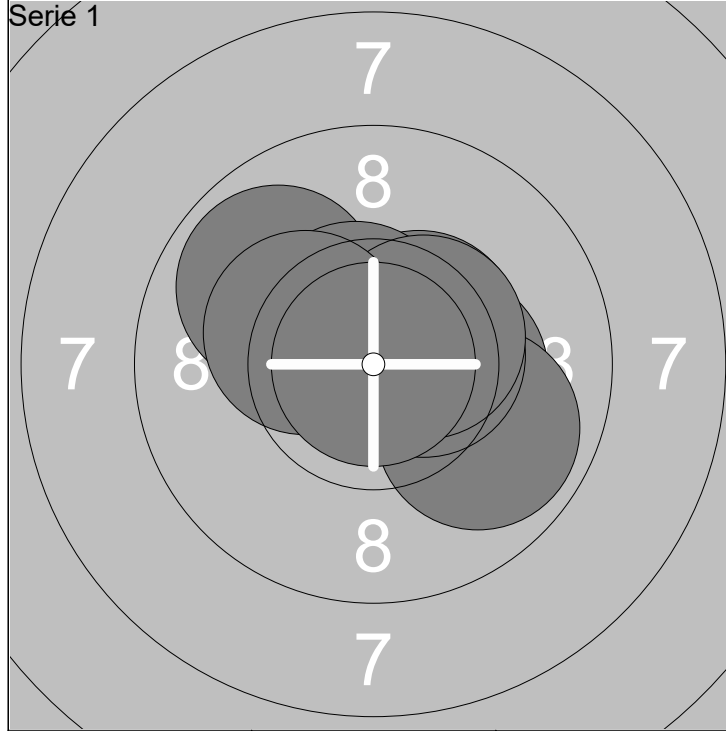

1: 10.5x ↖	6: 10.5x →	Serie	98 (8x)
2: 10.3x →	7: 10.5x ↖		
3: 9.8 ↘	8: 10.4x ↗	Total	98 (8x)
4: 9.9 ↗	9: 10.3x ↖		
5: 10.5x ↗	10: 10.9x		

1: 10.4x ↖	6: 10.4x ↓	Serie	100 (9x)
2: 10.1 ←	7: 10.4x ↙		
3: 10.7x ↓	8: 10.4x ↘	Total	198 (17x)
4: 10.8x ↙	9: 10.3x ↘		
5: 10.3x ↖	10: 10.4x ↑		

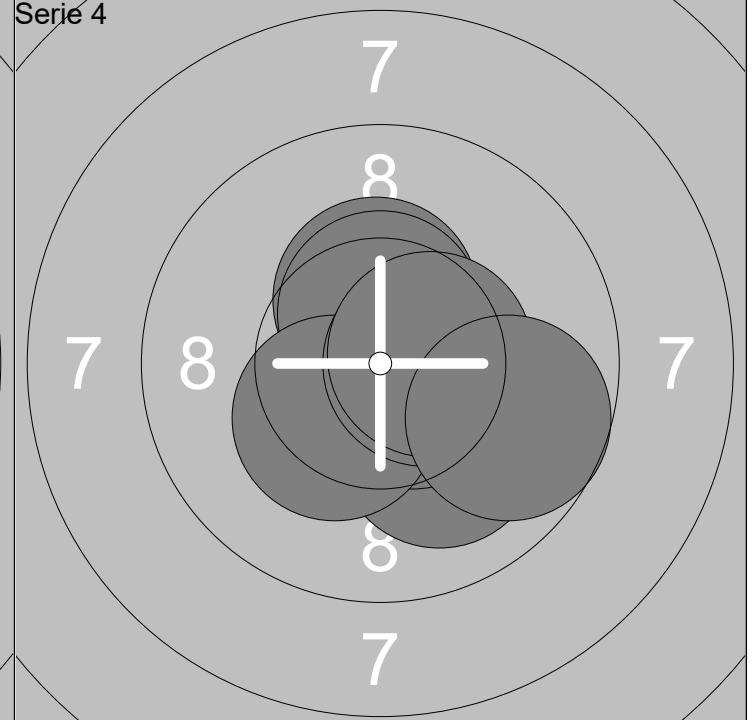
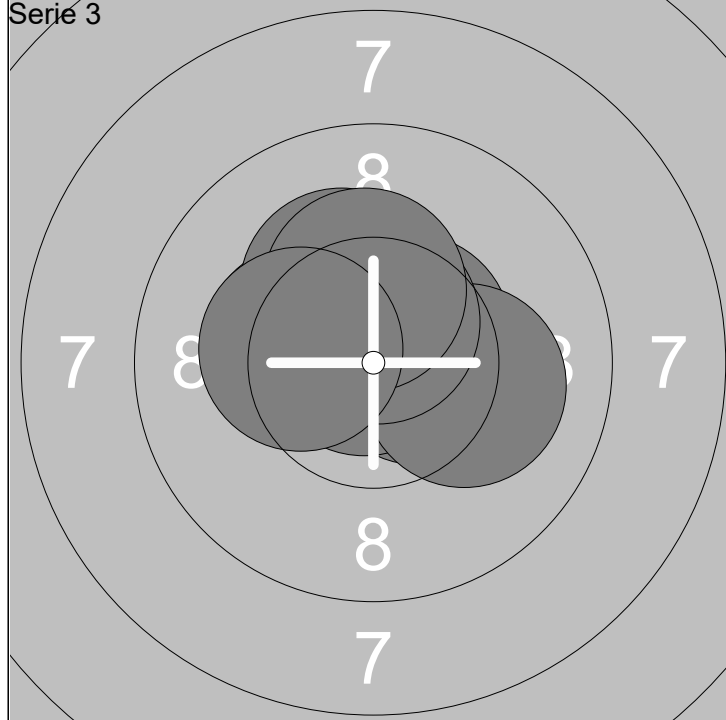

1: 10.3x ↖	6: 10.2x ↖	Serie	100 (9x)
2: 10.6x ↗	7: 10.1 →		
3: 10.5x →	8: 10.6x ↑	Total	298 (26x)
4: 10.5x ↗	9: 10.3x ↑		
5: 10.8x ↖	10: 10.3x ↖		

1: 10.8x →	6: 10.5x ↑	Serie	99 (8x)
2: 10.4x ↑	7: 10.3x ↙		
3: 10.6x ↓	8: 10.5x →	Total	397 (34x)
4: 10.0 ↓	9: 10.5x →		
5: 10.6x ↘	10: 9.7 ↘		

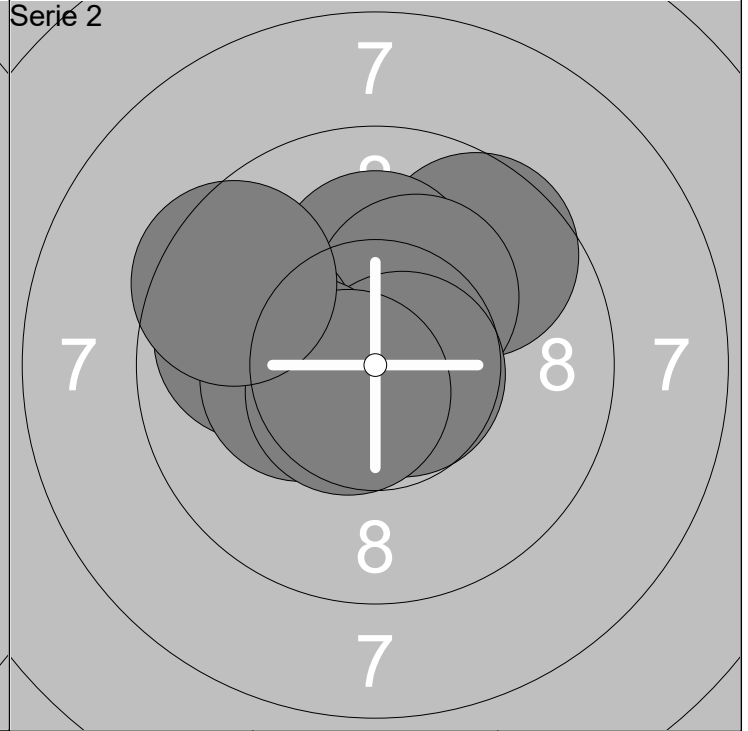
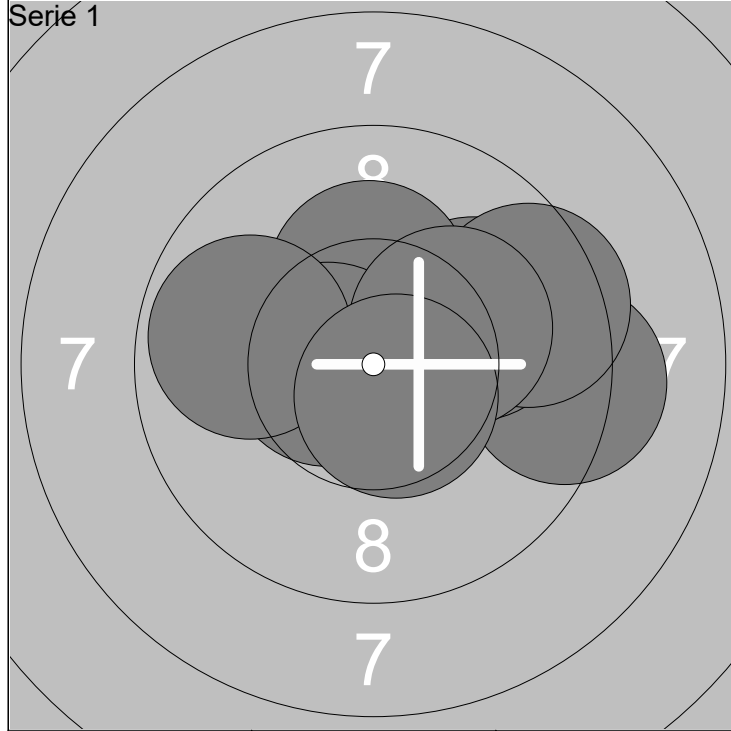

1: 10.5x →	6: 10.5x ←	Serie 96 (5x)
2: 9.6 →	7: 9.5 →	
3: 9.2 →	8: 10.2x →	Total 96 (5x)
4: 10.0 →	9: 9.8 ←	
5: 10.2x ↑	10: 10.6x ↓	

1: 9.7 ←	6: 9.8 ←	Serie 96 (5x)
2: 10.6x ↑	7: 10.7x →	
3: 9.6 ↗	8: 10.3x ←	Total 192 (10x)
4: 10.1 ↑	9: 10.6x ↙	
5: 10.2x ↗	10: 9.5 ←	

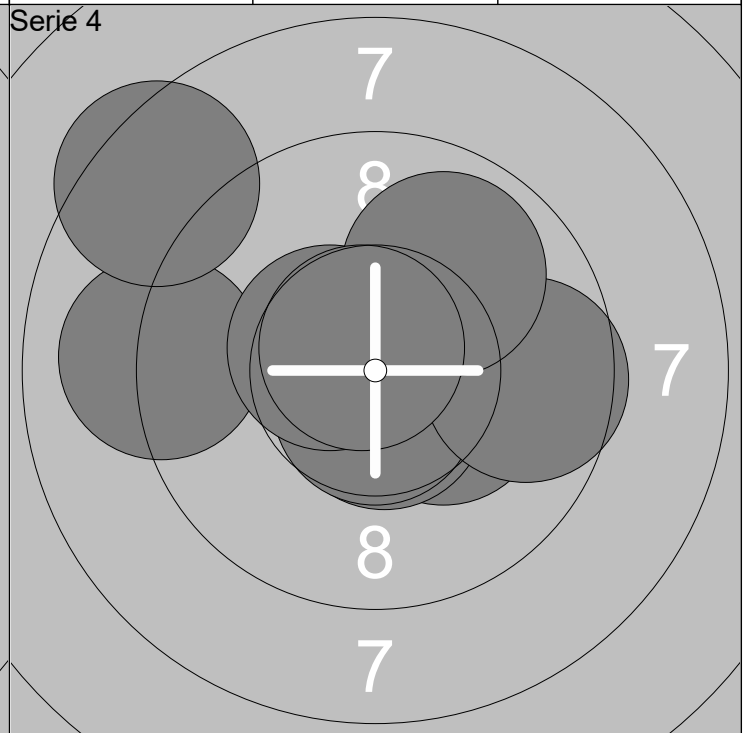
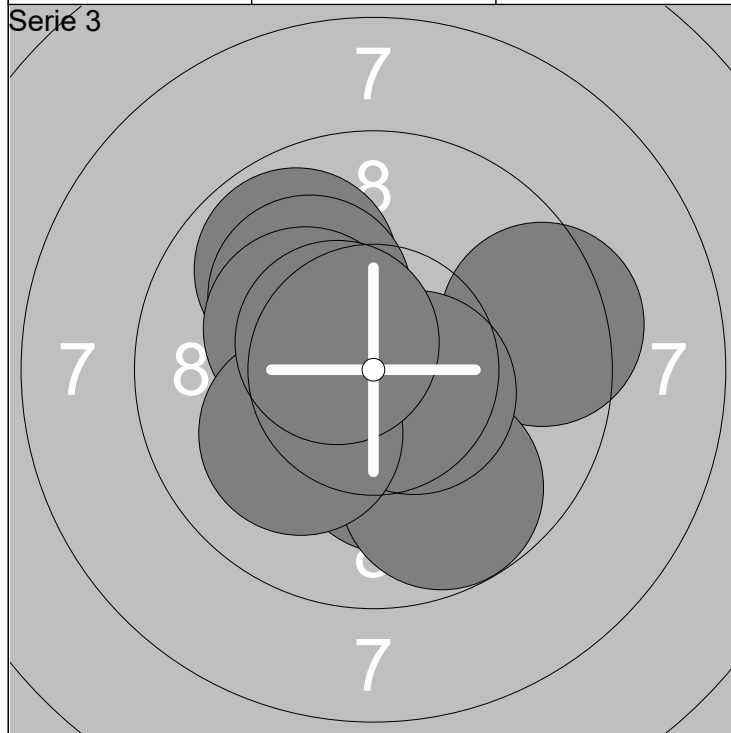

1: 9.8 ↗	6: 10.2x ↓	Serie 97 (5x)
2: 9.4 →	7: 9.7 ↓	
3: 10.3x ↗	8: 10.5x ↘	Total 289 (15x)
4: 10.1 ↗	9: 10.1 ↙	
5: 10.2x ↖	10: 10.5x ↖	

1: 10.5x →	6: 9.6 →	Serie 95 (6x)
2: 10.3x →	7: 8.4 ↖	
3: 10.6x ↓	8: 10.5x ↖	Total 384 (21x)
4: 10.7x ↓	9: 9.9 ↗	
5: 9.1 ←	10: 10.7x ↗	

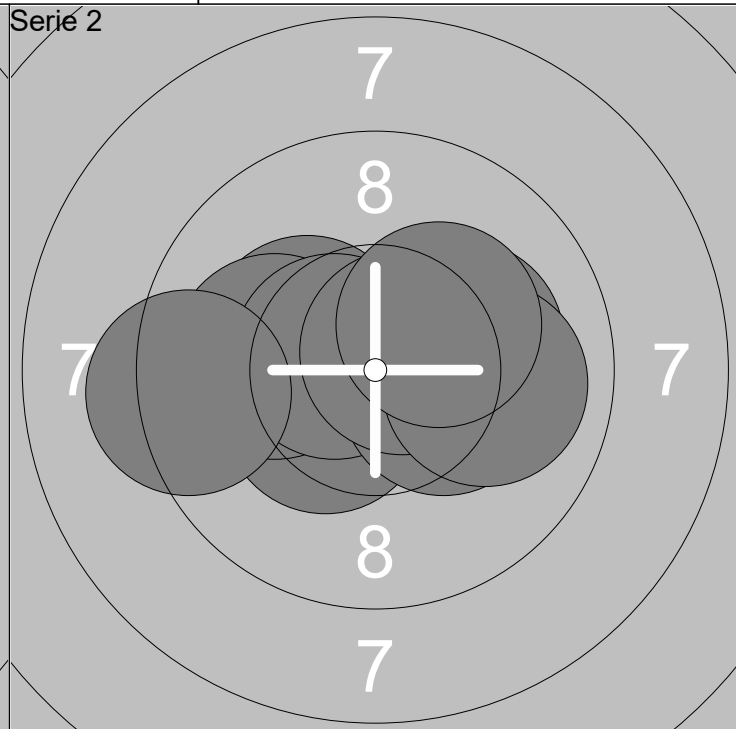
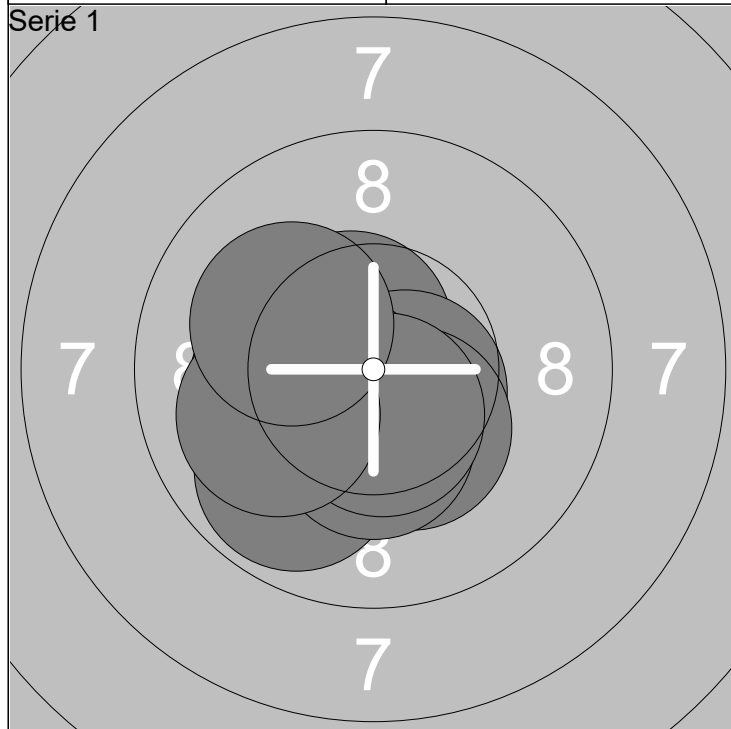

1: 10.5x ↗	6: 10.3x ↓	Serie 99 (7x)
2: 10.6x ↘	7: 10.5x ↙	
3: 9.8 ↙	8: 10.5x ↓	Total 99 (7x)
4: 10.3x ↘	9: 10.0 ↙	
5: 10.2x ←	10: 10.1 ↙	

1: 10.2x ↖	6: 10.3x →	Serie 99 (7x)
2: 10.4x ↙	7: 10.7x ↗	
3: 10.0 ↖	8: 10.0 →	Total 198 (14x)
4: 10.2x →	9: 10.2x ↗	
5: 10.5x ↖	10: 9.3 ←	

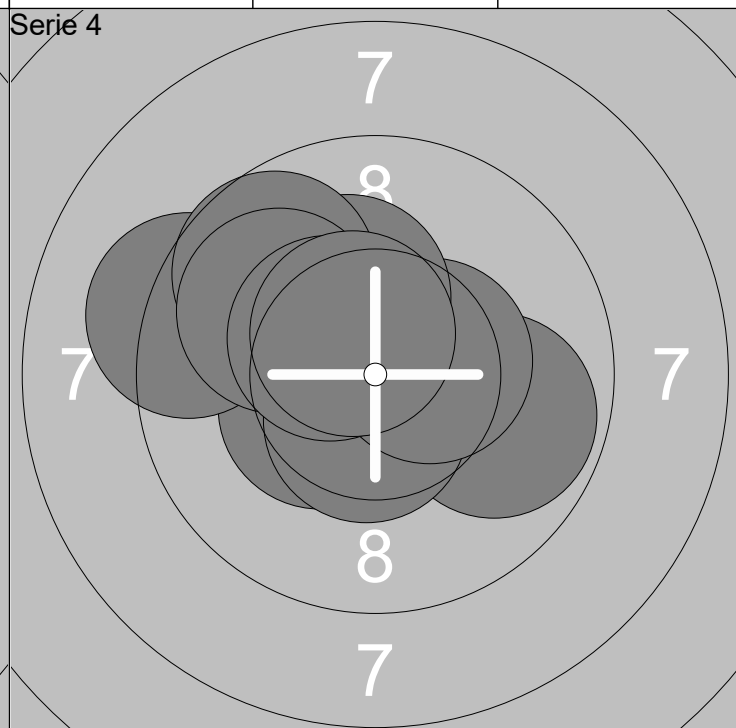
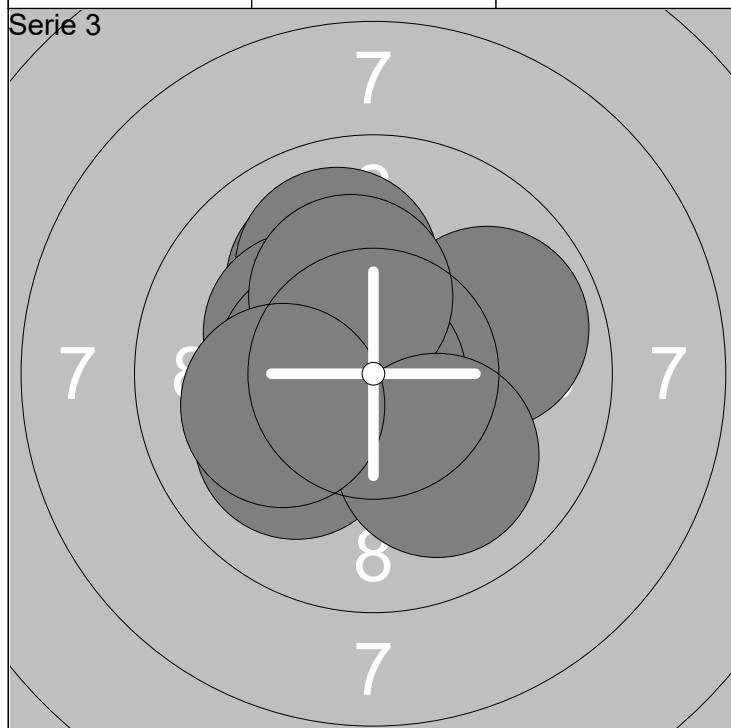

1: 9.8 →	6: 10.4x ←	Serie 99 (4x)
2: 10.8x ↙	7: 10.2x ↗	
3: 10.0 ↗	8: 10.0 ↙	Total 297 (18x)
4: 10.0 ↗	9: 10.0 ↓	
5: 10.2x ↖	10: 10.1 ←	

1: 9.8 →	6: 10.2x ↗	Serie 96 (6x)
2: 10.4x ↙	7: 9.7 ↖	
3: 10.5x ↓	8: 9.9 ↖	Total 393 (24x)
4: 9.2 ↖	9: 10.4x ↖	
5: 10.4x →	10: 10.5x ↗	

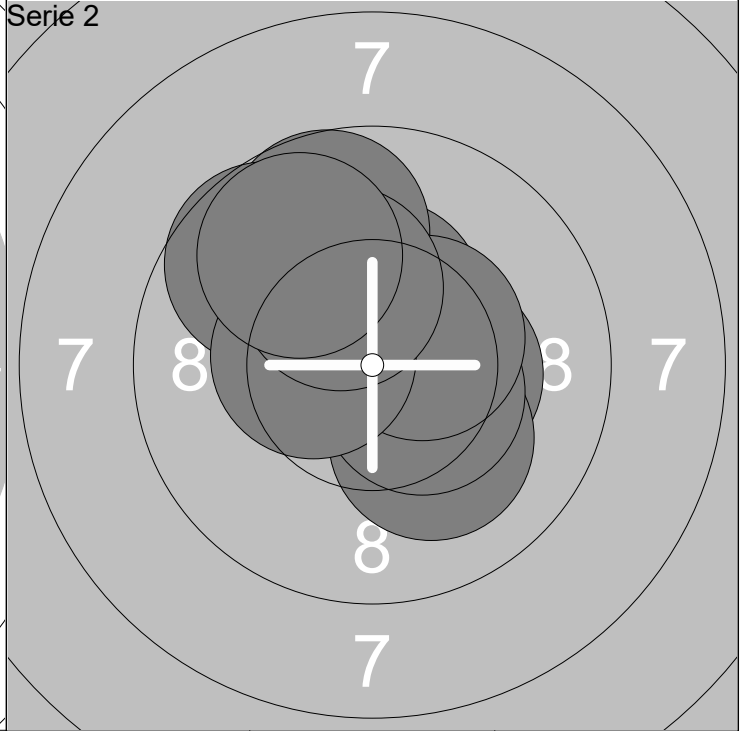
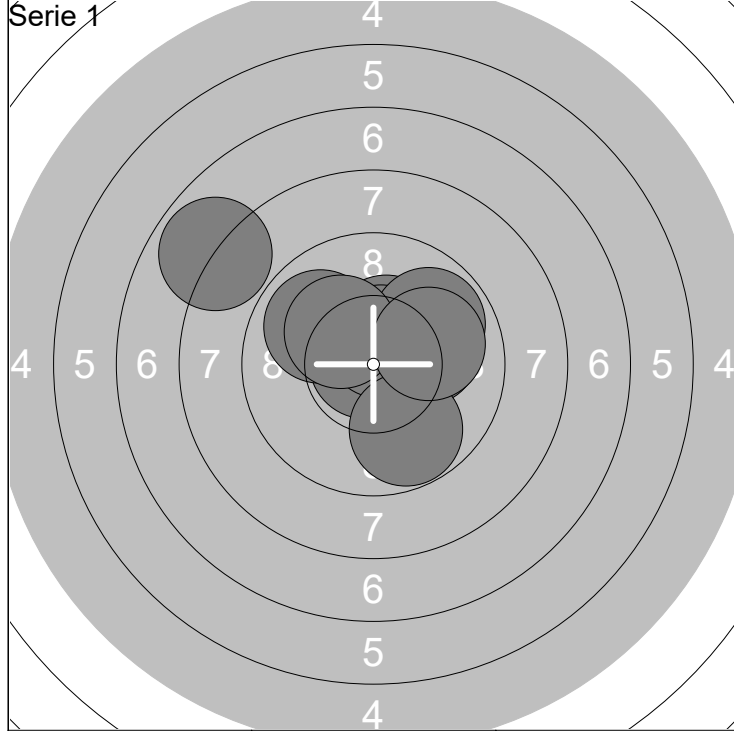

1: 10.8x ↙	6: 9.8 ↗	Serie 94 (4x)
2: 7.8 ↖	7: 9.9 ↖	
3: 10.1 →	8: 10.2x ↗	Total 94 (4x)
4: 10.4x ↗	9: 9.8 ↘	
5: 10.5x ↗	10: 10.0 →	

1: 10.3x →	6: 10.4x ↘	Serie 97 (6x)
2: 10.4x ↑	7: 10.4x ↗	
3: 10.1 ↘	8: 10.4x ↖	Total 191 (10x)
4: 9.7 ↗	9: 10.2x ↗	
5: 9.7 ↖	10: 9.8 ↗	

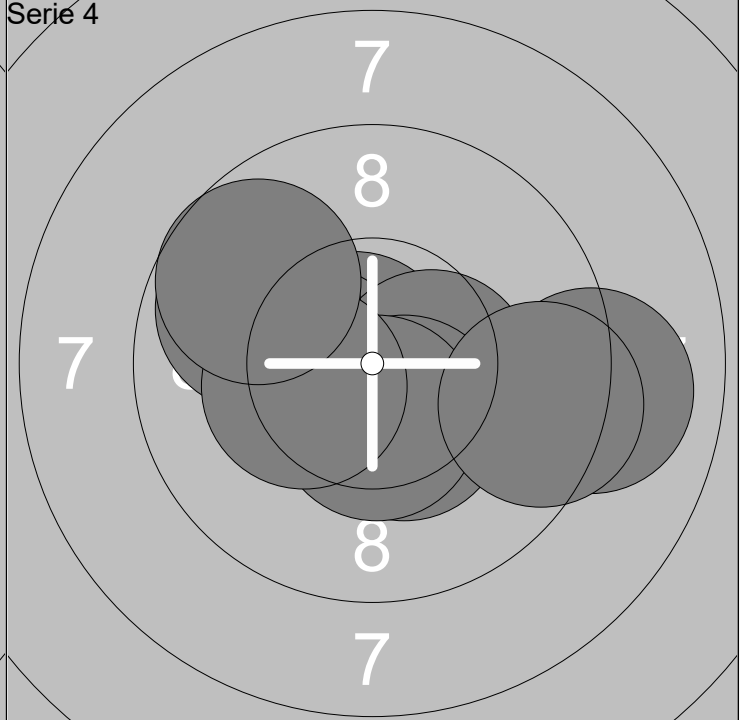
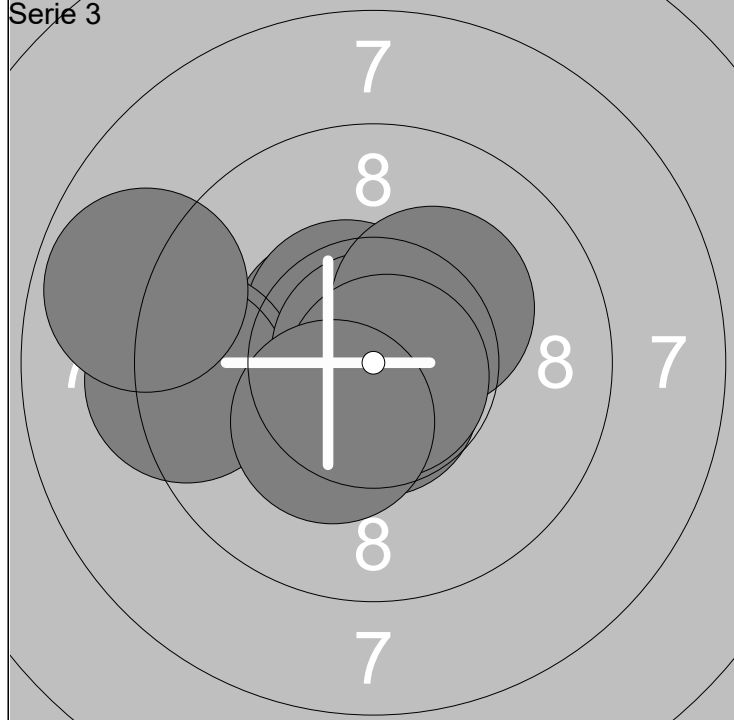

1: 10.5x ↖	6: 10.8x ↑	Serie 96 (7x)
2: 10.7x ↓	7: 8.8 ↖	
3: 10.5x ↗	8: 10.2x ↗	Total 287 (17x)
4: 9.4 ↖	9: 10.7x ↘	
5: 9.3 ↖	10: 10.3x ↘	

1: 10.7x ↖	6: 10.5x ↓	Serie 96 (6x)
2: 10.4x ↖	7: 9.0 →	
3: 10.4x →	8: 10.3x ↖	Total 383 (23x)
4: 10.4x ↘	9: 9.7 ↖	
5: 9.8 ↖	10: 9.4 →	

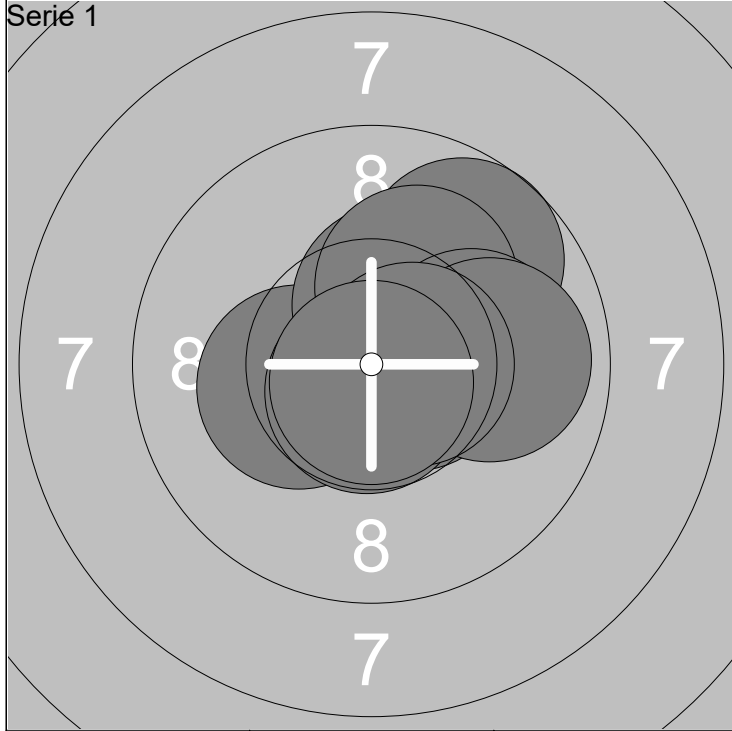

1: 10.3x ←	6: 10.1 ↗	Serie	98 (6x)
2: 10.6x →	7: 10.1 →		
3: 9.7 ↗	8: 9.9 →	Total	98 (6x)
4: 10.4x ↗	9: 10.6x →		
5: 10.7x ↓	10: 10.8x ↓		

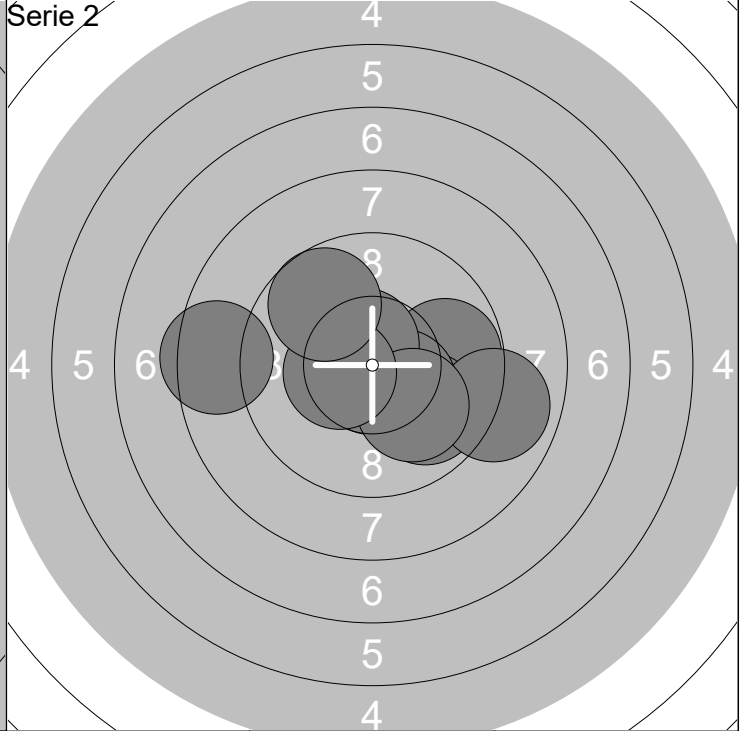

1: 10.7x ↓	6: 10.4x ↘	Serie	93 (4x)
2: 8.4 ←	7: 10.6x ↗		
3: 9.7 →	8: 10.0 ↓	Total	191 (10x)
4: 9.8 ↘	9: 10.4x ←		
5: 8.9 →	10: 9.7 ↗		

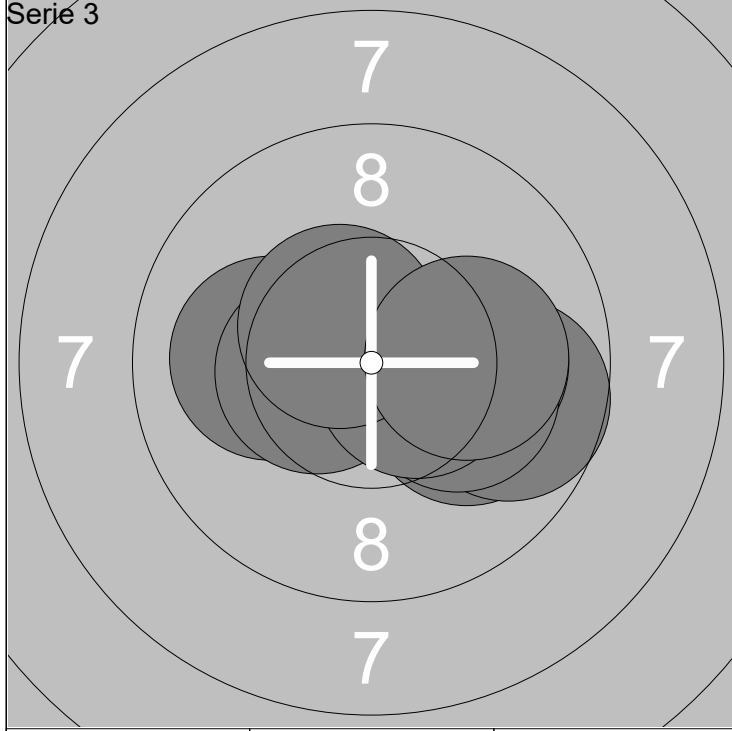

1: 10.6x ↖	6: 10.1 →	Serie	99 (4x)
2: 10.0 ←	7: 10.1 →		
3: 10.0 →	8: 10.5x →	Total	290 (14x)
4: 10.4x ←	9: 10.5x ↗		
5: 9.7 →	10: 10.1 →		

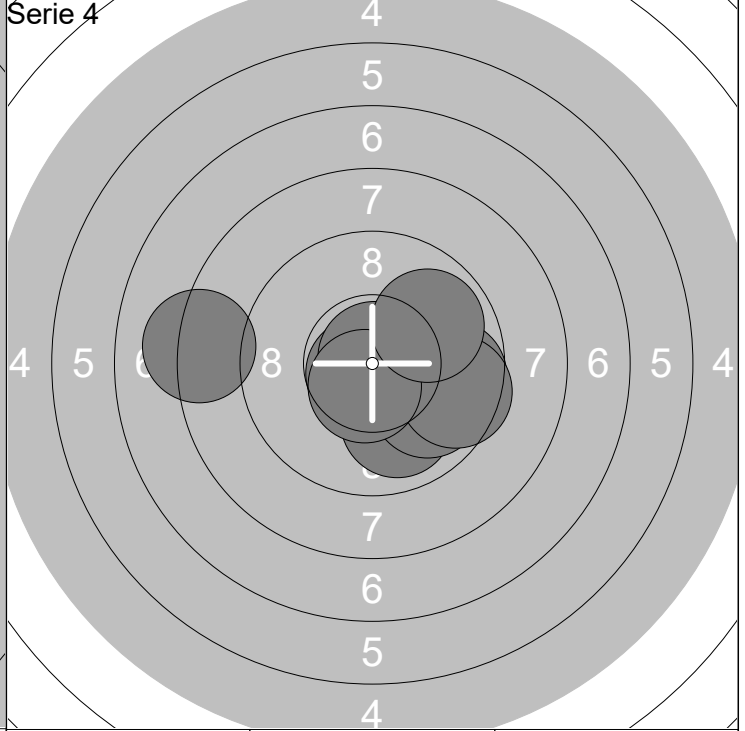

1: 10.7x ↙	6: 10.8x ↗	Serie	93 (4x)
2: 9.9 ↓	7: 9.8 ↘		
3: 10.8x ↓	8: 9.5 →	Total	383 (18x)
4: 9.7 →	9: 10.5x ↓		
5: 8.2 ←	10: 9.9 ↗		

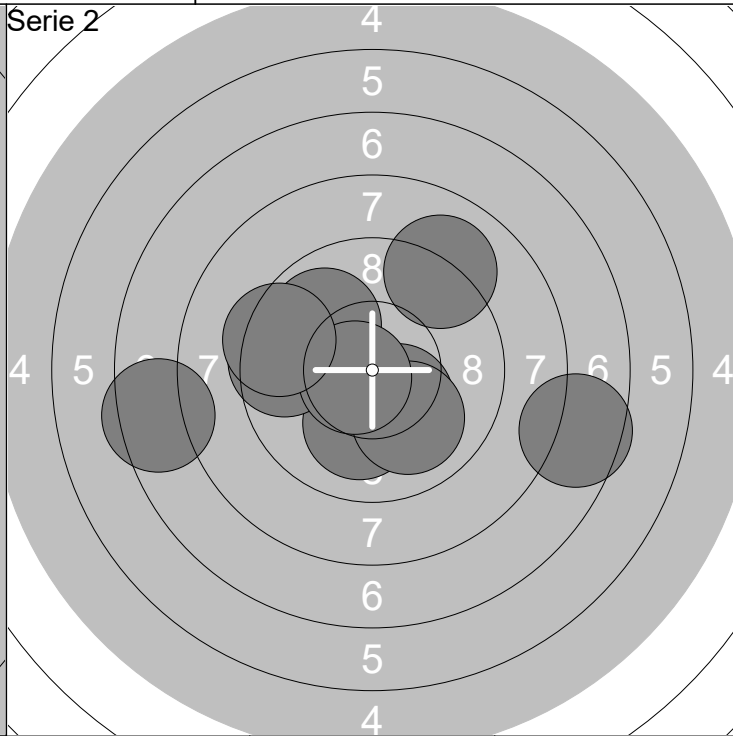
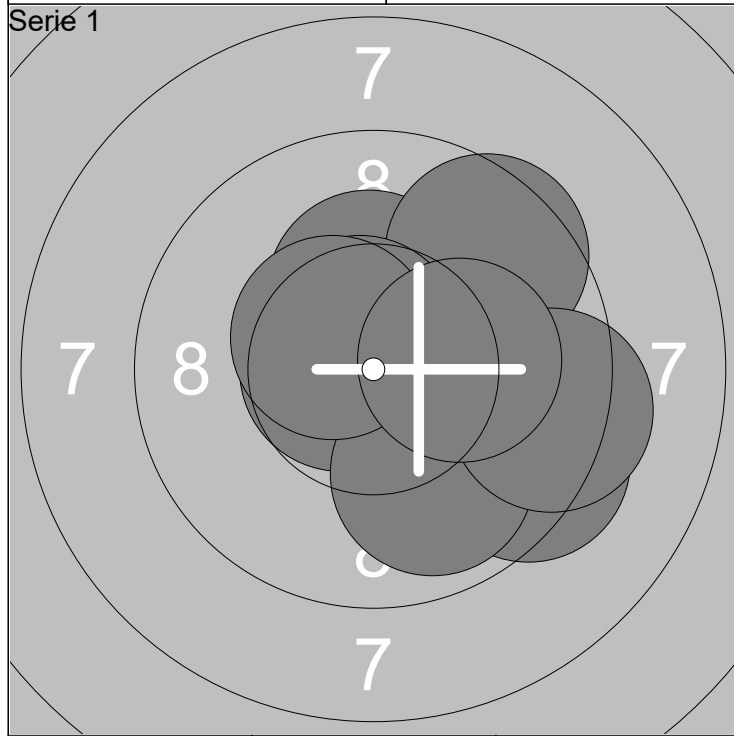

1: 10.7x ←	6: 10.6x ↗	Serie 96 (6x)
2: 10.3x ↑	7: 9.9 ↓	
3: 9.4 →	8: 9.3 →	Total 96 (6x)
4: 10.5x ↗	9: 10.5x ↖	
5: 9.5 ↗	10: 10.2x →	

1: 10.3x ↘	6: 7.6 →	Serie 90 (2x)
2: 10.1 ↓	7: 9.9 ↖	
3: 9.0 ↗	8: 10.6x ←	Total 186 (8x)
4: 9.5 ←	9: 7.4 ←	
5: 10.0 ↘	10: 9.4 ←	

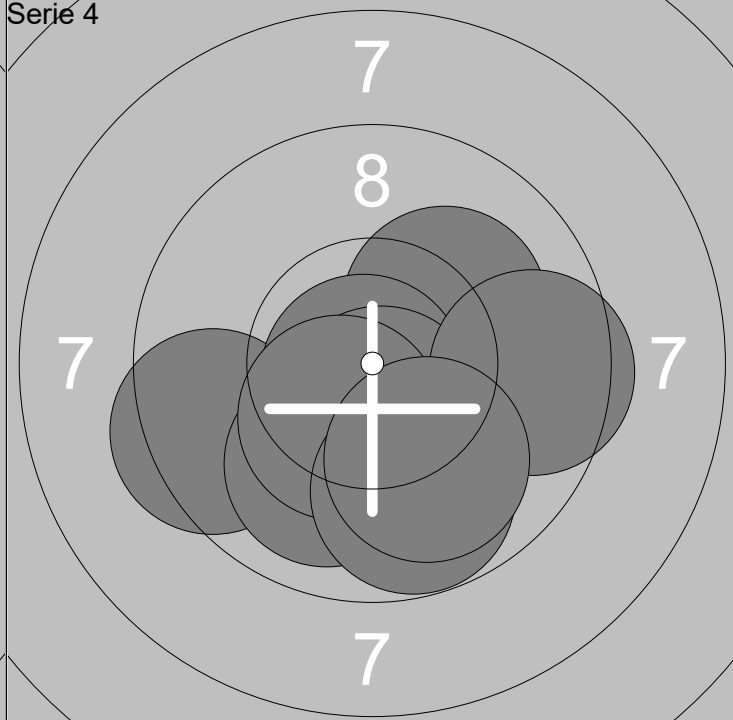
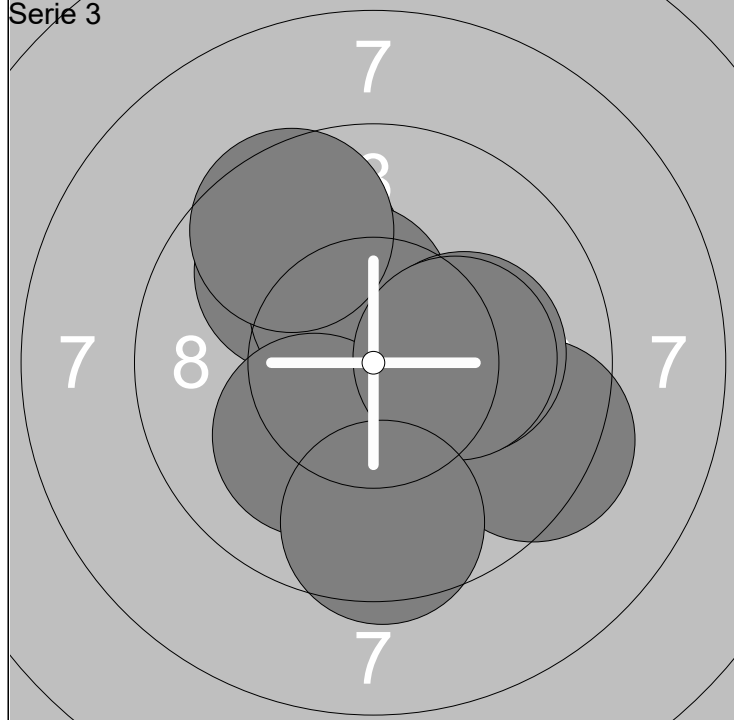

1: 9.8 ↗	6: 9.4 →	Serie 95 (3x)
2: 10.5x →	7: 10.1 →	
3: 9.9 ↗	8: 10.1 ↘	Total 281 (11x)
4: 10.4x ↗	9: 10.2x →	
5: 9.5 ↗	10: 9.5 ↓	

1: 9.4 ←	6: 10.5x ↓	Serie 96 (4x)
2: 10.8x ↓	7: 9.5 →	
3: 10.1 ↗	8: 10.4x ↘	Total 377 (15x)
4: 10.0 ↓	9: 9.8 ↓	
5: 10.8x ↘	10: 9.9 ↓	

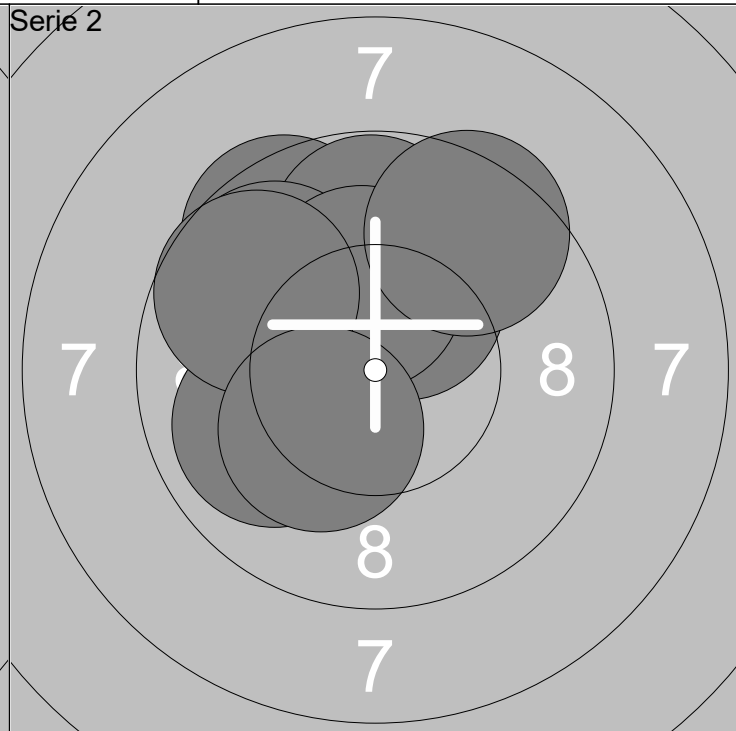
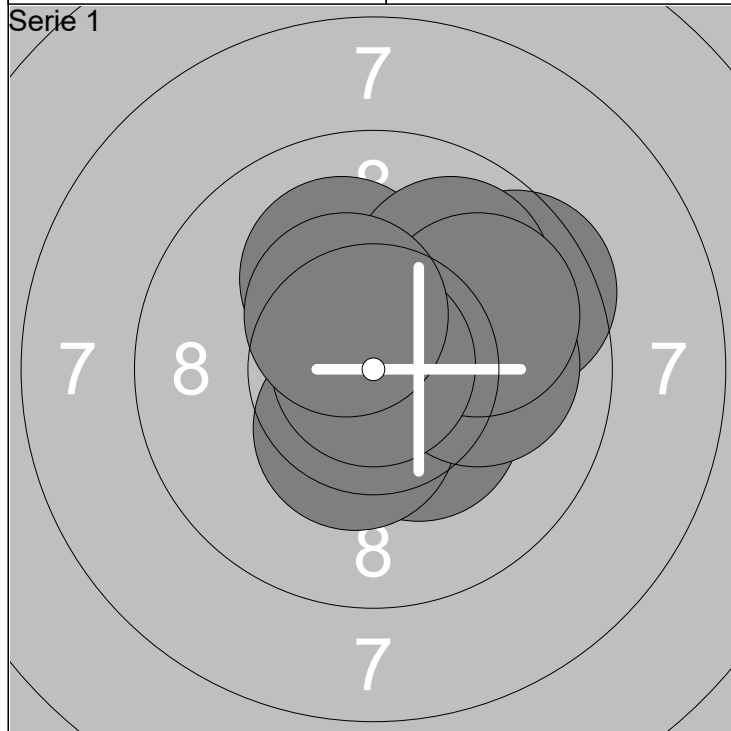

1: 10.3x ↘	6: 10.0 →	Serie 96 (4x)
2: 10.4x ↓	7: 9.9 ↗	
3: 9.9 ↗	8: 9.9 →	Total 96 (4x)
4: 9.5 ↗	9: 10.9x ↑	
5: 10.1 ↗	10: 10.4x ↖	

1: 10.4x ↖	6: 9.8 ↖	Serie 94 (4x)
2: 10.2x ↗	7: 10.2x ↑	
3: 9.5 ↖	8: 9.7 ↖	Total 190 (8x)
4: 9.8 ↑	9: 9.5 ↗	
5: 9.9 ↖	10: 10.2x ↘	

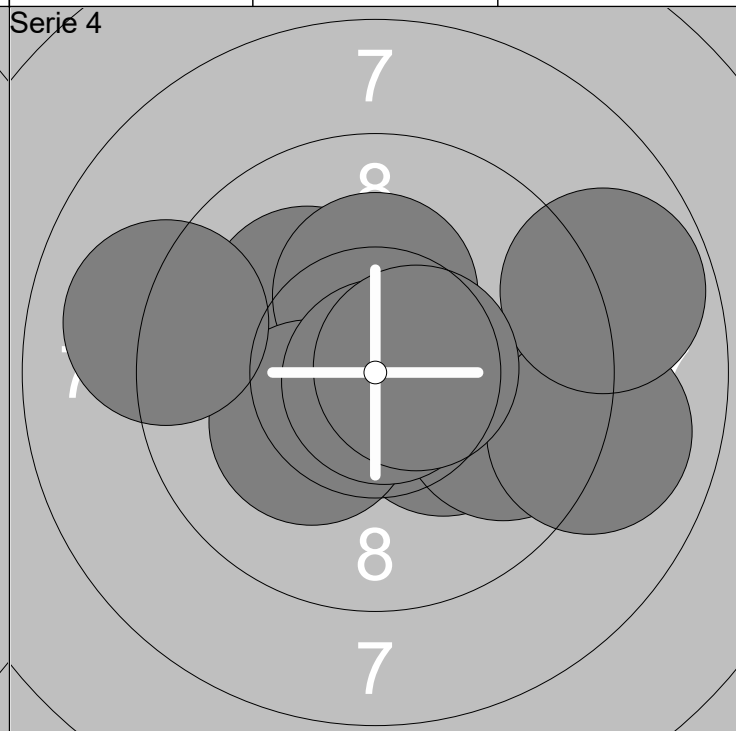
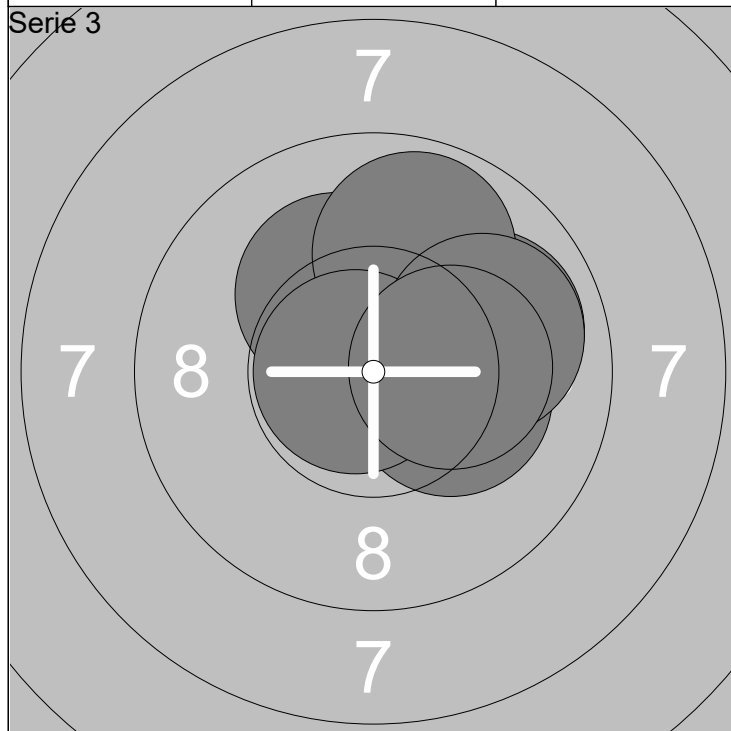

1: 10.3x ↑	6: 10.2x ↖	Serie 97 (7x)
2: 10.7x ↖	7: 9.8 ↑	
3: 9.9 →	8: 10.8x ←	Total 287 (15x)
4: 10.2x →	9: 9.9 →	
5: 10.7x ↑	10: 10.2x →	

1: 10.1 ↖	6: 9.0 →	Serie 95 (5x)
2: 10.2x →	7: 10.8x ↘	
3: 10.3x ↑	8: 8.8 →	Total 382 (20x)
4: 9.8 →	9: 9.0 ←	
5: 10.2x ↖	10: 10.6x →	

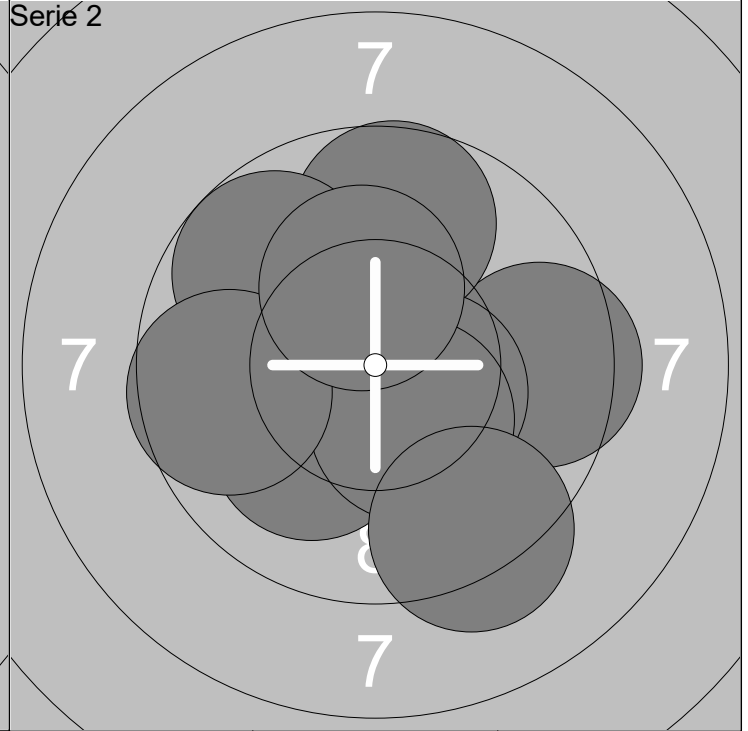
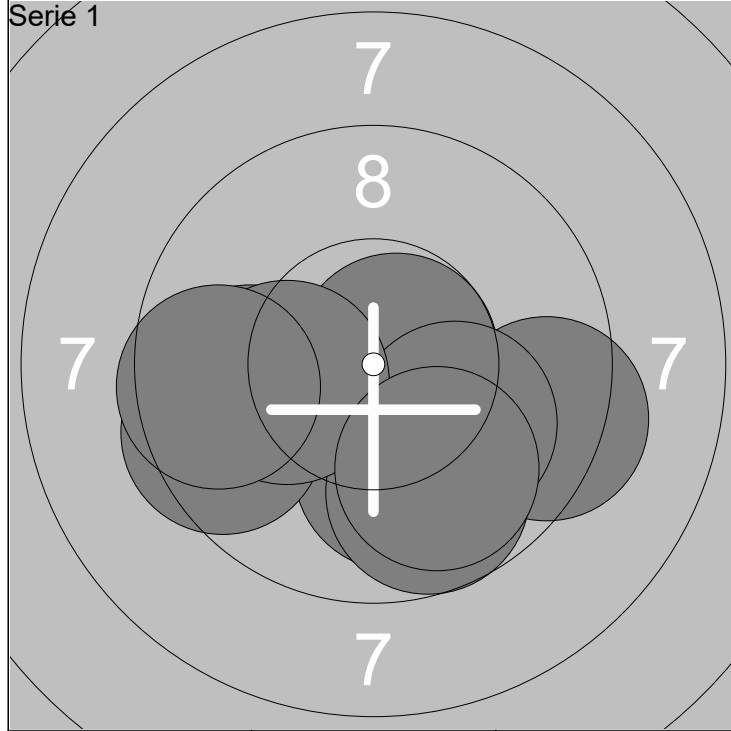

1: 9.8 ←	6: 9.7 ↓	Serie	94 (2x)
2: 10.7x →	7: 10.0 ↓		
3: 10.0 ↓	8: 10.2x ←	Total	94 (2x)
4: 9.5 ←	9: 9.9 ↓		
5: 9.3 →	10: 9.5 ←		

1: 9.5 →	6: 10.1 ↓	Serie	95 (4x)
2: 9.7 ↑	7: 10.4x ↓		
3: 10.5x ←	8: 9.6 ←	Total	189 (6x)
4: 9.7 ↗	9: 10.3x ↑		
5: 10.4x ↘	10: 9.2 ↓		

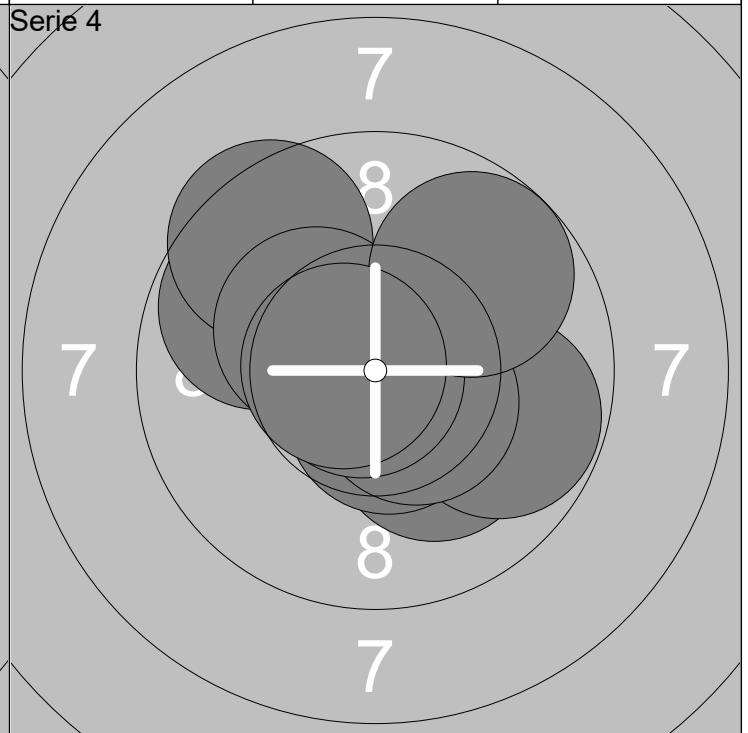
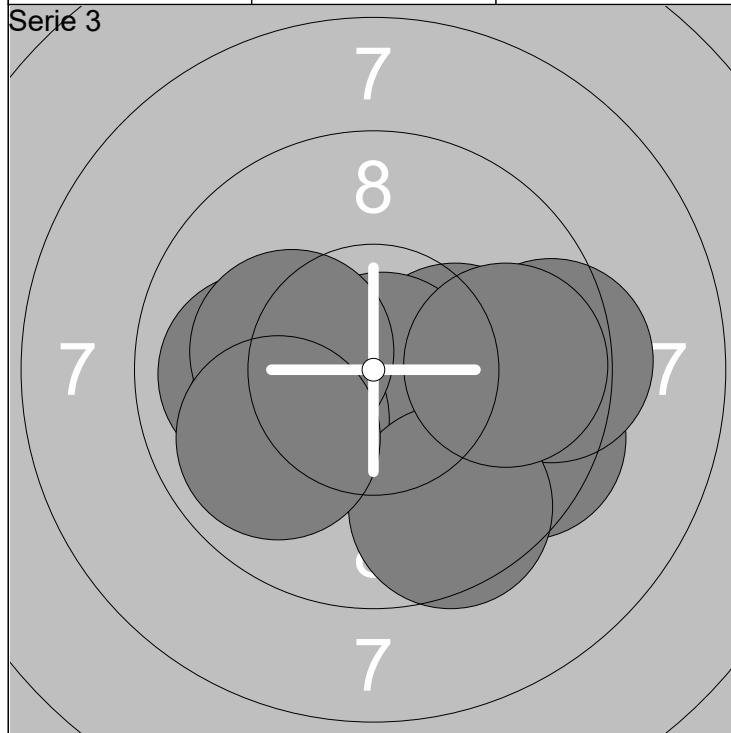

1: 9.5 →	6: 10.0 ←	Serie	94 (3x)
2: 10.2x →	7: 9.6 ↓		
3: 9.4 →	8: 9.8 →	Total	283 (9x)
4: 9.9 ←	9: 10.2x ←		
5: 10.8x ↘	10: 9.9 ↙		

1: 10.1 ↓	6: 9.5 ↗	Serie	96 (5x)
2: 9.8 →	7: 10.8x ←		
3: 10.6x ↓	8: 10.3x ↖	Total	379 (14x)
4: 10.5x ↓	9: 9.7 ↗		
5: 9.8 ↖	10: 10.7x ←		

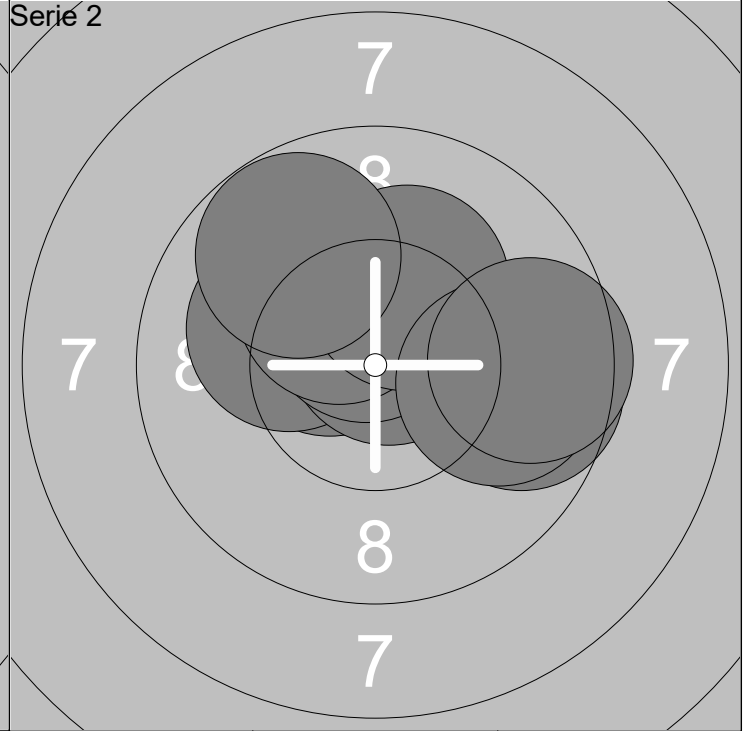
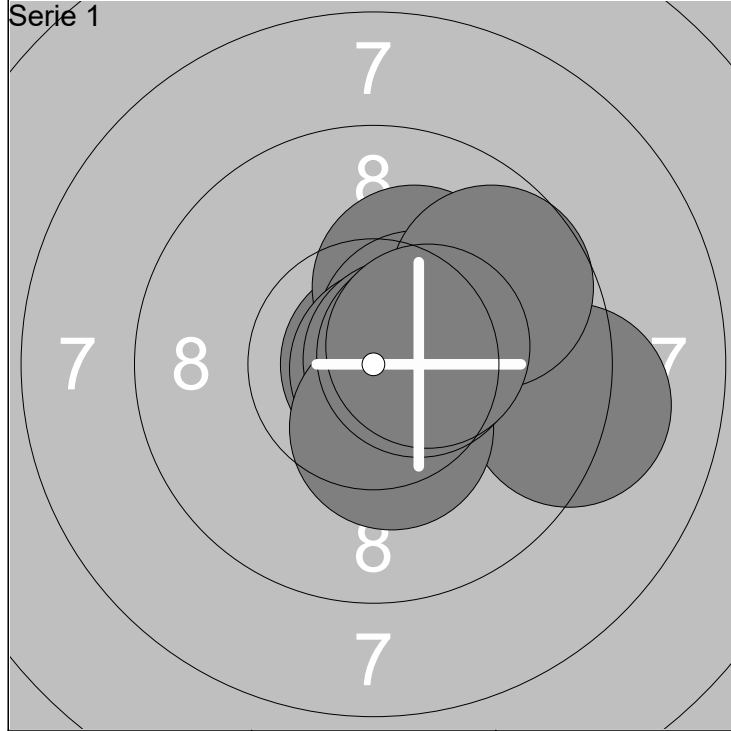

1: 10.8x →	6: 10.7x →	Serie	98 (7x)
2: 10.1 ↗	7: 10.3x ↓		
3: 10.4x ↗	8: 10.5x →	Total	98 (7x)
4: 9.2 →	9: 9.7 ↗		
5: 10.7x →	10: 10.4x →		

1: 10.4x ↖	6: 10.3x ↗	Serie	96 (5x)
2: 10.1 ↖	7: 10.2x ↗		
3: 9.6 →	8: 9.7 ↖	Total	194 (12x)
4: 10.7x ↗	9: 9.8 →		
5: 10.5x ↗	10: 9.6 →		

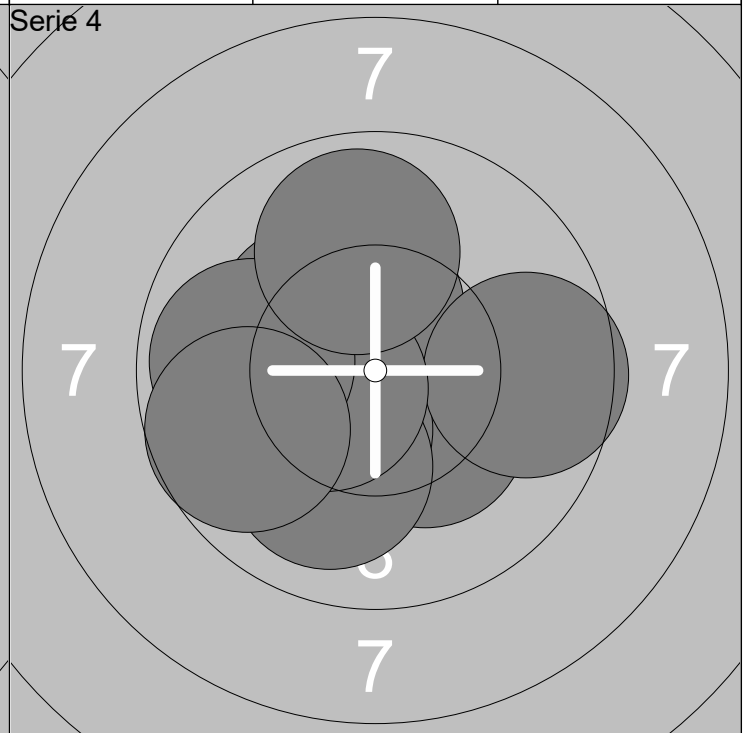
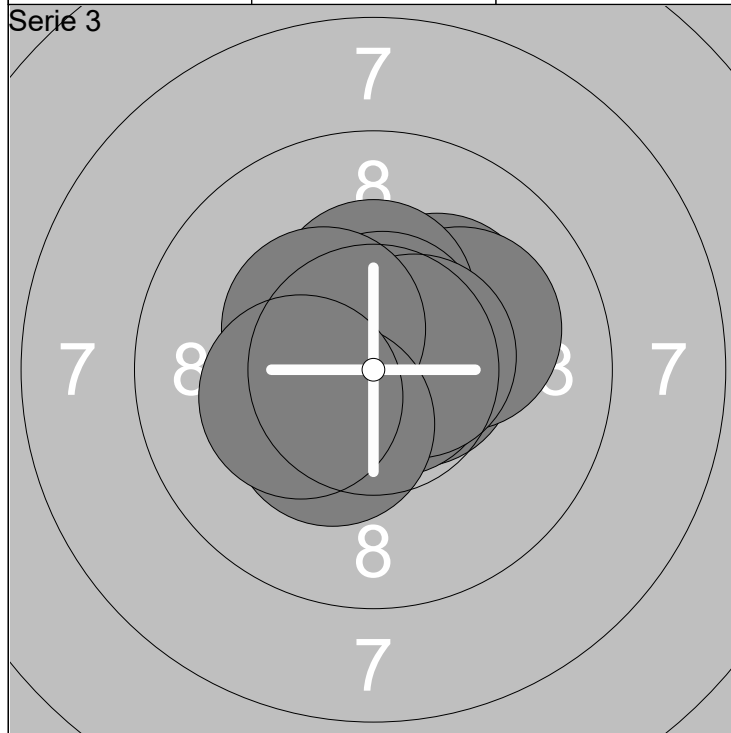

1: 10.6x →	6: 10.6x ↗	Serie	100 (9x)
2: 10.8x →	7: 10.6x →		
3: 10.2x ↗	8: 10.3x ↖	Total	294 (21x)
4: 10.1 ↗	9: 10.3x ↘		
5: 10.3x ↗	10: 10.3x ←		

1: 10.3x ↘	6: 9.6 →	Serie	96 (5x)
2: 10.3x ↘	7: 10.5x ←		
3: 10.3x ↖	8: 9.8 ←	Total	390 (26x)
4: 10.0 ↘	9: 9.9 ↗		
5: 10.4x ↗	10: 9.7 ←		

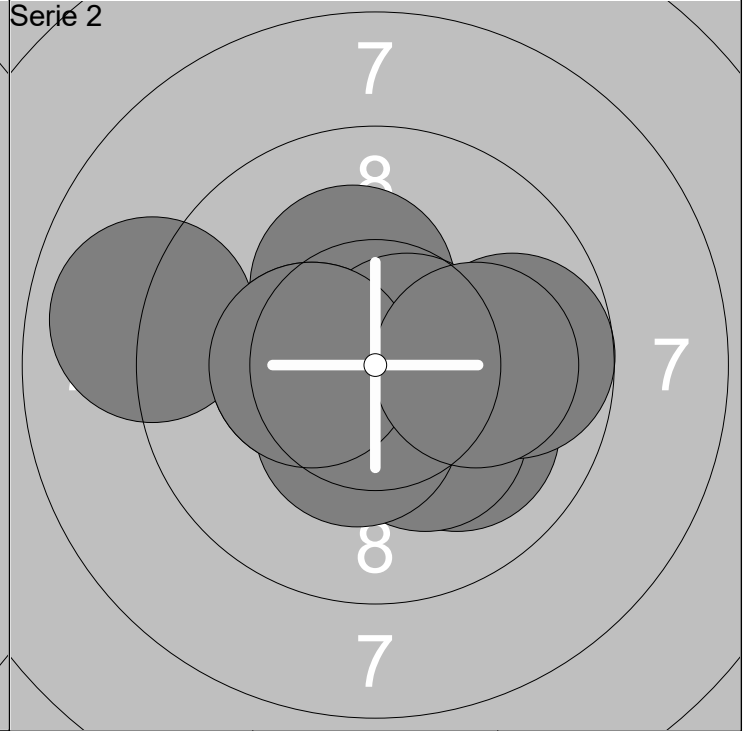
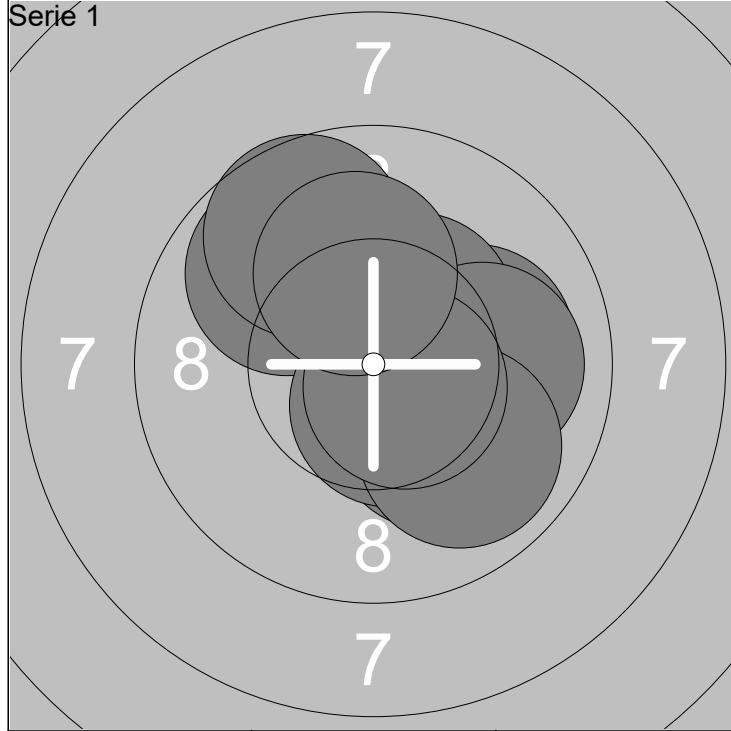

1: 10.0 →	6: 10.5x ↓	Serie 97 (4x)
2: 10.3x ↗	7: 9.7 ↗	
3: 10.0 →	8: 9.9 ↓	Total 97 (4x)
4: 9.8 ↗	9: 10.6x ↓	
5: 10.2x ↓	10: 10.1 ↑	

1: 10.2x ↑	6: 10.2x ↓	Serie 97 (6x)
2: 10.4x ←	7: 10.4x ↓	
3: 10.0 ↓	8: 10.4x ←	Total 194 (10x)
4: 10.6x →	9: 9.7 →	
5: 8.9 ←	10: 10.1 →	

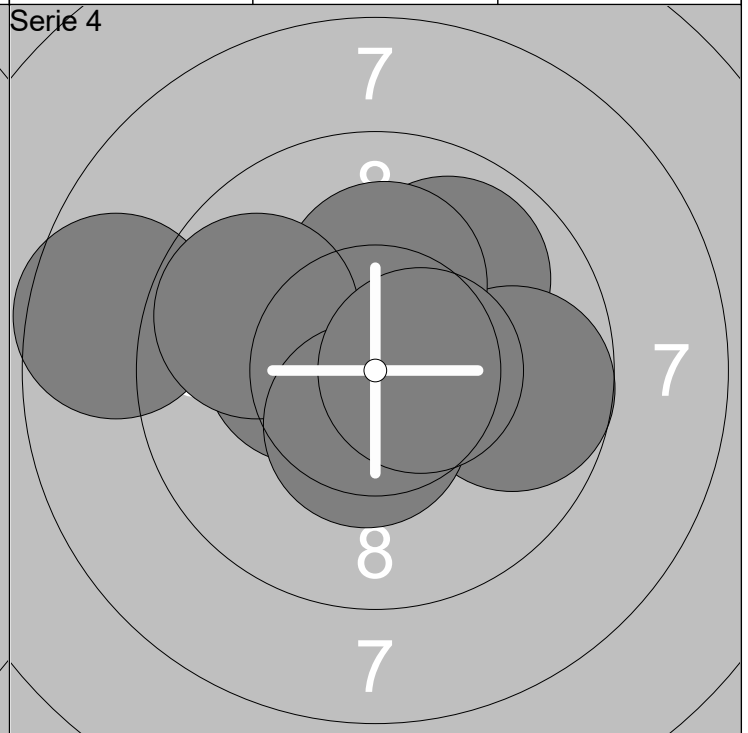
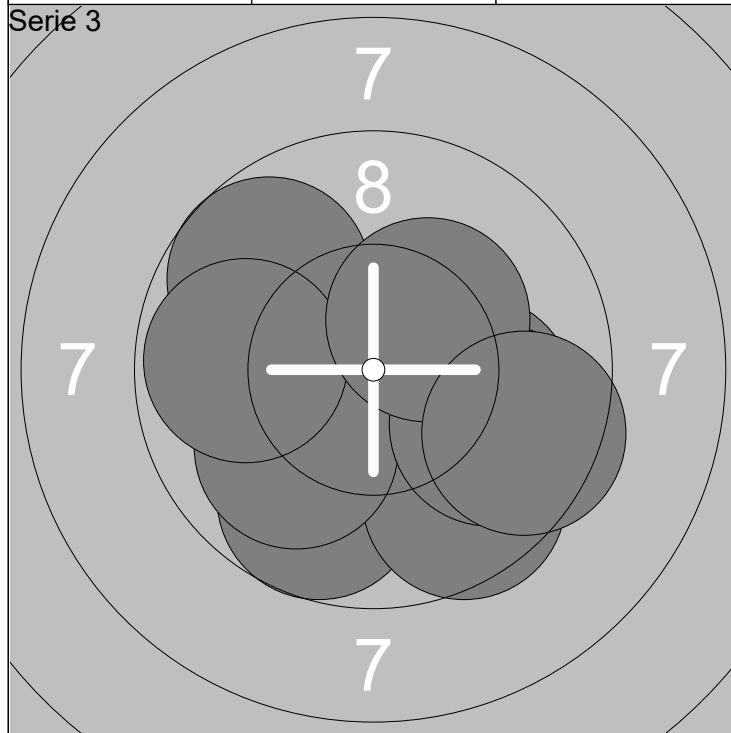

1: 10.4x ↙	6: 9.9 ↙	Serie 93 (2x)
2: 9.7 ↓	7: 9.8 →	
3: 10.0 →	8: 9.8 ←	Total 287 (12x)
4: 9.7 ↗	9: 10.3x ↗	
5: 9.5 ↓	10: 9.5 →	

1: 10.3x ←	6: 10.7x ↙	Serie 95 (6x)
2: 9.9 ↗	7: 10.2x ↑	
3: 9.7 →	8: 9.8 ←	Total 382 (18x)
4: 10.4x ↑	9: 10.5x ↓	
5: 8.6 ←	10: 10.5x →	

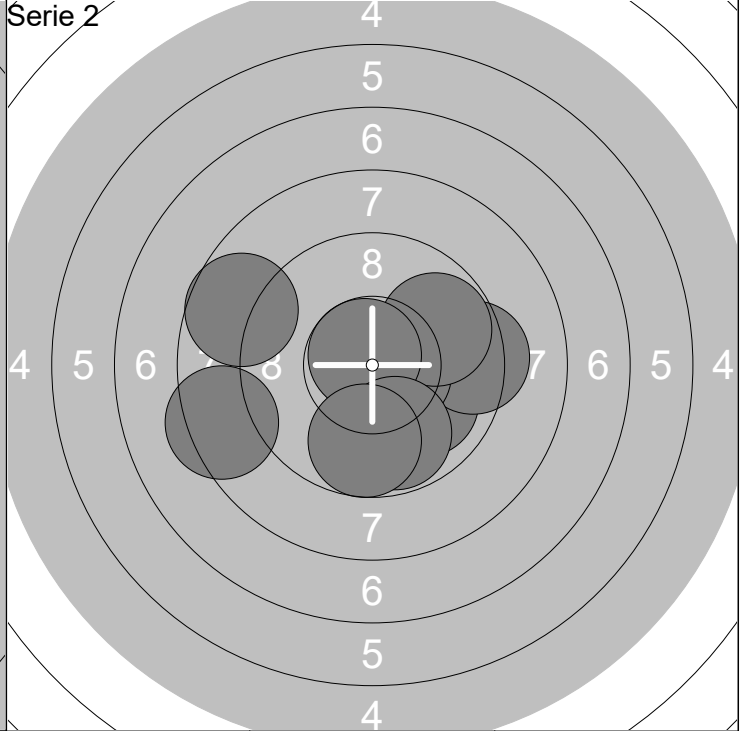
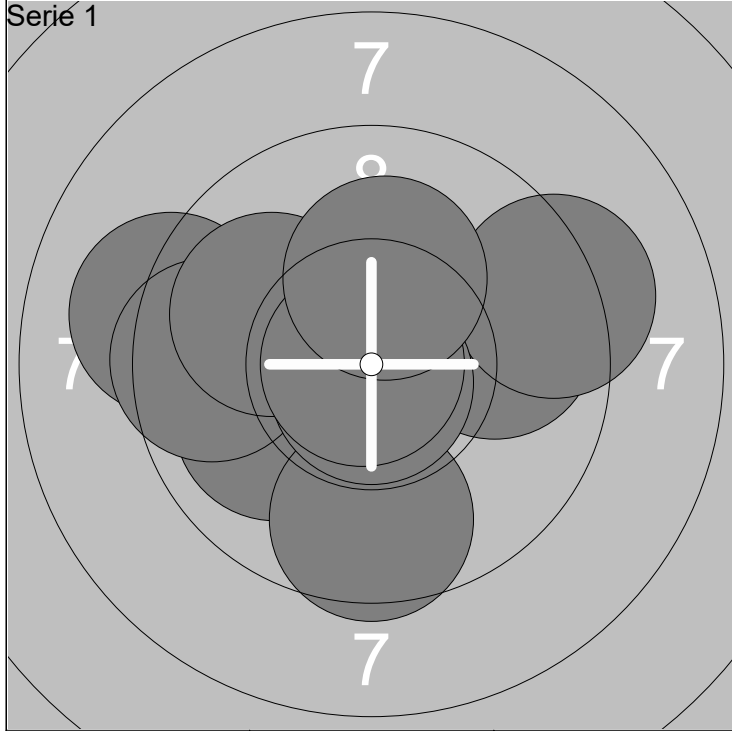

1: 9.8 →	6: 9.9 ←	Serie	94 (3x)
2: 9.1 ←	7: 9.6 ↓		
3: 10.0 ↙	8: 10.8x ↓	Total	94 (3x)
4: 9.5 ←	9: 10.8x ←		
5: 9.2 →	10: 10.2x ↑		

1: 9.9 ↘	6: 9.8 ↗	Serie	90 (2x)
2: 8.7 ←	7: 8.4 ←		
3: 9.3 →	8: 10.7x ↗	Total	184 (5x)
4: 9.9 ↓	9: 9.8 ↓		
5: 10.5x →	10: 9.7 ↓		

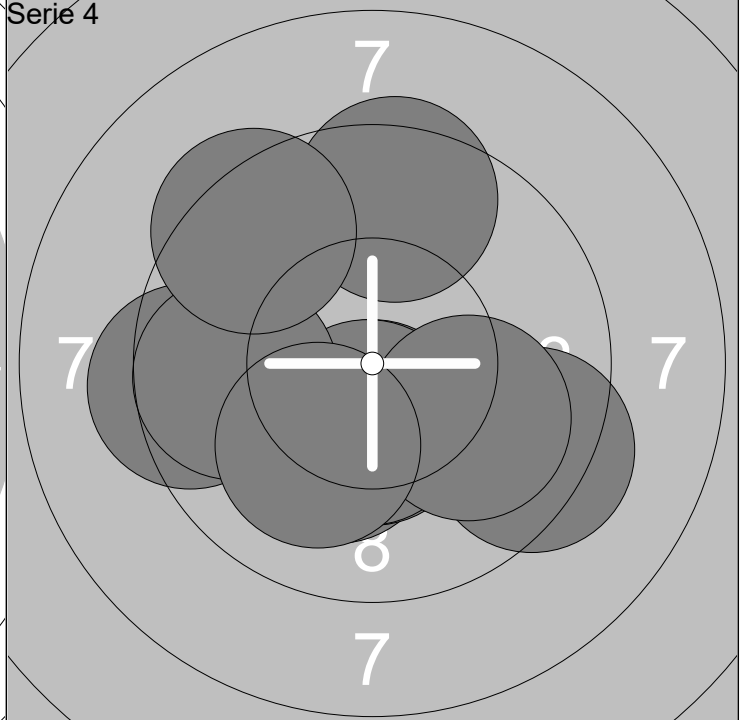
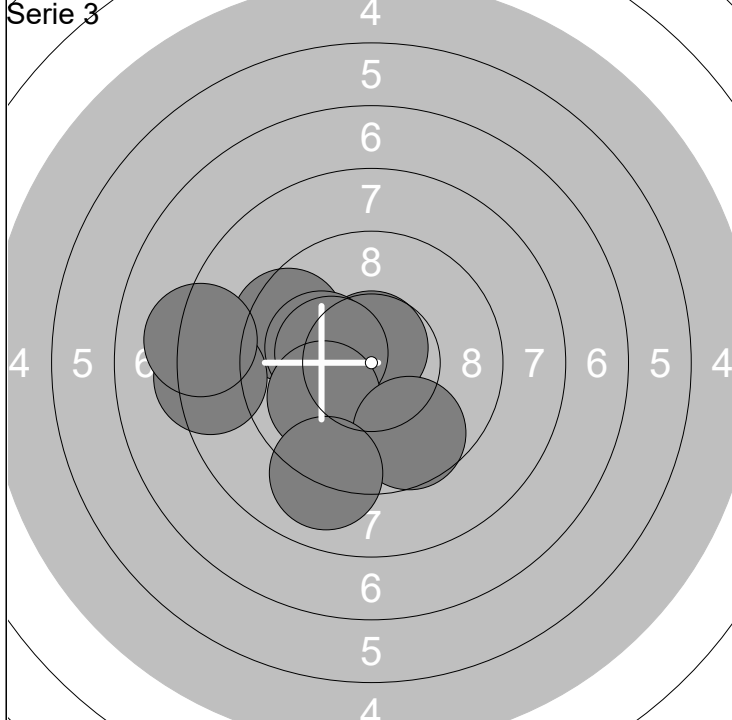

1: 10.3x ←	6: 10.0 ←	Serie	93 (3x)
2: 9.5 ←	7: 9.7 ↓		
3: 10.7x ↑	8: 9.0 ↓	Total	277 (8x)
4: 10.1 ←	9: 8.4 ←		
5: 10.3x ←	10: 8.2 ←		

1: 10.2x ↓	6: 10.0 ↘	Serie	95 (3x)
2: 10.4x ↓	7: 9.5 ↑		
3: 10.4x ↓	8: 9.7 ←	Total	372 (11x)
4: 9.3 ←	9: 10.1 ↓		
5: 9.3 →	10: 9.4 ↙		

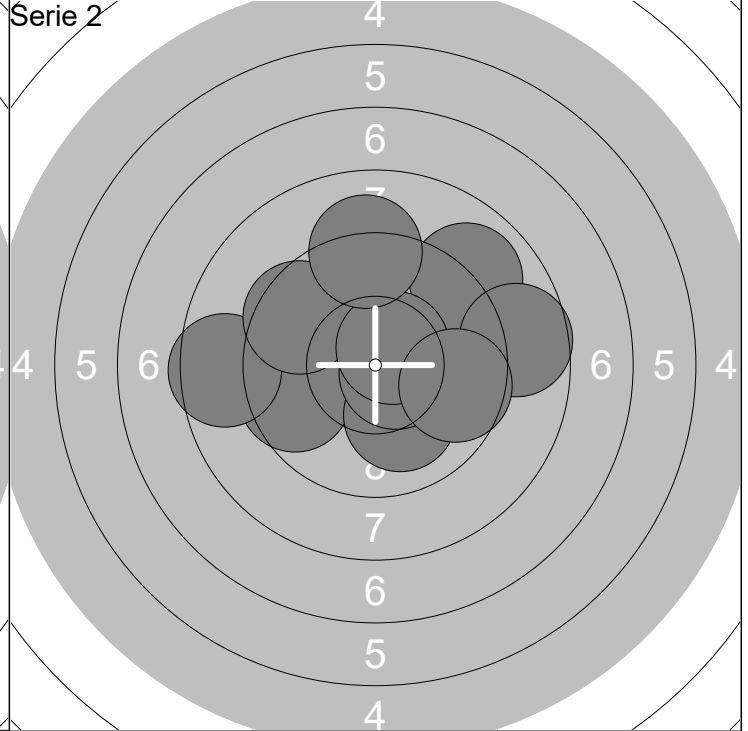
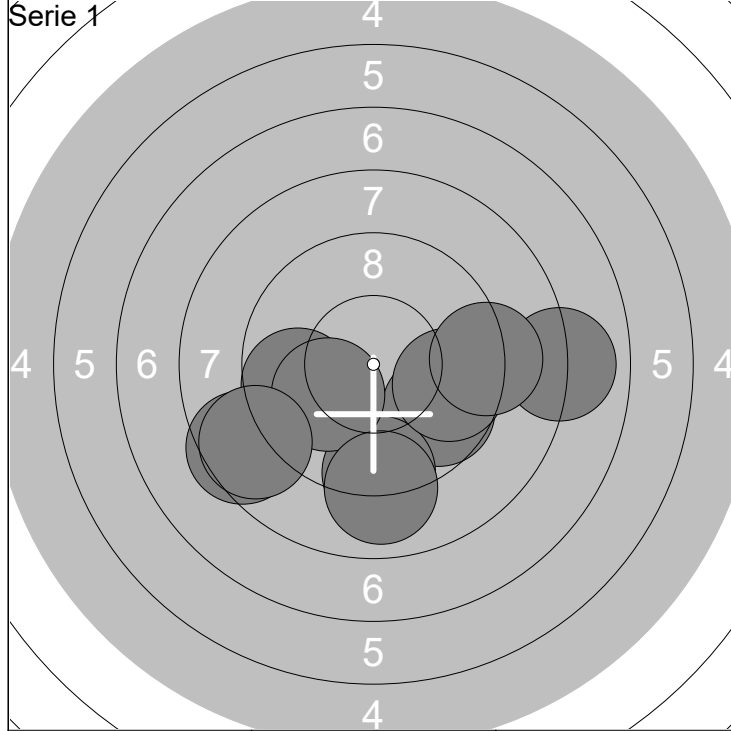

1: 9.7 ←	6: 10.1 ↙	Serie 88 (0x)
2: 9.7 ↘	7: 9.0 ↓	
3: 9.2 ↓	8: 8.0 →	Total 88 (0x)
4: 9.7 →	9: 8.7 ↙	
5: 8.5 ↙	10: 9.1 →	

1: 8.9 ↗	6: 8.6 →	Serie 90 (2x)
2: 9.6 ←	7: 10.6x →	
3: 8.5 ←	8: 10.5x ↗	Total 178 (2x)
4: 9.5 ↙	9: 9.6 →	
5: 10.1 ↓	10: 9.1 ↑	

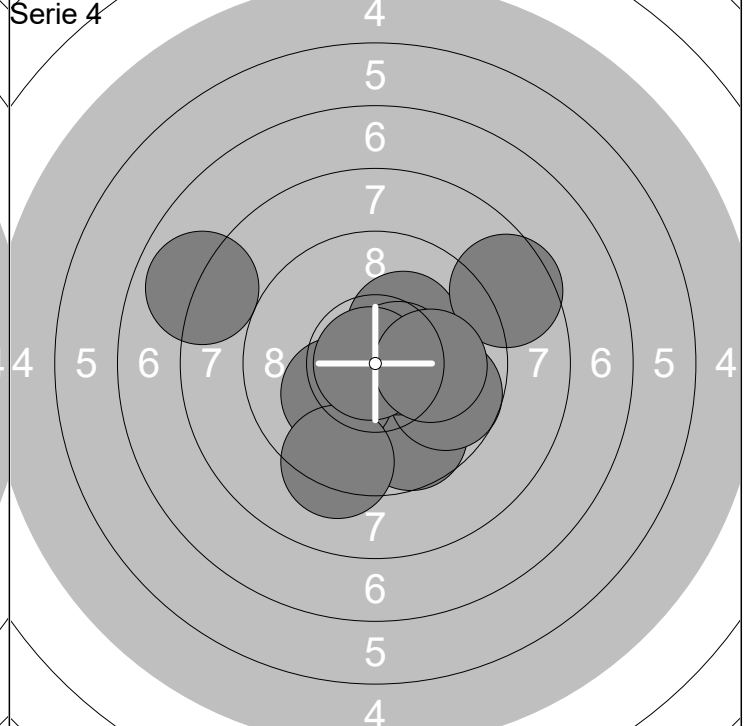
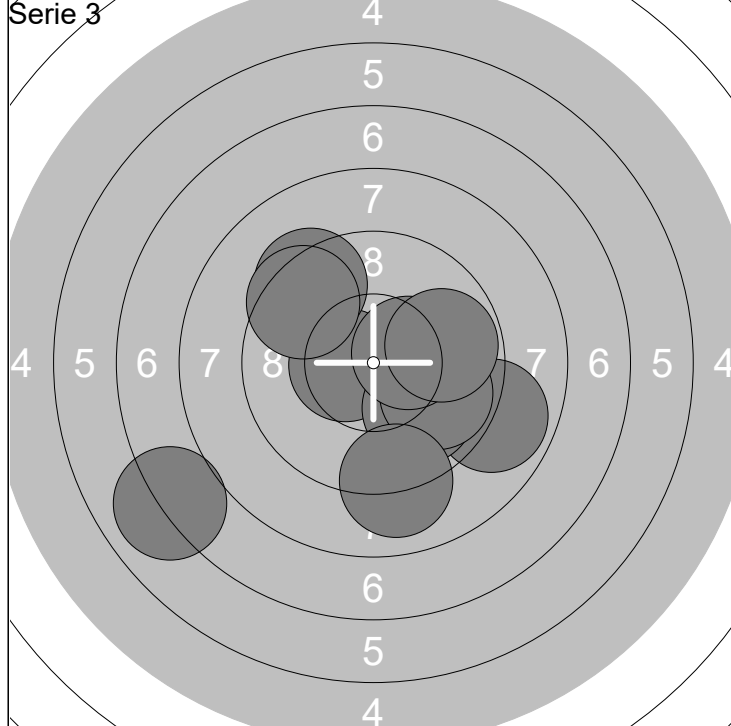

1: 8.9 →	6: 9.9 ↘	Serie 89 (2x)
2: 10.5x ←	7: 9.8 ↘	
3: 9.3 ↗	8: 9.0 ↓	Total 267 (4x)
4: 7.0 ↙	9: 10.4x →	
5: 9.5 ↙	10: 9.8 →	

1: 10.2x ↗	6: 9.7 →	Serie 92 (4x)
2: 9.7 ↓	7: 10.5x →	
3: 10.2x ↙	8: 10.8x ←	Total 359 (8x)
4: 8.5 ↗	9: 10.0 →	
5: 9.3 ↓	10: 7.9 ↙	

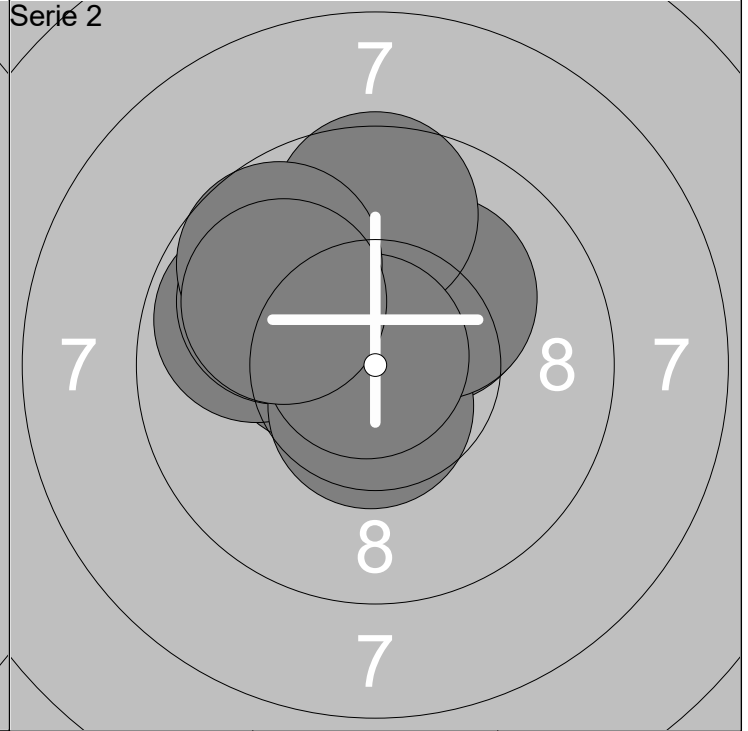
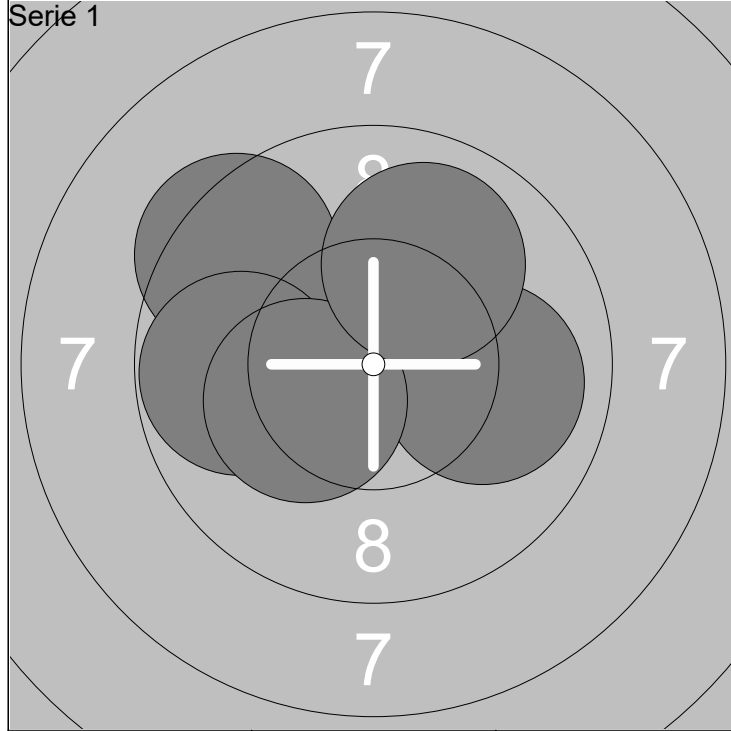

1: 10.7x ↑	6: 9.4 ↙	Serie 96 (6x)
2: 10.2x ↙	7: 9.9 →	
3: 10.4x ↑	8: 9.8 ←	Total 96 (6x)
4: 10.2x ↙	9: 10.3x ↙	
5: 10.4x ←	10: 9.9 ↗	

1: 10.4x ↙	6: 10.2x ↗	Serie 95 (5x)
2: 10.2x ↗	7: 9.6 ↑	
3: 9.8 ↙	8: 10.8x ↙	Total 191 (11x)
4: 9.9 ↙	9: 9.7 ↗	
5: 10.6x ↓	10: 9.9 ↙	

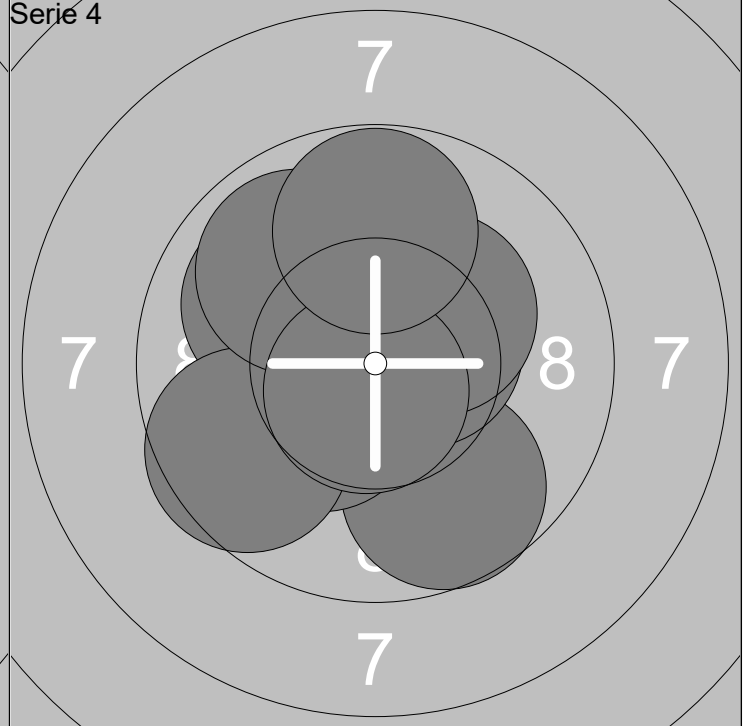
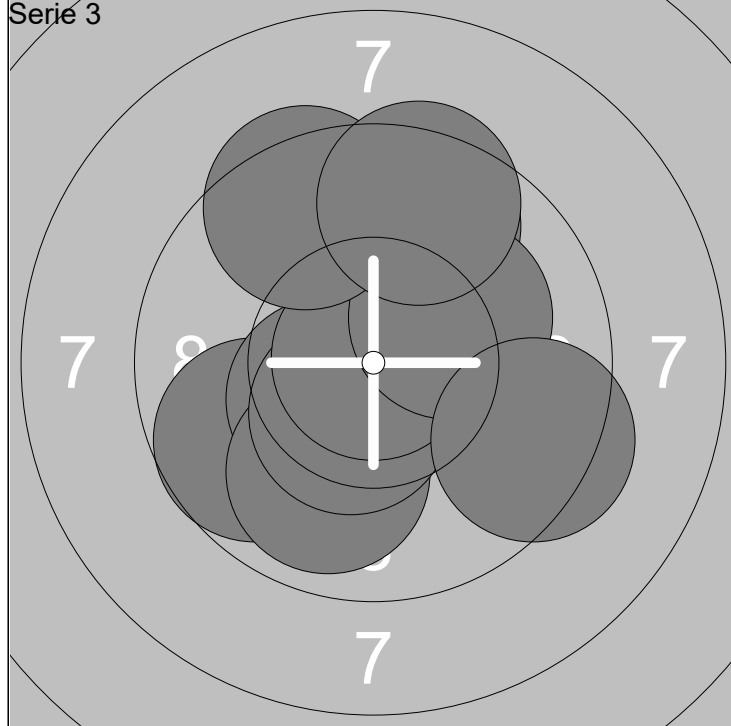

1: 9.7 ↙	6: 10.9x ↑	Serie 94 (3x)
2: 10.4x ↙	7: 10.1 ↗	
3: 9.9 ↓	8: 9.4 ↗	Total 285 (14x)
4: 10.4x ↓	9: 9.5 ↑	
5: 9.7 ↑	10: 9.4 →	

1: 10.5x ←	6: 10.5x →	Serie 96 (5x)
2: 9.7 ↓	7: 9.9 ↙	
3: 10.3x ↙	8: 10.2x ↗	Total 381 (19x)
4: 10.0 ↙	9: 10.7x ↓	
5: 9.6 ↙	10: 9.8 ↑	

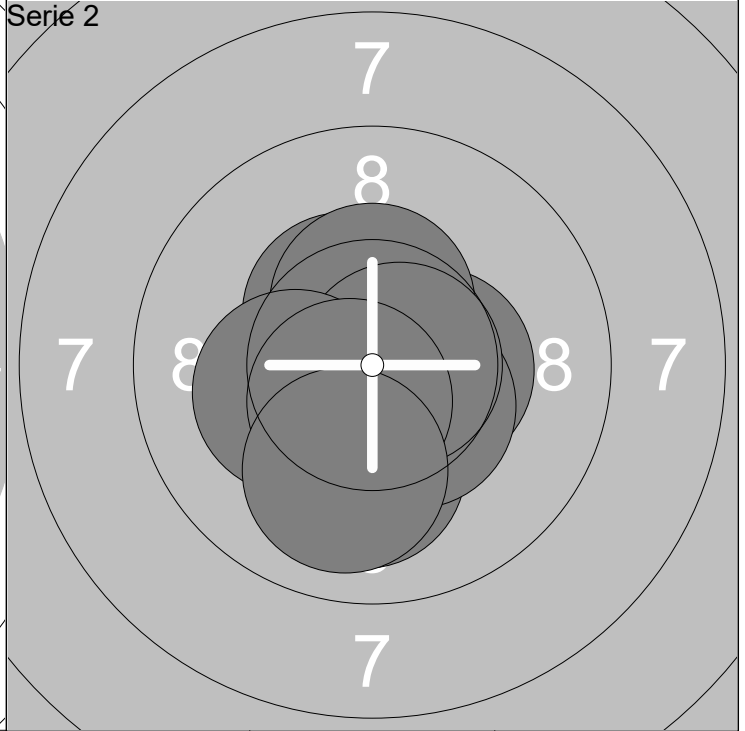
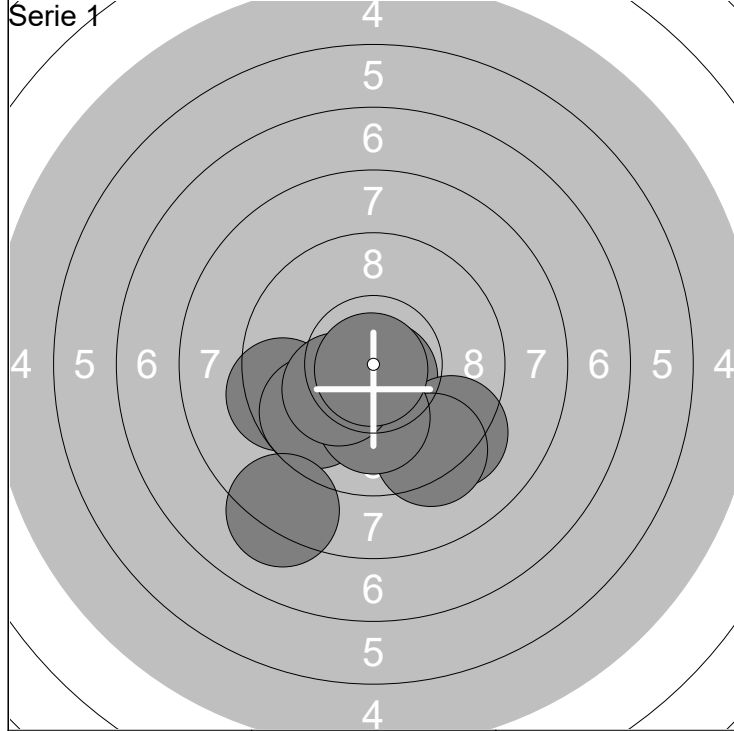

1: 10.4x ↘	6: 9.3 ↘	Serie 94 (4x)
2: 9.4 ←	7: 8.2 ↘	
3: 10.7x ↘	8: 10.1 ↓	Total 94 (4x)
4: 9.3 ↘	9: 10.2x ←	
5: 9.8 ↙	10: 10.8x ↘	

1: 10.4x ↗	6: 10.4x ↘	Serie 100 (8x)
2: 10.4x →	7: 10.7x →	
3: 10.6x ↘	8: 10.2x ←	Total 194 (12x)
4: 10.4x ↑	9: 10.5x ↘	
5: 10.0 ↓	10: 10.0 ↓	

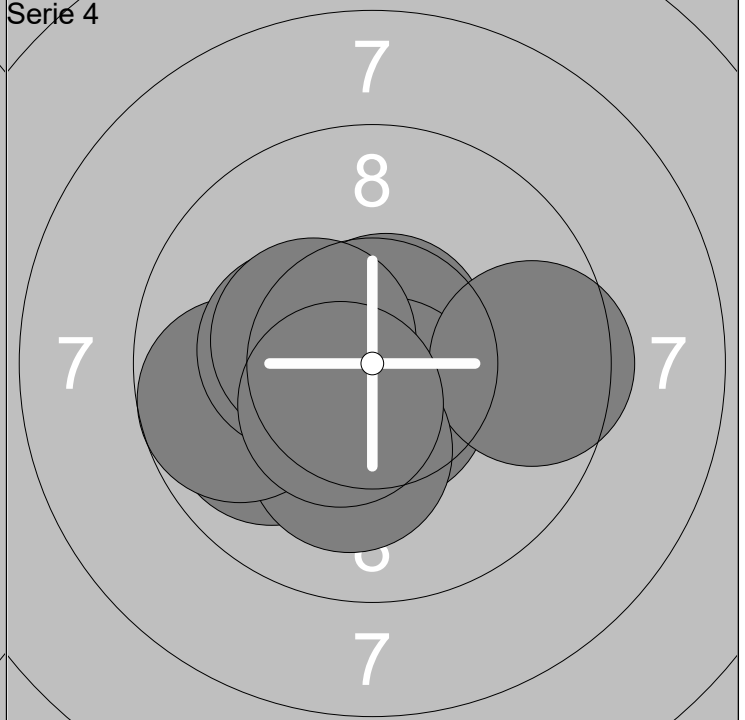
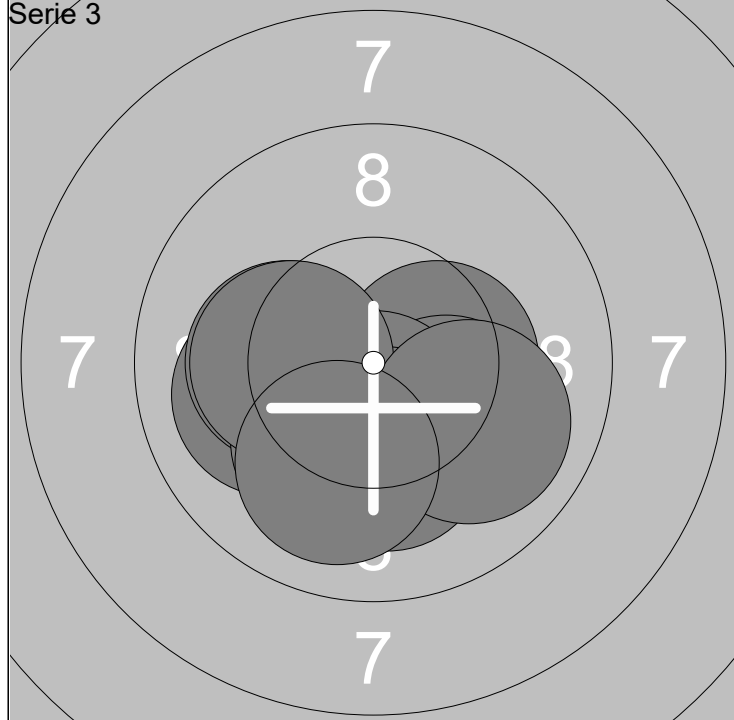

1: 10.4x →	6: 10.2x ↘	Serie 99 (6x)
2: 10.0 ←	7: 10.2x ↘	
3: 10.2x ←	8: 10.2x ←	Total 293 (18x)
4: 10.1 ↘	9: 9.9 ↘	
5: 10.5x ↓	10: 10.0 ↓	

1: 10.7x ↗	6: 10.2x ↘	Serie 97 (6x)
2: 10.1 ←	7: 9.7 ←	
3: 9.9 ←	8: 10.3x ←	Total 390 (24x)
4: 10.6x ↘	9: 10.4x ←	
5: 9.5 →	10: 10.5x ↘	

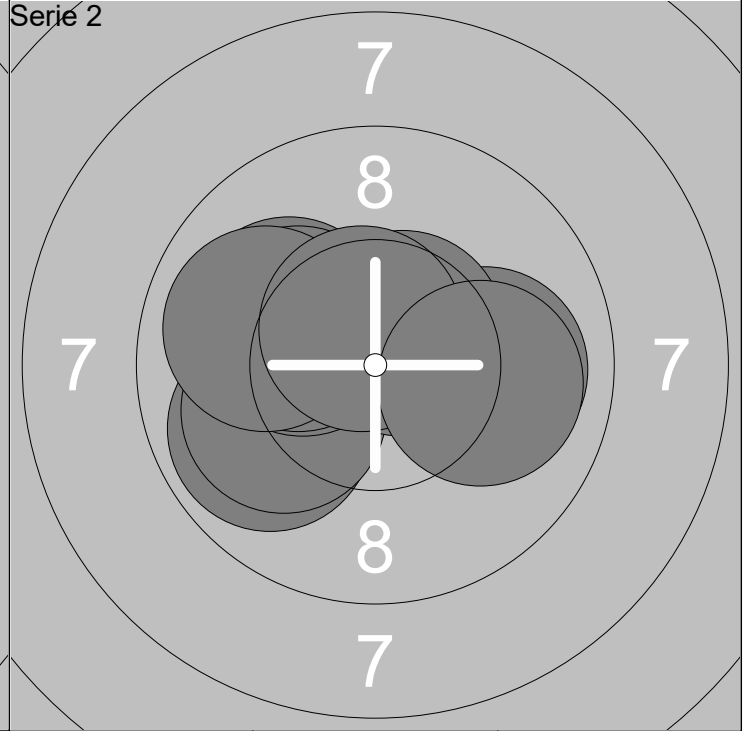
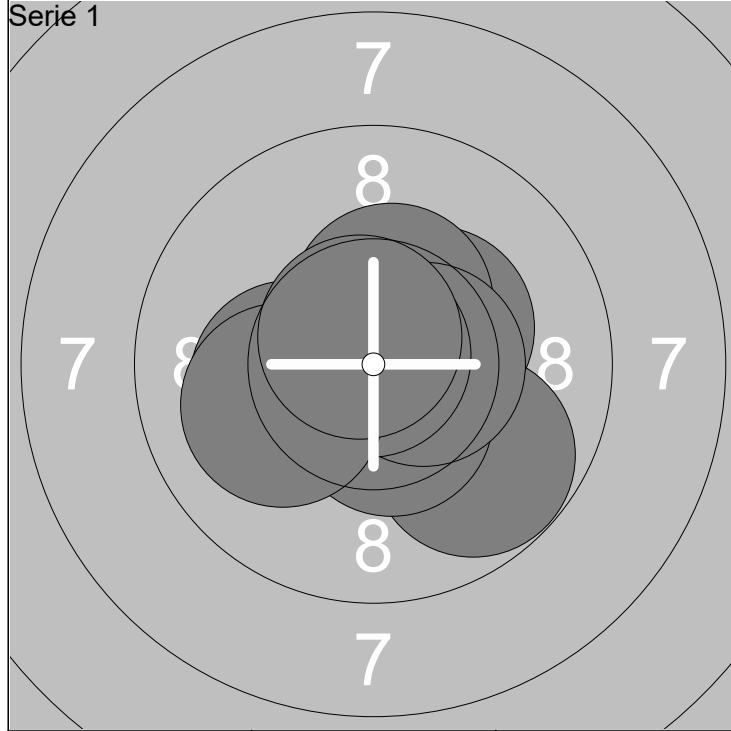

1: 9.7 ↘	6: 10.4x ↗	Serie 99 (8x)
2: 10.8x ↑	7: 10.5x →	
3: 10.3x ↗	8: 10.8x ↖	Total 99 (8x)
4: 10.5x ↘	9: 10.0 ←	
5: 10.2x ←	10: 10.6x ↖	

1: 9.8 ↙	6: 9.9 ←	Serie 98 (4x)
2: 10.0 ↙	7: 10.0 →	
3: 10.1 ↙	8: 10.6x ↗	Total 197 (12x)
4: 10.2x ↙	9: 10.6x ↗	
5: 10.2x ↙	10: 10.0 →	

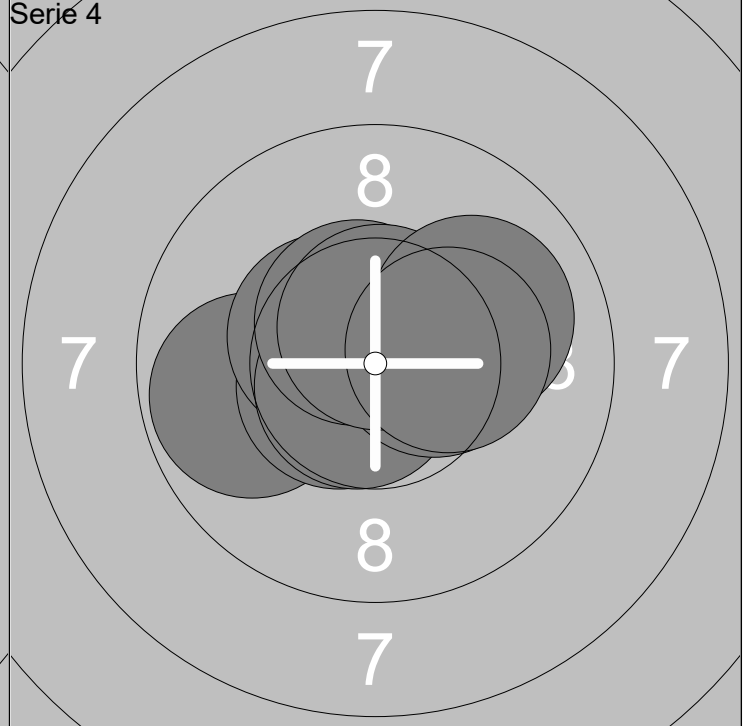
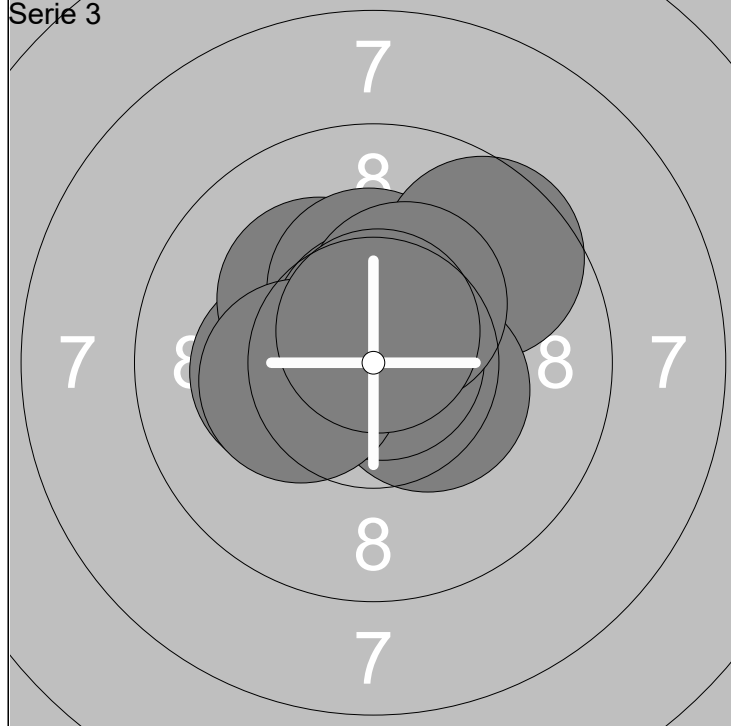

1: 10.2x ←	6: 10.4x ↘	Serie 99 (9x)
2: 10.2x ↖	7: 10.8x ↗	
3: 10.3x ↑	8: 10.4x ↗	Total 296 (21x)
4: 10.7x ↑	9: 10.3x ←	
5: 9.6 ↗	10: 10.6x ↑	

1: 10.7x ↗	6: 10.5x ↖	Serie 99 (8x)
2: 9.8 ←	7: 10.4x →	
3: 10.6x ↙	8: 10.6x ↑	Total 395 (29x)
4: 10.5x ↙	9: 10.0 ↗	
5: 10.7x ↙	10: 10.3x →	

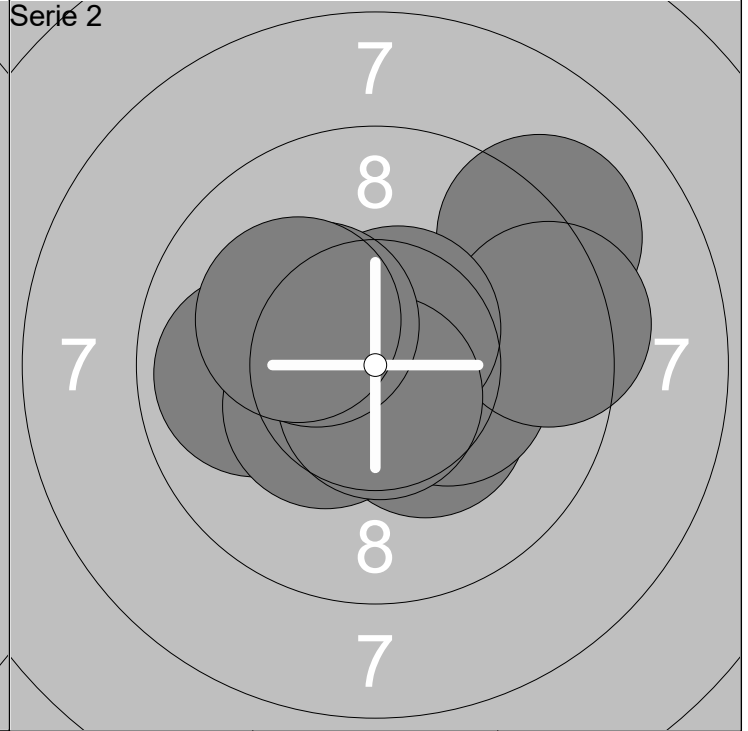
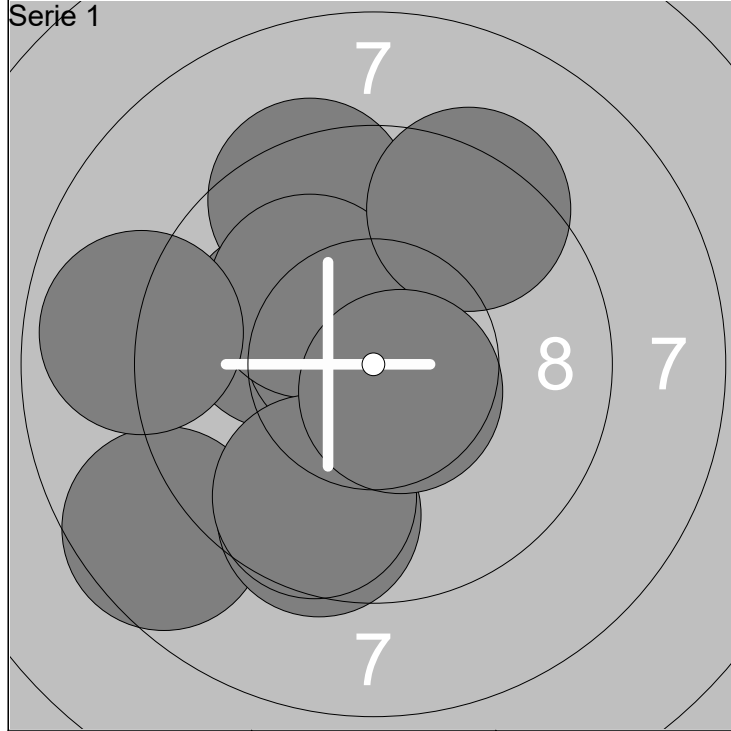

1: 8.6 ↙	6: 9.3 ↗	Serie	92 (2x)
2: 10.1 ↖	7: 9.5 ↓		
3: 9.4 ↗	8: 8.9 ←	Total	92 (2x)
4: 10.6x ↗	9: 9.7 ↓		
5: 10.1 ↗	10: 10.6x ↘		

1: 10.3x ↘	6: 9.4 →	Serie	97 (7x)
2: 9.1 ↗	7: 10.6x ↗		
3: 10.3x →	8: 10.7x ↓	Total	189 (9x)
4: 9.9 ←	9: 10.3x ↖		
5: 10.3x ↙	10: 10.2x ↖		

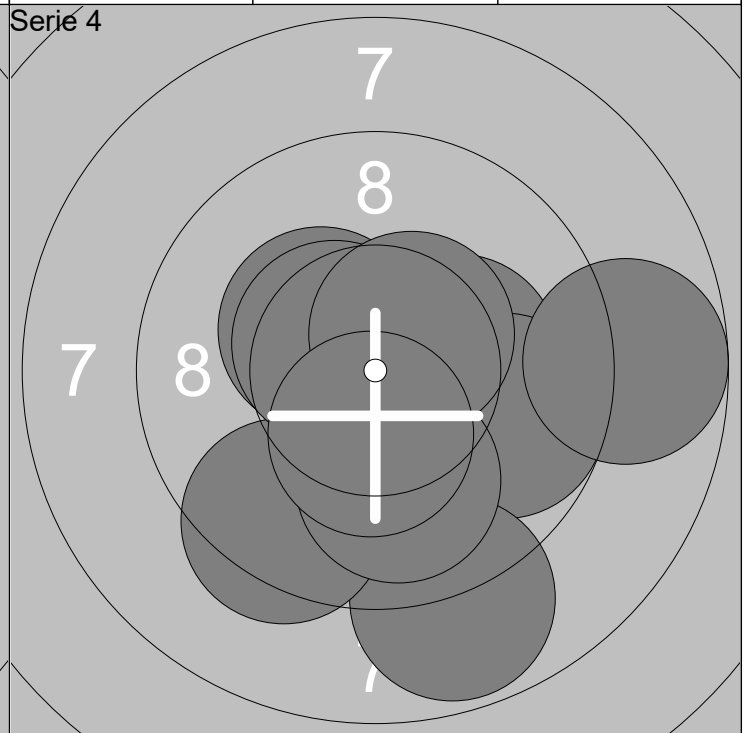
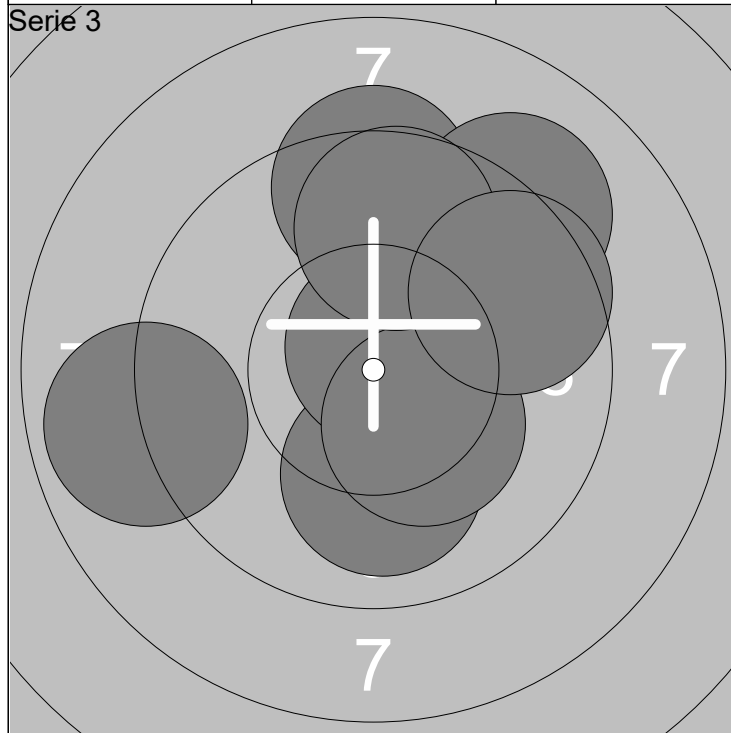

1: 10.5x ↗	6: 8.9 ←	Serie	93 (3x)
2: 9.3 ↑	7: 9.1 ↗		
3: 9.9 ↗	8: 10.3x ↘	Total	282 (12x)
4: 10.0 ↓	9: 9.7 ↑		
5: 10.7x ↗	10: 9.5 ↗		

1: 10.3x ↖	6: 10.5x ↖	Serie	93 (5x)
2: 10.2x →	7: 9.9 ↓		
3: 9.7 →	8: 10.5x ↗	Total	375 (17x)
4: 8.8 ↓	9: 8.7 →		
5: 9.4 ↙	10: 10.4x ↓		

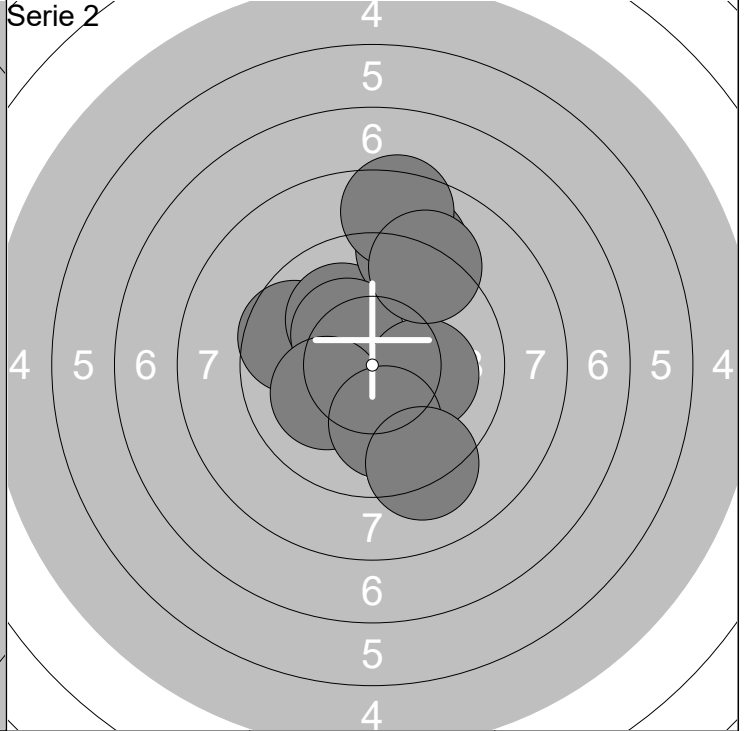
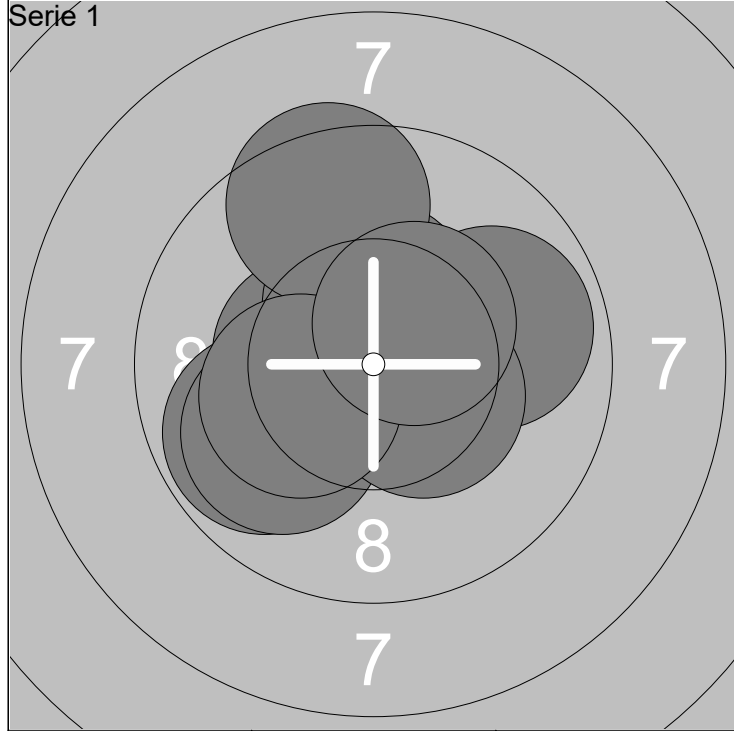

1: 9.8 ↙	6: 9.8 →	Serie	96 (6x)
2: 10.4x ↑	7: 9.5 ↑		
3: 9.9 ↙	8: 10.4x ↘	Total	96 (6x)
4: 10.4x ←	9: 10.2x ←		
5: 10.4x ↑	10: 10.4x ↗		

1: 9.6 ↙	6: 10.1 →	Serie	94 (1x)
2: 10.1 ↖	7: 9.2 ↗		
3: 9.0 ↑	8: 10.1 ↙	Total	190 (7x)
4: 8.5 ↑	9: 10.0 ↓		
5: 10.3x ↖	10: 9.2 ↓		

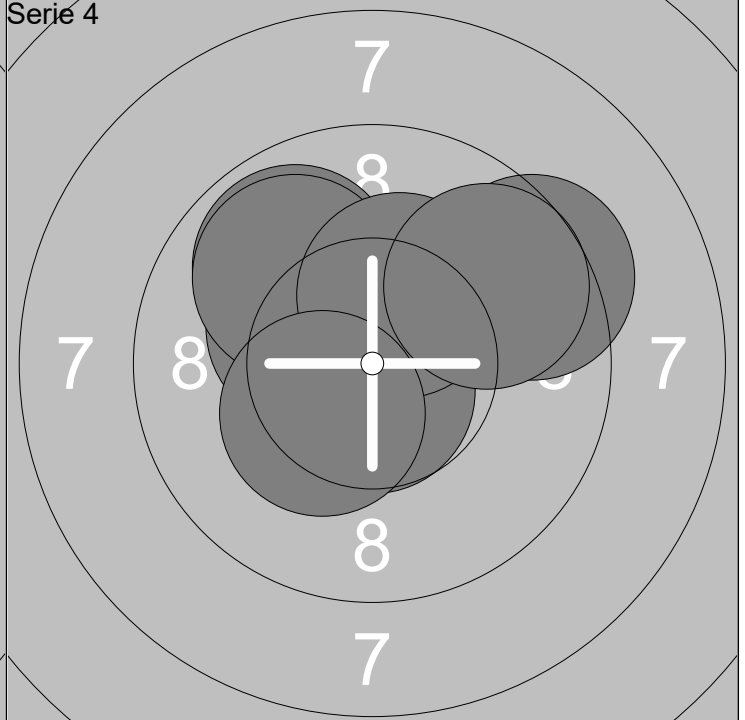
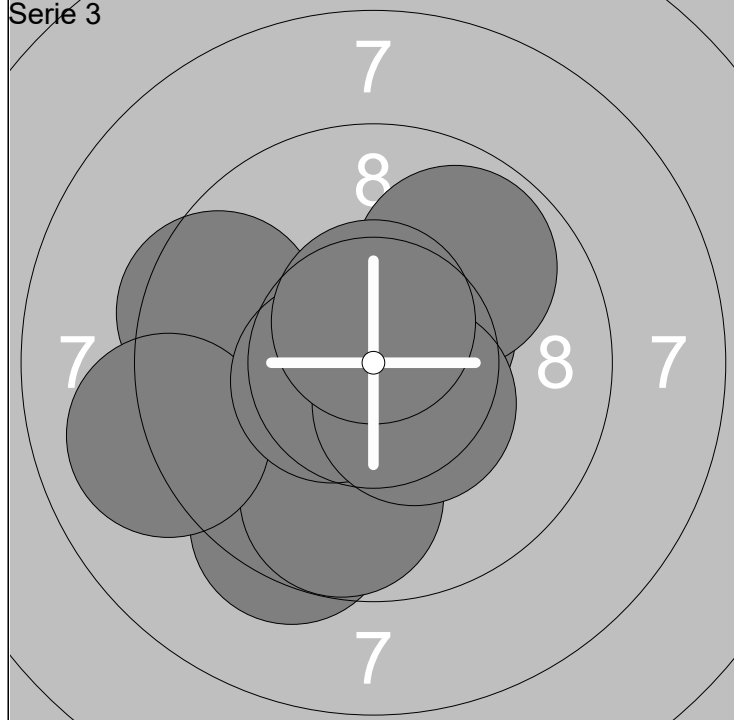

1: 10.5x ↗	6: 9.5 ←	Serie	95 (5x)
2: 10.4x ↗	7: 9.0 ←		
3: 9.8 ↗	8: 10.5x ←	Total	285 (12x)
4: 9.3 ↘	9: 10.4x ↘		
5: 9.7 ↓	10: 10.6x ↑		

1: 10.7x ↑	6: 9.9 ↖	Serie	96 (6x)
2: 9.9 ↖	7: 9.3 ↗		
3: 10.9x ↗	8: 10.3x ↑	Total	381 (18x)
4: 10.7x ↓	9: 9.7 ↗		
5: 10.3x ↖	10: 10.3x ↙		

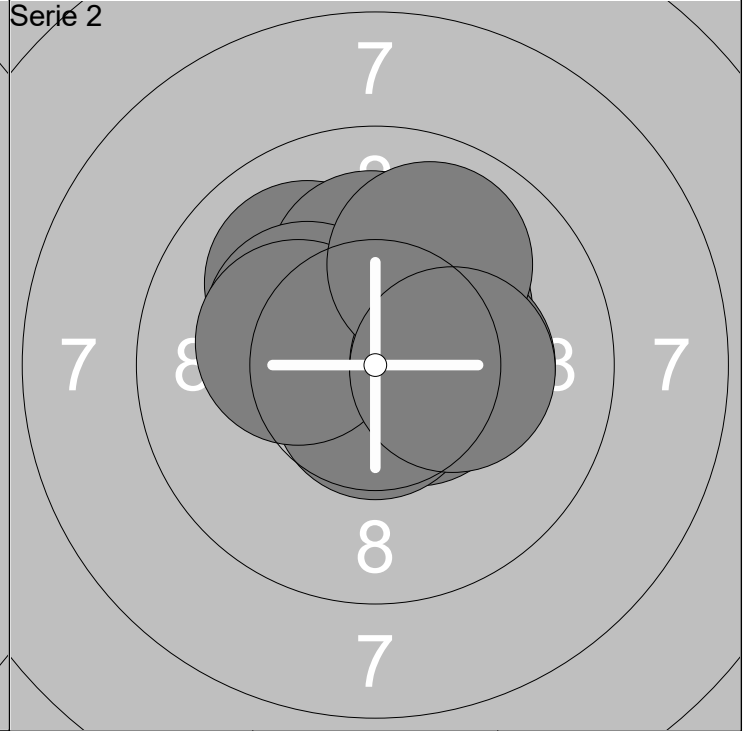
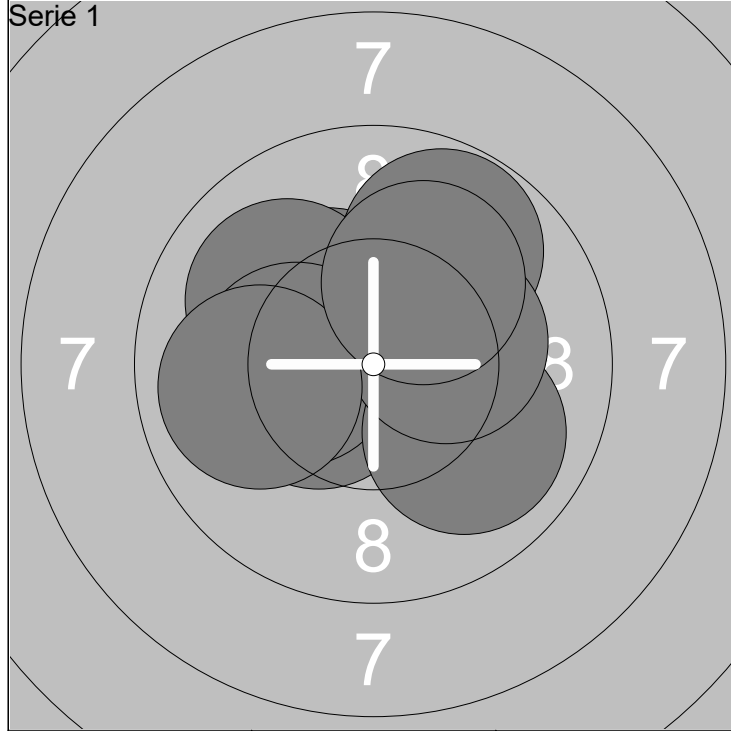

1: 10.4x ←	6: 9.7 ↗	Serie	97 (5x)
2: 10.5x ↗	7: 9.9 ↘		
3: 10.3x ↖	8: 10.2x →	Total	97 (5x)
4: 10.0 ↖	9: 9.9 ←		
5: 10.3x ←	10: 10.1 ↗		

1: 10.5x →	6: 10.2x ↖	Serie	99 (7x)
2: 10.6x ↓	7: 10.2x ←		
3: 10.0 ↖	8: 10.3x →	Total	196 (12x)
4: 10.1 ↑	9: 9.9 ↗		
5: 10.3x ↗	10: 10.2x →		

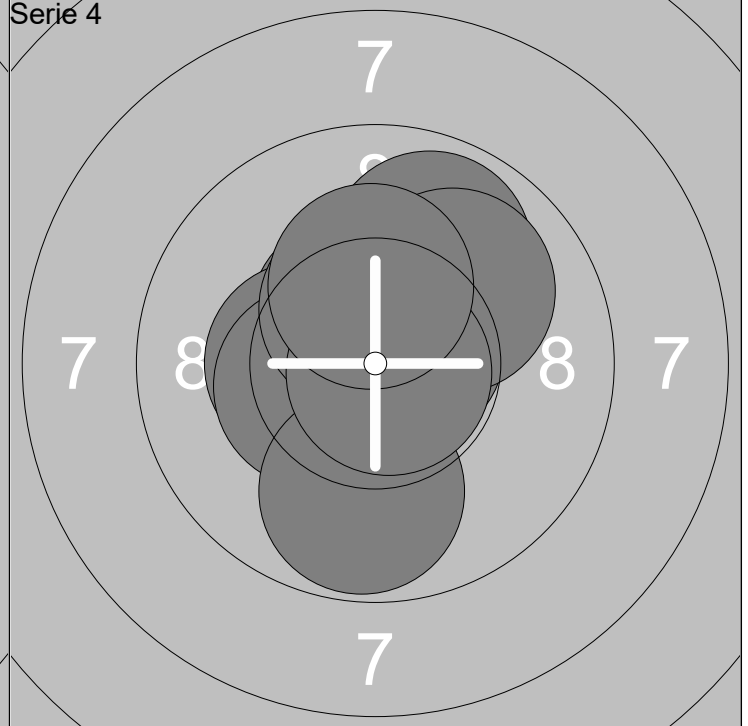
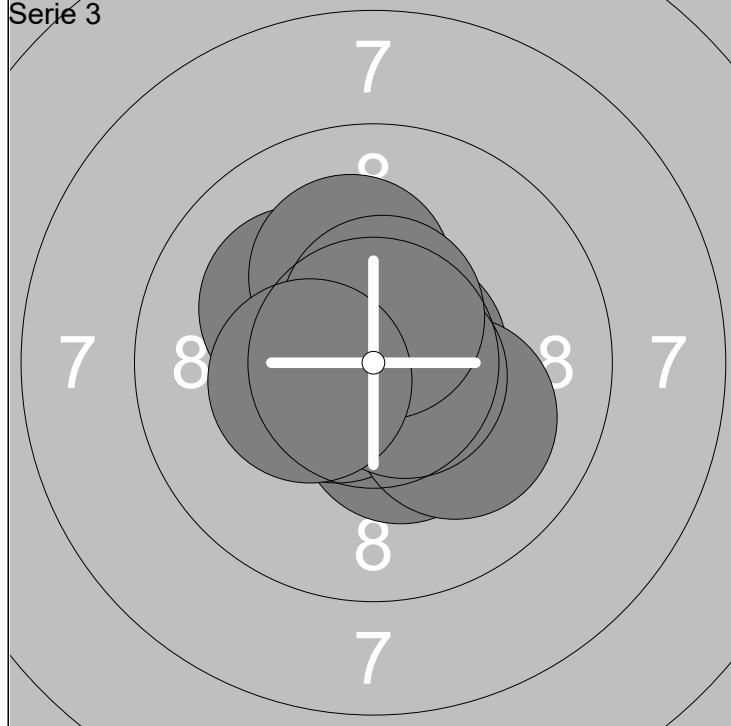

1: 10.4x ↓	6: 10.1 ↖	Serie	100 (7x)
2: 10.6x →	7: 10.6x →		
3: 10.8x ↘	8: 10.1 ↑	Total	296 (19x)
4: 10.6x ←	9: 10.5x ↑		
5: 10.0 ↘	10: 10.4x ←		

1: 9.9 ↗	6: 10.0 ↗	Serie	98 (7x)
2: 10.5x ↖	7: 9.8 ↓		
3: 10.6x ↗	8: 10.4x ↑	Total	394 (26x)
4: 10.3x ←	9: 10.8x ↘		
5: 10.4x ←	10: 10.2x ↑		

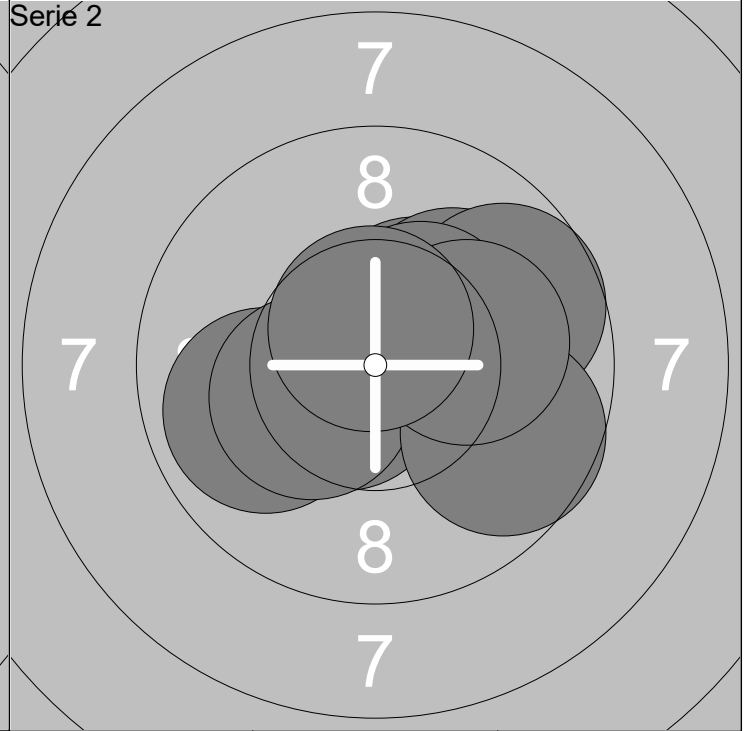
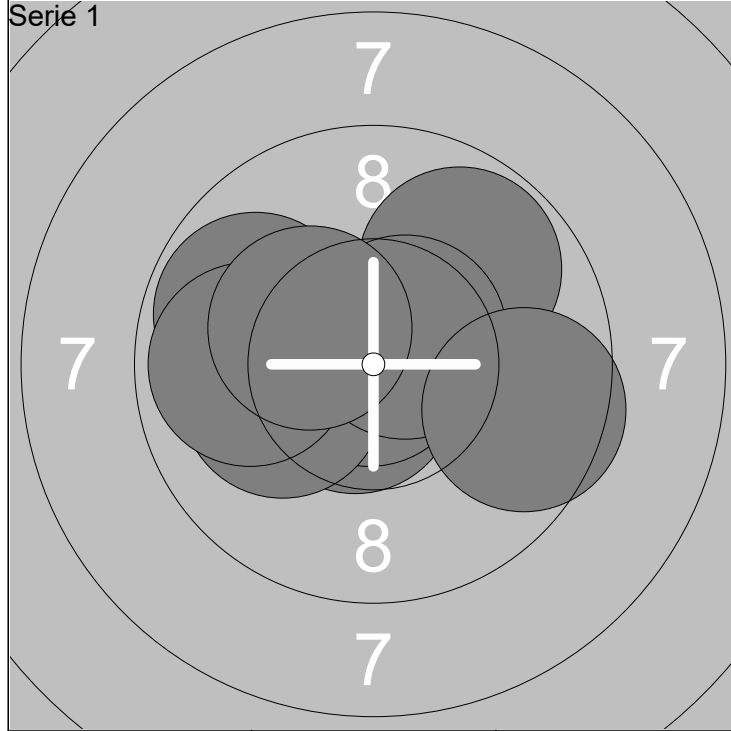

1: 10.2x ←	6: 10.1 ←	Serie	96 (5x)
2: 9.8 ↗	7: 10.6x ↗		
3: 10.7x ↘	8: 9.9 ←	Total	96 (5x)
4: 9.8 ←	9: 10.3x ↖		
5: 10.9x ←	10: 9.6 →		

1: 10.6x ↙	6: 10.3x ↙	Serie	97 (5x)
2: 10.4x ↗	7: 10.4x ↗		
3: 10.1 ↗	8: 9.6 →	Total	193 (10x)
4: 9.7 ↗	9: 10.1 →		
5: 9.9 ←	10: 10.6x ↑		

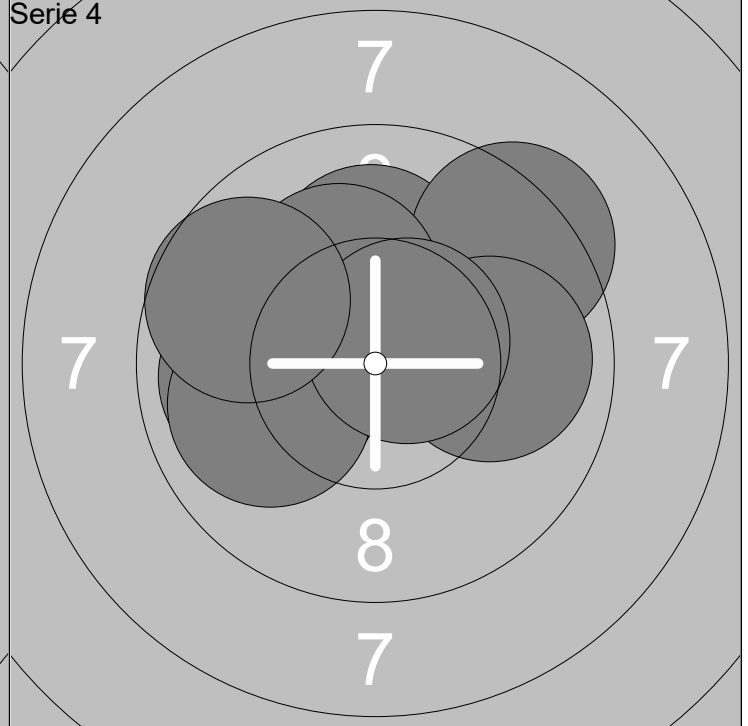
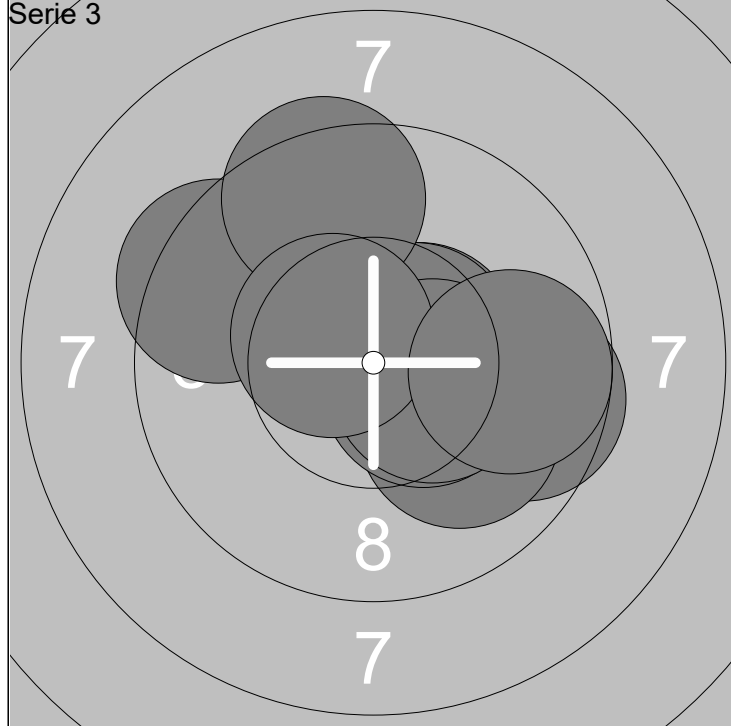

1: 9.6 →	6: 10.4x →	Serie	96 (5x)
2: 9.4 ↖	7: 9.4 ↑		
3: 10.5x ↗	8: 10.4x →	Total	289 (15x)
4: 10.0 ↘	9: 10.5x ↖		
5: 10.5x ↗	10: 9.7 →		

1: 10.1 ←	6: 10.2x ↗	Serie	95 (2x)
2: 10.1 ↑	7: 9.9 ↖		
3: 9.9 ←	8: 9.9 →	Total	384 (17x)
4: 10.1 ↖	9: 10.6x ↗		
5: 9.3 ↗	10: 9.7 ↖		

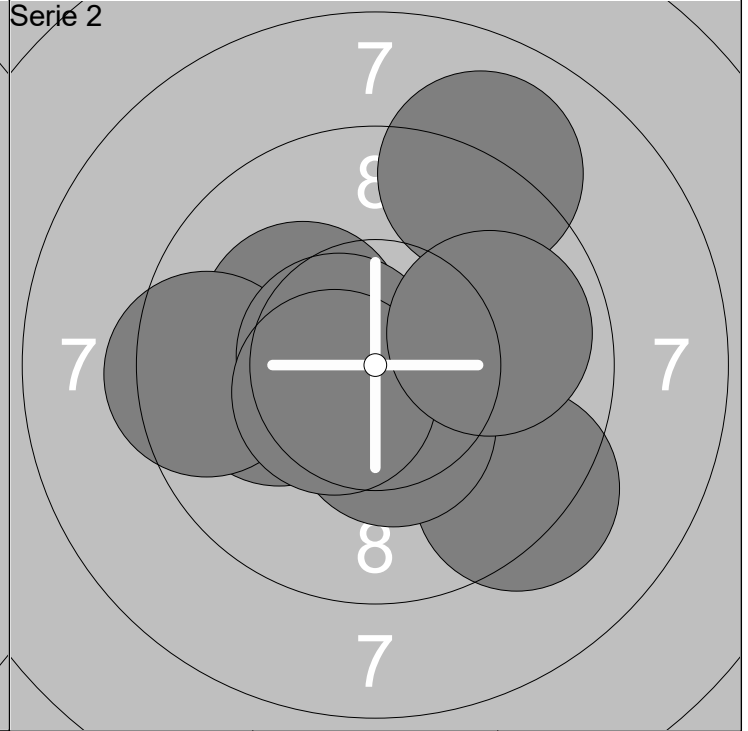
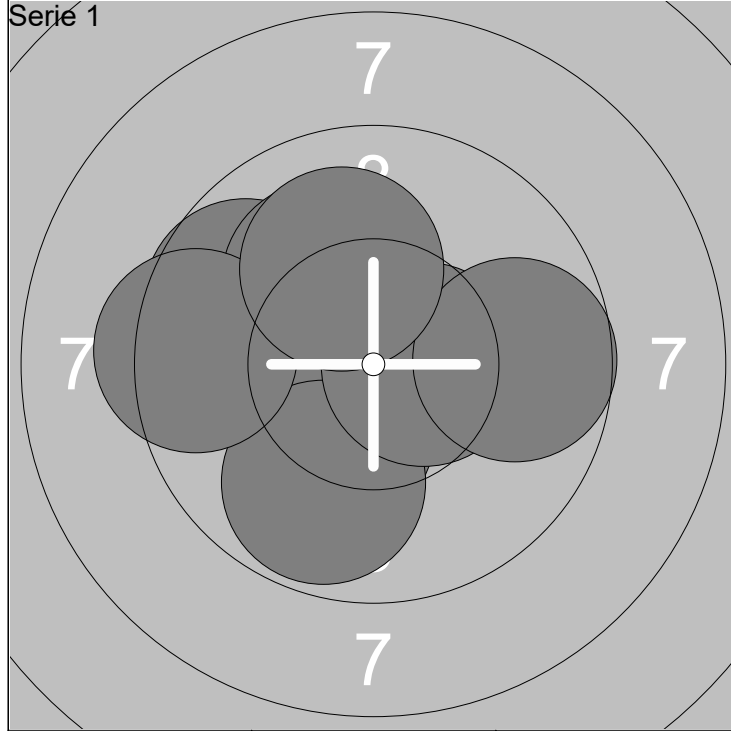

1: 10.4x ←	6: 9.8 ↓	Serie	96 (4x)
2: 9.7 ↖	7: 9.4 ←		
3: 10.8x ↓	8: 10.5x →	Total	96 (4x)
4: 10.1 ↗	9: 9.7 →		
5: 10.2x ↙	10: 10.0 ↗		

1: 10.1 ←	6: 10.6x ←	Serie	96 (5x)
2: 10.8x ↙	7: 10.4x ↓		
3: 9.3 ↘	8: 9.0 ↗	Total	192 (9x)
4: 10.2x ↖	9: 10.5x ←		
5: 9.5 ←	10: 9.9 →		

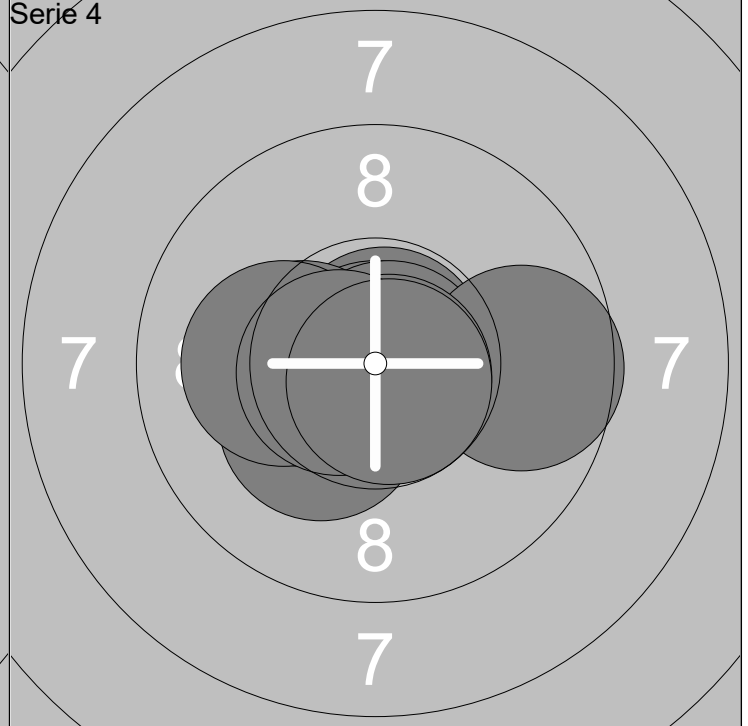
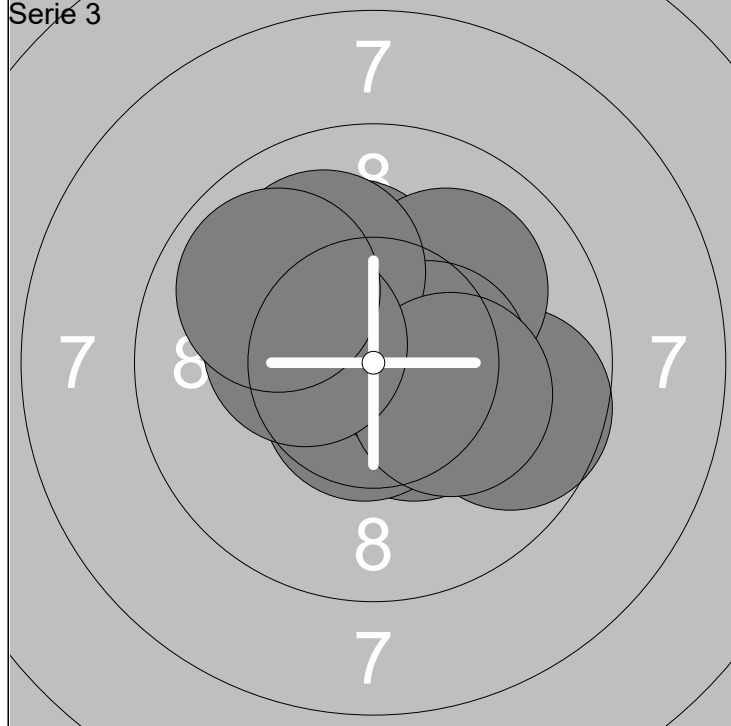

1: 10.4x ↘	6: 10.5x →	Serie	98 (6x)
2: 9.6 →	7: 10.0 ↗		
3: 10.6x ↓	8: 10.2x ↘	Total	290 (15x)
4: 10.2x ↗	9: 10.3x ←		
5: 10.0 ↗	10: 9.8 ↖		

1: 10.8x ↗	6: 10.1 ←	Serie	99 (8x)
2: 10.2x ↙	7: 9.6 →		
3: 10.9x	8: 10.8x ↓	Total	389 (23x)
4: 10.3x ←	9: 10.6x ←		
5: 10.8x →	10: 10.7x ↘		

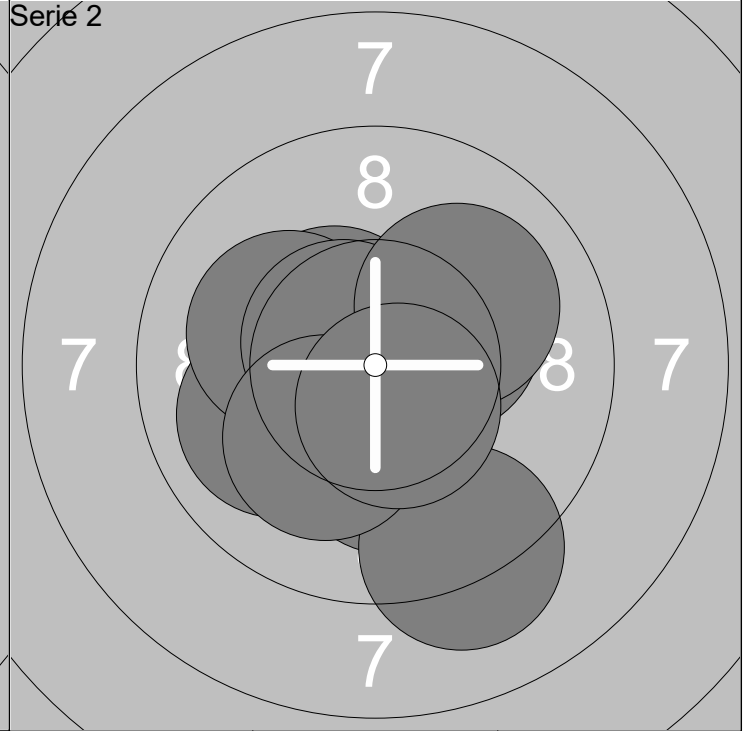
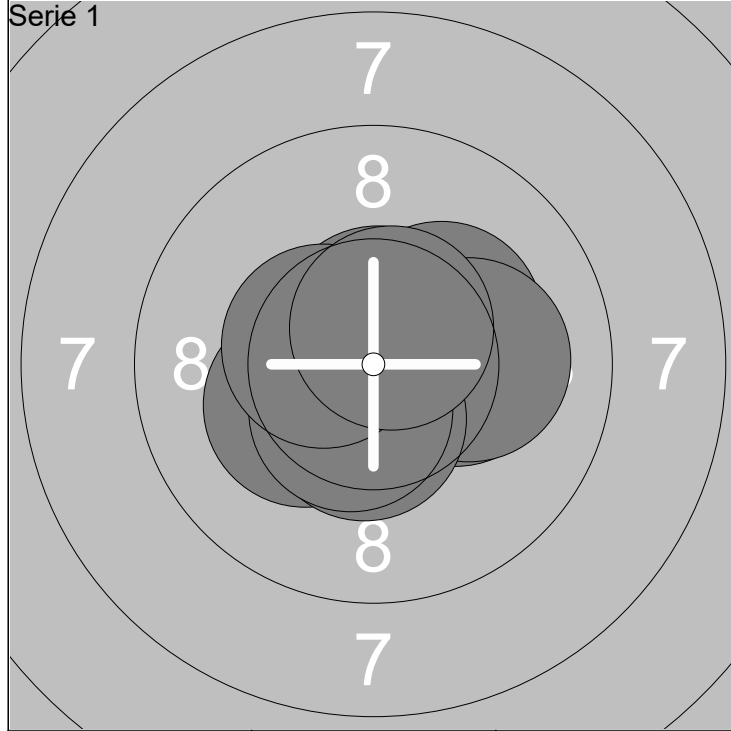

1: 10.2x →	6: 10.1 →	Serie 100 (9x)
2: 10.6x ↑	7: 10.4x ↓	
3: 10.2x ↗	8: 10.5x ↓	Total 100 (9x)
4: 10.2x ↙	9: 10.4x ↙	
5: 10.7x →	10: 10.6x ↗	

1: 10.0 ↙	6: 10.6x ↙	Serie 99 (6x)
2: 10.2x ↓	7: 9.1 ↓	
3: 10.3x ↗	8: 10.0 ↗	Total 199 (15x)
4: 10.5x ↙	9: 10.2x ↓	
5: 10.1 ↙	10: 10.5x ↓	

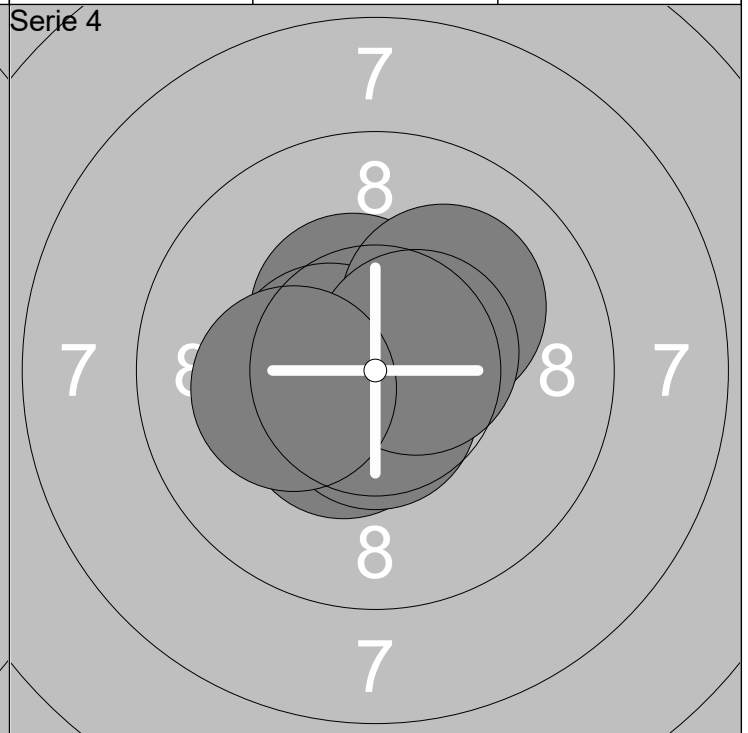
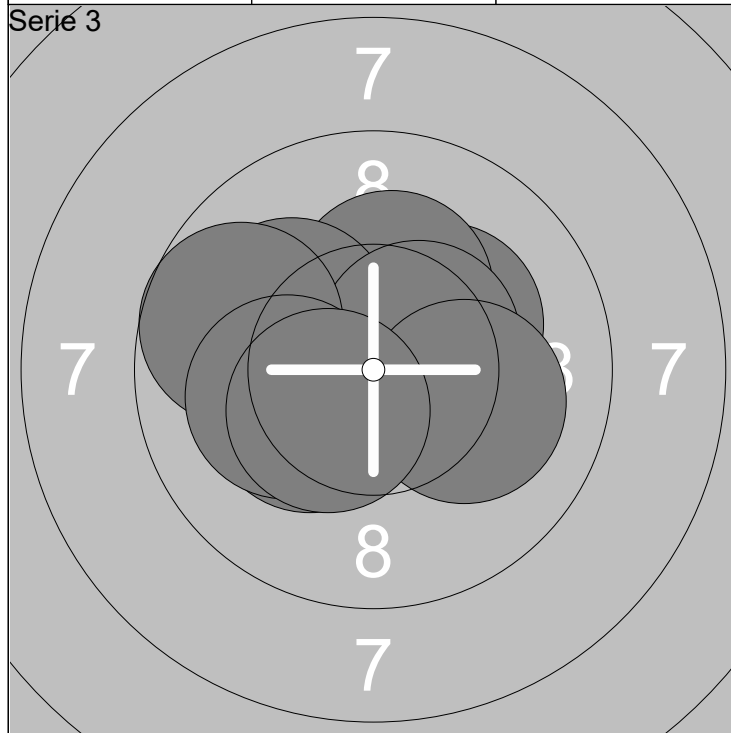

1: 10.7x ↙	6: 10.5x ↗	Serie 99 (6x)
2: 10.2x ↙	7: 10.1 →	
3: 10.2x ↗	8: 9.7 ↙	Total 298 (21x)
4: 10.2x ↑	9: 10.1 ↙	
5: 10.1 ↙	10: 10.4x ↓	

1: 10.6x ↙	6: 10.1 ↗	Serie 100 (9x)
2: 10.4x ↗	7: 10.4x ↓	
3: 10.9x ↑	8: 10.6x ↓	Total 398 (30x)
4: 10.7x ↙	9: 10.5x ↗	
5: 10.5x ↙	10: 10.2x ↙	

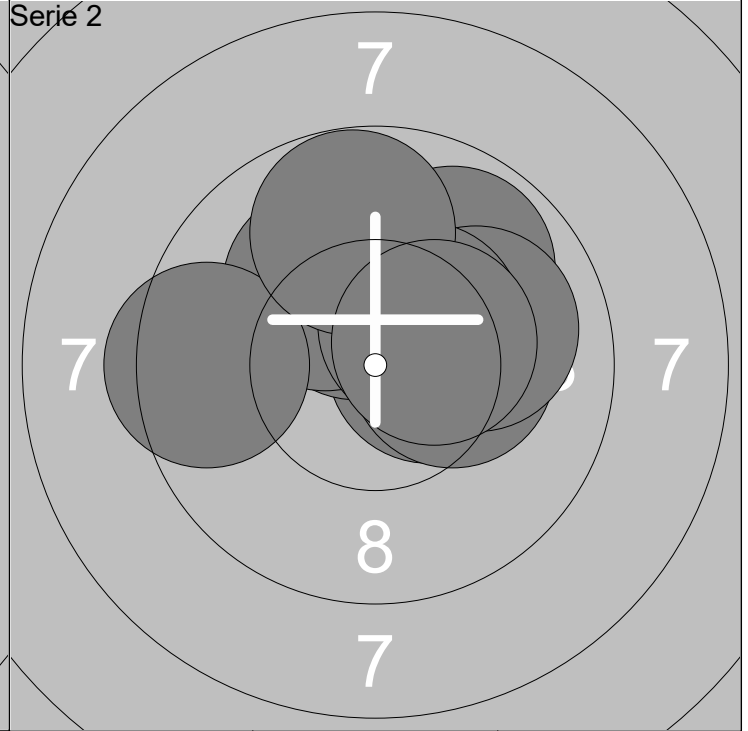
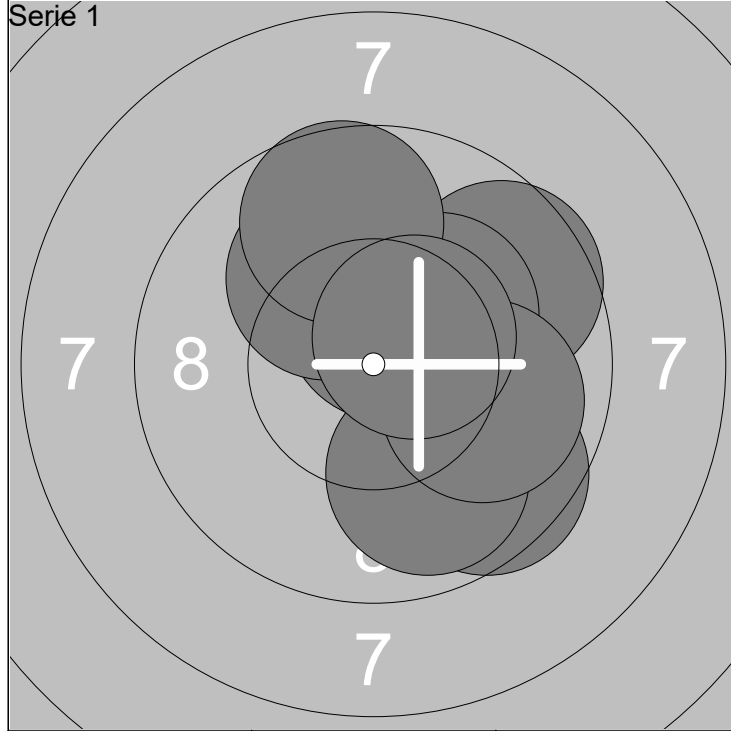

1: 10.5x ↑	6: 9.6 ↗	Serie	95 (3x)
2: 10.1 →	7: 10.2x ↗		
3: 10.1 ↑	8: 9.9 →	Total	95 (3x)
4: 9.5 ↘	9: 9.6 ↑		
5: 9.9 ↘	10: 10.5x ↗		

1: 10.5x →	6: 10.1 ↖	Serie	97 (5x)
2: 10.3x →	7: 10.4x ↗		
3: 9.8 ↗	8: 9.4 ←	Total	192 (8x)
4: 10.0 →	9: 9.7 ↑		
5: 10.3x ↑	10: 10.4x →		

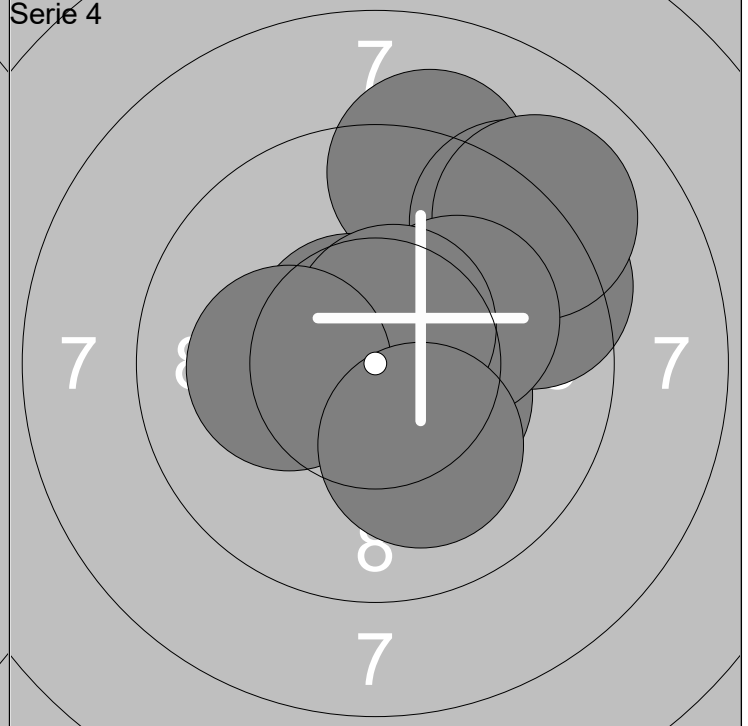
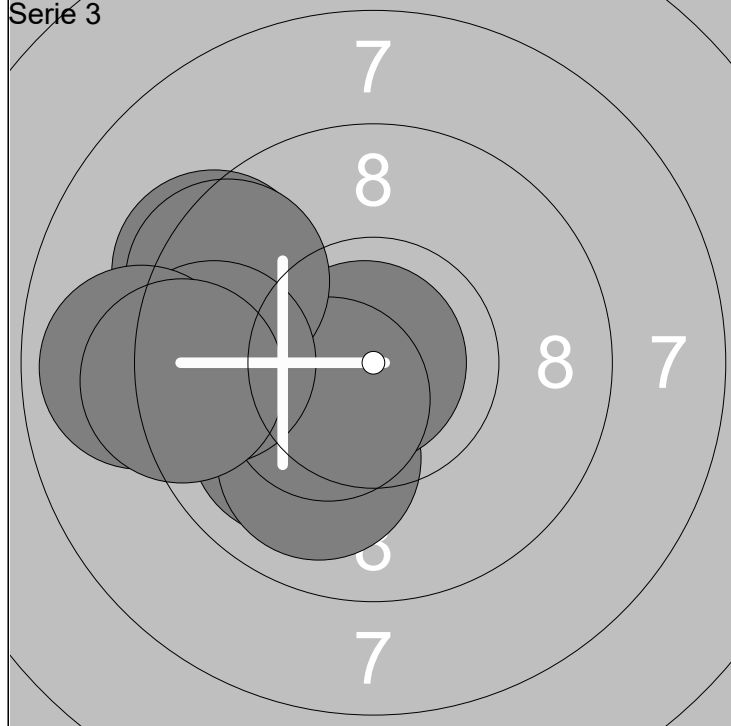

1: 10.2x ←	6: 10.4x ↙	Serie	93 (3x)
2: 9.9 ↙	7: 9.4 ↖		
3: 10.0 ↘	8: 9.5 ←	Total	285 (11x)
4: 9.3 ↖	9: 8.9 ←		
5: 10.9x ←	10: 9.2 ←		

1: 10.4x ↘	6: 10.1 ↗	Serie	96 (4x)
2: 9.2 ↑	7: 10.6x ↖		
3: 9.2 ↗	8: 10.6x ↗	Total	381 (15x)
4: 9.4 ↗	9: 10.2x ←		
5: 9.0 ↗	10: 10.1 ↘		

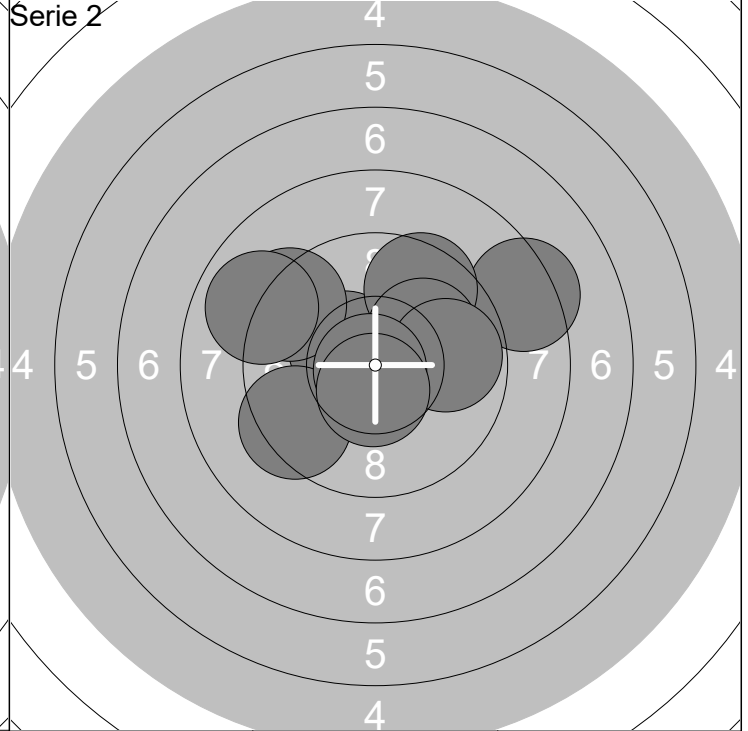
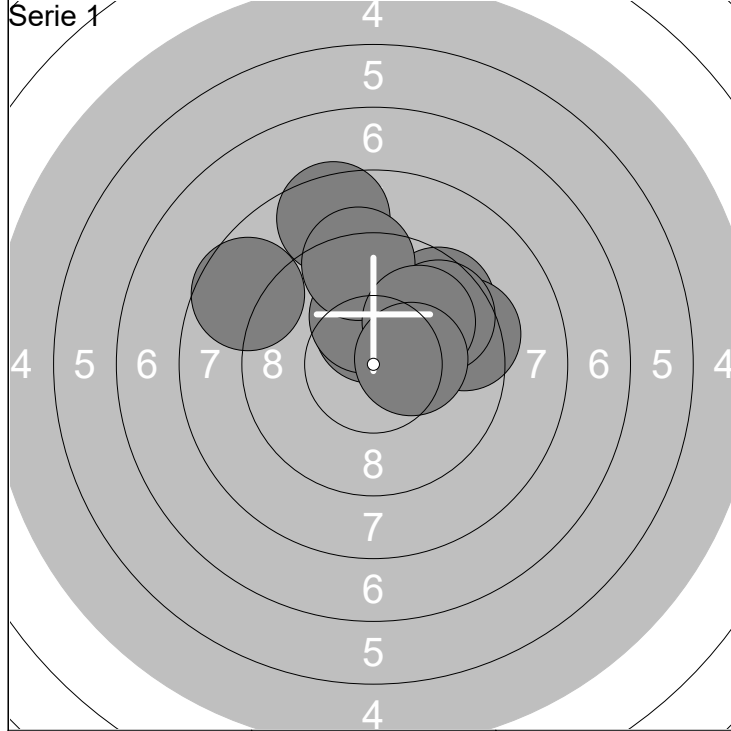

1: 9.5 ↗	6: 8.5 ↑	Serie 91 (2x)
2: 9.4 →	7: 9.3 ↑	
3: 9.6 ↗	8: 9.9 ↗	Total 91 (2x)
4: 10.3x ↑	9: 8.7 ↖	
5: 10.1 ↑	10: 10.3x →	

1: 10.4x ↖	6: 9.8 →	Serie 92 (3x)
2: 8.3 →	7: 9.4 ↙	
3: 9.5 ↗	8: 10.8x ↙	Total 183 (5x)
4: 9.3 ↖	9: 8.9 ↖	
5: 10.0 ↗	10: 10.5x ↓	

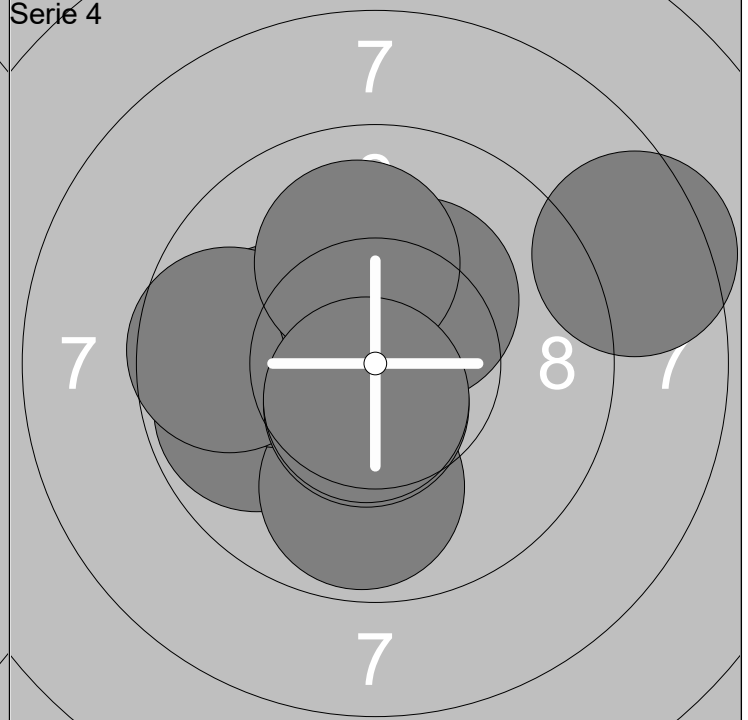
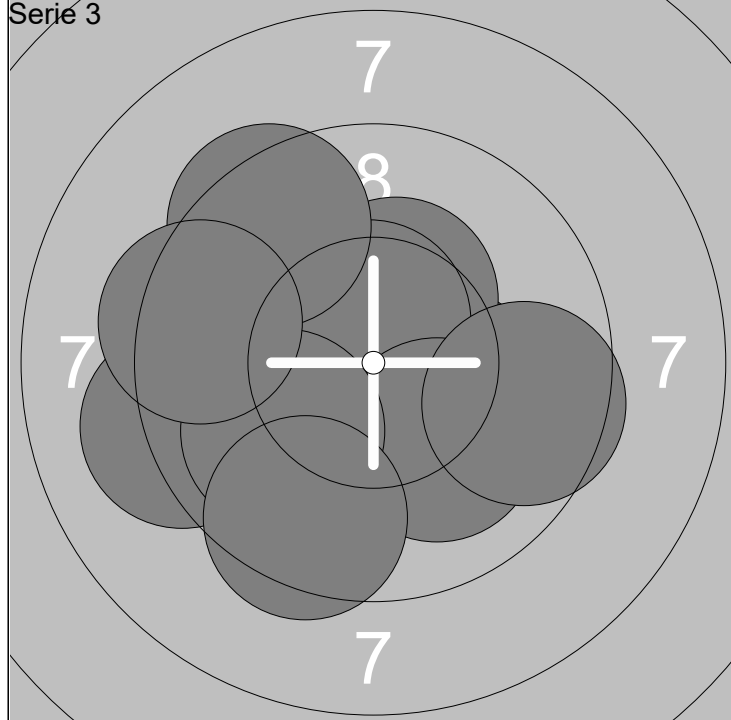

1: 10.2x →	6: 10.1 ↓	Serie 94 (3x)
2: 10.3x ↑	7: 9.9 ↙	
3: 10.6x ↑	8: 9.4 ↓	Total 277 (8x)
4: 9.4 ↖	9: 9.5 →	
5: 9.2 ↖	10: 9.3 ↖	

1: 8.5 →	6: 10.4x ↑	Serie 95 (4x)
2: 9.8 ↖	7: 10.2x ↗	
3: 9.8 ↓	8: 10.6x ↓	Total 372 (12x)
4: 10.1 ↖	9: 10.0 ↑	
5: 9.6 ↖	10: 10.6x ↓	

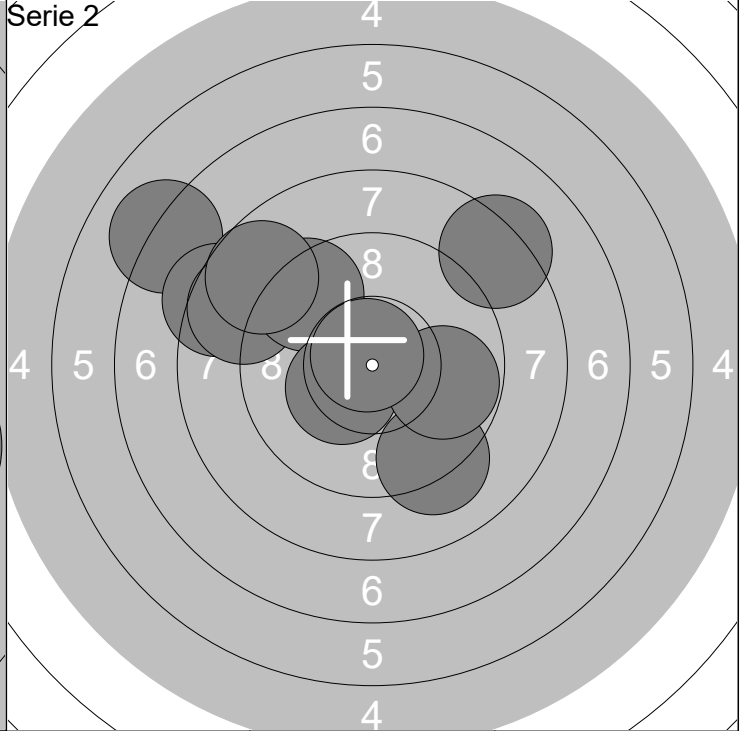
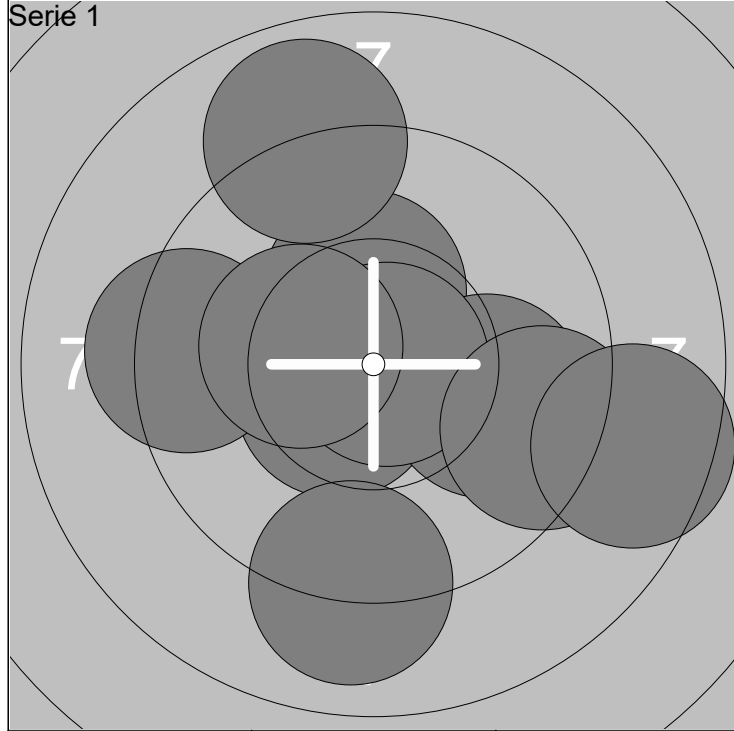

1: 10.5x ↙	6: 9.0 ↓	Serie	92 (4x)
2: 9.3 ←	7: 10.3x ←		
3: 10.3x ↑	8: 9.4 →	Total	92 (4x)
4: 9.9 →	9: 8.9 ↑		
5: 10.8x →	10: 8.5 →		

1: 7.1 ↖	6: 9.4 ↗	Serie	86 (2x)
2: 9.2 ↘	7: 10.3x ↙		
3: 8.3 ↖	8: 9.8 →	Total	178 (6x)
4: 8.7 ↖	9: 10.7x ↗		
5: 8.3 ↗	10: 8.7 ↖		

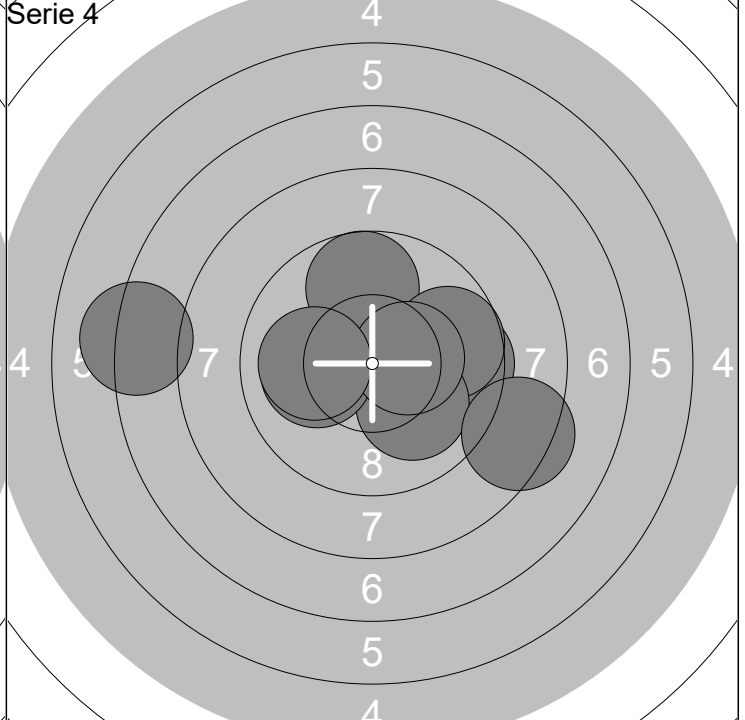
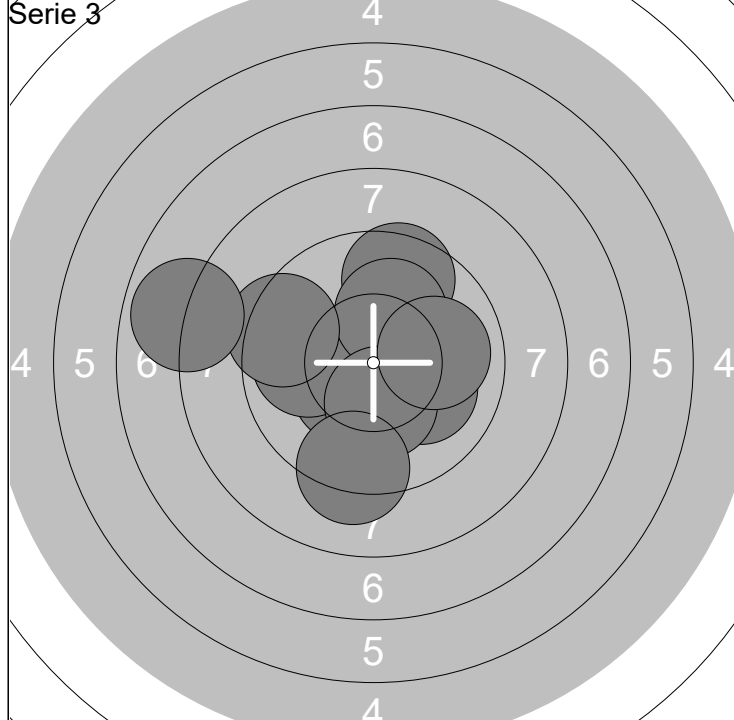

1: 9.6 ↑	6: 10.3x ↓	Serie	92 (2x)
2: 10.4x ↙	7: 9.9 →		
3: 9.9 ←	8: 9.4 ←	Total	270 (8x)
4: 10.1 →	9: 7.9 ←		
5: 10.1 ↑	10: 9.2 ↓		

1: 10.5x ↖	6: 10.0 ↘	Serie	92 (2x)
2: 9.7 ↑	7: 8.4 →		
3: 9.6 →	8: 10.1 ←	Total	362 (10x)
4: 7.2 ←	9: 10.4x →		
5: 9.7 →	10: 10.0 ←		

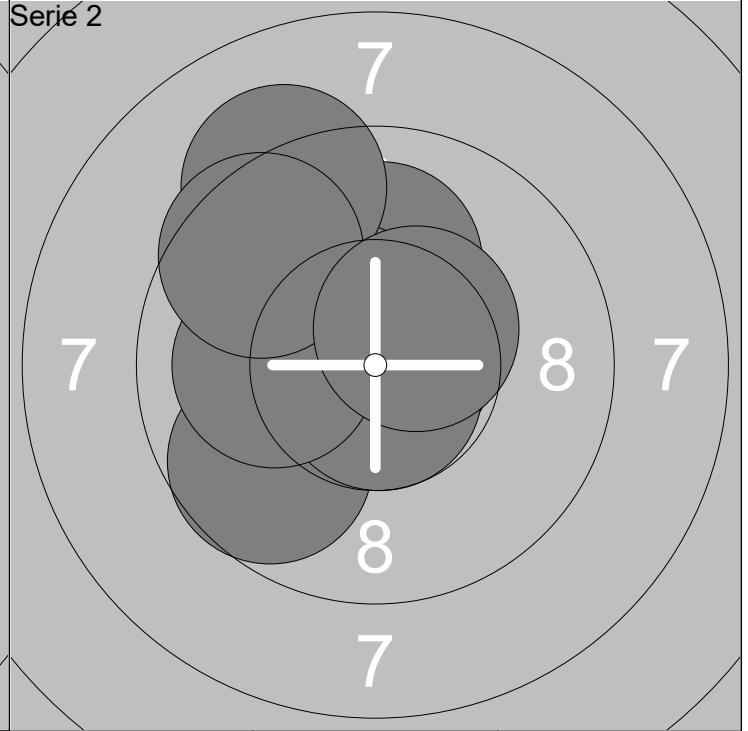
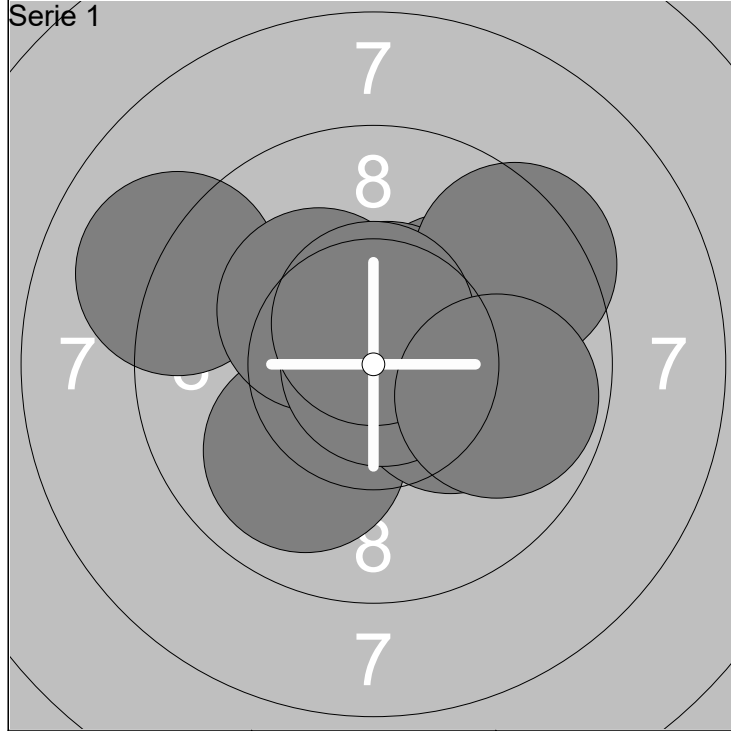

1: 10.0 ↙	6: 9.4 ↗	Serie	97 (5x)
2: 10.1 ↗	7: 10.2x ↖		
3: 10.2x →	8: 10.9x →	Total	97 (5x)
4: 10.5x ↑	9: 10.6x ↑		
5: 9.0 ↖	10: 9.8 →		

1: 10.8x ↗	6: 9.2 ↖	Serie	97 (4x)
2: 9.7 ↙	7: 10.7x ↓		
3: 10.1 ↑	8: 10.0 ←	Total	194 (9x)
4: 10.0 ↖	9: 9.6 ↖		
5: 10.5x ↖	10: 10.4x ↗		

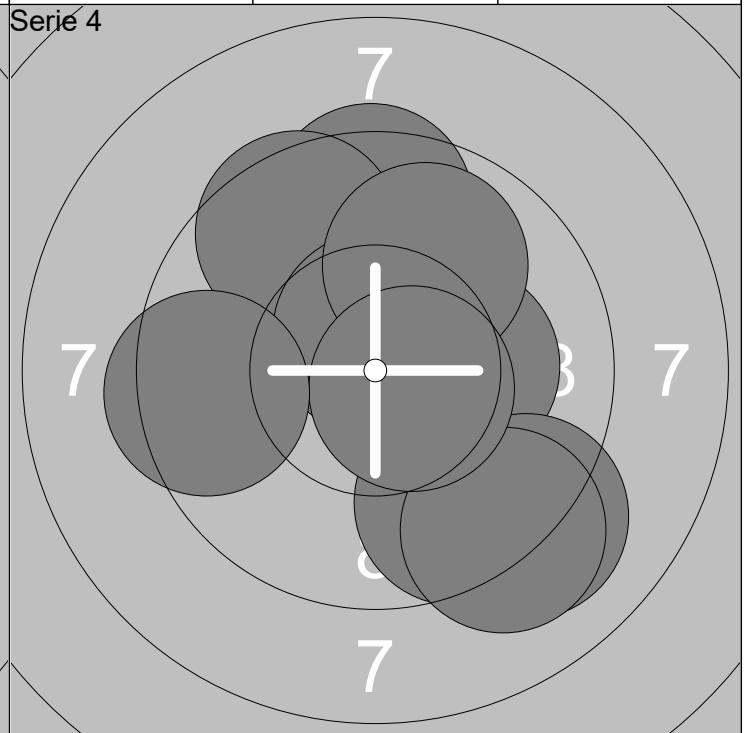
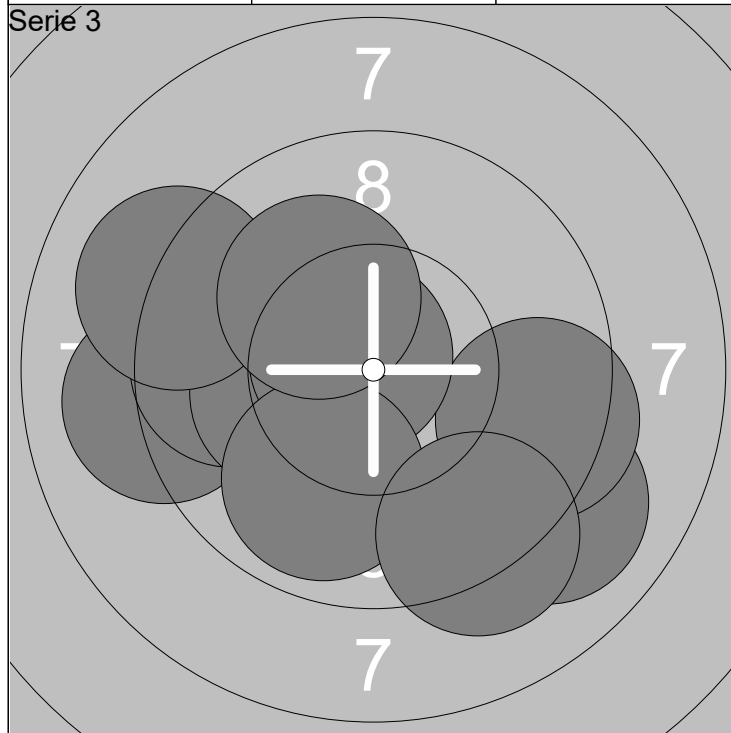

1: 9.1 ←	6: 9.1 ↖	Serie	93 (2x)
2: 9.7 ←	7: 10.7x ↖		
3: 9.0 ↙	8: 9.9 ↙	Total	287 (11x)
4: 9.4 →	9: 10.1 ↗		
5: 10.2x ←	10: 9.2 ↙		

1: 10.2x →	6: 9.9 ↗	Serie	93 (3x)
2: 9.5 ↑	7: 9.1 ↙		
3: 9.6 ↙	8: 9.1 ↙	Total	380 (14x)
4: 9.6 ↖	9: 10.6x ↙		
5: 10.6x ↑	10: 9.4 ←		

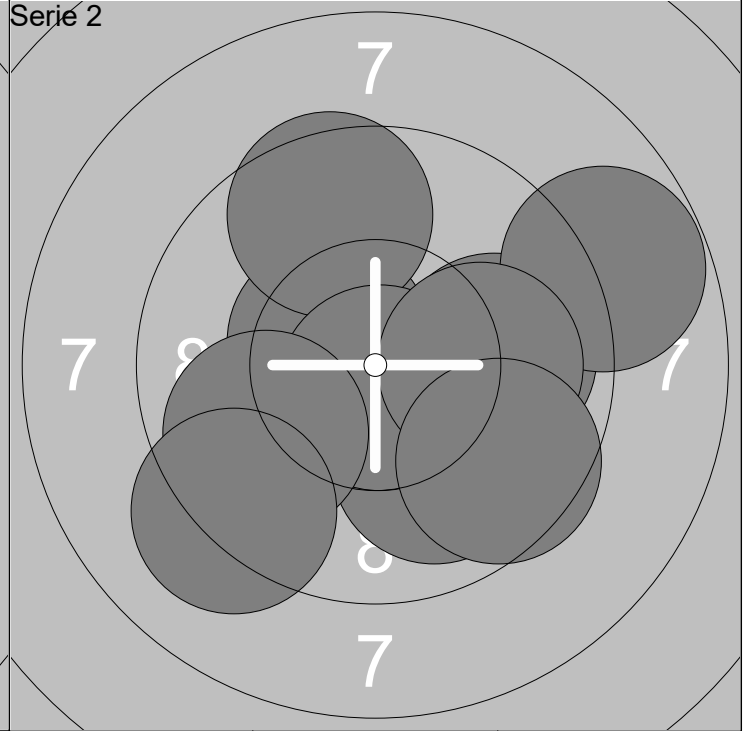
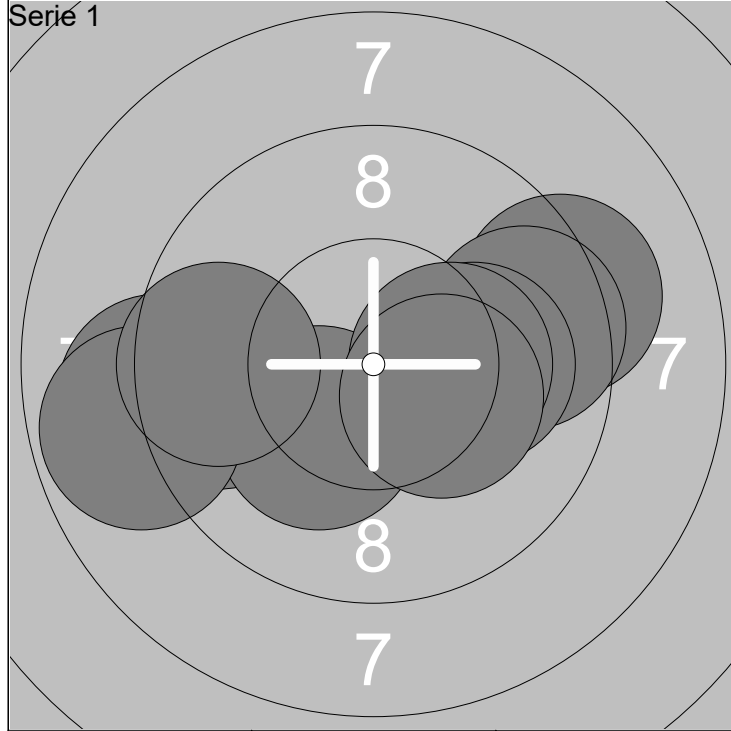

1: 9.6 ←	6: 10.0 →	Serie	93 (3x)
2: 10.2x ↙	7: 10.2x →		
3: 9.2 →	8: 8.8 ←	Total	93 (3x)
4: 9.6 →	9: 10.3x ↘		
5: 9.0 ←	10: 9.6 ←		

1: 9.9 →	6: 9.8 ←	Serie	93 (2x)
2: 10.5x ↖	7: 9.1 ↙		
3: 9.5 ↑	8: 8.8 →	Total	186 (5x)
4: 10.0 ↘	9: 10.0 →		
5: 10.7x ↘	10: 9.5 ↘		

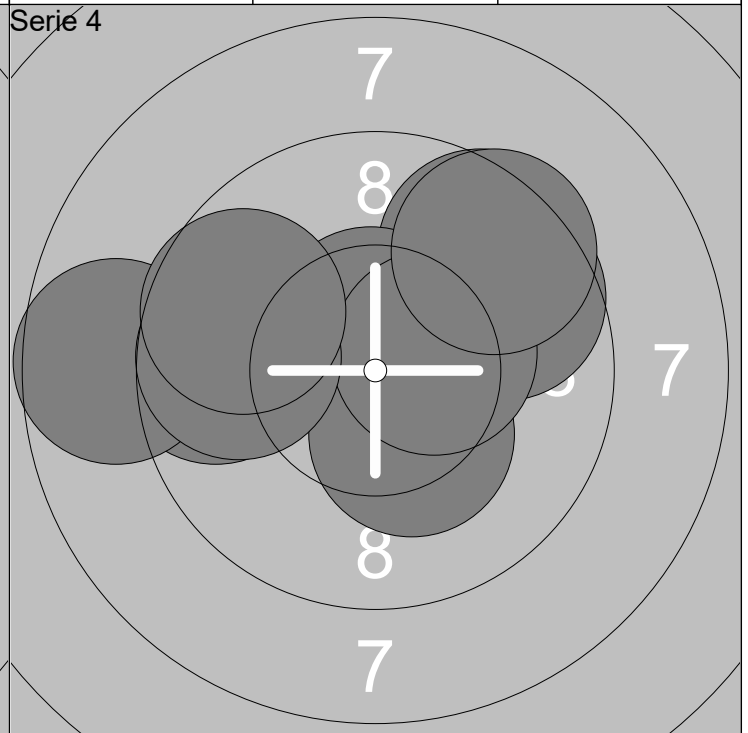
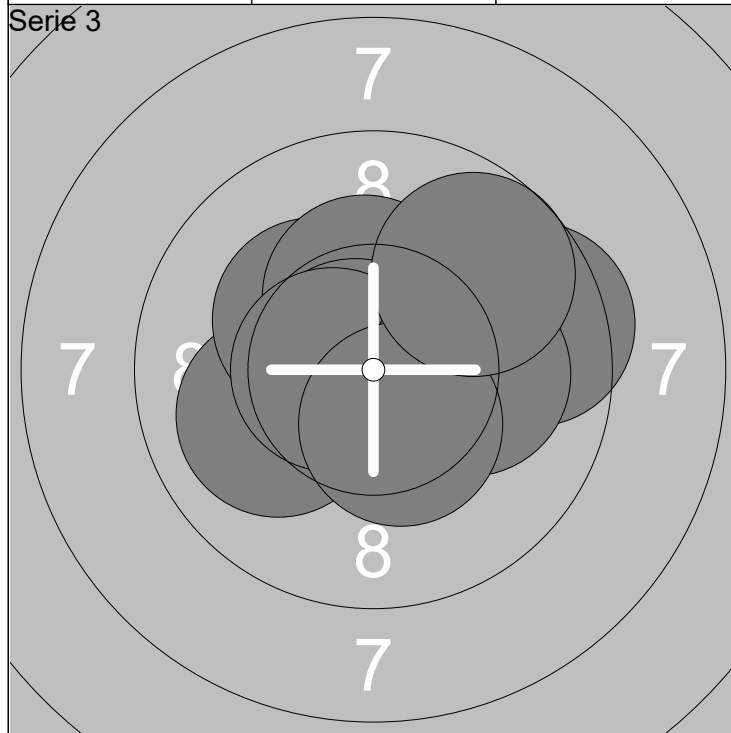

1: 10.0 ↖	6: 9.5 →	Serie	98 (6x)
2: 10.2x ↖	7: 10.6x ←		
3: 10.8x ↑	8: 10.1 →	Total	284 (11x)
4: 10.3x ↑	9: 10.4x ↘		
5: 10.7x ↖	10: 9.7 ↗		

1: 9.6 ↗	6: 8.6 ←	Serie	92 (3x)
2: 9.5 ←	7: 10.4x →		
3: 9.6 ↗	8: 9.7 ←	Total	376 (14x)
4: 10.6x ↑	9: 9.7 ↖		
5: 10.3x ↘	10: 9.5 ↗		

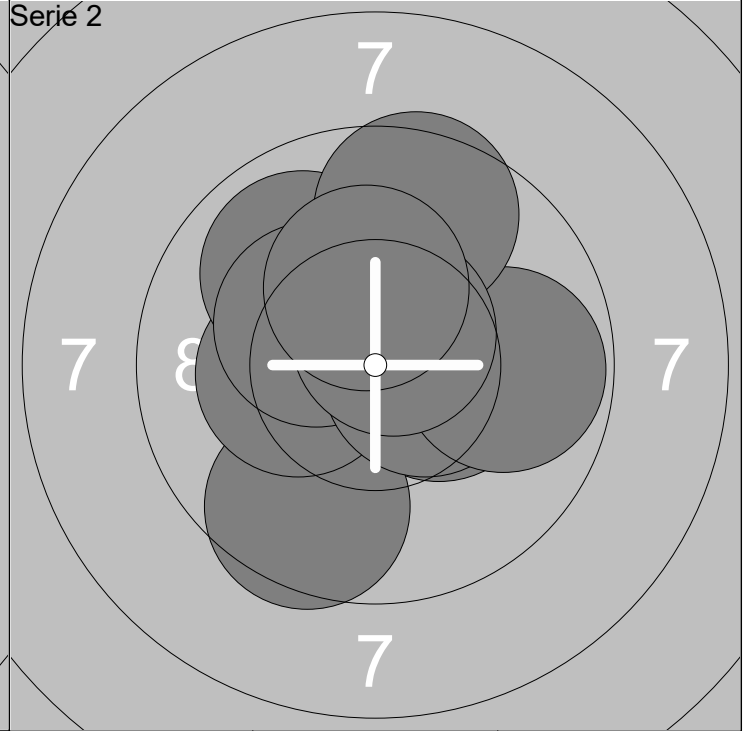
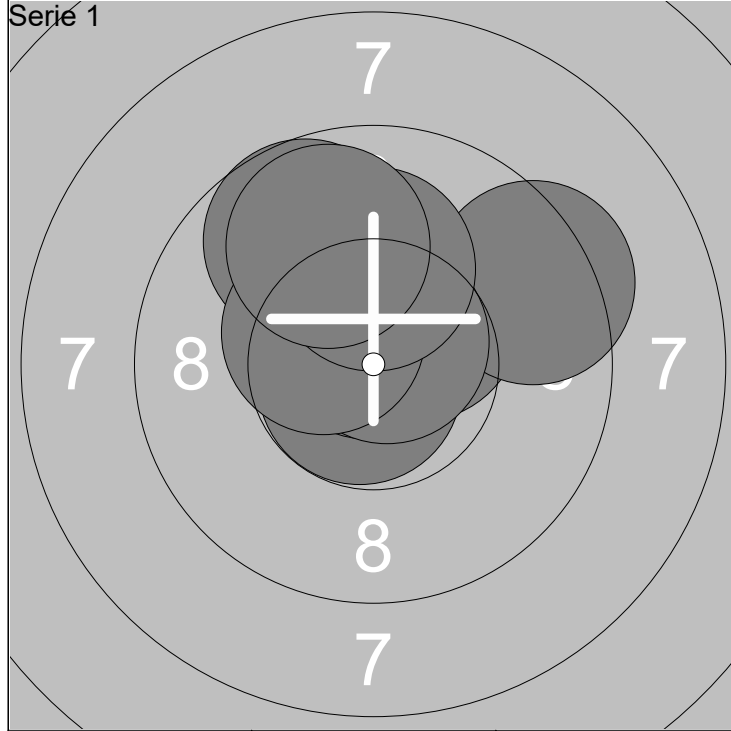

1: 10.6x ↑	6: 10.7x ↑	Serie	97 (6x)
2: 9.7 ↘	7: 10.7x ↗		
3: 10.7x ↙	8: 10.4x ↖	Total	97 (6x)
4: 10.4x ↗	9: 10.1 ↑		
5: 9.3 →	10: 9.8 ↖		

1: 10.4x →	6: 10.5x →	Serie	96 (6x)
2: 9.6 ↓	7: 9.8 →		
3: 10.3x ←	8: 9.5 ↑	Total	193 (12x)
4: 9.9 ↖	9: 10.6x ↗		
5: 10.3x ↖	10: 10.2x ↑		

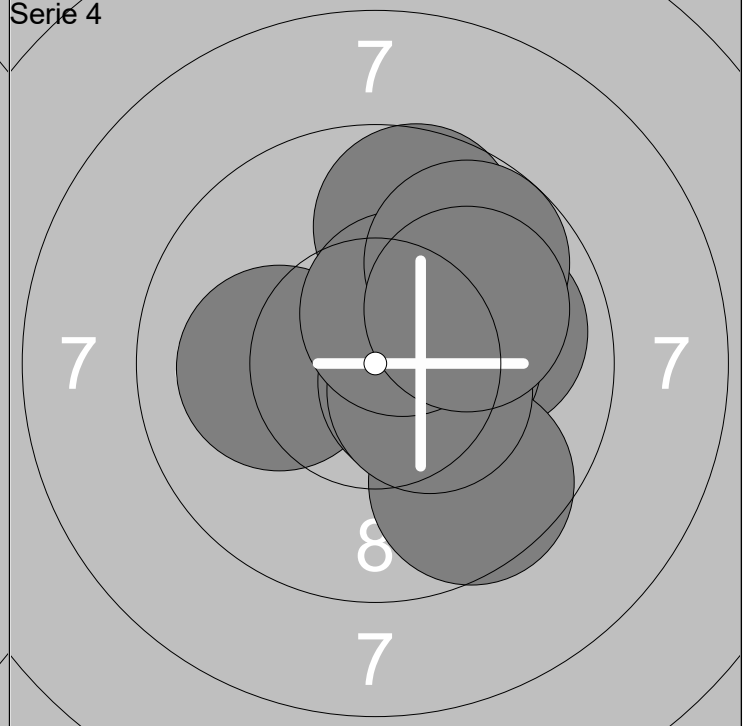
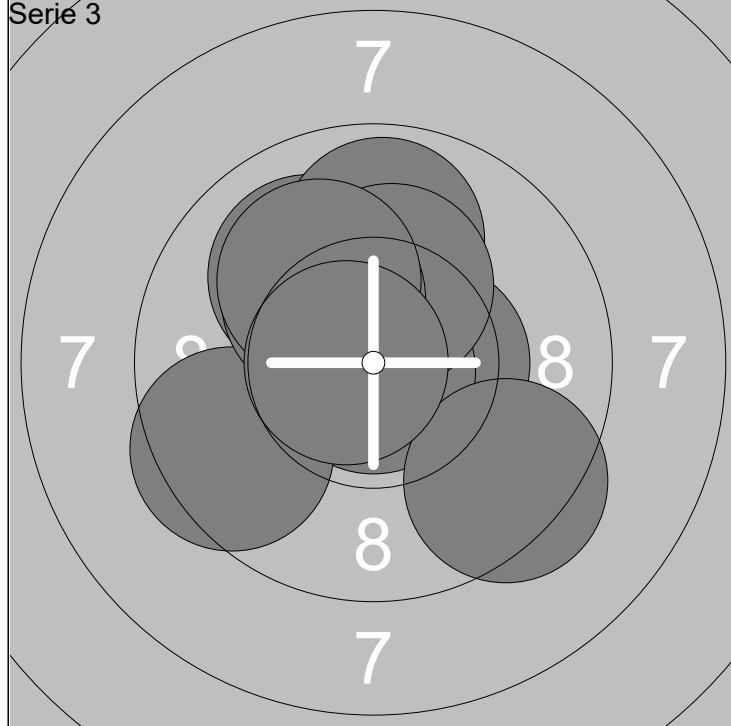

1: 10.0 ↖	6: 9.4 ←	Serie	97 (5x)
2: 9.9 ↑	7: 10.2x ↑		
3: 10.4x →	8: 10.2x ↖	Total	290 (17x)
4: 10.8x ↓	9: 10.1 ↖		
5: 9.4 ↘	10: 10.7x ←		

1: 9.9 →	6: 9.6 ↓	Serie	96 (4x)
2: 10.1 ←	7: 10.4x ↘		
3: 9.7 ↑	8: 10.4x ↗	Total	386 (21x)
4: 10.5x →	9: 9.7 ↗		
5: 10.4x →	10: 10.0 ↗		

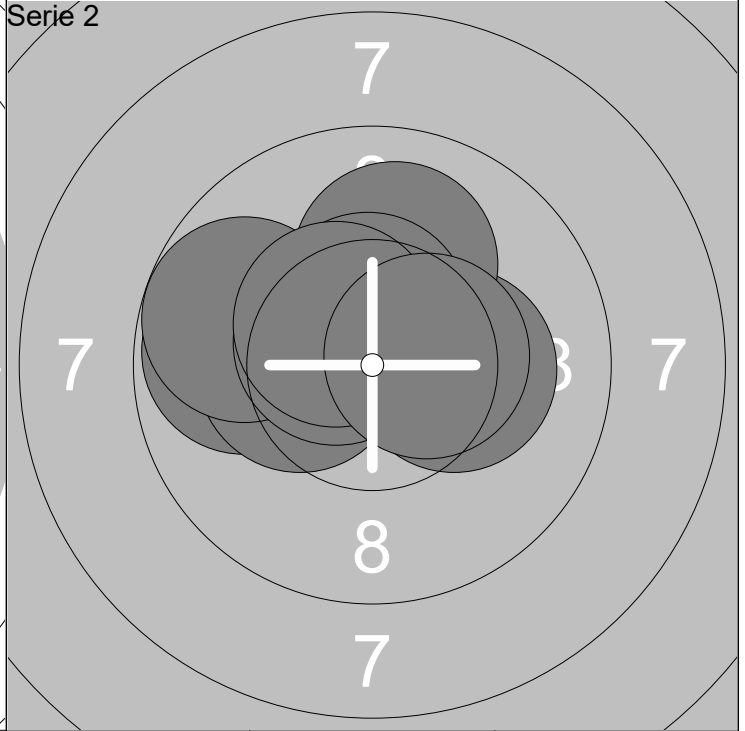
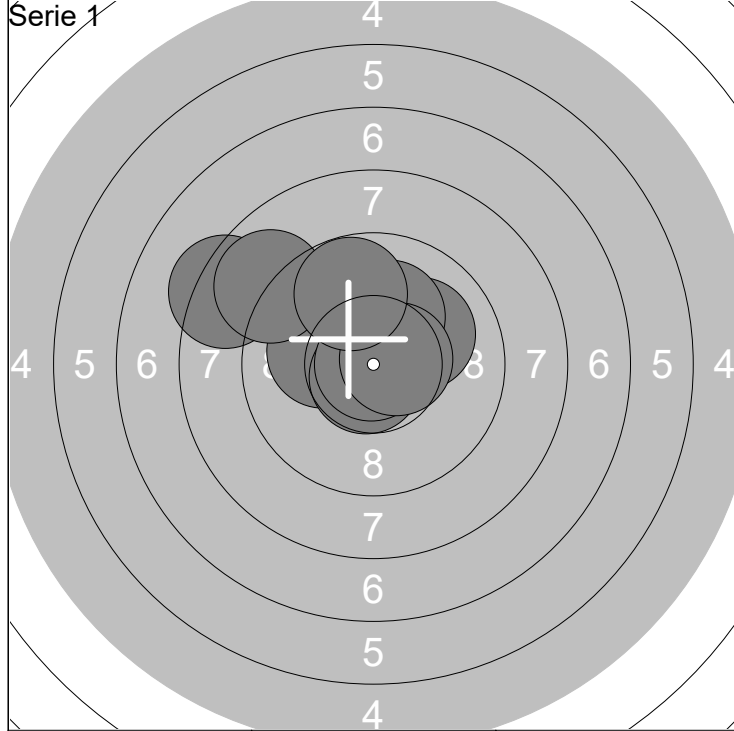

1: 10.1 ↗	6: 10.7x ↘	Serie	95 (4x)
2: 10.1 ↑	7: 10.9x ←		
3: 10.8x ↓	8: 10.6x →	Total	95 (4x)
4: 10.1 ←	9: 8.9 ↖		
5: 8.3 ↖	10: 9.8 ↑		

1: 9.8 ←	6: 10.5x ↖	Serie	98 (7x)
2: 10.3x ←	7: 10.0 ↑		
3: 9.7 ↖	8: 10.5x ↑	Total	193 (11x)
4: 10.4x ↑	9: 10.4x ↖		
5: 10.2x →	10: 10.5x →		

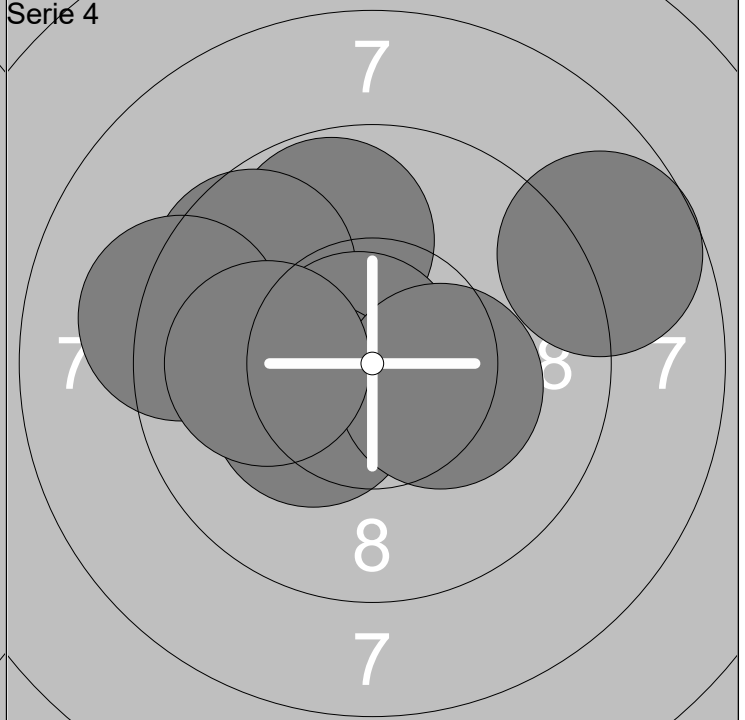
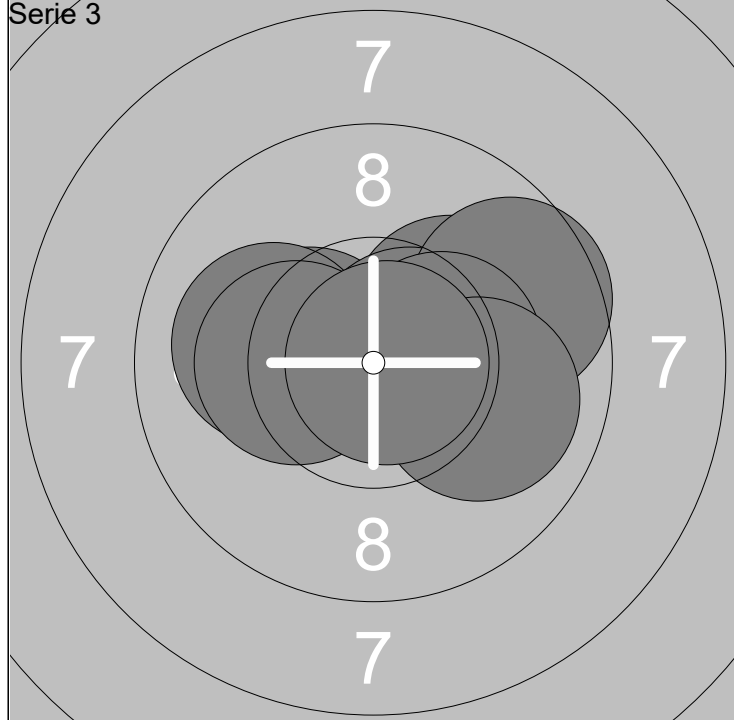

1: 10.3x ←	6: 9.6 ↗	Serie	99 (6x)
2: 10.0 ←	7: 10.3x ←		
3: 10.1 ↗	8: 10.3x →	Total	292 (17x)
4: 10.6x →	9: 10.0 →		
5: 10.4x →	10: 10.8x →		

1: 9.8 ↑	6: 10.3x ↖	Serie	94 (4x)
2: 9.5 ←	7: 9.2 ←		
3: 9.6 ↖	8: 10.3x →	Total	386 (21x)
4: 10.4x ↖	9: 10.0 ←		
5: 10.8x ↖	10: 8.7 ↗		

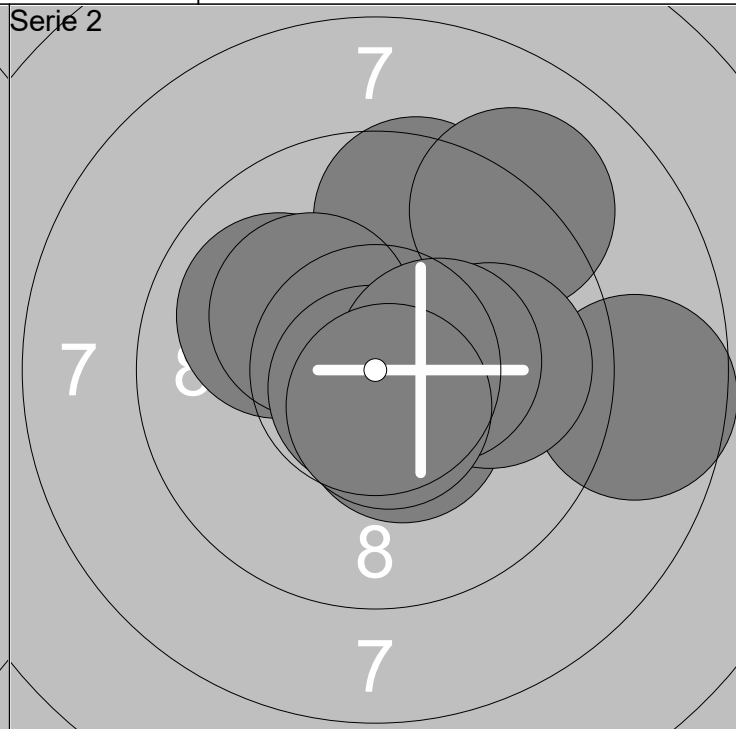
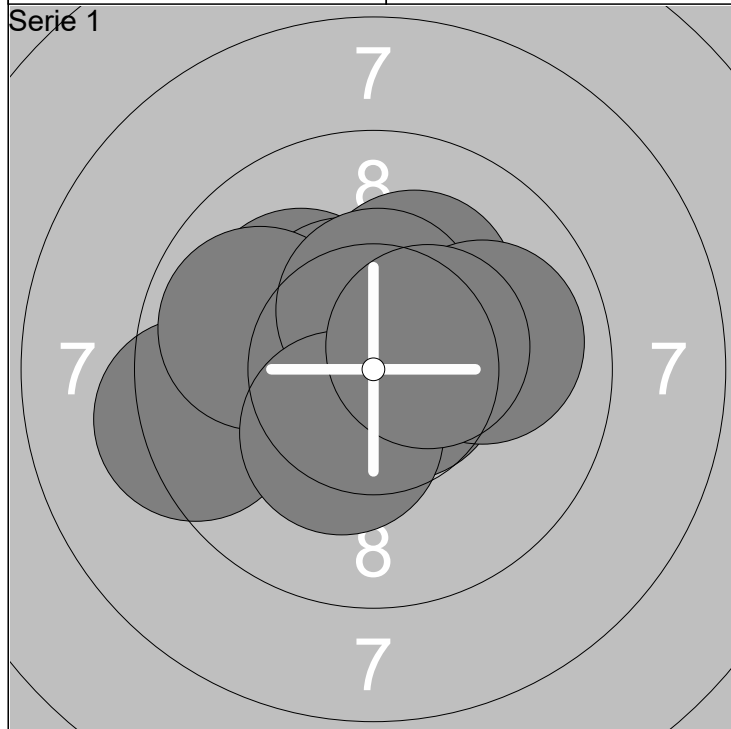

1: 9.3 ←	6: 10.7x →	Serie	97 (6x)
2: 10.2x ↗	7: 10.4x ↑		
3: 10.1 ↖	8: 9.9 →	Total	97 (6x)
4: 10.4x ↗	9: 10.3x ↘		
5: 9.8 ←	10: 10.4x →		

1: 9.6 ↑	6: 8.7 →	Serie	95 (5x)
2: 10.0 ↖	7: 9.9 →		
3: 10.4x ↘	8: 10.7x ↘	Total	192 (11x)
4: 9.1 ↗	9: 10.4x →		
5: 10.2x ↖	10: 10.6x ↘		

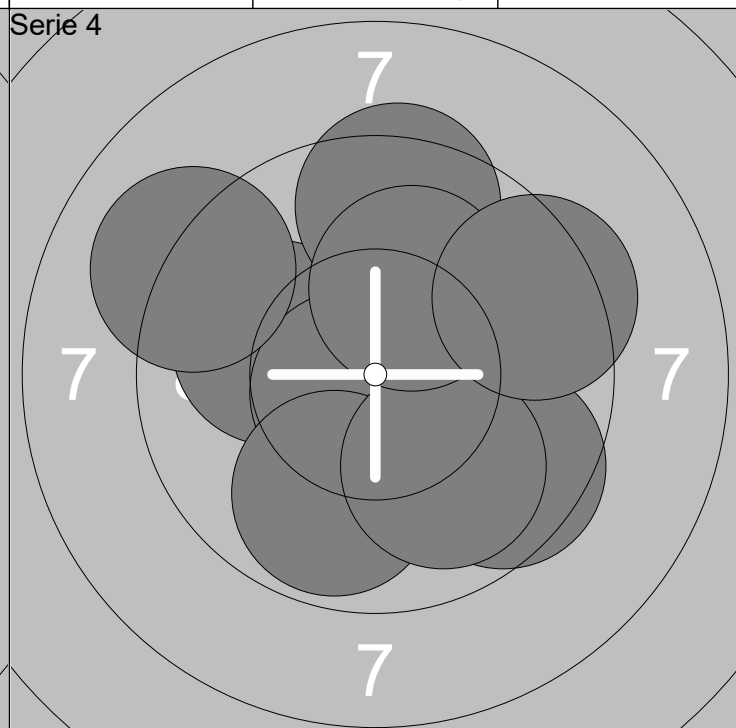
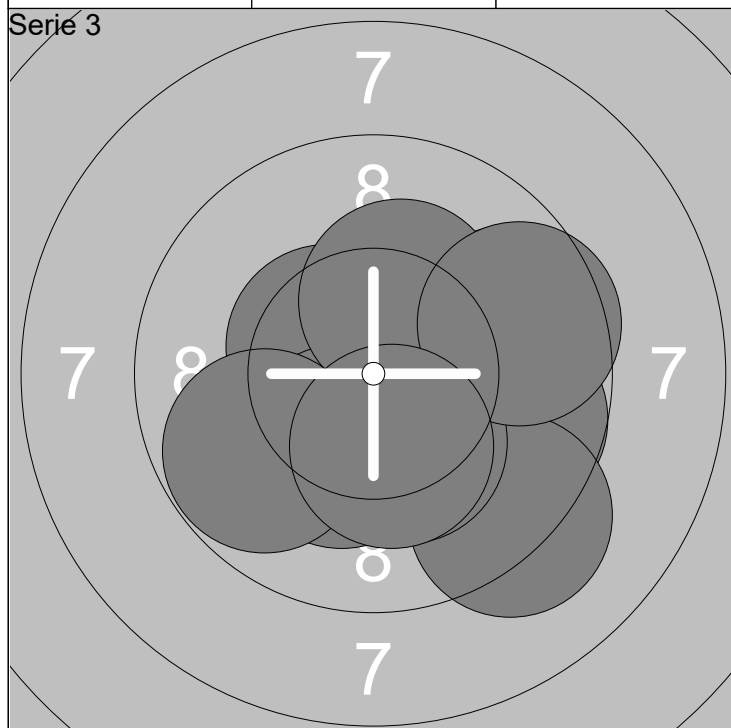

1: 9.7 →	6: 10.2x ↘	Serie	95 (5x)
2: 9.7 →	7: 10.2x ↑		
3: 9.2 ↘	8: 9.8 ←	Total	287 (16x)
4: 10.3x ↘	9: 9.6 →		
5: 10.5x ↖	10: 10.3x ↘		

1: 10.6x ↖	6: 9.6 ↘	Serie	94 (2x)
2: 10.0 ↖	7: 9.9 ↘		
3: 10.7x ↖	8: 9.1 ↖	Total	381 (18x)
4: 9.4 ↑	9: 10.1 ↑		
5: 9.8 ↘	10: 9.4 →		

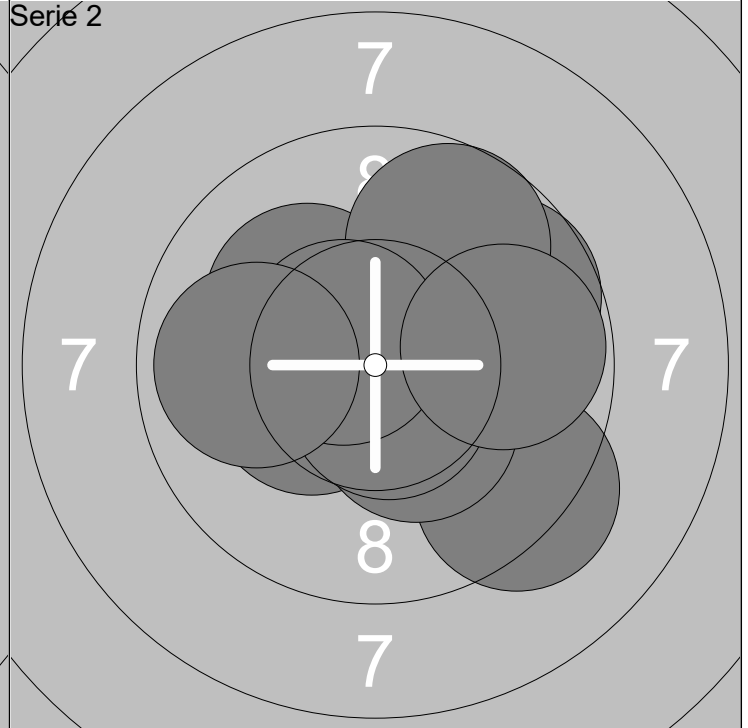
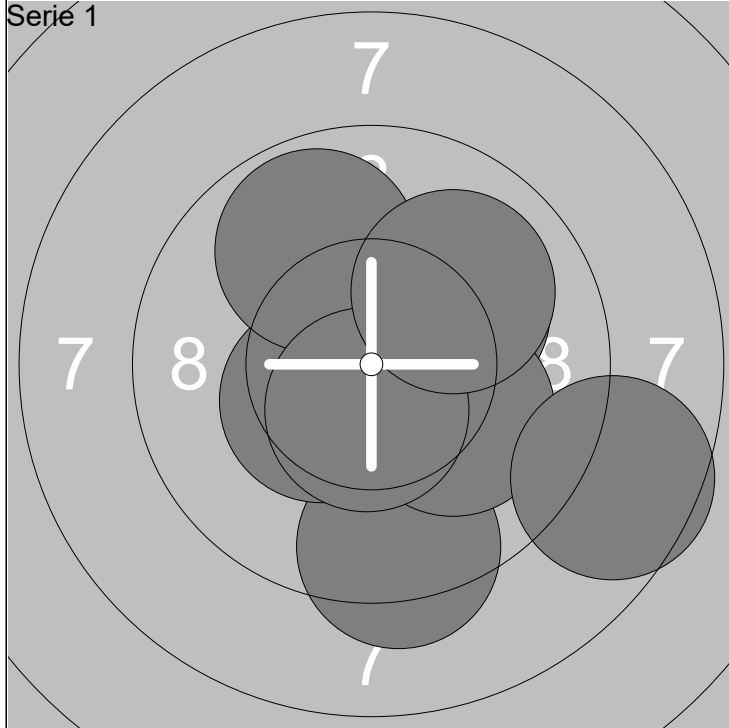

1: 10.1 ↗	6: 10.1 ➡	Serie 96 (4x)
2: 9.3 ↓	7: 9.8 ↗	
3: 10.6x ↑	8: 10.5x ↓	Total 96 (4x)
4: 10.4x ↙	9: 10.0 ↗	
5: 10.5x ➡	10: 8.6 ➡	

1: 10.1 ↖	6: 9.7 ↗	Serie 95 (4x)
2: 10.3x ↙	7: 10.6x ↓	
3: 9.3 ↓	8: 10.6x ↖	Total 191 (8x)
4: 10.3x ↓	9: 9.9 ←	
5: 9.7 ↗	10: 9.8 ➡	

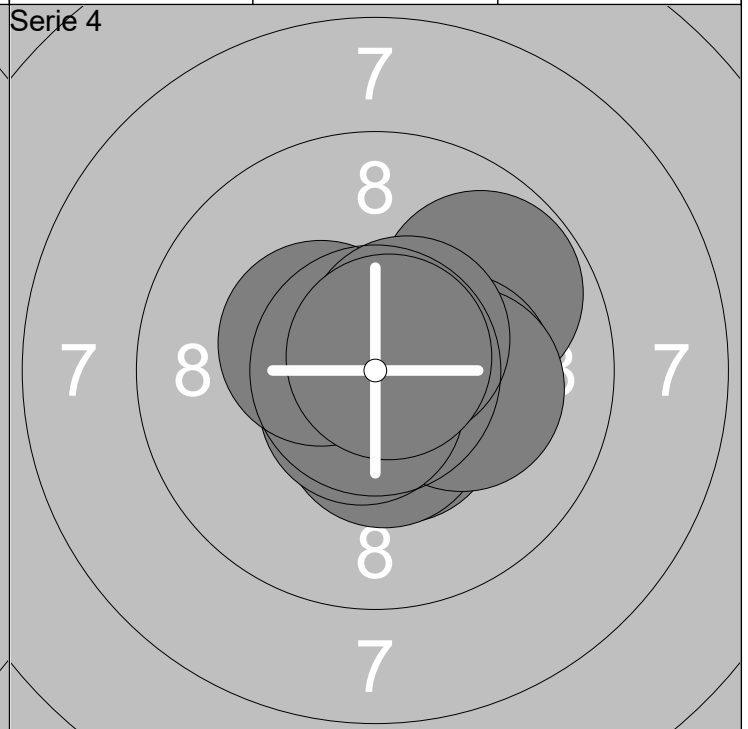
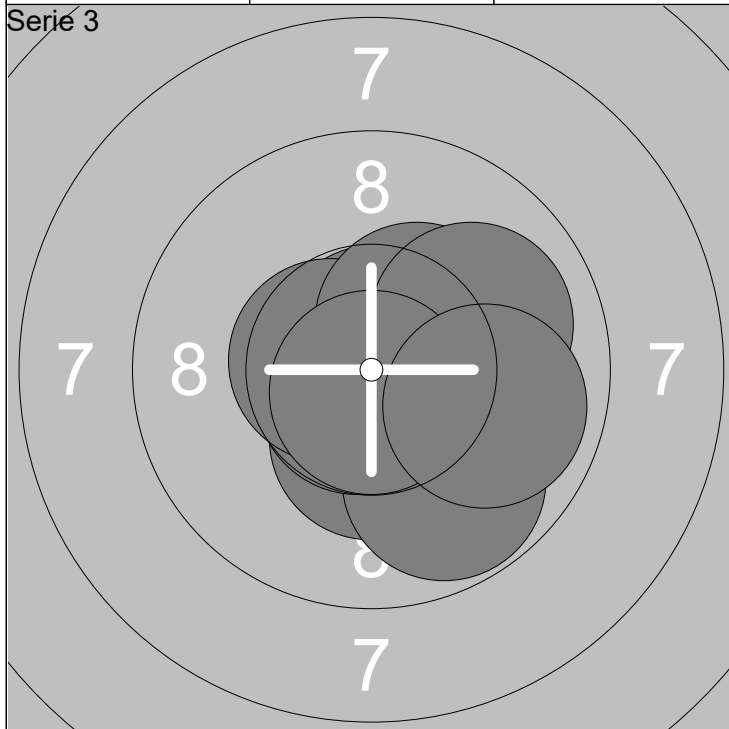

1: 10.7x ↓	6: 10.6x ←	Serie 98 (7x)
2: 10.3x ↓	7: 10.4x ↗	
3: 9.8 ↓	8: 10.0 ↗	Total 289 (15x)
4: 10.7x ↑	9: 10.7x ↓	
5: 10.7x ↙	10: 9.9 ➡	

1: 10.5x ↓	6: 10.2x ➡	Serie 99 (9x)
2: 9.8 ↗	7: 10.6x ↓	
3: 10.6x ➡	8: 10.4x ↖	Total 388 (24x)
4: 10.2x ➡	9: 10.5x ↗	
5: 10.4x ↓	10: 10.8x ↗	

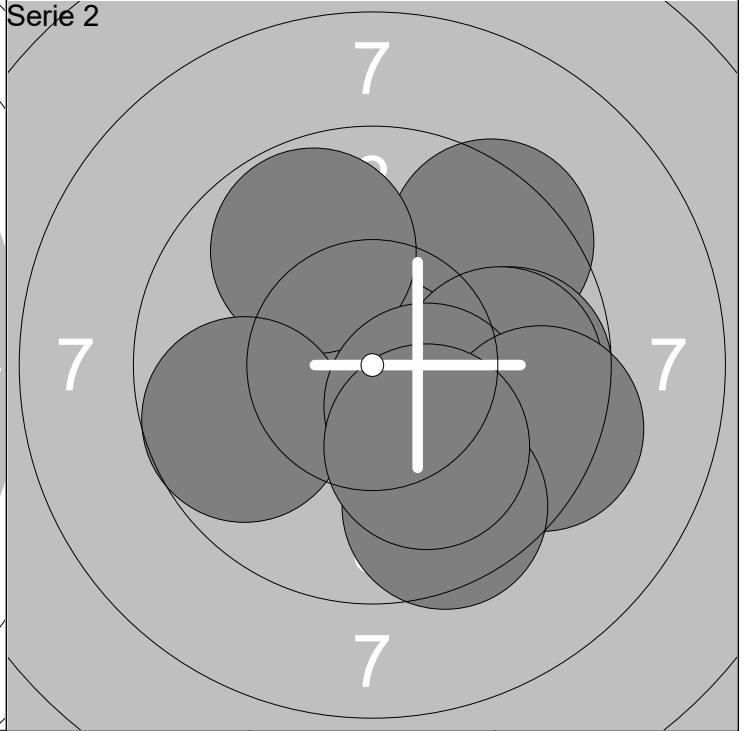
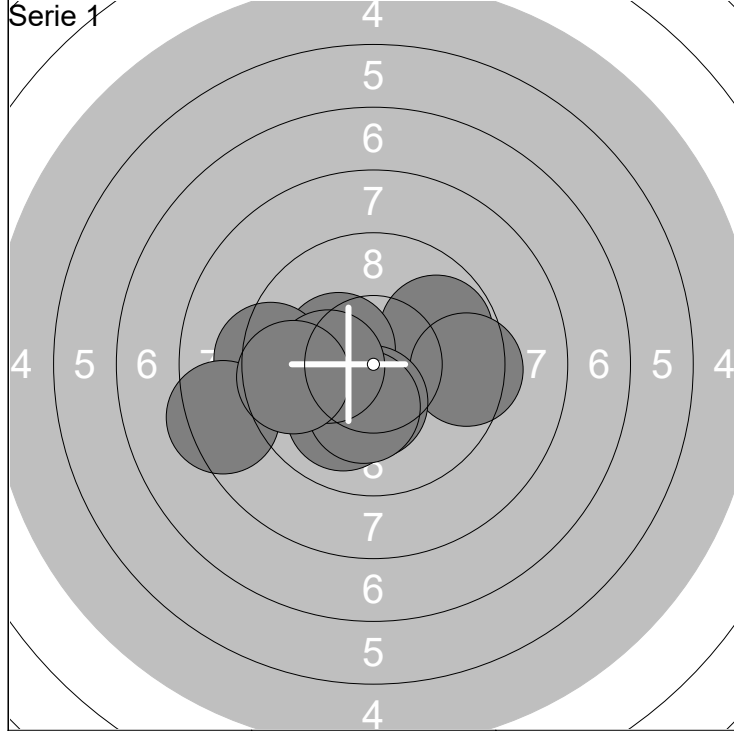

1: 9.8 ↗	6: 10.3x ↓	Serie 94 (4x)
2: 10.0 ↓	7: 10.2x ↓	
3: 9.4 →	8: 10.2x ←	Total 94 (4x)
4: 10.3x ↖	9: 8.4 ←	
5: 9.3 ←	10: 9.6 ←	

1: 9.4 ↗	6: 9.8 →	Serie 93 (2x)
2: 10.8x ↓	7: 10.3x ↓	
3: 9.8 ↗	8: 9.4 ↘	Total 187 (6x)
4: 9.7 →	9: 9.5 ↓	
5: 9.7 ←	10: 10.0 ↓	

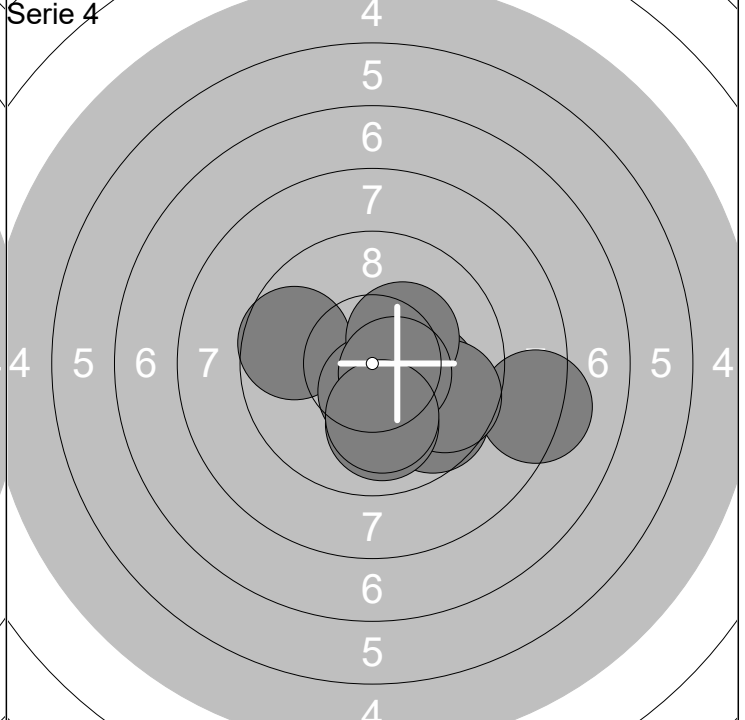
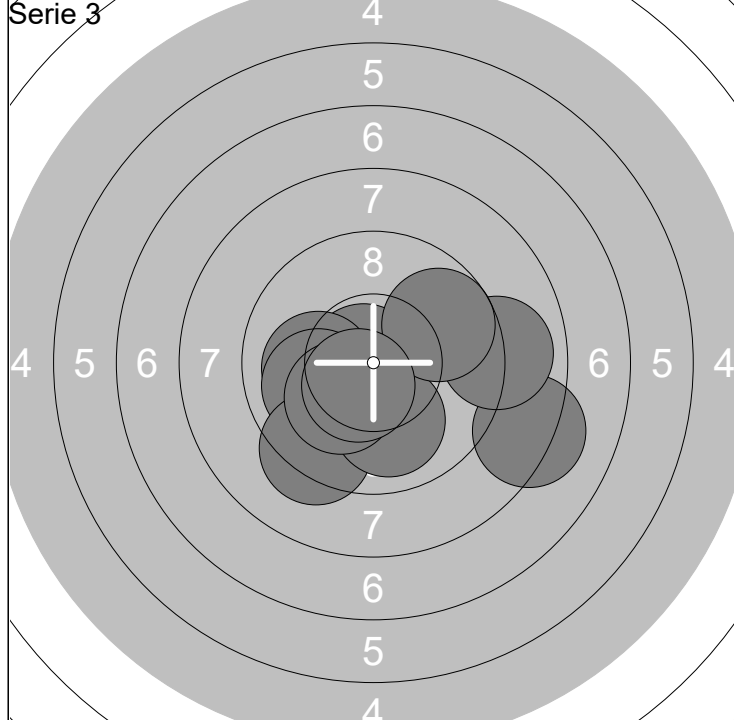

1: 10.7x ↖	6: 10.0 ↓	Serie 95 (3x)
2: 8.2 →	7: 9.0 →	
3: 10.1 ←	8: 9.7 ↗	Total 282 (9x)
4: 10.0 ↖	9: 10.2x ↓	
5: 9.3 ↓	10: 10.5x ↓	

1: 8.2 →	6: 10.5x ↓	Serie 94 (3x)
2: 10.1 →	7: 9.9 ↓	
3: 9.7 ↖	8: 10.3x ↗	Total 376 (12x)
4: 9.7 ↓	9: 10.5x →	
5: 9.7 →	10: 10.1 ↓	

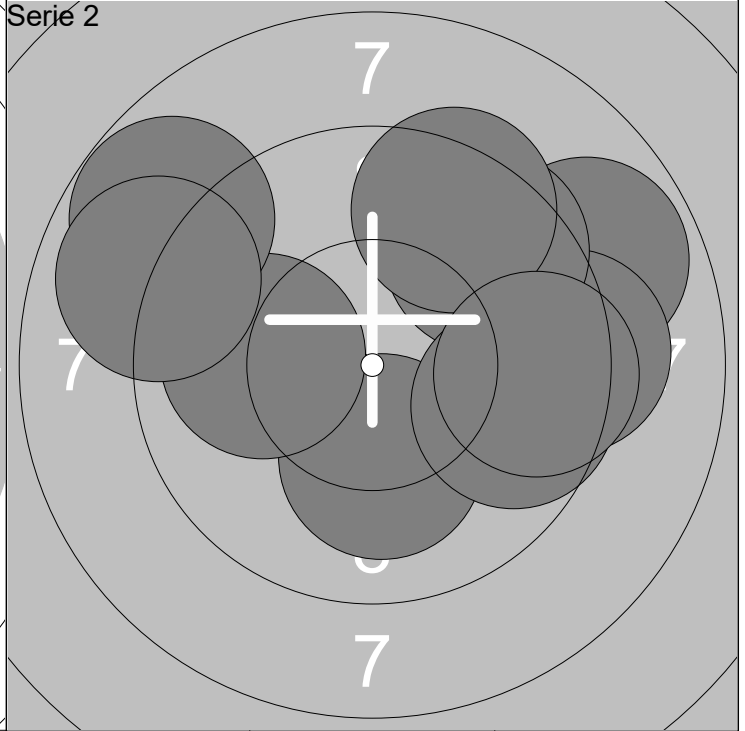
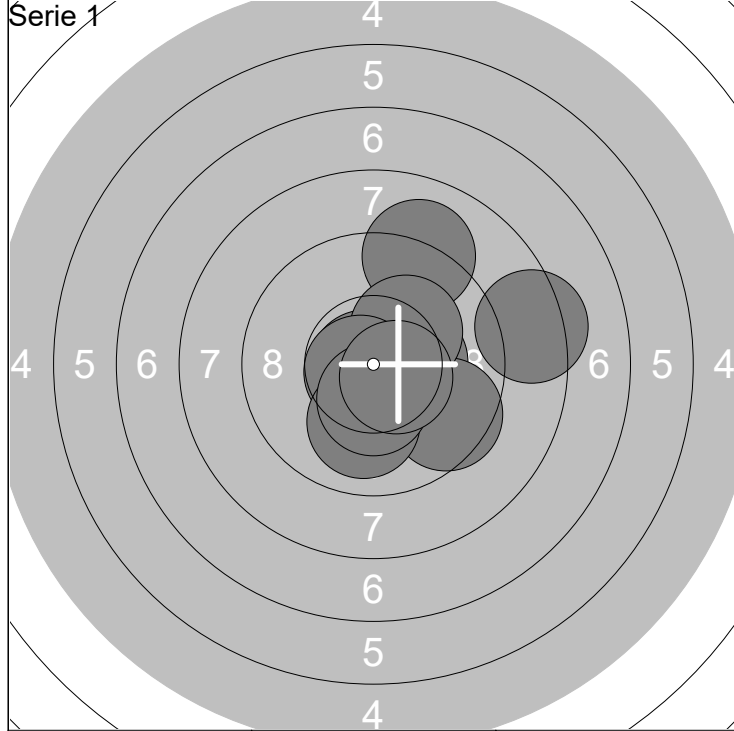

1: 9.0 ↗	6: 10.2x ↗	Serie	96 (6x)
2: 10.8x ←	7: 10.7x ←		
3: 8.3 →	8: 10.0 ↓	Total	96 (6x)
4: 10.3x →	9: 10.4x ↓		
5: 9.5 ↘	10: 10.5x ↘		

1: 8.8 →	6: 10.0 ←	Serie	89 (0x)
2: 10.1 ↓	7: 8.8 ↖		
3: 9.2 →	8: 8.9 ←	Total	185 (6x)
4: 9.5 ↗	9: 9.6 →		
5: 9.4 ↗	10: 9.5 →		

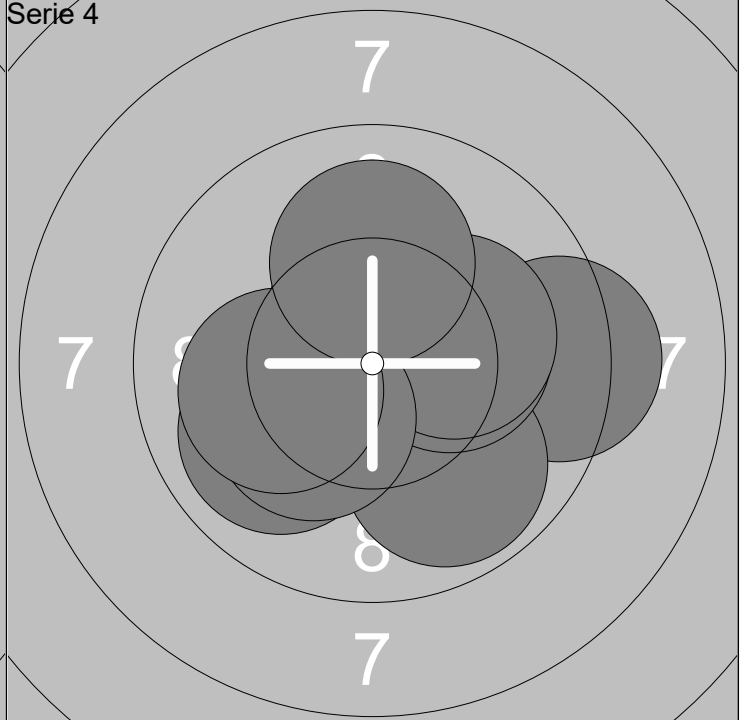
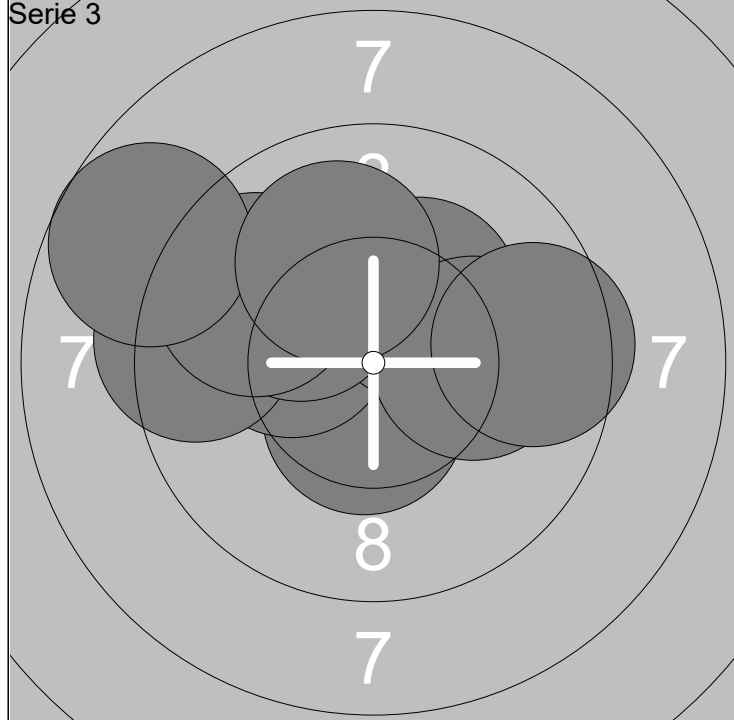

1: 10.5x ↓	6: 9.7 ↖	Serie	95 (3x)
2: 10.2x ←	7: 8.7 ↖		
3: 10.3x ↗	8: 10.0 →	Total	280 (9x)
4: 9.3 ←	9: 10.0 ↗		
5: 10.1 ↖	10: 9.5 →		

1: 10.1 →	6: 10.3x →	Serie	97 (4x)
2: 9.9 ↖	7: 10.2x →		
3: 10.4x ↑	8: 10.2x ↖	Total	377 (13x)
4: 9.3 →	9: 10.1 ←		
5: 9.8 ↘	10: 10.1 ↑		

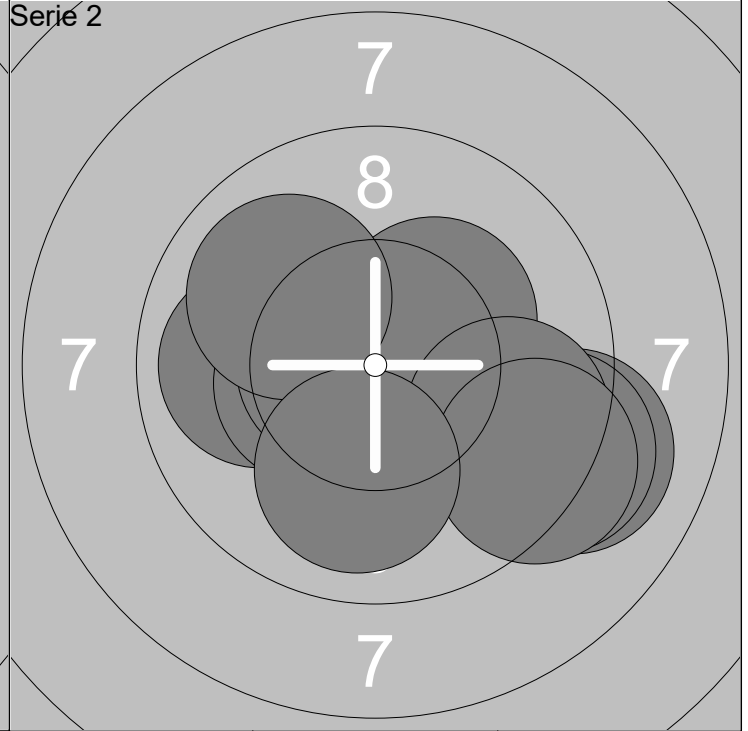
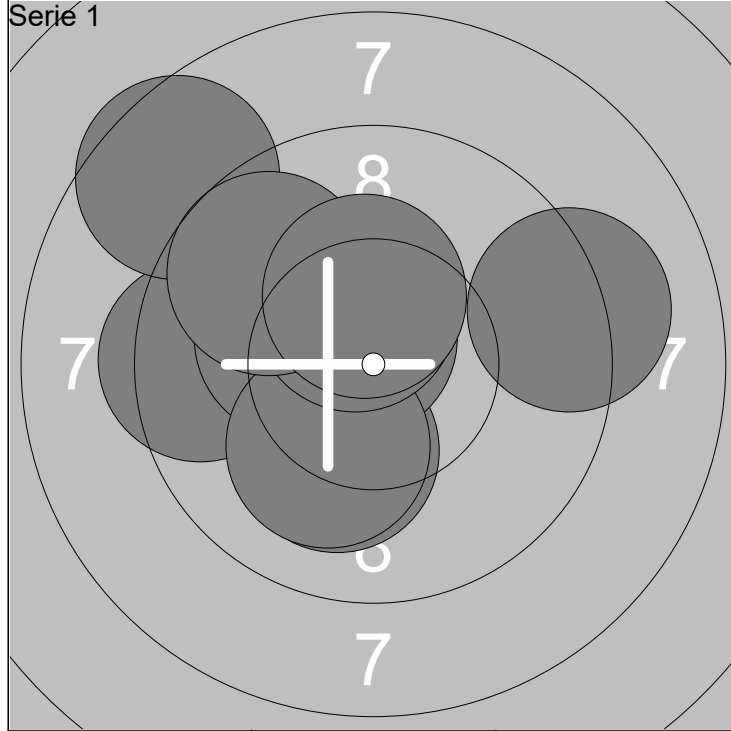

1: 9.4 ←	6: 10.1 ↘	Serie 95 (4x)
2: 10.2x ↖	7: 10.4x ↗	
3: 8.5 ↗	8: 9.7 ↖	Total 95 (4x)
4: 10.1 ↘	9: 10.3x ↗	
5: 10.6x ↗	10: 9.2 →	

1: 9.1 →	6: 10.3x ↗	Serie 94 (3x)
2: 9.9 ←	7: 9.7 →	
3: 10.4x ←	8: 9.9 ↗	Total 189 (7x)
4: 10.6x ←	9: 9.3 ↘	
5: 9.2 →	10: 10.0 ↓	

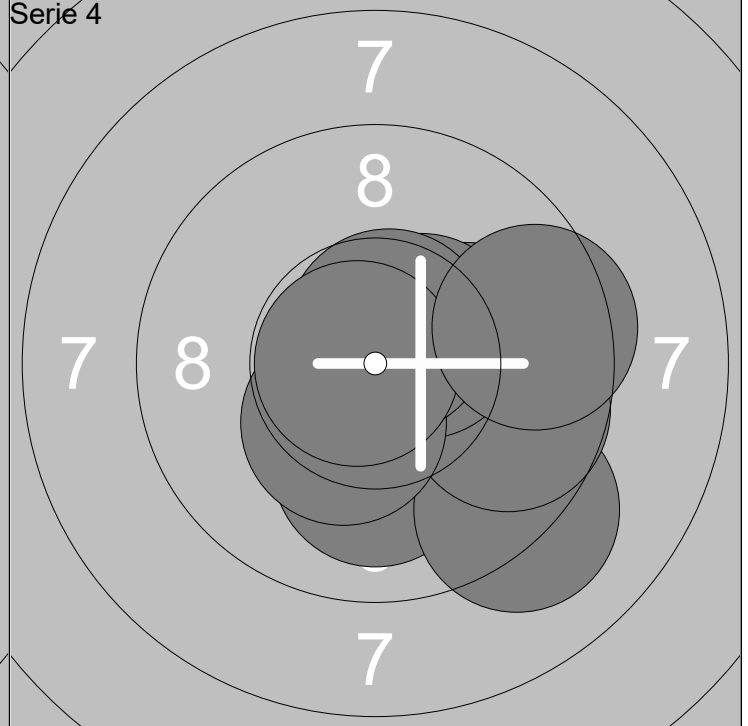
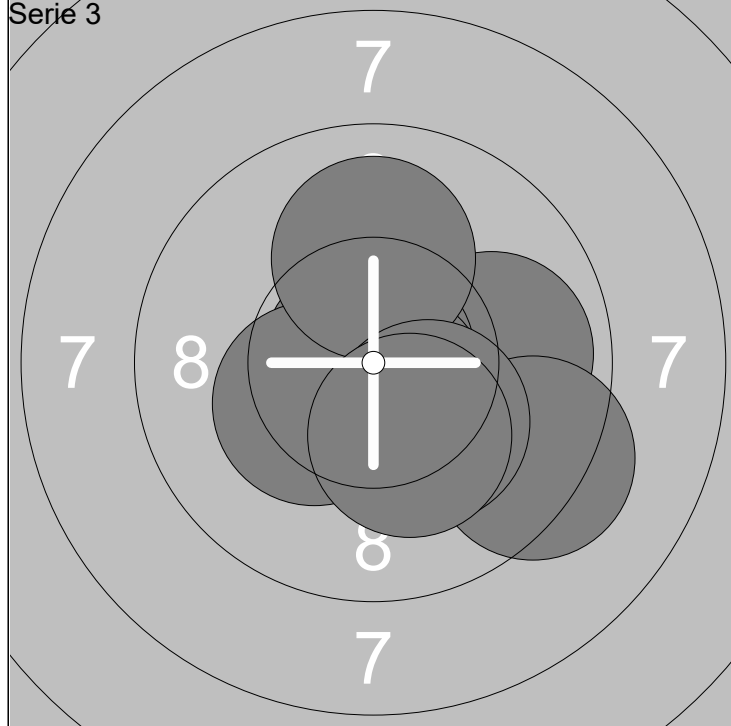

1: 10.8x ↑	6: 10.3x ←	Serie 98 (7x)
2: 10.8x ↖	7: 9.3 ↘	
3: 9.9 →	8: 10.0 ↑	Total 287 (14x)
4: 10.9x ↑	9: 10.2x ↘	
5: 10.6x ↘	10: 10.2x ↘	

1: 10.3x ↘	6: 10.5x ↗	Serie 97 (5x)
2: 10.0 ↓	7: 10.4x ↘	
3: 10.1 →	8: 10.6x ↗	Total 384 (19x)
4: 9.1 ↘	9: 10.8x ←	
5: 9.7 →	10: 9.5 →	

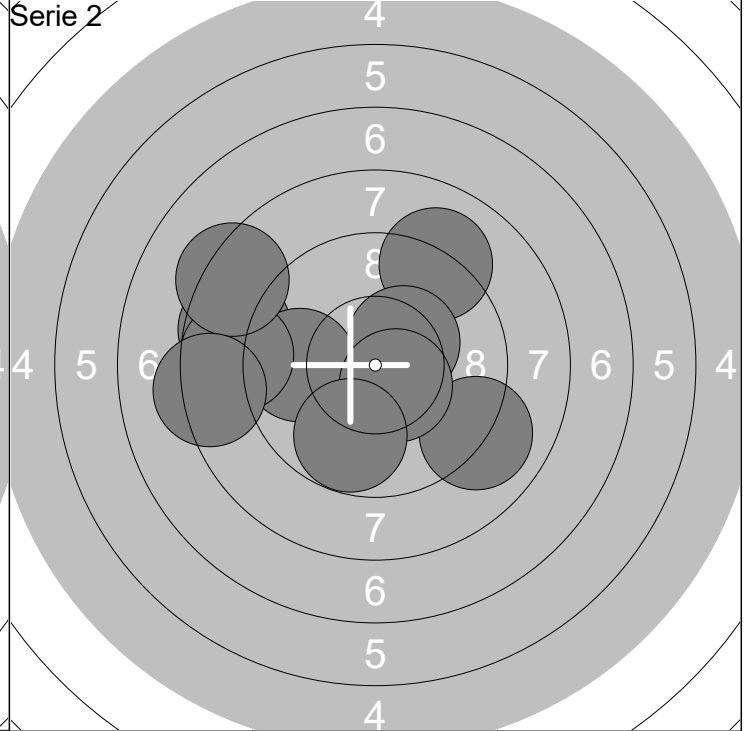
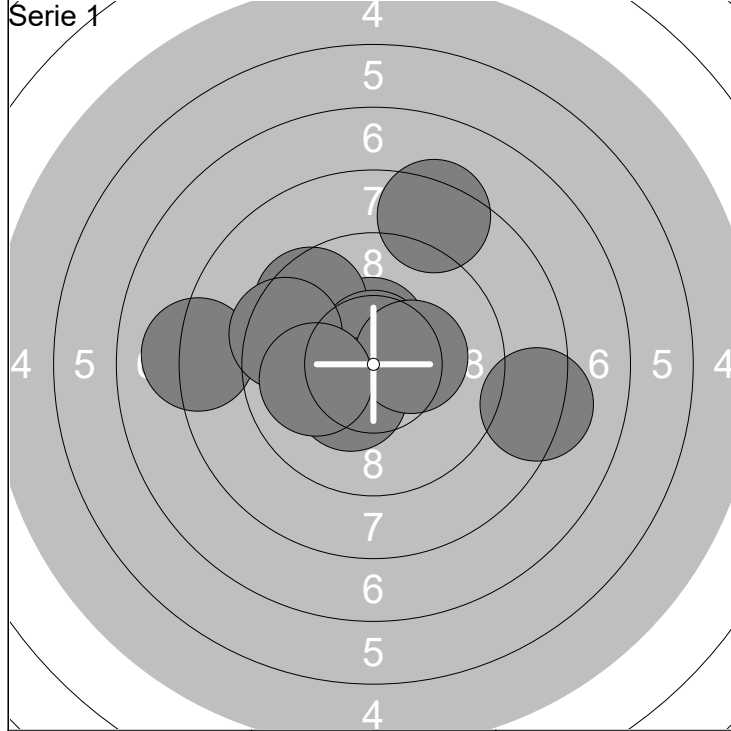

1: 8.1 ←	6: 9.4 ←	Serie	92 (4x)
2: 10.4x ↑	7: 10.3x ↘		
3: 8.4 ↑	8: 10.3x →	Total	92 (4x)
4: 9.5 ↖	9: 10.0 ←		
5: 10.6x ↑	10: 8.2 →		

1: 9.1 ↗	6: 8.7 ←	Serie	88 (2x)
2: 10.4x ↗	7: 8.3 ↖		
3: 9.0 ↘	8: 10.5x ↘	Total	180 (6x)
4: 8.6 ←	9: 9.8 ↓		
5: 9.7 ←	10: 8.3 ←		

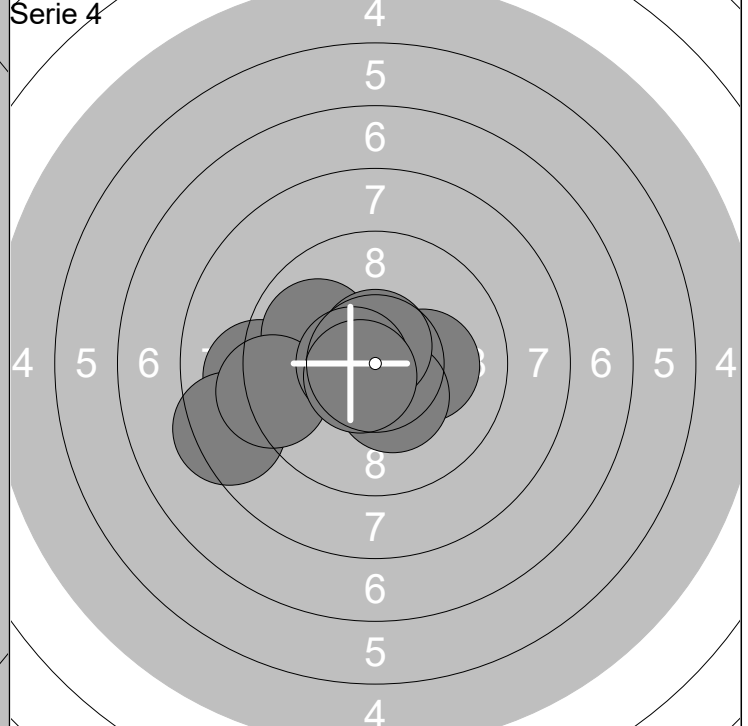
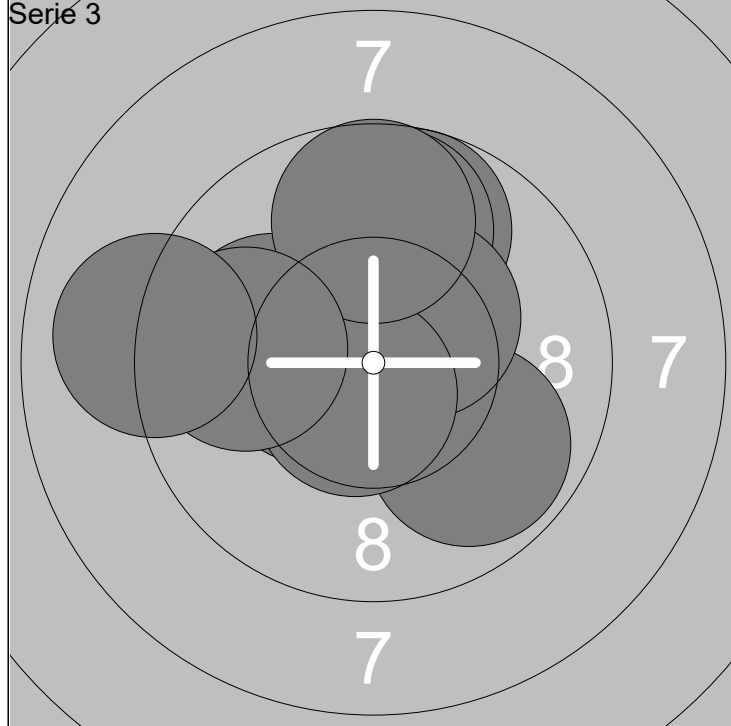

1: 9.7 ↑	6: 10.0 ←	Serie	94 (3x)
2: 9.8 ↑	7: 10.6x ↘		
3: 9.8 ↘	8: 9.7 ↑	Total	274 (9x)
4: 10.4x ↗	9: 9.8 ←		
5: 10.4x ←	10: 9.0 ←		

1: 9.1 ←	6: 9.9 ↖	Serie	95 (6x)
2: 10.2x →	7: 9.2 ←		
3: 10.2x ←	8: 10.7x ↑	Total	369 (15x)
4: 10.3x ↘	9: 10.6x ←		
5: 8.4 ←	10: 10.6x ↘		

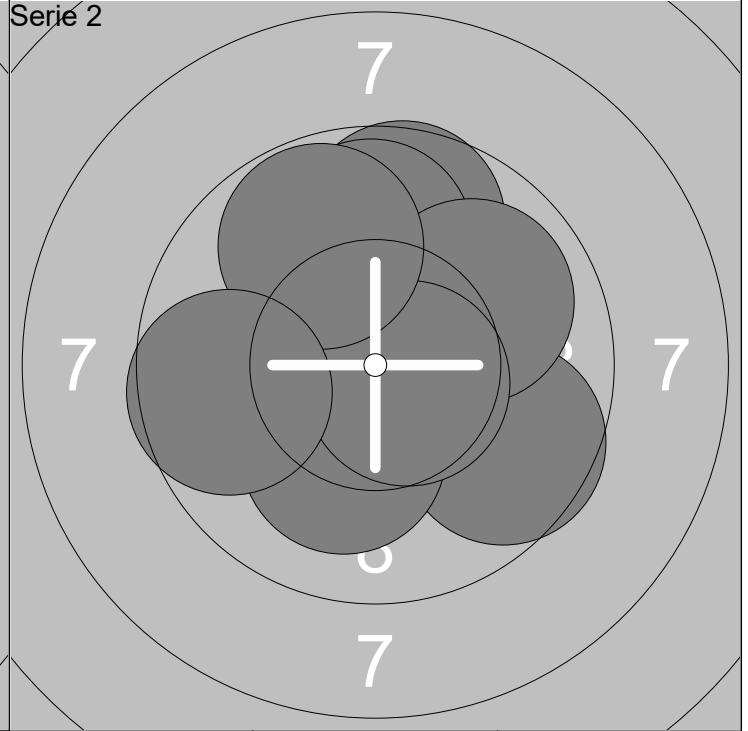
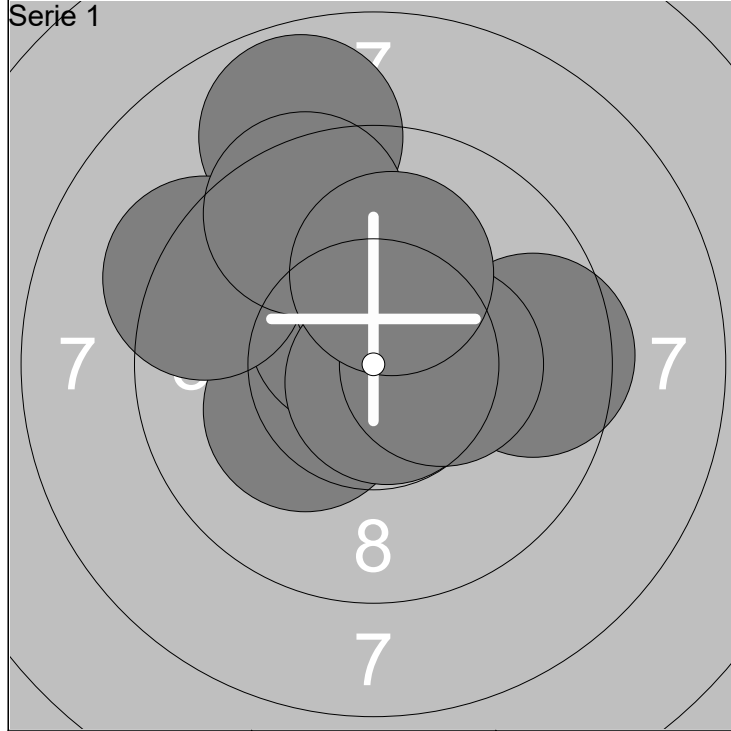

1: 10.2x ↙	6: 10.7x ↘	Serie	95 (5x)
2: 9.5 →	7: 9.3 ↖		
3: 8.8 ↑	8: 10.3x →	Total	95 (5x)
4: 10.6x ↗	9: 9.5 ↗		
5: 10.2x ↑	10: 10.1 ↑		

1: 10.7x ↓	6: 9.9 ↗	Serie	94 (3x)
2: 9.7 ↑	7: 10.1 ↓		
3: 9.6 ↘	8: 10.6x ↘	Total	189 (8x)
4: 9.9 ↑	9: 9.8 ↗		
5: 10.5x ↙	10: 9.6 ←		

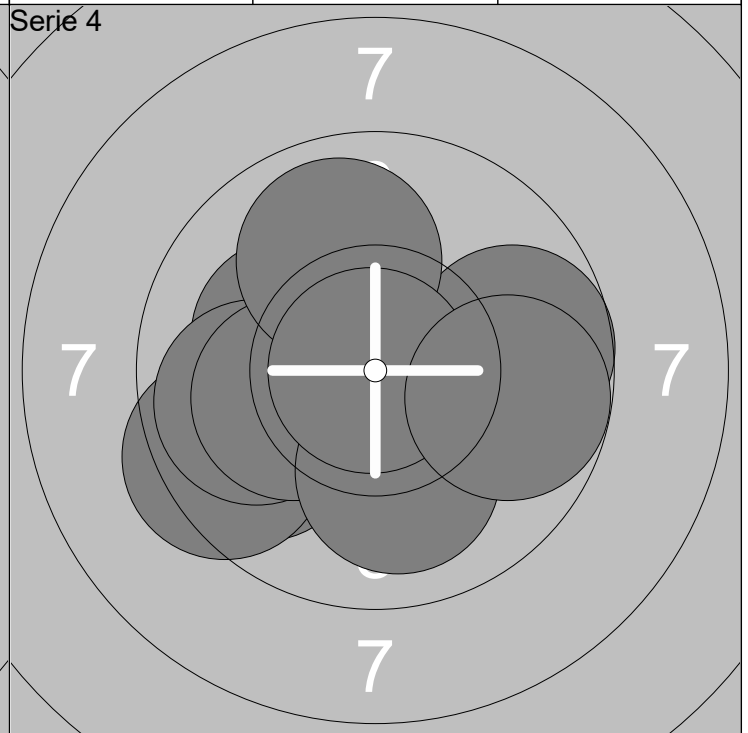
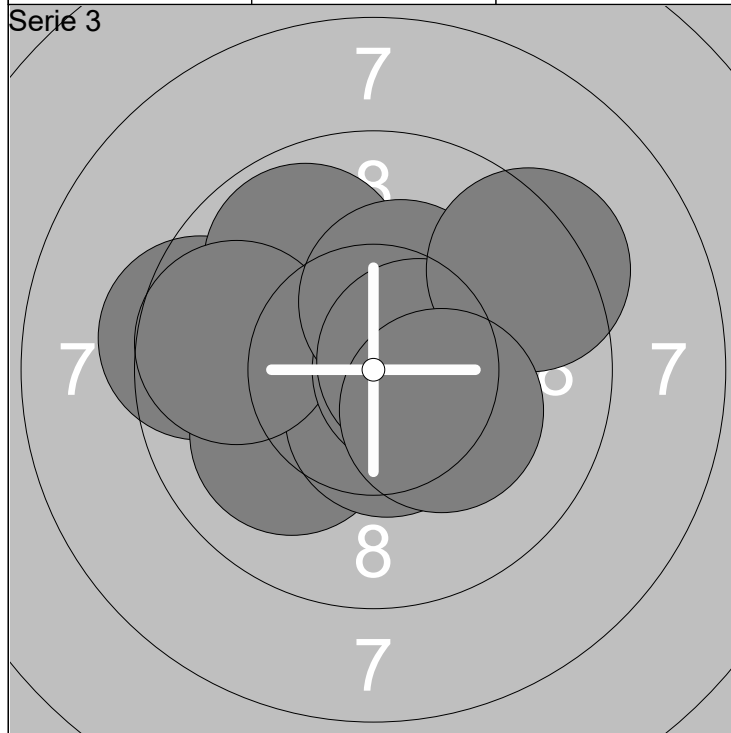

1: 9.4 ←	6: 10.6x →	Serie	96 (5x)
2: 10.0 ↙	7: 10.3x ↑		
3: 10.5x ↓	8: 10.5x →	Total	285 (13x)
4: 9.8 ↗	9: 9.3 ↗		
5: 9.7 ←	10: 10.2x ↘		

1: 9.7 →	6: 10.2x ←	Serie	94 (2x)
2: 9.8 ↙	7: 10.0 ↓		
3: 10.1 ↖	8: 9.9 ↗	Total	379 (15x)
4: 9.4 ↙	9: 10.9x ←		
5: 9.8 ←	10: 9.8 →		

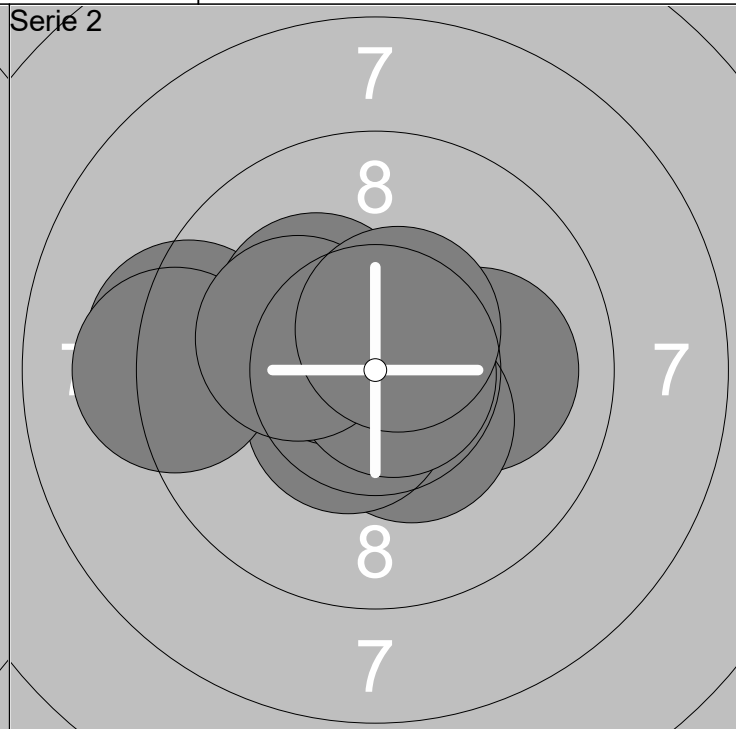
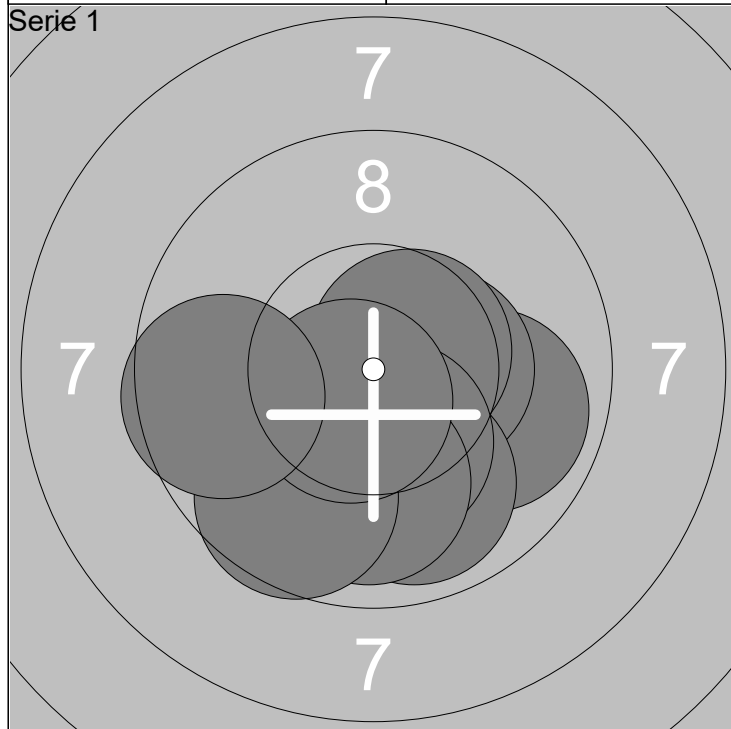

1: 9.9 →	6: 10.3x ↓	Serie	95 (5x)
2: 10.3x ↓	7: 9.9 ↓		
3: 10.4x →	8: 9.6 ↓	Total	95 (5x)
4: 9.9 ↓	9: 10.6x ↓		
5: 10.6x ↗	10: 9.6 ←		

1: 10.1 →	6: 10.5x ↖	Serie	98 (7x)
2: 10.4x ↓	7: 10.2x ↖		
3: 10.5x ↓	8: 10.7x →	Total	193 (12x)
4: 9.3 ←	9: 10.2x ↖		
5: 9.2 ←	10: 10.5x ↗		

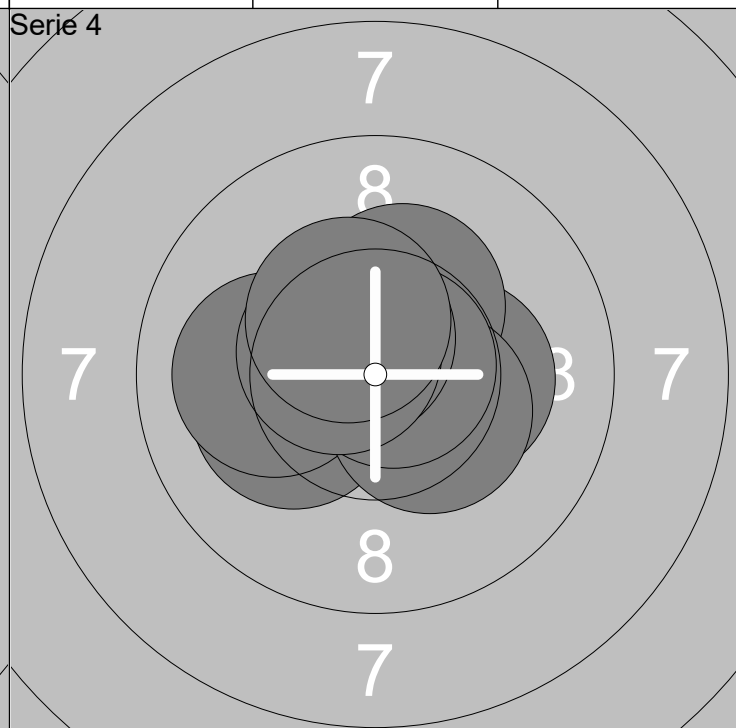
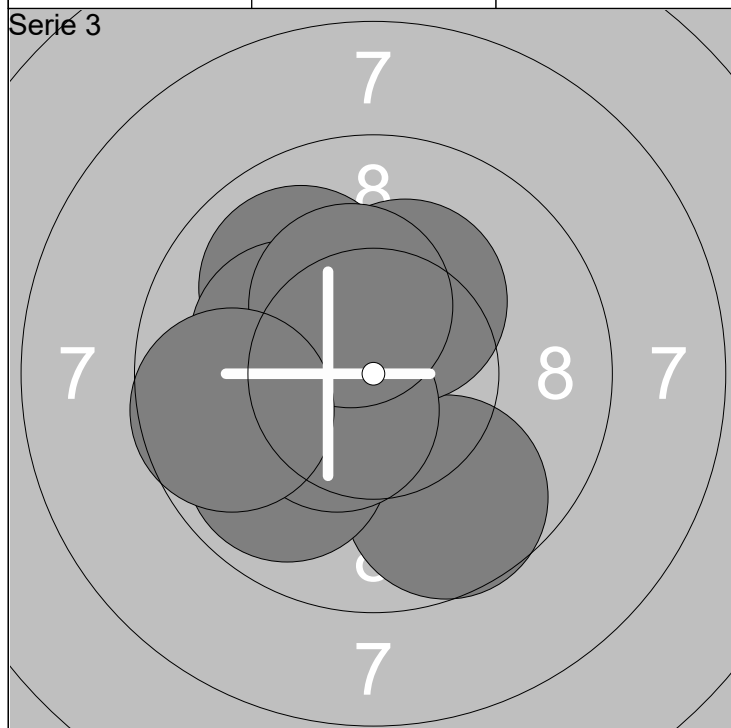

1: 10.5x ↗	6: 9.9 ↖	Serie	96 (5x)
2: 9.9 ↗	7: 10.2x ↖		
3: 9.7 ↓	8: 10.4x ↖	Total	289 (17x)
4: 10.2x ↗	9: 10.3x ↗		
5: 10.0 ←	10: 9.6 ←		

1: 10.2x ↖	6: 10.3x ↖	Serie	100 (9x)
2: 10.6x →	7: 10.7x →		
3: 10.2x →	8: 10.6x ↗	Total	389 (26x)
4: 10.3x ↗	9: 10.5x ↖		
5: 10.1 ←	10: 10.4x ↗		

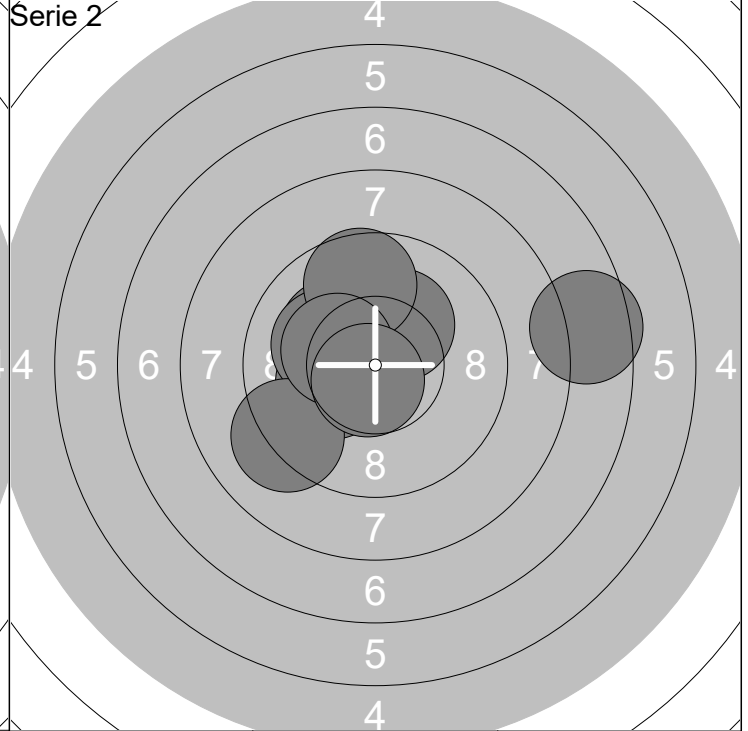
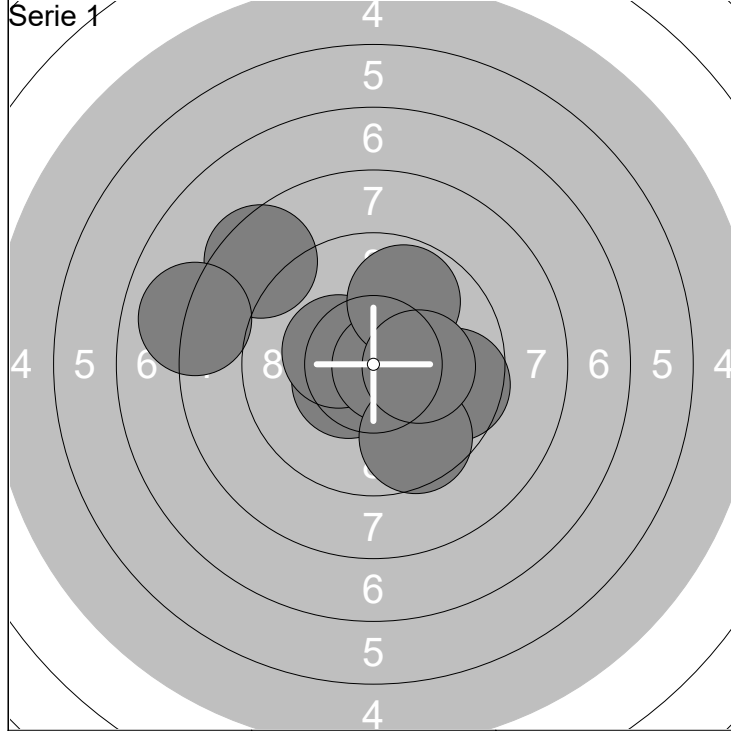

1: 10.8x ↗	6: 9.6 →	Serie 93 (5x)
2: 10.4x ↙	7: 9.6 ↘	
3: 10.3x ↖	8: 9.8 ↗	Total 93 (5x)
4: 10.7x →	9: 10.2x →	
5: 8.5 ↖	10: 8.0 ←	

1: 10.1 ↖	6: 7.5 →	Serie 95 (5x)
2: 10.2x ↙	7: 9.6 ↗	
3: 10.1 ↖	8: 9.1 ↘	Total 188 (10x)
4: 10.2x ↗	9: 10.3x ↖	
5: 10.5x ↙	10: 10.7x ↘	

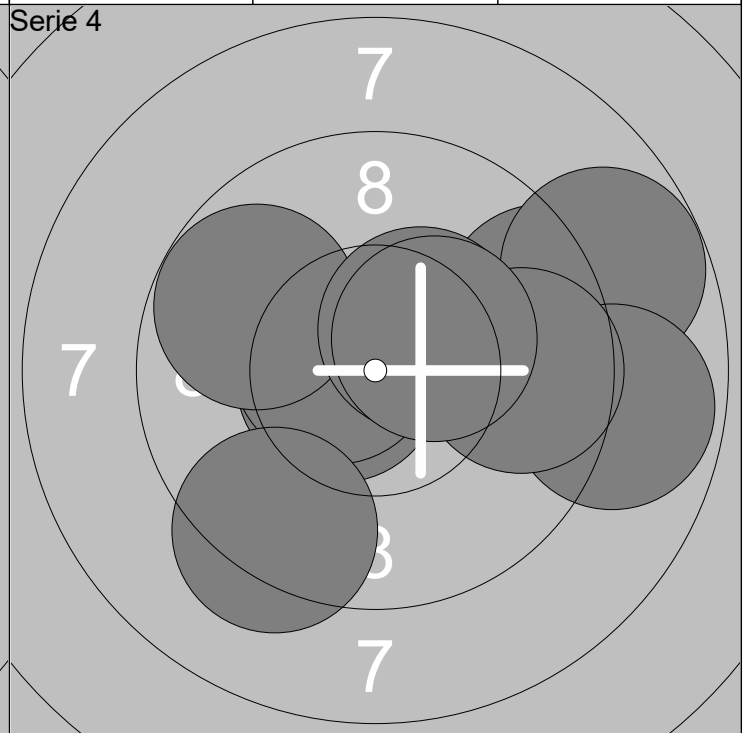
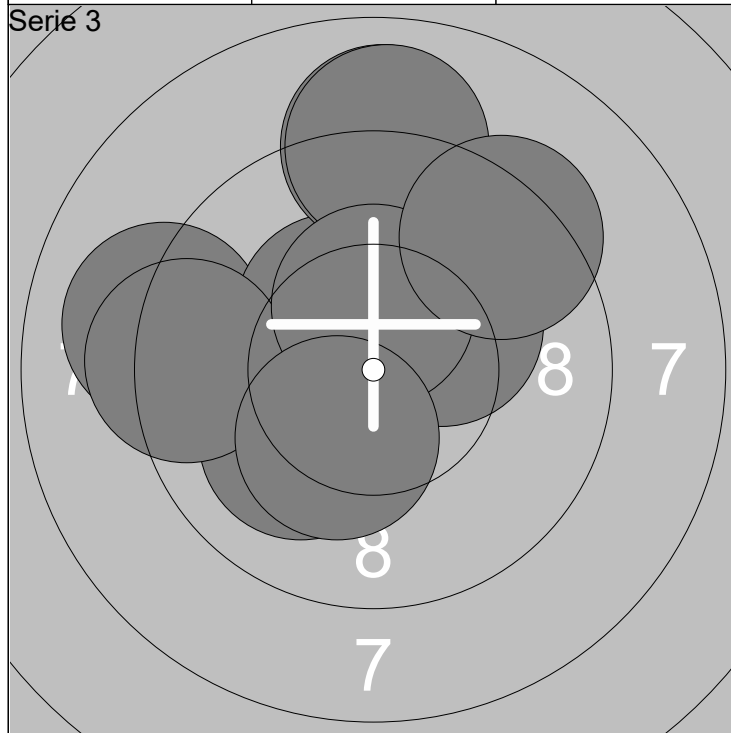

1: 9.1 ↖	6: 9.0 ↗	Serie 95 (4x)
2: 10.0 ↙	7: 9.3 ↖	
3: 10.3x ↖	8: 10.4x ↗	Total 283 (14x)
4: 9.0 ↗	9: 9.3 ↗	
5: 10.2x ↗	10: 10.2x ↘	

1: 10.6x ↖	6: 9.3 ↘	Serie 92 (4x)
2: 10.5x ↖	7: 8.8 →	
3: 9.7 ↖	8: 10.4x ↗	Total 375 (18x)
4: 9.3 →	9: 9.7 →	
5: 8.7 ↗	10: 10.3x ↗	

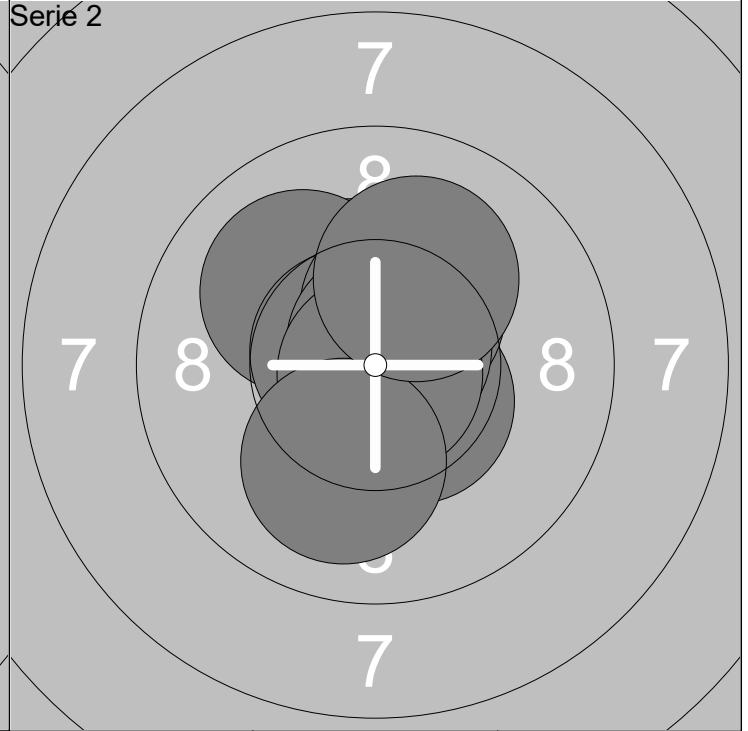
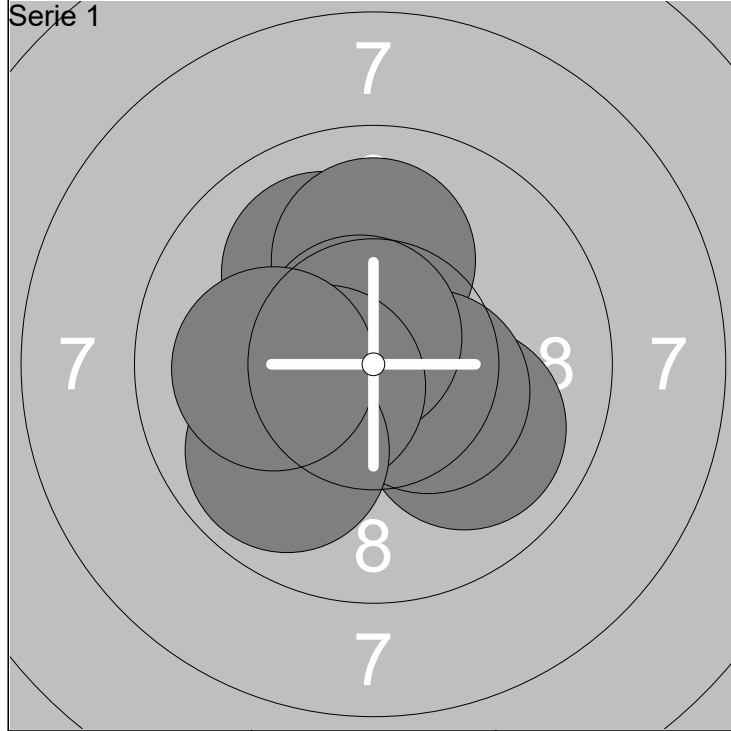

1: 9.9 ↘	6: 10.4x ↘	Serie 98 (5x)
2: 10.3x ←	7: 10.7x ↗	
3: 10.0 ↗	8: 10.4x ←	Total 98 (5x)
4: 10.0 ↑	9: 9.9 ↙	
5: 10.8x ↓	10: 10.0 ←	

1: 10.3x ↗	6: 10.4x ↗	Serie 100 (7x)
2: 10.0 ↗	7: 10.7x ↗	
3: 10.6x ↘	8: 10.9x ↘	Total 198 (12x)
4: 10.5x ↘	9: 10.1 ↓	
5: 10.7x ↗	10: 10.1 ↗	

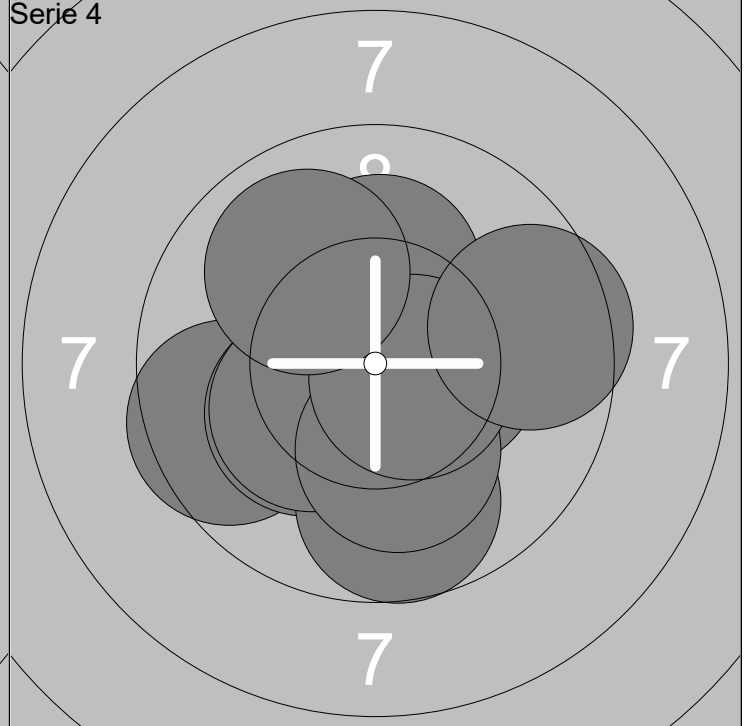
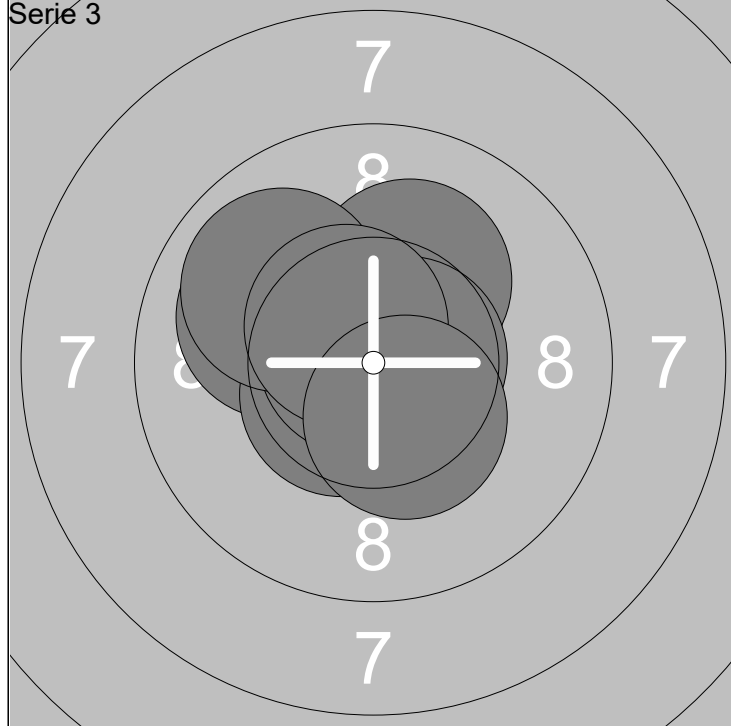

1: 10.0 ↖	6: 10.8x ↖	Serie 99 (7x)
2: 10.6x ↙	7: 9.9 ↗	
3: 10.4x ↗	8: 10.6x →	Total 297 (19x)
4: 10.1 ↗	9: 10.5x ↗	
5: 10.7x ↘	10: 10.4x ↘	

1: 9.5 ←	6: 10.1 ↓	Serie 96 (5x)
2: 10.2x ↙	7: 10.2x ↑	
3: 9.7 ↓	8: 10.6x →	Total 393 (24x)
4: 10.4x →	9: 9.5 →	
5: 10.2x ↙	10: 9.9 ↗	

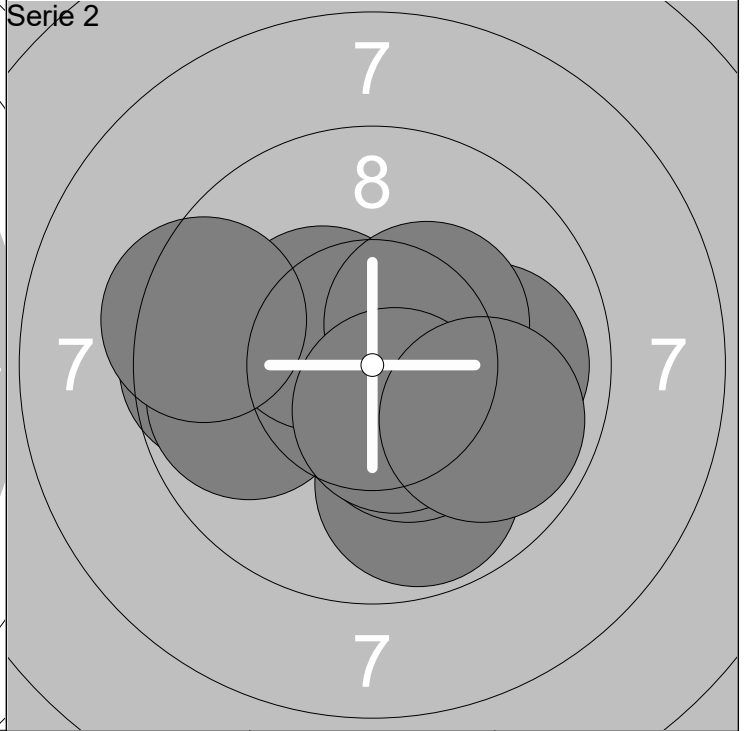
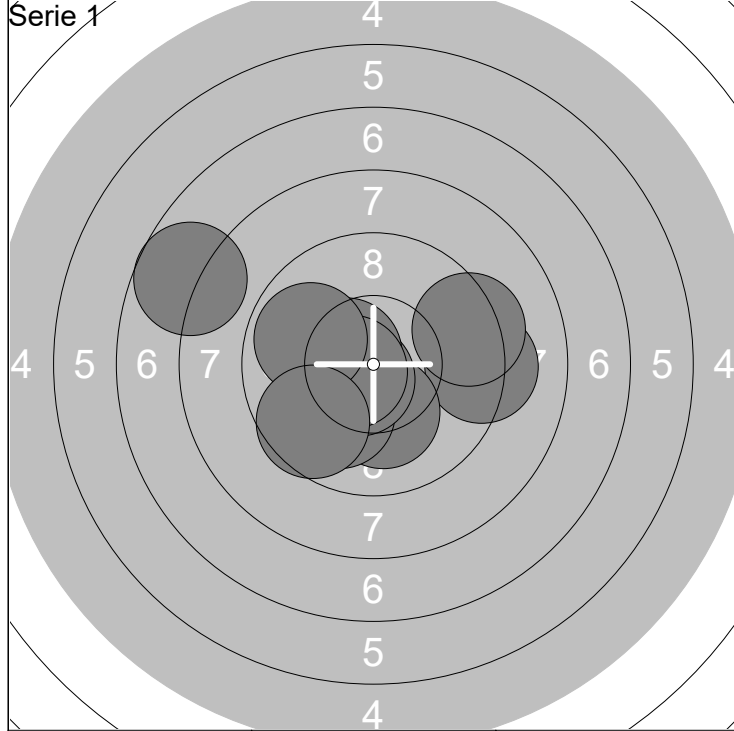

1: 9.2 →	6: 10.5x ←	Serie	93 (4x)
2: 7.7 ↖	7: 9.3 →		
3: 10.2x ↓	8: 10.5x ←	Total	93 (4x)
4: 10.0 ↙	9: 9.9 ←		
5: 10.6x ↙	10: 9.6 ↙		

1: 9.8 ↓	6: 9.9 →	Serie	94 (4x)
2: 10.4x ↓	7: 10.3x ↗		
3: 9.6 ←	8: 9.4 ←	Total	187 (8x)
4: 9.8 ←	9: 10.5x ↓		
5: 10.4x ↖	10: 9.9 ↘		

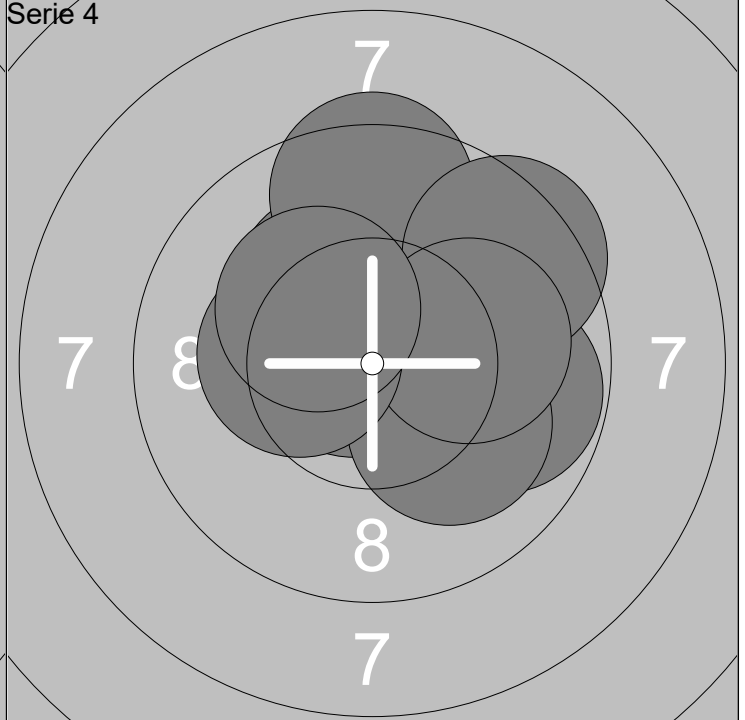
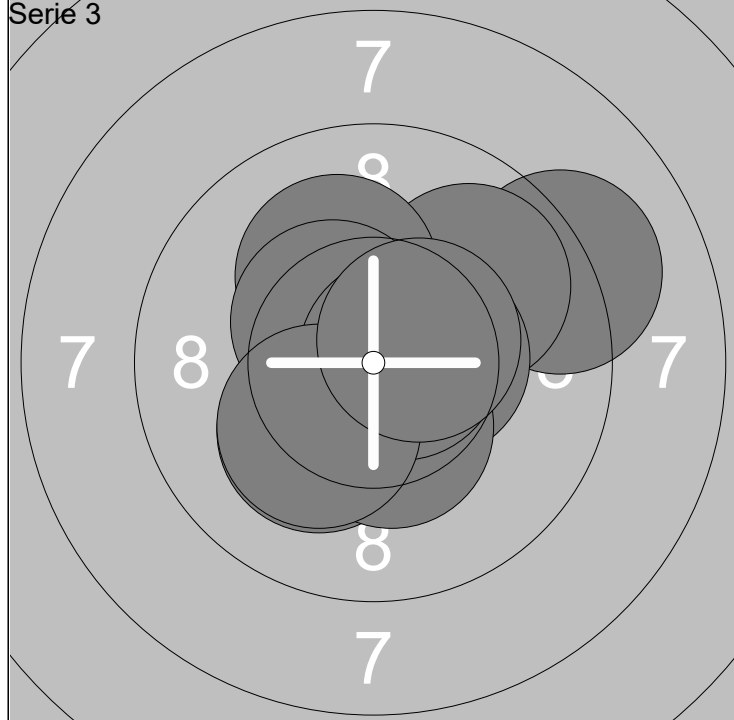

1: 9.1 ↗	6: 10.4x ↖	Serie	98 (6x)
2: 9.8 ↗	7: 10.4x ↓		
3: 10.1 ↖	8: 10.7x →	Total	285 (14x)
4: 10.5x →	9: 10.2x ↙		
5: 10.1 ↙	10: 10.5x ↗		

1: 9.8 →	6: 9.5 ↑	Serie	97 (5x)
2: 10.7x ↖	7: 9.5 ↗		
3: 10.6x ↑	8: 10.1 →	Total	382 (19x)
4: 10.2x ↖	9: 10.3x ←		
5: 10.1 ↘	10: 10.3x ↖		

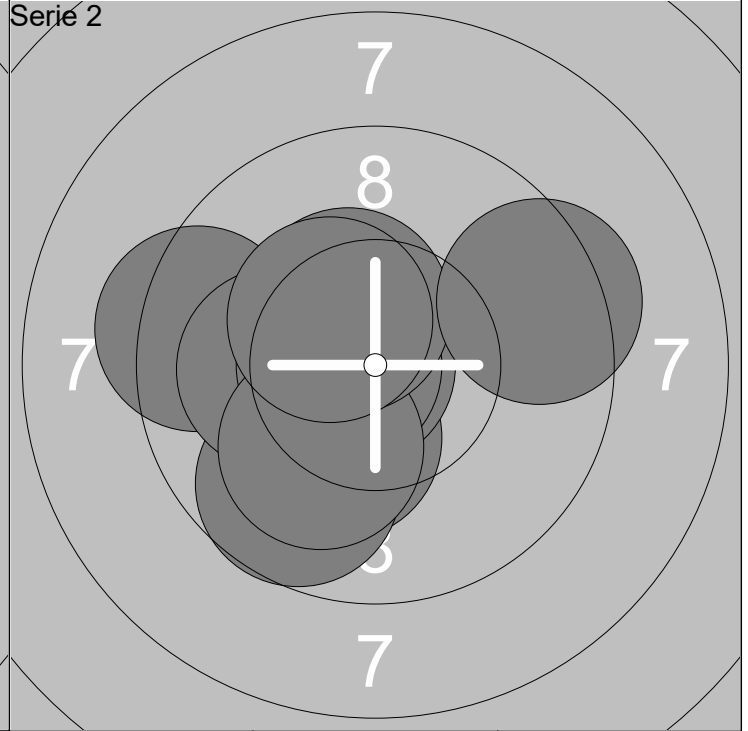
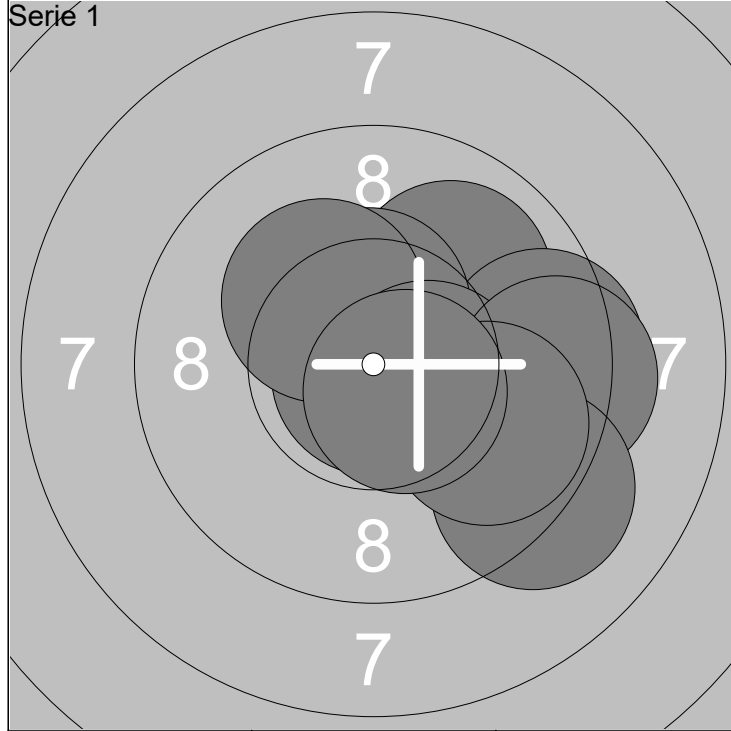

1: 9.9 ↗	6: 10.4x →	Serie	95 (5x)
2: 9.5 →	7: 9.3 →		
3: 10.5x ↑	8: 9.2 ↘	Total	95 (5x)
4: 10.9x ↓	9: 9.8 ↘		
5: 10.2x ↖	10: 10.6x ↘		

1: 10.2x ↘	6: 10.6x ←	Serie	97 (5x)
2: 9.7 ↘	7: 10.1 ↘		
3: 9.3 ←	8: 10.4x ↗	Total	192 (10x)
4: 10.1 ←	9: 10.4x ↗		
5: 10.7x ←	10: 9.4 →		

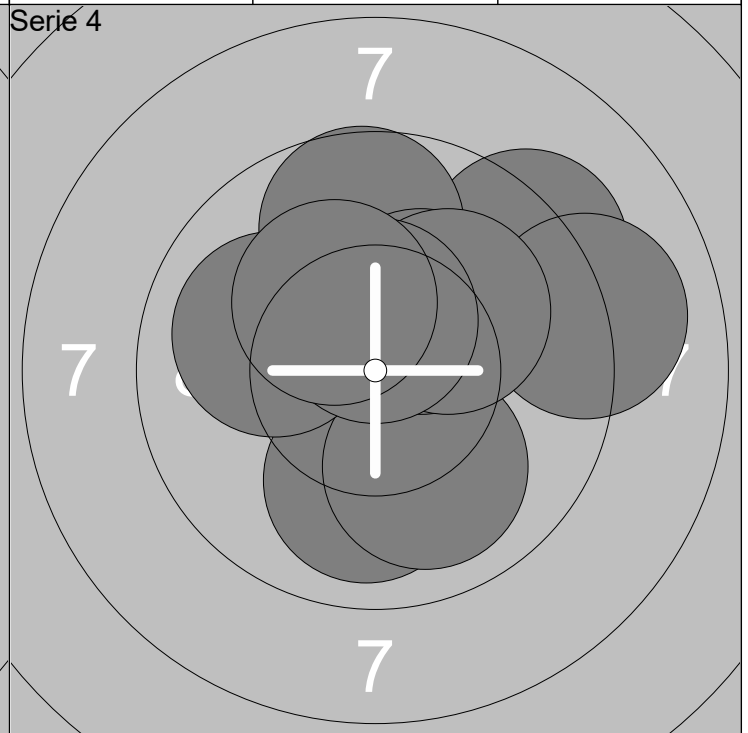
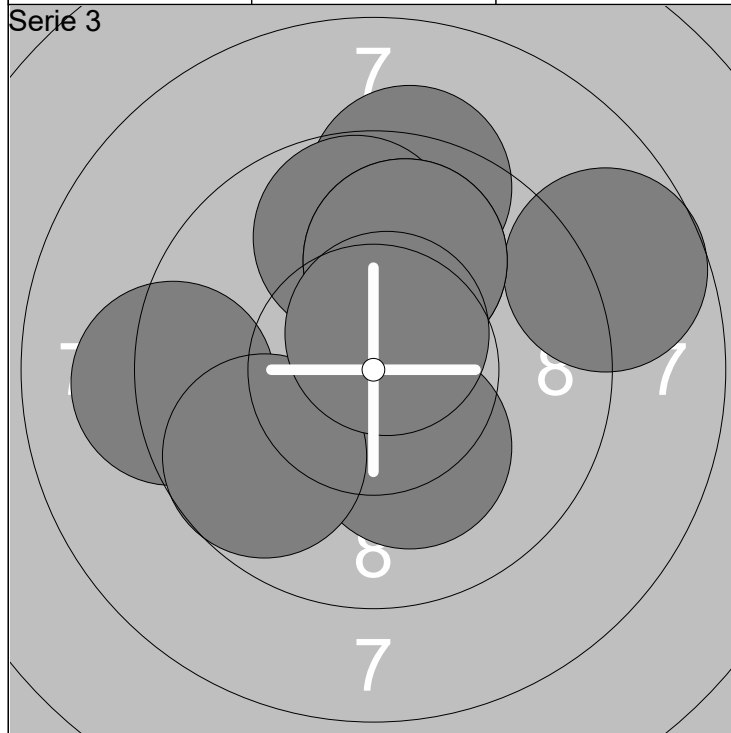

1: 9.2 ←	6: 9.8 ↑	Serie	92 (3x)
2: 10.4x ↓	7: 8.7 →		
3: 10.2x ↘	8: 9.9 ↑	Total	284 (13x)
4: 9.7 ↖	9: 9.9 ↑		
5: 9.3 ↑	10: 10.6x ↑		

1: 9.3 ↗	6: 10.2x ↗	Serie	97 (3x)
2: 10.0 ↓	7: 9.0 →		
3: 10.0 ↘	8: 10.1 ↗	Total	381 (16x)
4: 10.0 ←	9: 10.5x ↑		
5: 9.7 ↑	10: 10.2x ↖		

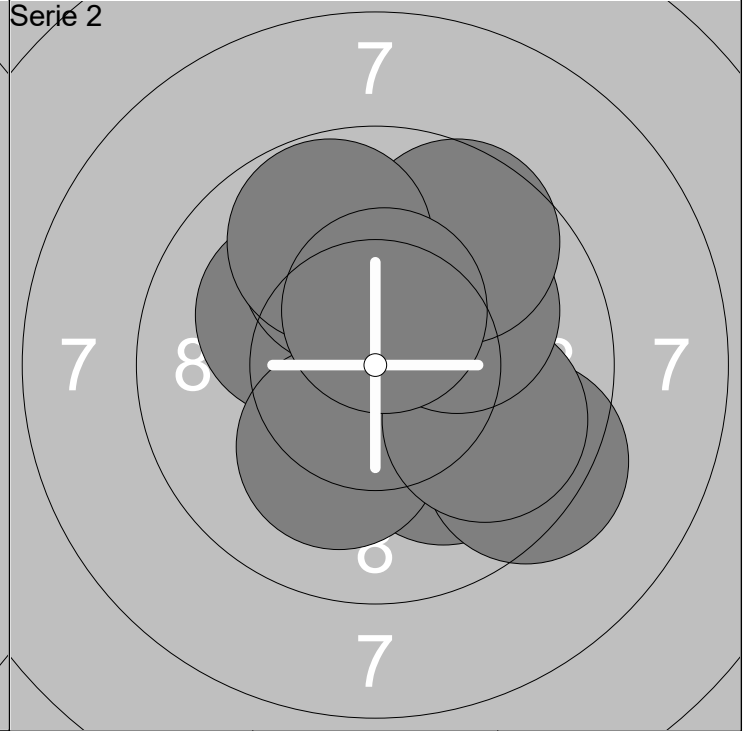
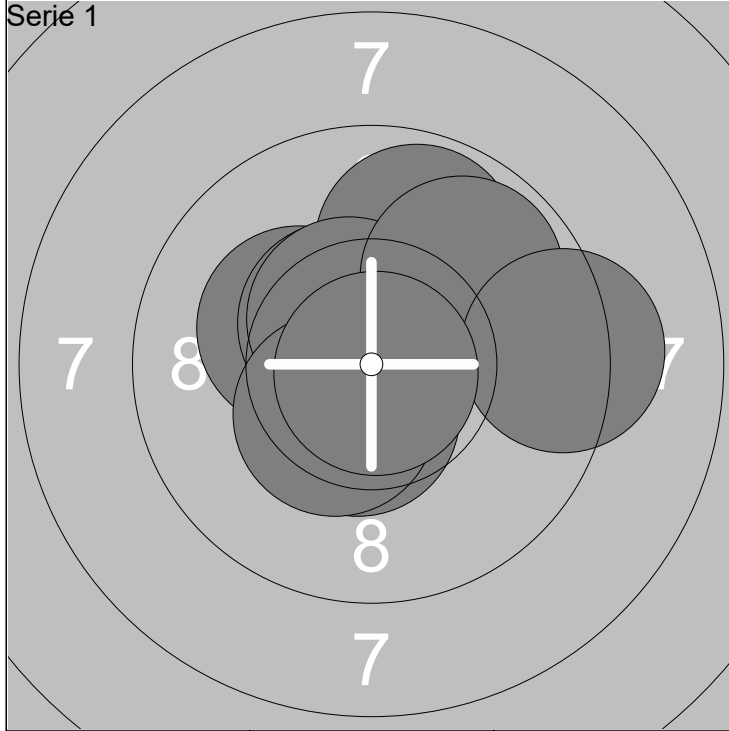

1: 10.3x ↗	6: 10.5x ↓	Serie	97 (7x)
2: 10.2x ↖	7: 9.8 ↗		
3: 10.5x ↖	8: 9.2 →	Total	97 (7x)
4: 9.8 ↗	9: 10.4x ↙		
5: 10.5x ↖	10: 10.9x ↓		

1: 10.0 ↓	6: 10.0 ↑	Serie	96 (1x)
2: 10.1 ↗	7: 10.0 ↗		
3: 10.1 ↓	8: 9.6 ↗	Total	193 (8x)
4: 9.4 ↓	9: 9.8 ↑		
5: 9.9 ↓	10: 10.4x ↑		

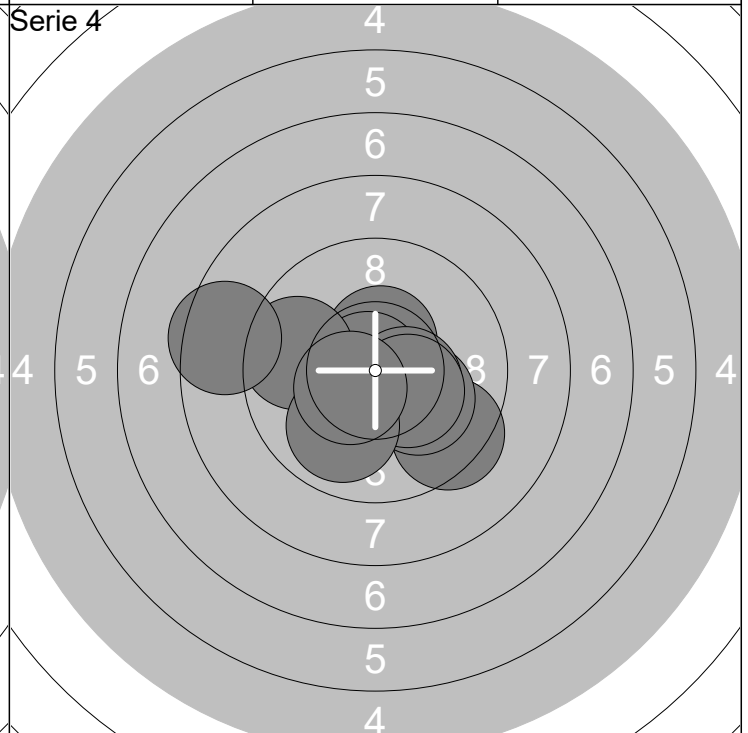
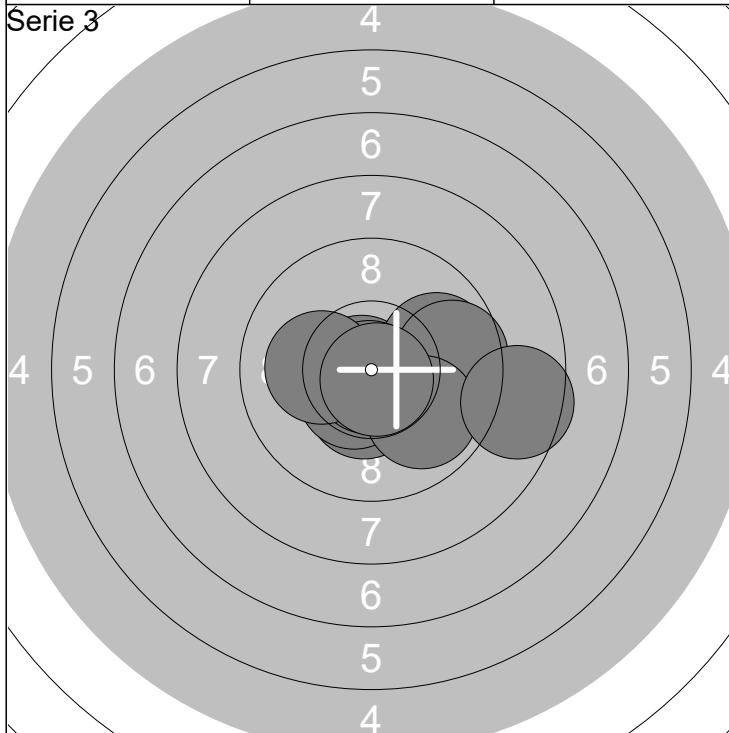

1: 10.4x ↓	6: 10.8x ↓	Serie	95 (5x)
2: 10.8x ←	7: 9.9 ↓		
3: 9.8 →	8: 10.1 ←	Total	288 (13x)
4: 9.6 →	9: 8.6 →		
5: 10.5x ↙	10: 10.7x ↓		

1: 10.5x ↑	6: 10.3x ↘	Serie	95 (5x)
2: 10.8x ←	7: 9.7 ←		
3: 9.4 ↓	8: 9.9 ↓	Total	383 (18x)
4: 10.1 ↓	9: 8.5 ←		
5: 10.4x ↘	10: 10.4x ↙		

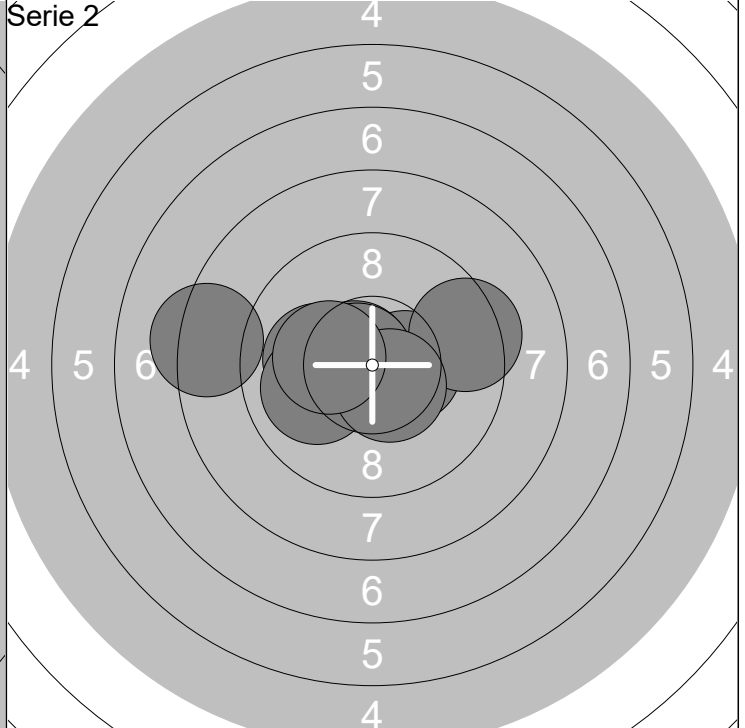
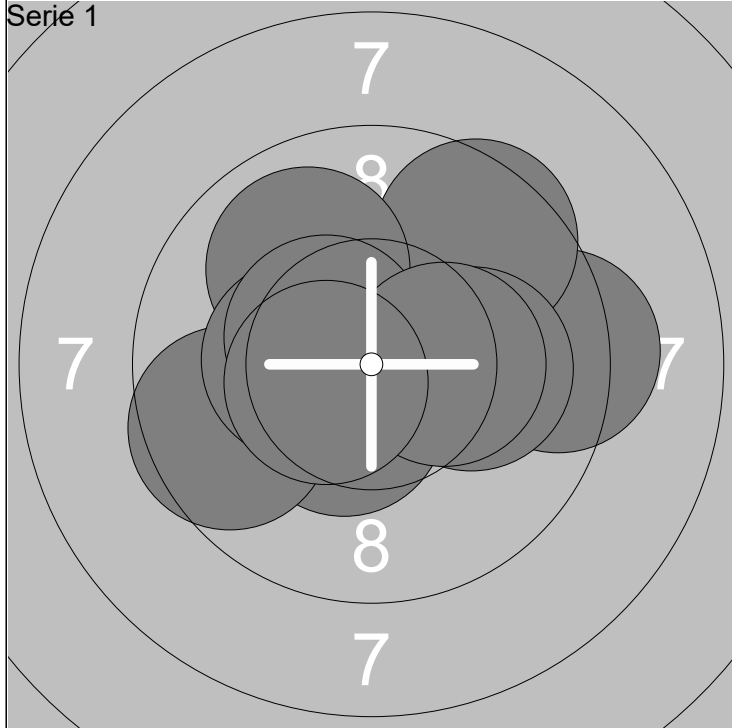

1: 9.3 →	6: 10.1 →	Serie	96 (5x)
2: 9.5 ↗	7: 10.3x ←		
3: 10.4x ↘	8: 10.5x ↖	Total	96 (5x)
4: 9.9 ↖	9: 10.3x →		
5: 9.6 ←	10: 10.5x ←		

1: 10.1 ←	6: 9.4 →	Serie	97 (6x)
2: 10.4x →	7: 10.0 ←		
3: 10.6x ←	8: 10.5x ↘	Total	193 (11x)
4: 10.7x ←	9: 8.3 ←		
5: 10.3x ←	10: 10.2x ←		

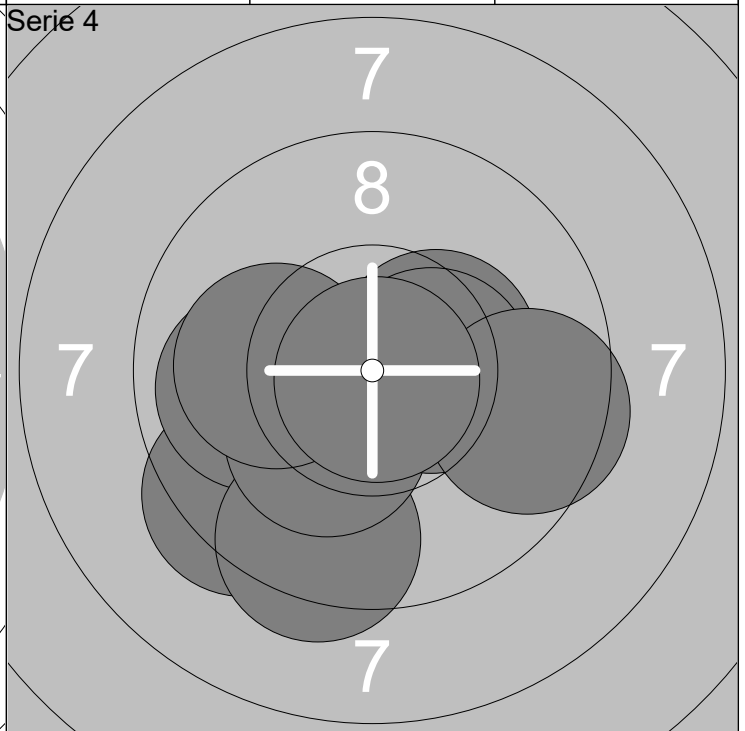
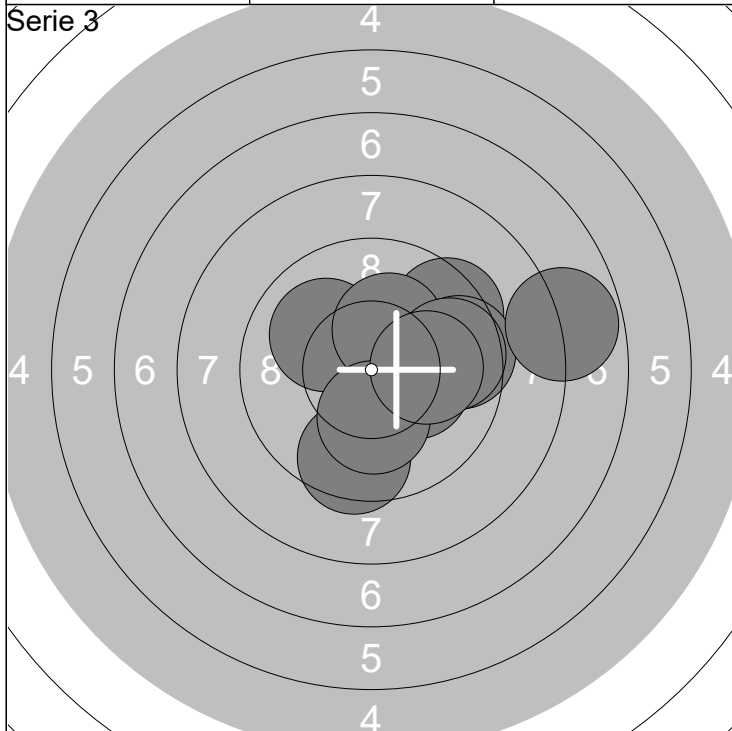

1: 10.0 ↖	6: 10.2x ↗	Serie	93 (3x)
2: 9.5 ↘	7: 7.8 →		
3: 9.4 ↗	8: 9.7 →	Total	286 (14x)
4: 9.5 →	9: 10.2x ↘		
5: 10.2x →	10: 10.1 →		

1: 9.4 ↘	6: 10.3x →	Serie	96 (5x)
2: 9.9 ←	7: 10.4x →		
3: 9.4 ↘	8: 9.5 →	Total	382 (19x)
4: 10.4x ←	9: 10.1 ←		
5: 10.2x ↘	10: 10.8x ↘		

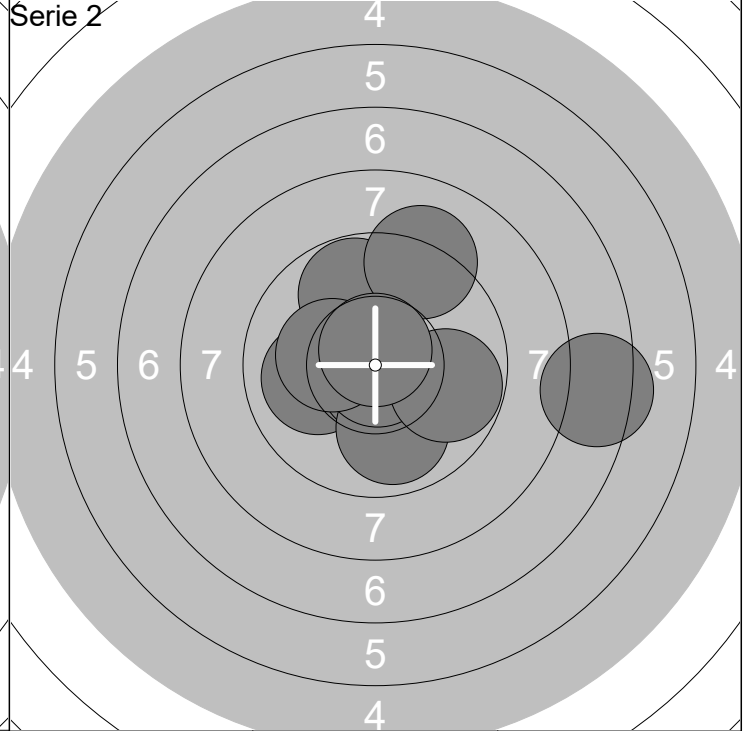
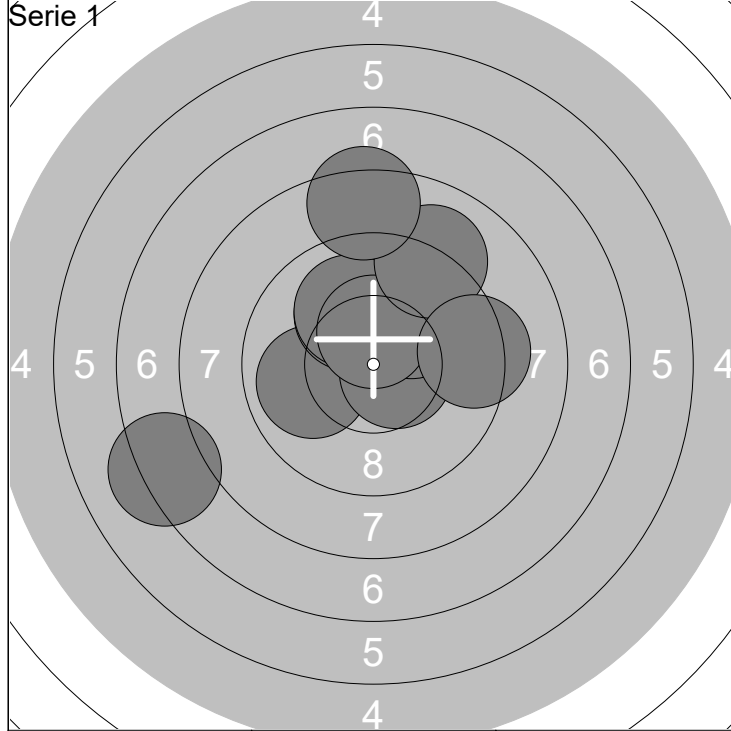

1: 9.9 ←	6: 10.4x ↑	Serie	92 (2x)
2: 10.0 ↗	7: 9.1 ↗		
3: 10.5x →	8: 9.3 →	Total	92 (2x)
4: 10.0 ↗	9: 7.2 ←		
5: 10.0 ↗	10: 8.4 ↑		

1: 10.0 ←	6: 9.2 ↗	Serie	93 (4x)
2: 10.7x ↓	7: 10.2x ←		
3: 9.9 ↓	8: 7.4 →	Total	185 (6x)
4: 9.8 ↗	9: 9.8 →		
5: 10.8x ↓	10: 10.7x ↑		

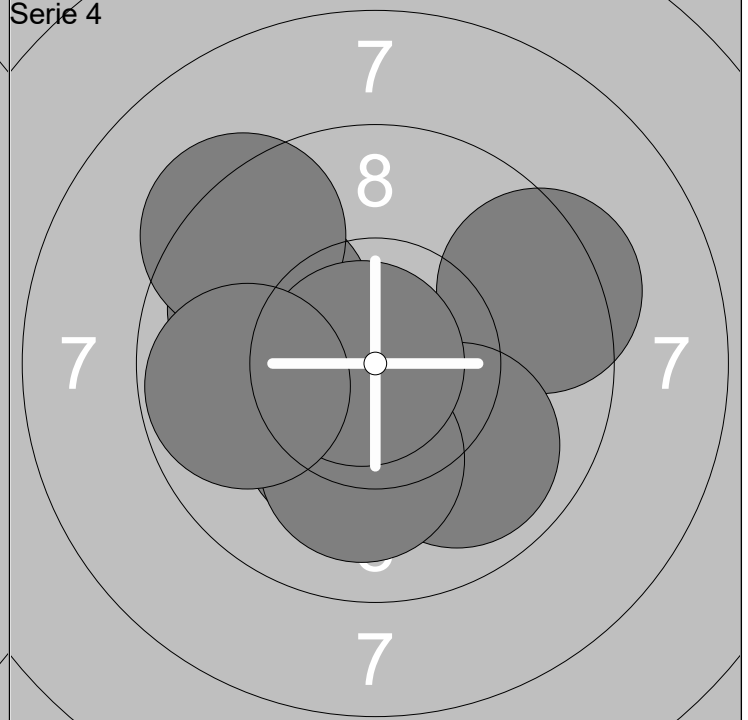
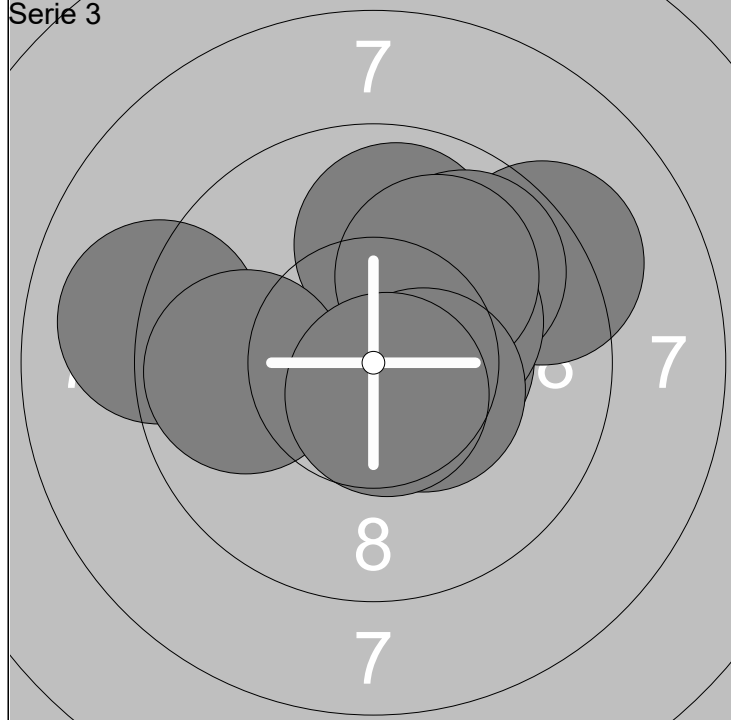

1: 9.0 ←	6: 10.2x ↗	Serie	95 (4x)
2: 9.9 ↑	7: 10.0 ↗		
3: 9.2 ↗	8: 10.4x →	Total	280 (10x)
4: 9.8 ↗	9: 9.8 ←		
5: 10.4x →	10: 10.6x ↓		

1: 9.9 ←	6: 9.4 ↗	Serie	95 (4x)
2: 9.3 ↗	7: 9.9 ↓		
3: 10.6x ↓	8: 10.1 ↓	Total	375 (14x)
4: 10.3x ↓	9: 10.8x ←		
5: 10.4x ↓	10: 9.8 ←		

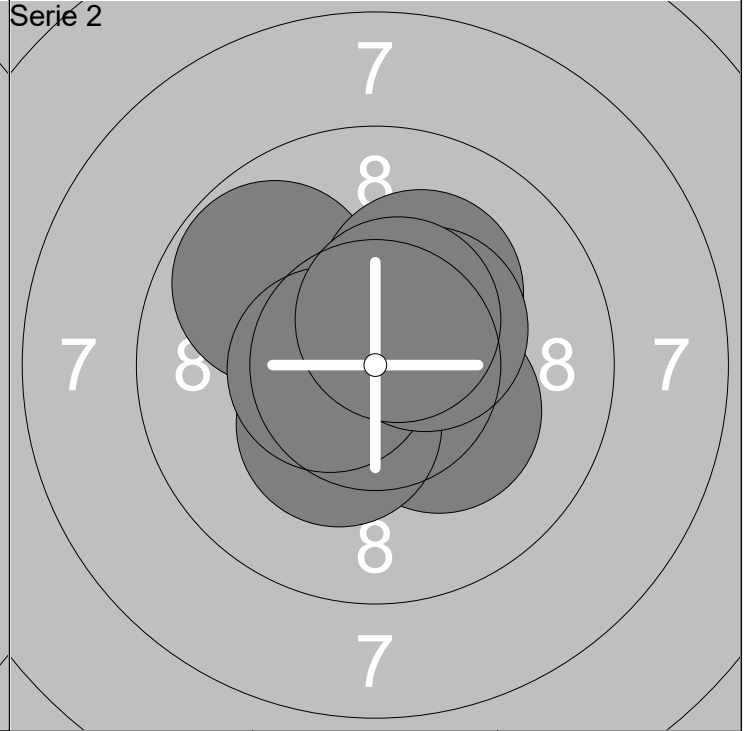
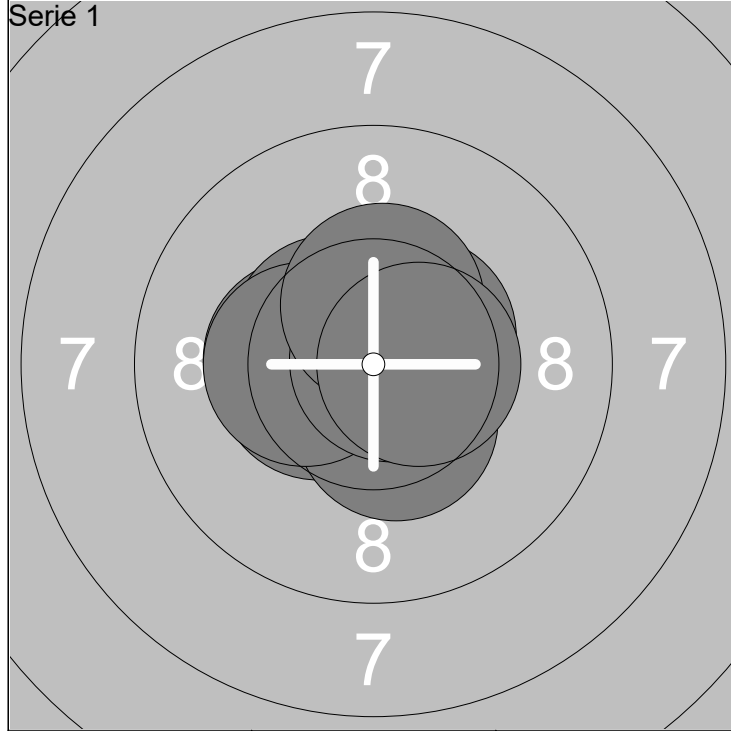

1: 10.3x ←	6: 10.4x ↓	Serie	100 (10x)
2: 10.5x ↖	7: 10.3x ←		
3: 10.5x ↗	8: 10.8x →	Total	100 (10x)
4: 10.4x ←	9: 10.4x ↑		
5: 10.9x	10: 10.5x →		

1: 10.7x ↘	6: 10.3x ↓	Serie	99 (9x)
2: 10.7x ↗	7: 10.5x ←		
3: 10.2x ↘	8: 10.2x ↗	Total	199 (19x)
4: 10.7x ←	9: 10.4x ↗		
5: 9.8 ↖	10: 10.5x ↗		

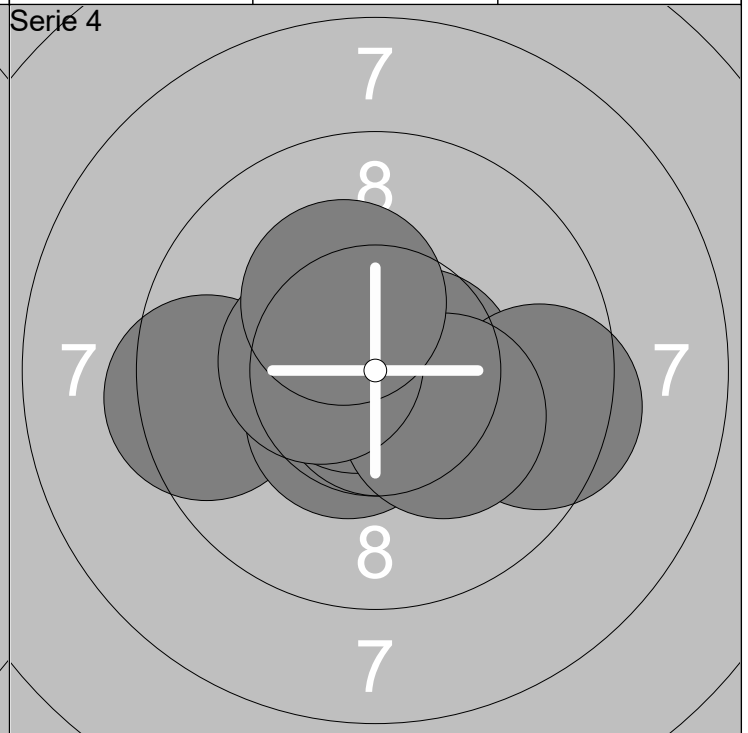
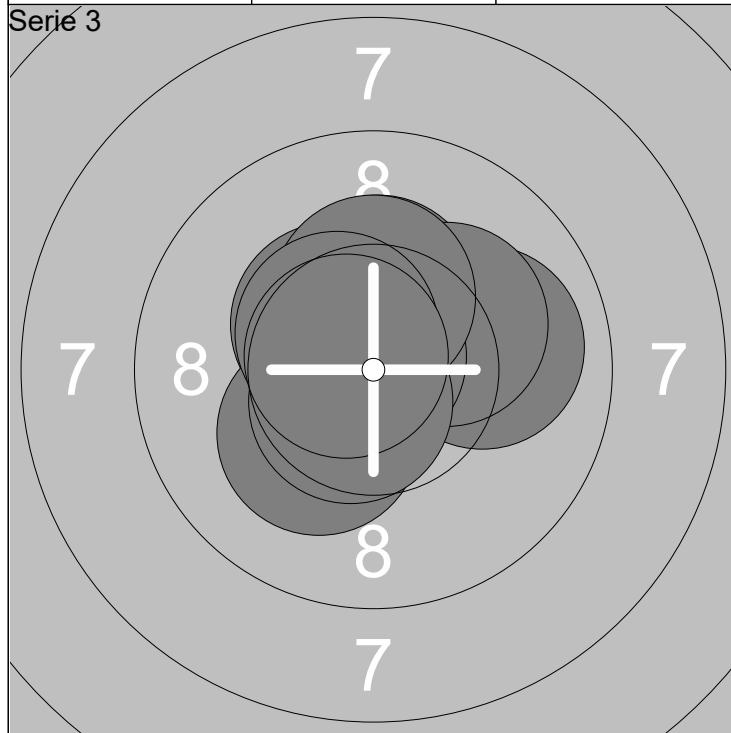

1: 10.0 →	6: 10.8x ↖	Serie	100 (9x)
2: 10.3x ↑	7: 10.6x ↓		
3: 10.4x ↖	8: 10.3x ↑	Total	299 (28x)
4: 10.2x ↗	9: 10.5x ↖		
5: 10.2x ↓	10: 10.6x ↖		

1: 10.6x →	6: 10.7x ↓	Serie	98 (8x)
2: 9.5 →	7: 10.8x ←		
3: 9.4 ←	8: 10.2x ↘	Total	397 (36x)
4: 10.5x ↓	9: 10.4x ←		
5: 10.6x ↖	10: 10.2x ↗		

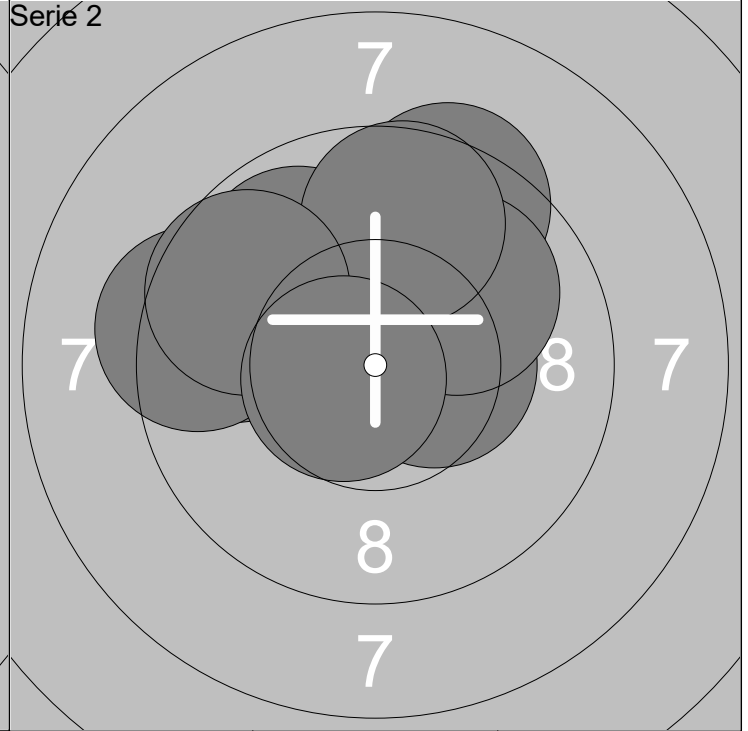
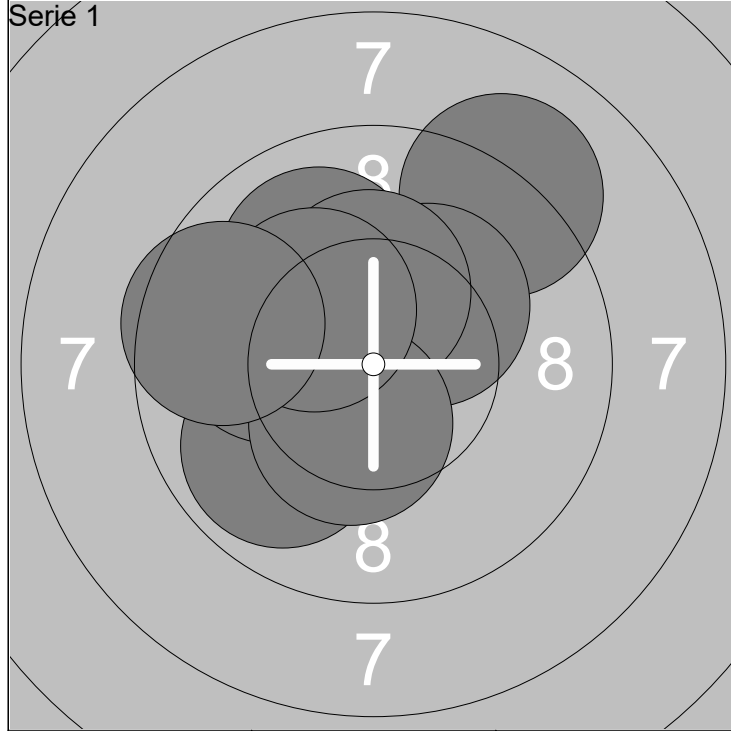

1: 9.1 ↗	6: 10.3x ↑	Serie	96 (5x)
2: 10.2x ↗	7: 10.0 ←		
3: 10.3x ↗	8: 10.4x ↓	Total	96 (5x)
4: 9.9 ↗	9: 10.2x ↘		
5: 9.9 ↘	10: 9.6 ←		

1: 9.8 ↖	6: 9.8 ↗	Serie	93 (2x)
2: 10.4x →	7: 9.3 ←		
3: 9.4 ↗	8: 9.6 ↑	Total	189 (7x)
4: 10.0 ↗	9: 9.6 ↘		
5: 9.6 ←	10: 10.6x ↖		

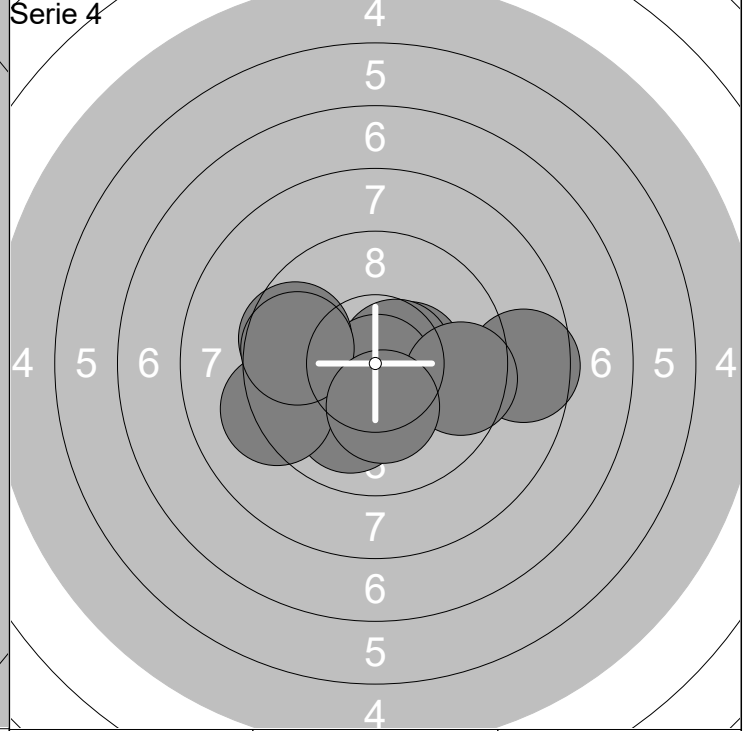
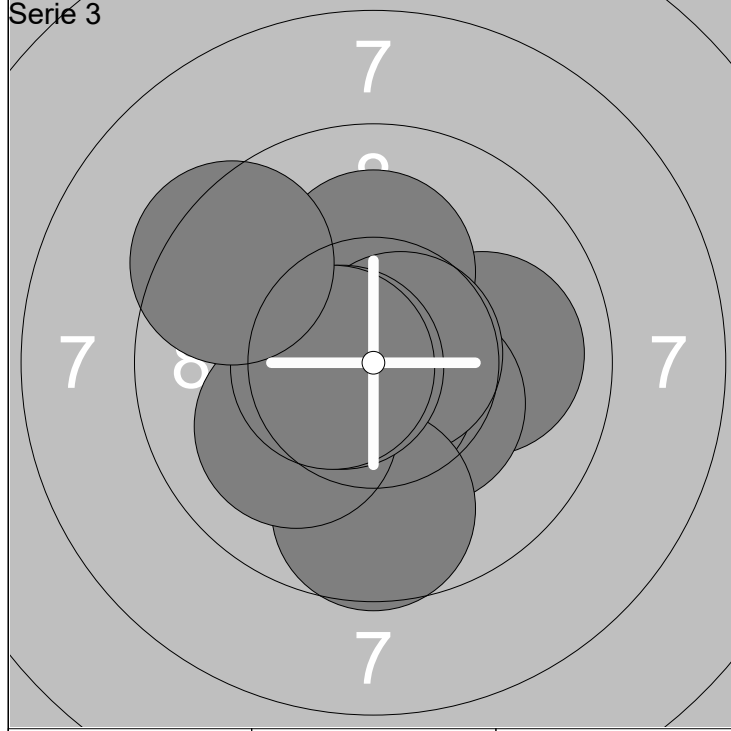

1: 10.0 →	6: 9.6 ↓	Serie	98 (5x)
2: 10.1 ↑	7: 10.0 ↘		
3: 10.4x ↘	8: 10.6x ←	Total	287 (12x)
4: 10.7x ↓	9: 10.6x ←		
5: 10.7x →	10: 9.4 ↖		

1: 10.4x →	6: 9.6 ←	Serie	94 (4x)
2: 10.0 ↓	7: 9.6 →		
3: 10.6x →	8: 9.2 ←	Total	381 (16x)
4: 8.6 →	9: 9.6 ←		
5: 10.8x ↓	10: 10.2x ↓		

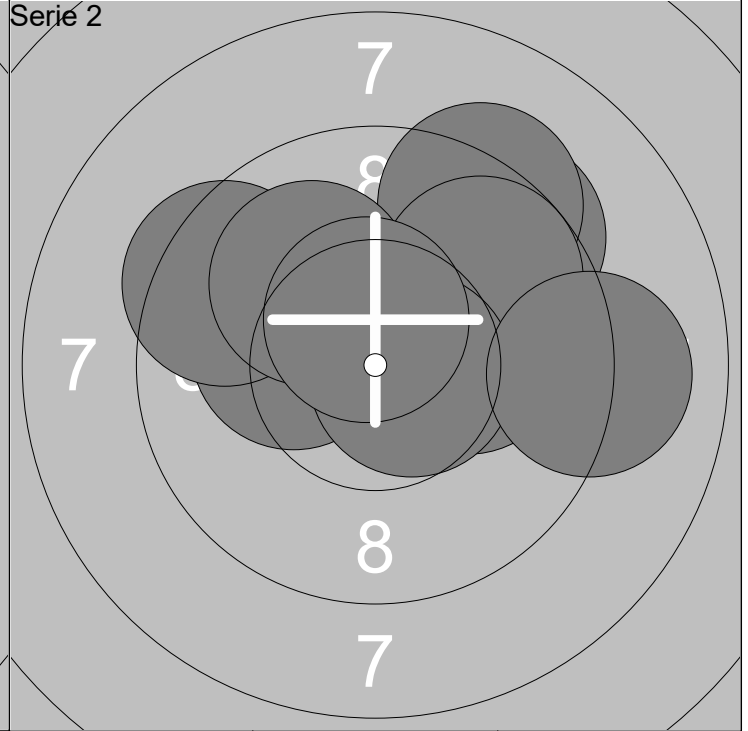
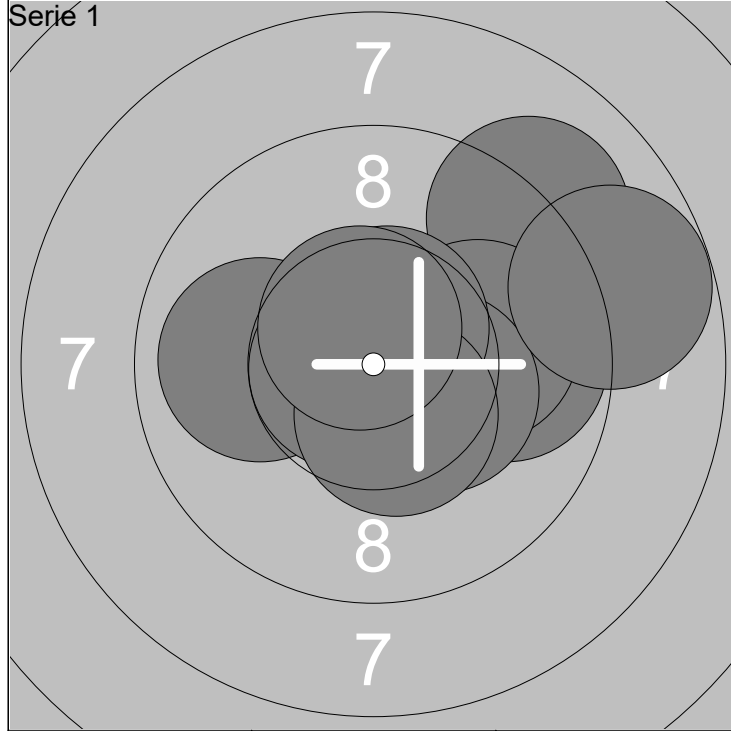

1: 9.9 ←	6: 10.7x ←	Serie	95 (5x)
2: 9.1 ↗	7: 10.6x ↗		
3: 9.8 →	8: 8.7 →	Total	95 (5x)
4: 10.0 →	9: 10.4x ↘		
5: 10.3x ↘	10: 10.6x ↗		

1: 10.2x ←	6: 9.7 ↗	Serie	95 (3x)
2: 9.4 ↗	7: 10.0 ↘		
3: 9.4 ←	8: 10.6x →	Total	190 (8x)
4: 10.1 →	9: 9.0 →		
5: 9.2 ↗	10: 10.5x ↗		

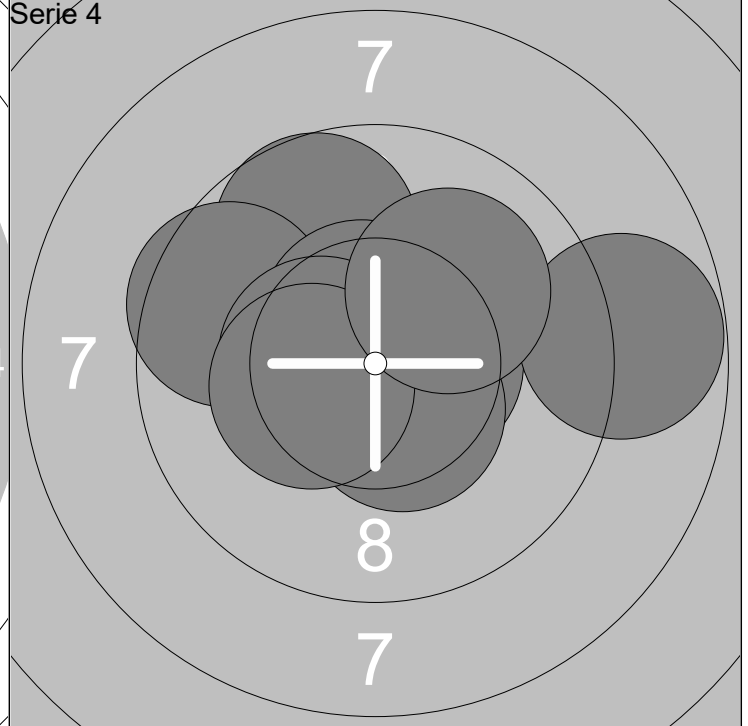
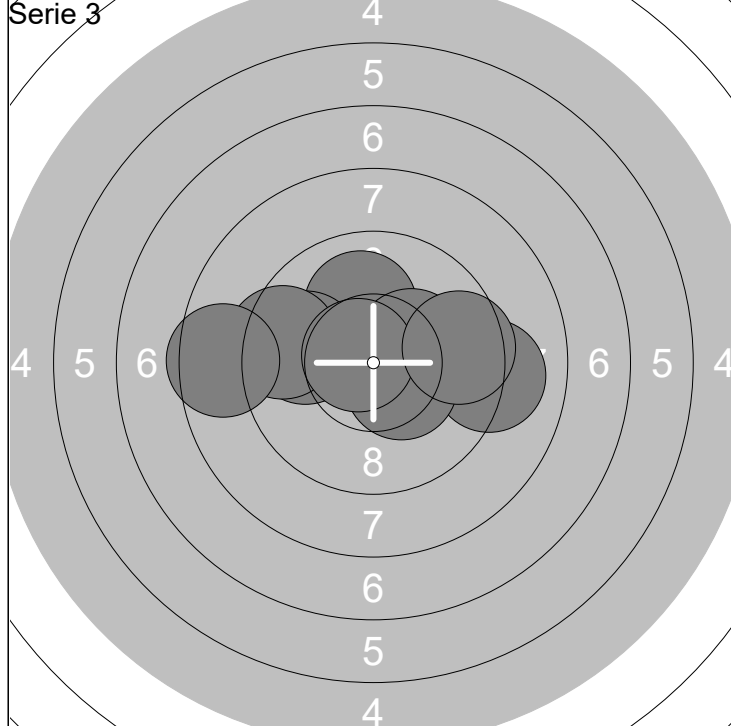

1: 10.0 ↗	6: 8.5 ←	Serie	94 (4x)
2: 10.8x →	7: 10.3x ↗		
3: 9.1 →	8: 10.4x ↘	Total	284 (12x)
4: 9.8 ←	9: 10.7x ↘		
5: 9.5 ←	10: 9.5 →		

1: 10.4x ←	6: 10.4x ←	Serie	96 (6x)
2: 9.7 ↗	7: 10.4x ↘		
3: 10.5x →	8: 8.8 →	Total	380 (18x)
4: 9.5 ←	9: 10.3x ←		
5: 10.6x ↗	10: 10.0 ↗		

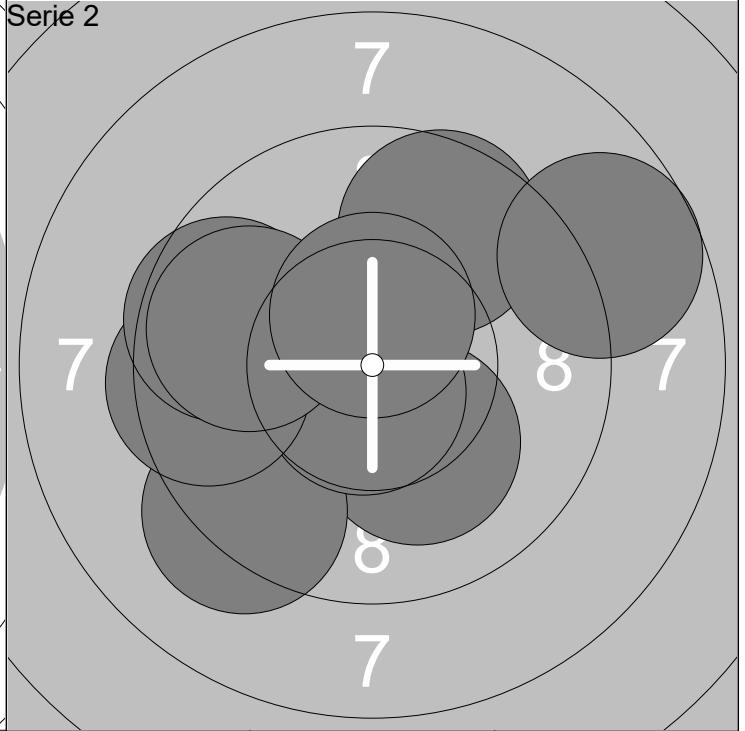
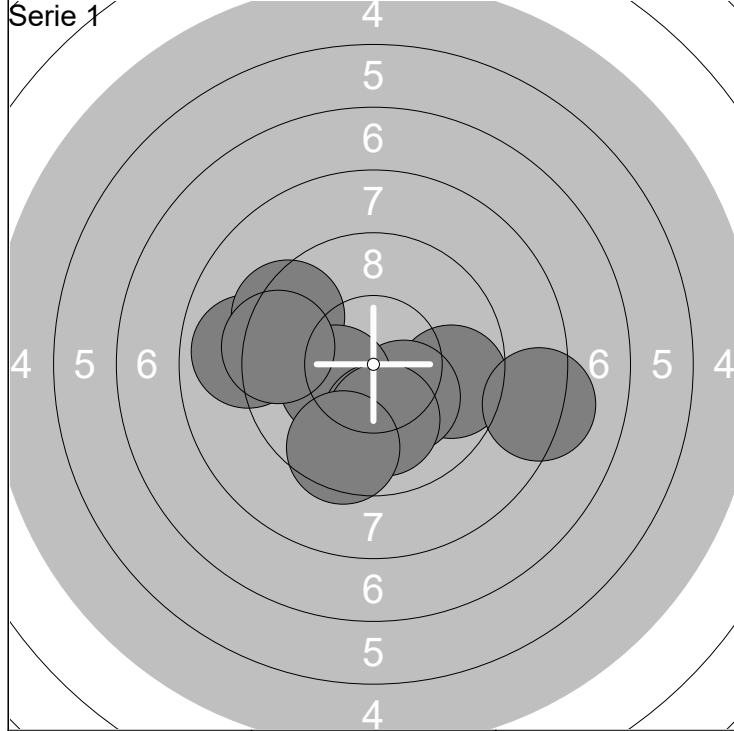

1: 9.7 →	6: 10.2x ←	Serie	92 (2x)
2: 10.2x ↓	7: 10.1 ↓		
3: 8.2 →	8: 9.4 ←	Total	92 (2x)
4: 8.9 ←	9: 10.0 ↓		
5: 9.4 ↗	10: 9.5 ↓		

1: 10.1 ↓	6: 8.7 ↗	Serie	93 (3x)
2: 10.3x ←	7: 9.5 ←		
3: 9.2 ↙	8: 9.6 ←	Total	185 (5x)
4: 10.7x ↓	9: 9.8 ←		
5: 9.6 ↗	10: 10.5x ↑		

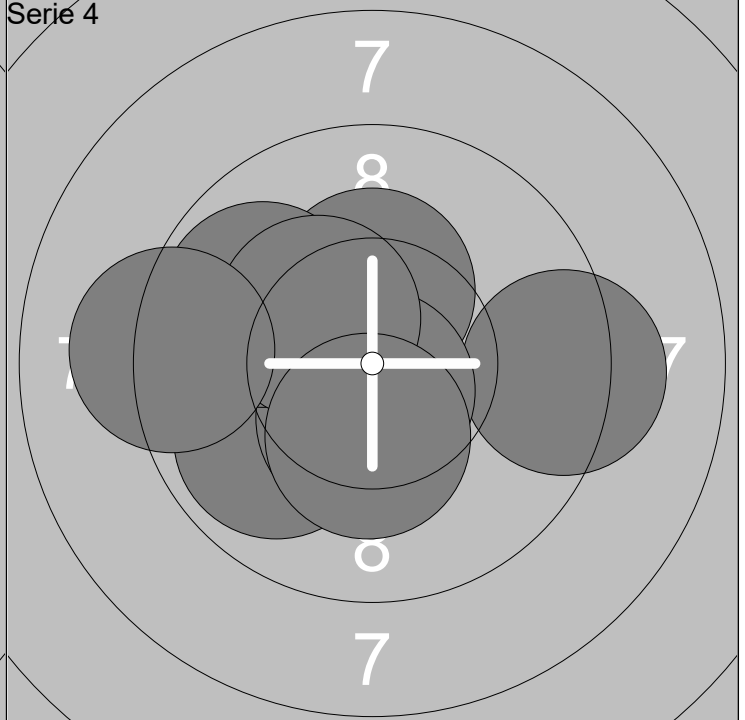
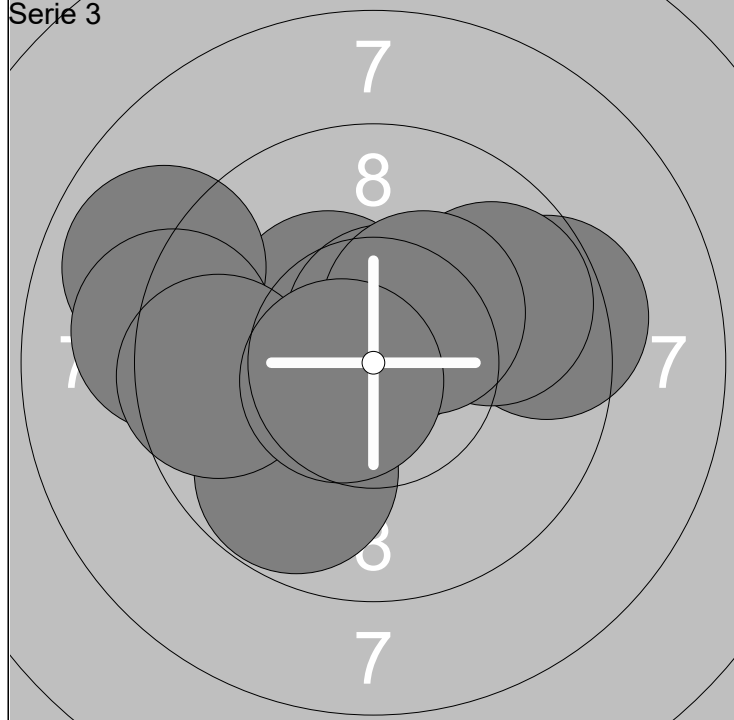

1: 10.3x ↖	6: 9.1 ←	Serie	93 (4x)
2: 9.7 ↓	7: 9.8 ↗		
3: 8.9 ←	8: 9.6 ←	Total	278 (9x)
4: 10.6x ↑	9: 10.3x ↗		
5: 9.4 →	10: 10.6x ←		

1: 9.3 →	6: 10.7x ↓	Serie	95 (5x)
2: 9.9 ←	7: 9.9 ←		
3: 10.3x ↑	8: 10.3x ↖	Total	373 (14x)
4: 9.9 ←	9: 10.3x ↓		
5: 10.4x ↓	10: 9.2 ←		