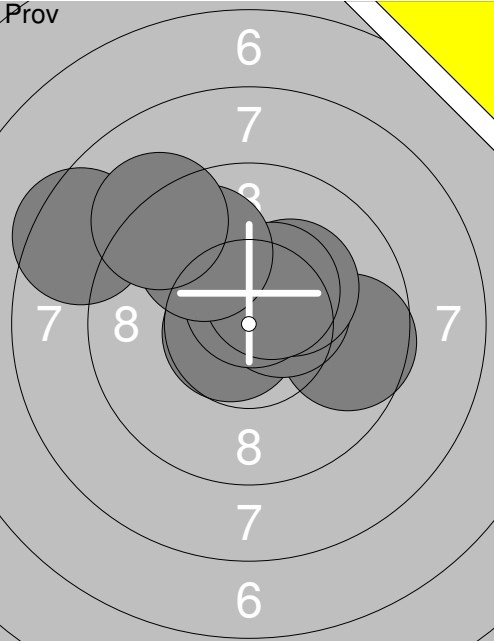
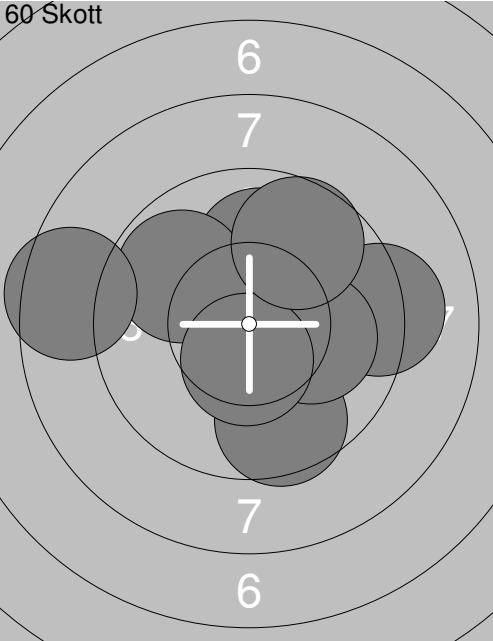
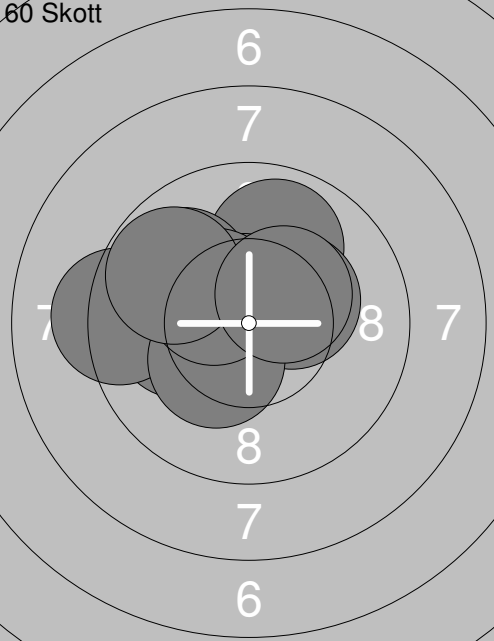
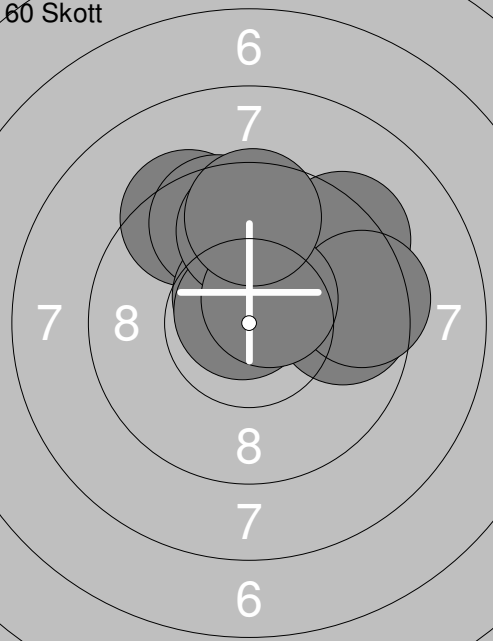
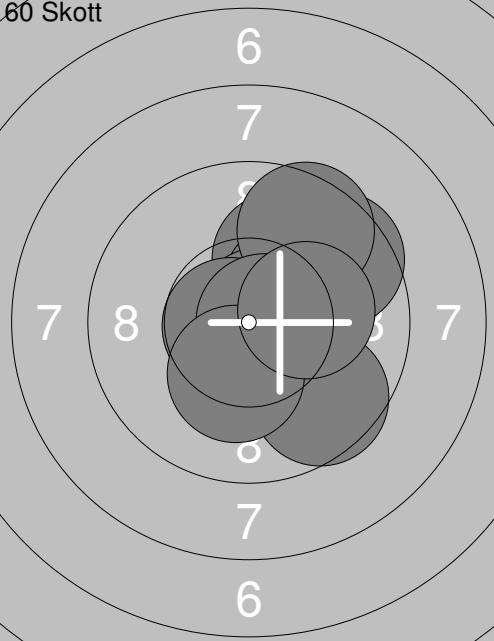
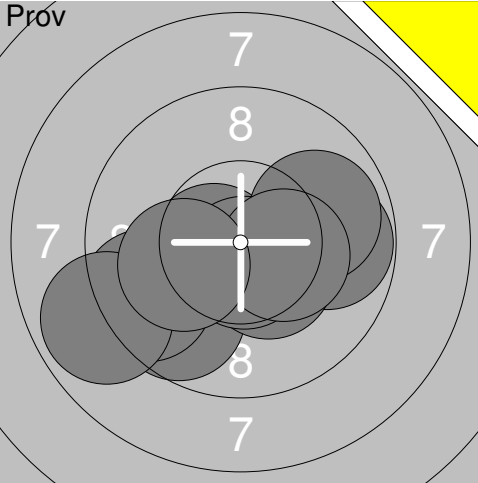
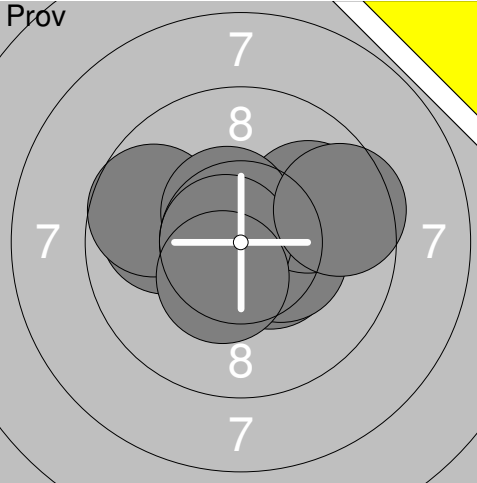
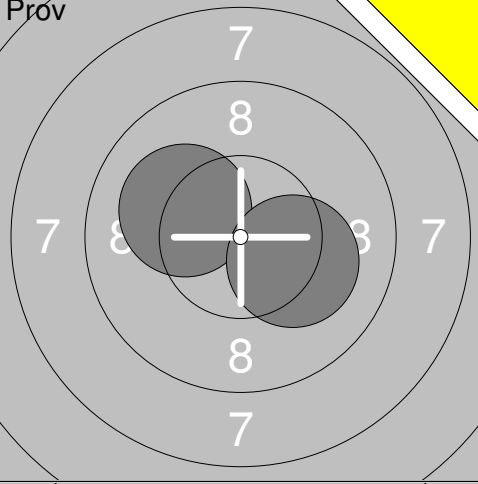
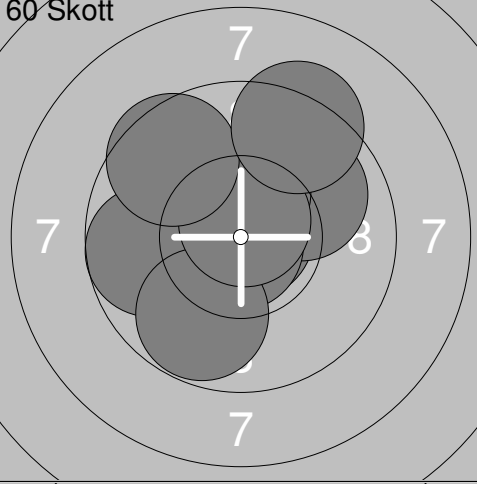
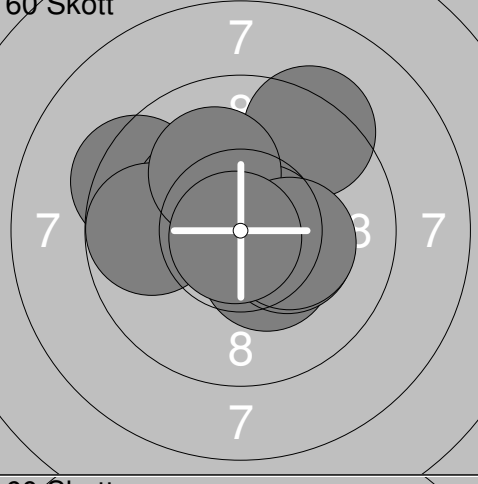
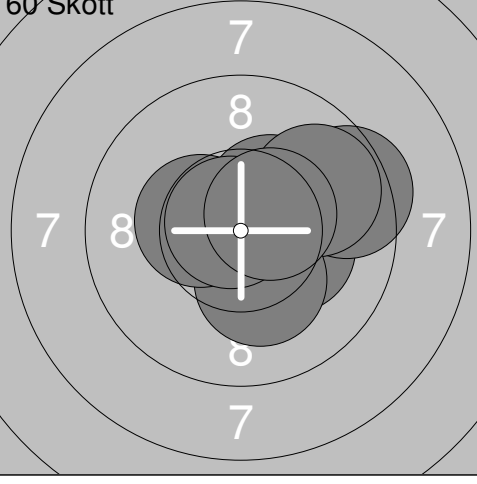
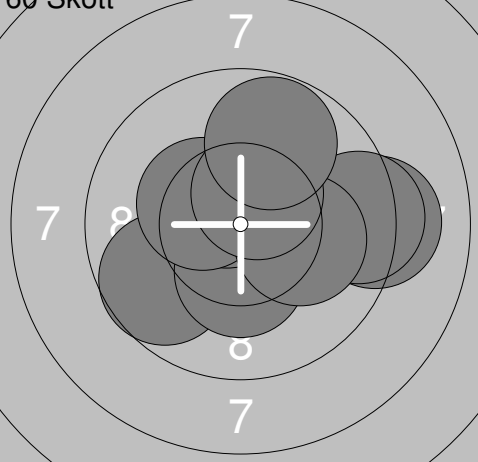
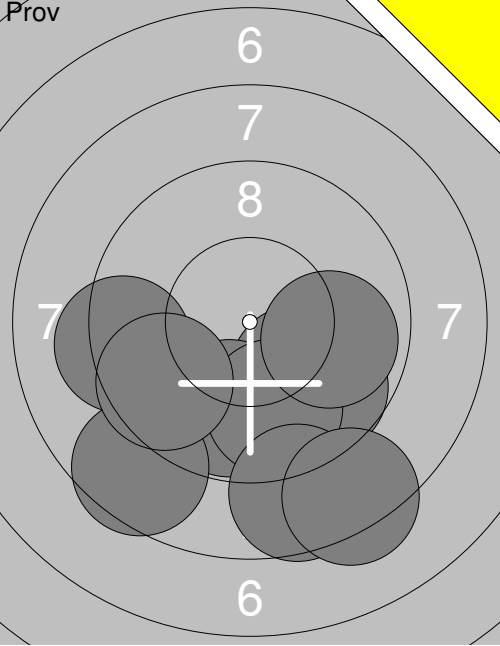
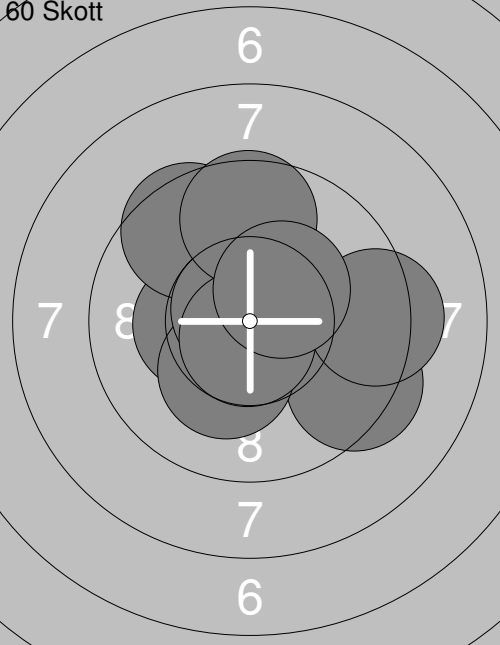
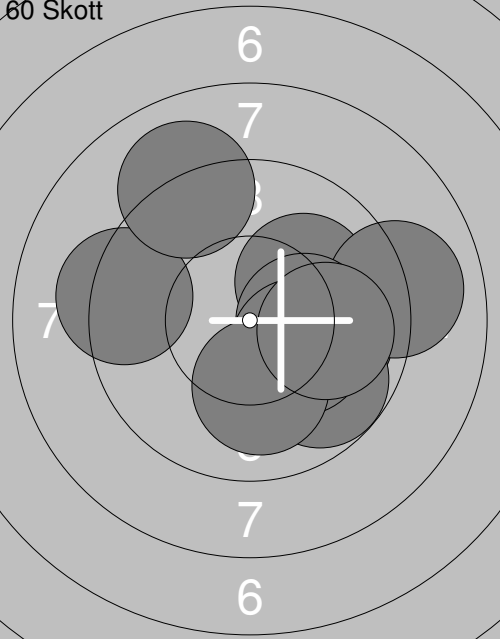
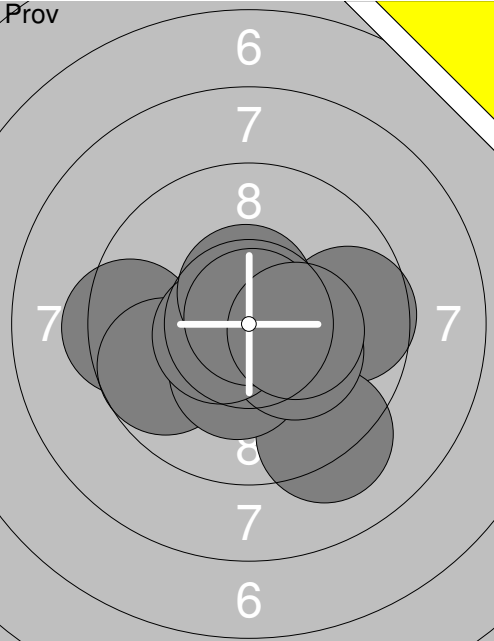
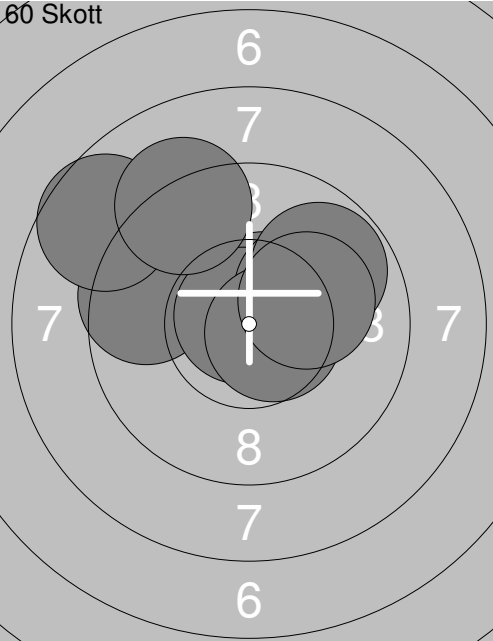
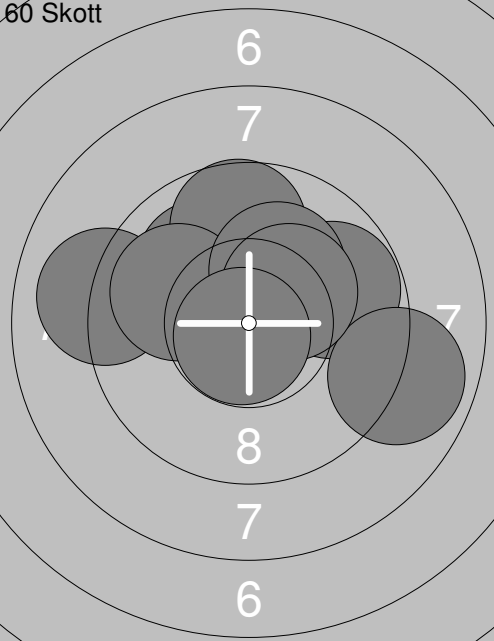
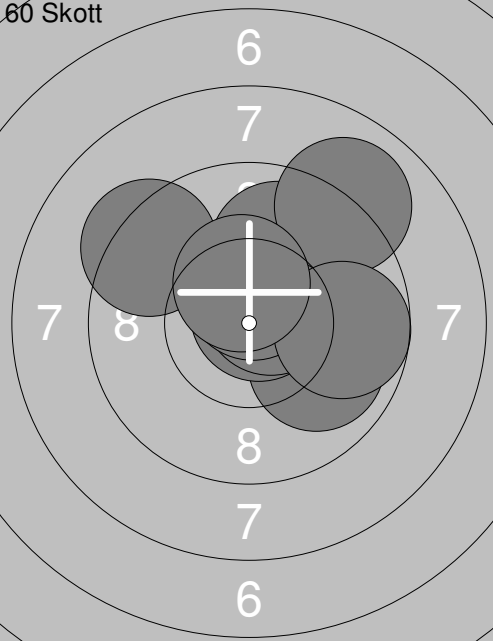
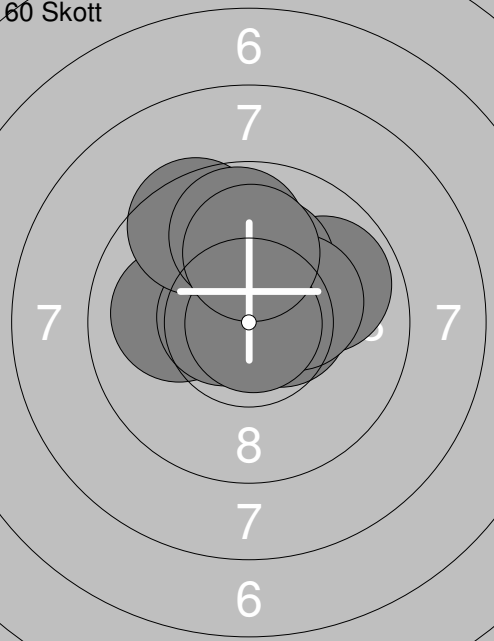

Skjutlag 1	Tavla 6	Erika Bergqvist	
S		Umeå Skytteförening	
02.11.2019		Nationellt SM 2019	
Prov		Umeå skytteallians	
	1: 10.7x ↘		1: 9.2 →
	2: 8.5 ↙		2: 10.3x ↘
	3: 9.6 →		3: 10.7x ↘
	4: 10.5x ↗		4: 10.0 ↑
	5: 10.2x ↗		5: 9.6 ↓
	6: 10.6x ↗		6: 10.1 →
	7: 10.4x ↗		7: 9.8 ↙
	8: 9.9 ↙		8: 10.5x ↓
	9: 9.2 ↙		9: 8.5 ←
	10: 9.7 ↗		10: 9.7 ↗
	Serie 85.0		Serie 94.0
	Total 0.0		Total 94.0
	11: 9.9 ↗		21: 9.4 ↙
	12: 10.1 ←		22: 9.6 ↑
	13: 10.3x ↗		23: 9.3 ↗
	14: 9.3 ←		24: 10.6x ↗
	15: 10.7x ↗		25: 10.8x ↘
	16: 9.9 ↙		26: 9.7 →
	17: 10.3x ↘		27: 9.5 →
	18: 10.4x ↘		28: 9.7 ↑
	19: 9.8 ↙		29: 10.5x ↗
	20: 10.4x ↗		30: 9.6 ↑
	Serie 96.0		Serie 93.0
	Total 190.0		Total 283.0
	31: 9.6 ↗		
	32: 10.0 ↗		
	33: 10.2x ↗		
	34: 10.8x ↗		
	35: 9.5 ↗		
	36: 10.7x ↘		
	37: 9.6 ↓		
	38: 10.7x ↗		
	39: 10.3x ↓		
	40: 10.2x ↗		
	Serie 97.0		
	Total 380.0		

Skjutlag 1	Tavla 7	Hanna Lundin			
S		Umeå Skytteförening			
02.11.2019		Nationellt SM 2019		Umeå skytteallians	
Prov		1: 9.7 ↙ 2: 9.5 ↙ 3: 10.6x ← 4: 9.8 → 5: 10.4x ↘ 6: 9.9 → 7: 8.9 ↙ 8: 10.7x ↓ 9: 10.3x → 10: 10.1 ↙	Prov		11: 10.9x ← 12: 10.5x ↘ 13: 10.4x → 14: 9.9 → 15: 9.9 ← 16: 9.7 ← 17: 10.5x ↗ 18: 10.7x ← 19: 9.5 → 20: 10.4x ↘
		Serie 94.0 Total 0.0			Serie 96.0 Total 0.0
Prov		21: 10.1 ↖ 22: 10.2x ↗	60 Skott		1: 10.8x ↗ 2: 10.4x ↗ 3: 10.0 ↗ 4: 10.8x ↓ 5: 9.7 ← 6: 10.3x ↑ 7: 9.8 ↓ 8: 10.7x ↑ 9: 9.6 ↖ 10: 9.3 ↗
		Serie 20.0 Total 0.0			Serie 96.0 Total 96.0
60 Skott		11: 9.4 ↖ 12: 9.3 ↗ 13: 10.3x ↗ 14: 9.8 ← 15: 10.7x → 16: 10.1 ↗ 17: 10.4x ↘ 18: 10.3x → 19: 10.3x → 20: 10.8x ↘	60 Skott		21: 10.3x → 22: 10.7x ↗ 23: 9.4 → 24: 10.4x ↗ 25: 10.7x → 26: 9.8 ↗ 27: 10.2x ↓ 28: 10.4x ← 29: 10.8x ↖ 30: 10.5x ↗
		Serie 97.0 Total 193.0			Serie 98.0 Total 291.0
60 Skott		31: 9.7 ↙ 32: 10.5x ↘ 33: 10.3x ↓ 34: 10.6x ↗ 35: 10.4x ↗ 36: 9.1 → 37: 9.4 → 38: 10.1 → 39: 10.5x ↗ 40: 9.8 ↗			
		Serie 96.0 Total 387.0			

Skjutlag	Tavla	Kevin Westberg	
S		Forsa Skytteförening	
02.11.2019	Nationellt SM 2019	Umeå skytteallians	
Prov		1: 10.0 ↘ 2: 9.3 ← 3: 9.8 ↓ 4: 8.6 ↘ 5: 9.7 ↘ 6: 9.8 ↓ 7: 8.6 ↓ 8: 8.3 ↓ 9: 9.6 ↙ 10: 9.9 →	11: 10.1 ↓ 12: 9.3 → 13: 9.9 ↗
	Serie 88.0	Serie 28.0	
	Total 0.0	Total 0.0	
60 Skott		1: 10.3x ← 2: 9.4 → 3: 9.5 ↗ 4: 10.2x ↓ 5: 10.4x ↗ 6: 9.3 → 7: 10.7x ↘ 8: 9.6 ↑ 9: 10.7x ↓ 10: 10.4x ↗	11: 9.5 ← 12: 10.6x ← 13: 9.8 ↑ 14: 10.4x → 15: 10.3x ↘ 16: 9.9 ↙ 17: 10.0 ↑ 18: 10.4x → 19: 10.1 ↑ 20: 10.0 ↙
	Serie 96.0	Serie 97.0	
	Total 96.0	Total 193.0	
60 Skott		21: 9.9 → 22: 9.3 ← 23: 10.1 ↗ 24: 9.1 ↑ 25: 9.8 ↘ 26: 9.0 → 27: 10.2x → 28: 10.2x → 29: 10.1 ↓ 30: 10.0 →	31: 9.5 ↓ 32: 10.3x ← 33: 10.0 ↓ 34: 9.2 → 35: 10.0 → 36: 10.9x ↗ 37: 10.2x ↗ 38: 10.1 ↓ 39: 10.1 ↓ 40: 9.8 ↓
	Serie 95.0	Serie 97.0	
	Total 288.0	Total 385.0	

Skjutlag 1	Tavla 10	Linus Eriksson	
S		Delsbo-Bjuråkers Skytteförening	
02.11.2019		Nationellt SM 2019	
Umeå skytteallians			
	1: 9.4 ← 2: 9.7 → 3: 9.7 ← 4: 9.2 ↘ 5: 10.3x↓ 6: 10.3x↘ 7: 10.6x↖ 8: 10.5x↑ 9: 10.8x↗ 10: 10.3x→ Serie 96.0 Total 0.0		1: 10.2x↗ 2: 9.6 ← 3: 10.6x↗ 4: 10.8x↖ 5: 10.1 ↗ 6: 10.6x↘ 7: 8.7 ↖ 8: 9.8 ↗ 9: 10.1 ↗ 10: 9.2 ↖ Serie 95.0 Total 95.0
	11: 10.0 ↖ 12: 9.0 ← 13: 10.7x↖ 14: 9.7 ↑ 15: 9.8 → 16: 8.9 → 17: 9.9 ← 18: 10.2x↗ 19: 10.3x↗ 20: 10.8x↘ Serie 94.0 Total 189.0		21: 9.9 ↘ 22: 10.2x↗ 23: 10.8x↗ 24: 10.6x↗ 25: 10.5x↑ 26: 9.9 ↑ 27: 9.3 ↖ 28: 9.0 ↗ 29: 9.7 → 30: 10.4x↑ Serie 95.0 Total 284.0
	31: 10.5x→ 32: 9.9 → 33: 10.0← 34: 10.2x↑ 35: 10.3x→ 36: 10.6x↖ 37: 10.9x→ 38: 9.5 ↖ 39: 9.8 ↑ 40: 10.0 ↑ Serie 97.0 Total 381.0		

Skjutlag	Tavla	Maya Björklund	
1	11		
S		Filipstads Skyttegille	
02.11.2019		Nationellt SM 2019	
Umeå skytteallians			
Prov		1: 8.7 ↗ 3: 9.9 ↘ 4: 8.8 ← 5: 9.4 → 6: 9.6 → 7: 10.3x ↘ 8: 10.3x ← 9: 9.6 ← 10: 9.7 ↘ Serie 81.0 Total 0.0	11: 10.1 ↗ 12: 10.3x ← 13: 10.7x ↘ 14: 10.0 ↗ 15: 8.6 ↗ 16: 10.1 ← 17: 7.7 ↗ 18: 9.3 ← 19: 10.4x ← 20: 10.3x ↗ Serie 94.0 Total 0.0
Prov		21: 9.7 ↘ Serie 9.0 Total 0.0	60 Skott
		1: 10.8x ↘ 2: 10.5x ↘ 3: 9.1 ↗ 4: 10.0 ↘ 5: 9.4 ↗ 6: 10.6x ← 7: 9.2 ↗ 8: 9.1 ← 9: 10.3x ↗ 10: 10.6x ↘ Serie 96.0 Total 96.0	
60 Skott		11: 10.4x ↗ 12: 10.0 ↗ 13: 9.7 ↘ 14: 9.5 ↘ 15: 10.2x → 16: 10.8x → 17: 10.4x ↗ 18: 10.3x ← 19: 10.5x ↗ 20: 9.9 ← Serie 97.0 Total 193.0	60 Skott
		21: 9.8 ↗ 22: 10.1 ↗ 23: 10.1 ← 24: 10.2x ↗ 25: 9.5 ↗ 26: 9.4 ↗ 27: 9.5 ← 28: 9.8 ↗ 29: 9.6 ↘ 30: 9.8 ↘ Serie 93.0 Total 286.0	
60 Skott		31: 10.2x ↘ 32: 9.5 ↗ 33: 9.0 ↘ 34: 9.5 ↗ 35: 9.9 → 36: 10.4x ↗ 37: 10.6x ↘ 38: 9.9 ↘ 39: 9.9 → 40: 9.9 → Serie 93.0 Total 379.0	

Skjutlag	Tavla	Nicolle Nygren	
S		Umeå Skytteförening	
02.11.2019	Nationellt SM 2019	Umeå skytteallians	
	1: 9.9 → 2: 9.7 ↘ 3: 9.5 ↓ 4: 10.7✕← 5: 10.9✕↓ 6: 9.4 ↙ 7: 9.4 ↓ 8: 9.6 ↘ 10: 10.3✕↗		11: 9.8 ← 12: 10.3✕↘ 13: 10.6✕← 14: 10.4✕↘
	Serie 84.0		Serie 39.0
	Total 0.0		Total 0.0
	1: 10.4✕↘ 2: 10.6✕↘ 3: 10.7✕↙ 4: 10.6✕↘ 5: 10.5✕↗ 6: 9.8 ↑ 7: 10.2✕↗ 8: 9.4 → 9: 9.2 ↑ 10: 10.3✕↘		11: 9.9 ↙ 12: 10.3✕↗ 13: 10.9✕↘ 14: 10.2✕↗ 15: 9.6 ↖ 16: 9.9 ← 17: 10.3✕↗ 18: 9.5 ← 19: 9.9 ← 20: 10.0 ↖
	Serie 97.0		Serie 95.0
	Total 97.0		Total 192.0
	21: 10.5✕↗ 22: 10.3✕↘ 23: 10.1 ↖ 24: 9.9 ↑ 25: 10.1 ↖ 26: 10.2✕← 27: 10.7✕↘ 28: 10.3✕← 29: 10.1 ↑ 30: 10.9✕↘		31: 10.4✕↓ 32: 10.6✕↘ 33: 9.8 ← 34: 9.8 ← 35: 10.2✕← 36: 9.7 ↖ 37: 9.4 ↗ 38: 10.3✕← 39: 10.7✕↘ 40: 10.5✕↗
	Serie 99.0		Serie 96.0
	Total 291.0		Total 387.0

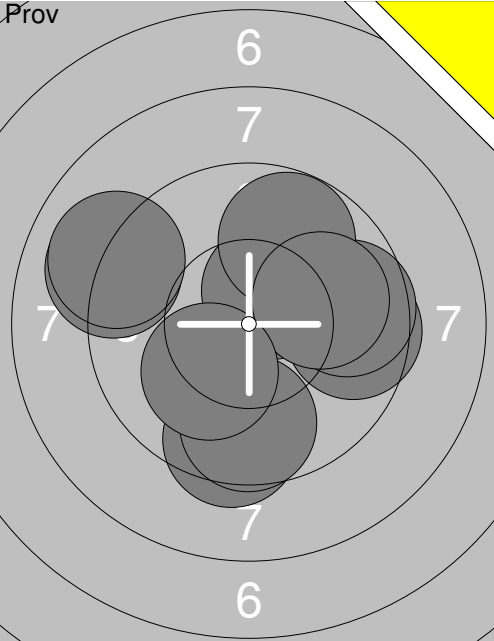
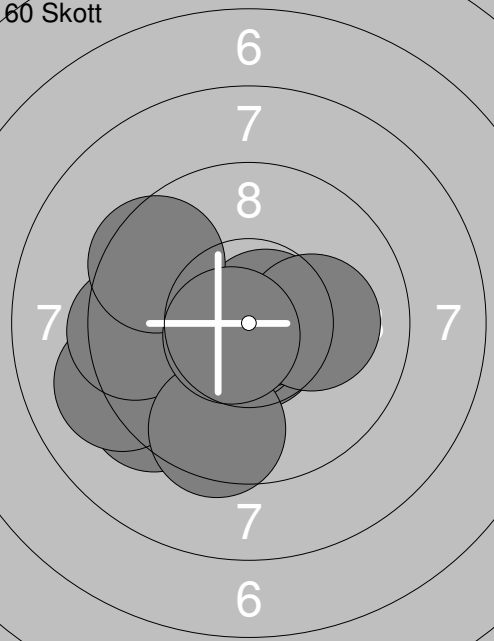
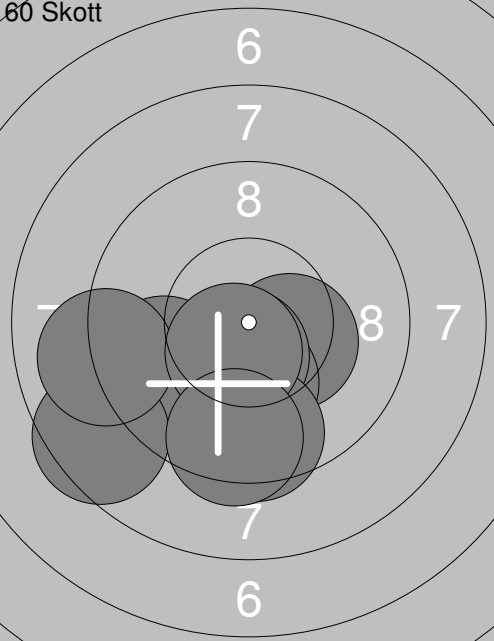
Skjutlag	Tavla	Beatrice Andersson	
1	13		
S	Ramselefors Skytteförening		
02.11.2019	Nationellt SM 2019	Umeå skytteallians	
Prov		1: 10.4x ↗ 2: 9.0 ← 3: 9.6 → 4: 9.7 → 5: 9.8 ↗ 6: 10.0 → 7: 9.4 ↓ 8: 9.7 ↓ 9: 10.1 ↘ 10: 9.0 ← Serie 93.0 Total 0.0	11: 9.2 ↓ 12: 9.7 ↗ 13: 9.8 ↓ 14: 10.5x ↘ Serie 37.0 Total 0.0
60 Skott		1: 10.7x ↘ 2: 10.7x ↘ 3: 9.3 ↙ 4: 9.1 ← 5: 9.5 ← 6: 10.7x → 7: 9.5 ↓ 8: 10.1 → 9: 9.5 ↙ 10: 10.7x ↘ Serie 95.0 Total 95.0	11: 8.5 ← 12: 9.4 ← 13: 9.0 ↓ 14: 8.9 ← 15: 10.0 ↙ 16: 9.5 ↓ 17: 9.1 ← 18: 10.7x ↘ 19: 10.5x ↘ 20: 9.8 ↓ Serie 91.0 Total 186.0
60 Skott		21: 9.1 ← 22: 10.4x ↘ 23: 10.2x ↓ 24: 9.7 ← 25: 8.5 ← 26: 9.0 ← 27: 10.5x ↓ 28: 9.5 ↓ 29: 10.5x ↘ 30: 9.4 ↓ Serie 93.0 Total 279.0	31: 9.1 ← 32: 10.5x ↘ 33: 8.8 ↓ 34: 8.7 ↓ 35: 8.7 ↓ 36: 9.0 ← 37: 10.1 ↙ 38: 10.2x ↓ 39: 9.6 ↗ 40: 10.1 ↘ Serie 91.0 Total 370.0

Skjutlag	Tavla	Hanna Johansson	
S		Vännäs Skytteförening	
02.11.2019	Nationellt SM 2019	Umeå skytteallians	
Prov		1: 9.0 ↗ 2: 10.9x↗ 4: 9.4 ← 5: 10.1 ↗ 6: 9.6 ↖ 7: 9.1 ↓ 8: 10.2x↘ 9: 9.0 ← 10: 9.1 →	Prov
		Serie 84.0	11: 9.9 ↖
		Total 0.0	
			Serie 9.0
			Total 0.0
60 Skott		1: 9.9 ↘ 2: 10.7x↘ 3: 9.0 ↘ 4: 10.5x↗ 5: 10.3x↘ 6: 10.1 ↗ 7: 10.5x↗ 8: 9.9 ↓ 9: 10.5x↖ 10: 10.2x↗	60 Skott
		Serie 97.0	11: 10.2x↗
		Total 97.0	12: 9.2 ↗
			13: 10.7x↗
			14: 9.7 →
			15: 10.4x↖
			16: 9.9 ↑
			17: 8.9 ↗
			18: 9.7 ↗
			19: 8.7 ↖
			20: 10.0 ↗
			Serie 92.0
			Total 189.0
60 Skott		21: 10.4x↗ 22: 10.0 ↖ 23: 9.1 ↖ 24: 9.9 ← 25: 9.4 ↘ 26: 9.7 ↗ 27: 10.7x↘ 28: 10.1 → 29: 8.4 → 30: 10.7x↗	60 Skott
		Serie 94.0	31: 10.0 →
		Total 283.0	32: 10.3x↖
			33: 9.6 →
			34: 10.6x↗
			35: 10.9x↖
			36: 10.0 ↖
			37: 10.2x↗
			38: 9.1 ↗
			39: 10.5x↗
			40: 10.1 ↗
			Serie 98.0
			Total 381.0

Skjutlag	Tavla	Ebba Lundstedt	
S		Ramselefors Skytteförening	
02.11.2019	Nationellt SM 2019	Umeå skytteallians	
Prov		1: 9.8 ↘ 2: 9.7 ← 3: 10.3x↘ 4: 10.5x↓ 5: 9.6 ↓ 6: 10.4x↗ 7: 10.2x↘ 8: 9.3 ↖ 10: 9.5 ↖ Serie 85.0 Total 0.0	11: 9.2 ↗ Serie 9.0 Total 0.0
60 Skott		1: 9.2 ↓ 2: 8.9 ↗ 3: 8.7 ↓ 4: 8.5 ↘ 5: 10.7x↓ 6: 8.7 ↖ 7: 8.7 ↓ 8: 10.6x→ 9: 9.0 ↓ 10: 9.6 ↓ Serie 87.0 Total 87.0	11: 9.7 ↖ 12: 9.2 → 13: 9.0 ← 14: 10.1↖ 15: 8.3 ↓ 16: 8.2 ← 17: 8.1 ↖ 18: 9.5 → 19: 8.4 ↓ 20: 10.4x↘ Serie 88.0 Total 175.0
60 Skott		21: 7.1 ↘ 22: 8.4 ← 23: 8.7 ↘ 24: 7.6 ← 25: 10.2x↓ 26: 9.1 ← 27: 9.2 ↑ 28: 9.6 ↑ 29: 7.2 ← 30: 8.9 ↖ Serie 82.0 Total 257.0	31: 9.0 ↖ 32: 10.0 ↗ 33: 9.2 ↑ 34: 8.3 ↑ 35: 7.9 ← 36: 9.9 ↖ 37: 8.8 ← 38: 10.2x↖ 39: 10.6x↖ 40: 8.8 ← Serie 88.0 Total 345.0

<p>Prov</p>	<p>1: 9.9 ↘ 2: 10.6x↘ 3: 10.2x↘ 4: 9.2 ↘ 5: 10.3x↗ 6: 10.8x↘ 7: 10.0 ↗ 8: 9.8 ↑ 9: 9.6 → 10: 10.0 ↘</p> <p>Serie 96.0 Total 0.0</p>	<p>Prov</p>	<p>12: 8.0 → 13: 10.5x↑</p> <p>Serie 18.0 Total 0.0</p>
-------------	---	-------------	---

<p>60 Skott</p>	<p>1: 9.9 ↘ 2: 10.1 ↘ 3: 10.1 ↑ 4: 10.9x→ 5: 10.4x↗ 6: 8.7 ← 7: 9.7 ↑ 8: 9.6 ↑ 9: 9.7 ↑ 10: 10.3x↘</p> <p>Serie 94.0 Total 94.0</p>	<p>60 Skott</p>	<p>11: 8.9 ↖ 12: 9.8 ↑ 13: 10.2x↑ 14: 9.8 ↑ 15: 10.3x→ 16: 9.6 ↗ 17: 9.6 ↗ 18: 10.0 ↘ 19: 10.3x← 20: 9.6 ↓</p> <p>Serie 93.0 Total 187.0</p>
-----------------	---	-----------------	--

<p>60 Skott</p>	<p>21: 10.7x↘ 22: 10.1 ↖ 23: 10.1 ↖ 24: 10.3x↘ 25: 10.8x↘ 26: 10.8x→ 27: 10.2x↘ 28: 10.4x↑ 29: 10.8x↘ 30: 10.0 ↖</p> <p>Serie 100.0 Total 287.0</p>	<p>60 Skott</p>	<p>31: 9.4 → 32: 9.8 ← 33: 9.5 ↑ 34: 10.5x↑ 35: 8.8 ← 36: 8.9 ↗ 37: 10.6x→ 38: 10.5x↘ 39: 9.2 ← 40: 10.5x↑</p> <p>Serie 92.0 Total 379.0</p>
-----------------	---	-----------------	--

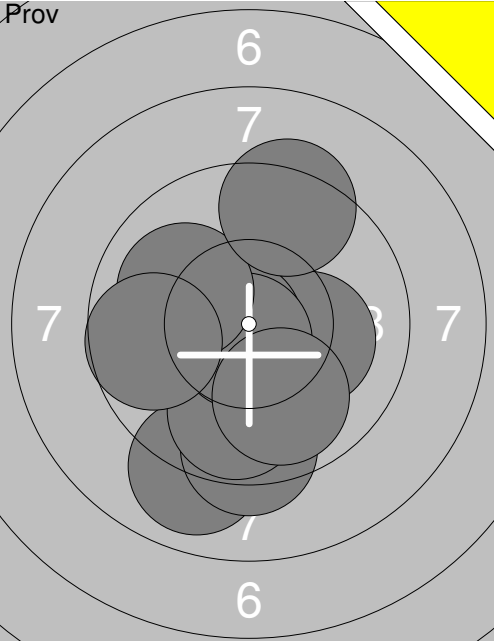
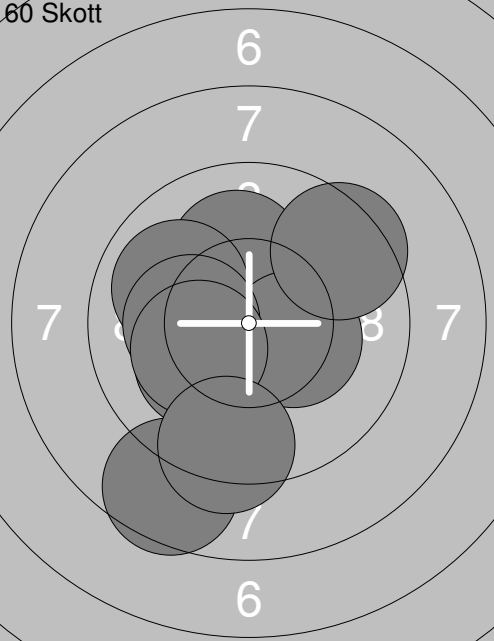
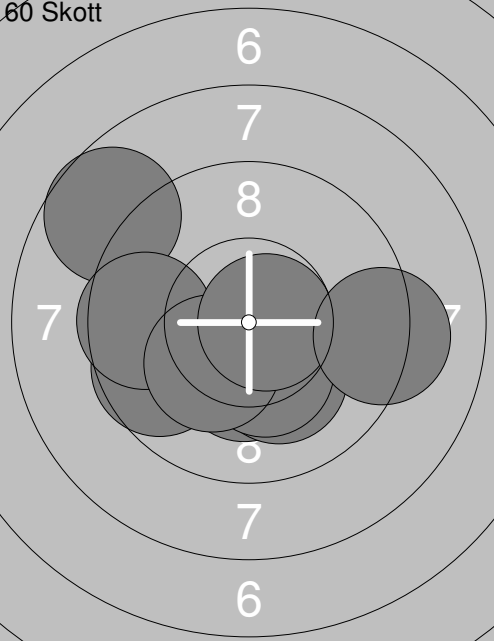
Skjutlag	Tavla	Beatrice Andersson	
S		Ramselefors Skytteförening	
02.11.2019	Nationellt SM 2019	Umeå skytteallians	
Prov		1: 9.0 ↓ 2: 9.3 ↓ 3: 9.8 ↓ 4: 10.2x → 5: 10.8x ← 6: 10.7x ↓ 7: 9.9 ↓ 8: 10.0 ← 9: 9.3 ↑ 10: 9.7 ←	11: 9.1 ← 12: 10.1 ←
		Serie 94.0	Serie 19.0
		Total 0.0	Total 0.0
60 Skott		1: 10.3x ← 2: 10.1 ↑ 3: 10.0 ← 4: 10.2x ← 5: 10.3x → 6: 8.6 ↓ 7: 10.2x ← 8: 9.4 ↗ 9: 10.2x ← 10: 9.3 ↓	11: 9.8 ← 12: 7.9 ← 13: 9.0 ← 14: 9.8 ← 15: 9.9 ↘ 16: 9.4 ← 17: 10.3x ← 18: 9.5 ↓ 19: 8.9 ↑ 20: 10.7x ←
		Serie 96.0	Serie 89.0
		Total 96.0	Total 185.0
60 Skott		21: 10.6x ↓ 22: 9.6 ← 23: 10.3x ↓ 24: 10.2x ↓ 25: 8.7 ↖ 26: 9.6 ← 27: 10.3x ↓ 28: 10.2x ↓ 29: 10.7x → 30: 9.2 →	31: 9.5 ← 32: 10.2x ↗ 33: 10.1 ↘ 34: 9.0 ← 35: 10.3x ← 36: 10.3x ↗ 37: 9.2 ← 38: 9.1 ↑ 39: 10.4x ↓ 40: 9.6 ↖
		Serie 95.0	Serie 95.0
		Total 280.0	Total 375.0

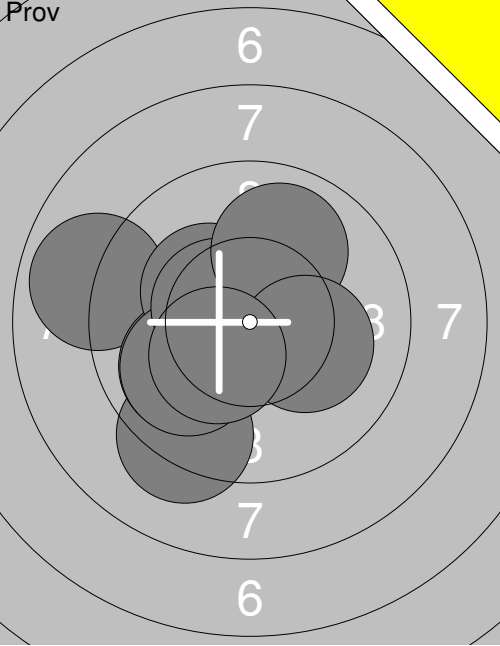
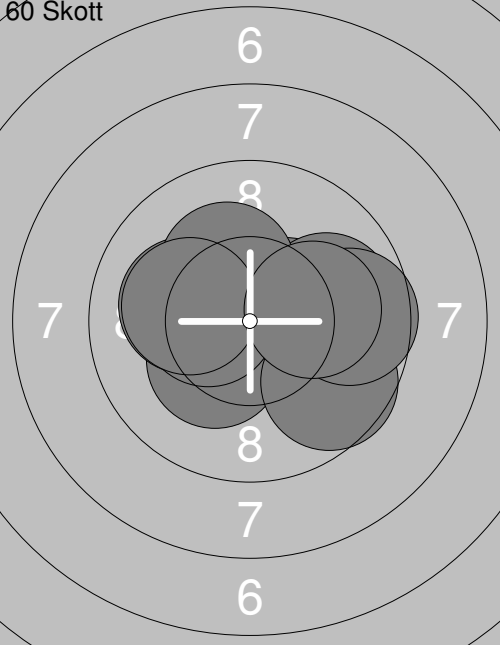
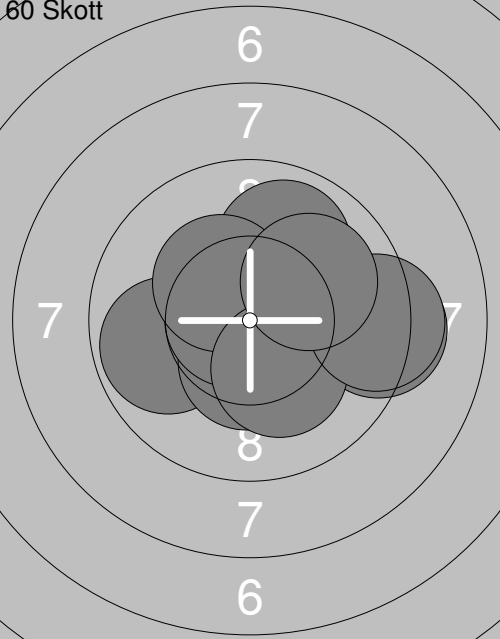
Skjutlag	Tavla	Hanna Lundin	
S		Umeå Skytteförening	
02.11.2019	Nationellt SM 2019	Umeå skytteallians	
Prov		1: 9.3 ↘ 2: 8.9 ← 3: 10.0 ↙ 4: 10.6x ↗ 5: 10.3x ↘ 6: 10.0 ↙ 7: 10.5x ↘ 8: 10.0 ↗ 9: 10.2x ↗ 10: 10.3x ↘ Serie 97.0 Total 0.0	11: 10.1 ↙ 12: 10.4x ↗ Serie 20.0 Total 0.0
60 Skott		1: 10.4x ↗ 2: 10.3x ↘ 3: 9.9 → 4: 10.1 ← 5: 10.4x ← 6: 9.6 ↘ 7: 9.6 → 8: 10.2x ↗ 9: 10.1 ← 10: 10.1 → Serie 97.0 Total 97.0	11: 10.0 ↗ 12: 9.8 → 13: 9.9 → 14: 10.2x ↗ 15: 10.7x ↗ 16: 10.6x ↘ 17: 10.4x ↘ 18: 9.8 ← 19: 10.9x ↗ 20: 10.3x ↘ Serie 97.0 Total 194.0
60 Skott		21: 10.1 ↗ 22: 9.8 ← 23: 10.4x ↘ 24: 9.3 → 25: 9.9 ↗ 26: 10.7x ← 27: 10.3x ↘ 28: 10.2x ↘ 29: 9.3 → 30: 10.0 ↗ Serie 96.0 Total 290.0	31: 10.4x ↗ 32: 10.0 ← 33: 9.6 ↘ 34: 10.9x ↘ 35: 10.5x ↗ 36: 10.6x ↘ 37: 10.7x ↘ 38: 10.3x ↗ 39: 9.7 → 40: 10.4x ↗ Serie 98.0 Total 388.0

<p>Prov</p>	<p>1: 9.5 ↗</p> <p>2: 10.5x↓</p> <p>3: 9.7 ↓</p> <p>4: 9.9 ←</p> <p>5: 10.1 ↘</p> <p>6: 9.0 ↘</p> <p>7: 10.2x→</p> <p>8: 7.9 ←</p> <p>9: 10.1 ↘</p> <p>10: 9.9 ←</p> <p>Serie 92.0</p> <p>Total 0.0</p>	<p>Prov</p>	<p>11: 10.2x↓</p> <p>Serie 10.0</p> <p>Total 0.0</p>
-------------	---	-------------	--

<p>60 Skott</p>	<p>1: 10.4x↗</p> <p>2: 10.2x↓</p> <p>3: 9.9 ↑</p> <p>4: 10.6x→</p> <p>5: 9.5 ←</p> <p>6: 10.3x↖</p> <p>7: 10.1 ↘</p> <p>8: 8.8 →</p> <p>9: 10.3x↗</p> <p>10: 10.4x→</p> <p>Serie 96.0</p> <p>Total 96.0</p>	<p>60 Skott</p>	<p>11: 9.0 ←</p> <p>12: 9.3 ↘</p> <p>13: 10.6x↗</p> <p>14: 10.4x↗</p> <p>15: 9.9 ↑</p> <p>16: 10.6x↖</p> <p>17: 9.8 ←</p> <p>18: 8.7 ↘</p> <p>19: 10.5x↗</p> <p>20: 10.1 ↘</p> <p>Serie 94.0</p> <p>Total 190.0</p>
-----------------	---	-----------------	---

<p>60 Skott</p>	<p>21: 10.3x↓</p> <p>22: 9.9 ↘</p> <p>23: 8.9 →</p> <p>24: 10.6x↓</p> <p>25: 10.5x↓</p> <p>26: 10.2x↖</p> <p>27: 9.9 →</p> <p>28: 9.2 →</p> <p>29: 9.8 ↓</p> <p>30: 10.6x↗</p> <p>Serie 94.0</p> <p>Total 284.0</p>	<p>60 Skott</p>	<p>31: 9.4 ←</p> <p>32: 10.3x↖</p> <p>33: 10.3x↓</p> <p>34: 9.8 ↘</p> <p>35: 9.8 ↗</p> <p>36: 10.8x↗</p> <p>37: 10.0 →</p> <p>38: 9.8 →</p> <p>39: 9.2 ←</p> <p>40: 10.6x↖</p> <p>Serie 95.0</p> <p>Total 379.0</p>
-----------------	---	-----------------	---

Skjutlag	Tavla	Linus Eriksson	
S		Delsbo-Bjuråkers Skytteförening	
02.11.2019	Nationellt SM 2019	Umeå skytteallians	
Prov		1: 10.0 ← 2: 9.8 ← 3: 10.7 ✕ 4: 9.3 ↑ 5: 9.4 → 6: 9.4 ← 7: 10.0 ↖ 8: 10.5 ✕ 9: 10.2 ✕ 10: 10.7 ✕	11: 9.5 ↗ 12: 10.2 ✕ 13: 10.7 ✕
	Serie 96.0	Serie 29.0	
	Total 0.0	Total 0.0	
60 Skott		1: 9.9 ↗ 2: 9.8 ↖ 3: 9.7 ↘ 4: 10.6 ✕ 5: 10.3 ✕ 6: 9.9 → 7: 9.5 → 8: 9.4 → 9: 10.1 → 10: 10.1 →	11: 9.3 → 12: 10.5 ✕ 13: 10.4 ✕ 14: 10.2 ✕ 15: 9.8 ↗ 16: 10.0 → 17: 10.0 → 18: 8.4 → 19: 10.1 ↘ 20: 10.4 ✕
	Serie 94.0	Serie 96.0	
	Total 94.0	Total 190.0	
60 Skott		21: 10.5 ✕ 22: 10.4 ✕ 23: 9.3 ← 24: 9.9 → 25: 9.4 ↗ 26: 9.4 → 27: 10.4 ✕ 28: 9.6 ↗ 29: 10.3 ✕ 30: 10.0 ↓	31: 9.8 ↘ 32: 10.3 ✕ 33: 7.2 ↓ 34: 10.1 ↘ 35: 9.7 ↗ 36: 10.3 ✕ 37: 8.1 → 38: 8.7 → 39: 9.7 ↑ 40: 10.0 →
	Serie 95.0	Serie 90.0	
	Total 285.0	Total 375.0	

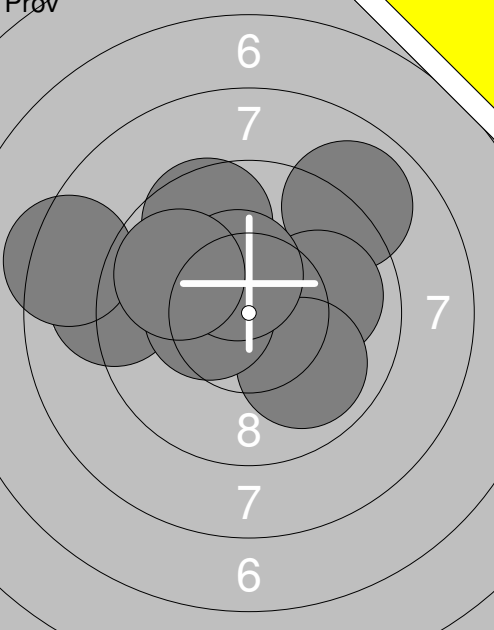
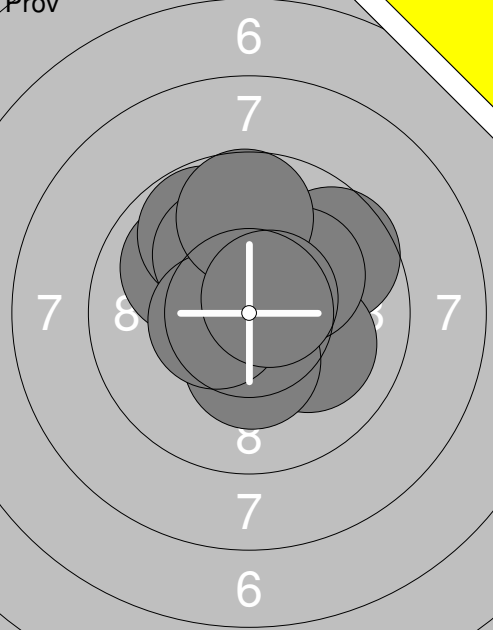
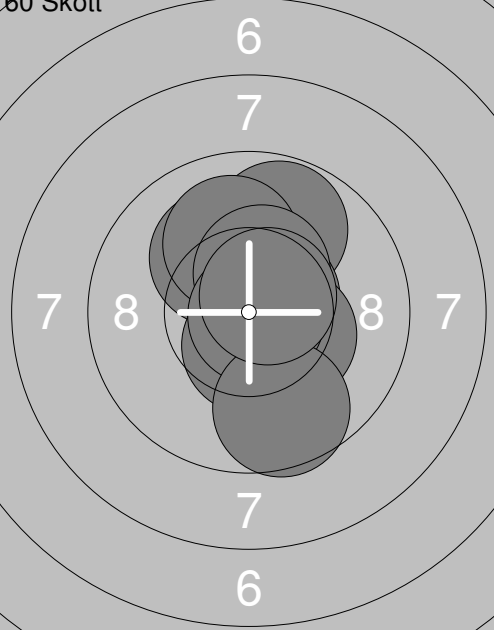
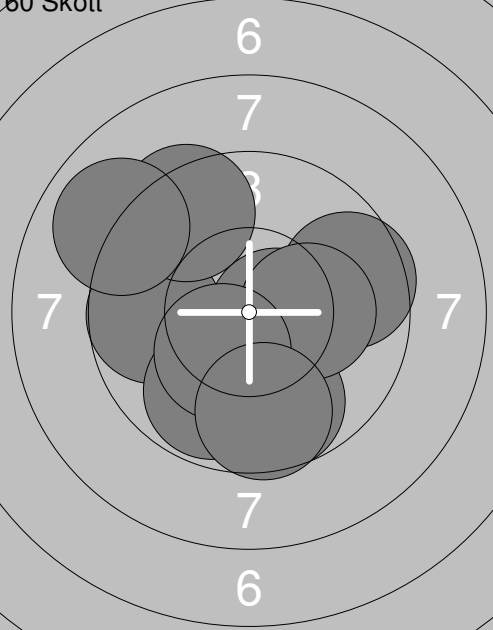
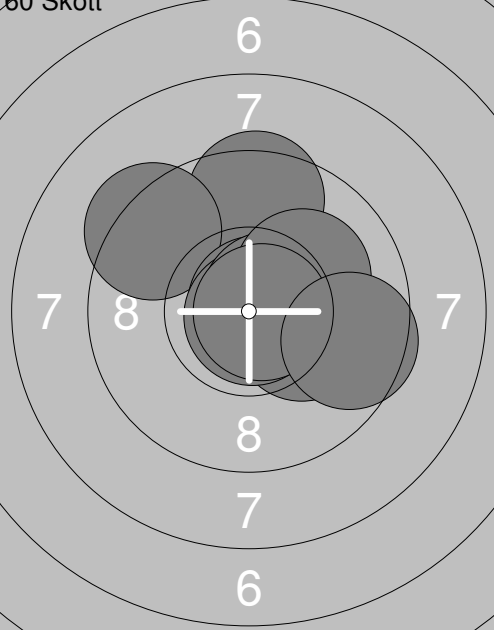
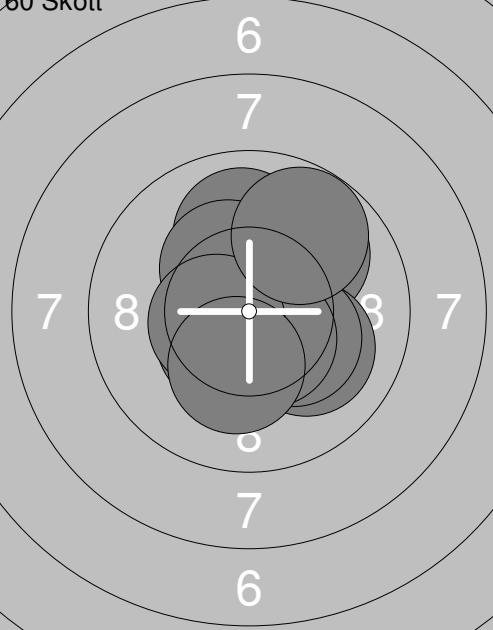
Prov	Prov	Prov
	1: 10.3x ↘ 2: 9.0 ↗ 3: 9.6 ↖ 4: 10.0 → 5: 9.9 ↘ 6: 9.1 ← 7: 10.4x ← 8: 8.4 ← 9: 10.4x ↗ 10: 9.9 ↖ Serie 93.0 Total 0.0	
	11: 9.6 ↗ 12: 10.1 ↘ 13: 10.0 ↖ 14: 10.2x ↗ 15: 9.8 ↖ 16: 10.1 ↖ 17: 10.3x ↘ 18: 10.5x ← 19: 9.7 ↑ 20: 10.6x ↗ Serie 97.0 Total 0.0	
	1: 10.1 ↖ 2: 10.5x ↘ 3: 9.8 ↗ 4: 10.0 ↗ 5: 10.6x ↗ 6: 10.4x ↗ 7: 10.4x ↘ 8: 10.8x ↘ 9: 9.6 ↘ 10: 10.6x ↗ Serie 98.0 Total 98.0	
	11: 9.7 ← 12: 9.4 ↖ 13: 8.9 ↖ 14: 9.6 → 15: 10.6x → 16: 9.7 ↘ 17: 10.2x → 18: 9.8 ↘ 19: 10.3x ↘ 20: 9.6 ↘ Serie 92.0 Total 190.0	
	21: 9.5 ↑ 22: 10.3x → 23: 10.2x → 24: 9.3 ↖ 25: 10.8x ↗ 26: 10.9x ↘ 27: 10.6x ↗ 28: 10.1 ↗ 29: 10.8x → 30: 9.6 → Serie 97.0 Total 287.0	
	31: 9.9 ↗ 32: 10.0 ↑ 33: 10.3x ↘ 34: 10.1 ↘ 35: 10.5x ↘ 36: 10.3x ↘ 37: 10.5x ↘ 38: 10.5x ← 39: 10.2x ↘ 40: 9.8 ↗ Serie 98.0 Total 385.0	

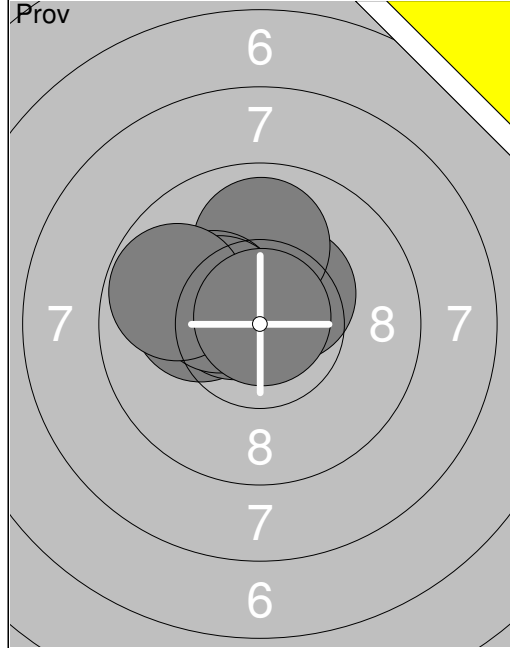

60 Skott

1:	10.2x↘
2:	10.7x↑
3:	10.6x↘
4:	10.4x↗
5:	9.9 ↑
6:	10.3x↘
7:	10.4x↘
8:	9.8 ↙
9:	10.9x↑
Serie 88.0	
Total 0.0	

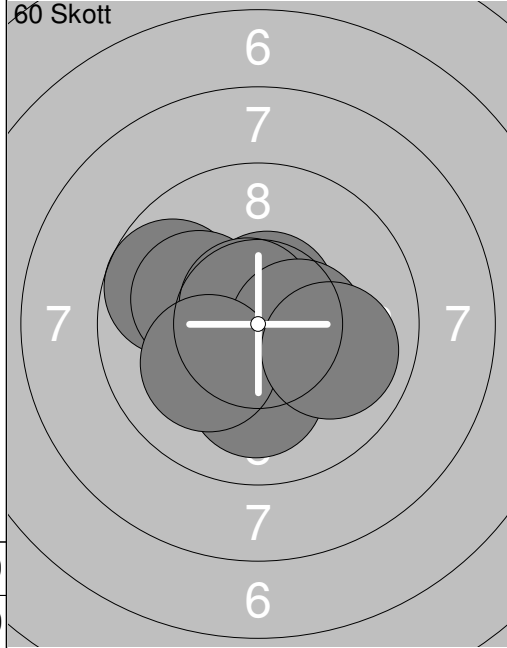

60 Skott

1:	10.4x↘
2:	9.7 ↙
3:	10.1 ↙
4:	10.8x↗
5:	10.6x↑
6:	10.7x↘
7:	10.4x➡
8:	10.1 ↓
9:	10.1 ↙
10:	10.0 ➡
Serie 99.0	
Total 99.0	

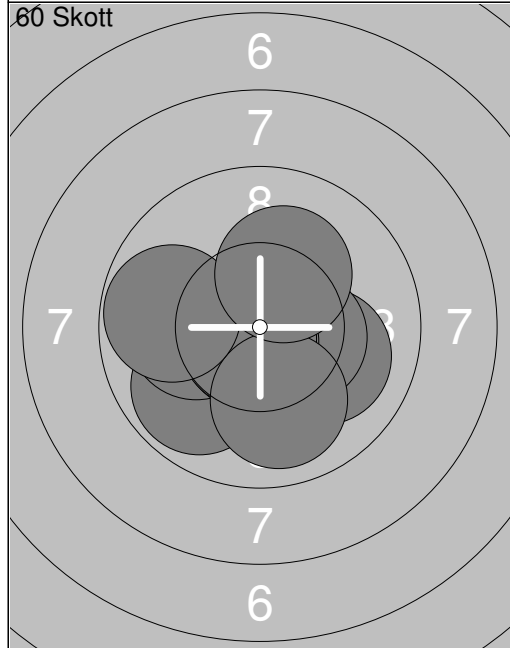

60 Skott

11:	10.6x➡
12:	10.0 ➡
13:	9.9 ↙
14:	10.1 ↙
15:	10.4x➡
16:	10.7x↘
17:	10.7x↘
18:	10.0 ↓
19:	9.8 ↙
20:	10.2x↑
Serie 98.0	
Total 197.0	

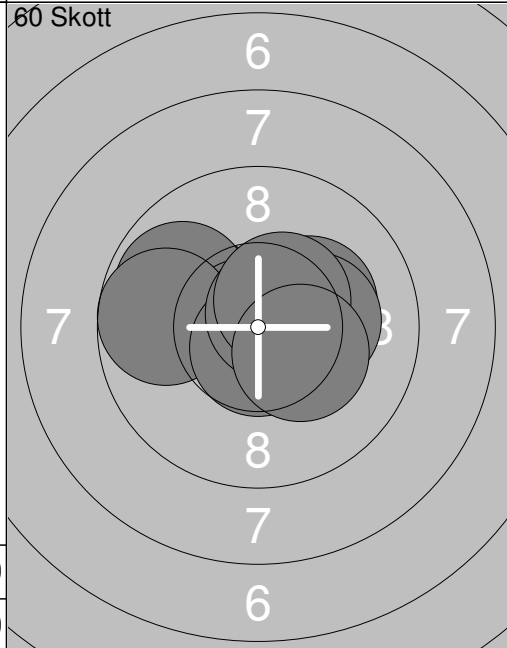

60 Skott

21:	10.2x➡
22:	10.2x➡
23:	10.3x↘
24:	9.9 ↙
25:	10.8x↘
26:	9.7 ↙
27:	10.7x↓
28:	10.7x↗
29:	10.5x↑
30:	10.3x↘
Serie 98.0	
Total 295.0	

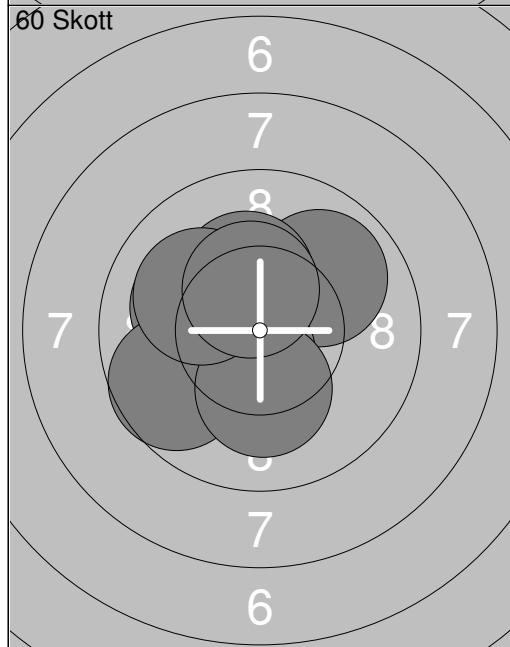

60 Skott

31:	10.1 ↙
32:	10.4x↑
33:	10.6x↘
34:	9.9 ↗
35:	10.3x↑
36:	10.6x↘
37:	9.7 ↙
38:	10.2x↓
39:	10.1 ↙
40:	10.4x↑
Serie 98.0	
Total 393.0	

1: 10.1 ← 2: 10.5 ↗ 3: 10.7 ↘ 4: 9.9 → 5: 10.3 ↙ 6: 10.4 ↘ 7: 10.6 ↗ 8: 10.5 ↘ 9: 10.4 ↓ 10: 10.3 ↗ Serie 99.0 Total 0.0	11: 10.3 ↗ 12: 10.1 ↓ 13: 10.0 ↖ 14: 10.6 ↘ 15: 10.6 ↗ Serie 50.0 Total 0.0

1: 10.5 ↘ 2: 10.5 ↙ 3: 10.3 ↗ 4: 10.7 ↘ 5: 10.3 ↘ 6: 9.8 ↗ 7: 10.5 ↙ 8: 10.5 ↗ 9: 10.3 ↙ 10: 10.8 ↗ Serie 99.0 Total 99.0	11: 10.7 ↗ 12: 10.0 ↖ 13: 10.7 ↘ 14: 10.3 ↗ 15: 10.6 ↘ 16: 10.4 ↗ 17: 10.5 ↙ 18: 10.5 ↗ 19: 10.0 ↗ 20: 10.2 ↗ Serie 100.0 Total 199.0

21: 10.7 ↙ 22: 10.7 ↙ 23: 9.3 ↖ 24: 10.2 ↙ 25: 10.5 ↘ 26: 10.9 ↗ 27: 10.2 ↗ 28: 10.4 ↙ 29: 10.4 ↘ 30: 10.8 ↘ Serie 99.0 Total 298.0	31: 10.5 ↙ 32: 9.6 ↗ 33: 10.0 ↖ 34: 10.5 ↙ 35: 10.7 ↘ 36: 10.0 → 37: 10.1 ↖ 38: 10.1 ← 39: 10.3 ↗ 40: 9.9 ↗ Serie 98.0 Total 396.0

	1: 10.1 →		11: 10.1 ←
	2: 9.7 ↘		12: 10.8 ↗
	3: 9.5 ↘		13: 9.8 ←
	4: 10.0 →		14: 10.4 ↗
	5: 9.9 ←		15: 10.5 ↘
	6: 10.3x →		16: 10.8x ↓
	7: 9.9 →		
	8: 9.9 ←		
	9: 10.3x ↘		
	10: 9.5 ↘		
Serie 94.0		Serie 59.0	
Total 0.0		Total 0.0	

	1: 10.6x ↘		11: 10.7x ↘
	2: 10.3x ↘		12: 10.5x ↗
	3: 10.0 ↓		13: 10.1 ↓
	4: 10.5x ↓		14: 10.7x ↘
	5: 9.8 ←		15: 10.3x ↘
	6: 10.7x ↘		16: 10.5x ↘
	7: 10.6x ↘		17: 9.9 →
	8: 10.6x ↓		18: 10.6x ↑
	9: 9.8 ←		19: 10.3x ↘
	10: 10.1 ←		20: 10.3x ↘
Serie 98.0		Serie 99.0	
Total 98.0		Total 197.0	

	21: 10.5x ↗		31: 10.4x ↗
	22: 10.5x ↘		32: 10.3x ↓
	23: 10.2x ↓		33: 9.9 ↓
	24: 10.3x ↘		34: 9.2 ←
	25: 10.0 ←		35: 10.6x →
	26: 10.4x ↘		36: 10.0 ↘
	27: 10.0 ←		37: 10.3x ↘
	28: 10.0 →		38: 10.2x ↓
	29: 10.1 ←		39: 10.4x ↘
	30: 10.0 →		40: 10.0 →
Serie 100.0		Serie 98.0	
Total 297.0		Total 395.0	

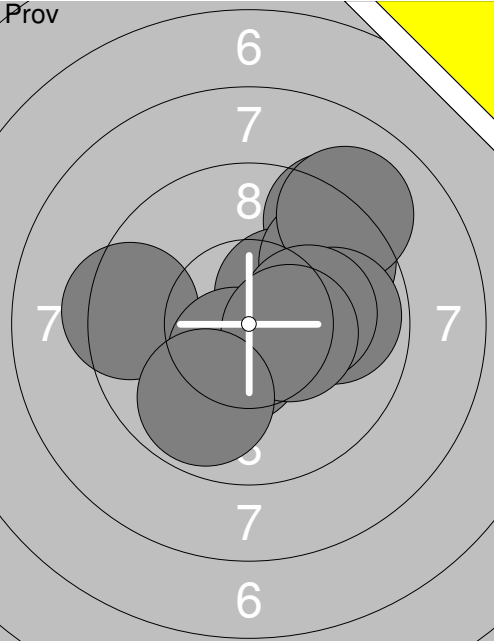
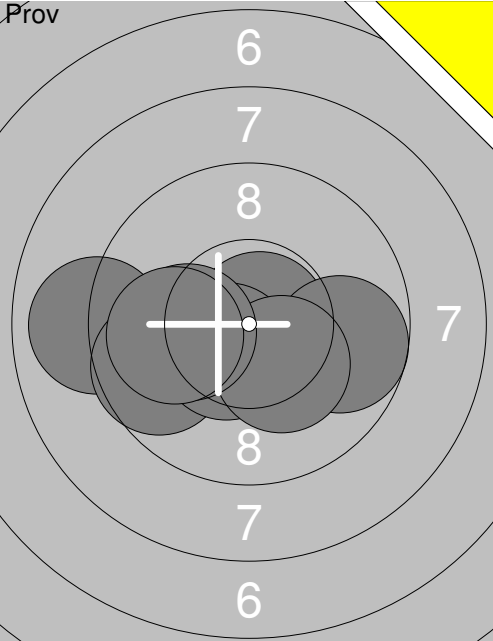
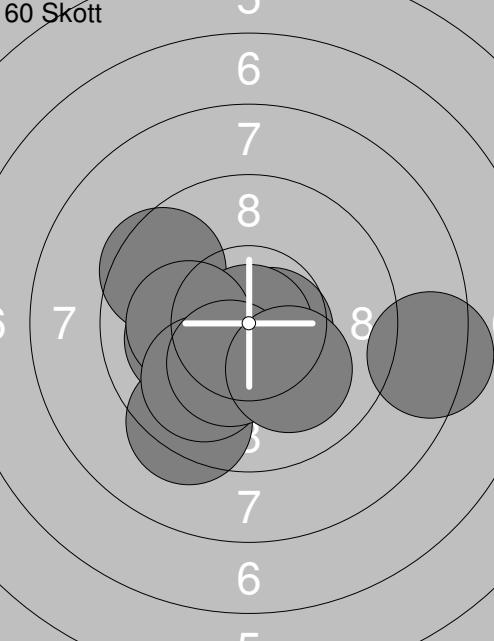
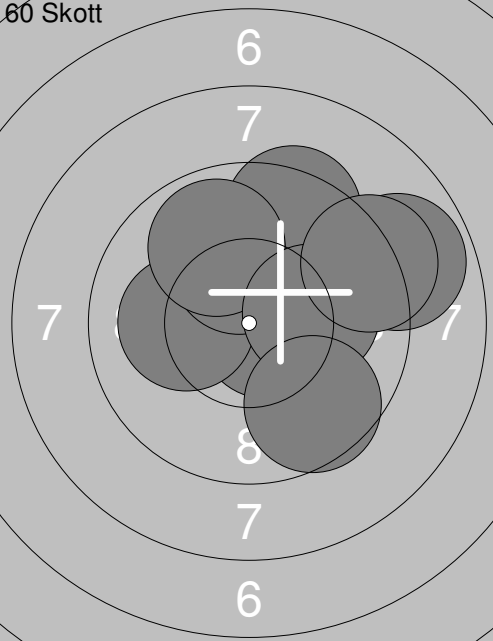
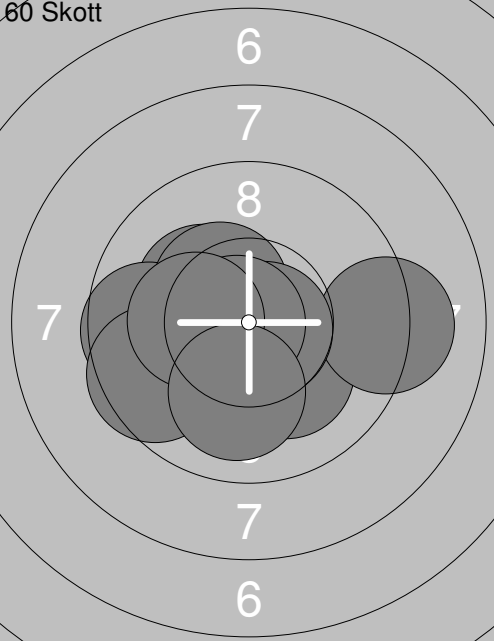
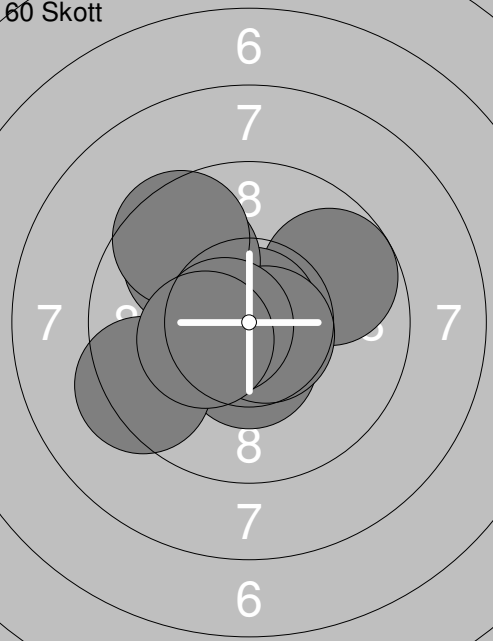
Skjutlag	Tavla	Anna Östman	
2	23	Ramselefors Skytteförening	
02.11.2019	Nationellt SM 2019	Umeå skytteallians	
Prov		Prov	
	1: 9.2 ↗ 2: 10.4x ↗ 3: 9.6 ↗ 4: 9.1 ↗ 5: 9.4 ← 6: 10.5x ↘ 7: 9.8 → 8: 10.2x → 9: 10.4x → 10: 9.8 ↘		11: 9.0 ← 12: 9.7 ← 13: 10.8x → 14: 10.5x ↘ 15: 9.7 → 16: 10.3x ↘ 17: 10.1 ← 18: 10.0 ←
	Serie 94.0		Serie 77.0
	Total 0.0		Total 0.0
60 Skott		60 Skott	
	1: 10.6x → 2: 9.3 ↘ 3: 10.1 ← 4: 9.5 ↖ 5: 10.9x ↘ 6: 10.1 ← 7: 9.9 ↘ 8: 8.3 → 9: 10.3x ↘ 10: 10.1 ↘		11: 10.2x ↘ 12: 10.7x → 13: 10.1 ← 14: 10.2x ↗ 15: 8.9 → 16: 9.4 ↗ 17: 9.9 ↗ 18: 10.1 → 19: 9.2 ↗ 20: 9.6 ↘
	Serie 95.0		Serie 94.0
	Total 95.0		Total 189.0
60 Skott		60 Skott	
	21: 10.2x ↘ 22: 10.2x ↘ 23: 9.6 ← 24: 10.4x ↘ 25: 9.2 → 26: 10.7x → 27: 9.6 ← 28: 10.8x ← 29: 10.3x ← 30: 10.0 ↘		31: 9.7 ↗ 32: 10.8x ↘ 33: 10.5x ↘ 34: 10.9x ↗ 35: 9.9 ↖ 36: 10.7x ↘ 37: 9.6 ↖ 38: 9.3 ← 39: 10.6x ← 40: 10.3x ←
	Serie 97.0		Serie 96.0
	Total 286.0		Total 382.0

<p>Prov</p>	<p>1: 9.2 ↖ 2: 10.2x↘ 3: 10.2x↔ 4: 10.5x↗ 5: 10.0 ↗ 6: 10.6x↖ 7: 10.3x↗ 8: 10.4x↖ 9: 9.9 → 10: 9.1 →</p> <p>Serie 97.0 Total 0.0</p>	<p>Prov</p>	<p>11: 10.4x↗ 12: 10.0 ↗ 13: 10.5x↔ 14: 10.5x↔</p> <p>Serie 40.0 Total 0.0</p>
<p>60 Skott</p>	<p>1: 9.4 → 2: 10.3x↘ 3: 10.0 → 4: 9.2 ↓ 5: 10.3x↘ 6: 10.3x↗ 7: 10.4x↔ 8: 9.8 ↘ 9: 10.5x↖ 10: 10.3x↔</p> <p>Serie 97.0 Total 97.0</p>	<p>60 Skott</p>	<p>11: 10.4x↔ 12: 10.0 ↖ 13: 10.7x↔ 14: 10.3x↔ 15: 9.8 ↗ 16: 10.8x↘ 17: 10.1 ↗ 18: 10.7x↔ 19: 9.5 ← 20: 10.9x↗</p> <p>Serie 98.0 Total 195.0</p>
<p>60 Skott</p>	<p>21: 10.7x↔ 22: 10.4x↔ 23: 10.8x↗ 24: 9.8 ↘ 25: 10.1← 26: 9.8 ← 27: 9.4 ← 28: 9.8 ↗ 29: 9.9 ← 30: 10.0 →</p> <p>Serie 95.0 Total 290.0</p>	<p>60 Skott</p>	<p>31: 9.5 ← 32: 10.5x↗ 33: 9.9 ↗ 34: 10.6x↗ 35: 10.5x↔ 36: 10.7x↘ 37: 10.3x↔ 38: 10.0 ↖ 39: 10.6x↔ 40: 10.2x↖</p> <p>Serie 98.0 Total 388.0</p>

<p>Prov</p>	<p>60 Skott</p>	<table style="width:100%; border-collapse: collapse;"> <tr><td>1:</td><td>9.0</td><td>←</td><td>1:</td><td>9.7</td><td>→</td></tr> <tr><td>2:</td><td>9.9</td><td>→</td><td>2:</td><td>9.3</td><td>←</td></tr> <tr><td>3:</td><td>9.6</td><td>↘</td><td>3:</td><td>10.7</td><td>✕</td></tr> <tr><td>4:</td><td>9.6</td><td>↓</td><td>4:</td><td>9.9</td><td>↙</td></tr> <tr><td>5:</td><td>9.5</td><td>←</td><td>5:</td><td>10.4</td><td>✕↗</td></tr> <tr><td>6:</td><td>9.9</td><td>↓</td><td>6:</td><td>10.0</td><td>↓</td></tr> <tr><td>7:</td><td>10.4</td><td>✕↓</td><td>7:</td><td>10.2</td><td>✕↘</td></tr> <tr><td>8:</td><td>9.5</td><td>←</td><td>8:</td><td>10.7</td><td>✕←</td></tr> <tr><td>9:</td><td>9.6</td><td>←</td><td>9:</td><td>9.9</td><td>↖</td></tr> <tr><td>10:</td><td>9.8</td><td>↖</td><td>10:</td><td>9.7</td><td>↗</td></tr> <tr><td colspan="2">Serie</td><td>91.0</td><td colspan="2">Serie</td><td>95.0</td></tr> <tr><td colspan="2">Total</td><td>0.0</td><td colspan="2">Total</td><td>95.0</td></tr> </table>	1:	9.0	←	1:	9.7	→	2:	9.9	→	2:	9.3	←	3:	9.6	↘	3:	10.7	✕	4:	9.6	↓	4:	9.9	↙	5:	9.5	←	5:	10.4	✕↗	6:	9.9	↓	6:	10.0	↓	7:	10.4	✕↓	7:	10.2	✕↘	8:	9.5	←	8:	10.7	✕←	9:	9.6	←	9:	9.9	↖	10:	9.8	↖	10:	9.7	↗	Serie		91.0	Serie		95.0	Total		0.0	Total		95.0
1:	9.0	←	1:	9.7	→																																																																					
2:	9.9	→	2:	9.3	←																																																																					
3:	9.6	↘	3:	10.7	✕																																																																					
4:	9.6	↓	4:	9.9	↙																																																																					
5:	9.5	←	5:	10.4	✕↗																																																																					
6:	9.9	↓	6:	10.0	↓																																																																					
7:	10.4	✕↓	7:	10.2	✕↘																																																																					
8:	9.5	←	8:	10.7	✕←																																																																					
9:	9.6	←	9:	9.9	↖																																																																					
10:	9.8	↖	10:	9.7	↗																																																																					
Serie		91.0	Serie		95.0																																																																					
Total		0.0	Total		95.0																																																																					

<p>60 Skott</p>	<p>60 Skott</p>	<table style="width:100%; border-collapse: collapse;"> <tr><td>11:</td><td>8.8</td><td>→</td><td>21:</td><td>10.5</td><td>✕←</td></tr> <tr><td>12:</td><td>10.1</td><td>↗</td><td>22:</td><td>10.6</td><td>✕↘</td></tr> <tr><td>13:</td><td>10.7</td><td>✕↗</td><td>23:</td><td>9.4</td><td>←</td></tr> <tr><td>14:</td><td>9.9</td><td>↙</td><td>24:</td><td>9.2</td><td>→</td></tr> <tr><td>15:</td><td>10.2</td><td>✕↓</td><td>25:</td><td>9.8</td><td>←</td></tr> <tr><td>16:</td><td>10.8</td><td>✕←</td><td>26:</td><td>10.0</td><td>→</td></tr> <tr><td>17:</td><td>9.6</td><td>→</td><td>27:</td><td>9.7</td><td>↗</td></tr> <tr><td>18:</td><td>10.2</td><td>✕↗</td><td>28:</td><td>10.0</td><td>↘</td></tr> <tr><td>19:</td><td>10.5</td><td>✕←</td><td>29:</td><td>10.0</td><td>→</td></tr> <tr><td>20:</td><td>9.4</td><td>↗</td><td>30:</td><td>10.1</td><td>←</td></tr> <tr><td colspan="2">Serie</td><td>95.0</td><td colspan="2">Serie</td><td>96.0</td></tr> <tr><td colspan="2">Total</td><td>190.0</td><td colspan="2">Total</td><td>286.0</td></tr> </table>	11:	8.8	→	21:	10.5	✕←	12:	10.1	↗	22:	10.6	✕↘	13:	10.7	✕↗	23:	9.4	←	14:	9.9	↙	24:	9.2	→	15:	10.2	✕↓	25:	9.8	←	16:	10.8	✕←	26:	10.0	→	17:	9.6	→	27:	9.7	↗	18:	10.2	✕↗	28:	10.0	↘	19:	10.5	✕←	29:	10.0	→	20:	9.4	↗	30:	10.1	←	Serie		95.0	Serie		96.0	Total		190.0	Total		286.0
11:	8.8	→	21:	10.5	✕←																																																																					
12:	10.1	↗	22:	10.6	✕↘																																																																					
13:	10.7	✕↗	23:	9.4	←																																																																					
14:	9.9	↙	24:	9.2	→																																																																					
15:	10.2	✕↓	25:	9.8	←																																																																					
16:	10.8	✕←	26:	10.0	→																																																																					
17:	9.6	→	27:	9.7	↗																																																																					
18:	10.2	✕↗	28:	10.0	↘																																																																					
19:	10.5	✕←	29:	10.0	→																																																																					
20:	9.4	↗	30:	10.1	←																																																																					
Serie		95.0	Serie		96.0																																																																					
Total		190.0	Total		286.0																																																																					

<p>60 Skott</p>	<table style="width:100%; border-collapse: collapse;"> <tr><td>31:</td><td>9.7</td><td>↙</td></tr> <tr><td>32:</td><td>9.6</td><td>→</td></tr> <tr><td>33:</td><td>10.6</td><td>✕→</td></tr> <tr><td>34:</td><td>9.0</td><td>→</td></tr> <tr><td>35:</td><td>9.6</td><td>↙</td></tr> <tr><td>36:</td><td>10.6</td><td>✕→</td></tr> <tr><td>37:</td><td>9.5</td><td>→</td></tr> <tr><td>38:</td><td>9.4</td><td>←</td></tr> <tr><td>39:</td><td>10.6</td><td>✕→</td></tr> <tr><td>40:</td><td>10.4</td><td>✕←</td></tr> <tr><td colspan="2">Serie</td><td>94.0</td></tr> <tr><td colspan="2">Total</td><td>380.0</td></tr> </table>	31:	9.7	↙	32:	9.6	→	33:	10.6	✕→	34:	9.0	→	35:	9.6	↙	36:	10.6	✕→	37:	9.5	→	38:	9.4	←	39:	10.6	✕→	40:	10.4	✕←	Serie		94.0	Total		380.0
31:	9.7	↙																																			
32:	9.6	→																																			
33:	10.6	✕→																																			
34:	9.0	→																																			
35:	9.6	↙																																			
36:	10.6	✕→																																			
37:	9.5	→																																			
38:	9.4	←																																			
39:	10.6	✕→																																			
40:	10.4	✕←																																			
Serie		94.0																																			
Total		380.0																																			

Skjuttag	Tavla	Tomas Hed	
2	26		
S	Forsa Skytteförening		
02.11.2019	Nationellt SM 2019	Umeå skytteallians	
Prov 	1: 10.3x↘ 2: 10.3x← 3: 10.4x↘ 4: 9.6 → 5: 10.1 ↖ 6: 10.8x↗ 7: 9.7 ↘ 8: 10.8x↘ 9: 10.3x↗ 10: 10.5x↘	Prov 	11: 9.5 ↓ 12: 10.1 ↖ 13: 9.6 → 14: 10.3x↘ 15: 10.9x↘ 16: 10.3x←
	Serie 98.0		Serie 58.0
	Total 0.0		Total 0.0
60 Skott 	1: 10.6x← 2: 10.8x↗ 3: 10.6x↗ 4: 9.9 ↖ 5: 9.5 ↗ 6: 10.2x↘ 7: 10.2x→ 8: 10.7x↗ 9: 10.2x↗ 10: 10.3x←	60 Skott 	11: 9.8 ↓ 12: 10.2x↘ 13: 10.3x↗ 14: 9.7 ↗ 15: 10.1 ↗ 16: 9.6 ↖ 17: 10.2x↘ 18: 9.5 ↖ 19: 10.3x↗ 20: 10.2x↗
	Serie 98.0		Serie 96.0
	Total 98.0		Total 194.0
60 Skott 	21: 10.2x← 22: 9.2 → 23: 8.9 ↗ 24: 9.8 ↗ 25: 10.2x↘ 26: 9.7 ↖ 27: 10.8x↘ 28: 10.5x← 29: 9.6 ← 30: 10.1 ↖	60 Skott 	31: 10.6x↗ 32: 10.0 ↓ 33: 9.8 ↖ 34: 9.5 → 35: 9.9 → 36: 10.2x← 37: 10.4x↘ 38: 10.4x↘ 39: 10.6x↗ 40: 10.2x←
	Serie 94.0		Serie 97.0
	Total 288.0		Total 385.0

<p>Prov</p>	<p>1: 9.3 ↓ 2: 9.6 ↓ 3: 10.5x↑ 4: 9.2 ↑ 5: 9.4 ← 6: 10.9x← 7: 9.7 ↑ 8: 9.1 ← 9: 9.8 → 10: 10.7x↓</p> <p>Serie 93.0 Total 0.0</p>	<p>Prov</p> <p>11: 10.4x➤</p> <p>Serie 10.0 Total 0.0</p>
<p>60 Skott</p>	<p>1: 8.9 → 2: 10.2x↘ 3: 9.4 ↖ 4: 8.5 ← 5: 10.4x↗ 6: 9.1 ← 7: 8.1 ↓ 8: 10.1 ↓ 9: 8.5 ← 10: 9.2 ↓</p> <p>Serie 89.0 Total 89.0</p>	<p>60 Skott</p> <p>11: 9.3 ↓ 12: 9.7 ↓ 13: 9.5 ↙ 14: 9.2 ↙ 15: 9.6 ➡ 16: 10.4x↘ 17: 10.0 ↓ 18: 8.6 ← 19: 9.8 ↑ 20: 9.2 ➡</p> <p>Serie 91.0 Total 180.0</p>
<p>60 Skott</p>	<p>21: 10.2x↘ 22: 9.5 ↑ 23: 9.6 ← 24: 10.7x↘ 25: 9.7 ↑ 26: 9.1 → 27: 9.9 ↑ 28: 9.7 ↓ 29: 8.1 ↑ 30: 10.4x↘</p> <p>Serie 92.0 Total 272.0</p>	<p>60 Skott</p> <p>31: 10.4x← 32: 9.1 ↑ 33: 9.3 ↓ 34: 10.2x← 35: 9.2 ↓ 36: 9.4 ↓ 37: 10.3x➤ 38: 9.5 ↙ 39: 9.8 → 40: 10.7x↗</p> <p>Serie 94.0 Total 366.0</p>

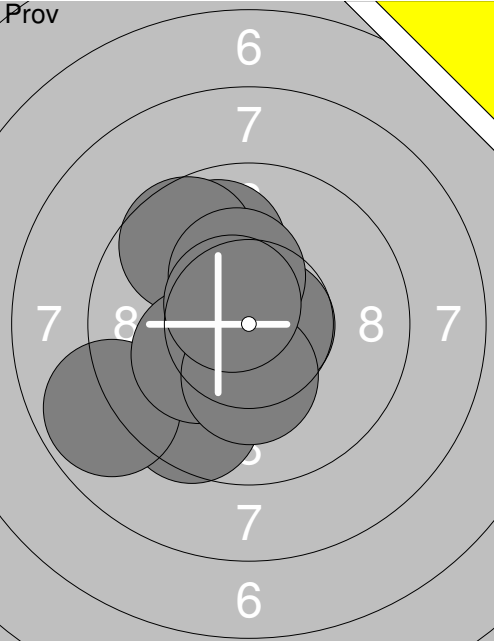
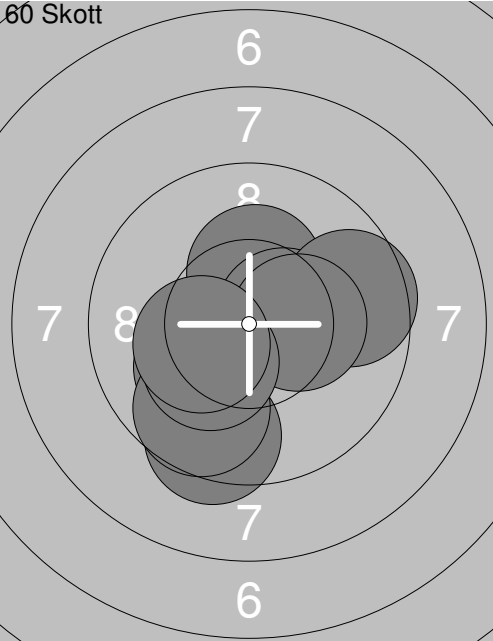
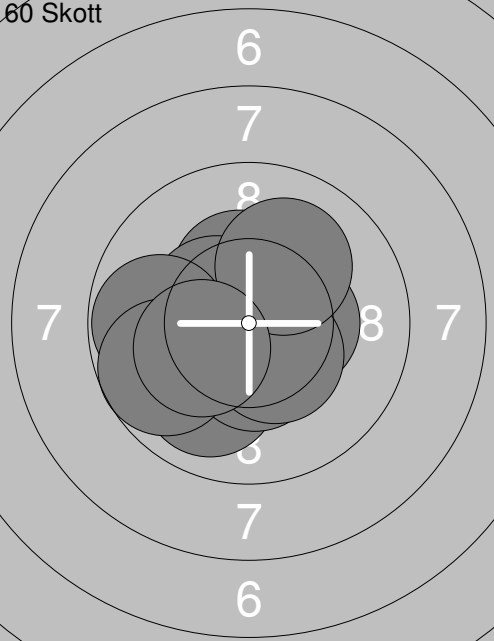
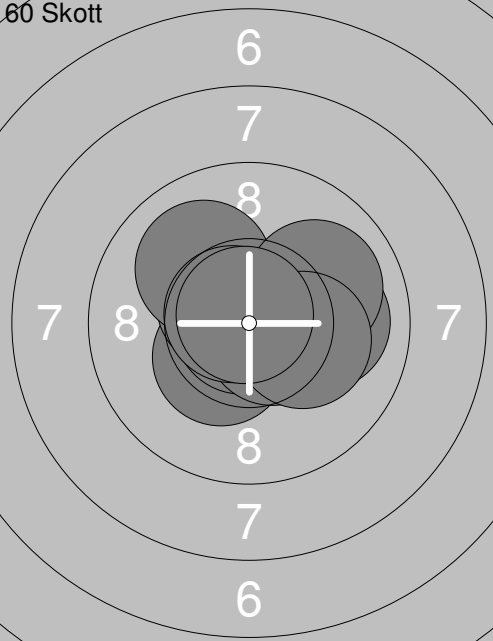
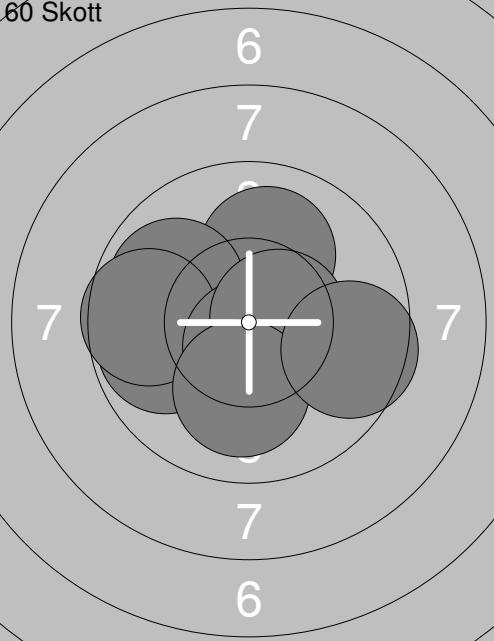
Skjutlag 2	Tavla 28	Saul Johansson	
S		Ramselefors Skytteförening	
02.11.2019	Nationellt SM 2019	Umeå skytteallians	
Prov		60 Skott	
	1: 10.7x➤ 2: 9.9 ↗ 3: 9.7 ↘ 4: 9.6 ↘ 5: 8.9 ↙ 6: 10.2x↙ 7: 10.3x↓ 8: 10.3x↗ 9: 10.6x↘	1: 10.7x↗ 2: 9.4 ↓ 3: 10.1 ↙ 4: 10.3x↗ 5: 9.7 ↘ 6: 10.5x➤ 7: 9.6 ➔ 8: 10.3x➤ 9: 10.2x↙ 10: 10.3x↙	
	Serie 85.0		Serie 97.0
	Total 0.0		Total 97.0
60 Skott		60 Skott	
	11: 10.4x↗ 12: 10.0 ↘ 13: 10.4x↓ 14: 10.5x↘ 15: 9.8 ← 16: 10.4x➤ 17: 10.4x↘ 18: 10.1 ↗ 19: 9.7 ↙ 20: 10.3x↙	21: 10.4x↙ 22: 10.9x↙ 23: 10.5x↘ 24: 10.6x↘ 25: 10.0 ↗ 26: 10.7x↘ 27: 10.0 ➔ 28: 10.0 ➔ 29: 10.2x➤ 30: 10.8x↗	
	Serie 98.0		Serie 100.0
	Total 195.0		Total 295.0
60 Skott			
	31: 10.5x↓ 32: 10.8x➤ 33: 10.0 ↗ 34: 9.9 ↙ 35: 9.8 ← 36: 9.6 ← 37: 10.6x↓ 38: 10.6x➤ 39: 10.1 ↓ 40: 9.6 ➔		
	Serie 96.0		
	Total 391.0		

<p>Pröv</p> 	<p>1: 7.2 →</p> <p>2: 10.6x ↗</p> <p>3: 9.4 ↘</p> <p>4: 9.8 ↗</p> <p>5: 9.9 →</p> <p>6: 9.6 ↑</p> <p>7: 8.7 ↗</p> <p>8: 10.7x ↗</p> <p>9: 10.3x ↘</p> <p>10: 10.0 ↙</p>	<p>Pröv</p> 
Serie 91.0		Serie 37.0
Total 0.0		Total 0.0

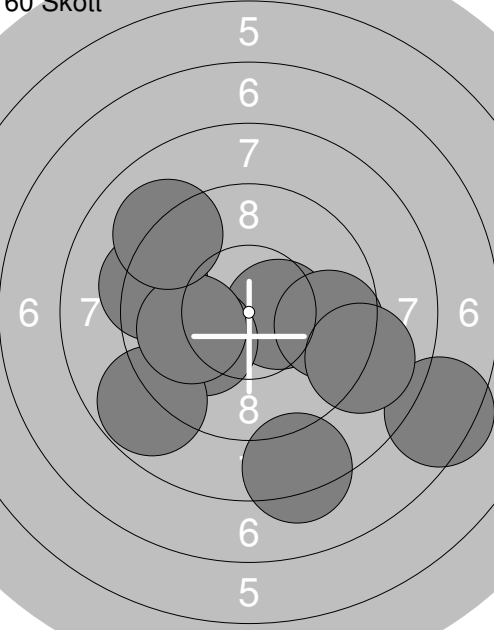
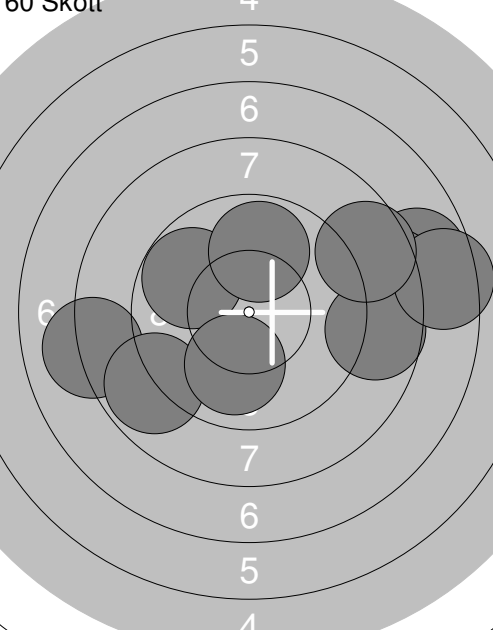
<p>60 Skott</p> 	<p>1: 10.5x ↘</p> <p>2: 9.3 ←</p> <p>3: 10.1 ↙</p> <p>4: 9.6 →</p> <p>5: 8.3 ↓</p> <p>6: 8.8 ↙</p> <p>7: 7.4 →</p> <p>8: 10.0 ↙</p> <p>9: 9.1 ↖</p> <p>10: 9.0 →</p>	<p>60 Skott</p> 
Serie 89.0		Serie 82.0
Total 89.0		Total 171.0

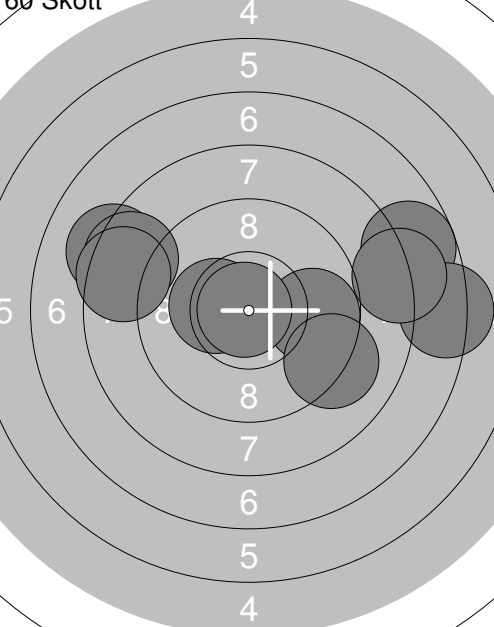
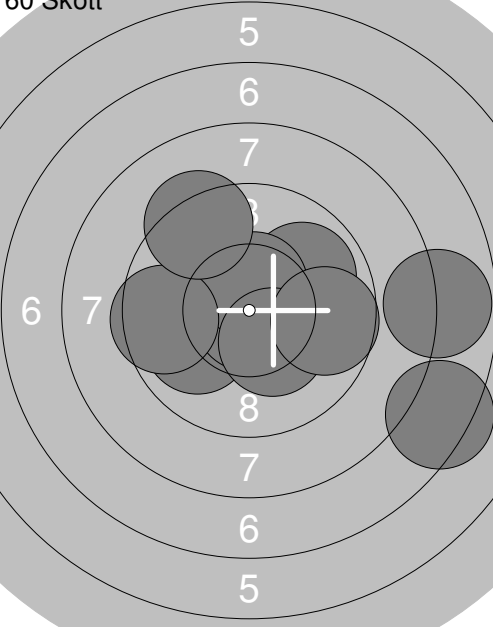
<p>60 Skott</p> 	<p>21: 7.7 →</p> <p>22: 8.2 ←</p> <p>23: 10.3x ←</p> <p>24: 9.7 →</p> <p>25: 7.2 →</p> <p>26: 9.1 ↘</p> <p>27: 8.5 ←</p> <p>28: 8.0 →</p> <p>29: 8.5 ←</p> <p>30: 10.9x ←</p>	<p>60 Skott</p> 
Serie 84.0		Serie 90.0
Total 255.0		Total 345.0