

1:	9.7	→
2:	9.7	↗
3:	10.3	←
4:	9.2	↗
5:	9.9	→
Serie		46
Total		0

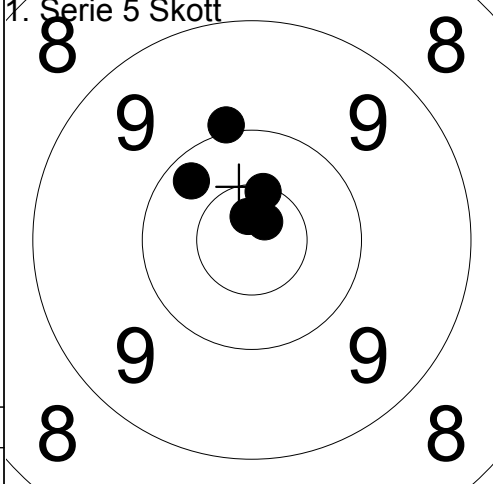

1:	10.0	↖
2:	10.8x	↗
3:	10.2	↖
4:	10.5x	↗
5:	10.7x	↗
Serie		50
Total		50

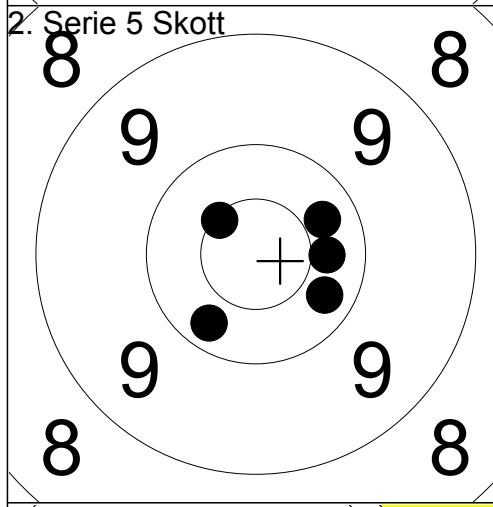

1:	10.3	↗
2:	10.3	↘
3:	10.3	↘
4:	10.5x	↗
5:	10.3	→
Serie		50
Total		100

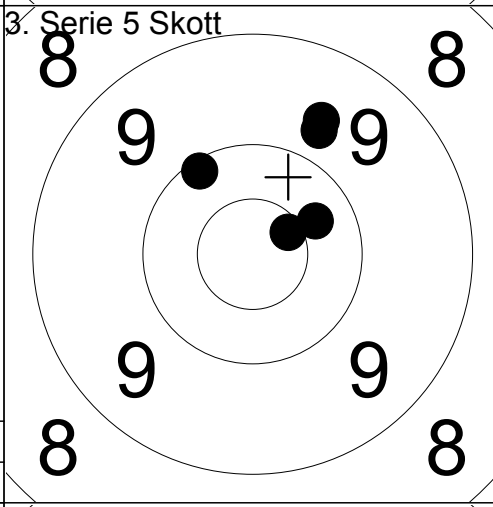

1:	10.4	↗
2:	9.8	↗
3:	10.6x	↗
4:	10.1	↖
5:	9.7	↗
Serie		48
Total		148

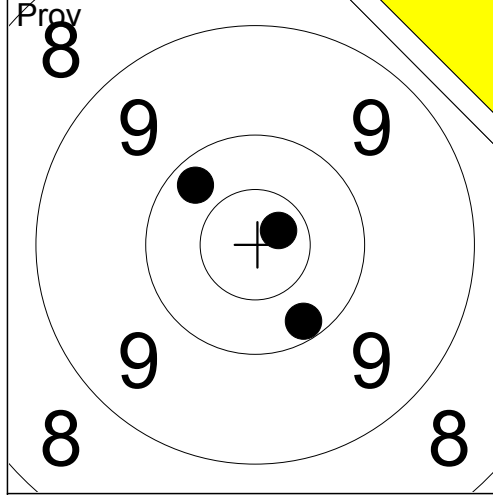

1:	10.2	↘
2:	10.7x	↗
3:	10.2	↗
Serie		30
Total		148

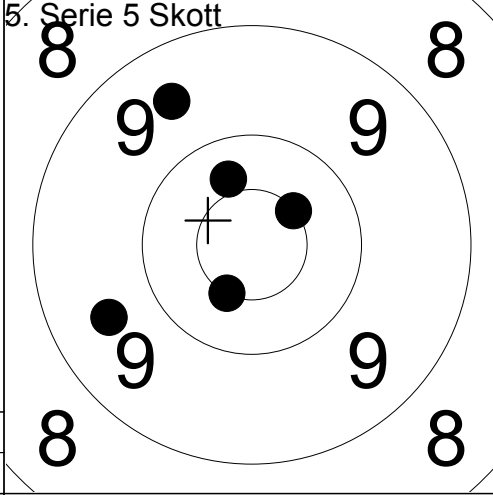

1:	9.5	↖
2:	9.6	←
3:	10.4	↗
4:	10.5x	↘
5:	10.5x	↗
Serie		48
Total		196

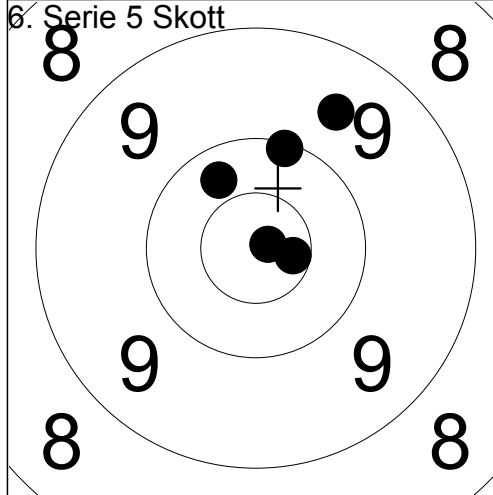

1:	10.8x	→
2:	10.1	↗
3:	9.6	↗
4:	10.3	↗
5:	10.6x	→
Serie		49
Total		245

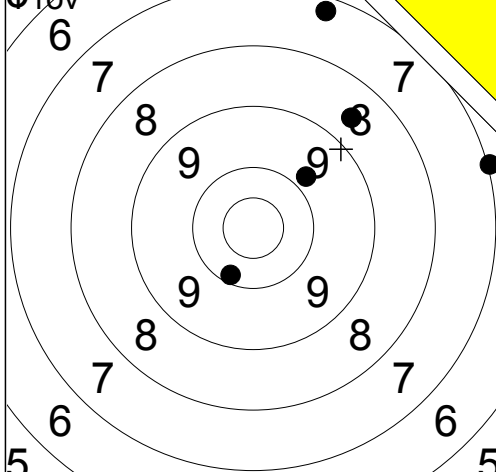

1:	8.6	↗
2:	7.0	→
3:	9.8	↗
4:	10.2	↘
5:	7.3	↗
Serie		41
Total		0

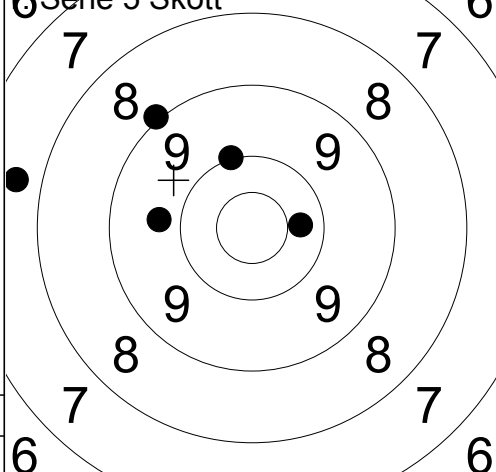

1:	9.0	↖
2:	9.7	←
3:	10.0	↗
4:	7.7	←
5:	10.3	→
Serie		45
Total		45

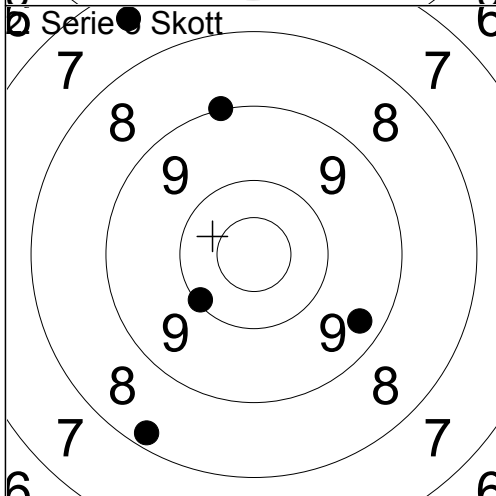

1:	7.4	↖
2:	9.3	→
3:	9.0	↗
4:	10.1	↙
5:	8.2	↘
Serie		43
Total		88

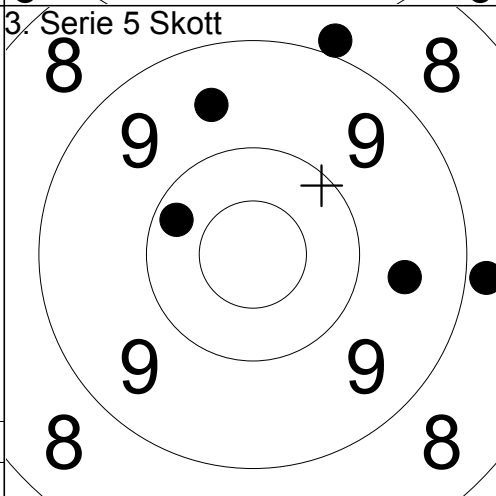

1:	10.2	↖
2:	8.8	→
3:	9.6	→
4:	9.6	↗
5:	8.9	↗
Serie		44
Total		132

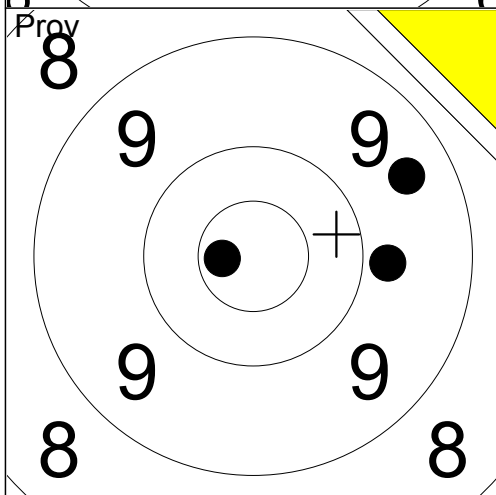

1:	10.7x	←
2:	9.5	↗
3:	9.8	→
Serie		28
Total		132

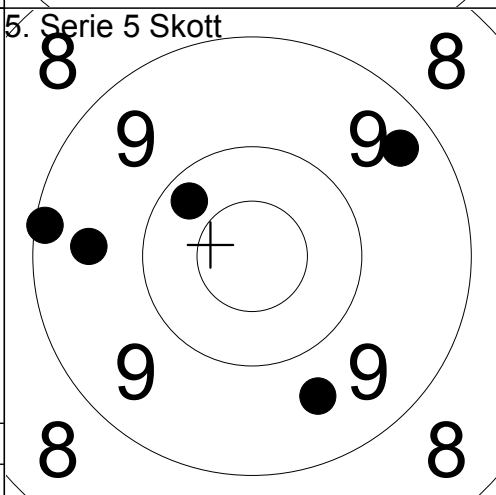

1:	9.4	↗
2:	9.5	←
3:	9.1	←
4:	10.2	↗
5:	9.6	↘
Serie		46
Total		178

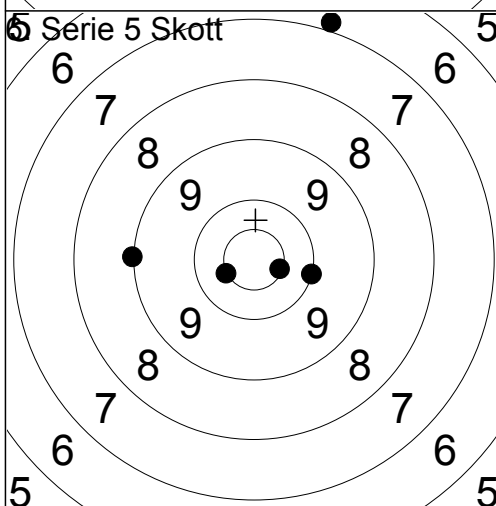

1:	10.5x	→
2:	9.0	←
3:	10.5x	←
4:	10.0	→
5:	6.9	↗
Serie		45
Total		223

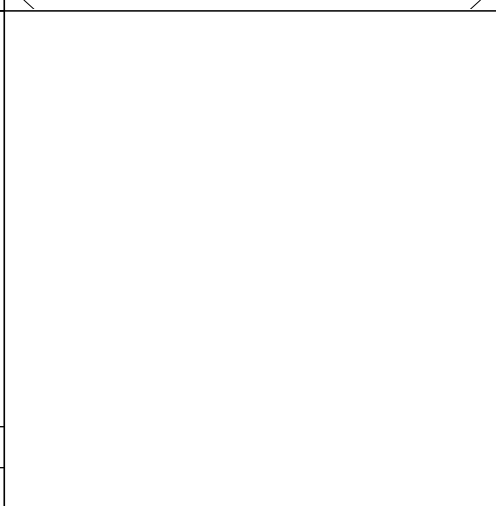

Serie		45
Total		223

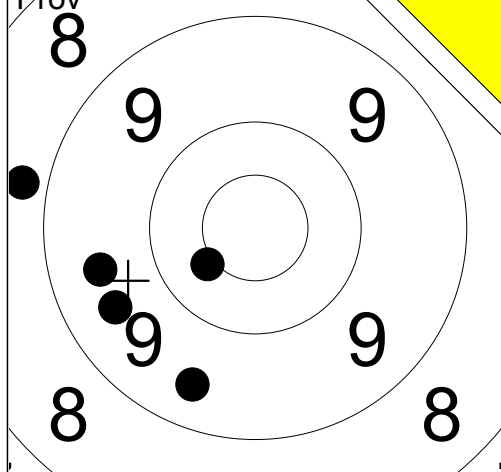

1:	8.8	←
2:	10.4x	↙
3:	9.5	↙
4:	9.5	←
5:	9.4	↘
Serie		45
Total		0

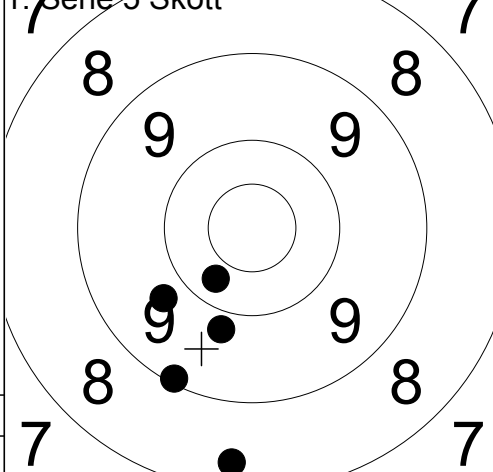

1:	8.3	↓
2:	9.8	↓
3:	9.7	↙
4:	9.1	↘
5:	10.3	↘
Serie		45
Total		45

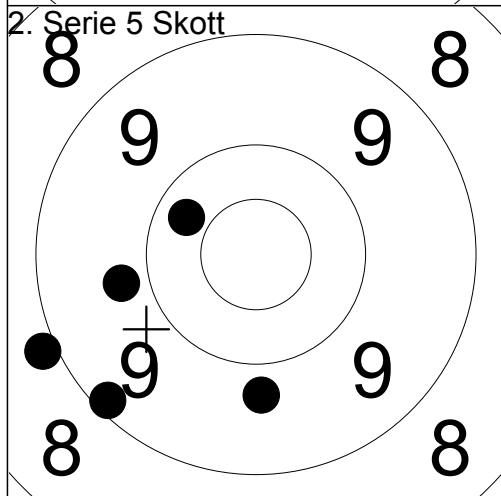

1:	10.3	↖
2:	9.1	↘
3:	9.8	←
4:	8.9	↙
5:	9.7	↓
Serie		45
Total		90

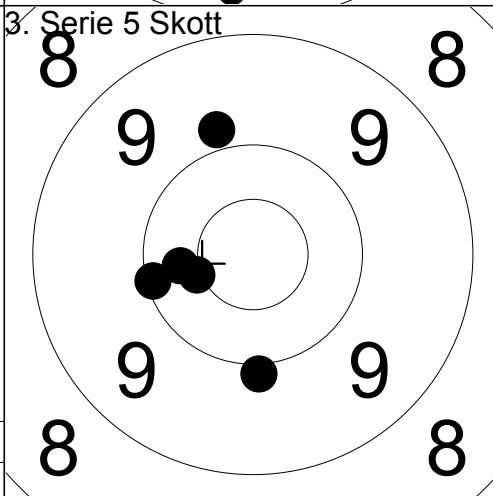

1:	10.3	←
2:	10.5x	←
3:	9.9	↓
4:	9.8	↑
5:	10.1	←
Serie		48
Total		138

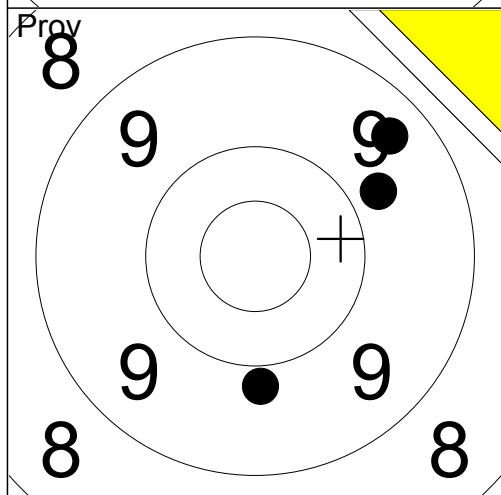

1:	9.8	↓
2:	9.8	↗
3:	9.4	↗
Serie		27
Total		138

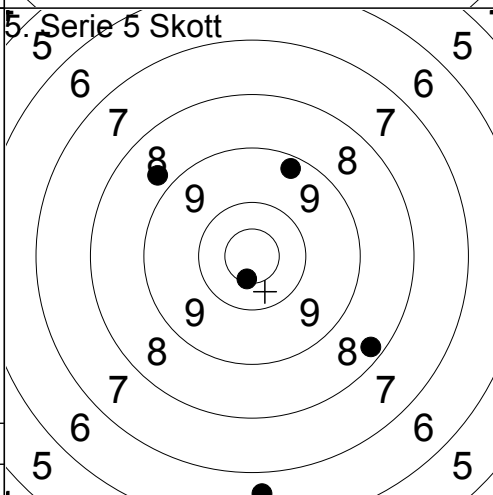

1:	8.3	↘
2:	9.3	↑
3:	8.7	↖
4:	6.6	↓
5:	10.5x	↓
Serie		41
Total		179

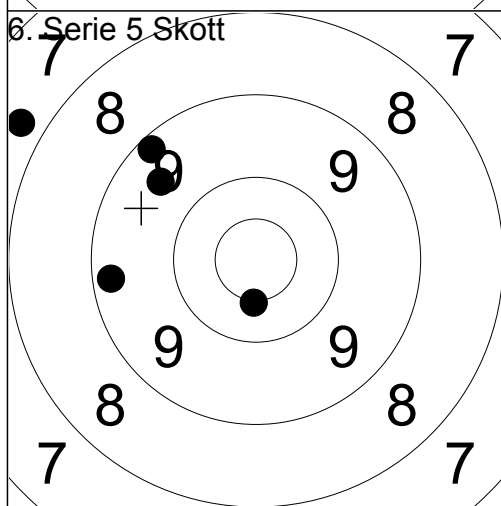

1:	9.2	↖
2:	10.5x	↓
3:	9.2	←
4:	9.5	↗
5:	7.7	↖
Serie		44
Total		223

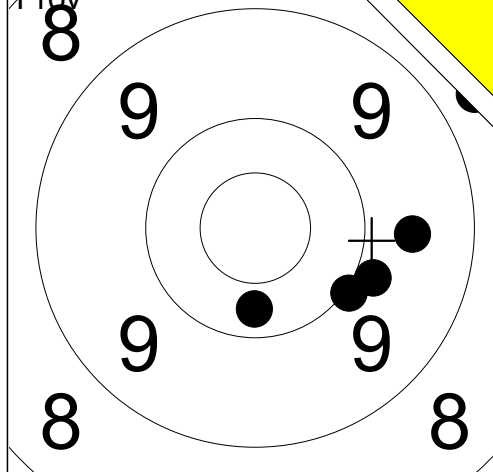

1:	10.3	↓
2:	8.7	↗
3:	10.0	↘
4:	9.6	→
5:	9.9	↘
Serie		46
Total		0

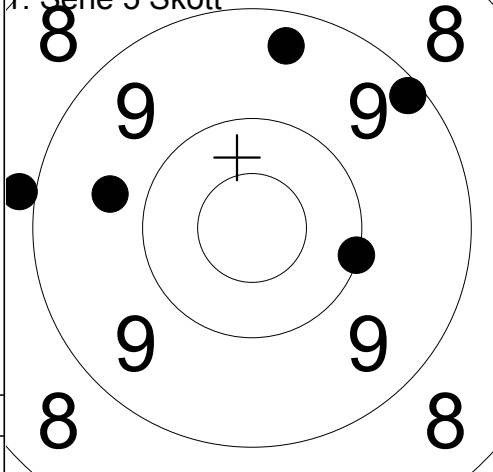

1:	8.9	←
2:	9.2	↗
3:	9.7	←
4:	10.0	→
5:	9.3	↑
Serie		45
Total		45

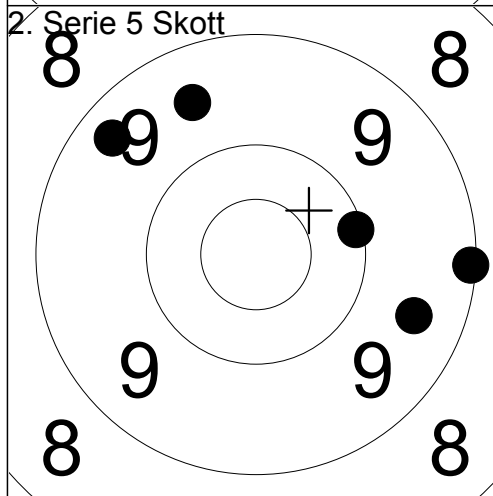

1:	9.3	↖
2:	9.5	↖
3:	9.1	→
4:	9.5	↘
5:	10.1	→
Serie		46
Total		91

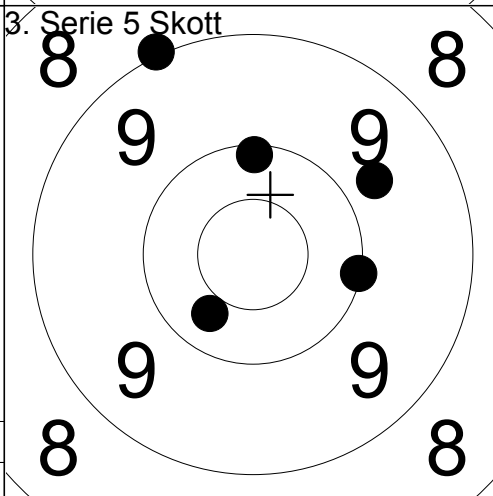

1:	9.0	↖
2:	10.3	↘
3:	9.7	↗
4:	10.1	↑
5:	10.0	→
Serie		48
Total		139

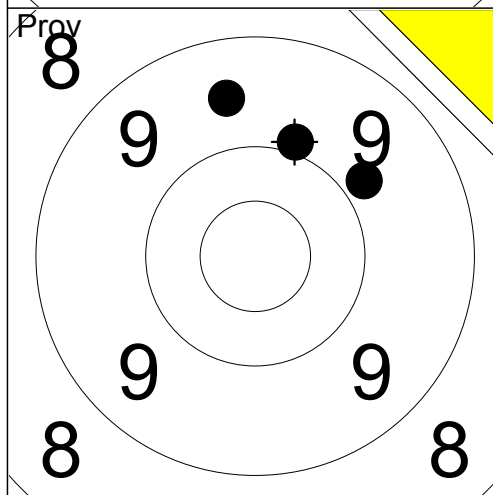

1:	9.6	↑
2:	9.9	↑
3:	9.8	↗
Serie		27
Total		139

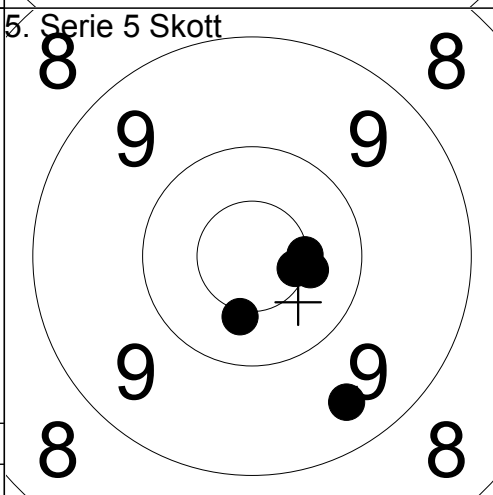

1:	10.4x	→
2:	10.5x	→
3:	10.4x	↓
4:	10.6x	→
5:	9.4	↘
Serie		49
Total		188

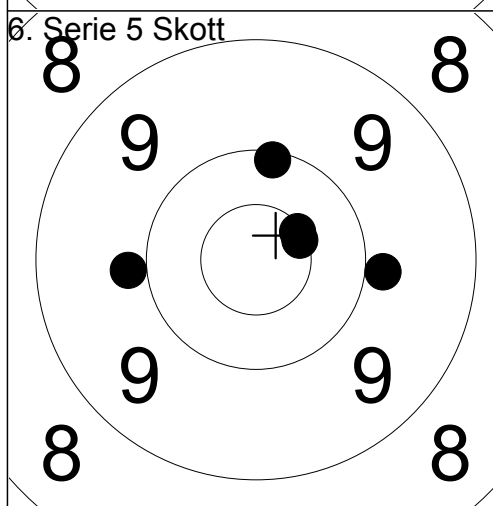

1:	9.9	←
2:	10.1	↑
3:	10.5x	↗
4:	10.5x	↗
5:	9.9	→
Serie		48
Total		236

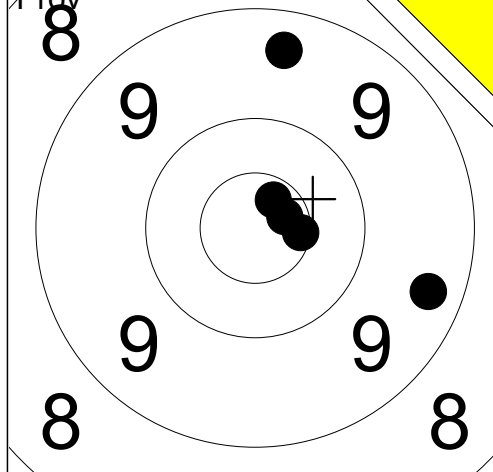

1:	9.4	↑
2:	10.7x	→
3:	10.6x	→
4:	9.3	→
5:	10.7x	↗

Serie	48
Total	0

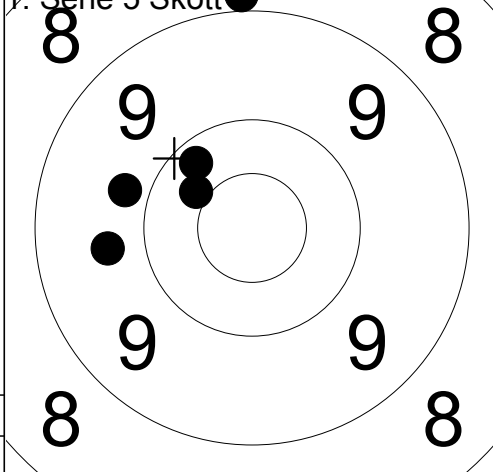

1:	8.9	↑
2:	10.2	↗
3:	9.7	←
4:	10.4	↗
5:	9.8	←

Serie	46
Total	46

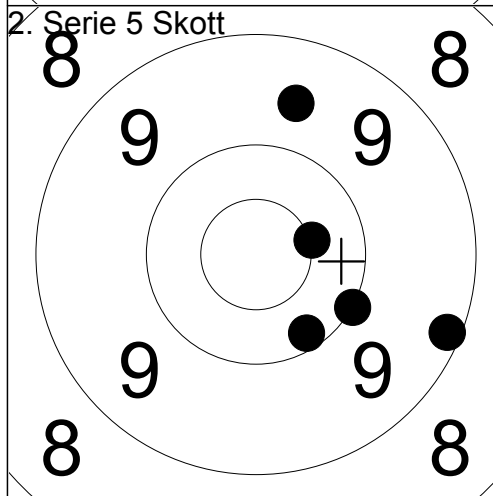

1:	9.6	↑
2:	10.5x	→
3:	10.0	↘
4:	9.2	↘
5:	10.2	↘

Serie	48
Total	94

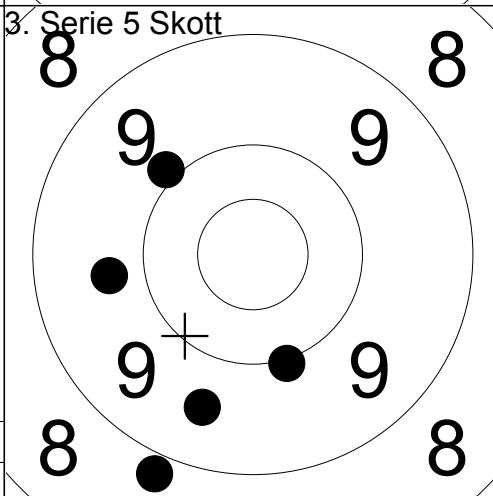

1:	9.9	↖
2:	9.6	↘
3:	10.0	↘
4:	9.7	←
5:	8.8	↘

Serie	45
Total	139

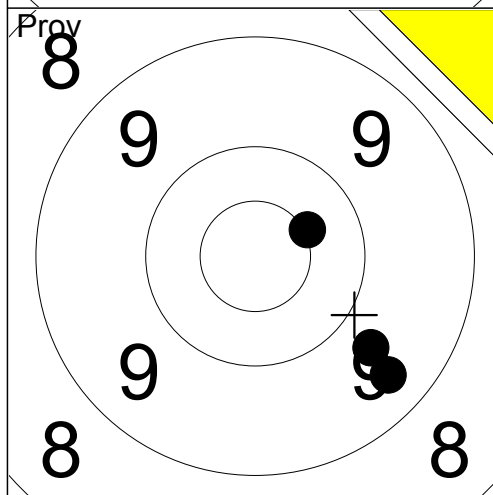

1:	10.5x	→
2:	9.4	↘
4:	9.7	↘

Serie	28
Total	139

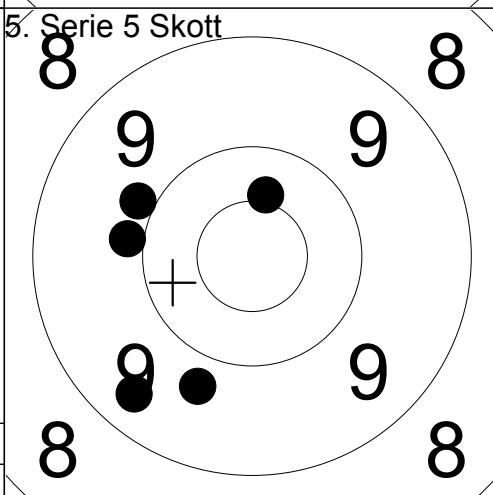

1:	9.9	↖
2:	9.9	←
3:	10.4x	↑
4:	9.7	↘
5:	9.4	↘

Serie	46
Total	185

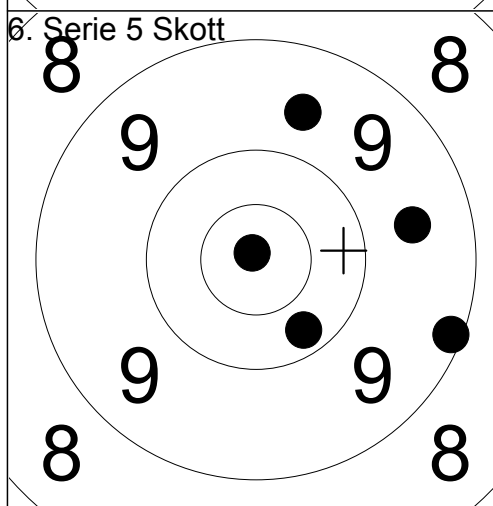

1:	9.6	↑
2:	10.9x	↗
3:	10.2	↘
4:	9.1	→
5:	9.6	→

Serie	47
Total	232

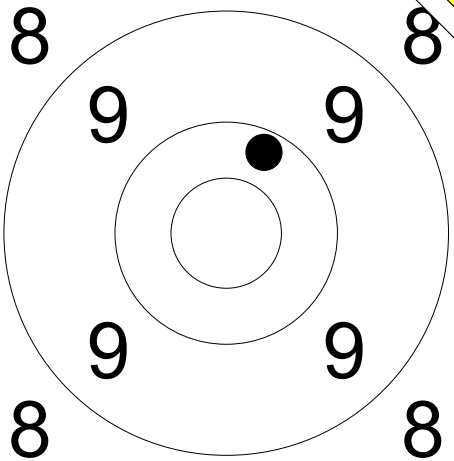
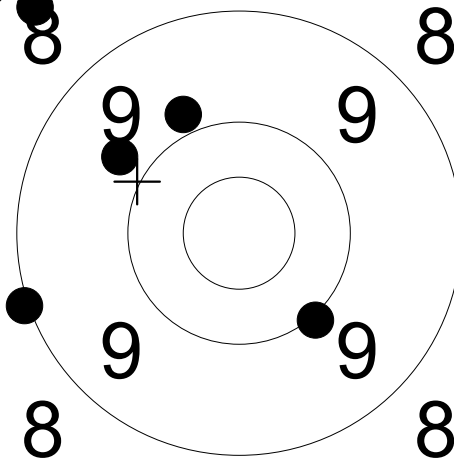
<p>Prov</p> 	<p>1: 10.2 ↗</p>	<p>1. Serie 5 Skott</p> 	<p>1: 9.0 ←</p> <p>2: 10.0 ↘</p> <p>3: 9.8 ↗</p> <p>4: 8.3 ↗</p> <p>5: 9.8 ↗</p>
Serie 10		Serie 45	
Total 0		Total 45	

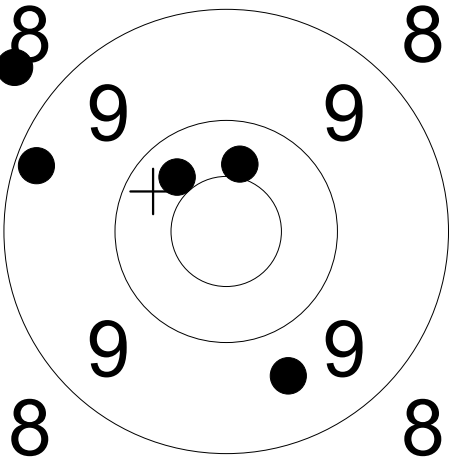
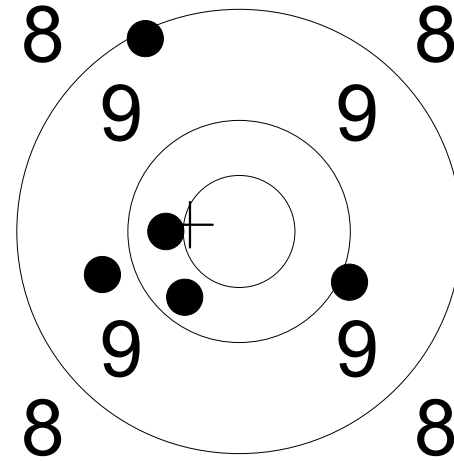
<p>2. Serie 5 Skott</p> 	<p>1: 10.4 ↗</p> <p>2: 9.2 ←</p> <p>3: 9.6 ↘</p> <p>4: 10.3 ↗</p> <p>5: 8.6 ↗</p>	<p>3. Serie 5 Skott</p> 	<p>1: 9.9 →</p> <p>2: 9.1 ↗</p> <p>3: 10.2 ↘</p> <p>4: 9.7 ←</p> <p>5: 10.3 ←</p>
Serie 46		Serie 47	
Total 91		Total 138	

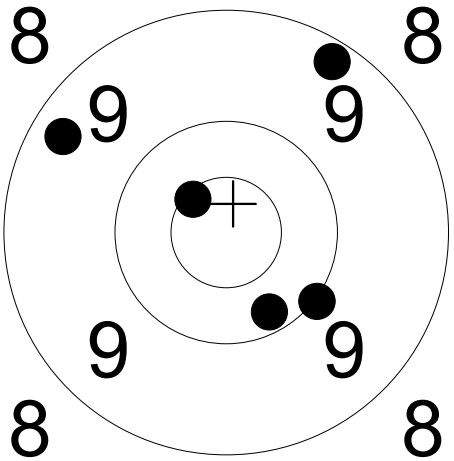
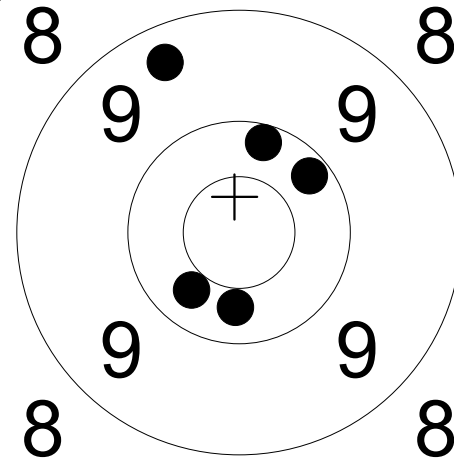
<p>5. Serie 5 Skott</p> 	<p>1: 10.0 ↘</p> <p>2: 9.2 ↗</p> <p>3: 10.2 ↘</p> <p>4: 9.3 ↗</p> <p>5: 10.6x ↗</p>	<p>6. Serie 5 Skott</p> 	<p>1: 10.3 ↓</p> <p>2: 10.2 ↗</p> <p>3: 10.2 ↗</p> <p>4: 9.4 ↗</p> <p>5: 10.3 ↘</p>
Serie 48		Serie 49	
Total 186		Total 235	

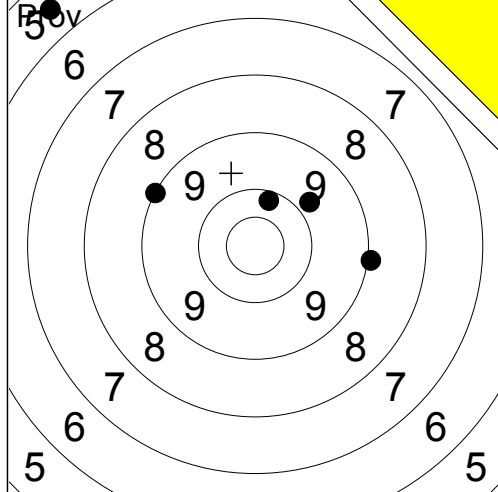

1:	5.5	↗
2:	9.0	↖
3:	10.2	↑
4:	9.8	↗
5:	9.0	→
Serie	42	
Total	0	

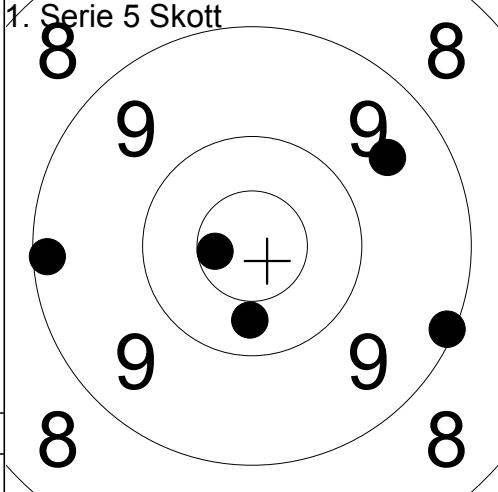

1:	9.6	↗
2:	9.2	←
3:	10.6x	←
4:	10.3	↓
5:	9.1	↘
Serie	47	
Total	47	

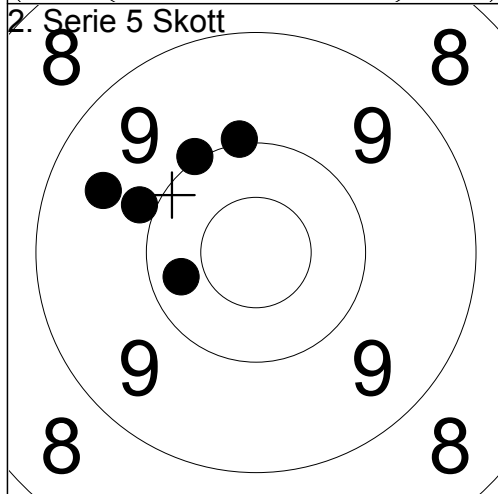

1:	10.0	↑
2:	10.3	←
3:	10.0	↗
4:	9.5	↖
5:	9.9	↖
Serie	48	
Total	95	

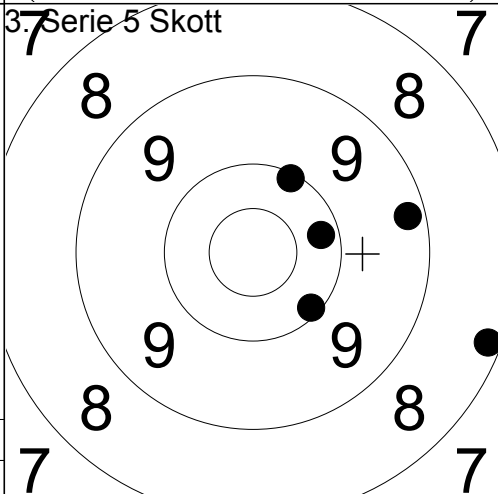

1:	10.1	↑
2:	10.2	→
3:	9.2	→
4:	8.2	→
5:	10.1	↘
Serie	47	
Total	142	

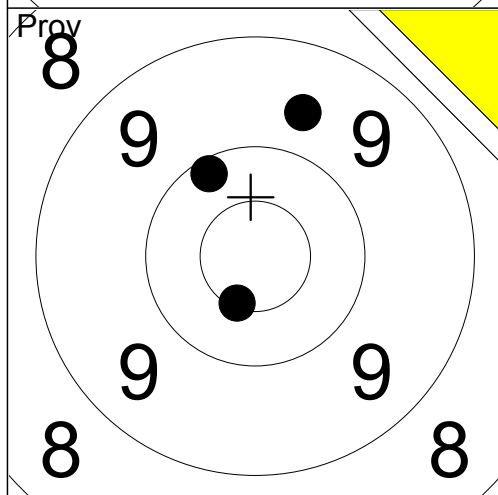

1:	9.6	↑
2:	10.2	↗
3:	10.5x	↘
Serie	29	
Total	142	

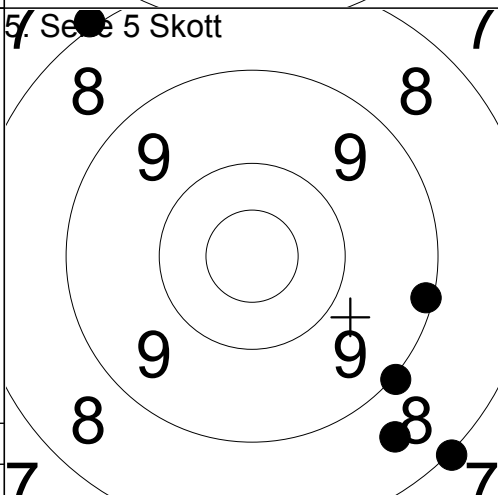

1:	9.1	→
2:	8.6	↘
3:	8.0	↗
4:	8.0	↘
5:	9.0	↘
Serie	42	
Total	184	

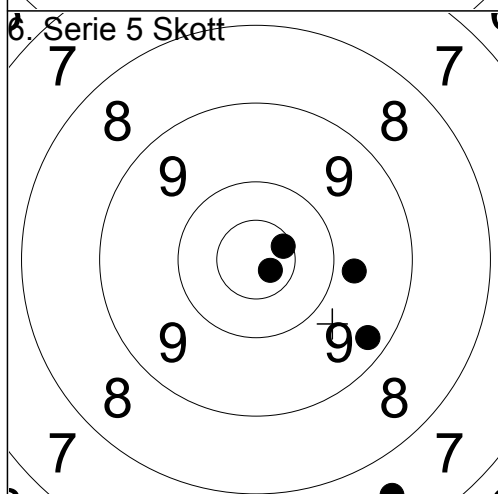

1:	9.3	↘
2:	9.8	→
3:	10.6x	↗
4:	10.7x	↘
5:	7.5	↘
Serie	45	
Total	229	



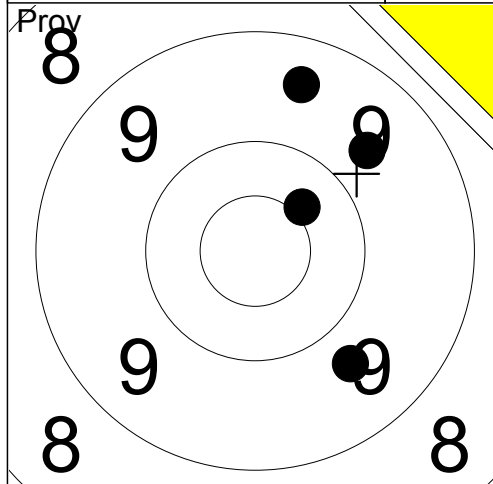

1:	8.5	↗
2:	9.7	↗
3:	9.5	↑
4:	9.7	↘
5:	10.4	↗
Serie		45
Total		0

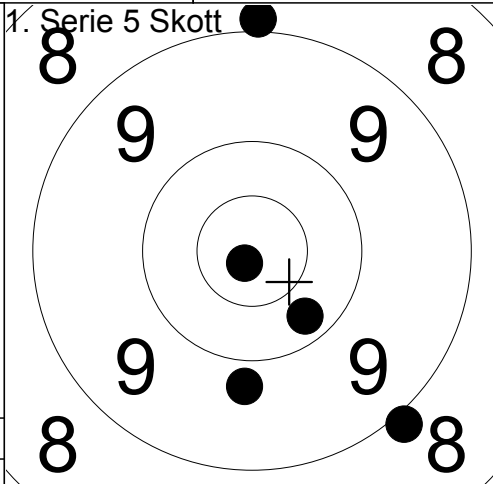

1:	8.9	↑
2:	9.8	↓
3:	8.9	↘
4:	10.8x	↘
5:	10.2	↘
Serie		45
Total		45

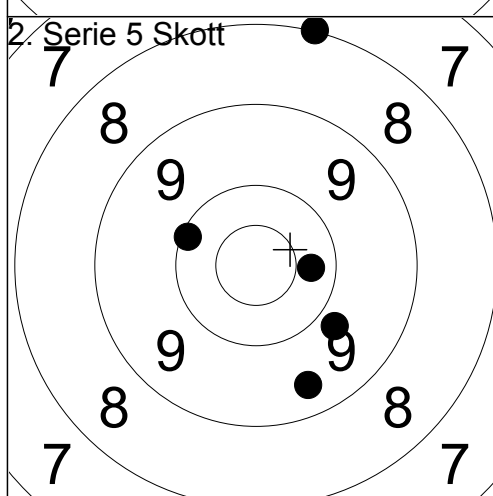

1:	10.3	→
2:	9.4	↘
3:	9.8	↘
4:	10.1	↖
5:	8.0	↑
Serie		46
Total		91

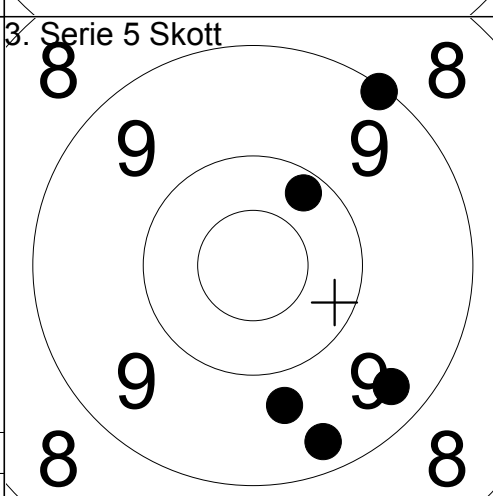

1:	10.2	↗
2:	9.3	↘
3:	9.1	↗
4:	9.4	↘
5:	9.7	↘
Serie		46
Total		137

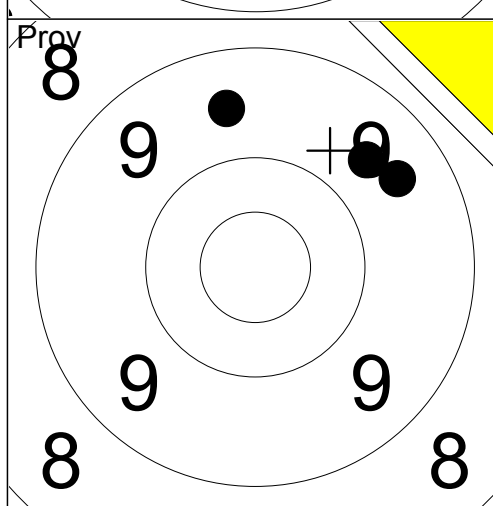

1:	9.5	↗
2:	9.6	↗
3:	9.6	↑
Serie		27
Total		137

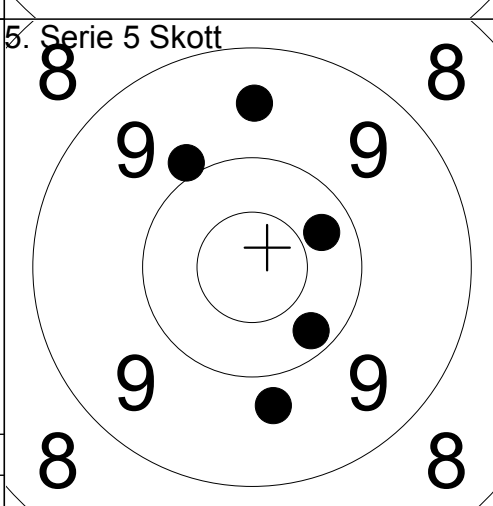

1:	10.3	↗
2:	9.5	↑
3:	9.9	↗
4:	10.2	↘
5:	9.8	↘
Serie		47
Total		184

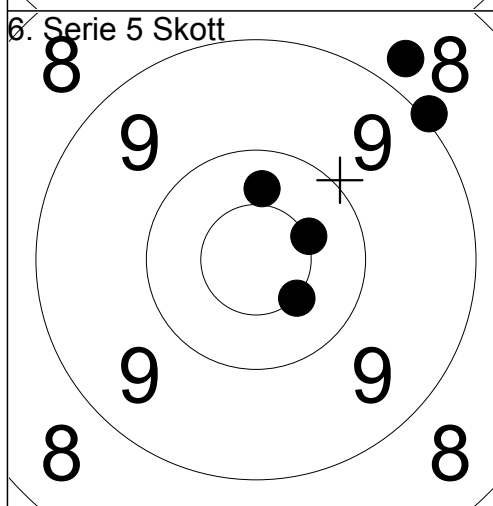

1:	8.8	↗
2:	10.5x	↘
3:	9.0	↗
4:	10.5x	↗
5:	10.3	↑
Serie		47
Total		231

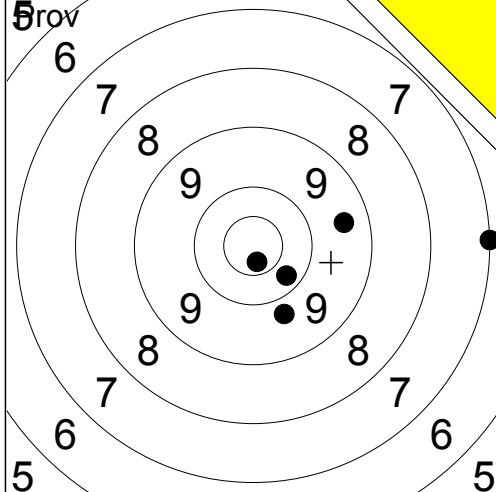

1:	10.7x	↓
2:	9.8	↓
3:	9.5	→
4:	10.3	↓
5:	7.0	→

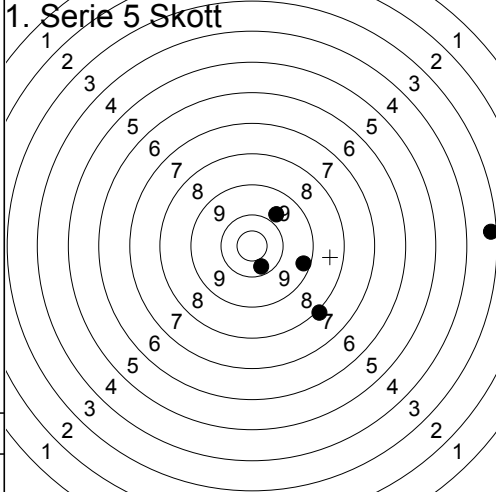

1:	8.0	↓
2:	10.3	↓
3:	9.7	↗
4:	9.3	→
5:	3.2	→

Serie	45
Total	0

Serie	39
Total	39

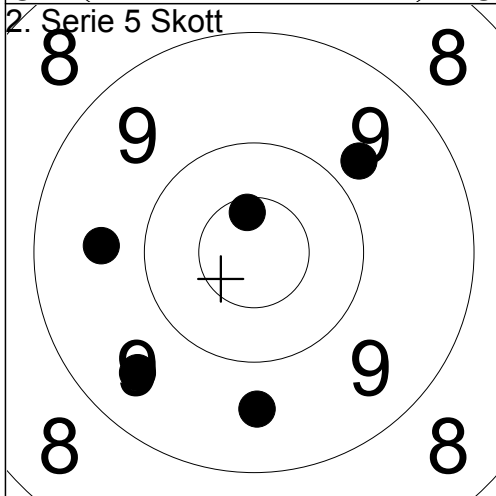

1:	10.6x	↑
2:	9.6	↓
3:	9.6	←
4:	9.5	↙
5:	9.8	↗

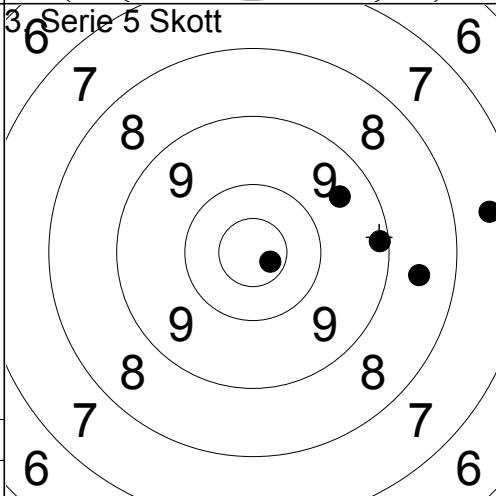

1:	9.5	↗
2:	10.7x	→
3:	7.5	→
4:	8.6	→
5:	9.2	→

Serie	46
Total	85

Serie	43
Total	128

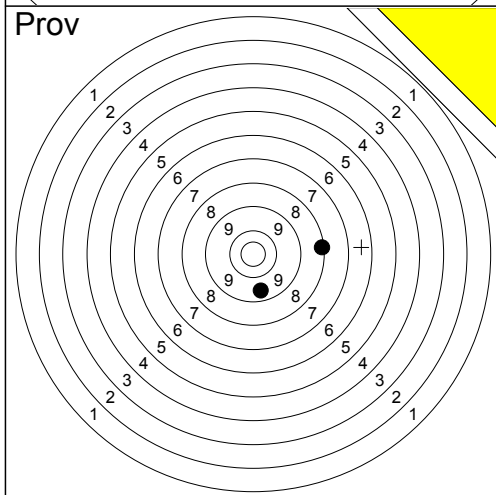

1:	9.5	↓
2:	8.1	→
3:	0.0	→

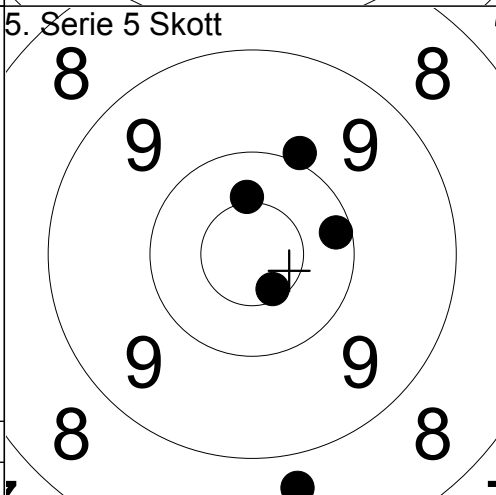

1:	10.4x	↑
2:	8.7	↓
3:	10.6x	↓
4:	9.9	↗
5:	10.2	→

Serie	17
Total	128

Serie	47
Total	175

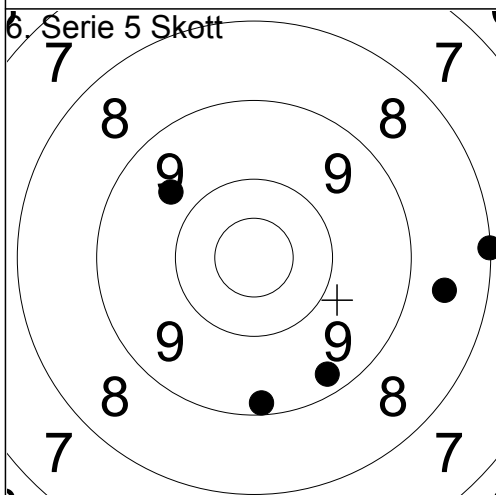

1:	8.6	→
2:	8.0	→
3:	9.7	↗
4:	9.2	↓
5:	9.3	↙

Serie	43
Total	218

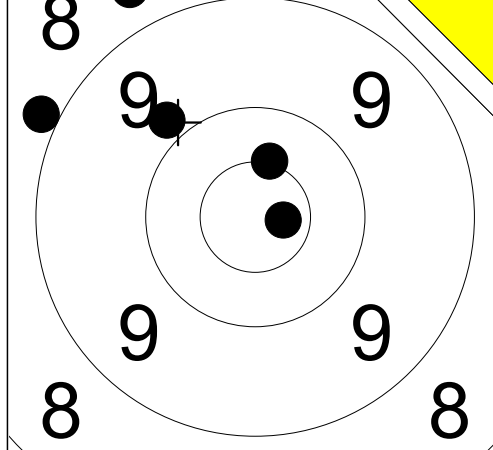

1:	8.7	↗
2:	9.8	↗
3:	8.9	↗
4:	10.7x	→
5:	10.5x	↑

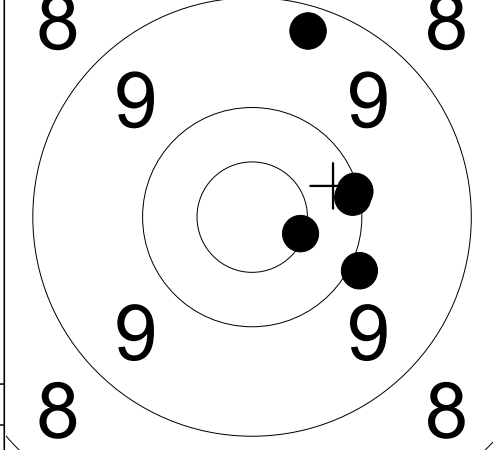

1:	9.3	↑
2:	9.9	→
3:	10.5x	→
4:	10.1	→
5:	10.1	→

Serie	45
Total	0

Serie	48
Total	48

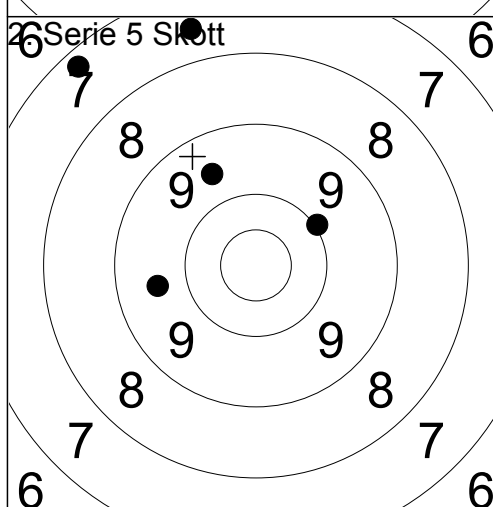

1:	7.6	↑
2:	7.3	↗
3:	9.6	↗
4:	9.6	←
5:	10.0	↗

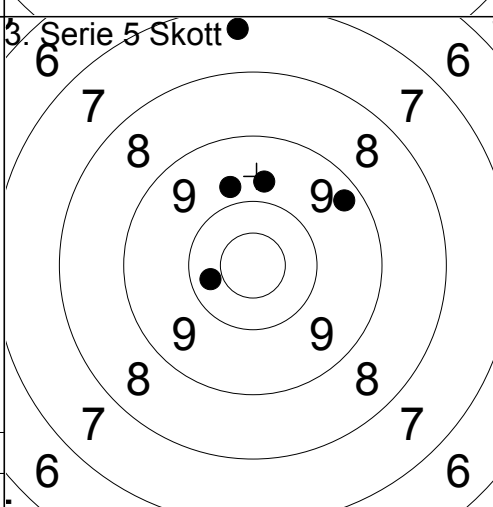

1:	7.4	↑
2:	9.7	↑
3:	10.3	←
4:	9.3	↗
5:	9.8	↑

Serie	42
Total	90

Serie	44
Total	134

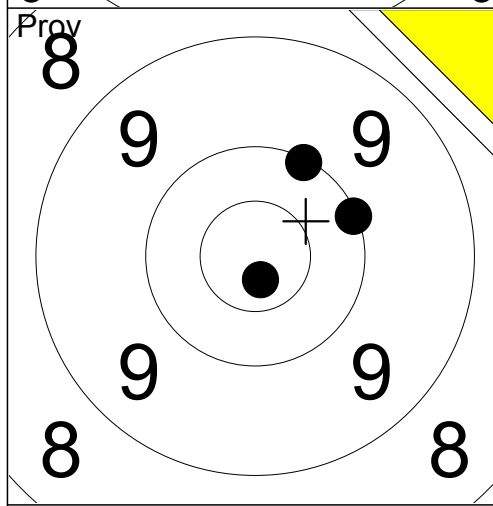

1:	10.1	→
2:	10.1	↑
3:	10.7x	↓

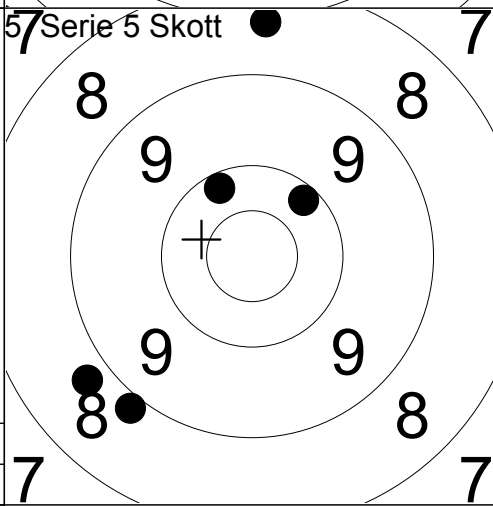

1:	8.4	↑
2:	10.2	↗
3:	10.2	↗
4:	8.8	↙
5:	8.9	↙

Serie	30
Total	134

Serie	44
Total	178

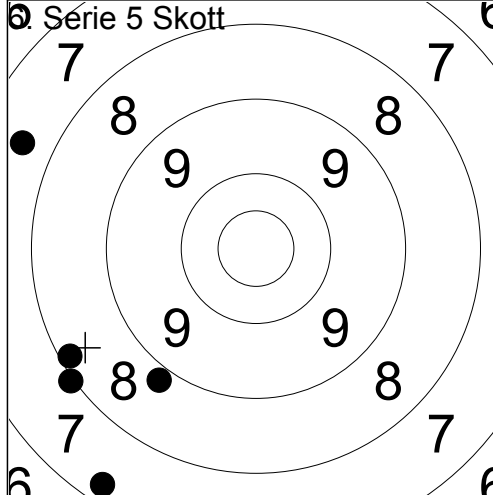

1:	8.0	↙
2:	8.2	↙
3:	7.6	↙
4:	7.3	↓
5:	8.8	↓

Serie	38
Total	216

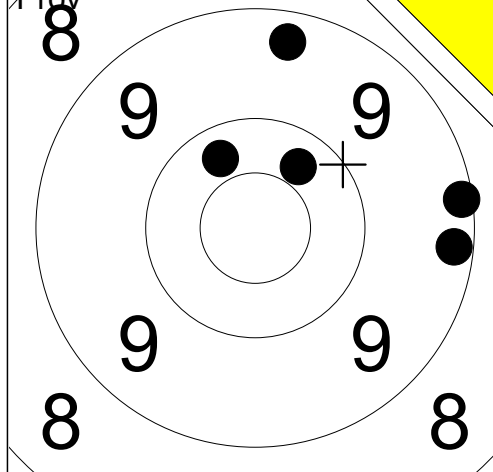

1:	10.3	↗
2:	9.3	↑
3:	9.1	→
4:	9.2	→
5:	10.3	↗
Serie		47
Total		0

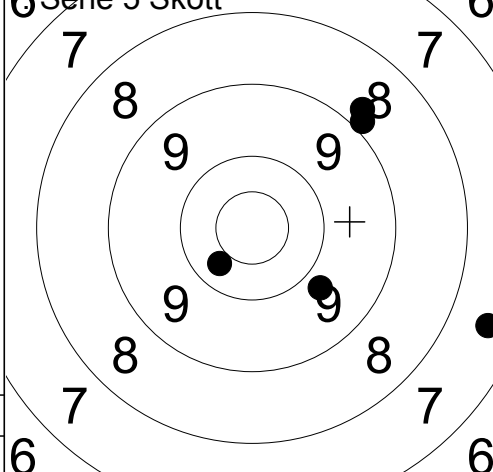

1:	8.8	↗
2:	7.5	→
3:	8.9	↗
4:	10.3	↘
5:	9.8	↘
Serie		42
Total		42

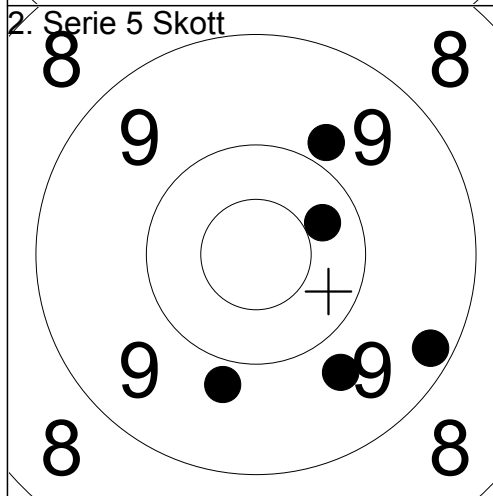

1:	10.3	↗
2:	9.8	↘
3:	9.7	↘
4:	9.2	↘
5:	9.8	↗
Serie		46
Total		88

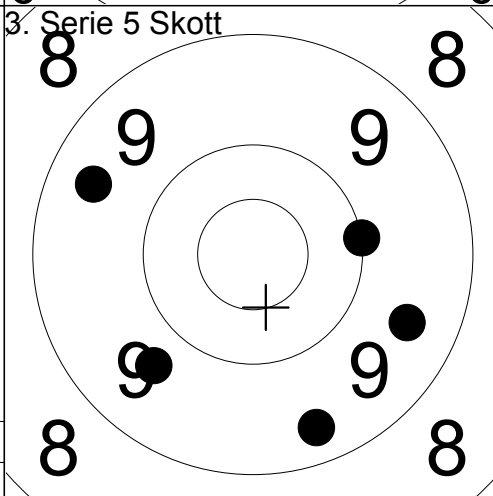

1:	9.4	↖
2:	9.5	→
3:	9.7	↘
4:	9.4	↘
5:	10.0	→
Serie		46
Total		134

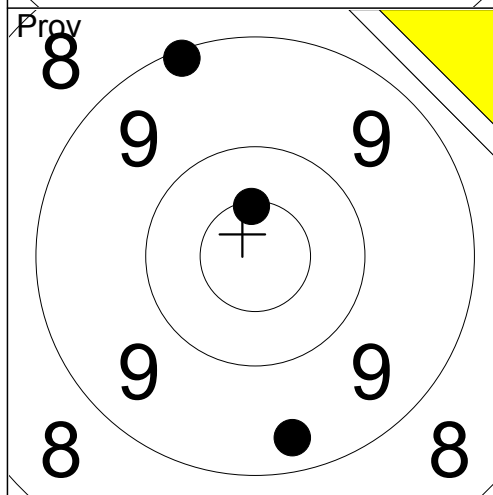

1:	9.1	↑
2:	9.3	↘
3:	10.5x	↑
Serie		28
Total		134

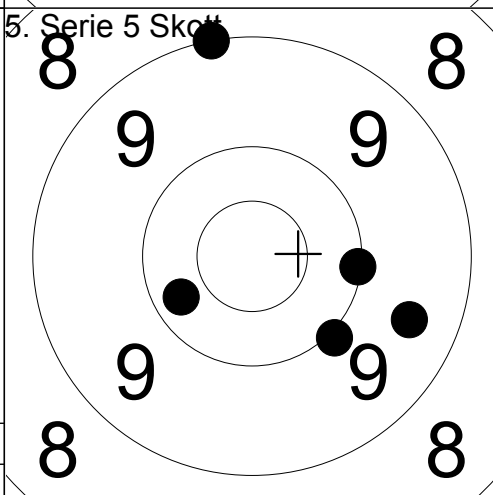

1:	10.3	↖
2:	9.0	↑
3:	10.0	↘
4:	9.5	→
5:	10.1	→
Serie		48
Total		182

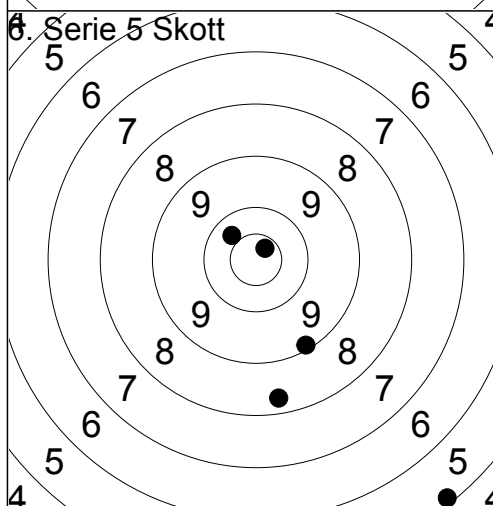

1:	10.7x	↗
2:	9.1	↘
3:	8.3	↘
4:	10.3	↗
5:	5.2	↘
Serie		42
Total		224

--	--	--

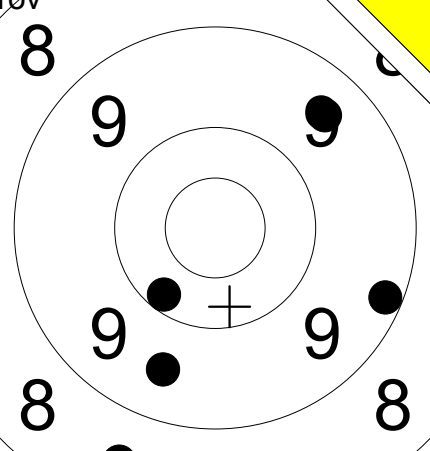
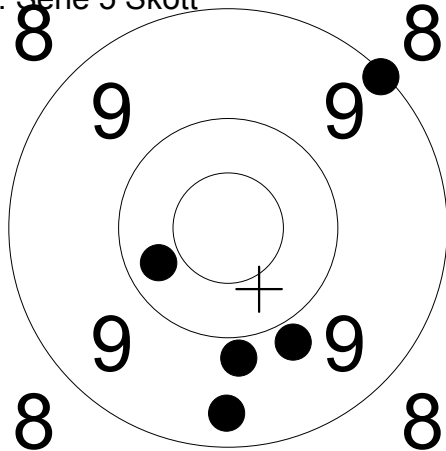
Pröv 	1: 9.5 ↗ 2: 9.2 → 3: 9.5 ↓ 4: 8.5 ↓ 5: 10.2 ↙	1. Serie 5 Skott 	1: 9.3 ↓ 2: 9.8 ↓ 3: 9.1 ↗ 4: 9.8 ↓ 5: 10.3 ↙
Serie	45	Serie	46
Total	0	Total	46

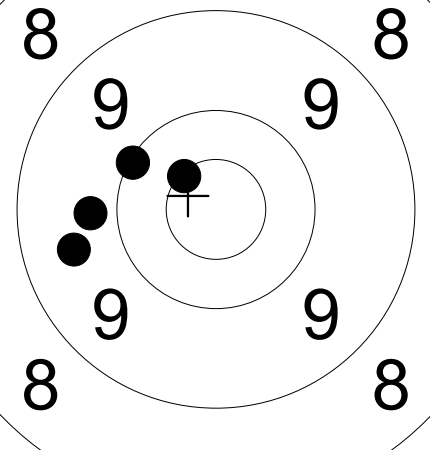
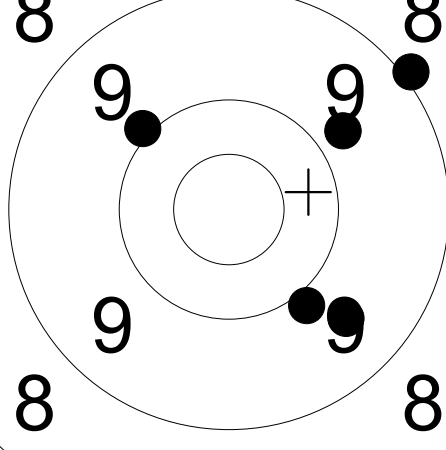
2. Serie 5 Skott 	1: 9.5 ← 2: 9.8 ← 3: 10.5x ↗ 4: 8.6 → 5: 10.1 ↗	3. Serie 5 Skott 	1: 9.6 ↓ 2: 9.0 ↗ 3: 9.8 ↗ 4: 10.0 ↗ 5: 9.9 ↓
Serie	46	Serie	46
Total	92	Total	138

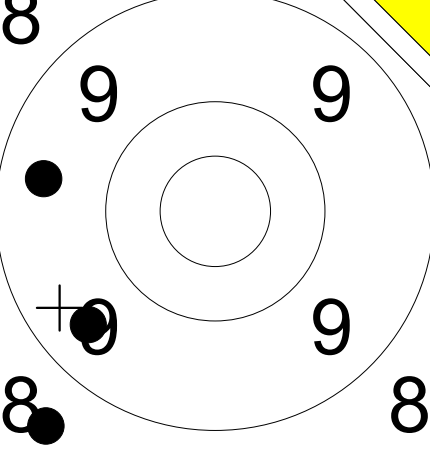
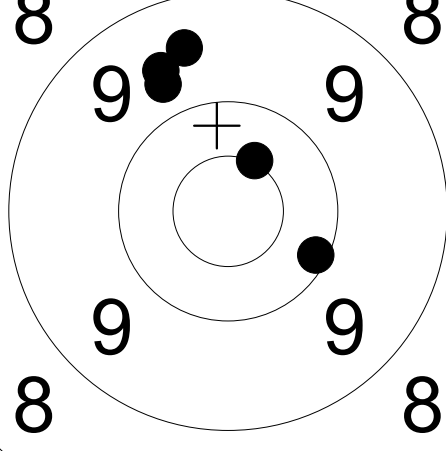
Pröv 	1: 8.5 ↓ 2: 9.5 ↓ 3: 9.4 ←	5. Serie 5 Skott 	1: 10.5x ↗ 2: 10.1 → 3: 9.5 ↗ 4: 9.6 ↗ 5: 9.7 ↗
Serie	26	Serie	47
Total	138	Total	185

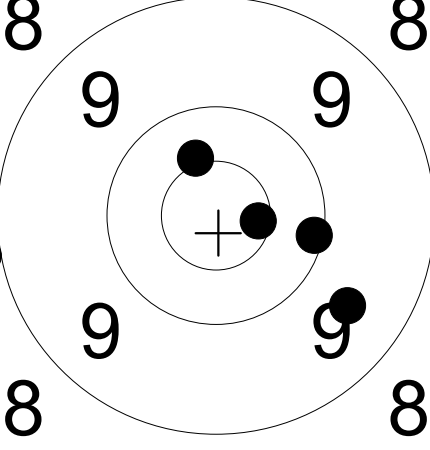
6. Serie 5 Skott 	1: 10.4x ↗ 2: 8.9 ← 3: 10.6x → 4: 9.6 ↓ 5: 10.1 →		
Serie	47		
Total	232		

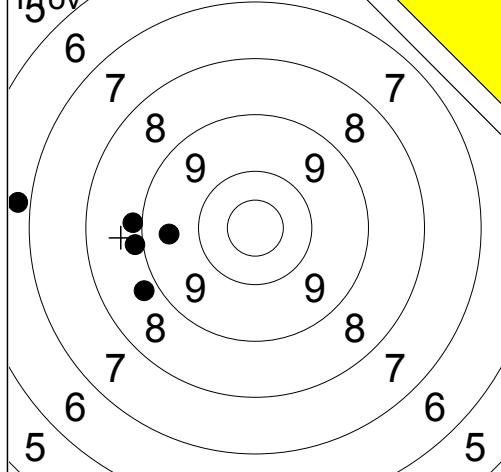

1:	8.9	←
2:	6.8	←
3:	9.5	←
4:	8.9	←
5:	8.8	←

Serie	39
Total	0

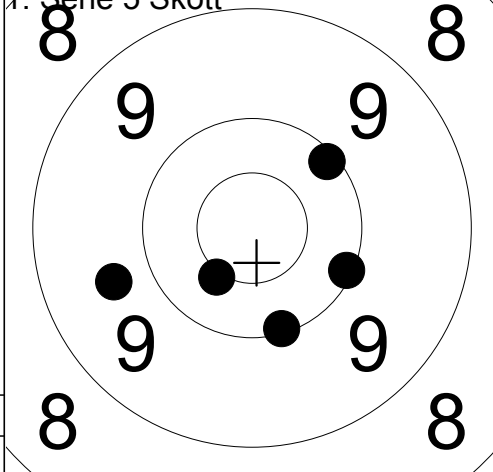

1:	9.7	←
2:	10.1	↗
3:	10.4x	↙
4:	10.1	→
5:	10.1	↘

Serie	49
Total	49

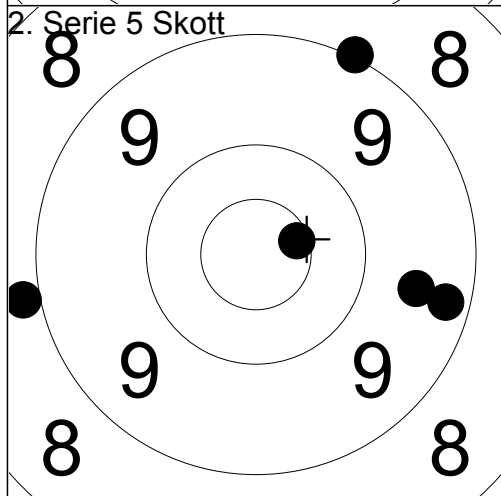

1:	8.9	←
2:	10.6x	→
3:	9.0	↗
4:	9.2	→
5:	9.5	→

Serie	45
Total	94

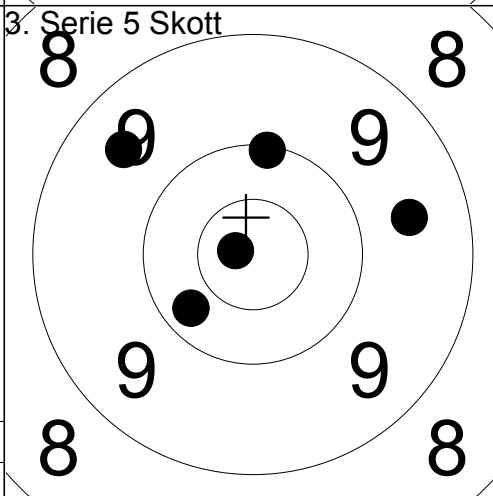

1:	10.8x	←
2:	9.5	↗
3:	10.3	↙
4:	10.1	↗
5:	9.6	→

Serie	48
Total	142

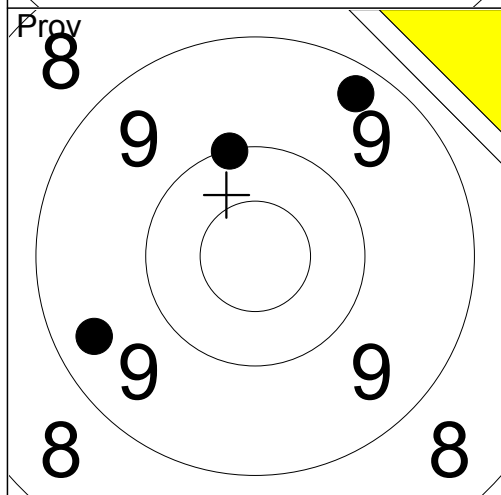

1:	9.3	↗
2:	10.0	↗
3:	9.4	←

Serie	28
Total	142

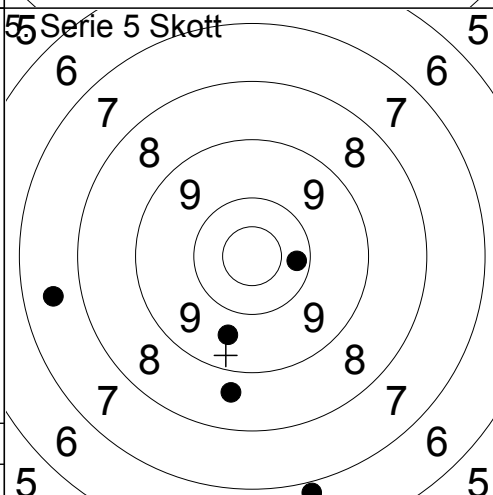

1:	7.5	←
2:	6.8	↘
3:	10.2	→
4:	8.7	↘
5:	9.6	↘

Serie	40
Total	182

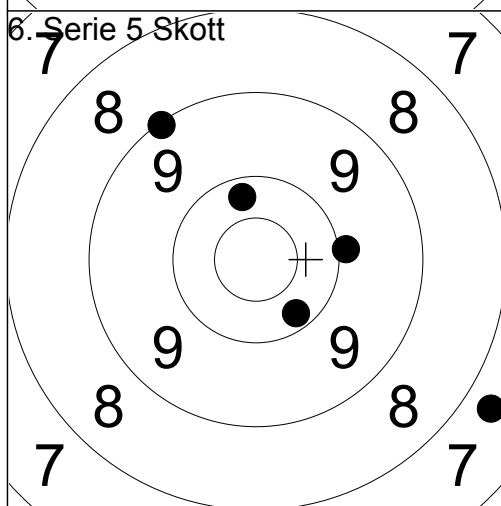

1:	10.2	↗
2:	7.7	↘
3:	9.9	→
4:	9.1	↗
5:	10.2	↘

Serie	45
Total	227

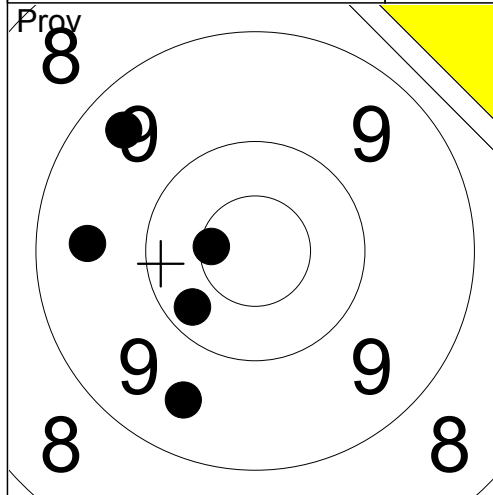

1:	9.5	↘
2:	10.2	↙
3:	10.6x	←
4:	9.4	↗
5:	9.5	←
Serie		47
Total		0

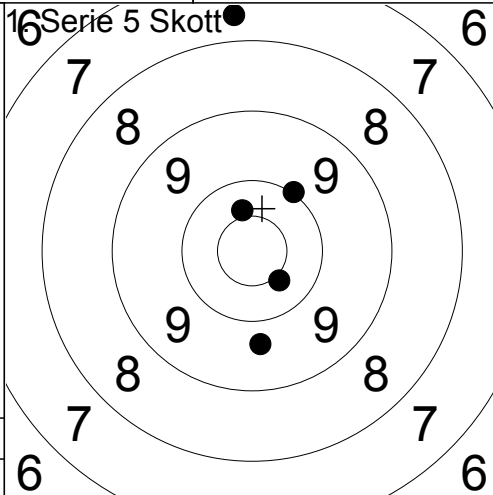

1:	7.6	↑
2:	10.4	↑
3:	10.4x	↘
4:	9.7	↓
5:	10.0	↗
Serie		46
Total		46

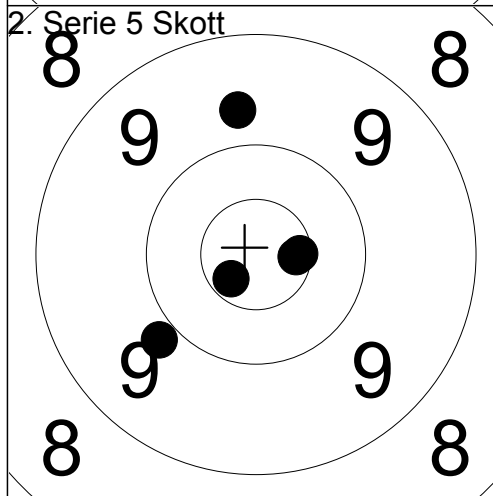

1:	9.7	↑
2:	10.6x	→
3:	9.9	↙
4:	10.7x	↙
5:	10.6x	→
Serie		48
Total		94

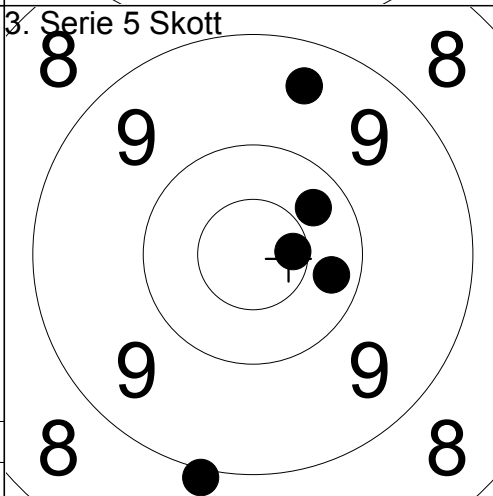

1:	9.4	↑
2:	10.6x	→
3:	10.3	↗
4:	10.3	→
5:	8.9	↓
Serie		47
Total		141

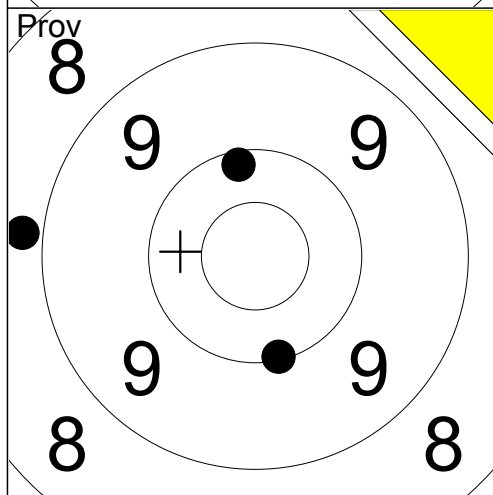

1:	10.1	↘
2:	10.1	↑
3:	8.8	←
Serie		28
Total		141

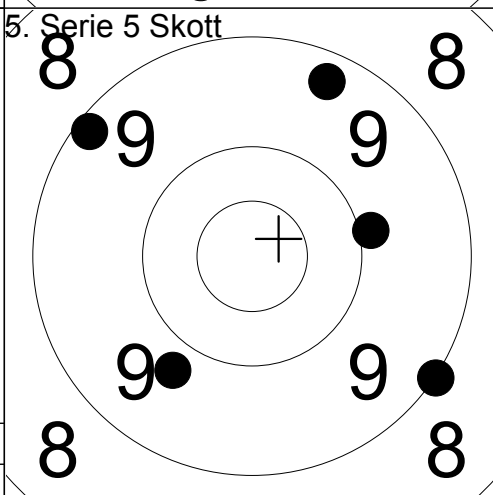

1:	9.3	↗
2:	9.2	↖
3:	9.8	↙
4:	9.9	→
5:	9.0	↘
Serie		45
Total		186

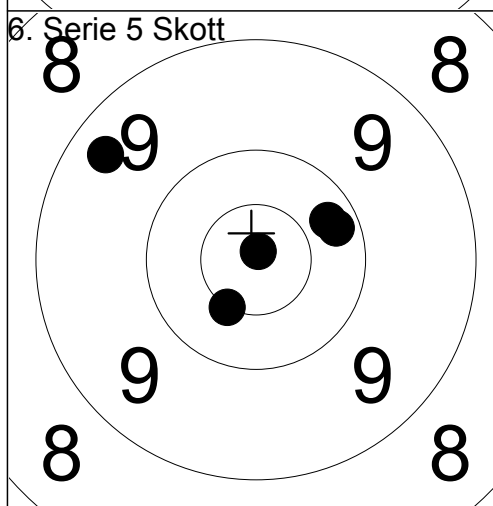

1:	10.9x	↑
2:	10.3	↗
3:	10.2	↗
4:	9.4	↖
5:	10.5x	↘
Serie		49
Total		235

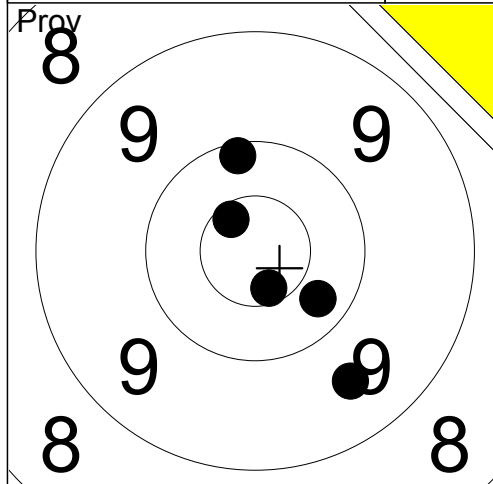

1:	10.6x	↗
2:	10.3	↘
3:	10.1	↗
4:	10.6x	↘
5:	9.6	↘

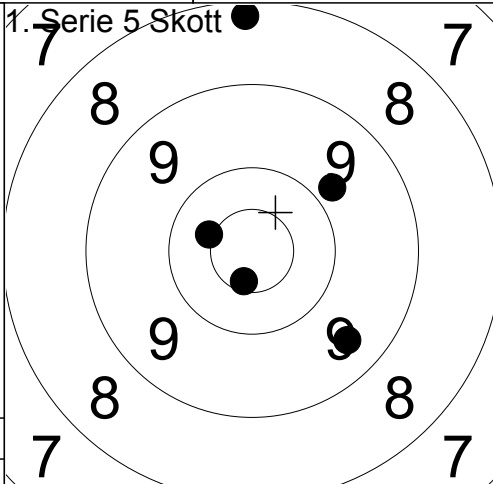

1:	8.2	↑
2:	9.5	↘
3:	10.6x	↘
4:	9.8	↗
5:	10.4x	←

Serie	49
Total	0

Serie	46
Total	46

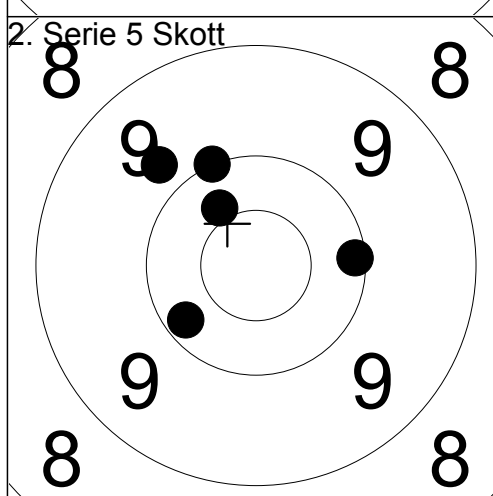

1:	10.0	↗
2:	10.1	→
3:	10.4	↗
4:	10.2	↖
5:	9.8	↗

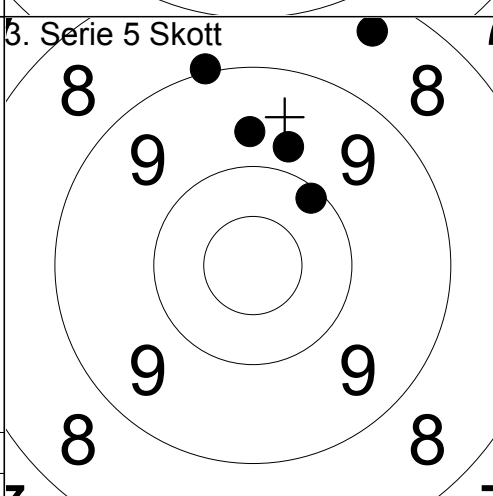

1:	9.8	↑
2:	8.4	↗
3:	9.7	↑
4:	10.1	↗
5:	9.0	↑

Serie	49
Total	95

Serie	45
Total	140

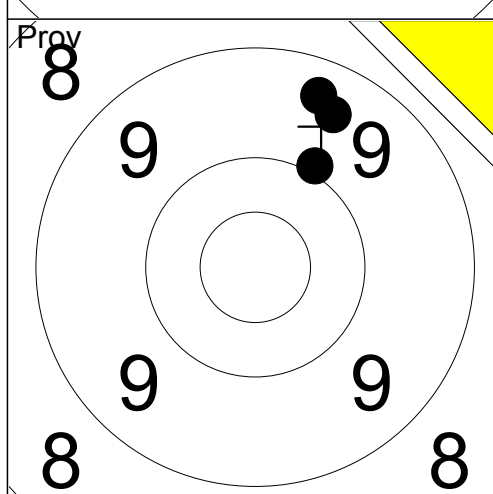

1:	9.4	↑
2:	10.0	↗
3:	9.5	↗

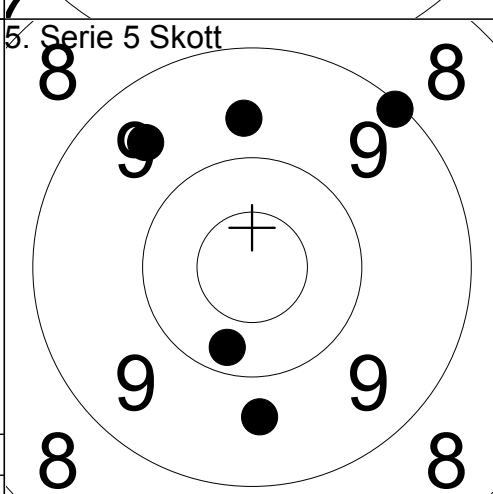

1:	9.5	↖
2:	9.1	↗
3:	9.7	↘
4:	9.7	↑
5:	10.2	↘

Serie	28
Total	140

Serie	46
Total	186

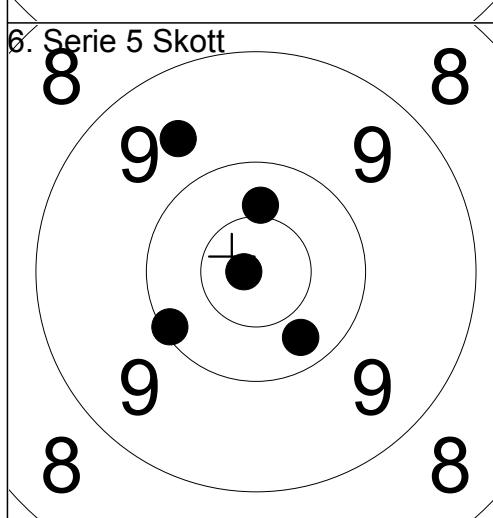

1:	10.4	↑
2:	9.6	↗
3:	10.3	↘
4:	10.1	↖
5:	10.8x	←

Serie	49
Total	235

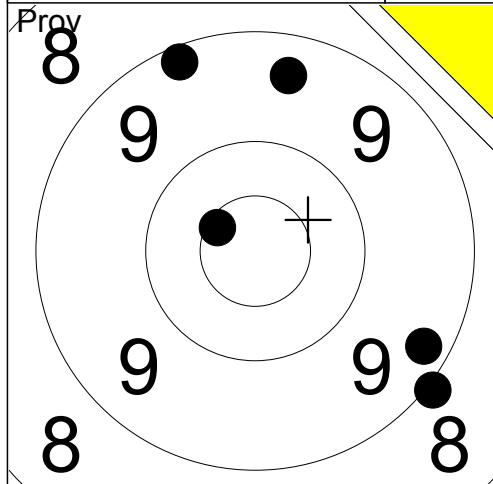

1:	9.0	↘
2:	9.3	↘
3:	10.6x	↗
4:	9.2	↗
5:	9.4	↑

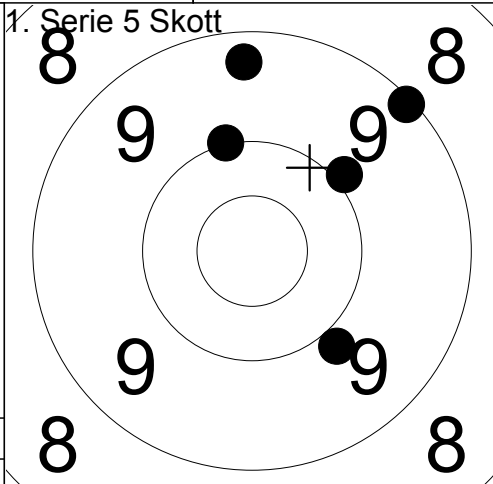

1:	9.3	↑
2:	9.1	↗
3:	9.9	↗
4:	10.0	↑
5:	9.9	↘

Serie	46
Total	0

Serie	46
Total	46

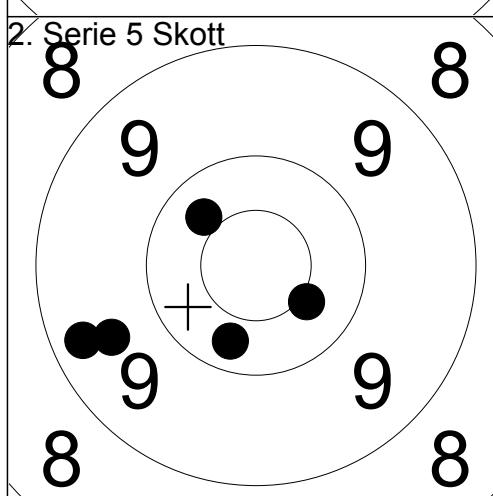

1:	10.3	↗
2:	10.4x	↘
3:	9.3	←
4:	10.3	↘
5:	9.6	←

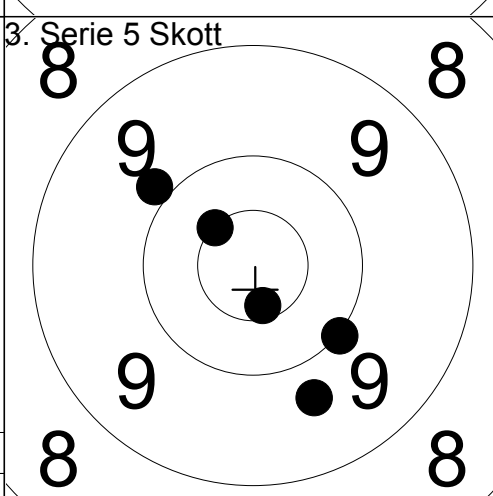

1:	10.5x	↗
2:	9.9	↗
3:	10.6x	↘
4:	9.7	↘
5:	10.0	↘

Serie	48
Total	94

Serie	48
Total	142

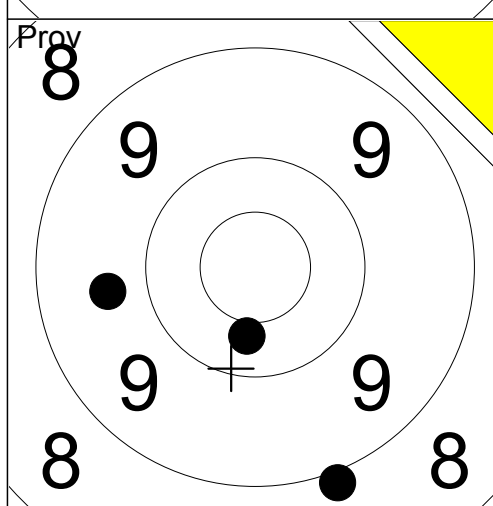

1:	8.9	↘
2:	10.4	↘
3:	9.7	←

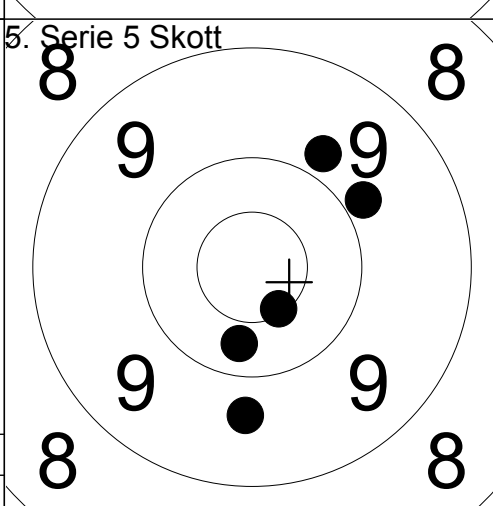

1:	9.8	↗
2:	10.3	↘
3:	9.7	↘
4:	10.5x	↘
5:	9.8	↗

Serie	27
Total	142

Serie	47
Total	189

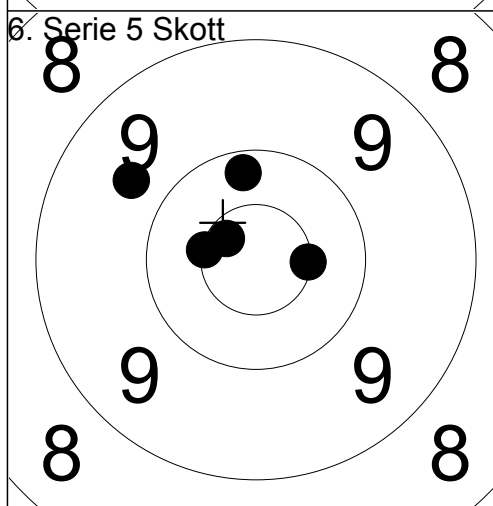

1:	10.5x	←
2:	10.5x	→
3:	10.2	↑
4:	10.6x	↗
5:	9.7	↗

Serie	49
Total	238

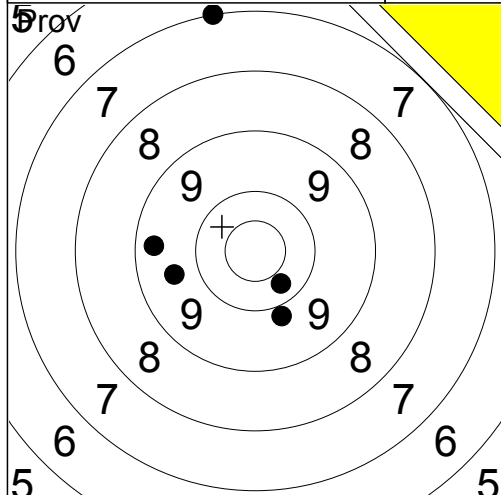

1:	7.0	↑
2:	9.3	←
3:	10.3	↘
4:	9.6	←
5:	9.9	↘
Serie		44
Total		0

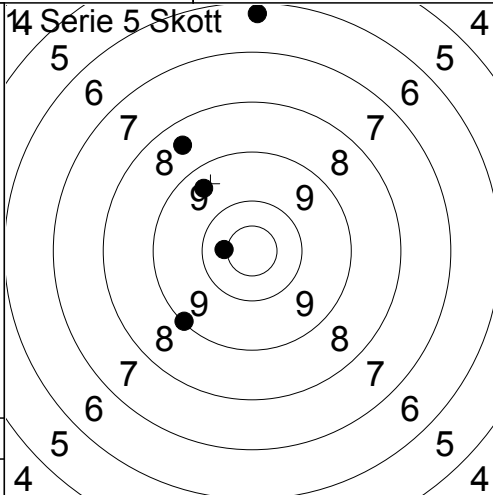

1:	6.2	↑
2:	10.4x	←
3:	9.1	↘
4:	8.5	↗
5:	9.4	↗
Serie		42
Total		42

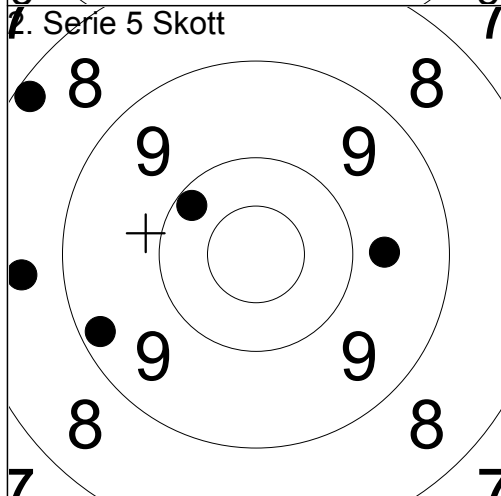

1:	8.2	↗
2:	10.2	↗
3:	8.6	←
4:	9.7	→
5:	9.2	←
Serie		44
Total		86

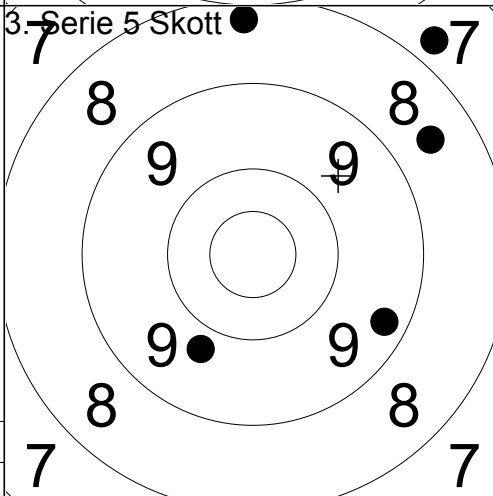

1:	8.6	↗
2:	7.8	↗
3:	8.3	↑
4:	9.3	→
5:	9.8	↘
Serie		41
Total		127

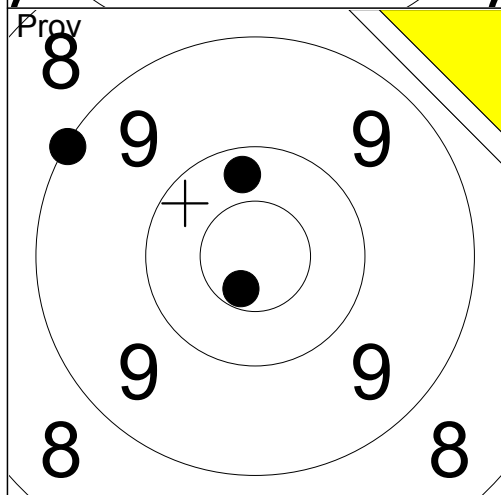

1:	9.1	↖
2:	10.7x	↘
3:	10.3	↑
Serie		29
Total		127

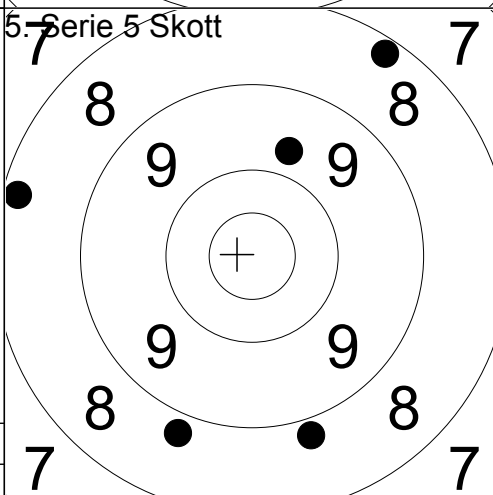

1:	9.7	↑
2:	8.8	↘
3:	8.2	↗
4:	8.2	←
5:	8.8	↘
Serie		41
Total		168

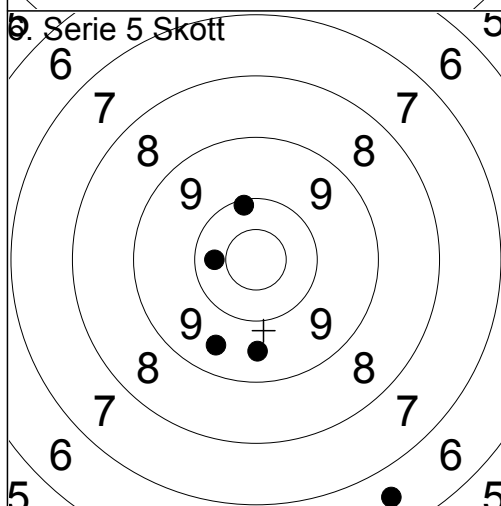

1:	10.3	←
2:	6.6	↘
3:	9.5	↘
4:	10.1	↑
5:	9.5	↘
Serie		44
Total		212

--	--	--

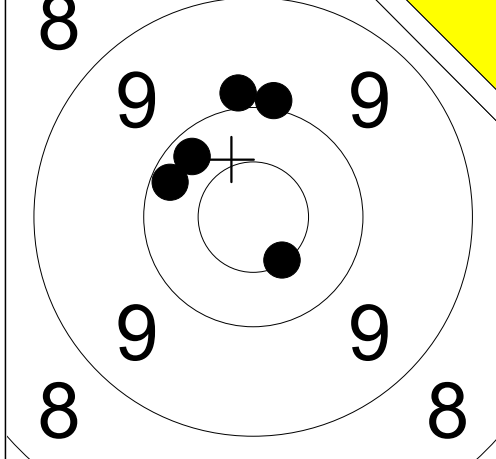

1:	10.2	↗
2:	10.0	↑
3:	10.2	↖
4:	9.9	↑
5:	10.5x	↘
Serie		49
Total		0

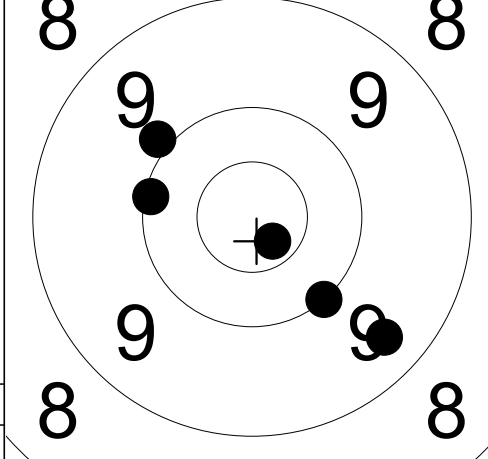

1:	9.9	↗
2:	9.4	↘
3:	10.7x	↘
4:	10.1	↖
5:	10.0	↘
Serie		48
Total		48

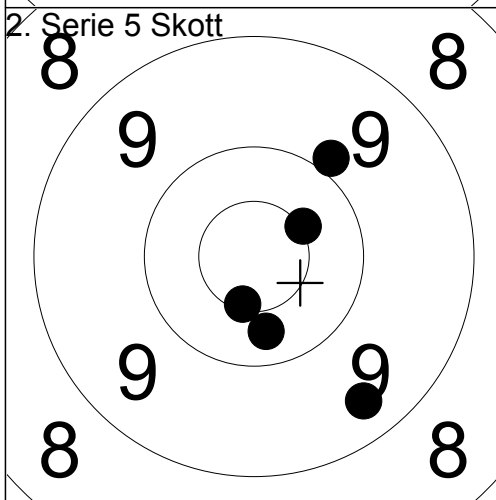

1:	10.3	↘
2:	9.4	↘
3:	10.5x	↗
4:	9.9	↗
5:	10.5x	↘
Serie		48
Total		96

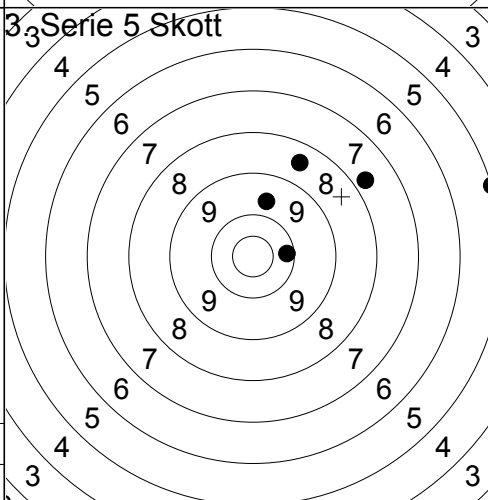

1:	9.7	↑
2:	10.2	→
3:	8.5	↗
4:	5.0	→
5:	7.7	↗
Serie		39
Total		135

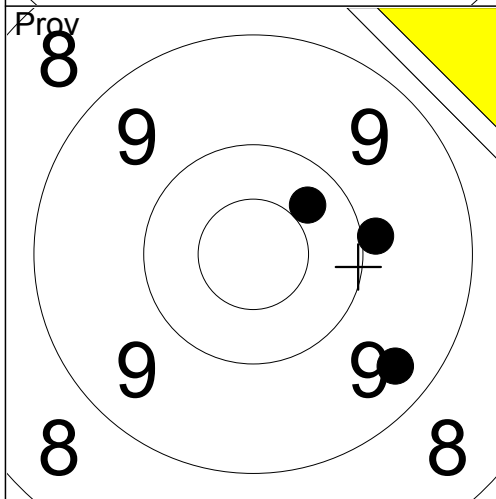

1:	9.4	↘
2:	10.3	↗
3:	9.9	→
Serie		28
Total		135

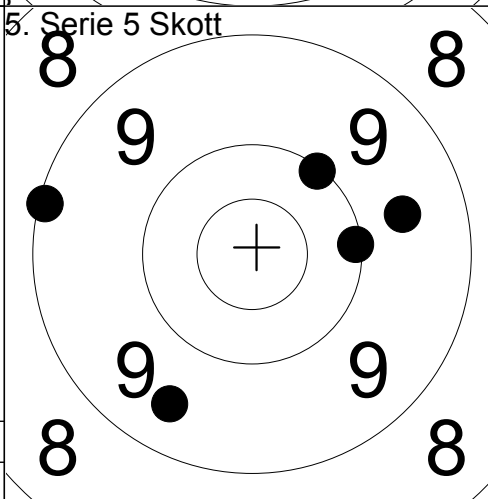

1:	10.1	↗
2:	10.1	→
3:	9.5	↘
4:	9.6	→
5:	9.1	↖
Serie		47
Total		182

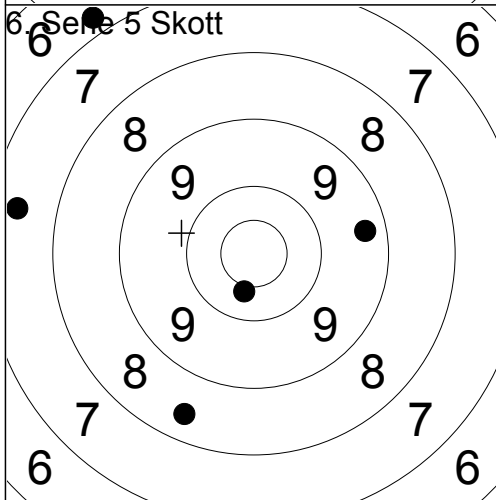

1:	7.4	↖
2:	9.3	→
3:	10.4	↘
4:	6.8	↗
5:	8.4	↘
Serie		40
Total		222

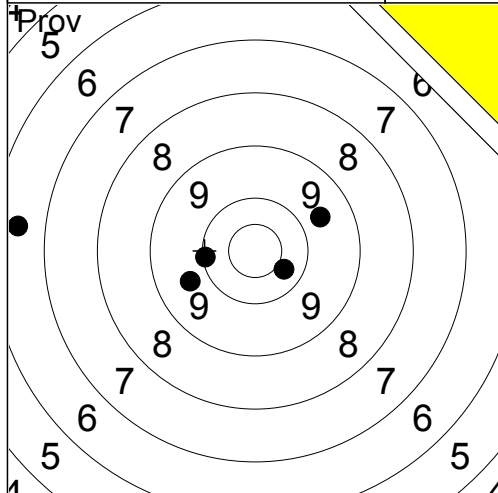

1:	9.6	➔
2:	10.1	←
3:	6.5	←
4:	9.7	↙
5:	10.4	➔

Serie	44
Total	0

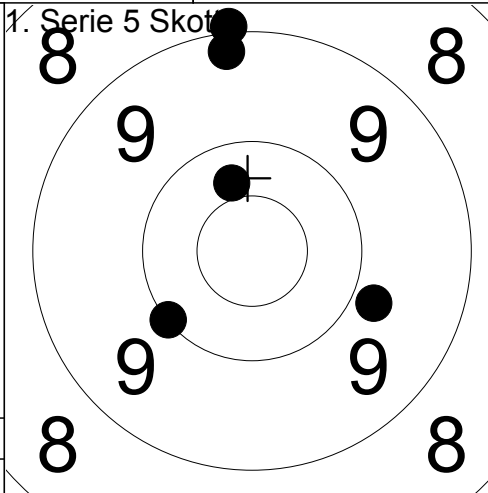

1:	9.0	↑
2:	9.2	↑
3:	10.3	↑
4:	10.0	↙
5:	9.8	➔

Serie	47
Total	47

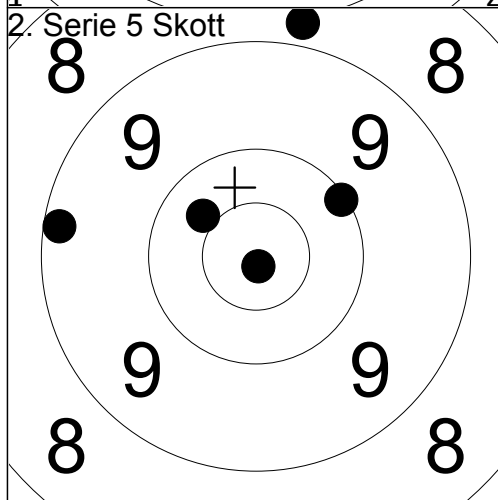

1:	8.8	↑
2:	10.4	↖
3:	10.1	➔
4:	9.2	←
5:	10.9x	↓

Serie	47
Total	94

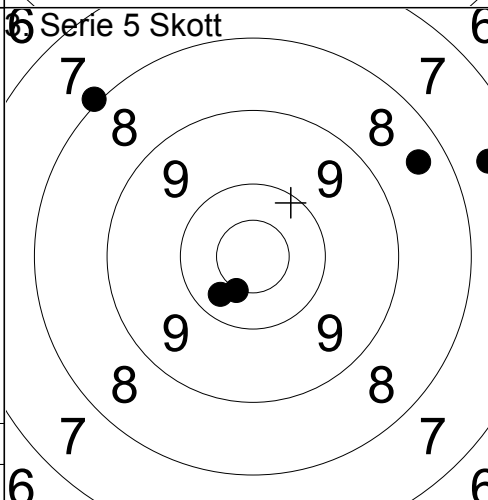

1:	8.0	↖
2:	10.3	↙
3:	10.5x	↓
4:	8.4	➔
5:	7.5	➔

Serie	43
Total	137

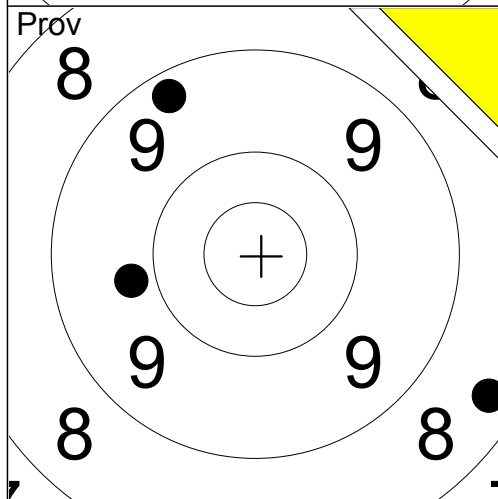

1:	9.3	↖
2:	9.8	←
3:	8.4	➔

Serie	26
Total	137

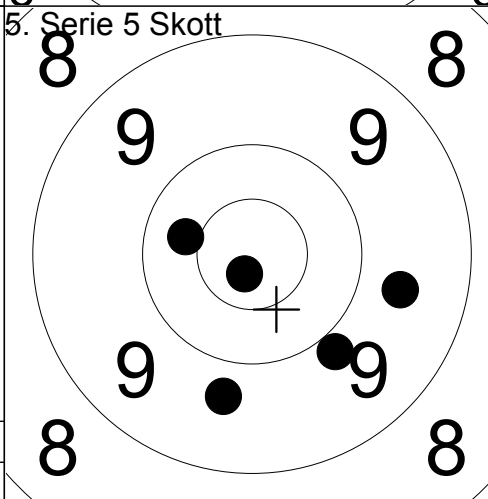

1:	9.9	↙
2:	10.8x	↓
3:	9.6	➔
4:	9.7	↓
5:	10.4	←

Serie	47
Total	184

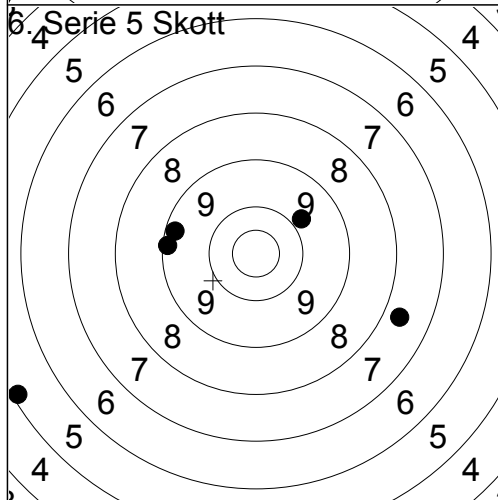

1:	9.2	←
2:	9.8	➔
3:	7.7	➔
4:	5.1	↙
5:	9.1	←

Serie	39
Total	223

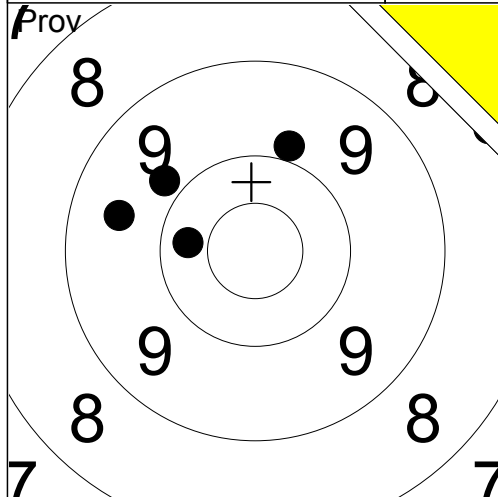

1:	8.3	↗
2:	9.5	←
3:	9.8	↗
4:	10.3	←
5:	9.9	↑

Serie	45
Total	0

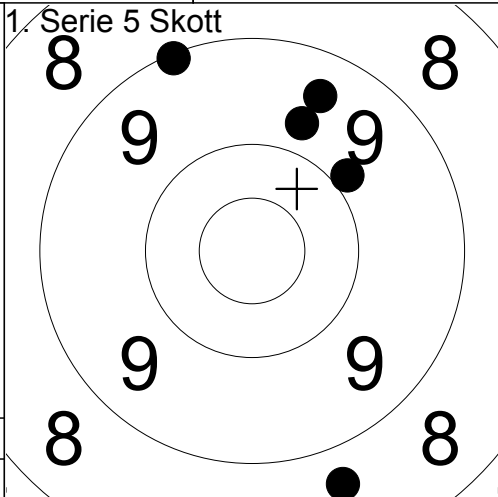

1:	9.1	↖
2:	9.4	↑
3:	9.7	↑
4:	9.9	↗
5:	8.7	↓

Serie	44
Total	44

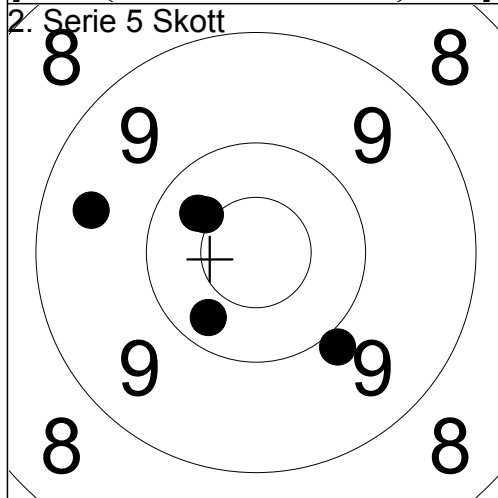

1:	9.9	↘
2:	10.4	↗
3:	10.4x	↗
4:	9.5	←
5:	10.3	↘

Serie	48
Total	92

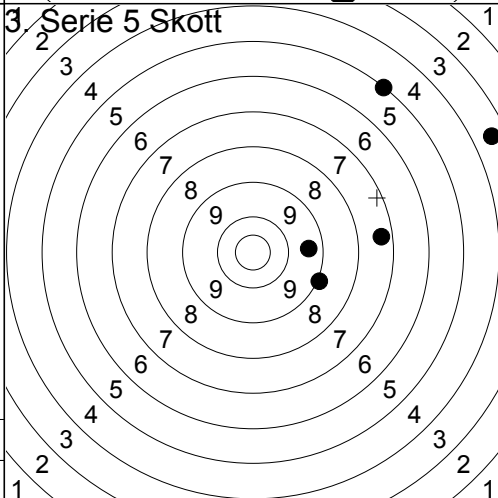

1:	9.0	→
2:	3.5	→
3:	9.4	→
4:	5.0	↗
5:	7.3	→

Serie	33
Total	125

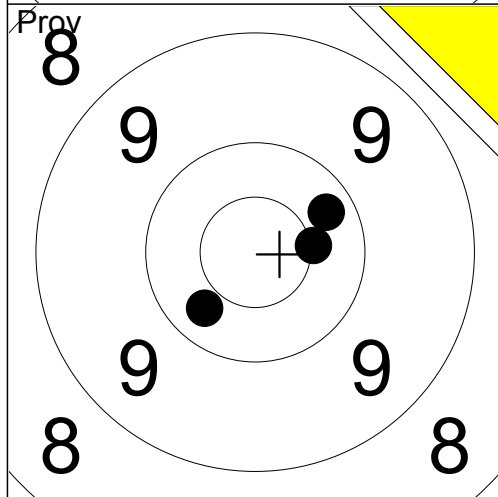

1:	10.3	↗
2:	10.5x	→
3:	10.3	↘

Serie	30
Total	125

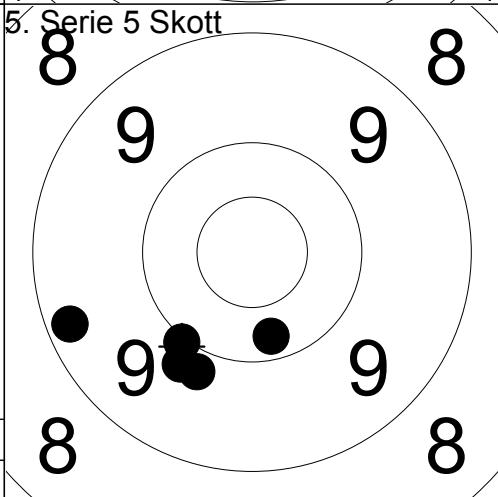

1:	10.0	↘
2:	9.2	←
3:	9.8	↘
4:	9.8	↘
5:	10.2	↓

Serie	47
Total	172

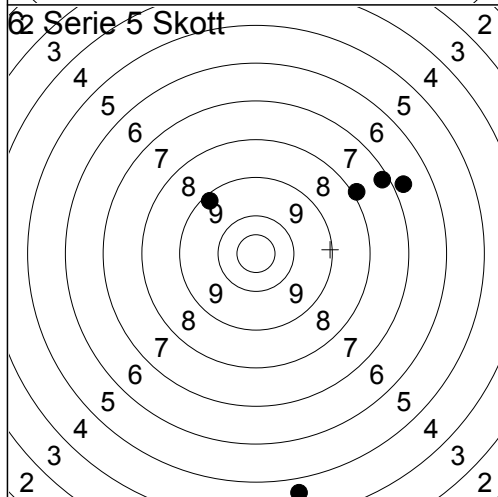

1:	7.2	↗
2:	6.7	↗
3:	9.2	↗
4:	4.7	↓
5:	7.9	↗

Serie	33
Total	205

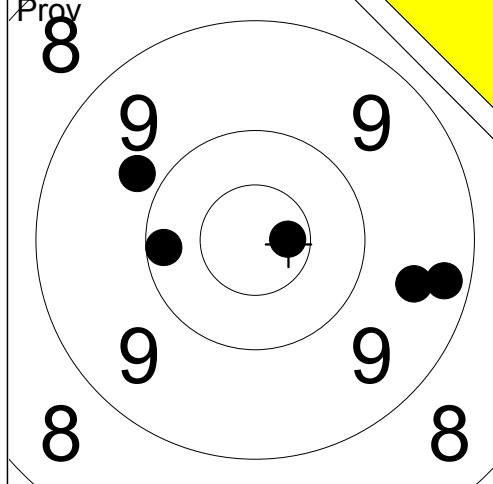

1:	9.8	↖
2:	9.3	→
3:	10.7x	→
4:	9.5	→
5:	10.2	←
Serie		47
Total		0

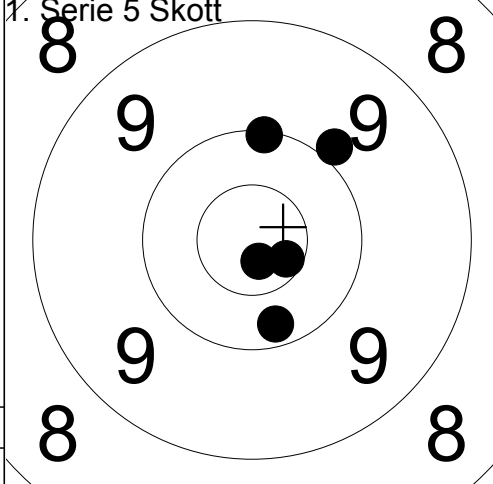

1:	10.1	↑
2:	10.6x	→
3:	9.9	↗
4:	10.8x	↓
5:	10.2	↓
Serie		49
Total		49

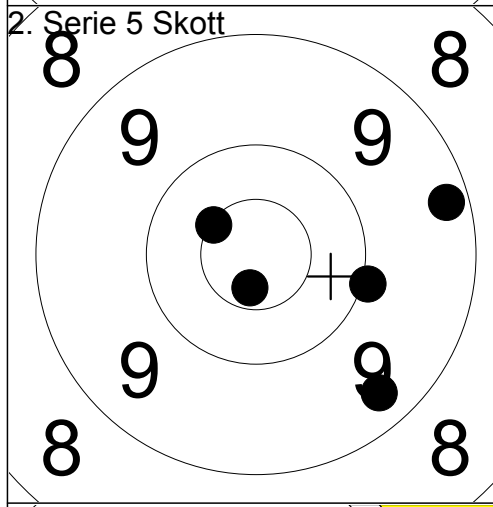

1:	9.2	→
2:	10.0	→
3:	10.5x	↗
4:	10.7x	↓
5:	9.3	↓
Serie		48
Total		97

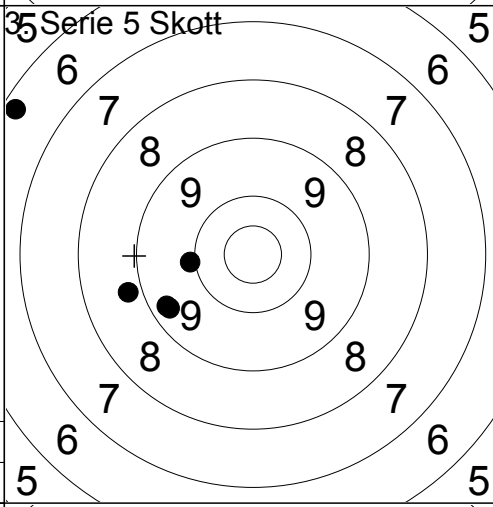

1:	9.3	↖
2:	6.2	↖
3:	9.9	←
4:	9.3	↖
5:	8.8	←
Serie		41
Total		138

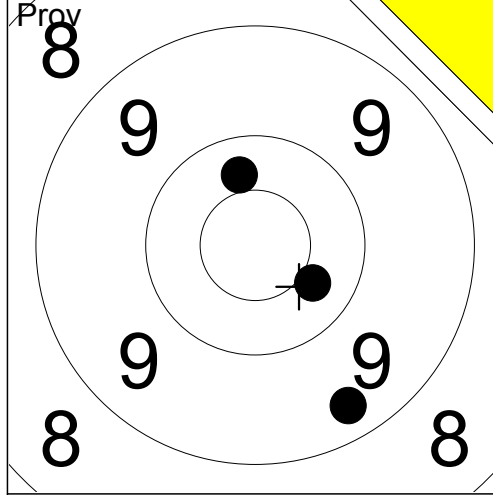

1:	10.4	↘
2:	10.3	↑
3:	9.3	↓
Serie		29
Total		138

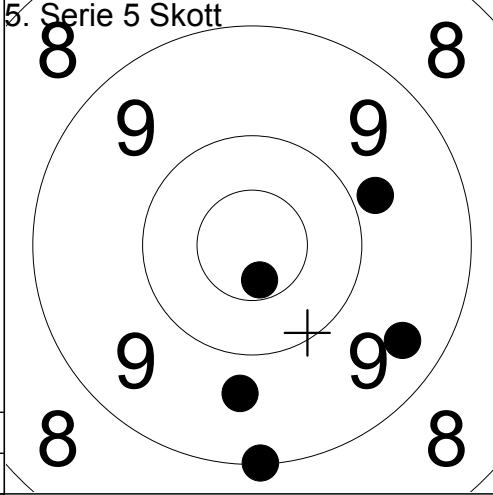

1:	9.8	↗
2:	9.4	→
3:	9.7	↓
4:	10.7x	↓
5:	9.0	↓
Serie		46
Total		184

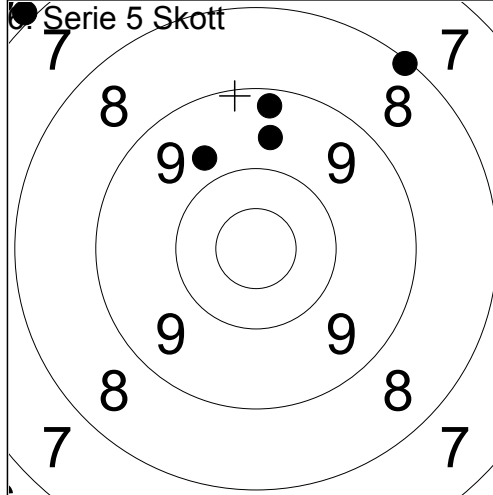

1:	9.7	↖
2:	9.2	↑
3:	6.9	↖
4:	9.6	↑
5:	8.1	↗
Serie		41
Total		225

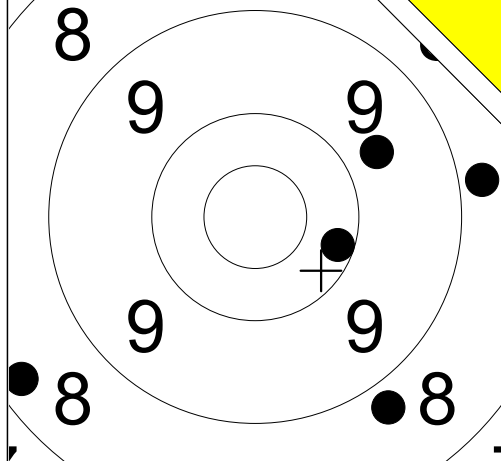

1:	8.8	→
2:	8.8	↓
3:	9.7	↗
4:	8.3	↙
5:	10.2	→

Serie	43
Total	0

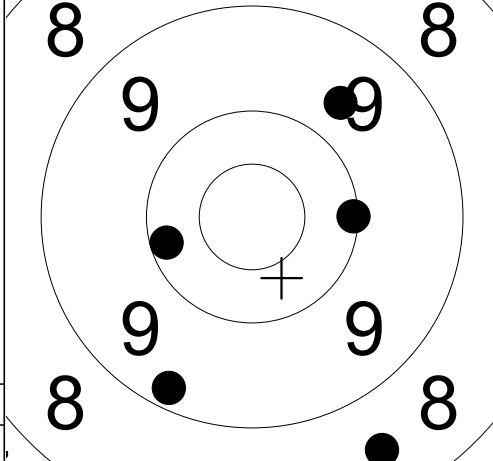

1:	9.7	↗
2:	10.1	→
3:	10.2	←
4:	8.5	↓
5:	9.2	↓

Serie	46
Total	46

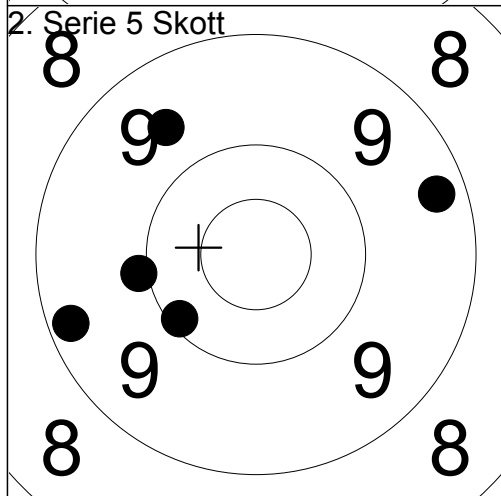

1:	9.6	↖
2:	9.2	←
3:	10.0	←
4:	10.1	↙
5:	9.3	→

Serie	47
Total	93

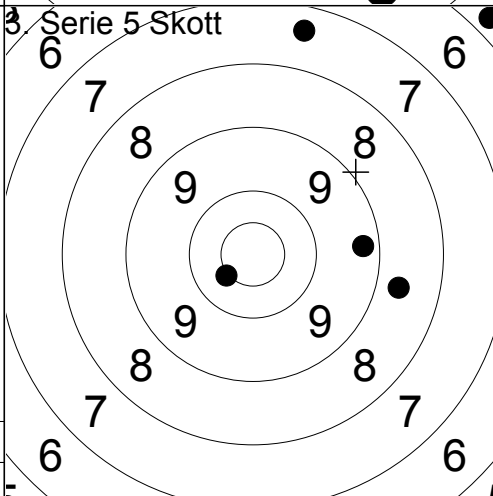

1:	8.7	→
2:	10.5x	↙
3:	9.3	→
4:	5.8	↗
5:	7.4	↑

Serie	39
Total	132

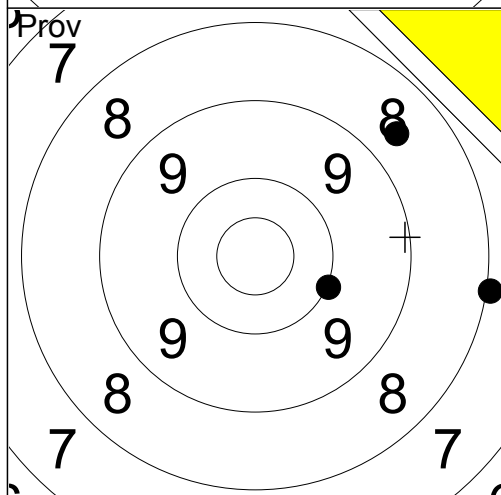

1:	8.6	↗
2:	10.0	→
3:	8.0	→

Serie	26
Total	132

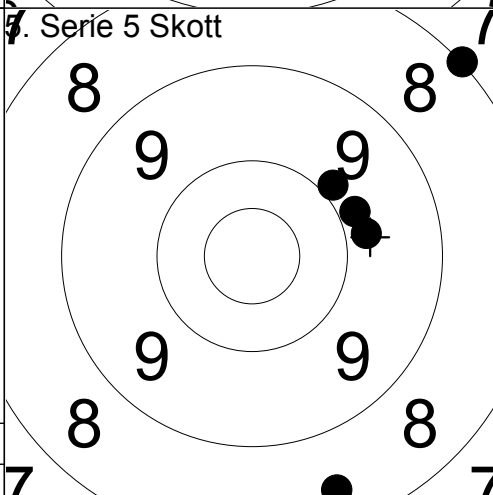

1:	8.0	↗
2:	9.9	↗
3:	9.9	→
4:	9.8	→
5:	8.4	↓

Serie	43
Total	175

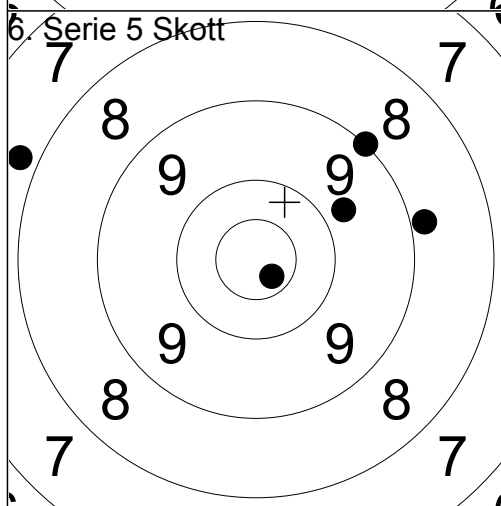

1:	9.0	↗
2:	8.9	→
3:	10.7x	↙
4:	9.8	↗
5:	7.8	↖

Serie	43
Total	218

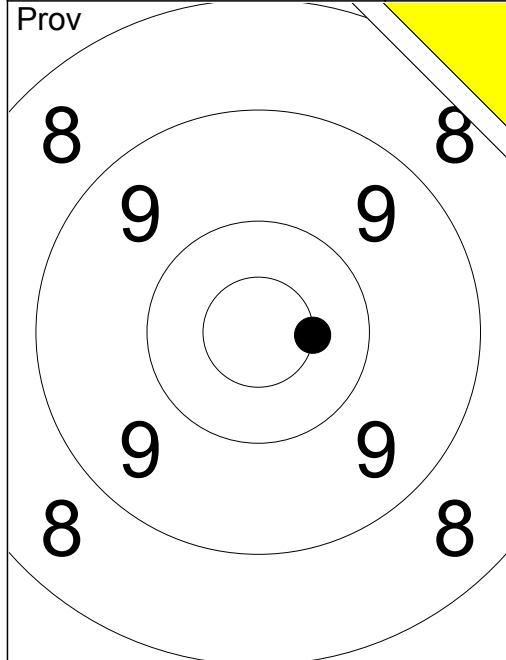

1: 10.5x →

Serie	10
Total	0

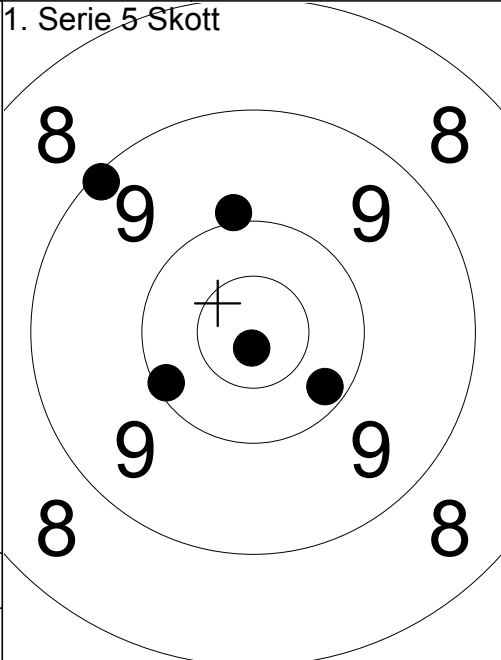

1:	9.9	↑
2:	10.2	↘
3:	9.1	↗
4:	10.8x	↓
5:	10.1	↙

Serie	48
Total	48

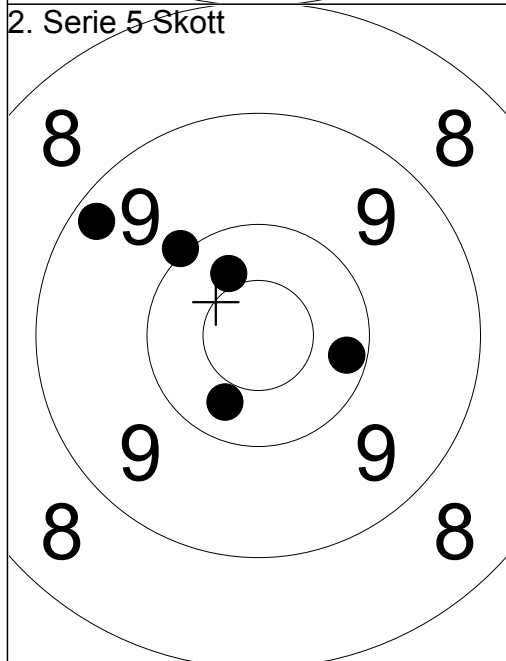

1:	10.3	↓
2:	9.2	↗
3:	10.0	↗
4:	10.4	↗
5:	10.2	→

Serie	49
Total	97

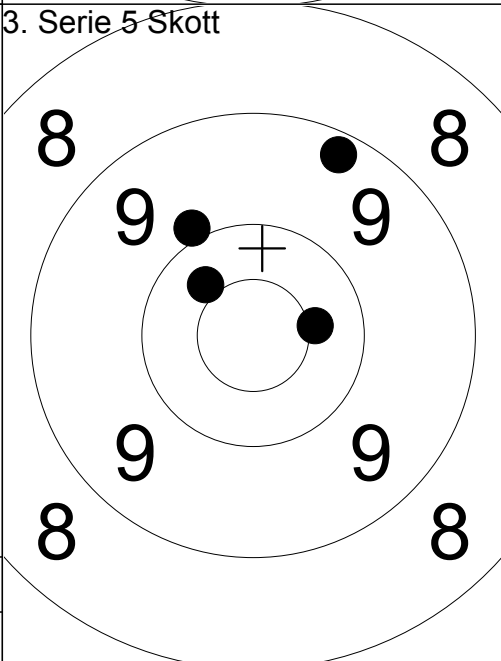

1:	0.0	
2:	10.4	↗
3:	9.9	↗
4:	10.4x	→
5:	9.2	↗

Serie	38
Total	135

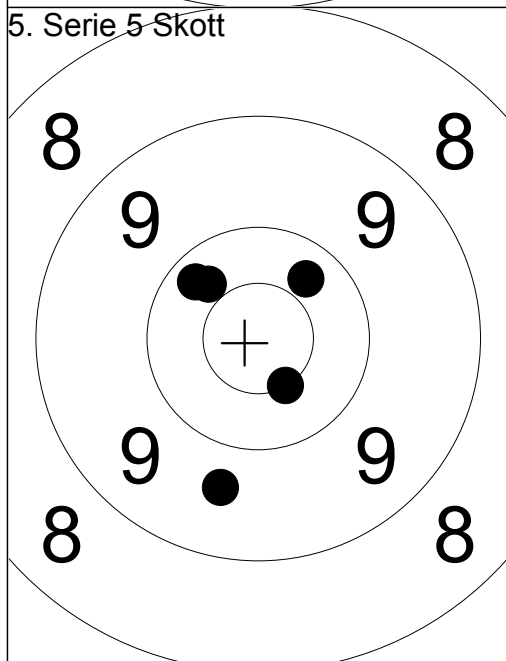

1:	10.2	↗
2:	10.3	↗
3:	9.6	↓
4:	10.5x	↘
5:	10.3	↗

Serie	49
Total	184

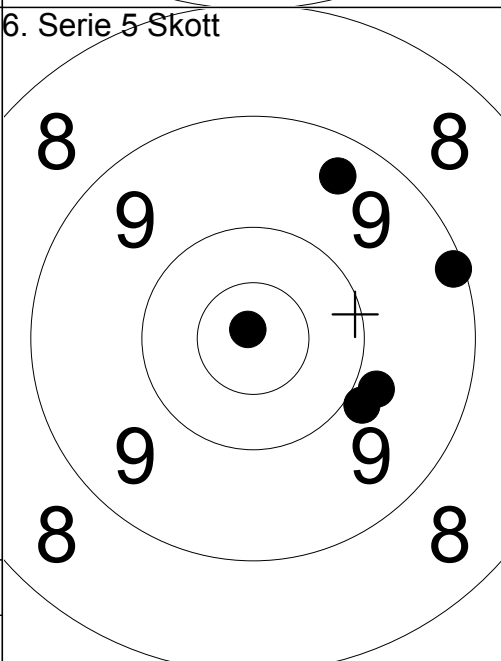

1:	9.4	↗
2:	9.8	→
3:	9.1	→
4:	9.9	↘
5:	10.9x	↗

Serie	46
Total	230

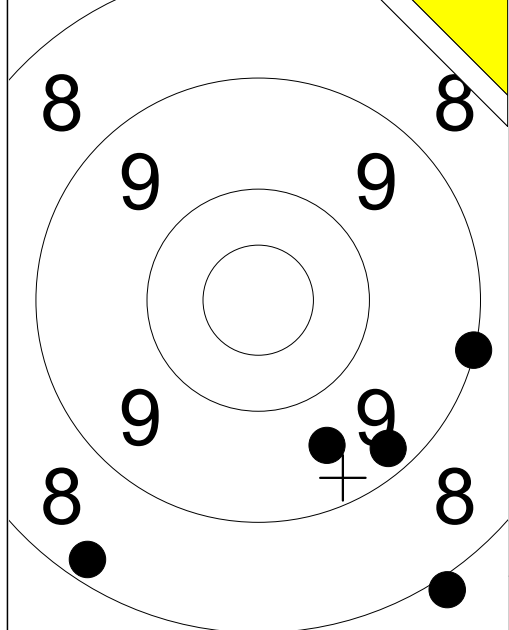

1:	7.9	↘
2:	9.6	↘
3:	8.2	↘
4:	9.0	→
5:	9.3	↘
Serie		42
Total		0

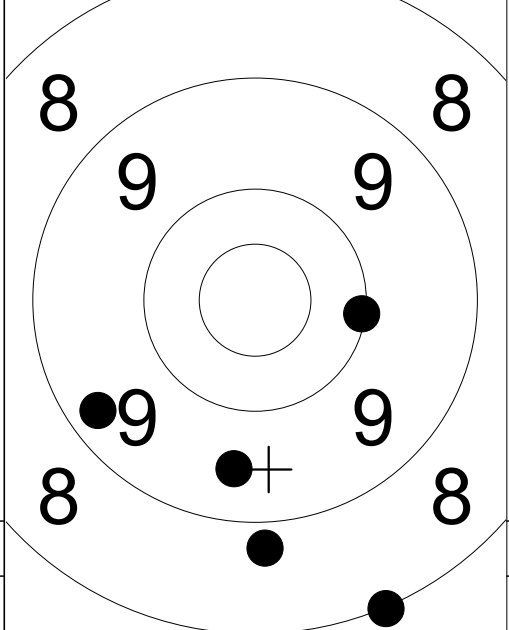

1:	9.5	↘
2:	9.3	↙
3:	8.0	↘
4:	8.8	↘
5:	10.1	→
Serie		44
Total		44

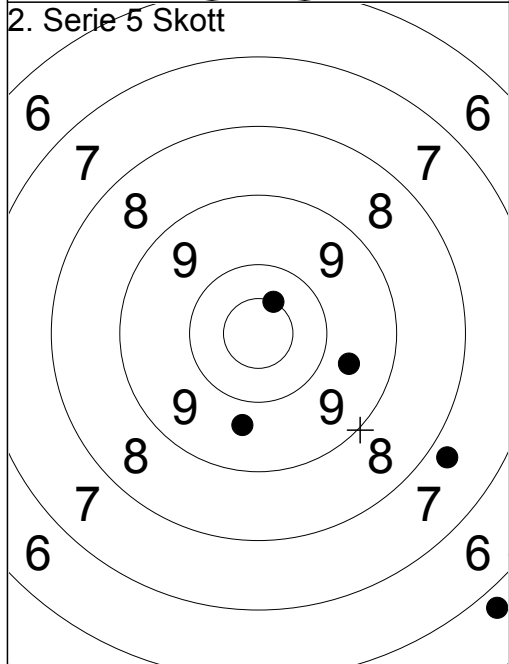

1:	9.6	→
2:	10.5x	↗
3:	9.7	↘
4:	7.8	↘
5:	5.8	↘
Serie		40
Total		84

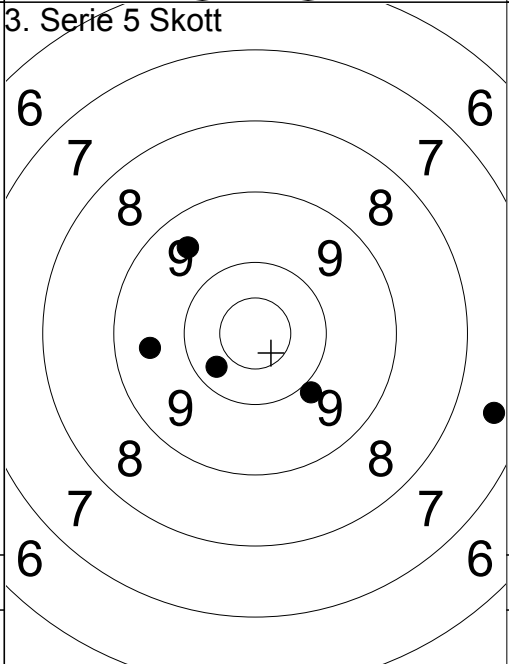

1:	7.5	→
2:	9.5	↗
3:	9.9	↘
4:	9.5	←
5:	10.3	↙
Serie		44
Total		128

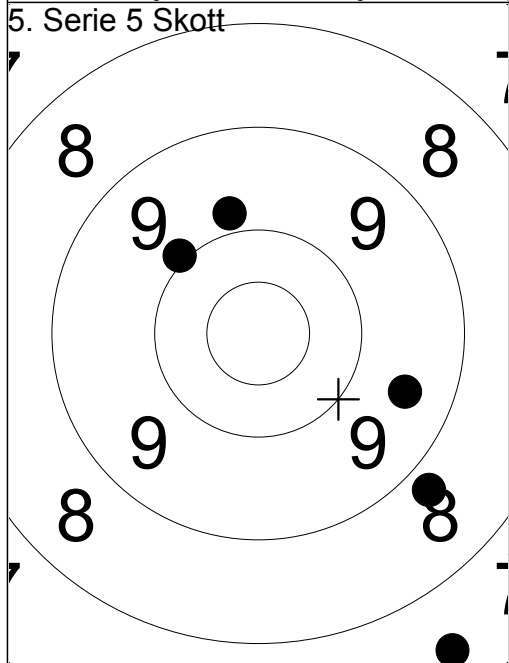

1:	10.0	↗
2:	9.8	↗
3:	9.5	↘
4:	8.8	↘
5:	7.4	↘
Serie		43
Total		171

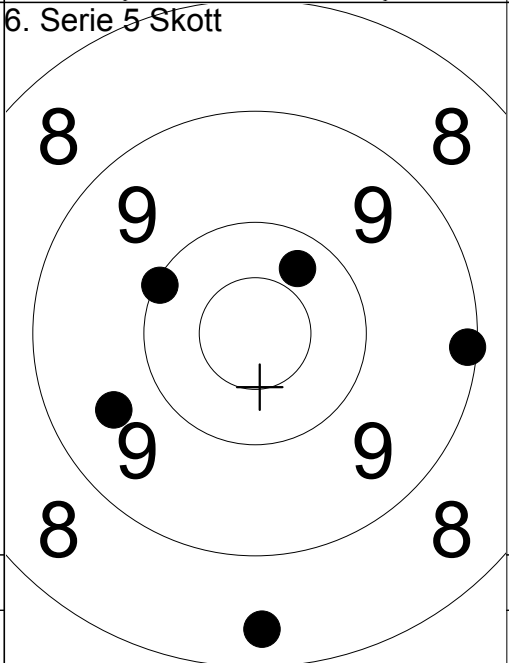

1:	10.1	↖
2:	8.4	↘
3:	10.3	↗
4:	9.6	↙
5:	9.1	→
Serie		46
Total		217

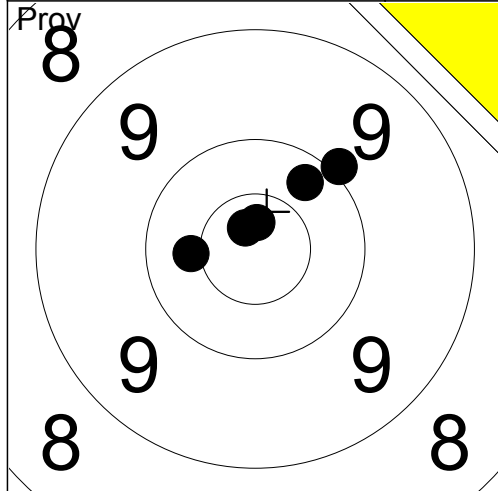

1:	10.0	↗
2:	10.4	←
3:	10.2	↗
4:	10.7x	↗
5:	10.7x	↑
Serie		50
Total		0

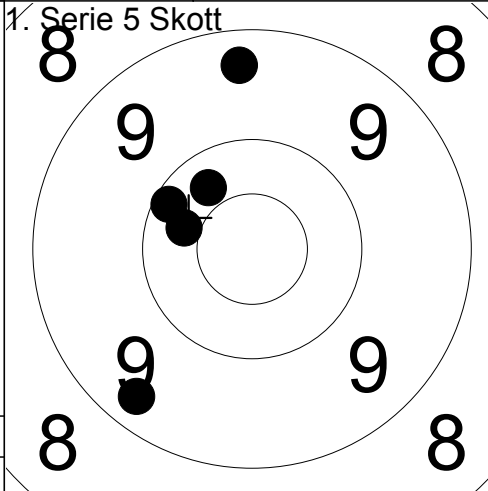

1:	9.4	↑
2:	9.3	↘
3:	10.3	←
4:	10.3	↗
5:	10.2	↗
Serie		48
Total		48

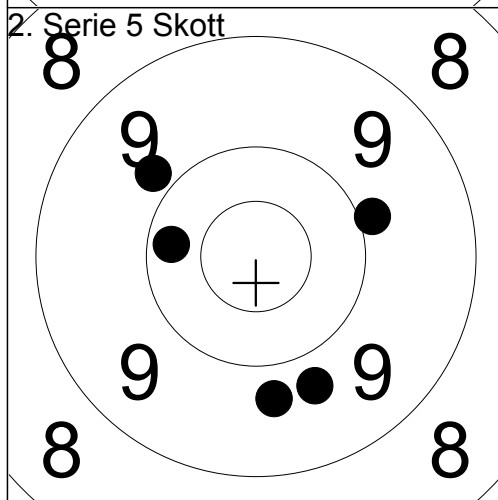

1:	9.9	→
2:	9.7	↘
3:	9.8	↗
4:	9.7	↘
5:	10.2	←
Serie		46
Total		94

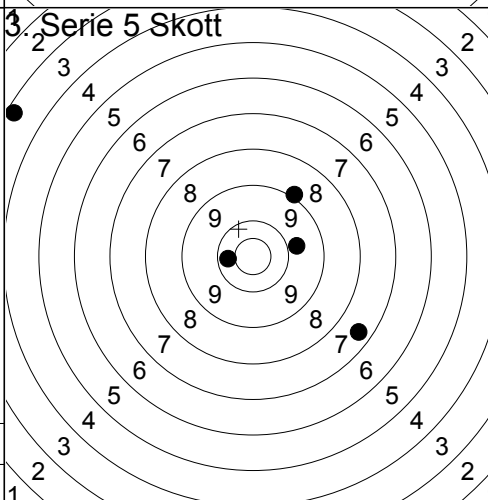

1:	10.3	←
2:	9.8	→
3:	8.9	↗
4:	3.2	←
5:	7.4	↘
Serie		37
Total		131

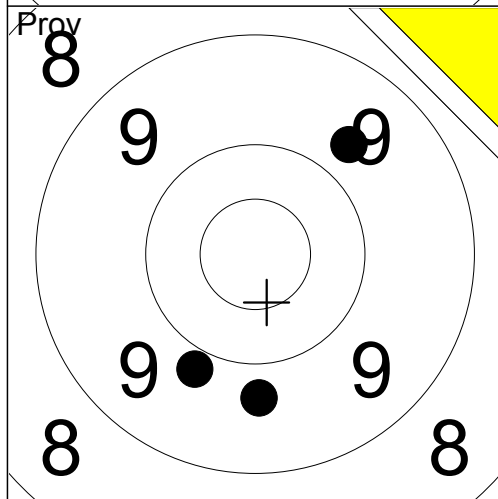

1:	9.8	↘
2:	9.7	↘
3:	9.7	↗
Serie		27
Total		131

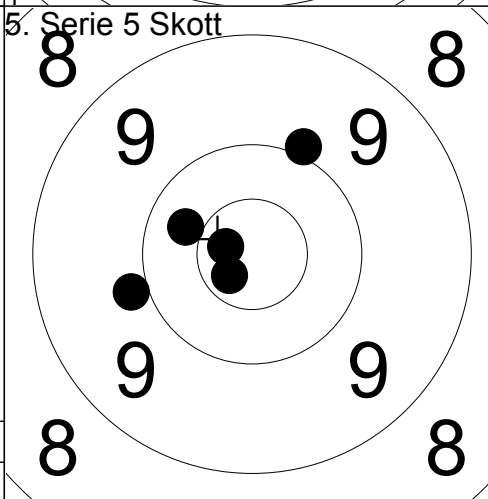

1:	9.9	↗
2:	10.7x	←
3:	10.3	←
4:	9.9	←
5:	10.7x	↘
Serie		48
Total		179

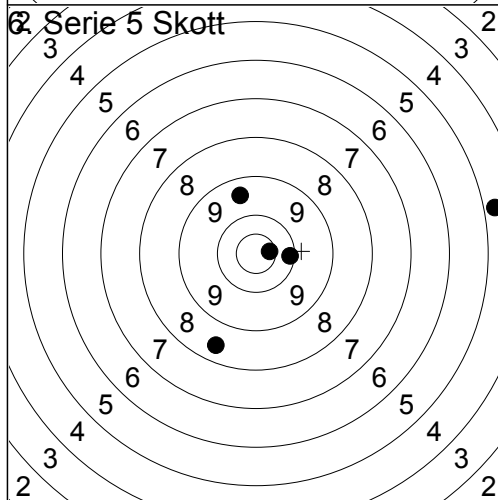

1:	9.5	↑
2:	10.1	→
3:	8.4	↘
4:	10.6x	→
5:	4.8	→
Serie		41
Total		220

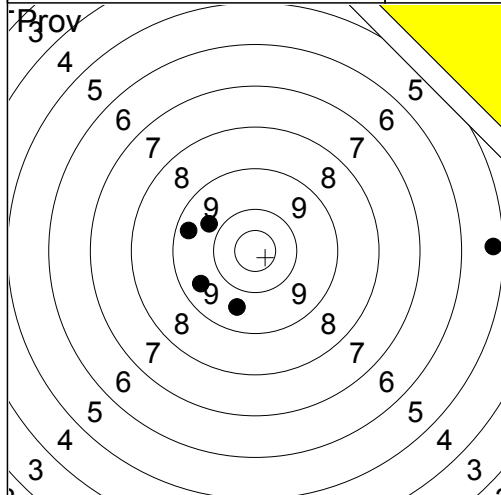

1: 9.7 ↖
 2: 5.3 →
 3: 9.6 ↓
 4: 9.3 ↖
 5: 9.5 ↖

Serie	41
Total	0

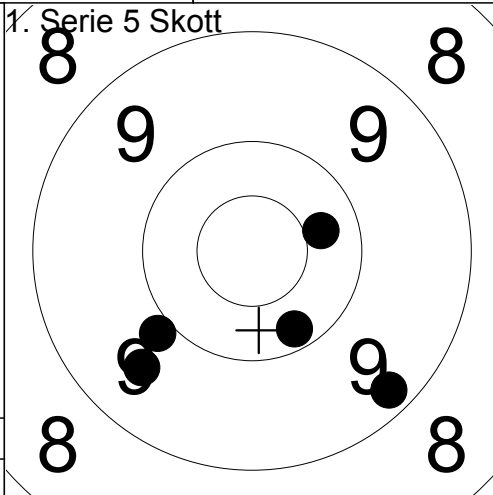

1. Serie 5 Skott

1: 10.3 →
 2: 10.2 ↓
 3: 9.9 ↖
 4: 9.3 ↓
 5: 9.6 ↖

Serie	47
Total	47

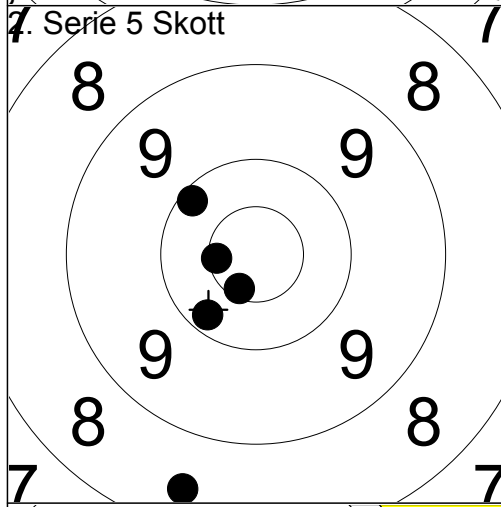

7. Serie 5 Skott

1: 8.4 ↓
 2: 10.6x ←
 3: 10.6x ↓
 4: 10.1 ↖
 5: 10.2 ↓

Serie	48
Total	95

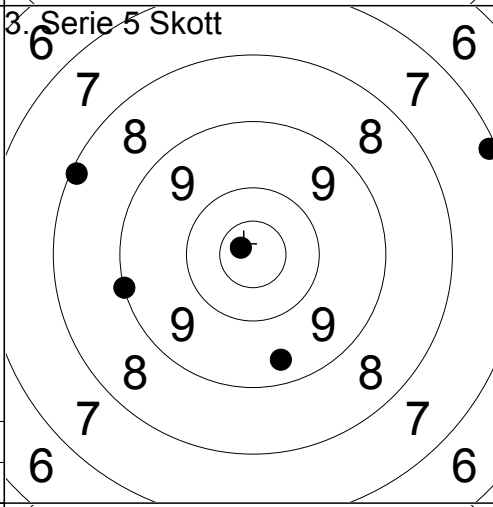

3. Serie 5 Skott

1: 9.0 ←
 2: 8.1 ↖
 3: 7.1 →
 4: 10.8x ↖
 5: 9.4 ↓

Serie	43
Total	138

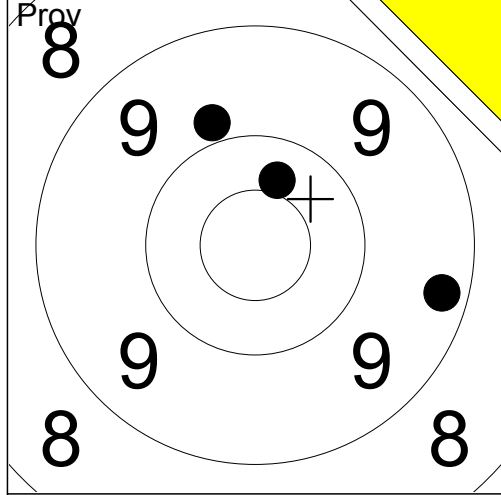

Provschytte

1: 10.4 ↗
 2: 9.3 →
 3: 9.8 ↗

Serie	28
Total	138

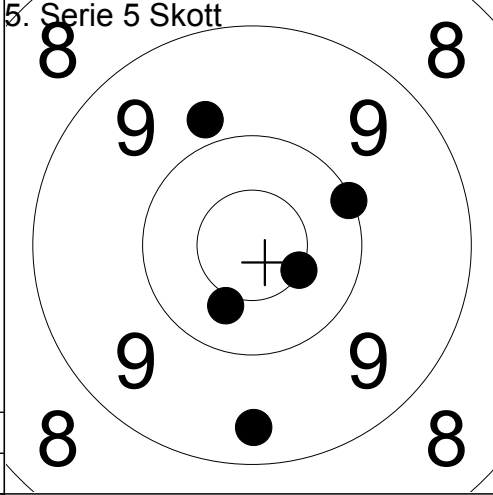

5. Serie 5 Skott

1: 9.8 ↗
 2: 9.4 ↓
 3: 10.0 →
 4: 10.4 ↓
 5: 10.5x →

Serie	48
Total	186

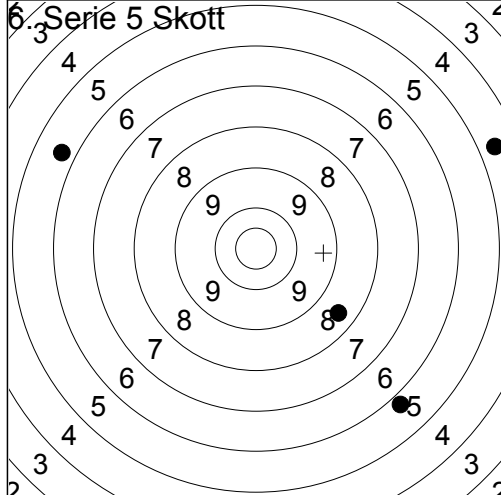

6. Serie 5 Skott

1: 5.7 ↖
 2: 4.6 →
 3: 8.5 ↓
 4: 5.8 ↓
 5: 0.0

Serie	22
Total	208

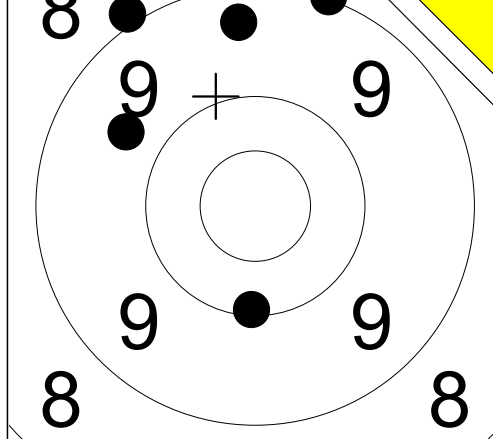

1:	9.0	↗
2:	8.9	↗
3:	9.7	↖
4:	9.3	↗
5:	10.1	↘
Serie		45
Total		0

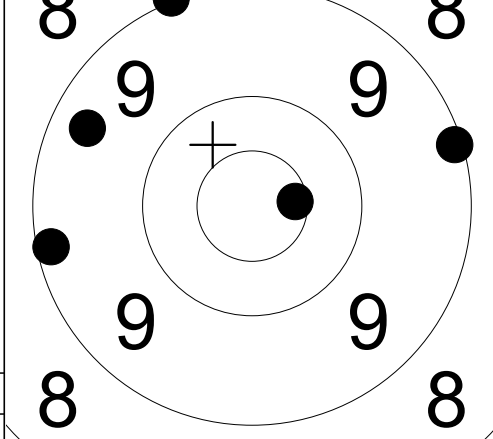

1:	9.0	↗
2:	9.1	→
3:	10.6x	→
4:	9.2	←
5:	9.4	↖
Serie		46
Total		46

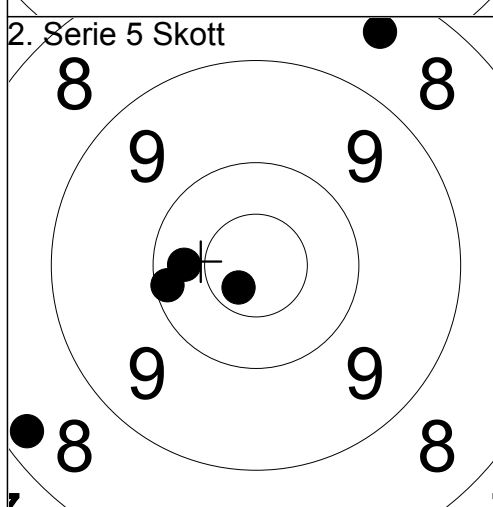

1:	8.4	↗
2:	10.3	←
3:	10.7x	↘
4:	8.3	↙
5:	10.1	←
Serie		46
Total		92

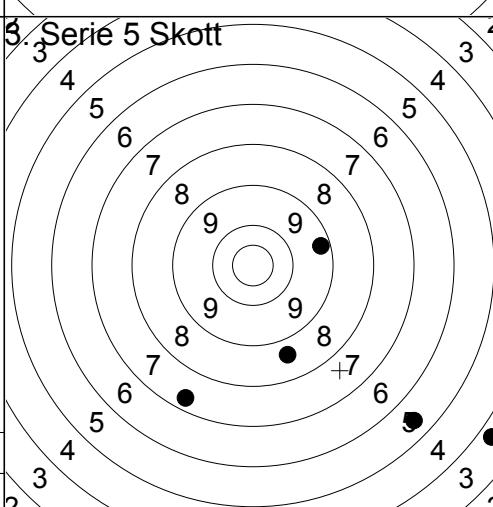

1:	8.6	↘
2:	7.3	↘
3:	9.3	→
4:	3.7	↘
5:	5.5	↘
Serie		32
Total		124

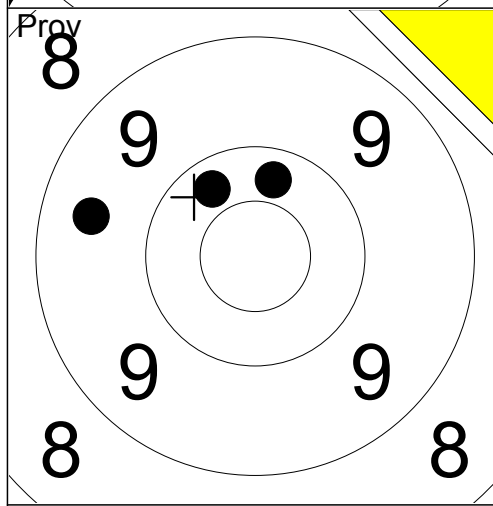

1:	10.3	↗
2:	9.5	←
3:	10.3	↗
Serie		29
Total		124

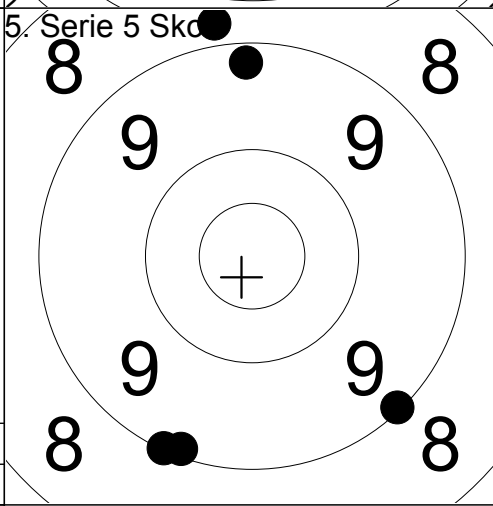

1:	8.8	↗
2:	9.2	↗
3:	9.1	↘
4:	9.1	↘
5:	9.0	↘
Serie		44
Total		168

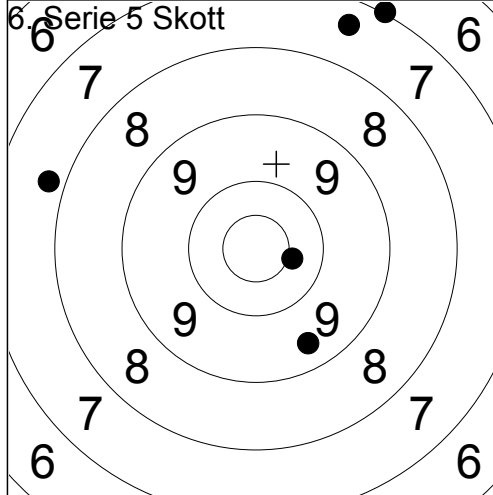

1:	7.4	↗
2:	9.4	↘
3:	10.4x	→
4:	7.0	↗
5:	7.8	←
Serie		40
Total		208

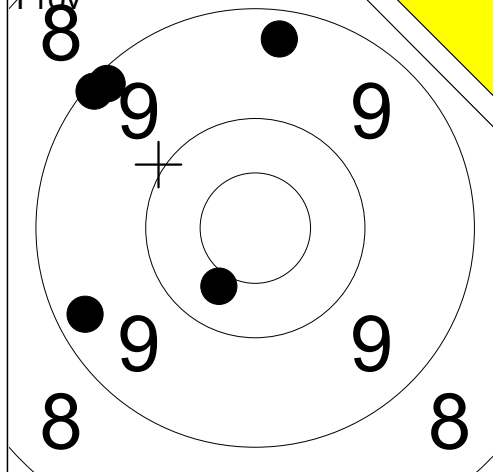

1:	9.3	↙
2:	9.3	↑
3:	9.1	↗
4:	9.1	↗
5:	10.4	↘
Serie		46
Total		0

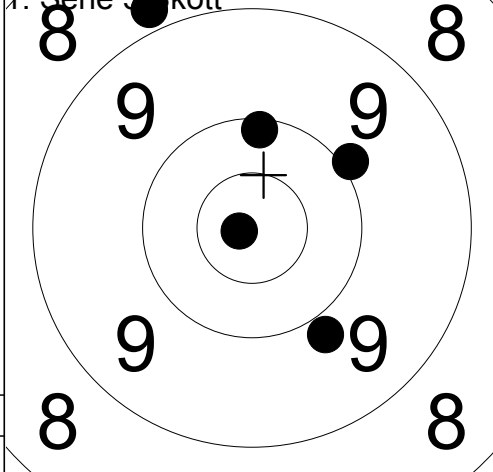

1:	9.9	↘
2:	10.0	↗
3:	10.8x	↙
4:	8.8	↗
5:	10.1	↑
Serie		47
Total		47

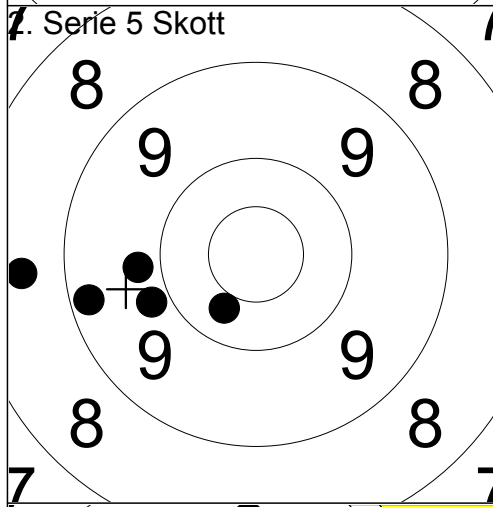

1:	9.8	↙
2:	8.6	↙
3:	9.2	↙
4:	10.3	↘
5:	9.8	↙
Serie		45
Total		92

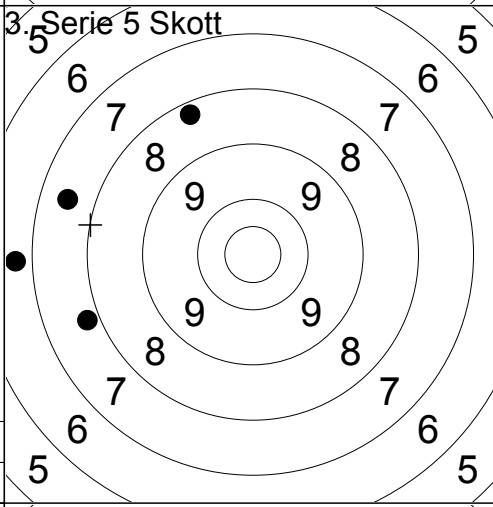

1:	8.3	↗
2:	7.8	↙
3:	7.5	↙
4:	0.0	↙
5:	6.7	↙
Serie		28
Total		120

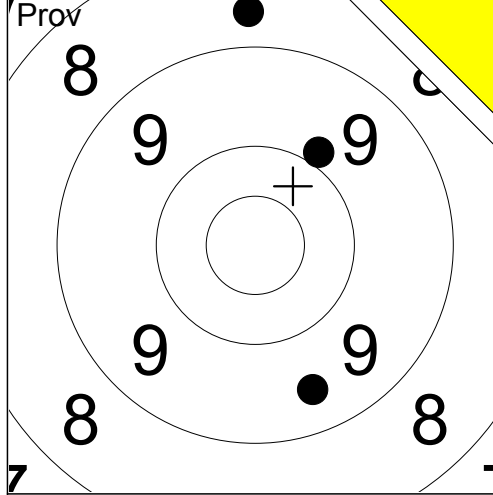

1:	9.5	↘
2:	9.9	↗
3:	8.7	↑
Serie		26
Total		120

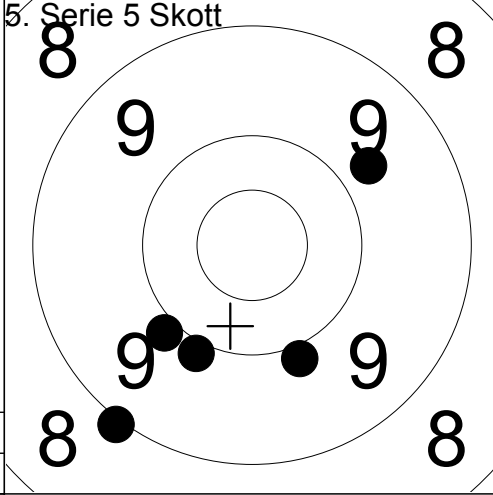

1:	9.9	↘
2:	9.7	↗
3:	9.9	↘
4:	9.9	↘
5:	9.0	↘
Serie		45
Total		165

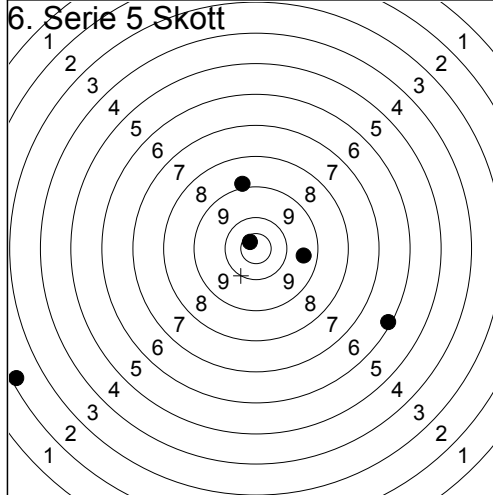

1:	8.9	↑
2:	10.7x	↗
3:	9.5	→
4:	6.1	↘
5:	2.2	↙
Serie		35
Total		200

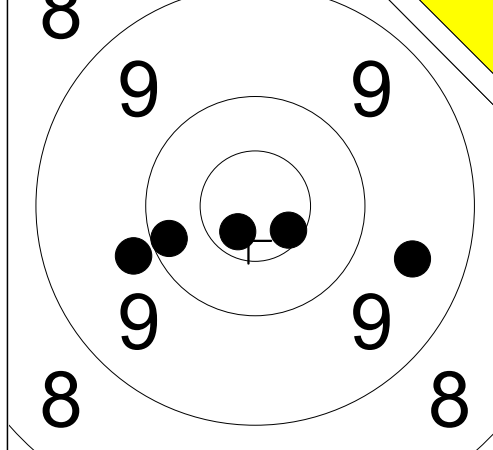

1:	10.7x	↘
2:	10.2	←
3:	9.8	←
4:	10.6x	↘
5:	9.5	↘
Serie		48
Total		0

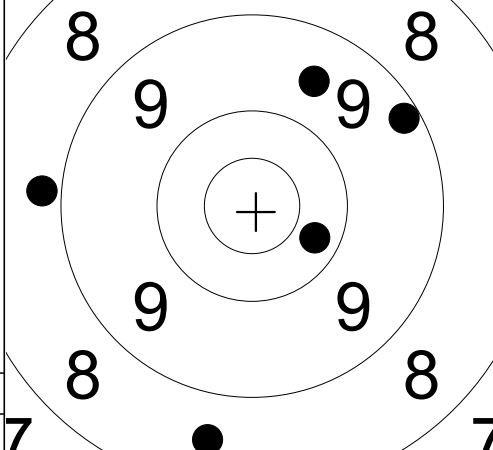

1:	9.6	↗
2:	10.3	→
3:	9.2	↗
4:	8.8	←
5:	8.5	↓
Serie		44
Total		44

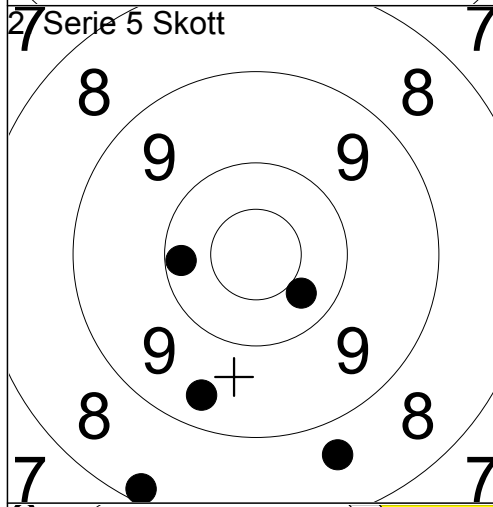

1:	10.2	←
2:	10.3	↘
3:	8.2	↘
4:	8.7	↘
5:	9.4	↘
Serie		45
Total		89

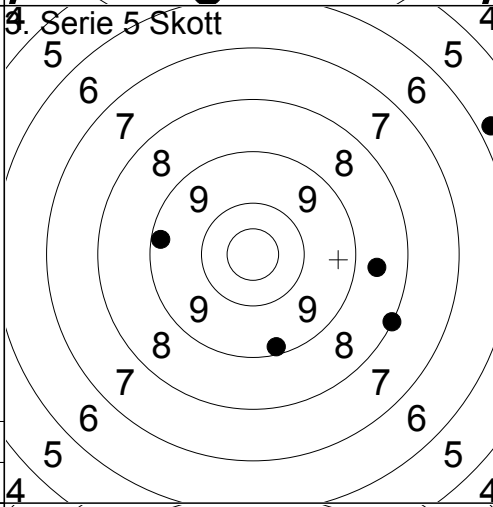

1:	8.0	→
2:	8.6	→
3:	9.2	↓
4:	5.8	↗
5:	9.2	←
Serie		39
Total		128

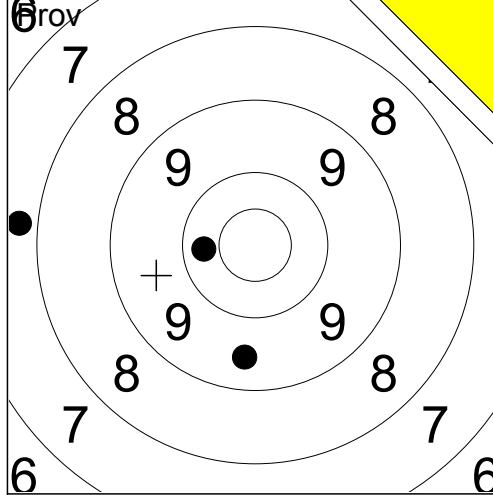

1:	9.5	↓
2:	7.8	←
3:	10.3	←
Serie		26
Total		128

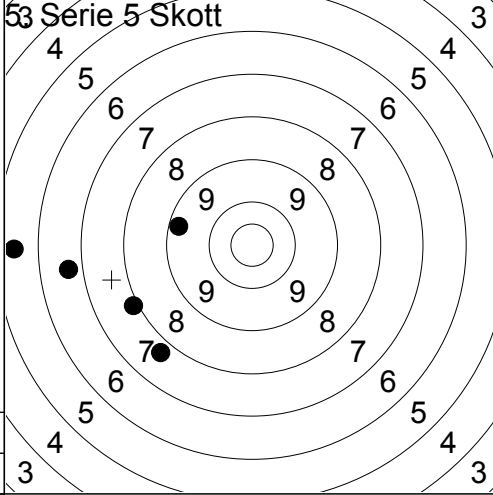

1:	6.7	←
2:	9.3	←
3:	5.5	←
4:	7.7	↘
5:	7.9	←
Serie		34
Total		162

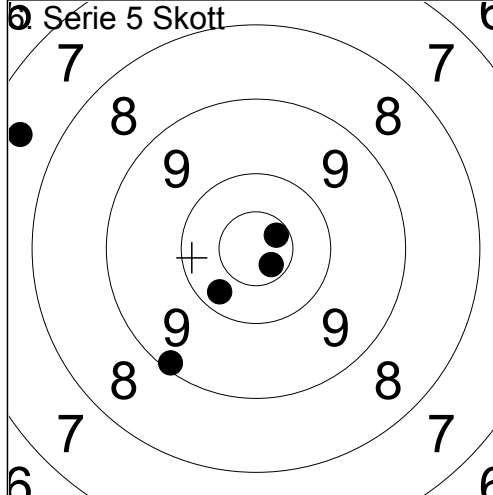

1:	10.3	↘
2:	9.1	↘
3:	10.7x	↘
4:	7.5	←
5:	10.6x	↗
Serie		46
Total		208

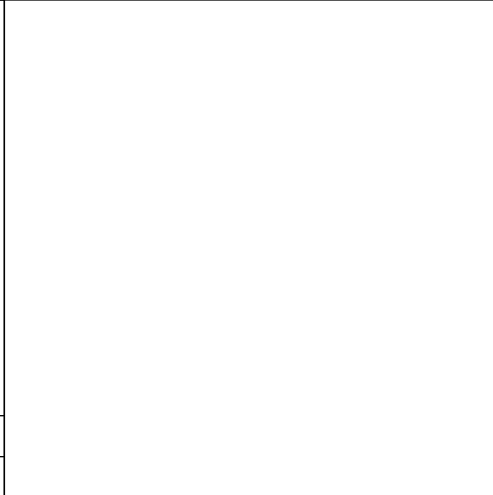

1:	9.6	↗
2:	10.3	→
3:	9.2	↗
4:	8.8	←
5:	8.5	↓
Serie		44
Total		44

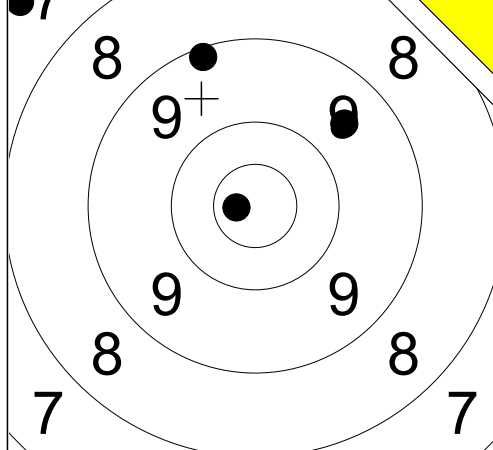

1:	9.1	↑
2:	7.3	↗
3:	9.6	↗
4:	10.7x	←
Serie		35
Total		0

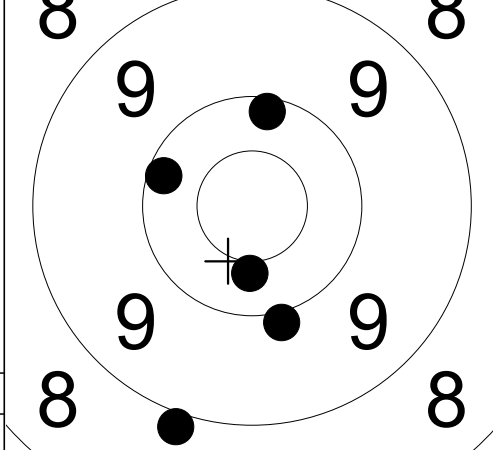

1:	10.2	↖
2:	8.9	↘
3:	10.4	↘
4:	10.1	↑
5:	9.9	↘
Serie		47
Total		47

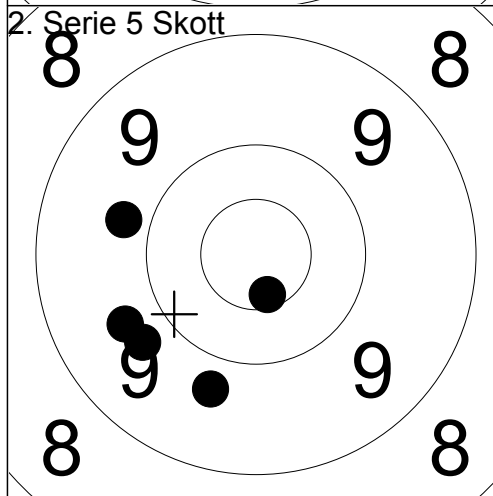

1:	9.8	↖
2:	9.7	↖
3:	9.7	↖
4:	10.6x	↘
5:	9.7	↘
Serie		46
Total		93

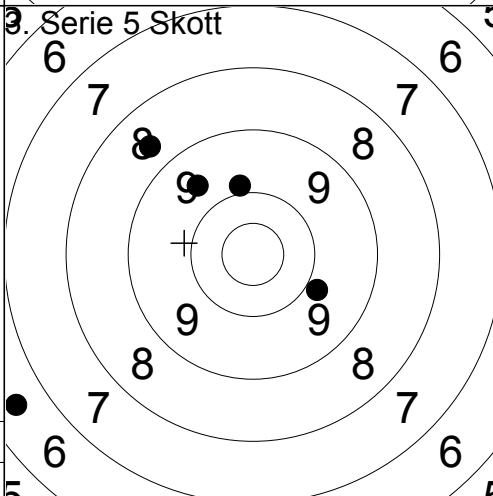

1:	9.9	↘
2:	9.6	↗
3:	9.9	↑
4:	8.6	↗
5:	6.5	↖
Serie		41
Total		134

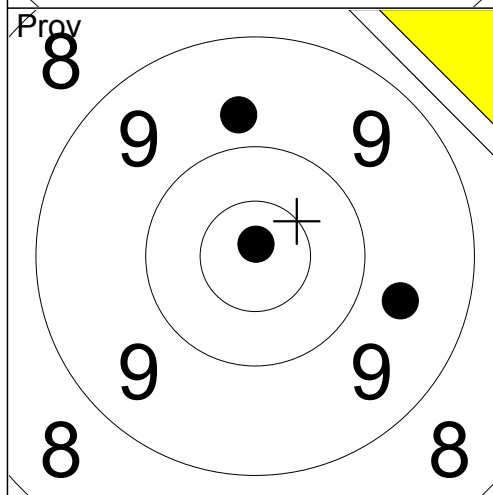

1:	9.7	↑
2:	10.8x	↑
3:	9.6	→
Serie		28
Total		134

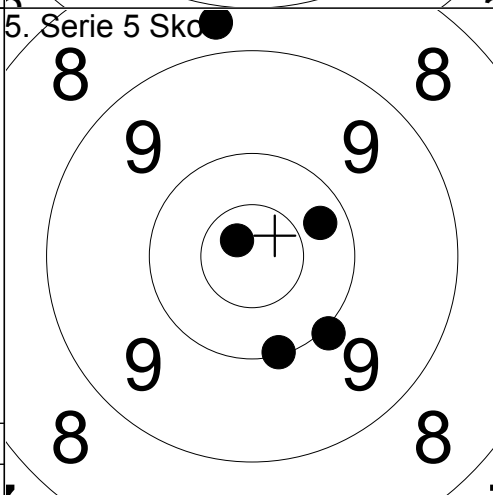

1:	8.7	↑
2:	10.1	↘
3:	10.0	↘
4:	10.8x	↗
5:	10.3	↗
Serie		48
Total		182

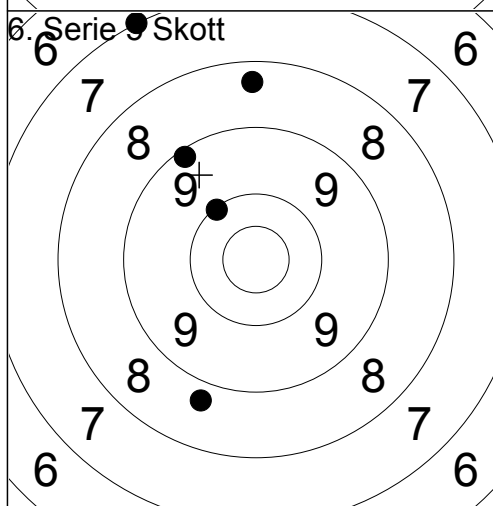

1:	10.1	↗
2:	9.1	↗
3:	7.0	↗
4:	8.7	↘
5:	8.3	↑
Serie		42
Total		224

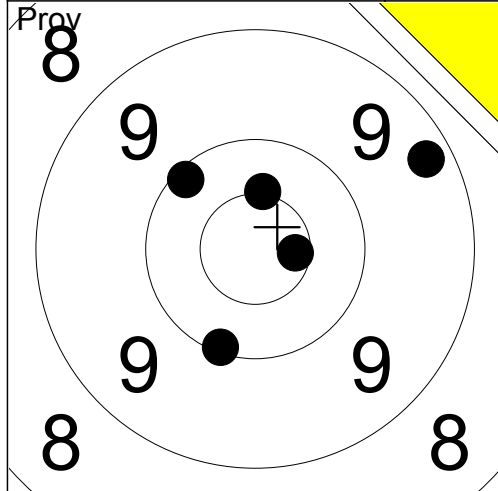

1:	9.3	↗
2:	10.1	↓
3:	10.5x	↑
4:	10.1	↖
5:	10.6x	→
Serie		49
Total		0

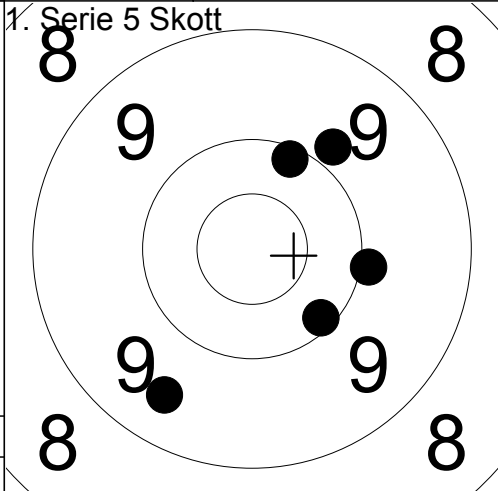

1:	10.0	→
2:	9.5	↓
3:	10.1	↘
4:	10.1	↑
5:	9.8	↗
Serie		48
Total		48

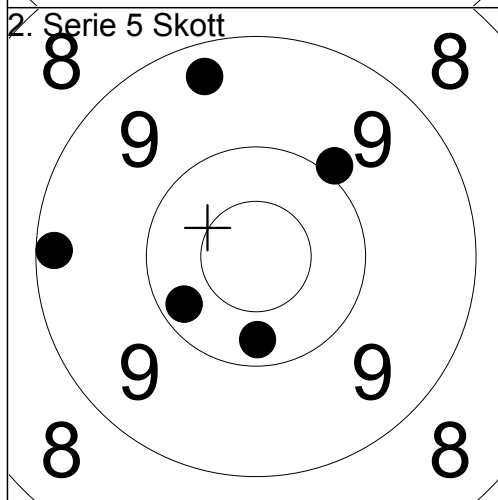

1:	10.2	↖
2:	9.9	↗
3:	10.2	↓
4:	9.2	←
5:	9.3	↑
Serie		47
Total		95

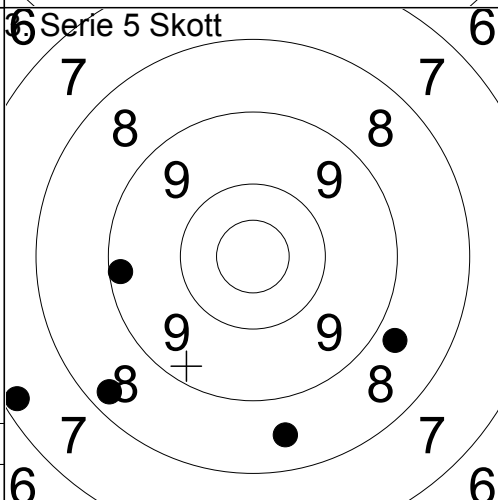

1:	8.8	↘
2:	8.3	↓
3:	7.2	↖
4:	8.5	↓
5:	9.2	←
Serie		40
Total		135

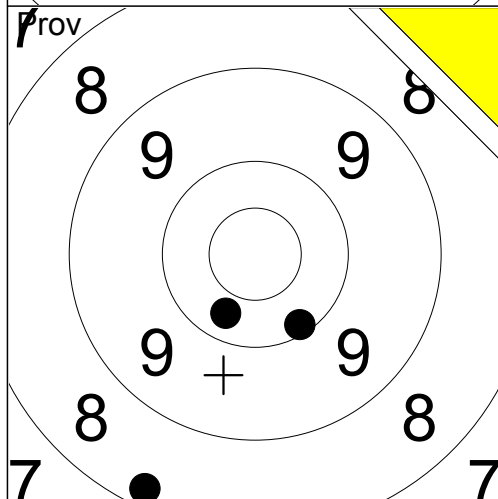

1:	10.3	↓
2:	10.1	↓
3:	8.2	↓
Serie		28
Total		135

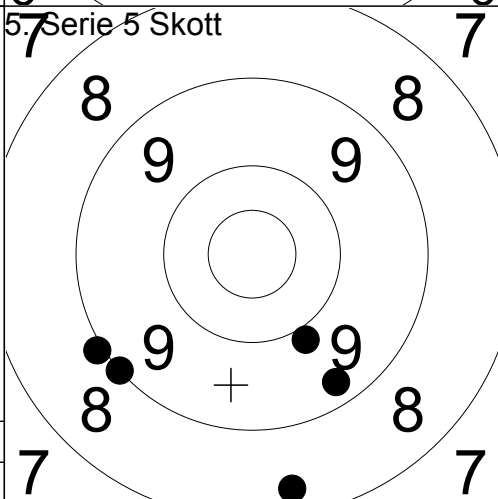

1:	9.9	↓
2:	8.3	↓
3:	9.0	↖
4:	9.0	↖
5:	9.3	↓
Serie		44
Total		179

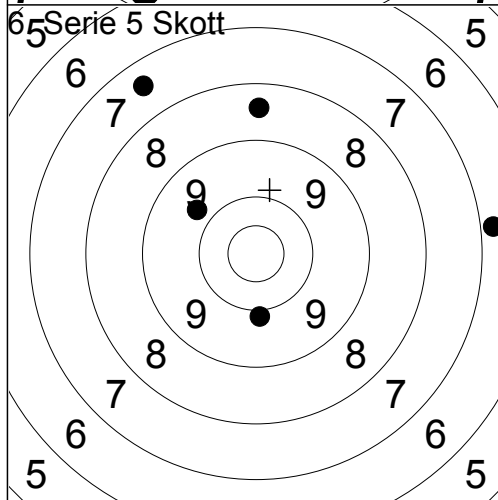

1:	8.5	↑
2:	6.8	→
3:	9.9	↓
4:	7.5	↗
5:	9.7	↗
Serie		39
Total		218