

Skjutlag 5	Tavla 1	Leif Sandberg		
Ramselefors		Kalix		C No
07.07.2019		Tavelträffen 2019		Ramselefors SKF
Prov 	1: 10.5x ↗ 2: 10.4 → 3: 10.0 ←	Ligg 	1: 10.4 ← 2: 10.6x ←← 3: 10.4x ↘ 4: 10.5x ←← 5: 10.8x ↗	
	Serie 30		Serie 50	
	Total 196		Total 246	
Knä 	1: 9.6 ↑ 2: 9.3 ↗ 3: 10.5x ↗ 4: 9.6 ← 5: 10.0 ↓	Stå 1 	1: 10.5x ←← 2: 10.1 ↑ 3: 10.2 ← 4: 9.5 ← 5: 10.3 ←	
	Serie 47		Serie 49	
	Total 293		Total 342	
Extra 	1: 10.9x ↗ 2: 10.2 ↘ 3: 10.5x ↘			
	Serie 30			
	Total 342			

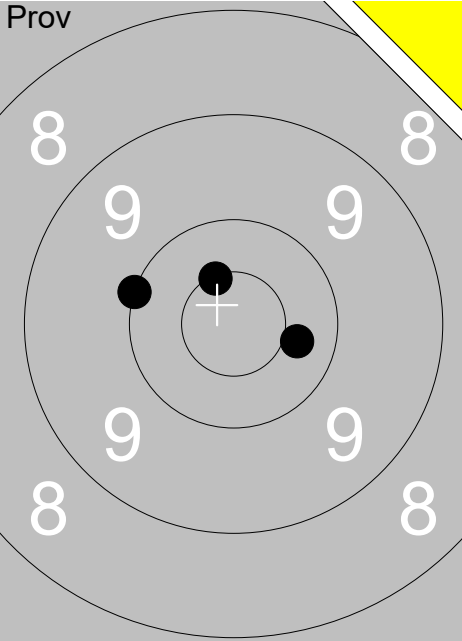

1:	10.7x →
2:	10.0 ←
3:	10.4x →
Serie 30	
Total 196	

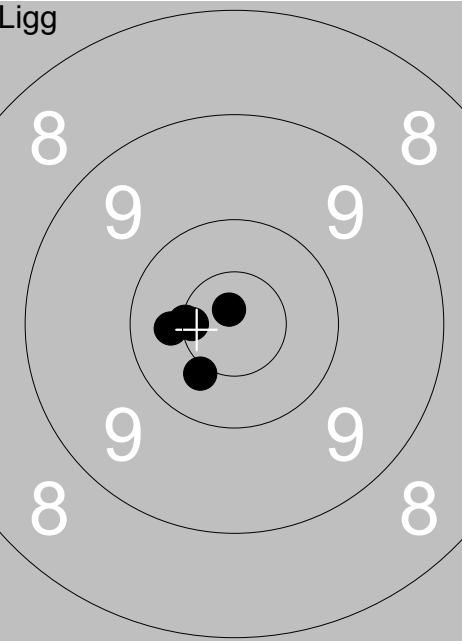
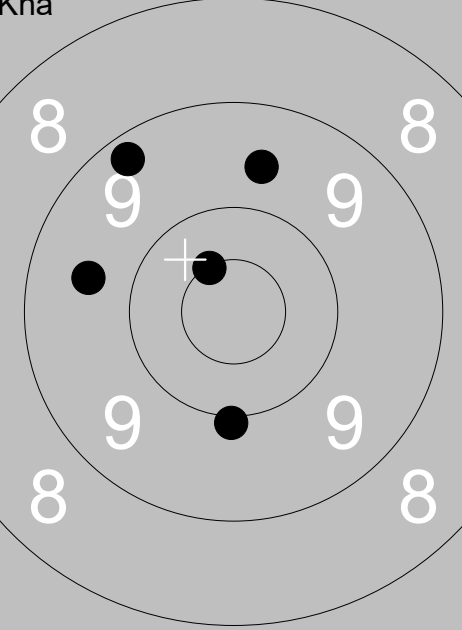
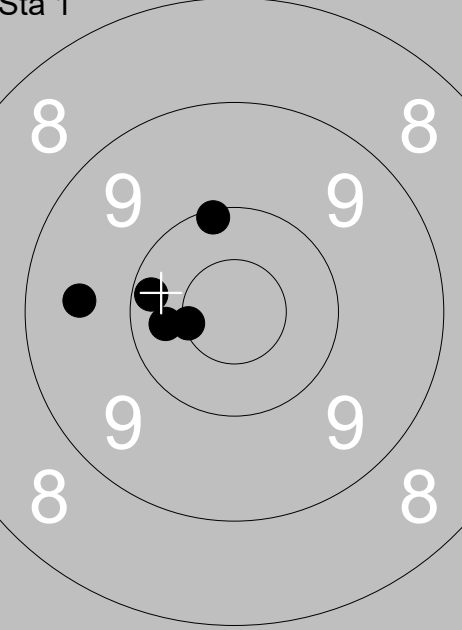
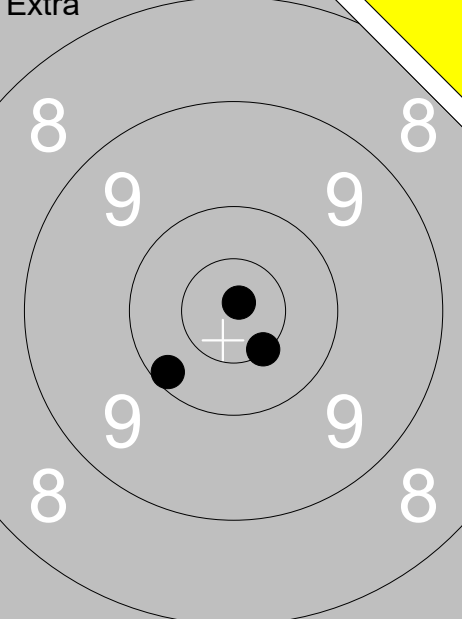
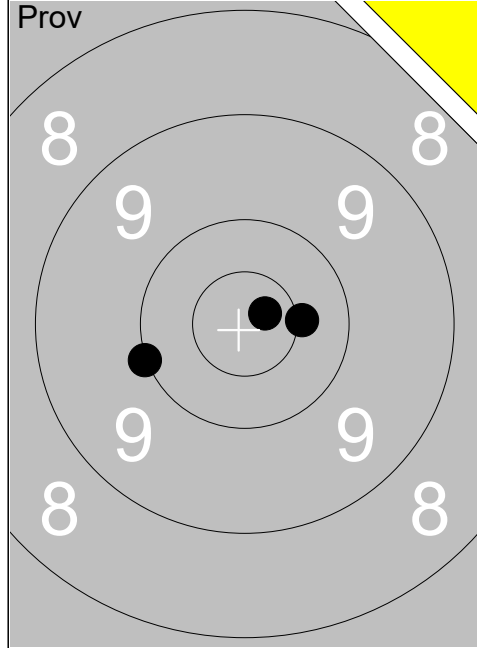
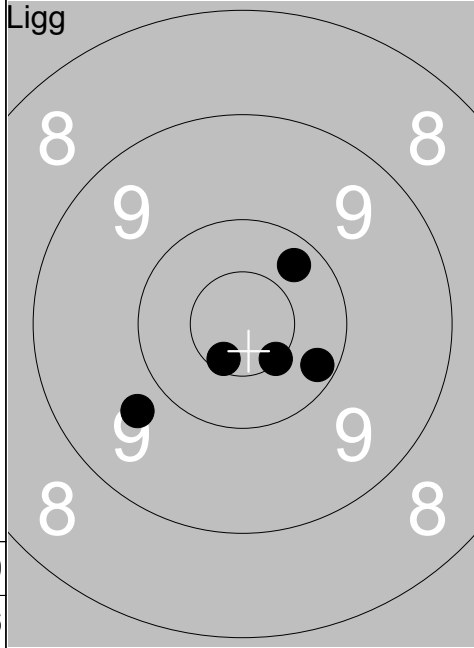

1:	10.3 ↗
2:	10.5x ↘
3:	10.2 ↘
4:	10.6x ↘
5:	9.7 ↙
Serie 49	
Total 245	

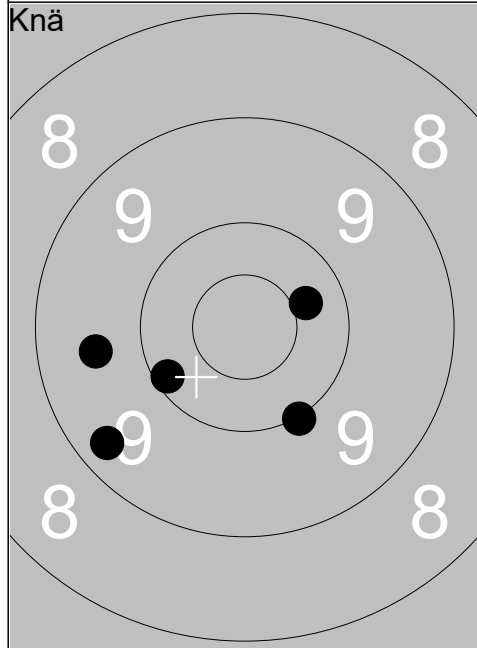

1:	10.0 ↘
2:	10.4 →
3:	9.3 ↙
4:	9.6 ←
5:	10.1 ↙
Serie 48	
Total 293	

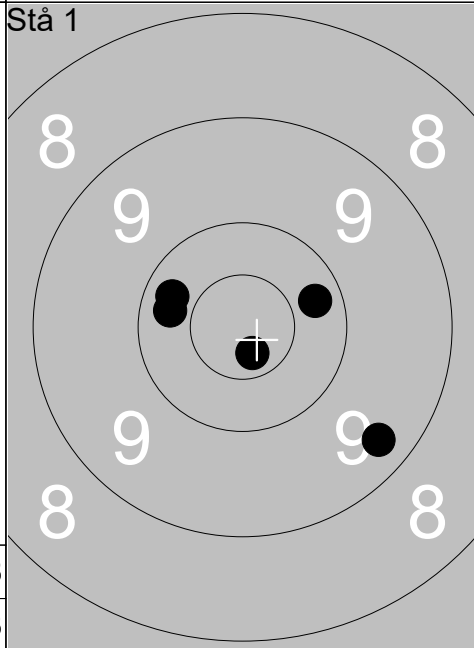

1:	9.3 ↘
2:	10.3 ←
3:	10.3 ←
4:	10.7x ↘
5:	10.3 →
Serie 49	
Total 342	

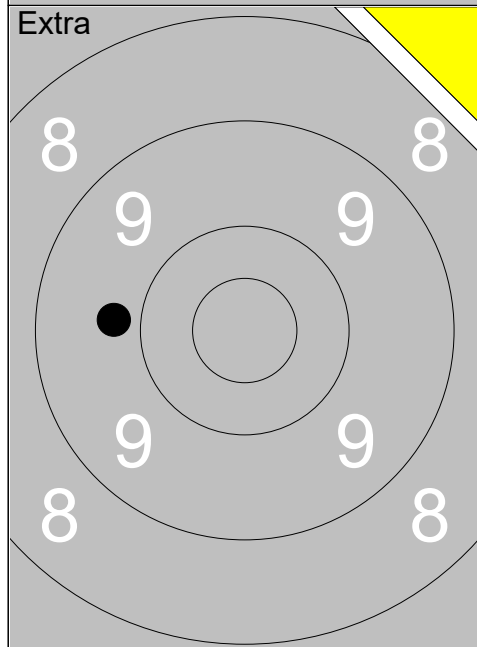

1:	9.8 ←
Serie 9	
Total 342	

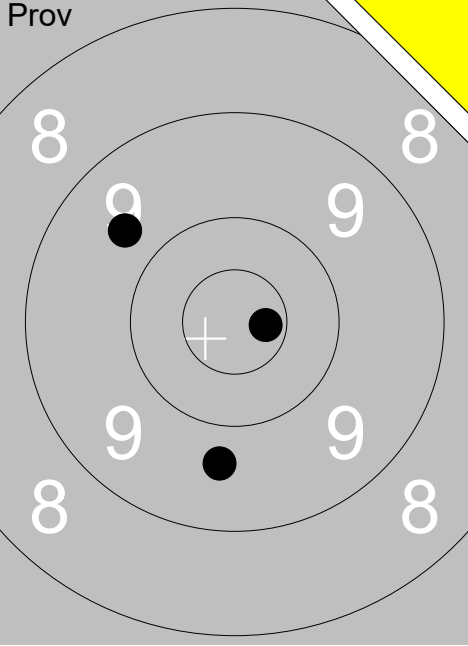
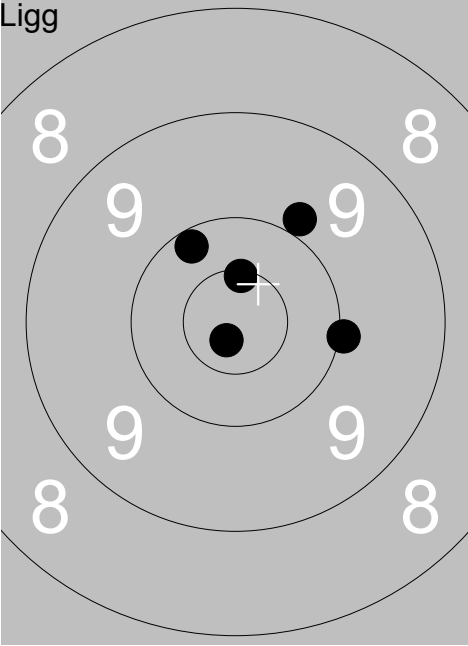
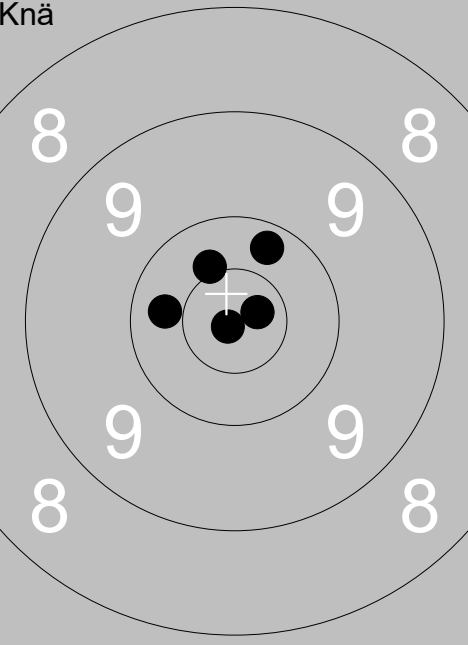
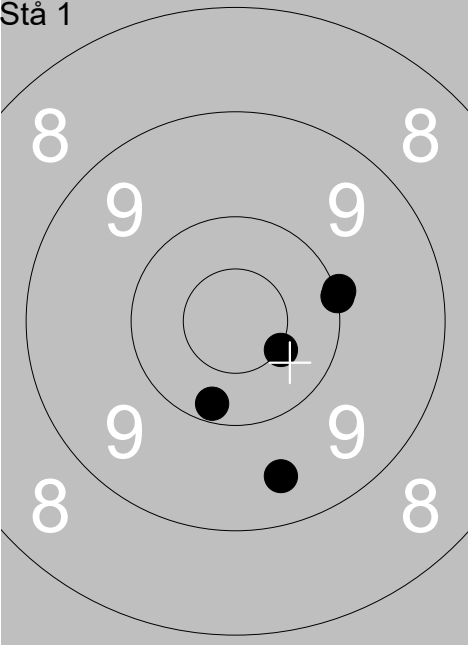
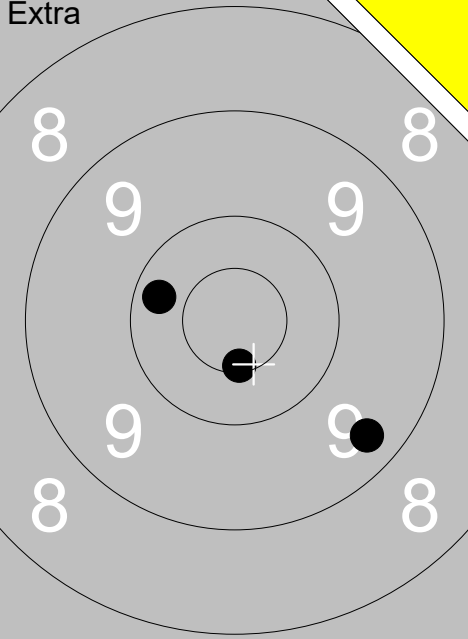
Skjutlag	Tavla	Jan-Erik Fäldt			
5	3	Ramselefors	Storfors	C	Vä
07.07.2019	Tavelträffen 2019	Ramselefors SKF			
Prov 	1: 9.7 ↓ 2: 9.7 ↖ 3: 10.7x →	Ligg 	1: 10.0 → 2: 10.5x ↑ 3: 10.8x ↘ 4: 9.9 ↗ 5: 10.2 ↖		
	Serie 28		Serie 49		
	Total 194		Total 243		
Knä 	1: 10.4x ↖ 2: 10.2 ↗ 3: 10.3 ← 4: 10.9x ↘ 5: 10.7x →	Stå 1 	1: 10.0 → 2: 10.5x ↘ 3: 9.5 ↓ 4: 10.0 → 5: 10.2 ↓		
	Serie 50		Serie 49		
	Total 293		Total 342		
Extra 	1: 10.2 ← 2: 10.5x ↓ 3: 9.4 ↘				
	Serie 29				
	Total 342				

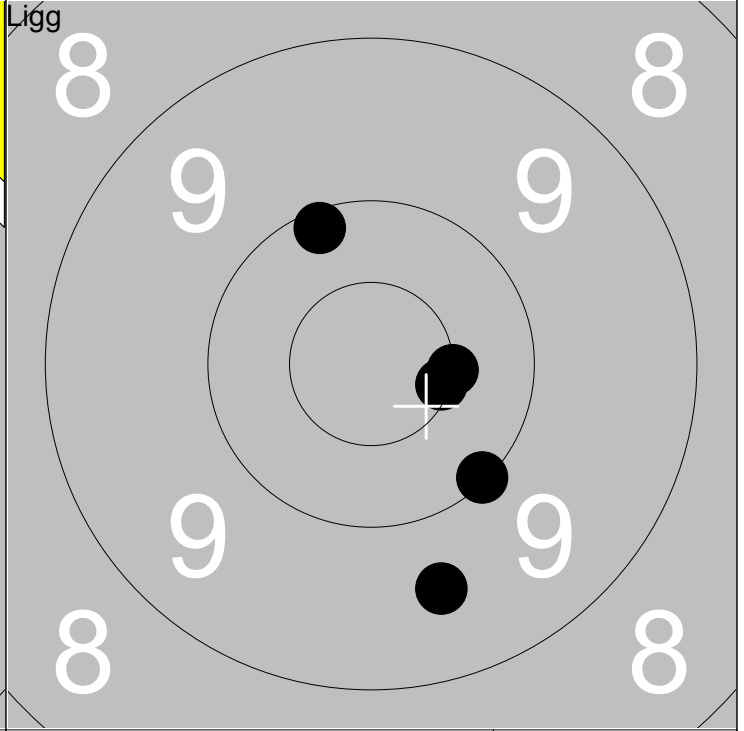
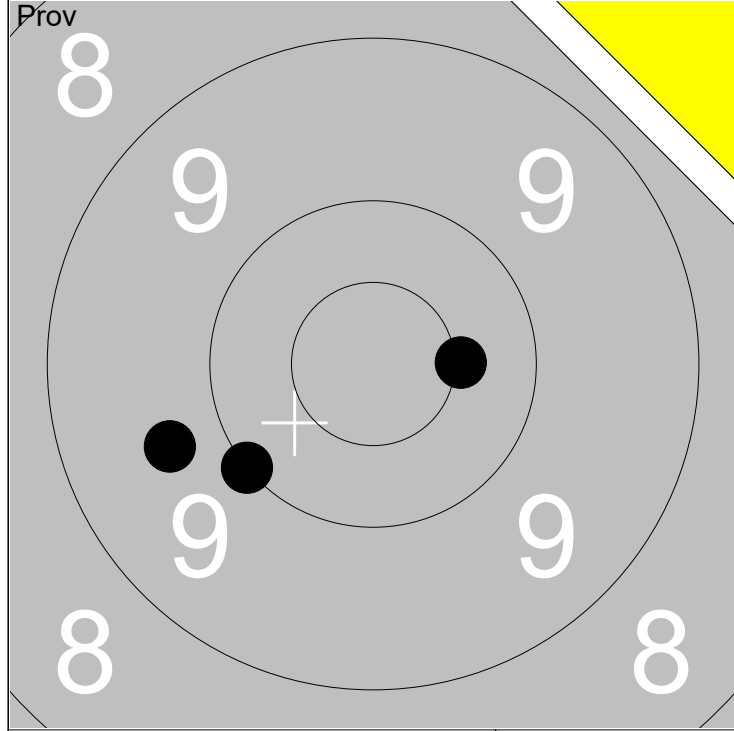

1: 9.7 ↙	Serie 29
2: 10.0 ↙	
3: 10.5x →	
Total 193	

1: 10.1 ↗	Serie 49
2: 10.5x →	
3: 10.5x →	
4: 10.0 ↘	
5: 9.6 ↘	
Total 242	

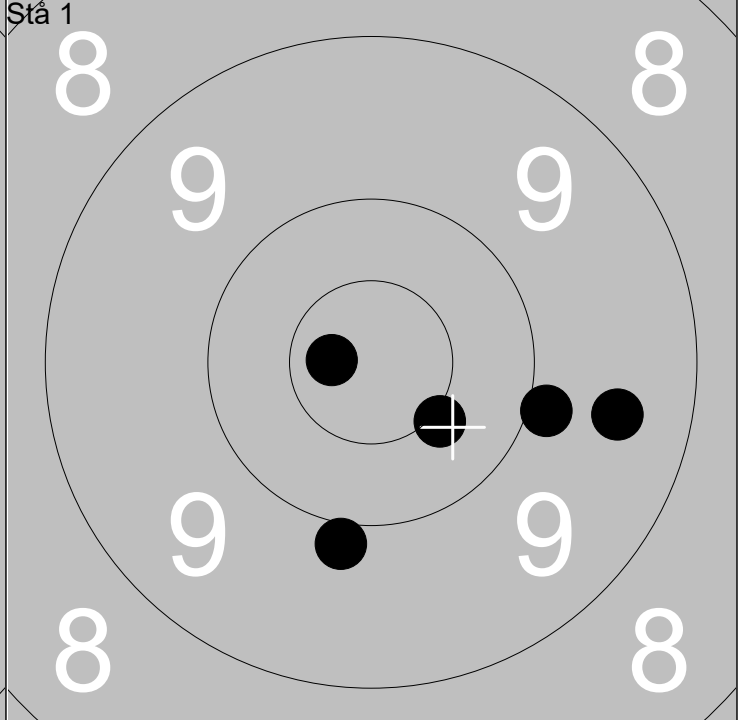
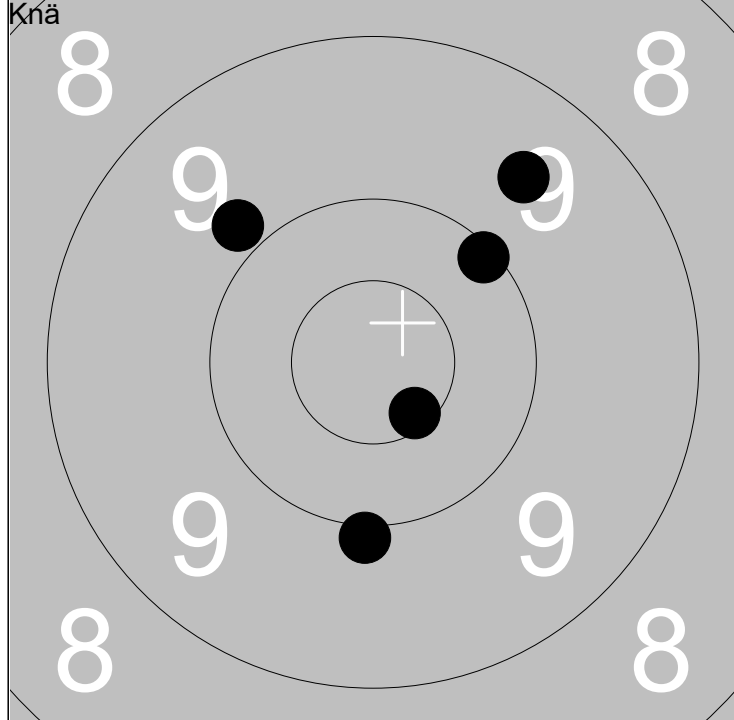

1: 9.6 ↗	Serie 48
2: 10.6x ↘	
3: 10.1 ↗	
4: 9.8 ↖	
5: 10.0 ↓	
Total 290	

1: 10.4x ↘	Serie 47
2: 9.5 →	
3: 9.9 →	
4: 10.7x ←	
5: 9.9 ↓	
Total 337	

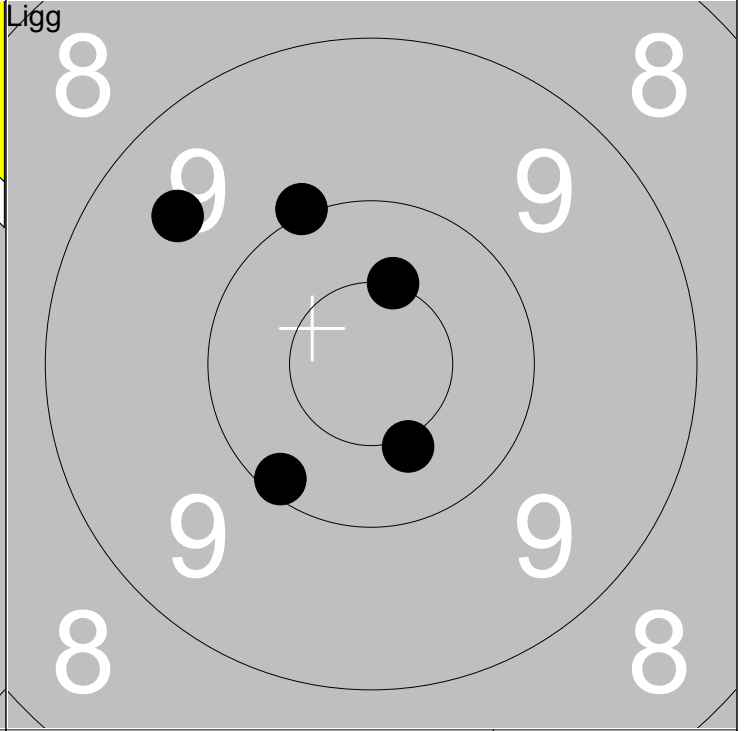
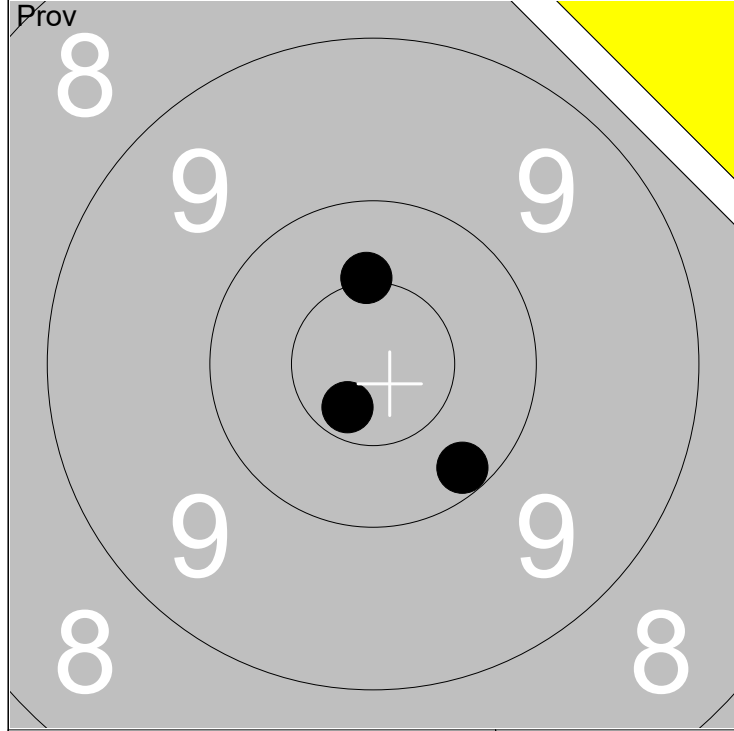

1: 10.5x ↑	Serie	30
2: 10.2 ↓		
3: 10.7x ↓		
Total		193

1: 10.1 ↙	Serie	49
2: 9.5 ↖		
3: 10.5x ↑		
4: 10.0 ↗	Total 242	
5: 10.4x ↓		

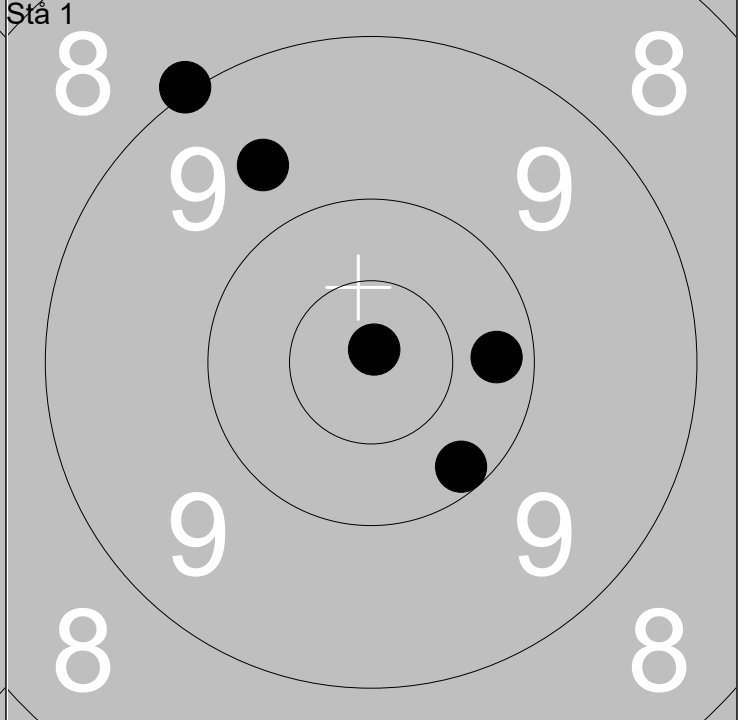
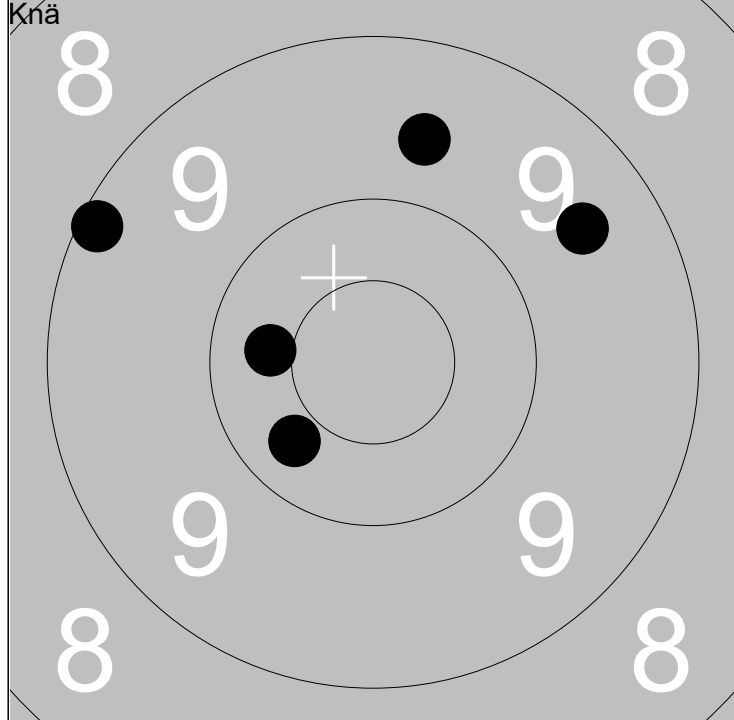

1: 9.1 ↖	Serie	47
2: 10.4 ←		
3: 10.3 ↙		
4: 9.6 ↑	Total 289	
5: 9.5 ↗		

1: 10.2 →	Serie	48
2: 9.7 ↗		
3: 10.2 ↓		
4: 9.0 ↖	Total 337	
5: 10.9x ↑		

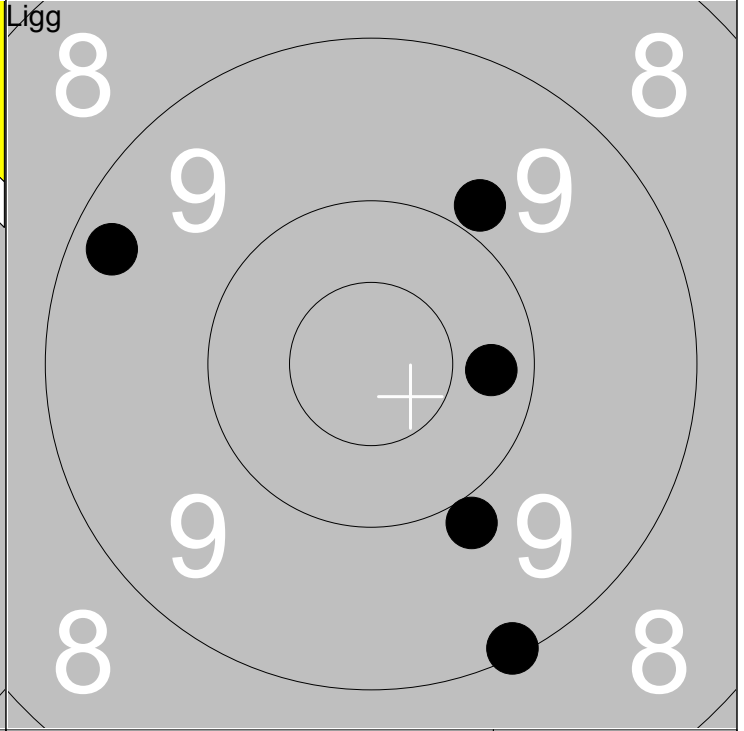
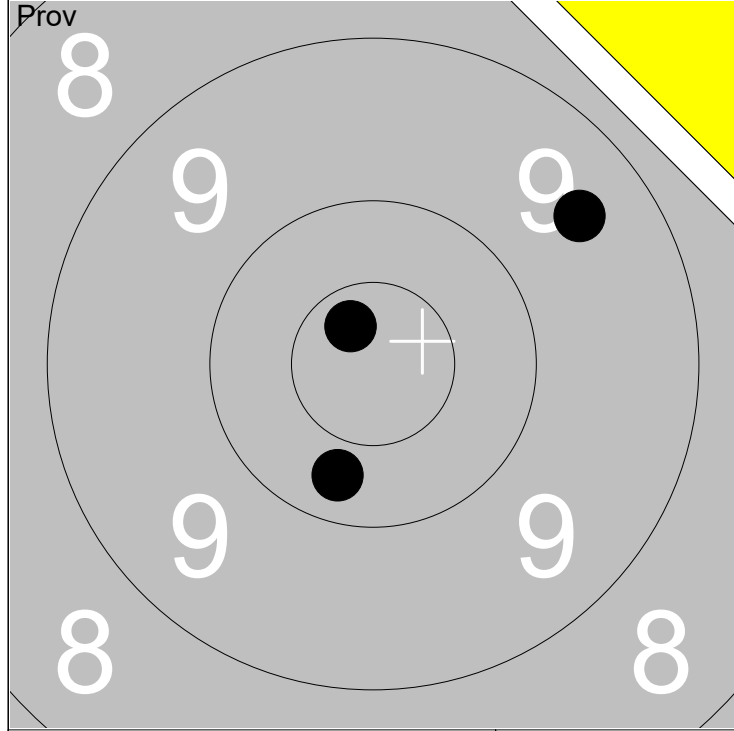

1: 10.3 ↓		Serie	29
2: 9.5 ↗			
3: 10.7x ↖			
		Total	192

1: 9.8 ↗		Serie	46
2: 9.3 ↖			
3: 9.9 ↓			
4: 9.1 ↓			
5: 10.3 →			
		Total	238

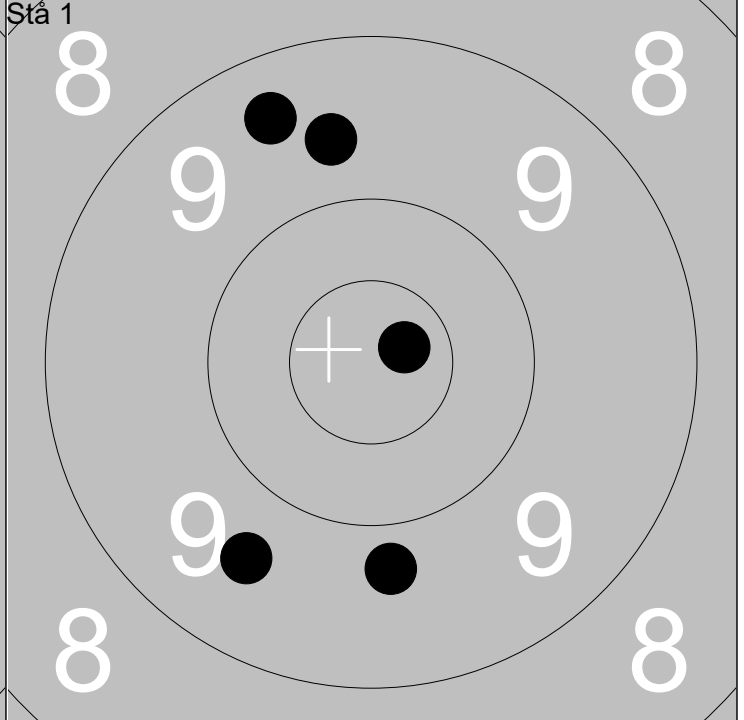
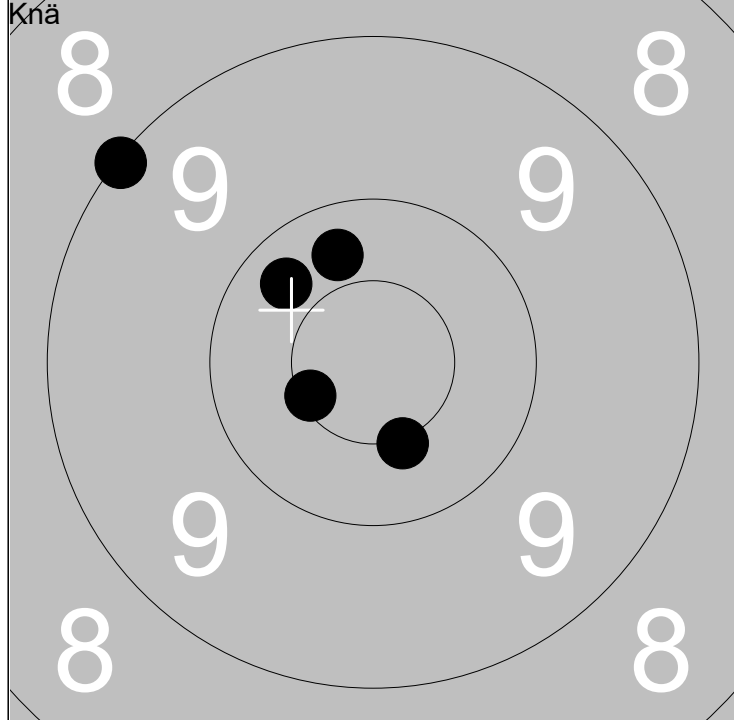

1: 10.3 ↖		Serie	49
2: 10.5x ↙			
3: 9.1 ↖			
4: 10.3 ↗			
5: 10.5x ↓			
		Total	287

1: 9.4 ↖		Serie	46
2: 10.7x ↗			
3: 9.8 ↓			
4: 9.6 ↗			
5: 9.6 ↓			
		Total	333

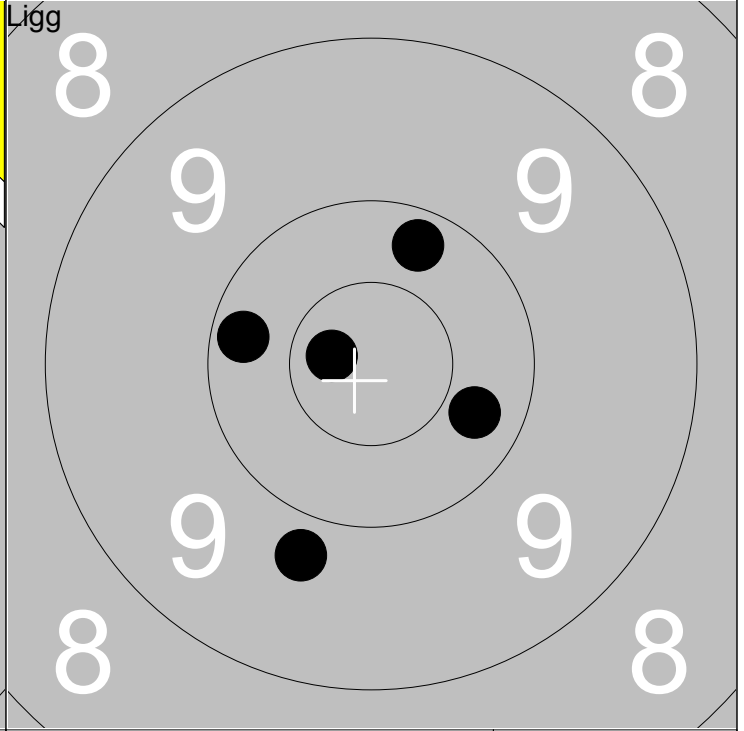
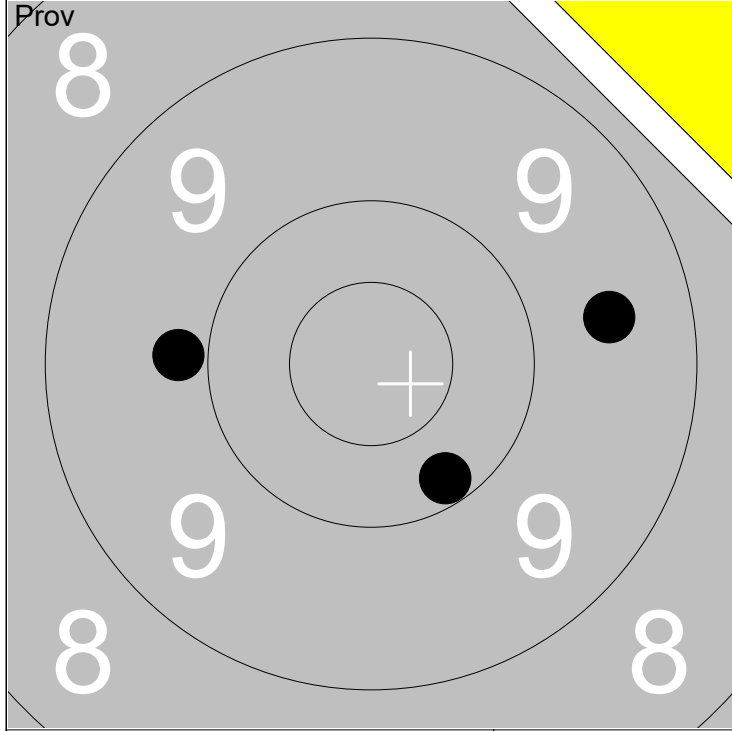

1: 9.8 ←	Serie 28
2: 9.5 →	
3: 10.2 ↘	
Total 192	

1: 10.3 →	Serie 49
2: 10.7x ←	
3: 9.8 ↘	
Total 241	

4: 10.2 ↗	Serie 46
5: 10.2 ←	
6: 9.6 ↘	
Total 334	

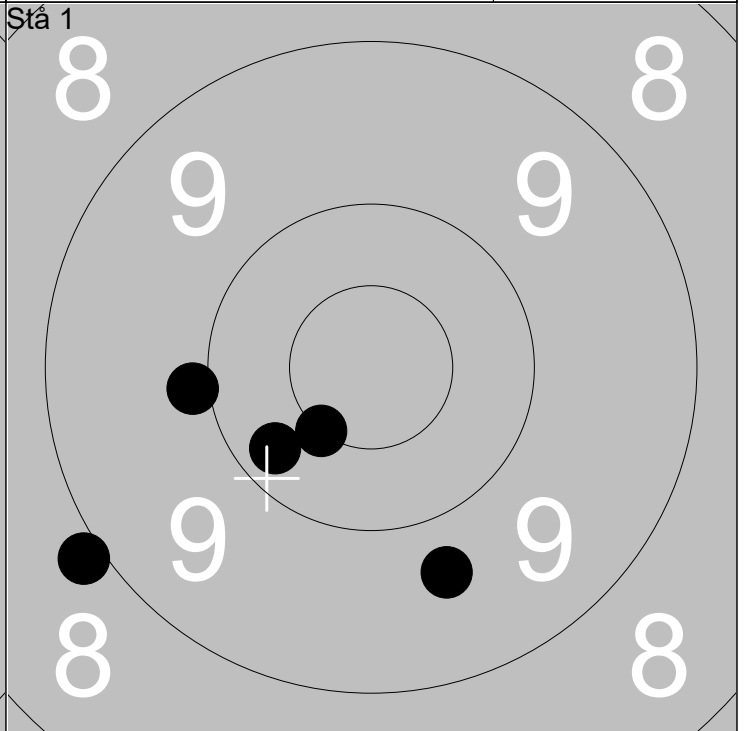
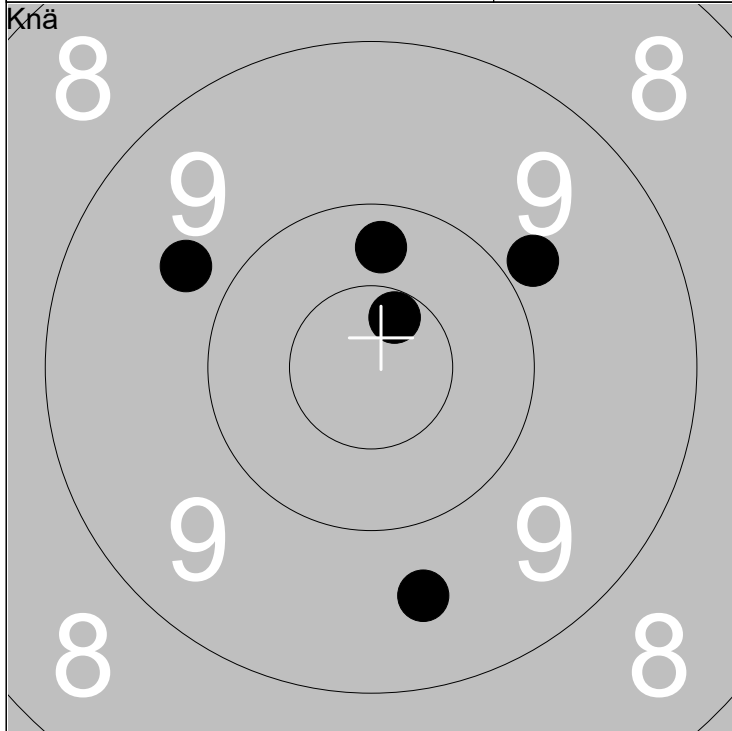

1: 10.3 ↑	Serie 47
2: 9.7 ←	
3: 10.6x ↗	
Total 288	

4: 9.8 ↗	Serie 46
5: 9.6 ↘	
6: 9.6 ↘	
Total 334	

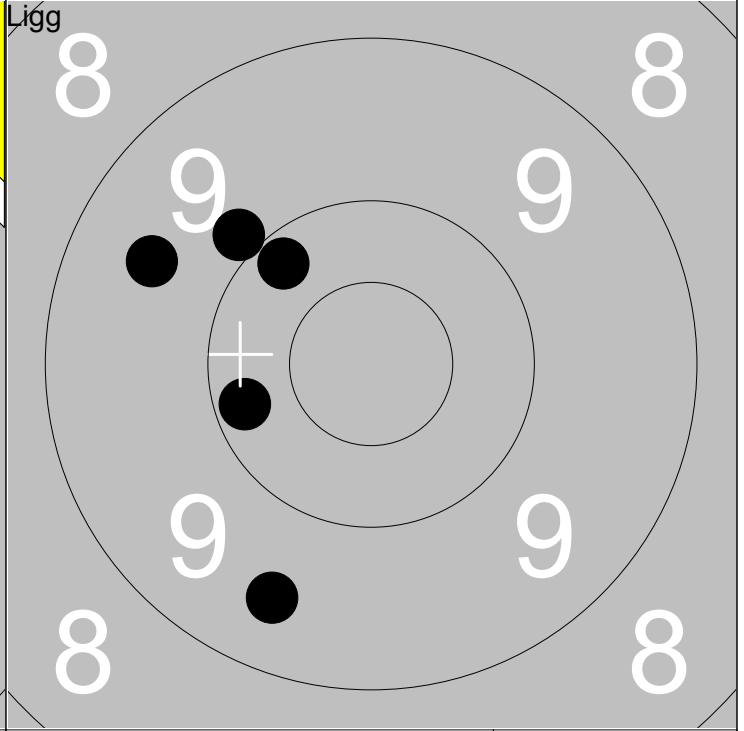
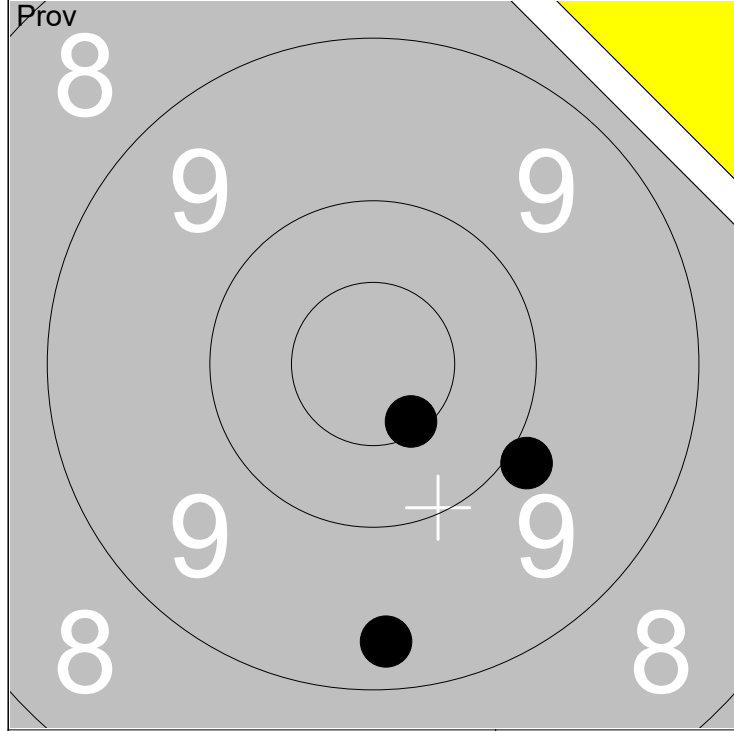

1: 9.3 ↓	Serie 28
2: 9.9 ↓	
3: 10.6x ↓	
Total 192	

1: 9.5 ↖	Serie 47
2: 9.5 ↓	
3: 10.2 ↗	
4: 9.9 ↗	
5: 10.2 ↖	
Total 239	

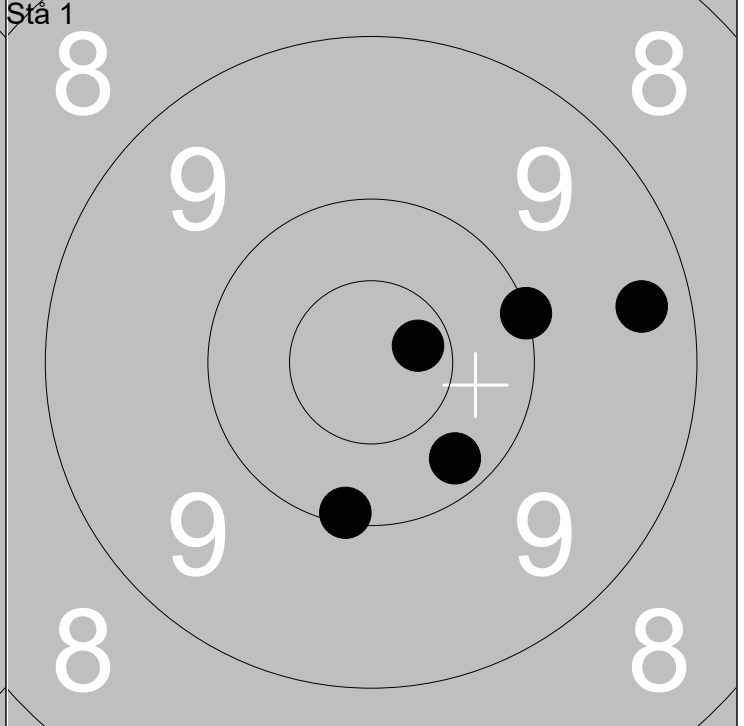
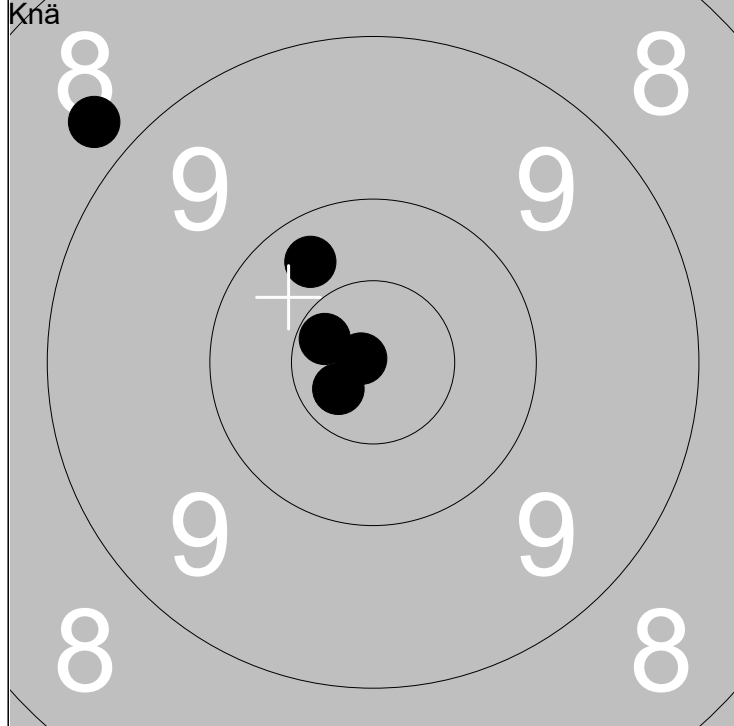

1: 10.7x ↖	Serie 48
2: 10.3 ↗	
3: 10.6x ↗	
4: 10.9x ↖	
5: 8.8 ↗	
Total 287	

1: 10.0 →	Serie 49
2: 10.7x →	
3: 9.3 →	
4: 10.1 ↓	
5: 10.2 ↓	
Total 336	

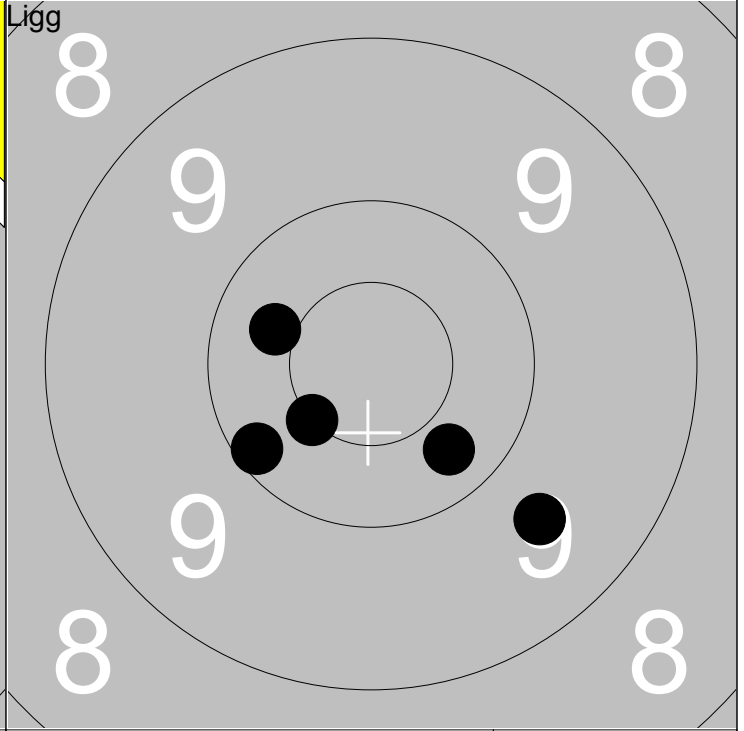
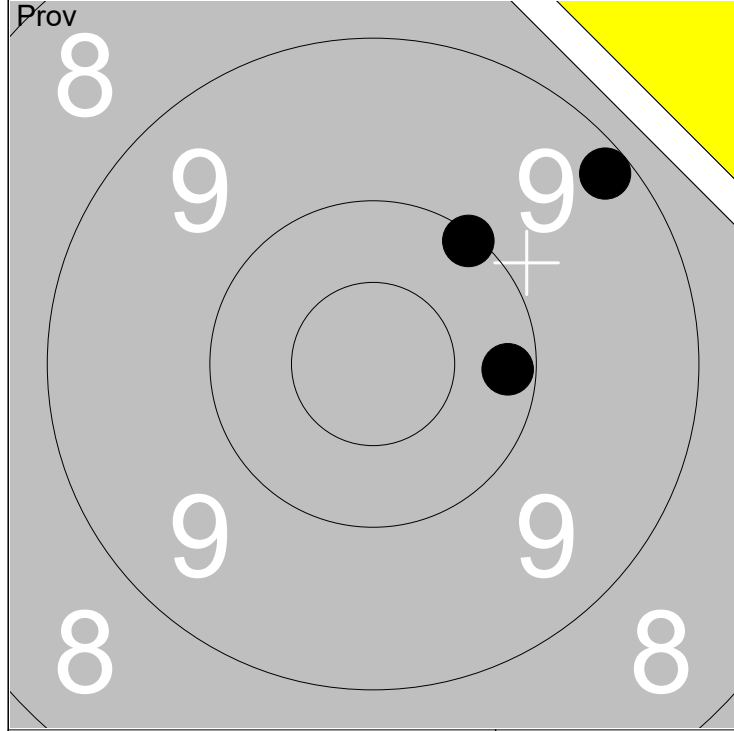

1: 10.2 →	Serie 29
2: 10.1 ↗	
3: 9.2 ↗	
Total 192	

1: 9.6 ↘	Serie 49
2: 10.5x ↙	
3: 10.4 ←	
4: 10.1 ↙	
5: 10.3 ↘	
Total 241	

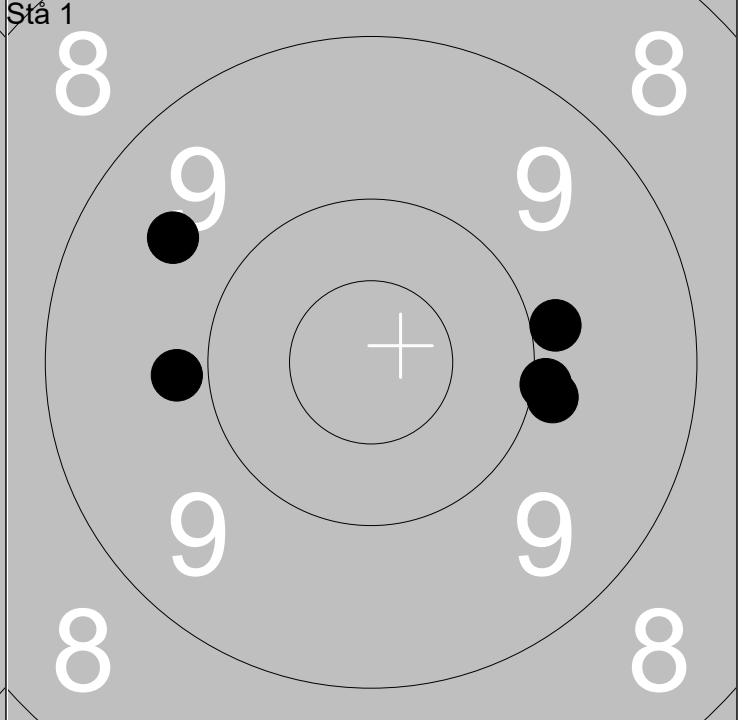
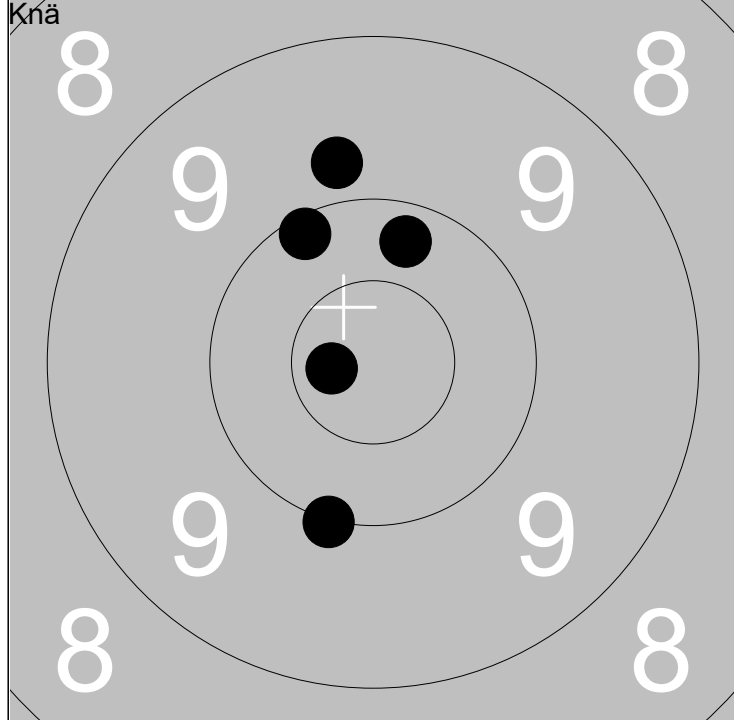

1: 10.7x ←	Serie 49
2: 9.8 ↑	
3: 10.1 ↗	
4: 10.0 ↘	
5: 10.2 ↑	
Total 290	

1: 9.9 →	Serie 46
2: 9.9 →	
3: 10.0 →	
4: 9.6 ↗	
5: 9.8 ←	
Total 336	

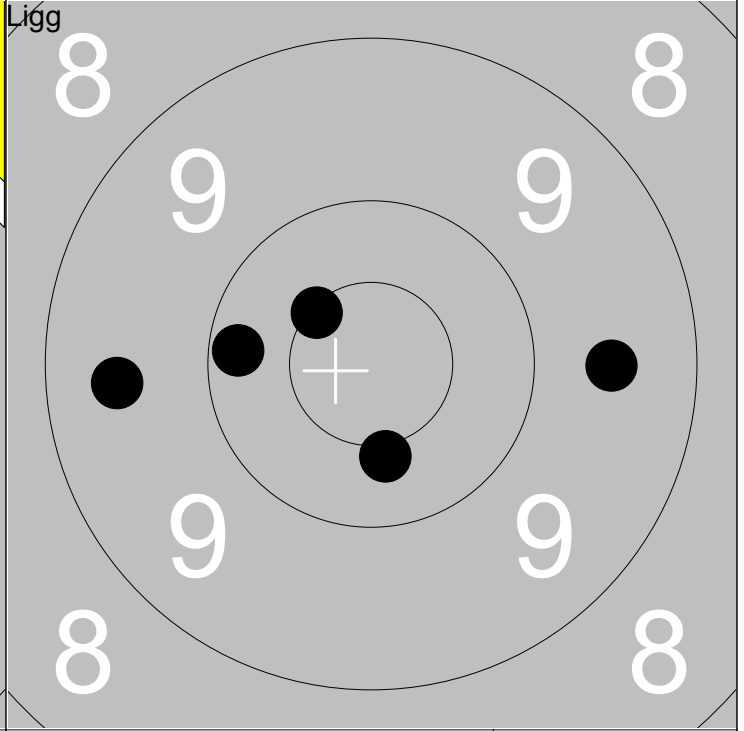
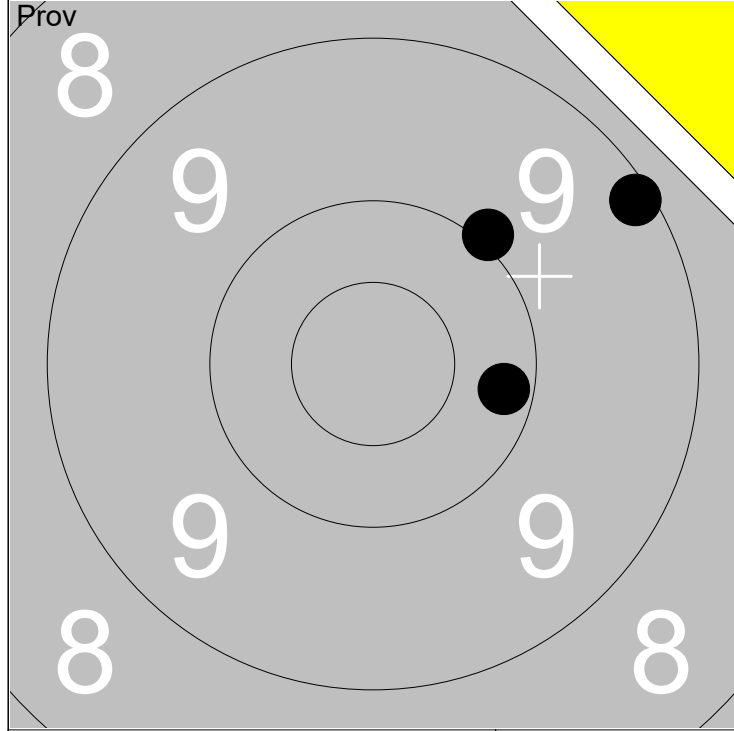

1: 9.1 ↗	Serie	29
2: 10.0 ↗		
3: 10.2 ➔		
Total		191

1: 9.5 ←	Serie	48
2: 10.2 ←		
3: 9.6 ➔		
4: 10.4x ↓		
5: 10.5x ↖		
Total		239

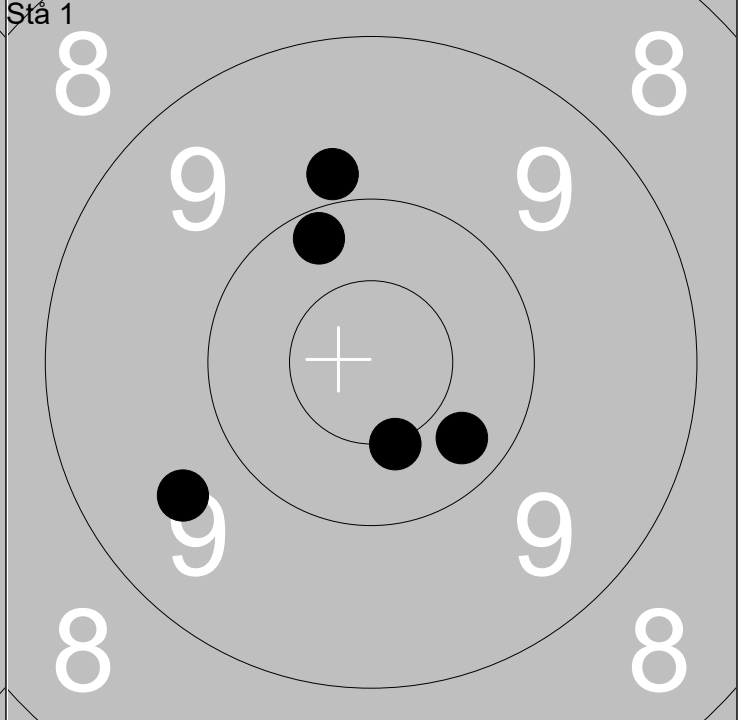
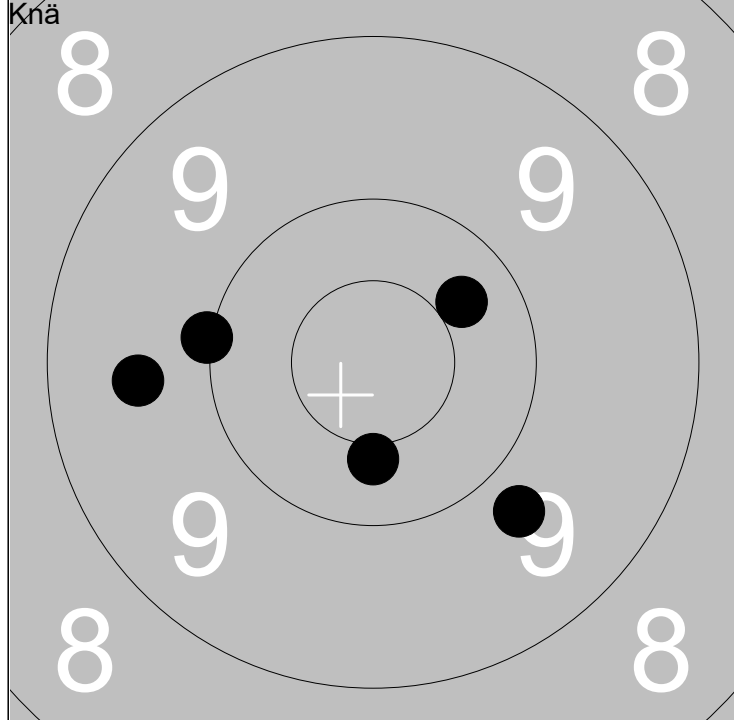

1: 10.0 ←	Serie	48
2: 10.3 ↗		
3: 9.8 ↘		
4: 10.4 ↓		
5: 9.6 ←		
Total		287

1: 10.2 ↗	Serie	48
2: 9.6 ←		
3: 10.3 ↘		
4: 10.5x ↓		
5: 9.9 ↗		
Total		335

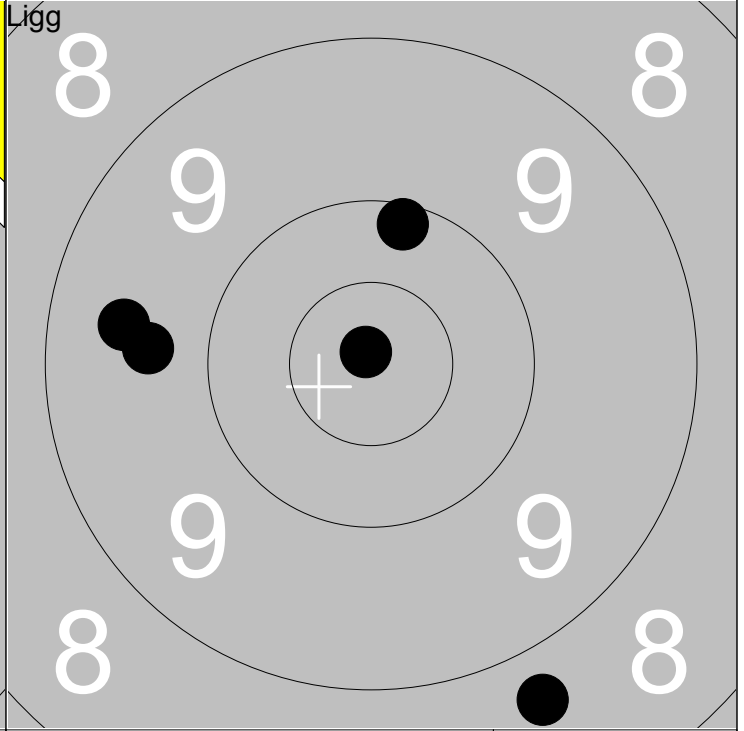
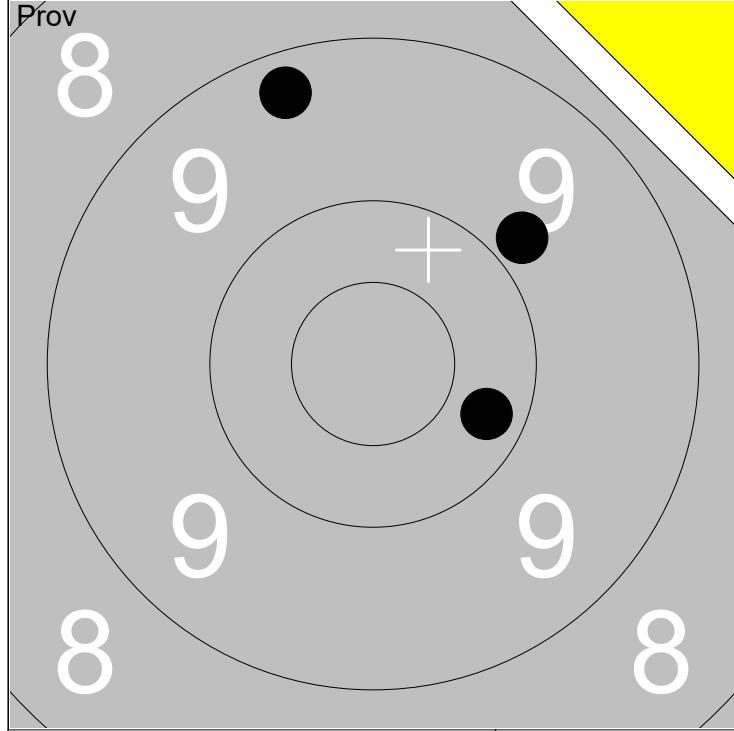

1: 9.8 ↗	Serie 28
2: 10.2 ➤	
3: 9.3 ↗	
Total 191	

1: 9.7 ←	Serie 46
2: 8.7 ↓	
3: 10.9x ↗	
4: 10.1 ↗	
5: 9.5 ←	
Total 237	

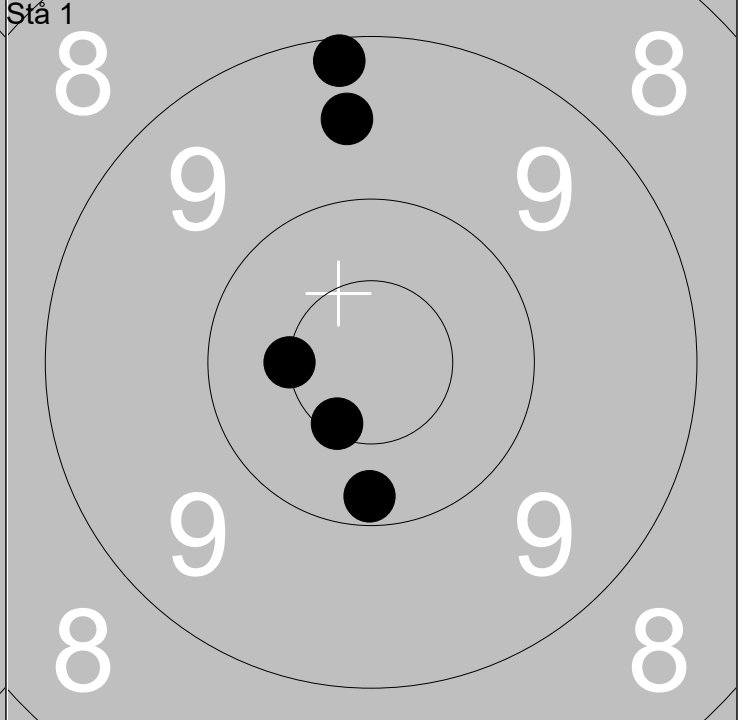
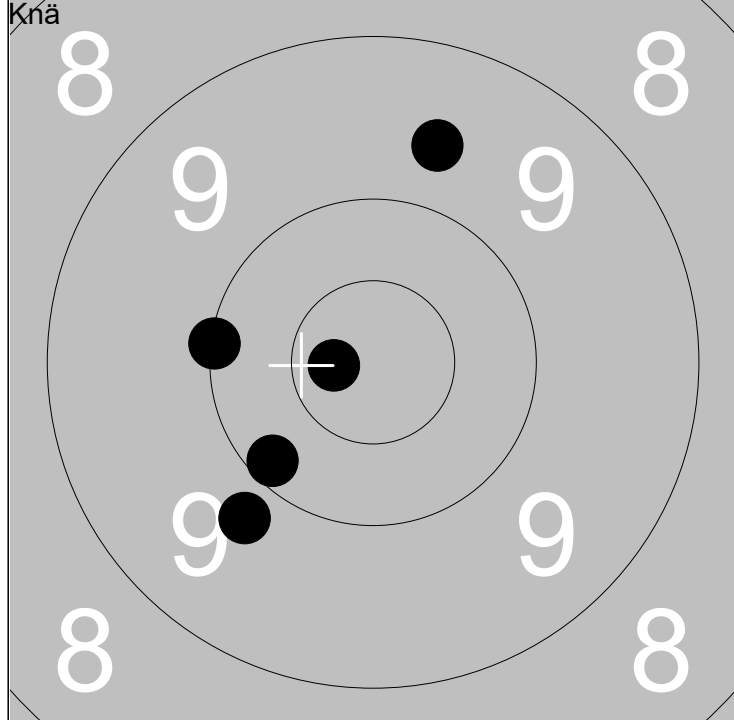

1: 10.2 ↙	Serie 48
2: 9.8 ↙	
3: 10.0 ←	
4: 10.7x ←	
5: 9.6 ↗	
Total 285	

1: 10.2 ↓	Serie 48
2: 10.6x ↙	
3: 9.5 ↗	
4: 10.5x ←	
5: 9.2 ↗	
Total 333	

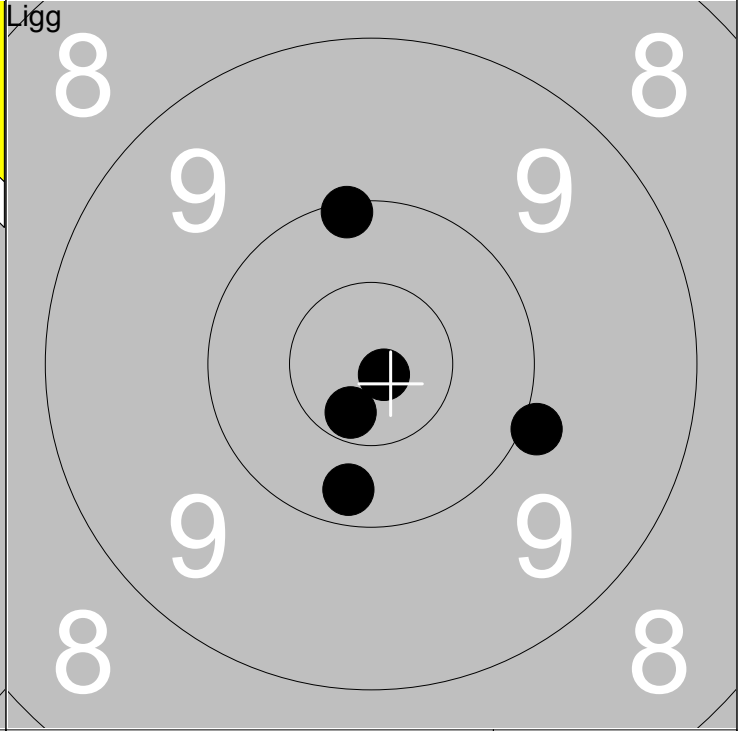
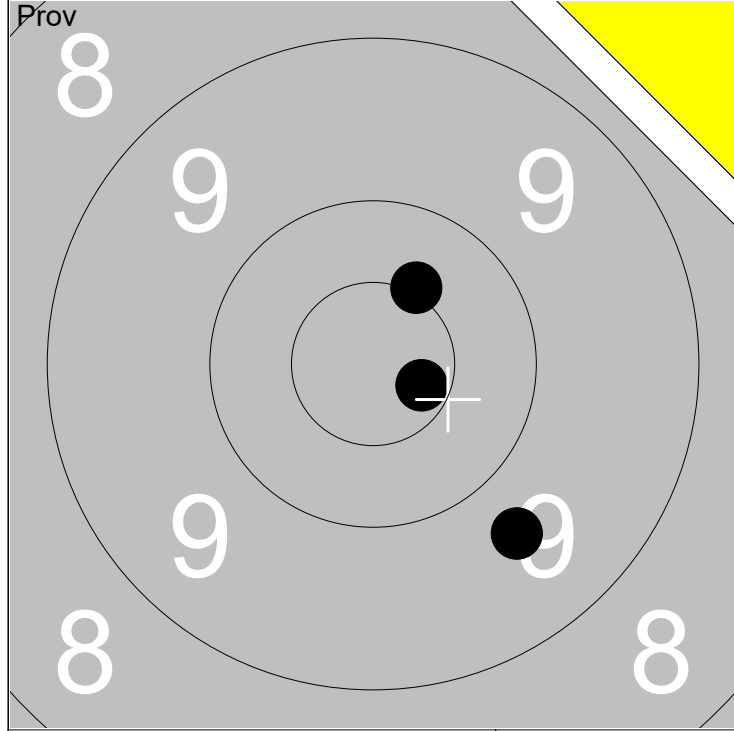

1: 10.7x →	Serie 29
2: 10.5x ↗	
3: 9.7 ↓	
Total 190	

1: 10.1 ↑	Serie 49
2: 10.9x ↘	
3: 10.2 ↓	
Total 239	

4: 9.9 →	Serie 48
5: 10.7x ↓	
Total 334	

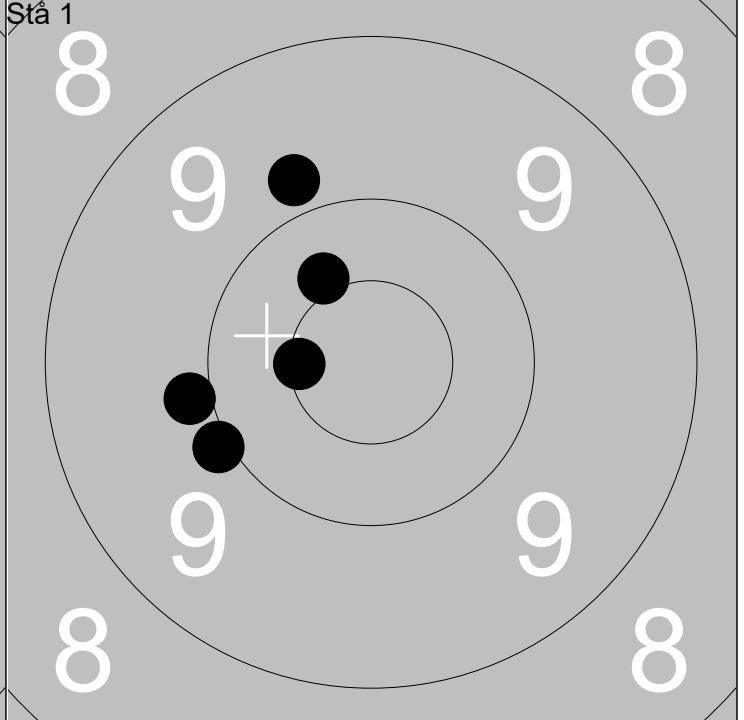
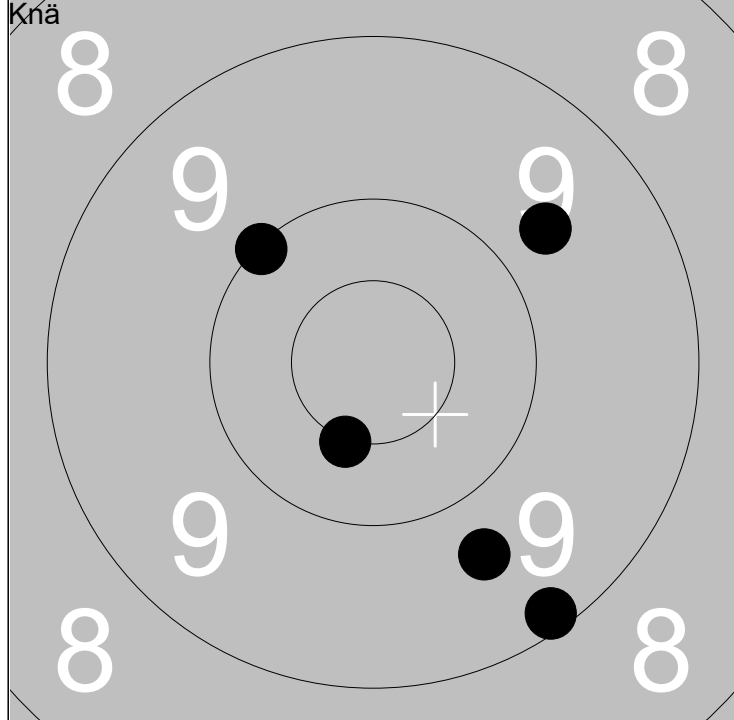

1: 10.5x ↓	Serie 47
2: 9.7 ↗	
3: 9.1 ↓	
Total 286	

4: 9.7 ↓	Serie 48
5: 10.0 ↗	
Total 334	

1: 10.5x ←	Serie 48
2: 10.0 ←	
3: 10.4 ↗	
Total 334	

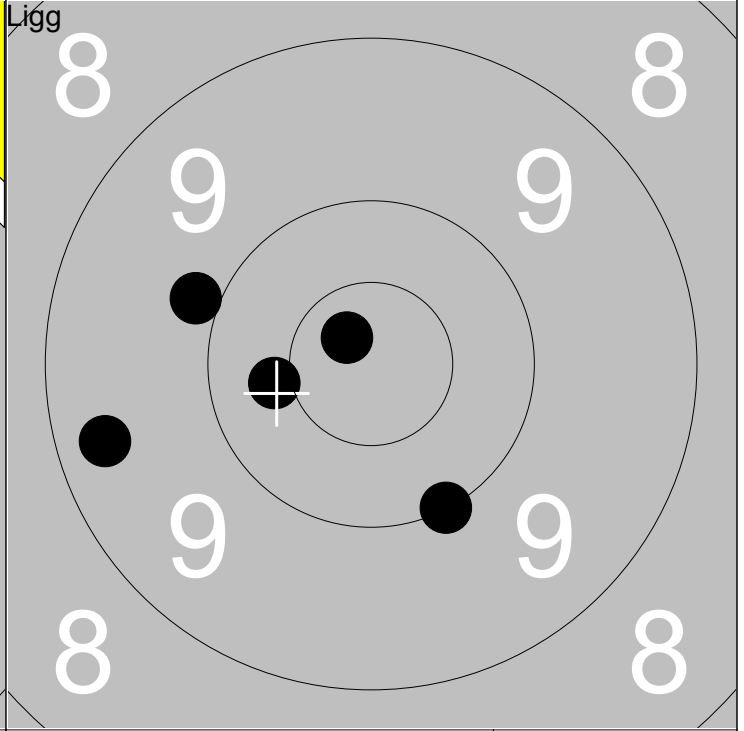
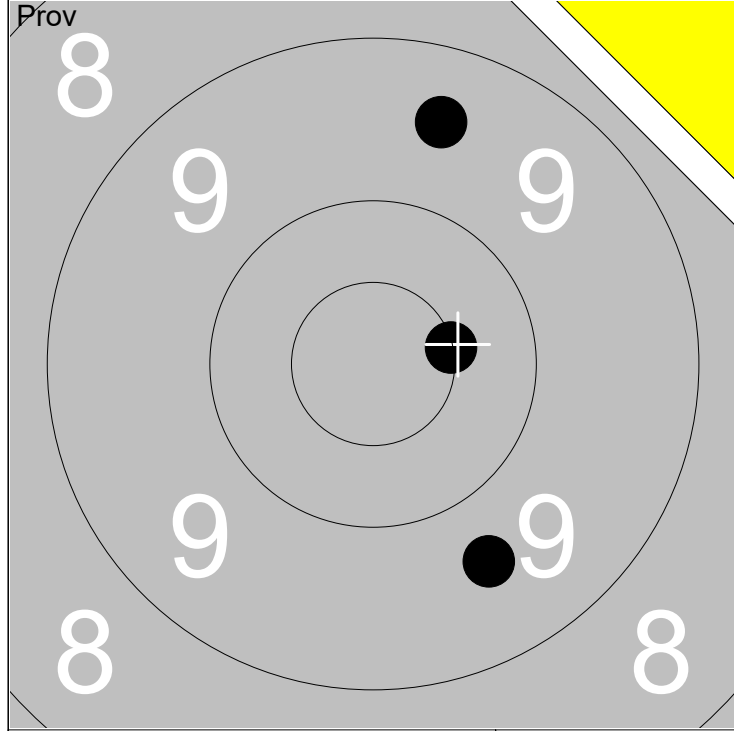

1: 9.5 ↗	Serie 28
2: 9.6 ↘	
3: 10.5x →	
Total 190	

1: 10.0 ↘	Serie 48
2: 10.4 ←	
3: 10.7x ↗	
Total 238	

4: 9.3 ←	Serie 46
5: 9.9 ↖	
Total 333	

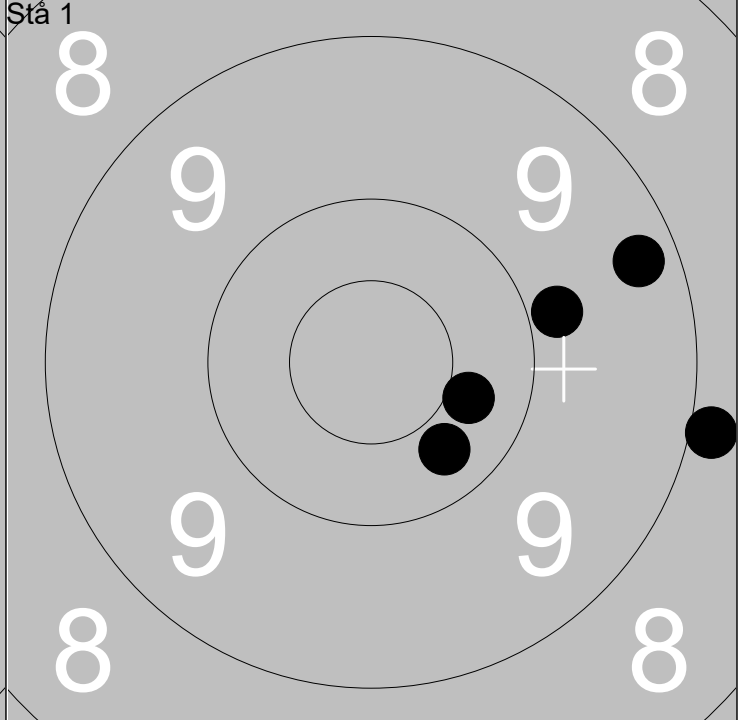
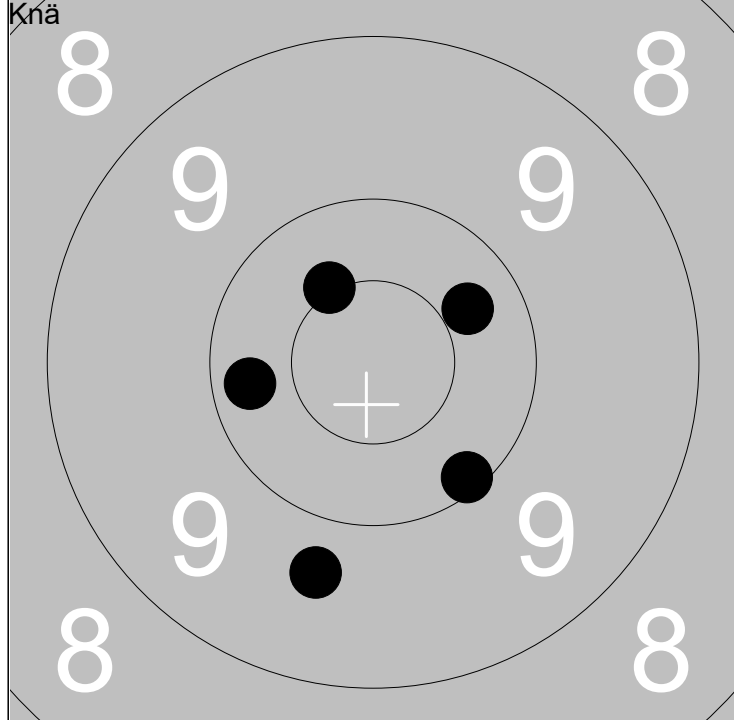

1: 10.3 ↗	Serie 49
2: 9.7 ↘	
3: 10.2 ←	
Total 287	

4: 10.1 ↘	Serie 46
5: 10.5x ↗	
Total 333	

1: 9.3 →	Serie 46
2: 9.8 →	
3: 10.4 →	
Total 333	

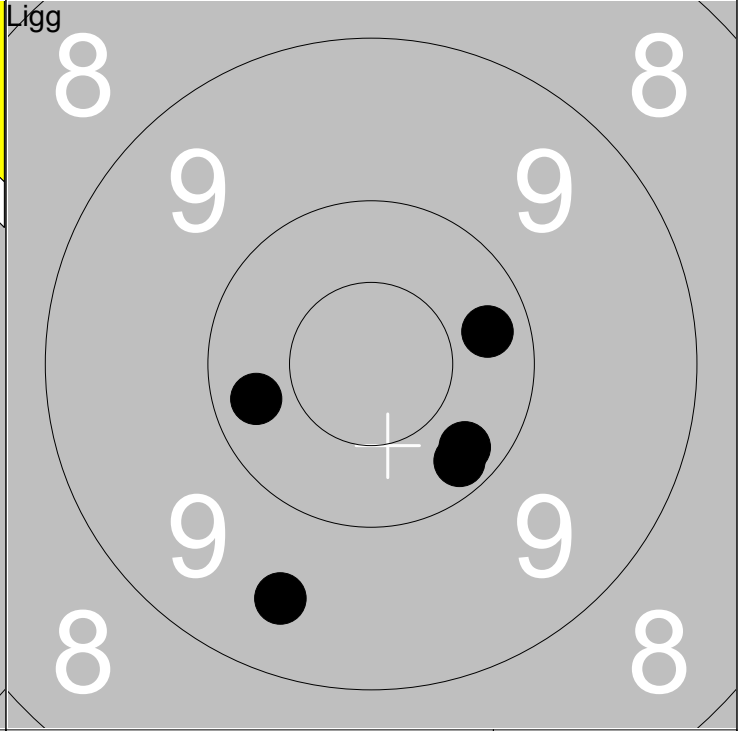
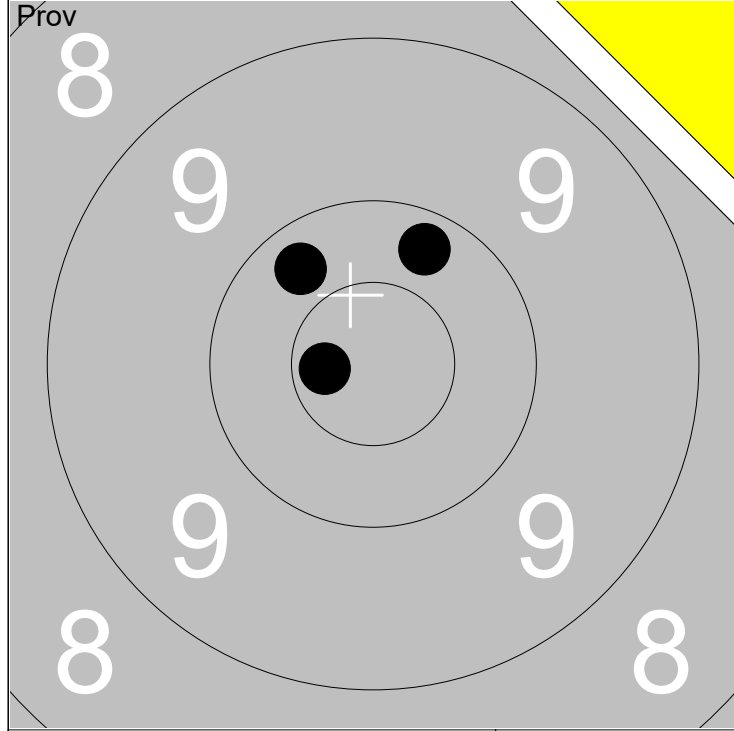

1: 10.2 ↗	Serie 30
2: 10.3 ↖	
3: 10.7x ←	
Total 190	

1: 10.3 →	Serie 49
2: 10.2 ↘	
3: 10.2 ↘	
4: 9.5 ↘	Total 239
5: 10.3 ←	

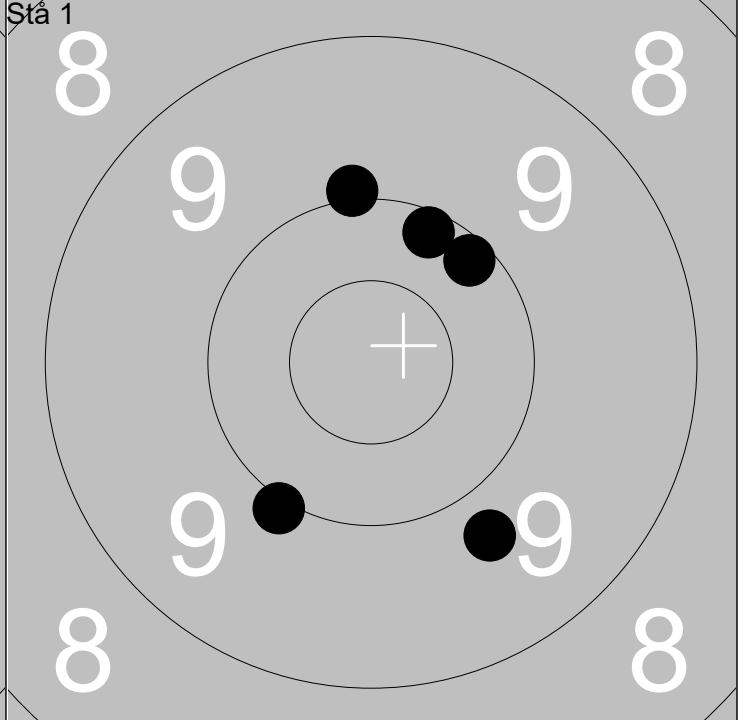
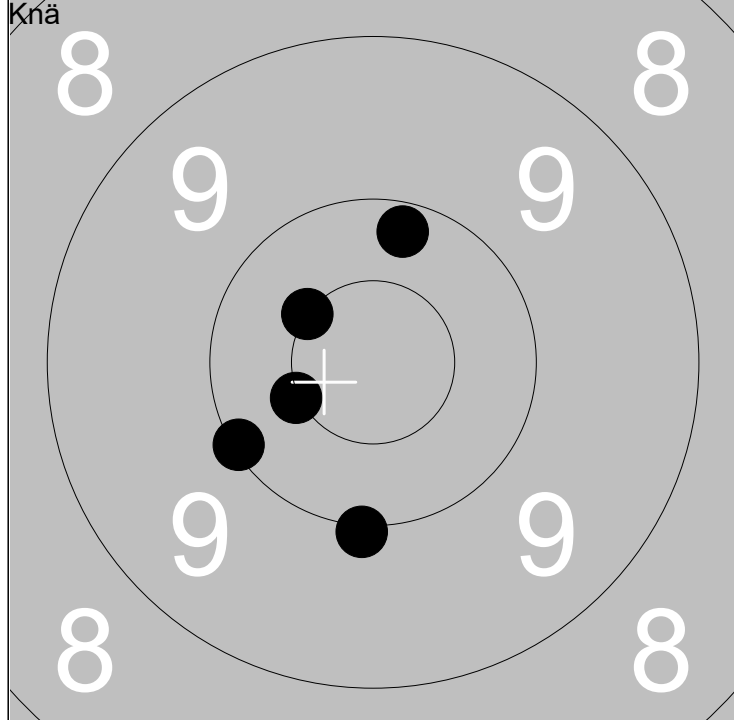

1: 10.5x ↖	Serie 50
2: 10.0 ↓	
3: 10.5x ←	
4: 10.1 ←	Total 289
5: 10.2 ↑	

1: 10.0 ↑	Serie 49
2: 9.7 ↘	
3: 10.1 ↗	
4: 10.1 ↑	Total 338
5: 10.0 ↘	

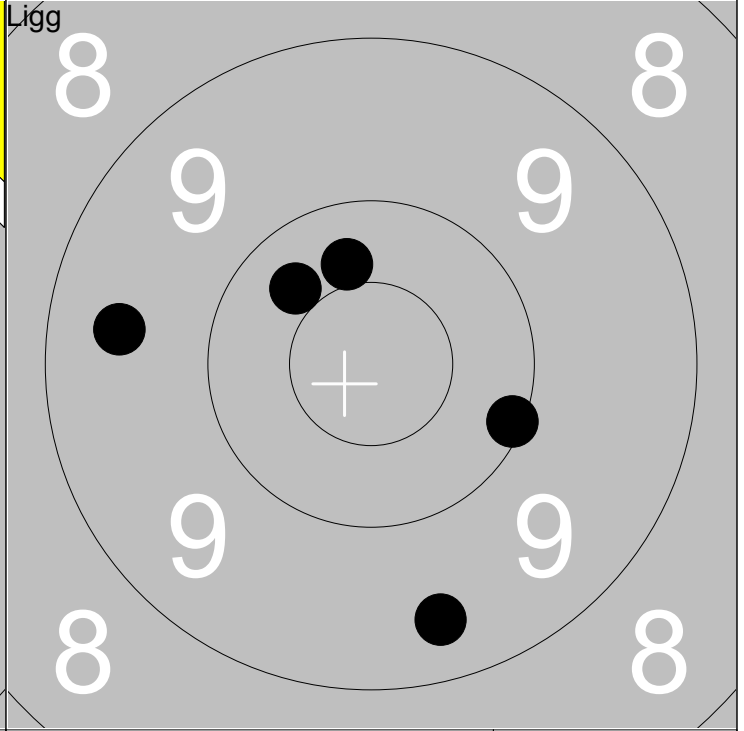
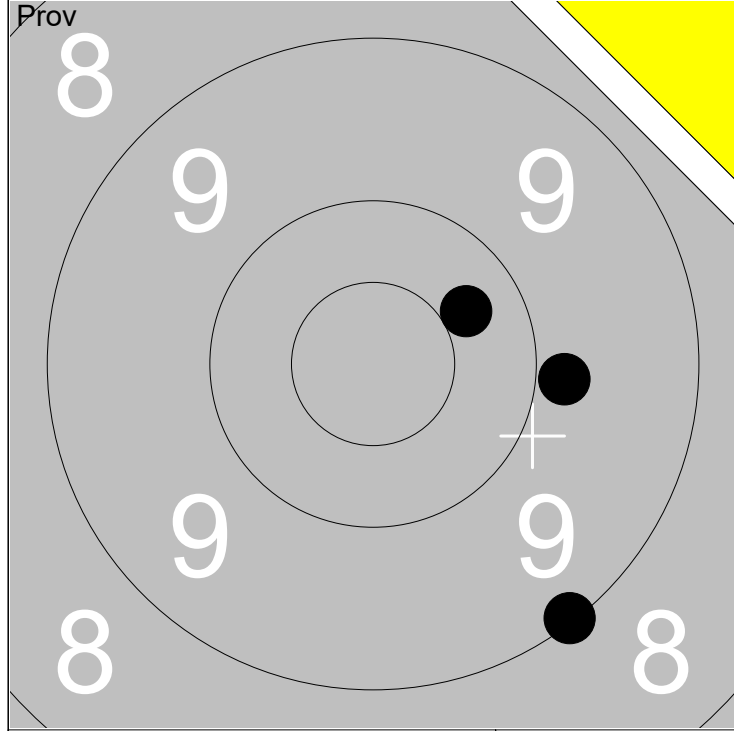

1: 9.1 ↘	Serie	28
2: 10.3 ↗		
3: 9.9 →		
Total		192

1: 9.5 ←	Serie	48
2: 10.3 ↗		
3: 10.1 ↘		
4: 10.4 ↗		
5: 9.4 ↘		
Total		240

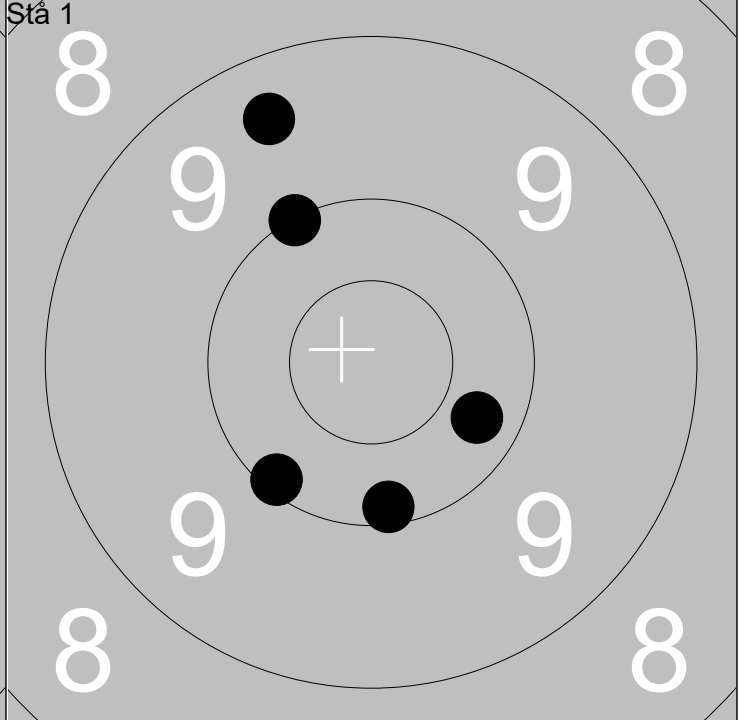
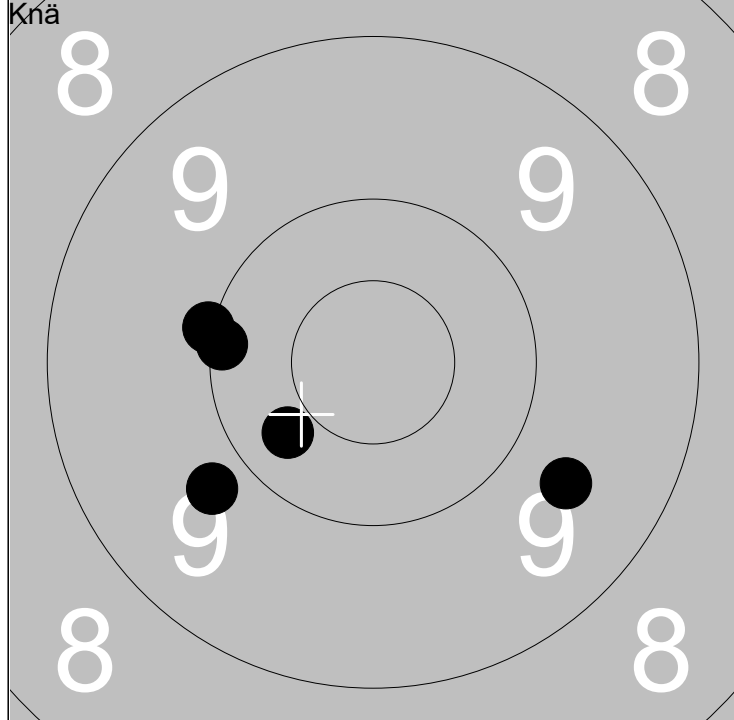

1: 10.3 ↙	Serie	48
2: 9.6 ↘		
3: 10.0 ←		
4: 10.1 ←		
5: 9.8 ↙		
Total		288

1: 10.1 ↙	Serie	49
2: 10.1 ↘		
3: 9.4 ↗		
4: 10.3 ↘		
5: 10.0 ↗		
Total		337

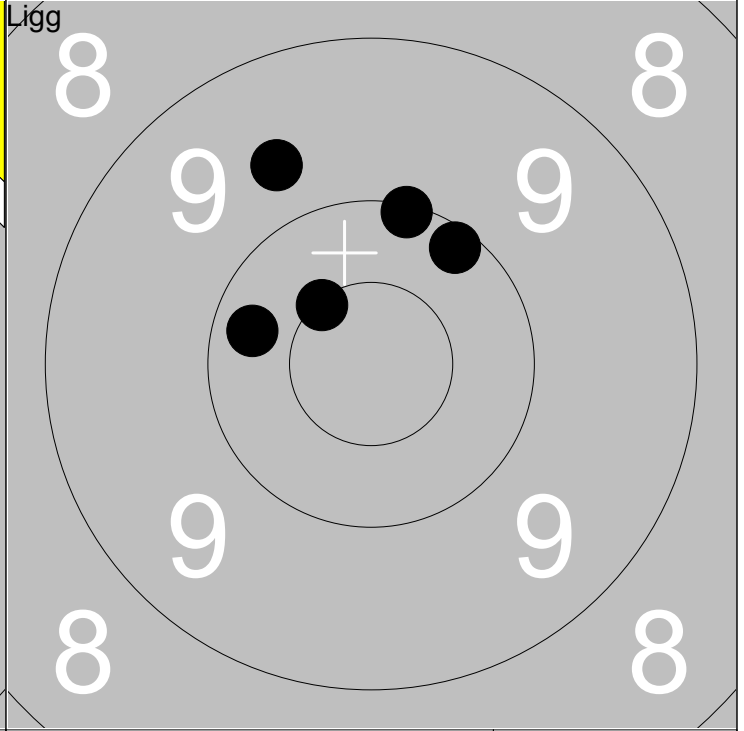
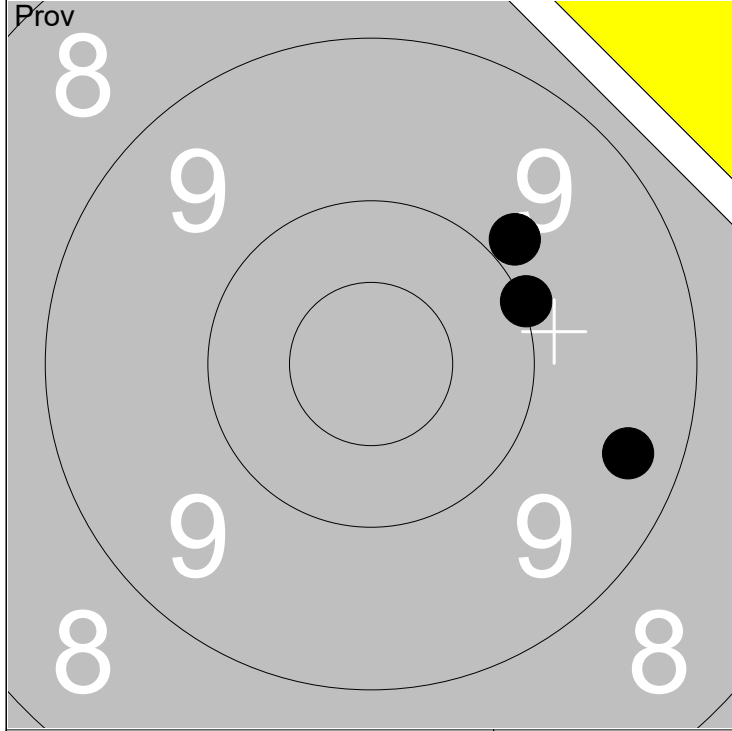

1: 9.4 →	Serie 28
2: 9.9 ↗	
3: 10.0 →	
Total 189	

1: 10.5x ↖	Serie 49
2: 10.1 ↗	
3: 9.7 ↖	
4: 10.2 ↖	
5: 10.1 ↗	
Total 238	

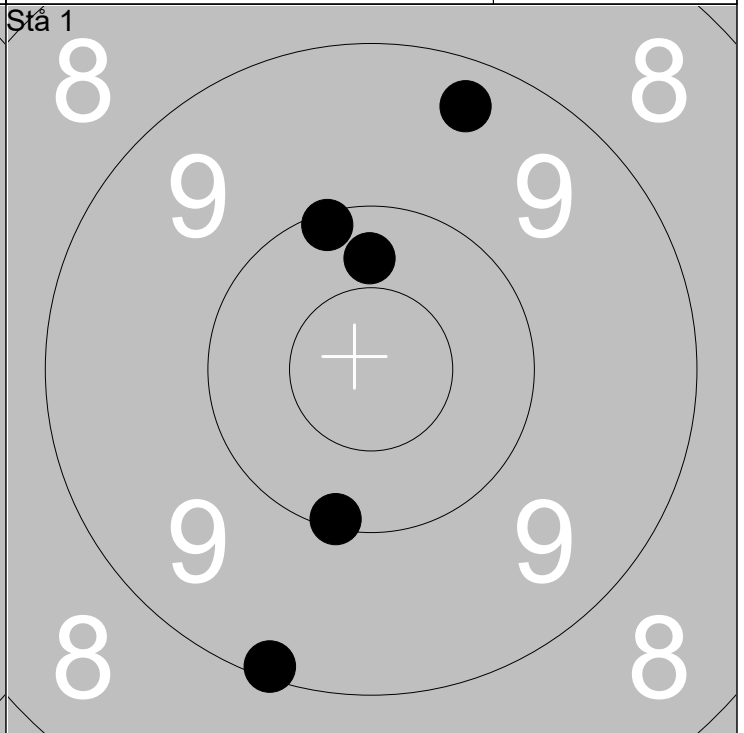
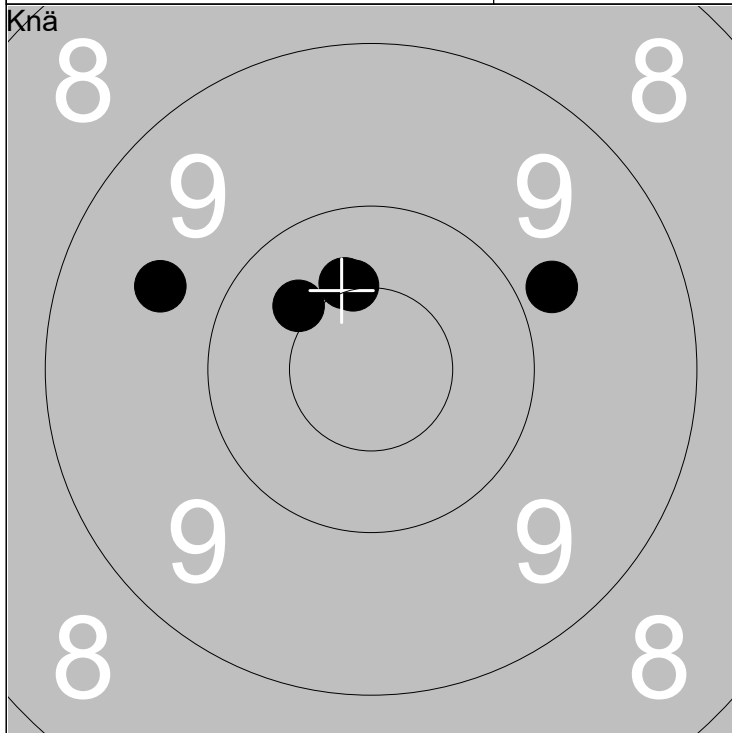

1: 9.8 ↗	Serie 48
2: 10.5x ↖	
3: 10.4 ↖	
4: 10.4x ↖	
5: 9.6 ↖	
Total 286	

1: 9.3 ↖	Serie 48
2: 10.1 ↖	
3: 9.1 ↘	
4: 10.3 ↖	
5: 10.1 ↘	
Total 334	

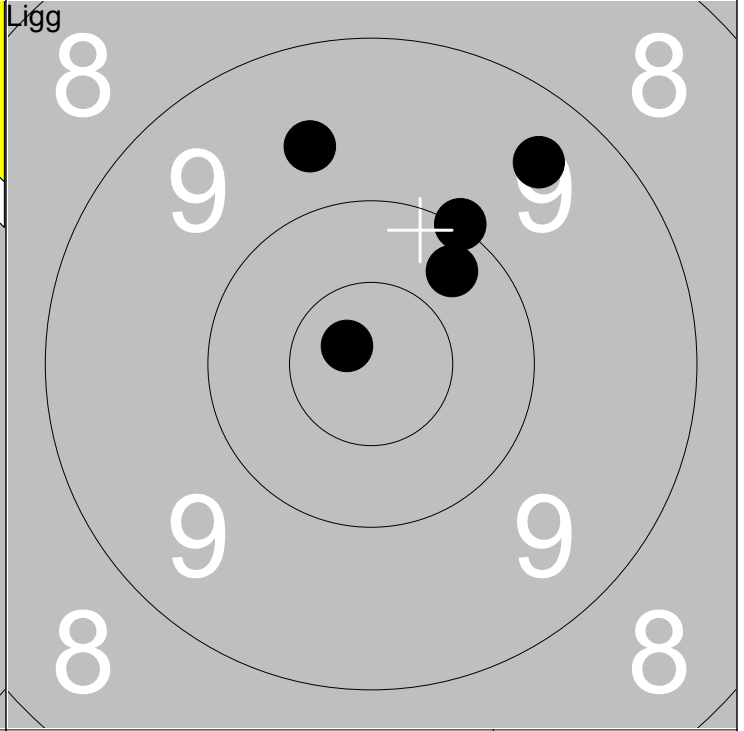
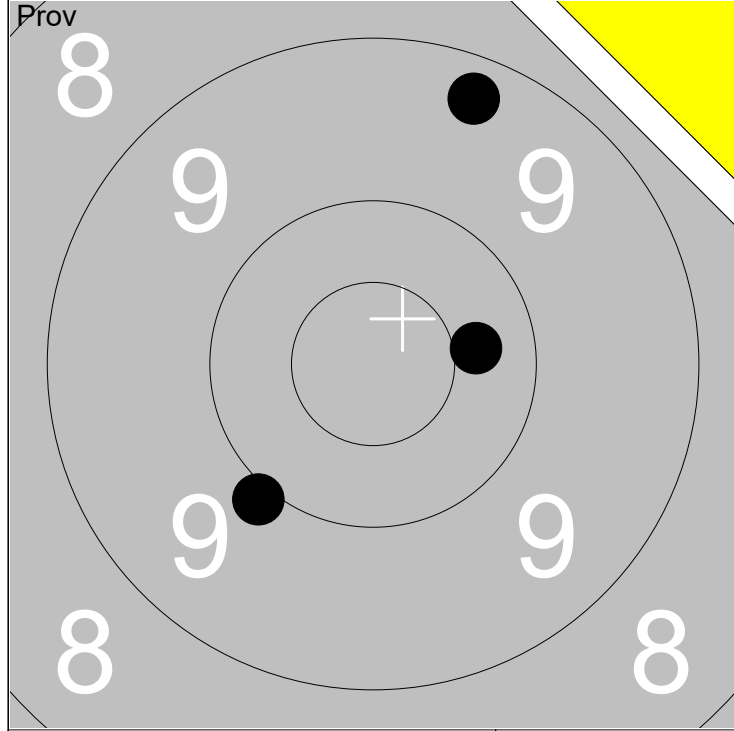

1: 9.3	↗
2: 10.4	→
3: 9.9	↘

Serie	28
Total	187

1: 10.2	↗
2: 9.4	↗
3: 9.6	↗
4: 10.0	↗
5: 10.8x	↖

Serie	48
Total	235

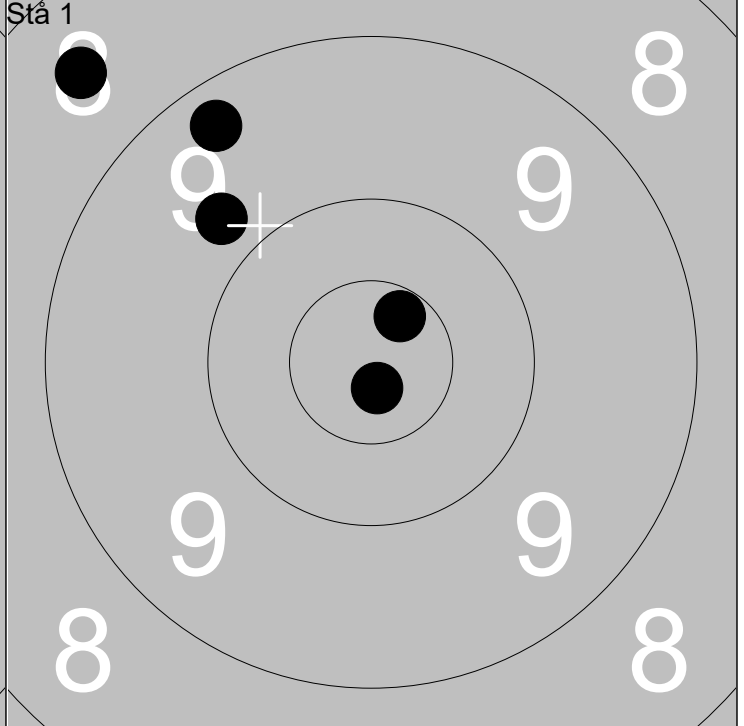
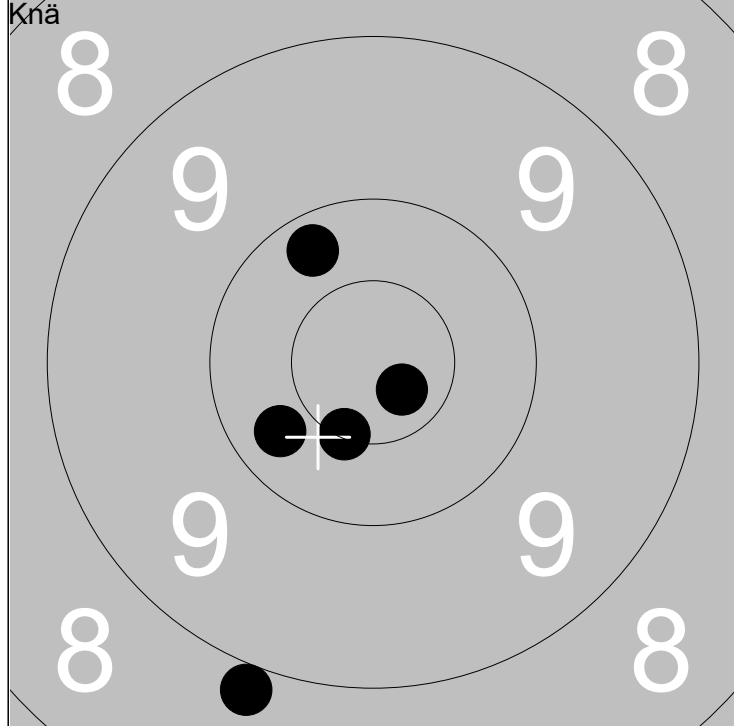

1: 10.2	↗
2: 10.5x	↘
3: 8.9	↘
4: 10.7x	↘
5: 10.3	↙

Serie	48
Total	283

1: 9.3	↗
2: 10.6x	↗
3: 8.5	↗
4: 9.8	↗
5: 10.8x	↘

Serie	46
Total	329

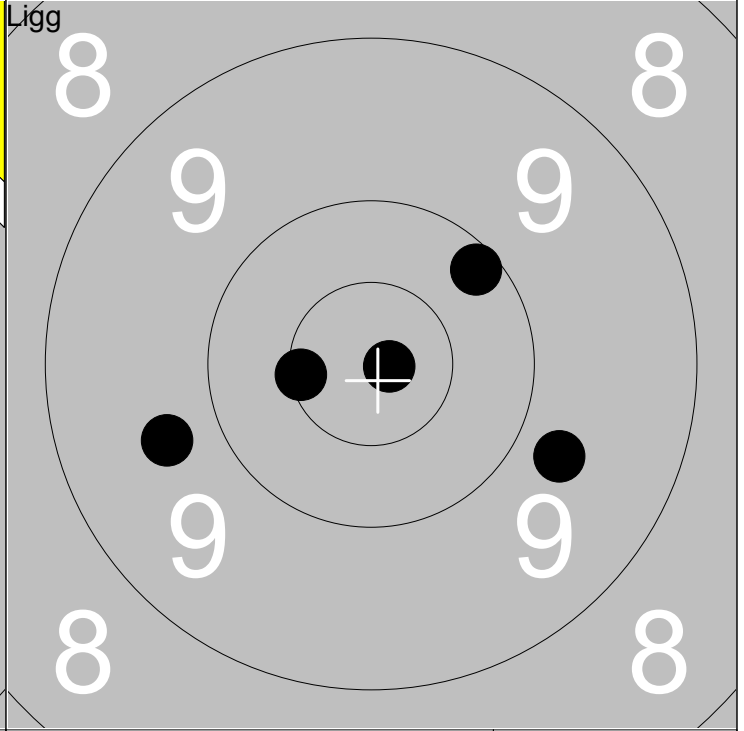
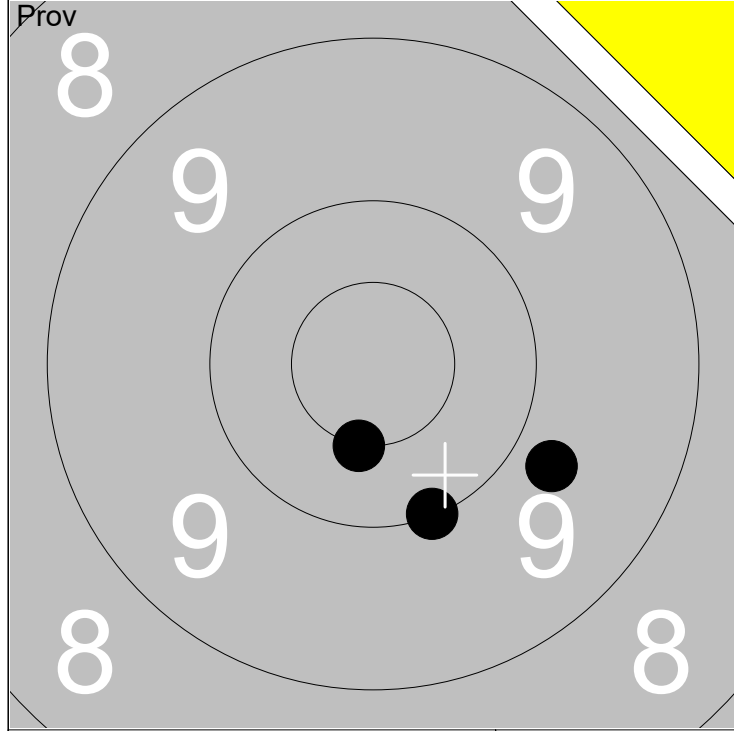

1: 10.0	↓
2: 10.5x	↓
3: 9.8	↘

Serie	29
Total	185

1: 10.8x	→
2: 9.7	←
3: 10.1	↗
4: 9.7	↘
5: 10.5x	←

Serie	48
Total	233

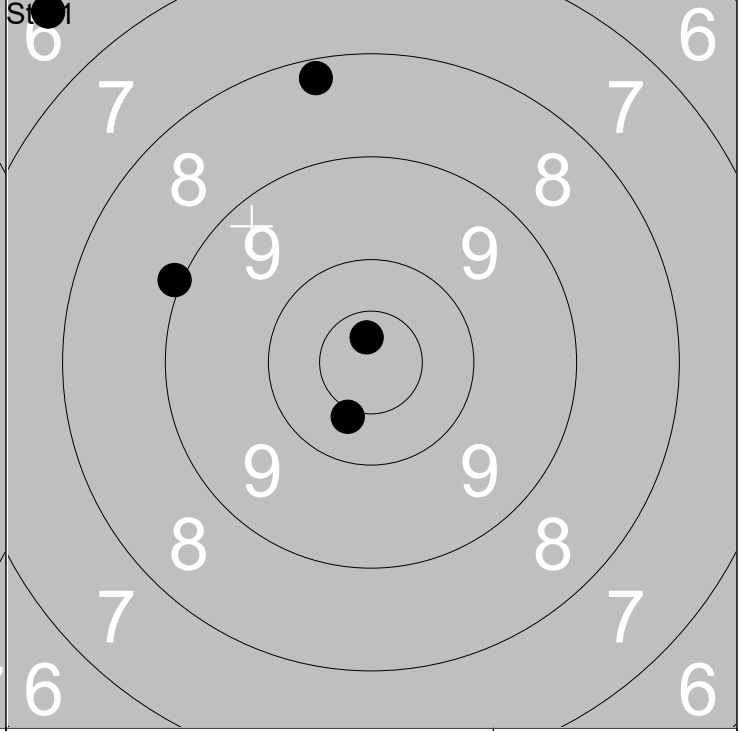
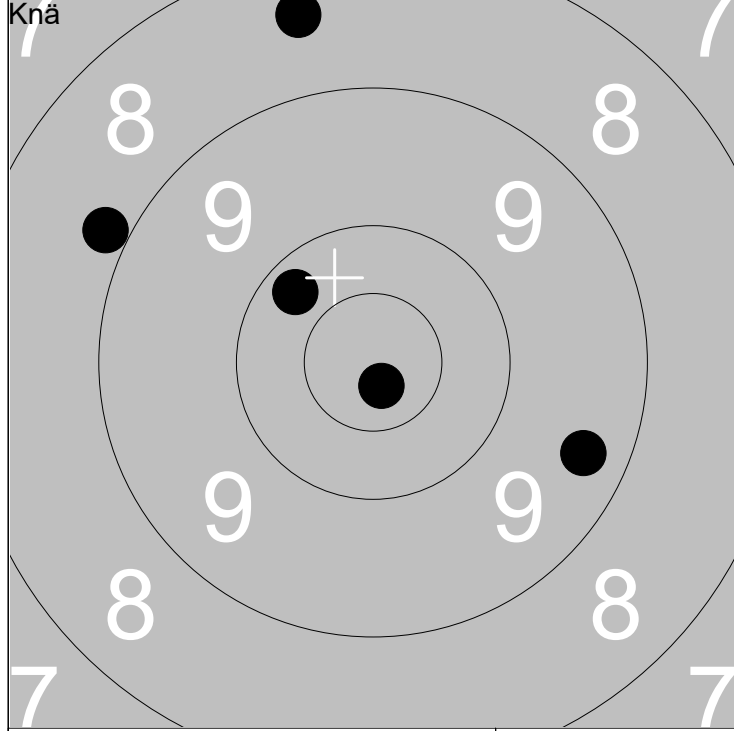

1: 8.4	↑
2: 8.9	↗
3: 10.8x	↓
4: 10.2	↗
5: 9.4	↘

Serie	45
Total	278

1: 6.4	↖
2: 10.7x	↑
3: 8.2	↑
4: 9.0	←
5: 10.4x	↘

Serie	43
Total	321

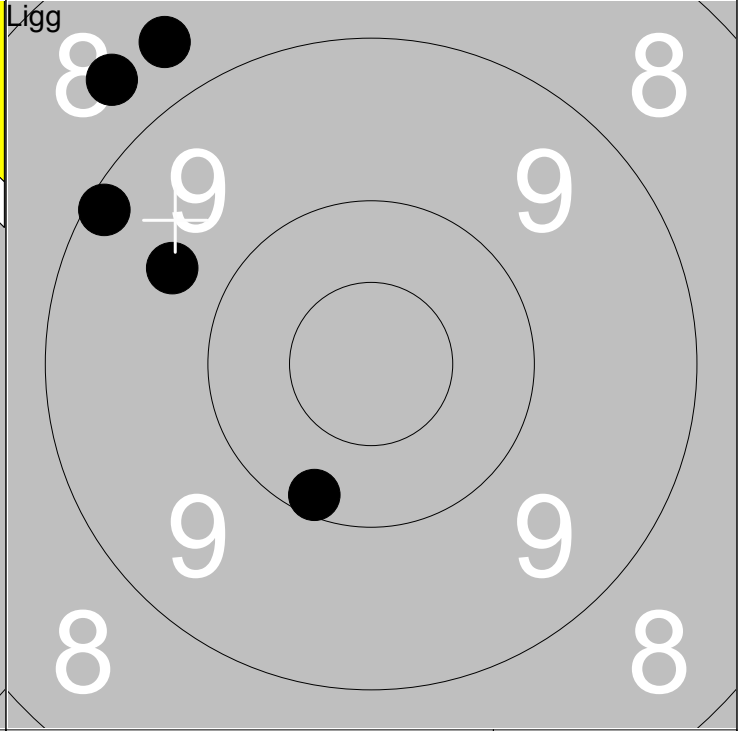
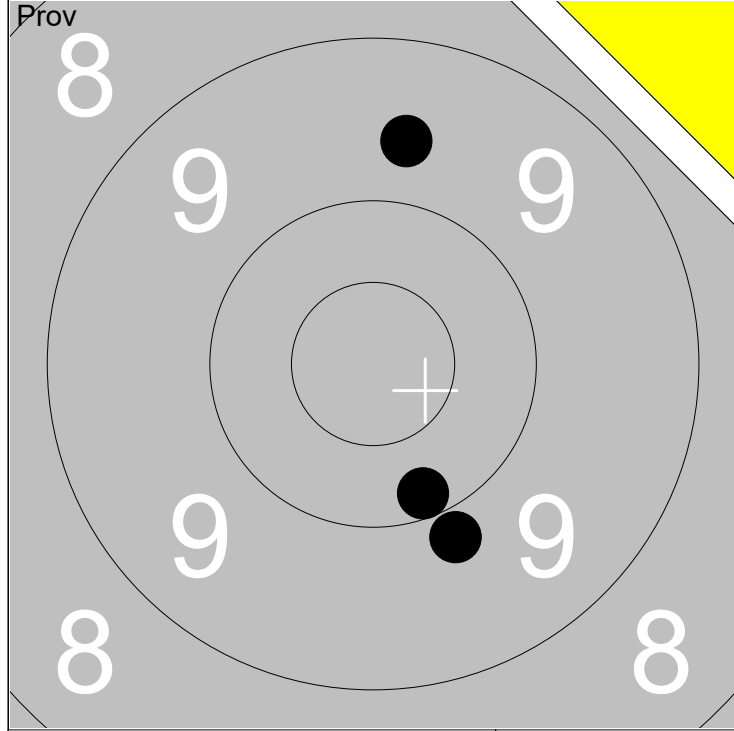

1: 9.9	↘
2: 10.2	↘
3: 9.6	↑

Serie	28
Total	185

1: 8.7	↗
2: 9.7	↖
3: 8.7	↗
4: 9.1	↖
5: 10.1	↘

Serie	44
Total	229

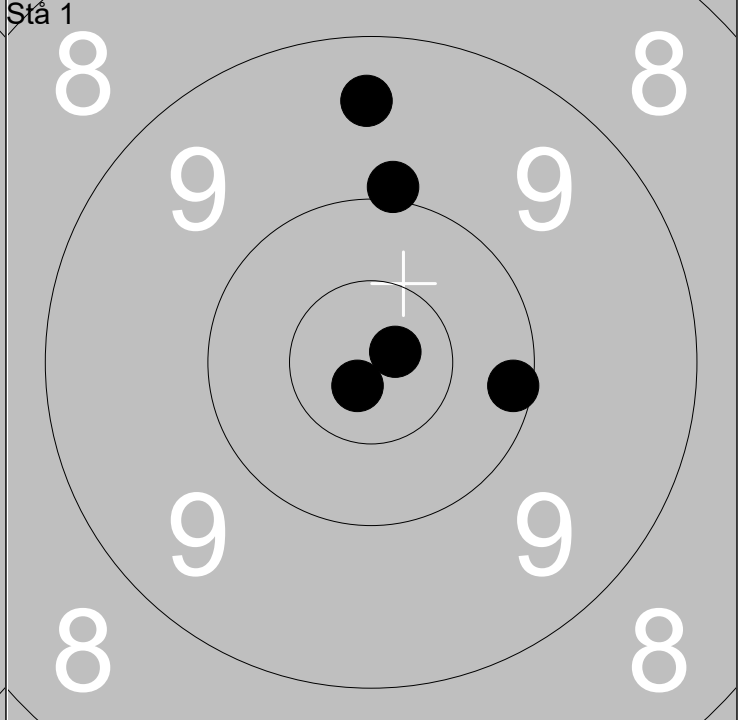
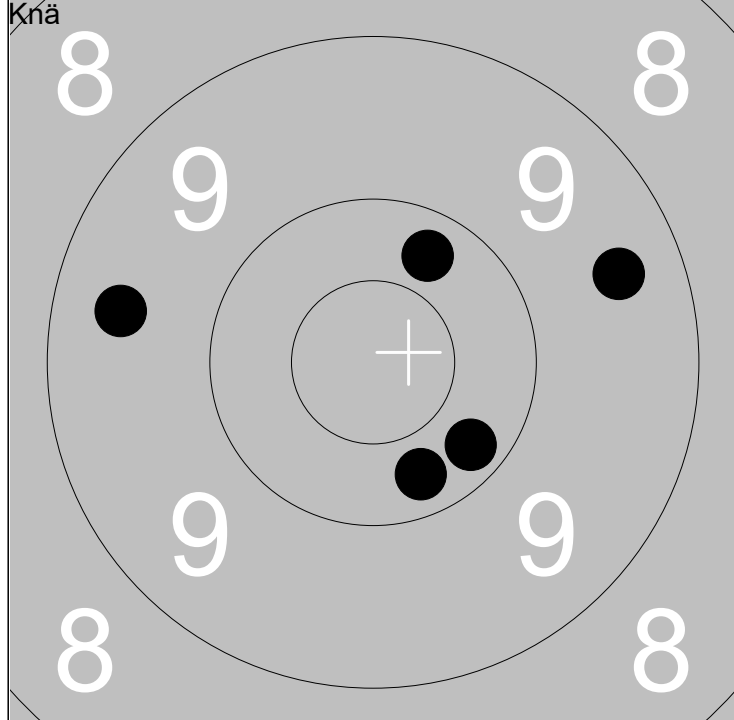

1: 9.4	←
2: 10.2	↘
3: 10.3	↗
4: 9.4	→
5: 10.3	↘

Serie	48
Total	277

1: 10.8x	↘
2: 9.4	↑
3: 9.9	↑
4: 10.1	→
5: 10.8x	↗

Serie	48
Total	325

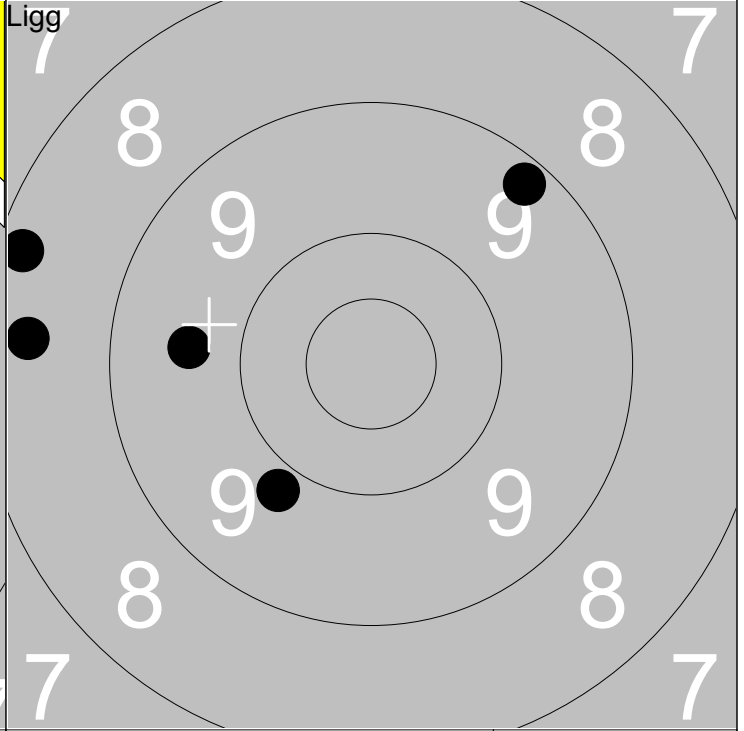
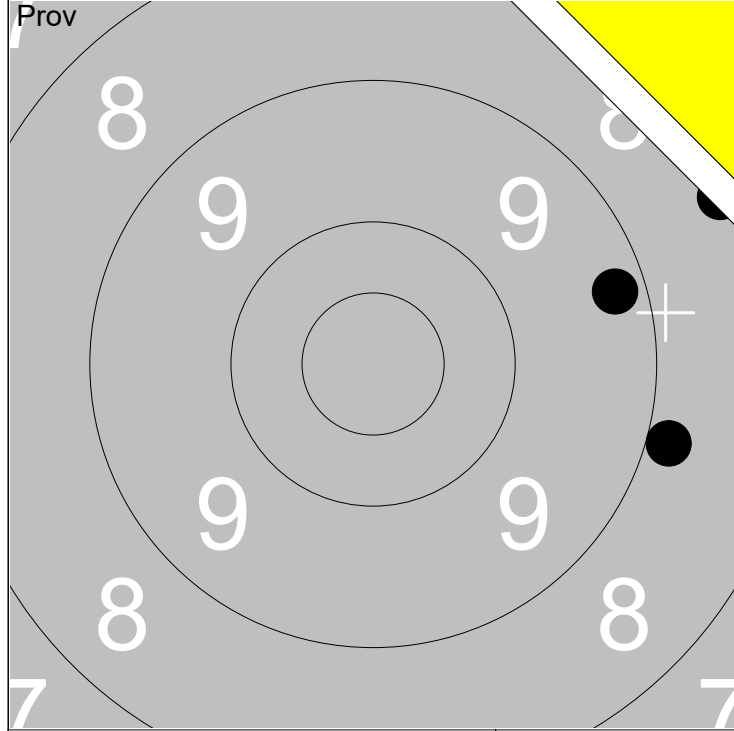

1: 9.3 →		Serie	25
2: 8.3 →			
3: 8.9 →			
Total			183

1: 9.6 ←		Serie	43
2: 9.2 ↗			
3: 9.8 ↘			
4: 8.4 ←			
5: 8.2 ←			
Total			226

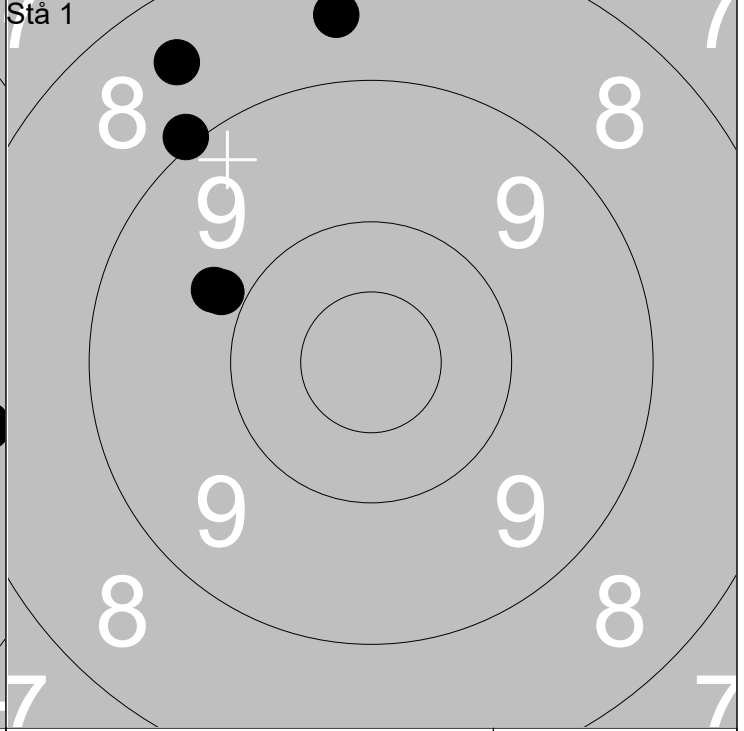
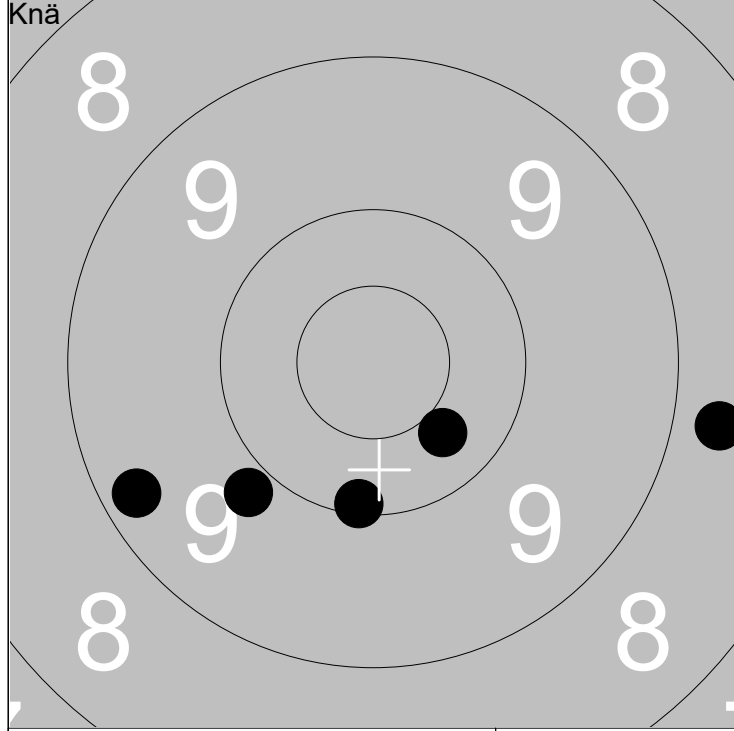

1: 9.9 ↙		Serie	46
2: 10.4 ↘			
3: 10.1 ↓			
4: 8.7 →			
5: 9.3 ↖			
Total			272

1: 9.0 ↗		Serie	43
2: 9.9 ↗			
3: 9.8 ↗			
4: 8.5 ↗			
5: 8.6 ↗			
Total			315

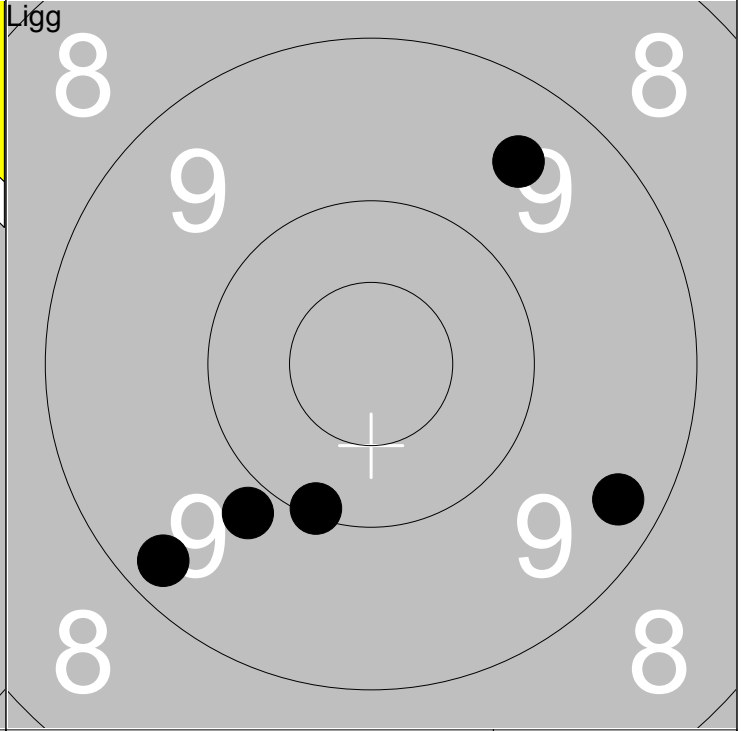
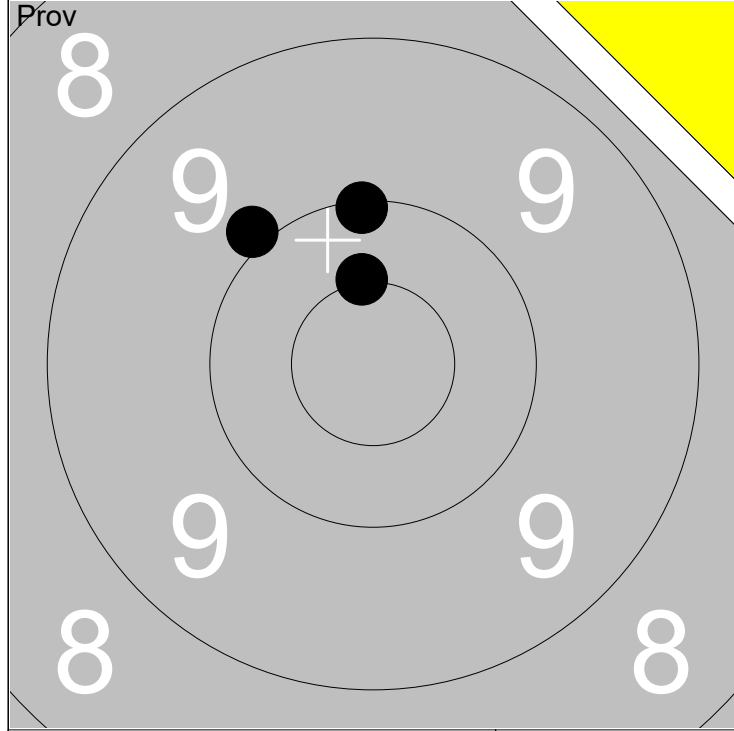

1: 10.1 ↑	Serie	29
2: 10.5x ↑		
3: 9.9 ↖		
Total		182

1: 9.3 ↙	Serie	46
2: 10.1 ↓		
3: 9.3 →		
4: 9.5 ↗		
5: 9.8 ↘		
Total		228

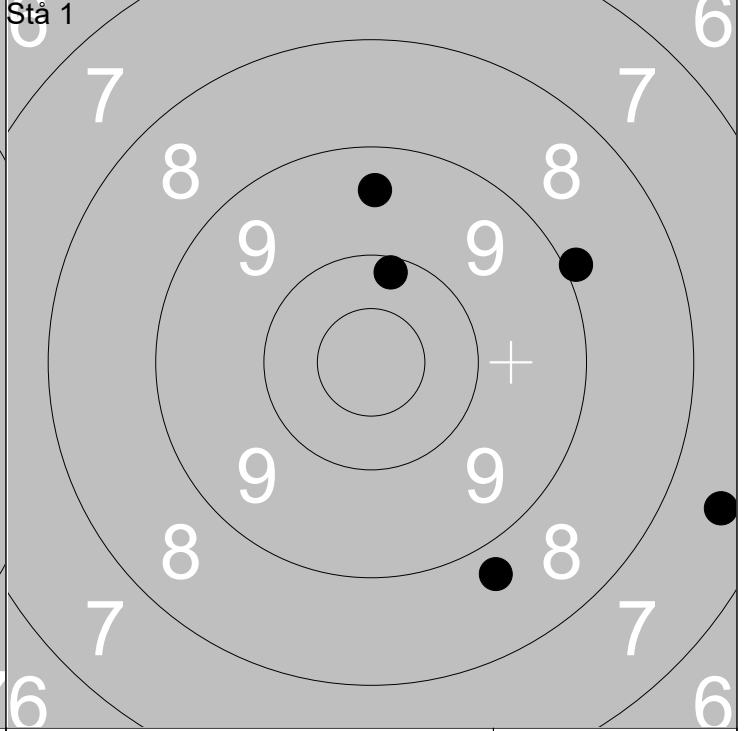
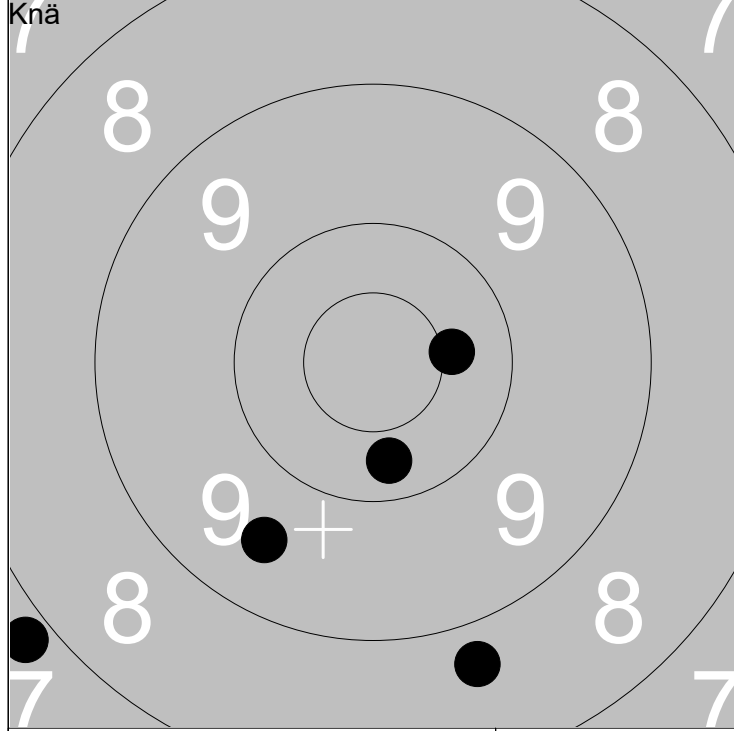

1: 10.3 ↓	Serie	44
2: 10.4x →		
3: 9.5 ↘		
4: 7.8 ↙		
5: 8.7 ↓		
Total		272

1: 8.9 ↗	Serie	42
2: 8.7 ↓		
3: 7.5 →		
4: 9.4 ↑		
5: 10.2 ↑		
Total		314

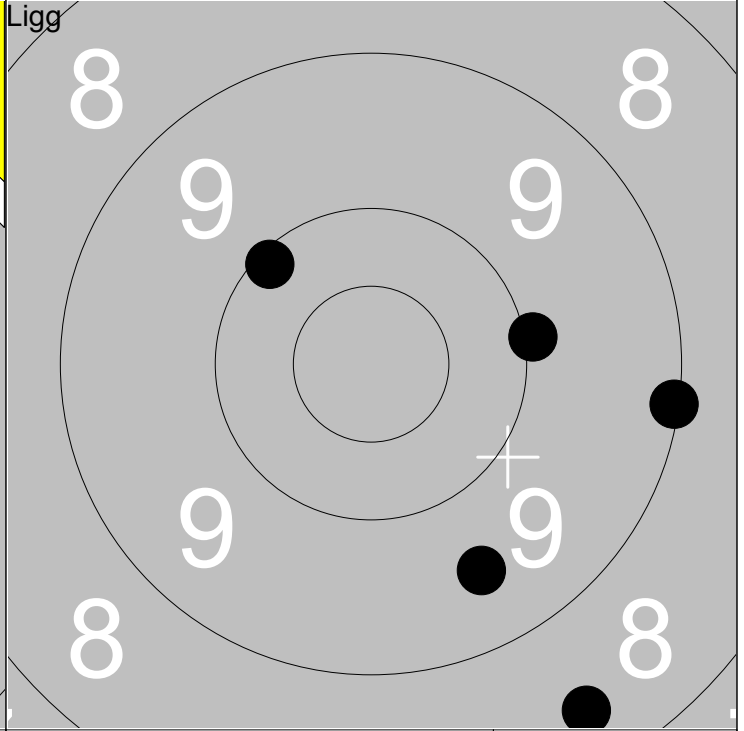
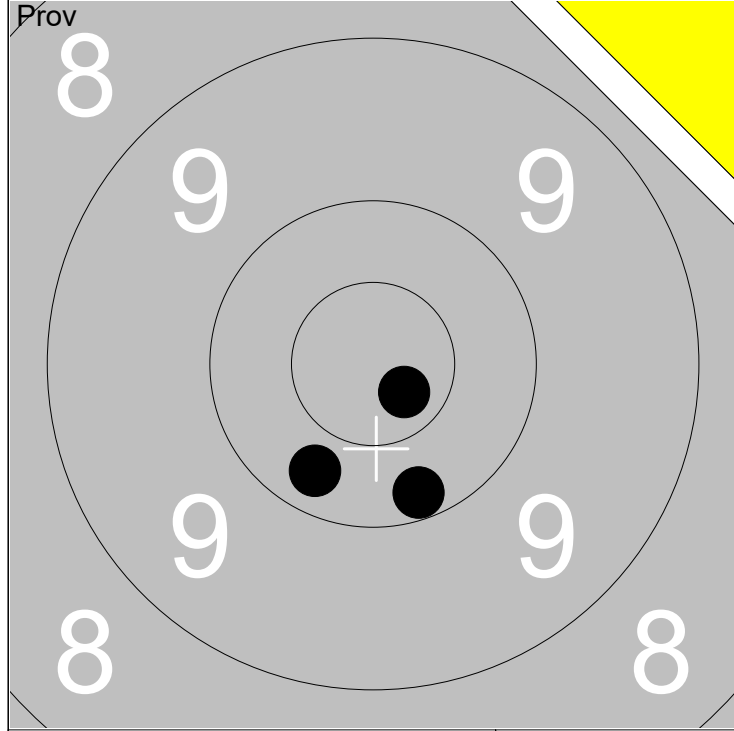

1: 10.7x ↘	Serie	30
2: 10.3 ↙		
3: 10.2 ↙		
Total		191

1: 9.1 →	Serie	46
2: 8.4 ↙		
3: 10.1 ↗		
4: 9.5 ↙		
5: 10.0 →		
Total		237

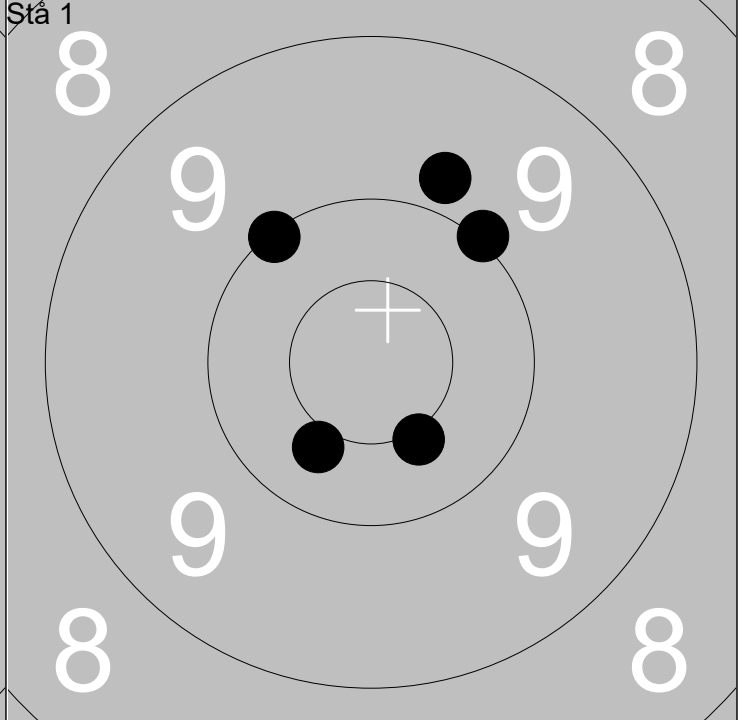
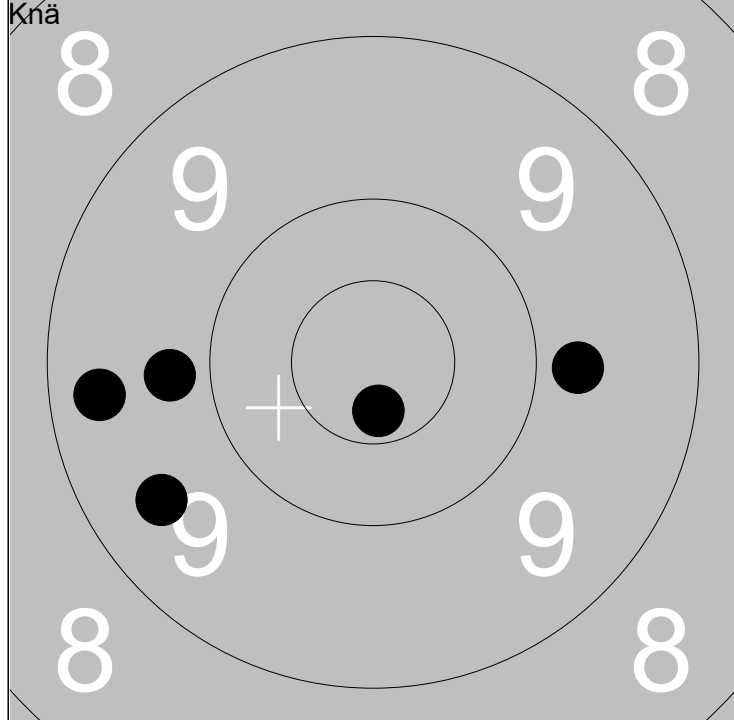

1: 9.5 ↙	Serie	46
2: 9.3 ←		
3: 9.8 ←		
4: 9.8 →		
5: 10.7x ↓		
Total		283

1: 9.8 ↗	Serie	49
2: 10.4x ↙		
3: 10.0 ↗		
4: 10.4 ↙		
5: 10.1 ↖		
Total		332

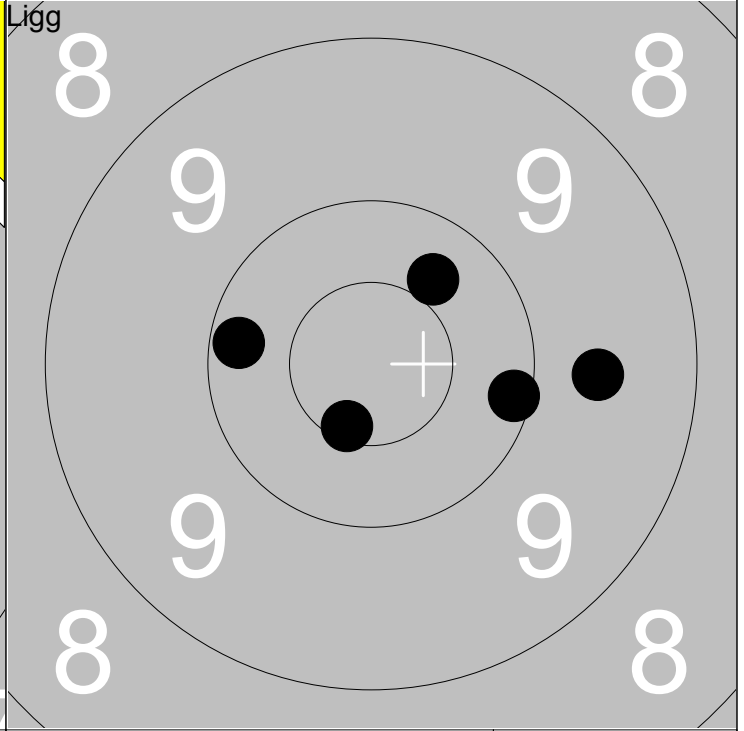
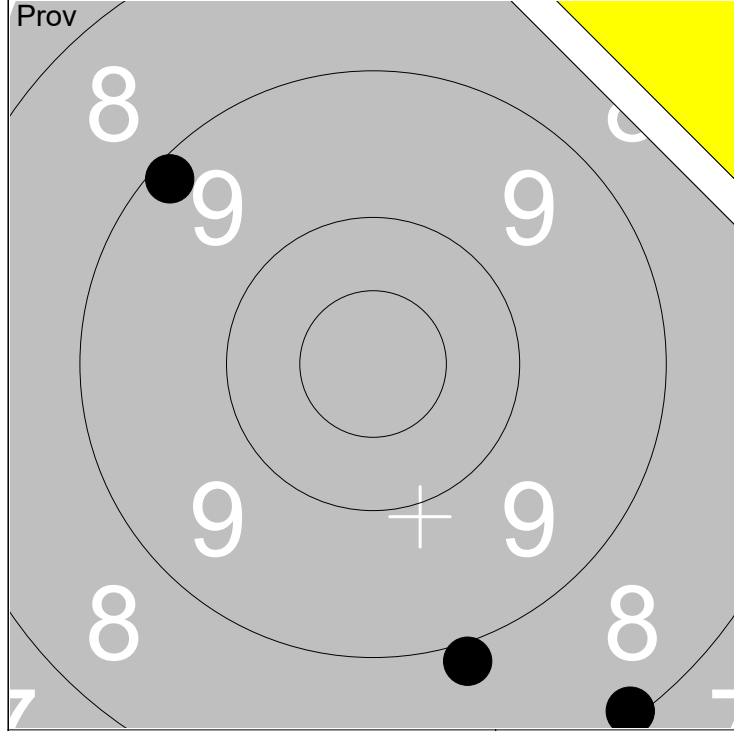

1: 8.9	↓
2: 8.1	↓
3: 9.2	↗

Serie	25
Total	185

1: 10.1	→
2: 10.6x	↓
3: 9.6	→
4: 10.2	←
5: 10.4	↗

Serie	49
Total	234

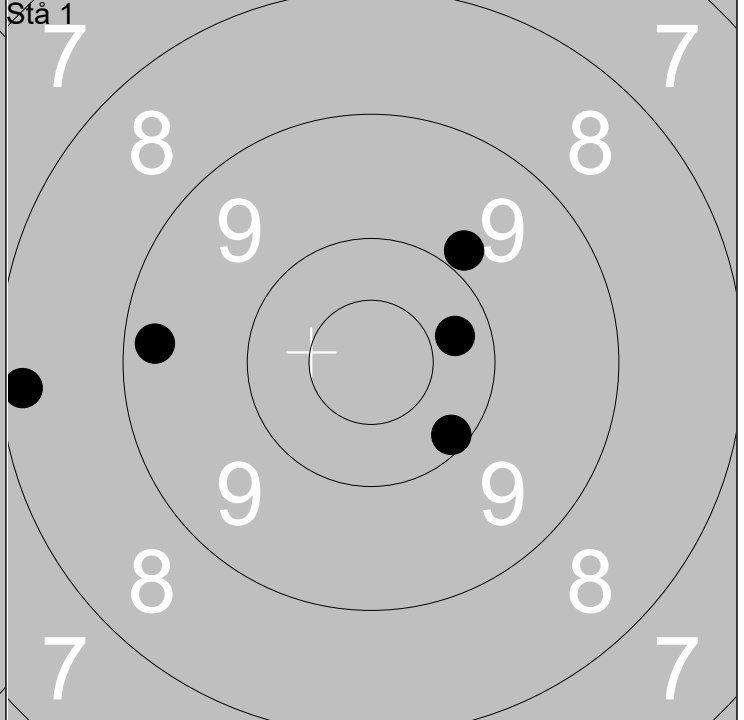
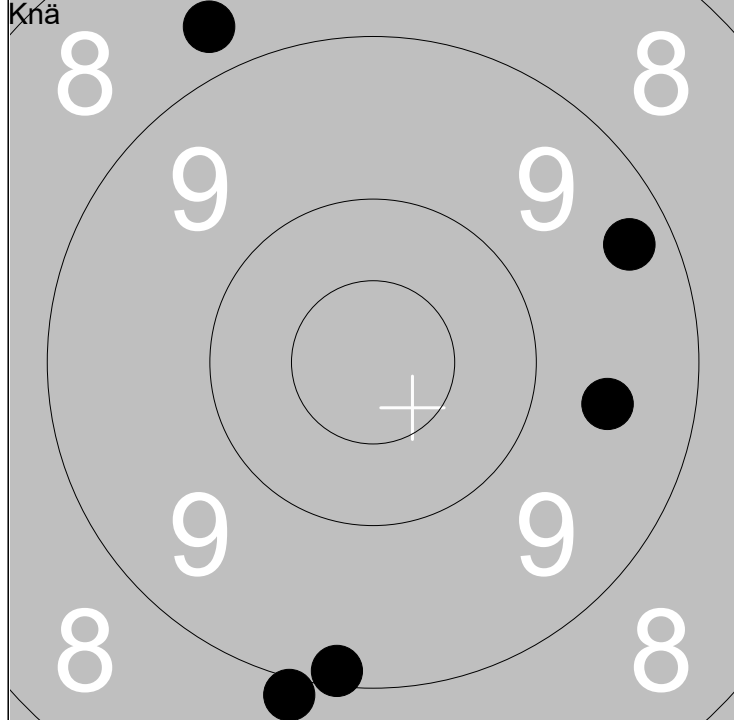

1: 9.1	↓
2: 8.9	↓
3: 9.3	↗
4: 8.7	↗
5: 9.6	→

Serie	43
Total	277

1: 9.9	↗
2: 10.3	→
3: 8.2	←
4: 9.3	←
5: 10.1	↓

Serie	46
Total	323

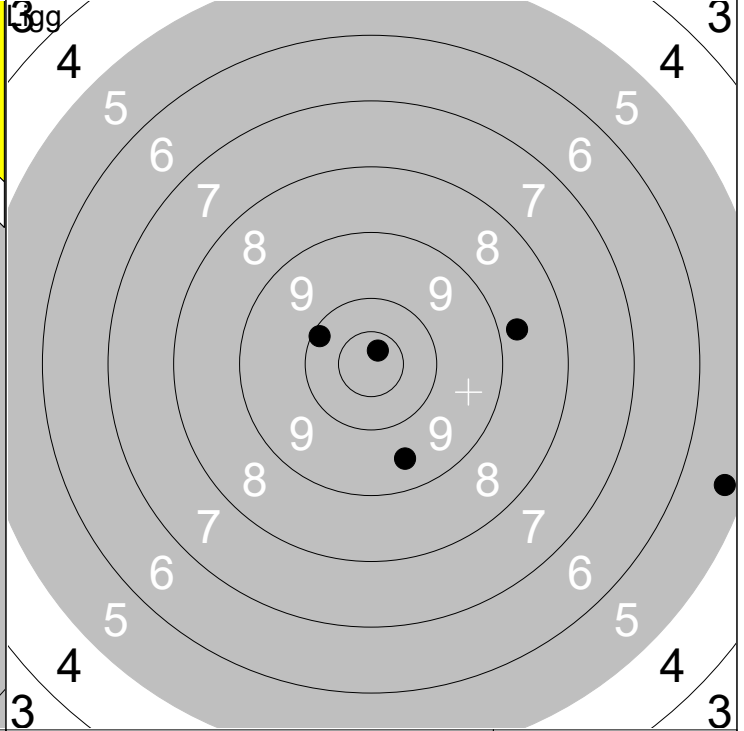
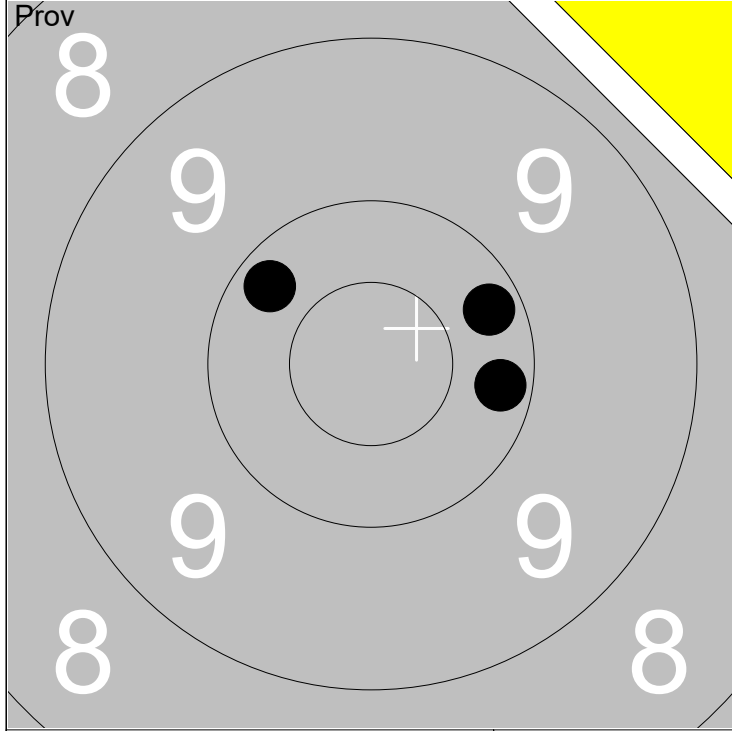

1: 10.2 →	Serie	30
2: 10.2 →		
3: 10.2 ↗		
Total		182

1: 5.3 →	Serie	42
2: 9.5 ↓		
3: 8.8 →		
4: 10.7x ↗		
5: 10.1 ↖		
Total		224

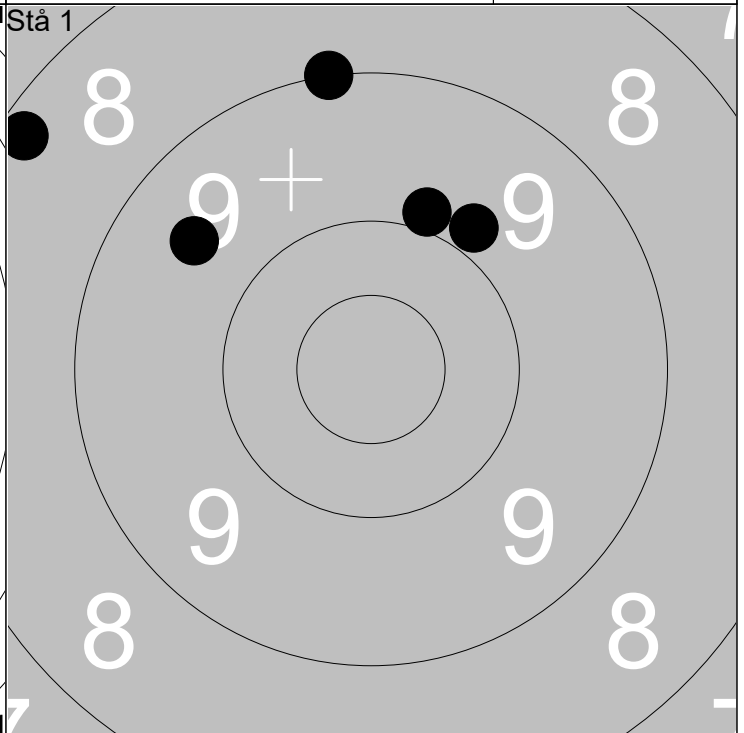
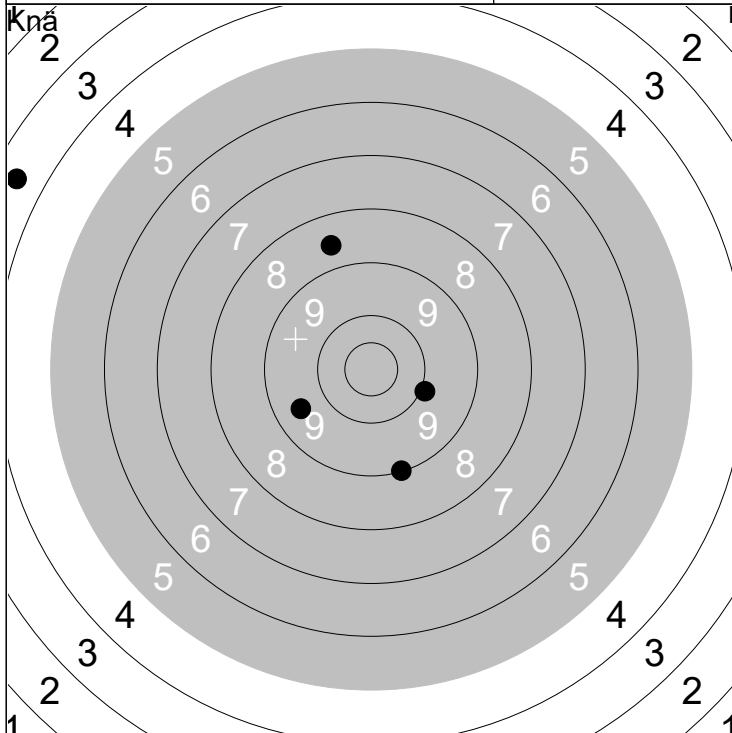

1: 9.9 →	Serie	38
2: 9.5 ↖		
3: 9.1 ↓		
4: 8.6 ↗		
5: 3.5 ↖		
Total		262

1: 9.6 ↖	Serie	44
2: 8.2 ↖		
3: 9.9 ↗		
4: 9.0 ↗		
5: 9.9 ↗		
Total		306

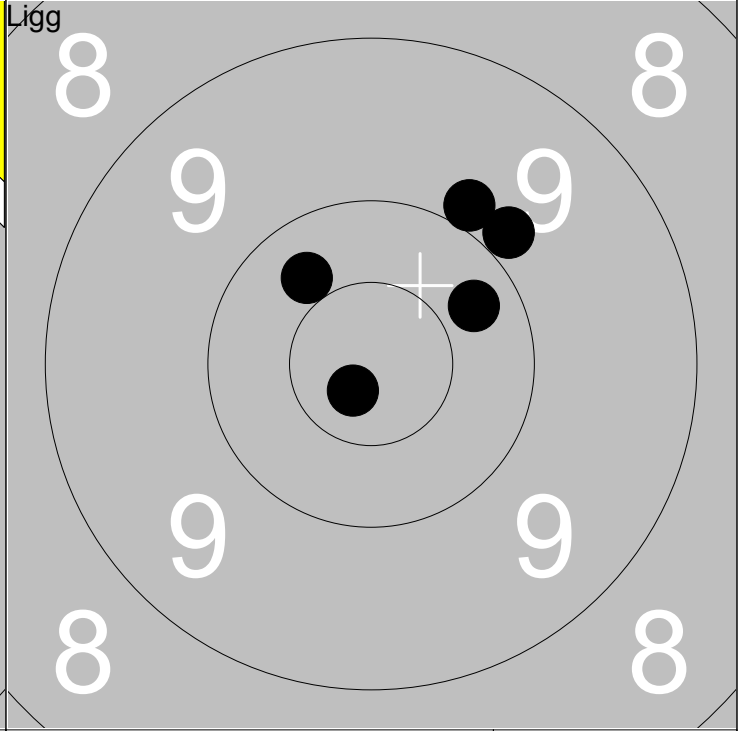
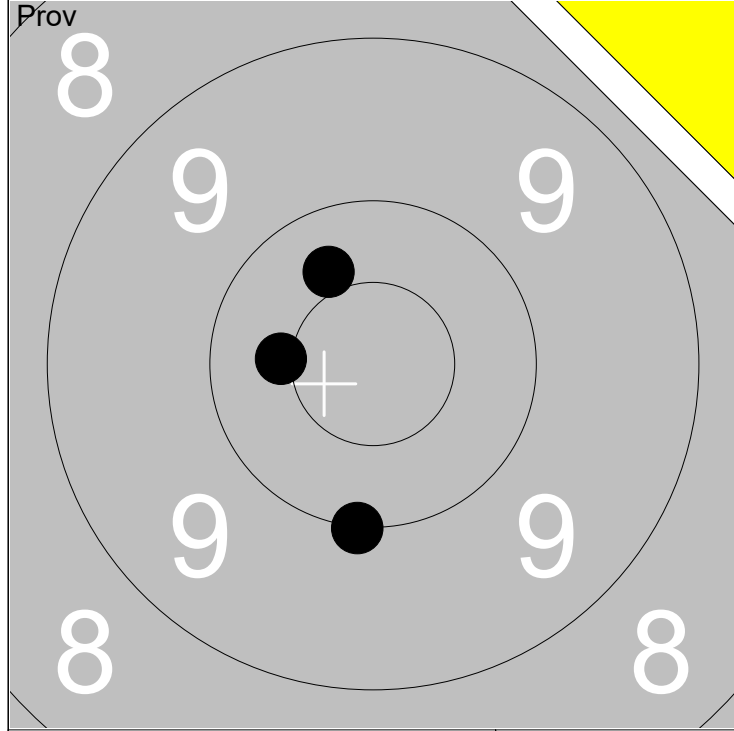

1: 10.4 ↖	Serie 30
2: 10.0 ↓	
3: 10.4x ←	
Total 198	

1: 10.3 ↗	Serie 48
2: 9.9 ↗	
3: 9.9 ↗	
4: 10.8x ↓	Total 246
5: 10.3 ↖	

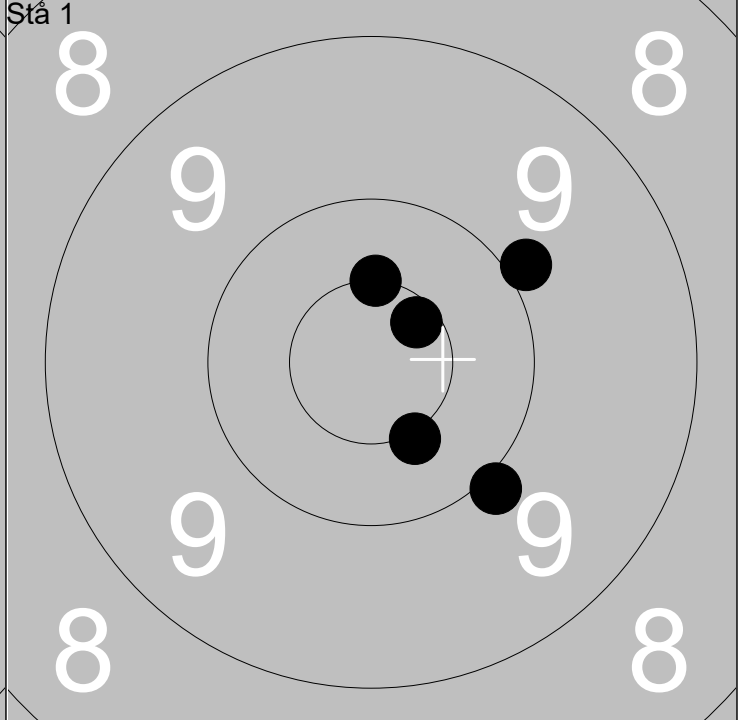
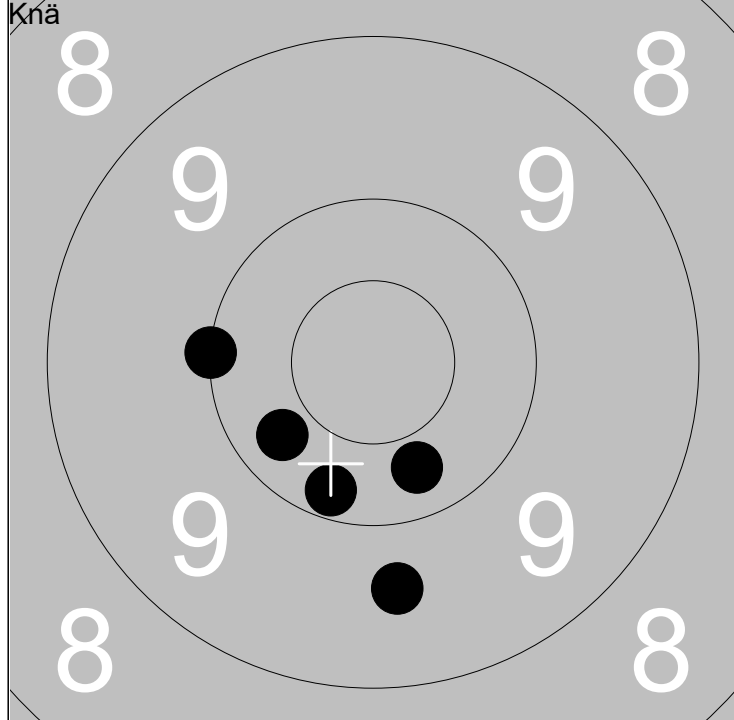

1: 9.6 ↓	Serie 49
2: 10.0 ←	
3: 10.2 ↓	
4: 10.3 ↖	Total 295
5: 10.3 ↓	

1: 10.6x ↗	Serie 48
2: 9.9 ↓	
3: 9.9 ↗	
4: 10.5x ↑	Total 343
5: 10.5x ↓	

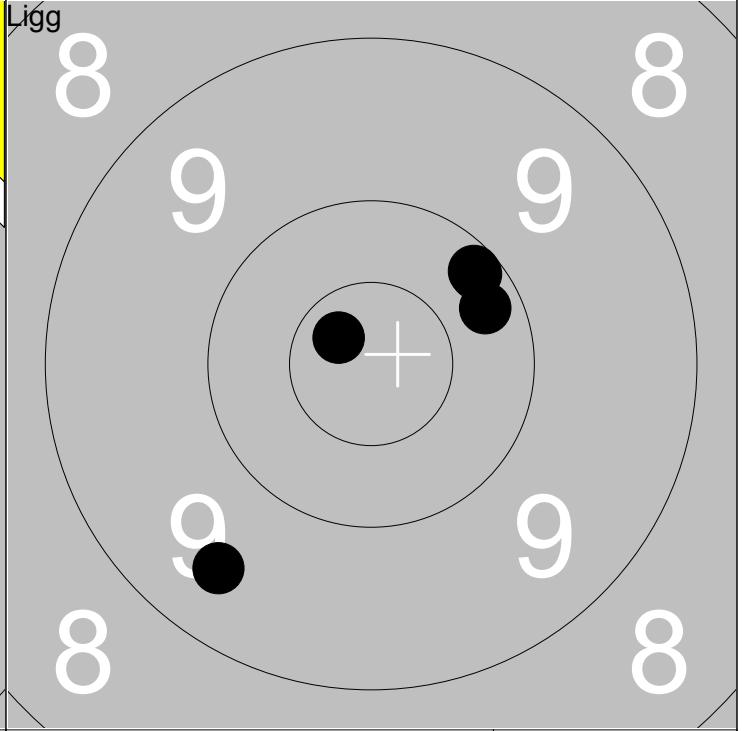
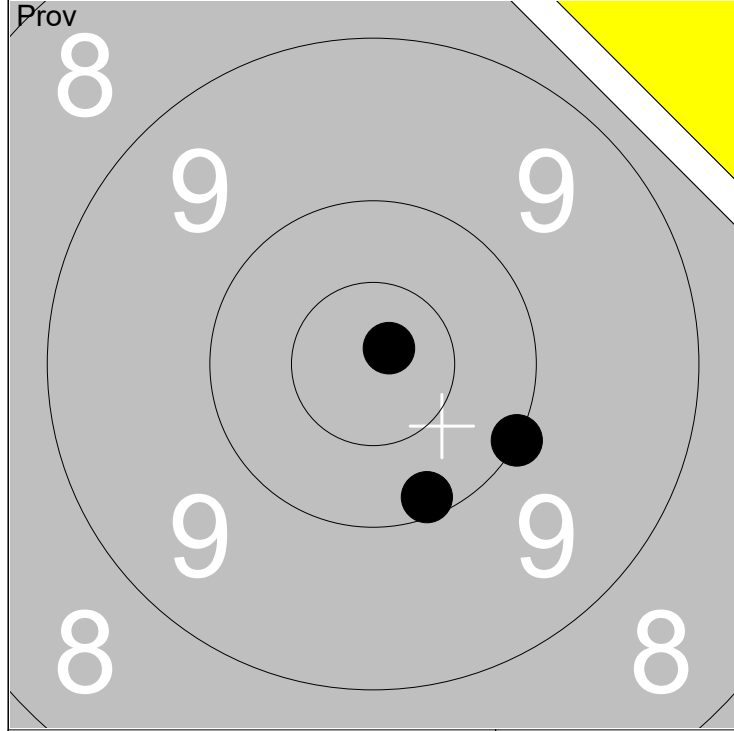

1: 10.0 ↘	Serie 30
2: 10.8x ↗	
3: 10.1 ↓	
Total 196	

1: 10.7x ↖	Serie 49
2: 10.2 ↗	
3: 10.2 ↗	
4: 9.5 ↓	
5: 10.2 →	
Total 245	

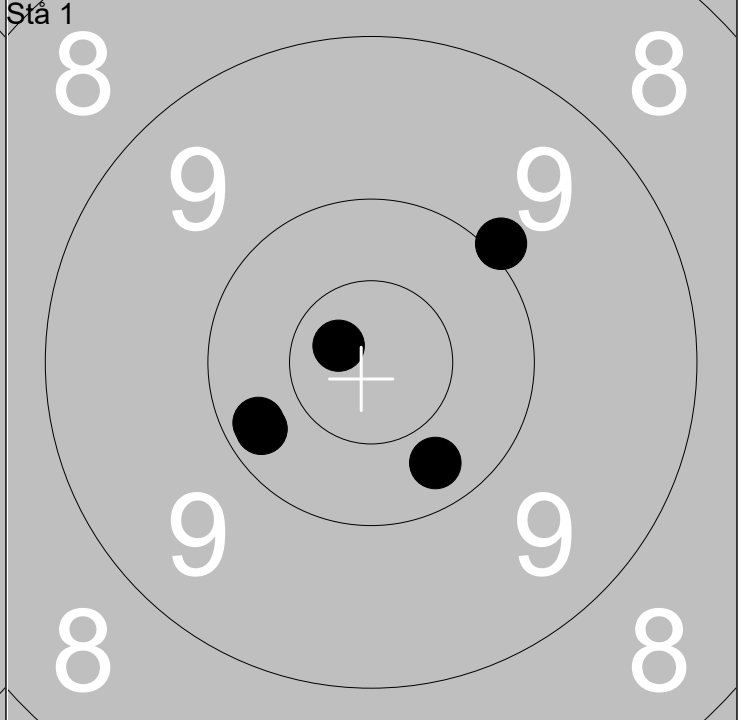
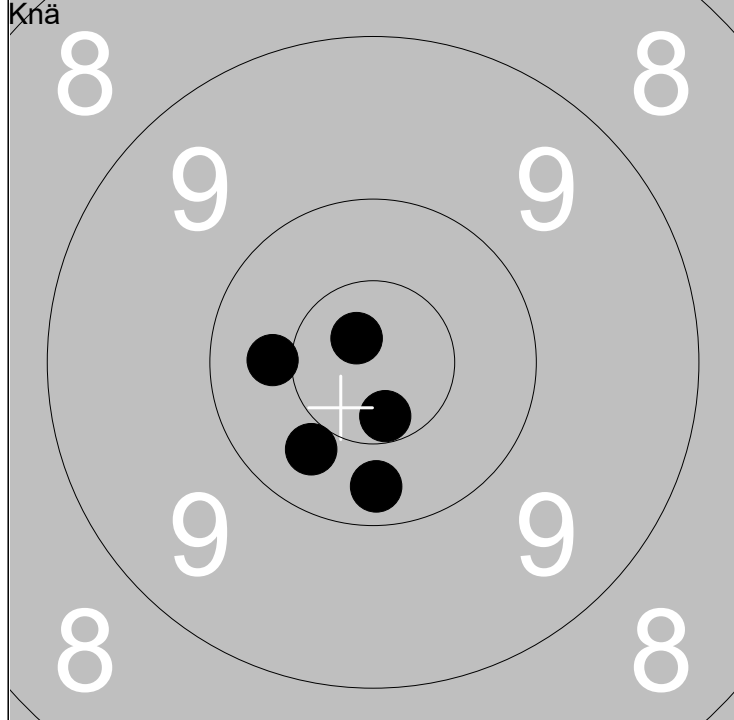

1: 10.4 ←	Serie 50
2: 10.2 ↓	
3: 10.8x ↗	
4: 10.6x ↓	
5: 10.3 ↘	
Total 295	

1: 10.2 ↖	Serie 50
2: 10.3 ↓	
3: 10.2 ↖	
4: 10.0 ↗	
5: 10.7x ↖	
Total 345	

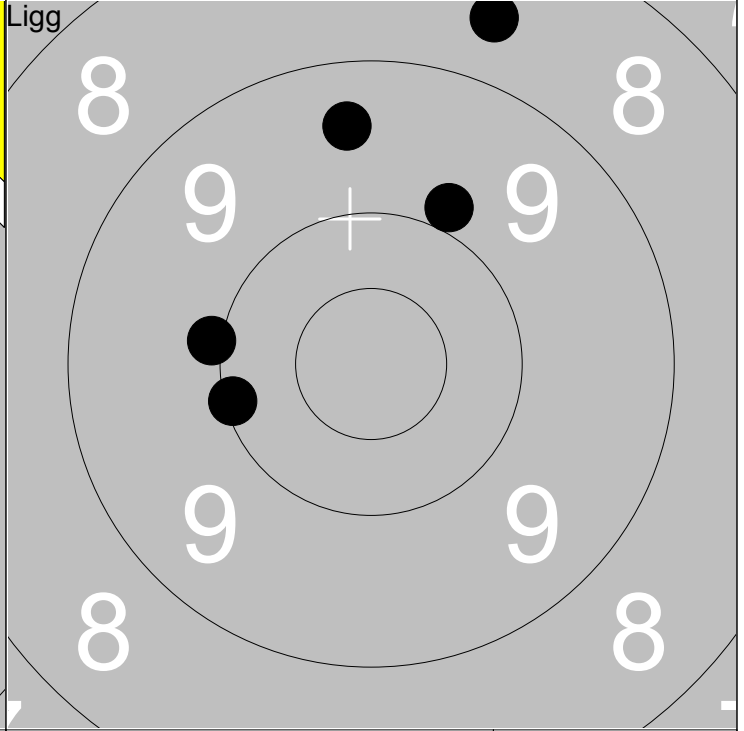
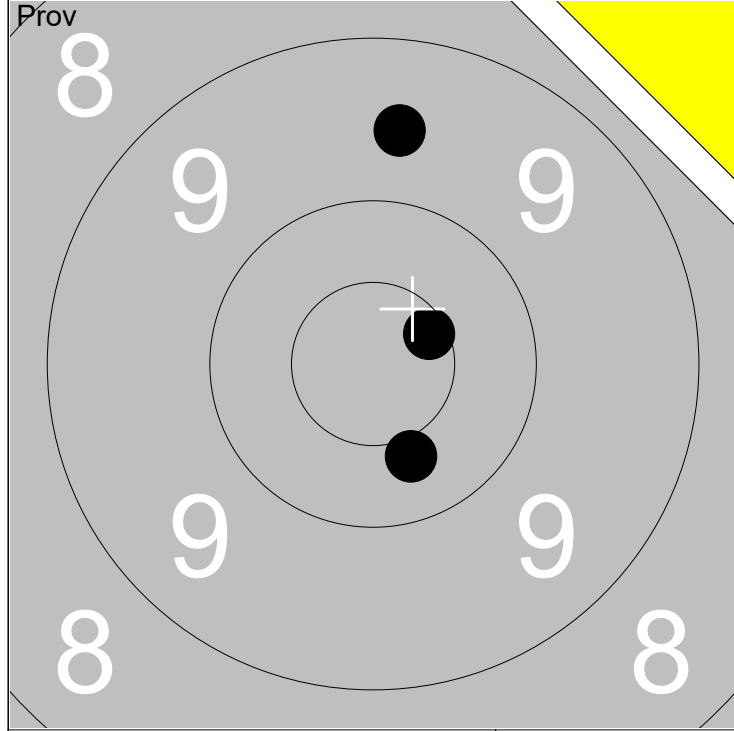

1: 9.6	↑
2: 10.6x	↗
3: 10.4	↓

Serie	29
Total	195

1: 8.6	↑
2: 9.9	↗
3: 10.1	←
4: 9.5	↑
5: 10.0	←

Serie	46
Total	241

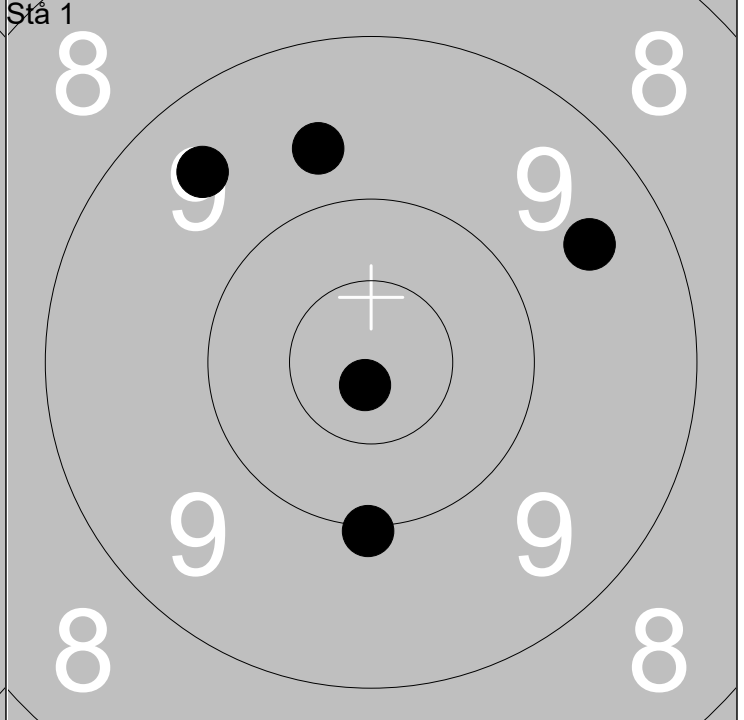
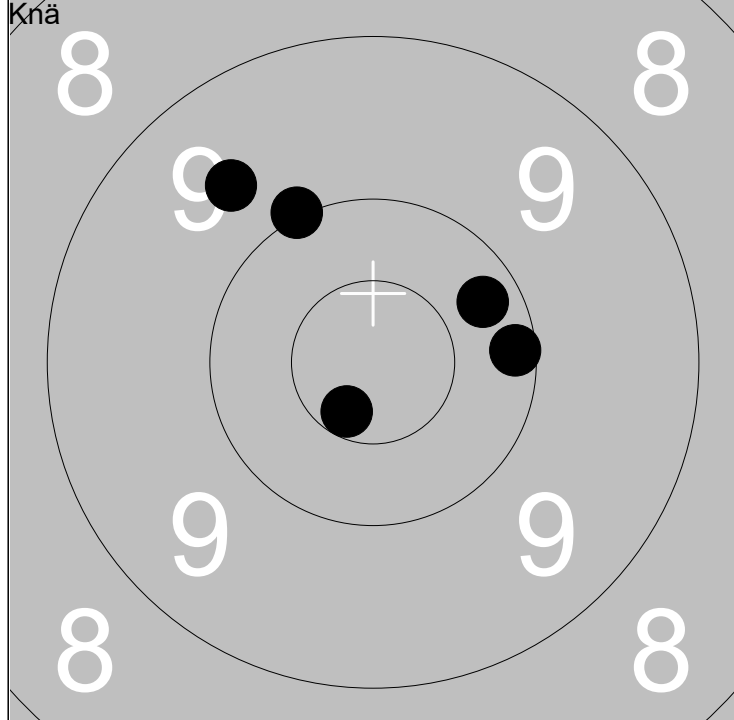

1: 10.2	↗
2: 10.1	→
3: 9.6	↖
4: 10.0	↖
5: 10.6x	↘

Serie	49
Total	290

1: 9.7	↑
2: 10.0	↓
3: 10.8x	↓
4: 9.5	↖
5: 9.5	↗

Serie	47
Total	337

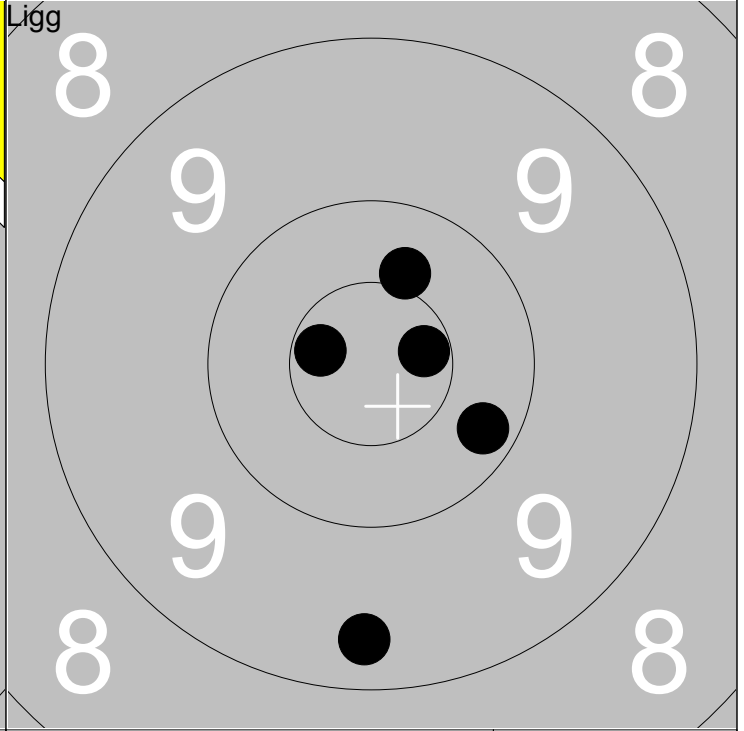
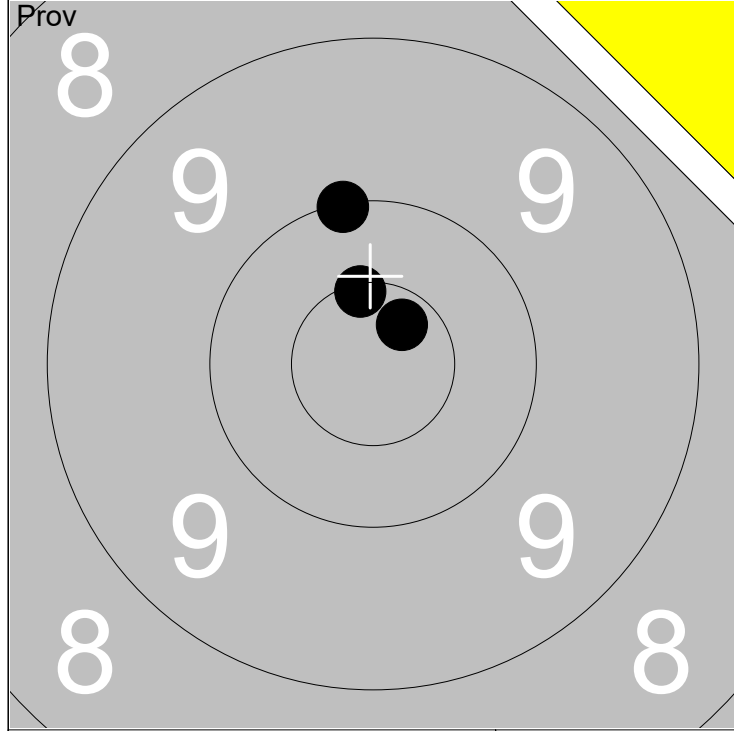

1: 10.7x ↗		Serie	30
2: 10.0 ↑		Total	195
3: 10.5x ↑			

1: 10.7x ←		Serie	49
2: 9.3 ↓		Total	244
3: 10.4 ↑			
4: 10.6x →			
5: 10.2 ↘			

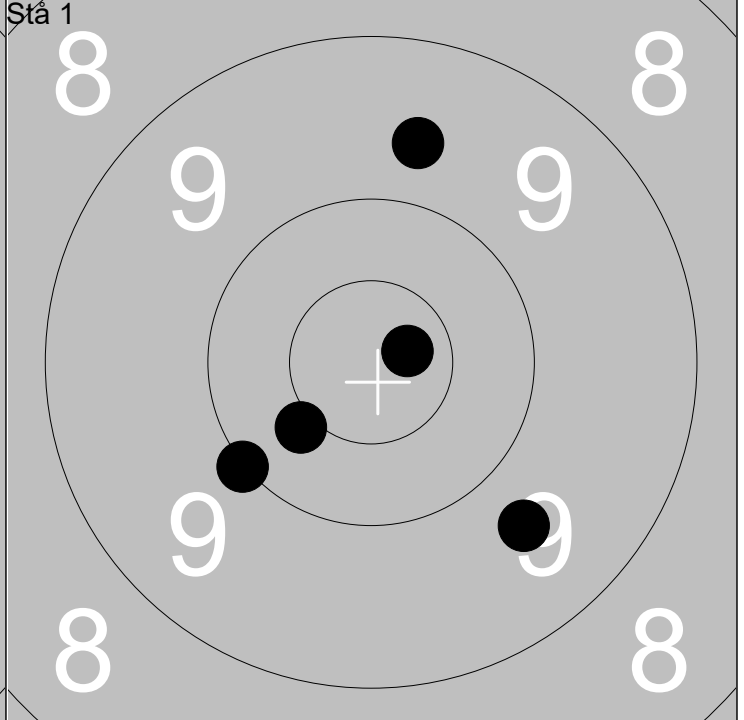
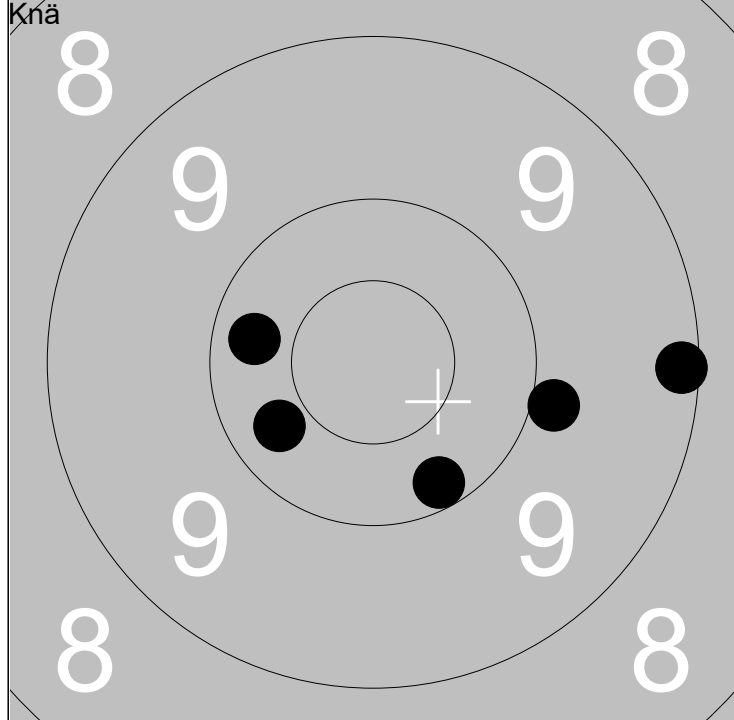

1: 10.3 ←		Serie	48
2: 10.3 ←		Total	292
3: 10.2 ↓			
4: 9.1 →			
5: 9.9 →			

1: 9.7 ↑		Serie	48
2: 10.0 ←		Total	340
3: 9.7 ↓			
4: 10.7x →			
5: 10.4 ↙			

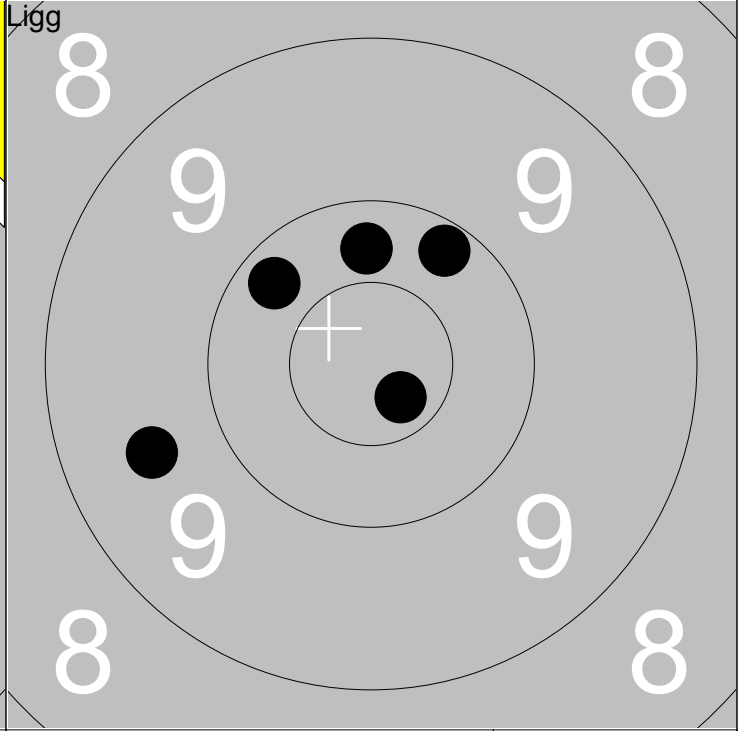
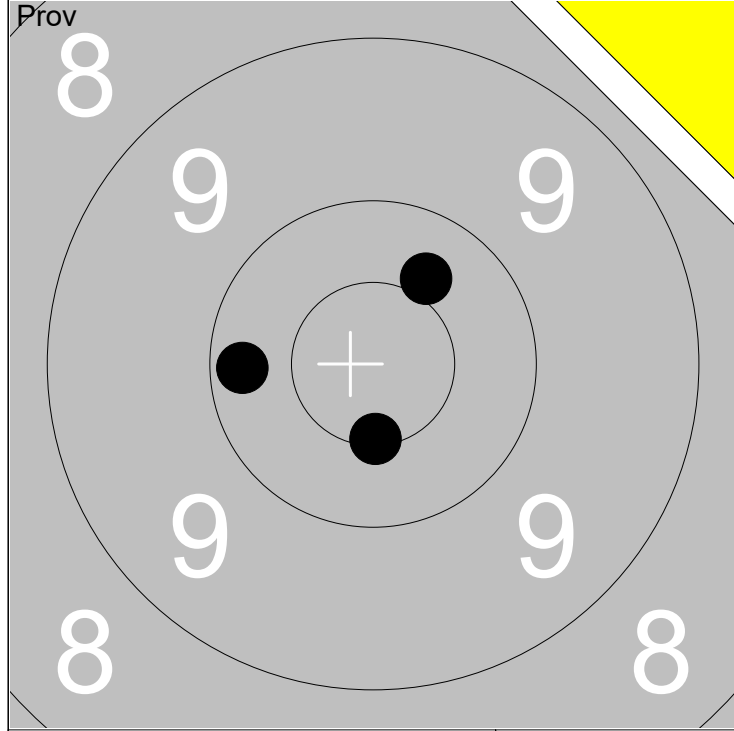

1: 10.2 ←
2: 10.4 ↗
3: 10.5x ↓

Serie	30
Total	194

1: 10.2 ↗
2: 10.2 ↖
3: 10.7x ↘
4: 10.3 ↑
5: 9.6 ←

Serie	49
Total	243

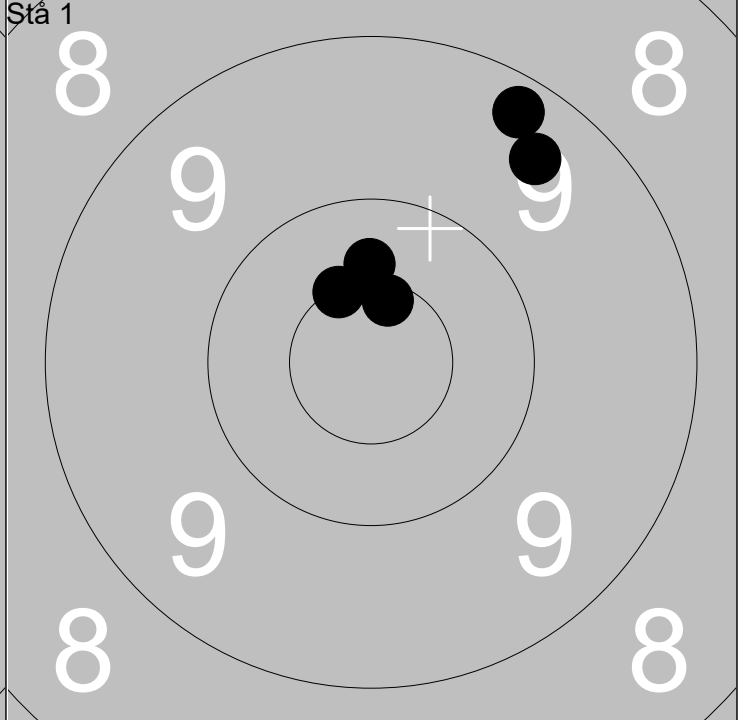
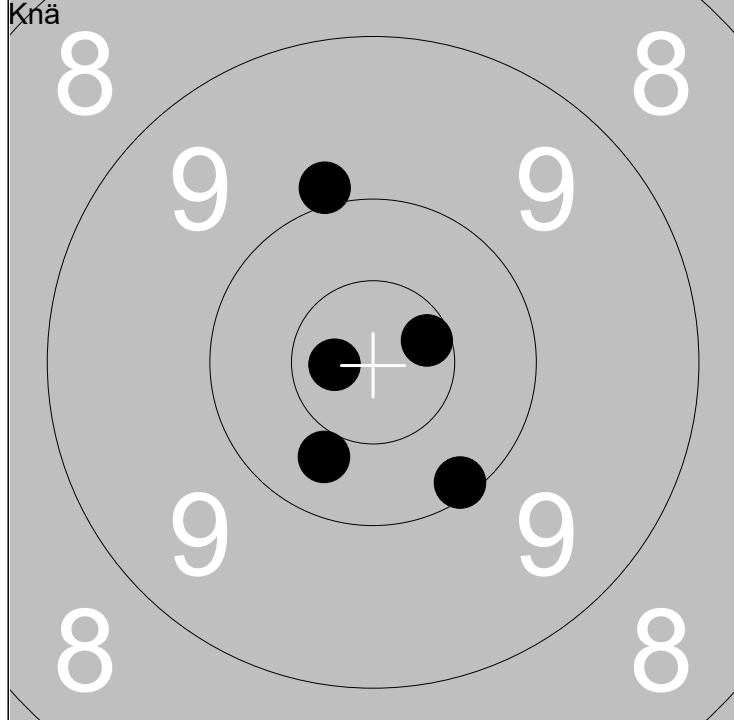

1: 10.3 ↘
2: 10.1 ↘
3: 10.7x ←
4: 9.9 ↑
5: 10.6x →

Serie	49
Total	292

1: 10.4 ↑
2: 9.2 ↗
3: 9.4 ↗
4: 10.6x ↑
5: 10.5x ↖

Serie	48
Total	340

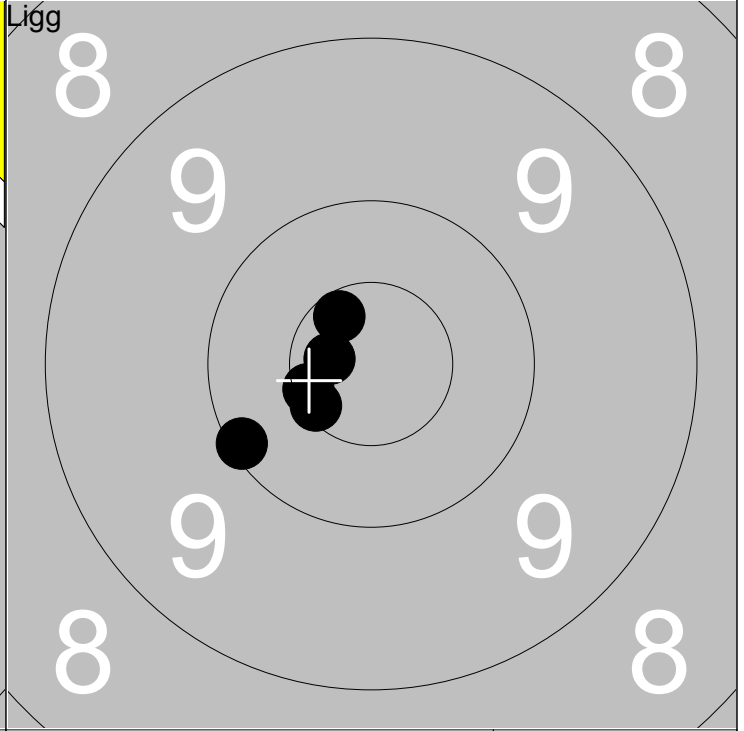
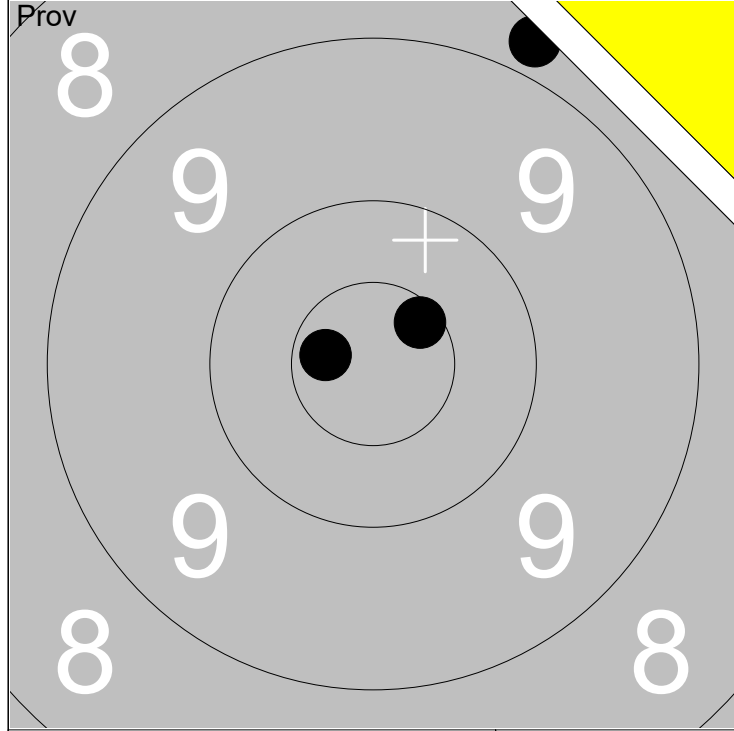

1: 8.8 ↗	Serie	28
2: 10.6x ↗		
3: 10.7x ←		
Total		194

1: 10.6x ↙	Serie	50
2: 10.7x ←		
3: 10.6x ↖		
4: 10.1 ←		
5: 10.6x ←		
Total		244

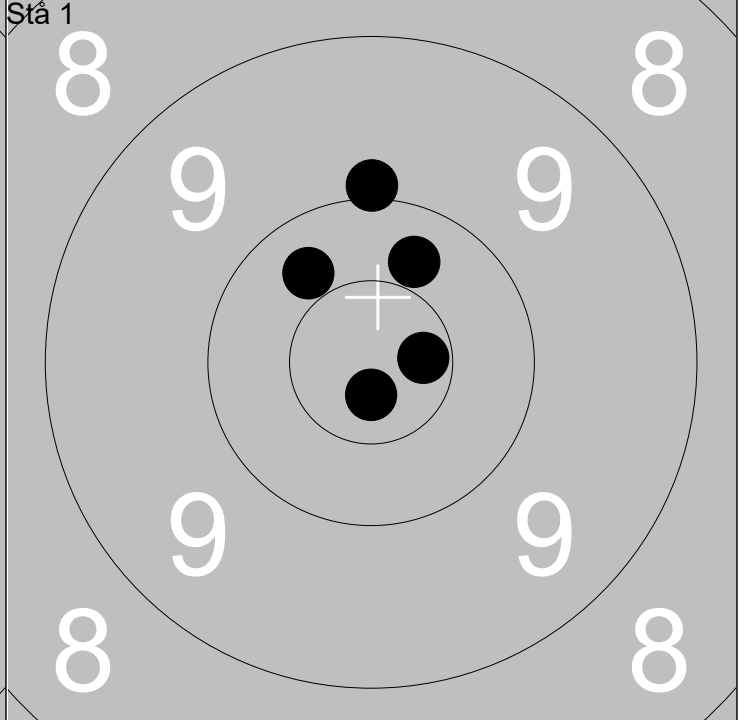
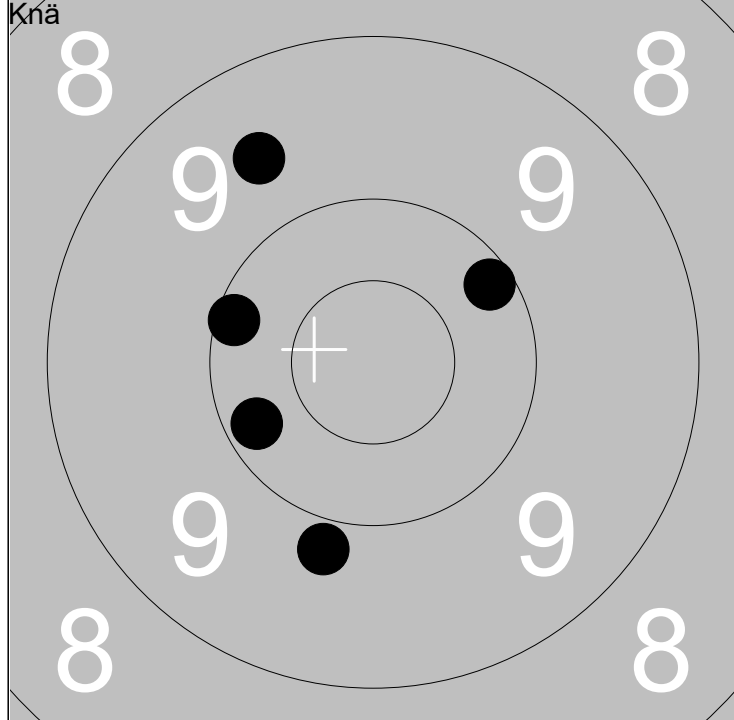

1: 9.6 ↖	Serie	48
2: 10.1 ←		
3: 10.2 ←		
4: 10.2 ↗		
5: 9.8 ↓		
Total		292

1: 9.9 ↑	Serie	49
2: 10.8x ↓		
3: 10.7x →		
4: 10.3 ↖		
5: 10.3 ↗		
Total		341

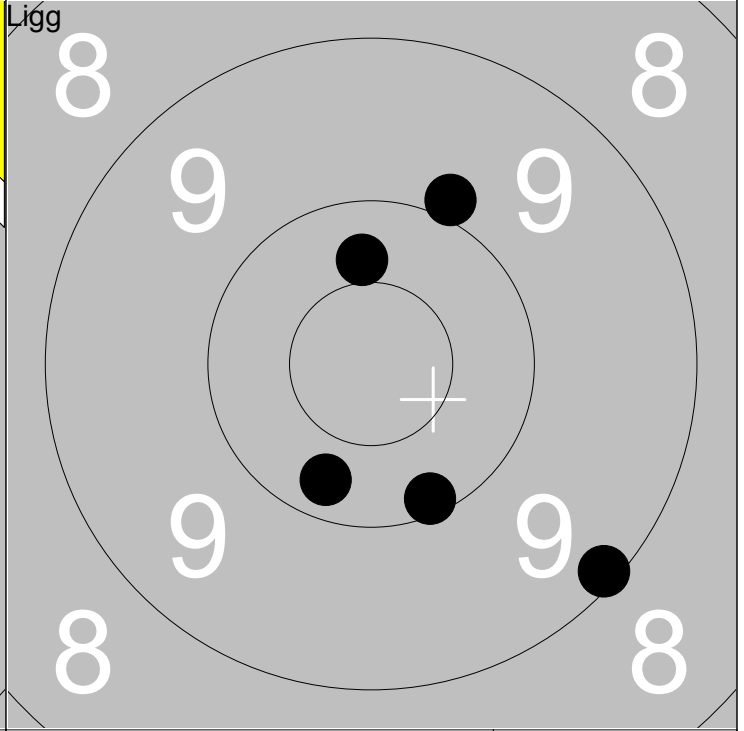
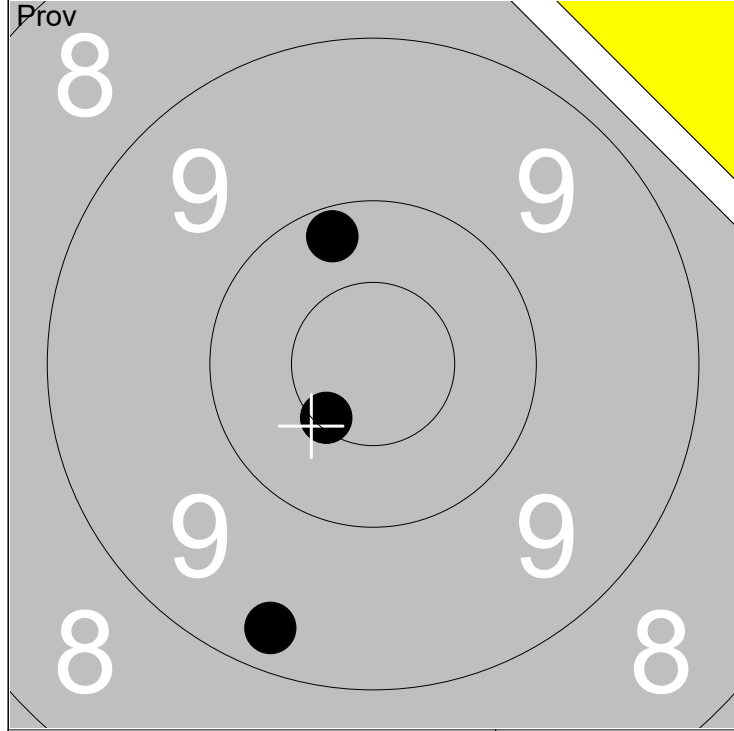

1: 10.5x ↙	Serie	29
2: 9.3 ↓		
3: 10.2 ↗		
Total		194

1: 10.2 ↓	Serie	48
2: 10.1 ↓		
3: 10.4 ↑		
4: 9.9 ↗		
5: 9.1 ↓		
Total		242

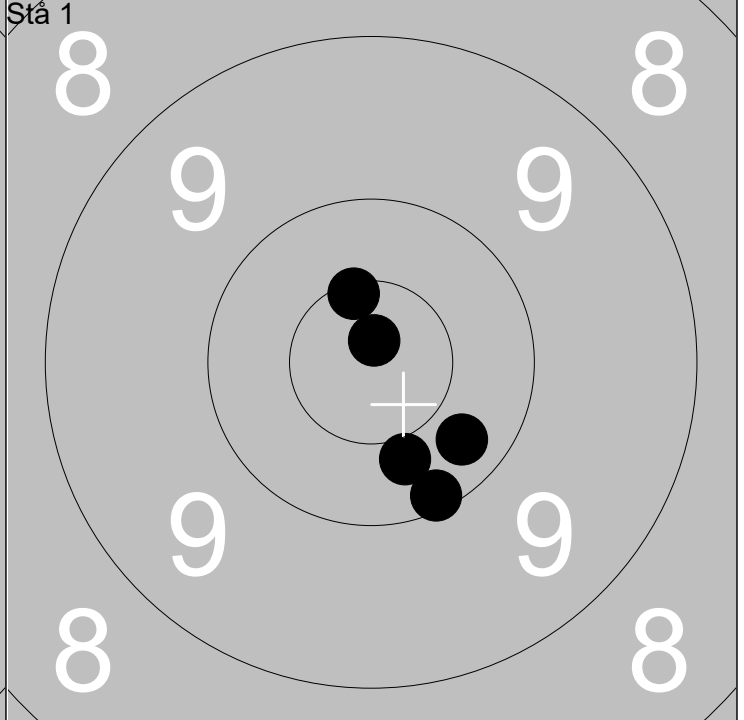
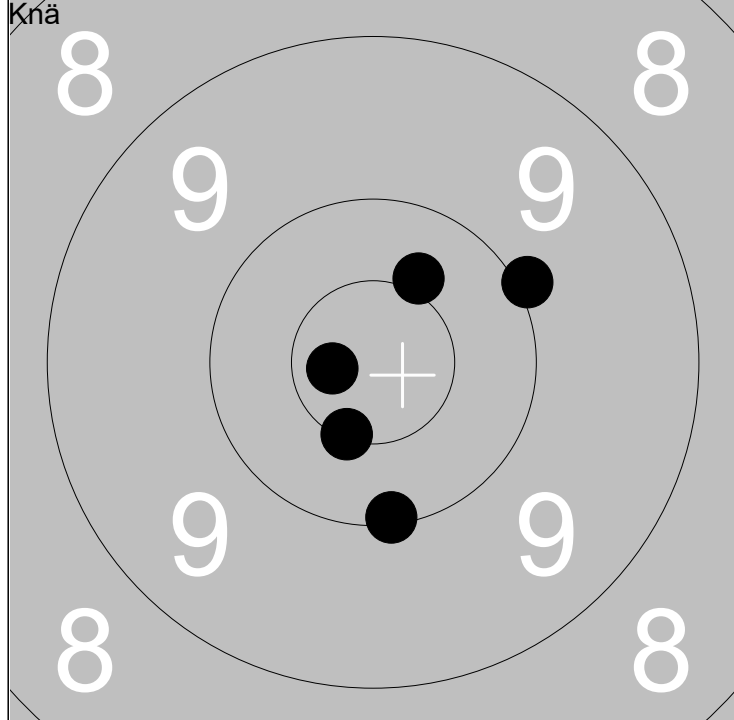

1: 10.0 ↗	Serie	50
2: 10.7x ←		
3: 10.5x ↓		
4: 10.1 ↓		
5: 10.4 ↗		
Total		292

1: 10.5x ↗	Serie	50
2: 10.4 ↓		
3: 10.3 ↓		
4: 10.1 ↓		
5: 10.8x ↗		
Total		342

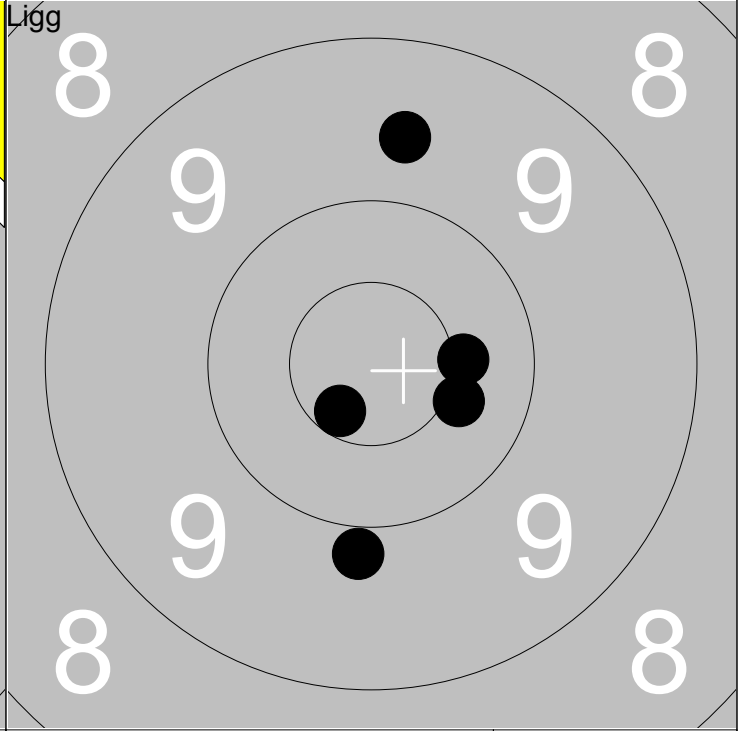
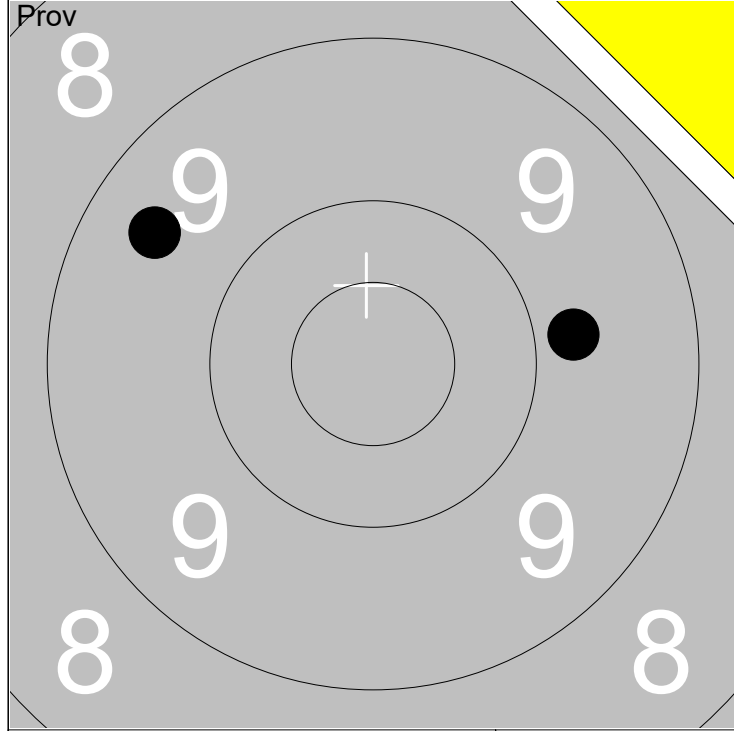

1:	9.5	↖			
2:	9.8	→			
			Serie	18	
			Total	197	

1:	9.6	↑			
2:	10.4x	→			
3:	9.9	↓			
4:	10.6x	↙			
5:	10.4	↘			
			Serie	48	
			Total	245	

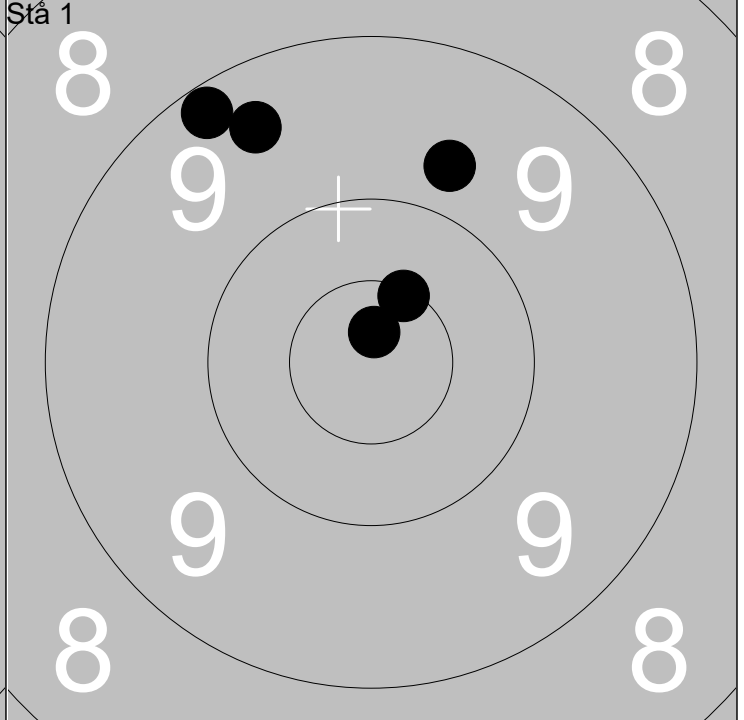
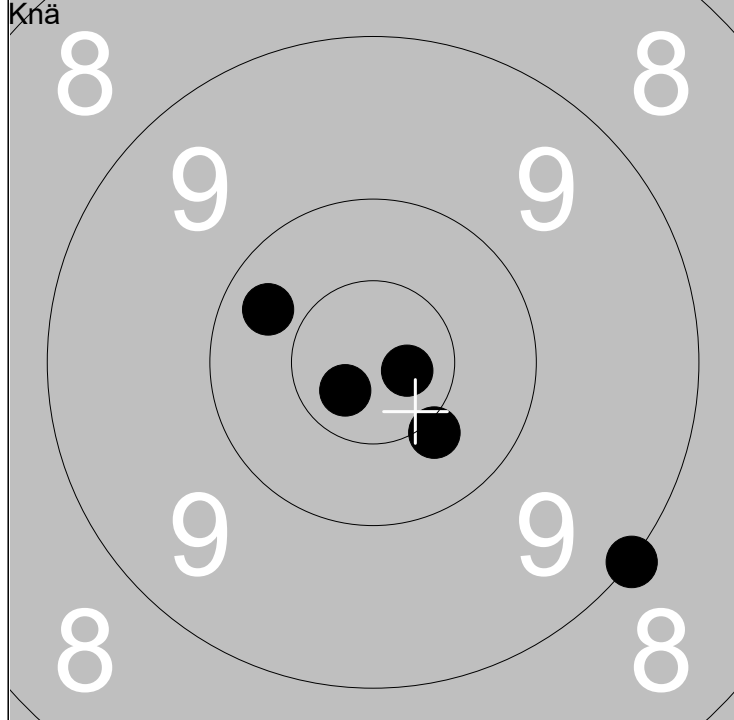

1:	10.3	↖			
2:	9.0	↙			
3:	10.8x	→			
4:	10.4x	↙			
5:	10.7x	↙			
			Serie	49	
			Total	294	

1:	10.5x	↖			
2:	9.7	↖			
3:	9.4	↖			
4:	9.2	↖			
5:	10.8x	↑			
			Serie	47	
			Total	341	

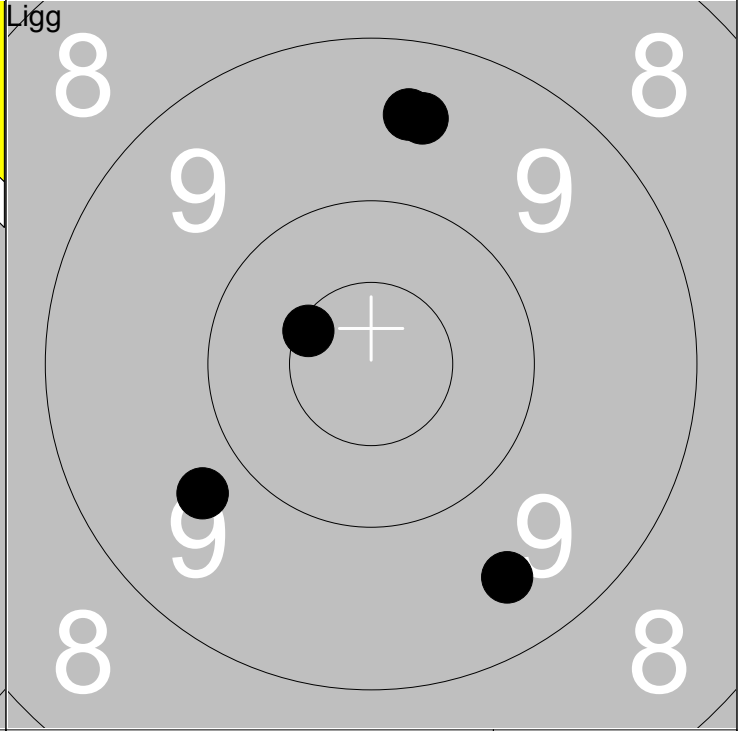
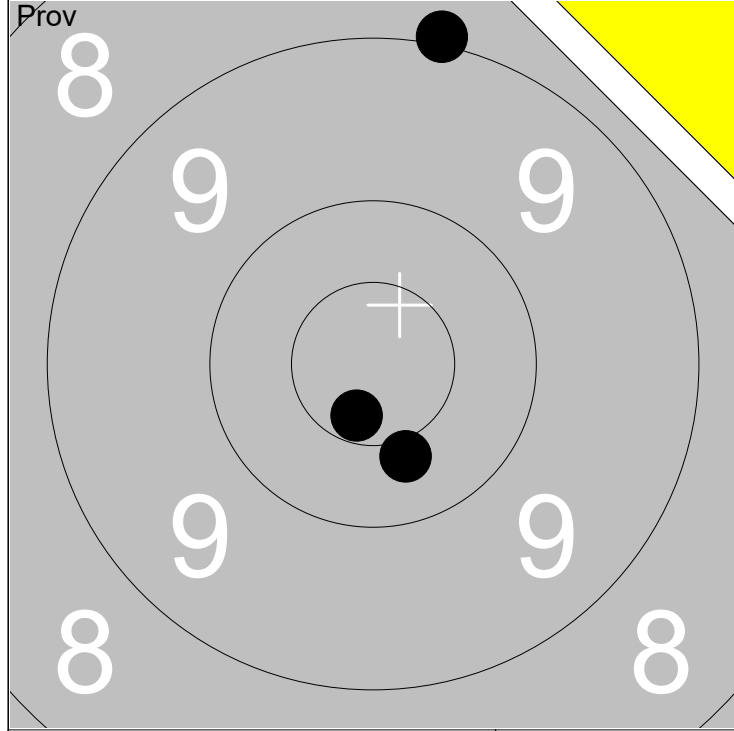

1: 9.0 ↑	Serie 29
2: 10.4 ↓	
3: 10.6x ↓	
Total 193	

1: 9.5 ↑	Serie 46
2: 9.5 ↑	
3: 9.5 ↓	
4: 10.5x ↖	
5: 9.7 ↙	
Total 239	

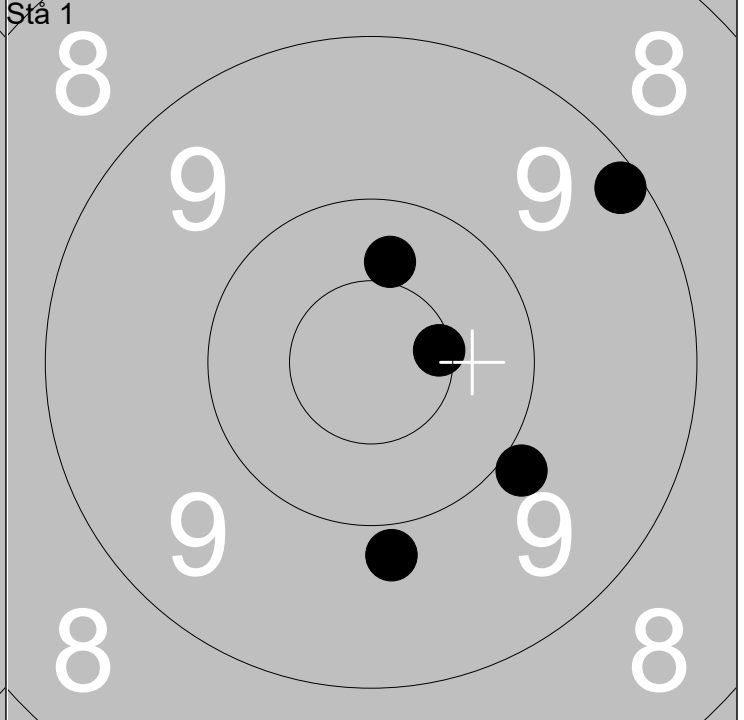
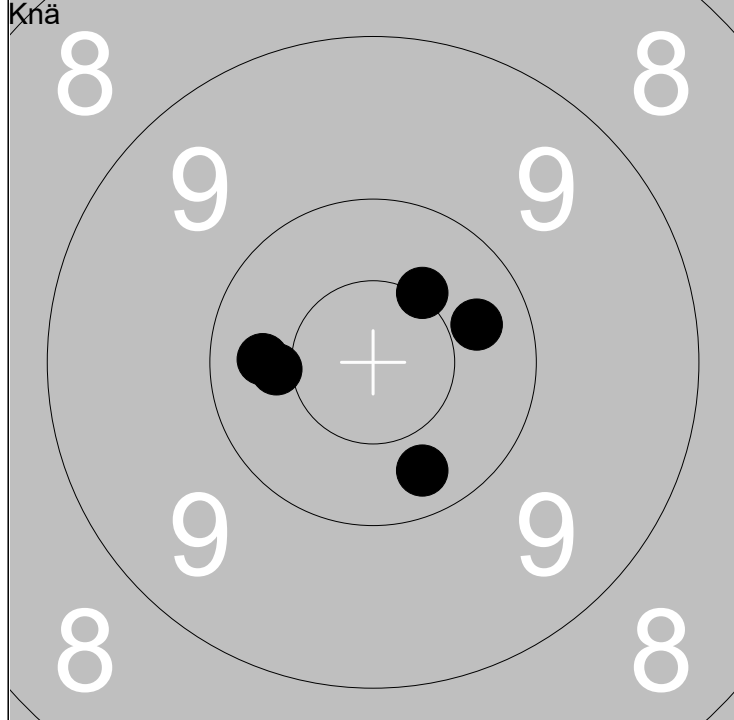

1: 10.3 ↓	Serie 50
2: 10.4 ←	
3: 10.3 ←	
4: 10.5x ↗	
5: 10.3 →	
Total 289	

1: 10.6x →	Serie 47
2: 10.4 ↑	
3: 9.2 ↗	
4: 9.9 ↓	
5: 9.8 ↓	
Total 336	

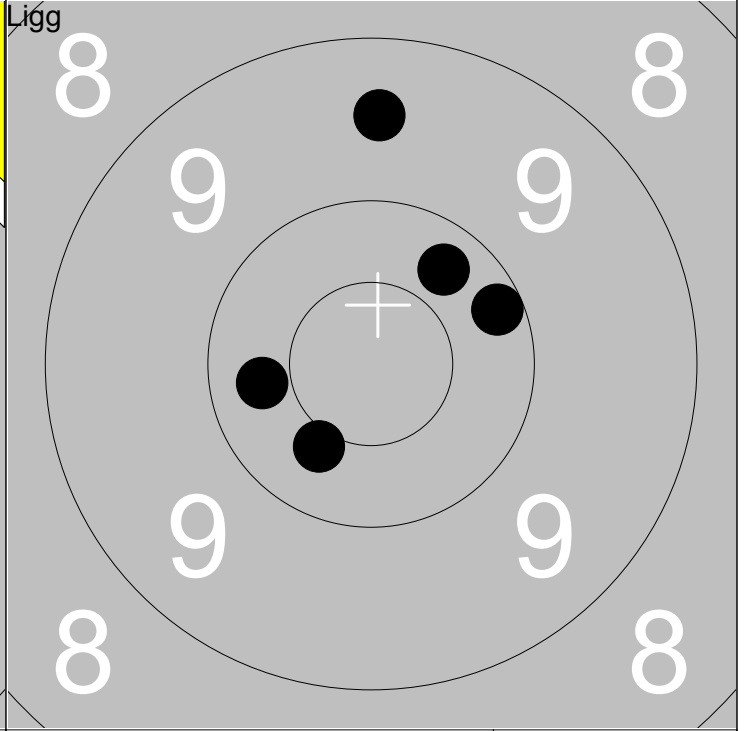
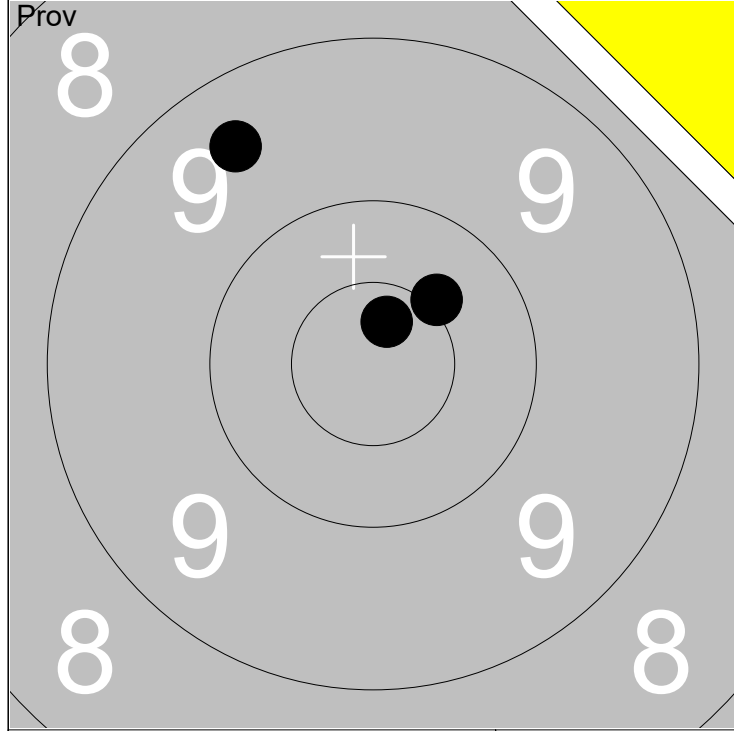

1: 9.5 ↖	Serie 29
2: 10.4x ↗	
3: 10.7x ↑	
Total 193	

1: 9.5 ↑	Serie 49
2: 10.4 ↓	
3: 10.2 →	
Total 242	

4: 10.3 ←	Serie 48
5: 10.3 ↗	
6: 10.0 ↑	
Total 338	

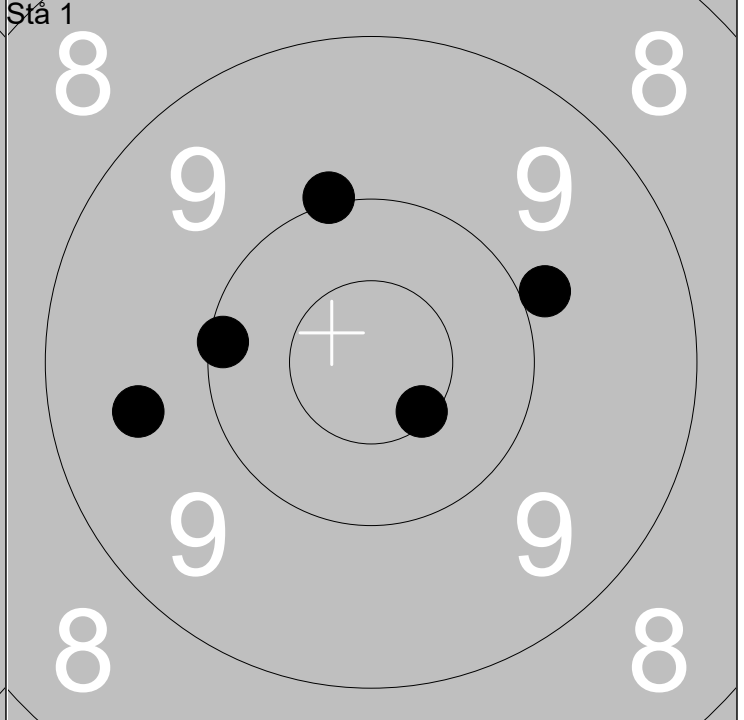
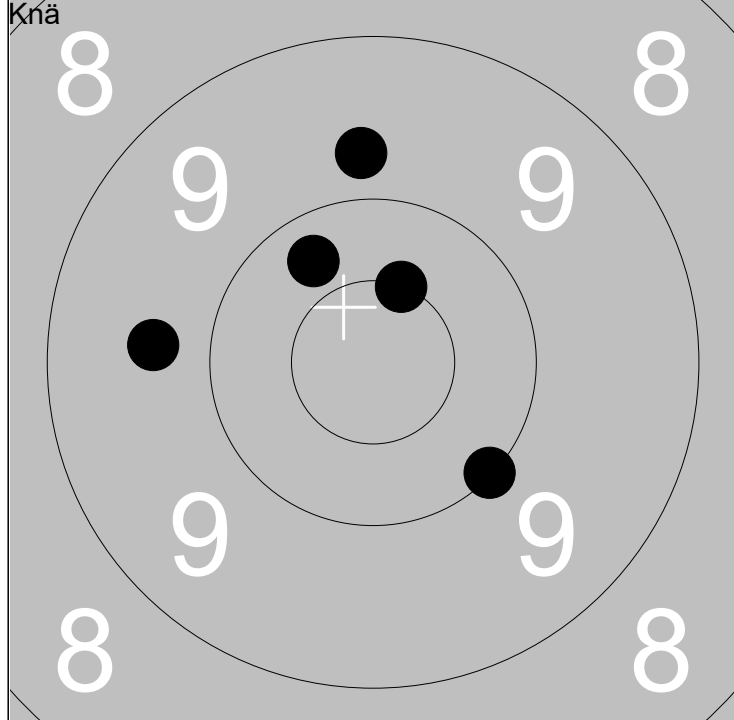

1: 10.3 ↖	Serie 48
2: 10.0 ↓	
3: 10.5x ↑	
Total 290	

4: 9.7 ←	Serie 48
5: 9.7 ↑	
6: 10.0 ↑	
Total 338	

1: 10.0 ↑	Serie 48
2: 10.5x ↓	
3: 9.9 →	
Total 338	

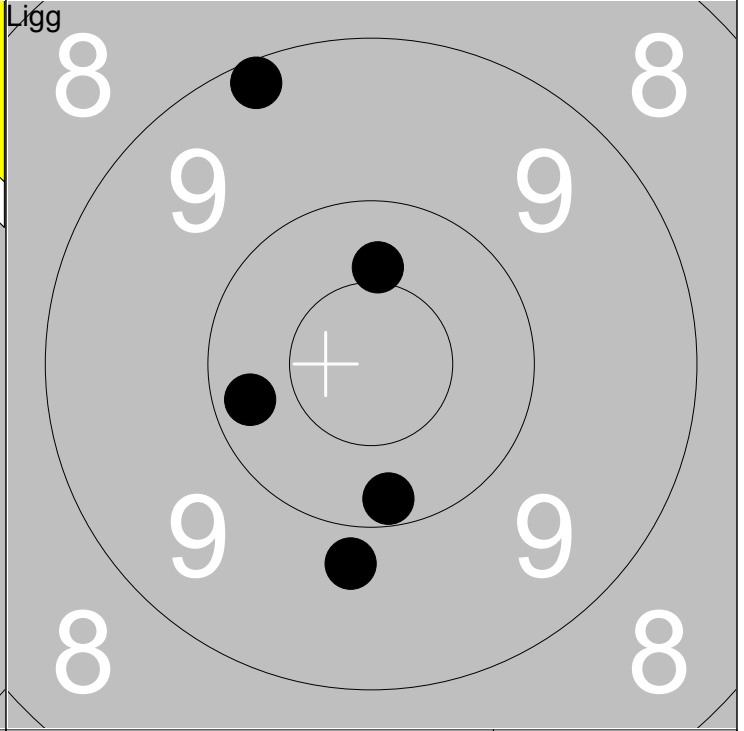
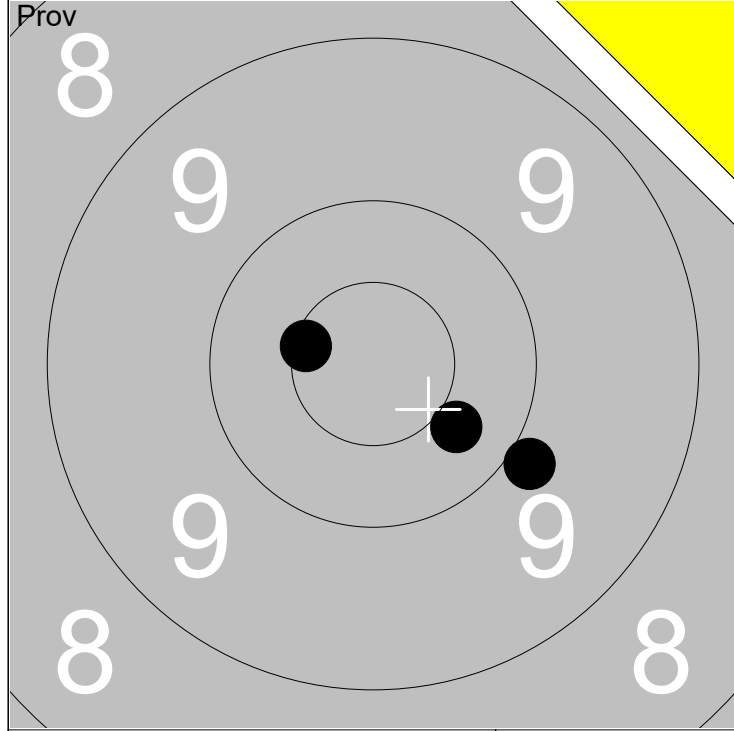

1: 10.6x ↙	Serie 29
2: 9.9 ↘	
3: 10.4 ↘	
Total 193	

1: 9.2 ↗	Serie 48
2: 10.2 ↙	
3: 10.2 ↓	
4: 9.8 ↓	
5: 10.4 ↑	
Total 241	

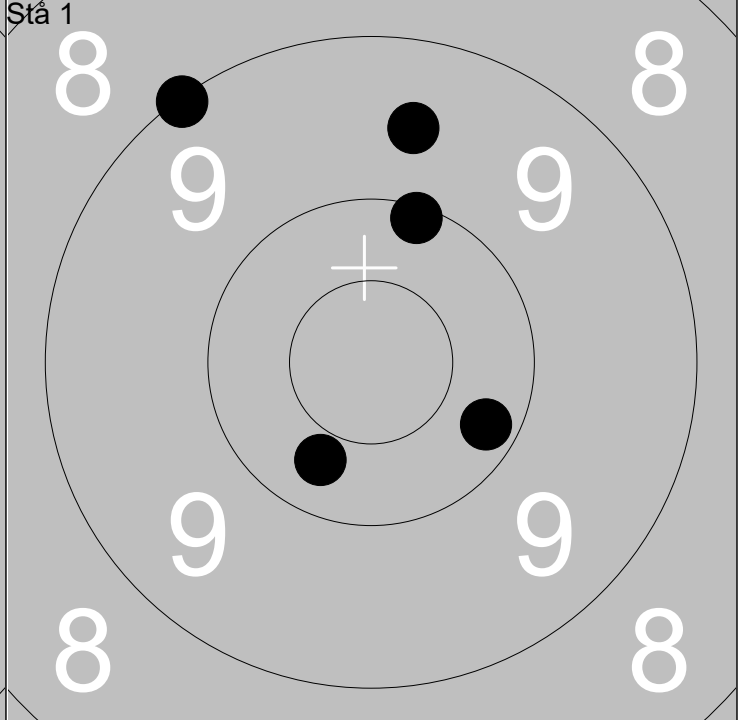
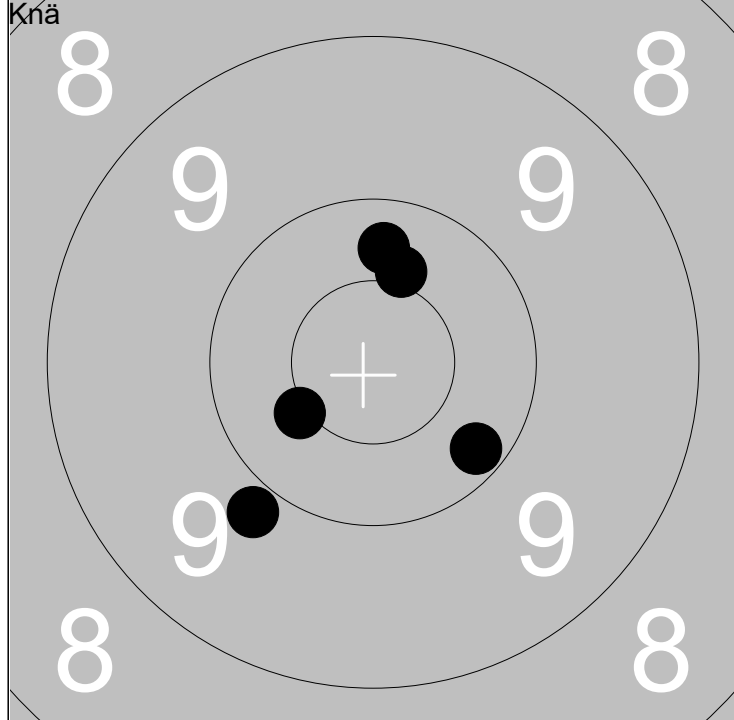

1: 10.4x ↙	Serie 49
2: 9.9 ↘	
3: 10.3 ↑	
4: 10.4 ↑	
5: 10.2 ↘	
Total 290	

1: 10.1 ↑	Serie 48
2: 9.6 ↑	
3: 10.2 ↘	
4: 9.1 ↗	
5: 10.3 ↓	
Total 338	

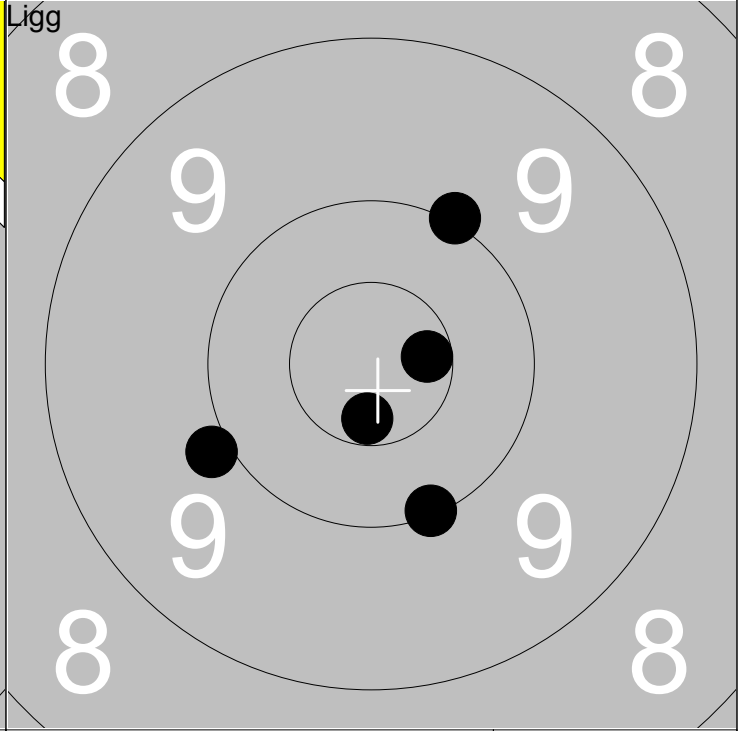
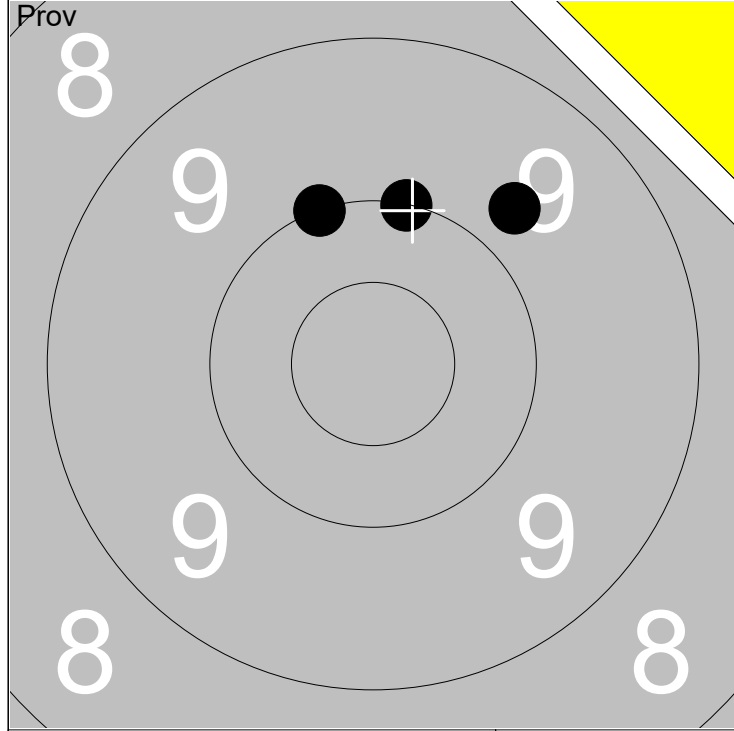

1: 10.0	↑
2: 10.0	↖
3: 9.7	↗

Serie	29
Total	193

1: 10.1	↓
2: 10.6x	↓
3: 10.0	↗
4: 10.6x	→
5: 9.9	↙

Serie	49
Total	242

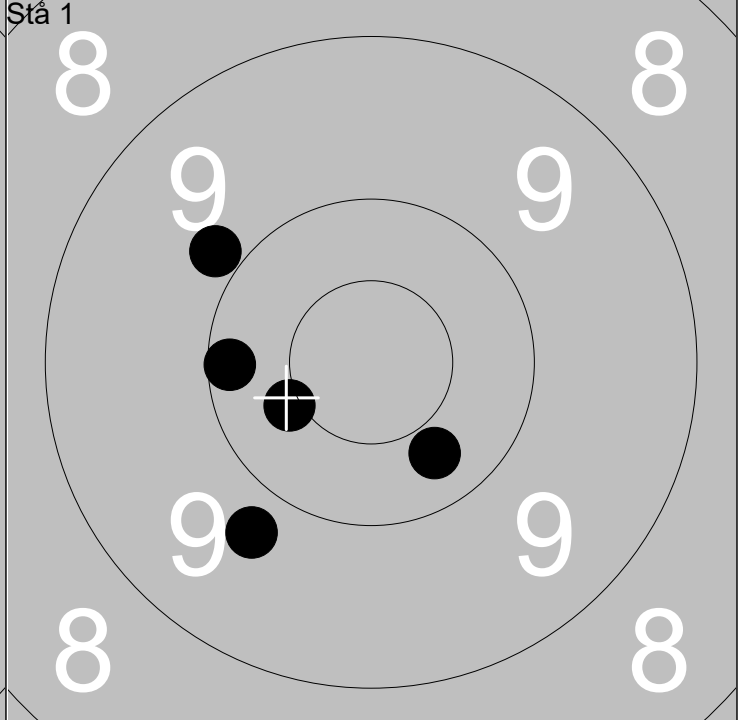
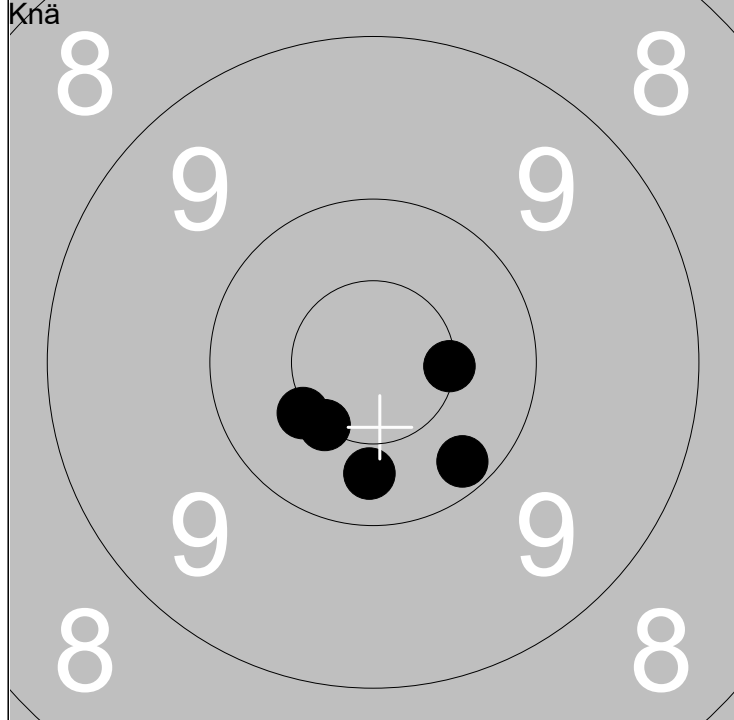

1: 10.5x	↙
2: 10.5x	→
3: 10.5x	↙
4: 10.2	↘
5: 10.3	↓

Serie	50
Total	292

1: 9.9	↖
2: 10.4x	↙
3: 10.3	↘
4: 10.1	←
5: 9.8	↙

Serie	48
Total	340

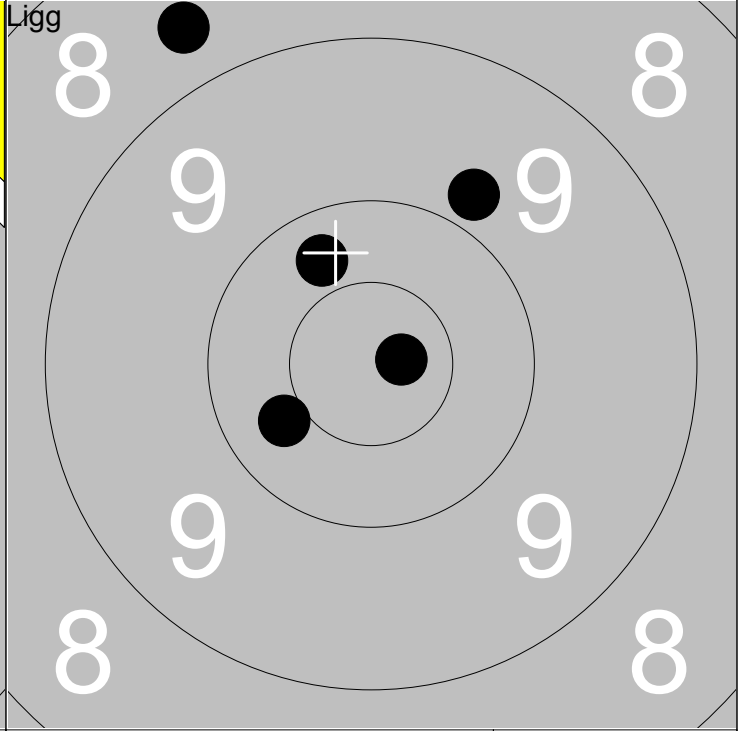
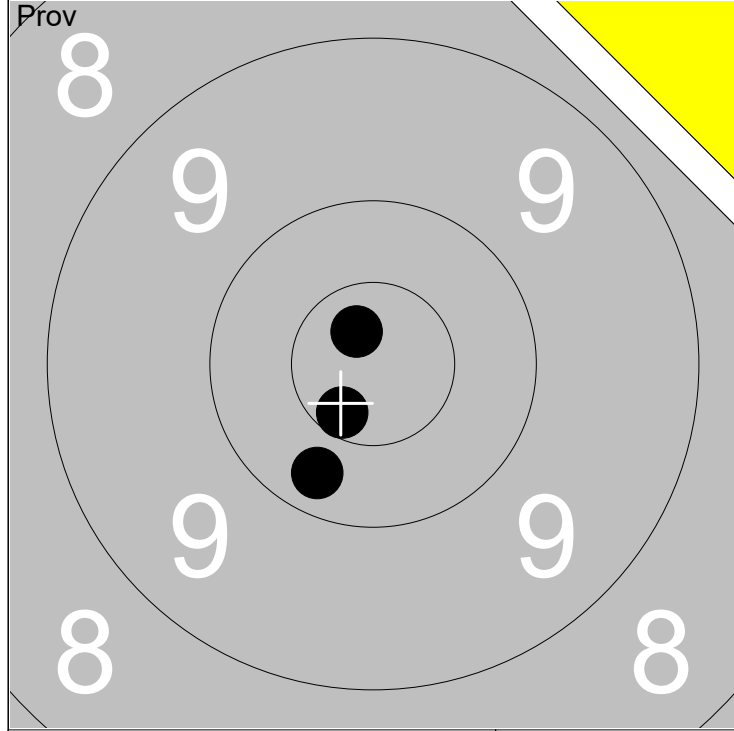

1: 10.3	↙
2: 10.7x	↖
3: 10.6x	↘

Serie	30
Total	192

1: 8.7	↖
2: 10.3	↖
3: 9.8	↗
4: 10.4	↙
5: 10.8x	→

Serie	47
Total	239

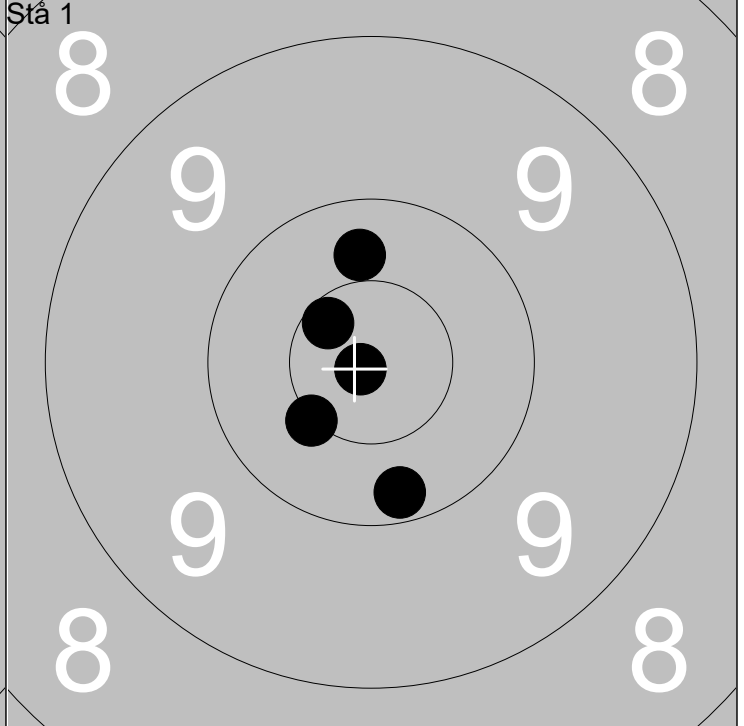
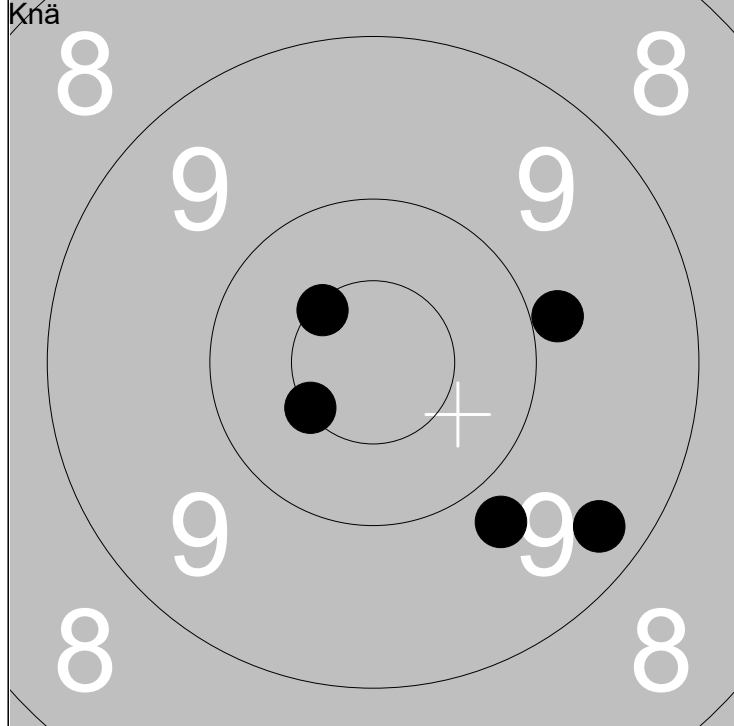

1: 10.5x	↙
2: 10.5x	↖
3: 9.3	↘
4: 9.8	↘
5: 9.9	→

Serie	47
Total	286

1: 10.6x	↖
2: 10.2	↘
3: 10.9x	↙
4: 10.3	↗
5: 10.5x	↙

Serie	50
Total	336

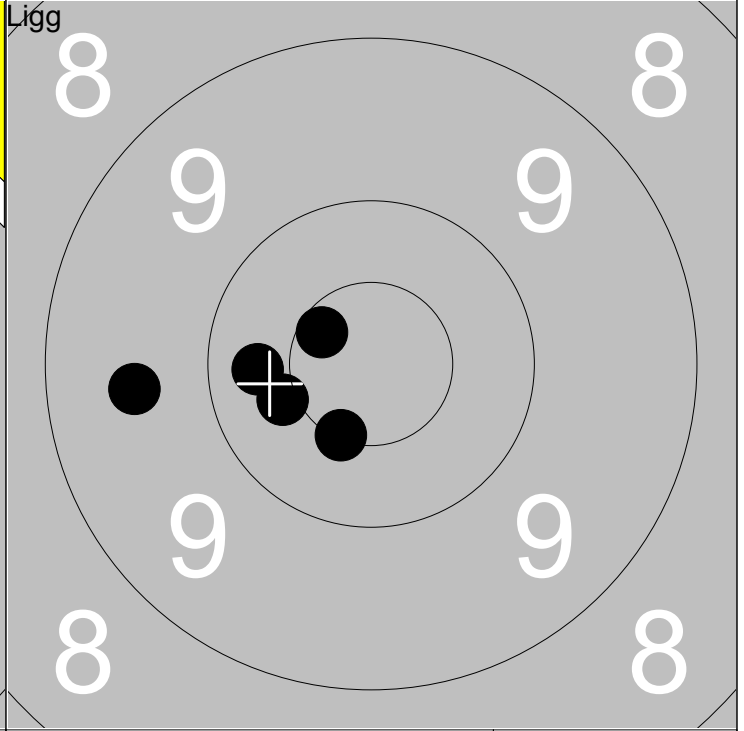
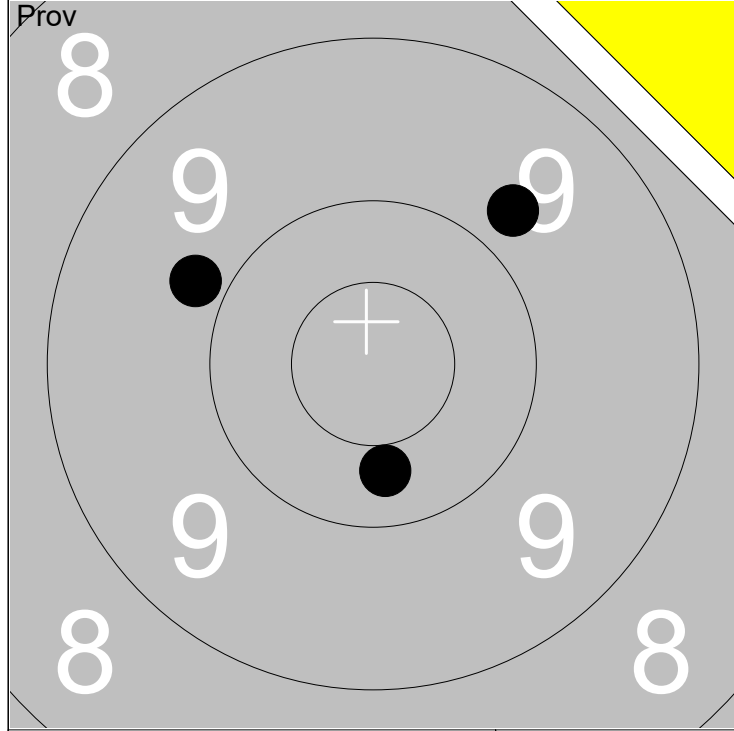

1: 9.8 ↗	Serie	28
2: 9.8 ↖		
3: 10.3 ↓		
Total		192

1: 10.5x ↓	Serie	49
2: 10.3 ←		
3: 9.6 ←		
4: 10.6x ↖		
5: 10.4 ←		
Total		241

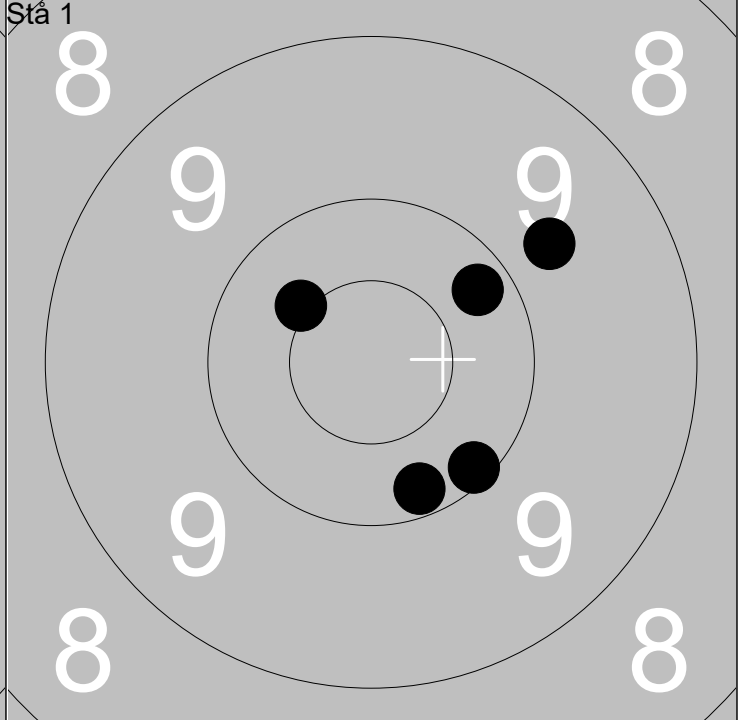
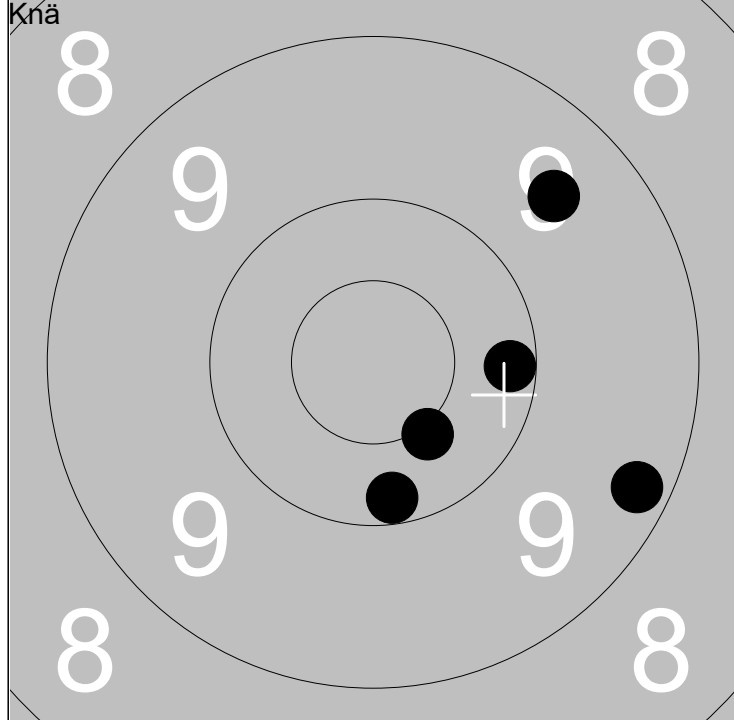

1: 10.2 →	Serie	48
2: 9.2 ↘		
3: 10.4x ↓		
4: 9.5 ↗		
5: 10.2 ↓		
Total		289

1: 10.2 ↓	Serie	49
2: 9.7 ↗		
3: 10.2 ↗		
4: 10.4x ↖		
5: 10.1 ↓		
Total		338

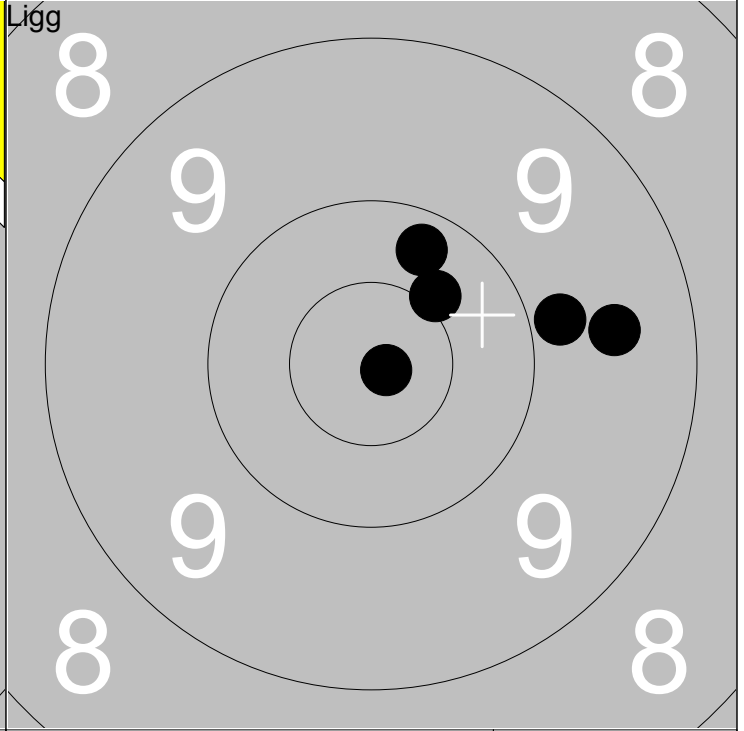
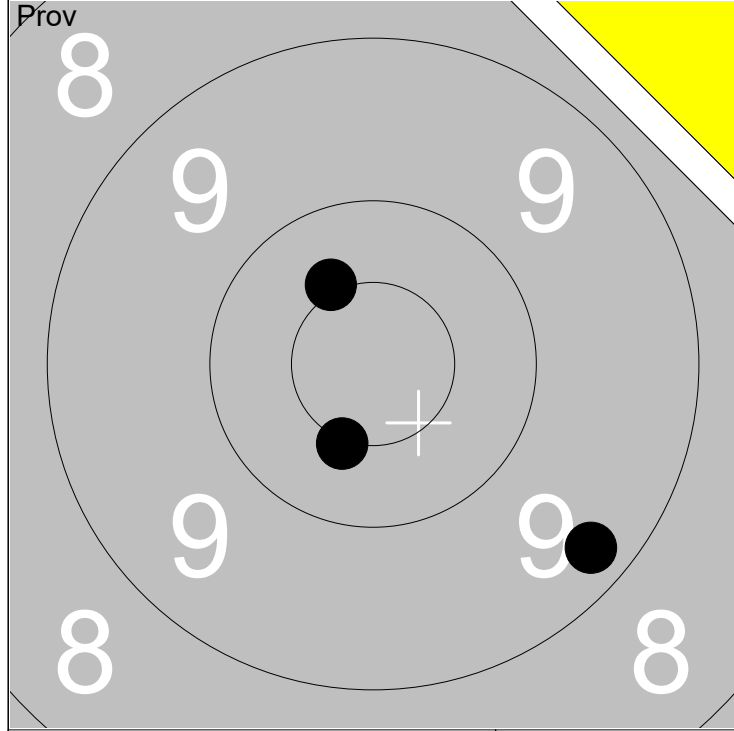

1: 9.3 ↘	Serie	29
2: 10.4x ↗		
3: 10.5x ↓		
Total		192

1: 9.5 →	Serie	48
2: 10.9x →		
3: 10.2 ↑		
4: 10.4x ↗		
5: 9.8 →		
Total		240

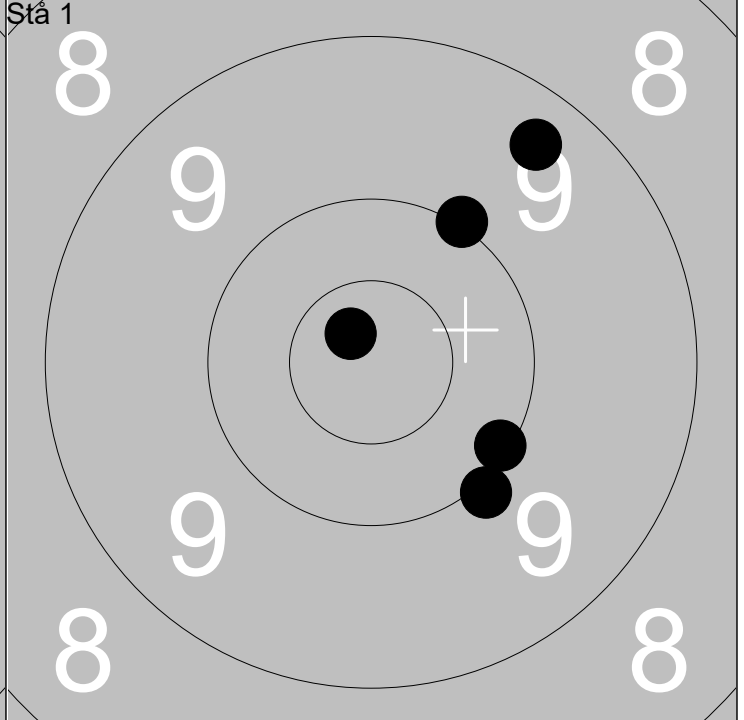
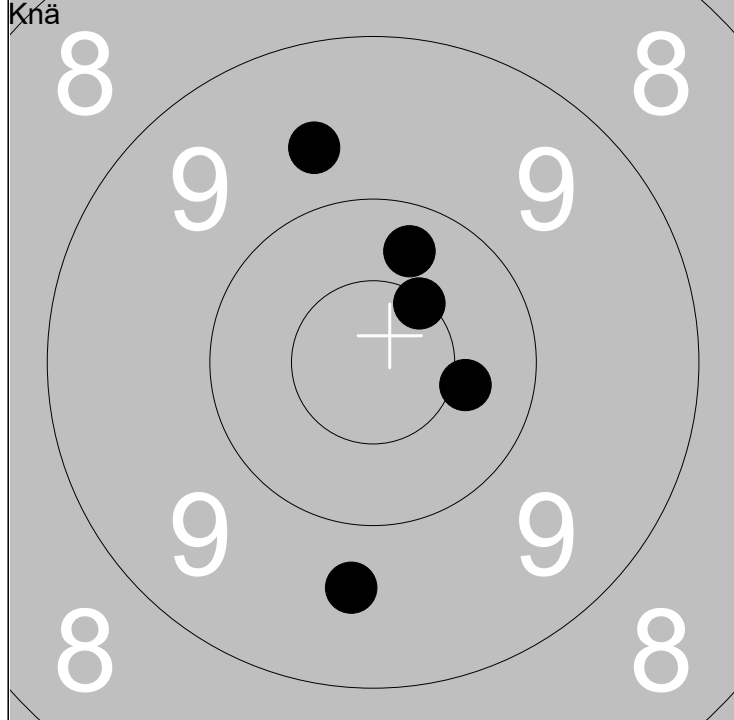

1: 9.6 ↓	Serie	48
2: 10.4 →		
3: 10.5x ↗		
4: 10.3 ↑		
5: 9.7 ↗		
Total		288

1: 10.0 ↓	Serie	49
2: 10.0 ↗		
3: 9.4 ↗		
4: 10.7x ↗		
5: 10.1 ↓		
Total		337

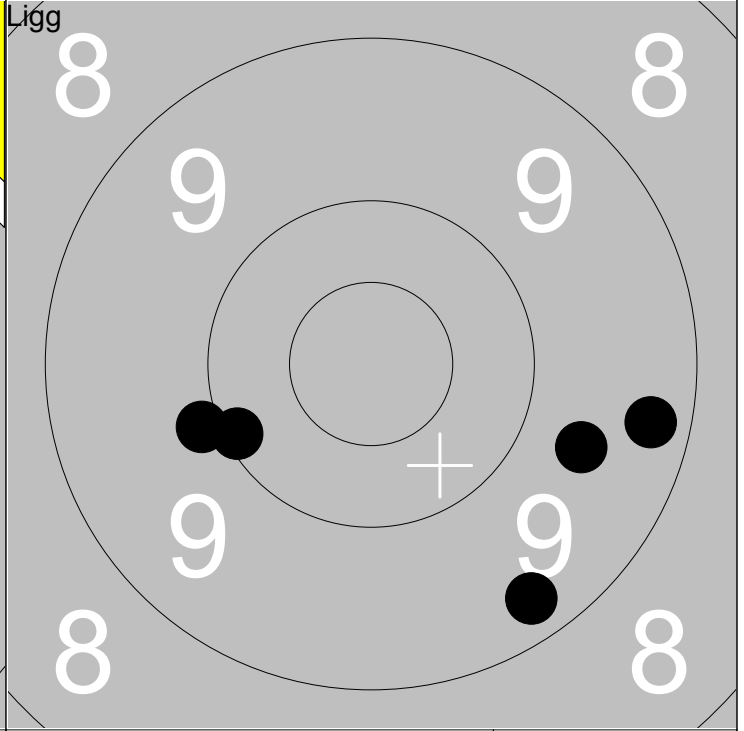
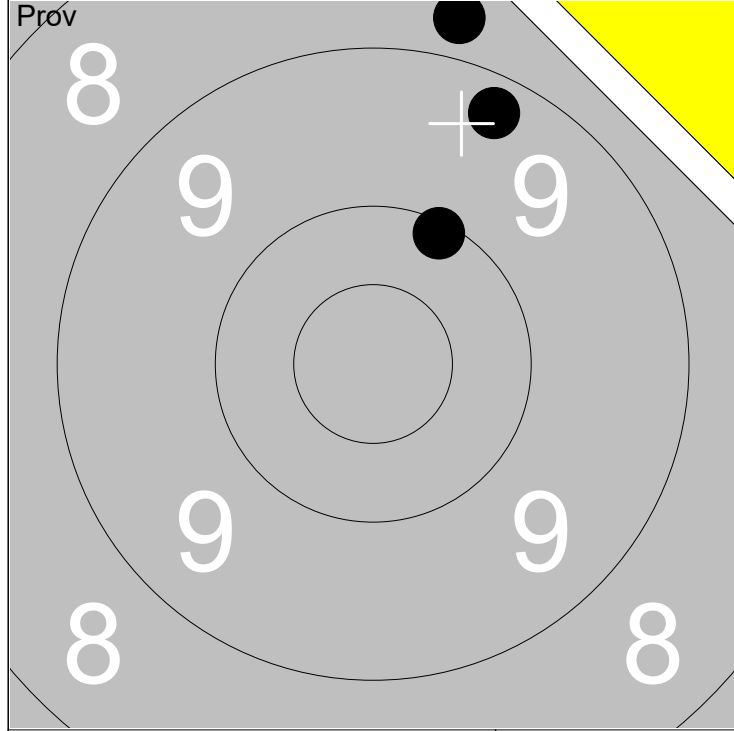

1: 8.8	↑
2: 9.3	↗
3: 10.1	↗

Serie	27
Total	191

1: 9.3	↘
2: 9.6	↘
3: 9.3	→
4: 10.1	↙
5: 9.9	↙

Serie	46
Total	237

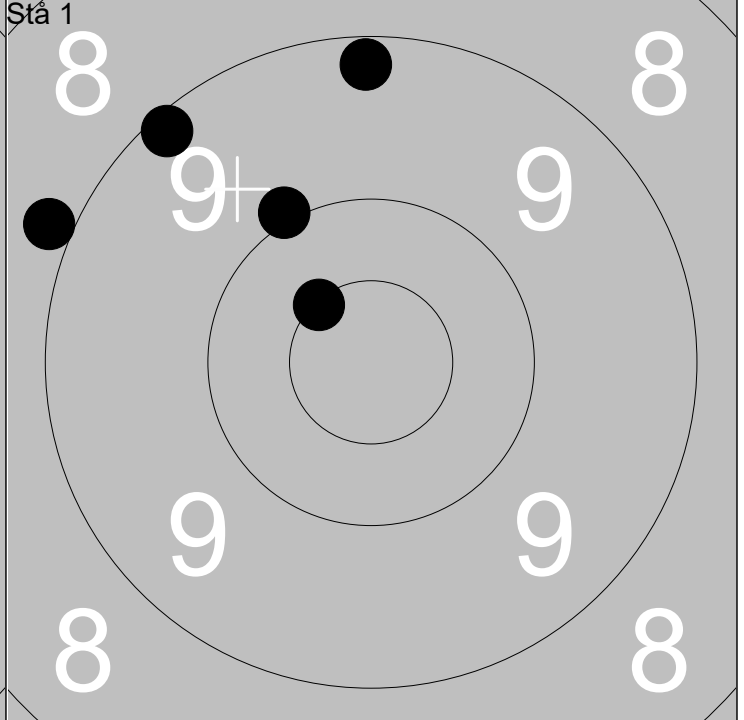
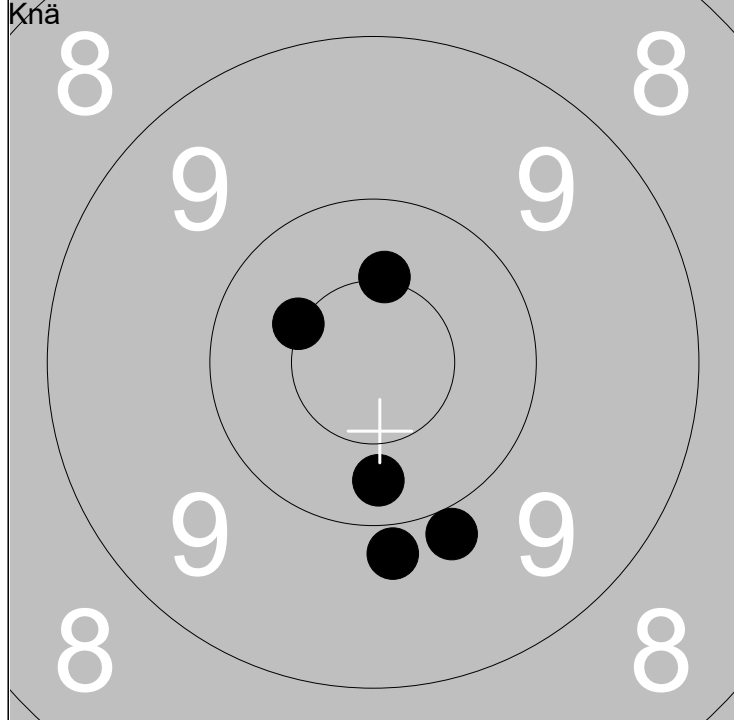

1: 10.5x	↑
2: 9.9	↓
3: 9.9	↓
4: 10.5x	↖
5: 10.3	↓

Serie	48
Total	285

1: 10.5x	↖
2: 10.0	↗
3: 9.1	↗
4: 9.2	↑
5: 8.9	↖

Serie	46
Total	331

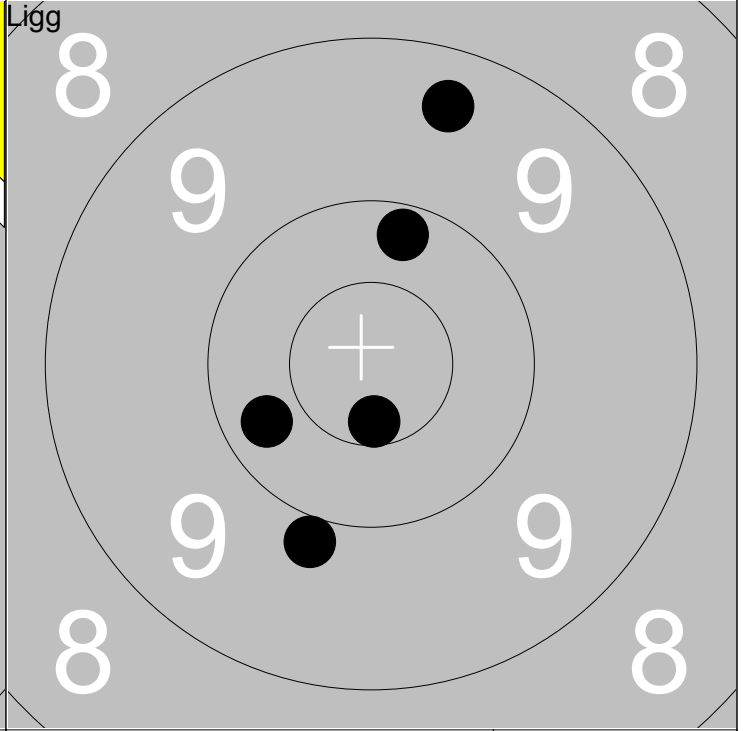
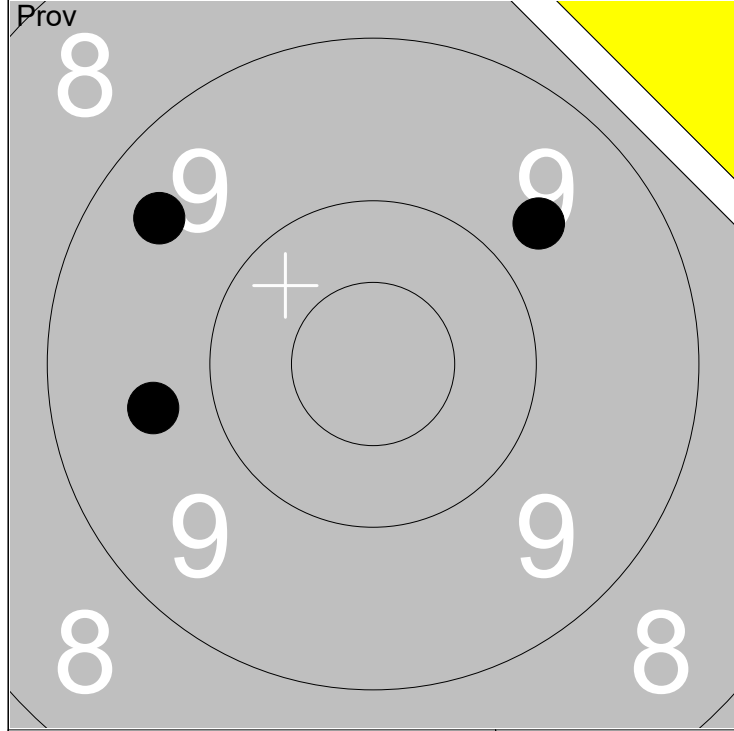

1: 9.7 ←	Serie 27
2: 9.4 ↖	
3: 9.7 ↗	
Total 191	

1: 10.3 ↙	Serie 48
2: 10.6x ↓	
3: 9.9 ↓	
4: 10.2 ↑	
5: 9.4 ↑	
Total 239	

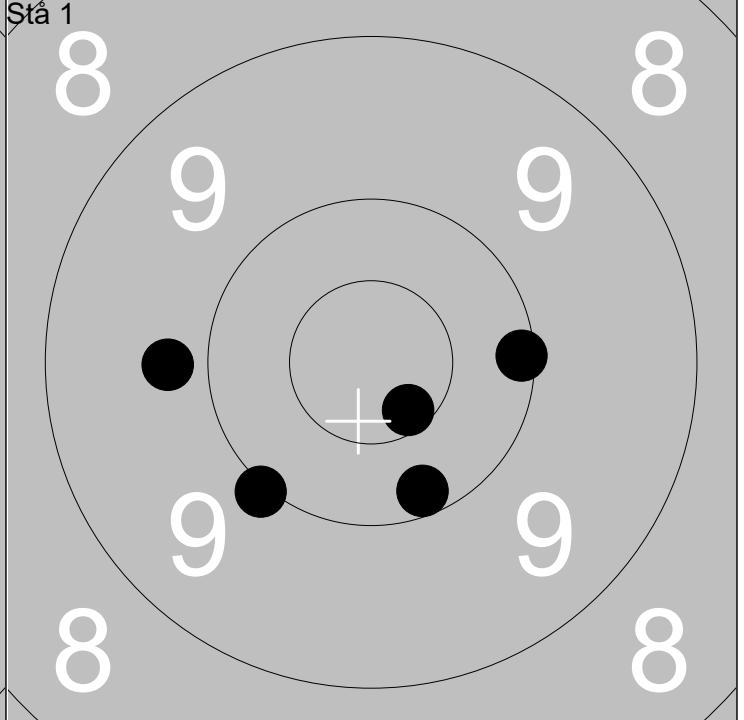
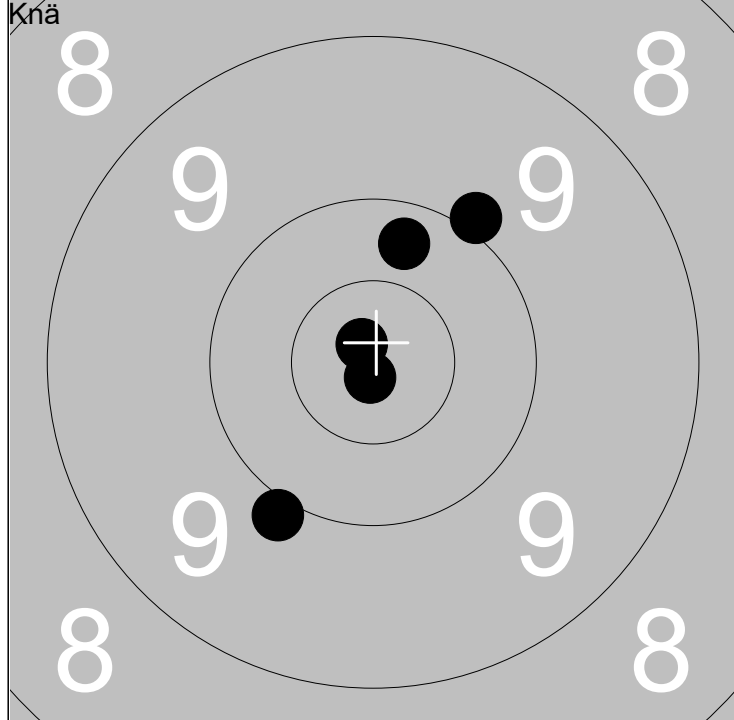

1: 9.9 ↗	Serie 48
2: 9.9 ↓	
3: 10.3 ↑	
4: 10.9x ↓	
5: 10.8x ↖	
Total 287	

1: 10.0 ↙	Serie 49
2: 9.8 ←	
3: 10.2 ↓	
4: 10.1 →	
5: 10.6x ↓	
Total 336	

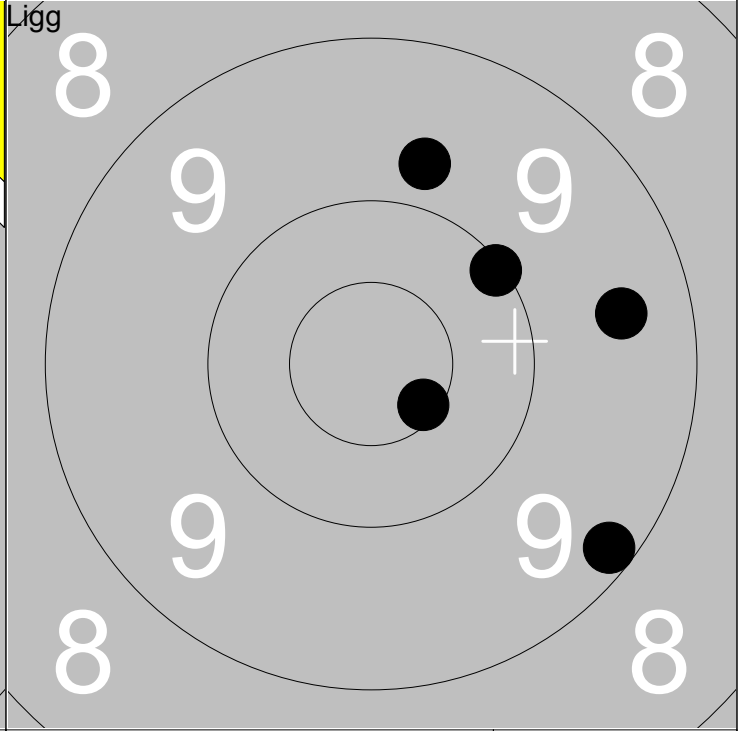
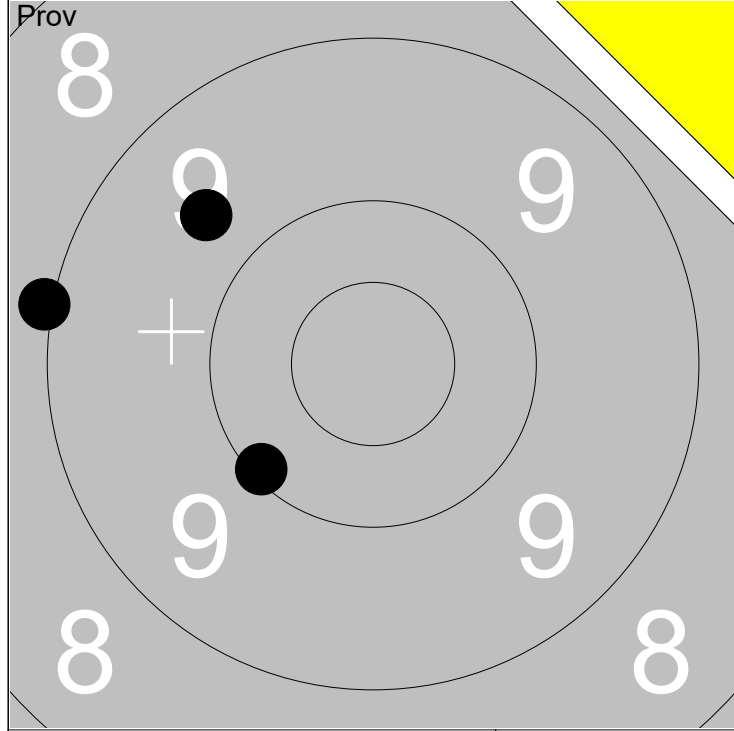

1: 9.7 ↖	Serie 28
2: 9.0 ←	
3: 10.1 ↙	
Total 190	

1: 9.8 ↑	Serie 47
2: 10.6x ↘	
3: 9.5 →	
Total 237	

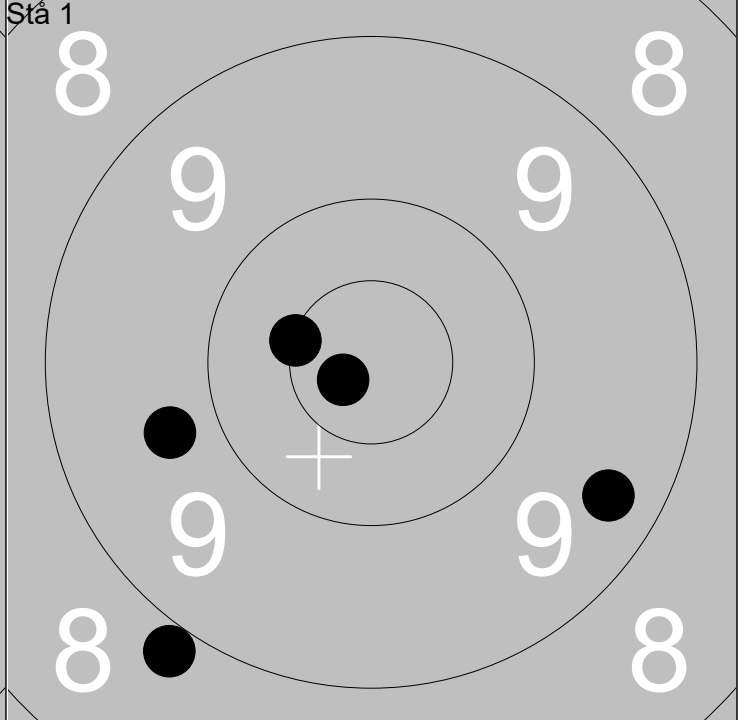
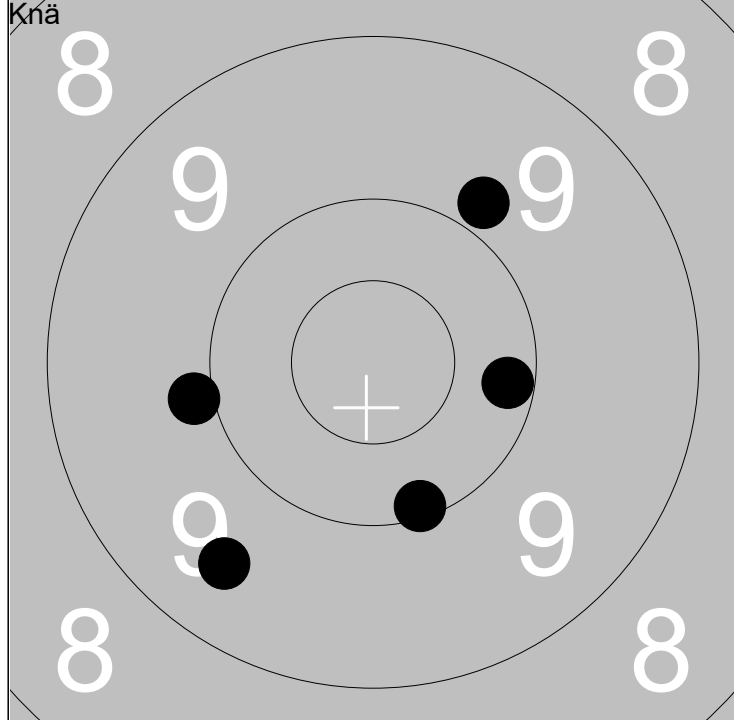

1: 9.8 ↗	Serie 47
2: 10.1 ↓	
3: 9.9 ←	
Total 284	

1: 8.9 ↘	Serie 46
2: 10.8x ←	
3: 9.4 ↘	
Total 330	

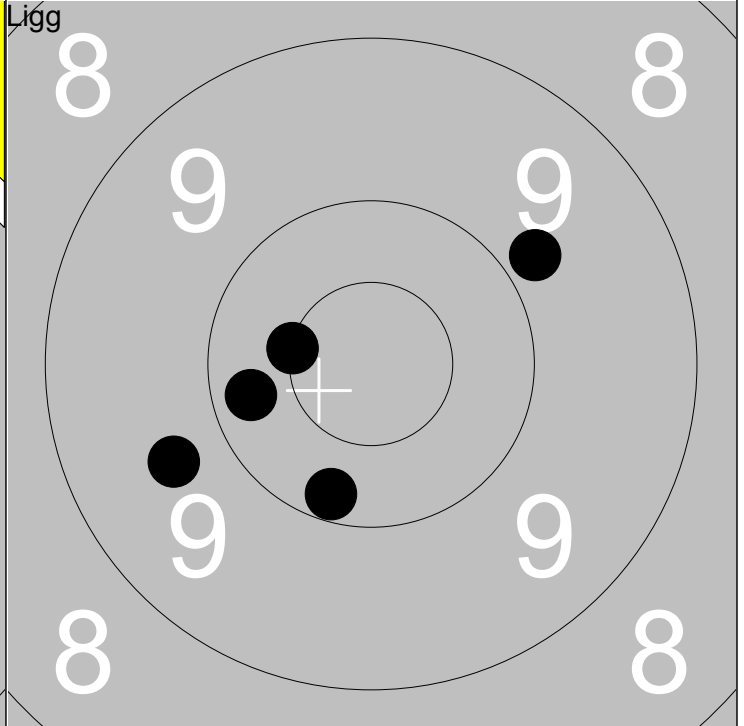
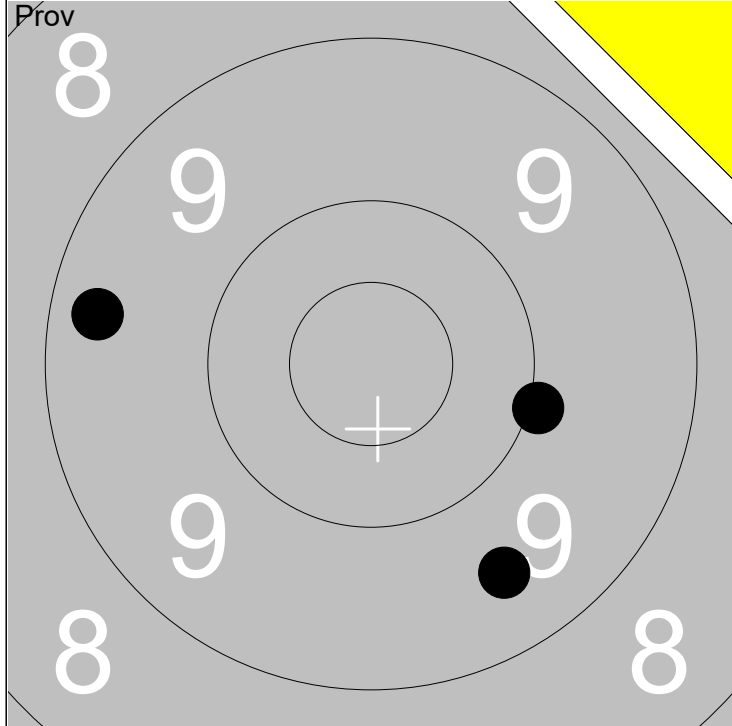

1: 9.5 ↘	Serie 28
2: 10.0 →	
3: 9.3 ←	
Total 190	

1: 9.7 ←	Serie 48
2: 10.2 ↓	
3: 10.2 ←	
4: 10.5x ←	
5: 9.8 ↗	
Total 238	

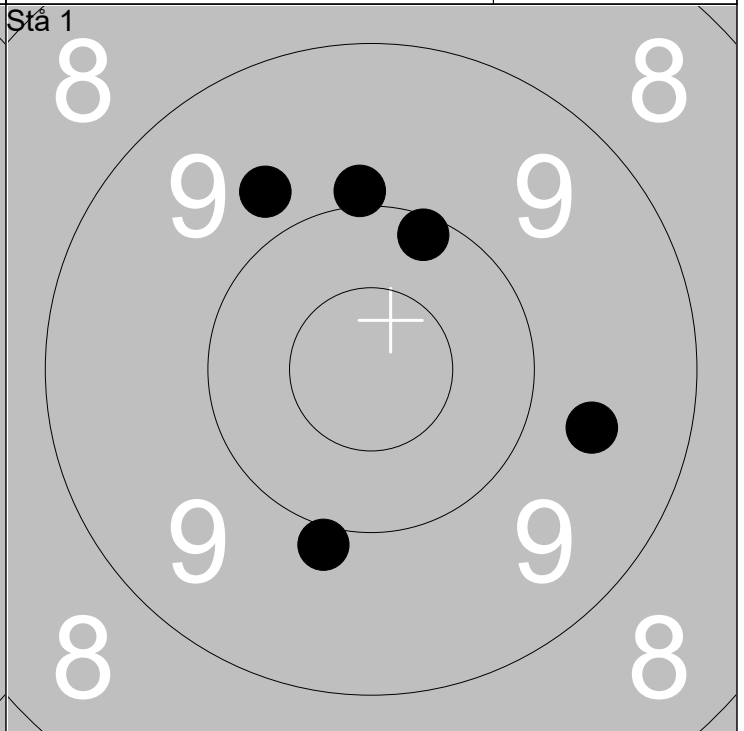
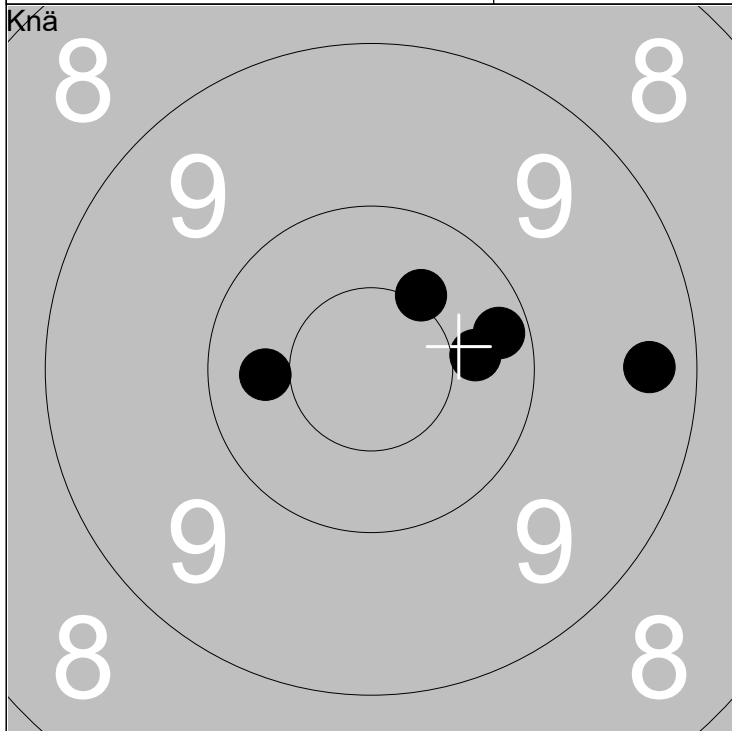

1: 10.3 ←	Serie 49
2: 10.4x ↗	
3: 10.2 →	
4: 9.3 →	
5: 10.4 →	
Total 287	

1: 10.1 ↗	Serie 46
2: 9.8 ↖	
3: 9.9 ↑	
4: 9.9 ↓	
5: 9.6 →	
Total 333	

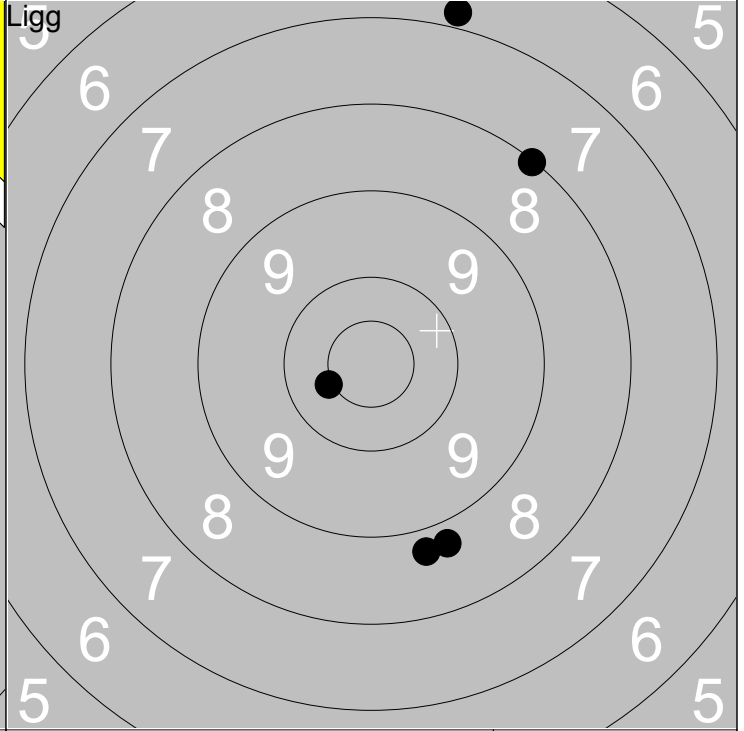
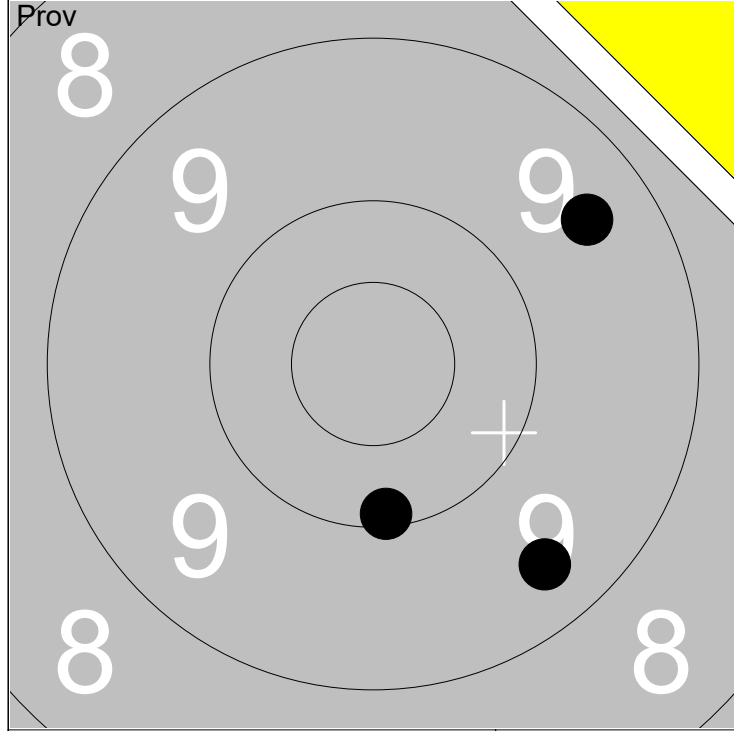

1: 10.1 ↓	Serie	28
2: 9.4 ↘		
3: 9.4 ↗		
Total		189

1: 8.8 ↓	Serie	40
2: 8.8 ↓		
3: 6.8 ↑		
4: 10.4x ←		
5: 8.1 ↗		
Total		229

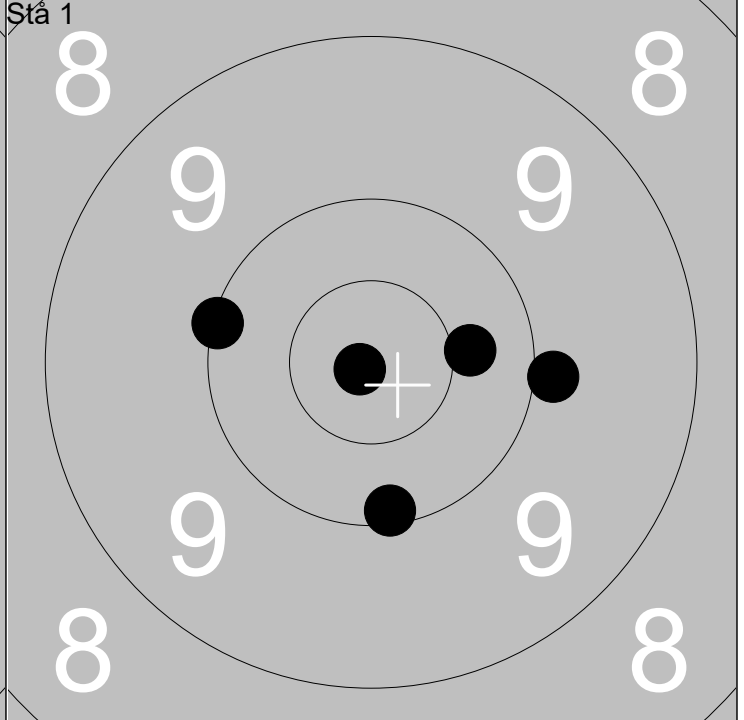
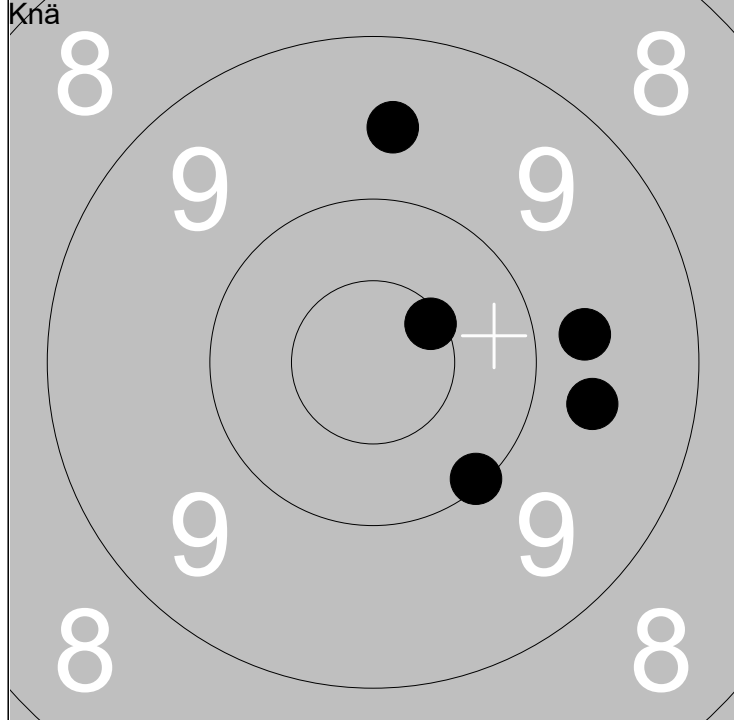

1: 10.1 ↘	Serie	47
2: 10.6x ↗		
3: 9.7 →		
4: 9.7 →		
5: 9.6 ↑		
Total		276

1: 10.9x ←	Serie	49
2: 10.1 ↓		
3: 10.1 ←		
4: 9.9 →		
5: 10.4 →		
Total		325

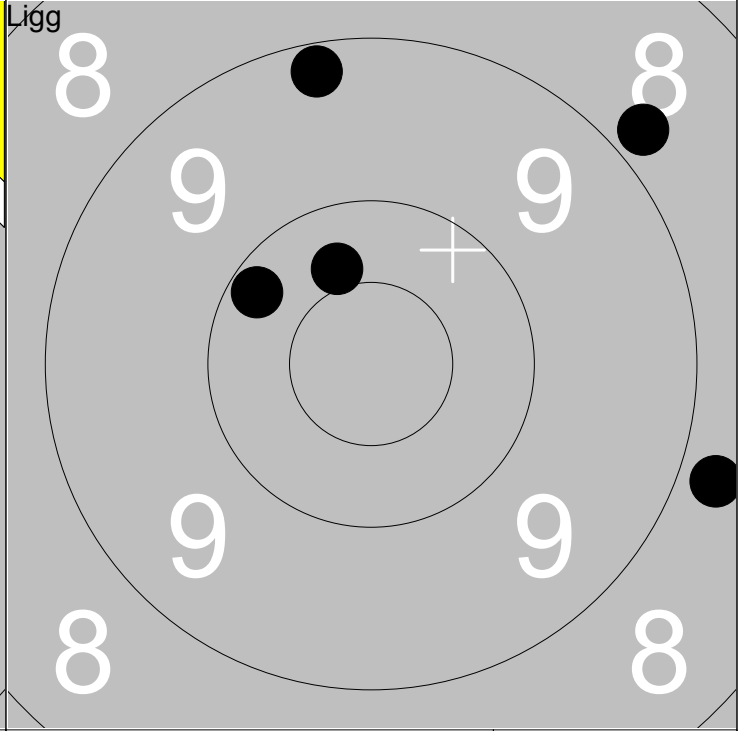
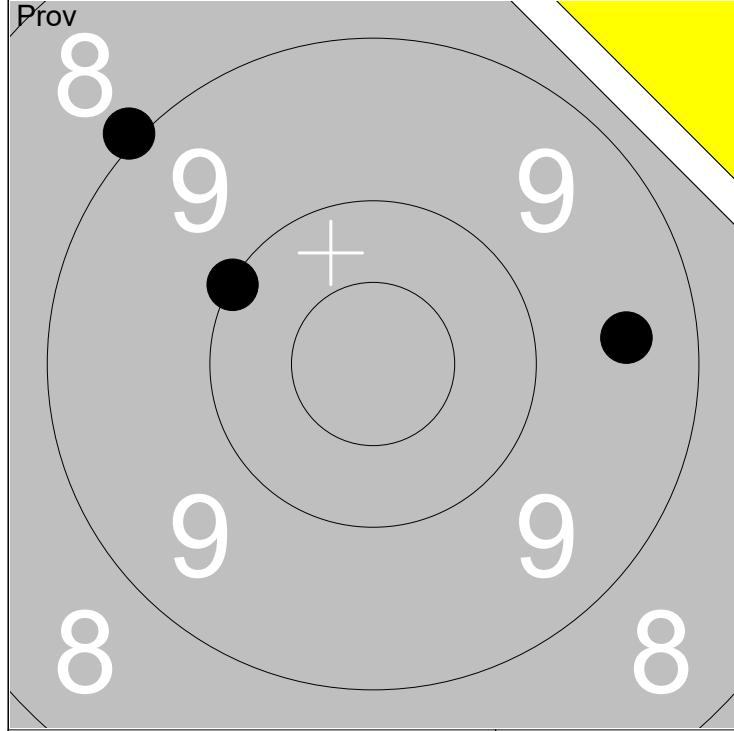

1:	9.5	→
2:	9.0	↗
3:	10.0	↖

Serie	28
Total	188

1:	10.4	↖
2:	8.8	→
3:	8.8	↗
4:	10.2	↖
5:	9.2	↖

Serie	45
Total	233

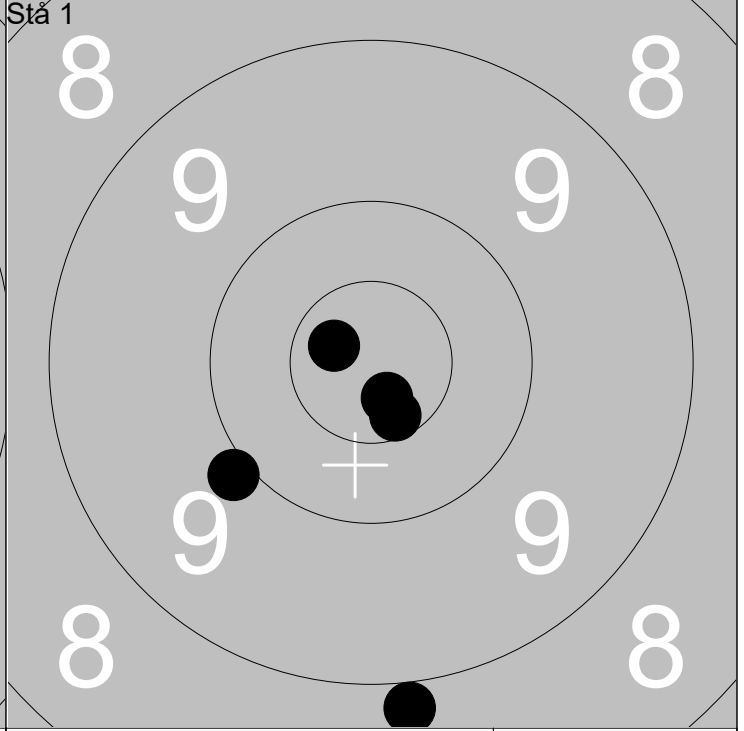
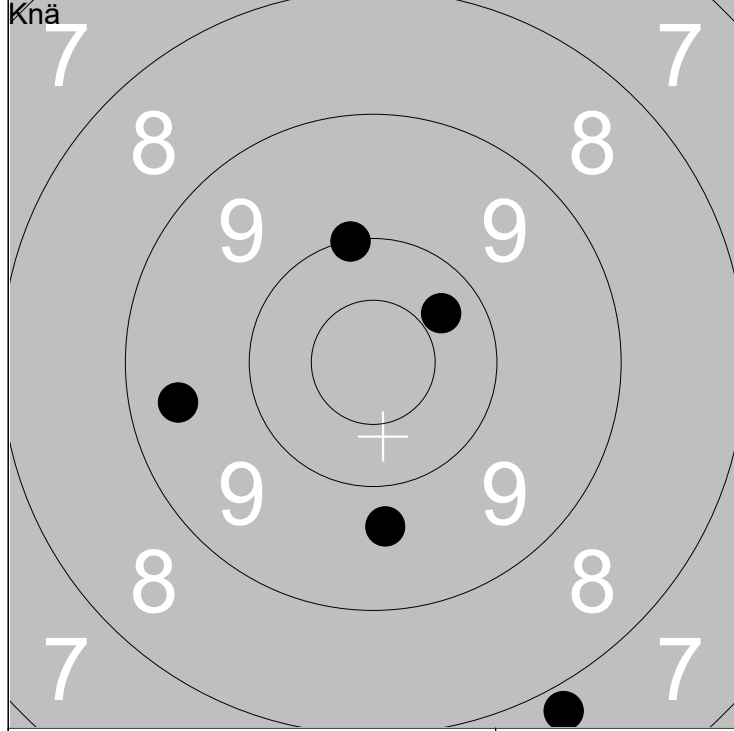

1:	10.3	↗
2:	9.7	↓
3:	10.0	↖
4:	7.8	↓
5:	9.4	←

Serie	45
Total	278

1:	10.6x	↓
2:	8.9	↓
3:	10.7x	↓
4:	10.7x	↖
5:	9.9	↖

Serie	47
Total	325

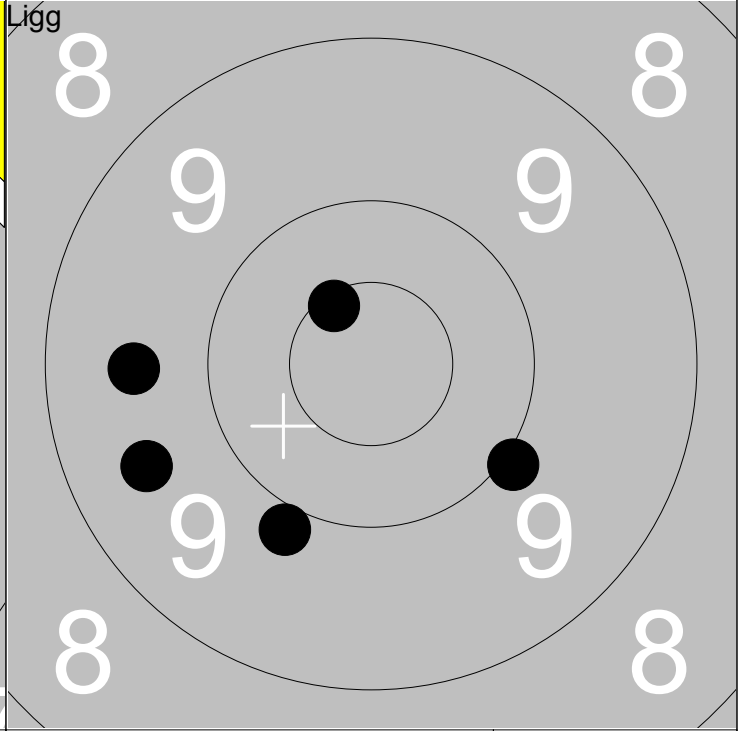
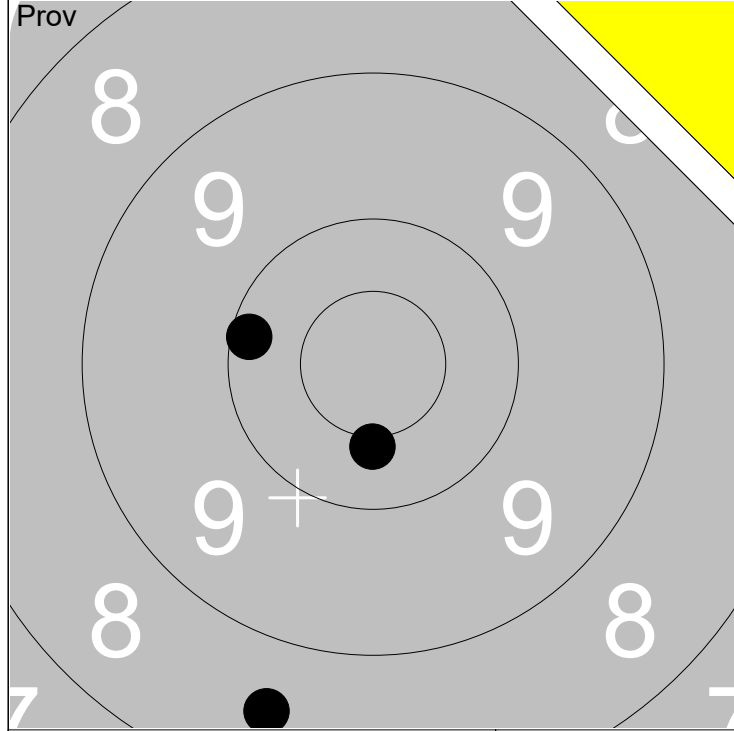

1: 10.4x ↓	Serie 28
2: 8.5 ↓	
3: 10.1 ←	
Total 188	

1: 10.6x ↖	Serie 47
2: 9.5 ←	
3: 9.6 ←	
Total 235	

1: 10.6x ↖	Serie 47
2: 9.5 ←	
3: 9.6 ←	
Total 235	

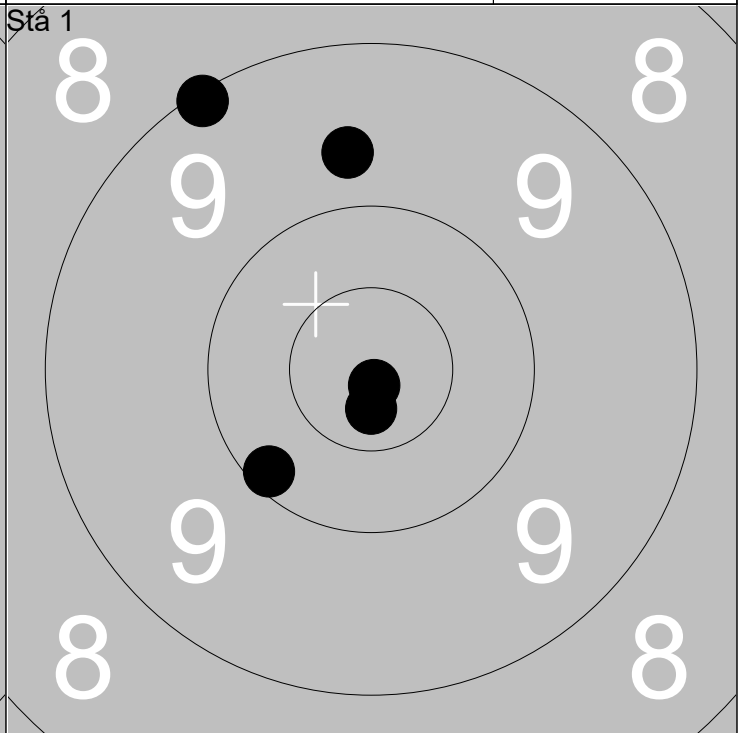
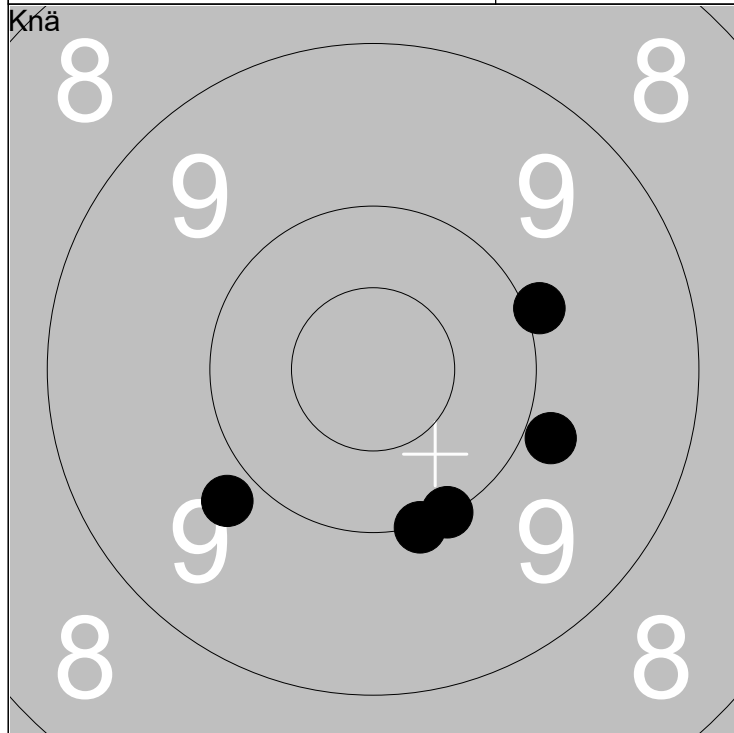

1: 9.9 →	Serie 47
2: 10.0 ↓	
3: 9.9 →	
Total 282	

1: 10.1 ↙	Serie 48
2: 10.9x ↓	
3: 9.1 ↖	
Total 330	

1: 10.1 ↙	Serie 48
2: 10.9x ↓	
3: 9.1 ↖	
Total 330	

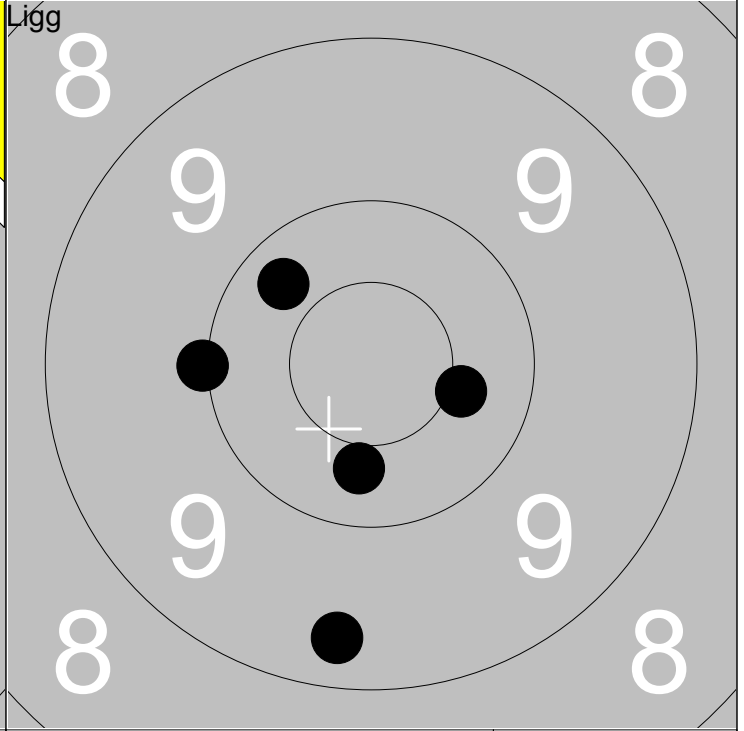
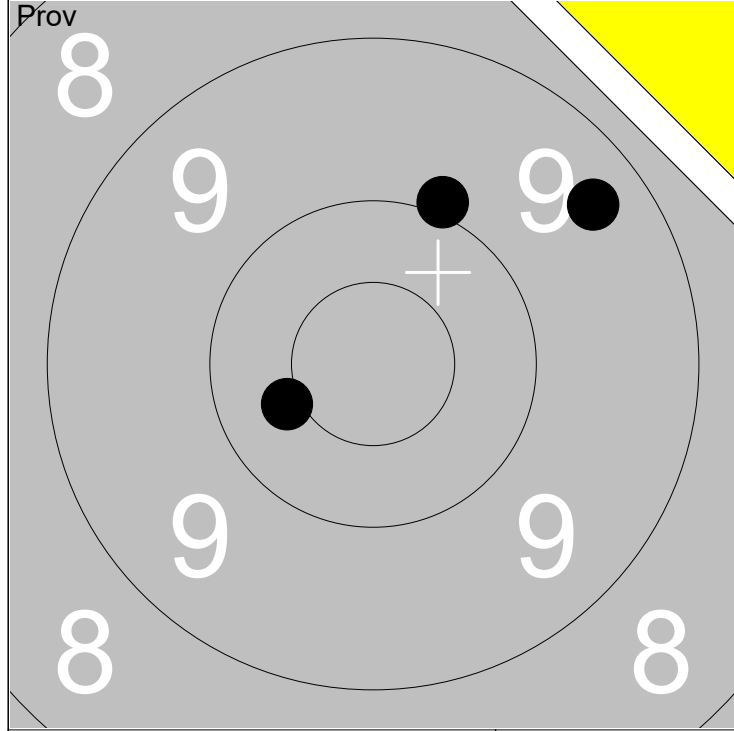

1: 10.4 ←
2: 9.9 ↑
3: 9.4 ↗

Serie	28
Total	187

1: 10.0 ←
2: 10.3 ↖
3: 10.4x →
4: 9.3 ↓
5: 10.4 ↓

Serie	49
Total	236

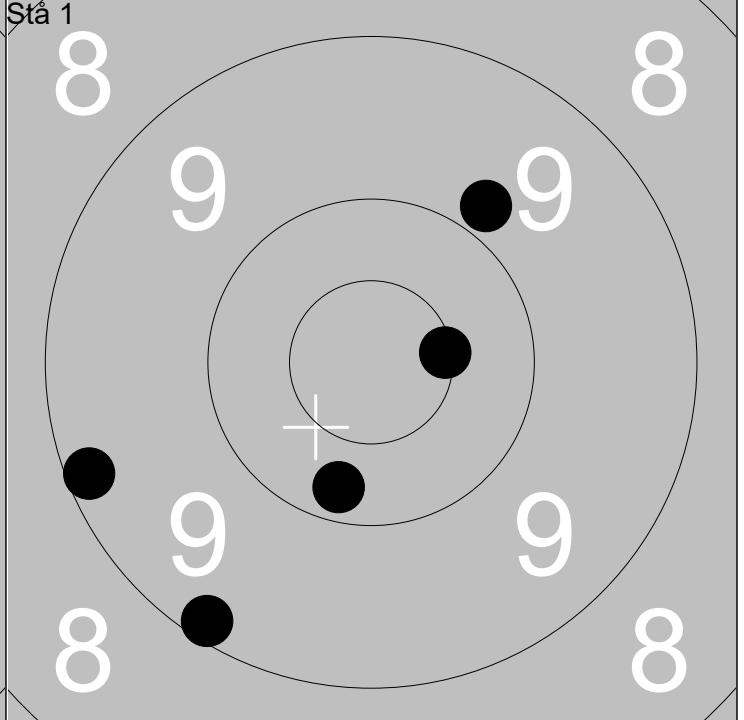
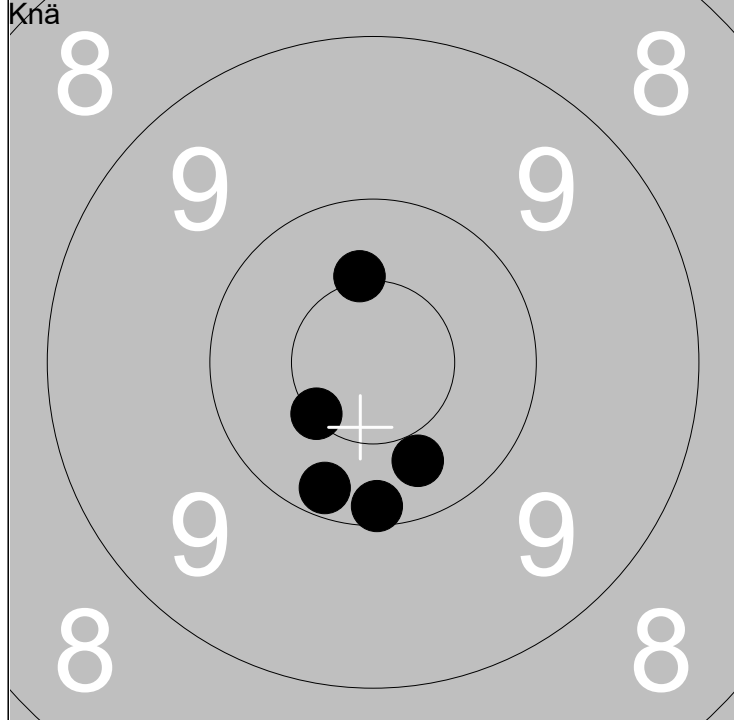

1: 10.5x ↑
2: 10.1 ↓
3: 10.5x ←
4: 10.3 ↓
5: 10.2 ↓

Serie	50
Total	286

1: 9.2 ←
2: 10.5x →
3: 9.8 ↗
4: 10.2 ↓
5: 9.2 ↓

Serie	47
Total	333

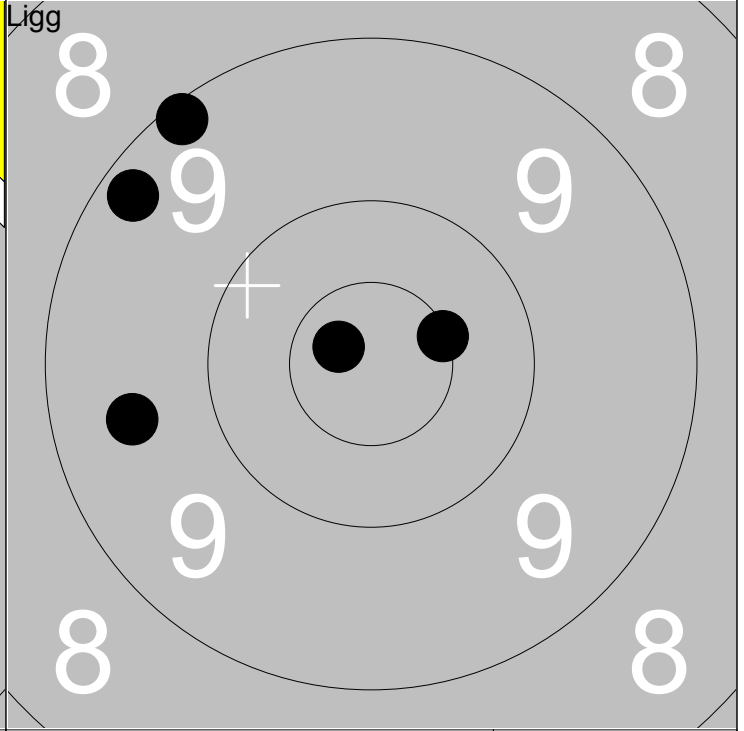
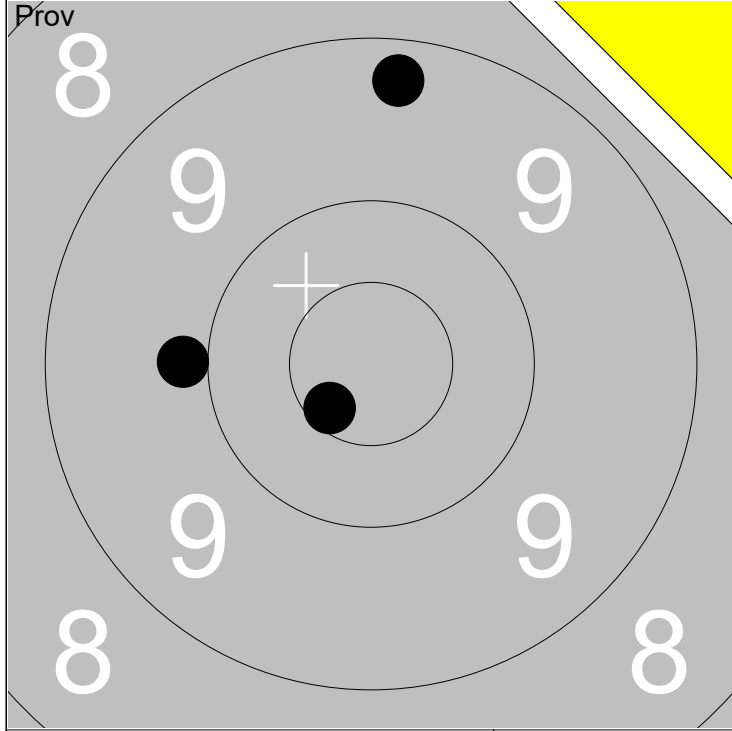

1: 9.3 ↑	Serie	28
2: 9.9 ←		
3: 10.6x ↙		
Total		187

1: 9.2 ↖	Serie	47
2: 10.7x ↖		
3: 9.5 ←		
4: 9.1 ↗		
5: 10.5x →		
Total		234

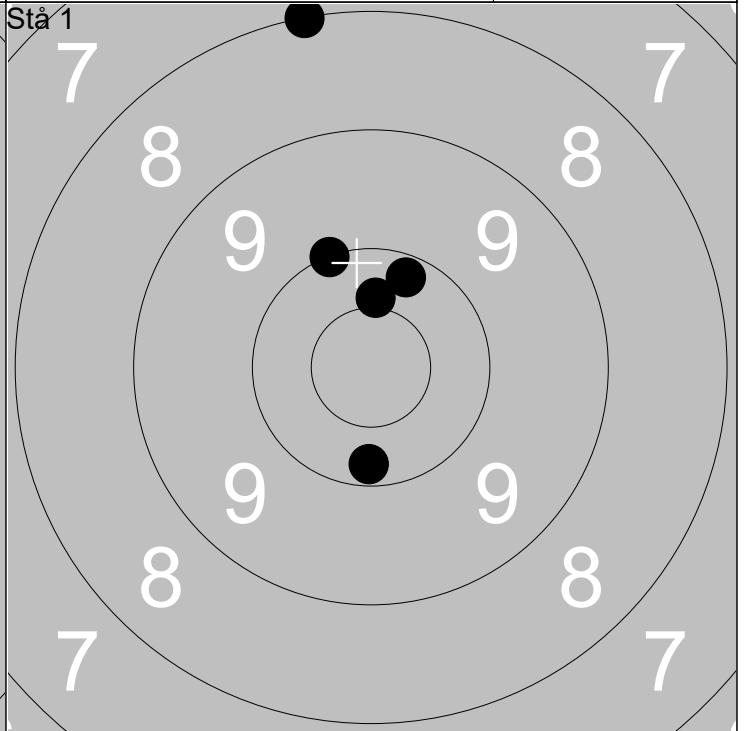
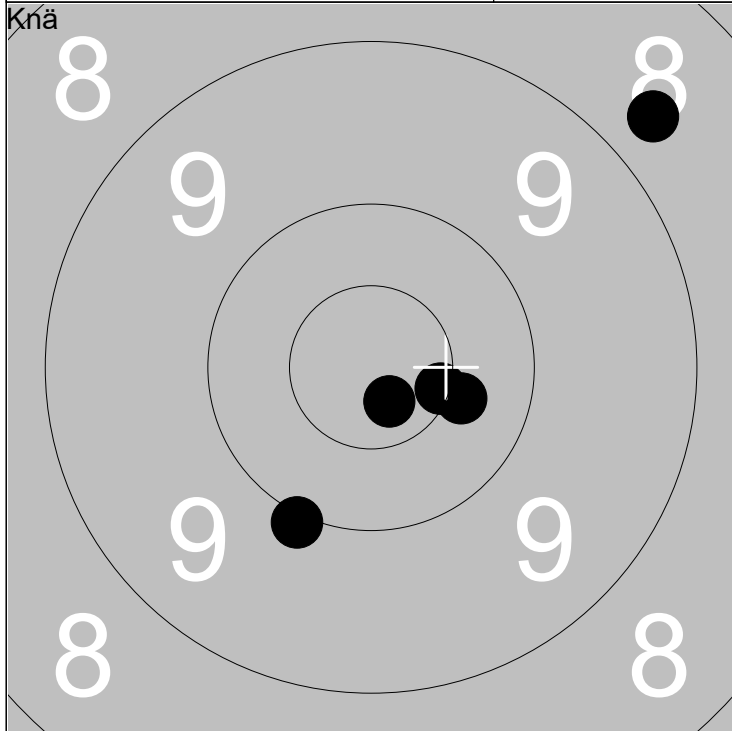

1: 8.7 ↗	Serie	48
2: 10.5x →		
3: 10.4 →		
4: 10.7x ↘		
5: 10.0 ↘		
Total		282

1: 10.4 ↑	Serie	48
2: 10.2 ↓		
3: 10.0 ↗		
4: 8.0 ↗		
5: 10.2 ↗		
Total		330

Skjutlag	Tavla	Leif Sandberg		
7	1	Ramselefors	Kalix	C No
07.07.2019	Tavelträffen 2019	Ramselefors SKF		
Prov 	1: 10.0 ↗ 2: 9.6 ↖ 3: 10.7x ↗	Ligg 	1: 10.3 ↙ 2: 10.1 → 3: 10.4x → 4: 10.4 ↗ 5: 9.6 ↘	
Serie 29		Serie 49		
Total 288		Total 337		
Prov 	1: 7.7 → 2: 9.5 ↖	Knä 	1: 10.7x ↘ 2: 8.5 ↘ 3: 9.7 → 4: 8.9 → 5: 9.7 ↘	
Serie 16		Serie 44		
Total 337		Total 381		
Stå 1 	1: 10.5x ↗ 2: 9.6 ↘ 3: 8.5 ↖ 4: 8.6 ↖ 5: 8.9 ↗	Extra 	1: 9.8 → 2: 9.7 ↘ 3: 9.8 ↗ 4: 8.8 ↗ 5: 9.8 ↗ 6: 10.5x ↘	
Serie 43		Serie 54		
Total 424		Total 424		

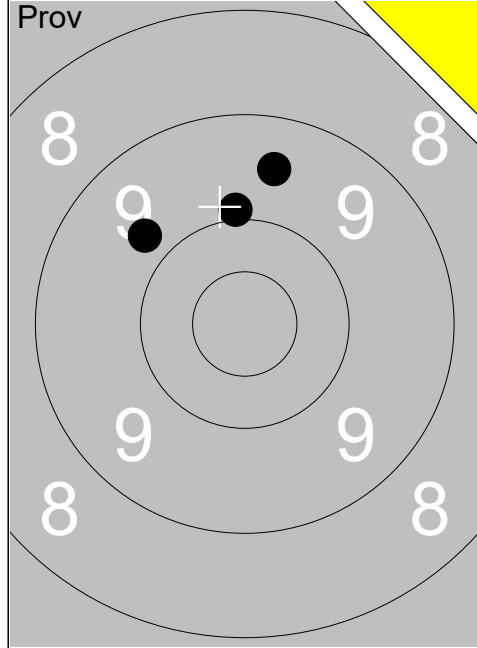

1:	9.5	↑
2:	9.9	↑
3:	9.8	↖
Serie		27
Total		286

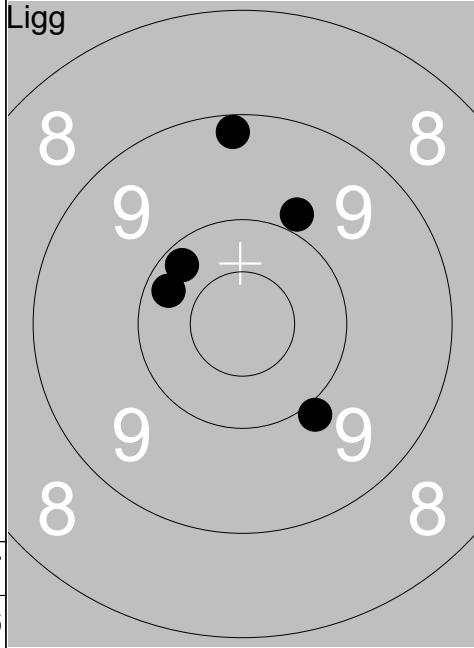

1:	10.2	↖
2:	9.2	↑
3:	9.9	↗
4:	9.9	↘
5:	10.2	↖
Serie		47
Total		333

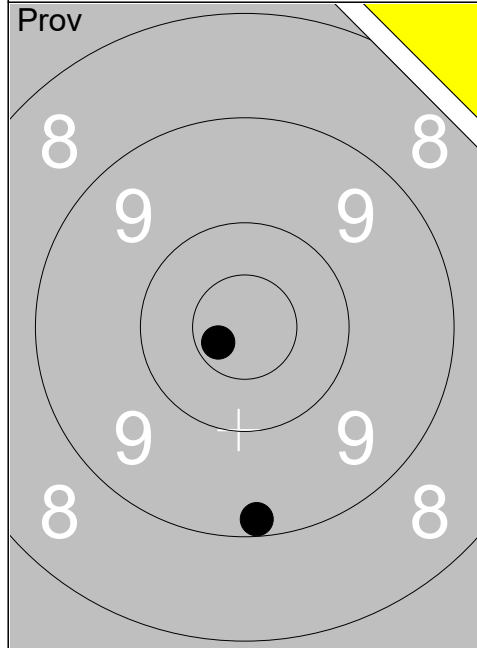

1:	9.2	↓
2:	10.7x	↙
Serie		19
Total		333

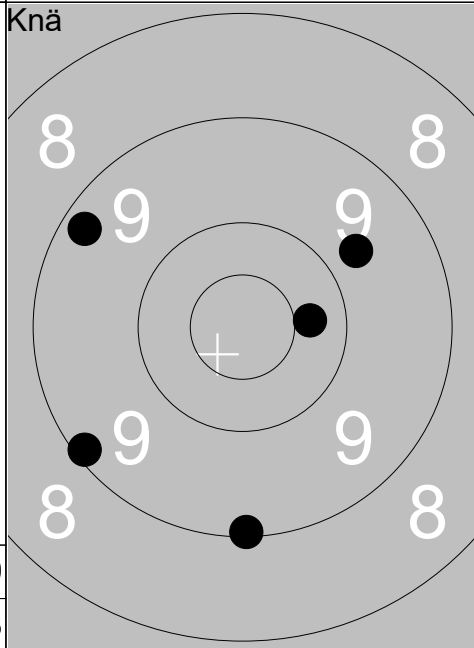

1:	9.1	↓
2:	9.1	↙
3:	9.3	↖
4:	9.7	↗
5:	10.3	→
Serie		46
Total		379

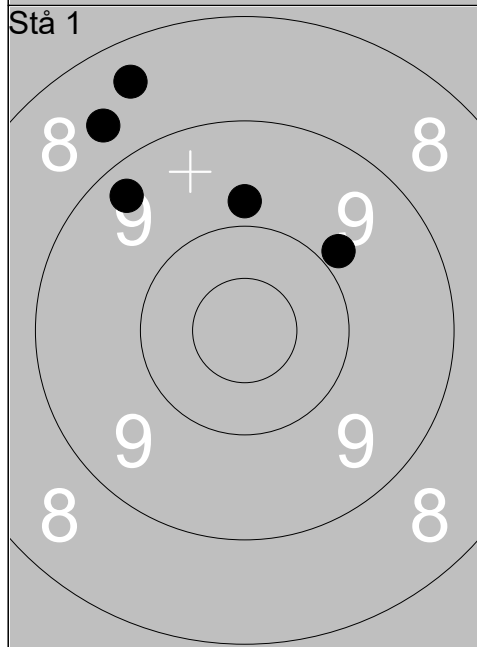

1:	8.4	↖
2:	9.9	↗
3:	8.7	↖
4:	9.8	↑
5:	9.3	↖
Serie		43
Total		422

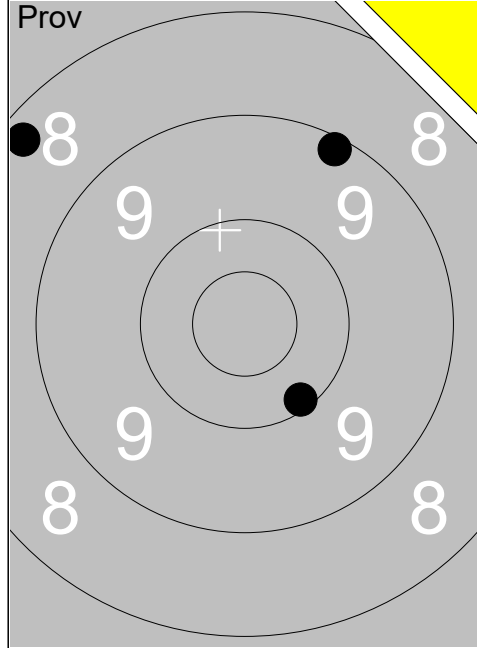

1:	10.1	↘
2:	9.1	↗
3:	8.3	↖
Serie		27
Total		284

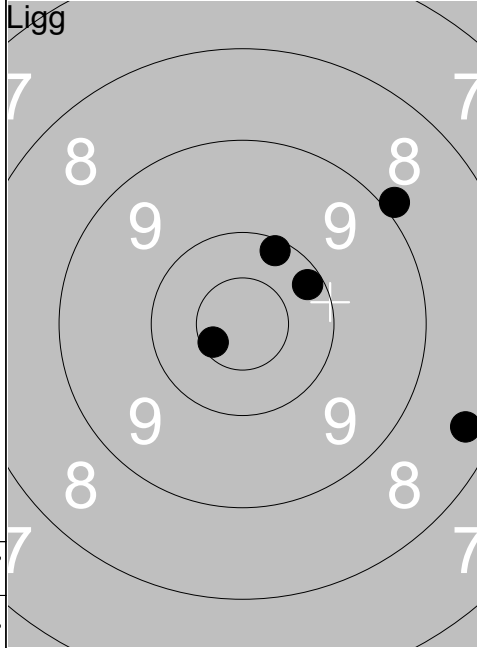

1:	8.9	↗
2:	10.6x	↙
3:	10.2	↗
4:	10.1	↗
5:	8.4	↘
Serie		46
Total		330

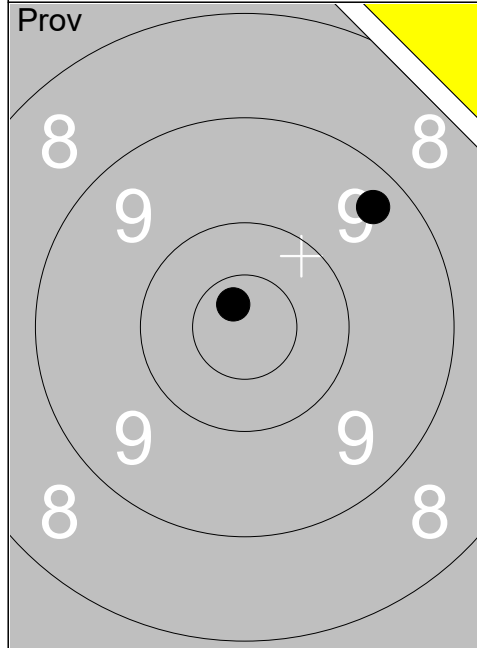

1:	10.7x	↖
2:	9.3	↗
Serie		19
Total		330

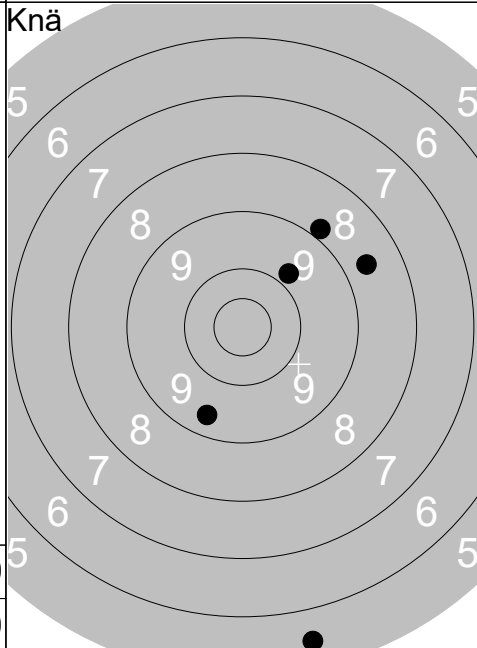

1:	9.4	↘
2:	8.6	↗
3:	9.8	↗
4:	5.5	↘
5:	8.9	↗
Serie		39
Total		369

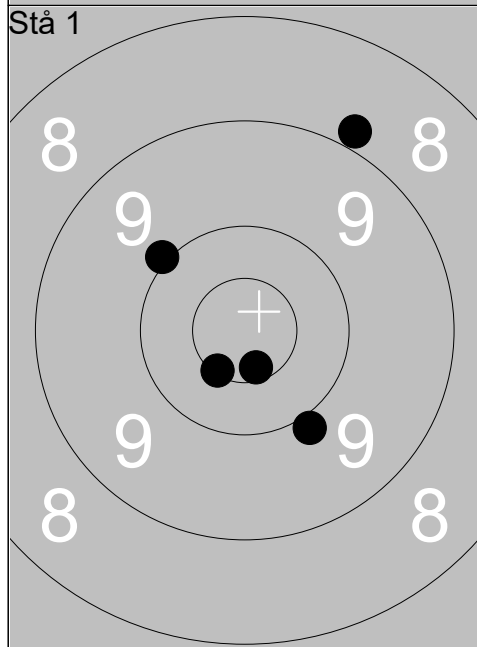

1:	8.9	↗
2:	10.6x	↘
3:	9.9	↘
4:	10.0	↖
5:	10.5x	↙
Serie		47
Total		416

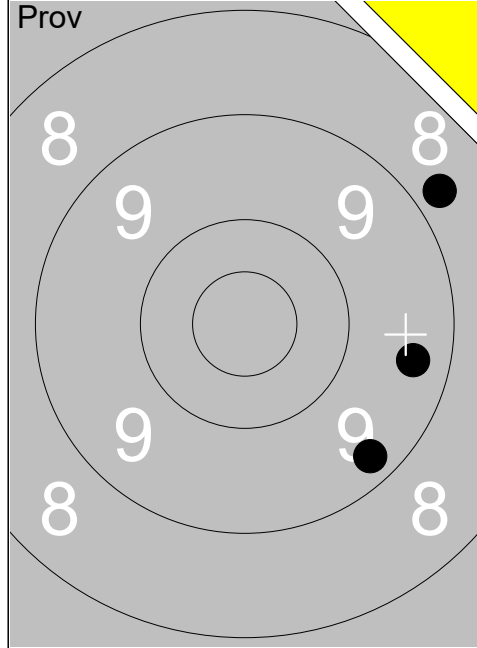

1:	8.8	↗
2:	9.3	↘
3:	9.4	→
Serie		26
Total		283

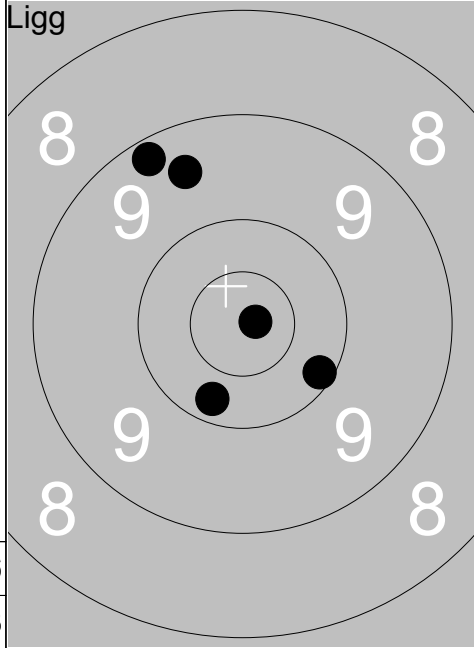

1:	10.1	↘
2:	9.5	↑
3:	10.8x	→
4:	9.2	↖
5:	10.2	↘
Serie		48
Total		331

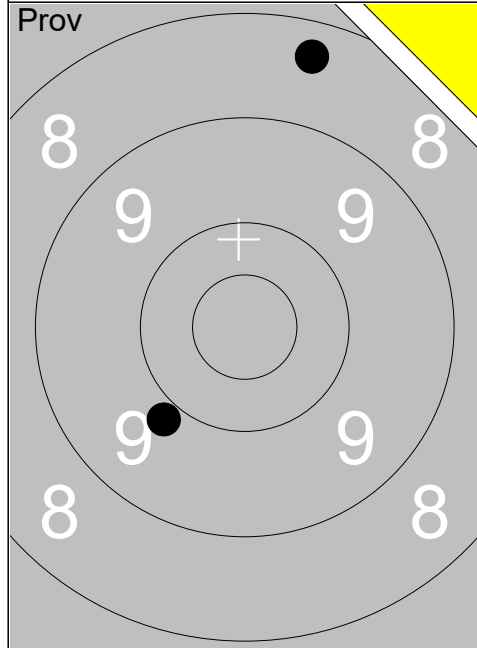

1:	8.4	↑
2:	9.9	↘
Serie		17
Total		331

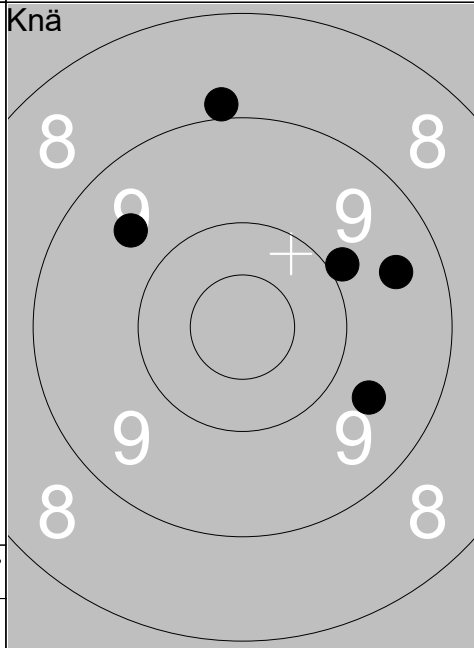

1:	8.9	↑
2:	9.5	→
3:	9.9	↗
4:	9.6	↖
5:	9.6	↘
Serie		44
Total		375

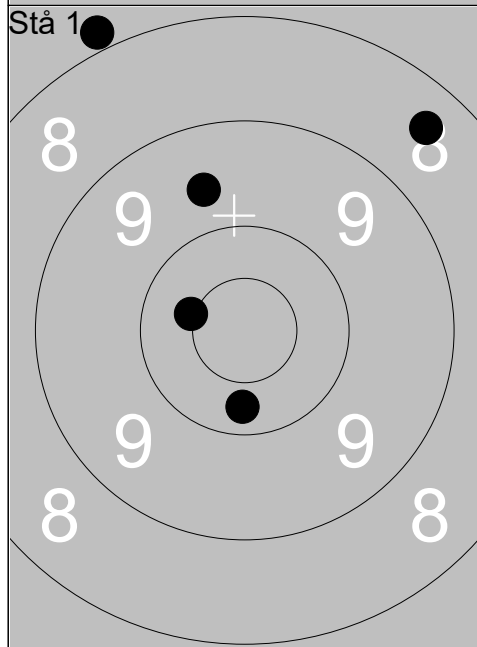

1:	10.3	↓
2:	9.6	↑
3:	7.9	↖
4:	10.5x	←
5:	8.4	↗
Serie		44
Total		419

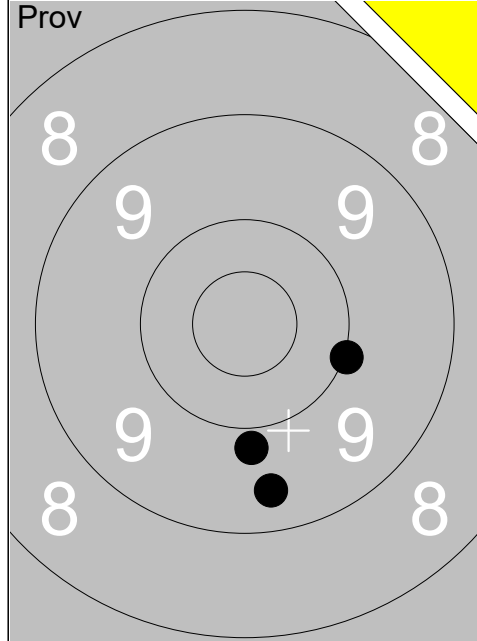

1:	9.4	↓
2:	10.0	→
3:	9.8	↓
Serie 28		
Total 282		

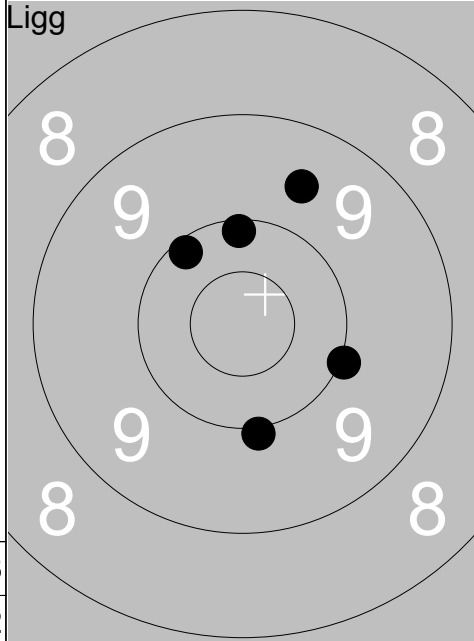

1:	10.1	↖
2:	10.1	↑
3:	10.0	→
4:	9.6	↗
5:	10.0	↓
Serie 49		
Total 331		

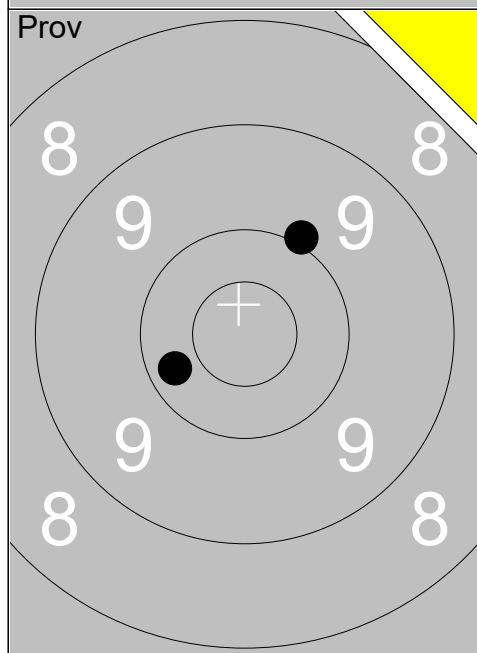

1:	10.3	↙
2:	10.0	↗
Serie 20		
Total 331		

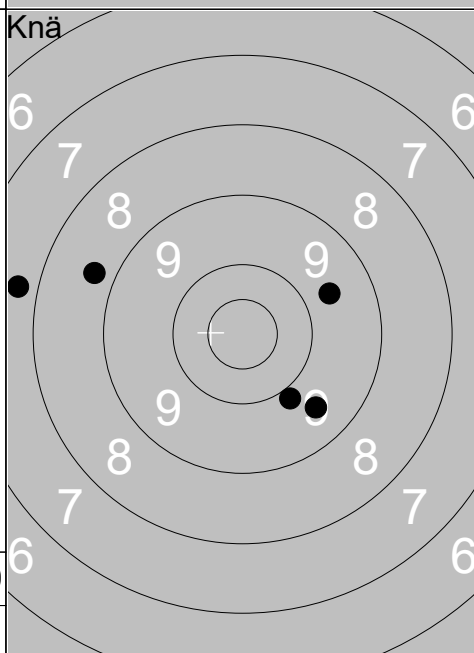

1:	7.7	↙
2:	8.7	↙
3:	9.6	→
4:	9.9	↓
5:	9.5	↘
Serie 42		
Total 373		

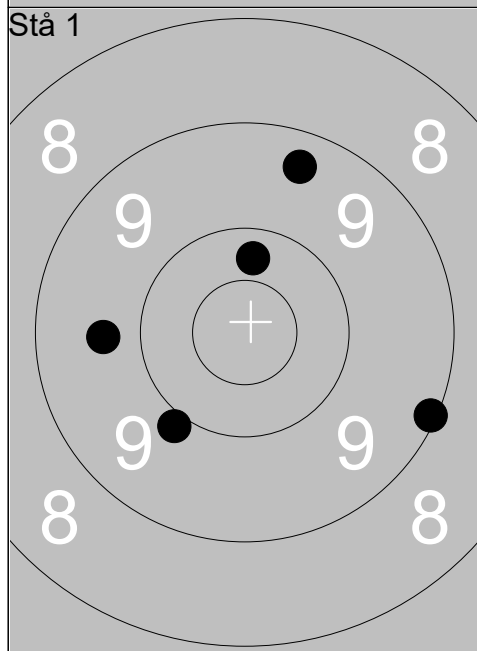

1:	9.4	↗
2:	10.3	↑
3:	9.7	↙
4:	9.1	→
5:	9.9	↘
Serie 46		
Total 419		

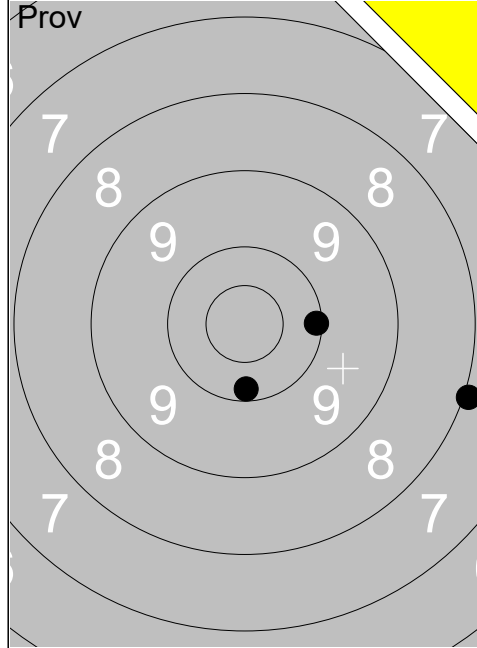

1:	10.1	→
2:	8.0	→
3:	10.2	↓
Serie 28		
Total 282		

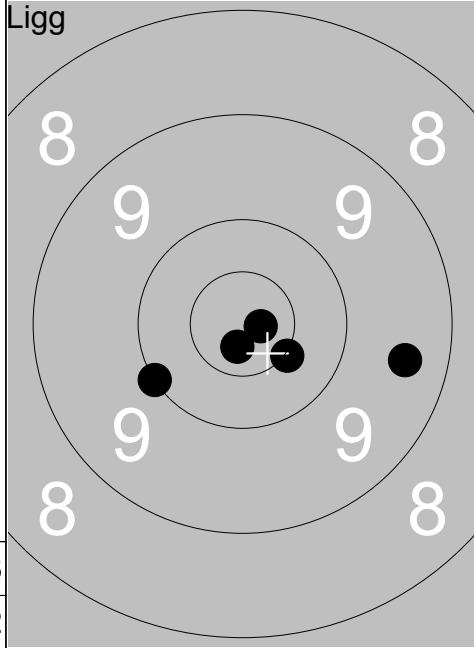

1:	10.0	↙
2:	10.7x	↓
3:	10.5x	↘
4:	9.4	→
5:	10.8x	→
Serie 49		
Total 331		

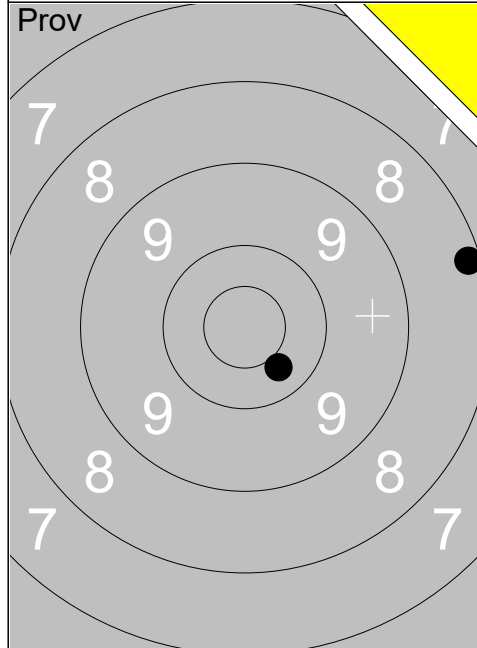

1:	8.2	→
2:	10.4	↘
Serie 18		
Total 331		

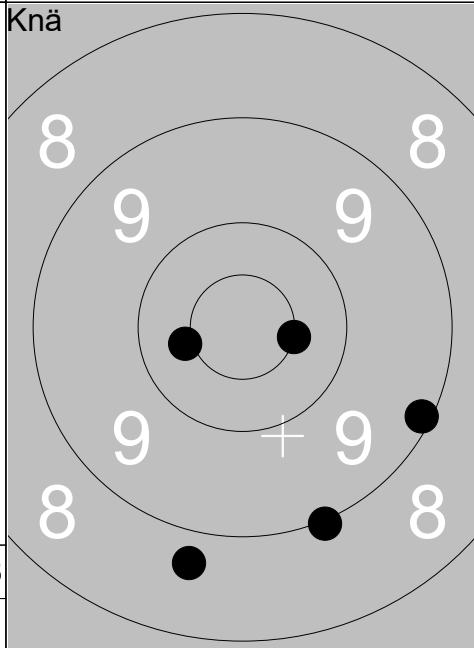

1:	10.5x	→
2:	9.1	→
3:	9.0	↓
4:	8.7	↓
5:	10.4x	↙
Serie 46		
Total 377		

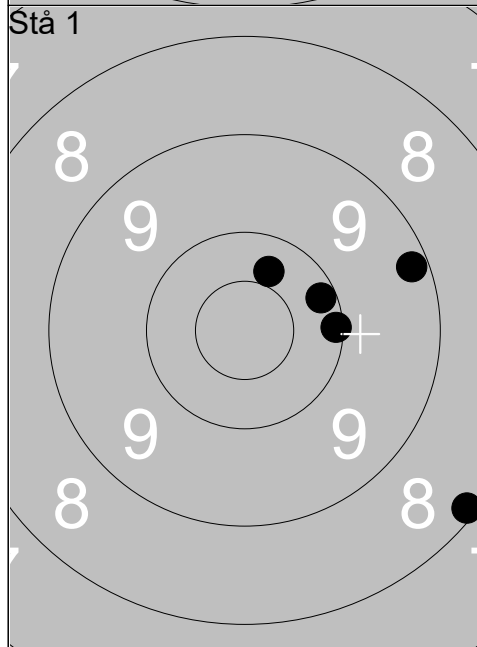

1:	8.1	↘
2:	10.3	↗
3:	10.1	→
4:	9.2	→
5:	10.2	→
Serie 47		
Total 424		

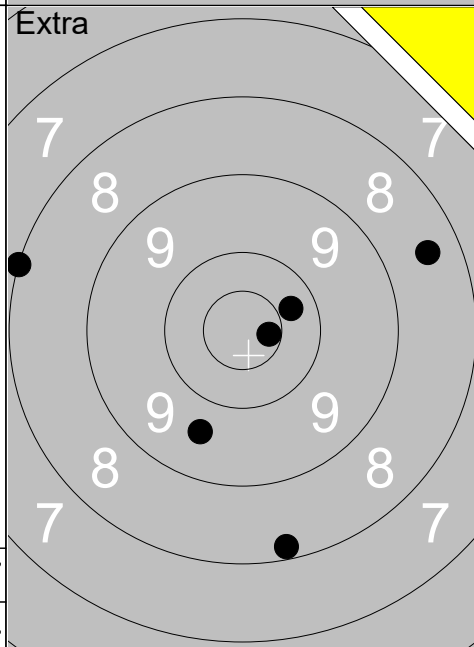

1:	8.0	↙
2:	9.6	↓
3:	10.6x	→
4:	10.3	→
5:	8.2	↓
6:	8.5	→
Serie 53		
Total 424		

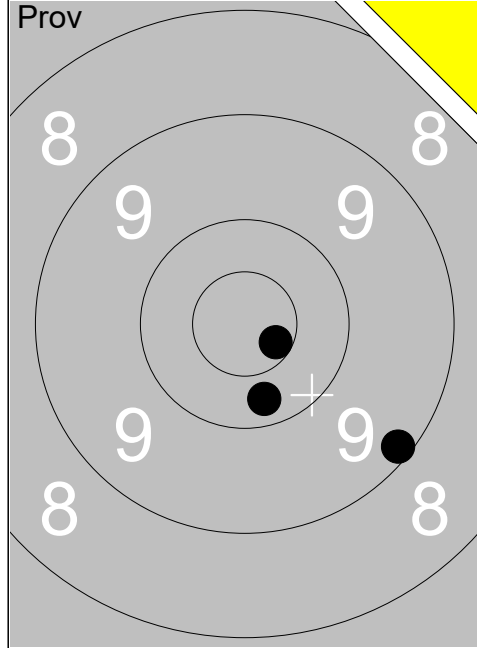

1:	9.2	↘
2:	10.3	↘
3:	10.6x	↘
Serie		29
Total		281

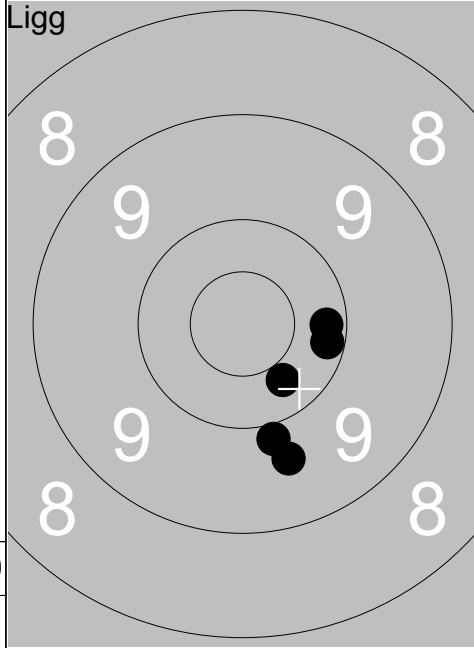

1:	9.9	↘
2:	10.2	→
3:	9.7	↘
4:	10.3	↘
5:	10.2	→
Serie		48
Total		329

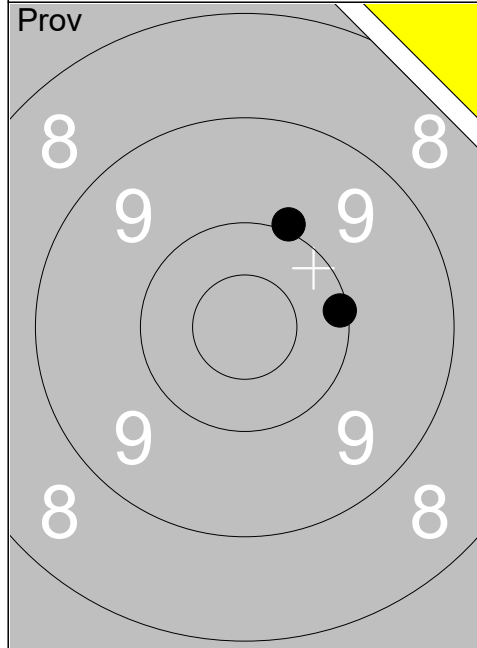

1:	10.1	→
2:	10.0	↑
Serie		20
Total		329

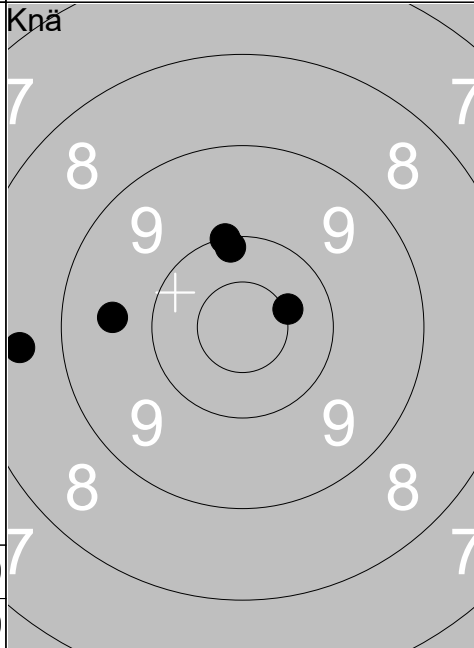

1:	10.4x	→
2:	9.6	←
3:	10.0	↑
4:	10.1	↑
5:	8.6	←
Serie		47
Total		376

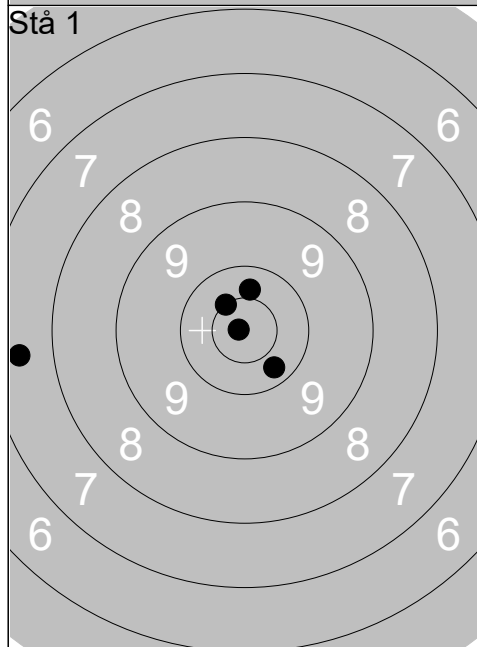

1:	10.5x	↖
2:	10.4	↑
3:	10.9x	←
4:	10.3	↘
5:	7.5	←
Serie		47
Total		423

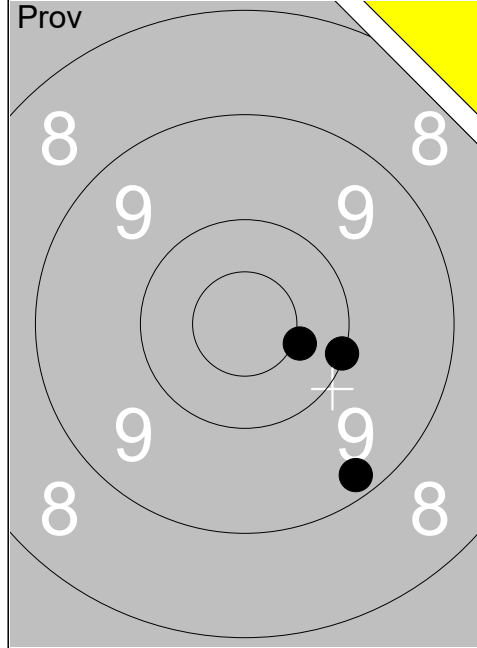

1:	10.4x	➤
2:	10.0	➤
3:	9.2	↘
Serie 29		
Total 281		

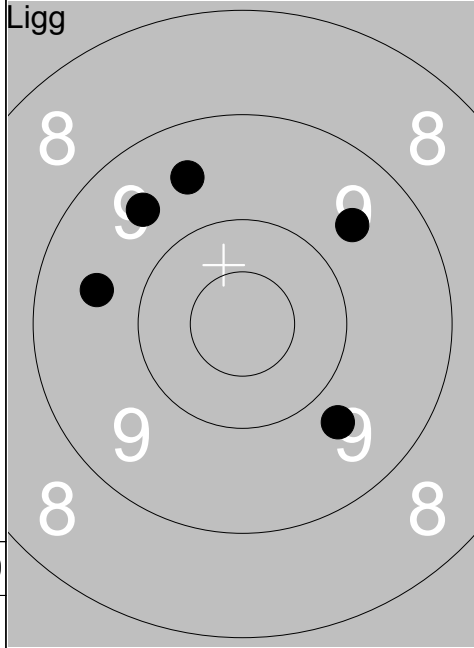

1:	9.7	↘
2:	9.6	↗
3:	9.6	←
4:	9.6	↗
5:	9.5	↗
Serie 45		
Total 326		

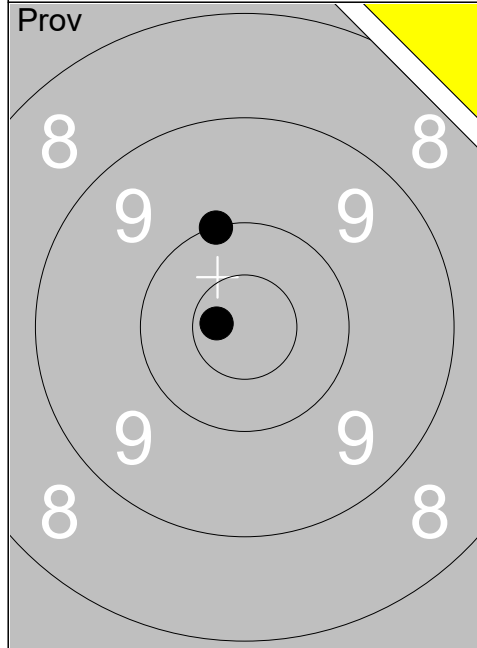

1:	10.0	↗
2:	10.7x	←
Serie 20		
Total 326		

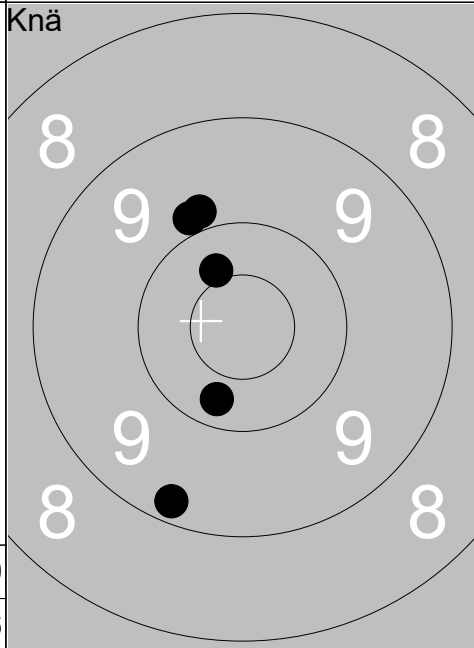

1:	9.9	↗
2:	10.4	↗
3:	9.2	↘
4:	9.8	↗
5:	10.3	↘
Serie 47		
Total 373		

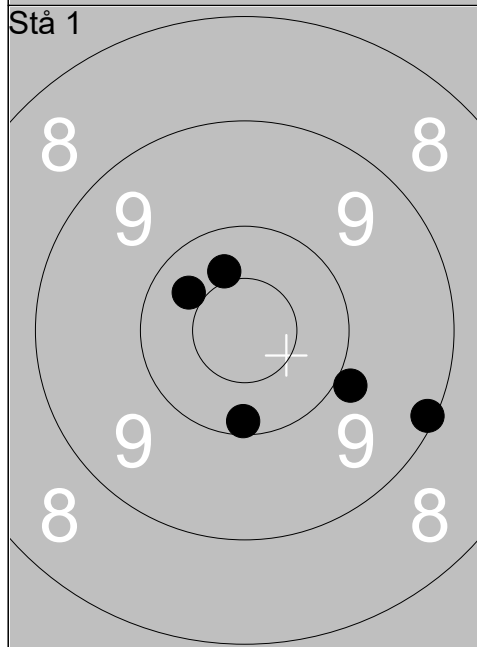

1:	9.1	➤
2:	10.1	↘
3:	10.4	↗
4:	10.4	↖
5:	9.9	↘
Serie 48		
Total 421		

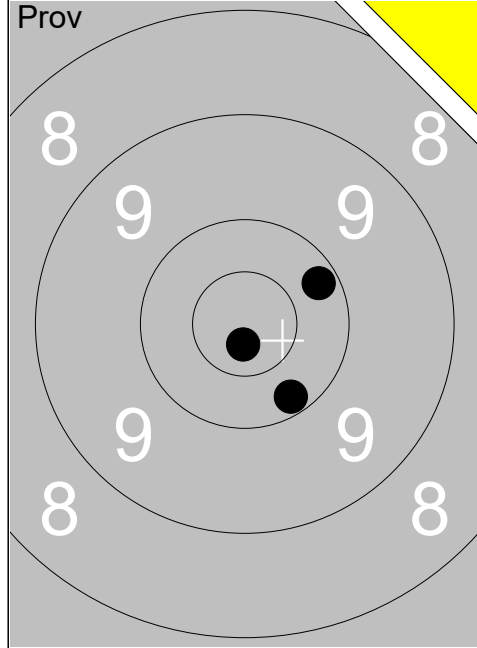

1:	10.2	↘
2:	10.2	↗
3:	10.8x	↓
Serie		30
Total		279

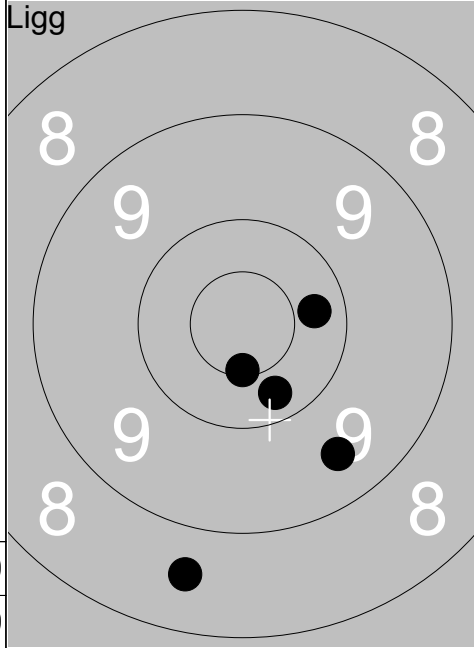

1:	9.5	↘
2:	8.6	↓
3:	10.5x	↓
4:	10.3	↗
5:	10.3	↘
Serie		47
Total		326

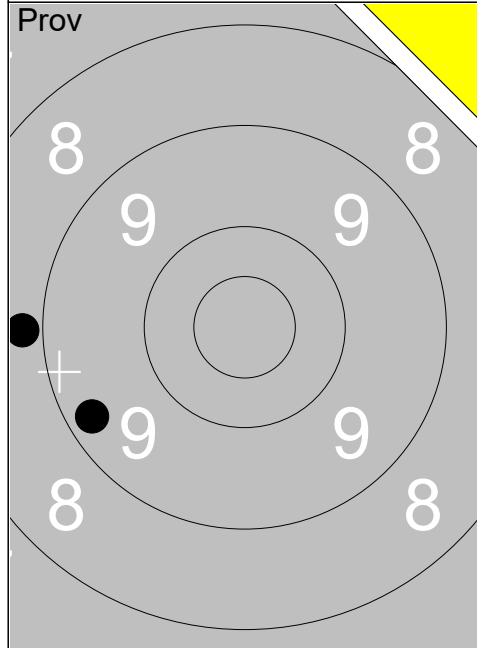

1:	8.8	←
2:	9.3	←
Serie		17
Total		326

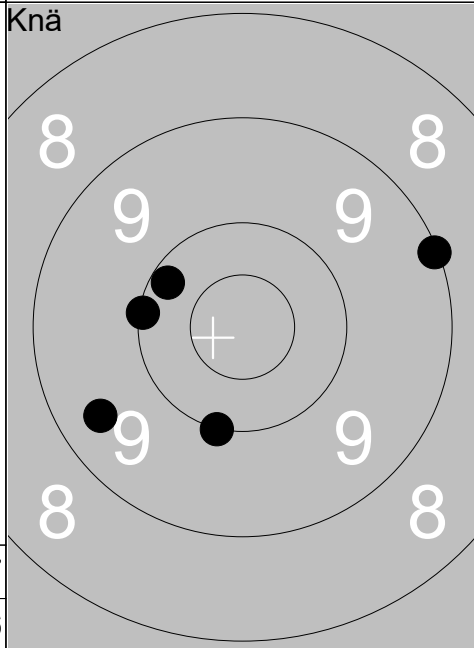

1:	9.4	↙
2:	10.0	↓
3:	10.2	↖
4:	9.1	↗
5:	10.1	←
Serie		48
Total		374

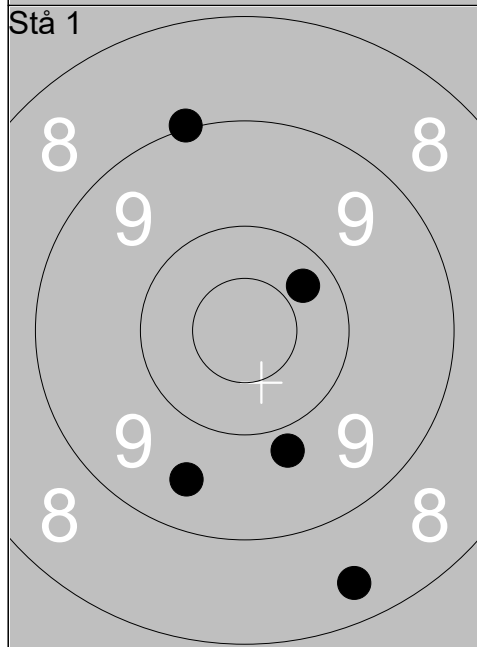

1:	8.4	↘
2:	10.3	↗
3:	9.5	↓
4:	9.0	↑
5:	9.8	↘
Serie		45
Total		419

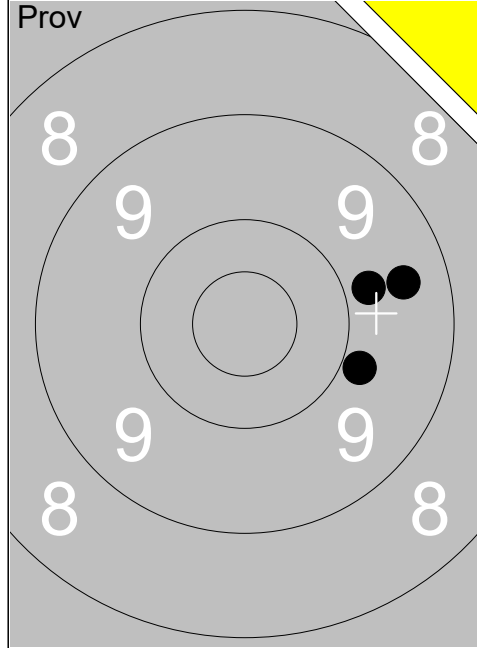

1:	9.8	→
2:	9.5	→
3:	9.9	→
<hr/>		
Serie	27	
Total	278	

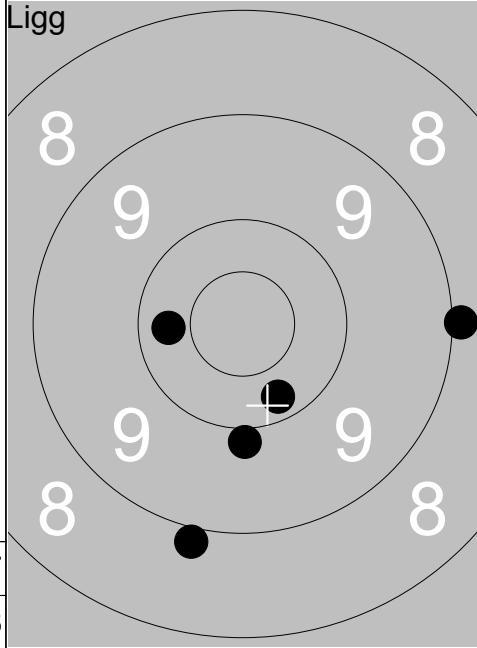

1:	8.9	→
2:	10.3	←
3:	9.9	↓
4:	8.9	↓
5:	10.2	↓
<hr/>		
Serie	45	
Total	323	

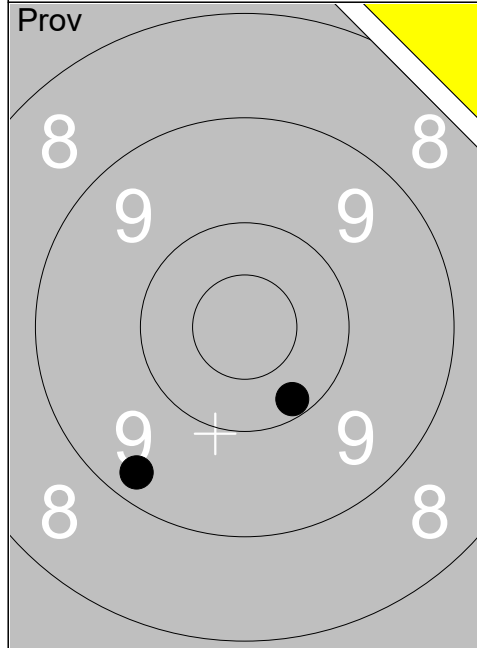

1:	10.2	↓
2:	9.3	↓
<hr/>		
Serie	19	
Total	323	

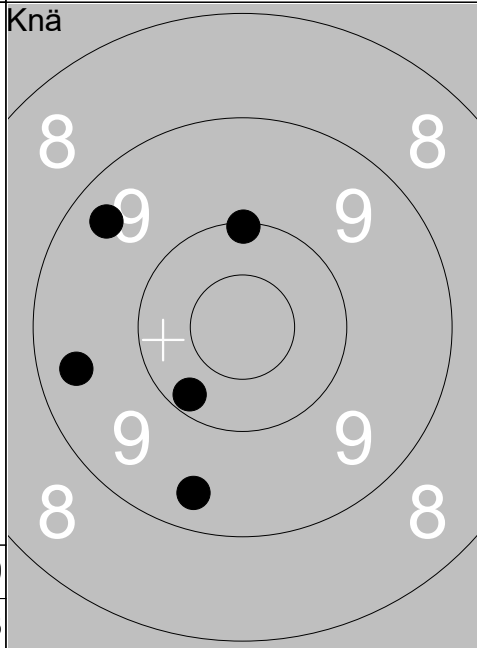

1:	9.4	↓
2:	10.2	↓
3:	9.4	↖
4:	9.4	←
5:	10.1	↑
<hr/>		
Serie	47	
Total	370	

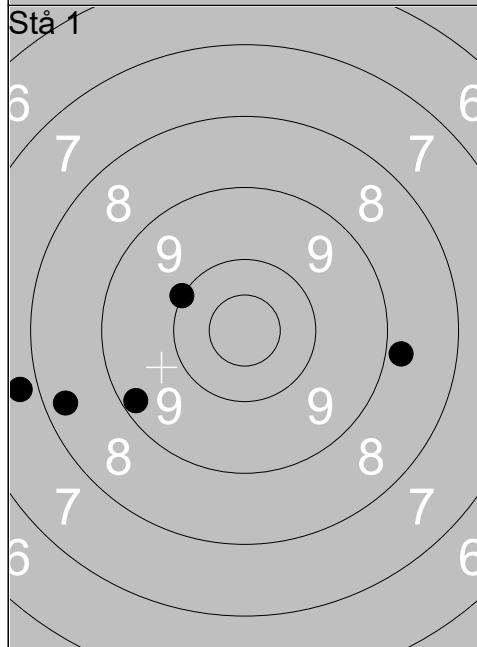

1:	9.2	↙
2:	7.8	←
3:	8.8	→
4:	10.0	↖
5:	8.3	←
<hr/>		
Serie	42	
Total	412	

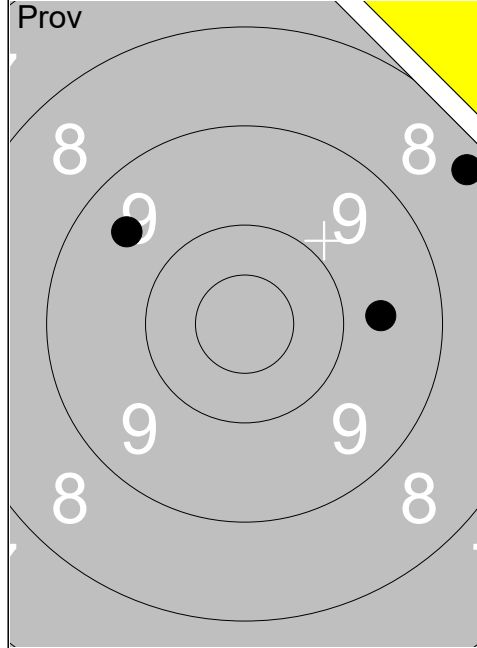

1:	9.7	→
2:	8.3	↗
3:	9.5	↖
Serie		26
Total		278

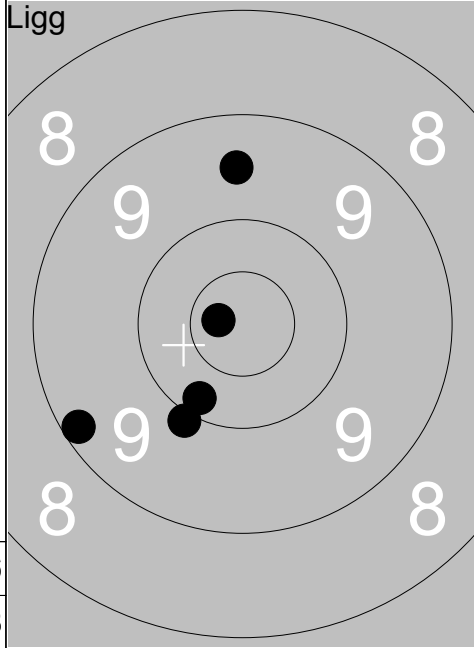

1:	10.7x	←
2:	10.2	↘
3:	9.2	↖
4:	10.0	↘
5:	9.5	↑
Serie		48
Total		326

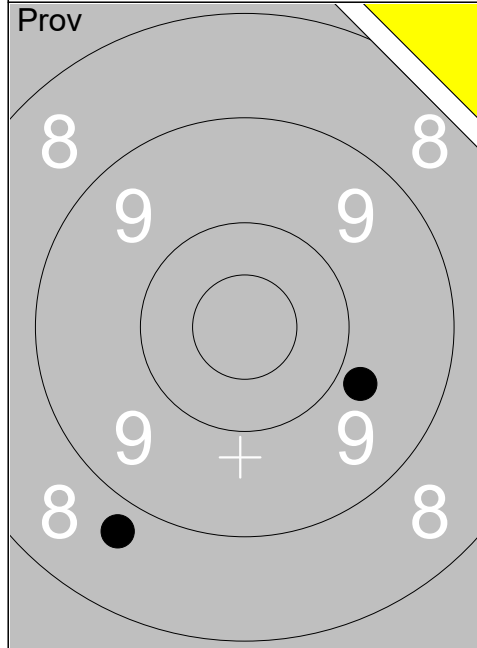

1:	9.8	↗
2:	8.7	↘
Serie		17
Total		326

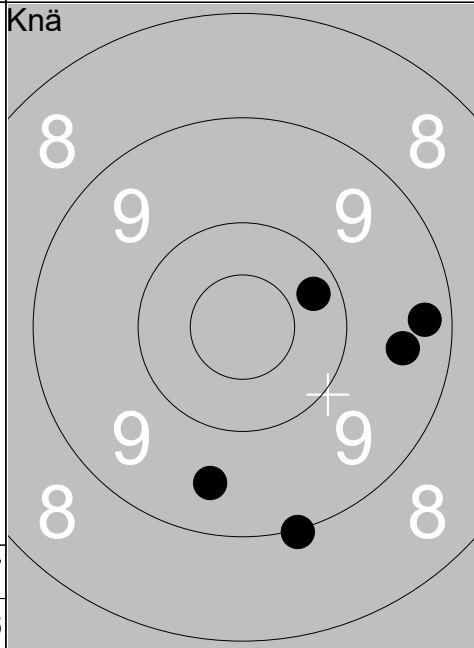

1:	9.3	→
2:	9.5	↘
3:	9.0	↘
4:	9.5	→
5:	10.3	↗
Serie		46
Total		372

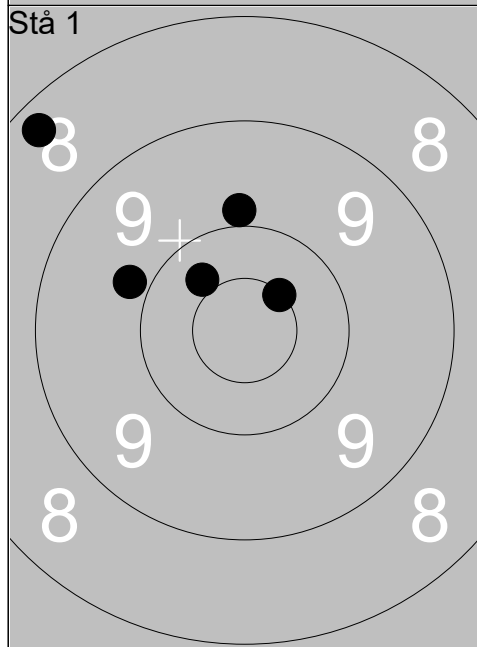

1:	9.8	↖
2:	9.9	↑
3:	10.5x	↗
4:	10.4	↖
5:	8.3	↖
Serie		46
Total		418

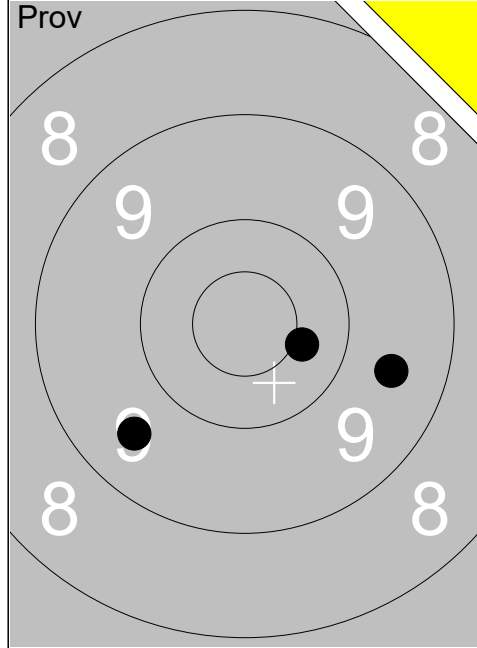

1:	9.6	➔
2:	10.4	➔
3:	9.5	↙
Serie		28
Total		274

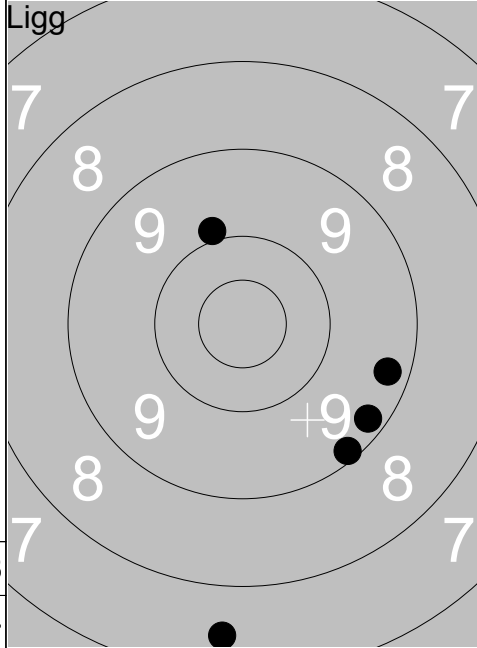

1:	9.9	↗
2:	9.2	↘
3:	9.1	↘
4:	9.3	➔
5:	7.5	↓
Serie		43
Total		317

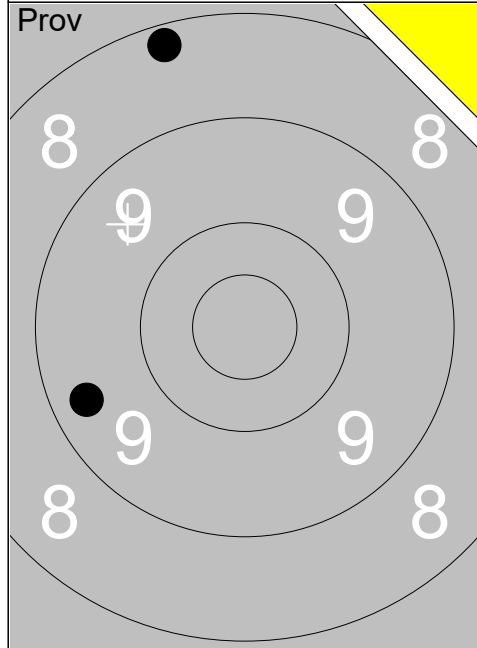

1:	9.4	↙
2:	8.2	↗
Serie		17
Total		317

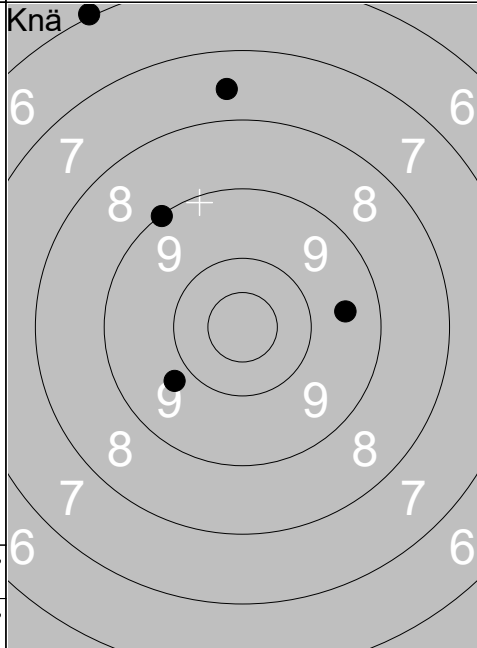

1:	9.0	↖
2:	9.5	➔
3:	7.6	↗
4:	6.0	↗
5:	9.8	↙
Serie		40
Total		357

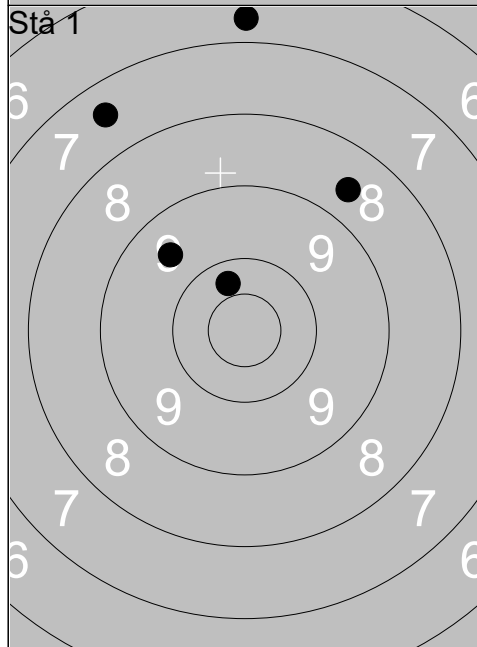

1:	6.7	↗
2:	8.6	↗
3:	7.5	↗
4:	10.3	↗
5:	9.6	↙
Serie		40
Total		397

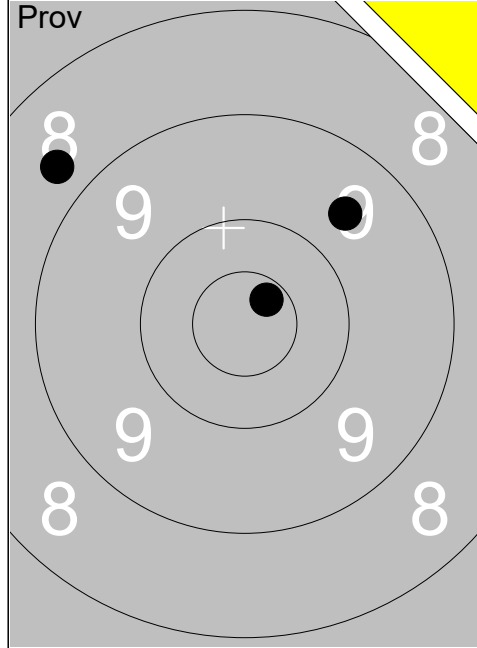

1:	8.7	↖
2:	9.6	↗
3:	10.7x	↗
Serie		27
Total		274

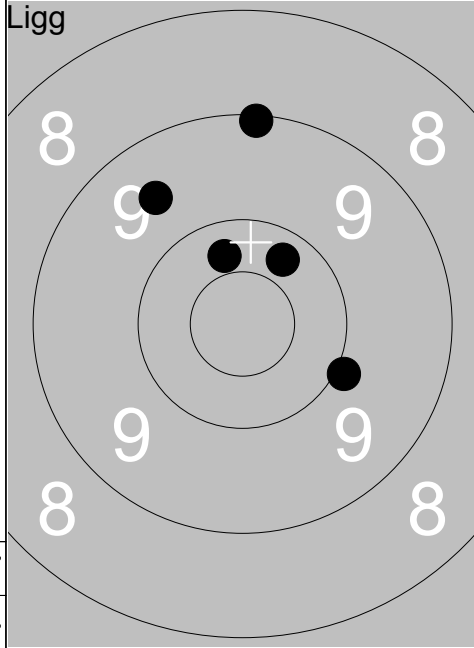

1:	10.3	↑
2:	10.3	↗
3:	9.1	↑
4:	9.6	↗
5:	10.0	➤
Serie		48
Total		322

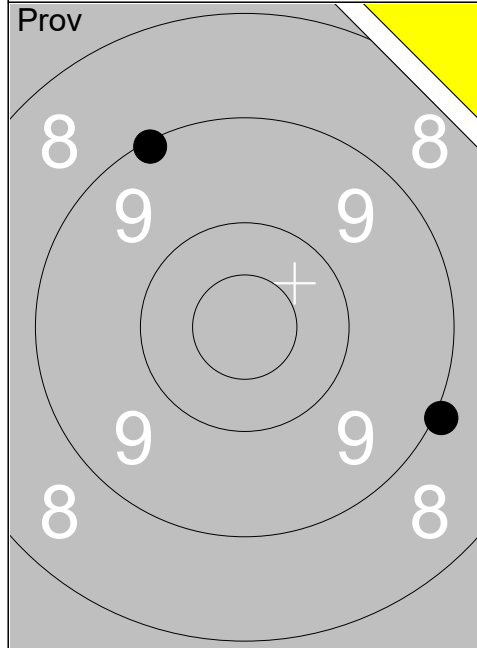

1:	9.0	➤
2:	9.1	↑
Serie		18
Total		322

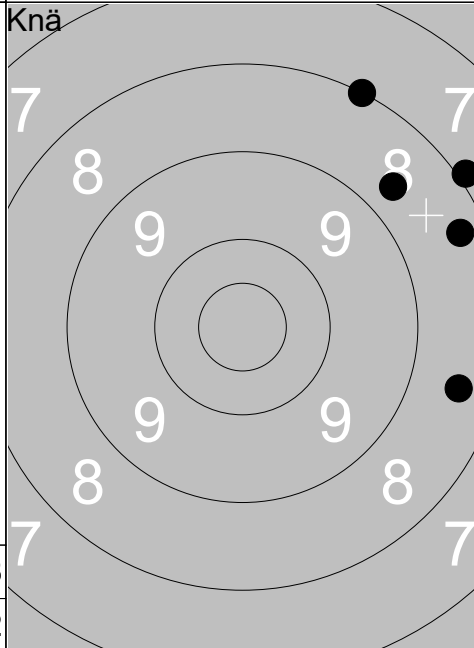

1:	8.0	↑
2:	8.3	➤
3:	7.9	↗
4:	8.5	➤
5:	8.7	↗
Serie		39
Total		361

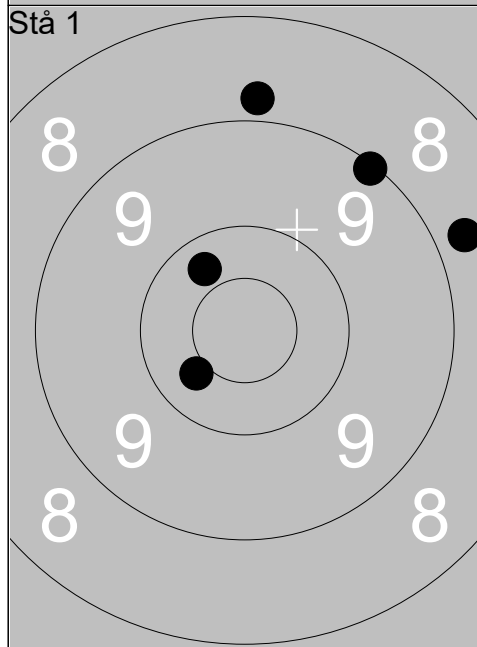

1:	10.3	↖
2:	8.8	↑
3:	8.7	➤
4:	9.1	↗
5:	10.4	↙
Serie		45
Total		406

Skjutlag

7

Tavla

14

Dan-Ivan Karlsson

Ramselefors

Ramselefors

C

Vb

07.07.2019

Tavelträffen 2019

Ramselefors SKF

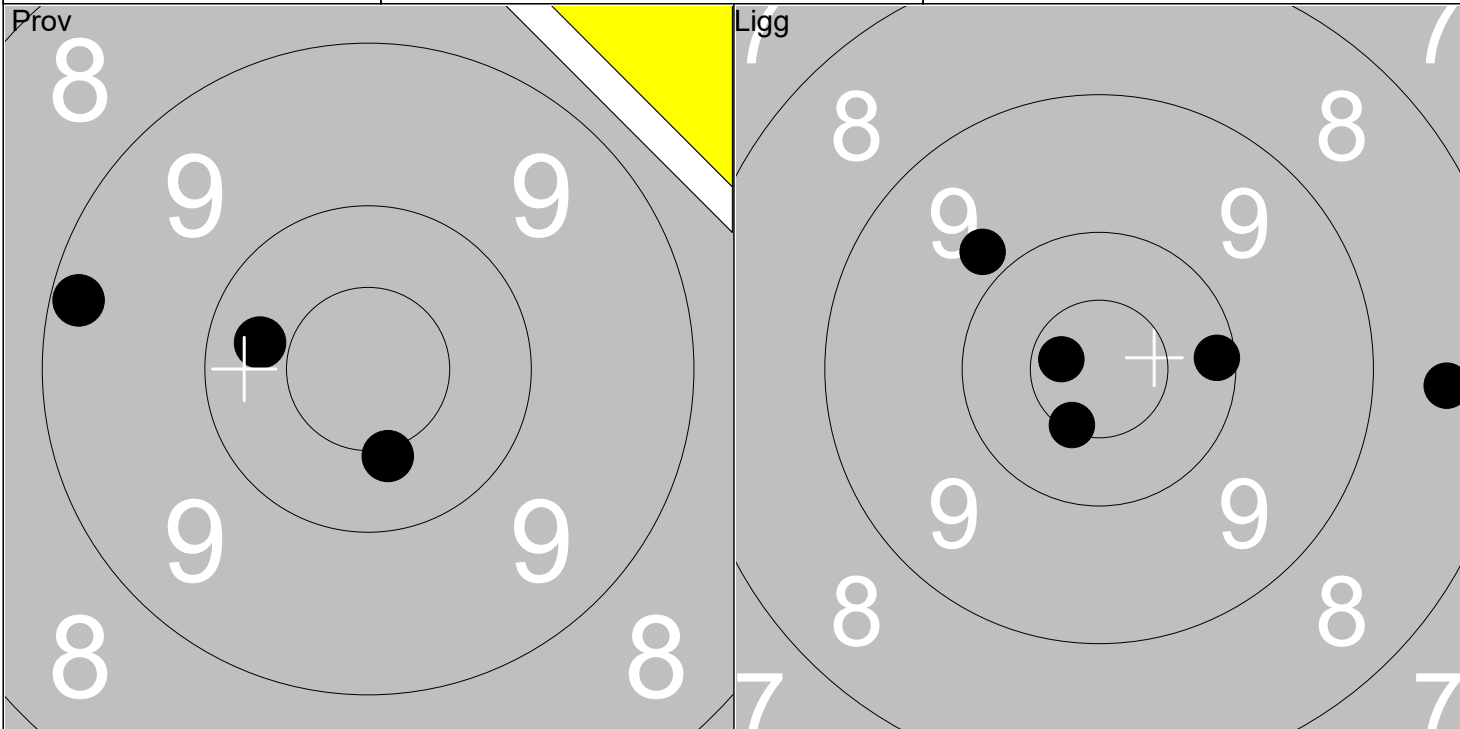

1: 9.2 ←
 2: 10.4x ↓
 3: 10.3 ←

Serie 29

Total 273

1: 8.5 →
 2: 10.1 →
 3: 10.7x ←
 4: 10.5x ↓
 5: 9.8 ↖

Serie 47

Total 320

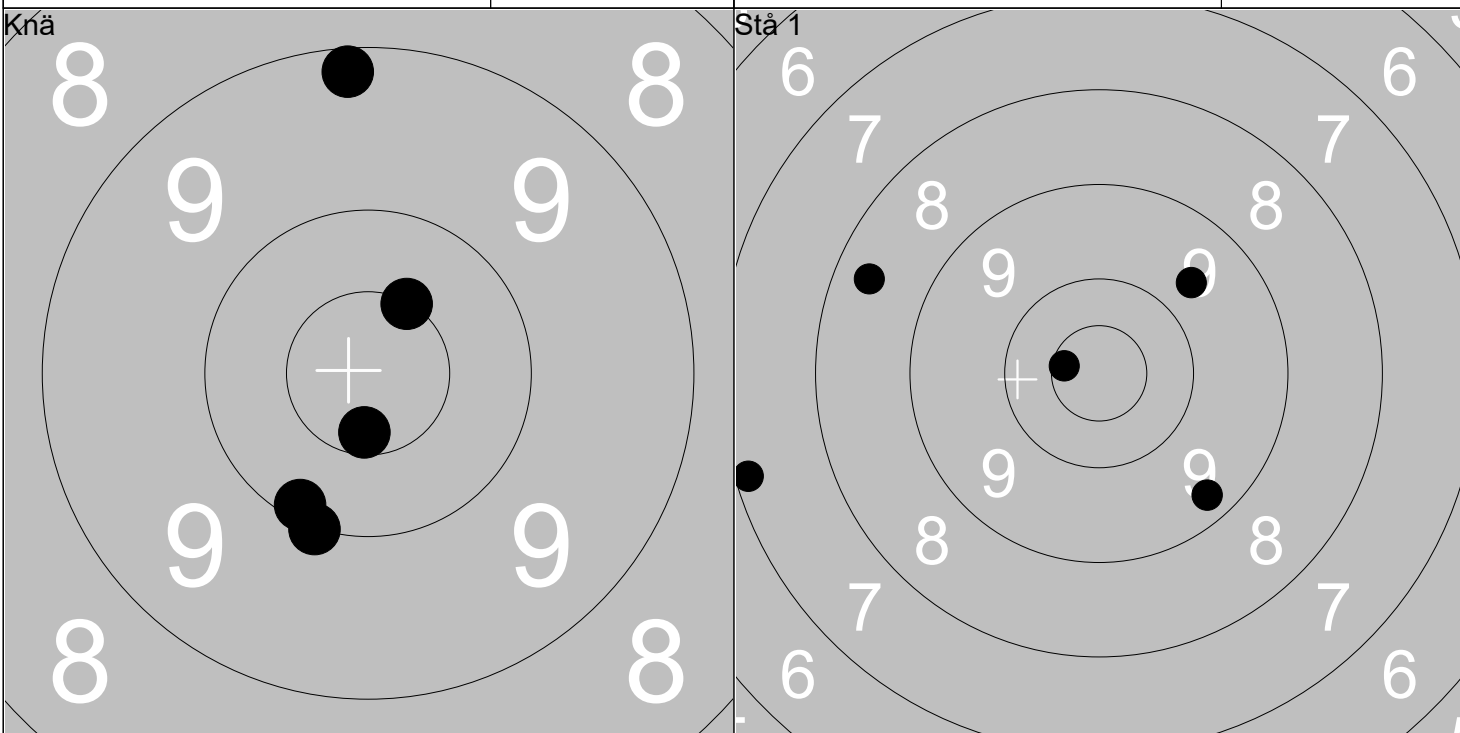

1: 10.0 ↓
 2: 9.2 ↑
 3: 10.6x ↓
 4: 10.1 ↓
 5: 10.5x ↗

Serie 49

Total 369

1: 9.7 ↗
 2: 9.3 ↓
 3: 7.2 ←
 4: 10.6x ←
 5: 8.4 ←

Serie 43

Total 412

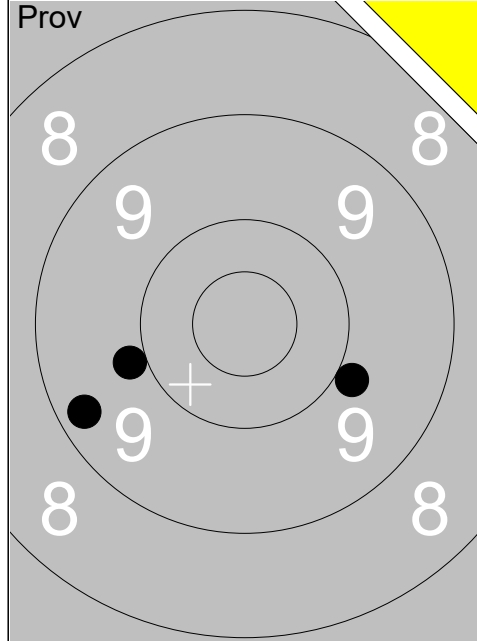

1:	9.9	←
2:	9.3	←
3:	9.9	→
<hr/>		
Serie	27	
Total	273	

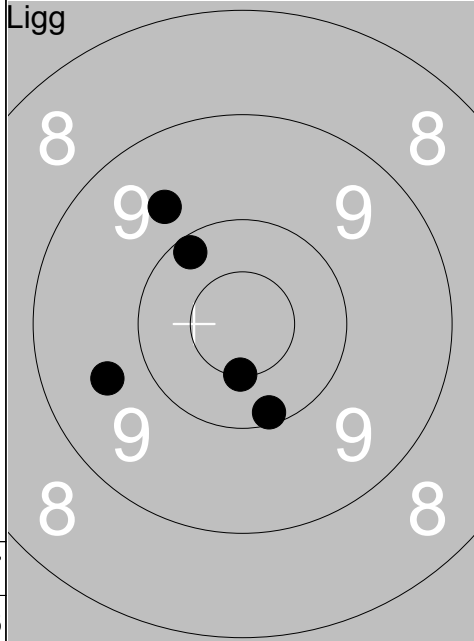

1:	10.5x	↓
2:	10.2	↗
3:	9.6	←
4:	9.7	↗
5:	10.1	↓
<hr/>		
Serie	48	
Total	321	

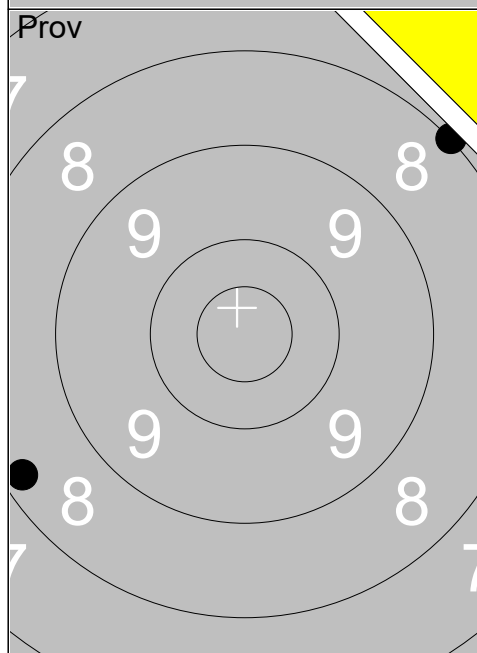

1:	8.0	↗
2:	8.2	←
<hr/>		
Serie	16	
Total	321	

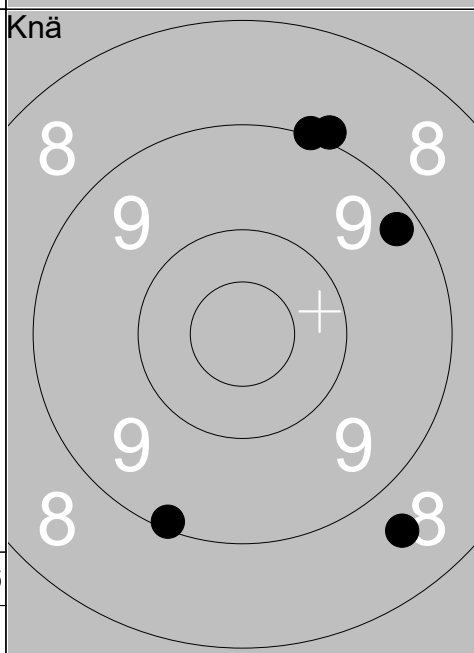

1:	8.6	↘
2:	8.9	↗
3:	9.2	↗
4:	9.0	↗
5:	9.1	↘
<hr/>		
Serie	43	
Total	364	

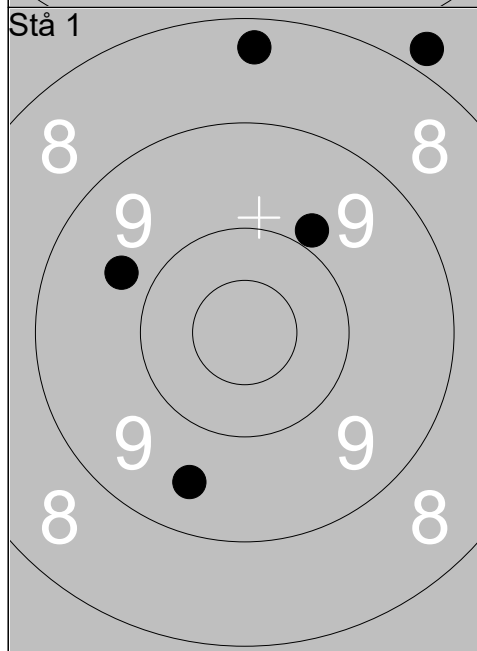

1:	9.5	↓
2:	7.8	↗
3:	9.9	↗
4:	9.7	←
5:	8.3	↑
<hr/>		
Serie	42	
Total	406	

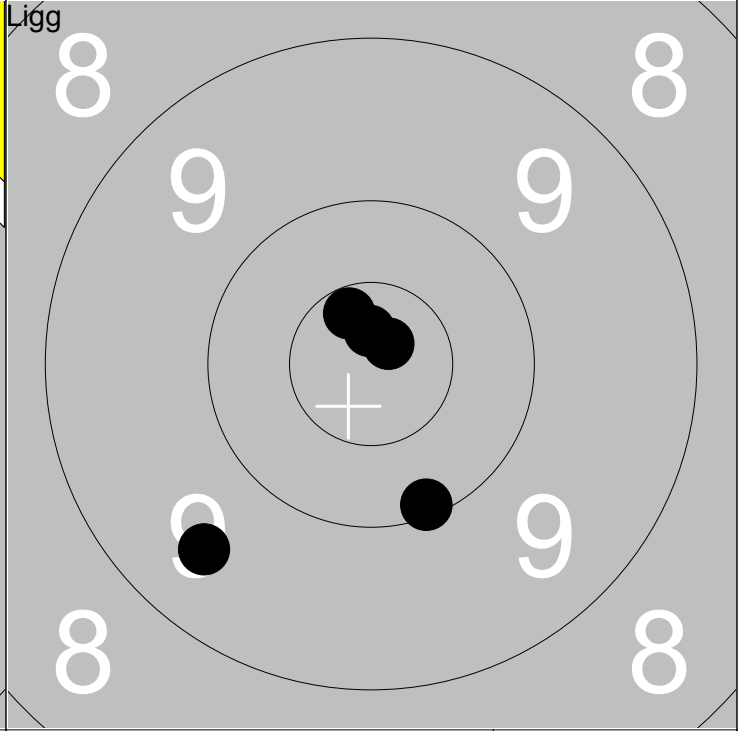
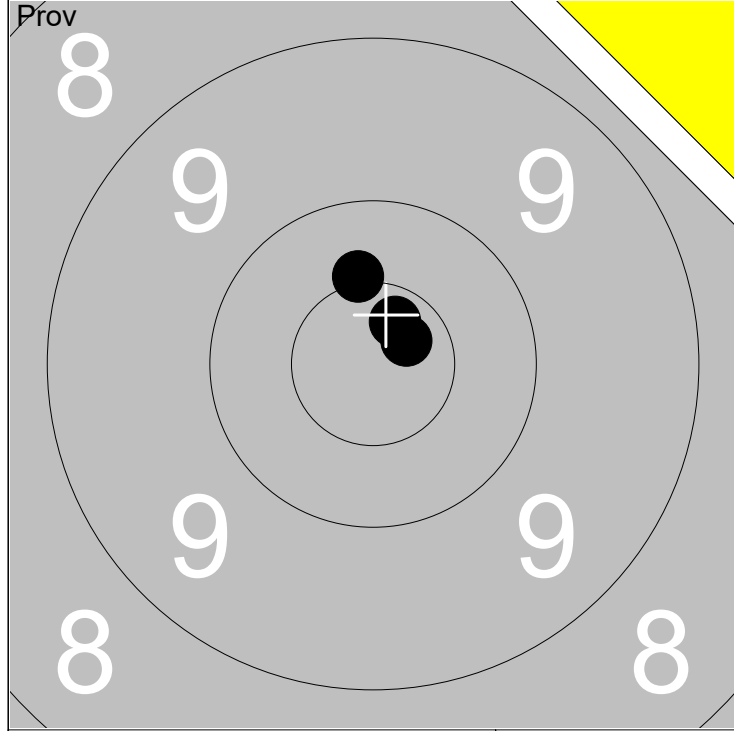

1: 10.7x ↗	Serie 30
2: 10.7x ↗	
3: 10.4x ↑	
Total 291	

1: 10.1 ↓	Serie 49
2: 9.5 ↙	
3: 10.6x ↖	
4: 10.8x ↑	
5: 10.8x ↗	
Total 340	

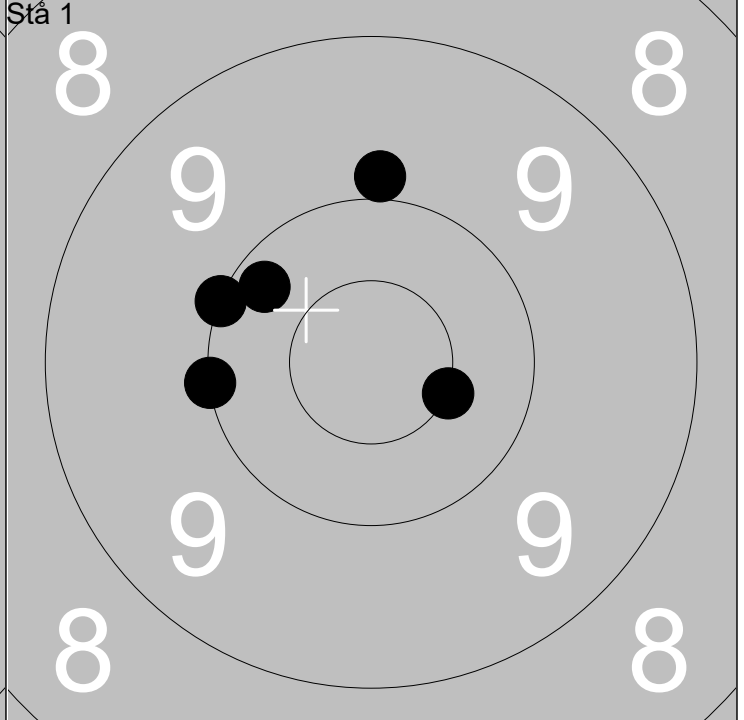
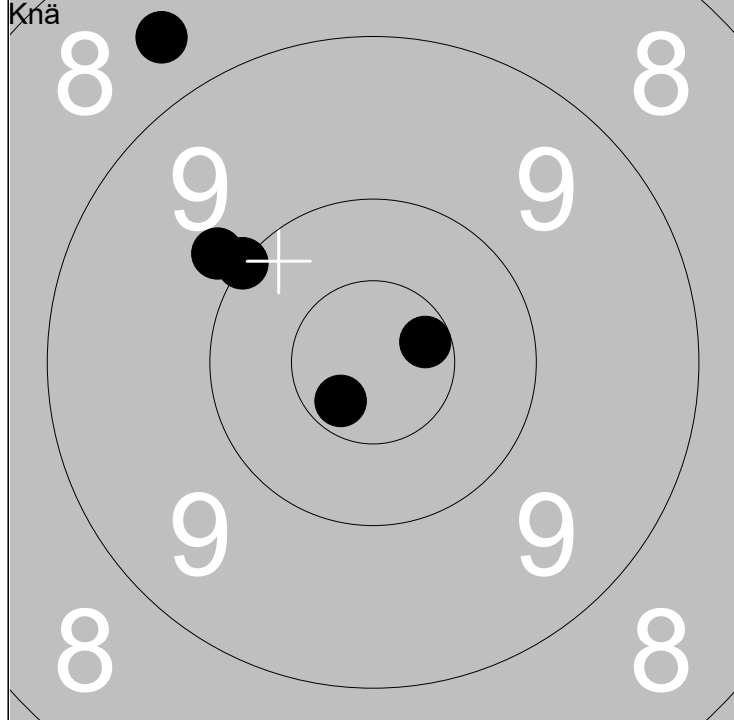

1: 10.7x ↙	Serie 47
2: 10.0 ↖	
3: 10.6x ↗	
4: 8.7 ↗	
5: 9.9 ↖	
Total 387	

1: 10.5x ➔	Serie 49
2: 10.0 ←	
3: 9.9 ↑	
4: 10.2 ↖	
5: 10.0 ←	
Total 436	

Ramselefors

Solberga

D

Vs

07.07.2019

Tavelträffen 2019

Ramselefors SKF

Prov

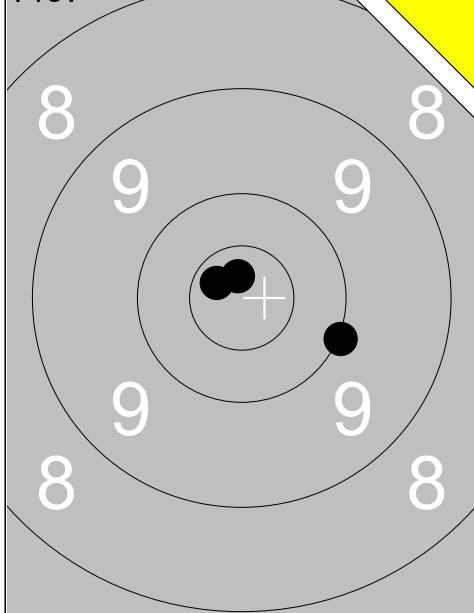

1: 10.0 ➤
 2: 10.7x ↙
 3: 10.8x ↑

Serie 30
 Total 288

Ligg

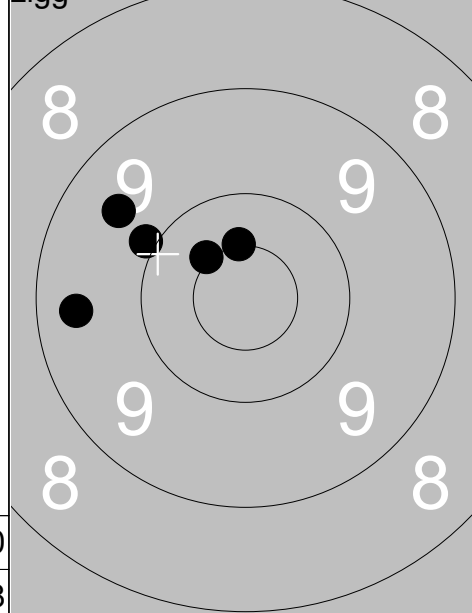

1: 9.6 ↖
 2: 9.9 ↖
 3: 10.4x ↙
 4: 9.4 ←
 5: 10.5x ↑

Serie 47
 Total 335

Prov

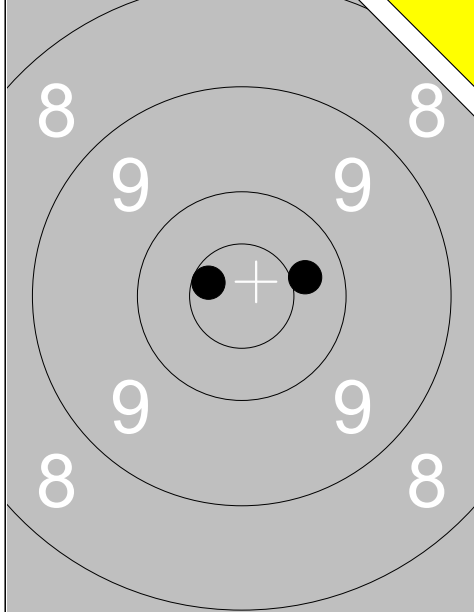

1: 10.6x ↙
 2: 10.4 ➤

Serie 20
 Total 335

Knä

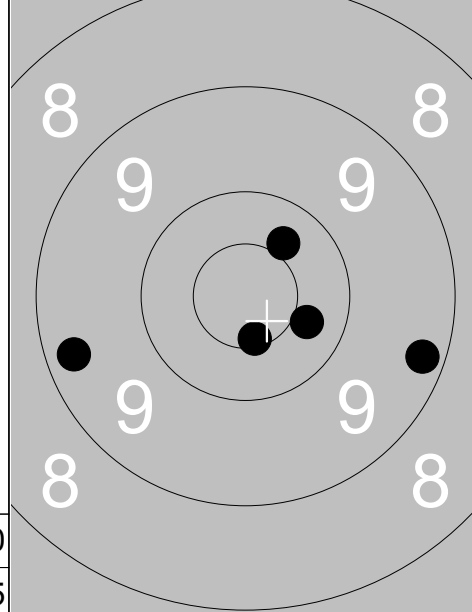

1: 9.2 ➤
 2: 10.6x ↓
 3: 10.4 ➤
 4: 10.4 ↗
 5: 9.3 ←

Serie 48
 Total 383

Stå 1

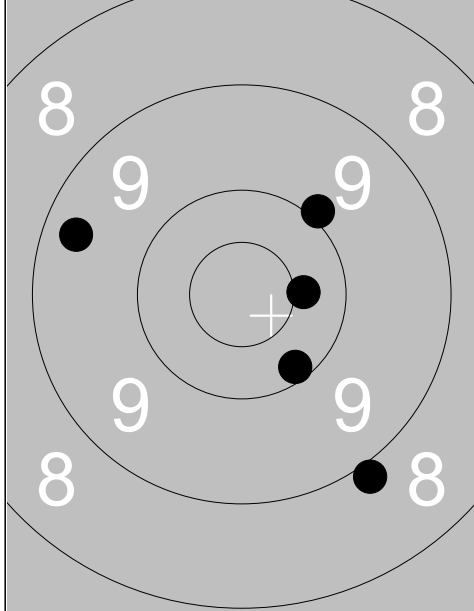

1: 10.0 ↗
 2: 10.4 ➤
 3: 10.2 ↓
 4: 9.3 ←
 5: 8.9 ↓

Serie 47
 Total 430

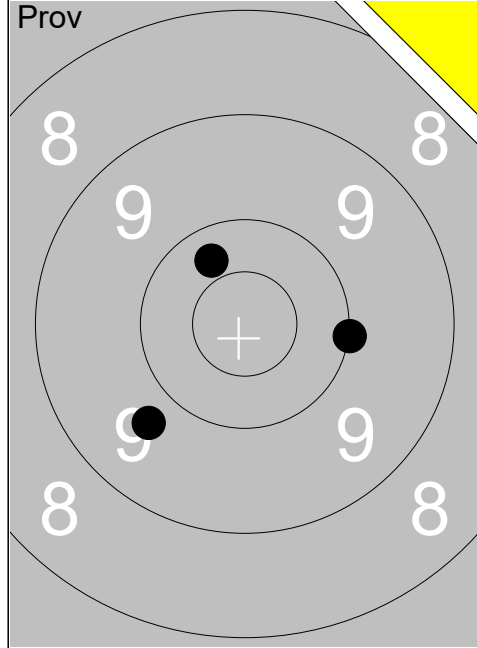

1:	10.0	→
2:	10.3	↗
3:	9.7	↘
Serie		29
Total		281

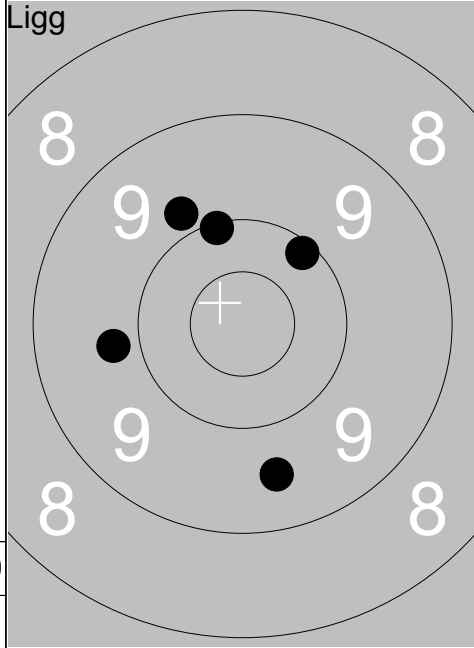

1:	9.8	←
2:	10.1	↗
3:	10.1	↑
4:	9.8	↗
5:	9.6	↓
Serie		47
Total		328

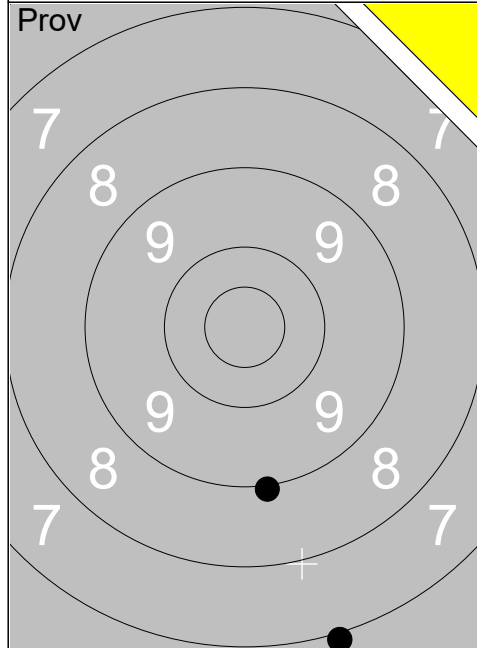

1:	6.9	↓
2:	9.0	↓
Serie		15
Total		328

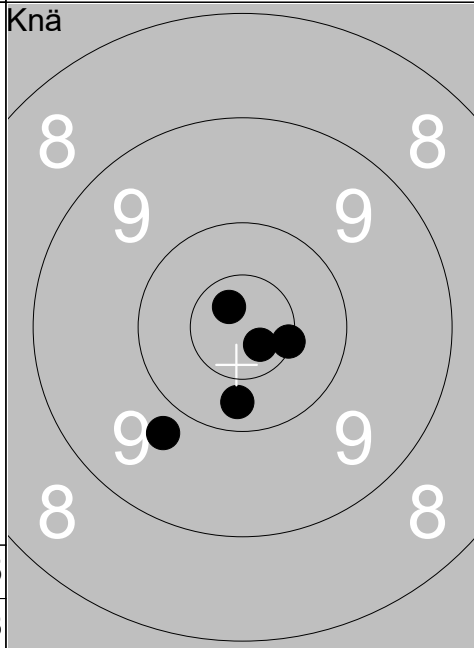

1:	10.7x	↖
2:	10.5x	→
3:	10.7x	↘
4:	10.3	↓
5:	9.8	↘
Serie		49
Total		377

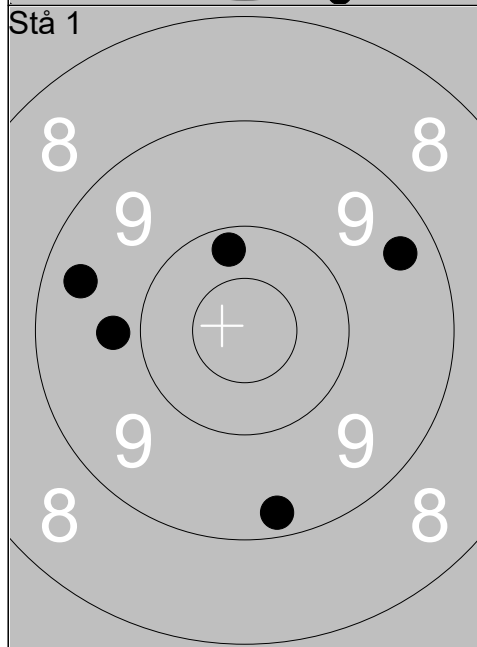

1:	9.4	←
2:	10.2	↑
3:	9.8	←
4:	9.3	↓
5:	9.4	↗
Serie		46
Total		423

Prov

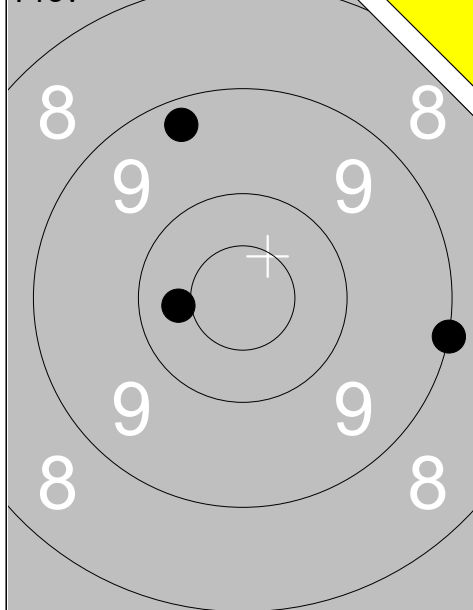

1: 9.3 ↗
 2: 10.4 ←
 3: 9.0 →

Serie 28
 Total 281

Ligg

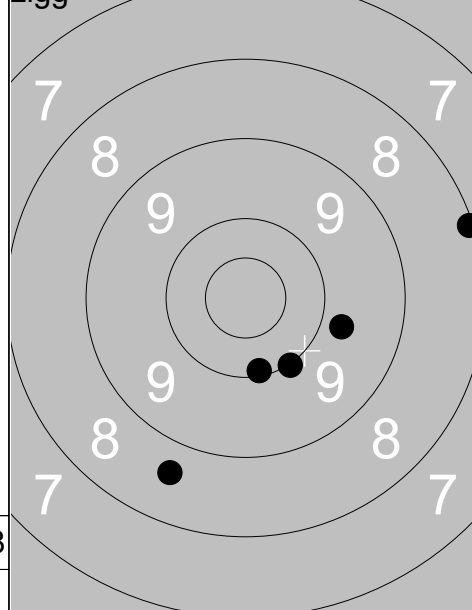

1: 8.1 →
 2: 10.0 ↘
 3: 9.8 →
 4: 8.6 ↘
 5: 10.1 ↘

Serie 45
 Total 326

Prov

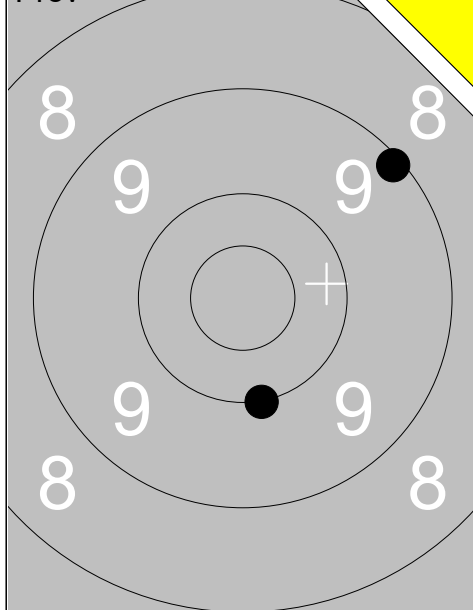

1: 9.1 ↗
 2: 10.0 ↘

Serie 19
 Total 326

Knä

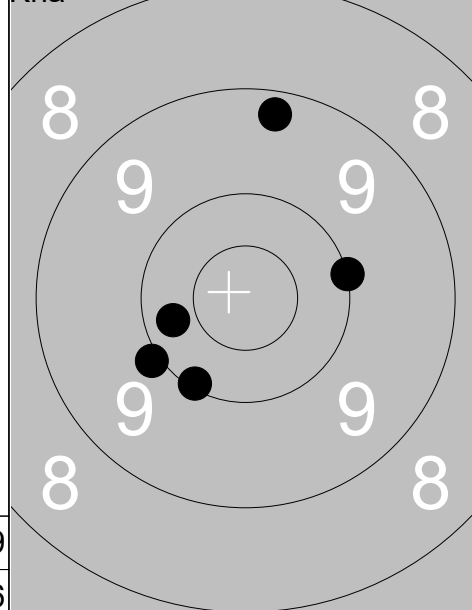

1: 9.2 ↑
 2: 10.1 ↘
 3: 10.0 ←
 4: 10.3 ←
 5: 10.0 →

Serie 49
 Total 375

Stå 1

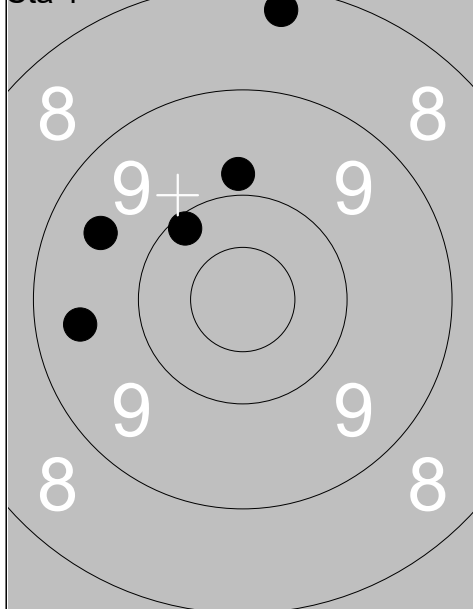

1: 10.1 ↗
 2: 9.8 ↑
 3: 9.5 ←
 4: 8.2 ↑
 5: 9.5 ←

Serie 45
 Total 420

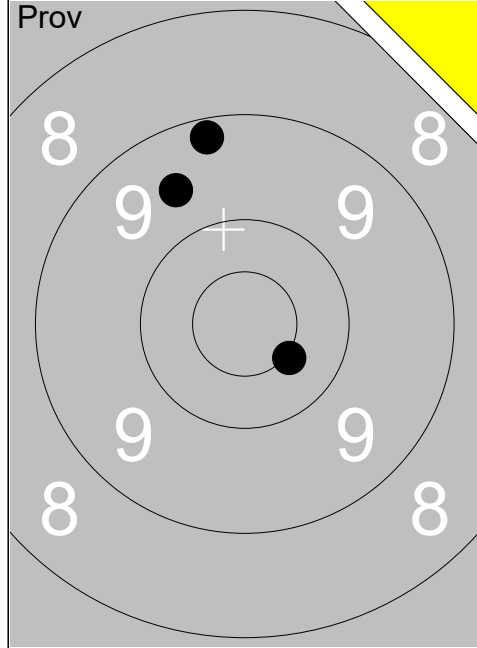

1:	9.2	↑
2:	9.6	↗
3:	10.5x	↘
Serie		28
Total		280

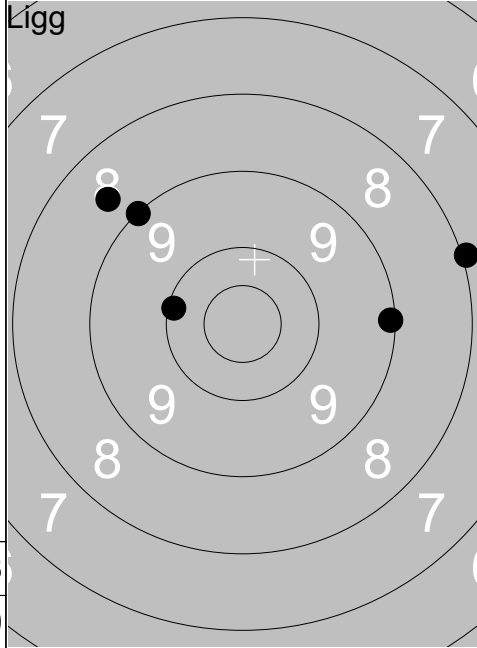

1:	8.6	↖
2:	10.1	↙
3:	9.0	↗
4:	8.0	→
5:	9.1	→
Serie		44
Total		324

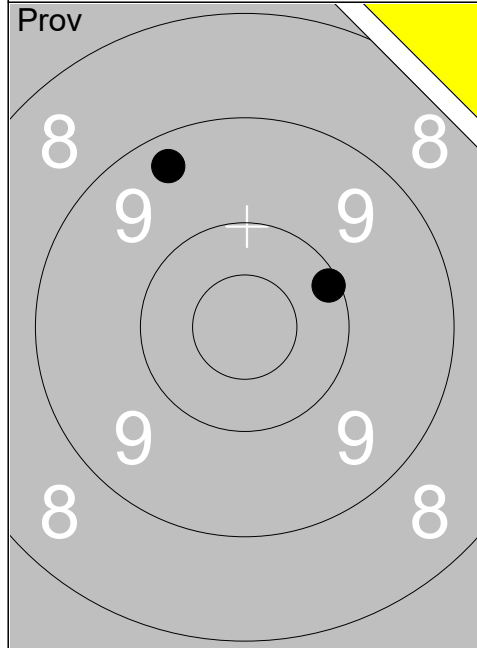

1:	9.3	↖
2:	10.1	↗
Serie		19
Total		324

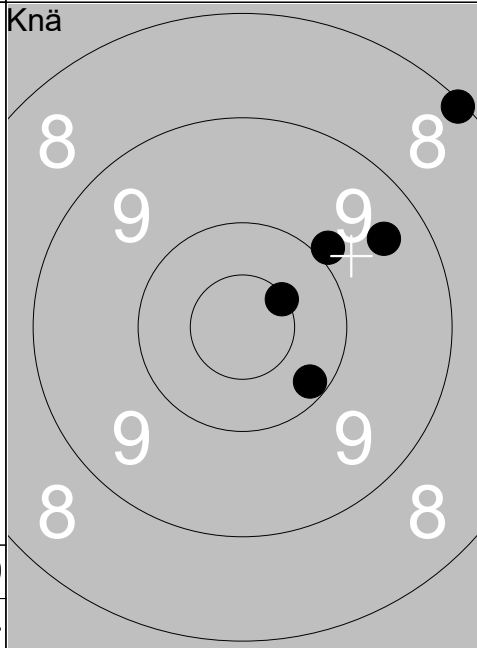

1:	8.1	↗
2:	9.4	↗
3:	10.5x	↗
4:	10.2	↘
5:	9.9	↗
Serie		46
Total		370

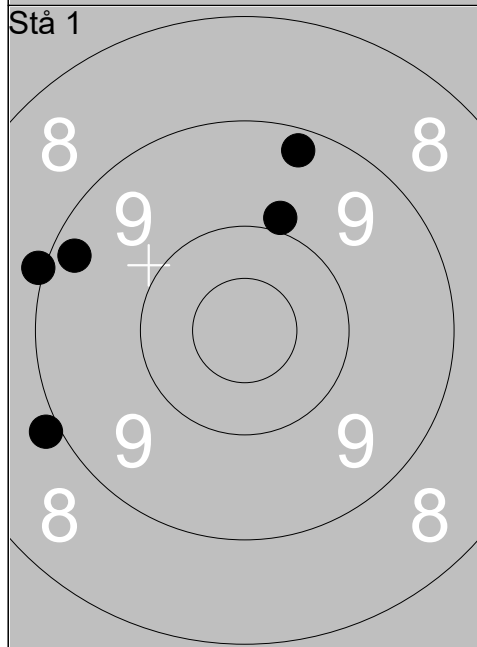

1:	8.9	↙
2:	9.0	↙
3:	9.2	↗
4:	9.3	↙
5:	9.9	↗
Serie		44
Total		414

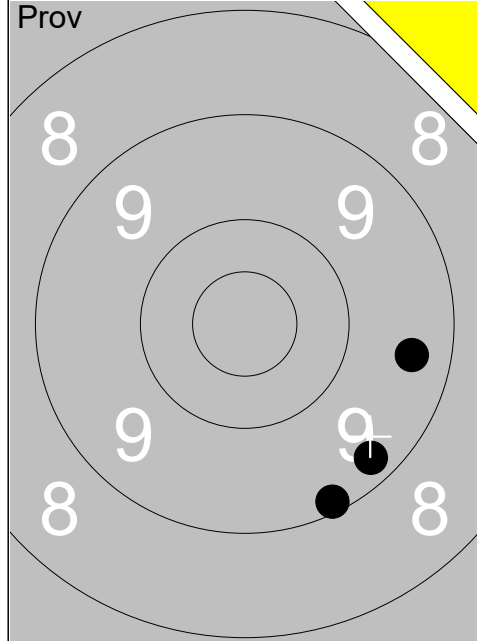

1:	9.3	↘
2:	9.1	↘
3:	9.4	→
Serie		27
Total		280

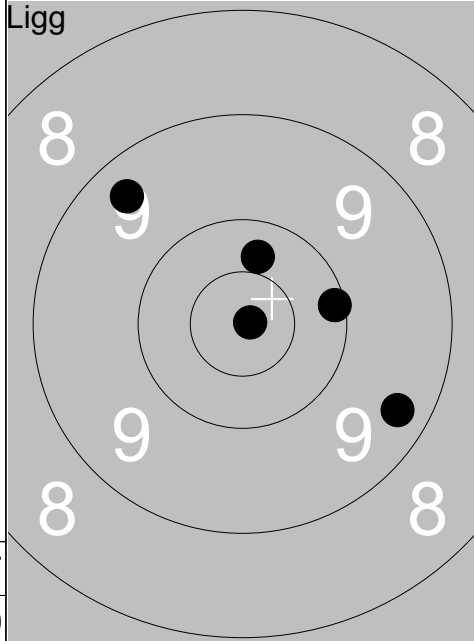

1:	10.1	→
2:	10.3	↑
3:	9.3	↘
4:	10.9x	→
5:	9.4	↖
Serie		48
Total		328

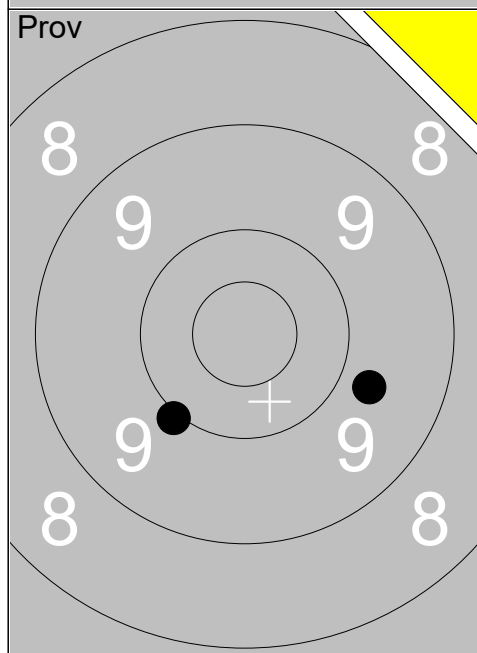

1:	9.7	→
2:	10.0	↘
Serie		19
Total		328

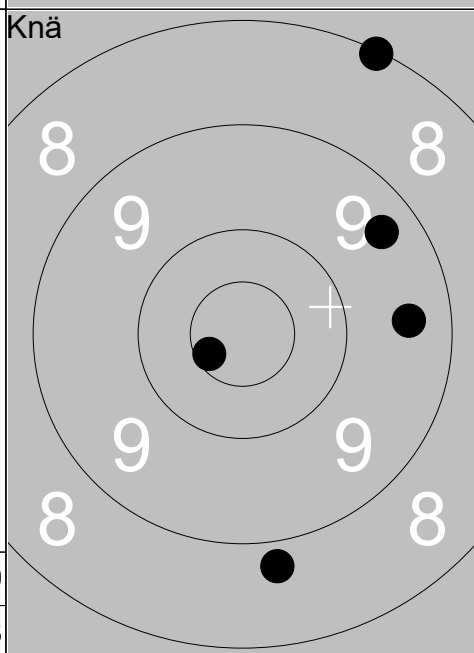

1:	8.1	↑
2:	9.4	→
3:	9.4	↗
4:	8.8	↓
5:	10.6x	↙
Serie		44
Total		372

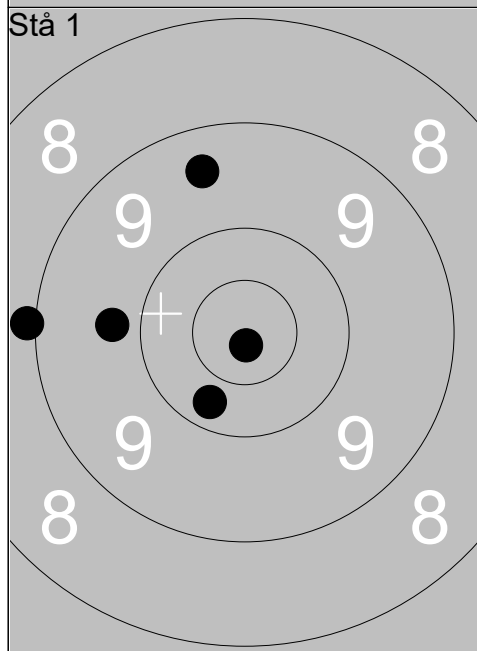

1:	9.4	↑
2:	10.8x	↓
3:	10.3	↘
4:	8.9	←
5:	9.8	←
Serie		46
Total		418

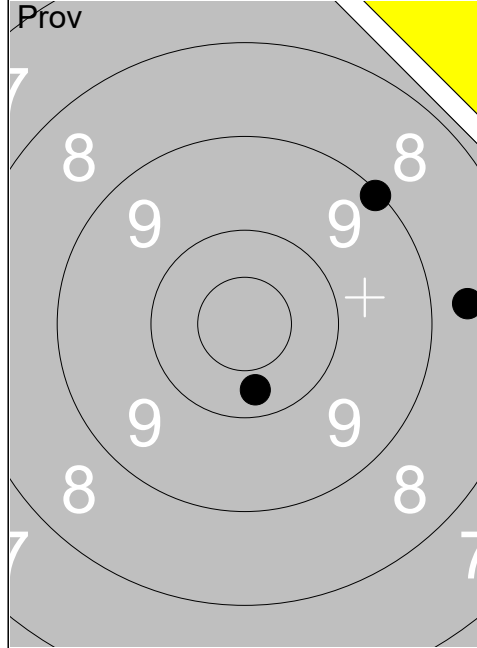

1:	8.6	→
2:	9.1	↗
3:	10.3	↓
Serie 27		
Total 278		

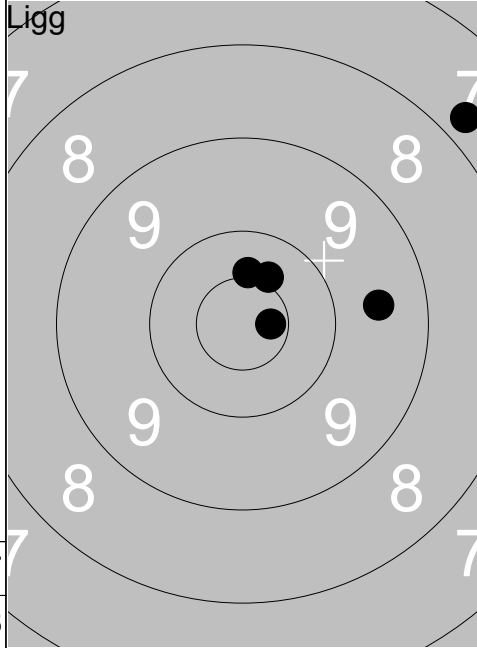

1:	10.4x	↑
2:	7.8	↗
3:	9.5	→
4:	10.7x	→
5:	10.4x	↗
Serie 46		
Total 324		

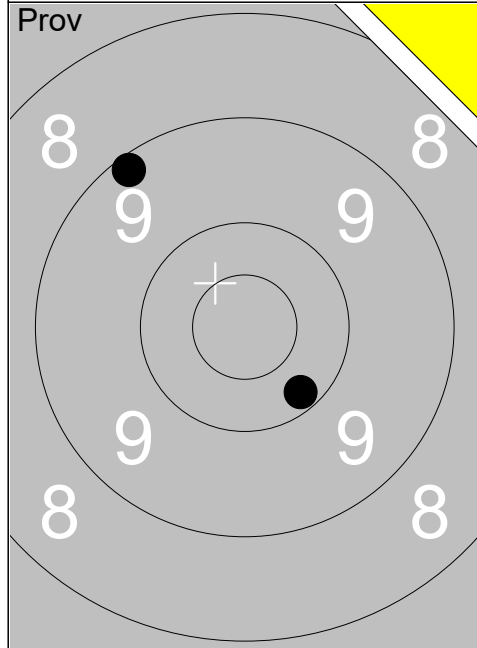

1:	10.2	↘
2:	9.2	↗
Serie 19		
Total 324		

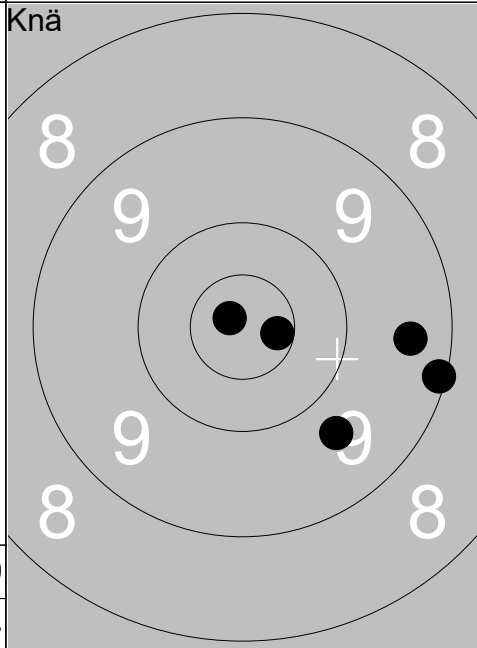

1:	10.6x	→
2:	10.8x	↖
3:	9.1	→
4:	9.4	→
5:	9.7	↘
Serie 47		
Total 371		

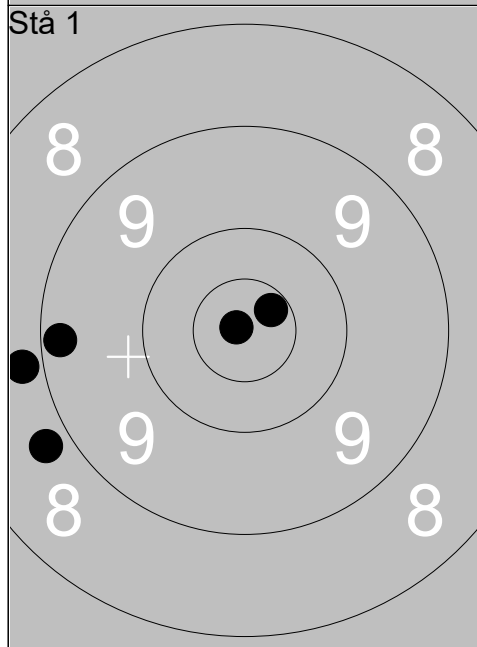

1:	8.8	↙
2:	8.8	←
3:	10.6x	↗
4:	9.2	←
5:	10.9x	↖
Serie 45		
Total 416		

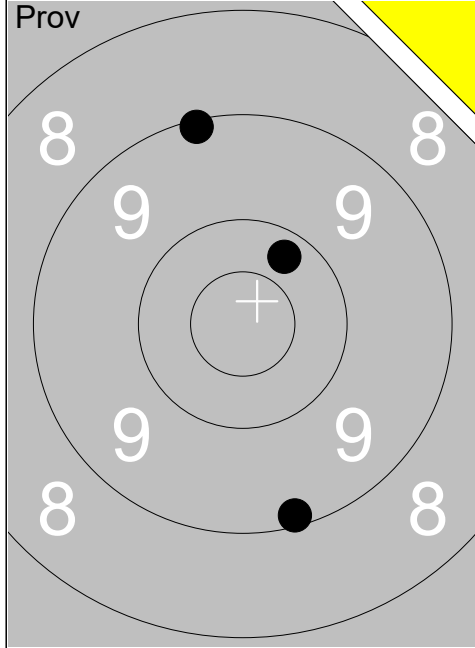

1:	9.1	↓
2:	9.1	↑
3:	10.3	↗
Serie		28
Total		274

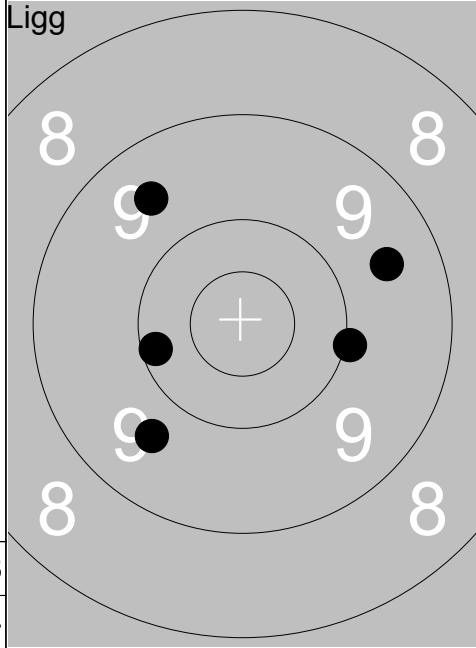

1:	10.1	←
2:	9.7	↙
3:	9.5	→
4:	10.0	→
5:	9.5	↖
Serie		47
Total		321

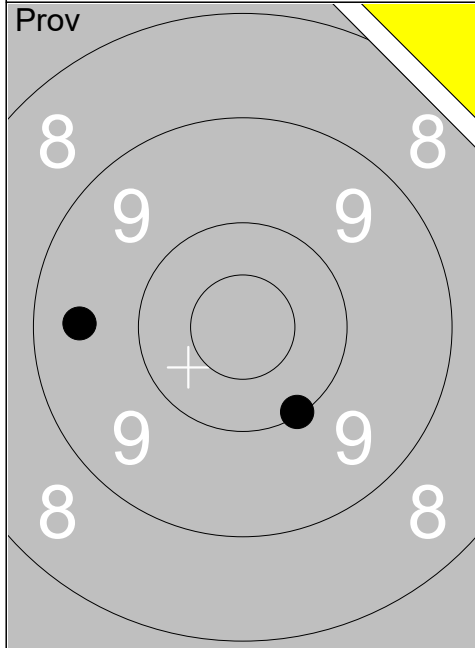

1:	10.1	↓
2:	9.5	←
Serie		19
Total		321

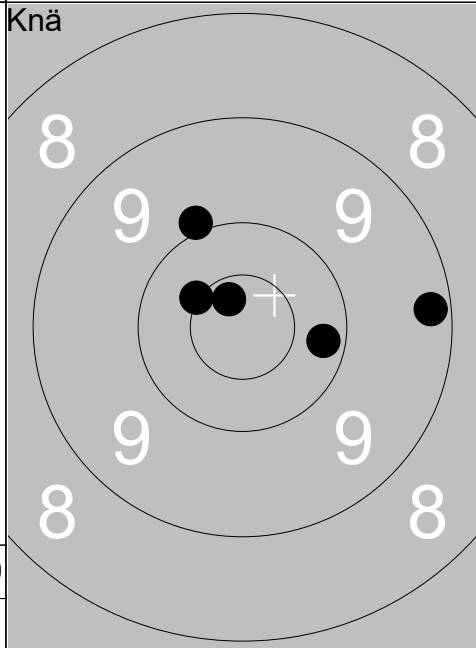

1:	9.2	→
2:	10.7x	↖
3:	10.2	→
4:	9.9	↑
5:	10.5x	↖
Serie		48
Total		369

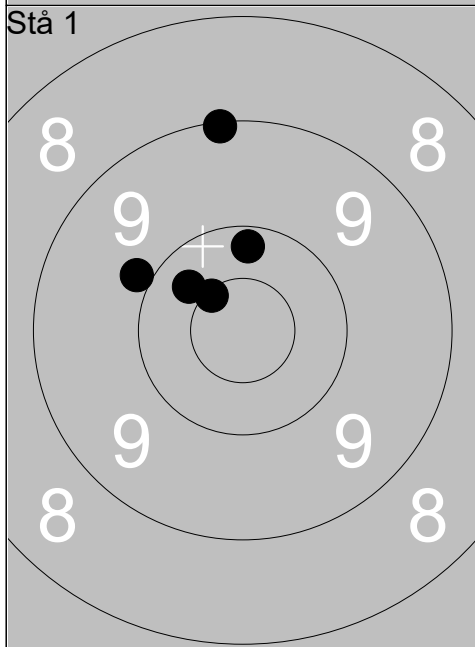

1:	10.5x	↖
2:	9.1	↑
3:	10.2	↑
4:	9.9	↖
5:	10.3	↖
Serie		48
Total		417

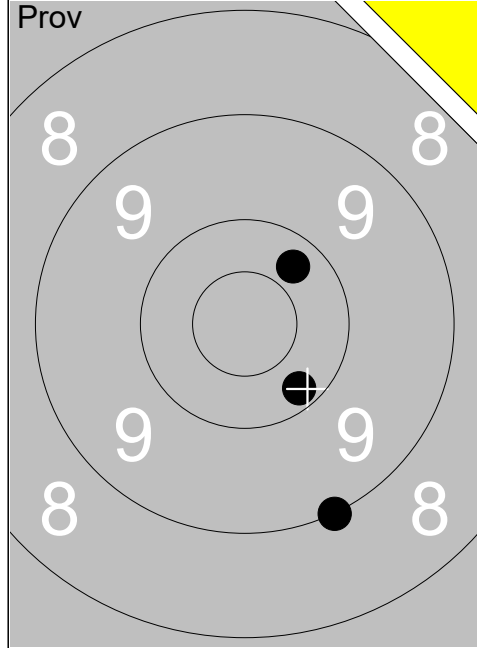

1:	9.0	↘
2:	10.2	↘
3:	10.3	↗
Serie		29
Total		267

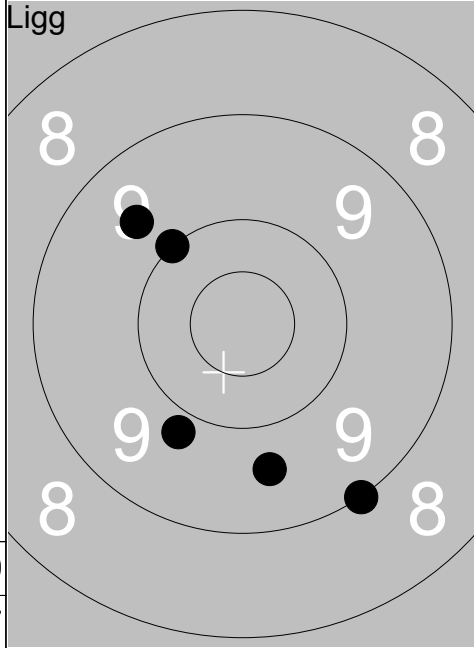

1:	9.6	↘
2:	9.8	↘
3:	10.0	↗
4:	9.6	↗
5:	9.0	↘
Serie		46
Total		313

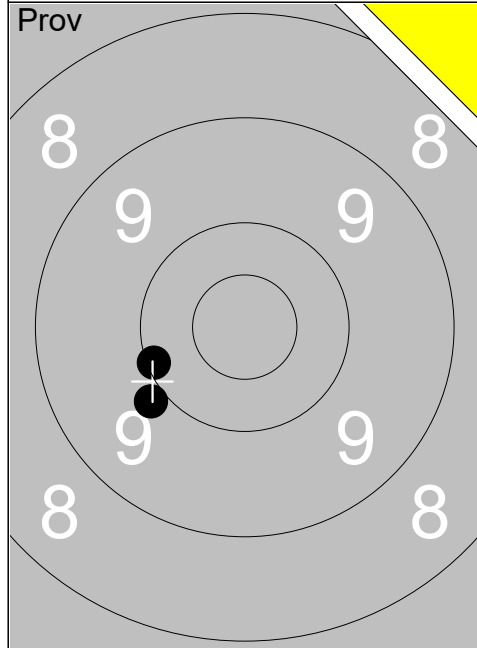

1:	10.1	↙
2:	9.9	↙
Serie		19
Total		313

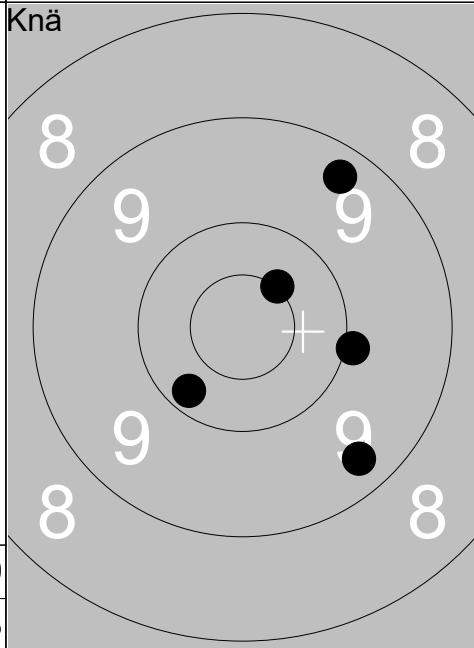

1:	9.3	↗
2:	9.4	↘
3:	10.2	↘
4:	10.0	→
5:	10.5x	↗
Serie		48
Total		361

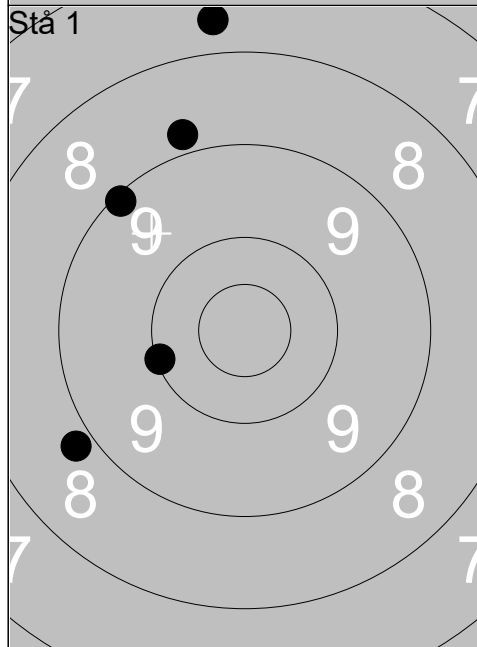

1:	8.8	↗
2:	9.1	↗
3:	8.8	↙
4:	10.1	↙
5:	7.7	↗
Serie		42
Total		403

Skjutlag	Tavla	Berit Olsson		
8	1	Ramselefors	Öved-Östraby	A Sk
07.07.2019	Tavelträffen 2019	Ramselefors SKF		
Prov 	1: 10.0 ↑ 2: 10.2 ↓ 3: 10.4x↙	Ligg 	1: 10.6x↙ 2: 10.6x↑ 3: 10.5x➤ 4: 10.4x↑ 5: 10.4x↙	
	Serie 30 Total 290		Serie 50 Total 340	
Prov 	1: 8.6 ➤ 2: 10.7x↘	Knä 	1: 9.8 ↓ 2: 8.5 ← 3: 10.0 ↓ 4: 9.2 ← 5: 10.1 ↙	
	Serie 18 Total 340		Serie 46 Total 386	
Stå 1 	1: 8.5 ← 2: 10.2 ➤ 3: 10.4 ↗ 4: 10.3 ↓ 5: 10.3 ↙			
	Serie 48 Total 434			

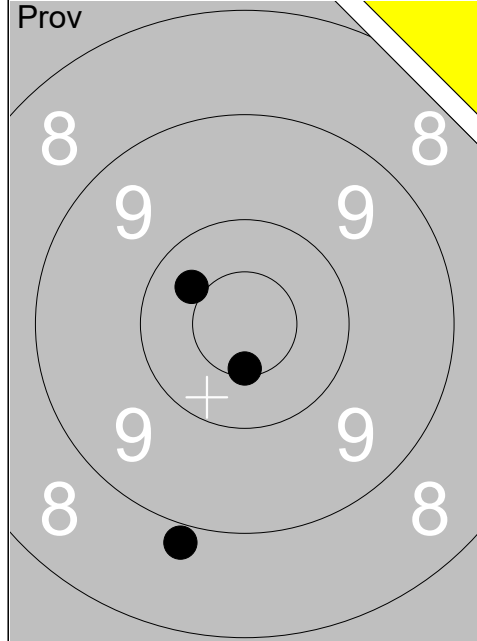

1:	8.9	↘
2:	10.6x	↘
3:	10.4	↙
Serie 28		
Total 285		

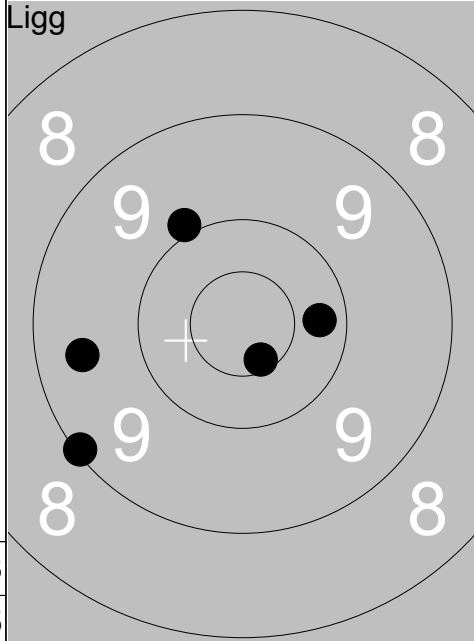

1:	9.9	↖
2:	9.1	↙
3:	9.5	←
4:	10.6x	↘
5:	10.3	→
Serie 47		
Total 332		

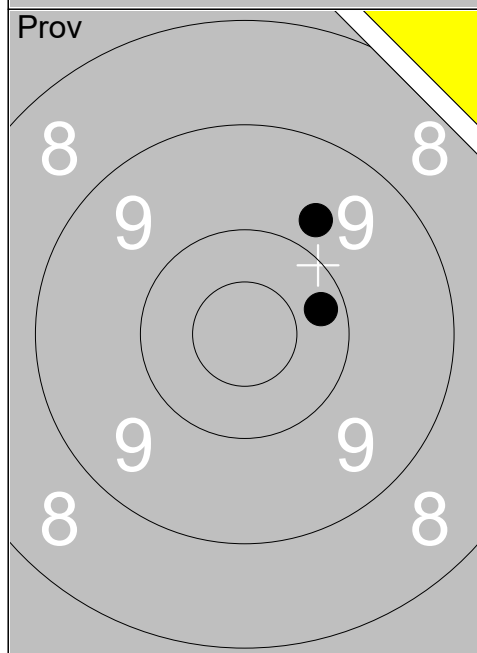

1:	9.7	↗
2:	10.2	→
Serie 19		
Total 332		

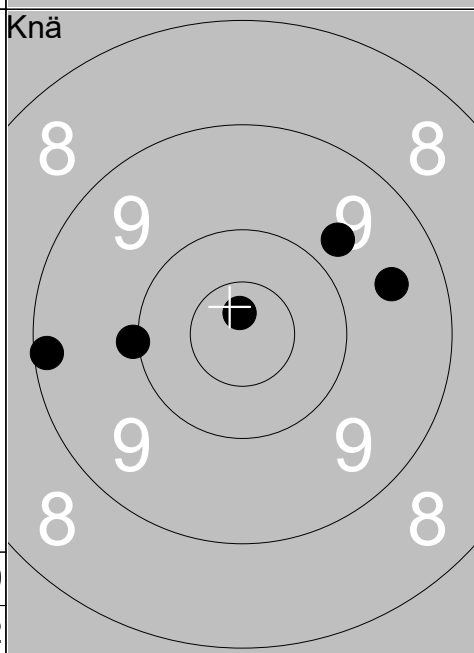

1:	9.7	↗
2:	10.8x	↑
3:	9.1	←
4:	10.0	←
5:	9.5	→
Serie 47		
Total 379		

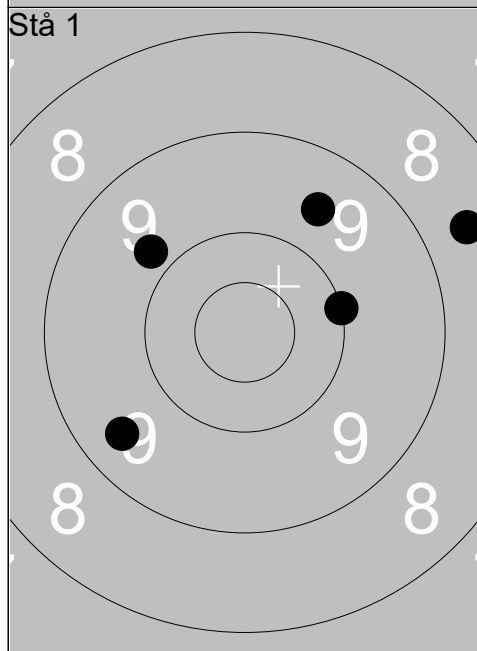

1:	9.4	↙
2:	9.6	↗
3:	8.6	→
4:	10.0	→
5:	9.8	↙
Serie 45		
Total 424		

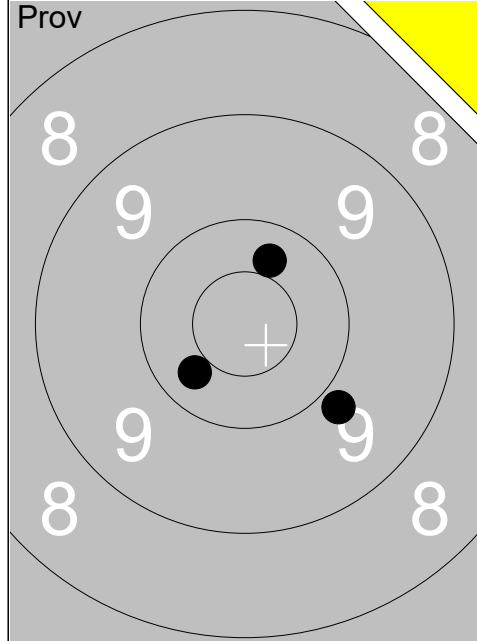

1:	10.3	↙
2:	9.8	↘
3:	10.3	↗
Serie		29
Total		285

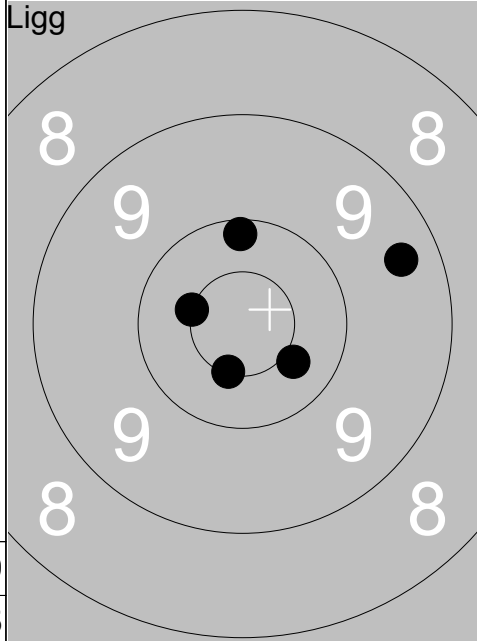

1:	9.4	➔
2:	10.5x	↙
3:	10.4	↘
4:	10.2	↗
5:	10.5x	↘
Serie		49
Total		334

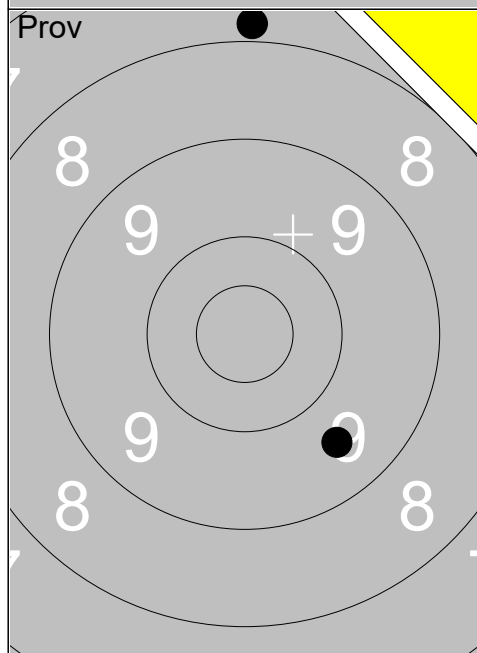

1:	7.8	↗
2:	9.6	↘
Serie		16
Total		334

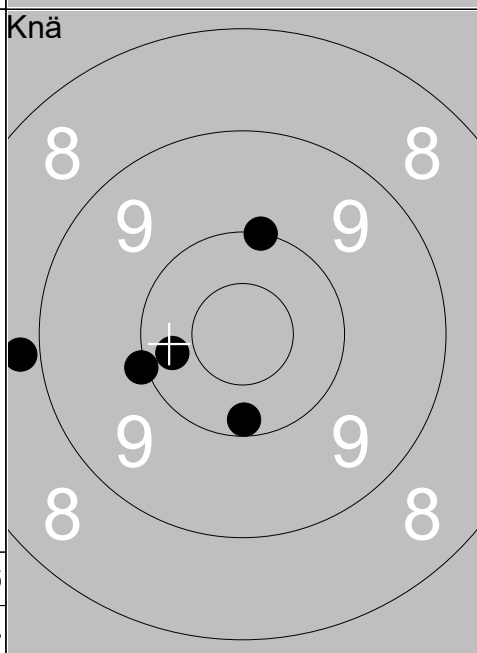

1:	10.2	↘
2:	10.0	↙
3:	10.0	↗
4:	10.3	↙
5:	8.8	↙
Serie		48
Total		382

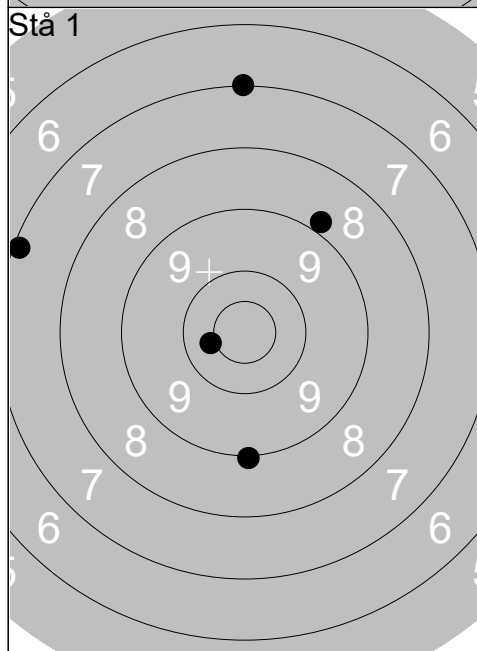

1:	9.0	↘
2:	10.4	↙
3:	7.1	↙
4:	8.8	↗
5:	7.0	↗
Serie		41
Total		423

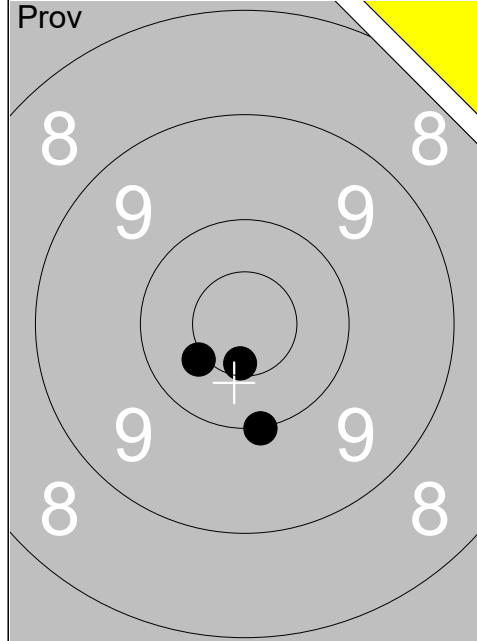

1:	10.4x ↙
2:	10.6x ↓
3:	10.0 ↓
<hr/>	
Serie	30
Total	284

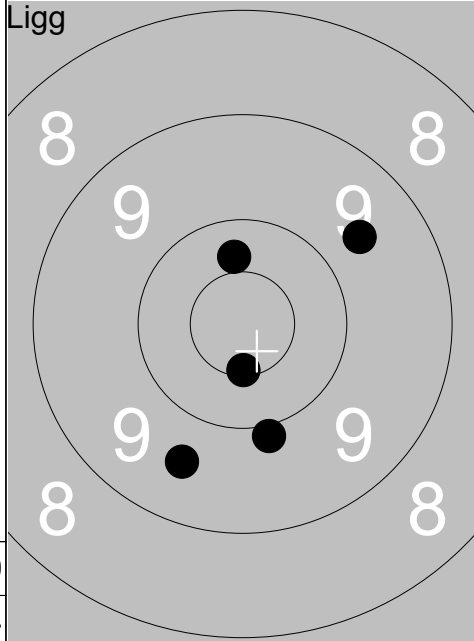

1:	10.4 ↑
2:	9.6 ↗
3:	9.6 ↓
4:	9.9 ↓
5:	10.5x ↓
<hr/>	
Serie	47
Total	331

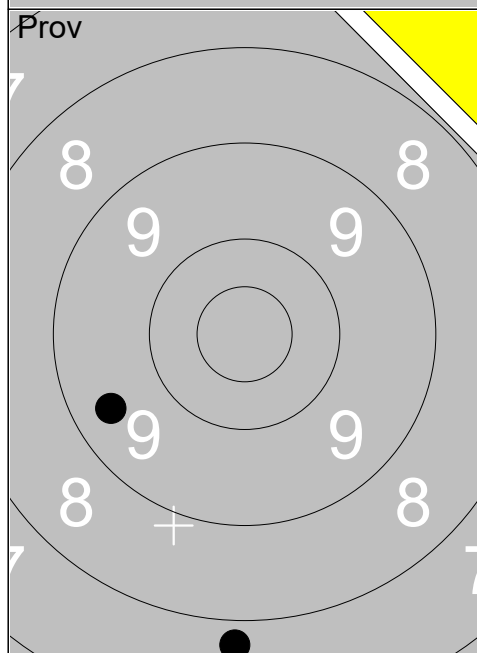

1:	9.4 ↙
2:	7.8 ↓
<hr/>	
Serie	16
Total	331

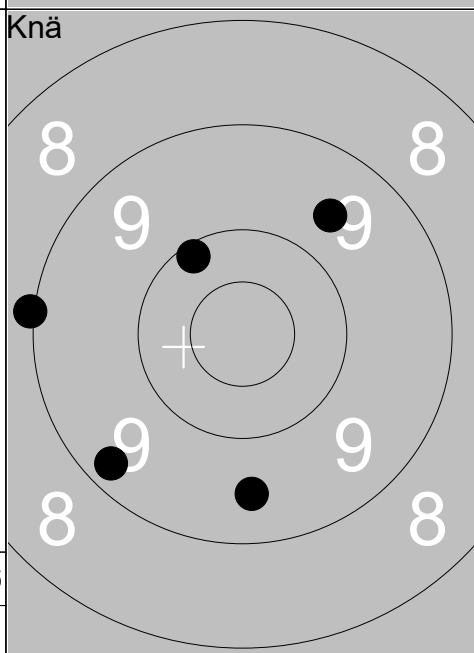

1:	9.0 ←
2:	9.6 ↗
3:	10.1 ↖
4:	9.5 ↓
5:	9.3 ↙
<hr/>	
Serie	46
Total	377

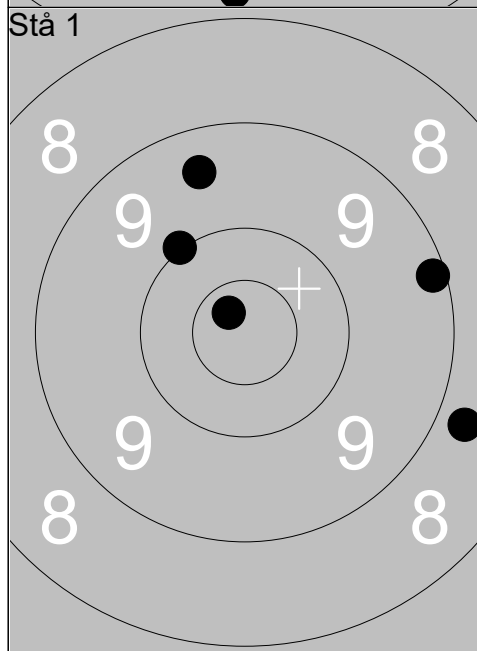

1:	9.4 ↑
2:	10.0 ↖
3:	9.1 →
4:	8.7 →
5:	10.7x ↖
<hr/>	
Serie	46
Total	423

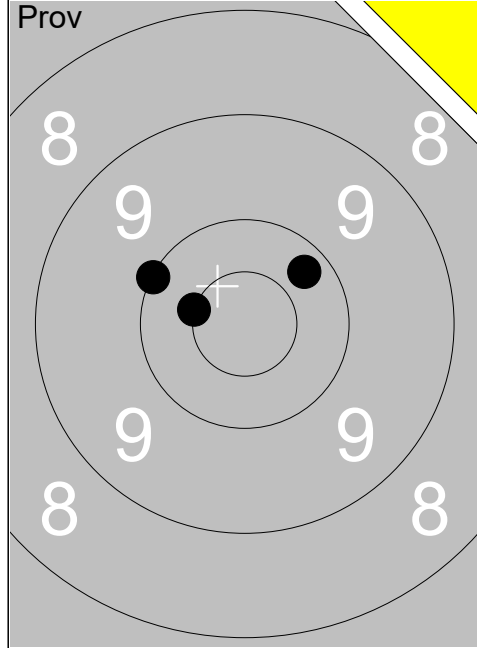

Serie	30
Total	283

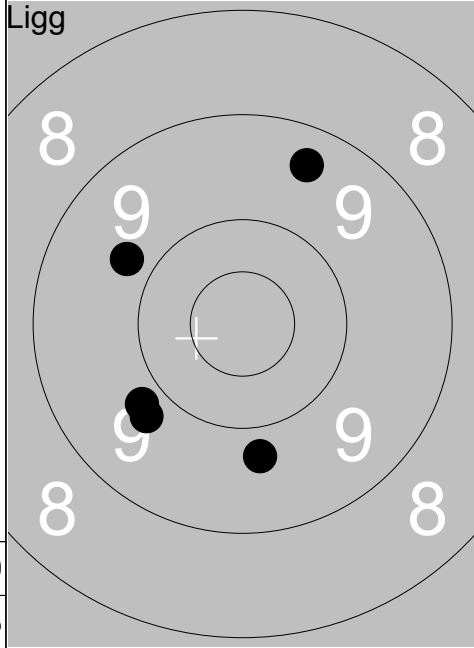

Serie	45
Total	328

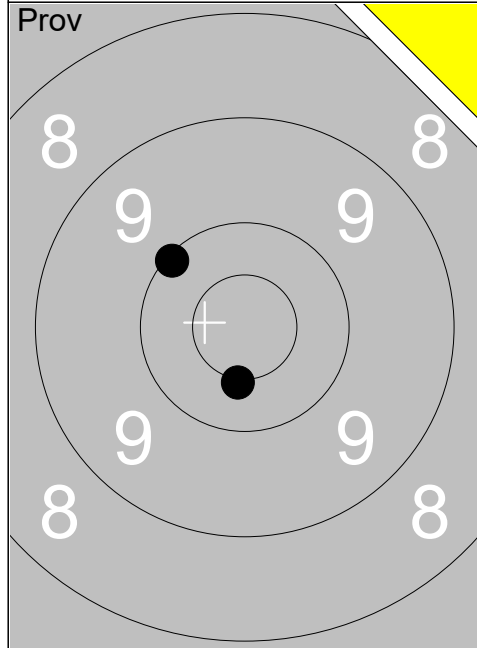

Serie	20
Total	328

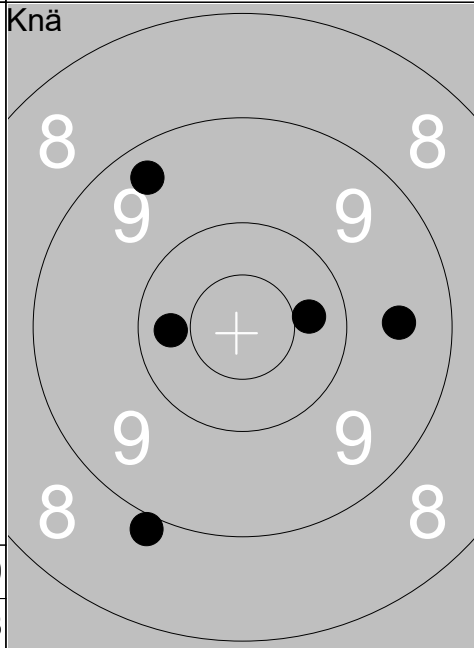

Serie	46
Total	374

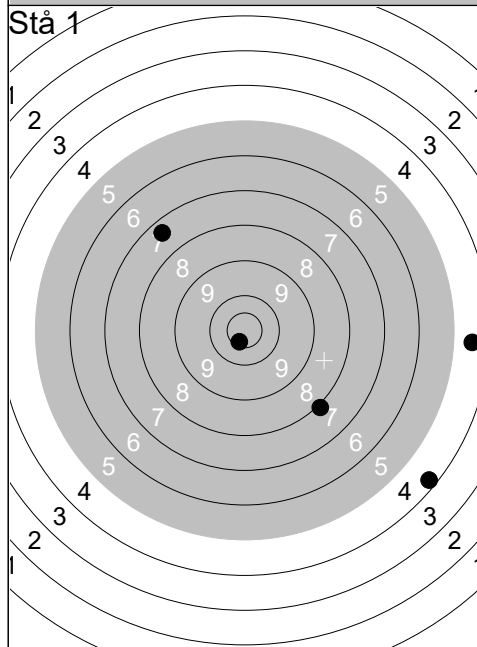

Serie	32
Total	406

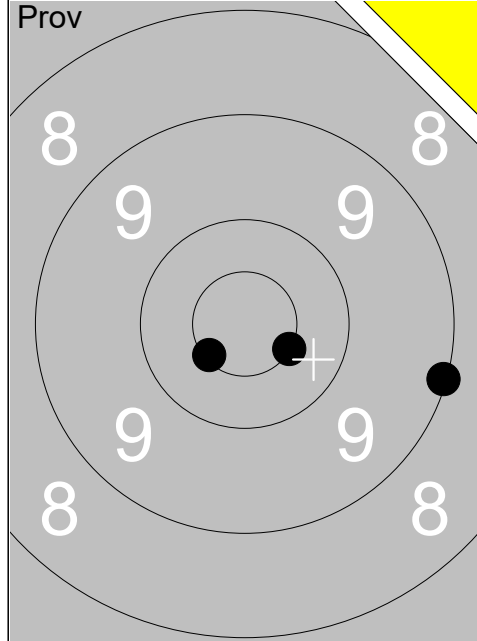

1:	10.5x	↘
2:	9.1	→
3:	10.5x	↙
Serie		29
Total		283

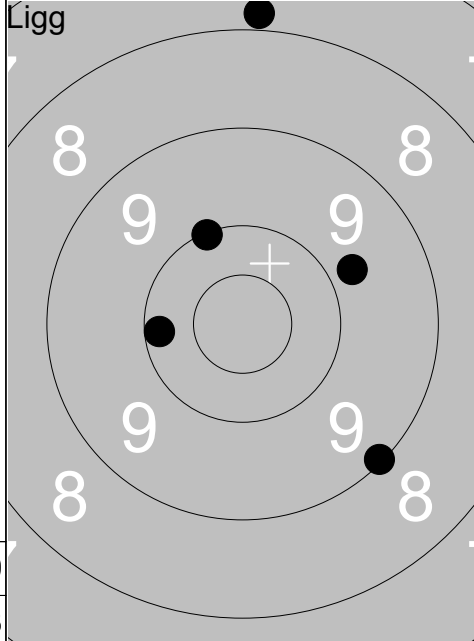

1:	9.8	↗
2:	10.2	←
3:	7.9	↑
4:	10.0	↖
5:	9.1	↘
Serie		45
Total		328

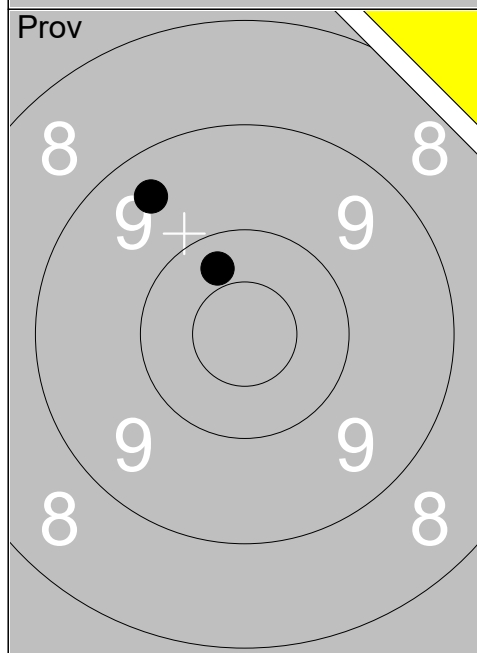

1:	10.3	↖
2:	9.4	↖
Serie		19
Total		328

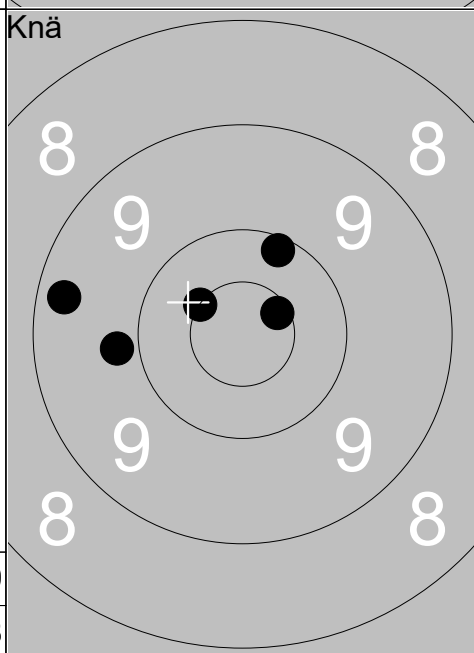

1:	10.5x	↙
2:	9.8	←
3:	9.3	←
4:	10.6x	↗
5:	10.1	↖
Serie		48
Total		376

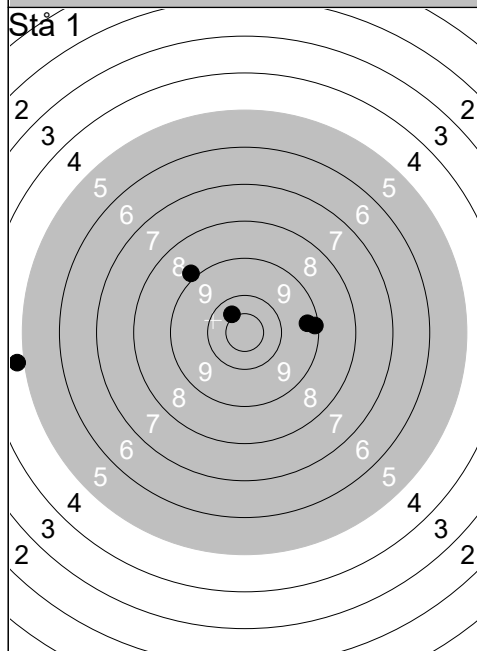

1:	10.4	↖
2:	9.3	→
3:	9.1	→
4:	8.9	↖
5:	4.8	←
Serie		40
Total		416

Ramselefors

Rommehed

A

Da

07.07.2019

Tavelträffen 2019

Ramselefors SKF

Prov

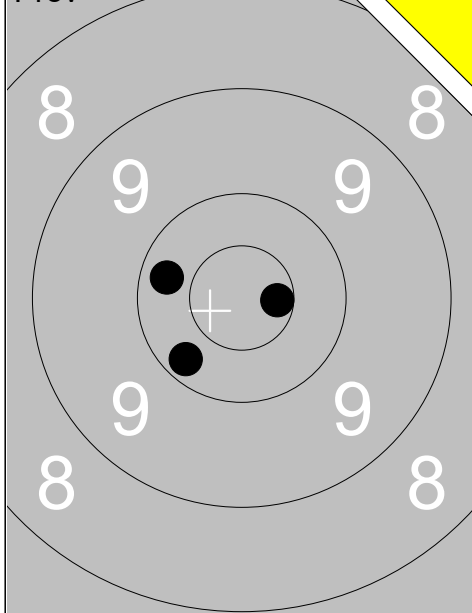

1: 10.3 ←
 2: 10.2 ↙
 3: 10.6x →

Serie 30
 Total 282

Ligg

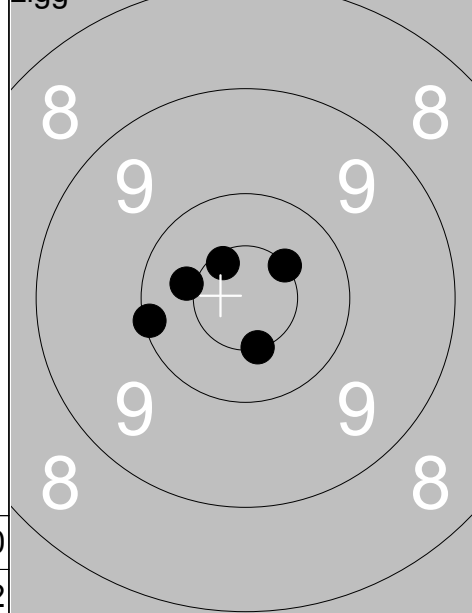

1: 10.5x ↓
 2: 10.4x ←←
 3: 10.1 ←
 4: 10.6x ↖
 5: 10.5x ↗

Serie 50
 Total 332

Prov

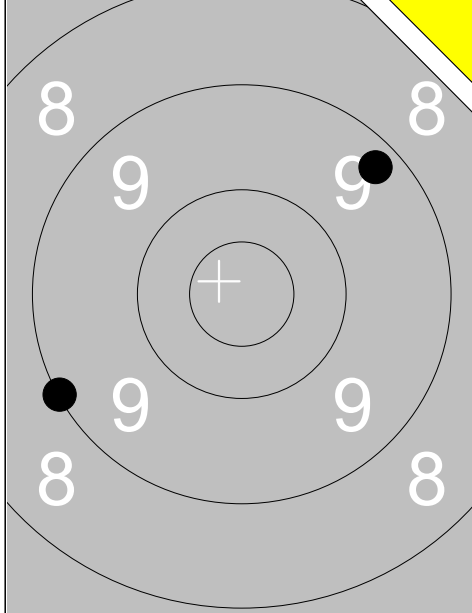

1: 9.3 ↗
 2: 9.0 ←

Serie 18
 Total 332

Knä

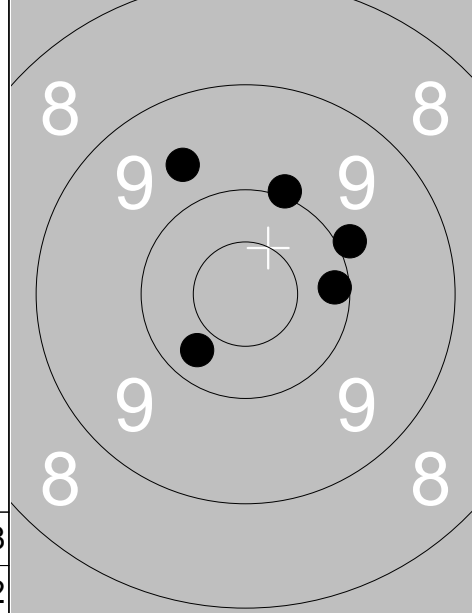

1: 9.9 ↗
 2: 10.2 →
 3: 10.3 ↙
 4: 9.7 ↖
 5: 10.0 ↗

Serie 48
 Total 380

Stå 1

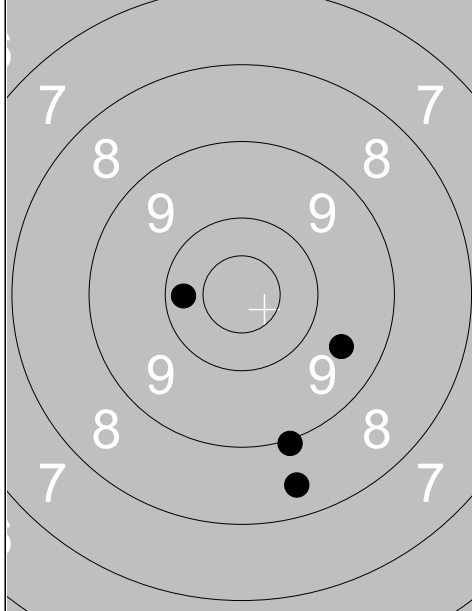

1: 9.6 ↗
 2: 10.2 ←
 3: 6.9 ↑
 4: 9.0 ↓
 5: 8.4 ↓

Serie 42
 Total 422

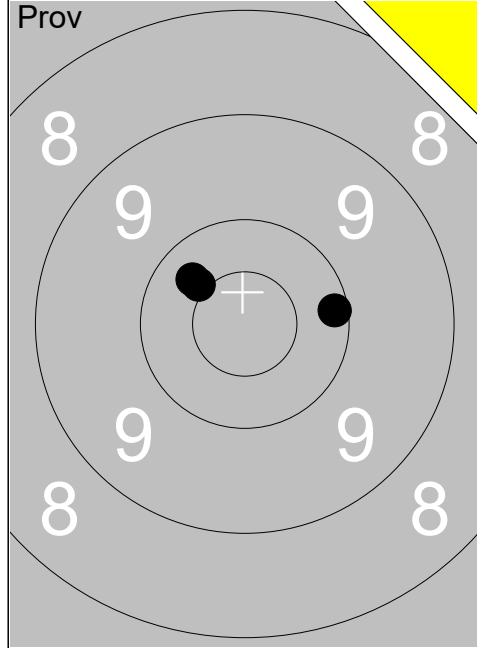

1:	10.3 ↖
2:	10.4x ↖
3:	10.1 →
Serie	30
Total	286

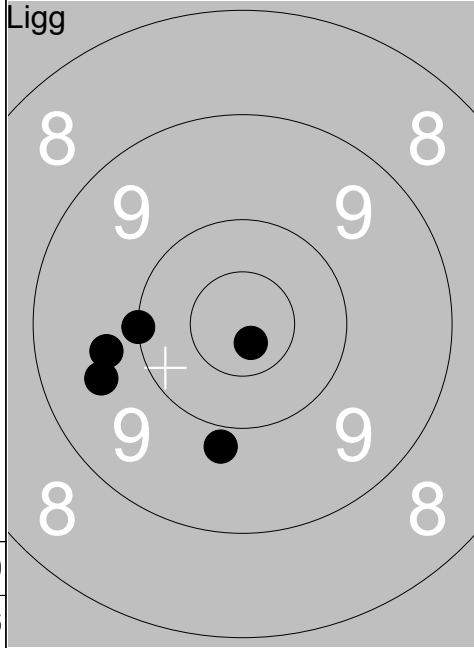

1:	10.8x ↓
2:	10.0 ←
3:	9.6 ←
4:	9.8 ↓
5:	9.7 ←
Serie	47
Total	333

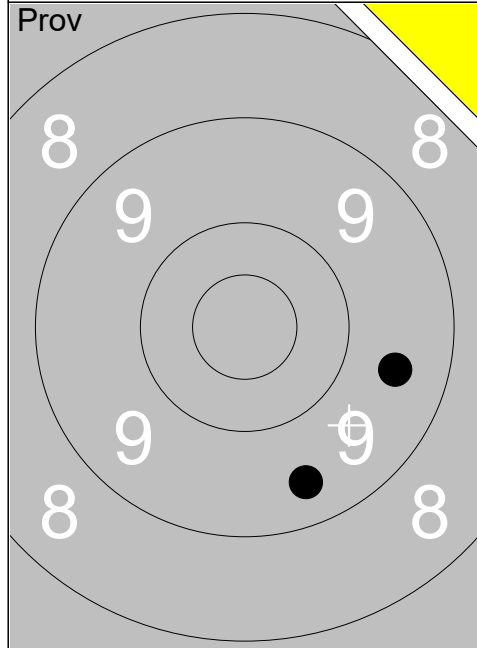

1:	9.4 ↓
2:	9.5 →
Serie	18
Total	333

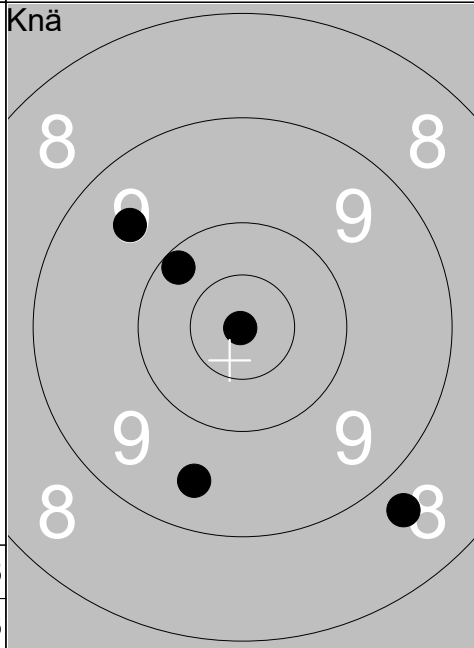

1:	10.9x ←
2:	9.5 ↓
3:	10.2 ↖
4:	8.7 ↓
5:	9.6 ↖
Serie	46
Total	379

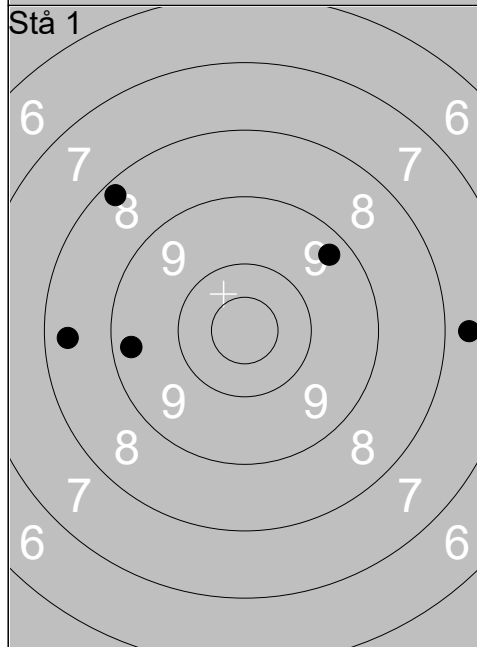

1:	9.3 ←
2:	8.4 ←
3:	9.3 ↗
4:	7.7 →
5:	8.2 ↖
Serie	41
Total	420

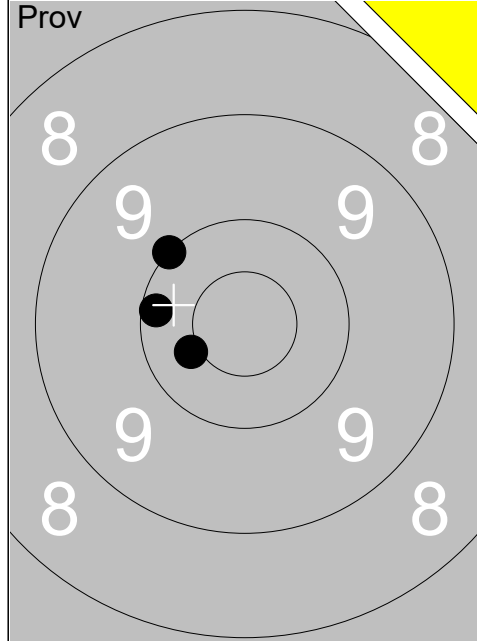

Serie	30
Total	285

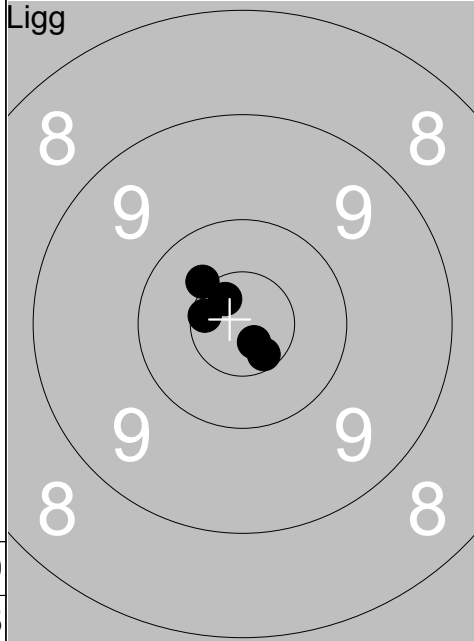

Serie	50
Total	335

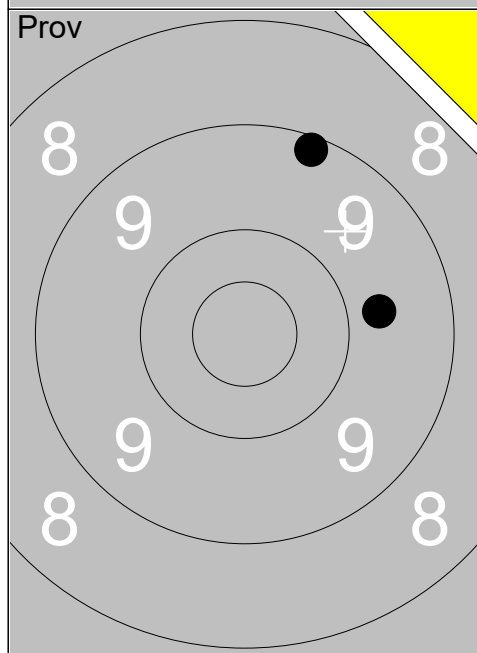

Serie	18
Total	335

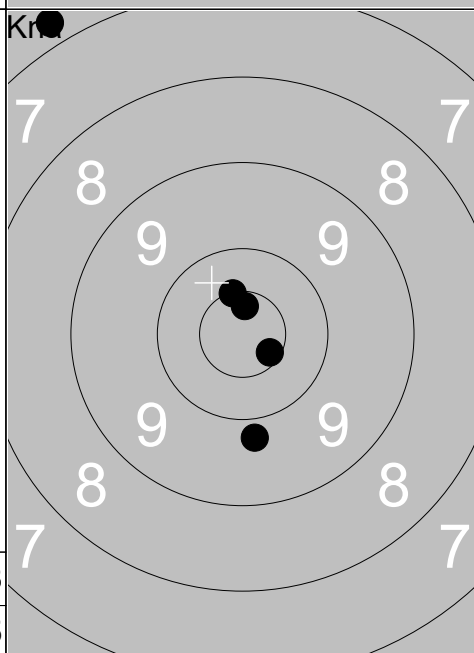

Serie	45
Total	380

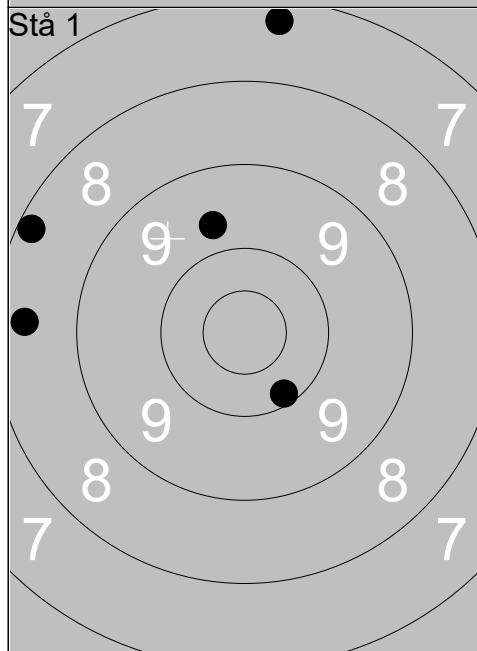

Serie	42
Total	422

Skjutlag	Tavla	Henrik Olsson	
Ramselefors	Öved-Östraby	B	Sk
07.07.2019	Tavelträffen 2019	Ramselefors SKF	
Prov 	1: 9.8 ↙ 2: 9.8 ↗ 3: 9.9 ↓	Ligg 	1: 10.5x ↓ 2: 9.8 ↖ 3: 10.3 ↗ 4: 9.9 ↓ 5: 10.2 ↓
	Serie 27		Serie 48
	Total 280		Total 328
Prov 	1: 9.3 ➡ 2: 8.9 ➡	Knä 	1: 9.5 ↖ 2: 10.6x ↗ 3: 9.6 ↑ 4: 10.1 ← 5: 8.3 ➡
	Serie 17		Serie 46
	Total 328		Total 374
Stå 1 	1: 6.9 ← 2: 7.3 ← 3: 10.1 ➡ 4: 9.8 ↓ 5: 7.5 ↖		
	Serie 39		
	Total 413		

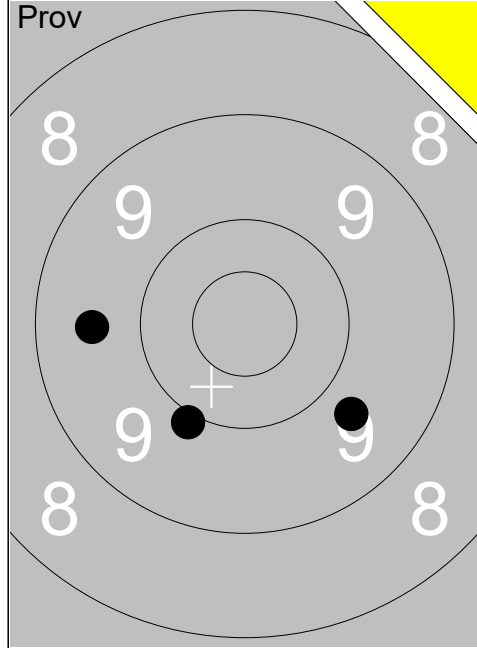

1:	9.9	↘
2:	9.7	↘
3:	9.6	←
Serie 27		
Total 278		

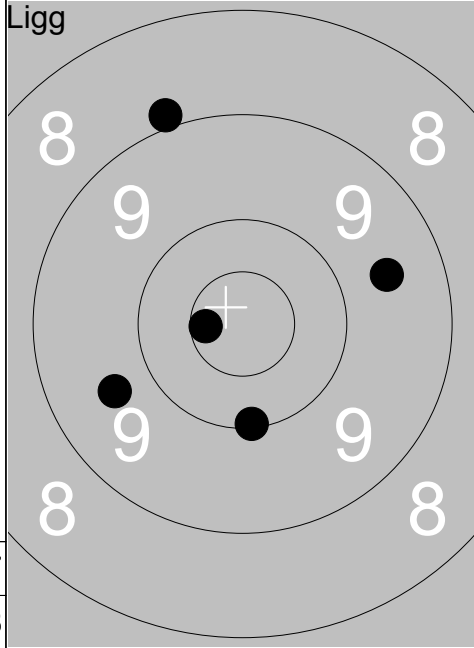

1:	8.9	↗
2:	10.6x	←
3:	9.6	←
4:	10.1	↓
5:	9.6	→
Serie 46		
Total 324		

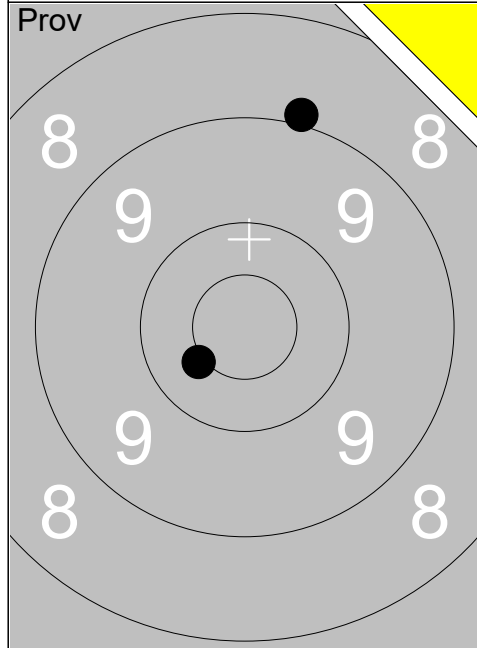

1:	8.9	↗
2:	10.4x	↙
Serie 18		
Total 324		

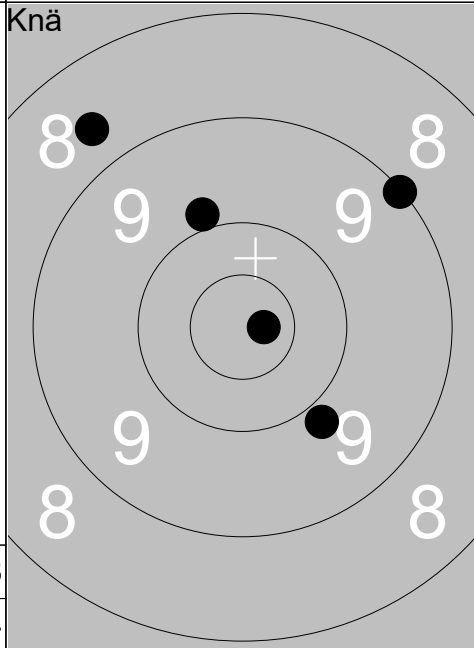

1:	8.7	↖
2:	9.9	↘
3:	10.8x	→
4:	9.0	↗
5:	9.9	↗
Serie 45		
Total 369		

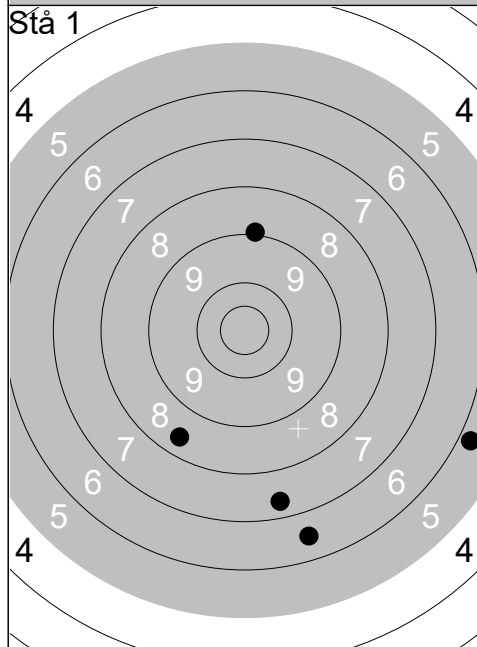

1:	6.5	↘
2:	8.4	↘
3:	9.0	↗
4:	7.4	↘
5:	5.8	↘
Serie 35		
Total 404		

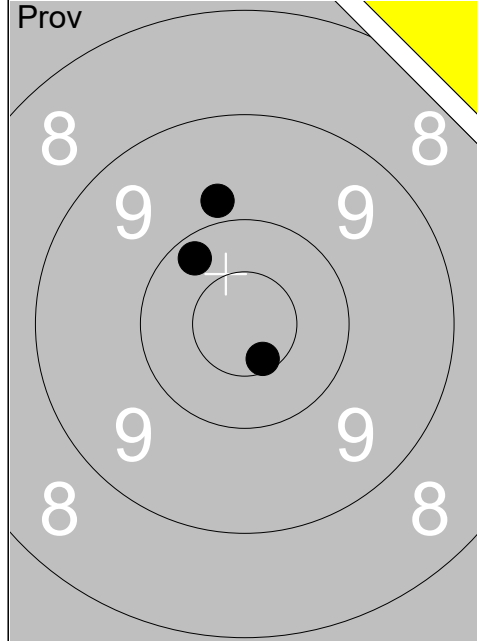

1:	10.2 ↗
2:	10.6x ↘
3:	9.8 ↗
Serie 29	
Total 278	

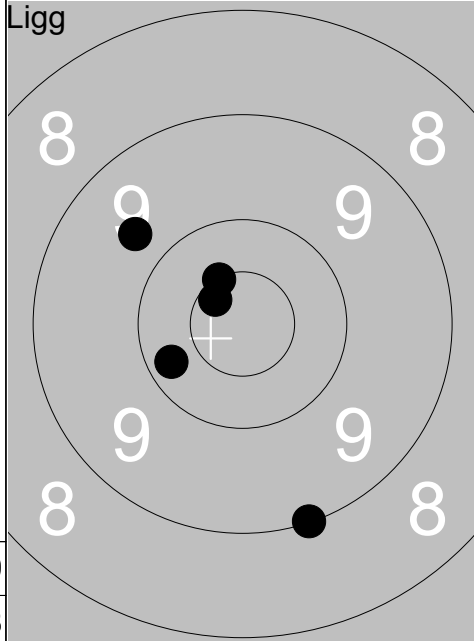

1:	10.6x ↗
2:	10.5x ↗
3:	10.2 ↖
4:	9.0 ↘
5:	9.7 ↗
Serie 48	
Total 326	

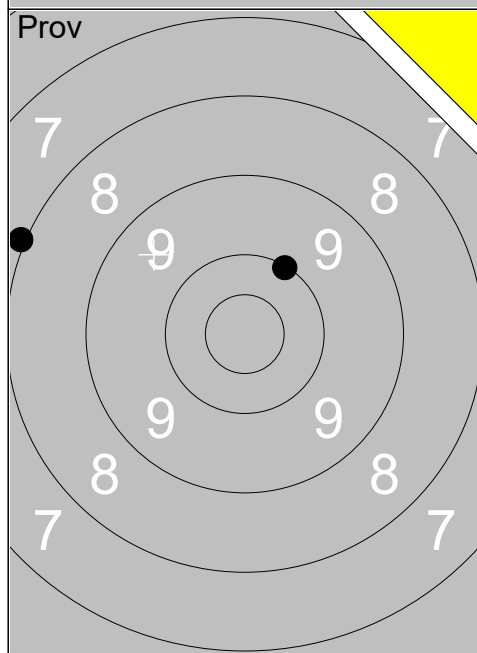

1:	8.0 ↖
2:	10.0 ↗
Serie 18	
Total 326	

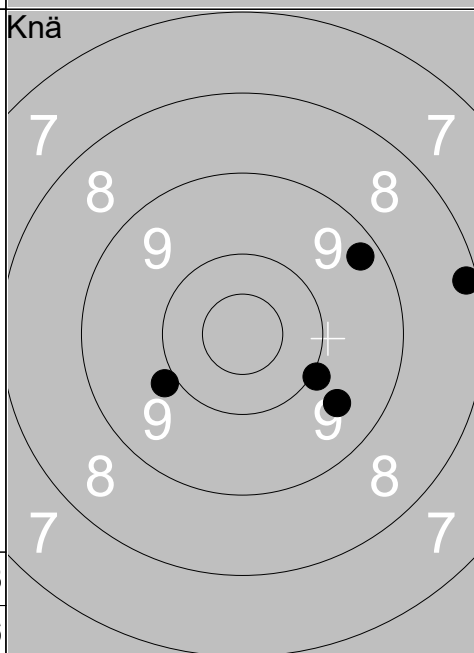

1:	9.6 ↘
2:	8.2 →
3:	9.9 ↖
4:	10.0 ↘
5:	9.3 ↗
Serie 45	
Total 371	

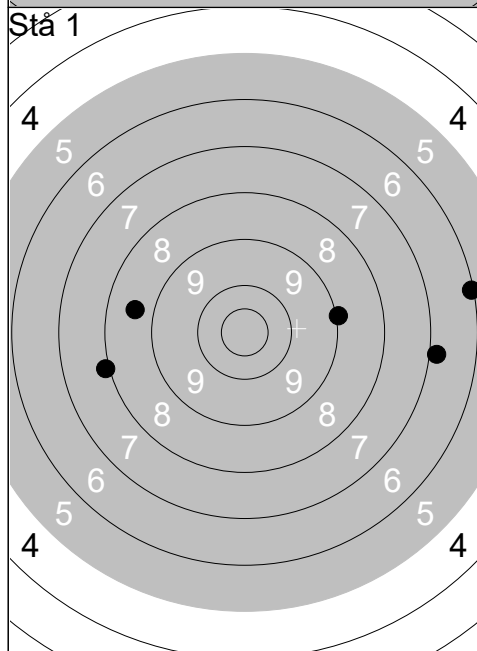

1:	6.9 →
2:	9.0 →
3:	7.9 ↖
4:	6.1 →
5:	8.6 ↖
Serie 36	
Total 407	

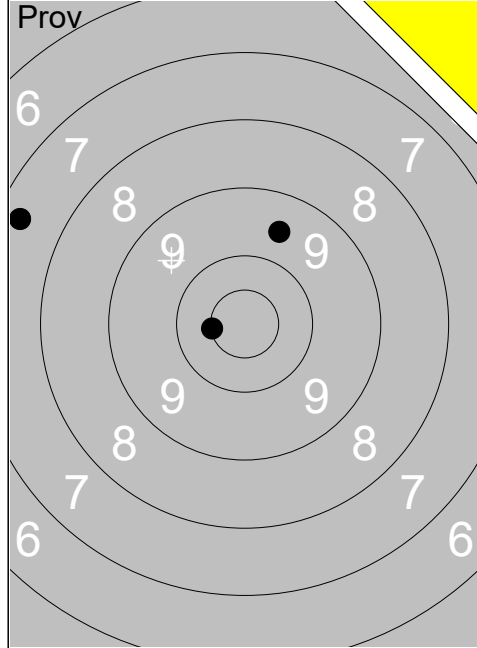

1:	7.4	↖
2:	10.5x	↖
3:	9.6	↗
<hr/>		
Serie	26	
Total	277	

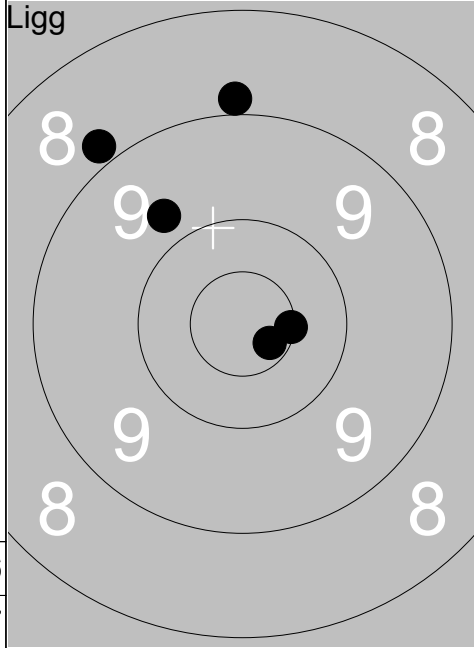

1:	8.8	↗
2:	9.8	↗
3:	8.9	↗
4:	10.5x	→
5:	10.7x	↘
<hr/>		
Serie	45	
Total	322	

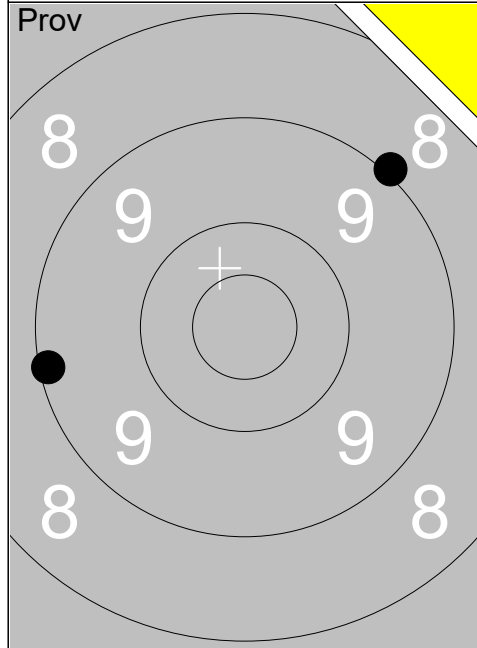

1:	9.0	↗
2:	9.1	←
<hr/>		
Serie	18	
Total	322	

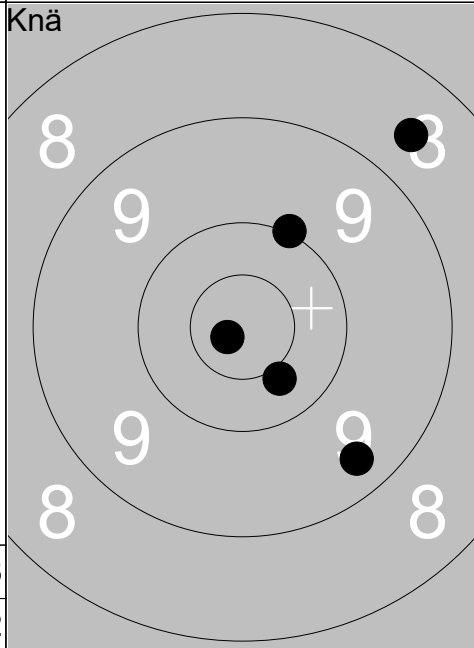

1:	8.6	↗
2:	9.4	↘
3:	10.0	↗
4:	10.8x	↖
5:	10.4	↘
<hr/>		
Serie	47	
Total	369	

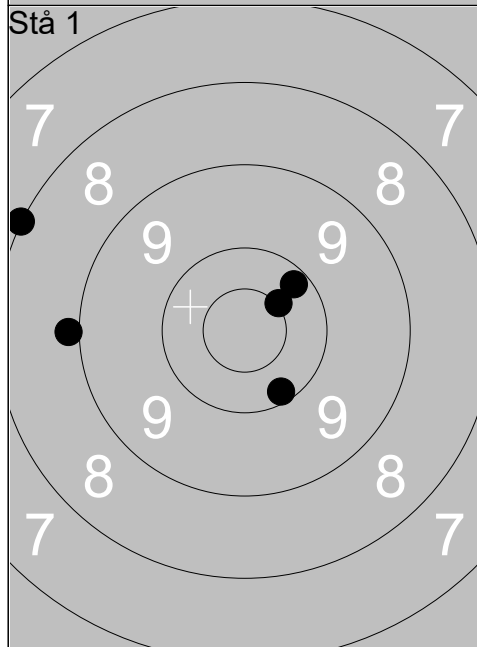

1:	10.2	↘
2:	8.9	←
3:	8.0	↖
4:	10.2	↗
5:	10.5x	↗
<hr/>		
Serie	46	
Total	415	

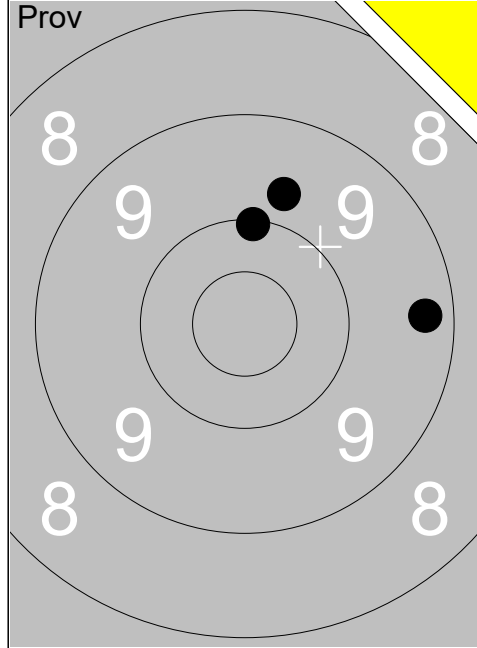

1:	10.1	↑
2:	9.7	↑
3:	9.3	→
Serie		28
Total		276

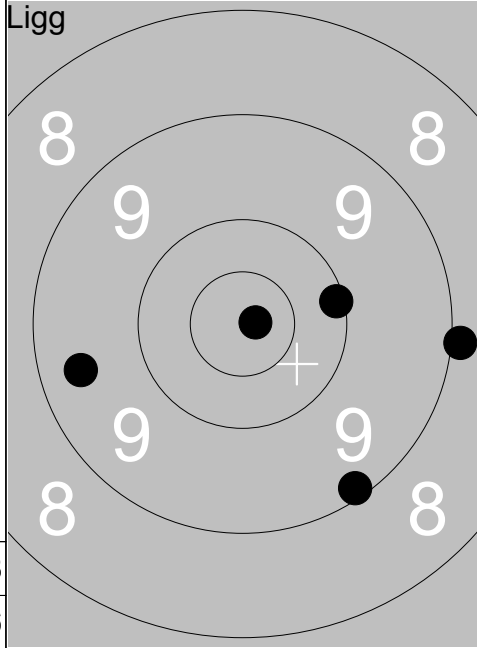

1:	8.9	→
2:	10.1	→
3:	9.1	↘
4:	9.4	←
5:	10.8x	→
Serie		46
Total		322

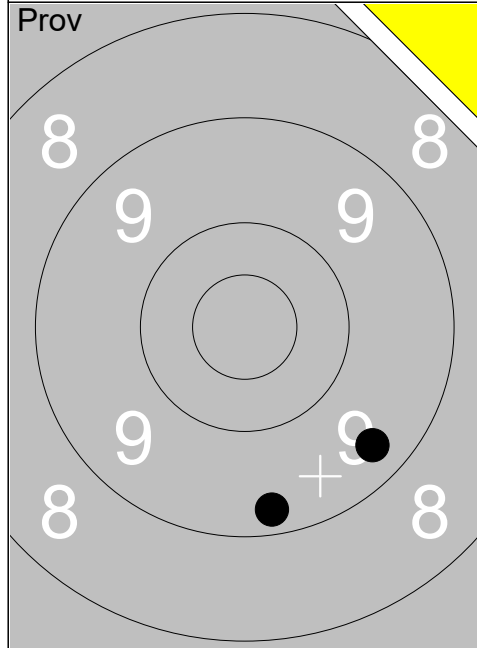

1:	9.3	↓
2:	9.4	↘
Serie		18
Total		322

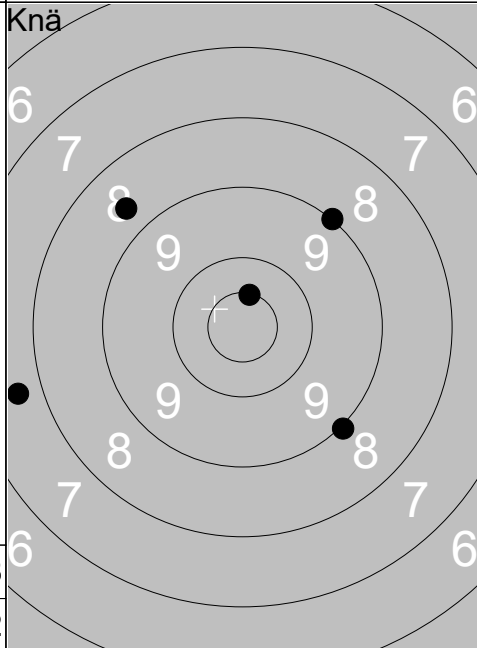

1:	10.5x	↑
2:	8.7	↖
3:	9.0	↗
4:	7.7	←
5:	9.0	↘
Serie		43
Total		365

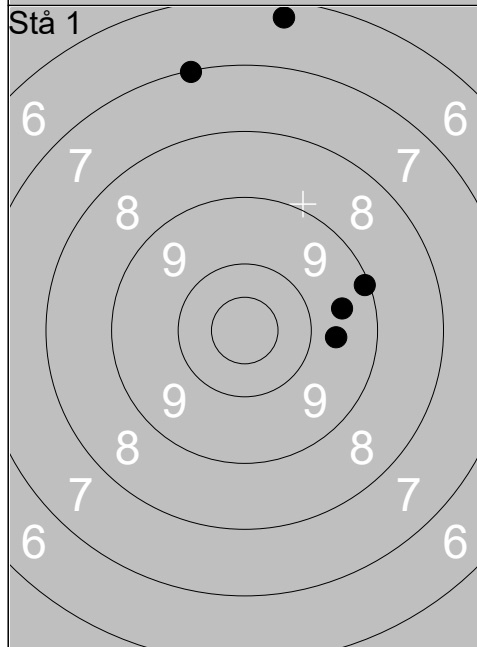

1:	9.1	→
2:	9.5	→
3:	6.3	↑
4:	9.7	→
5:	7.1	↑
Serie		40
Total		405

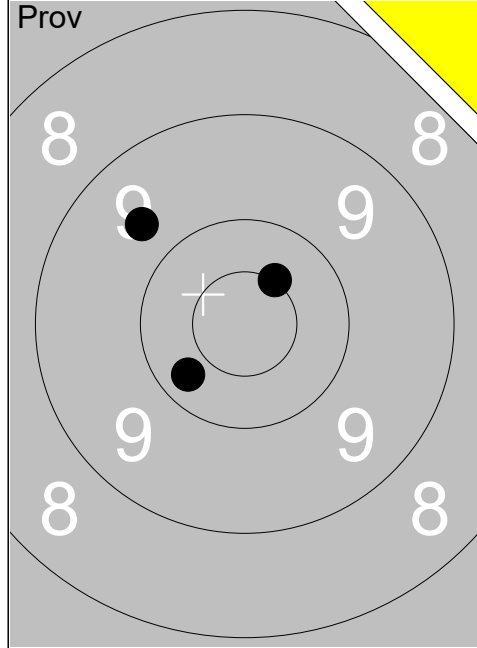

1:	9.7 ↖
2:	10.5x ↗
3:	10.3 ↙
Serie 29	
Total 276	

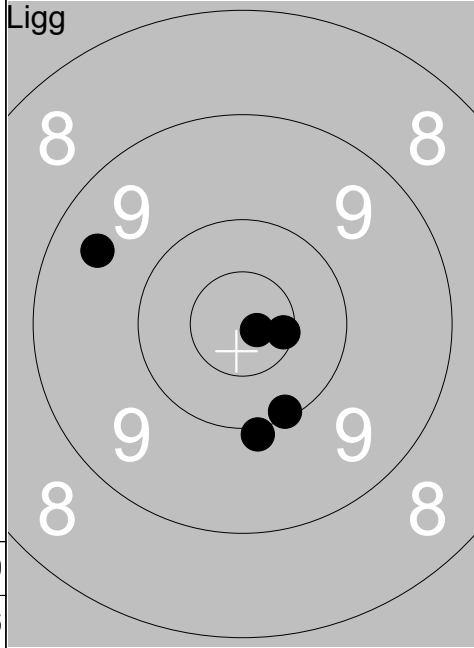

1:	10.8x ➤
2:	9.5 ↖
3:	10.6x ➤
4:	10.1 ↙
5:	10.0 ↙
Serie 49	
Total 325	

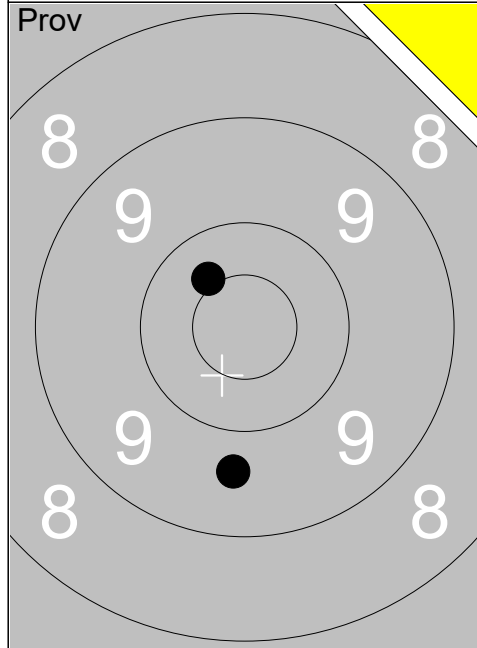

1:	9.6 ↘
2:	10.4 ↗
Serie 19	
Total 325	

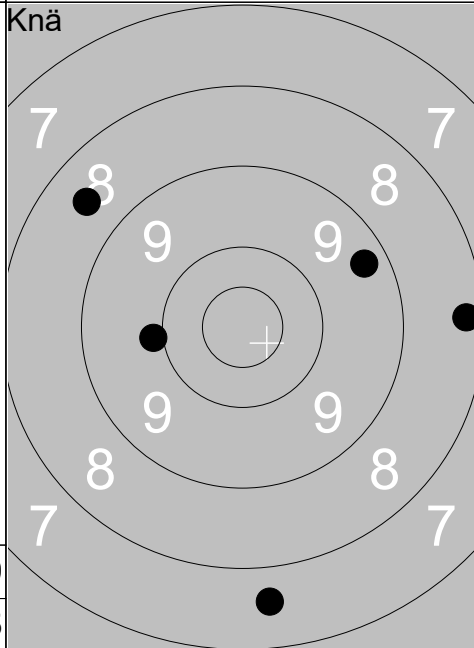

1:	9.9 ←
2:	8.5 ↖
3:	8.2 ➤
4:	7.6 ↘
5:	9.3 ➤
Serie 41	
Total 366	

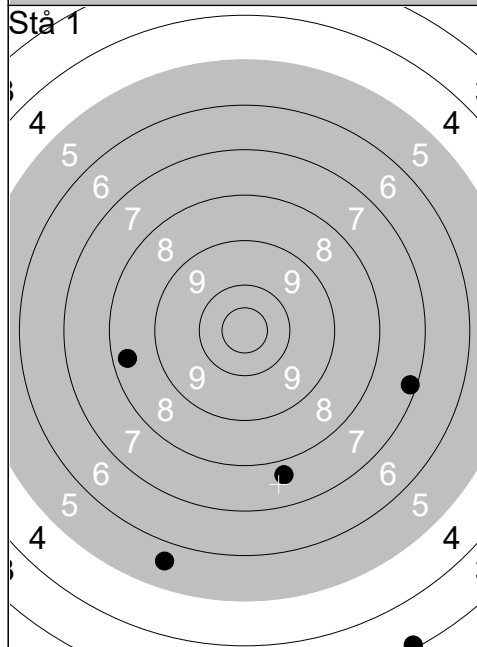

1:	8.4 ←
2:	7.2 ➤
3:	5.6 ↘
4:	7.7 ↘
5:	3.1 ↘
Serie 30	
Total 396	

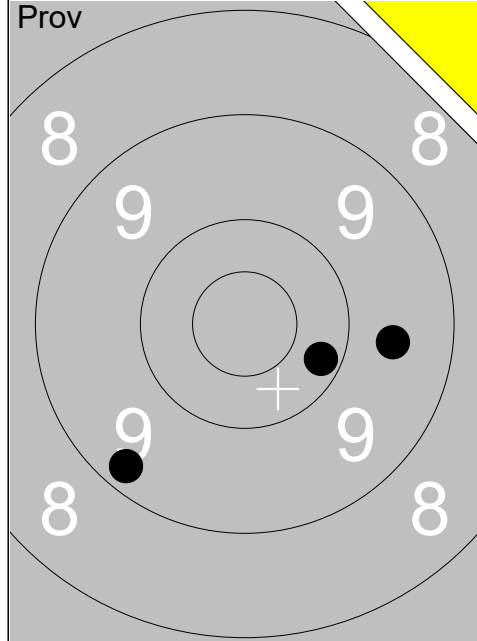

1:	9.6	→
2:	9.3	↙
3:	10.2	→
<hr/>		
Serie	28	
Total	274	

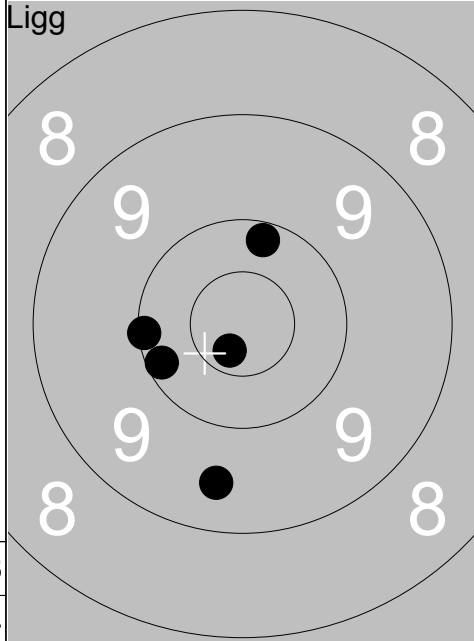

1:	9.5	↓
2:	10.2	↙
3:	10.1	←
4:	10.2	↑
5:	10.7x	↙
<hr/>		
Serie	49	
Total	323	

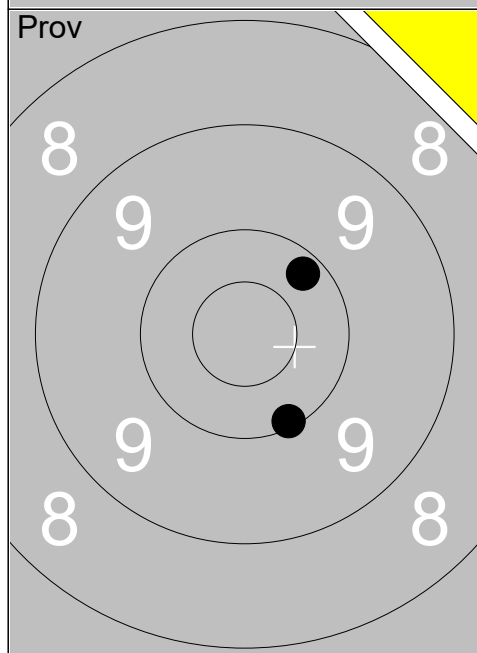

1:	10.1	↘
2:	10.2	↗
<hr/>		
Serie	20	
Total	323	

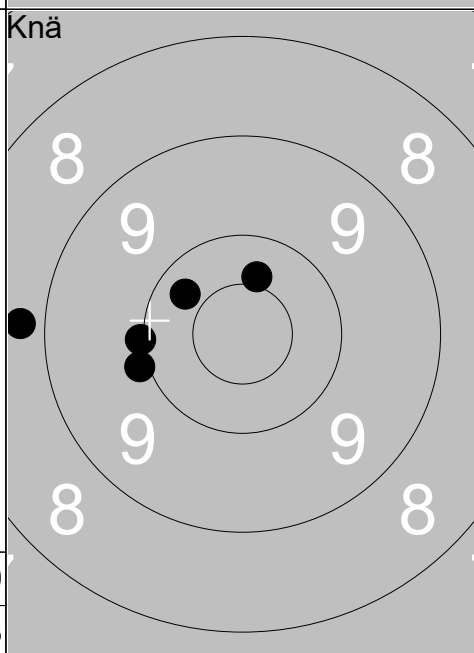

1:	9.9	←
2:	10.0	←
3:	8.8	←
4:	10.3	↖
5:	10.4	↑
<hr/>		
Serie	47	
Total	370	

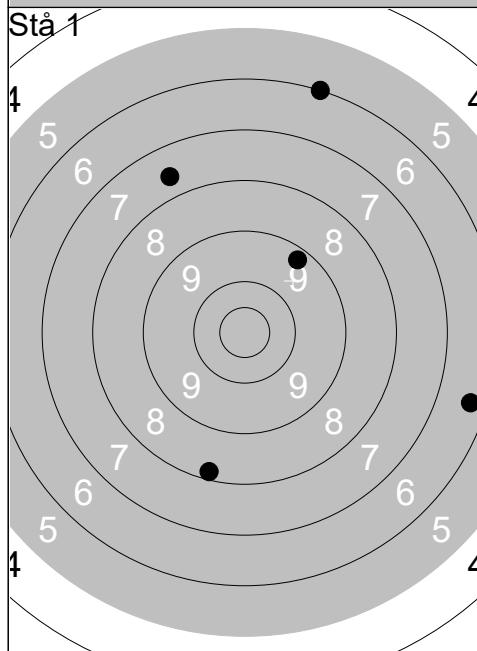

1:	9.3	↗
2:	8.2	↓
3:	6.3	→
4:	7.6	↖
5:	6.0	↗
<hr/>		
Serie	36	
Total	406	

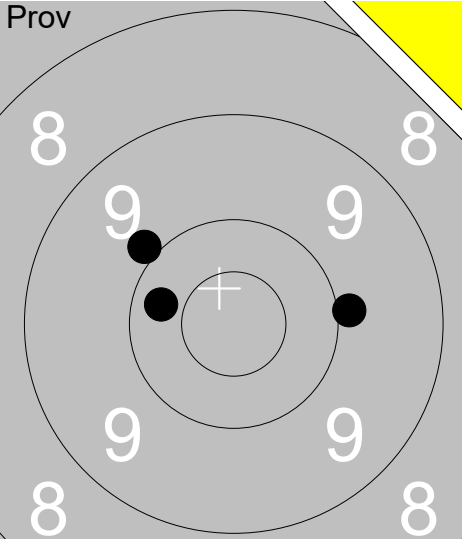
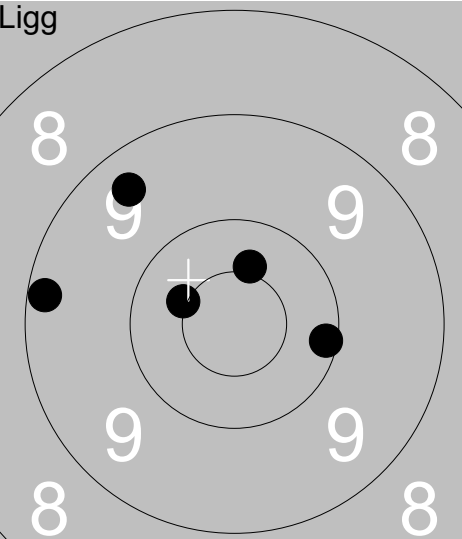
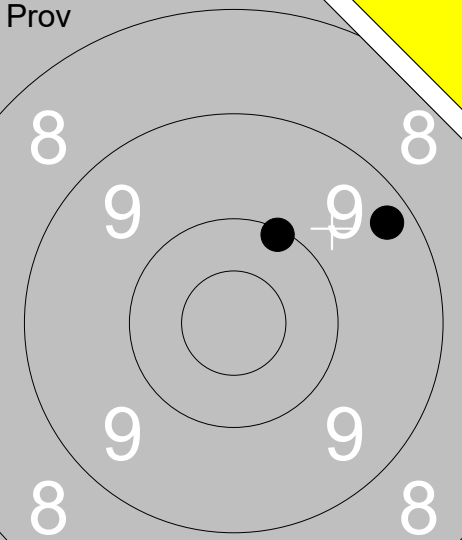
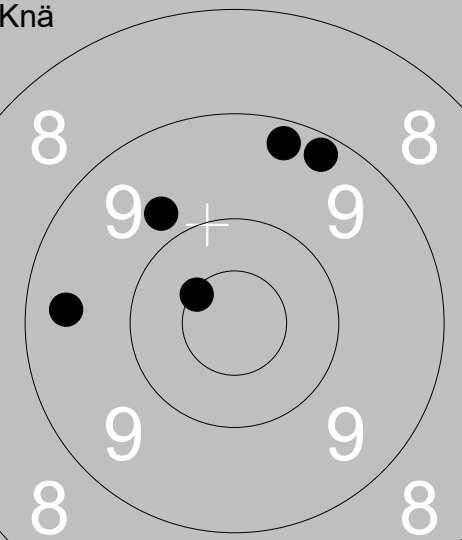
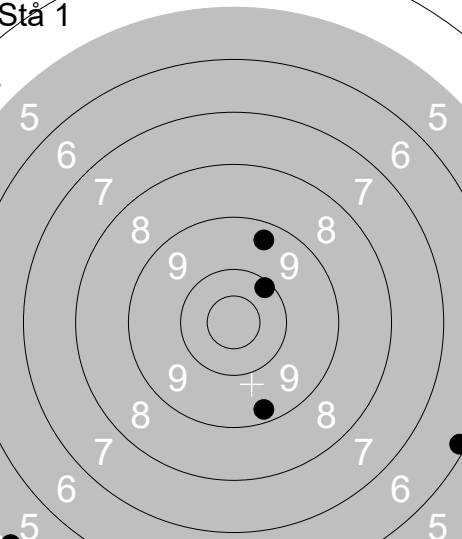
Skjutlag	Tavla	Kevin Arnmark		
8	17	Ramselefors	Västerås Friv Skarp	B Vm
07.07.2019	Tavelträffen 2019	Ramselefors SKF		
Prov 	1: 9.9 → 2: 10.3 ← 3: 9.9 ↗	Ligg 	1: 9.4 ↖ 2: 9.2 ← 3: 10.4x ↗ 4: 10.1 → 5: 10.5x ↖	
	Serie 28		Serie 48	
	Total 273		Total 321	
Prov 	1: 9.3 ↗ 2: 10.1 ↗	Knä 	1: 10.5x ↖ 2: 9.2 ↗ 3: 9.3 ↗ 4: 9.8 ↖ 5: 9.4 ←	
	Serie 19		Serie 46	
	Total 321		Total 367	
Stå 1 	1: 9.4 ↗ 2: 5.0 ↖ 3: 9.3 ↘ 4: 6.1 ↘ 5: 10.1 ↗			
	Serie 39			
	Total 406			

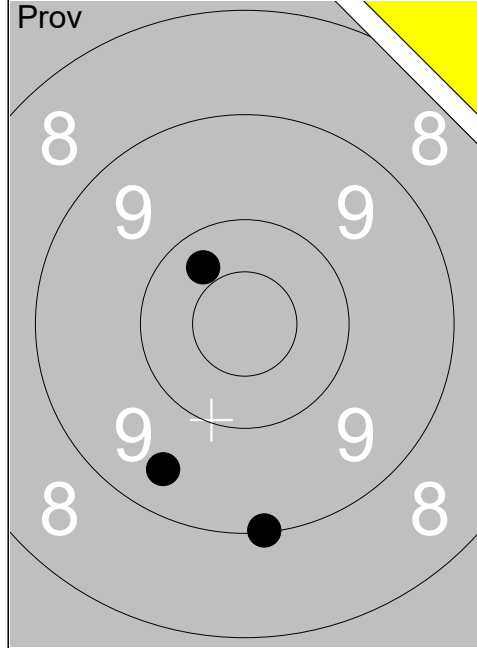

1:	10.3 ↖
2:	9.1 ↓
3:	9.4 ↘
Serie 28	
Total 271	

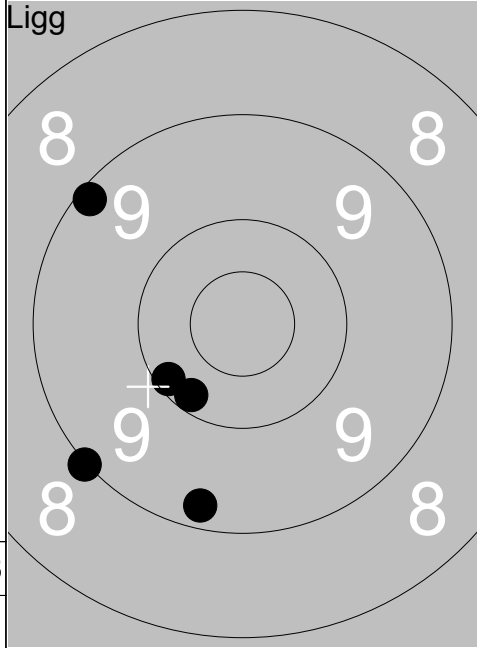

1:	9.1 ↖
2:	9.0 ↙
3:	10.2 ↘
4:	9.3 ↓
5:	10.1 ↙
Serie 47	
Total 318	

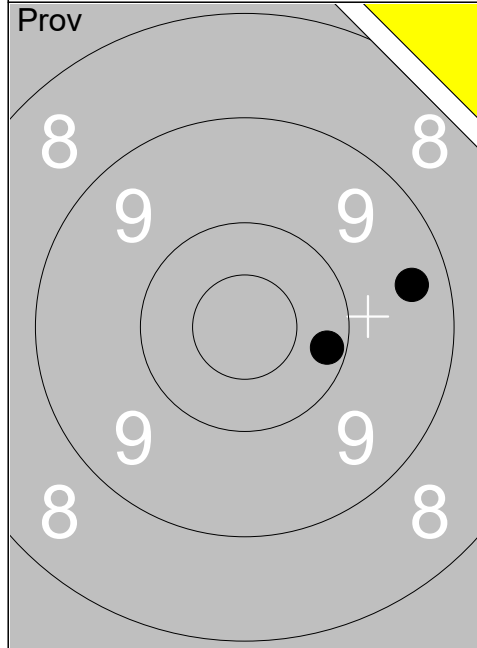

1:	10.2 →
2:	9.4 →
Serie 19	
Total 318	

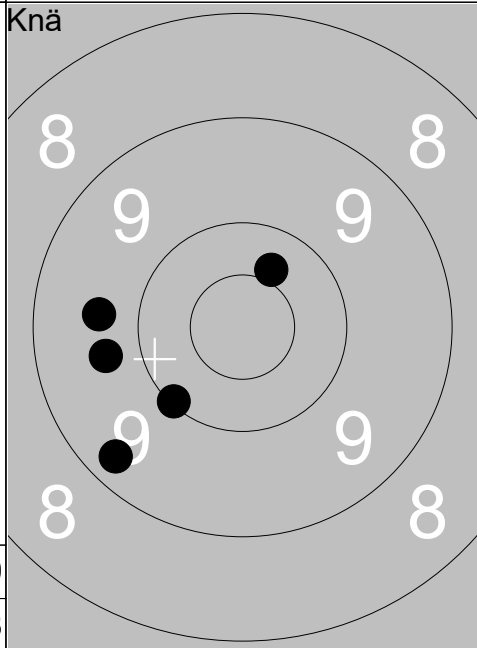

1:	10.1 ↙
2:	9.3 ↙
3:	10.4 ↗
4:	9.7 ←
5:	9.7 ←
Serie 47	
Total 365	

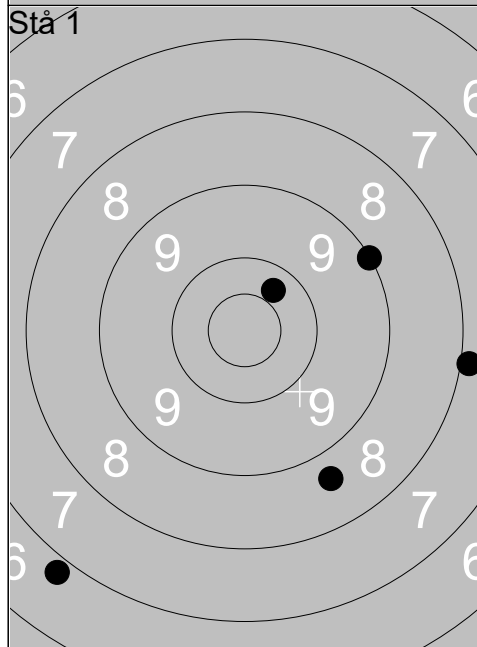

1:	10.3 ↗
2:	8.7 ↓
3:	7.9 →
4:	9.0 ↗
5:	6.8 ↙
Serie 40	
Total 405	

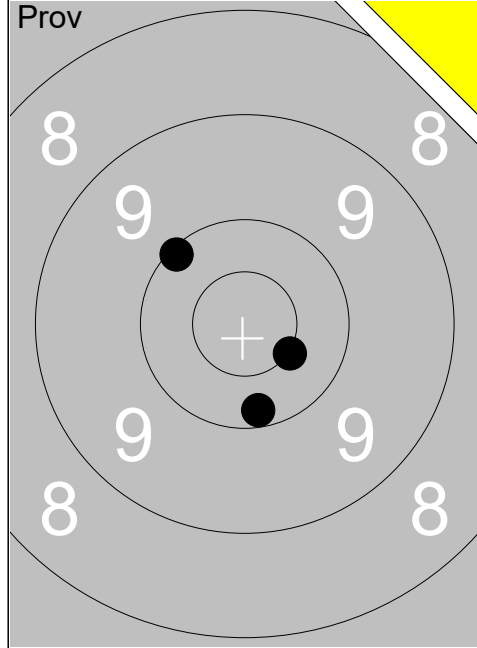

Serie	30
Total	269

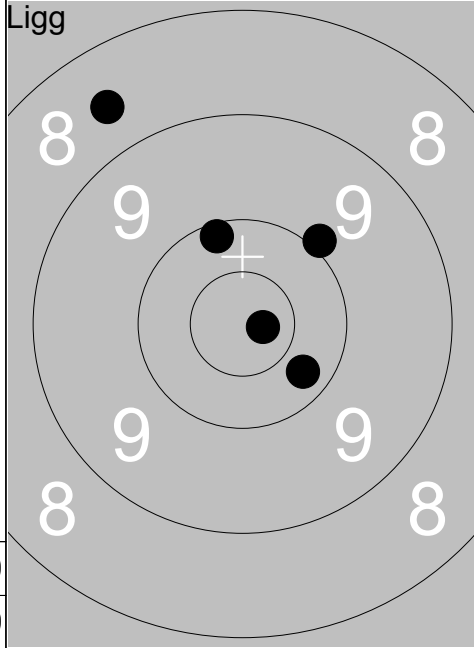

Serie	47
Total	316

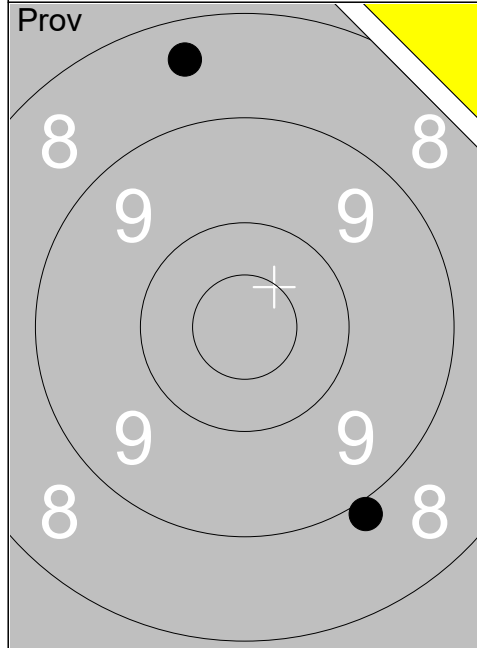

Serie	16
Total	316

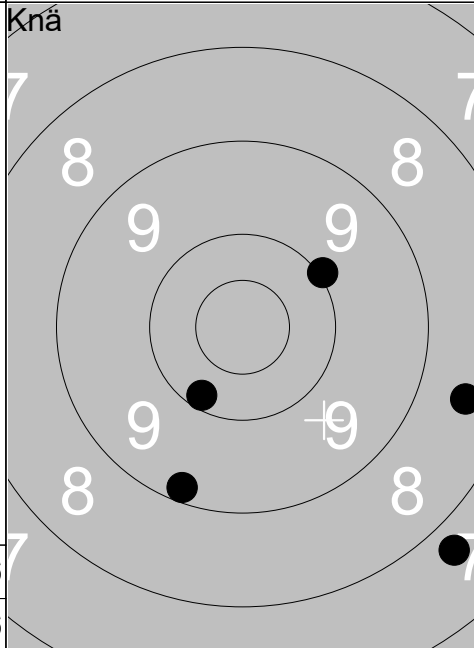

Serie	44
Total	360

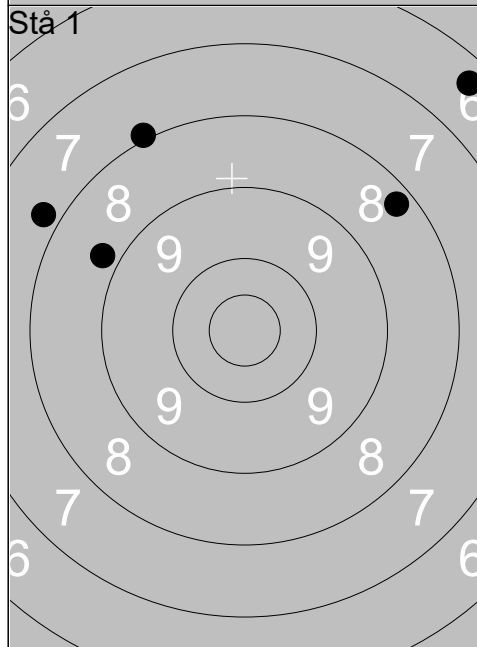

Serie	37
Total	397

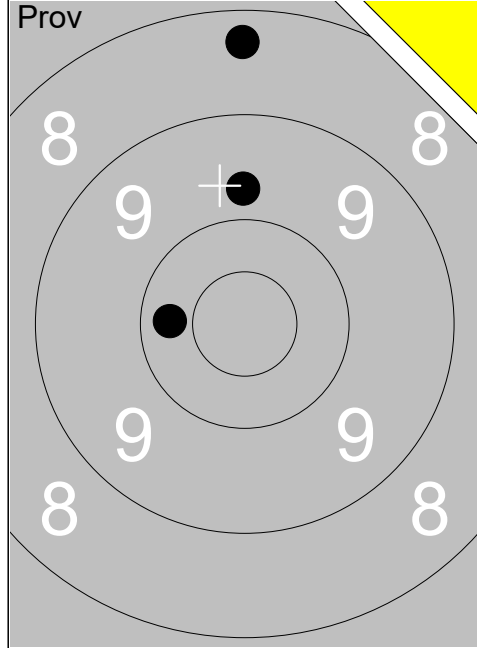

1:	8.3	↑
2:	9.7	↑
3:	10.3	←
Serie		27
Total		268

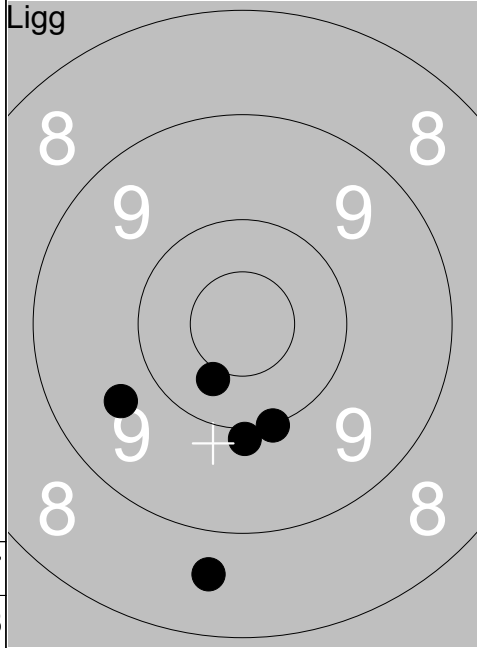

1:	9.7	↙
2:	10.0	↘
3:	8.6	↘
4:	9.9	↘
5:	10.4	↘
Serie		46
Total		314

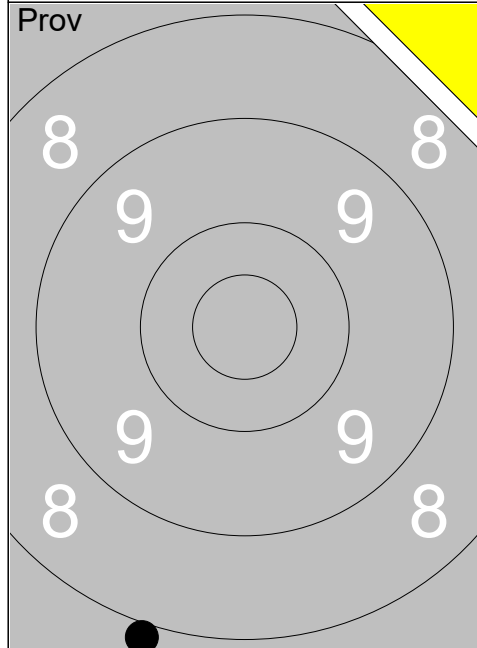

1:	7.9	↘
Serie		7
Total		314

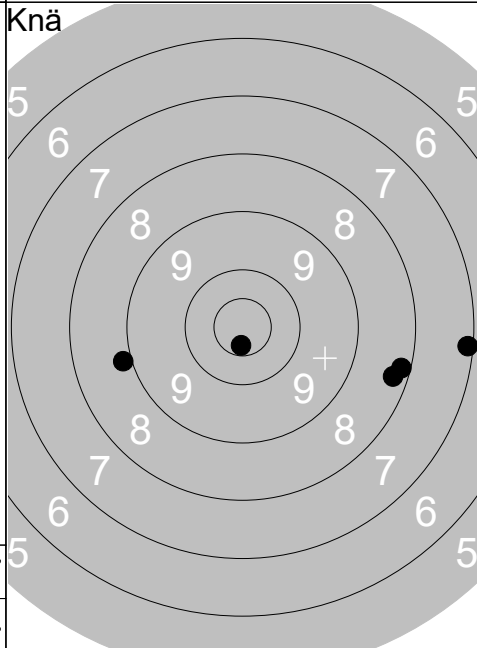

1:	7.1	→
2:	8.9	←
3:	10.7x	↘
4:	8.3	→
5:	8.2	→
Serie		41
Total		355

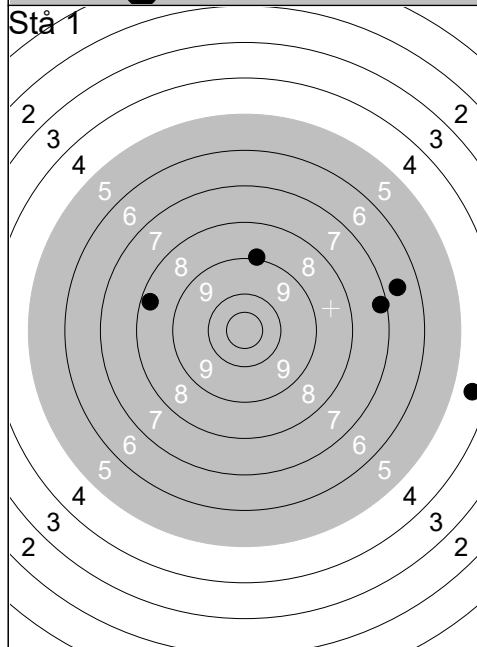

1:	6.6	→
2:	7.2	→
3:	8.3	←
4:	9.0	↑
5:	4.5	⇒
Serie		34
Total		389

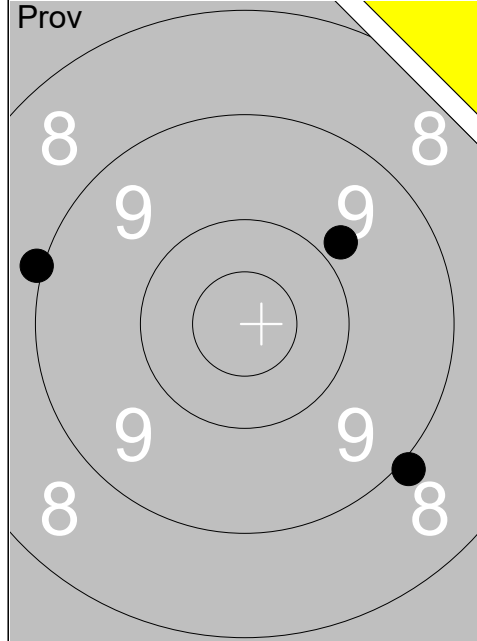

1:	9.0	←
2:	9.8	↗
3:	8.9	↘
<hr/>		
Serie	26	
Total	266	

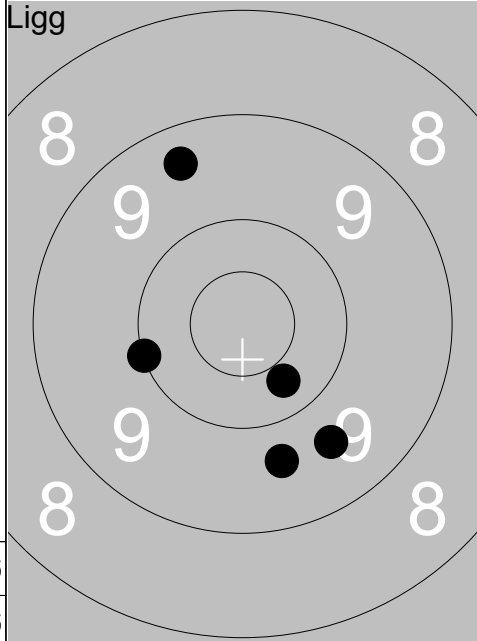

1:	10.3	↘
2:	9.6	↘
3:	9.4	↗
4:	9.7	↘
5:	10.0	←
<hr/>		
Serie	47	
Total	313	

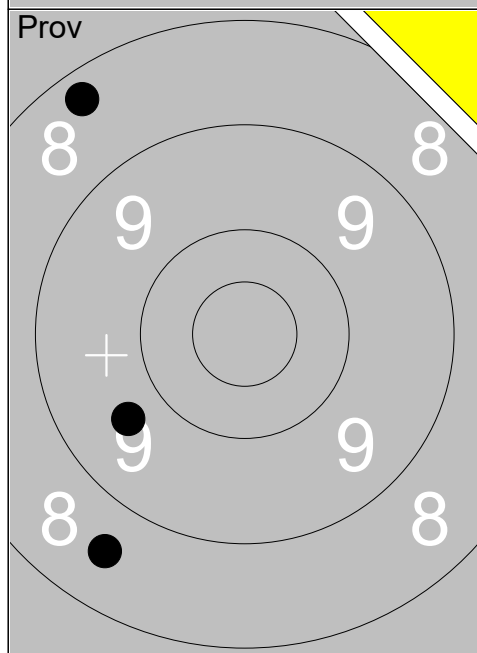

1:	8.3	↖
2:	8.6	↘
3:	9.7	←
<hr/>		
Serie	25	
Total	313	

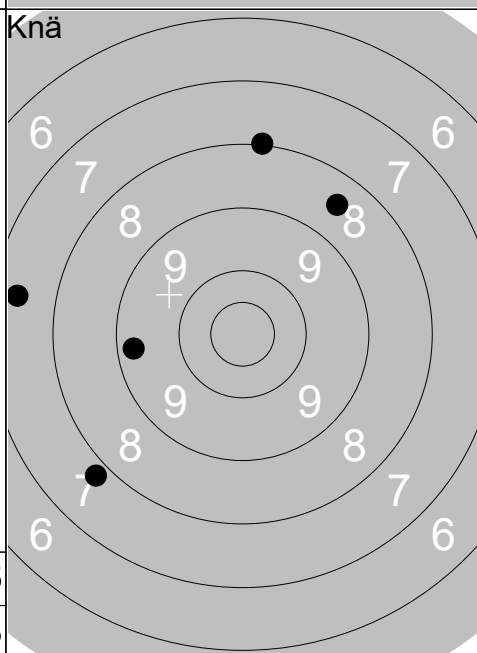

1:	8.0	↑
2:	8.5	↗
3:	7.8	↘
4:	9.3	←
5:	7.4	←
<hr/>		
Serie	39	
Total	352	

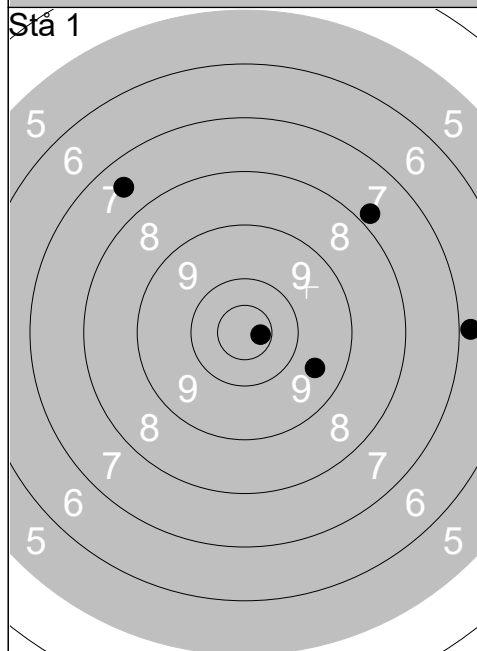

1:	7.8	↗
2:	10.7x	→
3:	7.5	↗
4:	9.6	↘
5:	6.8	→
<hr/>		
Serie	39	
Total	391	

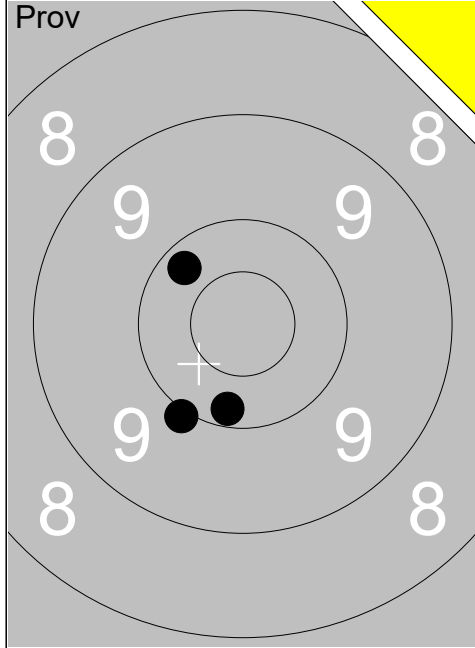

1:	10.2	↓
2:	10.0	↓
3:	10.2	↖
Serie 30		
Total 264		

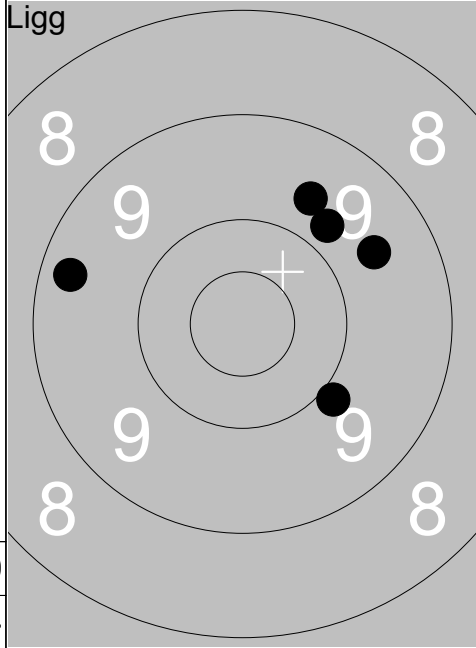

1:	9.3	←
2:	9.6	↗
3:	9.8	↗
4:	9.7	↗
5:	9.9	↘
Serie 45		
Total 309		

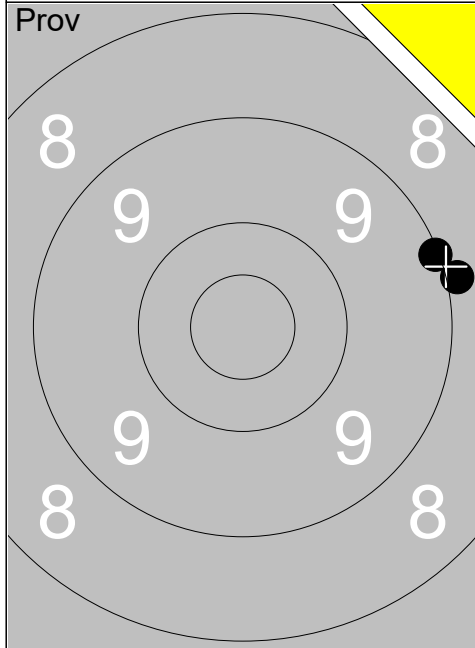

1:	9.1	→
2:	8.9	→
Serie 17		
Total 309		

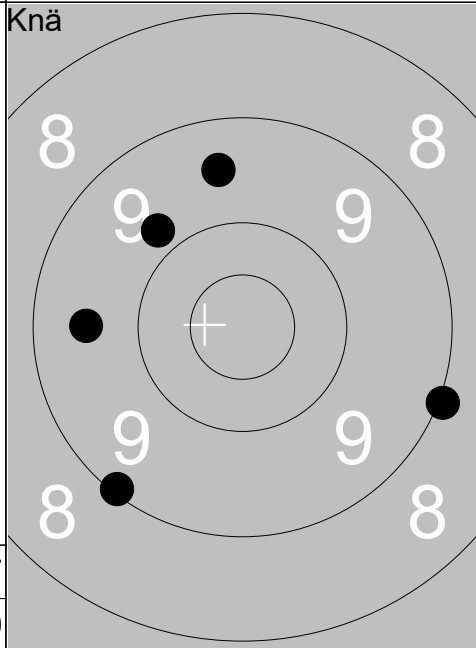

1:	9.8	↖
2:	9.5	←
3:	9.0	→
4:	9.1	↘
5:	9.5	↑
Serie 45		
Total 354		

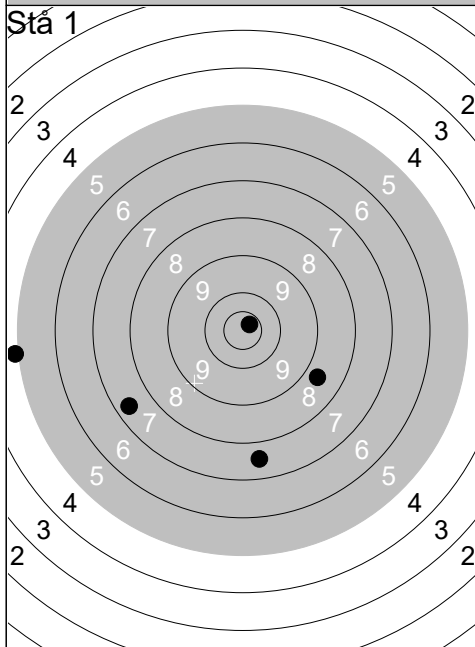

1:	8.7	↘
2:	4.9	←
3:	7.6	↓
4:	10.7x	↗
5:	7.4	↖
Serie 36		
Total 390		

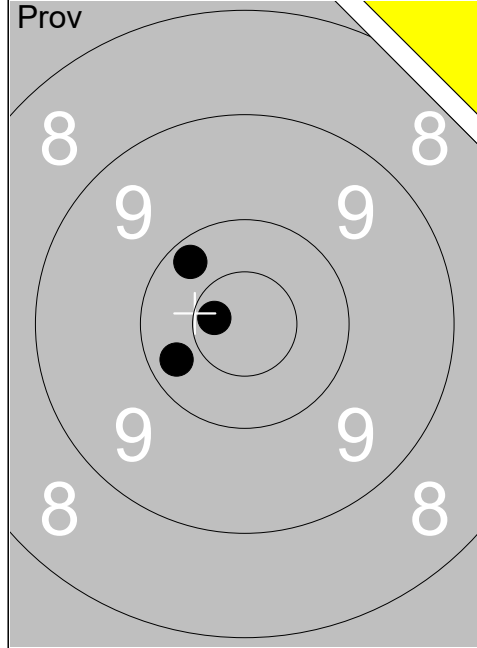

1:	10.2 ↖
2:	10.7x ←
3:	10.3 ←
Serie 30	
Total 262	

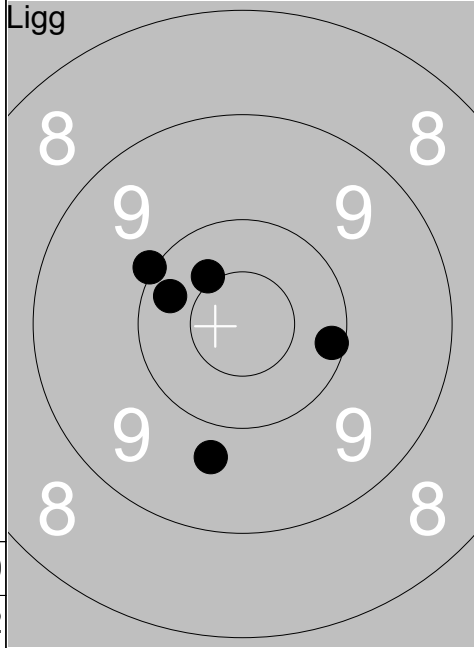

1:	10.0 ↖
2:	10.3 ←
3:	10.1 →
4:	10.4x ↗
5:	9.7 ↓
Serie 49	
Total 311	

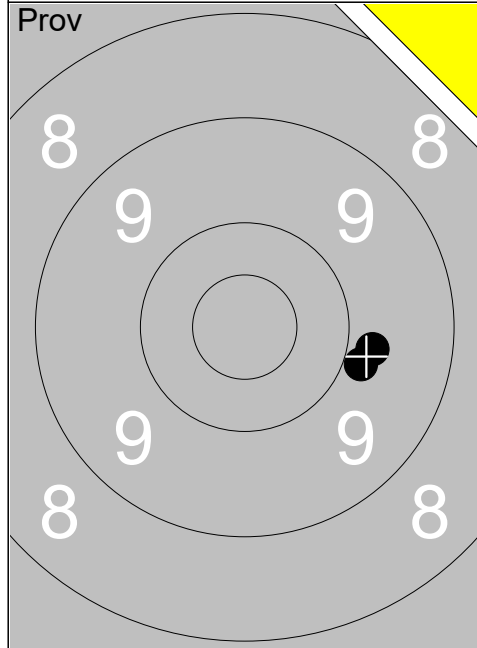

1:	9.8 →
2:	9.9 →
Serie 18	
Total 311	

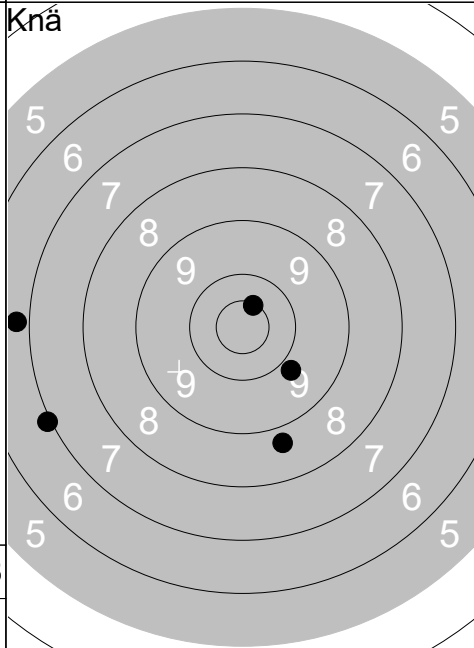

1:	9.8 ↘
2:	6.8 ←
3:	10.5x ↗
4:	7.0 ←
5:	8.7 ↓
Serie 40	
Total 351	

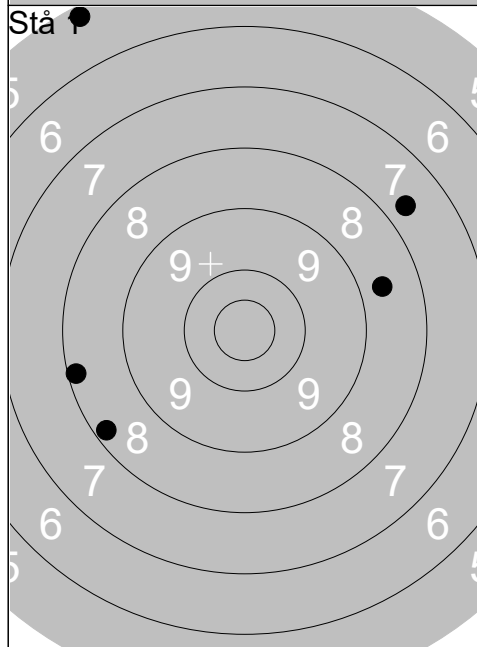

1:	5.2 ↖
2:	8.6 →
3:	8.2 ←
4:	8.2 ↙
5:	7.7 ↗
Serie 36	
Total 387	

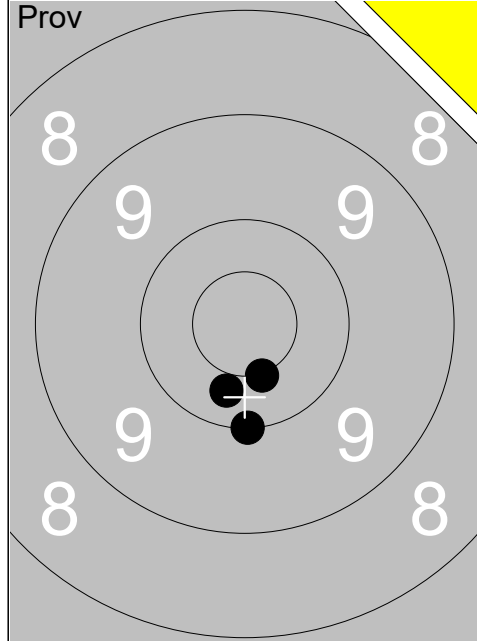

1:	10.5x	↓
2:	10.0	↓
3:	10.3	↓
Serie		30
Total		262

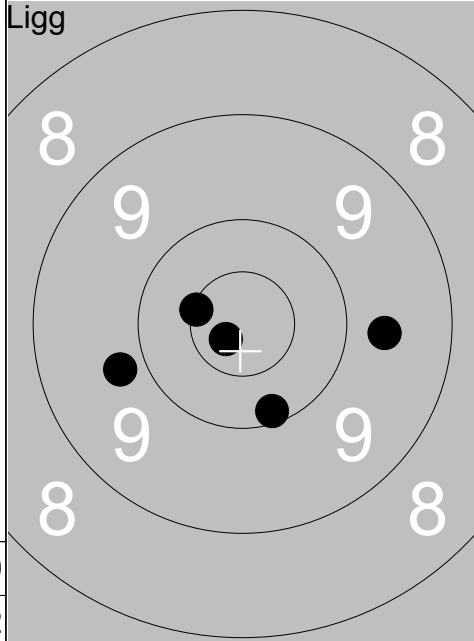

1:	10.1	↓
2:	9.8	←
3:	10.5x	↙
4:	10.8x	↙
5:	9.7	→
Serie		48
Total		310

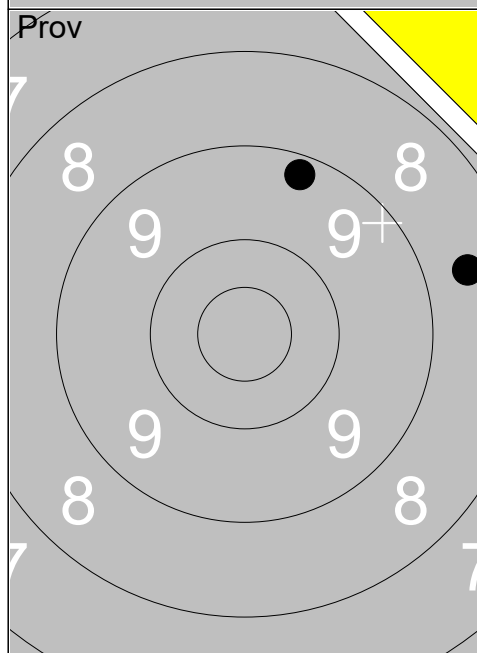

1:	8.6	→
2:	9.2	↑
Serie		17
Total		310

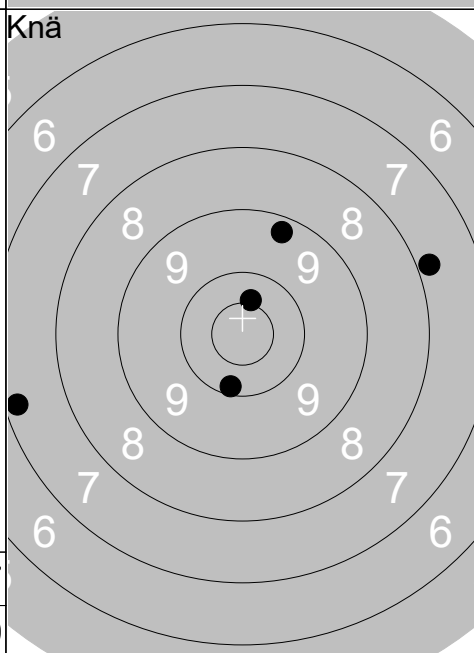

1:	9.3	↑
2:	7.2	←
3:	10.4x	↑
4:	10.2	↓
5:	7.8	→
Serie		43
Total		353

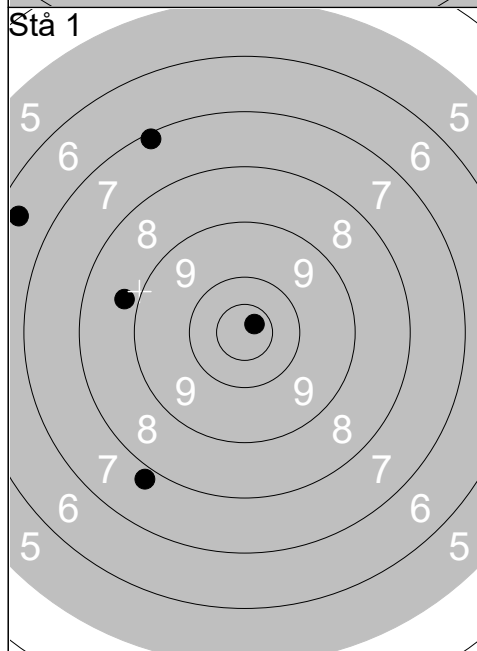

1:	7.1	↑
2:	7.8	↓
3:	6.4	←
4:	10.7x	↗
5:	8.8	←
Serie		38
Total		391