

1:	9.9	↙
2:	10.2	↓
3:	10.1	↙
4:	7.9	↗
5:	8.5	↗
Serie		44
Total		0

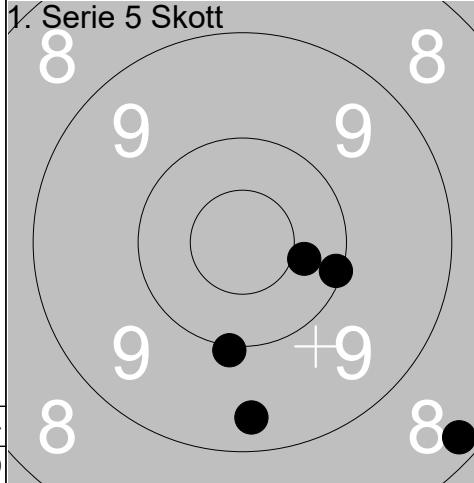

1:	10.1	→
2:	10.4	→
3:	8.2	↙
4:	10.0	↓
5:	9.4	↓
Serie		47
Total		47

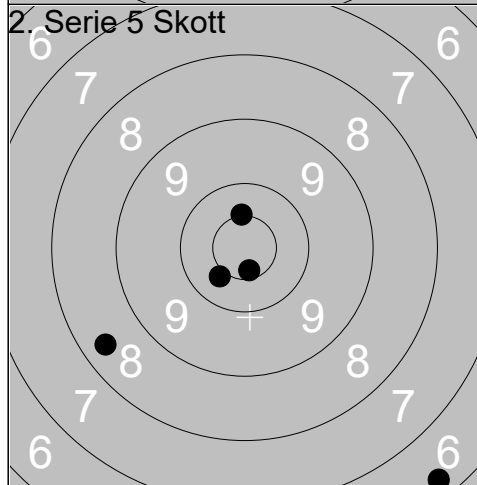

1:	8.4	↙
2:	10.5x	↑
3:	6.3	↘
4:	10.6x	↓
5:	10.4	↙
Serie		44
Total		91

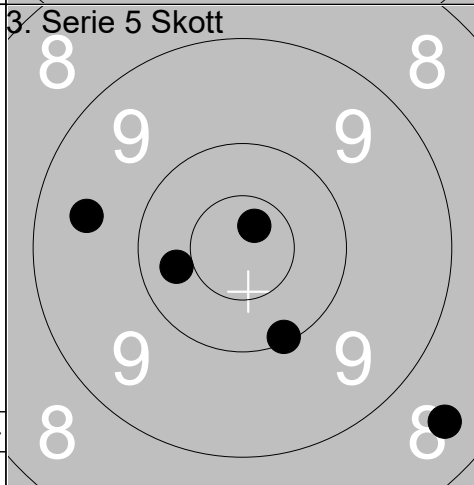

1:	10.1	↘
2:	9.5	←
3:	8.5	↘
4:	10.3	←
5:	10.7x	↗
Serie		47
Total		138

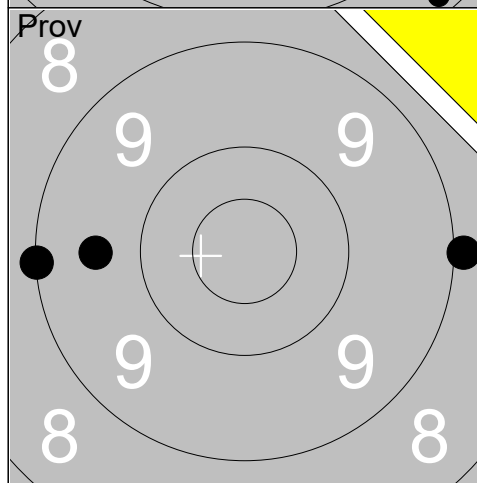

1:	9.6	←
2:	9.0	←
3:	8.9	→
Serie		26
Total		138

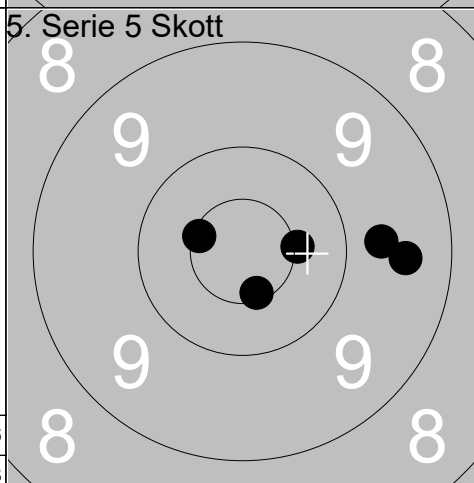

1:	10.6x	↘
2:	9.5	→
3:	10.5x	→
4:	9.7	→
5:	10.5x	←
Serie		48
Total		186

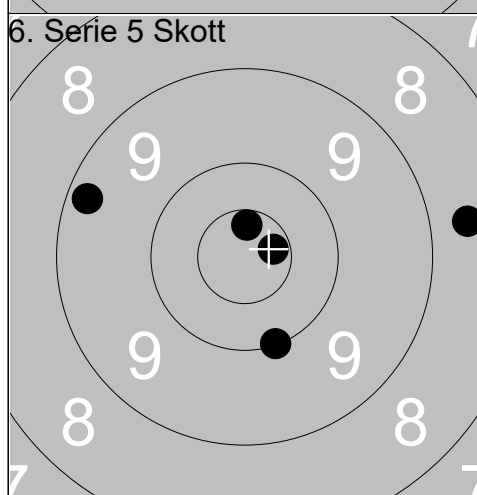

1:	9.2	←
2:	10.6x	↑
3:	10.0	↓
4:	10.7x	→
5:	8.6	→
Serie		47
Total		233

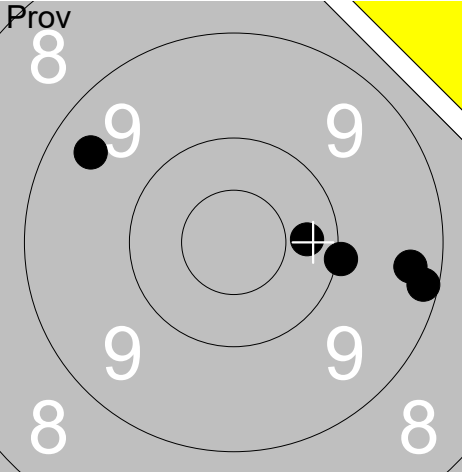
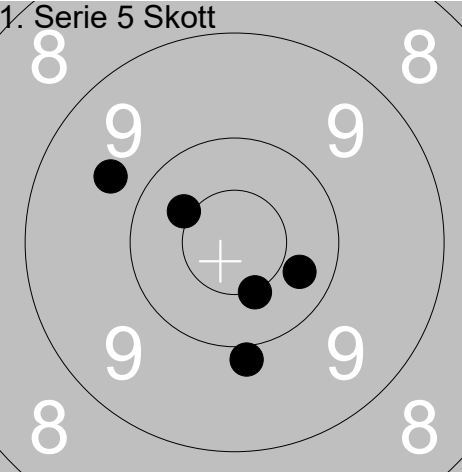
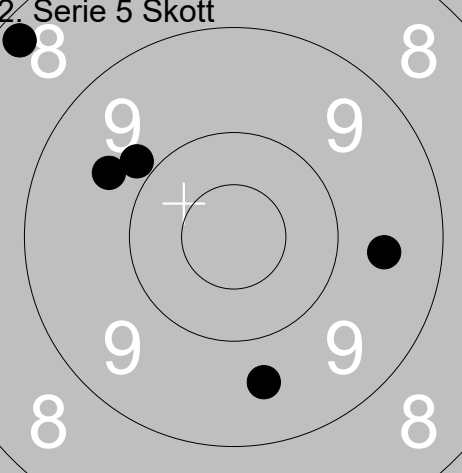
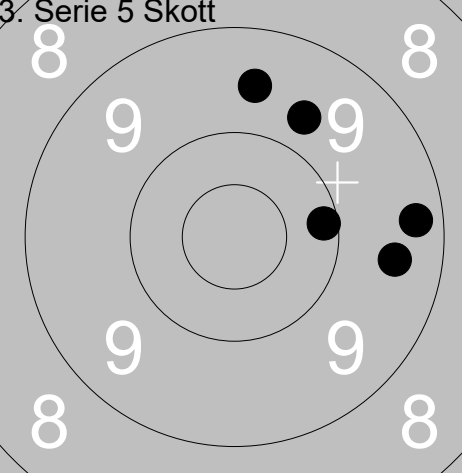
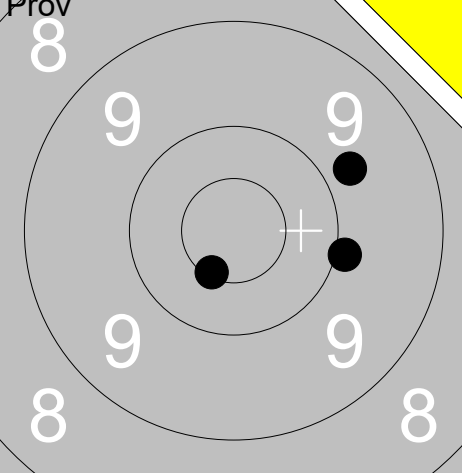
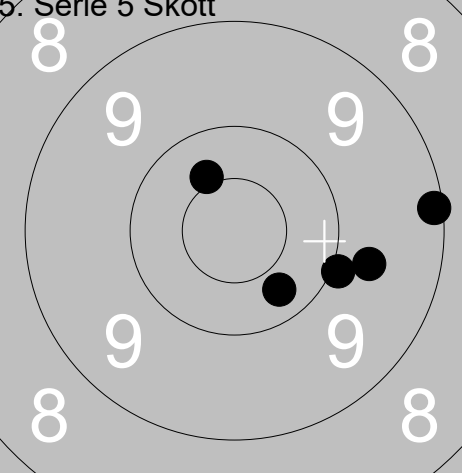
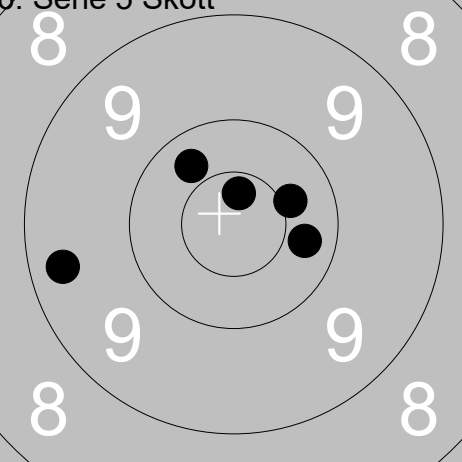
Skjutlag	Tavla	Bert-Ove Hägglund			
1	2	Ramselefors	Ramselefors	Ligg	Vb
06.07.2019	Björskottet 2019	Ramselefors SKF			
Prov 	1: 9.4 ↗ 2: 9.3 → 3: 10.0 → 4: 9.2 → 5: 10.3 → Serie 47 Total 0	1. Serie 5 Skott 	1: 9.9 ↓ 2: 10.3 → 3: 10.5x ↓ 4: 10.4x ↗ 5: 9.7 ↗ Serie 48 Total 48		
2. Serie 5 Skott 	1: 8.3 ↗ 2: 9.6 ↓ 3: 9.9 ↗ 4: 9.7 ↗ 5: 9.6 → Serie 44 Total 92	3. Serie 5 Skott 	1: 9.7 ↗ 2: 9.5 → 3: 9.6 ↑ 4: 10.1 → 5: 9.3 → Serie 46 Total 138		
Prov 	1: 10.5x ↓ 2: 9.9 → 3: 9.8 ↗ Serie 28 Total 138	5. Serie 5 Skott 	1: 10.4 ↗ 2: 9.1 → 3: 10.3 ↓ 4: 10.0 → 5: 9.7 → Serie 48 Total 186		
6. Serie 5 Skott 	1: 10.4 → 2: 9.3 ← 3: 10.7x ↑ 4: 10.3 ↗ 5: 10.3 → Serie 49 Total 235				

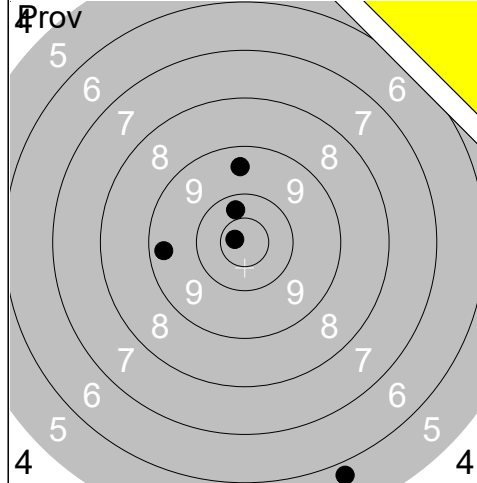

1:	5.7	↘
2:	9.4	↑
3:	10.3	↑
4:	9.3	←
5:	10.8x	↙
Serie		43
Total		0

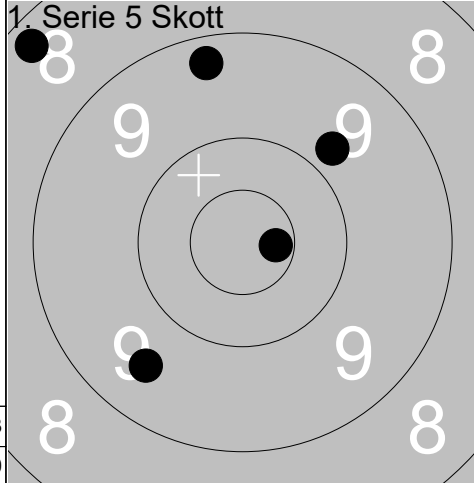

1:	8.3	↖
2:	9.3	↑
3:	9.5	↘
4:	9.8	↗
5:	10.7x	→
Serie		45
Total		45

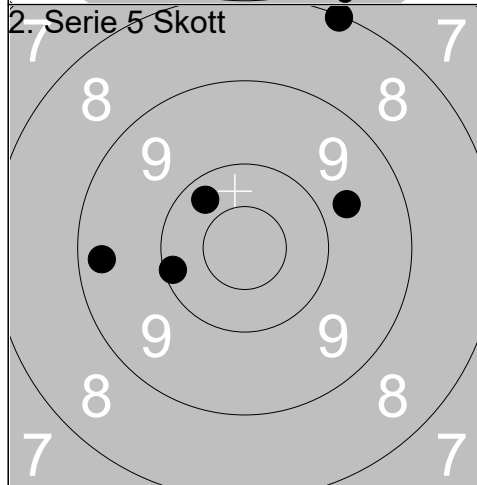

1:	10.1	←
2:	10.3	↗
3:	9.3	←
4:	9.7	→
5:	8.1	↑
Serie		46
Total		91

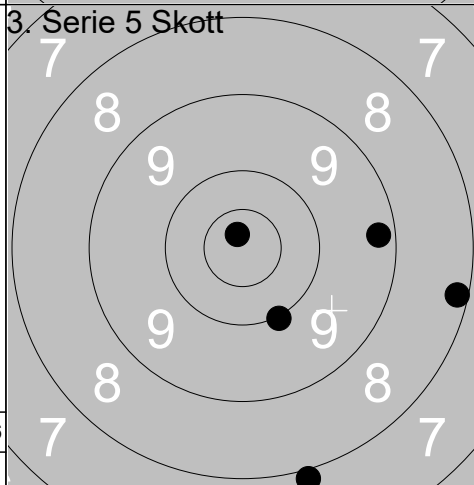

1:	10.8x	↑
2:	10.0	↘
3:	8.2	→
4:	7.9	↘
5:	9.2	→
Serie		44
Total		135

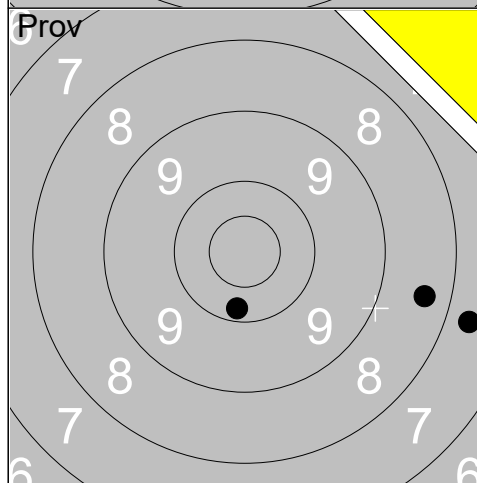

1:	10.2	↘
2:	7.7	→
3:	8.4	→
Serie		25
Total		135

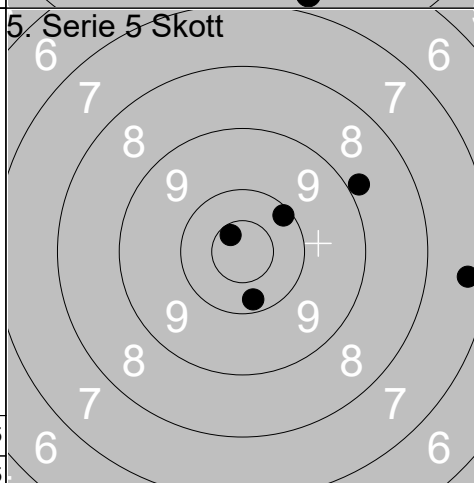

1:	10.2	↘
2:	10.6x	↗
3:	10.1	↗
4:	7.4	→
5:	8.9	↗
Serie		45
Total		180

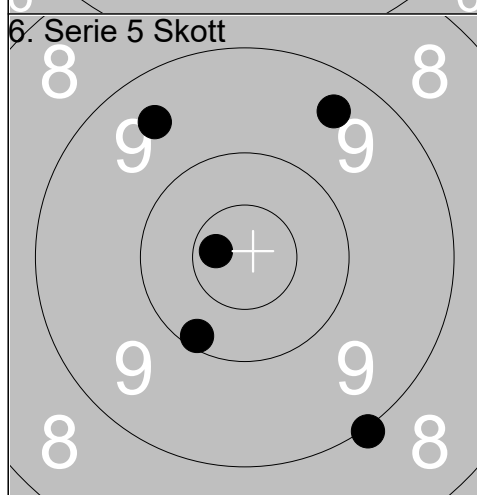

1:	10.1	↘
2:	10.7x	←
3:	9.5	↗
4:	9.0	↘
5:	9.4	↗
Serie		47
Total		227

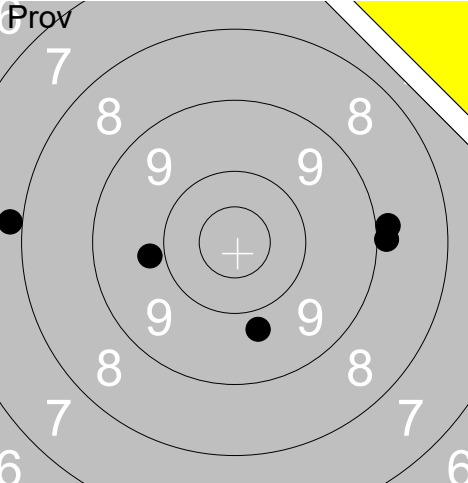
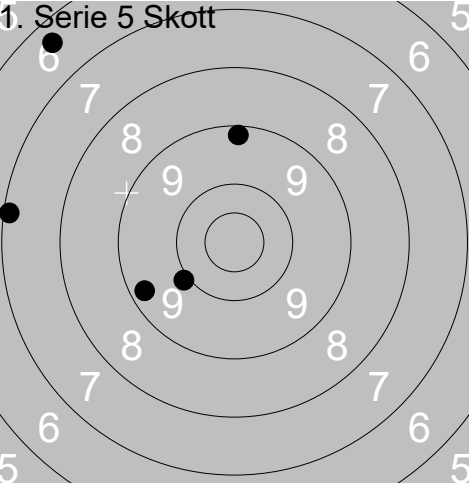
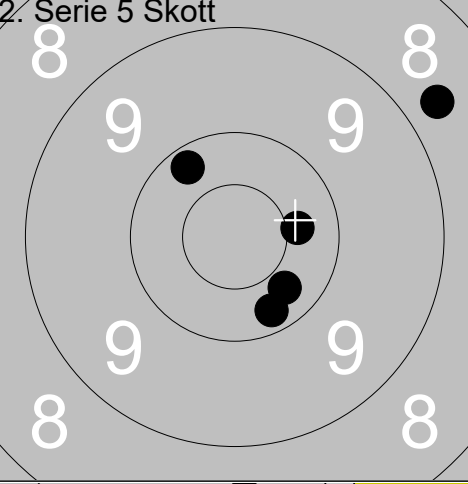
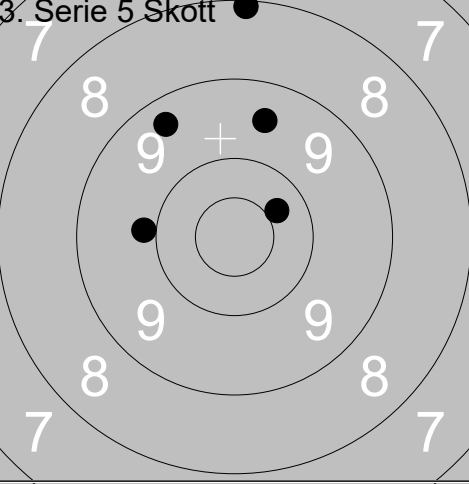
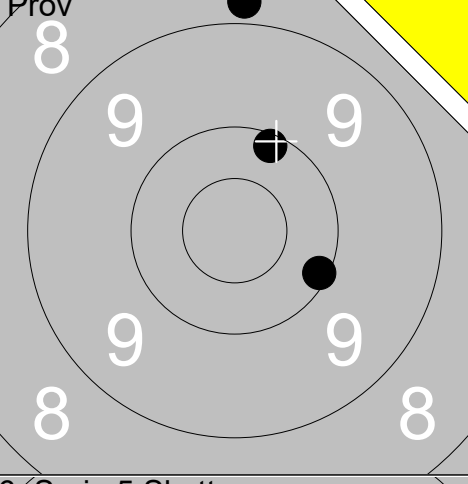
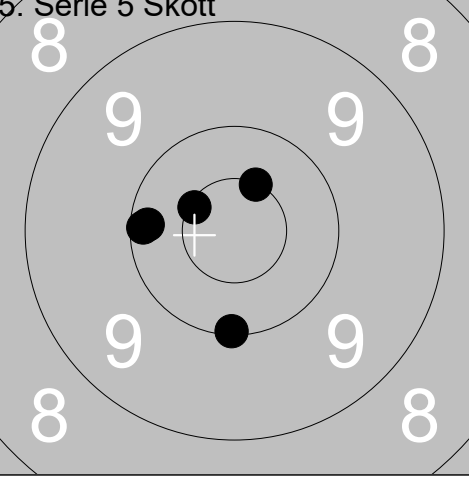
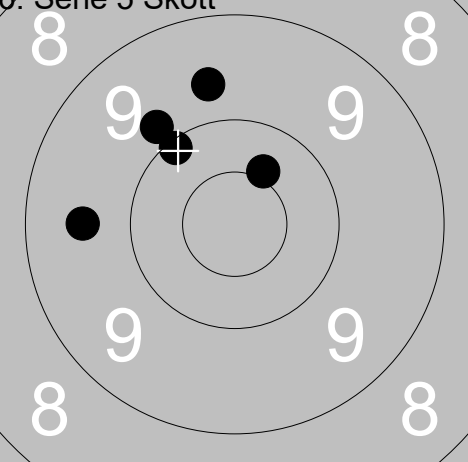
Skjutlag 1	Tavla 5	Ellen Jansson			
Ramselefors		Söderala		Ligg	Gä
06.07.2019		Björskottet 2019		Ramselefors SKF	
Prov 	1: 8.9 → 2: 8.9 → 3: 9.8 ↓ 4: 9.8 ← 5: 7.9 ←	1. Serie 5 Skott 	1: 9.2 ↑ 2: 7.1 ← 3: 6.4 ↗ 4: 9.3 ↙ 5: 9.9 ↙	Serie 41	Serie 40
	Total 0		Total 40		
2. Serie 5 Skott 	1: 8.7 ↗ 2: 10.4 → 3: 10.3 ↓ 4: 10.2 ↗ 5: 10.2 ↓	3. Serie 5 Skott 	1: 8.1 ↑ 2: 10.4 ↗ 3: 9.9 ← 4: 9.5 ↑ 5: 9.4 ↗	Serie 48	Serie 45
	Total 88		Total 133		
Prov 	1: 8.8 ↑ 2: 10.1 ↑ 3: 10.1 ↘	5. Serie 5 Skott 	1: 10.2 ← 2: 10.5x ↑ 3: 10.1 ← 4: 10.5x ↙ 5: 10.1 ↓	Serie 28	Serie 50
	Total 133		Total 183		
6. Serie 5 Skott 	1: 9.7 ↑ 2: 9.8 ↗ 3: 10.1 ↗ 4: 10.4x ↗ 5: 9.6 ←			Serie 47	
	Total 230				

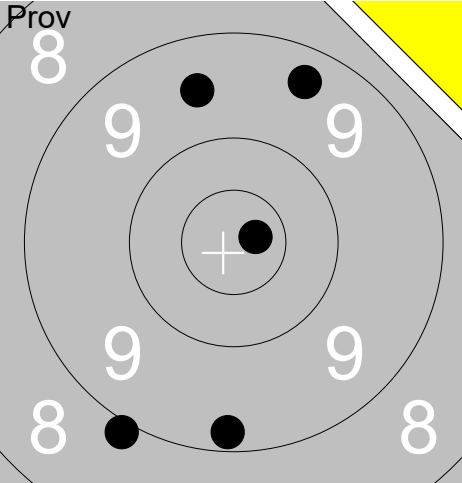
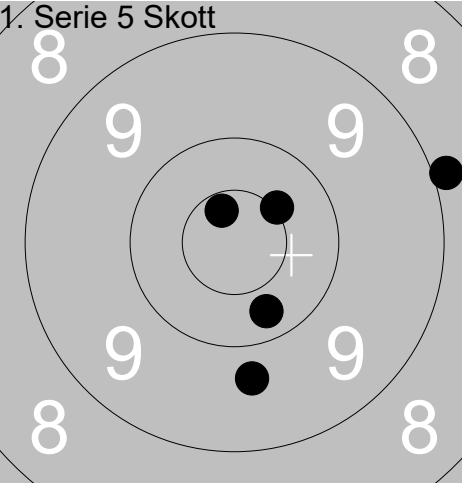
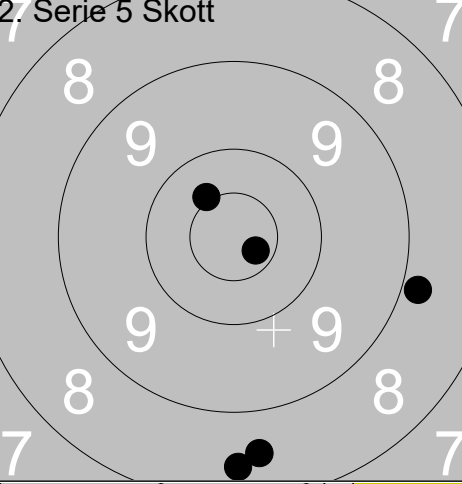
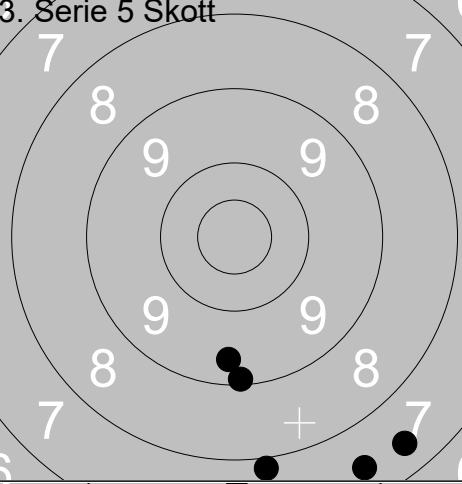
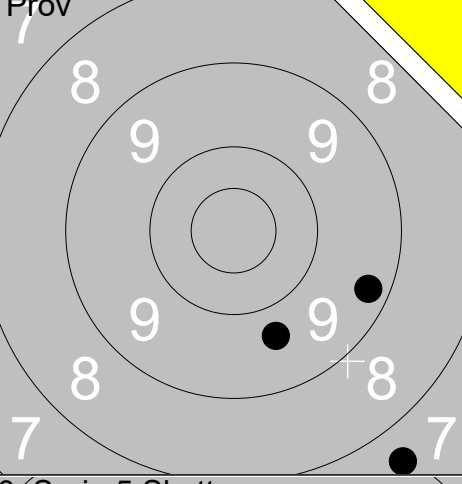
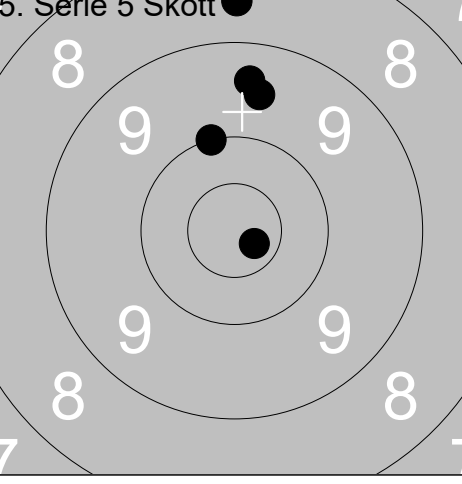
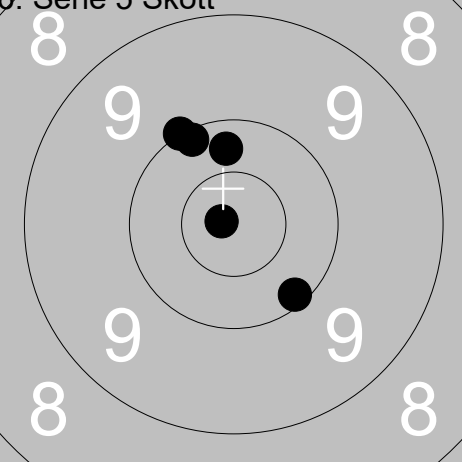
Skjutlag	Tavla	Emma Wallerström		
1	6	Ramselefors	Ununge	Ligg
06.07.2019	Björskottet 2019	Ramselefors SKF		
Prov 	1: 8.9 ↙ 2: 9.2 ↓ 3: 9.4 ↗ 4: 9.5 ↗ 5: 10.8x →	1. Serie 5 Skott 	1: 9.7 ↓ 2: 10.3 ↓ 3: 10.6x ↗ 4: 10.5x ↗ 5: 8.9 →	
	Serie 45 Total 0		Serie 47 Total 47	
2. Serie 5 Skott 	1: 10.4x ↗ 2: 8.5 ↓ 3: 8.4 ↓ 4: 8.8 → 5: 10.7x ↘	3. Serie 5 Skott 	1: 9.1 ↓ 2: 7.4 ↓ 3: 7.9 ↓ 4: 7.5 ↓ 5: 9.4 ↓	
	Serie 44 Total 91		Serie 39 Total 130	
Prov 	1: 9.3 → 2: 7.6 ↓ 3: 9.7 ↓	5. Serie 5 Skott 	1: 9.6 ↑ 2: 9.4 ↑ 3: 10.7x ↘ 4: 10.0 ↑ 5: 8.6 ↑	
	Serie 25 Total 130		Serie 46 Total 176	
6. Serie 5 Skott 	1: 10.3 ↑ 2: 10.0 ↗ 3: 10.1 ↗ 4: 10.1 ↓ 5: 10.8x ←			
	Serie 50 Total 226			

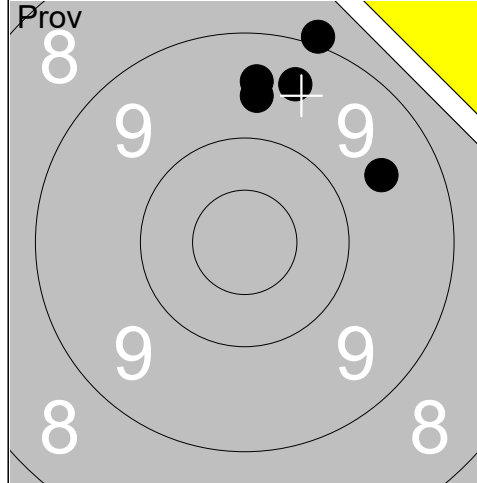

1:	9.5	↑
2:	8.9	↑
3:	9.6	→
4:	9.6	↑
5:	9.4	↑
Serie		44
Total		0

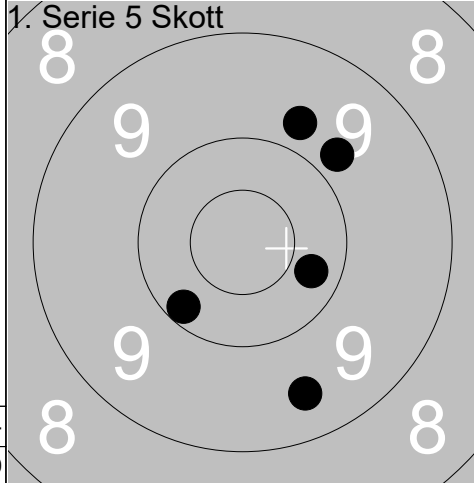

1:	9.8	↗
2:	10.3	→
3:	10.2	↙
4:	9.8	↑
5:	9.5	↓
Serie		47
Total		47

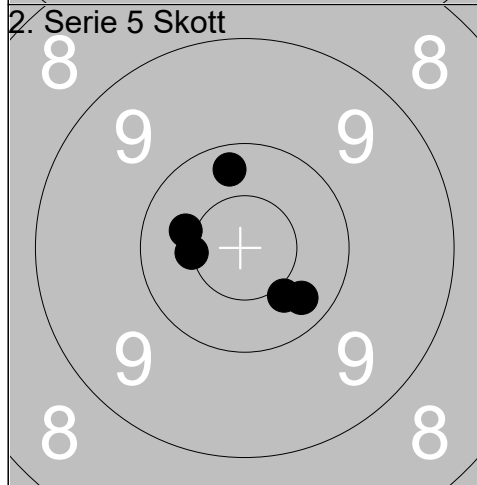

1:	10.4	↘
2:	10.3	↘
3:	10.5x	←
4:	10.2	↑
5:	10.4	←
Serie		50
Total		97

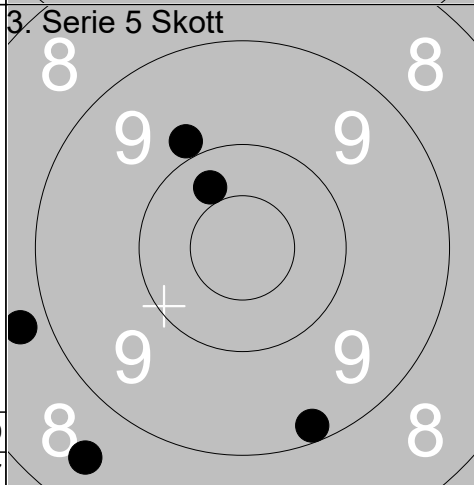

1:	9.9	↗
2:	10.3	↗
3:	8.8	←
4:	8.5	↙
5:	9.2	↘
Serie		44
Total		141

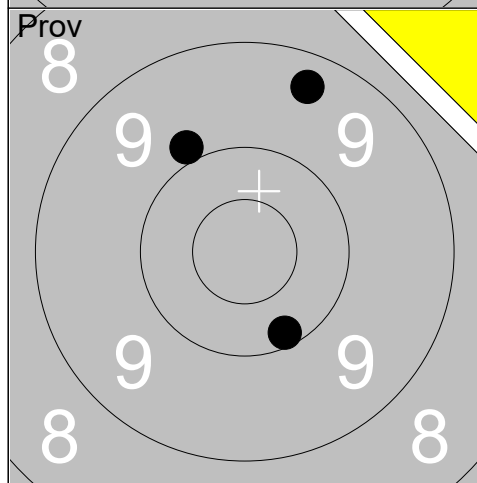

1:	9.3	↑
2:	9.9	↑
3:	10.2	↘
Serie		28
Total		141

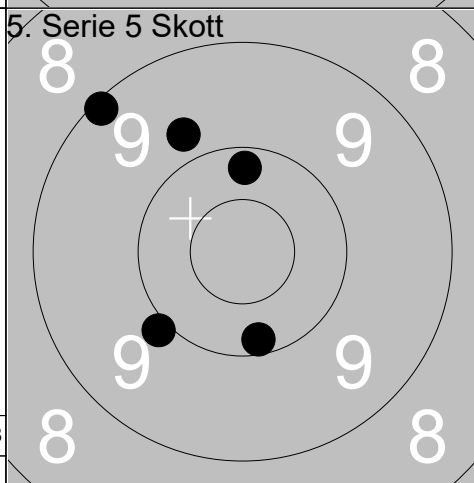

1:	10.2	↓
2:	9.9	↙
3:	9.8	↗
4:	9.1	↗
5:	10.2	↑
Serie		47
Total		188

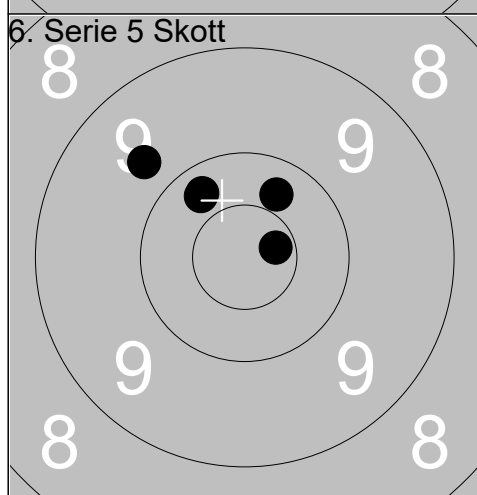

1:	10.7x	→
2:	10.3	↑
3:	9.7	↗
4:	10.3	↗
5:	10.3	↗
Serie		49
Total		237

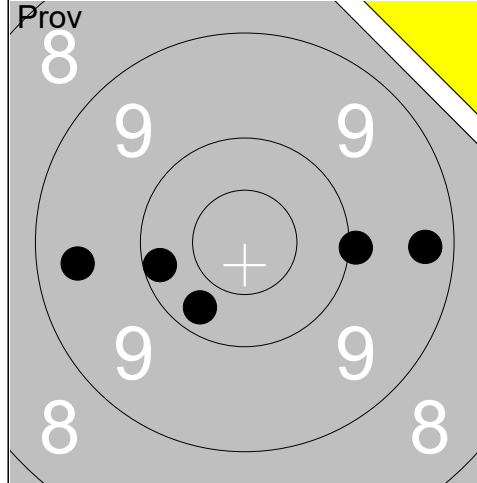

1:	9.4	←
2:	10.2	←
3:	10.0	→
4:	10.3	↓
5:	9.3	→
Serie		48
Total		0

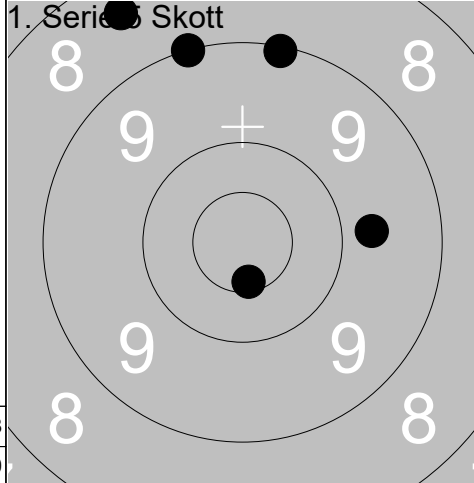

1:	9.7	→
2:	9.0	↑
3:	8.4	↑
4:	9.1	↑
5:	10.6x	↓
Serie		45
Total		45

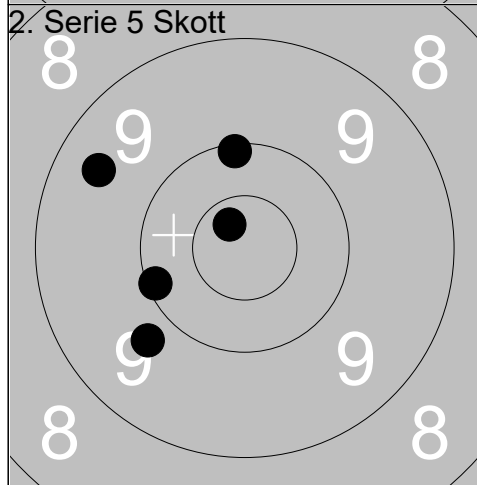

1:	10.1	↑
2:	10.7x	↑
3:	10.1	←
4:	9.4	↑
5:	9.8	↓
Serie		48
Total		93

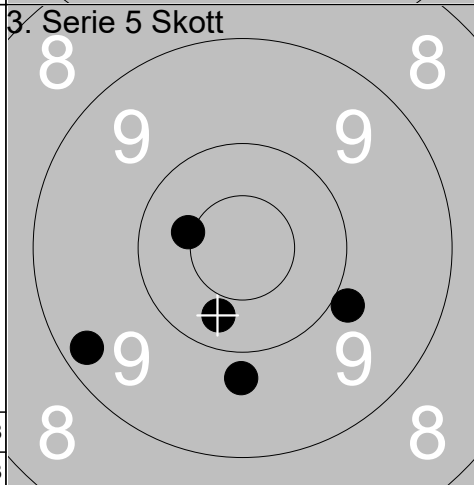

1:	9.3	←
2:	9.8	↓
3:	9.9	→
4:	10.3	↓
5:	10.4x	←
Serie		47
Total		140

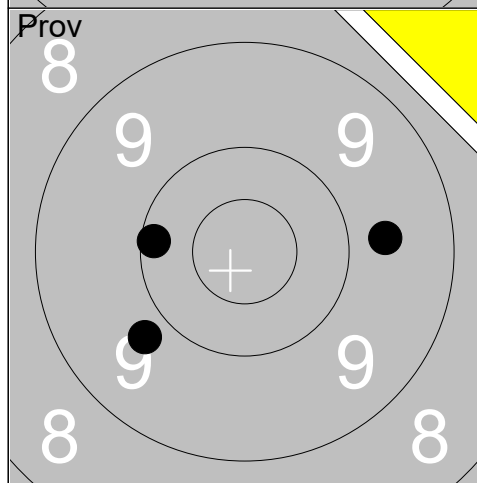

1:	9.7	→
2:	9.8	←
3:	10.1	←
Serie		28
Total		140

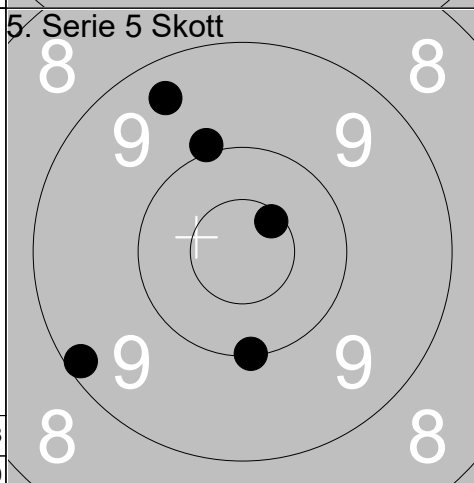

1:	9.4	↑
2:	10.0	↑
3:	10.6x	↗
4:	10.0	↓
5:	9.2	←
Serie		48
Total		188

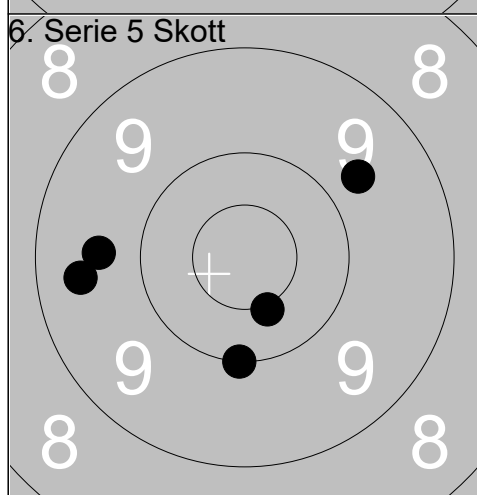

1:	9.6	←
2:	9.5	←
3:	9.7	↗
4:	10.4x	↓
5:	10.0	↓
Serie		47
Total		235

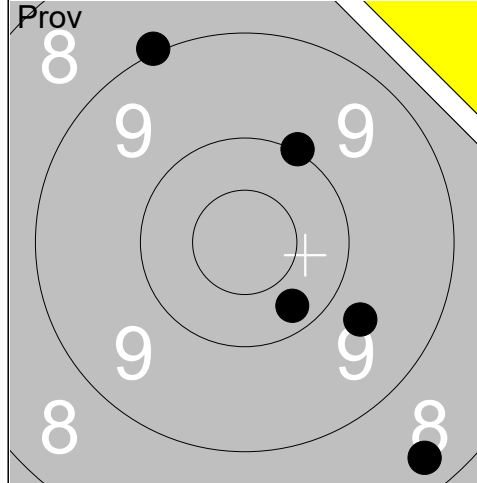

1:	8.4	↘
2:	10.0	↗
3:	9.0	↗
4:	9.7	↘
5:	10.2	↘
Serie		46
Total		0

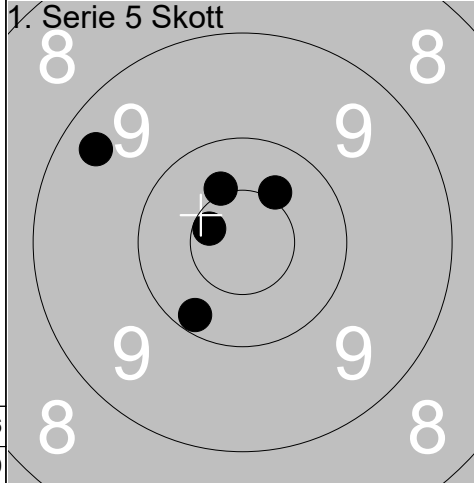

1:	10.4x	↗
2:	10.6x	↖
3:	10.4x	↗
4:	9.4	↖
5:	10.2	↘
Serie		49
Total		49

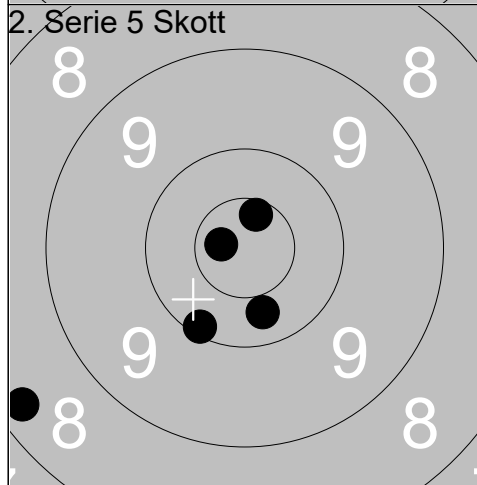

1:	10.6x	↗
2:	10.7x	↖
3:	10.3	↘
4:	10.1	↘
5:	8.3	↖
Serie		48
Total		97

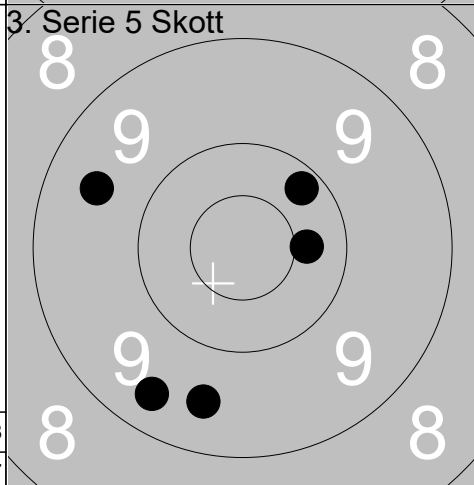

1:	9.5	↖
2:	10.2	↗
3:	9.4	↘
4:	10.4	→
5:	9.5	↘
Serie		47
Total		144

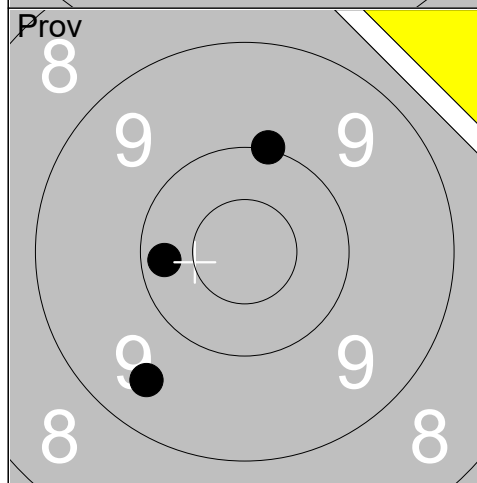

1:	9.5	↘
2:	10.0	↗
3:	10.2	↖
Serie		29
Total		144

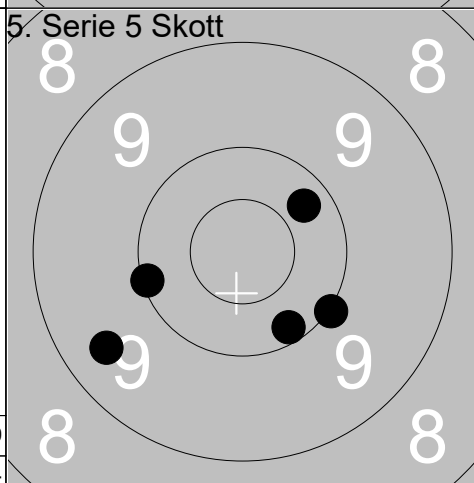

1:	10.3	↗
2:	10.0	↘
3:	10.2	↘
4:	9.4	↖
5:	10.1	↖
Serie		49
Total		193

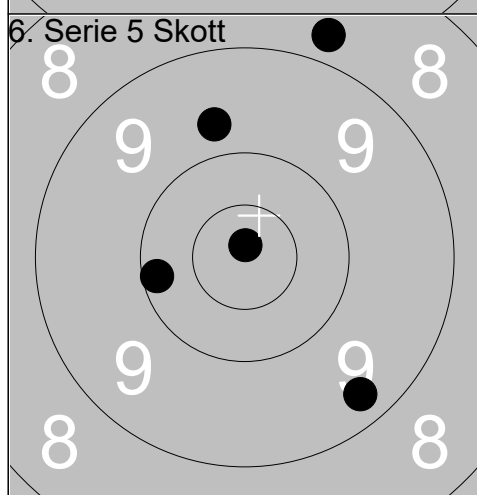

1:	10.8x	↗
2:	8.8	↗
3:	9.3	↘
4:	10.2	↖
5:	9.7	↗
Serie		46
Total		239

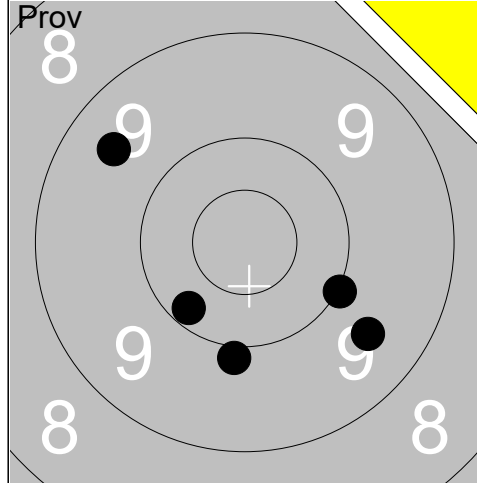

1:	9.5	↗
2:	9.6	↘
3:	9.9	↓
4:	10.2	↙
5:	10.0	↘

Serie	47
Total	0

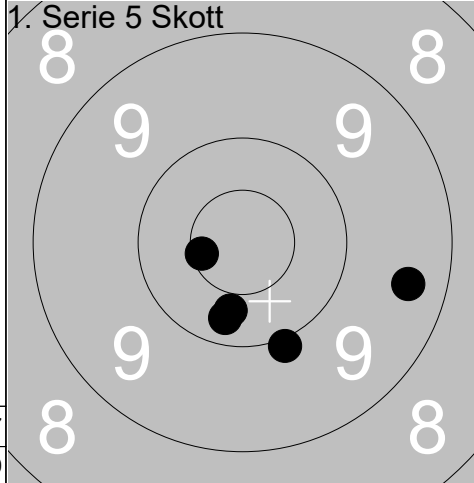

1:	10.3	↓
2:	10.6x	←
3:	10.3	↓
4:	9.4	→
5:	10.0	↘

Serie	49
Total	49

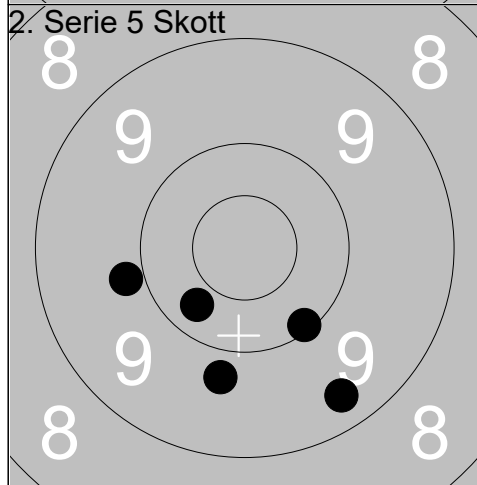

1:	9.3	↘
2:	9.9	←
3:	10.1	↘
4:	9.8	↓
5:	10.3	↙

Serie	47
Total	96

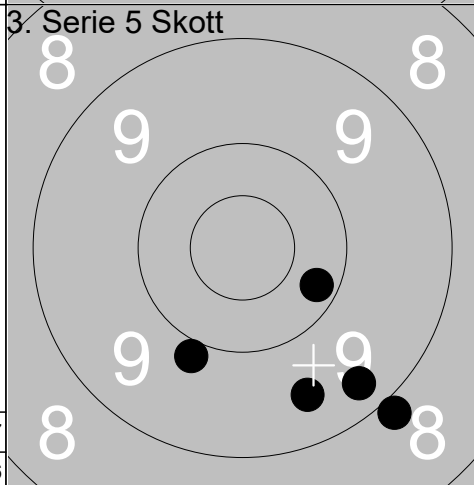

1:	10.2	→
2:	9.9	↘
3:	8.9	↘
4:	9.5	↘
5:	9.3	↘

Serie	45
Total	141

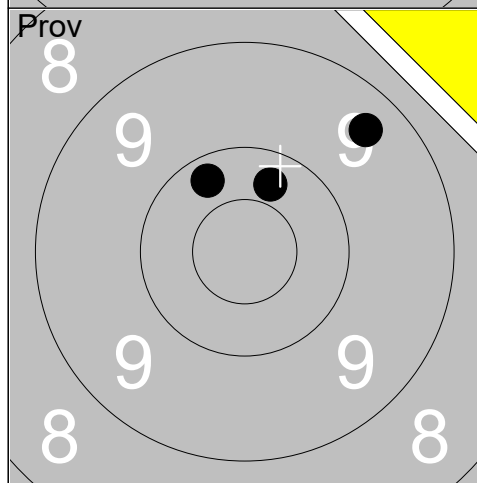

1:	10.2	↗
2:	9.4	↗
3:	10.3	↑

Serie	29
Total	141

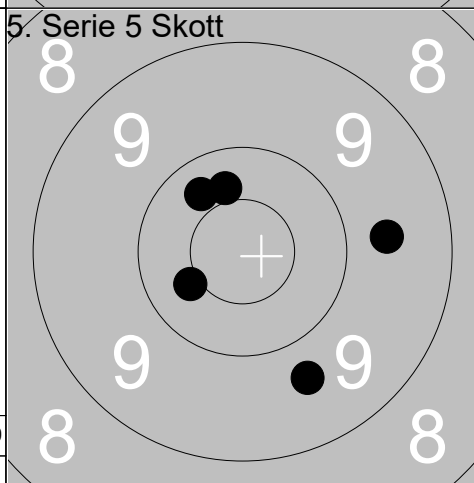

1:	9.7	↘
2:	10.3	↗
3:	10.4	←
4:	9.6	→
5:	10.4	↑

Serie	48
Total	189

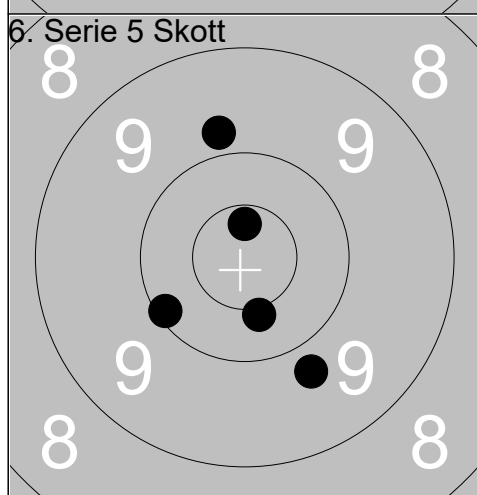

1:	10.7x	↑
2:	9.8	↑
3:	10.1	←
4:	9.8	↘
5:	10.4x	↘

Serie	48
Total	237

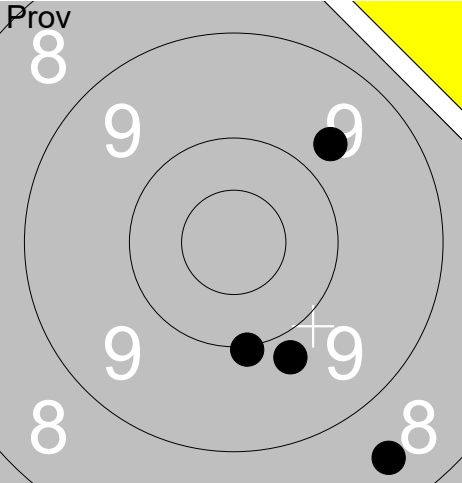
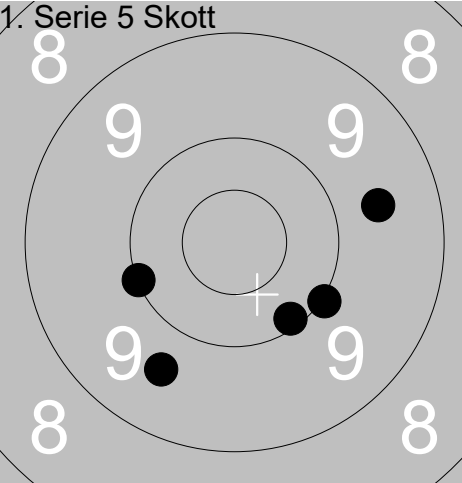
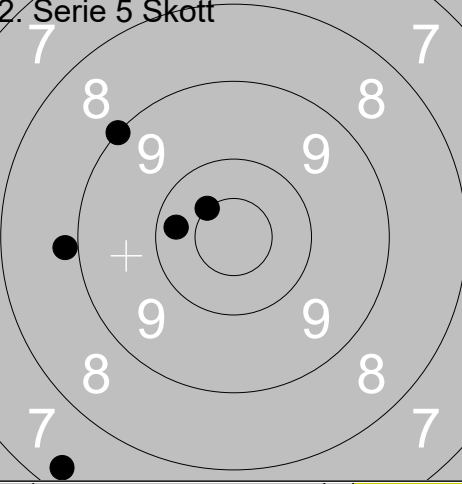
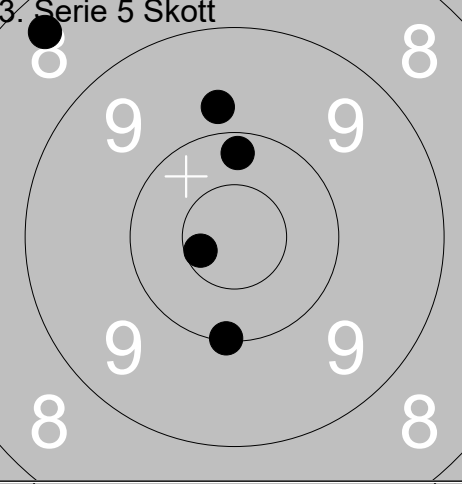
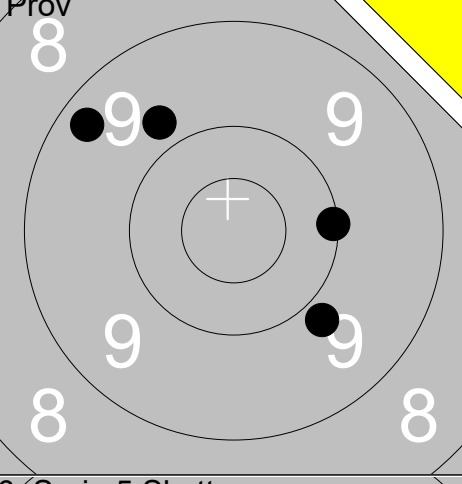
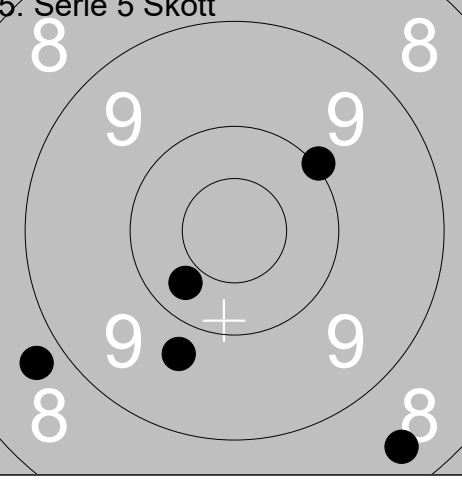
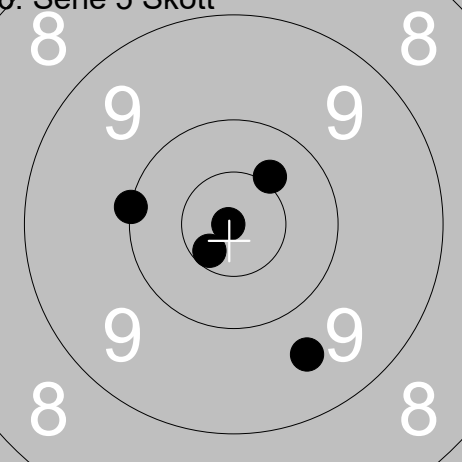
Skjutlag 1	Tavla 12	Martin Blombäck			
Ramselefors		Piteå		Ligg	No
06.07.2019		Björkskottet 2019		Ramselefors SKF	
Prov 	1: 9.8 ↘ 2: 8.5 ↘ 3: 10.0 ↘ 4: 9.7 ↗	1. Serie 5 Skott 	1: 10.0 ↘ 2: 9.6 → 3: 9.6 ↘ 4: 10.1 ↘ 5: 10.0 ←		
	Serie 36 Total 0		Serie 48 Total 48		
2. Serie 5 Skott 	1: 9.0 ↗ 2: 10.5x ↗ 3: 7.3 ↘ 4: 10.3 ← 5: 8.9 ←	3. Serie 5 Skott 	1: 10.6x ← 2: 8.4 ↖ 3: 10.2 ↑ 4: 10.1 ↘ 5: 9.8 ↑		
	Serie 44 Total 92		Serie 47 Total 139		
Prov 	1: 9.3 ↗ 2: 9.8 ↗ 3: 10.1 → 4: 9.8 ↘	5. Serie 5 Skott 	1: 10.0 ↗ 2: 8.4 ↘ 3: 10.3 ↘ 4: 9.7 ↘ 5: 8.7 ←		
	Serie 37 Total 139		Serie 45 Total 184		
6. Serie 5 Skott 	1: 10.9x ← 2: 10.4x ↗ 3: 9.6 ↘ 4: 10.0 ← 5: 10.6x ↘				
	Serie 49 Total 233				

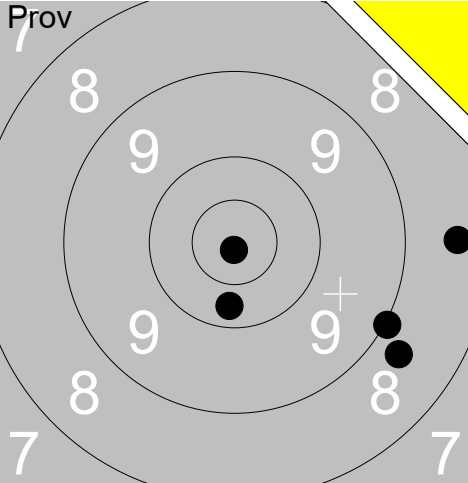
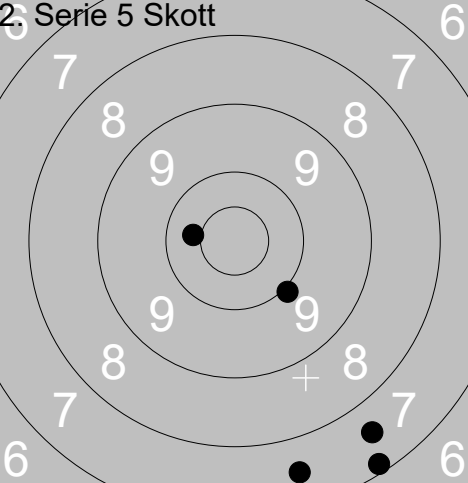
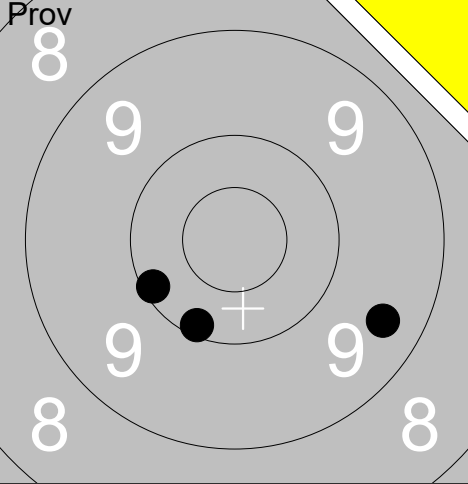
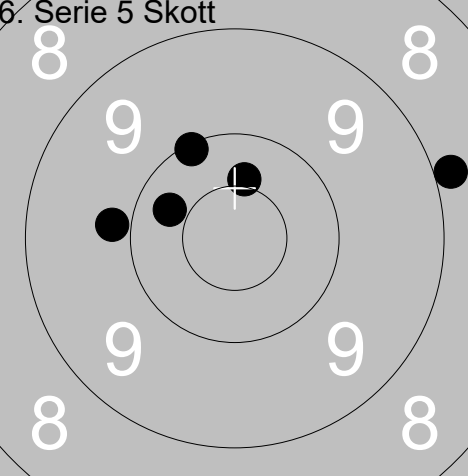
Skjutlag	Tavla	Mats Österlund		Ligg	Vb
1	13	Ramselefors	Ramselefors		
06.07.2019	Björskottet 2019	Ramselefors SKF			
Prov		1: 10.9x ↓ 2: 9.0 → 3: 10.3 ↓ 4: 8.4 → 5: 8.7 ↓	1. Serie 5 Skott	1: 9.4 ↓ 2: 9.8 ↗ 3: 9.3 ↗ 4: 8.4 → 5: 10.5x ↓	
		Serie 45 Total 0		Serie 45 Total 45	
2. Serie 5 Skott		1: 10.4 ← 2: 7.6 ↓ 3: 7.5 ↓ 4: 10.0 ↓ 5: 7.2 ↓	3. Serie 5 Skott	1: 10.0 ↗ 2: 9.4 → 3: 9.1 ↓ 4: 9.4 → 5: 9.3 ↓	
		Serie 41 Total 86		Serie 46 Total 132	
Prov		1: 9.4 → 2: 10.1 ↓ 3: 10.1 ←	5. Serie 5 Skott	1: 10.1 ↓ 2: 8.9 ← 3: 9.8 ↓ 4: 10.2 ↗ 5: 10.6x ↓	
		Serie 29 Total 132		Serie 47 Total 179	
6. Serie 5 Skott		1: 10.3 ↗ 2: 10.1 ↗ 3: 9.8 ← 4: 10.4x ↑ 5: 8.9 →			
		Serie 47 Total 226			

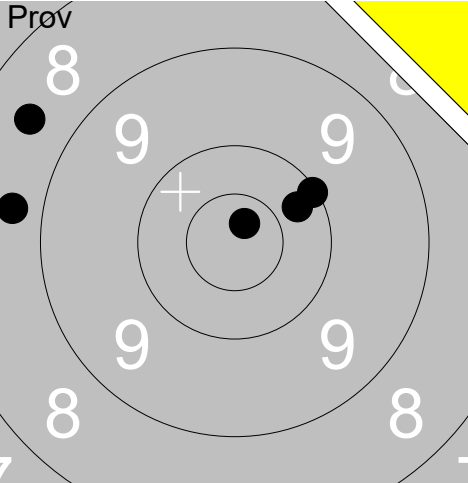
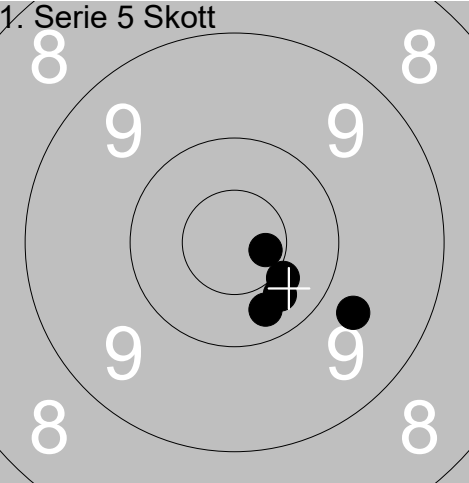
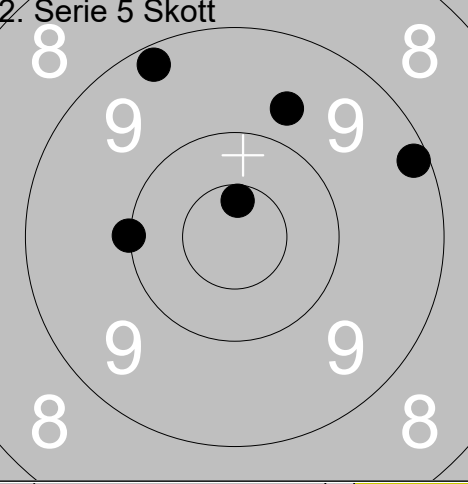
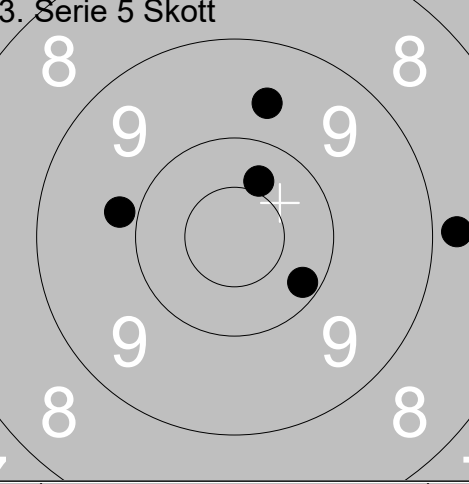
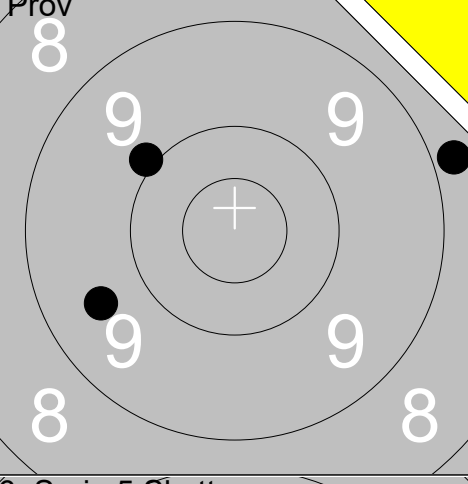
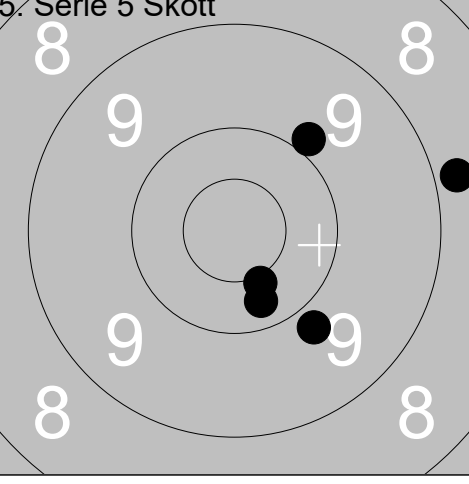
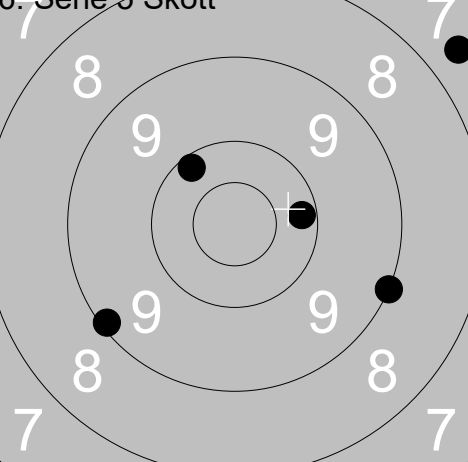
Skjutlag	Tavla	Mathias Fredriksson			
1	14	Ramselefors	Ramselefors	Ligg	Vb
06.07.2019	Björskottet 2019	Ramselefors SKF			
Prov 	1: 8.7 ← 2: 10.3 → 3: 10.1 → 4: 10.7x ↑ 5: 8.6 ↖	1. Serie 5 Skott 	1: 10.3 ↓ 2: 10.3 ↓ 3: 10.7x → 4: 9.7 ↓ 5: 10.4x ↓		
	Serie 46 Total 0		Serie 49 Total 49		
2. Serie 5 Skott 	1: 9.2 → 2: 10.6x ↑ 3: 9.7 ↑ 4: 9.2 ↖ 5: 10.0 ←	3. Serie 5 Skott 	1: 9.6 ↑ 2: 8.8 → 3: 9.8 ← 4: 10.4 ↑ 5: 10.2 ↘		
	Serie 47 Total 96		Serie 46 Total 142		
Prov 	1: 9.6 ← 2: 8.8 → 3: 9.9 ↖	5. Serie 5 Skott 	1: 8.8 → 2: 10.3 ↓ 3: 10.4x ↓ 4: 9.9 ↑ 5: 9.8 ↓		
	Serie 26 Total 142		Serie 46 Total 188		
6. Serie 5 Skott 	1: 9.0 → 2: 9.1 ← 3: 10.2 ↖ 4: 7.6 → 5: 10.2 →				
	Serie 45 Total 233				

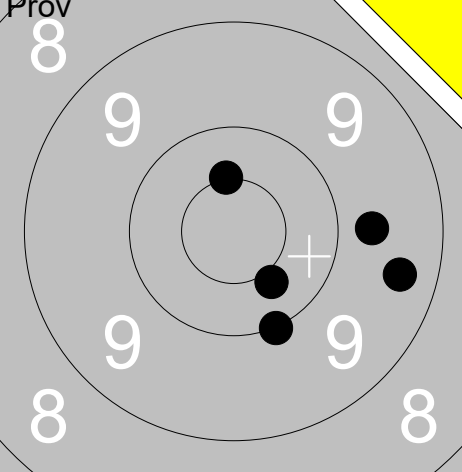
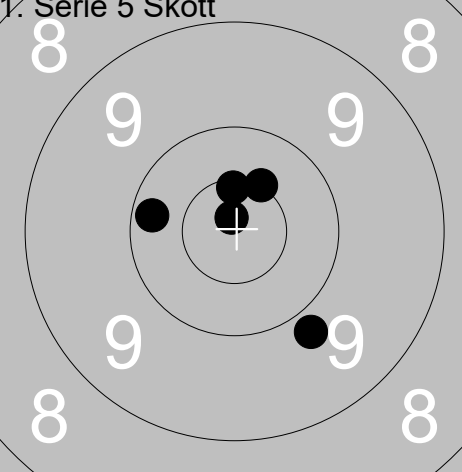
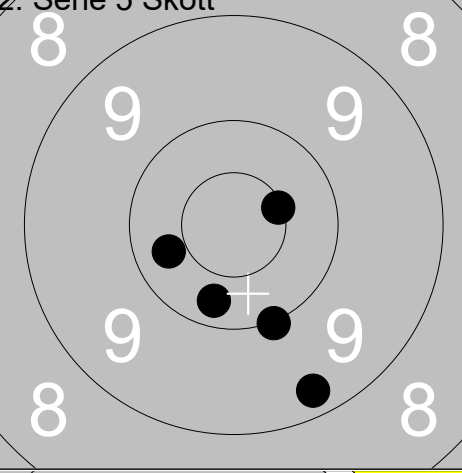
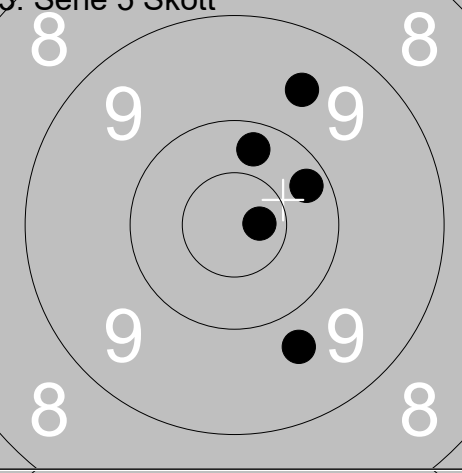
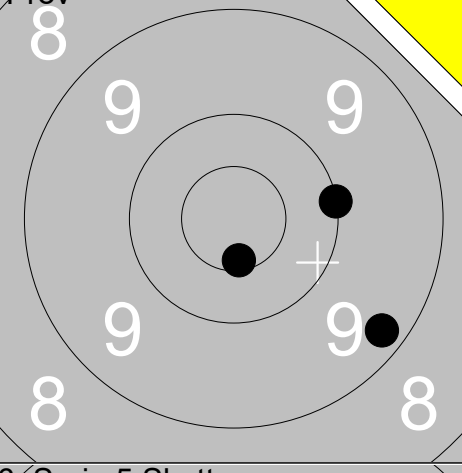
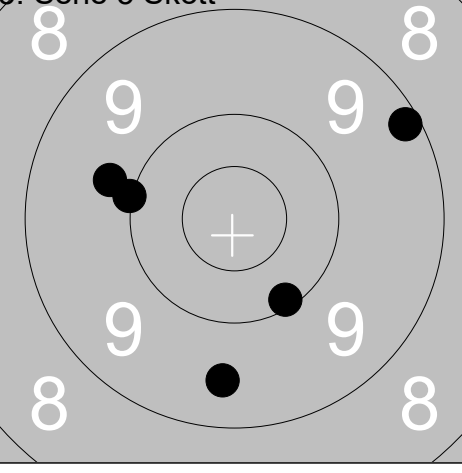
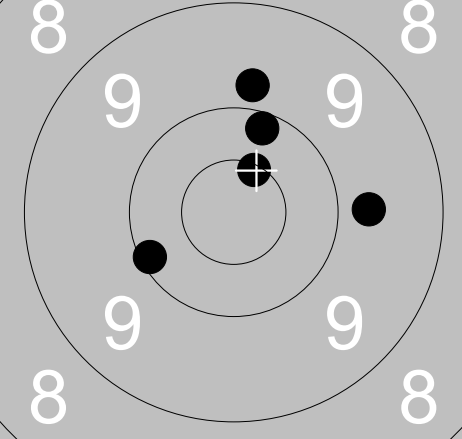
Prov 	1: 10.4 ↘ 2: 9.4 → 3: 10.0 ↘ 4: 10.5x ↑ 5: 9.7 → <hr/> Serie 48 Total 0	1. Serie 5 Skott 	1: 10.8x ↑ 2: 10.6x ↑ 3: 10.5x ↗ 4: 9.8 ↘ 5: 10.2 ← <hr/> Serie 49 Total 49
2. Serie 5 Skott 	1: 9.3 ↘ 2: 10.3 ← 3: 10.3 ↘ 4: 10.0 ↘ 5: 10.5x → <hr/> Serie 49 Total 98	3. Serie 5 Skott 	1: 10.3 ↑ 2: 10.2 ↗ 3: 10.7x → 4: 9.7 ↘ 5: 9.6 ↗ <hr/> Serie 48 Total 146
Prov 	1: 9.3 ↘ 2: 10.0 → 3: 10.6x ↘ <hr/> Serie 29 Total 146	5. Serie 5 Skott 	1: 9.2 ↗ 2: 10.1 ↘ 3: 9.5 ↘ 4: 10.0 ← 5: 9.8 ← <hr/> Serie 47 Total 193
6. Serie 5 Skott 	1: 10.5x ↗ 2: 10.1 ← 3: 10.2 ↗ 4: 9.8 ↑ 5: 9.7 → <hr/> Serie 48 Total 241		

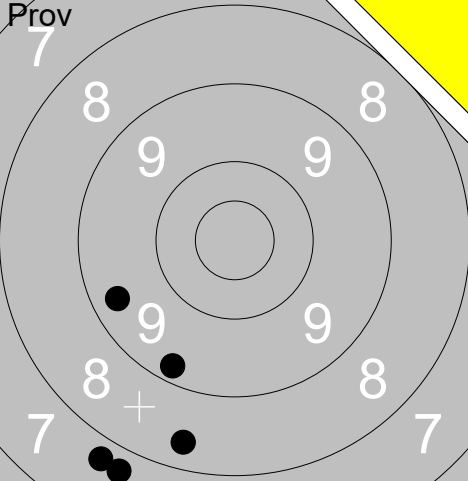
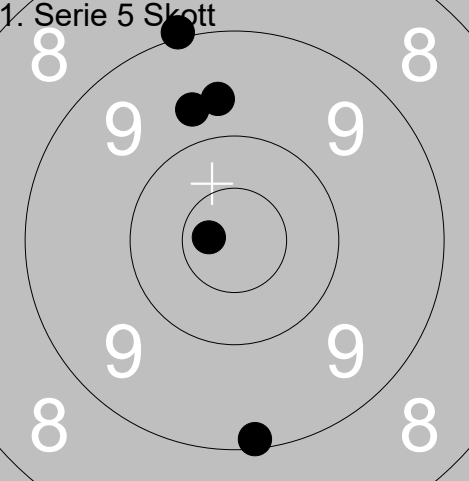
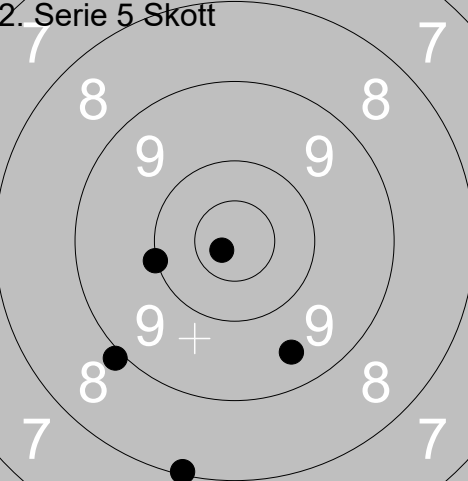
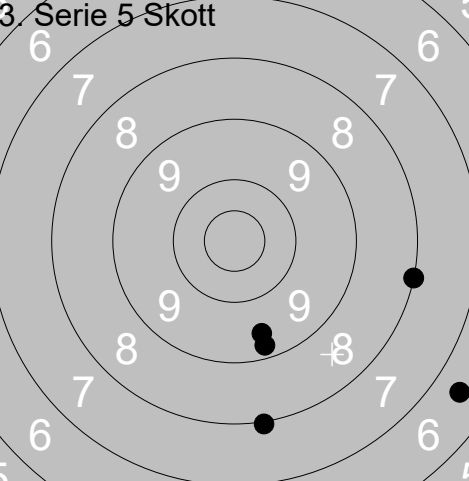
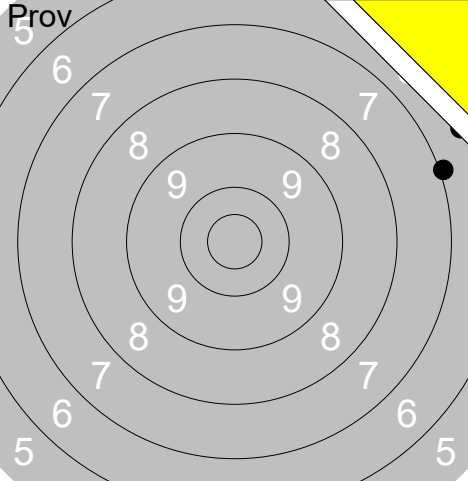
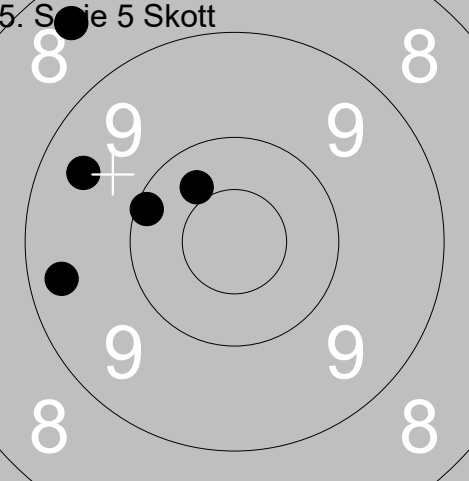
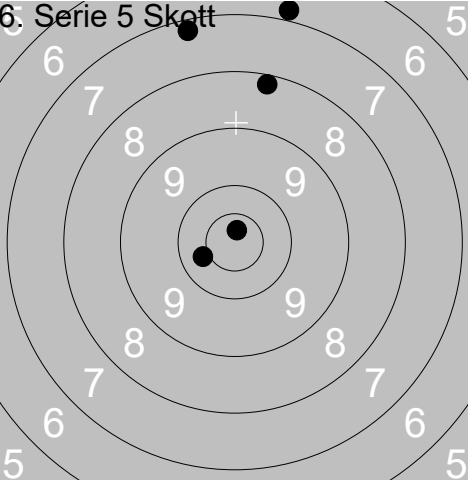
Skjutlag	Tavla	Joakim Arnkvist		Ligg	Vä
1	17	Ramselefors	Gräsmark		
06.07.2019	Björskottet 2019	Ramselefors SKF			
Prov		1: 7.7 ↘ 2: 7.8 ↘ 3: 9.2 ↘ 4: 9.4 ↙ 5: 8.4 ↘	1. Serie 5 Skott		1: 9.7 ↑ 2: 9.0 ↑ 3: 10.7x ← 4: 9.1 ↓ 5: 9.7 ↑
		Serie 40 Total 0		Serie 46 Total 46	
2. Serie 5 Skott		1: 10.8x ← 2: 8.9 ↘ 3: 10.0 ← 4: 9.5 ↘ 5: 8.1 ↘	3. Serie 5 Skott		1: 9.2 ↓ 2: 8.0 ↓ 3: 9.5 ↓ 4: 8.0 → 5: 6.6 ↘
		Serie 45 Total 91		Serie 40 Total 131	
Prov		1: 7.0 → 2: 5.6 ↗ 3: 6.4 ↗	5. Serie 5 Skott		1: 10.1 ← 2: 8.4 ↗ 3: 9.3 ← 4: 9.4 ↗ 5: 10.4 ↗
		Serie 18 Total 131		Serie 46 Total 177	
6. Serie 5 Skott		1: 8.2 ↑ 2: 7.2 ↑ 3: 6.8 ↑ 4: 10.7x ↑ 5: 10.4 ←			
		Serie 41 Total 218			

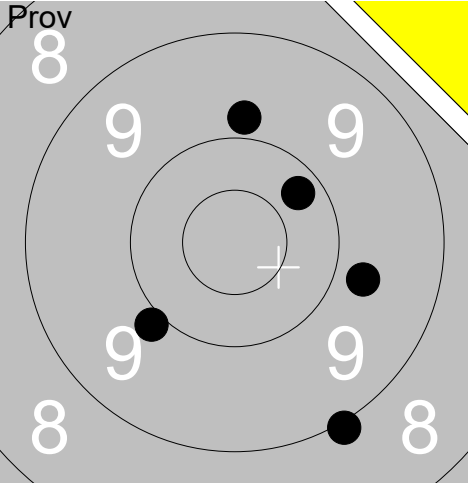
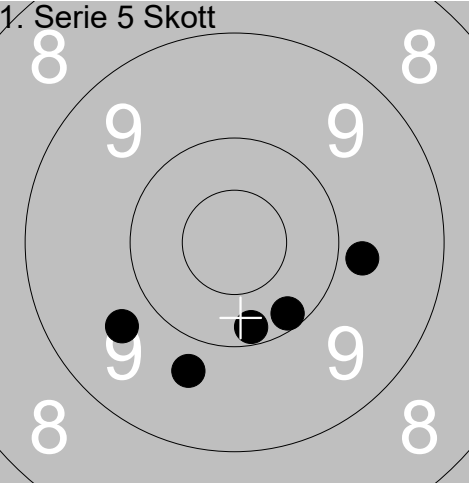
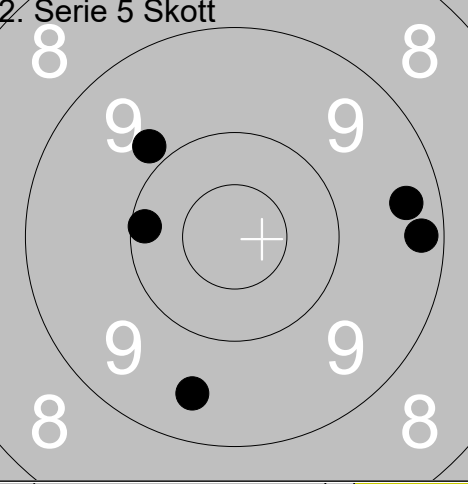
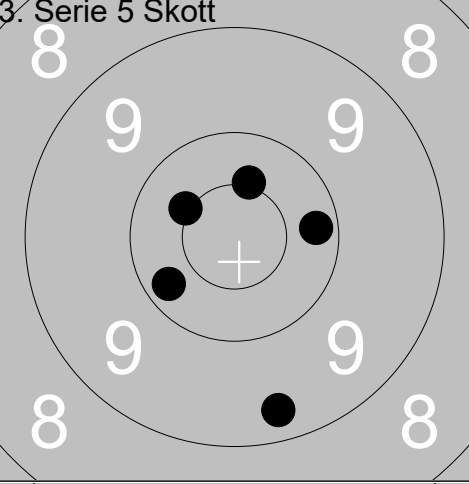
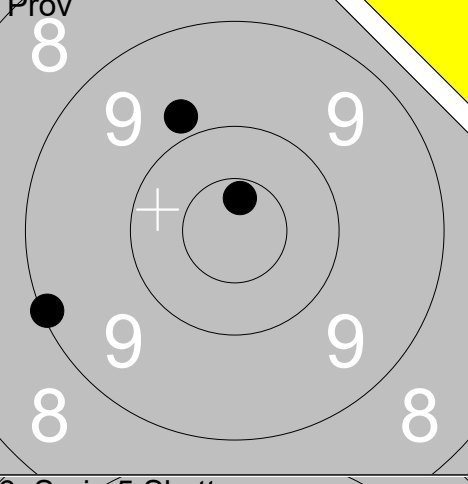
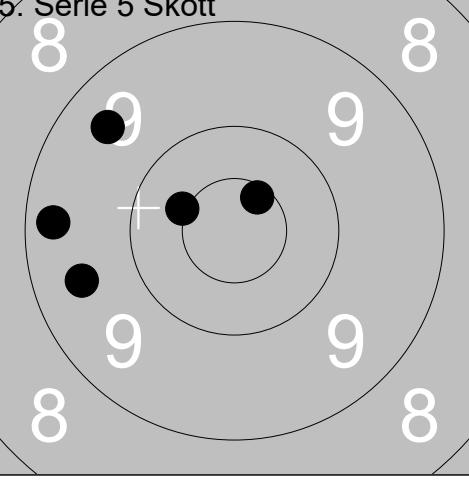
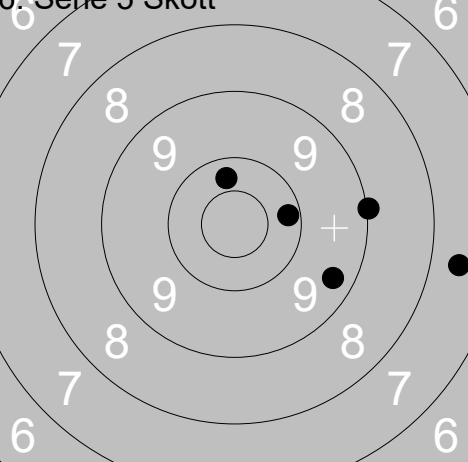
Skjutlag 1	Tavla 18	Hans Arnkvist			
Ramselefors		Gräsmark		Ligg	Vä
06.07.2019		Björskottet 2019		Ramselefors SKF	
Prov 	1: 9.8 ↑ 2: 9.8 → 3: 10.2 ↗ 4: 9.0 ↓ 5: 9.9 ↙	1. Serie 5 Skott 	1: 10.2 ↓ 2: 9.8 → 3: 10.2 ↓ 4: 9.7 ↙ 5: 9.7 ↓	Serie 46 Total 0	Serie 47 Total 47
2. Serie 5 Skott 	1: 9.2 → 2: 9.8 ↗ 3: 9.4 → 4: 9.5 ↓ 5: 10.1 ←	3. Serie 5 Skott 	1: 10.5x ↑ 2: 10.4x ↖ 3: 10.2 → 4: 9.3 ↓ 5: 10.2 ↙	Serie 46 Total 93	Serie 49 Total 142
Prov 	1: 9.8 ↖ 2: 10.7x ↑ 3: 9.1 ←	5. Serie 5 Skott 	1: 9.3 ← 2: 10.6x ↗ 3: 9.5 ← 4: 10.4x ↖ 5: 9.5 ↗	Serie 28 Total 142	Serie 47 Total 189
6. Serie 5 Skott 	1: 10.3 ↑ 2: 9.0 → 3: 10.2 → 4: 7.6 → 5: 9.4 ↘				
Serie 45 Total 234					

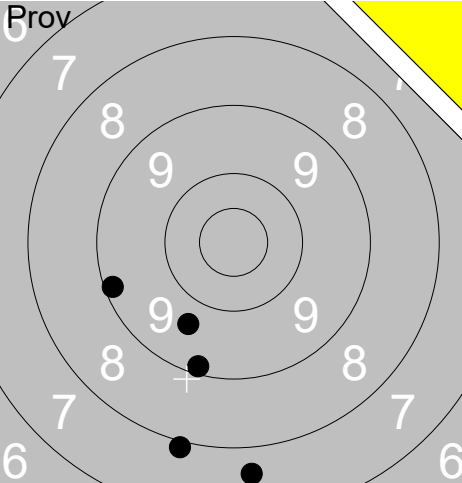
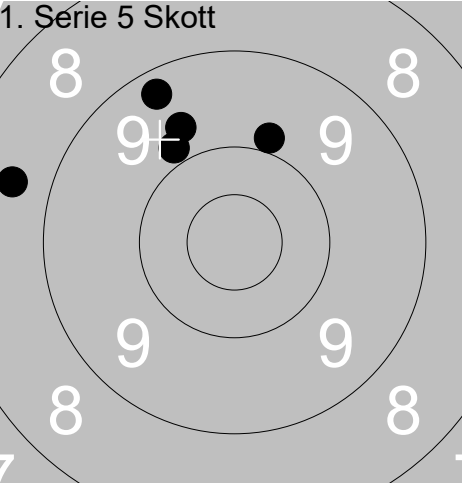
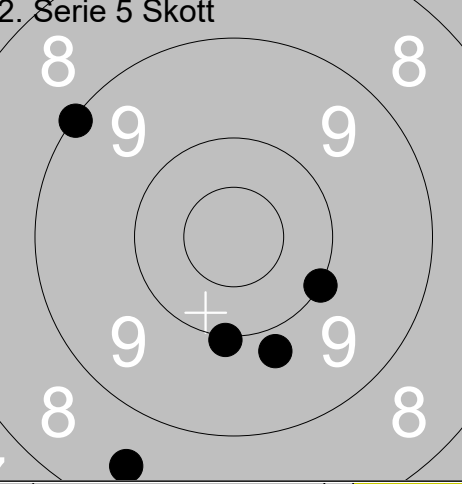
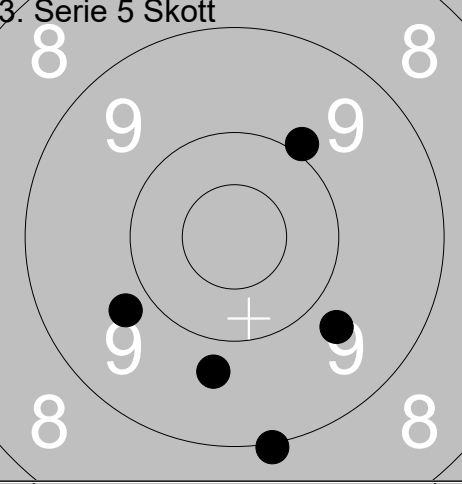
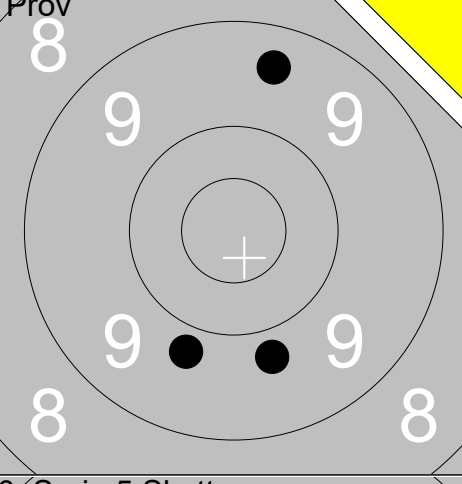
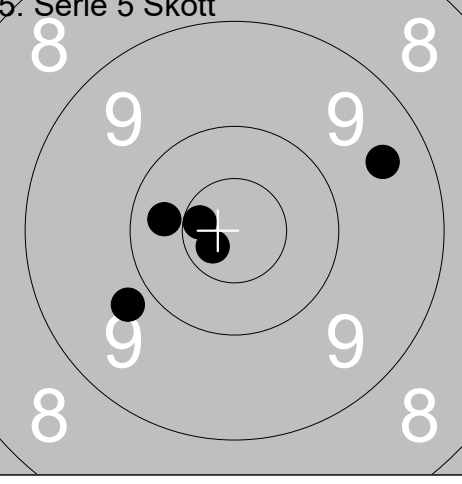
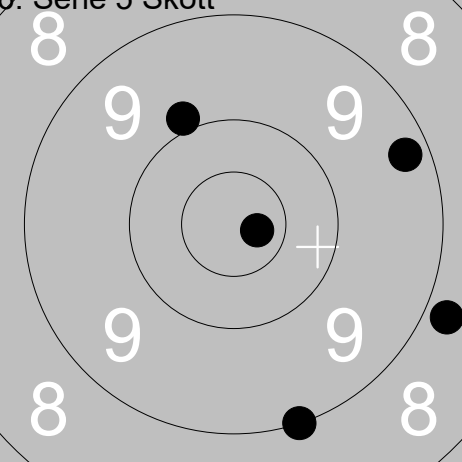
Skjutlag 1	Tavla 19	Stefan Thorin	
Ramselefors	Umeå	Ligg	Vb
06.07.2019	Björskottet 2019	Ramselefors SKF	
Prov 	1: 9.1 ← 2: 7.9 ↓ 3: 7.6 ↓ 4: 9.1 ↓ 5: 9.7 ↓ Serie 41 Total 07	1. Serie 5 Skott 	1: 8.6 ← 2: 9.9 ↑ 3: 9.7 ↑ 4: 9.3 ↑ 5: 9.9 ↑ Serie 44 Total 44
2. Serie 5 Skott 	1: 9.1 ↗ 2: 10.0 ↘ 3: 9.8 ↓ 4: 10.0 ↓ 5: 8.5 ↓ Serie 46 Total 90	3. Serie 5 Skott 	1: 9.9 ↗ 2: 9.7 ↘ 3: 9.8 ← 4: 9.7 ↓ 5: 9.0 ↓ Serie 45 Total 135
Prov 	1: 9.4 ↑ 2: 9.8 ↓ 3: 9.8 ↓ Serie 27 Total 135	5. Serie 5 Skott 	1: 10.3 ← 2: 10.6x ← 3: 9.8 ← 4: 9.5 → 5: 10.7x ← Serie 48 Total 183
6. Serie 5 Skott 	1: 9.9 ↗ 2: 9.3 → 3: 8.8 ↘ 4: 10.7x ↘ 5: 9.0 ↓ Serie 45 Total 228		

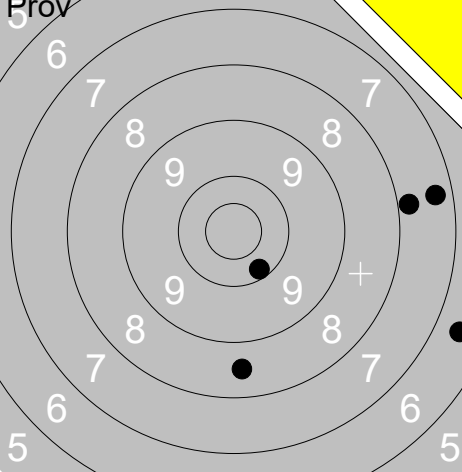
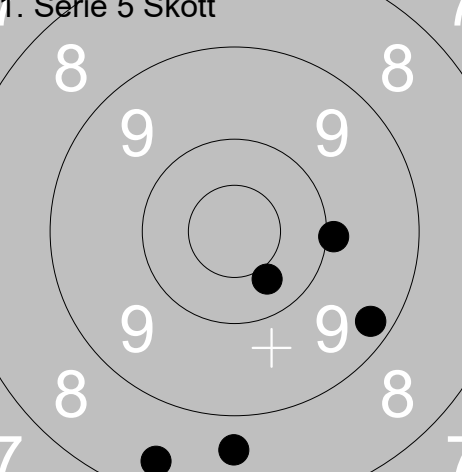
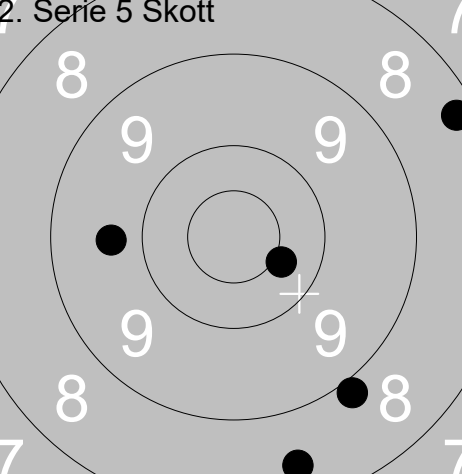
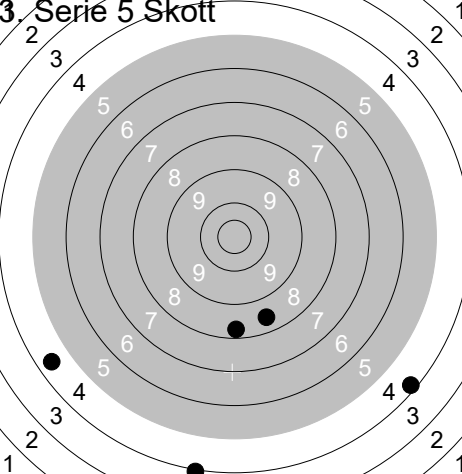
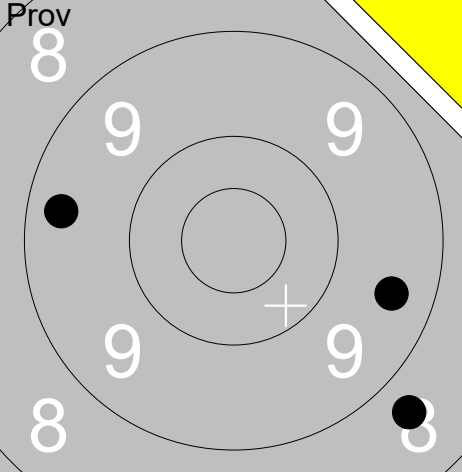
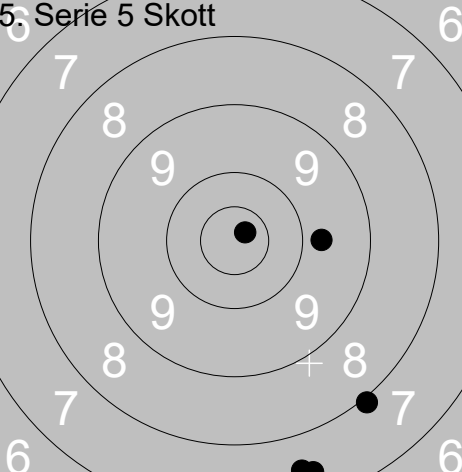
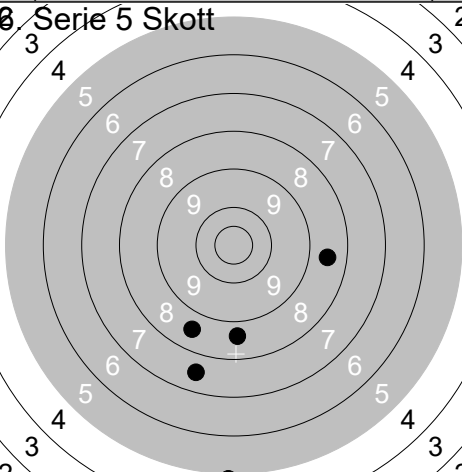
<p>Prov</p> 	<table border="1" style="width:100%; border-collapse: collapse;"> <tr><td>1:</td><td>7.8</td><td>→</td></tr> <tr><td>2:</td><td>7.3</td><td>→</td></tr> <tr><td>3:</td><td>8.5</td><td>↓</td></tr> <tr><td>4:</td><td>10.2</td><td>↓</td></tr> <tr><td>5:</td><td>6.6</td><td>→</td></tr> <tr><td colspan="2">Serie</td><td>38</td></tr> <tr><td colspan="2">Total</td><td>0</td></tr> </table>	1:	7.8	→	2:	7.3	→	3:	8.5	↓	4:	10.2	↓	5:	6.6	→	Serie		38	Total		0	<p>1. Serie 5 Skott</p> 	<table border="1" style="width:100%; border-collapse: collapse;"> <tr><td>1:</td><td>8.7</td><td>↓</td></tr> <tr><td>2:</td><td>9.3</td><td>↘</td></tr> <tr><td>3:</td><td>10.4</td><td>↓</td></tr> <tr><td>4:</td><td>8.4</td><td>↓</td></tr> <tr><td>5:</td><td>10.0</td><td>→</td></tr> <tr><td colspan="2">Serie</td><td>45</td></tr> <tr><td colspan="2">Total</td><td>45</td></tr> </table>	1:	8.7	↓	2:	9.3	↘	3:	10.4	↓	4:	8.4	↓	5:	10.0	→	Serie		45	Total		45
1:	7.8	→																																											
2:	7.3	→																																											
3:	8.5	↓																																											
4:	10.2	↓																																											
5:	6.6	→																																											
Serie		38																																											
Total		0																																											
1:	8.7	↓																																											
2:	9.3	↘																																											
3:	10.4	↓																																											
4:	8.4	↓																																											
5:	10.0	→																																											
Serie		45																																											
Total		45																																											
<p>2. Serie 5 Skott</p> 	<table border="1" style="width:100%; border-collapse: collapse;"> <tr><td>1:</td><td>10.4</td><td>↘</td></tr> <tr><td>2:</td><td>9.7</td><td>←</td></tr> <tr><td>3:</td><td>8.3</td><td>→</td></tr> <tr><td>4:</td><td>8.4</td><td>↓</td></tr> <tr><td>5:</td><td>8.9</td><td>↓</td></tr> <tr><td colspan="2">Serie</td><td>43</td></tr> <tr><td colspan="2">Total</td><td>88</td></tr> </table>	1:	10.4	↘	2:	9.7	←	3:	8.3	→	4:	8.4	↓	5:	8.9	↓	Serie		43	Total		88	<p>3. Serie 5 Skott</p> 	<table border="1" style="width:100%; border-collapse: collapse;"> <tr><td>1:</td><td>8.5</td><td>↓</td></tr> <tr><td>2:</td><td>4.2</td><td>↘</td></tr> <tr><td>3:</td><td>8.3</td><td>↓</td></tr> <tr><td>4:</td><td>4.0</td><td>↓</td></tr> <tr><td>5:</td><td>4.5</td><td>↙</td></tr> <tr><td colspan="2">Serie</td><td>28</td></tr> <tr><td colspan="2">Total</td><td>116</td></tr> </table>	1:	8.5	↓	2:	4.2	↘	3:	8.3	↓	4:	4.0	↓	5:	4.5	↙	Serie		28	Total		116
1:	10.4	↘																																											
2:	9.7	←																																											
3:	8.3	→																																											
4:	8.4	↓																																											
5:	8.9	↓																																											
Serie		43																																											
Total		88																																											
1:	8.5	↓																																											
2:	4.2	↘																																											
3:	8.3	↓																																											
4:	4.0	↓																																											
5:	4.5	↙																																											
Serie		28																																											
Total		116																																											
<p>Prov</p> 	<table border="1" style="width:100%; border-collapse: collapse;"> <tr><td>1:</td><td>9.4</td><td>←</td></tr> <tr><td>2:</td><td>9.4</td><td>→</td></tr> <tr><td>3:</td><td>8.7</td><td>↓</td></tr> <tr><td colspan="2">Serie</td><td>26</td></tr> <tr><td colspan="2">Total</td><td>116</td></tr> </table>	1:	9.4	←	2:	9.4	→	3:	8.7	↓	Serie		26	Total		116	<p>5. Serie 5 Skott</p> 	<table border="1" style="width:100%; border-collapse: collapse;"> <tr><td>1:</td><td>7.5</td><td>↓</td></tr> <tr><td>2:</td><td>10.8x</td><td>↗</td></tr> <tr><td>3:</td><td>9.8</td><td>→</td></tr> <tr><td>4:</td><td>8.0</td><td>↓</td></tr> <tr><td>5:</td><td>7.4</td><td>↓</td></tr> <tr><td colspan="2">Serie</td><td>41</td></tr> <tr><td colspan="2">Total</td><td>157</td></tr> </table>	1:	7.5	↓	2:	10.8x	↗	3:	9.8	→	4:	8.0	↓	5:	7.4	↓	Serie		41	Total		157						
1:	9.4	←																																											
2:	9.4	→																																											
3:	8.7	↓																																											
Serie		26																																											
Total		116																																											
1:	7.5	↓																																											
2:	10.8x	↗																																											
3:	9.8	→																																											
4:	8.0	↓																																											
5:	7.4	↓																																											
Serie		41																																											
Total		157																																											
<p>6. Serie 5 Skott</p> 	<table border="1" style="width:100%; border-collapse: collapse;"> <tr><td>1:</td><td>8.6</td><td>↓</td></tr> <tr><td>2:</td><td>7.6</td><td>↓</td></tr> <tr><td>3:</td><td>8.6</td><td>↓</td></tr> <tr><td>4:</td><td>4.9</td><td>↓</td></tr> <tr><td>5:</td><td>8.5</td><td>→</td></tr> <tr><td colspan="2">Serie</td><td>35</td></tr> <tr><td colspan="2">Total</td><td>192</td></tr> </table>	1:	8.6	↓	2:	7.6	↓	3:	8.6	↓	4:	4.9	↓	5:	8.5	→	Serie		35	Total		192																							
1:	8.6	↓																																											
2:	7.6	↓																																											
3:	8.6	↓																																											
4:	4.9	↓																																											
5:	8.5	→																																											
Serie		35																																											
Total		192																																											

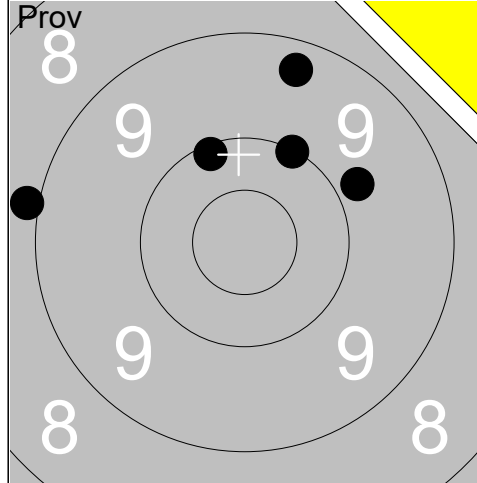

1:	10.0	↗
2:	9.3	↑
3:	9.8	→
4:	10.1	↗
5:	8.9	←
Serie		46
Total		0

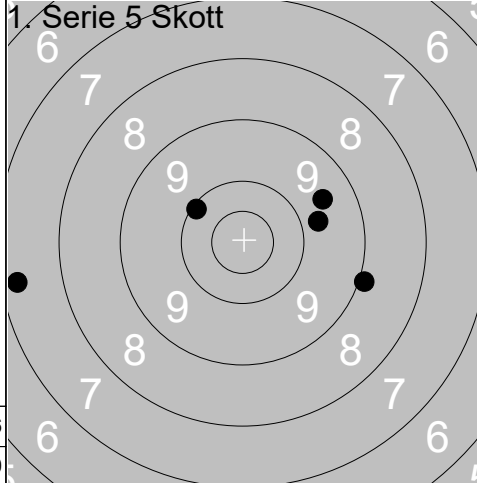

1:	9.7	→
2:	7.3	←
3:	10.1	↗
4:	8.9	→
5:	9.5	↗
Serie		43
Total		43

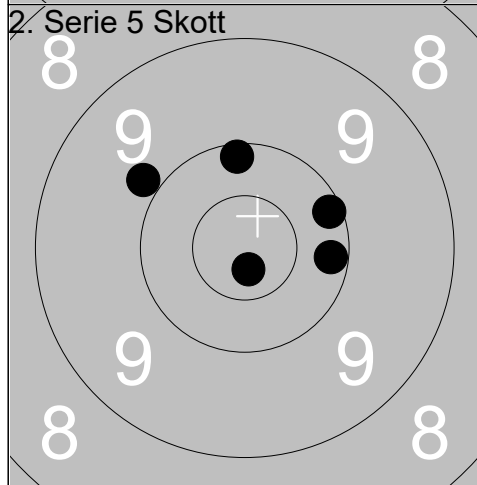

1:	10.2	→
2:	10.1	→
3:	10.8x	↓
4:	10.1	↑
5:	9.9	↖
Serie		49
Total		92

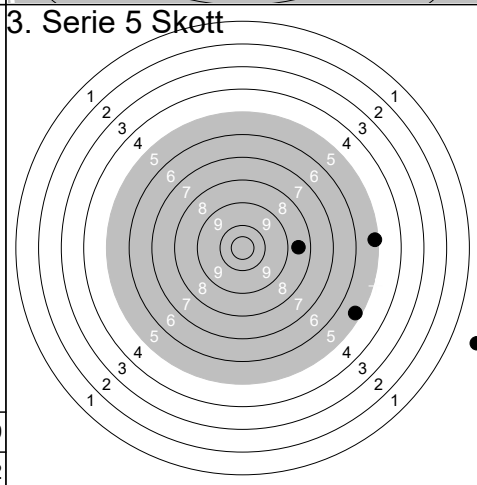

1:	5.3	↘
2:	5.2	→
3:	8.6	→
4:	0.0	
5:	0.0	↘
Serie		18
Total		110

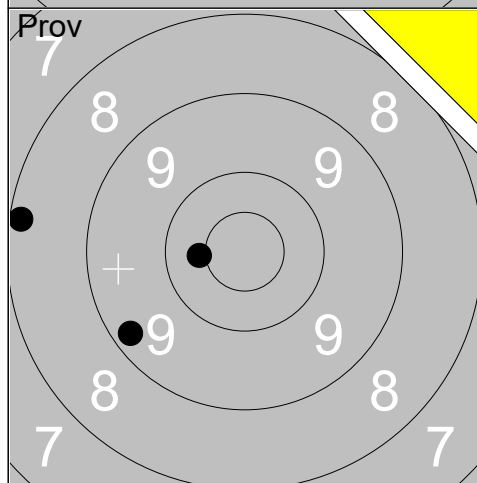

1:	10.4x	←
2:	8.2	←
3:	9.3	↖
Serie		27
Total		110

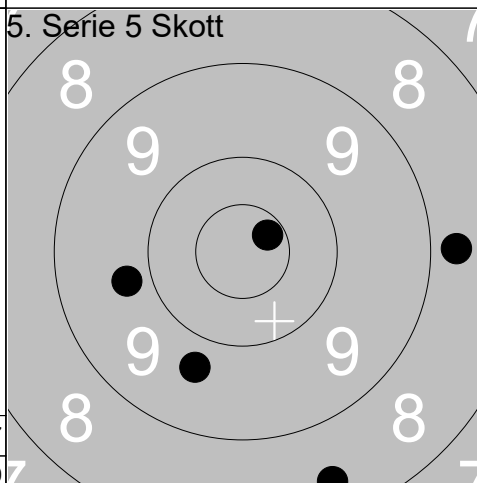

1:	9.8	←
2:	8.4	↓
3:	9.7	↓
4:	8.8	→
5:	10.7x	↗
Serie		44
Total		154

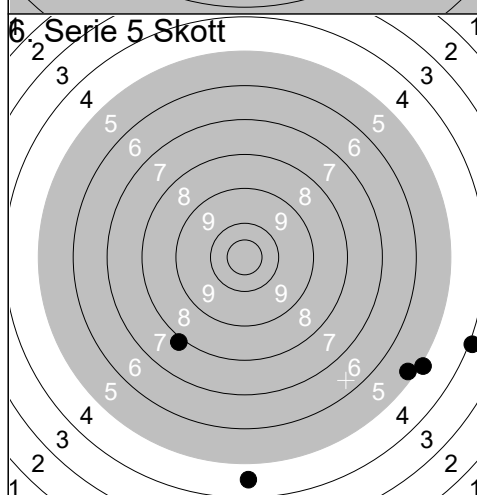

1:	7.9	↖
2:	4.6	↓
3:	5.2	↘
4:	5.0	↘
5:	3.9	→
Serie		24
Total		178

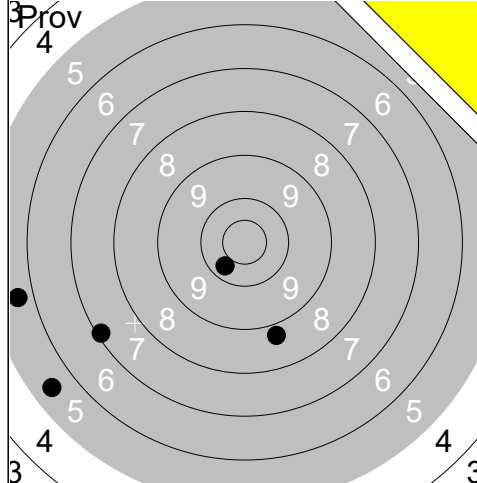

1:	5.7	←
2:	5.5	↙
3:	7.1	↙
4:	10.3	↙
5:	8.8	↘
Serie		35
Total		0

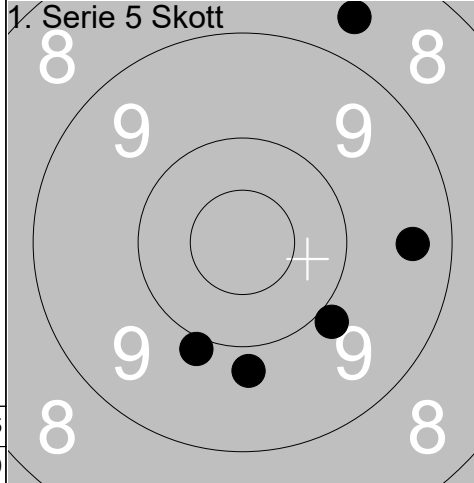

1:	8.6	↗
2:	9.9	↘
3:	9.8	↘
4:	9.4	→
5:	9.9	↘
Serie		44
Total		44

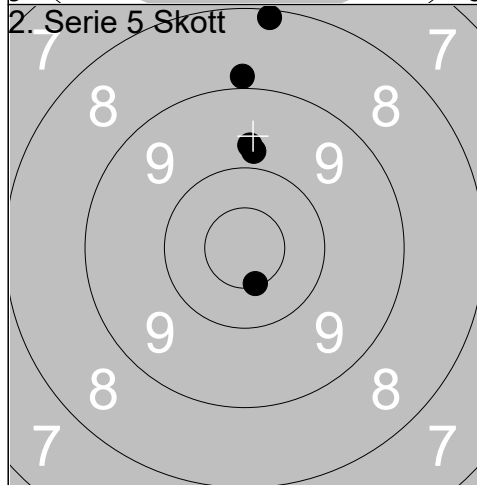

1:	8.1	↑
2:	8.9	↑
3:	9.8	↑
4:	9.7	↑
5:	10.5x	↓
Serie		44
Total		88

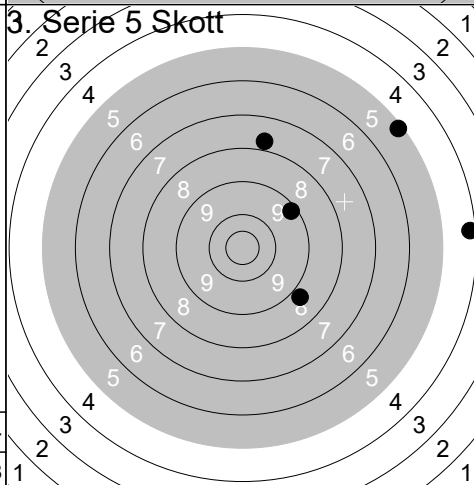

1:	7.8	↑
2:	8.8	↘
3:	4.2	→
4:	5.1	↗
5:	9.2	↗
Serie		33
Total		121

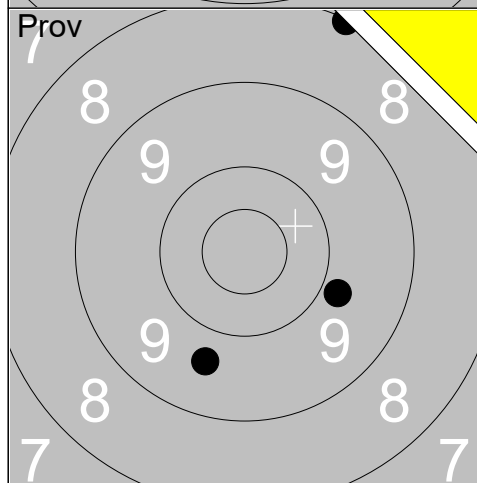

1:	8.1	↗
2:	9.8	→
3:	9.6	↘
Serie		26
Total		121

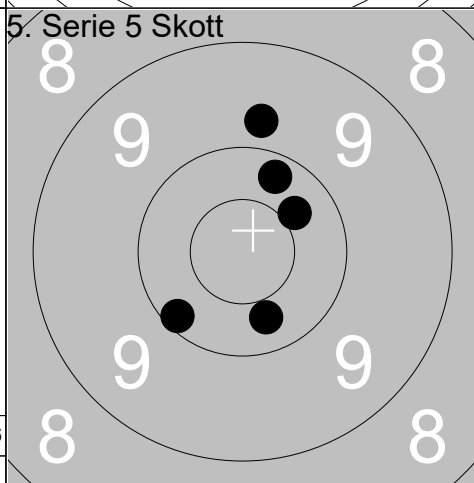

1:	10.2	↗
2:	10.1	↙
3:	9.8	↑
4:	10.4	↗
5:	10.3	↘
Serie		49
Total		170

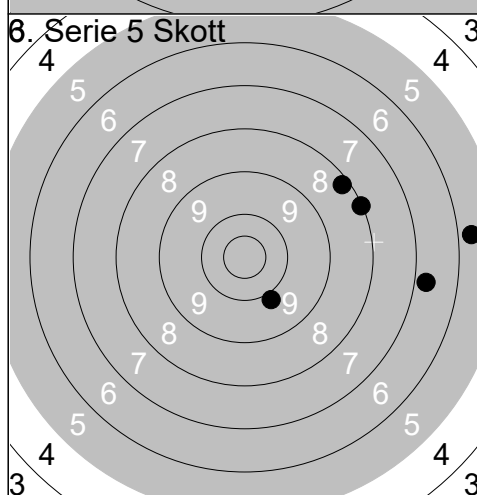

1:	8.1	→
2:	5.7	→
3:	9.9	↘
4:	8.2	↗
5:	6.8	→
Serie		36
Total		206

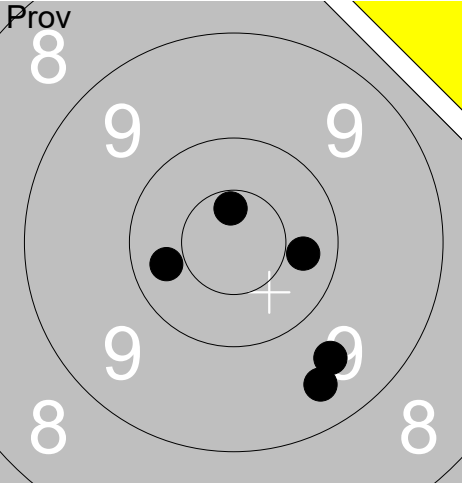
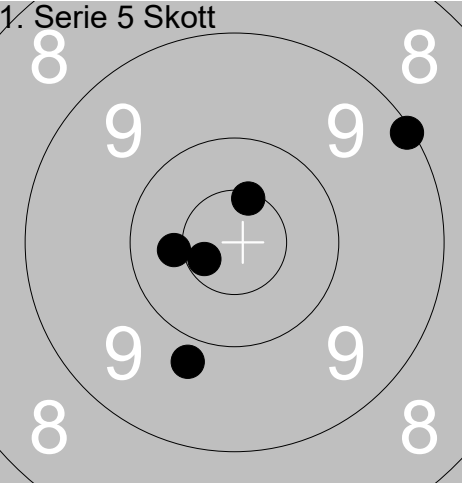
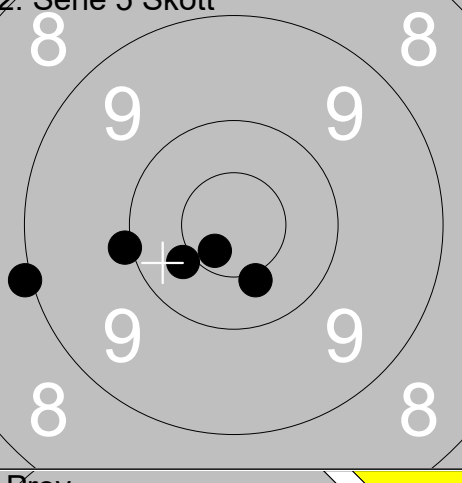
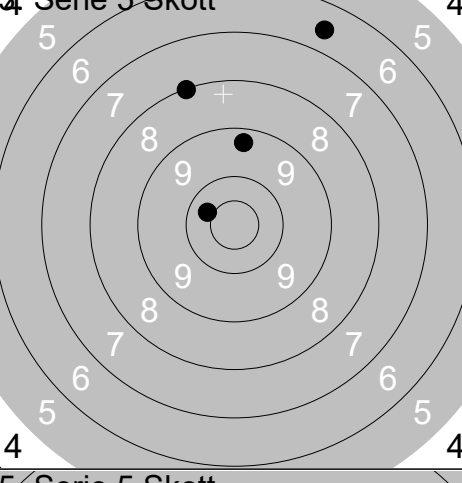
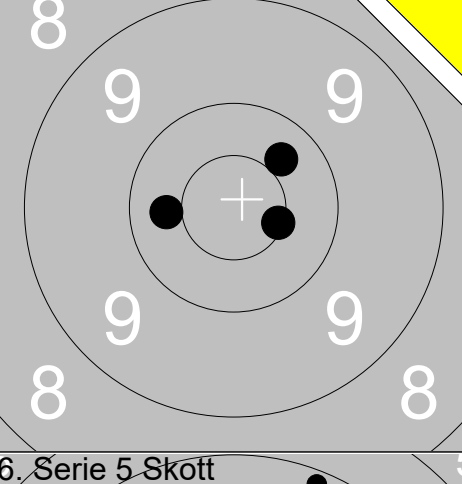
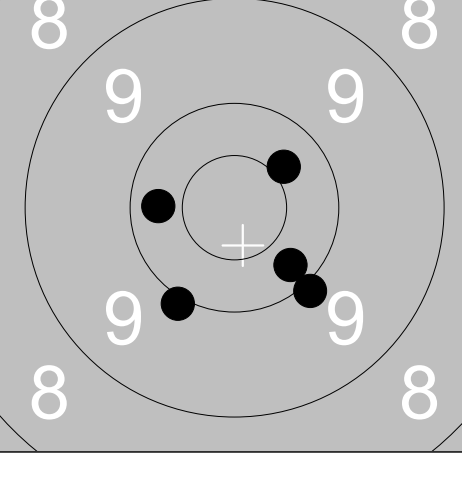
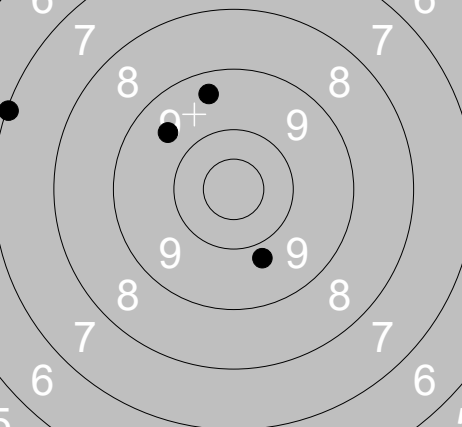
Skjutlag 2	Tavla 4	Jan Wallerström			
Ramselefors		Ununge		Sen/Vets	St
06.07.2019		Björkskottet 2019		Ramselefors SKF	
Prov 	1: 9.4 ↘ 2: 10.3 → 3: 10.6x ↑ 4: 10.3 ← 5: 9.6 ↘	1. Serie 5 Skott 	1: 10.4 ← 2: 9.8 ↓ 3: 10.6x ← 4: 9.1 ↗ 5: 10.5x ↑		
	Serie 48 Total 0		Serie 48 Total 48		
2. Serie 5 Skott 	1: 9.0 ← 2: 10.7x ↓ 3: 10.4x ↓ 4: 10.4 ← 5: 10.0 ←	3. Serie 5 Skott 	1: 8.1 ↑ 2: 10.4 ↖ 3: 6.6 ↑ 4: 9.3 ↑ 5: 5.9 ↑		
	Serie 49 Total 97		Serie 38 Total 135		
Prov 	1: 10.4 ← 2: 10.3 ↗ 3: 10.5x →	5. Serie 5 Skott 	1: 10.3 ← 2: 10.0 ↓ 3: 10.0 ↓ 4: 10.4 ↗ 5: 10.2 ↓		
	Serie 30 Total 135		Serie 50 Total 185		
6. Serie 5 Skott 	1: 9.6 ↗ 2: 9.4 ↑ 3: 7.1 ↖ 4: 7.3 ↑ 5: 9.8 ↓				
	Serie 41 Total 226				

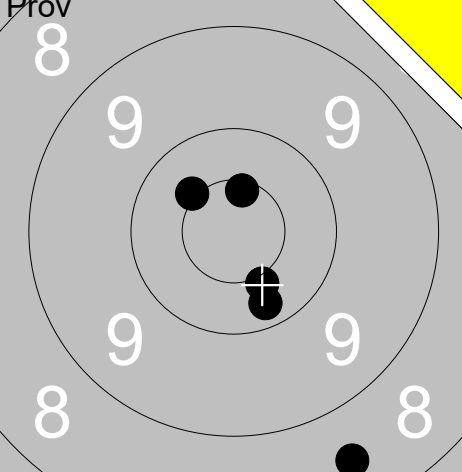
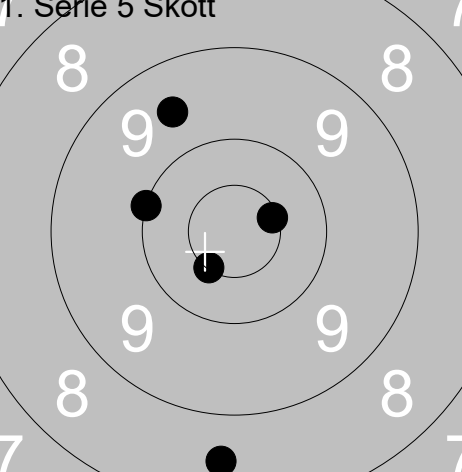
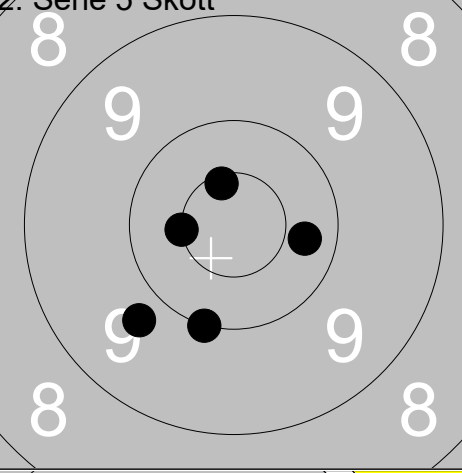
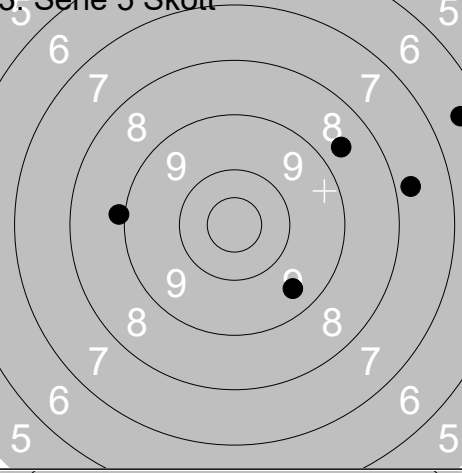
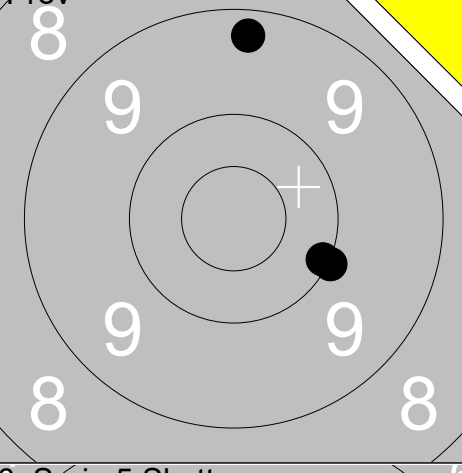
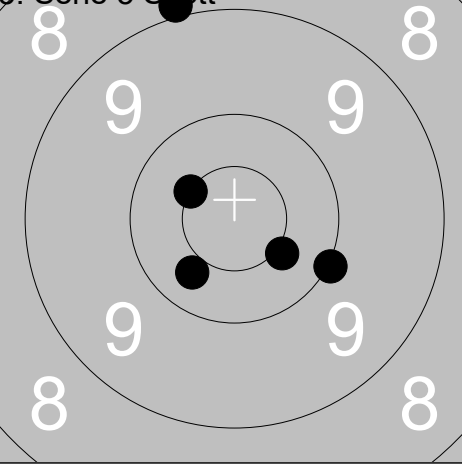
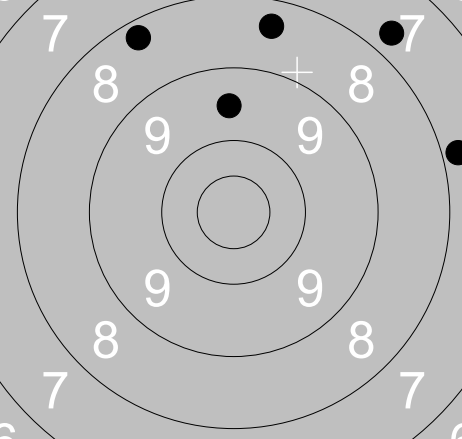
Prov 	1: 10.6x ↑ 2: 8.5 ↓ 3: 10.4x ↗ 4: 10.2 ↓ 5: 10.4x ↓ <hr/> Serie 48 Total 0	1. Serie 5 Skott 	1: 9.6 ↗ 2: 8.5 ↓ 3: 10.0 ← 4: 10.5x ↓ 5: 10.5x → <hr/> Serie 47 Total 47
2. Serie 5 Skott 	1: 10.3 → 2: 10.5x ← 3: 10.0 ↓ 4: 9.7 ↙ 5: 10.6x ↗ <hr/> Serie 49 Total 96	3. Serie 5 Skott 	1: 8.6 ↗ 2: 9.5 ↓ 3: 8.9 ← 4: 6.5 → 5: 7.7 → <hr/> Serie 38 Total 134
Prov 	1: 9.3 ↑ 2: 10.0 → 3: 10.1 → <hr/> Serie 29 Total 134	5. Serie 5 Skott 	1: 8.9 ↑ 2: 10.0 → 3: 10.5x ↗ 4: 10.3 ↓ 5: 10.4x ↓ <hr/> Serie 48 Total 182
6. Serie 5 Skott 	1: 8.4 ↑ 2: 7.8 → 3: 9.5 ↑ 4: 7.7 ↗ 5: 8.3 ↗ <hr/> Serie 39 Total 221		

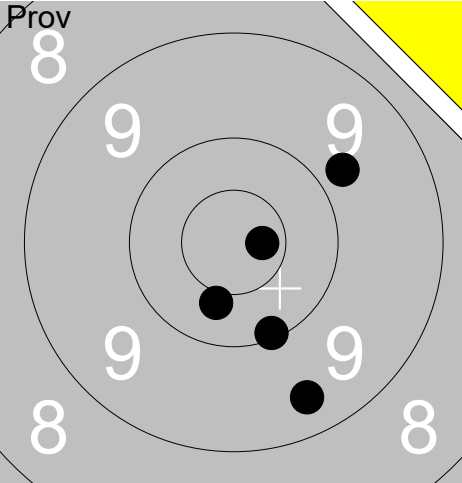
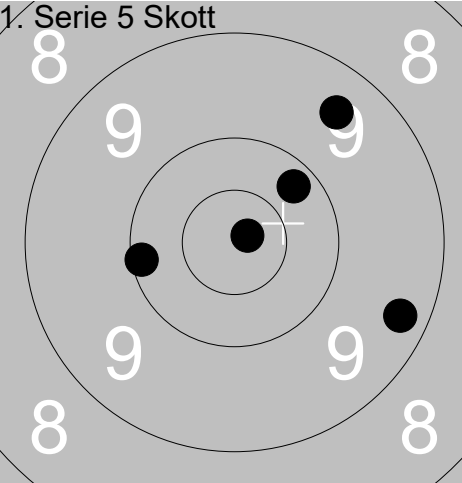
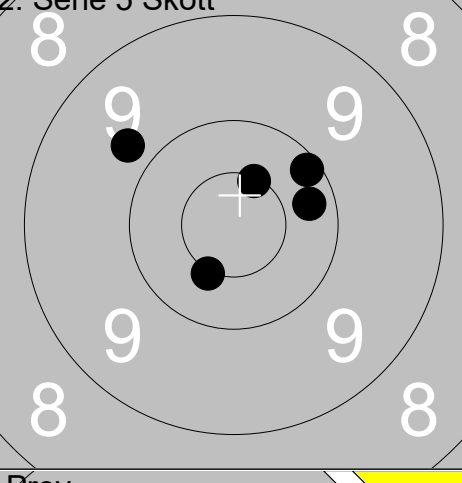
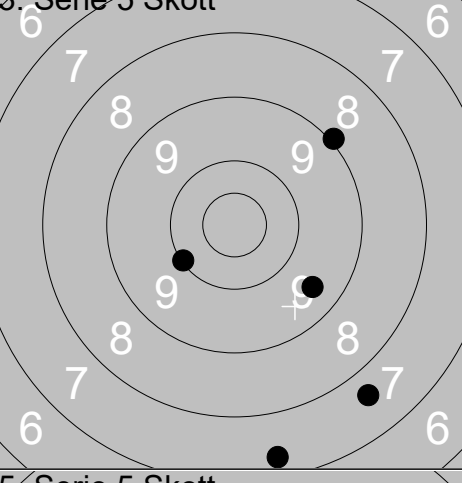
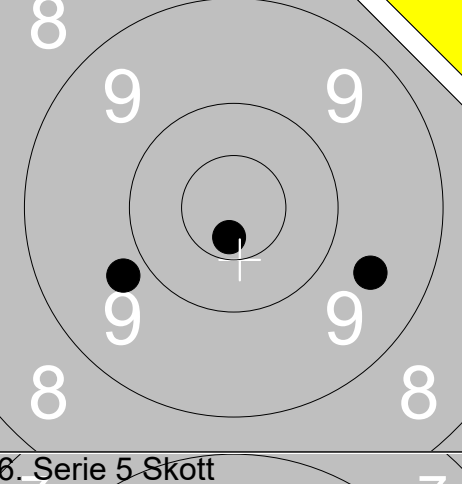
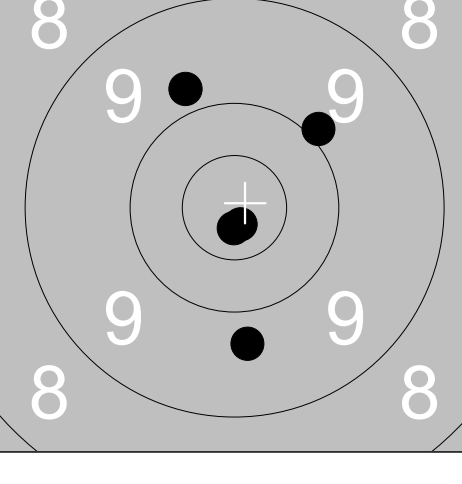
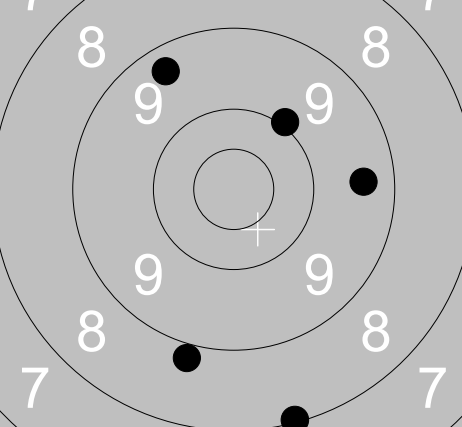
Skjutlag	Tavla	Kevin Arnmark		
2	6	Ramselefors	Västerås Friv Skarp	Sen/VetS Vm
06.07.2019	Björskottet 2019	Ramselefors SKF		
Prov 	1: 9.4 ↘ 2: 10.7x → 3: 10.4 ↘ 4: 9.8 ↗ 5: 10.1 ↘	1. Serie 5 Skott 	1: 10.1 ← 2: 10.8x → 3: 10.2 ↗ 4: 9.3 → 5: 9.5 ↗	
Serie 48 Total 0	Serie 48 Total 48			
2. Serie 5 Skott 	1: 9.8 ↖ 2: 10.1 ↗ 3: 10.5x ↑ 4: 10.3 → 5: 10.5x ↘	3. Serie 5 Skott 	1: 9.0 ↗ 2: 7.6 ↘ 3: 7.3 ↘ 4: 10.0 ← 5: 9.5 ↘	
Serie 49 Total 97	Serie 42 Total 139			
Prov 	1: 9.6 → 2: 9.8 ← 3: 10.7x ↘	5. Serie 5 Skott 	1: 9.8 ↖ 2: 10.8x ↘ 3: 9.9 ↗ 4: 10.8x ↘ 5: 9.7 ↘	
Serie 28 Total 139	Serie 47 Total 186			
6. Serie 5 Skott 	1: 9.3 ↖ 2: 8.9 ↘ 3: 8.1 ↘ 4: 9.4 → 5: 10.0 ↗			
Serie 44 Total 230				

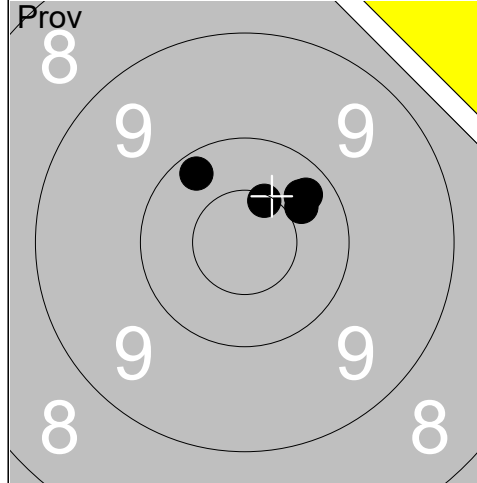

1:	10.5x	↗
2:	10.4	↗
3:	10.3	↗
4:	10.3	↗
5:	10.2	↖
Serie		50
Total		0

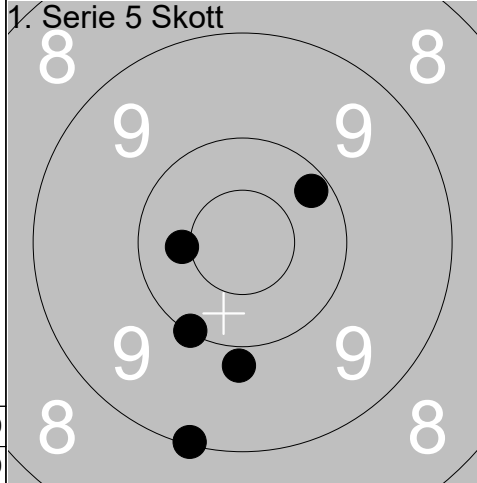

1:	10.4x	←
2:	10.2	↗
3:	9.9	↓
4:	10.0	↙
5:	9.1	↓
Serie		48
Total		48

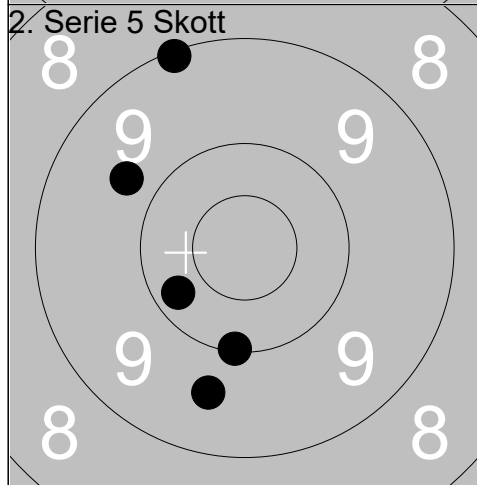

1:	9.1	↗
2:	9.7	↖
3:	9.6	↓
4:	10.2	↙
5:	10.1	↓
Serie		47
Total		95

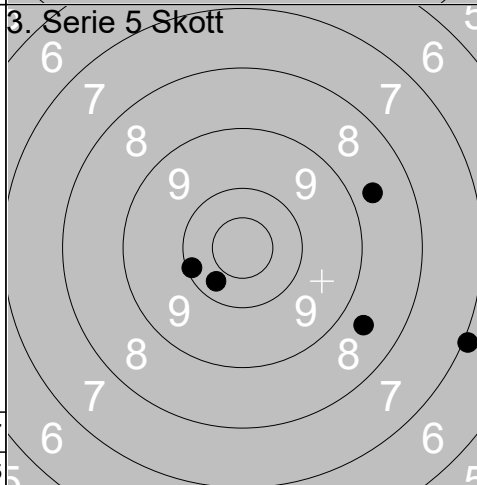

1:	8.6	↘
2:	10.1	←
3:	10.3	↙
4:	8.7	↗
5:	7.0	↘
Serie		43
Total		138

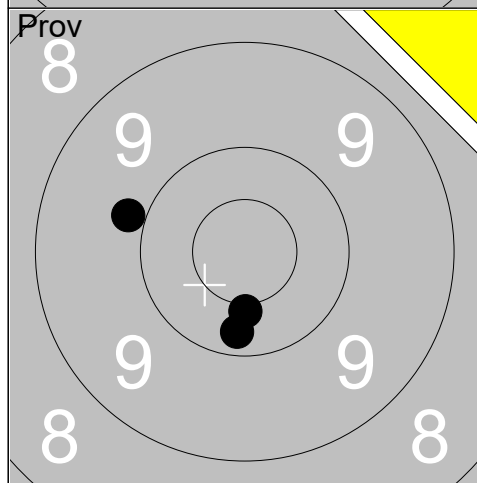

1:	9.9	←
2:	10.4x	↓
3:	10.2	↓
Serie		29
Total		138

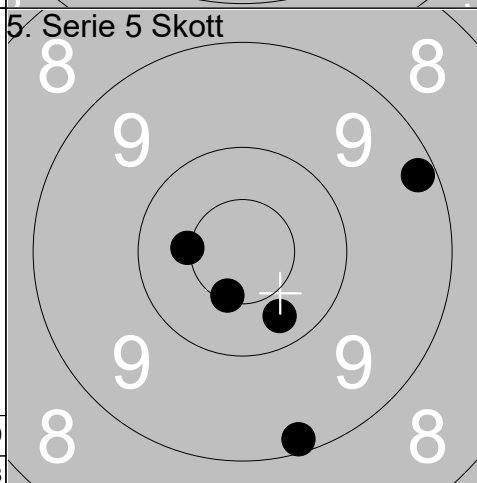

1:	10.5x	←
2:	10.5x	↓
3:	9.2	↓
4:	10.3	↙
5:	9.2	↗
Serie		48
Total		186

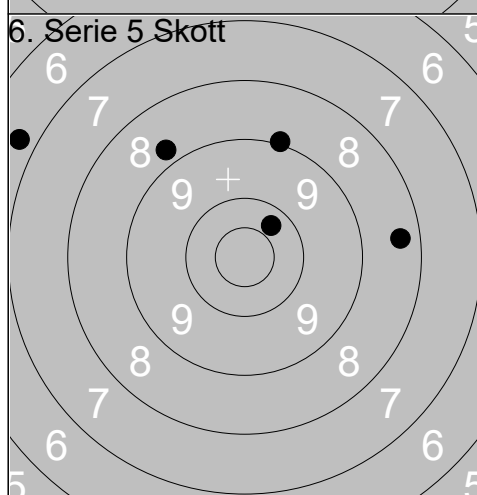

1:	9.0	↗
2:	10.3	↗
3:	8.4	→
4:	8.8	↗
5:	6.7	↖
Serie		41
Total		227

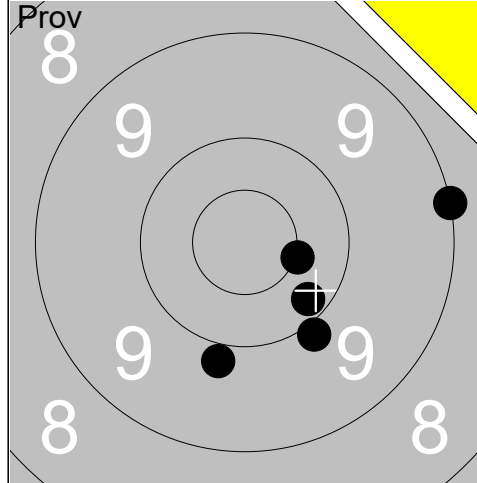

1:	9.9	↘
2:	9.9	↘
3:	9.0	→
4:	10.5x	→
5:	10.2	↘
Serie		47
Total		0

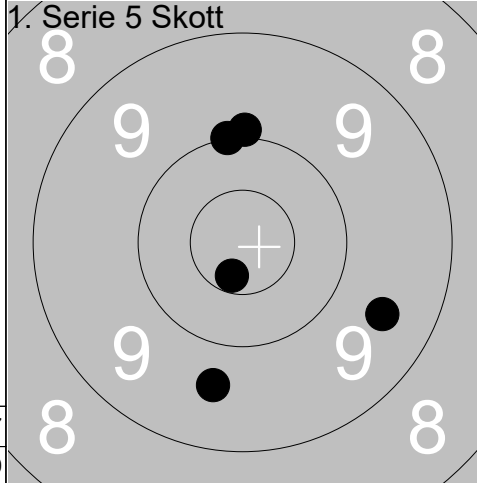

1:	10.6x	↘
2:	9.5	→
3:	9.6	↘
4:	10.0	↑
5:	10.0	↑
Serie		48
Total		48

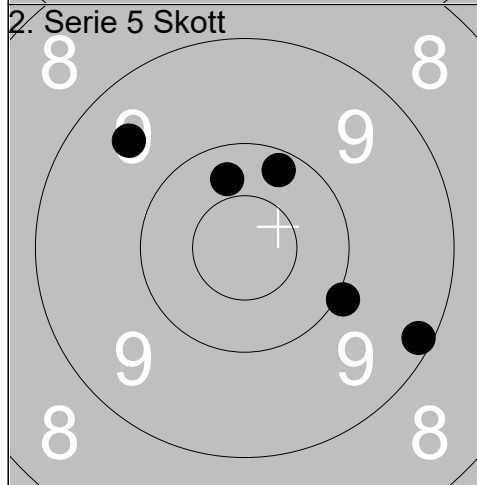

1:	10.2	↑
2:	10.0	→
3:	9.2	↘
4:	10.3	↑
5:	9.5	↗
Serie		48
Total		96

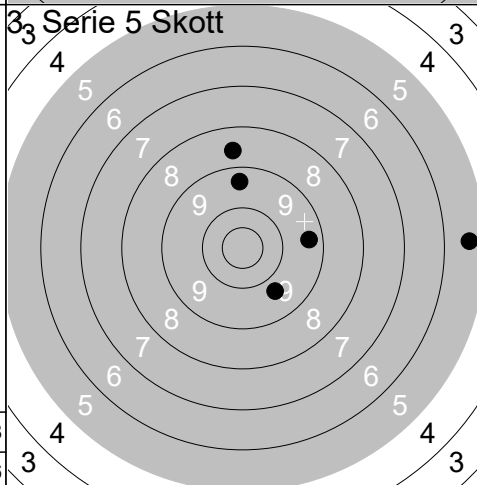

1:	9.4	→
2:	5.4	→
3:	9.4	↑
4:	9.7	↘
5:	8.6	↑
Serie		40
Total		136

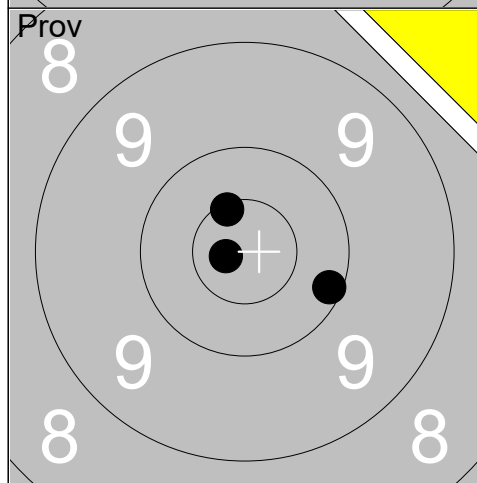

1:	10.5x	↗
2:	10.8x	←
3:	10.1	↘
Serie		30
Total		136

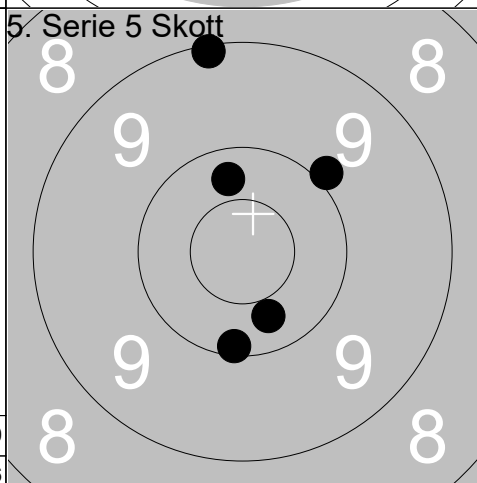

1:	10.1	↘
2:	9.1	↑
3:	10.3	↘
4:	10.3	↑
5:	9.9	↗
Serie		48
Total		184

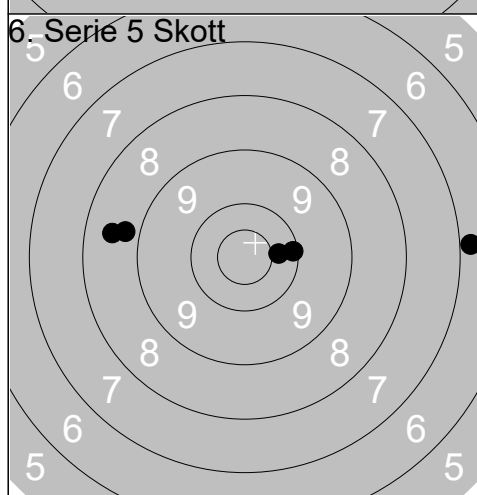

1:	6.8	→
2:	10.4	→
3:	8.8	←
4:	8.5	←
5:	10.1	→
Serie		42
Total		226

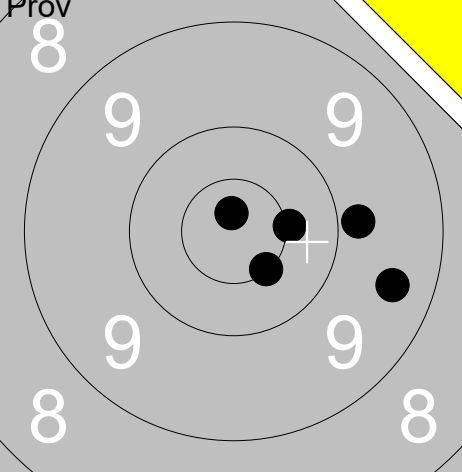
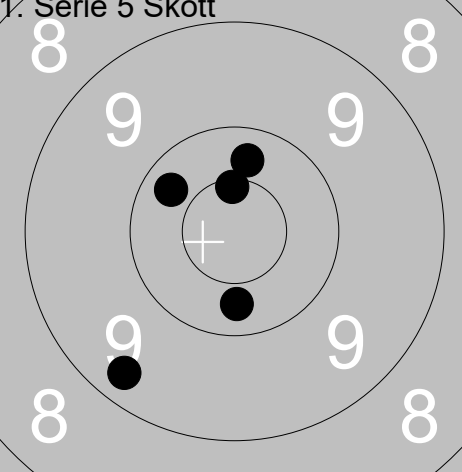
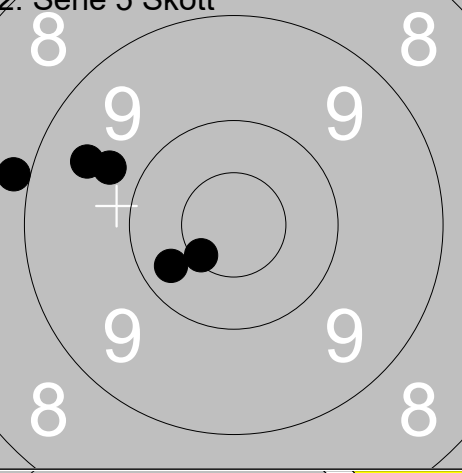
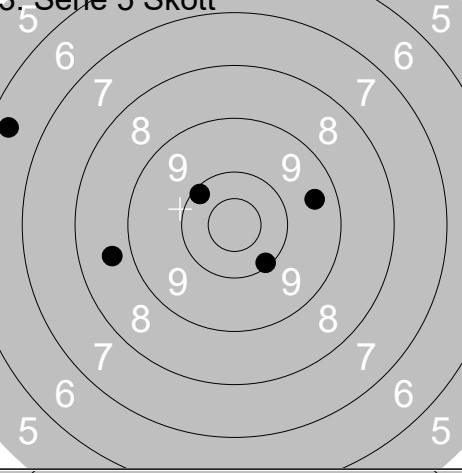
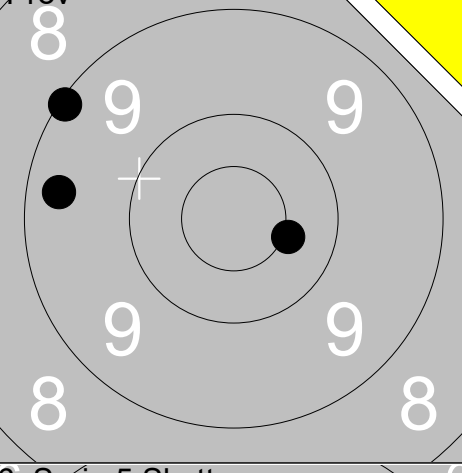
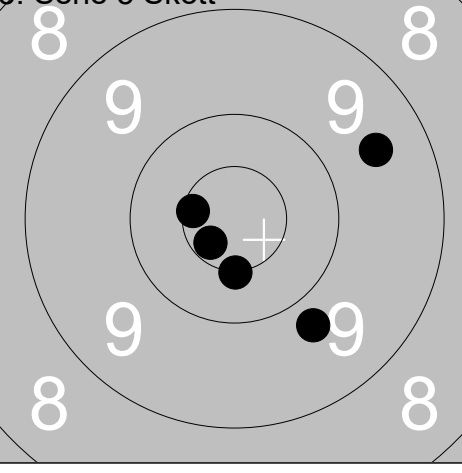
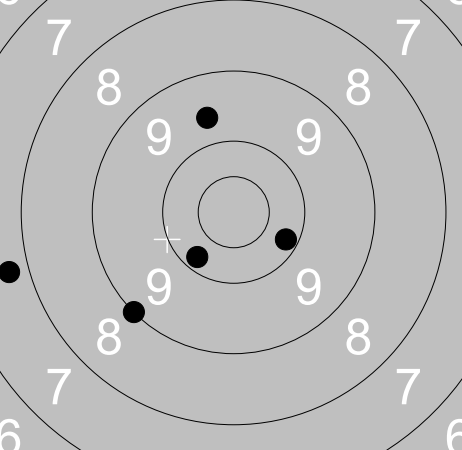
Prov 	<table border="1" style="width:100%; border-collapse: collapse;"> <tr><td>1:</td><td>9.8</td><td>→</td></tr> <tr><td>2:</td><td>9.4</td><td>→</td></tr> <tr><td>3:</td><td>10.5x</td><td>↘</td></tr> <tr><td>4:</td><td>10.8x</td><td>↑</td></tr> <tr><td>5:</td><td>10.5x</td><td>→</td></tr> <tr><td colspan="2">Serie</td><td>48</td></tr> <tr><td colspan="2">Total</td><td>0</td></tr> </table>	1:	9.8	→	2:	9.4	→	3:	10.5x	↘	4:	10.8x	↑	5:	10.5x	→	Serie		48	Total		0	1. Serie 5 Skott  <table border="1" style="width:100%; border-collapse: collapse;"> <tr><td>1:</td><td>10.6x</td><td>↑</td></tr> <tr><td>2:</td><td>10.3</td><td>↓</td></tr> <tr><td>3:</td><td>10.3</td><td>↑</td></tr> <tr><td>4:</td><td>10.3</td><td>↖</td></tr> <tr><td>5:</td><td>9.3</td><td>↙</td></tr> <tr><td colspan="2">Serie</td><td>49</td></tr> <tr><td colspan="2">Total</td><td>49</td></tr> </table>	1:	10.6x	↑	2:	10.3	↓	3:	10.3	↑	4:	10.3	↖	5:	9.3	↙	Serie		49	Total		49
1:	9.8	→																																										
2:	9.4	→																																										
3:	10.5x	↘																																										
4:	10.8x	↑																																										
5:	10.5x	→																																										
Serie		48																																										
Total		0																																										
1:	10.6x	↑																																										
2:	10.3	↓																																										
3:	10.3	↑																																										
4:	10.3	↖																																										
5:	9.3	↙																																										
Serie		49																																										
Total		49																																										
2. Serie 5 Skott 	<table border="1" style="width:100%; border-collapse: collapse;"> <tr><td>1:</td><td>10.6x</td><td>↙</td></tr> <tr><td>2:</td><td>8.9</td><td>↖</td></tr> <tr><td>3:</td><td>10.3</td><td>↖</td></tr> <tr><td>4:</td><td>9.5</td><td>↗</td></tr> <tr><td>5:</td><td>9.7</td><td>↗</td></tr> <tr><td colspan="2">Serie</td><td>46</td></tr> <tr><td colspan="2">Total</td><td>95</td></tr> </table>	1:	10.6x	↙	2:	8.9	↖	3:	10.3	↖	4:	9.5	↗	5:	9.7	↗	Serie		46	Total		95	3. Serie 5 Skott  <table border="1" style="width:100%; border-collapse: collapse;"> <tr><td>1:</td><td>10.1</td><td>↗</td></tr> <tr><td>2:</td><td>8.7</td><td>↖</td></tr> <tr><td>3:</td><td>10.1</td><td>↘</td></tr> <tr><td>4:</td><td>6.4</td><td>↗</td></tr> <tr><td>5:</td><td>9.4</td><td>→</td></tr> <tr><td colspan="2">Serie</td><td>43</td></tr> <tr><td colspan="2">Total</td><td>138</td></tr> </table>	1:	10.1	↗	2:	8.7	↖	3:	10.1	↘	4:	6.4	↗	5:	9.4	→	Serie		43	Total		138
1:	10.6x	↙																																										
2:	8.9	↖																																										
3:	10.3	↖																																										
4:	9.5	↗																																										
5:	9.7	↗																																										
Serie		46																																										
Total		95																																										
1:	10.1	↗																																										
2:	8.7	↖																																										
3:	10.1	↘																																										
4:	6.4	↗																																										
5:	9.4	→																																										
Serie		43																																										
Total		138																																										
Prov 	<table border="1" style="width:100%; border-collapse: collapse;"> <tr><td>1:</td><td>9.1</td><td>↗</td></tr> <tr><td>2:</td><td>9.3</td><td>↖</td></tr> <tr><td>3:</td><td>10.4x</td><td>↘</td></tr> <tr><td colspan="2">Serie</td><td>28</td></tr> <tr><td colspan="2">Total</td><td>138</td></tr> </table>	1:	9.1	↗	2:	9.3	↖	3:	10.4x	↘	Serie		28	Total		138	5. Serie 5 Skott  <table border="1" style="width:100%; border-collapse: collapse;"> <tr><td>1:</td><td>10.6x</td><td>↖</td></tr> <tr><td>2:</td><td>10.6x</td><td>↙</td></tr> <tr><td>3:</td><td>10.5x</td><td>↓</td></tr> <tr><td>4:</td><td>9.8</td><td>↘</td></tr> <tr><td>5:</td><td>9.5</td><td>↗</td></tr> <tr><td colspan="2">Serie</td><td>48</td></tr> <tr><td colspan="2">Total</td><td>186</td></tr> </table>	1:	10.6x	↖	2:	10.6x	↙	3:	10.5x	↓	4:	9.8	↘	5:	9.5	↗	Serie		48	Total		186						
1:	9.1	↗																																										
2:	9.3	↖																																										
3:	10.4x	↘																																										
Serie		28																																										
Total		138																																										
1:	10.6x	↖																																										
2:	10.6x	↙																																										
3:	10.5x	↓																																										
4:	9.8	↘																																										
5:	9.5	↗																																										
Serie		48																																										
Total		186																																										
6. Serie 5 Skott 	<table border="1" style="width:100%; border-collapse: collapse;"> <tr><td>1:</td><td>10.2</td><td>↙</td></tr> <tr><td>2:</td><td>10.2</td><td>→</td></tr> <tr><td>3:</td><td>9.0</td><td>↙</td></tr> <tr><td>4:</td><td>9.6</td><td>↑</td></tr> <tr><td>5:</td><td>7.7</td><td>↖</td></tr> <tr><td colspan="2">Serie</td><td>45</td></tr> <tr><td colspan="2">Total</td><td>231</td></tr> </table>	1:	10.2	↙	2:	10.2	→	3:	9.0	↙	4:	9.6	↑	5:	7.7	↖	Serie		45	Total		231																						
1:	10.2	↙																																										
2:	10.2	→																																										
3:	9.0	↙																																										
4:	9.6	↑																																										
5:	7.7	↖																																										
Serie		45																																										
Total		231																																										

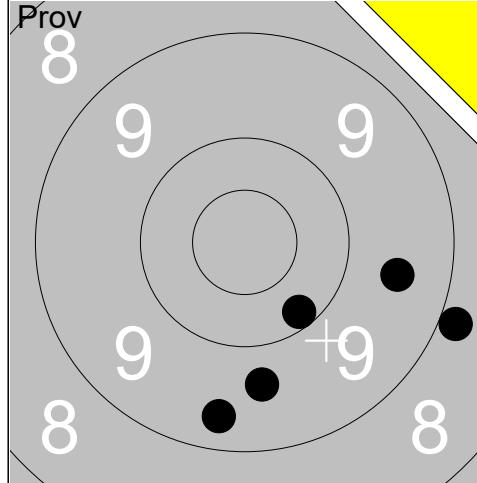

1:	8.9	→
2:	10.2	↓
3:	9.4	↓
4:	9.7	↓
5:	9.5	→
Serie		45
Total		0

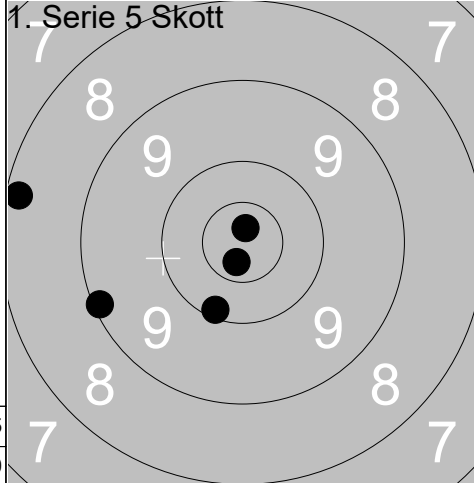

1:	8.2	←
2:	10.8x	↑
3:	10.1	↓
4:	10.7x	↓
5:	9.1	←
Serie		47
Total		47

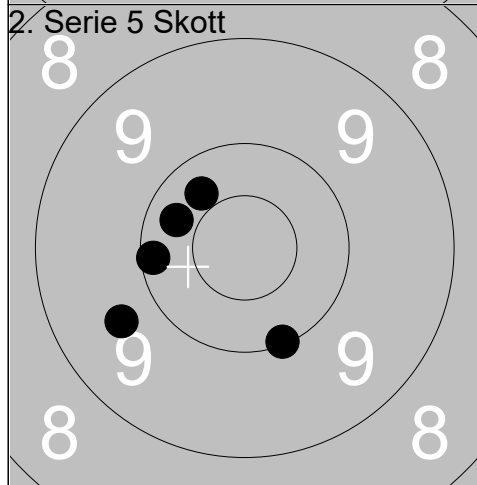

1:	10.1	←
2:	10.1	↓
3:	9.7	←
4:	10.3	↗
5:	10.3	↖
Serie		49
Total		96

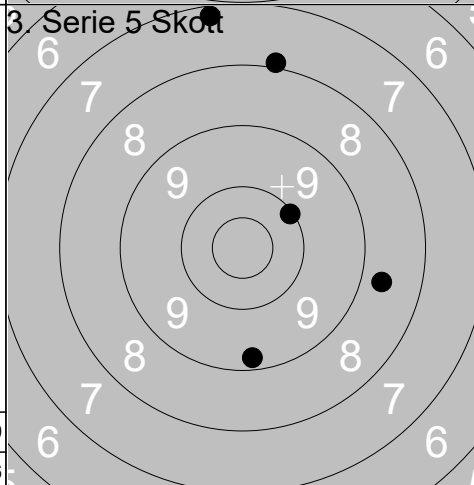

1:	8.7	→
2:	9.2	↓
3:	10.1	↗
4:	7.9	↑
5:	7.2	↑
Serie		41
Total		137

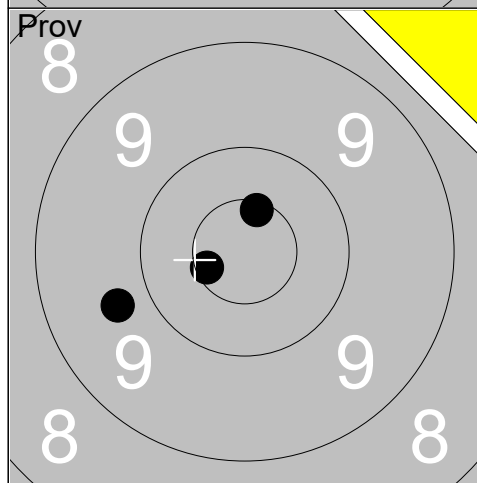

1:	10.6x	↑
2:	9.7	←
3:	10.6x	←
Serie		29
Total		137

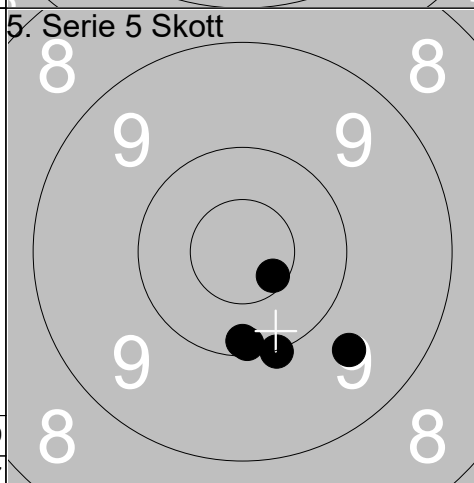

1:	10.1	↓
2:	9.6	↘
3:	10.6x	↘
4:	10.2	↓
5:	10.0	↓
Serie		49
Total		186

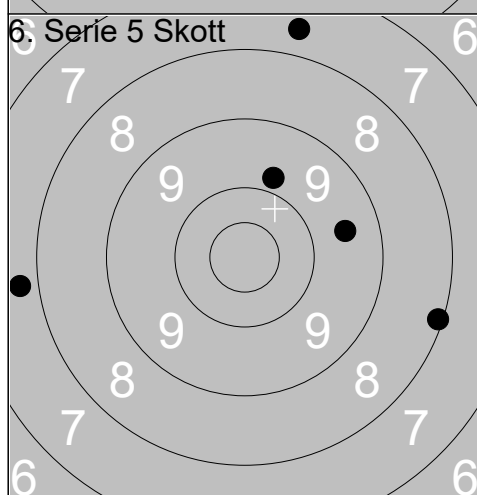

1:	9.5	→
2:	8.1	→
3:	7.8	←
4:	9.8	↑
5:	7.6	↑
Serie		40
Total		226

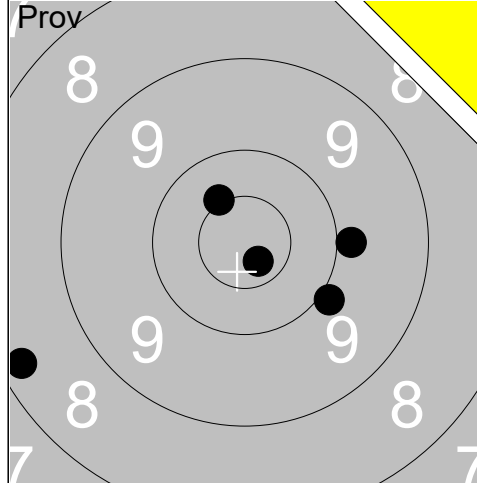

1: 10.5x ↗
 2: 8.3 ↙
 3: 9.9 →
 4: 9.9 ↘
 5: 10.7x ↘

Serie	46
Total	0

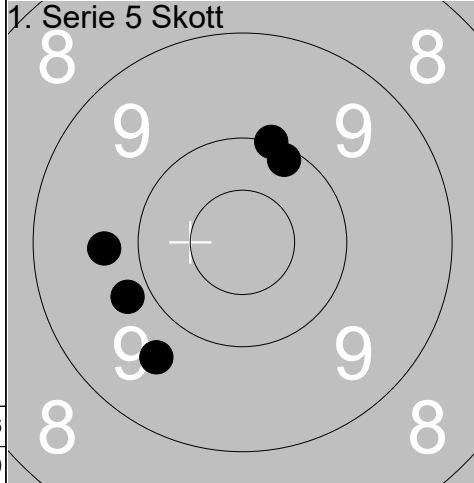

1: 9.7 ↘
 2: 9.7 ←
 3: 9.8 ↙
 4: 10.0 ↑
 5: 10.1 ↑

Serie	47
Total	47

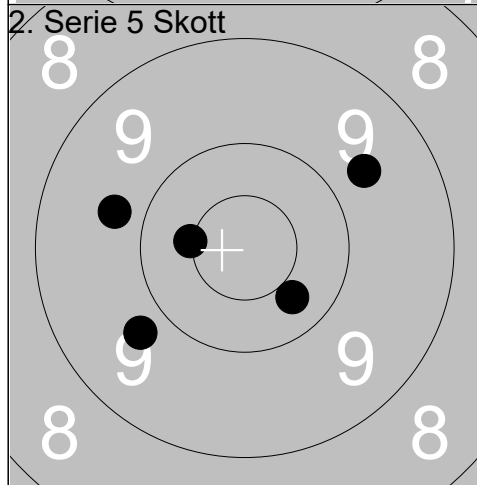

1: 9.7 ↗
 2: 10.3 ↘
 3: 9.7 ←
 4: 10.5x ←
 5: 9.7 ↙

Serie	47
Total	94

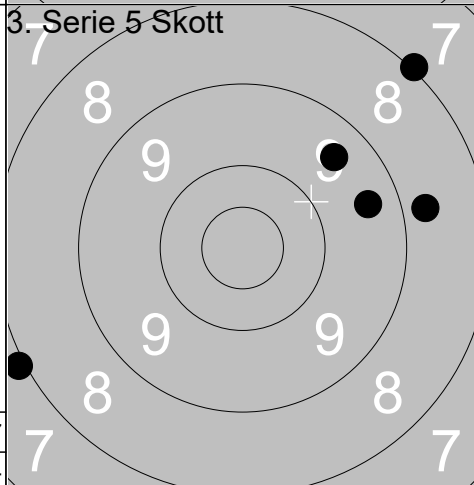

1: 8.7 →
 2: 8.0 ↗
 3: 8.0 ↙
 4: 9.4 →
 5: 9.5 ↗

Serie	42
Total	136

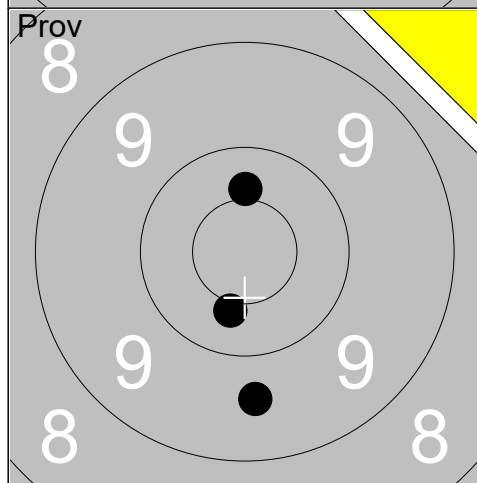

1: 10.4 ↘
 2: 10.4 ↑
 3: 9.6 ↘

Serie	29
Total	136

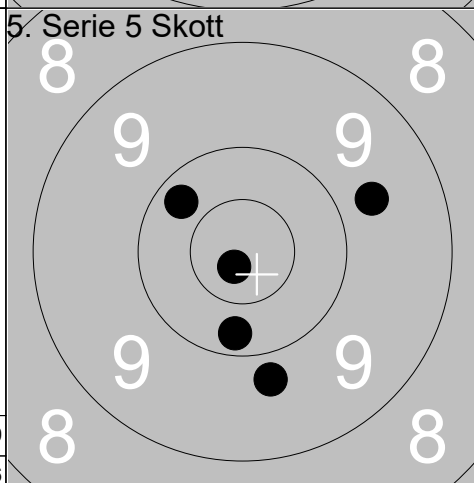

1: 10.8x ↘
 2: 9.7 →
 3: 9.8 ↘
 4: 10.2 ↘
 5: 10.3 ↖

Serie	48
Total	184

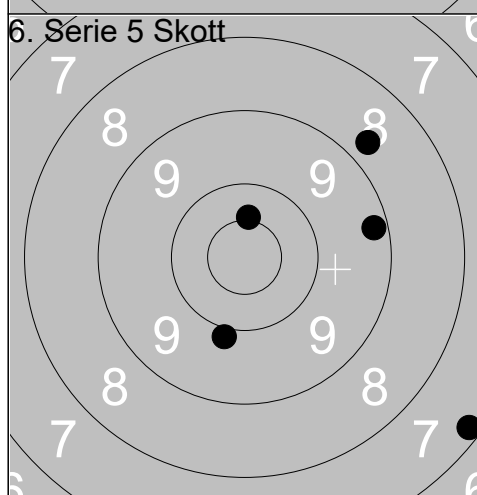

1: 9.9 ↘
 2: 8.7 ↗
 3: 7.2 ↘
 4: 9.2 →
 5: 10.4x ↑

Serie	43
Total	227

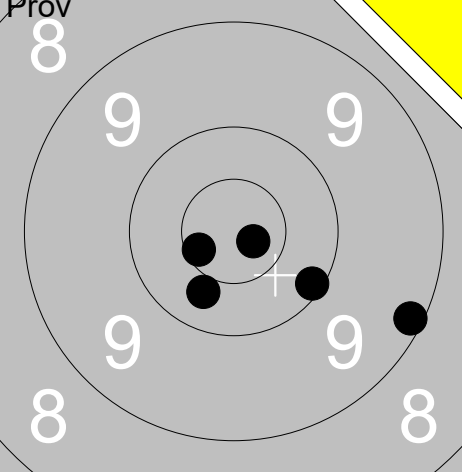
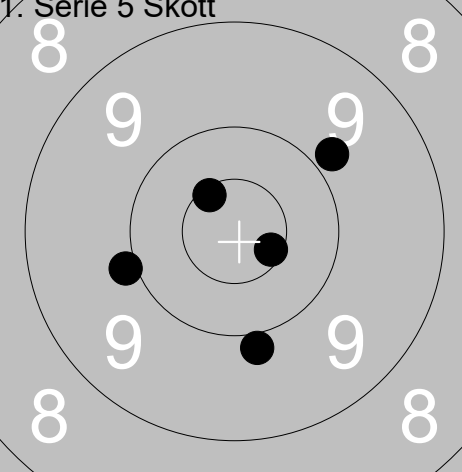
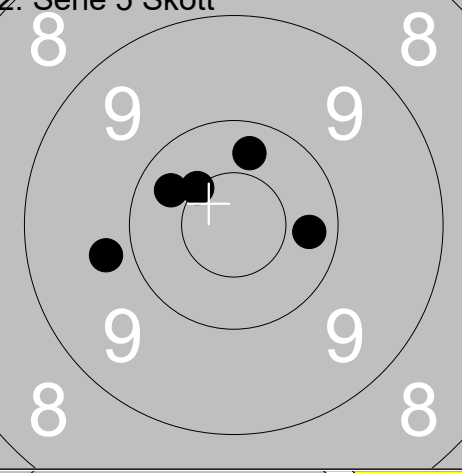
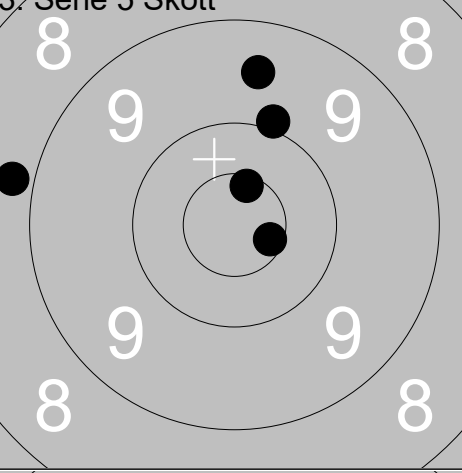
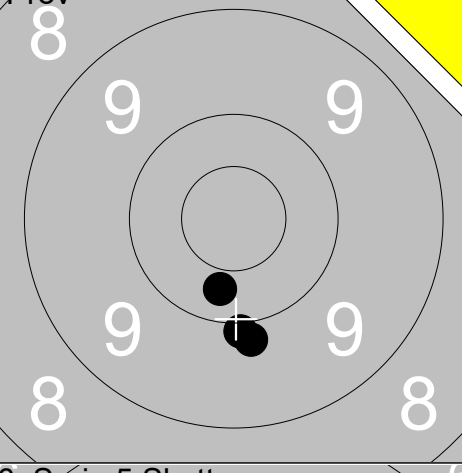
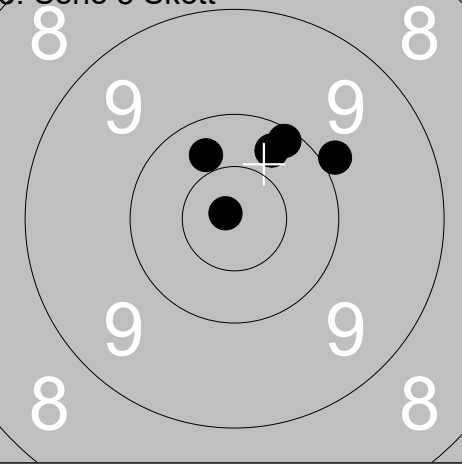
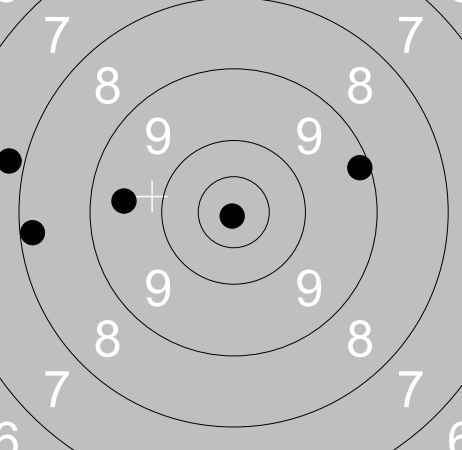
<p>Prov</p>  <p style="text-align: right;">8 8 8 8</p>	<p>1: 9.1 ➤</p> <p>2: 10.4 ↘</p> <p>3: 10.1 ➤</p> <p>4: 10.8x ➤</p> <p>5: 10.6x ↙</p> <hr/> <p>Serie 49</p> <p>Total 0</p>	<p>1. Serie 5 Skott</p>  <p style="text-align: right;">8 8</p>	<p>1: 9.9 ↙</p> <p>2: 10.6x ↗</p> <p>3: 9.8 ↗</p> <p>4: 10.6x ➤</p> <p>5: 9.9 ↘</p> <hr/> <p>Serie 47</p> <p>Total 47</p>
<p>2. Serie 5 Skott</p>  <p style="text-align: right;">8 8</p>	<p>1: 10.5x ↗</p> <p>2: 10.3 ↗</p> <p>3: 10.3 ↗</p> <p>4: 9.8 ↙</p> <p>5: 10.3 ➤</p> <hr/> <p>Serie 49</p> <p>Total 96</p>	<p>3. Serie 5 Skott</p>  <p style="text-align: right;">8 8</p>	<p>1: 9.5 ↗</p> <p>2: 10.6x ↗</p> <p>3: 9.9 ↗</p> <p>4: 8.8 ↙</p> <p>5: 10.6x ➤</p> <hr/> <p>Serie 46</p> <p>Total 142</p>
<p>Prov</p>  <p style="text-align: right;">8 8 8 8</p>	<p>1: 10.3 ↘</p> <p>2: 10.0 ↘</p> <p>3: 9.9 ↘</p> <hr/> <p>Serie 29</p> <p>Total 142</p>	<p>5. Serie 5 Skott</p>  <p style="text-align: right;">8 8</p>	<p>1: 9.9 ↗</p> <p>2: 10.1 ↗</p> <p>3: 10.9x ↙</p> <p>4: 10.3 ↗</p> <p>5: 10.3 ↗</p> <hr/> <p>Serie 49</p> <p>Total 191</p>
<p>6. Serie 5 Skott</p>  <p style="text-align: right;">7 7 6 6</p>	<p>1: 7.8 ↙</p> <p>2: 8.2 ↙</p> <p>3: 9.5 ↙</p> <p>4: 9.2 ➤</p> <p>5: 10.9x ↘</p> <hr/> <p>Serie 43</p> <p>Total 234</p>		

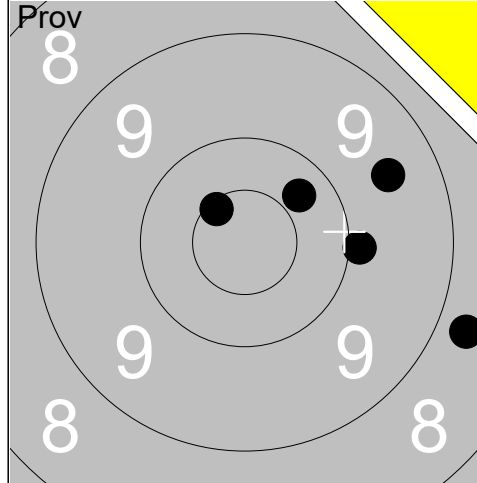

1:	9.5	➔
2:	10.6x	↖
3:	9.9	➔
4:	8.7	➔
5:	10.3	↗

Serie	46
Total	0

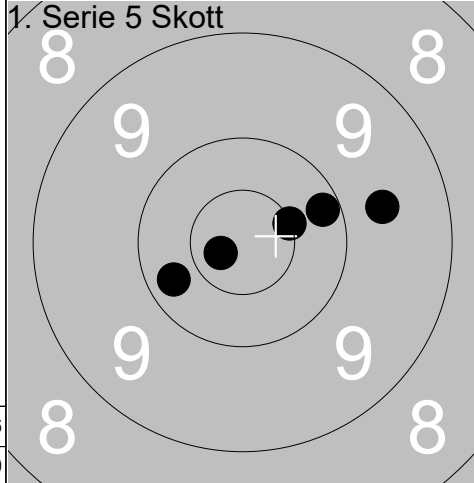

1:	10.3	↖
2:	10.2	➔
3:	9.7	➔
4:	10.7x	↖
5:	10.5x	➔

Serie	49
Total	49

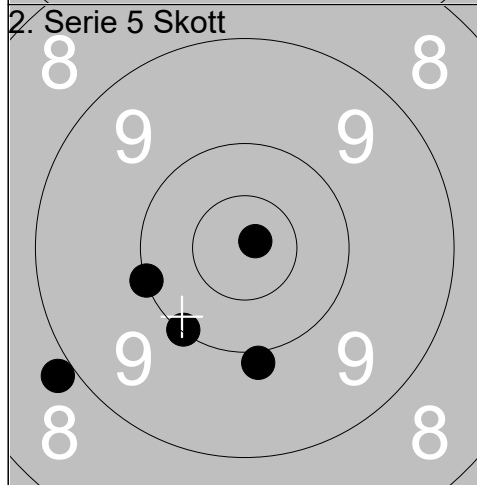

1:	10.8x	↗
2:	9.9	↓
3:	10.0	↖
4:	8.9	↖
5:	10.0	↖

Serie	47
Total	96

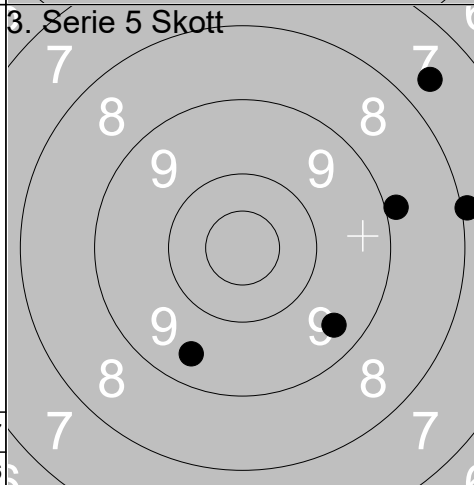

1:	7.6	↗
2:	9.4	↘
3:	8.0	➔
4:	8.9	➔
5:	9.4	↘

Serie	41
Total	137

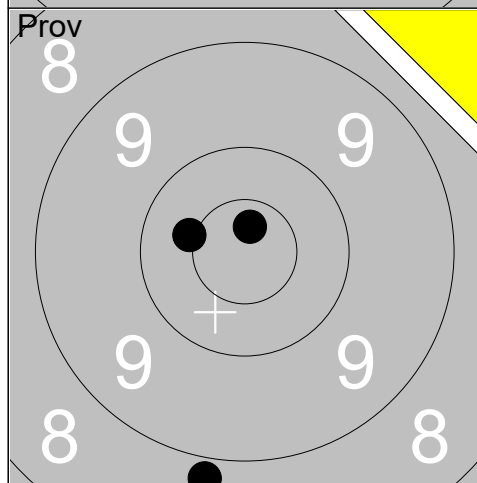

1:	8.8	↓
2:	10.4x	↖
3:	10.7x	↑

Serie	28
Total	137

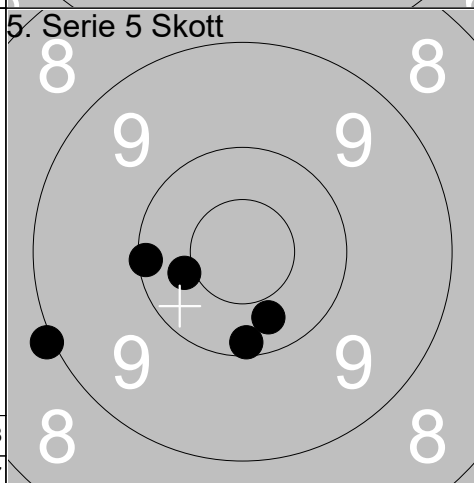

1:	10.1	↓
2:	9.0	↖
3:	10.1	↖
4:	10.3	↘
5:	10.4	↖

Serie	49
Total	186

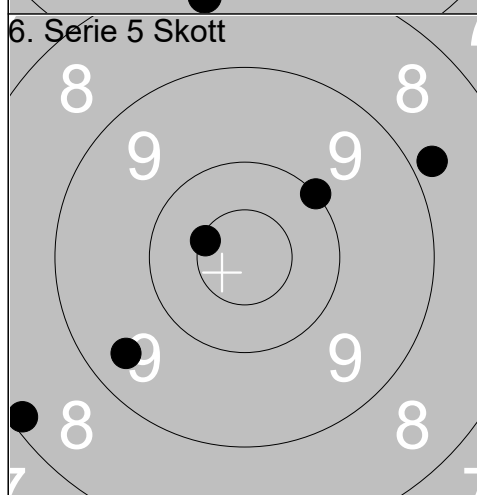

1:	10.0	↗
2:	10.5x	↖
3:	8.8	➔
4:	8.1	↖
5:	9.4	↖

Serie	45
Total	231

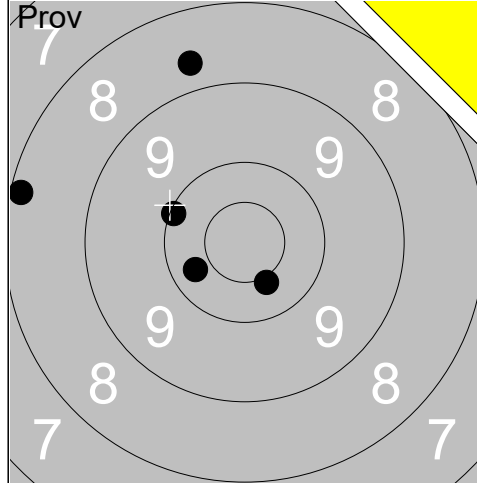

1:	8.7	↗
2:	8.2	↖
3:	10.1	↗
4:	10.3	↖
5:	10.4x	↘
Serie		46
Total		0

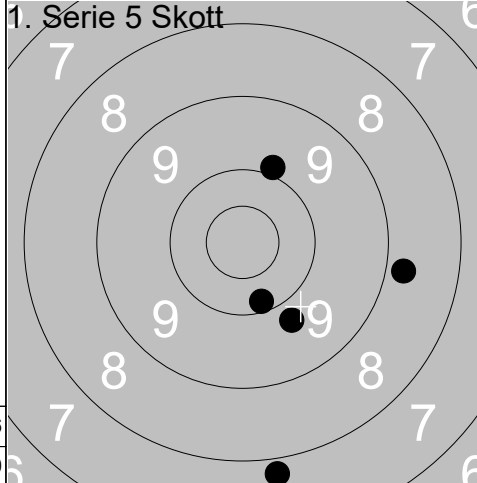

1:	9.9	↗
2:	10.2	↘
3:	8.8	→
4:	9.8	↘
5:	7.8	↘
Serie		43
Total		43

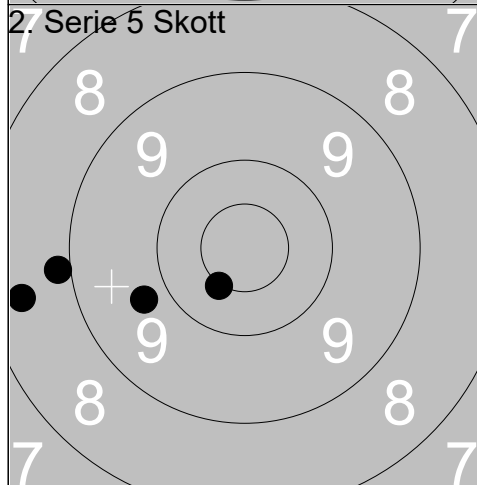

1:	10.5x	↘
2:	8.9	↖
3:	8.4	↖
4:	9.7	↖
5:	0.0	
Serie		35
Total		78

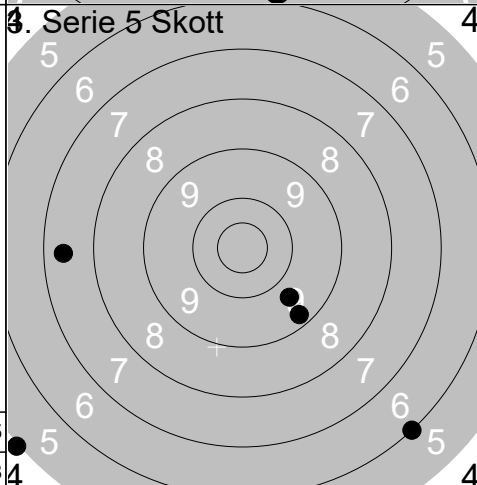

1:	7.4	↖
2:	5.0	↖
3:	9.3	↘
4:	9.7	↘
5:	6.0	↘
Serie		36
Total		114

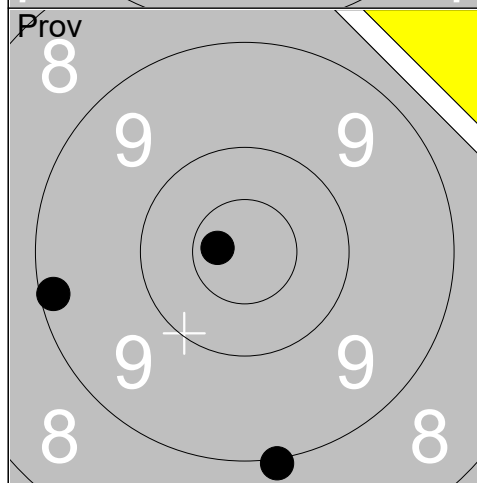

1:	10.7x	↖
2:	9.2	↖
3:	9.0	↘
Serie		28
Total		114

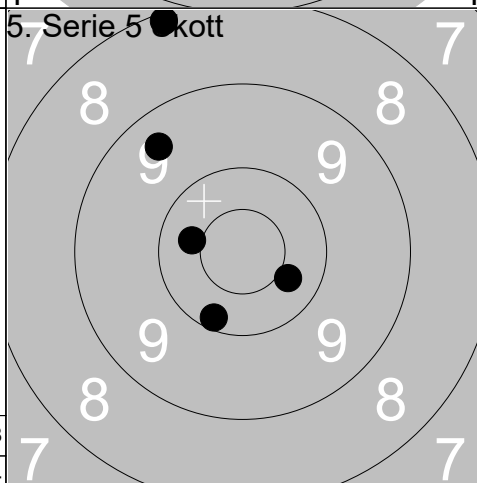

1:	8.1	↗
2:	9.4	↗
3:	10.4	↘
4:	10.2	↘
5:	10.4	↖
Serie		47
Total		161

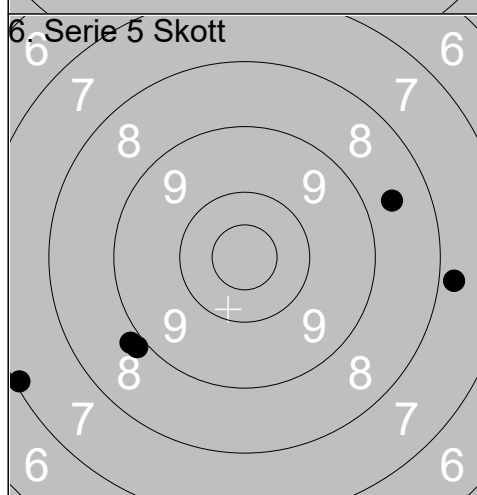

1:	7.1	↖
2:	8.8	↖
3:	7.8	→
4:	8.9	↖
5:	8.6	→
Serie		38
Total		199

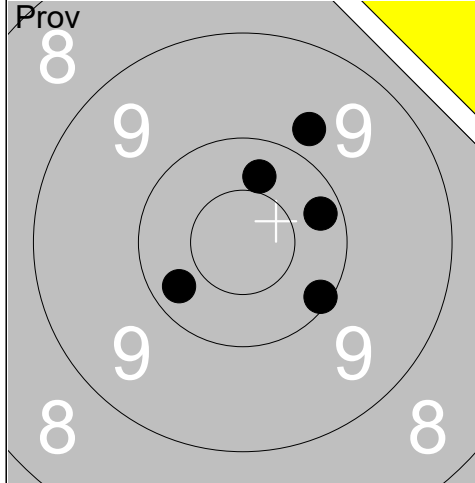

1:	10.3	↙
2:	10.3	↑
3:	10.2	→
4:	9.8	↑
5:	10.1	↘
Serie		49
Total		0

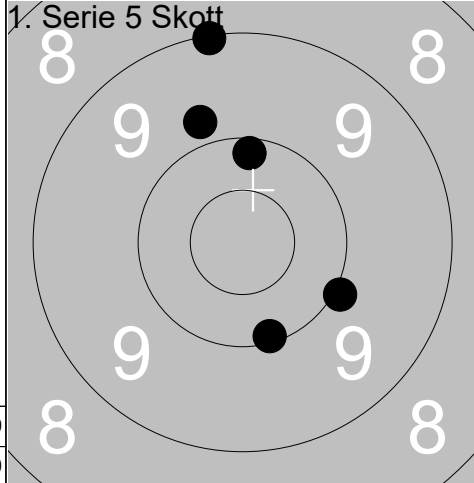

1:	9.1	↑
2:	9.8	↑
3:	10.2	↑
4:	10.1	↓
5:	10.0	↘
Serie		48
Total		48

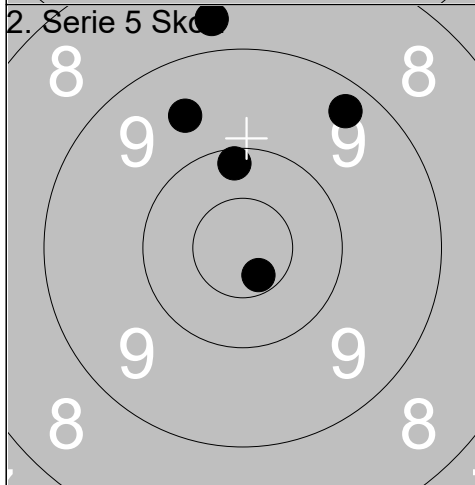

1:	9.3	↗
2:	10.7x	↘
3:	9.6	↑
4:	8.7	↑
5:	10.2	↑
Serie		46
Total		94

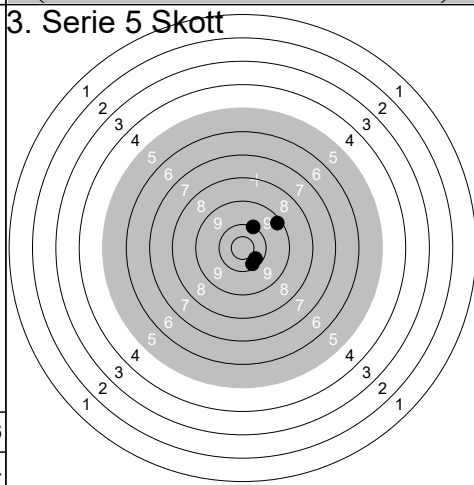

1:	10.2	↘
2:	0.0	↑
3:	9.2	↗
4:	10.0	↑
5:	10.3	↘
Serie		39
Total		133

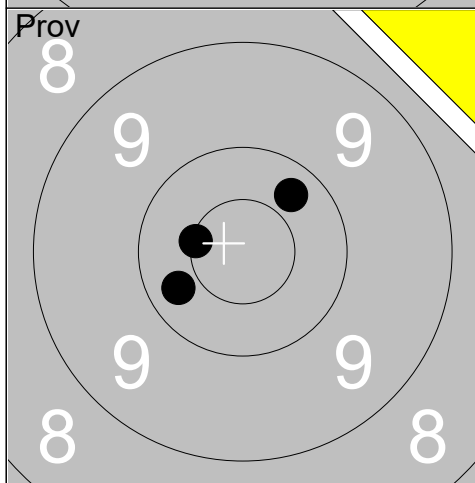

1:	10.5x	↙
2:	10.3	↗
3:	10.3	↙
Serie		30
Total		133

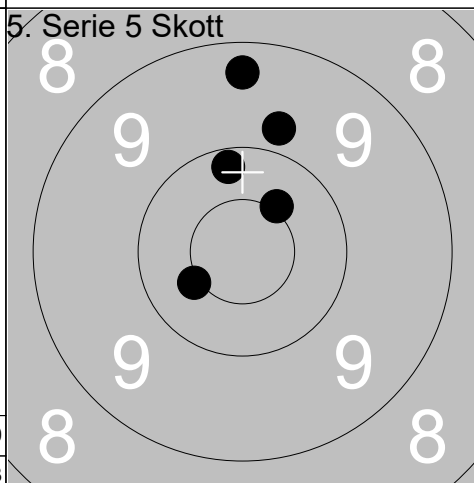

1:	10.4x	↗
2:	9.3	↑
3:	10.2	↑
4:	9.8	↑
5:	10.4x	↙
Serie		48
Total		181

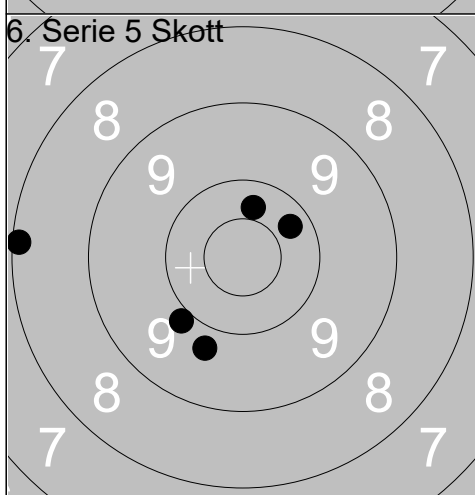

1:	10.3	↗
2:	8.1	↙
3:	9.8	↘
4:	9.9	↙
5:	10.3	↑
Serie		46
Total		227

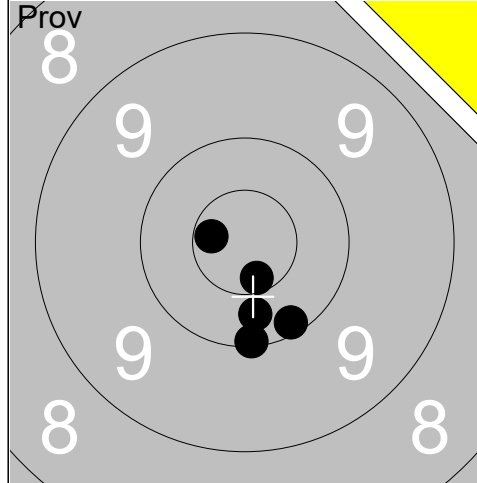

1:	10.6x	←
2:	10.1	↘
3:	10.6x	↘
4:	10.3	↘
5:	10.1	↘
Serie		50
Total		0

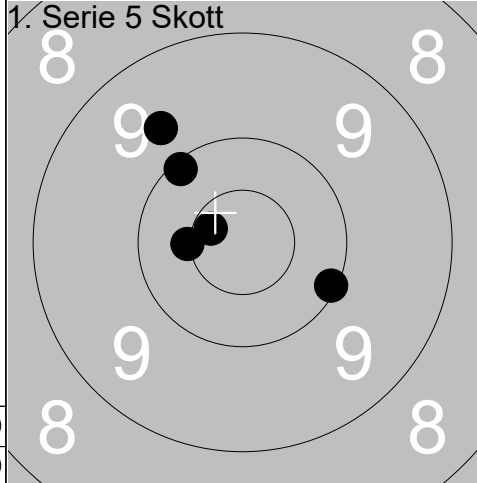

1:	9.7	↗
2:	10.1	↗
3:	10.1	↘
4:	10.6x	↗
5:	10.5x	←
Serie		49
Total		49

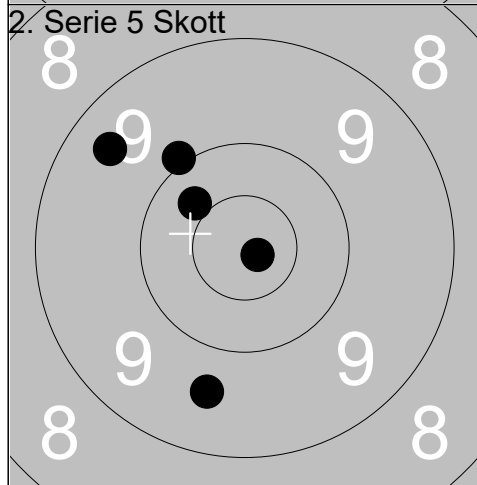

1:	10.0	↗
2:	9.4	↗
3:	10.8x	→
4:	10.4	↗
5:	9.6	↘
Serie		48
Total		97

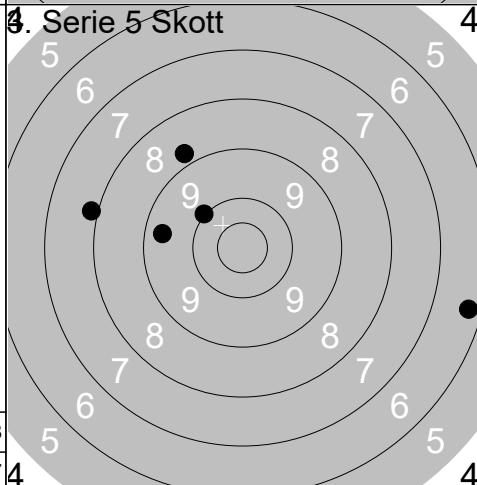

1:	6.3	→
2:	8.8	↗
3:	7.9	←
4:	9.4	←
5:	10.0	↗
Serie		40
Total		137

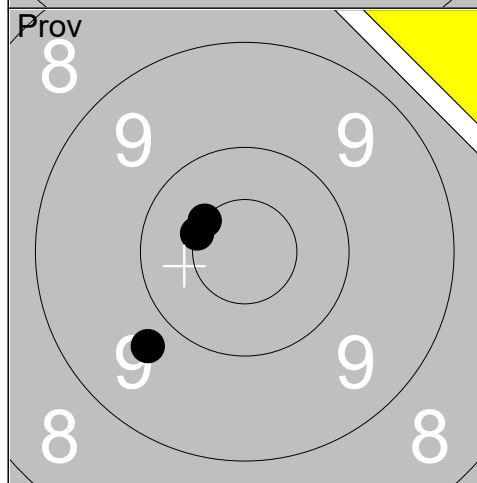

1:	10.5x	↗
2:	10.5x	←
3:	9.7	↘
Serie		29
Total		137

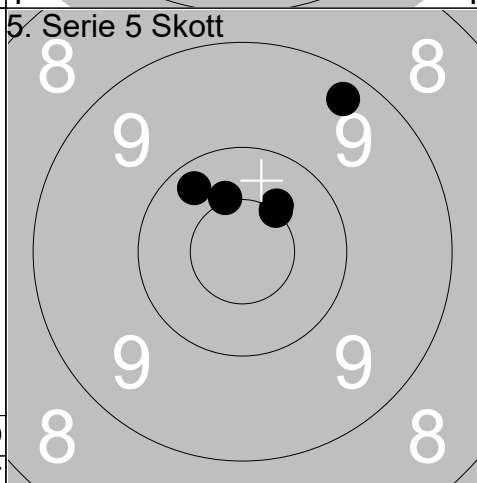

1:	9.3	↗
2:	10.4x	↗
3:	10.5x	↗
4:	10.2	↗
5:	10.5x	↗
Serie		49
Total		186

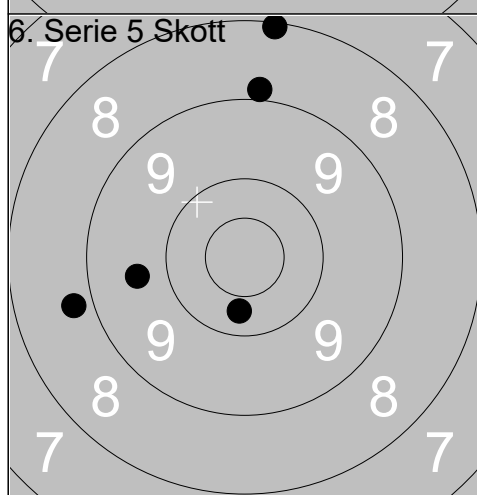

1:	8.1	↑
2:	8.9	↑
3:	8.8	←
4:	9.6	←
5:	10.3	↓
Serie		43
Total		229

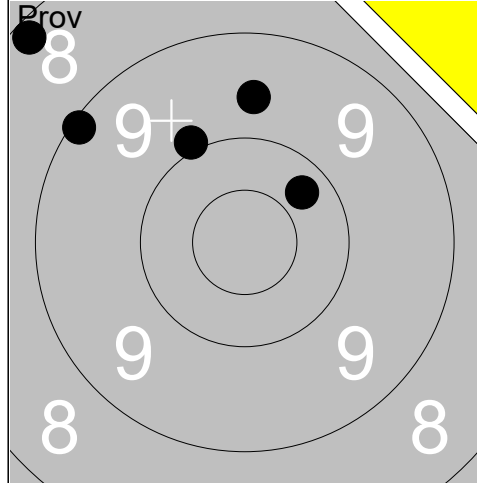

1:	8.2	↖
2:	9.1	↖
3:	9.6	↖
4:	9.9	↖
5:	10.3	↗
Serie		45
Total		0

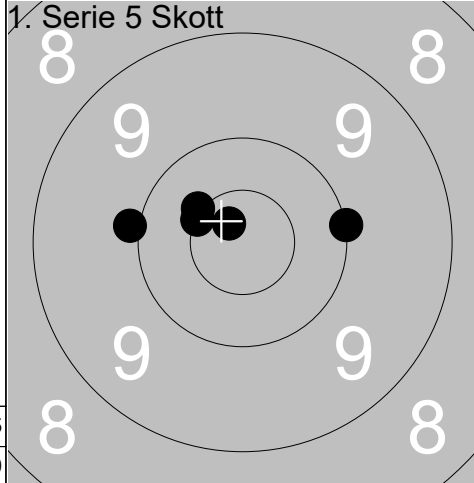

1:	10.5x	↖
2:	10.0	→
3:	10.7x	↖
4:	10.5x	↖
5:	9.9	←
Serie		49
Total		49

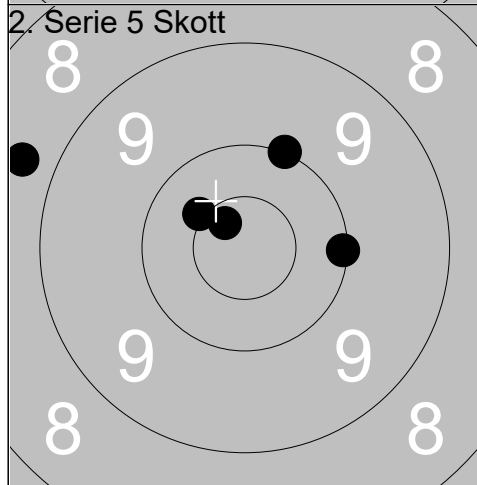

1:	10.1	→
2:	10.0	↖
3:	10.4x	↖
4:	10.7x	↖
5:	8.7	↖
Serie		48
Total		97

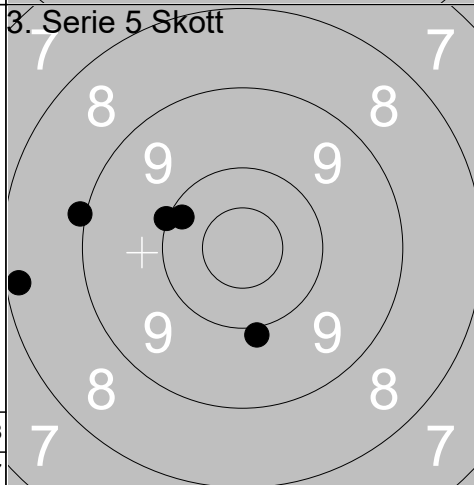

1:	10.0	←
2:	10.2	↖
3:	9.9	↓
4:	8.2	←
5:	9.0	←
Serie		46
Total		143

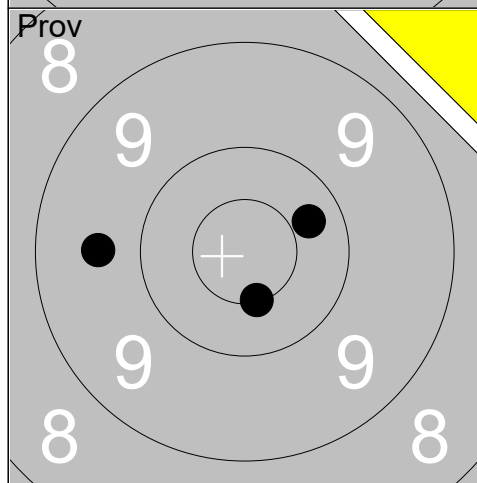

1:	10.5x	↓
2:	9.6	←
3:	10.3	↗
Serie		29
Total		143

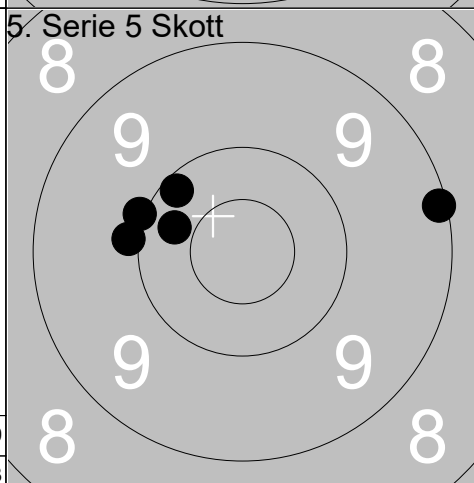

1:	10.0	←
2:	10.3	←
3:	10.2	↖
4:	9.1	→
5:	9.9	←
Serie		48
Total		191

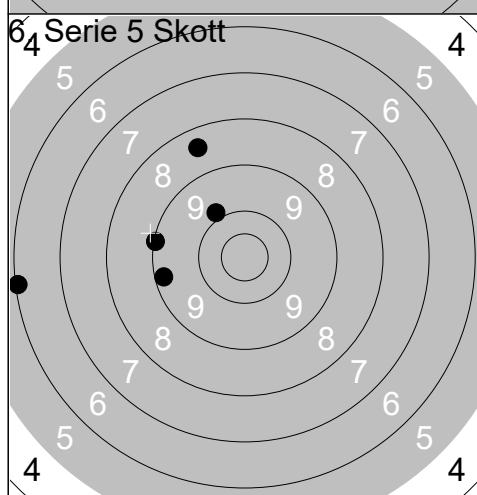

1:	9.9	↖
2:	8.5	↖
3:	6.1	←
4:	9.2	←
5:	9.1	←
Serie		41
Total		232

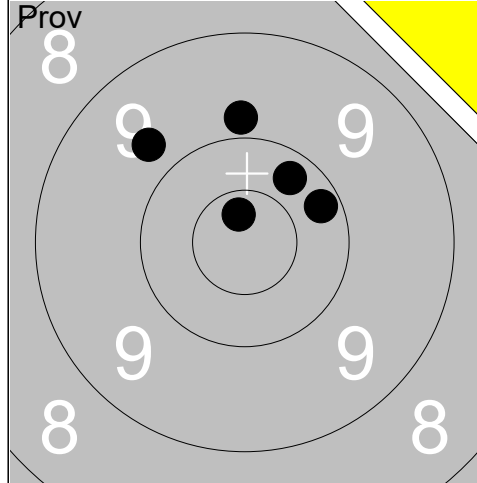

1:	9.8	↑
2:	9.7	↖
3:	10.3	↗
4:	10.2	→
5:	10.7x	↑
Serie		48
Total		0

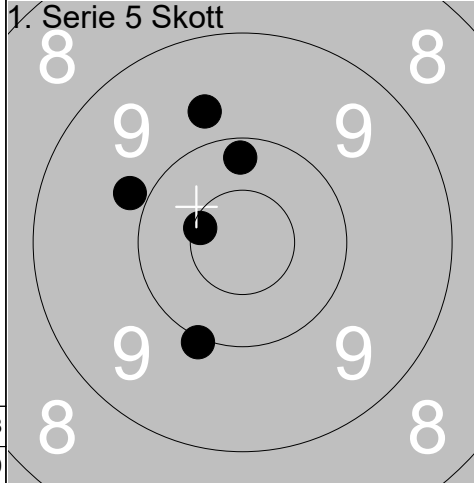

1:	9.7	↑
2:	9.9	↖
3:	10.0	↓
4:	10.2	↑
5:	10.6x	↖
Serie		48
Total		48

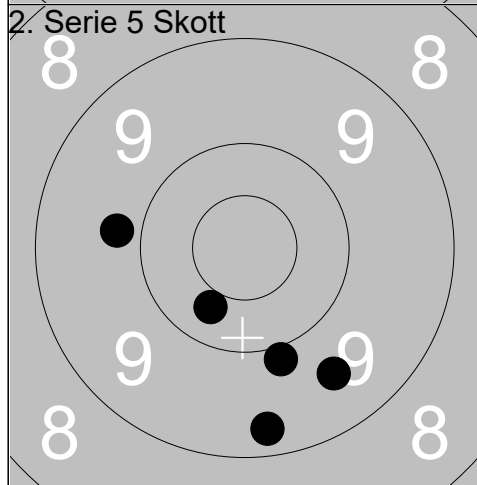

1:	9.3	↓
2:	9.9	↓
3:	10.3	↓
4:	9.8	↖
5:	9.6	↘
Serie		46
Total		94

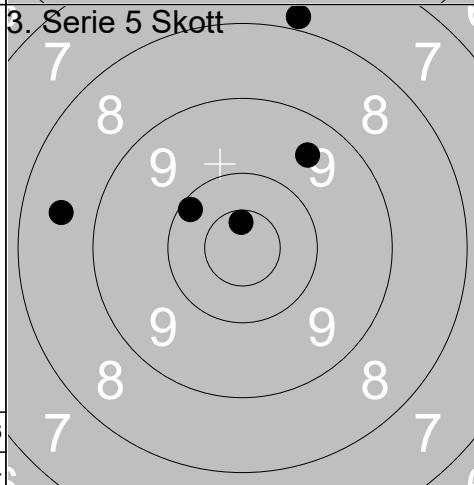

1:	10.1	↖
2:	8.6	↖
3:	9.5	↗
4:	7.9	↑
5:	10.6x	↑
Serie		44
Total		138

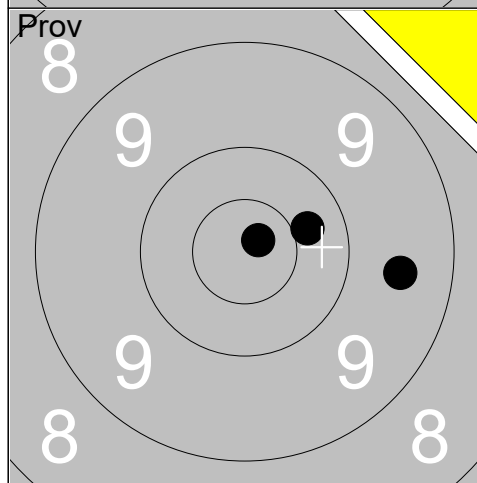

1:	10.8x	↗
2:	9.5	→
3:	10.4	→
Serie		29
Total		138

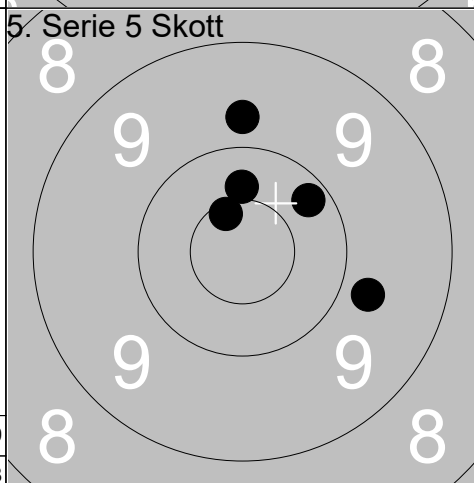

1:	10.4	↑
2:	10.2	↗
3:	9.7	↑
4:	9.8	→
5:	10.6x	↖
Serie		48
Total		186

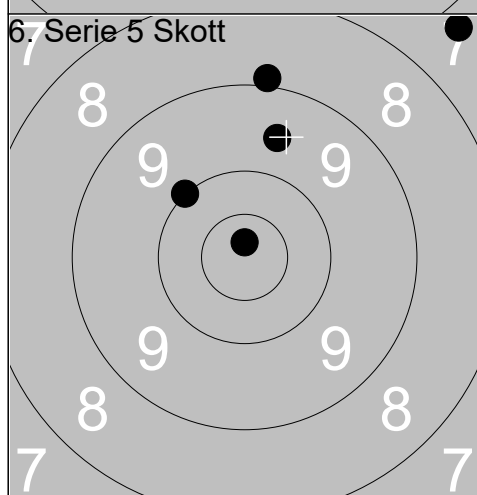

1:	10.8x	↑
2:	9.6	↑
3:	8.9	↑
4:	7.4	↗
5:	10.0	↖
Serie		44
Total		230

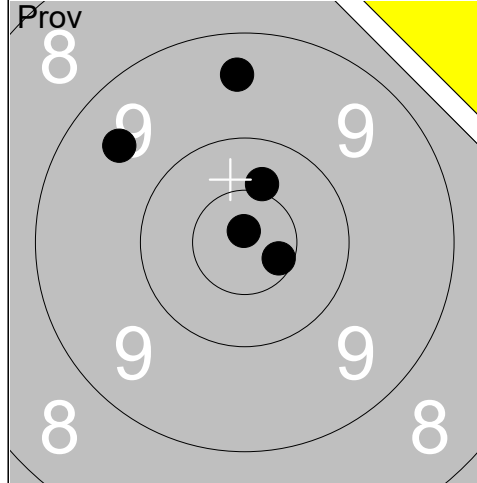

1:	10.4x	↑
2:	9.4	↑
3:	10.9x	↑
4:	9.5	↖
5:	10.6x	→
Serie		48
Total		0

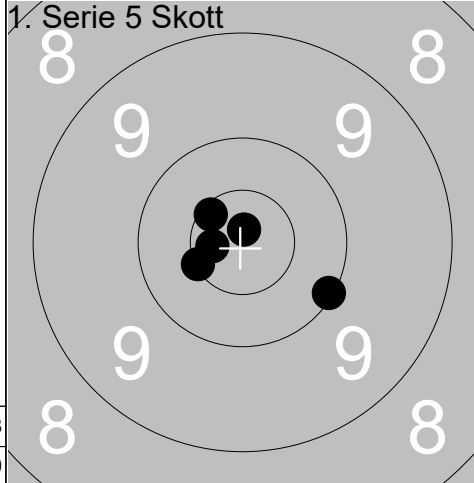

1:	10.6x	↖
2:	10.1	↗
3:	10.8x	↑
4:	10.5x	↖
5:	10.7x	←
Serie		50
Total		50

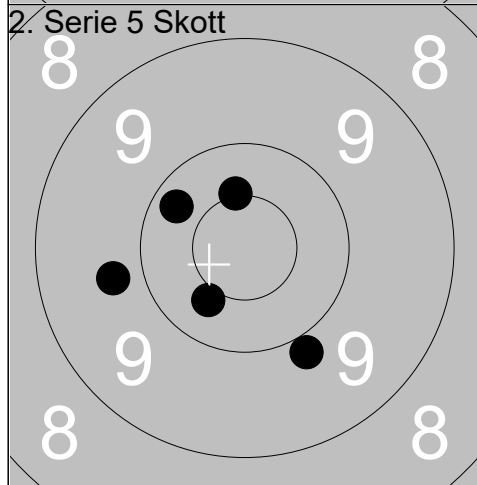

1:	10.5x	↑
2:	9.9	↘
3:	9.7	←
4:	10.4	↘
5:	10.2	↖
Serie		48
Total		98

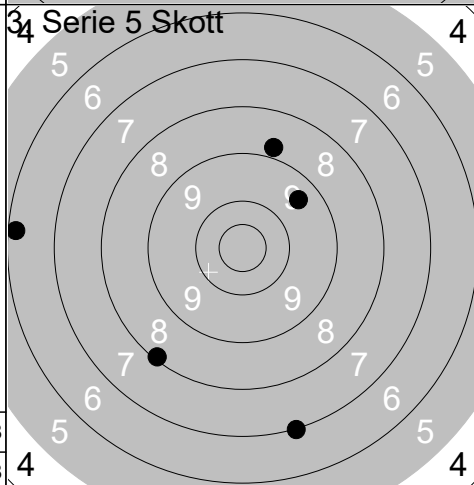

1:	8.8	↑
2:	9.5	↗
3:	8.1	↘
4:	7.0	↘
5:	6.2	←
Serie		38
Total		136

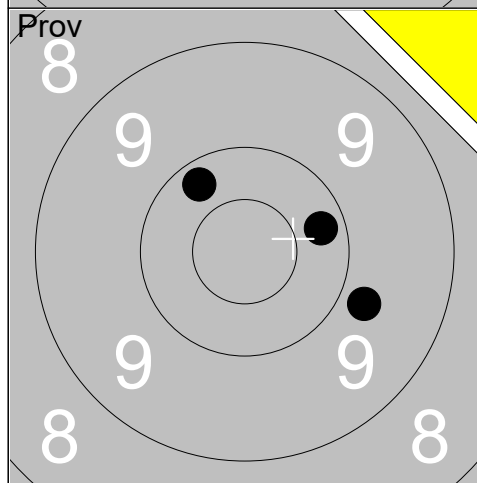

1:	9.8	→
2:	10.2	→
3:	10.2	↖
Serie		29
Total		136

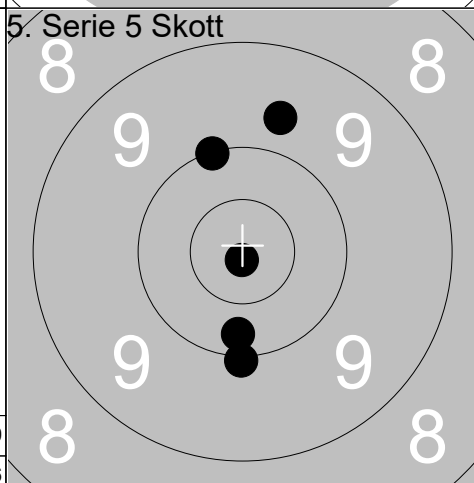

1:	10.2	↓
2:	9.7	↑
3:	10.0	↖
4:	10.0	↓
5:	10.9x	↓
Serie		49
Total		185

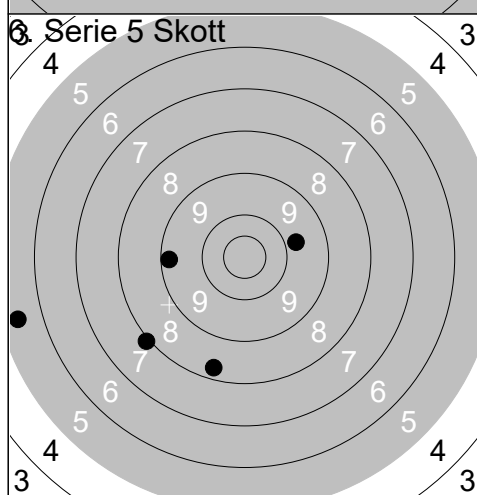

1:	9.2	←
2:	8.3	↓
3:	5.4	←
4:	8.0	↘
5:	9.8	→
Serie		39
Total		224

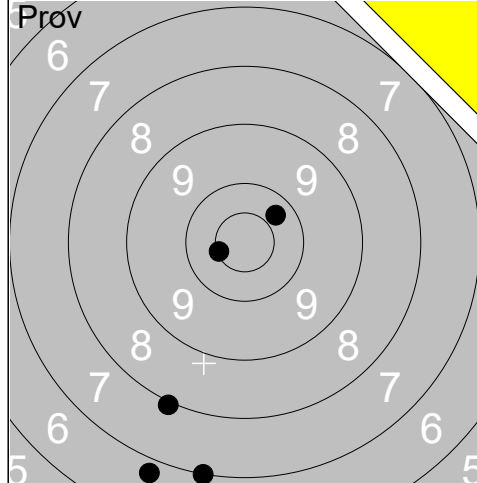

1:	10.5x	↔
2:	10.3	↗
3:	6.8	↘
4:	8.0	↘
5:	7.0	↘
Serie		41
Total		0

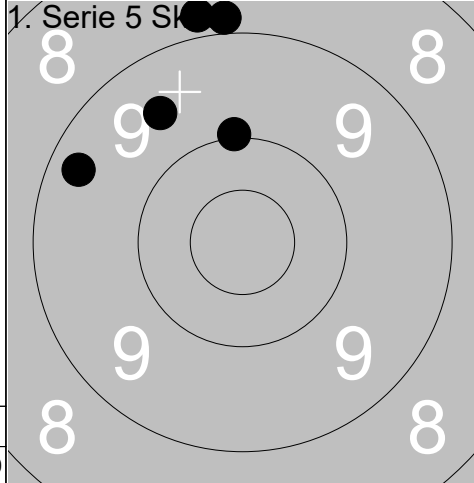

1:	9.6	↗
2:	9.3	↖
3:	10.0	↗
4:	8.8	↗
5:	8.9	↗
Serie		44
Total		44

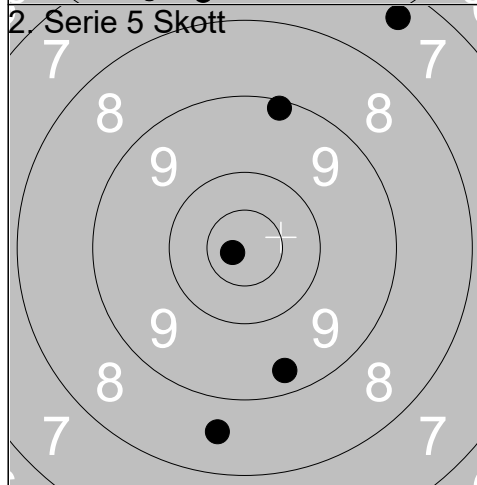

1:	9.1	↗
2:	10.8x	↖
3:	9.3	↘
4:	8.6	↘
5:	7.4	↗
Serie		43
Total		87

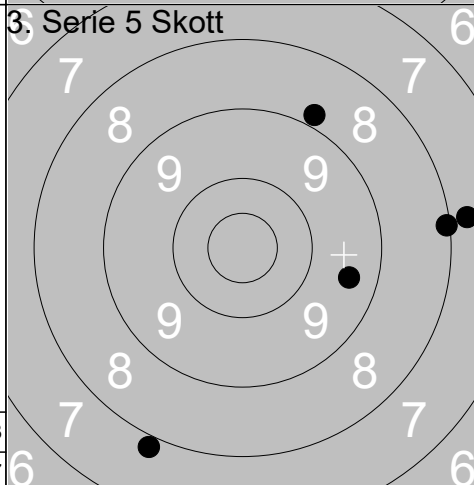

1:	8.8	↗
2:	7.9	↘
3:	7.8	→
4:	8.1	→
5:	9.4	→
Serie		39
Total		126

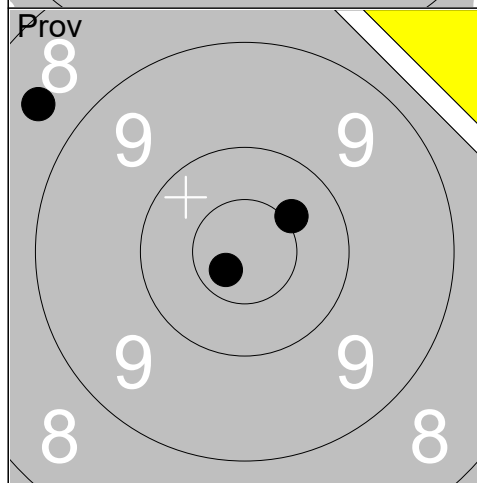

1:	8.6	↖
2:	10.7x	↖
3:	10.4x	↗
Serie		28
Total		126

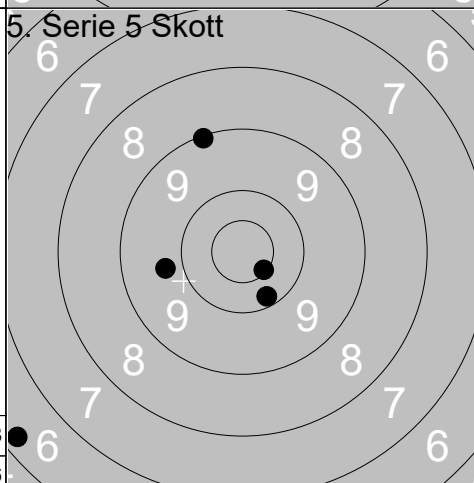

1:	9.1	↗
2:	10.2	↘
3:	9.7	↖
4:	6.3	↖
5:	10.5x	↘
Serie		44
Total		170

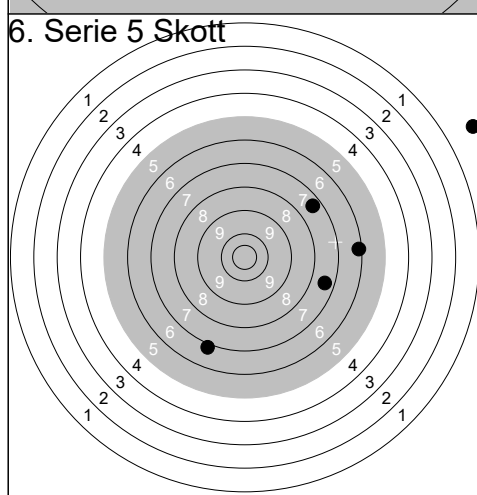

1:	6.2	→
2:	6.9	↘
3:	7.5	→
4:	0.0	↗
5:	7.4	↗
Serie		26
Total		196

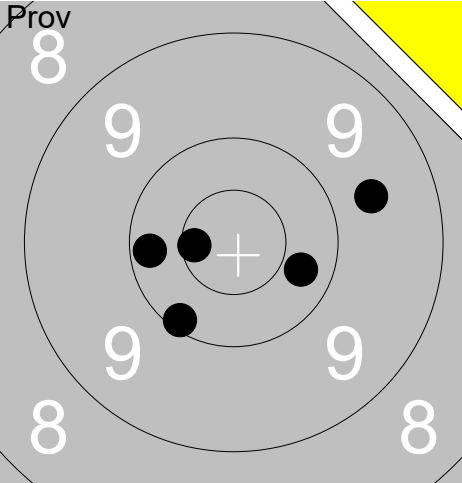
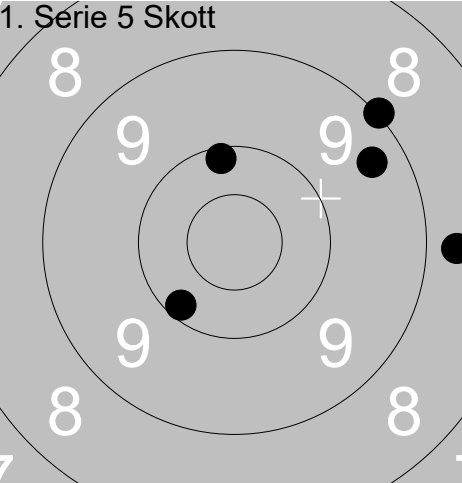
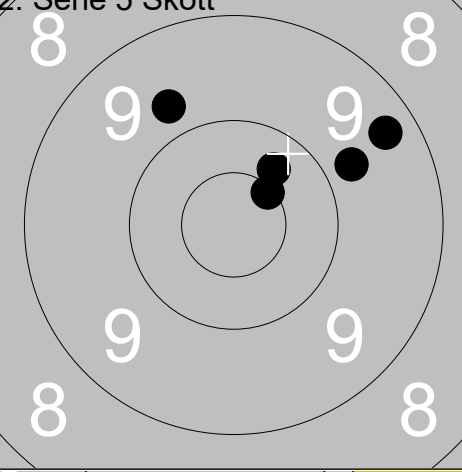
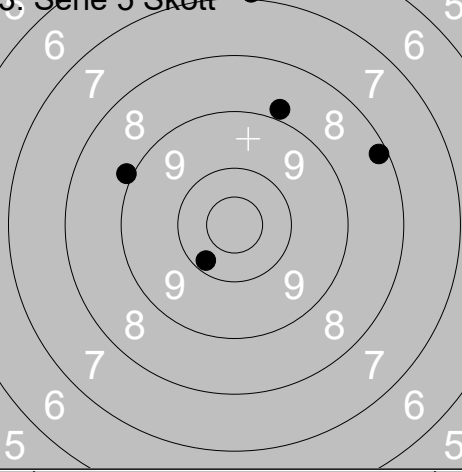
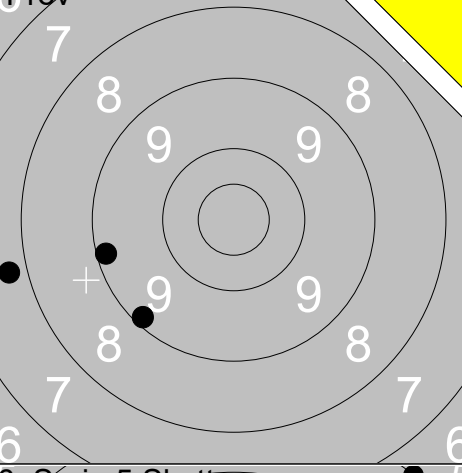
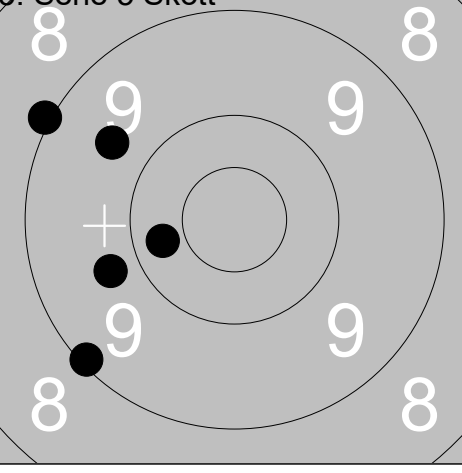
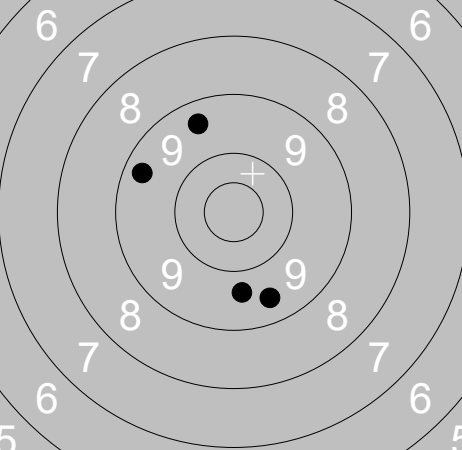
Skjutlag 3	Tavla 2	Anna Grönlund	
Ramselefors	Piteå	Jun	No
06.07.2019	Björskottet 2019	Ramselefors SKF	
Prov 	1: 10.1 ↙ 2: 9.6 → 3: 10.6x ← 4: 10.2 ← 5: 10.3 → Serie 49 Total 07	1. Serie 5 Skott 	1: 8.7 → 2: 9.0 ↗ 3: 10.1 ↑ 4: 10.2 ↘ 5: 9.4 → Serie 46 Total 46
2. Serie 5 Skott 	1: 9.8 → 2: 10.5x ↗ 3: 9.7 ↗ 4: 9.3 → 5: 10.3 ↗ Serie 47 Total 93	3. Serie 5 Skott 	1: 8.8 ↑ 2: 6.9 ↑ 3: 10.2 ↘ 4: 8.2 → 5: 8.9 ← Serie 40 Total 133
Prov 	1: 7.8 ← 2: 9.2 ↘ 3: 9.2 ← Serie 25 Total 133	5. Serie 5 Skott 	1: 9.6 ↖ 2: 9.1 ↘ 3: 9.0 ↖ 4: 9.7 ↖ 5: 10.3 ← Serie 46 Total 179
6. Serie 5 Skott 	1: 9.4 ↘ 2: 9.7 ↘ 3: 9.3 ↗ 4: 9.4 ↗ 5: 6.0 ↗ Serie 42 Total 221		

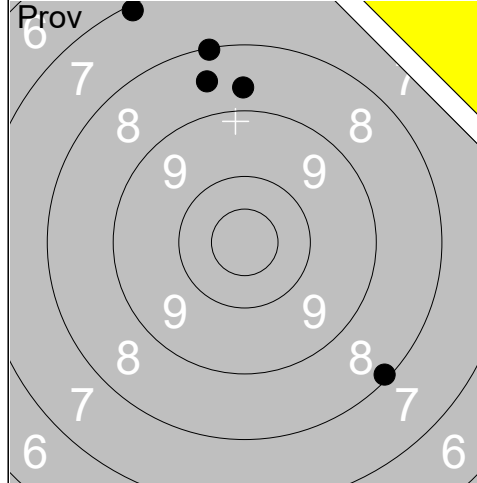

1:	8.5	↑
2:	7.1	↑
3:	8.7	↑
4:	8.1	↑
5:	8.1	↓
Serie		39
Total		0

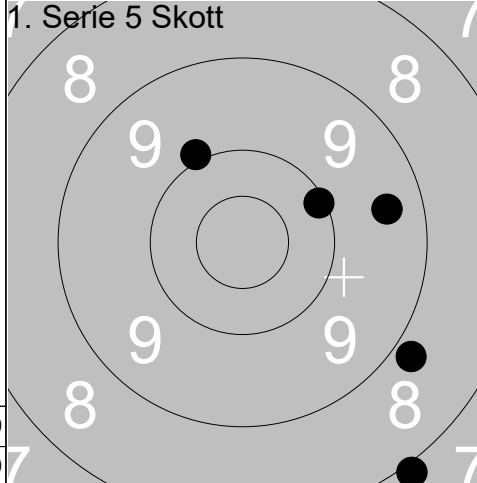

1:	9.9	↑
2:	7.9	↓
3:	8.8	↓
4:	9.4	→
5:	10.1	→
Serie		43
Total		43

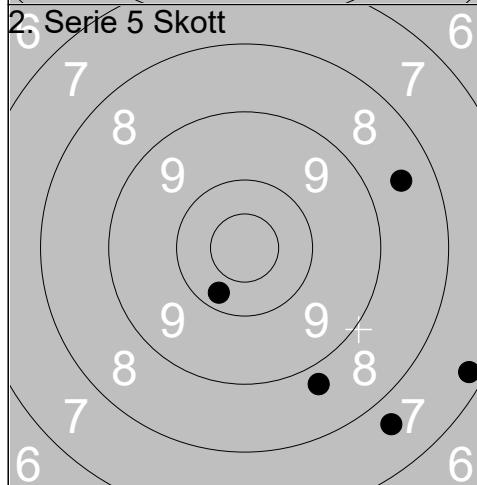

1:	8.8	↓
2:	7.7	↓
3:	10.2	↓
4:	7.3	↓
5:	8.5	→
Serie		40
Total		83

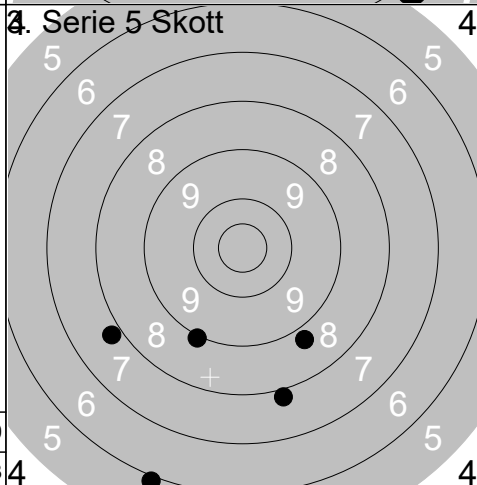

1:	9.0	↓
2:	7.8	←
3:	8.8	↓
4:	7.9	↓
5:	5.9	↓
Serie		36
Total		119

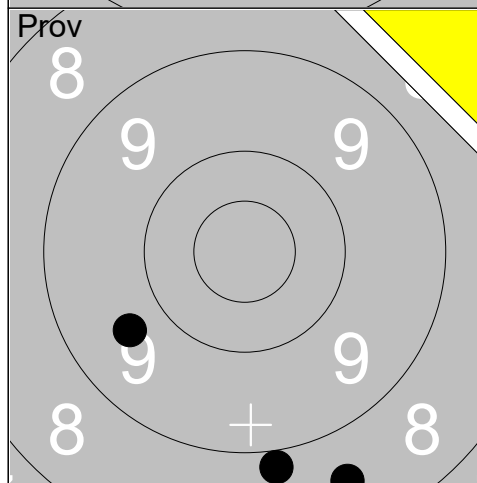

1:	8.5	↓
2:	8.9	↓
3:	9.6	←
Serie		25
Total		119

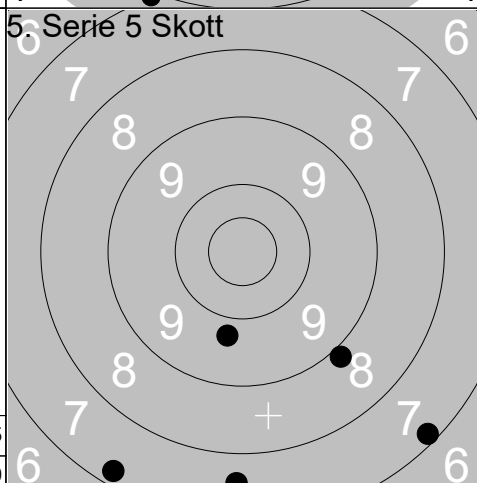

1:	7.2	↓
2:	9.8	↓
3:	7.6	↓
4:	7.3	↓
5:	8.9	↓
Serie		38
Total		157

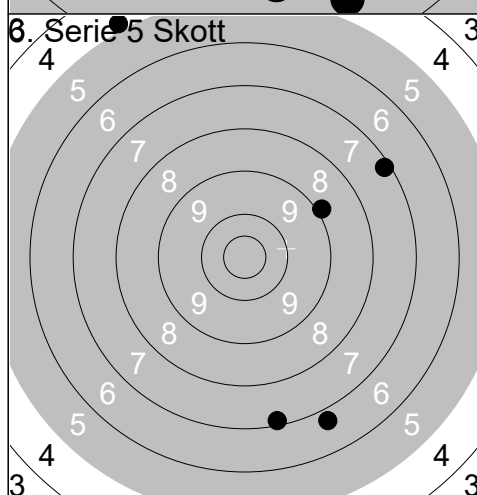

1:	8.9	→
2:	6.8	↓
3:	7.2	→
4:	4.8	↑
5:	7.2	↓
Serie		32
Total		189

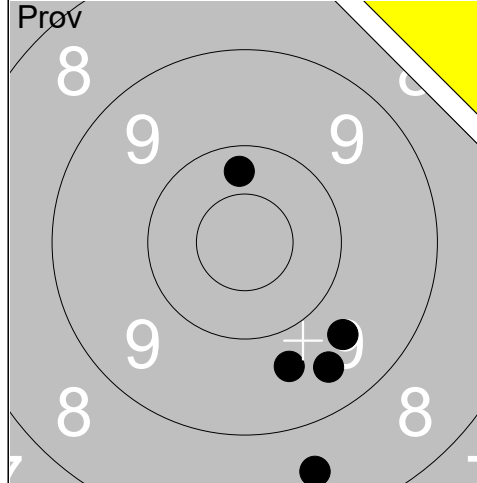

1:	8.5	↘
2:	10.3	↑
3:	9.5	↘
4:	9.6	↘
5:	9.7	↘
Serie		45
Total		0

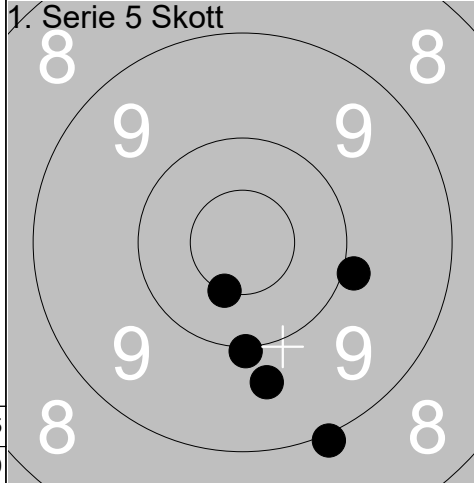

1:	9.9	→
2:	9.7	↘
3:	10.0	↘
4:	10.5x	↘
5:	9.0	↘
Serie		47
Total		47

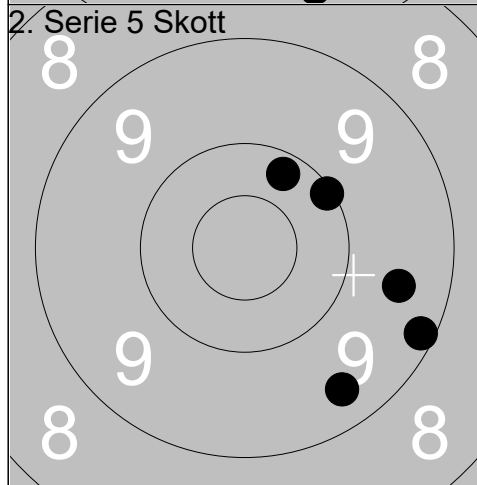

1:	10.1	↗
2:	9.4	↘
3:	9.2	↗
4:	10.2	↑
5:	9.5	→
Serie		47
Total		94

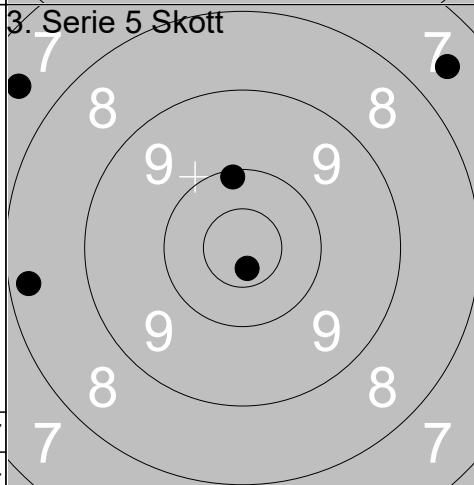

1:	7.5	↖
2:	8.3	←
3:	10.7x	↘
4:	10.1	↑
5:	7.6	↗
Serie		42
Total		136

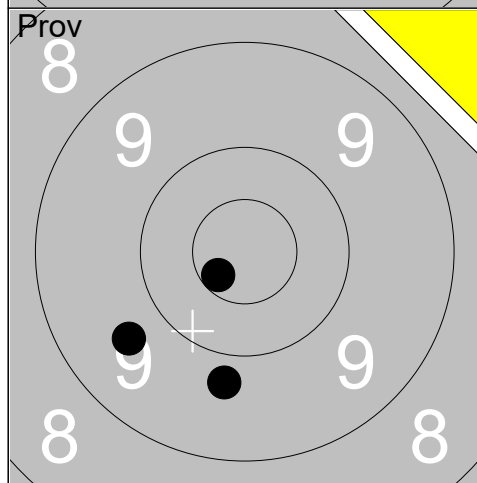

1:	10.6x	↙
2:	9.8	↘
3:	9.6	↙
Serie		28
Total		136

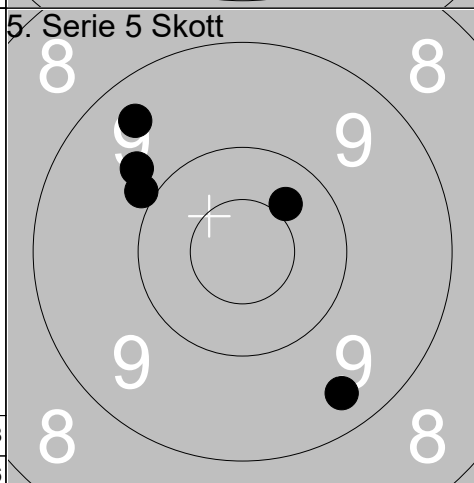

1:	9.4	↗
2:	10.4	↗
3:	9.7	↗
4:	9.9	↗
5:	9.4	↘
Serie		46
Total		182

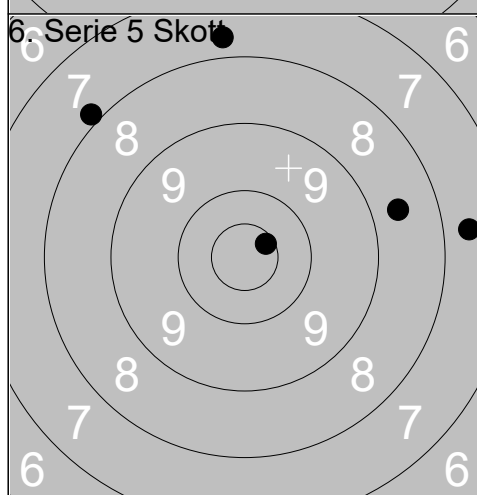

1:	7.7	↑
2:	10.6x	↗
3:	8.6	→
4:	7.9	↖
5:	7.6	→
Serie		39
Total		221

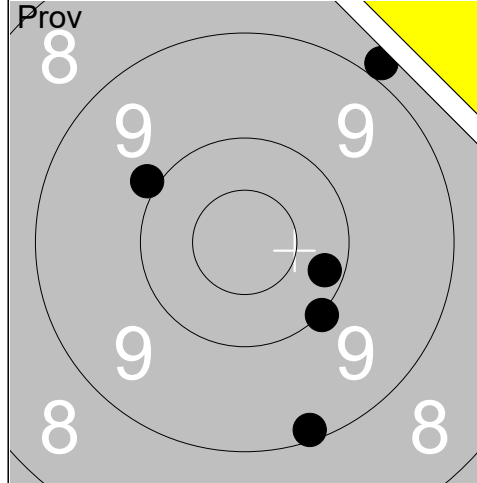

1:	8.9	↗
2:	10.2	→
3:	9.1	↘
4:	10.0	↘
5:	9.9	↗
Serie		46
Total		0

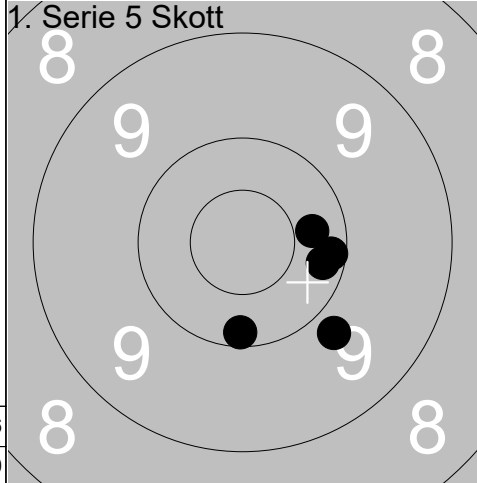

1:	10.3	→
2:	10.2	↘
3:	10.2	→
4:	10.2	→
5:	9.8	↘
Serie		49
Total		49

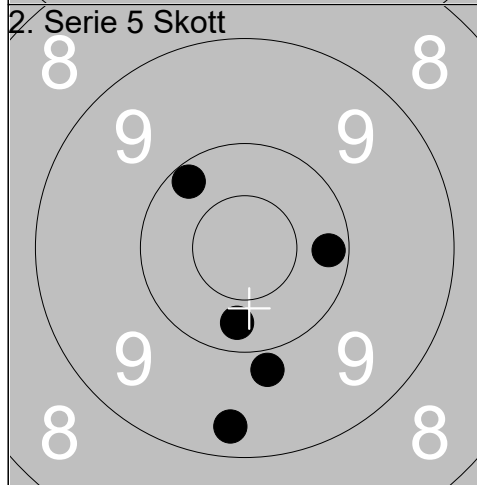

1:	10.2	↗
2:	9.8	↘
3:	10.2	→
4:	10.3	↘
5:	9.3	↘
Serie		48
Total		97

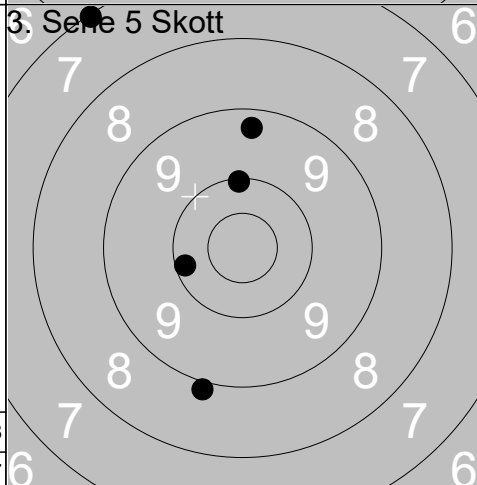

1:	9.3	↑
2:	10.1	↑
3:	10.1	←
4:	7.1	↖
5:	8.9	↘
Serie		44
Total		141

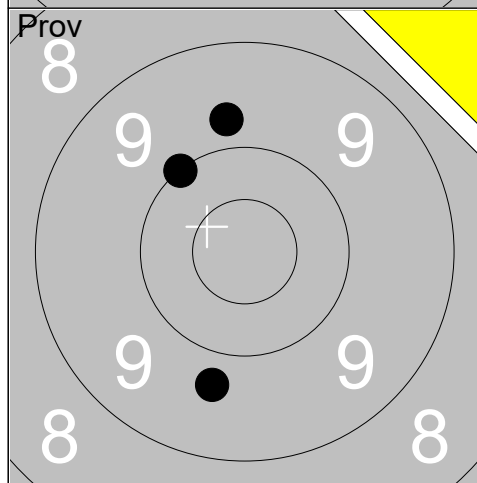

1:	9.8	↑
2:	9.7	↘
3:	10.0	↗
Serie		28
Total		141

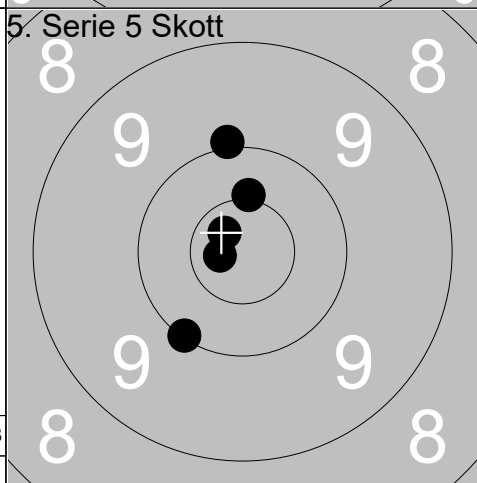

1:	10.0	↑
2:	10.0	↘
3:	10.4x	↑
4:	10.7x	←
5:	10.7x	↖
Serie		50
Total		191

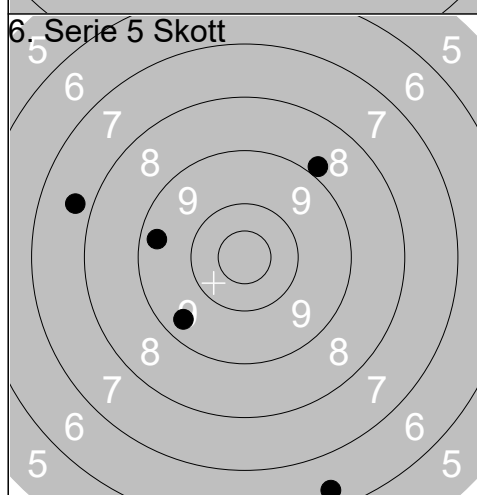

1:	8.8	↗
2:	9.4	←
3:	6.4	↘
4:	7.7	↖
5:	9.4	↘
Serie		39
Total		230

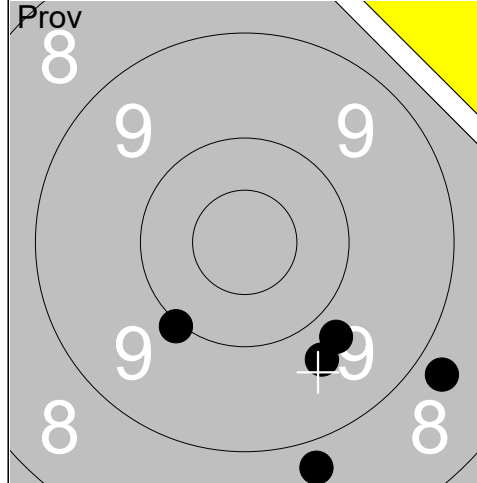

1:	8.8	↘
2:	8.8	↘
3:	10.0	↘
4:	9.7	↘
5:	9.8	↘
Serie		44
Total		0

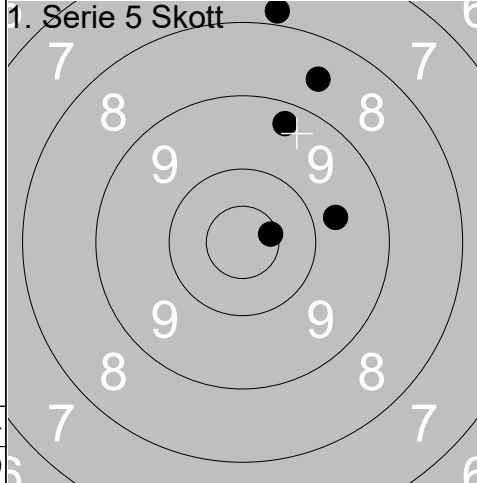

1:	10.6x	→
2:	7.8	↑
3:	9.3	↑
4:	8.6	↑
5:	9.7	→
Serie		43
Total		43

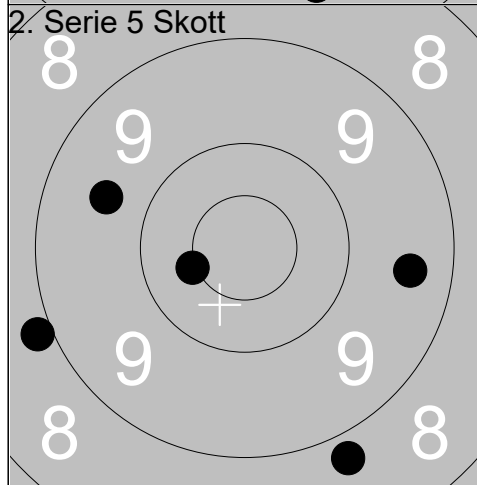

1:	9.4	→
2:	9.6	↗
3:	10.5x	←
4:	8.9	←
5:	8.8	↘
Serie		44
Total		87

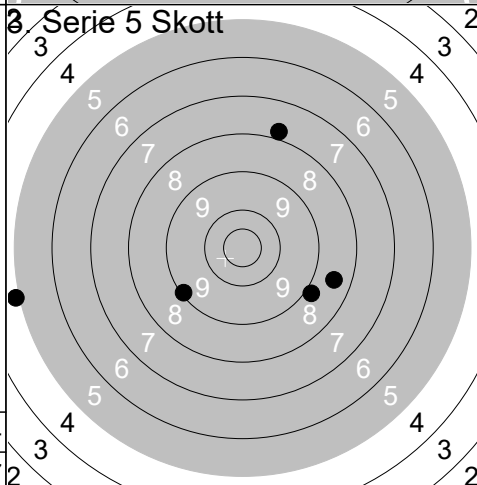

1:	8.9	↘
2:	9.1	↖
3:	8.5	→
4:	4.9	←
5:	7.8	↑
Serie		36
Total		123

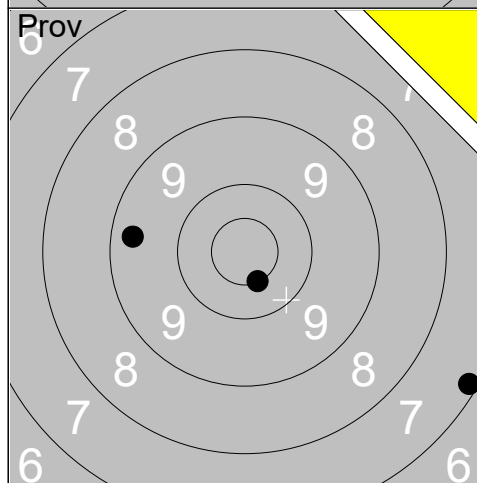

1:	10.5x	↘
2:	7.1	↘
3:	9.3	←
Serie		26
Total		123

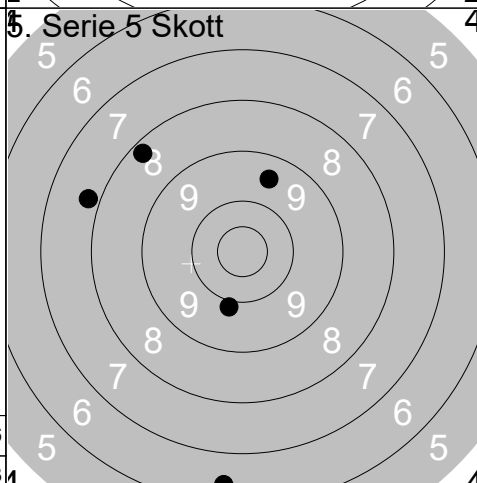

1:	9.5	↑
2:	9.9	↘
3:	7.8	↖
4:	8.3	↗
5:	6.4	↘
Serie		39
Total		162

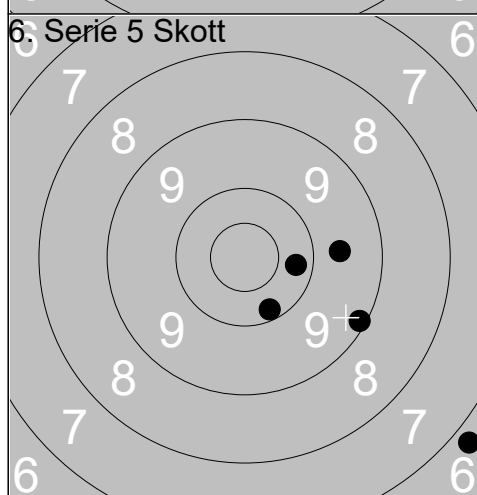

1:	6.8	↘
2:	9.1	↘
3:	9.6	→
4:	10.3	→
5:	10.2	↘
Serie		44
Total		206

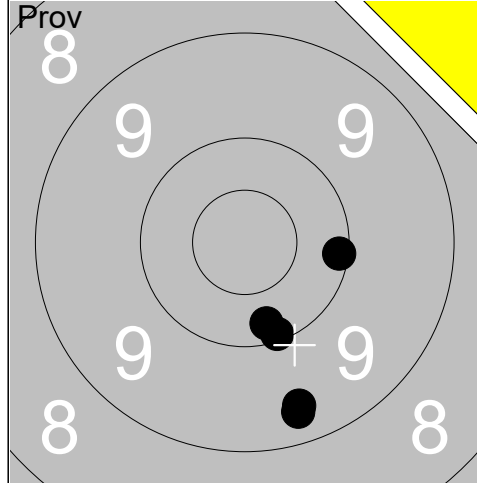

1:	10.2	↓
2:	9.4	↓
3:	9.3	↓
4:	10.1	→
5:	10.1	↓
Serie		48
Total		0

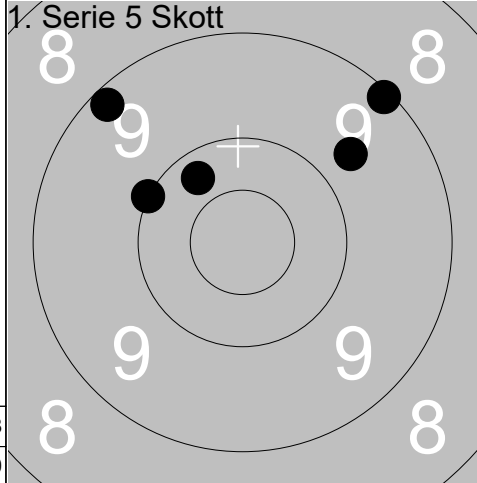

1:	10.3	↗
2:	9.2	↖
3:	9.1	↗
4:	9.7	↗
5:	10.0	↖
Serie		47
Total		47

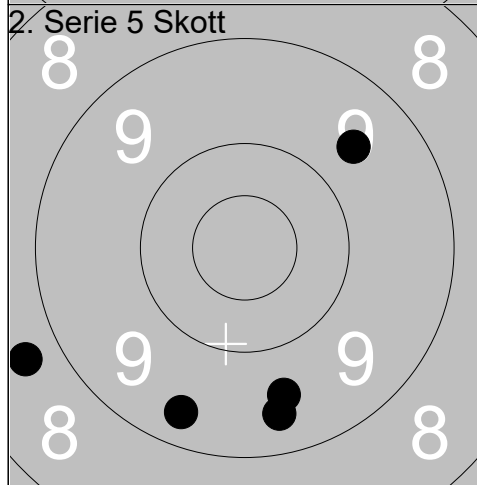

1:	9.6	↓
2:	9.4	↓
3:	9.4	↓
4:	8.7	←
5:	9.6	↗
Serie		44
Total		91

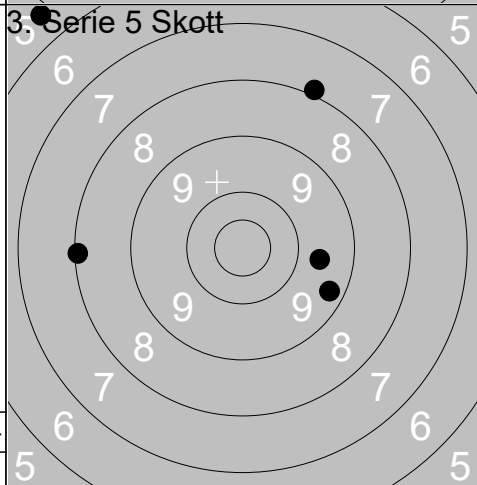

1:	9.3	→
2:	9.6	→
3:	8.1	←
4:	5.5	↗
5:	7.9	↗
Serie		38
Total		129

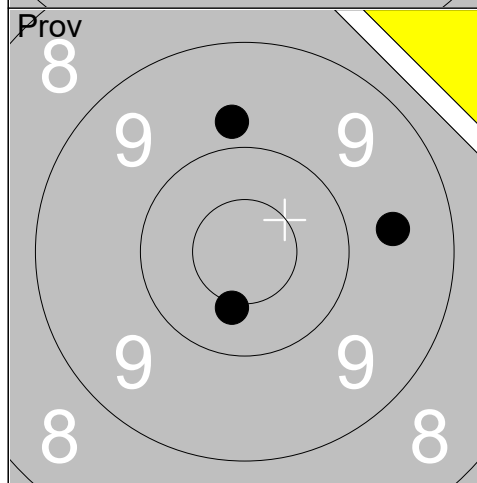

1:	9.8	↑
2:	9.6	→
3:	10.4x	↓
Serie		28
Total		129

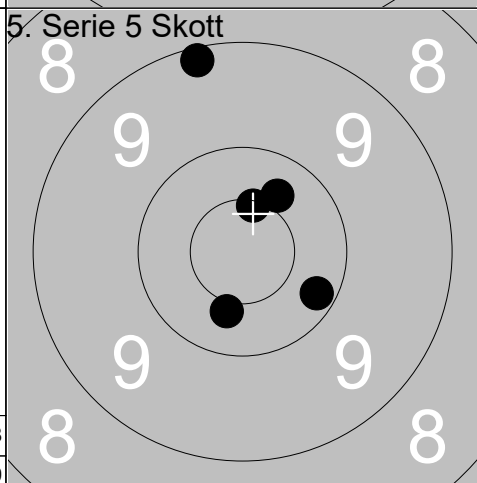

1:	9.1	↖
2:	10.2	→
3:	10.4	↗
4:	10.5x	↖
5:	10.4	↓
Serie		49
Total		178

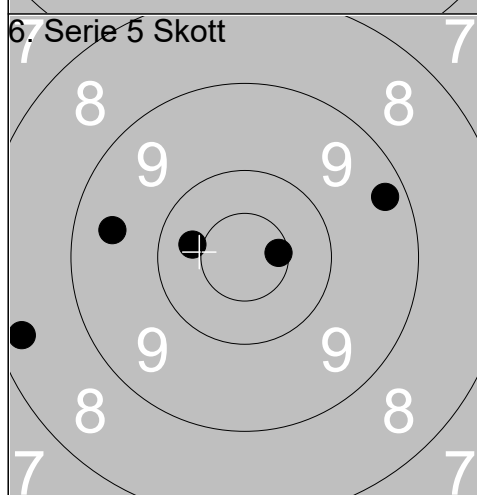

1:	10.6x	→
2:	9.3	↗
3:	9.5	←
4:	8.3	←
5:	10.4	←
Serie		46
Total		224

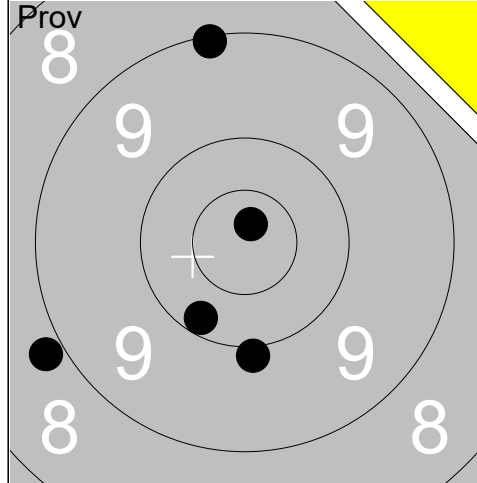

1:	8.8	↙
2:	9.1	↑
3:	10.2	↘
4:	9.9	↘
5:	10.8x	↑
Serie		46
Total		0

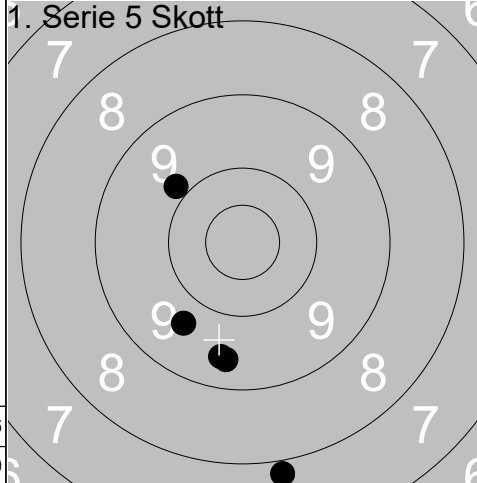

1:	9.9	↗
2:	7.9	↘
3:	9.4	↘
4:	9.7	↘
5:	9.5	↘
Serie		43
Total		43

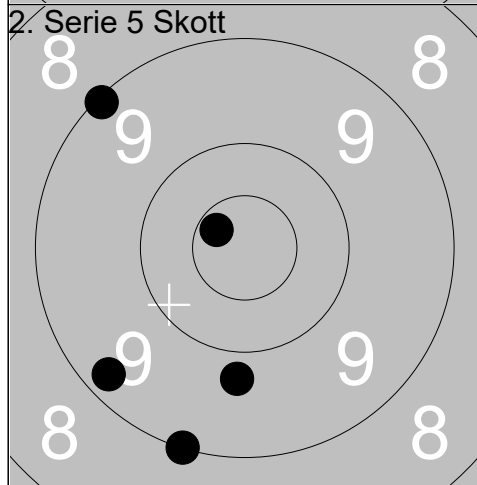

1:	9.0	↘
2:	9.8	↘
3:	9.1	↗
4:	10.7x	↗
5:	9.3	↘
Serie		46
Total		89

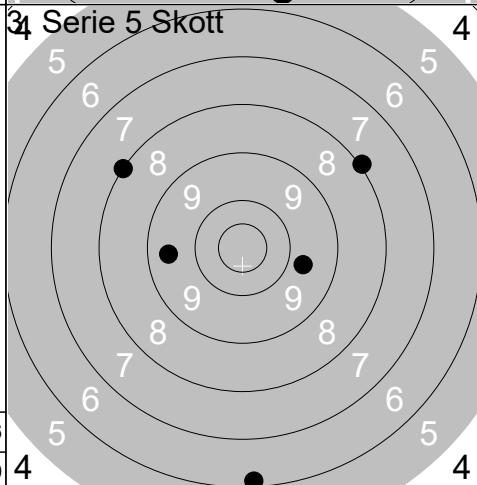

1:	8.0	↗
2:	9.5	←
3:	9.7	→
4:	8.0	↗
5:	6.1	↘
Serie		40
Total		129

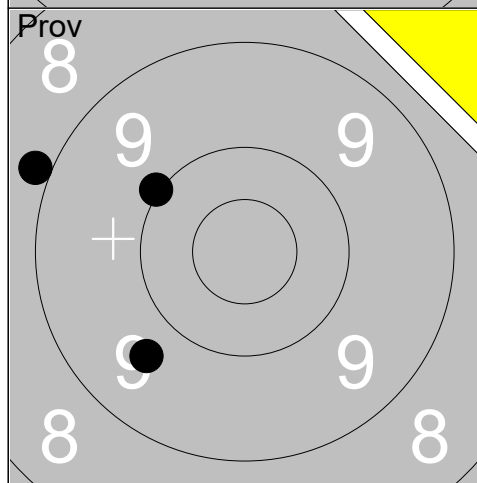

1:	10.0	↗
2:	9.7	↘
3:	8.9	↗
Serie		27
Total		129

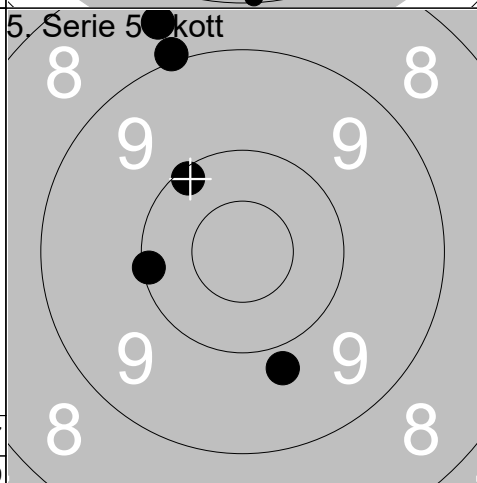

1:	10.1	←
2:	9.0	↗
3:	8.6	↗
4:	10.1	↗
5:	9.8	↘
Serie		46
Total		175

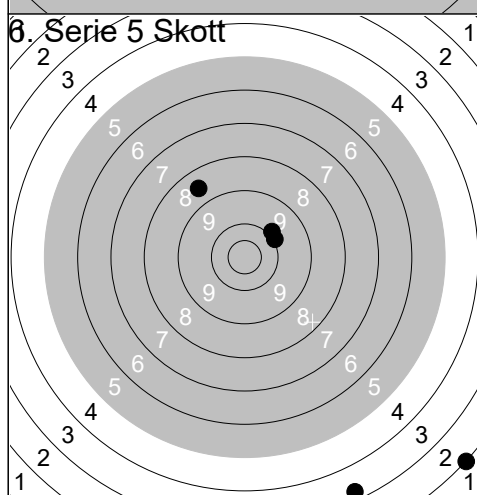

1:	8.5	↗
2:	9.9	↗
3:	10.0	↗
4:	3.3	↘
5:	2.0	↘
Serie		32
Total		207

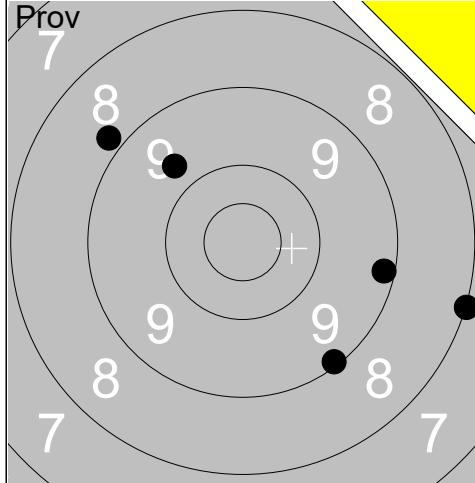

1:	8.8	↗
2:	8.0	→
3:	9.2	→
4:	9.7	↗
5:	9.1	↘
Serie		43
Total		0

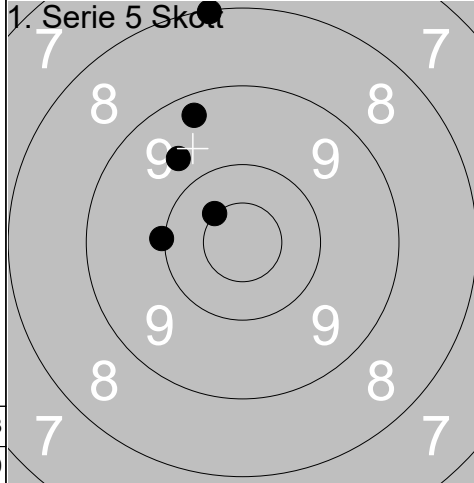

1:	8.0	↑
2:	9.7	↗
3:	10.5x	↗
4:	10.0	←
5:	9.3	↑
Serie		46
Total		46

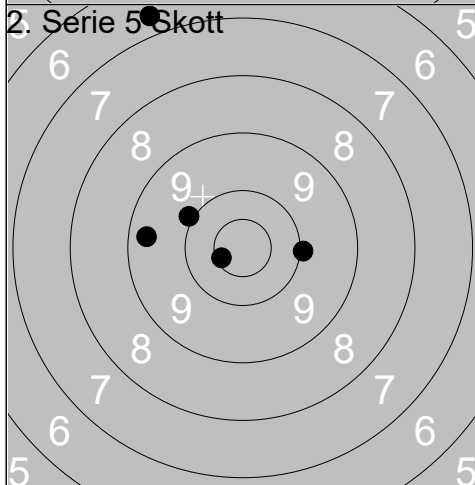

1:	9.9	↗
2:	9.3	←
3:	10.0	→
4:	10.6x	←
5:	6.7	↑
Serie		44
Total		90

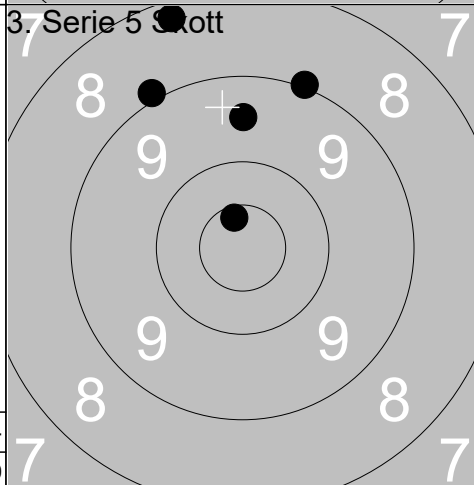

1:	10.6x	↑
2:	8.9	↗
3:	9.0	↑
4:	9.5	↑
5:	8.2	↑
Serie		44
Total		134

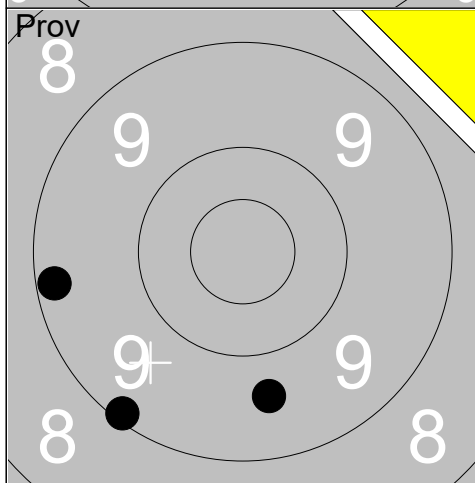

1:	9.1	↘
2:	9.6	↘
3:	9.2	←
Serie		27
Total		134

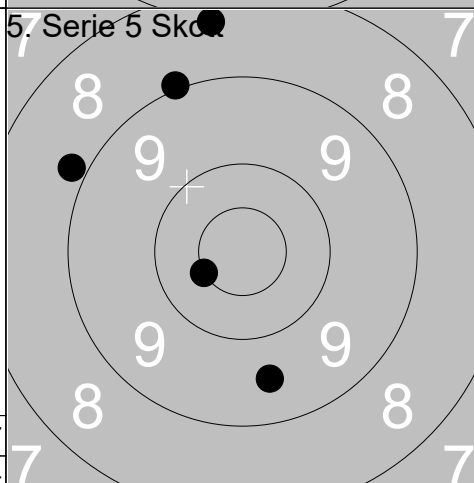

1:	8.4	↑
2:	8.9	←
3:	9.0	↑
4:	10.5x	←
5:	9.5	↓
Serie		44
Total		178

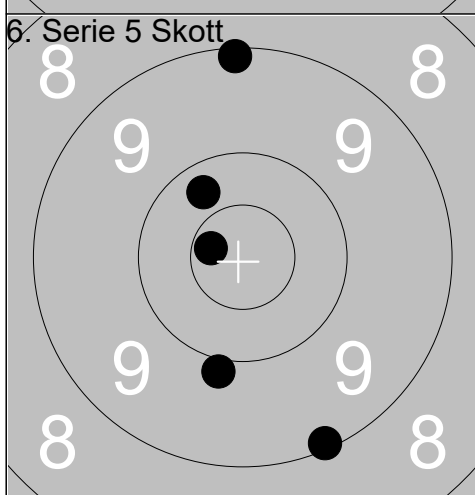

1:	9.1	↑
2:	9.9	↓
3:	10.7x	↗
4:	9.1	↘
5:	10.3	↗
Serie		47
Total		225

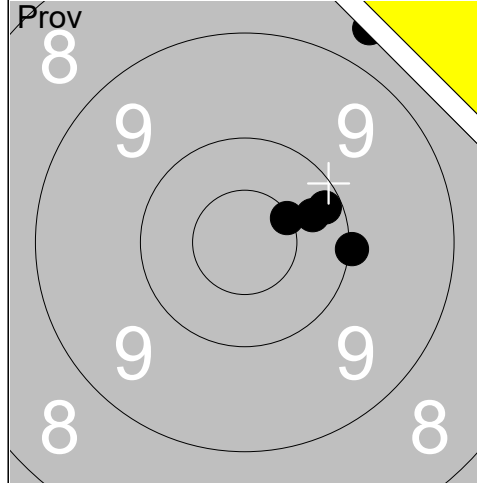

1:	8.7	↗
2:	10.5x	↗
3:	10.3	↗
4:	10.0	→
5:	10.2	↗
Serie		48
Total		0

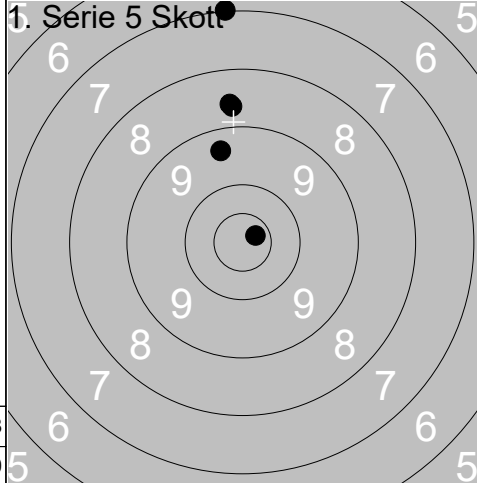

1:	7.0	↑
2:	10.7x	↗
3:	9.4	↑
4:	8.6	↑
5:	8.7	↑
Serie		42
Total		42

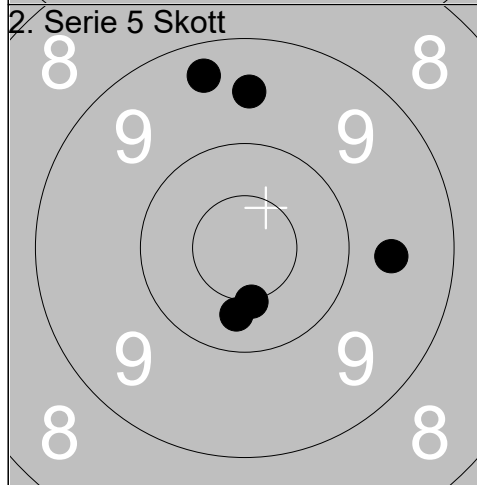

1:	9.3	↑
2:	9.5	↑
3:	10.4	↓
4:	10.5x	↓
5:	9.6	→
Serie		47
Total		89

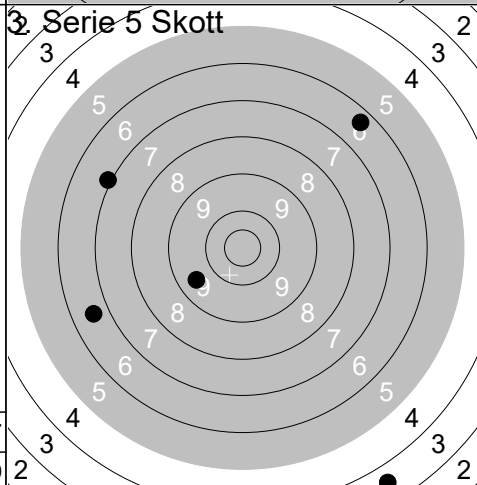

1:	6.4	↗
2:	9.5	↖
3:	6.6	↖
4:	7.0	↖
5:	3.6	↓
Serie		31
Total		120

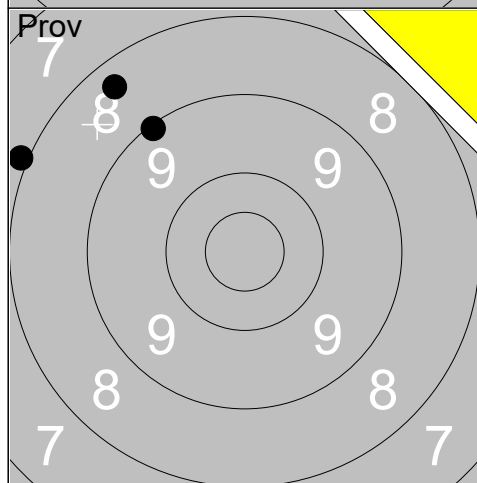

1:	8.4	↗
2:	9.1	↗
3:	7.9	↗
Serie		24
Total		120

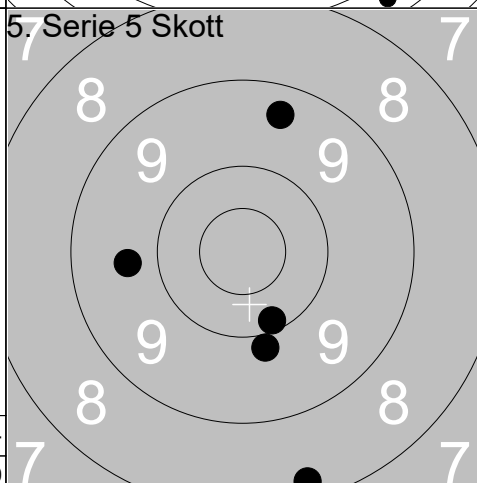

1:	9.4	↑
2:	8.2	↓
3:	9.7	↖
4:	9.9	↓
5:	10.1	↓
Serie		45
Total		165

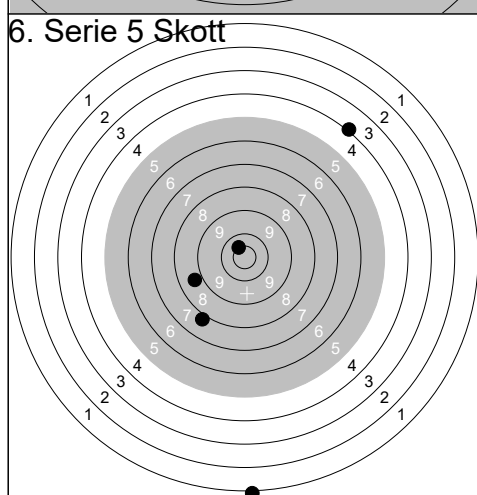

1:	10.5x	↖
2:	7.8	↓
3:	8.7	↖
4:	4.0	↗
5:	0.0	↓
Serie		29
Total		194

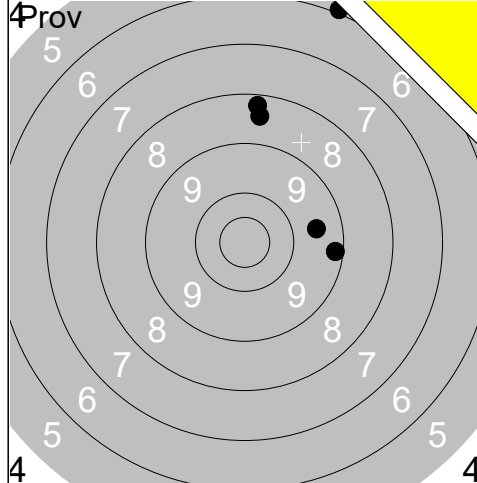

1:	6.0	↑
2:	8.3	↑
3:	9.6	→
4:	9.2	→
5:	8.5	↑
Serie		40
Total		0

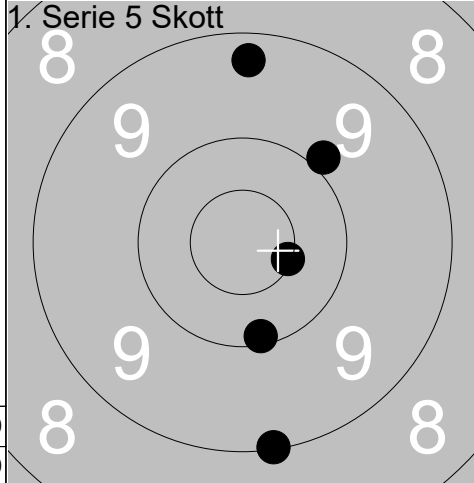

1:	9.0	↓
2:	10.5x	→
3:	9.9	↗
4:	9.3	↑
5:	10.1	↓
Serie		47
Total		47

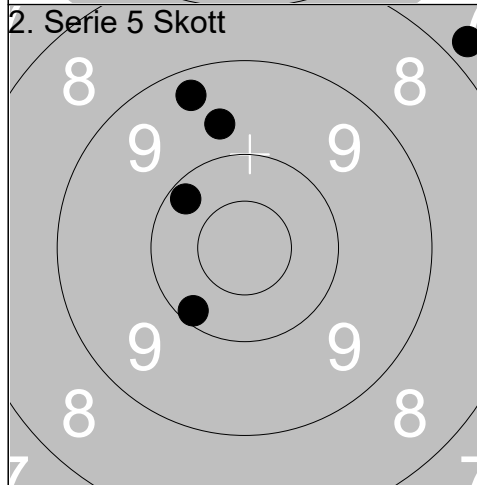

1:	9.7	↑
2:	10.2	↖
3:	10.1	↙
4:	9.3	↑
5:	7.8	↗
Serie		45
Total		92

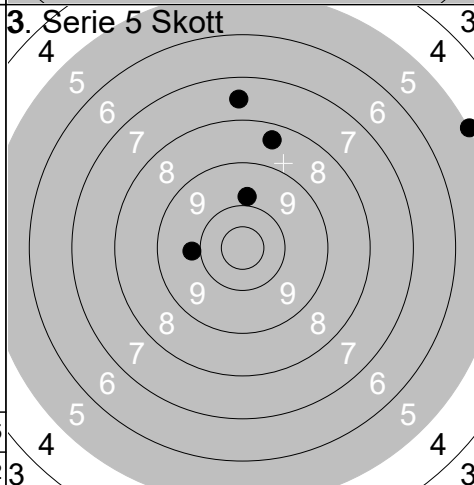

1:	8.4	↑
2:	9.8	↑
3:	7.5	↑
4:	9.8	←
5:	5.0	↗
Serie		38
Total		130

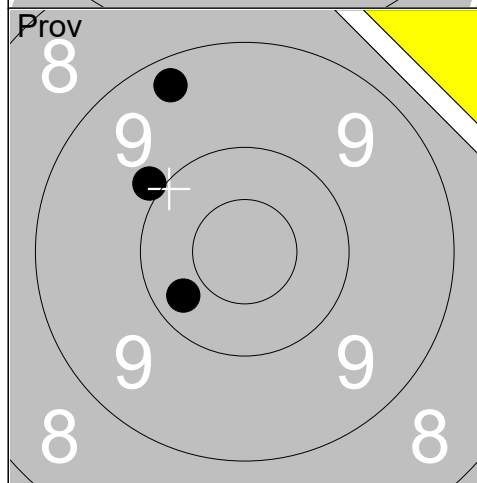

1:	9.3	↑
2:	9.9	↗
3:	10.3	↙
Serie		28
Total		130

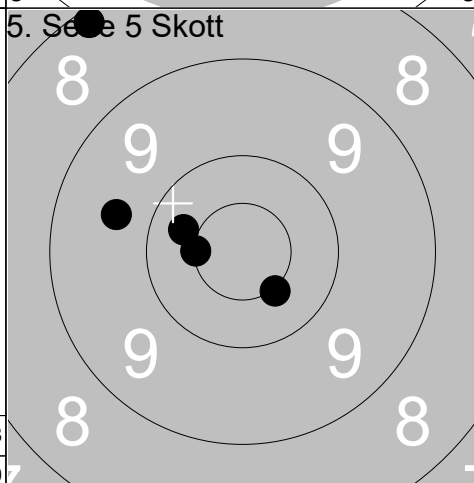

1:	10.5x	←
2:	10.5x	↙
3:	8.2	↗
4:	9.7	←
5:	10.3	↖
Serie		47
Total		177

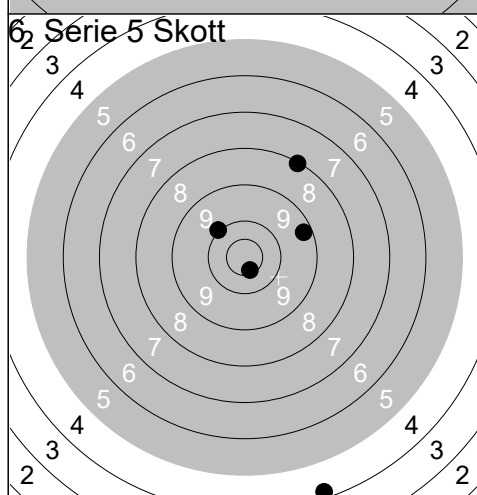

1:	9.3	→
2:	10.6x	↓
3:	10.0	↗
4:	8.1	↗
5:	4.2	↓
Serie		41
Total		218

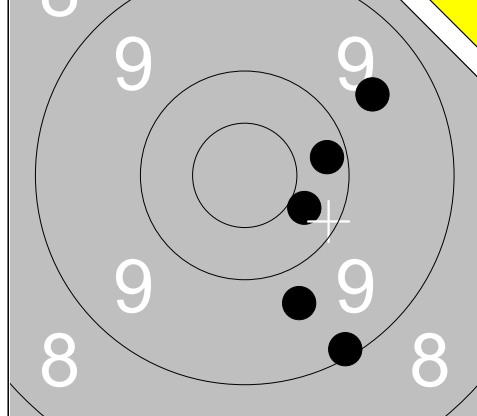

1:	9.7	↘
2:	10.2	→
3:	9.6	→
4:	9.1	↘
5:	10.4	↘
Serie		47
Total		0

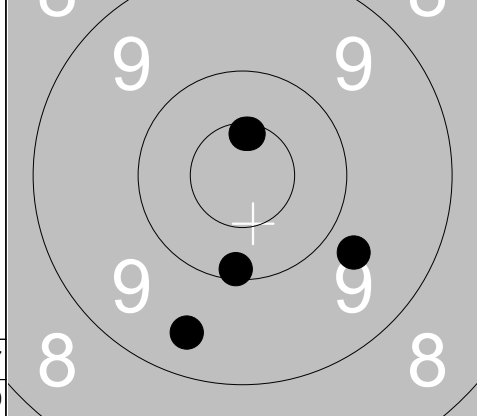

1:	10.1	↓
2:	9.7	↘
3:	10.6x	↑
4:	10.6x	↑
5:	9.4	↘
Serie		48
Total		48

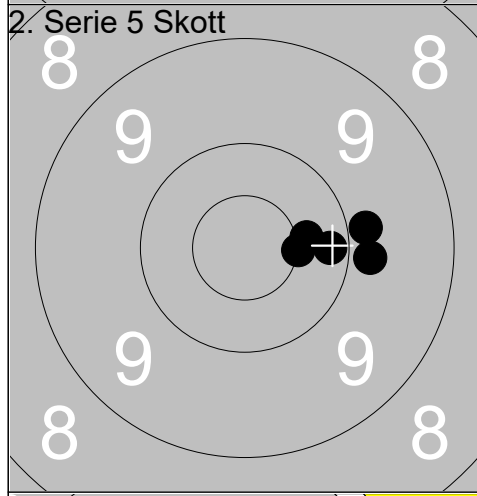

1:	9.8	→
2:	10.4	→
3:	9.9	→
4:	10.2	→
5:	10.5x	→
Serie		48
Total		96

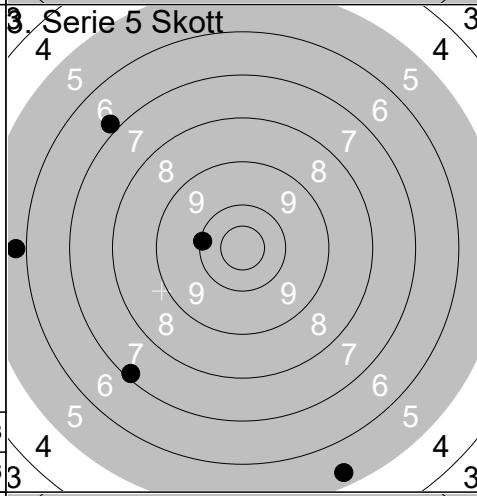

1:	6.8	↗
2:	10.1	←
3:	5.8	←
4:	5.3	↘
5:	7.1	↘
Serie		33
Total		129

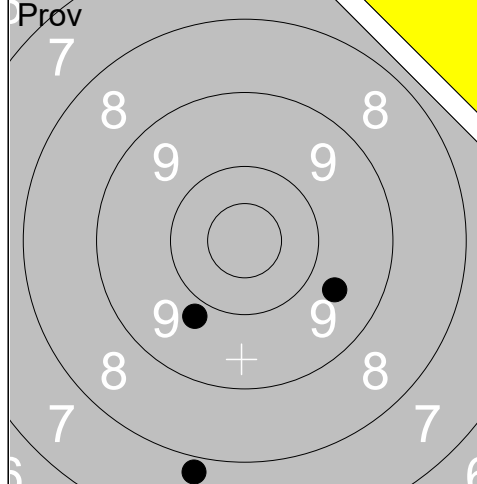

1:	9.6	↘
2:	7.8	↘
3:	9.8	↘
Serie		25
Total		129

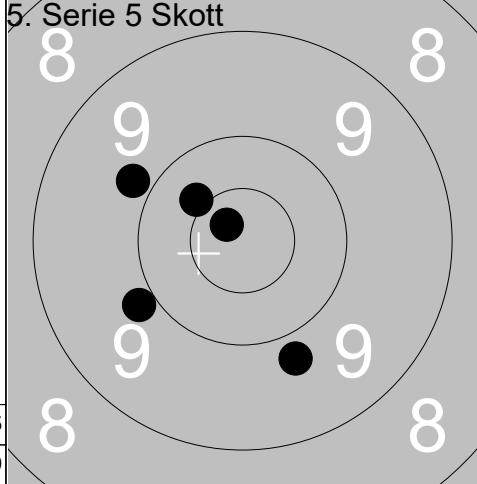

1:	10.4	↗
2:	9.8	↗
3:	10.8x	↗
4:	9.9	←
5:	9.8	↘
Serie		47
Total		176

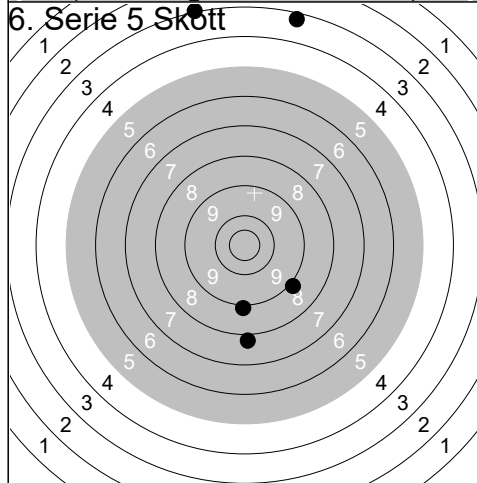

1:	8.9	↘
2:	7.8	↓
3:	8.9	↓
4:	3.0	↑
5:	3.2	↑
Serie		29
Total		205

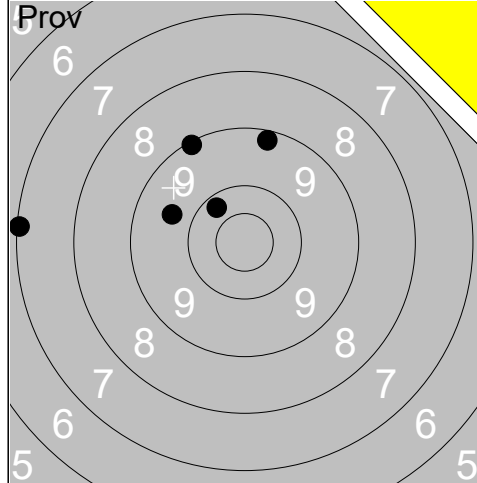

1:	9.2	↑
2:	7.1	←
3:	10.2	↗
4:	9.1	↗
5:	9.7	↗
Serie	44	
Total	0	

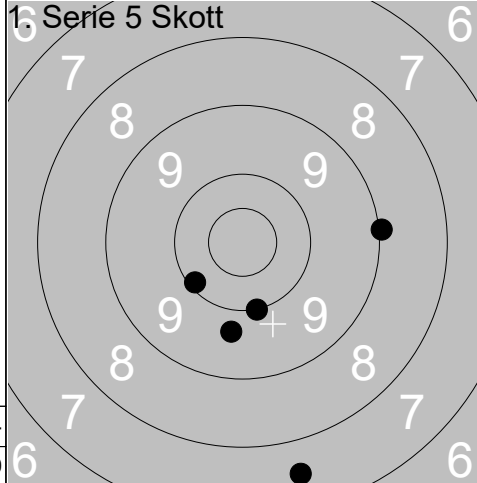

1:	10.1	↙
2:	9.0	→
3:	10.0	↓
4:	9.7	↓
5:	7.5	↓
Serie	45	
Total	45	

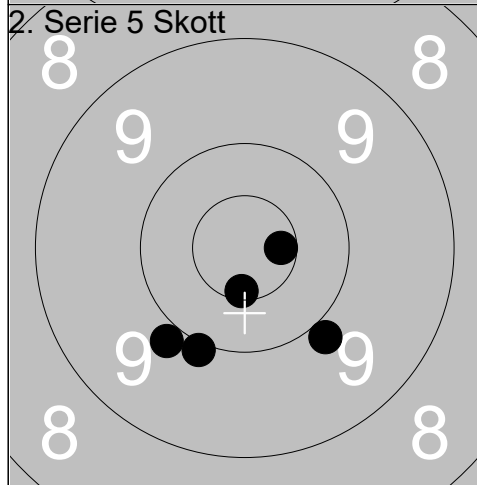

1:	10.0	↓
2:	9.9	↓
3:	10.6x	→
4:	9.9	↙
5:	10.6x	↓
Serie	48	
Total	93	

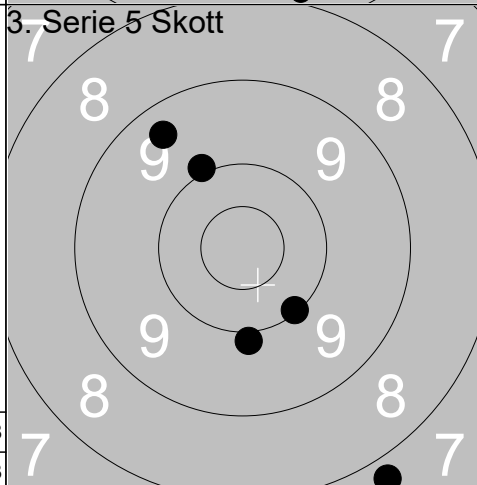

1:	9.4	↗
2:	10.1	↙
3:	10.0	↗
4:	9.9	↓
5:	7.8	↙
Serie	45	
Total	138	

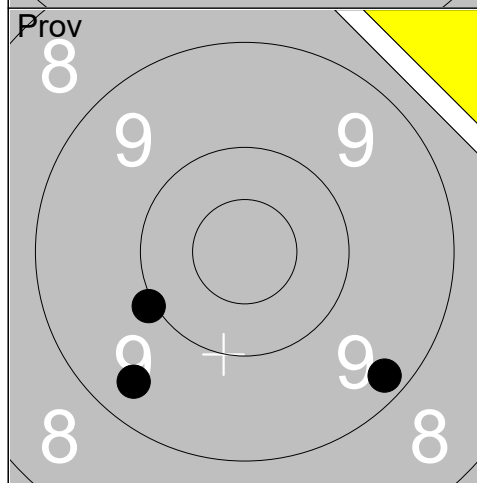

1:	10.0	↙
2:	9.2	↘
3:	9.4	↙
Serie	28	
Total	138	

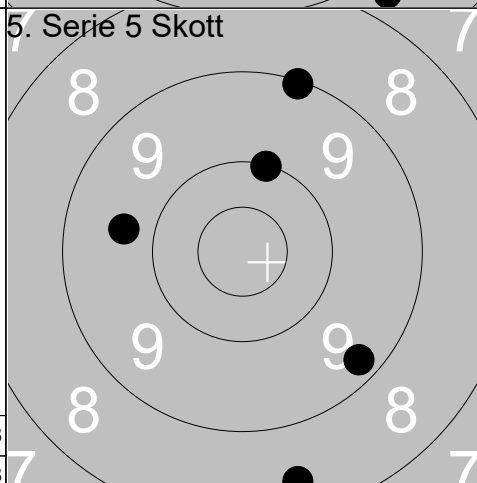

1:	10.0	↑
2:	9.1	↑
3:	9.3	↘
4:	9.7	←
5:	8.4	↓
Serie	45	
Total	183	

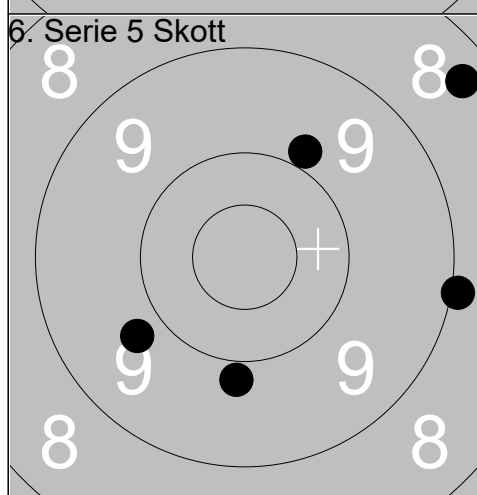

1:	9.8	↙
2:	9.9	↗
3:	9.0	→
4:	9.9	↓
5:	8.4	↗
Serie	44	
Total	227	

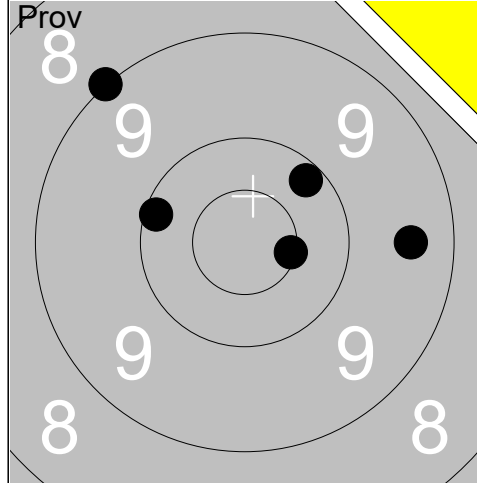

1:	10.5x	→
2:	9.4	→
3:	10.2	↗
4:	10.1	↖
5:	9.0	↗
Serie		48
Total		0

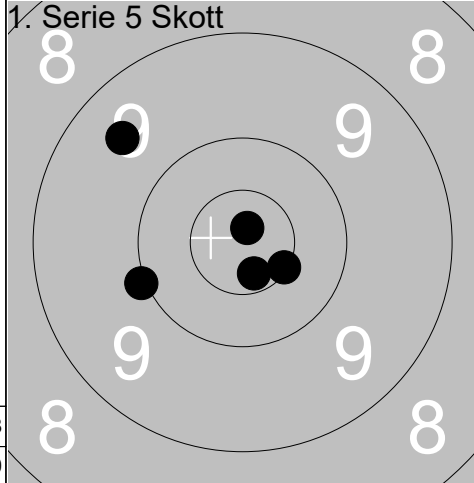

1:	10.5x	→
2:	10.8x	↑
3:	10.7x	↓
4:	10.0	↖
5:	9.5	↗
Serie		49
Total		49

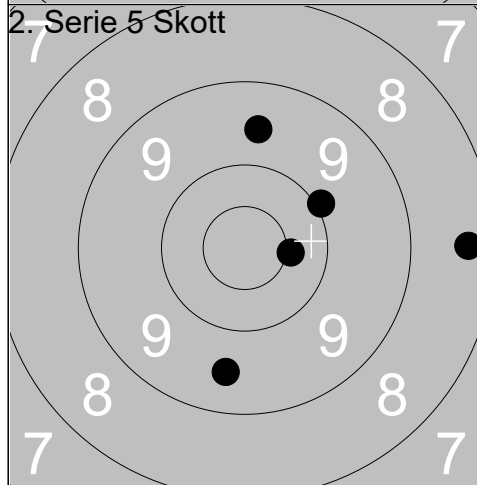

1:	10.4x	→
2:	8.3	→
3:	10.0	↗
4:	9.6	↑
5:	9.5	↓
Serie		46
Total		95

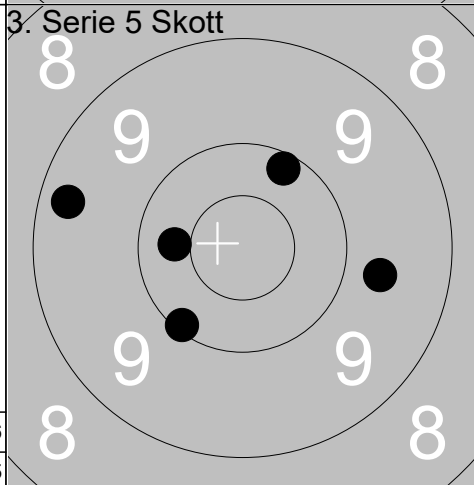

1:	10.2	↗
2:	9.3	↖
3:	9.7	→
4:	10.3	↖
5:	10.1	↘
Serie		48
Total		143

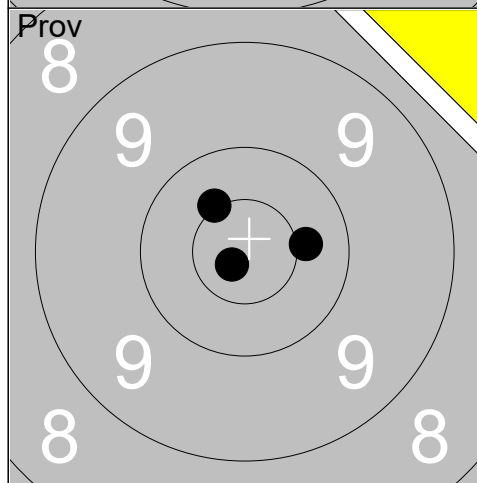

1:	10.4	→
2:	10.5x	↗
3:	10.8x	↘
Serie		30
Total		143

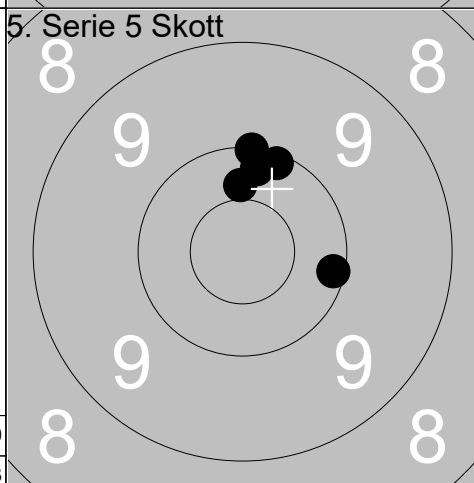

1:	10.1	↗
2:	10.4	↑
3:	10.2	↑
4:	10.0	↑
5:	10.1	→
Serie		50
Total		193

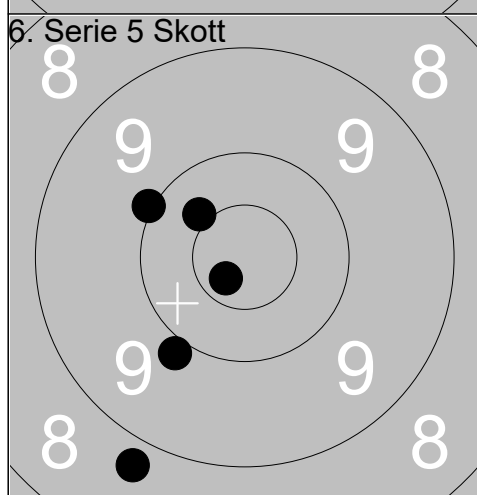

1:	10.7x	↖
2:	9.9	↖
3:	10.4	↗
4:	8.8	↖
5:	10.0	↗
Serie		47
Total		240

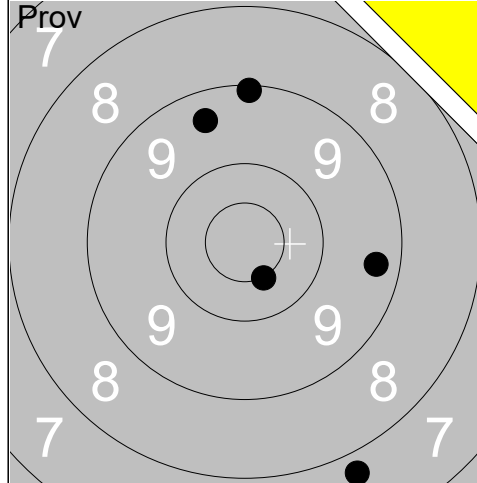

1:	10.5x	↘
2:	9.1	↑
3:	7.8	↘
4:	9.4	↑
5:	9.3	→
Serie		44
Total		0

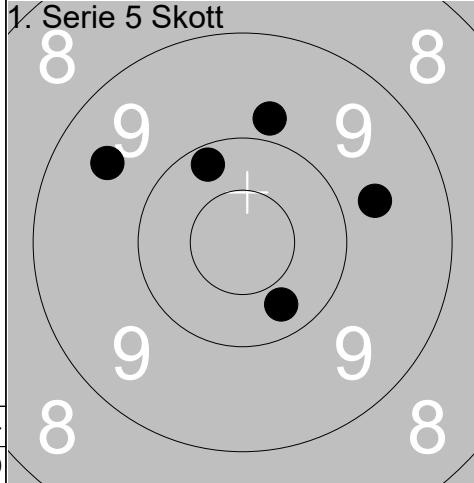

1:	10.2	↑
2:	9.8	↑
3:	10.3	↘
4:	9.5	↖
5:	9.7	→
Serie		47
Total		47

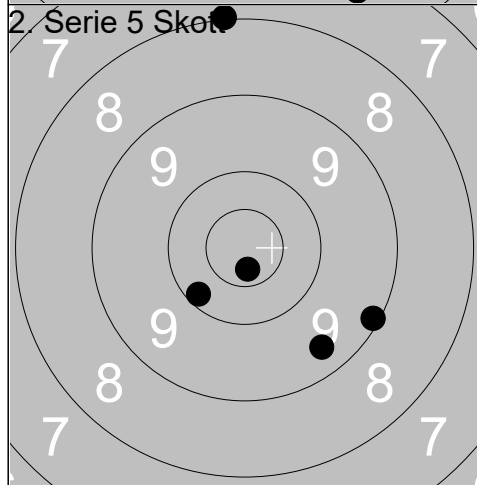

1:	10.7x	↓
2:	9.1	↘
3:	9.4	↘
4:	8.0	↑
5:	10.2	↙
Serie		46
Total		93

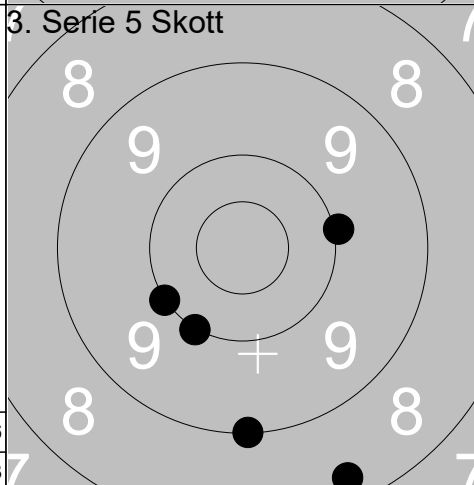

1:	9.0	↓
2:	10.0	↘
3:	10.0	↙
4:	8.3	↓
5:	10.0	→
Serie		47
Total		140

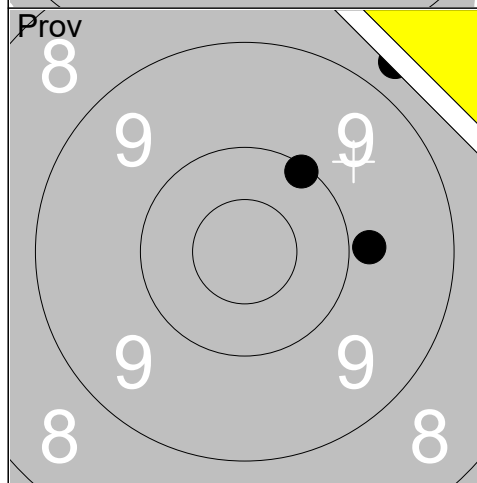

1:	10.1	↗
2:	8.7	↗
3:	9.8	→
Serie		27
Total		140

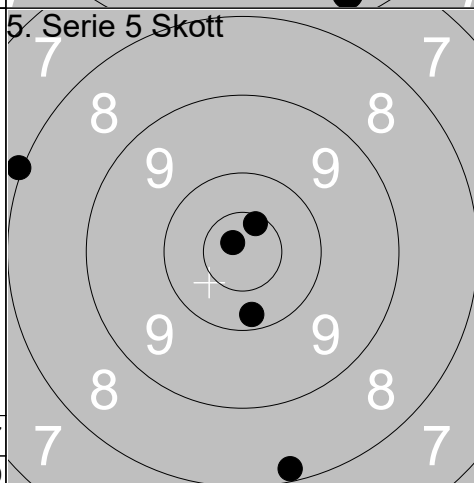

1:	10.6x	↑
2:	8.0	↖
3:	10.2	↓
4:	8.2	↓
5:	10.8x	↗
Serie		46
Total		186

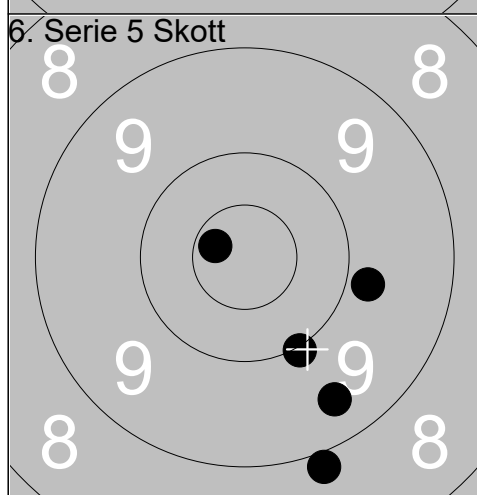

1:	10.7x	↗
2:	9.8	→
3:	9.4	↘
4:	10.0	↘
5:	8.9	↘
Serie		46
Total		232

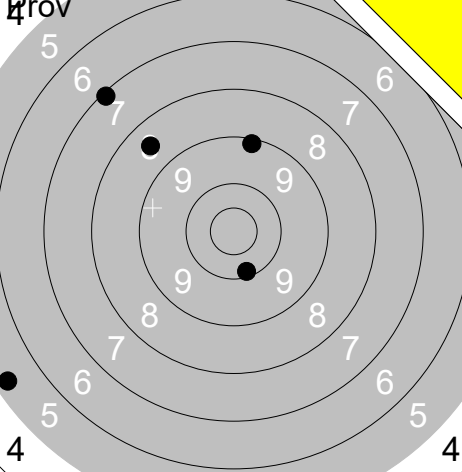
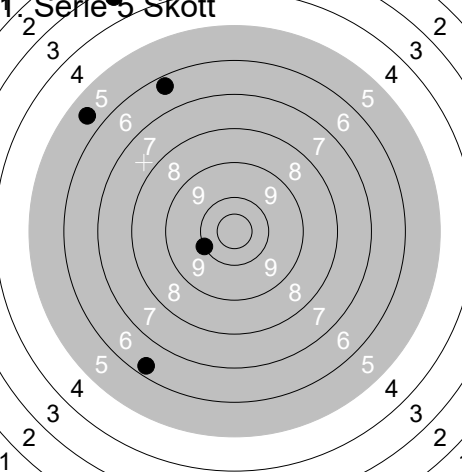
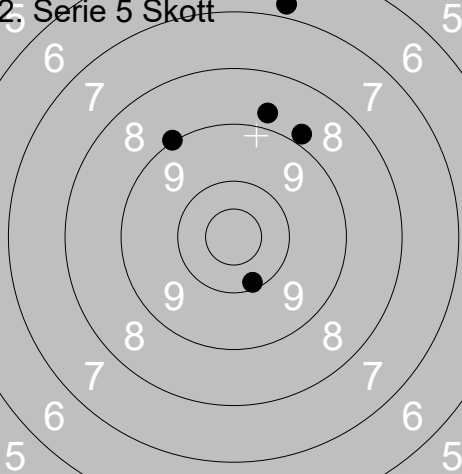
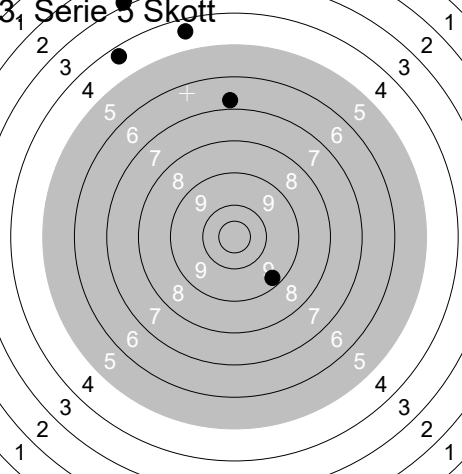
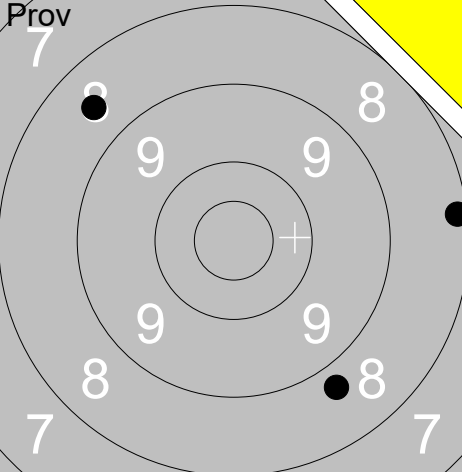
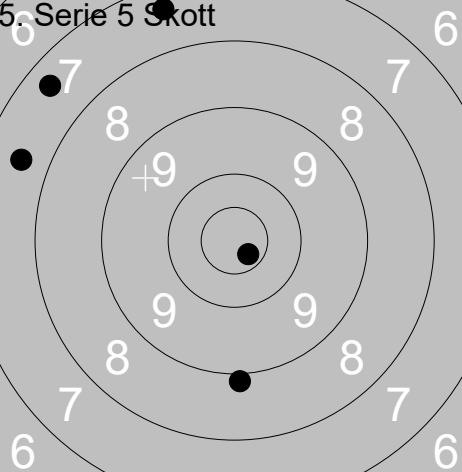
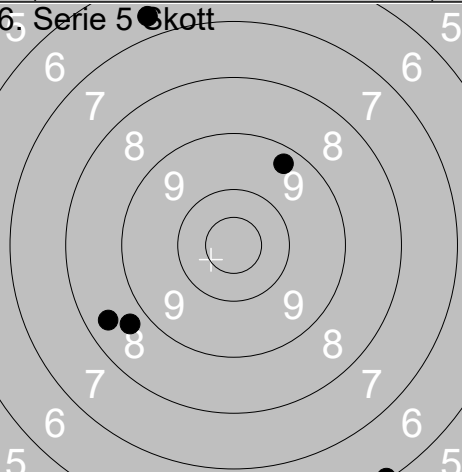
<p>Prov</p>  <p style="text-align: right;">4</p>	<table style="width:100%; border-collapse: collapse;"> <tr><td>1:</td><td>10.1</td><td>↘</td></tr> <tr><td>2:</td><td>8.5</td><td>↗</td></tr> <tr><td>3:</td><td>9.1</td><td>↗</td></tr> <tr><td>4:</td><td>7.1</td><td>↗</td></tr> <tr><td>5:</td><td>5.3</td><td>↙</td></tr> <tr><td colspan="2">Serie</td><td style="text-align: right;">39</td></tr> <tr><td colspan="2">Total</td><td style="text-align: right;">01</td></tr> </table>	1:	10.1	↘	2:	8.5	↗	3:	9.1	↗	4:	7.1	↗	5:	5.3	↙	Serie		39	Total		01	<p>1. Serie 5 Skott</p>  <p style="text-align: right;">1</p> <table style="width:100%; border-collapse: collapse;"> <tr><td>1:</td><td>6.3</td><td>↙</td></tr> <tr><td>2:</td><td>3.3</td><td>↗</td></tr> <tr><td>3:</td><td>6.3</td><td>↗</td></tr> <tr><td>4:</td><td>5.6</td><td>↗</td></tr> <tr><td>5:</td><td>10.0</td><td>↙</td></tr> <tr><td colspan="2">Serie</td><td style="text-align: right;">30</td></tr> <tr><td colspan="2">Total</td><td style="text-align: right;">30</td></tr> </table>	1:	6.3	↙	2:	3.3	↗	3:	6.3	↗	4:	5.6	↗	5:	10.0	↙	Serie		30	Total		30
1:	10.1	↘																																										
2:	8.5	↗																																										
3:	9.1	↗																																										
4:	7.1	↗																																										
5:	5.3	↙																																										
Serie		39																																										
Total		01																																										
1:	6.3	↙																																										
2:	3.3	↗																																										
3:	6.3	↗																																										
4:	5.6	↗																																										
5:	10.0	↙																																										
Serie		30																																										
Total		30																																										
<p>2. Serie 5 Skott</p>  <p style="text-align: right;">5</p>	<table style="width:100%; border-collapse: collapse;"> <tr><td>1:</td><td>10.1</td><td>↘</td></tr> <tr><td>2:</td><td>9.0</td><td>↗</td></tr> <tr><td>3:</td><td>8.8</td><td>↗</td></tr> <tr><td>4:</td><td>8.7</td><td>↗</td></tr> <tr><td>5:</td><td>6.8</td><td>↗</td></tr> <tr><td colspan="2">Serie</td><td style="text-align: right;">41</td></tr> <tr><td colspan="2">Total</td><td style="text-align: right;">71</td></tr> </table>	1:	10.1	↘	2:	9.0	↗	3:	8.8	↗	4:	8.7	↗	5:	6.8	↗	Serie		41	Total		71	<p>3. Serie 5 Skott</p>  <p style="text-align: right;">1</p> <table style="width:100%; border-collapse: collapse;"> <tr><td>1:</td><td>9.3</td><td>↘</td></tr> <tr><td>2:</td><td>4.4</td><td>↗</td></tr> <tr><td>3:</td><td>2.9</td><td>↗</td></tr> <tr><td>4:</td><td>4.3</td><td>↗</td></tr> <tr><td>5:</td><td>6.8</td><td>↗</td></tr> <tr><td colspan="2">Serie</td><td style="text-align: right;">25</td></tr> <tr><td colspan="2">Total</td><td style="text-align: right;">96</td></tr> </table>	1:	9.3	↘	2:	4.4	↗	3:	2.9	↗	4:	4.3	↗	5:	6.8	↗	Serie		25	Total		96
1:	10.1	↘																																										
2:	9.0	↗																																										
3:	8.8	↗																																										
4:	8.7	↗																																										
5:	6.8	↗																																										
Serie		41																																										
Total		71																																										
1:	9.3	↘																																										
2:	4.4	↗																																										
3:	2.9	↗																																										
4:	4.3	↗																																										
5:	6.8	↗																																										
Serie		25																																										
Total		96																																										
<p>Prov</p>  <p style="text-align: right;">7</p>	<table style="width:100%; border-collapse: collapse;"> <tr><td>1:</td><td>8.2</td><td>→</td></tr> <tr><td>2:</td><td>8.7</td><td>↘</td></tr> <tr><td>3:</td><td>8.6</td><td>↗</td></tr> <tr><td colspan="2">Serie</td><td style="text-align: right;">24</td></tr> <tr><td colspan="2">Total</td><td style="text-align: right;">96</td></tr> </table>	1:	8.2	→	2:	8.7	↘	3:	8.6	↗	Serie		24	Total		96	<p>5. Serie 5 Skott</p>  <p style="text-align: right;">6</p> <table style="width:100%; border-collapse: collapse;"> <tr><td>1:</td><td>10.7x</td><td>↘</td></tr> <tr><td>2:</td><td>7.4</td><td>↗</td></tr> <tr><td>3:</td><td>7.6</td><td>↗</td></tr> <tr><td>4:</td><td>7.4</td><td>↗</td></tr> <tr><td>5:</td><td>8.9</td><td>↘</td></tr> <tr><td colspan="2">Serie</td><td style="text-align: right;">39</td></tr> <tr><td colspan="2">Total</td><td style="text-align: right;">135</td></tr> </table>	1:	10.7x	↘	2:	7.4	↗	3:	7.6	↗	4:	7.4	↗	5:	8.9	↘	Serie		39	Total		135						
1:	8.2	→																																										
2:	8.7	↘																																										
3:	8.6	↗																																										
Serie		24																																										
Total		96																																										
1:	10.7x	↘																																										
2:	7.4	↗																																										
3:	7.6	↗																																										
4:	7.4	↗																																										
5:	8.9	↘																																										
Serie		39																																										
Total		135																																										
<p>6. Serie 5 Skott</p>  <p style="text-align: right;">5</p>	<table style="width:100%; border-collapse: collapse;"> <tr><td>1:</td><td>6.1</td><td>↘</td></tr> <tr><td>2:</td><td>8.4</td><td>↙</td></tr> <tr><td>3:</td><td>9.3</td><td>↗</td></tr> <tr><td>4:</td><td>6.7</td><td>↗</td></tr> <tr><td>5:</td><td>8.7</td><td>↙</td></tr> <tr><td colspan="2">Serie</td><td style="text-align: right;">37</td></tr> <tr><td colspan="2">Total</td><td style="text-align: right;">172</td></tr> </table>	1:	6.1	↘	2:	8.4	↙	3:	9.3	↗	4:	6.7	↗	5:	8.7	↙	Serie		37	Total		172																						
1:	6.1	↘																																										
2:	8.4	↙																																										
3:	9.3	↗																																										
4:	6.7	↗																																										
5:	8.7	↙																																										
Serie		37																																										
Total		172																																										

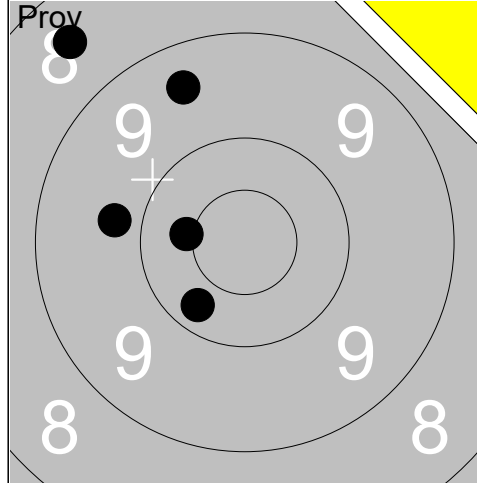

1:	9.4	↑
2:	8.5	↖
3:	10.3	↖
4:	10.4x	←
5:	9.8	←

Serie	46
Total	0

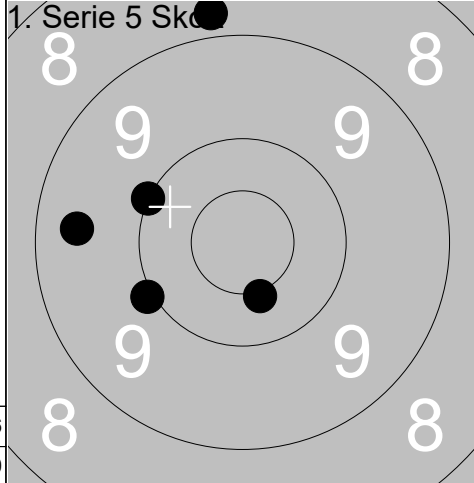

1:	8.8	↑
2:	10.0	↖
3:	10.0	↖
4:	9.4	←
5:	10.4x	↓

Serie	47
Total	47

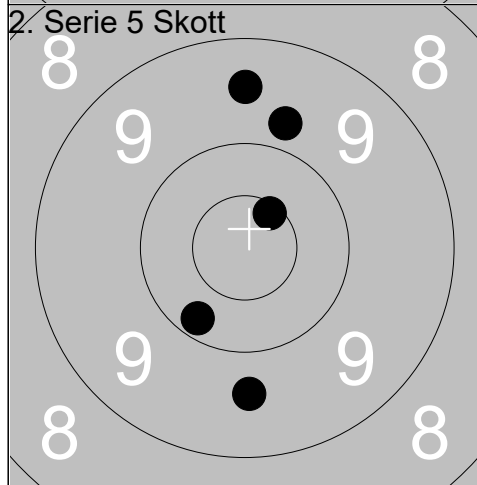

1:	10.2	↙
2:	10.6x	↗
3:	9.8	↑
4:	9.5	↑
5:	9.6	↓

Serie	47
Total	94

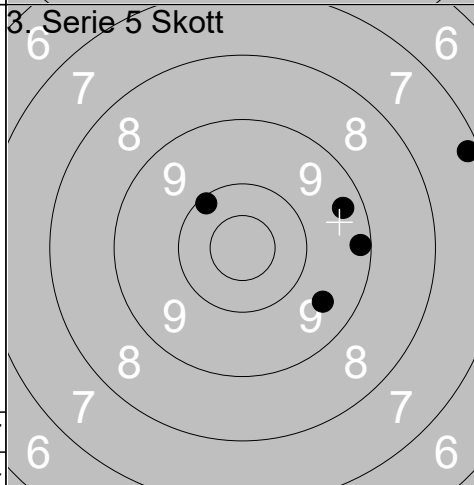

1:	9.2	→
2:	9.3	→
3:	10.1	↗
4:	9.5	↘
5:	7.2	→

Serie	44
Total	138

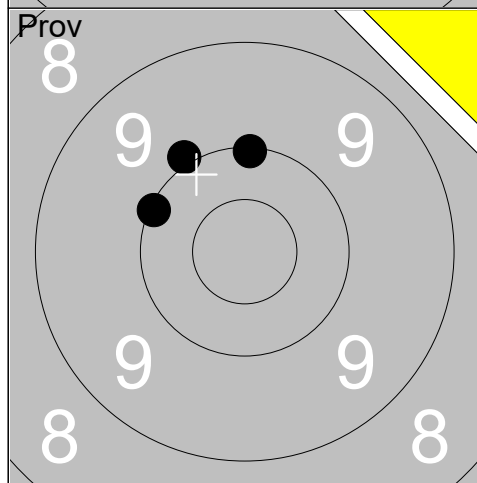

1:	10.1	↑
2:	10.0	↑
3:	10.1	↖

Serie	30
Total	138

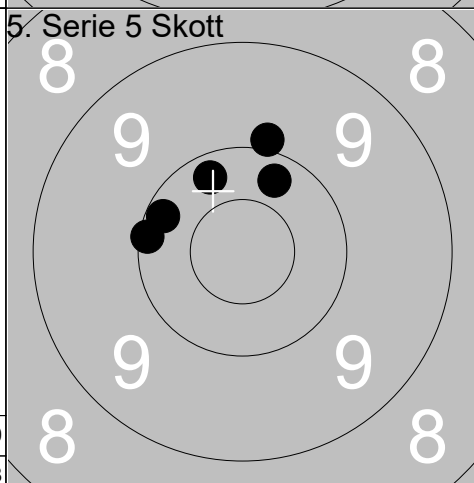

1:	9.9	↑
2:	10.2	↖
3:	10.2	↗
4:	10.1	←
5:	10.3	↑

Serie	49
Total	187

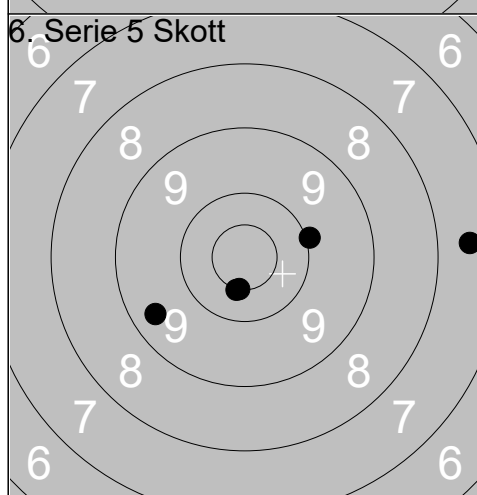

1:	10.5x	↓
2:	9.4	↖
3:	7.5	→
4:	10.0	→
5:	10.5x	↓

Serie	46
Total	233

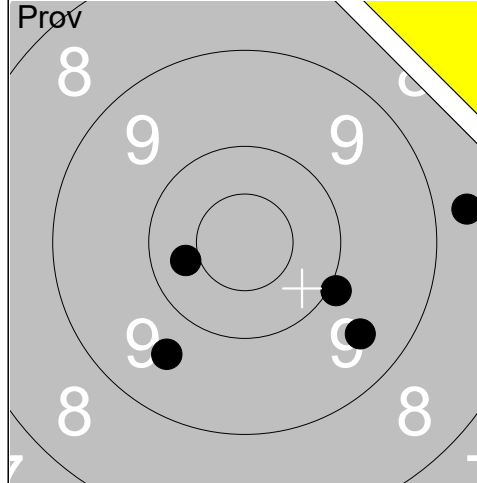

1:	9.5	↘
2:	8.7	→
3:	10.0	↘
4:	10.4	↙
5:	9.6	↘
Serie		46
Total		0

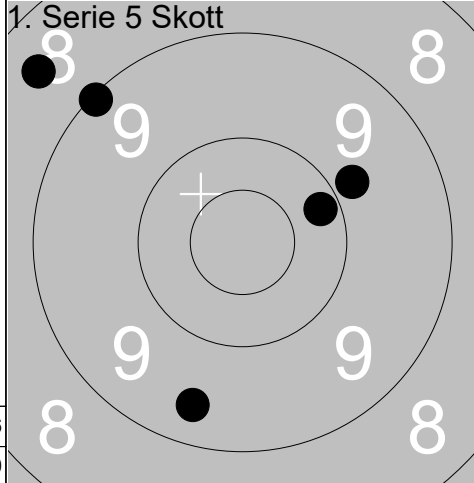

1:	10.2	→
2:	9.8	→
3:	9.1	↗
4:	8.5	↗
5:	9.4	↘
Serie		45
Total		45

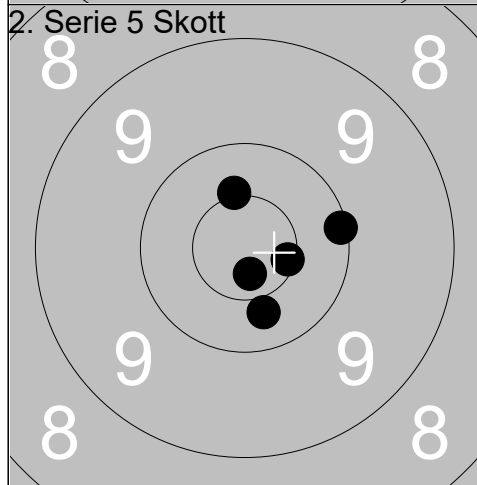

1:	10.5x	↑
2:	10.1	→
3:	10.4	↘
4:	10.6x	→
5:	10.7x	↘
Serie		50
Total		95

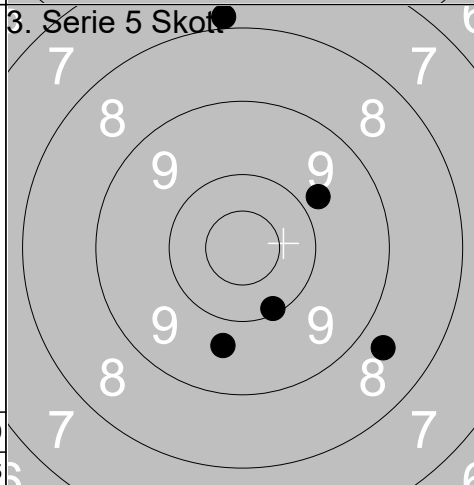

1:	7.9	↑
2:	9.7	↘
3:	10.1	↘
4:	9.8	→
5:	8.7	↘
Serie		43
Total		138

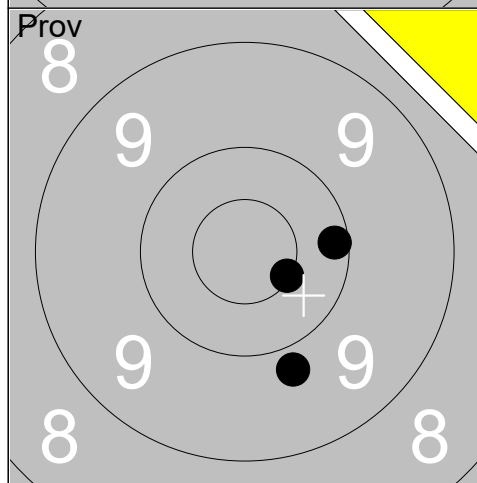

1:	10.5x	↘
2:	10.2	→
3:	9.8	↘
Serie		29
Total		138

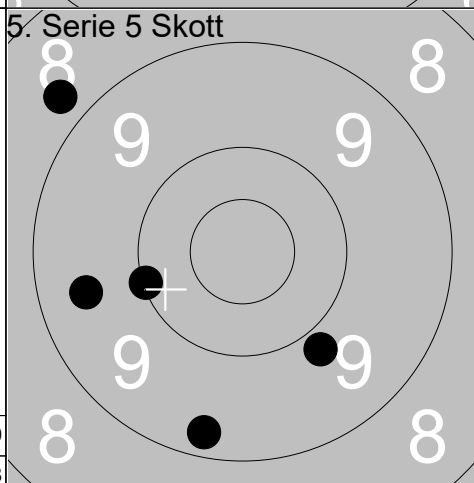

1:	10.0	↙
2:	8.7	↗
3:	9.3	↘
4:	9.5	↙
5:	9.8	↘
Serie		45
Total		183

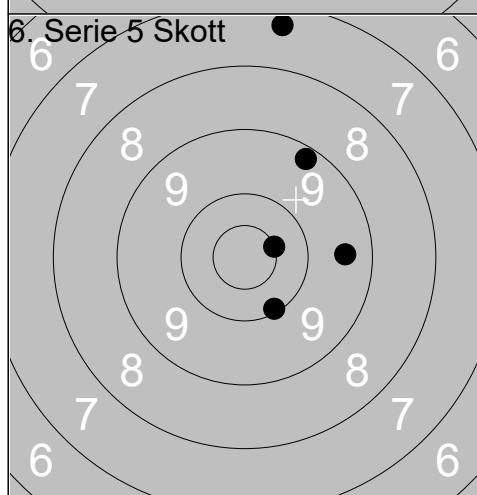

1:	7.3	↑
2:	9.5	→
3:	9.2	↗
4:	10.1	↘
5:	10.5x	→
Serie		45
Total		228

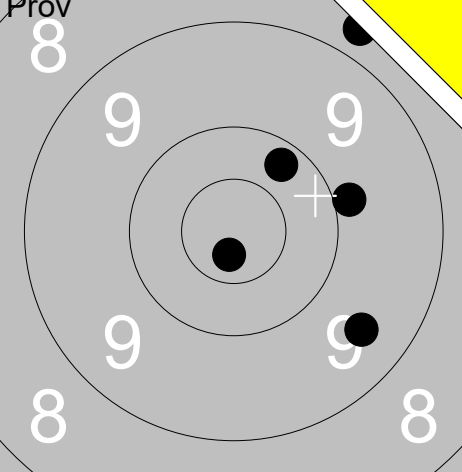
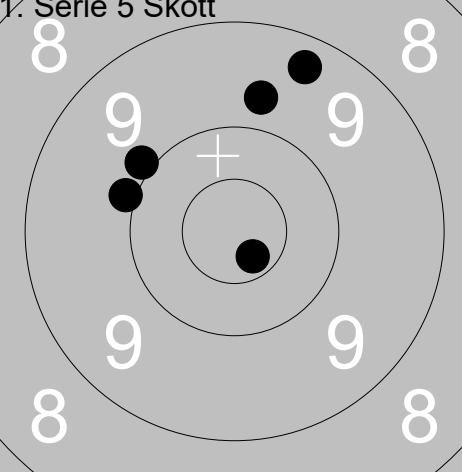
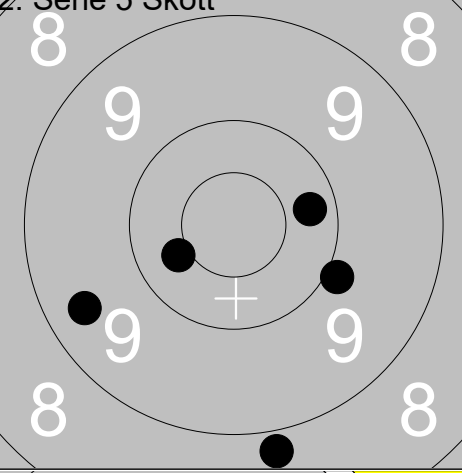
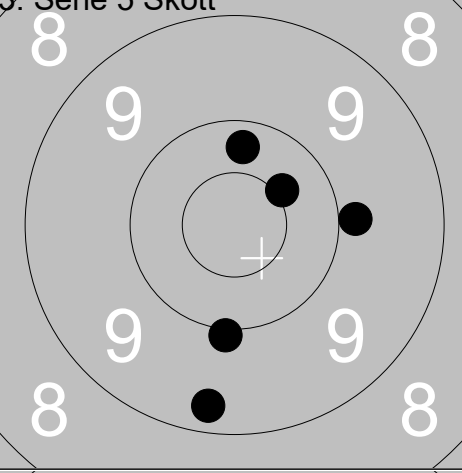
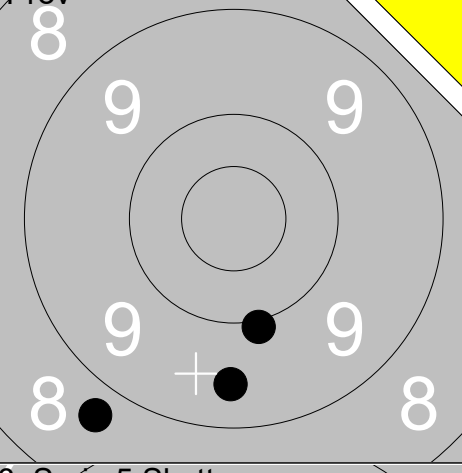
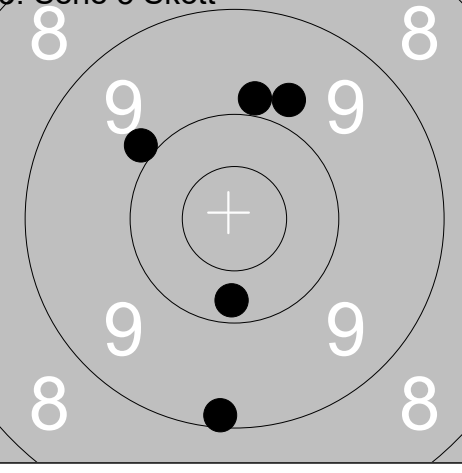
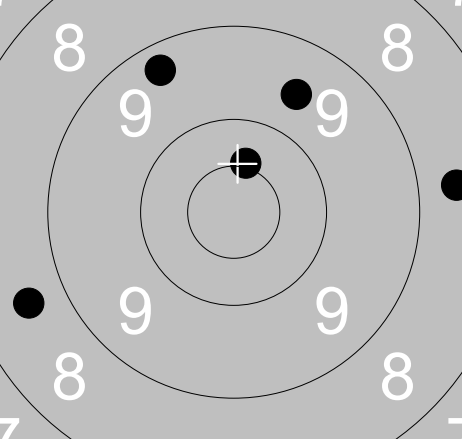
<p>Prov</p>  <p style="text-align: right;">8</p>	<p>1: 9.5 ↘ 2: 8.7 ↗ 3: 9.9 → 4: 10.7x ↓ 5: 10.2 ↗</p> <hr/> <p>Serie 46 Total 0</p>	<p>1. Serie 5 Skott</p>  <p style="text-align: right;">8</p>	<p>1: 10.7x ↓ 2: 9.7 ↗ 3: 9.9 ← 4: 9.3 ↗ 5: 9.9 ↗</p> <hr/> <p>Serie 46 Total 46</p>
<p>2. Serie 5 Skott</p>  <p style="text-align: right;">8</p>	<p>1: 9.9 ↘ 2: 8.8 ↓ 3: 10.3 → 4: 10.4 ← 5: 9.4 ↙</p> <hr/> <p>Serie 46 Total 92</p>	<p>3. Serie 5 Skott</p>  <p style="text-align: right;">8</p>	<p>1: 10.0 ↓ 2: 9.9 → 3: 9.3 ↓ 4: 10.3 ↑ 5: 10.4x ↗</p> <hr/> <p>Serie 48 Total 140</p>
<p>Prov</p>  <p style="text-align: right;">8</p>	<p>1: 8.7 ↙ 2: 10.0 ↓ 3: 9.4 ↓</p> <hr/> <p>Serie 27 Total 140</p>	<p>5. Serie 5 Skott</p>  <p style="text-align: right;">8</p>	<p>1: 9.1 ↓ 2: 9.9 ↖ 3: 9.9 ↑ 4: 9.8 ↑ 5: 10.2 ↓</p> <hr/> <p>Serie 46 Total 186</p>
<p>6. Serie 5 Skott</p>  <p style="text-align: right;">7</p>	<p>1: 8.6 ← 2: 9.6 ↗ 3: 10.4x ↗ 4: 8.6 → 5: 9.3 ↗</p> <hr/> <p>Serie 44 Total 230</p>		

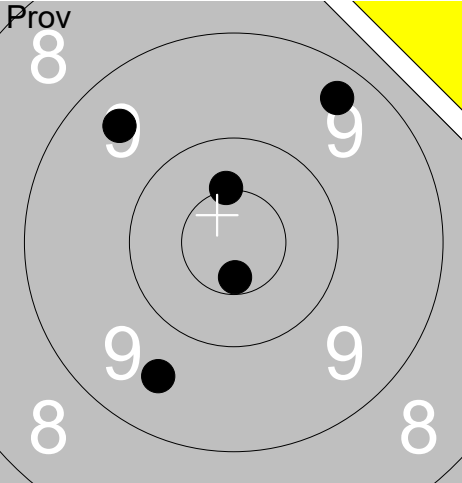
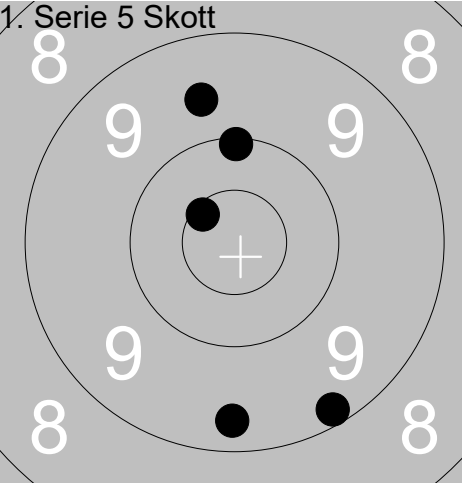
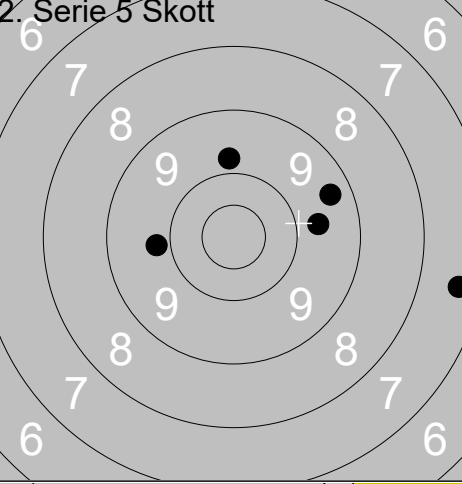
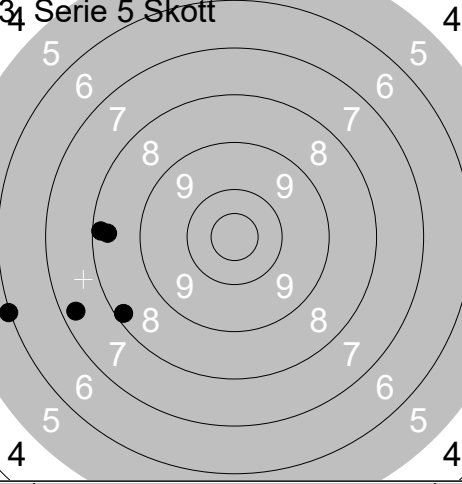
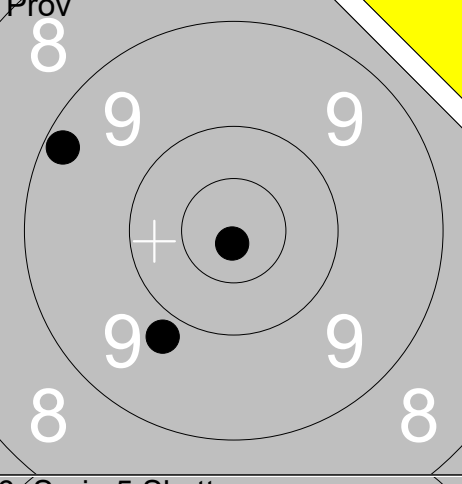
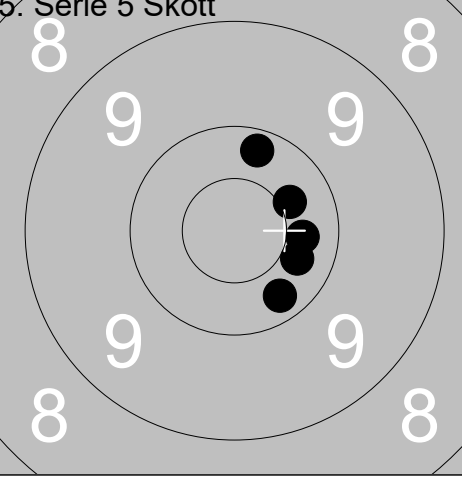
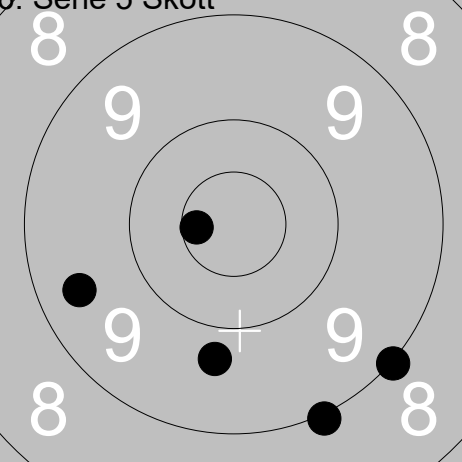
Skjutlag 3	Tavla 22	Stefan Jonasson			
Ramselefors		Hogdal		Vet	Jä
06.07.2019		Björskottet 2019		Ramselefors SKF	
Prov 	1: 9.3 ↗ 2: 9.5 ↖ 3: 10.5x ↑ 4: 10.6x ↓ 5: 9.6 ↘	1. Serie 5 Skott 	1: 9.2 ↘ 2: 10.1 ↑ 3: 9.3 ↓ 4: 9.6 ↑ 5: 10.6x ↖	Serie	47
	Total	0		Total	47
2. Serie 5 Skott 	1: 7.4 → 2: 9.4 → 3: 9.7 → 4: 9.8 ↑ 5: 9.8 ←	3. Serie 5 Skott 	1: 7.3 ← 2: 8.2 ← 3: 8.3 ← 4: 8.2 ↘ 5: 6.0 ←	Serie	43
	Total	90		Total	37
Prov 	1: 9.2 ↖ 2: 9.8 ↘ 3: 10.8x ↓	5. Serie 5 Skott 	1: 10.3 → 2: 10.2 ↑ 3: 10.4 → 4: 10.3 ↘ 5: 10.3 →	Serie	28
	Total	127		Total	50
6. Serie 5 Skott 	1: 9.0 ↘ 2: 9.7 ↘ 3: 9.0 ↘ 4: 10.6x ← 5: 9.4 ↖			Serie	46
	Total	223		Total	177

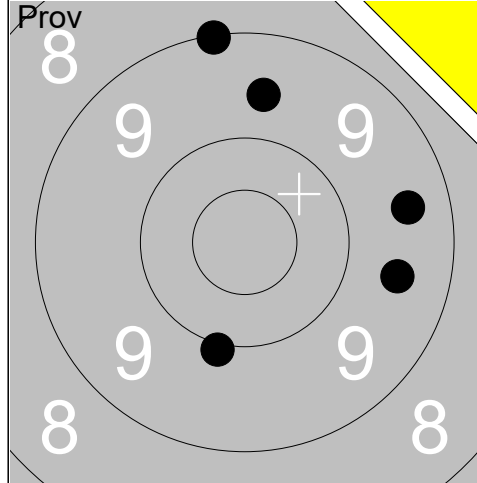

1:	9.6	↑
2:	9.4	→
3:	9.5	→
4:	10.0	↓
5:	9.0	↑
Serie		46
Total		0

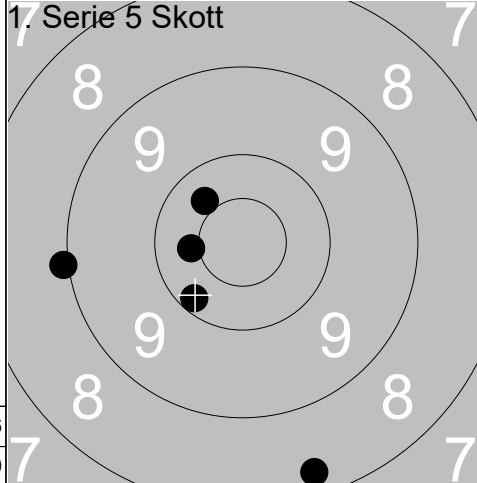

1:	10.4	↖
2:	10.2	↙
3:	8.3	↓
4:	10.4	←
5:	9.0	←
Serie		47
Total		47

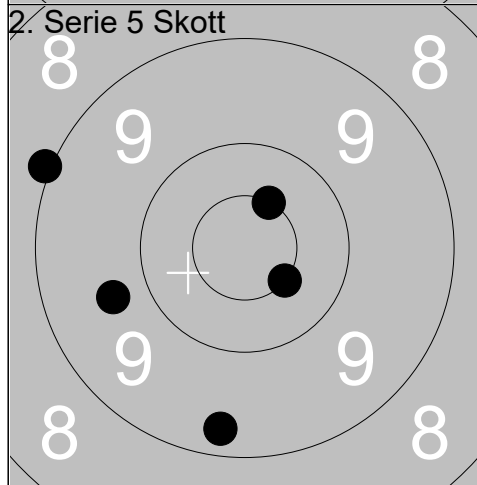

1:	10.5x	↑
2:	9.0	↖
3:	10.5x	↘
4:	9.3	↓
5:	9.7	←
Serie		47
Total		94

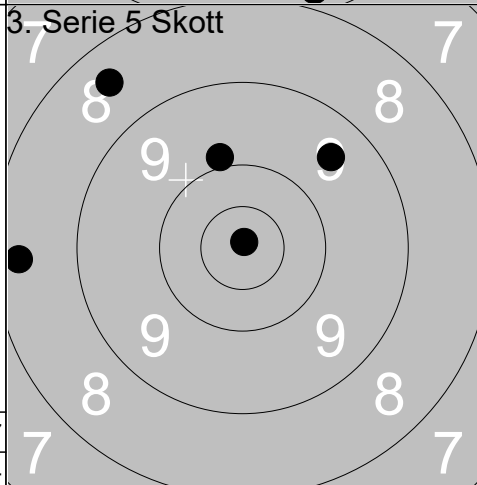

1:	8.3	←
2:	9.5	↗
3:	8.5	↖
4:	9.9	↑
5:	10.9x	↑
Serie		44
Total		138

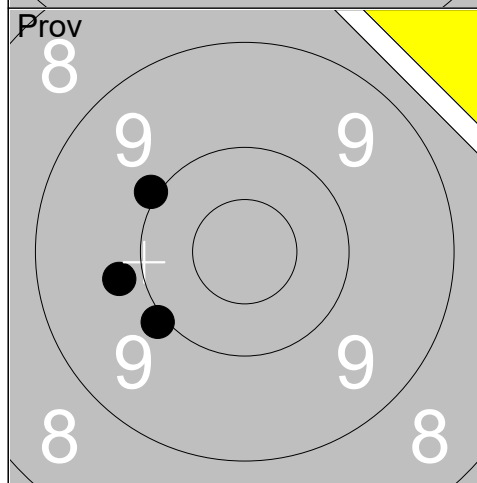

1:	10.0	↖
2:	10.0	←
3:	9.8	←
Serie		29
Total		138

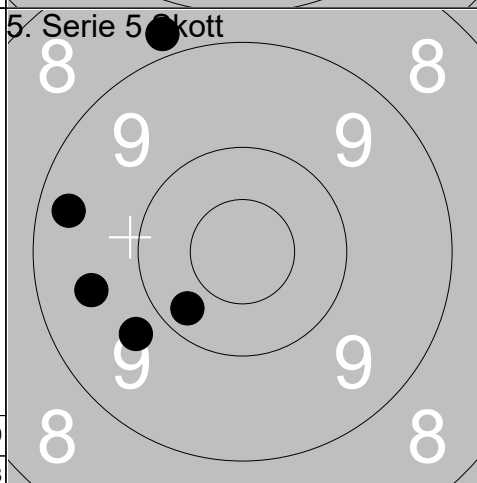

1:	8.8	↖
2:	9.3	←
3:	9.7	↙
4:	9.5	←
5:	10.2	↙
Serie		45
Total		183

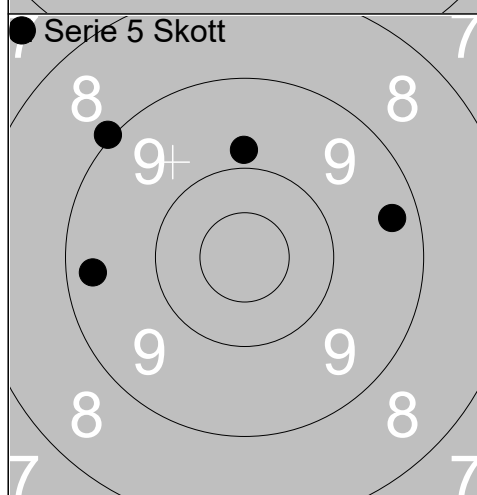

1:	9.8	↑
2:	9.0	↖
3:	7.5	↖
4:	9.3	←
5:	9.3	→
Serie		43
Total		226

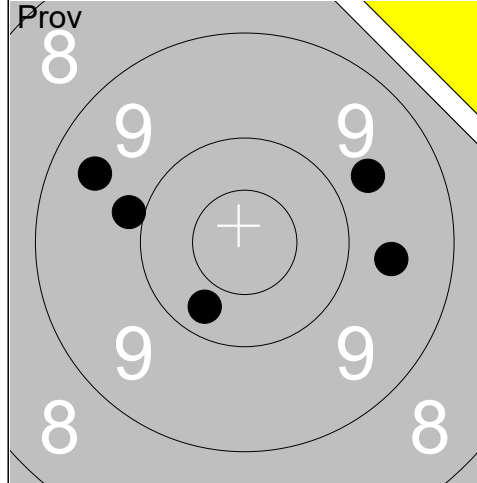

1:	10.3	↘
2:	9.7	→
3:	9.6	→
4:	9.5	↗
5:	9.9	↖
Serie		46
Total		0

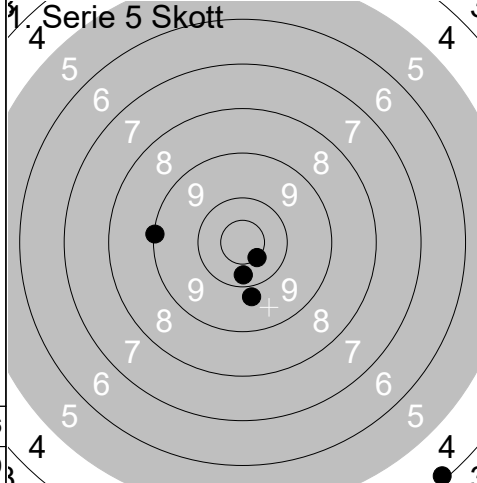

1:	4.1	↘
2:	10.3	↘
3:	10.5x	↘
4:	9.8	↘
5:	9.1	←
Serie		42
Total		42

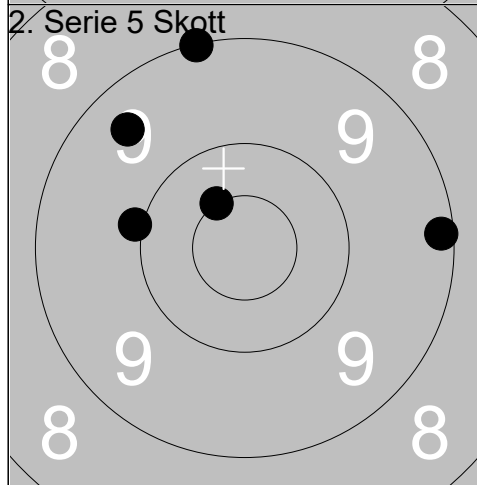

1:	9.1	→
2:	10.0	←
3:	9.4	↗
4:	9.0	↗
5:	10.5x	↗
Serie		47
Total		89

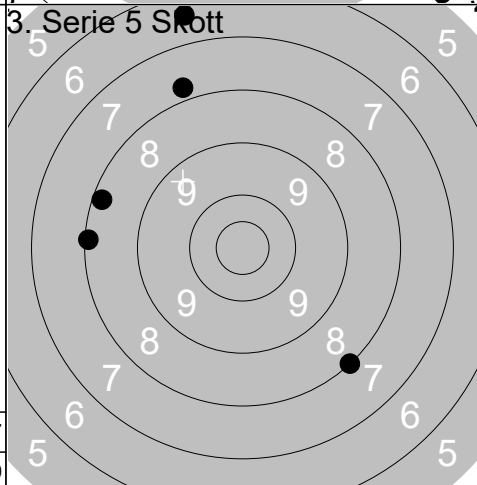

1:	7.8	↗
2:	6.5	↗
3:	8.1	←
4:	8.2	↗
5:	8.0	↘
Serie		37
Total		126

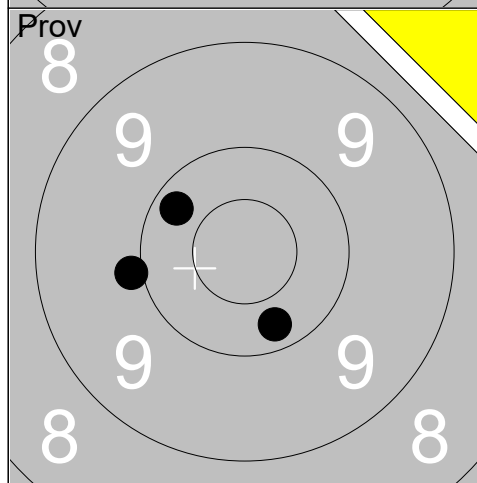

1:	10.2	↗
2:	10.3	↘
3:	9.9	←
Serie		29
Total		126

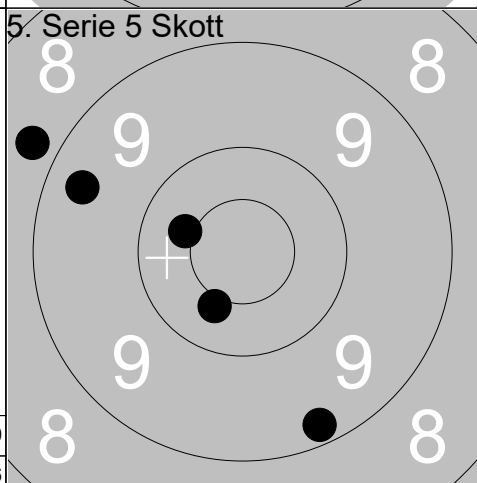

1:	8.8	↗
2:	10.4	↗
3:	9.2	↘
4:	10.4	↘
5:	9.4	↗
Serie		46
Total		172

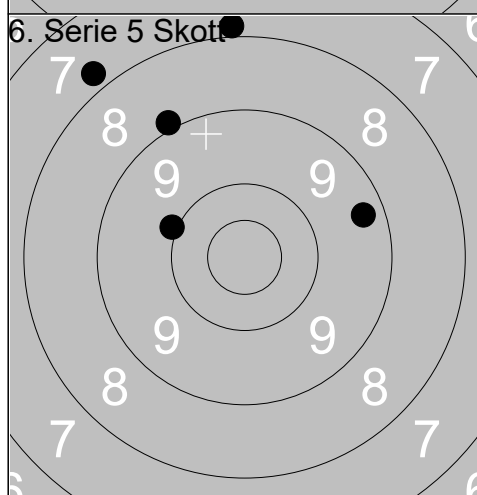

1:	9.3	→
2:	8.9	↗
3:	7.9	↗
4:	7.8	↗
5:	10.0	↖
Serie		41
Total		213

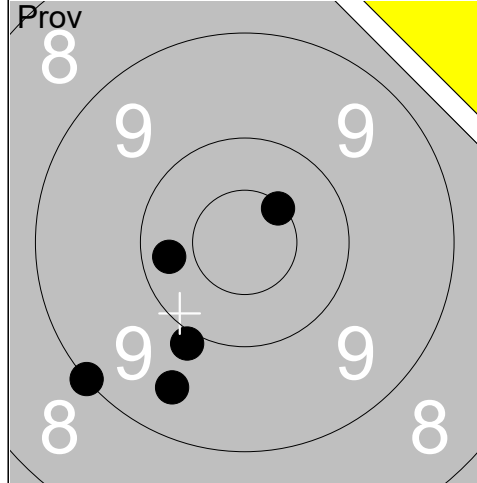

1:	9.0	↙
2:	10.3	←
3:	9.5	↙
4:	9.9	↙
5:	10.5x	↗
Serie		47
Total		0

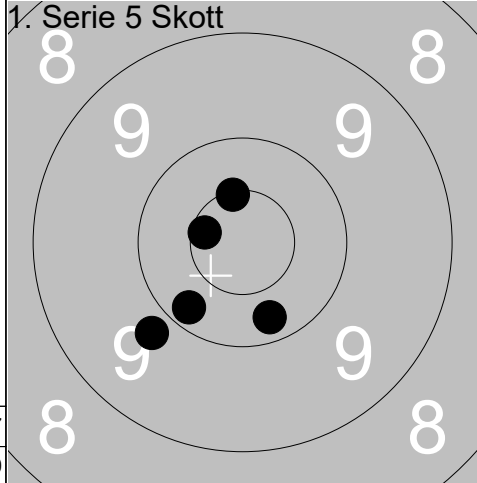

1:	10.2	↘
2:	9.8	↙
3:	10.2	↙
4:	10.5x	↑
5:	10.6x	←
Serie		49
Total		49

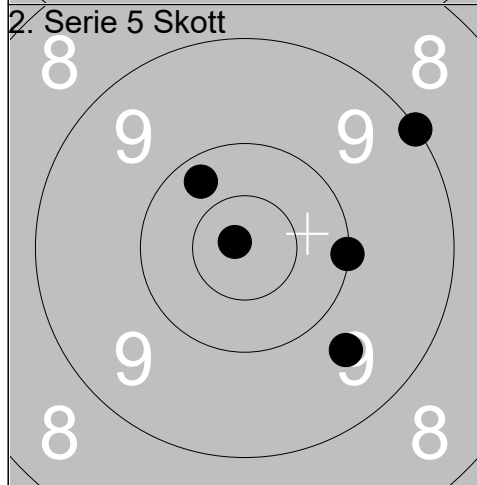

1:	10.2	↗
2:	10.8x	↗
3:	10.0	→
4:	9.7	↘
5:	9.0	↗
Serie		48
Total		97

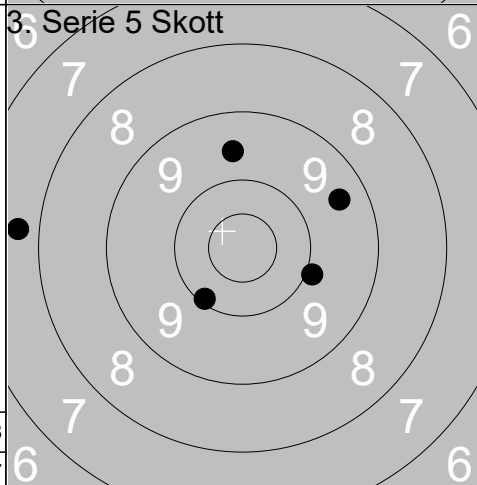

1:	9.4	↗
2:	9.9	→
3:	9.6	↑
4:	7.7	←
5:	10.1	↘
Serie		44
Total		141

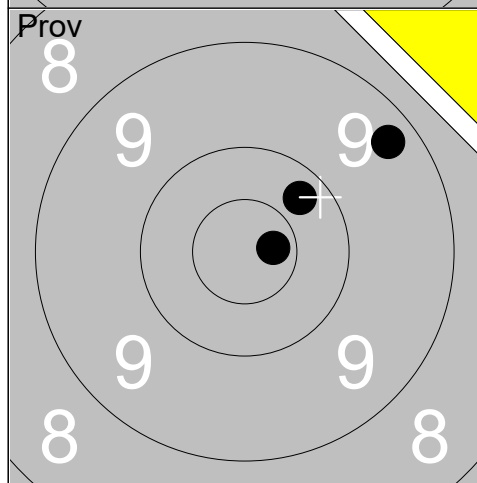

1:	10.7x	→
2:	9.3	↗
3:	10.3	↗
Serie		29
Total		141

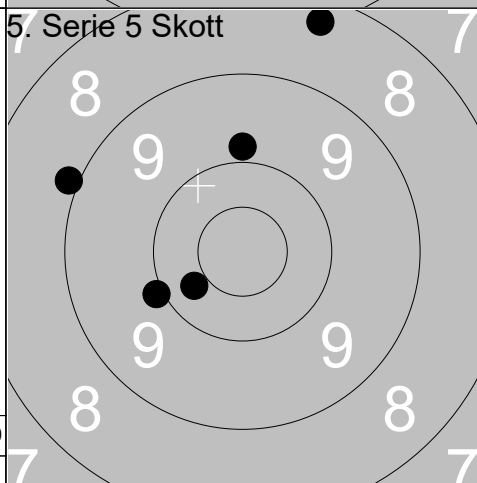

1:	10.3	↙
2:	8.3	↑
3:	8.9	↙
4:	9.8	↑
5:	10.0	↙
Serie		45
Total		186

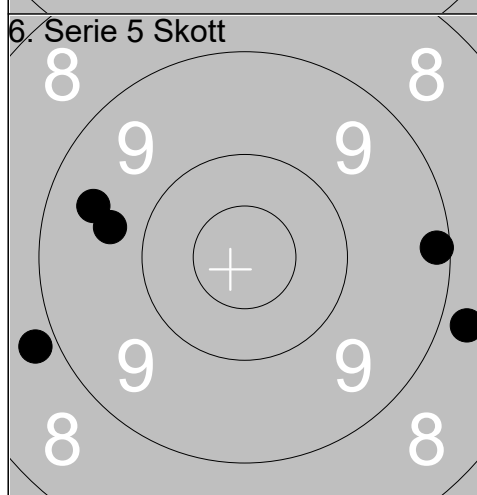

1:	9.5	←
2:	9.2	→
3:	8.8	→
4:	8.8	↙
5:	9.7	←
Serie		43
Total		229

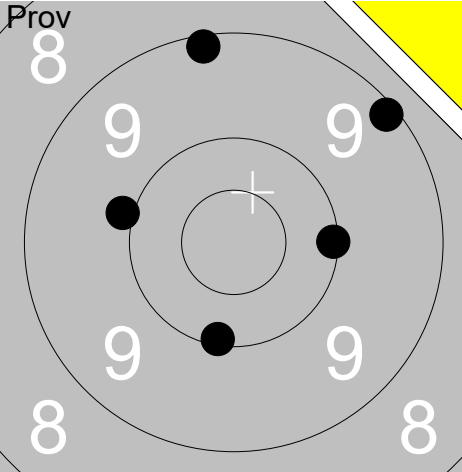
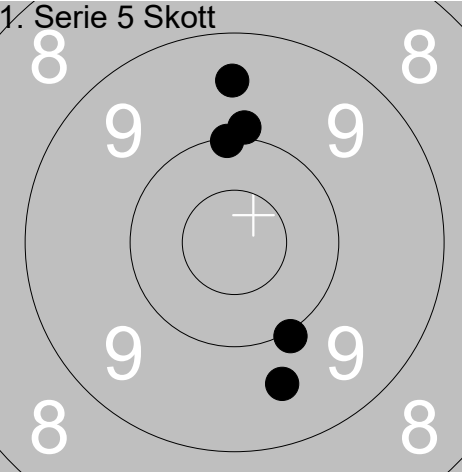
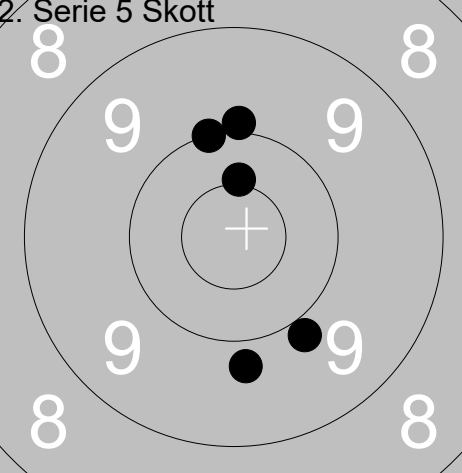
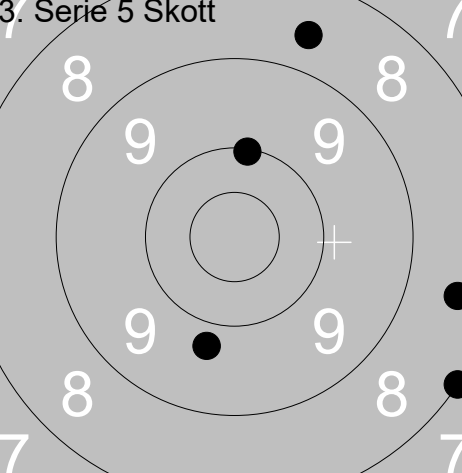
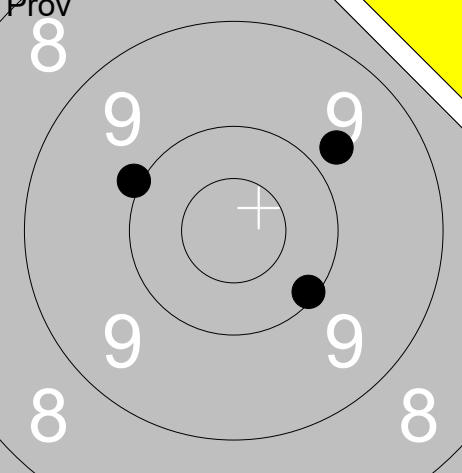
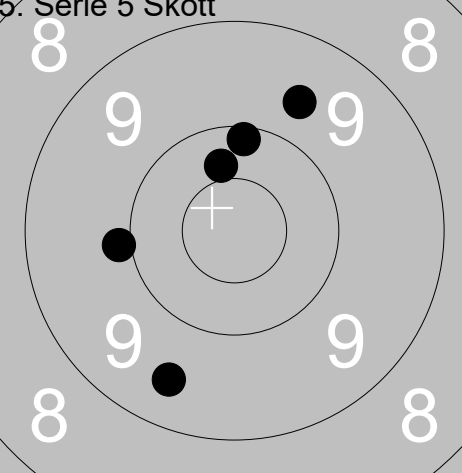
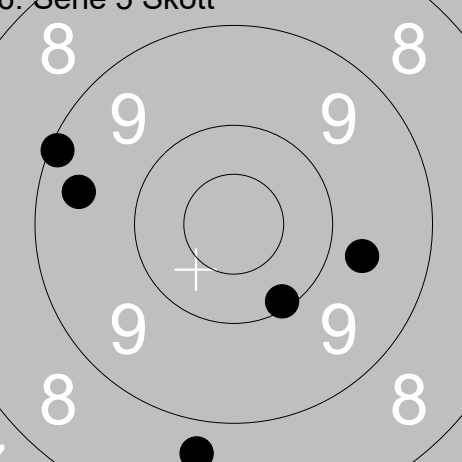
Skjutlag 4	Tavla 4	Bengt Jansson	
Ramselefors		Söderala	SenE Gä
06.07.2019		Björskottet 2019	Ramselefors SKF
Prov 	1: 9.1 ↗ 2: 10.1 → 3: 9.1 ↑ 4: 9.9 ← 5: 10.1 ↓ Serie 47 Total 0	1. Serie 5 Skott 	1: 9.6 ↓ 2: 10.1 ↑ 3: 9.9 ↑ 4: 9.5 ↑ 5: 10.0 ↓ Serie 47 Total 47
2. Serie 5 Skott 	1: 9.9 ↓ 2: 9.8 ↓ 3: 10.4x ↑ 4: 10.0 ↑ 5: 9.9 ↑ Serie 47 Total 94	3. Serie 5 Skott 	1: 9.8 ↓ 2: 8.4 → 3: 8.0 ↘ 4: 10.1 ↑ 5: 8.6 ↑ Serie 43 Total 137
Prov 	1: 9.8 ↗ 2: 10.1 ↘ 3: 10.0 ↑ Serie 29 Total 137	5. Serie 5 Skott 	1: 10.4 ↑ 2: 9.9 ← 3: 9.5 ↓ 4: 10.1 ↑ 5: 9.7 ↑ Serie 47 Total 184
6. Serie 5 Skott 	1: 9.4 ← 2: 9.1 ↗ 3: 9.7 → 4: 10.1 ↓ 5: 8.7 ↓ Serie 45 Total 229		

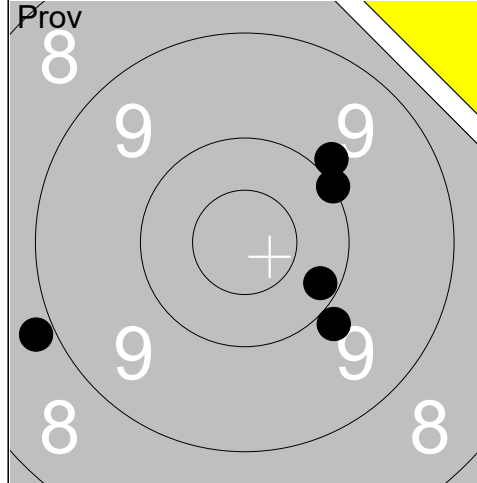

1:	10.0	↗
2:	9.9	↗
3:	9.9	↘
4:	10.2	↘
5:	8.9	↙
Serie		46
Total		0

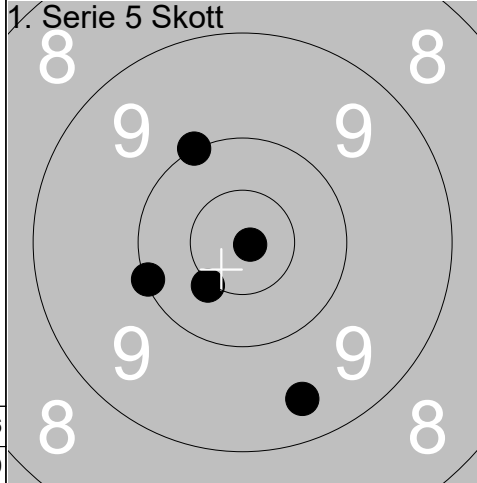

1:	9.4	↘
2:	10.0	↗
3:	10.9x	↘
4:	10.5x	↘
5:	10.1	↙
Serie		49
Total		49

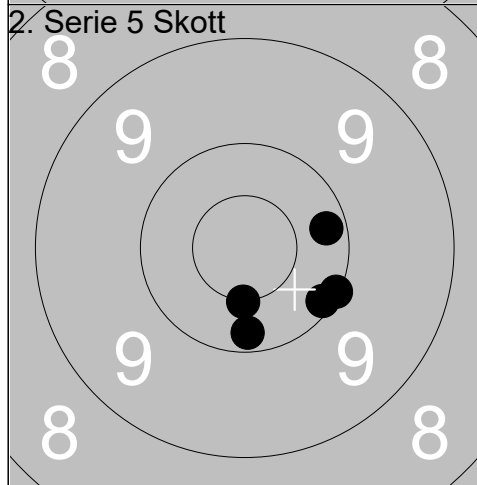

1:	10.1	↘
2:	10.1	↘
3:	10.2	→
4:	10.5x	↘
5:	10.2	↘
Serie		50
Total		99

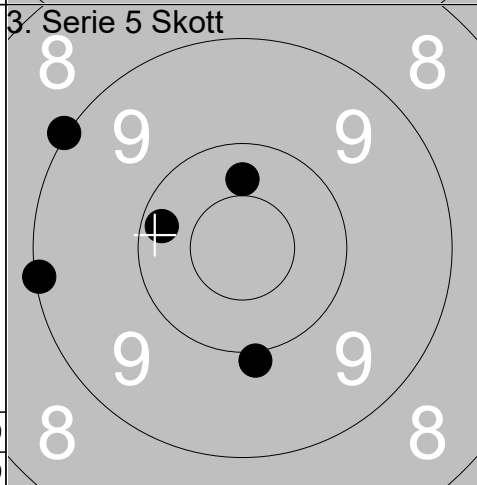

1:	9.0	↖
2:	9.9	↘
3:	9.1	↖
4:	10.2	↖
5:	10.3	↑
Serie		47
Total		146

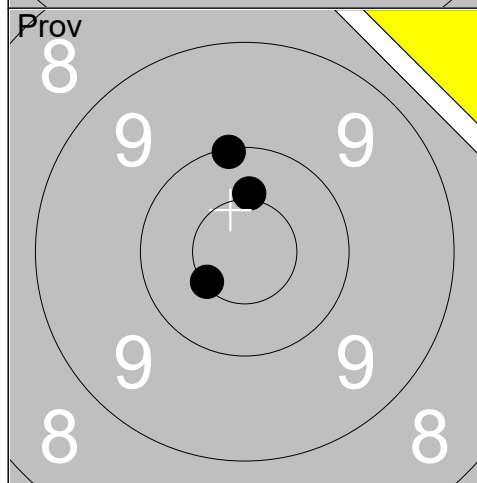

1:	10.4x	↑
2:	10.1	↑
3:	10.5x	↙
Serie		30
Total		146

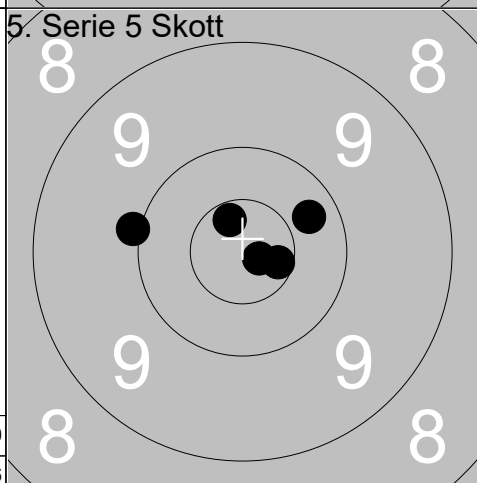

1:	10.6x	↗
2:	10.0	↖
3:	10.6x	↘
4:	10.8x	↘
5:	10.3	↗
Serie		50
Total		196

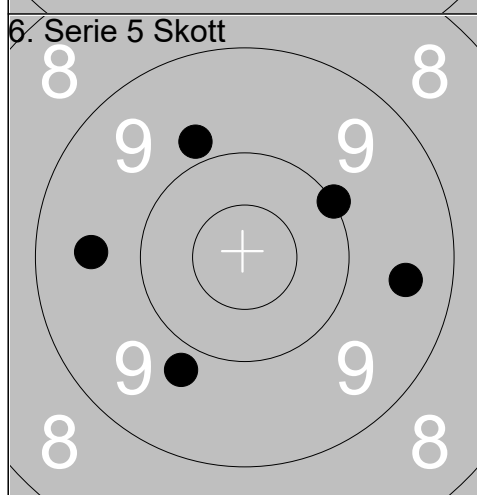

1:	9.8	↘
2:	9.8	↗
3:	9.6	↖
4:	9.5	→
5:	10.0	↗
Serie		46
Total		242

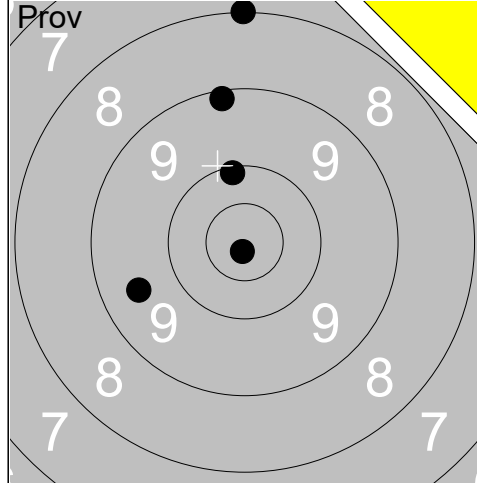

1:	8.0	↑
2:	10.1	↑
3:	9.1	↑
4:	10.8x	↓
5:	9.5	←
Serie		46
Total		0

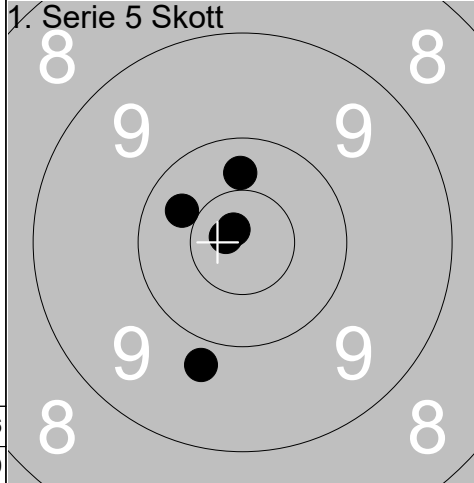

1:	10.3	↑
2:	10.3	↖
3:	10.8x	↖
4:	9.8	↓
5:	10.8x	↗
Serie		49
Total		49

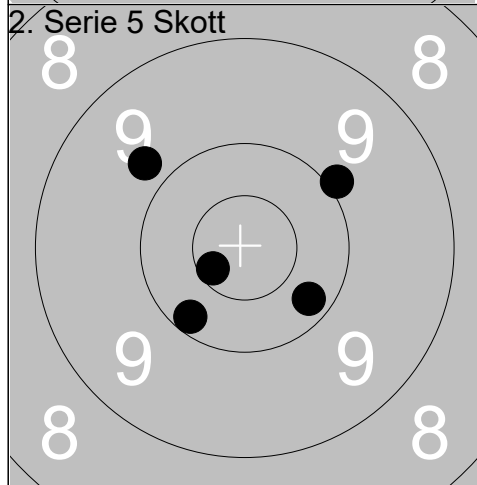

1:	9.8	↖
2:	10.2	↙
3:	10.6x	↙
4:	9.9	↗
5:	10.2	↘
Serie		48
Total		97

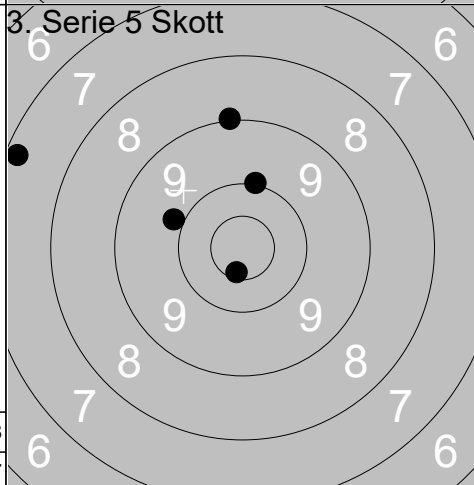

1:	9.0	↑
2:	9.9	↖
3:	10.0	↑
4:	7.2	↖
5:	10.6x	↓
Serie		45
Total		142

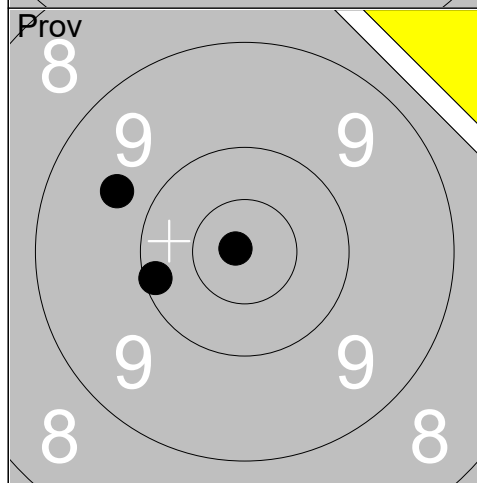

1:	10.1	←
2:	9.7	↖
3:	10.9x	↖
Serie		29
Total		142

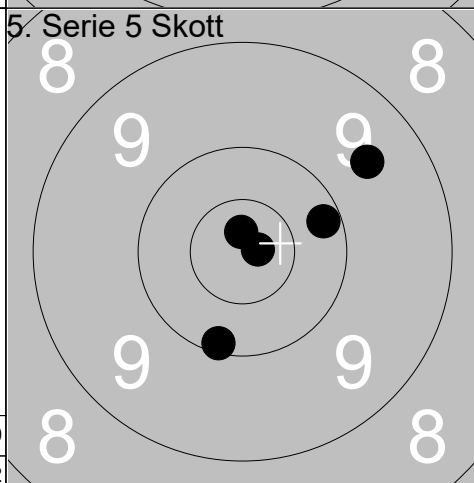

1:	10.8x	↑
2:	10.1	↓
3:	10.2	→
4:	10.8x	→
5:	9.6	↗
Serie		49
Total		191

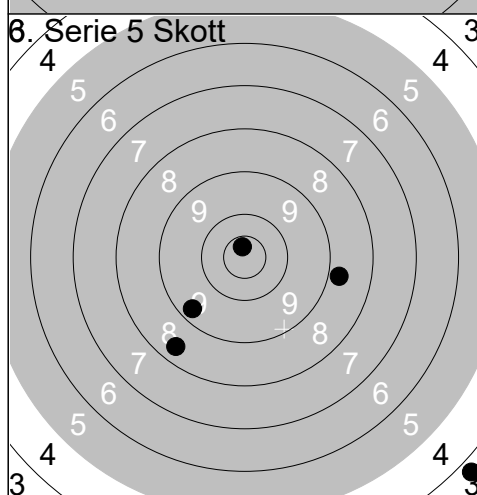

1:	9.3	↙
2:	10.7x	↑
3:	8.8	→
4:	3.7	↘
5:	8.4	↙
Serie		38
Total		229

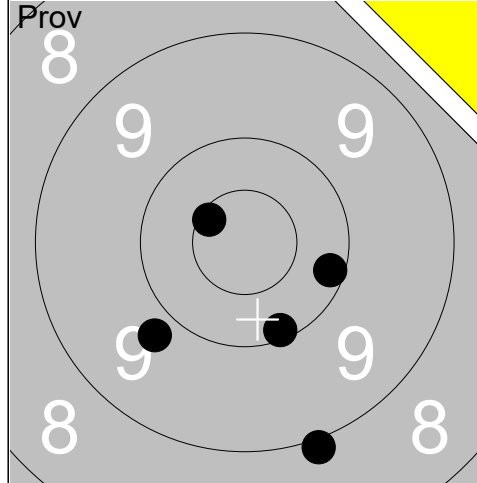

1:	10.2	→
2:	10.6x	↗
3:	10.1	↓
4:	9.8	↘
5:	8.9	↓
Serie		47
Total		0

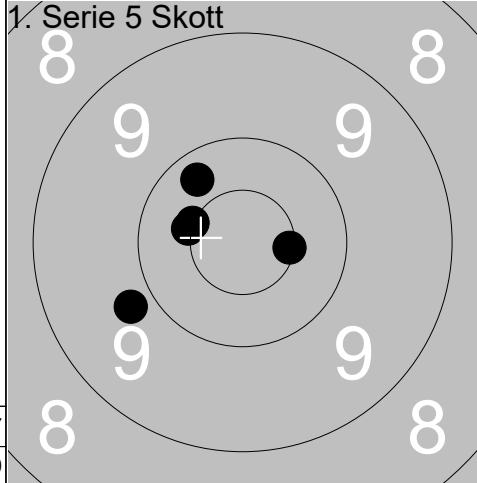

1:	10.3	↗
2:	10.5x	←
3:	9.8	↘
4:	10.5x	←
5:	10.5x	→
Serie		49
Total		49

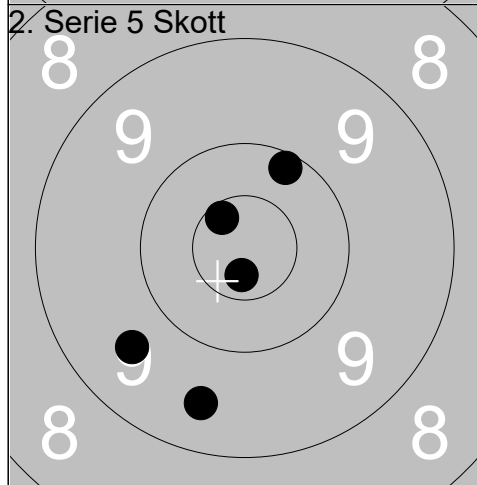

1:	9.5	↓
2:	10.6x	↗
3:	10.7x	↓
4:	9.6	↘
5:	10.2	↗
Serie		48
Total		97

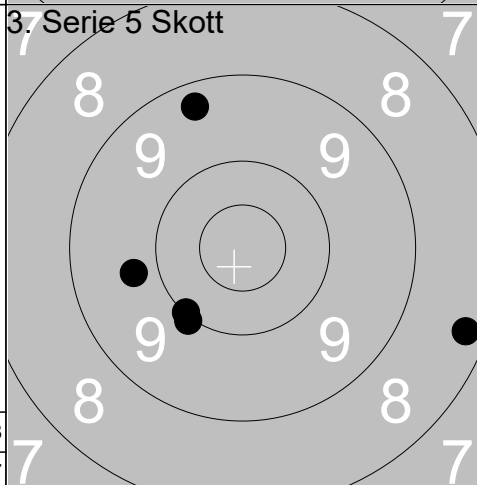

1:	10.0	↘
2:	9.7	←
3:	8.3	→
4:	10.0	↘
5:	9.3	↗
Serie		46
Total		143

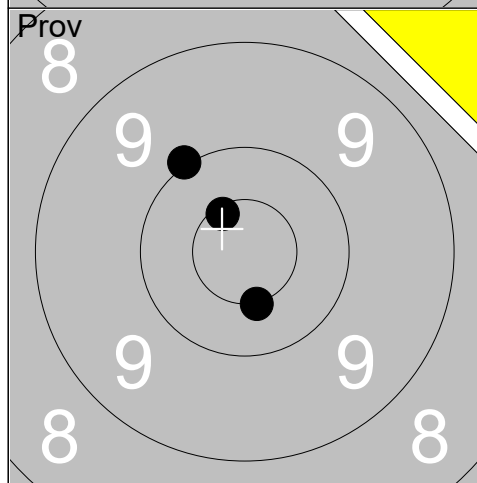

1:	10.0	↗
2:	10.6x	↗
3:	10.5x	↓
Serie		30
Total		143

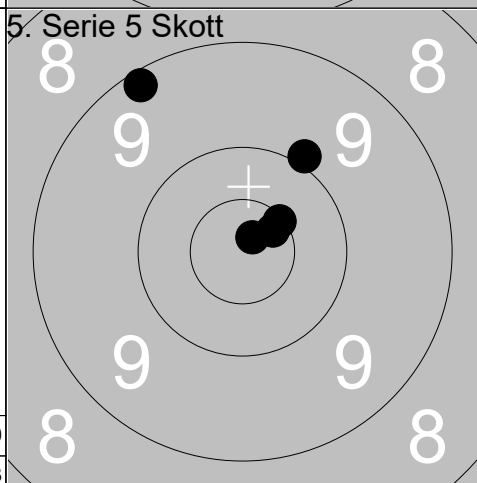

1:	9.9	↗
2:	9.2	↗
3:	10.6x	↗
4:	10.5x	↗
5:	10.8x	↗
Serie		48
Total		191

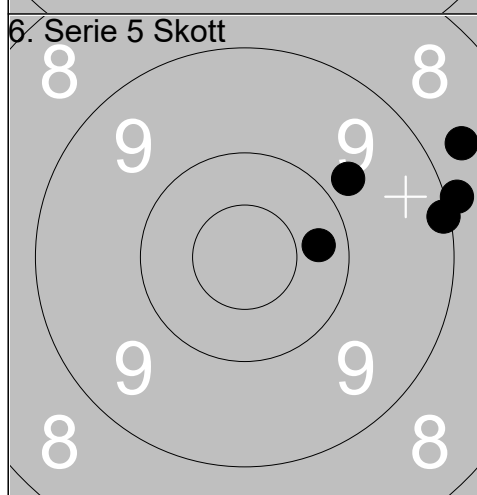

1:	10.3	→
2:	9.1	→
3:	9.8	↗
4:	8.9	→
5:	8.7	↗
Serie		44
Total		235

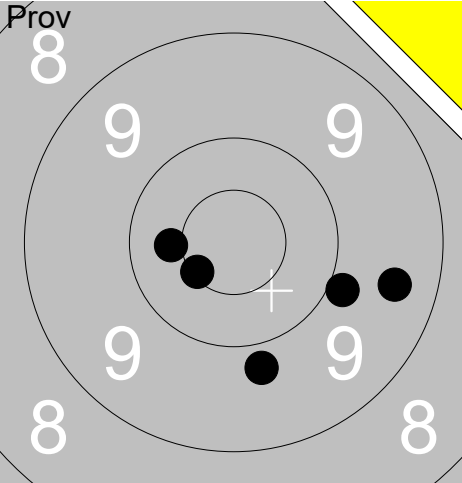
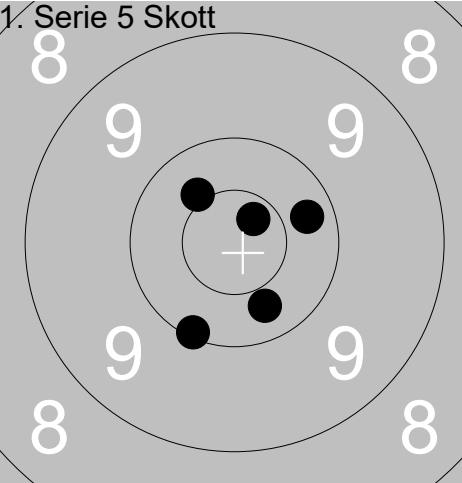
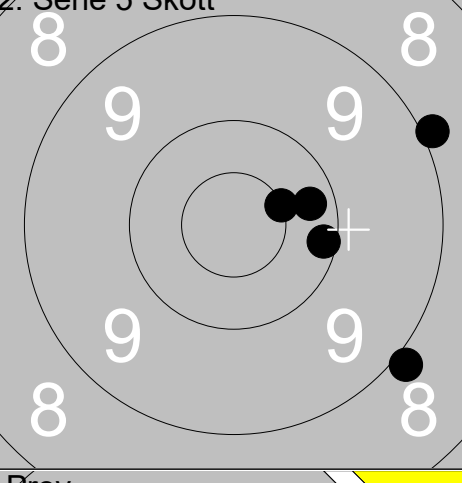
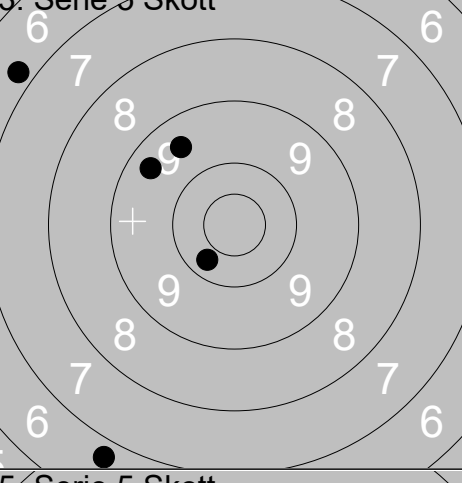
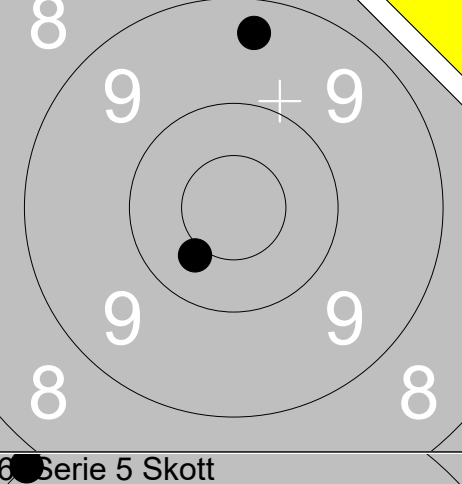
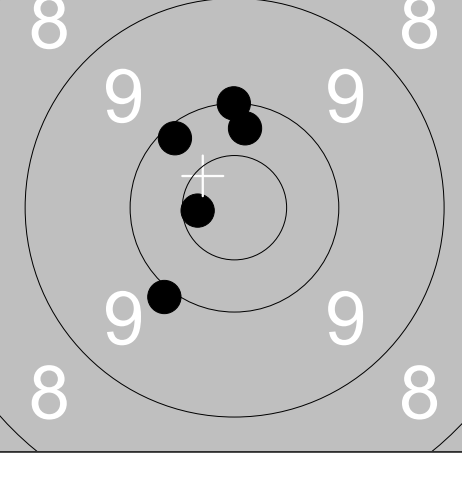
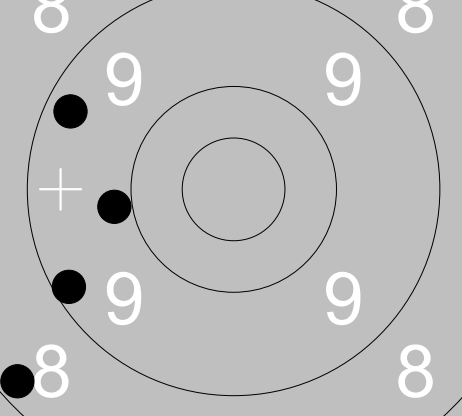
Skjutlag 4	Tavla 8	Martin Nilsson	
Ramselefors		Kvistbro	SenE Ör
06.07.2019		Björskottet 2019	Ramselefors SKF
Prov 	1: 9.4 → 2: 9.8 ↓ 3: 10.4 ← 4: 10.5x ↙ 5: 9.9 → Serie 47 Total 0	1. Serie 5 Skott 	1: 10.3 → 2: 10.1 ↓ 3: 10.7x ↗ 4: 10.4x ↗ 5: 10.3 ↓ Serie 50 Total 50
2. Serie 5 Skott 	1: 8.9 → 2: 10.1 → 3: 10.3 → 4: 10.5x → 5: 8.9 ↓ Serie 46 Total 96	3. Serie 5 Skott 	1: 9.5 ↗ 2: 10.3 ↓ 3: 9.4 ↗ 4: 6.7 ↓ 5: 6.8 ↗ Serie 40 Total 136
Prov 	1: 8.6 ↗ 2: 9.3 ↑ 3: 10.4 ↓ Serie 27 Total 136	5. Serie 5 Skott 	1: 10.6x ← 2: 10.1 ↗ 3: 10.2 ↑ 4: 9.9 ↓ 5: 10.0 ↑ Serie 49 Total 185
6. Serie 5 Skott 	1: 8.0 ↗ 2: 8.2 ↓ 3: 9.2 ← 4: 9.9 ← 5: 9.3 ↗ Serie 43 Total 228		

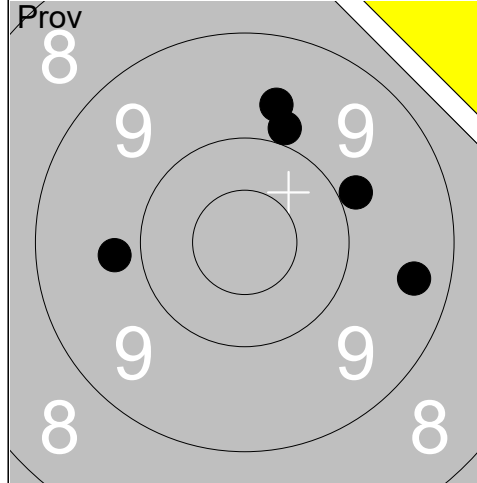

1:	9.4	→
2:	9.7	↑
3:	9.9	↑
4:	9.9	→
5:	9.8	←

Serie	45
Total	0

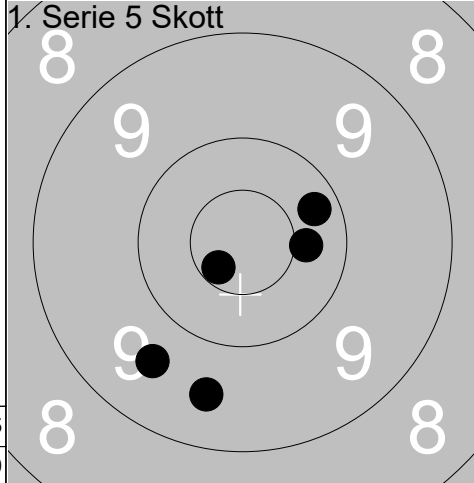

1:	9.5	↓
2:	10.3	→
3:	10.6x	↙
4:	9.6	↙
5:	10.4	→

Serie	48
Total	48

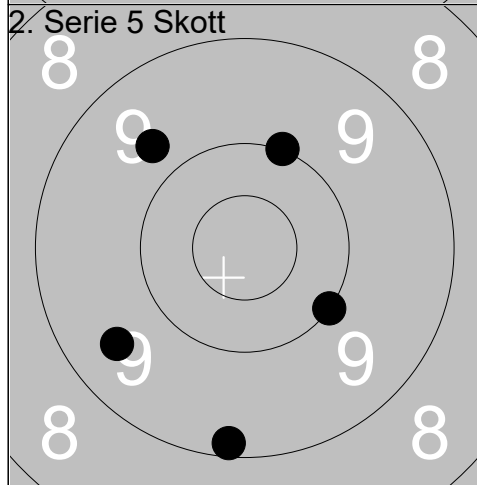

1:	9.7	↖
2:	10.0	↑
3:	9.2	↓
4:	9.5	↙
5:	10.0	↘

Serie	47
Total	95

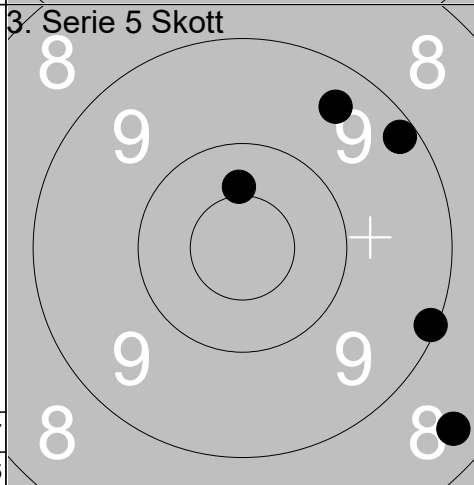

1:	9.4	↗
2:	8.4	↘
3:	10.4	↑
4:	9.2	↗
5:	9.1	↘

Serie	45
Total	140

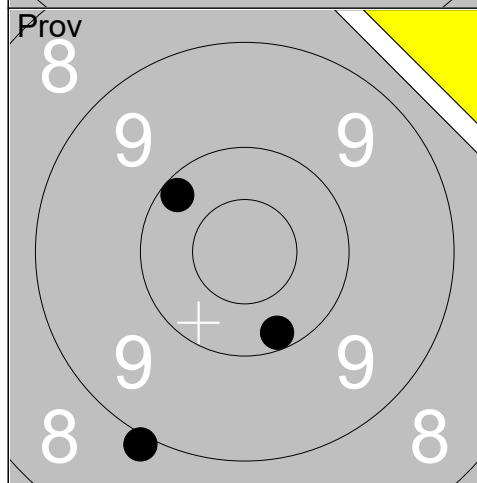

1:	8.9	↙
2:	10.2	↙
3:	10.2	↗

Serie	28
Total	140

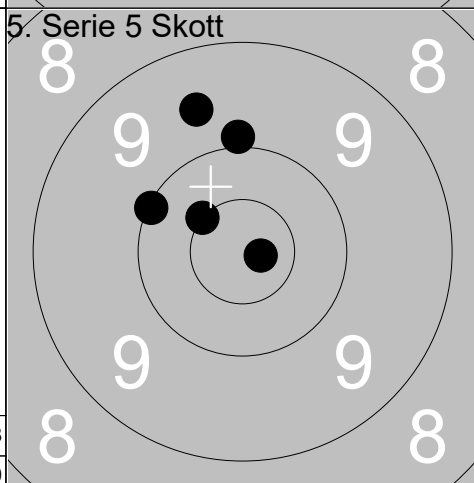

1:	10.8x	→
2:	9.9	↑
3:	9.6	↑
4:	10.0	↖
5:	10.5x	↖

Serie	48
Total	188

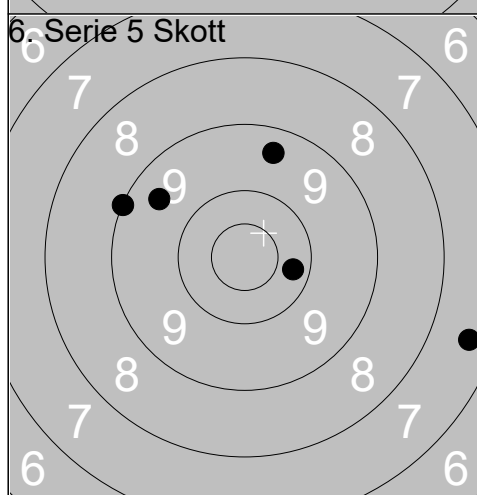

1:	9.5	↗
2:	9.0	↖
3:	9.4	↑
4:	7.4	↘
5:	10.3	→

Serie	44
Total	232

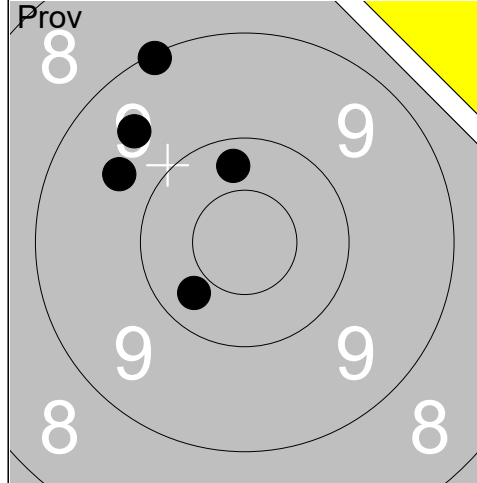

1:	10.3	↙
2:	9.1	↗
3:	9.5	↗
4:	10.3	↗
5:	9.7	↗
Serie		47
Total		0

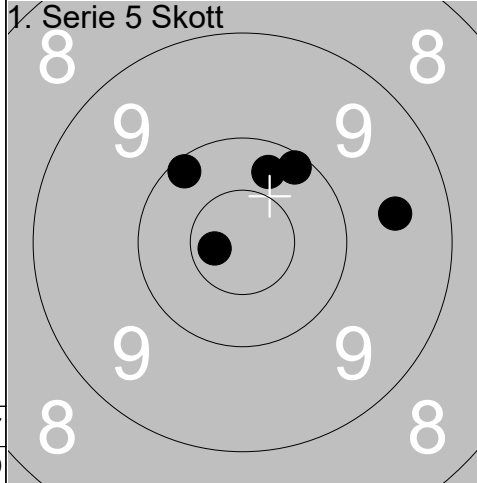

1:	9.5	→
2:	10.7x	←
3:	10.3	↗
4:	10.1	↗
5:	10.1	↖
Serie		49
Total		49

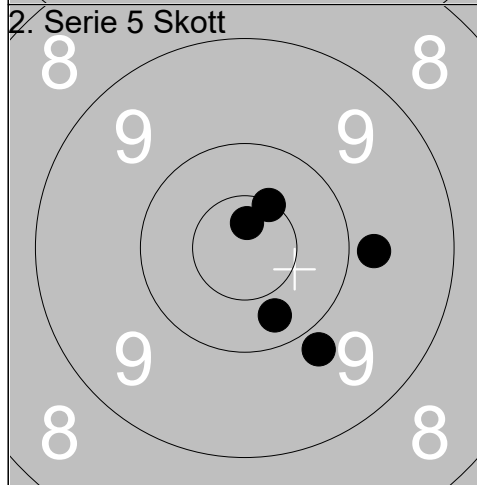

1:	9.8	↘
2:	9.8	→
3:	10.5x	↗
4:	10.7x	↗
5:	10.3	↘
Serie		48
Total		97

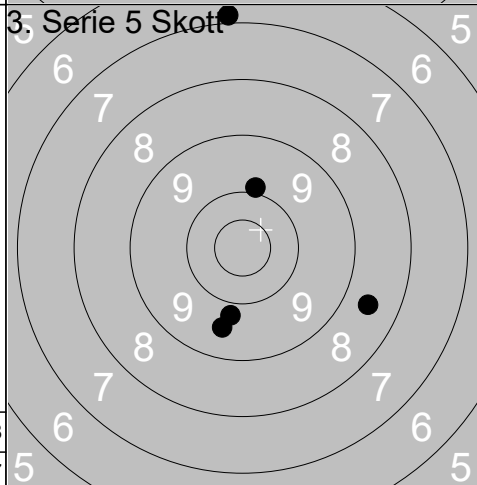

1:	8.6	→
2:	9.8	↓
3:	9.9	↗
4:	9.6	↓
5:	6.9	↗
Serie		41
Total		138

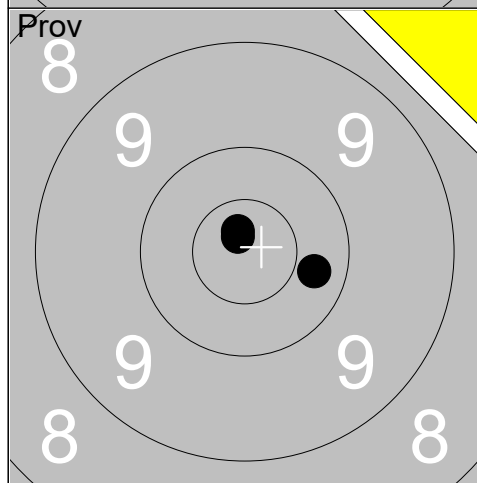

1:	10.3	→
2:	10.8x	↗
3:	10.8x	↗
Serie		30
Total		138

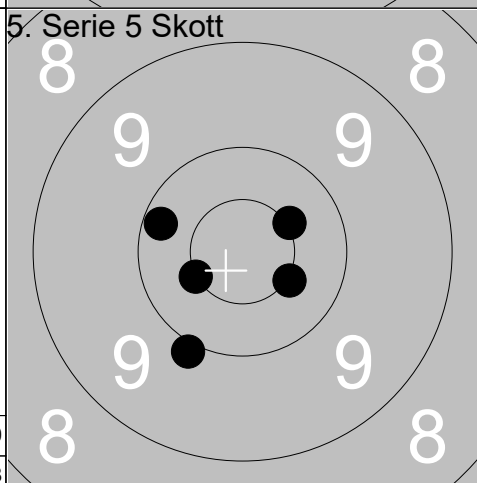

1:	10.5x	↗
2:	10.2	←
3:	10.5x	↘
4:	10.5x	←
5:	9.9	↓
Serie		49
Total		187

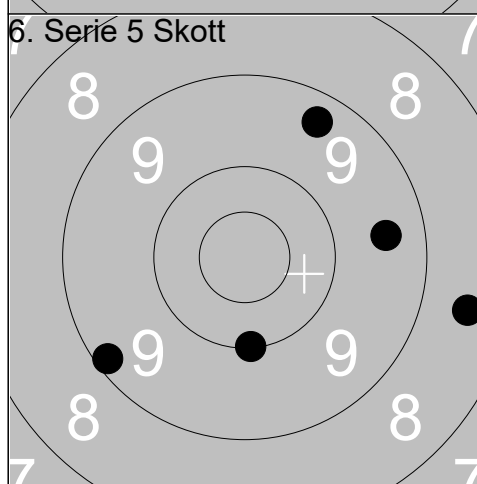

1:	8.5	→
2:	9.3	↗
3:	9.5	→
4:	9.2	↙
5:	10.0	↓
Serie		45
Total		232

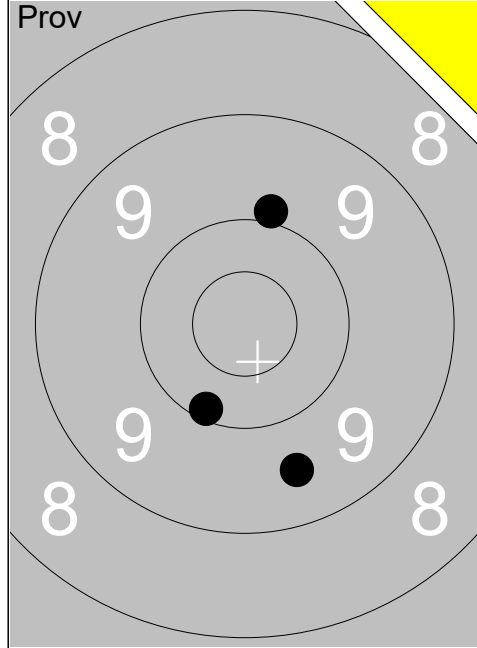

1:	9.5	↘
2:	9.9	↑
3:	10.1	↘
Serie		28
Total		0

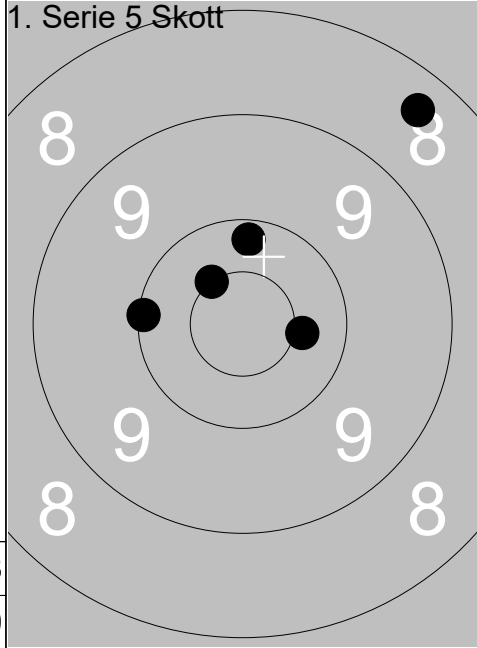

1:	10.1	←
2:	8.4	↗
3:	10.2	↑
4:	10.4x	→
5:	10.5x	↖
Serie		48
Total		48

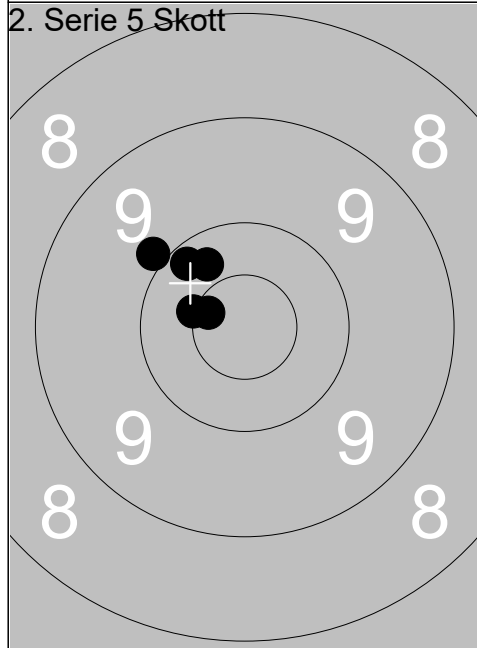

1:	10.3	↖
2:	10.6x	↖
3:	10.2	↗
4:	10.5x	↖
5:	9.9	↖
Serie		49
Total		97

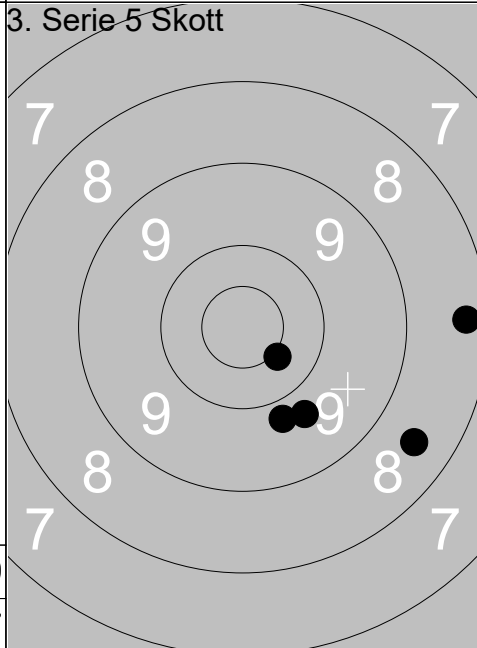

1:	8.3	→
2:	9.8	↘
3:	10.4x	↘
4:	8.5	↘
5:	9.7	↘
Serie		44
Total		141

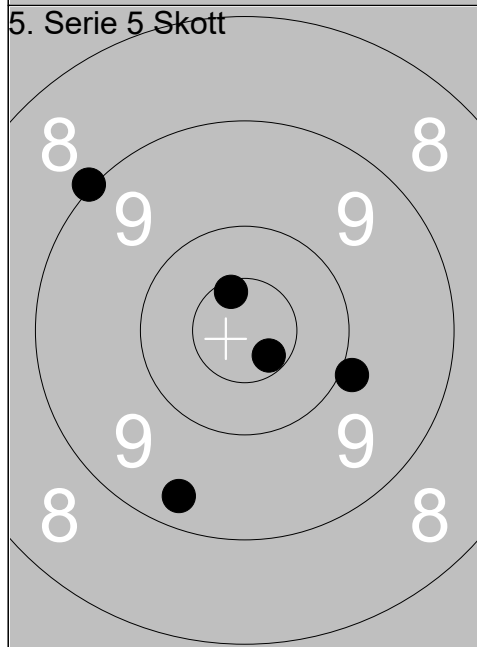

1:	9.9	→
2:	10.6x	↖
3:	9.0	↗
4:	9.3	↘
5:	10.6x	↘
Serie		47
Total		188

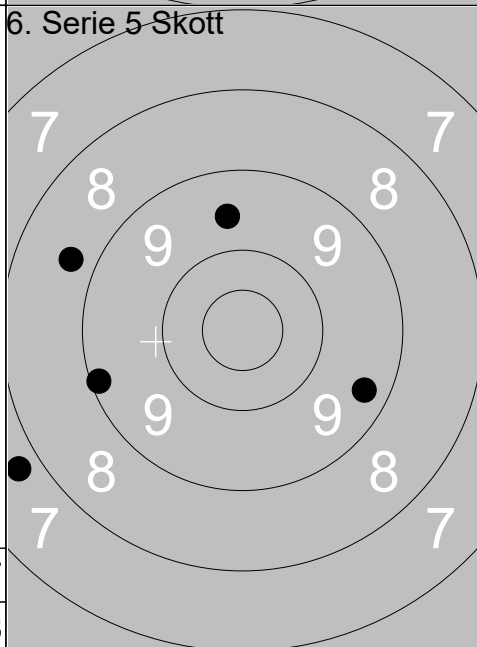

1:	9.3	↘
2:	9.6	↑
3:	8.7	↖
4:	9.1	↖
5:	7.8	↖
Serie		42
Total		230

<p>Prov 7</p>	<p>1: 7.5 ↘ 2: 8.7 ↓ 3: 9.7 ← 4: 10.5x ↓ 5: 10.2 ↓</p> <p>Serie 44 Total 0</p>	<p>1. Serie 5 Skott 8</p>	<p>1: 9.7 ↓ 2: 10.5x ← 3: 10.5x → 4: 9.9 ↗ 5: 9.8 ↗</p> <p>Serie 47 Total 47</p>
<p>2. Serie 5 Skott 8</p>	<p>1: 10.3 ↗ 2: 10.5x ← 3: 10.5x ↗ 4: 10.0 ← 5: 10.0 ↓</p> <p>Serie 50 Total 97</p>	<p>3. Serie 5 Skott 8</p>	<p>1: 9.9 ↗ 2: 9.5 ↓ 3: 10.2 ↗ 4: 8.9 ↓ 5: 10.6x ←</p> <p>Serie 46 Total 143</p>
<p>Prov 8</p>	<p>1: 10.8x →</p> <p>Serie 10 Total 143</p>	<p>5. Serie 5 Skott 8</p>	<p>1: 10.3 ↗ 2: 10.0 ← 3: 10.7x ↗ 4: 10.8x ← 5: 9.8 ←</p> <p>Serie 49 Total 192</p>
<p>6. Serie 5 Skott 8</p>	<p>1: 9.7 → 2: 9.4 ↗ 3: 10.6x ↗ 4: 9.1 ← 5: 10.5x ↓</p> <p>Serie 47 Total 239</p>		

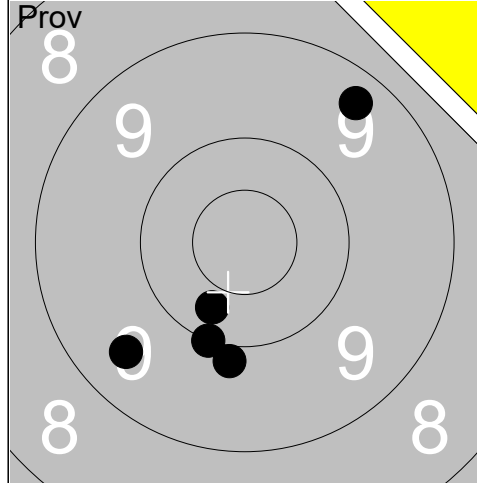

1:	9.3	↗
2:	10.0	↓
3:	10.3	↓
4:	9.5	↙
5:	9.9	↓
Serie		47
Total		0

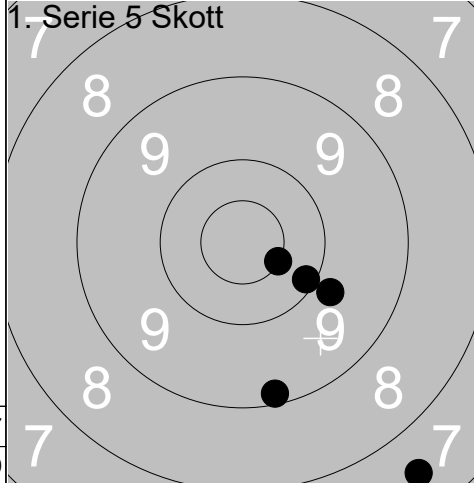

1:	9.8	↘
2:	7.5	↓
3:	9.2	↓
4:	10.1	↘
5:	10.5x	↘
Serie		45
Total		45

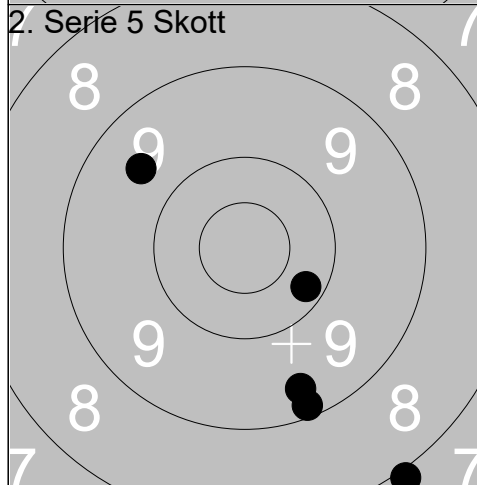

1:	9.6	↗
2:	10.2	↘
3:	7.9	↓
4:	9.2	↓
5:	9.4	↓
Serie		44
Total		89

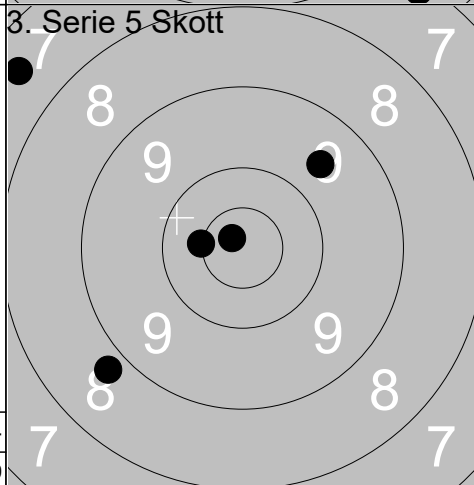

1:	10.5x	←
2:	7.5	↗
3:	10.8x	↗
4:	8.8	↙
5:	9.6	↗
Serie		44
Total		133

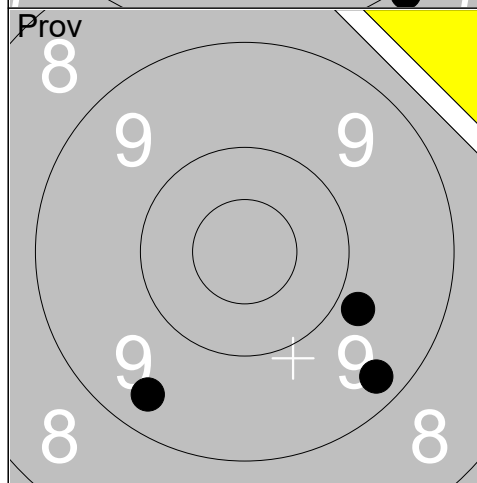

1:	9.8	↘
2:	9.3	↓
3:	9.4	↙
Serie		27
Total		133

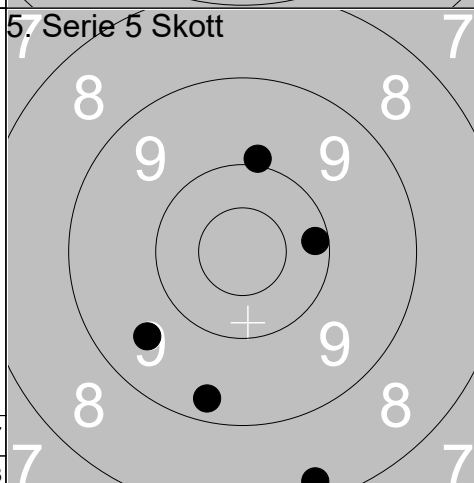

1:	9.9	↑
2:	8.3	↓
3:	9.6	↙
4:	9.3	↓
5:	10.2	→
Serie		45
Total		178

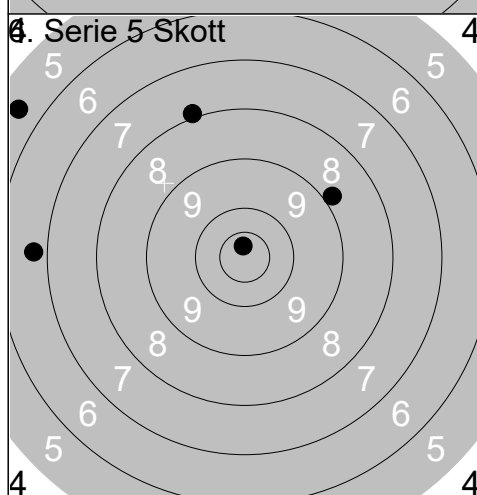

1:	10.7x	↑
2:	8.9	↗
3:	7.9	↗
4:	6.7	←
5:	5.5	↗
Serie		36
Total		214

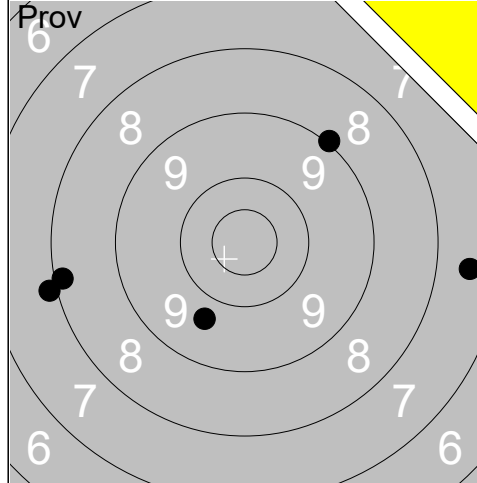

1:	7.5	→
2:	8.1	←
3:	9.0	↗
4:	9.7	↓
5:	7.9	←
Serie		40
Total		0

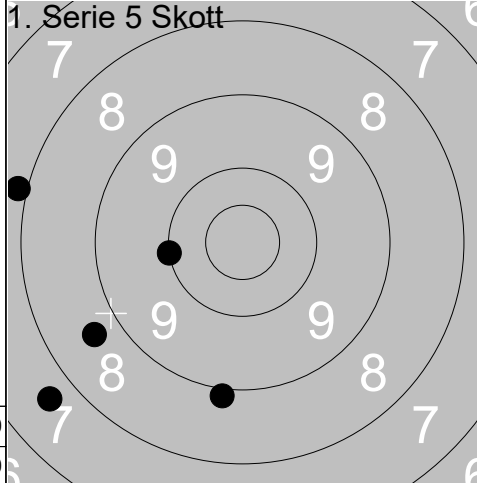

1:	7.9	←
2:	7.7	↙
3:	10.0	←
4:	8.7	↙
5:	8.9	↓
Serie		40
Total		40

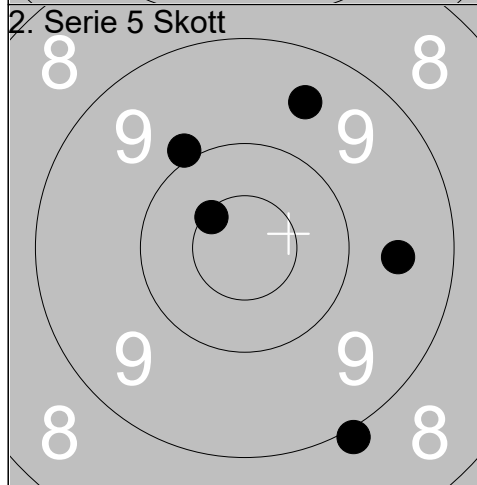

1:	9.6	→
2:	8.9	↘
3:	9.5	↗
4:	9.9	↗
5:	10.5x	↗
Serie		45
Total		85

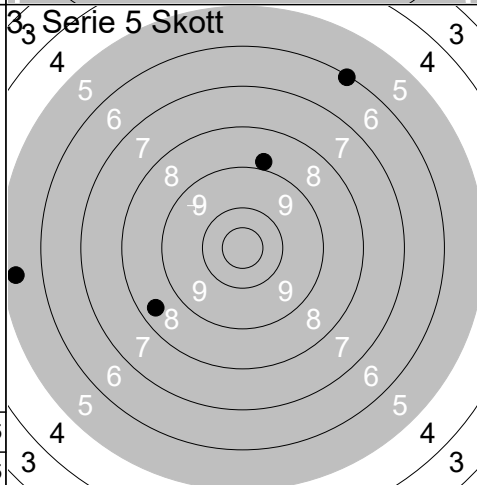

1:	8.4	↙
2:	5.4	←
3:	8.8	↑
4:	6.1	↗
5:	0.0	
Serie		27
Total		112

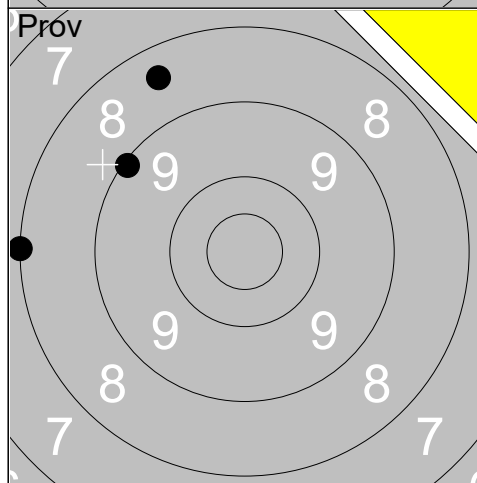

1:	8.4	↗
2:	9.1	↗
3:	8.0	←
Serie		25
Total		112

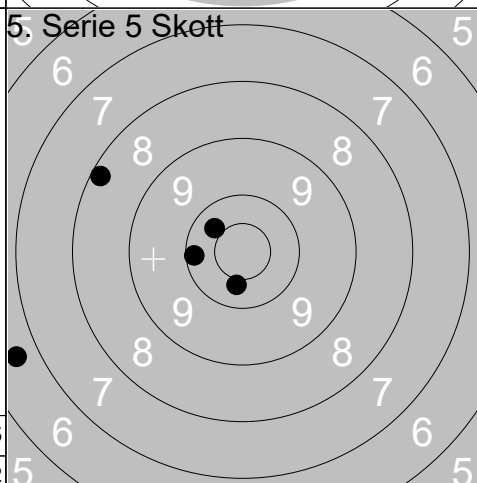

1:	8.2	↙
2:	6.6	←
3:	10.4	↗
4:	10.2	←
5:	10.4	↓
Serie		44
Total		156

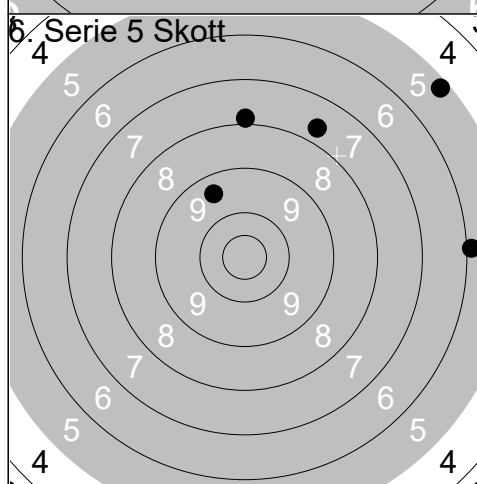

1:	5.9	→
2:	5.2	↗
3:	7.9	↑
4:	7.7	↗
5:	9.4	↗
Serie		33
Total		189

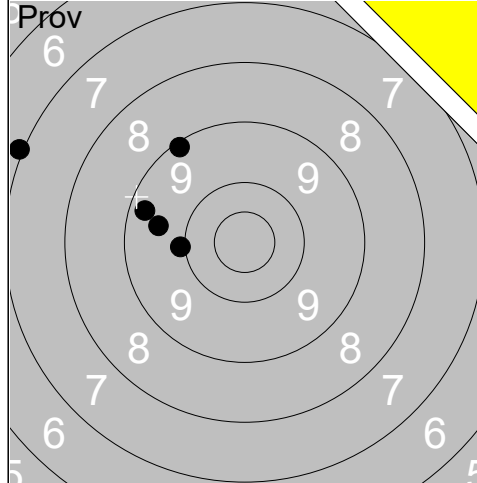

1:	10.0	←
2:	7.0	↗
3:	9.3	↗
4:	9.6	←
5:	9.1	↗
Serie		44
Total		0

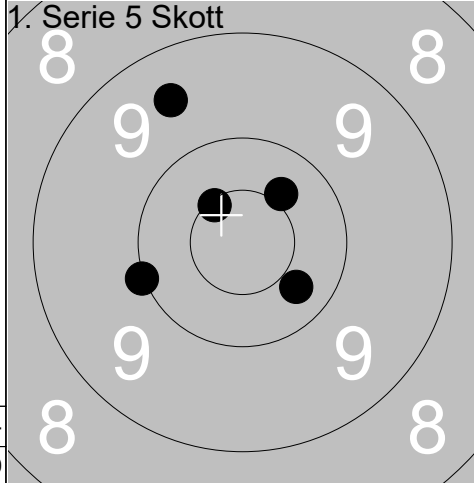

1:	10.0	←
2:	10.3	↘
3:	10.4	↗
4:	9.5	↗
5:	10.5x	↗
Serie		49
Total		49

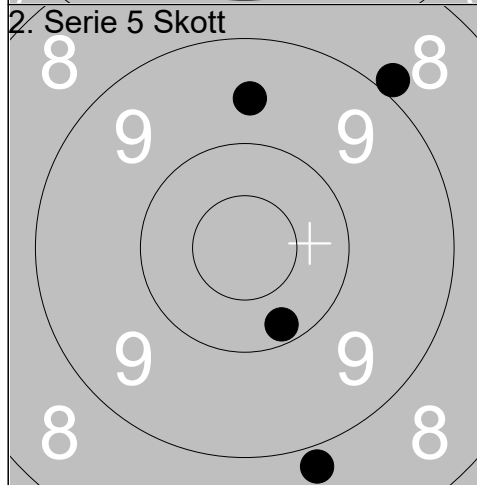

1:	10.2	↘
2:	8.8	↘
3:	9.6	↗
4:	8.9	↗
5:	0.0	
Serie		35
Total		84

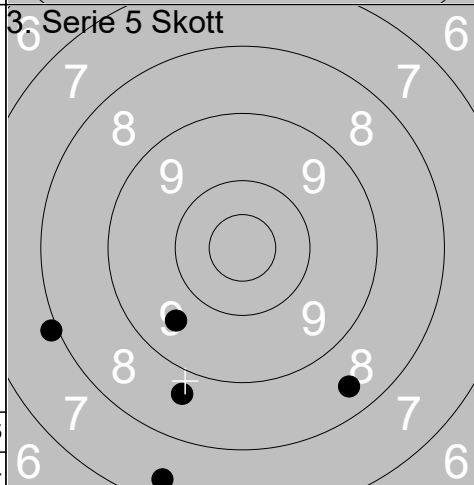

1:	7.4	↘
2:	8.4	↘
3:	8.7	↘
4:	7.9	←
5:	9.6	↘
Serie		39
Total		123

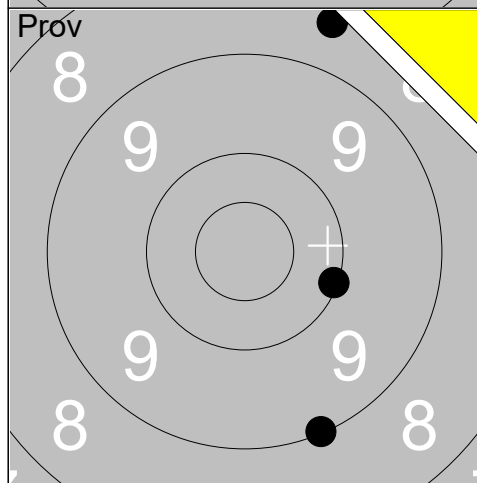

1:	8.5	↗
2:	10.1	→
3:	9.0	↘
Serie		27
Total		123

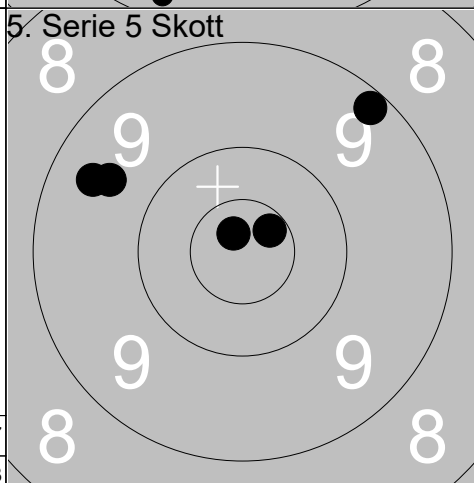

1:	9.2	↗
2:	9.6	←
3:	10.8x	↗
4:	10.6x	↗
5:	9.4	←
Serie		47
Total		170

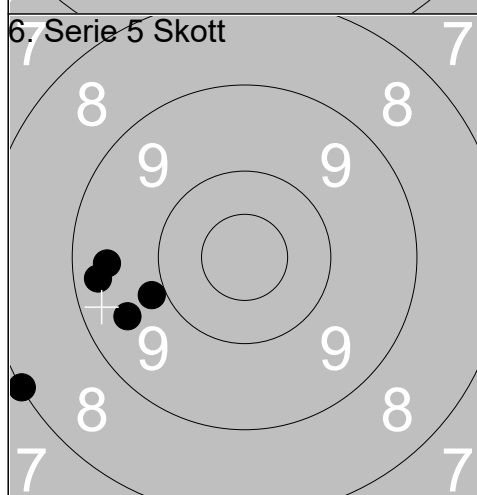

1:	9.5	←
2:	9.4	←
3:	8.0	←
4:	9.3	←
5:	9.9	←
Serie		44
Total		214

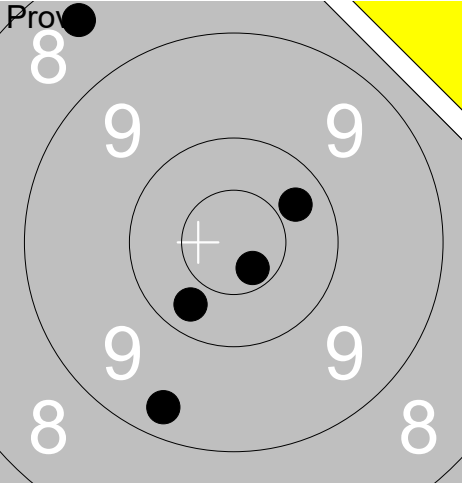
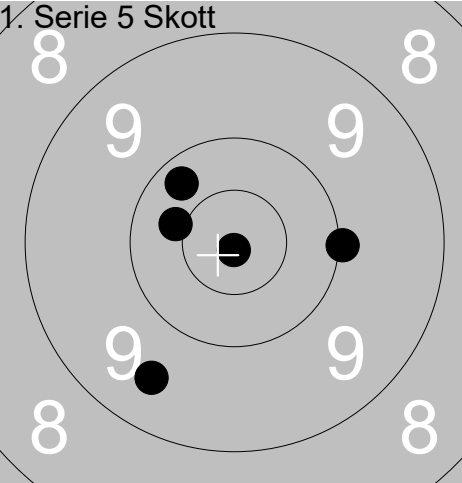
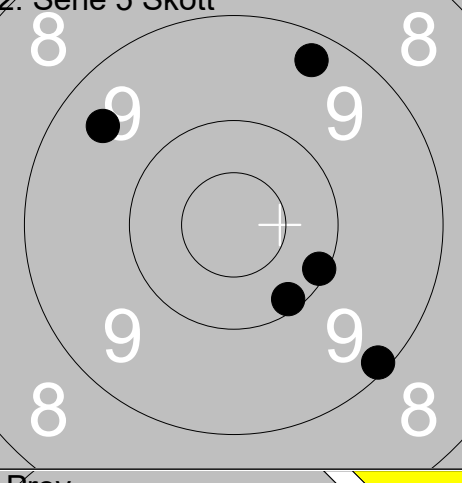
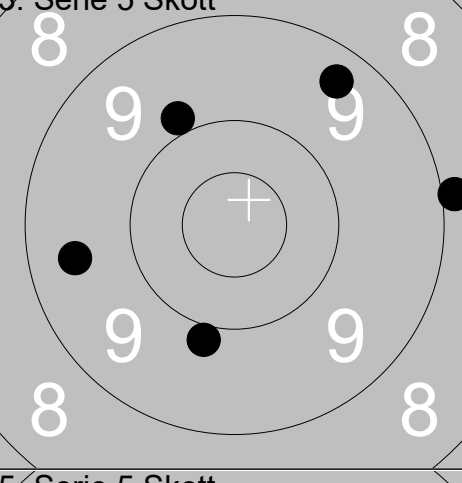
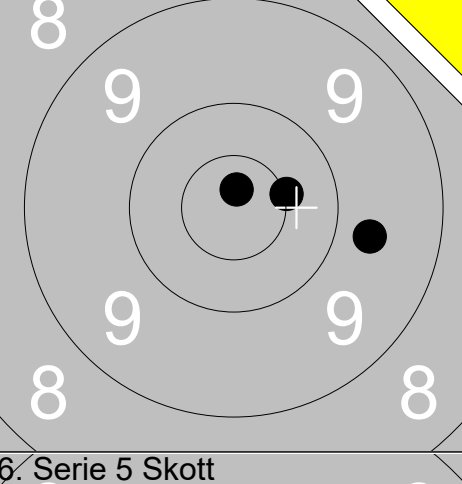
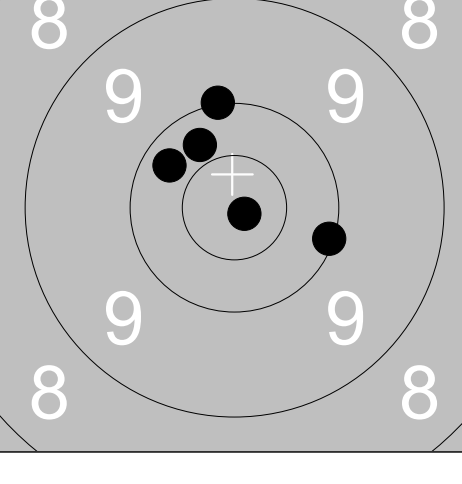
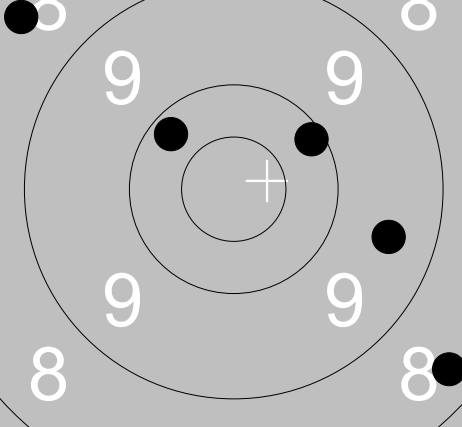
Skjutlag 4	Tavla 20	Håkan Lidman	
Ramselefors		Piteå	Vet No
06.07.2019		Björskottet 2019	Ramselefors SKF
Prov 	1: 9.3 ↘ 2: 8.4 ↗ 3: 10.3 ↘ 4: 10.3 ↗ 5: 10.7x ↘	1. Serie 5 Skott 	1: 10.9x ↘ 2: 10.4 ↖ 3: 10.0 → 4: 10.2 ↗ 5: 9.5 ↘
	Serie 47 Total 0		Serie 49 Total 49
2. Serie 5 Skott 	1: 10.1 → 2: 9.1 ↘ 3: 9.3 ↗ 4: 10.1 ↘ 5: 9.5 ↗	3. Serie 5 Skott 	1: 9.9 ↗ 2: 9.3 ↗ 3: 8.9 → 4: 9.5 ↖ 5: 9.9 ↘
	Serie 47 Total 96		Serie 44 Total 140
Prov 	1: 9.7 → 2: 10.8x ↑ 3: 10.5x →	5. Serie 5 Skott 	1: 10.3 ↖ 2: 10.1 → 3: 10.0 ↑ 4: 10.8x ↘ 5: 10.3 ↗
	Serie 29 Total 140		Serie 50 Total 190
6. Serie 5 Skott 	1: 9.5 → 2: 10.2 ↗ 3: 8.3 ↘ 4: 8.4 ↗ 5: 10.1 ↗		
	Serie 45 Total 235		