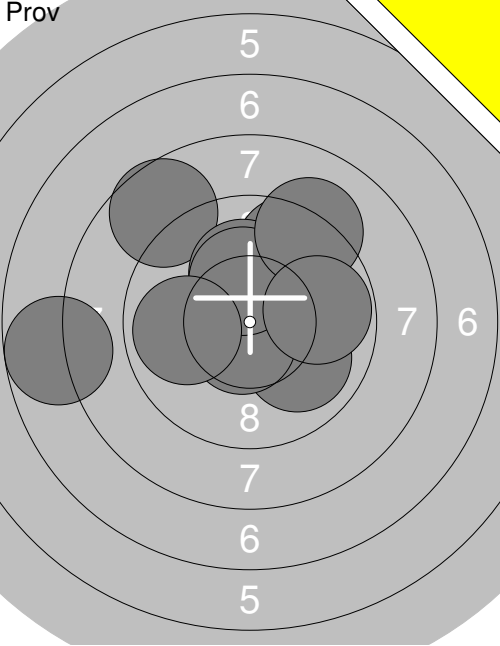
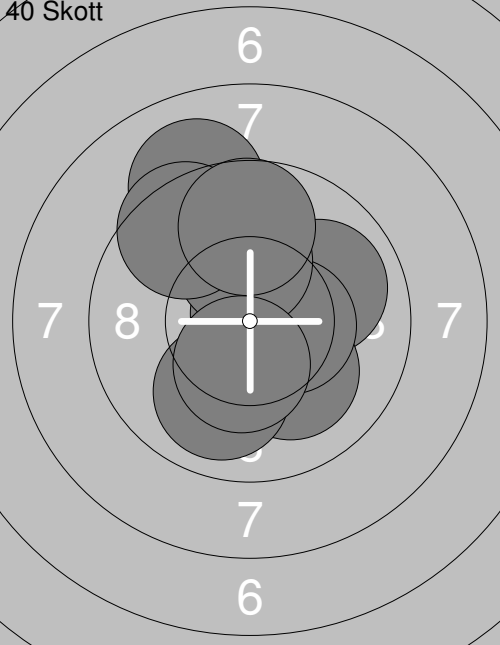
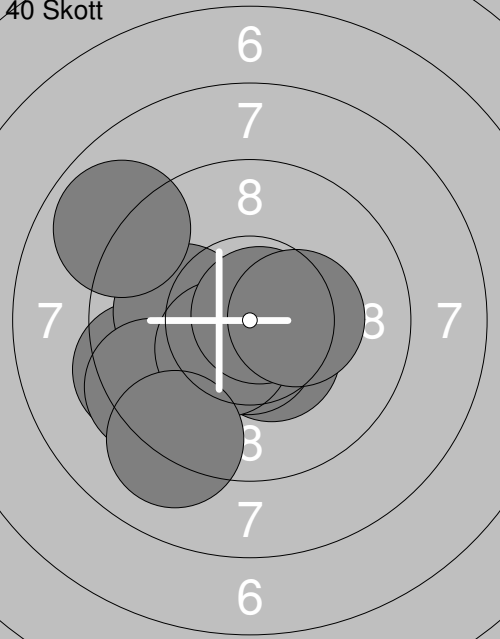
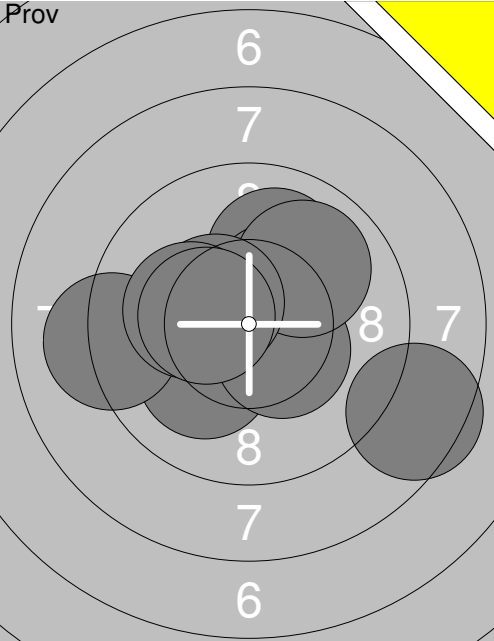
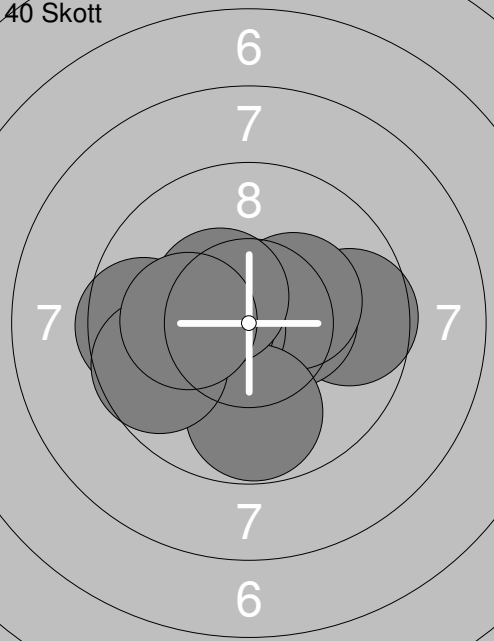
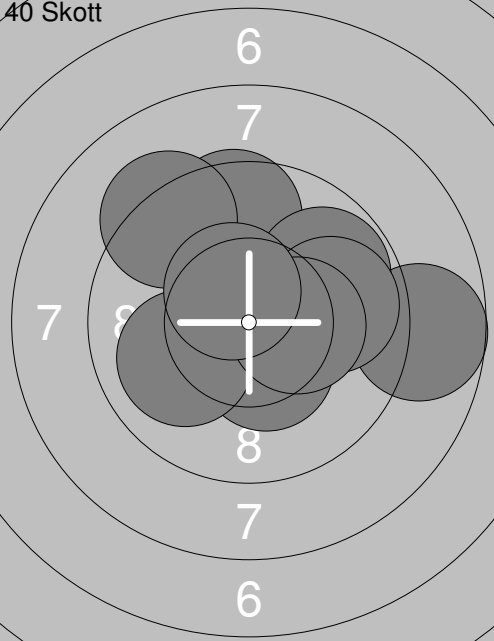
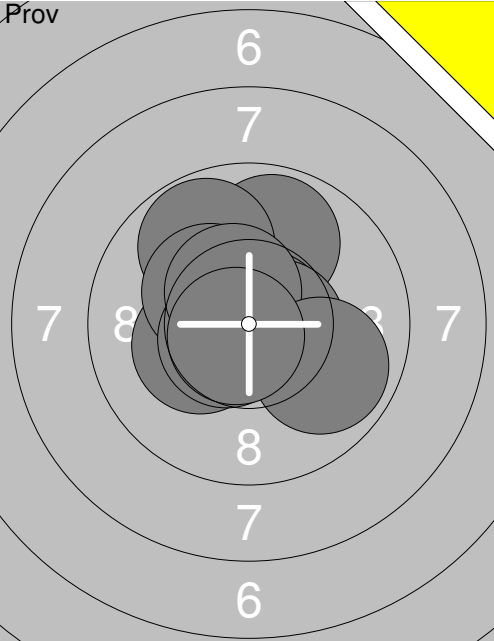
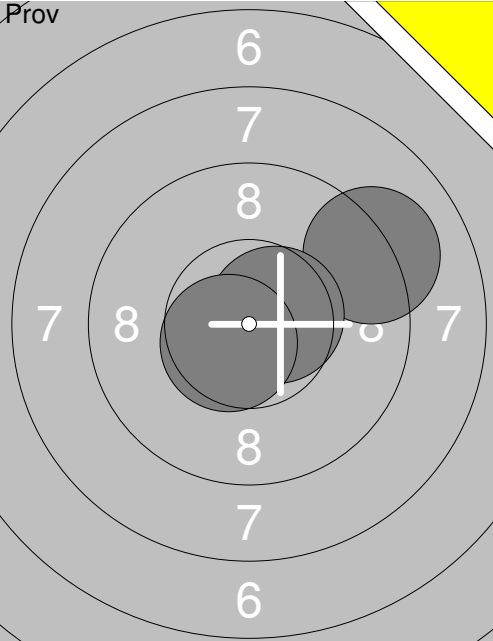
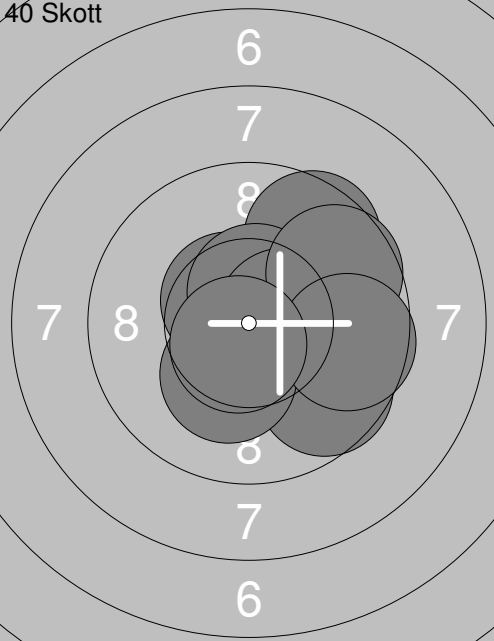
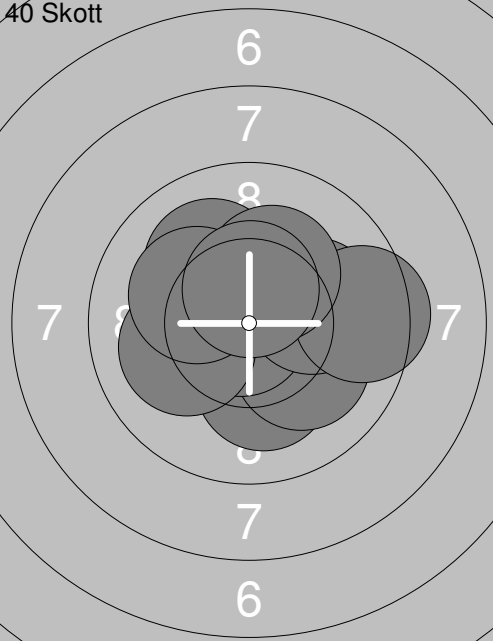
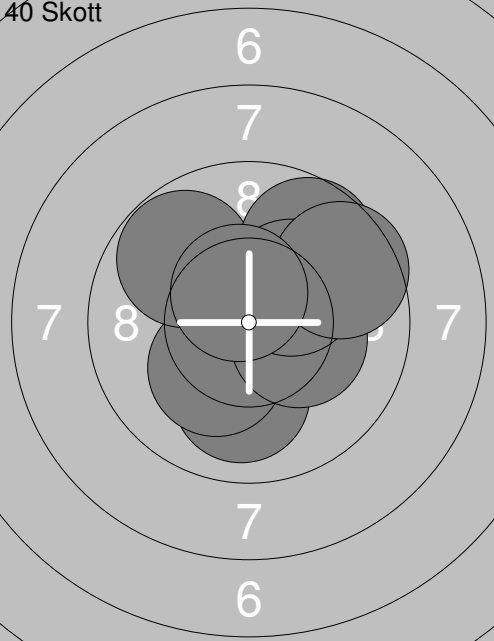
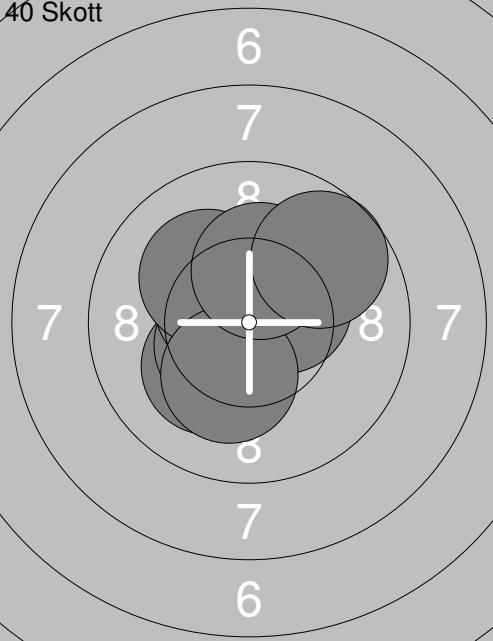
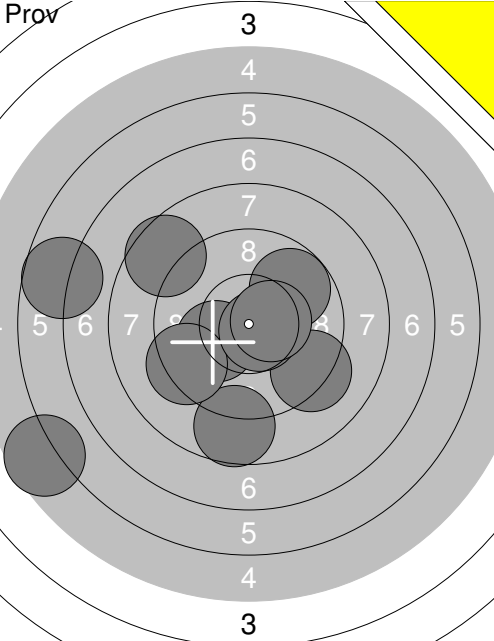
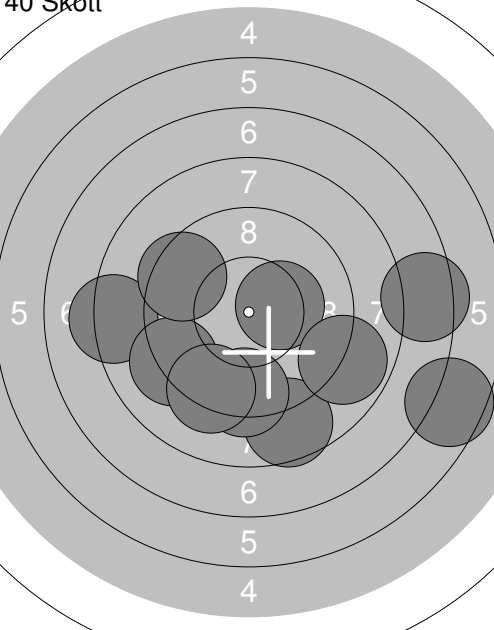
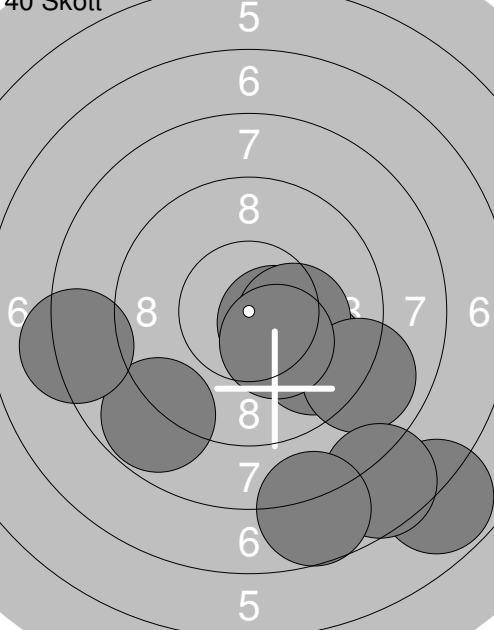

Skjutlag	Tavla	Klas Jonsson	
S	2	Aspås USKF	L21stå
02.02.2019	Skyttiaden Regionfinal 2019	Umeå skytteallians	
Prov		1: 8.7 ↗ 2: 7.8 ← 3: 10.0 ↘ 4: 10.6x↘ 5: 9.6 ↗ 6: 10.1 ↑ 7: 10.3x↑ 8: 9.2 ↗ 9: 9.9 ← 10: 9.8 →	11: 9.9 ← 12: 10.4x↑ 13: 9.4 ↗ 14: 9.5 ↗ 15: 10.4x↑ 16: 10.2x↘ 17: 10.0 ↗ 18: 9.3 ←
		Serie 96.0	Serie 79.1
		Total 0.0	Total 0.0
40 Skott		1: 10.0 → 2: 10.8x↗ 3: 10.1 ↘ 4: 10.5x→ 5: 10.2x↑ 6: 9.1 ↑ 7: 9.5 ↗ 8: 10.0 ↘ 9: 10.4x↘ 10: 9.7 ↑	11: 10.0 ← 12: 9.1 ↘ 13: 9.3 ↘ 14: 8.6 → 15: 9.2 ↑ 16: 9.7 → 17: 10.5x↗ 18: 10.6x↘ 19: 10.0 ↘ 20: 7.6 ↘
		Serie 100.3	Serie 94.6
		Total 100.3	Total 194.9
40 Skott		21: 9.4 ← 22: 10.1 ← 23: 9.4 ← 24: 10.4x↘ 25: 10.6x↘ 26: 8.9 ↗ 27: 10.5x↘ 28: 10.8x↗ 29: 9.1 ↘ 30: 10.3x→	31: 10.3x↘ 32: 9.5 ↗ 33: 9.9 ↗ 34: 10.4x→ 35: 9.3 ↘ 36: 9.2 ↘ 37: 8.8 ↘ 38: 10.4x→ 39: 9.6 ↗ 40: 8.4 ↘
		Serie 99.5	Serie 95.8
		Total 294.4	Total 390.2

Skjutlag	Tavla	Anna Östman	
1	3	Ramselefors Skf	L21stå
02.02.2019	Skyttiaden Regionfinal 2019	Umeå skytteallians	
Prov		1: 8.5 → 2: 10.1 ↙ 3: 10.0 ↗ 4: 10.4x ↗ 5: 10.4x ↘ 6: 9.9 ↗ 7: 9.2 ← 8: 10.4x ↘ 9: 10.2x ↘ 10: 10.4x ↘ Serie 99.5 Total 0.0	11: 9.9 ← 12: 10.0 ↑ 13: 10.1 ↙ 14: 10.8x ↘ 15: 10.6x ↗ Serie 51.4 Total 0.0
40 Skott		1: 9.6 → 2: 10.4x → 3: 10.3x ↗ 4: 10.5x ↘ 5: 10.4x ↘ 6: 9.6 ← 7: 9.8 ↓ 8: 9.7 ← 9: 10.4x ↘ 10: 10.2x ↘ Serie 100.9 Total 100.9	11: 10.5x ↘ 12: 10.9x ↓ 13: 8.7 → 14: 10.3x ↗ 15: 10.3x ↗ 16: 10.3x → 17: 10.5x ↘ 18: 9.6 → 19: 10.5x ↗ 20: 9.6 → Serie 101.2 Total 202.1
40 Skott		21: 10.6x ↗ 22: 10.4x ↓ 23: 9.6 ↑ 24: 8.7 → 25: 10.0 ↙ 26: 9.8 ↗ 27: 9.9 → 28: 9.3 ↙ 29: 10.3x → 30: 10.5x ↗ Serie 99.1 Total 301.2	31: 10.8x ↘ 32: 10.7x ↓ 33: 10.7x ↓ 34: 10.2x ↗ 35: 10.0 ↙ 36: 9.4 ↗ 37: 9.7 → 38: 9.4 ↑ 39: 10.0 ↗ 40: 9.6 → Serie 100.5 Total 401.7

Skjutlag	Tavla	Emma Fjällström	
1	4	Gällivare Skf	L21stå
02.02.2019	Skyttiaden Regionfinal 2019	Umeå skytteallians	
Prov		Prov	
	1: 10.3x 2: 9.9 3: 10.8x 4: 9.8 5: 10.6x 6: 10.3x 7: 10.6x 8: 10.5x 9: 9.9 10: 10.7x		11: 9.1 12: 10.6x 13: 10.6x
	Serie 103.4 Total 0.0		Serie 30.3 Total 0.0
40 Skott		40 Skott	
	1: 10.9x 2: 10.6x 3: 9.6 4: 10.5x 5: 10.5x 6: 9.7 7: 9.7 8: 10.2x 9: 9.6 10: 10.6x		11: 10.1 12: 10.2x 13: 10.1 14: 10.8x 15: 10.1 16: 9.5 17: 10.1 18: 10.2x 19: 10.2x 20: 10.5x
	Serie 101.9 Total 101.9		Serie 101.8 Total 203.7
40 Skott		40 Skott	
	21: 10.6x 22: 10.0 23: 10.6x 24: 10.2x 25: 9.8 26: 10.3x 27: 9.7 28: 10.2x 29: 9.6 30: 10.5x		31: 10.6x 32: 10.2x 33: 10.6x 34: 10.5x 35: 10.5x 36: 10.5x 37: 10.2x 38: 10.2x 39: 10.3x 40: 9.7
	Serie 101.5 Total 305.2		Serie 103.3 Total 408.5

Skjuttag	Tavla	Fluk Jonsson	
S	Ramselefors Skf	L17stå	
02.02.2019	Skyttiaden Regionfinal 2019	Umeå skytteallians	
Prov		1: 5.6 ↙ 2: 6.7 ← 3: 9.8 ↗ 4: 8.7 ↓ 5: 10.1 ↙ 6: 9.3 ↙ 7: 9.2 ↘ 8: 10.7x↘ 9: 10.5x→ 10: 8.6 ↙	11: 8.9 ↙ 12: 8.6 → 13: 10.6x↓ 14: 10.8x↓ 17: 8.5 → 18: 10.8x↑
	Serie 89.2	Serie 58.2	
	Total 0.0	Total 0.0	
40 Skott		1: 10.3x→ 2: 8.2 ← 3: 6.6 → 4: 9.2 ↙ 5: 8.6 ↓ 6: 7.4 → 7: 9.3 ↓ 8: 8.8 → 9: 9.2 ↓ 10: 9.4 ↙	11: 9.2 ↙ 12: 8.0 ↑ 13: 9.0 → 14: 8.7 → 15: 9.9 ↑ 16: 7.8 ← 17: 6.9 → 18: 8.2 ↗ 19: 4.4 → 20: 9.6 ↓
	Serie 87.0	Serie 81.7	
	Total 87.0	Total 168.7	
40 Skott		21: 8.8 ↙ 22: 6.8 ↘ 23: 9.7 ↘ 24: 10.5x↘ 25: 10.2x↘ 26: 9.0 ↘ 27: 7.6 ↘ 28: 7.7 ↓ 29: 8.2 ← 30: 10.3x↘	31: 8.9 ↓ 32: 8.4 → 33: 8.3 ↙ 34: 8.0 ↙ 35: 6.8 ← 36: 8.2 ↙ 37: 7.9 ↙ 38: 10.3x↗ 39: 9.3 ↓ 40: 9.7 ↘
	Serie 88.8	Serie 85.8	
	Total 257.5	Total 343.3	

Skjutlag	Tavla	Petter Hemå	
1	7	Fältjägarna SkF	L17stå
02.02.2019	Skyttiaden Regionfinal 2019	Umeå skytteallians	
Prov		1: 10.2x↘ 2: 9.4 ↗ 3: 7.1 ← 4: 8.0 → 5: 9.8 ↙ 6: 10.5x↘ 7: 9.9 ↑ 8: 10.5x↘ 9: 10.4x↗ 10: 10.4x↘	Prov
		11: 10.2x→	
	Serie 96.2		Serie 10.2
	Total 0.0		Total 0.0
40 Skott		1: 9.9 → 2: 8.4 ↘ 3: 8.3 ↘ 4: 8.9 → 5: 8.5 ↑ 6: 9.5 ↗ 7: 10.9x→ 8: 9.2 → 9: 9.3 → 10: 10.1↙	40 Skott
		11: 9.1 → 12: 9.6 → 13: 7.9 → 14: 8.8 ← 15: 9.9 ↑ 16: 9.8 ← 17: 10.4x↘ 18: 9.5 ← 19: 8.5 ← 20: 9.6 ←	
	Serie 93.0		Serie 93.1
	Total 93.0		Total 186.1
40 Skott		21: 9.5 ↙ 22: 10.2x↙ 23: 10.7x↙ 24: 8.2 → 25: 9.9 → 26: 9.9 ← 27: 9.0 ↘ 28: 10.1 ↗ 29: 9.1 ↘ 30: 10.0↙	40 Skott
		31: 8.3 ↙ 32: 10.2x↗ 33: 8.5 ↘ 34: 9.0 → 35: 8.9 ↘ 36: 8.2 → 37: 8.7 ↗ 38: 8.0 → 39: 7.8 → 40: 7.9 ↘	
	Serie 96.6		Serie 85.5
	Total 282.7		Total 368.2

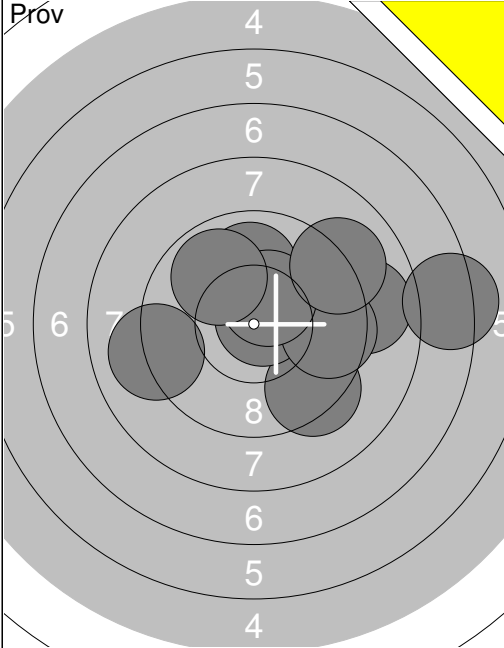
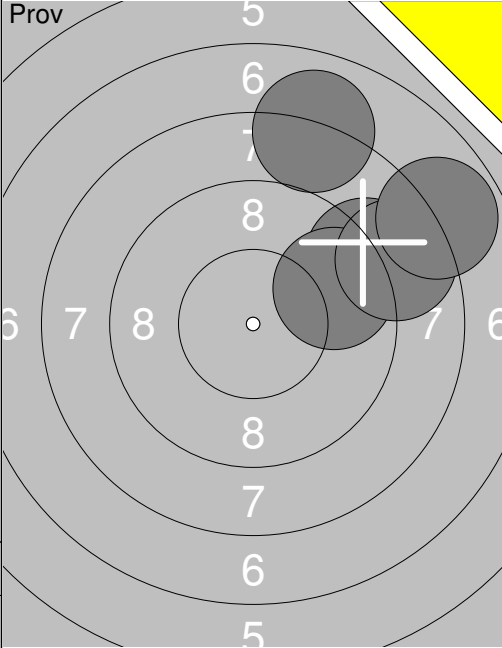
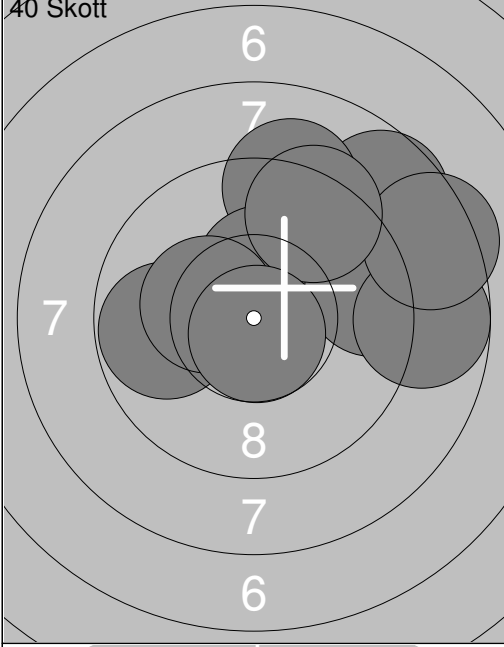
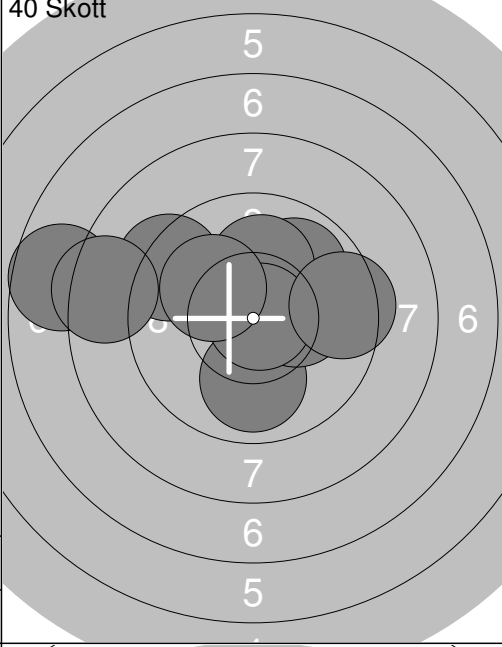
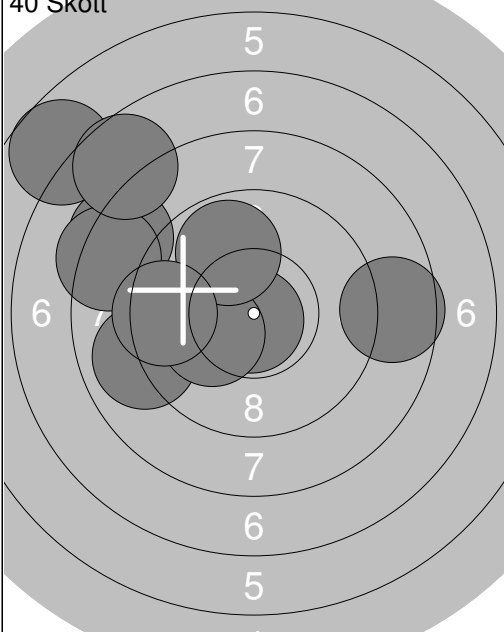
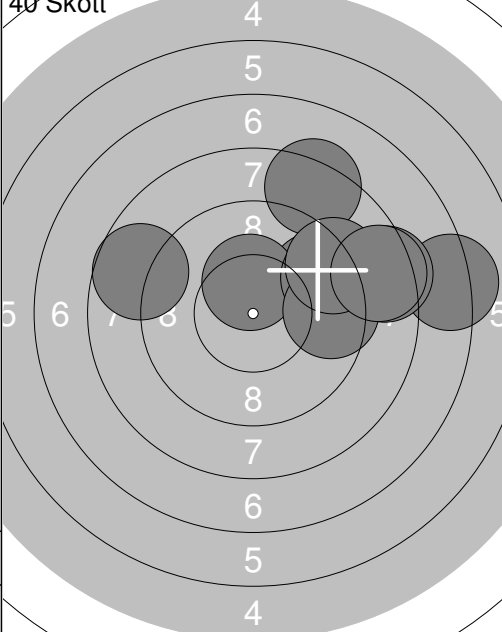

Skjutlag	Tavla	Hanna Johansson	
1	8	Vännäs Skf	L17stå
02.02.2019	Skyttiaden Regionfinal 2019	Umeå skytteallians	
Prov		1: 10.4x 2: 9.2 3: 9.1 4: 9.8 5: 9.5 6: 9.6 7: 10.5x 8: 10.3x 9: 9.5 10: 8.0 Serie 95.9 Total 0.0	11: 8.5 12: 10.5x 13: 9.8 14: 10.4x 15: 9.6 Serie 48.8 Total 0.0
40 Skott		1: 10.1 2: 9.1 3: 9.2 4: 10.2x 5: 10.0 6: 8.6 7: 10.4x 8: 10.0 9: 10.5x 10: 10.4x Serie 98.5 Total 98.5	11: 10.2x 12: 9.2 13: 10.7x 14: 10.4x 15: 8.0 16: 8.2 17: 10.0 18: 10.1 19: 10.6x 20: 9.0 Serie 96.4 Total 194.9
40 Skott		21: 10.2x 22: 9.4 23: 10.0 24: 10.1 25: 9.4 26: 9.7 27: 9.9 28: 9.7 29: 10.2x 30: 10.5x Serie 99.1 Total 294.0	31: 10.2x 32: 10.3x 33: 9.0 34: 10.4x 35: 10.5x 36: 8.9 37: 9.3 38: 10.2x 39: 9.4 40: 10.5x Serie 98.7 Total 392.7

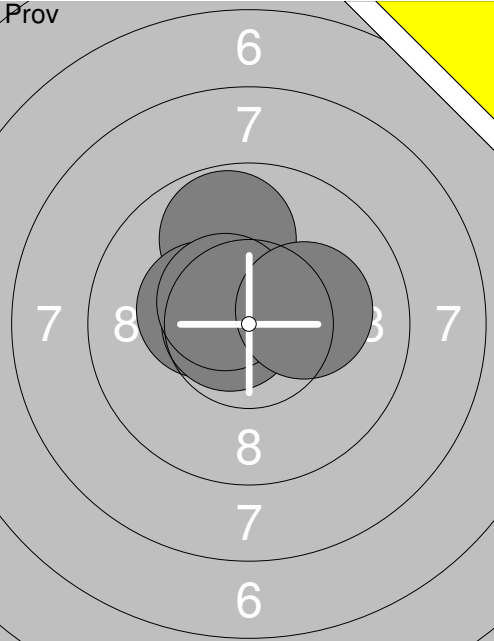
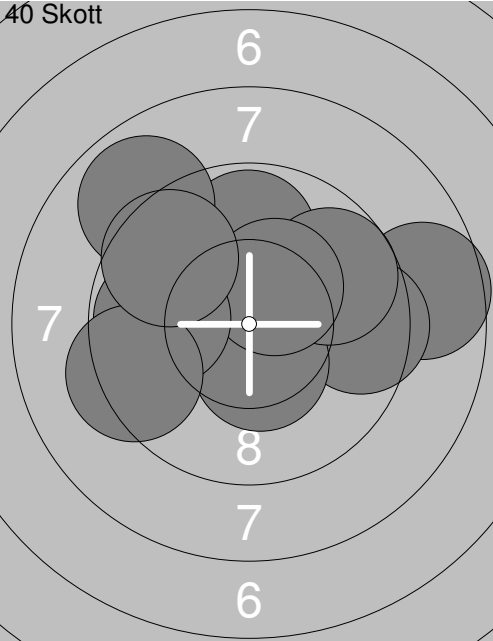
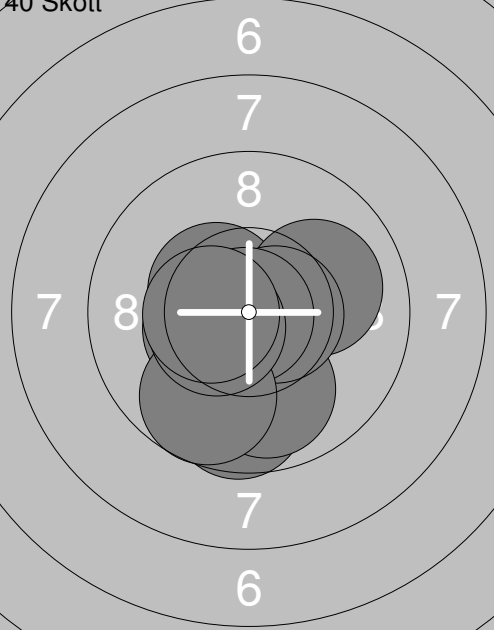
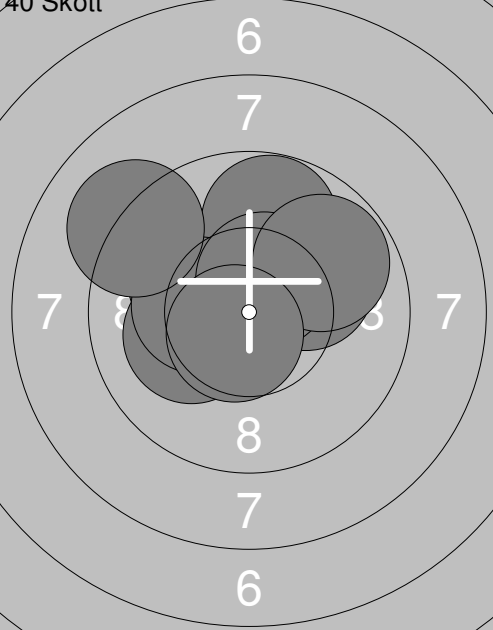
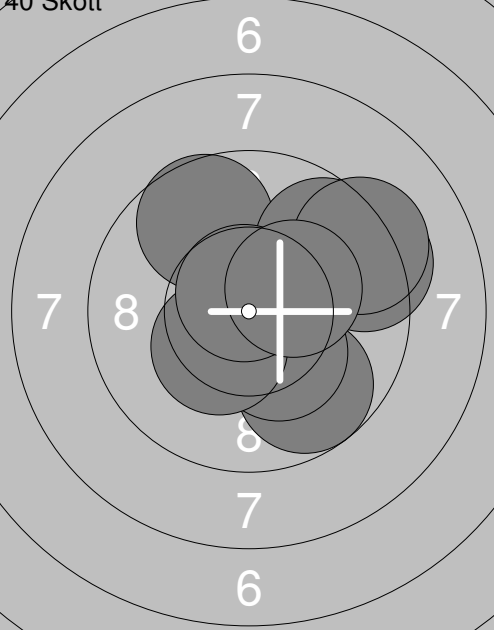
Skjutlag	Tavla	Linnéa Andersson	
1	9		
S	Hammerdal SkF	L17stå	
02.02.2019	Skyttiaden Regionfinal 2019	Umeå skytteallians	
Pröv		1: 9.1 ← 2: 10.0 ↑ 3: 8.9 → 4: 9.3 ↘ 5: 10.8x↗ 6: 9.6 → 7: 7.3 → 8: 10.4x↗ 9: 9.9 ↖ 10: 9.1 ↗ Serie 94.4 Total 0.0	Pröv  11: 9.0 ↗ 12: 8.0 ↑ 13: 9.7 ↗ 14: 8.7 ↗ 15: 7.9 ↗ Serie 43.3 Total 0.0
40 Skott		1: 8.7 ↗ 2: 9.2 ↑ 3: 10.4x↗ 4: 9.3 → 5: 8.8 → 6: 8.4 → 7: 9.4 ↗ 8: 9.8 ← 9: 10.3x↖ 10: 10.7x↘ Serie 95.0 Total 95.0	40 Skott  11: 9.9 ↓ 12: 9.9 ↗ 13: 10.2x→ 14: 10.1 ↑ 15: 10.8x→ 16: 9.3 ↖ 17: 9.4 → 18: 10.1 ↖ 19: 7.7 ← 20: 8.4 ← Serie 95.8 Total 190.8
40 Skott		21: 9.0 ← 22: 10.8x↘ 23: 10.2x↖ 24: 8.4 ↖ 25: 9.8 ↗ 26: 6.7 ↖ 27: 8.3 ← 28: 8.6 → 29: 7.7 ↖ 30: 9.4 ← Serie 88.9 Total 279.7	40 Skott  31: 9.6 ↗ 32: 8.3 ↑ 33: 8.7 ↖ 34: 10.4x↗ 35: 7.2 → 36: 9.4 ↗ 37: 9.5 → 38: 8.4 → 39: 9.2 ↗ 40: 8.5 → Serie 89.2 Total 368.9

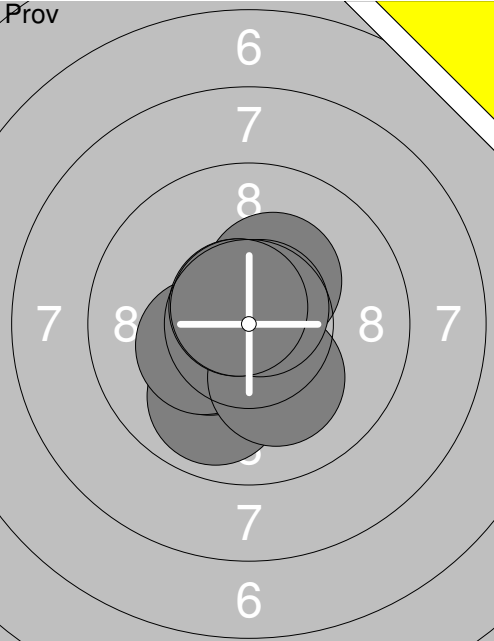
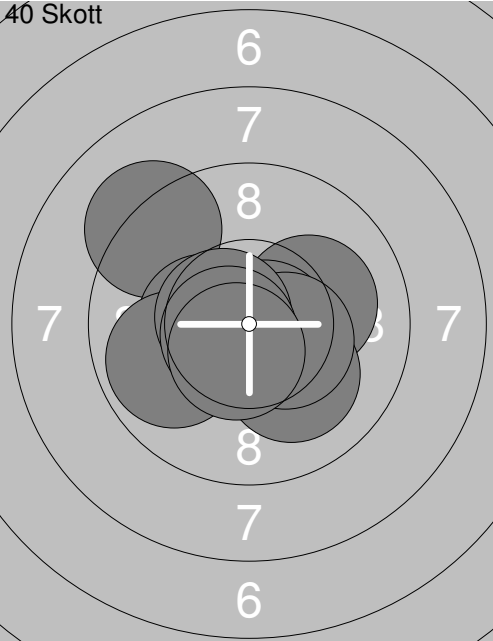
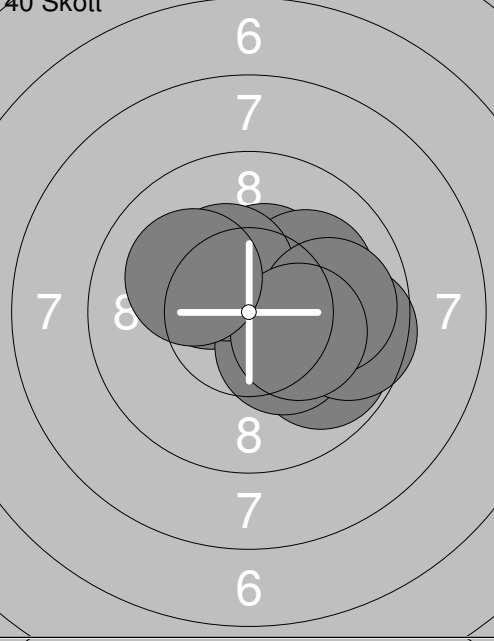
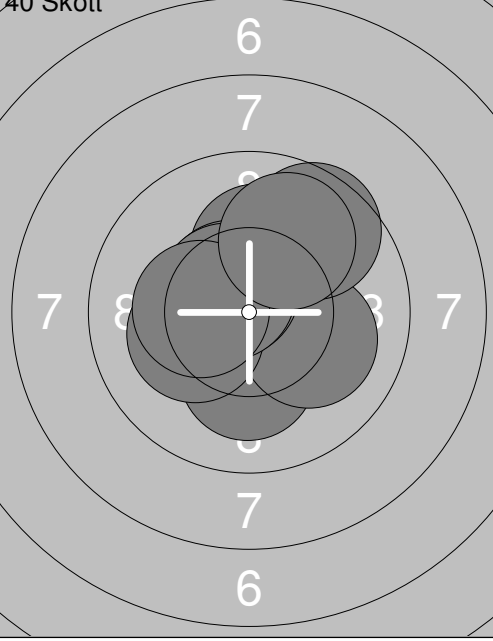
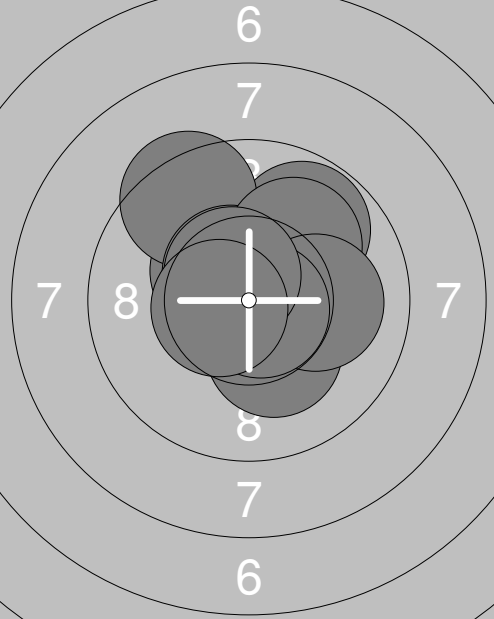

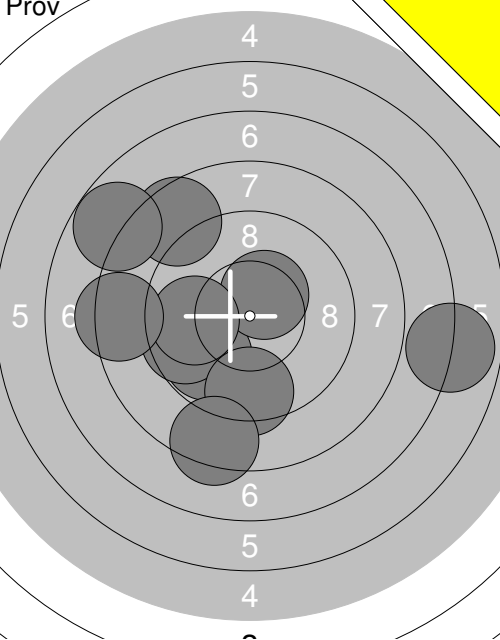
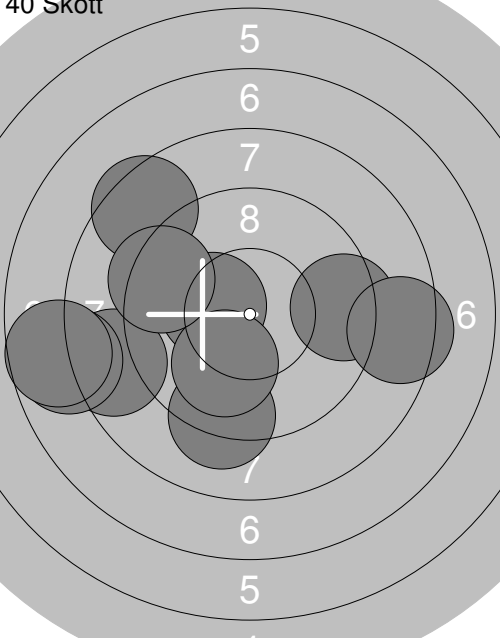
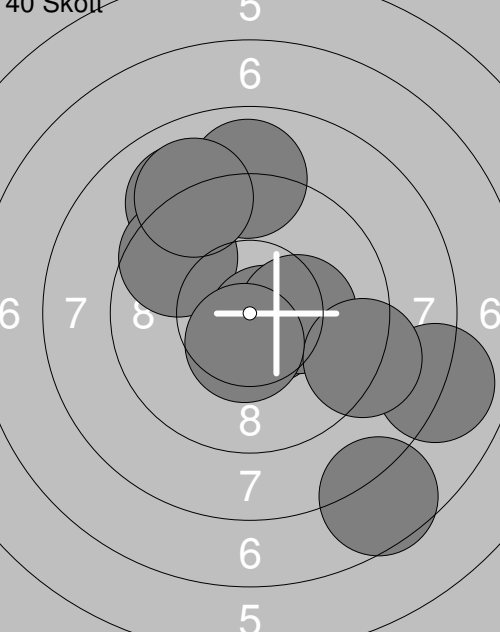
Skjutlag 1	Tavla 11	Hugo Nyberg	
S		Drängsmarks Skf	L17stå
02.02.2019	Skyttiaden Regionfinal 2019		Umeå skytteallians
Prov		1: 9.8 ↗ 2: 10.3 ✕ 3: 10.7 ✕ 4: 10.5 ✕ 5: 10.2 ✕	40 Skott 
		Serie 51.5 Total 0.0	1: 8.7 → 2: 9.5 → 3: 9.8 ↗ 4: 10.4 ✕ 5: 9.7 ↗ 6: 8.9 ↗ 7: 10.4 ✕ 8: 9.8 ← 9: 9.3 ← 10: 9.6 ↗
		Serie 96.1 Total 96.1	
40 Skott		11: 10.4 ✕ 12: 9.7 ↓ 13: 9.9 ↓ 14: 10.0 → 15: 10.6 ✕ 16: 10.4 ✕ 17: 10.9 ✕ 18: 9.7 ↓ 19: 10.5 ✕ 20: 10.5 ✕	40 Skott 
		Serie 102.6 Total 198.7	21: 10.3 ✕ 22: 10.1 ↗ 23: 10.1 ← 24: 9.8 ↗ 25: 10.3 ✕ 26: 10.1 → 27: 9.1 ↗ 28: 10.5 ✕ 29: 9.8 → 30: 10.6 ✕
		Serie 100.7 Total 299.4	
40 Skott		31: 9.7 ↗ 32: 9.7 ↓ 33: 9.3 → 34: 10.8 ✕ 35: 10.3 ✕ 36: 9.7 ↗ 37: 10.4 ✕ 38: 9.3 → 39: 10.7 ✕ 40: 10.3 ✕	
		Serie 100.2 Total 399.6	

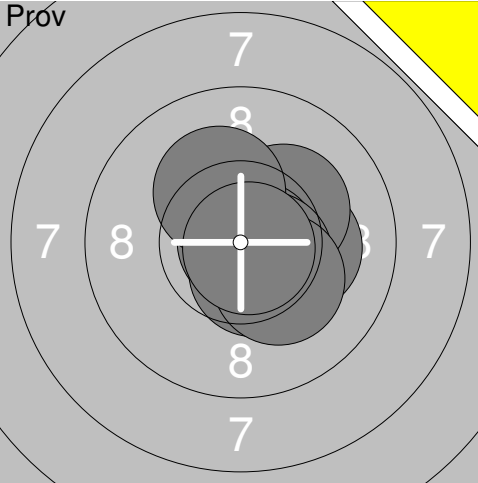
Skjutlag 1	Tavla 12	Hanna Lundin		
S		Umeå Skf	L17stå	
02.02.2019	Skyttiaden Regionfinal 2019		Umeå skytteallians	
Prov		1: 9.9 ↘ 2: 10.4x ↘ 3: 10.3x ↘ 4: 10.3x ↗ 5: 10.2x ↘ 6: 10.7x ↘ 7: 10.7x ↗ 8: 10.7x ↘	40 Skott 	1: 9.2 ↗ 2: 10.1 → 3: 10.4x ← 4: 9.9 ← 5: 10.7x → 6: 10.1 ↘ 7: 10.4x → 8: 10.6x ← 9: 10.7x ← 10: 10.6x ↘
		Serie 83.2	Serie 102.7	
		Total 0.0	Total 102.7	
40 Skott		11: 10.3x ↘ 12: 9.8 ↘ 13: 10.3x ↘ 14: 10.4x ↗ 15: 10.1 ↗ 16: 10.4x ↘ 17: 9.6 → 18: 9.9 → 19: 10.3x → 20: 10.1 ↘	40 Skott 	21: 10.4x ↘ 22: 10.2x ↘ 23: 10.1 → 24: 10.2x ← 25: 10.2x ↗ 26: 10.6x ↘ 27: 10.6x ↘ 28: 9.6 ↗ 29: 10.3x ← 30: 9.9 ↗
		Serie 101.2	Serie 102.1	
		Total 203.9	Total 306.0	
40 Skott		31: 10.2x ↘ 32: 9.8 ↗ 33: 10.4x ↘ 34: 9.4 ↗ 35: 10.5x ↘ 36: 10.0 ↗ 37: 10.1 → 38: 10.8x ↘ 39: 10.6x ↘ 40: 10.5x ←		
		Serie 102.3		
		Total 408.3		

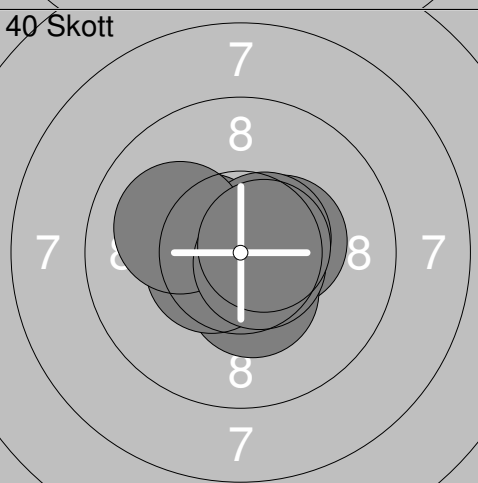
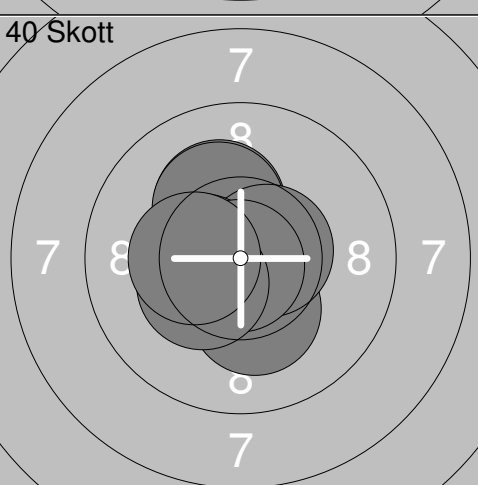

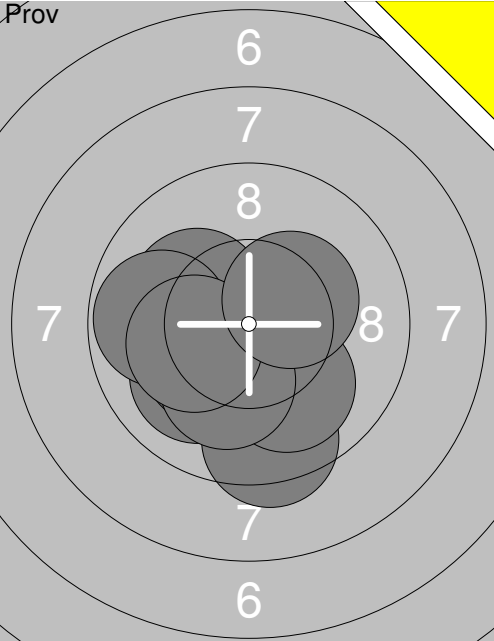
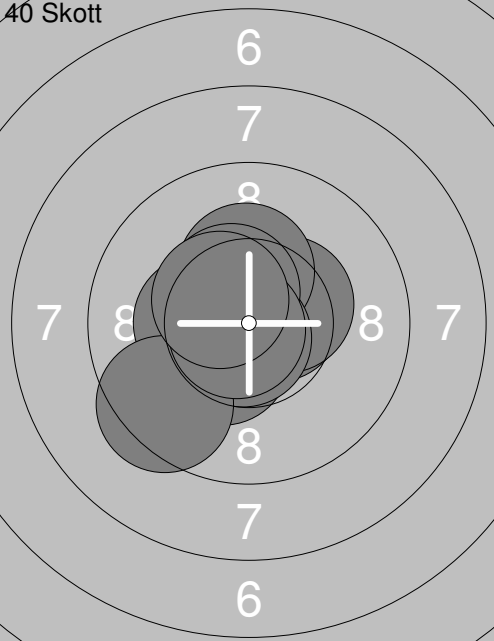
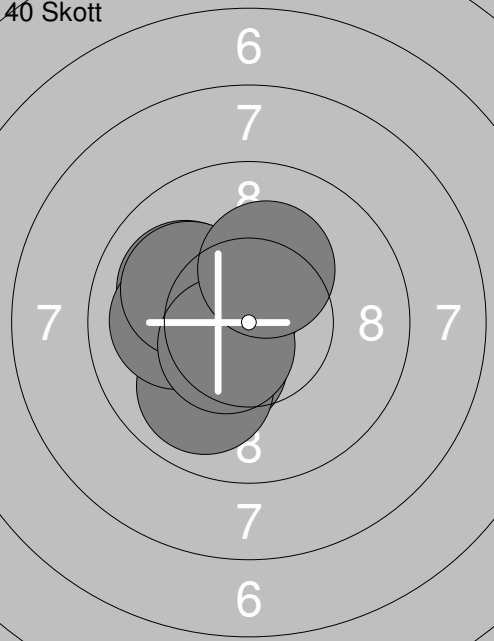
Skjutlag	Tavla	André Engström	
1	13	Piteå Skf	L17stå
02.02.2019	Skyttiaden Regionfinal 2019	Umeå skytteallians	
Prov		1: 9.8 ↘ 2: 9.6 ← 3: 8.6 ↗ 4: 10.4x↗ 5: 6.9 → 6: 7.8 ↗ 7: 9.4 ↓ 8: 8.4 ↓ 9: 9.8 ← 10: 8.3 ← Serie 89.0 Total 0.0	11: 10.4x↘ 12: 9.1 ← 13: 9.3 ↘ 14: 9.9 ↗ 15: 8.3 ← Serie 47.0 Total 0.0
40 Skott		1: 8.5 ← 2: 8.5 ↗ 3: 9.2 ↓ 4: 9.4 → 5: 10.3x↘ 6: 7.8 ← 7: 7.7 ← 8: 10.0 ↓ 9: 8.4 → 10: 9.4 ← Serie 89.2 Total 89.2	11: 9.2 ↑ 12: 8.3 ← 13: 9.4 → 14: 10.5x→ 15: 9.2 ↘ 16: 8.8 ← 17: 9.6 → 18: 7.5 ↗ 19: 8.8 ← 20: 10.0↘ Serie 91.3 Total 180.5
40 Skott		21: 7.6 ↘ 22: 8.9 ↑ 23: 9.0 ↗ 24: 8.0 → 25: 9.6 ↗ 26: 10.7x↘ 27: 10.2x→ 28: 9.1 → 29: 9.0 ↗ 30: 10.5x↓ Serie 92.6 Total 273.1	31: 8.0 ← 32: 9.1 ↗ 33: 8.9 ↓ 34: 8.7 ↗ 35: 8.9 ↓ 36: 9.7 → 37: 10.8x↘ 38: 10.6x↘ 39: 7.8 ↓ 40: 9.5 ↓ Serie 92.0 Total 365.1

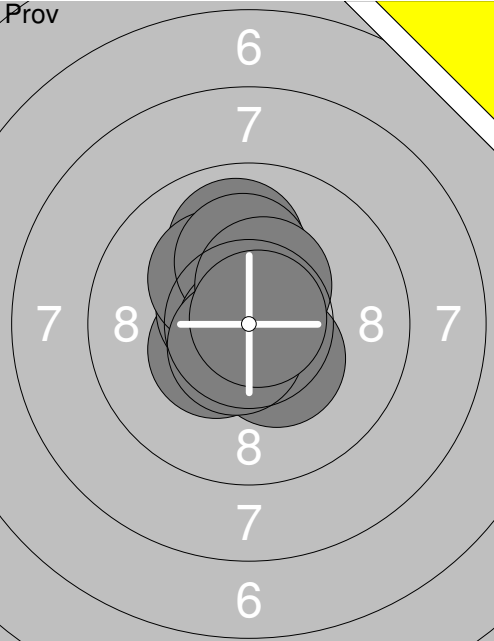
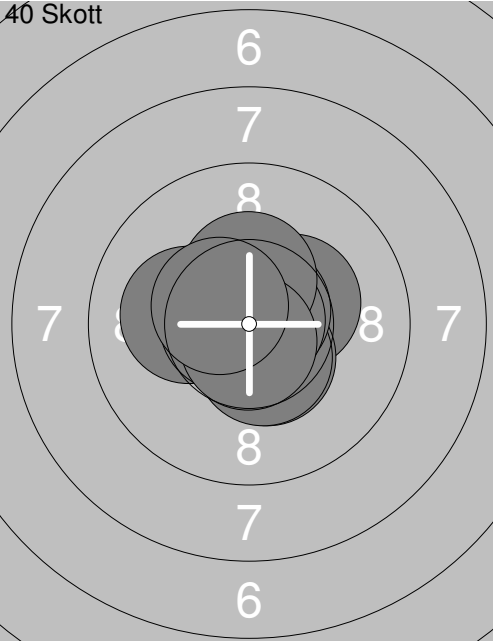
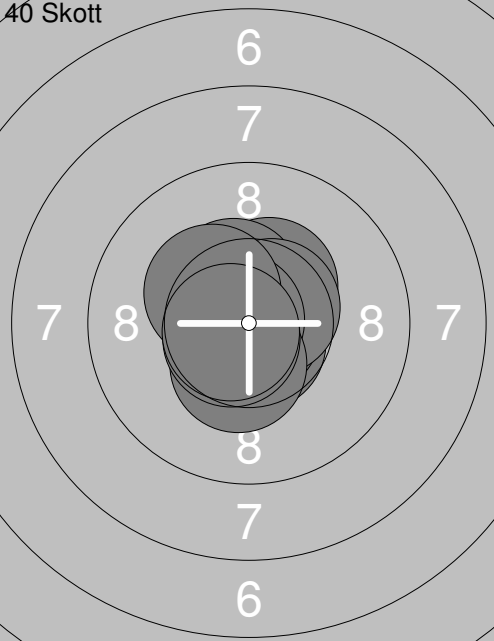
Skjutlag 1	Tavla 16	Hanna Augustsson	
S		Vännäs Skf	L15
02.02.2019		Skyttiaden Regionfinal 2019	Umeå skytteallians
Prov		1: 10.2x → 2: 10.3x ↗ 3: 10.9x → 4: 10.2x ↗ 5: 10.5x ↓ 6: 10.8x → 7: 10.5x ↓ 8: 10.2x ↗ 9: 10.2x ↓ 10: 10.8x ↓	11: 10.3x ↘ 12: 10.6x ↗ 13: 10.6x ↙ 14: 10.3x ↙ 15: 10.3x → 16: 10.5x ↗ 17: 10.3x ↓ 18: 10.6x ↓ 19: 10.3x ↓ 20: 10.4x →
		Serie 104.6	Serie 104.2
		Total 0.0	Total 0.0
Prov		21: 10.6x ↑	40 Skott
		Serie 10.6	Serie 103.8
		Total 0.0	Total 103.8
40 Skott		11: 10.4x → 12: 10.9x ↗ 13: 10.4x ↖ 14: 10.4x ↖ 15: 10.4x ↓ 16: 10.6x → 17: 10.5x ↖ 18: 10.1 ↖ 19: 10.7x ↘ 20: 10.6x →	21: 10.5x ↓ 22: 10.6x → 23: 10.9x ↗ 24: 10.4x ↓ 25: 10.4x ↓ 26: 10.5x ↗ 27: 10.6x → 28: 10.4x ↓ 29: 10.7x ↗ 30: 10.3x ↖
		Serie 105.0	Serie 105.3
		Total 208.8	Total 314.1
40 Skott		31: 10.2x ↗ 32: 10.6x ↓ 33: 10.2x ↓ 34: 10.2x ↗ 35: 10.8x ↖ 36: 10.6x → 37: 10.4x ↖ 38: 10.8x ↓ 39: 10.3x ↖ 40: 10.3x ↖	
		Serie 104.4	
		Total 418.5	

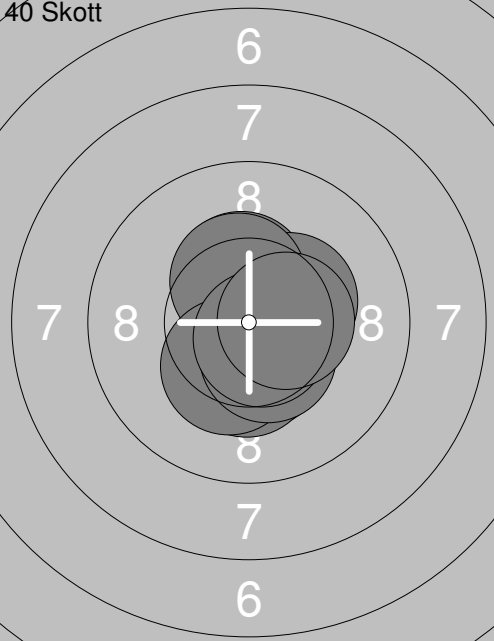
Skjutlag	Tavla	John Karlsson	
S	Fältjägarna SkF	L15	
02.02.2019	Skyttiaden Regionfinal 2019	Umeå skytteallians	
Prov		1: 9.4 ↓ 2: 10.0 ↓ 3: 10.0 ↘ 4: 10.4 ✕ 5: 10.3 ✕ 6: 10.2 ✕ 7: 10.2 ✕ 8: 9.8 ← 9: 10.2 ✕ 10: 10.3 ✕↗ Serie 100.8 Total 0.0	11: 9.7 ↘ 12: 10.0 ↘ 13: 10.1 ← 14: 10.4 ✕ 15: 10.2 ✕ 16: 10.0 ↙ 17: 10.7 ✕ 18: 10.8 ✕ Serie 81.9 Total 0.0
40 Skott		1: 10.6 ✕↗ 2: 10.4 ✕↗ 3: 10.4 ✕ 4: 10.3 ✕↑ 5: 10.7 ✕ 6: 10.5 ✕ 7: 10.3 ✕ 8: 9.4 ↓ 9: 10.8 ✕ 10: 10.5 ✕ Serie 103.9 Total 103.9	11: 10.1 ← 12: 10.8 ✕↘ 13: 9.9 ← 14: 10.9 ✕ 15: 10.6 ✕ 16: 10.5 ✕ 17: 10.6 ✕ 18: 10.4 ✕ 19: 10.8 ✕↑ 20: 10.7 ✕ Serie 105.3 Total 209.2
40 Skott		21: 10.3 ✕ 22: 9.9 ↓ 23: 10.6 ✕ 24: 10.6 ✕ 25: 10.3 ✕ 26: 10.0 ↙ 27: 10.0 ← 28: 10.1 ↙ 29: 10.5 ✕ 30: 10.2 ✕↑ Serie 102.5 Total 311.7	31: 9.7 ← 32: 10.5 ✕↑ 33: 10.2 ✕↑ 34: 10.3 ✕↑ 35: 10.6 ✕↑ 36: 10.6 ✕↑ 37: 10.1 ↗ 38: 10.5 ✕↑ 39: 10.5 ✕ 40: 10.4 ✕ Serie 103.4 Total 415.1

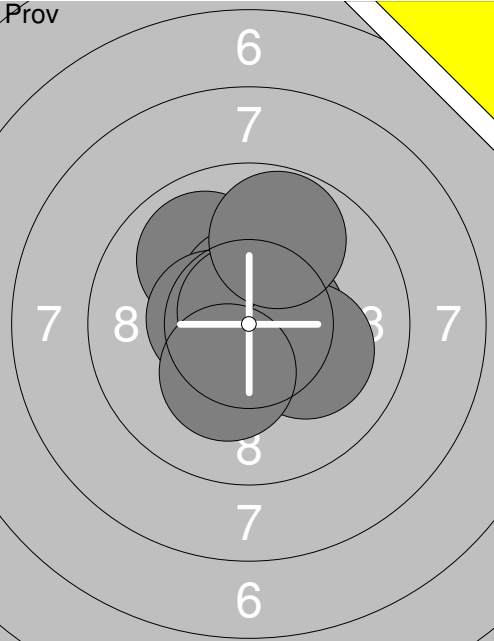
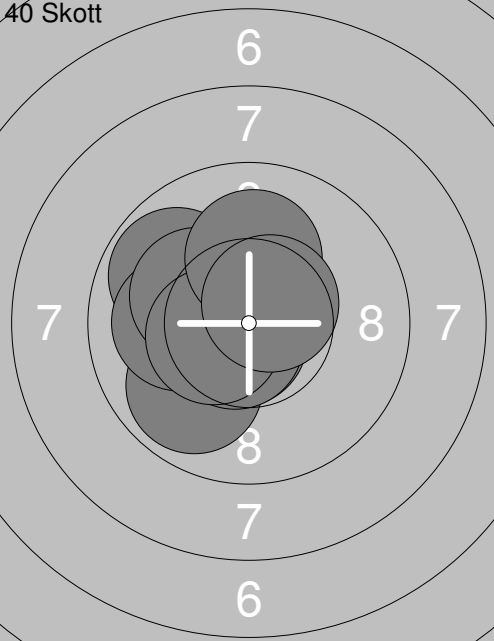
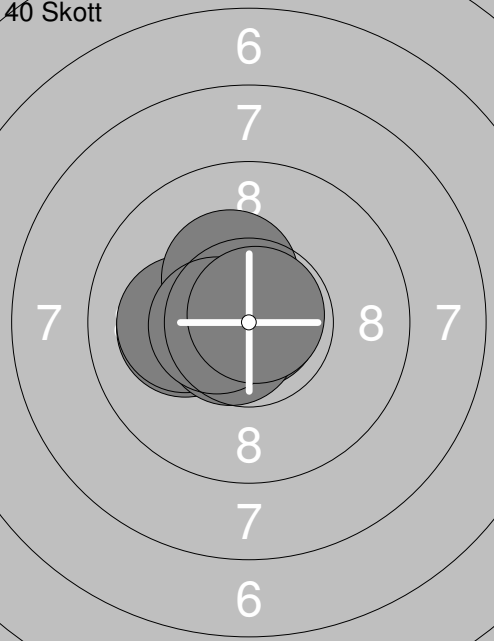
Skjutlag	Tavla	Beatrice Andersson	
S	Ramselefors Skf	L15	
02.02.2019	Skyttiaden Regionfinal 2019	Umeå skytteallians	
Prov		40 Skott	
	1: 10.4x↘ 2: 9.9 ↑ 3: 10.6x↘ 4: 10.2x↘ 5: 10.1 ↑ 6: 10.9x↘ 7: 10.4x↗ 8: 10.4x↘ 9: 10.6x↘ 10: 10.8x↗	1: 10.3x↗ 2: 10.5x↘ 3: 10.5x↘ 4: 10.1← 5: 10.7x↗ 6: 10.7x↘ 7: 10.8x↗ 8: 10.4x↑ 9: 10.7x↘ 10: 10.5x↘	
	Serie 104.3	Serie 105.2	
	Total 0.0	Total 105.2	
40 Skott		40 Skott	
	11: 10.7x↘ 12: 10.4x↗ 13: 10.9x↘ 14: 10.4x↗ 15: 10.6x↗ 16: 10.8x↘ 17: 10.3x↘ 18: 10.4x↘ 19: 10.6x↘ 20: 10.7x↘	21: 10.4x↘ 22: 10.6x↘ 23: 10.8x↘ 24: 10.5x↘ 25: 10.5x↗ 26: 10.4x↘ 27: 10.6x↘ 28: 10.9x↘ 29: 10.7x↑ 30: 10.7x↘	
	Serie 105.8	Serie 106.1	
	Total 211.0	Total 317.1	
40 Skott			
	31: 10.4x↘ 32: 10.4x↘ 33: 10.4x↑ 34: 10.4x↗ 35: 10.4x↗ 36: 10.3x↘ 37: 10.5x↘ 38: 10.5x↘ 39: 10.7x↘ 40: 10.5x→		
	Serie 104.5		
	Total 421.6		

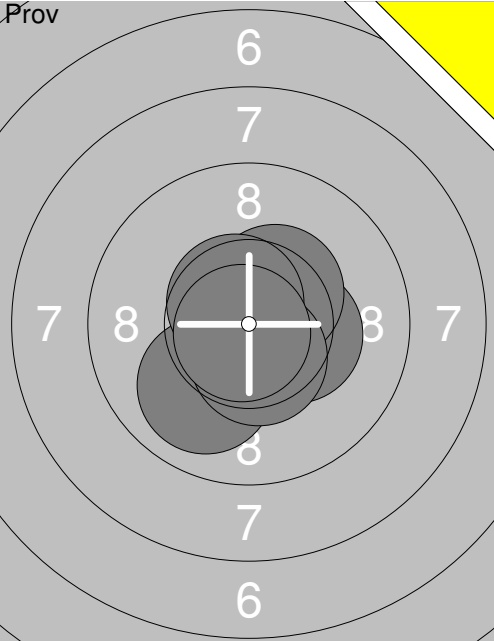
Skjutlag	Tavla	Mikaela Edelsvärd	
1	20	Hammerdal SkF	L15
02.02.2019	Skyttiaden Regionfinal 2019	Umeå skytteallians	
Prov		1: 10.6x↗ 2: 9.9 ↖ 3: 10.6x➤ 4: 10.7x➤ 5: 10.5x↑ 6: 10.5x↙ 7: 10.8x↗ 8: 10.1 ➤ 9: 9.8 ↗ 10: 10.3x↘ Serie 103.8 Total 0.0	11: 10.7x↑ 12: 10.4x↑ 13: 10.4x↗ 14: 10.7x➤ 15: 10.0↙ 16: 10.5x↘ 17: 10.2x↙ 18: 9.9 ↙ 19: 10.5x↙ 20: 10.4x↘ 21: 10.2x↙ Serie 103.2 Total 206.7
40 Skott		1: 10.7x↘ 2: 10.9x↘ 3: 9.9 ↙ 4: 9.8 ↙ 5: 10.1↙ 6: 10.7x↘ 7: 10.2x↙ 8: 10.5x↙ 9: 10.1 ↗ 10: 10.6x↗ Serie 103.5 Total 103.5	31: 10.1↙ 32: 10.5x↘ 33: 10.7x➤ 34: 10.7x↘ 35: 10.1↙ 36: 10.0↙ 37: 10.1 ↗ 38: 10.5x↗ 39: 10.4x↙ 40: 10.6x↘ Serie 103.7 Total 415.5
40 Skott		21: 10.9x↗ 22: 10.5x↙ 23: 10.8x↘ 24: 10.1↙ 25: 10.5x↙ 26: 10.1↙ 27: 10.3x↗ 28: 10.6x↙ 29: 10.5x↙ 30: 10.8x↗ Serie 105.1 Total 311.8	

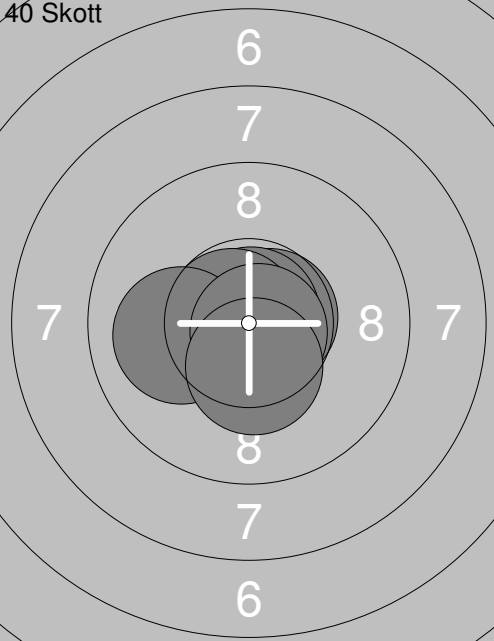
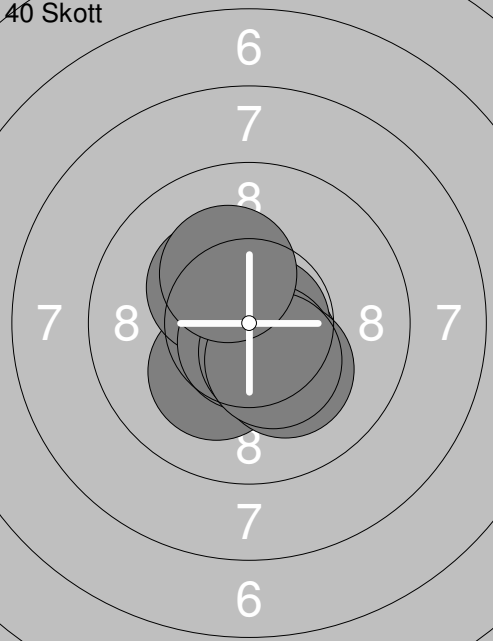
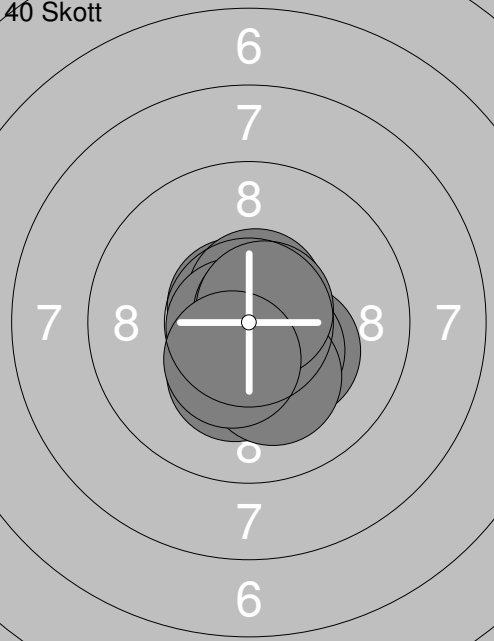
Skjutlag	Tavla	Lia Edholm	
S	Umeå Skf	L15	
02.02.2019	Skyttiaden Regionfinal 2019	Umeå skytteallians	
Prov		40 Skott	
	1: 10.6x↗ 2: 10.3x→ 3: 10.7x↗ 4: 10.4x↗ 5: 10.0↘ 6: 10.6x↖ 7: 10.5x↘ 8: 10.8x↘	1: 10.7x↖ 2: 10.6x→ 3: 9.9↘ 4: 10.7x↘ 5: 10.8x↘ 6: 10.5x↘ 7: 9.8↘ 8: 10.6x↖ 9: 10.9x↘ 10: 10.7x↘	
	Serie 83.9	Serie 105.2	
	Total 0.0	Total 105.2	
40 Skott		40 Skott	
	11: 10.5x↘ 12: 10.8x↘ 13: 10.9x↘ 14: 10.7x→ 15: 10.8x↘ 16: 10.8x↗ 17: 10.7x↖ 18: 10.1← 19: 10.8x↘ 20: 10.4x↘	21: 10.5x↘ 22: 10.2x↘ 23: 10.3x↖ 24: 10.5x↘ 25: 10.8x→ 26: 10.7x↘ 27: 10.5x↘ 28: 10.2x↘ 29: 10.4x↘ 30: 10.3x↗	
	Serie 106.5	Serie 104.4	
	Total 211.7	Total 316.1	
40 Skott			
	31: 10.7x↖ 32: 10.3x↘ 33: 10.6x↗ 34: 10.3x↘ 35: 10.8x↖ 36: 10.4x↘ 37: 10.8x↗ 38: 10.2x↘ 39: 10.7x↗ 40: 10.4x↘		
	Serie 105.2		
	Total 421.3		

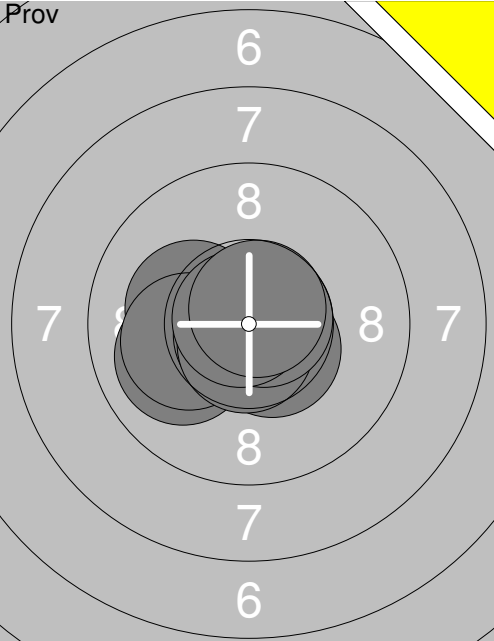
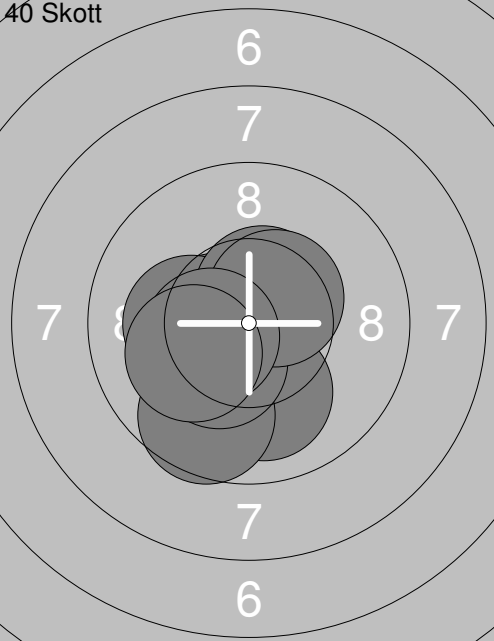
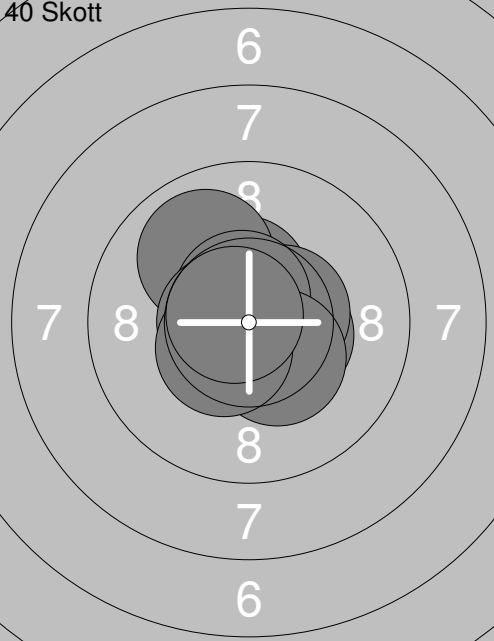
Skjutlag	Tavla	Fabian Grindborg	
1	22	Fältjägarna SkF	L15
02.02.2019	Skyttiaden Regionfinal 2019	Umeå skytteallians	
Prov		1: 10.2x↘ 2: 10.8x↓ 3: 10.0↙ 4: 10.1↙ 5: 10.8x↓ 6: 10.5x↘ 7: 10.7x↓ 8: 10.7x➤ 9: 10.8x↘ 10: 10.7x↗ Serie 105.3 Total 0.0	11: 10.4x↓ 12: 10.6x↘ Serie 21.0 Total 0.0
40 Skott		1: 10.6x↗ 2: 10.5x↔ 3: 10.0↓ 4: 10.2x↔ 5: 9.6↓ 6: 10.3x↓ 7: 10.5x↗ 8: 10.5x↗ 9: 10.4x↔ 10: 10.1↙ Serie 102.7 Total 102.7	11: 10.8x↗ 12: 10.6x↗ 13: 10.0↙ 14: 10.9x↗ 15: 10.7x➤ 16: 10.4x↗ 17: 10.8x↘ 18: 10.4x➤ 19: 10.8x↘ 20: 10.2x↗ Serie 105.6 Total 208.3
40 Skott		21: 10.4x↗ 22: 10.6x↘ 23: 10.4x➤ 24: 9.9↖ 25: 10.5x➤ 26: 10.6x↗ 27: 10.6x↔ 28: 10.4x↘ 29: 10.5x↓ 30: 10.7x↘ Serie 104.6 Total 312.9	31: 10.6x↓ 32: 10.2x↔ 33: 10.5x↔ 34: 10.6x↔ 35: 9.7↓ 36: 10.1↓ 37: 10.0↙ 38: 10.5x↘ 39: 10.5x↔ 40: 10.7x↓ Serie 103.4 Total 416.3

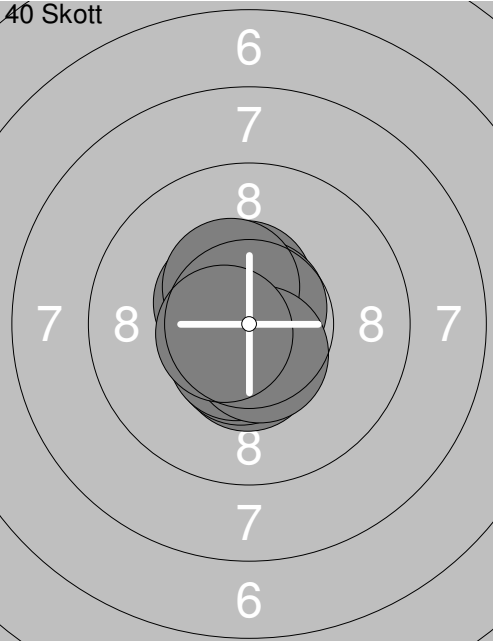
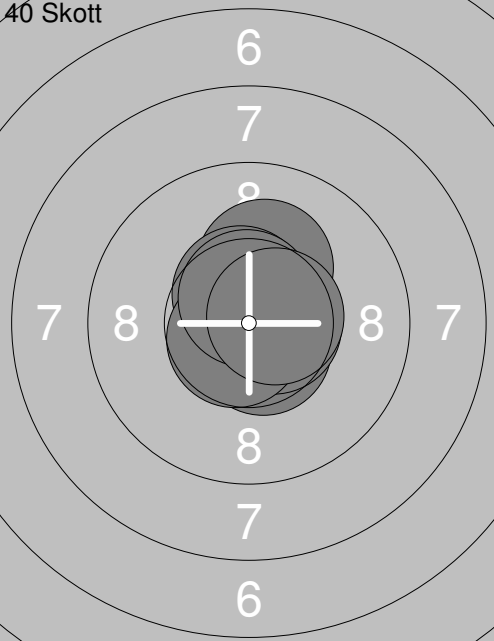
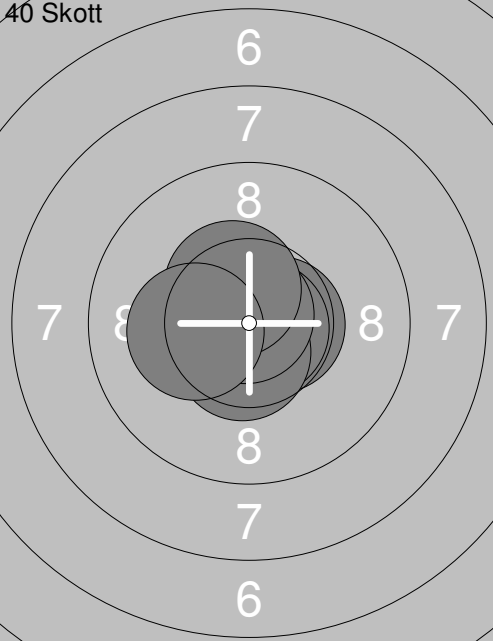
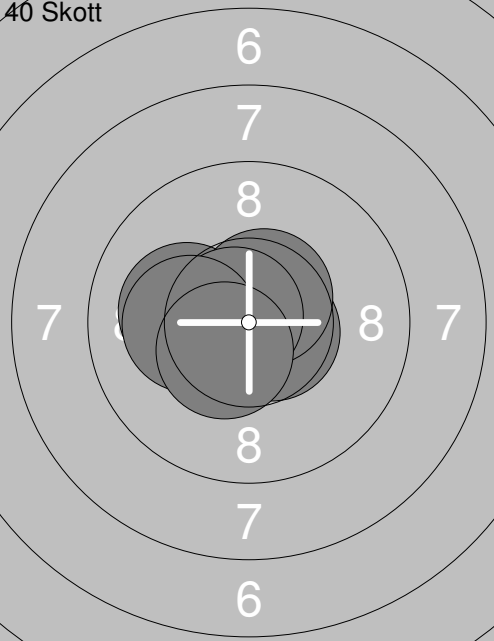
Skjutlag 1	Tavla 23	Martin Blombäck	
S	Piteå Skf	L15	
02.02.2019	Skyttiäden Regionfinal 2019	Umeå skytteallians	
Prov		40 Skott	
	1: 10.6x ↗ 2: 10.6x ↗ 3: 10.2x ↖ 4: 10.1 ↓ 5: 10.3x → 6: 10.9x ↘		1: 10.5x ↖ 2: 10.6x ↖ 3: 10.5x ↗ 4: 10.4x ↓ 5: 10.7x ↗ 6: 10.5x ↓ 7: 10.4x ↖ 8: 10.5x ↓ 9: 10.5x ↓ 10: 10.6x ↖
	Serie 62.7 Total 0.0		Serie 105.2 Total 105.2
40 Skott		40 Skott	
	11: 10.6x ↗ 12: 10.7x ↗ 13: 10.6x ↗ 14: 10.2x ↗ 15: 10.6x ↓ 16: 10.6x ↗ 17: 10.6x → 18: 10.7x ↘ 19: 10.6x ↗ 20: 10.6x →		21: 10.6x → 22: 10.6x ↓ 23: 10.7x ↓ 24: 10.4x ↖ 25: 10.4x ↖ 26: 10.8x → 27: 10.6x ↓ 28: 10.8x ↖ 29: 10.5x ↖ 30: 10.2x ↖
	Serie 105.8 Total 211.0		Serie 105.6 Total 316.6
40 Skott			
	31: 10.7x ↖ 32: 10.8x ↗ 33: 10.5x ↖ 34: 10.8x ↓ 35: 10.6x → 36: 10.1 ← 37: 10.6x ↗ 38: 10.7x ↖ 39: 10.2x ↖ 40: 10.5x ↓		
	Serie 105.5 Total 422.1		

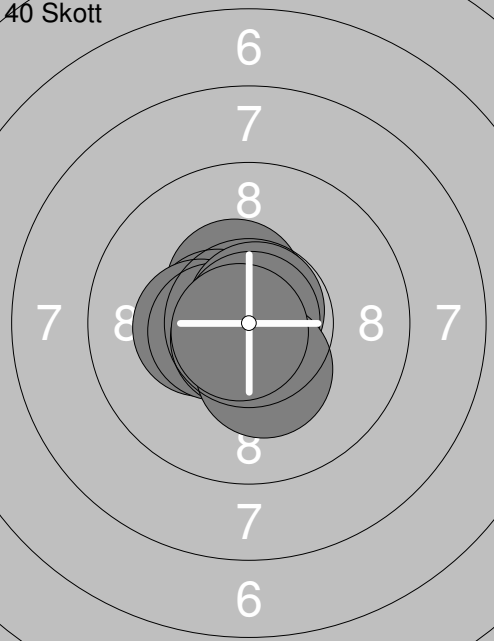
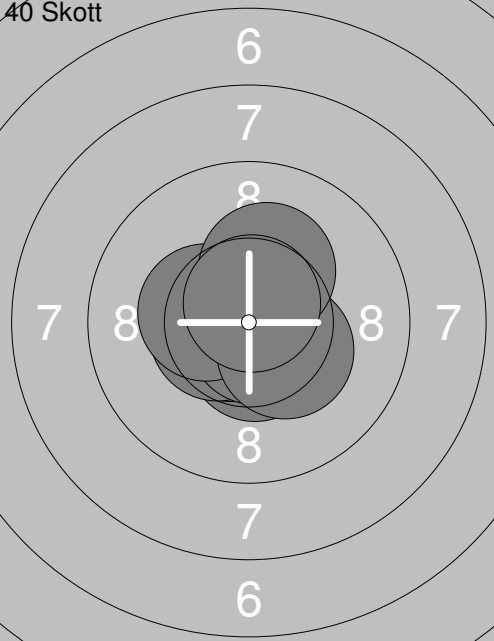
Skjutlag	Tavla	Mattis Hemå	
1	24	Fältjägarna SkF	L15
02.02.2019	Skyttiaden Regionfinal 2019	Umeå skytteallians	
Prov		40 Skott 1: 10.6x↘ 2: 10.8x↔ 3: 10.6x↔ 4: 10.2x↘ 5: 10.6x↘ 6: 10.4x↔ 7: 10.8x↗ Serie 74.0 Total 0.0	40 Skott 1: 10.3x↗ 2: 10.7x↘ 3: 10.6x↔ 4: 10.6x↔ 5: 10.7x↗ 6: 10.6x↔ 7: 10.6x↘ 8: 10.5x↗ 9: 10.2x↗ 10: 10.4x↔ Serie 105.2 Total 105.2
40 Skott		40 Skott 11: 10.7x↗ 12: 10.4x↗ 13: 10.5x↔ 14: 10.3x↔ 15: 10.5x↔ 16: 10.8x↗ 17: 10.7x↘ 18: 10.9x↗ 19: 10.3x↘ 20: 10.8x↘ Serie 105.9 Total 211.1	40 Skott 21: 10.8x↗ 22: 10.3x↘ 23: 10.4x↘ 24: 10.7x↘ 25: 10.6x↗ 26: 10.6x↔ 27: 10.3x↘ 28: 10.3x↔ 29: 10.9x↘ 30: 10.8x↔ Serie 105.7 Total 316.8
40 Skott		40 Skott 31: 10.5x↘ 32: 10.7x↘ 33: 10.5x↔ 34: 10.9x↘ 35: 10.7x↘ 36: 10.4x↔ 37: 10.7x↗ 38: 10.4x↘ 39: 10.2x↗ 40: 10.7x↗ Serie 105.7 Total 422.5	

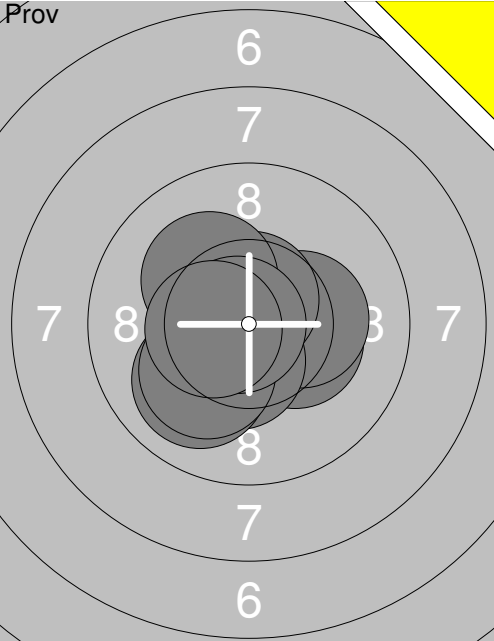
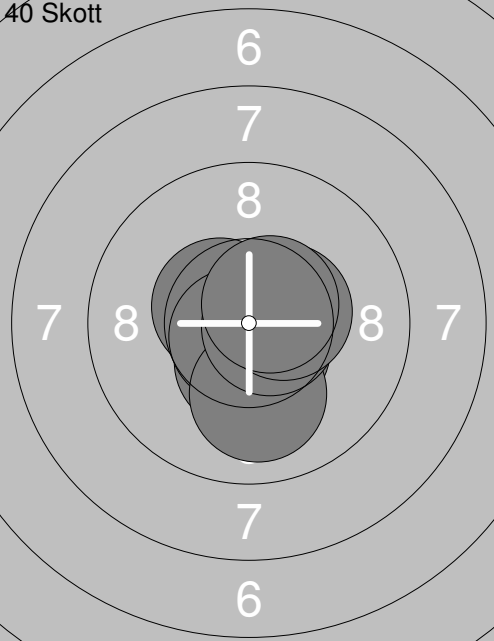
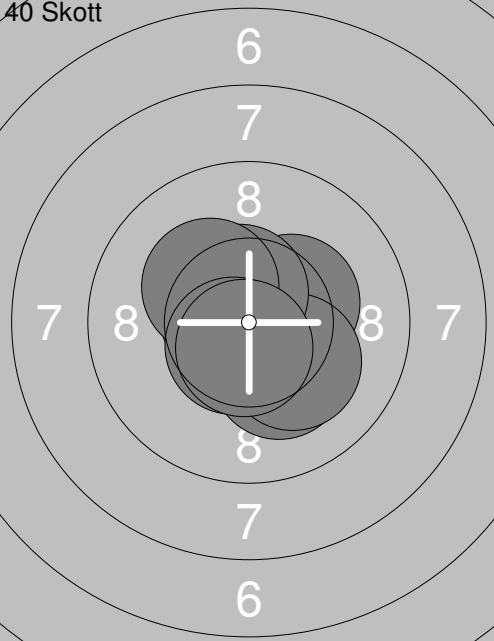
Skjutlag	Tavla	Erika Augustsson	
S	Vännäs Skf	L15	
02.02.2019	Skyttiaden Regionfinal 2019	Umeå skytteallians	
Prov		1: 10.3x➤ 2: 10.7x➤ 3: 10.3x➤ 4: 10.4x↓ 5: 10.0↓ 6: 10.6x↑ 7: 10.2x↘ 8: 10.1↓ 9: 10.8x↔ 10: 10.5x↔ Serie 103.9 Total 0.0	11: 10.3x↘ 12: 10.3x↗ 13: 10.9x↔ 14: 10.6x➤ 15: 10.7x↑ 16: 10.9x↓ Serie 63.7 Total 0.0
40 Skott		1: 10.7x➤ 2: 10.5x↔ 3: 10.4x↓ 4: 10.7x↘ 5: 10.6x↓ 6: 10.7x↘ 7: 10.0↓ 8: 10.7x➤ 9: 10.5x➤ 10: 10.6x↗ Serie 105.4 Total 105.4	11: 10.9x↓ 12: 10.5x➤ 13: 10.7x↓ 14: 10.7x↘ 15: 10.5x↓ 16: 10.4x↘ 17: 10.5x↘ 18: 10.5x↑ 19: 10.2x↑ 20: 10.6x↓ Serie 105.5 Total 210.9
40 Skott		21: 10.5x↓ 22: 10.8x➤ 23: 10.2x↓ 24: 10.3x➤ 25: 10.7x↔ 26: 10.2x↘ 27: 10.5x↑ 28: 10.3x↘ 29: 10.6x↓ 30: 10.6x↓ Serie 104.7 Total 315.6	31: 10.9x➤ 32: 10.7x↘ 33: 10.6x↓ 34: 10.3x↓ 35: 10.3x↘ 36: 10.7x↓ 37: 10.7x↘ 38: 10.6x➤ 39: 10.7x↓ 40: 10.7x↔ Serie 106.2 Total 421.8

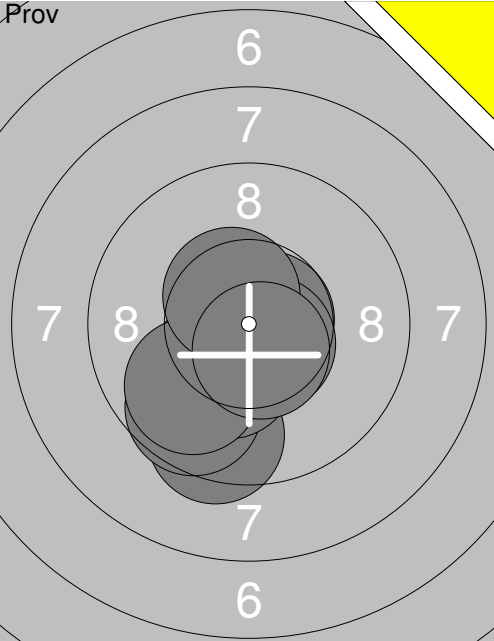
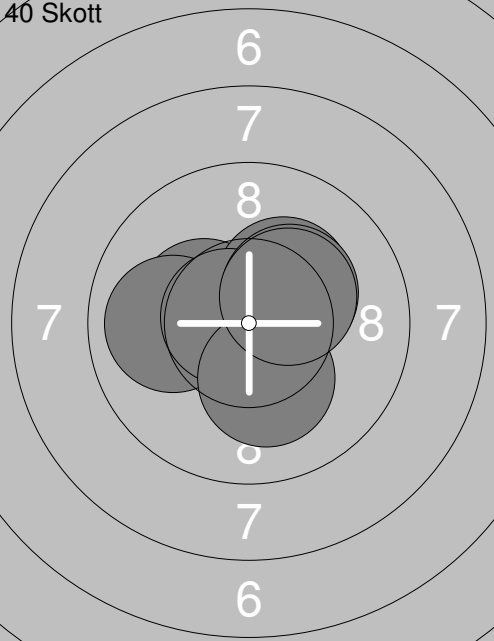
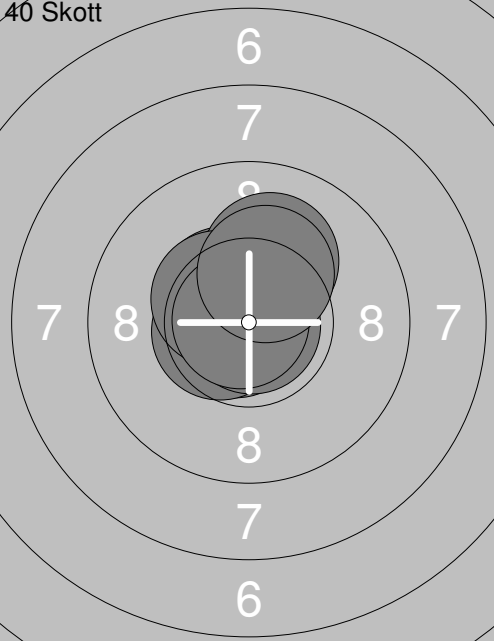

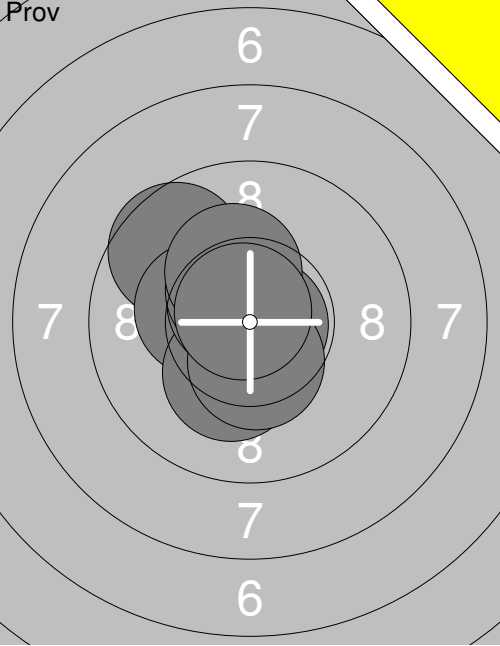
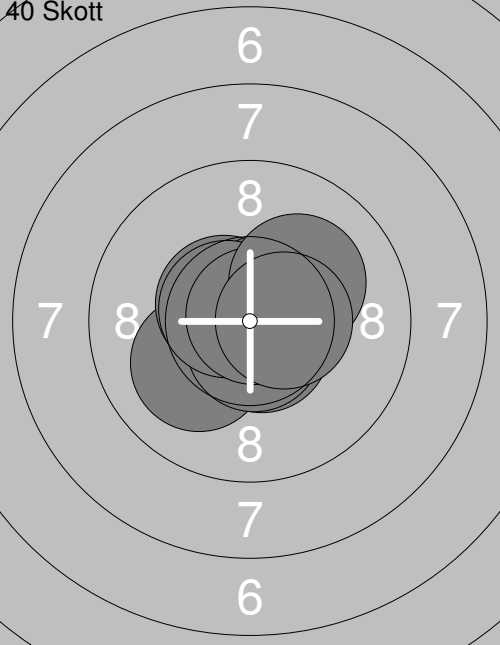
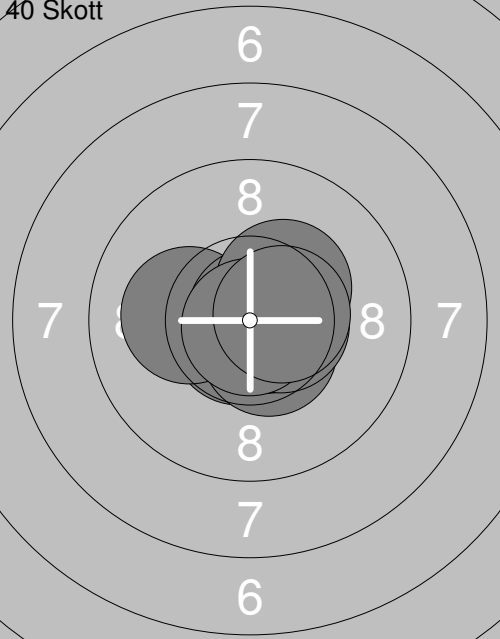
Skjutlag	Tavla	Anna Grönlund	
1	26	Pietå Skf	L15
02.02.2019	Skyttiaden Regionfinal 2019	Umeå skytteallians	
Prov		1: 10.7x↗ 2: 10.6x↘ 3: 9.4 ↓ 4: 10.6x↘ 5: 9.6 ↓ 6: 10.3x↘ 7: 10.3x↘ 8: 9.9 ↓ 9: 10.5x↗ 10: 10.6x↘ Serie 102.5 Total 0.0	11: 10.5x↘ 12: 10.7x↘ Serie 21.2 Total 0.0
40 Skott		1: 10.5x↘ 2: 10.3x↘ 3: 10.0← 4: 10.9x↗ 5: 10.3x↗ 6: 10.8x↗ 7: 10.7x↘ 8: 10.2x↘ 9: 10.3x↗ 10: 10.3x↗ Serie 104.3 Total 104.3	11: 10.6x↘ 12: 10.3x↘ 13: 10.6x→ 14: 10.5x→ 15: 10.5x↘ 16: 10.5x↘ 17: 10.7x↘ 18: 10.2x↘ 19: 10.5x→ 20: 10.6x↗ Serie 105.0 Total 209.3
40 Skott		21: 10.5x↘ 22: 10.7x↘ 23: 10.8x↘ 24: 10.5x↘ 25: 10.1 ↑ 26: 10.6x↘ 27: 10.5x↘ 28: 10.9x↘ 29: 10.8x↘ 30: 10.3x↗ Serie 105.7 Total 315.0	31: 10.4x↘ 32: 10.6x↘ 33: 10.7x↗ 34: 10.6x→ 35: 10.6x→ 36: 10.6x↘ 37: 10.3x↘ 38: 10.3x↘ 39: 10.5x↘ 40: 10.6x↗ Serie 105.2 Total 420.2

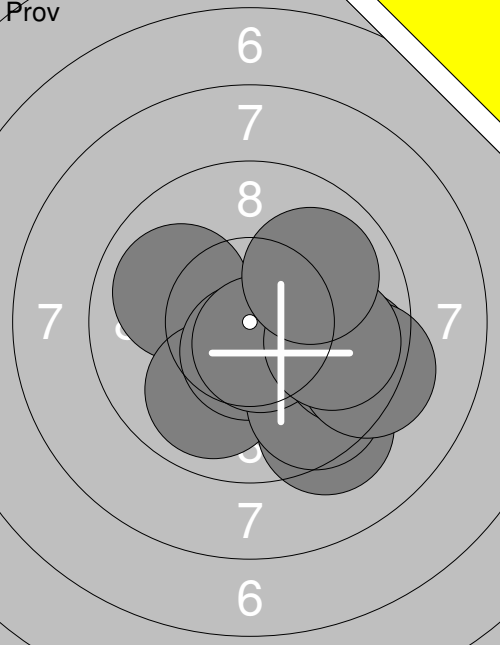
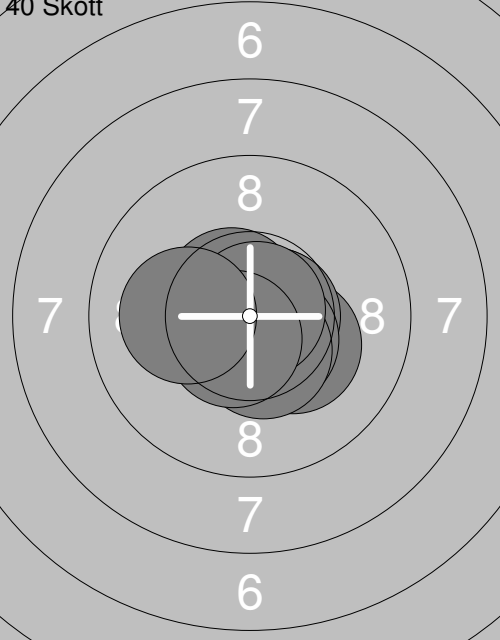
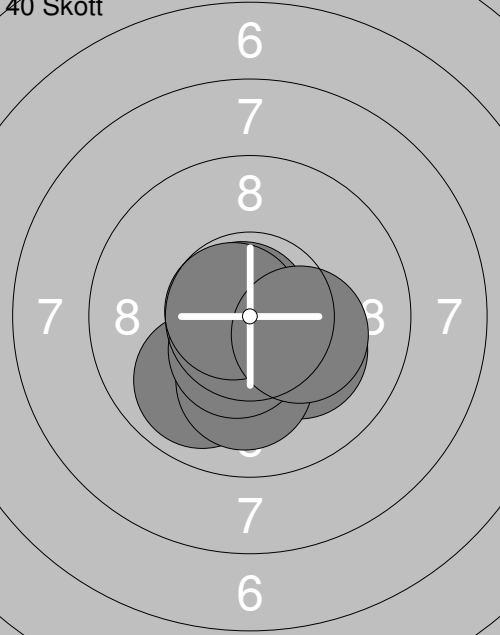
Skjuttag	Tavla	Chris Johansson	
S	Hammerdal SkF	L13	
02.02.2019	Skyttiaden Regionfinal 2019	Umeå skytteallians	
Prov		1: 9.6 ↖ 2: 10.4x↓ 3: 10.3x↖ 4: 10.8x→ 5: 10.2x↓ 6: 10.6x↖ 7: 10.5x↖ 8: 10.3x↖ 9: 10.4x↓ 10: 10.8x↖ Serie 103.9 Total 0.0	11: 10.5x↖ 12: 10.6x↖ 13: 10.0↓ 14: 10.6x↖ 15: 9.9↖ 16: 10.7x↓ Serie 62.3 Total 0.0
40 Skott		1: 10.6x↓ 2: 10.1↖ 3: 10.5x↖ 4: 10.6x↖ 5: 10.7x↓ 6: 10.7x→ 7: 10.6x↖ 8: 10.9x↖ 9: 10.1↗ 10: 10.5x→ Serie 105.3 Total 105.3	11: 10.8x↖ 12: 10.9x↖ 13: 10.5x↖ 14: 10.7x↖ 15: 10.6x→ 16: 10.7x→ 17: 10.6x→ 18: 10.6x↖ 19: 10.5x↓ 20: 10.7x↖ Serie 106.6 Total 211.9
40 Skott		21: 10.7x↓ 22: 10.2x↖ 23: 10.6x→ 24: 10.5x↓ 25: 10.8x→ 26: 10.8x↖ 27: 10.3x↖ 28: 10.5x→ 29: 10.9x↓ 30: 10.5x→ Serie 105.8 Total 317.7	31: 10.6x→ 32: 10.1↖ 33: 10.8x↖ 34: 10.6x↓ 35: 10.4x↖ 36: 10.4x↖ 37: 10.4x↖ 38: 10.2x→ 39: 10.8x→ 40: 10.3x↖ Serie 104.6 Total 422.3

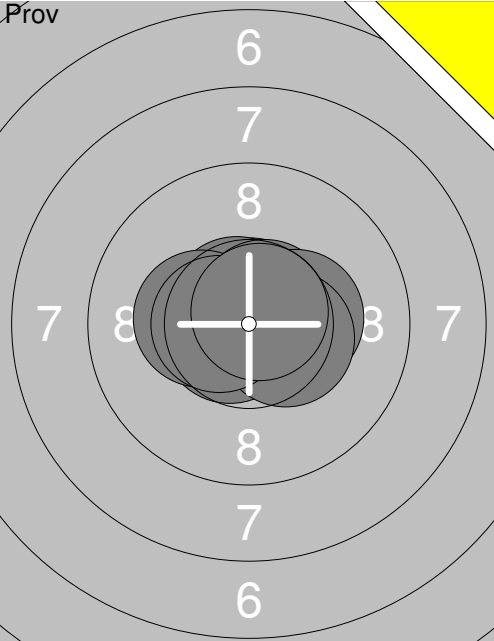
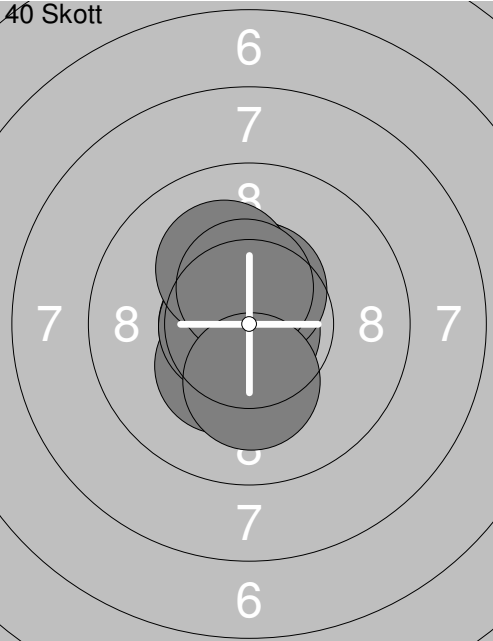
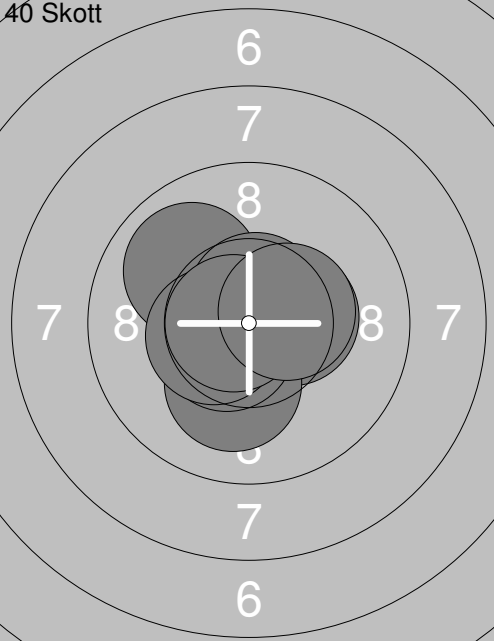
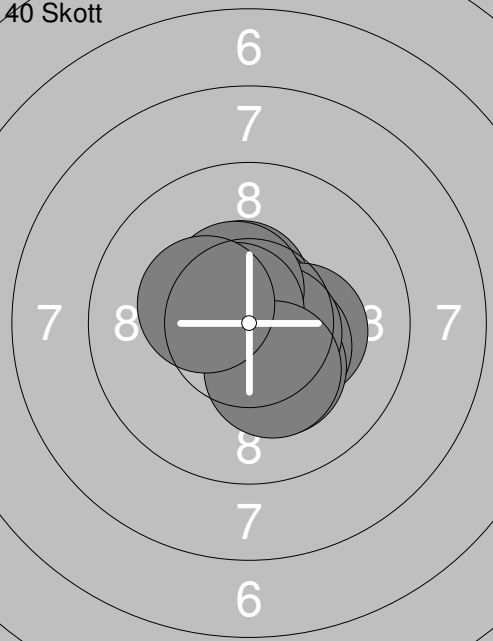
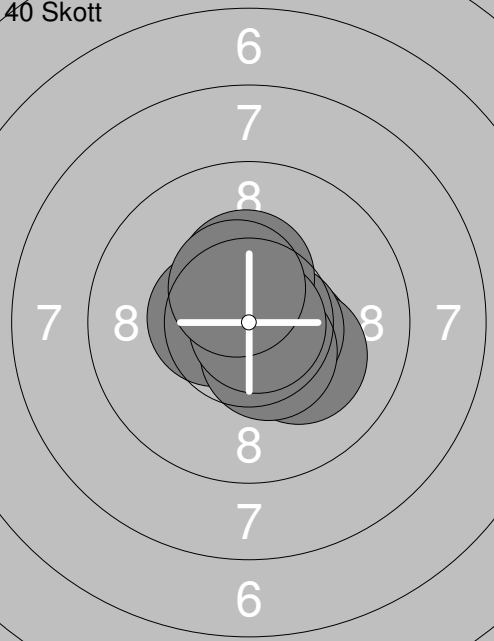
Skjutlag	Tavla	Ebba Lundstedt	
1	29	Ramselefors Skf	L13
02.02.2019	Skyttiaden Regionfinal 2019	Umeå skytteallians	
Prov		1: 10.0 ↙ 2: 9.9 ↓ 3: 9.3 ↓ 4: 10.6x↓ 5: 9.6 ↓ 6: 10.6x↓ 7: 9.6 → 8: 9.3 → 9: 9.8 → 10: 10.0 ↗	11: 9.6 → 12: 9.7 ↗ 13: 9.6 → 14: 10.7x↗ 15: 10.0 → 16: 10.1 → 17: 10.0 ↓ 18: 10.8x↑ 19: 10.2x↖ 20: 10.3x↓
		Serie 98.7	Serie 101.0
		Total 0.0	Total 0.0
40 Skott		1: 10.7x→ 2: 10.8x→ 3: 10.3x↘ 4: 10.7x→ 5: 10.5x↘ 6: 10.6x↘ 7: 10.5x↓ 8: 10.8x↗ 9: 10.6x↓ 10: 10.1←	11: 10.4x↓ 12: 10.7x↖ 13: 10.4x↓ 14: 10.4x↘ 15: 9.7 ↖ 16: 10.3x↖ 17: 10.3x↖ 18: 10.0 ↓ 19: 10.4x↓ 20: 10.5x↓
		Serie 105.6	Serie 103.1
		Total 105.6	Total 208.7
40 Skott		21: 10.8x↘ 22: 9.9 ↓ 23: 10.3x↓ 24: 10.6x↓ 25: 10.2x↘ 26: 10.7x↓ 27: 10.1 ↓ 28: 10.5x↓ 29: 10.7x↖ 30: 10.3x→	31: 10.4x↓ 32: 10.5x↘ 33: 10.6x↓ 34: 10.7x↖ 35: 9.9 ← 36: 10.4x↖ 37: 10.4x↗ 38: 10.0 ↑ 39: 10.7x↘ 40: 9.9 ←
		Serie 104.1	Serie 103.5
		Total 312.8	Total 416.3

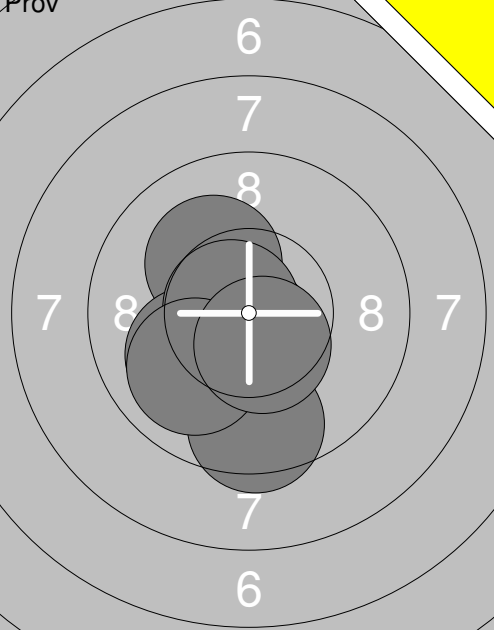
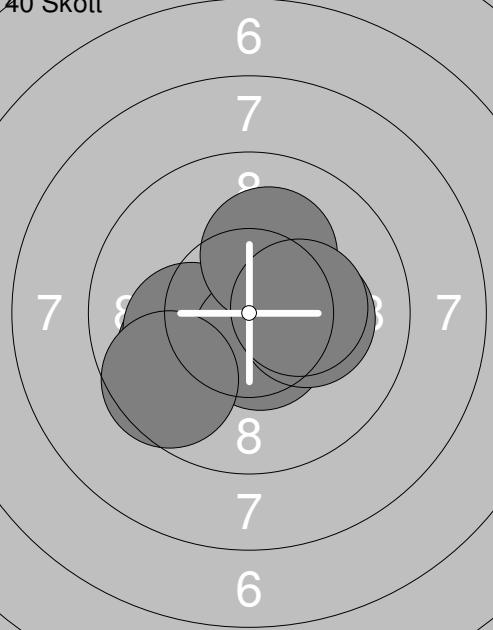
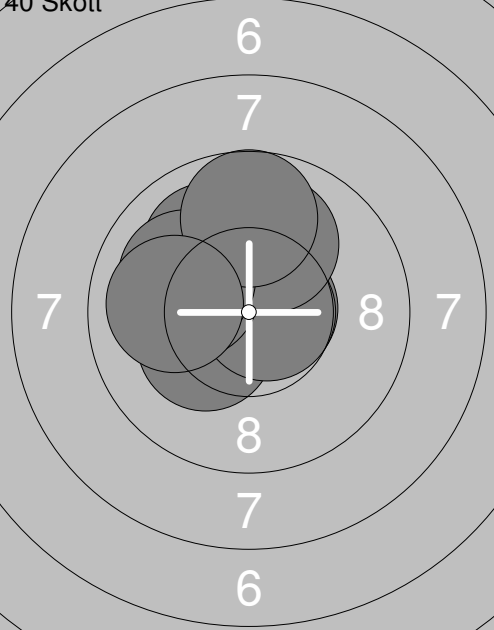
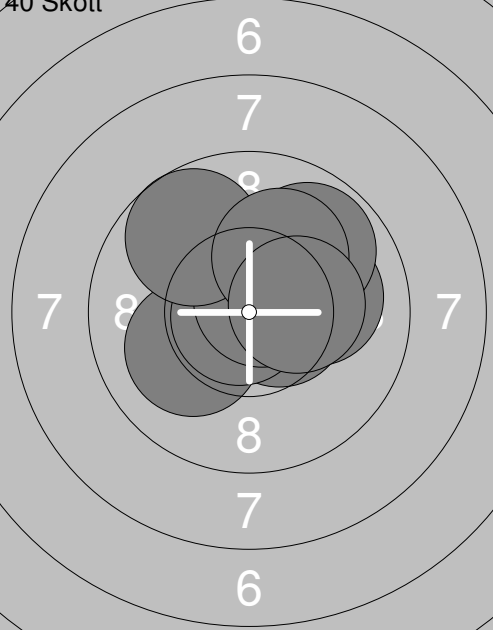
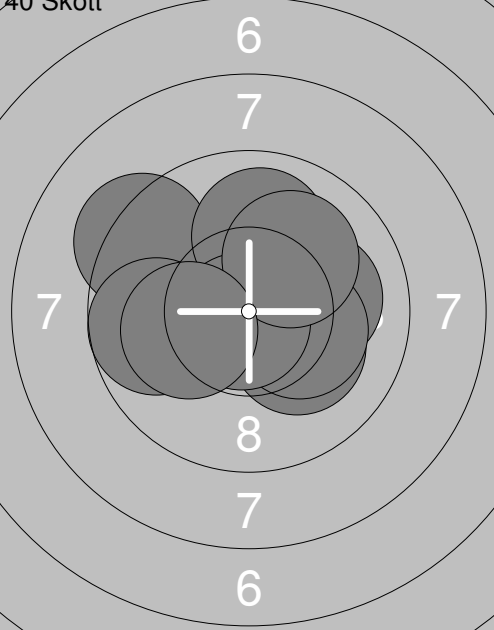
Skjutlag 1	Tavla 30	Leon Brink	
S		Kyrkås SkF	L13
02.02.2019	Skyttiäden Regionfinal 2019		Umeå skytteallians
Prov		1: 10.7x↑ 2: 10.7x↗ 3: 10.7x↘ 4: 10.7x↗ 5: 10.7x↘ 6: 10.3x→ 7: 10.4x→ 8: 10.3x↖ 9: 10.6x↖ 10: 10.7x↗ Serie 105.8 Total 0.0	40 Skott  1: 10.3x↘ 2: 10.8x↘ 3: 10.5x↑ 4: 10.7x↖ 5: 10.7x↖ 6: 10.5x↑ 7: 10.7x↖ 8: 10.2x↘ 9: 10.5x↑ 10: 10.2x↓ Serie 105.1 Total 105.1
40 Skott		11: 10.4x→ 12: 10.7x→ 13: 10.6x→ 14: 10.1↓ 15: 9.9↖ 16: 10.6x↘ 17: 10.5x↖ 18: 10.7x↑ 19: 10.8x↖ 20: 10.4x→ Serie 104.7 Total 209.8	40 Skott  21: 10.5x↑ 22: 10.8x↑ 23: 10.3x→ 24: 10.4x↘ 25: 10.3x↓ 26: 10.6x↘ 27: 10.5x↑ 28: 10.7x↖ 29: 10.3x↓ 30: 10.3x↖ Serie 104.7 Total 314.5
40 Skott		31: 10.9x↑ 32: 10.4x↘ 33: 10.2x↘ 34: 10.7x↘ 35: 10.6x→ 36: 10.4x↑ 37: 10.5x↖ 38: 10.5x↘ 39: 10.8x→ 40: 10.5x↑ Serie 105.5 Total 420.0	

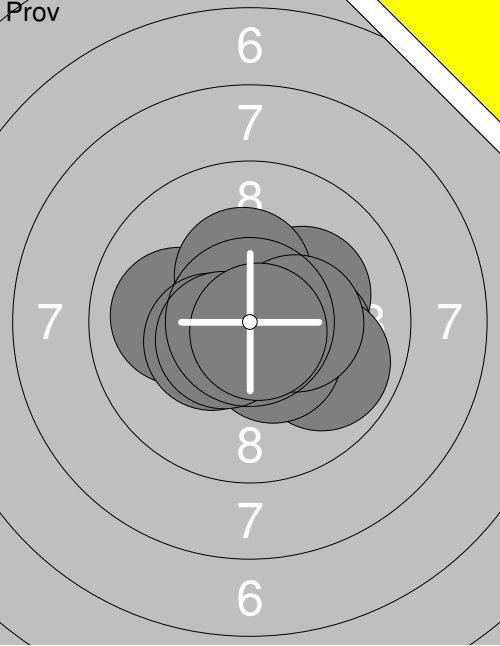
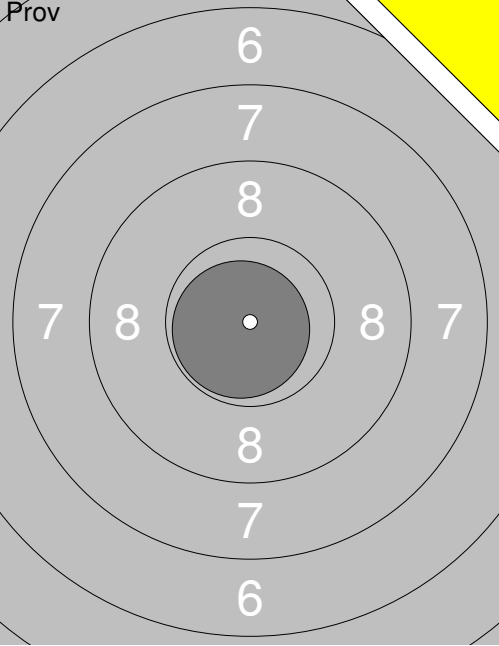
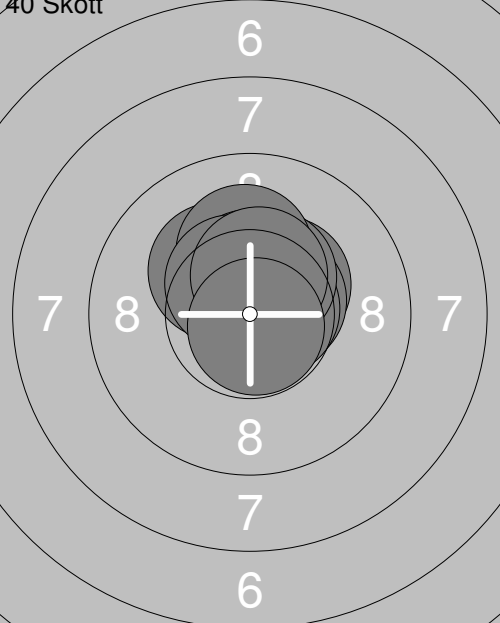
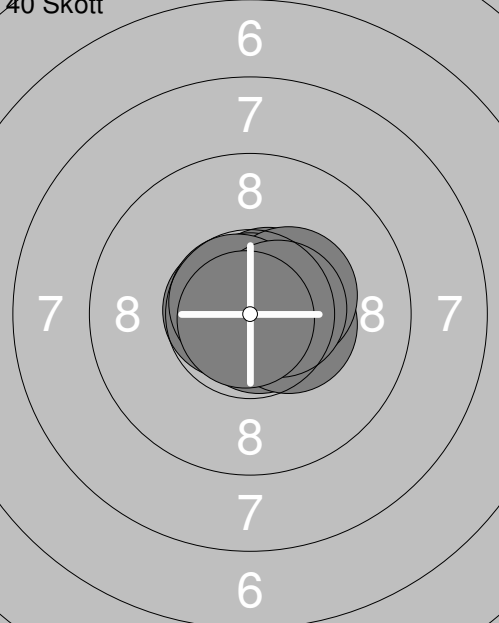
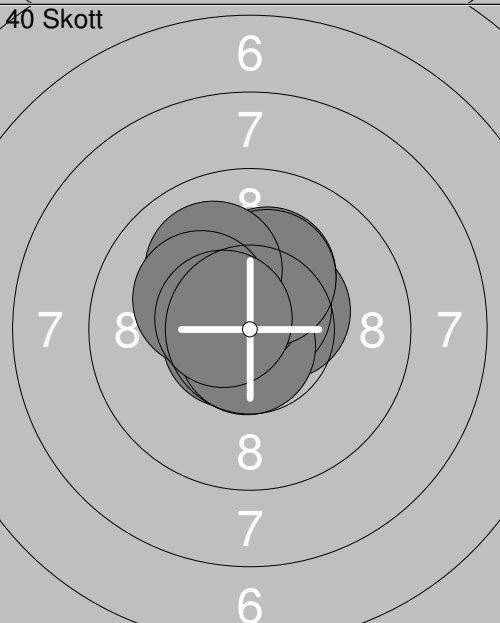
<p>Prov</p>  <p style="text-align: center;">6 7 8 7 8 7 6</p>	<p>40 Skott</p> <p>1: 10.5x↓ 2: 9.5 ↓ 3: 10.2x↘ 4: 10.7x↘ 5: 10.7x↓ 6: 10.0↙ 7: 10.7x↘ 8: 10.0↙ 9: 10.5x↓</p> <table border="1" style="width:100%; border-collapse: collapse;"> <tr><td>Serie</td><td>92.8</td></tr> <tr><td>Total</td><td>0.0</td></tr> </table>	Serie	92.8	Total	0.0	<p>40 Skott</p>  <p style="text-align: center;">6 7 8 7 8 7 6</p> <p>1: 10.0↙ 2: 10.7x↘ 3: 10.3x↘ 4: 10.6x→ 5: 10.2x↘ 6: 10.5x↓ 7: 10.2x↗ 8: 10.2x→ 9: 10.3x→ 10: 9.6 ↙</p> <table border="1" style="width:100%; border-collapse: collapse;"> <tr><td>Serie</td><td>102.6</td></tr> <tr><td>Total</td><td>102.6</td></tr> </table>	Serie	102.6	Total	102.6
Serie	92.8									
Total	0.0									
Serie	102.6									
Total	102.6									
<p>40 Skott</p>  <p style="text-align: center;">6 7 8 7 8 7 6</p>	<p>40 Skott</p> <p>11: 10.0 ↖ 12: 10.3x↘ 13: 10.2x↘ 14: 10.7x→ 15: 10.7x→ 16: 10.1↙ 17: 10.0 ↗ 18: 10.0↙ 19: 9.7 ↗ 20: 10.0←</p> <table border="1" style="width:100%; border-collapse: collapse;"> <tr><td>Serie</td><td>101.7</td></tr> <tr><td>Total</td><td>204.3</td></tr> </table>	Serie	101.7	Total	204.3	<p>40 Skott</p>  <p style="text-align: center;">6 7 8 7 8 7 6</p> <p>21: 10.5x↘ 22: 10.5x→ 23: 10.1→ 24: 10.1↙ 25: 10.8x↘ 26: 10.7x↗ 27: 9.7 ↖ 28: 9.8 ↗ 29: 10.1 ↗ 30: 10.3x→</p> <table border="1" style="width:100%; border-collapse: collapse;"> <tr><td>Serie</td><td>102.6</td></tr> <tr><td>Total</td><td>306.9</td></tr> </table>	Serie	102.6	Total	306.9
Serie	101.7									
Total	204.3									
Serie	102.6									
Total	306.9									
<p>40 Skott</p>  <p style="text-align: center;">6 7 8 7 8 7 6</p>	<p>31: 10.2x↘ 32: 10.2x↘ 33: 10.1→ 34: 10.2x→ 35: 9.3 ↖ 36: 10.0 ↗ 37: 9.7 ← 38: 10.8x↘ 39: 10.1 ↗ 40: 10.1←</p> <table border="1" style="width:100%; border-collapse: collapse;"> <tr><td>Serie</td><td>100.7</td></tr> <tr><td>Total</td><td>407.6</td></tr> </table>	Serie	100.7	Total	407.6					
Serie	100.7									
Total	407.6									

Skjuttag	Tavla	Olivia Österholm	
1	32	Hammerdal SkF	L13
02.02.2019	Skyttiaden Regionfinal 2019	Umeå skytteallians	
Prov		Prov	
	1: 10.2x↗ 2: 10.2x→ 3: 9.9 ↘ 4: 10.4x↘ 5: 10.0← 6: 10.3x↑ 7: 10.4x↘ 8: 10.5x↘ 9: 10.4x→ 10: 10.8x↘		11: 10.8x↘
	Serie 103.1		Serie 10.8
	Total 0.0		Total 0.0
40 Skott		40 Skott	
	1: 10.4x↗ 2: 10.5x↗ 3: 10.7x→ 4: 10.4x↑ 5: 10.2x↘ 6: 10.2x↑ 7: 10.5x↑ 8: 10.5x↘ 9: 10.4x↑ 10: 10.8x↘		11: 10.7x↘ 12: 10.8x→ 13: 10.6x↗ 14: 10.8x↑ 15: 10.8x↘ 16: 10.4x→ 17: 10.4x↗ 18: 10.7x↘ 19: 10.6x→ 20: 10.9x↘
	Serie 104.6		Serie 106.7
	Total 104.6		Total 211.3
40 Skott		40 Skott	
	21: 10.5x↗ 22: 10.7x↘ 23: 10.6x↑ 24: 10.7x↘ 25: 10.5x↘ 26: 10.2x↑ 27: 10.2x↑ 28: 10.0 ↘ 29: 10.2x↘ 30: 10.6x↘		31: 10.8x→ 32: 10.7x→ 33: 10.3x↑ 34: 10.1 ↘ 35: 10.8x↘ 36: 10.5x↘ 37: 10.5x↘ 38: 10.7x↘ 39: 10.3x↑ 40: 10.4x↑
	Serie 104.2		Serie 105.1
	Total 315.5		Total 420.6

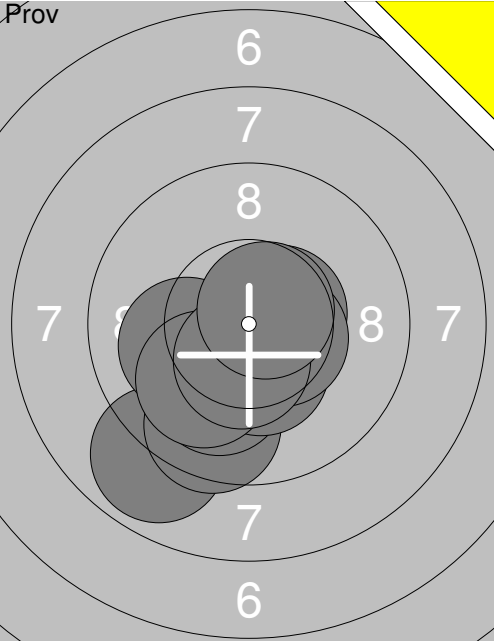
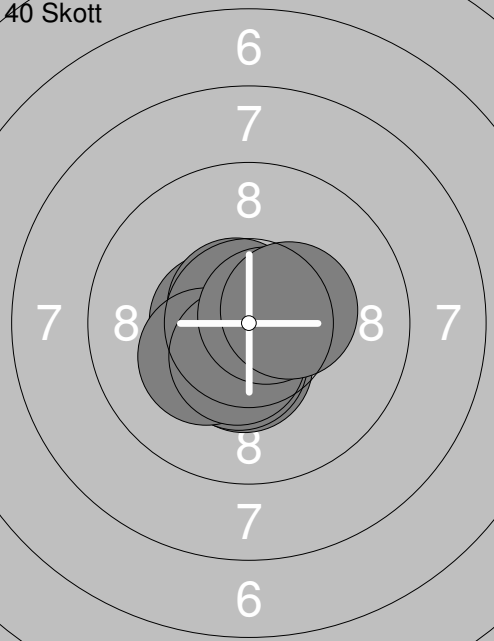
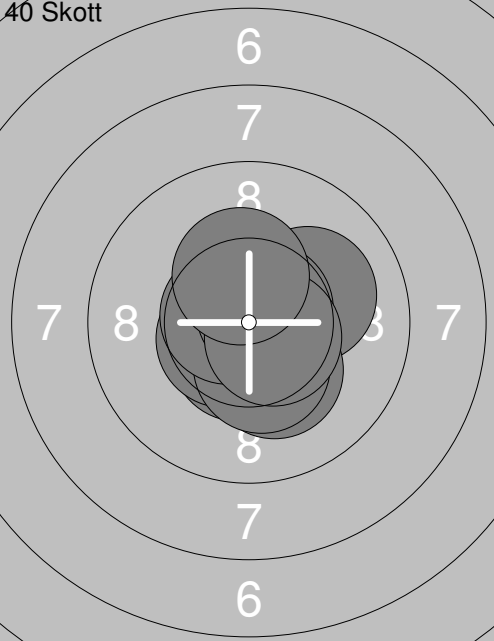
Skjuttag	Tavla	Agnes Ebbhagen	
1	33	Ramselefors Skf	L13
02.02.2019	Skyttiaden Regionfinal 2019	Umeå skytteallians	
Prov		1: 8.9 ↘ 2: 9.6 ↓ 3: 10.1 ← 4: 10.5x → 5: 10.0 ↓ 6: 10.4x ↓ 7: 10.0 ↓ 8: 10.5x → 9: 10.5x ↓ 10: 10.7x →	11: 10.9x ↓ 12: 10.9x ↓
	Serie 101.2	Serie 21.8	
	Total 0.0	Total 0.0	
40 Skott		1: 10.5x ← 2: 10.9x ← 3: 10.7x → 4: 10.4x ↓ 5: 10.7x ↘ 6: 10.4x ↓ 7: 10.2x ↘ 8: 10.5x ↓ 9: 10.7x → 10: 10.4x →	11: 10.4x ↓ 12: 10.5x ← 13: 10.4x → 14: 10.6x ↘ 15: 10.9x → 16: 10.4x ↓ 17: 10.2x → 18: 10.5x ↗ 19: 9.8 ↓ 20: 10.9x →
	Serie 105.4	Serie 104.6	
	Total 105.4	Total 210.0	
40 Skott		21: 10.5x ↓ 22: 10.1 → 23: 10.2x ↓ 24: 10.6x ↓ 25: 10.6x ↘ 26: 10.4x ↓ 27: 10.7x ↘ 28: 10.7x → 29: 10.6x → 30: 10.3x ↗	31: 10.8x → 32: 10.7x → 33: 10.9x ← 34: 10.8x ↓ 35: 10.5x ← 36: 10.1 ↗ 37: 10.7x ↘ 38: 10.5x → 39: 10.6x ↓ 40: 10.7x ↗
	Serie 104.7	Serie 106.3	
	Total 314.7	Total 421.0	

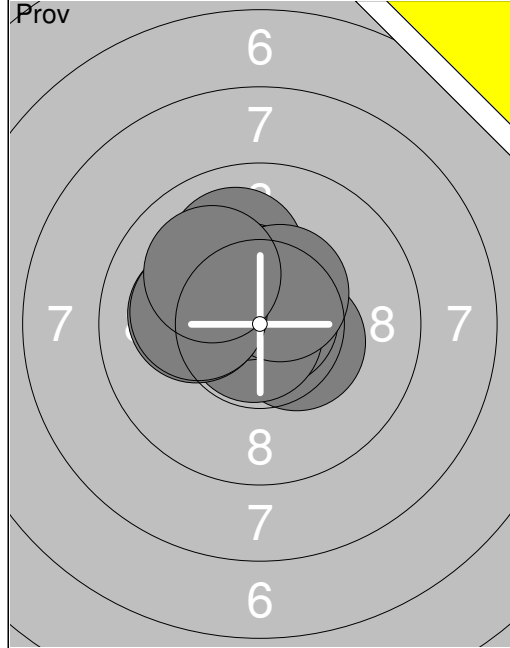

1:	10.0 ↗
2:	10.4x ↘
3:	10.8x ↗
4:	10.8x ↘
5:	10.5x ↘
7:	10.5x ↗
8:	10.1 ←
9:	10.1 ←
10:	10.1 ↖
Serie	93.3
Total	0.0

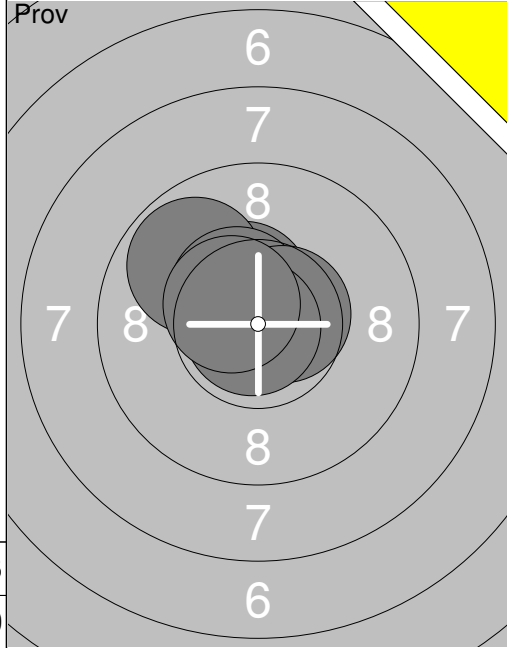

11:	10.5x ↘
12:	9.8 ↖
13:	10.5x ↘
14:	10.6x ↗
15:	10.9x ↘
16:	10.5x ↘
Serie	62.8
Total	0.0

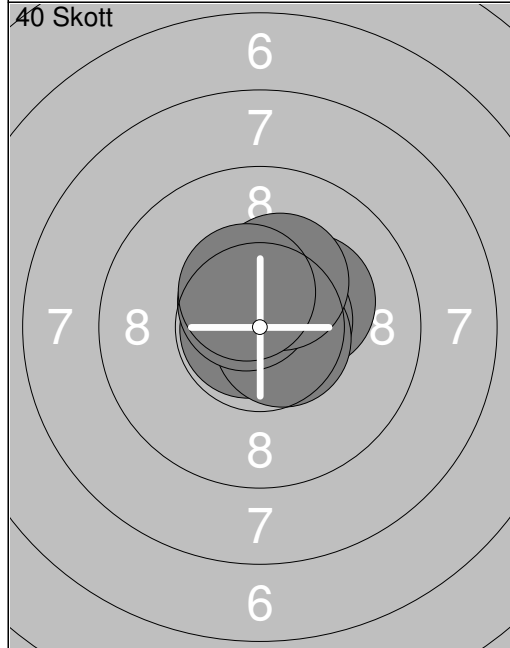

1:	10.9x ↗
2:	10.8x ↘
3:	10.5x ↗
4:	10.7x ↗
5:	10.3x ↗
6:	10.6x ↗
7:	10.6x ↘
8:	10.6x ↘
9:	10.3x ↗
10:	10.5x ↘
Serie	105.8
Total	105.8

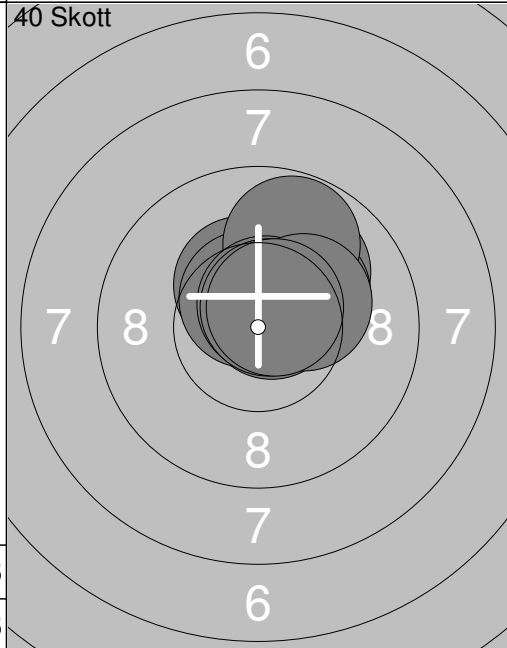

11:	10.4x ↘
12:	10.7x ↗
13:	10.0 ↗
14:	10.6x ↘
15:	10.2x ↗
16:	9.8 ↗
17:	10.6x ↗
18:	10.3x ↗
19:	10.7x ↗
20:	10.6x ↗
Serie	103.9
Total	209.7

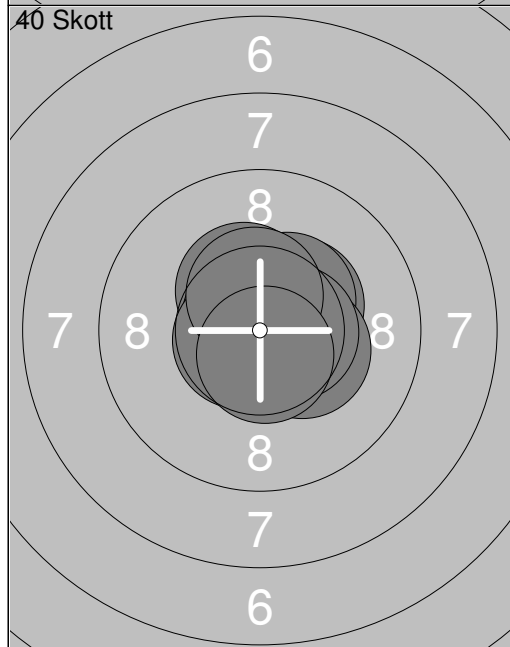

21:	10.4x ↘
22:	10.6x ↘
23:	10.8x ↘
24:	10.4x ↗
25:	10.4x ↗
26:	10.7x ↘
27:	10.3x ↘
28:	10.6x ↘
29:	10.5x ↗
30:	10.6x ↘
Serie	105.3
Total	315.0

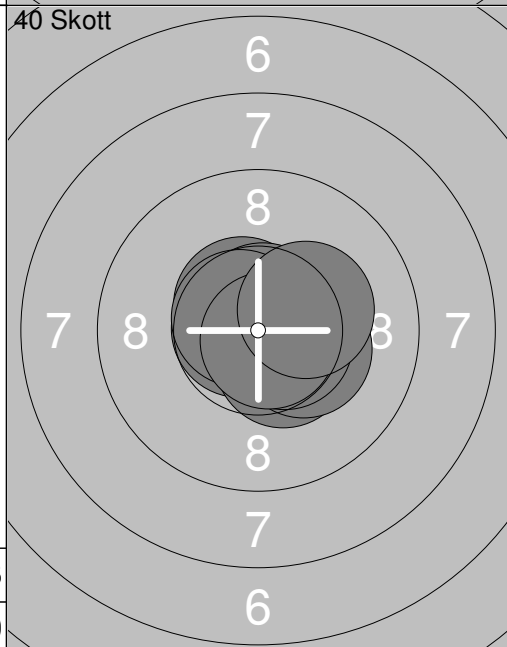

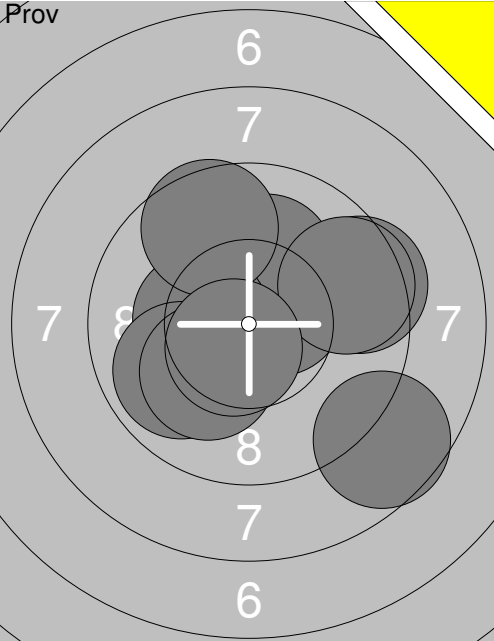
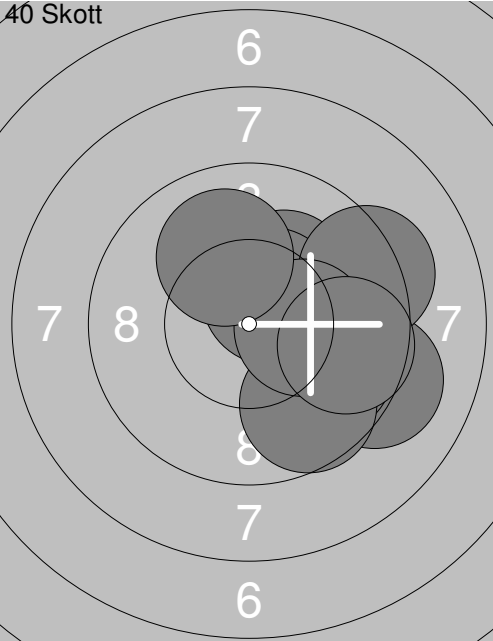
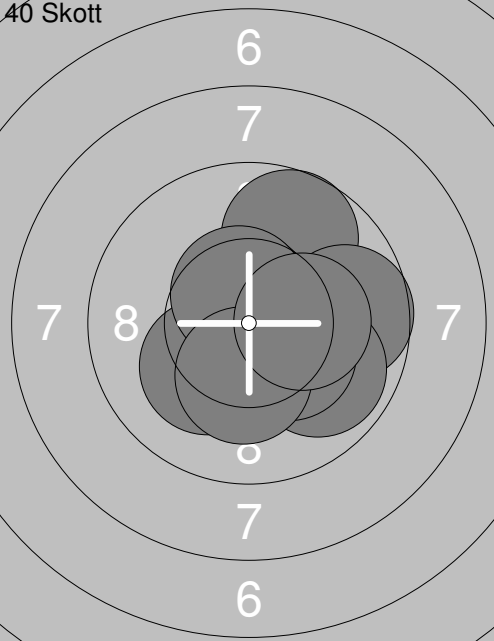
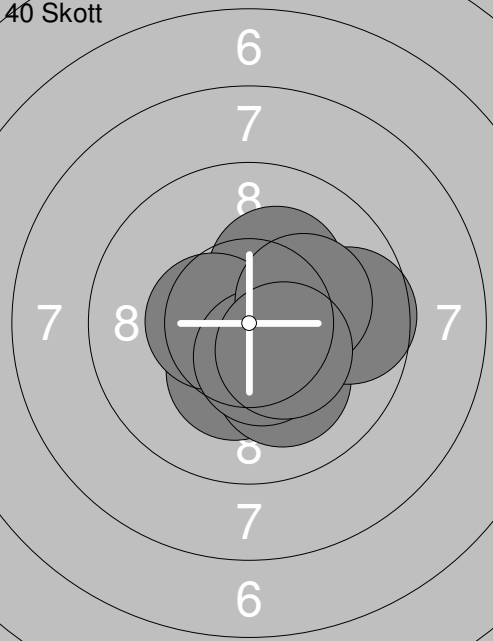
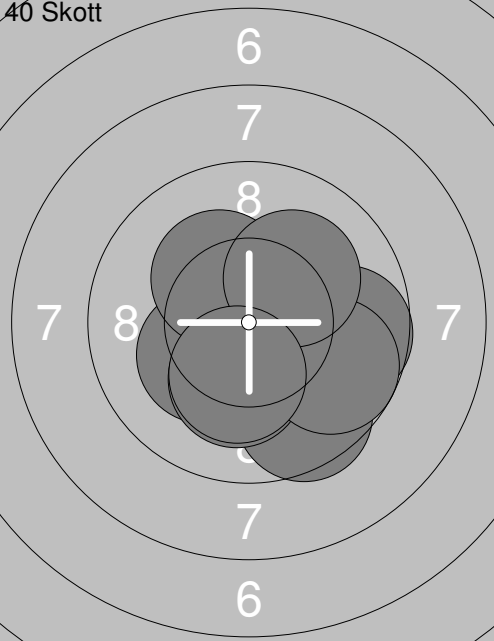

31:	10.7x ↘
32:	10.7x ↗
33:	10.6x ↘
34:	10.7x ↗
35:	10.5x ↘
36:	10.3x ↘
37:	10.6x ↘
38:	10.7x ↘
39:	10.8x ↘
40:	10.3x ↗
Serie	105.9
Total	420.9

Skjutlag	Tavla	Elis Eliasson	
1	35	Piteå Skf	L13
02.02.2019	Skyttiaden Regionfinal 2019	Umeå skytteallians	
Prov		Prov	
	1: 8.1 ↓ 2: 10.3x↗ 3: 10.3x↗ 4: 10.8x↔ 5: 10.1 ↖ 6: 10.4x↖ 7: 10.4x↖ 8: 10.5x↓ 9: 10.3x↓ 10: 10.5x↖		11: 10.5x↗ 12: 10.6x↖ 13: 10.2x→
	Serie 101.7 Total 0.0		Serie 31.3 Total 0.0
40 Skott		40 Skott	
	1: 10.8x↖ 2: 9.7 ↗ 3: 10.5x↓ 4: 9.9 ↗ 5: 10.6x→ 6: 9.7 → 7: 10.2x→ 8: 10.3x↗ 9: 10.5x→ 10: 10.3x↖		11: 10.3x→ 12: 10.7x↓ 13: 10.4x↗ 14: 10.6x→ 15: 10.9x↗ 16: 10.1 ↖ 17: 10.3x↖ 18: 10.5x↓ 19: 10.5x→ 20: 10.7x→
	Serie 102.5 Total 102.5		Serie 105.0 Total 207.5
40 Skott		40 Skott	
	21: 10.8x↓ 22: 10.3x↖ 23: 10.6x→ 24: 10.7x↗ 25: 10.5x↓ 26: 10.4x↓ 27: 10.2x→ 28: 10.3x↗ 29: 10.1 → 30: 10.3x→		31: 10.7x↖ 32: 10.2x↗ 33: 10.7x↗ 34: 10.3x↖ 35: 10.6x↓ 36: 10.7x↖ 37: 10.3x↖ 38: 10.3x↓ 39: 10.5x↓ 40: 10.2x↗
	Serie 104.2 Total 311.7		Serie 104.5 Total 416.2

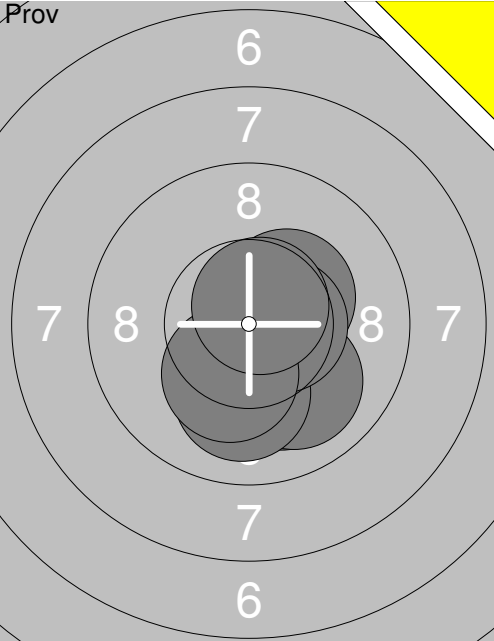
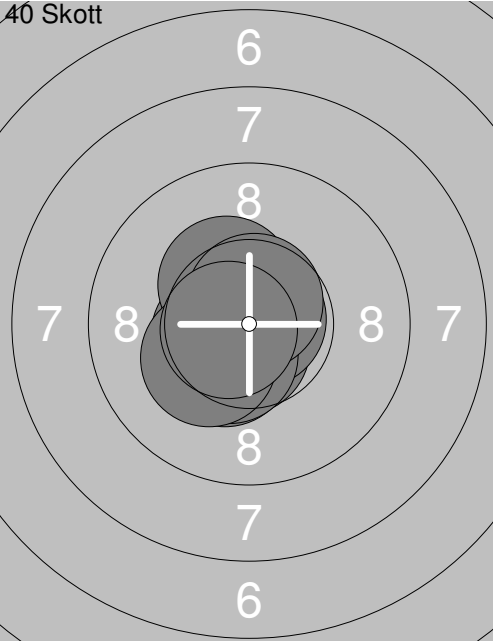
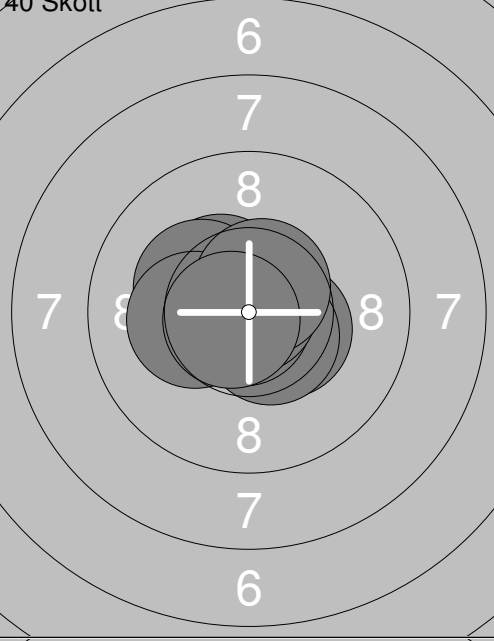
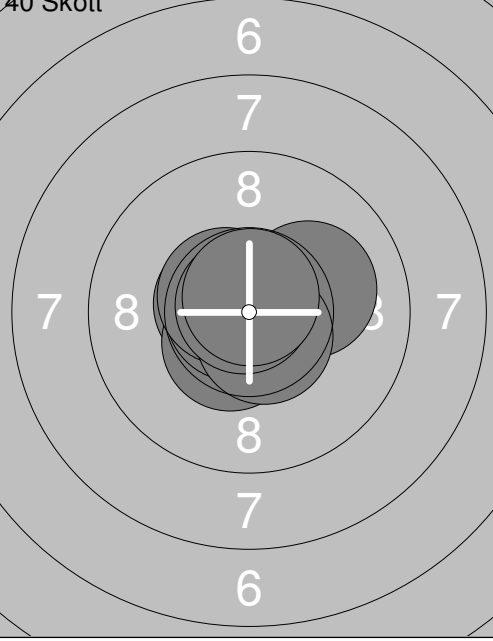
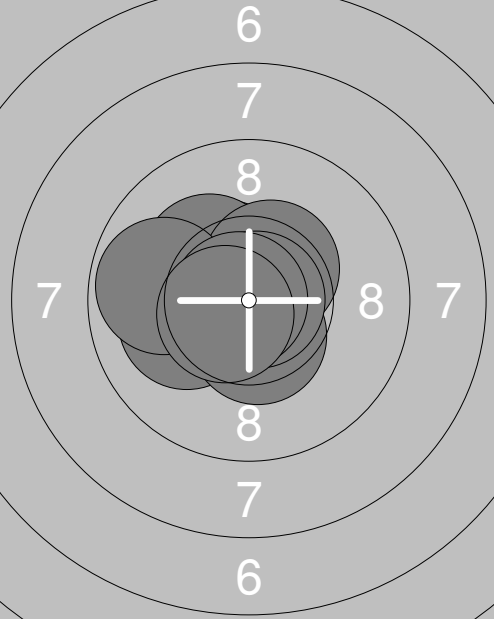
Skjutlag 1	Tavla 36	Hampus Holmlund	
S		Gideå Skf	L13
02.02.2019	Skyttiaden Regionfinal 2019	Umeå skytteallians	
Prov		40 Skott	
	1: 10.5x↗ 2: 9.4 → 3: 10.1 ↑ 4: 10.3↖ 5: 8.6 ↘ 6: 9.6 ↑ 7: 9.9 ↙ 8: 10.1 ↘ 9: 9.6 → 10: 10.6x↘ Serie 98.7 Total 0.0	1: 9.2 ↘ 2: 9.8 → 3: 9.8 ↘ 4: 10.2x↗ 5: 10.5x↗ 6: 9.7 ↘ 7: 9.3 → 8: 10.2x→ 9: 10.0 ↑ 10: 9.7 → Serie 98.4 Total 98.4	
40 Skott		40 Skott	
	11: 9.7 ↑ 12: 10.2x↘ 13: 10.7x↑ 14: 10.8x→ 15: 9.7 → 16: 9.9 ↘ 17: 10.3x↘ 18: 10.6x↑ 19: 10.3x↓ 20: 10.2x→ Serie 102.4 Total 200.8	21: 10.5x→ 22: 10.3x↘ 23: 10.4x↑ 24: 10.1 ↘ 25: 10.2x↑ 26: 9.7 → 27: 10.5x↖ 28: 10.5x↓ 29: 10.2x→ 30: 10.4x↘ Serie 102.8 Total 303.6	
40 Skott			
	31: 10.8x↖ 32: 10.2x→ 33: 9.6 ↘ 34: 10.2x↖ 35: 10.2x↓ 36: 9.7 → 37: 10.3x↖ 38: 9.7 ↘ 39: 10.1 ↗ 40: 10.3x↓ Serie 101.1 Total 404.7		

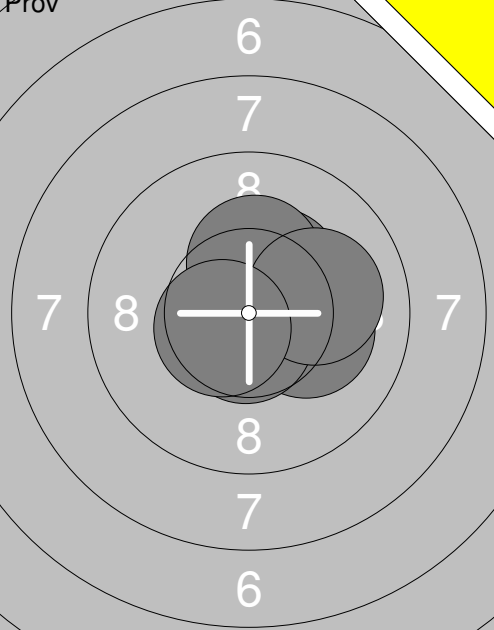
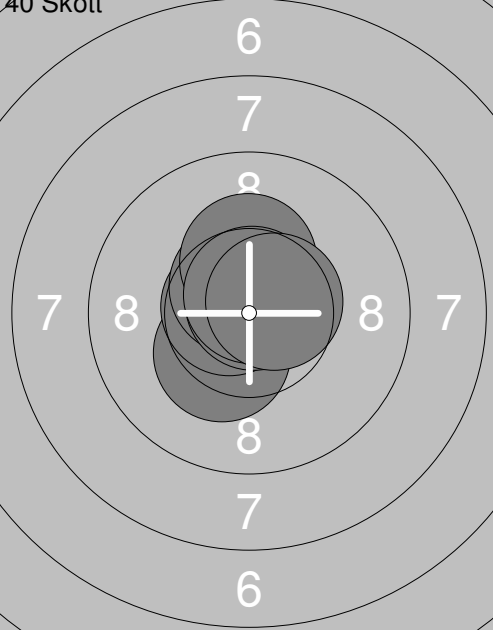
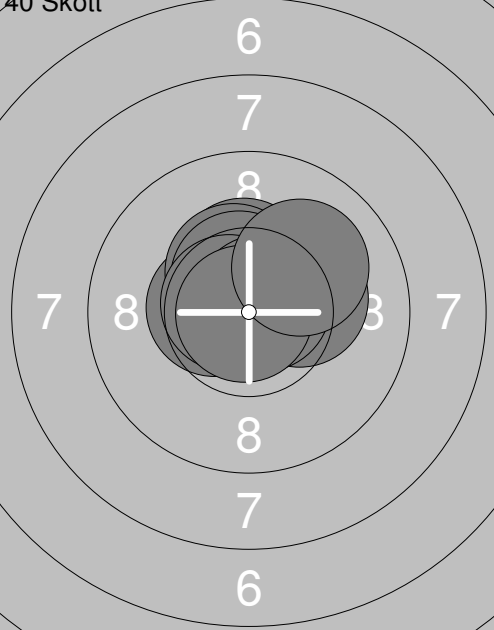
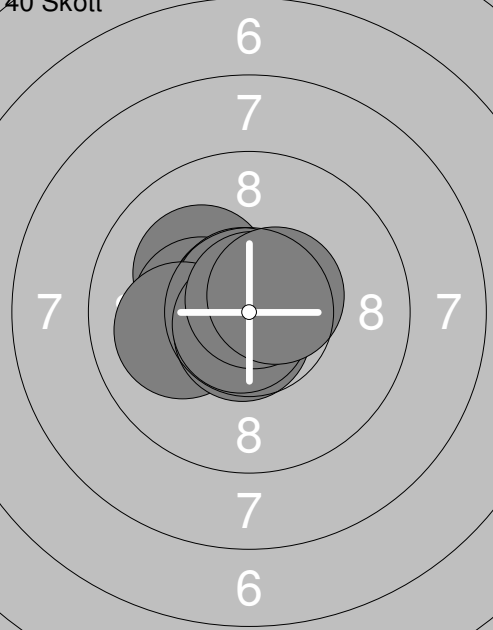
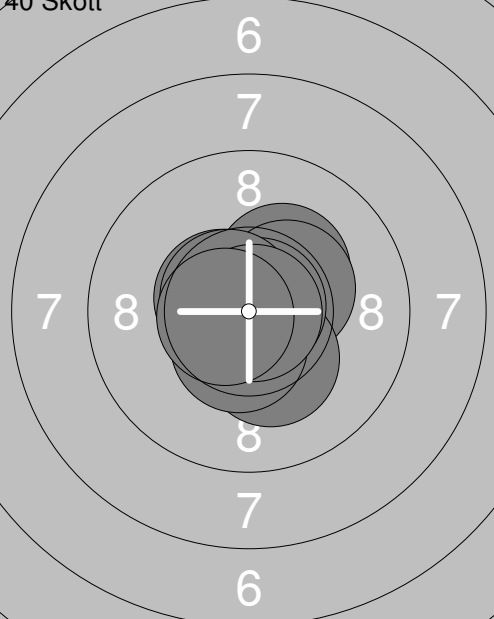
Skjutlag 1	Tavla 37	Lukas Wallin	
S		Aspås USkF	L13
02.02.2019	Skyttiaden Regionfinal 2019		Umeå skytteallians
Prov		1: 10.1 ↓ 2: 10.0 ↓ 3: 10.1 ↓ 4: 10.3x ↗ 5: 10.6x → 6: 10.3x ↓ 7: 10.7x ↗	40 Skott  1: 10.6x ↓ 2: 10.5x ↘ 3: 10.4x ↘ 4: 10.8x ↗ 5: 10.4x ↓ 6: 10.7x ↘ 7: 10.5x ↓ 8: 10.3x ↘ 9: 10.7x ↗ 10: 10.7x ↘
		Serie 72.1	Serie 105.6
		Total 0.0	Total 105.6
40 Skott		11: 10.4x ↘ 12: 10.4x → 13: 10.5x ↓ 14: 10.8x ↘ 15: 10.9x ↗ 16: 10.6x ↘ 17: 10.3x ↘ 18: 10.2x ↘ 19: 10.6x ↗ 20: 10.7x ↘	40 Skott  21: 10.7x ↗ 22: 10.7x ↓ 23: 10.6x ↘ 24: 10.5x ↓ 25: 10.8x ↘ 26: 10.6x ↘ 27: 10.1 → 28: 10.6x ↓ 29: 10.8x ↘ 30: 10.8x ↗
		Serie 105.4	Serie 106.2
		Total 211.0	Total 317.2
40 Skott		31: 10.4x ↘ 32: 10.2x ↘ 33: 10.4x ↗ 34: 10.1 ← 35: 10.5x ↓ 36: 10.9x → 37: 10.9x → 38: 9.8 ← 39: 10.8x ↘ 40: 10.6x ↘	
		Serie 104.6	
		Total 421.8	

<p>Prov</p>  <p style="text-align: center;">6 7 8 7 8 7 6</p>	<p>40 Skott</p>  <p style="text-align: center;">6 7 8 7 8 7 6</p>	<table style="width:100%; border-collapse: collapse;"> <tr><td>1:</td><td>10.9x↘</td><td>1:</td><td>10.3x↘</td></tr> <tr><td>2:</td><td>10.4x↗</td><td>2:</td><td>10.6x↗</td></tr> <tr><td>3:</td><td>10.2x➤</td><td>3:</td><td>10.7x↗</td></tr> <tr><td>4:</td><td>10.9x↘</td><td>4:</td><td>10.7x↖</td></tr> <tr><td>5:</td><td>10.7x↘</td><td>5:</td><td>10.6x↘</td></tr> <tr><td>6:</td><td>10.3x↗</td><td>6:</td><td>10.7x↗</td></tr> <tr><td>7:</td><td>10.1➔</td><td>7:</td><td>10.3x↗</td></tr> <tr><td>8:</td><td>10.6x↖</td><td>8:</td><td>10.8x↗</td></tr> <tr><td></td><td></td><td>9:</td><td>10.7x↗</td></tr> <tr><td></td><td></td><td>10:</td><td>10.6x➤</td></tr> </table> <table style="width:100%; border-collapse: collapse; margin-top: 5px;"> <tr><td style="border-top: 1px solid black;">Serie</td><td style="border-top: 1px solid black;">84.1</td><td style="border-top: 1px solid black;">Serie</td><td style="border-top: 1px solid black;">106.0</td></tr> <tr><td style="border-top: 1px solid black;">Total</td><td style="border-top: 1px solid black;">0.0</td><td style="border-top: 1px solid black;">Total</td><td style="border-top: 1px solid black;">106.0</td></tr> </table>	1:	10.9x↘	1:	10.3x↘	2:	10.4x↗	2:	10.6x↗	3:	10.2x➤	3:	10.7x↗	4:	10.9x↘	4:	10.7x↖	5:	10.7x↘	5:	10.6x↘	6:	10.3x↗	6:	10.7x↗	7:	10.1➔	7:	10.3x↗	8:	10.6x↖	8:	10.8x↗			9:	10.7x↗			10:	10.6x➤	Serie	84.1	Serie	106.0	Total	0.0	Total	106.0
1:	10.9x↘	1:	10.3x↘																																															
2:	10.4x↗	2:	10.6x↗																																															
3:	10.2x➤	3:	10.7x↗																																															
4:	10.9x↘	4:	10.7x↖																																															
5:	10.7x↘	5:	10.6x↘																																															
6:	10.3x↗	6:	10.7x↗																																															
7:	10.1➔	7:	10.3x↗																																															
8:	10.6x↖	8:	10.8x↗																																															
		9:	10.7x↗																																															
		10:	10.6x➤																																															
Serie	84.1	Serie	106.0																																															
Total	0.0	Total	106.0																																															
<p>40 Skott</p>  <p style="text-align: center;">6 7 8 7 8 7 6</p>	<p>40 Skott</p>  <p style="text-align: center;">6 7 8 7 8 7 6</p>	<table style="width:100%; border-collapse: collapse;"> <tr><td>11:</td><td>10.5x↗</td><td>21:</td><td>10.1↖</td></tr> <tr><td>12:</td><td>10.5x↖</td><td>22:</td><td>10.9x↘</td></tr> <tr><td>13:</td><td>10.4x↗</td><td>23:</td><td>10.3x↖</td></tr> <tr><td>14:</td><td>10.4x↗</td><td>24:</td><td>10.7x↖</td></tr> <tr><td>15:</td><td>10.3x➤</td><td>25:</td><td>10.7x↘</td></tr> <tr><td>16:</td><td>10.5x↗</td><td>26:</td><td>10.1↖</td></tr> <tr><td>17:</td><td>10.7x↖</td><td>27:</td><td>10.7x↘</td></tr> <tr><td>18:</td><td>10.7x➤</td><td>28:</td><td>10.8x↘</td></tr> <tr><td>19:</td><td>10.9x↖</td><td>29:</td><td>10.8x↗</td></tr> <tr><td>20:</td><td>10.1↗</td><td>30:</td><td>10.5x➤</td></tr> </table> <table style="width:100%; border-collapse: collapse; margin-top: 5px;"> <tr><td style="border-top: 1px solid black;">Serie</td><td style="border-top: 1px solid black;">105.0</td><td style="border-top: 1px solid black;">Serie</td><td style="border-top: 1px solid black;">105.6</td></tr> <tr><td style="border-top: 1px solid black;">Total</td><td style="border-top: 1px solid black;">211.0</td><td style="border-top: 1px solid black;">Total</td><td style="border-top: 1px solid black;">316.6</td></tr> </table>	11:	10.5x↗	21:	10.1↖	12:	10.5x↖	22:	10.9x↘	13:	10.4x↗	23:	10.3x↖	14:	10.4x↗	24:	10.7x↖	15:	10.3x➤	25:	10.7x↘	16:	10.5x↗	26:	10.1↖	17:	10.7x↖	27:	10.7x↘	18:	10.7x➤	28:	10.8x↘	19:	10.9x↖	29:	10.8x↗	20:	10.1↗	30:	10.5x➤	Serie	105.0	Serie	105.6	Total	211.0	Total	316.6
11:	10.5x↗	21:	10.1↖																																															
12:	10.5x↖	22:	10.9x↘																																															
13:	10.4x↗	23:	10.3x↖																																															
14:	10.4x↗	24:	10.7x↖																																															
15:	10.3x➤	25:	10.7x↘																																															
16:	10.5x↗	26:	10.1↖																																															
17:	10.7x↖	27:	10.7x↘																																															
18:	10.7x➤	28:	10.8x↘																																															
19:	10.9x↖	29:	10.8x↗																																															
20:	10.1↗	30:	10.5x➤																																															
Serie	105.0	Serie	105.6																																															
Total	211.0	Total	316.6																																															
<p>40 Skott</p>  <p style="text-align: center;">6 7 8 7 8 7 6</p>	<table style="width:100%; border-collapse: collapse;"> <tr><td>31:</td><td>10.6x↖</td></tr> <tr><td>32:</td><td>10.3x↗</td></tr> <tr><td>33:</td><td>10.4x➤</td></tr> <tr><td>34:</td><td>10.8x↘</td></tr> <tr><td>35:</td><td>10.3x↘</td></tr> <tr><td>36:</td><td>10.8x➤</td></tr> <tr><td>37:</td><td>10.5x↘</td></tr> <tr><td>38:</td><td>10.6x↖</td></tr> <tr><td>39:</td><td>10.9x➤</td></tr> <tr><td>40:</td><td>10.6x↖</td></tr> </table> <table style="width:100%; border-collapse: collapse; margin-top: 5px;"> <tr><td style="border-top: 1px solid black;">Serie</td><td style="border-top: 1px solid black;">105.8</td></tr> <tr><td style="border-top: 1px solid black;">Total</td><td style="border-top: 1px solid black;">422.4</td></tr> </table>		31:	10.6x↖	32:	10.3x↗	33:	10.4x➤	34:	10.8x↘	35:	10.3x↘	36:	10.8x➤	37:	10.5x↘	38:	10.6x↖	39:	10.9x➤	40:	10.6x↖	Serie	105.8	Total	422.4																								
31:	10.6x↖																																																	
32:	10.3x↗																																																	
33:	10.4x➤																																																	
34:	10.8x↘																																																	
35:	10.3x↘																																																	
36:	10.8x➤																																																	
37:	10.5x↘																																																	
38:	10.6x↖																																																	
39:	10.9x➤																																																	
40:	10.6x↖																																																	
Serie	105.8																																																	
Total	422.4																																																	

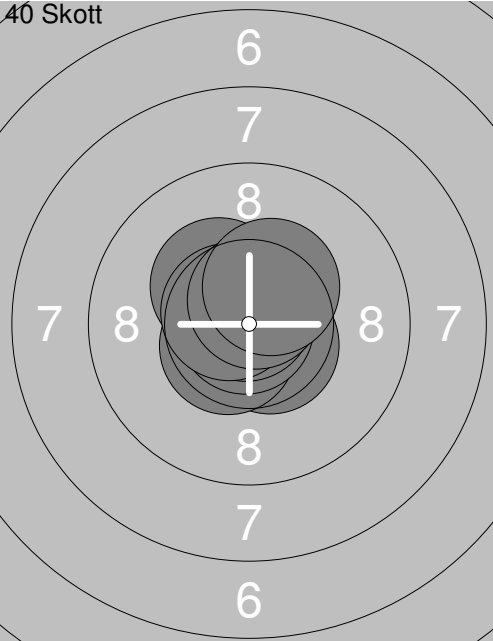
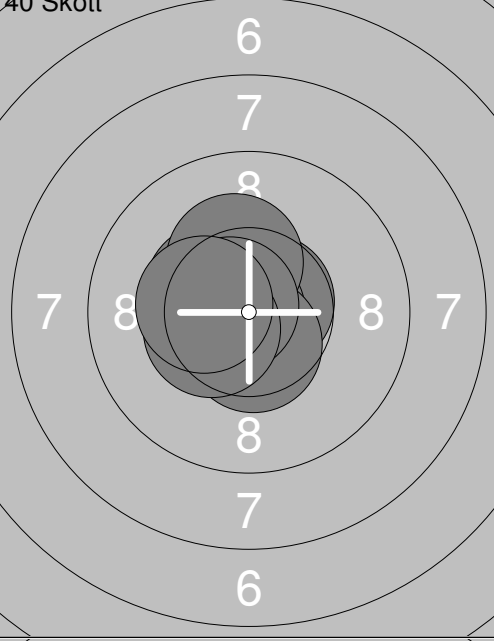
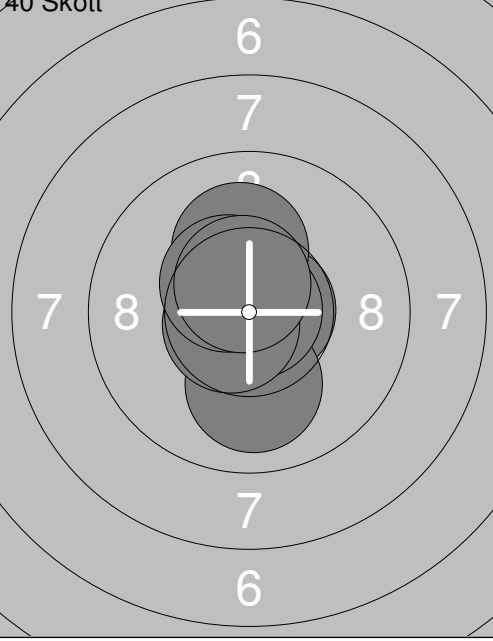
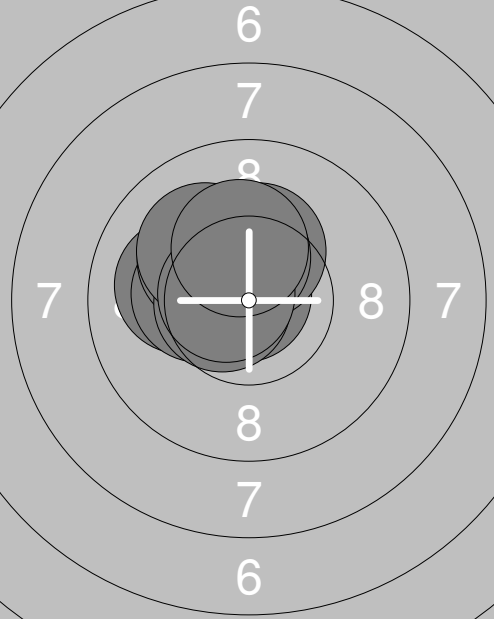
Skjutlag 1	Tavla 39	Sofia Öhman	
S		Gällivare Skf	L13
02.02.2019	Skyttiaden Regionfinal 2019		Umeå skytteallians
Prov		1: 10.9x↖ 2: 10.8x↖ 3: 10.2x↘ 4: 10.7x↗	40 Skott 
		Serie 42.6 Total 0.0	1: 10.6x↘ 2: 10.6x↗ 3: 10.6x↘ 4: 10.7x↘ 5: 10.9x↖ 6: 10.8x↗ 7: 10.3x↘ 8: 10.6x↖ 9: 10.6x↗ 10: 10.4x↗
			Serie 106.1 Total 106.1
40 Skott		11: 10.4x↖ 12: 10.7x↘ 13: 10.7x↗ 14: 10.6x↖ 15: 10.8x↖ 16: 10.5x↓ 17: 10.3x↗ 18: 10.7x↖ 19: 10.4x↖ 20: 10.4x↖	40 Skott 
		Serie 105.5 Total 211.6	21: 10.7x➤ 22: 10.9x➤ 23: 10.7x↘ 24: 10.0 ↓ 25: 10.9x↖ 26: 10.9x↗ 27: 10.7x↘ 28: 10.1 ↑ 29: 10.5x↖ 30: 10.6x↗
			Serie 106.0 Total 317.6
40 Skott		31: 10.1↖ 32: 10.3x↖ 33: 10.8x↖ 34: 10.3x↗ 35: 10.2x↖ 36: 10.6x↖ 37: 10.1↖ 38: 10.4x↗ 39: 10.6x↖ 40: 10.3x↗	
		Serie 103.7 Total 421.3	

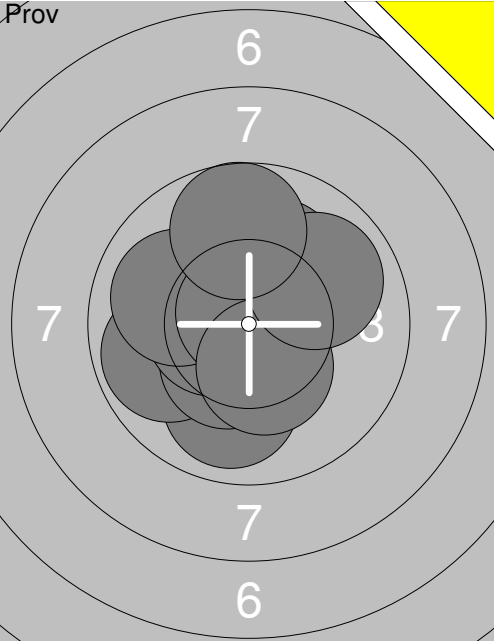
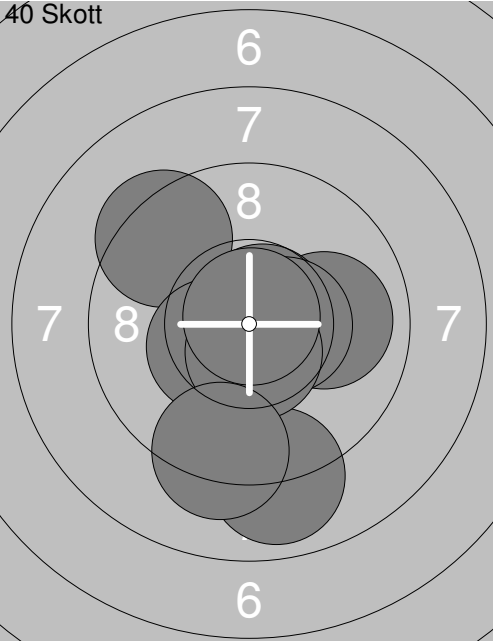
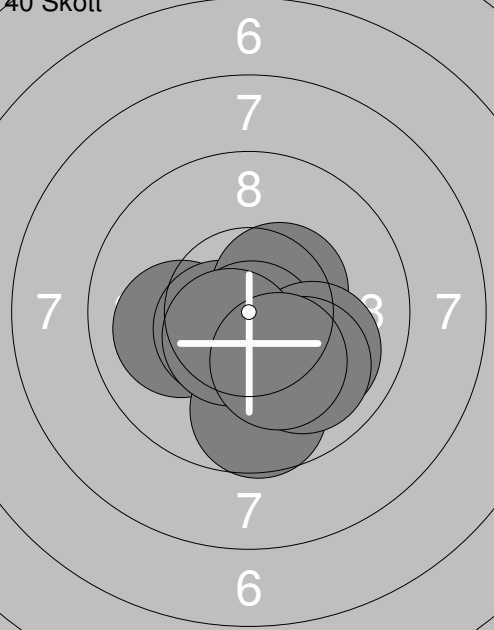
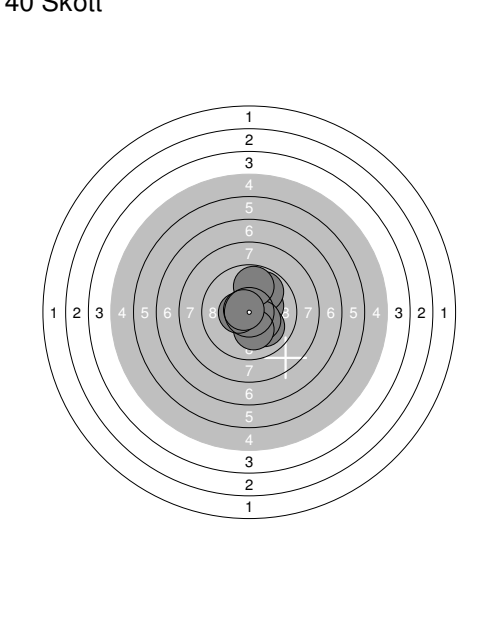
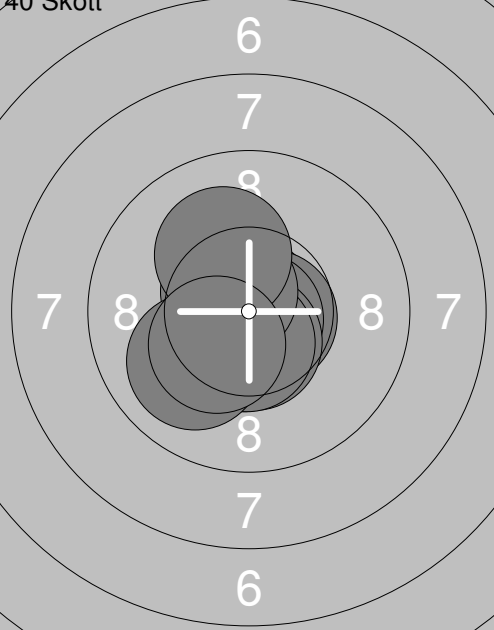
Skjuttag 1	Tavla 40	Pontus Holmlund	
S		Gideå Skf	L13
02.02.2019		Skyttiaden Regionfinal 2019	Umeå skytteallians
Prov		1: 9.9 ↓ 2: 9.8 ← 3: 10.4x ↘ 4: 10.1 ↗ 5: 10.5x ← 6: 10.0 ← 7: 10.8x ↗ 8: 10.4x ↓ 9: 9.9 ↗ 10: 9.7 ↑ Serie 101.5 Total 0.0	40 Skott  1: 10.0 → 2: 10.4x ↘ 3: 9.4 ↖ 4: 10.4x ↘ 5: 10.7x ↗ 6: 10.5x → 7: 8.9 ↓ 8: 10.6x ↓ 9: 10.8x ↗ 10: 9.3 ↓ Serie 101.0 Total 101.0
40 Skott		11: 10.0 ← 12: 10.7x ↘ 13: 10.5x ↘ 14: 10.5x ↗ 15: 10.7x ↓ 16: 9.7 ↓ 17: 10.0 → 18: 10.5x ↘ 19: 10.0 ↓ 20: 10.2x ↓ Serie 102.8 Total 203.8	40 Skott  21: 10.4x ↗ 22: 10.3x → 23: 9.8 ↗ 24: 10.0 ↓ 25: 10.3x ↘ 26: 10.1 ↓ 27: 9.8 ↑ 28: 10.5x ← 29: 10.7x ↘ 30: 0.0 ↓ Serie 91.9 Total 295.7
40 Skott		31: 10.9x ↗ 32: 10.7x → 33: 10.5x ↓ 34: 10.8x ↓ 35: 10.6x ↓ 36: 10.5x ↓ 37: 10.6x ↘ 38: 10.0 ↘ 39: 10.1 ↖ 40: 10.3x ↘ Serie 105.0 Total 400.7	

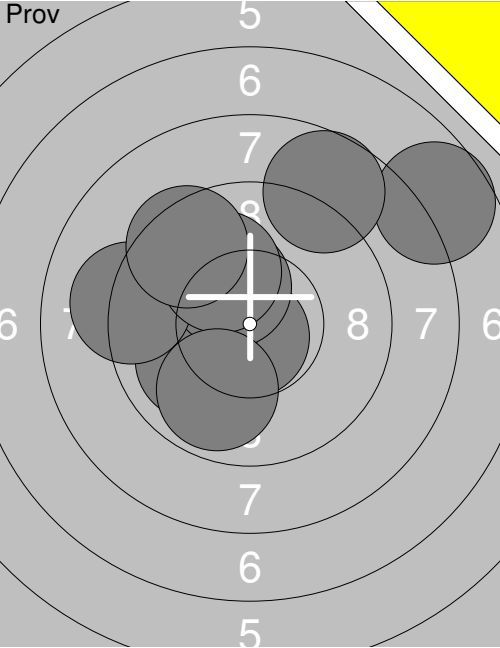
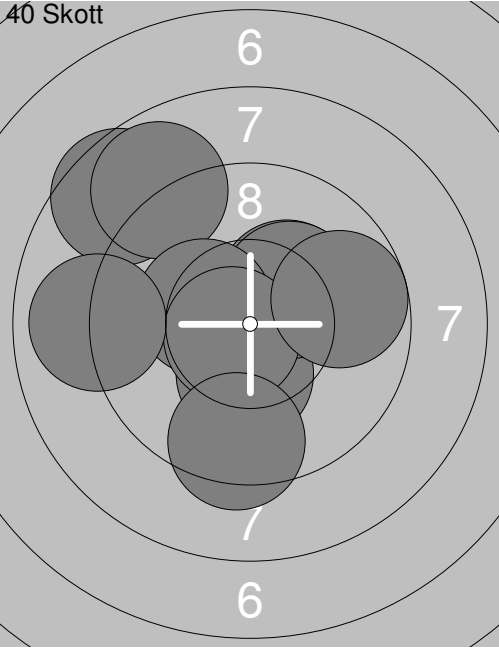
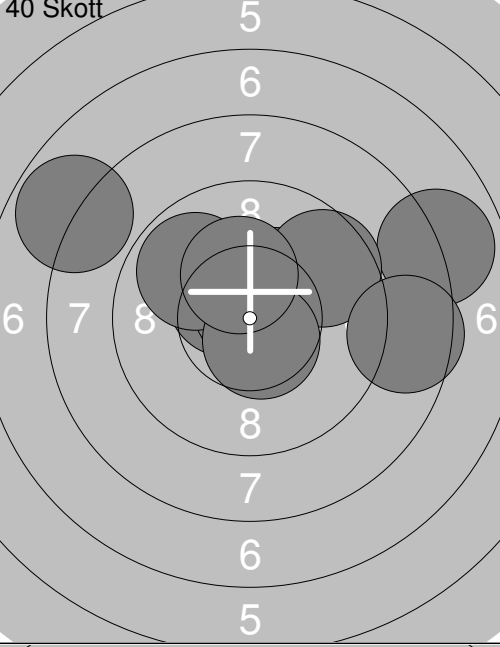
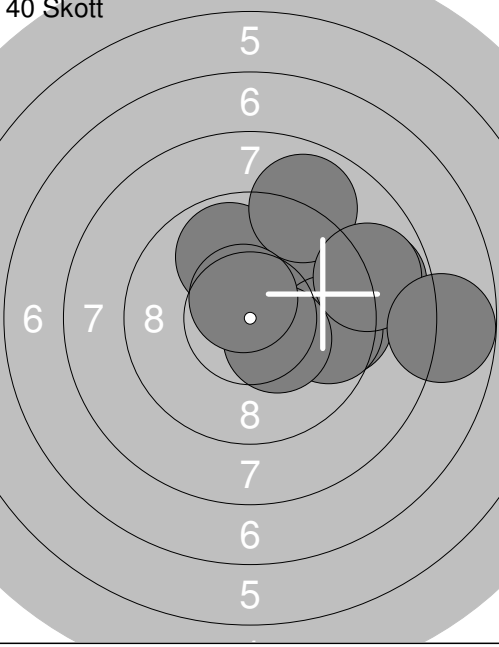
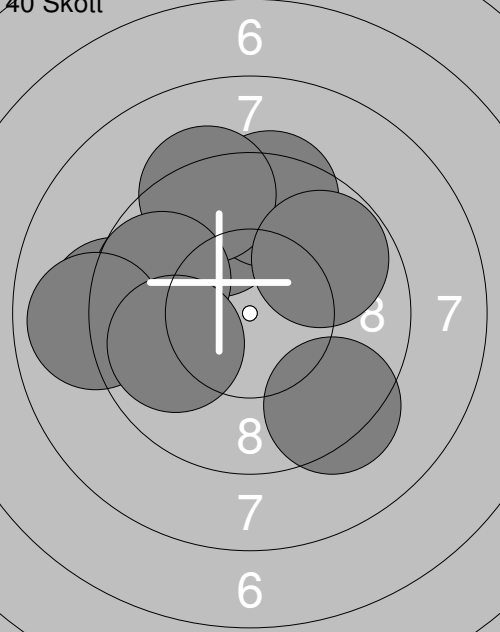
Skjuttag	Tavla	Beatrice Andersson	
S	Ramselefors Skf	L15stå	
02.02.2019	Skyttiaden Regionfinal 2019	Umeå skytteallians	
Prov		40 Skott	
	1: 10.8x↓ 2: 10.2x↖ 3: 10.0↙ 4: 10.3x↗ 5: 9.2← 6: 10.1↖ 7: 7.7↗ 8: 9.5↖ 9: 8.7↗ 10: 9.9↓	1: 10.3x↓ 2: 8.6↖ 3: 10.3x↗ 4: 10.3x↗ 5: 8.8↖ 6: 10.3x↖ 7: 10.7x↙ 8: 9.0← 9: 9.4↓ 10: 9.7↗	
	Serie 96.4	Serie 97.4	
	Total 0.0	Total 97.4	
40 Skott		40 Skott	
	11: 7.9↗ 12: 7.8↖ 13: 10.3x↗ 14: 10.5x↖ 15: 10.8x↗ 16: 9.6↗ 17: 8.6↗ 18: 9.9↖ 19: 10.6x↓ 20: 10.3x↗	21: 8.8↗ 22: 9.9↖ 23: 9.5→ 24: 9.5↗ 25: 8.9↖ 26: 9.6→ 27: 8.9↗ 28: 10.4x↖ 29: 10.6x↗ 30: 7.8→	
	Serie 96.3	Serie 93.9	
	Total 193.7	Total 287.6	
40 Skott			
	31: 9.7↖ 32: 9.8↖ 33: 9.4↖ 34: 9.3↖ 35: 9.8↗ 36: 9.2← 37: 9.3↓ 38: 9.7← 39: 8.9← 40: 9.9←		
	Serie 95.0		
	Total 382.6		

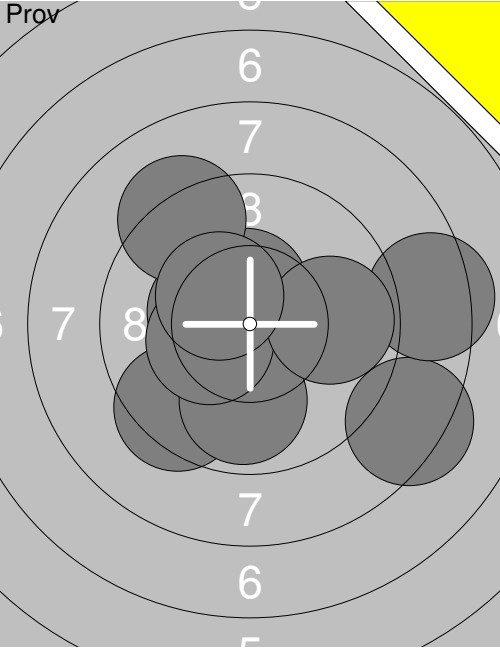
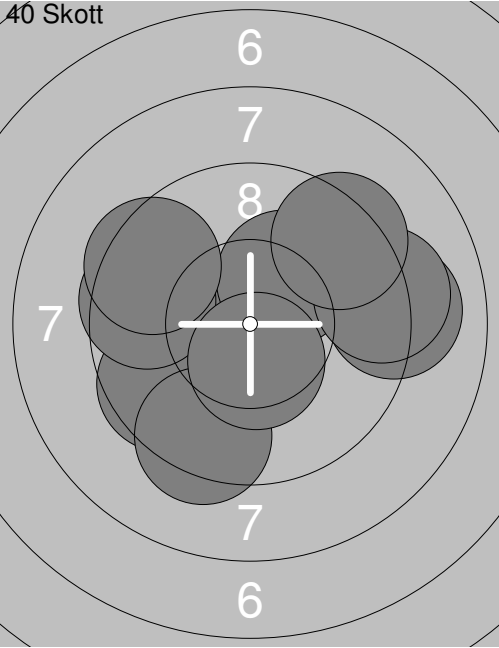
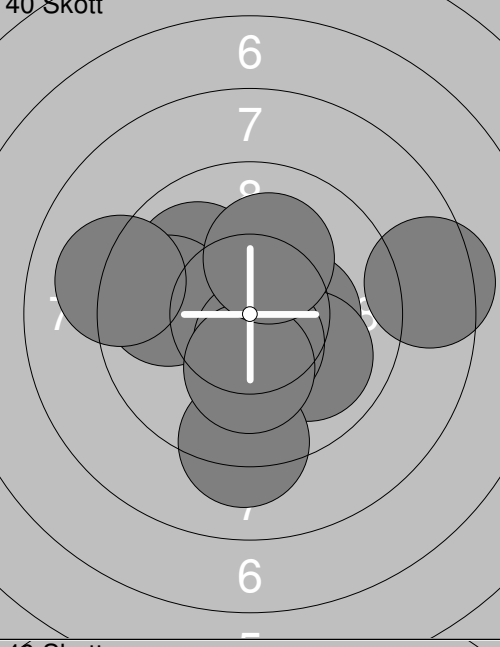
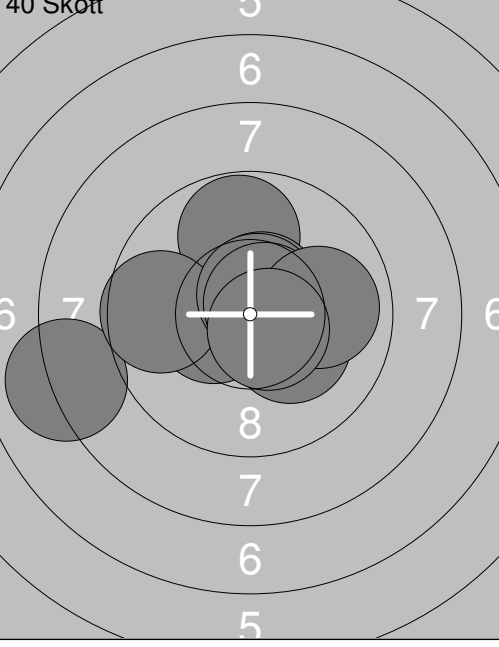
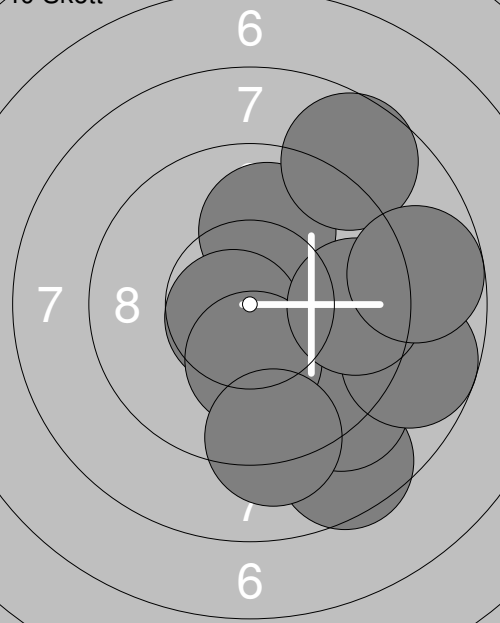
Skjuttag 2	Tavla 3	Carl Bergling	
S		Umeå Skf	L15stå
02.02.2019		Skyttiaden Regionfinal 2019	Umeå skytteallians
Prov		1: 9.4 ↙ 2: 8.3 ↘ 3: 10.5x↗ 4: 8.4 → 5: 9.9 ↓ 6: 10.4x↖ 7: 9.2 ↗ 8: 10.3x↖ 9: 9.8 → 10: 10.4x↖ Serie 96.6 Total 0.0	40 Skott  1: 10.1← 2: 9.1 → 3: 9.6 ↖ 4: 10.2x↗ 5: 9.2 → 6: 9.6 ← 7: 9.4 ↓ 8: 9.4 ↗ 9: 9.5 ↖ 10: 10.5x↓ Serie 96.6 Total 96.6
40 Skott		11: 10.0 ↖ 12: 10.3x→ 13: 10.0 ↘ 14: 9.8 ← 15: 8.4 → 16: 10.5x↓ 17: 9.2 ↓ 18: 10.2x↓ 19: 10.1 ↗ 20: 9.1 ← Serie 97.6 Total 194.2	40 Skott  21: 10.4x↖ 22: 10.2x↘ 23: 9.8 ↑ 24: 8.1 ← 25: 10.6x↗ 26: 9.6 ← 27: 10.6x↗ 28: 10.7x↗ 29: 9.9 → 30: 10.6x↘ Serie 100.5 Total 294.7
40 Skott		31: 8.6 ↓ 32: 10.0 ↑ 33: 9.2 ↘ 34: 10.7x↖ 35: 10.2x↓ 36: 9.2 ↓ 37: 8.7 → 38: 8.7 ↗ 39: 9.6 → 40: 8.8 → Serie 93.7 Total 388.4	

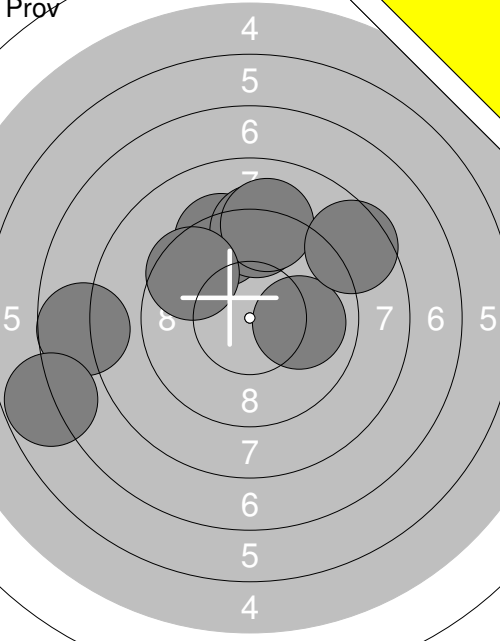
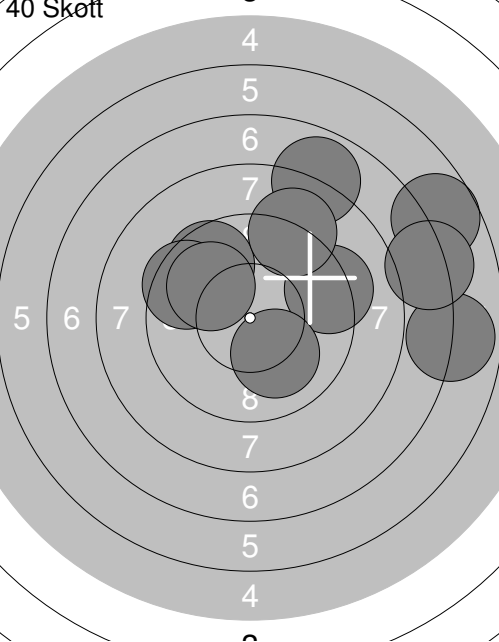
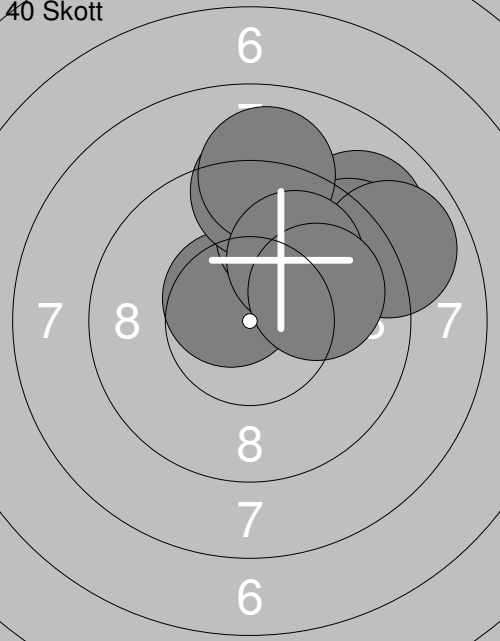
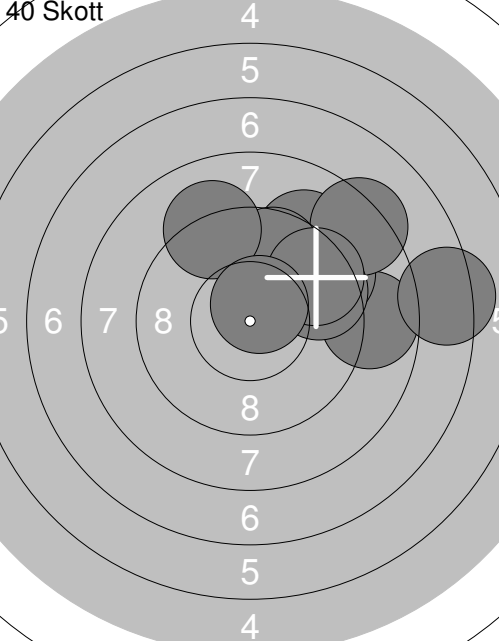
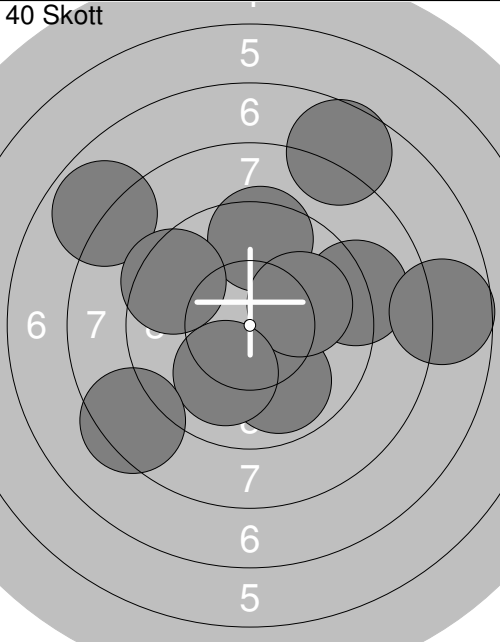
Skjutlag 2	Tavla 4	John Karlsson		
S		Fältjägarna SkF	L15stå	
02.02.2019	Skyttiaden Regionfinal 2019		Umeå skytteallians	
Prov		1: 9.3 ↗ 2: 9.3 ↑ 3: 7.7 ← 4: 6.8 ↙ 5: 10.0 → 6: 9.1 ↑ 7: 9.5 ↖ 8: 8.6 ↘	40 Skott 	1: 9.6 ↖ 2: 6.9 → 3: 9.3 → 4: 7.9 ↗ 5: 10.1 ↘ 6: 9.5 ↖ 7: 6.7 ↗ 8: 7.2 → 9: 9.0 ↗ 10: 9.9 ↖
		Serie 70.3		Serie 86.1
		Total 0.0		Total 86.1
40 Skott		11: 9.8 ↗ 12: 10.6x ↘ 13: 9.0 ↗ 14: 9.7 ↗ 15: 9.3 ↑ 16: 9.3 ↗ 17: 9.0 ↑ 18: 8.9 ↗ 19: 9.9 ↗ 20: 10.0 ↗	40 Skott 	21: 8.8 → 22: 9.2 ↗ 23: 9.3 ↗ 24: 8.3 ↗ 25: 9.6 ↗ 26: 7.3 → 27: 9.7 ↗ 28: 9.5 ↗ 29: 9.1 ↖ 30: 10.6x ↗
		Serie 95.5		Serie 91.4
		Total 181.6		Total 273.0
40 Skott		31: 9.1 → 32: 9.9 ↘ 33: 9.5 ↑ 34: 10.0 → 35: 7.9 ↖ 36: 7.7 → 37: 10.1 ↘ 38: 9.5 ↖ 39: 7.7 ↗ 40: 8.4 ↙		
		Serie 89.8		
		Total 362.8		

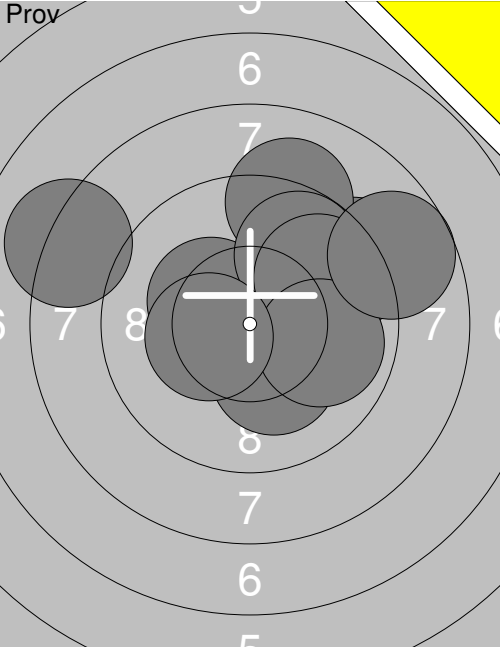
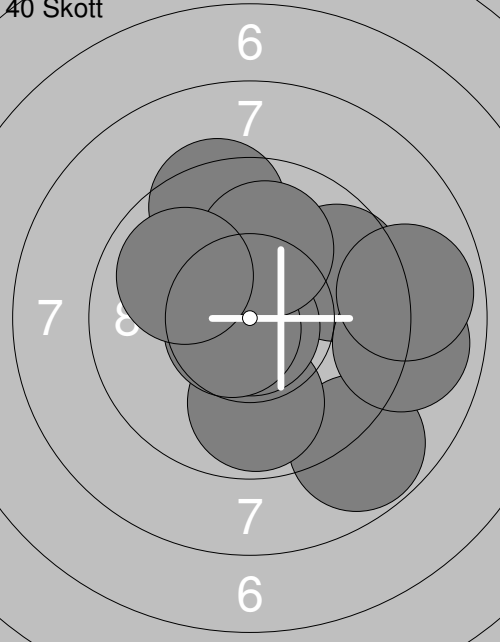
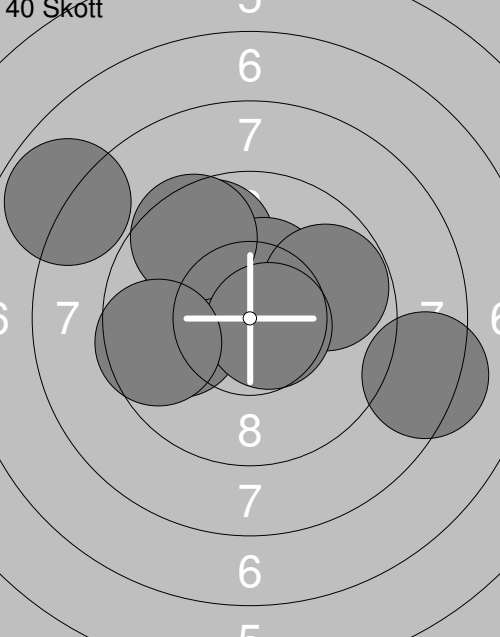
Skjuttag	Tavla	Lia Edholm	
S	Umeå Skf	L15stå	
02.02.2019	Skyttiaden Regionfinal 2019	Umeå skytteallians	
Prov		1: 8.2 ↙ 2: 9.2 ↗ 3: 10.3 ✕ 4: 9.2 ↗ 5: 10.2 ✕ 6: 9.8 ↗ 7: 9.8 ↗ 8: 9.9 → 9: 10.4 ✕ 10: 8.7 ↗ Serie 95.7 Total 0.0	11: 10.6 ✕ 12: 9.4 ↗ 13: 9.4 ↓ 14: 9.8 → 15: 8.5 ↘ 16: 10.1 ← Serie 57.8 Total 0.0
40 Skott		1: 8.8 ↘ 2: 9.8 ↓ 3: 9.7 ↗ 4: 10.8 ✕ 5: 9.0 → 6: 9.4 ↗ 7: 10.7 ✕ 8: 10.0 ↗ 9: 8.9 → 10: 9.9 ↙ Serie 97.0 Total 97.0	11: 9.9 ↗ 12: 10.1 ← 13: 10.4 ✕ 14: 9.4 ↗ 15: 9.8 ← 16: 9.7 → 17: 10.2 ✕ 18: 9.7 ↗ 19: 9.5 → 20: 10.0 → Serie 98.7 Total 195.7
40 Skott		21: 10.6 ✕ 22: 9.7 ↗ 23: 10.4 ✕ 24: 9.8 → 25: 9.9 ← 26: 9.5 ↗ 27: 10.7 ✕ 28: 8.3 → 29: 7.9 ↙ 30: 9.6 ← Serie 96.4 Total 292.1	31: 10.5 ✕ 32: 9.6 ↙ 33: 8.1 → 34: 7.8 ← 35: 9.8 ↗ 36: 10.0 → 37: 6.3 → 38: 9.4 → 39: 10.1 ↗ 40: 9.9 ↗ Serie 91.5 Total 383.6

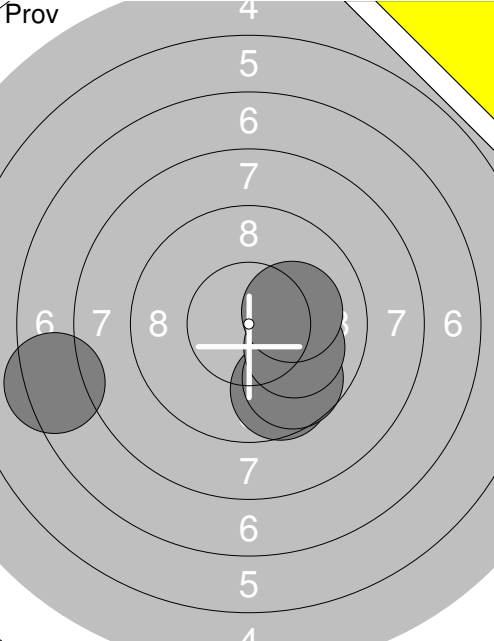
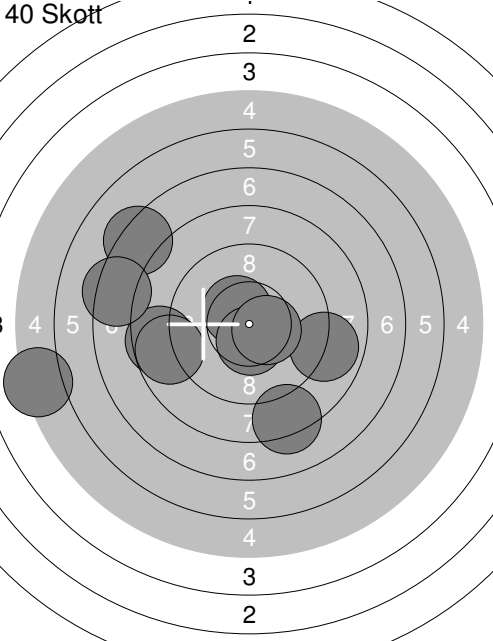
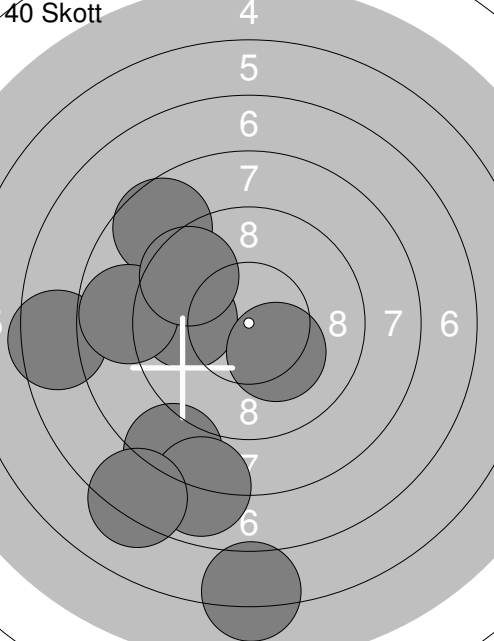
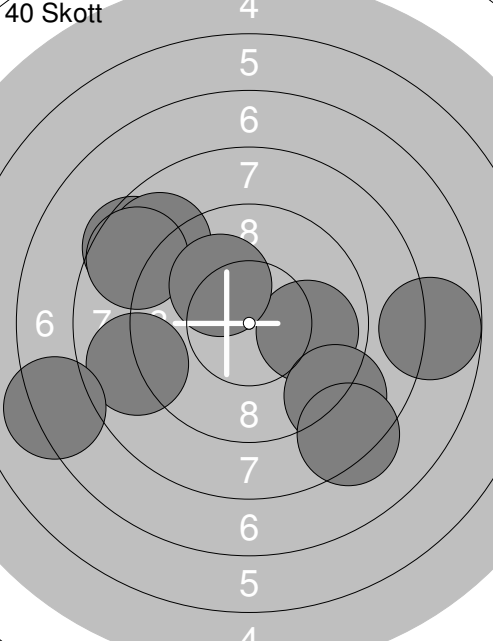
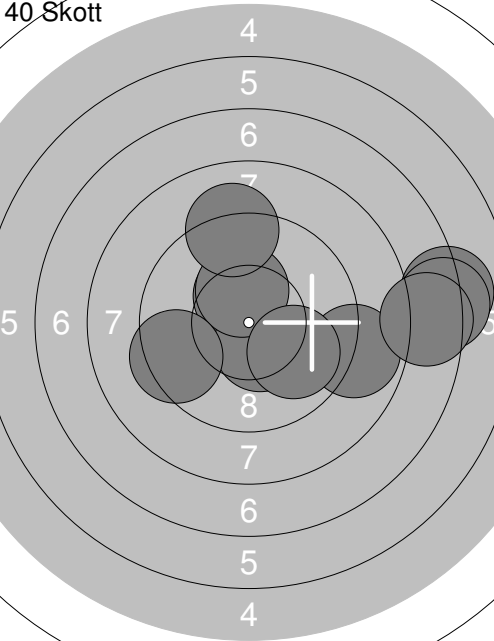
Skjutlag 2	Tavla 6	Alva Persson	
S		Kyrkås SkF	L15stå
02.02.2019		Skyttiäden Regionfinal 2019	
Prov		Umeå skytteallians	
	1: 9.7 ↘		1: 8.6 ←
	2: 7.4 ←		2: 10.5x ↘
	3: 9.7 ↘		3: 7.3 ↗
	4: 10.1 →		4: 8.8 ←
	5: 10.2x →		5: 7.4 ←
	Serie 47.1		Serie 86.0
	Total 0.0		Total 86.0
	11: 8.2 ↘		21: 7.8 →
	12: 7.5 ←		22: 8.5 ↗
	13: 9.8 ←		23: 8.8 ↗
	14: 6.1 ↓		24: 9.9 →
	15: 8.6 ↗		25: 8.8 ←
	16: 10.2x ↘		26: 9.0 ↘
	17: 7.9 ↘		27: 8.3 ↘
	18: 8.8 ←		28: 7.2 ←
	19: 9.6 ↗		29: 8.7 ↗
	20: 7.2 ↘		30: 10.1 ↗
	Serie 83.9		Serie 87.1
	Total 169.9		Total 257.0
	31: 7.1 →		
	32: 7.2 →		
	33: 10.4x ↗		
	34: 10.5x ↘		
	35: 10.3x ↗		
	36: 8.9 →		
	37: 7.5 →		
	38: 9.9 ↘		
	39: 9.4 ←		
	40: 9.1 ↑		
	Serie 90.3		
	Total 347.3		

<p>Prov</p>	<p>1: 9.5 ↙ 2: 9.3 ↓ 3: 9.9 ← 4: 9.9 → 5: 9.6 ↓ 6: 9.9 ↗ 7: 10.1 → 8: 10.0 ↖ 9: 10.9x → 10: 9.7 →</p> <p>Serie 98.8 Total 0.0</p>	<p>Prov</p>	<p>11: 10.0 ↖</p> <p>Serie 10.0 Total 0.0</p>
<p>40 Skott</p>	<p>1: 9.4 → 2: 10.0 ↑ 3: 9.6 → 4: 9.7 ↓ 5: 10.6x ↓ 6: 9.7 ← 7: 10.0 ↗ 8: 9.8 ↖ 9: 9.3 → 10: 10.3x ↖</p> <p>Serie 98.4 Total 98.4</p>	<p>40 Skott</p>	<p>11: 9.8 ↘ 12: 10.7x ↑ 13: 10.1 → 14: 9.7 → 15: 10.6x ↖ 16: 10.4x ↗ 17: 10.1 ↗ 18: 9.3 ↗ 19: 10.1 ↖ 20: 10.2x ↗</p> <p>Serie 101.0 Total 199.4</p>
<p>40 Skott</p>	<p>21: 9.5 ↘ 22: 10.0 ↘ 23: 10.7x ← 24: 9.5 ↓ 25: 10.2x ↗ 26: 10.5x ↑ 27: 10.0 ↗ 28: 10.1 ← 29: 10.2x ↑ 30: 9.2 ↖</p> <p>Serie 99.9 Total 299.3</p>	<p>40 Skott</p>	<p>31: 10.4x ↑ 32: 9.5 → 33: 10.6x ↑ 34: 10.2x ↓ 35: 10.2x ← 36: 10.5x ↘ 37: 10.1 ← 38: 9.7 → 39: 10.1 ↖ 40: 9.7 →</p> <p>Serie 101.0 Total 400.3</p>

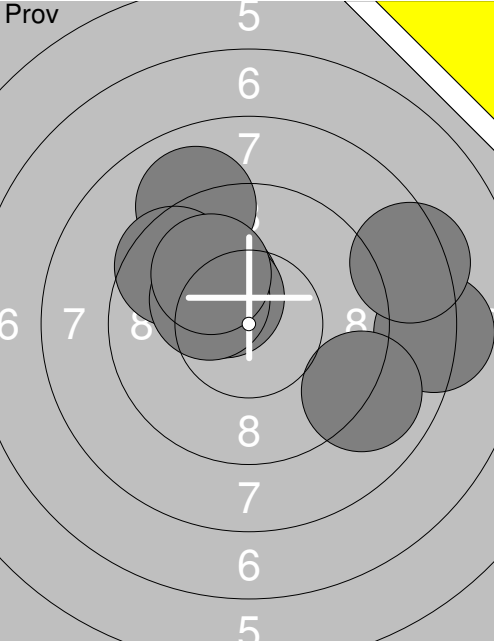
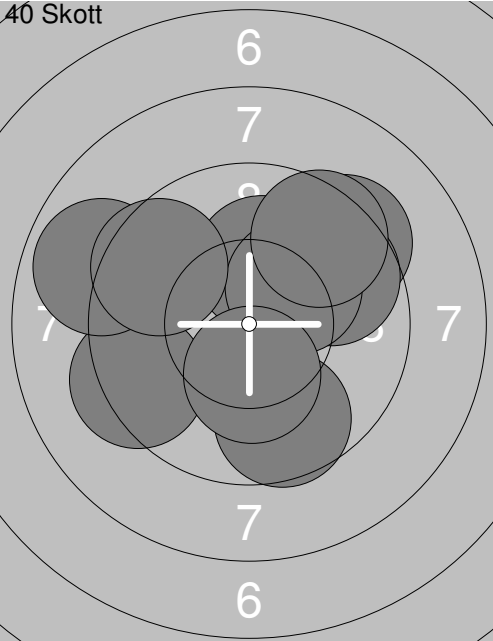
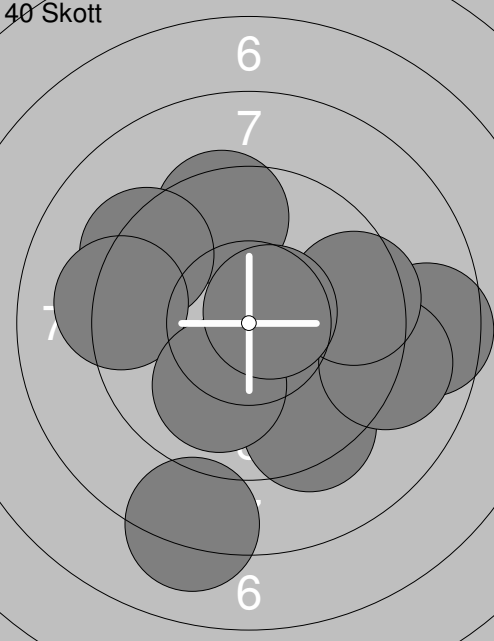
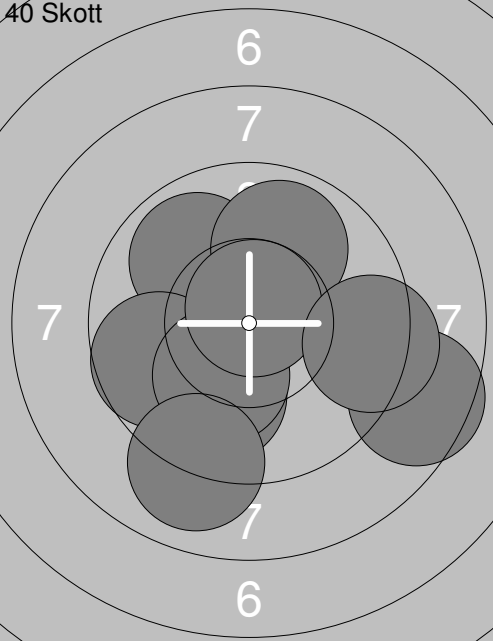
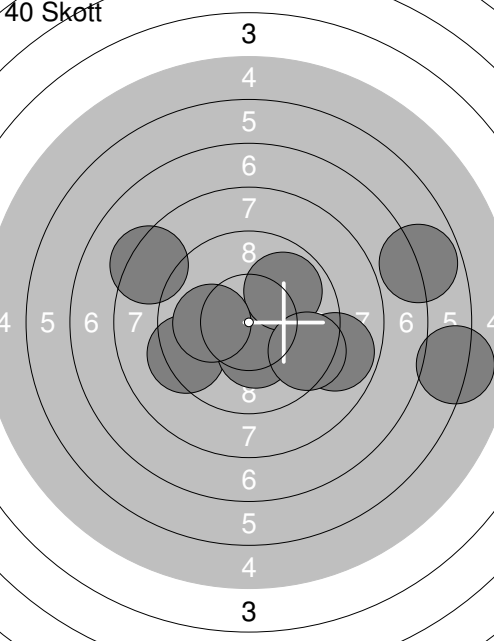
Skjutlag 2	Tavla 8	Anna Grönlund	
S		Piteå Skf	L15stå
02.02.2019		Skyttiaden Regionfinal 2019	Umeå skytteallians
Prov		1: 8.2 → 2: 10.2x ↘ 3: 9.0 → 4: 9.0 ↗ 5: 9.5 ↖ 6: 10.4x ↘ 7: 8.4 → 8: 10.3x ↘ 9: 10.0 ↖ Serie 85.0 Total 0.0	40 Skott  1: 9.3 ↗ 2: 9.3 ↖ 3: 10.2x ↗ 4: 9.7 ↗ 5: 8.9 ↖ 6: 10.2x ↗ 7: 9.6 ↓ 8: 10.3x ↓ 9: 9.5 ↗ 10: 9.6 ↖ Serie 96.6 Total 96.6
40 Skott		11: 8.6 → 12: 9.4 ↓ 13: 9.0 → 14: 9.5 ↗ 15: 9.3 ↖ 16: 9.2 ↖ 17: 9.5 → 18: 10.0 ↓ 19: 8.2 ↓ 20: 10.6x ↗ Serie 93.3 Total 189.9	40 Skott  21: 10.2x ↖ 22: 9.9 ↖ 23: 9.9 ↓ 24: 9.7 ↖ 25: 8.6 → 26: 9.9 ↗ 27: 10.2x ↖ 28: 9.0 ↓ 29: 10.7x ↗ 30: 9.3 → Serie 97.4 Total 287.3
40 Skott		31: 9.3 ↖ 32: 10.3x ↖ 33: 8.9 → 34: 10.3x ↓ 35: 6.1 → 36: 8.3 ↖ 37: 9.9 ↗ 38: 6.8 → 39: 10.1 ↖ 40: 9.5 → Serie 89.5 Total 376.8	

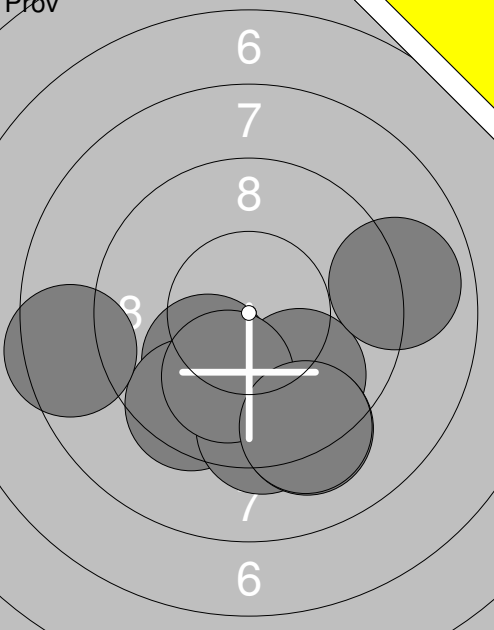
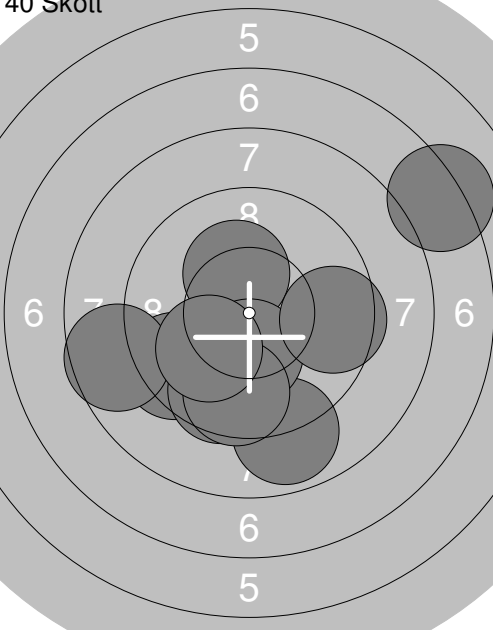
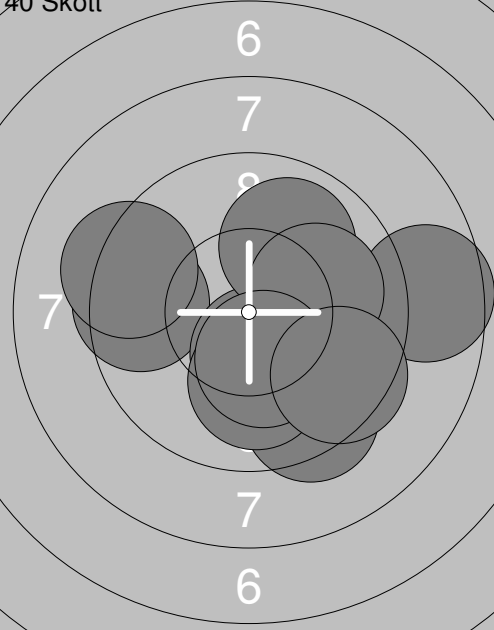
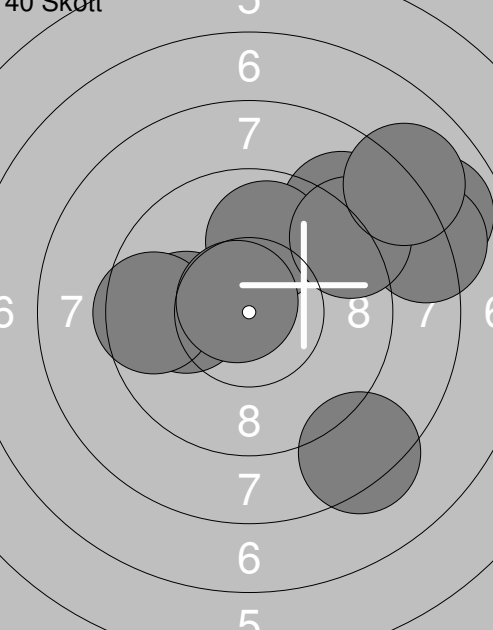
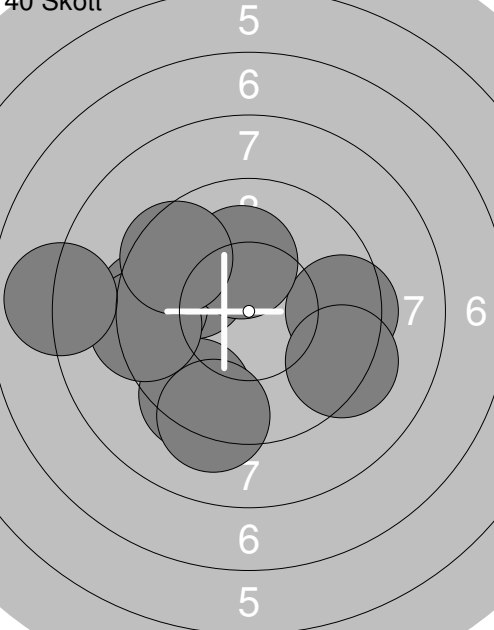
Skjutlag	Tavla	Elin Elnrud	
2	9		
S	Fältjägarna SkF	L15stå	
02.02.2019	Skyttiaden Regionfinal 2019	Umeå skytteallians	
Prov		40 Skott	
	1: 10.1 ↙ 2: 9.5 ↘ 3: 8.5 ← 4: 9.4 ↓ 5: 9.9 ↘ 6: 9.2 ↘ 7: 10.0 ↓ 8: 8.9 → 9: 9.2 ↘		1: 9.4 ↙ 2: 10.3x ↗ 3: 9.6 ↓ 4: 8.6 ← 5: 8.9 ↓ 6: 10.3x ↓ 7: 9.6 ↓ 8: 9.5 → 9: 10.1 ↙ 10: 7.2 ↗
	Serie 84.7 Total 0.0		Serie 93.5 Total 93.5
40 Skott		40 Skott	
	11: 9.4 ↘ 12: 8.6 → 13: 9.5 ← 14: 9.3 ← 15: 10.4x ↓ 16: 10.0 ↓ 17: 9.9 ↗ 18: 10.0 → 19: 10.3x ↓ 20: 9.5 ↘		21: 9.0 ↗ 22: 7.9 ↗ 23: 10.0 ← 24: 8.2 ↗ 25: 9.9 ↑ 26: 9.6 ← 27: 10.7x ↘ 28: 9.1 ↗ 29: 8.0 ↗ 30: 8.3 ↘
	Serie 96.9 Total 190.4		Serie 90.7 Total 281.1
40 Skott			
	31: 10.0 ← 32: 9.4 ↘ 33: 9.2 ↓ 34: 9.4 ← 35: 9.5 → 36: 10.2x ↗ 37: 9.3 ← 38: 9.5 ↗ 39: 9.3 ↘ 40: 8.0 ←		
	Serie 93.8 Total 374.9		

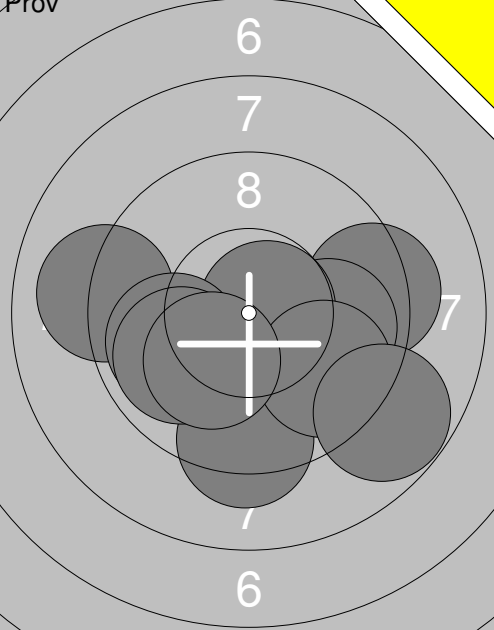
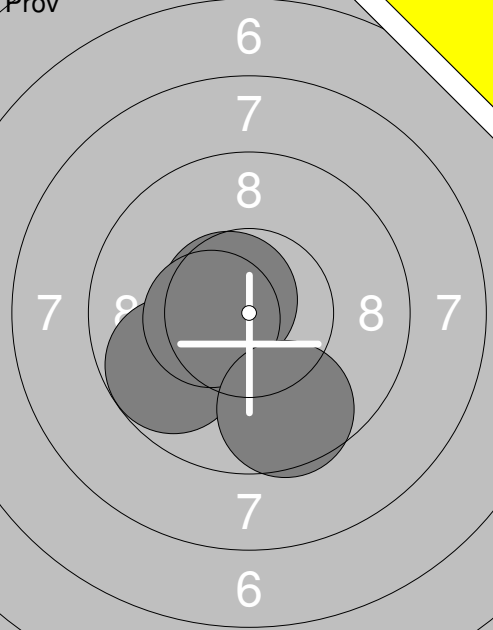
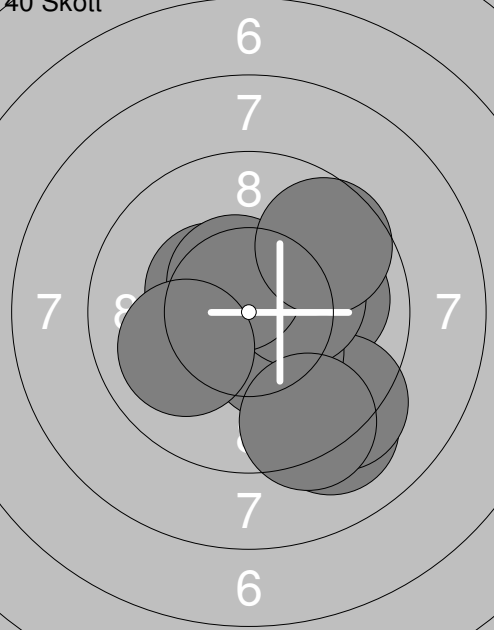
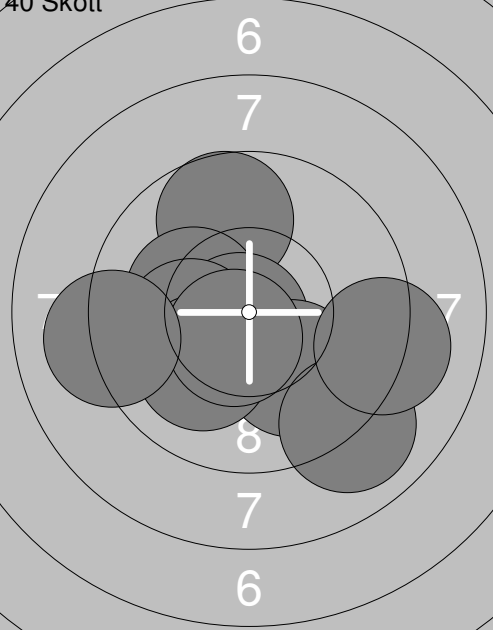
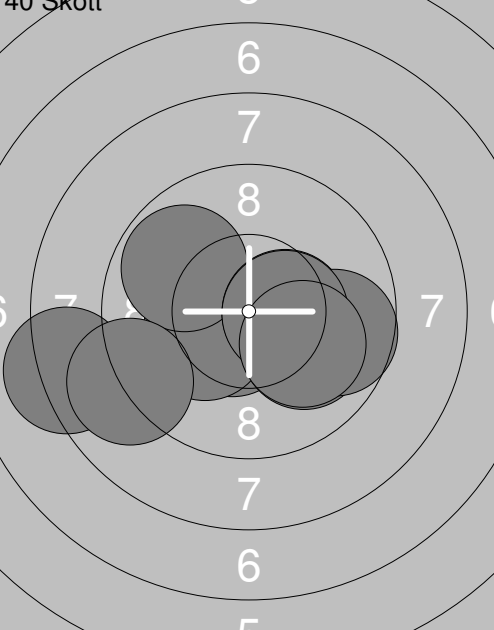
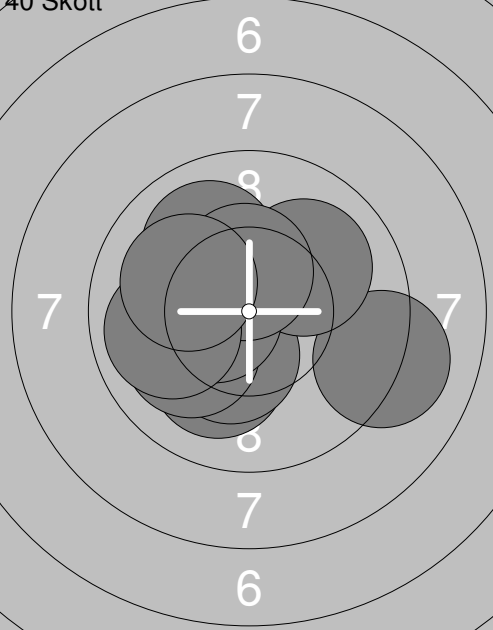
<p>Prov</p>  <p style="text-align: center;">6 7 8 7 6</p>	<p>1: 9.3 →</p> <p>2: 9.1 ←</p> <p>3: 9.9 →</p> <p>4: 9.3 ↓</p> <p>5: 10.7x→</p> <p>6: 9.9 ←</p> <p>7: 9.7 ↘</p> <p>8: 9.9 ←</p> <p>9: 8.8 ↘</p> <p>10: 10.2x↘</p> <p>Serie 96.8</p> <p>Total 0.0</p>	<p>Prov</p>  <p style="text-align: center;">6 7 8 7 6</p> <p>11: 9.8 ↙</p> <p>12: 10.6x↘</p> <p>13: 10.4x↘</p> <p>14: 9.6 ↓</p> <p>Serie 40.4</p> <p>Total 0.0</p>
<p>40 Skott</p>  <p style="text-align: center;">6 7 8 7 6</p>	<p>1: 10.0 →</p> <p>2: 9.1 ↘</p> <p>3: 9.3 ↘</p> <p>4: 10.3x↘</p> <p>5: 10.3x→</p> <p>6: 10.4x↘</p> <p>7: 10.5x↗</p> <p>8: 10.0 ↙</p> <p>9: 9.3 ↘</p> <p>10: 9.6 ↗</p> <p>Serie 98.8</p> <p>Total 98.8</p>	<p>40 Skott</p>  <p style="text-align: center;">6 7 8 7 6</p> <p>11: 9.7 ↗</p> <p>12: 10.2x↘</p> <p>13: 10.8x↘</p> <p>14: 10.0 ↘</p> <p>15: 10.2x↘</p> <p>16: 9.0 ↘</p> <p>17: 10.1 ↘</p> <p>18: 9.2 →</p> <p>19: 10.6x↘</p> <p>20: 9.1 ←</p> <p>Serie 98.9</p> <p>Total 197.7</p>
<p>40 Skott</p>  <p style="text-align: center;">6 7 8 7 6</p>	<p>21: 10.6x↘</p> <p>22: 10.0 ↘</p> <p>23: 10.2x↘</p> <p>24: 9.8 ↖</p> <p>25: 10.4x→</p> <p>26: 9.7 →</p> <p>27: 8.2 ←</p> <p>28: 9.0 ←</p> <p>29: 10.4x→</p> <p>30: 10.1 ↘</p> <p>Serie 98.4</p> <p>Total 296.1</p>	<p>40 Skott</p>  <p style="text-align: center;">6 7 8 7 6</p> <p>31: 10.1 ↘</p> <p>32: 9.1 →</p> <p>33: 10.3x↘</p> <p>34: 10.0 ↗</p> <p>35: 10.1 ↙</p> <p>36: 10.0 ↖</p> <p>37: 10.5x↖</p> <p>38: 10.4x↗</p> <p>39: 9.9 ←</p> <p>40: 10.1 ↖</p> <p>Serie 100.5</p> <p>Total 396.6</p>

<p>Prov</p>	<p>1: 8.7 ←</p> <p>2: 8.4 ←</p> <p>3: 7.8 ←</p> <p>4: 8.2 ←</p> <p>5: 7.0 ←</p> <p>6: 9.5 ←</p> <p>7: 9.2 ←</p> <p>8: 8.5 ←</p> <p>9: 8.4 ←</p> <p>10: 9.6 ←</p> <p>Serie 85.3</p> <p>Total 0.0</p>	<p>Prov</p>	<p>11: 10.4x←</p> <p>12: 8.8 ←</p> <p>13: 10.0←</p> <p>14: 10.1 ↙</p> <p>15: 9.9 ↙</p> <p>16: 9.9 ↙</p> <p>17: 9.3 ↘</p> <p>18: 10.5x↗</p> <p>19: 10.5x↗</p> <p>20: 9.5 ↗</p> <p>Serie 98.9</p> <p>Total 0.0</p>
-------------	-----------------------------------------------------------------------------------------------------------------------------------------------------------------------------------------------------	-------------	------------------------------------------------------------------------------------------------------------------------------------------------------------------------------------------------------------------

<p>40 Skott</p>	<p>1: 9.7 →</p> <p>2: 10.7x←</p> <p>3: 10.5x→</p> <p>4: 9.6 ↘</p> <p>5: 9.9 ↙</p> <p>6: 9.9 ↓</p> <p>7: 10.3x↘</p> <p>8: 9.3 →</p> <p>9: 10.1 ↘</p> <p>10: 9.0 ↘</p> <p>Serie 99.0</p> <p>Total 99.0</p>	<p>40 Skott</p>	<p>11: 9.2 →</p> <p>12: 9.9 →</p> <p>13: 10.4x←</p> <p>14: 9.9 ↙</p> <p>15: 9.8 ↘</p> <p>16: 9.8 ↑</p> <p>17: 8.6 ↗</p> <p>18: 10.5x↘</p> <p>19: 9.6 →</p> <p>20: 9.5 ↓</p> <p>Serie 97.2</p> <p>Total 196.2</p>
-----------------	----------------------------------------------------------------------------------------------------------------------------------------------------------------------------------------------------------	-----------------	------------------------------------------------------------------------------------------------------------------------------------------------------------------------------------------------------------------

<p>40 Skott</p>	<p>21: 9.7 ↘</p> <p>22: 10.4x←</p> <p>23: 9.1 →</p> <p>24: 9.2 ↘</p> <p>25: 10.4x→</p> <p>26: 9.8 ↗</p> <p>27: 9.6 →</p> <p>28: 10.5x←</p> <p>29: 10.6x→</p> <p>30: 9.8 →</p> <p>Serie 99.1</p> <p>Total 295.3</p>	<p>40 Skott</p>	<p>31: 10.0 ↑</p> <p>32: 9.7 ↗</p> <p>33: 9.8 →</p> <p>34: 9.8 →</p> <p>35: 9.5 ↗</p> <p>36: 9.9 ↗</p> <p>37: 9.6 ↙</p> <p>38: 10.0 ↘</p> <p>39: 10.0 ←</p> <p>40: 10.6x↗</p> <p>Serie 98.9</p> <p>Total 394.2</p>
-----------------	--------------------------------------------------------------------------------------------------------------------------------------------------------------------------------------------------------------------	-----------------	--------------------------------------------------------------------------------------------------------------------------------------------------------------------------------------------------------------------

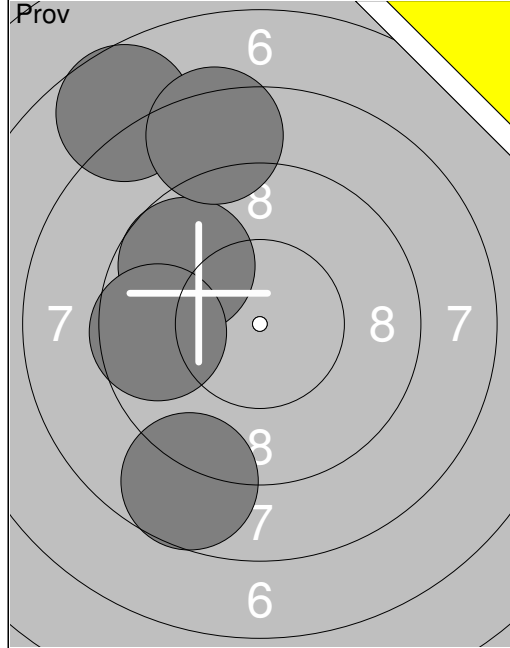

- 1: 9.7 ↖
- 2: 9.6 ←
- 3: 7.7 ↖
- 4: 8.7 ↓
- 5: 8.4 ↑

Serie 44.1
Total 0.0

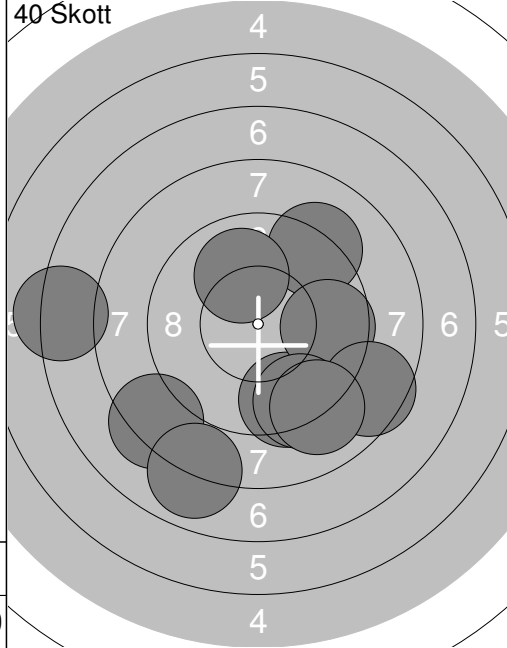

- 1: 9.2 ↗
- 2: 10.0 ↑
- 3: 9.4 ↓
- 4: 9.6 →
- 5: 8.3 ↙
- 6: 7.2 ←
- 7: 8.5 ↘
- 8: 7.9 ↓
- 9: 9.3 ↓
- 10: 9.0 ↓

Serie 88.4
Total 88.4

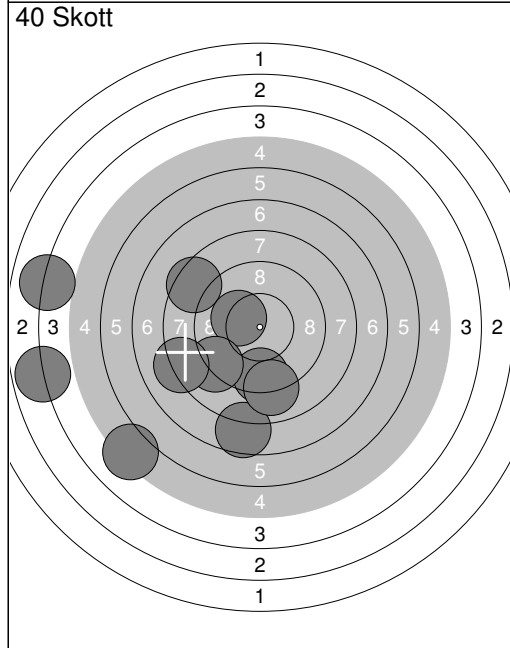

- 11: 8.4 ↖
- 12: 10.2x ↖
- 13: 7.6 ↓
- 14: 9.4 ↓
- 15: 5.2 ↙
- 16: 9.0 ↓
- 17: 9.1 ↙
- 18: 8.1 ←
- 19: 3.8 ←
- 20: 4.0 ←

Serie 74.8
Total 163.2

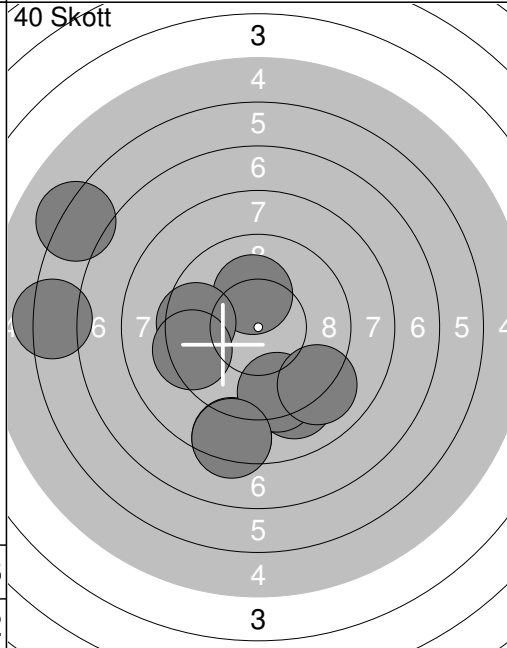

- 21: 10.2x ↗
- 22: 8.4 ↓
- 23: 9.5 ←
- 24: 9.4 ←
- 25: 6.2 ↖
- 26: 9.1 ↓
- 27: 9.4 ↓
- 28: 9.1 ↓
- 29: 6.3 ←
- 30: 8.4 ↓

Serie 86.0
Total 249.2

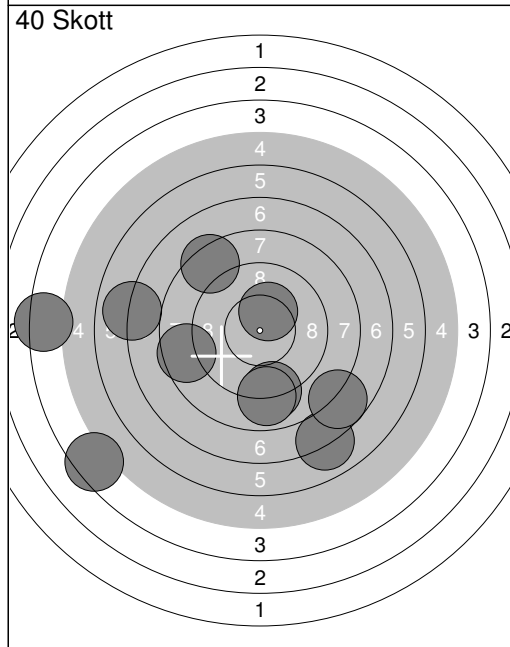

- 31: 10.3x ↗
- 32: 7.0 ←
- 33: 9.0 ↓
- 34: 4.4 ↙
- 35: 8.9 ↓
- 36: 8.4 ↗
- 37: 4.3 ←
- 38: 8.6 ←
- 39: 7.0 ↓
- 40: 7.7 ↘

Serie 75.6
Total 324.8

<p>Prov</p>	<p>1: 10.8x ↗</p> <p>2: 9.3 ↗</p> <p>3: 9.1 →</p> <p>4: 7.7 ↗</p> <p>5: 9.5 ↓</p> <p>6: 7.5 ↖</p> <p>7: 10.4x ↖</p> <p>8: 8.9 ↓</p> <p>9: 8.9 ↓</p> <p>10: 8.0 →</p> <p>Serie 90.1</p> <p>Total 0.0</p>	<p>Prov</p>	<p>11: 10.2x ↖</p> <p>Serie 10.2</p> <p>Total 0.0</p>
-------------	---------------------------------------------------------------------------------------------------------------------------------------------------------------------------------------------------------	-------------	-------------------------------------------------------

<p>40 Skott</p>	<p>1: 10.4x ↗</p> <p>2: 9.6 ←</p> <p>3: 9.6 ↘</p> <p>4: 8.7 ↘</p> <p>5: 9.8 ↓</p> <p>6: 7.5 ↓</p> <p>7: 8.5 →</p> <p>8: 9.9 →</p> <p>9: 9.8 ↑</p> <p>10: 10.4x ↖</p> <p>Serie 94.2</p> <p>Total 94.2</p>	<p>40 Skott</p>	<p>11: 8.6 ↑</p> <p>12: 10.4x ↗</p> <p>13: 8.6 ↑</p> <p>14: 9.5 ↓</p> <p>15: 7.0 ↖</p> <p>16: 9.6 ↓</p> <p>17: 10.2x ↗</p> <p>18: 7.9 ↗</p> <p>19: 9.1 ↗</p> <p>20: 9.7 ↗</p> <p>Serie 90.6</p> <p>Total 184.8</p>
-----------------	----------------------------------------------------------------------------------------------------------------------------------------------------------------------------------------------------------	-----------------	--------------------------------------------------------------------------------------------------------------------------------------------------------------------------------------------------------------------

<p>40 Skott</p>	<p>21: 9.8 ←</p> <p>22: 10.3x ↖</p> <p>23: 9.4 ↓</p> <p>24: 9.7 ←</p> <p>25: 9.0 ↖</p> <p>26: 9.6 →</p> <p>27: 8.0 ↑</p> <p>28: 8.7 →</p> <p>29: 9.6 ↑</p> <p>30: 9.4 ↑</p> <p>Serie 93.5</p> <p>Total 278.3</p>	<p>40 Skott</p>	<p>31: 9.6 ←</p> <p>32: 9.6 →</p> <p>33: 8.8 ↗</p> <p>34: 10.2x ↗</p> <p>35: 10.4x ↗</p> <p>36: 10.3x ↗</p> <p>37: 8.4 ↖</p> <p>38: 9.5 ←</p> <p>39: 9.5 ↓</p> <p>40: 9.8 →</p> <p>Serie 96.1</p> <p>Total 374.4</p>
-----------------	------------------------------------------------------------------------------------------------------------------------------------------------------------------------------------------------------------------	-----------------	----------------------------------------------------------------------------------------------------------------------------------------------------------------------------------------------------------------------

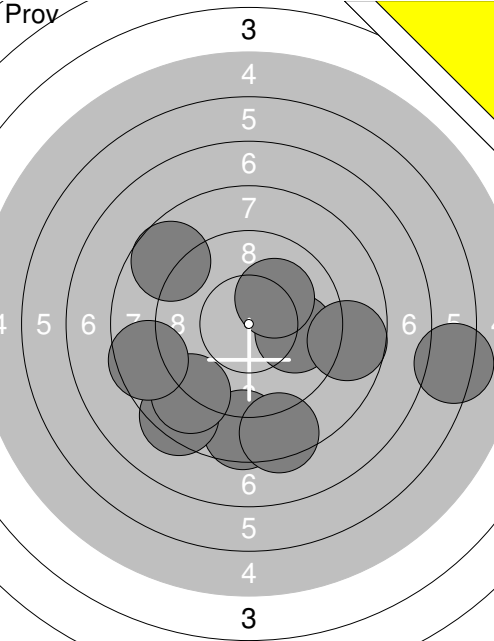
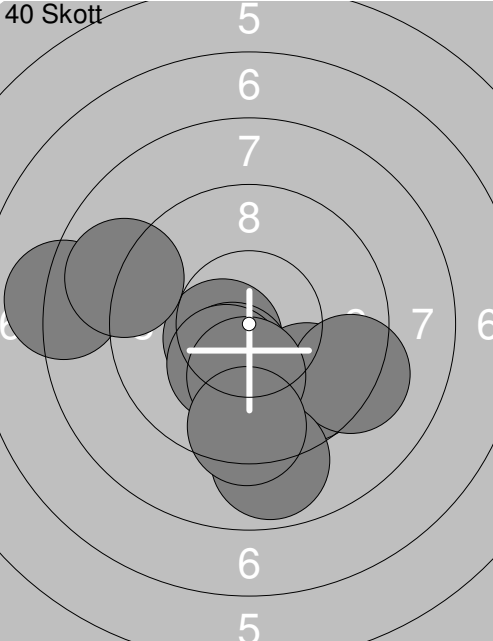
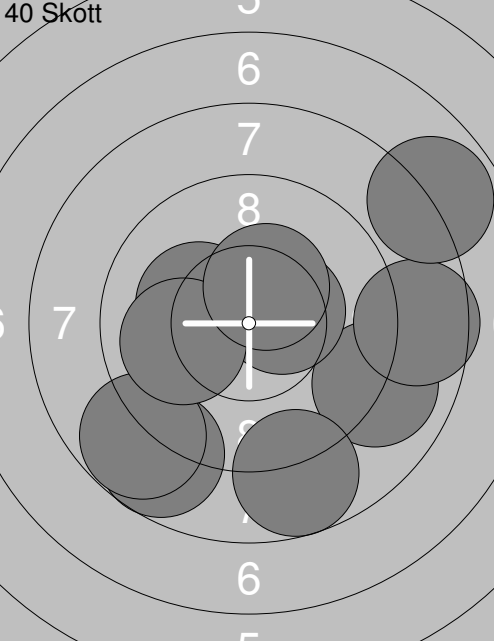
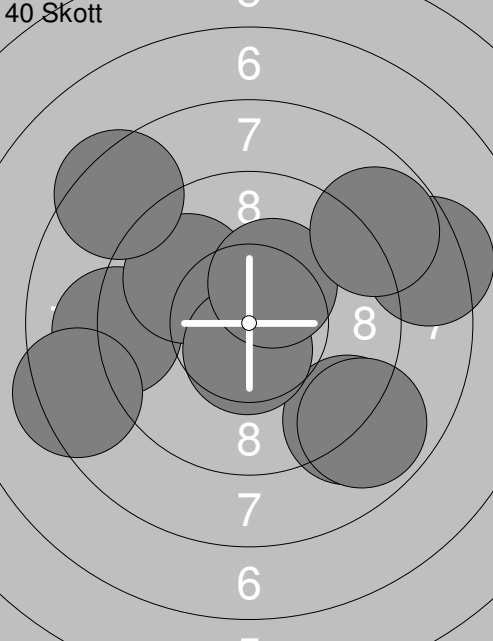
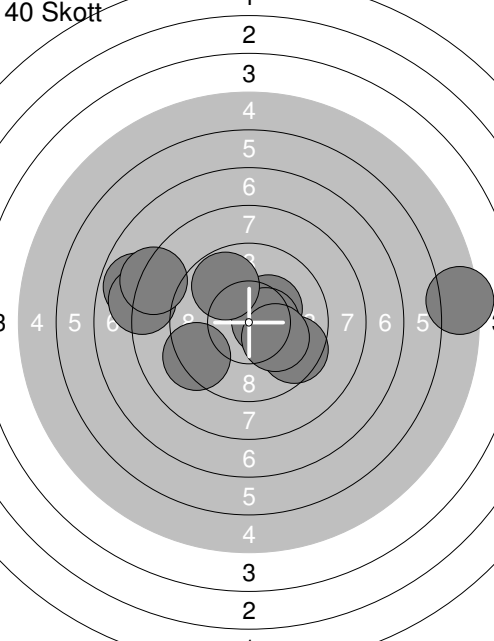
Skjuttlag	Tavla	William Wallin	
2	16	Aspås USkF	L13stå
02.02.2019	Skyttiaden Regionfinal 2019	Umeå skytteallians	
	1: 8.6 ↓		1: 9.7 ↘
	2: 8.4 ↘		2: 10.5x↙
	3: 8.9 ↘		3: 10.3x↘
	4: 8.4 ↓		4: 8.1 ←
	5: 9.9 →		5: 9.3 ↘
	6: 8.7 →		6: 9.0 ←
	7: 8.6 ←		7: 8.9 ↓
	8: 8.7 ↖		8: 10.3x↘
	9: 6.3 →		9: 10.2x↘
	10: 10.1 ↗		10: 9.4 ↓
Serie 86.6		Serie 95.7	
Total 0.0		Total 95.7	
	11: 9.0 ↘		21: 9.1 ←
	12: 8.6 →		22: 9.0 ↘
	13: 8.7 ↘		23: 9.9 ↖
	14: 7.9 ↗		24: 10.6x↘
	15: 10.5x↗		25: 8.3 →
	16: 10.2x↙		26: 8.9 ↘
	17: 8.7 ↓		27: 10.3x↗
	18: 8.8 ↘		28: 8.8 ↗
	19: 10.0←		29: 8.4 ↖
	20: 10.4x↗		30: 8.4 ←
Serie 92.8		Serie 91.7	
Total 188.5		Total 280.2	
	31: 9.3 ↖		
	32: 10.3x↗		
	33: 9.5 ↘		
	34: 7.8 ←		
	35: 10.5x↗		
	36: 8.1 ←		
	37: 9.8 ↗		
	38: 5.3 →		
	39: 8.2 ↖		
	40: 10.1 ↘		
Serie 88.9			
Total 369.1			

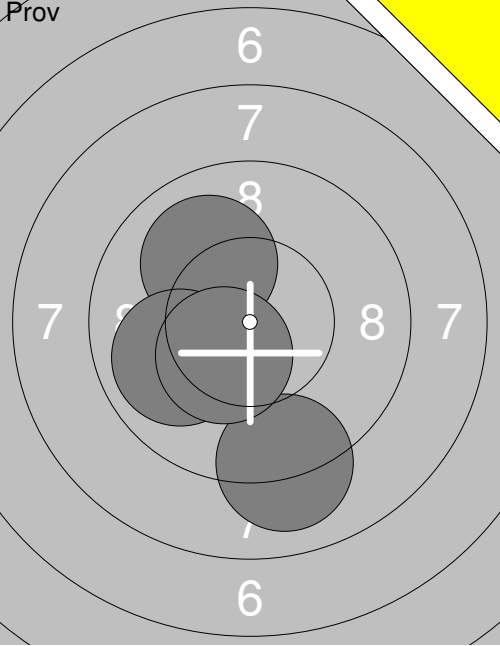
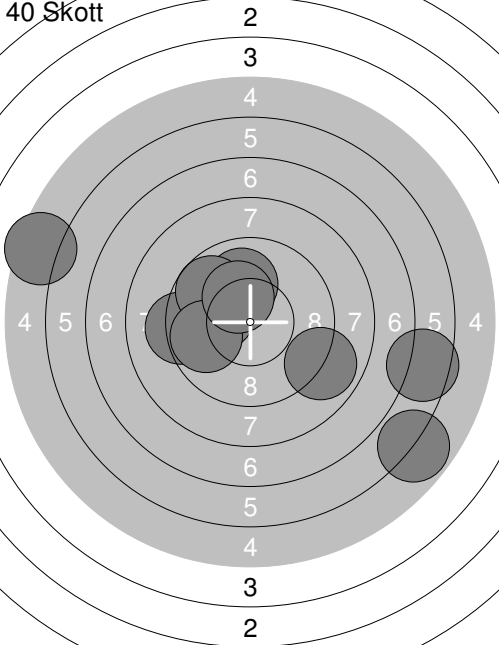
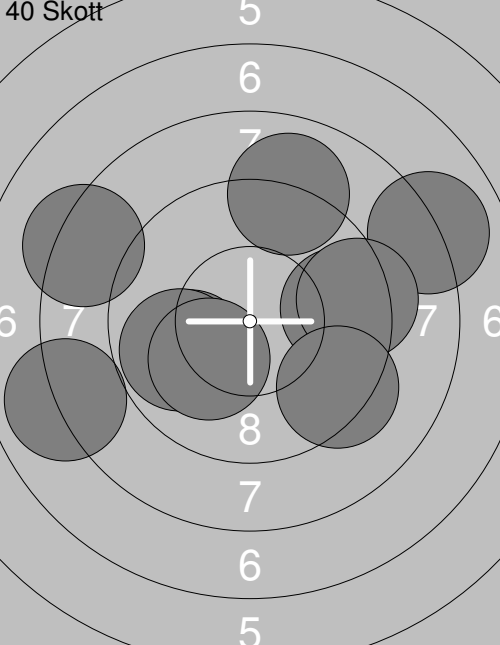
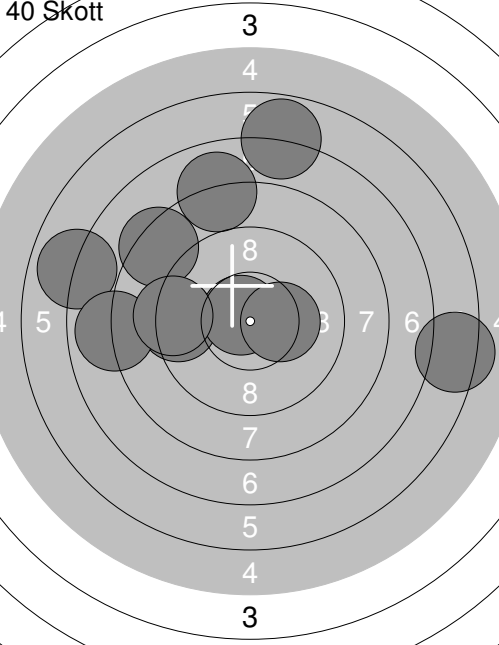
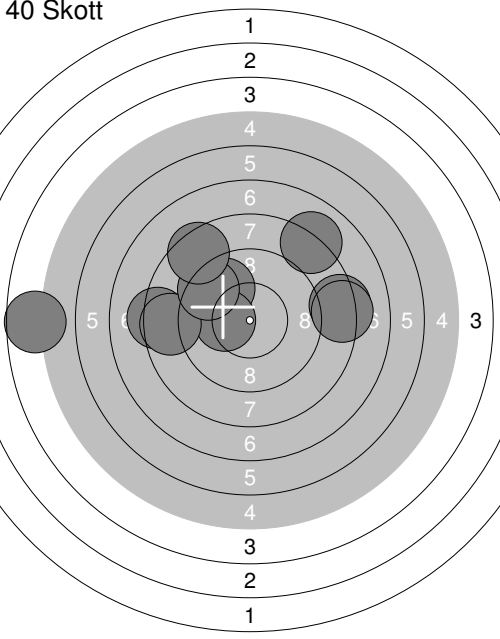
Skjutlag 2	Tavla 17	Einar Kurkkio		
S		Gällivare Skf	L13stå	
02.02.2019	Skyttiaden Regionfinal 2019		Umeå skytteallians	
Prov		1: 9.1 ↓ 2: 10.0 ↗ 3: 9.9 ← 4: 10.4x ↘	40 Skott 	1: 10.2x ↖ 2: 8.9 ↘ 3: 10.0 ↑ 4: 6.5 → 5: 9.2 ← 6: 9.7 ↗ 7: 5.4 ← 8: 9.8 ← 9: 10.3x ↗ 10: 5.9 ↘
		Serie 39.4	Serie 85.9	
		Total 0.0	Total 85.9	
40 Skott		11: 10.0 ← 12: 9.8 ← 13: 8.0 → 14: 8.3 ← 15: 8.0 ← 16: 9.6 → 17: 10.1 ← 18: 9.3 → 19: 9.0 ↑ 20: 9.3 ↘	40 Skott 	21: 9.3 ← 22: 6.3 → 23: 6.9 ← 24: 6.8 ↑ 25: 10.7x ↖ 26: 7.9 ← 27: 8.3 ↗ 28: 8.0 ↑ 29: 9.2 ← 30: 10.3x →
		Serie 91.4	Serie 83.7	
		Total 177.3	Total 261.0	
40 Skott		31: 4.7 ← 32: 9.8 ↗ 33: 8.3 → 34: 8.3 ← 35: 10.2x ↖ 36: 8.2 → 37: 8.6 ← 38: 9.4 ↗ 39: 8.5 ↗ 40: 8.1 ↗		
		Serie 84.1		
		Total 345.1		

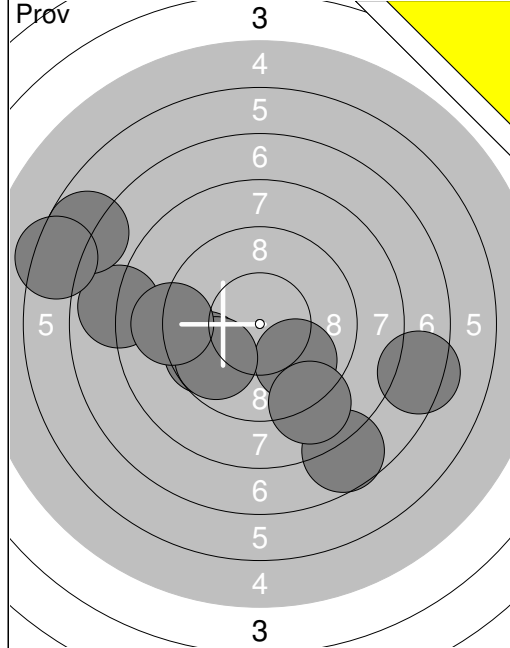

1:	7.4	➔
2:	7.9	↙
3:	7.7	↘
4:	9.6	↙
5:	9.9	↘
6:	8.9	↘
7:	9.8	↙
8:	9.1	↙
9:	6.7	↙
10:	6.3	↙
Serie	83.3	
Total	0.0	

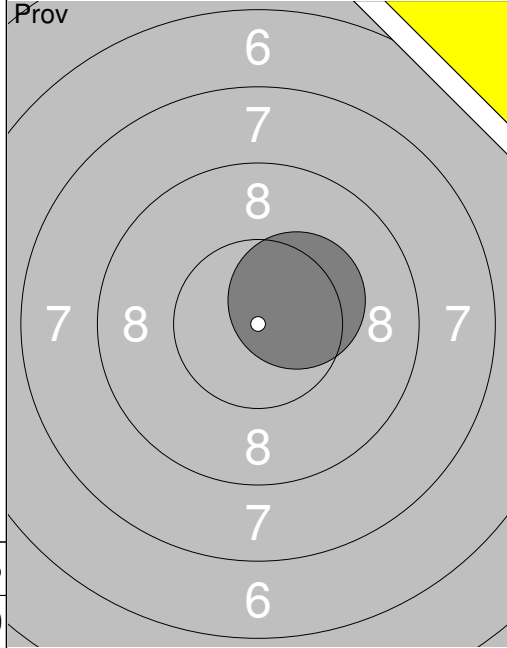

11:	10.4	↗
Serie	10.4	
Total	0.0	

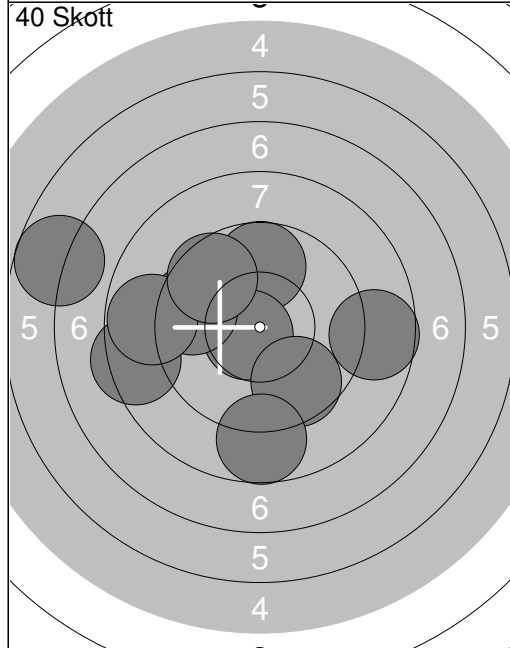

1:	8.4	↙
2:	9.7	↑
3:	10.7	↘
4:	8.7	➔
5:	9.6	↘
6:	6.7	↙
7:	8.7	↘
8:	9.6	↙
9:	8.8	↙
10:	9.6	↗
Serie	90.5	
Total	90.5	

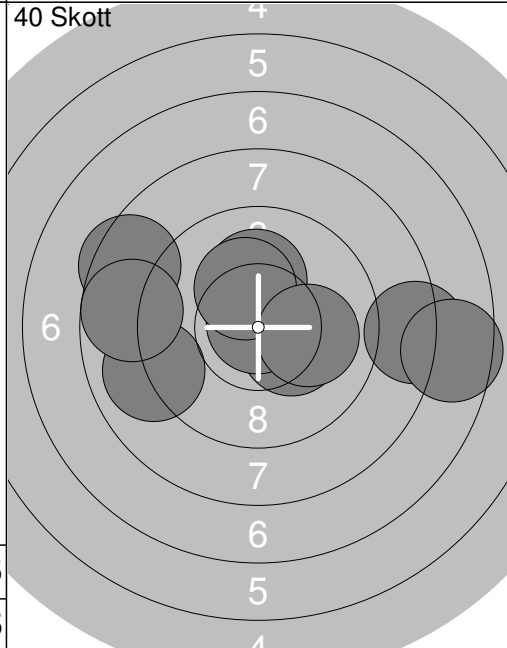

11:	9.0	↙
12:	8.5	↙
13:	10.1	↑
14:	10.3	↘
15:	10.9	↗
16:	8.7	↙
17:	10.2	↗
18:	8.2	➔
19:	7.6	➔
20:	10.1	➔
Serie	93.6	
Total	184.1	

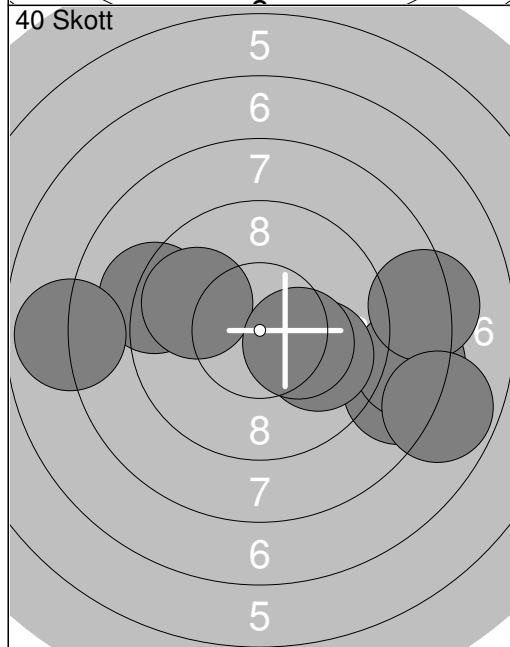

21:	8.5	➔
22:	8.5	➔
23:	8.3	➔
24:	9.9	➔
25:	9.2	↙
26:	7.9	↙
27:	9.9	↙
28:	10.3	↘
29:	7.8	➔
30:	0.0	
Serie	80.3	
Total	264.4	

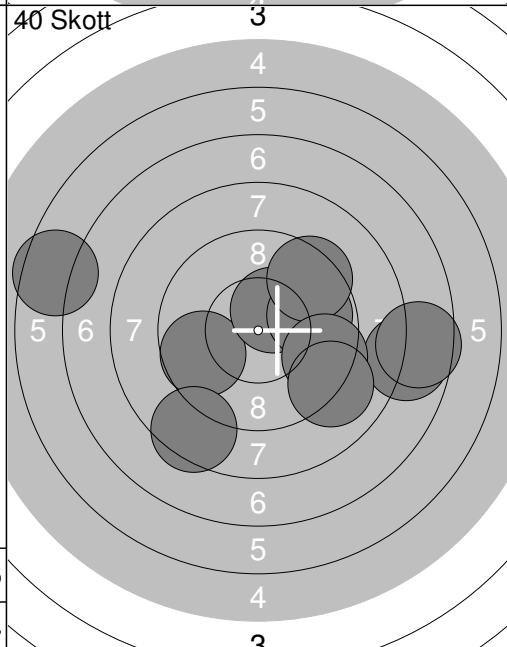

31:	9.7	↙
32:	8.5	↘
33:	10.4	↗
34:	7.8	➔
35:	9.8	➔
36:	7.6	➔
37:	6.5	↙
38:	9.4	↗
39:	9.5	➔
40:	9.1	↘
Serie	88.3	
Total	352.7	

<p>Prov</p>	<p>1: 9.7 ↖</p> <p>2: 7.7 ↗</p> <p>3: 8.7 ↖</p> <p>4: 9.7 ↘</p> <p>5: 9.4 ↗</p> <p>6: 10.3x↗</p> <p>7: 7.7 ↖</p> <p>8: 10.2x↘</p> <p>9: 9.9 →</p> <p>10: 9.7 ↖</p>	<p>Prov</p>		<p>11: 9.5 ↗</p>
Serie	93.0	Serie		9.5
Total	0.0	Total		0.0

<p>40 Skott</p>	<p>1: 9.9 ↗</p> <p>2: 10.2x↘</p> <p>3: 9.7 ↗</p> <p>4: 10.6x↓</p> <p>5: 10.9x↘</p> <p>6: 10.4x↗</p> <p>7: 10.0 ↘</p> <p>8: 9.9 ↗</p> <p>9: 9.0 ↖</p> <p>10: 10.5x↓</p>	<p>40 Skott</p>		<p>11: 8.3 ↗</p> <p>12: 8.7 ↖</p> <p>13: 9.4 ↗</p> <p>14: 9.3 ↗</p> <p>15: 10.5x↗</p> <p>16: 10.4x↘</p> <p>17: 9.6 →</p> <p>18: 10.3x↗</p> <p>19: 10.6x↘</p> <p>20: 9.6 ↘</p>
Serie	101.1	Serie		96.7
Total	101.1	Total		197.8

<p>40 Skott</p>	<p>21: 10.8x></p> <p>22: 9.9 ↘</p> <p>23: 10.2x↗</p> <p>24: 9.8 ↗</p> <p>25: 10.3x↓</p> <p>26: 9.0 ↖</p> <p>27: 9.5 ↗</p> <p>28: 9.2 ↗</p> <p>29: 9.9 ↓</p> <p>30: 10.7x↗</p>	<p>40 Skott</p>		<p>31: 10.6x↗</p> <p>32: 10.3x↖</p> <p>33: 10.2x></p> <p>34: 10.6x↗</p> <p>35: 9.9 ↘</p> <p>36: 10.1 ↓</p> <p>37: 9.7 ↖</p> <p>38: 10.3x↘</p> <p>39: 10.4x↖</p> <p>40: 10.2x↗</p>
Serie	99.3	Serie		102.3
Total	297.1	Total		399.4

	1: 8.3 ↙		11: 10.0 ↘
	2: 8.8 ↓		
	3: 9.3 ←		
	4: 10.1 ↓		
	5: 9.8 ↓		
	6: 10.3x ↘		
	7: 10.4x ←		
	8: 8.9 ↓		
	9: 8.6 ↘		
	10: 9.6 ↓		
Serie	94.1	Serie	10.0
Total	0.0	Total	0.0

	1: 8.4 ←		11: 9.4 ←
	2: 8.2 →		12: 9.5 ↖
	3: 8.2 ↓		13: 9.6 ←
	4: 9.8 ↓		14: 10.0 →
	5: 7.6 ↘		15: 8.3 ↘
	6: 9.4 →		16: 8.6 ←
	7: 9.1 →		17: 9.7 ↓
	8: 9.7 ↓		18: 10.8x ↘
	9: 9.0 ↓		19: 9.4 ↓
	10: 10.0 ↙		20: 10.2x →
Serie	89.4	Serie	95.5
Total	89.4	Total	184.9

	21: 9.7 ↗		31: 9.5 ↗
	22: 10.5x ↘		32: 8.8 ←
	23: 8.3 ↓		33: 10.7x →
	24: 8.5 ↓		34: 10.8x →
	25: 9.9 ↓		35: 10.8x →
	26: 8.0 →		36: 8.8 ↓
	27: 7.8 ←		37: 6.6 →
	28: 10.7x ↗		38: 8.9 ↙
	29: 10.4x →		39: 9.7 ↓
	30: 9.9 →		40: 9.3 ↙
Serie	93.7	Serie	93.9
Total	278.6	Total	372.5

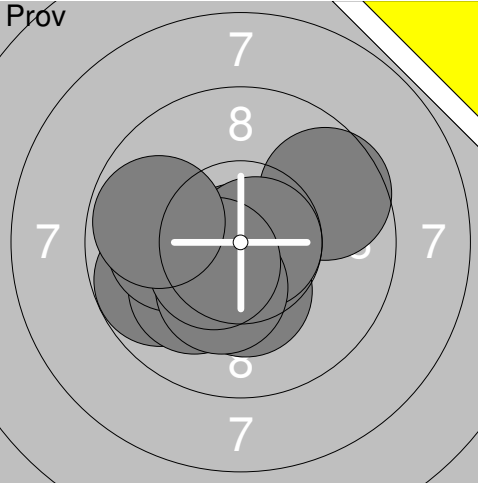
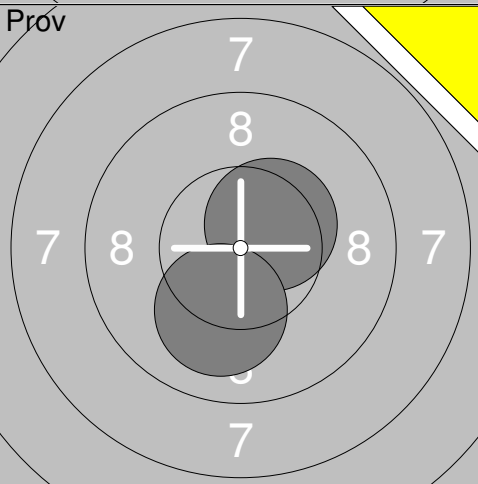
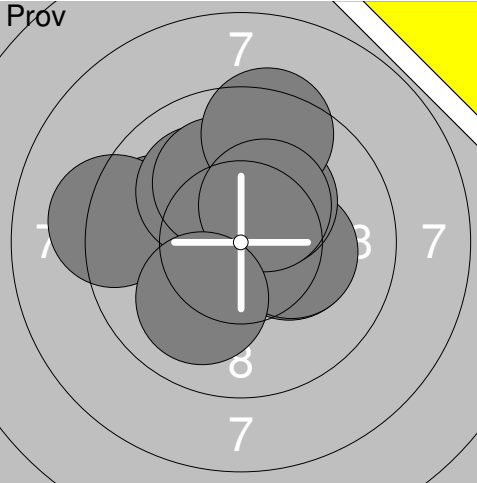
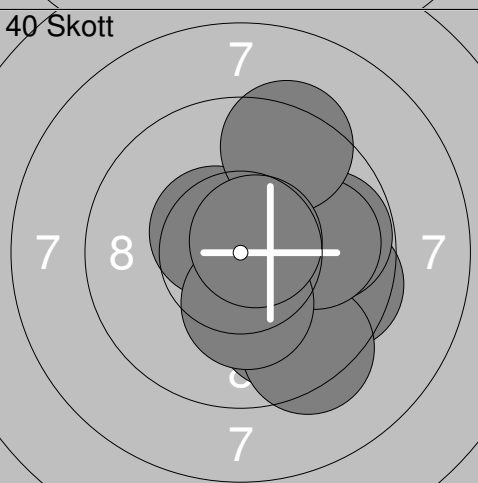
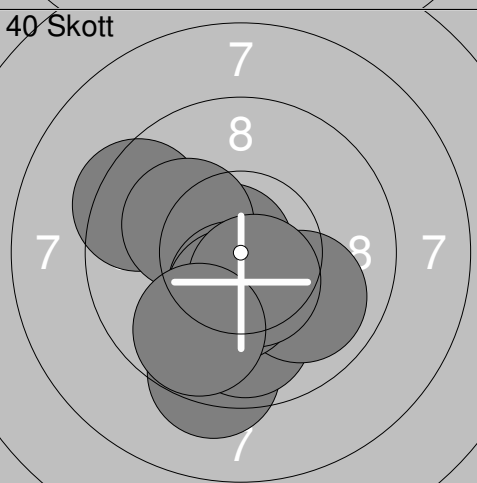
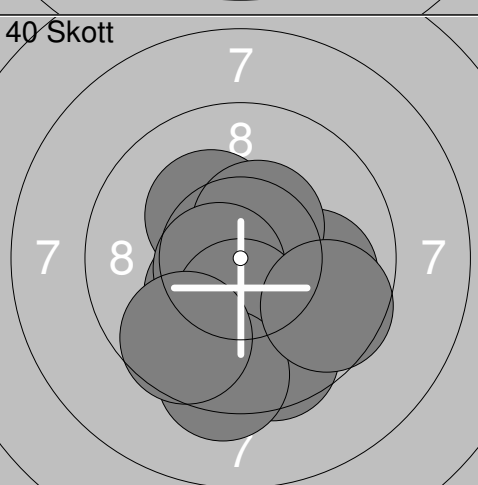
Skjutlag 2	Tavla 23	Elsa Martinsson	
S		Hammerdal SkF	L11
02.02.2019		Skyttiaden Regionfinal 2019	
Umeå skytteallians			
Prov		1: 10.3x ↓ 2: 9.8 ↙ 3: 10.1 ↙ 4: 10.8x ↓ 5: 9.6 → 6: 10.7x → 7: 10.0 ← 8: 10.3x ↓ 9: 10.5x ↙ 10: 9.8 ↙ Serie 101.9 Total 0.0	11: 10.3x → 12: 9.8 ↙ 13: 9.2 ↙ 14: 10.1 ↗ 15: 10.1 ↗ 16: 10.3x → 17: 10.3x ↗ 18: 9.4 ↑ 19: 10.4x ↗ 20: 10.0 ↙ Serie 99.9 Total 0.0
Prov		21: 10.4x ↗ 22: 10.1 ↓ Serie 20.5 Total 0.0	40 Skott
			1: 9.8 ↗ 2: 10.7x ↙ 3: 10.3x ↗ 4: 10.4x ↙ 5: 9.8 ↓ 6: 10.1 ↘ 7: 9.4 ← 8: 10.7x → 9: 10.6x ↓ 10: 10.2x ↓ Serie 102.0 Total 102.0
40 Skott		11: 10.4x ↗ 12: 10.5x ↗ 13: 9.6 → 14: 9.8 → 15: 9.8 ↓ 16: 9.4 ↓ 17: 9.9 → 18: 9.4 ↑ 19: 10.3x ↓ 20: 10.7x ↗ Serie 99.8 Total 201.8	40 Skott
			21: 10.8x ↙ 22: 9.4 ↗ 23: 10.1 ↗ 24: 9.3 ↓ 25: 10.5x ↓ 26: 9.9 ↓ 27: 9.9 ↘ 28: 10.4x ↓ 29: 10.5x ↓ 30: 9.8 ↙ Serie 100.6 Total 302.4
40 Skott		31: 10.3x ↗ 32: 10.3x ↙ 33: 10.0 → 34: 10.5x ↗ 35: 9.6 ↓ 36: 10.6x ↙ 37: 10.3x ↓ 38: 9.4 ↓ 39: 9.6 → 40: 9.6 ↙ Serie 100.2 Total 402.6	

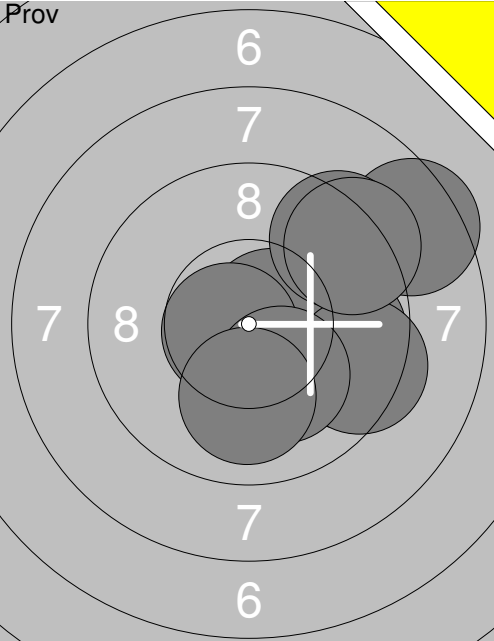
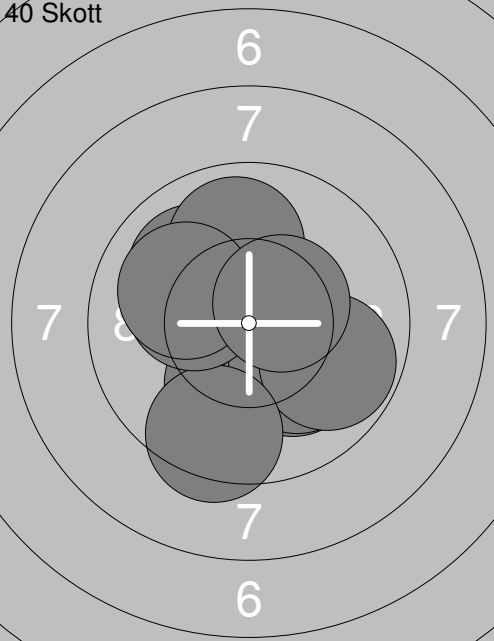
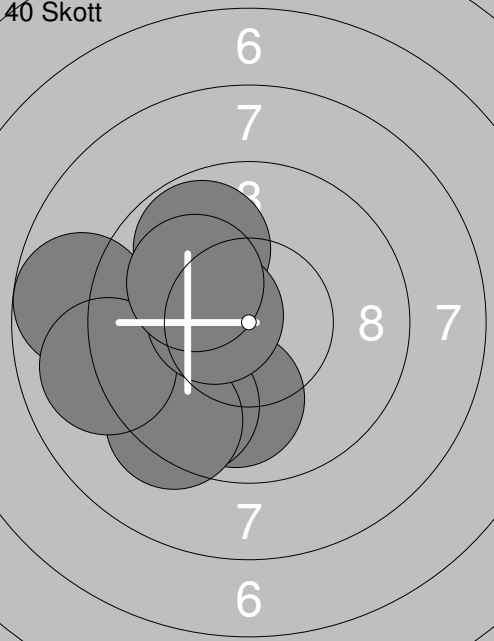
Skjuttag	Tavla	Oscar Jonsson	
2	24	Vännäs Skf	L11
02.02.2019	Skyttiaden Regionfinal 2019	Umeå skytteallians	
Prov		1: 9.8 → 2: 8.5 ↗ 3: 9.7 → 4: 10.6x→ 5: 10.7x↖ 6: 9.3 ↗ 7: 9.4 → 8: 10.2x↘ 9: 9.3 ↗ 10: 10.0 ↓ Serie 97.5 Total 0.0	11: 9.7 ↙ 12: 9.9 → 13: 10.3x↗ 14: 9.5 → 15: 10.2x↘ 16: 9.8 → 17: 10.2x↑ 18: 10.5x↓ 19: 10.2x↓ Serie 90.3 Total 0.0
40 Skott		1: 10.0 ↖ 2: 9.9 ↑ 3: 10.1 ↓ 4: 10.1 ↘ 5: 10.1 ↘ 6: 9.8 → 7: 9.4 ↓ 8: 10.2x↖ 9: 10.0 ↖ 10: 10.5x↗ Serie 100.1 Total 100.1	11: 10.5x→ 12: 10.6x↓ 13: 9.3 ↗ 14: 9.7 → 15: 9.7 ← 16: 9.7 ↓ 17: 10.5x↓ 18: 8.8 ↖ 19: 9.5 ← 20: 9.3 ↓ Serie 97.6 Total 197.7
40 Skott		21: 9.9 ↓ 22: 10.1↖ 23: 9.6 ↓ 24: 9.3 ↓ 25: 10.2x↖ 26: 8.7 ← 27: 9.0 ← 28: 9.8 ↗ 29: 10.5x↖ 30: 10.1 ↖ Serie 97.2 Total 294.9	31: 10.7x↗ 32: 8.9 → 33: 10.4x↘ 34: 8.6 ↗ 35: 10.4x↖ 36: 10.1 ↑ 37: 9.6 ↓ 38: 10.4x↗ 39: 10.6x↘ 40: 10.2x↖ Serie 99.9 Total 394.8

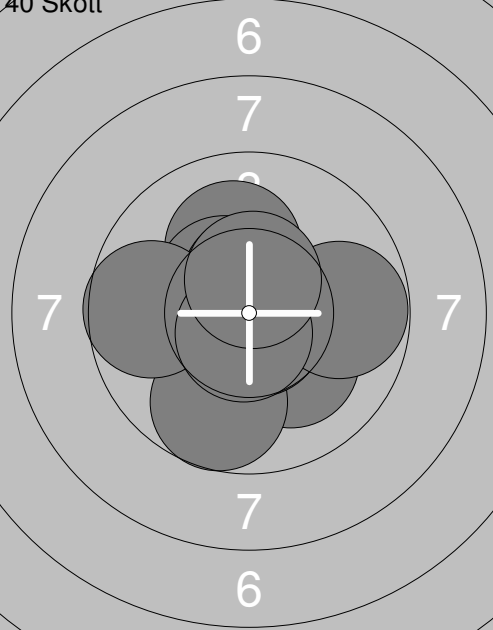
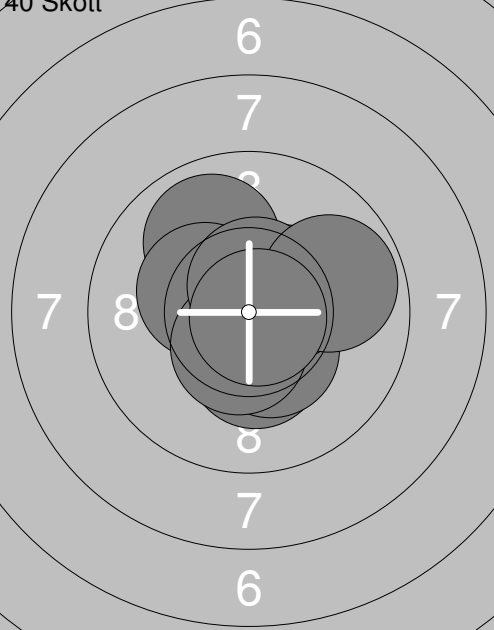
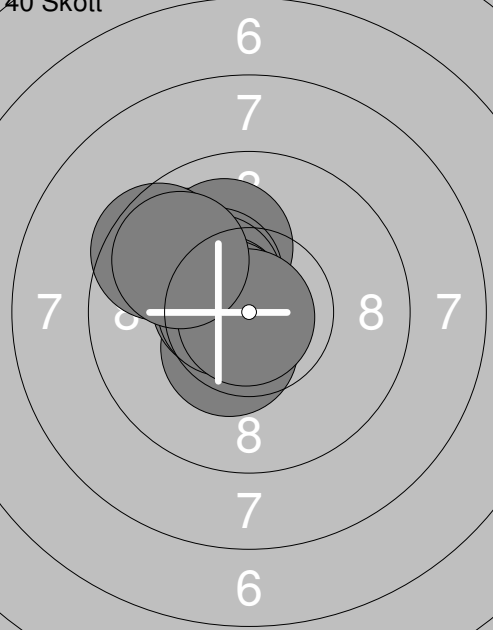
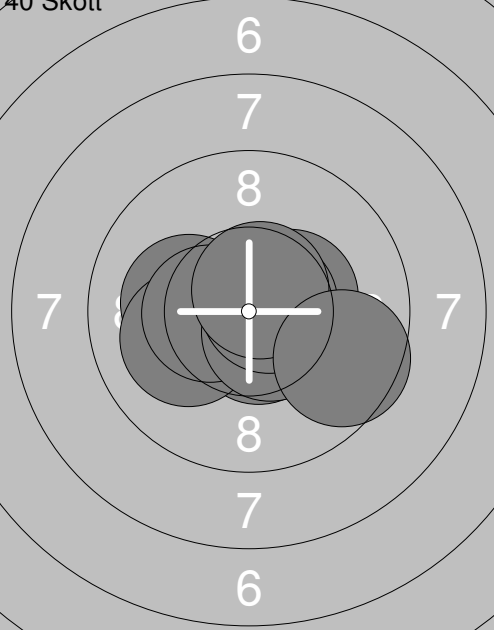
<p>Prov</p>  <p style="text-align: center;">6 7 8 7 6</p>	<p>1: 10.8x↘ 2: 10.5x↗ 3: 10.1 ↓ 4: 10.7x↗</p> <table border="1" style="width:100%; border-collapse: collapse;"> <tr><td>Serie</td><td>42.1</td></tr> <tr><td>Total</td><td>0.0</td></tr> </table>	Serie	42.1	Total	0.0	<p>40 Skott</p>  <p style="text-align: center;">6 7 8 7 6</p> <p>5: 10.6x↗ 6: 10.7x↘ 7: 9.7 ← 8: 9.8 → 9: 10.7x↘ 10: 10.5x↗</p> <table border="1" style="width:100%; border-collapse: collapse;"> <tr><td>Serie</td><td>102.4</td></tr> <tr><td>Total</td><td>102.4</td></tr> </table>	Serie	102.4	Total	102.4
Serie	42.1									
Total	0.0									
Serie	102.4									
Total	102.4									
<p>40 Skott</p>  <p style="text-align: center;">6 7 8 7 6</p>	<p>11: 10.3x↘ 12: 10.4x↘ 13: 10.4x↗ 14: 9.9 ↖ 15: 10.7x↘ 16: 10.3x↘ 17: 10.5x↘ 18: 10.6x↗ 19: 9.8 → 20: 10.8x↘</p> <table border="1" style="width:100%; border-collapse: collapse;"> <tr><td>Serie</td><td>103.7</td></tr> <tr><td>Total</td><td>206.1</td></tr> </table>	Serie	103.7	Total	206.1	<p>40 Skott</p>  <p style="text-align: center;">6 7 8 7 6</p> <p>21: 9.8 ↖ 22: 10.4x↘ 23: 10.0 ↖ 24: 10.3x↘ 25: 9.5 ↖ 26: 10.4x↘ 27: 10.6x↘ 28: 10.6x↘ 29: 10.9x↘ 30: 9.8 ↖</p> <table border="1" style="width:100%; border-collapse: collapse;"> <tr><td>Serie</td><td>102.3</td></tr> <tr><td>Total</td><td>308.4</td></tr> </table>	Serie	102.3	Total	308.4
Serie	103.7									
Total	206.1									
Serie	102.3									
Total	308.4									
<p>40 Skott</p>  <p style="text-align: center;">6 7 8 7 6</p>	<p>31: 10.2x↘ 32: 10.6x↘ 33: 10.7x↘ 34: 10.1 ← 35: 10.4x↘ 36: 10.6x↘ 37: 10.4x↗ 38: 10.7x↗ 39: 10.6x↗ 40: 9.6 ↘</p> <table border="1" style="width:100%; border-collapse: collapse;"> <tr><td>Serie</td><td>103.9</td></tr> <tr><td>Total</td><td>412.3</td></tr> </table>	Serie	103.9	Total	412.3					
Serie	103.9									
Total	412.3									

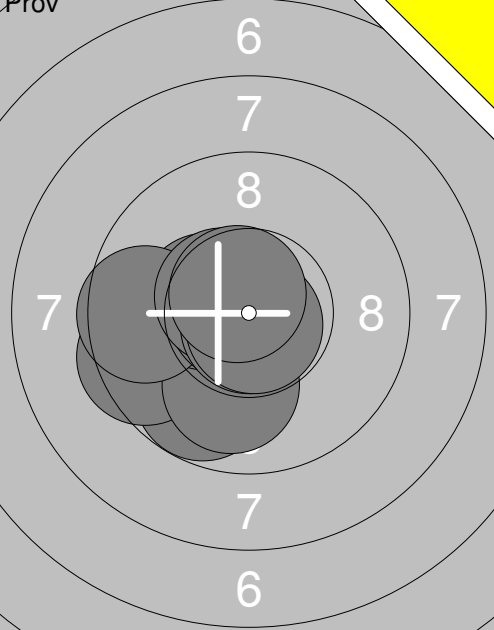
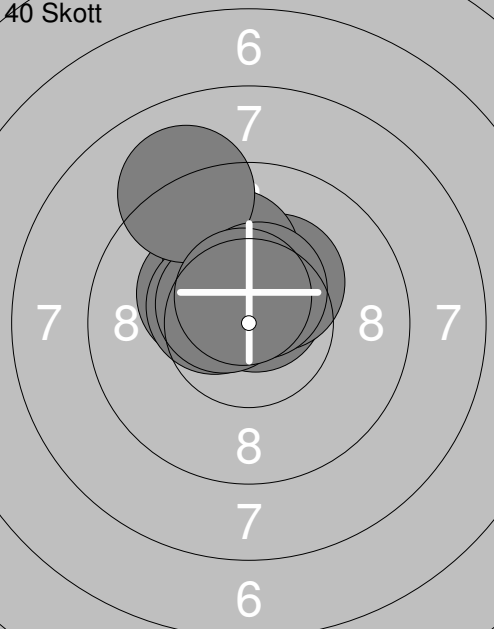
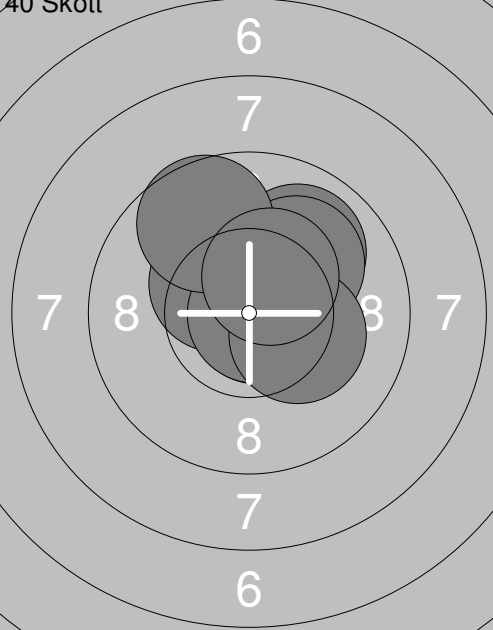
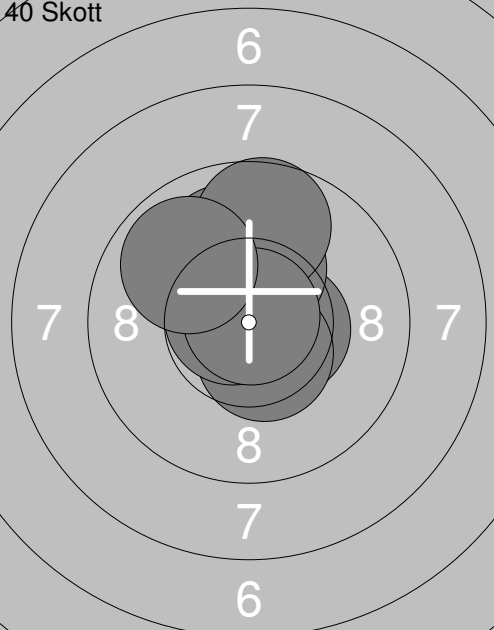
<p>Prov</p>  <p style="text-align: center;">6 7 8 7 6</p>	<p>40 Skott</p>  <p style="text-align: center;">6 7 8 7 6</p>	<p>40 Skott</p>  <p style="text-align: center;">6 7 8 7 6</p>
<p>1: 9.7 ↘ 2: 9.5 ← 3: 10.0 ↓ 4: 10.4 ↗ 5: 9.6 ← 6: 10.8 ↗ 7: 10.5 ↗ 8: 10.8x ↓ 9: 10.8x ↓ 10: 10.7x ↗</p> <p>Serie 102.8 Total 0.0</p>	<p>11: 10.5x ↗ 12: 10.7x ↗ 13: 10.3x ↗ 14: 10.3x ↗ 15: 10.1 ↑ 16: 10.5x ↗ 17: 10.5x ↗ 18: 9.1 ↑ 19: 10.5x ↗ 20: 10.6x ↗</p> <p>Serie 103.1 Total 206.8</p>	<p>21: 10.3x ↗ 22: 10.4x ↗ 23: 9.8 ↗ 24: 10.5x ↗ 25: 9.5 ↑ 26: 10.4x ↗ 27: 10.3x ↑ 28: 9.9 ↑ 29: 10.0 ↑ 30: 9.5 ↑</p> <p>Serie 100.6 Total 307.4</p>
<p>40 Skott</p>  <p style="text-align: center;">6 7 8 7 6</p>	<p>31: 10.0 ↑ 32: 10.5x > 33: 10.3x ↗ 34: 10.5x ↓ 35: 10.7x ↗ 36: 10.2x ↑ 37: 10.2x ↑ 38: 9.7 ↑ 39: 10.9x ↗ 40: 9.9 ↗</p> <p>Serie 102.9 Total 410.3</p>	

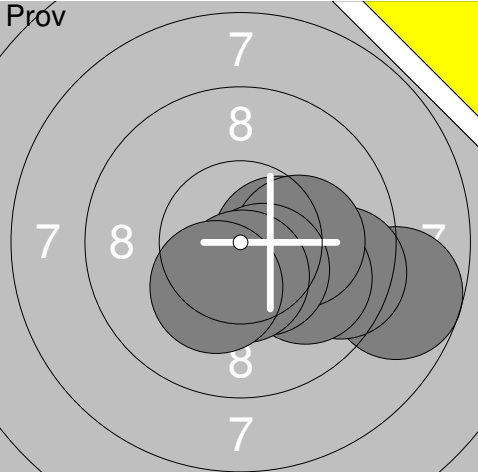
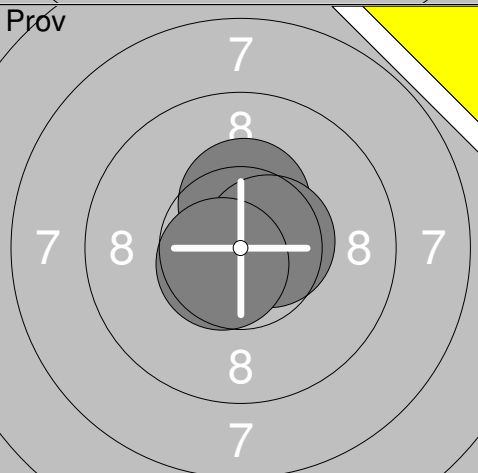
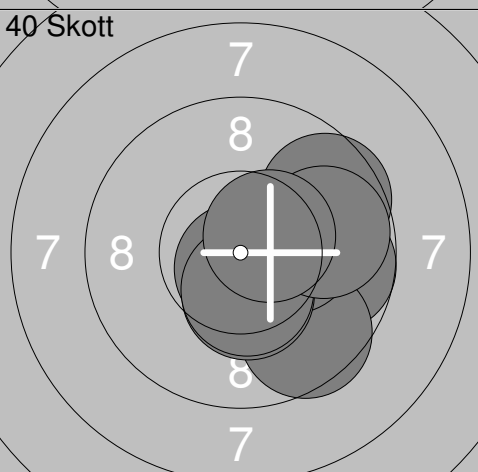
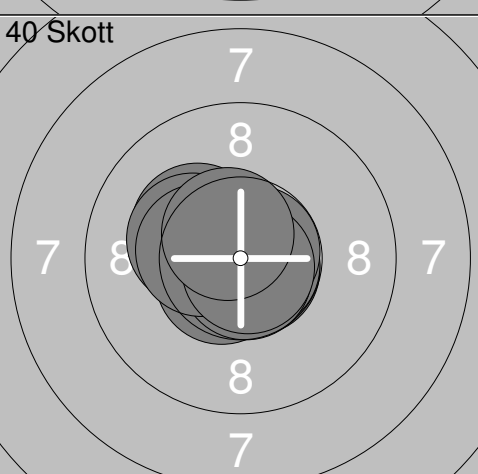
Skjutlag	Tavla	Rasmus Alfredsson	
S	Umeå Skf	L11	
02.02.2019	Skyttiaden Regionfinal 2019	Umeå skytteallians	
Prov		1: 8.7 → 2: 9.9 → 3: 10.2x → 4: 9.5 → 5: 10.0 → 6: 10.4x → 7: 10.2x → 8: 10.5x ↓ 9: 10.5x ↓ 10: 10.3x ↓	11: 9.7 → 12: 10.6x → 13: 10.7x ↓ 14: 10.0 → 15: 10.5x ↓ 16: 10.4x ↗ 17: 10.2x → 18: 10.3x ↓ 19: 10.1 → 20: 10.1 ↓
		Serie 100.2	Serie 102.6
		Total 0.0	Total 0.0
Prov		21: 10.4x ↑ 22: 10.6x → 23: 10.6x ↙	1: 10.5x ↓ 2: 10.6x ↓ 3: 9.6 ↙ 4: 10.0 → 5: 10.4x ↓ 6: 10.7x → 7: 10.7x ↗ 8: 10.6x ↓ 9: 10.0 ↓ 10: 10.0 ↓
		Serie 31.6	Serie 103.1
		Total 0.0	Total 103.1
40 Skott		11: 9.7 → 12: 9.6 ↓ 13: 10.6x → 14: 10.3x → 15: 10.4x ↓ 16: 9.6 ↗ 17: 10.7x ↓ 18: 10.4x ↓ 19: 9.8 → 20: 10.5x ↗	21: 10.3x ↓ 22: 10.6x ↓ 23: 10.8x → 24: 10.0 → 25: 9.9 → 26: 10.4x ↙ 27: 9.9 ↑ 28: 9.8 ↓ 29: 10.4x → 30: 10.2x ↓
		Serie 101.6	Serie 102.3
		Total 204.7	Total 307.0
40 Skott		31: 10.6x ↙ 32: 10.7x ↓ 33: 10.2x ↗ 34: 10.7x ↓ 35: 10.3x ↗ 36: 10.7x ↓ 37: 10.4x ↙ 38: 10.7x ↗ 39: 10.8x ↓ 40: 10.6x ↗	
		Serie 105.7	
		Total 412.7	

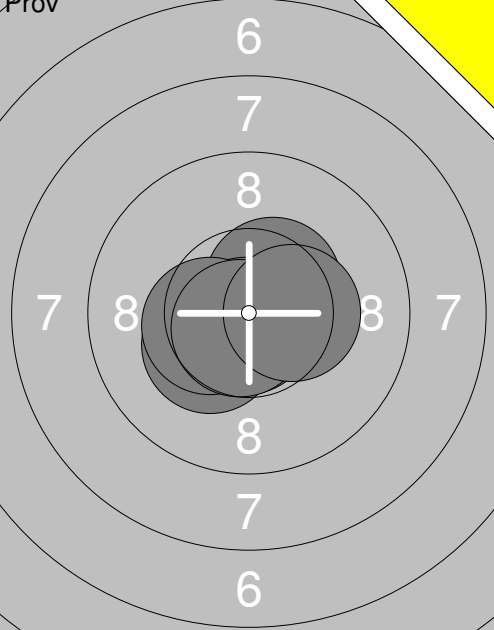
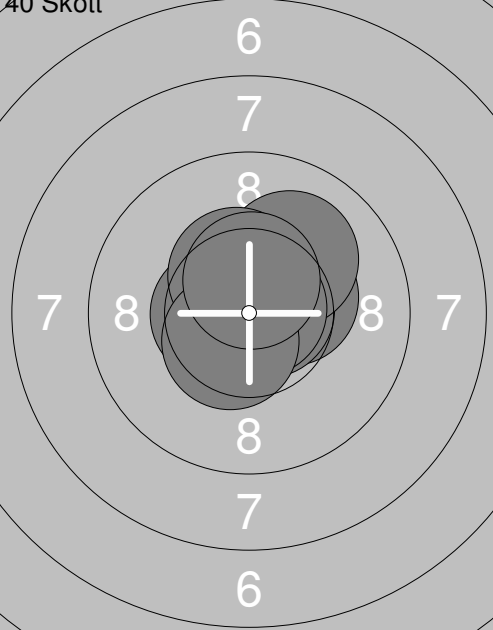
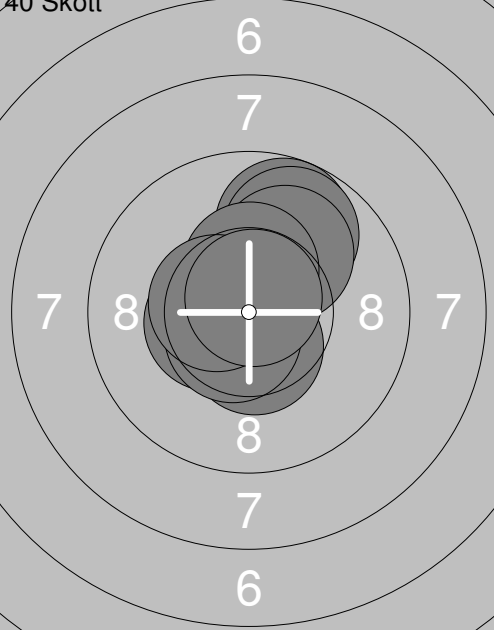
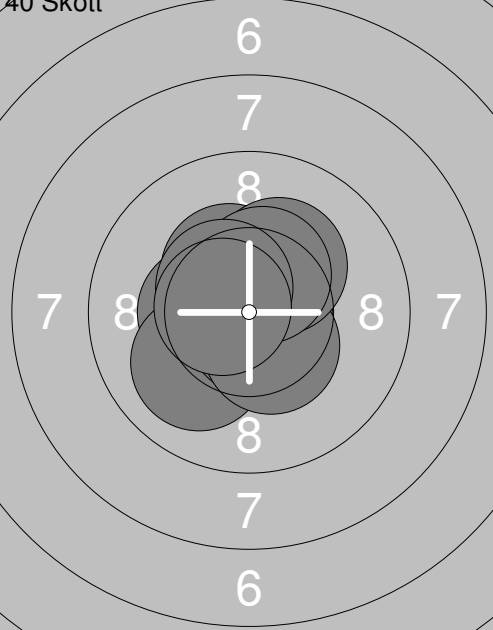
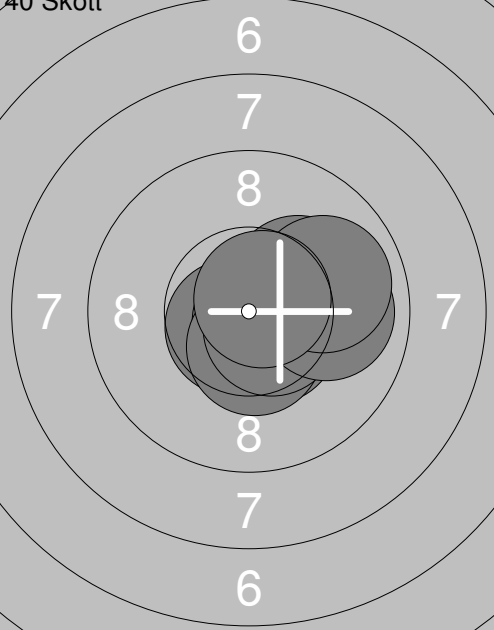
<p>Prov</p>  <p style="text-align: center;">6 7 8 7 8 8 7 8 7 6</p>	<p>40 Skott</p> <p>1: 10.5x ↗ 2: 10.8x ↓ 3: 10.3x ↘ 4: 10.4x ← 5: 10.7x ↓ 6: 10.4x →</p> <p>Serie 63.1 Total 0.0</p>	<p>40 Skott</p>  <p style="text-align: center;">6 7 8 7 8 8 7 8 7 6</p> <p>1: 10.4x ↗ 2: 10.6x ↘ 3: 10.4x → 4: 10.7x → 5: 10.1 ↗ 6: 10.8x → 7: 10.5x ← 8: 10.4x ↗ 9: 10.5x ↓ 10: 10.5x ↗</p> <p>Serie 104.9 Total 104.9</p>
<p>40 Skott</p>  <p style="text-align: center;">6 7 8 7 8 8 7 8 7 6</p>	<p>40 Skott</p> <p>11: 10.7x ↗ 12: 9.7 ↗ 13: 10.5x ← 14: 9.8 ↗ 15: 10.1 ↗ 16: 10.5x ↓ 17: 10.4x ↗ 18: 10.6x ↘ 19: 10.5x ← 20: 10.8x ↗</p> <p>Serie 103.6 Total 208.5</p>	<p>40 Skott</p>  <p style="text-align: center;">6 7 8 7 8 8 7 8 7 6</p> <p>21: 10.7x → 22: 10.4x ← 23: 10.0 ↘ 24: 10.7x ↓ 25: 10.4x ↓ 26: 10.4x ↘ 27: 10.2x ↗ 28: 10.4x ↗ 29: 10.5x ↘ 30: 10.6x ←</p> <p>Serie 104.3 Total 312.8</p>
<p>40 Skott</p>  <p style="text-align: center;">6 7 8 7 8 8 7 8 7 6</p>	<p>40 Skott</p> <p>31: 10.5x ↓ 32: 10.2x → 33: 10.7x ↘ 34: 10.2x → 35: 10.7x ↘ 36: 10.5x ↓ 37: 10.6x ↘ 38: 9.9 → 39: 9.9 → 40: 10.7x ↗</p> <p>Serie 103.9 Total 416.7</p>	

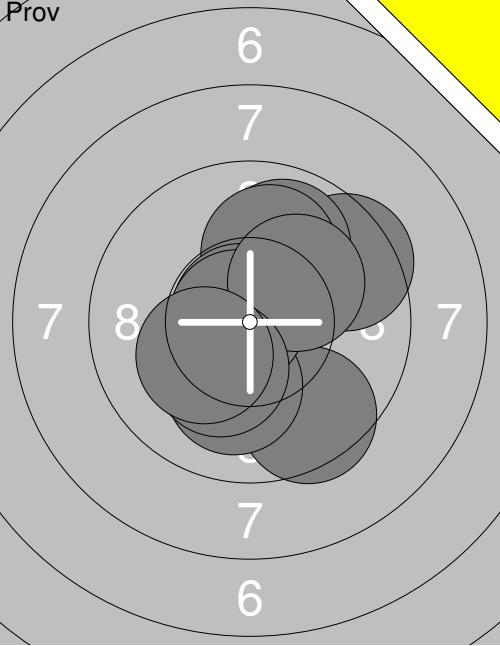
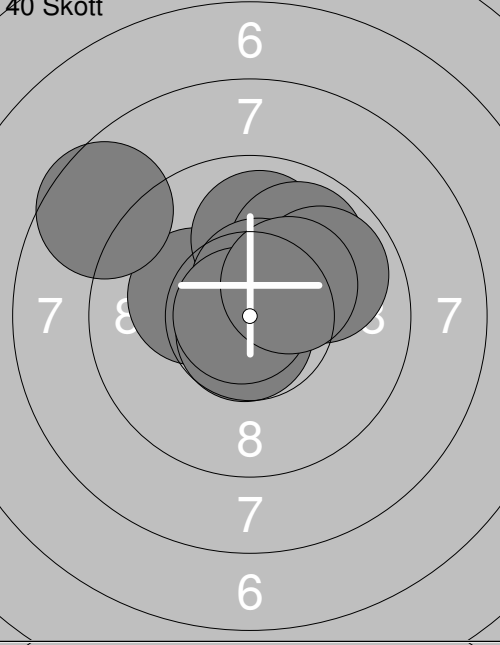
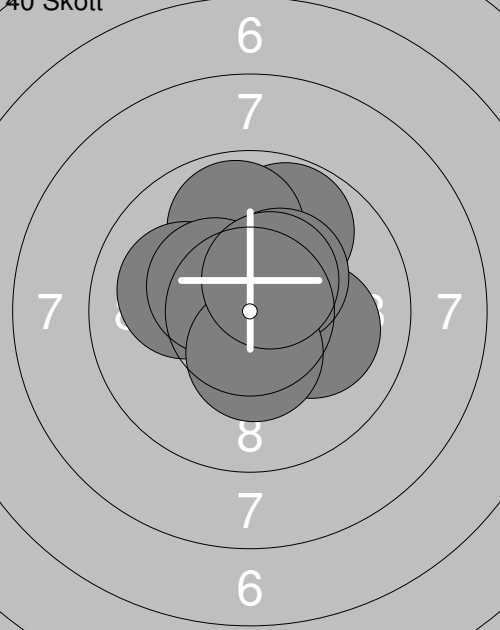
Skjuttag	Tavla	Anna Kuusiniemi	
2	29	Hammerdal SkF	L11
02.02.2019	Skyttiaden Regionfinal 2019	Umeå skytteallians	
Prov		1: 9.5 ↗ 2: 9.9 ↗ 3: 10.0 ↗ 4: 9.5 ↘ 5: 10.1 ↘ 6: 10.8x ↘ 7: 10.8x ↘ 8: 10.2x ↗ 9: 10.2x ↘ 10: 10.2x ↘ Serie 101.2 Total 0.0	11: 10.5x ↗ 12: 10.2x ↗ 13: 10.3x ↘ 14: 10.3x ↘ 15: 10.5x ↘ 16: 10.1 ↖ 17: 10.5x ↗ Serie 72.4 Total 0.0
40 Skott		1: 10.7x ↗ 2: 10.2x ↘ 3: 8.6 ↖ 4: 9.9 ↗ 5: 9.9 ↗ 6: 9.9 ↗ 7: 10.6x ↗ 8: 10.7x ↘ 9: 10.8x ↘ 10: 10.3x ↗ Serie 101.6 Total 101.6	11: 10.4x ↘ 12: 10.4x ↗ 13: 10.2x ↗ 14: 10.2x ↘ 15: 9.6 ↘ 16: 10.6x ↘ 17: 10.2x ↗ 18: 10.3x ↗ 19: 10.5x ↗ 20: 10.6x ↗ Serie 103.0 Total 204.6
40 Skott		21: 10.2x ↗ 22: 10.3x ↗ 23: 10.1 → 24: 9.8 ↗ 25: 9.9 ↗ 26: 10.1 ↖ 27: 10.4x ↘ 28: 10.4x ↗ 29: 10.4x ↘ 30: 10.5x ↗ Serie 102.1 Total 306.7	31: 10.6x ↘ 32: 10.0 ↘ 33: 10.6x ↘ 34: 10.1 ↘ 35: 10.2x ↘ 36: 10.5x ↘ 37: 10.6x ↗ 38: 9.9 ↗ 39: 10.6x ↗ 40: 10.2x ↗ Serie 103.3 Total 410.0

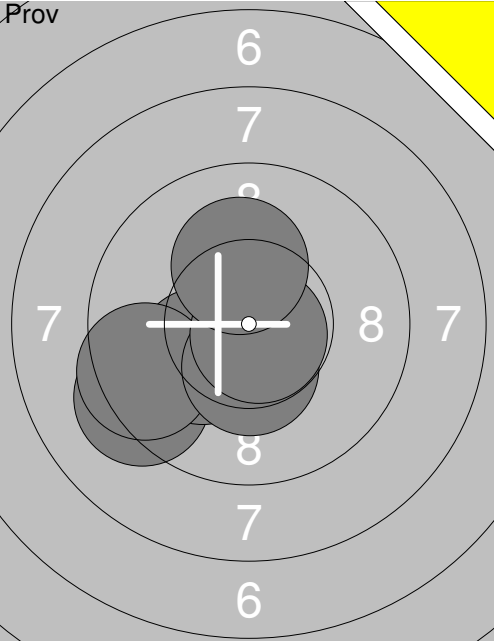
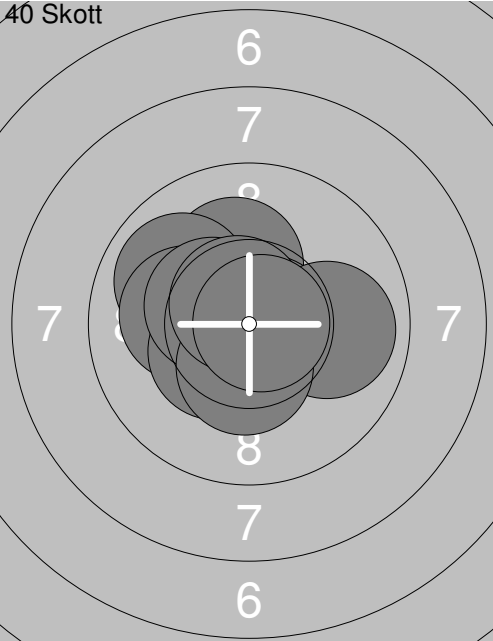
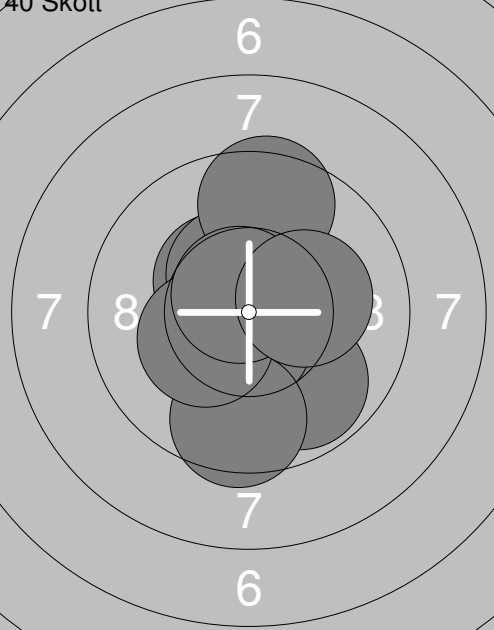
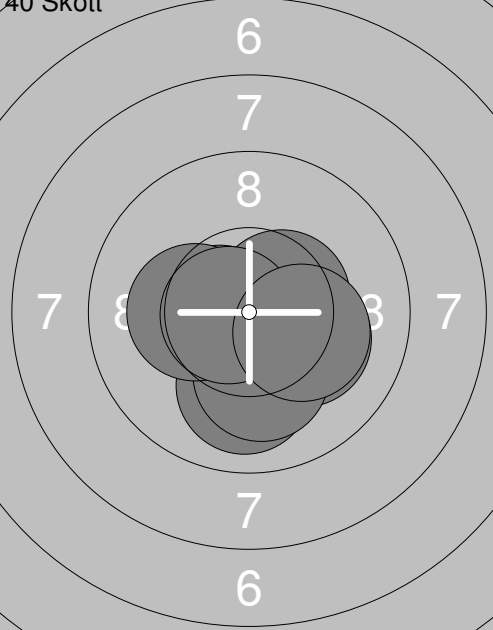
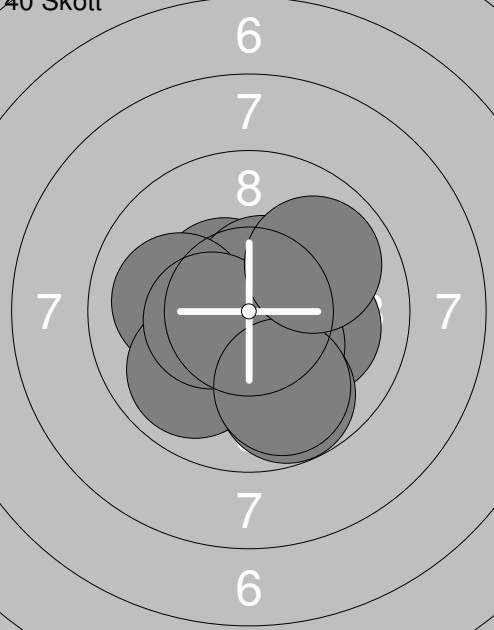
Skjutlag 2	Tavla 30	Filip Hansson	
S	Vännäs Skf	L11	
02.02.2019	Skyttiäden Regionfinal 2019	Umeå skytteallians	
Prov		40 Skott	
	1: 9.3 ↙ 2: 10.2x↘ 3: 9.5 ↙ 4: 10.4x↓ 5: 10.8x↘ 6: 10.2x↑	1: 10.2x↗ 2: 9.9 ↙ 3: 10.1↙ 4: 10.4x↘ 5: 10.7x➤ 6: 10.4x↖ 7: 9.9 ➔ 8: 10.4x↓ 9: 10.7x↘ 10: 10.8x➤	
	Serie 60.4	Serie 103.5	
	Total 0.0	Total 103.5	
40 Skott		40 Skott	
	11: 10.4x↘ 12: 10.4x↗ 13: 9.5 ↑ 14: 10.6x↘ 15: 9.8 ↘ 16: 10.6x↓ 17: 9.6 ↓ 18: 10.3x↘ 19: 10.7x↘ 20: 10.2x➤	21: 10.3x↓ 22: 10.5x➤ 23: 10.6x↖ 24: 10.0 ↓ 25: 10.2x↘ 26: 10.7x↖ 27: 10.1 ↓ 28: 10.3x↖ 29: 10.7x↖ 30: 10.2x➤	
	Serie 102.1	Serie 103.6	
	Total 205.6	Total 309.2	
40 Skott			
	31: 10.5x↘ 32: 10.5x↗ 33: 10.0↙ 34: 10.1➔ 35: 10.4x↘ 36: 9.9 ↘ 37: 10.5x↖ 38: 9.8 ↘ 39: 9.9 ↘ 40: 9.9 ↗		
	Serie 101.5		
	Total 410.7		

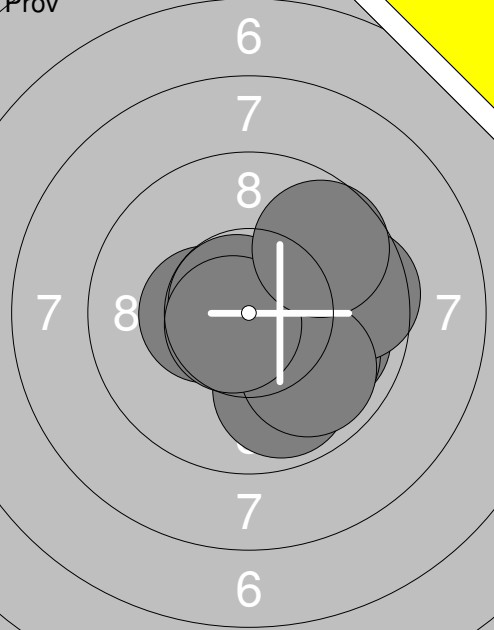
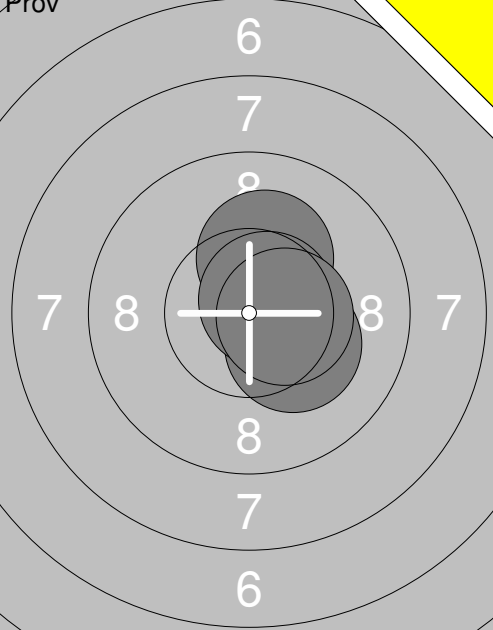
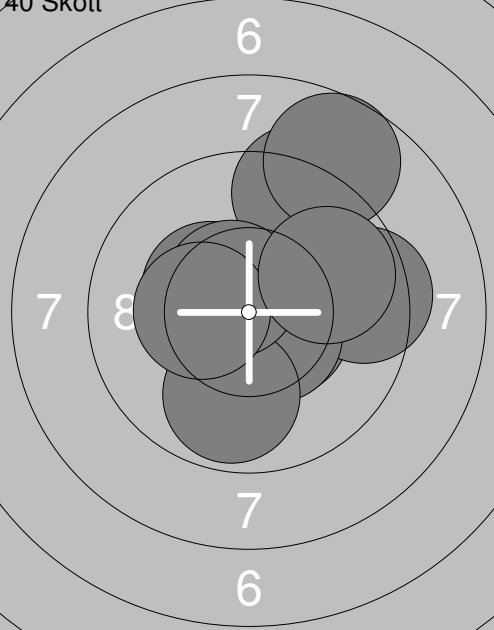
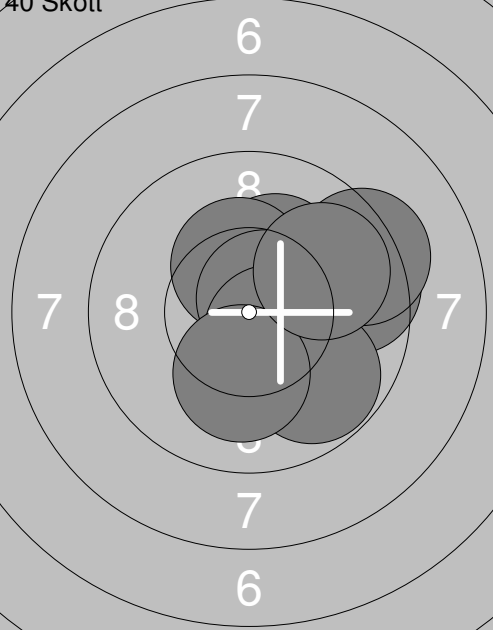
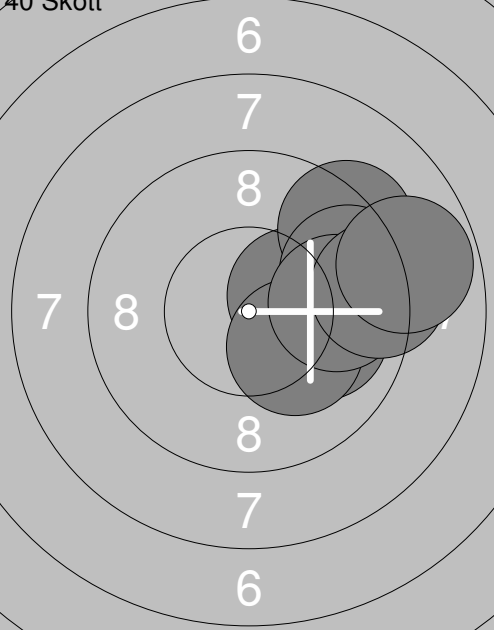
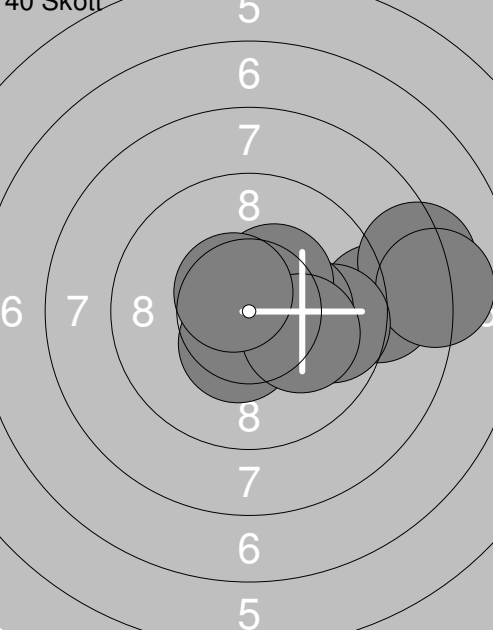
Prov 	1: 10.4x↔ 2: 10.2x→ 3: 9.9 → 4: 9.9 ↓ 5: 10.0 ↘ 6: 10.7x↖ 7: 9.6 → 8: 9.9 ↘ 9: 10.7x↖ 10: 9.7 ↗ Serie 101.0 Total 0.0	Prov 	11: 10.3x↘ 12: 10.2x↗ 13: 10.7x↖ 14: 10.5x→ Serie 41.7 Total 0.0
40 Skott 	1: 10.5x↘ 2: 9.3 ↗ 3: 9.4 → 4: 10.4x↖ 5: 10.5x↘ 6: 9.9 ↓ 7: 10.6x↖ 8: 8.7 ↗ 9: 10.3x↖ 10: 9.8 ↗ Serie 99.4 Total 99.4	40 Skott 	11: 10.2x↗ 12: 10.3x↘ 13: 10.3x↗ 14: 9.6 → 15: 10.7x↖ 16: 10.5x↘ 17: 9.3 ↗ 18: 9.8 ↘ 19: 10.1 ↓ 20: 9.9 ↗ Serie 100.7 Total 200.1
40 Skott 	21: 10.0 → 22: 10.1 → 23: 10.2x→ 24: 10.3x→ 25: 9.3 ↗ 26: 10.2x↘ 27: 9.6 → 28: 9.8 → 29: 9.2 → 30: 8.8 → Serie 97.5 Total 297.6	40 Skott 	31: 9.0 → 32: 8.3 → 33: 8.1 → 34: 9.7 → 35: 10.5x→ 36: 10.3x→ 37: 10.4x↗ 38: 10.4x↘ 39: 10.1 → 40: 10.6x↖ Serie 97.4 Total 395.0

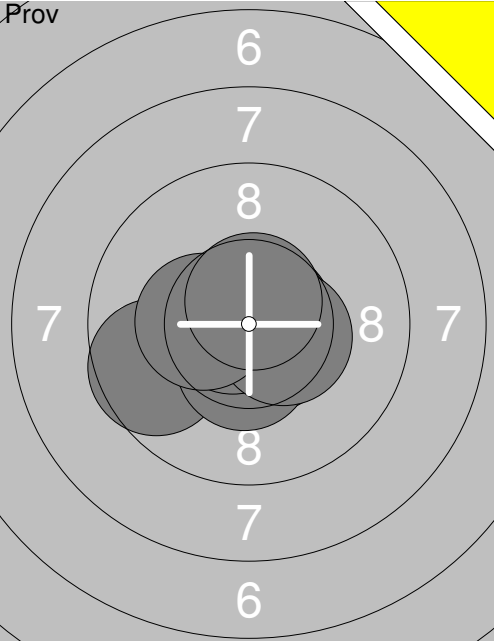
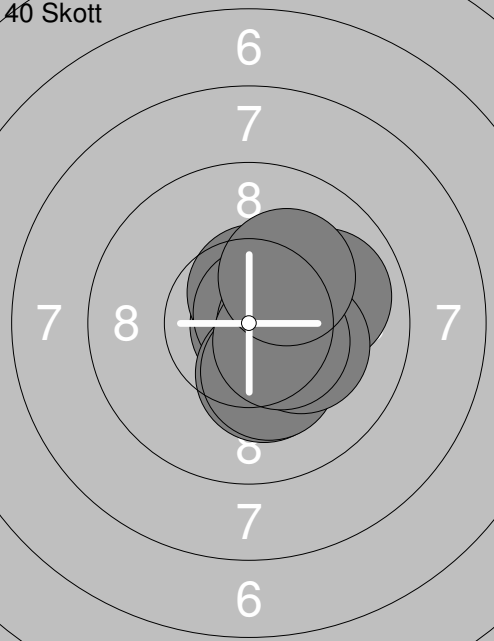
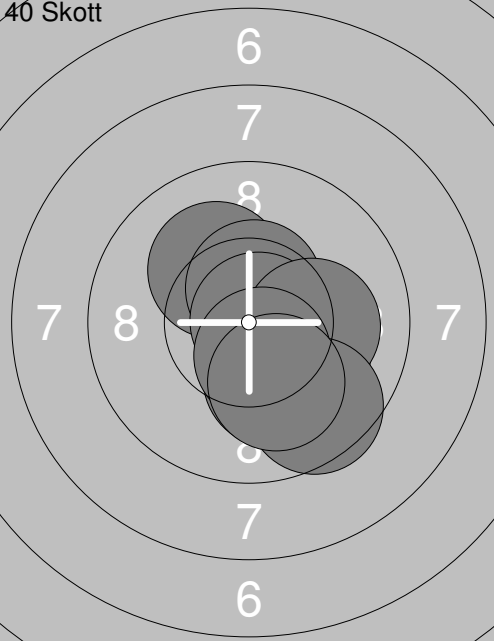
Skjutlag	Tavla	Gisela Grönblad Anders	
2	32	Fältjägarerna SkF	L11
02.02.2019	Skyttiaden Regionfinal 2019	Umeå skytteallians	
Prov		1: 10.6x↘ 2: 9.6 ← 3: 10.9x→ 4: 10.5x↓ 5: 10.7x← 6: 10.7x↗ 7: 10.8x↑ 8: 10.5x→ 9: 10.4x← 10: 10.6x↑ Serie 105.3 Total 0.0	11: 10.6x↗ Serie 10.6 Total 0.0
40 Skott		1: 10.8x→ 2: 10.5x↑ 3: 10.7x↗ 4: 10.3x↓ 5: 10.5x→ 6: 9.9 → 7: 10.3x↓ 8: 10.2x→ 9: 10.5x↘ 10: 10.2x↗ Serie 103.9 Total 103.9	11: 10.7x↗ 12: 10.4x↘ 13: 9.7 ← 14: 10.4x→ 15: 10.4x↗ 16: 10.1 ↑ 17: 10.0 ↗ 18: 10.5x↗ 19: 10.7x↓ 20: 10.6x↘ Serie 103.5 Total 207.4
40 Skott		21: 10.1 ↓ 22: 10.2x↘ 23: 10.5x↑ 24: 10.1 ↓ 25: 10.8x→ 26: 10.1 → 27: 10.2x↓ 28: 10.5x↓ 29: 9.6 ↓ 30: 10.1 ↓ Serie 102.2 Total 309.6	31: 10.8x↓ 32: 9.9 ↓ 33: 10.5x→ 34: 9.7 ↓ 35: 10.3x→ 36: 10.8x↘ 37: 10.4x↑ 38: 10.3x↘ 39: 10.1 ↓ 40: 10.6x↗ Serie 103.4 Total 413.0

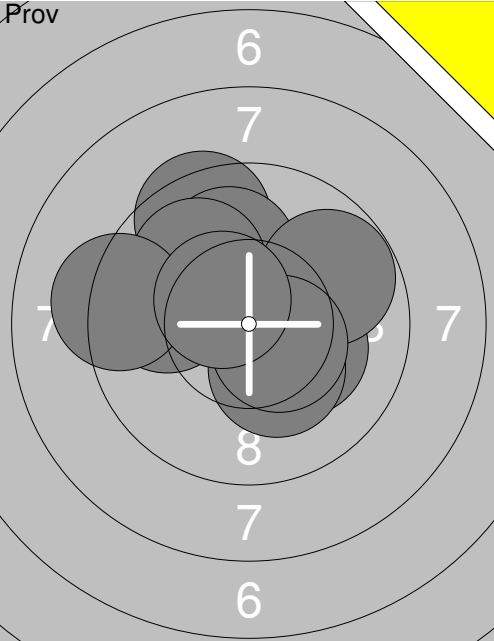
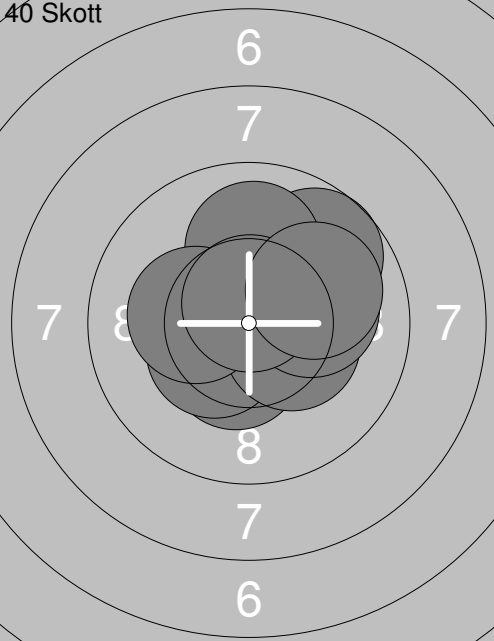
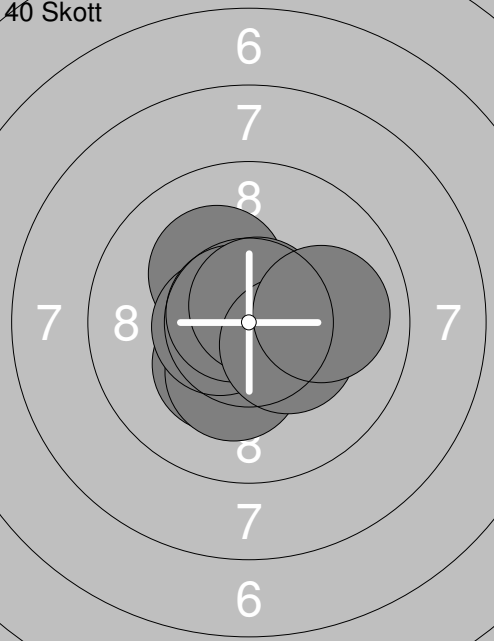
Skjuttag	Tavla	Vilhelm Lundstedt	
2	33	Ramselefors Skf	L11
02.02.2019	Skyttiaden Regionfinal 2019	Umeå skytteallians	
Prov		1: 9.5 ↗ 2: 10.0 ↑ 3: 9.9 ← 4: 10.0 ↖ 5: 9.2 ← 6: 10.2x↘ 7: 10.3x↓ 8: 9.8 ↗ 9: 10.5x↘ 10: 10.5x↖ Serie 99.9 Total 0.0	11: 9.6 ↑ 12: 9.9 ↓ 13: 10.6x↑ 14: 10.8x↓ 15: 10.4x↓ 16: 10.4x↖ 17: 10.2x↘ 18: 10.4x↖ Serie 82.3 Total 0.0
40 Skott		1: 10.5x↘ 2: 10.4x↓ 3: 9.7 ↗ 4: 10.4x↘ 5: 10.0 ↑ 6: 10.3x↘ 7: 10.1 → 8: 10.3x← 9: 10.7x↑ 10: 10.0 ↗ Serie 102.4 Total 102.4	11: 10.3x↑ 12: 9.6 ↑ 13: 10.7x↘ 14: 9.6 ↓ 15: 10.1← 16: 10.6x↑ 17: 10.8x↑ 18: 9.6 ← 19: 10.3x↘ 20: 10.3x→ Serie 101.9 Total 204.3
40 Skott		21: 10.2x↘ 22: 10.9x↑ 23: 10.9x↘ 24: 10.3x↓ 25: 10.3x↓ 26: 10.6x↖ 27: 10.7x↖ 28: 10.7x↑ 29: 10.4x↘ 30: 10.0 → Serie 105.0 Total 309.3	31: 10.1← 32: 10.6x← 33: 10.4x↖ 34: 10.4x↑ 35: 9.7 ↓ 36: 9.8 → 37: 10.5x↖ 38: 10.5x↘ 39: 9.7 ↑ 40: 10.1 → Serie 101.8 Total 411.1

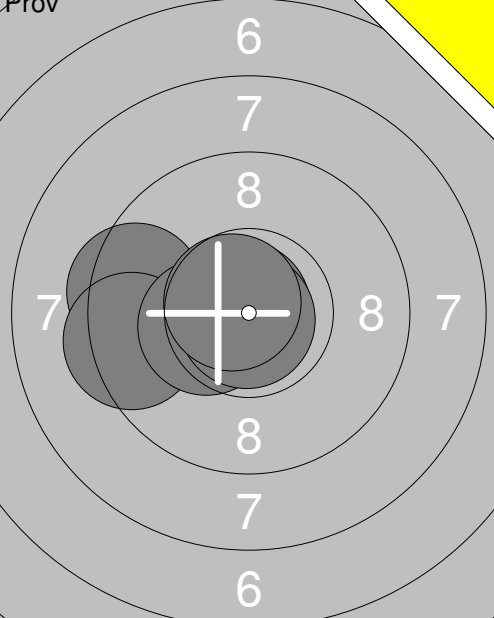
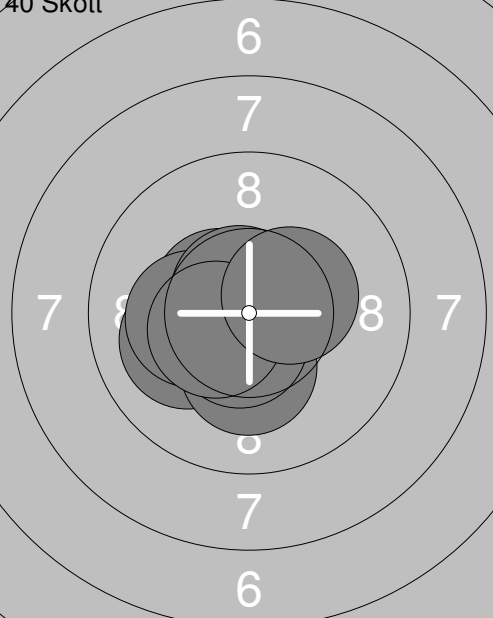
<p>Prov</p>  <p style="text-align: center;">6 7 8 7 8 7 6</p>	<p>40 Skott</p>  <p style="text-align: center;">6 7 8 7 6</p>	<p>1: 9.4 ←</p> <p>2: 9.4 ←</p> <p>3: 10.4x↘</p> <p>4: 10.8x↘</p> <p>5: 10.9x↓</p> <p>6: 10.7x↘</p> <hr/> <p>Serie 61.6</p> <p>Total 0.0</p>	<p>1: 10.7x➤</p> <p>2: 10.7x↗</p> <p>3: 10.5x↘</p> <p>4: 10.1↙</p> <p>5: 10.2x↘</p> <p>6: 10.7x↘</p> <p>7: 10.2x↓</p> <p>8: 10.6x↓</p> <p>9: 10.5x↘</p> <p>10: 10.4x➤</p> <hr/> <p>Serie 104.6</p> <p>Total 104.6</p>
-----------------------------------------------------------------------------------------------------------------------------------------------------------------------	-----------------------------------------------------------------------------------------------------------------------------------------------------------------	----------------------------------------------------------------------------------------------------------------------------------------------	-----------------------------------------------------------------------------------------------------------------------------------------------------------------------------------------------------------------------

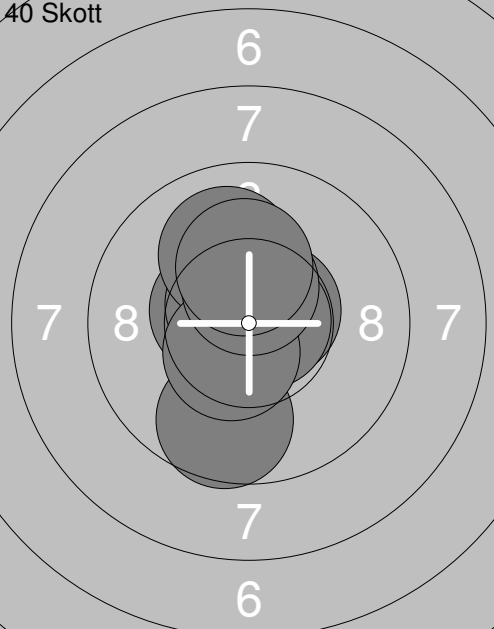
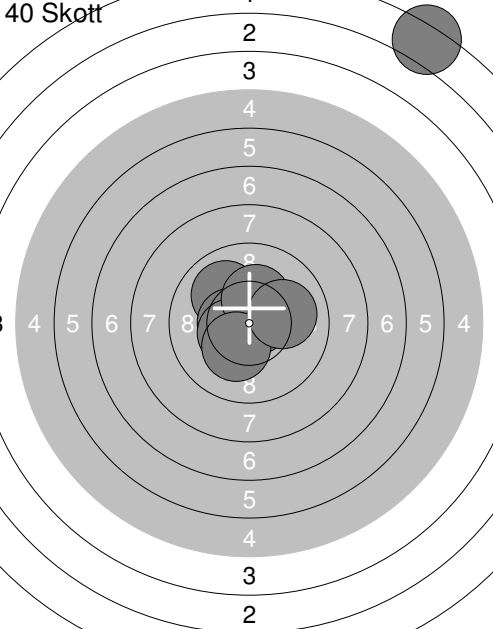
<p>40 Skott</p>  <p style="text-align: center;">6 7 7 7 6</p>	<p>40 Skott</p>  <p style="text-align: center;">2 3 4 5 6 7 8 7 6 5 4 3 2</p>	<p>11: 10.8x↓</p> <p>12: 10.6x➤</p> <p>13: 10.5x↘</p> <p>14: 9.6 ↓</p> <p>15: 10.6x↘</p> <p>16: 10.0 ↑</p> <p>17: 10.8x➤</p> <p>18: 10.5x↓</p> <p>19: 10.5x↑</p> <p>20: 10.2x↑</p> <hr/> <p>Serie 104.1</p> <p>Total 208.7</p>	<p>21: 10.0 ↖</p> <p>22: 10.7x↘</p> <p>23: 10.5x↘</p> <p>24: 10.7x➤</p> <p>25: 10.5x↘</p> <p>26: 10.4x↘</p> <p>27: 2.2 ↗</p> <p>28: 10.3x↑</p> <p>29: 10.3x↓</p> <p>30: 10.1 ➤</p> <hr/> <p>Serie 95.7</p> <p>Total 304.4</p>
----------------------------------------------------------------------------------------------------------------------------------------------------------------	------------------------------------------------------------------------------------------------------------------------------------------------------------------------------------------------------------------	--------------------------------------------------------------------------------------------------------------------------------------------------------------------------------------------------------------------------------	-------------------------------------------------------------------------------------------------------------------------------------------------------------------------------------------------------------------------------

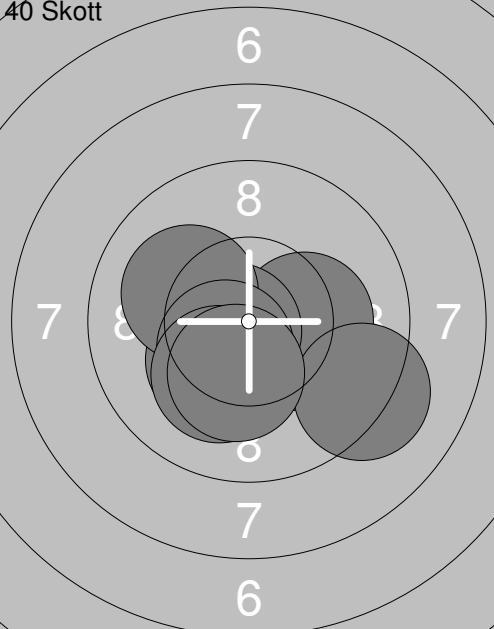
<p>40 Skott</p>  <p style="text-align: center;">6 7 8 7 6</p>	<p>31: 10.4x↘</p> <p>32: 10.6x↘</p> <p>33: 10.2x➤</p> <p>34: 9.2 ↘</p> <p>35: 10.7x↘</p> <p>36: 10.3x↘</p> <p>37: 10.1 ↙</p> <p>38: 10.5x↘</p> <p>39: 10.2x↓</p> <p>40: 10.3x↓</p> <hr/> <p>Serie 102.5</p> <p>Total 406.9</p>
-----------------------------------------------------------------------------------------------------------------------------------------------------------------	--------------------------------------------------------------------------------------------------------------------------------------------------------------------------------------------------------------------------------

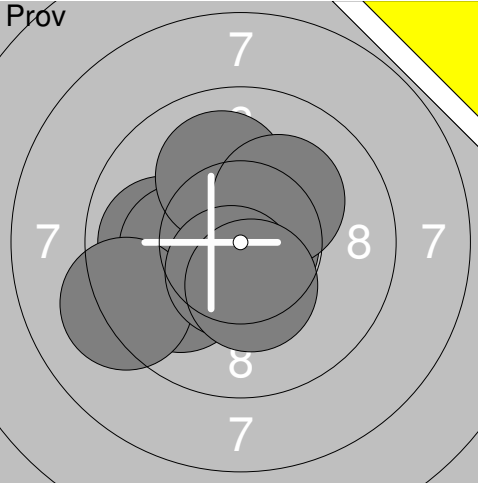
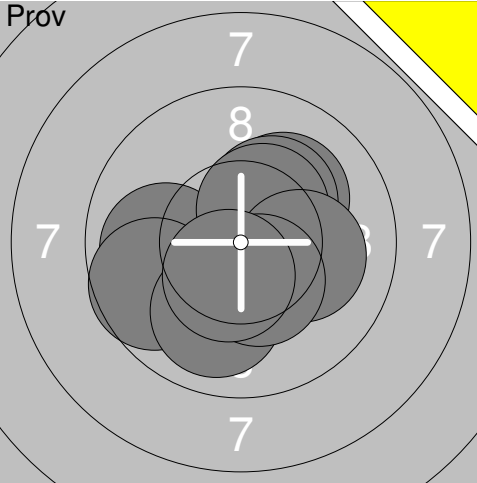
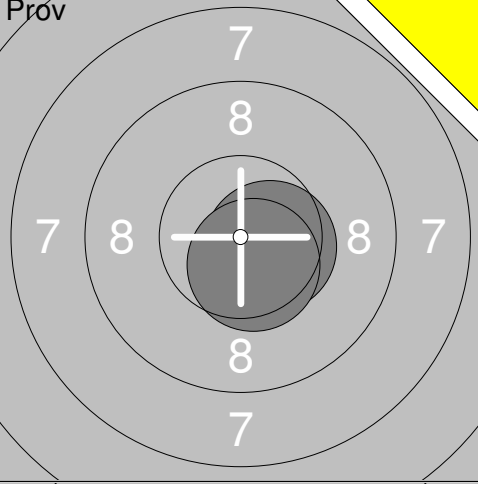
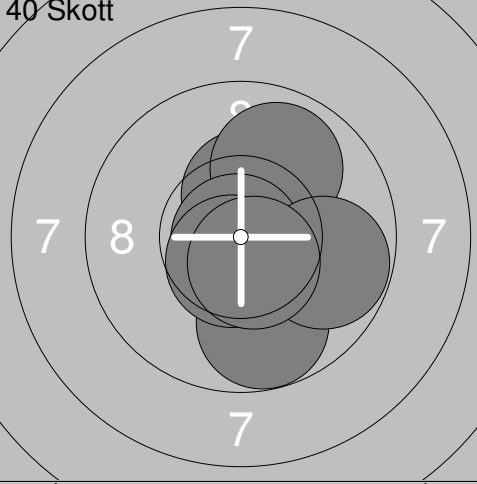
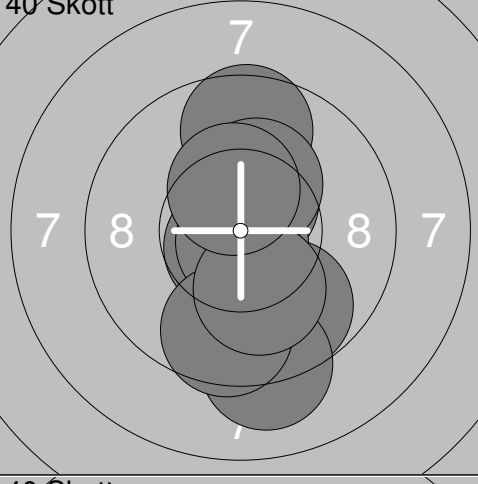
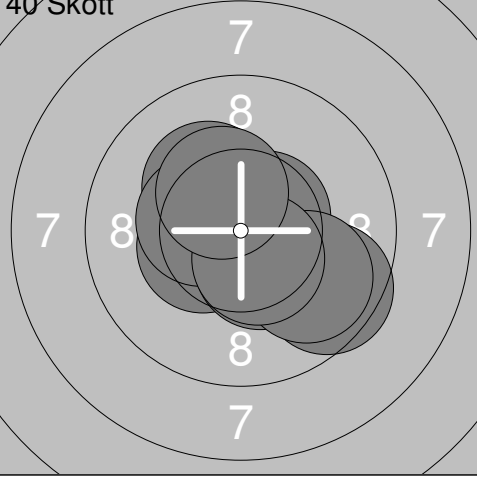
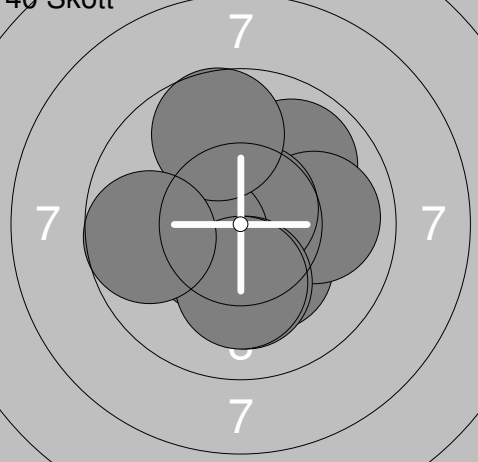
Skjutlag 2	Tavla 35	Lova Oskarsson	
S		Gideå Skf	L11
02.02.2019	Skyttiaden Regionfinal 2019		Umeå skytteallians
Prov		1: 9.9 ← 2: 10.4x ← 3: 9.9 ↙ 4: 10.8x → 5: 10.2x ← 6: 9.2 ← 7: 10.0 ↗ 8: 10.2x ↗ 9: 10.5x ↓ 10: 10.3x ↓ Serie 101.4 Total 0.0	Prov  11: 9.9 ← 12: 10.1 ↗ 13: 9.7 ↙ 14: 10.4x ↗ 15: 10.3x ↗ 16: 10.4x ↗ 17: 10.1 → 18: 10.0 ↓ 19: 10.4x ↓ 20: 10.5x ↓ Serie 101.8 Total 0.0
Prov		21: 10.5x → 22: 10.5x ↓ Serie 21.0 Total 0.0	40 Skott  1: 10.4x ↗ 2: 10.6x → 3: 9.9 ↗ 4: 10.4x ↓ 5: 10.6x ↓ 6: 10.9x ↙ 7: 9.8 ↓ 8: 9.8 → 9: 10.6x ↓ 10: 10.6x ↓ Serie 103.6 Total 103.6
40 Skott		11: 9.8 ↓ 12: 10.5x ↗ 13: 10.7x ↙ 14: 10.8x ↓ 15: 9.1 ↓ 16: 9.6 ↗ 17: 9.6 ↓ 18: 10.3x ↗ 19: 10.1 ↓ 20: 10.4x ↗ Serie 100.9 Total 204.5	40 Skott  21: 10.8x ↗ 22: 10.6x ↗ 23: 10.2x ↗ 24: 10.4x ← 25: 10.4x ← 26: 10.4x ↓ 27: 9.6 ↓ 28: 9.9 ↓ 29: 10.5x ↓ 30: 10.4x ↗ Serie 103.2 Total 307.7
40 Skott		31: 10.5x ↙ 32: 9.9 ↗ 33: 10.3x ↓ 34: 10.0 → 35: 10.7x ↗ 36: 10.4x ← 37: 10.2x ↓ 38: 10.2x ↓ 39: 9.7 ↗ 40: 9.7 ← Serie 101.6 Total 409.3	

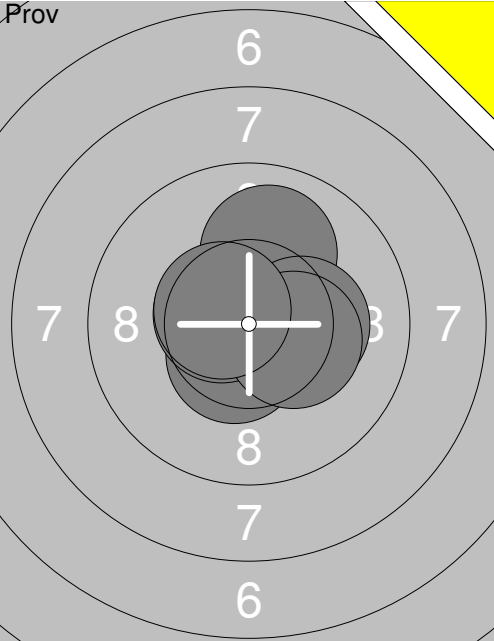
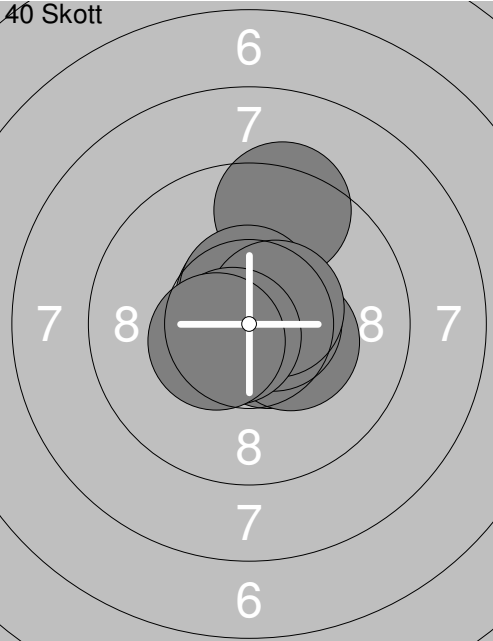
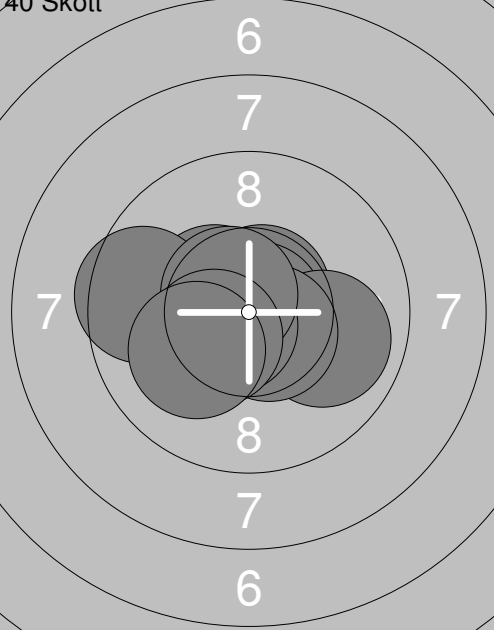
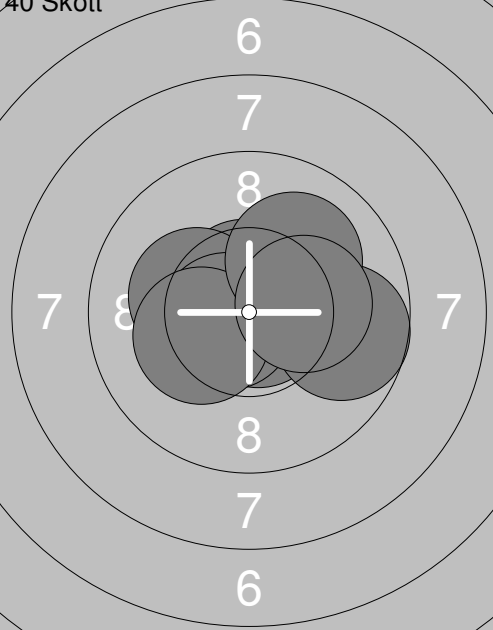
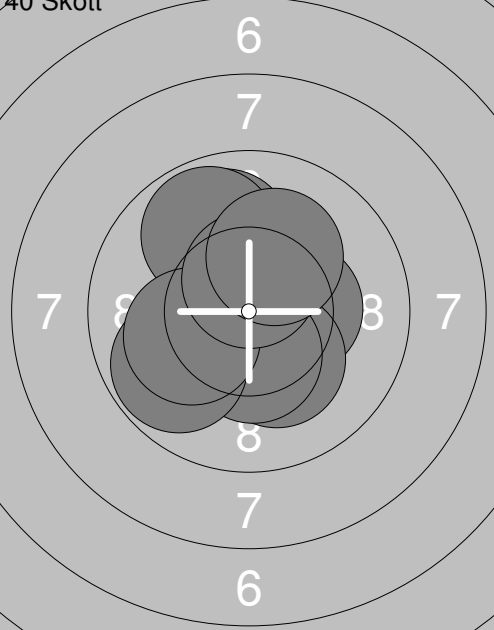
Skjutlag	Tavla	Ellen Öhnstedt	
2	36	Aspås USkF	L11
02.02.2019	Skyttiaden Regionfinal 2019	Umeå skytteallians	
Prov		1: 10.5x ↘ 2: 10.6x ↘ 3: 10.6x ➤ 4: 10.5x ➤ 5: 10.0 ↑ 6: 10.3x ➤ 7: 10.3x ➤ 8: 10.6x ↘	40 Skott 
		Serie 83.4 Total 0.0	1: 10.6x ↗ 2: 10.6x ↘ 3: 10.9x ↘ 4: 9.4 ↑ 5: 10.6x ↗ 6: 10.4x ➤ 7: 10.6x ➤ 8: 10.6x ↗ 9: 10.7x ↘ 10: 10.5x ↘
		Serie 104.9 Total 104.9	
40 Skott		11: 10.6x ↗ 12: 10.8x ➤ 13: 9.9 ➤ 14: 10.4x ↘ 15: 10.6x ↘ 16: 10.6x ↘ 17: 9.5 ← 18: 10.6x ↘ 19: 10.4x ↘ 20: 10.1 ↙	40 Skott 
		Serie 103.5 Total 208.4	21: 10.8x ➤ 22: 10.6x ↗ 23: 10.6x ↘ 24: 10.8x ↘ 25: 9.7 ➤ 26: 10.2x ↘ 27: 10.6x ↘ 28: 10.3x ↘ 29: 10.1 ↗ 30: 10.2x ➤
		Serie 103.9 Total 312.3	
40 Skott		31: 10.4x ➤ 32: 10.2x ↘ 33: 10.8x ↘ 34: 10.4x ↘ 35: 9.9 ↑ 36: 9.8 ↗ 37: 9.8 ↙ 38: 10.1 ↙ 39: 10.5x ↗ 40: 10.2x ↗	
		Serie 102.1 Total 414.4	

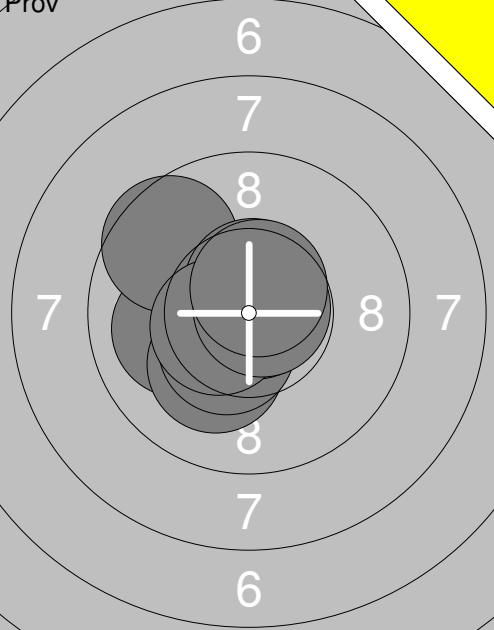
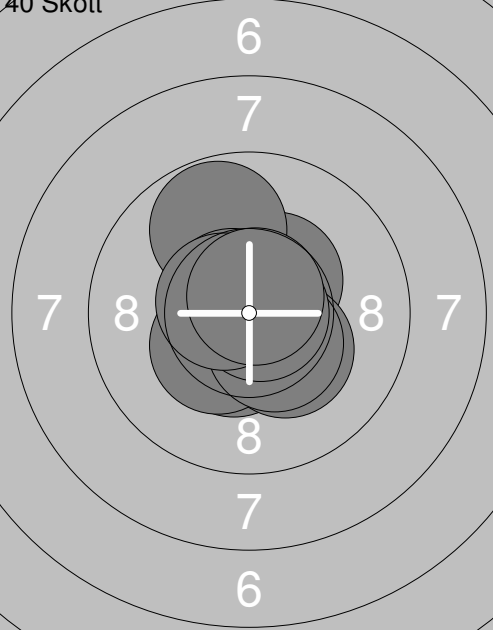
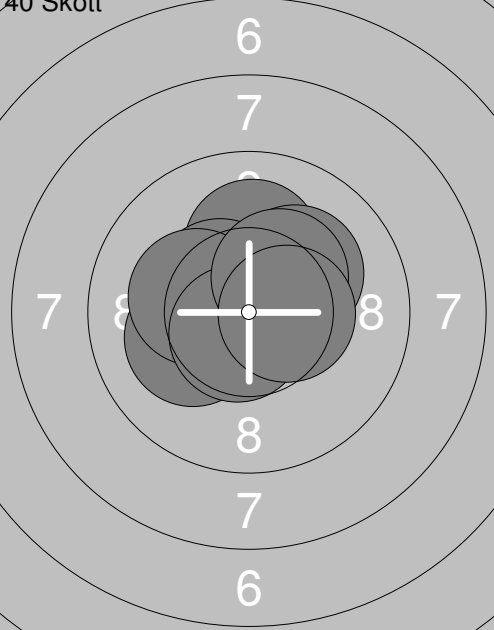
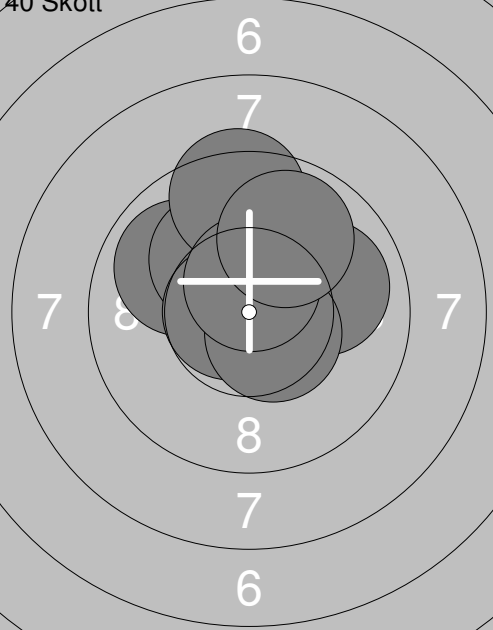
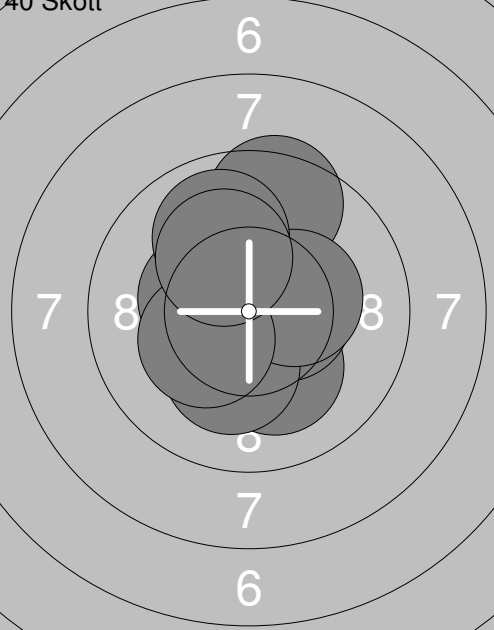
<p>Prov</p>  <p style="text-align: center;">6 7 8 7 8 7 6</p>	<p>40 Skott</p> <p>1: 10.0 ← 2: 10.2x ↘ 3: 9.6 ↖ 4: 10.6x ↗ 5: 10.4x ↘ 6: 10.9x → 7: 10.5x ↙ 8: 10.8x → 9: 10.6x ↗</p> <p>Serie 93.6 Total 0.0</p>	<p>40 Skott</p>  <p style="text-align: center;">6 7 8 7 8 7 6</p> <p>1: 10.4x ↘ 2: 10.4x ↗ 3: 10.3x ↘ 4: 9.8 ↖ 5: 10.6x ↘ 6: 10.4x ↘ 7: 10.4x ↘ 8: 10.8x → 9: 10.6x ↘ 10: 10.7x ↗</p> <p>Serie 104.4 Total 104.4</p>
<p>40 Skott</p>  <p style="text-align: center;">6 7 8 7 8 7 6</p>	<p>40 Skott</p> <p>11: 10.1 ↑ 12: 10.7x ↗ 13: 10.1 ← 14: 10.2x ↗ 15: 10.5x ↘ 16: 10.8x ↙ 17: 10.2x ↘ 18: 10.6x ↘ 19: 10.3x ↗ 20: 10.5x →</p> <p>Serie 104.0 Total 208.4</p>	<p>40 Skott</p>  <p style="text-align: center;">6 7 8 7 8 7 6</p> <p>21: 10.1 ↗ 22: 9.9 ↖ 23: 10.1 ↖ 24: 10.7x ↙ 25: 9.4 ↑ 26: 10.2x ↗ 27: 10.0 → 28: 10.5x ↘ 29: 10.6x ↗ 30: 9.9 ↗</p> <p>Serie 101.4 Total 309.8</p>
<p>40 Skott</p>  <p style="text-align: center;">6 7 8 7 8 7 6</p>	<p>40 Skott</p> <p>31: 10.1 ↓ 32: 10.5x ↗ 33: 10.5x → 34: 10.4x ↘ 35: 10.2x ↘ 36: 9.5 ↑ 37: 10.3x → 38: 9.9 ↖ 39: 10.3x ↙ 40: 10.2x ↘</p> <p>Serie 101.9 Total 411.7</p>	

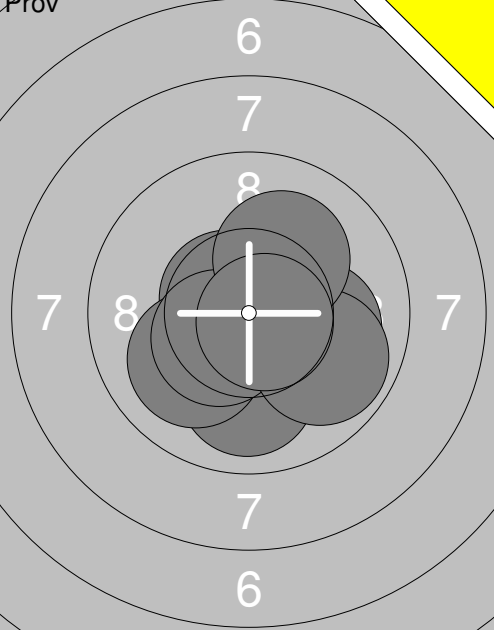
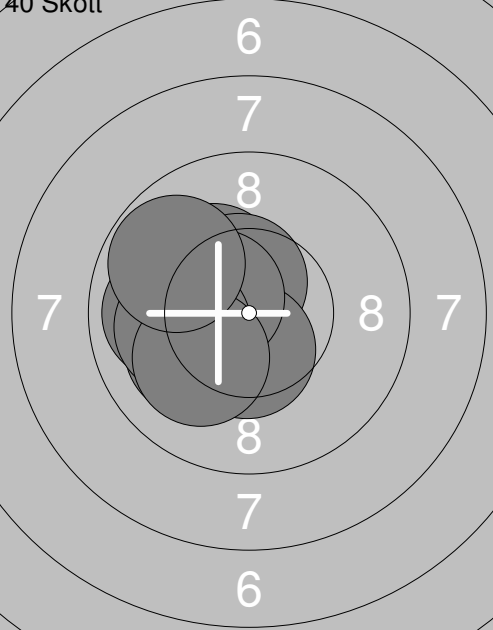
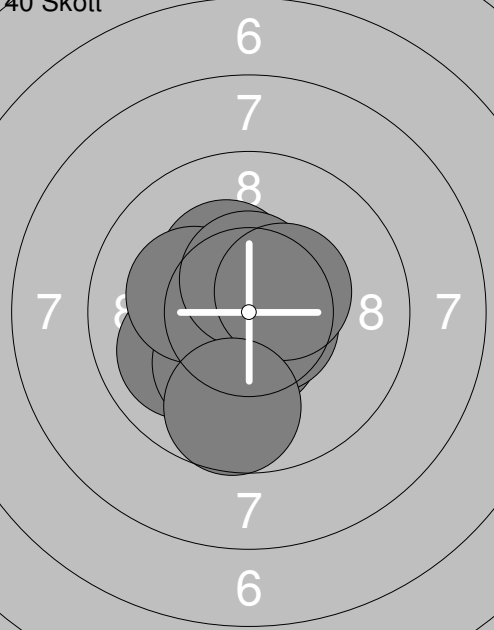
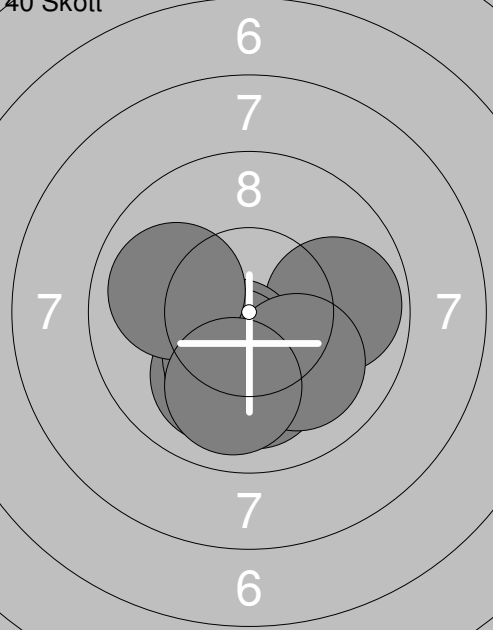
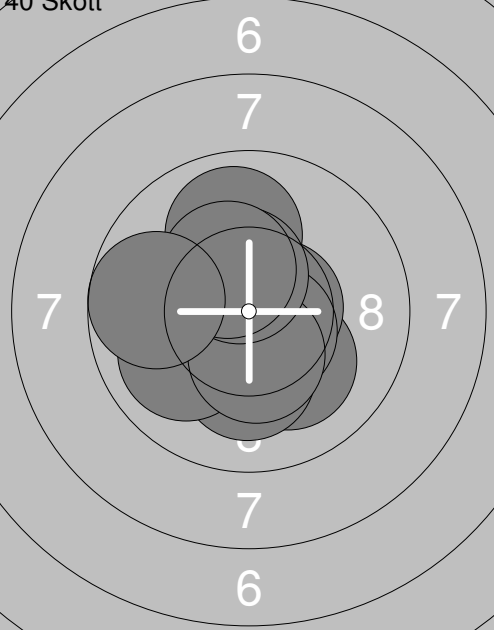
<p>Prov</p>  <p style="text-align: center;">6 7 8 7 6</p>	<p>1: 10.7x ↗</p> <p>2: 10.5x ↓</p> <p>3: 10.0 ↓</p> <p>4: 10.1 →</p> <p>5: 10.6x ↘</p> <p>6: 10.0 ↙</p> <p>7: 10.4x ↘</p> <p>8: 9.9 ↘</p> <p>9: 10.1 ↗</p> <p>10: 10.7x ↘</p> <p>Serie 103.0</p> <p>Total 0.0</p>	<p>40 Skott</p>  <p style="text-align: center;">6 7 8 7 6</p> <p>1: 10.3x ↘</p> <p>2: 10.2x ↘</p> <p>3: 9.9 ←</p> <p>4: 10.5x ↗</p> <p>5: 10.1 ↙</p> <p>6: 10.5x ↓</p> <p>7: 10.5x ↘</p> <p>8: 10.1 ←</p> <p>9: 10.1 ↙</p> <p>10: 9.8 ↖</p> <p>Serie 102.0</p> <p>Total 102.0</p>
<p>40 Skott</p>  <p style="text-align: center;">6 7 8 7 6</p>	<p>11: 10.0 ↙</p> <p>12: 10.3x ↘</p> <p>13: 10.2x ↘</p> <p>14: 10.8x ↗</p> <p>15: 10.5x ↓</p> <p>16: 10.6x ↘</p> <p>17: 10.2x ↘</p> <p>18: 10.5x ↗</p> <p>19: 10.4x ↗</p> <p>20: 9.7 ↓</p> <p>Serie 103.2</p> <p>Total 205.2</p>	<p>40 Skott</p>  <p style="text-align: center;">6 7 8 7 6</p> <p>21: 9.9 →</p> <p>22: 10.0 ↓</p> <p>23: 10.5x ↘</p> <p>24: 10.2x ↓</p> <p>25: 10.2x ↓</p> <p>26: 10.3x ↘</p> <p>27: 10.1 ↓</p> <p>28: 10.0 ↖</p> <p>29: 10.1 ↘</p> <p>30: 10.0 ↓</p> <p>Serie 101.3</p> <p>Total 306.5</p>
<p>40 Skott</p>  <p style="text-align: center;">6 7 8 7 6</p>	<p>31: 10.1 ↓</p> <p>32: 10.6x →</p> <p>33: 10.2x ↓</p> <p>34: 10.6x ↘</p> <p>35: 10.0 ↙</p> <p>36: 10.4x ↓</p> <p>37: 9.9 ↑</p> <p>38: 10.5x ↗</p> <p>39: 10.3x ↘</p> <p>40: 9.7 ←</p> <p>Serie 102.3</p> <p>Total 408.8</p>	

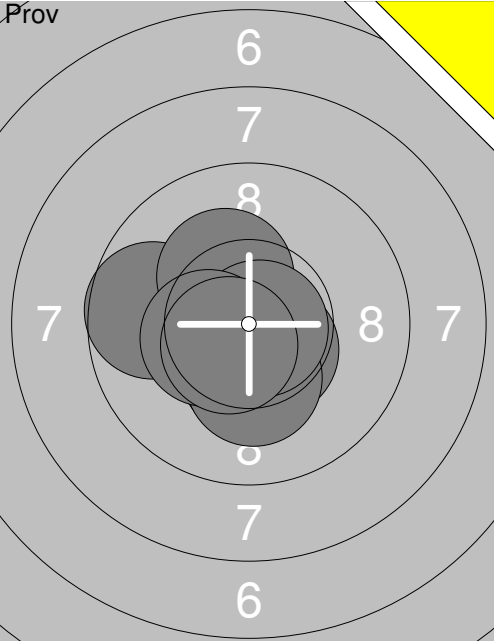
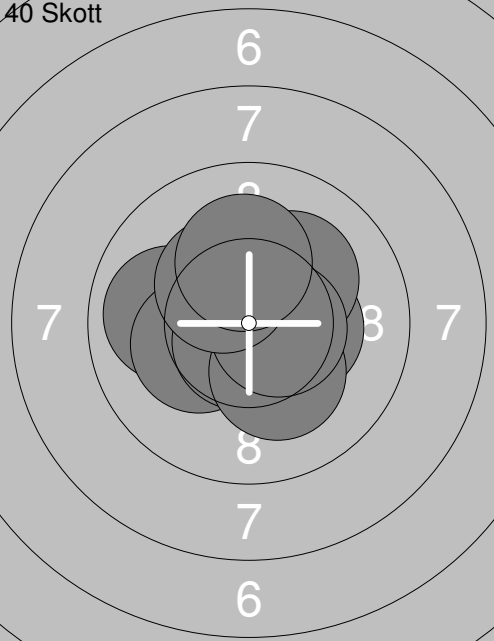
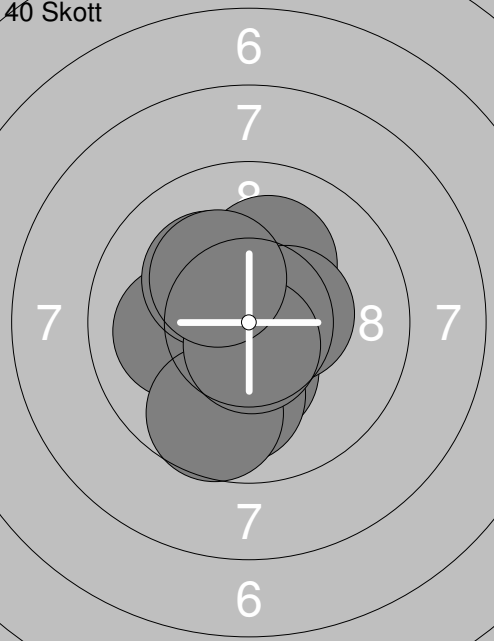
Skjutlag	Tavla	Elvina Bohman	
2	39	Gideå Skf	L11
02.02.2019	Skyttiaden Regionfinal 2019	Umeå skytteallians	
Prov		1: 10.4x↓ 2: 10.5x↘ 3: 10.5x↘ 4: 10.7x↓ 5: 10.2x↓ 6: 9.7 ← 7: 10.3x↗ 8: 10.8x↘ 9: 10.4x↖ 10: 10.6x↖ Serie 104.1 Total 0.0	11: 9.9 ↑ 12: 10.3x↖ 13: 10.6x→ 14: 10.5x↗ Serie 41.3 Total 0.0
40 Skott		1: 10.3x→ 2: 10.9x↗ 3: 9.9 ← 4: 10.2x↖ 5: 10.7x↓ 6: 10.2x↓ 7: 10.2x↗ 8: 10.6x→ 9: 10.3x↘ 10: 10.2x↑ Serie 103.5 Total 103.5	11: 10.6x→ 12: 10.1 → 13: 10.3x↗ 14: 10.2x→ 15: 9.3 ↖ 16: 10.2x↖ 17: 9.7 ↖ 18: 10.2x↘ 19: 10.2x↖ 20: 10.4x→ Serie 101.2 Total 204.7
40 Skott		21: 10.3x↓ 22: 10.1 ↑ 23: 10.4x↖ 24: 10.5x→ 25: 10.0 ↓ 26: 10.1 ← 27: 9.7 ↓ 28: 10.2x↘ 29: 10.7x↓ 30: 10.3x↘ Serie 102.3 Total 307.0	31: 10.5x↖ 32: 10.3x↑ 33: 10.8x↖ 34: 10.7x↘ 35: 10.2x↑ 36: 9.4 ↖ 37: 10.5x↘ 38: 9.7 ← 39: 10.0↙ 40: 9.6 ↓ Serie 101.7 Total 408.7