

1: 9.4 ↙
2: 10.5x ↓
3: 9.9 ↓
4: 10.6x →

Serie	38
Total	0

1: 10.3 ↑
2: 9.6 ↙
3: 10.2 ↖
4: 9.9 ↓
5: 9.2 ↓

Serie	47
Total	47

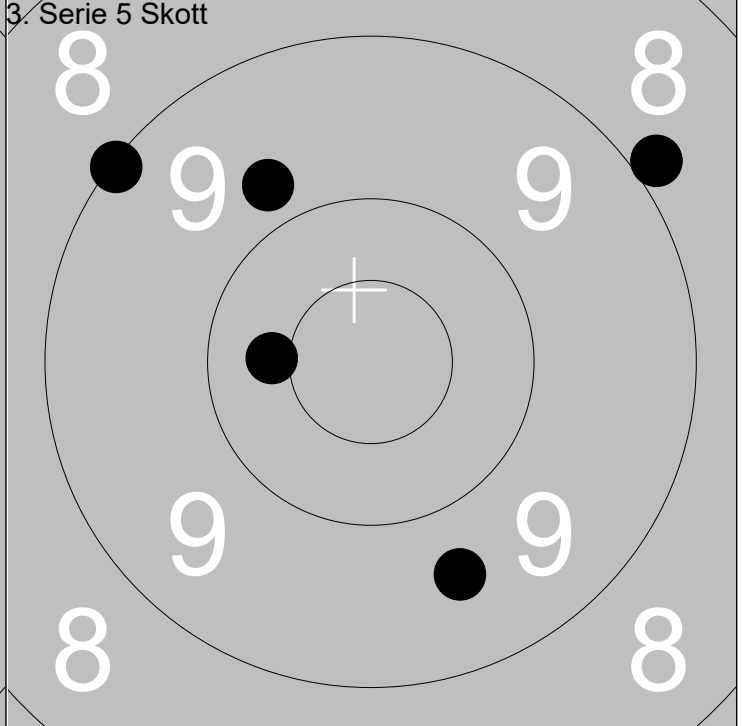
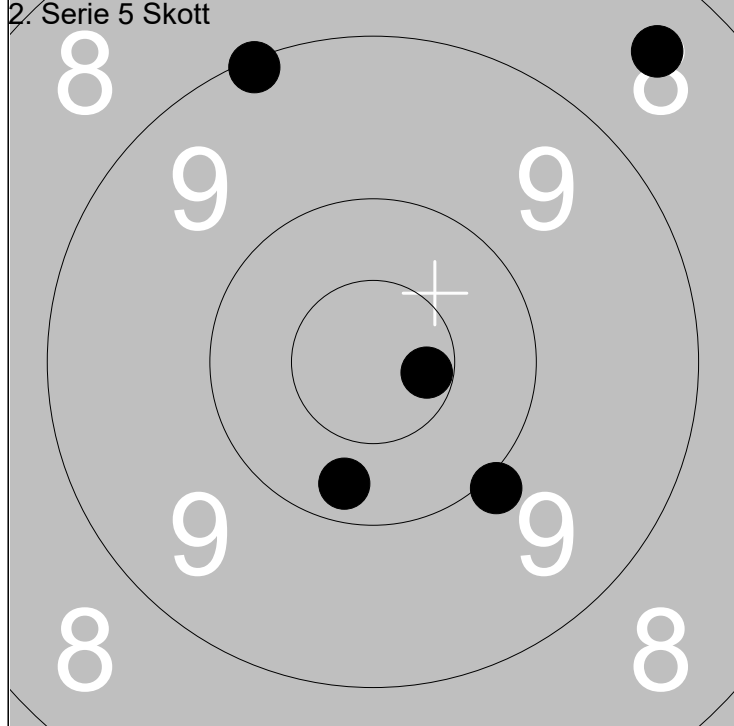

1: 10.6x →
2: 8.4 ↗
3: 9.1 ↗
4: 10.2 ↓
5: 9.9 ↓

Serie	46
Total	93

1: 8.9 ↗
2: 9.6 ↓
3: 10.4 ←
4: 9.8 ↗
5: 9.1 ↖

Serie	45
Total	138

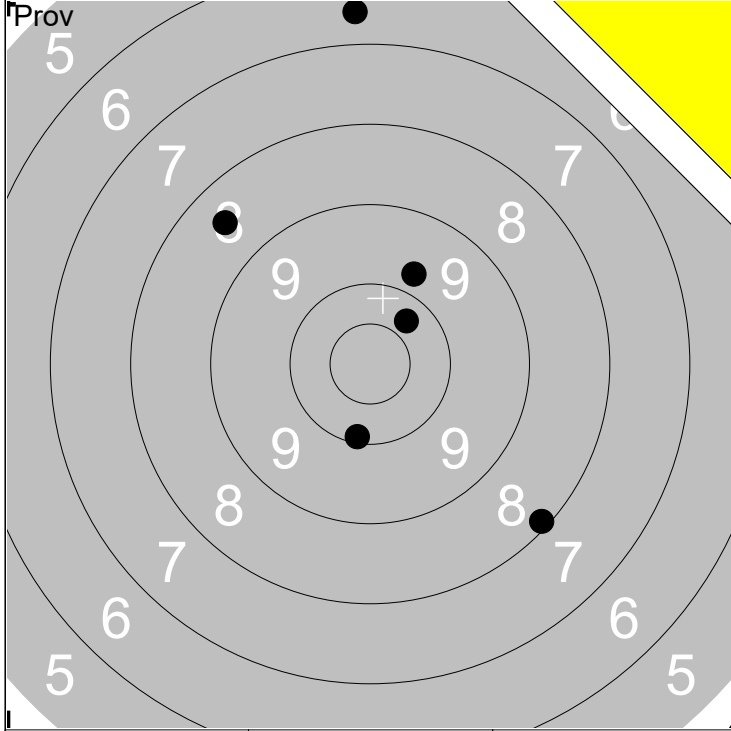

1: 8.5 ↖	6: 10.3 ↗
2: 9.8 ↗	
3: 10.1 ↓	
4: 8.1 ↘	
5: 6.6 ↑	

Serie	51
Total	0

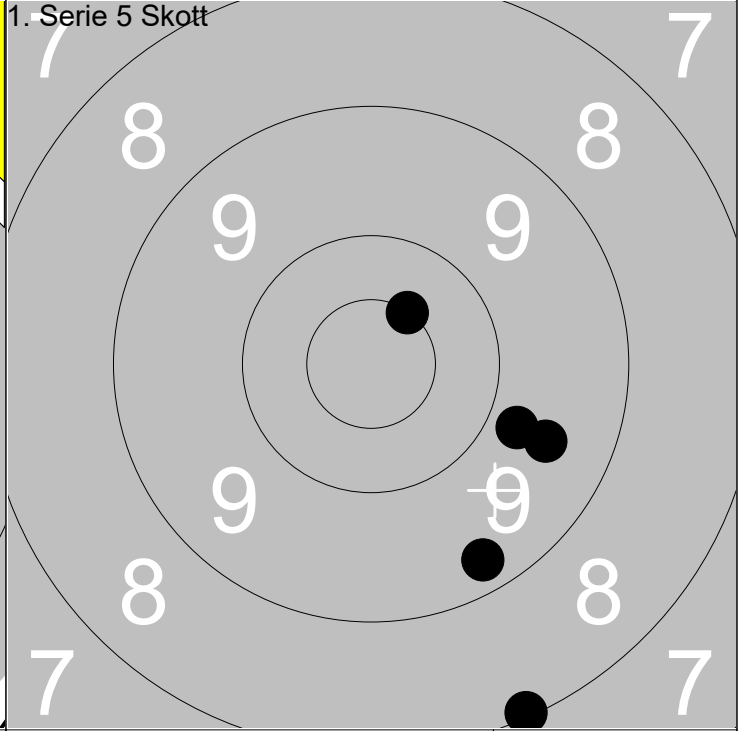

1: 9.8 →	Serie	45
2: 9.5 →		
3: 10.5x ↗		
4: 9.3 ↓		
5: 8.1 ↓		
Total		45

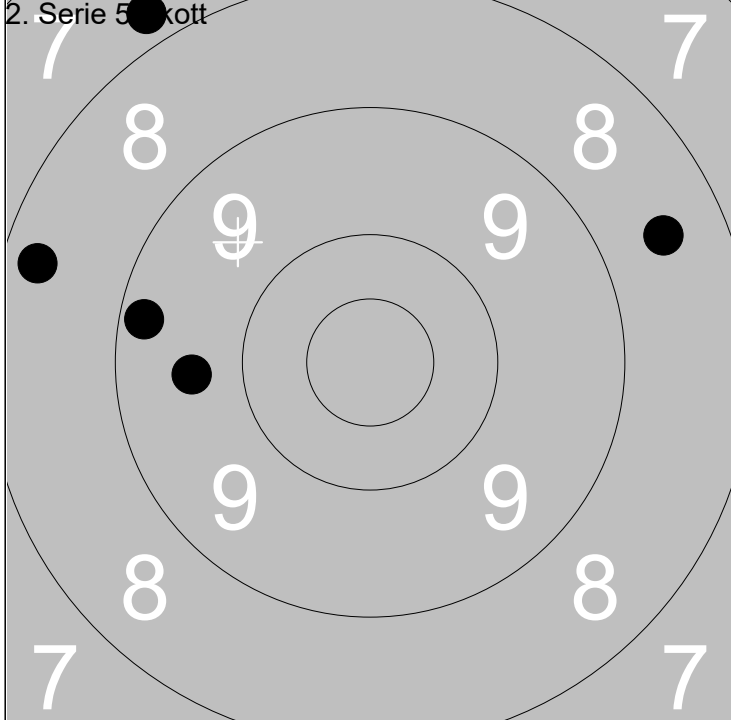

1: 8.3 ←	Serie	41
2: 9.6 ←		
3: 7.8 ↗		
4: 8.5 →		
5: 9.2 ←		
Total		86

1: 10.4 ↓	Serie	38
2: 7.8 ↖		
3: 4.4 ↖		
4: 8.9 ←		
5: 9.2 ↖		
Total		124

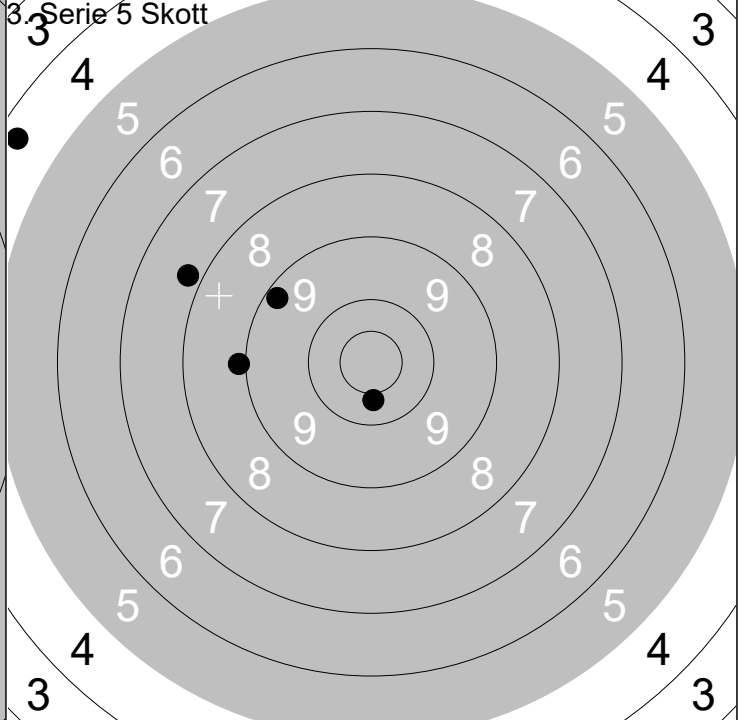

1: 10.4 ↓	Serie	38
2: 7.8 ↖		
3: 4.4 ↖		
4: 8.9 ←		
5: 9.2 ↖		
Total		124

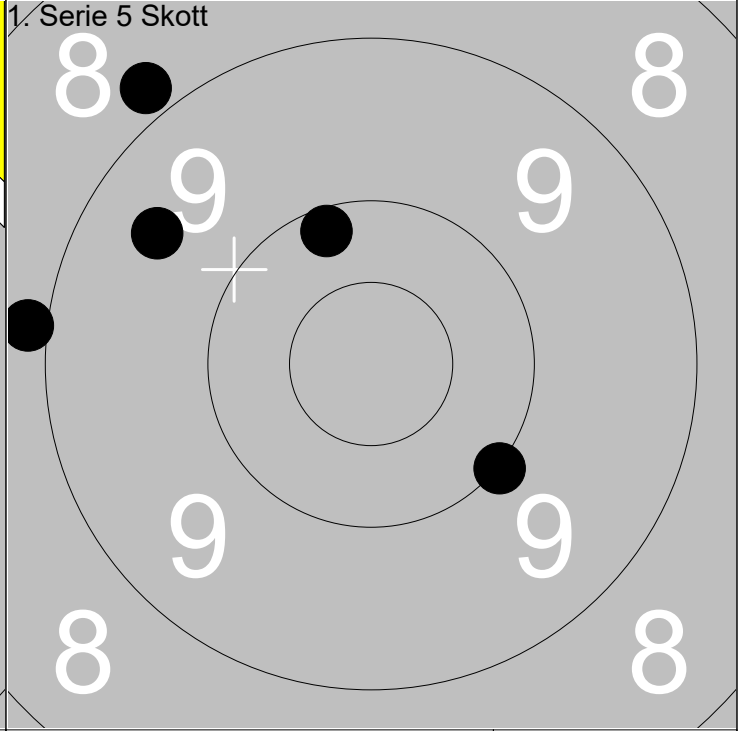
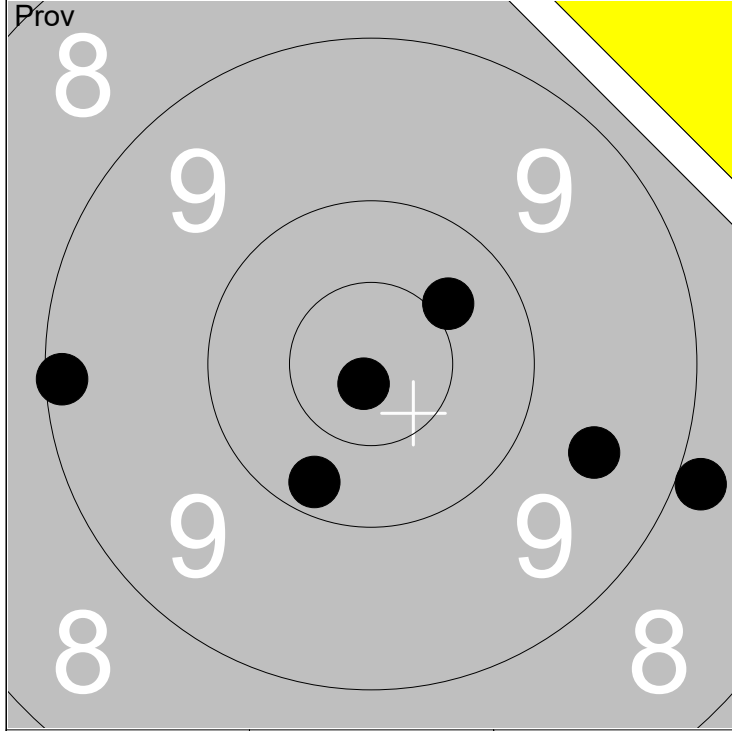

1: 9.1 ←	6: 9.6 →		
2: 10.2 ↓		Serie	56
3: 10.8x ↓			Total
4: 10.4 ↗			
5: 8.9 →			

1: 10.2 ↗			
2: 9.5 ↗		Serie	45
3: 8.8 ↗			Total
4: 8.9 ←			
5: 10.0 ↓			

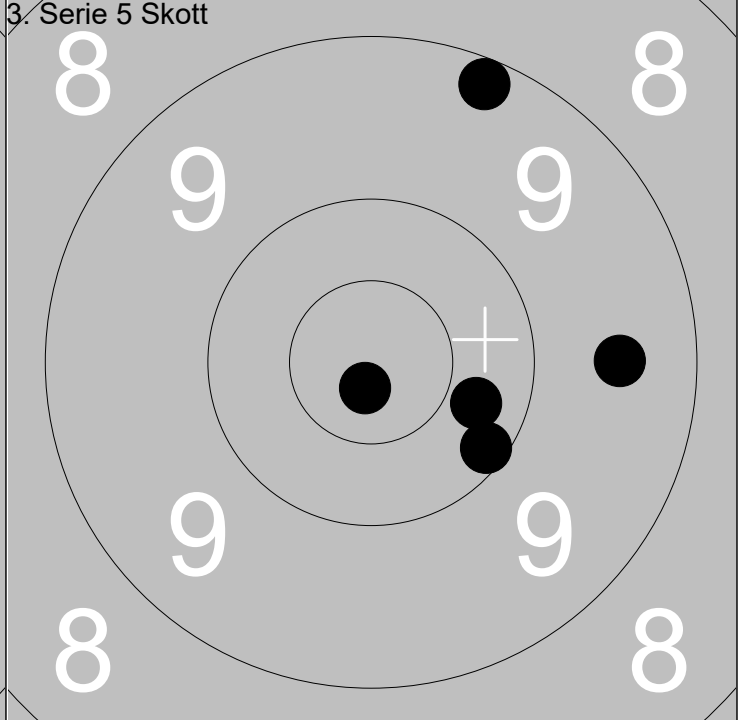
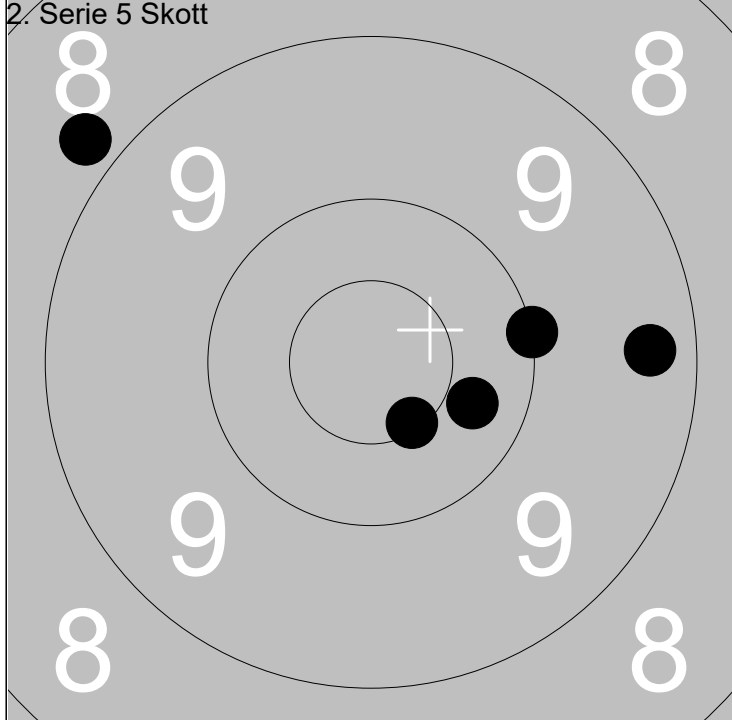

1: 8.8 ↗			
2: 9.3 →		Serie	47
3: 10.5x ↓			Total
4: 10.0 →			
5: 10.3 ↓			

1: 10.1 ↓			
2: 10.8x ↓		Serie	48
3: 9.5 →			Total
4: 10.3 ↓			
5: 9.2 ↗			

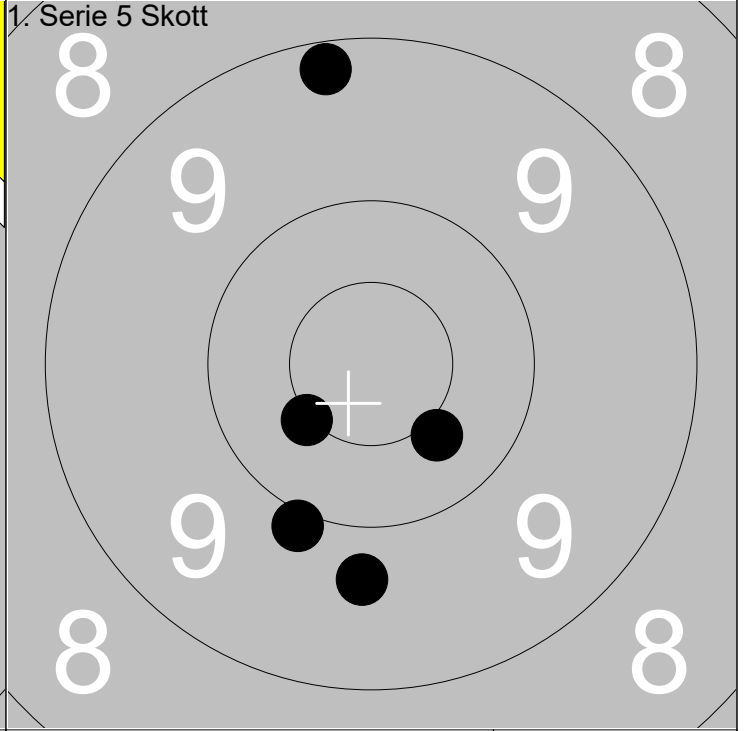
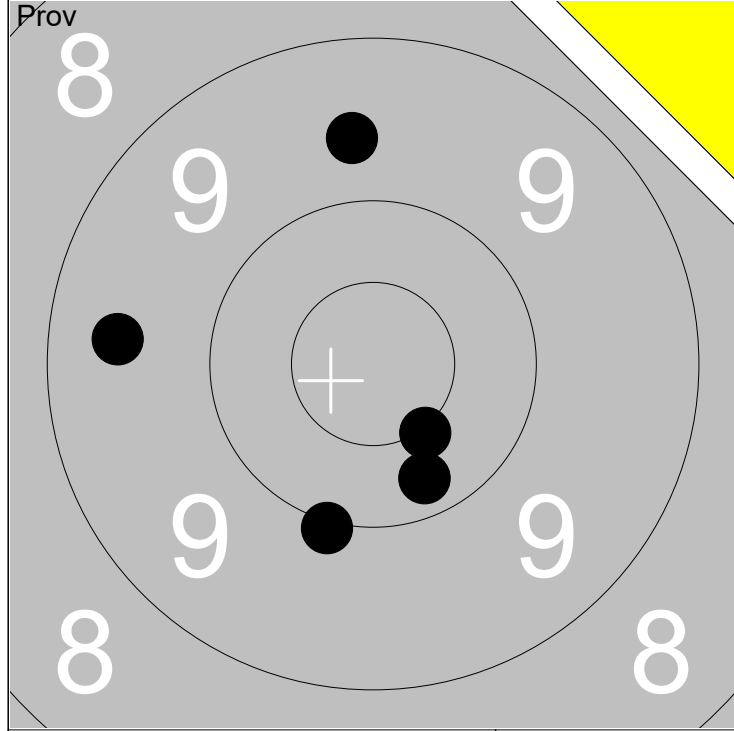

1: 10.0	↘
2: 10.2	↘
3: 10.5x	↘
4: 9.6	↗
5: 9.5	←

Serie	48
Total	0

1: 10.4	↘
2: 10.5x	↙
3: 9.2	↗
4: 9.9	↘
5: 9.7	↘

Serie	47
Total	47

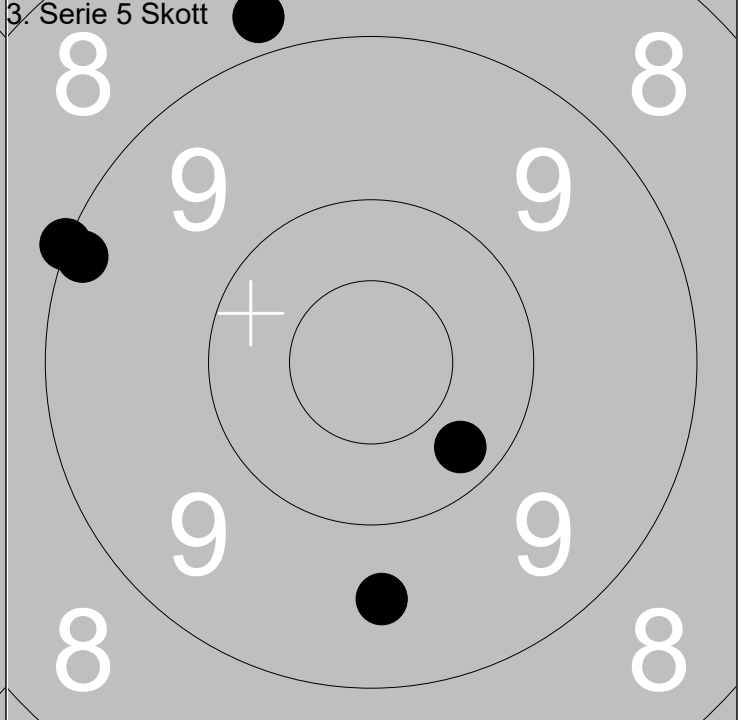
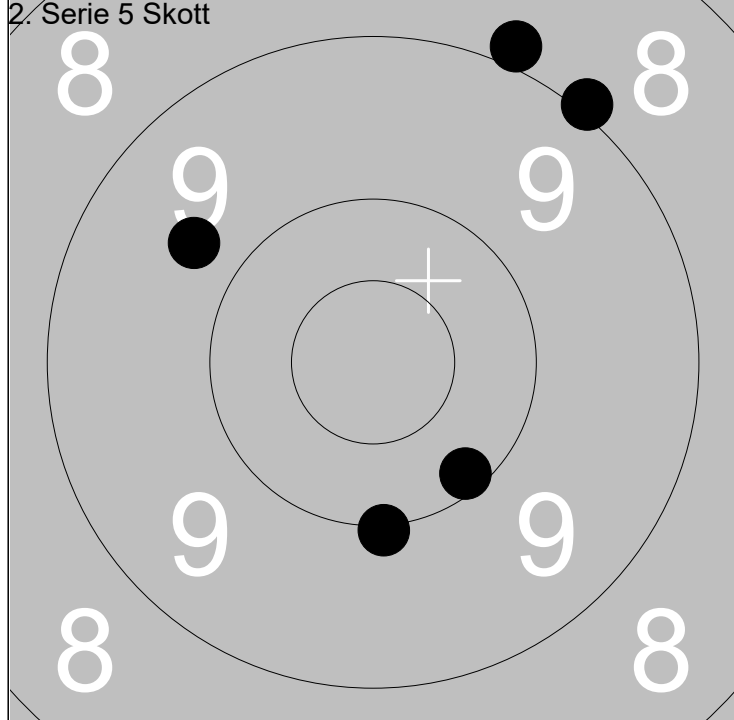

1: 9.0	↗
2: 10.0	↘
3: 9.7	↙
4: 8.9	↗
5: 10.1	↘

Serie	46
Total	93

1: 8.8	↗
2: 10.3	↘
3: 9.0	↙
4: 9.1	↙
5: 9.6	↘

Serie	45
Total	138

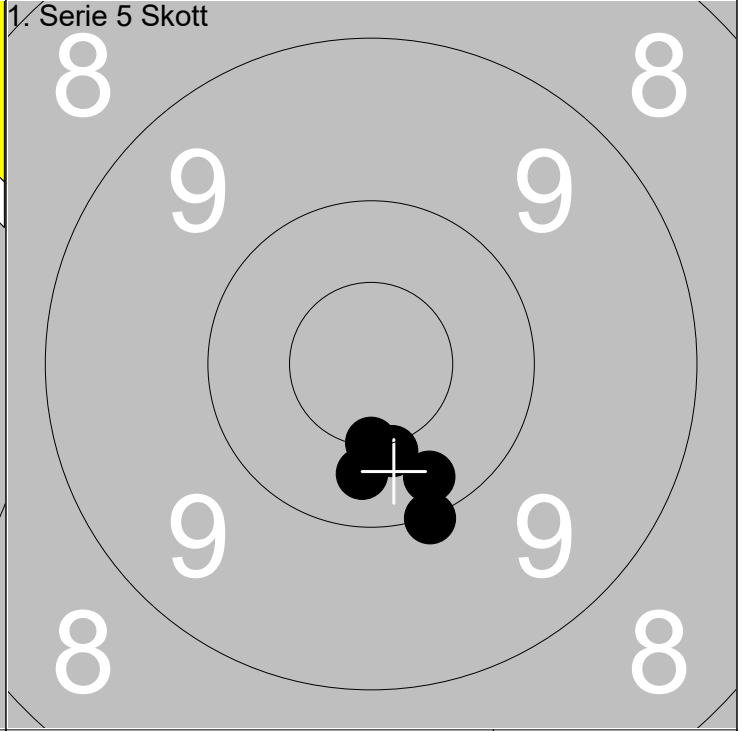
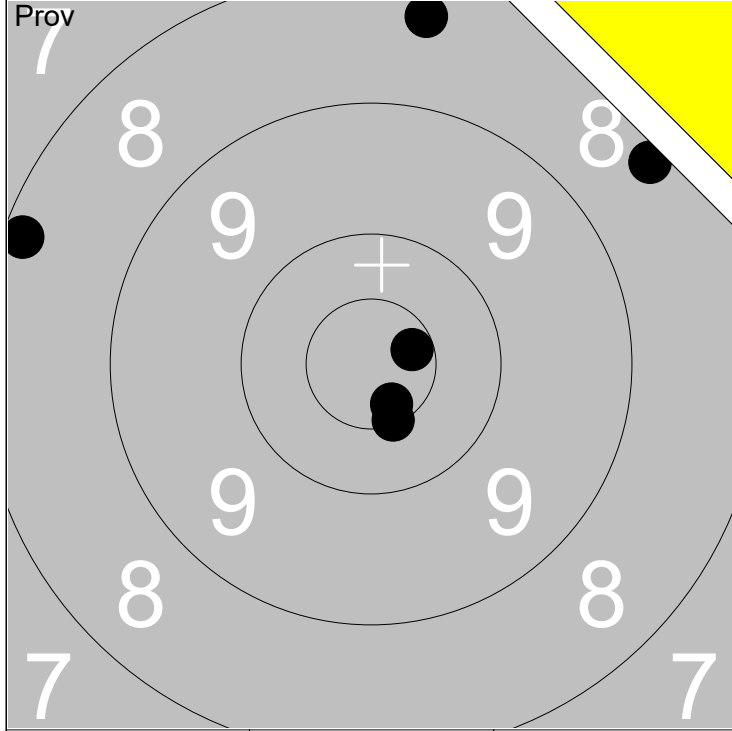

1: 10.6x →	6: 8.2 ←				
2: 8.4 ↗		Serie	54		
3: 8.3 ↑			Total	0	
4: 10.6x ↓					
5: 10.5x ↓					

1: 10.5x ↓					
2: 10.3 ↓		Serie	50		
3: 10.4x ↓			Total	50	
4: 10.0 ↓					
5: 10.2 ↓					

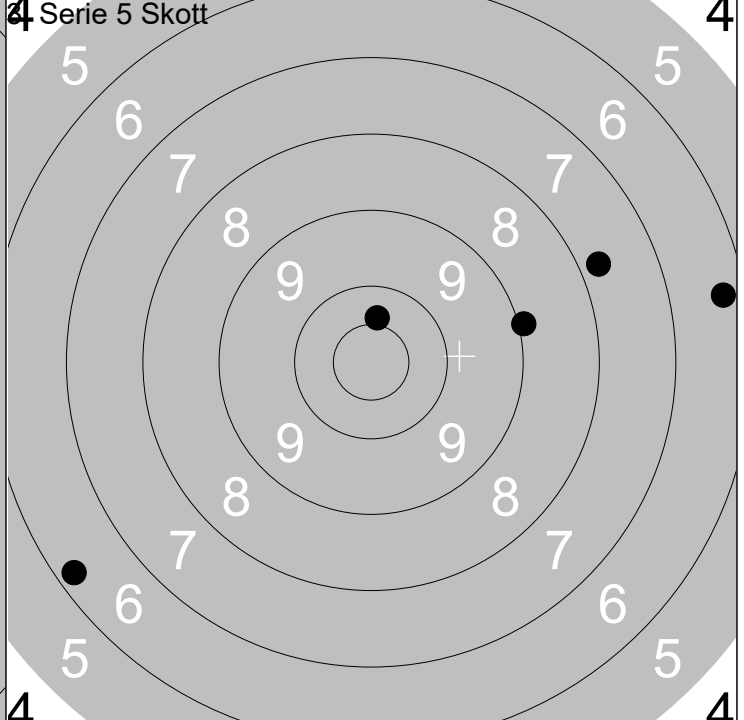
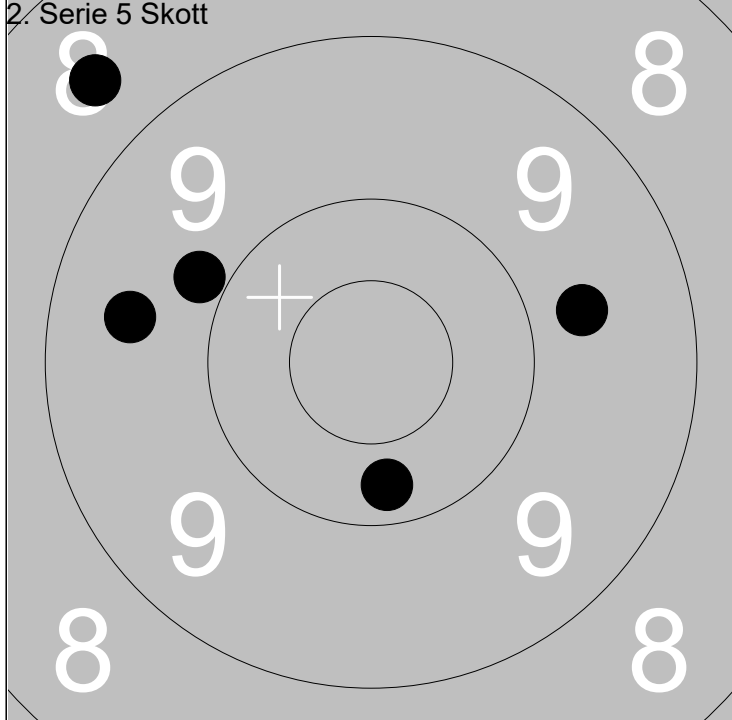

1: 9.9 ←					
2: 9.5 ←		Serie	45		
3: 10.2 ↓			Total	95	
4: 8.6 ↗					
5: 9.7 →					

1: 10.4 ↑					
2: 6.2 ←		Serie	38		
3: 6.3 →			Total	133	
4: 7.8 ↗					
5: 9.0 →					

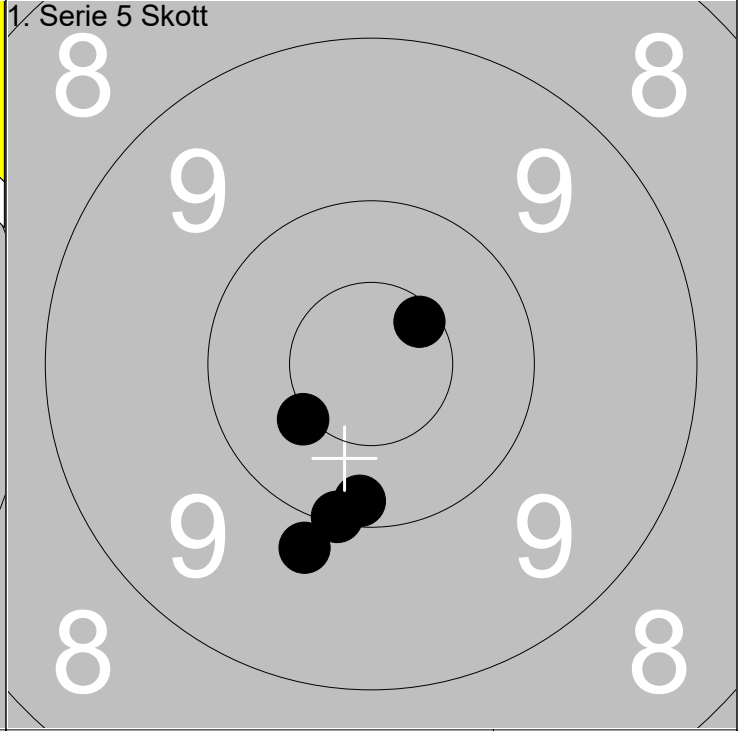
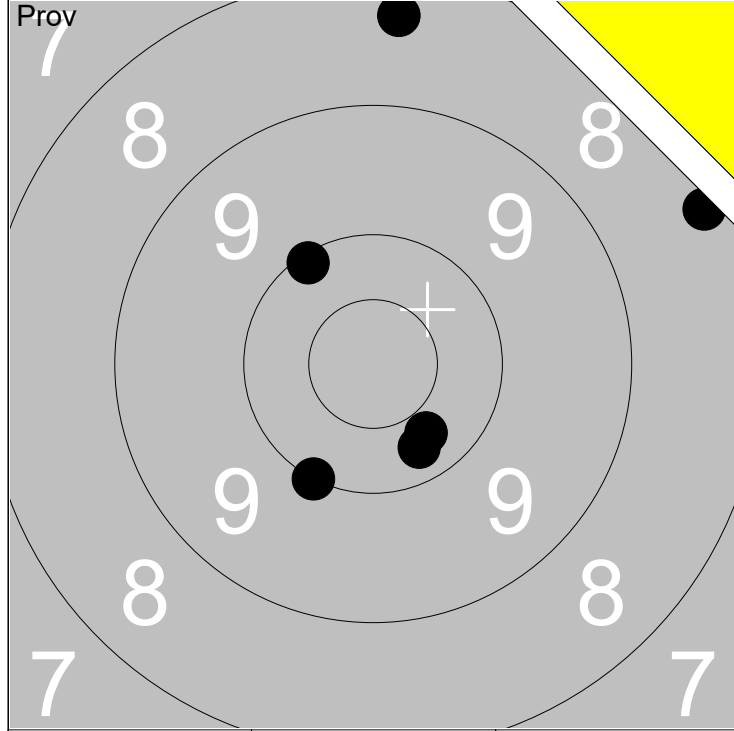

1: 10.1 ↗	6: 8.2 →		
2: 10.3 ↓		Serie	56
3: 10.0 ↓			
4: 10.3 ↓		Total	0
5: 8.3 ↑			

1: 10.5x ↙			
2: 10.6x ↗		Serie	49
3: 10.2 ↓			
4: 9.8 ↓		Total	49
5: 10.1 ↓			

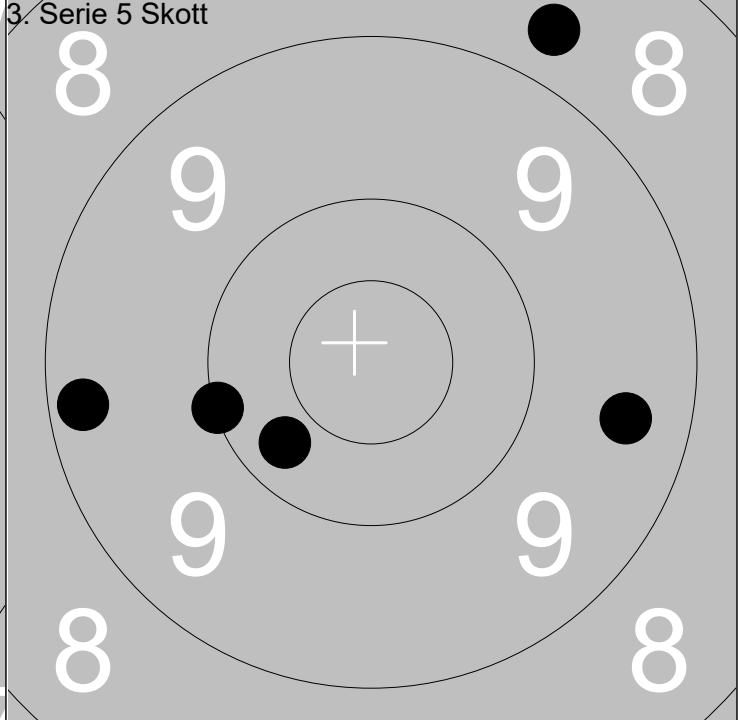
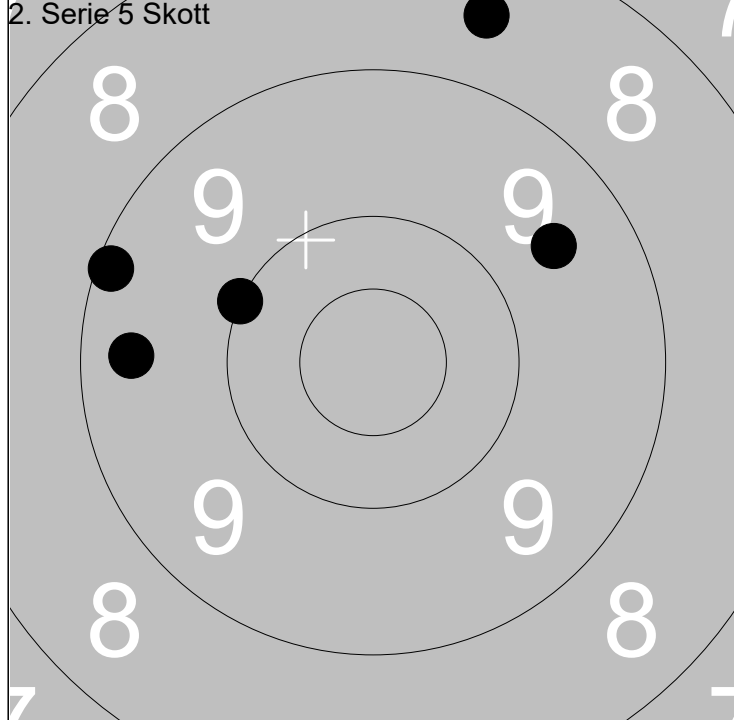

1: 8.5 ↑			
2: 9.1 ←		Serie	45
3: 9.4 ←			
4: 9.6 ↗		Total	94
5: 10.0 ←			

1: 10.0 ←			
2: 9.2 ←		Serie	46
3: 9.4 →			
4: 8.7 ↑		Total	140
5: 10.3 ↙			

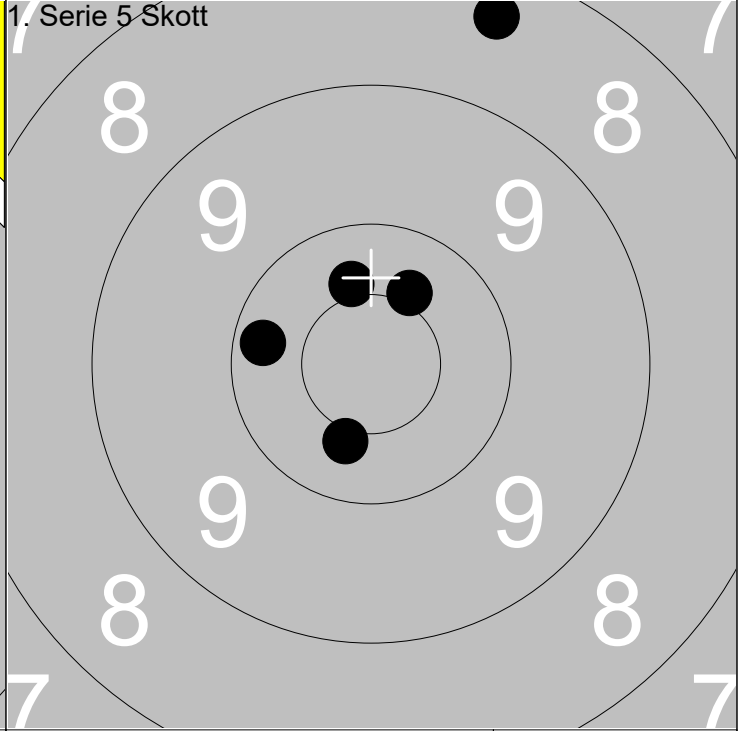
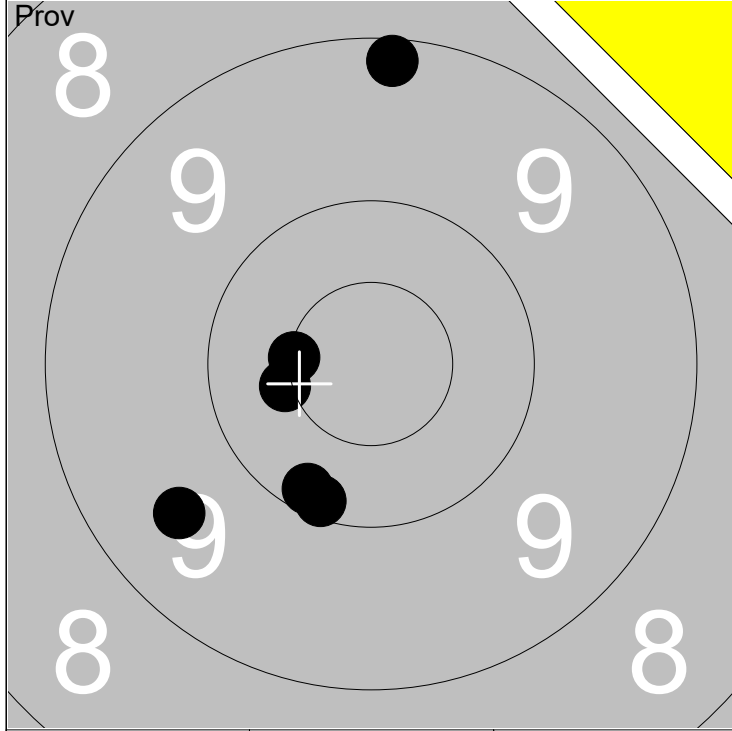

1: 10.1 ↓	6: 9.5 ↙		
2: 10.2 ↓		Serie	58
3: 10.5x ←			
4: 10.4x ←		Total	0
5: 9.2 ↑			

1: 8.4 ↑			
2: 10.4 ↓		Serie	48
3: 10.2 ←			
4: 10.4 ↑		Total	48
5: 10.4 ↑			

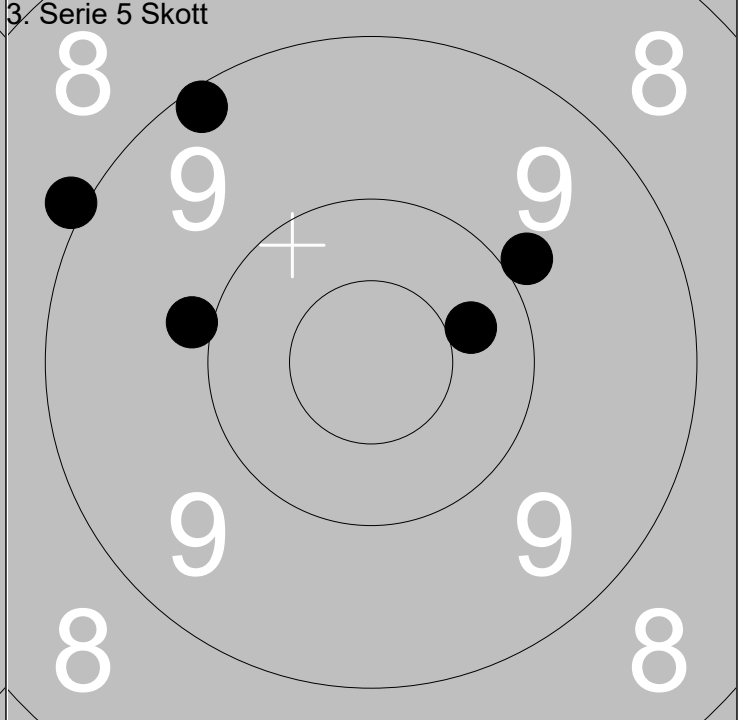
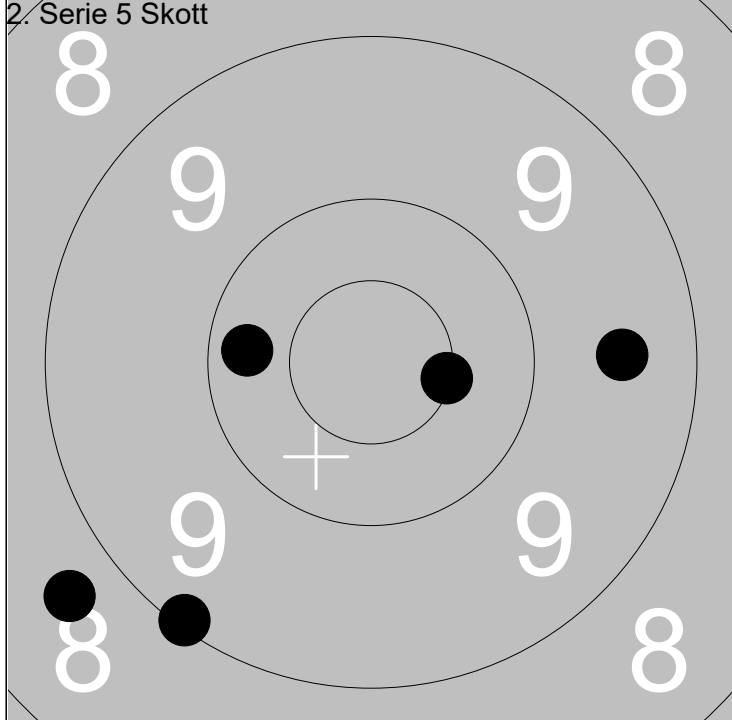

1: 10.2 ←			
2: 10.5x →		Serie	46
3: 9.5 →			
4: 9.1 ↓		Total	94
5: 8.7 ↓			

1: 9.9 ←			
2: 10.3 →		Serie	45
3: 8.9 ←			
4: 9.9 ↗		Total	139
5: 9.2 ↗			

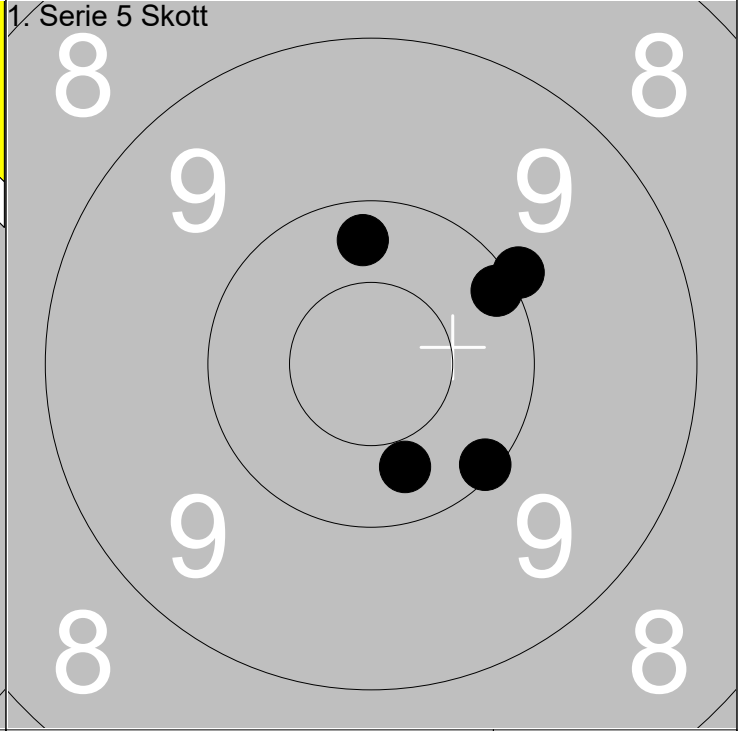
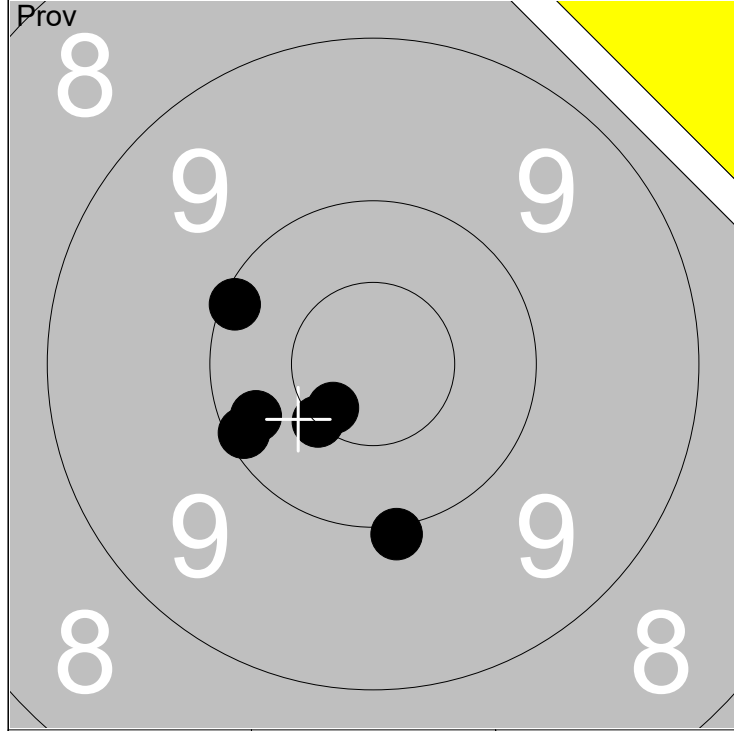

1: 10.6x ↙	6: 10.0 ↓		
2: 10.1 ↙		Serie	60
3: 10.5x ↙			
4: 10.1 ↖		Total	0
5: 10.2 ↙			

1: 10.1 ↗			
2: 10.1 ↘		Serie	50
3: 10.3 ↓			
4: 10.2 ↑		Total	50
5: 10.0 ↗			

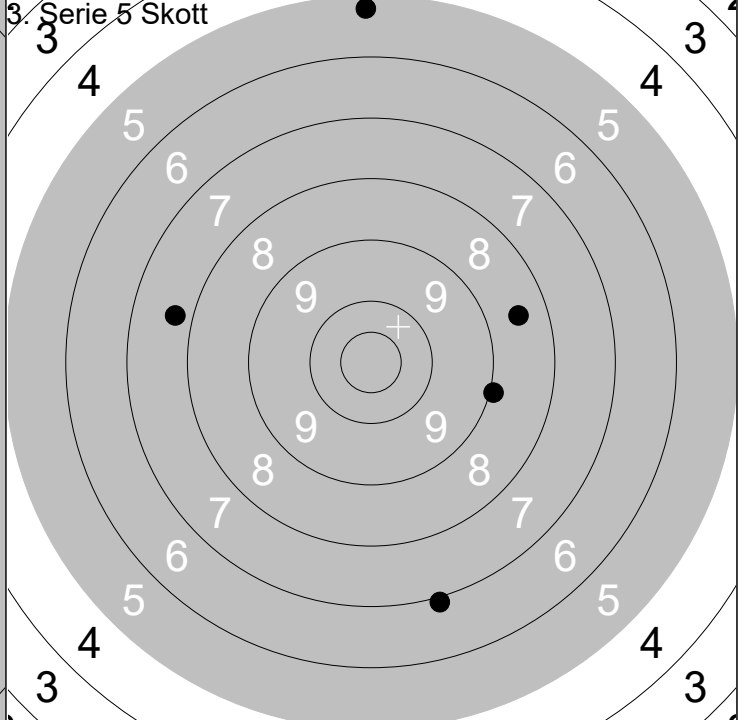
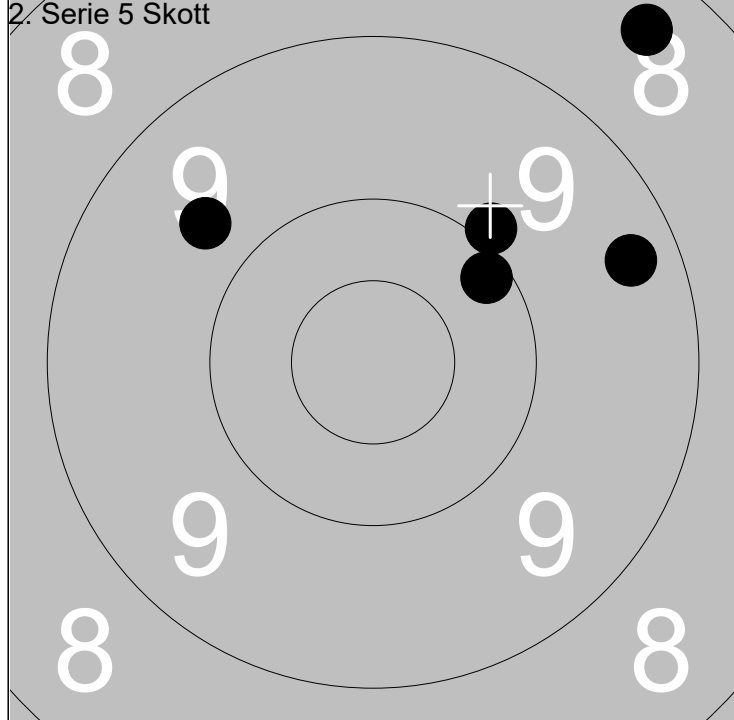

1: 8.4 ↗			
2: 9.9 ↗		Serie	45
3: 9.7 ↖			
4: 10.1 ↗		Total	95
5: 9.3 ↗			

1: 9.0 →			
2: 7.0 ↓		Serie	36
3: 5.2 ↑			
4: 8.5 →		Total	131
5: 7.7 ←			

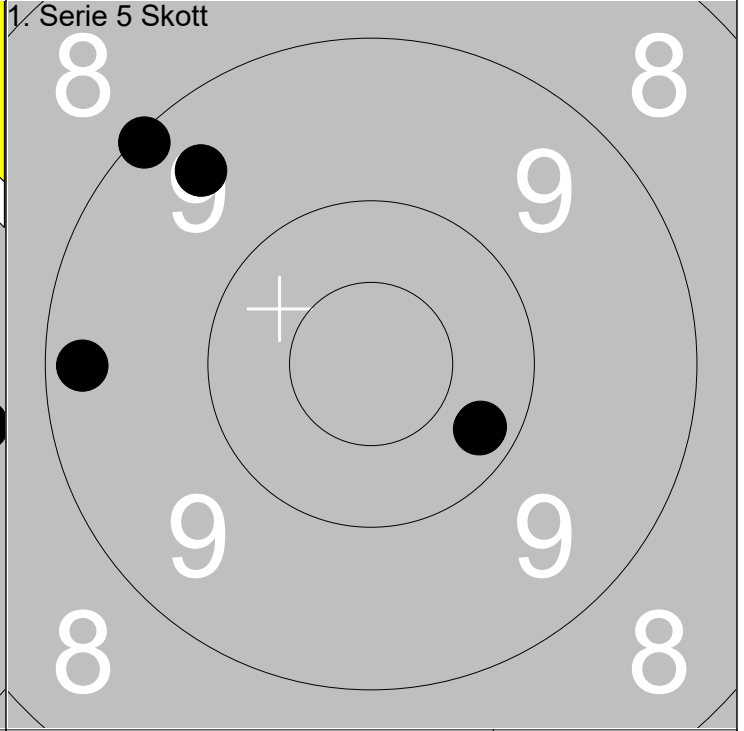
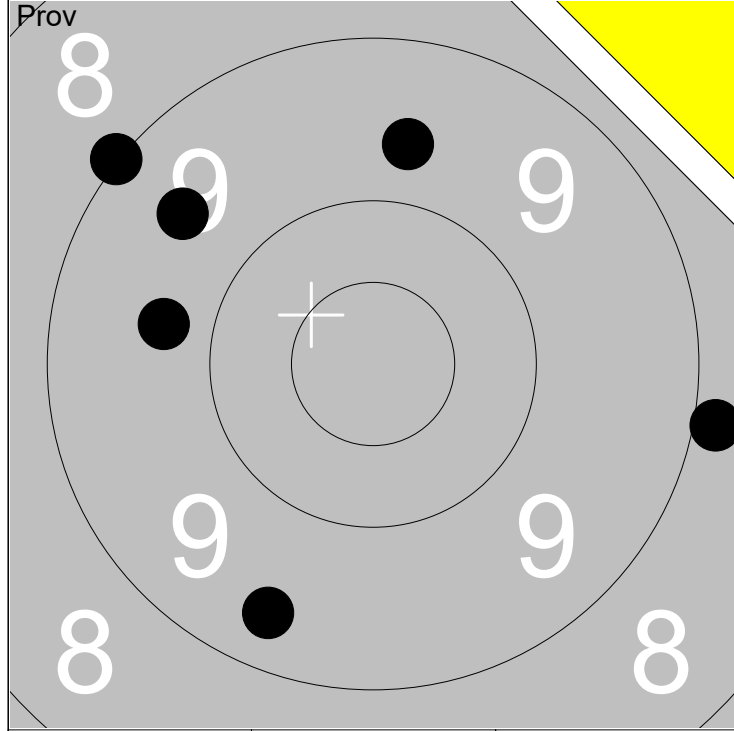

1: 9.5 ↗	6: 9.7 ↑		
2: 9.7 ←		Serie	53
3: 9.0 ↗			
4: 8.9 →		Total	0
5: 9.4 ↓			

1: 9.4 ↗			
2: 10.2 ↘		Serie	47
3: 10.2 ↘			
4: 9.3 ←		Total	47
5: 9.1 ↗			

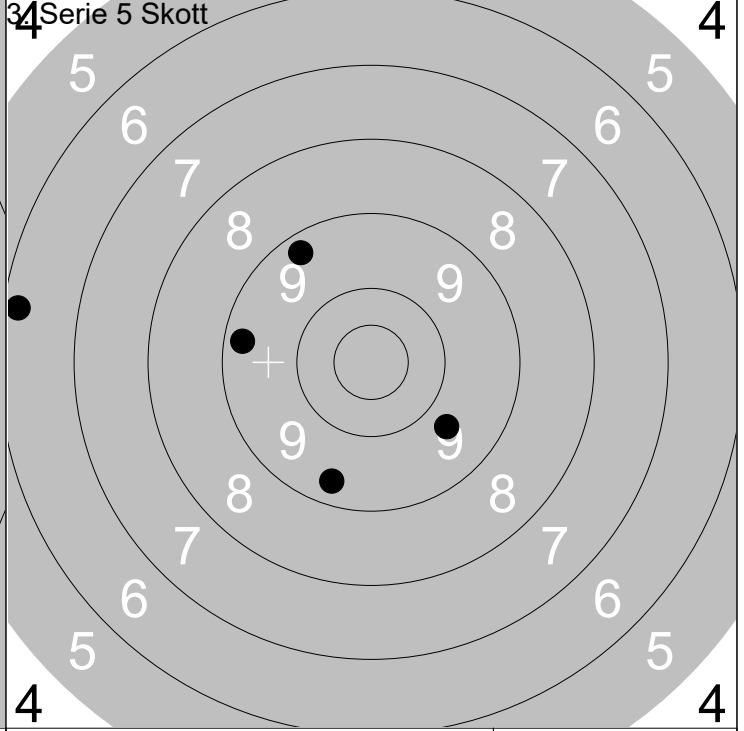
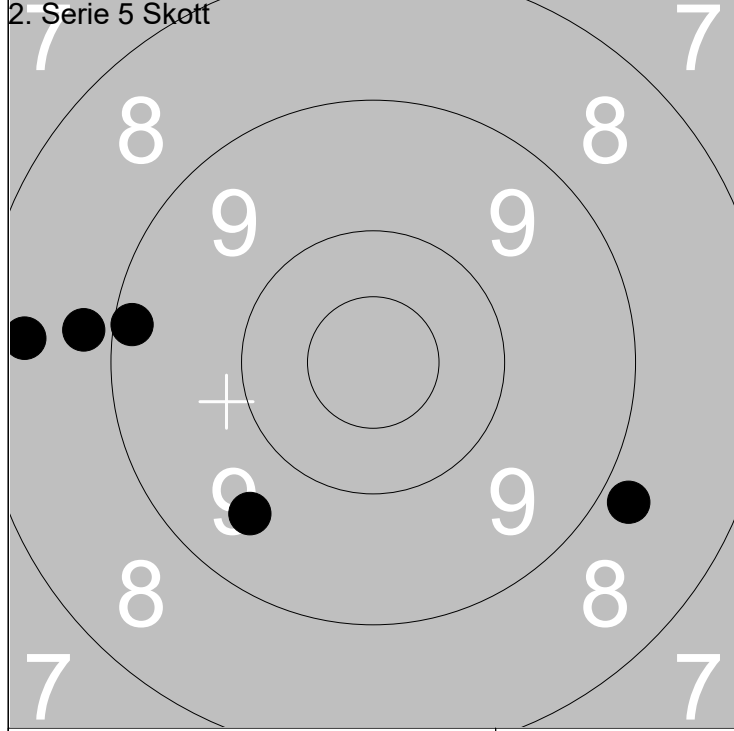

1: 9.5 ↓			
2: 8.4 ←		Serie	42
3: 9.2 ←			
4: 8.8 →		Total	89
5: 8.8 ←			

1: 9.3 ↗			
2: 9.7 ↘		Serie	42
3: 6.2 ←			
4: 9.4 ↓		Total	131
5: 9.3 ←			

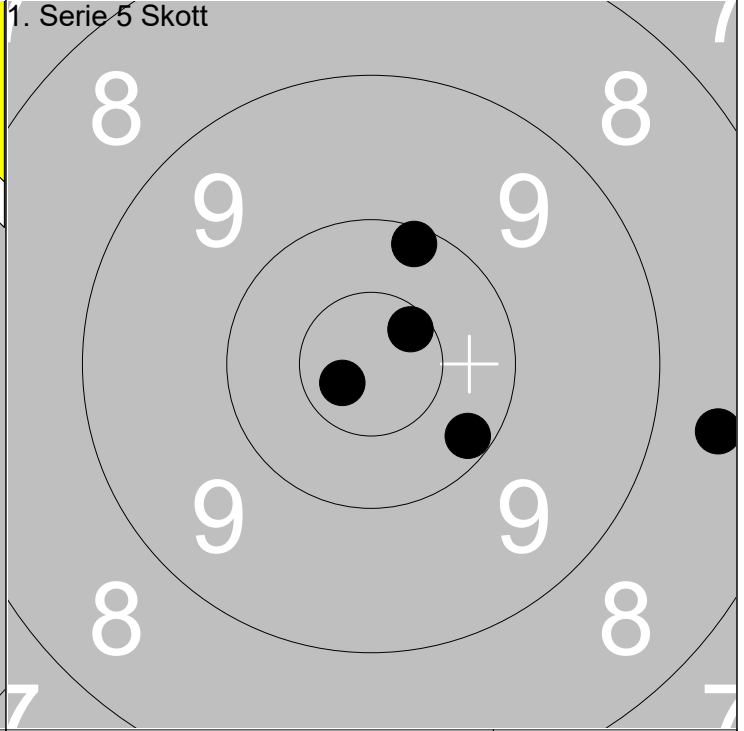
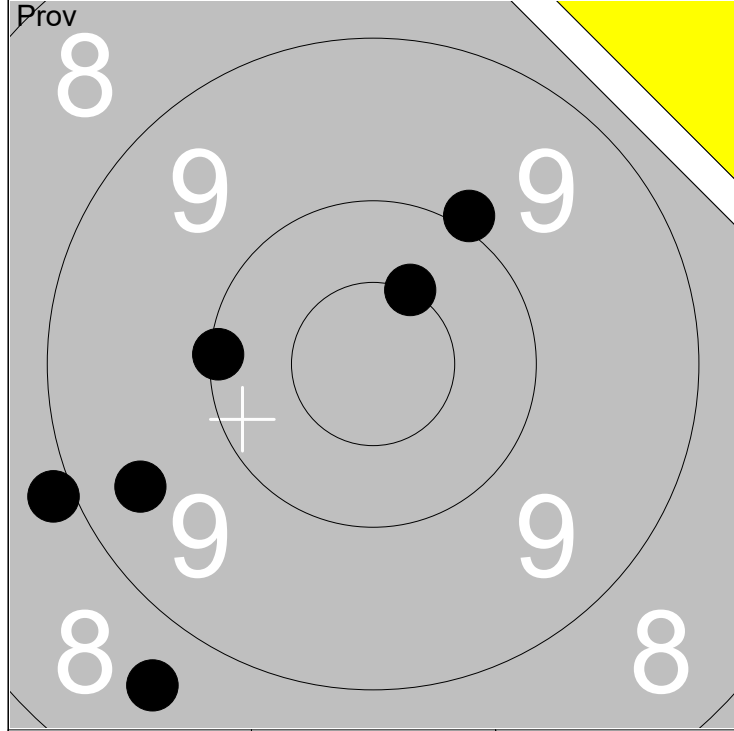

1: 9.4 ↙	6: 8.9 ←				
2: 8.6 ↘		Serie	54		
3: 10.5x ↗		Total	0		
4: 9.9 ↗					
5: 10.1 ←					

1: 10.1 ↗					
2: 10.6x ↗		Serie	48		
3: 8.6 →		Total	48		
4: 10.2 ↘					
5: 10.7x ↘					

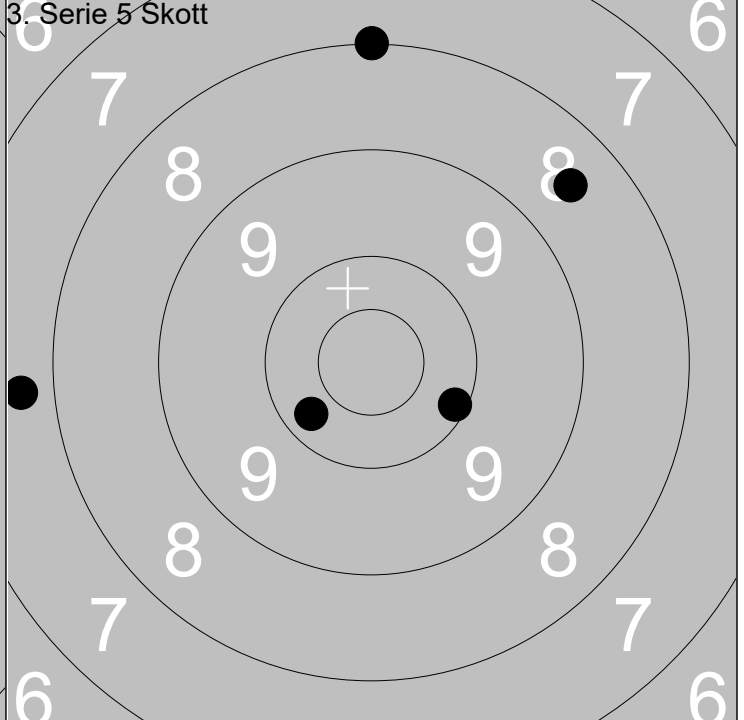
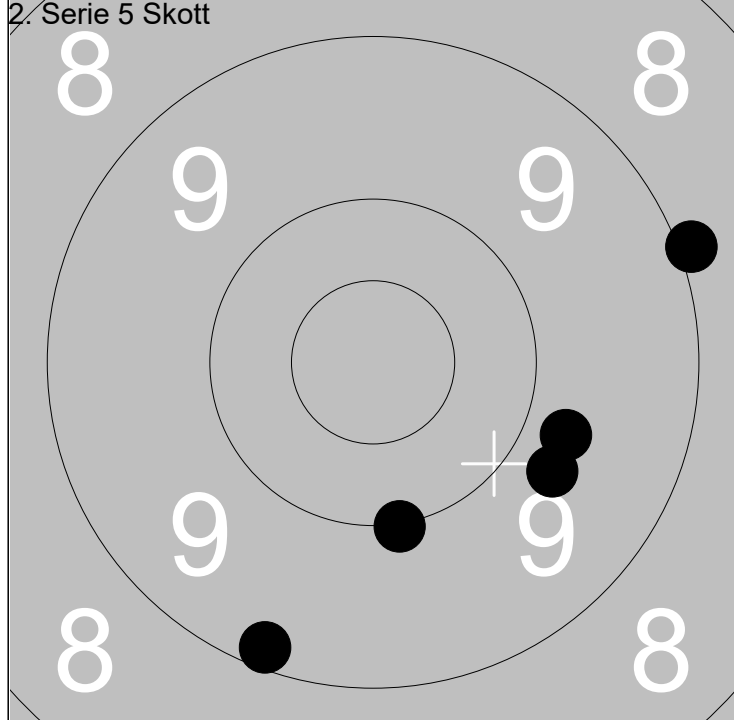

1: 9.7 →					
2: 9.2 ↘		Serie	46		
3: 9.8 →		Total	94		
4: 10.0 ↘					
5: 9.0 →					

1: 8.0 ↗					
2: 10.3 ↙		Serie	43		
3: 8.5 ↗		Total	137		
4: 10.1 →					
5: 7.7 ←					

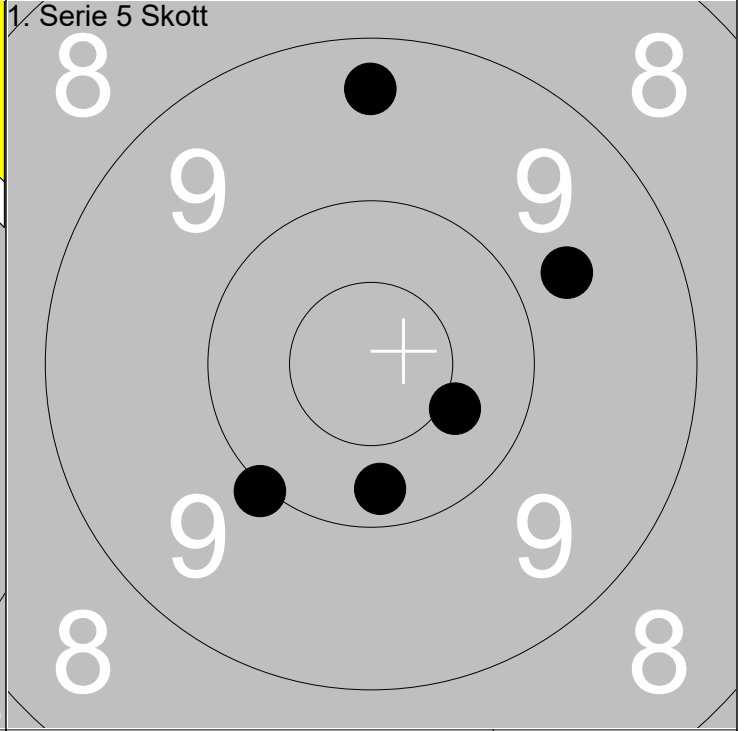
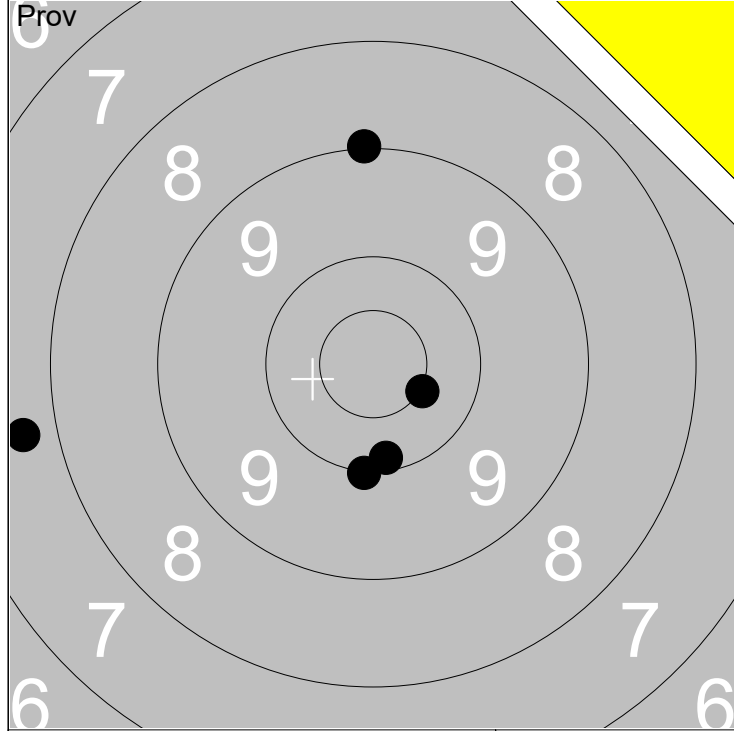

1: 10.1 ↓	Serie 46
2: 9.0 ↑	
3: 10.0 ↓	
4: 10.5x ➤	
5: 7.7 ←	
Total 0	

1: 10.2 ↓	Serie 48
2: 10.4 ➤	
3: 10.0 ↙	
4: 9.7 ➤	
5: 9.3 ↑	
Total 48	

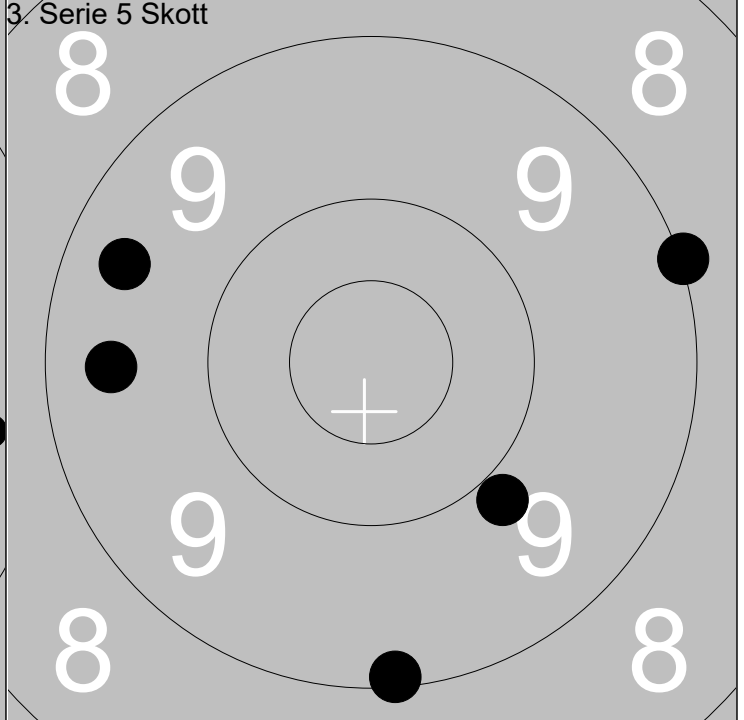
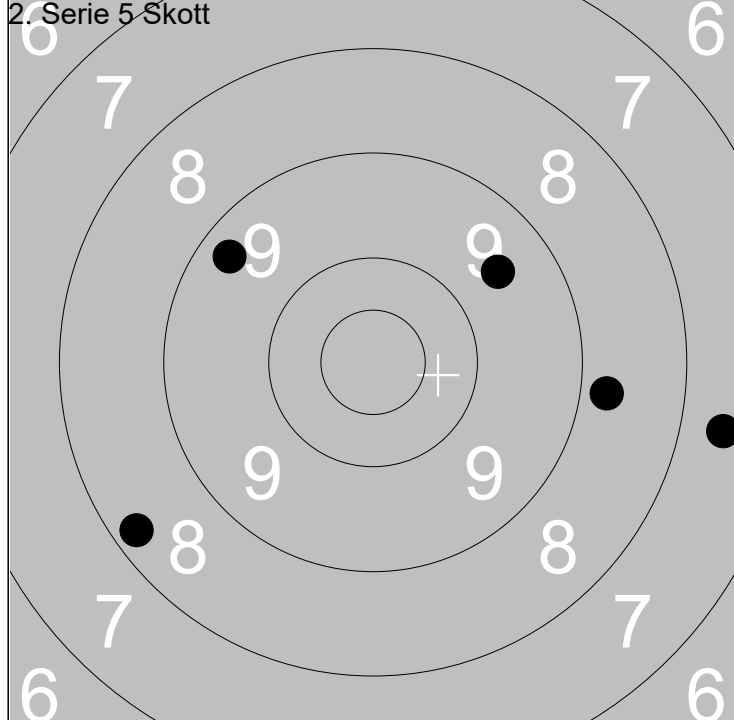

1: 9.6 ➤	Serie 41
2: 9.3 ↙	
3: 8.3 ↙	
4: 8.8 ➤	
5: 7.6 ➤	
Total 89	

1: 9.1 ↓	Serie 45
2: 9.4 ←	
3: 9.4 ↙	
4: 9.9 ↙	
5: 9.0 ➤	
Total 134	

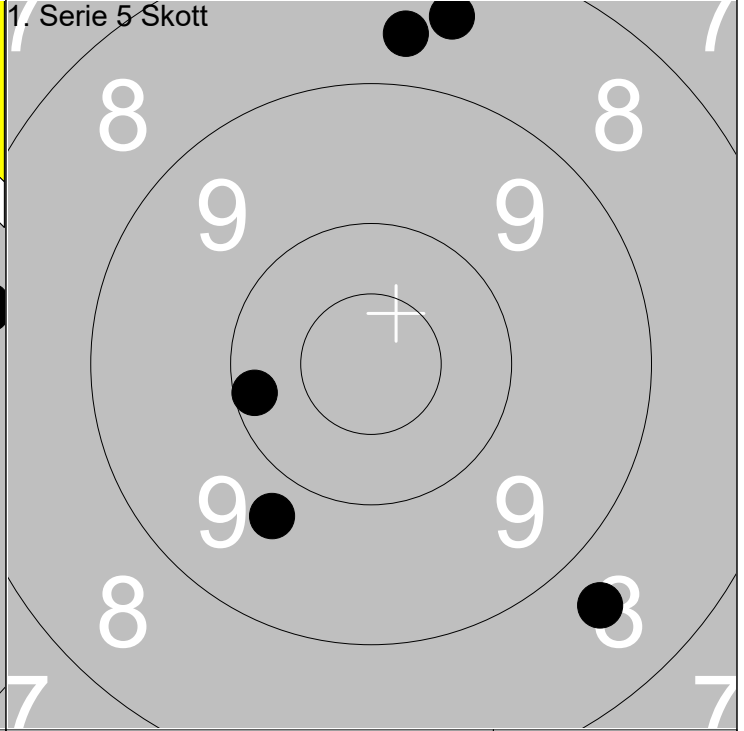
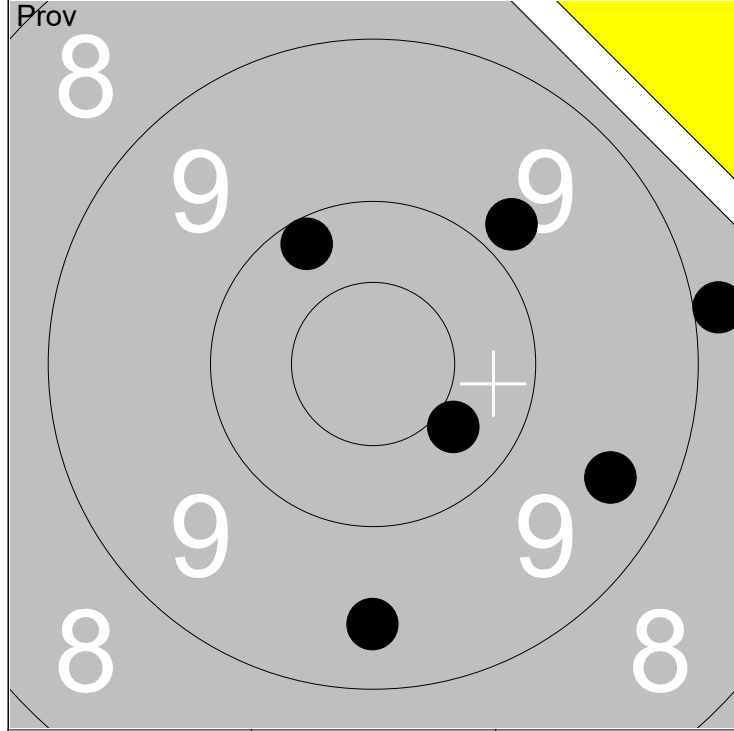

1: 8.9 →	6: 9.4 →				
2: 10.2 ↗		Serie	55		
3: 9.8 ↗					
4: 10.4 ↘		Total	0		
5: 9.4 ↓					

1: 10.2 ←					
2: 8.7 ↘		Serie	43		
3: 8.7 ↑					
4: 8.5 ↑		Total	43		
5: 9.7 ↘					

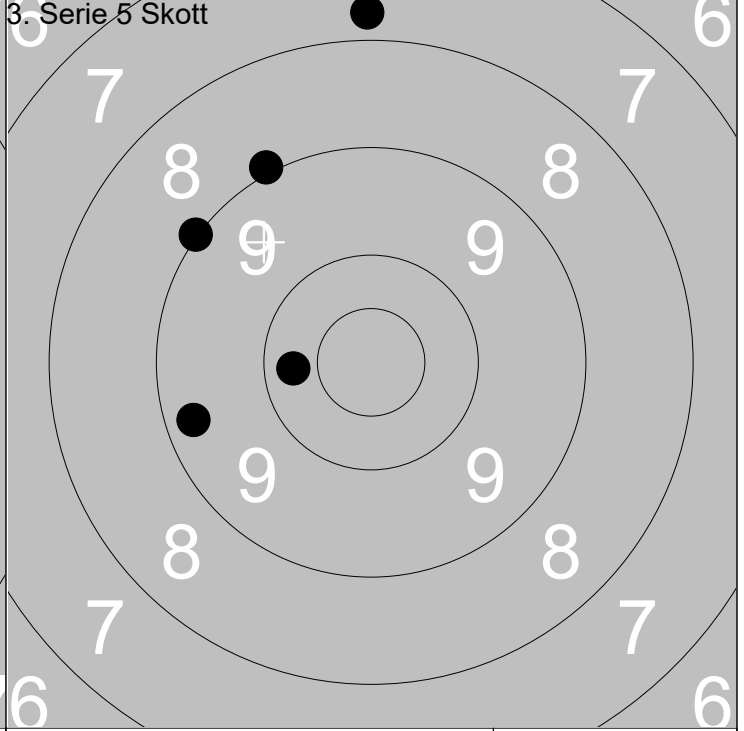
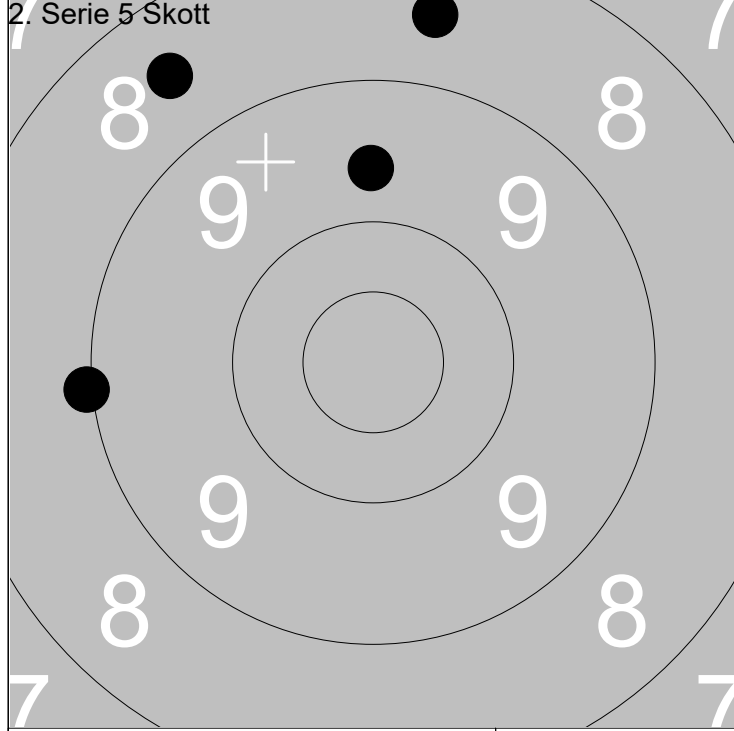

1: 8.5 ↑					
2: 9.7 ↑		Serie	34		
3: 9.0 ←					
4: 8.5 ↗		Total	77		
5: 0.0					

1: 9.0 ↖					
2: 7.8 ↑		Serie	44		
3: 9.0 ↗					
4: 10.3 ←		Total	121		
5: 9.3 ←					

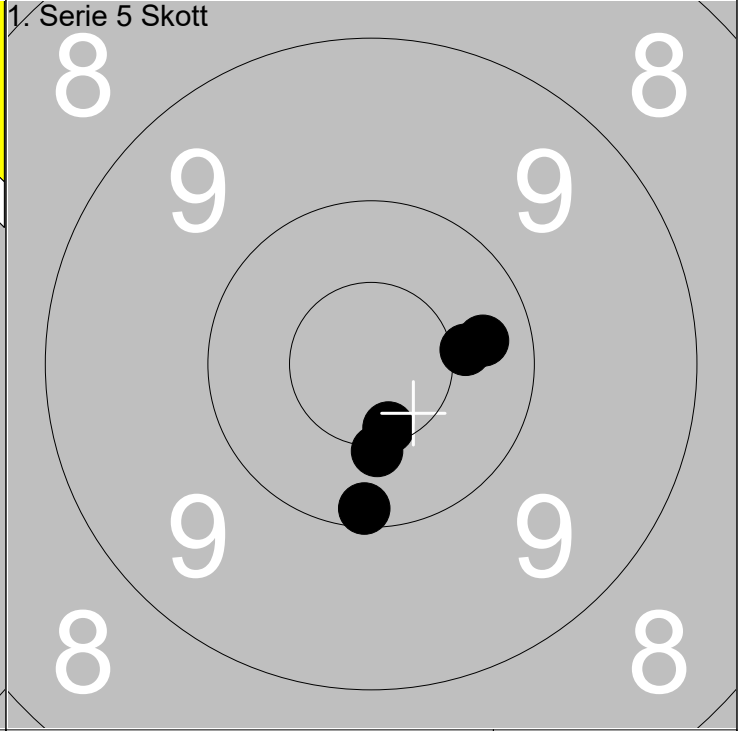
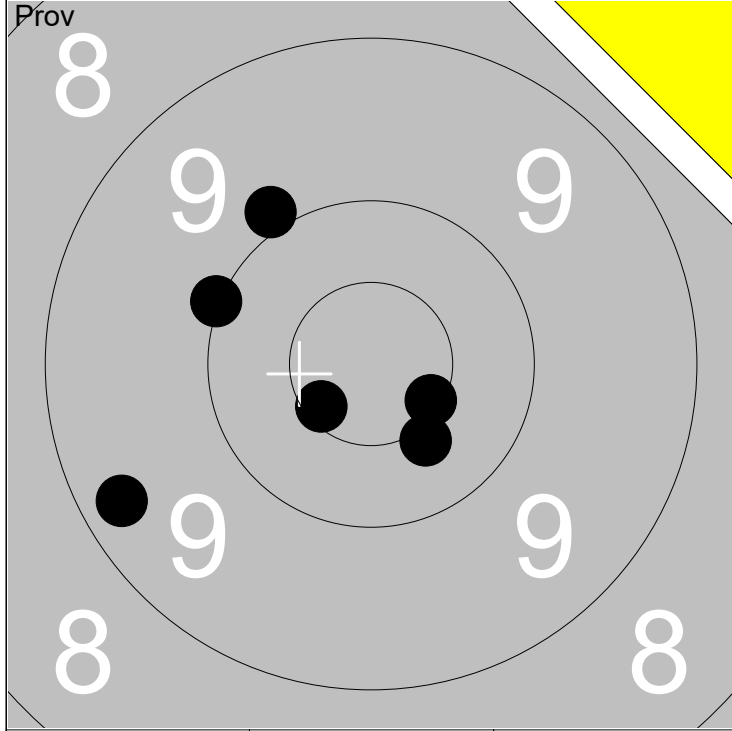

1: 10.0 ↖	6: 10.6x ↙		
2: 10.6x ↘		Serie	58
3: 9.9 ↗			
4: 10.4x ↘		Total	0
5: 9.3 ↖			

1: 10.3 →			
2: 10.4 →		Serie	50
3: 10.6x ↓			
4: 10.5x ↓		Total	50
5: 10.1 ↓			

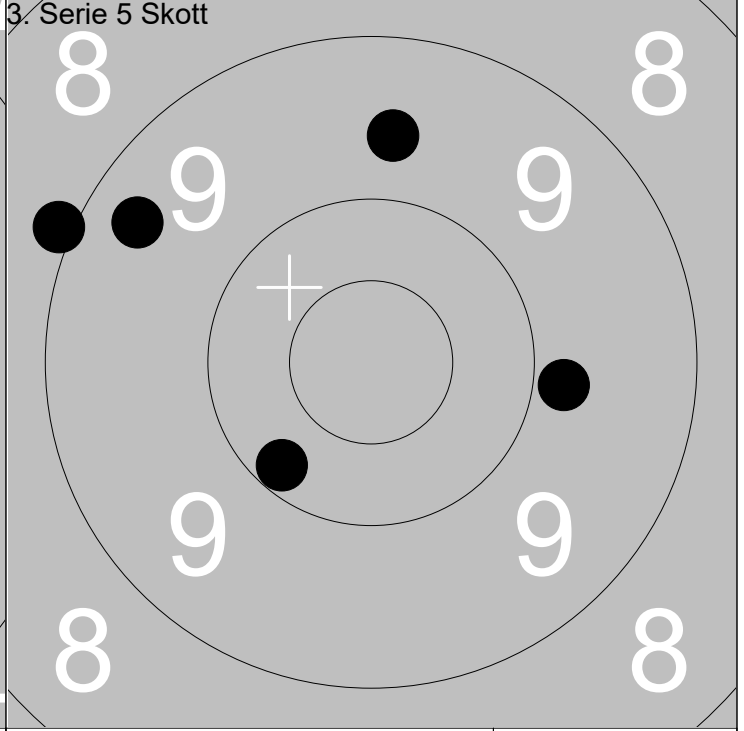
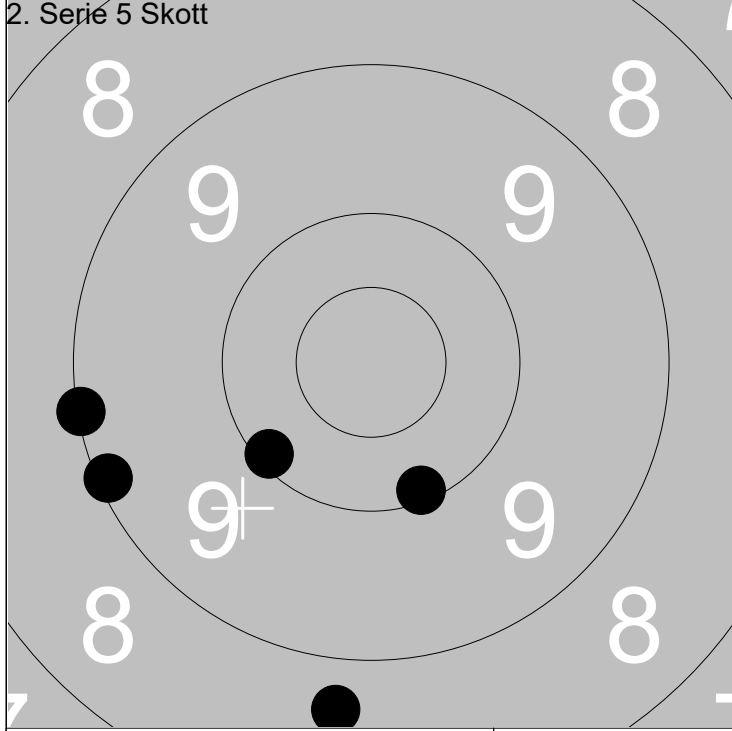

1: 10.1 ↓			
2: 9.1 ↖		Serie	46
3: 10.1 ↙			
4: 8.7 ↓		Total	96
5: 9.1 ↖			

1: 9.4 ↖			
2: 9.8 →		Serie	45
3: 8.9 ↖			
4: 9.6 ↑		Total	141
5: 10.2 ↙			

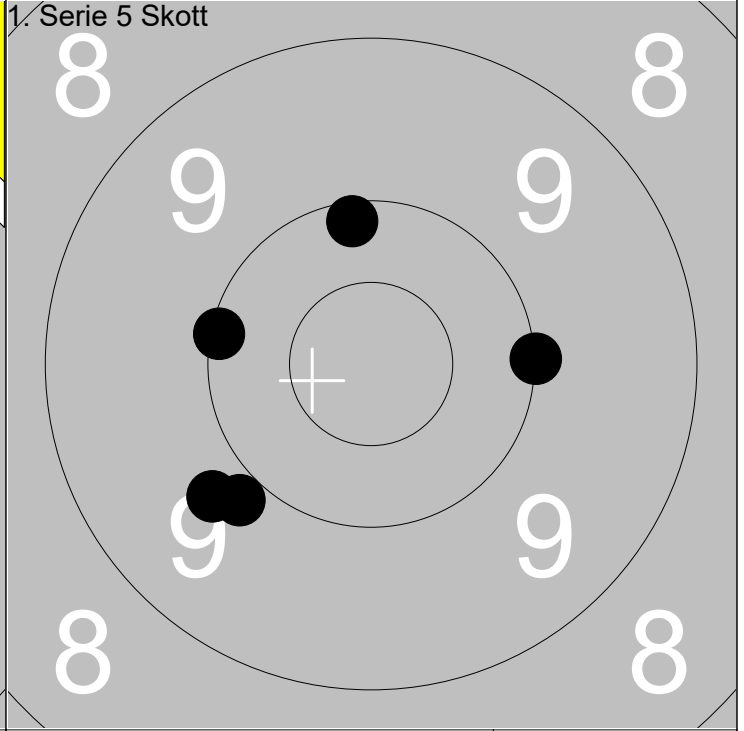
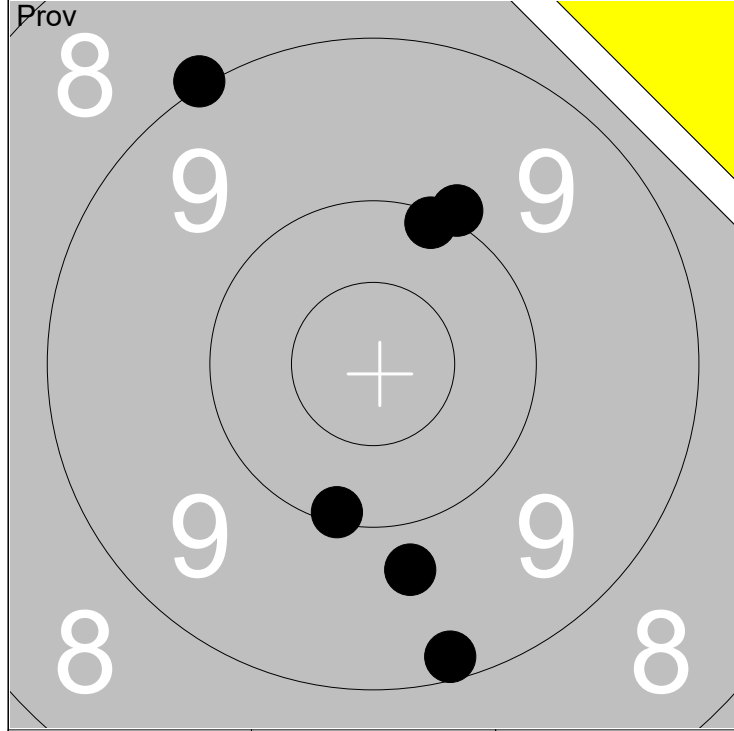

1: 10.1 ↗	6: 9.2 ↓
2: 10.1 ↓	
3: 10.0 ↗	
4: 9.8 ↓	
5: 9.0 ↖	

Serie	57
Total	0

1: 10.1 ←	
2: 10.0 →	
3: 10.1 ↑	
4: 9.8 ↙	
5: 9.9 ↘	

Serie	48
Total	48

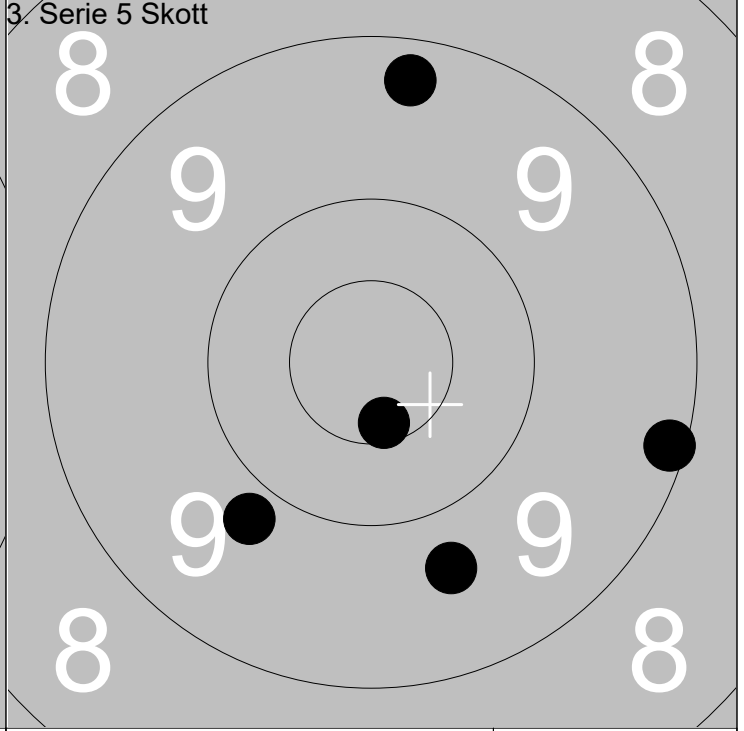
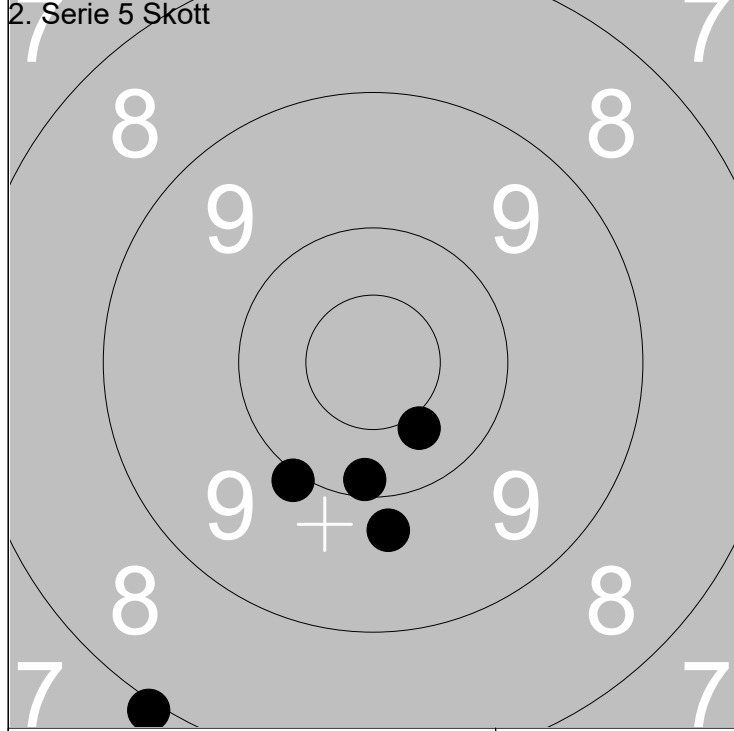

1: 10.0 ↙	
2: 9.8 ↓	
3: 10.1 ↓	
4: 8.0 ↙	
5: 10.4 ↘	

Serie	47
Total	95

1: 9.3 ↑	
2: 9.8 ↙	
3: 9.1 →	
4: 9.7 ↓	
5: 10.6x ↓	

Serie	46
Total	141

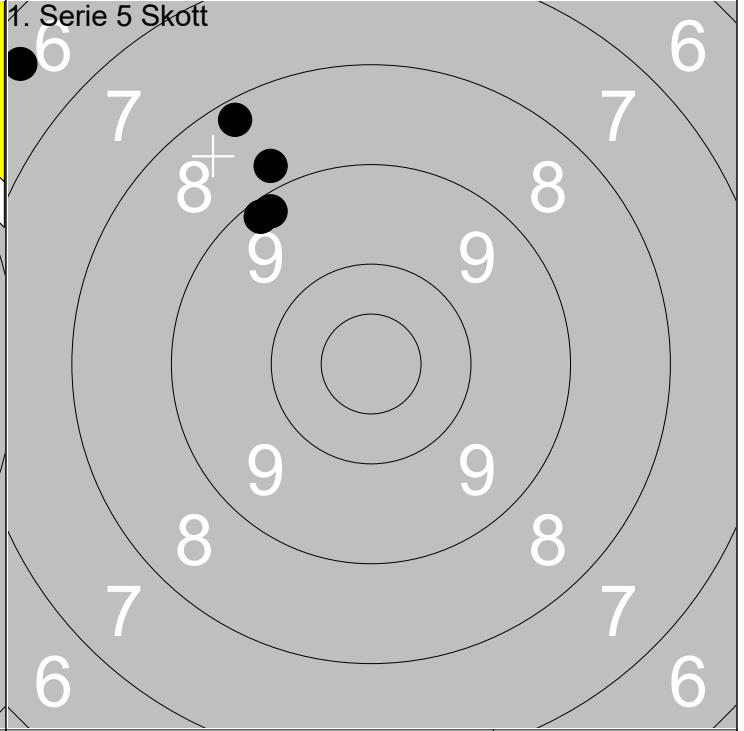
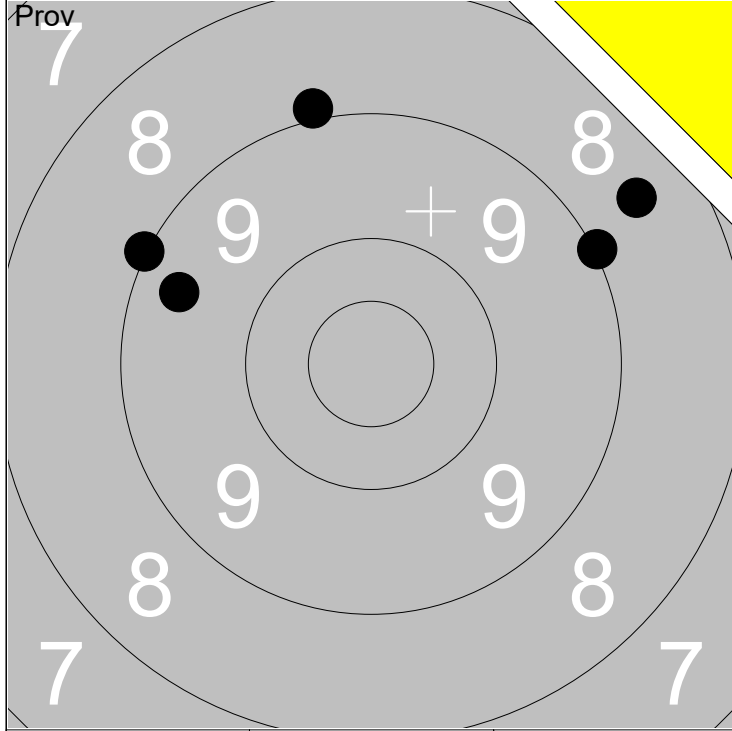

1: 9.0 ↗	6: 9.0 ↖		
2: 8.9 ↑		Serie	50
3: 7.8 ↗			
4: 8.5 ↗		Total	0
5: 9.4 ↖			

1: 6.4 ↖			
2: 9.2 ↗		Serie	40
3: 9.2 ↗			
4: 8.2 ↗		Total	40
5: 8.8 ↗			

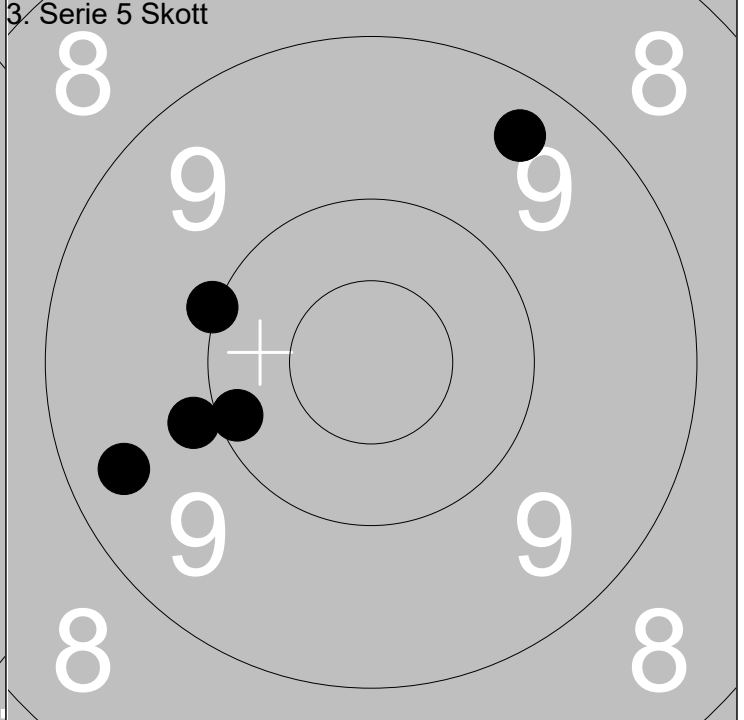
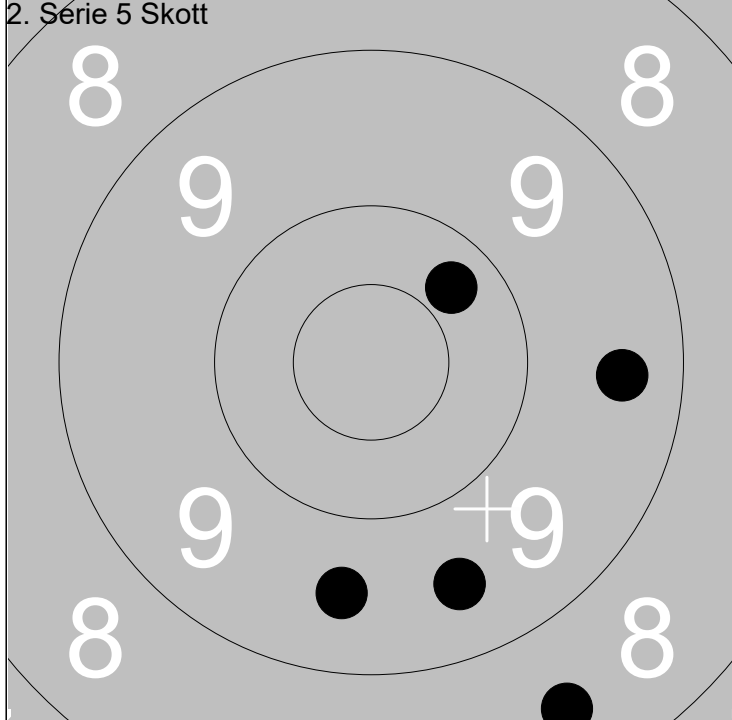

1: 9.4 →			
2: 9.5 ↓		Serie	45
3: 8.5 ↓			
4: 10.3 ↗		Total	85
5: 9.5 ↓			

1: 9.9 ↖			
2: 9.4 ↖		Serie	47
3: 9.4 ↗			
4: 10.0 ↖		Total	132
5: 10.1 ↖			

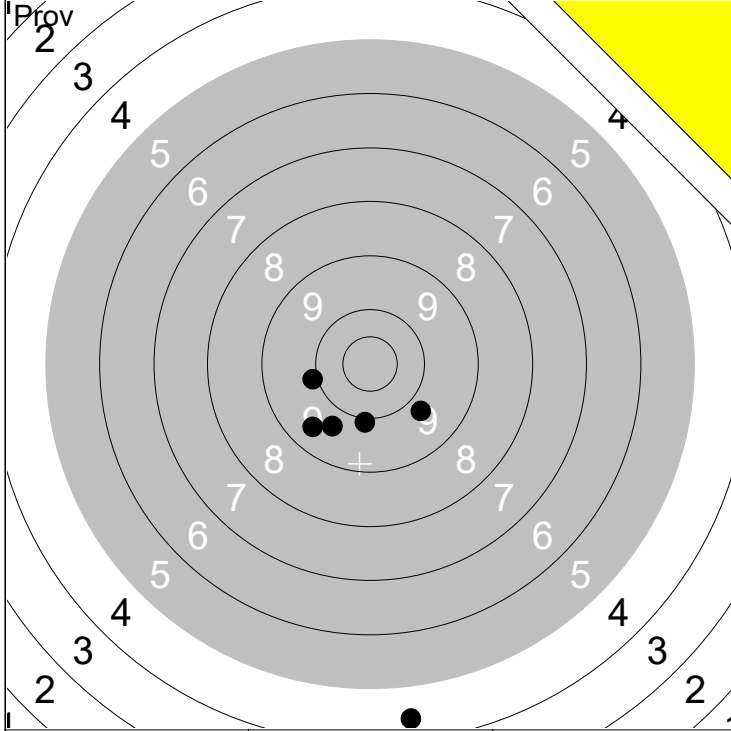

1: 9.9 ←	6: 4.4 ↓		
2: 9.9 ↓		Serie	49
3: 9.5 ↙			
4: 9.8 ↘		Total	0
5: 9.7 ↘			

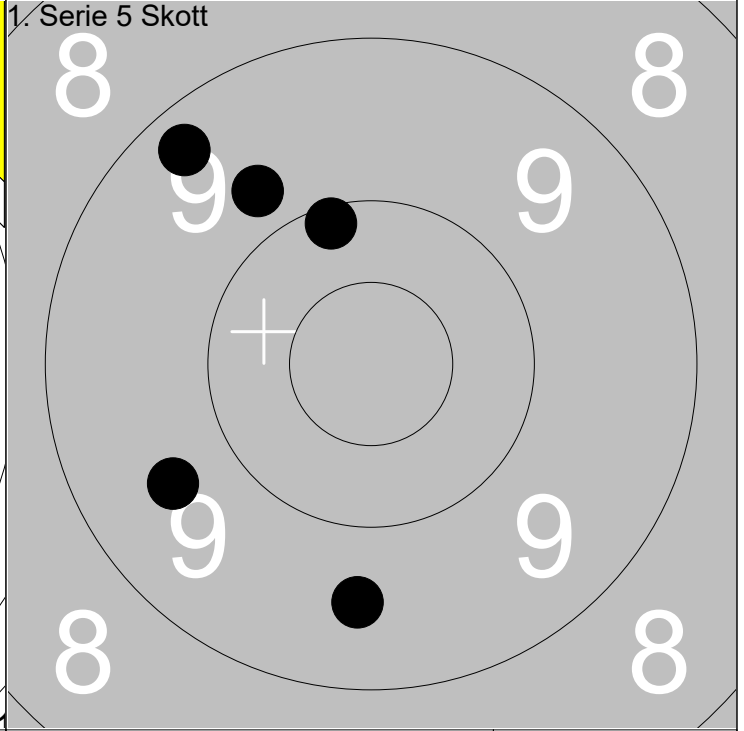

1: 9.8 ↖			
2: 10.1 ↗		Serie	46
3: 9.6 ↙			
4: 9.3 ↖		Total	46
5: 9.6 ↓			

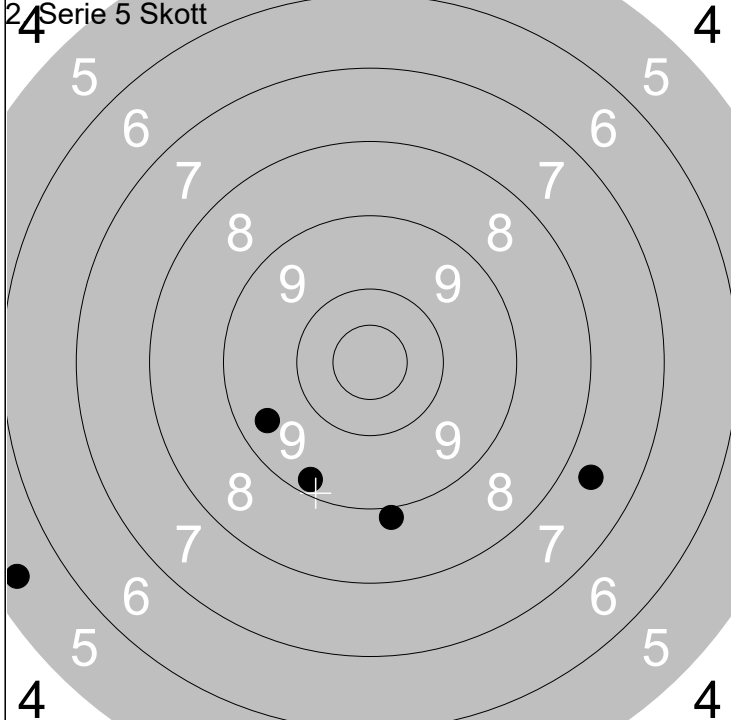

1: 7.6 →			
2: 8.9 ↓		Serie	38
3: 9.2 ↙			
4: 5.4 ←		Total	84
5: 9.4 ↙			

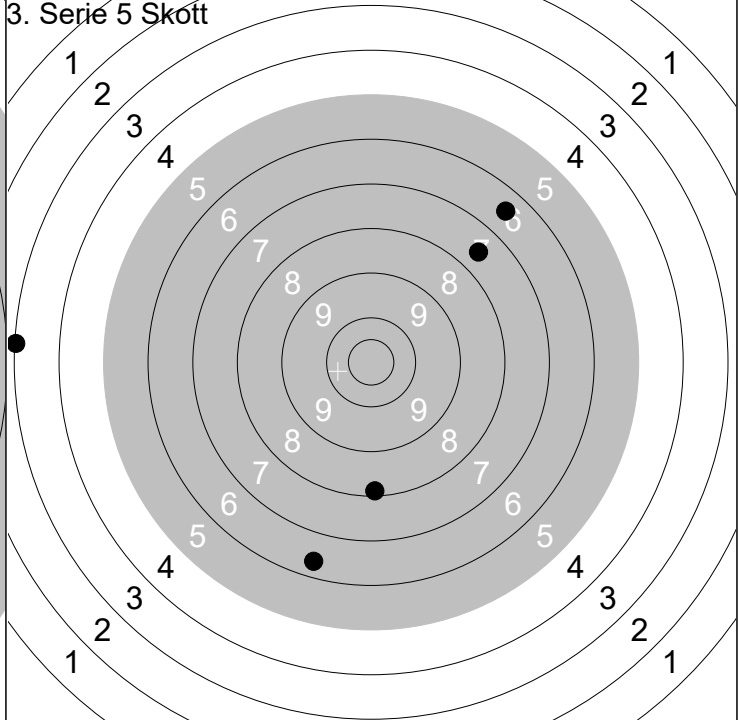

1: 3.1 ←			
2: 8.1 ↓		Serie	30
3: 6.4 ↙			
4: 6.5 ↗		Total	114
5: 7.6 ↗			

Skjutlag

1

Tavla

18

Marlene Forsell Forsman

Ramselefors

Ramselefors

B

Vb

09.07.2018

Tavelträffen B 2018

Ramselefors SKF

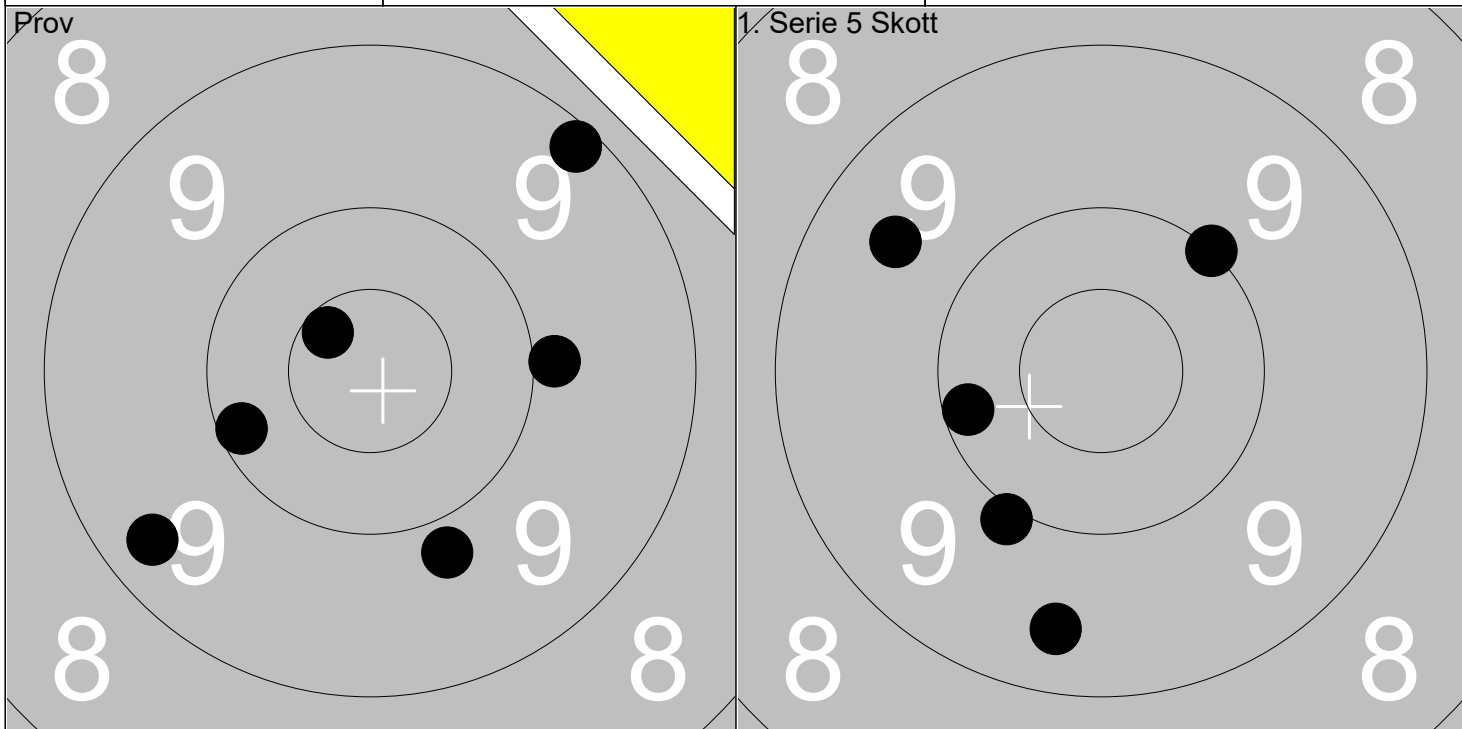

1: 9.9 →
2: 9.2 ↗
3: 10.6x ↖
4: 9.8 ↓
5: 10.2 ←

6: 9.3 ↙

Serie 56

Total 0

1: 10.2 ←
2: 9.4 ↓
3: 9.5 ↖
4: 10.0 ↗
5: 10.0 ↓

Serie 48

Total 48

2. Serie 5 Skott

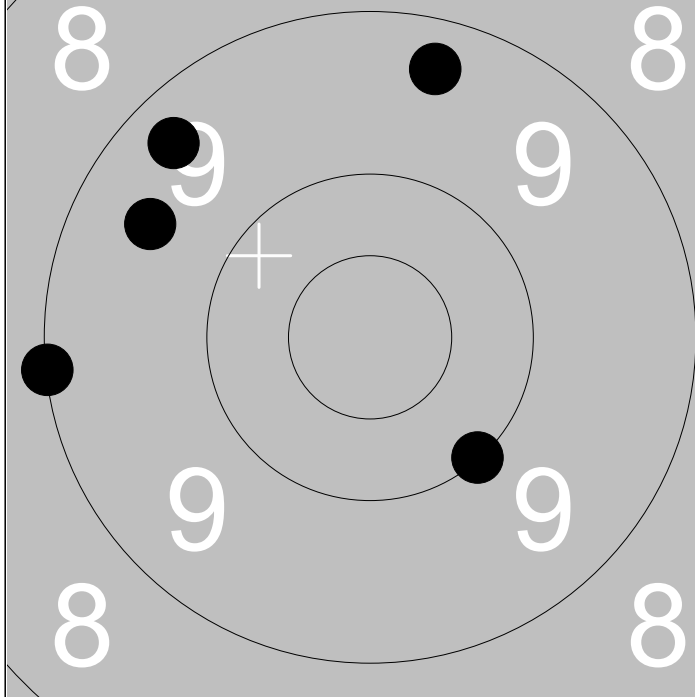

1: 9.0 ←
2: 9.3 ↗
3: 9.5 ↖
4: 9.3 ↗
5: 10.0 ↓

Serie 46

Total 94

3. Serie 5 Skott

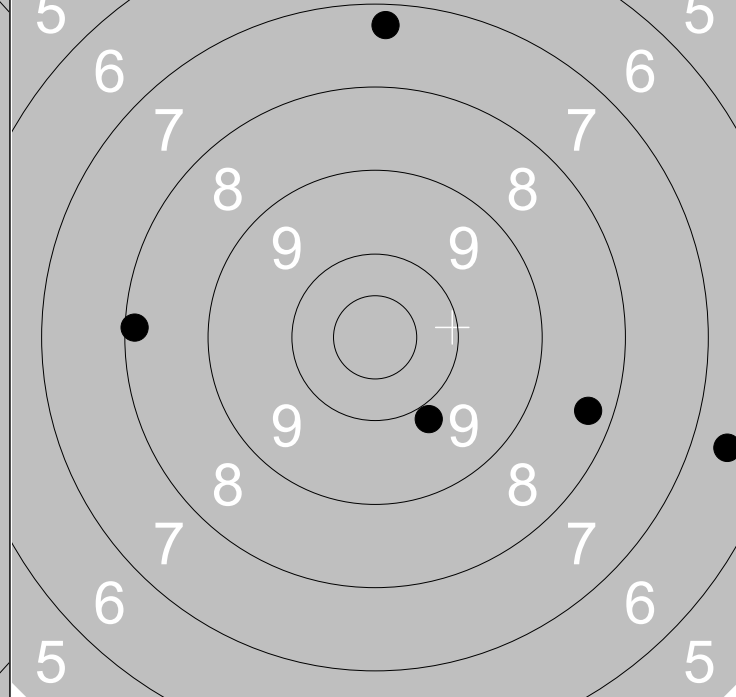

1: 7.3 ↑
2: 8.1 ←
3: 8.3 →
4: 6.6 →
5: 9.9 ↓

Serie 38

Total 132

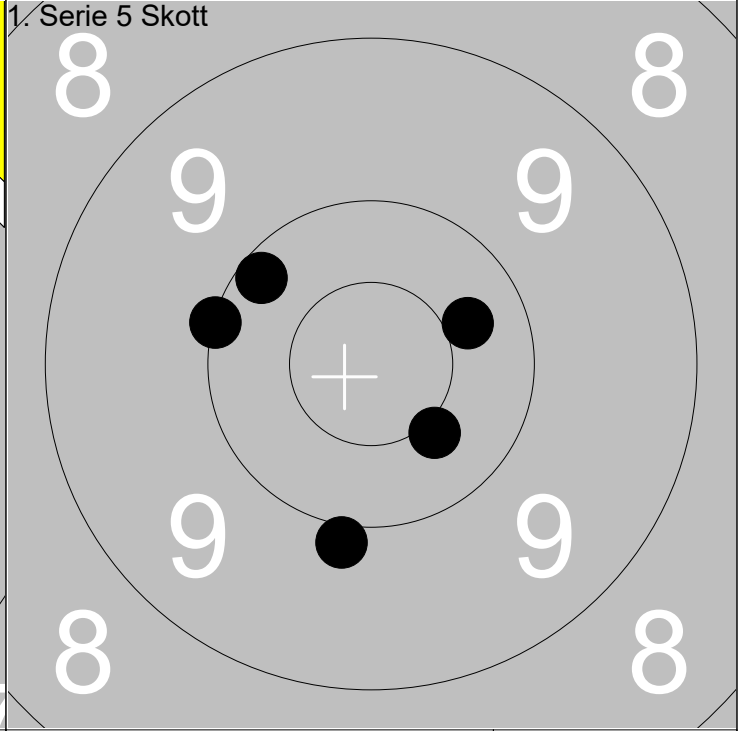
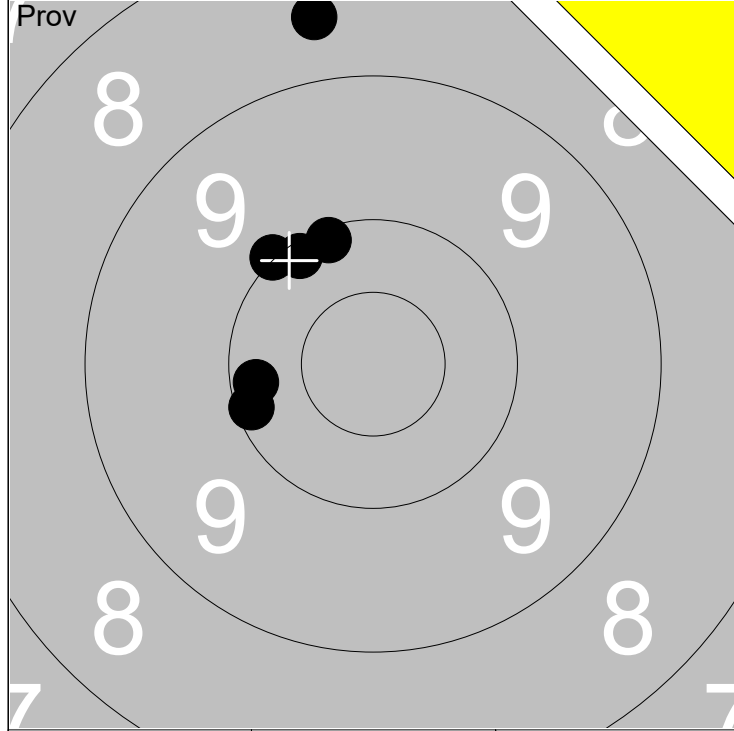

1: 10.1 ←	6: 8.6 ↑		
2: 10.1 ↗		Serie	58
3: 10.2 ←			
4: 10.0 ↗		Total	0
5: 10.1 ↗			

1: 10.4x ↘			
2: 10.4 →		Serie	49
3: 9.9 ↓			
4: 10.2 ↗		Total	49
5: 10.0 ←			

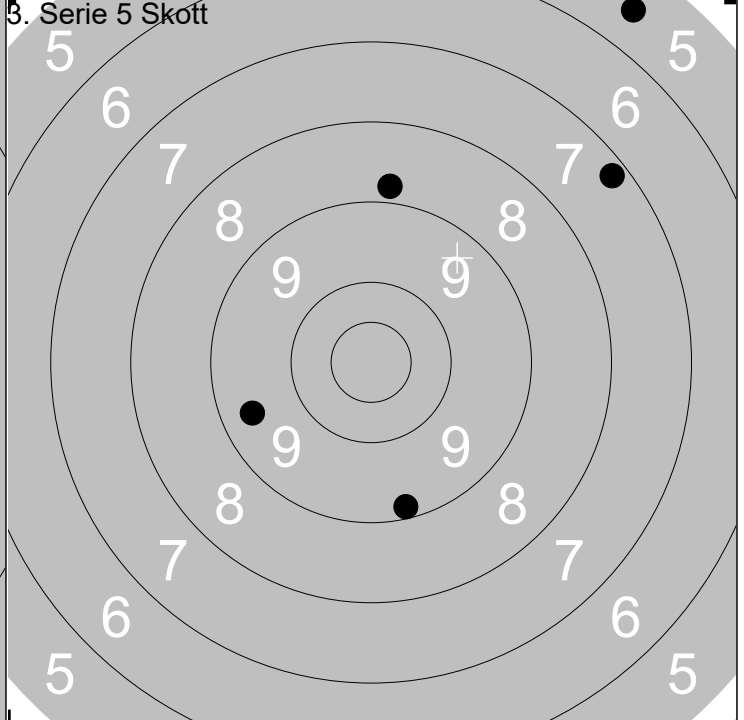
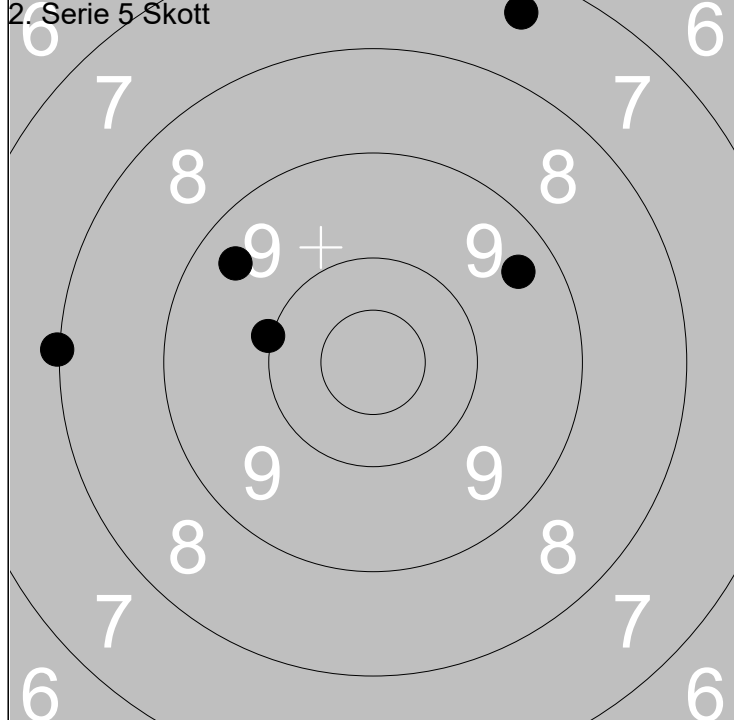

1: 7.4 ↗			
2: 8.0 ←		Serie	43
3: 9.4 ↗			
4: 10.0 ←		Total	92
5: 9.4 ↗			

1: 7.2 ↗			
2: 5.5 ↗		Serie	38
3: 8.8 ↑			
4: 9.4 ←		Total	130
5: 9.2 ↓			

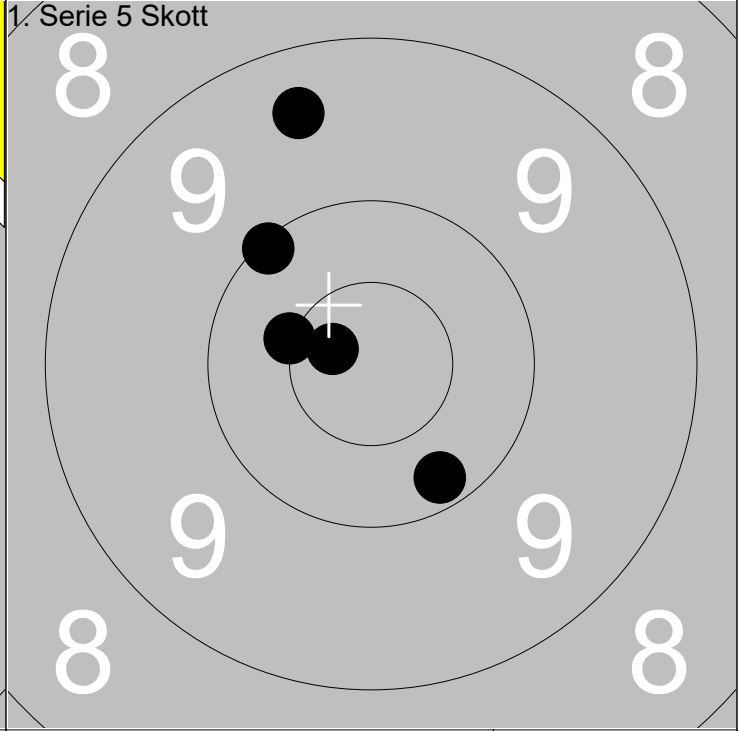
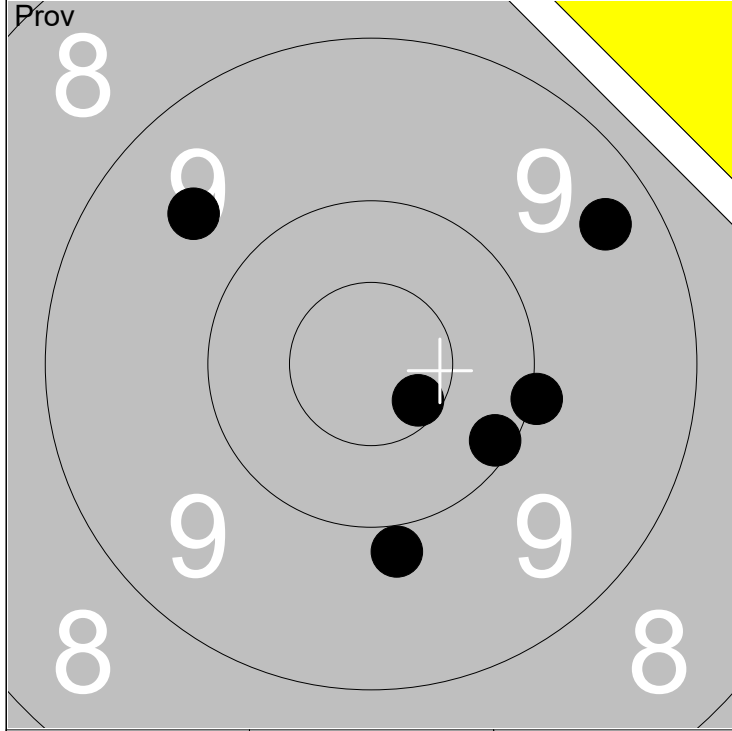

1: 9.4 ↗	6: 10.0 →		
2: 10.1 ↘		Serie	57
3: 9.6 ↗		Total	0
4: 9.9 ↘			
5: 10.6x ↘			

1: 10.2 ↘			
2: 9.4 ↗		Serie	49
3: 10.1 ↗		Total	49
4: 10.7x ↖			
5: 10.5x ↖			

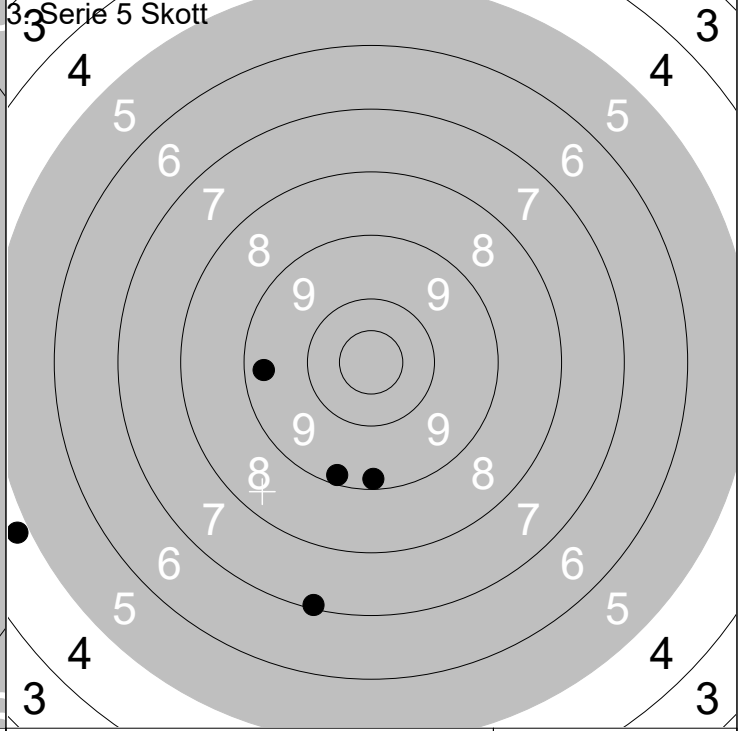
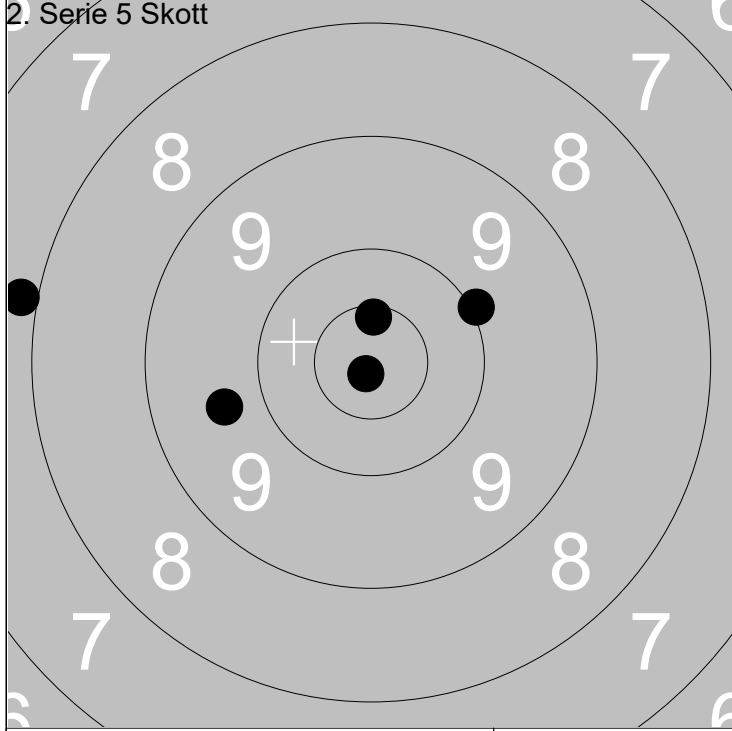

1: 7.9 ←			
2: 9.7 ←		Serie	46
3: 10.6x ↑		Total	95
4: 10.0 ↗			
5: 10.8x ↘			

1: 7.1 ↘			
2: 9.3 ←		Serie	38
3: 9.2 ↘		Total	133
4: 4.8 ←			
5: 9.2 ↘			

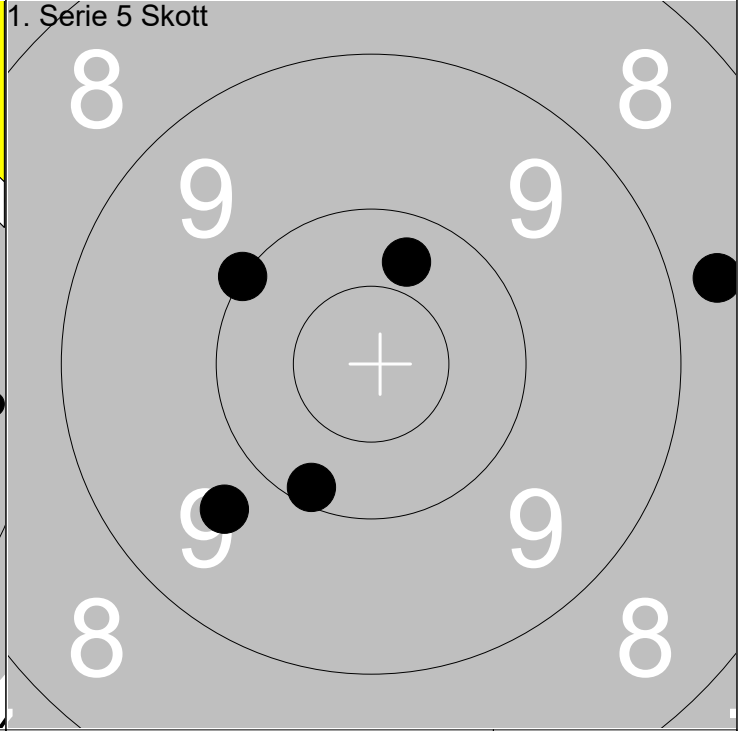
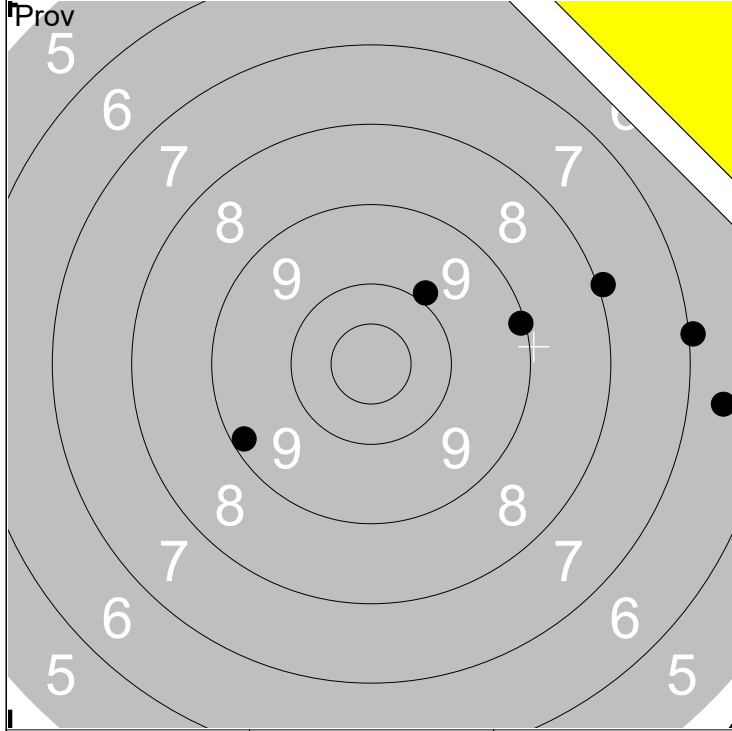

1: 7.0 →	6: 9.2 ←		
2: 6.6 →		Serie	48
3: 9.1 →			
4: 9.9 ↗		Total	0
5: 8.0 →			

1: 10.1 ↘			
2: 10.0 ↖		Serie	47
3: 10.3 ↗			
4: 8.7 →		Total	47
5: 9.7 ↘			

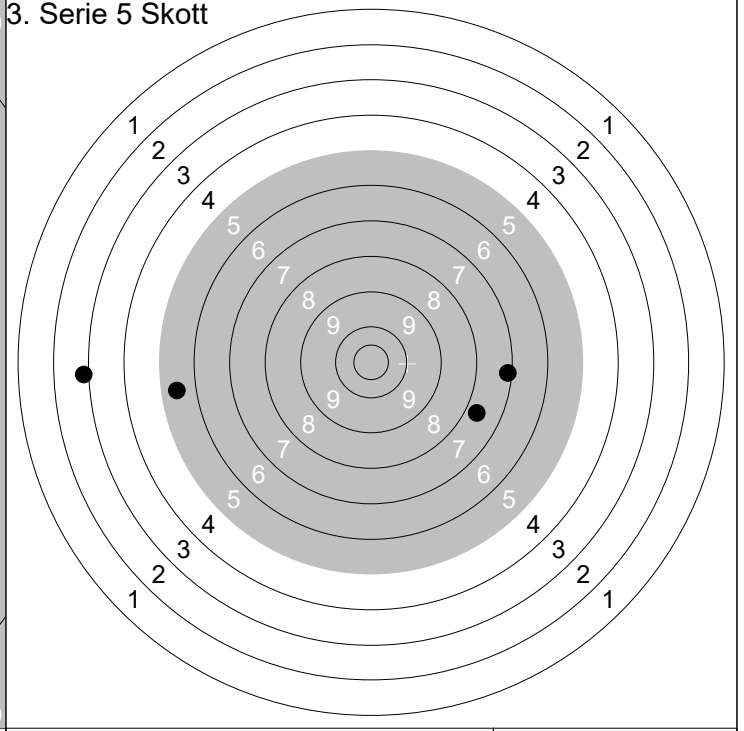
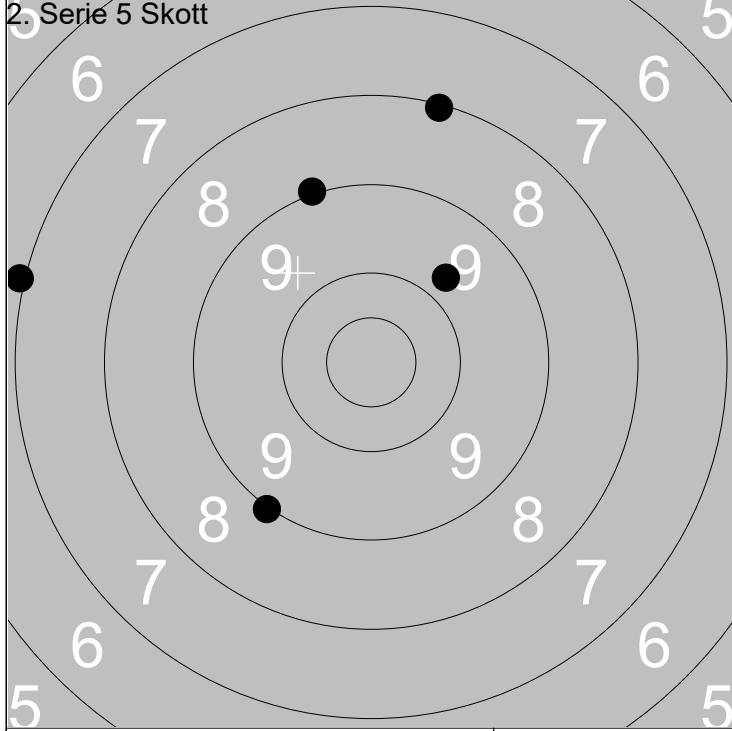

1: 8.1 ↗			
2: 9.0 ↗		Serie	42
3: 9.8 ↗			
4: 7.0 ←		Total	89
5: 9.0 ↘			

1: 2.9 ←			
2: 5.5 ←		Serie	21
3: 0.0 →			
4: 7.7 →		Total	110
5: 7.1 →			

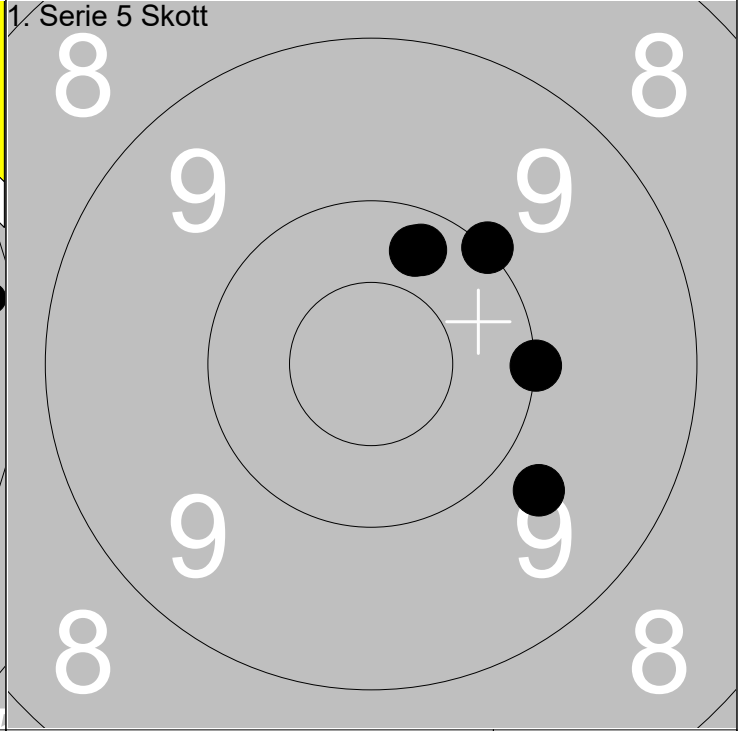
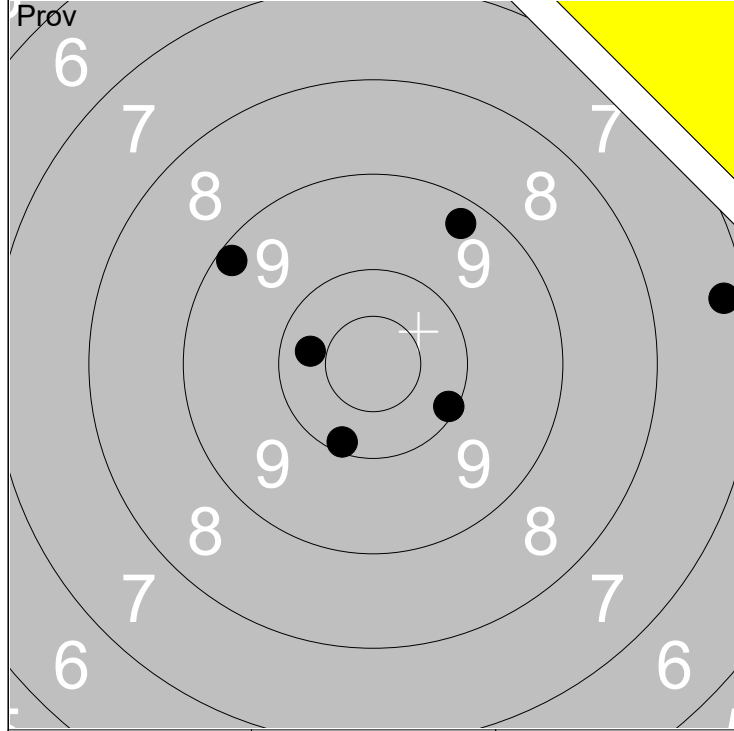

1: 10.1 →	6: 7.3 →				
2: 10.3 ←		Serie	55		
3: 10.1 ↓		Total	0		
4: 9.2 ↖					
5: 9.3 ↗					

1: 10.3 ↗					
2: 10.0 →		Serie	49		
3: 9.7 ↘		Total	49		
4: 10.2 ↗					
5: 10.0 ↗					

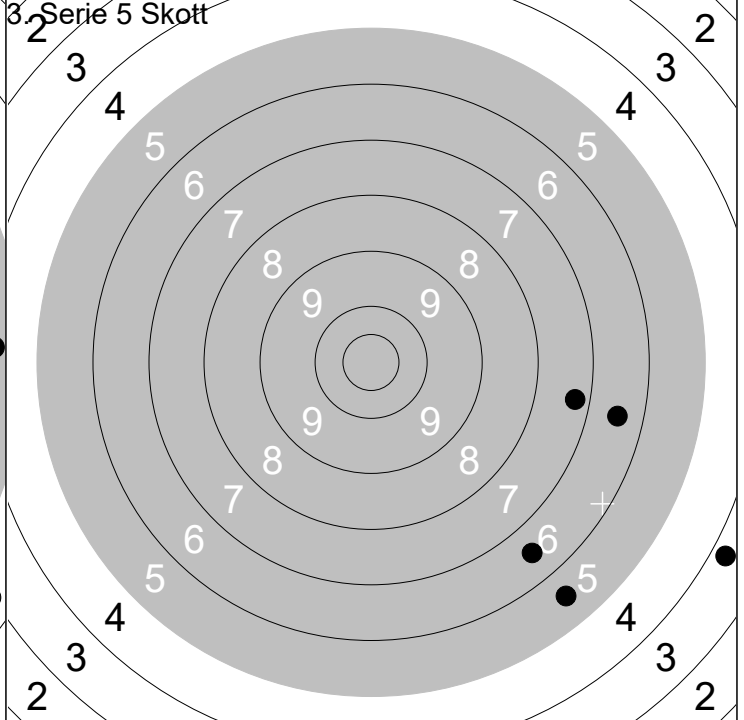
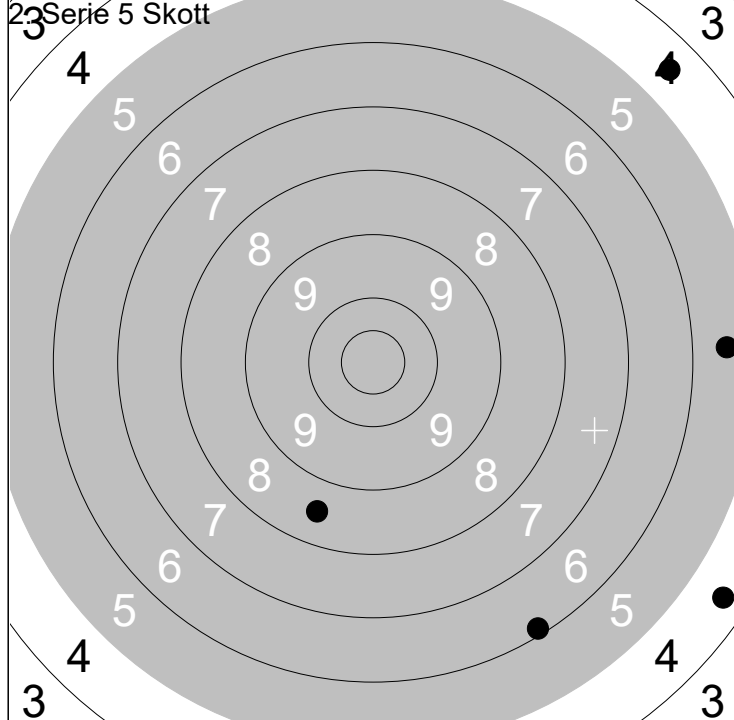

1: 4.5 ↗					
2: 5.5 →		Serie	27		
3: 6.1 ↓		Total	76		
4: 8.5 ↓					
5: 4.4 ↘					

1: 3.8 ↘					
2: 6.5 →		Serie	27		
3: 5.6 ↓		Total	103		
4: 7.3 →					
5: 6.5 ↓					

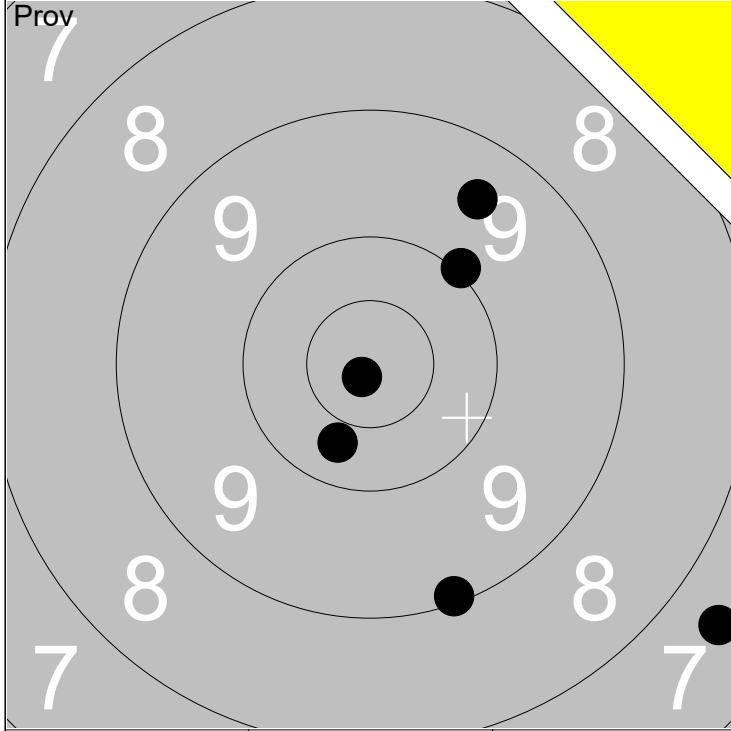

1: 9.5 ↗	6: 9.1 ↓
2: 10.0 ↗	
3: 10.3 ↓	
4: 10.8x ↓	
5: 7.6 ↘	

Serie	55
Total	0

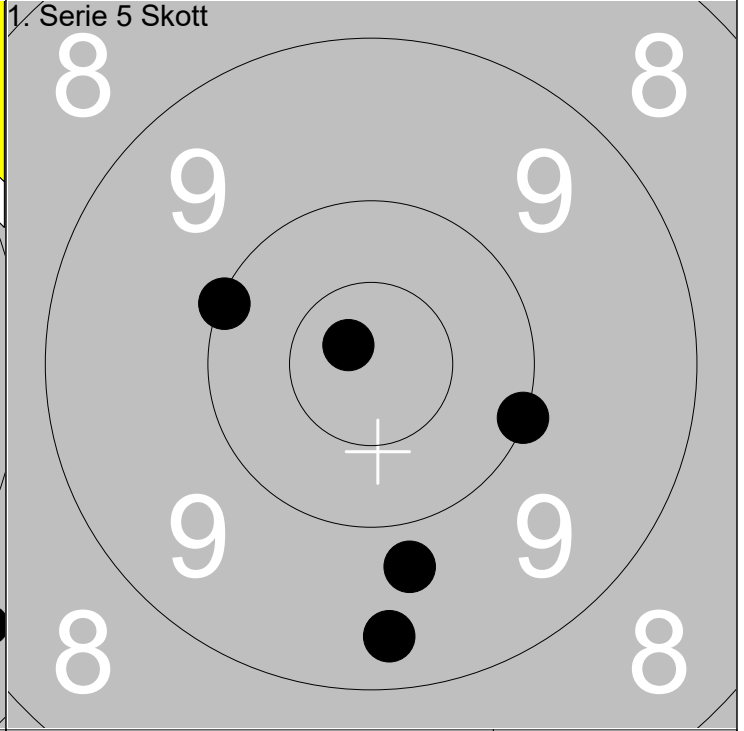

1: 9.4 ↓	2: 9.8 ↓
3: 10.0 →	
4: 10.0 ↖	
5: 10.8x ↖	

Serie	48
Total	48

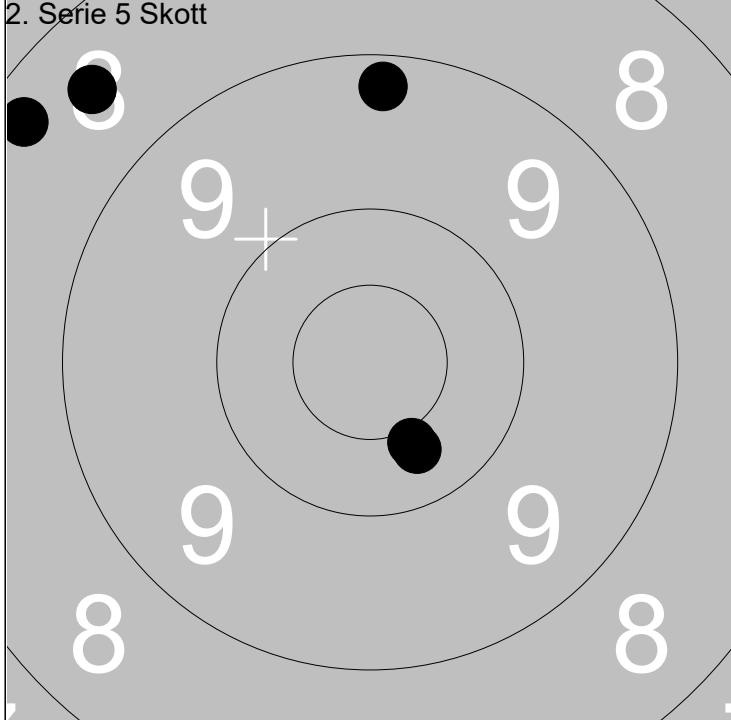

1: 8.3 ↖	2: 10.4 ↓
3: 10.4 ↓	
4: 8.5 ↗	
5: 9.2 ↑	

Serie	45
Total	93

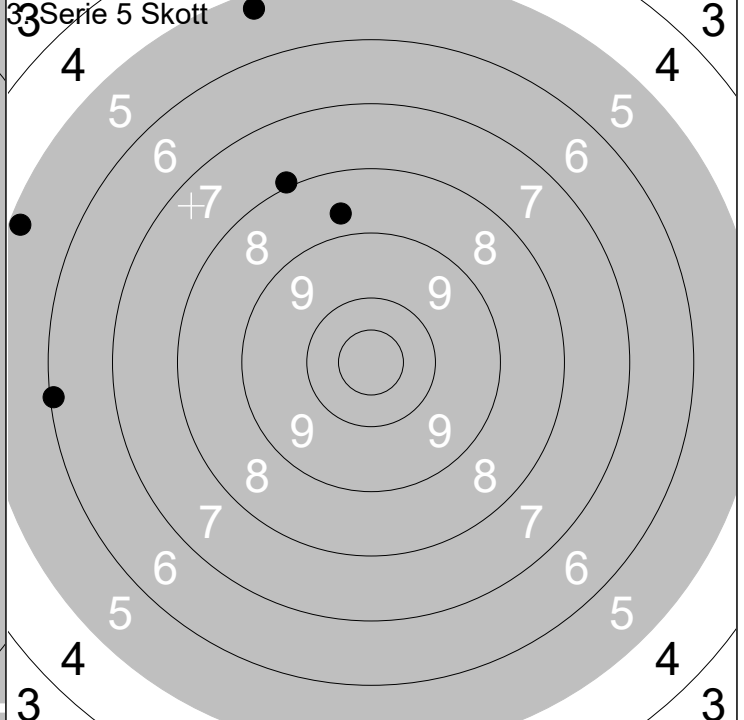

1: 8.7 ↗	2: 5.3 ↗
3: 6.1 ←	
4: 7.9 ↗	
5: 5.2 ↖	

Serie	31
Total	124

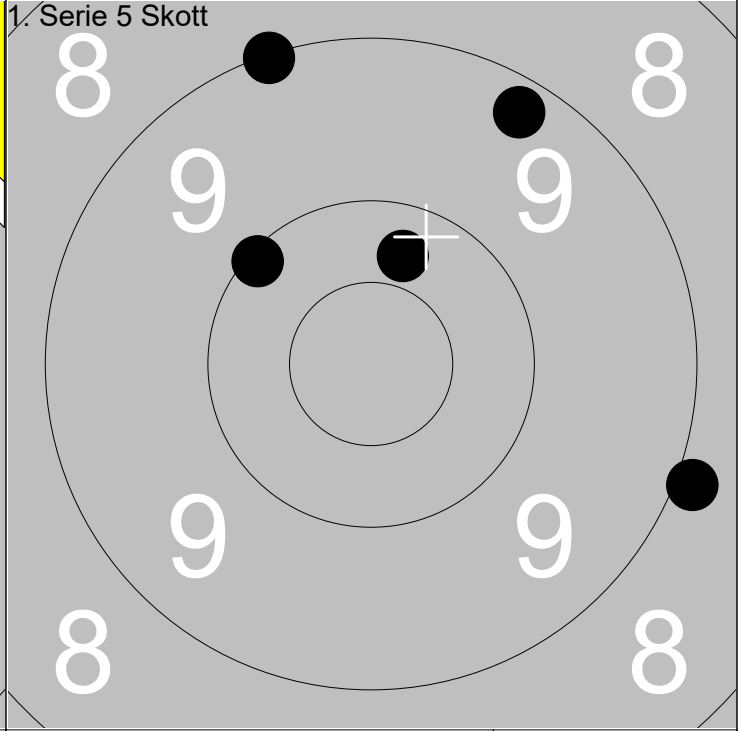
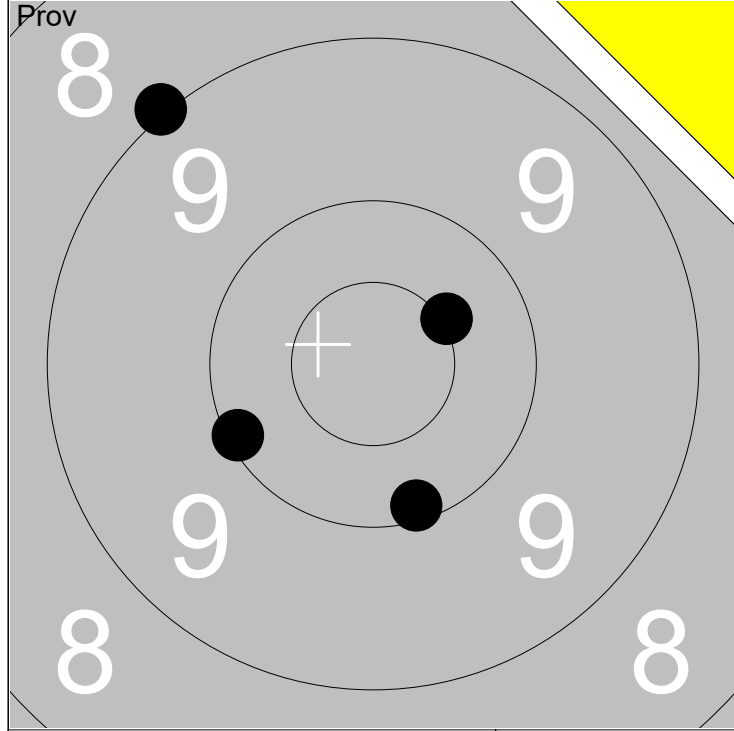

1: 9.0 ↖
2: 10.5x ↗
3: 10.1 ↙
4: 10.1 ↘

Serie	39
Total	0

1: 9.2 ↗
2: 8.9 →
3: 9.1 ↗
4: 10.3 ↗
5: 10.1 ↖

Serie	46
Total	46

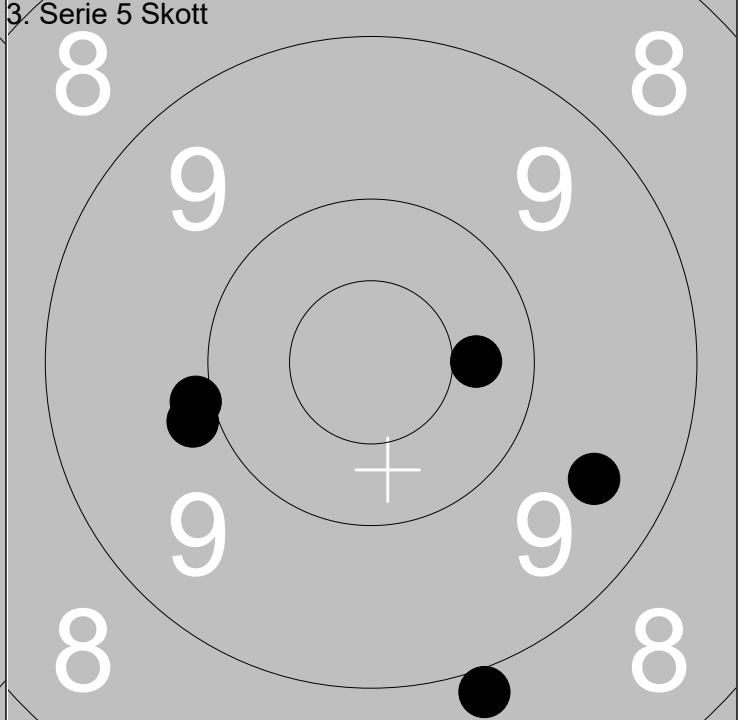
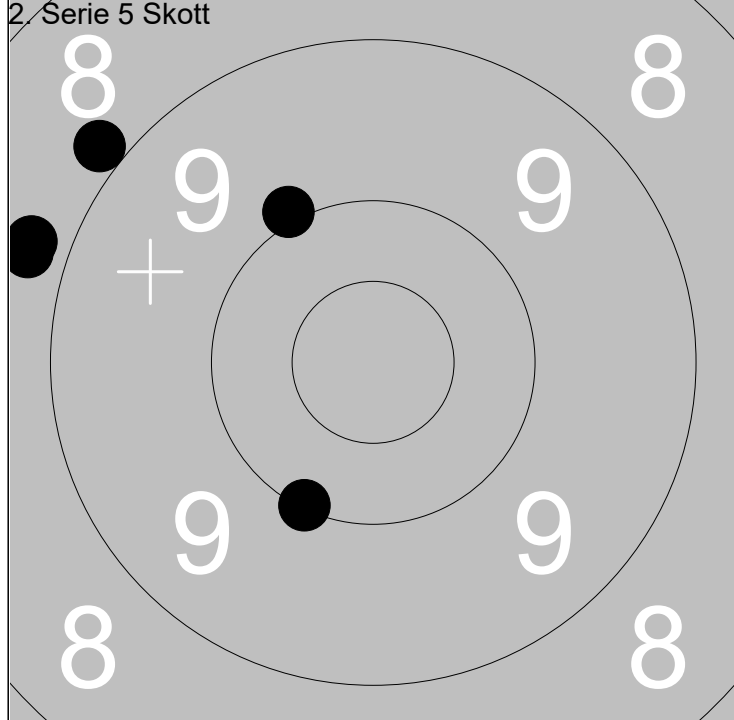

1: 10.0 ↗
2: 8.8 ↙
3: 8.8 ↙
4: 8.9 ↗
5: 10.0 ↘

Serie	44
Total	90

1: 8.9 ↘
2: 9.9 ↙
3: 9.9 ↙
4: 10.4 →
5: 9.5 →

Serie	45
Total	135

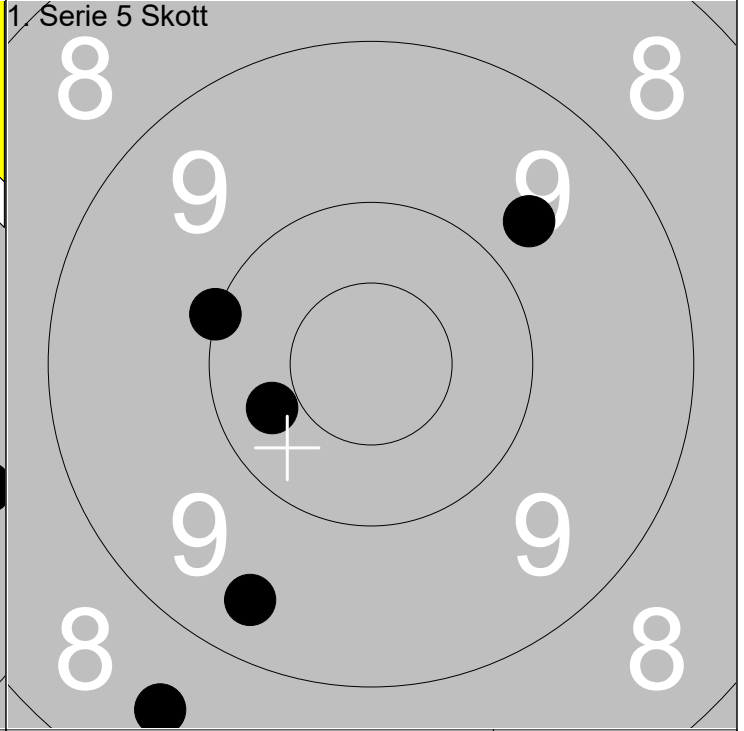
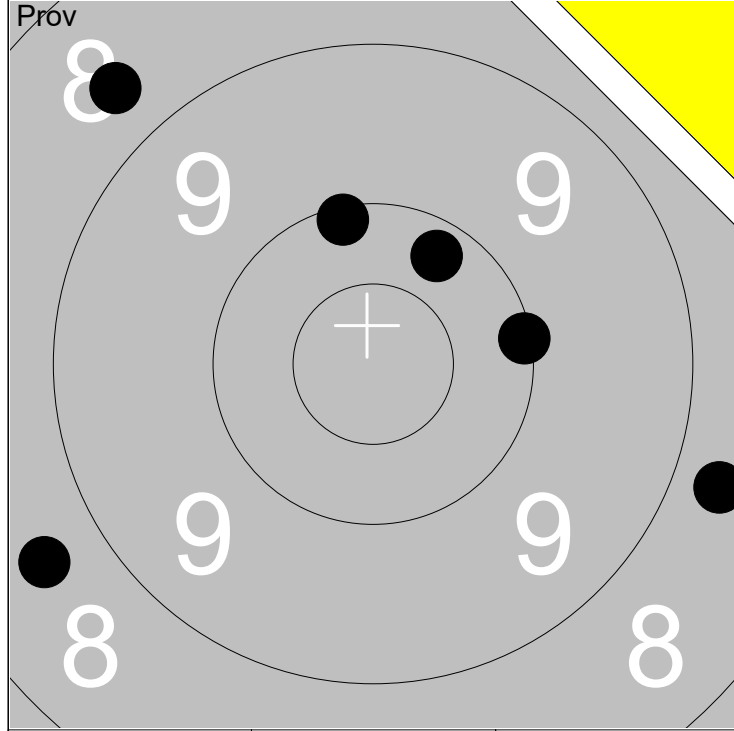

1: 8.7 →	6: 8.6 ←					
2: 10.1 ↑		Serie	54			
3: 10.2 ↗						
4: 10.1 →				Total	0	
5: 8.7 ↖						

1: 9.7 ↗						
2: 10.3 ←		Serie	46			
3: 9.4 ↓						
4: 8.5 ↓				Total	46	
5: 10.0 ←						

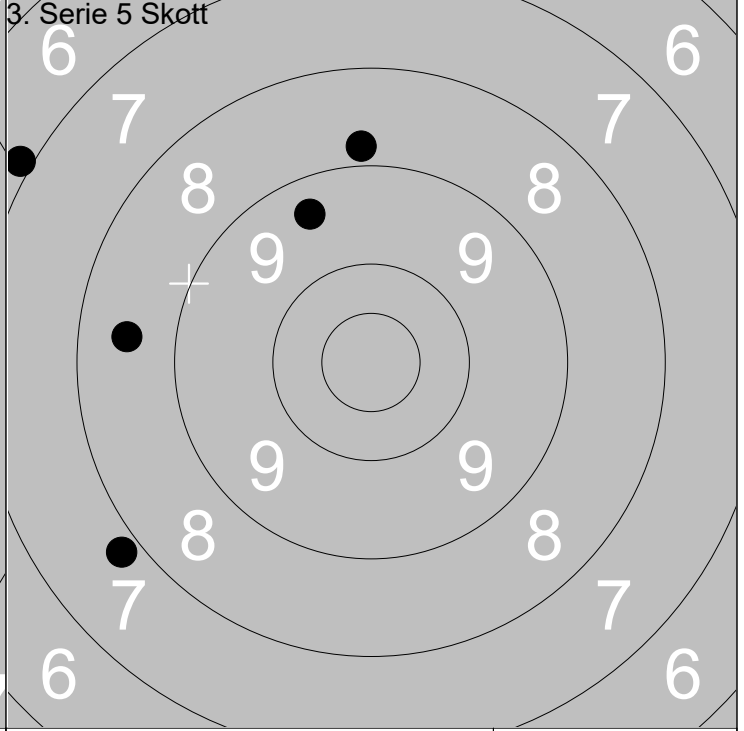
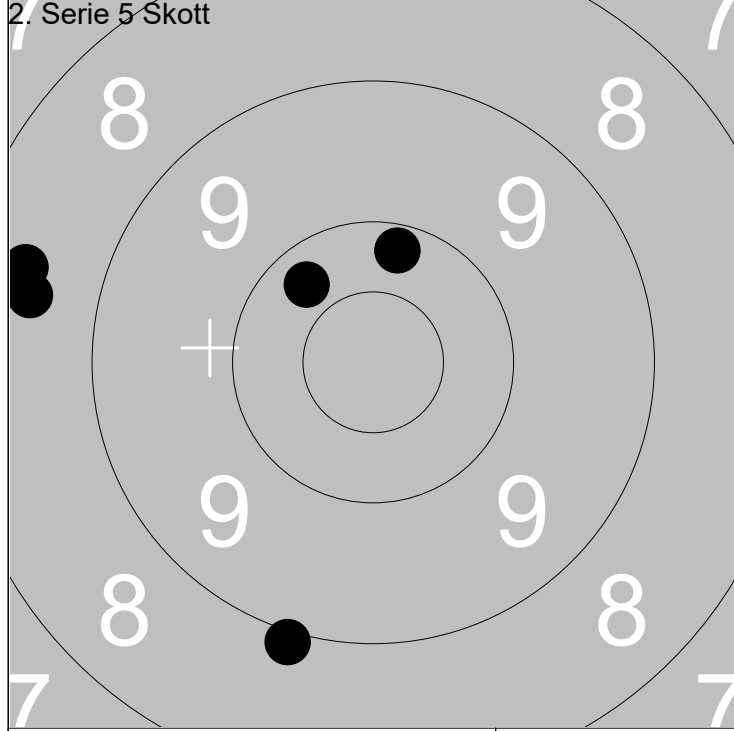

1: 10.2 ↑						
2: 8.5 ←		Serie	44			
3: 8.5 ←						
4: 10.3 ↗				Total	90	
5: 8.9 ↓						

1: 6.9 ↖						
2: 7.8 ←		Serie	38			
3: 9.4 ↑						
4: 8.5 ←				Total	128	
5: 8.8 ↑						

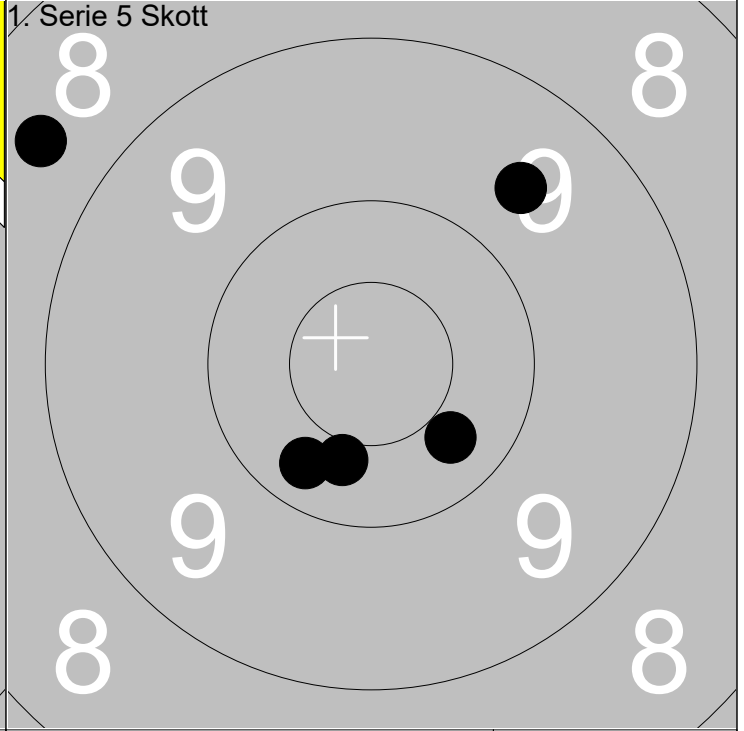
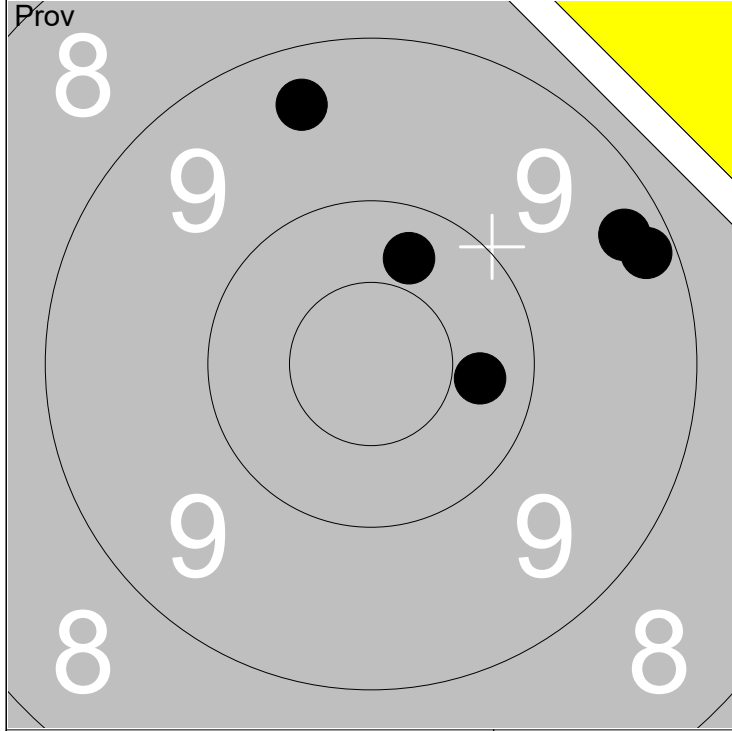

1: 9.3 ↗	Serie 47
2: 9.2 →	
3: 9.4 ↑	
4: 10.3 →	
5: 10.3 ↑	
Total 0	

1: 10.4 ↓	Serie 47
2: 8.6 ↖	
3: 10.3 ↓	
4: 10.3 ↓	
5: 9.6 ↗	
Total 47	

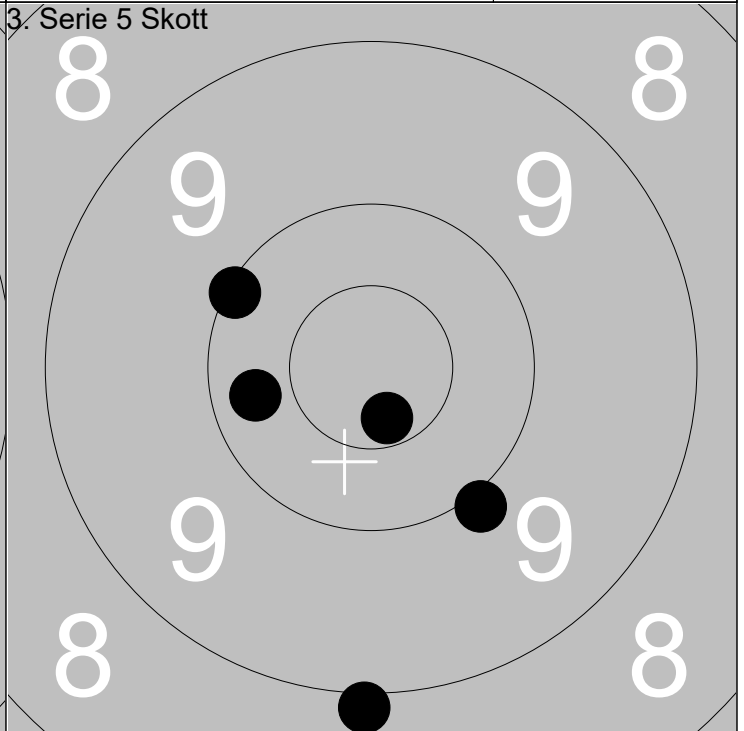
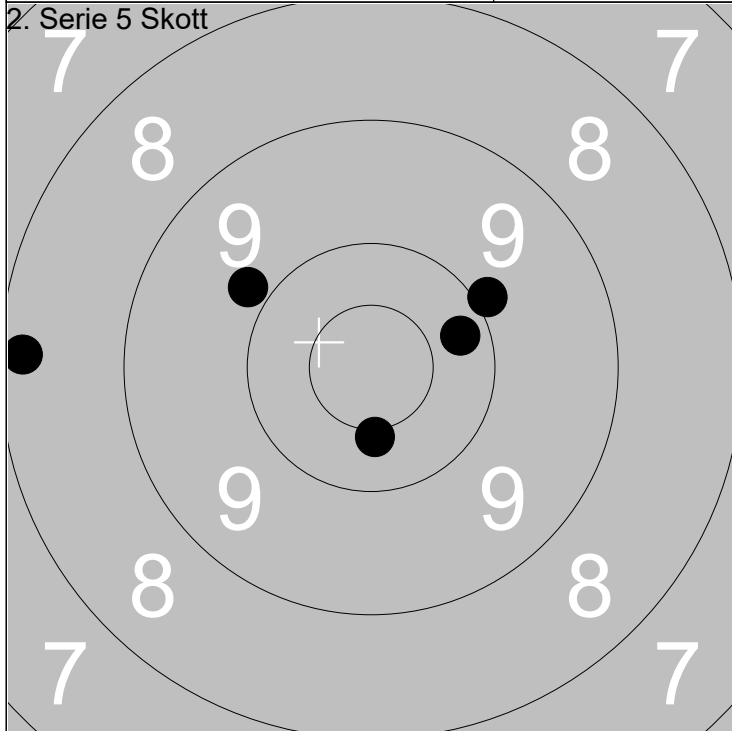

1: 9.9 ↗	Serie 46
2: 9.8 ↖	
3: 8.2 ←	
4: 10.2 →	
5: 10.4x ↓	
Total 93	

1: 8.9 ↓	Serie 47
2: 10.6x ↓	
3: 9.9 ↓	
4: 10.1 ↖	
5: 10.3 ←	
Total 140	

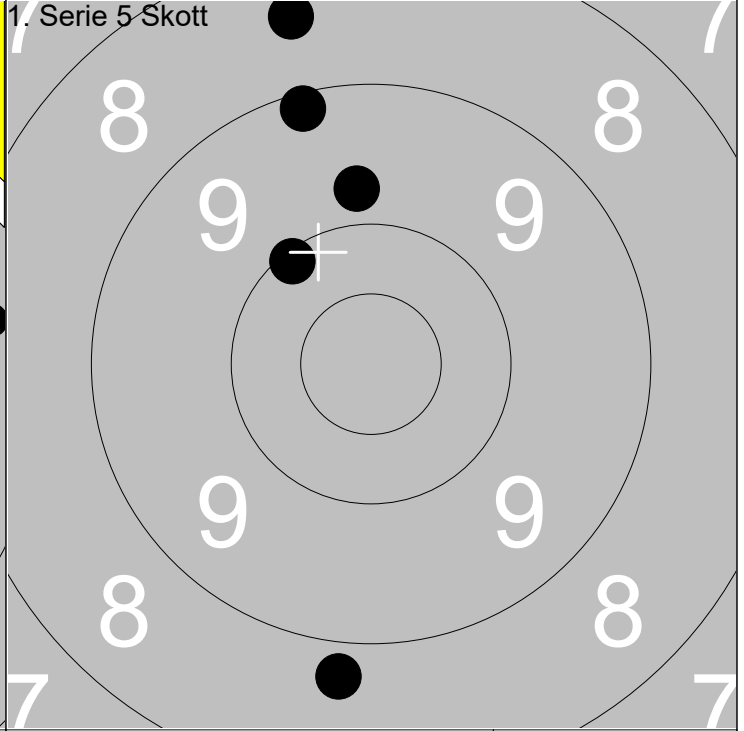
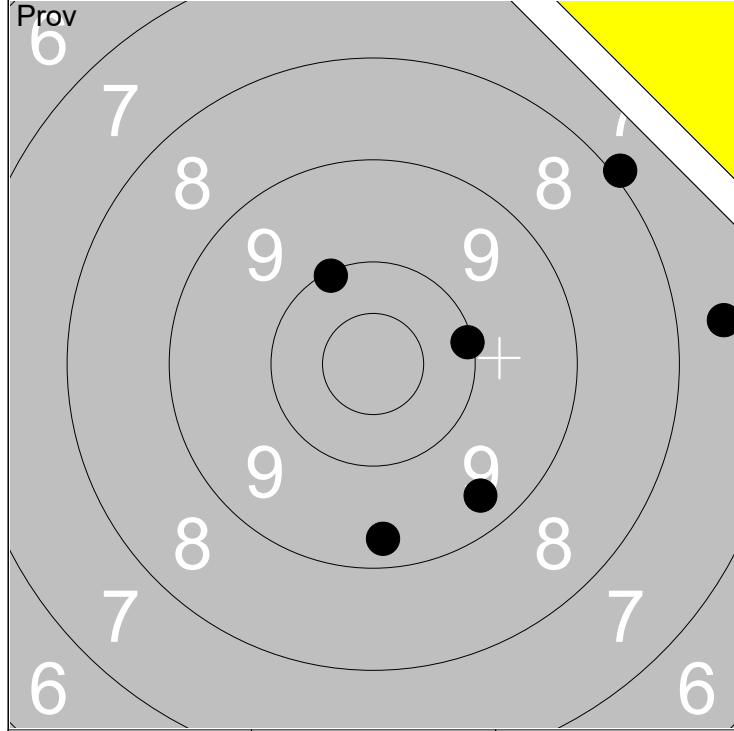

1: 10.1 →	6: 9.3 ↓				
2: 7.6 →		Serie	53		
3: 9.4 ↘		Total	0		
4: 10.1 ↗					
5: 8.0 ↗					

1: 8.5 ↑					
2: 9.1 ↑		Serie	44		
3: 9.8 ↑		Total	44		
4: 8.8 ↓					
5: 10.1 ↖					

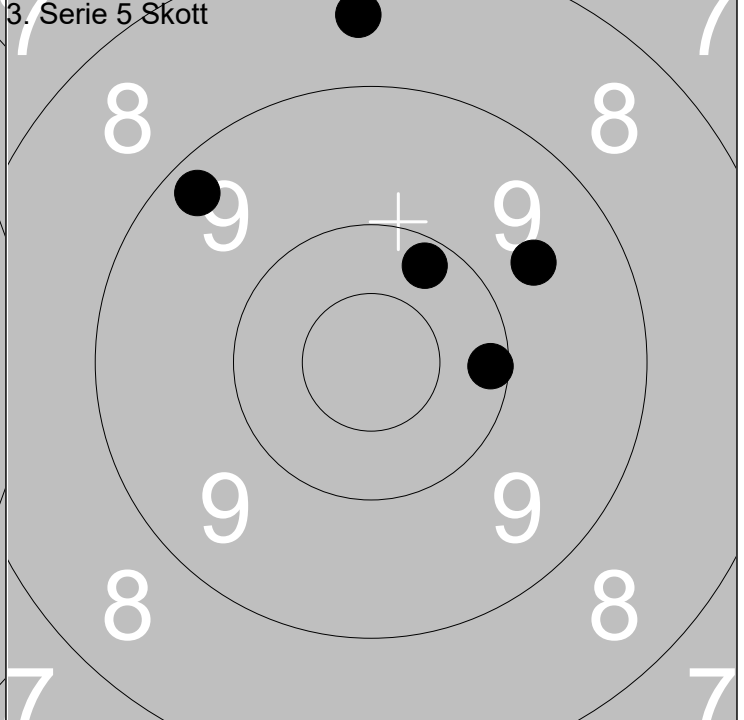
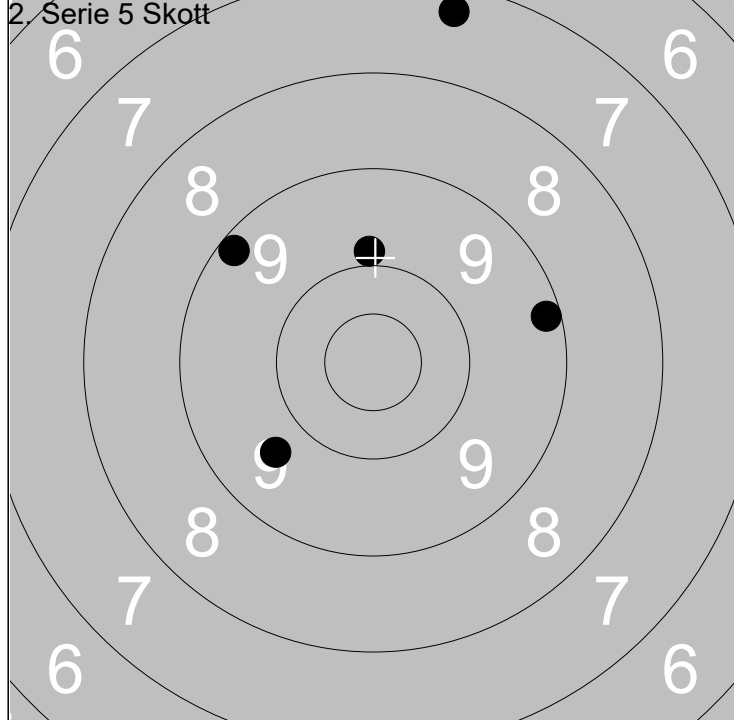

1: 9.7 ↙					
2: 7.3 ↑		Serie	43		
3: 9.2 ↖		Total	87		
4: 9.9 ↑					
5: 9.2 →					

1: 9.6 ↗					
2: 9.3 ↖		Serie	46		
3: 8.5 ↑		Total	133		
4: 10.2 ↗					
5: 10.1 →					

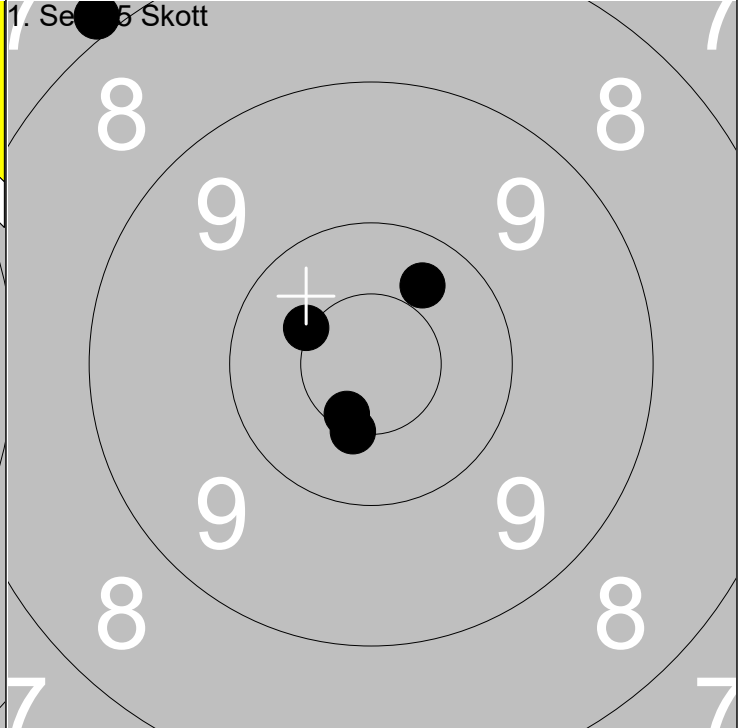
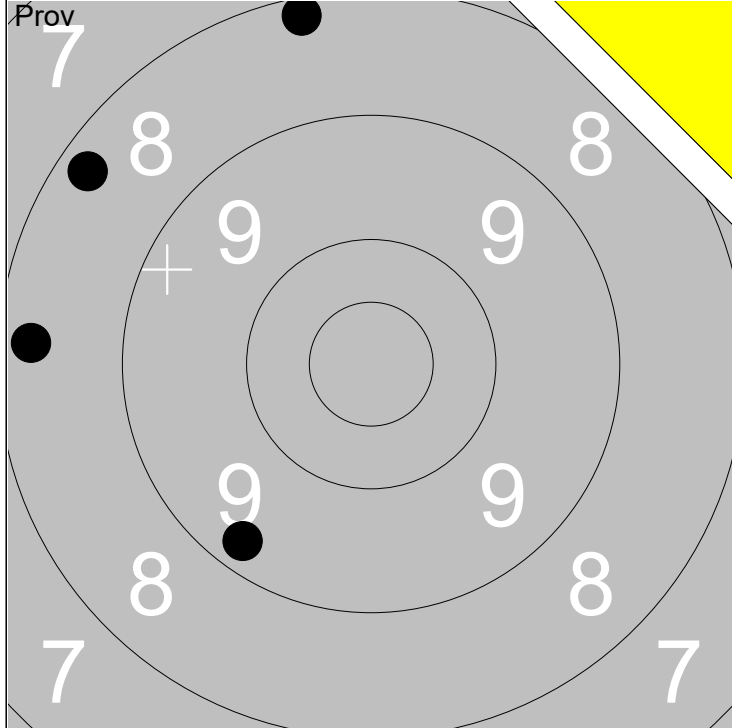

1: 9.3 ↙	Serie 33
2: 8.2 ↑	
3: 8.3 ←	
4: 8.3 ↖	
Total 0	

1: 10.5x ↖	Serie 47
2: 10.6x ↙	
3: 7.9 ↖	
4: 10.3 ↗	
5: 10.5x ↙	
Total 47	

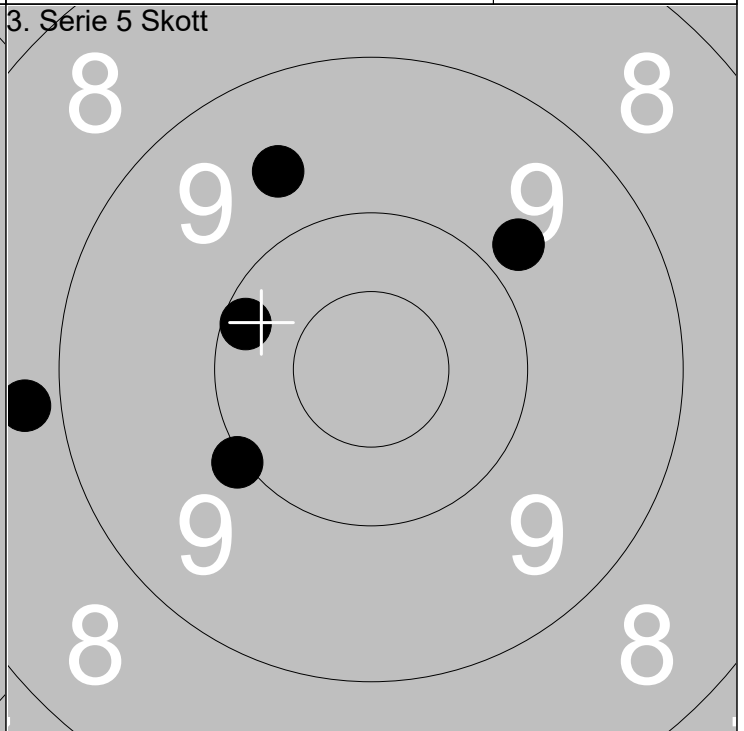
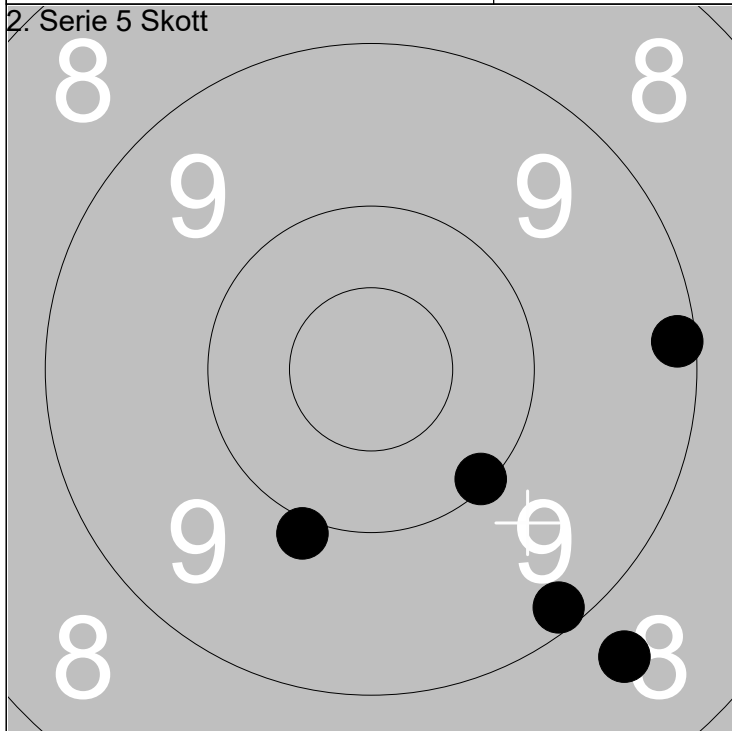

1: 9.1 →	Serie 45
2: 8.7 ↙	
3: 9.2 ↙	
4: 10.1 ↙	
5: 9.9 ↙	
Total 92	

1: 8.8 ←	Serie 46
2: 10.0 ↙	
3: 9.6 ↗	
4: 10.2 ↖	
5: 9.8 ↗	
Total 138	

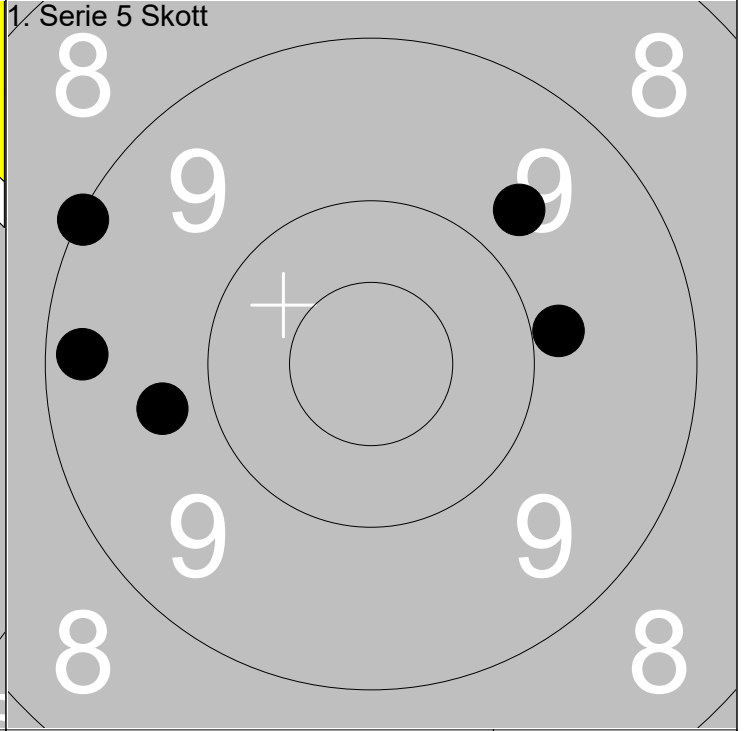
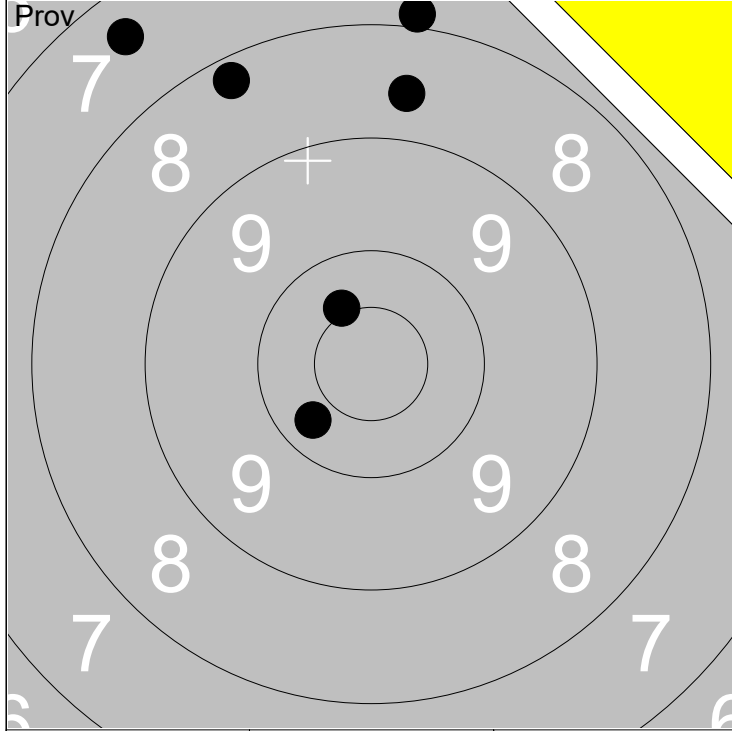

1: 10.4x ↖	6: 7.9 ↑		
2: 10.3 ↙		Serie	50
3: 7.4 ↖			
4: 8.2 ↖		Total	0
5: 8.6 ↑			

1: 9.1 ↖			
2: 9.3 ←		Serie	45
3: 9.7 ↗			
4: 9.7 ←		Total	45
5: 9.9 →			

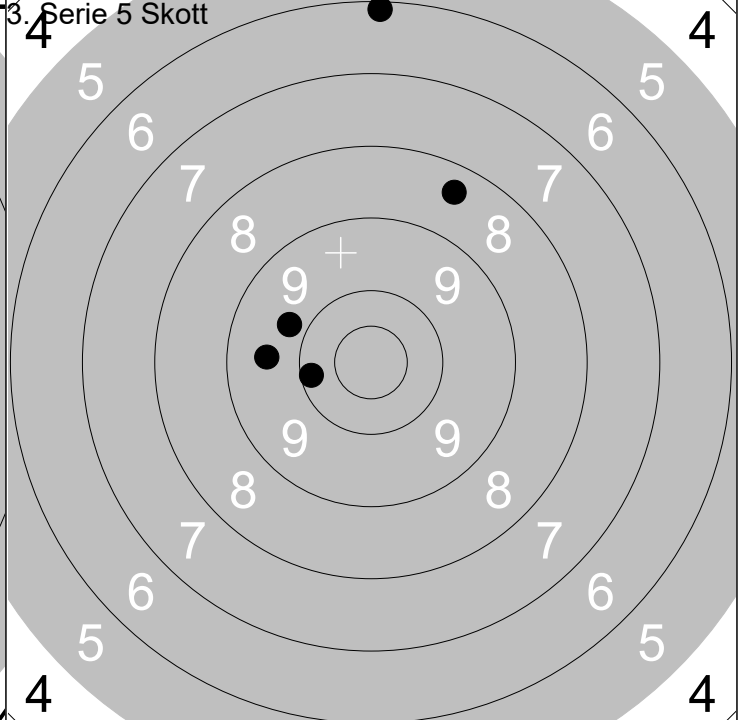
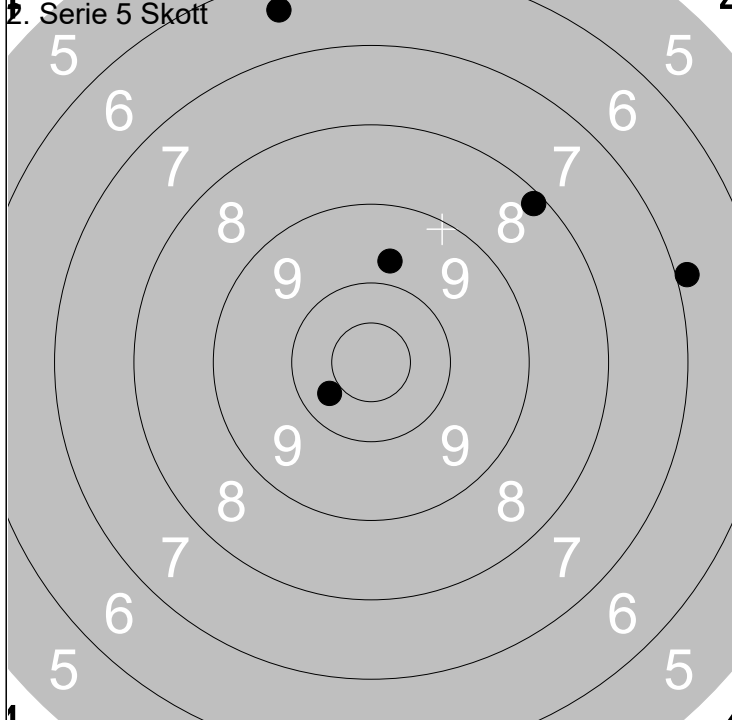

1: 10.3 ↙			
2: 6.4 ↑		Serie	39
3: 9.7 ↑			
4: 6.9 →		Total	84
5: 8.2 ↗			

1: 9.8 ↖			
2: 8.4 ↗		Serie	42
3: 10.2 ←			
4: 6.1 ↑		Total	126
5: 9.6 ←			

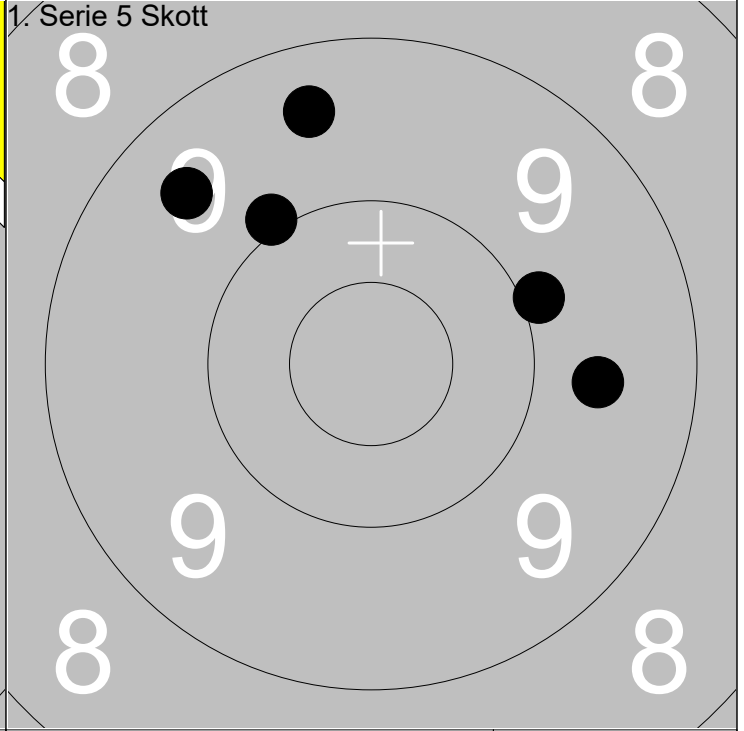
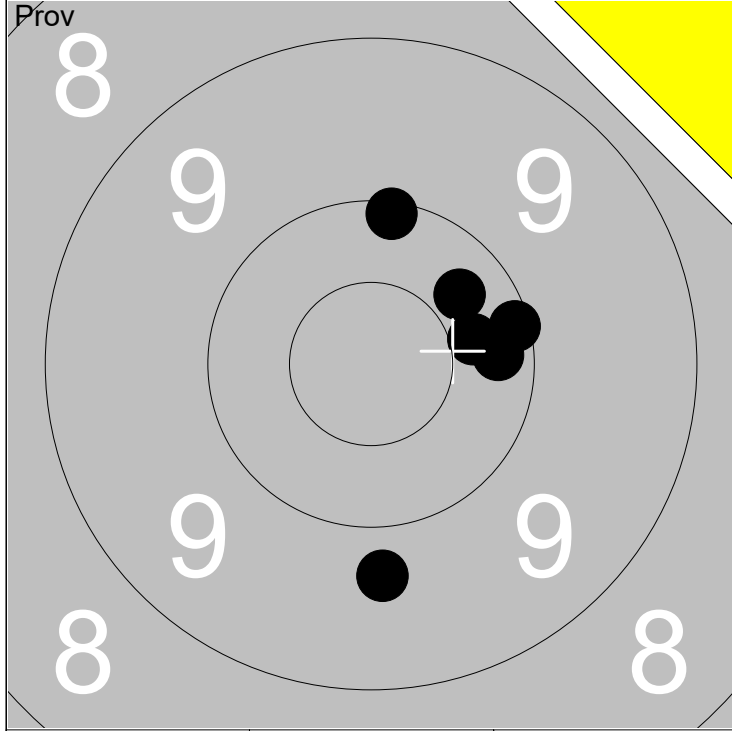

1: 9.7 ↓	6: 10.2 →		
2: 10.1 ↑		Serie	59
3: 10.1 →			
4: 10.3 ↗		Total	0
5: 10.4 →			

1: 9.5 ↖			
2: 10.0 ↖		Serie	46
3: 9.4 ↑			
4: 9.6 →		Total	46
5: 9.9 →			

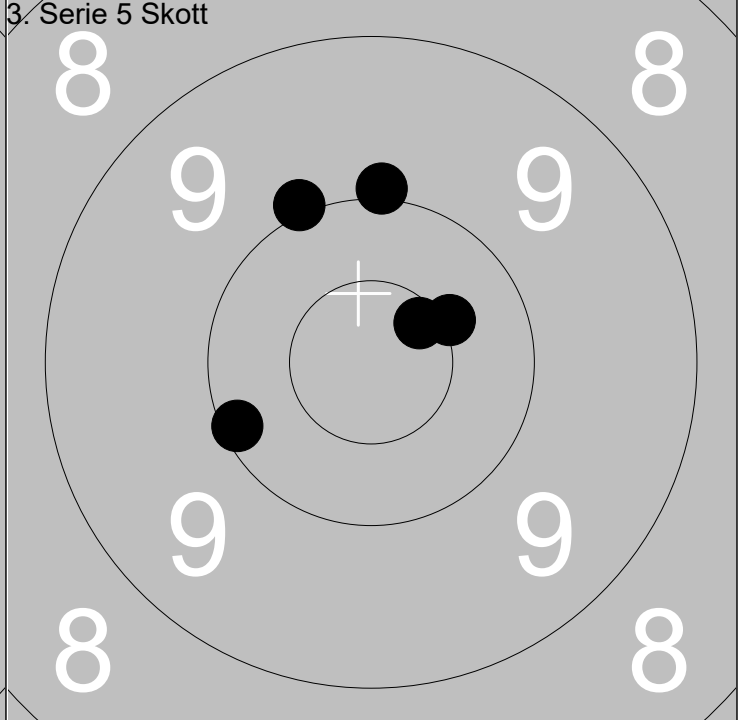
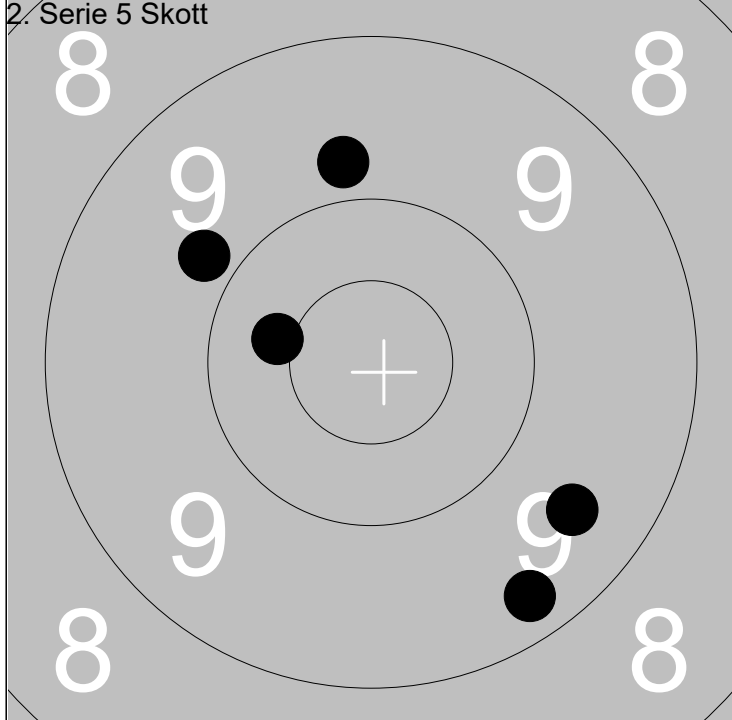

1: 10.4 ↖			
2: 9.8 ↗		Serie	46
3: 9.3 ↓			
4: 9.8 ↑		Total	92
5: 9.5 ↘			

1: 10.6x ↗			
2: 10.0 ↖		Serie	50
3: 10.4x ↗			
4: 10.0 ↑		Total	142
5: 10.1 ↖			

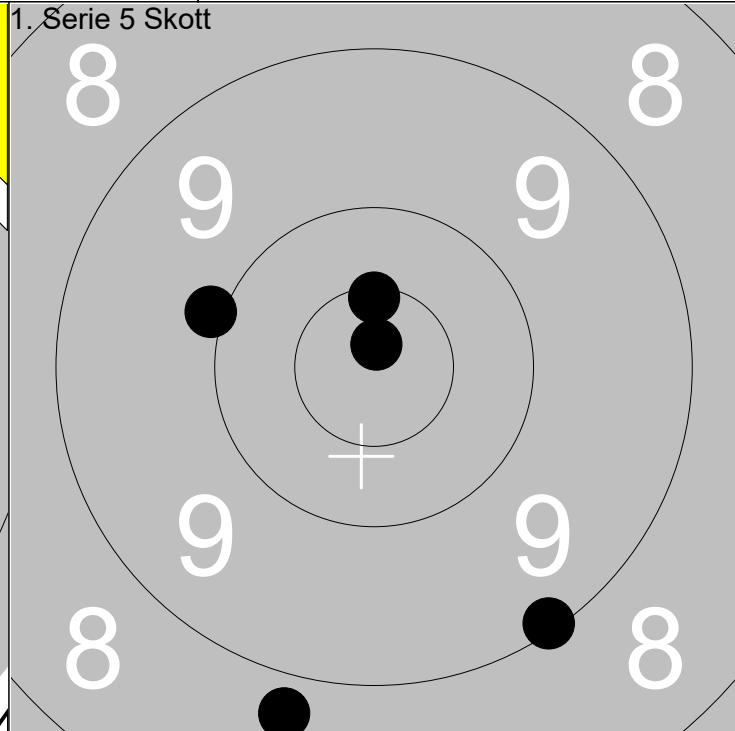
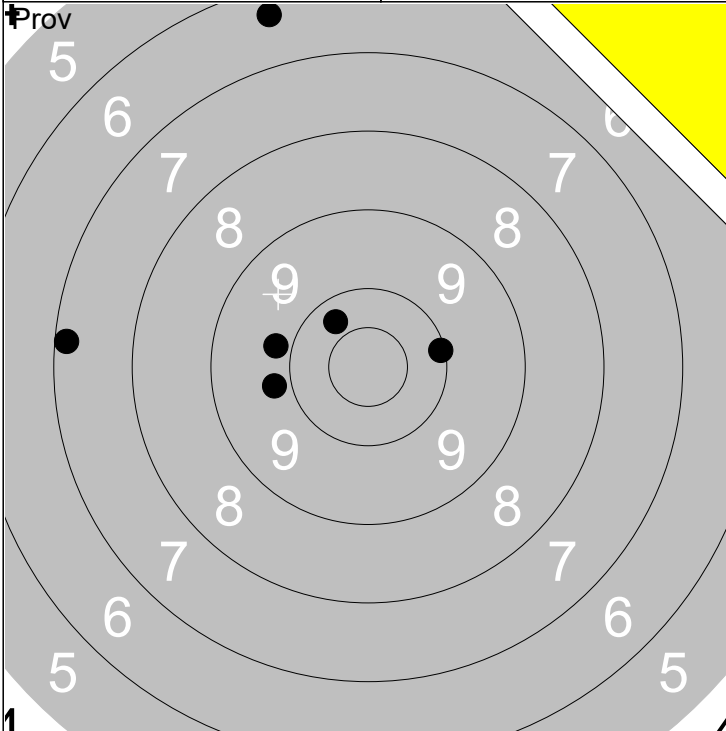

1: 9.8	←
2: 10.1	→
3: 7.2	←
4: 10.3	↗
5: 6.4	↗
Serie	51
Total	0

1: 9.9	↖
2: 9.1	↘
3: 8.8	↘
4: 10.5x	↑
5: 10.8x	↑
Serie	46
Total	46

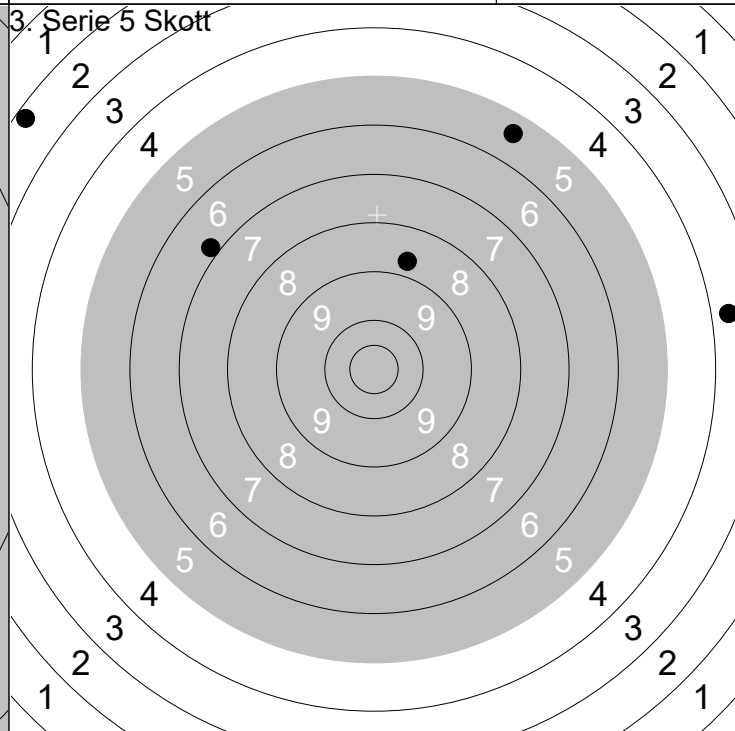
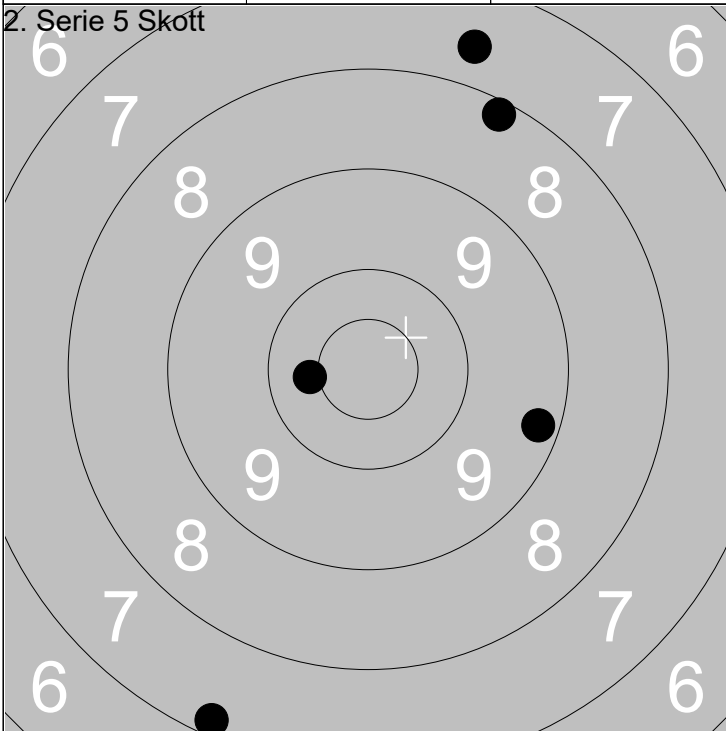

1: 7.6	↗
2: 10.4	←
3: 9.2	→
4: 8.2	↗
5: 7.2	↘
Serie	41
Total	87

1: 3.7	→
2: 2.2	↖
3: 8.7	↗
4: 6.9	↖
5: 5.4	↗
Serie	24
Total	111

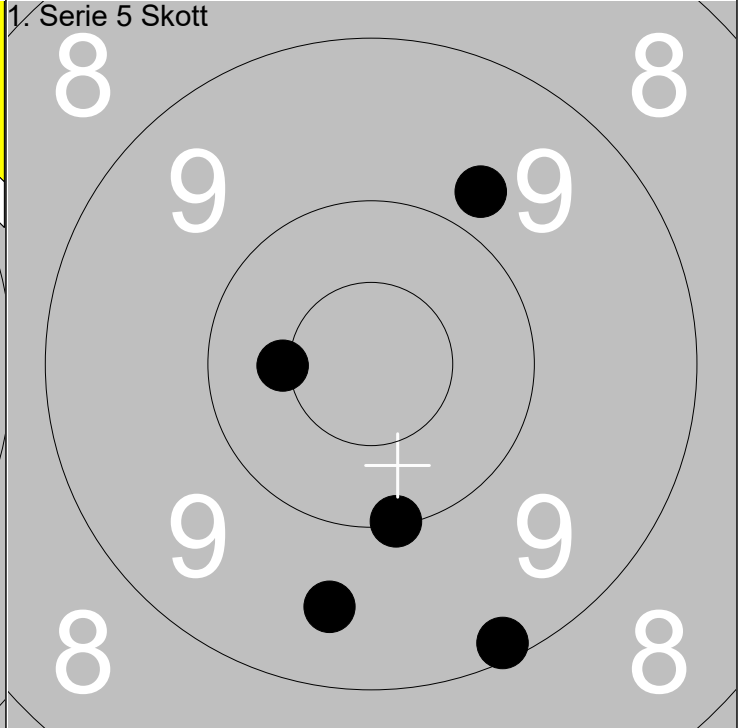
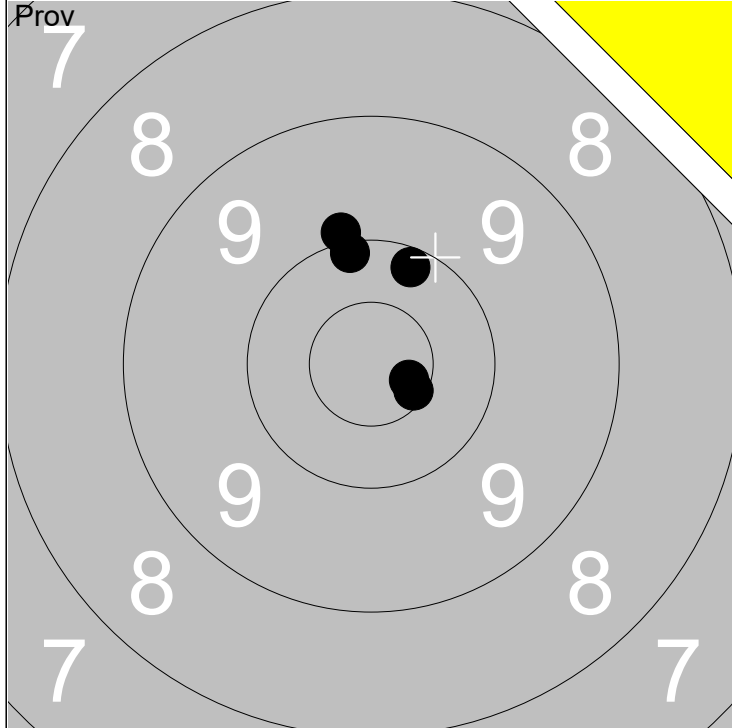

1: 7.2 ↗	6: 10.6x ↘	Serie	56
2: 10.2 ↑			
3: 9.9 ↑		Total	0
4: 10.1 ↑			
5: 10.6x ➤			

1: 9.8 ↗	Serie	47
2: 10.0 ↓		
3: 9.5 ↓	Total	47
4: 9.1 ↓		
5: 10.4x ←		

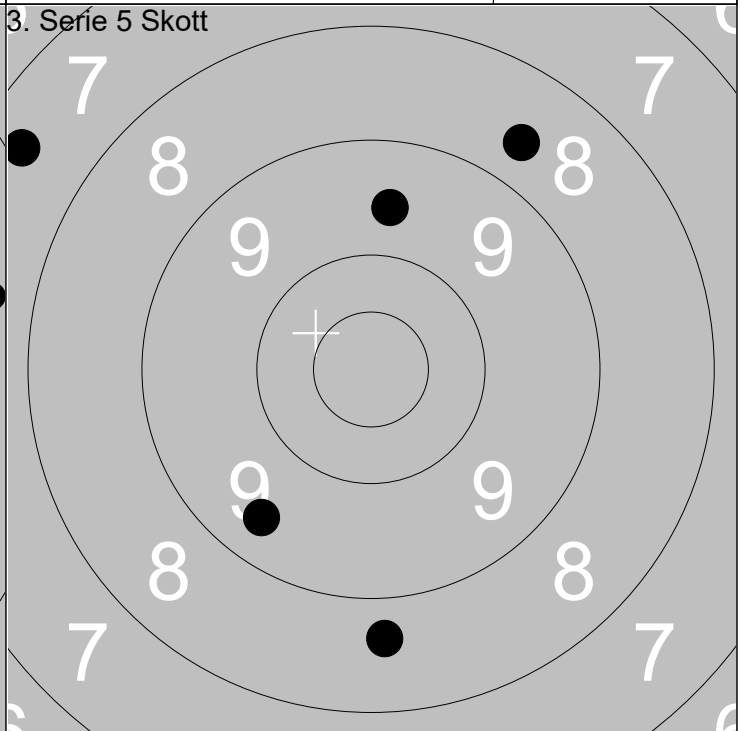
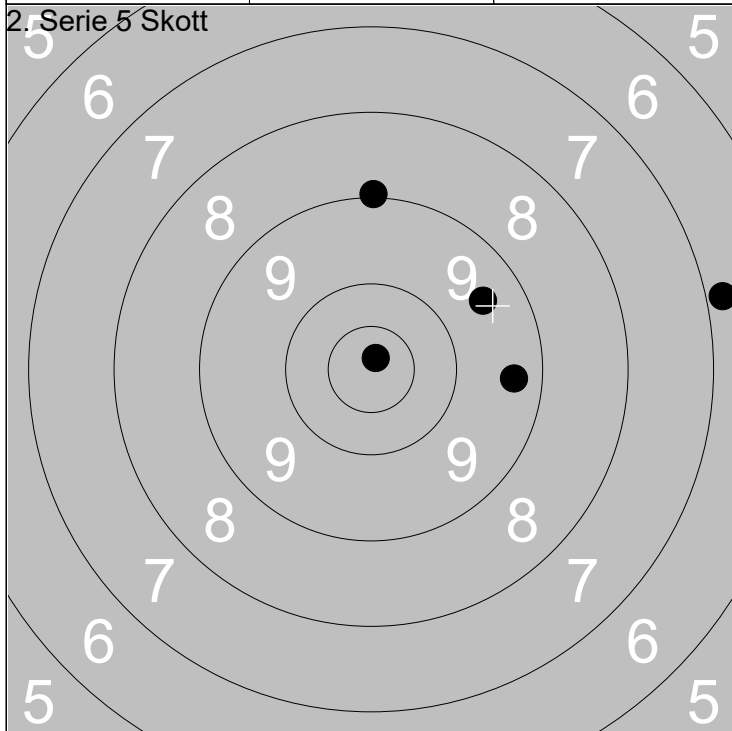

1: 10.8x ↑	Serie	43
2: 9.5 ↗		
3: 9.0 ↑	Total	90
4: 9.4 ➔		
5: 6.8 ➔		

1: 9.6 ↑	Serie	41
2: 9.4 ↘		
3: 8.7 ↓	Total	131
4: 8.7 ↗		
5: 7.4 ↖		

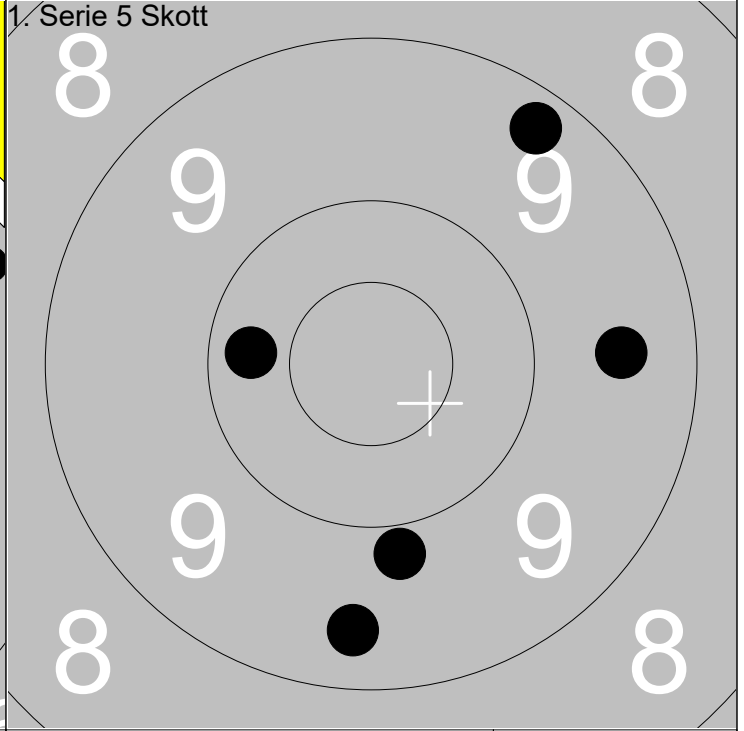
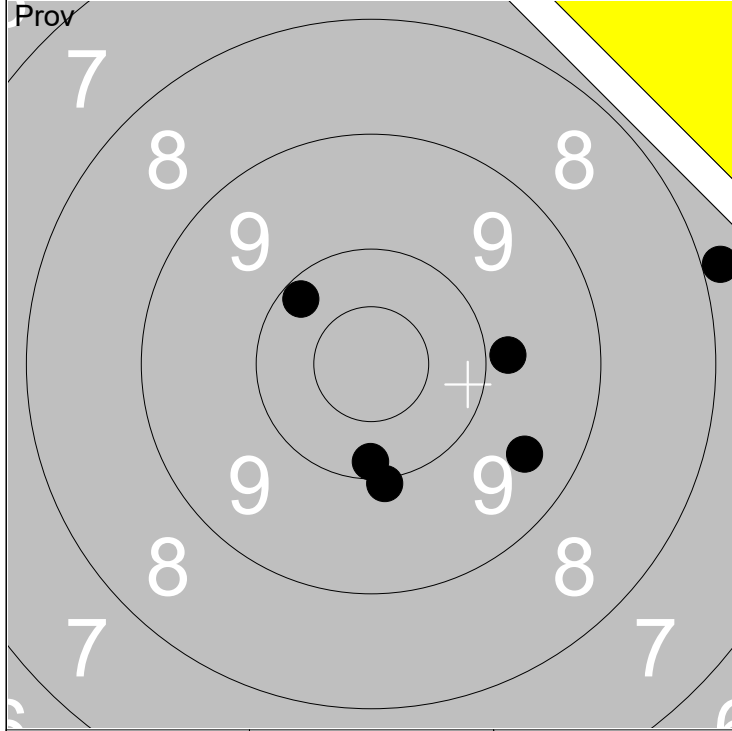

1: 10.2 ↓	6: 9.5 ↘		
2: 9.8 →		Serie	55
3: 7.9 →			
4: 10.0 ↓		Total	0
5: 10.2 ↖			

1: 9.4 ↓			
2: 9.5 →		Serie	46
3: 10.3 ←			
4: 9.9 ↓		Total	46
5: 9.3 ↗			

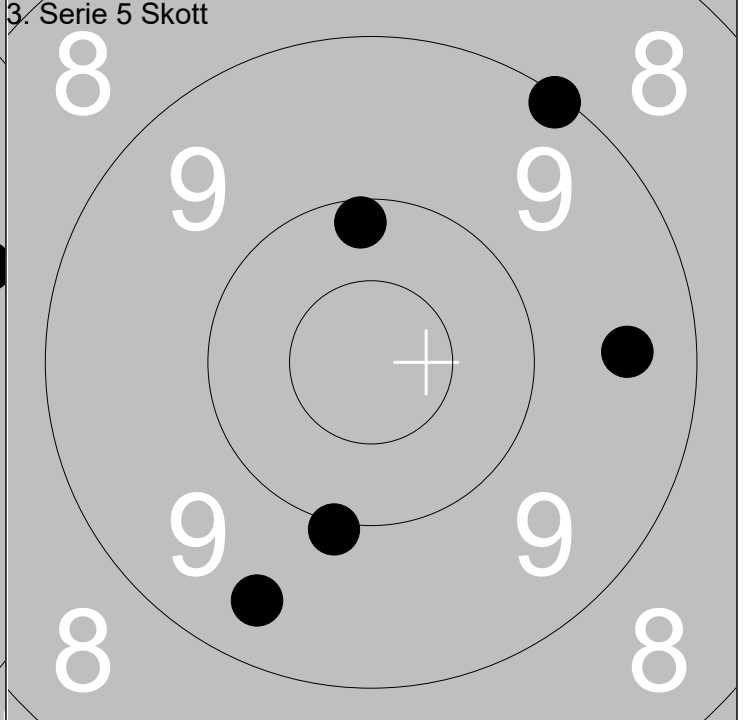
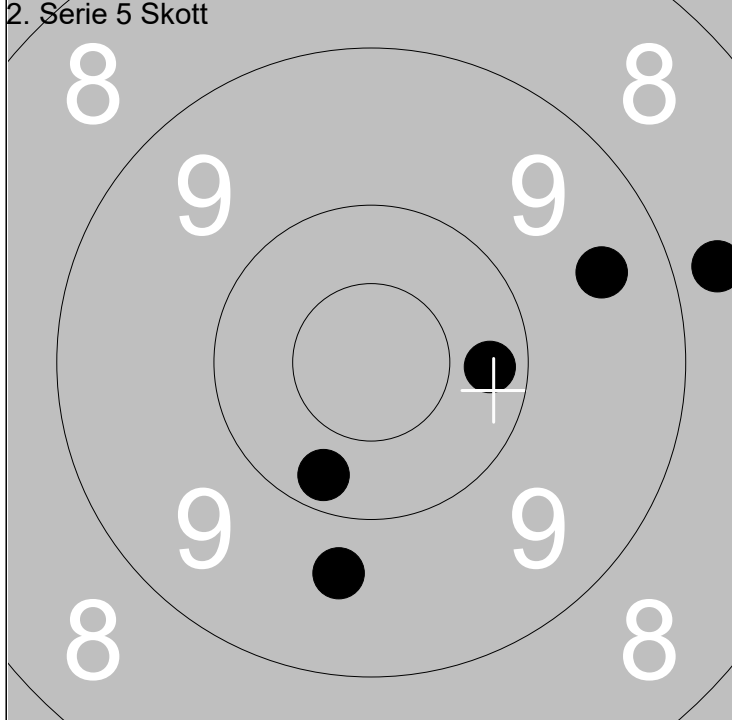

1: 10.2 ↓			
2: 8.7 →		Serie	46
3: 10.2 →			
4: 9.5 →		Total	92
5: 9.7 ↓			

1: 9.4 ↓			
2: 10.2 ↑		Serie	47
3: 9.1 ↗			
4: 9.5 →		Total	139
5: 10.0 ↓			

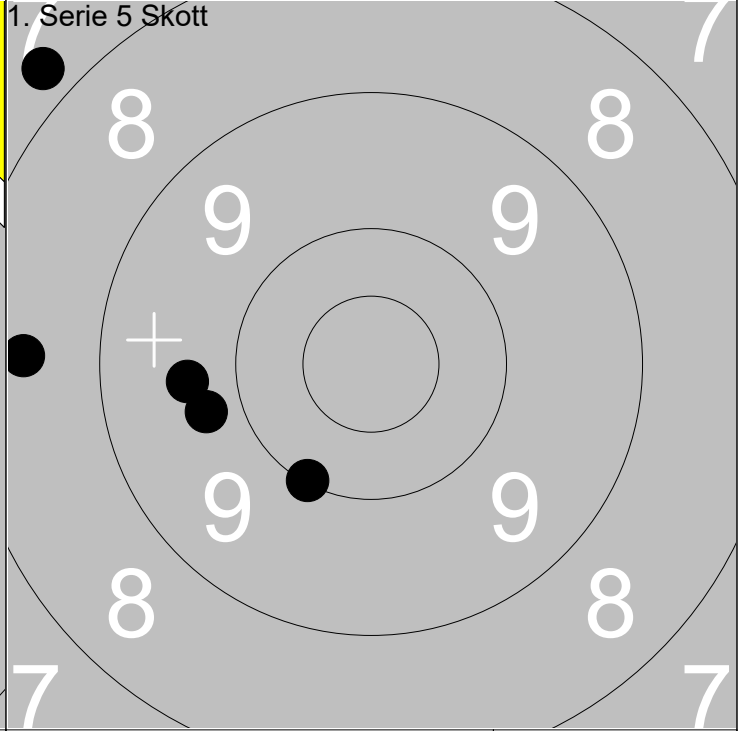
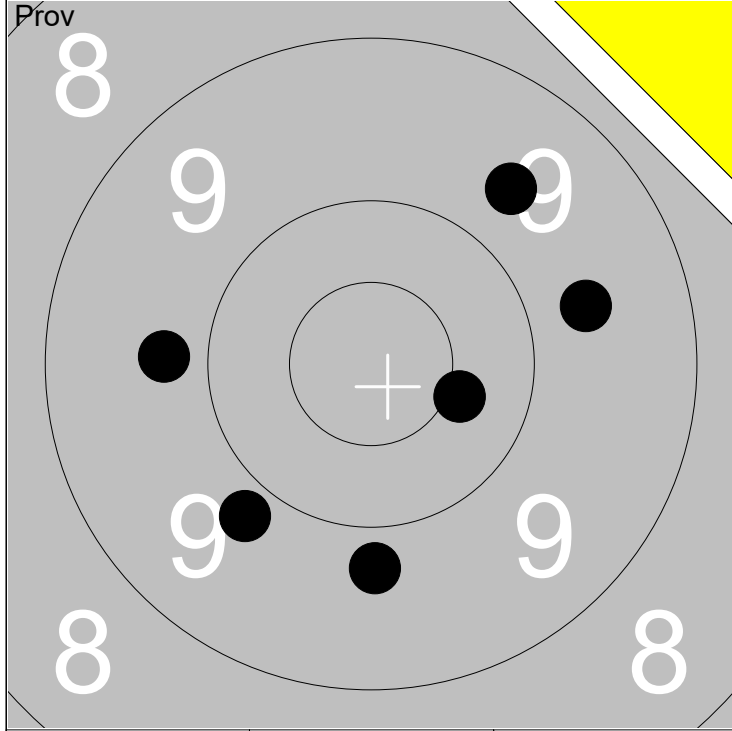

1: 9.8 ←	6: 10.4x →		
2: 9.8 ↓		Serie	55
3: 9.7 ↗			
4: 9.8 ↘		Total	0
5: 9.7 →			

1: 9.8 ←			
2: 7.8 ↖		Serie	43
3: 9.7 ←			
4: 8.5 ←		Total	43
5: 10.0 ↓			

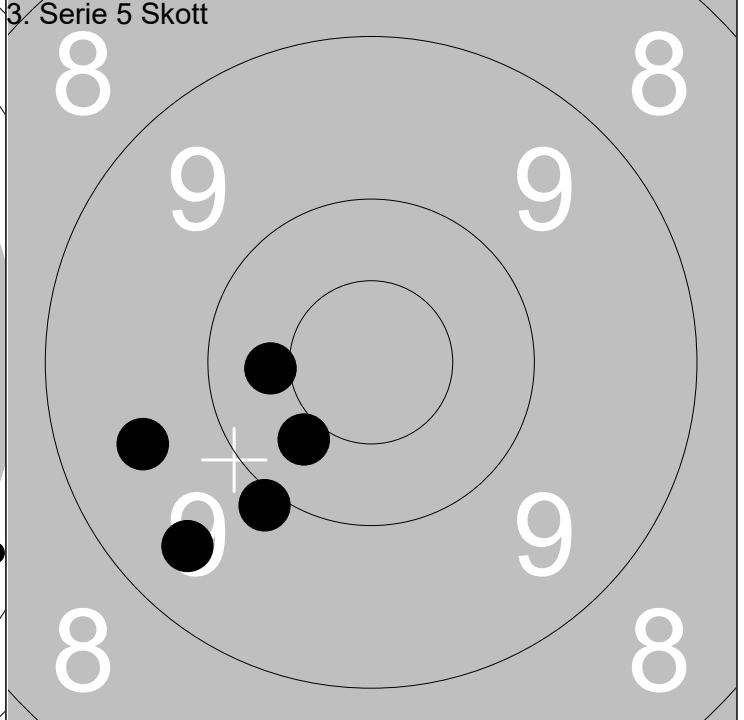
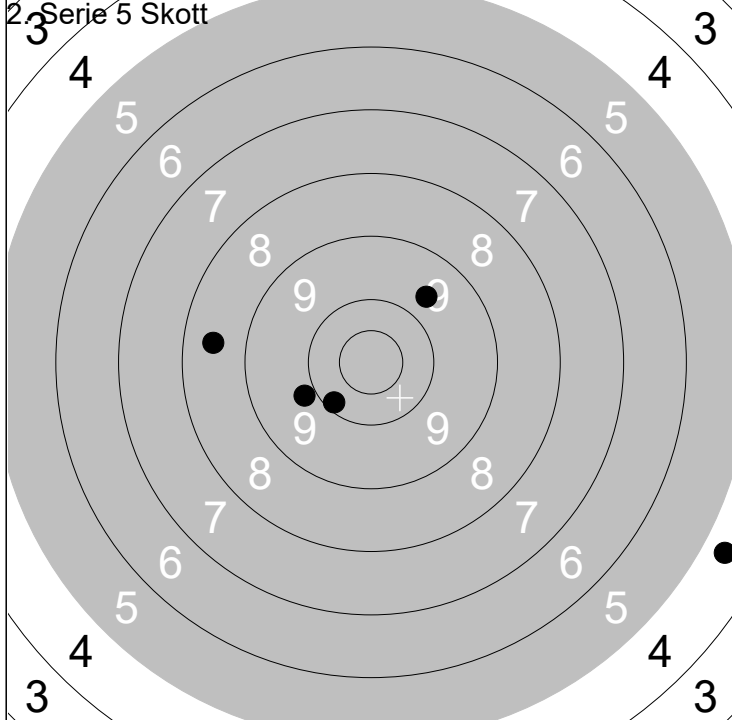

1: 8.5 ←			
2: 9.9 ↖		Serie	40
3: 9.7 ↗			
4: 4.7 →		Total	83
5: 10.2 ↘			

1: 9.9 ↘			
2: 10.4 ↘		Serie	47
3: 10.4 ←			
4: 9.4 ↘		Total	130
5: 9.5 ←			

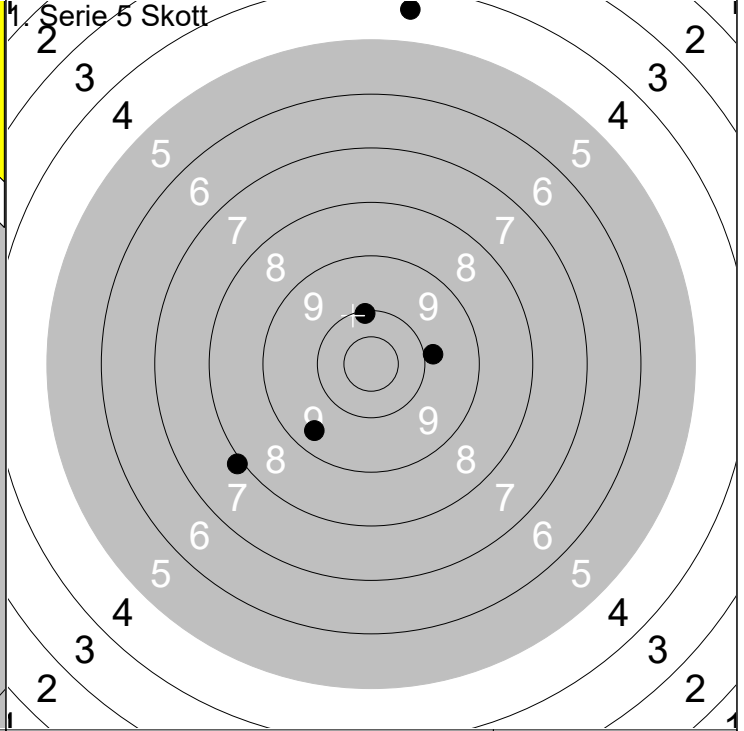
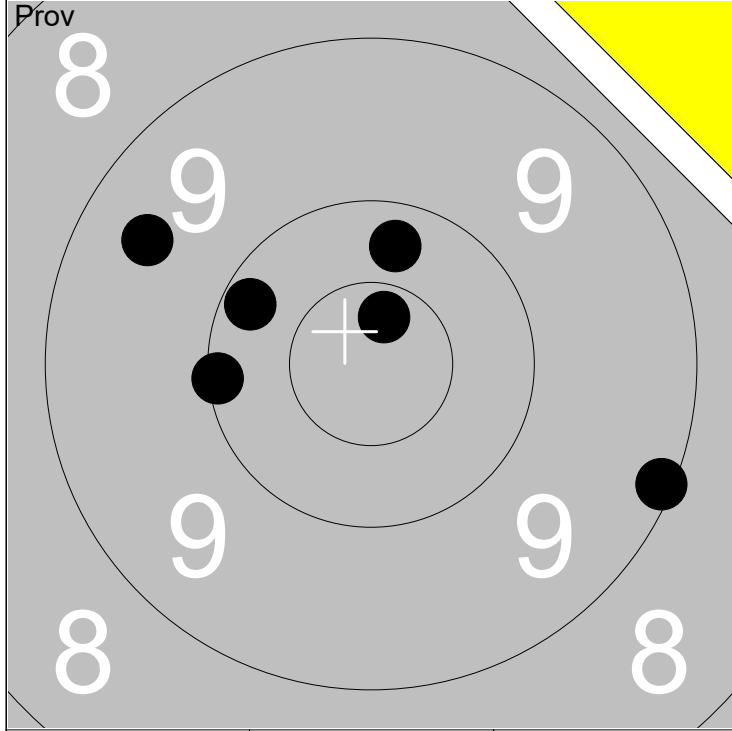

1: 9.1 →	6: 10.2 ←		
2: 10.3 ↑		Serie	58
3: 10.1 ←			
4: 10.7x ↑		Total	0
5: 9.5 ←			

1: 9.9 →			
2: 4.4 ↑		Serie	39
3: 10.1 ↑			
4: 7.9 ↙		Total	39
5: 9.4 ↘			

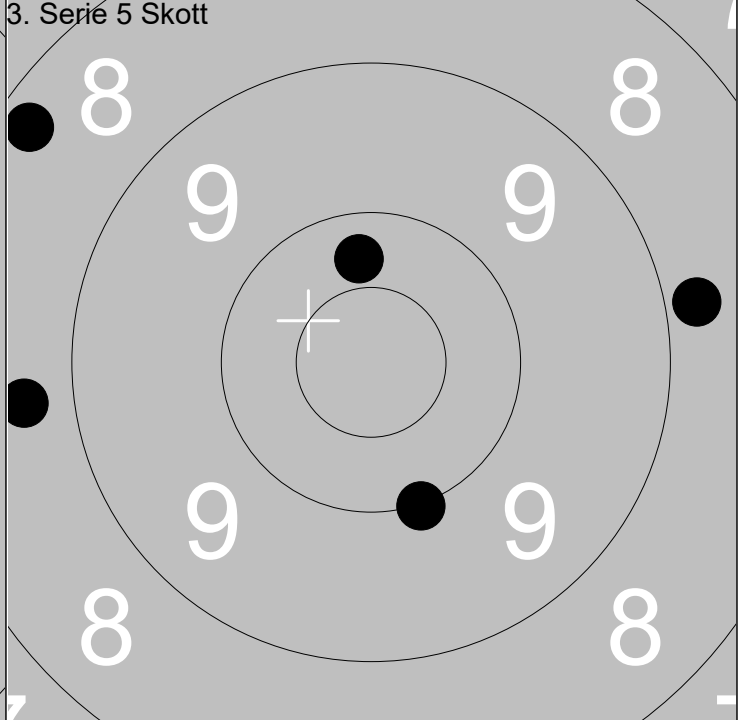
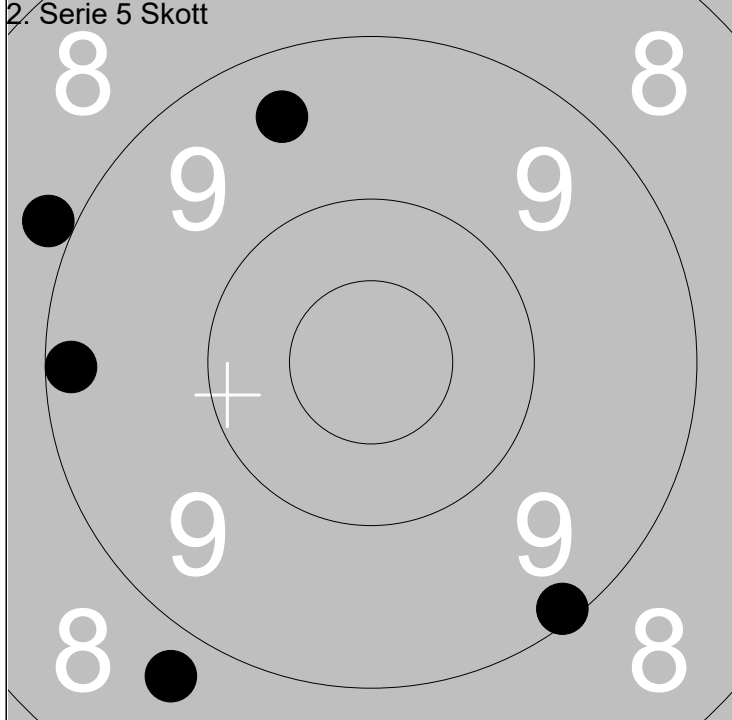

1: 8.7 ↙			
2: 9.4 ↑		Serie	43
3: 9.1 ↘			
4: 8.9 ↑		Total	82
5: 9.2 ←			

1: 8.3 ↙			
2: 8.7 ←		Serie	44
3: 10.3 ↑			
4: 8.8 →		Total	126
5: 10.0 ↓			

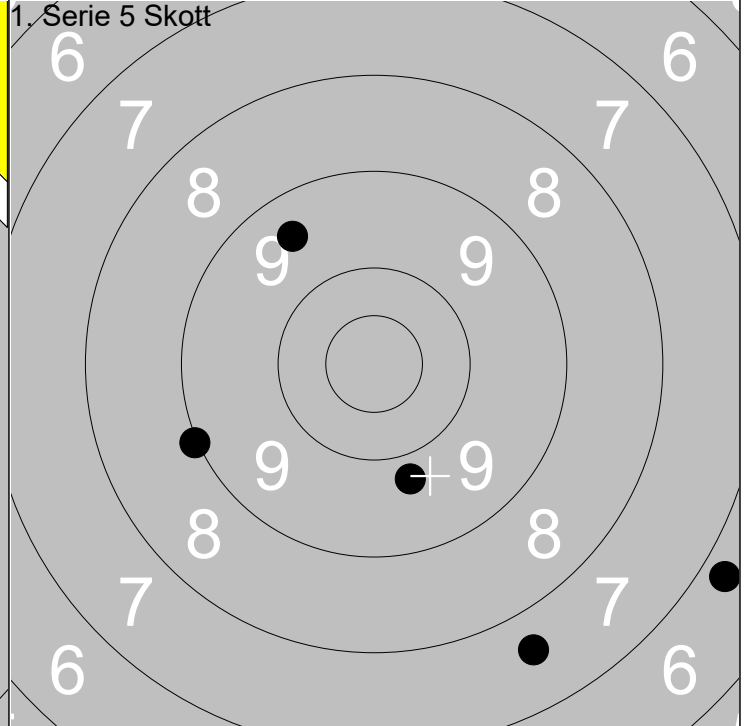
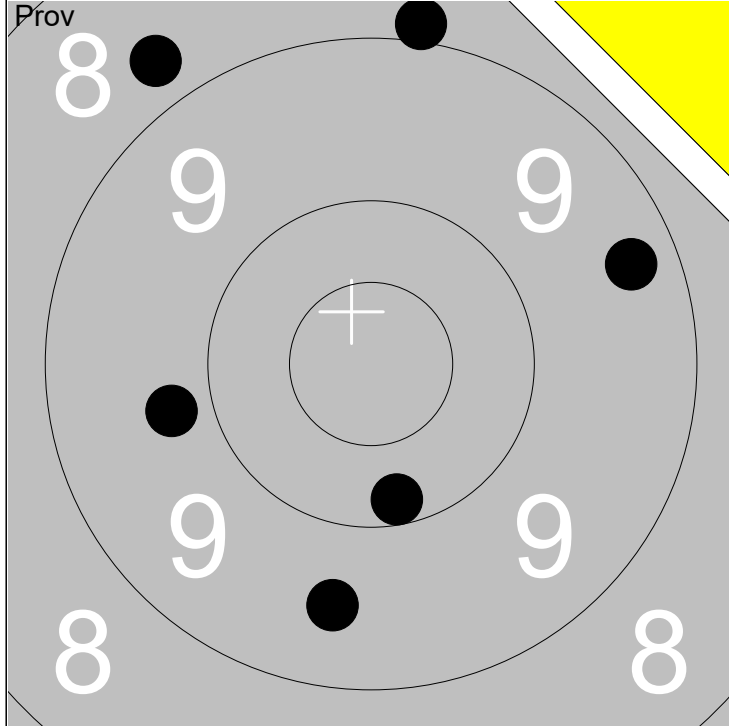

1: 10.2 ↓	6: 9.3 →		
2: 9.8 ←		Serie	53
3: 8.8 ↗			
4: 9.5 ↓		Total	0
5: 8.9 ↑			

1: 9.8 ↓			
2: 7.6 ↓		Serie	40
3: 9.0 ←			
4: 9.5 ↗		Total	40
5: 6.8 ↓			

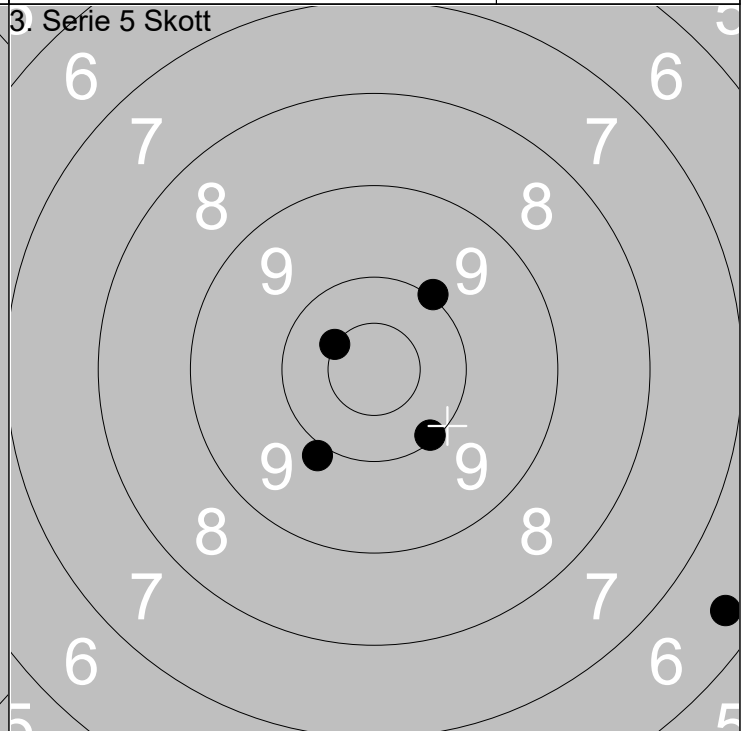
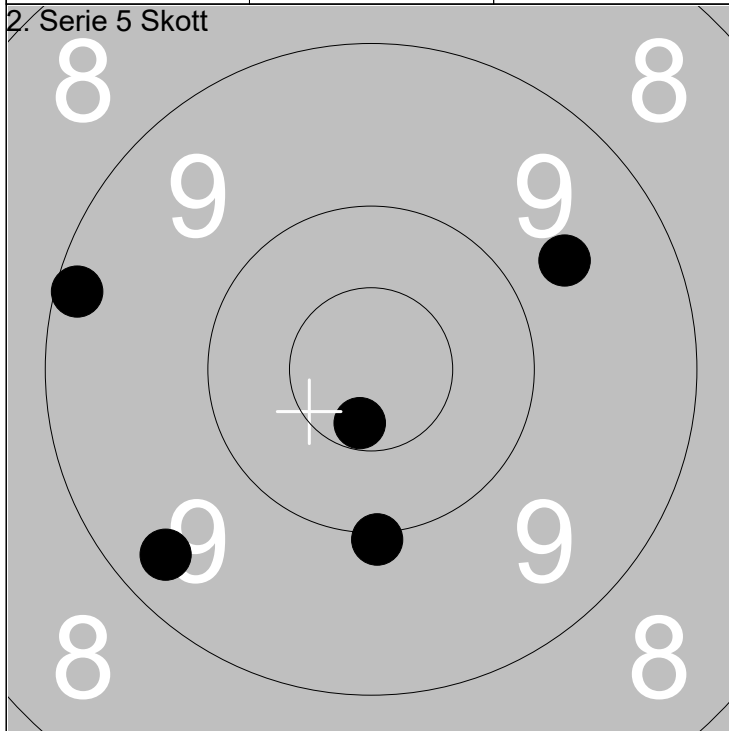

1: 9.7 ↗			
2: 9.3 ↘		Serie	47
3: 10.0 ↓			
4: 9.2 ←		Total	87
5: 10.6x ↓			

1: 10.1 ↓			
2: 9.9 ↓		Serie	45
3: 6.4 ↓			
4: 10.5x ↗		Total	132
5: 10.0 ↗			

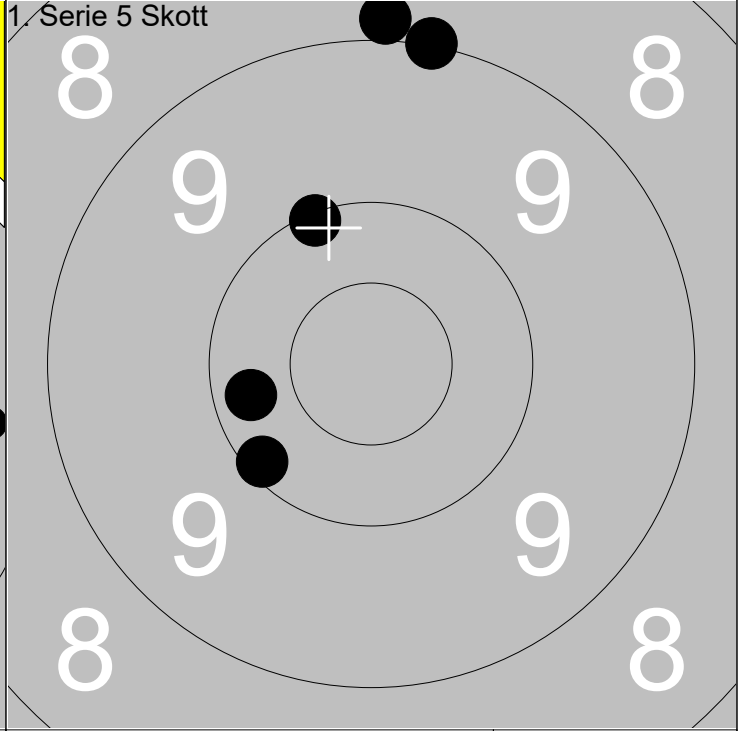
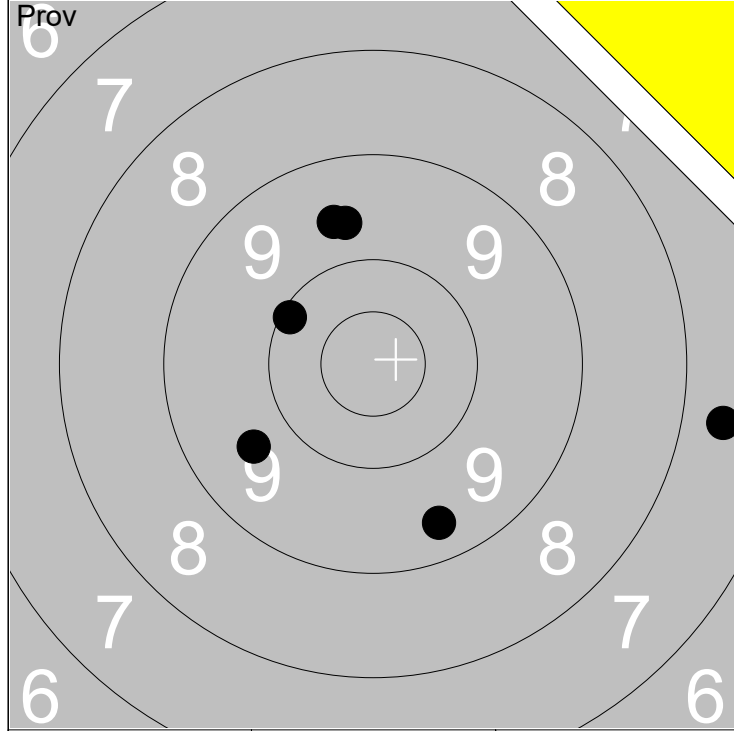

1: 7.6 →	6: 9.4 ↓		
2: 9.7 ↑		Serie	53
3: 9.6 ↙			
4: 10.1 ↖		Total	0
5: 9.6 ↑			

1: 10.1 ↖			
2: 10.2 ←		Serie	47
3: 8.9 ↑			
4: 9.0 ↑		Total	47
5: 10.1 ↙			

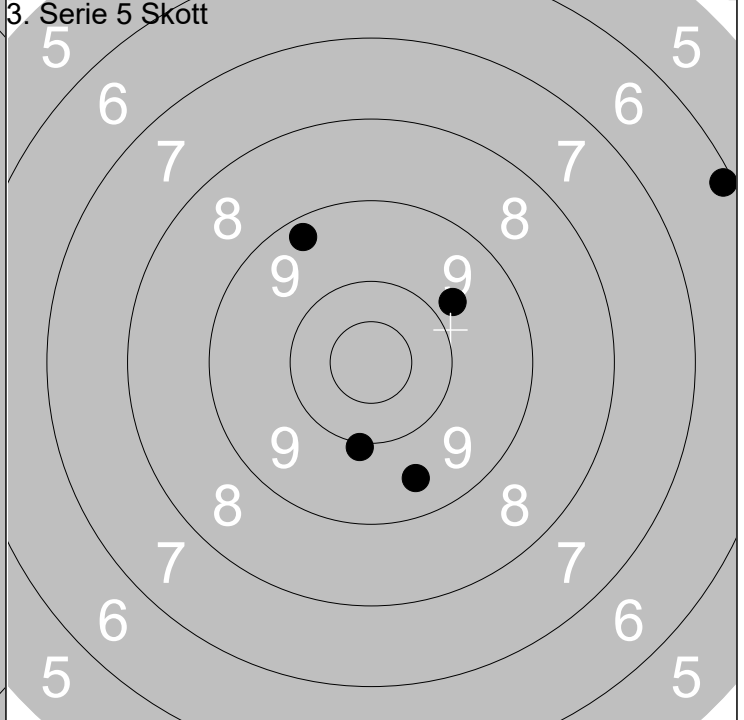
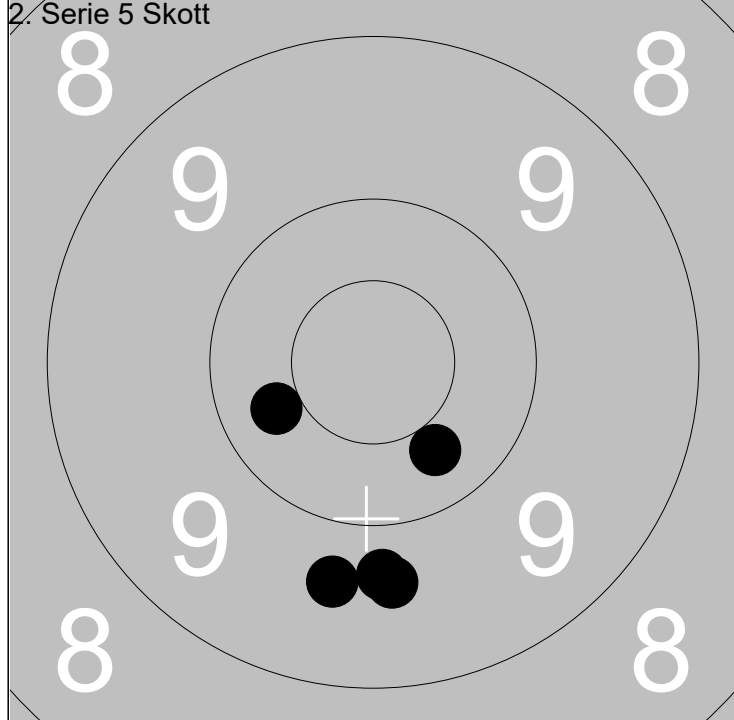

1: 10.3 ↓			
2: 9.7 ↓		Serie	47
3: 9.7 ↓			
4: 9.7 ↓		Total	94
5: 10.3 ↖			

1: 9.3 ↖			
2: 10.0 ↓		Serie	43
3: 6.2 ↗			
4: 9.8 ↗		Total	137
5: 9.5 ↓			

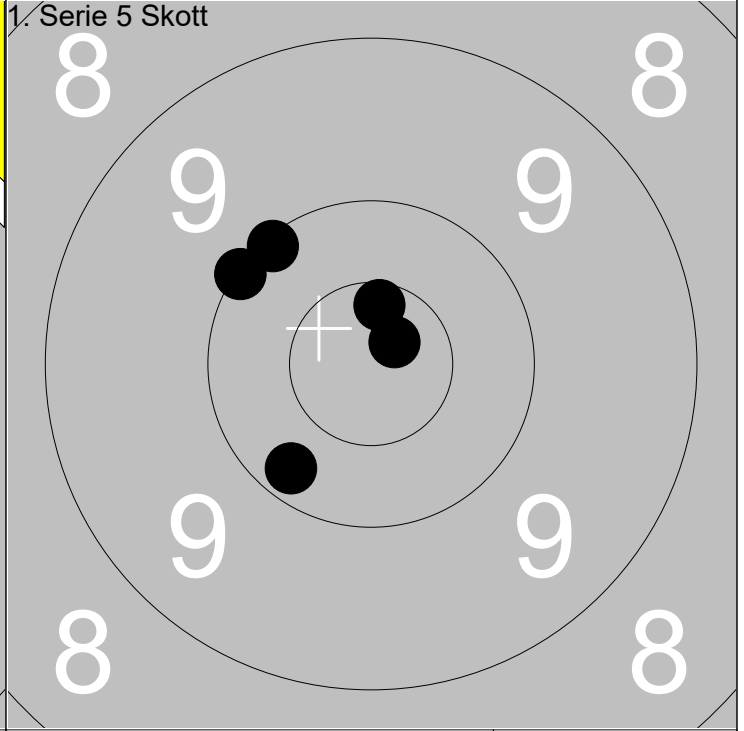
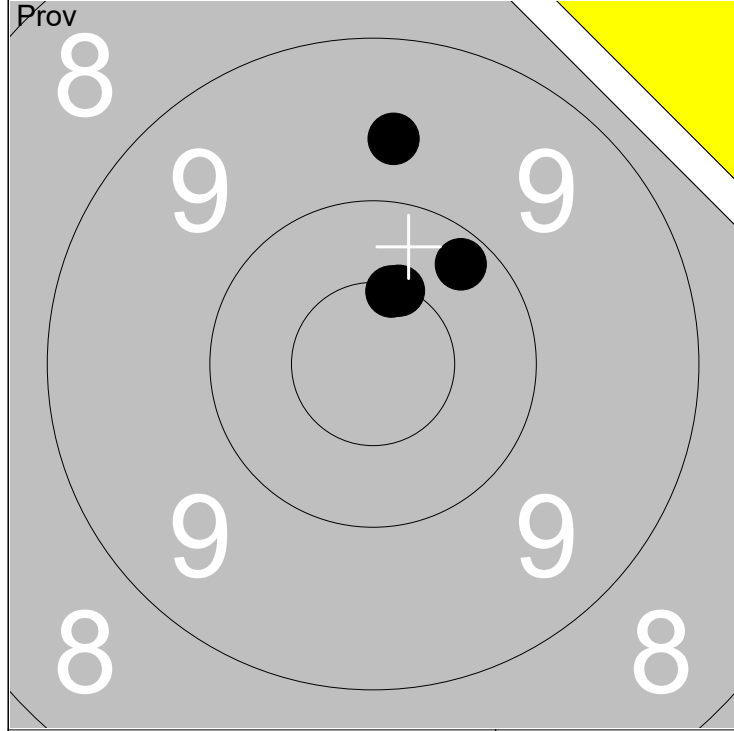

1: 10.5x ↑
2: 9.6 ↑
3: 10.2 ↗
4: 10.5x ↑

Serie	39
Total	0

1: 10.8x ↗
2: 10.6x ↑
3: 10.0 ↖
4: 10.1 ↖
5: 10.2 ↘

Serie	50
Total	50

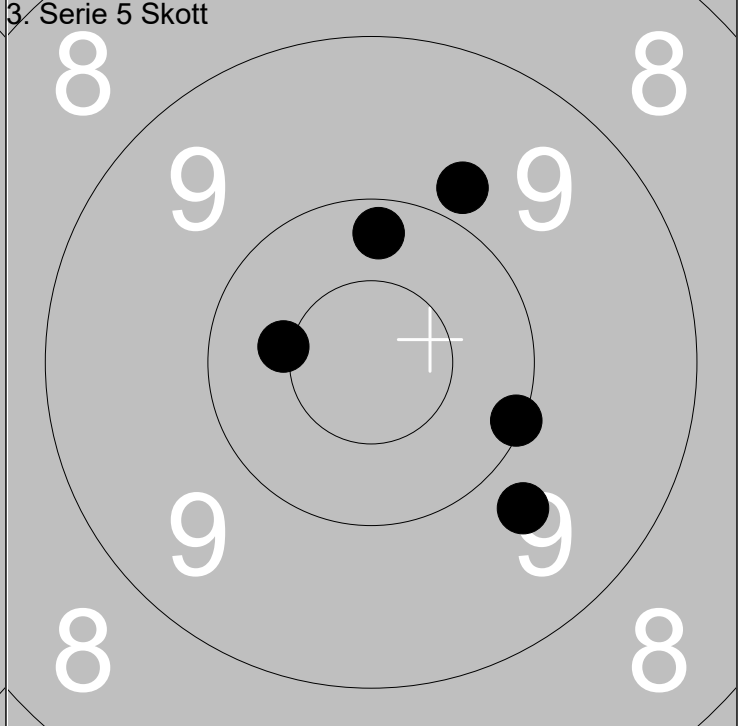
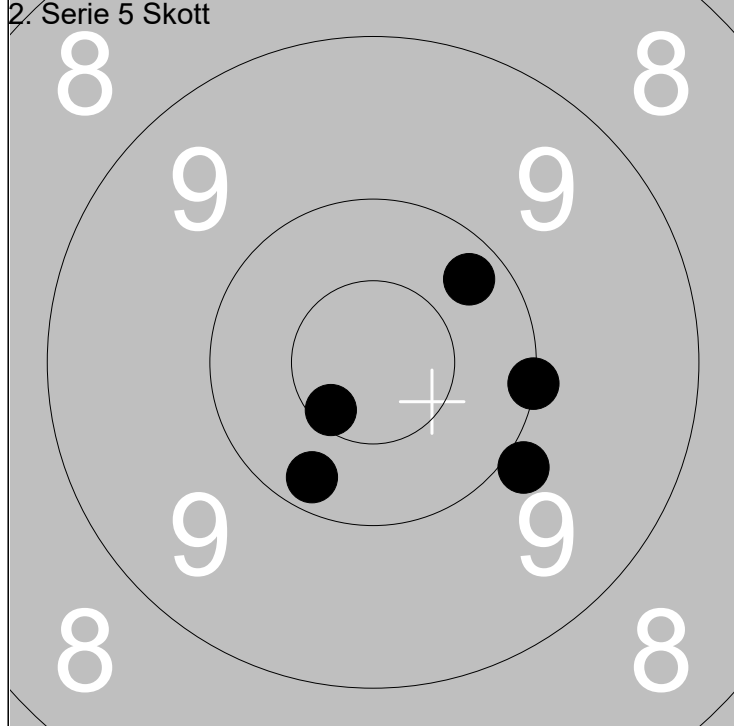

1: 10.6x ↙
2: 10.2 ↘
3: 10.0 →
4: 10.2 ↗
5: 9.9 ↘

Serie	49
Total	99

1: 10.4x ←
2: 9.8 ↑
3: 10.1 →
4: 9.7 ↘
5: 10.2 ↑

Serie	48
Total	147

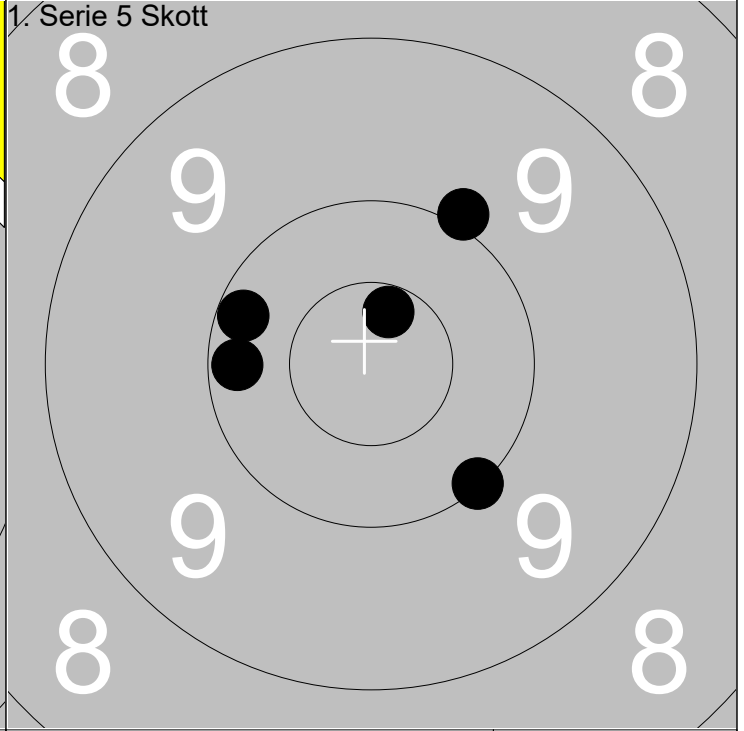
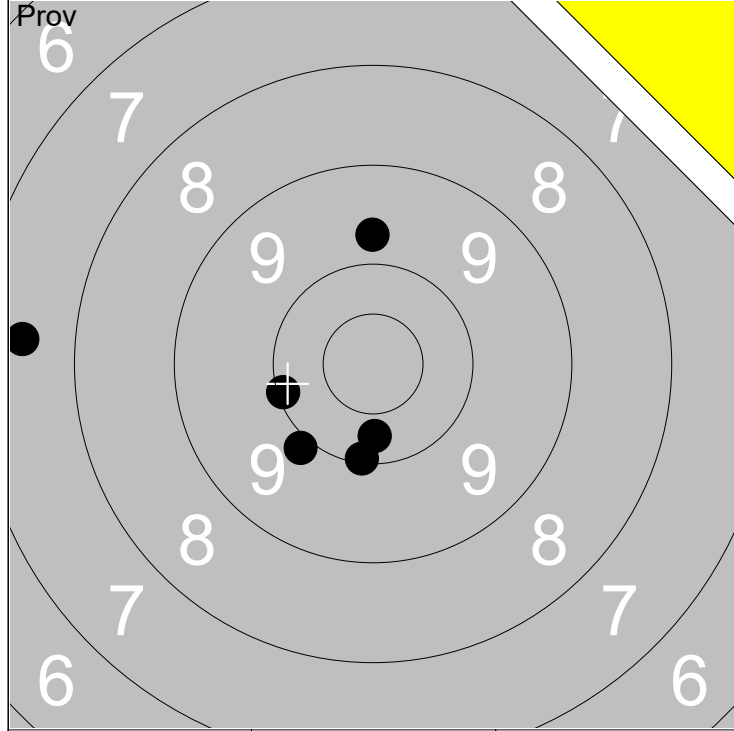

1: 9.9 ↙	6: 10.1 ↓		
2: 10.3 ↓		Serie	55
3: 10.1 ←			
4: 9.7 ↑		Total	0
5: 7.5 ←			

1: 10.6x ↗			
2: 10.0 ↗		Serie	50
3: 10.0 ↓			
4: 10.2 ←		Total	50
5: 10.2 ←			

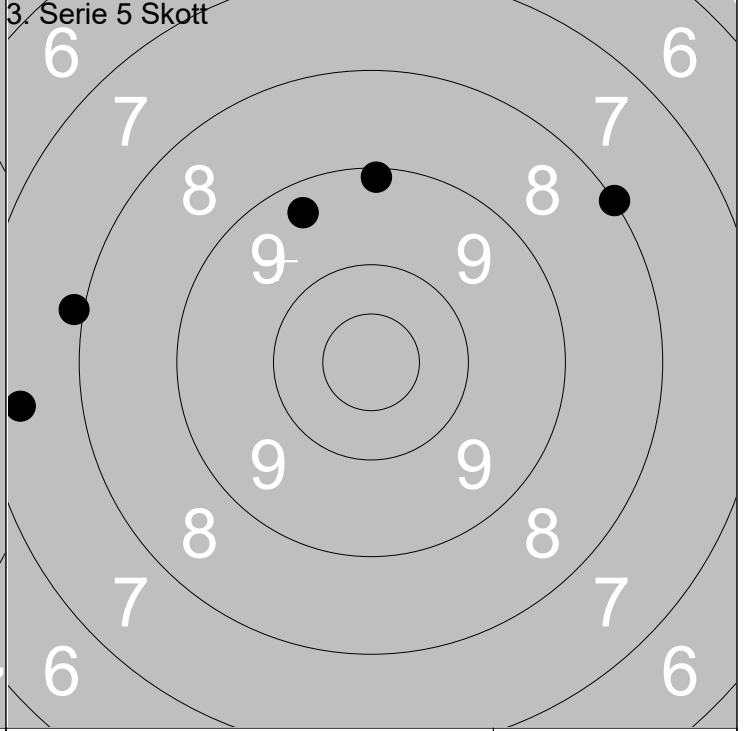
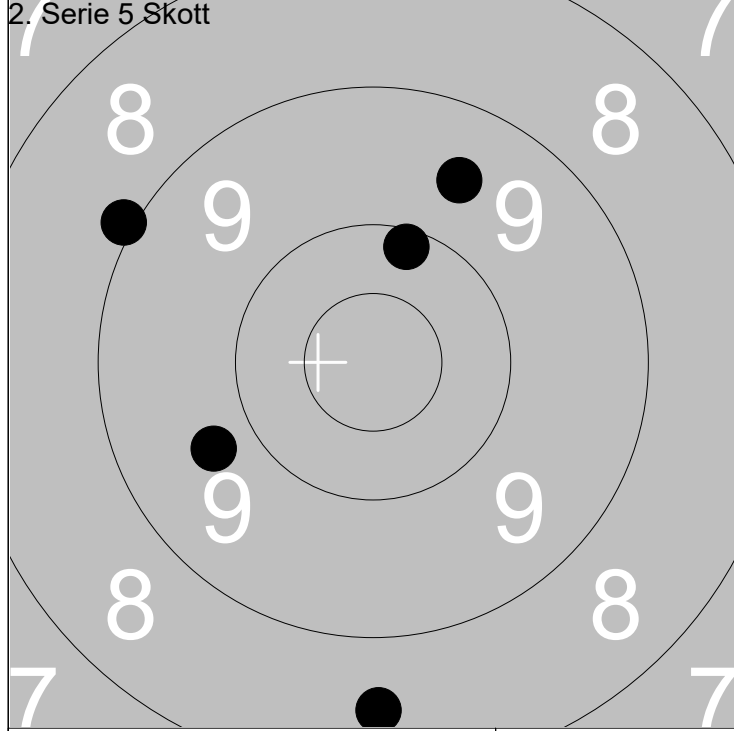

1: 9.6 ↗			
2: 8.9 ↖		Serie	44
3: 9.7 ↖			
4: 10.1 ↗		Total	94
5: 8.5 ↓			

1: 9.1 ↑			
2: 7.9 ←		Serie	40
3: 7.4 ←			
4: 8.0 ↗		Total	134
5: 9.3 ↗			

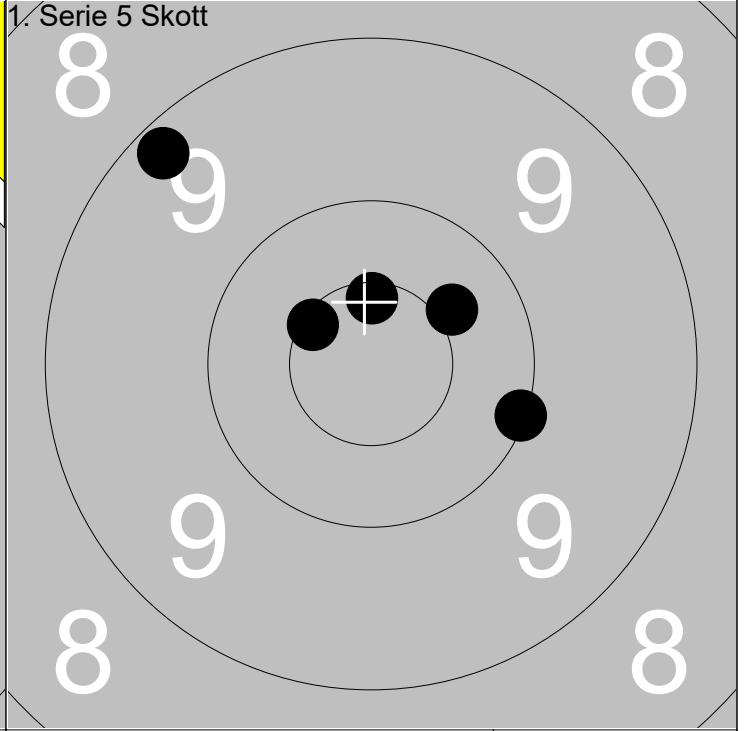
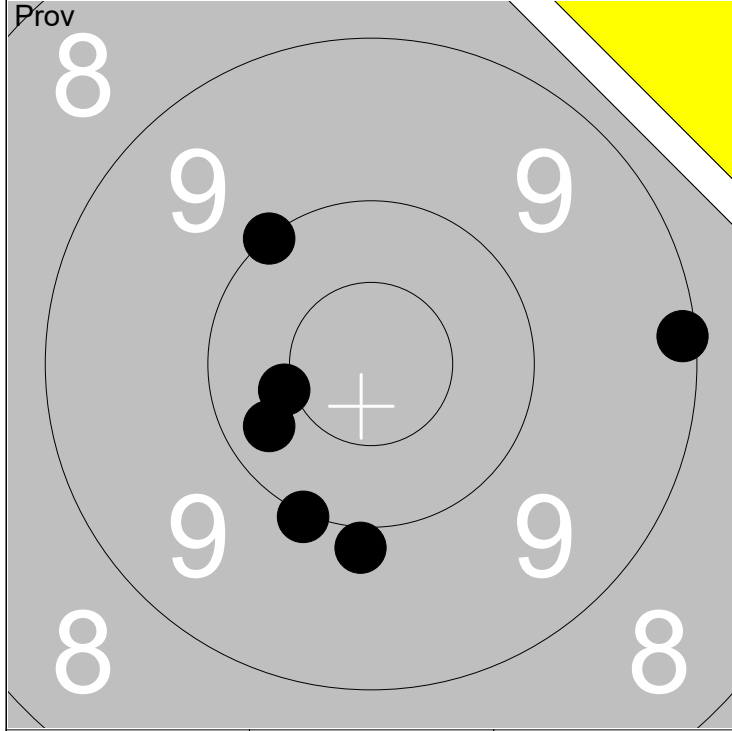

1: 10.4x ←	6: 9.1 →		
2: 10.0 ↗		Serie	58
3: 9.9 ↓			
4: 10.0 ↘		Total	0
5: 10.3 ←			

1: 10.4 ↗			
2: 10.1 →		Serie	49
3: 10.6x ↑			
4: 9.2 ↗		Total	49
5: 10.6x ←			

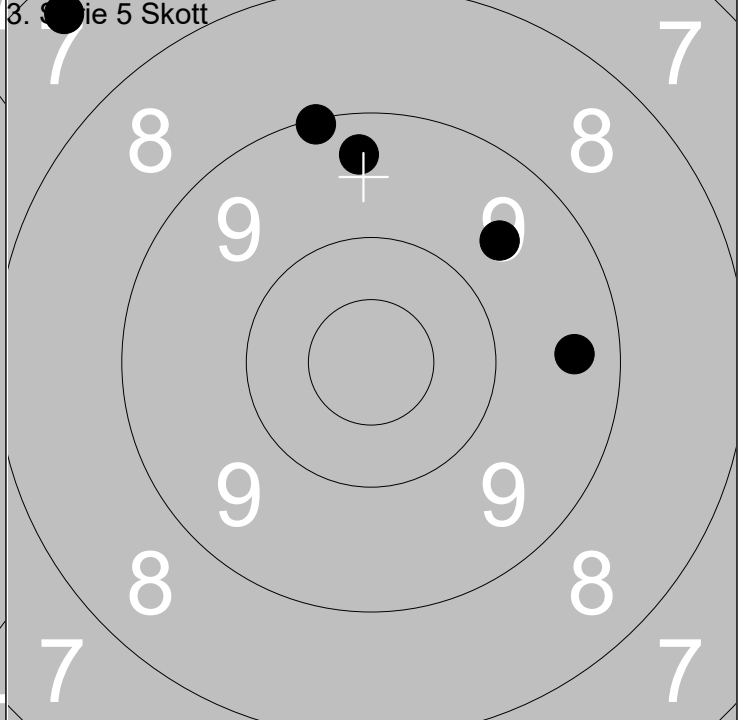
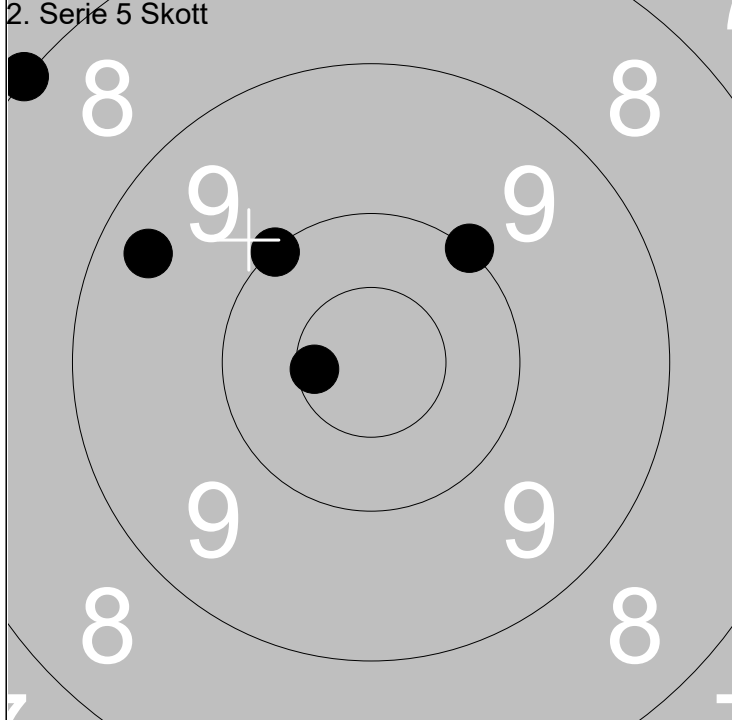

1: 10.0 ↗			
2: 10.0 ↗		Serie	47
3: 9.4 ↗			
4: 8.0 ↗		Total	96
5: 10.6x ←			

1: 9.6 ↗			
2: 9.4 ↑		Serie	43
3: 9.1 ↑			
4: 7.3 ↗		Total	139
5: 9.4 →			

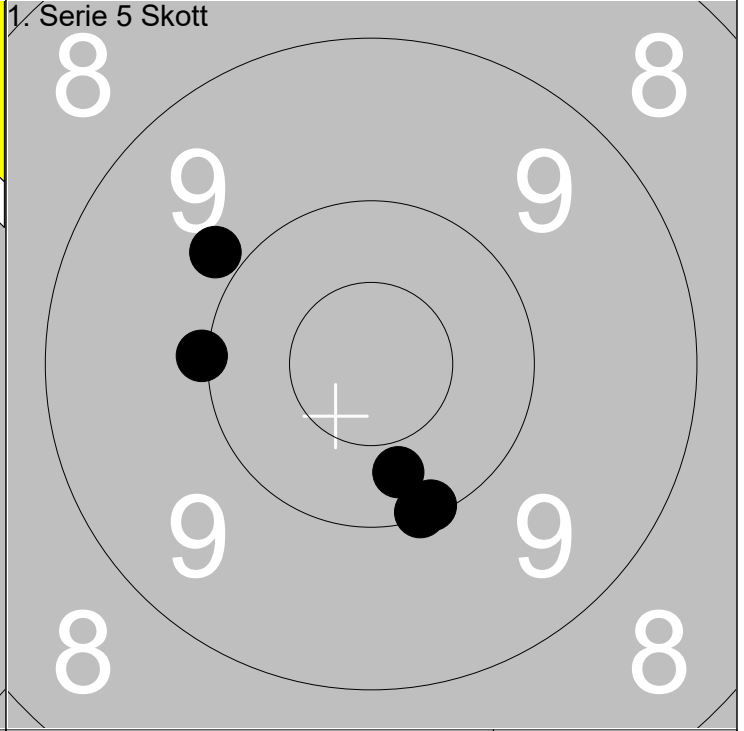
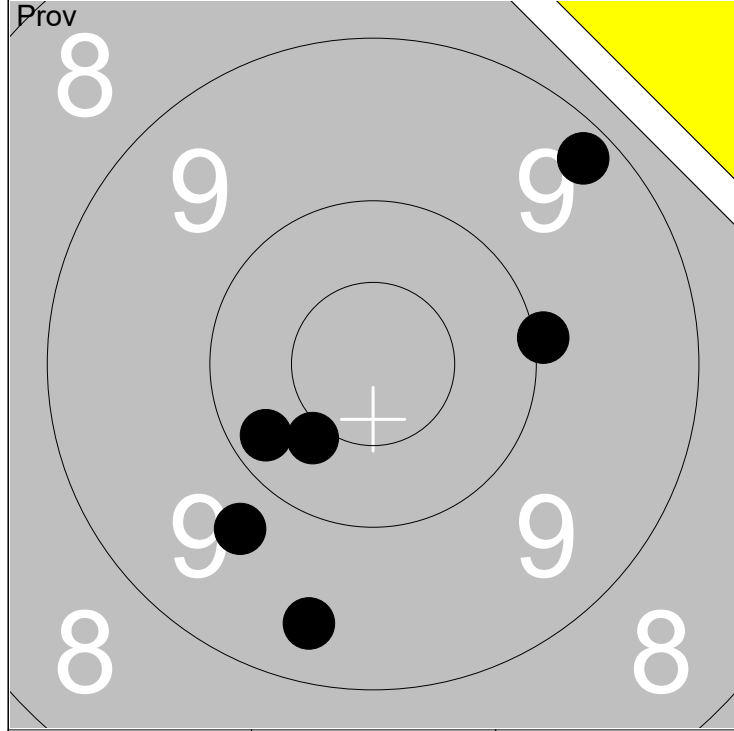

1: 10.4 ↙	6: 10.0 →		
2: 9.7 ↙		Serie	57
3: 10.2 ↙			
4: 9.4 ↙		Total	0
5: 9.2 ↗			

1: 10.1 ↓			
2: 10.3 ↓		Serie	49
3: 10.1 ↓			
4: 10.0 ←		Total	49
5: 9.9 ↖			

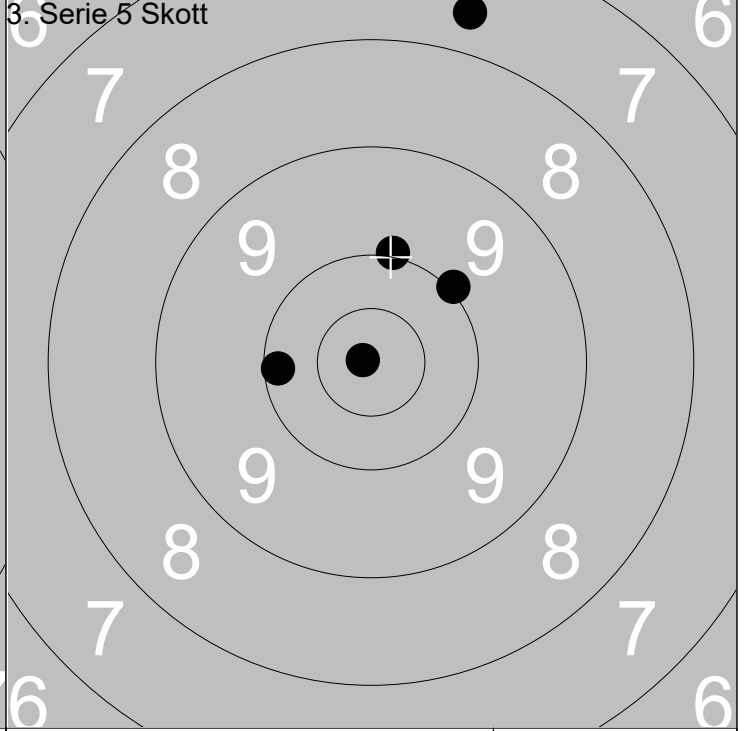
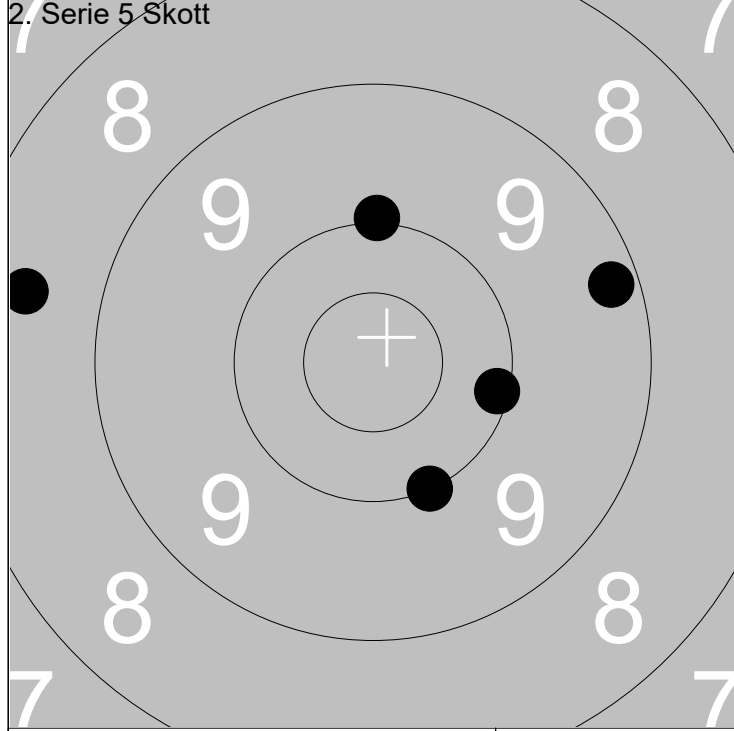

1: 10.0 ↑			
2: 10.1 →		Serie	47
3: 9.2 →			
4: 8.5 ←		Total	96
5: 10.0 ↓			

1: 10.0 ↑			
2: 10.1 ←		Serie	47
3: 10.0 ↗			
4: 7.6 ↑		Total	143
5: 10.9x ←			

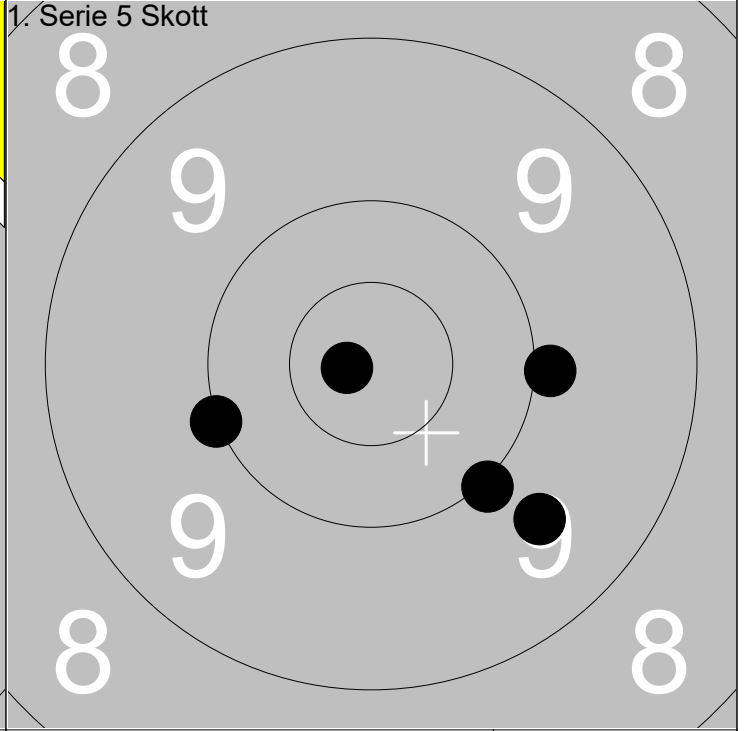
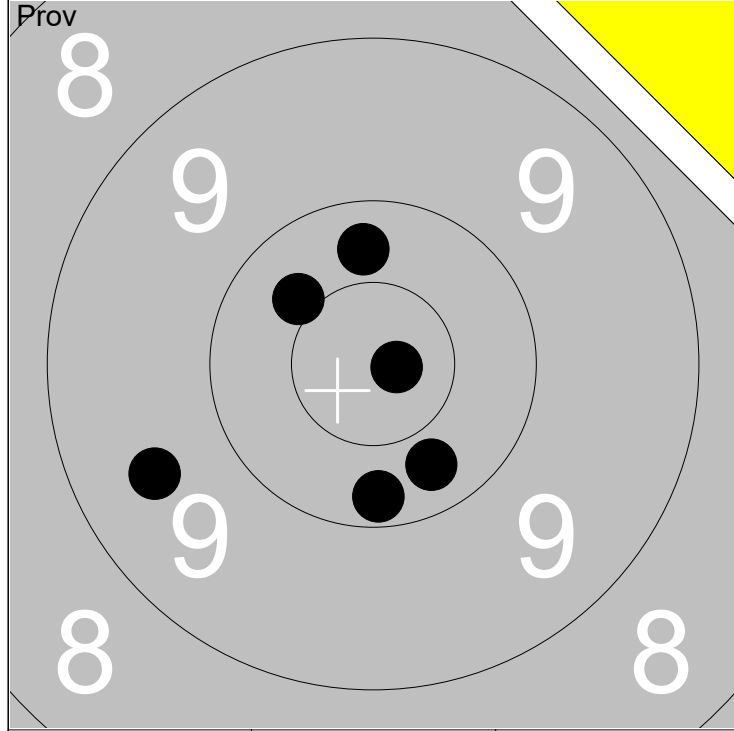

1: 10.8x →	6: 10.2 ↓				
2: 10.4 ↗		Serie	59		
3: 9.5 ↖					
4: 10.3 ↑		Total	0		
5: 10.3 ↘					

1: 9.9 →					
2: 9.6 ↘		Serie	48		
3: 10.8x ←					
4: 10.0 ←		Total	48		
5: 10.0 ↘					

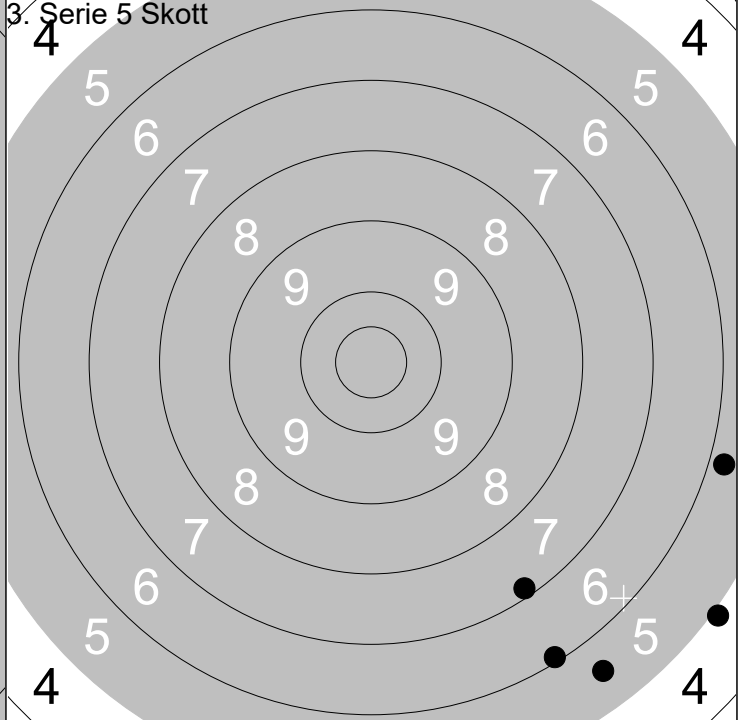
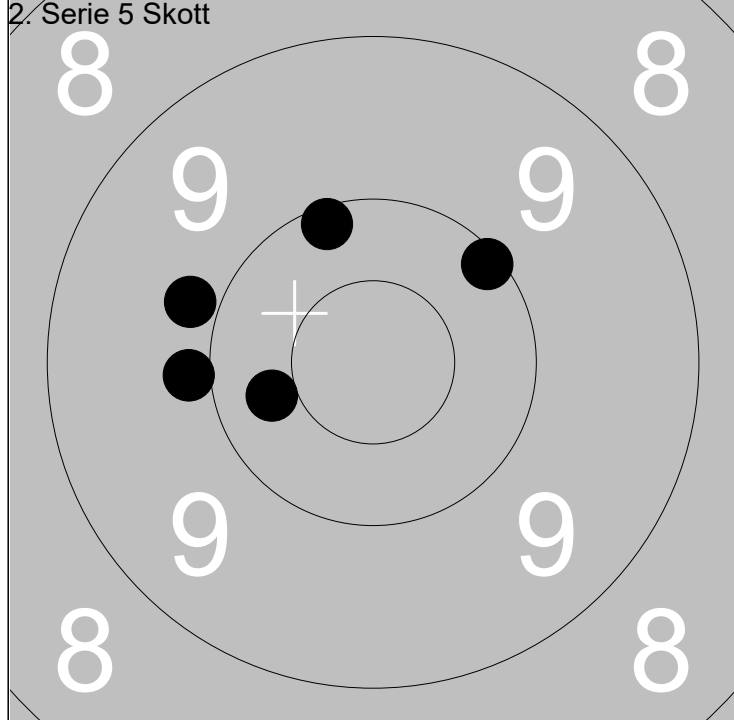

1: 10.1 ↗					
2: 9.8 ↖		Serie	48		
3: 9.9 ←					
4: 10.3 ←		Total	96		
5: 10.1 ↗					

1: 7.2 ↘					
2: 5.8 →		Serie	27		
3: 4.9 ↘					
4: 6.1 ↘		Total	123		
5: 5.6 ↘					

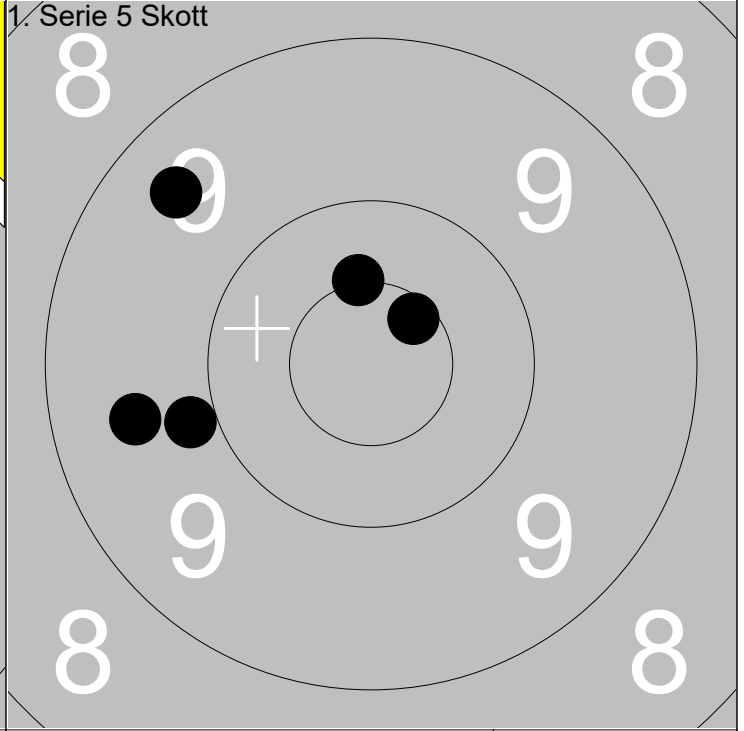
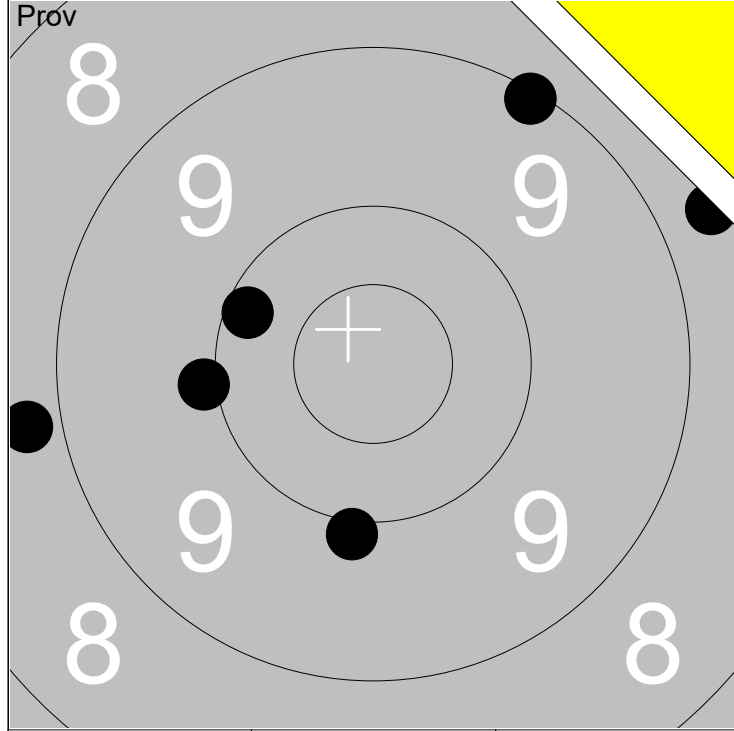

1: 9.1 ↗	6: 9.9 ↓				
2: 10.2 ↖		Serie	54		
3: 8.8 ←					
4: 10.0 ←		Total	0		
5: 8.7 →					

1: 10.6x ↗					
2: 9.9 ←		Serie	47		
3: 10.5x ↗					
4: 9.4 ↖		Total	47		
5: 9.5 ←					

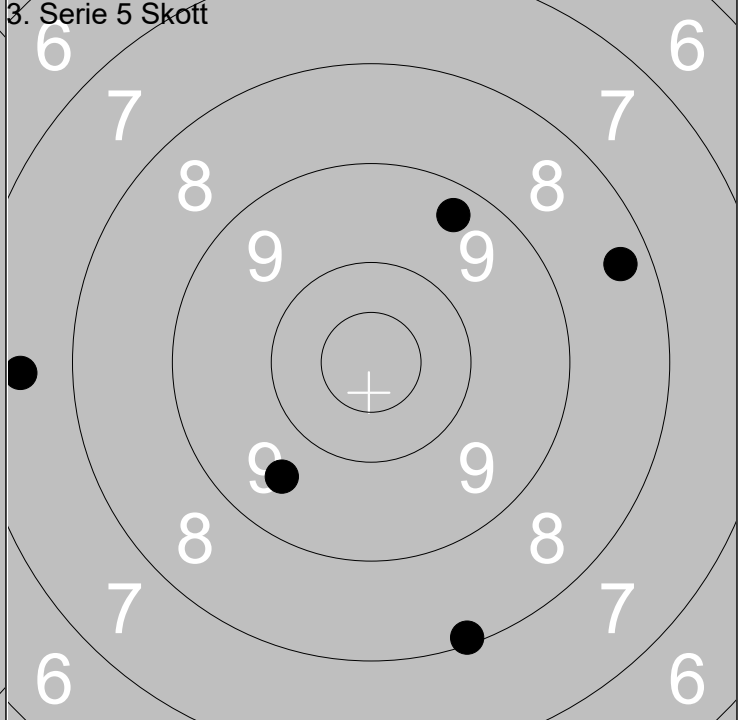
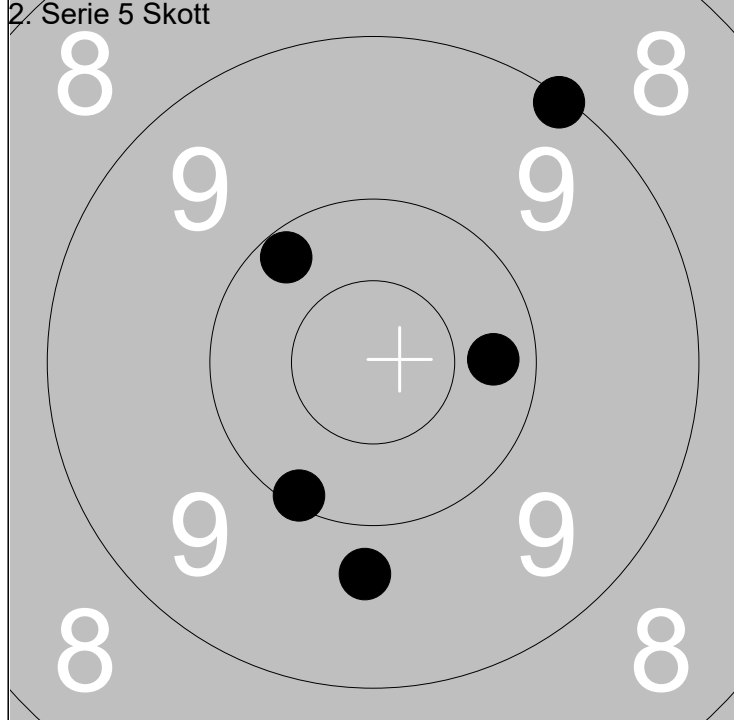

1: 9.1 ↗					
2: 10.1 ↘		Serie	48		
3: 10.3 →					
4: 10.2 ↖		Total	95		
5: 9.7 ↓					

1: 8.1 ↓					
2: 7.5 ←		Serie	41		
3: 9.6 ↘					
4: 9.3 ↗		Total	136		
5: 8.3 →					

Skjutlag

3

Tavla

7

Helena Jansson

Ramselefors

Söderala

A

Gä

09.07.2018

Tavelträffen B 2018

Ramselefors SKF

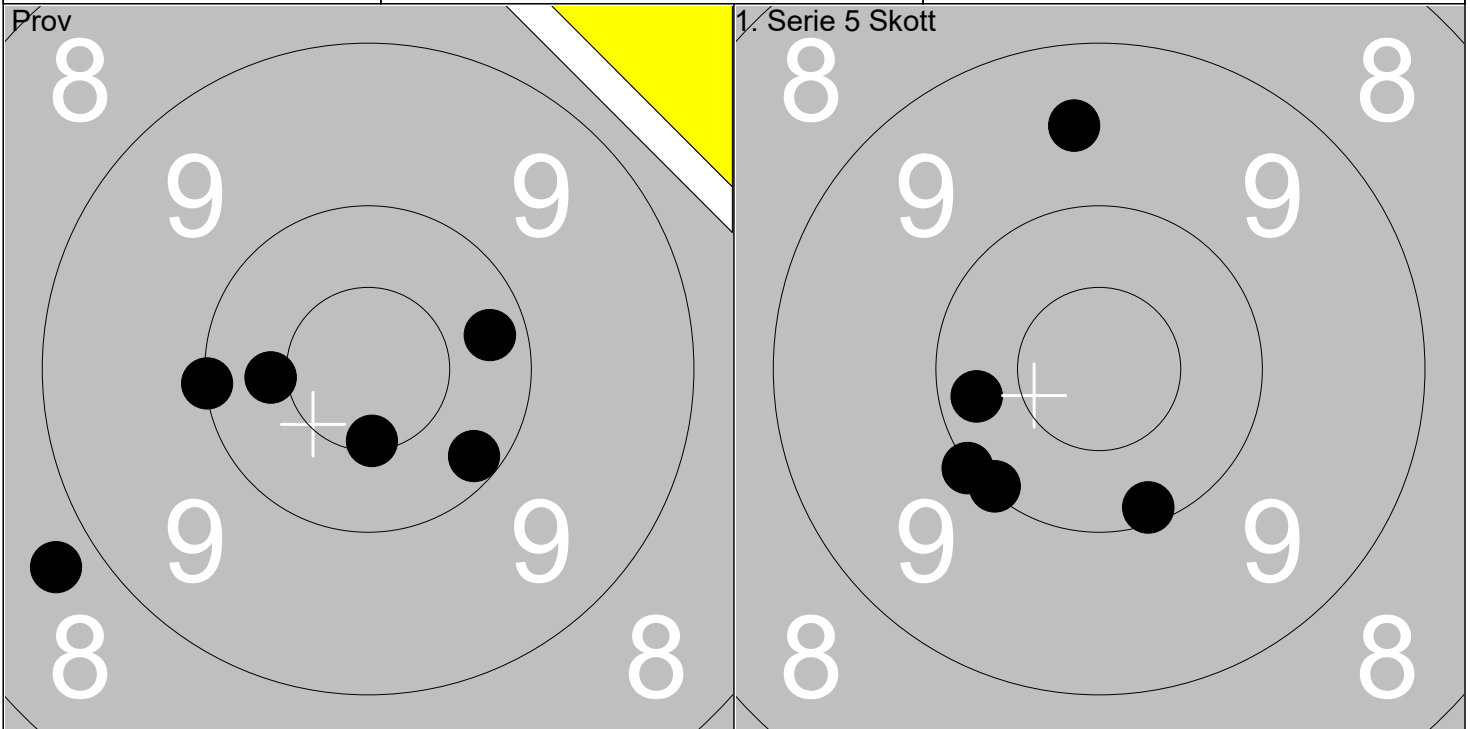

1: 10.2 ↘
 2: 10.0 ←
 3: 10.4 ←
 4: 10.5x ↓
 5: 10.2 →

6: 8.8 ↙

Serie 58

Total 0

1: 10.1 ↓
 2: 10.1 ↙
 3: 9.5 ↑
 4: 10.0 ↙
 5: 10.2 ←

Serie 49

Total 49

2. Serie 5 Skott

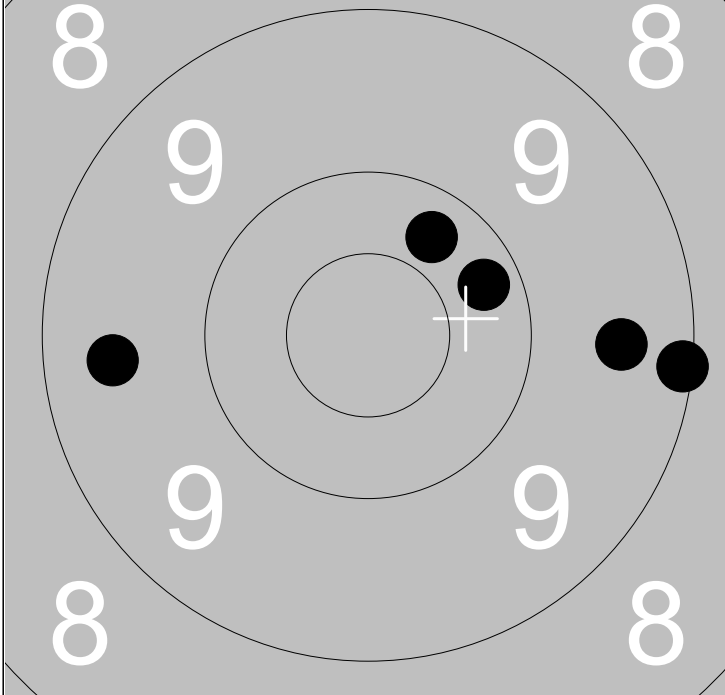

1: 10.2 →
 2: 9.1 →
 3: 10.3 ↗
 4: 9.5 ←
 5: 9.5 →

Serie 47

Total 96

3. Serie 5 Skott

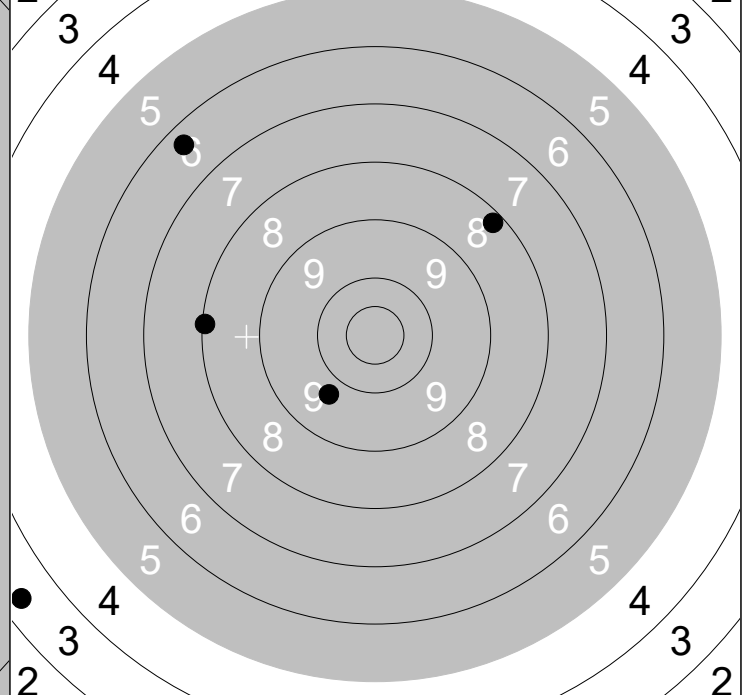

1: 3.4 ↙
 2: 8.1 ←
 3: 6.4 ↖
 4: 9.7 ↙
 5: 8.2 ↗

Serie 34

Total 130

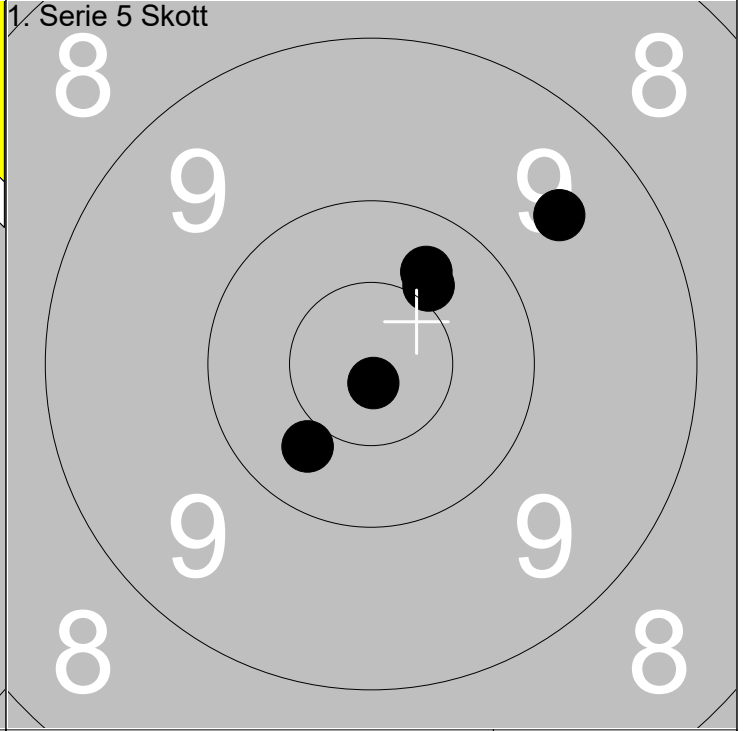
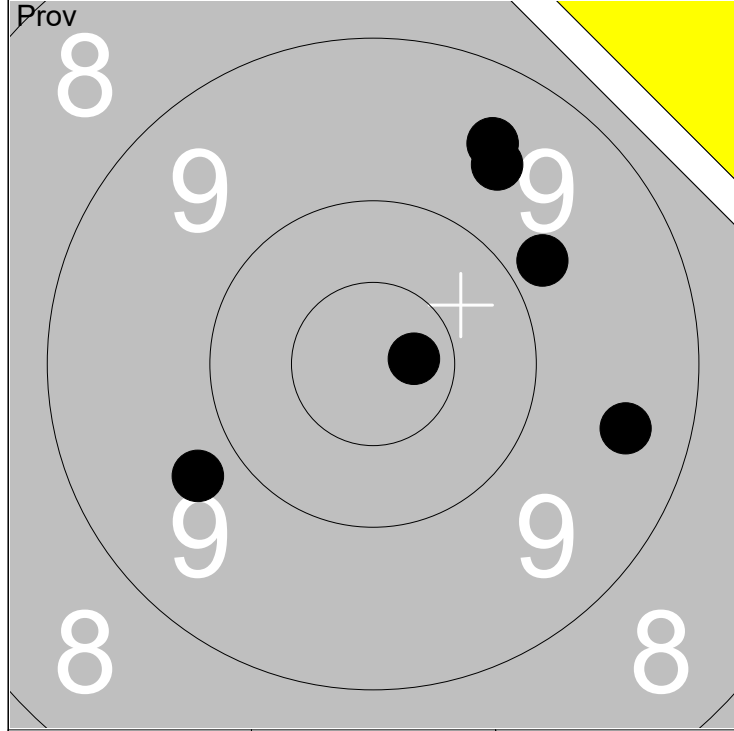

1: 9.4 →	6: 9.8 ↗		
2: 9.8 ↙		Serie	55
3: 9.5 ↗			
4: 10.7x →		Total	0
5: 9.6 ↗			

1: 10.4 ↙			
2: 10.4 ↗		Serie	49
3: 10.3 ↗			
4: 9.6 ↗		Total	49
5: 10.8x ↘			

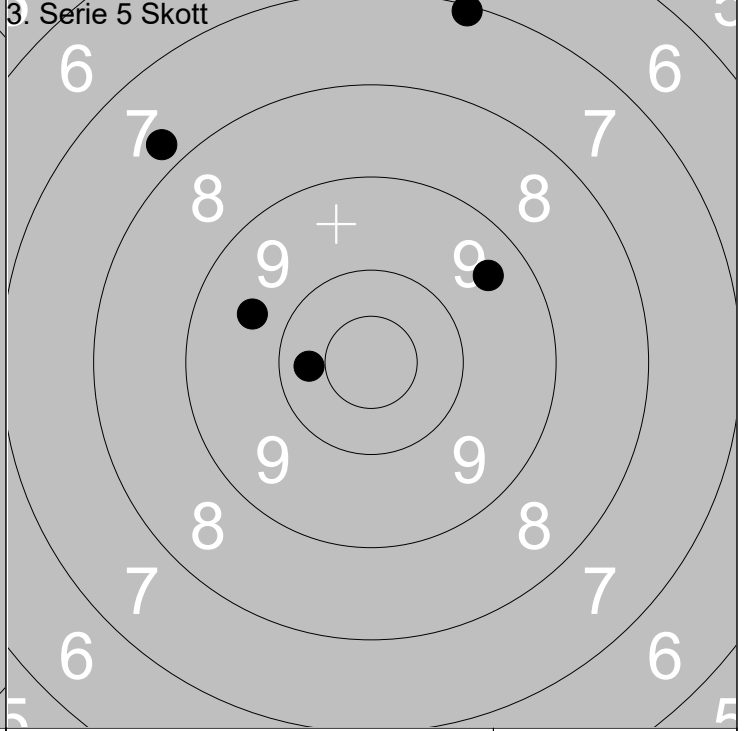
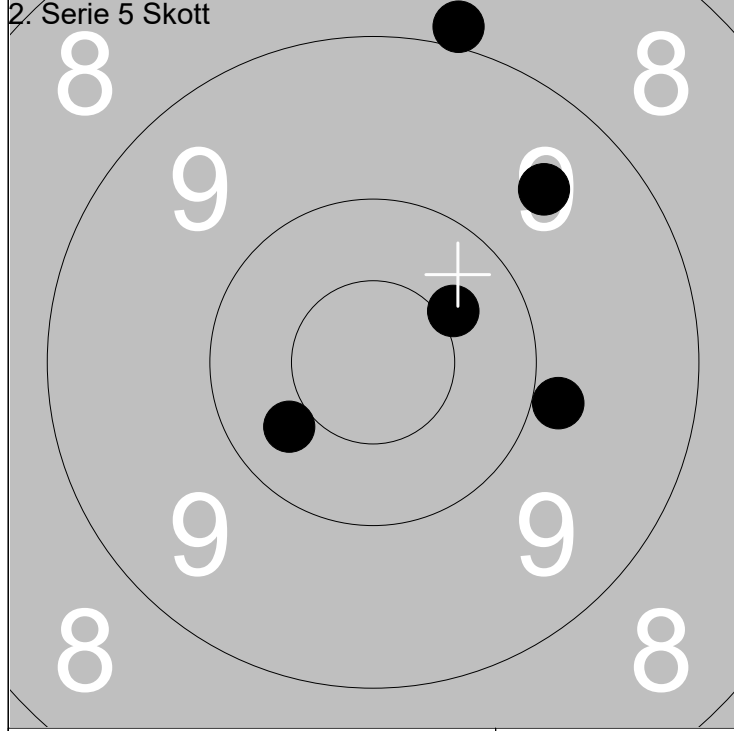

1: 8.9 ↗			
2: 10.4 ↗		Serie	46
3: 9.5 ↗			
4: 10.4 ↙		Total	95
5: 9.9 →			

1: 10.3 ←			
2: 9.6 ↙		Serie	42
3: 7.8 ↙			
4: 7.1 ↗		Total	137
5: 9.5 ↗			

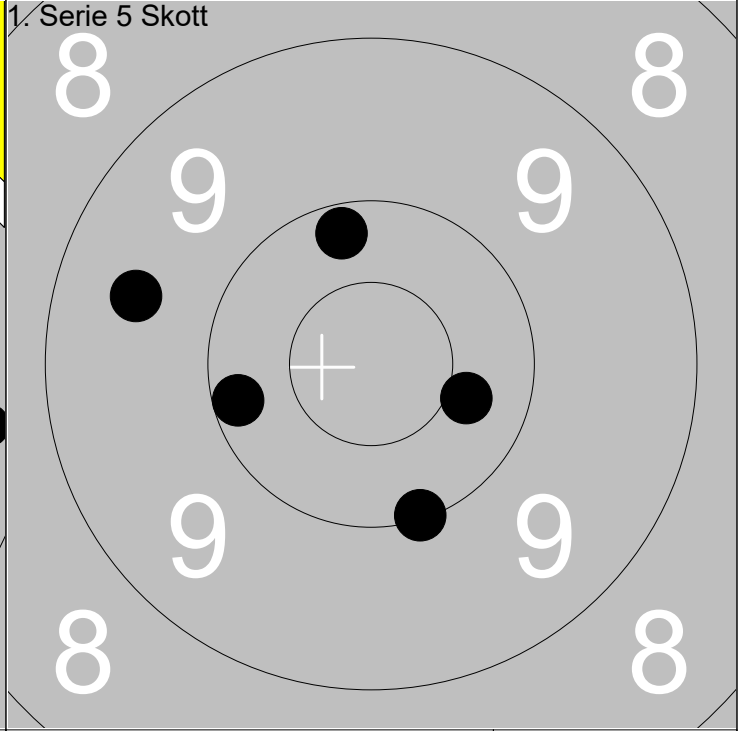
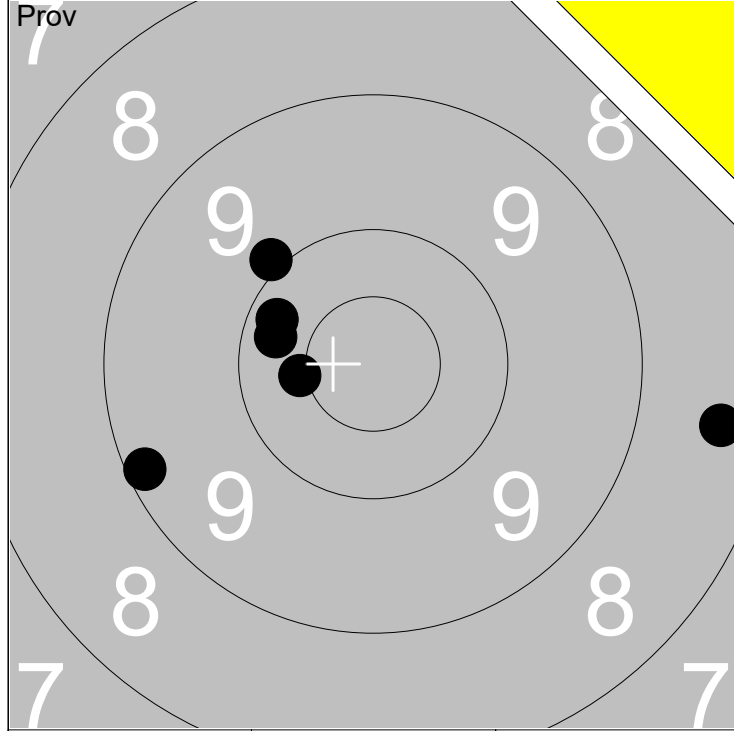

1: 9.9 ↖	6: 8.4 →				
2: 10.3 ↖		Serie	56		
3: 10.4x ↖					
4: 9.2 ↖		Total	0		
5: 10.2 ↖					

1: 10.0 ↓					
2: 10.2 ↖		Serie	49		
3: 10.2 ↗					
4: 9.5 ↖		Total	49		
5: 10.4 →					

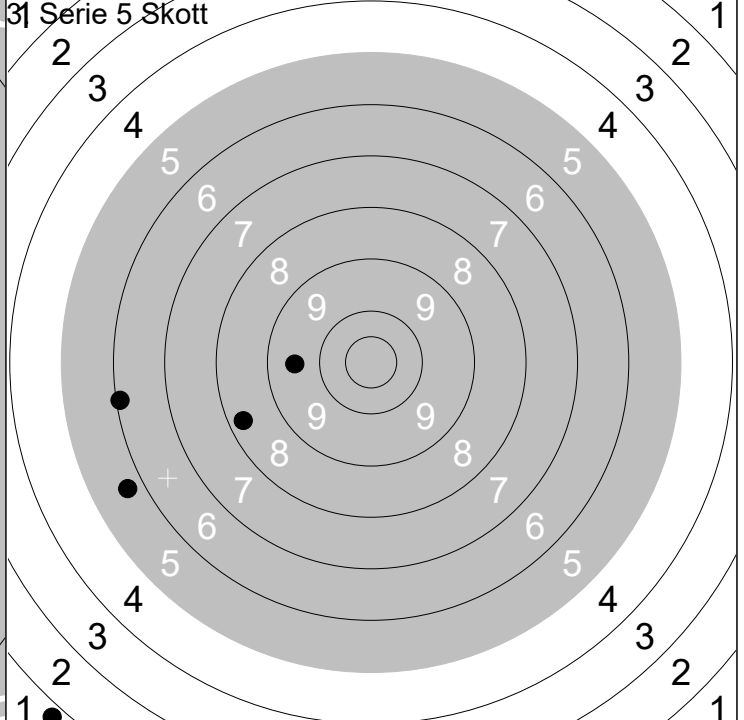
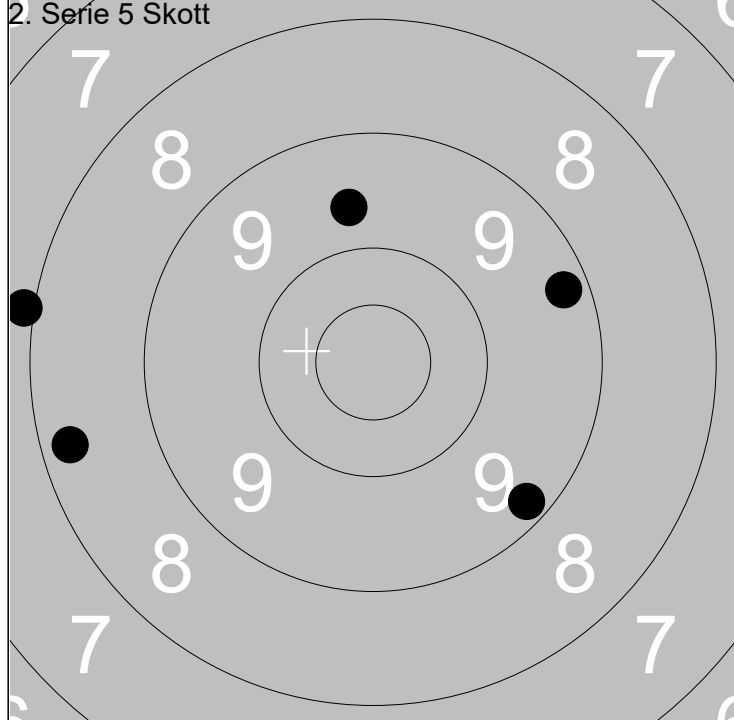

1: 9.2 ↘					
2: 9.2 →		Serie	42		
3: 7.9 ↖					
4: 8.3 ↖		Total	91		
5: 9.7 ↗					

1: 8.3 ↖					
2: 9.5 ↖		Serie	29		
3: 5.7 ↖					
4: 1.8 ↘		Total	120		
5: 6.1 ↖					

Skjutlag

3

Tavla

11

Fanny Storm

Ramselefors

Loos

B

Gä

09.07.2018

Tavelträffen B 2018

Ramselefors SKF

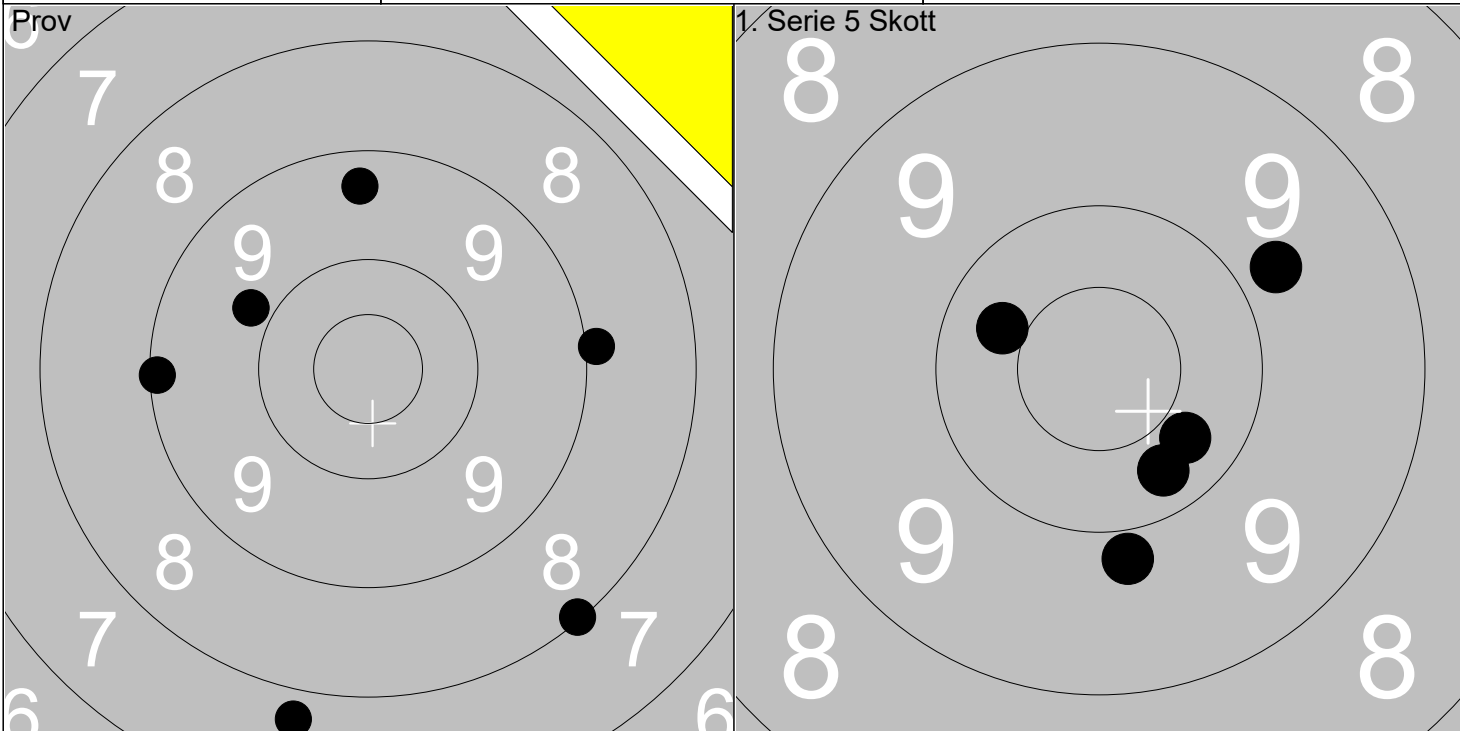

1: 8.1 ↘
 2: 7.8 ↓
 3: 8.9 →
 4: 9.1 ←
 5: 9.4 ↑

6: 9.8 ↖

Serie 50

Total 0

1: 9.9 ↓
 2: 10.3 ↘
 3: 10.3 ↓
 4: 9.8 ↗
 5: 10.4 ↖

Serie 48

Total 48

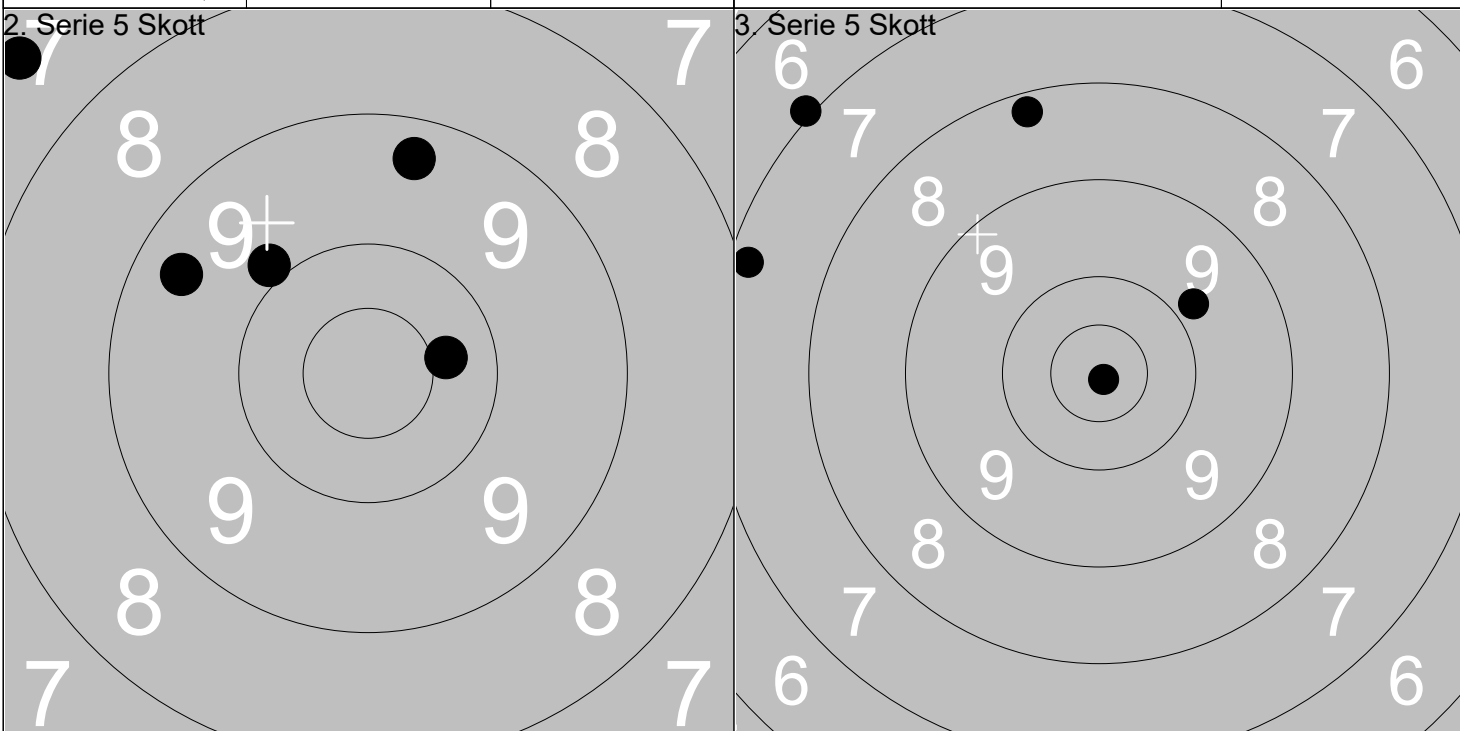

1: 7.4 ↖
 2: 9.4 ↖
 3: 9.3 ↑
 4: 9.9 ↖
 5: 10.4 →

Serie 44

Total 92

1: 9.8 ↗
 2: 8.2 ↑
 3: 7.0 ↖
 4: 10.9x ↓
 5: 7.2 ↖

Serie 41

Total 133

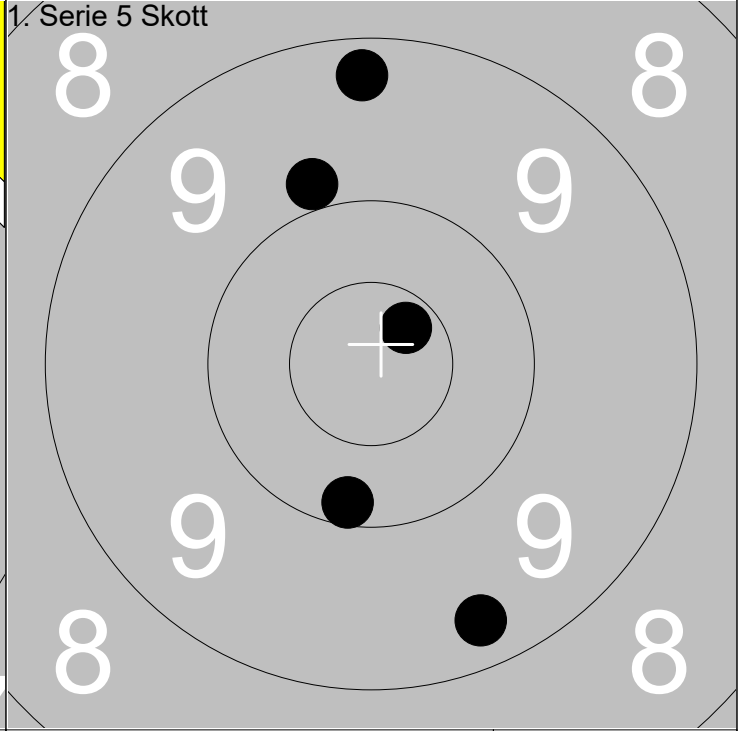
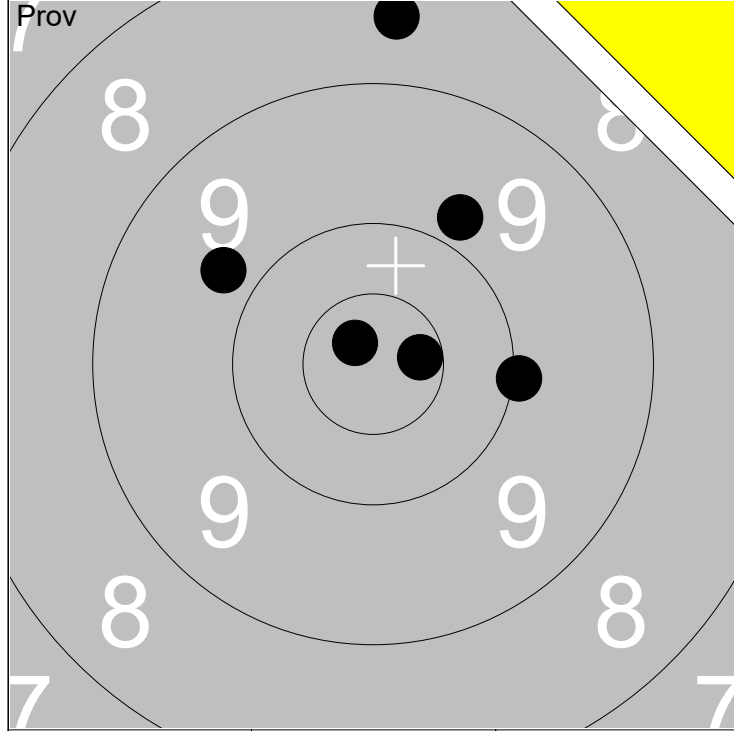

1: 10.0 →	6: 10.6x →		
2: 9.8 ↖		Serie	56
3: 10.8x ↖			
4: 8.5 ↑		Total	0
5: 9.8 ↗			

1: 9.3 ↑			
2: 10.7x ↗		Serie	47
3: 10.2 ↓			
4: 9.9 ↖		Total	47
5: 9.3 ↓			

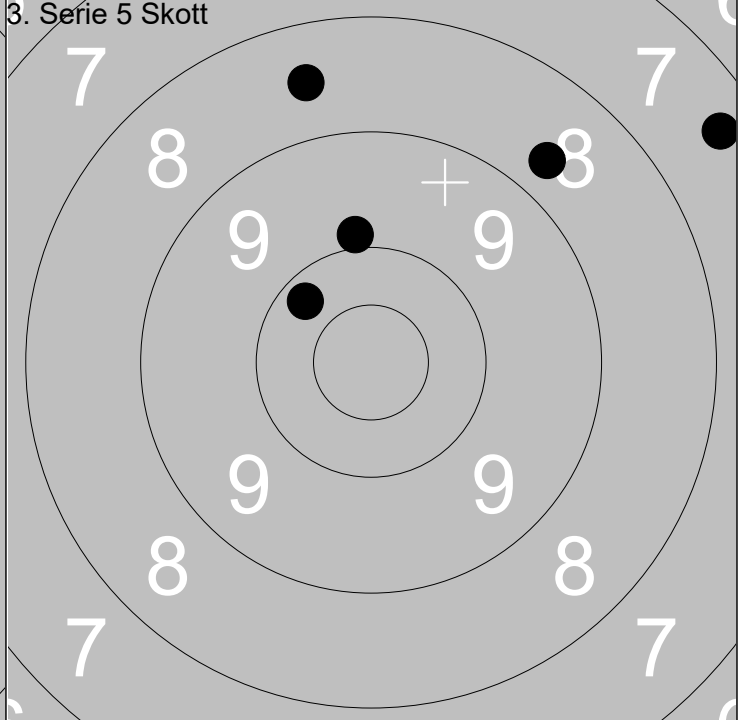
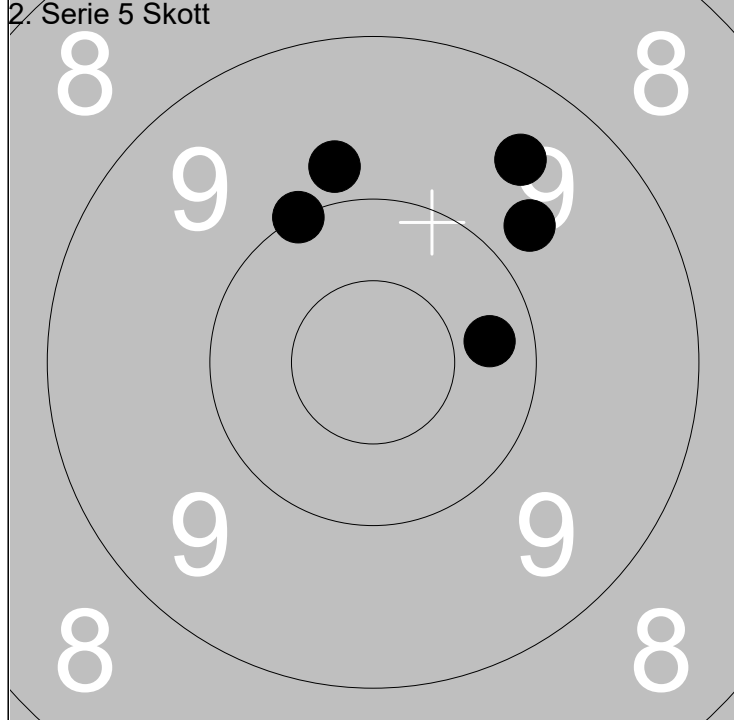

1: 10.3 →			
2: 10.0 ↖		Serie	47
3: 9.5 ↗			
4: 9.8 ↗		Total	94
5: 9.8 ↑			

1: 7.4 ↗			
2: 9.9 ↑		Serie	42
3: 10.2 ↖			
4: 8.7 ↗		Total	136
5: 8.5 ↑			

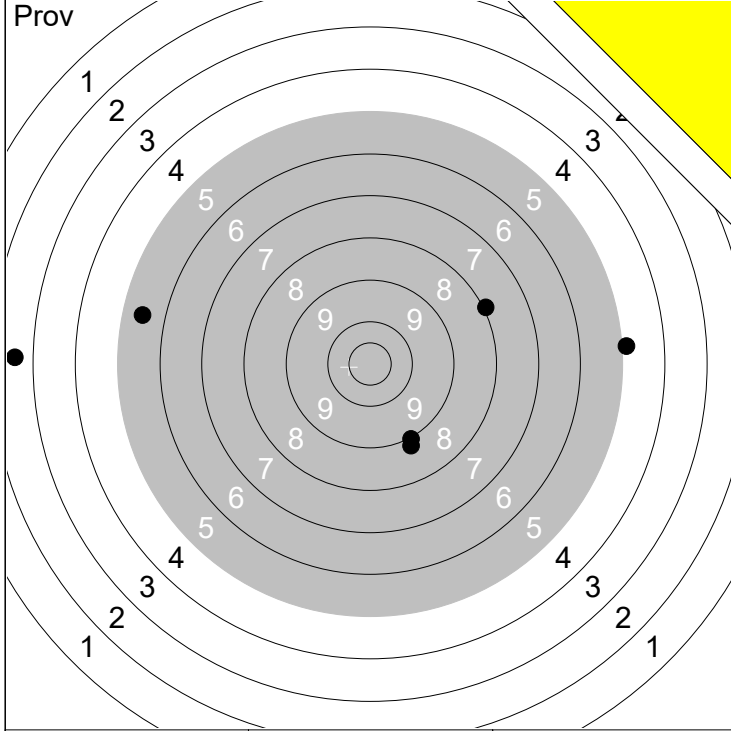

1: 2.6 ←	6: 4.9 →
2: 5.5 ←	
3: 8.9 ↓	
4: 8.0 ↗	
5: 9.0 ↓	

Serie	36
Total	0

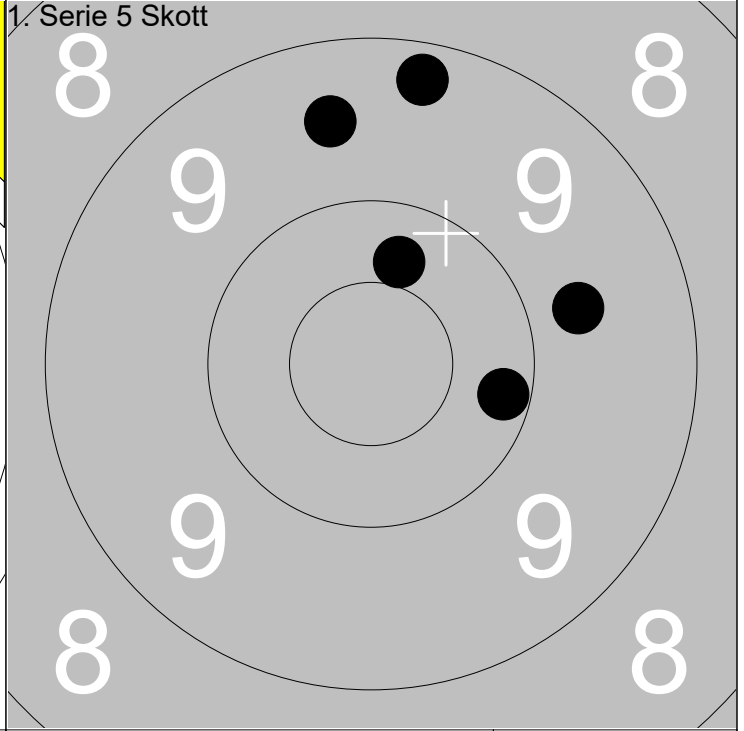

1: 10.2 →	5: 9.7 →
2: 10.3 ↑	
3: 9.3 ↑	
4: 9.5 ↑	

Serie	47
Total	47

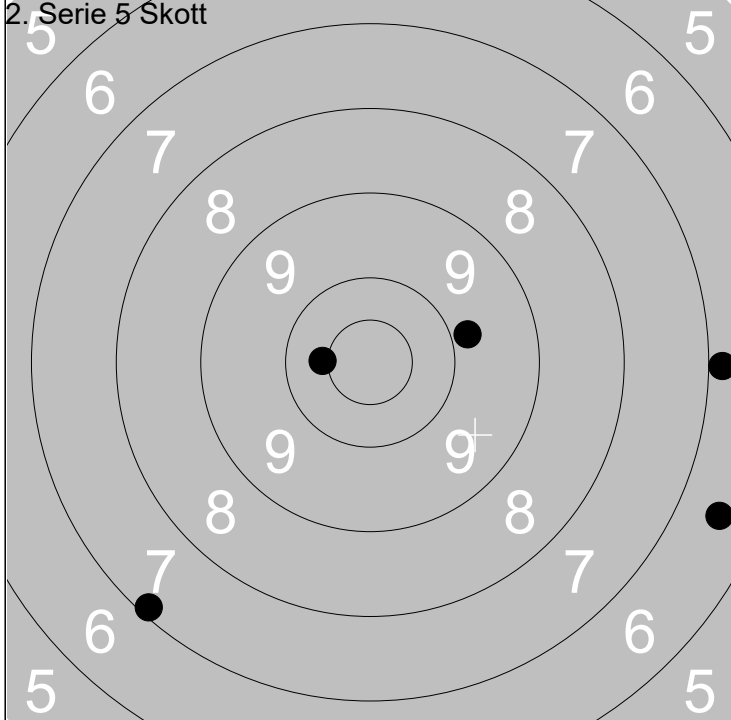

1: 6.5 →	5: 7.1 ↙
2: 10.4x ←	
3: 6.9 →	
4: 9.8 →	

Serie	38
Total	85

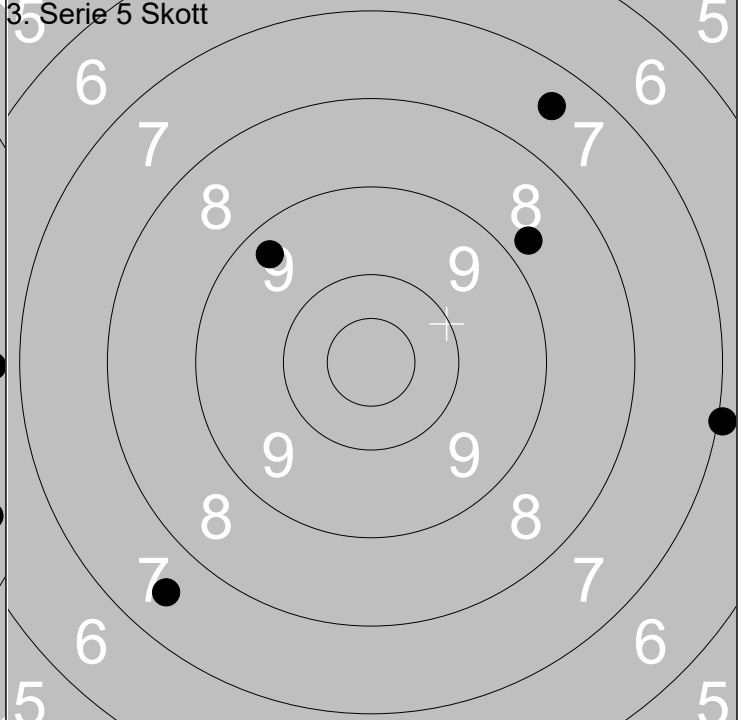

1: 7.5 ↗	5: 7.5 ↙
2: 7.0 →	
3: 8.8 ↗	
4: 9.3 ↖	

Serie	38
Total	123

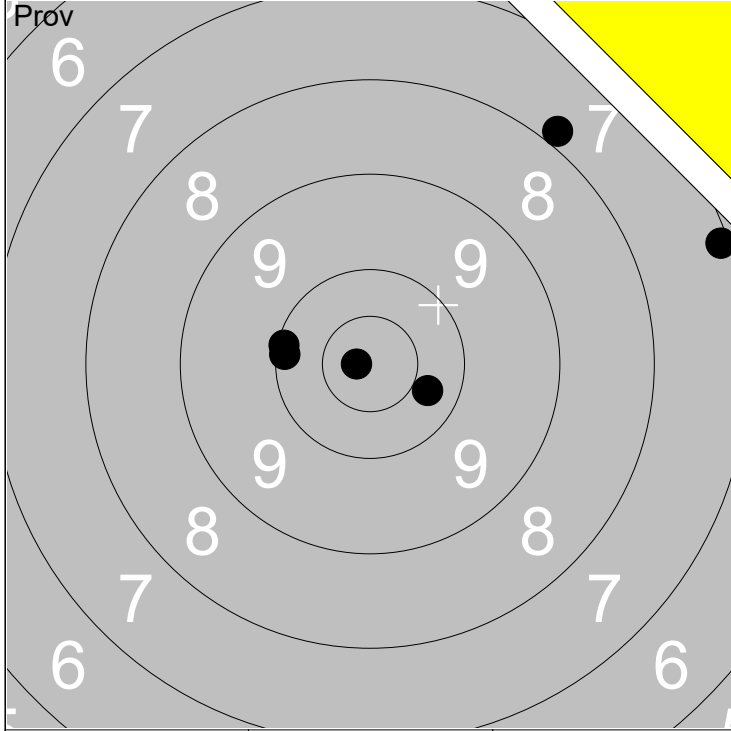

1: 10.1 ←
2: 10.3 →
3: 10.8x ←
4: 10.1 ←
5: 7.9 ↗

6: 7.1 →

Serie	54
Total	0

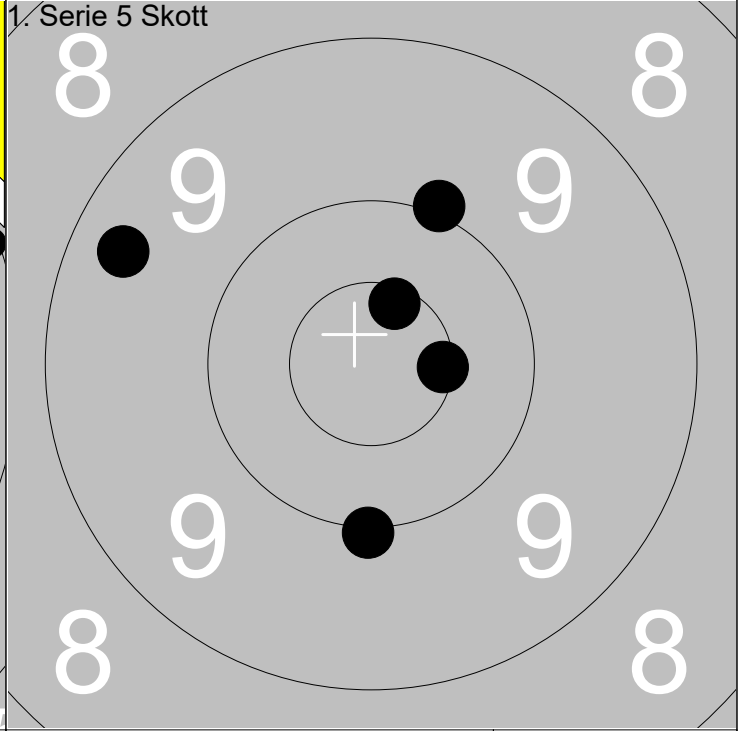

1: 10.0 ↓
2: 9.4 ←
3: 10.6x ↗
4: 10.0 ↗
5: 10.5x →

Serie	49
Total	49

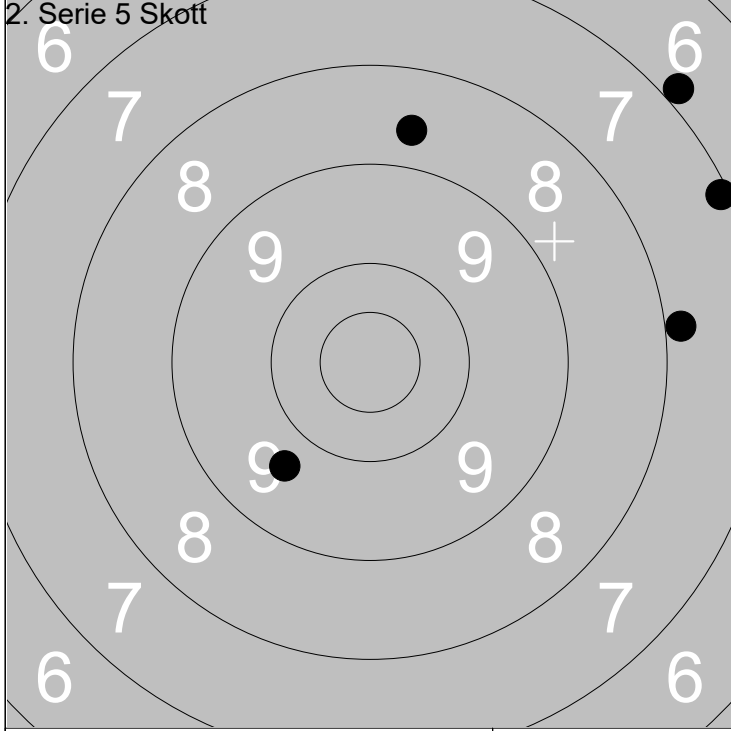

1: 8.7 ↗
2: 7.1 →
3: 6.9 ↗
4: 9.7 ↘
5: 7.9 →

Serie	37
Total	86

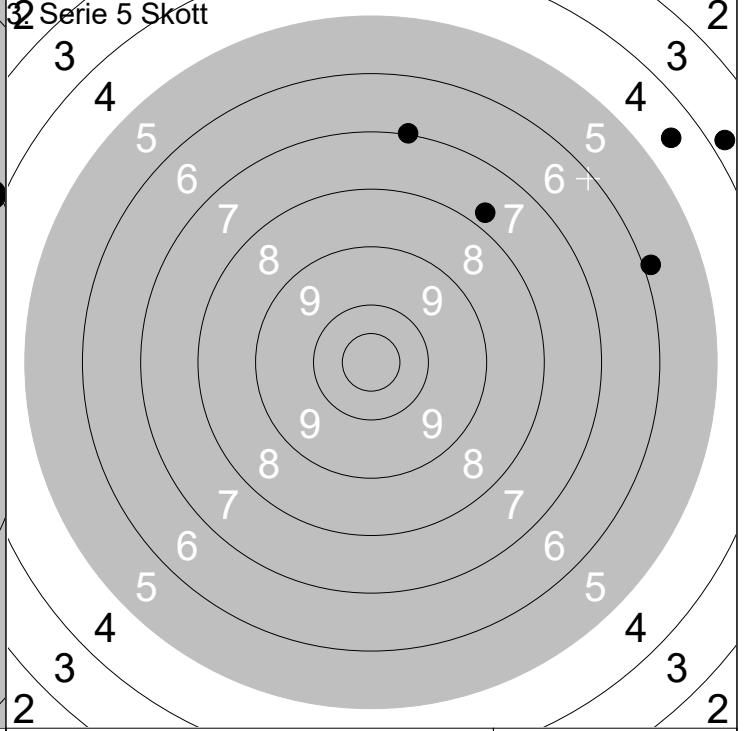

1: 3.8 ↗
2: 7.0 ↗
3: 4.5 ↗
4: 5.9 →
5: 7.8 ↗

Serie	26
Total	112

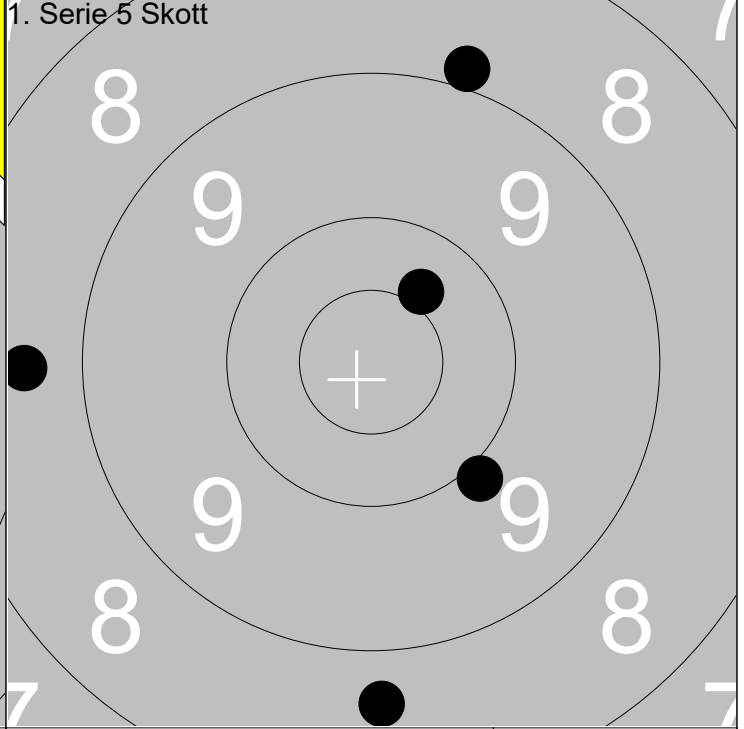
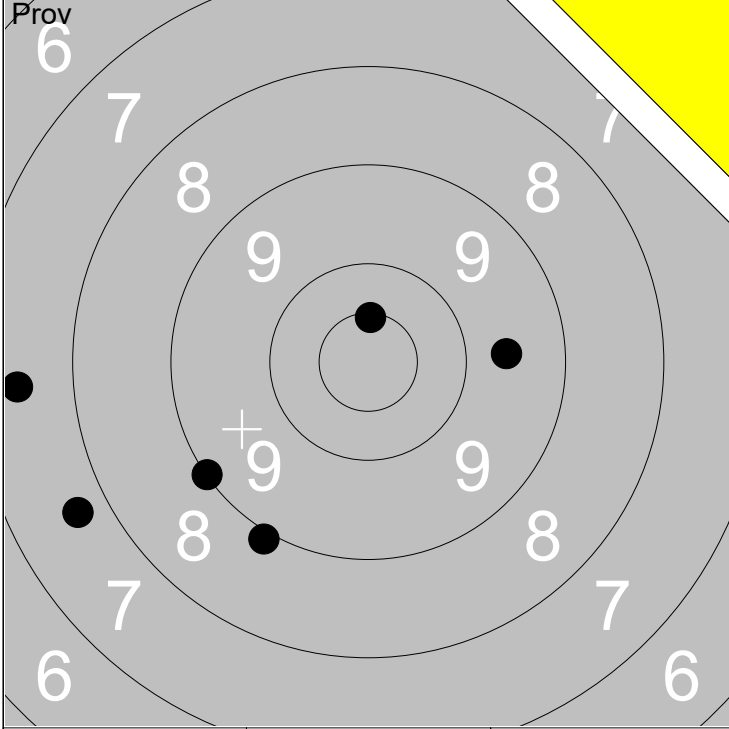

1: 7.7 ↙	6: 9.6 →
2: 7.5 ←	
3: 9.0 ↙	
4: 10.5x ↑	
5: 8.9 ↘	

Serie	50
Total	0

1: 8.9 ↑	
2: 10.4 ↗	
3: 8.7 ↓	
4: 8.6 ←	
5: 9.9 ↘	

Serie	43
Total	43

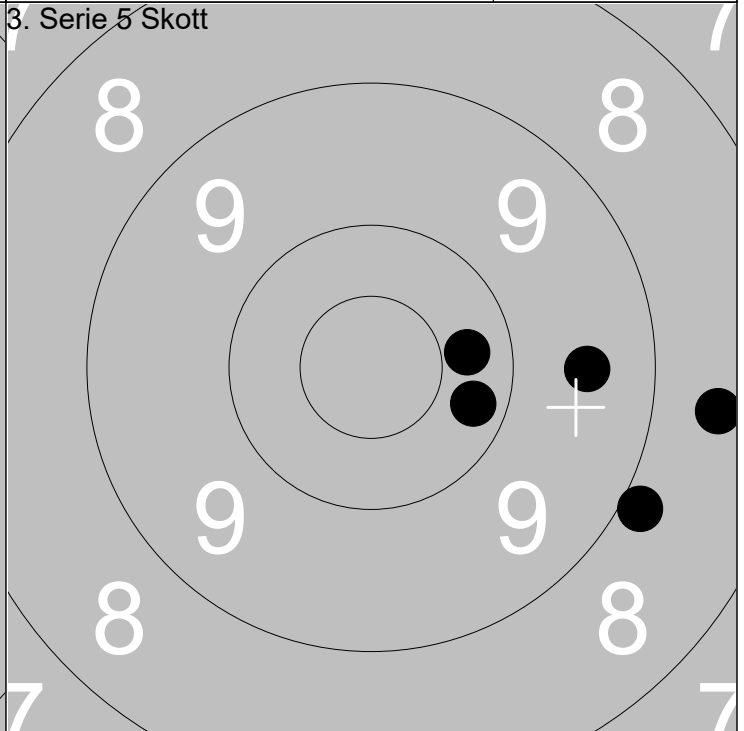
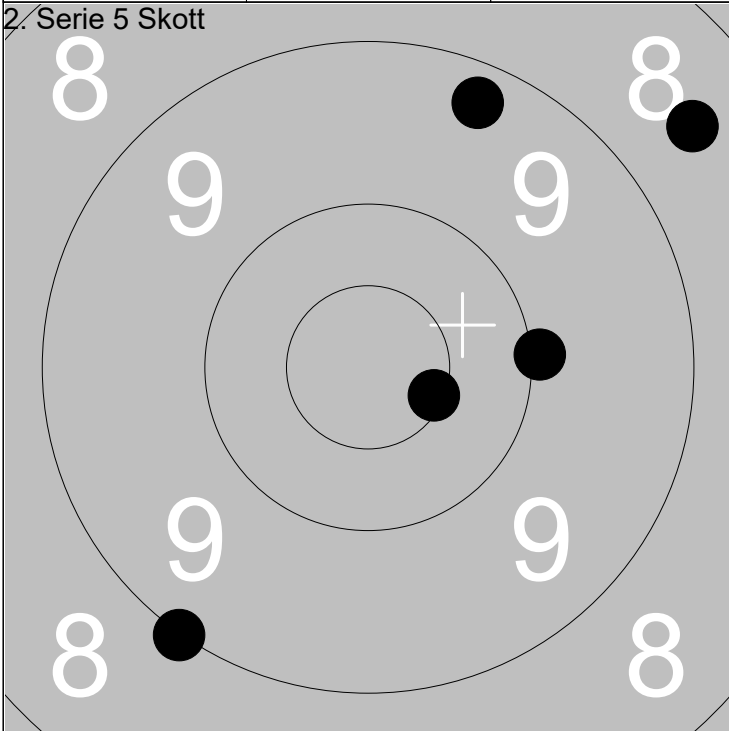

1: 10.5x →	
2: 9.3 ↑	
3: 8.5 ↗	
4: 10.0 →	
5: 9.0 ↘	

Serie	46
Total	89

1: 10.3 →	
2: 10.2 →	
3: 9.5 →	
4: 8.6 →	
5: 8.9 ↘	

Serie	45
Total	134

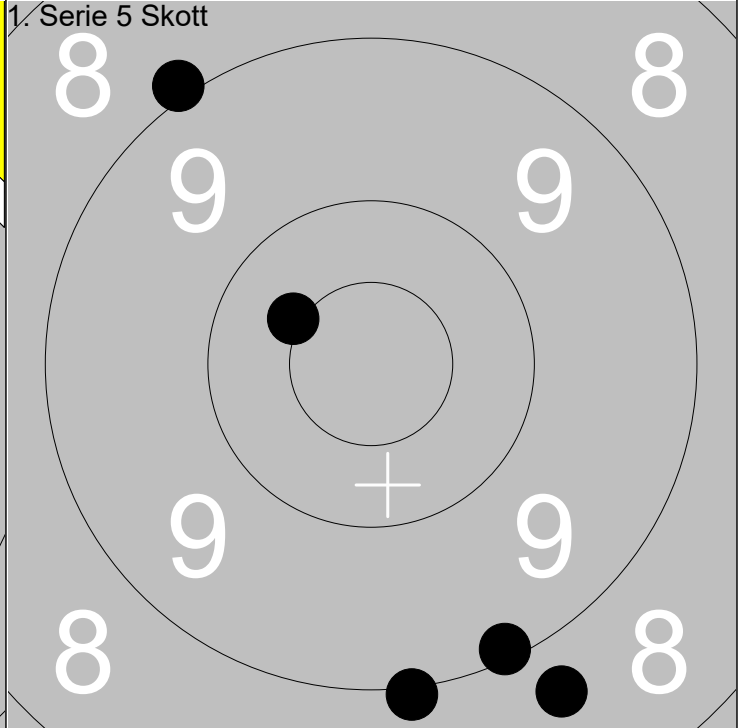
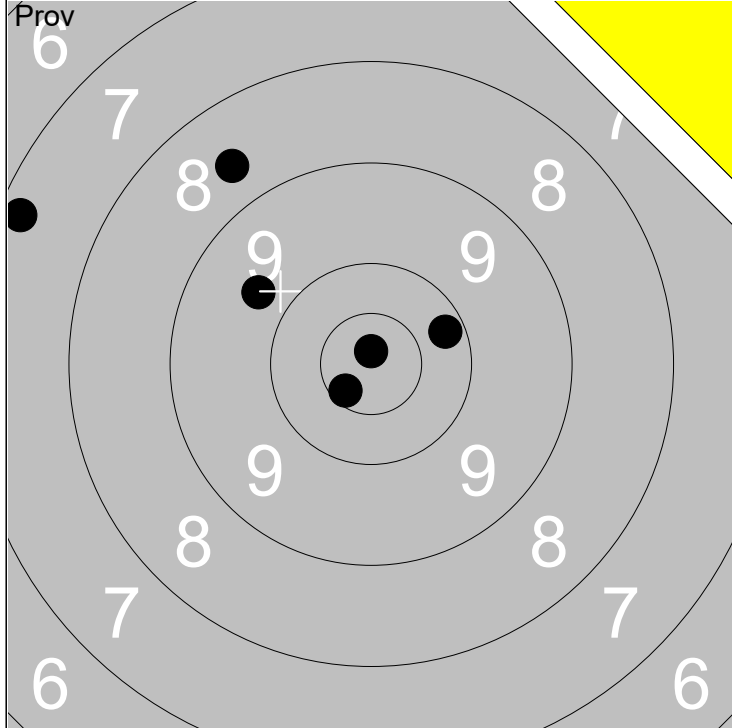

1: 9.7 ↖	6: 10.8x ↑				
2: 8.6 ↗		Serie	54		
3: 10.2 →					
4: 10.6x ↘		Total	0		
5: 7.2 ↖					

1: 9.1 ↘					
2: 8.7 ↘		Serie	45		
3: 9.0 ↗					
4: 9.0 ↘		Total	45		
5: 10.4x ↖					

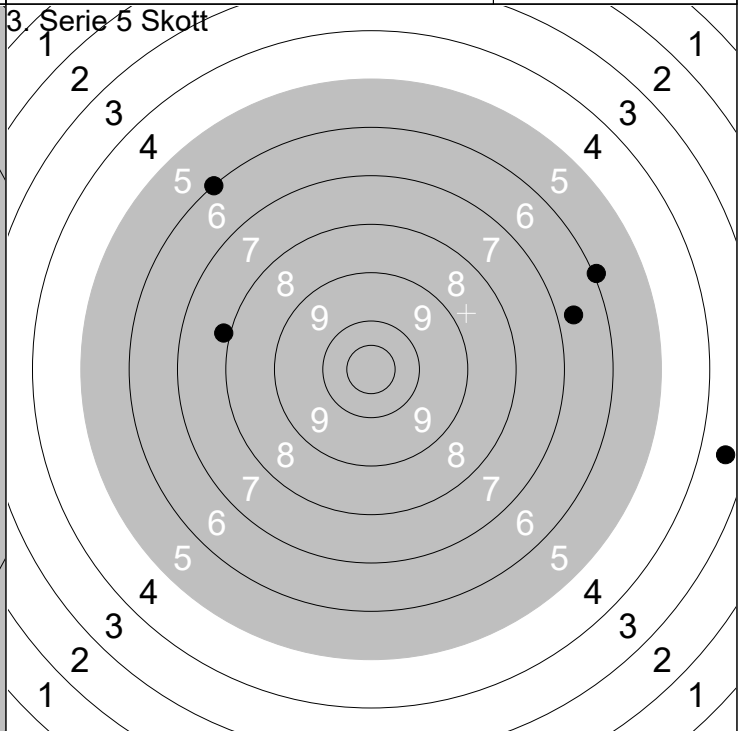
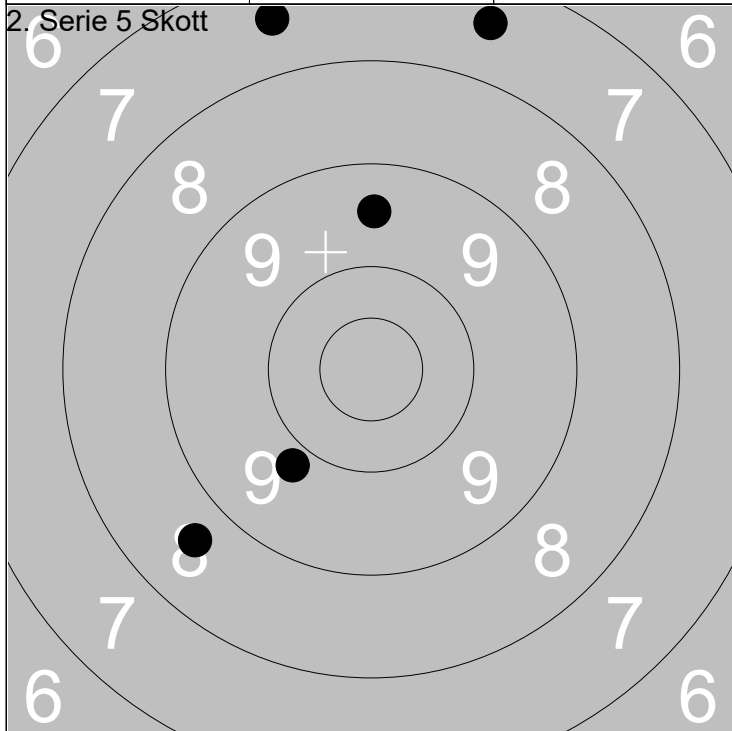

1: 9.8 ↘					
2: 8.6 ↘		Serie	40		
3: 7.5 ↗					
4: 7.5 ↗		Total	85		
5: 9.5 ↑					

1: 3.5 →					
2: 6.0 ↗		Serie	28		
3: 6.0 →					
4: 6.7 →		Total	113		
5: 7.9 ↖					

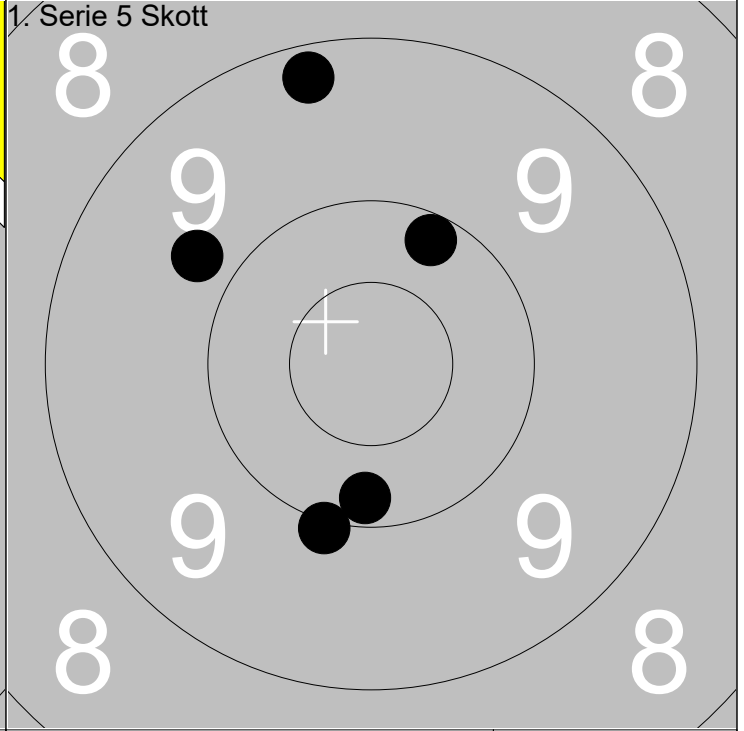
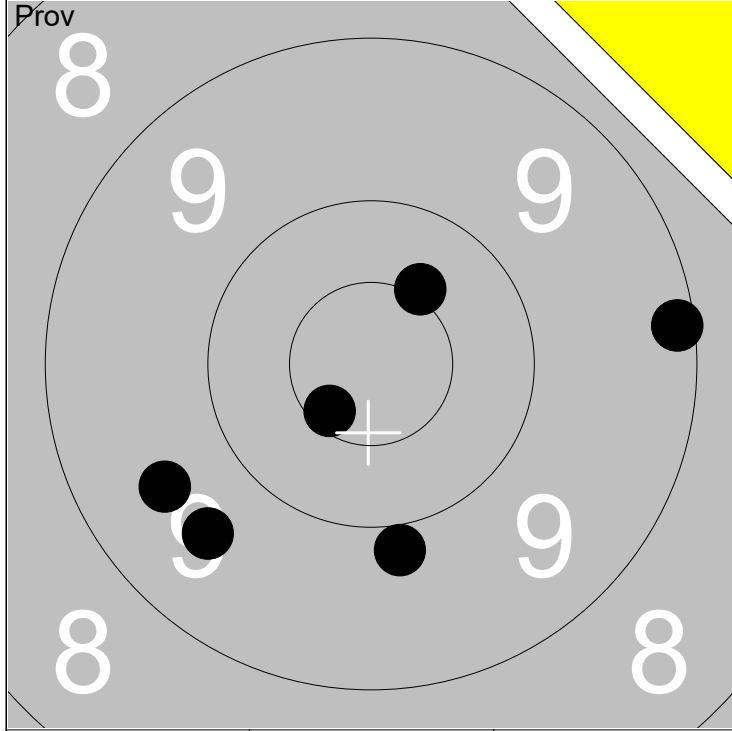

1: 9.6 ↙	6: 9.1 →		
2: 10.4x ↗		Serie	56
3: 9.9 ↓			
4: 10.6x ↙		Total	0
5: 9.6 ↙			

1: 9.8 ↖			
2: 10.2 ↗		Serie	48
3: 10.0 ↓			
4: 9.2 ↗		Total	48
5: 10.2 ↓			

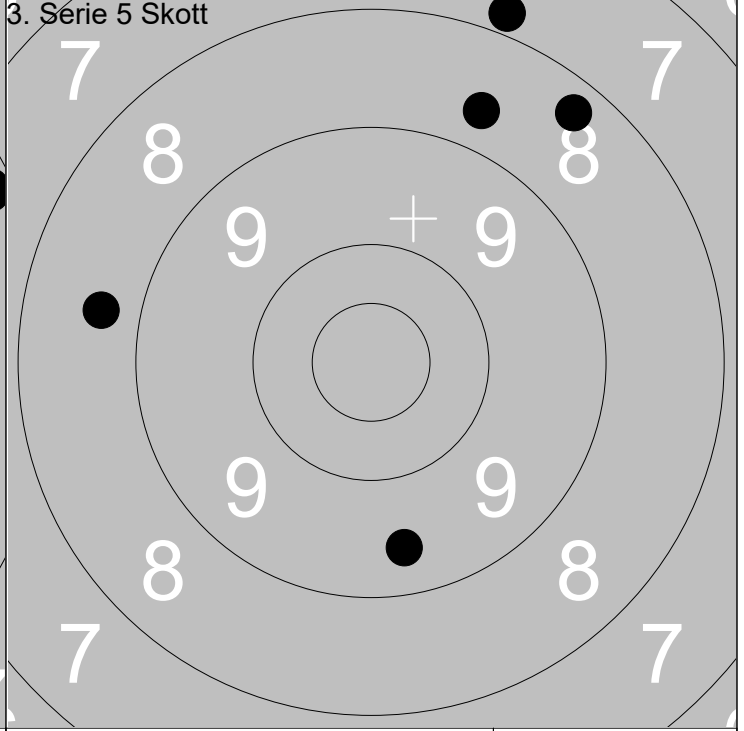
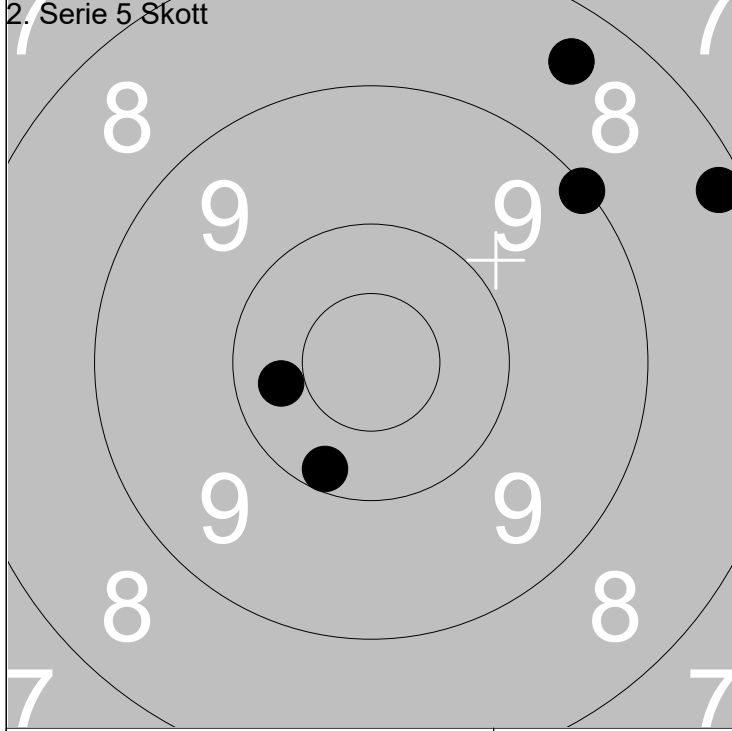

1: 8.2 ↗			
2: 10.2 ↓		Serie	45
3: 8.4 ↗			
4: 9.1 ↗		Total	93
5: 10.3 ↖			

1: 8.3 ↗			
2: 8.7 ↖		Serie	40
3: 7.8 ↗			
4: 8.7 ↗		Total	133
5: 9.4 ↓			

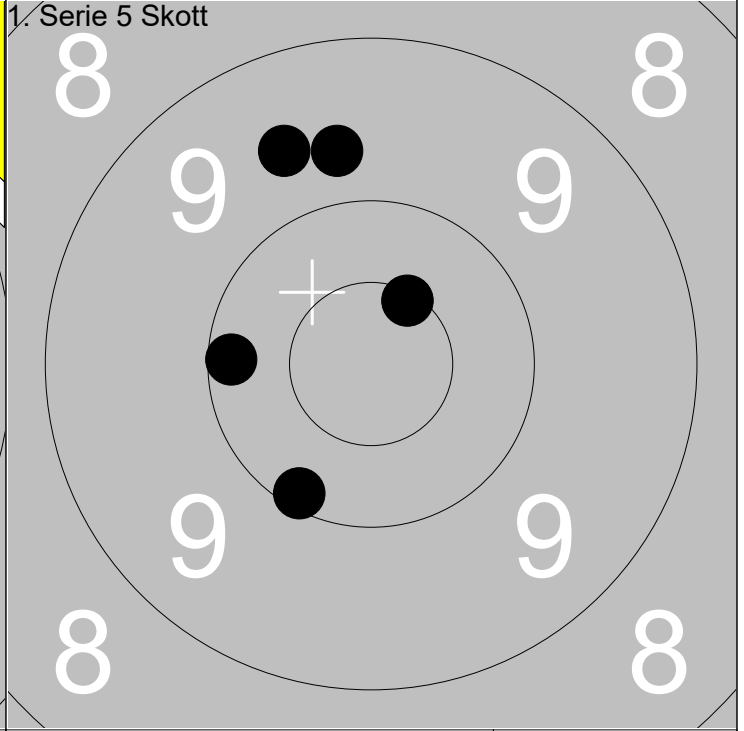
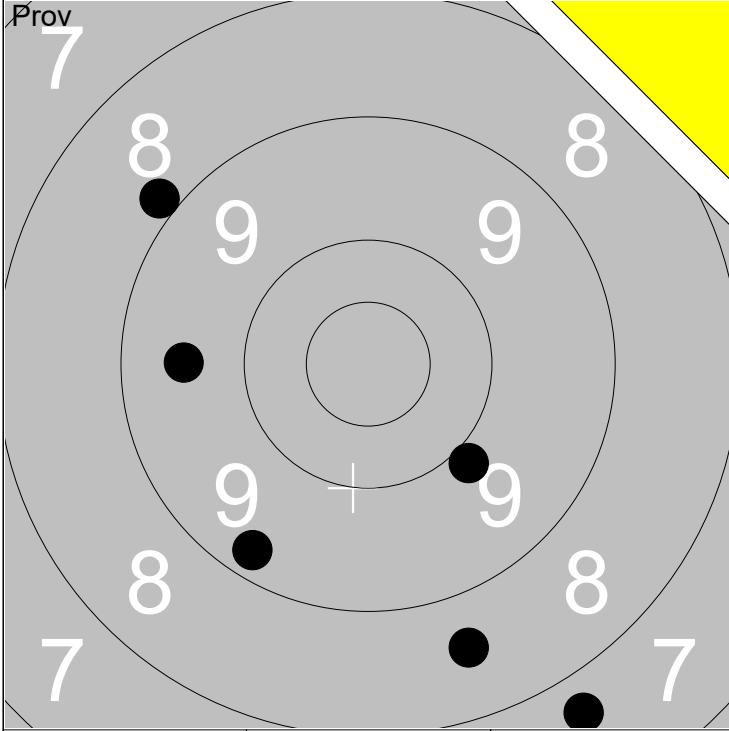

1: 9.3 ↘	6: 7.7 ↘		
2: 9.5 ←		Serie	50
3: 9.9 ↘			
4: 8.6 ↘		Total	0
5: 8.9 ↗			

1: 9.6 ↗			
2: 9.7 ↗		Serie	48
3: 10.2 ←			
4: 10.5x ↗		Total	48
5: 10.1 ↘			

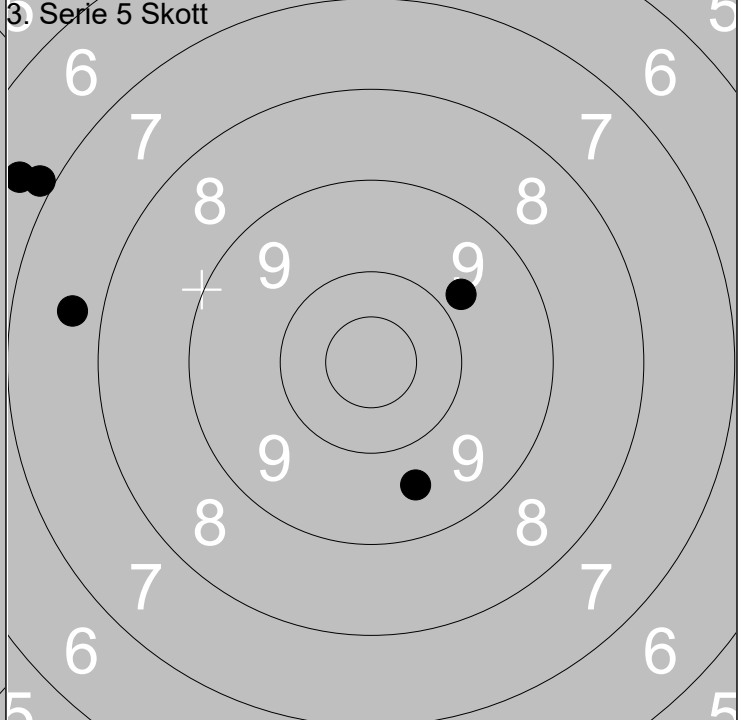
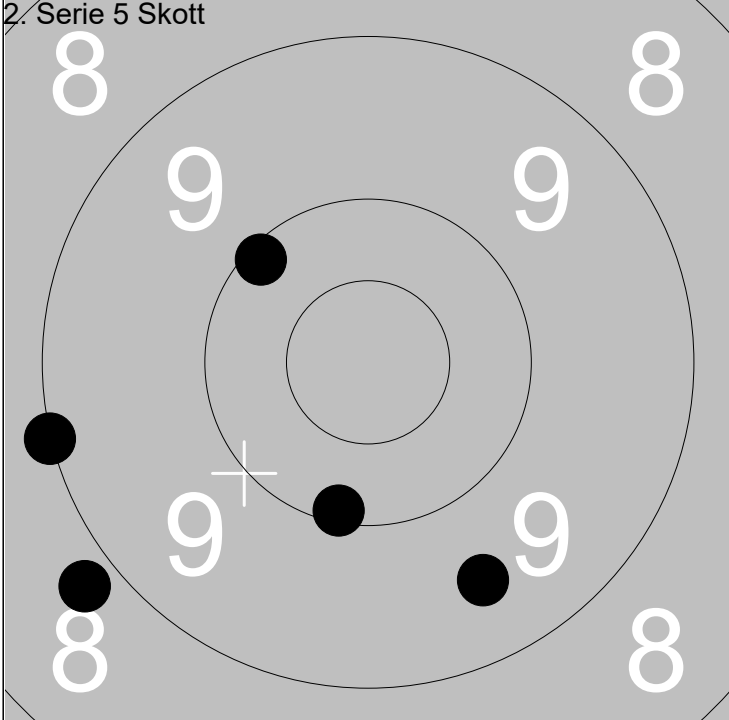

1: 9.0 ←			
2: 10.1 ↗		Serie	46
3: 8.8 ←			
4: 10.1 ↘		Total	94
5: 9.5 ↘			

1: 6.9 ↗			
2: 7.7 ←		Serie	37
3: 6.7 ↗			
4: 9.6 ↘		Total	131
5: 9.8 ↗			

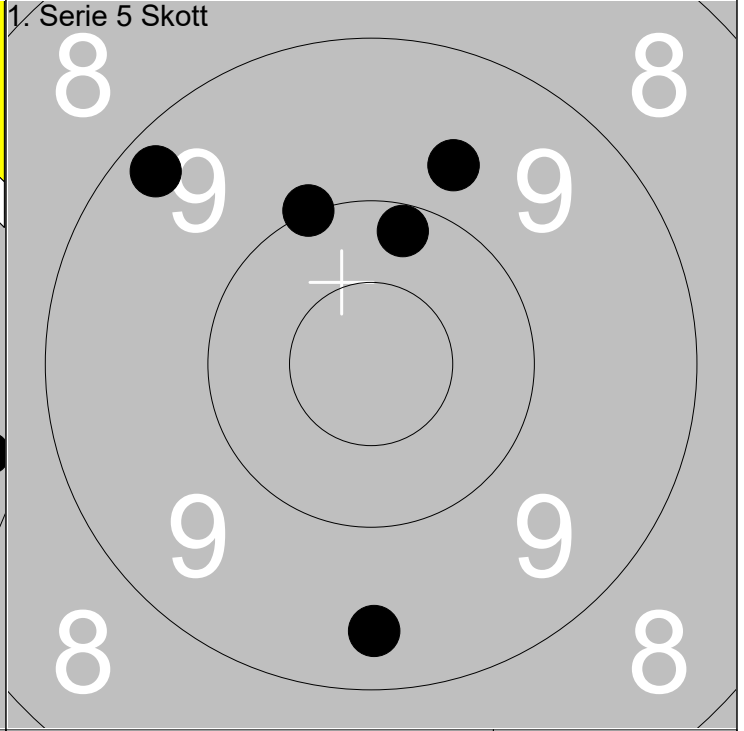
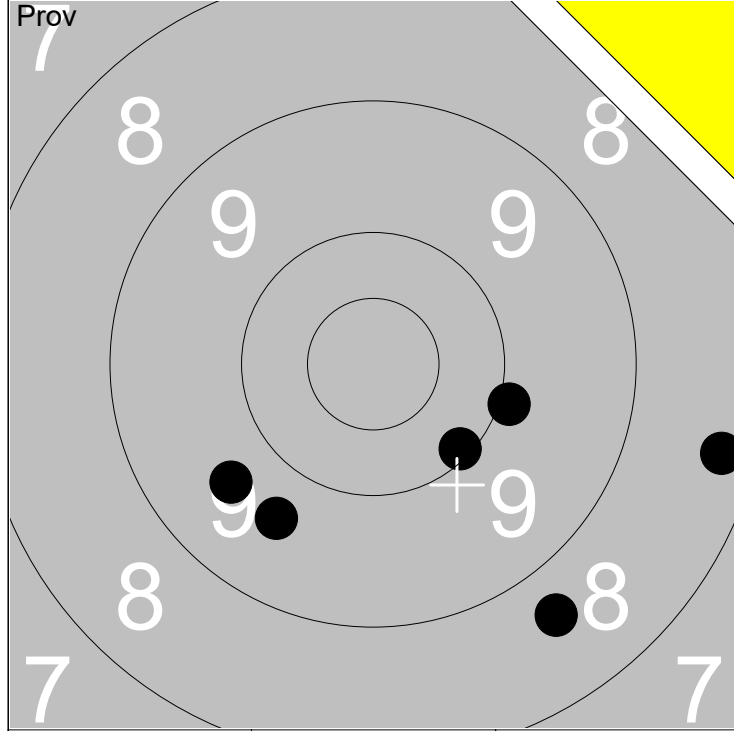

1: 9.6 ↙	6: 10.1 ↘				
2: 9.6 ↙		Serie	54		
3: 10.0 →		Total	0		
4: 8.7 ↘					
5: 8.3 →					

1: 9.3 ↖					
2: 9.4 ↓		Serie	47		
3: 10.2 ↑		Total	47		
4: 9.7 ↑					
5: 10.0 ↖					

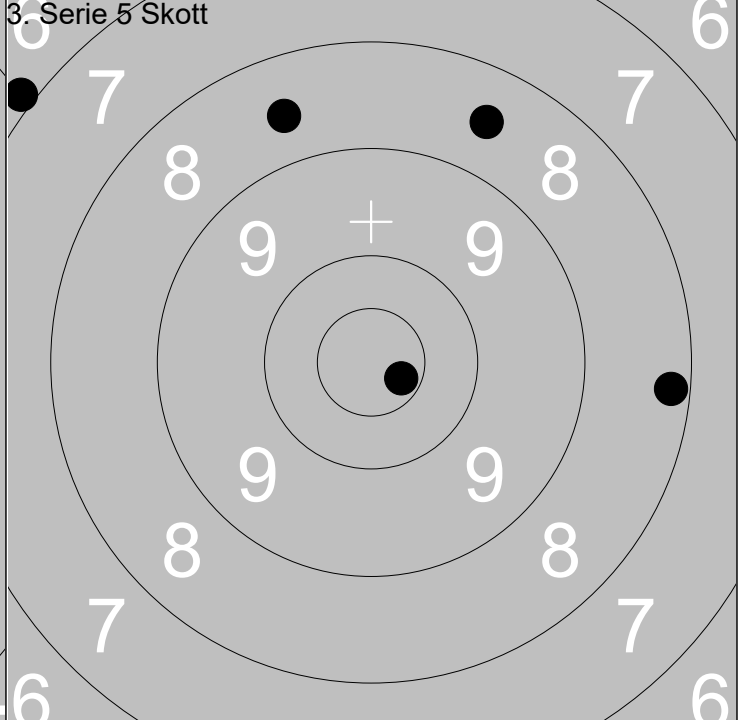
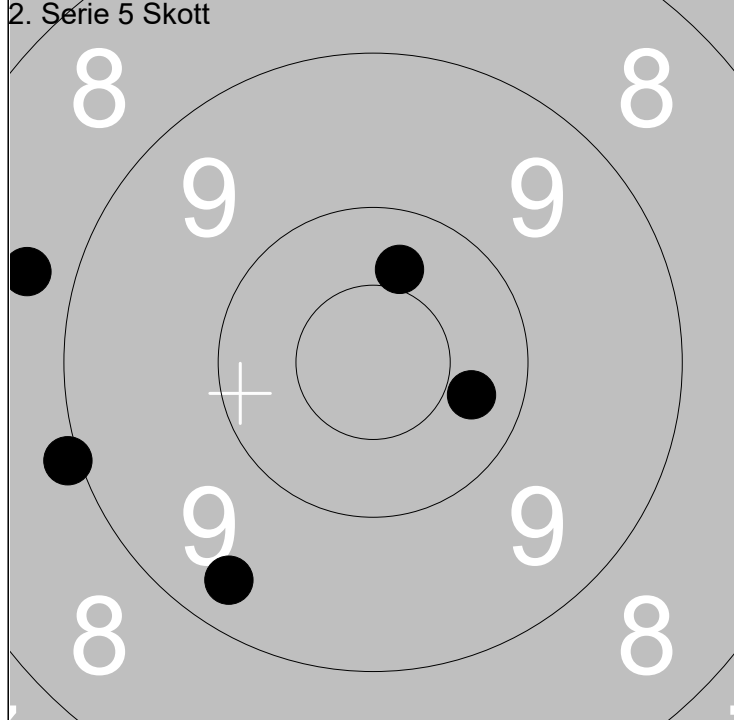

1: 9.3 ↙					
2: 10.3 →		Serie	46		
3: 10.4 ↑		Total	93		
4: 9.0 ←					
5: 8.7 ←					

1: 6.9 ↖					
2: 8.6 ↑		Serie	40		
3: 8.5 ↑		Total	133		
4: 10.7x →					
5: 8.2 →					

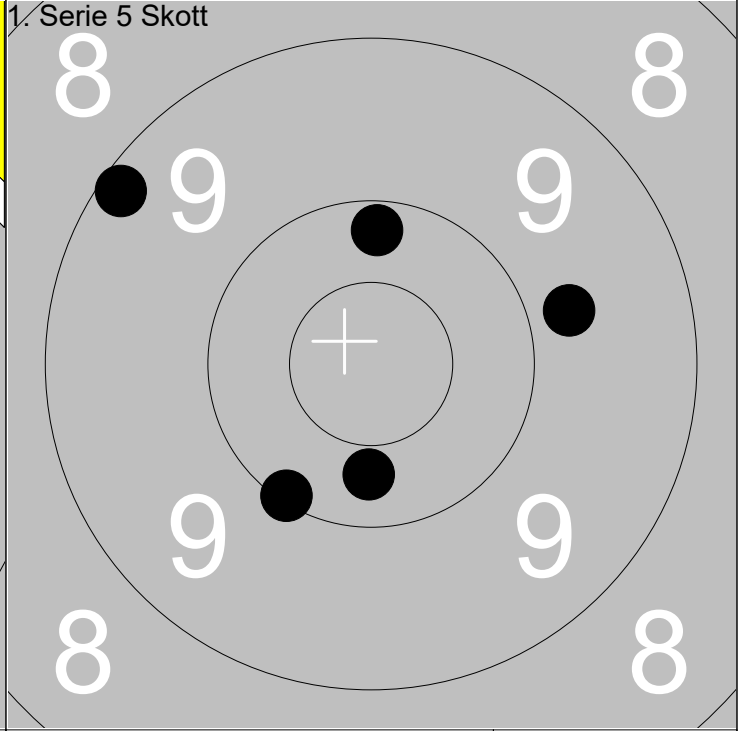
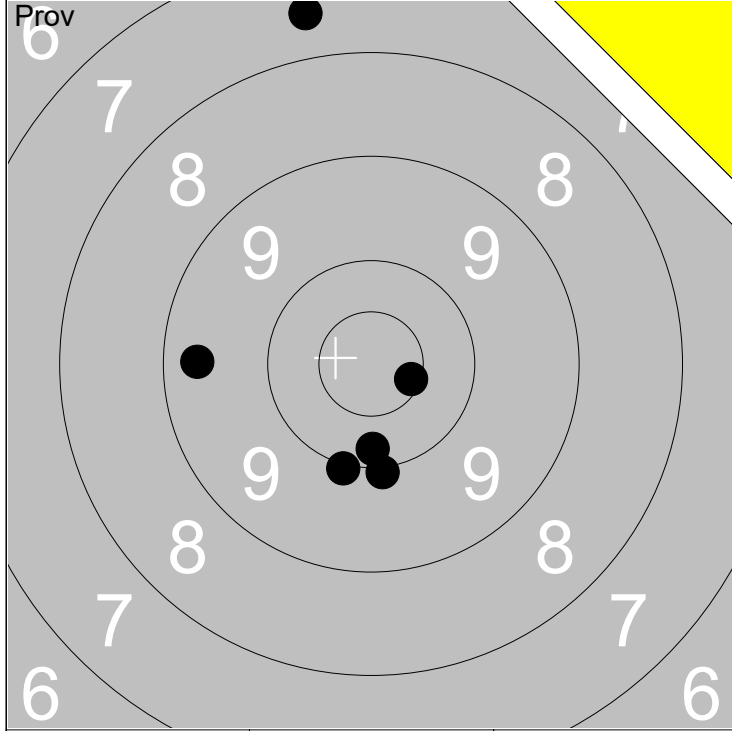

1: 10.0 ↓	6: 10.2 ↓		
2: 10.0 ↓		Serie	56
3: 9.4 ←			
4: 10.6x →		Total	0
5: 7.6 ↑			

1: 10.1 ↙			
2: 10.2 ↑		Serie	48
3: 9.2 ↖			
4: 10.3 ↓		Total	48
5: 9.8 →			

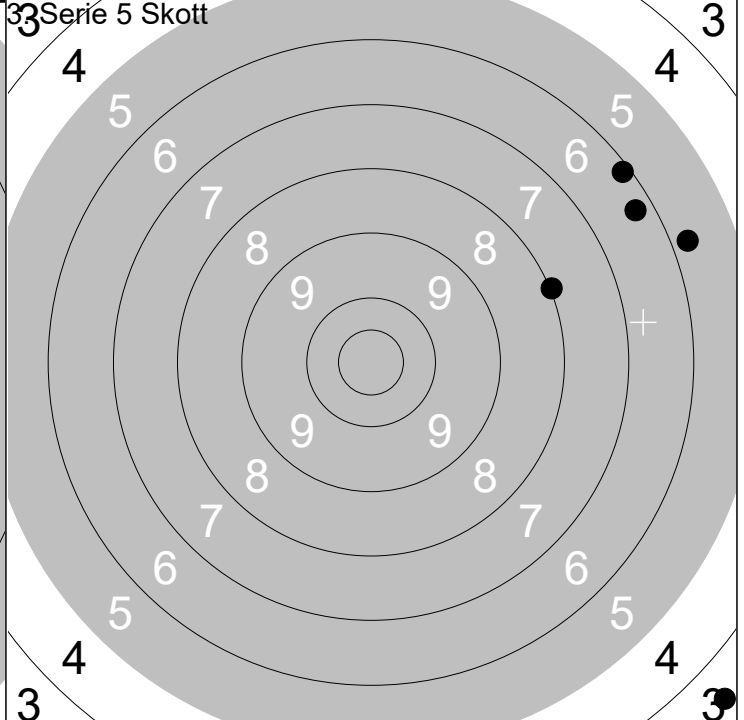
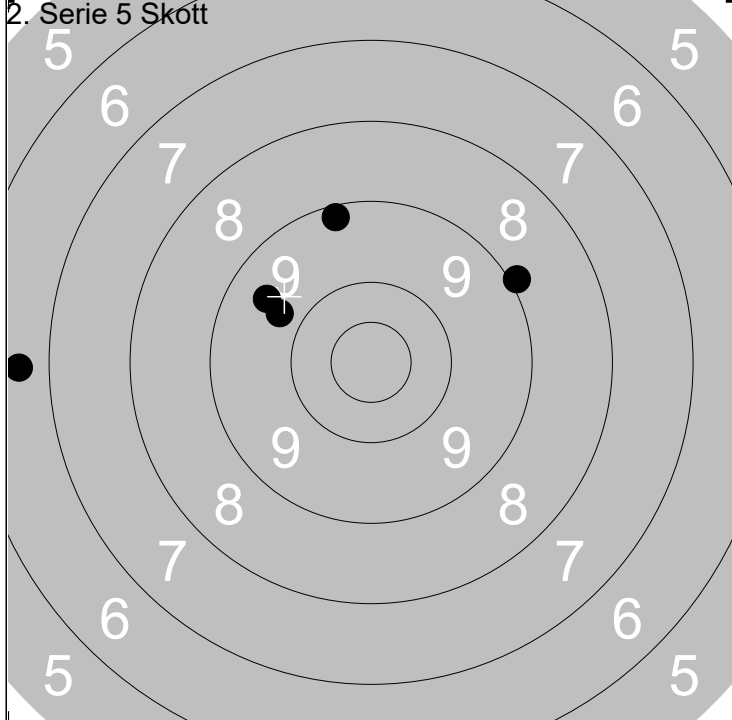

1: 9.2 ↑			
2: 8.9 ↗		Serie	41
3: 6.7 ←			
4: 9.7 ↖		Total	89
5: 9.5 ↖			

1: 6.3 ↗			
2: 3.5 ↓		Serie	28
3: 8.0 ↗			
4: 6.1 ↗		Total	117
5: 5.8 →			

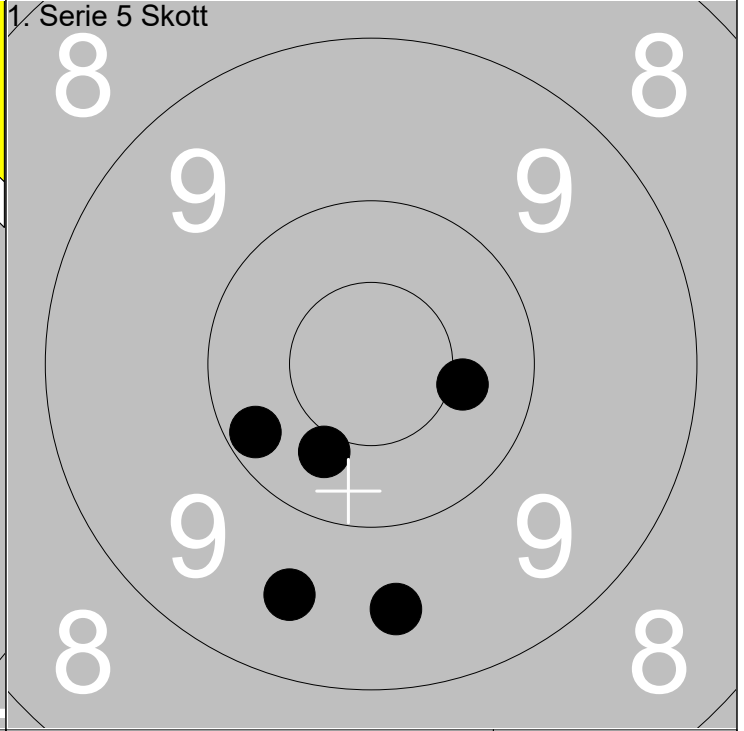
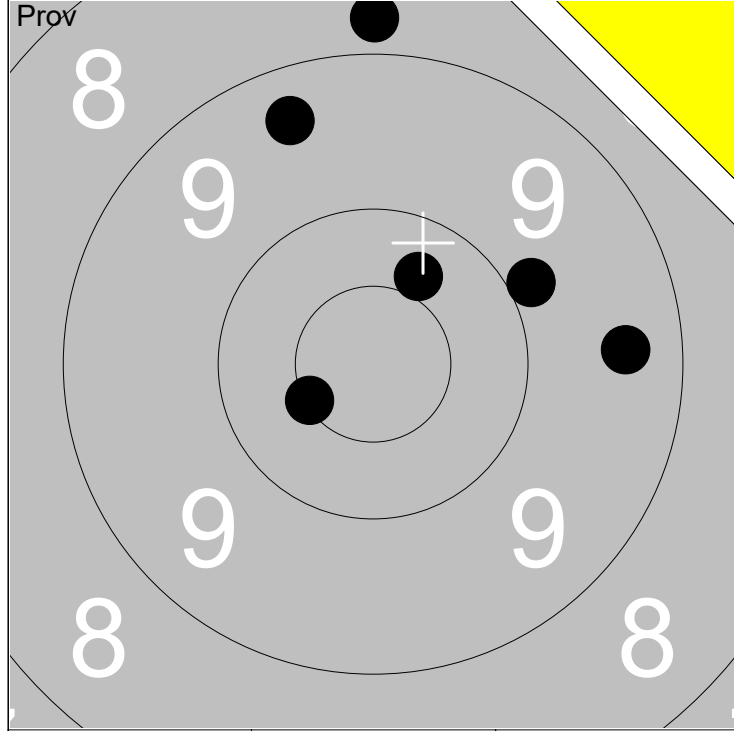

1: 10.5x ↙	6: 9.9 ↗				
2: 9.4 ↗		Serie	55		
3: 10.4 ↗					
4: 9.4 →		Total	0		
5: 8.8 ↑					

1: 9.5 ↓					
2: 10.4x →		Serie	48		
3: 10.4 ↓					
4: 10.2 ↙		Total	48		
5: 9.5 ↓					

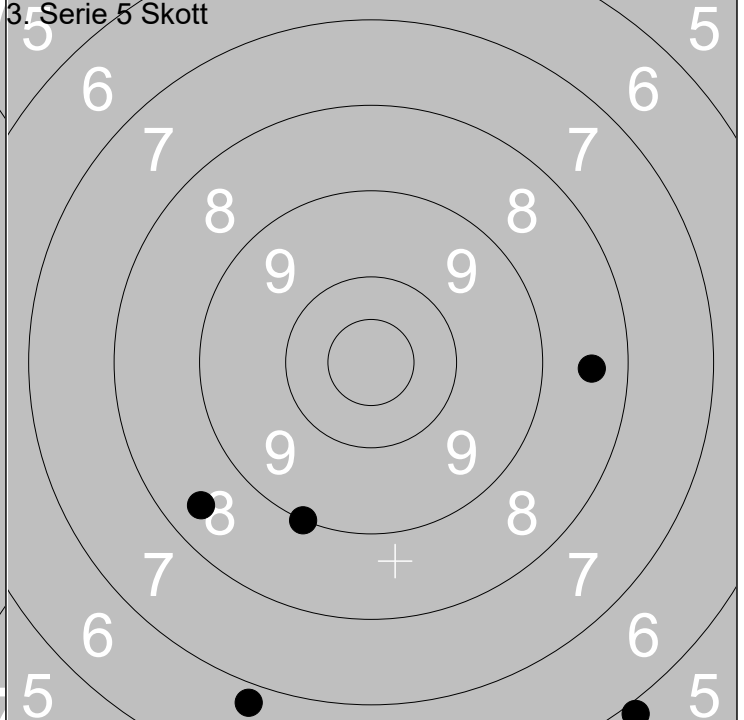
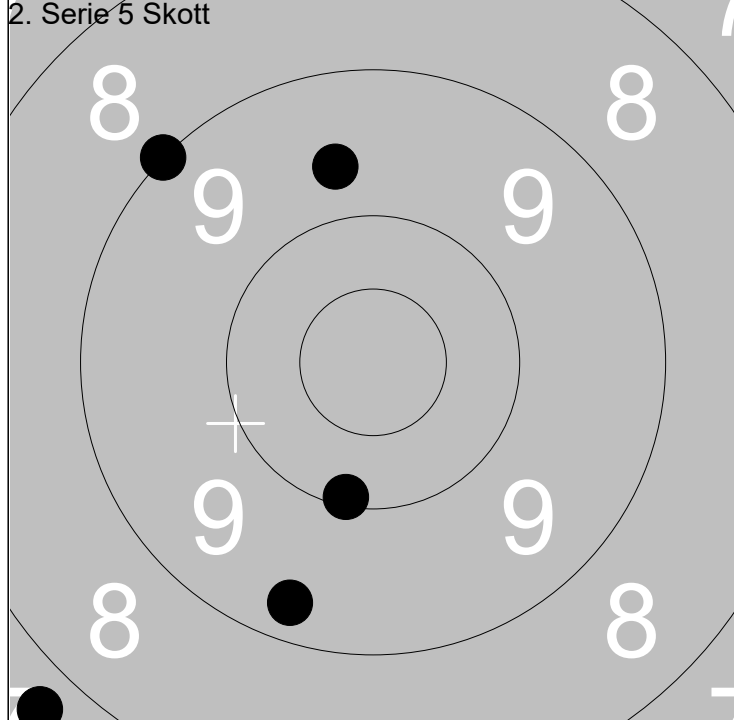

1: 9.0 ↖					
2: 9.7 ↗		Serie	44		
3: 7.7 ↙					
4: 10.1 ↓		Total	92		
5: 9.3 ↓					

1: 5.9 ↓					
2: 9.0 ↓		Serie	36		
3: 8.5 →					
4: 8.4 ↙		Total	128		
5: 6.8 ↓					

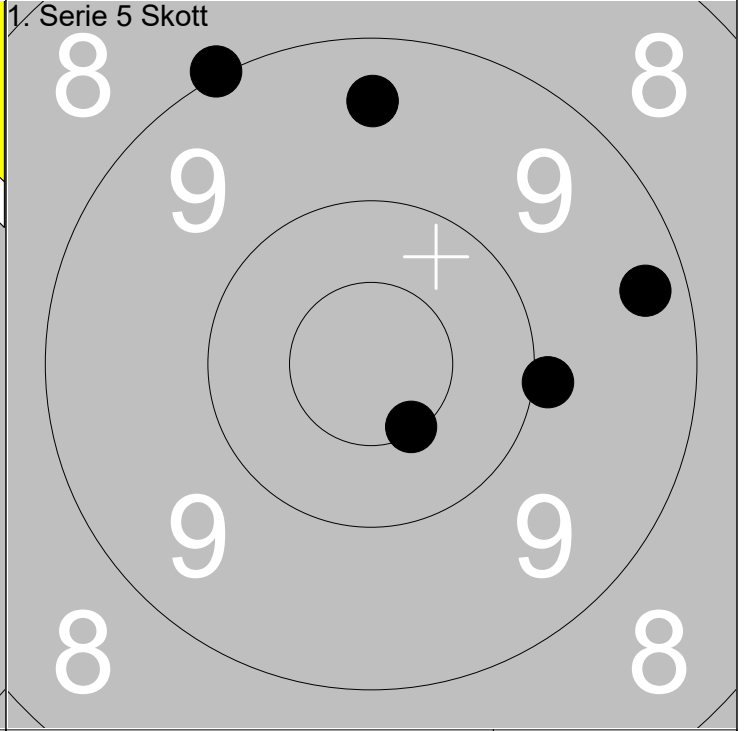
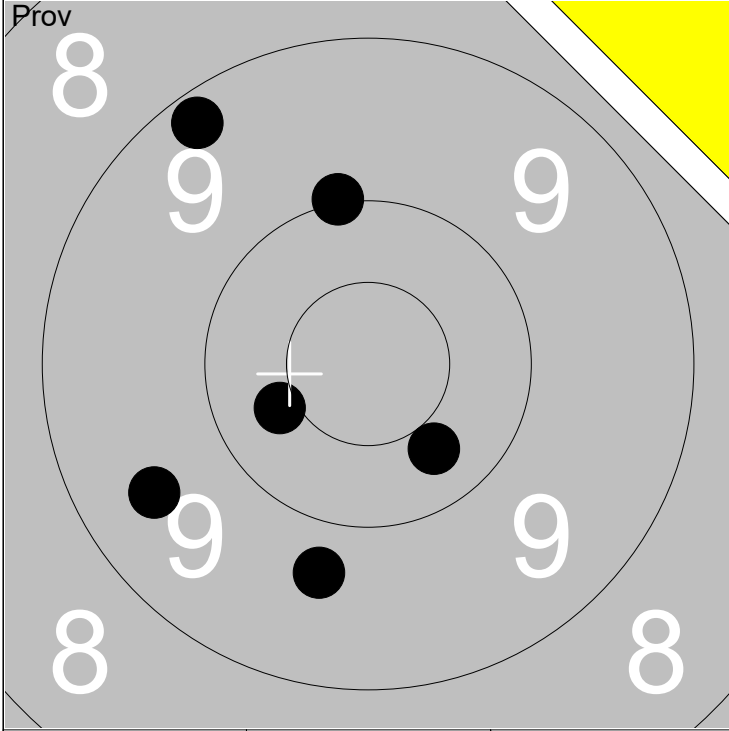

1: 10.4 ↙	6: 9.2 ↗		
2: 9.5 ↙		Serie	57
3: 9.7 ↓			
4: 10.3 ↘		Total	0
5: 10.0 ↑			

1: 9.4 ↑			
2: 9.9 →		Serie	46
3: 9.0 ↗			
4: 10.5x ↘		Total	46
5: 9.3 →			

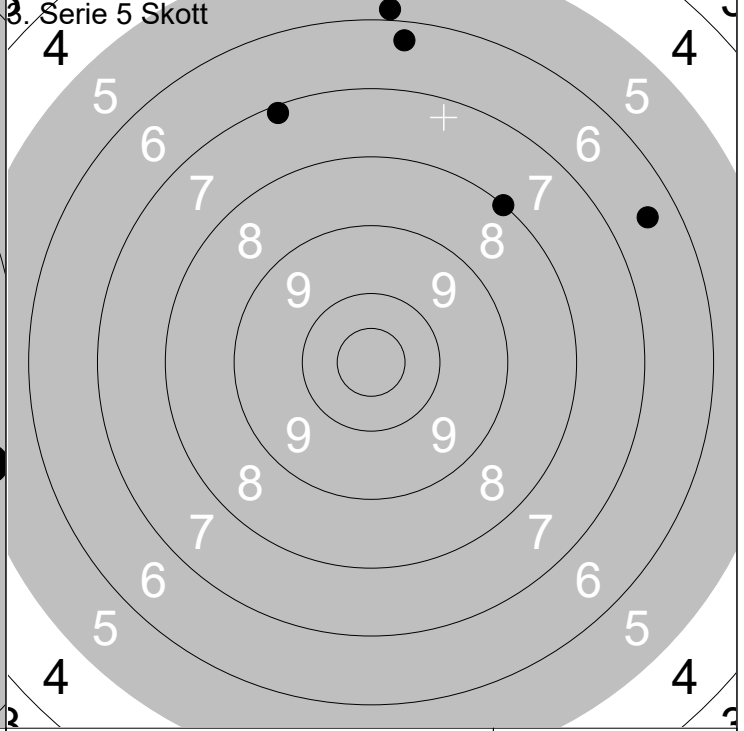
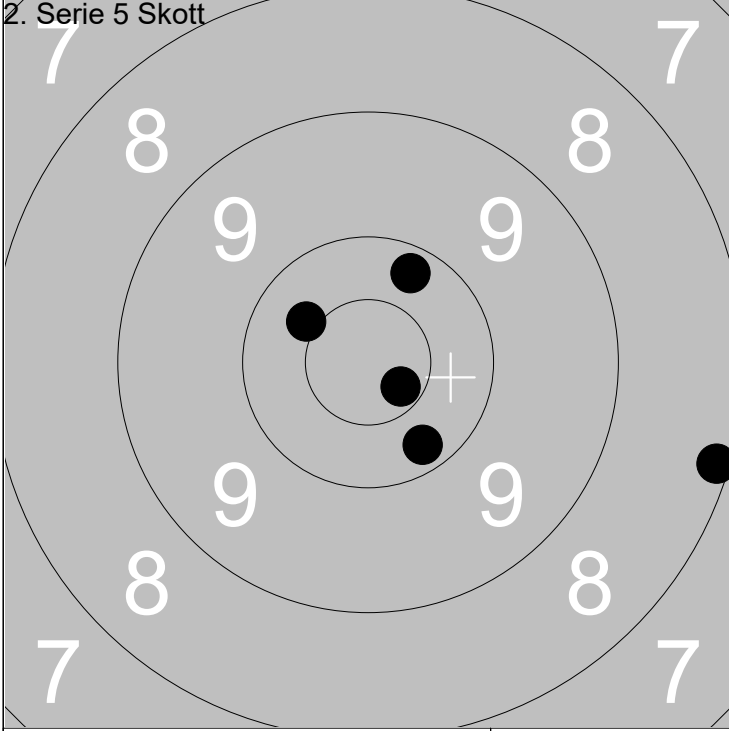

1: 10.2 ↘			
2: 8.1 →		Serie	48
3: 10.2 ↑			
4: 10.6x ↘		Total	94
5: 10.4 ↖			

1: 6.3 ↑			
2: 5.9 ↑		Serie	32
3: 7.1 ↖			
4: 6.5 ↗		Total	126
5: 8.0 ↗			

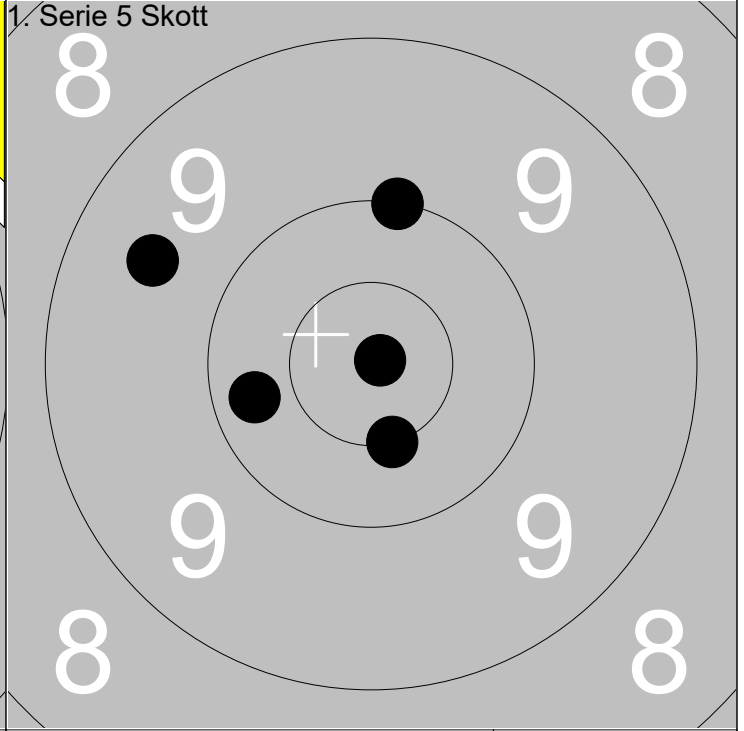
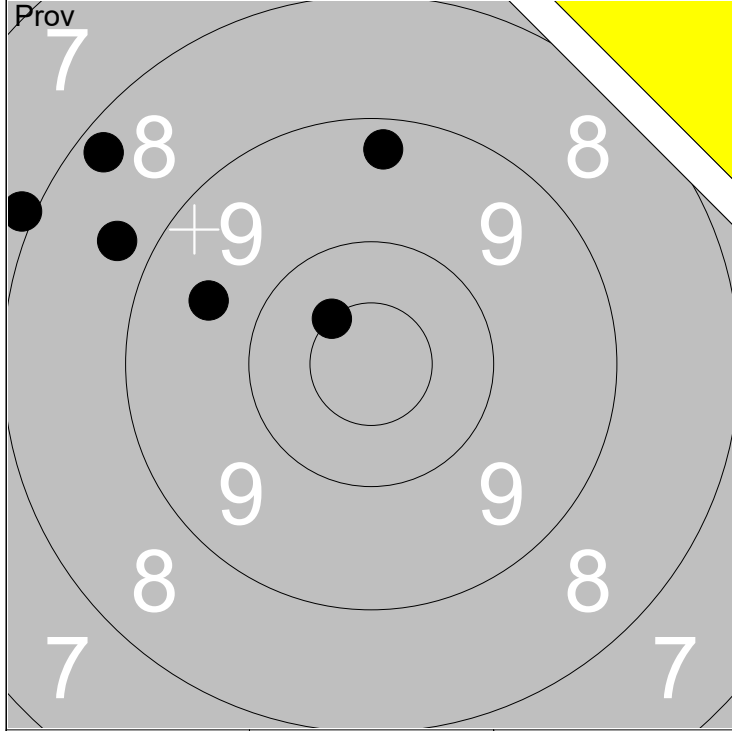

1: 8.7 ↖	6: 8.2 ↖	Serie	51
2: 9.3 ↑			
3: 9.6 ↖		Total	0
4: 10.5x ↗			
5: 7.9 ↖			

1: 10.0 ↑	Serie	49
2: 10.5x ↓		
3: 9.5 ↖	Total	49
4: 10.9x →		
5: 10.3 ←		

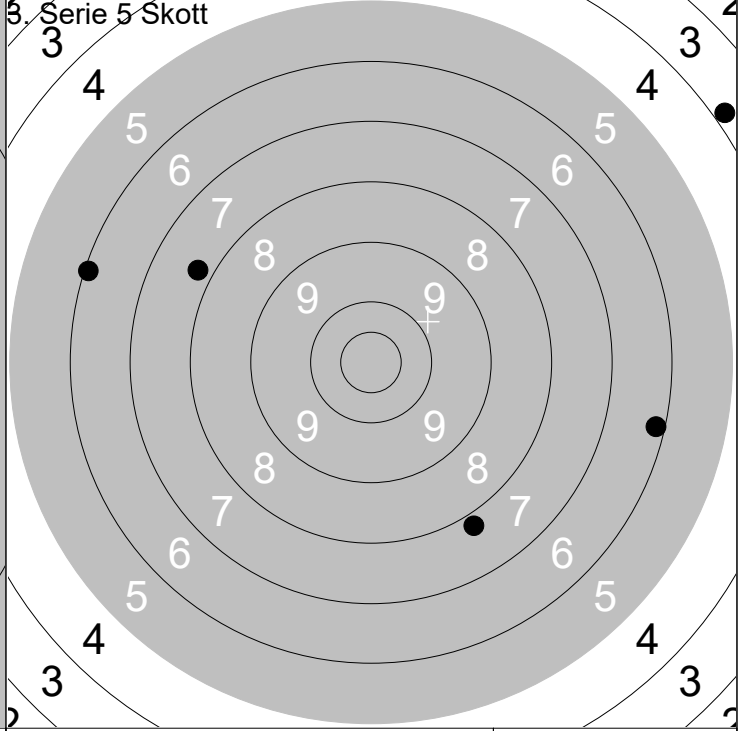
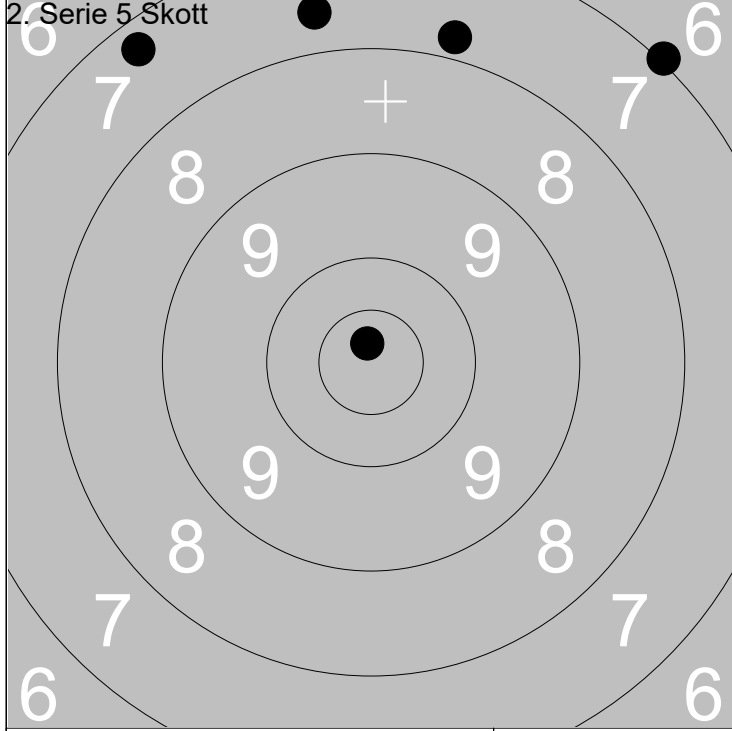

1: 7.3 ↖	Serie	38
2: 7.6 ↑		
3: 7.8 ↑	Total	87
4: 10.8x ↑		
5: 7.0 ↗		

1: 7.8 ↓	Serie	29
2: 6.1 ↖		
3: 7.8 ↖	Total	116
4: 6.2 →		
5: 3.8 ↗		