

1:	9.9	↘
2:	10.3	→
3:	5.4	↓
4:	8.2	→
5:	8.7	→
Serie	40	
Total	0	

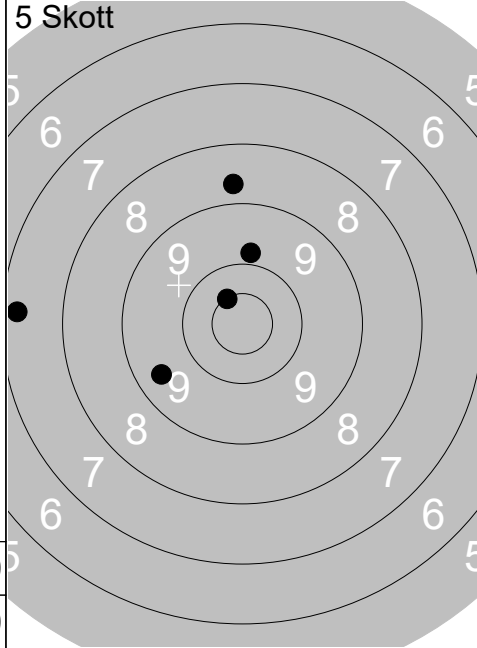

1:	10.5x	↖
2:	7.3	←
3:	9.4	↙
4:	9.8	↑
5:	8.7	↑
Serie	43	
Total	43	

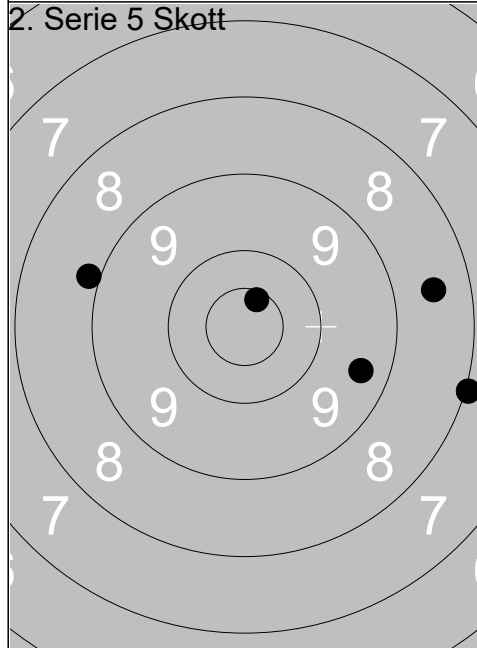

1:	8.9	←
2:	10.6x	↗
3:	8.5	→
4:	9.4	→
5:	8.0	→
Serie	43	
Total	86	

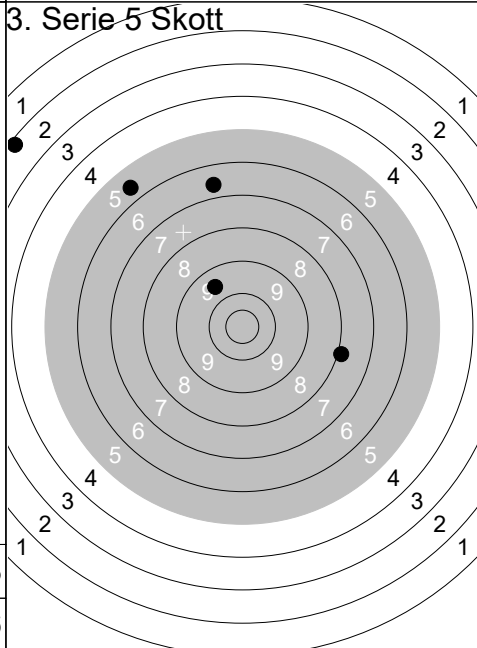

1:	2.2	↖
2:	7.9	→
3:	5.6	↗
4:	6.6	↑
5:	9.6	↗
Serie	29	
Total	115	

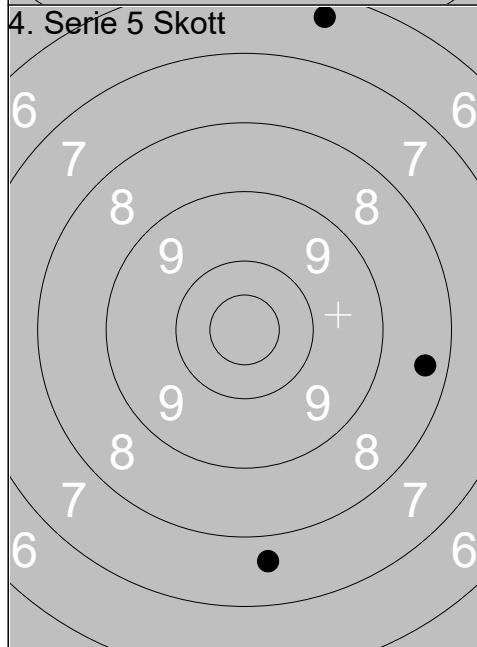

1:	8.4	→
2:	6.4	↑
3:	7.7	↓
Serie	21	
Total	136	

Skjutlag	Tavla	Kvistbro	
1	6	Emil B, Björn J, Gustaf B	Lag
08.07.2018	Tavelträffen Lagtävling 2018	Ramselefors SKF	
Prov	1: 10.2 ← 2: 8.9 ↙ 3: 9.3 ↘ 4: 9.9 ↓ 5: 10.4 ↓	5 Skott	1: 9.8 ↙ 2: 10.2 ↙ 3: 9.5 ↖ 4: 10.2 ↓ 5: 10.3 ↗
	Serie 46 Total 0		Serie 48 Total 48
2. Serie 5 Skott	1: 9.6 ↗ 2: 8.7 ↖ 3: 8.8 ↑ 4: 10.5x ↓ 5: 10.8x ↓	3. Serie 5 Skott	1: 7.2 → 2: 8.9 ← 3: 7.2 ↙ 4: 0.0 ↙ 5: 8.2 →
	Serie 45 Total 93		Serie 30 Total 123
4. Serie 5 Skott	1: 10.5x ↙ 2: 10.2 ↗ 3: 10.7x ↓		
	Serie 30 Total 153		

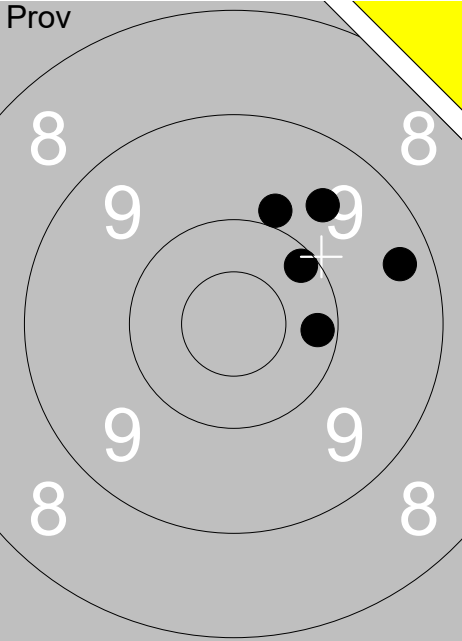
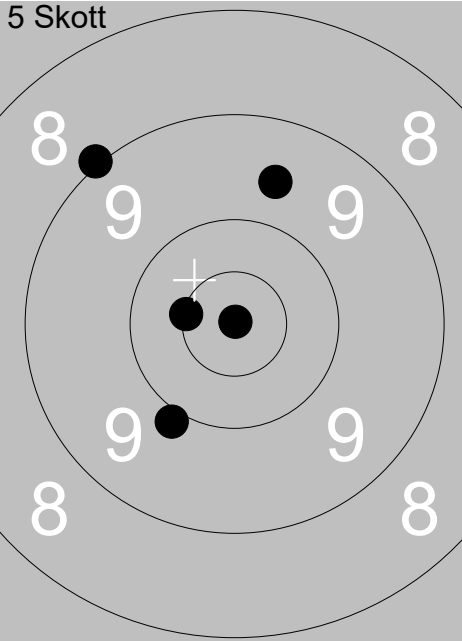
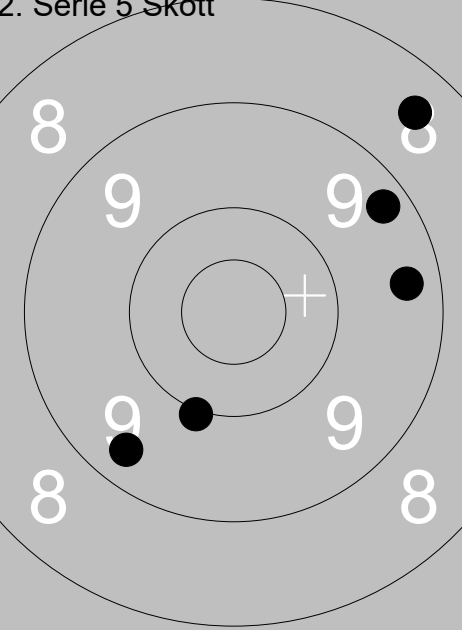
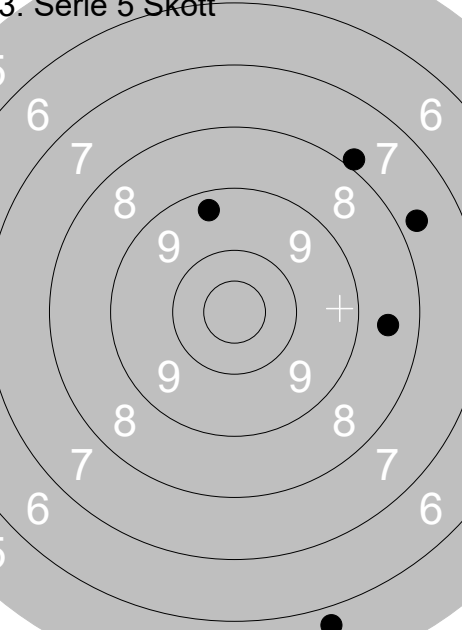
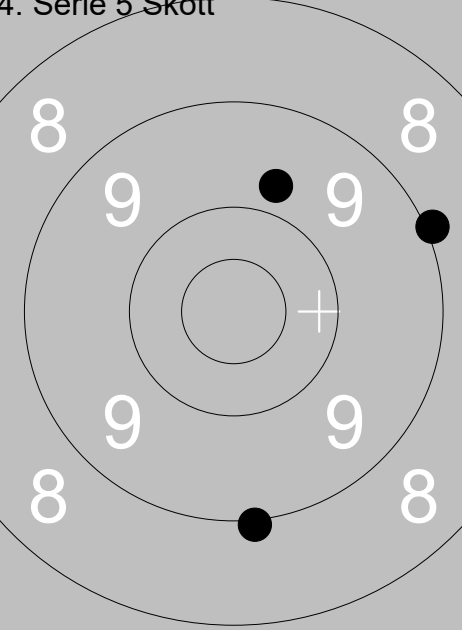
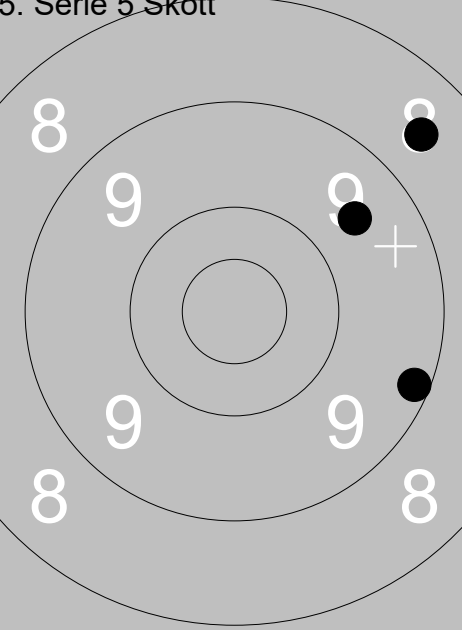
Skjutlag	Tavla	Ramselefors Lag 1		
1	8	B-O H, Marlene F F, Casper F	Lag	
08.07.2018	Tavelträffen Lagtävling 2018	Ramselefors SKF		
Prov		1: 10.2 ↗ 2: 9.6 ↗ 3: 9.9 ↗ 4: 10.2 → 5: 9.3 →	5 Skott 	1: 9.9 ↘ 2: 9.6 ↗ 3: 10.9x ↗ 4: 9.0 ↖ 5: 10.5x↙
	Serie 47		Serie 47	
	Total 0		Total 47	
2. Serie 5 Skott		1: 9.4 ↘ 2: 10.0 ↘ 3: 9.4 → 4: 9.3 ↗ 5: 8.5 ↗	3. Serie 5 Skott 	1: 7.7 ↗ 2: 9.3 ↗ 3: 8.5 → 4: 7.9 ↗ 5: 5.7 ↘
	Serie 45		Serie 36	
	Total 92		Total 128	
4. Serie 5 Skott		1: 9.8 ↗ 2: 9.0 → 3: 9.0 ↘	5. Serie 5 Skott 	1: 9.6 ↗ 2: 8.6 ↗ 3: 9.2 →
	Serie 27		Serie 26	
	Total 155		Total 181	

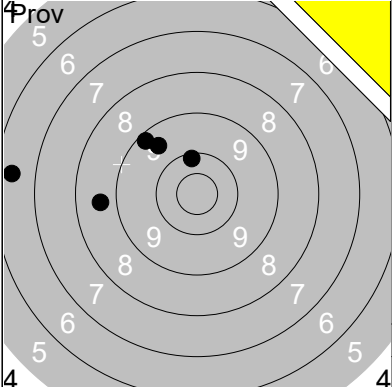
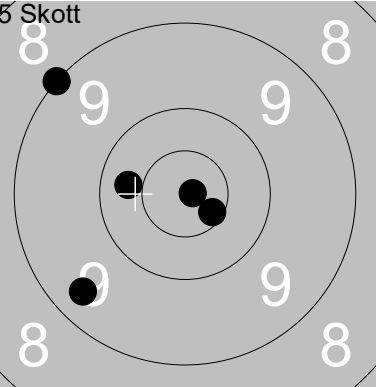
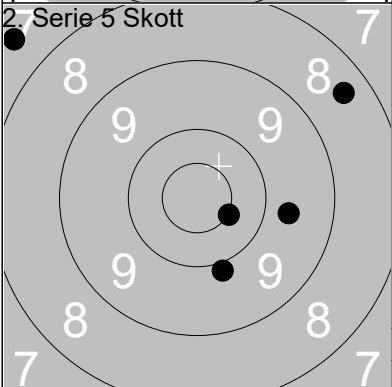
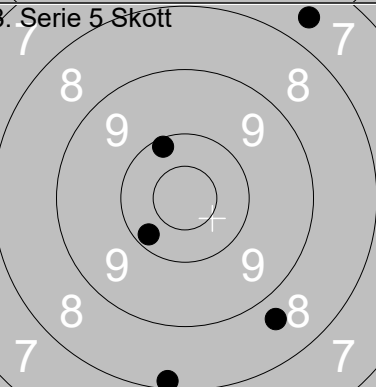
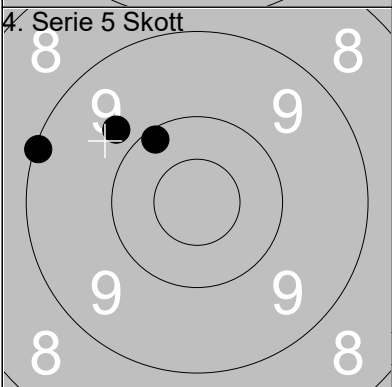
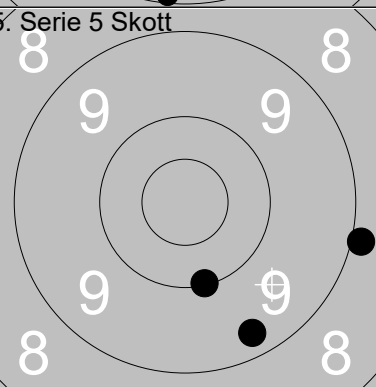
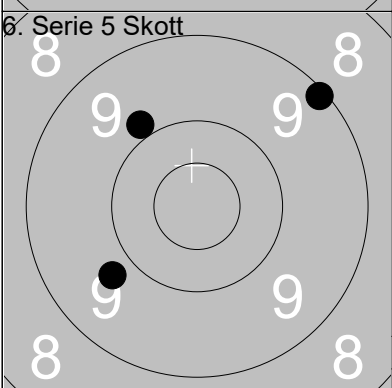
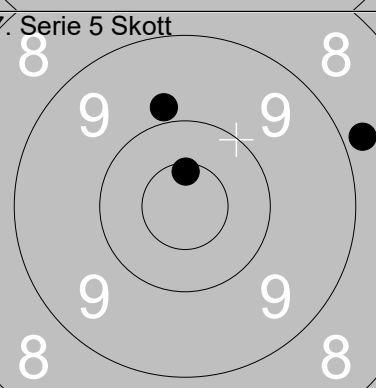
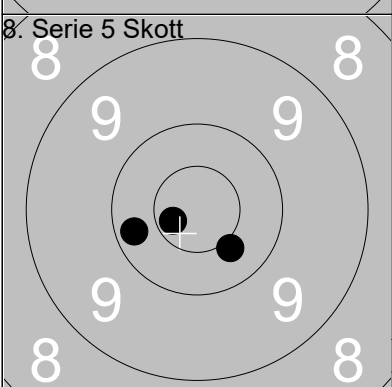
Skjutlag	Tavla	Två normmän och en svensk	
1	10		
Ramselefors	Elise S, Marcus A, Hans B		Lag
08.07.2018	Tavelträffen Lagtävling 2018	Ramselefors SKF	
	1: 10.1 ↑ 2: 9.5 ↗ 3: 6.4 ← 4: 8.6 ← 5: 9.2 ↗		1: 10.3 ← 2: 9.4 ↘ 3: 9.0 ↗ 4: 10.9x → 5: 10.6x ↘
	Serie 42		Serie 48
	Total 0		Total 48
	1: 10.5x → 2: 7.5 ↗ 3: 8.4 ↗ 4: 9.7 → 5: 9.9 ↘		1: 8.2 ↓ 2: 7.6 ↗ 3: 10.1 ↑ 4: 8.7 ↘ 5: 10.2 ↘
	Serie 43		Serie 43
	Total 91		Total 134
	1: 9.8 ↗ 2: 10.1 ↗ 3: 9.1 ←		1: 10.1 ↓ 2: 8.9 → 3: 9.3 ↘
	Serie 28		Serie 27
	Total 162		Total 189
	1: 9.1 ↗ 2: 9.9 ↗ 3: 9.8 ↘		1: 8.8 → 2: 10.6x ↑ 3: 9.8 ↑
	Serie 27		Serie 27
	Total 216		Total 243
	1: 10.4 ↓ 2: 10.7x ← 3: 10.2 ←		
	Serie 30		
	Total 273		

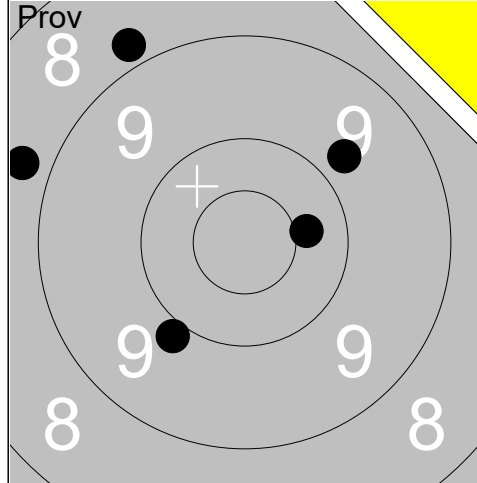

1:	8.7	↖
2:	10.4	→
3:	8.8	↗
4:	9.9	↘
5:	9.8	↗
Serie		44
Total		0

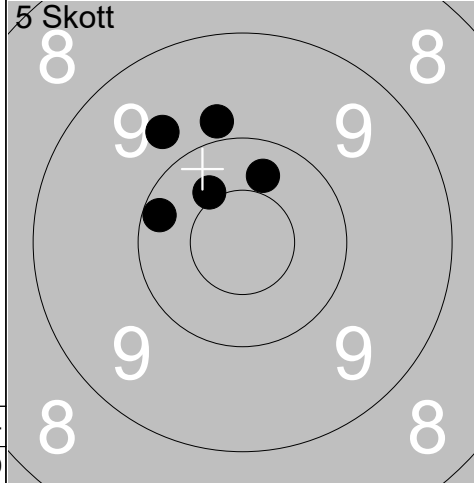

1:	10.4x	↗
2:	9.8	↗
3:	10.2	↖
4:	9.7	↗
5:	10.3	↗
Serie		48
Total		48

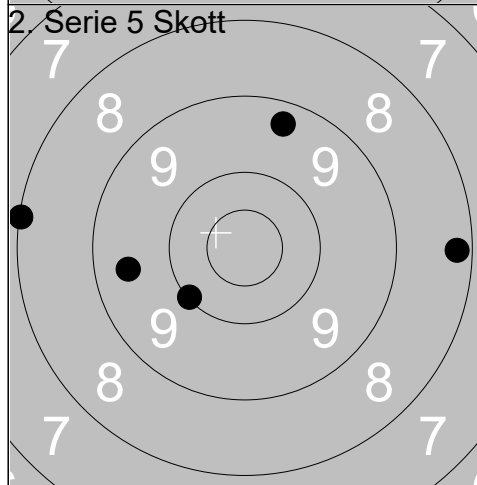

1:	9.3	↗
2:	8.0	↖
3:	9.5	↖
4:	8.2	→
5:	10.0	↘
Serie		44
Total		92

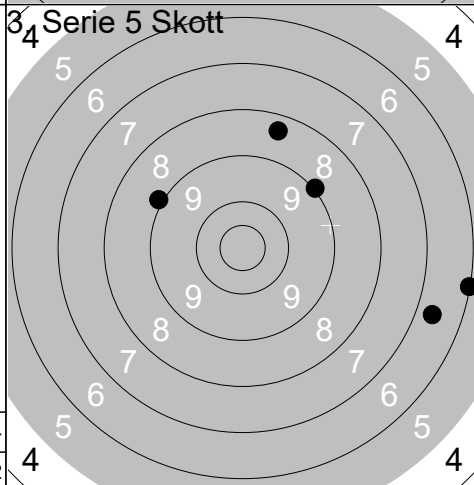

1:	9.0	↗
2:	8.4	↗
3:	6.7	→
4:	6.0	→
5:	8.9	↖
Serie		37
Total		129

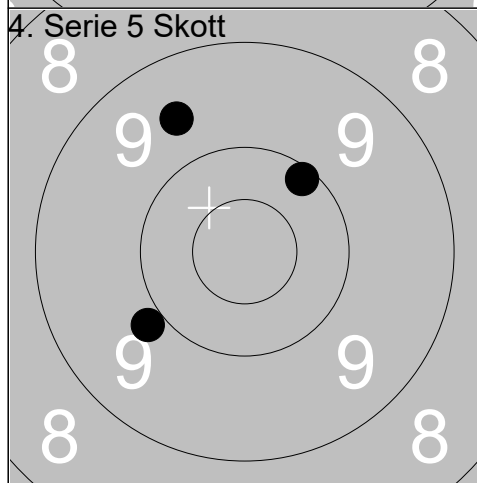

1:	9.6	↖
2:	10.1	↗
3:	9.9	↘
Serie		28
Total		157

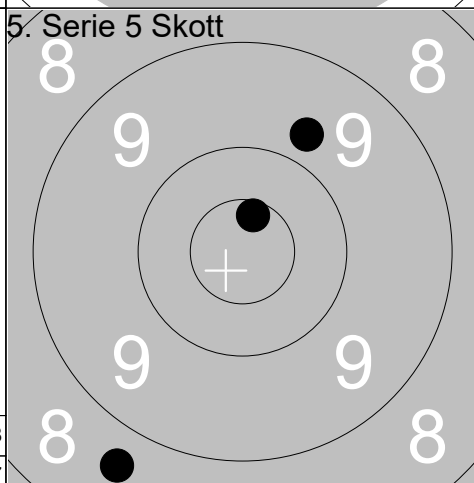

1:	8.7	↘
2:	9.8	↗
3:	10.6x	↗
Serie		27
Total		184

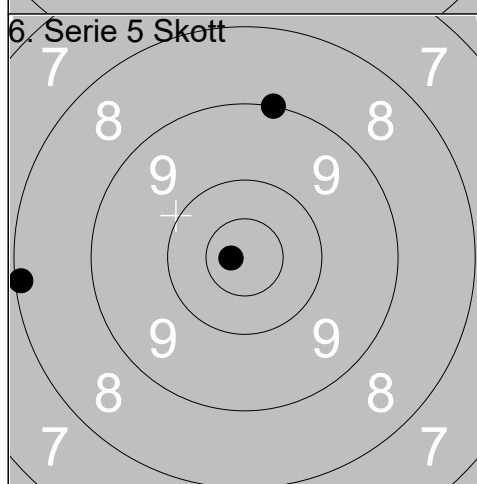

1:	8.1	↖
2:	10.8x	↖
3:	9.0	↗
Serie		27
Total		211

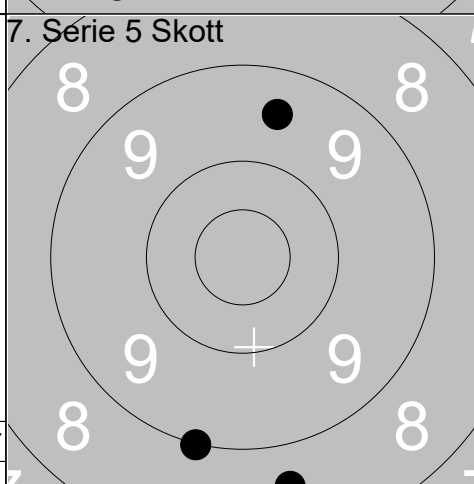

1:	9.5	↗
2:	9.0	↘
3:	8.6	↘
Serie		26
Total		237

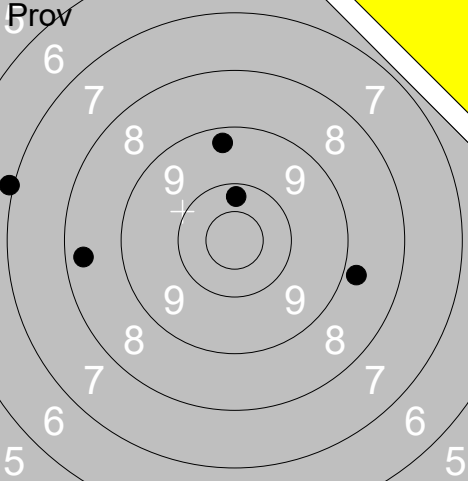
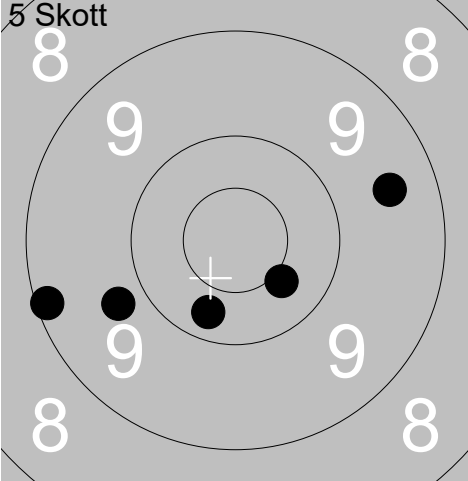
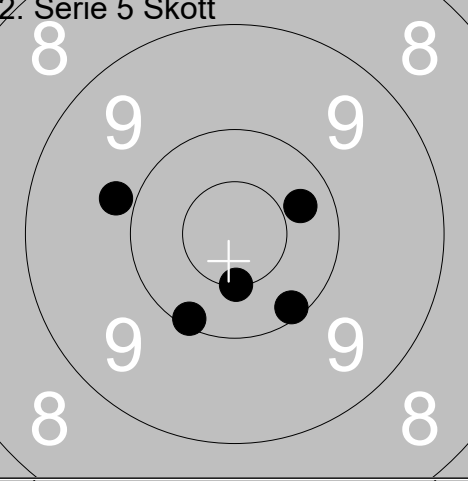
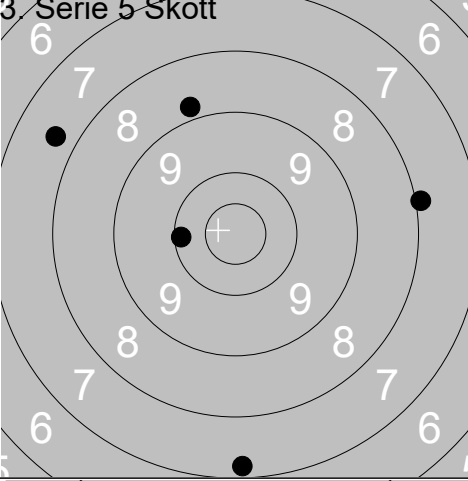
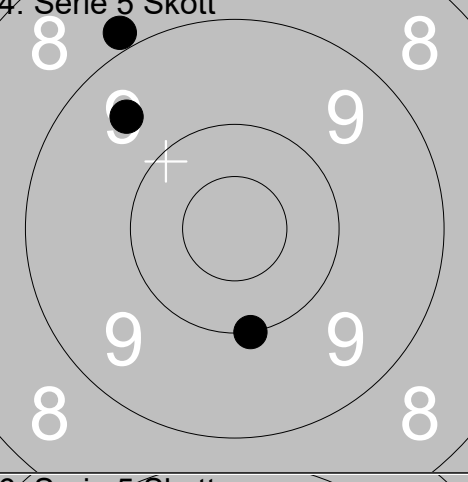
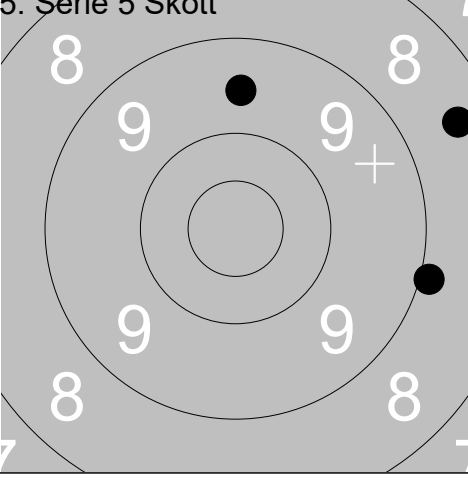
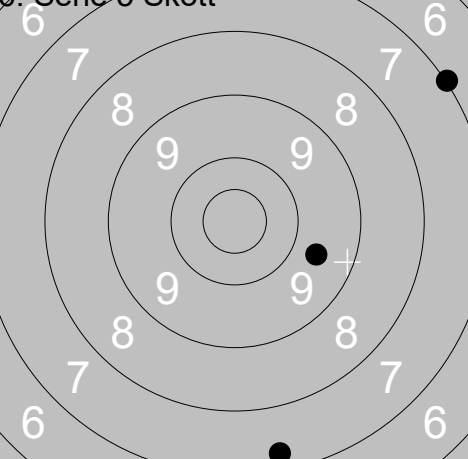
Skjutlag 1	Tavla 14	Loos	
Ramselefors		Johnny, Daniel, Fanny	
08.07.2018		Tavelträffen Lagtävling 2018	
Prov		Ramselefors SKF	
	1: 8.4 ← 2: 8.8 → 3: 6.9 ← 4: 10.2 ↑ 5: 9.3 ↑		1: 10.3 ↓ 2: 9.8 ← 3: 10.4 ↘ 4: 9.1 ← 5: 9.5 →
Serie 41	Total 0	Serie 47	Total 47
	1: 10.1 ↘ 2: 10.1 ↓ 3: 10.3 → 4: 9.8 ← 5: 10.5x ↓		1: 8.8 ↑ 2: 7.7 ← 3: 10.1 ← 4: 7.9 → 5: 7.2 ↓
Serie 49	Total 96	Serie 39	Total 135
	1: 9.5 ↗ 2: 10.0 ↓ 3: 8.9 ↗		1: 9.6 ↑ 2: 8.9 → 3: 8.4 ↗
Serie 27	Total 162	Serie 25	Total 187
	1: 7.3 ↓ 2: 9.6 → 3: 7.0 ↗		
Serie 23	Total 210		

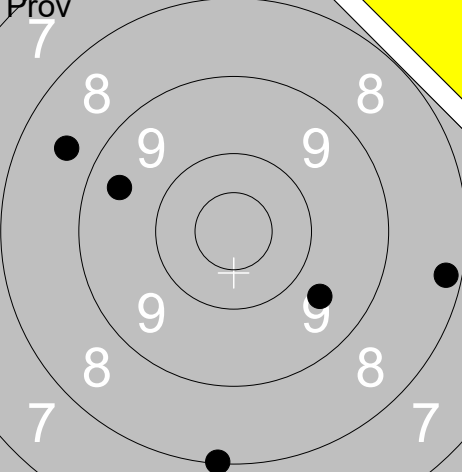
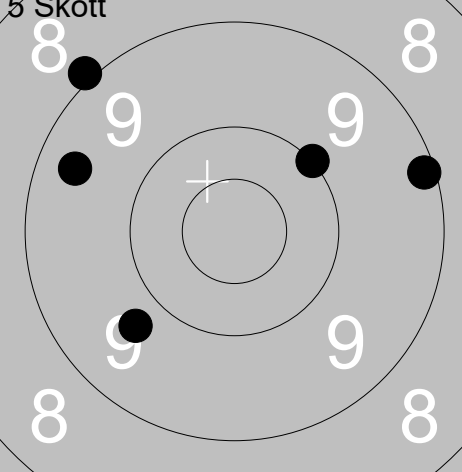
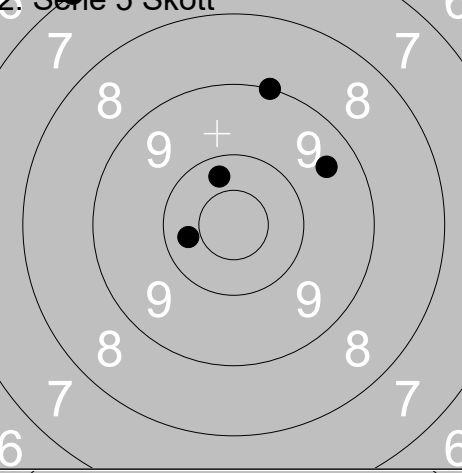
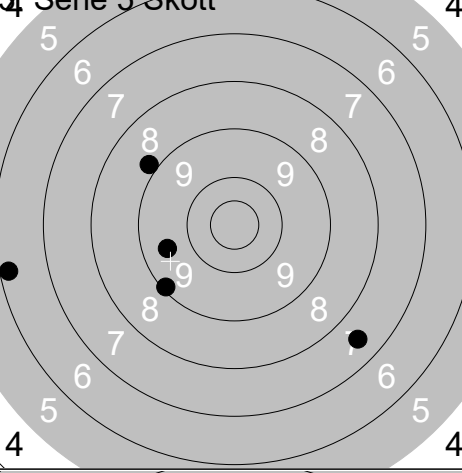
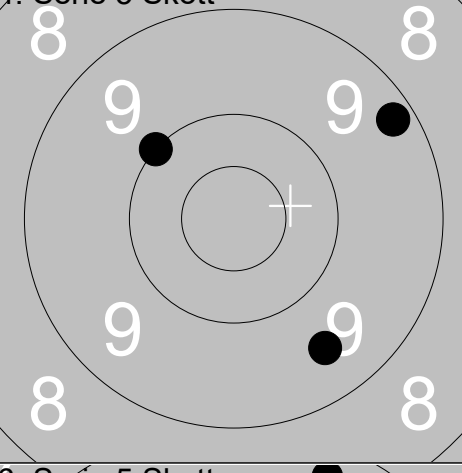
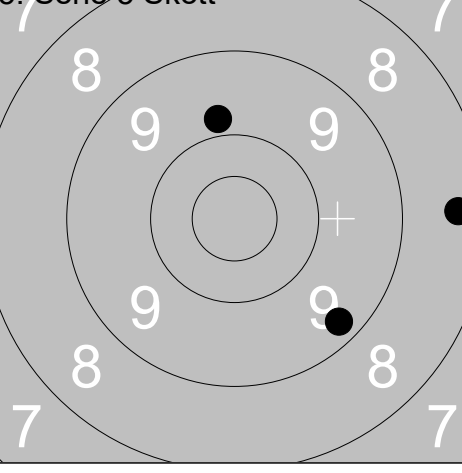
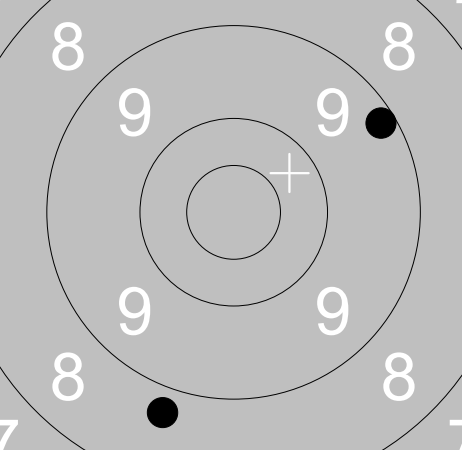
<p>Prov</p>  <p>7 8 9 9 8 7</p>	<p>1: 9.6 ↘ 2: 8.2 → 3: 8.1 ↓ 4: 8.6 ↗ 5: 9.5 ↗</p> <p>Serie 42 Total 0</p>	<p>5 Skott</p>  <p>8 8 9 9 8 8</p> <p>1: 10.0 ↗ 2: 9.4 ← 3: 9.7 ↓ 4: 9.0 ↗ 5: 9.1 →</p> <p>Serie 46 Total 46</p>
<p>2. Serie 5 Skott</p>  <p>7 8 9 9 8 7</p>	<p>1: 9.5 ↗ 2: 9.0 ↑ 3: 7.0 ↗ 4: 10.3 ↑ 5: 10.3 ←</p> <p>Serie 45 Total 91</p>	<p>3. Serie 5 Skott</p>  <p>5 6 7 8 9 8 7 6 5</p> <p>1: 9.5 ← 2: 9.1 ↓ 3: 8.8 ↗ 4: 7.5 ↓ 5: 6.2 ←</p> <p>Serie 39 Total 130</p>
<p>4. Serie 5 Skott</p>  <p>8 9 9 9 8 8</p>	<p>1: 9.2 ↗ 2: 9.5 ↓ 3: 10.0 ↗</p> <p>Serie 28 Total 158</p>	<p>5. Serie 5 Skott</p>  <p>8 9 9 9 8 7</p> <p>1: 8.4 → 2: 9.3 ↓ 3: 9.8 ↑</p> <p>Serie 26 Total 184</p>
<p>6. Serie 5 Skott</p>  <p>8 9 9 9 8 7</p>	<p>1: 8.4 ↑ 2: 9.2 ↗ 3: 8.8 ↓</p> <p>Serie 25 Total 209</p>	

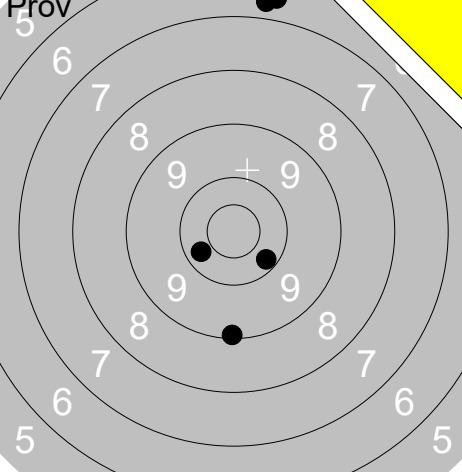
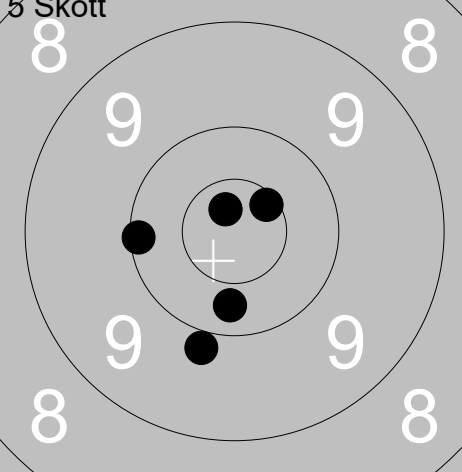
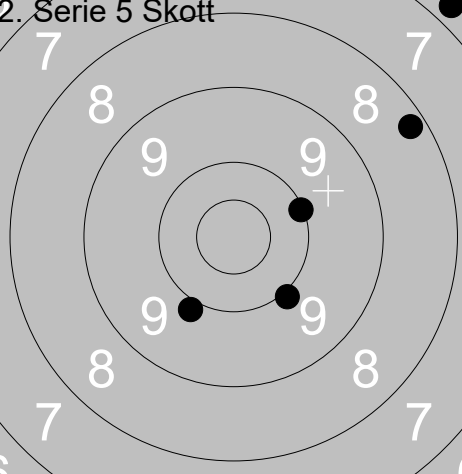
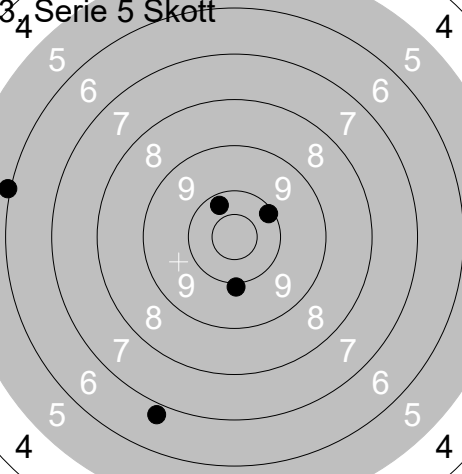
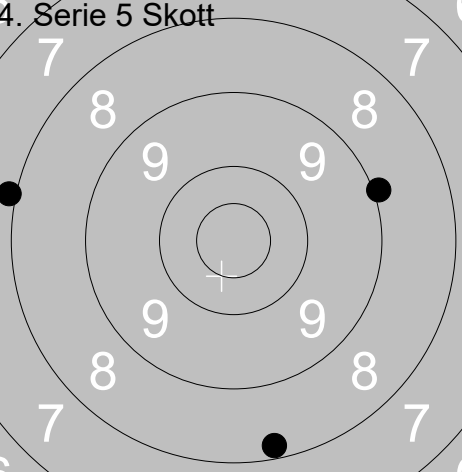
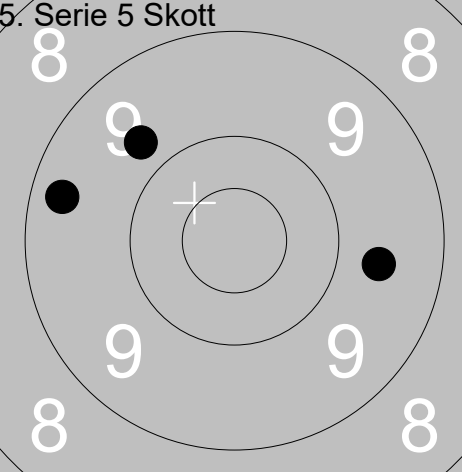
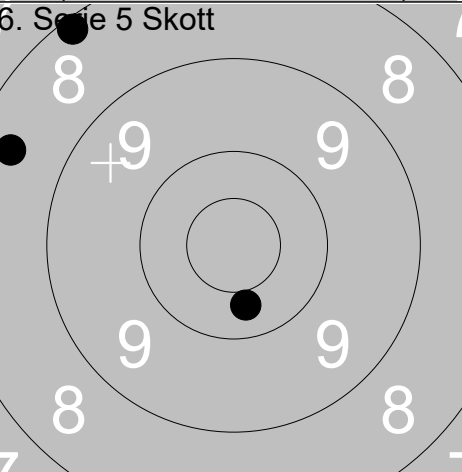
<p>Prov</p> 	<p>5 Skott</p> 	<p>1: 10.2 ↘ 2: 9.1 ↓ 3: 6.7 ↑ 4: 10.3 ↙ 5: 6.6 ↑</p> <p>Serie 41 Total 0</p>	<p>1: 10.7x ↗ 2: 10.3 ↓ 3: 9.9 ↓ 4: 10.1 ← 5: 10.6x ↗</p> <p>Serie 49 Total 49</p>
<p>2. Serie 5 Skott</p> 	<p>3. Serie 5 Skott</p> 	<p>1: 9.9 ↓ 2: 10.1 ↗ 3: 6.8 ↗ 4: 8.2 ↗ 5: 10.0 ↓</p> <p>Serie 43 Total 92</p>	<p>1: 6.8 ↓ 2: 9.9 ↓ 3: 10.1 ↗ 4: 10.2 ↗ 5: 6.0 ←</p> <p>Serie 41 Total 133</p>
<p>4. Serie 5 Skott</p> 	<p>5. Serie 5 Skott</p> 	<p>1: 8.2 ↓ 2: 7.9 ← 3: 9.0 ↗</p> <p>Serie 24 Total 157</p>	<p>1: 9.6 → 2: 9.3 ← 3: 9.7 ↗</p> <p>Serie 27 Total 184</p>
<p>6. Serie 5 Skott</p> 	<p>1: 10.3 ↓ 2: 8.1 ↗ 3: 8.4 ↗</p> <p>Serie 26 Total 210</p>		

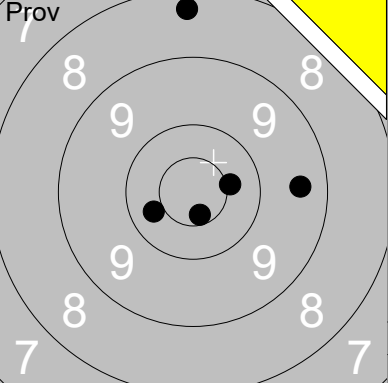
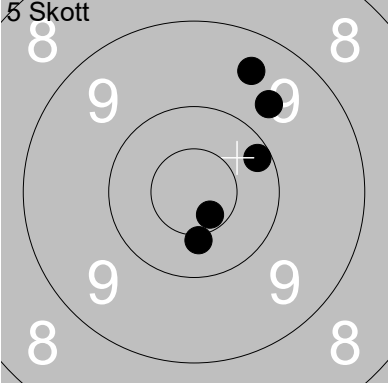
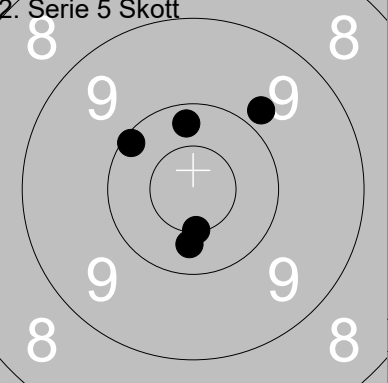
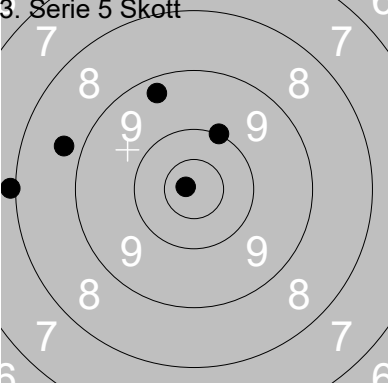
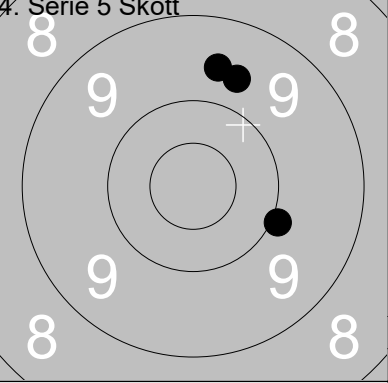
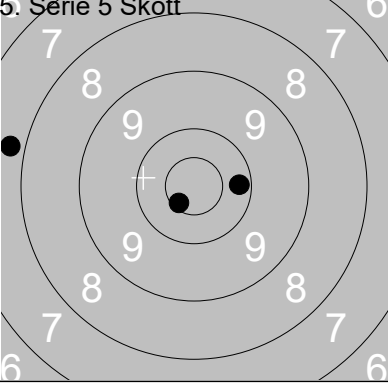
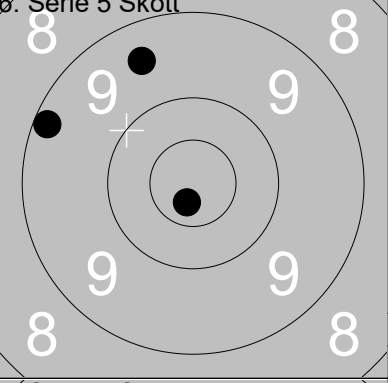
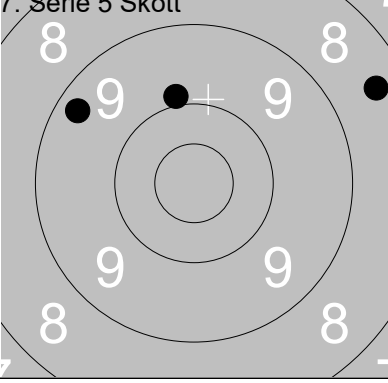
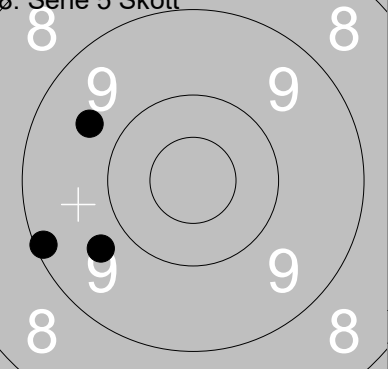
Skjutlag 1	Tavla 20	Lapua	
Ramselefors		Henning A, Lars-Göran L, Bengt	
08.07.2018		Tavelträffen Lagtävling 2018	Ramselefors SKF
Prov 	1: 10.6x ↓ 2: 10.4x → 3: 10.3 ← 4: 8.3 ↑ 5: 9.4 →	5 Skott 	1: 9.5 ↑ 2: 9.7 ↗ 3: 10.4x ↓ 4: 10.2 ↗ 5: 10.7x ↓
Serie 47	Total 0	Serie 48	Total 48
2. Serie 5 Skott 	1: 9.8 ↗ 2: 10.1 ↖ 3: 10.5x ↓ 4: 10.3 ↓ 5: 10.2 ↑	3. Serie 5 Skott 	1: 10.8x ← 2: 9.3 ↑ 3: 10.0 ↗ 4: 8.7 ← 5: 7.9 ←
Serie 49	Total 97	Serie 44	Total 141
4. Serie 5 Skott 	1: 10.0 → 2: 9.7 ↑ 3: 9.6 ↑	5. Serie 5 Skott 	1: 10.2 → 2: 7.8 ← 3: 10.6x ↘
Serie 28	Total 169	Serie 27	Total 196
6. Serie 5 Skott 	1: 9.5 ↑ 2: 10.7x ↓ 3: 9.2 ←	7. Serie 5 Skott 	1: 9.9 ↑ 2: 8.4 ↗ 3: 9.3 ↖
Serie 28	Total 224	Serie 26	Total 250
8. Serie 5 Skott 	1: 9.1 ← 2: 9.7 ← 3: 9.7 ↖		
Serie 27	Total 277		

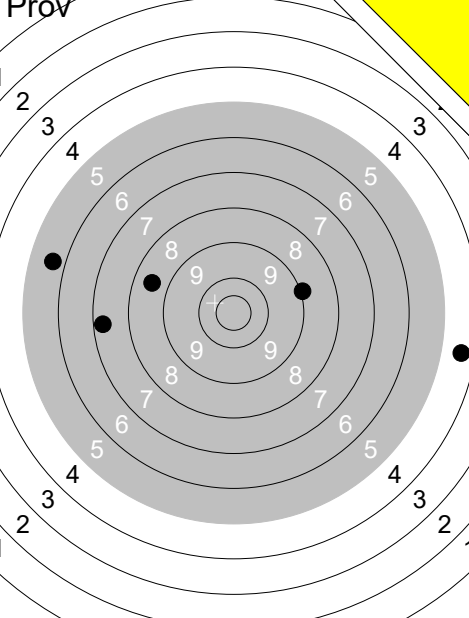
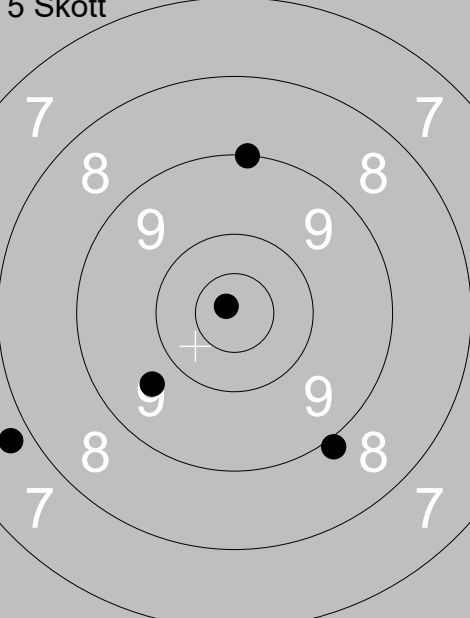
<p>Prov</p> 	<p>1: 8.6 ←</p> <p>2: 9.0 →</p> <p>3: 7.3 ←</p> <p>4: 4.5 →</p> <p>5: 5.7 ←</p>	<p>5 Skott</p> 	<p>1: 8.9 ↘</p> <p>2: 9.0 ↑</p> <p>3: 7.8 ←</p> <p>4: 9.7 ↘</p> <p>5: 10.8x ↘</p>
Serie 33		Serie 43	
Total 0		Total 43	

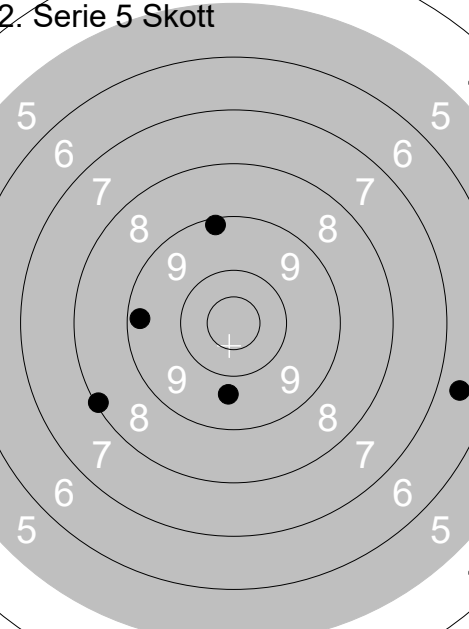
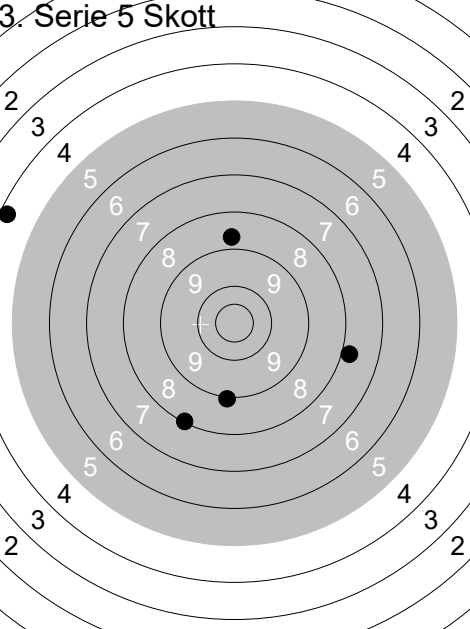
<p>2. Serie 5 Skott</p> 	<p>1: 9.2 ↑</p> <p>2: 6.6 →</p> <p>3: 9.7 ↓</p> <p>4: 9.3 ←</p> <p>5: 8.1 ←</p>	<p>3. Serie 5 Skott</p> 	<p>1: 8.7 ↑</p> <p>2: 7.8 →</p> <p>3: 4.2 ←</p> <p>4: 9.0 ↓</p> <p>5: 8.1 ↓</p>
Serie 41		Serie 36	
Total 84		Total 120	

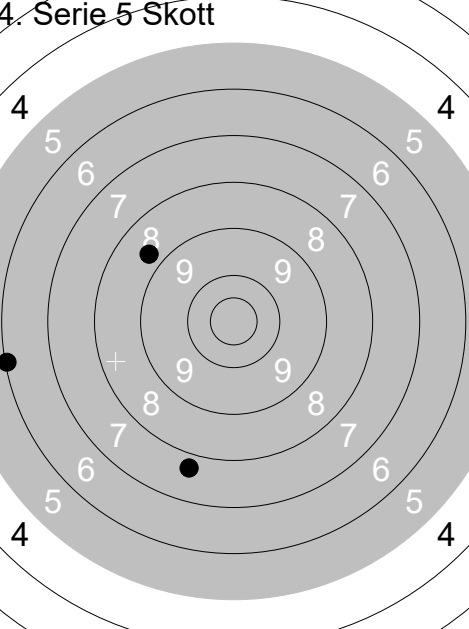
<p>4. Serie 5 Skott</p> 	<p>1: 8.7 ↘</p> <p>2: 6.1 ←</p> <p>3: 7.7 ↓</p>		
Serie 21			
Total 141			