

1:	10.9x	↗
2:	10.1	→
3:	10.2	↗
<b>Serie</b>		<b>30</b>
<b>Total</b>		<b>239</b>

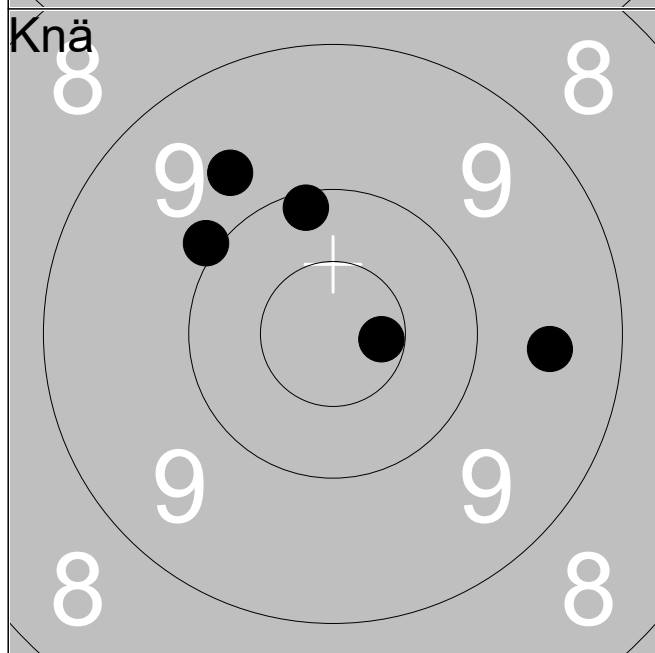

1:	10.1	↑
2:	10.0	↗
3:	9.5	→
4:	10.6x	→
5:	9.7	↗
<b>Serie</b>		<b>48</b>
<b>Total</b>		<b>287</b>

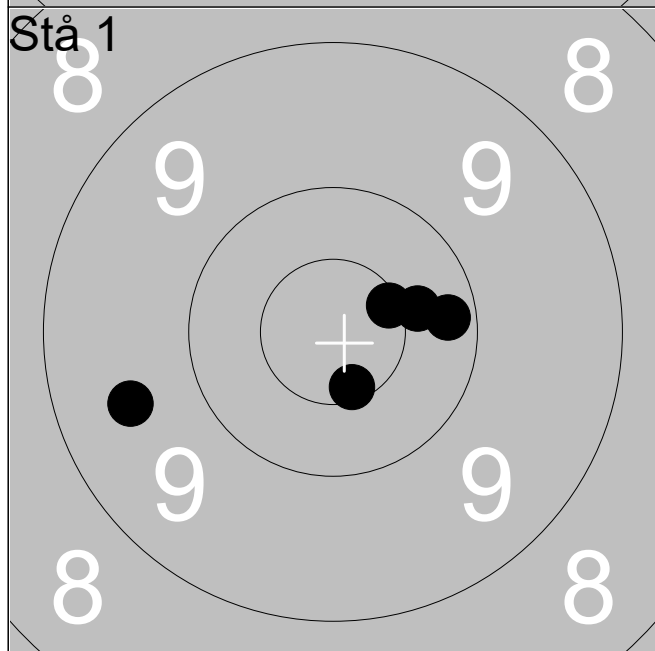

1:	9.5	←
2:	10.2	→
3:	10.6x	↓
4:	10.4	→
5:	10.6x	↗
<b>Serie</b>		<b>49</b>
<b>Total</b>		<b>336</b>

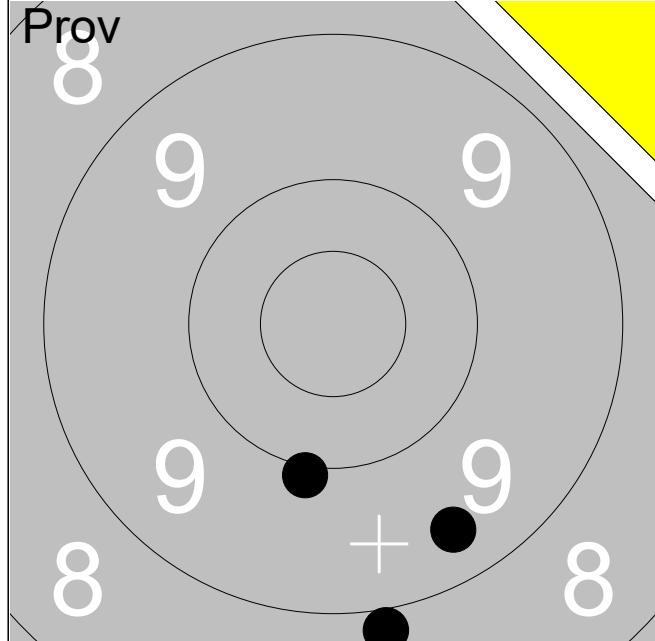

1:	10.0	↓
2:	9.4	↓
3:	8.9	↓
<b>Serie</b>		<b>27</b>
<b>Total</b>		<b>238</b>

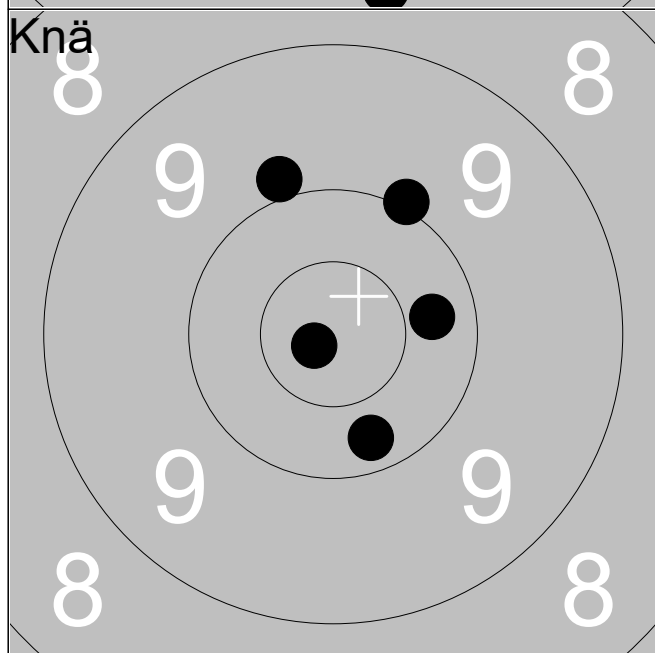

1:	10.0	↗
2:	9.9	↗
3:	10.3	→
4:	10.8x	↖
5:	10.2	↓
<b>Serie</b>		<b>49</b>
<b>Total</b>		<b>287</b>

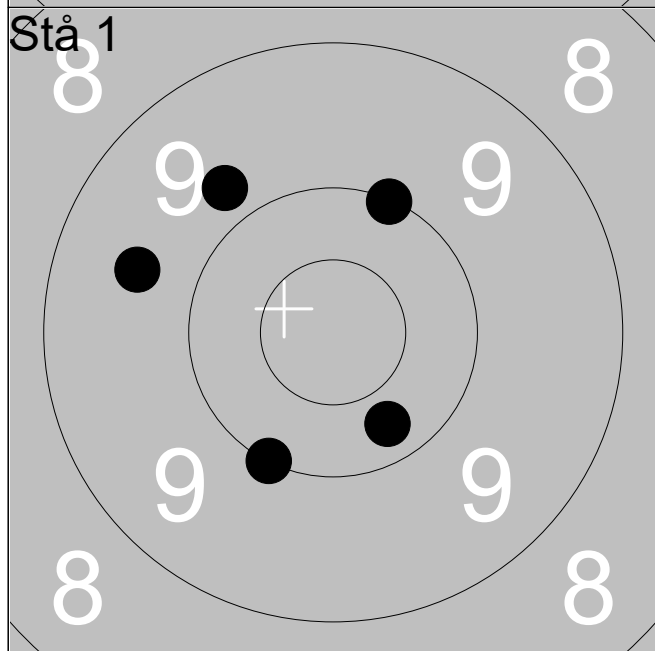

1:	10.0	↓
2:	9.8	↗
3:	9.6	↖
4:	10.0	↗
5:	10.3	↓
<b>Serie</b>		<b>48</b>
<b>Total</b>		<b>335</b>

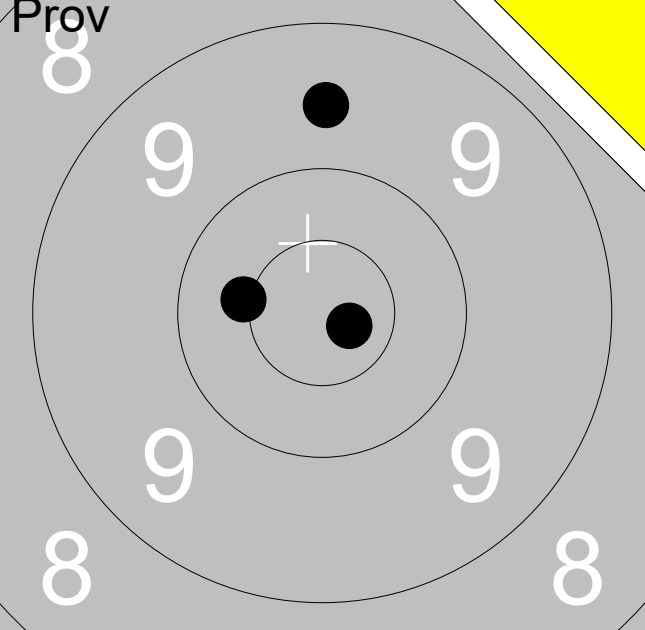
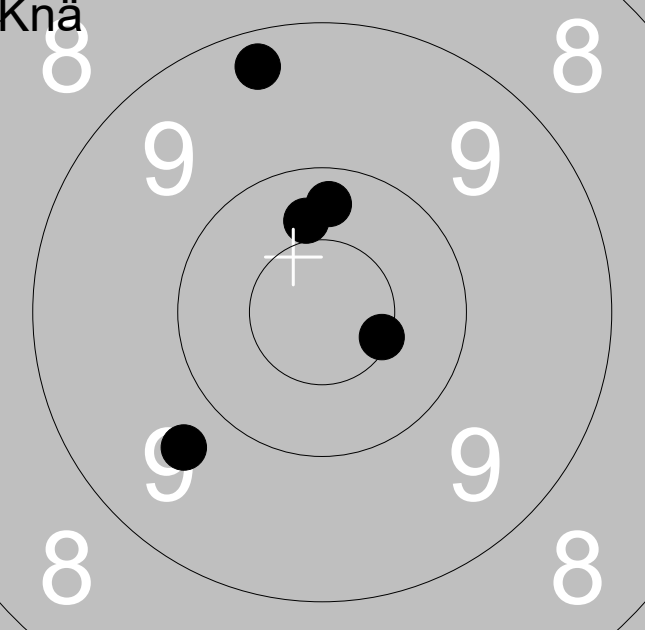
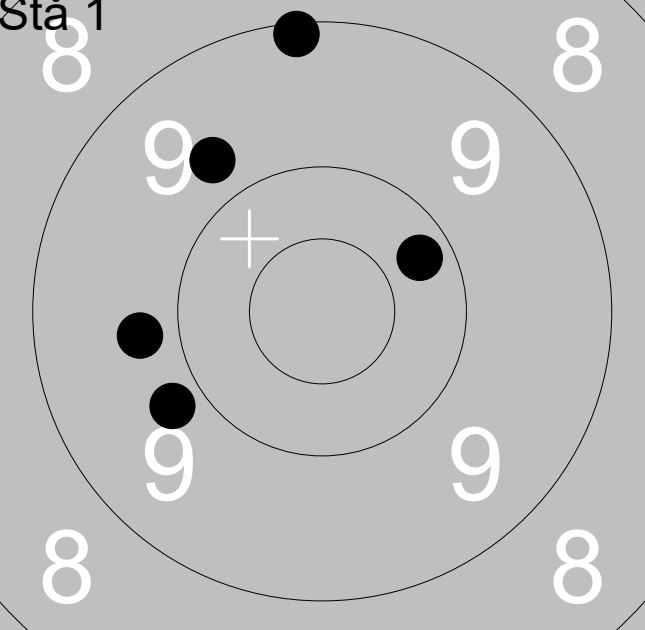
07.07.2018	Björkskottet 2018	Ramselefors SKF														
<b>Prov</b> 	<table style="width:100%; border-collapse: collapse;"> <tr> <td style="width:10%;">1:</td> <td style="width:80%;">10.4x</td> <td style="width:10%; text-align: right;">←</td> </tr> <tr> <td>2:</td> <td>10.8x</td> <td style="text-align: right;">↘</td> </tr> <tr> <td>3:</td> <td>9.6</td> <td style="text-align: right;">↑</td> </tr> </table>	1:	10.4x	←	2:	10.8x	↘	3:	9.6	↑						
1:	10.4x	←														
2:	10.8x	↘														
3:	9.6	↑														
Serie		29														
Total		236														
<b>Knä</b> 	<table style="width:100%; border-collapse: collapse;"> <tr> <td style="width:10%;">1:</td> <td style="width:80%;">10.3</td> <td style="width:10%; text-align: right;">↑</td> </tr> <tr> <td>2:</td> <td>9.3</td> <td style="text-align: right;">↑</td> </tr> <tr> <td>3:</td> <td>10.4</td> <td style="text-align: right;">↑</td> </tr> <tr> <td>4:</td> <td>9.7</td> <td style="text-align: right;">↙</td> </tr> <tr> <td>5:</td> <td>10.5x</td> <td style="text-align: right;">→</td> </tr> </table>	1:	10.3	↑	2:	9.3	↑	3:	10.4	↑	4:	9.7	↙	5:	10.5x	→
1:	10.3	↑														
2:	9.3	↑														
3:	10.4	↑														
4:	9.7	↙														
5:	10.5x	→														
Serie		48														
Total		284														
<b>Stå 1</b> 	<table style="width:100%; border-collapse: collapse;"> <tr> <td style="width:10%;">1:</td> <td style="width:80%;">9.8</td> <td style="width:10%; text-align: right;">←</td> </tr> <tr> <td>2:</td> <td>9.8</td> <td style="text-align: right;">↙</td> </tr> <tr> <td>3:</td> <td>9.1</td> <td style="text-align: right;">↑</td> </tr> <tr> <td>4:</td> <td>10.2</td> <td style="text-align: right;">↗</td> </tr> <tr> <td>5:</td> <td>9.7</td> <td style="text-align: right;">↖</td> </tr> </table>	1:	9.8	←	2:	9.8	↙	3:	9.1	↑	4:	10.2	↗	5:	9.7	↖
1:	9.8	←														
2:	9.8	↙														
3:	9.1	↑														
4:	10.2	↗														
5:	9.7	↖														
Serie		46														
Total		330														

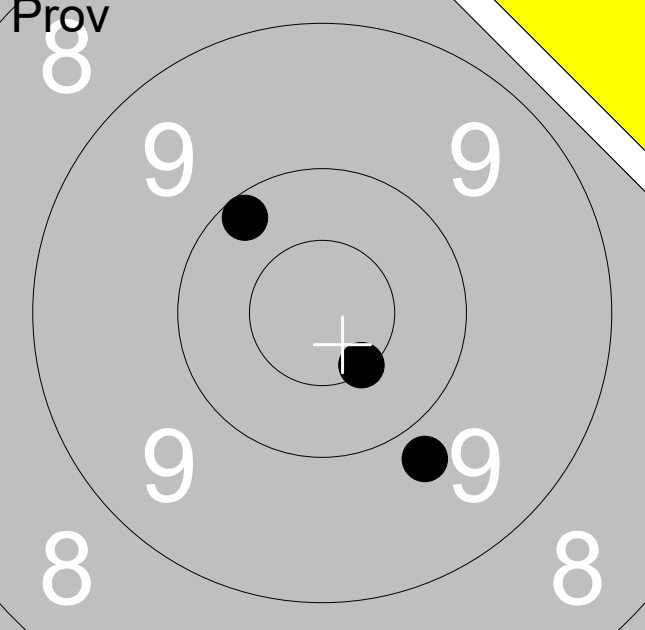
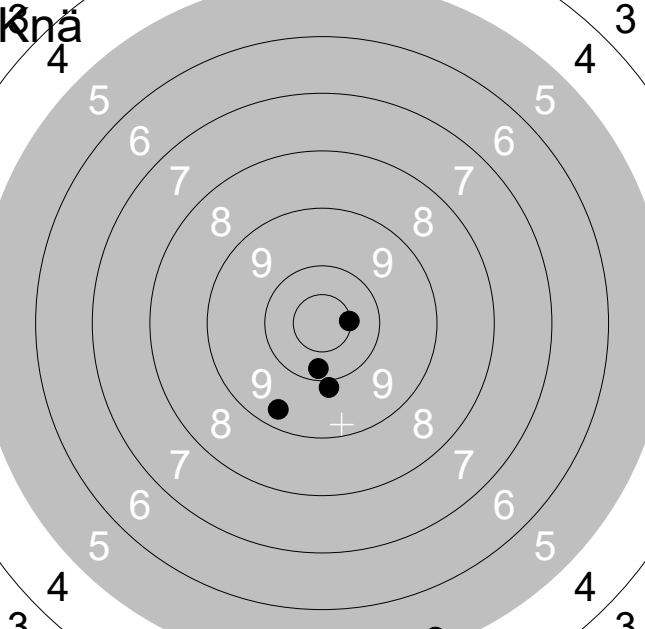
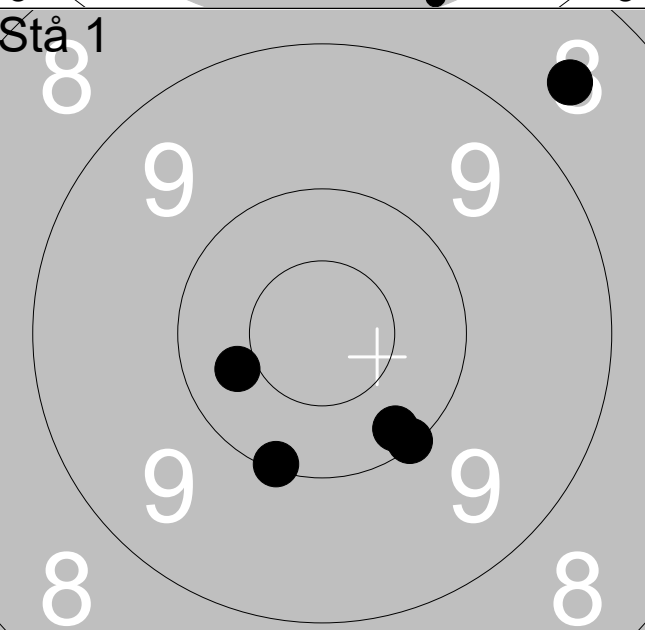
07.07.2018	Björskottet 2018	Ramselefors SKF														
<b>Prov</b> 	<table style="width:100%; border-collapse: collapse;"> <tr> <td style="width:10%;">1:</td> <td style="width:80%;">10.5x</td> <td style="width:10%; text-align: right;">↘</td> </tr> <tr> <td>2:</td> <td>10.2</td> <td style="text-align: right;">↗</td> </tr> <tr> <td>3:</td> <td>9.8</td> <td style="text-align: right;">↘</td> </tr> </table>	1:	10.5x	↘	2:	10.2	↗	3:	9.8	↘						
1:	10.5x	↘														
2:	10.2	↗														
3:	9.8	↘														
		Serie <span style="float: right;">29</span>														
		Total <span style="float: right;">234</span>														
<b>Knä</b> 	<table style="width:100%; border-collapse: collapse;"> <tr> <td style="width:10%;">1:</td> <td style="width:80%;">9.3</td> <td style="width:10%; text-align: right;">↘</td> </tr> <tr> <td>2:</td> <td>10.5x</td> <td style="text-align: right;">→</td> </tr> <tr> <td>3:</td> <td>10.2</td> <td style="text-align: right;">↘</td> </tr> <tr> <td>4:</td> <td>5.2</td> <td style="text-align: right;">↘</td> </tr> <tr> <td>5:</td> <td>9.9</td> <td style="text-align: right;">↘</td> </tr> </table>	1:	9.3	↘	2:	10.5x	→	3:	10.2	↘	4:	5.2	↘	5:	9.9	↘
1:	9.3	↘														
2:	10.5x	→														
3:	10.2	↘														
4:	5.2	↘														
5:	9.9	↘														
		Serie <span style="float: right;">43</span>														
		Total <span style="float: right;">277</span>														
<b>Stå 1</b> 	<table style="width:100%; border-collapse: collapse;"> <tr> <td style="width:10%;">1:</td> <td style="width:80%;">10.2</td> <td style="width:10%; text-align: right;">↘</td> </tr> <tr> <td>2:</td> <td>10.1</td> <td style="text-align: right;">↘</td> </tr> <tr> <td>3:</td> <td>10.4</td> <td style="text-align: right;">←</td> </tr> <tr> <td>4:</td> <td>10.1</td> <td style="text-align: right;">↘</td> </tr> <tr> <td>5:</td> <td>8.6</td> <td style="text-align: right;">↗</td> </tr> </table>	1:	10.2	↘	2:	10.1	↘	3:	10.4	←	4:	10.1	↘	5:	8.6	↗
1:	10.2	↘														
2:	10.1	↘														
3:	10.4	←														
4:	10.1	↘														
5:	8.6	↗														
		Serie <span style="float: right;">48</span>														
		Total <span style="float: right;">325</span>														

07.07.2018	Björskottet 2018	Ramselefors SKF
------------	------------------	-----------------

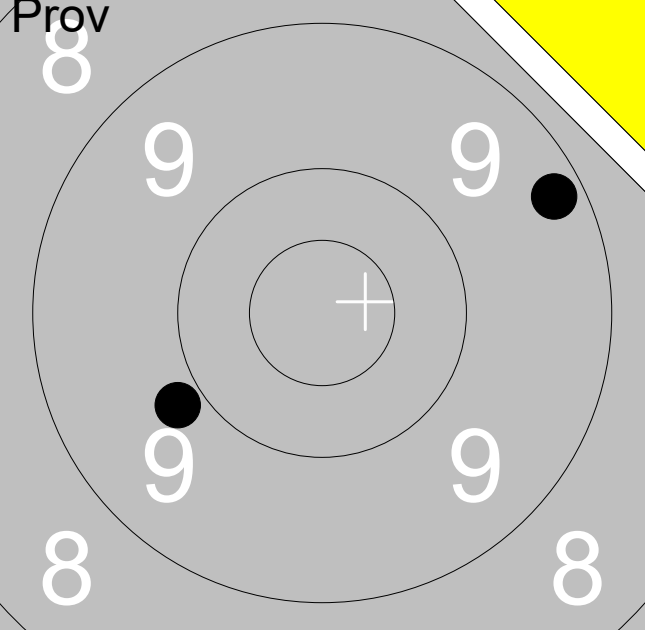

1:	9.2	↗
2:	9.8	↙

Serie	18
Total	230

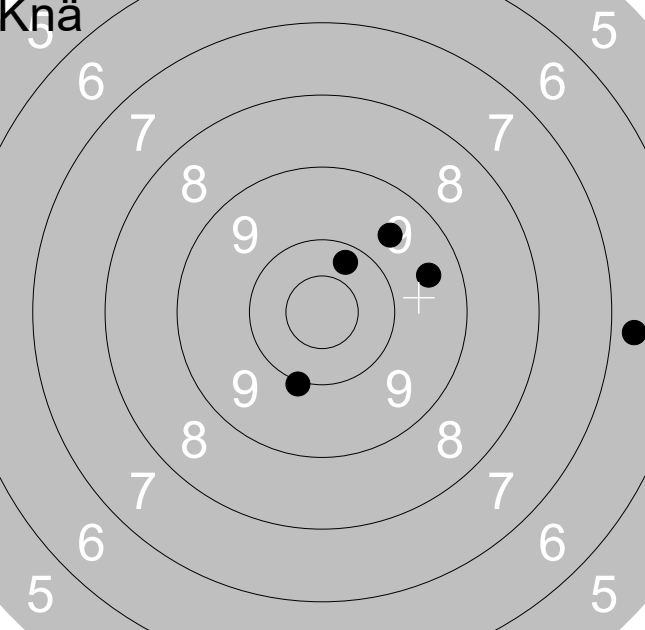

1:	10.0	↓
2:	10.2	↑
3:	9.6	↗
4:	9.5	→
5:	6.7	→

Serie	44
Total	274

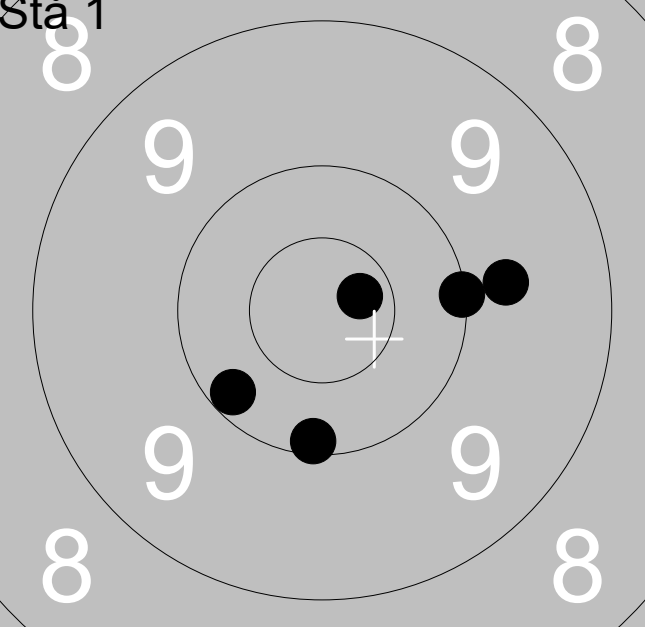

1:	10.2	↙
2:	10.0	→
3:	10.1	↓
4:	10.7x	↗
5:	9.7	→

Serie	49
Total	323

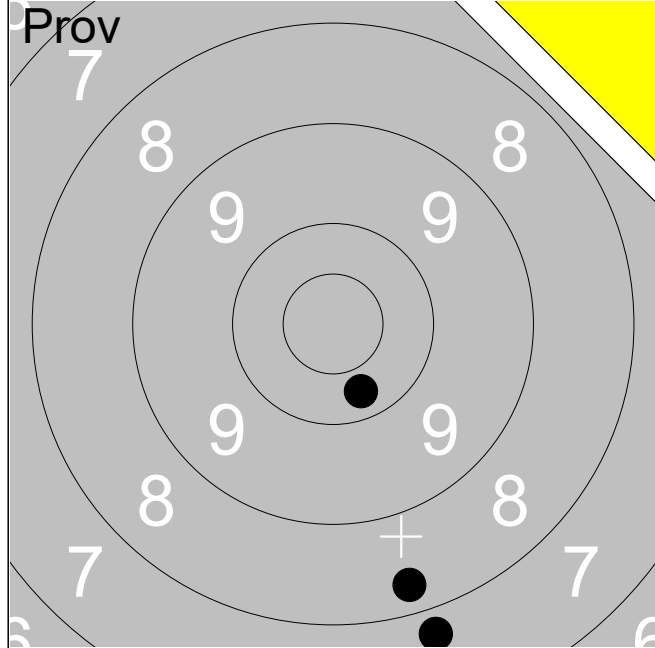

1:	7.8	↓
2:	10.3	↓
3:	8.3	↓
<b>Serie</b>		<b>25</b>
<b>Total</b>		<b>230</b>

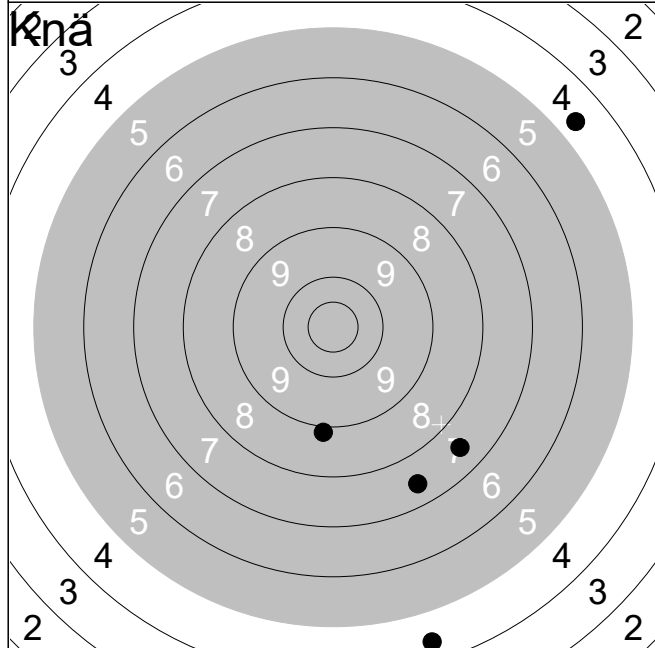

1:	7.5	↓
2:	4.4	↓
3:	8.9	↓
4:	7.5	↘
5:	4.7	↗
<b>Serie</b>		<b>30</b>
<b>Total</b>		<b>260</b>

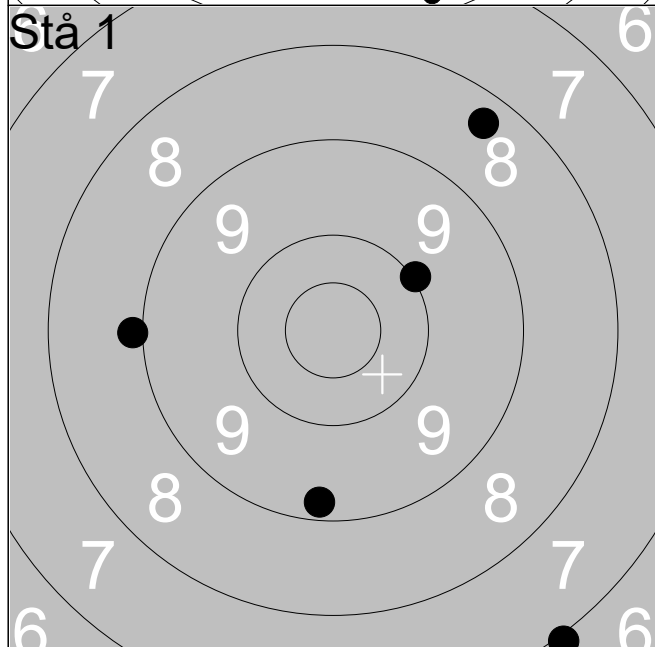

1:	7.0	↓
2:	8.3	↗
3:	10.0	↗
4:	9.2	↓
5:	8.9	←
<b>Serie</b>		<b>42</b>
<b>Total</b>		<b>302</b>

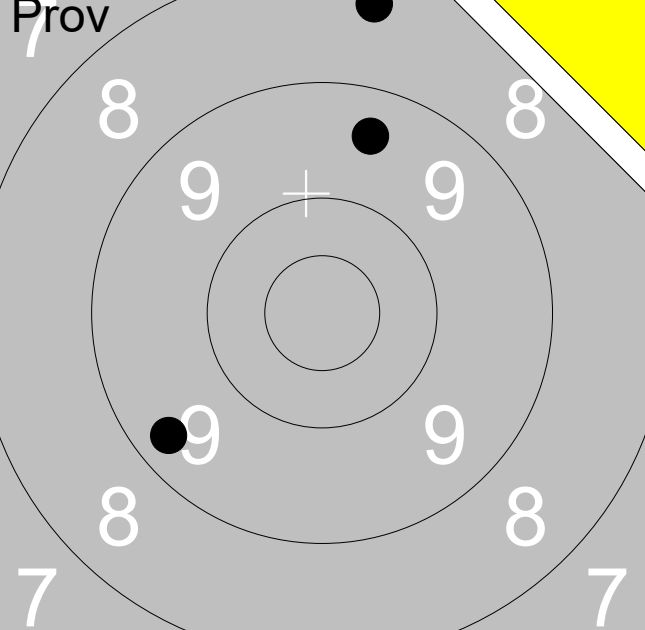
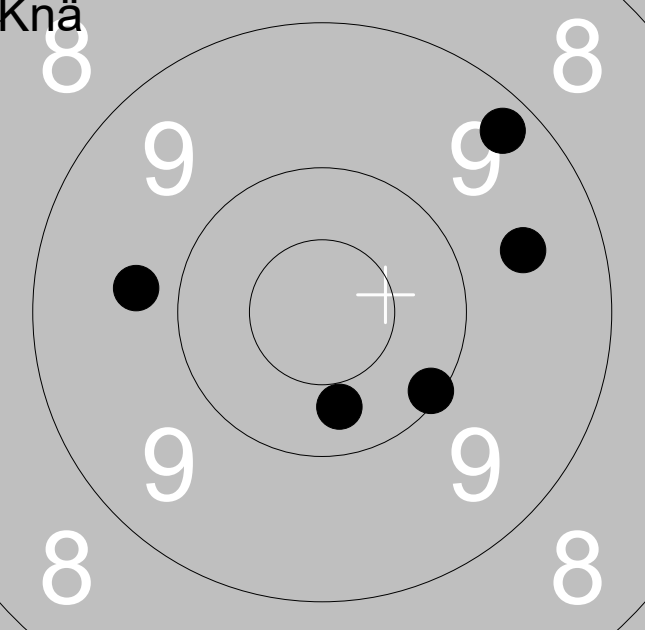
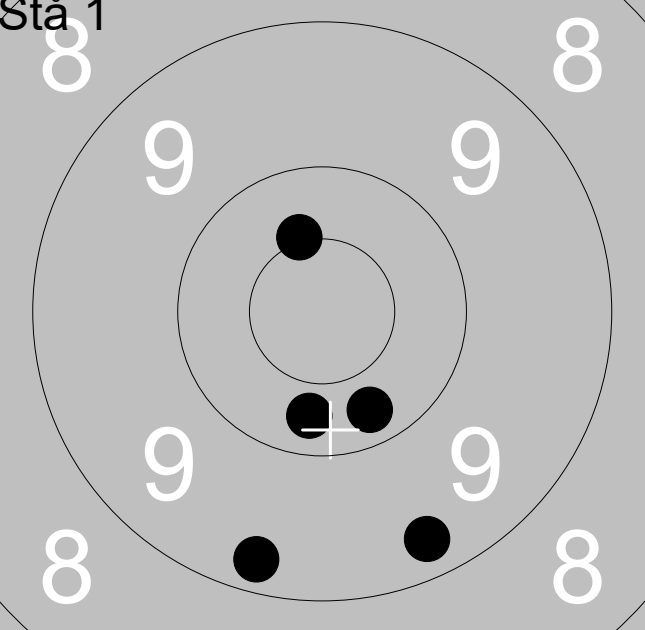
07.07.2018	Björskottet 2018	Ramselefors SKF															
<b>Prov</b> 	<table style="width:100%; border-collapse: collapse;"> <tr><td style="width:10%;">1:</td><td style="width:10%;">9.4</td><td style="width:10%; text-align: right;">↑</td></tr> <tr><td>2:</td><td>9.3</td><td style="text-align: right;">↙</td></tr> <tr><td>3:</td><td>8.3</td><td style="text-align: right;">↑</td></tr> </table>	1:	9.4	↑	2:	9.3	↙	3:	8.3	↑							
1:	9.4	↑															
2:	9.3	↙															
3:	8.3	↑															
Serie		26															
Total		229															
<b>Knä</b> 	<table style="width:100%; border-collapse: collapse;"> <tr><td style="width:10%;">1:</td><td style="width:10%;">9.6</td><td style="width:10%; text-align: right;">→</td></tr> <tr><td>2:</td><td>9.7</td><td style="text-align: right;">←</td></tr> <tr><td>3:</td><td>10.1</td><td style="text-align: right;">↘</td></tr> <tr><td>4:</td><td>10.3</td><td style="text-align: right;">↓</td></tr> <tr><td>5:</td><td>9.3</td><td style="text-align: right;">↗</td></tr> </table>	1:	9.6	→	2:	9.7	←	3:	10.1	↘	4:	10.3	↓	5:	9.3	↗	
1:	9.6	→															
2:	9.7	←															
3:	10.1	↘															
4:	10.3	↓															
5:	9.3	↗															
Serie		47															
Total		276															
<b>Stå 1</b> 	<table style="width:100%; border-collapse: collapse;"> <tr><td style="width:10%;">1:</td><td style="width:10%;">10.3</td><td style="width:10%; text-align: right;">↓</td></tr> <tr><td>2:</td><td>9.3</td><td style="text-align: right;">↓</td></tr> <tr><td>3:</td><td>10.5x</td><td style="text-align: right;">↑</td></tr> <tr><td>4:</td><td>9.3</td><td style="text-align: right;">↓</td></tr> <tr><td>5:</td><td>10.3</td><td style="text-align: right;">↓</td></tr> </table>	1:	10.3	↓	2:	9.3	↓	3:	10.5x	↑	4:	9.3	↓	5:	10.3	↓	
1:	10.3	↓															
2:	9.3	↓															
3:	10.5x	↑															
4:	9.3	↓															
5:	10.3	↓															
Serie		48															
Total		324															

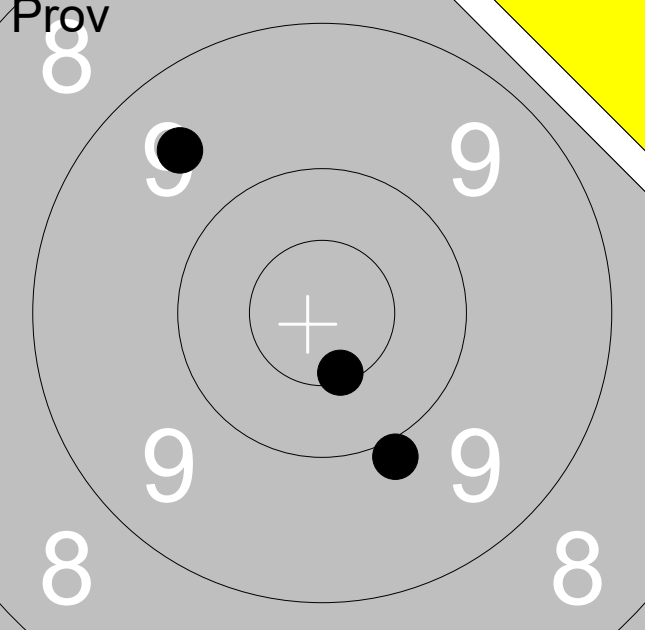
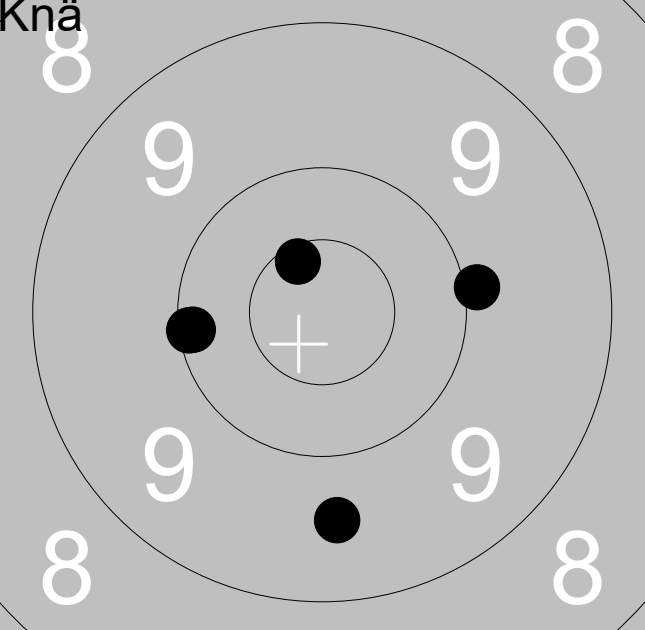
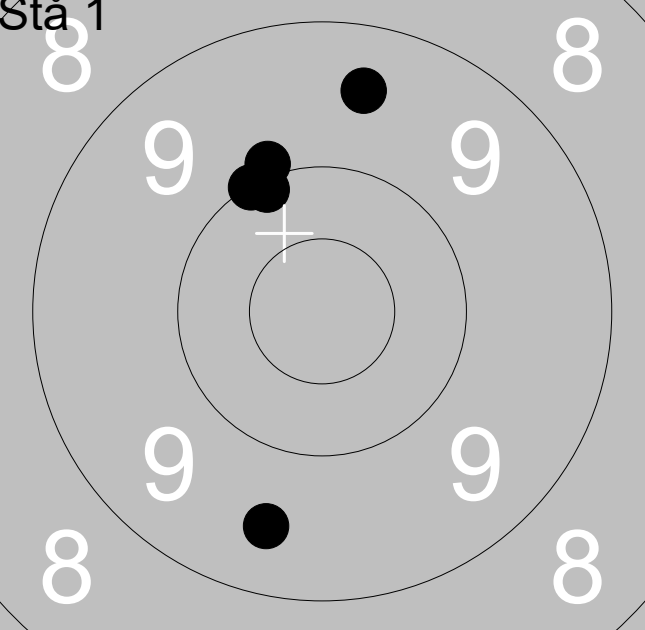
07.07.2018	Björkskottet 2018	Ramselefors SKF
<b>Prov</b> 	1: 9.5	↗
	2: 10.6x	↘
	3: 9.9	↘
	<b>Serie</b>	<b>28</b>
<b>Total</b>	<b>229</b>	
<b>Knä</b> 	1: 10.1	←
	2: 9.9	→
	3: 9.6	↓
	4: 10.1	←
	5: 10.6x	↗
<b>Serie</b>	<b>48</b>	
<b>Total</b>	<b>277</b>	
<b>Stå 1</b> 	1: 10.1	↗
	2: 9.9	↗
	3: 9.5	↘
	4: 10.0	↗
	5: 9.5	↑
<b>Serie</b>	<b>47</b>	
<b>Total</b>	<b>324</b>	



07.07.2018	Björskottet 2018	Ramselefors SKF
------------	------------------	-----------------

**Pröv**



1:	9.1	↘
2:	8.1	↗
3:	4.7	↗
<b>Serie</b>		<b>21</b>
<b>Total</b>		<b>229</b>

**Knä**

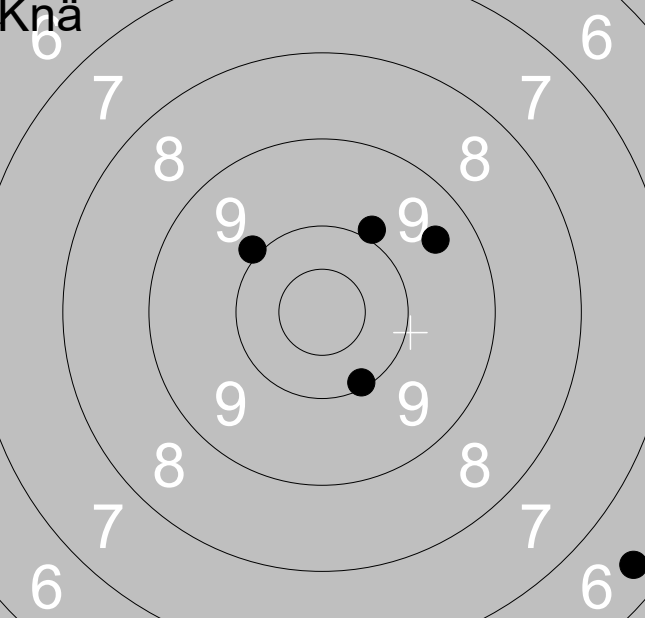

1:	10.1	↘
2:	9.5	↗
3:	9.9	↗
4:	9.9	↗
5:	6.4	↘
<b>Serie</b>		<b>43</b>
<b>Total</b>		<b>272</b>

**Stå 1**

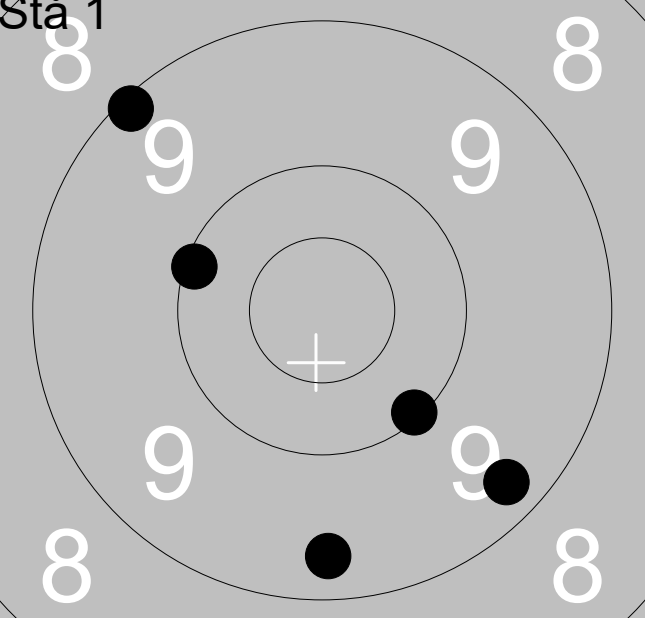

1:	10.1	↖
2:	9.1	↗
3:	9.3	↘
4:	10.1	↘
5:	9.3	↘
<b>Serie</b>		<b>47</b>
<b>Total</b>		<b>319</b>

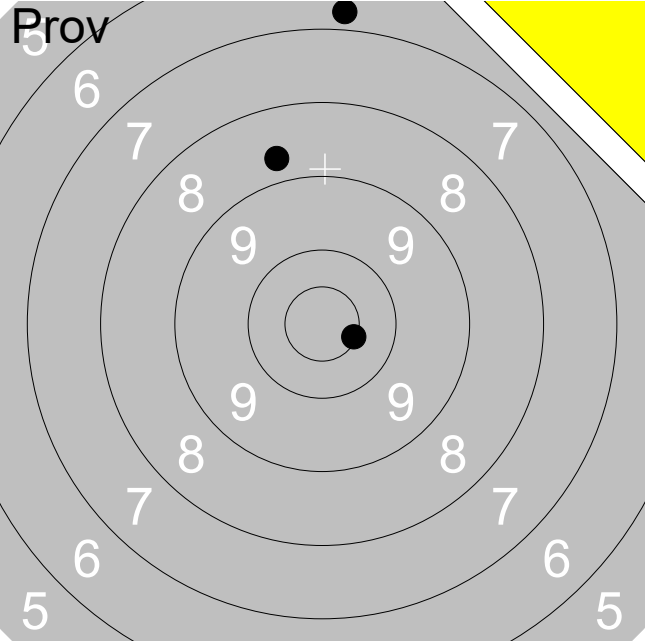
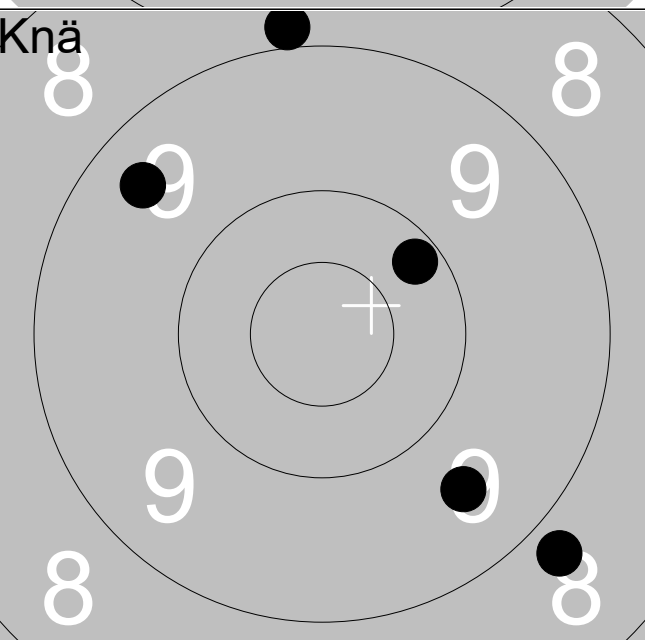
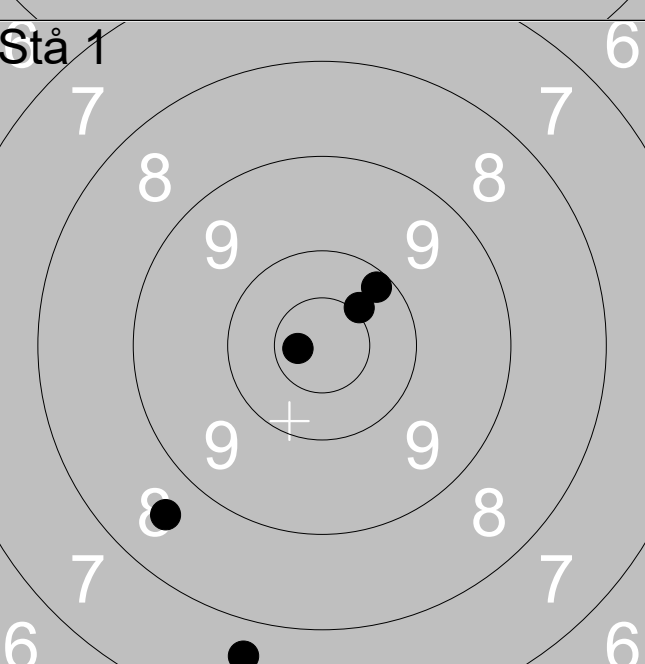
07.07.2018	Björskottet 2018	Ramselefors SKF															
<b>Prov</b> 	<table style="width:100%; border-collapse: collapse;"> <tr><td style="width:10%;">1:</td><td style="width:60%;">6.8</td><td style="width:10%; text-align: center;">↑</td></tr> <tr><td>2:</td><td>8.7</td><td style="text-align: center;">↑</td></tr> <tr><td>3:</td><td>10.5x</td><td style="text-align: center;">➤</td></tr> </table>	1:	6.8	↑	2:	8.7	↑	3:	10.5x	➤							
1:	6.8	↑															
2:	8.7	↑															
3:	10.5x	➤															
		Serie <span style="float: right;">24</span>															
		Total <span style="float: right;">227</span>															
<b>Knä</b> 	<table style="width:100%; border-collapse: collapse;"> <tr><td style="width:10%;">1:</td><td style="width:60%;">9.6</td><td style="width:10%; text-align: center;">↘</td></tr> <tr><td>2:</td><td>8.8</td><td style="text-align: center;">↘</td></tr> <tr><td>3:</td><td>9.4</td><td style="text-align: center;">↗</td></tr> <tr><td>4:</td><td>8.9</td><td style="text-align: center;">↑</td></tr> <tr><td>5:</td><td>10.2</td><td style="text-align: center;">↗</td></tr> </table>	1:	9.6	↘	2:	8.8	↘	3:	9.4	↗	4:	8.9	↑	5:	10.2	↗	
1:	9.6	↘															
2:	8.8	↘															
3:	9.4	↗															
4:	8.9	↑															
5:	10.2	↗															
		Serie <span style="float: right;">44</span>															
		Total <span style="float: right;">271</span>															
<b>Stå 1</b> 	<table style="width:100%; border-collapse: collapse;"> <tr><td style="width:10%;">1:</td><td style="width:60%;">7.6</td><td style="width:10%; text-align: center;">↓</td></tr> <tr><td>2:</td><td>10.7x</td><td style="text-align: center;">←</td></tr> <tr><td>3:</td><td>10.2</td><td style="text-align: center;">↗</td></tr> <tr><td>4:</td><td>10.4x</td><td style="text-align: center;">↗</td></tr> <tr><td>5:</td><td>8.6</td><td style="text-align: center;">↘</td></tr> </table>	1:	7.6	↓	2:	10.7x	←	3:	10.2	↗	4:	10.4x	↗	5:	8.6	↘	
1:	7.6	↓															
2:	10.7x	←															
3:	10.2	↗															
4:	10.4x	↗															
5:	8.6	↘															
		Serie <span style="float: right;">45</span>															
		Total <span style="float: right;">316</span>															

07.07.2018	Björskottet 2018	Ramselefors SKF																			
<b>Prov</b> 	<table style="width:100%; border-collapse: collapse;"> <tr> <td style="width:10%;">1:</td> <td style="width:60%;">10.6x</td> <td style="width:10%; text-align: center;">↙</td> </tr> </table>	1:	10.6x	↙	<table style="width:100%; border-collapse: collapse;"> <tr> <td style="width:80%;"><b>Serie</b></td> <td style="width:20%; text-align: right;"><b>10</b></td> </tr> <tr> <td><b>Total</b></td> <td style="text-align: right;"><b>227</b></td> </tr> </table>	<b>Serie</b>	<b>10</b>	<b>Total</b>	<b>227</b>												
1:	10.6x	↙																			
<b>Serie</b>	<b>10</b>																				
<b>Total</b>	<b>227</b>																				
<b>Knä</b> 	<table style="width:100%; border-collapse: collapse;"> <tr> <td style="width:10%;">1:</td> <td style="width:60%;">6.8</td> <td style="width:10%; text-align: center;">↓</td> </tr> <tr> <td>2:</td> <td>8.8</td> <td style="text-align: center;">↗</td> </tr> <tr> <td>3:</td> <td>8.5</td> <td style="text-align: center;">↖</td> </tr> <tr> <td>4:</td> <td>9.5</td> <td style="text-align: center;">↗</td> </tr> <tr> <td>5:</td> <td>10.3</td> <td style="text-align: center;">↗</td> </tr> </table>	1:	6.8	↓	2:	8.8	↗	3:	8.5	↖	4:	9.5	↗	5:	10.3	↗	<table style="width:100%; border-collapse: collapse;"> <tr> <td style="width:80%;"><b>Serie</b></td> <td style="width:20%; text-align: right;"><b>41</b></td> </tr> <tr> <td><b>Total</b></td> <td style="text-align: right;"><b>268</b></td> </tr> </table>	<b>Serie</b>	<b>41</b>	<b>Total</b>	<b>268</b>
1:	6.8	↓																			
2:	8.8	↗																			
3:	8.5	↖																			
4:	9.5	↗																			
5:	10.3	↗																			
<b>Serie</b>	<b>41</b>																				
<b>Total</b>	<b>268</b>																				
<b>Stå 1</b> 	<table style="width:100%; border-collapse: collapse;"> <tr> <td style="width:10%;">1:</td> <td style="width:60%;">10.3</td> <td style="width:10%; text-align: center;">↘</td> </tr> <tr> <td>2:</td> <td>8.3</td> <td style="text-align: center;">↖</td> </tr> <tr> <td>3:</td> <td>8.7</td> <td style="text-align: center;">←</td> </tr> <tr> <td>4:</td> <td>8.7</td> <td style="text-align: center;">↓</td> </tr> <tr> <td>5:</td> <td>7.0</td> <td style="text-align: center;">→</td> </tr> </table>	1:	10.3	↘	2:	8.3	↖	3:	8.7	←	4:	8.7	↓	5:	7.0	→	<table style="width:100%; border-collapse: collapse;"> <tr> <td style="width:80%;"><b>Serie</b></td> <td style="width:20%; text-align: right;"><b>41</b></td> </tr> <tr> <td><b>Total</b></td> <td style="text-align: right;"><b>309</b></td> </tr> </table>	<b>Serie</b>	<b>41</b>	<b>Total</b>	<b>309</b>
1:	10.3	↘																			
2:	8.3	↖																			
3:	8.7	←																			
4:	8.7	↓																			
5:	7.0	→																			
<b>Serie</b>	<b>41</b>																				
<b>Total</b>	<b>309</b>																				

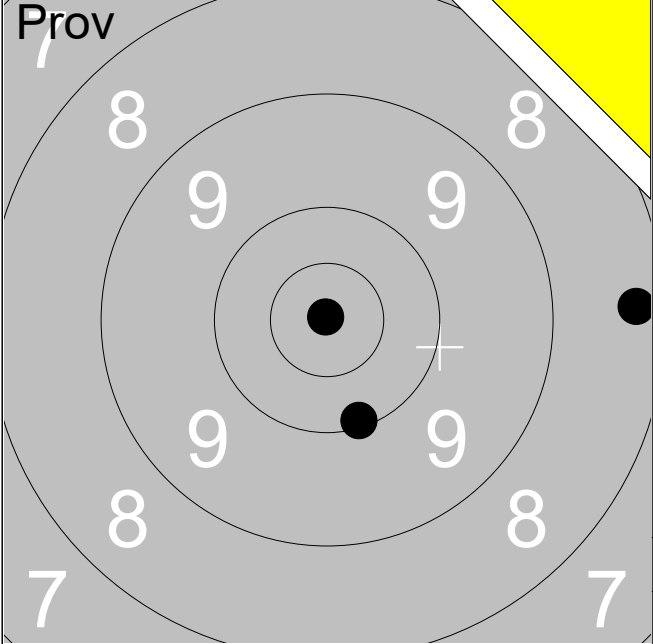
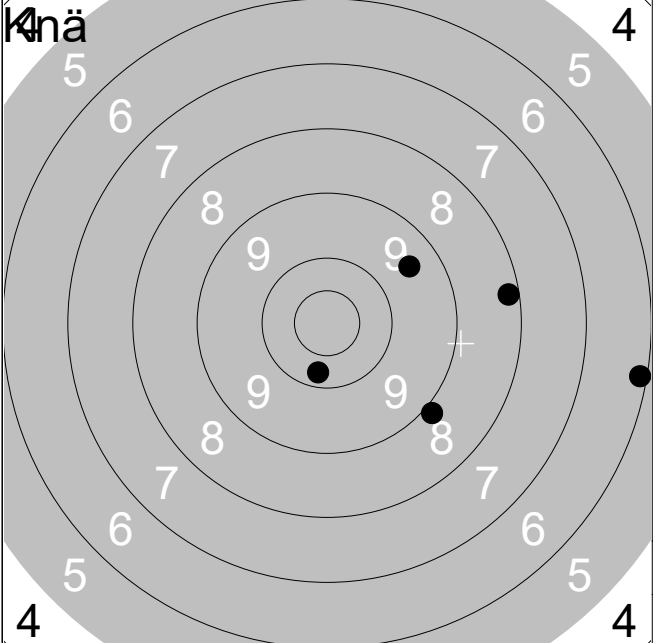
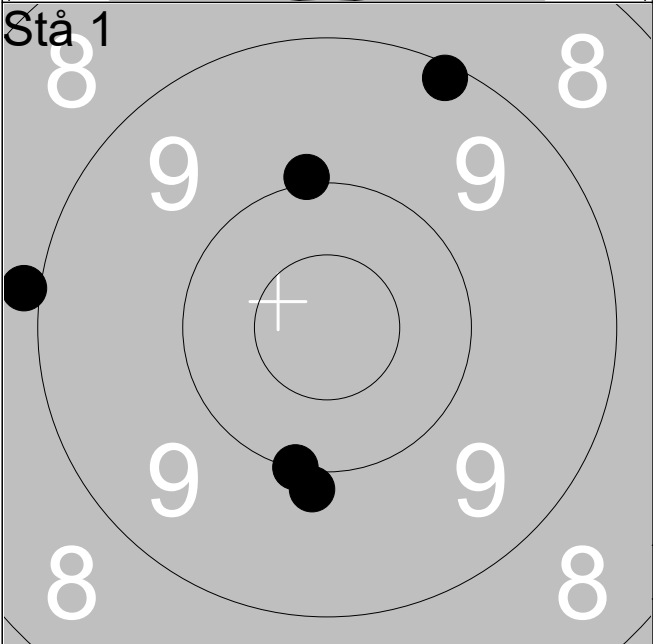
07.07.2018	Björskottet 2018	Ramselefors SKF															
<b>Prov</b>		<table border="1"> <tr><td>1:</td><td>10.1</td><td>↓</td></tr> <tr><td>2:</td><td>8.3</td><td>→</td></tr> <tr><td>3:</td><td>10.9x</td><td>↗</td></tr> </table>	1:	10.1	↓	2:	8.3	→	3:	10.9x	↗						
1:	10.1	↓															
2:	8.3	→															
3:	10.9x	↗															
	<b>Serie</b>	<b>28</b>															
	<b>Total</b>	<b>226</b>															
<b>Knä</b>		<table border="1"> <tr><td>1:</td><td>9.5</td><td>↗</td></tr> <tr><td>2:</td><td>10.2</td><td>↓</td></tr> <tr><td>3:</td><td>8.2</td><td>→</td></tr> <tr><td>4:</td><td>6.1</td><td>→</td></tr> <tr><td>5:</td><td>8.9</td><td>↘</td></tr> </table>	1:	9.5	↗	2:	10.2	↓	3:	8.2	→	4:	6.1	→	5:	8.9	↘
1:	9.5	↗															
2:	10.2	↓															
3:	8.2	→															
4:	6.1	→															
5:	8.9	↘															
	<b>Serie</b>	<b>41</b>															
	<b>Total</b>	<b>267</b>															
<b>Stå 1</b>		<table border="1"> <tr><td>1:</td><td>8.9</td><td>←</td></tr> <tr><td>2:</td><td>10.0</td><td>↑</td></tr> <tr><td>3:</td><td>9.9</td><td>↓</td></tr> <tr><td>4:</td><td>10.0</td><td>↓</td></tr> <tr><td>5:</td><td>9.1</td><td>↗</td></tr> </table>	1:	8.9	←	2:	10.0	↑	3:	9.9	↓	4:	10.0	↓	5:	9.1	↗
1:	8.9	←															
2:	10.0	↑															
3:	9.9	↓															
4:	10.0	↓															
5:	9.1	↗															
	<b>Serie</b>	<b>46</b>															
	<b>Total</b>	<b>313</b>															

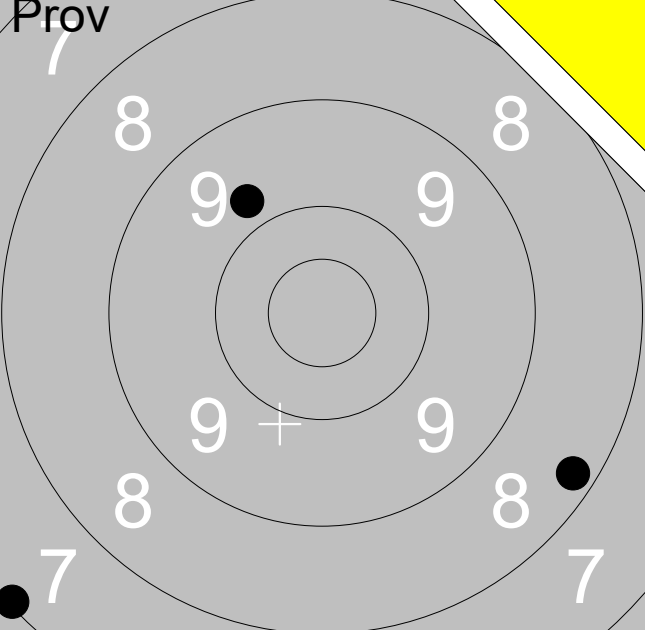
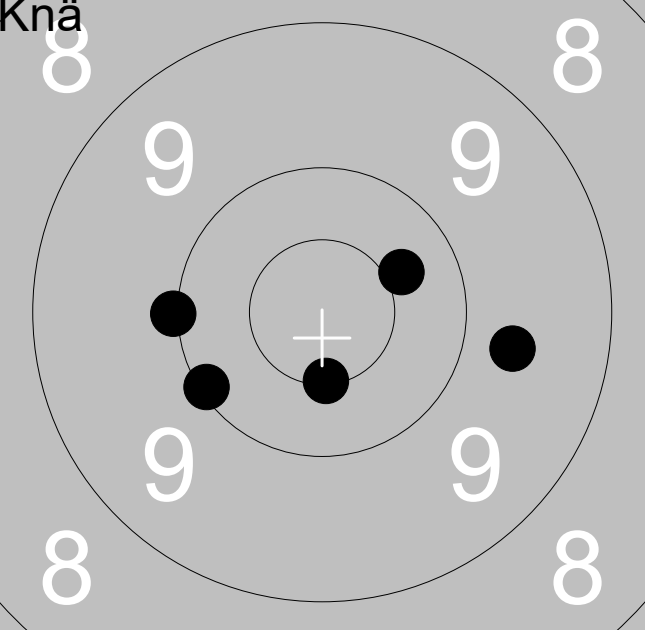
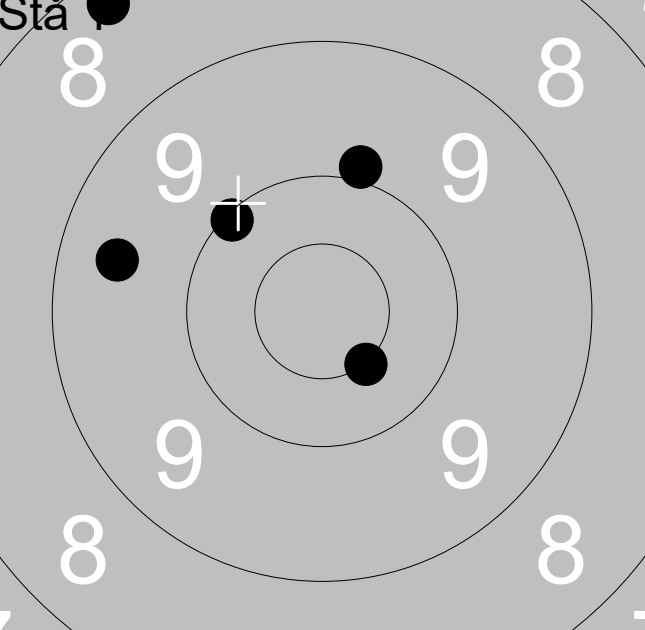
07.07.2018	Björskottet 2018	Ramselefors SKF
<b>Prov</b> 	1: 8.2 ↘ 2: 7.1 ↙ 3: 9.8 ↗	
Serie		24
Total		222
<b>Knä</b> 	1: 10.1 ↙ 2: 10.5x ↓ 3: 10.0 ← 4: 9.7 → 5: 10.4 ↗	
Serie		49
Total		271
<b>Stå</b> 	1: 9.5 ← 2: 10.1 ↗ 3: 8.3 ↗ 4: 9.9 ↑ 5: 10.5x ↓	
Serie		46
Total		317

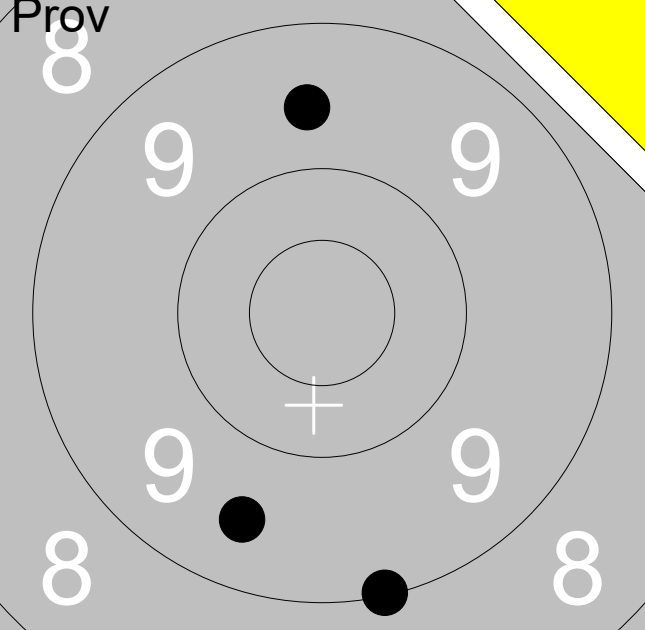
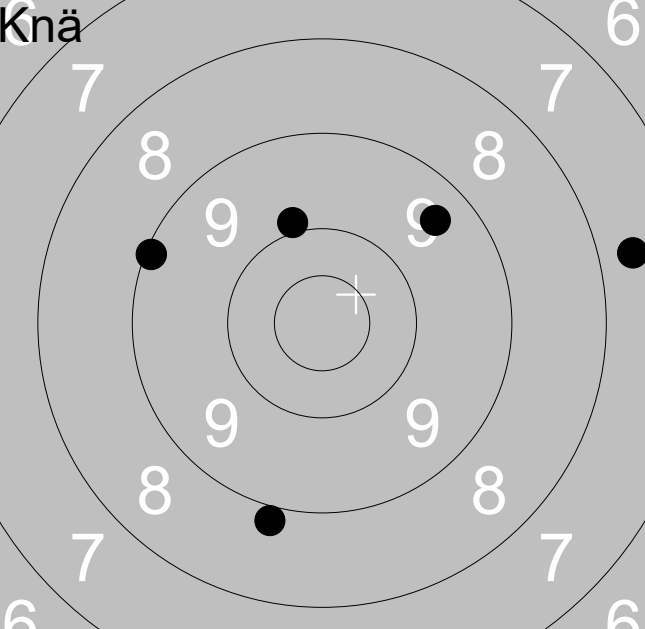
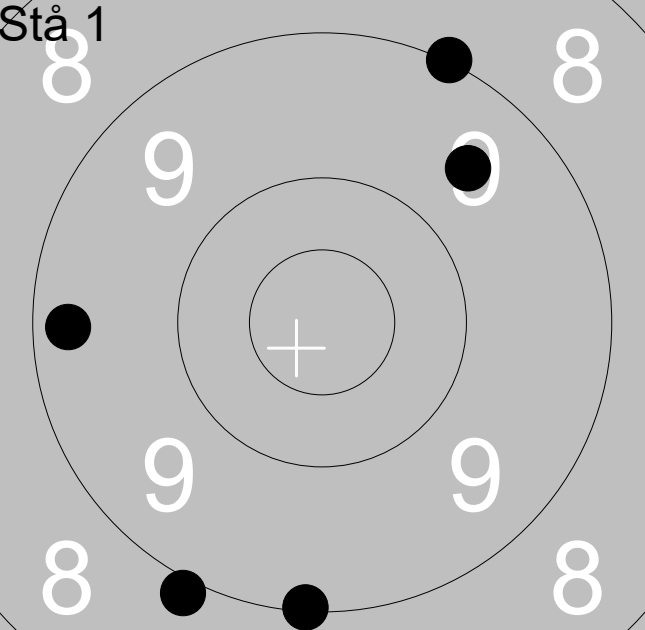
07.07.2018	Björskottet 2018	Ramselefors SKF	
<b>Prov</b> 	1:	9.6	↑
	2:	9.5	↓
	3:	9.0	↓
	<b>Serie</b>		<b>27</b>
<b>Total</b>		<b>217</b>	
<b>Knä</b> 	1:	8.9	↓
	2:	9.9	↑
	3:	7.7	→
	4:	9.4	↗
	5:	9.1	↖
	<b>Serie</b>		<b>42</b>
<b>Total</b>		<b>259</b>	
<b>Stå 1</b> 	1:	9.0	↗
	2:	8.9	↓
	3:	9.6	↗
	4:	9.3	←
	5:	9.1	↓
	<b>Serie</b>		<b>44</b>
<b>Total</b>		<b>303</b>	

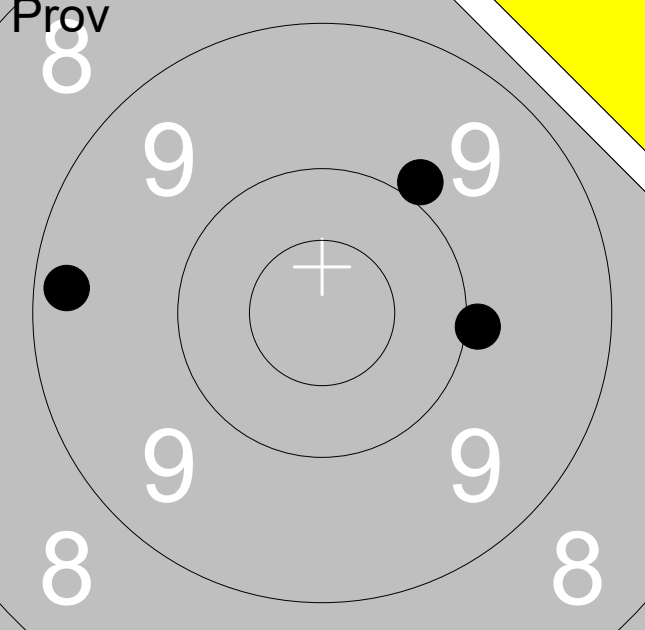
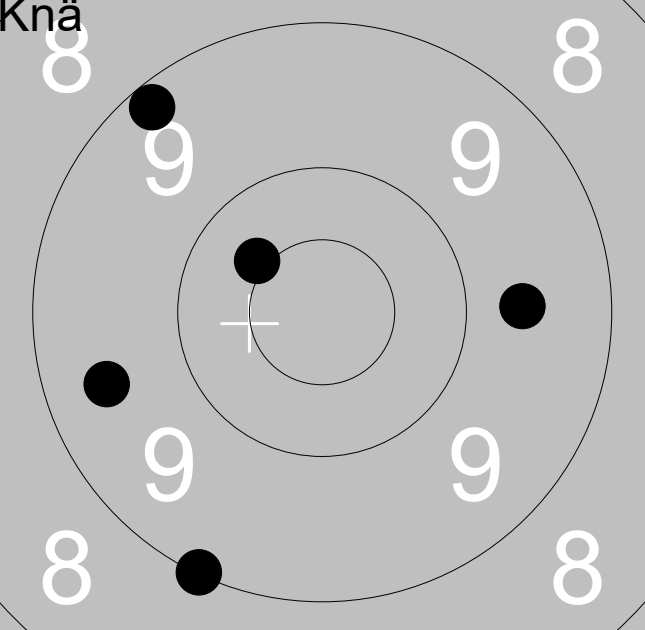
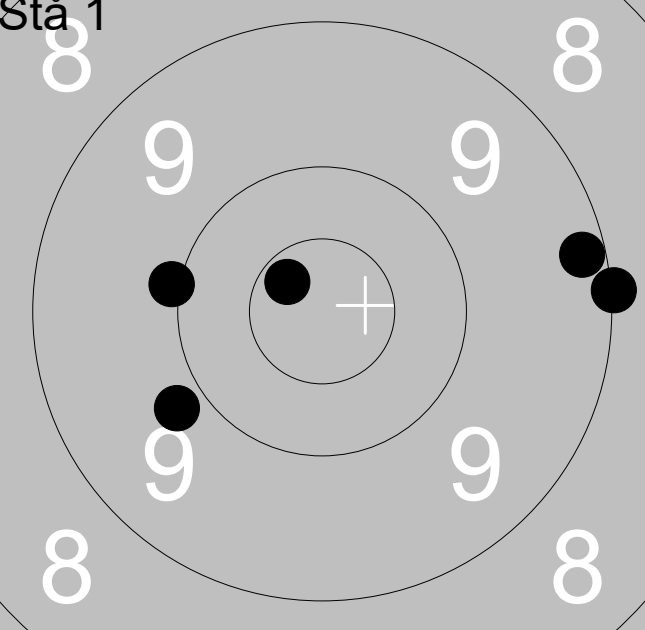
07.07.2018	Björskottet 2018	Ramselefors SKF																			
<b>Prov</b> 	<table style="width:100%; border-collapse: collapse;"> <tr><td style="width:10%;">1:</td><td style="width:10%;">9.9</td><td style="width:10%; text-align: right;">→</td></tr> <tr><td>2:</td><td>9.9</td><td style="text-align: right;">↗</td></tr> <tr><td>3:</td><td>9.3</td><td style="text-align: right;">←</td></tr> </table>	1:	9.9	→	2:	9.9	↗	3:	9.3	←	<table style="width:100%; border-collapse: collapse;"> <tr><td style="width:80%;">Serie</td><td style="text-align: right;">27</td></tr> <tr><td>Total</td><td style="text-align: right;">215</td></tr> </table>	Serie	27	Total	215						
1:	9.9	→																			
2:	9.9	↗																			
3:	9.3	←																			
Serie	27																				
Total	215																				
<b>Knä</b> 	<table style="width:100%; border-collapse: collapse;"> <tr><td style="width:10%;">1:</td><td style="width:10%;">9.0</td><td style="width:10%; text-align: right;">↘</td></tr> <tr><td>2:</td><td>10.4x</td><td style="text-align: right;">↖</td></tr> <tr><td>3:</td><td>9.5</td><td style="text-align: right;">←</td></tr> <tr><td>4:</td><td>9.6</td><td style="text-align: right;">→</td></tr> <tr><td>5:</td><td>9.2</td><td style="text-align: right;">↗</td></tr> </table>	1:	9.0	↘	2:	10.4x	↖	3:	9.5	←	4:	9.6	→	5:	9.2	↗	<table style="width:100%; border-collapse: collapse;"> <tr><td style="width:80%;">Serie</td><td style="text-align: right;">46</td></tr> <tr><td>Total</td><td style="text-align: right;">261</td></tr> </table>	Serie	46	Total	261
1:	9.0	↘																			
2:	10.4x	↖																			
3:	9.5	←																			
4:	9.6	→																			
5:	9.2	↗																			
Serie	46																				
Total	261																				
<b>Stå 1</b> 	<table style="width:100%; border-collapse: collapse;"> <tr><td style="width:10%;">1:</td><td style="width:10%;">10.0</td><td style="width:10%; text-align: right;">←</td></tr> <tr><td>2:</td><td>9.8</td><td style="text-align: right;">↙</td></tr> <tr><td>3:</td><td>10.7x</td><td style="text-align: right;">↗</td></tr> <tr><td>4:</td><td>9.0</td><td style="text-align: right;">→</td></tr> <tr><td>5:</td><td>9.2</td><td style="text-align: right;">→</td></tr> </table>	1:	10.0	←	2:	9.8	↙	3:	10.7x	↗	4:	9.0	→	5:	9.2	→	<table style="width:100%; border-collapse: collapse;"> <tr><td style="width:80%;">Serie</td><td style="text-align: right;">47</td></tr> <tr><td>Total</td><td style="text-align: right;">308</td></tr> </table>	Serie	47	Total	308
1:	10.0	←																			
2:	9.8	↙																			
3:	10.7x	↗																			
4:	9.0	→																			
5:	9.2	→																			
Serie	47																				
Total	308																				

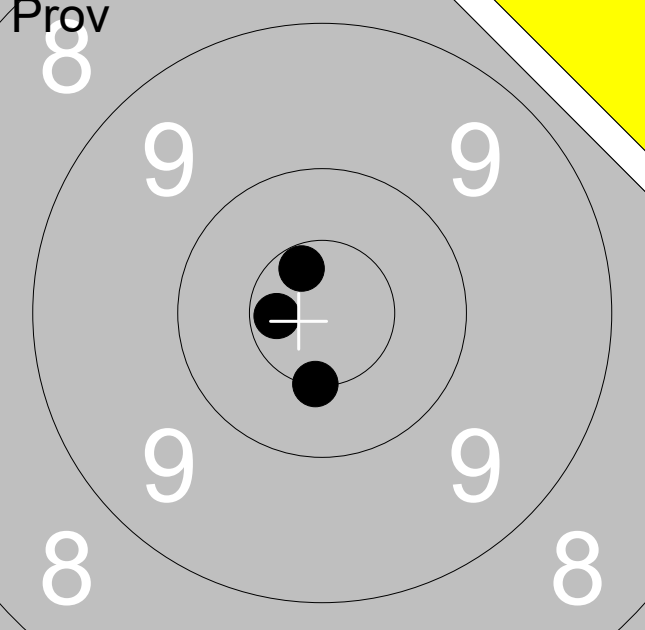
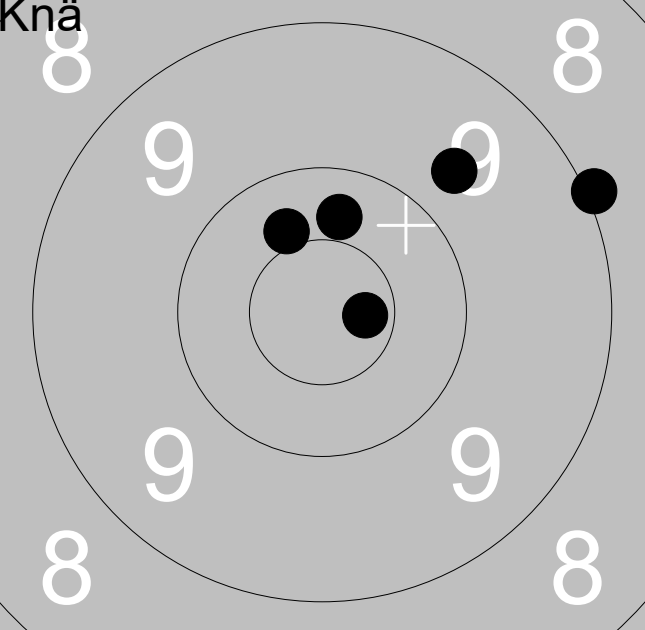
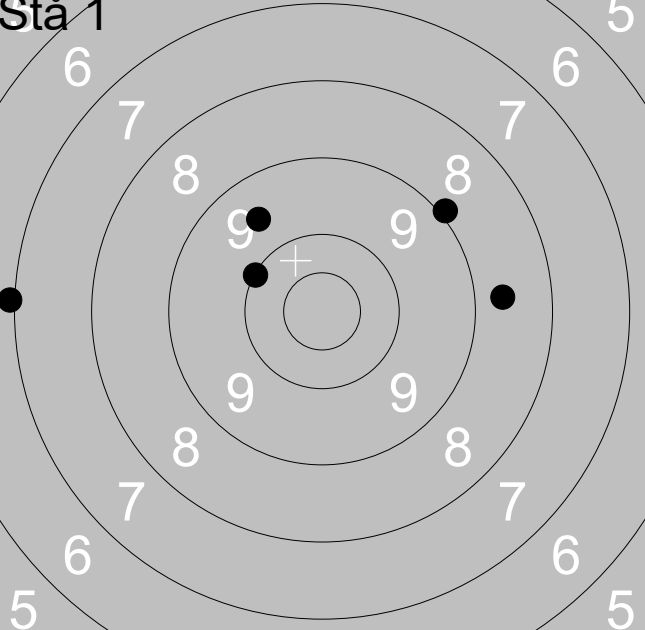
07.07.2018	Björkskottet 2018	Ramselefors SKF														
<b>Prov</b> 	<table style="width:100%; border-collapse: collapse;"> <tr> <td style="width:10%;">1:</td> <td style="width:70%;">10.6x</td> <td style="width:20%; text-align: right;">↖</td> </tr> <tr> <td>2:</td> <td>10.5x</td> <td style="text-align: right;">↓</td> </tr> <tr> <td>3:</td> <td>10.7x</td> <td style="text-align: right;">←</td> </tr> </table>	1:	10.6x	↖	2:	10.5x	↓	3:	10.7x	←						
1:	10.6x	↖														
2:	10.5x	↓														
3:	10.7x	←														
Serie		30														
Total		235														
<b>Knä</b> 	<table style="width:100%; border-collapse: collapse;"> <tr> <td style="width:10%;">1:</td> <td style="width:70%;">9.0</td> <td style="width:20%; text-align: right;">↗</td> </tr> <tr> <td>2:</td> <td>9.7</td> <td style="text-align: right;">↗</td> </tr> <tr> <td>3:</td> <td>10.3</td> <td style="text-align: right;">↑</td> </tr> <tr> <td>4:</td> <td>10.4</td> <td style="text-align: right;">↖</td> </tr> <tr> <td>5:</td> <td>10.7x</td> <td style="text-align: right;">→</td> </tr> </table>	1:	9.0	↗	2:	9.7	↗	3:	10.3	↑	4:	10.4	↖	5:	10.7x	→
1:	9.0	↗														
2:	9.7	↗														
3:	10.3	↑														
4:	10.4	↖														
5:	10.7x	→														
Serie		48														
Total		283														
<b>Stå 1</b> 	<table style="width:100%; border-collapse: collapse;"> <tr> <td style="width:10%;">1:</td> <td style="width:70%;">9.6</td> <td style="width:20%; text-align: right;">↖</td> </tr> <tr> <td>2:</td> <td>7.0</td> <td style="text-align: right;">←</td> </tr> <tr> <td>3:</td> <td>9.0</td> <td style="text-align: right;">↗</td> </tr> <tr> <td>4:</td> <td>8.7</td> <td style="text-align: right;">→</td> </tr> <tr> <td>5:</td> <td>10.0</td> <td style="text-align: right;">↖</td> </tr> </table>	1:	9.6	↖	2:	7.0	←	3:	9.0	↗	4:	8.7	→	5:	10.0	↖
1:	9.6	↖														
2:	7.0	←														
3:	9.0	↗														
4:	8.7	→														
5:	10.0	↖														
Serie		43														
Total		326														



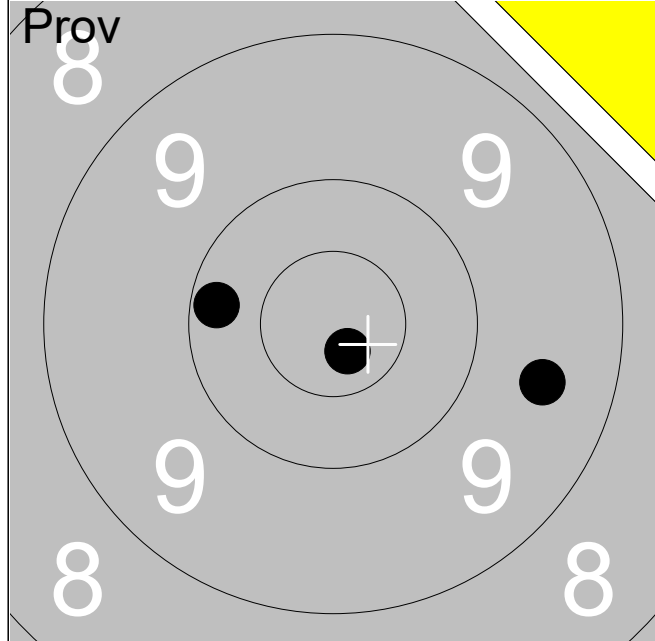

1:	10.8x	↘
2:	10.2	←
3:	9.5	↗
<b>Serie</b>		<b>29</b>
<b>Total</b>		<b>233</b>

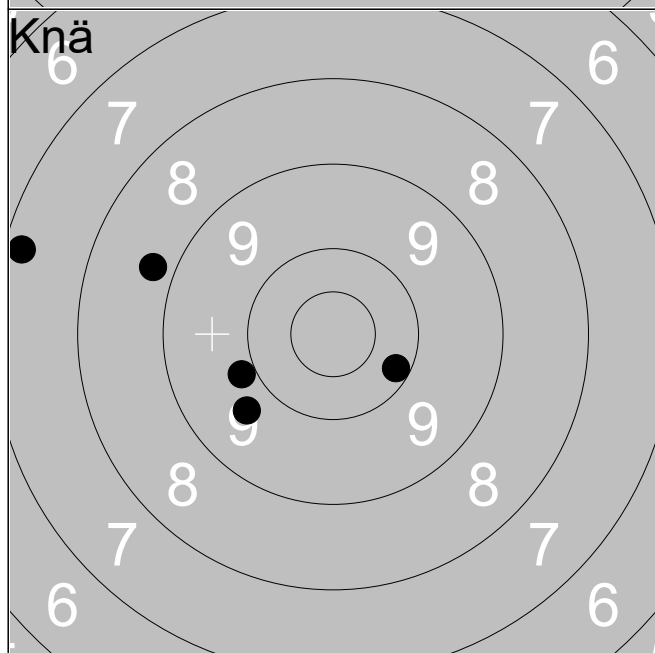

1:	10.2	↗
2:	9.9	←
3:	7.2	←
4:	8.8	←
5:	9.7	↘
<b>Serie</b>		<b>43</b>
<b>Total</b>		<b>276</b>

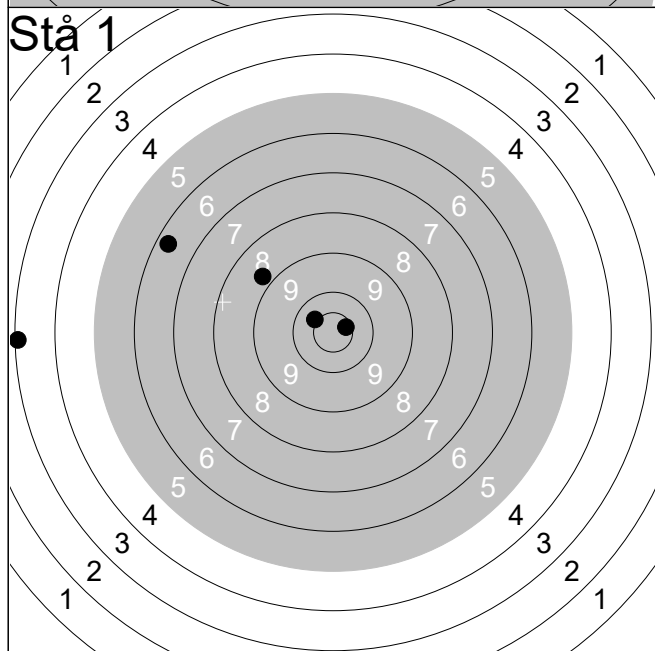

1:	6.3	↖
2:	8.8	↖
3:	10.6x	↗
4:	10.4x	↖
5:	3.1	←
<b>Serie</b>		<b>37</b>
<b>Total</b>		<b>313</b>

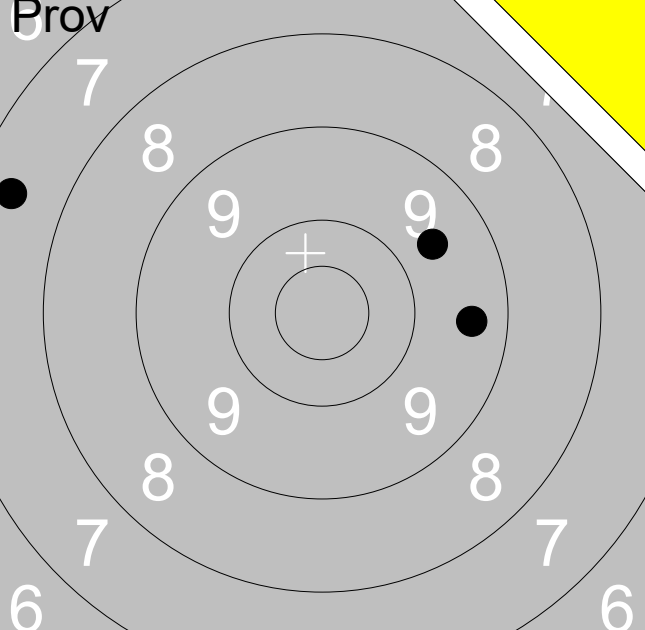
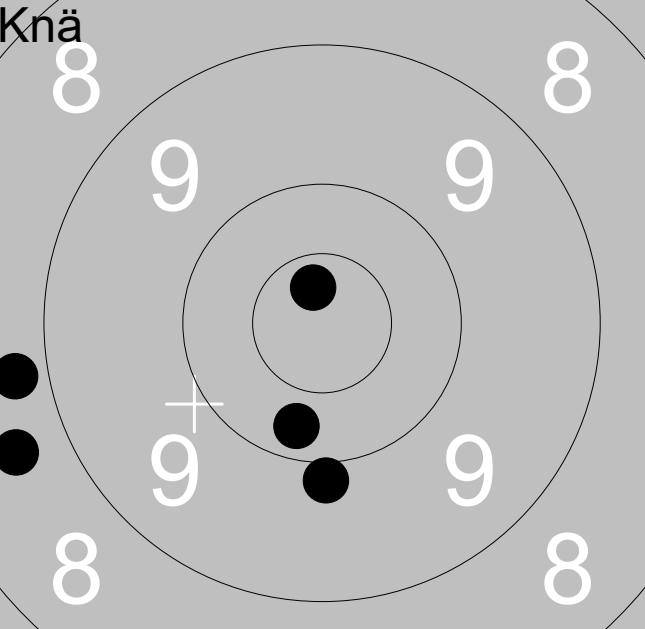
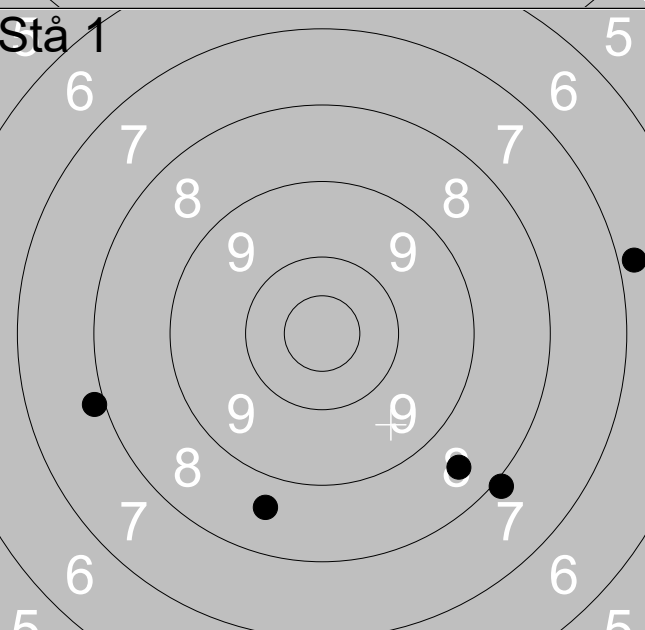
07.07.2018	Björskottet 2018	Ramselefors SKF
<b>Prov</b> 	1: 9.6	↗
	2: 9.4	→
	3: 7.4	↖
<b>Serie</b>		<b>25</b>
<b>Total</b>		<b>224</b>
<b>Knä</b> 	1: 9.9	↓
	2: 8.6	←
	3: 10.7x	↑
	4: 8.8	←
	5: 10.2	↓
<b>Serie</b>		<b>45</b>
<b>Total</b>		<b>269</b>
<b>Stå 1</b> 	1: 6.8	→
	2: 7.9	←
	3: 8.6	↓
	4: 7.9	↘
	5: 8.5	↘
<b>Serie</b>		<b>36</b>
<b>Total</b>		<b>305</b>

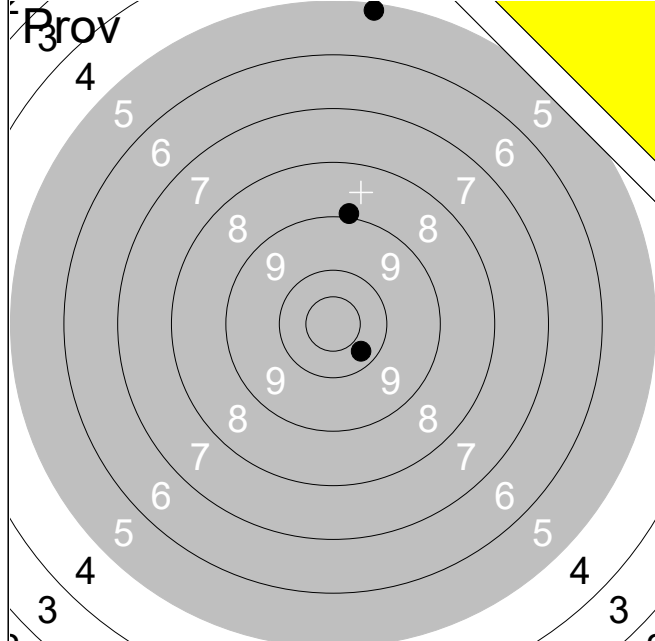

1:	5.2	↑
2:	10.3	↘
3:	9.0	↑
<b>Serie</b>		<b>24</b>
<b>Total</b>		<b>212</b>

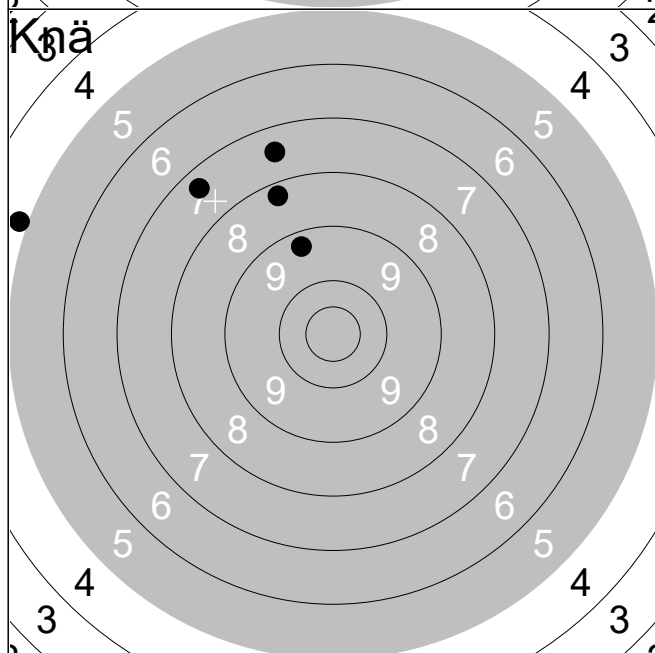

1:	4.9	←
2:	7.5	↑
3:	9.3	↑
4:	8.3	↑
5:	7.4	↗
<b>Serie</b>		<b>35</b>
<b>Total</b>		<b>247</b>

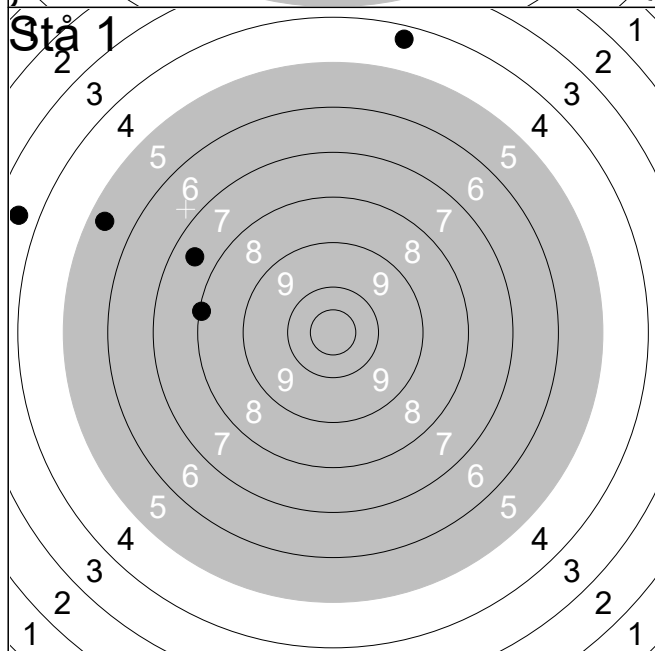

1:	4.3	↑
2:	3.6	←
3:	8.1	←
4:	5.4	←
5:	7.5	↖
<b>Serie</b>		<b>27</b>
<b>Total</b>		<b>274</b>

07.07.2018	Björskottet 2018	Ramselefors SKF
------------	------------------	-----------------

1:	6.4	↘
2:	8.4	↘
3:	8.1	→

Serie	22
Total	209

1:	8.6	↖
2:	7.3	↓
3:	8.9	↗
4:	7.4	←
5:	8.1	↘

Serie	38
Total	247

1:	7.0	↖
2:	8.8	↗
3:	7.0	←
4:	7.3	↓
5:	8.1	↘

Serie	37
Total	284

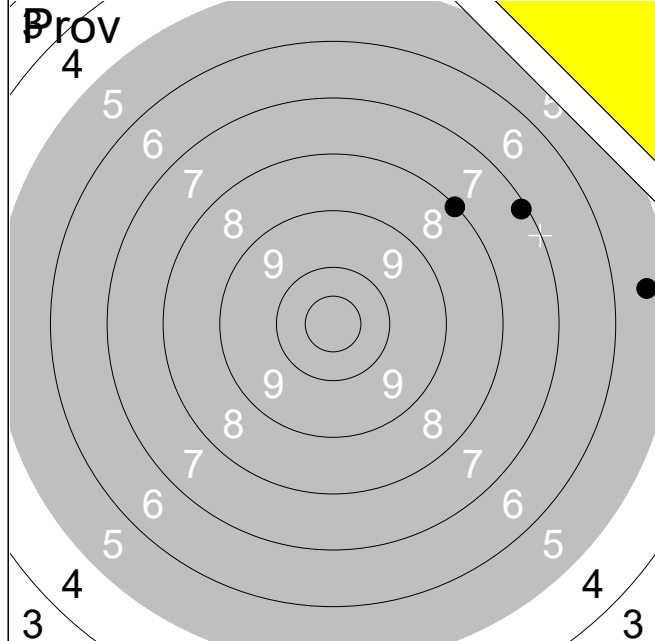

1:	8.0	↗
2:	5.4	→
3:	7.1	↗
<b>Serie</b>		<b>20</b>
<b>Total</b>		<b>207</b>

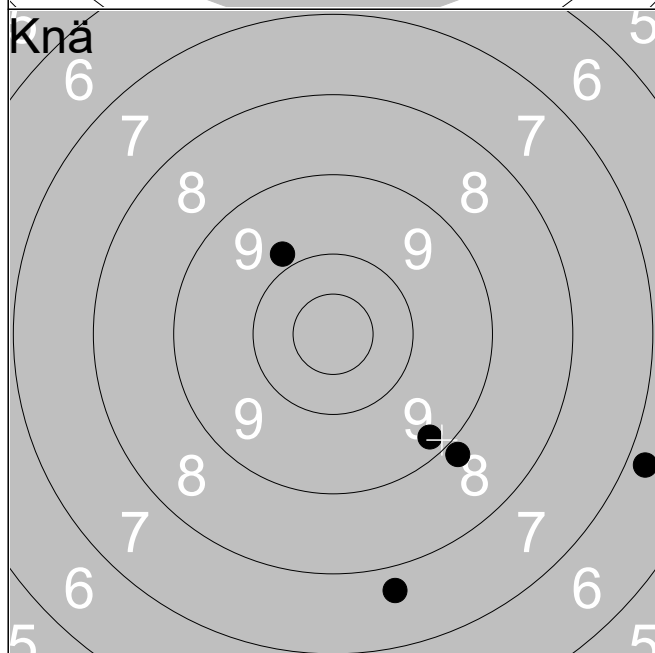

1:	6.8	↘
2:	7.7	↓
3:	9.8	↗
4:	8.9	↘
5:	9.3	↘
<b>Serie</b>		<b>39</b>
<b>Total</b>		<b>246</b>

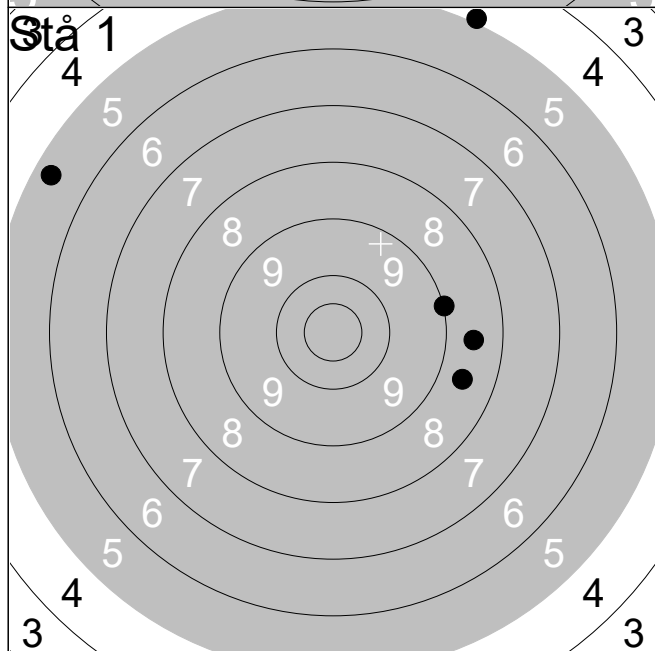

1:	4.9	↗
2:	8.5	→
3:	5.3	↗
4:	9.0	→
5:	8.6	↘
<b>Serie</b>		<b>34</b>
<b>Total</b>		<b>280</b>

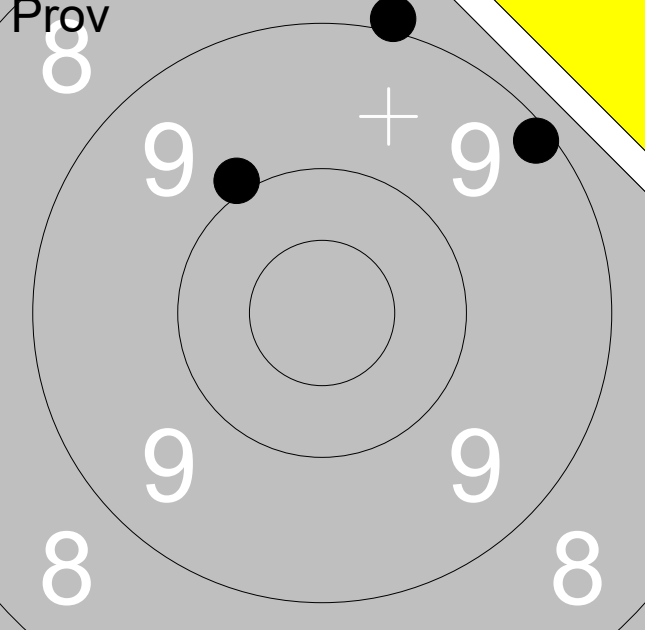
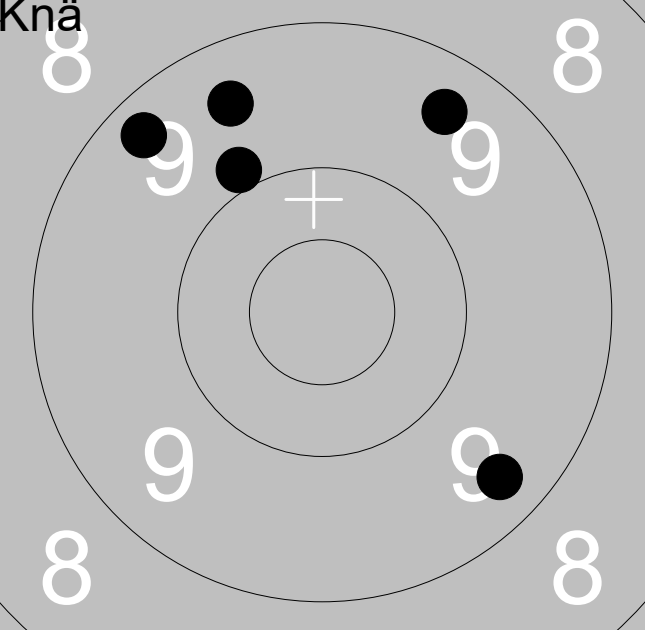
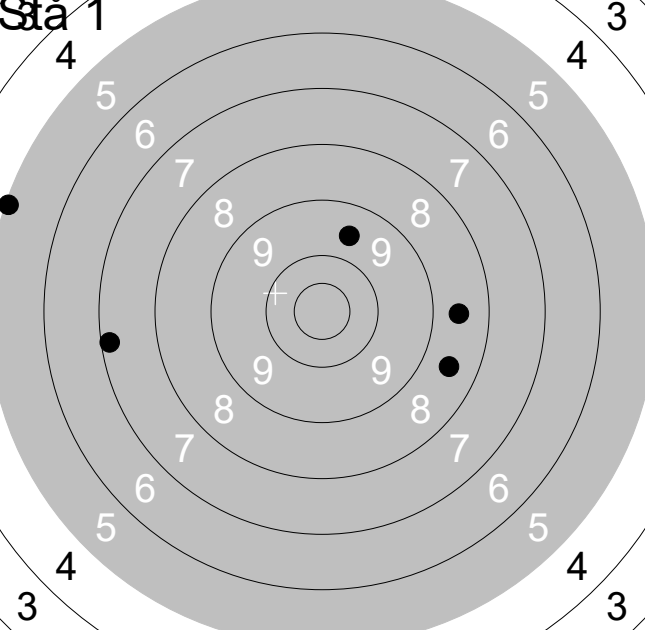
<p><b>Prov</b></p> 	<table style="width:100%; border-collapse: collapse;"> <tr> <td style="width:10%; text-align: right;">1:</td> <td style="width:30%;">8.9</td> <td style="width:10%; text-align: center;">↑</td> </tr> <tr> <td style="text-align: right;">2:</td> <td>9.9</td> <td style="text-align: center;">↖</td> </tr> <tr> <td style="text-align: right;">3:</td> <td>9.1</td> <td style="text-align: center;">↗</td> </tr> </table>	1:	8.9	↑	2:	9.9	↖	3:	9.1	↗						
1:	8.9	↑														
2:	9.9	↖														
3:	9.1	↗														
<table style="width:100%; border-collapse: collapse;"> <tr> <td style="width:45%;"><b>Serie</b></td> <td style="width:55%; text-align: right;"><b>26</b></td> </tr> <tr> <td><b>Total</b></td> <td style="text-align: right;"><b>207</b></td> </tr> </table>		<b>Serie</b>	<b>26</b>	<b>Total</b>	<b>207</b>											
<b>Serie</b>	<b>26</b>															
<b>Total</b>	<b>207</b>															
<p><b>Knä</b></p> 	<table style="width:100%; border-collapse: collapse;"> <tr> <td style="width:10%; text-align: right;">1:</td> <td style="width:30%;">9.3</td> <td style="width:10%; text-align: center;">↖</td> </tr> <tr> <td style="text-align: right;">2:</td> <td>9.4</td> <td style="text-align: center;">↘</td> </tr> <tr> <td style="text-align: right;">3:</td> <td>9.9</td> <td style="text-align: center;">↗</td> </tr> <tr> <td style="text-align: right;">4:</td> <td>9.4</td> <td style="text-align: center;">↗</td> </tr> <tr> <td style="text-align: right;">5:</td> <td>9.5</td> <td style="text-align: center;">↗</td> </tr> </table>	1:	9.3	↖	2:	9.4	↘	3:	9.9	↗	4:	9.4	↗	5:	9.5	↗
1:	9.3	↖														
2:	9.4	↘														
3:	9.9	↗														
4:	9.4	↗														
5:	9.5	↗														
<table style="width:100%; border-collapse: collapse;"> <tr> <td style="width:45%;"><b>Serie</b></td> <td style="width:55%; text-align: right;"><b>45</b></td> </tr> <tr> <td><b>Total</b></td> <td style="text-align: right;"><b>252</b></td> </tr> </table>		<b>Serie</b>	<b>45</b>	<b>Total</b>	<b>252</b>											
<b>Serie</b>	<b>45</b>															
<b>Total</b>	<b>252</b>															
<p><b>Stå 1</b></p> 	<table style="width:100%; border-collapse: collapse;"> <tr> <td style="width:10%; text-align: right;">1:</td> <td style="width:30%;">9.6</td> <td style="width:10%; text-align: center;">↗</td> </tr> <tr> <td style="text-align: right;">2:</td> <td>7.2</td> <td style="text-align: center;">←</td> </tr> <tr> <td style="text-align: right;">3:</td> <td>8.6</td> <td style="text-align: center;">→</td> </tr> <tr> <td style="text-align: right;">4:</td> <td>8.5</td> <td style="text-align: center;">↘</td> </tr> <tr> <td style="text-align: right;">5:</td> <td>5.1</td> <td style="text-align: center;">←</td> </tr> </table>	1:	9.6	↗	2:	7.2	←	3:	8.6	→	4:	8.5	↘	5:	5.1	←
1:	9.6	↗														
2:	7.2	←														
3:	8.6	→														
4:	8.5	↘														
5:	5.1	←														
<table style="width:100%; border-collapse: collapse;"> <tr> <td style="width:45%;"><b>Serie</b></td> <td style="width:55%; text-align: right;"><b>37</b></td> </tr> <tr> <td><b>Total</b></td> <td style="text-align: right;"><b>289</b></td> </tr> </table>		<b>Serie</b>	<b>37</b>	<b>Total</b>	<b>289</b>											
<b>Serie</b>	<b>37</b>															
<b>Total</b>	<b>289</b>															

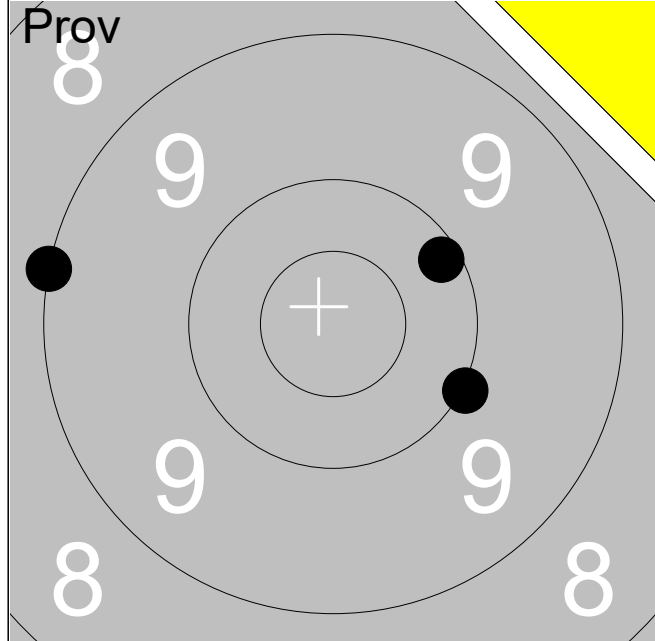

1:	10.0	↘
2:	10.1	↗
3:	9.0	←
<b>Serie</b>		<b>29</b>
<b>Total</b>		<b>206</b>

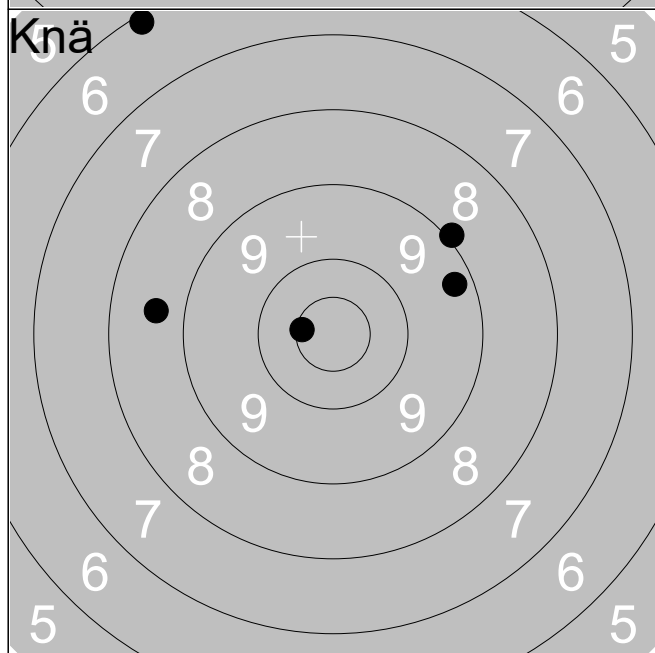

1:	6.1	↖
2:	9.0	↗
3:	9.3	↗
4:	8.6	←
5:	10.6x	←
<b>Serie</b>		<b>42</b>
<b>Total</b>		<b>248</b>

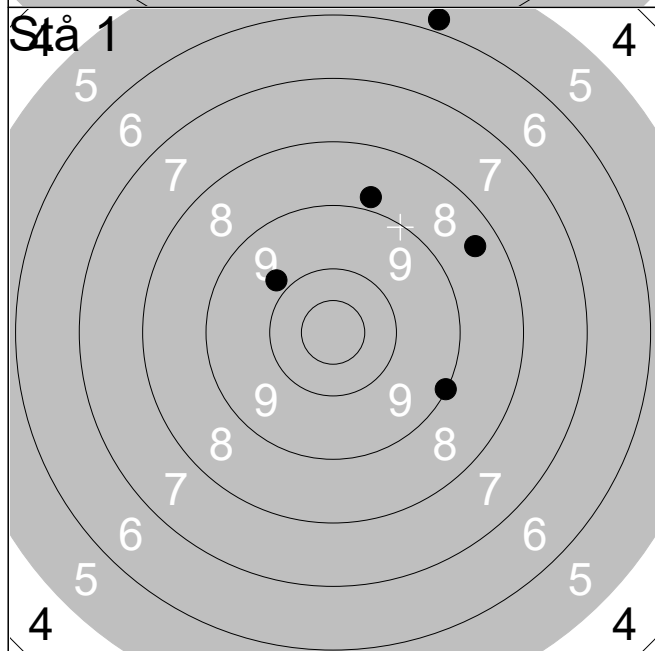

1:	8.8	↑
2:	8.4	↗
3:	9.8	↖
4:	9.0	↘
5:	5.8	↑
<b>Serie</b>		<b>39</b>
<b>Total</b>		<b>287</b>

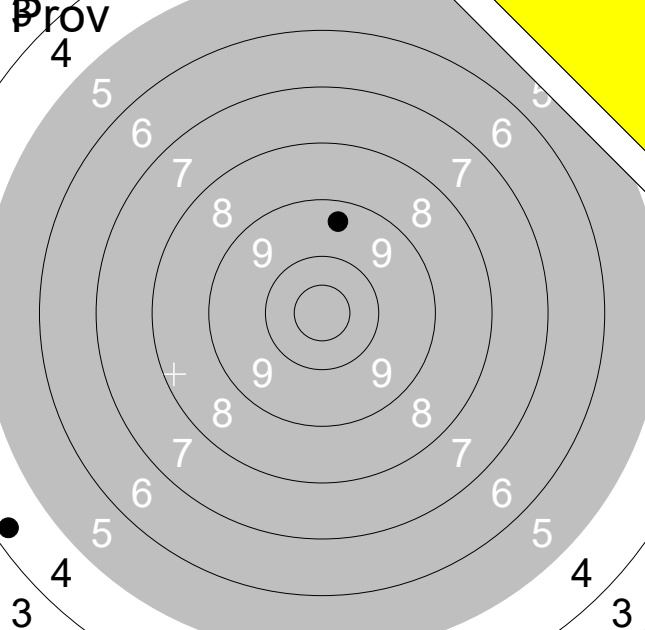
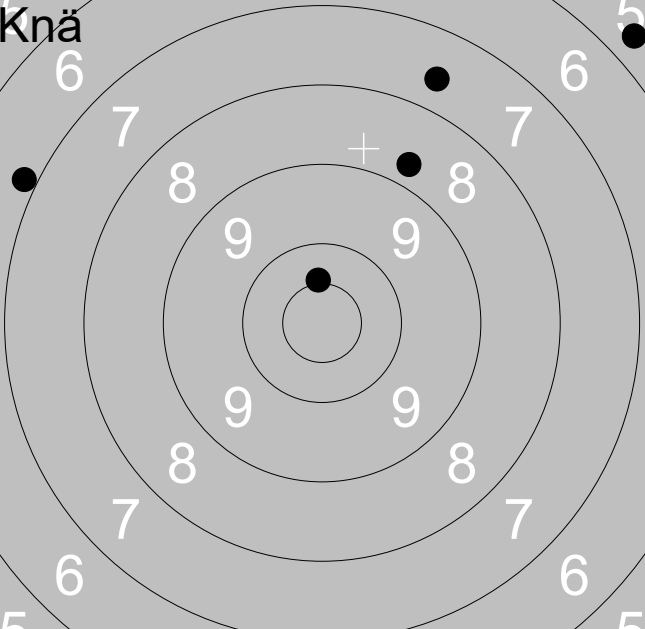
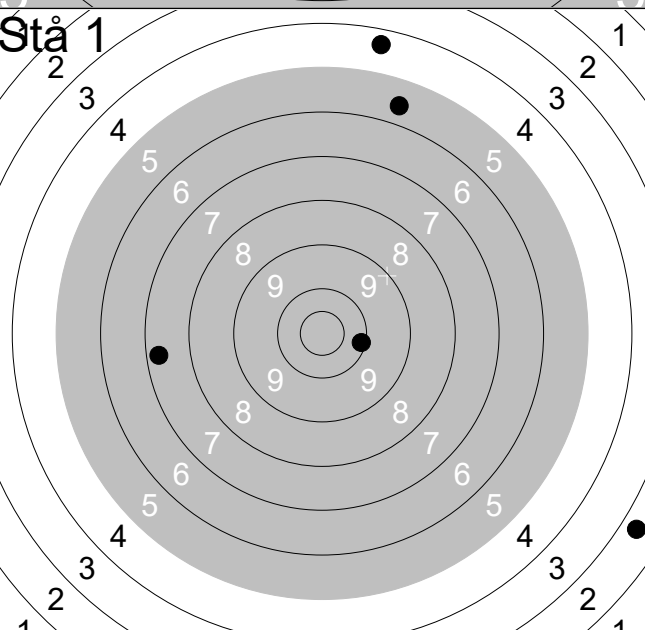
07.07.2018	Björskottet 2018	Ramselefors SKF																			
<b>Prov</b> 	<table style="width:100%; border-collapse: collapse;"> <tr> <td style="width:10%;">1:</td> <td style="width:10%;">4.3</td> <td style="width:10%; text-align: right;">↙</td> </tr> <tr> <td>2:</td> <td>9.4</td> <td style="text-align: right;">↑</td> </tr> </table>	1:	4.3	↙	2:	9.4	↑	<table style="width:100%; border-collapse: collapse;"> <tr> <td style="width:80%;">Serie</td> <td style="width:20%; text-align: right;">13</td> </tr> <tr> <td>Total</td> <td style="text-align: right;">205</td> </tr> </table>	Serie	13	Total	205									
1:	4.3	↙																			
2:	9.4	↑																			
Serie	13																				
Total	205																				
<b>Knä</b> 	<table style="width:100%; border-collapse: collapse;"> <tr> <td style="width:10%;">1:</td> <td style="width:10%;">6.9</td> <td style="width:10%; text-align: right;">↙</td> </tr> <tr> <td>2:</td> <td>5.7</td> <td style="text-align: right;">↗</td> </tr> <tr> <td>3:</td> <td>10.4x</td> <td style="text-align: right;">↑</td> </tr> <tr> <td>4:</td> <td>7.6</td> <td style="text-align: right;">↗</td> </tr> <tr> <td>5:</td> <td>8.7</td> <td style="text-align: right;">↗</td> </tr> </table>	1:	6.9	↙	2:	5.7	↗	3:	10.4x	↑	4:	7.6	↗	5:	8.7	↗	<table style="width:100%; border-collapse: collapse;"> <tr> <td style="width:80%;">Serie</td> <td style="width:20%; text-align: right;">36</td> </tr> <tr> <td>Total</td> <td style="text-align: right;">241</td> </tr> </table>	Serie	36	Total	241
1:	6.9	↙																			
2:	5.7	↗																			
3:	10.4x	↑																			
4:	7.6	↗																			
5:	8.7	↗																			
Serie	36																				
Total	241																				
<b>Stå 1</b> 	<table style="width:100%; border-collapse: collapse;"> <tr> <td style="width:10%;">1:</td> <td style="width:10%;">5.6</td> <td style="width:10%; text-align: right;">↑</td> </tr> <tr> <td>2:</td> <td>10.1</td> <td style="text-align: right;">→</td> </tr> <tr> <td>3:</td> <td>7.3</td> <td style="text-align: right;">↙</td> </tr> <tr> <td>4:</td> <td>4.4</td> <td style="text-align: right;">↑</td> </tr> <tr> <td>5:</td> <td>2.7</td> <td style="text-align: right;">↘</td> </tr> </table>	1:	5.6	↑	2:	10.1	→	3:	7.3	↙	4:	4.4	↑	5:	2.7	↘	<table style="width:100%; border-collapse: collapse;"> <tr> <td style="width:80%;">Serie</td> <td style="width:20%; text-align: right;">28</td> </tr> <tr> <td>Total</td> <td style="text-align: right;">269</td> </tr> </table>	Serie	28	Total	269
1:	5.6	↑																			
2:	10.1	→																			
3:	7.3	↙																			
4:	4.4	↑																			
5:	2.7	↘																			
Serie	28																				
Total	269																				



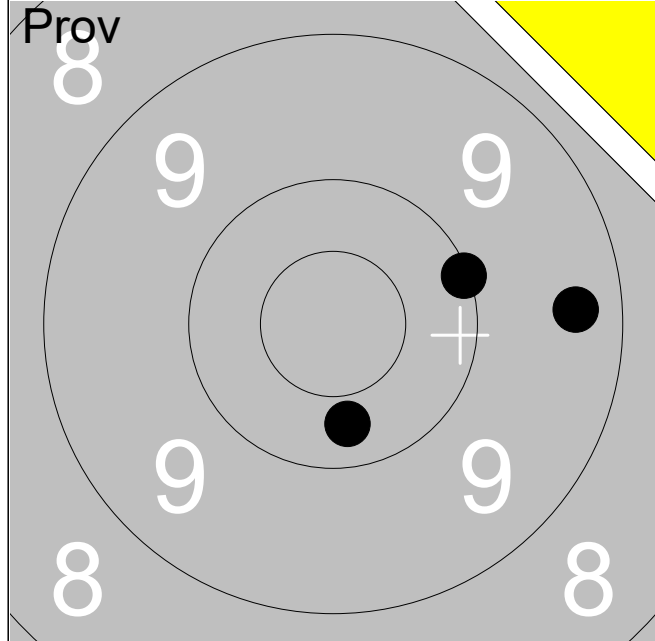

1:	10.1	→
2:	9.4	→
3:	10.3	↓
<b>Serie</b>		<b>29</b>
<b>Total</b>		<b>196</b>

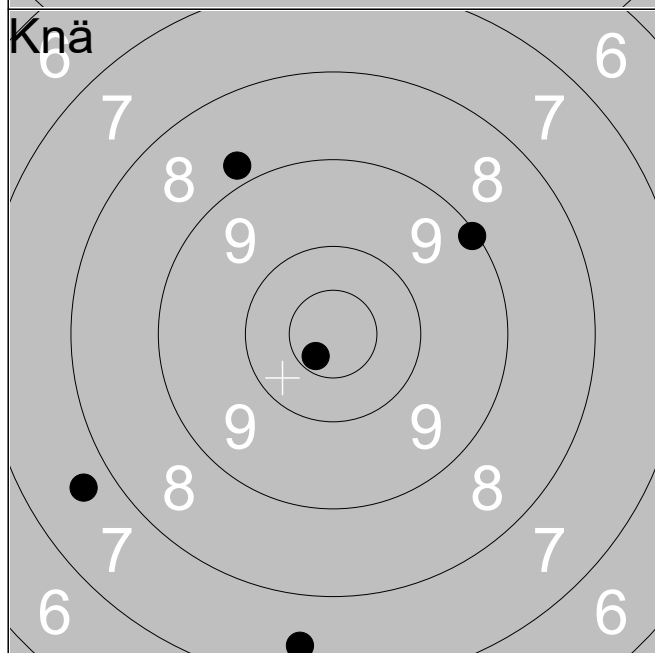

1:	8.8	↖
2:	9.1	↗
3:	10.7x	↘
4:	7.7	↙
5:	7.4	↓
<b>Serie</b>		<b>41</b>
<b>Total</b>		<b>237</b>

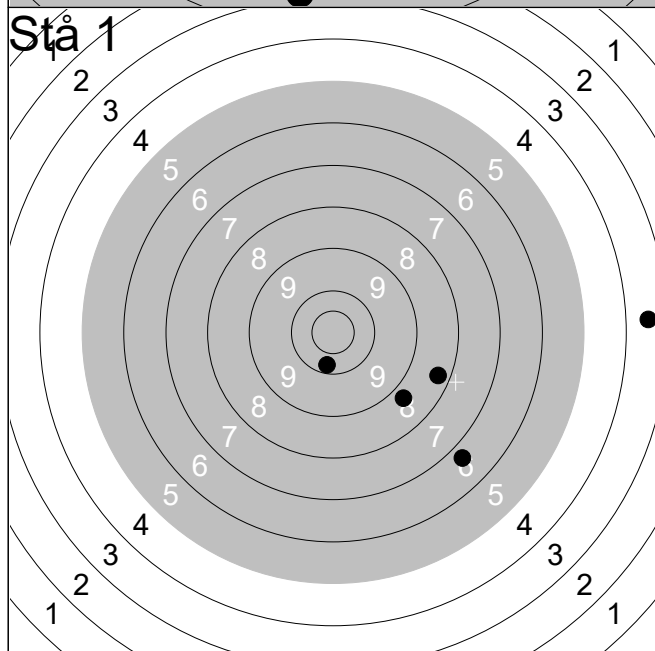

1:	8.3	→
2:	10.2	↓
3:	3.5	→
4:	8.7	↘
5:	6.7	↘
<b>Serie</b>		<b>35</b>
<b>Total</b>		<b>272</b>

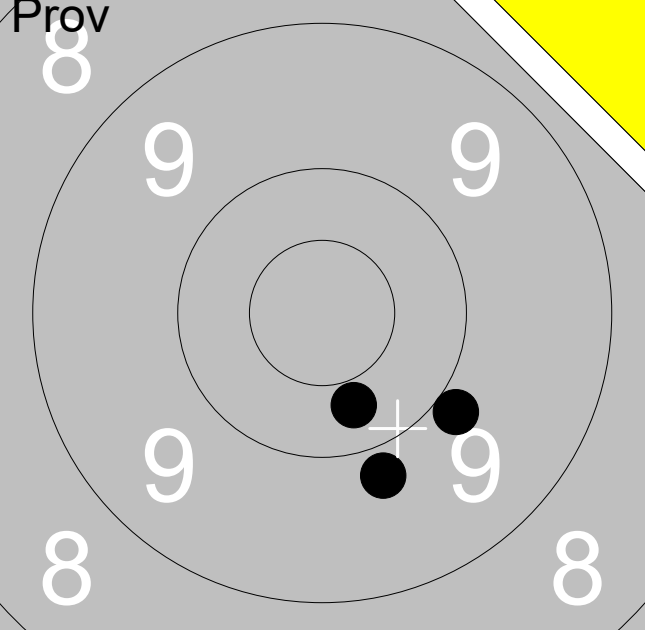
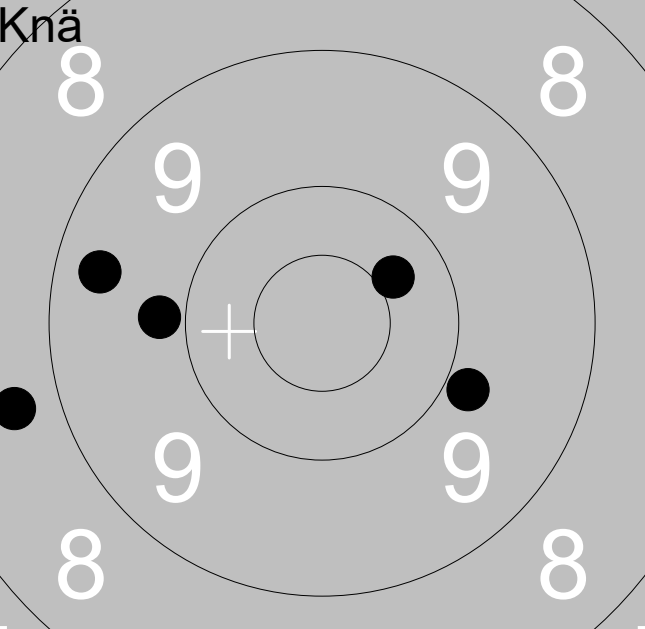
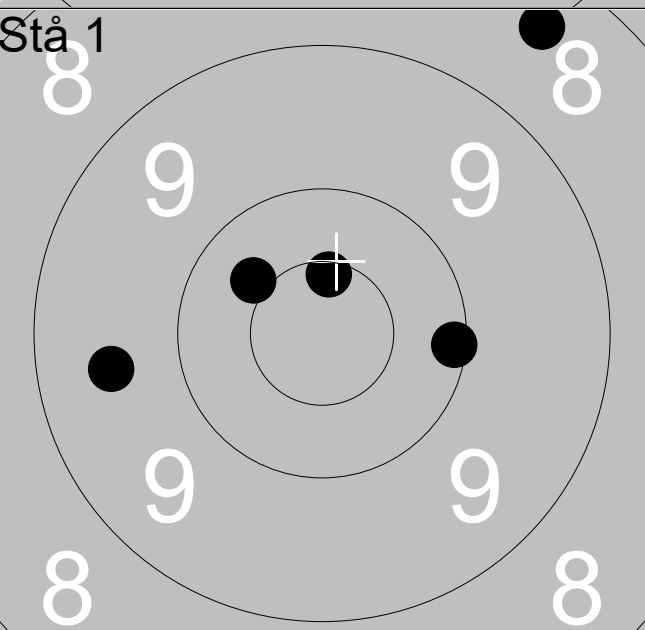
07.07.2018	Björskottet 2018	Ramselefors SKF
<b>Prov</b> 	1: 10.3	↓
	2: 9.9	↘
	3: 9.8	↓
	<b>Serie</b>	<b>28</b>
<b>Total</b>		<b>239</b>
<b>Knä</b> 	1: 10.4	↗
	2: 9.9	→
	3: 9.4	←
	4: 9.8	←
	5: 8.7	←
	<b>Serie</b>	<b>45</b>
<b>Total</b>		<b>284</b>
<b>Stå 1</b> 	1: 9.5	←
	2: 8.4	↗
	3: 10.1	→
	4: 10.4	↖
	5: 10.6x	↑
	<b>Serie</b>	<b>47</b>
<b>Total</b>		<b>331</b>

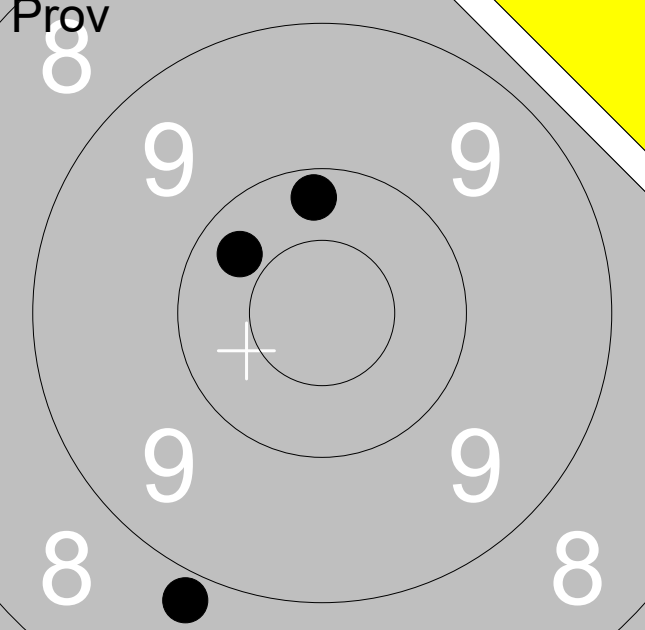
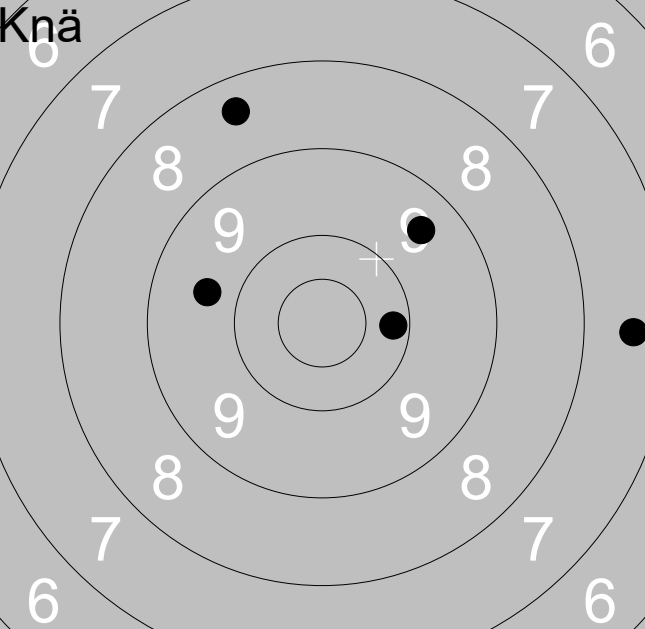
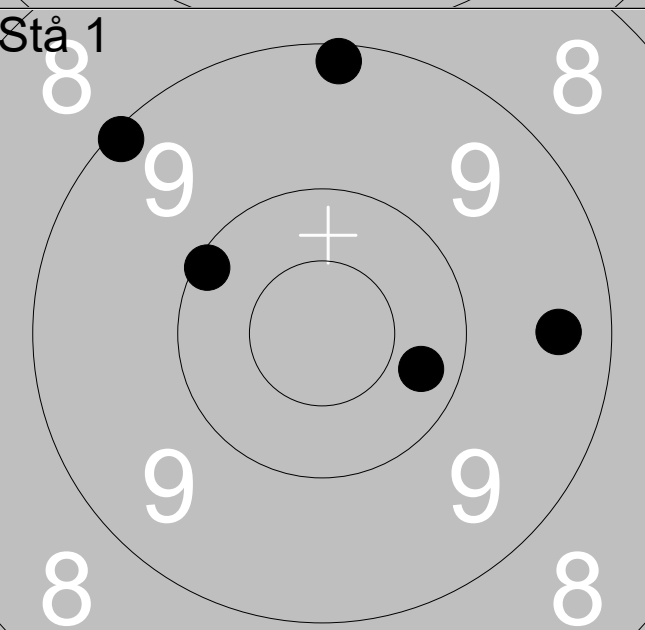
07.07.2018	Björskottet 2018	Ramselefors SKF															
<b>Prov</b>		<table border="1"> <tr><td>1:</td><td>10.3</td><td>↖</td></tr> <tr><td>2:</td><td>10.2</td><td>↑</td></tr> <tr><td>3:</td><td>8.8</td><td>↘</td></tr> </table>	1:	10.3	↖	2:	10.2	↑	3:	8.8	↘						
1:	10.3	↖															
2:	10.2	↑															
3:	8.8	↘															
<b>Serie</b>		<b>28</b>															
<b>Total</b>		<b>236</b>															
<b>Knä</b>		<table border="1"> <tr><td>1:</td><td>8.4</td><td>↖</td></tr> <tr><td>2:</td><td>10.2</td><td>→</td></tr> <tr><td>3:</td><td>9.5</td><td>↗</td></tr> <tr><td>4:</td><td>9.7</td><td>←</td></tr> <tr><td>5:</td><td>7.5</td><td>→</td></tr> </table>	1:	8.4	↖	2:	10.2	→	3:	9.5	↗	4:	9.7	←	5:	7.5	→
1:	8.4	↖															
2:	10.2	→															
3:	9.5	↗															
4:	9.7	←															
5:	7.5	→															
<b>Serie</b>		<b>43</b>															
<b>Total</b>		<b>279</b>															
<b>Stå 1</b>		<table border="1"> <tr><td>1:</td><td>9.1</td><td>↖</td></tr> <tr><td>2:</td><td>9.4</td><td>→</td></tr> <tr><td>3:</td><td>9.1</td><td>↑</td></tr> <tr><td>4:</td><td>10.3</td><td>↗</td></tr> <tr><td>5:</td><td>10.1</td><td>↖</td></tr> </table>	1:	9.1	↖	2:	9.4	→	3:	9.1	↑	4:	10.3	↗	5:	10.1	↖
1:	9.1	↖															
2:	9.4	→															
3:	9.1	↑															
4:	10.3	↗															
5:	10.1	↖															
<b>Serie</b>		<b>47</b>															
<b>Total</b>		<b>326</b>															

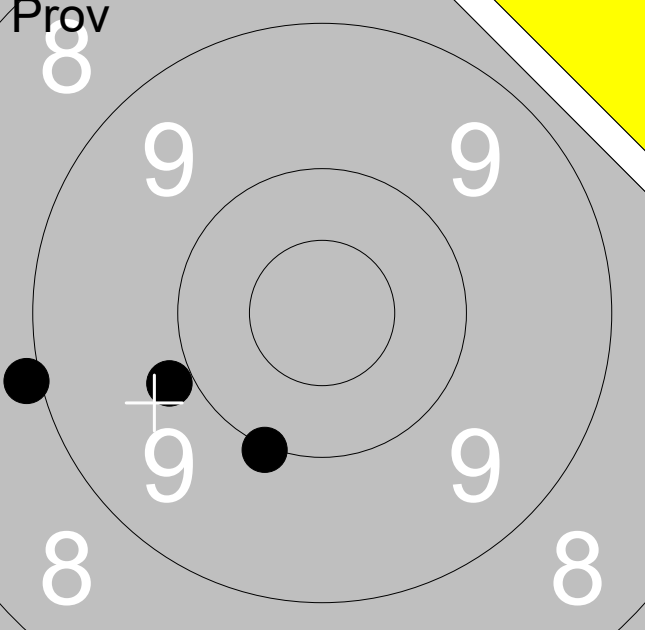
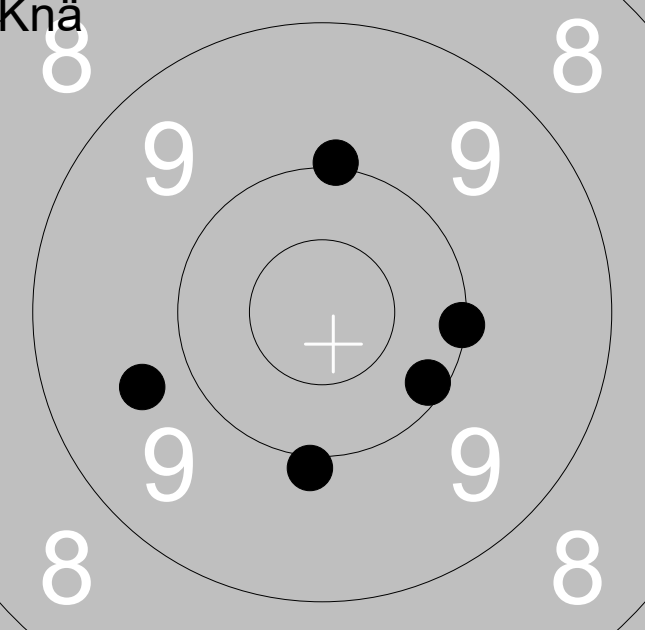
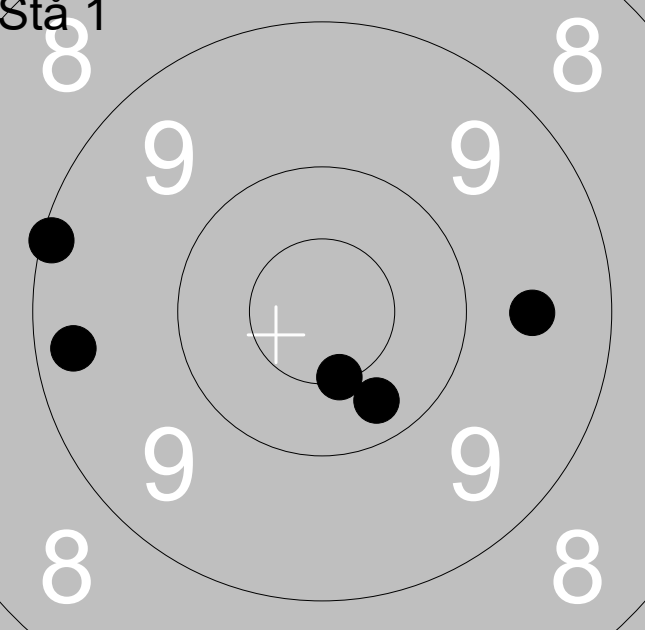
07.07.2018	Björskottet 2018	Ramselefors SKF															
<b>Prov</b> 	<table style="width:100%; border-collapse: collapse;"> <tr><td style="width:10%;">1:</td><td style="width:10%;">10.0</td><td style="width:10%; text-align: right;">↓</td></tr> <tr><td>2:</td><td>8.9</td><td style="text-align: right;">←</td></tr> <tr><td>3:</td><td>9.9</td><td style="text-align: right;">←</td></tr> </table>	1:	10.0	↓	2:	8.9	←	3:	9.9	←							
1:	10.0	↓															
2:	8.9	←															
3:	9.9	←															
Serie		27															
Total		233															
<b>Knä</b> 	<table style="width:100%; border-collapse: collapse;"> <tr><td style="width:10%;">1:</td><td style="width:10%;">10.1</td><td style="width:10%; text-align: right;">↘</td></tr> <tr><td>2:</td><td>10.0</td><td style="text-align: right;">↑</td></tr> <tr><td>3:</td><td>10.0</td><td style="text-align: right;">↓</td></tr> <tr><td>4:</td><td>9.7</td><td style="text-align: right;">←</td></tr> <tr><td>5:</td><td>10.1</td><td style="text-align: right;">→</td></tr> </table>	1:	10.1	↘	2:	10.0	↑	3:	10.0	↓	4:	9.7	←	5:	10.1	→	
1:	10.1	↘															
2:	10.0	↑															
3:	10.0	↓															
4:	9.7	←															
5:	10.1	→															
Serie		49															
Total		282															
<b>Stå 1</b> 	<table style="width:100%; border-collapse: collapse;"> <tr><td style="width:10%;">1:</td><td style="width:10%;">9.1</td><td style="width:10%; text-align: right;">←</td></tr> <tr><td>2:</td><td>10.3</td><td style="text-align: right;">↓</td></tr> <tr><td>3:</td><td>10.5x</td><td style="text-align: right;">↓</td></tr> <tr><td>4:</td><td>9.6</td><td style="text-align: right;">→</td></tr> <tr><td>5:</td><td>9.3</td><td style="text-align: right;">←</td></tr> </table>	1:	9.1	←	2:	10.3	↓	3:	10.5x	↓	4:	9.6	→	5:	9.3	←	
1:	9.1	←															
2:	10.3	↓															
3:	10.5x	↓															
4:	9.6	→															
5:	9.3	←															
Serie		47															
Total		329															

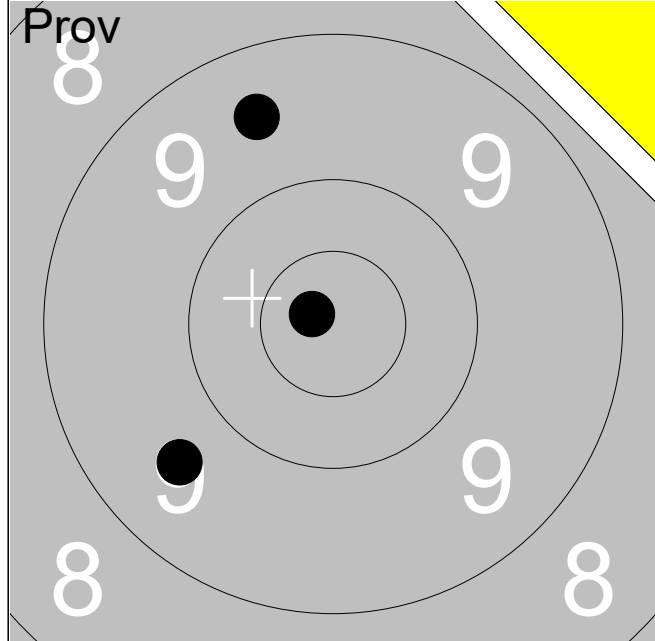

1:	10.8x	↖
2:	9.5	↑
3:	9.6	↙
<b>Serie</b>		<b>28</b>
<b>Total</b>		<b>232</b>

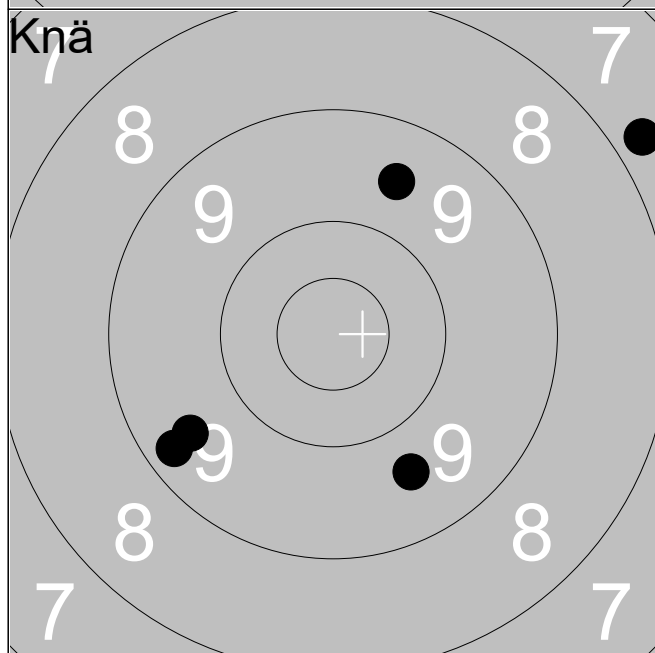

1:	9.6	↑
2:	7.8	↗
3:	9.3	↙
4:	9.5	↙
5:	9.6	↘
<b>Serie</b>		<b>43</b>
<b>Total</b>		<b>275</b>

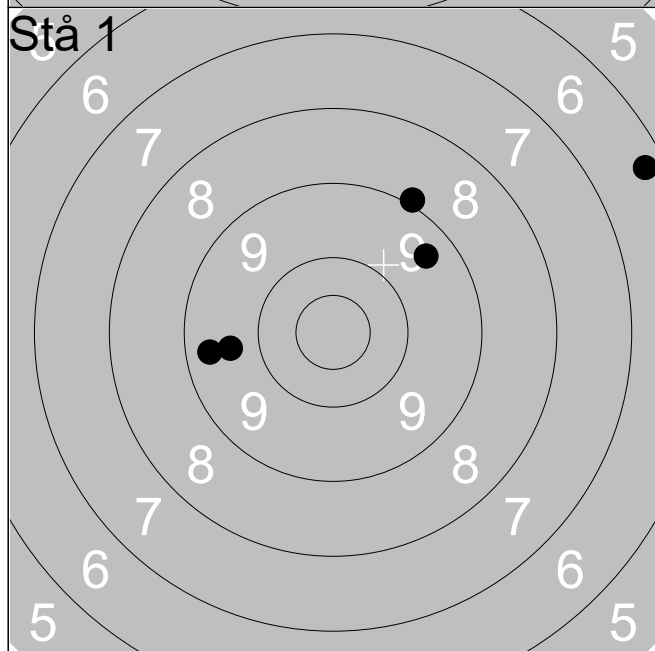

1:	9.4	←
2:	9.0	↑
3:	9.4	↗
4:	6.3	↗
5:	9.6	←
<b>Serie</b>		<b>42</b>
<b>Total</b>		<b>317</b>

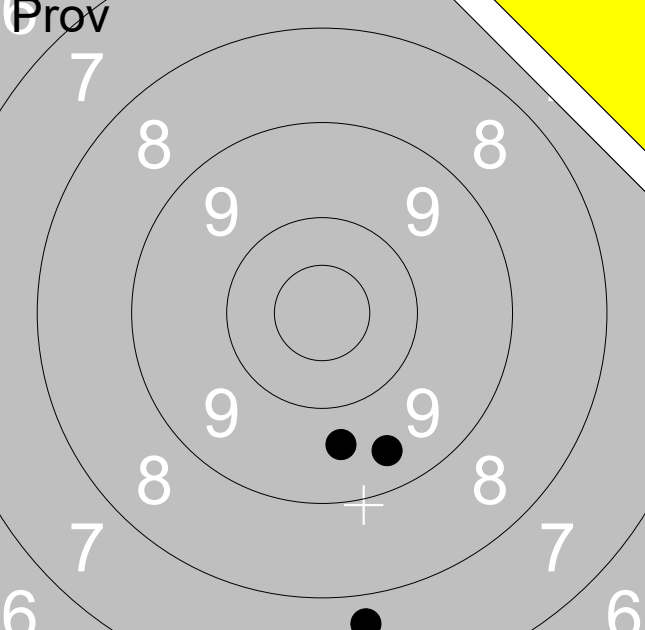
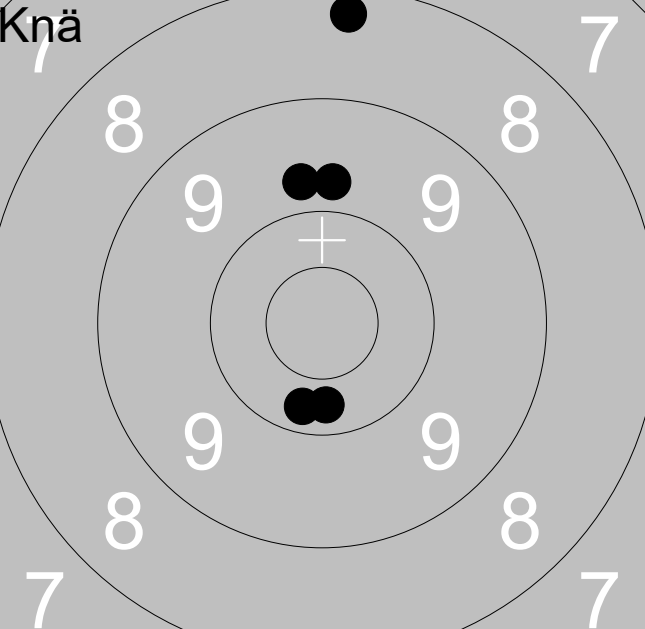
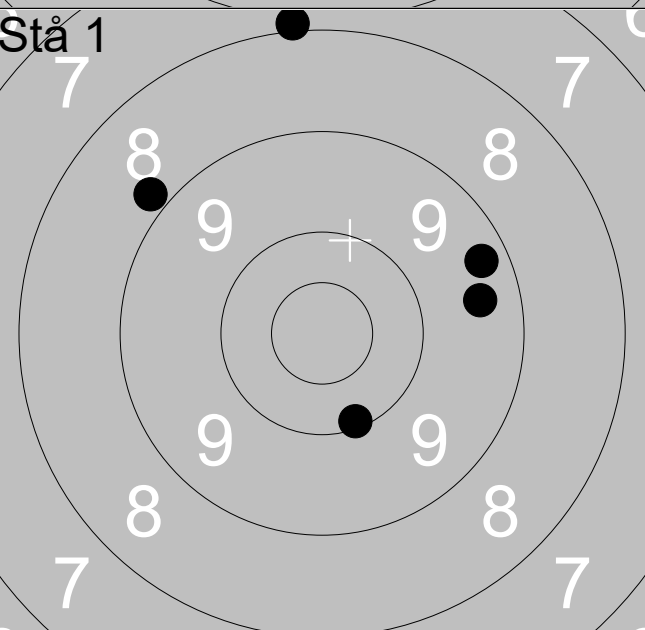
07.07.2018	Björskottet 2018	Ramselefors SKF
<b>Prov</b> 	1: 9.6	↓
	2: 9.4	↓
	3: 7.7	↓
	<b>Serie</b>	<b>25</b>
<b>Total</b>		<b>232</b>
<b>Knä</b> 	1: 8.3	↑
	2: 10.2	↓
	3: 9.8	↑
	4: 10.3	↓
	5: 9.8	↑
	<b>Serie</b>	<b>46</b>
<b>Total</b>		<b>278</b>
<b>Stå 1</b> 	1: 10.1	↓
	2: 9.4	→
	3: 8.8	↗
	4: 7.9	↑
	5: 9.3	→
	<b>Serie</b>	<b>43</b>
<b>Total</b>		<b>321</b>

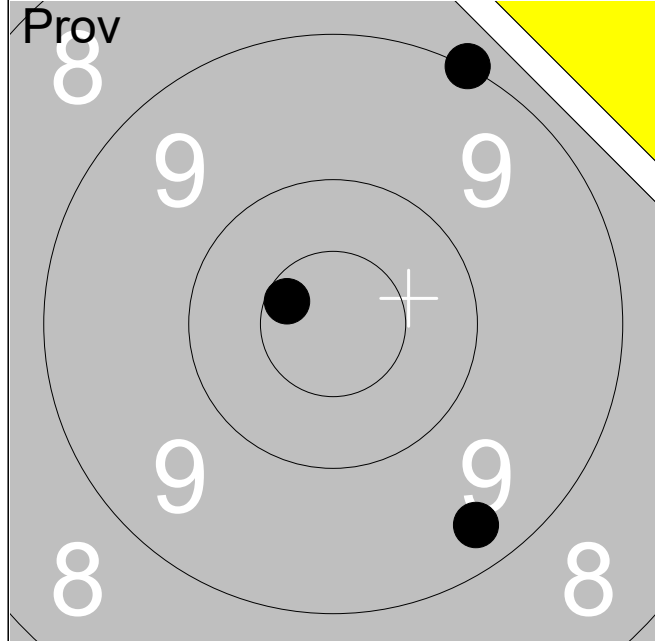

1:	9.0	↗
2:	10.6x	↖
3:	9.3	↘
<b>Serie</b>		<b>28</b>
<b>Total</b>		<b>229</b>

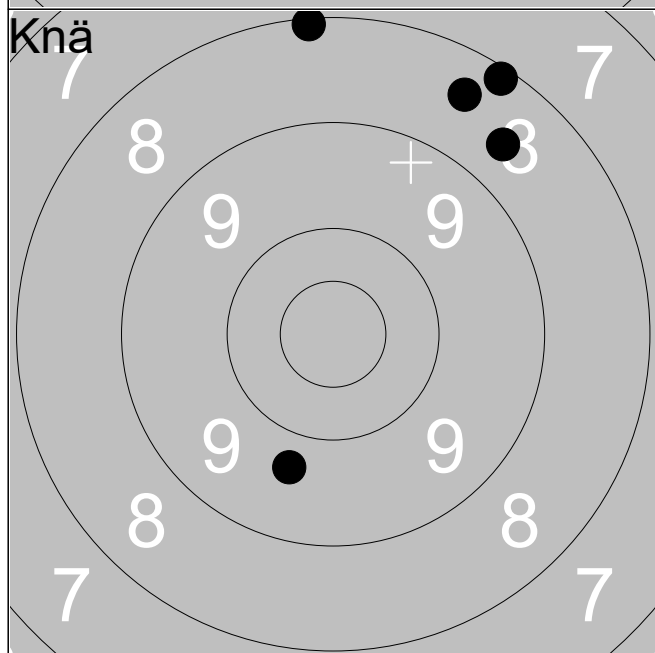

1:	8.4	↗
2:	8.1	↑
3:	9.7	↘
4:	8.1	↗
5:	8.6	↗
<b>Serie</b>		<b>41</b>
<b>Total</b>		<b>270</b>

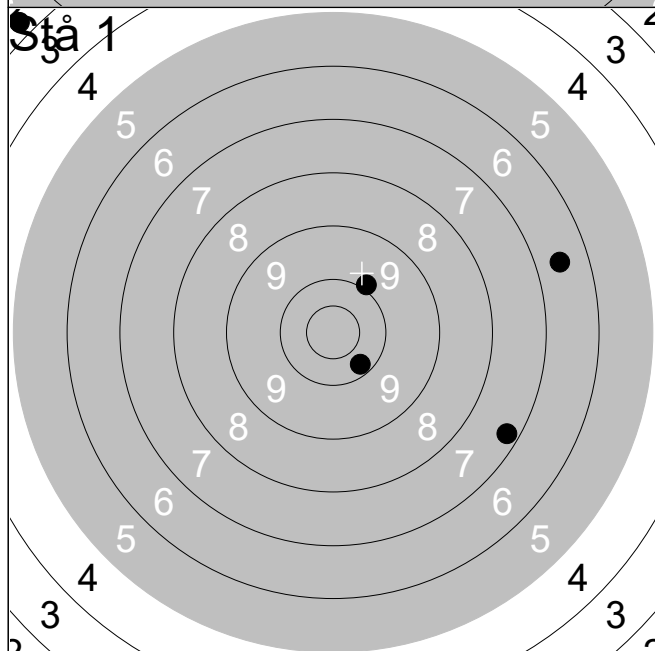

1:	2.8	↗
2:	10.2	↘
3:	9.9	↗
4:	7.3	↘
5:	6.6	→
<b>Serie</b>		<b>34</b>
<b>Total</b>		<b>304</b>

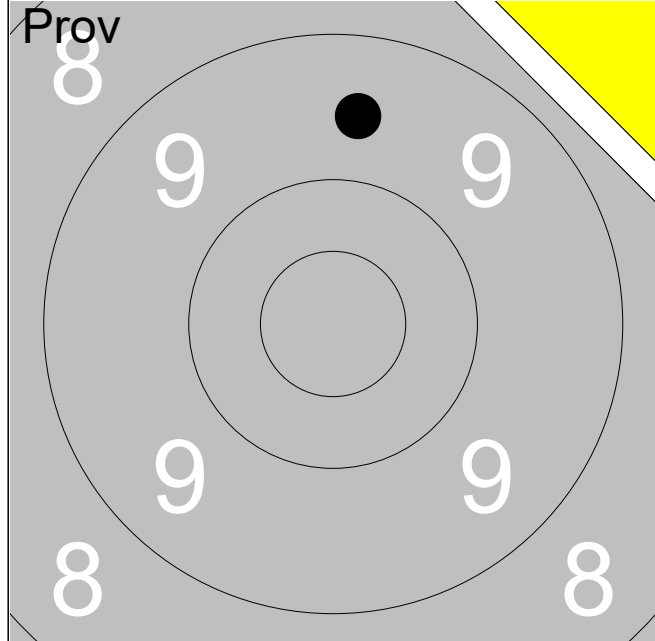

	1:	9.6	↑
<b>Serie</b>			<b>9</b>
<b>Total</b>			<b>229</b>

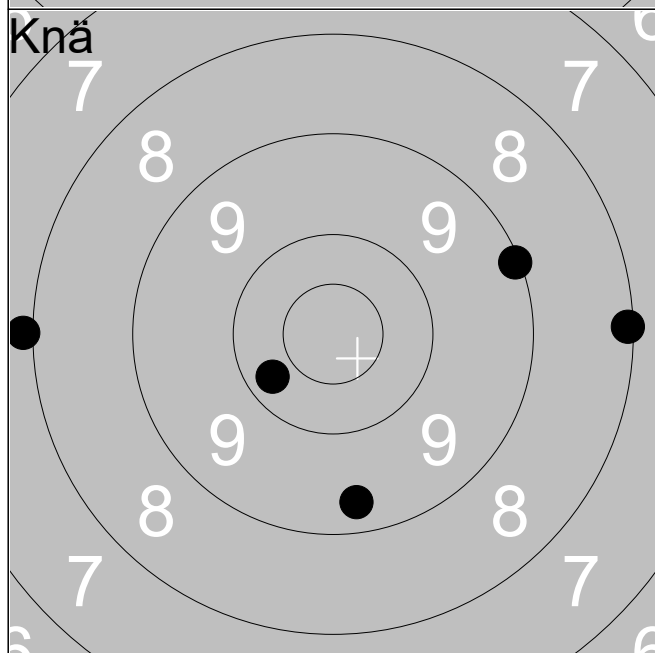

	1:	8.1	→
	2:	9.3	↓
	3:	7.9	←
	4:	10.3	↙
	5:	9.1	↘
<b>Serie</b>			<b>43</b>
<b>Total</b>			<b>272</b>

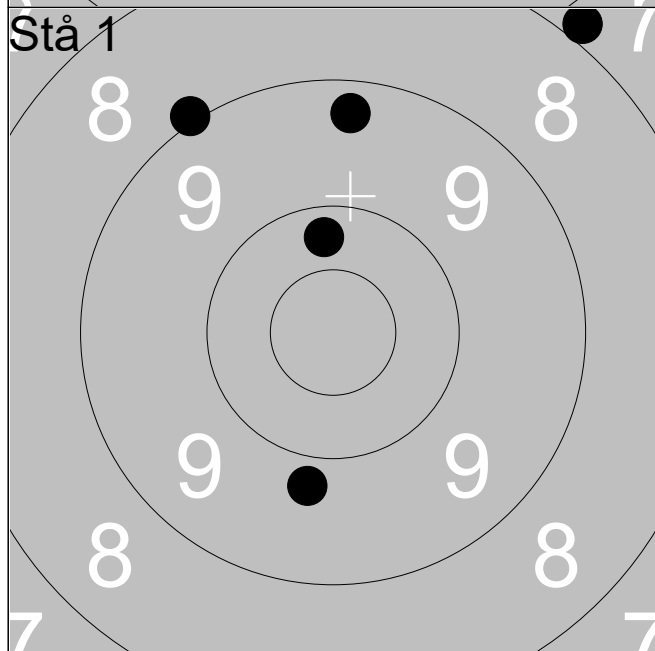

	1:	7.9	↗
	2:	9.0	↖
	3:	9.3	↑
	4:	9.8	↓
	5:	10.2	↑
<b>Serie</b>			<b>44</b>
<b>Total</b>			<b>316</b>



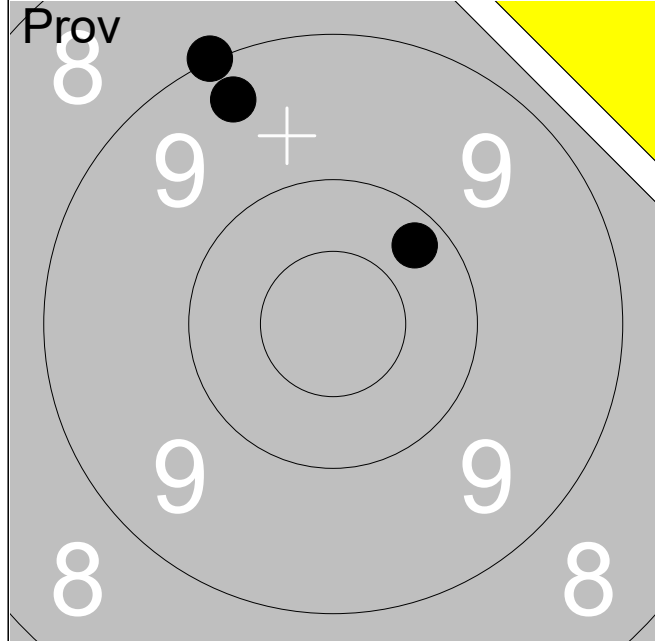

1:	9.3	↗
2:	9.0	↗
3:	10.2	↗
<b>Serie</b>		<b>28</b>
<b>Total</b>		<b>221</b>

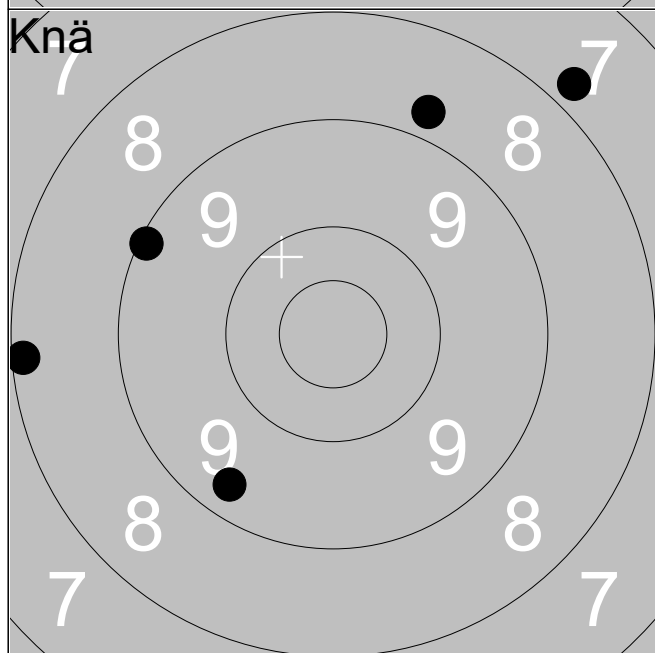

1:	7.8	↗
2:	8.8	↗
3:	8.1	←
4:	9.3	↘
5:	9.1	↖
<b>Serie</b>		<b>41</b>
<b>Total</b>		<b>262</b>

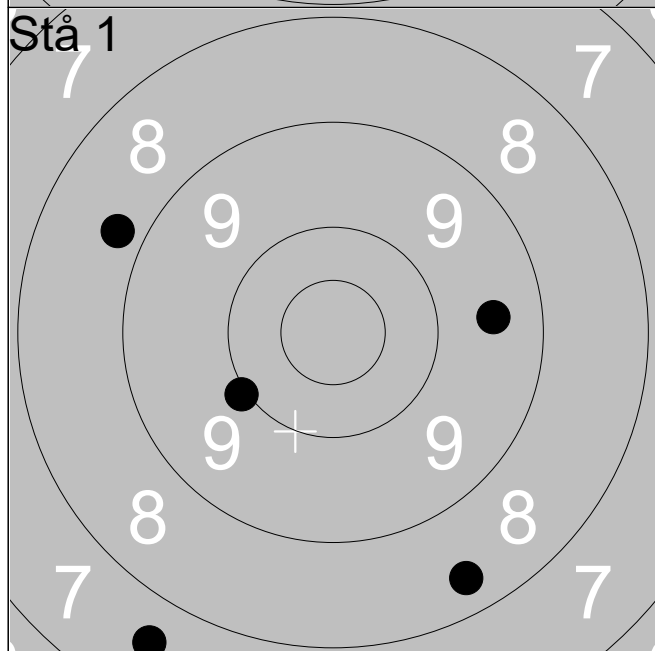

1:	8.8	↖
2:	7.6	↘
3:	10.0	↖
4:	8.4	↘
5:	9.5	→
<b>Serie</b>		<b>42</b>
<b>Total</b>		<b>304</b>

07.07.2018	Björskottet 2018	Ramselefors SKF
------------	------------------	-----------------

**Prov**

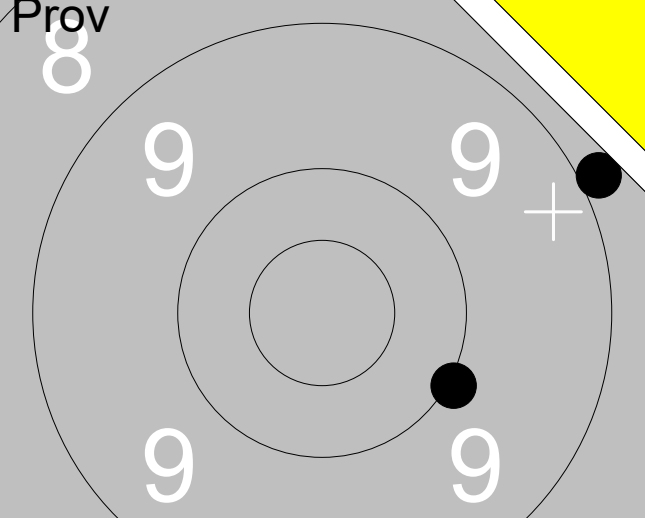

1:	8.4	↗
2:	8.9	↗
3:	10.0	↘

Serie	26
-------	----

Total	215
-------	-----

**Knä**

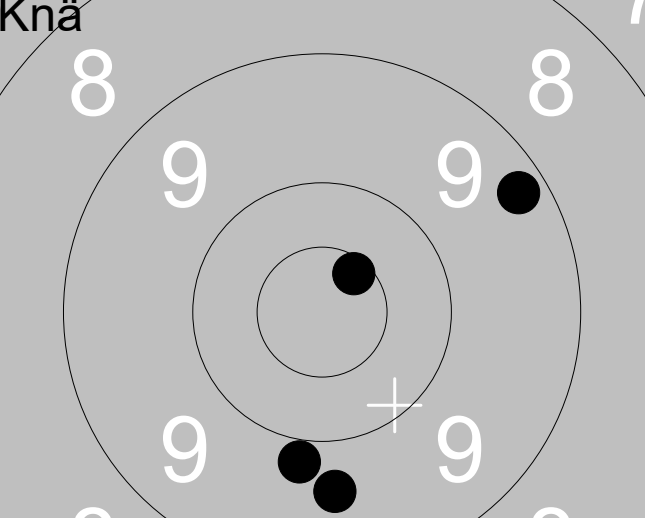

1:	9.3	↗
2:	8.4	↘
3:	9.9	↘
4:	10.6x	↗
5:	9.6	↘

Serie	45
-------	----

Total	260
-------	-----

**Stå 1**

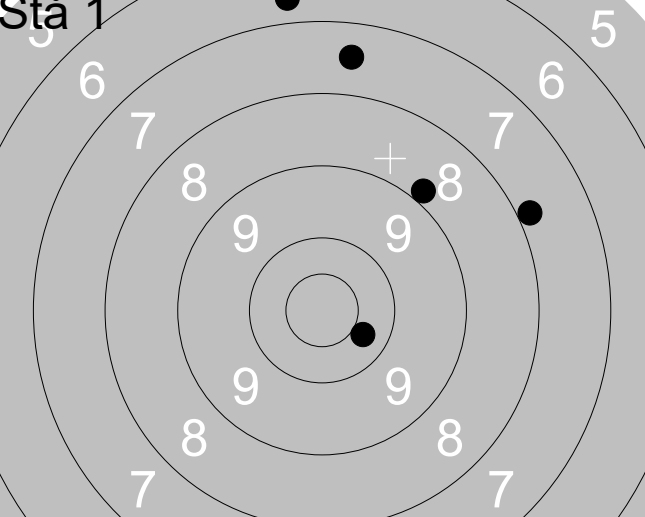

1:	10.3	↘
2:	7.5	↑
3:	6.7	↑
4:	8.9	↗
5:	7.8	↗

Serie	38
-------	----

Total	298
-------	-----

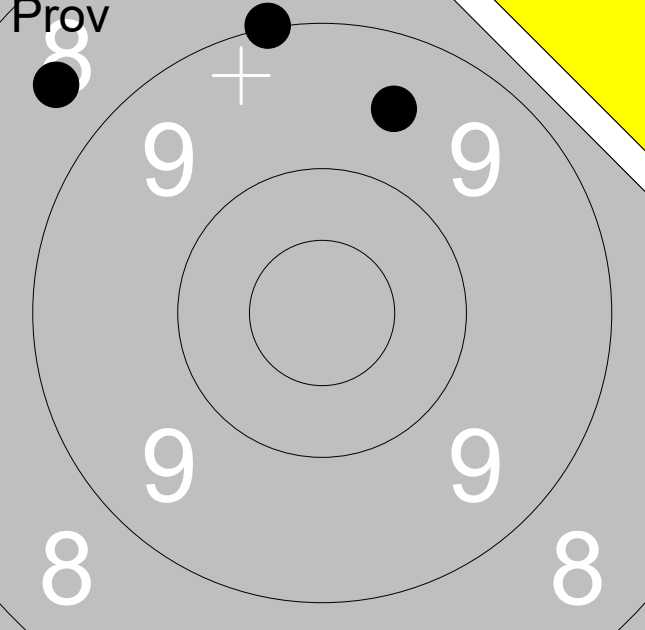
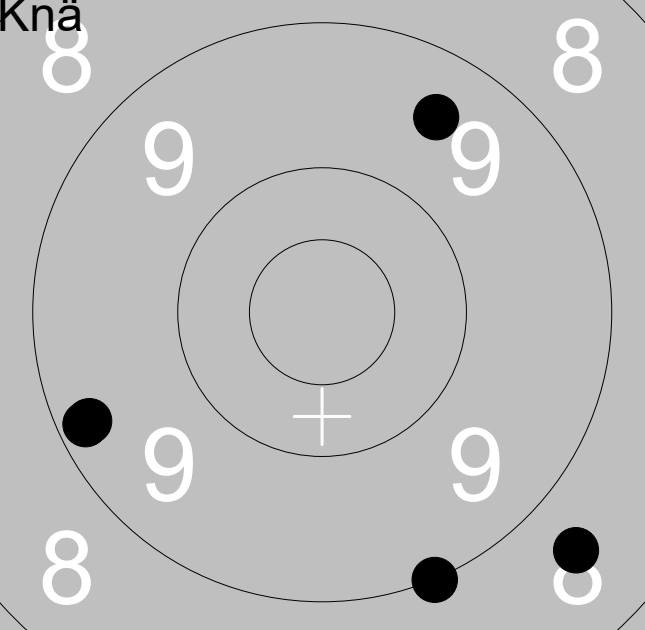
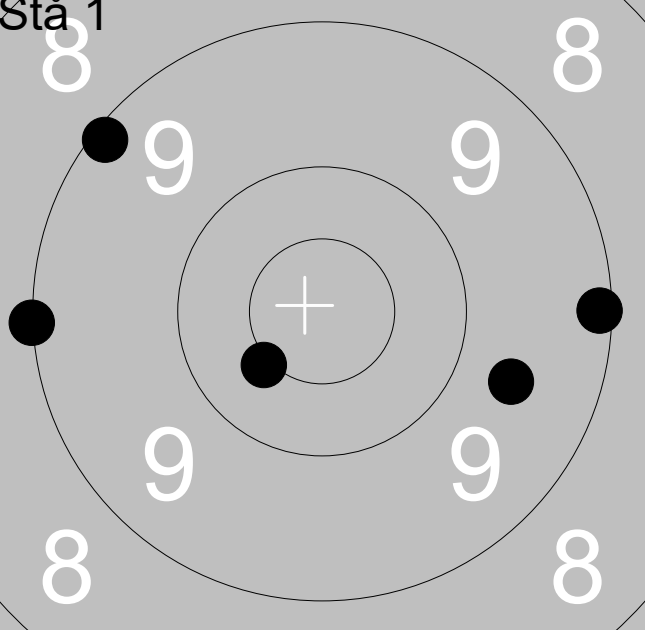
07.07.2018	Björskottet 2018	Ramselefors SKF															
<b>Prov</b> 	<table style="width:100%; border-collapse: collapse;"> <tr> <td style="width:10%;">1:</td> <td style="width:10%;">9.0</td> <td style="width:10%; text-align: right;">↑</td> </tr> <tr> <td>2:</td> <td>9.5</td> <td style="text-align: right;">↑</td> </tr> <tr> <td>3:</td> <td>8.6</td> <td style="text-align: right;">↖</td> </tr> </table>	1:	9.0	↑	2:	9.5	↑	3:	8.6	↖							
1:	9.0	↑															
2:	9.5	↑															
3:	8.6	↖															
		Serie <span style="float: right;">26</span>															
		Total <span style="float: right;">194</span>															
<b>Knä</b> 	<table style="width:100%; border-collapse: collapse;"> <tr> <td style="width:10%;">1:</td> <td style="width:10%;">8.6</td> <td style="width:10%; text-align: right;">↘</td> </tr> <tr> <td>2:</td> <td>9.5</td> <td style="text-align: right;">↑</td> </tr> <tr> <td>3:</td> <td>9.2</td> <td style="text-align: right;">←</td> </tr> <tr> <td>4:</td> <td>9.3</td> <td style="text-align: right;">←</td> </tr> <tr> <td>5:</td> <td>9.0</td> <td style="text-align: right;">↓</td> </tr> </table>	1:	8.6	↘	2:	9.5	↑	3:	9.2	←	4:	9.3	←	5:	9.0	↓	
1:	8.6	↘															
2:	9.5	↑															
3:	9.2	←															
4:	9.3	←															
5:	9.0	↓															
		Serie <span style="float: right;">44</span>															
		Total <span style="float: right;">238</span>															
<b>Stå 1</b> 	<table style="width:100%; border-collapse: collapse;"> <tr> <td style="width:10%;">1:</td> <td style="width:10%;">9.0</td> <td style="width:10%; text-align: right;">←</td> </tr> <tr> <td>2:</td> <td>9.1</td> <td style="text-align: right;">↖</td> </tr> <tr> <td>3:</td> <td>9.1</td> <td style="text-align: right;">→</td> </tr> <tr> <td>4:</td> <td>10.4x</td> <td style="text-align: right;">↙</td> </tr> <tr> <td>5:</td> <td>9.6</td> <td style="text-align: right;">↘</td> </tr> </table>	1:	9.0	←	2:	9.1	↖	3:	9.1	→	4:	10.4x	↙	5:	9.6	↘	
1:	9.0	←															
2:	9.1	↖															
3:	9.1	→															
4:	10.4x	↙															
5:	9.6	↘															
		Serie <span style="float: right;">46</span>															
		Total <span style="float: right;">284</span>															

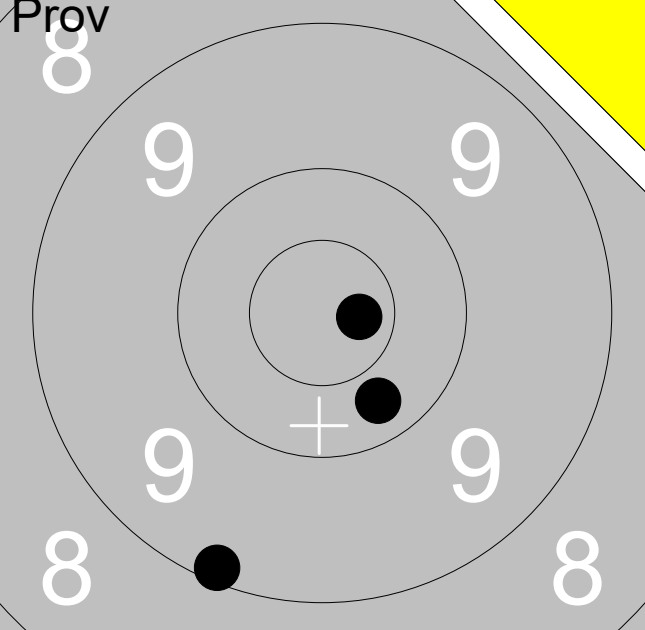
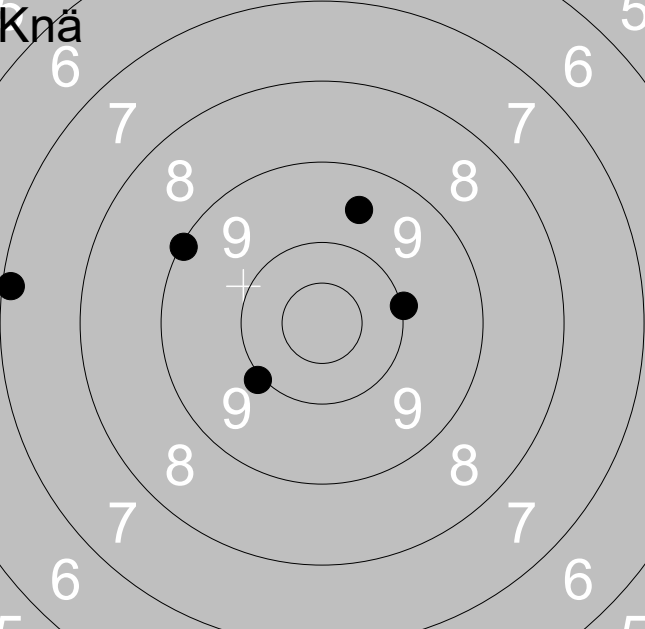
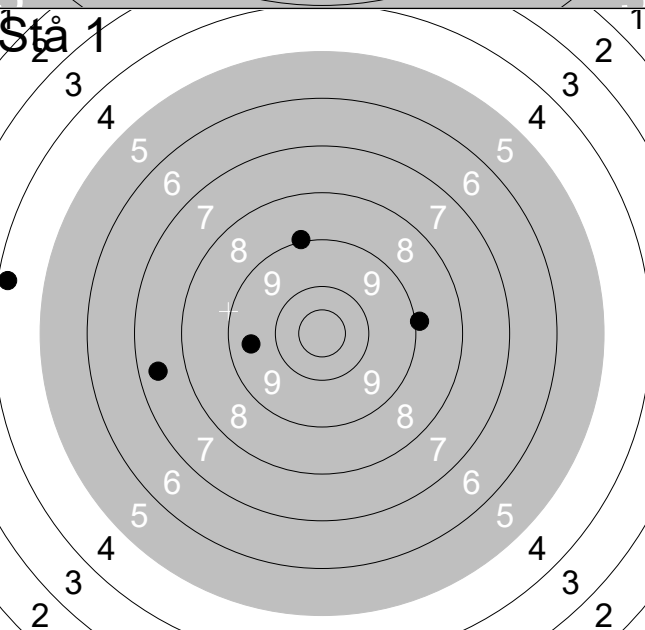
07.07.2018	Björskottet 2018	Ramselefors SKF															
<b>Prov</b> 	<table style="width:100%; border-collapse: collapse;"> <tr> <td style="width:10%;">1:</td> <td style="width:10%;">10.3</td> <td style="width:10%; text-align: right;">↘</td> </tr> <tr> <td>2:</td> <td>9.1</td> <td style="text-align: right;">↘</td> </tr> <tr> <td>3:</td> <td>10.7x</td> <td style="text-align: right;">→</td> </tr> </table>	1:	10.3	↘	2:	9.1	↘	3:	10.7x	→							
1:	10.3	↘															
2:	9.1	↘															
3:	10.7x	→															
Serie		29															
Total		236															
<b>Knä</b> 	<table style="width:100%; border-collapse: collapse;"> <tr> <td style="width:10%;">1:</td> <td style="width:10%;">9.5</td> <td style="width:10%; text-align: right;">↑</td> </tr> <tr> <td>2:</td> <td>7.1</td> <td style="text-align: right;">←</td> </tr> <tr> <td>3:</td> <td>10.0</td> <td style="text-align: right;">↘</td> </tr> <tr> <td>4:</td> <td>9.1</td> <td style="text-align: right;">↖</td> </tr> <tr> <td>5:</td> <td>10.0</td> <td style="text-align: right;">→</td> </tr> </table>	1:	9.5	↑	2:	7.1	←	3:	10.0	↘	4:	9.1	↖	5:	10.0	→	
1:	9.5	↑															
2:	7.1	←															
3:	10.0	↘															
4:	9.1	↖															
5:	10.0	→															
Serie		45															
Total		281															
<b>Stå 1</b> 	<table style="width:100%; border-collapse: collapse;"> <tr> <td style="width:10%;">1:</td> <td style="width:10%;">9.0</td> <td style="width:10%; text-align: right;">↑</td> </tr> <tr> <td>2:</td> <td>8.9</td> <td style="text-align: right;">→</td> </tr> <tr> <td>3:</td> <td>4.2</td> <td style="text-align: right;">←</td> </tr> <tr> <td>4:</td> <td>9.5</td> <td style="text-align: right;">←</td> </tr> <tr> <td>5:</td> <td>7.4</td> <td style="text-align: right;">←</td> </tr> </table>	1:	9.0	↑	2:	8.9	→	3:	4.2	←	4:	9.5	←	5:	7.4	←	
1:	9.0	↑															
2:	8.9	→															
3:	4.2	←															
4:	9.5	←															
5:	7.4	←															
Serie		37															
Total		318															

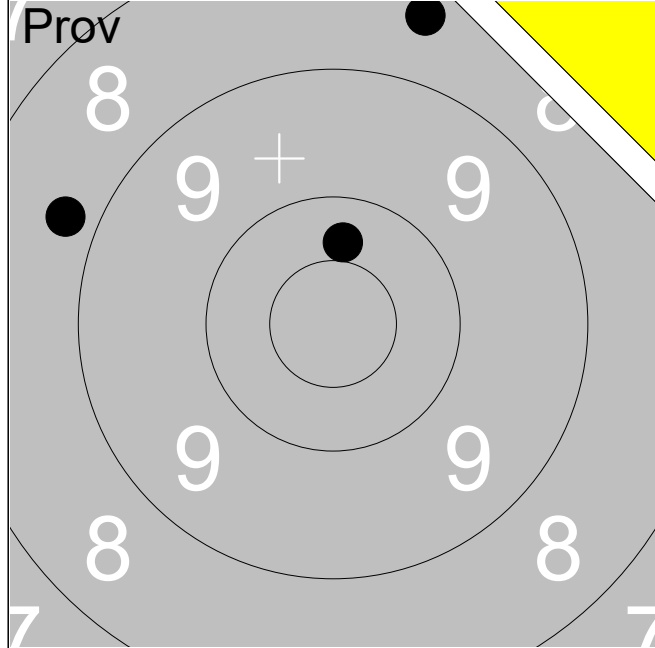

1:	8.5	↑
2:	8.8	←
3:	10.3	↑
<b>Serie</b>		<b>26</b>
<b>Total</b>		<b>233</b>

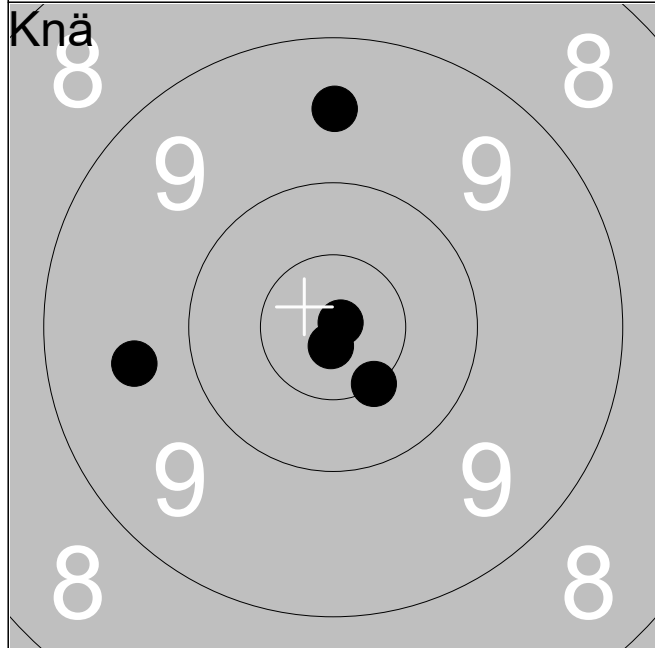

1:	9.5	↑
2:	10.9x	↗
3:	10.8x	↓
4:	9.6	←
5:	10.5x	↘
<b>Serie</b>		<b>48</b>
<b>Total</b>		<b>281</b>

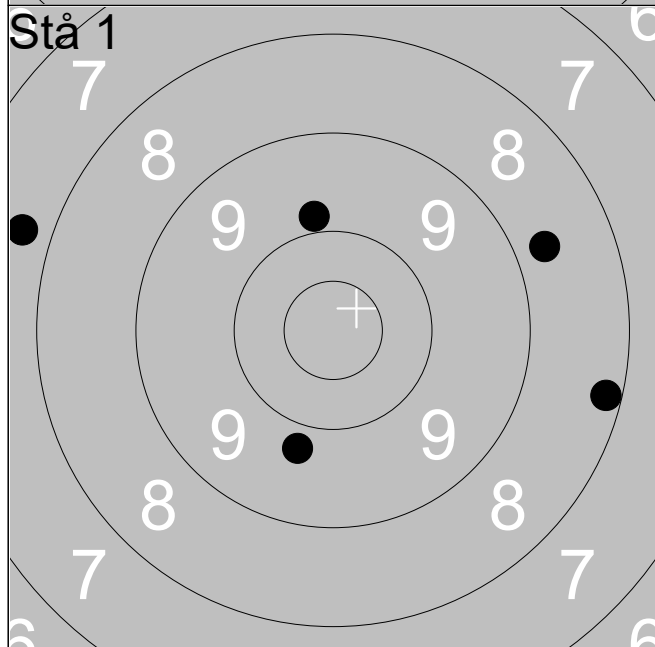

1:	9.8	↓
2:	9.9	↑
3:	8.7	↗
4:	8.2	→
5:	7.7	←
<b>Serie</b>		<b>41</b>
<b>Total</b>		<b>322</b>

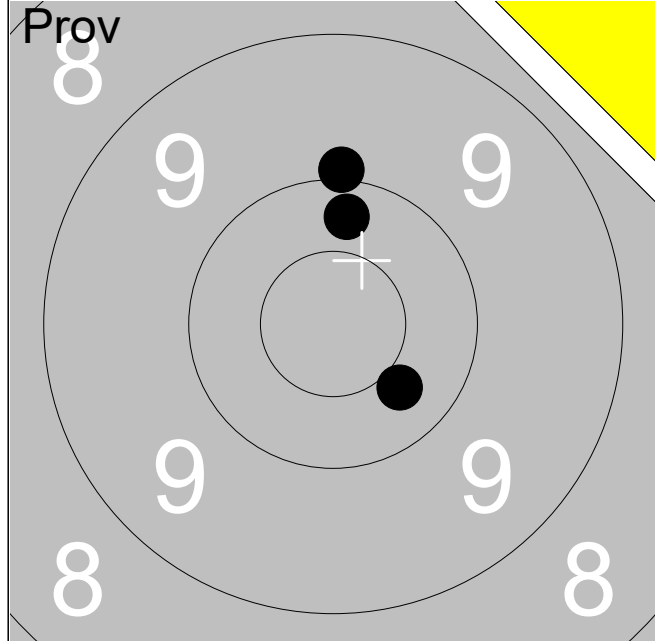

1:	10.3	↑
2:	10.4	↘
3:	10.0	↑
<b>Serie</b>		<b>30</b>
<b>Total</b>		<b>233</b>

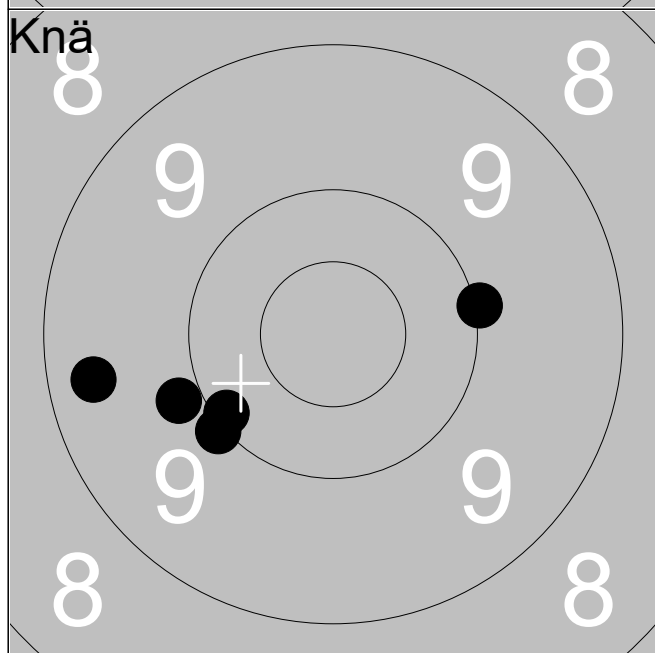

1:	10.0	→
2:	10.1	↙
3:	10.0	↙
4:	9.3	←
5:	9.9	↙
<b>Serie</b>		<b>48</b>
<b>Total</b>		<b>281</b>

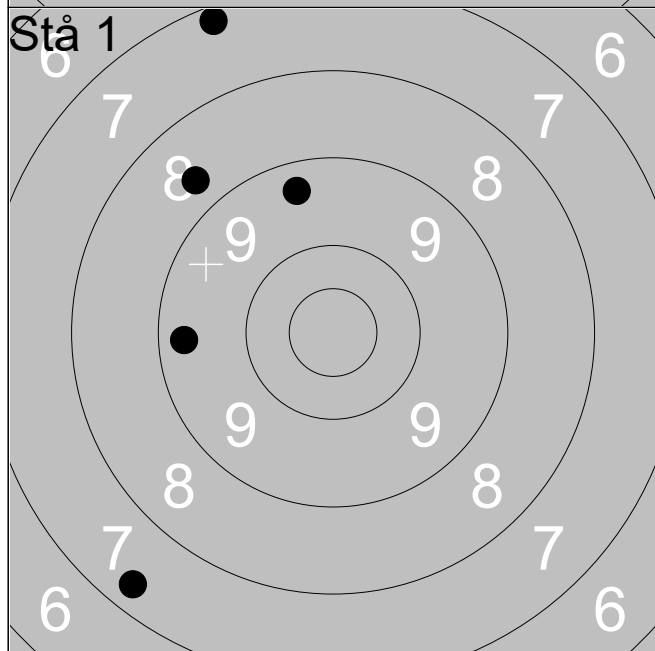

1:	9.3	←
2:	7.2	↑
3:	7.3	↘
4:	9.4	↑
5:	8.7	↗
<b>Serie</b>		<b>40</b>
<b>Total</b>		<b>321</b>

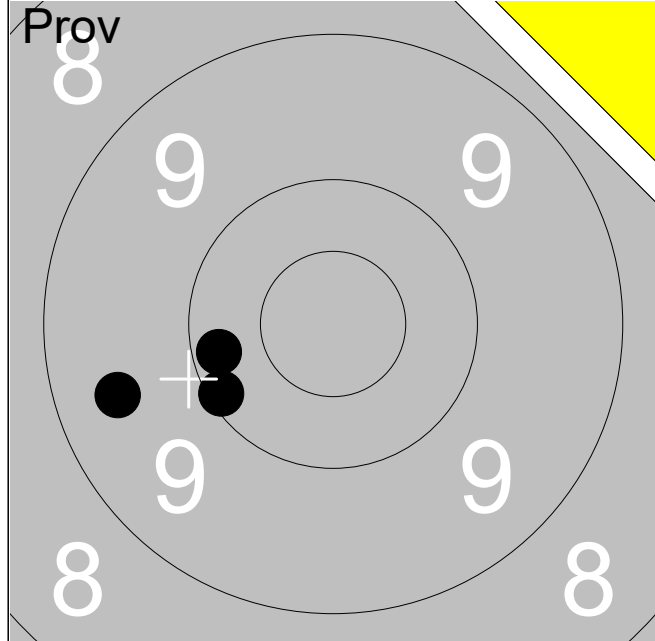

1:	10.2	←
2:	9.5	←
3:	10.1	←

Serie 29

Total 228

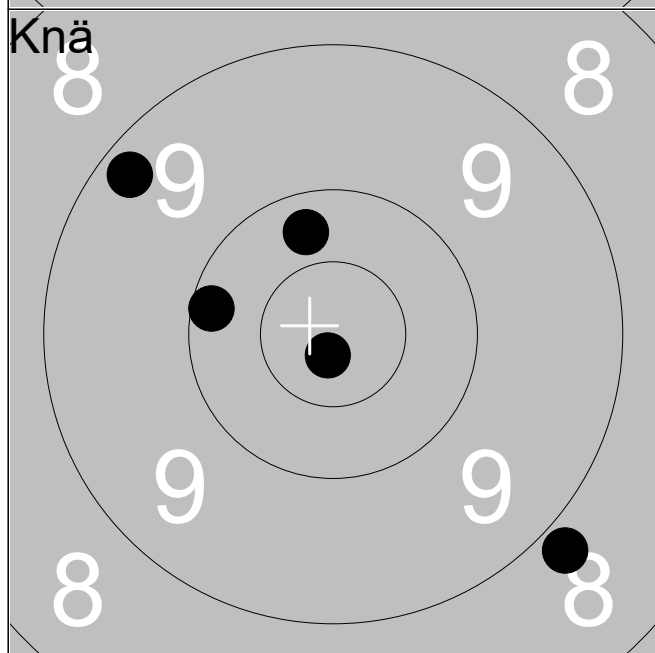

1:	10.2	←
2:	10.8x	↓
3:	10.3	↑
4:	9.2	↗
5:	8.8	↘

Serie 47

Total 275

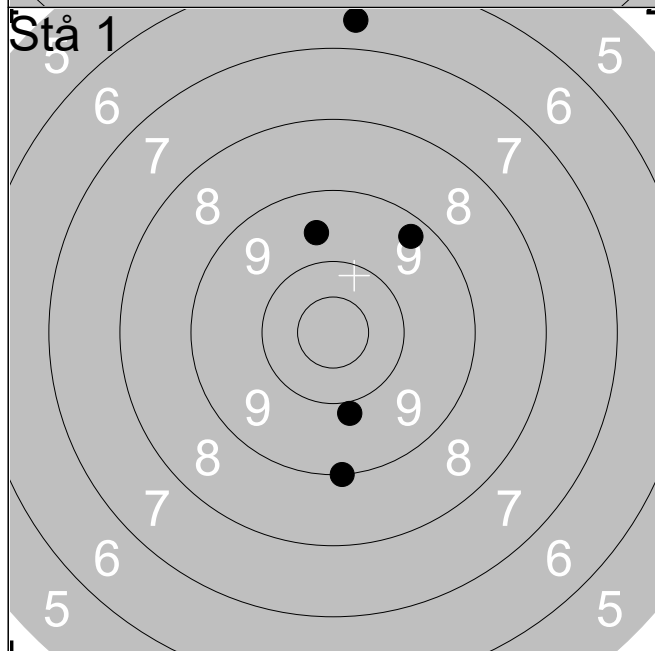

1:	6.6	↑
2:	9.9	↓
3:	9.6	↑
4:	9.0	↓
5:	9.3	↗

Serie 42

Total 317

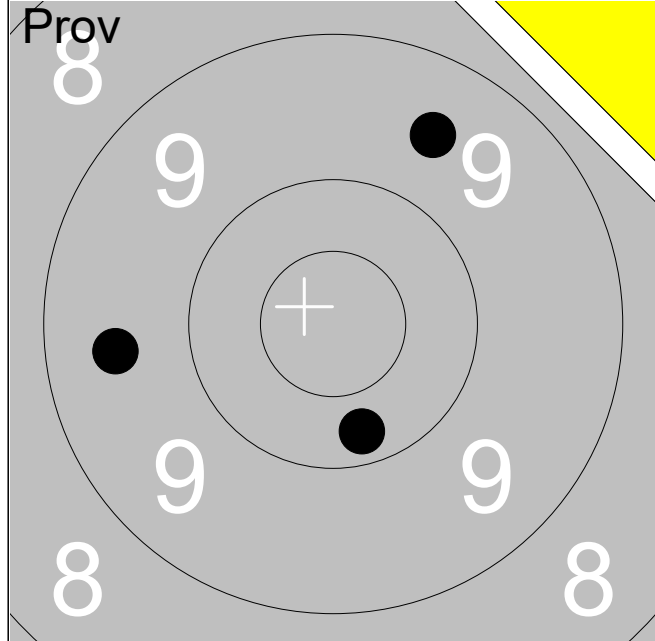

1:	10.2	↓
2:	9.6	↗
3:	9.5	←

Serie	28
-------	----

Total	226
-------	-----

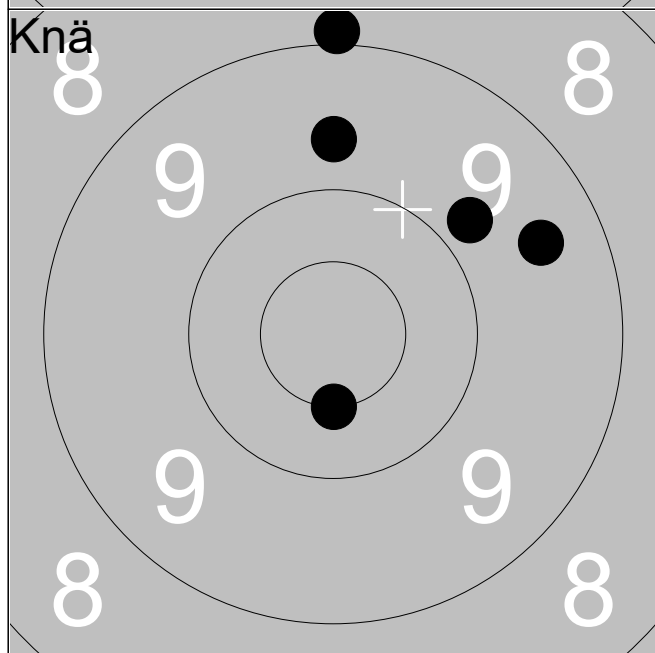

1:	8.9	↑
2:	9.5	↗
3:	9.8	↗
4:	10.5x	↓
5:	9.7	↑

Serie	45
-------	----

Total	271
-------	-----

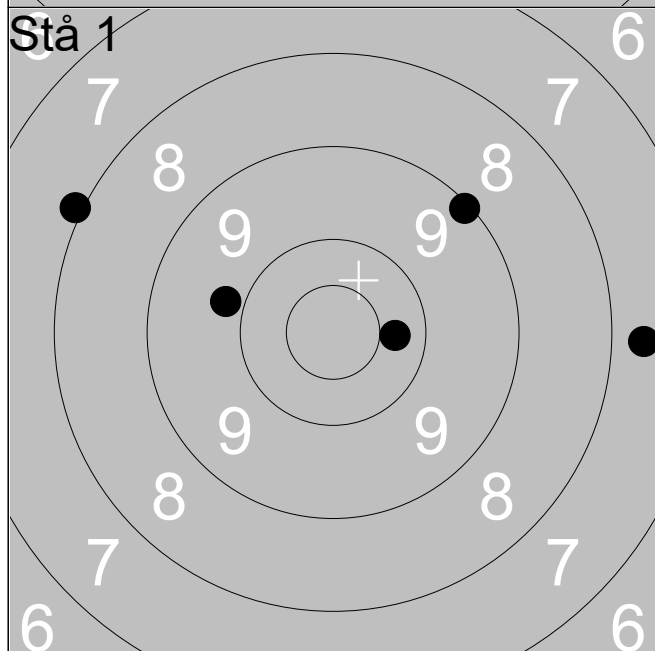

1:	8.0	↖
2:	9.8	↖
3:	9.1	↗
4:	10.3	→
5:	7.7	→

Serie	43
-------	----

Total	314
-------	-----



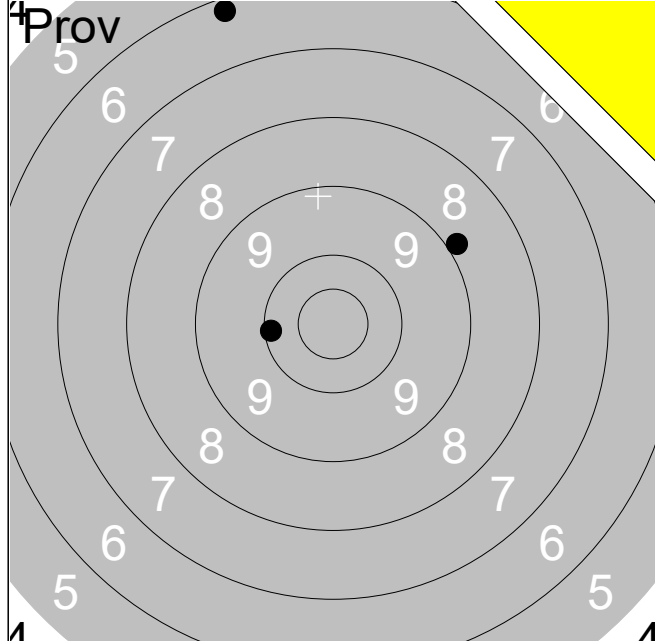

1:	6.2	↑
2:	8.9	↗
3:	10.1	←

Serie	24
-------	----

Total	218
-------	-----

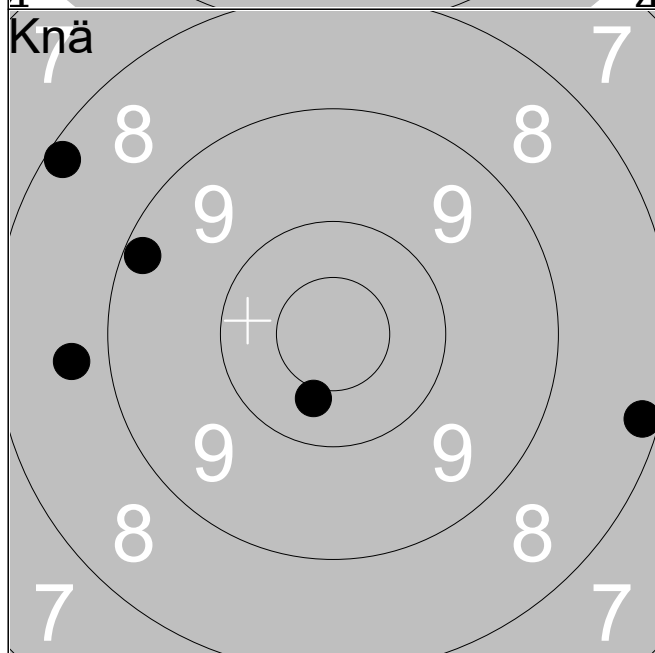

1:	9.2	↖
2:	8.2	→
3:	10.4	↓
4:	8.2	↗
5:	8.7	←

Serie	43
-------	----

Total	261
-------	-----

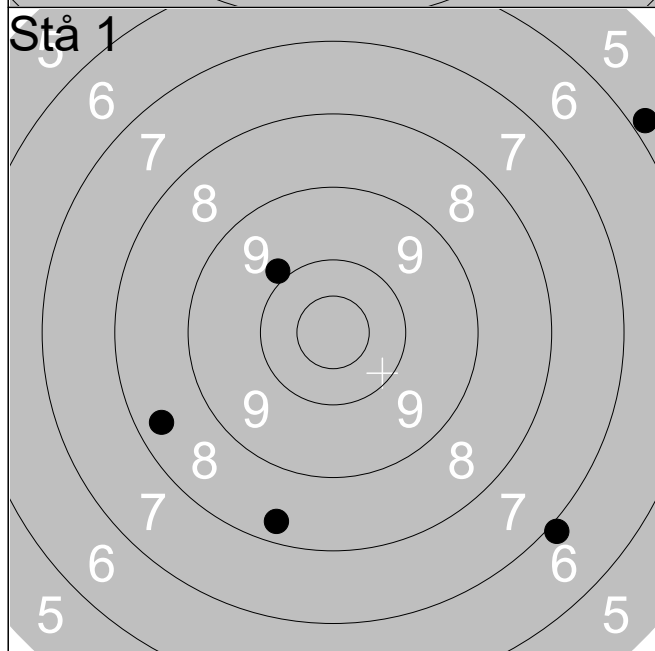

1:	5.8	↗
2:	8.4	↖
3:	9.9	↗
4:	6.9	↘
5:	8.3	↓

Serie	36
-------	----

Total	297
-------	-----

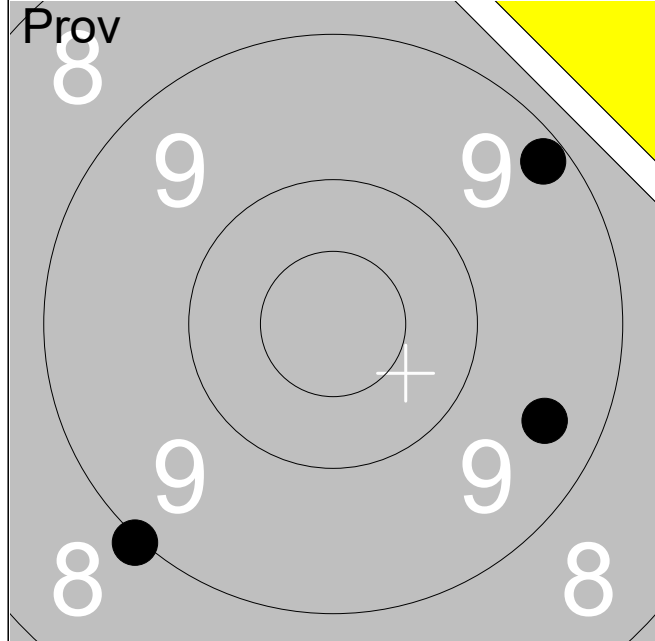

1:	9.4	↘
2:	9.2	↗
3:	9.0	↙

Serie	27
-------	----

Total	209
-------	-----

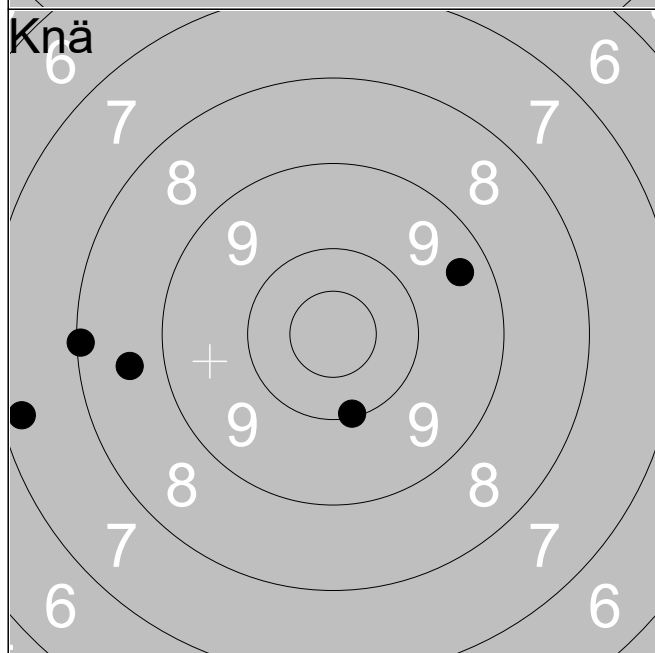

1:	9.4	↗
2:	7.3	←
3:	10.1	↓
4:	8.6	←
5:	8.1	←

Serie	42
-------	----

Total	251
-------	-----

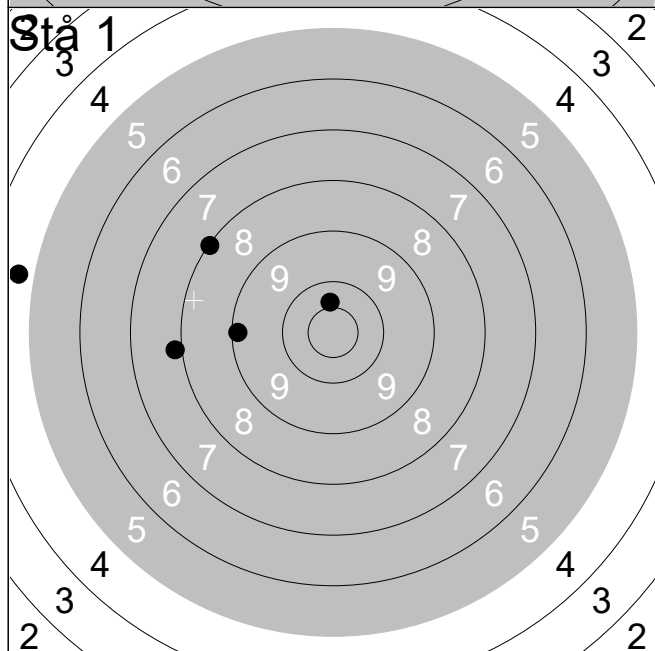

1:	10.4	↑
2:	8.1	↖
3:	4.7	←
4:	7.9	←
5:	9.2	←

Serie	38
-------	----

Total	289
-------	-----

07.07.2018	Björskottet 2018	Ramselefors SKF
------------	------------------	-----------------

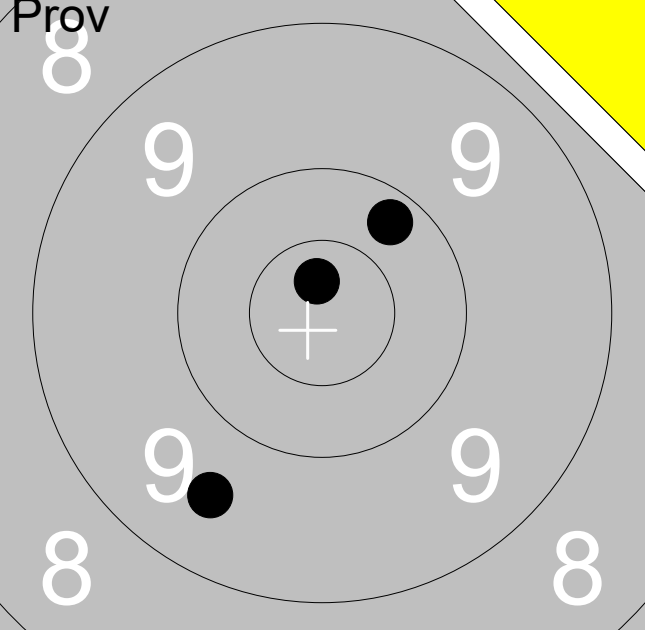

<b>Prov</b> 	<table style="width:100%; border-collapse: collapse;"> <tr> <td style="width:10%;">1:</td> <td style="width:35%;">9.6</td> <td style="width:55%; text-align: right;">↘</td> </tr> <tr> <td>2:</td> <td>10.2</td> <td style="text-align: right;">↗</td> </tr> <tr> <td>3:</td> <td>10.7x</td> <td style="text-align: right;">↑</td> </tr> </table>	1:	9.6	↘	2:	10.2	↗	3:	10.7x	↑
1:	9.6	↘								
2:	10.2	↗								
3:	10.7x	↑								
Serie		29								
Total		233								

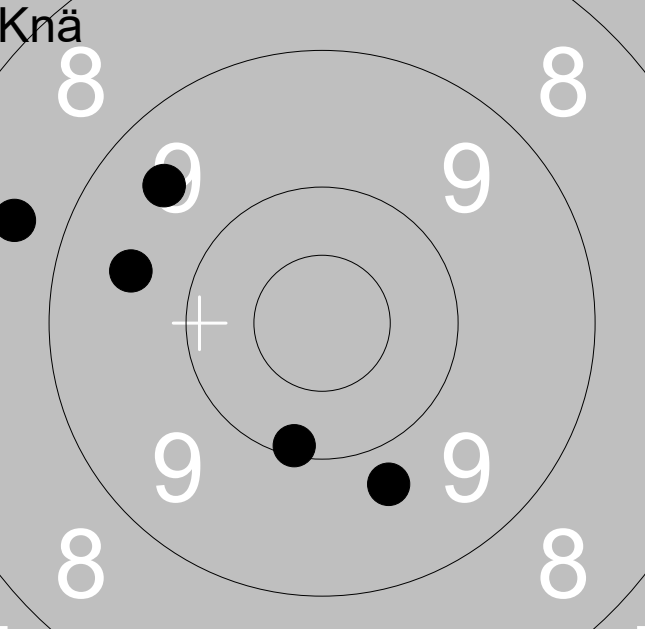

<b>Knä</b> 	<table style="width:100%; border-collapse: collapse;"> <tr> <td style="width:10%;">1:</td> <td style="width:35%;">8.7</td> <td style="width:55%; text-align: right;">←</td> </tr> <tr> <td>2:</td> <td>9.6</td> <td style="text-align: right;">←</td> </tr> <tr> <td>3:</td> <td>9.5</td> <td style="text-align: right;">↗</td> </tr> <tr> <td>4:</td> <td>9.8</td> <td style="text-align: right;">↘</td> </tr> <tr> <td>5:</td> <td>10.1</td> <td style="text-align: right;">↘</td> </tr> </table>	1:	8.7	←	2:	9.6	←	3:	9.5	↗	4:	9.8	↘	5:	10.1	↘
1:	8.7	←														
2:	9.6	←														
3:	9.5	↗														
4:	9.8	↘														
5:	10.1	↘														
Serie		45														
Total		278														

<b>Stå 1</b> 	<table style="width:100%; border-collapse: collapse;"> <tr> <td style="width:10%;">1:</td> <td style="width:35%;">4.5</td> <td style="width:55%; text-align: right;">↗</td> </tr> <tr> <td>2:</td> <td>10.1</td> <td style="text-align: right;">↗</td> </tr> <tr> <td>3:</td> <td>10.7x</td> <td style="text-align: right;">↘</td> </tr> <tr> <td>4:</td> <td>8.6</td> <td style="text-align: right;">↘</td> </tr> <tr> <td>5:</td> <td>6.4</td> <td style="text-align: right;">↘</td> </tr> </table>	1:	4.5	↗	2:	10.1	↗	3:	10.7x	↘	4:	8.6	↘	5:	6.4	↘
1:	4.5	↗														
2:	10.1	↗														
3:	10.7x	↘														
4:	8.6	↘														
5:	6.4	↘														
Serie		38														
Total		316														

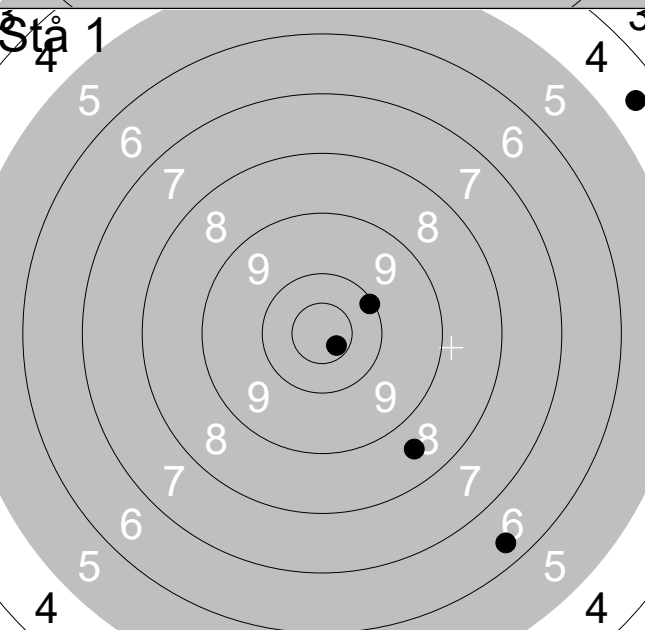
07.07.2018	Björskottet 2018	Ramselefors SKF	
<b>Prov</b> 	1:	10.6x	↑
	2:	9.1	↑
	3:	9.1	↗
	<b>Serie</b>		<b>28</b>
<b>Total</b>		<b>231</b>	
<b>Knä</b> 	1:	10.1	↖
	2:	8.8	←
	3:	9.2	→
	4:	10.2	↘
	5:	7.7	←
	<b>Serie</b>		<b>44</b>
<b>Total</b>		<b>275</b>	
<b>Stå 1</b> 	1:	4.7	→
	2:	7.8	→
	3:	0.0	↖
	4:	5.7	↘
	5:	9.8	↖
	<b>Serie</b>		<b>25</b>
<b>Total</b>		<b>300</b>	

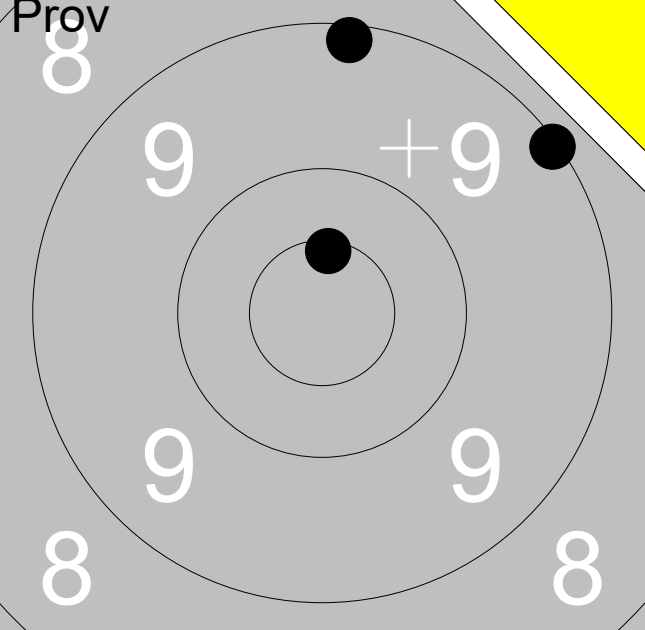
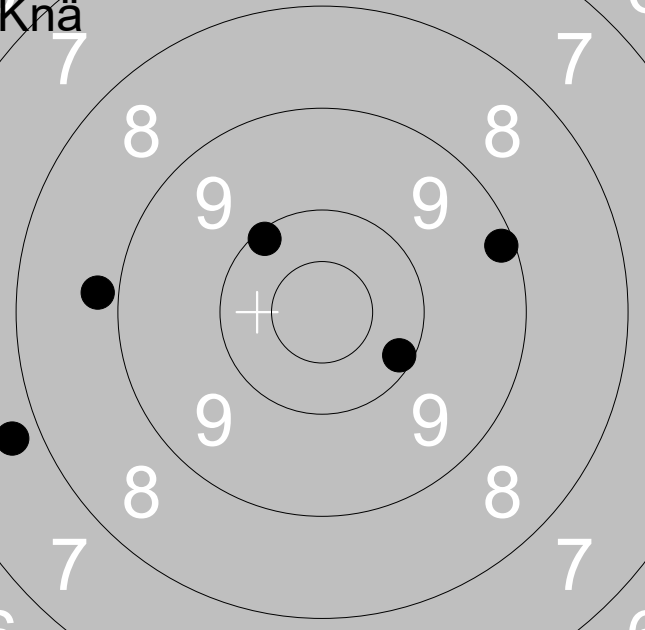
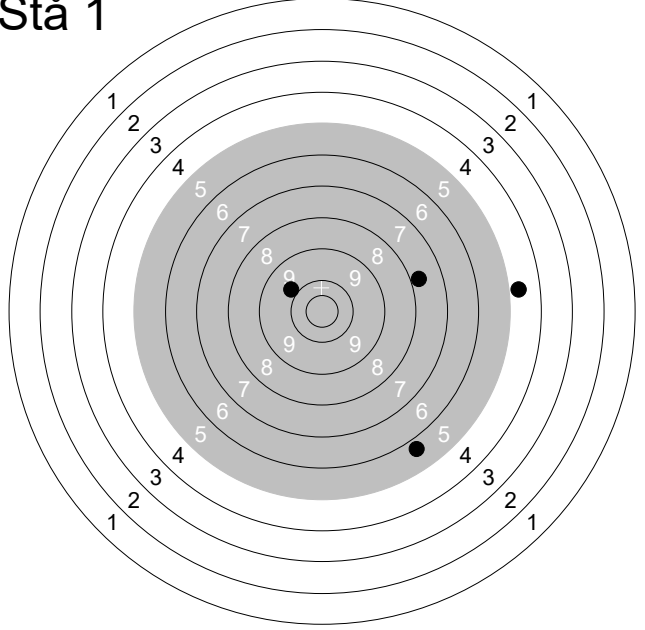
07.07.2018	Björskottet 2018	Ramselefors SKF	
<b>Prov</b> 	1:	9.7	↑
	2:	9.1	↗
	3:	8.1	↘
	<b>Serie</b>		<b>26</b>
<b>Total</b>		<b>229</b>	
<b>Knä</b> 	1:	9.0	→
	2:	8.4	↘
	3:	7.7	↖
	4:	9.9	↗
	5:	10.6x	→
	<b>Serie</b>		<b>43</b>
<b>Total</b>		<b>272</b>	
<b>Stå 1</b> 	1:	8.5	↖
	2:	8.2	↑
	3:	10.4x	→
	4:	5.1	↗
	5:	8.4	↖
	<b>Serie</b>		<b>39</b>
<b>Total</b>		<b>311</b>	

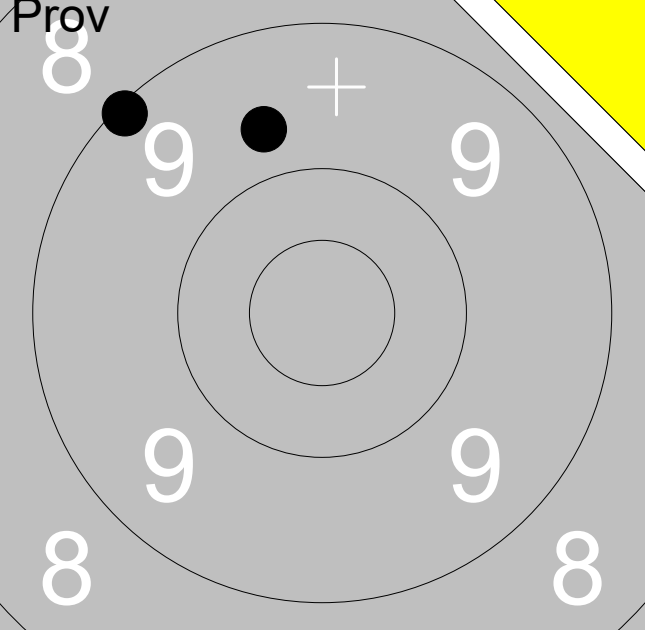
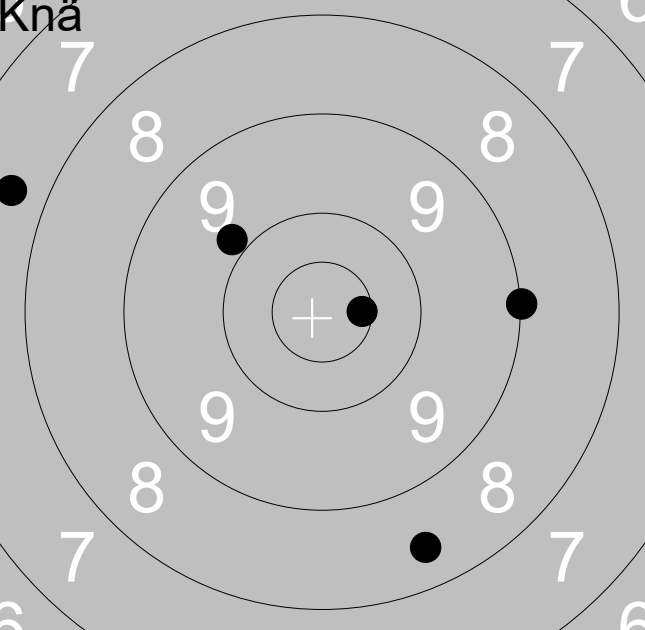
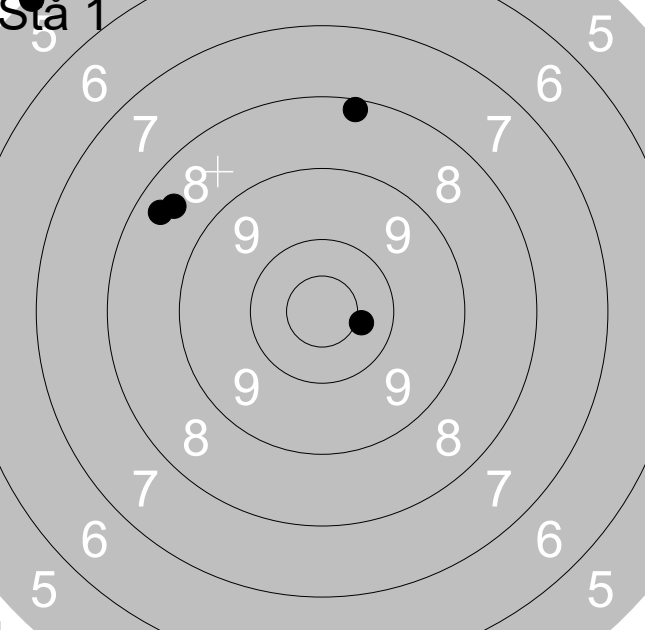

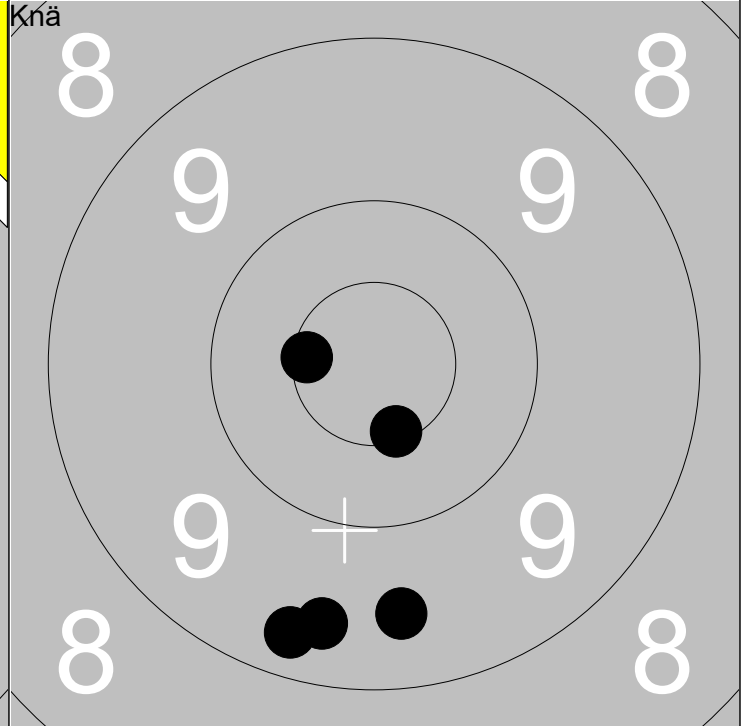
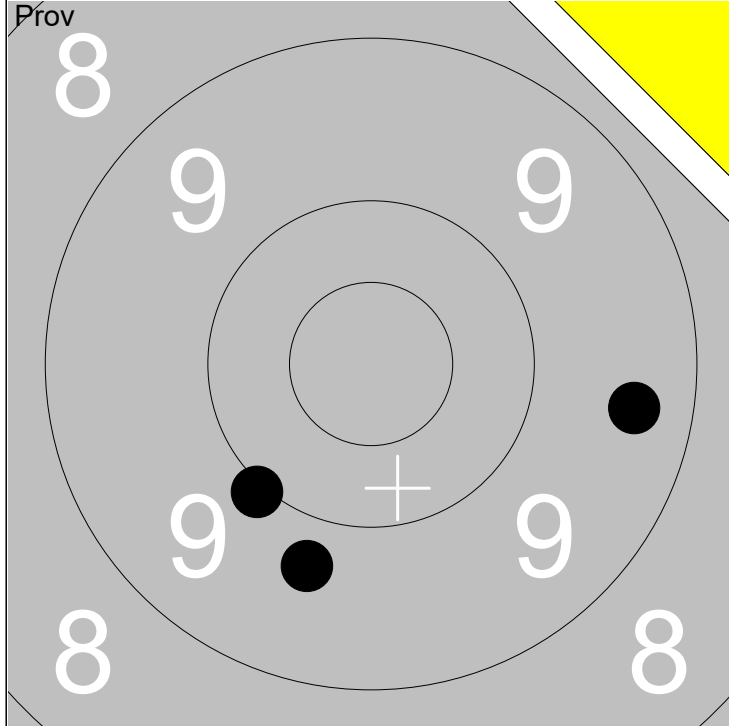
1: 10.0 ↙	Serie 28
2: 9.7 ↓	
3: 9.4 →	
Total 227	

1: 10.6x ←	Serie 47
2: 9.5 ↓	
3: 9.3 ↓	
4: 9.4 ↓	
5: 10.5x ↓	
Total 274	

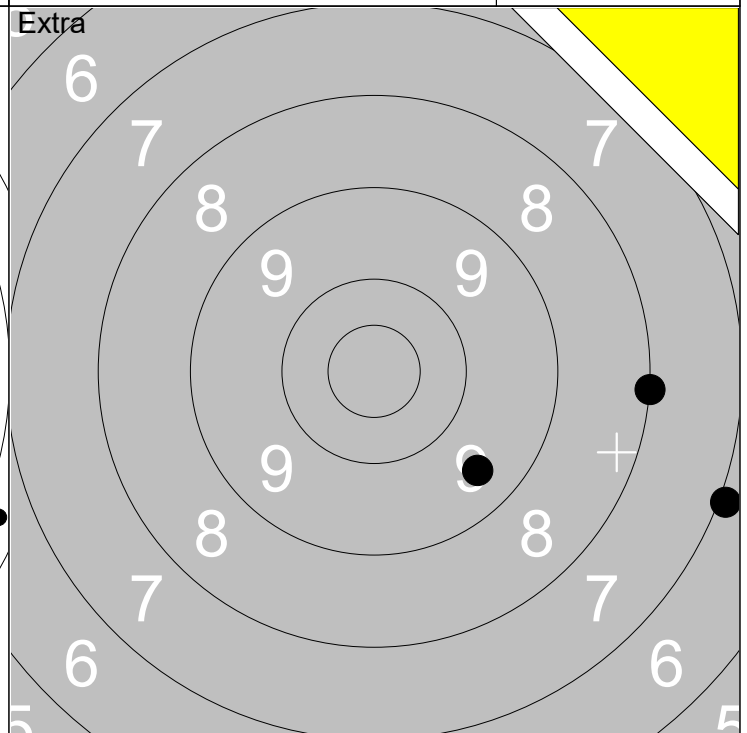
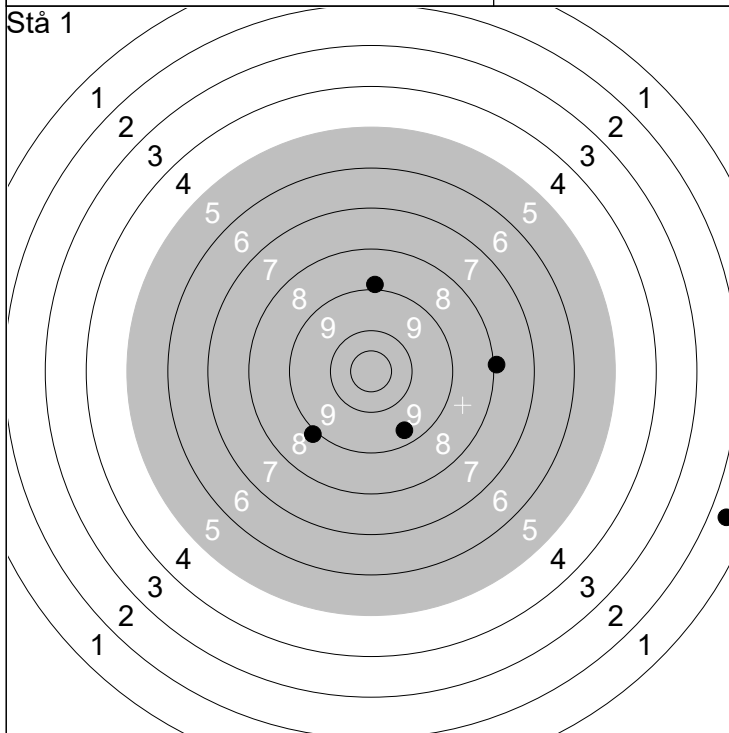

1: 9.4 ↓	Serie 33
2: 7.9 →	
3: 8.9 ↙	
4: 1.6 →	
5: 8.9 ↑	
Total 307	

1: 9.5 ↓	Serie 24
2: 8.0 →	
3: 7.0 →	
Total 307	

Skjutlag

6

Tavla

14

Lars Möllsten

Ramselefors

Umeå

Sen/Vet S/Vb

07.07.2018

Björskottet 2018

Ramselefors SKF

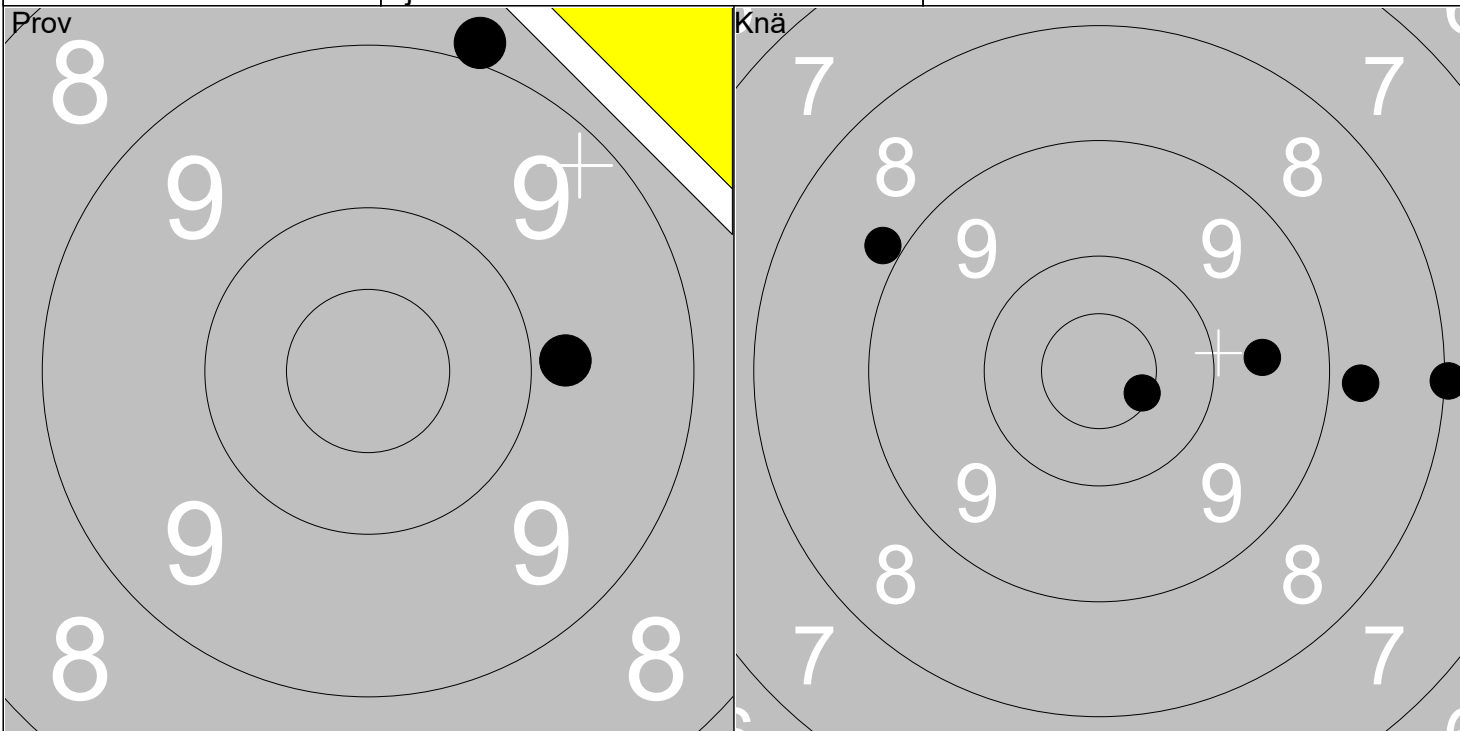

1: 8.9 ↗  
 2: 9.8 →  
 3: 8.4 ↗

Serie 25

Total 224

1: 8.9 ↖  
 2: 8.0 →  
 3: 10.6x ↘  
 4: 9.6 →  
 5: 8.8 →

Serie 43

Total 267

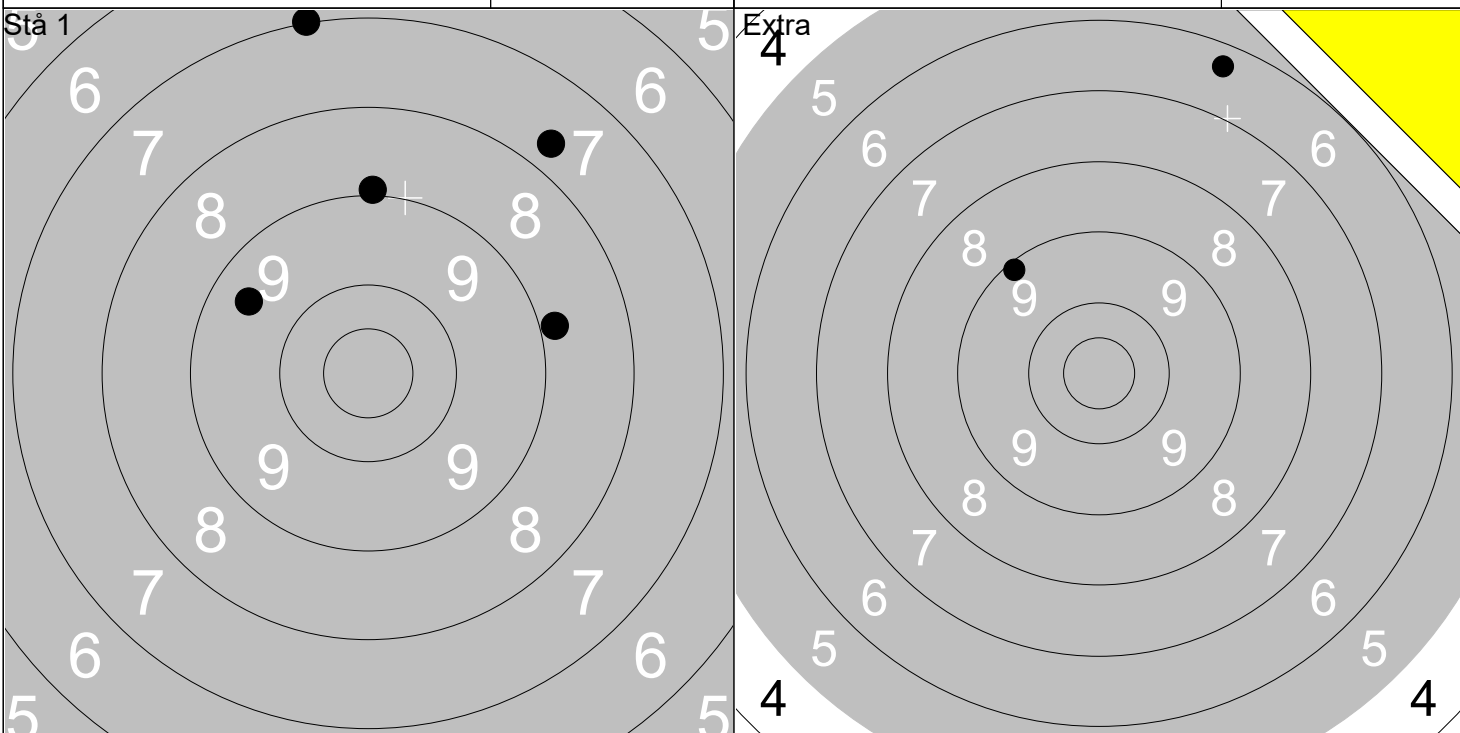

1: 9.0 ↗  
 2: 7.7 ↗  
 3: 7.0 ↗  
 4: 9.5 ↖  
 5: 8.9 →

Serie 40

Total 307

1: 6.3 ↗  
 2: 4.0 ↗  
 3: 9.1 ↖

Serie 19

Total 307

07.07.2018	Björskottet 2018	Ramselefors SKF
------------	------------------	-----------------

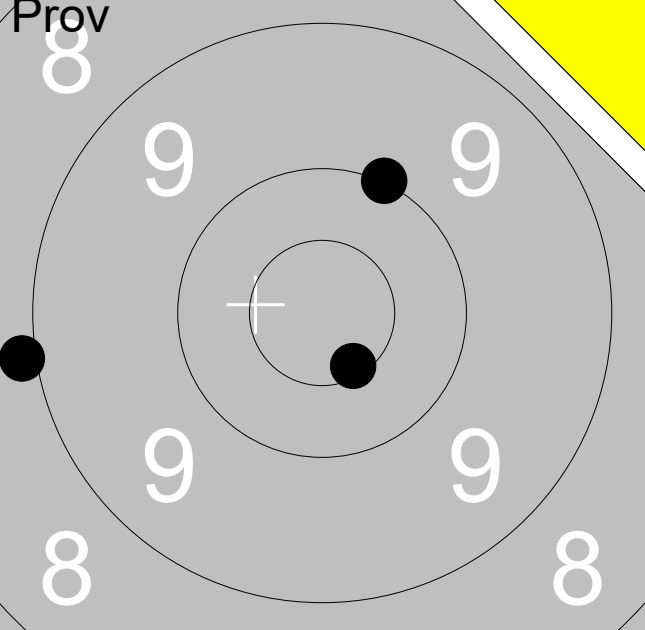

<b>Prov</b> 	<table style="width:100%; border-collapse: collapse;"> <tr> <td style="width:10%;">1:</td> <td style="width:70%;">10.6x</td> <td style="width:20%; text-align: right;">↘</td> </tr> <tr> <td>2:</td> <td>10.0</td> <td style="text-align: right;">↗</td> </tr> <tr> <td>3:</td> <td>8.9</td> <td style="text-align: right;">←</td> </tr> </table>	1:	10.6x	↘	2:	10.0	↗	3:	8.9	←
1:	10.6x	↘								
2:	10.0	↗								
3:	8.9	←								
Serie		28								
Total		221								

<b>Knä</b> 	<table style="width:100%; border-collapse: collapse;"> <tr> <td style="width:10%;">1:</td> <td style="width:70%;">8.7</td> <td style="width:20%; text-align: right;">↗</td> </tr> <tr> <td>2:</td> <td>9.5</td> <td style="text-align: right;">↘</td> </tr> <tr> <td>3:</td> <td>8.7</td> <td style="text-align: right;">←</td> </tr> <tr> <td>4:</td> <td>10.0</td> <td style="text-align: right;">↑</td> </tr> <tr> <td>5:</td> <td>7.7</td> <td style="text-align: right;">↗</td> </tr> </table>	1:	8.7	↗	2:	9.5	↘	3:	8.7	←	4:	10.0	↑	5:	7.7	↗
1:	8.7	↗														
2:	9.5	↘														
3:	8.7	←														
4:	10.0	↑														
5:	7.7	↗														
Serie		42														
Total		263														

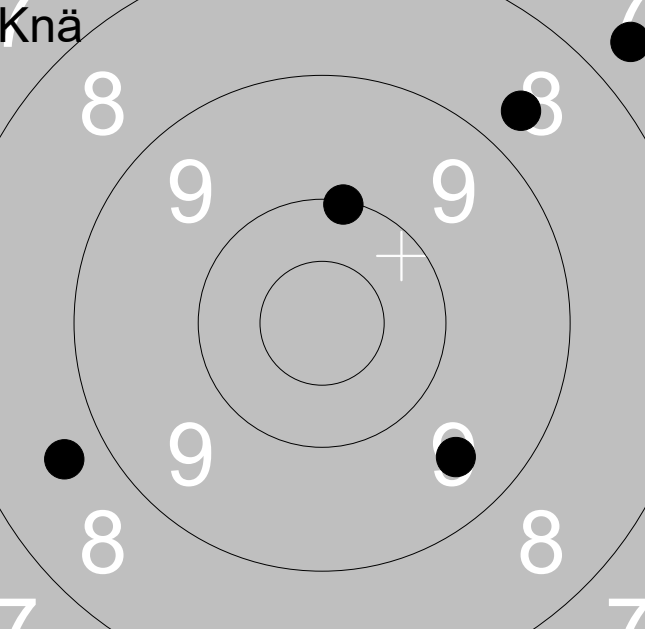
<b>Stå 1</b> 	<table style="width:100%; border-collapse: collapse;"> <tr> <td style="width:10%;">1:</td> <td style="width:70%;">6.5</td> <td style="width:20%; text-align: right;">↗</td> </tr> <tr> <td>2:</td> <td>5.8</td> <td style="text-align: right;">↗</td> </tr> <tr> <td>3:</td> <td>7.4</td> <td style="text-align: right;">↗</td> </tr> <tr> <td>4:</td> <td>5.5</td> <td style="text-align: right;">↘</td> </tr> <tr> <td>5:</td> <td>7.6</td> <td style="text-align: right;">→</td> </tr> </table>	1:	6.5	↗	2:	5.8	↗	3:	7.4	↗	4:	5.5	↘	5:	7.6	→
1:	6.5	↗														
2:	5.8	↗														
3:	7.4	↗														
4:	5.5	↘														
5:	7.6	→														
Serie		30														
Total		293														

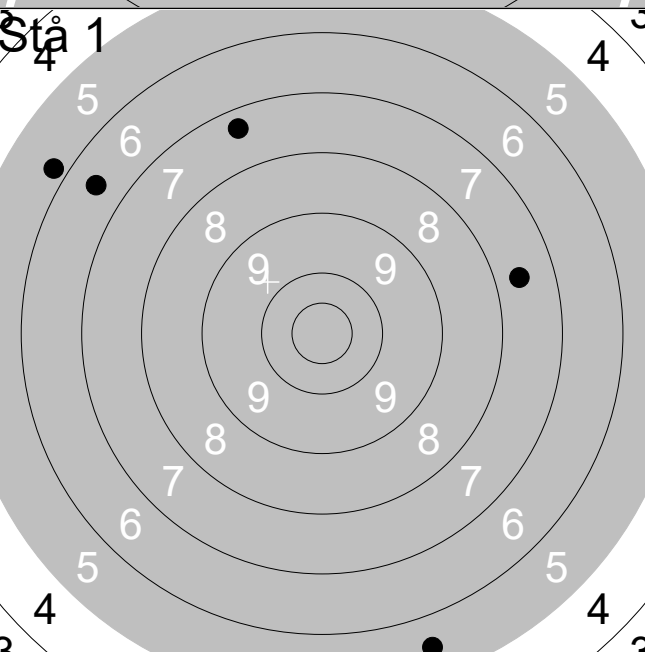

07.07.2018	Björskottet 2018	Ramselefors SKF
------------	------------------	-----------------

**Brov**

1:	9.8	↗
2:	4.0	↖
3:	7.3	←

Serie	20
Total	220

**Knå**

1:	8.4	↖
2:	10.5x	←
3:	7.1	→
4:	7.9	↖
5:	6.0	↙

Serie	38
Total	258

**Stå 1**

1:	0.0	↓
2:	9.5	↑
3:	6.4	↘
4:	3.6	←
5:	9.6	↖

Serie	27
Total	285

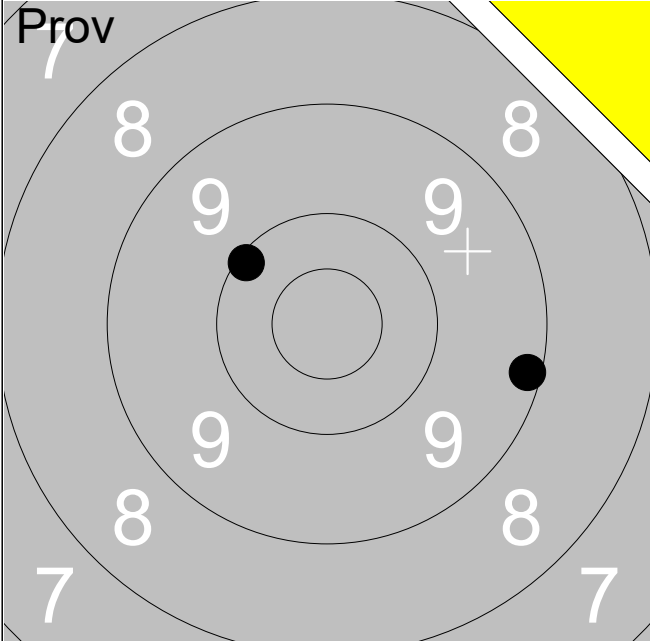
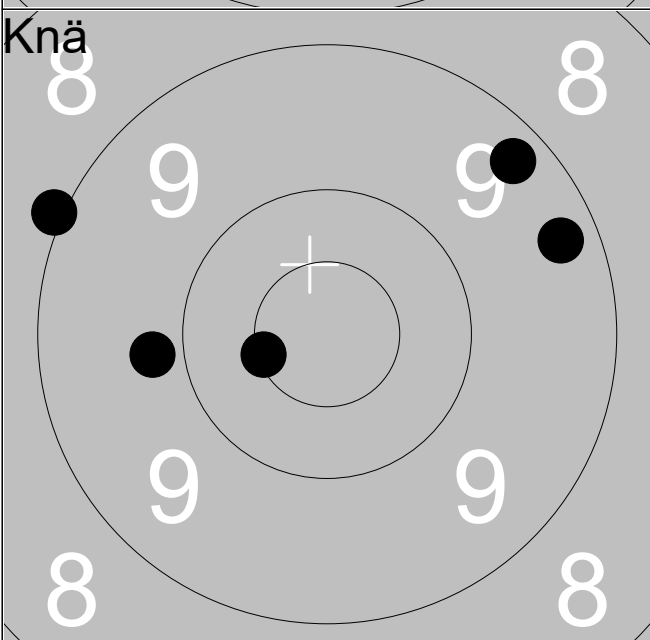
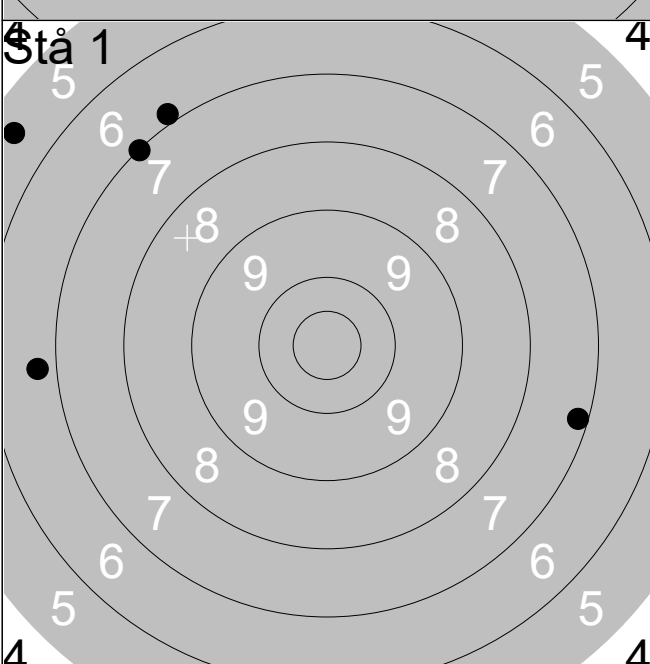
07.07.2018	Björskottet 2018	Ramselefors SKF															
<b>Prov</b> 	<table style="width:100%;"> <tr><td>1:</td><td>10.1</td><td style="text-align: right;">↖</td></tr> <tr><td>2:</td><td>7.6</td><td style="text-align: right;">↗</td></tr> <tr><td>3:</td><td>9.2</td><td style="text-align: right;">→</td></tr> </table>	1:	10.1	↖	2:	7.6	↗	3:	9.2	→							
1:	10.1	↖															
2:	7.6	↗															
3:	9.2	→															
Serie		26															
Total		218															
<b>Knä</b> 	<table style="width:100%;"> <tr><td>1:</td><td>9.0</td><td style="text-align: right;">↖</td></tr> <tr><td>2:</td><td>10.5x</td><td style="text-align: right;">←</td></tr> <tr><td>3:</td><td>9.3</td><td style="text-align: right;">↗</td></tr> <tr><td>4:</td><td>9.8</td><td style="text-align: right;">←</td></tr> <tr><td>5:</td><td>9.3</td><td style="text-align: right;">↗</td></tr> </table>	1:	9.0	↖	2:	10.5x	←	3:	9.3	↗	4:	9.8	←	5:	9.3	↗	
1:	9.0	↖															
2:	10.5x	←															
3:	9.3	↗															
4:	9.8	←															
5:	9.3	↗															
Serie		46															
Total		264															
<b>Stå 1</b> 	<table style="width:100%;"> <tr><td>1:</td><td>7.0</td><td style="text-align: right;">↗</td></tr> <tr><td>2:</td><td>5.5</td><td style="text-align: right;">↗</td></tr> <tr><td>3:</td><td>7.2</td><td style="text-align: right;">→</td></tr> <tr><td>4:</td><td>6.7</td><td style="text-align: right;">←</td></tr> <tr><td>5:</td><td>6.9</td><td style="text-align: right;">↗</td></tr> </table>	1:	7.0	↗	2:	5.5	↗	3:	7.2	→	4:	6.7	←	5:	6.9	↗	
1:	7.0	↗															
2:	5.5	↗															
3:	7.2	→															
4:	6.7	←															
5:	6.9	↗															
Serie		31															
Total		295															

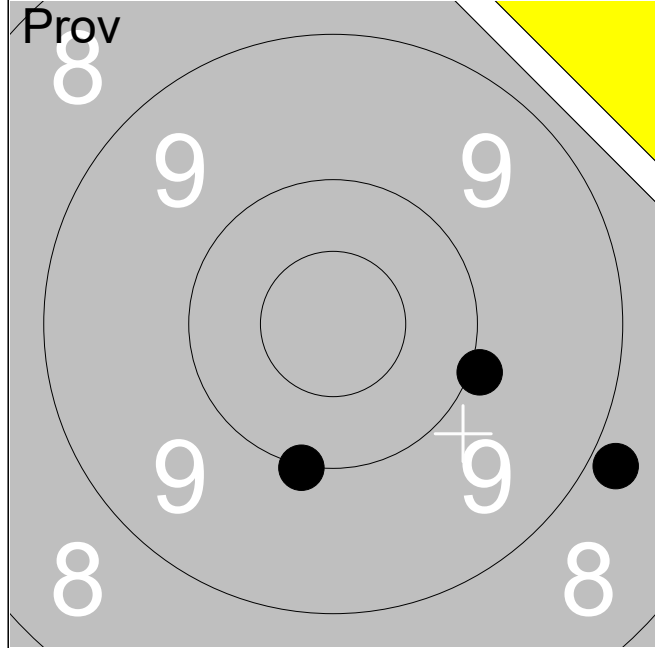

1:	10.0	→
2:	8.8	↘
3:	10.0	↓

Serie	28
Total	217

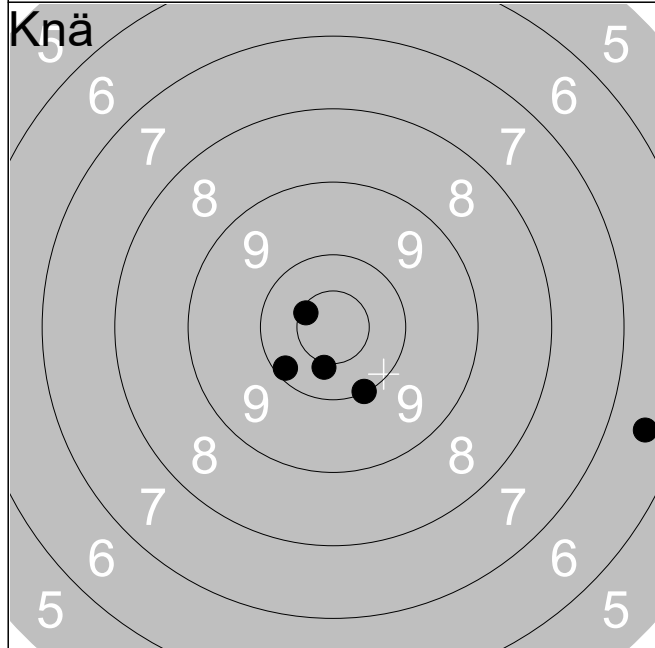

1:	10.4x	↓
2:	6.5	→
3:	10.0	↓
4:	10.6x	↗
5:	10.1	↙

Serie	46
Total	263

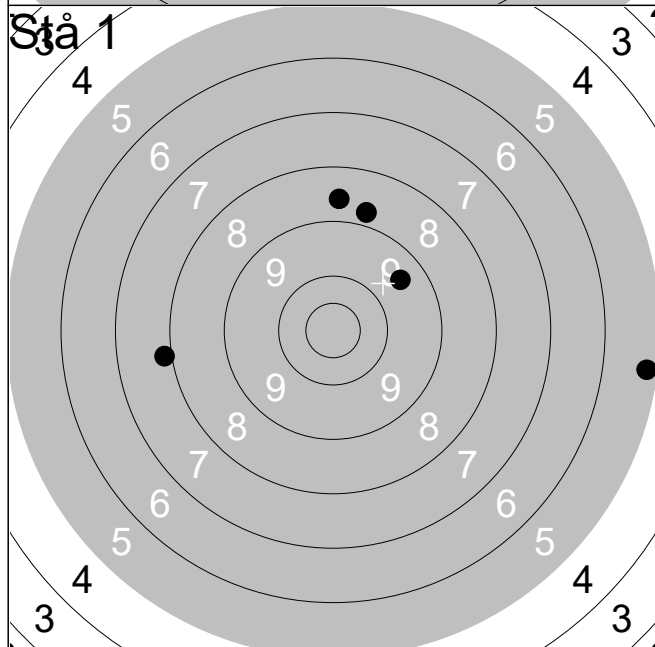

1:	7.9	←
2:	9.5	↗
3:	8.6	↑
4:	8.8	↑
5:	5.2	→

Serie	37
Total	300

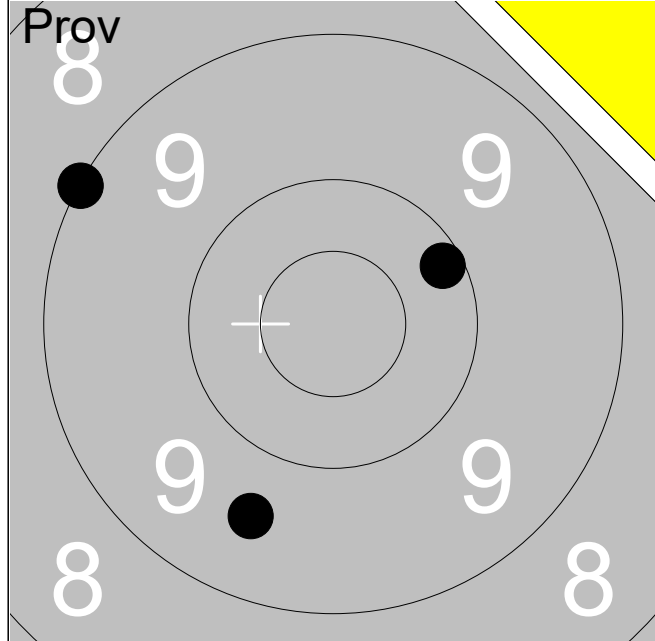

1:	10.2	↗
2:	9.0	↖
3:	9.6	↓
<b>Serie</b>		<b>28</b>
<b>Total</b>		<b>215</b>

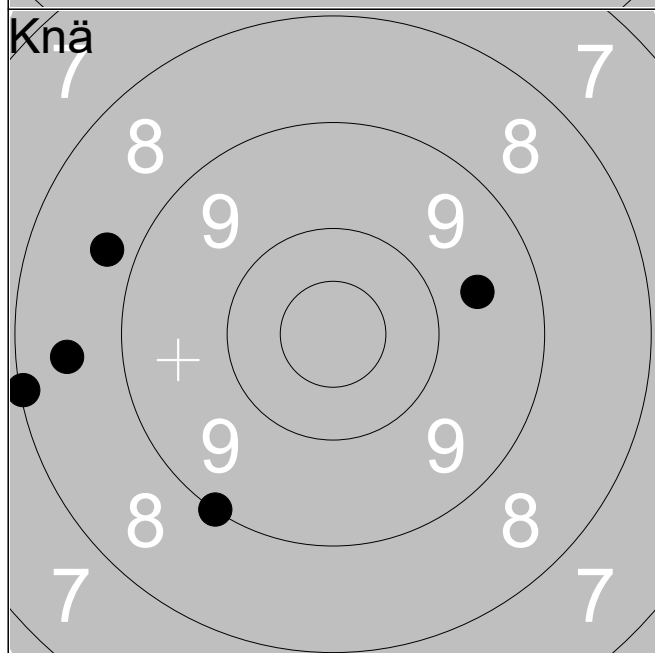

1:	9.0	↓
2:	8.1	←
3:	8.8	↖
4:	8.5	←
5:	9.6	↗
<b>Serie</b>		<b>42</b>
<b>Total</b>		<b>257</b>

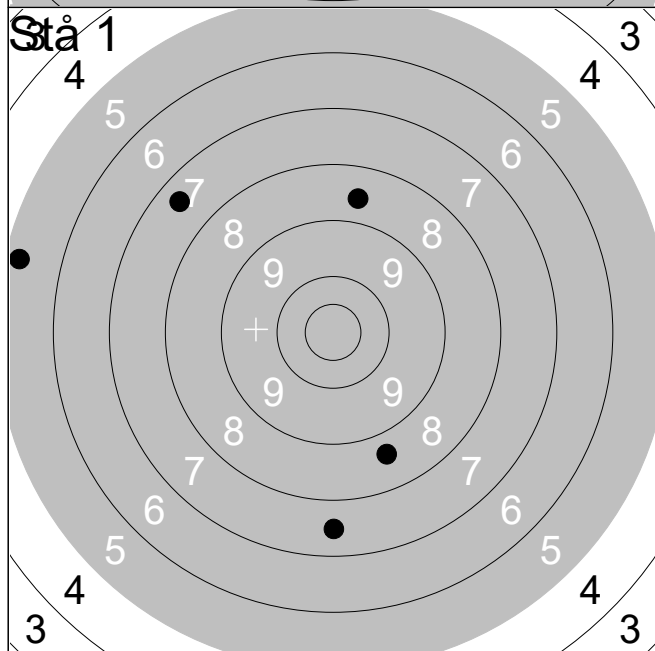

1:	8.6	↑
2:	8.7	↓
3:	7.4	↗
4:	5.3	←
5:	7.5	↓
<b>Serie</b>		<b>35</b>
<b>Total</b>		<b>292</b>

07.07.2018	Björskottet 2018	Ramselefors SKF
------------	------------------	-----------------

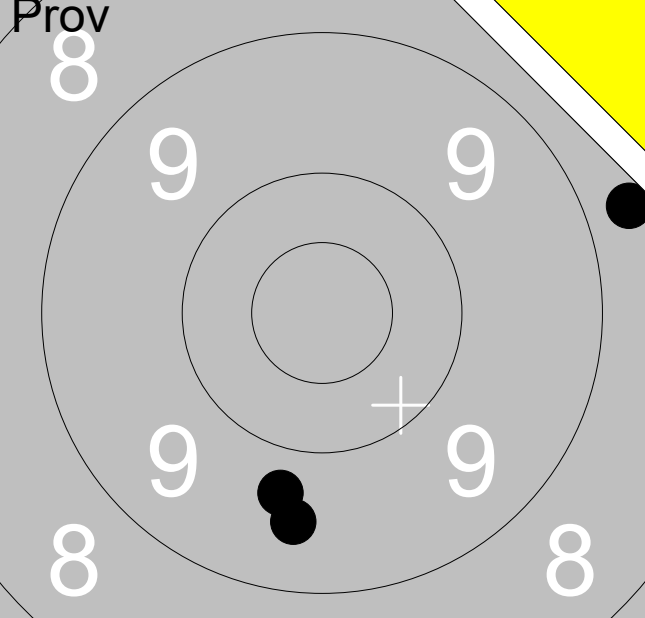

**Prov**

1:	9.7	↓
2:	8.7	→
3:	9.5	↓

Serie	26
Total	214

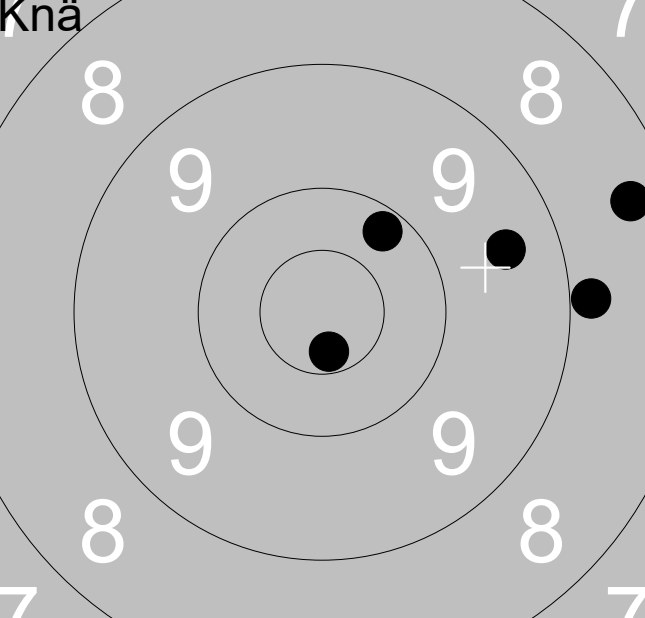

**Knä**

1:	10.2	↗
2:	8.4	→
3:	9.5	→
4:	8.9	→
5:	10.7x	↓

Serie	45
Total	259

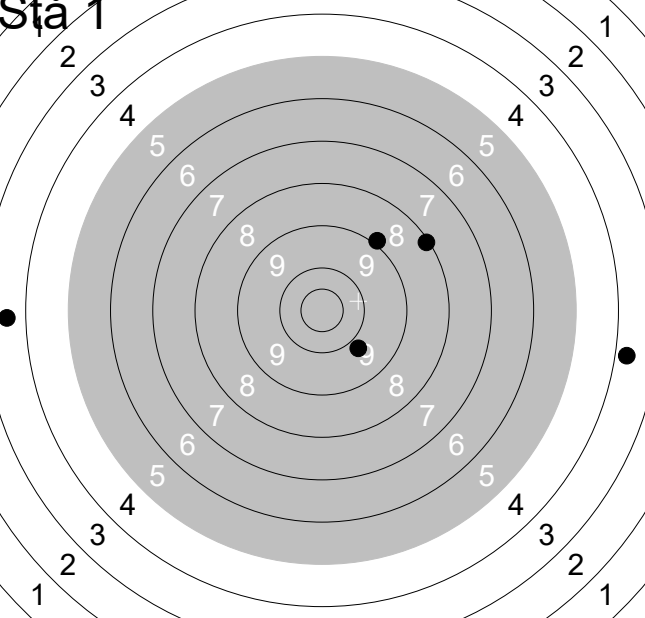

**Stå 1**

1:	9.8	↘
2:	8.9	↗
3:	3.6	←
4:	8.1	↗
5:	3.8	→

Serie	31
Total	290

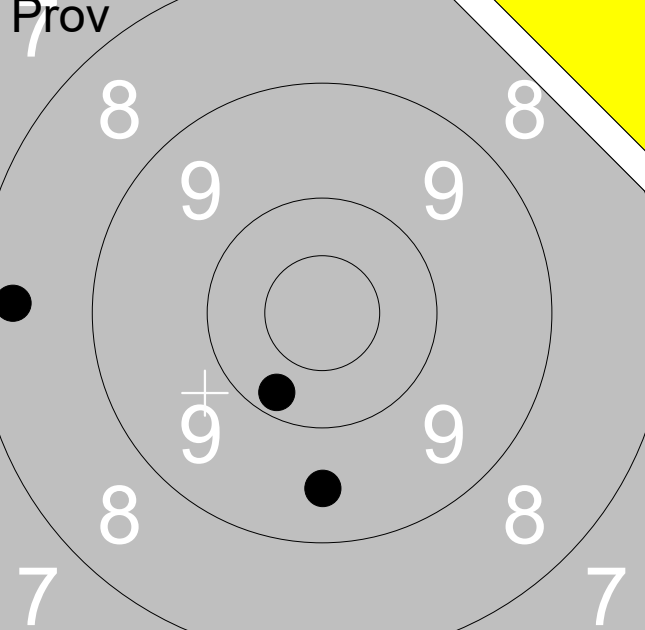
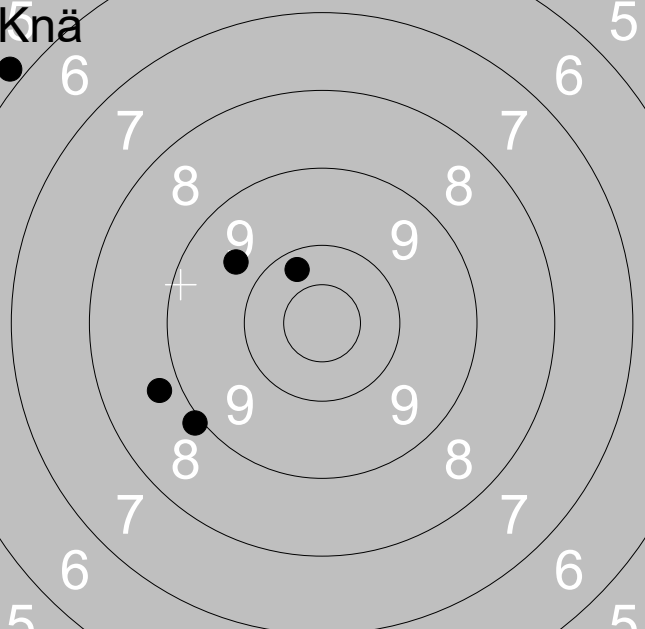
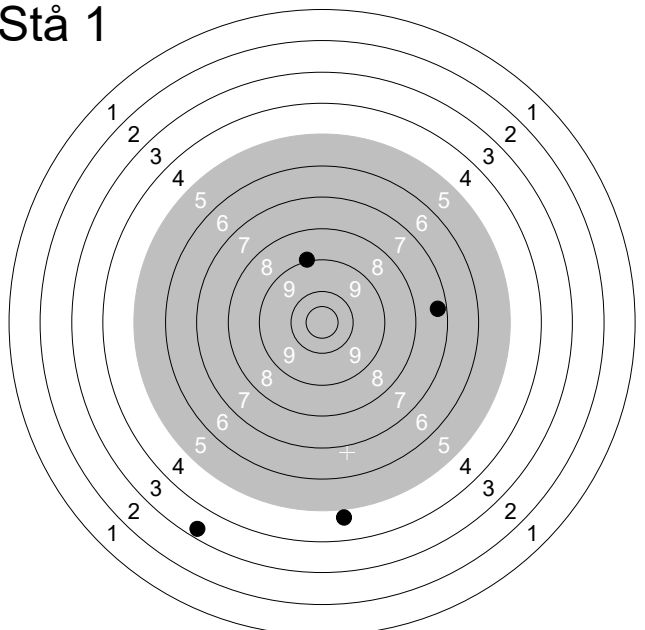
07.07.2018	Björskottet 2018	Ramselefors SKF															
<b>Prov</b> 	<table style="width:100%; border-collapse: collapse;"> <tr> <td style="width:10%;">1:</td> <td style="width:10%;">9.5</td> <td style="width:10%; text-align: right;">↓</td> </tr> <tr> <td>2:</td> <td>10.2</td> <td style="text-align: right;">↙</td> </tr> <tr> <td>3:</td> <td>8.3</td> <td style="text-align: right;">←</td> </tr> </table>	1:	9.5	↓	2:	10.2	↙	3:	8.3	←							
1:	9.5	↓															
2:	10.2	↙															
3:	8.3	←															
Serie		27															
Total		203															
<b>Knä</b> 	<table style="width:100%; border-collapse: collapse;"> <tr> <td style="width:10%;">1:</td> <td style="width:10%;">10.2</td> <td style="width:10%; text-align: right;">↑</td> </tr> <tr> <td>2:</td> <td>5.8</td> <td style="text-align: right;">↗</td> </tr> <tr> <td>3:</td> <td>8.9</td> <td style="text-align: right;">↘</td> </tr> <tr> <td>4:</td> <td>9.7</td> <td style="text-align: right;">↖</td> </tr> <tr> <td>5:</td> <td>8.8</td> <td style="text-align: right;">←</td> </tr> </table>	1:	10.2	↑	2:	5.8	↗	3:	8.9	↘	4:	9.7	↖	5:	8.8	←	
1:	10.2	↑															
2:	5.8	↗															
3:	8.9	↘															
4:	9.7	↖															
5:	8.8	←															
Serie		40															
Total		243															
<b>Stå 1</b> 	<table style="width:100%; border-collapse: collapse;"> <tr> <td style="width:10%;">1:</td> <td style="width:10%;">7.3</td> <td style="width:10%; text-align: right;">→</td> </tr> <tr> <td>2:</td> <td>3.3</td> <td style="text-align: right;">↙</td> </tr> <tr> <td>3:</td> <td>9.0</td> <td style="text-align: right;">↑</td> </tr> <tr> <td>4:</td> <td>0.0</td> <td style="text-align: right;">↘</td> </tr> <tr> <td>5:</td> <td>4.8</td> <td style="text-align: right;">↓</td> </tr> </table>	1:	7.3	→	2:	3.3	↙	3:	9.0	↑	4:	0.0	↘	5:	4.8	↓	
1:	7.3	→															
2:	3.3	↙															
3:	9.0	↑															
4:	0.0	↘															
5:	4.8	↓															
Serie		23															
Total		266															

07.07.2018	Björkskottet 2018	Ramselefors SKF
------------	-------------------	-----------------

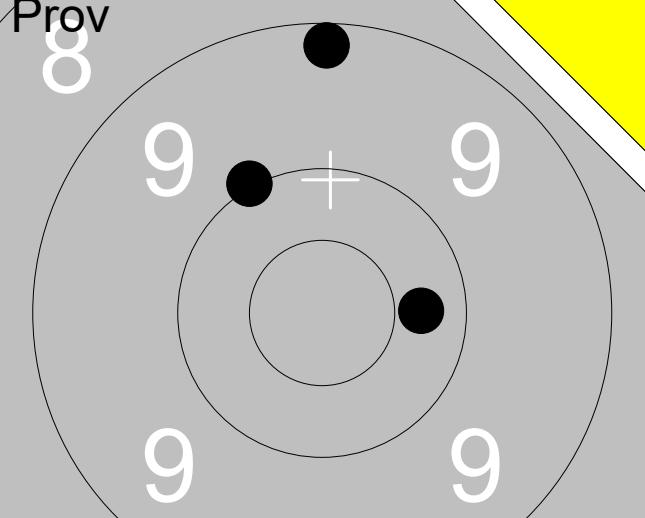

**Prov**

1:	10.0	↖
2:	9.2	↑
3:	10.3	→

Serie	29
Total	199

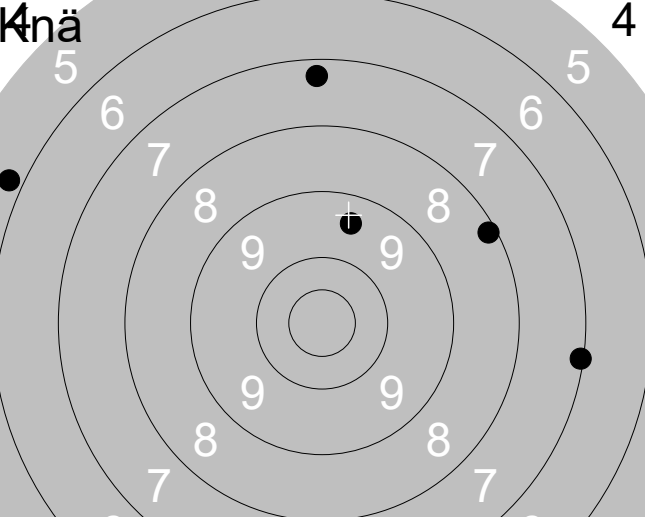

**Knä**

1:	5.8	↖
2:	7.1	→
3:	7.3	↑
4:	9.5	↑
5:	8.2	↗

Serie	36
Total	235

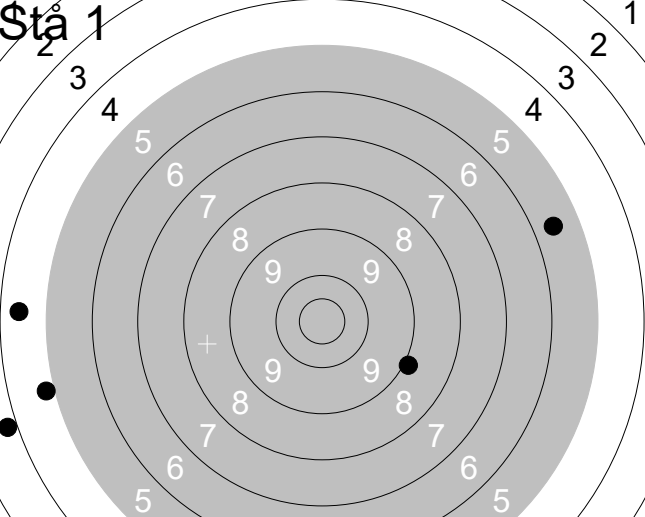

**Stå 1**

1:	4.8	↖
2:	5.6	↗
3:	8.9	↘
4:	4.4	↖
5:	3.8	↖

Serie	24
Total	259

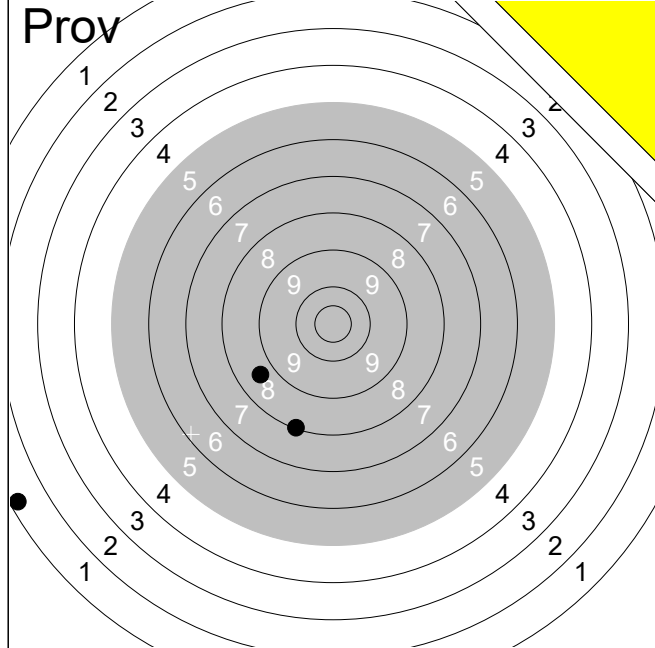

1:	1.2	↙
2:	8.0	↓
3:	8.6	↙
<b>Serie</b>		<b>17</b>
<b>Total</b>		<b>196</b>

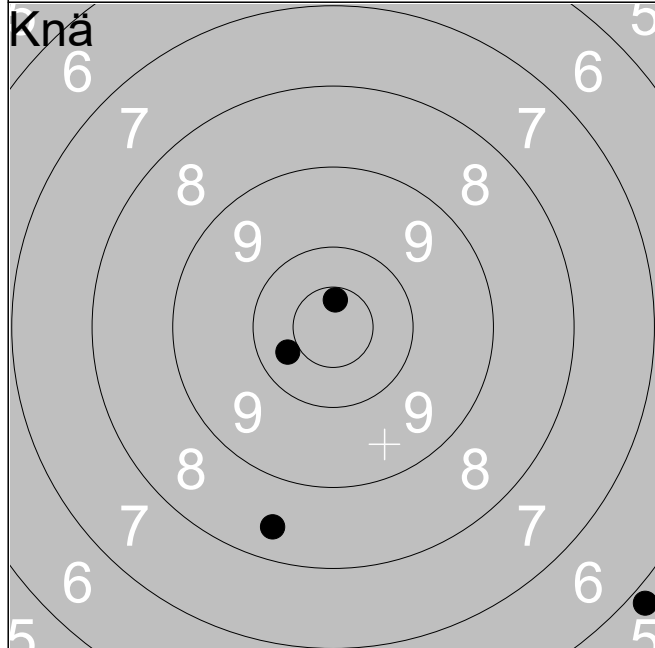

1:	10.4	↙
2:	5.8	↘
3:	8.4	↓
4:	10.6x	↑
5:	0.0	
<b>Serie</b>		<b>33</b>
<b>Total</b>		<b>229</b>

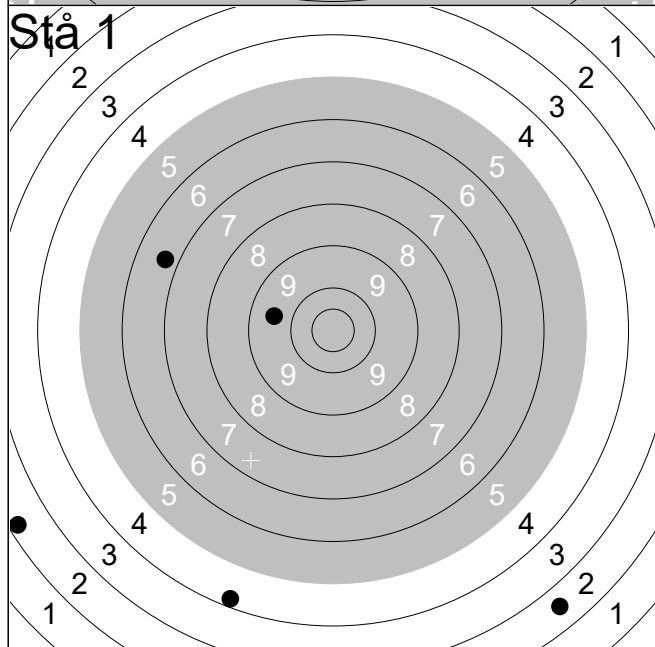

1:	6.7	↙
2:	9.6	↙
3:	2.3	↙
4:	2.6	↘
5:	4.2	↓
<b>Serie</b>		<b>23</b>
<b>Total</b>		<b>252</b>