

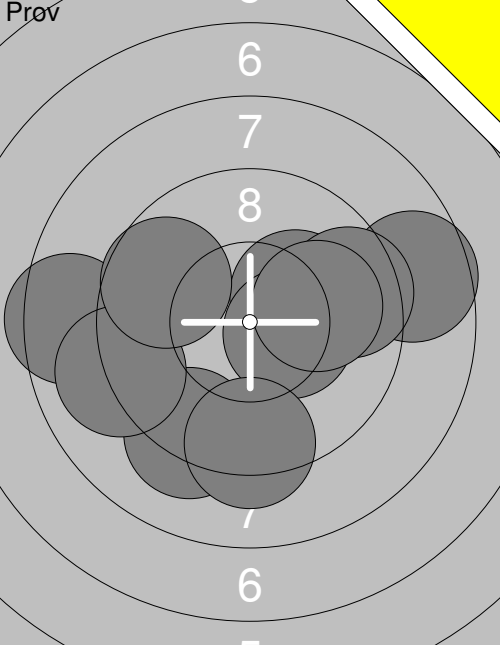
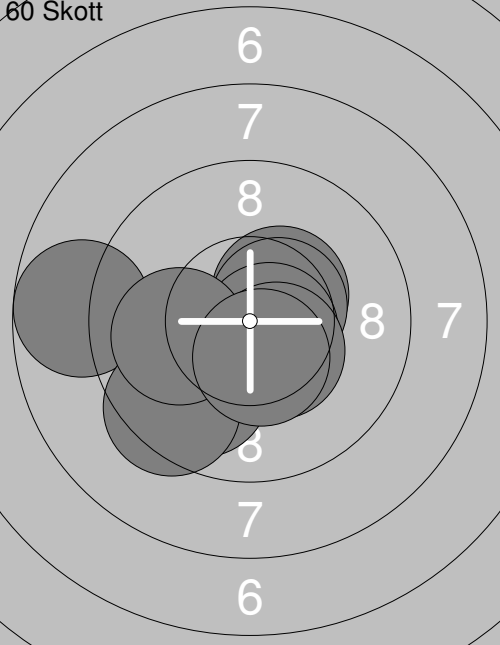
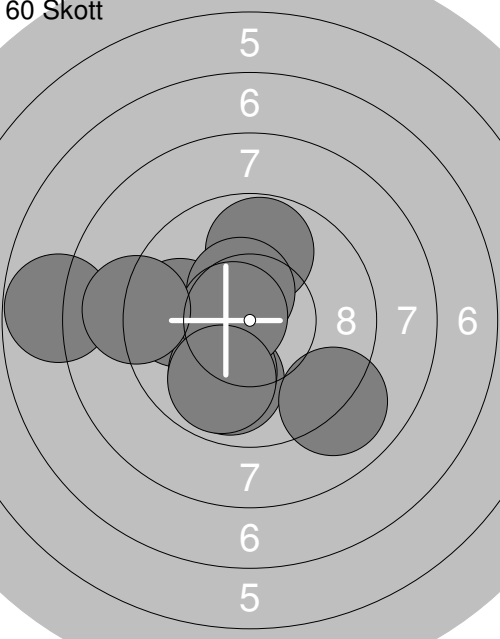
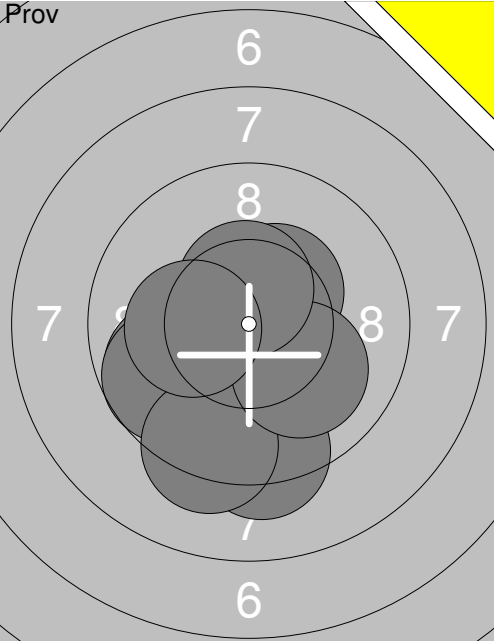
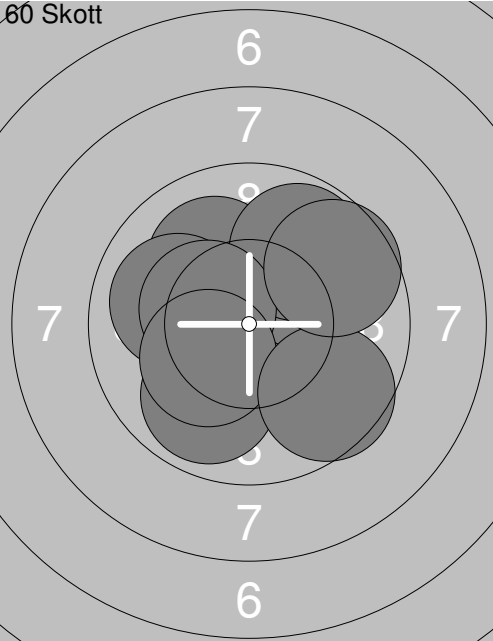
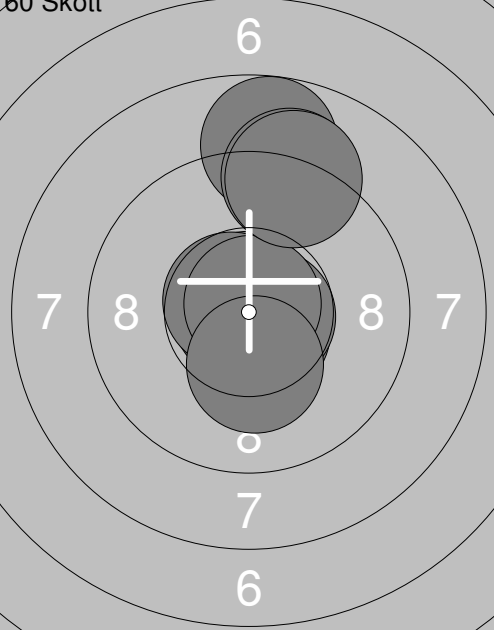
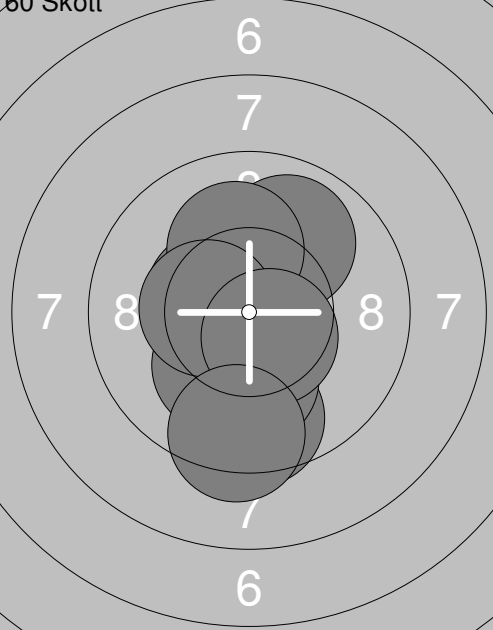
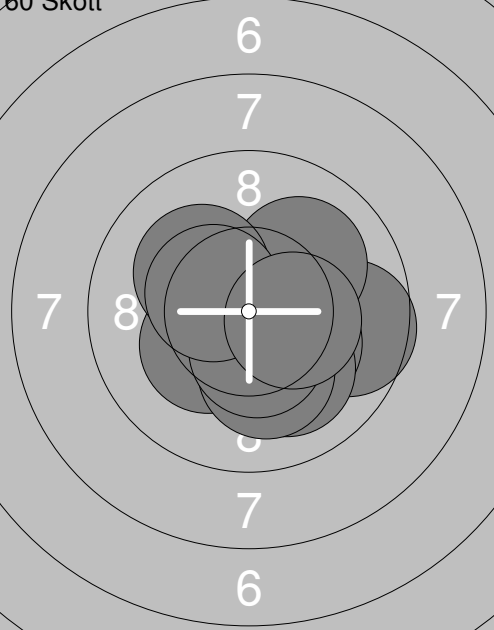
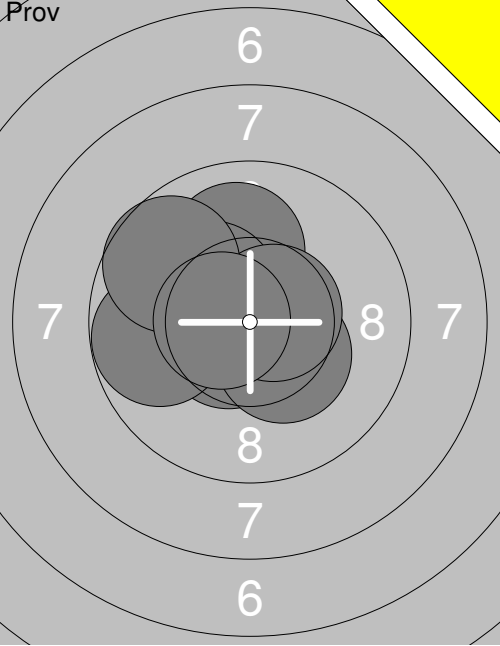
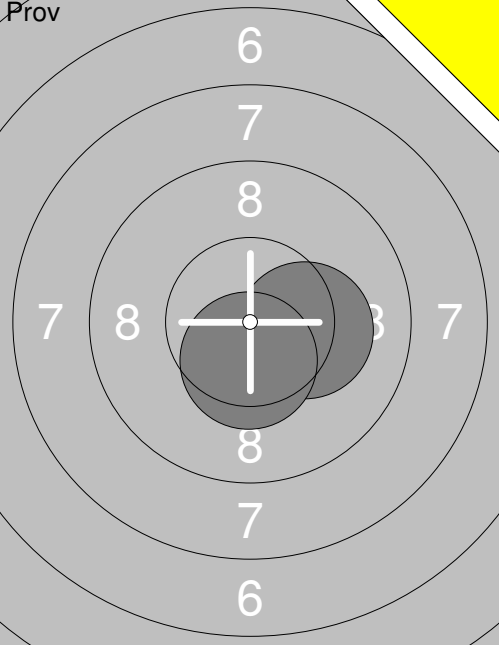
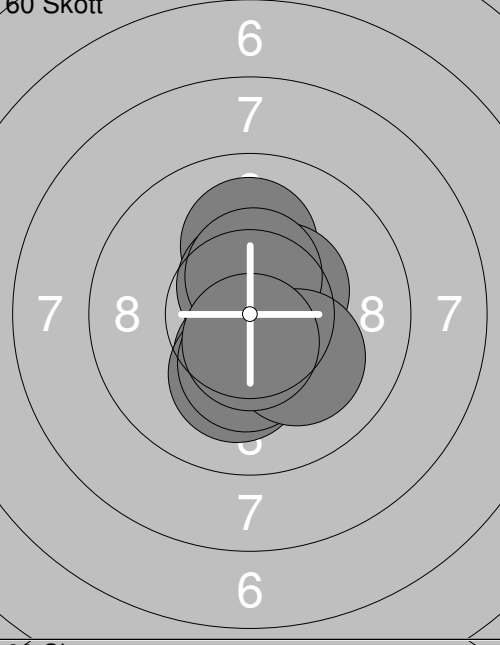
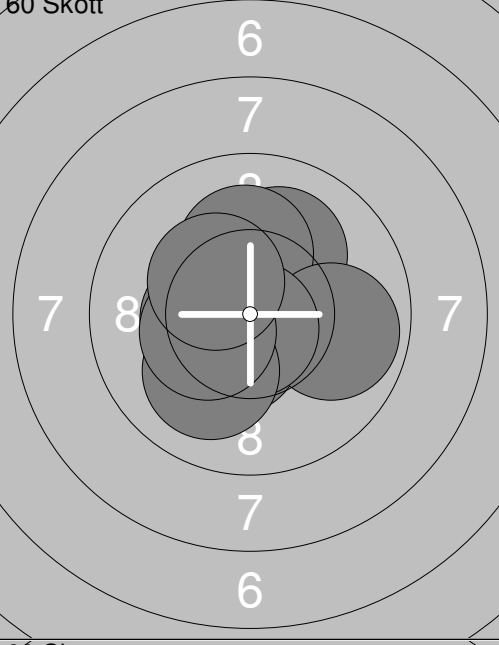
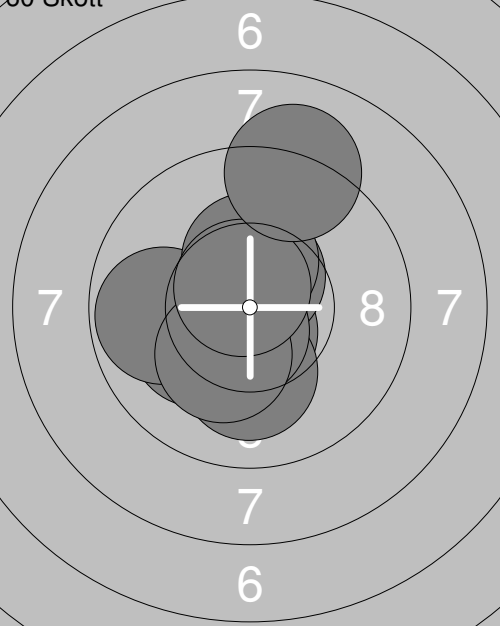
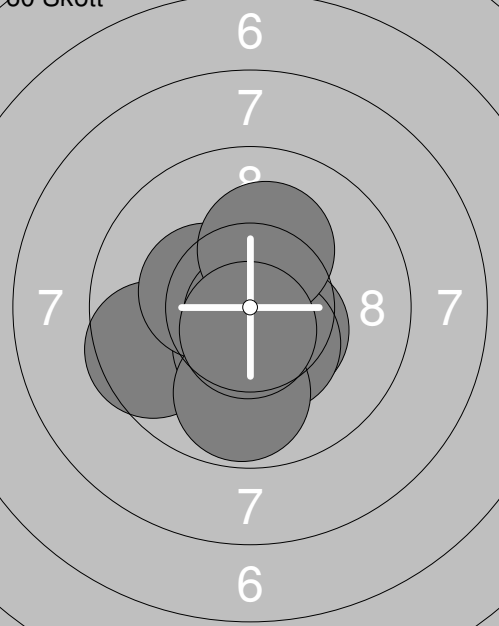
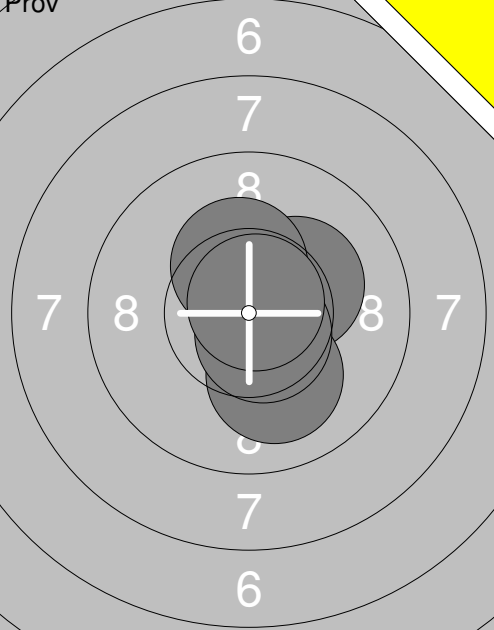
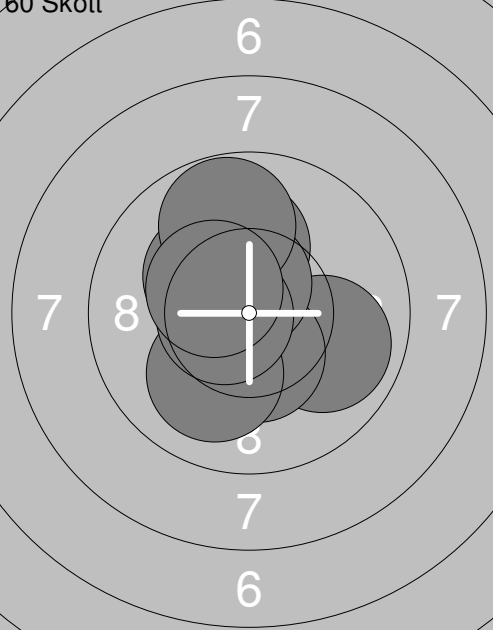
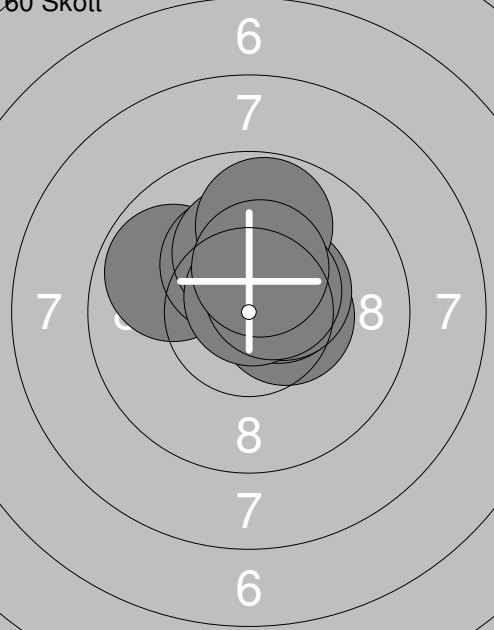
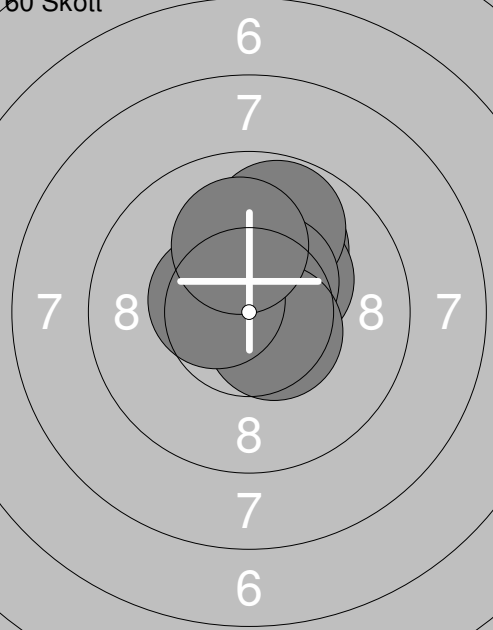
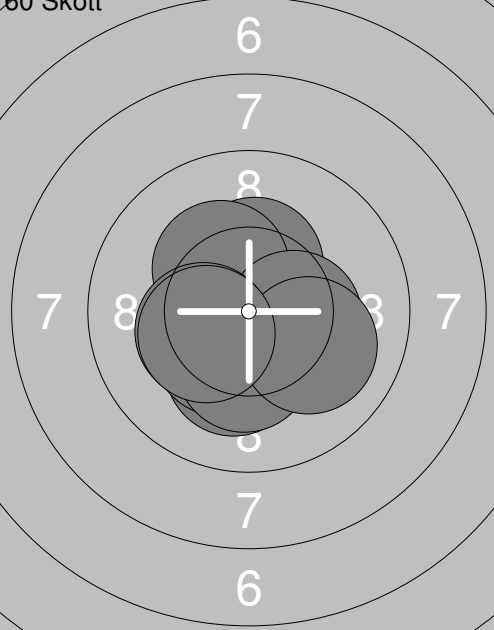

Skjutlag	Tavla	Hanna Johansson	
S	Vännäs Skf		
27.01.2018	Förbundsmästerskap 2018	Umeå skytteallians	
Pröv		1: 8.6 → 2: 10.2x↗ 3: 9.6 → 4: 8.5 ← 5: 9.2 ↓ 6: 9.1 ← 7: 9.7 ↖ 8: 10.4x→ 9: 10.0→ 10: 9.3 ↓ Serie 91.0 Total 0.0	11: 10.1 ↘ 12: 9.5 ↙ 13: 10.2x↓ 14: 9.7 ↓ 15: 8.2 ↓ Serie 46.0 Total 0.0
60 Skott		1: 10.1 ↙ 2: 9.9 ↙ 3: 8.8 ← 4: 10.4x↗ 5: 10.5x↗ 6: 10.7x→ 7: 9.4 ↙ 8: 10.0← 9: 10.4x↘ 10: 10.5x↓ Serie 96.0 Total 96.0	11: 10.6x↖ 12: 10.2x↖ 13: 10.1← 14: 10.2x↗ 15: 9.1 ↖ 16: 10.0↖ 17: 9.7 → 18: 10.5x↗ 19: 10.0 ↓ 20: 9.9 ↓ Serie 97.0 Total 193.0
60 Skott		21: 9.9 ↓ 22: 9.8 ← 23: 9.0 ↘ 24: 7.8 ← 25: 10.0 ↓ 26: 9.8 ↑ 27: 10.5x↗ 28: 10.7x↖ 29: 9.9 ↓ 30: 9.1 ← Serie 91.0 Total 284.0	31: 9.1 ↙ 32: 10.0 ↖ 33: 9.7 ↓ 34: 9.7 → 35: 9.5 → 36: 9.9 ↓ 37: 9.0 ↓ 38: 9.6 ← 39: 10.1 ↘ 40: 9.5 ↑ Serie 92.0 Total 376.0

Skjutlag <b>1</b>	Tavla <b>21</b>	<b>Markus-Pekka Dreyer Perkiömäki</b>	
S		Umeå Skf	
27.01.2018		Förbundsmästerskap 2018	Umeå skytteallians
	1: 9.8 ↙ 2: 9.7 ↙ 3: 10.4x↗ 4: 9.3 ↓ 5: 9.3 ↓ 6: 10.1 ↘ 7: 10.5x↑ 8: 10.2x←		1: 10.4x↘ 2: 10.0 ↗ 3: 10.1 ↖ 4: 9.8 ↗ 5: 10.0 ← 6: 10.4x↖ 7: 9.9 ↓ 8: 10.3x↘ 9: 9.6 ↘ 10: 9.6 ↗
Serie 76.0		Serie 96.0	
Total 0.0		Total 96.0	
	11: 10.6x↘ 12: 10.7x→ 13: 10.8x← 14: 10.8x↑ 15: 10.7x↖ 16: 10.8x↑ 17: 8.8 ↑ 18: 9.1 ↑ 19: 9.1 ↑ 20: 10.3x↓		21: 9.6 ↓ 22: 10.4x↘ 23: 10.5x↖ 24: 10.1 ↓ 25: 10.2x↘ 26: 9.9 ↗ 27: 10.1 ↑ 28: 10.4x← 29: 10.5x↘ 30: 9.4 ↓
Serie 96.0		Serie 97.0	
Total 192.0		Total 289.0	
	31: 10.3x↘ 32: 9.6 → 33: 10.1 ↗ 34: 10.2x↘ 35: 10.1 ↓ 36: 10.2x↖ 37: 10.1 ↓ 38: 10.5x↘ 39: 10.4x↖ 40: 10.4x→		
Serie 99.0			
Total 388.0			

Skjutlag	Tavla	Linda Strandgren	
1	23		
S	Umeå Skf		
27.01.2018	Förbundsmästerskap 2018	Umeå skytteallians	
Prov		Prov	
	1: 10.6x↘ 2: 10.7x↘ 3: 10.7x↘ 4: 10.0 ↑ 5: 10.3x↘ 6: 10.3x↘ 7: 10.6x➤ 8: 9.8 ← 9: 9.7 ↙ 10: 10.6x↖		11: 10.2x➤ 12: 10.4x↓ 13: 10.4x↖ 14: 10.5x↓ 15: 10.7x➤ 16: 10.1 ↑ 17: 10.2x↑ 18: 9.9 ➡ 19: 10.8x↓ 20: 10.1 ↓ 21: 10.4x↖ 22: 10.5x↓ 23: 10.7x➤ 24: 10.1 ↑ 25: 10.2x↑ 26: 9.9 ➡ 27: 10.8x↓ 28: 10.1 ↓ 29: 10.4x↖ 30: 10.3x↘
	Serie 98.0		Serie 20.0
	Total 0.0		Total 0.0
60 Skott		60 Skott	
	1: 10.1 ↑ 2: 10.6x↑ 3: 10.4x↓ 4: 10.2x↓ 5: 10.3x↓ 6: 10.6x➤ 7: 10.4x➤ 8: 10.5x↑ 9: 10.1 ↘ 10: 10.6x↓		11: 10.4x↖ 12: 10.5x↓ 13: 10.7x➤ 14: 10.1 ↑ 15: 10.2x↑ 16: 9.9 ➡ 17: 10.8x↓ 18: 10.1 ↓ 19: 10.4x↖ 20: 10.3x↘
	Serie 100.0		Serie 99.0
	Total 100.0		Total 199.0
60 Skott		60 Skott	
	21: 10.2x↘ 22: 10.6x↓ 23: 10.5x↑ 24: 10.1 ↓ 25: 10.6x↓ 26: 9.8 ← 27: 10.2x↓ 28: 10.3x↑ 29: 10.7x↘ 30: 9.1 ↑		31: 10.6x↑ 32: 9.6 ← 33: 10.4x↓ 34: 10.4x↖ 35: 10.8x↓ 36: 10.5x↘ 37: 10.4x↓ 38: 9.8 ↓ 39: 10.2x↑ 40: 10.7x↓
	Serie 98.0		Serie 98.0
	Total 297.0		Total 395.0

Skjutlag <b>1</b>	Tavla <b>24</b>	<b>Edvin Strömberg</b>	
S		Vännäs Skf	
27.01.2018		Förbundsmästerskap 2018	Umeå skytteallians
Prov 	1: 10.2x ↗ 2: 10.1 ↓ 3: 10.3x ↗ 4: 10.6x ↘ 5: 10.8x ↗	60 Skott 	1: 10.3x ↗ 2: 10.1 ↑ 3: 9.9 ➤ 4: 10.4x ↘ 5: 10.0 ↘ 6: 10.6x ↗ 7: 10.3x ↗ 8: 9.8 ↑ 9: 10.6x ✕ 10: 10.4x ✕
	Serie 50.0		Serie 98.0
	Total 0.0		Total 98.0
60 Skott 	11: 9.8 ↙ 12: 10.5x ➤ 13: 10.5x ↗ 14: 10.4x ↗ 15: 10.3x ↗ 16: 10.2x ↗ 17: 10.8x ↗ 18: 9.8 ↑ 19: 10.5x ↗ 20: 10.4x ↗	60 Skott 	21: 10.7x ↗ 22: 10.3x ↗ 23: 10.0 ↗ 24: 10.6x ↗ 25: 10.3x ↗ 26: 9.8 ↑ 27: 10.5x ↗ 28: 10.5x ↘ 29: 10.5x ✕ 30: 10.1 ↑
	Serie 98.0		Serie 99.0
	Total 196.0		Total 295.0
60 Skott 	31: 10.4x ↗ 32: 10.2x ↘ 33: 10.3x ✕ 34: 10.4x ↘ 35: 10.5x ↘ 36: 10.4x ➤ 37: 10.3x ↘ 38: 10.1 ➤ 39: 10.3x ✕ 40: 10.3x ✕		
	Serie 100.0		
	Total 395.0		

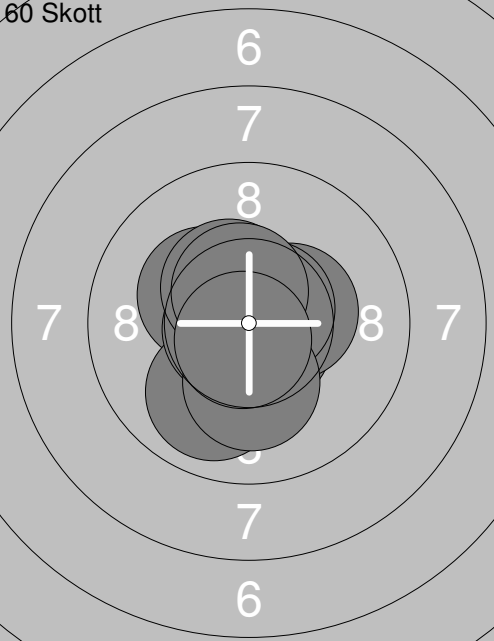
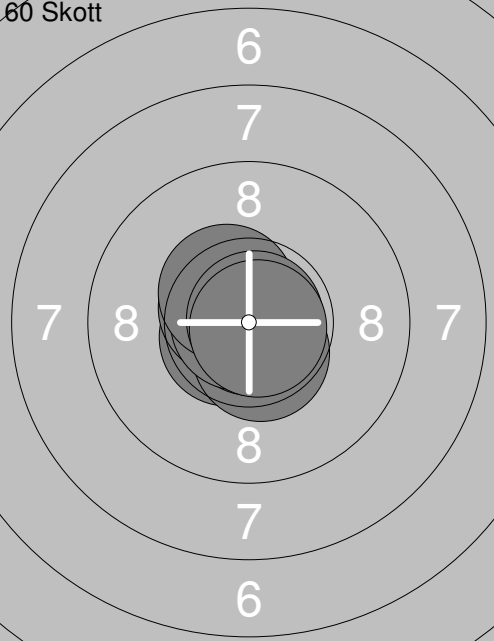
Skjutlag	Tavla	Claes-Göran Johansson	
1	25		
S	Umeå Skf		
27.01.2018	Förbundsmästerskap 2018	Umeå skytteallians	
Prov		1: 10.7x↘ 2: 10.5x↔ 3: 10.3x↘ 4: 10.5x↘ 5: 10.7x↗ 6: 10.5x↘ 7: 10.3x↗ 8: 10.4x➤ 9: 10.4x↘ 10: 10.6x↘ Serie 100.0 Total 0.0	11: 10.5x↔ 12: 10.5x➤ 13: 10.8x↘ Serie 30.0 Total 0.0
60 Skott		1: 10.7x↘ 2: 10.3x↘ 3: 9.9 ↘ 4: 10.7x↘ 5: 10.4x↘ 6: 10.4x➤ 7: 10.7x↗ 8: 10.5x↗ 9: 10.2x↓ 10: 10.7x↓ Serie 99.0 Total 99.0	11: 10.6x↘ 12: 10.3x➤ 13: 10.5x↗ 14: 10.7x➤ 15: 10.7x↘ 16: 10.8x↘ 17: 10.6x↗ 18: 10.4x↘ 19: 10.5x➤ 20: 10.4x↗ Serie 100.0 Total 199.0
60 Skott		21: 10.7x↓ 22: 10.8x↘ 23: 10.6x↘ 24: 10.5x↓ 25: 10.9x↘ 26: 10.6x↘ 27: 10.8x↔ 28: 10.5x↘ 29: 10.9x➤ 30: 10.8x↘ Serie 100.0 Total 299.0	31: 10.8x↘ 32: 10.6x↓ 33: 10.8x↘ 34: 10.5x↘ 35: 10.7x↔ 36: 10.6x↗ 37: 10.7x➤ 38: 10.5x↘ 39: 10.6x↗ 40: 10.8x↗ Serie 100.0 Total 399.0

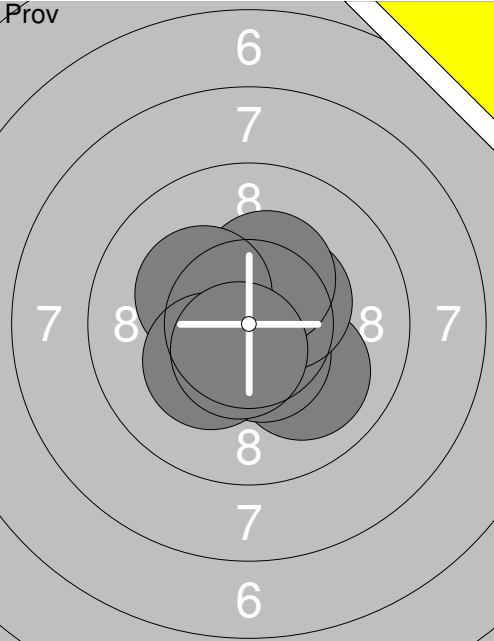
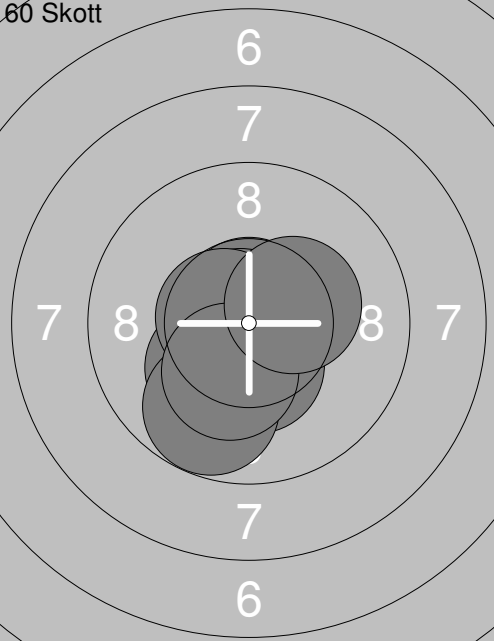
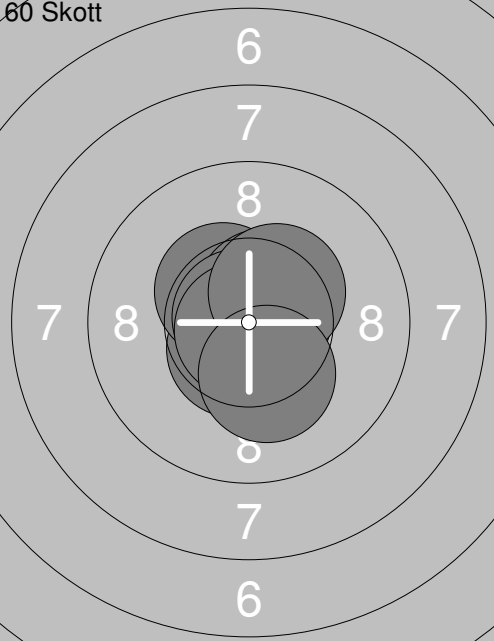
Skjutlag	Tavla	Hanna Augustsson	
S	Vännäs Skf		
27.01.2018	Förbundsmästerskap 2018	Umeå skytteallians	
Prov		1: 10.0 ↘ 2: 10.5x↑ 3: 10.7x↘ 4: 10.5x↘ 5: 10.4x↗ 6: 10.6x↘ 7: 10.3x↑ 8: 10.2x↘ 9: 10.3x↘ 10: 10.6x↘ Serie 100.0 Total 0.0	11: 10.4x↘ 12: 10.2x↘ 13: 10.9x↘ 14: 10.7x➤ Serie 40.0 Total 0.0
60 Skott		1: 10.6x↘ 2: 10.7x↑ 3: 10.2x↘ 4: 10.8x↘ 5: 10.8x↘ 6: 10.6x↘ 7: 10.4x↘ 8: 9.8 ↘ 9: 10.3x↘ 10: 10.3x➤ Serie 99.0 Total 99.0	11: 10.2x↘ 12: 10.3x➤ 13: 9.9 ↑ 14: 10.5x↑ 15: 10.5x↑ 16: 10.6x↘ 17: 10.6x↑ 18: 10.8x➤ 19: 10.8x➤ 20: 10.5x↘ Serie 99.0 Total 198.0
60 Skott		21: 10.8x↑ 22: 10.6x↘ 23: 10.7x↘ 24: 10.4x↘ 25: 10.6x↑ 26: 10.8x↘ 27: 10.8x➤ 28: 10.8x↘ 29: 10.4x↑ 30: 10.2x↘ Serie 100.0 Total 298.0	31: 10.6x↘ 32: 10.4x↘ 33: 10.8x↑ 34: 10.6x↘ 35: 10.3x↘ 36: 10.4x➤ 37: 10.0 ↘ 38: 10.4x↘ 39: 10.3x➤ 40: 10.5x↘ Serie 100.0 Total 398.0

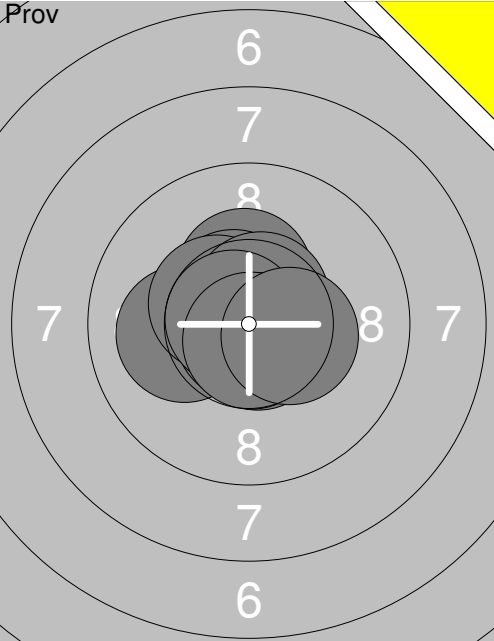
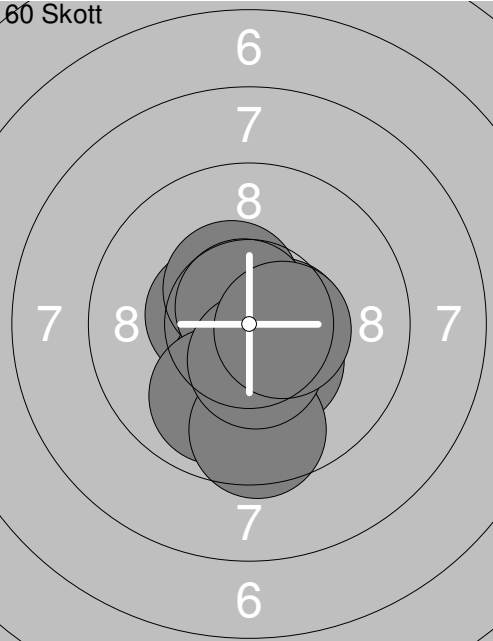
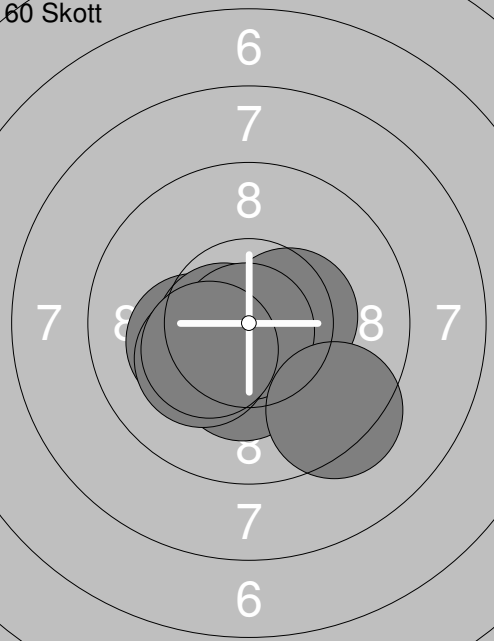
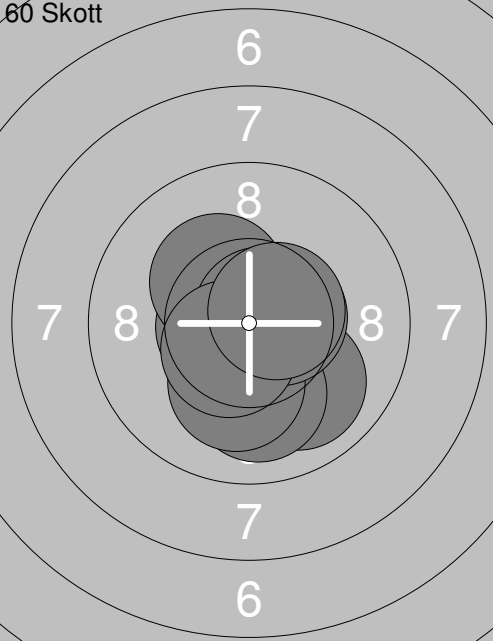
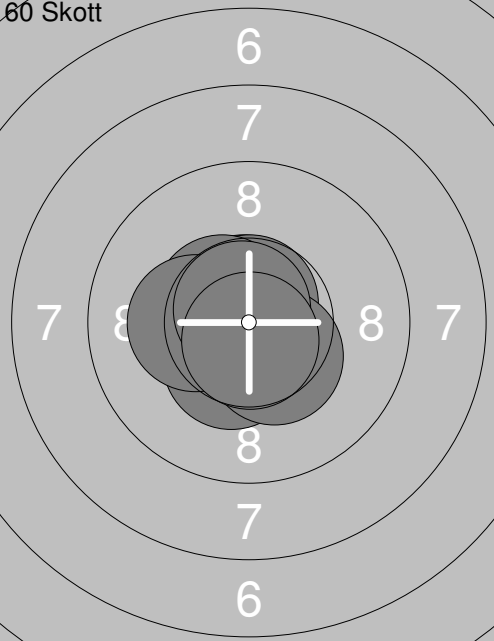

Skjutlag <b>1</b>	Tavla <b>28</b>	<b>Morgan Renman</b>	
S		Umeå Skf	
27.01.2018		Förbundsmästerskap 2018	Umeå skytteallians
Prov 	1: 10.3x↑ 2: 10.1← 3: 10.6x↘ 4: 10.8x↘ 5: 10.5x↘ 6: 10.6x↗ 7: 10.7x↘ 8: 10.7x↘ 9: 10.7x↘ 10: 10.4x➤ Serie 100.0 Total 0.0	60 Skott 	1: 10.5x↘ 2: 10.6x➤ 3: 10.4x↘ 4: 10.3x↘ 5: 10.7x↗ 6: 10.4x↘ 7: 9.9 ↓ 8: 9.6 ↓ 9: 10.5x↘ 10: 10.5x➤ Serie 98.0 Total 98.0
60 Skott 	11: 10.4x↘ 12: 10.7x↘ 13: 10.2x↘ 14: 10.4x➤ 15: 10.6x↘ 16: 10.3x↘ 17: 10.8x↘ 18: 10.2x↘ 19: 10.3x↘ 20: 9.4 ↓ Serie 99.0 Total 197.0	60 Skott 	21: 10.0 ↓ 22: 10.7x↘ 23: 10.0 ↓ 24: 10.2x↘ 25: 10.6x↘ 26: 10.3x↘ 27: 10.6x➤ 28: 10.8x➤ 29: 10.5x↘ 30: 10.6x➤ Serie 100.0 Total 297.0
60 Skott 	31: 10.7x↗ 32: 10.7x↘ 33: 10.7x↗ 34: 10.4x↘ 35: 10.7x↘ 36: 10.5x↘ 37: 10.3x↘ 38: 10.4x↘ 39: 10.8x↗ 40: 10.7x↘ Serie 100.0 Total 397.0		

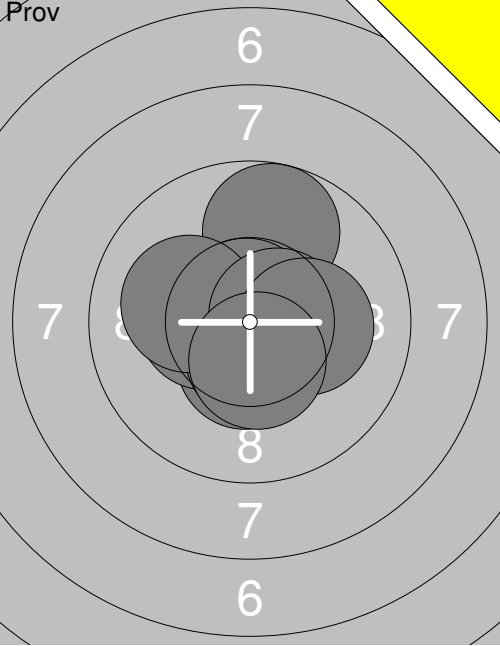
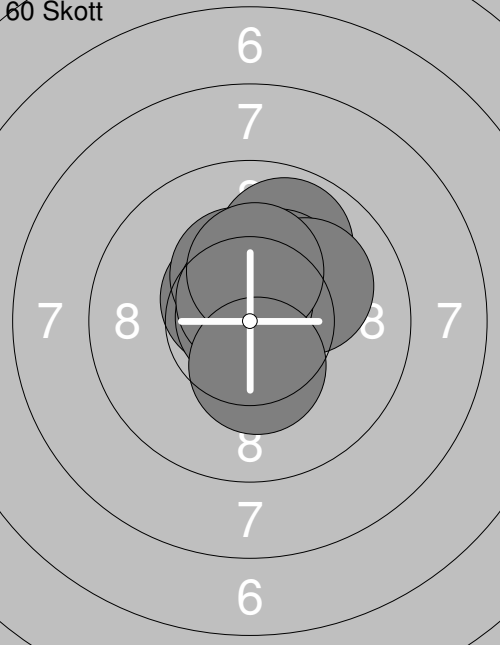
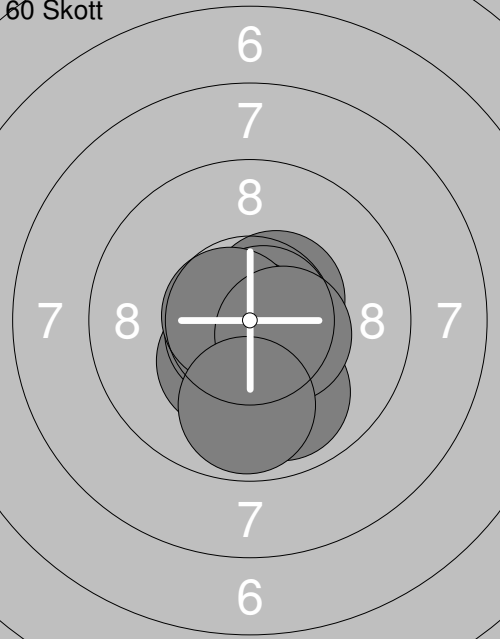
Skjuttlag	Tavla	Hanna Åsberg	
1	29		
S	Ramselefors Skf		
27.01.2018	Förbundsmästerskap 2018	Umeå skytteallians	
Prov		1: 9.7 ↑ 2: 10.4x↓ 3: 10.7x↔ 4: 10.4x↔ 5: 10.5x↓ 6: 10.7x↑ 7: 10.1↔ 8: 10.6x➤ 9: 10.2x➤ 10: 10.4x↓ Serie 99.0 Total 0.0	11: 10.5x↘ 12: 10.9x➤ 13: 10.5x↘ Serie 30.0 Total 0.0
60 Skott		1: 10.6x↘ 2: 10.9x↘ 3: 10.8x↑ 4: 9.9 ↑ 5: 10.3x↑ 6: 10.1 ➤ 7: 10.3x↑ 8: 10.7x↑ 9: 10.3x↑ 10: 10.4x↓ Serie 99.0 Total 99.0	11: 10.4x↓ 12: 10.5x↑ 13: 10.2x↘ 14: 10.6x↘ 15: 10.0 ↓ 16: 10.7x↔ 17: 10.1 ↑ 18: 10.8x➤ 19: 10.7x↓ 20: 10.8x↔ Serie 100.0 Total 199.0
60 Skott		21: 10.5x↗ 22: 10.8x➤ 23: 9.9 ↓ 24: 10.3x↓ 25: 10.9x↓ 26: 10.7x↔ 27: 10.7x↓ 28: 10.7x↔ 29: 10.5x➤ 30: 9.8 ↓ Serie 98.0 Total 297.0	31: 9.8 ↓ 32: 10.4x↑ 33: 10.4x↘ 34: 10.7x↗ 35: 10.5x↘ 36: 10.7x↓ 37: 10.5x↑ 38: 10.7x↑ 39: 10.9x↘ 40: 10.6x➤ Serie 99.0 Total 396.0

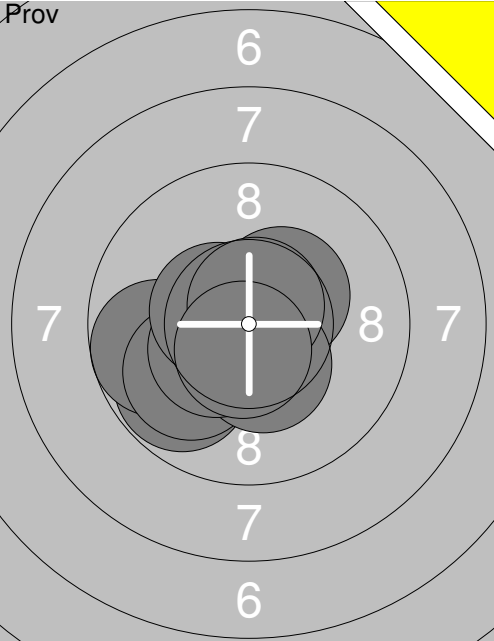
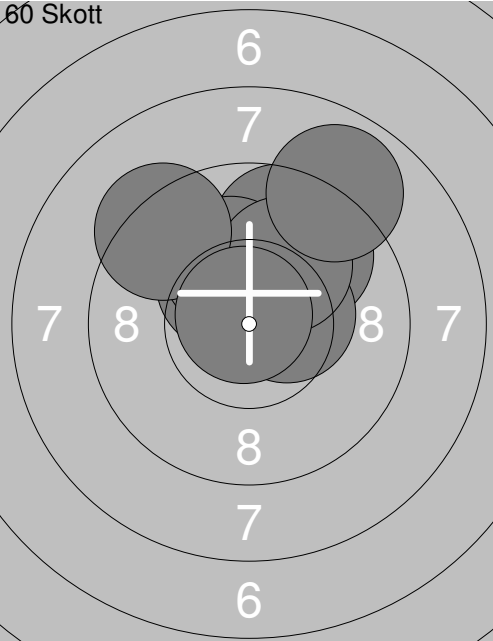
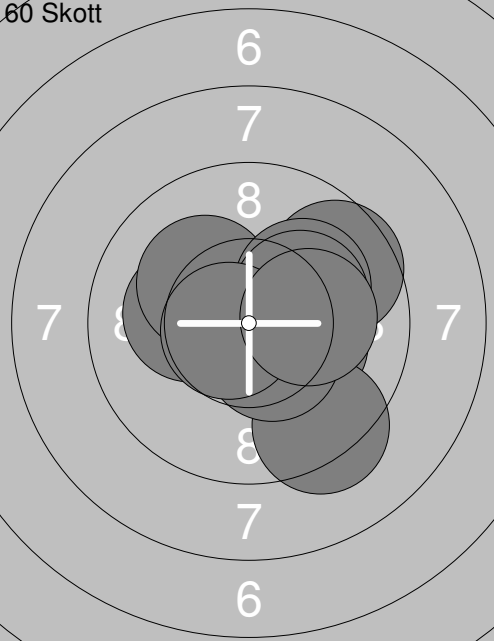
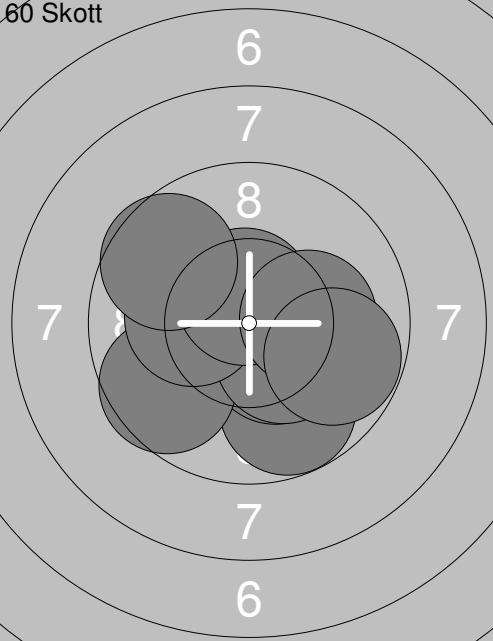
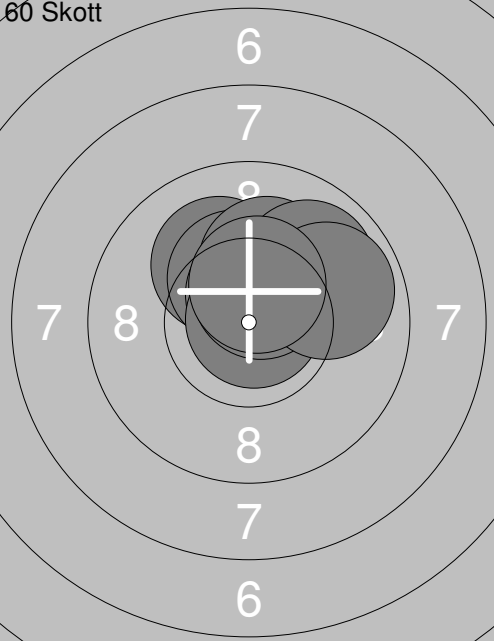

Skjutlag	Tavla	Irma Karlsson	
S	Vännäs Skf		
27.01.2018	Förbundsmästerskap 2018	Umeå skytteallians	
Prov		Prov	
	1: 8.8 ↘ 2: 8.6 ↘ 3: 9.3 ➤ 4: 9.8 ➔ 5: 10.3x↘ 6: 9.6 ➤ 7: 9.5 ➤ 8: 9.4 ➔ 9: 10.3x↘ 10: 10.7x↗		11: 10.5x↘ 12: 10.5x↘ 13: 10.2x↗ 14: 10.7x➤ 15: 10.8x↗
	Serie 91.0 Total 0.0		Serie 50.0 Total 0.0
60 Skott		60 Skott	
	1: 10.6x↘ 2: 10.4x↘ 3: 10.3x↗ 4: 10.6x↗ 5: 10.5x↗ 6: 10.7x↗ 7: 10.1 ↑ 8: 9.8 ↖ 9: 10.0 ↘ 10: 10.3x↘		11: 10.8x↘ 12: 10.0 ↓ 13: 10.4x↖ 14: 10.0 ↓ 15: 10.5x↗ 16: 10.0 ↑ 17: 10.5x↖ 18: 10.8x↘ 19: 10.7x↗ 20: 10.3x↗
	Serie 99.0 Total 99.0		Serie 100.0 Total 199.0
60 Skott		60 Skott	
	21: 10.6x↘ 22: 10.5x↘ 23: 10.3x↖ 24: 10.4x↘ 25: 10.8x↗ 26: 10.4x↘ 27: 10.7x➤ 28: 10.4x➤ 29: 10.0 ↗ 30: 10.1 ↓		31: 10.0 ↓ 32: 10.3x↗ 33: 9.4 ↘ 34: 10.1 ↓ 35: 10.1 ↓ 36: 10.5x↘ 37: 10.5x↖ 38: 10.7x↘ 39: 10.5x↖ 40: 10.0 ↖
	Serie 100.0 Total 299.0		Serie 99.0 Total 398.0

Skjutlag <b>1</b>	Tavla <b>31</b>	<b>Jakob Hedman</b>	
S		Umeå Skf	
27.01.2018		Förbundsmästerskap 2018	Umeå skytteallians
	1: 9.8 ↙ 2: 10.0 ↙ 3: 9.7 ← 4: 10.4x ↗ 5: 10.0 ↙ 6: 10.4x ↘ 7: 10.4x ↘ 8: 10.5x ↘ 9: 10.7x ↗ 10: 10.6x ↘ Serie 98.0 Total 0.0		1: 10.3x ↘ 2: 10.5x ↗ 3: 9.7 ↗ 4: 9.8 ↗ 5: 10.1 ↗ 6: 10.4x ↗ 7: 10.1 ↗ 8: 8.9 ↗ 9: 9.3 ↙ 10: 10.8x ↘ Serie 95.0 Total 95.0
	11: 10.2x ↘ 12: 10.2x ↗ 13: 9.6 ↗ 14: 10.2x ↘ 15: 10.1 ↗ 16: 10.2x ↗ 17: 9.3 ↘ 18: 10.5x ↘ 19: 10.7x ↘ 20: 10.2x ↗ Serie 98.0 Total 193.0		21: 9.8 ↘ 22: 10.8x ↘ 23: 10.4x ↘ 24: 9.6 ↙ 25: 10.3x ↘ 26: 10.2x ↘ 27: 10.6x ↗ 28: 9.6 ↙ 29: 10.2x ↗ 30: 9.8 ↗ Serie 96.0 Total 289.0
	31: 10.3x ↗ 32: 10.1 ↗ 33: 10.4x ↗ 34: 10.6x ↗ 35: 10.2x ↗ 36: 10.9x ↗ 37: 9.9 ↗ 38: 10.5x ↗ 39: 9.9 ↗ 40: 10.4x ↗ Serie 98.0 Total 387.0		

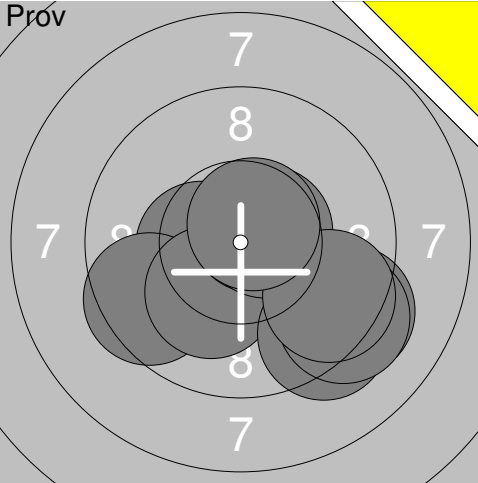
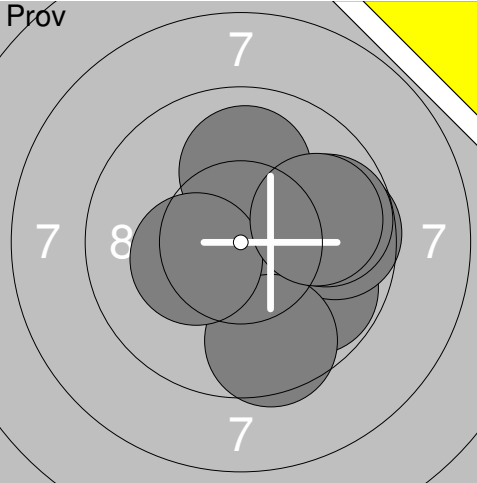
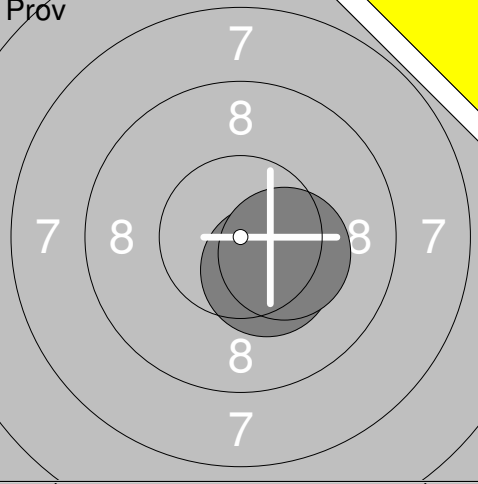
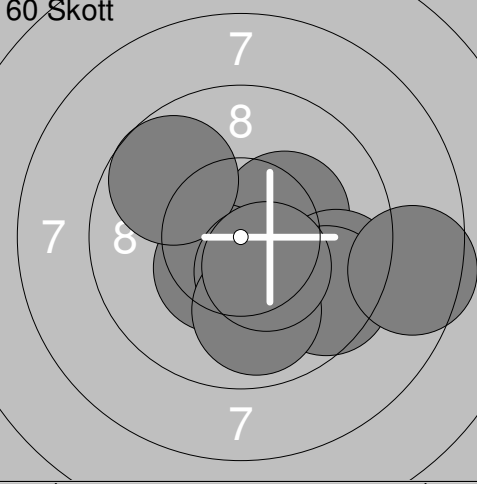
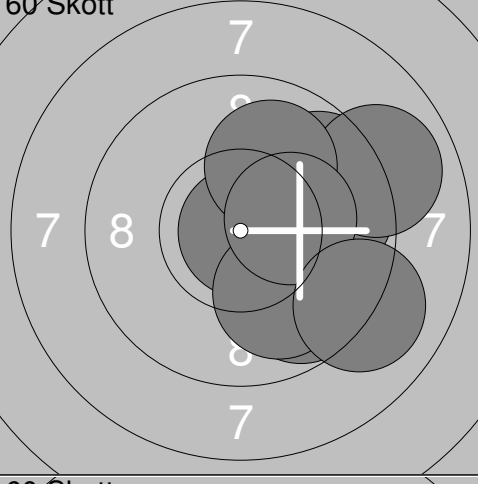
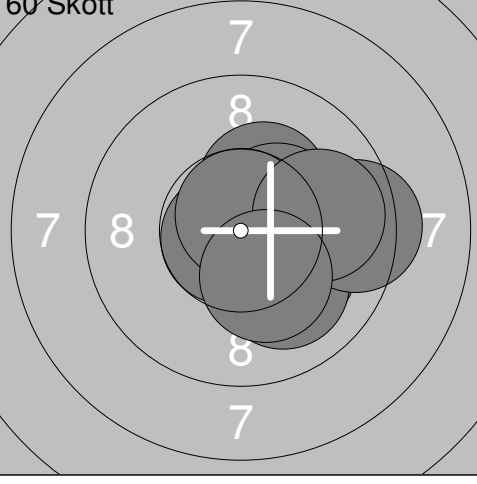
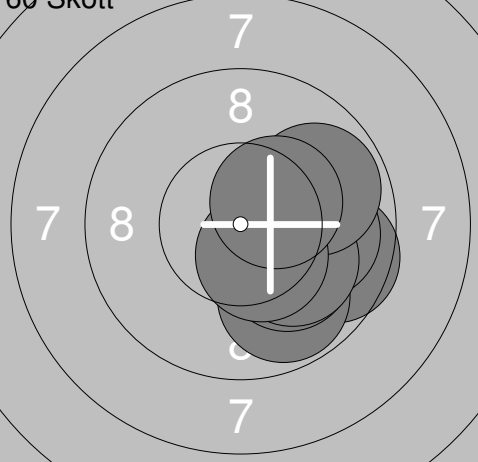
Skjutlag <b>1</b>	Tavla <b>32</b>	<b>Oscar Jonsson</b>	
S		Vännäs Skf	
27.01.2018		Förbundsmästerskap 2018	Umeå skytteallians
<b>Pröv</b> 	1: 10.4x ← 2: 9.5 ↙ 3: 10.2x ↘ 4: 9.3 ↘ 5: 9.2 ↘ 6: 10.7x ↗ 7: 10.6x → 8: 9.2 ↘ 9: 9.6 ↘ 10: 10.7x ↗ Serie 95.0 Total 0.0	<b>Pröv</b> 	11: 10.3x → 12: 10.7x → 13: 9.8 ↘ 14: 10.7x → 15: 9.7 → 16: 10.0 ↑ 17: 9.8 → 18: 9.6 ↘ 19: 10.3x ← 20: 9.9 → Serie 95.0 Total 0.0
<b>Pröv</b> 	21: 10.4x ↘ 22: 10.3x → Serie 20.0 Total 0.0	<b>60 Skott</b> 	1: 10.3x → 2: 9.5 → 3: 10.4x ↘ 4: 10.0 ↘ 5: 9.7 ↗ 6: 10.4x ↘ 7: 9.6 ↘ 8: 9.9 ↘ 9: 8.5 → 10: 10.4x ↘ Serie 94.0 Total 94.0
<b>60 Skott</b> 	11: 10.2x ↘ 12: 9.8 → 13: 10.9x → 14: 9.7 ↗ 15: 8.9 → 16: 9.7 ↘ 17: 10.0 ↗ 18: 10.0 ↘ 19: 10.3x → 20: 9.1 ↘ Serie 94.0 Total 188.0	<b>60 Skott</b> 	21: 10.3x ↗ 22: 10.1 ↘ 23: 10.0 ↘ 24: 10.7x ← 25: 10.7x → 26: 10.4x ↗ 27: 9.4 → 28: 10.7x ↑ 29: 9.9 → 30: 10.3x ↘ Serie 98.0 Total 286.0
<b>60 Skott</b> 	31: 10.2x ↘ 32: 9.6 ↘ 33: 9.8 ↘ 34: 10.4x ↘ 35: 10.1 ↘ 36: 9.9 → 37: 10.1 ↘ 38: 9.8 → 39: 10.4x ↘ 40: 10.4x ↗ Serie 96.0 Total 382.0		

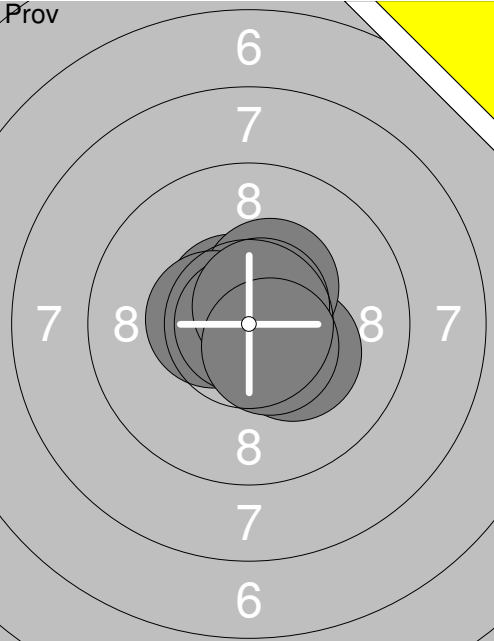
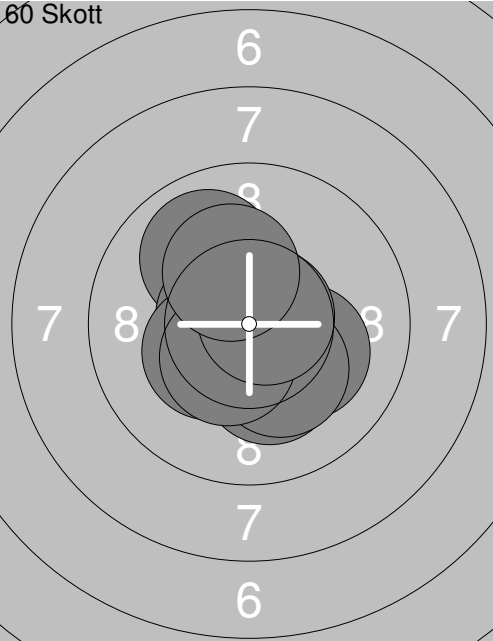
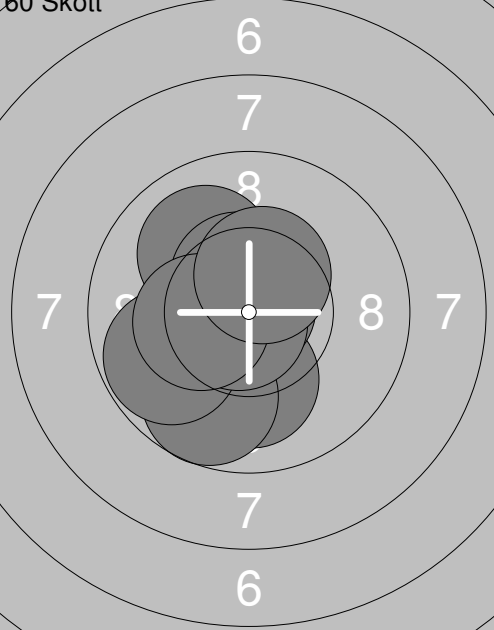
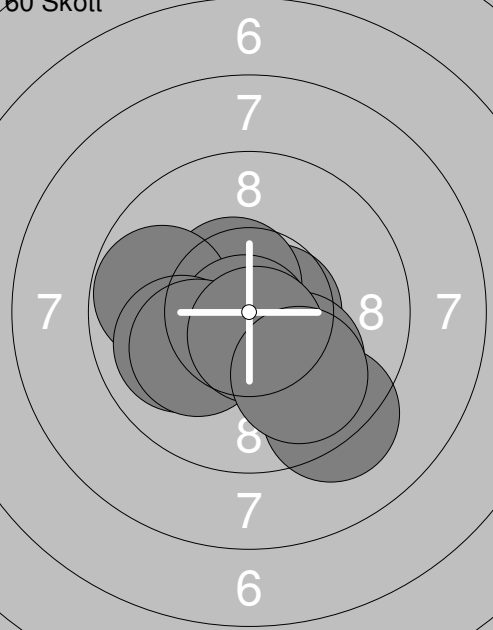
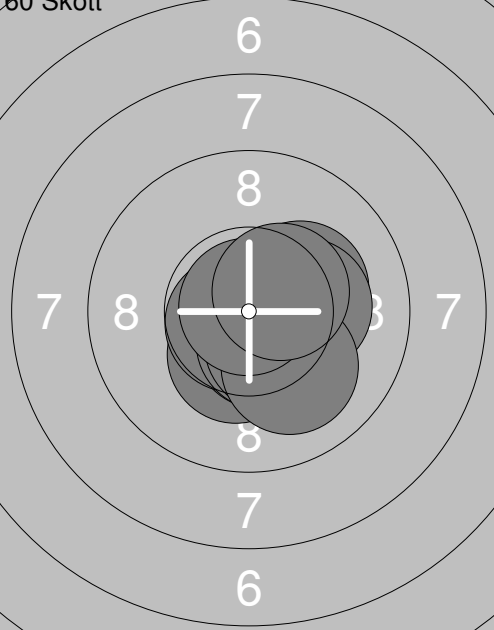
Skjutlag <b>1</b>	Tavla <b>33</b>	<b>Rasmus Alfredsson</b>	
S		Umeå Skf	
27.01.2018		Förbundsmästerskap 2018	Umeå skytteallians
	1: 10.6x↖ 2: 10.3x↘ 3: 10.4x↗ 4: 10.5x← 5: 10.9x← 6: 10.7x↗ 7: 10.5x↘		8: 9.9 ↖ 9: 10.2x↘ 10: 10.6x← 11: 10.2x↘ 12: 10.3x↘ 13: 10.9x↗ 14: 10.2x↘ 15: 10.4x↘ 16: 10.7x↗ 17: 10.2x↘
Serie 70.0		Serie 99.0	
Total 0.0		Total 99.0	
	11: 10.1 ↓ 12: 10.7x↘ 13: 9.7 ↓ 14: 10.0 ↖ 15: 10.5x↗ 16: 9.8 ← 17: 10.9x↗ 18: 10.8x↘ 19: 10.3x← 20: 10.4x↗		21: 10.6x→ 22: 10.5x↘ 23: 9.8 ← 24: 10.8x↘ 25: 10.0 ← 26: 10.1 ← 27: 10.1 ↘ 28: 10.6x↘ 29: 9.3 ↘ 30: 9.9 ↘
Serie 98.0		Serie 97.0	
Total 197.0		Total 294.0	
	31: 10.4x↘ 32: 10.2x→ 33: 10.5x↘ 34: 10.7x↘ 35: 10.5x↘ 36: 10.4x↘ 37: 10.2x→ 38: 10.1 ↘ 39: 10.9x↗ 40: 10.5x→		
Serie 100.0			
Total 394.0			

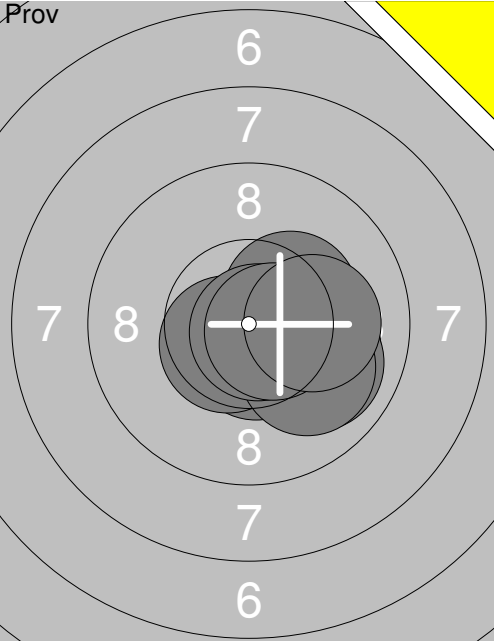
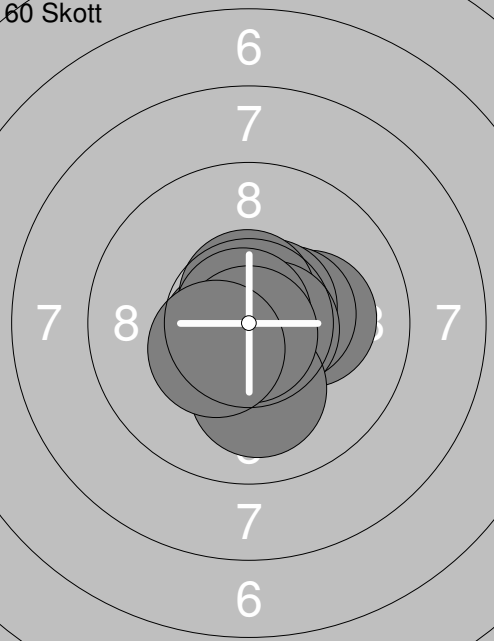
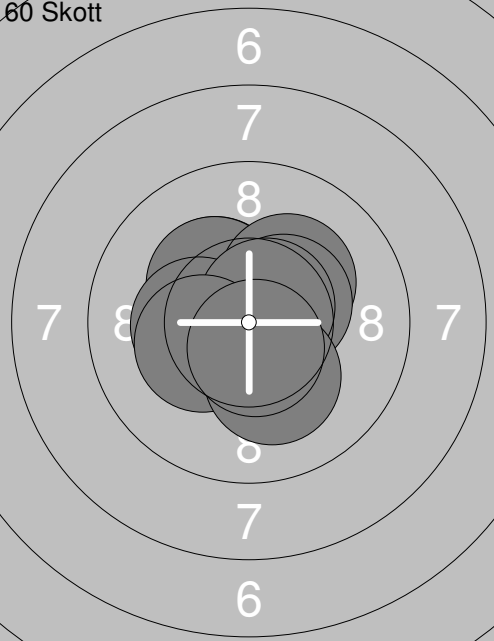
Skjutlag	Tavla	Ebba Lundstedt	
S		Ramselefors Skf	
27.01.2018	Förbundsmästerskap 2018	Umeå skytteallians	
Prov		1: 10.1 → 2: 10.4x ↘ 3: 10.6x ↘ 4: 9.9 → 5: 10.3x ↗ 6: 10.6x ↘ 7: 10.0 ↘ 8: 10.8x ↘ 9: 10.6x → 10: 10.1 → Serie 99.0 Total 0.0	11: 10.2x ↘ 12: 10.5x ↘ 13: 10.3x ↘ Serie 30.0 Total 0.0
60 Skott		1: 10.2x → 2: 10.4x → 3: 10.6x ↗ 4: 10.6x ↘ 5: 10.6x ↗ 6: 10.7x → 7: 10.8x ↘ 8: 10.1 ↓ 9: 10.8x ↘ 10: 10.4x ↘ Serie 100.0 Total 100.0	11: 10.7x ↗ 12: 10.2x ↘ 13: 10.6x ↘ 14: 10.8x ↘ 15: 10.4x ↗ 16: 10.6x ↘ 17: 10.4x ↗ 18: 10.3x ↘ 19: 10.3x ↗ 20: 10.7x ↗ Serie 100.0 Total 200.0
60 Skott		21: 10.3x ↘ 22: 10.3x ↘ 23: 10.3x ↘ 24: 10.2x ↗ 25: 10.3x ↘ 26: 10.4x ↗ 27: 10.6x ↗ 28: 10.3x ↘ 29: 10.2x ↘ 30: 10.6x ↘ Serie 100.0 Total 300.0	31: 10.0 → 32: 10.3x ↘ 33: 10.2x → 34: 10.0 ↘ 35: 10.4x ↘ 36: 10.0 ↘ 37: 10.9x ↘ 38: 10.7x ↗ 39: 10.2x → 40: 10.6x → Serie 100.0 Total 400.0

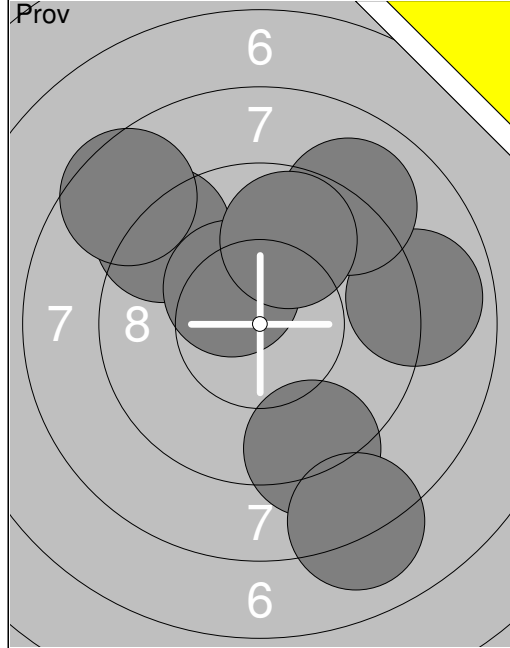

1:	9.2	↘
2:	8.1	↘
3:	8.9	→
4:	9.0	↗
5:	9.2	↖
6:	8.6	↖
7:	10.4x	↖
8:	9.8	↗
<b>Serie</b>		<b>70.0</b>
<b>Total</b>		<b>0.0</b>

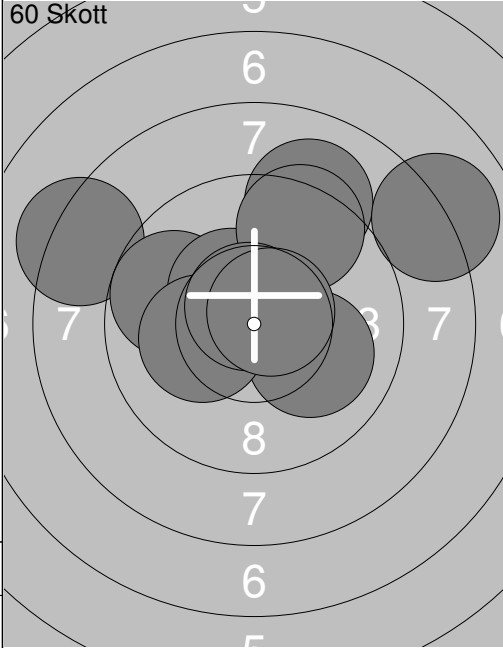

1:	8.3	↖
2:	9.8	↖
3:	9.1	↗
4:	10.1	↘
5:	10.4x	↖
6:	9.5	↗
7:	10.2x	↖
8:	10.7x	↗
9:	10.7x	↗
10:	8.0	↗
<b>Serie</b>		<b>93.0</b>
<b>Total</b>		<b>93.0</b>

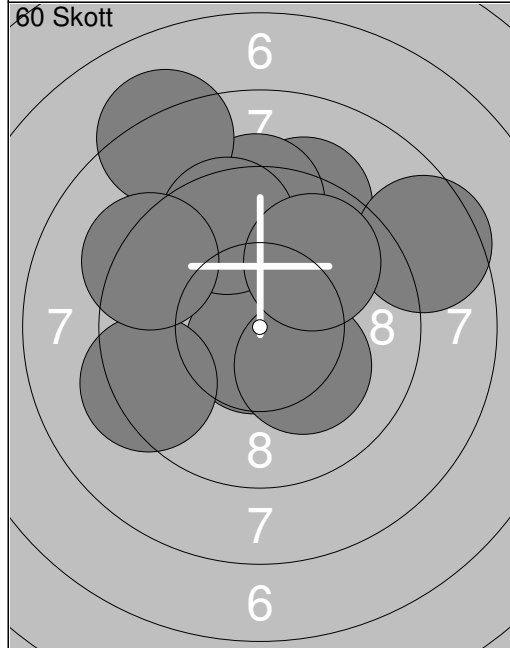

11:	9.3	↗
12:	10.7x	↘
13:	10.2x	↘
14:	9.3	↗
15:	8.2	↖
16:	9.6	↗
17:	8.6	↗
18:	9.3	↖
19:	9.9	↗
20:	9.3	↖
<b>Serie</b>		<b>90.0</b>
<b>Total</b>		<b>183.0</b>

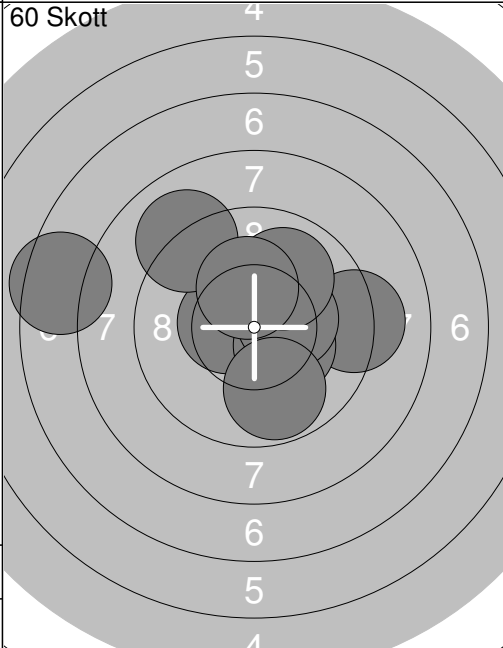

21:	10.4x	↘
22:	10.5x	↖
23:	9.2	→
24:	10.3x	↘
25:	10.4x	↗
26:	9.0	↖
27:	9.8	↘
28:	10.0	↗
29:	10.3x	↗
30:	7.5	↖
<b>Serie</b>		<b>94.0</b>
<b>Total</b>		<b>277.0</b>

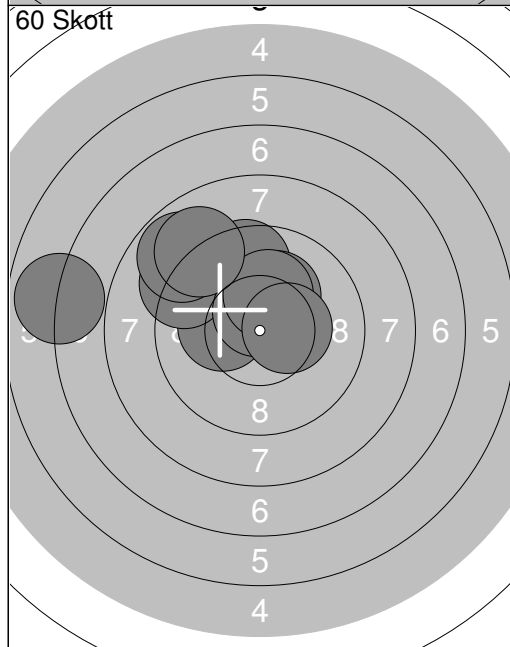

31:	10.2x	↖
32:	9.6	↗
33:	9.2	↖
34:	10.6x	↗
35:	6.9	↖
36:	10.2x	↗
37:	8.8	↖
38:	10.2x	↗
39:	10.4x	↗
40:	9.0	↖
<b>Serie</b>		<b>91.0</b>
<b>Total</b>		<b>368.0</b>

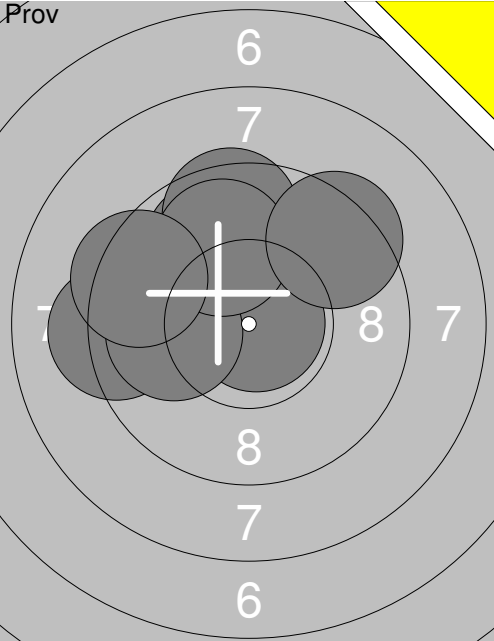
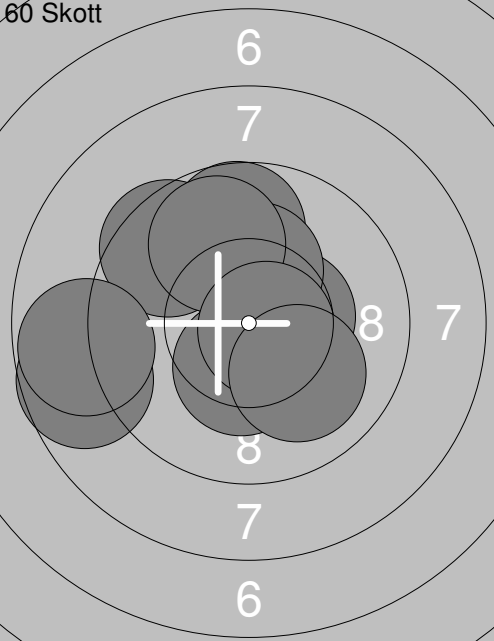
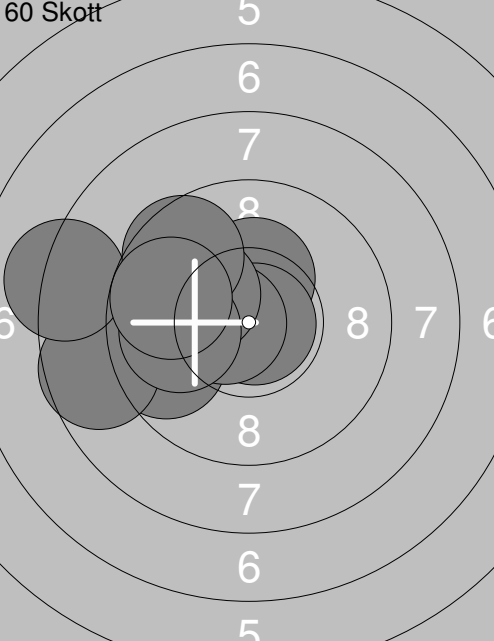

Skjutlag	Tavla	Siri Karlsson	
1	39		
S	Vännäs Skf		
27.01.2018	Förbundsmästerskap 2018	Umeå skytteallians	
Prov		1: 9.9 ↑ 2: 9.8 ↗ 3: 9.5 ↑ 4: 9.2 ← 5: 10.2 ✕ 6: 10.8x ➤ 7: 10.0 ← 8: 9.9 ↑ 9: 9.4 ↗ 10: 9.4 ← Serie 93.0 Total 0.0	11: 9.6 ↗ 12: 9.7 ↑ 13: 10.6x ↘ 14: 10.1 ↗ 15: 10.2x ↘ Serie 48.0 Total 0.0
60 Skott		1: 9.7 ↑ 2: 10.5x ➤ 3: 8.7 ← 4: 9.5 ↗ 5: 10.3x ↗ 6: 9.8 ↑ 7: 10.4x ↘ 8: 10.7x ➤ 9: 10.0 ↘ 10: 8.8 ← Serie 93.0 Total 93.0	11: 10.0 ← 12: 9.9 ↗ 13: 9.2 ← 14: 10.4x ↘ 15: 10.7x ✕ 16: 10.9x ↗ 17: 9.8 ↘ 18: 9.3 ↑ 19: 10.7x ↘ 20: 10.1 ↘ Serie 96.0 Total 189.0
60 Skott		21: 9.6 ← 22: 10.3x ↗ 23: 10.9x ➤ 24: 8.7 ← 25: 10.6x ✕ 26: 10.1 ↗ 27: 8.2 ← 28: 9.6 ↗ 29: 9.9 ← 30: 9.8 ← Serie 92.0 Total 281.0	31: 9.1 ← 32: 10.5x ✕ 33: 10.3x ↘ 34: 9.7 ↗ 35: 9.9 ↑ 36: 9.2 ↘ 37: 10.0 ↘ 38: 9.6 ← 39: 10.3x ➤ 40: 10.1 ↑ Serie 95.0 Total 376.0

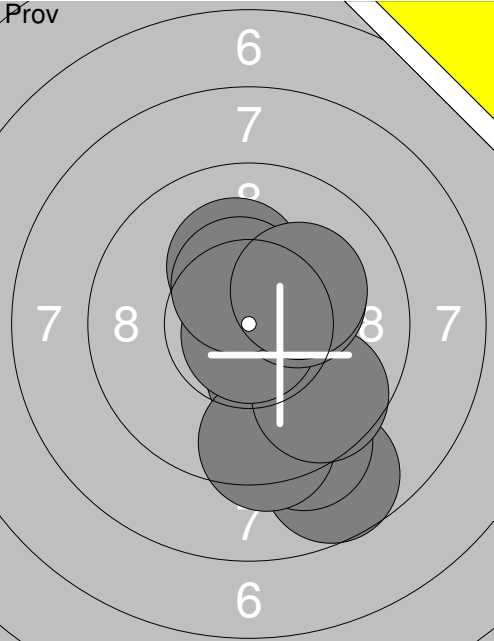
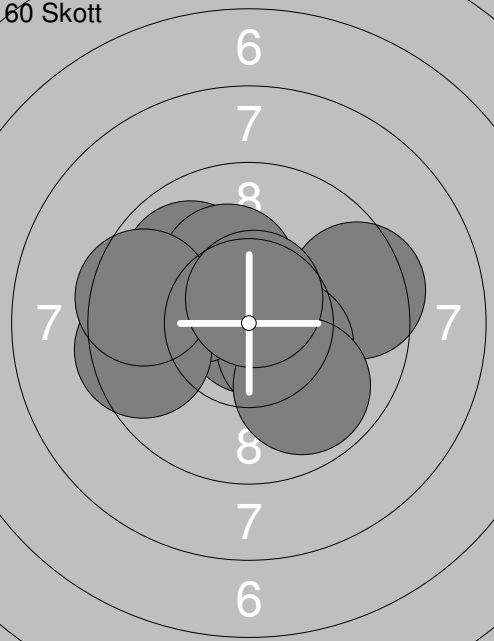
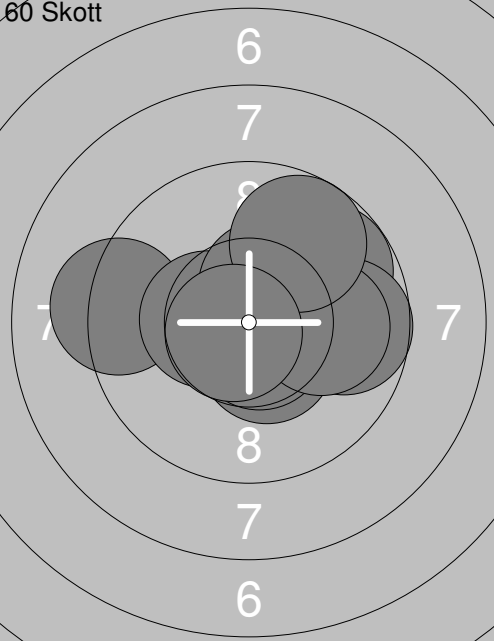
Skjutlag	Tavla	Ylva Lundstedt	
S		Ramselefors Skf	
27.01.2018	Förbundsmästerskap 2018	Umeå skytteallians	
Prov		1: 8.7 ↘ 2: 10.2x↘ 3: 9.2 ↘ 4: 9.4 ↘ 5: 9.6 ↘ 6: 10.2x↗ 7: 10.8x↘ 8: 10.2x↗ 9: 10.4x↗ 10: 10.2x↗ Serie 95.0 Total 0.0	11: 10.5x↘ Serie 10.0 Total 0.0
60 Skott		1: 9.5 → 2: 10.9x↘ 3: 10.4x↘ 4: 10.2x↘ 5: 9.9 ↖ 6: 9.5 ← 7: 9.9 ↘ 8: 10.2x↗ 9: 9.5 ← 10: 10.6x↗ Serie 95.0 Total 95.0	11: 10.6x↘ 12: 10.2x↗ 13: 10.6x↗ 14: 10.0 ↗ 15: 10.9x↗ 16: 9.6 ↖ 17: 10.2x↗ 18: 9.2 ↖ 19: 10.5x↘ 20: 10.4x↘ Serie 98.0 Total 193.0
60 Skott		21: 9.2 ← 22: 10.4x↖ 23: 10.5x↘ 24: 10.7x↘ 25: 10.4x↗ 26: 9.8 ↗ 27: 9.7 → 28: 10.0 → 29: 9.7 ↗ 30: 10.7x↖ Serie 96.0 Total 289.0	31: 10.6x↗ 32: 10.6x↖ 33: 10.3x↗ 34: 10.3x↖ 35: 9.8 ← 36: 10.4x↘ 37: 10.9x↗ 38: 10.3x↗ 39: 10.6x↗ 40: 10.0 ↘ Serie 99.0 Total 388.0

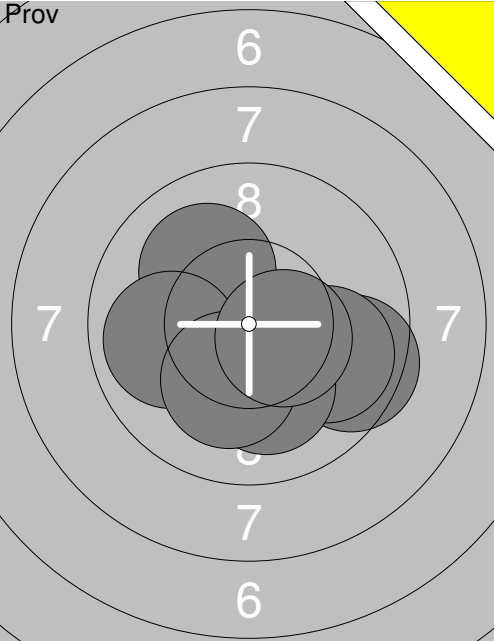
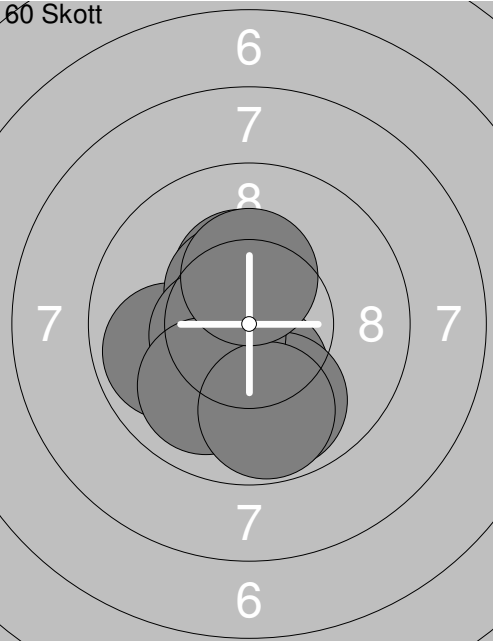
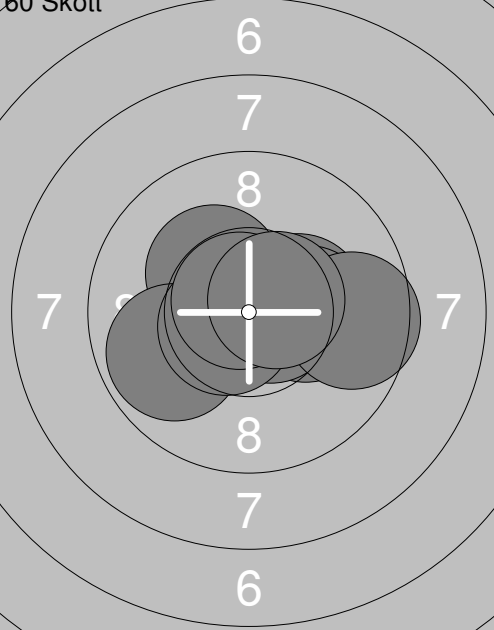
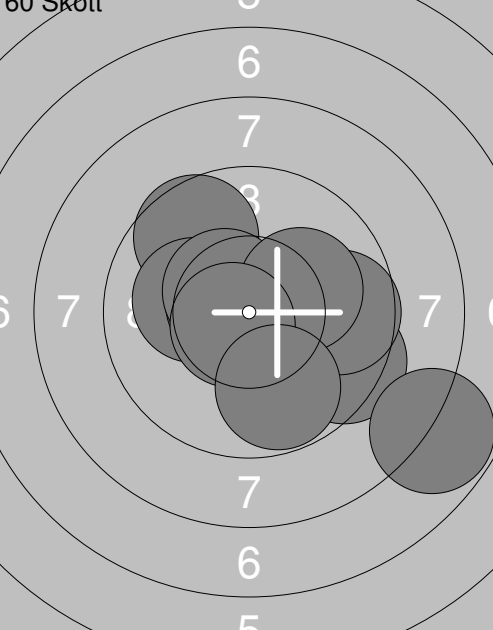
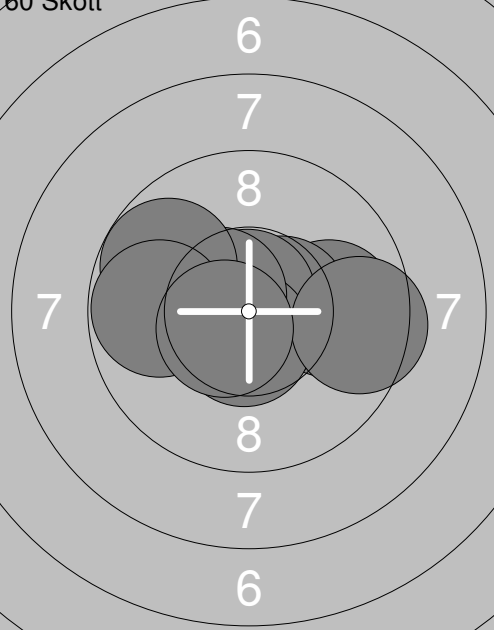
Skjuttlag <b>2</b>	Tavla <b>4</b>	<b>Hanna Lundin</b>	
S		Umeå Skf	
27.01.2018		Förbundsmästerskap 2018	Umeå skytteallians
	1: 10.1 ↗ 2: 9.5 → 3: 9.9 → 4: 9.9 ← 5: 10.1 ↓ 6: 10.2x ↓ 7: 10.5x →		1: 10.6x ↗ 2: 10.3x ↓ 3: 9.9 ← 4: 9.9 ↓ 5: 10.3x ↑ 6: 10.5x ↗ 7: 10.5x ← 8: 10.0 ↓ 9: 9.8 ↓ 10: 10.3x ↑
Serie 67.0		Serie 97.0	
Total 0.0		Total 97.0	
	11: 10.3x → 12: 10.2x → 13: 10.6x ← 14: 10.3x ↗ 15: 9.9 ← 16: 10.7x → 17: 10.6x ← 18: 9.6 → 19: 10.8x ↗ 20: 10.6x →		21: 9.4 → 22: 9.7 → 23: 9.6 ↗ 24: 10.1 ← 25: 10.6x ↗ 26: 10.5x ↗ 27: 10.1 → 28: 7.8 → 29: 10.6x ← 30: 9.8 ↓
Serie 98.0		Serie 93.0	
Total 195.0		Total 288.0	
	31: 9.9 → 32: 10.5x → 33: 10.8x ↑ 34: 10.6x ↓ 35: 10.6x ↓ 36: 9.5 → 37: 10.5x ↗ 38: 9.8 ↗ 39: 9.8 ← 40: 10.6x ←		
Serie 96.0			
Total 384.0			

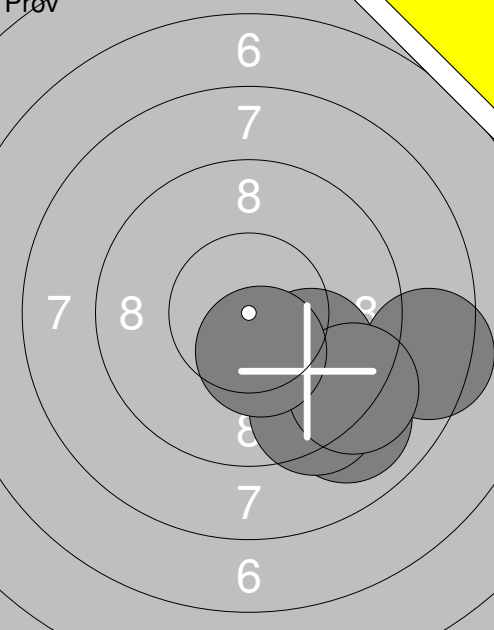
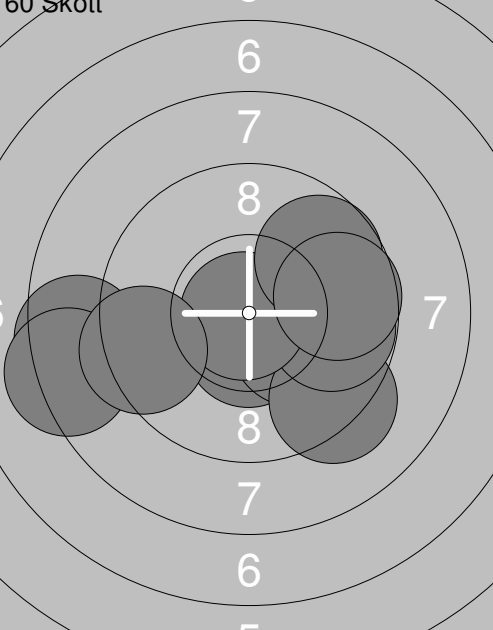
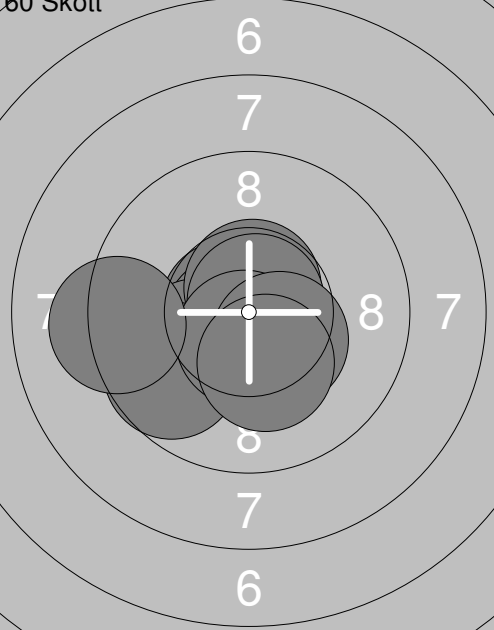
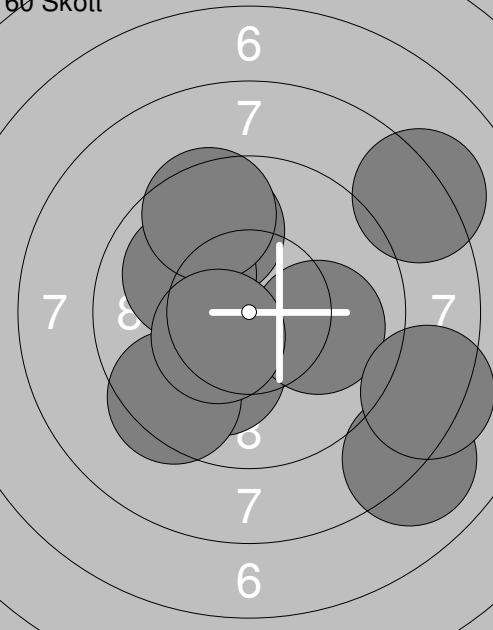
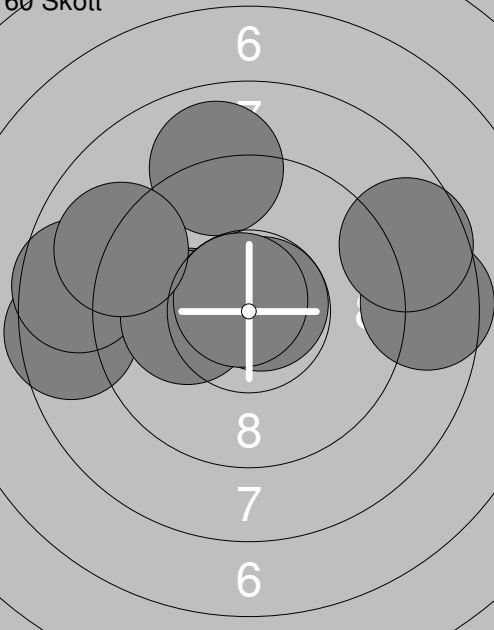
<p>Pröv</p> 	<p>1: 9.0 ↘ 2: 8.4 → 3: 9.9 ↘ 4: 9.3 ↘ 5: 9.2 ↘ 6: 10.4x↓</p> <p>Serie 54.0 Total 0.0</p>	<p>60 Skott</p> 	<p>1: 10.5x↓ 2: 10.2x↘ 3: 9.3 ↘ 4: 8.5 ← 5: 8.3 ← 6: 9.8 → 7: 10.9x↙ 8: 9.4 ← 9: 9.7 ↗ 10: 9.7 →</p> <p>Serie 91.0 Total 91.0</p>
<p>60 Skott</p> 	<p>11: 10.7x↙ 12: 10.7x↙ 13: 10.1 ↙ 14: 10.6x↑ 15: 10.8x↗ 16: 9.7 ↙ 17: 10.6x↓ 18: 10.4x↘ 19: 10.3x↓ 20: 9.2 ←</p> <p>Serie 98.0 Total 189.0</p>	<p>60 Skott</p> 	<p>21: 10.1 ↘ 22: 8.0 ↘ 23: 10.0 → 24: 9.8 ↑ 25: 10.0 ↖ 26: 8.3 → 27: 9.4 ↙ 28: 9.5 ↑ 29: 8.2 ↗ 30: 10.4x↙</p> <p>Serie 91.0 Total 280.0</p>
<p>60 Skott</p> 	<p>31: 10.8x↗ 32: 10.1 ← 33: 8.6 → 34: 8.5 ← 35: 9.0 ↑ 36: 8.6 ← 37: 8.7 ↗ 38: 10.1 ← 39: 10.8x↗ 40: 9.0 ↖</p> <p>Serie 90.0 Total 370.0</p>		

<p>Pröv</p>	<p>1: 10.1 ↙ 2: 7.3 → 3: 10.2x ↙ 4: 8.5 → 5: 8.7 ↘ 6: 7.8 ↗ 7: 8.9 ↗ 8: 8.0 ← 9: 9.2 ← 10: 10.3x ↗</p> <p>Serie 85.0 Total 0.0</p>	<p>Pröv</p>	<p>11: 9.3 ← 12: 10.2x ↗ 13: 8.7 ← 14: 9.3 → 15: 9.1 → 16: 8.5 → 17: 8.4 ↙ 18: 9.5 → 19: 9.5 ↙</p> <p>Serie 79.0 Total 0.0</p>
-------------	--	-------------	--

<p>60 Skott</p>	<p>1: 9.2 ↗ 2: 9.6 ↗ 3: 9.4 ↘ 4: 8.9 ↘ 5: 7.1 ← 6: 10.1 ↑ 7: 8.8 ← 8: 9.7 ↙ 9: 8.9 ↗ 10: 9.5 →</p> <p>Serie 86.0 Total 86.0</p>	<p>60 Skott</p>	<p>11: 9.0 ← 12: 10.3x ↘ 13: 8.2 ↘ 14: 8.4 ↙ 15: 9.7 ← 16: 7.5 ↘ 17: 8.5 ← 18: 9.6 ↘ 19: 10.7x ↘ 20: 10.4x →</p> <p>Serie 88.0 Total 174.0</p>
-----------------	---	-----------------	--

<p>60 Skott</p>	<p>21: 9.1 ↑ 22: 9.9 ↘ 23: 8.9 → 24: 9.7 ↘ 25: 9.4 → 26: 9.5 ← 27: 7.7 → 28: 7.6 ← 29: 10.6x ↘ 30: 9.4 ↙</p> <p>Serie 86.0 Total 260.0</p>	<p>60 Skott</p>	<p>31: 10.2x ↘ 32: 9.3 → 33: 8.5 ↘ 34: 9.1 ↗ 35: 9.6 ↗ 36: 9.6 → 37: 9.0 → 38: 7.4 → 39: 8.8 ↗ 40: 9.2 ←</p> <p>Serie 87.0 Total 347.0</p>
-----------------	--	-----------------	--

<p>Prov</p>	<p>1: 8.5 →</p> <p>2: 7.7 ↘</p> <p>3: 8.0 ↘</p> <p>4: 8.4 →</p> <p>5: 9.8 ←</p> <p>6: 9.7 ↓</p> <p>7: 8.8 ↙</p> <p>8: 9.6 ↓</p> <p>9: 8.2 ↙</p> <p>10: 8.3 ←</p> <p>Serie 82.0</p> <p>Total 0.0</p>	<p>Prov</p>	<p>11: 10.4x ↘</p> <p>12: 8.7 →</p> <p>13: 8.6 ↙</p> <p>14: 10.4x ↘</p> <p>Serie 36.0</p> <p>Total 0.0</p>
-------------	---	-------------	--

<p>60 Skott</p>	<p>1: 10.9x →</p> <p>2: 9.5 ↓</p> <p>3: 9.9 ↑</p> <p>4: 9.7 ←</p> <p>5: 9.9 ←</p> <p>6: 10.0 ↘</p> <p>7: 9.0 ←</p> <p>8: 10.2x ↗</p> <p>9: 9.6 ↓</p> <p>10: 8.3 ↘</p> <p>Serie 92.0</p> <p>Total 92.0</p>	<p>60 Skott</p>	<p>11: 10.5x →</p> <p>12: 9.6 ↙</p> <p>13: 8.0 ↓</p> <p>14: 9.5 ↘</p> <p>15: 7.1 ←</p> <p>16: 8.7 ←</p> <p>17: 8.9 ↙</p> <p>18: 7.2 ↓</p> <p>19: 9.7 ↑</p> <p>20: 10.3x →</p> <p>Serie 85.0</p> <p>Total 177.0</p>
-----------------	---	-----------------	--

<p>60 Skott</p>	<p>21: 7.4 ↙</p> <p>22: 8.6 ↙</p> <p>23: 9.9 ←</p> <p>24: 9.1 ↑</p> <p>25: 10.0 ←</p> <p>26: 10.2x ↘</p> <p>27: 10.2x ↘</p> <p>28: 9.1 ↓</p> <p>29: 8.6 →</p> <p>30: 9.0 ↓</p> <p>Serie 89.0</p> <p>Total 266.0</p>	<p>60 Skott</p>	<p>31: 9.1 ↓</p> <p>32: 8.5 ↙</p> <p>33: 8.9 ↙</p> <p>34: 8.7 ↙</p> <p>35: 9.9 ↘</p> <p>36: 8.3 ↓</p> <p>37: 7.8 ↙</p> <p>38: 9.9 ←</p> <p>39: 9.8 ↓</p> <p>40: 8.1 ↙</p> <p>Serie 83.0</p> <p>Total 349.0</p>
-----------------	---	-----------------	--

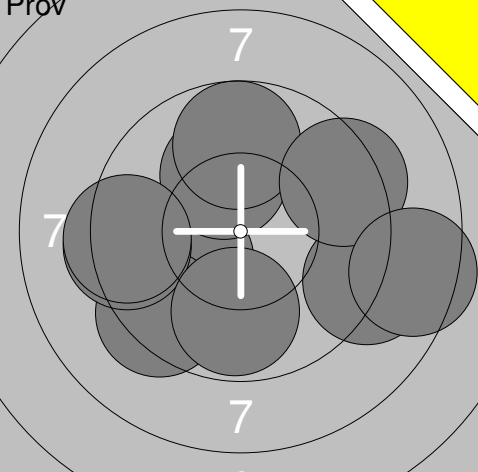
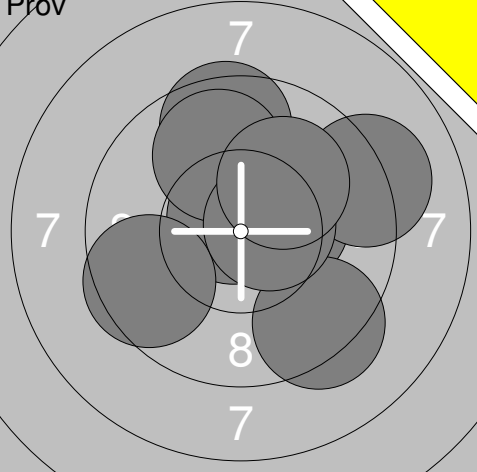
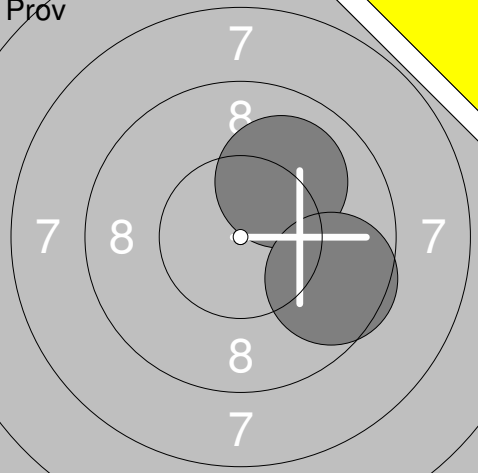
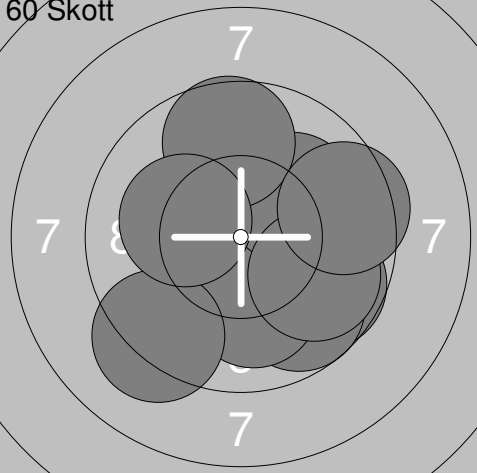
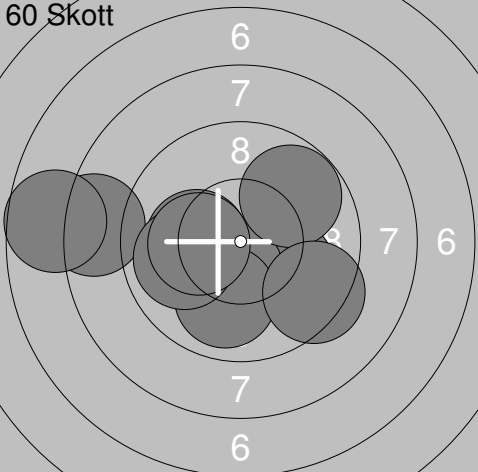
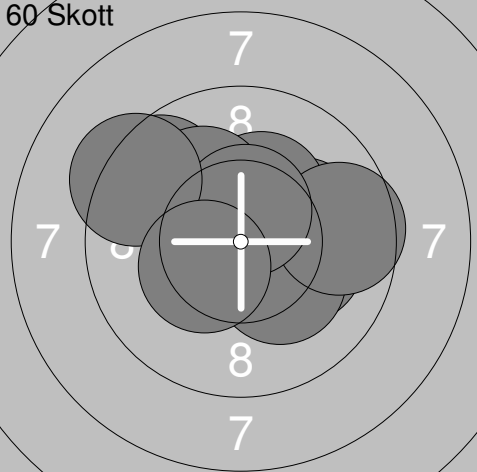
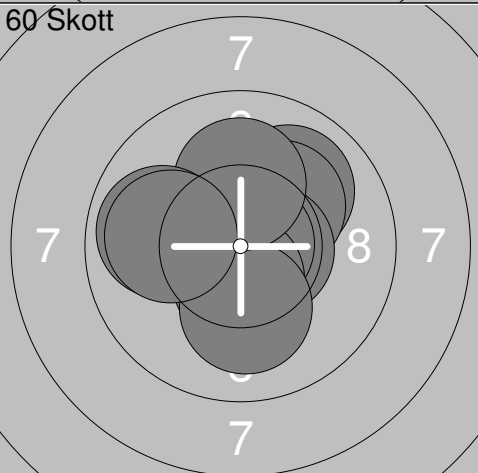

Skjutlag	Tavla	Nicolle Nygren	
2	12	Umeå Skf	
S			
27.01.2018	Förbundsmästerskap 2018	Umeå skytteallians	
Prov		1: 10.1 ↙ 2: 9.3 ↙ 3: 10.1 ↗ 4: 9.1 → 5: 9.4 ← 6: 9.7 ↑ 7: 9.4 → 8: 9.8 ↓ 9: 8.5 → 10: 9.4 ← Serie 91.0 Total 0.0	Prov  11: 10.4x → 12: 10.7x ↗ 13: 9.1 → 14: 10.4x ↗ 15: 9.3 ↓ 16: 9.5 ↙ 17: 9.5 ↑ 18: 9.9 ↑ 19: 10.5x → 20: 10.1 ↗ Serie 95.0 Total 0.0
Prov		21: 10.0 ↗ 22: 9.6 → Serie 19.0 Total 0.0	60 Skott  1: 9.7 → 2: 9.7 ↓ 3: 10.8x ↓ 4: 10.1 ↓ 5: 10.1 ↗ 6: 9.2 ↙ 7: 9.8 → 8: 9.7 ↑ 9: 10.2x ← 10: 9.5 → Serie 94.0 Total 94.0
60 Skott		11: 10.2x ← 12: 8.4 ← 13: 10.1 → 14: 10.4x ↓ 15: 9.9 ↓ 16: 9.8 ↗ 17: 7.7 ← 18: 9.9 ← 19: 9.4 → 20: 10.2x ← Serie 91.0 Total 185.0	60 Skott  21: 10.1 → 22: 10.1 → 23: 10.3x ↑ 24: 10.2x ↓ 25: 9.6 ↗ 26: 9.6 → 27: 10.1 ↗ 28: 10.5x ↑ 29: 9.3 ↙ 30: 10.4x ↙ Serie 97.0 Total 282.0
60 Skott		31: 10.0 ↗ 32: 10.2x ↗ 33: 10.7x ← 34: 10.6x → 35: 10.8x → 36: 10.5x ↓ 37: 10.1 ↓ 38: 10.1 ↑ 39: 9.9 ← 40: 10.0 ← Serie 99.0 Total 381.0	

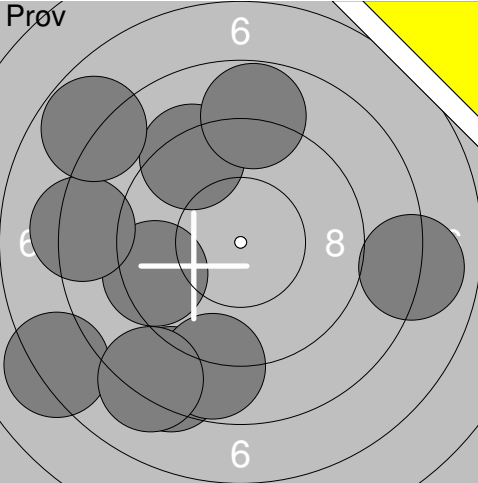
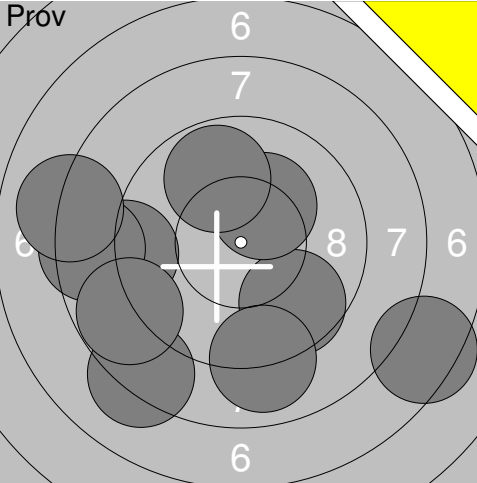
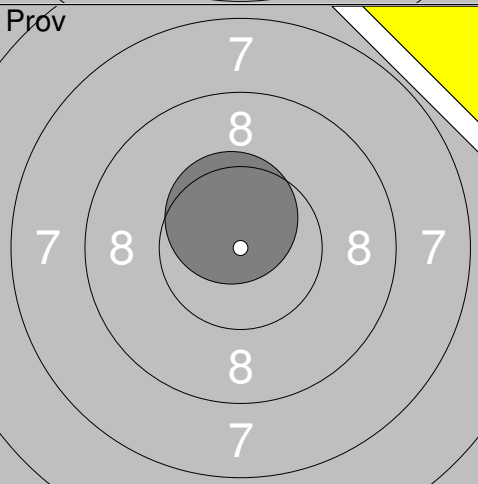
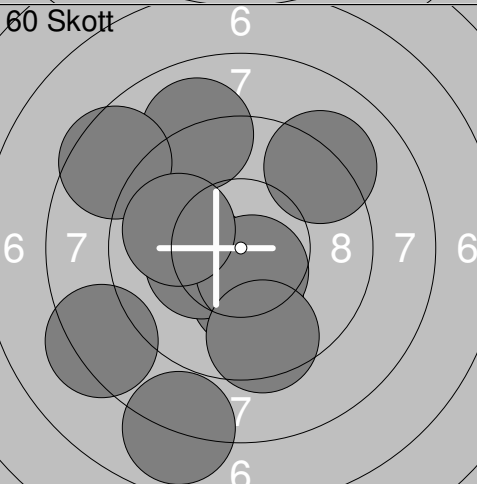
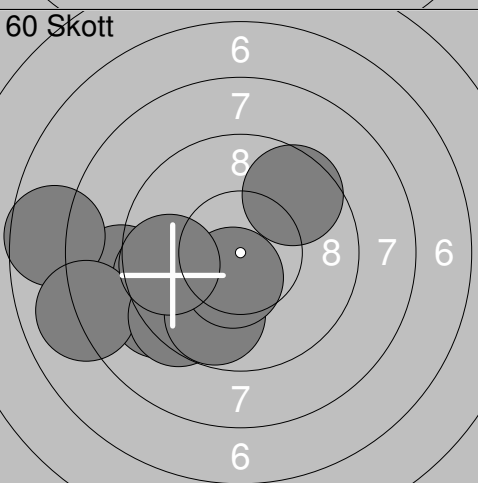
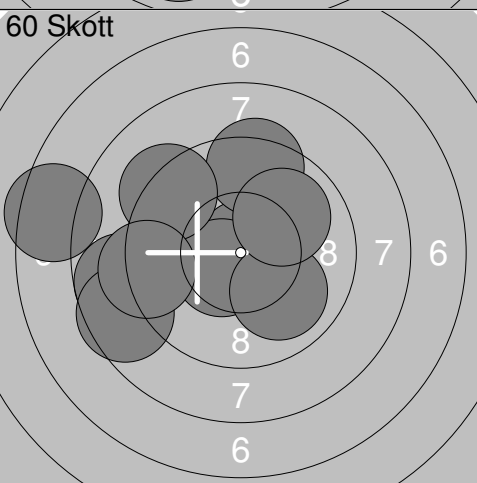
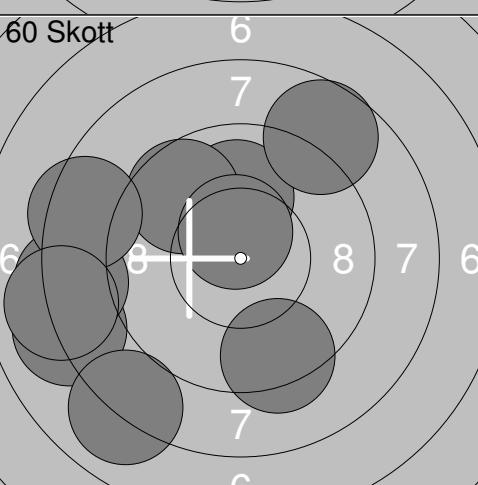
Skjutlag <b>2</b>	Tavla <b>14</b>	<b>Ida Lundmark</b>	
<b>S</b>		Drängsmark Skf	
<b>27.01.2018</b>		<b>Förbundsmästerskap 2018</b>	
<b>Pröv</b>		<b>Umeå skytteallians</b>	
	1: 8.0 → 2: 9.4 ← 3: 8.3 ↓ 4: 8.8 ↓ 5: 9.3 ↗ 6: 7.2 ← 7: 8.3 ← 8: 8.8 ↑ 9: 8.2 ↓ 10: 7.8 ↖		11: 7.4 ↘ 12: 9.6 ↓ 13: 9.0 ← 14: 9.0 ↓ 15: 10.2x ↗ 16: 8.2 ↓ 17: 8.5 ← 18: 8.8 ← 19: 8.0 ← 20: 9.8 ↗
Serie 80.0		Serie 85.0	
Total 0.0		Total 0.0	
	21: 10.5x ↗		1: 9.0 ↗ 2: 7.9 ↓ 3: 8.5 ↖ 4: 9.2 ↗ 5: 10.2x ↓ 6: 10.3x ← 7: 8.3 ← 8: 10.5x ↓ 9: 9.9 ← 10: 9.5 ↓
Serie 10.0		Serie 89.0	
Total 0.0		Total 89.0	
	11: 8.8 ← 12: 7.6 ← 13: 9.6 ↗ 14: 9.2 ← 15: 9.5 ← 16: 8.0 ← 17: 9.4 ↓ 18: 9.8 ↓ 19: 10.5x ↓ 20: 9.7 ←		21: 8.7 ← 22: 10.8x ↗ 23: 9.4 ↑ 24: 10.5x ← 25: 10.0 ↓ 26: 9.2 ↗ 27: 7.5 ← 28: 10.0 ↗ 29: 8.6 ← 30: 9.2 ←
Serie 87.0		Serie 90.0	
Total 176.0		Total 266.0	
	31: 9.3 ↓ 32: 10.0 ↑ 33: 8.1 ← 34: 8.0 ↓ 35: 8.3 ← 36: 9.6 ↗ 37: 8.4 ← 38: 10.5x ↑ 39: 8.7 ↗ 40: 8.1 ←		
Serie 86.0			
Total 352.0			

Skjutlag <b>2</b>	Tavla <b>15</b>	<b>Jonathan Sundström</b>			
S		Rönnskärs Skf			
27.01.2018		Förbundsmästerskap 2018	Umeå skytteallians		
Prov		1: 10.3x ↘ 2: 8.7 ↘ 3: 8.9 ↗ 4: 8.0 ↗ 5: 9.4 → 6: 10.3x ↘ 7: 9.7 ← 8: 9.9 → 9: 8.7 ← 10: 10.4x ↗ Serie 89.0 Total 0.0	Prov 	11: 9.4 ↗ 12: 9.2 ↗ 13: 10.2x → 14: 9.5 ↗ 15: 9.5 ↘ 16: 9.1 ↘ 17: 6.6 ↗ 18: 9.5 ← 19: 8.7 ↘ 20: 10.2x ↘ Serie 88.0 Total 0.0	
Prov		21: 7.5 ↗ 22: 6.9 → 23: 9.7 ↗ 24: 9.7 ↘ 25: 10.1 ↗ 26: 7.7 ↗ 27: 10.4x ↘ Serie 58.0 Total 0.0	60 Skott		1: 7.5 ↘ 2: 9.1 ↘ 3: 9.6 ↗ 4: 9.7 ↘ 5: 9.6 ← 6: 9.3 ↗ 7: 9.0 ↗ 8: 7.8 ↗ 9: 8.3 ↗ 10: 9.0 ↗ Serie 85.0 Total 85.0
60 Skott		11: 8.1 ↗ 12: 9.1 ← 13: 8.3 ↗ 14: 8.9 ↘ 15: 7.1 ↗ 16: 7.3 → 17: 7.0 → 18: 7.9 ↗ 19: 9.4 ↗ 20: 5.5 ↗ Serie 75.0 Total 160.0	60 Skott		21: 9.4 ↗ 22: 8.8 ↗ 23: 9.5 ↘ 24: 6.4 ↗ 25: 8.6 → 26: 10.3x → 27: 10.3x ↗ 28: 6.0 ↗ 29: 7.5 ↗ 30: 9.5 ↗ Serie 82.0 Total 242.0
60 Skott		31: 8.2 ↗ 32: 6.8 ↗ 33: 7.9 ↘ 34: 9.4 ↗ 35: 8.6 ↗ 36: 8.8 ↗ 37: 7.6 ↗ 38: 7.2 ↗ 39: 8.5 ↗ 40: 10.6x ↘ Serie 78.0 Total 320.0			

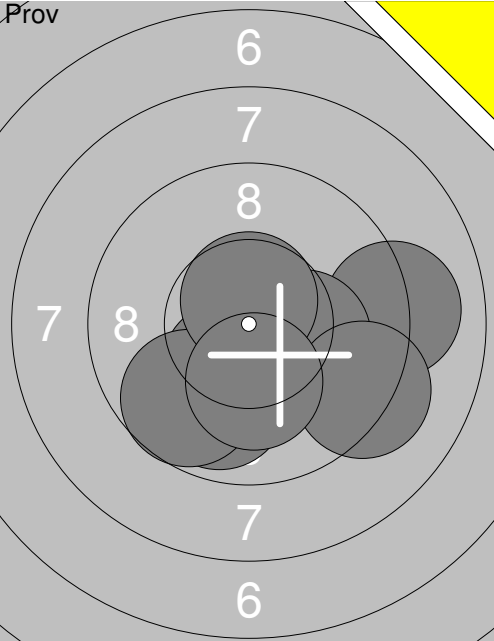
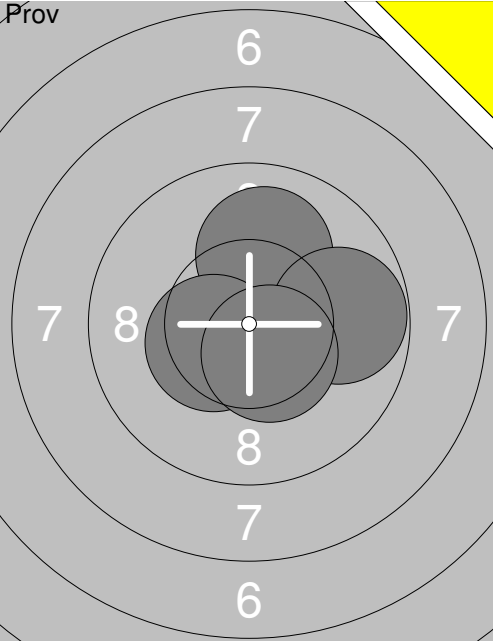
Skjutlag	Tavla	Saul Johansson	
2	16	Saul Johansson	
S	Ramselefors Skf		
27.01.2018	Förbundsmästerskap 2018	Umeå skytteallians	
Prov		Prov	
	1: 9.4 → 2: 9.9 ↓ 3: 9.1 → 4: 10.8x↘ 5: 10.3x↓ 6: 10.2x→ 7: 9.2 → 8: 9.7 ↓ 9: 10.6x↑ 10: 10.2x↓ Serie 95.0 Total 0.0		11: 10.0 ↑ 12: 9.8 → 13: 10.4x↙ 14: 10.5x↘ Serie 39.0 Total 0.0
60 Skott	1: 9.8 ↓ 2: 10.6x↘ 3: 10.7x↙ 4: 9.4 ↓ 5: 10.8x↙ 6: 10.7x→ 7: 10.1↙ 8: 10.5x↓ 9: 9.9 ↙ 10: 10.2x↘ Serie 97.0 Total 97.0	60 Skott	11: 10.1 ↗ 12: 10.1 ↗ 13: 9.9 → 14: 9.9 → 15: 10.3x→ 16: 10.0 ↗ 17: 9.3 ← 18: 10.4x↘ 19: 10.3x→ 20: 10.2x↑ Serie 97.0 Total 194.0
60 Skott	21: 9.7 ← 22: 10.5x↘ 23: 10.6x↘ 24: 9.9 ↑ 25: 10.6x↑ 26: 9.5 ← 27: 10.2x↘ 28: 9.7 → 29: 10.3x↓ 30: 10.2x↗ Serie 96.0 Total 290.0	60 Skott	31: 10.1 ← 32: 10.2x↗ 33: 10.5x↘ 34: 10.3x→ 35: 10.5x↘ 36: 10.1 ↗ 37: 10.4x↘ 38: 8.4 ↙ 39: 10.7x→ 40: 10.8x↘ Serie 98.0 Total 388.0

<p>Prov</p>	<p>1: 8.6 ↘ 2: 8.7 ↑ 3: 8.3 ↘ 4: 5.3 ↖ 5: 4.4 ↖ 6: 6.6 ↓ 7: 8.6 ↓ 8: 8.7 ↖ 9: 10.9x ↘ 10: 7.8 ↘</p> <p>Serie 72.0 Total 0.0</p>	<p>Prov</p>	<p>11: 8.6 ↖ 12: 10.0 ← 13: 8.7 ↓ 14: 9.8 ↓ 15: 9.5 ↖ 16: 10.2x → 17: 8.8 ↓ 18: 9.4 ↑ 19: 9.1 ↖ 20: 9.3 ↖</p> <p>Serie 89.0 Total 0.0</p>
-------------	---	-------------	---

<p>60 Skott</p>	<p>1: 9.1 ← 2: 10.3x ↘ 3: 9.5 ↓ 4: 8.4 ↖ 5: 9.3 ↘ 6: 8.2 ↘ 7: 6.0 ↖ 8: 9.3 ↓ 9: 6.0 ↖ 10: 8.8 ↖</p> <p>Serie 82.0 Total 82.0</p>	<p>60 Skott</p>	<p>11: 7.6 ↖ 12: 9.6 ↖ 13: 7.7 ↓ 14: 9.6 ↖ 15: 8.9 ↖ 16: 9.4 ↓ 17: 9.1 ↓ 18: 10.2x ↖ 19: 7.9 → 20: 8.5 ↓</p> <p>Serie 83.0 Total 165.0</p>
-----------------	--	-----------------	--

<p>60 Skott</p>	<p>21: 9.4 ↓ 22: 7.5 → 23: 10.2x ↖ 24: 9.8 ↓ 25: 9.6 ↘ 26: 8.7 → 27: 4.9 → 28: 8.9 ↓ 29: 8.9 → 30: 9.7 ↑</p> <p>Serie 81.0 Total 246.0</p>	<p>60 Skott</p>	<p>31: 8.0 ↖ 32: 8.7 ↖ 33: 8.7 ↖ 34: 8.8 ↘ 35: 8.2 ↖ 36: 7.1 ↖ 37: 9.9 ↖ 38: 10.0 ↓ 39: 7.1 ↓ 40: 7.7 ↖</p> <p>Serie 80.0 Total 326.0</p>
-----------------	--	-----------------	---



Prov 	1: 7.7 ↗ 2: 10.2x↗ 3: 9.7 ↙ 4: 9.6 ↘ 5: 6.4 ↗ 6: 9.4 ↗ 7: 7.7 ← 8: 9.9 ← 9: 7.1 ↗ 10: 10.2x↘ Serie 83.0 Total 0.0	Prov 	11: 8.8 ↗ 12: 8.1 → 13: 10.3x↘ Serie 26.0 Total 0.0
----------	--	----------	---

60 Skott 	1: 9.2 ↗ 2: 9.4 ↗ 3: 9.4 ↗ 4: 10.1 ↗ 5: 10.6x↘ 6: 9.6 ↗ 7: 10.0 ↗ 8: 9.7 ↗ 9: 10.3x↗ 10: 10.1 ↘ Serie 95.0 Total 95.0	60 Skott 	11: 10.2x↘ 12: 10.0 ↗ 13: 10.2x↘ 14: 7.6 ← 15: 10.0 ↗ 16: 9.8 ↘ 17: 10.5x↗ 18: 9.0 ↗ 19: 10.6x← 20: 8.1 ↗ Serie 93.0 Total 188.0
--------------	--	--------------	---

60 Skott 	21: 9.5 ↗ 22: 10.8x↘ 23: 7.7 ↗ 24: 7.8 ← 25: 9.3 ↗ 26: 8.3 ↗ 27: 10.0 ↙ 28: 9.4 ↙ 29: 8.9 → 30: 9.4 → Serie 86.0 Total 274.0	60 Skott 	31: 9.5 → 32: 9.5 ↗ 33: 10.0 ↗ 34: 9.0 ↘ 35: 8.5 ↘ 36: 10.1 ↘ 37: 10.6x↗ 38: 8.8 ← 39: 10.3x↗ 40: 9.9 ↗ Serie 92.0 Total 366.0
--------------	---	--------------	---



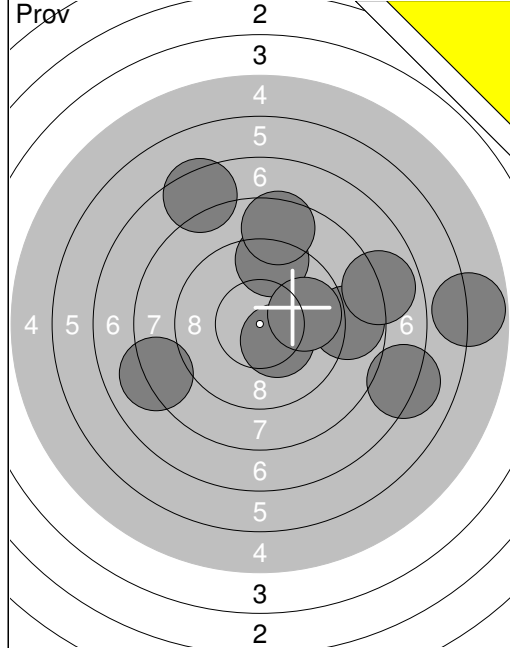

1:	9.3	↑
2:	8.6	↑
3:	8.8	→
4:	5.8	→
5:	10.3	↘
6:	8.1	←
7:	7.5	↑
8:	7.9	→
9:	9.8	→
10:	7.2	→
<b>Serie</b>	<b>78.0</b>	
<b>Total</b>	<b>0.0</b>	

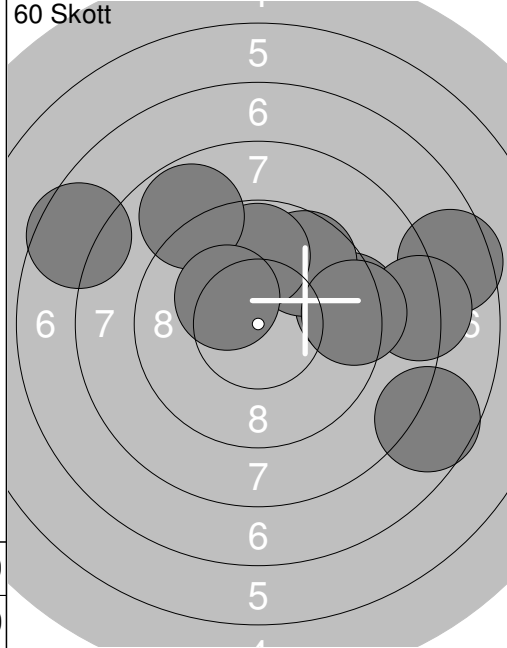

1:	7.5	→
2:	9.4	→
3:	9.7	↗
4:	9.8	↑
5:	8.2	→
6:	8.8	↖
7:	10.3	↘
8:	7.6	←
9:	7.7	↘
10:	9.3	→
<b>Serie</b>	<b>83.0</b>	
<b>Total</b>	<b>83.0</b>	

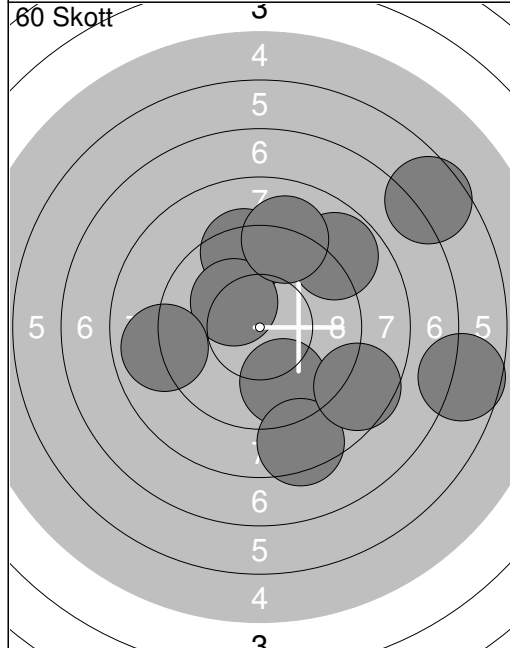

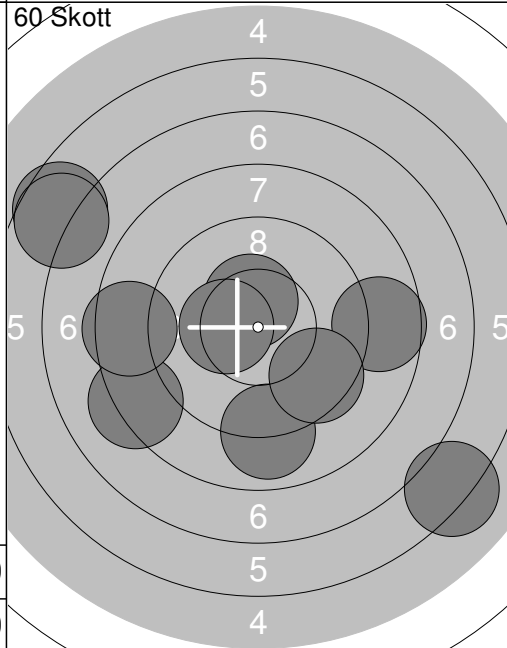

11:	9.7	↘
12:	8.4	↘
13:	9.4	↑
14:	8.6	↘
15:	10.2	↘
16:	6.7	→
17:	8.8	↗
18:	9.1	↑
19:	8.9	←
20:	6.6	↗
<b>Serie</b>	<b>81.0</b>	
<b>Total</b>	<b>164.0</b>	



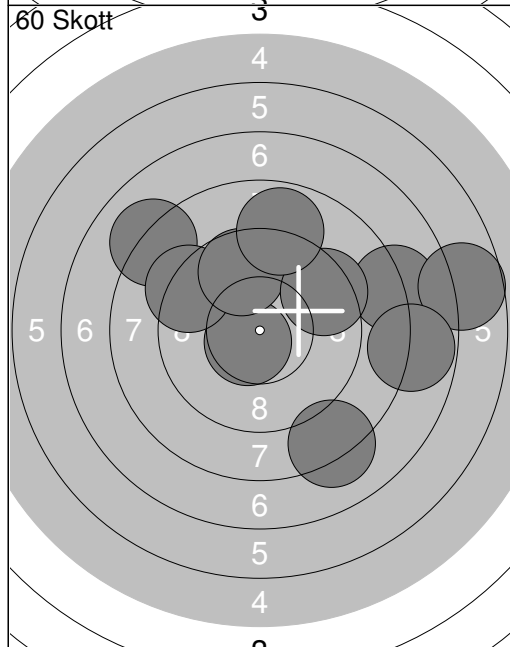

21:	8.7	→
22:	9.0	↓
23:	8.2	↙
24:	10.4	↗
25:	6.6	↖
26:	6.2	↘
27:	10.4	↖
28:	9.5	↘
29:	6.7	↖
30:	8.5	←
<b>Serie</b>	<b>80.0</b>	
<b>Total</b>	<b>244.0</b>	

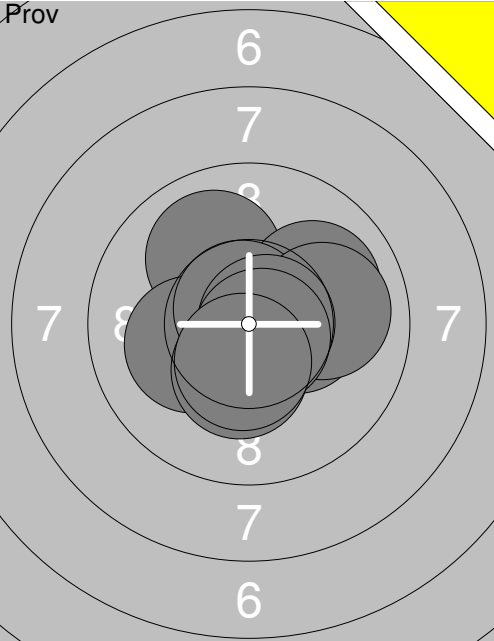

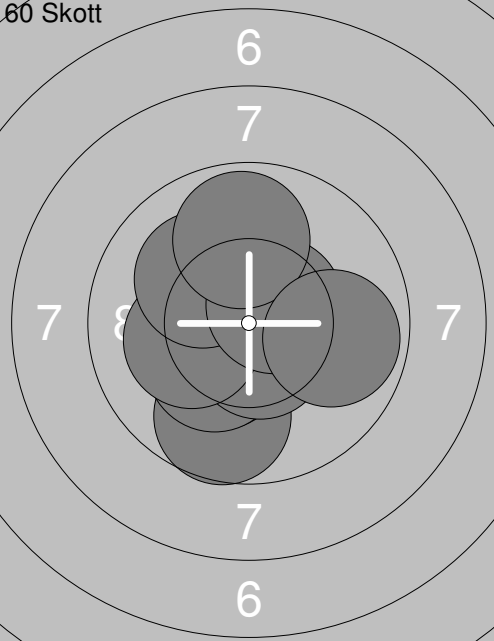
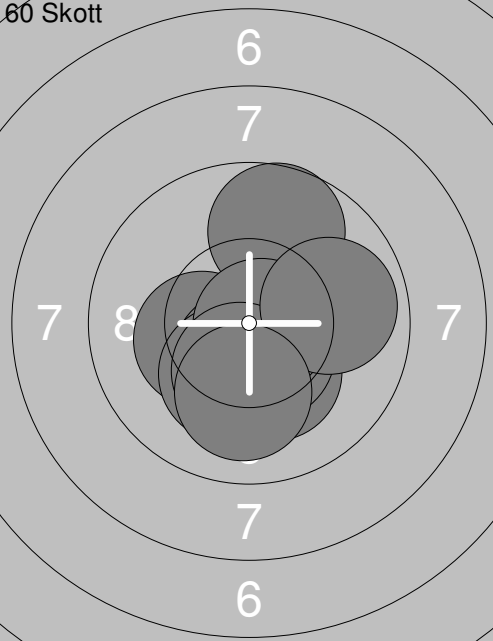
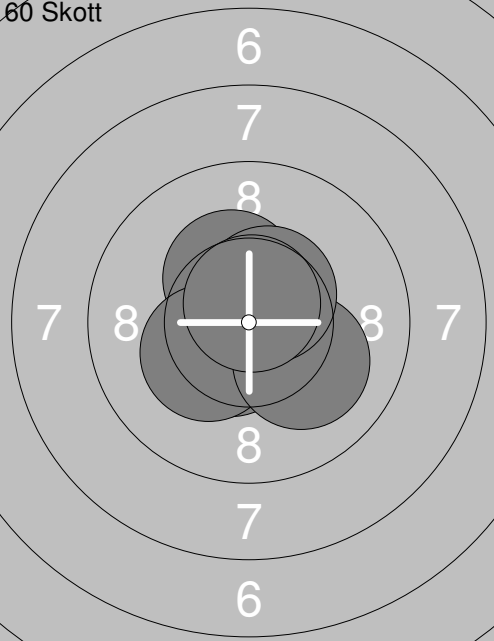
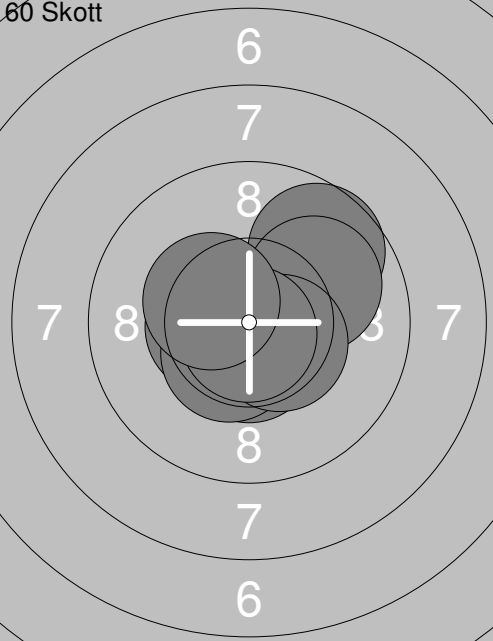
31:	8.0	→
32:	6.7	→
33:	7.8	→
34:	8.1	↖
35:	10.6	↘
36:	9.3	↖
37:	8.2	↘
38:	9.7	↑
39:	9.4	↗
40:	8.9	↑
<b>Serie</b>	<b>82.0</b>	
<b>Total</b>	<b>326.0</b>	

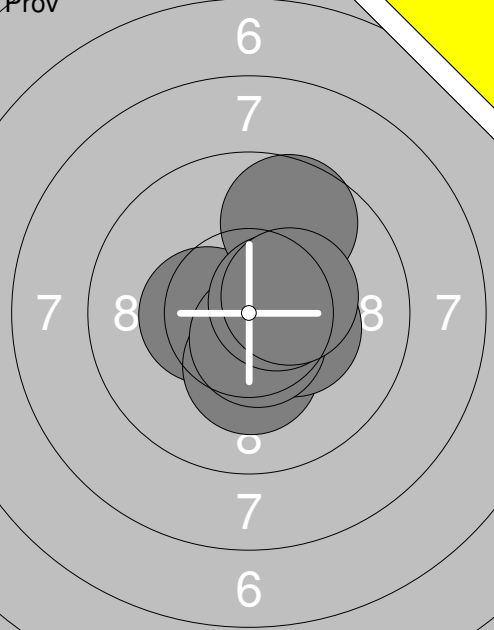
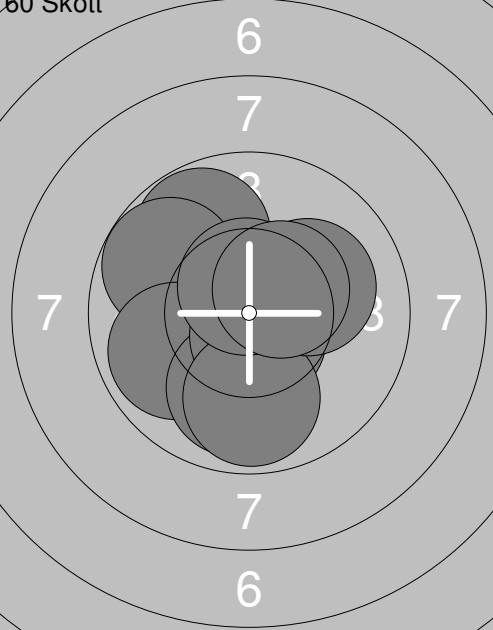
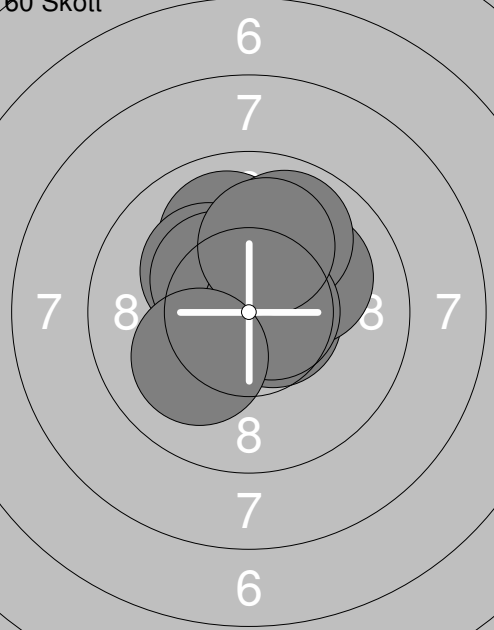
Skjutlag	Tavla	Beatrice Andersson	
2	22		
S	Ramselefors Skf		
27.01.2018	Förbundsmästerskap 2018	Umeå skytteallians	
	1: 10.0 ↖		11: 10.6x↓
	2: 10.0 →		12: 10.7x↙
	3: 10.2x↙		
	4: 10.7x↖		
	5: 10.3x→		
	6: 10.0→		
	7: 10.3x↓		
	8: 10.7x→		
	9: 10.7x↘		
	10: 10.4x↓		
	Serie 100.0		Serie 20.0
	Total 0.0		Total 0.0
	1: 10.5x↗		11: 9.7 ↗
	2: 9.7 ↓		12: 10.3x↙
	3: 10.3x↙		13: 10.2x↓
	4: 10.3x↙		14: 10.5x↓
	5: 10.6x↓		15: 10.2x↓
	6: 10.2x↙		16: 10.5x↓
	7: 10.1 ↖		17: 10.8x→
	8: 10.5x↗		18: 10.3x↓
	9: 9.9 ↗		19: 9.9 →
	10: 9.9 →		20: 10.1 ↓
	Serie 97.0		Serie 98.0
	Total 97.0		Total 195.0
	21: 10.8x↓		31: 10.5x↓
	22: 10.6x↓		32: 10.5x↙
	23: 10.8x↖		33: 10.8x↙
	24: 10.6x↘		34: 10.8x↖
	25: 10.5x↓		35: 9.7 ↗
	26: 10.3x↖		36: 10.0 ↗
	27: 10.3x↙		37: 10.5x↓
	28: 10.1 ↘		38: 10.5x↘
	29: 10.5x↗		39: 10.8x↓
	30: 10.7x↗		40: 10.4x↙
	Serie 100.0		Serie 99.0
	Total 295.0		Total 394.0

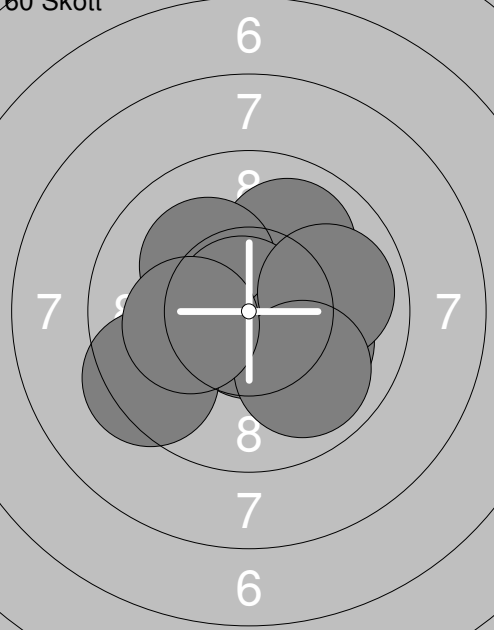
<p>Prov</p> 	<p>80 Skott</p> 	<table style="width:100%; border-collapse: collapse;"> <tr><td>1:</td><td>10.7x</td><td>↘</td></tr> <tr><td>2:</td><td>10.4x</td><td>↔</td></tr> <tr><td>3:</td><td>10.3x</td><td>↓</td></tr> <tr><td>4:</td><td>10.3x</td><td>↘</td></tr> <tr><td>5:</td><td>10.6x</td><td>↓</td></tr> <tr><td>6:</td><td>9.7</td><td>↗</td></tr> <tr><td>7:</td><td>10.6x</td><td>↘</td></tr> <tr><td>8:</td><td>10.4x</td><td>↘</td></tr> <tr><td colspan="3"><hr/></td></tr> <tr><td>Serie</td><td>79.0</td><td></td></tr> <tr><td>Total</td><td>0.0</td><td></td></tr> </table>	1:	10.7x	↘	2:	10.4x	↔	3:	10.3x	↓	4:	10.3x	↘	5:	10.6x	↓	6:	9.7	↗	7:	10.6x	↘	8:	10.4x	↘	<hr/>			Serie	79.0		Total	0.0																																														
1:	10.7x	↘																																																																														
2:	10.4x	↔																																																																														
3:	10.3x	↓																																																																														
4:	10.3x	↘																																																																														
5:	10.6x	↓																																																																														
6:	9.7	↗																																																																														
7:	10.6x	↘																																																																														
8:	10.4x	↘																																																																														
<hr/>																																																																																
Serie	79.0																																																																															
Total	0.0																																																																															
<p>80 Skott</p> 	<p>80 Skott</p> 	<table style="width:100%; border-collapse: collapse;"> <tr><td>9:</td><td>10.6x</td><td>↗</td></tr> <tr><td>10:</td><td>10.4x</td><td>↘</td></tr> <tr><td colspan="3"><hr/></td></tr> <tr><td>Serie</td><td>96.0</td><td></td></tr> <tr><td>Total</td><td>96.0</td><td></td></tr> </table> <table style="width:100%; border-collapse: collapse;"> <tr><td>11:</td><td>10.0</td><td>↗</td></tr> <tr><td>12:</td><td>10.6x</td><td>↘</td></tr> <tr><td>13:</td><td>10.2x</td><td>↘</td></tr> <tr><td>14:</td><td>10.1</td><td>↘</td></tr> <tr><td>15:</td><td>10.8x</td><td>↗</td></tr> <tr><td>16:</td><td>9.9</td><td>↗</td></tr> <tr><td>17:</td><td>10.4x</td><td>↘</td></tr> <tr><td>18:</td><td>10.6x</td><td>↘</td></tr> <tr><td>19:</td><td>10.1</td><td>↗</td></tr> <tr><td>20:</td><td>10.1</td><td>↙</td></tr> <tr><td colspan="3"><hr/></td></tr> <tr><td>Serie</td><td>99.0</td><td></td></tr> <tr><td>Total</td><td>195.0</td><td></td></tr> </table>	9:	10.6x	↗	10:	10.4x	↘	<hr/>			Serie	96.0		Total	96.0		11:	10.0	↗	12:	10.6x	↘	13:	10.2x	↘	14:	10.1	↘	15:	10.8x	↗	16:	9.9	↗	17:	10.4x	↘	18:	10.6x	↘	19:	10.1	↗	20:	10.1	↙	<hr/>			Serie	99.0		Total	195.0																									
9:	10.6x	↗																																																																														
10:	10.4x	↘																																																																														
<hr/>																																																																																
Serie	96.0																																																																															
Total	96.0																																																																															
11:	10.0	↗																																																																														
12:	10.6x	↘																																																																														
13:	10.2x	↘																																																																														
14:	10.1	↘																																																																														
15:	10.8x	↗																																																																														
16:	9.9	↗																																																																														
17:	10.4x	↘																																																																														
18:	10.6x	↘																																																																														
19:	10.1	↗																																																																														
20:	10.1	↙																																																																														
<hr/>																																																																																
Serie	99.0																																																																															
Total	195.0																																																																															
<p>80 Skott</p> 	<table style="width:100%; border-collapse: collapse;"> <tr><td>21:</td><td>10.3x</td><td>↘</td></tr> <tr><td>22:</td><td>10.5x</td><td>↗</td></tr> <tr><td>23:</td><td>10.5x</td><td>↗</td></tr> <tr><td>24:</td><td>10.1</td><td>↘</td></tr> <tr><td>25:</td><td>10.5x</td><td>↓</td></tr> <tr><td>26:</td><td>10.2x</td><td>↘</td></tr> <tr><td>27:</td><td>10.1</td><td>↗</td></tr> <tr><td>28:</td><td>10.4x</td><td>↓</td></tr> <tr><td>29:</td><td>10.4x</td><td>↘</td></tr> <tr><td>30:</td><td>10.8x</td><td>↘</td></tr> <tr><td colspan="3"><hr/></td></tr> <tr><td>Serie</td><td>100.0</td><td></td></tr> <tr><td>Total</td><td>295.0</td><td></td></tr> </table> <table style="width:100%; border-collapse: collapse;"> <tr><td>31:</td><td>10.6x</td><td>↗</td></tr> <tr><td>32:</td><td>10.7x</td><td>↓</td></tr> <tr><td>33:</td><td>10.0</td><td>↗</td></tr> <tr><td>34:</td><td>10.2x</td><td>↘</td></tr> <tr><td>35:</td><td>10.8x</td><td>↘</td></tr> <tr><td>36:</td><td>10.1</td><td>↘</td></tr> <tr><td>37:</td><td>9.9</td><td>→</td></tr> <tr><td>38:</td><td>9.9</td><td>↘</td></tr> <tr><td>39:</td><td>9.4</td><td>↙</td></tr> <tr><td>40:</td><td>10.2x</td><td>↔</td></tr> <tr><td colspan="3"><hr/></td></tr> <tr><td>Serie</td><td>97.0</td><td></td></tr> <tr><td>Total</td><td>392.0</td><td></td></tr> </table>		21:	10.3x	↘	22:	10.5x	↗	23:	10.5x	↗	24:	10.1	↘	25:	10.5x	↓	26:	10.2x	↘	27:	10.1	↗	28:	10.4x	↓	29:	10.4x	↘	30:	10.8x	↘	<hr/>			Serie	100.0		Total	295.0		31:	10.6x	↗	32:	10.7x	↓	33:	10.0	↗	34:	10.2x	↘	35:	10.8x	↘	36:	10.1	↘	37:	9.9	→	38:	9.9	↘	39:	9.4	↙	40:	10.2x	↔	<hr/>			Serie	97.0		Total	392.0	
21:	10.3x	↘																																																																														
22:	10.5x	↗																																																																														
23:	10.5x	↗																																																																														
24:	10.1	↘																																																																														
25:	10.5x	↓																																																																														
26:	10.2x	↘																																																																														
27:	10.1	↗																																																																														
28:	10.4x	↓																																																																														
29:	10.4x	↘																																																																														
30:	10.8x	↘																																																																														
<hr/>																																																																																
Serie	100.0																																																																															
Total	295.0																																																																															
31:	10.6x	↗																																																																														
32:	10.7x	↓																																																																														
33:	10.0	↗																																																																														
34:	10.2x	↘																																																																														
35:	10.8x	↘																																																																														
36:	10.1	↘																																																																														
37:	9.9	→																																																																														
38:	9.9	↘																																																																														
39:	9.4	↙																																																																														
40:	10.2x	↔																																																																														
<hr/>																																																																																
Serie	97.0																																																																															
Total	392.0																																																																															

Skjutlag	Tavla	Elvira Söderlund	
2	25		
S	Ramselefors Skf		
27.01.2018	Förbundsmästerskap 2018	Umeå skytteallians	
	1: 9.9 ↓		11: 10.7 ✕
	2: 10.4x ↓		12: 10.1 ↖
	3: 9.9 ↘		13: 10.8x ↗
	4: 10.3x ↗		
	5: 10.3 ✕		
	6: 9.6 ↖		
	7: 10.0 ↖		
	8: 10.1 ↙		
	9: 10.5 ✕		
	10: 10.4x ➔		
Serie	97.0	Serie	30.0
Total	0.0	Total	0.0
	1: 10.4x ↗		11: 10.7 ✕
	2: 10.0 ↗		12: 9.9 ↓
	3: 10.3x ➔		13: 10.1 ↓
	4: 10.5 ✕		14: 10.8x ↘
	5: 10.3x ↗		15: 10.7x ✕
	6: 10.0 ➔		16: 10.5 ✕
	7: 10.3x ➔		17: 10.5x ✕
	8: 10.2x ↗		18: 10.0 ↓
	9: 10.7 ✕		19: 10.6x ↓
	10: 10.2x ✕		20: 10.9x ↗
Serie	100.0	Serie	99.0
Total	100.0	Total	199.0
	21: 10.6 ✕		31: 10.4x ↘
	22: 10.4x ➔		32: 10.6x ➔
	23: 10.8x ↘		33: 10.2x ↓
	24: 10.4 ✕		34: 10.6 ✕
	25: 10.6 ✕		35: 10.9x ↘
	26: 10.8x ↘		36: 10.8x ↘
	27: 10.0 ↖		37: 10.7x ↗
	28: 10.1 ↙		38: 10.5 ✕
	29: 10.5 ✕		39: 10.5 ✕
	30: 10.5x ↓		40: 10.8x ↗
Serie	100.0	Serie	100.0
Total	299.0	Total	399.0

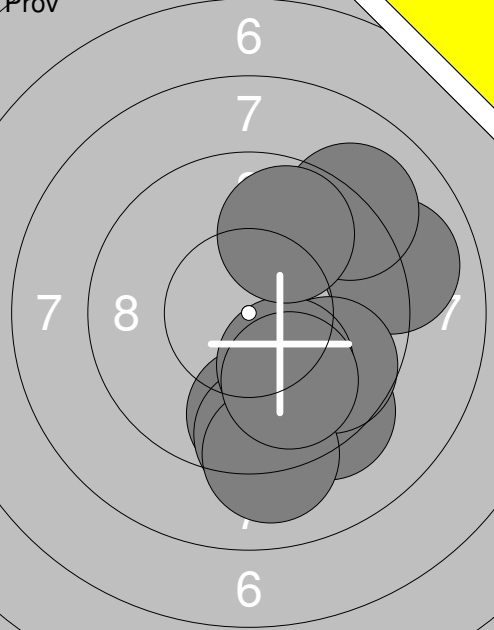
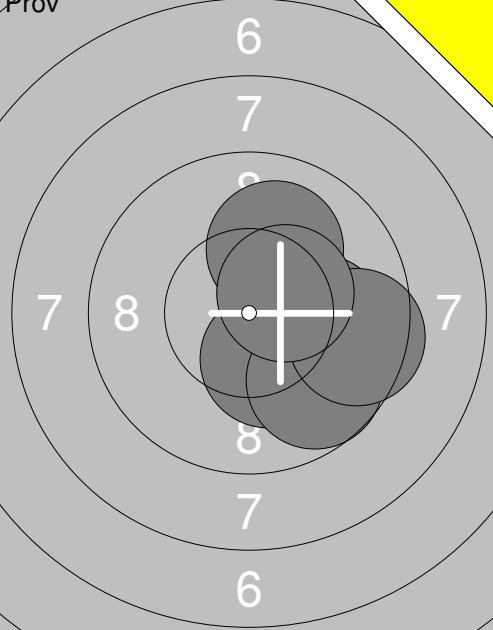
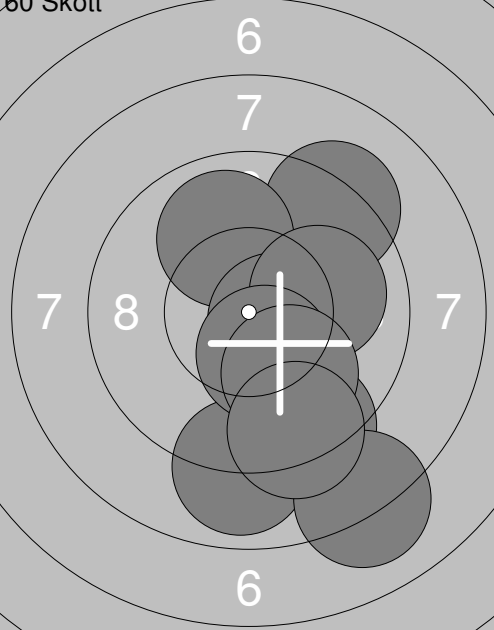
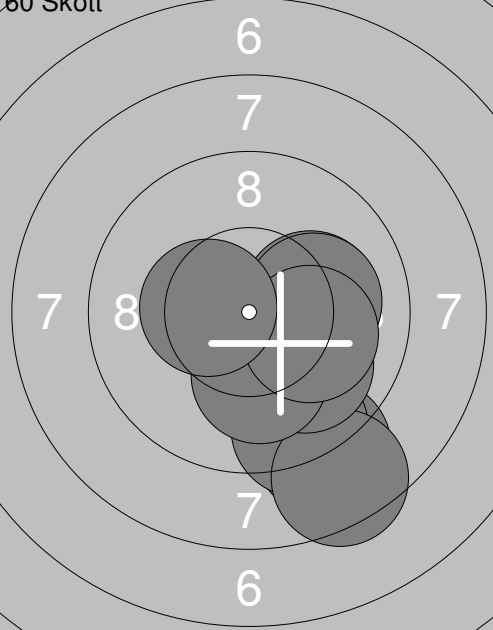
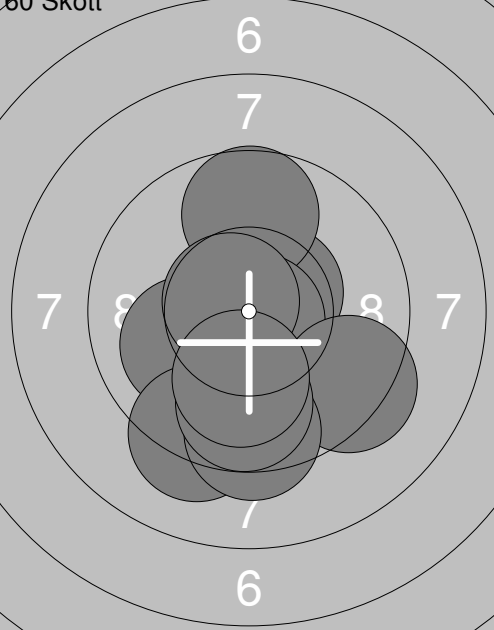
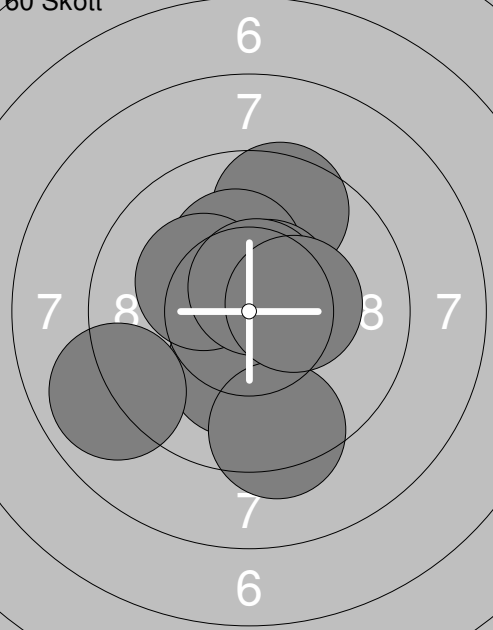
<p>Prov</p> 	<p>1: 9.0 →</p> <p>2: 9.1 ↗</p> <p>3: 9.6 ↓</p> <p>4: 9.3 ↘</p> <p>5: 9.7 ↘</p> <p>6: 9.4 ↓</p> <p>7: 10.1 ↘</p> <p>8: 9.1 ↓</p> <p>9: 9.8 ↗</p> <p>10: 9.9 ↘</p> <p>Serie 91.0</p> <p>Total 0.0</p>	<p>Prov</p> 	<p>11: 10.0 →</p> <p>12: 10.3x ↘</p> <p>13: 9.7 ↘</p> <p>14: 10.1 ↗</p> <p>15: 9.5 →</p> <p>16: 10.4x ↗</p> <p>Serie 58.0</p> <p>Total 0.0</p>
<p>60 Skott</p> 	<p>1: 9.2 ↗</p> <p>2: 9.9 ↗</p> <p>3: 10.6x →</p> <p>4: 10.0 →</p> <p>5: 8.9 ↓</p> <p>6: 9.3 ↓</p> <p>7: 10.4x ↘</p> <p>8: 8.1 ↓</p> <p>9: 10.0 ↓</p> <p>10: 9.3 ↓</p> <p>Serie 92.0</p> <p>Total 92.0</p>	<p>60 Skott</p> 	<p>11: 8.9 ↓</p> <p>12: 9.3 ↓</p> <p>13: 10.3x →</p> <p>14: 8.5 ↓</p> <p>15: 10.0 ↘</p> <p>16: 10.1 →</p> <p>17: 10.1 ↓</p> <p>18: 10.1 →</p> <p>19: 10.1 →</p> <p>20: 10.4x ↖</p> <p>Serie 95.0</p> <p>Total 187.0</p>
<p>60 Skott</p> 	<p>21: 10.0 ↖</p> <p>22: 10.5x ↗</p> <p>23: 9.2 ↓</p> <p>24: 9.7 ↗</p> <p>25: 10.8x ↘</p> <p>26: 9.3 ↘</p> <p>27: 10.7x ↖</p> <p>28: 9.4 ↓</p> <p>29: 9.8 ↓</p> <p>30: 10.1 ↓</p> <p>Serie 95.0</p> <p>Total 282.0</p>	<p>60 Skott</p> 	<p>31: 10.6x ↗</p> <p>32: 10.2x ↘</p> <p>33: 8.9 ↖</p> <p>34: 9.4 ↓</p> <p>35: 9.6 ↗</p> <p>36: 10.2x ↗</p> <p>37: 10.2x ↖</p> <p>38: 10.6x ↗</p> <p>39: 10.6x ↗</p> <p>40: 10.4x →</p> <p>Serie 96.0</p> <p>Total 378.0</p>

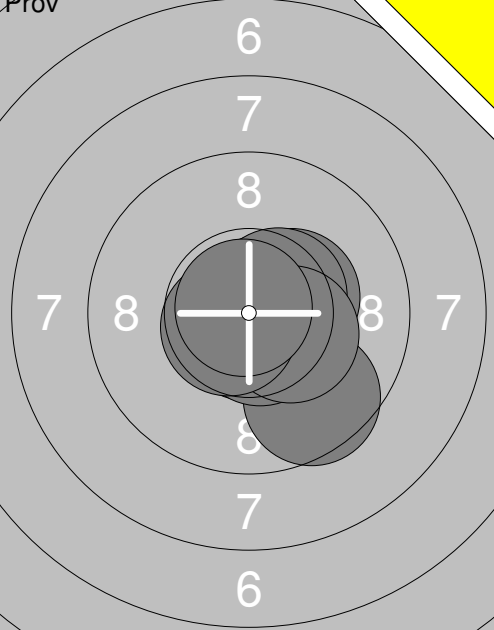
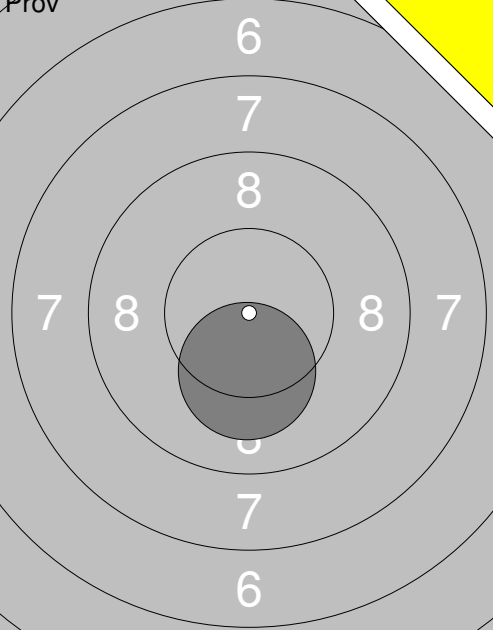
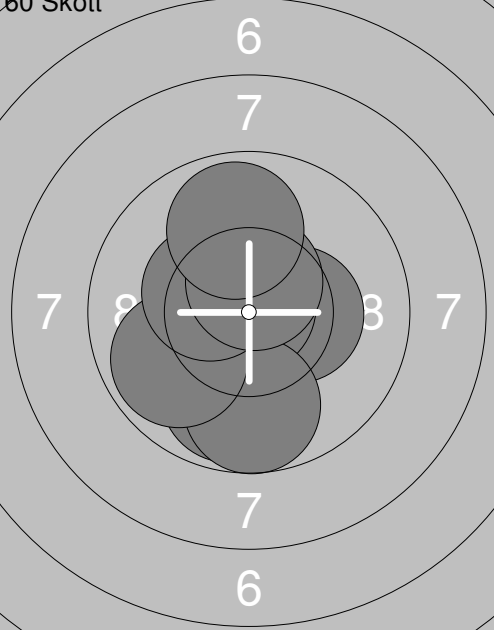
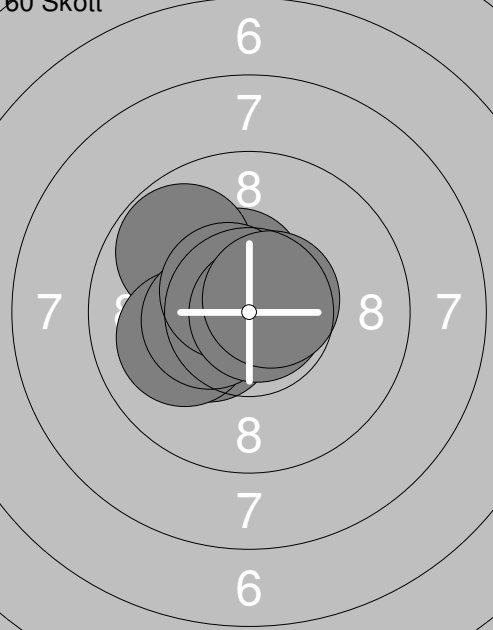
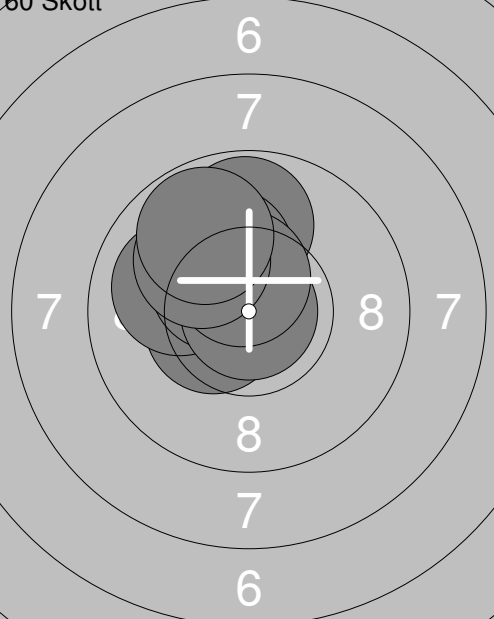
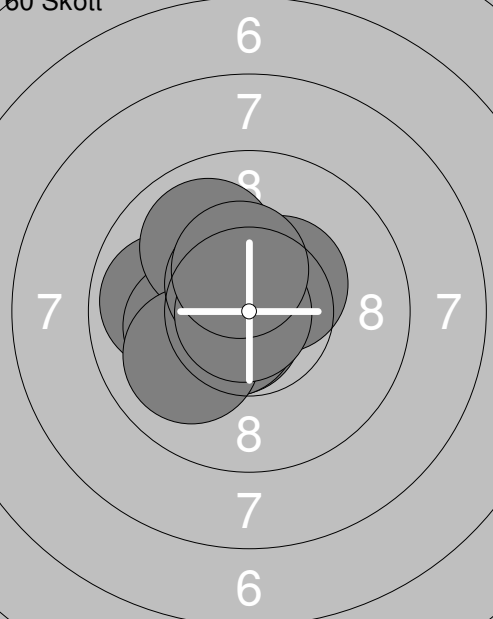
<p>Prov</p> 	<p>1: 10.4x➤</p> <p>2: 10.7x↘</p> <p>3: 10.7x↗</p> <p>4: 9.6 ↘</p> <p>5: 10.5x↗</p> <p>6: 10.7x↓</p> <p>7: 10.6x↘</p> <p>8: 10.3x↘</p> <p>9: 10.6x↙</p> <p>10: 10.8x↖</p> <p>Serie 99.0</p> <p>Total 0.0</p>	<p>Prov</p>  <p>11: 10.2x↓</p> <p>Serie 10.0</p> <p>Total 0.0</p>
<p>60 Skott</p> 	<p>1: 10.3x➤</p> <p>2: 10.6x↙</p> <p>3: 10.7x↙</p> <p>4: 10.9x↗</p> <p>5: 9.9 ↘</p> <p>6: 9.7 ↘</p> <p>7: 9.9 ↙</p> <p>8: 10.4x↖</p> <p>9: 10.6x↗</p> <p>10: 9.9 ↗</p> <p>Serie 96.0</p> <p>Total 96.0</p>	<p>60 Skott</p>  <p>11: 10.8x↙</p> <p>12: 10.5x↖</p> <p>13: 10.4x↙</p> <p>14: 9.8 ↖</p> <p>15: 10.3x↙</p> <p>16: 10.0↙</p> <p>17: 10.4x↙</p> <p>18: 10.6x↖</p> <p>19: 10.8x➤</p> <p>20: 10.6x↗</p> <p>Serie 99.0</p> <p>Total 195.0</p>
<p>60 Skott</p> 	<p>21: 9.8 ↗</p> <p>22: 10.4x↖</p> <p>23: 10.2x↖</p> <p>24: 10.5x↙</p> <p>25: 10.0↙</p> <p>26: 10.4x↖</p> <p>27: 10.9x</p> <p>28: 10.5x↗</p> <p>29: 10.0 ↖</p> <p>30: 9.8 ↖</p> <p>Serie 98.0</p> <p>Total 293.0</p>	<p>60 Skott</p>  <p>31: 9.9 ↙</p> <p>32: 10.4x↗</p> <p>33: 10.2x↙</p> <p>34: 10.0 ↖</p> <p>35: 10.7x↙</p> <p>36: 10.6x↙</p> <p>37: 10.0 ↙</p> <p>38: 10.5x↖</p> <p>39: 10.9x↙</p> <p>40: 10.4x↗</p> <p>Serie 99.0</p> <p>Total 392.0</p>



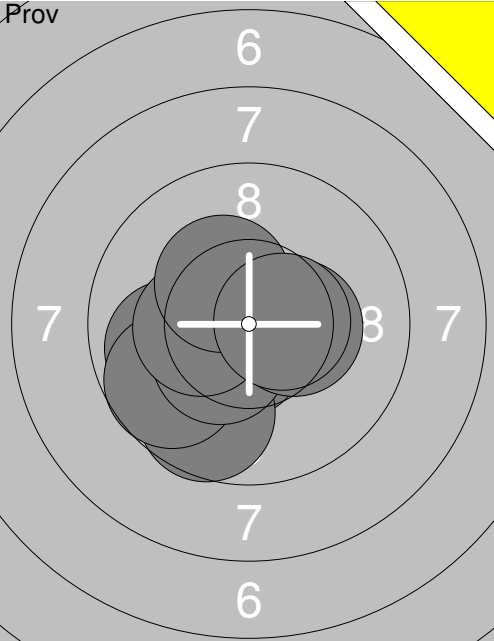
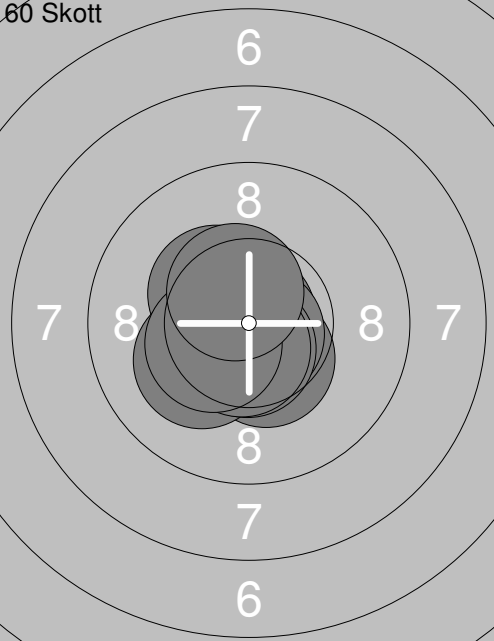
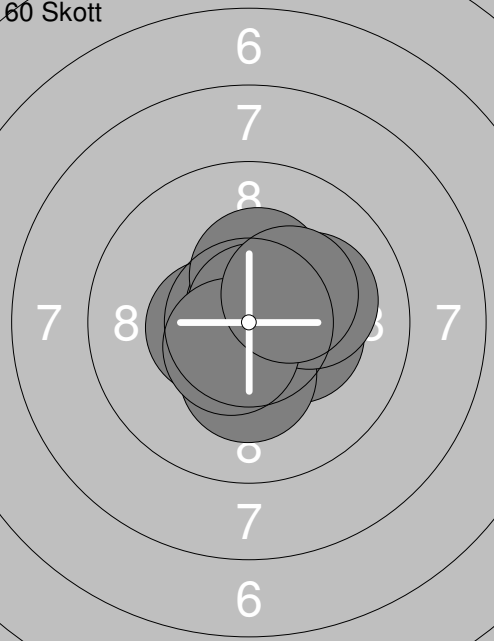

<p>Prov</p>	<p>1: 9.4 ↓                  2: 10.5x↓                  3: 9.7 ↓                  4: 9.9 ↓                  5: 10.4x↘                  6: 10.3x↓                  7: 9.5 ←                  8: 10.0 ↓                  9: 10.6x↓                  10: 9.7 ↓</p> <p>Serie 95.0 Total 0.0</p>	<p>Prov</p>	<p>11: 10.7x↗                  12: 9.6 ↓                  13: 10.1 ←                  14: 9.8 ↓                  15: 10.0 ↓                  16: 10.4x↘</p> <p>Serie 58.0 Total 0.0</p>
<p>60 Skott</p>	<p>1: 9.8 ←                  2: 9.5 ↘                  3: 9.3 ↓                  4: 10.2x↓                  5: 10.3x↓                  6: 10.5x↘                  7: 10.5x↓                  8: 10.5x↘                  9: 10.0 ←                  10: 10.3x↑</p> <p>Serie 97.0 Total 97.0</p>	<p>60 Skott</p>	<p>11: 10.5x↘                  12: 10.0 →                  13: 10.5x↓                  14: 9.5 ↘                  15: 10.1 ↖                  16: 10.3x↘                  17: 9.9 ↑                  18: 10.8x↘                  19: 10.8x→                  20: 10.4x↓</p> <p>Serie 98.0 Total 195.0</p>
<p>60 Skott</p>	<p>21: 10.7x→                  22: 9.2 ↗                  23: 9.8 →                  24: 10.1 ↑                  25: 10.5x→                  26: 10.6x↗                  27: 10.8x↗                  28: 10.2x↗                  29: 9.9 ↑                  30: 9.8 ↗</p> <p>Serie 96.0 Total 291.0</p>	<p>60 Skott</p>	<p>31: 10.0 →                  32: 9.7 ↗                  33: 10.3x↗                  34: 10.5x↗                  35: 10.3x↗                  36: 10.1 ↗                  37: 10.4x↗                  38: 9.9 ↗                  39: 9.8 ↗                  40: 10.3x↗</p> <p>Serie 97.0 Total 388.0</p>

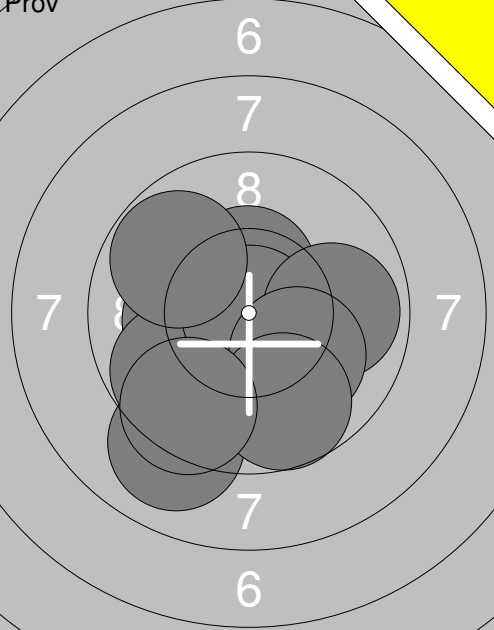
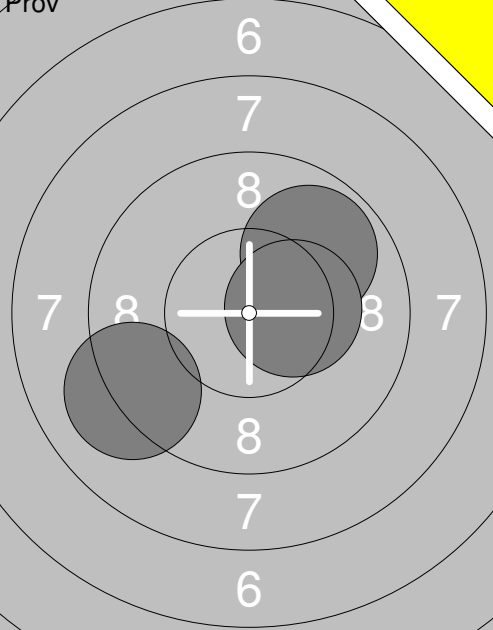
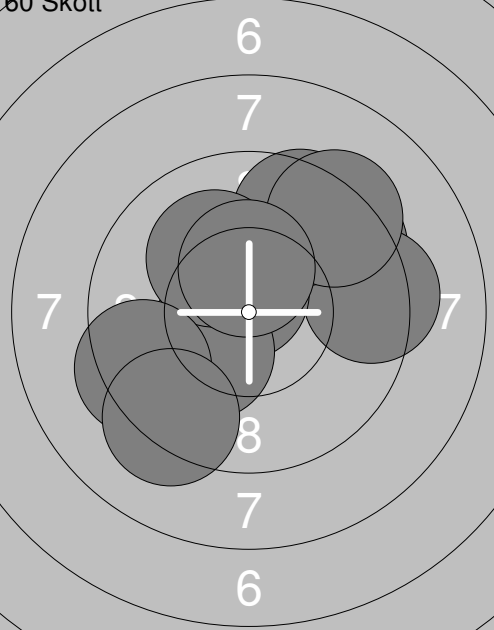
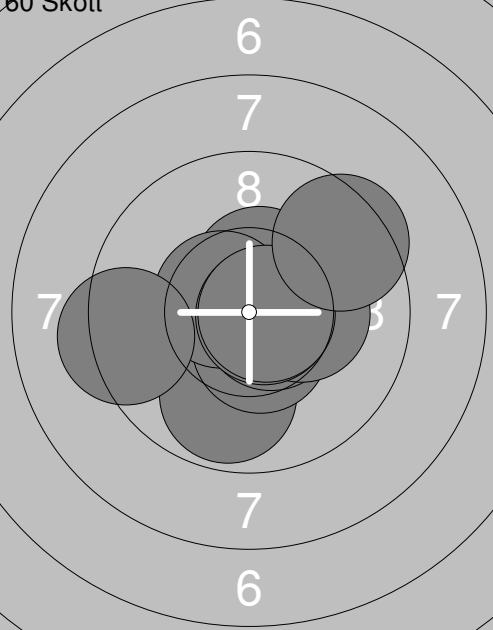
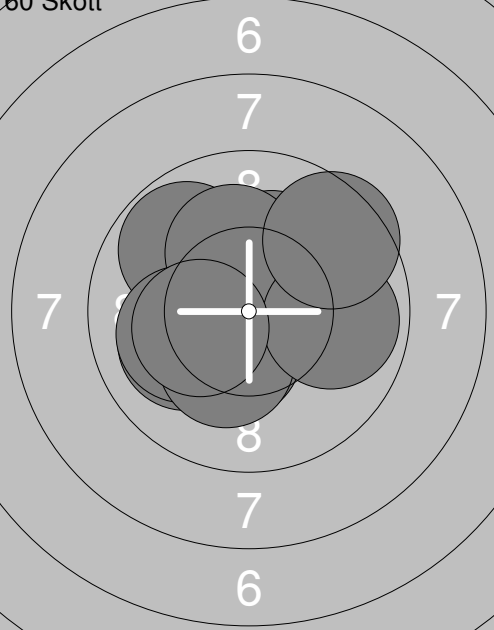
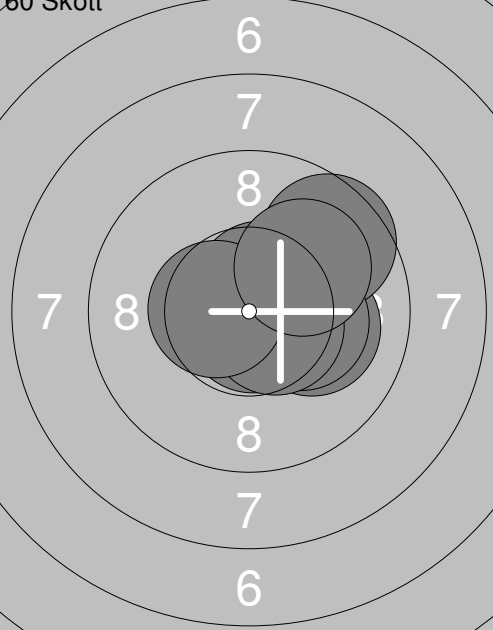
Skjuttag	Tavla	Vilhelm Lundstedt	
2	29		
S	Ramselefors Skf		
27.01.2018	Föbunds mästerskap 2018	Umeå skytteallians	
Prov		1: 9.9 ← 2: 10.6x ↓ 3: 10.9x ↓ 4: 9.7 ↓ 5: 9.7 ← 6: 10.4x ↓ 7: 10.3x ← 8: 10.3x ↘ 9: 10.4x → 10: 10.5x → Serie 97.0 Total 0.0	11: 10.3x ↘ Serie 10.0 Total 0.0
60 Skott		1: 10.4x ↘ 2: 10.9x ↘ 3: 10.4x ↘ 4: 10.9x ↗ 5: 10.2x ↘ 6: 10.8x ↘ 7: 10.6x ↘ 8: 10.6x ↘ 9: 10.4x ↘ 10: 10.5x ↘ Serie 100.0 Total 100.0	11: 10.7x ↘ 12: 10.4x ↗ 13: 10.2x ← 14: 10.4x ↘ 15: 10.5x ↓ 16: 10.0 ↙ 17: 10.3x ↘ 18: 10.2x ↗ 19: 10.3x ↘ 20: 10.6x ↘ Serie 100.0 Total 200.0
60 Skott		21: 10.5x ↘ 22: 10.8x ↗ 23: 10.7x ↘ 24: 10.3x → 25: 10.3x ↓ 26: 10.3x ↗ 27: 10.8x ↗ 28: 10.1 → 29: 10.6x ↘ 30: 10.3x ↗ Serie 100.0 Total 300.0	31: 10.8x ↗ 32: 10.3x ↗ 33: 10.1 ↗ 34: 10.6x ↗ 35: 10.4x ↘ 36: 10.8x ↘ 37: 10.6x ↗ 38: 10.4x ↘ 39: 10.5x ↘ 40: 10.6x ↘ Serie 100.0 Total 400.0

<p>Prov</p> 	<p>1: 9.0 ↘                  2: 10.2x↔                  3: 9.8 ↙                  4: 10.4x↑                  5: 10.9x➤                  6: 9.9 →                  7: 9.8 ↖                  8: 10.1 ↘                  9: 9.7 ↘                  10: 9.5 ↘</p> <p>Serie 94.0 Total 0.0</p>	<p>Prov</p> 	<p>11: 9.1 ↙                  12: 9.9 ↗                  13: 10.4x➤</p> <p>Serie 28.0 Total 0.0</p>
<p>60 Skott</p> 	<p>1: 9.5 ↗                  2: 9.3 →                  3: 9.5 ↗                  4: 9.3 ↗                  5: 10.7x↘                  6: 10.2x↔                  7: 10.1 ↖                  8: 10.4x↑                  9: 9.4 ↙                  10: 9.2 ↘</p> <p>Serie 94.0 Total 94.0</p>	<p>60 Skott</p> 	<p>11: 10.4x↑                  12: 9.8 ↘                  13: 10.5x↓                  14: 10.6x↔                  15: 10.3x➤                  16: 10.6x↔                  17: 9.3 ←                  18: 10.7x➤                  19: 10.7x➤                  20: 9.5 ↗</p> <p>Serie 97.0 Total 191.0</p>
<p>60 Skott</p> 	<p>21: 9.8 ↖                  22: 10.4x↓                  23: 10.2x↑                  24: 10.0 ↙                  25: 10.2x↑                  26: 10.1 ↙                  27: 10.3x↓                  28: 9.9 →                  29: 10.3x↔                  30: 9.5 ↗</p> <p>Serie 97.0 Total 288.0</p>	<p>60 Skott</p> 	<p>31: 10.8x➤                  32: 10.4x➤                  33: 10.1 ➤                  34: 10.8x↓                  35: 9.6 ↗                  36: 10.3x➤                  37: 10.6x↑                  38: 10.5x↔                  39: 10.5x↔                  40: 10.0 ↗</p> <p>Serie 99.0 Total 387.0</p>

<p><b>Pröv</b></p>	<p><b>Pröv</b></p>	
<p><b>Pröv</b></p>	<p><b>60 Skott</b></p>	<p><b>60 Skott</b></p>
<p><b>60 Skott</b></p>	<p><b>60 Skott</b></p>	<p><b>60 Skott</b></p>

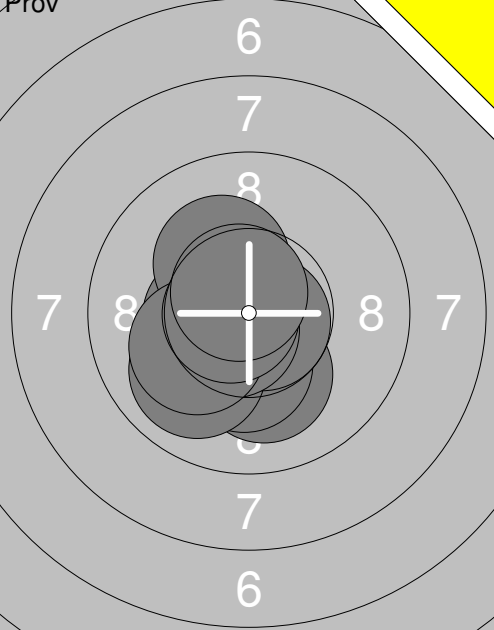
<p><b>Pröv</b></p>	<p>1: 10.5x ↘ 2: 9.6 → 3: 10.2x ↑ 4: 10.1 ↘ 5: 10.4x ↘ 6: 10.3x ← 7: 10.7x ↘ 8: 10.6x ↗ 9: 10.7x ↘ 10: 10.8x ↗</p> <p>Serie 99.0 Total 0.0</p>	<p><b>Pröv</b></p>	<p>11: 10.5x ↘ 12: 10.7x ↘ 13: 10.3x → 14: 9.7 ↘ 15: 9.9 ← 16: 10.6x ← 17: 10.2x ↗ 18: 10.2x ← 19: 10.3x ↘ 20: 10.2x ↖</p> <p>Serie 98.0 Total 0.0</p>
<p><b>Pröv</b></p>	<p>21: 10.0 ← 22: 10.6x ← 23: 9.4 ↑ 24: 9.5 ↗ 25: 10.7x ↑</p> <p>Serie 48.0 Total 0.0</p>	<p><b>60 Skott</b></p>	<p>1: 10.1 → 2: 10.1 ↖ 3: 10.5x ↗ 4: 10.1 → 5: 10.7x ↘ 6: 10.3x ↗ 7: 10.5x ↑ 8: 10.2x → 9: 10.3x ↘ 10: 10.6x ↘</p> <p>Serie 100.0 Total 100.0</p>
<p><b>60 Skott</b></p>	<p>11: 10.8x ↘ 12: 10.3x ↘ 13: 10.9x ↘ 14: 10.3x ↗ 15: 10.4x ← 16: 10.6x ↗ 17: 10.8x ↑ 18: 10.6x ↑ 19: 9.9 → 20: 10.1 ↘</p> <p>Serie 99.0 Total 199.0</p>	<p><b>60 Skott</b></p>	<p>21: 10.8x ↘ 22: 10.6x ↗ 23: 9.7 ↑ 24: 10.7x ← 25: 9.9 ↑ 26: 10.1 ↑ 27: 10.2x ↗ 28: 10.8x → 29: 10.6x ↗ 30: 10.6x ↖</p> <p>Serie 98.0 Total 297.0</p>
<p><b>60 Skott</b></p>	<p>31: 10.3x ↗ 32: 10.4x ← 33: 10.6x ↗ 34: 10.3x ↗ 35: 10.1 ↑ 36: 10.4x ↑ 37: 10.2x → 38: 10.1 ↘ 39: 10.5x ↗ 40: 10.3x ↖</p> <p>Serie 100.0 Total 397.0</p>		

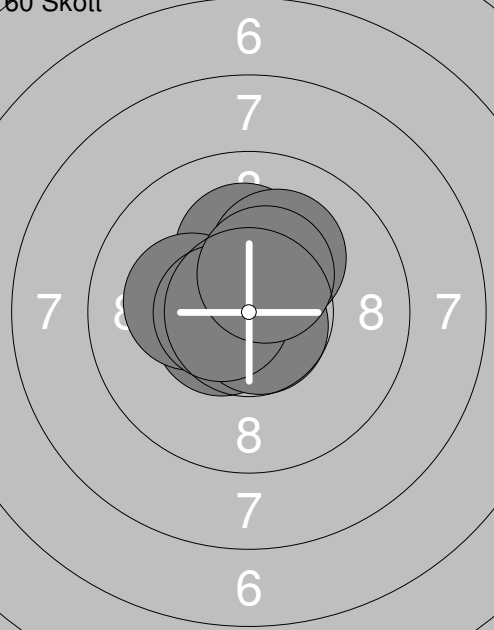
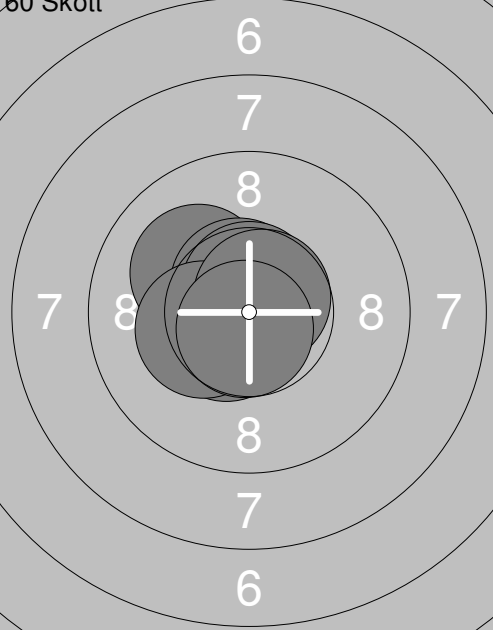
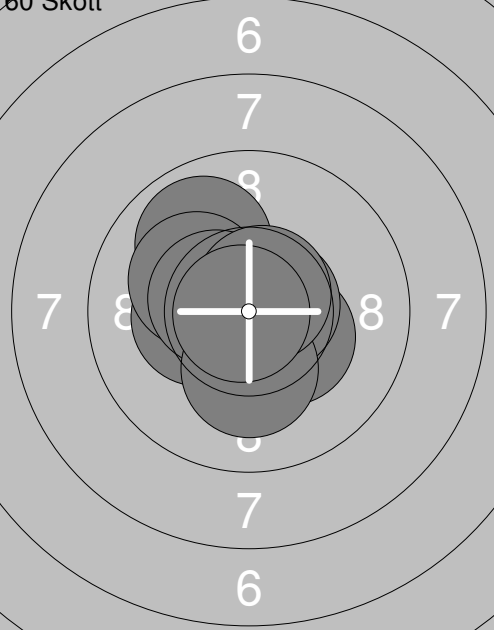
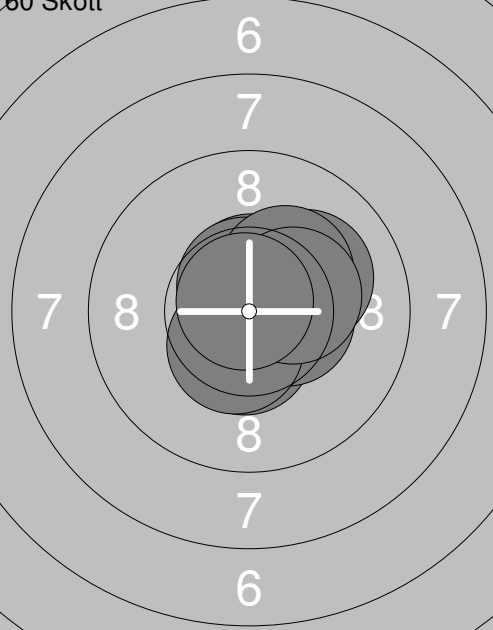
Prov 	1: 10.1 ↓ 2: 10.3x ↓ 3: 10.0 ↘ 4: 10.7x ↘ 5: 10.5x ← 6: 10.2x ↖ 7: 10.6x ↘ 8: 10.2x ↘ 9: 10.7x ← 10: 10.7x ↖ Serie 100.0 Total 0.0	Prov 	11: 10.5x → 12: 10.9x ↘ 13: 10.8x ↘ 14: 10.7x ↘ 15: 10.6x ↘ Serie 50.0 Total 0.0
60 Skott 	1: 10.4x ↑ 2: 10.8x ↓ 3: 10.2x ↑ 4: 10.9x ↘ 5: 10.1 ↗ 6: 10.5x ↘ 7: 10.7x ↘ 8: 10.2x ↘ 9: 10.6x ← 10: 10.4x ↑ Serie 100.0 Total 100.0	60 Skott 	11: 10.8x ← 12: 10.1 ↖ 13: 10.8x ↗ 14: 10.6x ↘ 15: 10.6x ↘ 16: 10.8x ↓ 17: 10.7x ↑ 18: 10.3x ↘ 19: 10.7x ↗ 20: 10.7x ↓ Serie 100.0 Total 200.0
60 Skott 	21: 10.3x ↘ 22: 10.3x ← 23: 10.4x ↘ 24: 10.6x → 25: 9.9 ↖ 26: 10.2x ↘ 27: 10.5x ↘ 28: 10.2x ↓ 29: 10.7x ↗ 30: 10.8x ← Serie 99.0 Total 299.0	60 Skott 	31: 10.6x ↗ 32: 10.6x ↑ 33: 10.1 ↗ 34: 10.6x ↑ 35: 10.5x ↓ 36: 10.3x ↗ 37: 10.5x → 38: 10.5x ↓ 39: 10.3x → 40: 10.8x ↘ Serie 100.0 Total 399.0

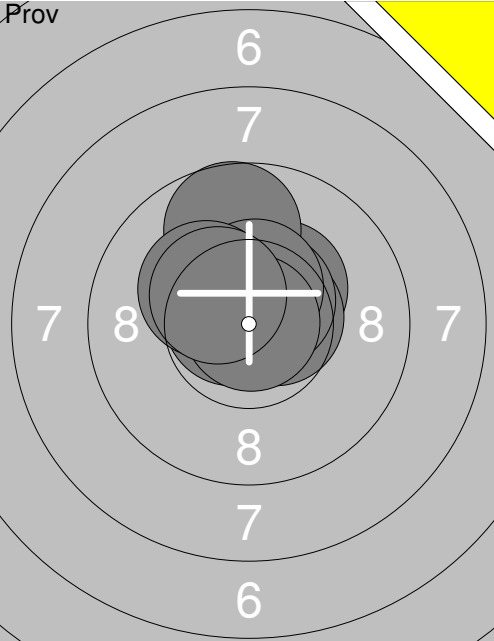
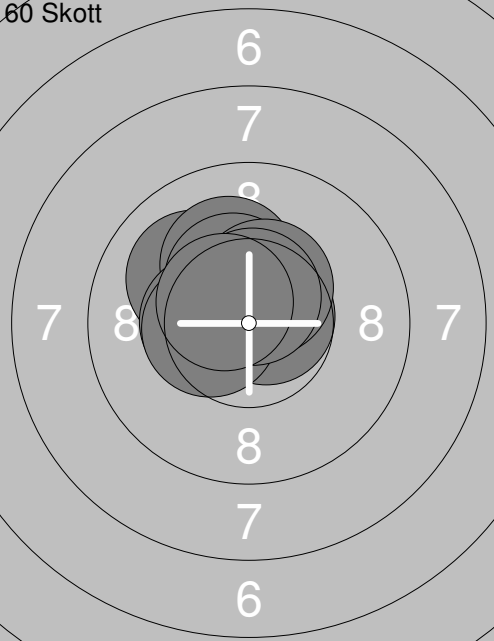
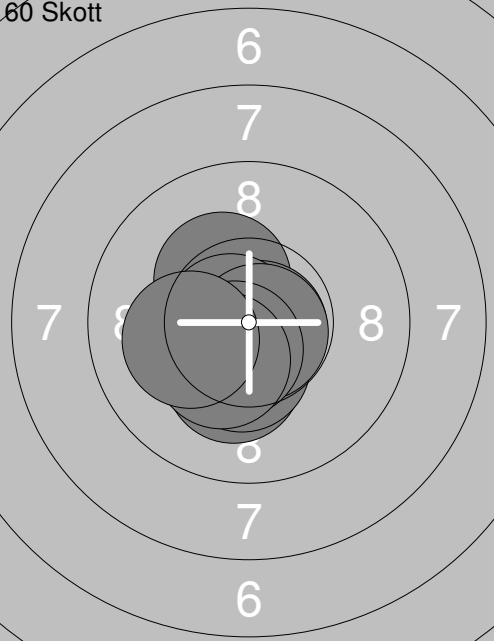

Skjutlag	Tavla	Jennifer Gustafsson	
S		Ramselefors Skf	
27.01.2018		Förbundsmästerskap 2018	Umeå skytteallians
Prov		1: 10.4x↗ 2: 10.3x↘ 3: 10.6x→ 4: 10.6x↗ 5: 9.7 ↑ 6: 10.7↖ 7: 10.5x↗ 8: 10.9x↗ 9: 10.2x↖ 10: 10.4x↖ Serie 99.0 Total 0.0	11: 10.8x↖ 12: 10.8x↖ 13: 10.4x↖ 14: 10.9x→ 15: 10.6x↗ 16: 10.8x↖ 17: 10.7↖ 18: 10.2x↖ 19: 10.4x↖ 20: 10.5x↖ 21: 10.7x↖ 22: 10.2x↖ 23: 10.7x↖ 24: 10.3x↖ 25: 10.7x↖ 26: 10.5x↖ 27: 10.5x↖ 28: 10.7x↖ 29: 10.7x↖ 30: 10.5x↖ 31: 10.7x↖ 32: 10.2x↖ 33: 10.7x↖ 34: 10.3x↖ 35: 10.7x↖ 36: 10.5x↖ 37: 10.5x↖ 38: 10.7x↖ 39: 10.7x↖ 40: 10.5x↖ Serie 10.0 Total 0.0
60 Skott		1: 10.6x↖ 2: 10.0↖ 3: 10.1 ↑ 4: 10.7x→ 5: 10.4x↖ 6: 10.4x↗ 7: 10.4x↖ 8: 10.4x↖ 9: 10.6x↗ 10: 10.5x↖ Serie 100.0 Total 100.0	11: 10.8x↖ 12: 10.4x↖ 13: 10.9x→ 14: 10.6x↗ 15: 10.8x↖ 16: 10.7x↖ 17: 10.2x↖ 18: 10.4x↖ 19: 10.5x↖ 20: 10.7x↖ Serie 100.0 Total 200.0
60 Skott		21: 10.2x↖ 22: 10.7x↖ 23: 10.3x↖ 24: 10.8x↖ 25: 10.4x↖ 26: 10.7x↖ 27: 10.8x↖ 28: 10.5x↖ 29: 10.3x↖ 30: 10.2x↖ Serie 100.0 Total 300.0	31: 10.7x↖ 32: 10.2x↖ 33: 10.7x↖ 34: 10.3x↖ 35: 10.7x↖ 36: 10.5x↖ 37: 10.5x↖ 38: 10.7x↖ 39: 10.7x↖ 40: 10.5x↖ Serie 100.0 Total 400.0

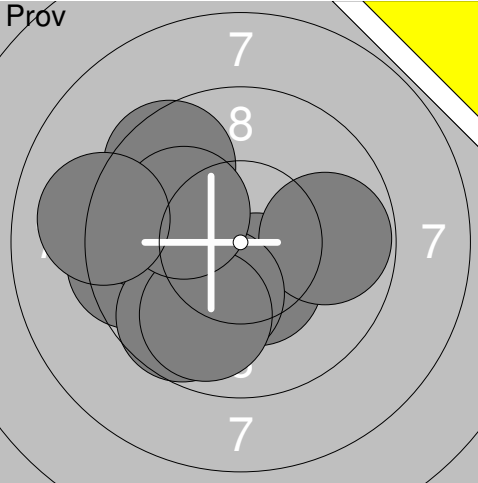
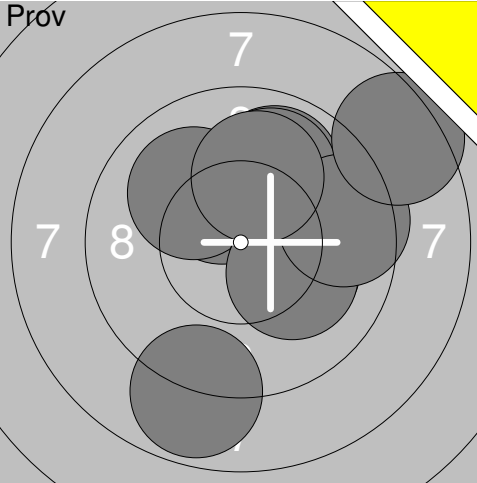
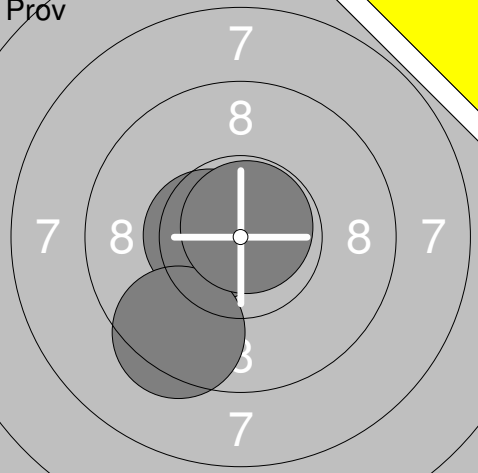
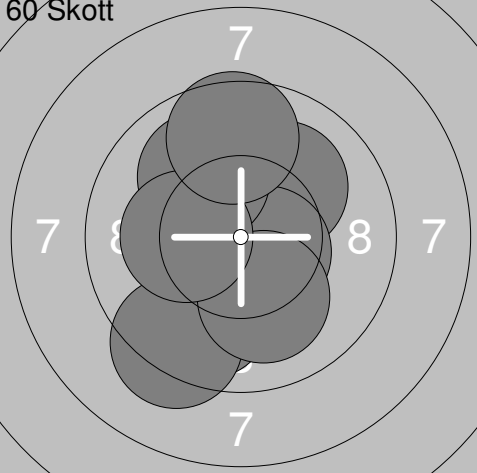
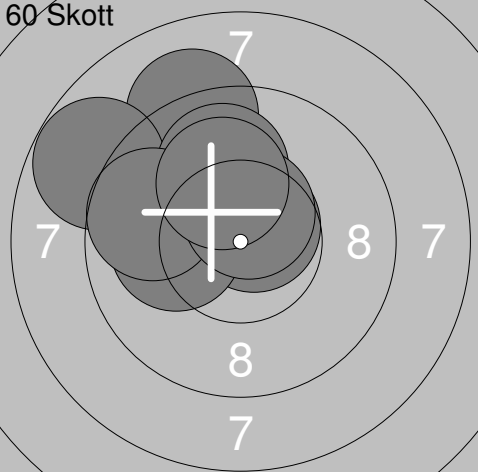
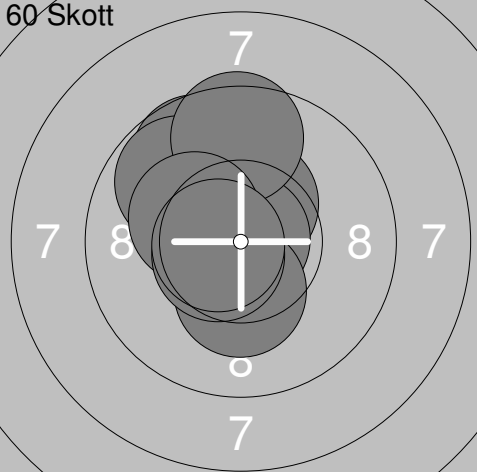
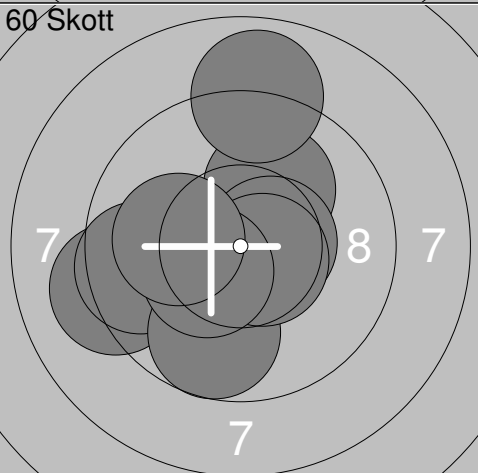
Skjutlag <b>2</b>	Tavla <b>35</b>	<b>Jonathan Ebbhagen</b>	
S		Ramselefors Skf	
27.01.2018		Förbundsmästerskap 2018	Umeå skytteallians
<b>Pröv</b> 	1: 10.4x ↘ 2: 9.5 ← 3: 9.7 ← 4: 9.8 → 5: 10.2x ↘ 6: 9.7 ↘ 7: 9.9 ↘ 8: 9.5 ↗ 9: 10.1 ↗ 10: 9.1 ← Serie 93.0 Total 0.0	<b>Pröv</b> 	11: 10.3x ↗ 12: 10.0 ↗ 13: 10.2x → 14: 9.9 ↗ 15: 9.9 ↗ 16: 10.1 → 17: 9.5 → 18: 10.0 ↗ 19: 8.4 ↗ 20: 8.8 ↓ Serie 93.0 Total 0.0
<b>Pröv</b> 	21: 10.5x ← 22: 9.4 ↘ 23: 10.8x ↗ Serie 29.0 Total 0.0	<b>60 Skott</b> 	1: 10.4x ↘ 2: 10.6x ↗ 3: 9.8 ↘ 4: 9.3 ↘ 5: 10.1 ↗ 6: 10.6x → 7: 10.0 ↗ 8: 10.1 ↘ 9: 10.2x ← 10: 9.6 ↗ Serie 97.0 Total 97.0
<b>60 Skott</b> 	11: 10.7x ↗ 12: 10.1 ↗ 13: 9.8 ↗ 14: 10.1 ← 15: 9.1 ↗ 16: 8.8 ↗ 17: 9.9 ↗ 18: 9.7 ← 19: 10.5x ↗ 20: 10.1 ↗ Serie 94.0 Total 191.0	<b>60 Skott</b> 	21: 10.4x ↗ 22: 9.7 ↗ 23: 10.7x ↗ 24: 10.9x ↗ 25: 9.8 ↗ 26: 9.6 ↗ 27: 10.3x ↗ 28: 10.3x ↓ 29: 10.6x ← 30: 10.6x ← Serie 97.0 Total 288.0
<b>60 Skott</b> 	31: 10.1 ← 32: 9.2 ← 33: 9.6 ← 34: 10.1 ↗ 35: 10.5x → 36: 9.7 ↘ 37: 10.6x → 38: 10.4x ← 39: 10.1 ← 40: 8.9 ↗ Serie 95.0 Total 383.0		

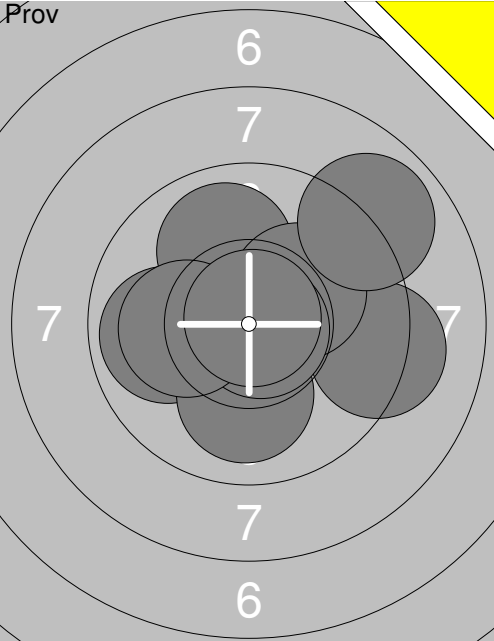
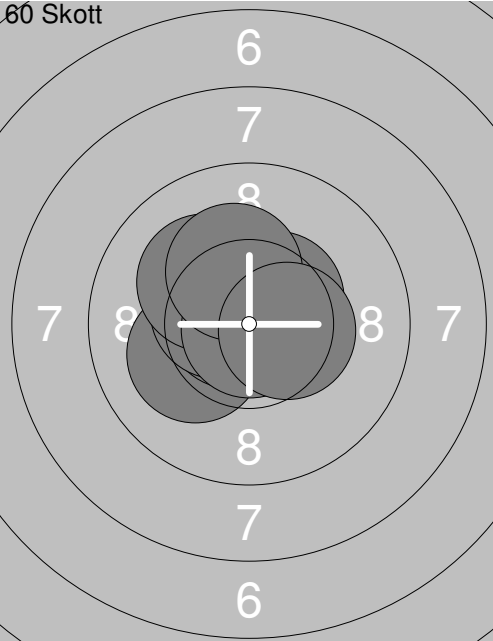
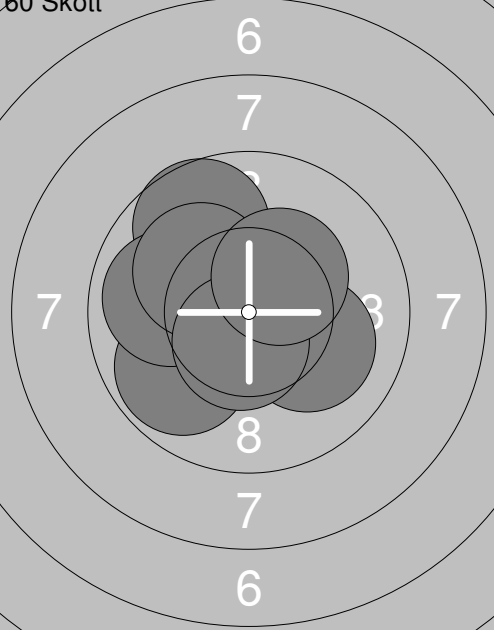
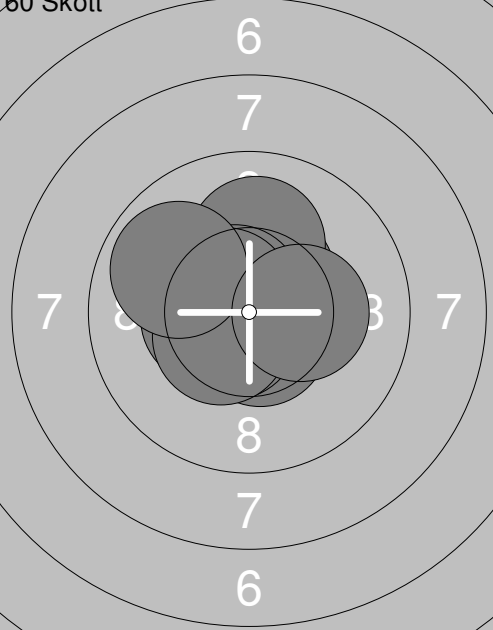
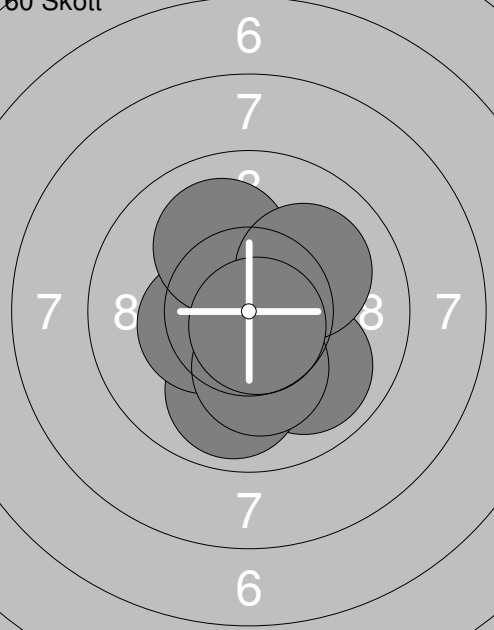
Skjutlag <b>2</b>	Tavla <b>37</b>	<b>Erika Gustafsson</b>	
S		Ramselefors Skf	
27.01.2018	Förbundsmästerskap 2018	Umeå skytteallians	
Prov 	1: 10.7x↗ 2: 9.9 ← 3: 9.2 → 4: 10.0 ↑ 5: 10.2x↗ 6: 10.0 ↓ 7: 10.8x↘ 8: 8.9 ↗ 9: 10.1 ← 10: 10.9x↗ Serie 96.0 Total 0.0	60 Skott 	1: 10.1 ↙ 2: 10.7x↘ 3: 10.8x↗ 4: 10.7x↘ 5: 10.5x↗ 6: 10.5x↘ 7: 10.2x↘ 8: 10.9x↓ 9: 10.2x↗ 10: 10.4x→ Serie 100.0 Total 100.0
60 Skott 	11: 9.7 ↘ 12: 9.8 ↙ 13: 10.6x→ 14: 10.1 → 15: 10.4x↘ 16: 10.7x↘ 17: 9.9 ← 18: 10.1 ↙ 19: 10.5x↓ 20: 10.3x↗ Serie 97.0 Total 197.0	60 Skott 	21: 10.4x↗ 22: 10.6x↓ 23: 10.4x↘ 24: 10.1 ↑ 25: 10.6x↙ 26: 10.6x↘ 27: 10.6x↘ 28: 10.5x↙ 29: 9.9 ↙ 30: 10.3x→ Serie 99.0 Total 296.0
60 Skott 	31: 10.5x→ 32: 10.3x↓ 33: 9.9 ↘ 34: 9.9 ↓ 35: 10.4x↘ 36: 10.7x↗ 37: 10.0 ↑ 38: 10.1 ↗ 39: 10.2x↓ 40: 10.7x↓ Serie 98.0 Total 394.0		

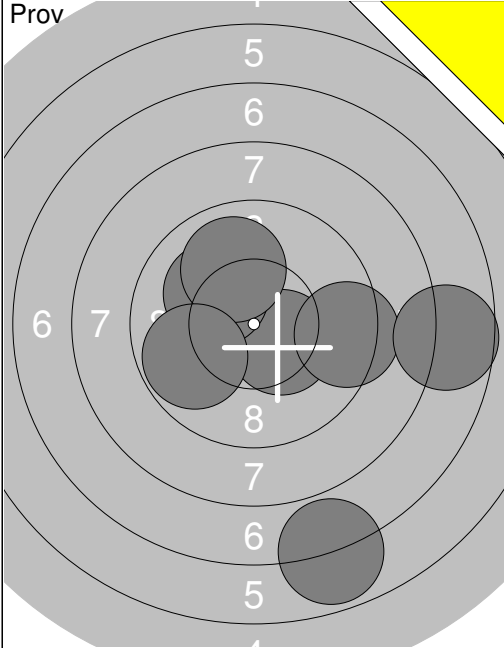
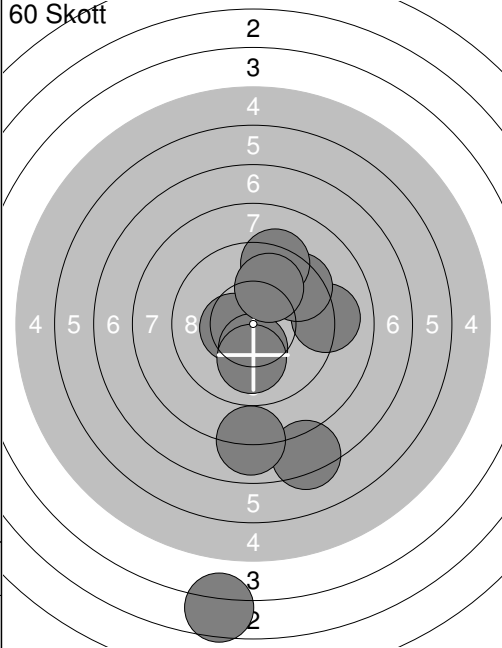
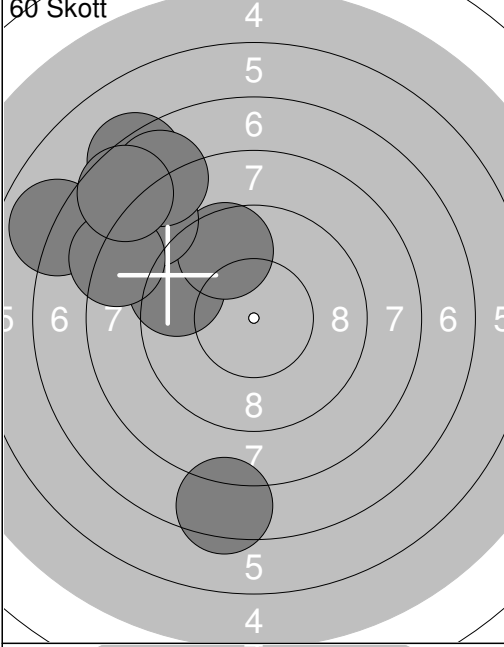
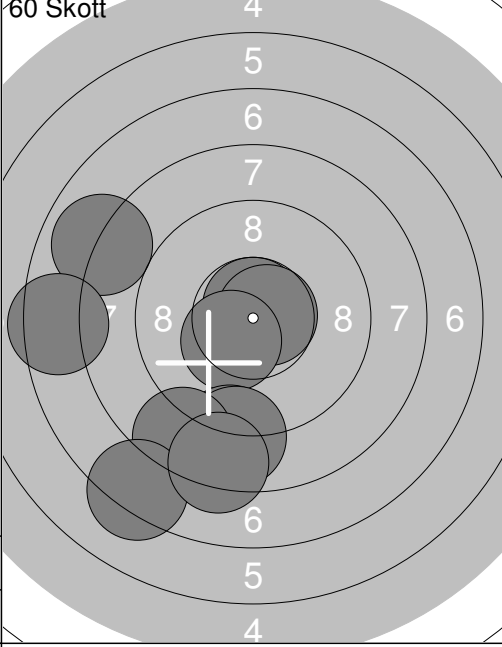
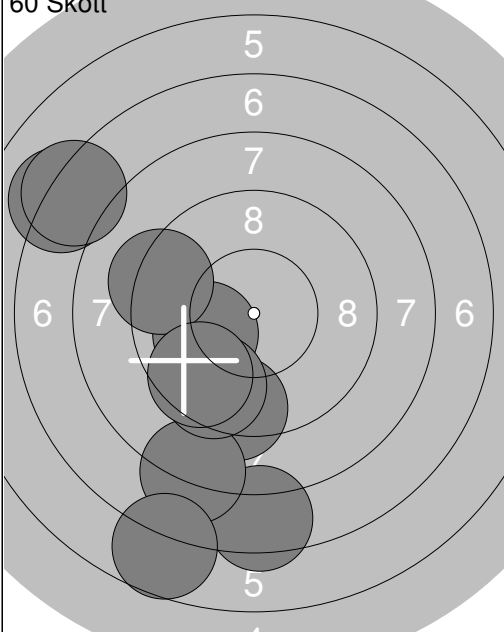
Skjutlag <b>2</b>	Tavla <b>40</b>	<b>Jan-Olov Jonsson</b>	
S		Umeå Skf	
27.01.2018		Förbundsmästerskap 2018	Umeå skytteallians
Prov		1: 6.9 ↓ 2: 10.4x ↘ 3: 9.4 → 4: 7.7 → 5: 10.1 ↖ 6: 10.0 ↑ 7: 9.8 ↙	60 Skott  1: 10.4x ↖ 2: 7.3 ↓ 3: 9.1 → 4: 9.5 ↗ 5: 10.3x ↓ 6: 8.0 ↓ 7: 3.6 ↓ 8: 10.1 ↓ 9: 9.3 ↑ 10: 9.9 ↑
		Serie 61.0	Serie 84.0
		Total 0.0	Total 84.0
60 Skott		11: 7.4 ↓ 12: 7.3 ↗ 13: 9.2 ↖ 14: 9.4 ↖ 15: 9.6 ↑ 16: 8.3 ↗ 17: 7.8 ↗ 18: 6.9 ↖ 19: 8.2 ↖ 20: 7.6 ↗	60 Skott  21: 7.9 ↖ 22: 10.8x ↑ 23: 10.7x → 24: 10.4x ↖ 25: 8.8 ↓ 26: 8.8 ↓ 27: 8.5 ↓ 28: 7.3 ↓ 29: 8.3 ↓ 30: 7.5 ←
		Serie 77.0	Serie 83.0
		Total 161.0	Total 244.0
60 Skott		31: 7.4 ↓ 32: 10.1 ↖ 33: 9.3 ↖ 34: 9.3 ↓ 35: 8.1 ↓ 36: 6.7 ↓ 37: 9.5 ↓ 38: 9.6 ↖ 39: 7.1 ↖ 40: 7.2 ↖	
		Serie 81.0	
		Total 325.0	