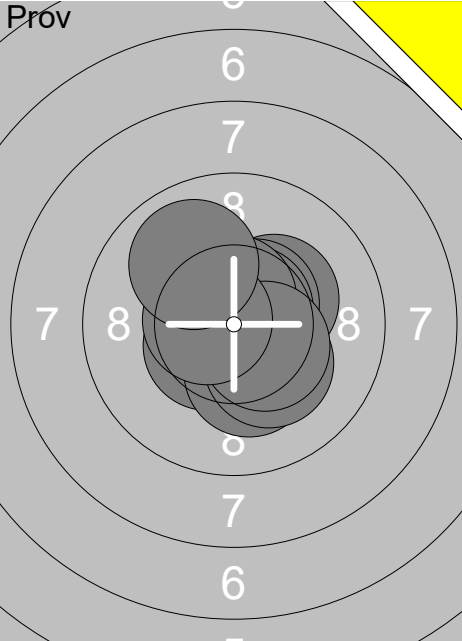
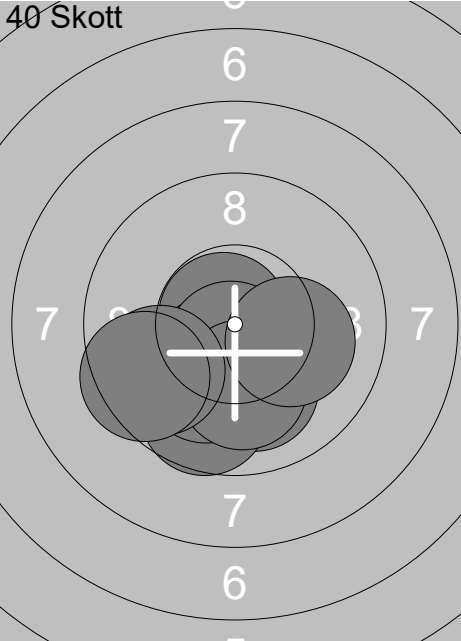
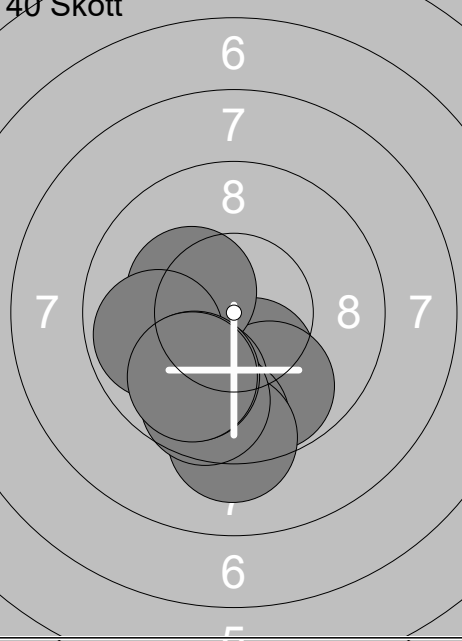
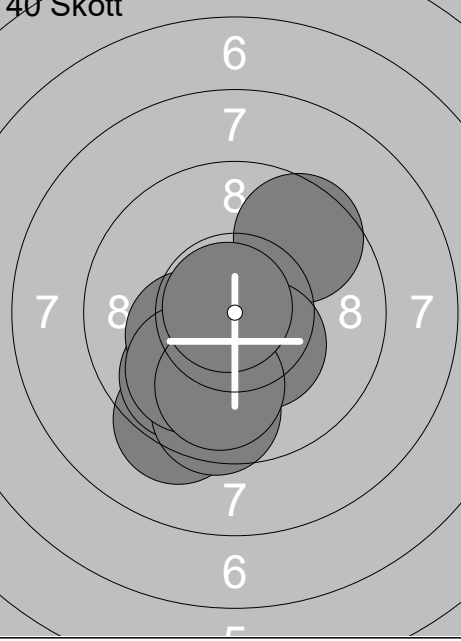
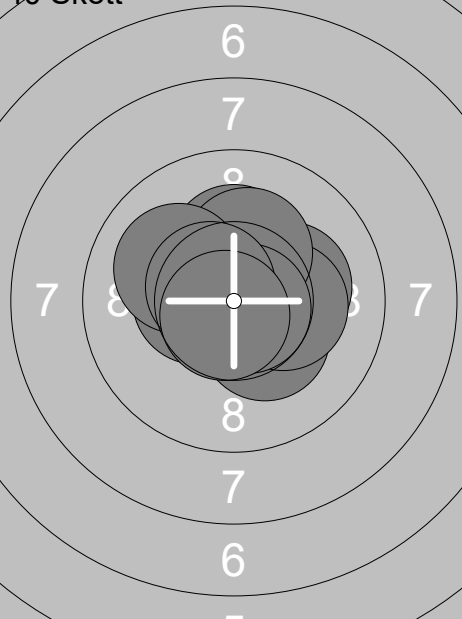

Skjuttag	Tavla	Jennifer Gustafsson			
1	11	Ramselefors	Ramselefors	13	Vb
13.01.2018	Skyttiadens distriktsfinal 2018	Ramselefors SKF			
<b>Prov</b> 	1: 10.2x ↗ 2: 10.4x ↗ 3: 9.4 → 4: 9.8 ↗ 5: 9.3 → 6: 10.9x ← 7: 10.5x ↗ 8: 10.5x ← 9: 10.4x ↗ 10: 10.3x →	<b>Prov</b> 	11: 10.2x ↗ 12: 10.8x ⇒ 13: 10.7x ↘ 14: 10.3x ↗ 15: 10.6x ⇒ 16: 9.9 ↑ 17: 10.8x ← 18: 10.6x ⇒		
	Serie 101.7		Serie 83.9		
	Total 0.0		Total 0.0		
<b>40 Skott</b> 	1: 10.8x ↖ 2: 10.6x ← 3: 10.6x ↗ 4: 10.8x → 5: 10.6x ← 6: 10.6x ↑ 7: 10.9x ← 8: 10.5x ← 9: 10.8x ↘ 10: 10.4x ↘	<b>40 Skott</b> 	11: 10.7x ↑ 12: 10.7x ↖ 13: 10.3x ← 14: 10.6x ↘ 15: 10.8x ↘ 16: 10.4x ↗ 17: 10.4x ↖ 18: 10.8x ↓ 19: 10.7x ↘ 20: 10.4x →		
	Serie 106.6		Serie 105.8		
	Total 106.6		Total 212.4		
<b>40 Skott</b> 	21: 10.8x → 22: 10.1 ↓ 23: 10.9x ↘ 24: 10.4x ← 25: 10.7x ↓ 26: 10.8x → 27: 10.2x ↖ 28: 10.7x ↘ 29: 10.6x ← 30: 10.5x ↘	<b>40 Skott</b> 	31: 10.8x ↑ 32: 10.4x ↑ 33: 10.7x ↑ 34: 10.3x ↖ 35: 10.6x ↓ 36: 10.6x ← 37: 10.8x ↑ 38: 10.6x ⇒ 39: 10.6x ↗ 40: 10.7x ↘		
	Serie 105.7		Serie 106.1		
	Total 318.1		Total 424.2		

Skjuttlag	Tavla	Hanna Åsberg		
1	12	Ramselefors	13	Vb
13.01.2018	Skyttiadens distriktsfinal 2018	Ramselefors SKF		
<b>Prov</b> 	1: 10.5x ↙ 2: 10.3x ↓ 3: 10.3x ↗ 4: 10.5x ↗ 5: 10.7x ↗ 6: 10.2x ↓ 7: 10.6x ↑ 8: 10.4x ↘ 9: 10.6x ← 10: 9.9 ↖ Serie 104.0 Total 0.0	<b>40 Skott</b> 	1: 10.0 ↓ 2: 9.7 ↓ 3: 10.8x ↖ 4: 10.1 ↓ 5: 10.4x ↓ 6: 10.6x ↓ 7: 10.1 ↓ 8: 10.1 → 9: 9.7 ↙ 10: 9.5 ↙ Serie 101.0 Total 101.0	
<b>40 Skott</b> 	11: 10.2x ↓ 12: 9.8 ↓ 13: 10.3x ↖ 14: 9.9 ← 15: 9.9 ↓ 16: 9.5 ↓ 17: 9.2 ↓ 18: 9.7 ↓ 19: 9.9 ↓ 20: 9.9 ↓ Serie 98.3 Total 199.3	<b>40 Skott</b> 	21: 9.3 ↓ 22: 9.8 ↓ 23: 9.6 ↓ 24: 10.7x ↓ 25: 10.3x ↙ 26: 9.6 ↗ 27: 10.0 ↓ 28: 10.4x ↘ 29: 9.9 ↓ 30: 10.8x ↖ Serie 100.4 Total 299.7	
<b>40 Skott</b> 	31: 10.2x → 32: 10.3x ↘ 33: 10.2x ↑ 34: 10.3x → 35: 10.3x ↑ 36: 10.8x ↘ 37: 10.4x ← 38: 10.1 ↖ 39: 10.6x ↖ 40: 10.7x ↓ Serie 103.9 Total 403.6			

Skjuttlag	Tavla	Beatrice Andersson		
1	13	Ramselefors	13	Vb
13.01.2018	Skytтиадens distriktsfinal 2018	Ramselefors SKF		
<b>Prov</b> 	1: 10.2x ↙ 2: 9.7 ↑ 3: 10.0 ↑ 4: 10.4x ↙ 5: 10.5x ↗ 6: 10.5x ↗ 7: 10.4x ↗ 8: 10.5x ↗ 9: 10.6x ↘ 10: 10.0 →	<b>Prov</b> 	11: 10.1 ↘ 12: 10.7x ↘ 13: 10.5x → 14: 10.8x →	
	Serie 102.8 Total 0.0		Serie 42.1 Total 0.0	
	<b>40 Skott</b> 		1: 10.6x ↗ 2: 10.0 ↗ 3: 10.5x ↑ 4: 10.0 → 5: 10.5x ↗ 6: 10.3x ↑ 7: 10.5x ↙ 8: 10.7x ↗ 9: 10.3x ↑ 10: 10.4x ↑	<b>40 Skott</b> 
Serie 103.8 Total 103.8	Serie 104.2 Total 208.0			
<b>40 Skott</b> 	21: 10.8x ↘ 22: 10.3x ↑ 23: 10.2x ← 24: 10.3x ↗ 25: 10.5x ↑ 26: 9.7 ↑ 27: 10.8x ↘ 28: 10.7x ↑ 29: 10.5x → 30: 10.4x ↗	<b>40 Skott</b> 	31: 10.6x ↑ 32: 10.7x ↘ 33: 10.4x → 34: 10.5x → 35: 10.3x ↗ 36: 10.6x ↘ 37: 10.0 ↘ 38: 10.8x ↑ 39: 10.7x ↑ 40: 10.2x ←	
Serie 104.2 Total 312.2	Serie 104.8 Total 417.0			

Skjutlag	Tavla	Erika Augustsson	
1	14	Ramselefors	Vännäs
13.01.2018	Skyttiadens distriktsfinal 2018	13	Vb
13.01.2018	Skyttiadens distriktsfinal 2018	Ramselefors SKF	
<b>Pröv</b> 	1: 10.0 ↘ 2: 9.5 ↘ 3: 9.9 ↘ 4: 10.3x ↘ 5: 10.3x → 6: 10.9x ↗ 7: 10.7x ← 8: 10.5x ← 9: 10.3x ↓ 10: 10.8x ↘ Serie 103.2 Total 0.0	<b>Pröv</b> 	11: 10.1 ↗ 12: 10.5x ← 13: 10.0 ↗ 14: 10.6x ← 15: 10.4x ← 16: 10.9x ↘ Serie 62.5 Total 0.0
<b>40 Skott</b> 	1: 10.0 ↘ 2: 10.5x ↗ 3: 10.3x ↓ 4: 10.8x ↘ 5: 10.8x ↑ 6: 10.7x ↗ 7: 10.6x ← 8: 10.7x → 9: 10.7x ↑ 10: 10.4x ↘ Serie 105.5 Total 105.5	<b>40 Skott</b> 	11: 10.4x ↗ 12: 10.8x → 13: 10.6x ↗ 14: 10.2x ↗ 15: 10.7x ↑ 16: 10.8x ↘ 17: 10.3x ← 18: 10.8x ↗ 19: 10.3x ↘ 20: 10.4x ↗ Serie 105.3 Total 210.8
<b>40 Skott</b> 	21: 10.6x ↓ 22: 10.9x ↓ 23: 10.6x → 24: 10.4x ← 25: 10.7x ↑ 26: 10.3x ← 27: 10.8x ↓ 28: 10.6x ↓ 29: 10.7x ← 30: 10.1 → Serie 105.7 Total 316.5	<b>40 Skott</b> 	31: 10.5x ↓ 32: 10.7x ↘ 33: 10.5x → 34: 10.5x ↑ 35: 10.4x ← 36: 10.7x → 37: 10.5x → 38: 10.9x ↘ 39: 10.4x ← 40: 10.3x ↗ Serie 105.4 Total 421.9

Skjuttlag	Tavla	Hanna Augustsson	
1	15	Ramselefors	Vännäs
13.01.2018	Skyttiadens distriktsfinal 2018	13	Vb
13.01.2018	Skyttiadens distriktsfinal 2018	Ramselefors SKF	
<b>Prov</b> 	1: 8.3 → 2: 9.0 ↘ 3: 8.7 → 4: 9.6 ↘ 5: 10.6x ↓ 6: 10.3x → 7: 10.0 ↑ 8: 10.6x ↑ 9: 10.0 ↘ 10: 10.7x ↙	<b>Prov</b> 	11: 10.6x ↑ 12: 10.0 ↓ 13: 10.3x ↓ 14: 10.6x ↘ 15: 10.3x ↗ 16: 10.6x ↑ 17: 10.4x ↘ 18: 10.3x ↙ 19: 10.4x ↗ 20: 10.6x ↙
	Serie 97.8		Serie 104.1
	Total 0.0		Total 0.0
<b>40 Skott</b> 	1: 10.6x ↙ 2: 10.6x ↑ 3: 10.5x ↙ 4: 10.6x ↙ 5: 10.5x ↙ 6: 10.7x ↘ 7: 10.5x ↙ 8: 10.7x ↑ 9: 10.6x ↙ 10: 10.3x ↙	<b>40 Skott</b> 	11: 10.1 ↑ 12: 10.6x ↓ 13: 10.6x ↙ 14: 10.8x ↙ 15: 10.8x ↙ 16: 9.8 ↙ 17: 10.0 → 18: 10.6x ↙ 19: 10.7x → 20: 10.4x ↙
	Serie 105.6		Serie 104.4
	Total 105.6		Total 210.0
<b>40 Skott</b> 	21: 10.2x ↑ 22: 10.1 ↑ 23: 10.3x ↓ 24: 10.3x → 25: 10.2x ↓ 26: 10.3x ↑ 27: 10.6x → 28: 9.9 ↙ 29: 10.8x ↘ 30: 10.6x ↘	<b>40 Skott</b> 	31: 10.2x ↑ 32: 10.3x ↙ 33: 10.8x ↙ 34: 10.4x ↘ 35: 10.4x ↘ 36: 10.5x ↑ 37: 10.4x ↙ 38: 10.7x ↓ 39: 10.2x ↓ 40: 10.8x ↑
	Serie 103.3		Serie 104.7
	Total 313.3		Total 418.0

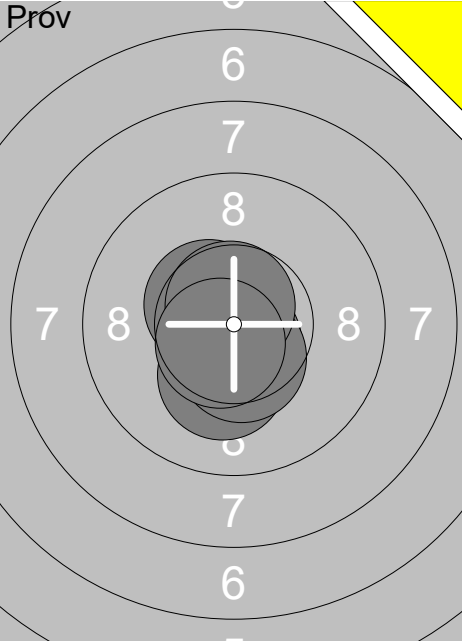
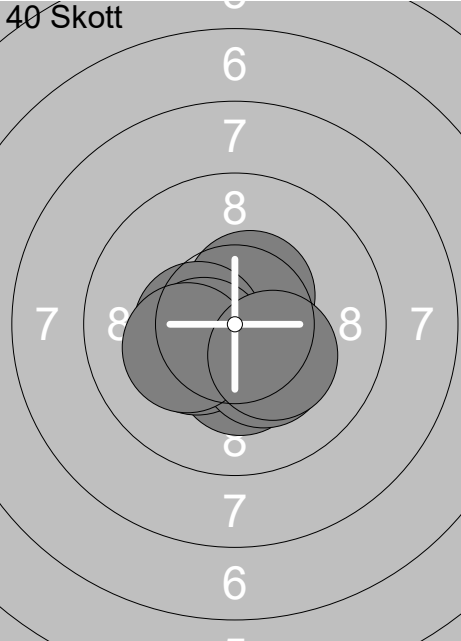
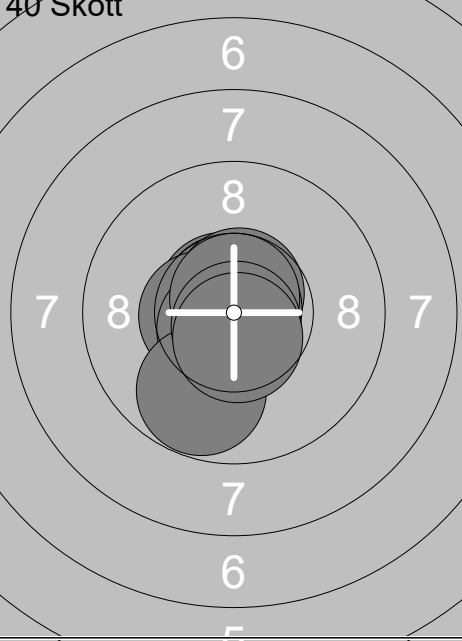
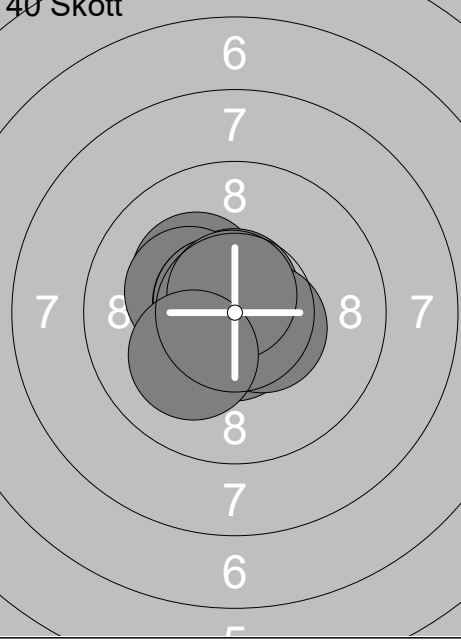
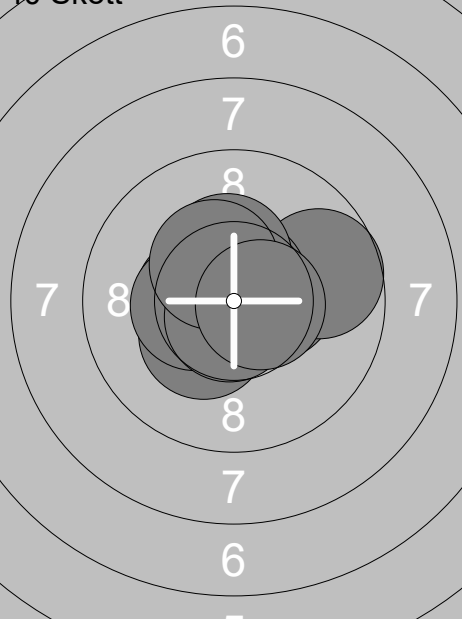
Skjutlag <b>1</b>	Tavla <b>21</b>	<b>Sofi Jonsson</b>	
Ramselefors	Ramselefors	15	Vb
13.01.2018	Skyttiadens distriktsfinal 2018	Ramselefors SKF	
Prov		40 Skott 	
	1: 10.5x ↘ 2: 10.7x ↓ 3: 10.2x ↓ 4: 10.5x ↓ 5: 10.7x ↑ 6: 10.6x ↘	1: 10.6x ↓ 2: 10.4x ↙ 3: 10.5x ↗ 4: 10.3x ↓ 5: 10.3x ↙ 6: 10.4x ← 7: 10.5x ↙ 8: 10.3x ↓ 9: 10.2x ↙ 10: 10.3x ↘	
	Serie 63.2 Total 0.0	Serie 103.8 Total 103.8	
40 Skott		40 Skott 	
	11: 10.7x ↘ 12: 10.7x ↗ 13: 10.7x ↗ 14: 10.5x ← 15: 10.9x ↗ 16: 10.7x ↘ 17: 10.8x ↑ 18: 9.8 ↓ 19: 10.8x ↓ 20: 10.6x ↓	21: 10.2x ↘ 22: 10.7x ↑ 23: 10.6x ↓ 24: 10.3x ↙ 25: 10.5x ↘ 26: 10.3x ↙ 27: 10.7x ↘ 28: 10.7x ↘ 29: 10.7x ↑ 30: 10.1 ↙	
	Serie 106.2 Total 210.0	Serie 104.8 Total 314.8	
40 Skott			
	31: 10.4x → 32: 9.7 → 33: 10.7x ↗ 34: 10.3x ↙ 35: 10.5x ← 36: 10.4x ↑ 37: 10.4x ← 38: 10.7x ↓ 39: 10.4x ↗ 40: 10.6x →		
	Serie 104.1 Total 418.9		

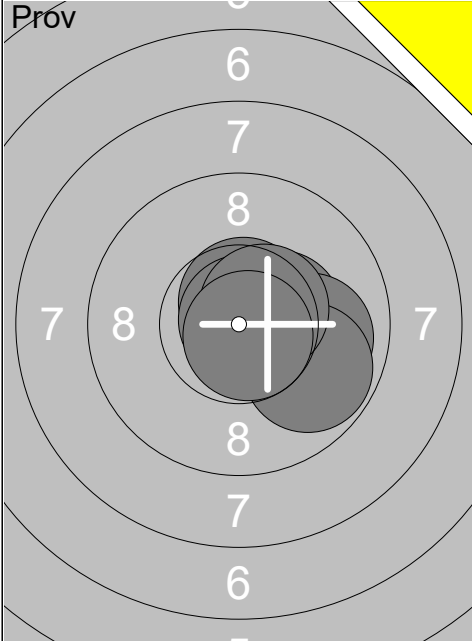
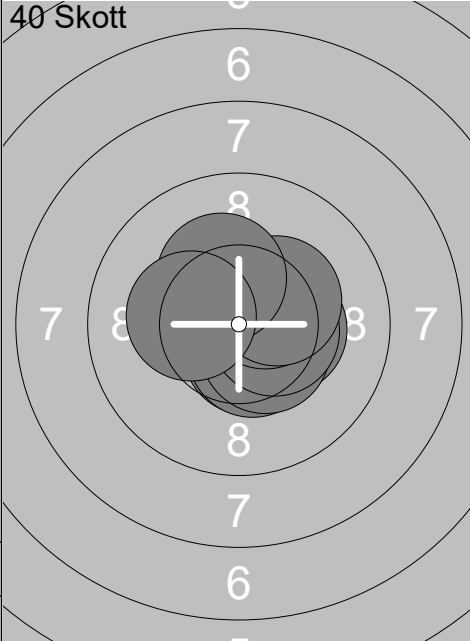
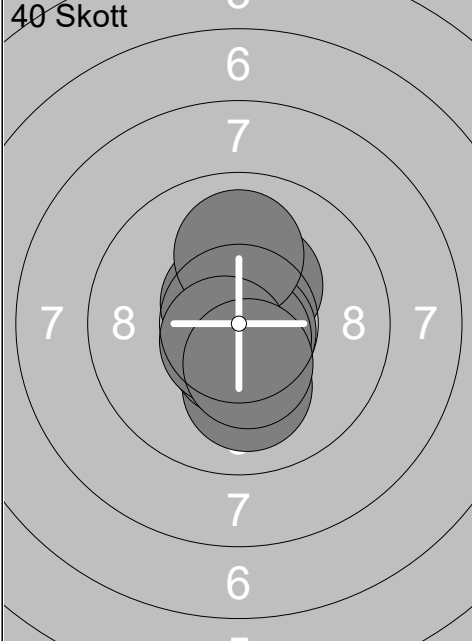
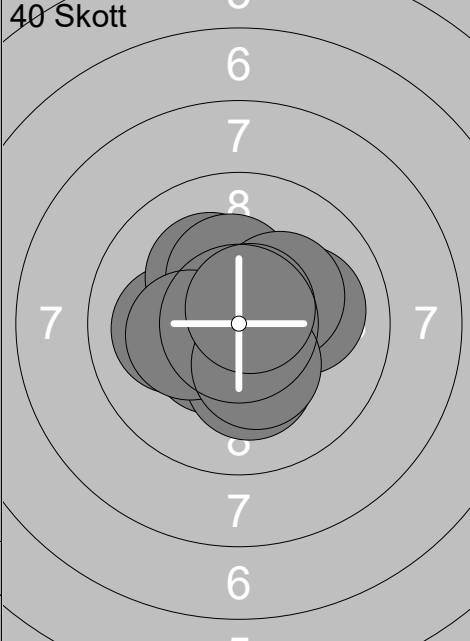
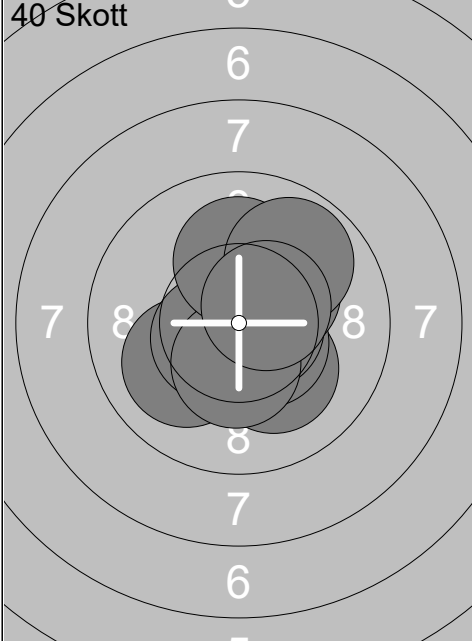
Skjuttag	Tavla	Fluk Jonsson		
1	22	Ramselefors	Ramselefors	15 Vb
13.01.2018		Skyttiadens distriktsfinal 2018	Ramselefors SKF	
Prov		1: 10.4x → 2: 10.0 → 3: 9.8 ↘ 4: 10.6x ↑ 5: 10.9x ↗ 6: 10.6x ↗ 7: 10.8x ↘	40 Skott 	1: 10.6x ↓ 2: 10.5x ↓ 3: 10.4x → 4: 10.5x ↘ 5: 10.6x ↗ 6: 10.4x → 7: 10.5x ↗ 8: 10.3x ↗ 9: 10.3x ↑ 10: 10.3x ←
		Serie 73.1 Total 0.0		Serie 104.4 Total 104.4
40 Skott		11: 10.1 ↓ 12: 10.8x ↙ 13: 10.5x ↓ 14: 10.6x ↘ 15: 10.4x ↗ 16: 10.7x ↘ 17: 10.7x ↓ 18: 10.0 ↑ 19: 10.6x ↙ 20: 10.4x ↓	40 Skott 	21: 10.5x ↙ 22: 10.1 ← 23: 10.2x ↘ 24: 10.1 → 25: 10.3x ↑ 26: 10.2x ↓ 27: 10.3x ↗ 28: 10.3x ← 29: 10.3x ↓ 30: 10.7x ↗
		Serie 104.8 Total 209.2		Serie 103.0 Total 312.2
40 Skott		31: 10.2x ↓ 32: 10.5x ↘ 33: 10.0 ↙ 34: 10.6x ↙ 35: 10.7x → 36: 10.3x ↗ 37: 10.4x ↓ 38: 10.1 ↑ 39: 9.9 ↗ 40: 10.5x ↗		
		Serie 103.2 Total 415.4		

Skjuttlag	Tavla	Saga Ebbhagen		
1	23	Ramselefors	Ramselefors	15 Vb
13.01.2018		Skyttiadens distriktsfinal 2018	Ramselefors SKF	
Prov		1: 9.2 ↓ 2: 10.8x ↗ 3: 9.9 ← 4: 10.6x ↗ 5: 10.7x → 6: 10.6x ↓	40 Skott	1: 10.4x → 2: 10.7x ↖ 3: 10.2x ↓ 4: 9.9 ↗ 5: 10.2x → 6: 10.6x ↙ 7: 9.8 ← 8: 10.6x ↖ 9: 10.6x ↖ 10: 10.3x ↖
		Serie 61.8		Serie 103.3
		Total 0.0		Total 103.3
40 Skott		11: 10.4x ↗ 12: 9.9 ↗ 13: 10.8x ↑ 14: 10.3x → 15: 10.9x ↖ 16: 10.5x → 17: 10.0 ↗ 18: 10.3x ↖ 19: 10.7x ↖ 20: 10.6x →	40 Skott	21: 10.6x ↗ 22: 10.6x ↙ 23: 10.5x ↗ 24: 10.2x ↑ 25: 10.5x ↖ 26: 9.9 ↓ 27: 10.6x → 28: 10.0 ↗ 29: 10.5x ↓ 30: 10.6x ↗
		Serie 104.4		Serie 104.0
		Total 207.7		Total 311.7
40 Skott		31: 10.8x ↙ 32: 10.4x ↓ 33: 9.9 ↓ 34: 10.7x → 35: 10.8x ↖ 36: 10.3x ↗ 37: 10.2x → 38: 10.5x ↖ 39: 10.5x ↗ 40: 10.9x →		
		Serie 105.0		
		Total 416.7		

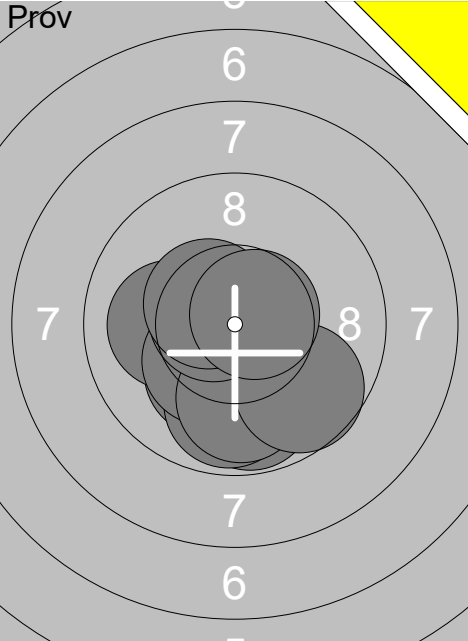
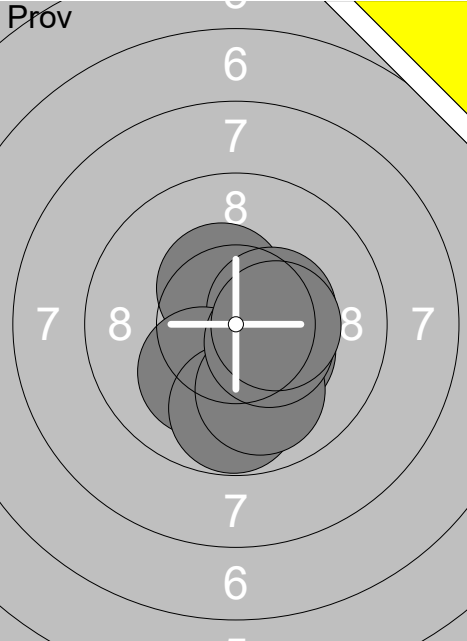
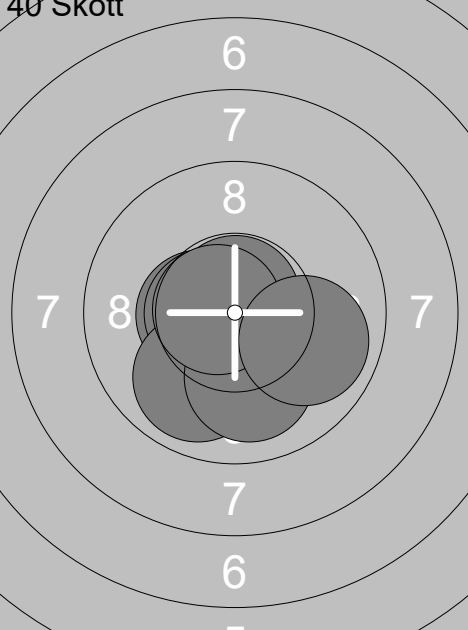
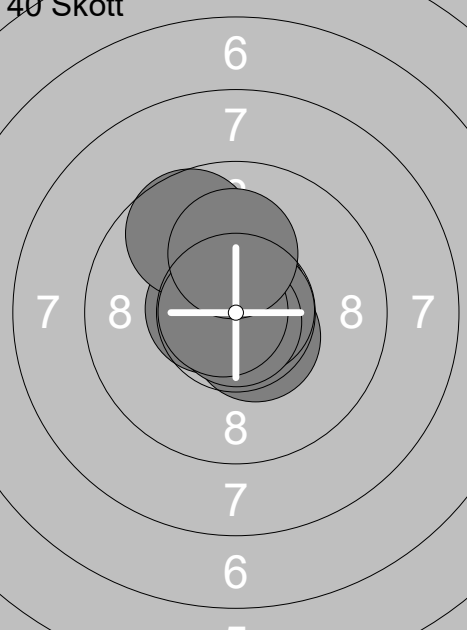
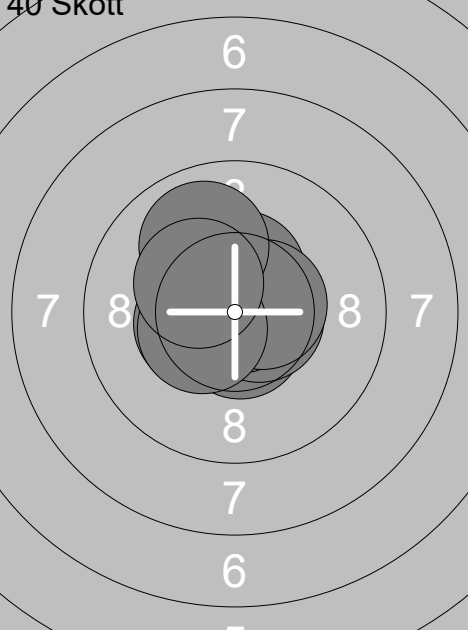
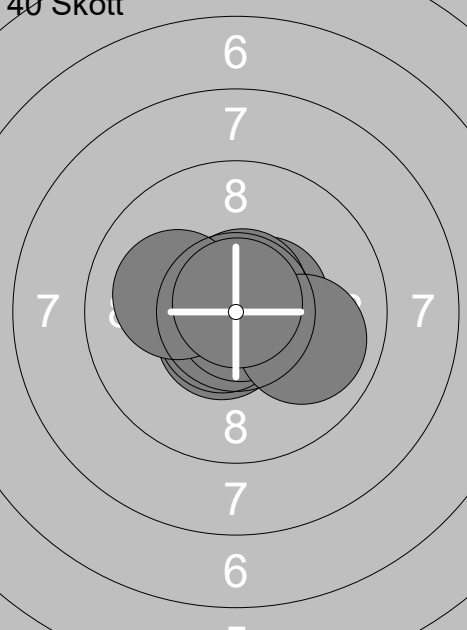

Skjuttlag	Tavla	Maja Lindberg	
1	24	Ramselefors	Vb
Ramselefors	Ramselefors	15	
13.01.2018	Skyttiadens distriktsfinal 2018	Ramselefors SKF	
Prov		Prov	
	1: 9.8 ↓ 2: 10.2x ↓ 3: 9.9 ↓ 4: 10.1 ← 5: 10.3x ↓ 6: 9.9 ↓ 7: 10.6x ← 8: 9.7 ↘ 9: 10.5x ↖ 10: 10.6x →		11: 10.4x ↖ 12: 10.4x → 13: 10.3x ↘ 14: 10.1 ↓ 15: 9.8 ↓ 16: 10.0 ↓ 17: 10.4x ↘ 18: 10.4x →
Serie 101.6	Total 0.0	Serie 81.8	Total 0.0
40 Skott		40 Skott	
	1: 10.8x ↓ 2: 10.5x ← 3: 10.8x ↑ 4: 10.6x ← 5: 10.8x ↓ 6: 10.3x ↓ 7: 9.9 ↓ 8: 10.0 ↓ 9: 10.7x ← 10: 9.9 →		11: 10.7x ↗ 12: 10.5x ↘ 13: 10.8x ↖ 14: 10.6x ← 15: 10.2x ↑ 16: 10.8x → 17: 9.7 ↖ 18: 10.8x ↓ 19: 10.8x ← 20: 10.1 ↑
Serie 104.3	Total 104.3	Serie 105.0	Total 209.3
40 Skott		40 Skott	
	21: 10.4x ↑ 22: 10.4x ← 23: 10.6x → 24: 10.6x ↓ 25: 10.6x → 26: 10.9x ↗ 27: 10.6x → 28: 9.9 ↖ 29: 10.4x ← 30: 10.3x ↖		31: 10.8x ↘ 32: 10.8x ↖ 33: 10.6x ↓ 34: 10.7x ↓ 35: 10.5x → 36: 10.9x ↘ 37: 10.7x ↑ 38: 10.1 ← 39: 10.0 → 40: 10.8x ↑
Serie 104.7	Total 314.0	Serie 105.9	Total 419.9

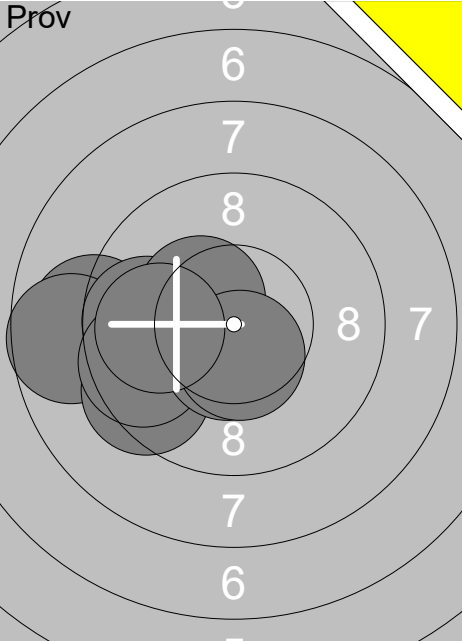
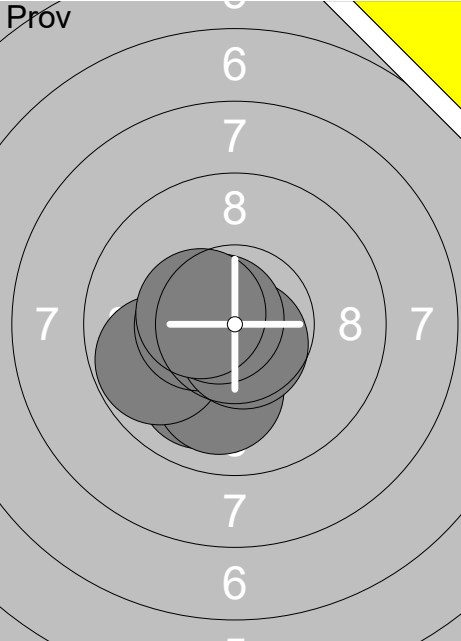
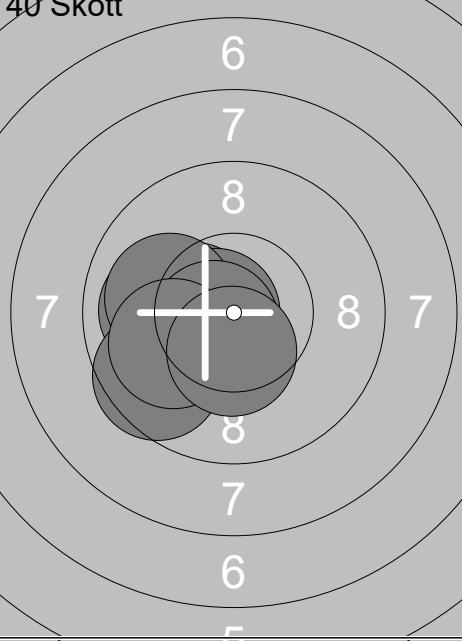
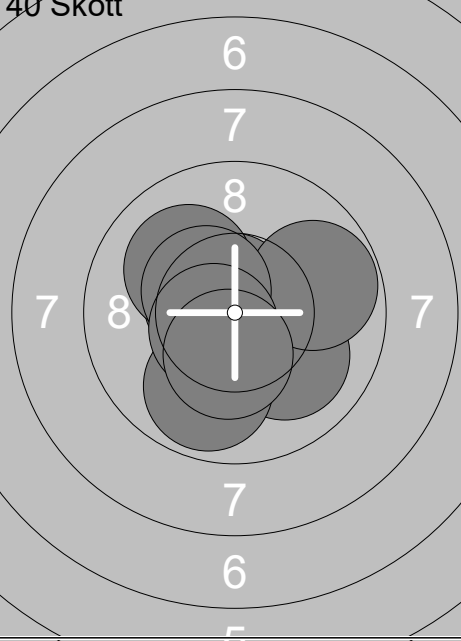
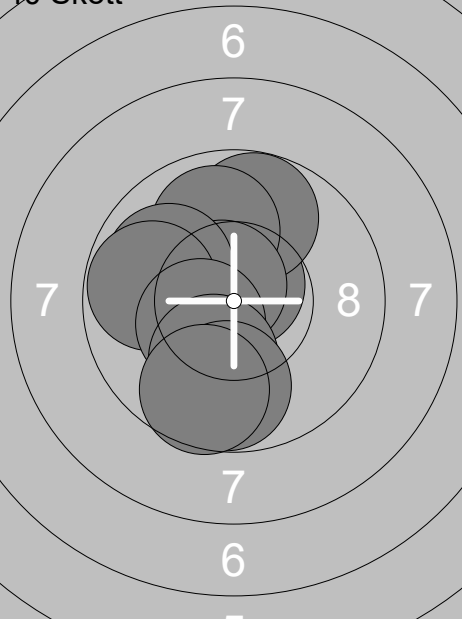
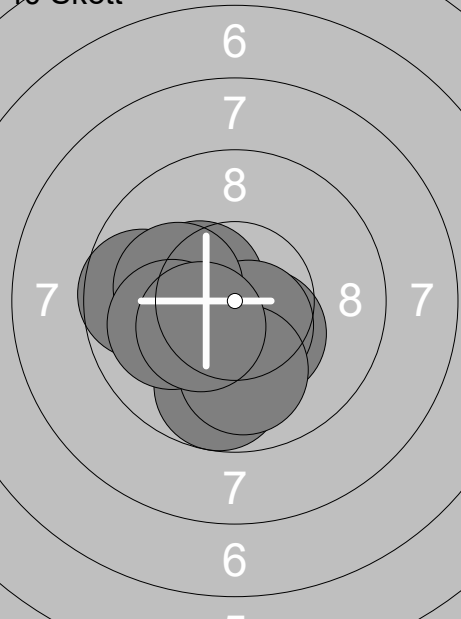
Skjuttlag	Tavla	Emma Eriksson	
1	25	Ramselefors	Vb
Ramselefors	Ramselefors	15	
13.01.2018	Skyttiadens distriktsfinal 2018	Ramselefors SKF	
Prov		Prov	
	1: 9.0 ← 2: 8.7 ← 3: 10.1 ← 4: 9.7 ← 5: 9.4 ↙ 6: 9.6 ← 7: 10.5x ↓ 8: 10.4x ↖ 9: 10.5x ↓ 10: 9.9 ←		11: 10.0 ↘ 12: 10.0 ↓ 13: 9.8 ← 14: 10.5x ← 15: 10.6x ↓ 16: 10.7x ↖ 17: 10.5x ↖
Serie	97.8	Serie	72.1
Total	0.0	Total	0.0
40 Skott		40 Skott	
	1: 10.4x ↖ 2: 10.2x ↖ 3: 10.4x ↙ 4: 10.0 ← 5: 10.7x ↖ 6: 10.0 ← 7: 10.6x ↙ 8: 9.6 ↙ 9: 10.0 ← 10: 10.4x ↓		11: 10.4x ↓ 12: 10.6x ↖ 13: 10.7x ↑ 14: 10.0 ↓ 15: 9.9 ↓ 16: 10.1 ↖ 17: 9.8 → 18: 10.5x ↖ 19: 10.6x ↙ 20: 10.4x ↓
Serie	102.3	Serie	103.0
Total	102.3	Total	205.3
40 Skott		40 Skott	
	21: 10.7x ↑ 22: 9.8 ↑ 23: 9.9 ↑ 24: 10.7x ↖ 25: 9.9 ← 26: 9.8 ← 27: 10.4x ↙ 28: 10.1 ↓ 29: 9.8 ↓ 30: 9.7 ↓		31: 9.7 ← 32: 9.8 ↓ 33: 10.4x ↖ 34: 10.4x ↓ 35: 10.6x ↓ 36: 10.1 ← 37: 10.1 ← 38: 10.0 ← 39: 10.0 ↓ 40: 10.4x ↙
Serie	100.8	Serie	101.5
Total	306.1	Total	407.6

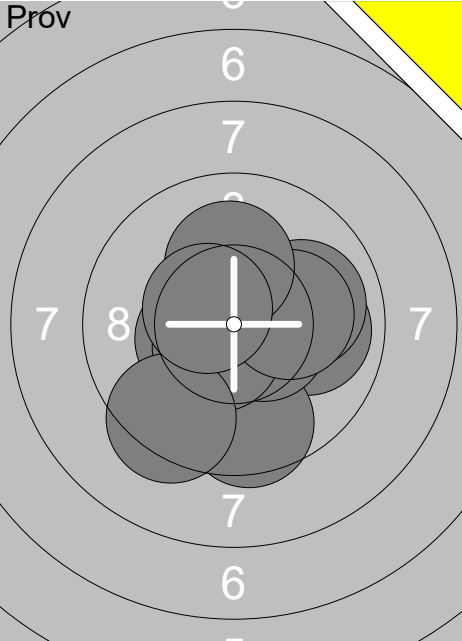
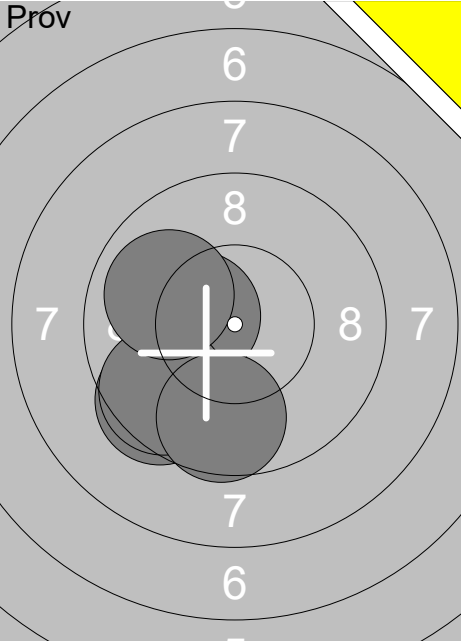
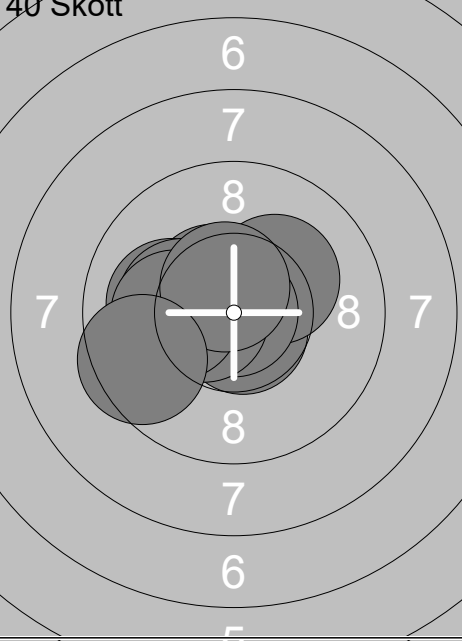
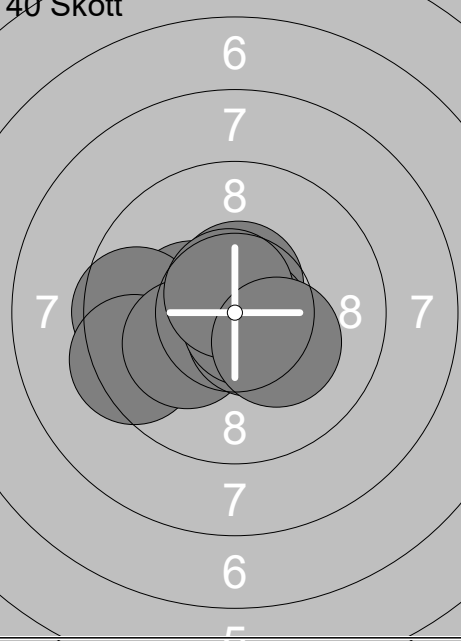
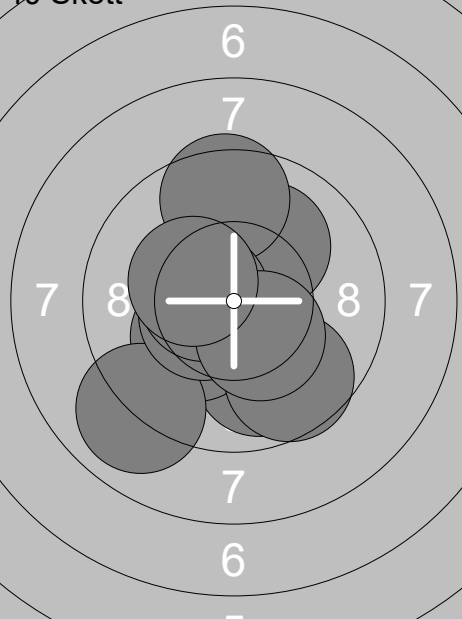
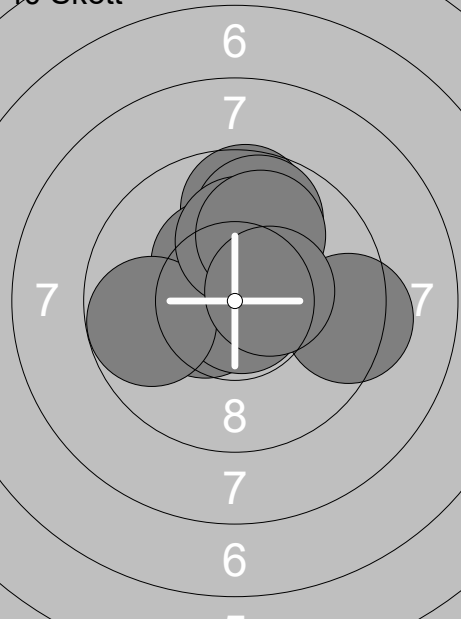
Skjuttag	Tavla	Rasmus Alfredsson			
1	27	Ramselefors	Umeå	Mini	Vb
13.01.2018		Skyttiadens distriktsfinal 2018		Ramselefors SKF	
Prov 	1: 9.9 →	Prov 	11: 9.9 ↙		
	2: 9.6 ↓		12: 9.5 ↙		
	3: 10.5x →		13: 10.4x ←←		
	4: 10.4x ←←		14: 9.6 ↙		
	5: 10.0 →		15: 9.9 ←		
	6: 10.6x ↙		16: 9.6 ↓		
	7: 10.2x →				
	8: 9.4 ↙				
	9: 10.1 ↑				
	10: 10.5x ↙				
	Serie 101.2		Serie 58.9		
	Total 0.0		Total 0.0		
40 Skott 	1: 10.7x ↘	40 Skott 	11: 10.2x ←←		
	2: 10.2x ↗		12: 10.4x ←←		
	3: 10.9x ↖		13: 9.6 ←		
	4: 10.5x ↖		14: 9.4 ←		
	5: 10.1 ←		15: 10.6x ↑		
	6: 10.2x ←←		16: 10.2x ←←		
	7: 10.5x ←←		17: 10.6x ↘		
	8: 10.1 ←		18: 10.7x ↘		
	9: 10.6x ↖		19: 10.7x ↑		
	10: 9.5 ←		20: 10.2x ↘		
	Serie 103.3		Serie 102.6		
	Total 103.3		Total 205.9		
40 Skott 	21: 9.9 ↓	40 Skott 	31: 10.5x ←←		
	22: 10.2x ↙		32: 10.8x ↘		
	23: 9.0 ↙		33: 9.7 ↑		
	24: 9.7 ↘		34: 9.4 →		
	25: 10.1 ↗		35: 10.4x ↖		
	26: 10.5x ←←		36: 9.8 ↑		
	27: 9.5 ↑		37: 9.8 ←		
	28: 10.5x ←←		38: 10.1 ↑		
	29: 10.3x ↘		39: 10.0 ↑		
	30: 10.3x ←		40: 10.5x →		
	Serie 100.0		Serie 101.0		
	Total 305.9		Total 406.9		

Skjutlag	Tavla	Melissa Kinnunen	
1	28	Ramselefors	Mini Vb
13.01.2018	Skyttiadens distriktsfinal 2018	Ramselefors SKF	
<b>Prov</b> 	1: 9.9 ↓ 2: 10.1 ↓ 3: 8.9 ↓ 4: 8.7 ← 5: 8.9 ← 6: 10.2x← 7: 9.5 ← 8: 8.9 ↓ 9: 9.7 ↓ 10: 10.2x↓	<b>Prov</b> 	11: 10.5x← 12: 10.3x↓
	Serie 95.0		Serie 20.8
	Total 0.0		Total 0.0
<b>40 Skott</b> 	1: 9.6 ← 2: 9.4 ← 3: 9.2 ↓ 4: 10.3x← 5: 8.9 ↓ 6: 9.3 ↓ 7: 9.3 ↓ 8: 9.7 ← 9: 7.3 ↓ 10: 9.0 →	<b>40 Skott</b> 	11: 9.5 ↓ 12: 10.2x← 13: 7.9 → 14: 10.1 ↓ 15: 10.3x← 16: 7.7 → 17: 10.2x↓ 18: 10.1 → 19: 8.5 ↗ 20: 9.5 ↓
	Serie 92.0		Serie 94.0
	Total 92.0		Total 186.0
<b>40 Skott</b> 	21: 7.6 ← 22: 9.4 → 23: 10.1 ↗ 24: 9.0 ↓ 25: 7.3 ← 26: 9.9 ← 27: 9.4 ↓ 28: 10.0 ↗ 29: 10.2x← 30: 8.8 ↓	<b>40 Skott</b> 	31: 9.6 ← 32: 9.6 ↗ 33: 9.8 ↓ 34: 10.5x← 35: 9.8 ↓ 36: 8.7 ← 37: 9.9 ↗ 38: 10.0 ↓ 39: 10.4x↗ 40: 9.3 ←
	Serie 91.7		Serie 97.6
	Total 277.7		Total 375.3

Skjutlag	Tavla	Erika Gustafsson	
1	29	Ramselefors	Mini Vb
13.01.2018	Skyttiadens distriktsfinal 2018	Ramselefors SKF	
<b>Prov</b> 	1: 9.3 ← 2: 10.0 ← 3: 10.0 ↗ 4: 10.1 ↗ 5: 9.8 ↖ 6: 9.6 ← 7: 9.4 ↘ 8: 9.7 → 9: 10.6x ↑ 10: 10.5x ↗ Serie 99.0 Total 0.0	<b>40 Skott</b> 	1: 10.7x ↑ 2: 10.6x ← 3: 10.3x ← 4: 10.6x → 5: 10.6x ↓ 6: 10.2x ↗ 7: 10.2x → 8: 10.0 → 9: 10.2x ↑ 10: 10.2x ↓ Serie 103.6 Total 103.6
<b>40 Skott</b> 	11: 10.8x ← 12: 9.9 ↑ 13: 10.1 ↘ 14: 10.6x ↘ 15: 10.0 ↘ 16: 9.7 ↑ 17: 10.6x → 18: 10.4x ← 19: 10.4x ← 20: 10.4x ↓ Serie 102.9 Total 206.5	<b>40 Skott</b> 	21: 10.0 ↓ 22: 10.1 ↗ 23: 10.6x ↓ 24: 10.4x ↗ 25: 10.3x → 26: 10.5x ↑ 27: 10.4x ↓ 28: 10.5x ↓ 29: 10.8x ↓ 30: 9.9 ↗ Serie 103.5 Total 310.0
<b>40 Skott</b> 	31: 10.3x → 32: 10.1 ↘ 33: 10.6x ↖ 34: 10.0 ← 35: 9.9 ↘ 36: 10.6x ↓ 37: 10.4x ↑ 38: 10.2x → 39: 10.7x → 40: 10.8x ↓ Serie 103.6 Total 413.6		

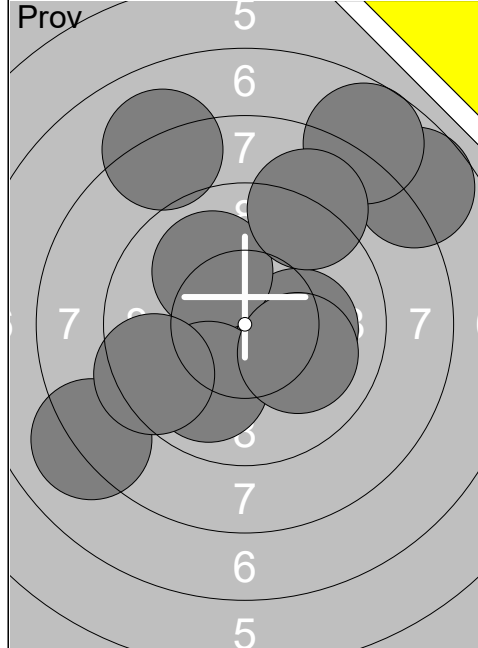

1:	8.1	↙
2:	10.2x	→
3:	7.7	↗
4:	10.0	↖
5:	9.9	↘
6:	7.7	↗
7:	8.1	↖
8:	10.1	→
9:	9.0	↗
10:	9.4	↙
Serie		90.2
Total		0.0

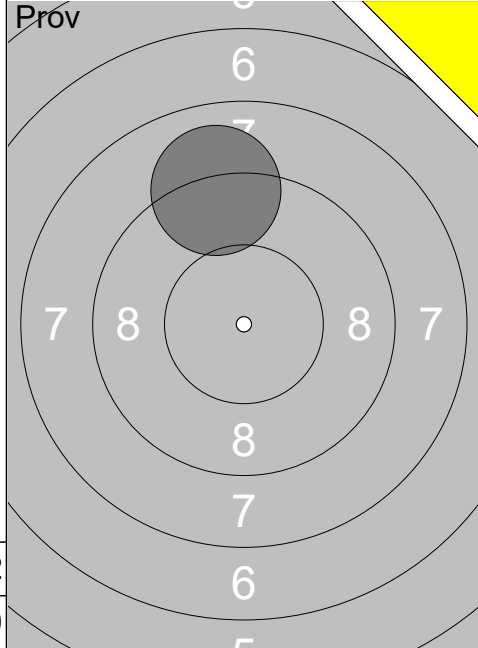

11:	9.1	↖
Serie		9.1
Total		0.0

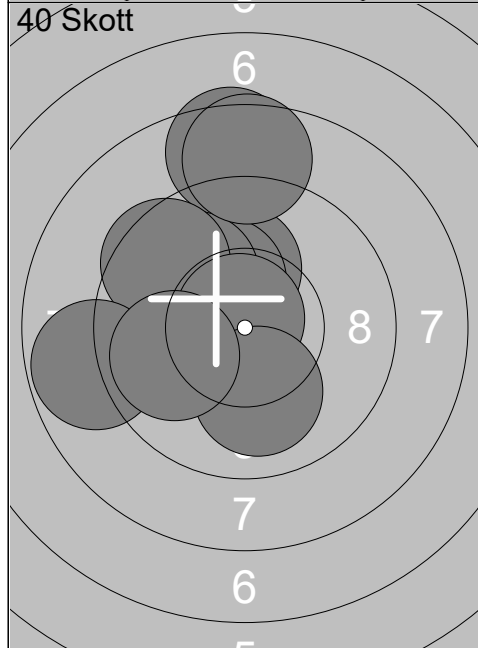

1:	10.1	↖
2:	8.5	↖
3:	10.2x	↖
4:	10.0	↖
5:	9.5	↖
6:	10.8x	↖
7:	10.1	↘
8:	8.8	←
9:	8.6	↖
10:	9.9	←
Serie		96.5
Total		96.5

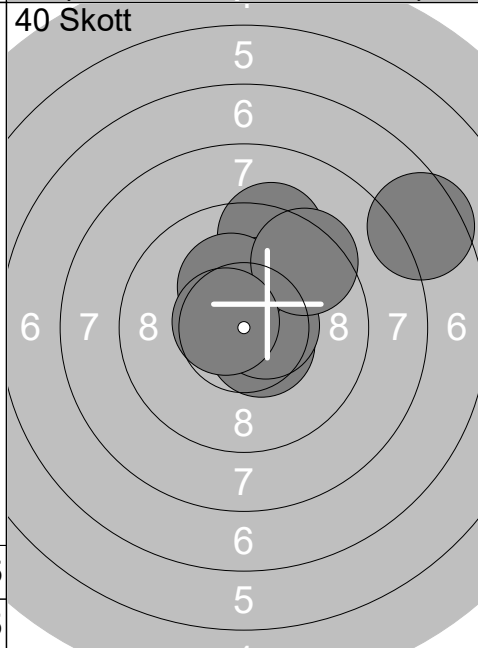

11:	7.5	↗
12:	9.3	↖
13:	10.8x	↗
14:	10.3x	↖
15:	10.4x	↖
16:	10.6x	↘
17:	10.6x	→
18:	10.2x	↖
19:	9.4	↗
20:	10.6x	↙
Serie		99.7
Total		196.2

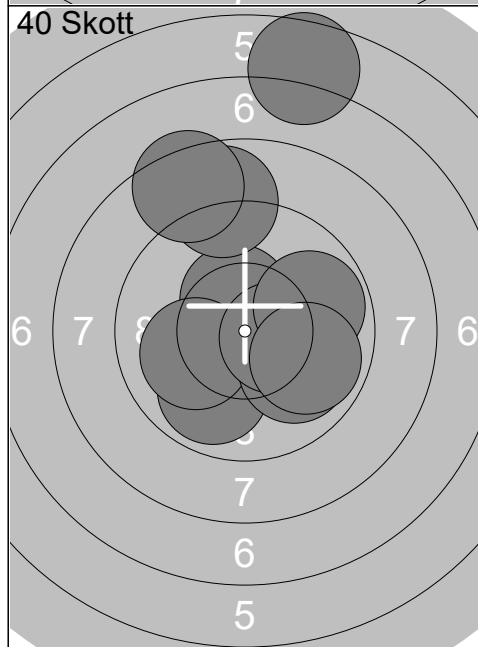

21:	9.9	↘
22:	10.4x	↖
23:	10.1	←
24:	10.0	↘
25:	8.8	↖
26:	10.4x	→
27:	8.4	↖
28:	6.6	↖
29:	9.8	↗
30:	9.9	→
Serie		94.3
Total		290.5

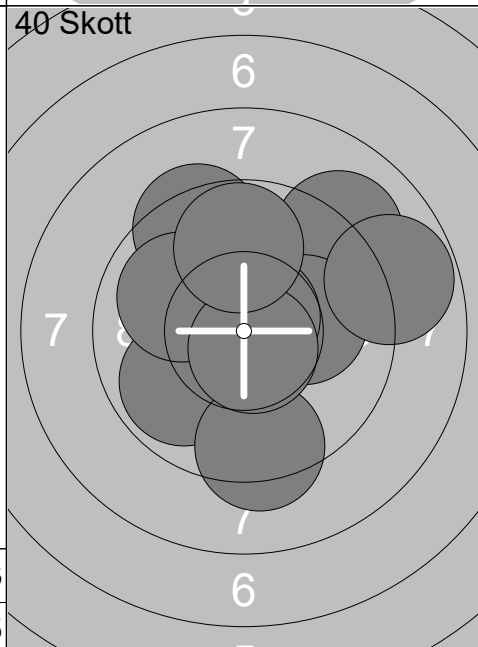

31:	9.1	↗
32:	10.1	→
33:	8.8	↗
34:	9.4	↖
35:	9.9	↙
36:	10.7x	↗
37:	10.0	↙
38:	9.3	↘
39:	10.7x	↘
40:	9.8	↖
Serie		97.8
Total		388.3

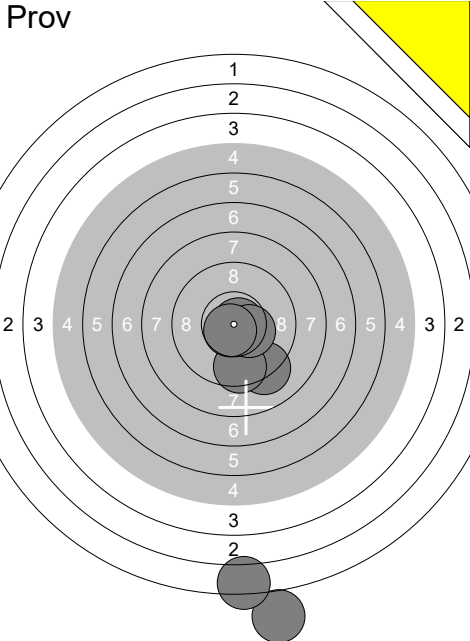
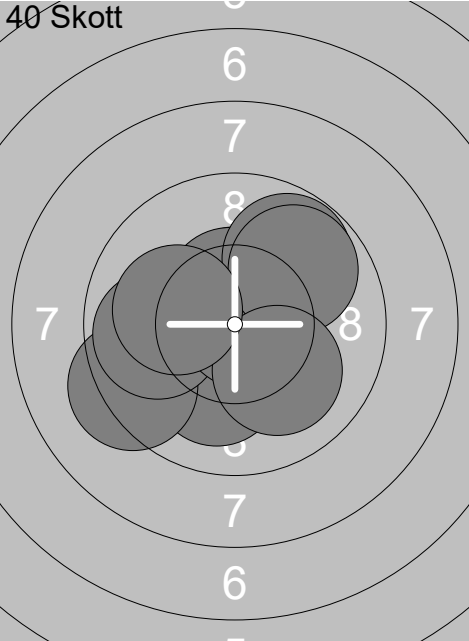
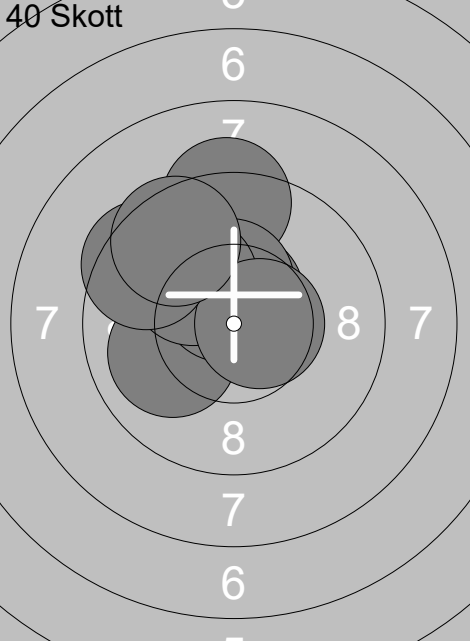
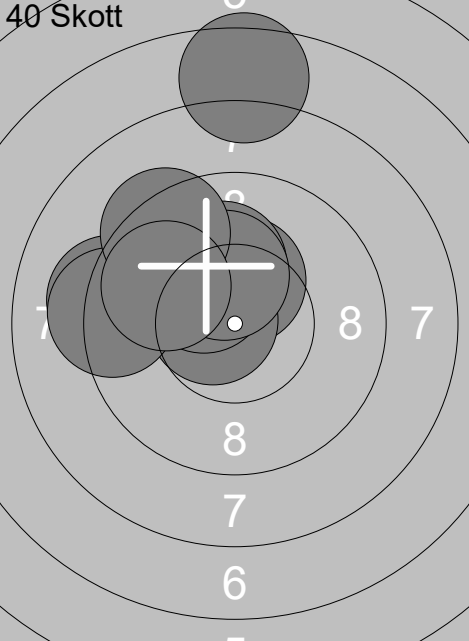
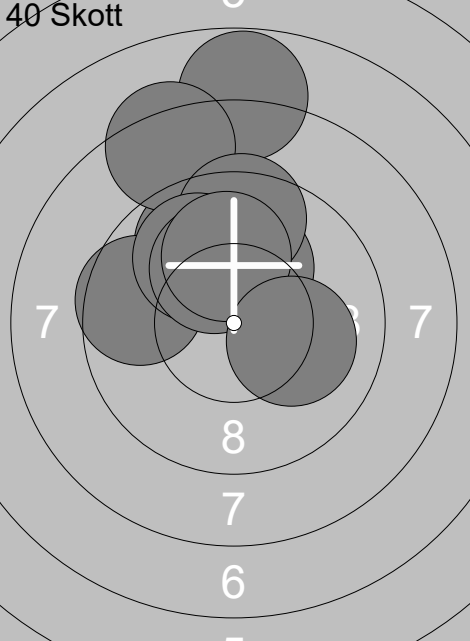
Skjuttag	Tavla	Izabelle Mikaelsson			
1	31	Ramselefors	Ramselefors	Mini	Vb
13.01.2018		Skytтиадens distriktsfinal 2018		Ramselefors SKF	
	1: 1.0 ↓		1: 10.1 ↓		
	2: 2.2 ↓		2: 9.3 ←		
	3: 9.2 ↘		3: 9.9 ←		
	4: 9.5 ↓		4: 10.5x ↑		
	5: 10.8x →		5: 10.5x ↑		
	6: 10.4x →		6: 10.8x →		
	7: 10.7x ↘		7: 9.8 ↗		
			8: 9.8 ↗		
			9: 10.1 ↓		
			10: 10.1 ←		
	Serie 53.8		Serie 100.9		
	Total 0.0		Total 100.9		
	11: 9.3 ↑		21: 7.5 ↑		
	12: 10.6x ↑		22: 9.2 ←		
	13: 10.4x ↘		23: 10.4x ↑		
	14: 10.0 ←		24: 10.1 ↑		
	15: 10.6x ↑		25: 10.6x ←		
	16: 10.4x ↑		26: 9.2 ←		
	17: 10.1 ↗		27: 10.3x ↘		
	18: 10.6x →		28: 10.3x ↑		
	19: 9.5 ↘		29: 9.4 ↗		
	20: 9.6 ↗		30: 9.9 ↘		
	Serie 101.1		Serie 96.9		
	Total 202.0		Total 298.9		
	31: 9.8 ↗				
	32: 10.2x ↑				
	33: 7.8 ↑				
	34: 9.6 ←				
	35: 8.3 ↗				
	36: 9.5 ↑				
	37: 9.9 ↗				
	38: 10.1 ↗				
	39: 10.0 ↑				
	40: 10.1 →				
	Serie 95.3				
	Total 394.2				

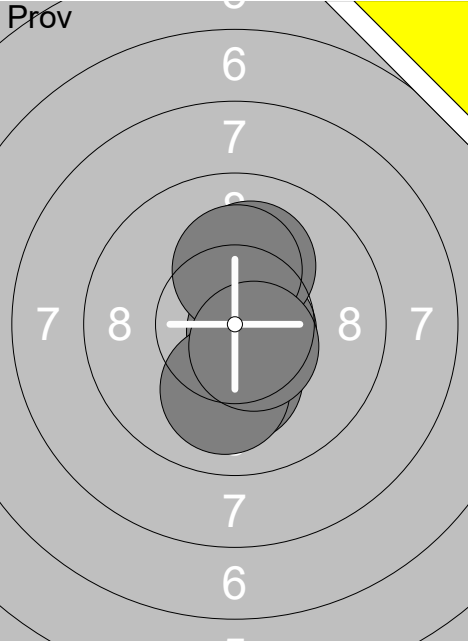
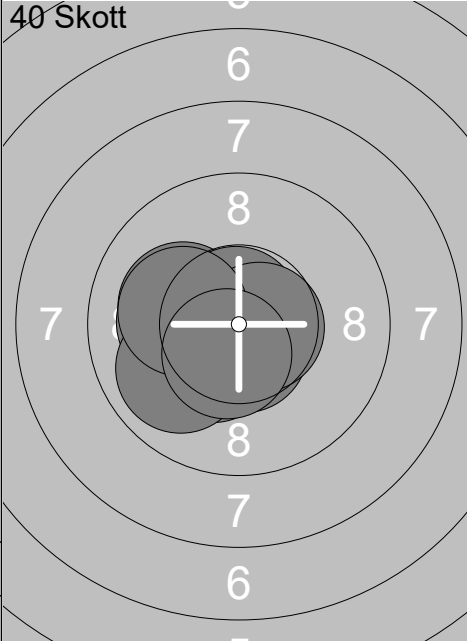
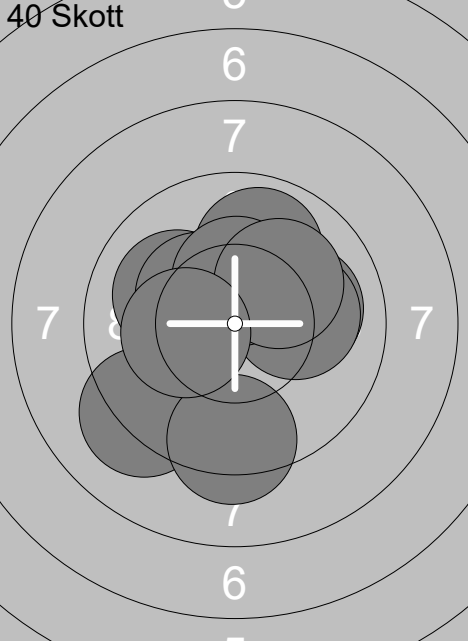
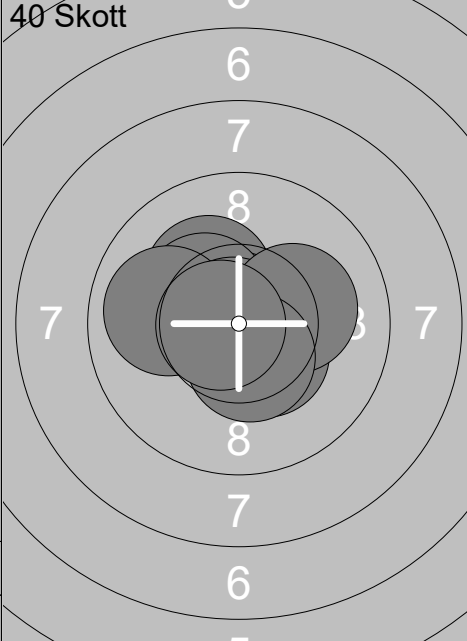
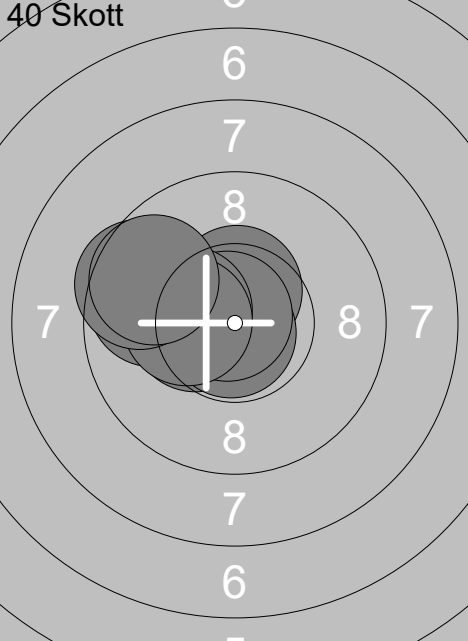
Skjutlag	Tavla	Elvira Söderlund	
1	32	Ramselefors	Mini Vb
13.01.2018	Skyttiadens distriktsfinal 2018	Ramselefors SKF	
Prov		40 Skott	
	1: 10.7x → 2: 10.2x ↓ 3: 10.0 ↓ 4: 10.1 ↑ 5: 10.2x ↑ 6: 10.5x ↘		1: 10.8x ↖ 2: 10.4x ↙ 3: 10.1 ← 4: 10.2x ← 5: 10.8x ↑ 6: 10.6x ↓ 7: 9.9 ↙ 8: 10.7x → 9: 10.2x ← 10: 10.5x ↓
	Serie 61.7		Serie 104.2
	Total 0.0		Total 104.2
40 Skott		40 Skott	
	11: 10.0 → 12: 10.1 → 13: 9.2 ↙ 14: 9.3 ↓ 15: 10.1 ↖ 16: 9.9 ↑ 17: 10.3x ↖ 18: 10.4x ↑ 19: 10.1 ↗ 20: 10.2x ←		21: 10.8x ↓ 22: 10.2x ↖ 23: 10.8x ↖ 24: 10.4x ↘ 25: 10.4x ↖ 26: 10.0 ← 27: 10.9x ← 28: 10.2x → 29: 10.5x ↓ 30: 10.7x ←
	Serie 99.6		Serie 104.9
	Total 203.8		Total 308.7
40 Skott			
	31: 10.4x ← 32: 10.7x ↖ 33: 10.5x ↑ 34: 10.8x ↓ 35: 10.8x ↖ 36: 10.3x ← 37: 9.8 ← 38: 10.3x ← 39: 9.5 ← 40: 9.7 ↖		
	Serie 102.8		
	Total 411.5		

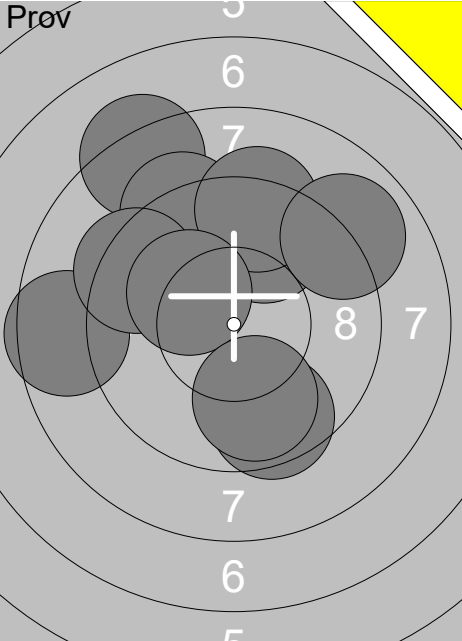
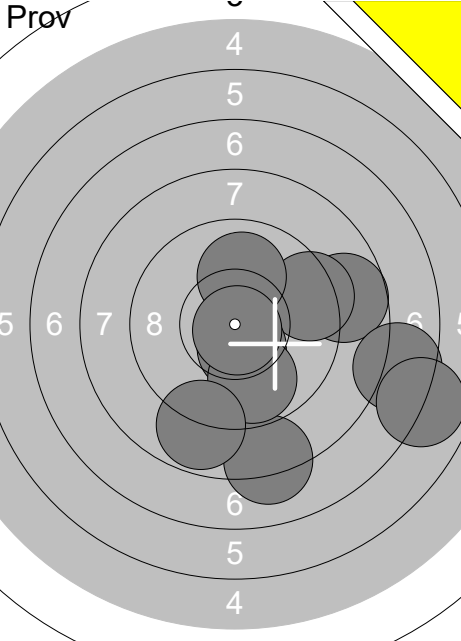
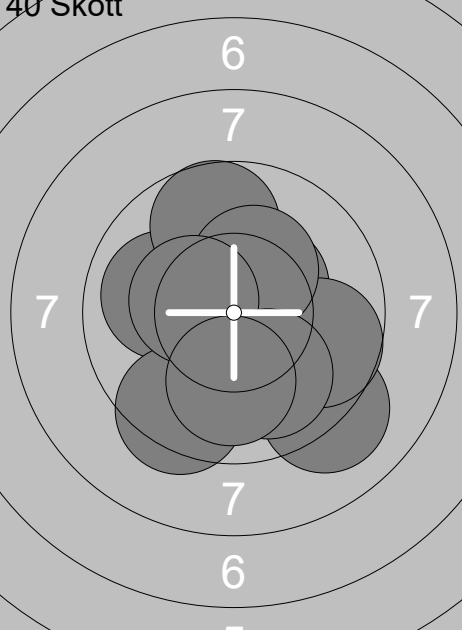
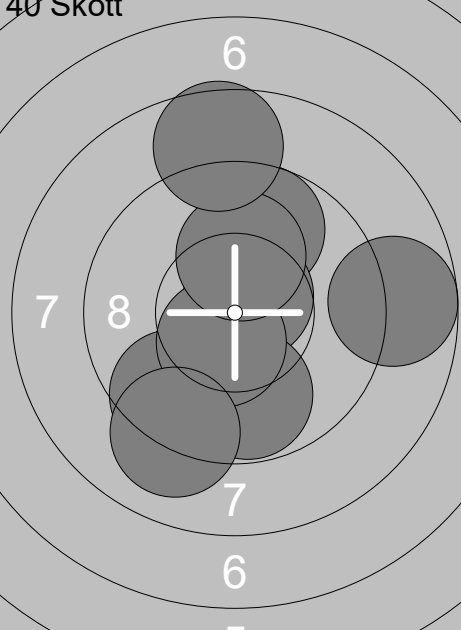
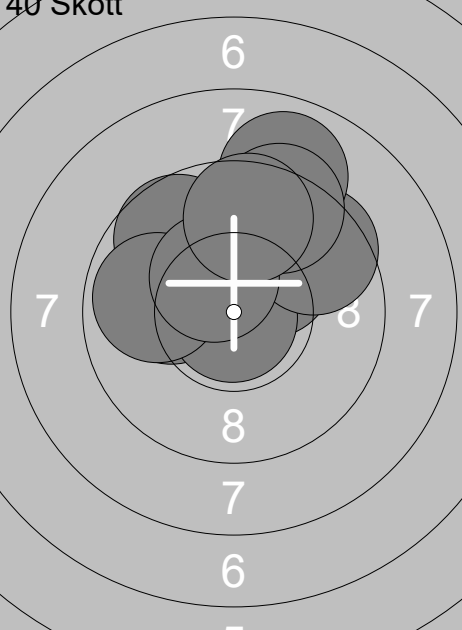
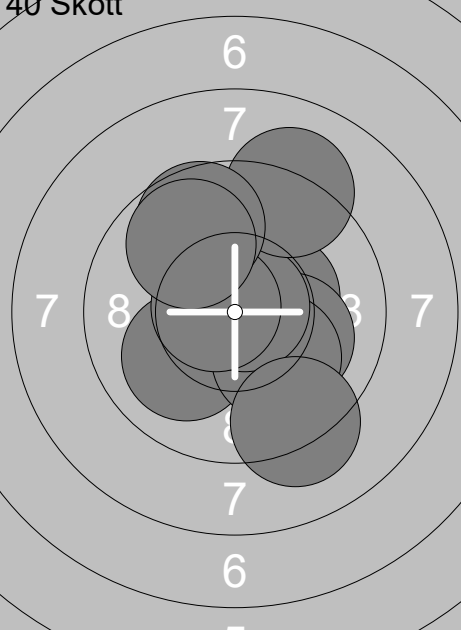

Skjuttag	Tavla	Dennis Alenius			
1	33	Ramselefors	Ramselefors	Mini	Vb
13.01.2018	Skyttiadens distriktsfinal 2018	Ramselefors SKF			
	1: 8.2 ↗		11: 8.7 →		
	2: 8.6 ←		12: 7.6 →		
	3: 9.2 ↗		13: 9.4 →		
	4: 9.4 ↖		14: 8.2 ↓		
	5: 9.7 ↗		15: 10.5x ↓		
	6: 9.3 ↗		16: 6.9 →		
	7: 9.5 ↓		17: 9.8 ↓		
	8: 10.2x ↖		18: 8.8 ↓		
	9: 9.8 ↓		19: 10.0 ↑		
	10: 8.9 ↗		20: 10.8x ↓		
	Serie 92.8		Serie 90.7		
	Total 0.0		Total 0.0		
	1: 9.1 ↓		11: 9.5 ↓		
	2: 10.4x ↗		12: 9.5 ↓		
	3: 9.7 →		13: 9.7 ↑		
	4: 10.0 ←		14: 10.6x ↗		
	5: 9.4 ↓		15: 9.8 ↓		
	6: 9.7 ↑		16: 10.5x ↓		
	7: 10.3x ↗		17: 10.2x ↑		
	8: 10.4x ↖		18: 8.8 →		
	9: 10.0 ↓		19: 9.1 ↓		
	10: 10.0 ↓		20: 8.6 ↑		
	Serie 99.0		Serie 96.3		
	Total 99.0		Total 195.3		
	21: 9.7 ↖		31: 10.4x →		
	22: 10.2x ↗		32: 10.1 →		
	23: 10.1 ←		33: 10.0 ↖		
	24: 10.9x ↓		34: 10.1 ↓		
	25: 9.9 ←		35: 10.8x ↗		
	26: 9.6 ↗		36: 10.7x ↖		
	27: 9.0 ↑		37: 9.1 ↑		
	28: 10.4x ↖		38: 9.2 ↓		
	29: 9.4 ↗		39: 9.7 ↑		
	30: 9.6 ↑		40: 9.8 ↖		
	Serie 98.8		Serie 99.9		
	Total 294.1		Total 394.0		

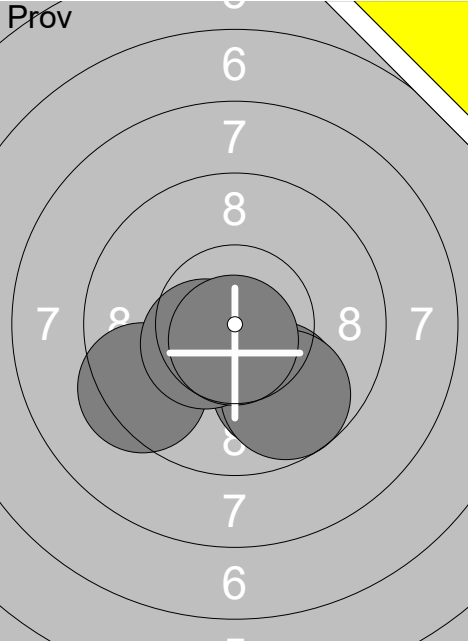
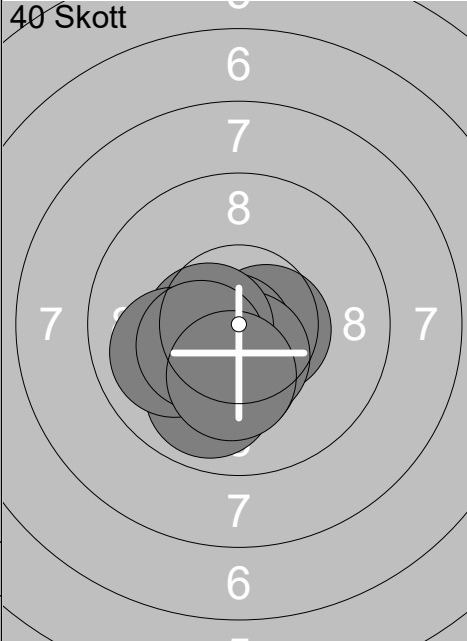
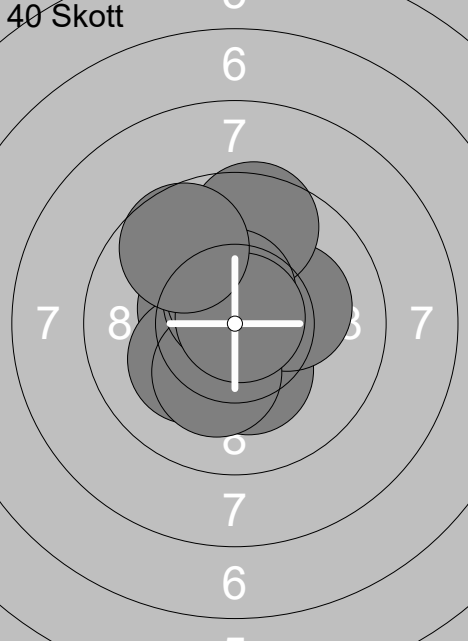
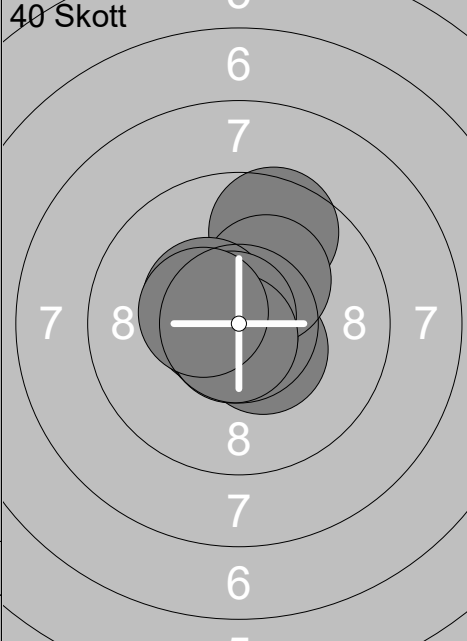
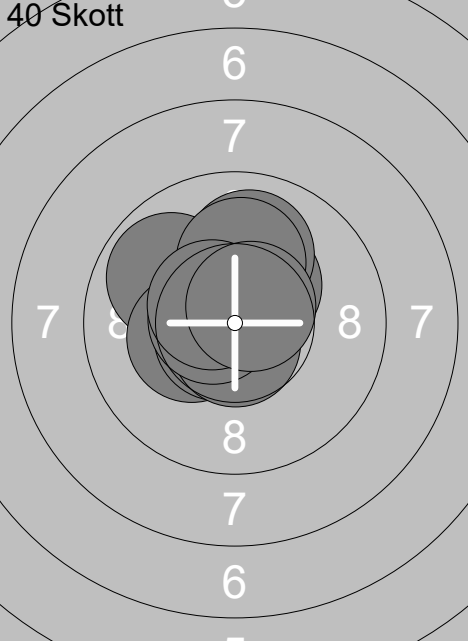
Skjuttag	Tavla	Vilhelm Lundstedt	
1	34	Ramselefors	Mini Vb
13.01.2018	Skyttiadens distriktsfinal 2018	Ramselefors SKF	
Prov		40 Skott	
	1: 9.9 ↘ 2: 9.7 ↘ 3: 9.4 ↙ 4: 10.5x↙ 5: 10.7x↓		1: 10.6x→ 2: 9.9 ↓ 3: 10.3x↙ 4: 10.3x↓ 5: 10.7x↙ 6: 10.5x↓ 7: 10.5x↙ 8: 10.0 ↙ 9: 10.4x↙ 10: 10.2x↓
	Serie 50.2		Serie 103.4
	Total 0.0		Total 103.4
40 Skott		40 Skott	
	11: 10.3x↓ 12: 10.5x↙ 13: 10.2x↙ 14: 10.2x→ 15: 9.6 ↑ 16: 10.2x↓ 17: 10.6x↑ 18: 10.5x↑ 19: 10.8x↗ 20: 9.7 ↘		21: 10.5x↘ 22: 10.8x↙ 23: 9.6 ↑ 24: 10.2x↗ 25: 10.6x↙ 26: 10.7x↙ 27: 10.4x↙ 28: 10.8x↙ 29: 10.7x↓ 30: 10.4x↙
	Serie 102.6		Serie 104.7
	Total 206.0		Total 310.7
40 Skott			
	31: 9.9 ↙ 32: 10.3x↗ 33: 10.0 ↑ 34: 10.3x↙ 35: 10.7x↙ 36: 10.1 ↑ 37: 10.7x↓ 38: 10.6x↙ 39: 10.5x↙ 40: 10.6x↗		
	Serie 103.7		
	Total 414.4		

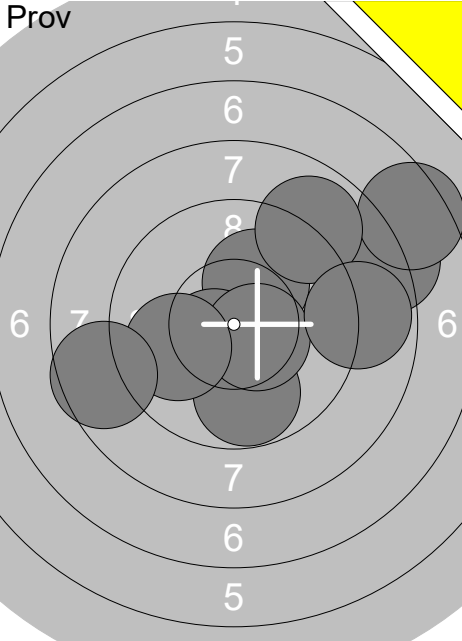
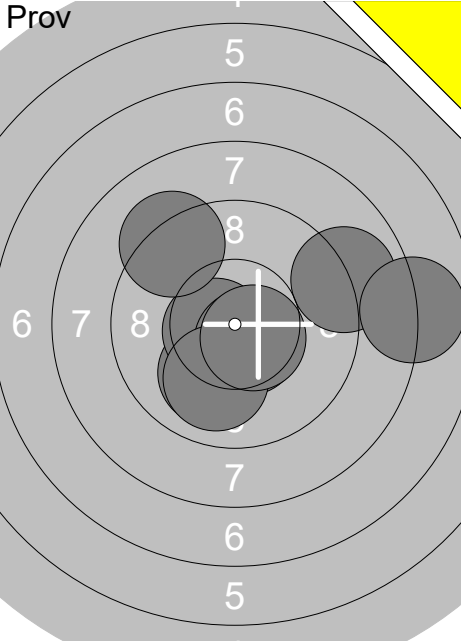
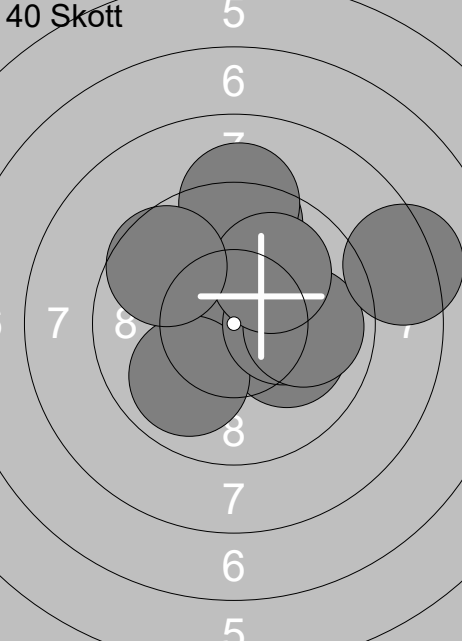
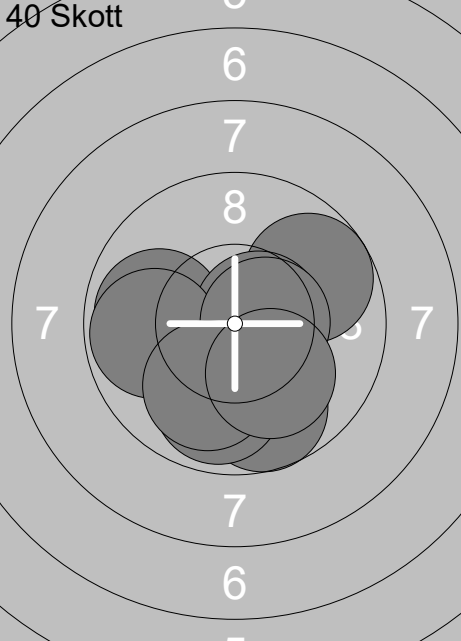
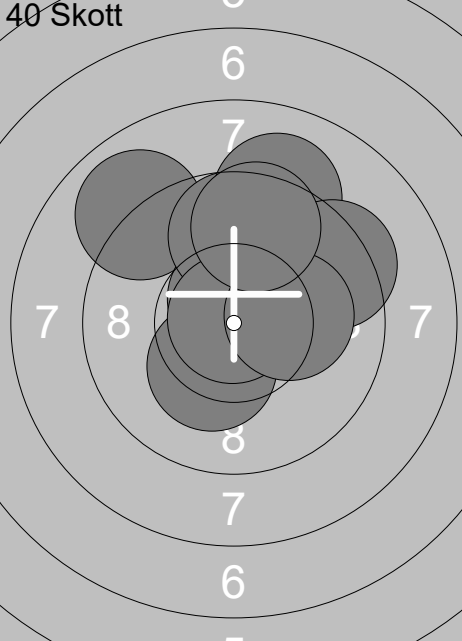
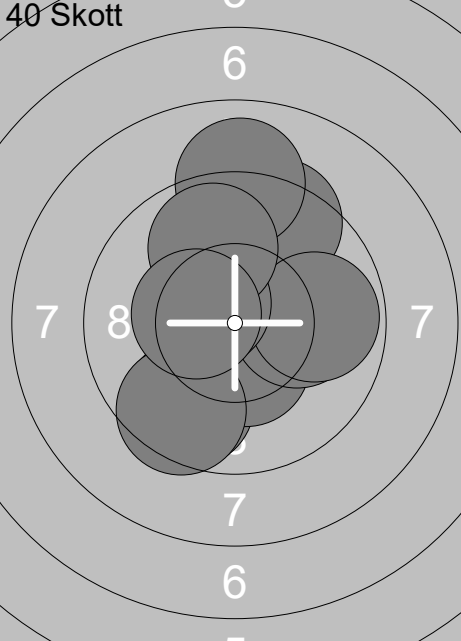
Skjuttlag	Tavla	Otto Norgren	
1	35	Ramselefors	Mini Vb
13.01.2018	Skyttiadens distriktsfinal 2018	Ramselefors SKF	
Prov 	1: 10.2x ↗	Prov 	11: 10.0 ↘
	2: 8.2 →		12: 10.6x ←
	3: 10.5x ↙		13: 8.9 →
	4: 7.5 →		14: 7.9 →
	5: 9.8 ↓		15: 10.6x ↘
	6: 8.9 ↗		16: 10.0 ↓
	7: 10.5x ↘		17: 9.2 ↗
	8: 8.9 →		18: 10.6x ↘
	9: 9.9 ←		
	10: 8.6 ←		
Serie	93.0	Serie	77.8
Total	0.0	Total	0.0
40 Skott 	1: 10.8x ↑	40 Skott 	11: 9.7 ↓
	2: 10.1 →		12: 9.9 ↓
	3: 9.9 ↙		13: 9.9 ←
	4: 10.2x →		14: 9.8 ↗
	5: 9.9 →		15: 10.6x →
	6: 9.5 ↑		16: 10.3x ↘
	7: 9.2 ↑		17: 9.8 ←
	8: 8.3 →		18: 10.5x →
	9: 10.0 ↗		19: 10.0 ↓
	10: 9.6 ↘		20: 10.1 ↘
Serie	97.5	Serie	100.6
Total	97.5	Total	198.1
40 Skott 	21: 9.0 ↘	40 Skott 	31: 9.7 ↓
	22: 10.9x ↗		32: 10.4x ↘
	23: 10.6x ↑		33: 10.1 →
	24: 9.7 ↑		34: 9.5 ↘
	25: 10.3x ↘		35: 9.4 ↗
	26: 10.9x ↗		36: 9.8 →
	27: 9.1 ↗		37: 9.0 ↑
	28: 9.4 ↗		38: 10.5x ↘
	29: 10.2x →		39: 9.9 ↗
	30: 9.6 ↑		40: 10.4x ←
Serie	99.7	Serie	98.7
Total	297.8	Total	396.5

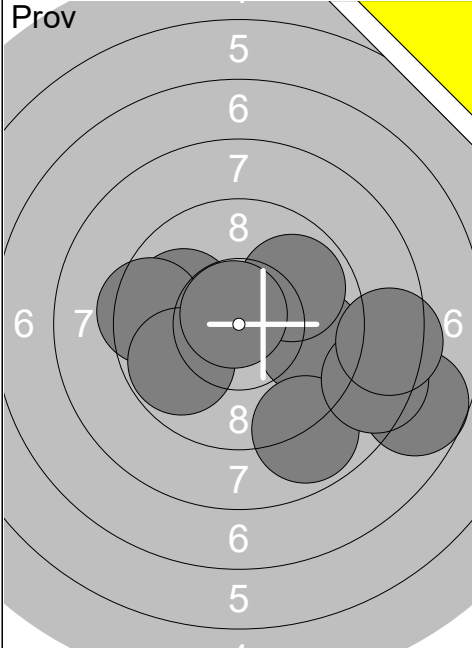
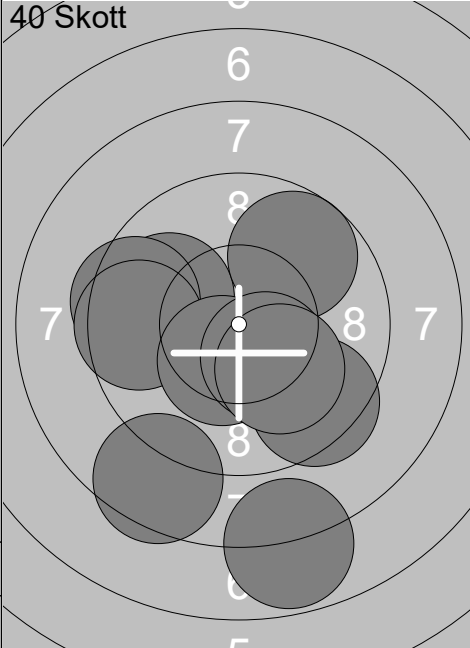
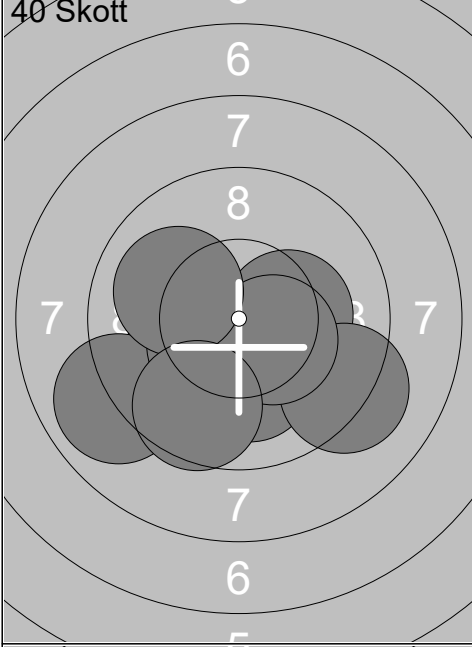
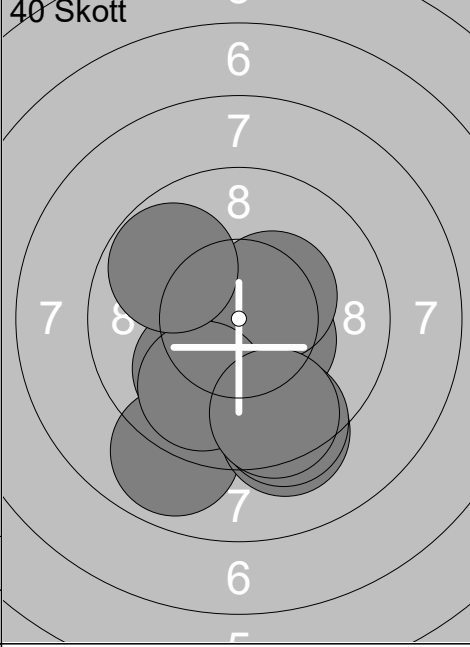
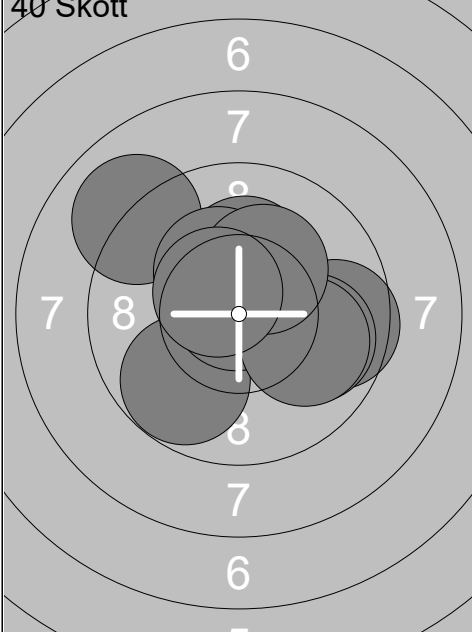
Skjuttag <b>1</b>	Tavla <b>36</b>	<b>Olívia Mikaelsson</b>	
Ramselefors	Ramselefors	Mini	Vb
13.01.2018	Skyttiadens distriktsfinal 2018	Ramselefors SKF	
Prov		40 Skott	
	1: 7.7 → 2: 9.7 → 3: 8.9 ↓ 4: 8.5 → 5: 9.9 ↗ 6: 8.4 → 7: 10.0 ← 8: 9.5 ← 9: 9.8 ↙ 10: 10.8x ↖		1: 9.9 ← 2: 9.5 ← 3: 9.7 ↗ 4: 9.4 ↓ 5: 8.5 ↓ 6: 9.6 ← 7: 10.4x ↓ 8: 10.4x ↓ 9: 7.8 ↓ 10: 10.1 ↓
	Serie 93.2		Serie 95.3
	Total 0.0		Total 95.3
40 Skott		40 Skott	
	11: 10.1 ↓ 12: 10.1 ↓ 13: 10.3x → 14: 9.2 → 15: 10.0 ← 16: 8.9 ← 17: 10.4x ↙ 18: 10.4x ↘ 19: 10.0 ← 20: 9.6 ↓		21: 8.9 ↓ 22: 10.1 ↓ 23: 10.3x ↓ 24: 10.4x ↘ 25: 9.3 ↓ 26: 9.4 ↓ 27: 10.4x ↗ 28: 9.9 ↓ 29: 9.8 ↗ 30: 9.5 ↓
	Serie 99.0		Serie 98.0
	Total 194.3		Total 292.3
40 Skott			
	31: 9.6 → 32: 9.8 ↓ 33: 10.8x ↗ 34: 9.0 ↖ 35: 10.2x ↑ 36: 9.9 → 37: 10.0 → 38: 10.3x ↗ 39: 10.3x ↗ 40: 10.5x ↖		
	Serie 100.4		
	Total 392.7		

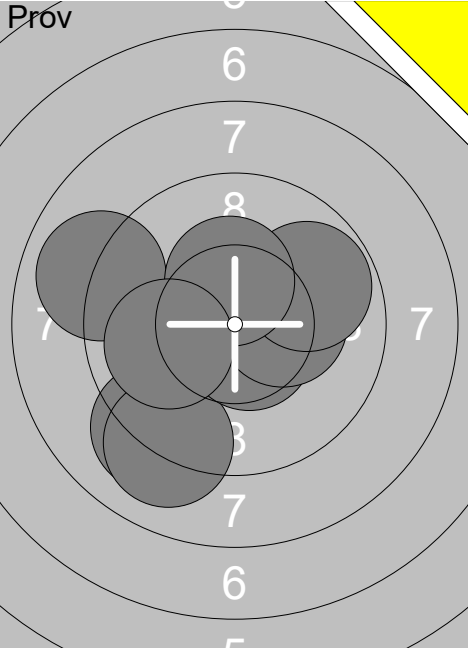
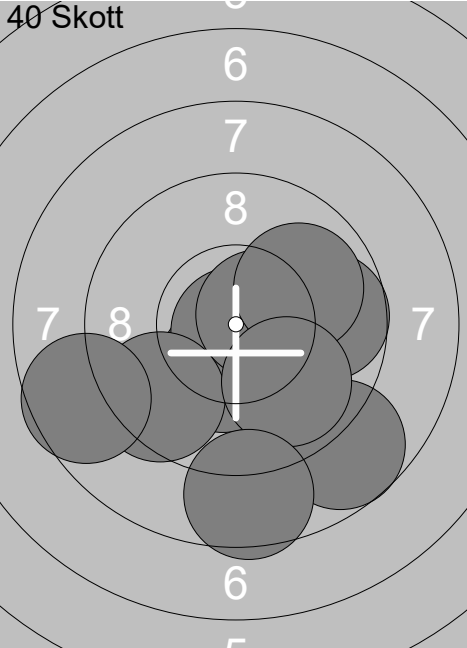
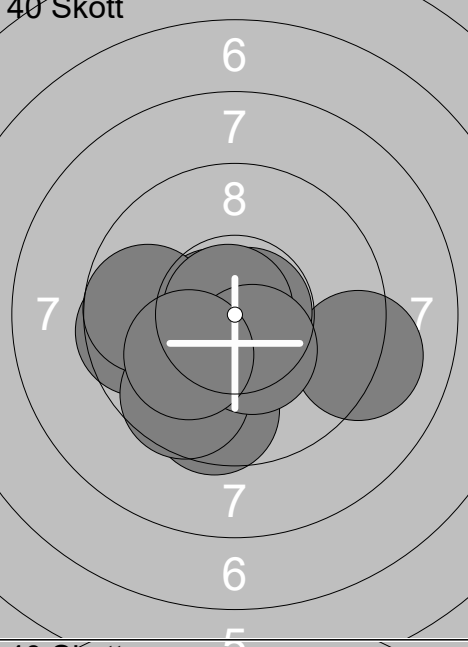
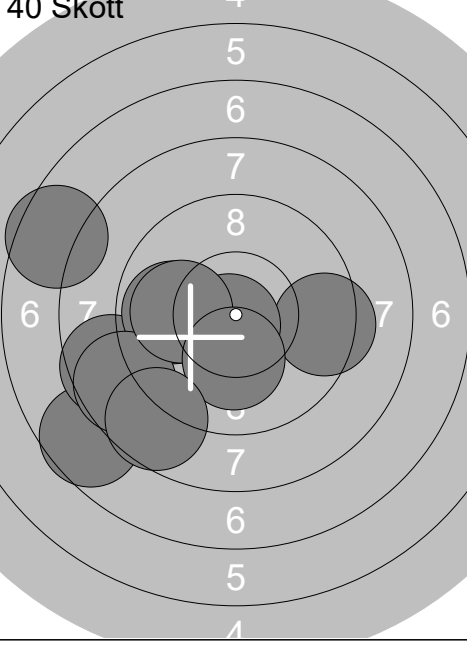
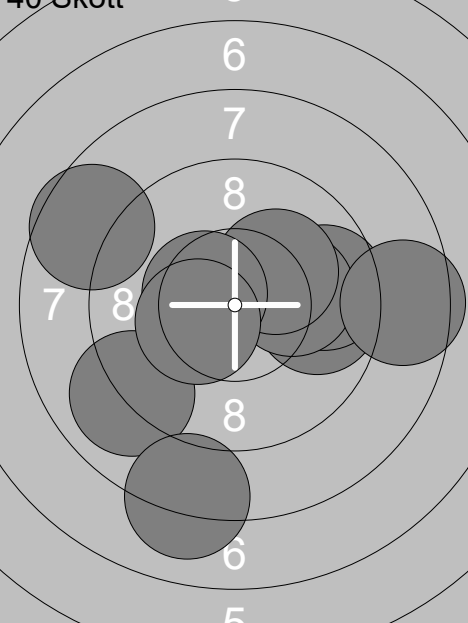
Skjuttlag	Tavla	Tilda Rosendahl		
1	37	Ramselefors	Ramselefors	Mini Vb
13.01.2018		Skyttiadens distriktsfinal 2018	Ramselefors SKF	
<b>Prov</b> 	1: 9.0 ← 2: 9.1 ↙ 3: 9.1 ↙ 4: 10.6x ↘ 5: 10.3x → 6: 9.8 ↗ 7: 10.3x ↑ 8: 10.0 ←	<b>40 Skott</b> 	1: 9.7 → 2: 10.3x ↙ 3: 10.8x ↘ 4: 8.7 ↘ 5: 10.6x → 6: 9.9 ↗ 7: 9.5 ↙ 8: 9.9 ↘ 9: 8.6 ↓ 10: 8.6 ←	
	Serie 78.2		Serie 96.6	
	Total 0.0		Total 96.6	
<b>40 Skott</b> 	11: 9.1 → 12: 9.6 ← 13: 10.8x → 14: 9.6 ↓ 15: 9.6 ↘ 16: 10.7x ← 17: 9.7 ← 18: 10.8x ↖ 19: 10.4x ↘ 20: 10.1 ↘	<b>40 Skott</b> 	21: 7.6 ↙ 22: 9.4 → 23: 8.6 ← 24: 9.8 ← 25: 10.7x ↘ 26: 8.7 ↙ 27: 10.0 ← 28: 7.5 ↙ 29: 10.2x ↘ 30: 8.7 ↘	
	Serie 100.4		Serie 91.2	
	Total 197.0		Total 288.2	
<b>40 Skott</b> 	31: 9.0 ↙ 32: 9.8 → 33: 8.1 ↓ 34: 9.6 → 35: 10.1 → 36: 10.2x ↗ 37: 10.5x ← 38: 8.5 → 39: 10.4x ↖ 40: 8.6 ↖			
	Serie 94.8			
	Total 383.0			

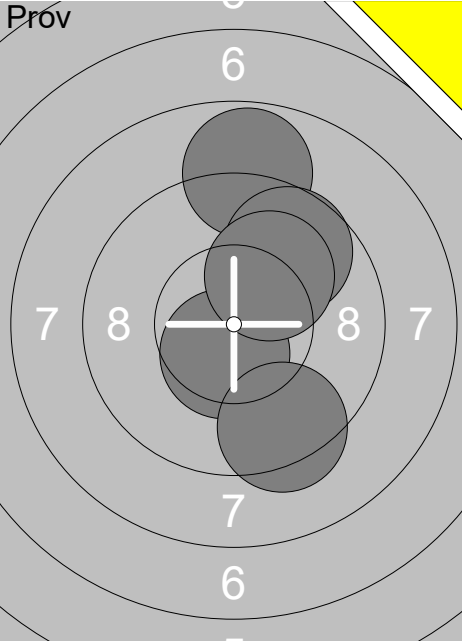
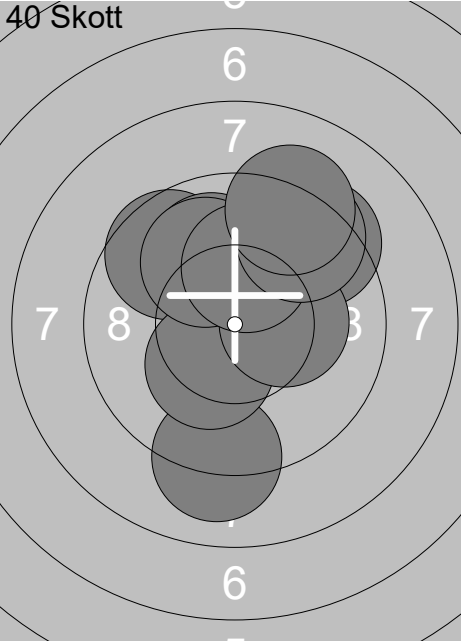
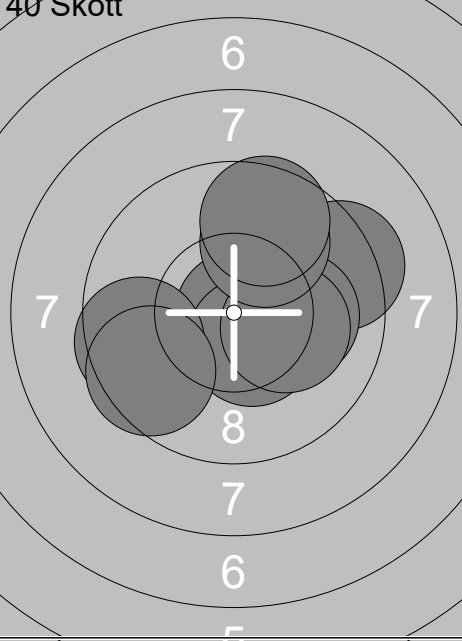
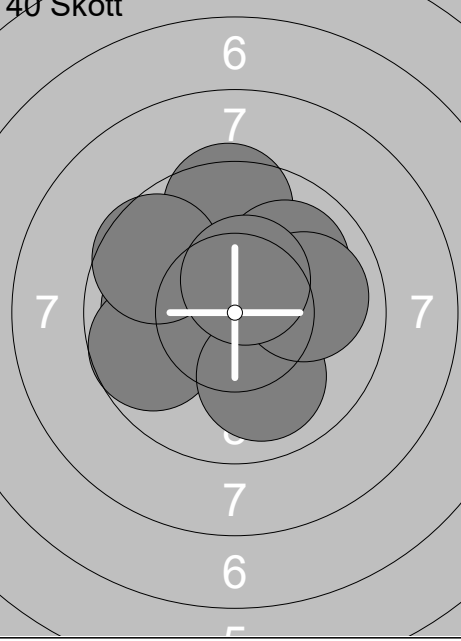
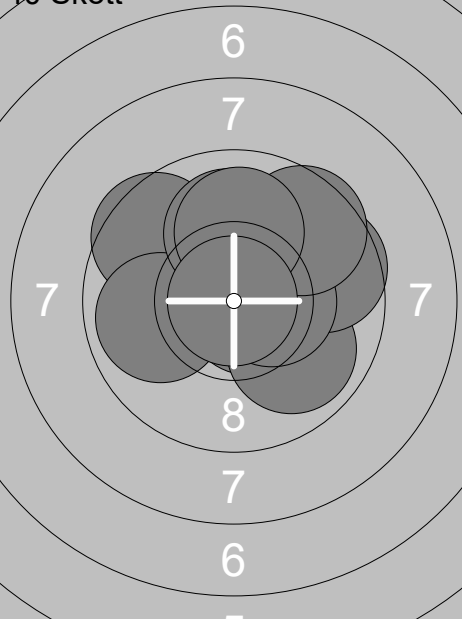
Skjutlag	Tavla	Dina Stjärnbäck	
1	38	Ramselefors	Mini Vb
13.01.2018	Skyttiadens distriktsfinal 2018	Ramselefors SKF	
<b>Prov</b> 	1: 8.8 ↑ 2: 9.7 ↗ 3: 10.5x ↓ 4: 9.4 ↓ 5: 10.1 ↗	<b>40 Skott</b> 	1: 9.6 ↖ 2: 9.4 ↗ 3: 10.0 ↑ 4: 9.1 ↓ 5: 10.3x ↓ 6: 10.0 ↑ 7: 10.3x → 8: 10.1 ↑ 9: 9.4 ↗ 10: 9.2 ↑
	Serie 48.5		Serie 97.4
	Total 0.0		Total 97.4
<b>40 Skott</b> 	11: 10.2x → 12: 10.9x → 13: 9.3 → 14: 10.5x ↓ 15: 10.1 → 16: 10.2x → 17: 9.9 ↑ 18: 9.6 ↑ 19: 9.6 ← 20: 9.5 ↙	<b>40 Skott</b> 	21: 10.0 ↑ 22: 10.0 ← 23: 10.1 ↑ 24: 9.7 ← 25: 9.5 ↑ 26: 9.6 ↖ 27: 10.0 ↗ 28: 10.0 ↓ 29: 10.0 → 30: 10.5x ↑
	Serie 99.8		Serie 99.4
	Total 197.2		Total 296.6
<b>40 Skott</b> 	31: 10.7x ↘ 32: 9.9 ↘ 33: 9.6 → 34: 10.4x → 35: 9.6 ↗ 36: 9.6 ↖ 37: 9.9 ← 38: 10.0 ↑ 39: 10.0 ↑ 40: 10.9x ←		
	Serie 100.6		
	Total 397.2		

Skjutlag	Tavla	Emmy Burström		
1	39	Ramselefors	Mini	Vb
13.01.2018	Skyttiadens distriktsfinal 2018	Ramselefors SKF		
<b>Prov</b> 	1: 9.8 ↓ 2: 9.7 ↓ 3: 10.3x ← 4: 9.6 ↓ 5: 10.6x ↖ 6: 9.5 ↓ 7: 10.3x ↗ 8: 9.9 ↗ 9: 10.5x ➤ 10: 9.5 ➤ <b>Serie 99.7</b> <b>Total 0.0</b>	<b>40 Skott</b> 	1: 10.2x ↙ 2: 9.8 ↙ 3: 10.0 ↗ 4: 10.7x ↙ 5: 9.4 ↓ 6: 9.8 ➤ 7: 10.3x ➤ 8: 10.8x ↓ 9: 9.6 ➔ 10: 10.3x ↗ <b>Serie 100.9</b> <b>Total 100.9</b>	
<b>40 Skott</b> 	11: 9.1 ↑ 12: 9.9 ↗ 13: 10.7x ➤ 14: 10.1 ↑ 15: 9.1 ➤ 16: 9.7 ↑ 17: 9.9 ↑ 18: 9.4 ↑ 19: 10.1 ↖ 20: 10.0 ↗ <b>Serie 98.0</b> <b>Total 198.9</b>	<b>40 Skott</b> 	21: 9.4 ↖ 22: 9.3 ↗ 23: 10.6x ➔ 24: 10.0 ➤ 25: 10.0 ← 26: 9.9 ↓ 27: 9.9 ➔ 28: 9.3 ↗ 29: 10.5x ↑ 30: 9.5 ↖ <b>Serie 98.4</b> <b>Total 297.3</b>	
<b>40 Skott</b> 	31: 10.5x ➤ 32: 9.4 ↗ 33: 9.1 ↗ 34: 10.6x ↗ 35: 10.7x ↗ 36: 10.7x ↖ 37: 10.8x ➔ 38: 9.6 ➔ 39: 10.3x ↓ 40: 9.9 ➔ <b>Serie 101.6</b> <b>Total 398.9</b>			

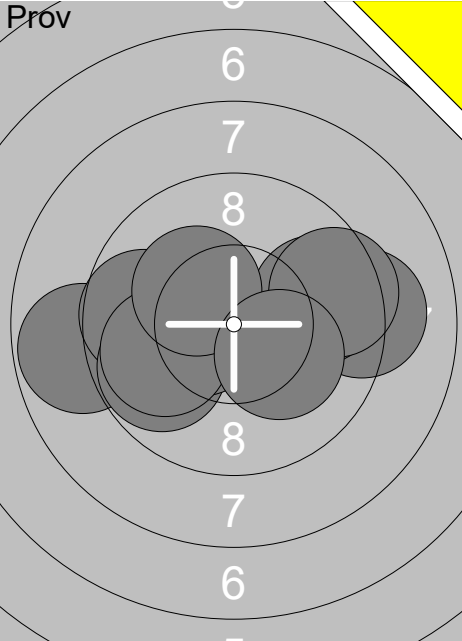
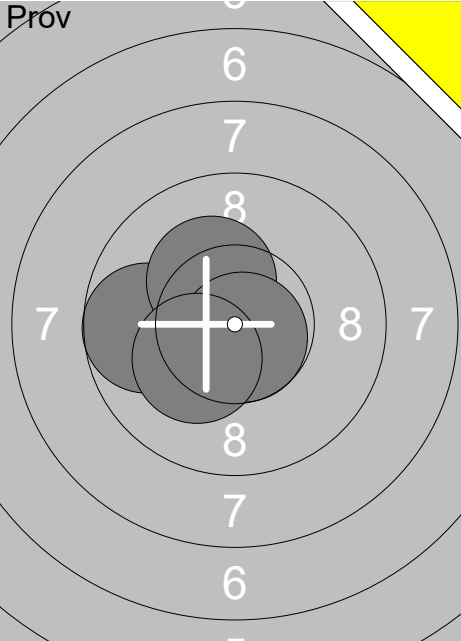
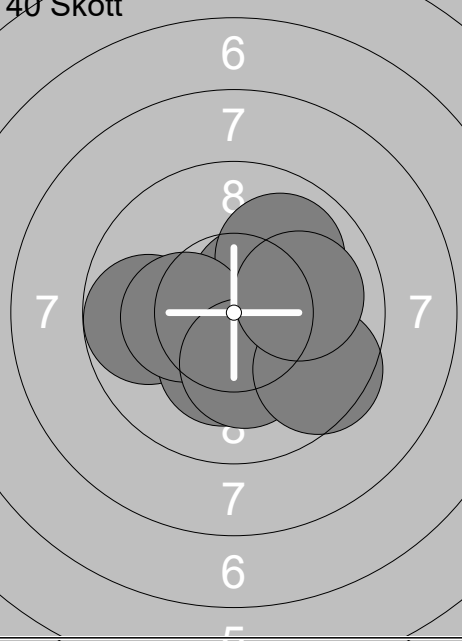
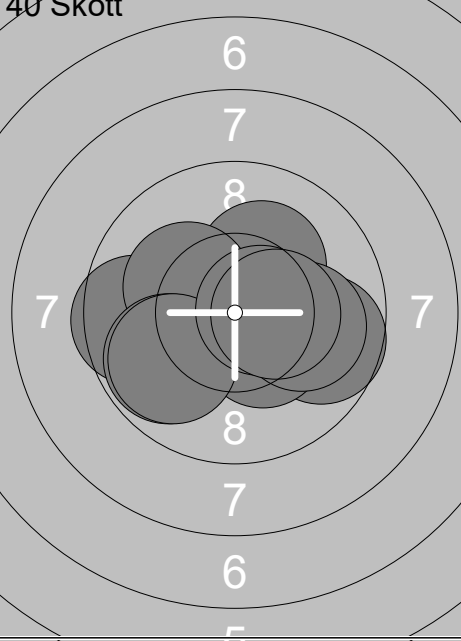
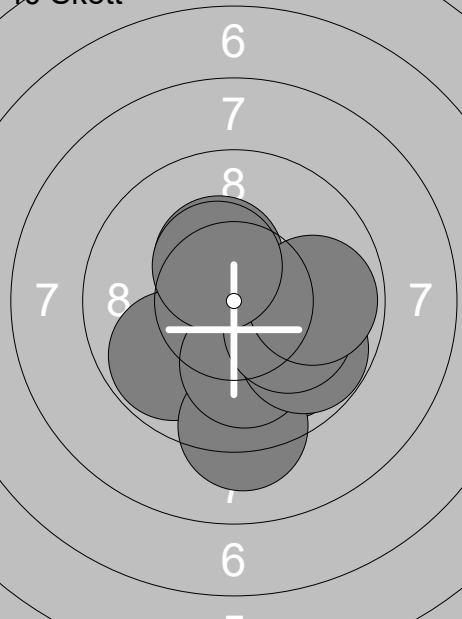
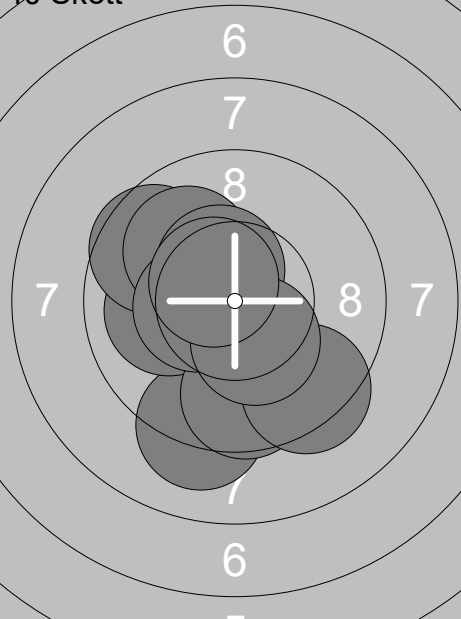
Skjutlag	Tavla	Hanna Lundin	
2	2		
Ramselefors	Umeå	17	Vb
13.01.2018	Skyttiadens distriktsfinal 2018	Ramselefors SKF	
Prov 	1: 8.8 ←	Prov 	11: 9.7 ←
	2: 9.7 ←		12: 10.3x ↗
	3: 9.8 ←		13: 10.7x ↘
	4: 10.5x ←←		14: 10.2x ↙
	5: 9.2 →		
	6: 9.8 →		
	7: 9.9 ←		
	8: 9.5 →		
	9: 10.3x ↗		
	10: 10.2x ↘		
	Serie 97.7		Serie 40.9
	Total 0.0		Total 0.0
40 Skott 	1: 9.8 ←	40 Skott 	11: 10.2x ↗
	2: 10.7x ↘		12: 9.6 ←
	3: 10.4x ↘		13: 9.7 →
	4: 10.5x ↗		14: 10.2x ↖
	5: 10.3x ↘		15: 10.4x ↘
	6: 10.0 ↗		16: 9.8 ←
	7: 10.3x ←←		17: 10.0 →
	8: 10.2x ↘		18: 9.9 ←
	9: 9.5 ↘		19: 10.6x →
	10: 10.0 →		20: 10.4x →
	Serie 101.7		Serie 100.8
	Total 101.7		Total 202.5
40 Skott 	21: 9.9 ↘	40 Skott 	31: 9.2 ↘
	22: 10.7x ←←		32: 10.0 ←
	23: 9.8 ←		33: 9.6 ↖
	24: 9.2 ↘		34: 10.0 ↗
	25: 10.1 ↘		35: 9.6 ↘
	26: 10.3x ↗		36: 9.4 ↘
	27: 9.8 ↘		37: 10.4x ←←
	28: 10.1 ↘		38: 10.5x ↗
	29: 9.9 →		39: 10.3x ↘
	30: 10.4x ↗		40: 10.6x ↖
	Serie 100.2		Serie 99.6
	Total 302.7		Total 402.3

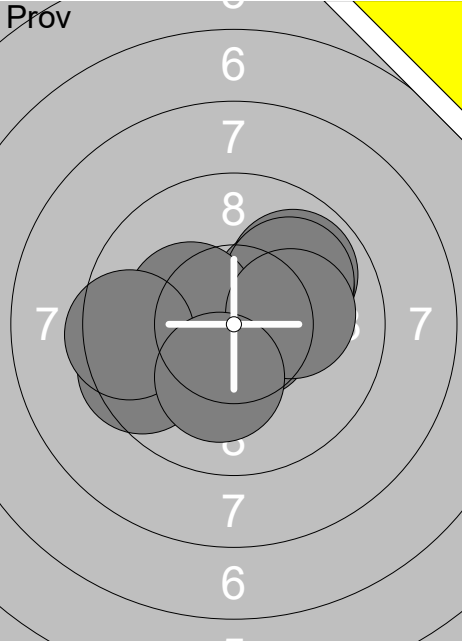
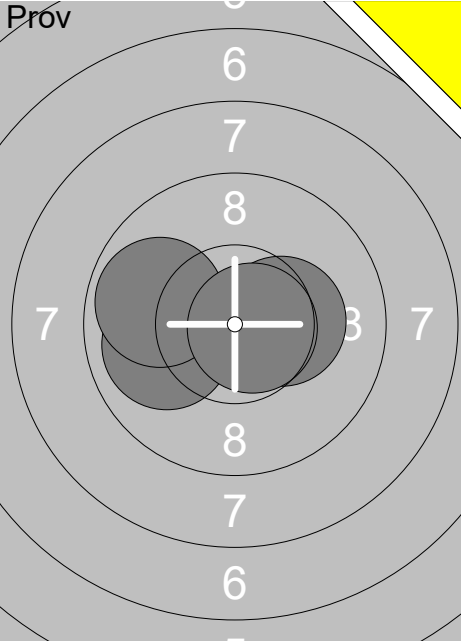
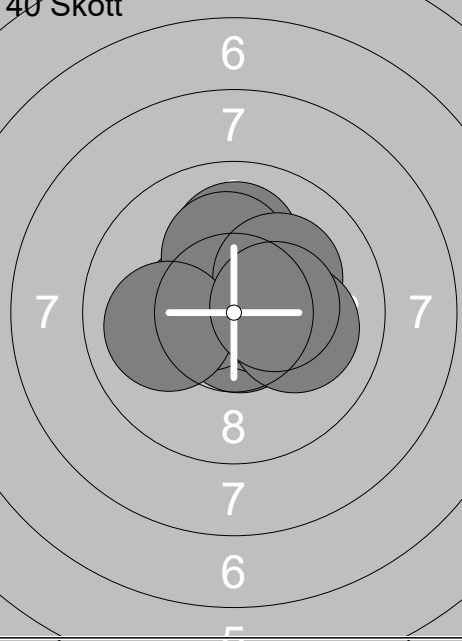
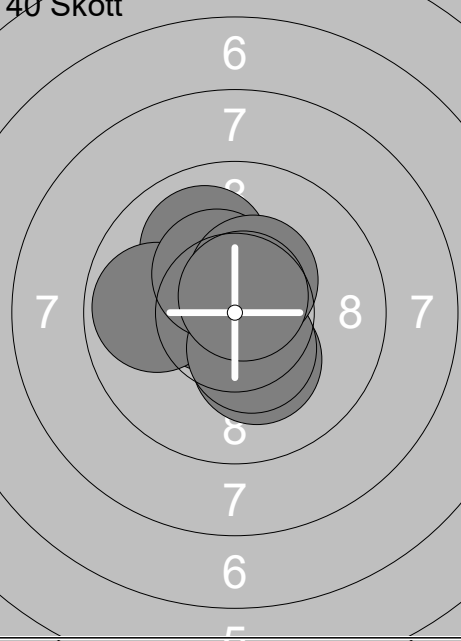
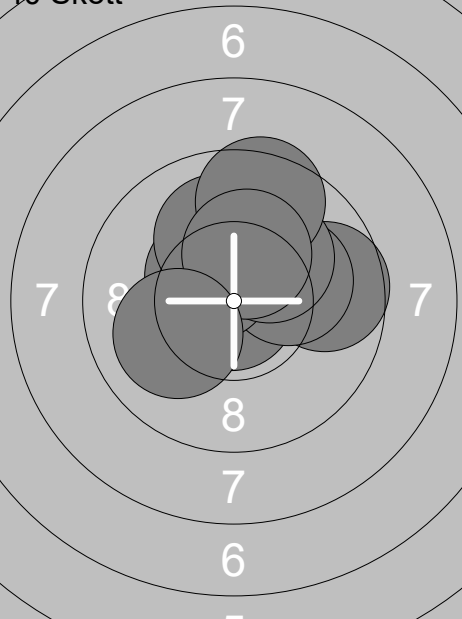
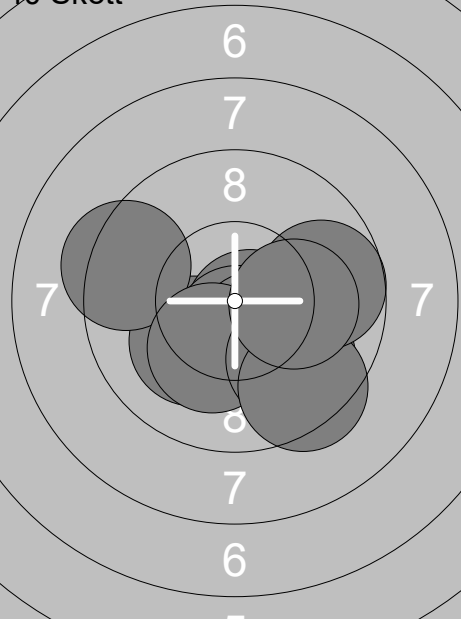

Skjuttlag	Tavla	Saul Johansson			
2	3	Ramselefors	Ramselefors	21	Vb
13.01.2018	Skyttiadens distriktsfinal 2018	Ramselefors SKF			
Prov		1: 10.7x ↘	Prov		11: 10.0 ←
		2: 9.9 ↗			12: 10.3x →
		3: 10.0 ↗			13: 9.9 ←
		4: 10.2x ↗			14: 10.7x →
		5: 10.0 ↗			
		6: 10.3x ↙			
		7: 9.5 ←			
		8: 10.1 →			
		9: 9.5 ←			
		10: 10.2x ↓			
		Serie 100.4			Serie 40.9
		Total 0.0			Total 0.0
40 Skott		1: 10.7x ↓	40 Skott		11: 10.0 ↗
		2: 10.6x →			12: 10.4x ↗
		3: 10.0 ↑			13: 10.5x ↗
		4: 10.6x ↙			14: 10.6x ↙
		5: 10.6x ↗			15: 9.9 ←
		6: 10.2x ↑			16: 10.2x ↓
		7: 10.2x ↗			17: 10.4x ↓
		8: 10.1 →			18: 10.4x ↗
		9: 10.0 ←			19: 10.4x ↗
		10: 10.4x →			20: 10.7x ↗
		Serie 103.4			Serie 103.5
		Total 103.4			Total 206.9
40 Skott		21: 10.9x ↙	40 Skott		31: 10.2x ↙
		22: 9.7 →			32: 10.7x ↘
		23: 10.9x ↓			33: 9.4 ←
		24: 10.1 →			34: 10.5x ↓
		25: 10.5x ↙			35: 10.4x ↓
		26: 10.2x ↗			36: 10.2x ↓
		27: 10.1 ↑			37: 9.8 ↓
		28: 9.5 ↑			38: 9.4 ↓
		29: 10.3x ↑			39: 9.7 →
		30: 10.0 ←			40: 10.1 →
		Serie 102.2			Serie 100.4
		Total 309.1			Total 409.5

Skjutlag	Tavla	Anna Östman		
2	4	Ramselefors	21	Vb
13.01.2018	Skyttiadens distriktsfinal 2018	Ramselefors SKF		
<b>Prov</b> 	1: 9.6 ↗ 2: 10.3x ➔ 3: 9.6 ➔ 4: 10.2x ➔ 5: 9.9 ↗ 6: 10.5x ← 7: 8.5 ↗ 8: 10.6x ↘ 9: 9.6 ↗ 10: 10.5x ➔ <b>Serie 99.3</b> <b>Total 0.0</b>	<b>Prov</b> 	11: 9.9 ➔ <b>Serie 9.9</b> <b>Total 0.0</b>	
<b>40 Skott</b> 	1: 10.4x ← 2: 9.7 ↗ 3: 10.5x ← 4: 8.8 ← 5: 10.2x ↗ 6: 9.4 ↘ 7: 10.3x ← 8: 9.6 ← 9: 10.2x ↘ 10: 10.8x ↘ <b>Serie 99.9</b> <b>Total 99.9</b>	<b>40 Skott</b> 	11: 9.2 ↙ 12: 9.0 ↗ 13: 9.5 ← 14: 10.5x ↘ 15: 9.7 ↘ 16: 10.8x ↘ 17: 10.4x ↙ 18: 9.8 ↘ 19: 9.5 ↘ 20: 10.6x ↘ <b>Serie 99.0</b> <b>Total 198.9</b>	
<b>40 Skott</b> 	21: 10.1 ➔ 22: 10.7x ↙ 23: 9.9 ← 24: 9.8 ↙ 25: 8.6 ↗ 26: 9.8 ↗ 27: 10.6x ↘ 28: 10.7x ↙ 29: 9.0 ↙ 30: 9.1 ↙ <b>Serie 98.3</b> <b>Total 297.2</b>	<b>40 Skott</b> 	31: 10.0 ← 32: 10.8x ↘ 33: 10.2x ↘ 34: 10.7x ↙ 35: 10.8x ↘ 36: 10.3x ➔ 37: 8.8 ↘ 38: 10.4x ➔ 39: 9.8 ↘ 40: 10.7x ↘ <b>Serie 102.5</b> <b>Total 399.7</b>	

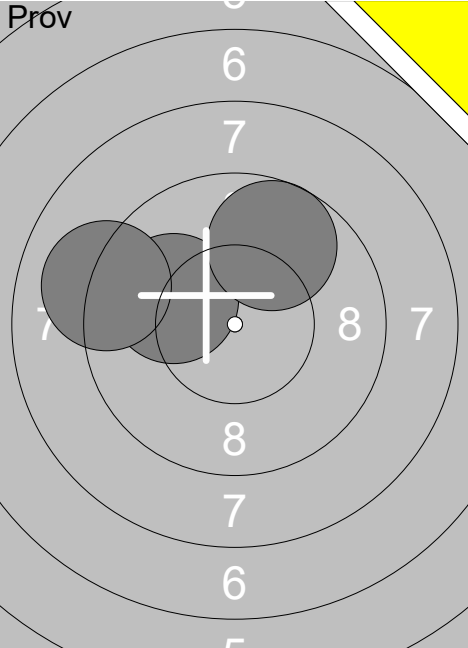
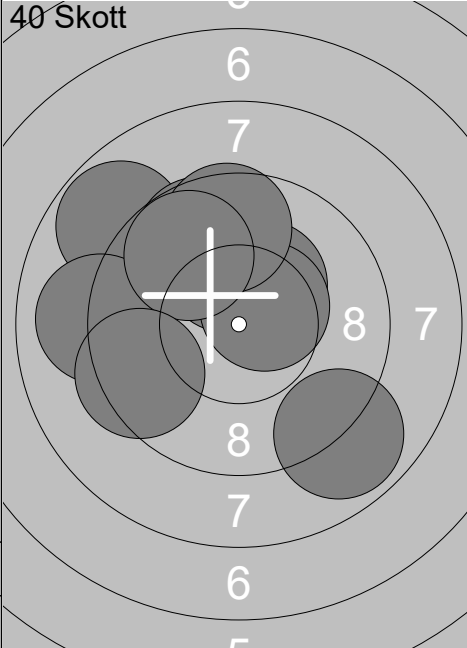
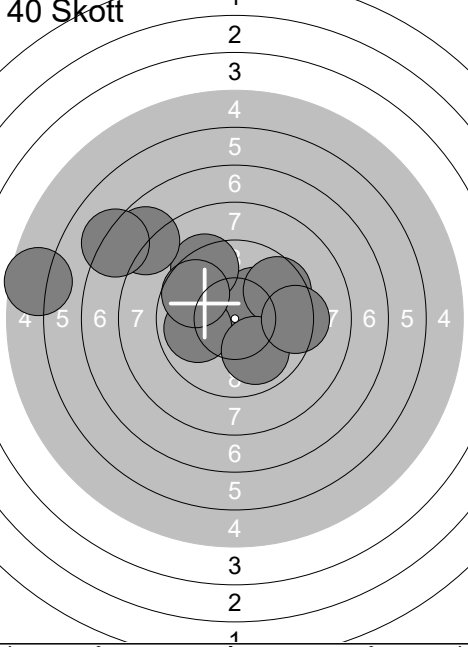
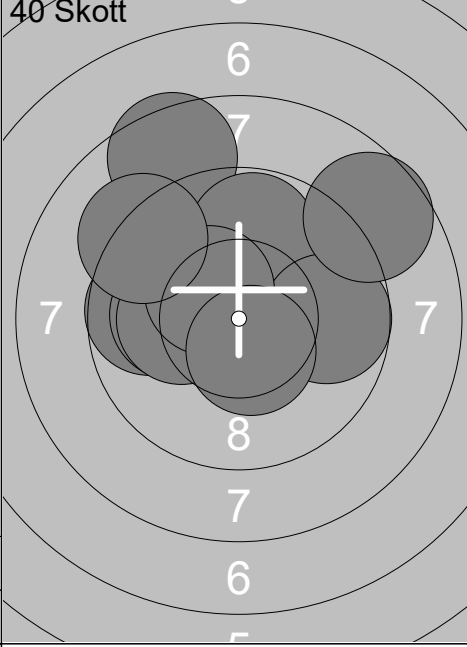
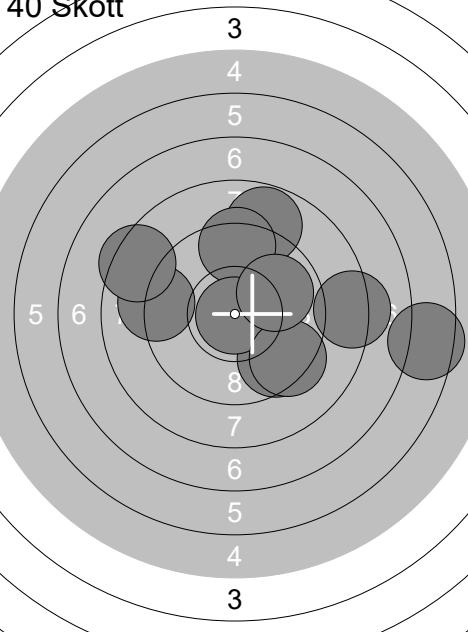
Skjuttag <b>2</b>	Tavla <b>5</b>	<b>Jennifer Gustafsson</b>	
Ramselefors	Ramselefors	13S	Vb
13.01.2018	Skyttiadens distriktsfinal 2018	Ramselefors SKF	
<b>Prov</b> 	1: 10.0 ← 2: 9.7 ↗ 3: 9.1 ←  <b>Serie 28.8</b> <b>Total 0.0</b>	<b>40 Skott</b> 	1: 10.1 ↗ 2: 10.3x ↗ 3: 8.8 ↖ 4: 9.7 ↗ 5: 9.0 ← 6: 8.9 ↘ 7: 10.5x ↗ 8: 9.6 ↗ 9: 9.8 ↗ 10: 9.4 ←  <b>Serie 96.1</b> <b>Total 96.1</b>
<b>40 Skott</b> 	11: 10.2x ↗ 12: 9.4 ↗ 13: 9.6 ↗ 14: 5.6 ← 15: 7.8 ↗ 16: 7.2 ↖ 17: 9.9 ← 18: 9.9 ↘ 19: 9.7 ↗ 20: 9.3 →  <b>Serie 88.6</b> <b>Total 184.7</b>	<b>40 Skott</b> 	21: 8.5 ↗ 22: 9.8 ↗ 23: 9.7 → 24: 9.7 ← 25: 8.7 ↗ 26: 10.1 ← 27: 10.1 ← 28: 10.4x ↗ 29: 9.2 ↖ 30: 10.5x ↘  <b>Serie 96.7</b> <b>Total 281.4</b>
<b>40 Skott</b> 	31: 6.5 → 32: 9.1 ← 33: 8.8 ↗ 34: 9.4 ↗ 35: 9.6 ↘ 36: 8.2 → 37: 8.4 ↖ 38: 10.9x ↘ 39: 9.4 ↘ 40: 9.9 ↗  <b>Serie 90.2</b> <b>Total 371.6</b>		

Skjuttlag	Tavla	Hanna Augustsson	
2	6	Ramselefors	Vännäs
13.01.2018	Skyttiadens distriktsfinal 2018	13S	Vb
13.01.2018	Skyttiadens distriktsfinal 2018	Ramselefors SKF	
Prov		Prov	
	1: 9.9 → 2: 7.9 ← 3: 10.1 ↗ 4: 10.1 ↘ 5: 9.5 ← 6: 9.4 ← 7: 9.9 ↓ 8: 9.8 ← 9: 10.1 ↘ 10: 9.4 ↘		11: 7.9 ← 12: 9.8 ↘
	Serie 96.1		Serie 17.7
	Total 0.0		Total 0.0
40 Skott		40 Skott	
	1: 8.2 → 2: 9.0 ↘ 3: 4.5 ← 4: 9.3 → 5: 8.6 → 6: 9.9 ↑ 7: 9.9 ← 8: 8.6 ← 9: 8.4 ↑ 10: 8.5 ←		11: 10.0 ← 12: 9.2 ↓ 13: 7.5 ← 14: 10.5x ← 15: 9.3 ← 16: 8.2 → 17: 6.8 → 18: 10.8x → 19: 10.7x ↑ 20: 8.8 ←
	Serie 84.9		Serie 91.8
	Total 84.9		Total 176.7
40 Skott		40 Skott	
	21: 9.4 → 22: 9.4 → 23: 7.9 ↘ 24: 9.9 ← 25: 9.2 ↘ 26: 10.7x ← 27: 10.3x ↓ 28: 9.5 → 29: 9.6 ↓ 30: 10.6x ↘		31: 9.6 ← 32: 10.4x → 33: 9.9 ← 34: 8.9 ↓ 35: 8.3 → 36: 7.1 ← 37: 9.2 ↘ 38: 10.4x ↘ 39: 10.8x ↑ 40: 7.4 ↓
	Serie 96.5		Serie 92.0
	Total 273.2		Total 365.2

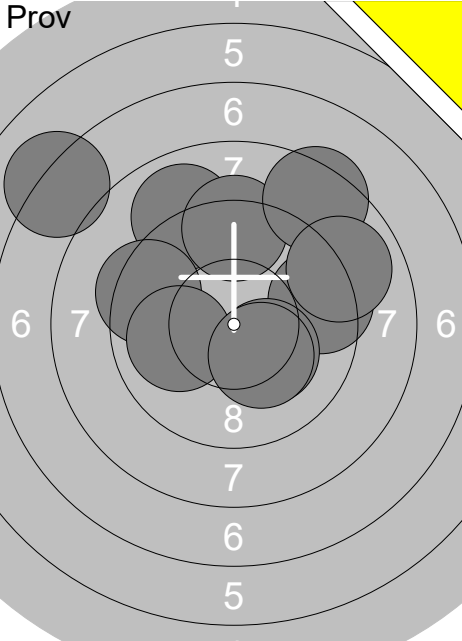
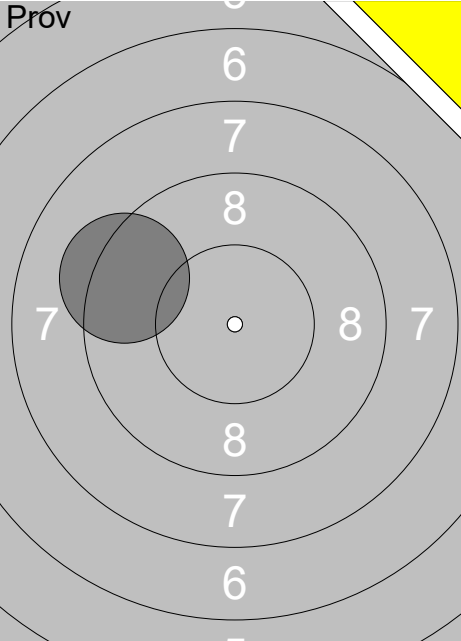
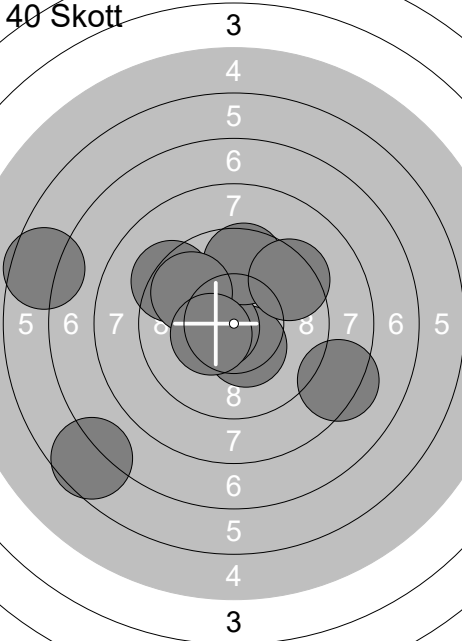
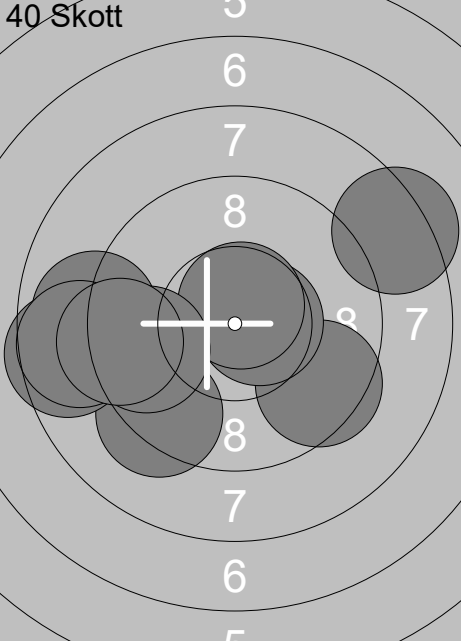
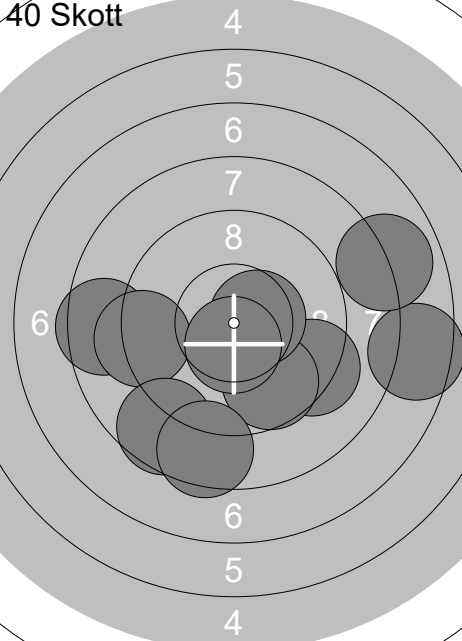
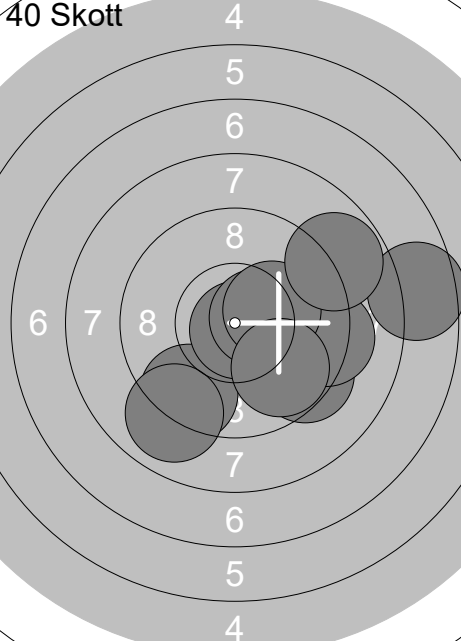
Skjuttlag	Tavla	Sofi Jonsson			
2	7	Ramselefors	Ramselefors	15S	Vb
13.01.2018		Skyttiadens distriktsfinal 2018		Ramselefors SKF	
Prov 	1: 7.1 ↖	Prov 	11: 9.3 ↖		
	2: 9.4 →		12: 9.5 ↘		
	3: 8.9 ↗		13: 10.6x →		
	4: 9.3 ↑		14: 8.5 ←		
	5: 8.4 ↗		15: 8.9 ←		
	6: 10.2x ↘		16: 10.7x ↑		
	7: 9.4 ←		17: 8.7 ←		
	8: 10.0 ←		18: 9.6 ←		
	9: 10.3x ↘		19: 9.3 ←		
	10: 8.9 ↗		20: 8.3 ↗		
	Serie 91.9		Serie 93.4		
	Total 0.0		Total 184.4		
40 Skott 	1: 10.4x ↘	40 Skott 	11: 9.3 ↙		
	2: 8.3 ↘		12: 9.5 ↘		
	3: 9.3 ↖		13: 10.6x →		
	4: 10.6x ←		14: 8.5 ←		
	5: 9.6 ↑		15: 8.9 ←		
	6: 6.6 ←		16: 10.7x ↑		
	7: 9.4 ↗		17: 8.7 ←		
	8: 9.8 ↖		18: 9.6 ←		
	9: 10.4x ←		19: 9.3 ←		
	10: 6.6 ↙		20: 8.3 ↗		
	Serie 91.0		Serie 93.4		
	Total 91.0		Total 184.4		
40 Skott 	21: 9.3 ↘	40 Skott 	31: 9.4 ↙		
	22: 7.5 →		32: 9.4 ↘		
	23: 8.5 ←		33: 9.3 →		
	24: 9.7 ↘		34: 7.6 →		
	25: 9.2 ←		35: 10.8x ↘		
	26: 10.5x →		36: 9.0 ↙		
	27: 8.6 ↙		37: 10.5x →		
	28: 7.9 →		38: 10.2x →		
	29: 8.5 ↘		39: 8.8 ↗		
	30: 10.5x ↘		40: 9.8 ↘		
	Serie 90.2		Serie 94.8		
	Total 274.6		Total 369.4		

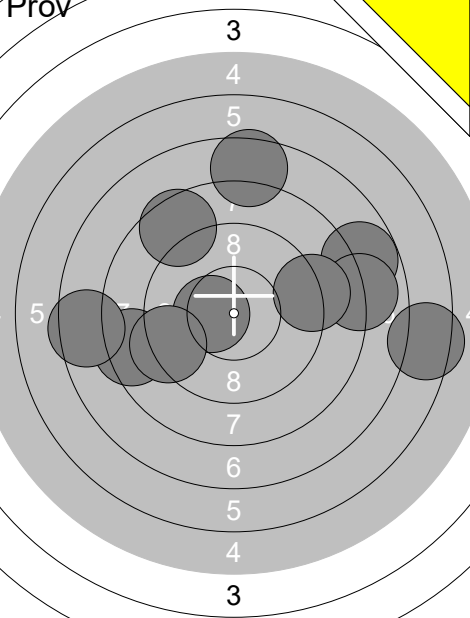
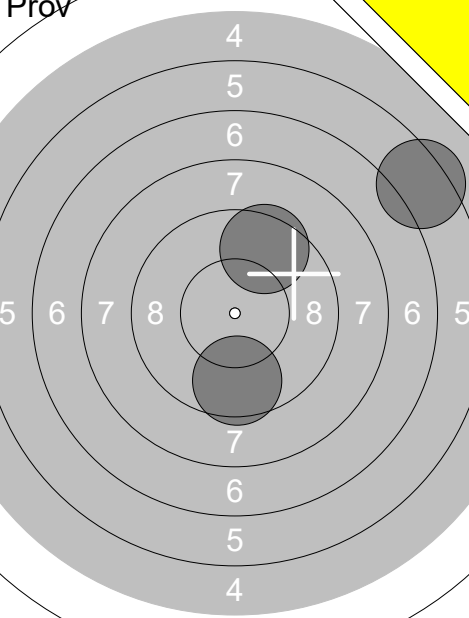
	<p>1: 8.4 ←</p> <p>2: 7.8 →</p> <p>3: 6.4 →</p> <p>4: 10.4x←</p> <p>5: 8.0 →</p> <p>6: 7.5 ←</p> <p>7: 9.1 →</p> <p>8: 9.3 ←</p> <p>9: 8.6 ↗</p> <p>10: 7.5 ↑</p> <p>Serie 83.0</p> <p>Total 0.0</p>		<p>11: 9.5 ↗</p> <p>12: 6.4 →</p> <p>13: 9.6 ↓</p> <p>Serie 25.5</p> <p>Total 0.0</p>
--	--	--	---

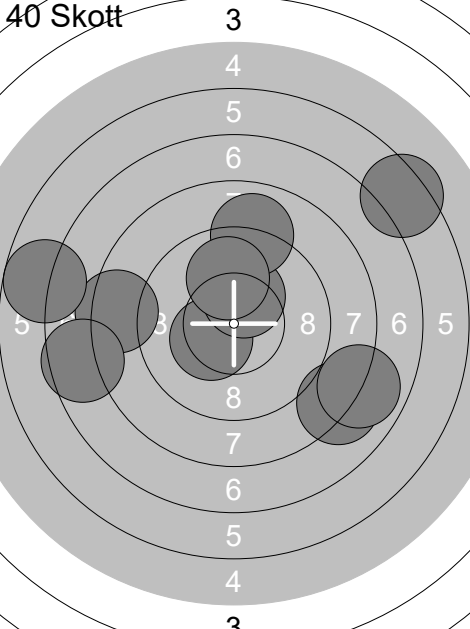
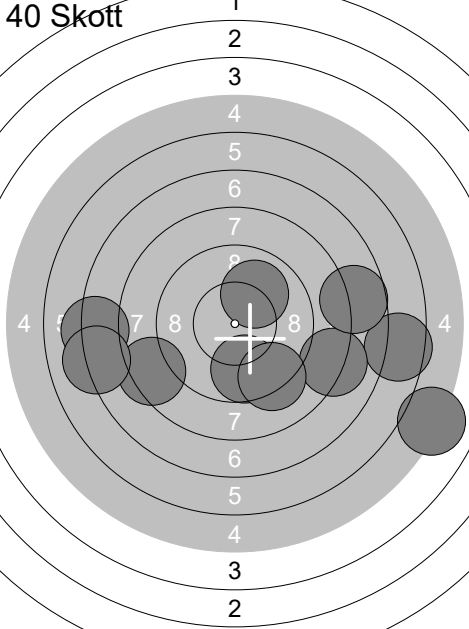
<p>40 Skott</p> 	<p>1: 8.4 ←</p> <p>2: 6.8 ←</p> <p>3: 10.4x←</p> <p>4: 8.1 ↘</p> <p>5: 6.4 ↗</p> <p>6: 7.6 ←</p> <p>7: 10.3x↗</p> <p>8: 7.9 ↘</p> <p>9: 9.0 ↑</p> <p>10: 10.0 ↑</p> <p>Serie 84.9</p> <p>Total 84.9</p>	<p>40 Skott</p> 	<p>11: 6.5 →</p> <p>12: 9.7 ↓</p> <p>13: 8.1 →</p> <p>14: 10.0 ↗</p> <p>15: 7.7 →</p> <p>16: 8.4 ←</p> <p>17: 7.2 ←</p> <p>18: 5.1 ↘</p> <p>19: 7.1 ←</p> <p>20: 9.2 ↓</p> <p>Serie 79.0</p> <p>Total 163.9</p>
---	---	---	---

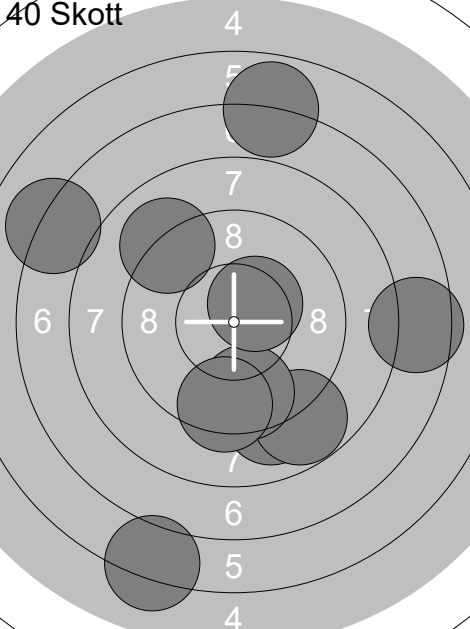
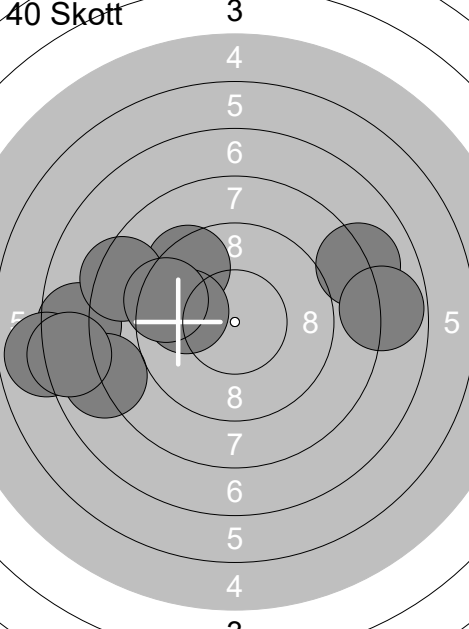
<p>40 Skott</p> 	<p>21: 9.0 ↗</p> <p>22: 7.1 ←</p> <p>23: 7.5 →</p> <p>24: 9.0 ↓</p> <p>25: 6.2 ↓</p> <p>26: 6.9 ↑</p> <p>27: 8.8 ↓</p> <p>28: 9.6 ↓</p> <p>29: 10.4x↗</p> <p>30: 9.4 ↓</p> <p>Serie 83.9</p> <p>Total 247.8</p>	<p>40 Skott</p> 	<p>31: 7.6 ←</p> <p>32: 9.4 ↗</p> <p>33: 6.9 ←</p> <p>34: 8.0 ←</p> <p>35: 8.4 ←</p> <p>36: 7.4 ←</p> <p>37: 9.9 ←</p> <p>38: 8.1 →</p> <p>39: 7.8 →</p> <p>40: 9.4 ←</p> <p>Serie 82.9</p> <p>Total 330.7</p>
--	---	--	--

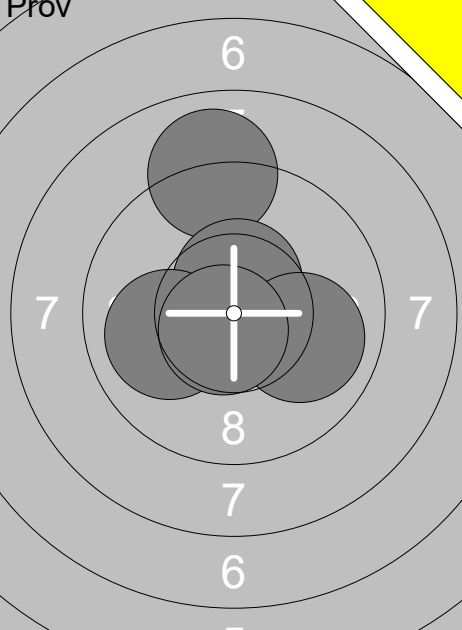
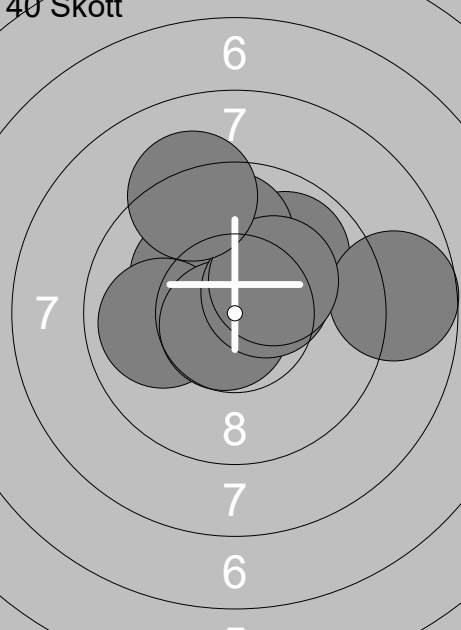
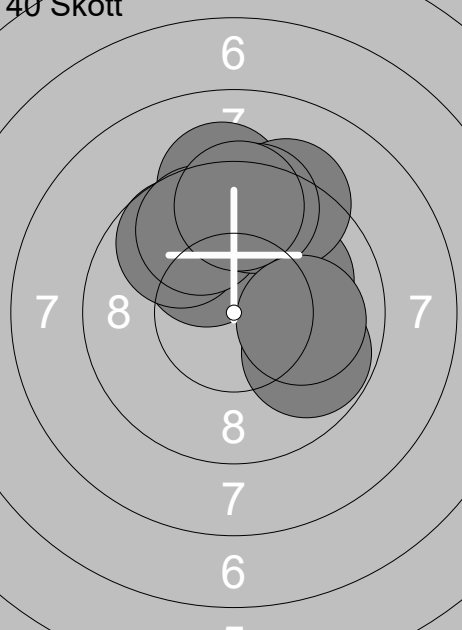
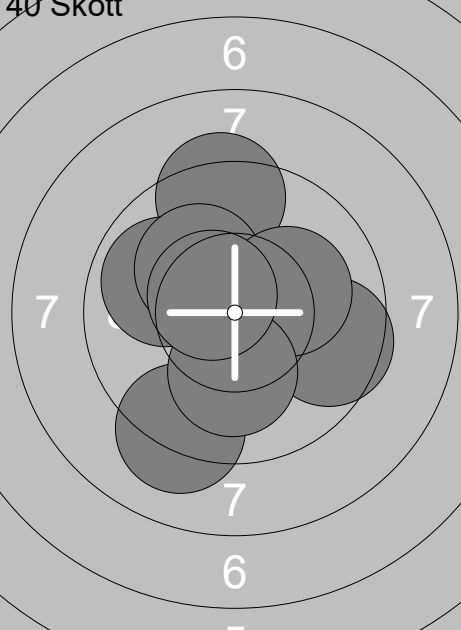
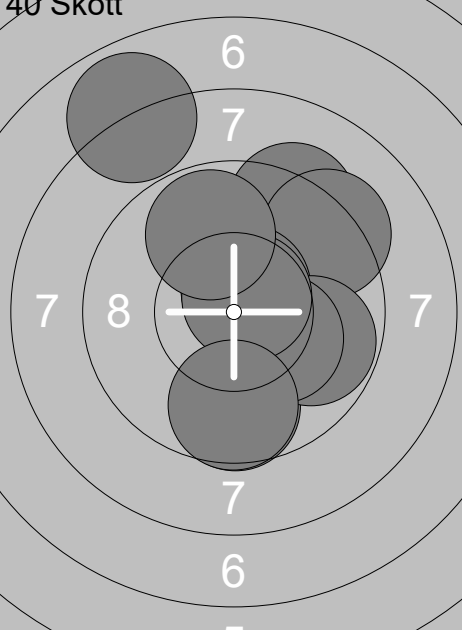
<p>Prov</p> 	<p>1: 9.0 ↑</p> <p>2: 10.5x ↑</p> <p>3: 10.0 ←</p> <p>4: 10.0 →</p> <p>5: 10.7x ↙</p>	<p>40 Skott</p> 	<p>1: 10.4x ↗</p> <p>2: 9.9 ↗</p> <p>3: 9.9 ↑</p> <p>4: 10.2x ↖</p> <p>5: 9.9 ←</p> <p>6: 10.7x ↙</p> <p>7: 8.7 →</p> <p>8: 10.4x ↗</p> <p>9: 10.3x ↗</p> <p>10: 9.2 ↑</p>
Serie 50.2		Serie 99.6	
Total 0.0		Total 99.6	
<p>40 Skott</p> 	<p>11: 10.1 ↗</p> <p>12: 9.2 ↑</p> <p>13: 9.3 ↗</p> <p>14: 10.2x ↖</p> <p>15: 9.8 →</p> <p>16: 9.7 ↖</p> <p>17: 9.7 ↗</p> <p>18: 9.5 ↑</p> <p>19: 10.0 →</p> <p>20: 9.5 ↑</p>	<p>40 Skott</p> 	<p>21: 9.3 ↑</p> <p>22: 10.5x ↖</p> <p>23: 9.9 ←</p> <p>24: 10.6x →</p> <p>25: 9.2 ↙</p> <p>26: 9.6 →</p> <p>27: 10.2x ↖</p> <p>28: 10.2x →</p> <p>29: 10.1 ↓</p> <p>30: 10.6x ↖</p>
Serie 97.0		Serie 100.2	
Total 196.6		Total 296.8	
<p>40 Skott</p> 	<p>31: 9.3 ↗</p> <p>32: 9.3 ↗</p> <p>33: 9.6 ↓</p> <p>34: 10.6x ↗</p> <p>35: 7.9 ↖</p> <p>36: 9.8 →</p> <p>37: 10.2x →</p> <p>38: 10.7x ↗</p> <p>39: 9.7 ↓</p> <p>40: 9.8 ↑</p>		
Serie 96.9			
Total 393.7			

Skjutlag	Tavla	Hanna Johansson			
2	10	Ramselefors	Vännäs	15S	Vb
13.01.2018		Skyttiadens distriktsfinal 2018		Ramselefors SKF	
	1: 8.1 ↖		11: 9.0 ↗		
	2: 9.3 ←		12: 9.5 ↑		
	3: 10.4x ↙		13: 8.8 ↑		
	4: 9.4 →				
	5: 9.4 ←				
	6: 8.8 ←				
	7: 9.7 ←				
	8: 9.0 ↗				
	9: 10.1 ↙				
	10: 9.7 ↗				
	Serie 93.9			Serie 27.3	
	Total 0.0			Total 0.0	
	1: 9.8 ←		11: 9.1 →		
	2: 9.6 ↑		12: 9.2 →		
	3: 10.0 ↑		13: 9.1 ↑		
	4: 8.5 ↗	14: 9.7 ↖			
	5: 10.5x ↗	15: 7.6 →			
	6: 10.3x ↘	16: 9.8 →			
	7: 7.9 ↖	17: 9.6 ←			
	8: 8.2 →	18: 9.9 ↘			
	9: 9.9 ↑	19: 8.8 ↑			
	10: 7.1 →	20: 7.1 →			
	Serie 91.8		Serie 89.9		
	Total 91.8		Total 181.7		
	21: 10.4x ↙		31: 7.9 ↑		
	22: 9.5 →		32: 9.5 ↑		
	23: 9.5 →		33: 9.2 ↗		
	24: 9.5 →	34: 10.8x ↙			
	25: 9.0 ←	35: 9.3 ↗			
	26: 5.8 →	36: 9.2 →			
	27: 8.9 ↗	37: 9.4 ↑			
	28: 10.4x ↗	38: 8.5 ←			
	29: 9.8 ↑	39: 7.8 →			
	30: 5.5 →	40: 9.4 ↘			
	Serie 88.3		Serie 91.0		
	Total 270.0		Total 361.0		

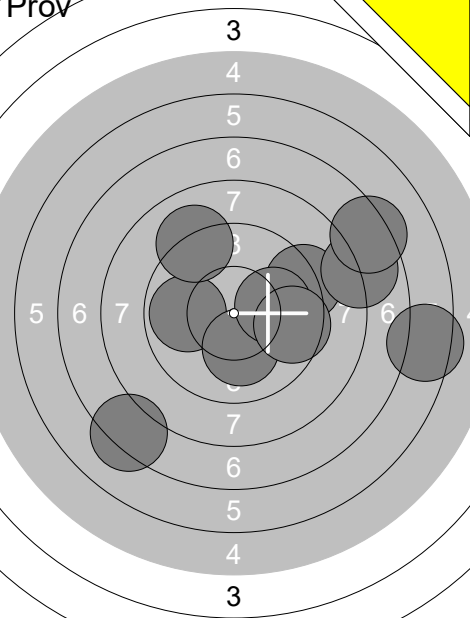
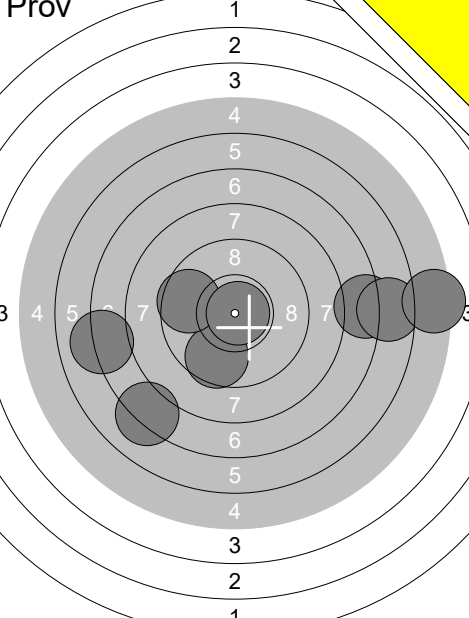

<b>Prov</b> 	1: 6.4 → 2: 9.9 ← 3: 9.2 → 4: 9.1 ↗ 5: 10.1 ↓ 6: 7.3 ↙ 7: 7.9 → 8: 10.0 → 9: 7.3 ↗ 10: 9.6 → <b>Serie 86.8</b> <b>Total 0.0</b>	<b>Prov</b> 	11: 7.2 → 12: 7.2 ↙ 13: 6.6 → 14: 9.6 ↙ 15: 7.1 ← 16: 5.3 → 17: 9.6 ← 18: 10.9x → <b>Serie 63.5</b> <b>Total 0.0</b>
---	--	---	---

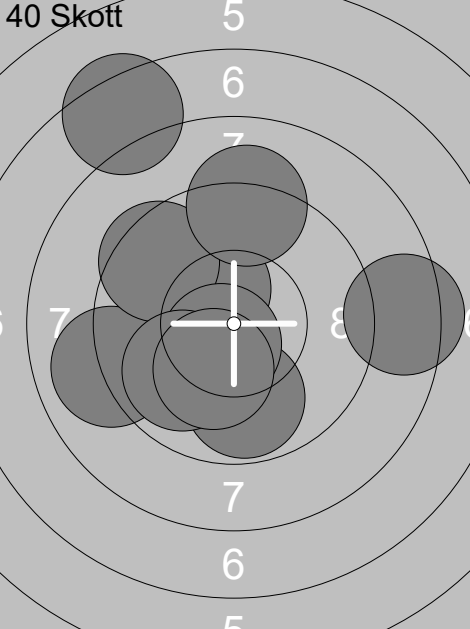
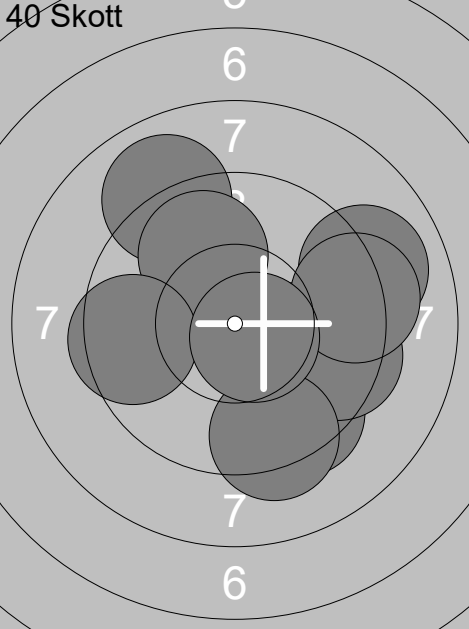
<b>40 Skott</b> 	1: 10.3x ↘ 2: 9.0 ← 3: 7.4 ↗ 4: 9.5 ↗ 5: 9.8 ↓ 6: 9.2 ↑ 7: 10.6x ↙ 8: 8.4 → 9: 9.9 ↙ 10: 10.2x ↙ <b>Serie 94.3</b> <b>Total 94.3</b>	<b>40 Skott</b> 	11: 9.0 ↗ 12: 9.4 ↙ 13: 9.9 ↗ 14: 10.1 → 15: 9.5 ← 16: 9.5 → 17: 9.0 → 18: 9.3 ↙ 19: 9.2 → 20: 10.6x ↘ <b>Serie 95.5</b> <b>Total 189.8</b>
--	---	--	--

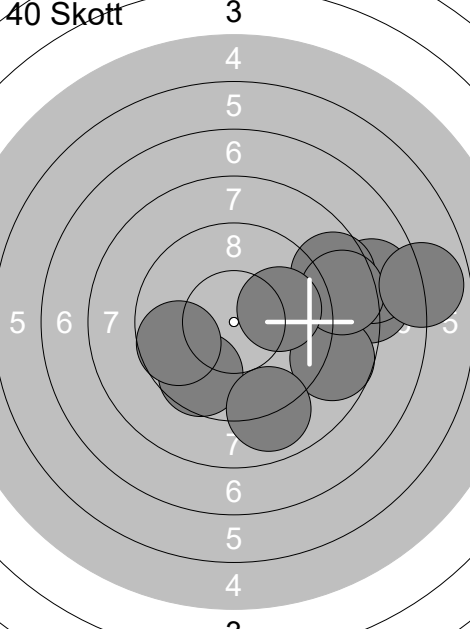
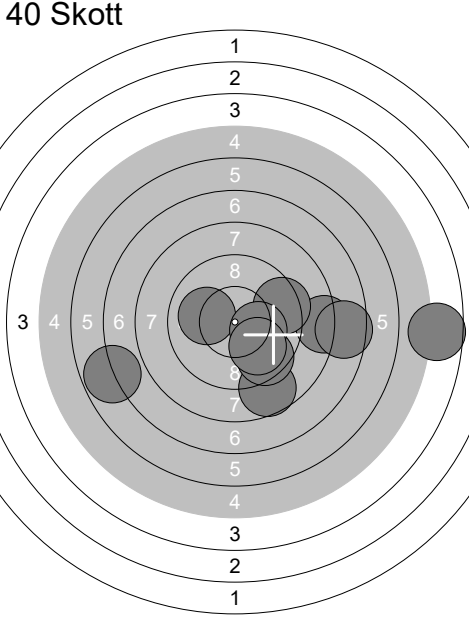
<b>40 Skott</b> 	21: 9.6 ↙ 22: 8.1 → 23: 7.9 → 24: 8.6 → 25: 8.7 → 26: 8.6 → 27: 9.9 → 28: 9.7 ← 29: 6.9 → 30: 9.0 ↙ <b>Serie 87.0</b> <b>Total 276.8</b>	<b>40 Skott</b> 	31: 10.1 ← 32: 4.7 → 33: 8.7 ↙ 34: 8.2 → 35: 6.8 ← 36: 9.4 → 37: 9.5 ↙ 38: 7.5 → 39: 10.2x → 40: 9.9 ↙ <b>Serie 85.0</b> <b>Total 361.8</b>
---	---	---	--

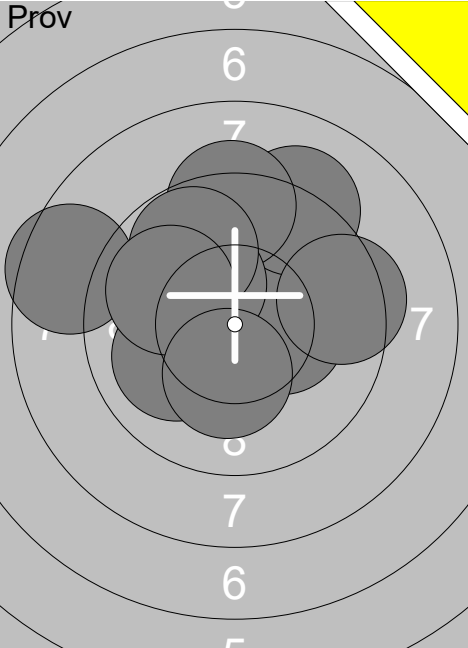
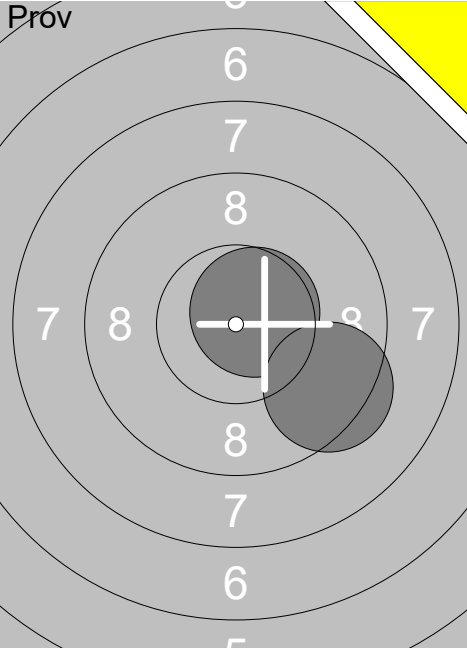
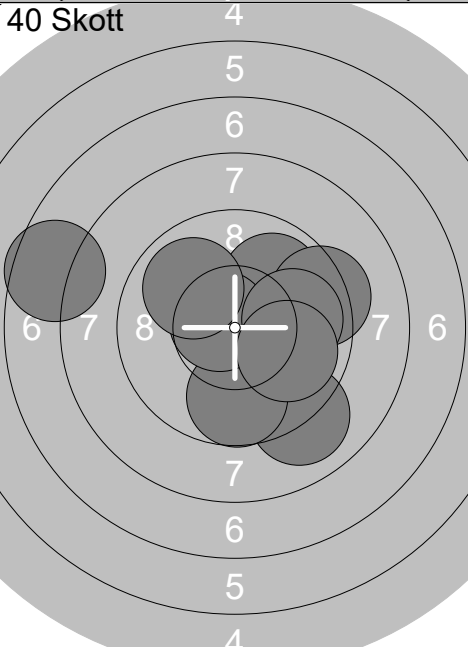
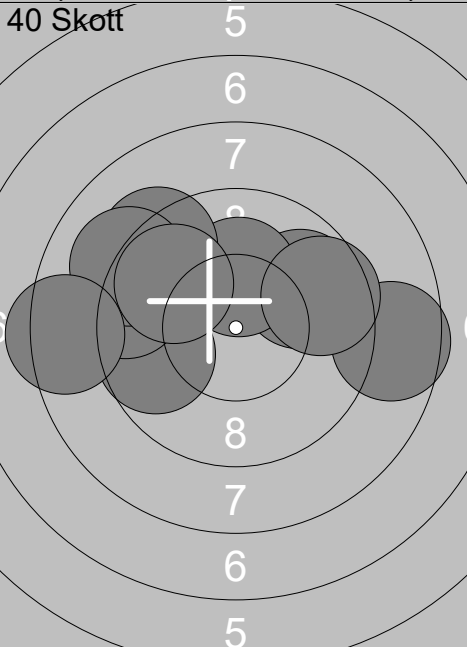
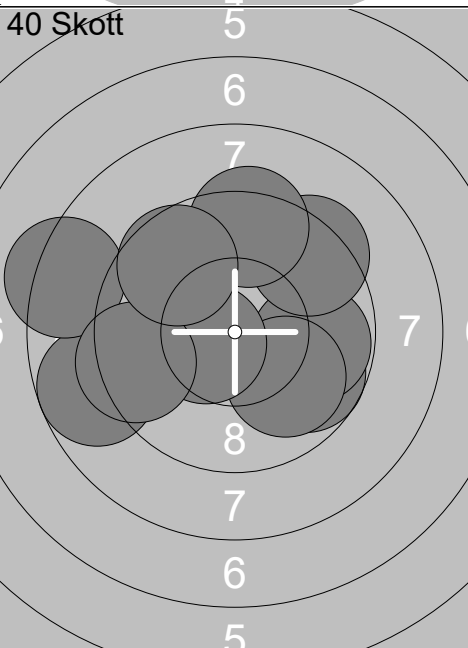
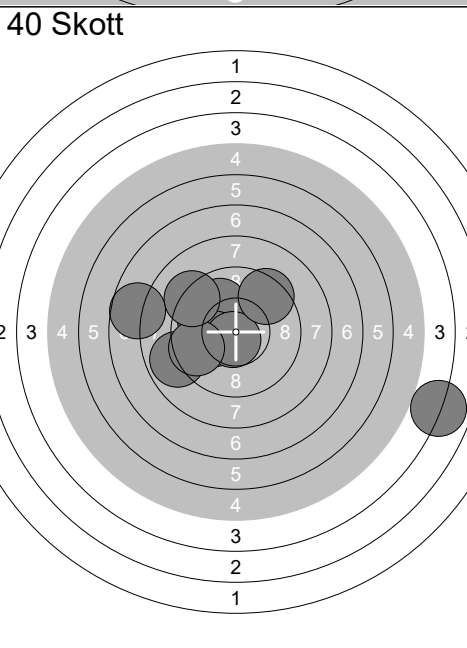
Skjutlag	Tavla	Helena Dreyer Perkiömäki	
2	13	Ramselefors	Umeå
13.01.2018	Skyttiadens distriktsfinal 2018	13S	Vb
13.01.2018	Skyttiadens distriktsfinal 2018	Ramselefors SKF	
<b>Prov</b> 	1: 10.3x → 2: 9.2 ↗ 3: 8.5 ← 4: 9.3 ↑ 5: 10.2x ↖ 6: 9.8 ↗ 7: 9.4 → 8: 10.0 ← 9: 9.9 ↖ 10: 10.3x ↓ <b>Serie 96.9</b> <b>Total 0.0</b>	<b>Prov</b> 	11: 10.6x ↗ 12: 9.4 ↘ <b>Serie 20.0</b> <b>Total 0.0</b>
<b>40 Skott</b> 	1: 9.0 ↘ 2: 7.6 ← 3: 9.7 ↓ 4: 10.0 ↗ 5: 9.9 ↗ 6: 10.7x ↖ 7: 9.9 ↗ 8: 9.3 → 9: 9.9 → 10: 9.9 ↘ <b>Serie 95.9</b> <b>Total 95.9</b>	<b>40 Skott</b> 	11: 9.8 ↗ 12: 9.7 ← 13: 9.2 ← 14: 8.6 → 15: 10.2x ↑ 16: 9.3 ↗ 17: 9.1 ↖ 18: 9.8 ↖ 19: 9.6 → 20: 8.4 ← <b>Serie 93.7</b> <b>Total 189.6</b>
<b>40 Skott</b> 	21: 9.7 ↘ 22: 9.8 → 23: 9.9 ↘ 24: 9.4 ↗ 25: 8.7 ← 26: 10.5x ↖ 27: 8.3 ← 28: 9.4 ← 29: 9.4 ↑ 30: 9.6 ↖ <b>Serie 94.7</b> <b>Total 284.3</b>	<b>40 Skott</b> 	31: 8.9 ← 32: 9.8 ← 33: 10.0 ↗ 34: 10.2x ↖ 35: 10.7x ↓ 36: 9.6 ← 37: 9.4 ↗ 38: 9.2 ↖ 39: 7.7 ← 40: 3.9 → <b>Serie 89.4</b> <b>Total 373.7</b>

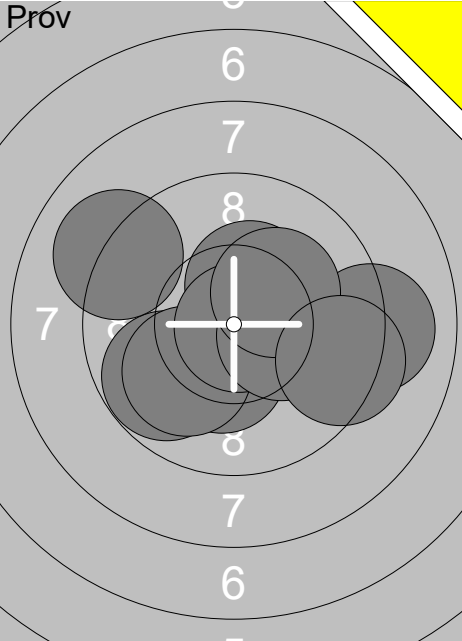
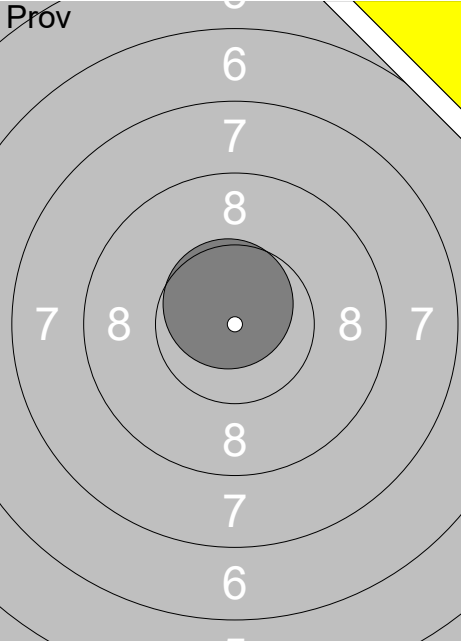
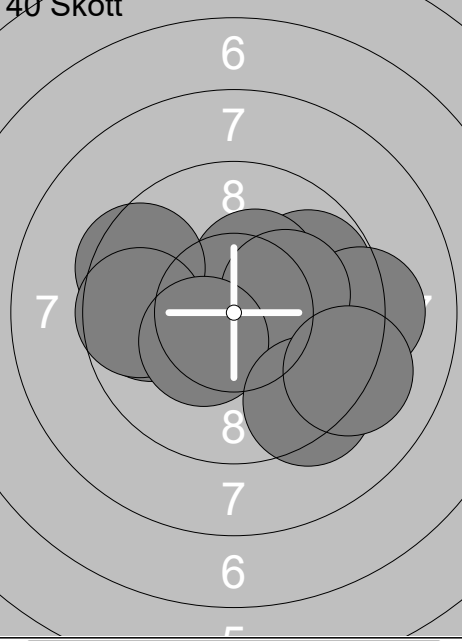
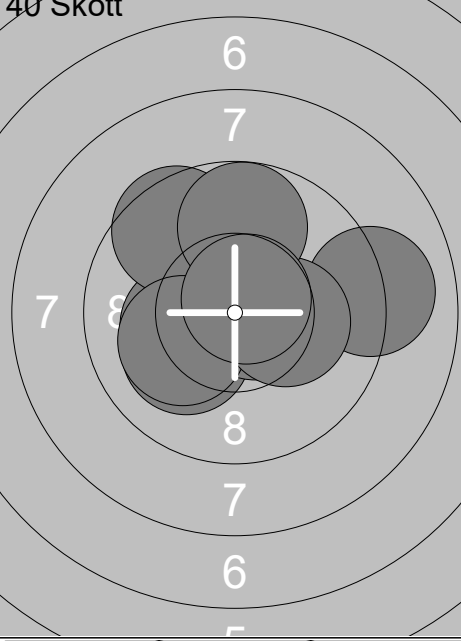
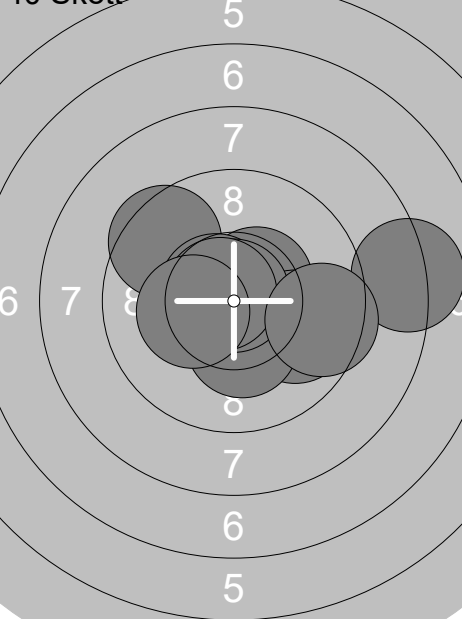
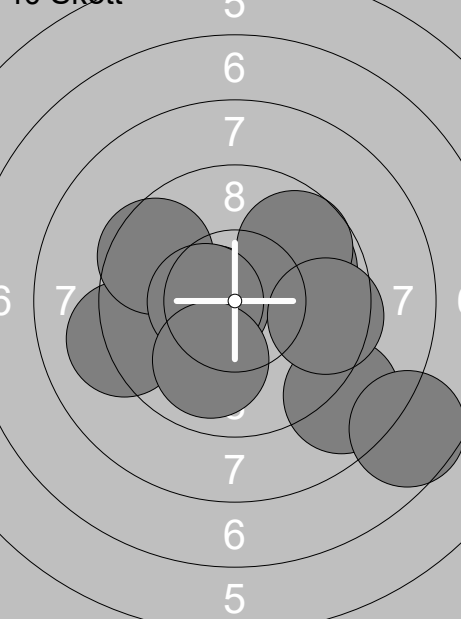
Skjutlag	Tavla	Nicolle Nygren		
2	14	Umeå	13S	Vb
13.01.2018	Skyttiadens distriktsfinal 2018	Ramselefors SKF		
<b>Prov</b> 	1: 10.3x ↓ 2: 9.1 → 3: 10.4x ↑ 4: 9.8 ↙ 5: 10.0 ↘ 6: 9.1 ↖ 7: 10.9x ↗ 8: 10.3x → 9: 10.2x ↗ 10: 9.4 →	<b>Prov</b> 	11: 10.6x ↑	
	Serie 99.5		Serie 10.6	
	Total 0.0		Total 0.0	
<b>40 Skott</b> 	1: 9.8 ← 2: 9.8 ↗ 3: 10.3x ↑ 4: 9.5 ↖ 5: 9.2 → 6: 10.2x → 7: 9.7 ← 8: 10.4x ↙ 9: 9.3 ↘ 10: 9.2 ↘	<b>40 Skott</b> 	11: 9.1 → 12: 10.4x ← 13: 10.2x ← 14: 9.6 ↖ 15: 10.1 ↘ 16: 10.7x → 17: 10.1 ↖ 18: 10.2x → 19: 9.8 ↑ 20: 10.7x ↗	
	Serie 97.4		Serie 100.9	
	Total 97.4		Total 198.3	
<b>40 Skott</b> 	21: 10.5x ↗ 22: 9.5 ↖ 23: 9.9 → 24: 10.6x ↖ 25: 8.1 → 26: 10.3x ↓ 27: 10.9x ↑ 28: 10.7x ↖ 29: 9.5 → 30: 10.3x ←	<b>40 Skott</b> 	31: 9.8 ↗ 32: 8.8 ↘ 33: 9.2 ← 34: 10.6x ← 35: 9.5 ↖ 36: 7.6 ↘ 37: 9.7 ↗ 38: 10.5x ← 39: 9.5 → 40: 10.0 ↓	
	Serie 100.3		Serie 95.2	
	Total 298.6		Total 393.8	

<p>Prov</p> <p>1: 9.1 ↗ 2: 9.9 ↙ 3: 9.9 → 4: 8.4 → 5: 10.3x ↘ 6: 9.9 ↘ 7: 9.4 → 8: 10.1 → 9: 9.8 → 10: 10.7x ↗</p> <p>Serie 97.5 Total 0.0</p>	<p>Prov</p> <p>11: 9.2 ↙ 12: 8.3 ← 13: 10.6x ↙ 14: 10.1 ↖</p> <p>Serie 38.2 Total 0.0</p>
<p>40 Skott</p> <p>1: 9.8 ↘ 2: 10.5x ↗ 3: 10.3x → 4: 9.2 → 5: 9.9 ↑ 6: 9.6 ← 7: 10.5x ↑ 8: 9.8 → 9: 10.5x ← 10: 10.6x ↘</p> <p>Serie 100.7 Total 100.7</p>	<p>40 Skott</p> <p>11: 9.8 ↑ 12: 10.2x → 13: 10.2x ↘ 14: 9.0 ↖ 15: 10.4x ↘ 16: 9.6 → 17: 10.1 ↖ 18: 10.1 ↓ 19: 9.2 ↘ 20: 10.4x →</p> <p>Serie 99.0 Total 199.7</p>
<p>40 Skott</p> <p>21: 10.5x ↘ 22: 9.0 ↖ 23: 9.7 ↗ 24: 10.4x ↘ 25: 10.2x ↑ 26: 10.1 ↗ 27: 9.9 ↘ 28: 9.5 ↗ 29: 9.8 → 30: 10.4x ↘</p> <p>Serie 99.5 Total 299.2</p>	<p>40 Skott</p> <p>31: 10.0 ← 32: 10.5x ↗ 33: 10.0 ↘ 34: 10.1 ↖ 35: 9.9 ↓ 36: 10.3x ↘ 37: 10.7x ↓ 38: 9.7 ↘ 39: 9.1 ↓ 40: 9.5 ↗</p> <p>Serie 99.8 Total 399.0</p>

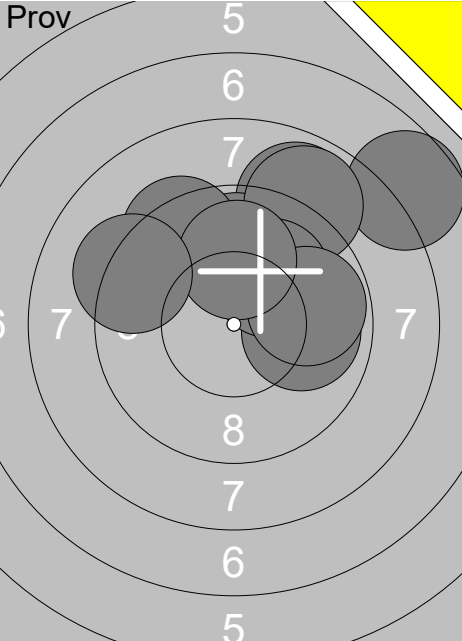
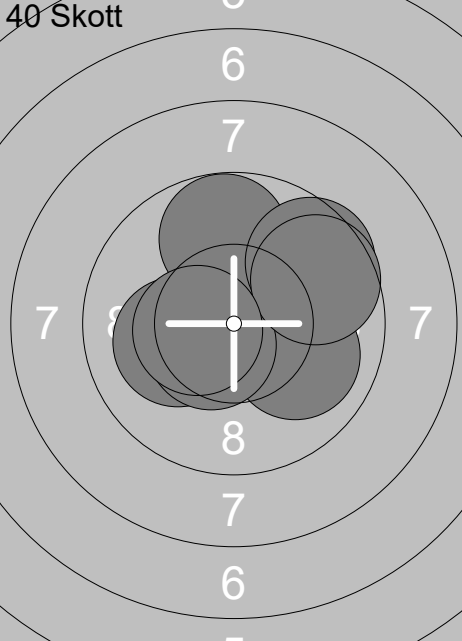
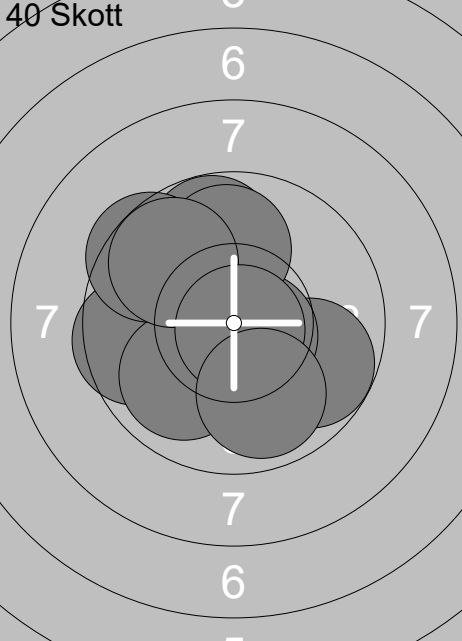
Skjuttlag	Tavla	Erika Bergqvist	
2	16	Umeå	15S Vb
13.01.2018	Skyttiadens distriktsfinal 2018	Ramselefors SKF	
Prov		1: 8.9 ↗ 2: 9.9 ↑ 3: 9.9 → 4: 9.4 ↗ 5: 7.7 ↗ 6: 8.9 ↗ 7: 10.1 ↗ 8: 9.8 → 9: 10.0 ↑ 10: 9.2 ↖	11: 9.8 ↗ 12: 10.5x ↖ 13: 10.2x ↗ 14: 10.1 ↖ 15: 9.8 →
	Serie 93.8		Serie 50.4
	Total 0.0		Total 0.0
40 Skott		1: 10.0 ↗ 2: 10.1 ↖ 3: 10.4x → 4: 10.6x ↑ 5: 9.8 ↑ 6: 10.0 → 7: 10.5x ↖ 8: 9.6 ↗ 9: 9.7 ↗ 10: 10.4x ↖	11: 9.7 ↑ 12: 9.3 → 13: 10.3x ↖ 14: 9.0 ↖ 15: 10.2x → 16: 9.8 ↗ 17: 10.3x ↘ 18: 9.2 → 19: 9.3 → 20: 9.6 ↗
	Serie 101.1		Serie 96.7
	Total 101.1		Total 197.8
40 Skott		21: 9.8 ↑ 22: 9.6 ↖ 23: 9.8 → 24: 9.9 ↖ 25: 10.6x ↘ 26: 9.5 ↗ 27: 9.9 ↑ 28: 9.8 ↗ 29: 10.8x ↘ 30: 9.9 ↘	31: 9.7 → 32: 10.9x ↗ 33: 10.2x ↖ 34: 10.2x ↗ 35: 9.5 ↘ 36: 10.3x ↖ 37: 9.4 → 38: 10.5x ↖ 39: 10.7x → 40: 9.7 ↖
	Serie 99.6		Serie 101.1
	Total 297.4		Total 398.5

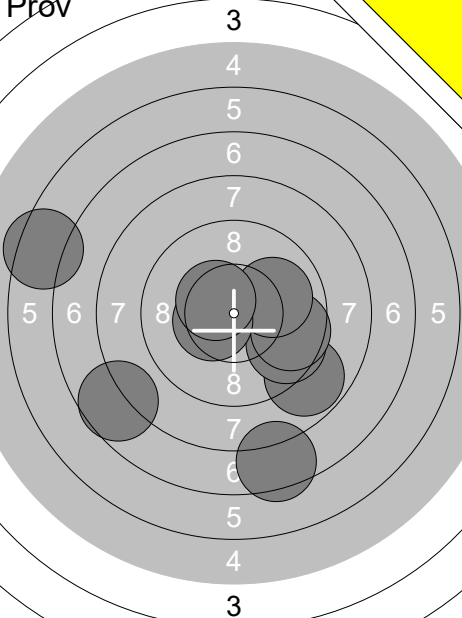
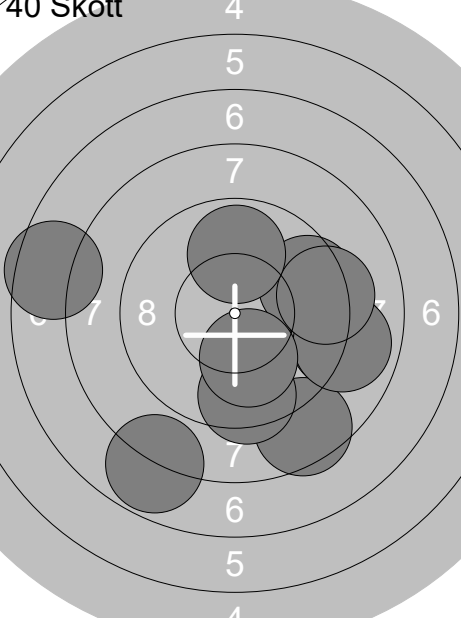
<b>Prov</b> 	1: 7.5 ↘ 2: 8.8 ↘ 3: 9.6 ↘ 4: 9.6 → 5: 10.0 → 6: 7.7 ← 7: 10.4x ← 8: 6.4 ← 9: 10.4x ↗  <b>Serie</b> 80.4 <b>Total</b> 0.0	<b>40 Skott</b> 	1: 9.0 → 2: 8.5 ↘ 3: 9.4 ↘ 4: 8.9 → 5: 9.5 → 6: 7.8 ↘ 7: 10.1 ↘ 8: 9.3 → 9: 7.5 ← 10: 9.9 ↑  <b>Serie</b> 89.9 <b>Total</b> 89.9
---	--	---	--

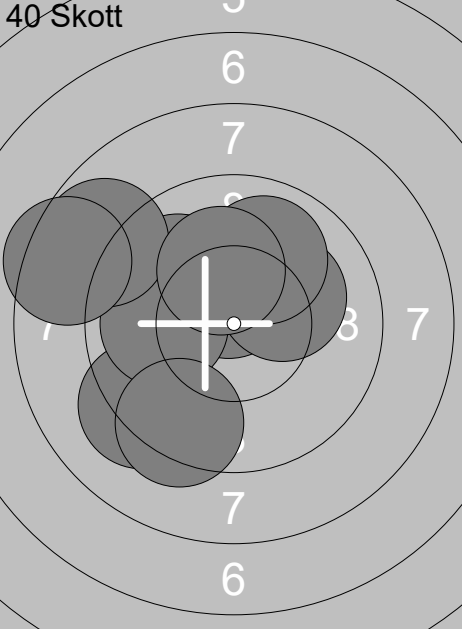
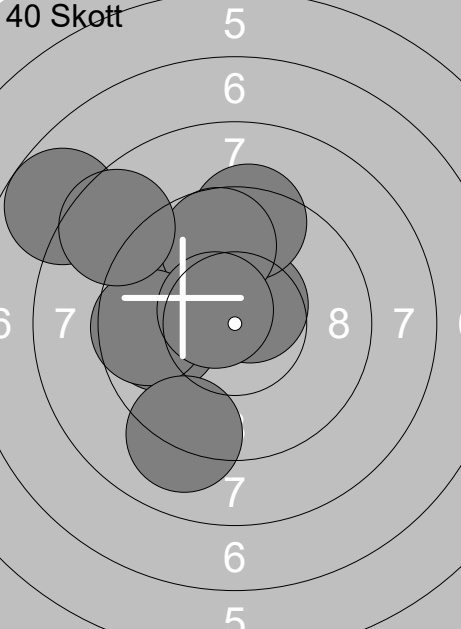
<b>40 Skott</b> 	11: 9.9 ↗ 12: 10.5x ↑ 13: 10.2x → 14: 9.2 ↘ 15: 10.0 ↑ 16: 10.0 ← 17: 8.8 ↗ 18: 10.2x ↑ 19: 9.4 ↘ 20: 8.4 ←  <b>Serie</b> 96.6 <b>Total</b> 186.5	<b>40 Skott</b> 	21: 7.7 ↗ 22: 10.4x ↗ 23: 10.6x ↗ 24: 9.4 ↑ 25: 9.7 ↑ 26: 9.8 ← 27: 9.6 ← 28: 8.6 ↗ 29: 10.6x ↗ 30: 9.1 ↘  <b>Serie</b> 95.5 <b>Total</b> 282.0
--	---	--	---

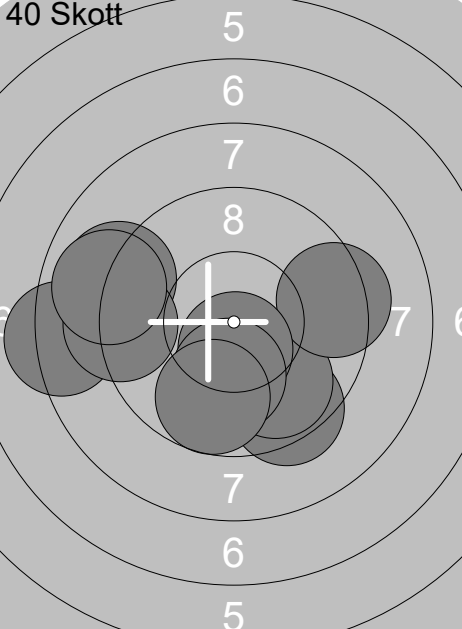
<b>40 Skott</b> 	31: 9.4 ↘ 32: 9.0 ← 33: 9.8 ↘ 34: 9.4 → 35: 8.2 ← 36: 10.5x ↘ 37: 10.1 ↘ 38: 9.2 ← 39: 9.7 ↘ 40: 8.9 ←  <b>Serie</b> 94.2 <b>Total</b> 376.2		
---	--	--	--

<b>Prov</b> 	1: 9.4 ↑ 2: 9.5 ↑ 3: 10.3x ↖ 4: 9.5 ↑ 5: 9.4 ← 6: 10.0 ← 7: 10.0 ↑ 8: 9.6 ↘ 9: 10.1 ↘ 10: 9.9 ← Serie 97.7 Total 0.0	<b>Prov</b> 	11: 10.1 ← 12: 10.6x ← 13: 10.2x → 14: 10.1 ↑ 15: 10.1 → 16: 10.9x → Serie 62.0 Total 0.0
<b>40 Skott</b> 	1: 10.4x → 2: 10.3x ← 3: 10.4x ↘ 4: 10.3x ↘ 5: 9.8 ← 6: 10.1 ← 7: 10.0 ↘ 8: 10.4x ↘ 9: 10.0 ↘ 10: 10.7x ← Serie 102.4 Total 102.4	<b>40 Skott</b> 	11: 10.4x ↘ 12: 10.5x ↘ 13: 10.2x ↑ 14: 10.4x ↗ 15: 9.6 → 16: 9.8 ↑ 17: 10.1 → 18: 10.1 ↗ 19: 10.2x → 20: 10.4x ↖ Serie 101.7 Total 204.1
<b>40 Skott</b> 	21: 9.6 ↘ 22: 10.1 ↑ 23: 10.4x ↖ 24: 9.6 ↘ 25: 10.4x ↑ 26: 10.1 ↑ 27: 10.2x → 28: 10.3x ↖ 29: 10.1 → 30: 10.1 ↑ Serie 100.9 Total 305.0	<b>40 Skott</b> 	31: 10.5x ↑ 32: 10.5x ↖ 33: 9.7 ← 34: 10.2x → 35: 9.9 ← 36: 10.5x → 37: 10.6x ← 38: 9.5 ← 39: 10.0 ↘ 40: 9.6 ↘ Serie 101.0 Total 406.0

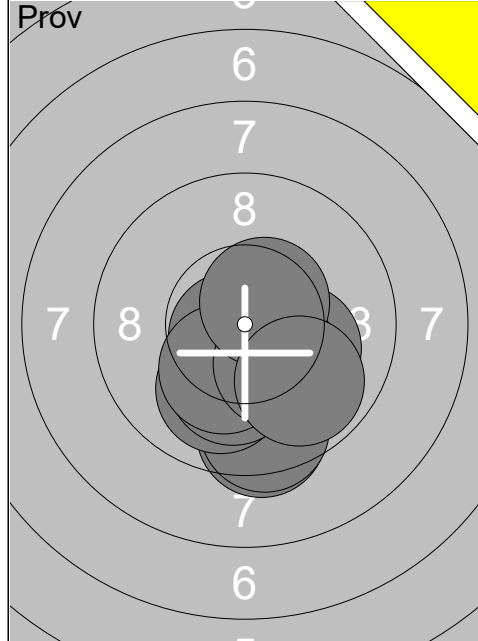

1:	9.4	↓
2:	10.2x	→
3:	9.5	↓
4:	10.7x	↙
5:	10.0	↓
6:	10.2x	↓
7:	10.3x	↓
8:	10.2x	↘
9:	10.5x	↗
10:	9.9	↘
Serie		100.9
Total		0.0

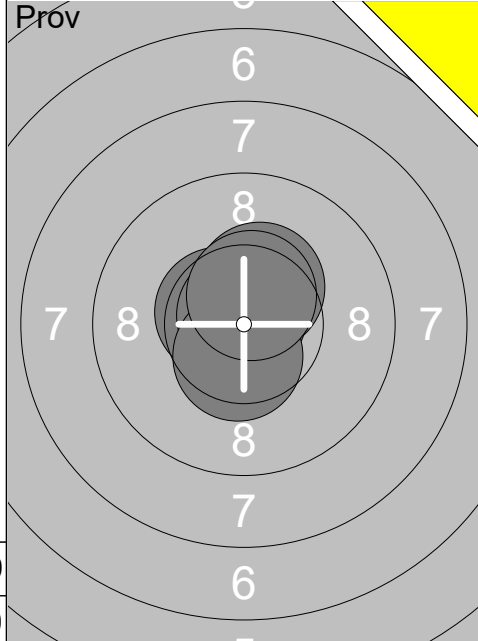

11:	10.6x	↖
12:	10.4x	↑
13:	10.8x	↑
14:	10.5x	↓
15:	10.5x	↑
Serie		52.8
Total		0.0

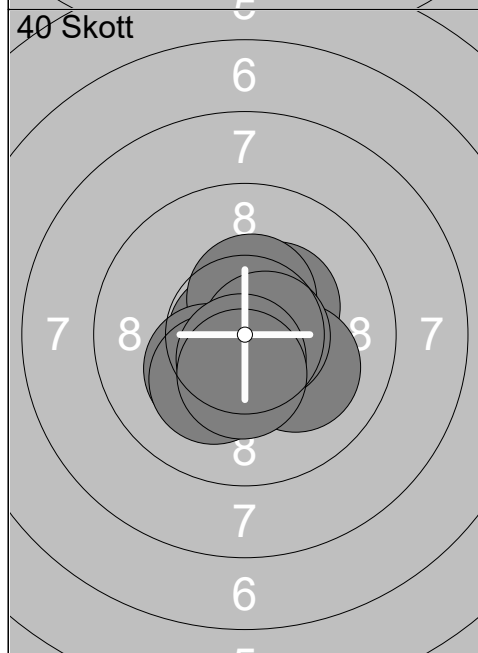

1:	10.8x	←
2:	10.4x	↗
3:	10.4x	↑
4:	10.5x	↘
5:	10.3x	↙
6:	10.2x	↓
7:	10.1	↘
8:	10.7x	→
9:	10.6x	↓
10:	10.4x	↓
Serie		104.4
Total		104.4

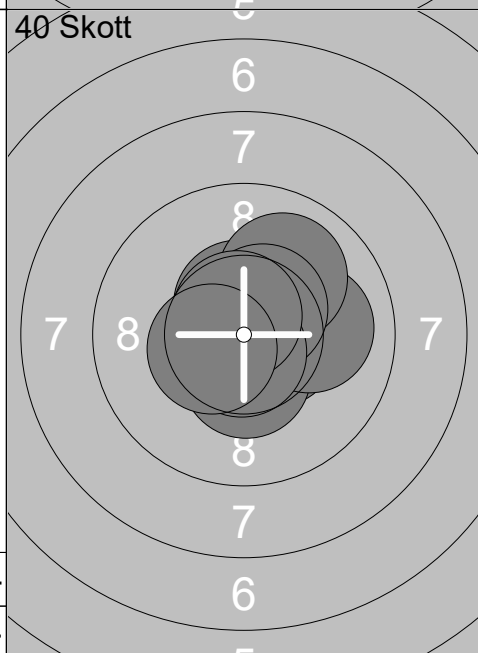

11:	10.5x	→
12:	10.4x	↓
13:	10.0	→
14:	10.5x	↑
15:	10.0	↗
16:	10.5x	↗
17:	10.8x	↙
18:	10.7x	↓
19:	10.7x	↑
20:	10.5x	↙
Serie		104.6
Total		209.0

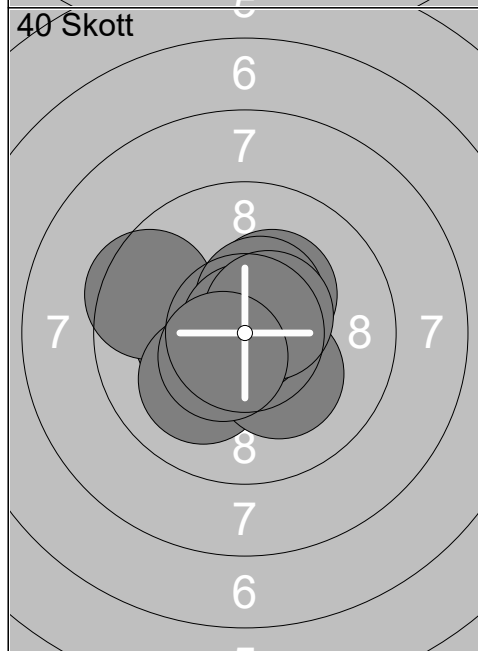

21:	10.4x	↙
22:	10.3x	←
23:	9.5	↖
24:	10.1	↙
25:	10.2x	↘
26:	10.3x	↗
27:	10.5x	↑
28:	10.9x	↑
29:	10.5x	↗
30:	10.5x	↙
Serie		103.2
Total		312.2

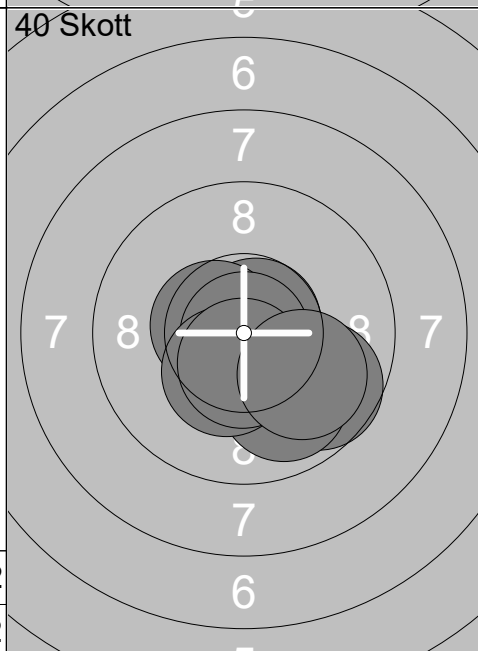

31:	10.7x	↗
32:	10.4x	↓
33:	9.7	↘
34:	10.5x	↓
35:	10.5x	↖
36:	10.9x	↓
37:	9.9	↘
38:	10.4x	↓
39:	10.5x	↓
40:	10.0	↘
Serie		103.5
Total		415.7



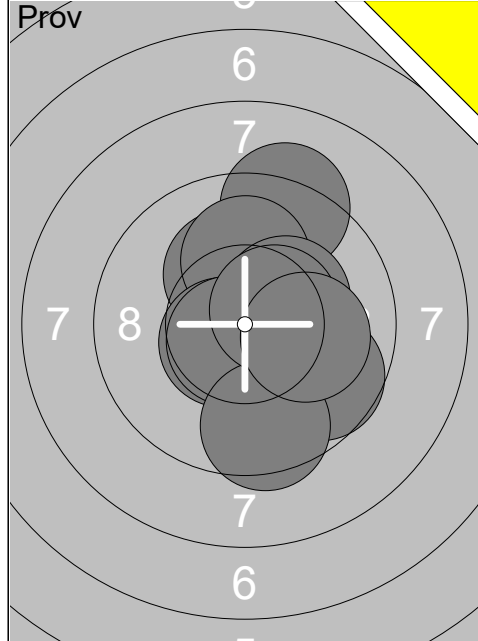

1:	10.2x ↗
2:	9.2 ↗
3:	10.1 ↗
4:	10.6x ↙
5:	10.6x ↙
6:	10.3x ↗
7:	9.7 ↘
8:	9.5 ↓
9:	10.5x ↗
10:	10.1 →
Serie	100.8
Total	0.0

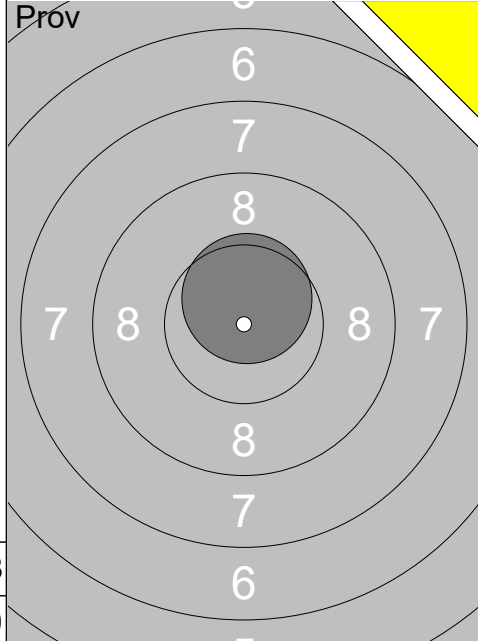

11:	10.6x ↗
Serie	10.6
Total	0.0

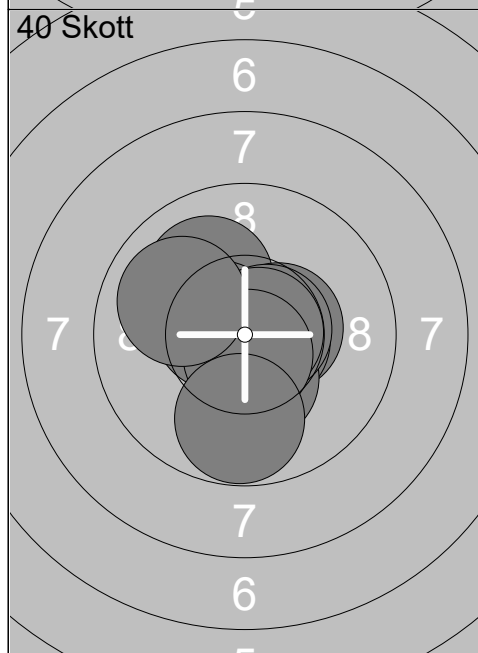

1:	10.1 ↗
2:	10.6x ↙
3:	10.5x →
4:	10.7x →
5:	10.3x ↓
6:	10.6x →
7:	10.8x →
8:	10.7x ↓
9:	10.0 ↖
10:	9.8 ↓
Serie	104.1
Total	104.1

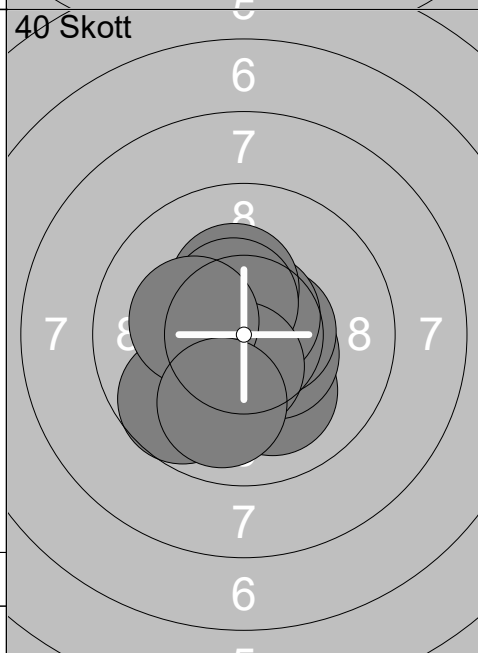

11:	9.7 ↙
12:	10.1 ↓
13:	10.5x ↘
14:	10.6x →
15:	10.7x ↗
16:	10.3x ↗
17:	10.5x ↗
18:	10.5x ↓
19:	10.2x ↙
20:	10.0 ↓
Serie	103.1
Total	207.2

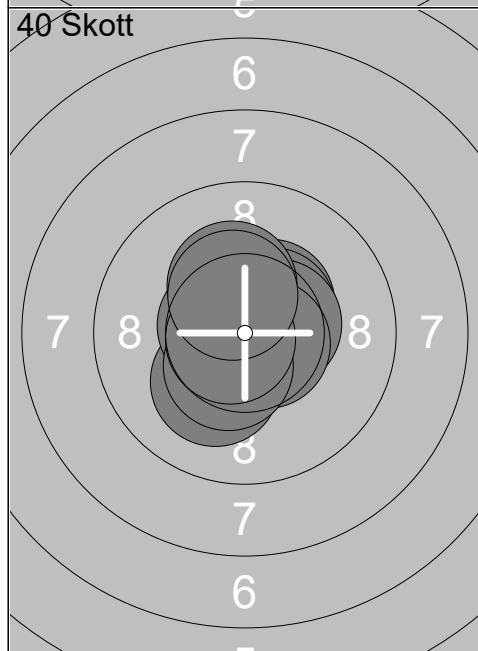

21:	10.4x ↗
22:	10.5x ↗
23:	10.5x →
24:	10.2x ↓
25:	10.6x ↙
26:	10.3x ↗
27:	10.6x ↘
28:	10.4x ↓
29:	10.7x ↙
30:	10.4x ↗
Serie	104.6
Total	311.8

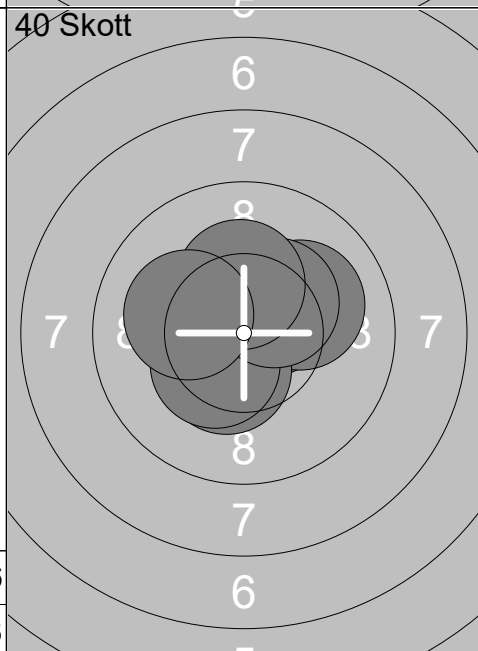

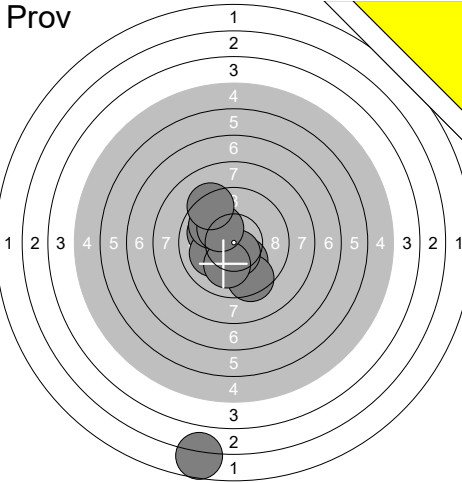
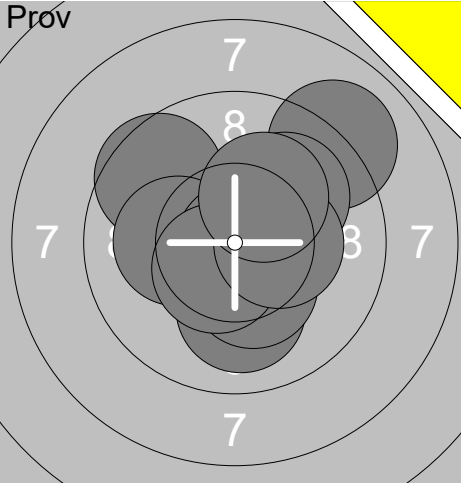
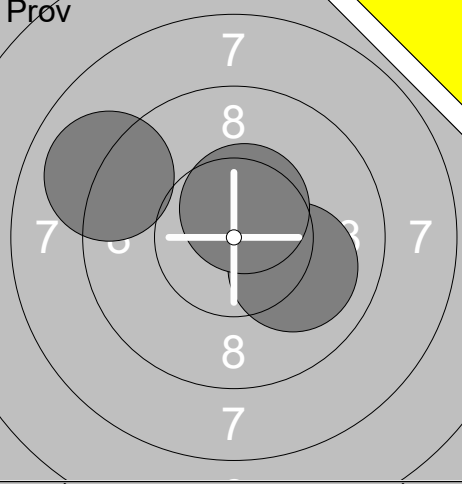
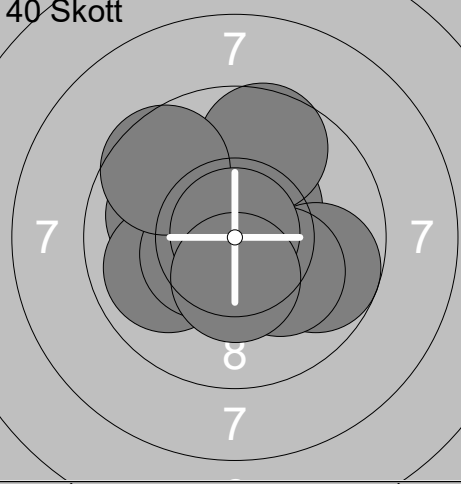
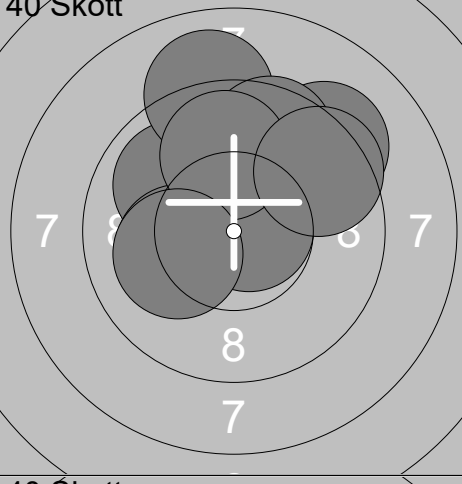
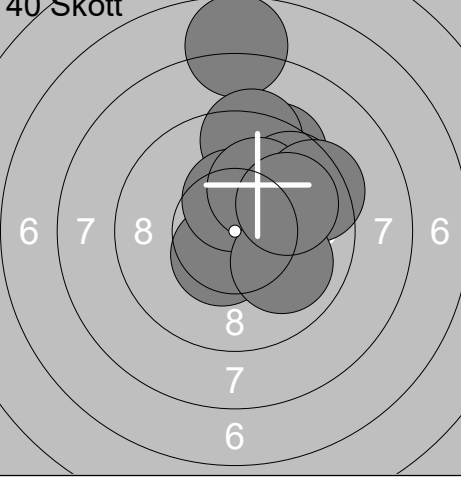
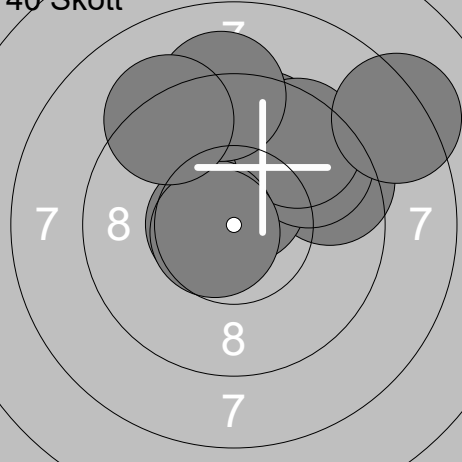

31:	10.5x ↗
32:	10.7x ↗
33:	10.1 →
34:	10.4x ↓
35:	10.7x ↗
36:	10.7x ↙
37:	10.4x ↙
38:	10.4x ↗
39:	10.3x ↗
40:	10.1 ↖
Serie	104.3
Total	416.1

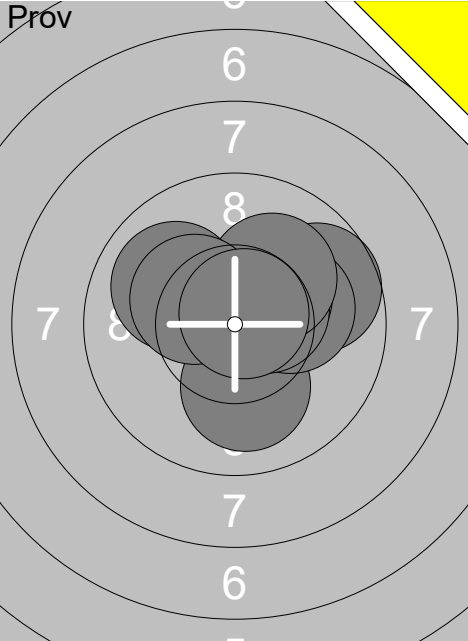
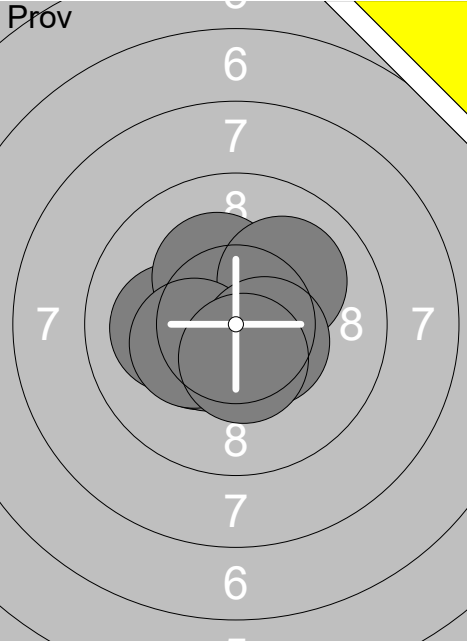
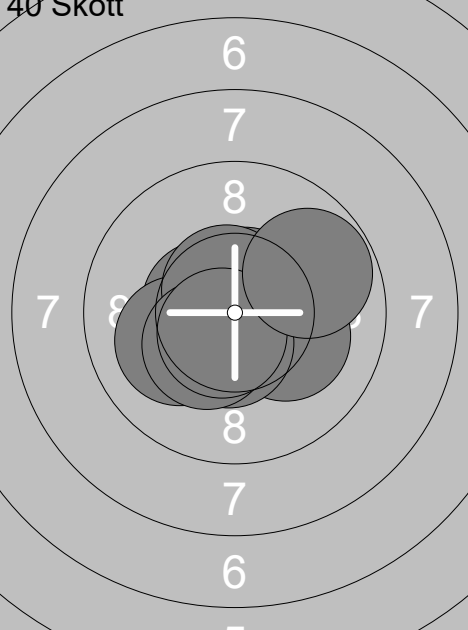
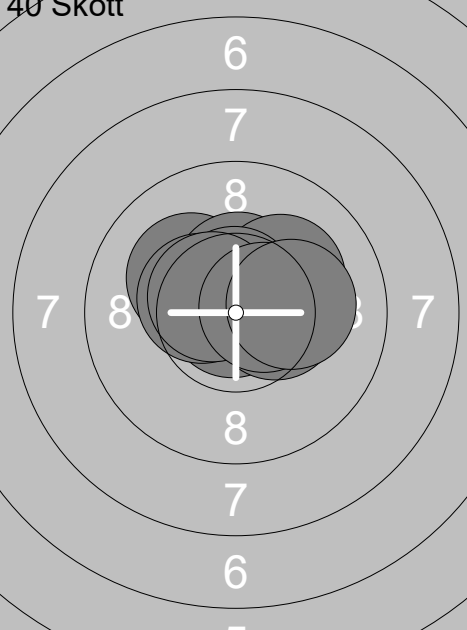
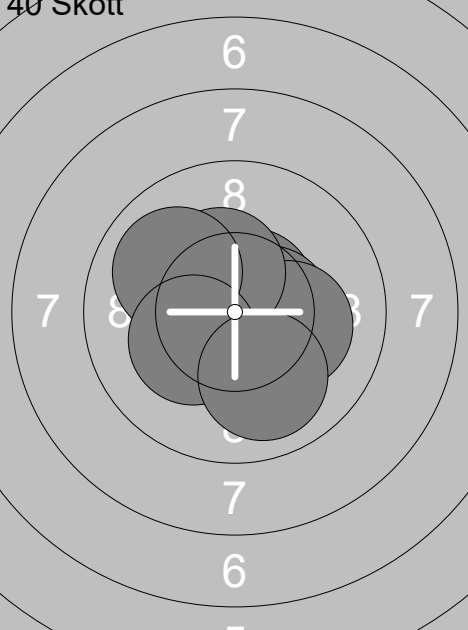
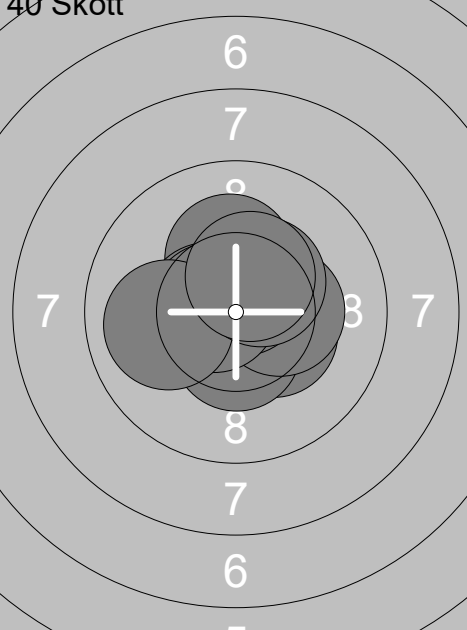
Skjutlag <b>2</b>	Tavla <b>21</b>	<b>Gabriel Rönndahl</b>			
Ramselefors	Ramselefors	11	Vb		
13.01.2018	Skyttiadens distriktsfinal 2018	Ramselefors SKF			
Prov		1: 2.7 ↓ 2: 10.0 ↖ 3: 10.1 ↓ 4: 9.5 ↓ 5: 10.1 ← 6: 10.5x ↓ 7: 10.1 ↓ 8: 9.9 ↗ 9: 10.2x ↗ 10: 9.3 ↗ Serie 92.4 Total 0.0	Prov		11: 9.6 ↖ 12: 9.0 ↗ 13: 10.0 ↓ 14: 10.3x ↓ 15: 10.2x ← 16: 10.9x → 17: 10.0 ↗ 18: 10.5x ↓ 19: 10.3x → 20: 10.2x ↗ Serie 101.0 Total 0.0
Prov		21: 9.0 ↖ 22: 10.0 → 23: 10.5x ↗ Serie 29.5 Total 0.0	40 Skott		1: 10.4x ↗ 2: 9.8 → 3: 10.0 ← 4: 9.9 ← 5: 9.7 ↑ 6: 10.5x ← 7: 9.6 ↖ 8: 10.2x → 9: 10.9x ↑ 10: 10.4x ↓ Serie 101.4 Total 101.4
40 Skott		11: 9.9 ↖ 12: 10.2x ← 13: 9.2 ↗ 14: 9.0 ↑ 15: 10.2x ↑ 16: 9.6 ↑ 17: 10.7x → 18: 9.9 ↑ 19: 9.5 ↗ 20: 10.1 ← Serie 98.3 Total 199.7	40 Skott		21: 9.4 ↗ 22: 10.5x ↓ 23: 7.7 ↑ 24: 9.3 ↑ 25: 9.7 ↗ 26: 10.4x ↑ 27: 10.1 ↗ 28: 9.4 → 29: 10.0 → 30: 9.9 → Serie 96.4 Total 296.1
40 Skott		31: 9.5 → 32: 9.6 ↑ 33: 10.6x ↑ 34: 9.6 ↗ 35: 9.5 ↗ 36: 10.6x ← 37: 10.7x ← 38: 9.2 ↑ 39: 9.2 ↗ 40: 8.2 ↗ Serie 96.7 Total 392.8			

Skjuttlag	Tavla	Agnes Ebbhagen	
2	22	Ramselefors	Vb
Ramselefors	Ramselefors	11	
13.01.2018	Skyttiadens distriktsfinal 2018	Ramselefors SKF	
Prov		Prov	
	1: 9.7 → 2: 10.2x ↗ 3: 10.1 ↓ 4: 10.2x → 5: 10.4x ↗ 6: 10.5x ↗ 7: 10.1 ↗ 8: 10.0 ← 9: 10.3x ↖ 10: 10.8x ↗		11: 10.1 ← 12: 10.4x ↙ 13: 10.5x ↙ 14: 10.3x ↖ 15: 10.1 ↗ 16: 10.3x ↙ 17: 10.5x ↘ 18: 10.5x ↓
Serie 102.3	Total 0.0	Serie 82.7	Total 0.0
40 Skott		40 Skott	
	1: 10.6x ↗ 2: 10.6x ↙ 3: 10.5x ↙ 4: 10.1 ← 5: 10.6x ↖ 6: 10.2x ↘ 7: 10.5x ↓ 8: 10.4x ↙ 9: 10.6x ↘ 10: 9.8 →		11: 10.2x ↖ 12: 10.5x ↑ 13: 10.9x ← 14: 10.2x ↗ 15: 10.4x → 16: 10.7x ↑ 17: 10.4x ↙ 18: 10.6x ↖ 19: 10.6x → 20: 10.2x →
Serie 103.9	Total 103.9	Serie 104.7	Total 208.6
40 Skott		40 Skott	
	21: 10.7x ↖ 22: 10.5x ↖ 23: 10.6x ↗ 24: 10.5x → 25: 10.6x ↓ 26: 10.2x → 27: 10.4x ↗ 28: 10.0 ← 29: 10.2x ↙ 30: 10.0 ↓		31: 10.4x ↘ 32: 10.5x ↓ 33: 10.3x → 34: 10.2x ↑ 35: 10.6x ↙ 36: 10.6x ↗ 37: 10.6x ↙ 38: 10.0 ← 39: 10.4x ↗ 40: 10.4x ↗
Serie 103.7	Total 312.3	Serie 104.0	Total 416.3

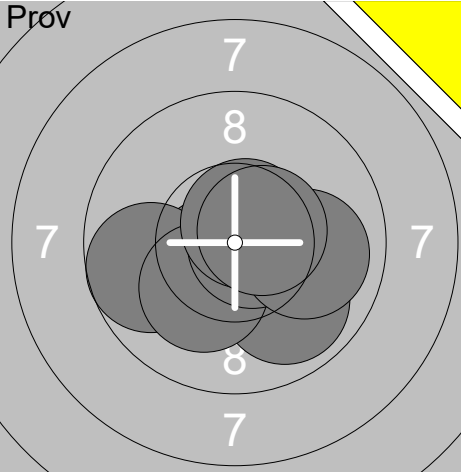
Skjuttlag	Tavla	Ebba Lundstedt	
2	23	Ramselefors	Vb
13.01.2018	Skyttiadens distriktsfinal 2018	Ramselefors SKF	11
Prov		1: 9.5 ↙ 2: 10.1 ↙ 3: 9.5 ↓ 4: 10.0 ↓ 5: 10.3x ↙ 6: 10.4x ← 7: 10.3x ↓ 8: 9.8 ↓ 9: 10.2x → 10: 10.1 ↗ Serie 100.2 Total 0.0	11: 10.6x ↘ 12: 10.7x ↑ 13: 10.3x ↑ 14: 10.6x ← Serie 42.2 Total 0.0
40 Skott		1: 10.3x ↗ 2: 10.1 ↓ 3: 10.3x ↘ 4: 9.9 ← 5: 10.6x ← 6: 9.5 ↘ 7: 10.9x → 8: 10.7x ↘ 9: 10.3x ↙ 10: 10.2x ↓ Serie 102.8 Total 102.8	11: 10.3x ↑ 12: 10.2x ↑ 13: 9.1 ← 14: 10.2x ↑ 15: 10.8x ← 16: 10.6x → 17: 10.6x ↘ 18: 10.7x ↗ 19: 10.5x ↓ 20: 10.5x ↑ Serie 103.5 Total 206.3
40 Skott		21: 10.3x ↘ 22: 10.7x ↘ 23: 10.7x ↗ 24: 10.7x → 25: 10.3x → 26: 10.5x ← 27: 10.4x ↑ 28: 10.2x ↘ 29: 10.4x → 30: 10.5x ← Serie 104.7 Total 311.0	31: 10.5x ↗ 32: 10.8x ↓ 33: 10.0 ↙ 34: 10.5x ↙ 35: 10.2x ↘ 36: 10.6x ↗ 37: 10.1 ↗ 38: 9.9 → 39: 10.3x ← 40: 10.5x → Serie 103.4 Total 414.4

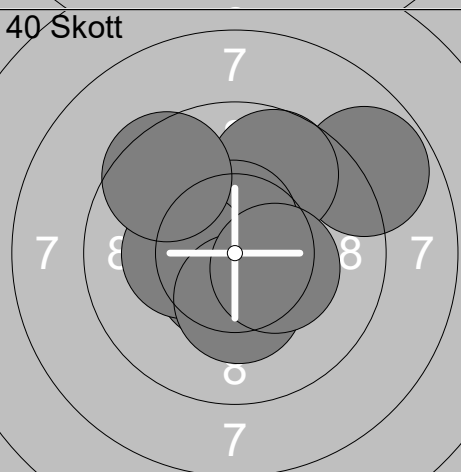
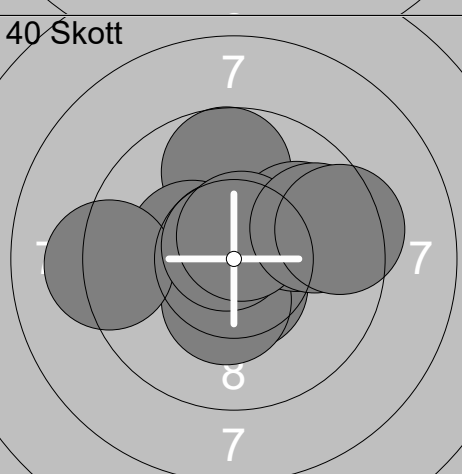
Skjutlag	Tavla	Oscar Jonsson		
2	24	Ramselefors	Vännäs	Mini Vb
13.01.2018	Skyttiadens distriktsfinal 2018	Ramselefors SKF		
<b>Pröv</b> 	1: 10.1 → 2: 8.6 ↓ 3: 9.2 ↓ 4: 10.5x ↓ 5: 10.3x ↓ 6: 10.5x ↓ 7: 10.0 ↗ 8: 10.4x ↗ 9: 10.3x → 10: 9.4 → Serie 99.3 Total 0.0	<b>Pröv</b> 	11: 10.3x ↓ 12: 10.7x → 13: 10.6x ↓ 14: 9.7 ← 15: 9.9 ↓ 16: 10.2x ↓ 17: 10.7x → 18: 10.6x ↗ 19: 10.0 → 20: 10.5x → Serie 103.2 Total 0.0	
<b>Pröv</b> 	21: 9.3 ↗ 22: 10.6x ↗ 23: 9.8 ↖ Serie 29.7 Total 0.0	<b>40 Skott</b> 	1: 10.0 ↖ 2: 10.6x ↓ 3: 10.4x → 4: 10.3x ↗ 5: 10.2x ← 6: 10.6x ↓ 7: 10.4x → 8: 10.6x ↗ 9: 9.9 ↗ 10: 9.3 ↗ Serie 102.3 Total 102.3	
<b>40 Skott</b> 	11: 10.2x ↗ 12: 10.0 ↗ 13: 10.6x → 14: 10.1 → 15: 10.6x ↗ 16: 10.8x → 17: 10.0 ↓ 18: 10.4x ↓ 19: 10.3x ↗ 20: 10.6x ↓ Serie 103.6 Total 205.9	<b>40 Skott</b> 	21: 10.8x → 22: 10.6x ↓ 23: 10.4x ← 24: 8.8 ↗ 25: 9.7 ↗ 26: 10.6x ↗ 27: 10.3x ← 28: 9.5 ↖ 29: 10.3x ↓ 30: 10.4x → Serie 101.4 Total 307.3	
<b>40 Skott</b> 	31: 10.6x ↓ 32: 9.7 ↗ 33: 10.3x ← 34: 10.4x ↓ 35: 9.2 ← 36: 10.7x ↗ 37: 10.0 → 38: 10.6x ↗ 39: 9.7 → 40: 9.4 → Serie 100.6 Total 407.9			

Prov

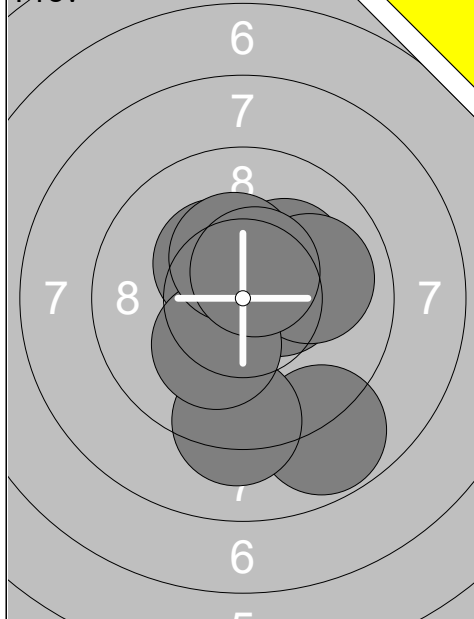

1: 8.8 ↘  
 2: 9.2 ↓  
 3: 10.8x ↗  
 4: 10.2x ↗  
 5: 10.5x →  
 6: 10.4x ↖  
 7: 10.0 →  
 8: 10.2x ↘  
 9: 10.4x ↑  
 10: 10.5x ↗

Serie 101.0  
 Total 0.0

40 Skott

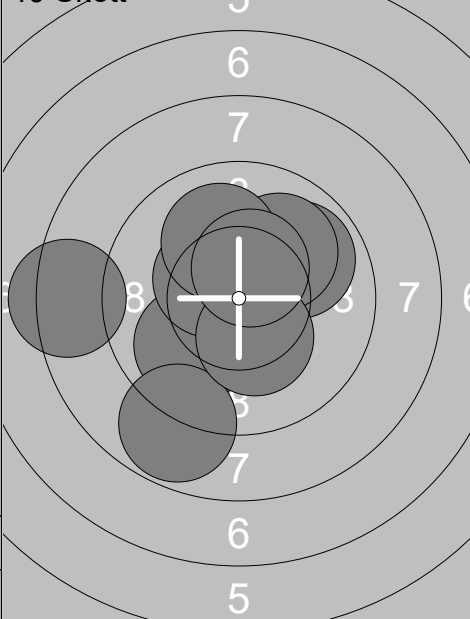

1: 10.6x ↙  
 2: 8.3 ←  
 3: 10.0 ↘  
 4: 9.9 ↗  
 5: 10.4x ↖  
 6: 8.8 ↓  
 7: 10.0 ↗  
 8: 10.0 ↑  
 9: 10.3x ↘  
 10: 10.5x ↗

Serie 98.8  
 Total 98.8

40 Skott

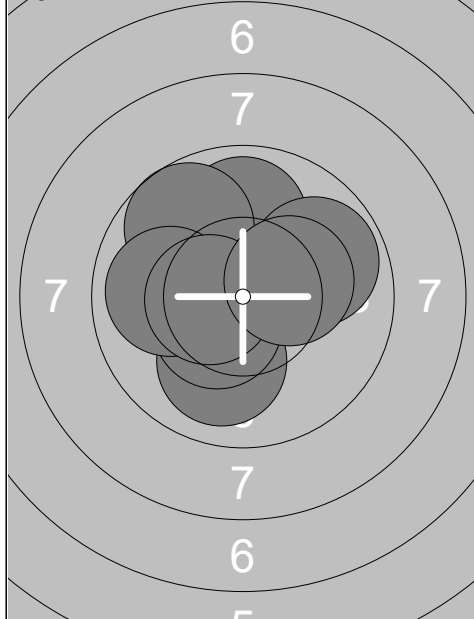

11: 10.0 ↓  
 12: 10.6x ↑  
 13: 10.4x ↗  
 14: 9.9 ↑  
 15: 10.4x ↘  
 16: 9.7 ↖  
 17: 9.9 ←  
 18: 9.9 ↗  
 19: 10.5x ↙  
 20: 10.3x ↗

Serie 101.6  
 Total 200.4

40 Skott

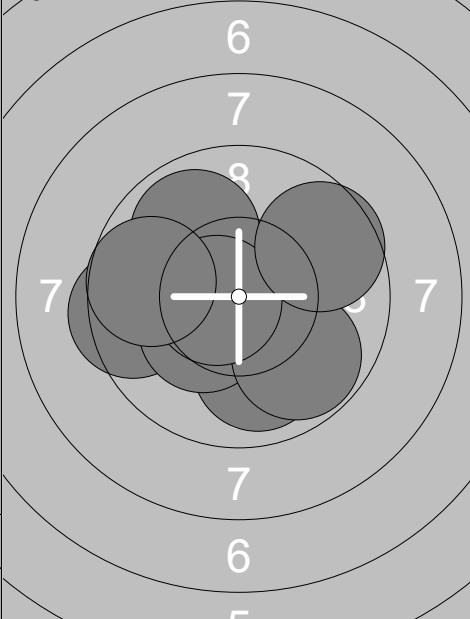

21: 10.1 ↘  
 22: 9.5 ←  
 23: 9.9 ↓  
 24: 10.3x ↙  
 25: 10.7x ↖  
 26: 9.8 ↘  
 27: 9.9 ↗  
 28: 10.6x ↙  
 29: 9.6 ↗  
 30: 9.7 ←

Serie 100.1  
 Total 300.5

40 Skott

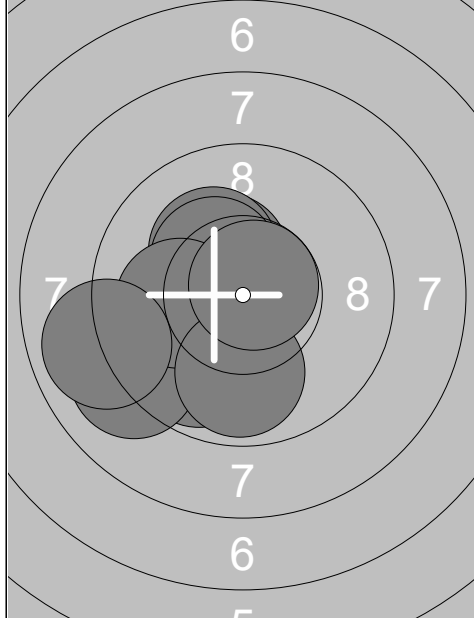

31: 9.8 ↘  
 32: 10.4x ↖  
 33: 9.1 ↙  
 34: 10.2x ↖  
 35: 10.4x ↙  
 36: 10.4x ↖  
 37: 10.1 ←  
 38: 9.9 ↓  
 39: 8.9 ←  
 40: 10.7x ↗

Serie 99.9  
 Total 400.4

<p><b>Prov</b></p>	<table style="width:100%; border-collapse: collapse;"> <tr><td>1: 10.4x</td><td>↘</td></tr> <tr><td>2: 9.5</td><td>↘</td></tr> <tr><td>3: 9.6</td><td>↙</td></tr> <tr><td>4: 10.7x</td><td>↙</td></tr> <tr><td>5: 10.1</td><td>↙</td></tr> <tr><td>6: 10.4x</td><td>↙</td></tr> <tr><td>7: 10.8x</td><td>→</td></tr> <tr><td>8: 10.3x</td><td>↖</td></tr> <tr><td>9: 10.4x</td><td>↙</td></tr> <tr><td>10: 10.3x</td><td>↖</td></tr> <tr><td colspan="2"><hr/></td></tr> <tr><td>Serie</td><td style="text-align: right;">102.5</td></tr> <tr><td>Total</td><td style="text-align: right;">0.0</td></tr> </table>	1: 10.4x	↘	2: 9.5	↘	3: 9.6	↙	4: 10.7x	↙	5: 10.1	↙	6: 10.4x	↙	7: 10.8x	→	8: 10.3x	↖	9: 10.4x	↙	10: 10.3x	↖	<hr/>		Serie	102.5	Total	0.0	<p><b>Prov</b></p>	<table style="width:100%; border-collapse: collapse;"> <tr><td>11: 9.8</td><td>↑</td></tr> <tr><td>12: 9.3</td><td>↖</td></tr> <tr><td>13: 10.5x</td><td>↑</td></tr> <tr><td>14: 9.7</td><td>↑</td></tr> <tr><td>15: 10.2x</td><td>↖</td></tr> <tr><td>16: 9.9</td><td>↖</td></tr> <tr><td>17: 10.1</td><td>↖</td></tr> <tr><td>18: 10.1</td><td>→</td></tr> <tr><td>19: 10.4x</td><td>→</td></tr> <tr><td>20: 10.5x</td><td>↙</td></tr> <tr><td colspan="2"><hr/></td></tr> <tr><td>Serie</td><td style="text-align: right;">100.5</td></tr> <tr><td>Total</td><td style="text-align: right;">0.0</td></tr> </table>	11: 9.8	↑	12: 9.3	↖	13: 10.5x	↑	14: 9.7	↑	15: 10.2x	↖	16: 9.9	↖	17: 10.1	↖	18: 10.1	→	19: 10.4x	→	20: 10.5x	↙	<hr/>		Serie	100.5	Total	0.0
1: 10.4x	↘																																																						
2: 9.5	↘																																																						
3: 9.6	↙																																																						
4: 10.7x	↙																																																						
5: 10.1	↙																																																						
6: 10.4x	↙																																																						
7: 10.8x	→																																																						
8: 10.3x	↖																																																						
9: 10.4x	↙																																																						
10: 10.3x	↖																																																						
<hr/>																																																							
Serie	102.5																																																						
Total	0.0																																																						
11: 9.8	↑																																																						
12: 9.3	↖																																																						
13: 10.5x	↑																																																						
14: 9.7	↑																																																						
15: 10.2x	↖																																																						
16: 9.9	↖																																																						
17: 10.1	↖																																																						
18: 10.1	→																																																						
19: 10.4x	→																																																						
20: 10.5x	↙																																																						
<hr/>																																																							
Serie	100.5																																																						
Total	0.0																																																						
<p><b>Prov</b></p>	<table style="width:100%; border-collapse: collapse;"> <tr><td>21: 9.9</td><td>↗</td></tr> <tr><td>22: 10.1</td><td>↘</td></tr> <tr><td>23: 9.2</td><td>↘</td></tr> <tr><td>24: 10.5x</td><td>↘</td></tr> <tr><td>25: 10.1</td><td>↙</td></tr> <tr><td>26: 10.7x</td><td>↘</td></tr> <tr><td colspan="2"><hr/></td></tr> <tr><td>Serie</td><td style="text-align: right;">60.5</td></tr> <tr><td>Total</td><td style="text-align: right;">0.0</td></tr> </table>	21: 9.9	↗	22: 10.1	↘	23: 9.2	↘	24: 10.5x	↘	25: 10.1	↙	26: 10.7x	↘	<hr/>		Serie	60.5	Total	0.0	<p><b>40 Skott</b></p>	<table style="width:100%; border-collapse: collapse;"> <tr><td>1: 10.9x</td><td>↗</td></tr> <tr><td>2: 10.2x</td><td>→</td></tr> <tr><td>3: 10.6x</td><td>↘</td></tr> <tr><td>4: 10.5x</td><td>↘</td></tr> <tr><td>5: 10.2x</td><td>→</td></tr> <tr><td>6: 10.4x</td><td>↘</td></tr> <tr><td>7: 10.4x</td><td>↘</td></tr> <tr><td>8: 10.5x</td><td>←</td></tr> <tr><td>9: 10.1</td><td>→</td></tr> <tr><td>10: 10.2x</td><td>↑</td></tr> <tr><td colspan="2"><hr/></td></tr> <tr><td>Serie</td><td style="text-align: right;">104.0</td></tr> <tr><td>Total</td><td style="text-align: right;">104.0</td></tr> </table>	1: 10.9x	↗	2: 10.2x	→	3: 10.6x	↘	4: 10.5x	↘	5: 10.2x	→	6: 10.4x	↘	7: 10.4x	↘	8: 10.5x	←	9: 10.1	→	10: 10.2x	↑	<hr/>		Serie	104.0	Total	104.0								
21: 9.9	↗																																																						
22: 10.1	↘																																																						
23: 9.2	↘																																																						
24: 10.5x	↘																																																						
25: 10.1	↙																																																						
26: 10.7x	↘																																																						
<hr/>																																																							
Serie	60.5																																																						
Total	0.0																																																						
1: 10.9x	↗																																																						
2: 10.2x	→																																																						
3: 10.6x	↘																																																						
4: 10.5x	↘																																																						
5: 10.2x	→																																																						
6: 10.4x	↘																																																						
7: 10.4x	↘																																																						
8: 10.5x	←																																																						
9: 10.1	→																																																						
10: 10.2x	↑																																																						
<hr/>																																																							
Serie	104.0																																																						
Total	104.0																																																						
<p><b>40 Skott</b></p>	<table style="width:100%; border-collapse: collapse;"> <tr><td>11: 9.9</td><td>→</td></tr> <tr><td>12: 10.0</td><td>↖</td></tr> <tr><td>13: 10.2x</td><td>→</td></tr> <tr><td>14: 9.9</td><td>↘</td></tr> <tr><td>15: 10.6x</td><td>↙</td></tr> <tr><td>16: 10.7x</td><td>↘</td></tr> <tr><td>17: 10.2x</td><td>→</td></tr> <tr><td>18: 9.4</td><td>↗</td></tr> <tr><td>19: 10.1</td><td>↖</td></tr> <tr><td>20: 9.9</td><td>↗</td></tr> <tr><td colspan="2"><hr/></td></tr> <tr><td>Serie</td><td style="text-align: right;">100.9</td></tr> <tr><td>Total</td><td style="text-align: right;">204.9</td></tr> </table>	11: 9.9	→	12: 10.0	↖	13: 10.2x	→	14: 9.9	↘	15: 10.6x	↙	16: 10.7x	↘	17: 10.2x	→	18: 9.4	↗	19: 10.1	↖	20: 9.9	↗	<hr/>		Serie	100.9	Total	204.9	<p><b>40 Skott</b></p>	<table style="width:100%; border-collapse: collapse;"> <tr><td>21: 10.3x</td><td>↑</td></tr> <tr><td>22: 10.4x</td><td>↖</td></tr> <tr><td>23: 10.3x</td><td>↖</td></tr> <tr><td>24: 9.9</td><td>↖</td></tr> <tr><td>25: 10.6x</td><td>↑</td></tr> <tr><td>26: 9.8</td><td>↑</td></tr> <tr><td>27: 10.8x</td><td>←</td></tr> <tr><td>28: 9.5</td><td>↘</td></tr> <tr><td>29: 10.6x</td><td>↘</td></tr> <tr><td>30: 10.0</td><td>↗</td></tr> <tr><td colspan="2"><hr/></td></tr> <tr><td>Serie</td><td style="text-align: right;">102.2</td></tr> <tr><td>Total</td><td style="text-align: right;">307.1</td></tr> </table>	21: 10.3x	↑	22: 10.4x	↖	23: 10.3x	↖	24: 9.9	↖	25: 10.6x	↑	26: 9.8	↑	27: 10.8x	←	28: 9.5	↘	29: 10.6x	↘	30: 10.0	↗	<hr/>		Serie	102.2	Total	307.1
11: 9.9	→																																																						
12: 10.0	↖																																																						
13: 10.2x	→																																																						
14: 9.9	↘																																																						
15: 10.6x	↙																																																						
16: 10.7x	↘																																																						
17: 10.2x	→																																																						
18: 9.4	↗																																																						
19: 10.1	↖																																																						
20: 9.9	↗																																																						
<hr/>																																																							
Serie	100.9																																																						
Total	204.9																																																						
21: 10.3x	↑																																																						
22: 10.4x	↖																																																						
23: 10.3x	↖																																																						
24: 9.9	↖																																																						
25: 10.6x	↑																																																						
26: 9.8	↑																																																						
27: 10.8x	←																																																						
28: 9.5	↘																																																						
29: 10.6x	↘																																																						
30: 10.0	↗																																																						
<hr/>																																																							
Serie	102.2																																																						
Total	307.1																																																						
<p><b>40 Skott</b></p>	<table style="width:100%; border-collapse: collapse;"> <tr><td>31: 10.7x</td><td>↘</td></tr> <tr><td>32: 10.8x</td><td>←</td></tr> <tr><td>33: 10.0</td><td>→</td></tr> <tr><td>34: 10.0</td><td>↗</td></tr> <tr><td>35: 9.6</td><td>↘</td></tr> <tr><td>36: 10.7x</td><td>↘</td></tr> <tr><td>37: 9.9</td><td>→</td></tr> <tr><td>38: 10.2x</td><td>↘</td></tr> <tr><td>39: 9.6</td><td>→</td></tr> <tr><td>40: 9.7</td><td>↘</td></tr> <tr><td colspan="2"><hr/></td></tr> <tr><td>Serie</td><td style="text-align: right;">101.2</td></tr> <tr><td>Total</td><td style="text-align: right;">408.3</td></tr> </table>	31: 10.7x	↘	32: 10.8x	←	33: 10.0	→	34: 10.0	↗	35: 9.6	↘	36: 10.7x	↘	37: 9.9	→	38: 10.2x	↘	39: 9.6	→	40: 9.7	↘	<hr/>		Serie	101.2	Total	408.3																												
31: 10.7x	↘																																																						
32: 10.8x	←																																																						
33: 10.0	→																																																						
34: 10.0	↗																																																						
35: 9.6	↘																																																						
36: 10.7x	↘																																																						
37: 9.9	→																																																						
38: 10.2x	↘																																																						
39: 9.6	→																																																						
40: 9.7	↘																																																						
<hr/>																																																							
Serie	101.2																																																						
Total	408.3																																																						



<p>Prov</p>	<p>1: 9.7 →</p> <p>2: 8.8 ↘</p> <p>3: 10.1 ↙</p> <p>4: 10.0 ←</p> <p>5: 9.8 ↗</p> <p>6: 7.4 →</p> <p>7: 9.8 ↑</p> <p>8: 8.9 ↑</p> <p>9: 8.9 ↗</p> <p>10: 9.6 ↗</p> <p>Serie 93.0</p> <p>Total 0.0</p>	<p>Prov</p>	<p>11: 10.3x →</p> <p>12: 9.7 ↑</p> <p>13: 8.7 ↗</p> <p>Serie 28.7</p> <p>Total 0.0</p>
-------------	---	-------------	---

<p>40 Skott</p>	<p>1: 9.3 ↗</p> <p>2: 9.5 →</p> <p>3: 8.0 ←</p> <p>4: 8.1 →</p> <p>5: 9.0 ↗</p> <p>6: 10.0 ↖</p> <p>7: 9.6 ↑</p> <p>8: 10.4x →</p> <p>9: 9.6 →</p> <p>10: 8.9 ↑</p> <p>Serie 92.4</p> <p>Total 92.4</p>	<p>40 Skott</p>	<p>11: 8.1 ↑</p> <p>12: 9.6 ←</p> <p>13: 8.6 ↘</p> <p>14: 9.7 ↖</p> <p>15: 10.6x ↗</p> <p>16: 9.0 ↑</p> <p>17: 9.4 ↓</p> <p>18: 10.5x ↙</p> <p>19: 9.8 ↖</p> <p>20: 8.1 ↑</p> <p>Serie 93.4</p> <p>Total 185.8</p>
-----------------	---	-----------------	--

<p>40 Skott</p>	<p>21: 10.2x ↗</p> <p>22: 9.5 →</p> <p>23: 9.8 ←</p> <p>24: 8.3 ↑</p> <p>25: 10.1 ↖</p> <p>26: 9.5 →</p> <p>27: 8.9 ↑</p> <p>28: 9.8 ↘</p> <p>29: 10.6x ↗</p> <p>30: 10.1 ↖</p> <p>Serie 96.8</p> <p>Total 282.6</p>	<p>40 Skott</p>	<p>31: 10.3x ←</p> <p>32: 9.5 ←</p> <p>33: 9.1 ↗</p> <p>34: 9.9 ↗</p> <p>35: 10.7x ↗</p> <p>36: 9.2 ↑</p> <p>37: 9.7 ↗</p> <p>38: 10.0 ←</p> <p>39: 9.9 ↗</p> <p>40: 8.5 ↗</p> <p>Serie 96.8</p> <p>Total 379.4</p>
-----------------	--	-----------------	---

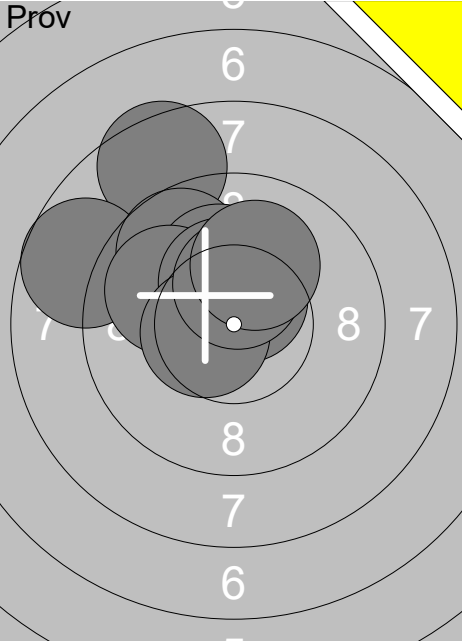
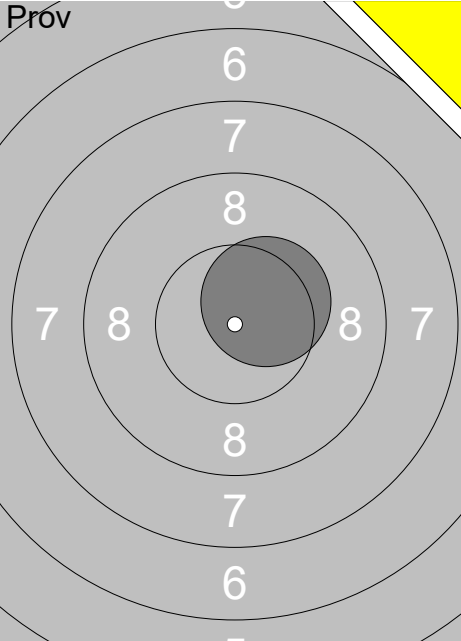
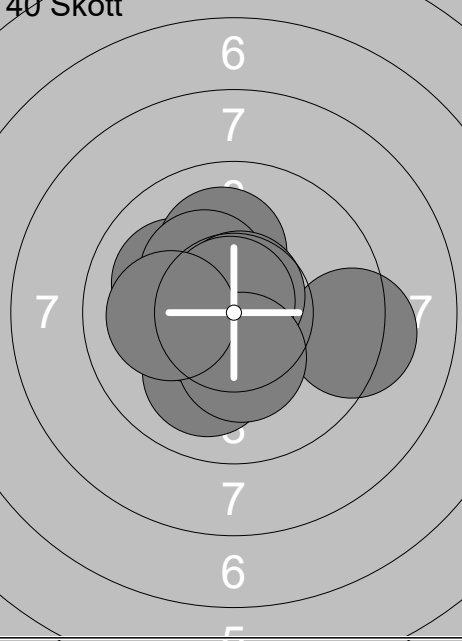
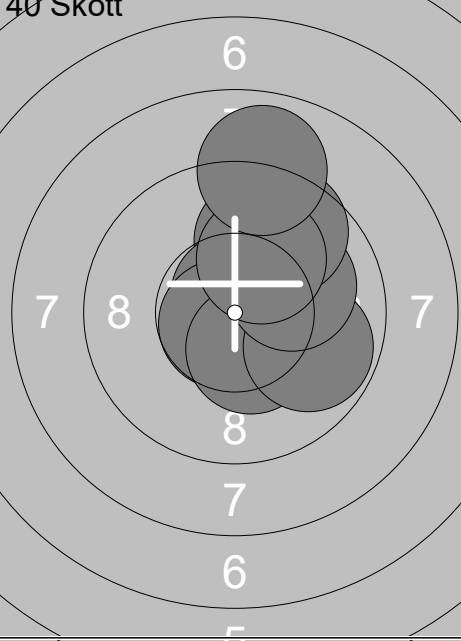
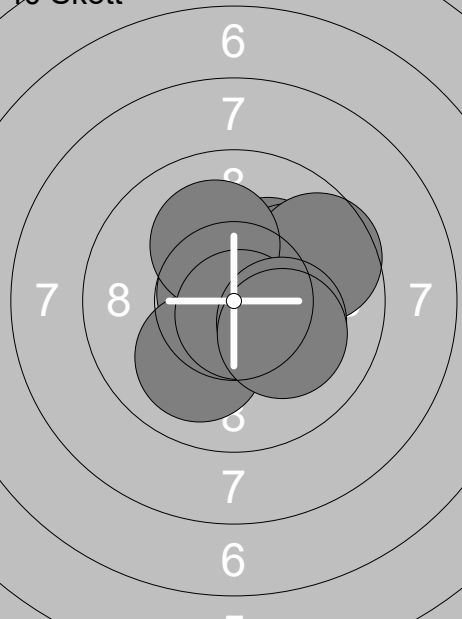
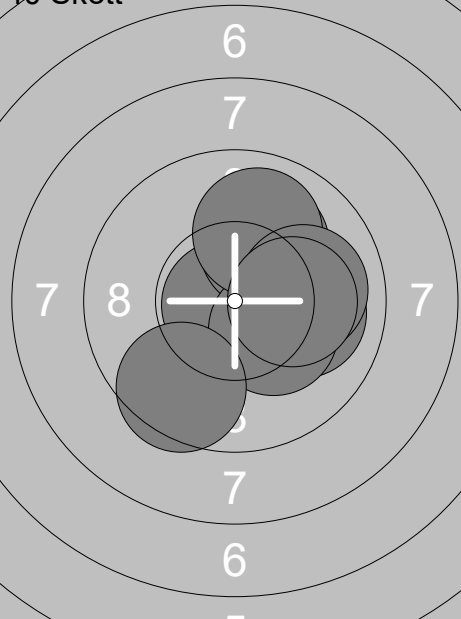

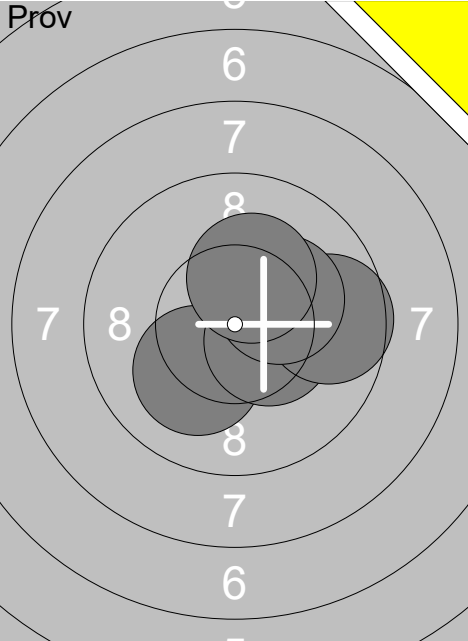
Skjuttlag	Tavla	Ylva Lundstedt	
2	30	Ramselefors	Mini Vb
13.01.2018	Skyttiadens distriktsfinal 2018	Ramselefors SKF	
Prov		1: 8.5 ↗ 2: 8.7 ↖ 3: 9.7 ↗ 4: 10.2x ↗ 5: 10.6x ↗ 6: 9.9 ↖ 7: 10.4x ↗ 8: 10.5x ↖ 9: 10.4x ↗ 10: 10.1 ↗ Serie 99.0 Total 0.0	11: 10.4x ↗ 
40 Skott		1: 10.1 ↘ 2: 10.3x ↖ 3: 10.1 ↖ 4: 10.1 ↗ 5: 10.3x ↗ 6: 9.3 ➔ 7: 10.7x ↗ 8: 10.8x ↗ 9: 10.3x ↘ 10: 10.1 ↖ Serie 102.1 Total 102.1	
40 Skott		21: 10.5x ↗ 22: 10.7x ↖ 23: 10.2x ↗ 24: 10.1 ➔ 25: 9.7 ➔ 26: 10.0 ↘ 27: 10.1 ↗ 28: 10.7x ↘ 29: 10.2x ➔ 30: 10.1 ↘ Serie 102.3 Total 305.3	
			11: 10.7x ➔ 12: 9.9 ↗ 13: 10.7x ↗ 14: 10.7x ↖ 15: 10.4x ↘ 16: 9.8 ➔ 17: 10.1 ➔ 18: 9.6 ↗ 19: 10.1 ↗ 20: 8.9 ↗ Serie 100.9 Total 203.0
			31: 10.9x ↗ 32: 10.8x ↖ 33: 10.1 ➔ 34: 10.0 ➔ 35: 10.1 ↗ 36: 10.3x ↘ 37: 10.0 ↗ 38: 10.0 ➔ 39: 10.2x ➔ 40: 9.5 ↘ Serie 101.9 Total 407.2

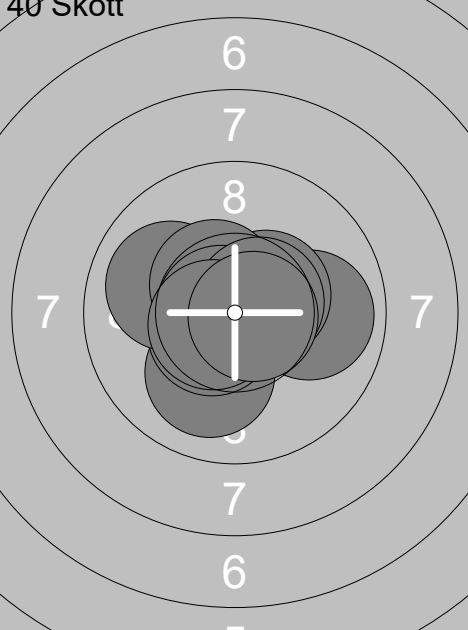
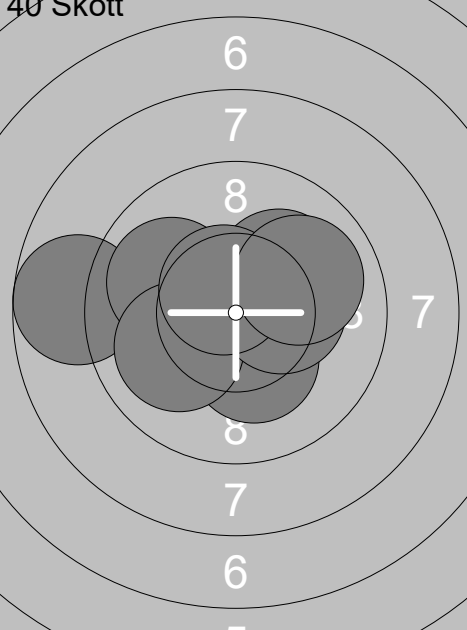
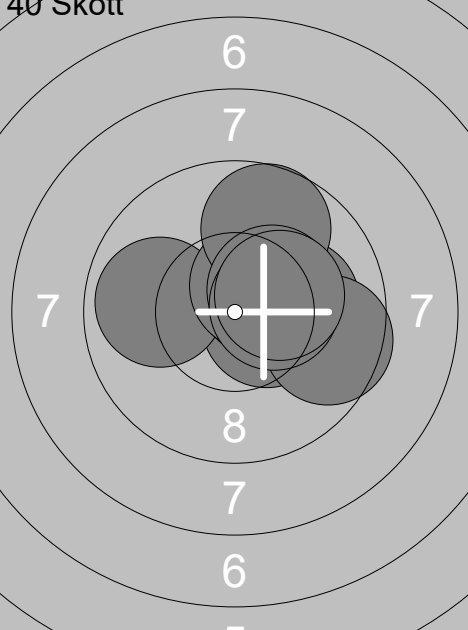
Skjutlag	Tavla	Oskar Lindgren		
2	32	Ramselefors	Umeå	Funk Vb
13.01.2018	Skyttiadens distriktsfinal 2018	Ramselefors SKF		
<b>Prov</b> 	1: 10.3x → 2: 10.6x → 3: 10.1 ↘ 4: 10.4x ⇒ 5: 9.6 → 6: 10.2x ↗ 7: 10.3x ↑	<b>40 Skott</b> 	1: 10.1 ↑ 2: 10.2x ↑ 3: 10.9x ↘ 4: 10.5x ↖ 5: 10.6x ↑ 6: 10.6x ↘ 7: 10.4x ↑ 8: 10.2x ↑ 9: 10.8x ↗ 10: 10.9x →	
	Serie 71.5		Serie 105.2	
	Total 0.0		Total 105.2	
<b>40 Skott</b> 	11: 10.0 ↘ 12: 9.9 → 13: 10.5x ↙ 14: 10.5x ↗ 15: 10.0 ← 16: 10.5x ↘ 17: 10.8x ← 18: 10.6x → 19: 10.6x ↙ 20: 10.7x →	<b>40 Skott</b> 	21: 10.6x ↖ 22: 10.1 ↗ 23: 8.8 ← 24: 10.5x ↙ 25: 10.3x ↘ 26: 10.0 ← 27: 10.0 ← 28: 10.3x → 29: 10.6x ↘ 30: 10.0 ↗	
	Serie 104.1		Serie 101.2	
	Total 209.3		Total 310.5	
<b>40 Skott</b> 	31: 10.5x ⇒ 32: 9.9 ← 33: 10.5x ↗ 34: 10.5x ↗ 35: 10.1 → 36: 9.7 ↑ 37: 10.3x ↗ 38: 9.6 ⇒ 39: 10.4x → 40: 10.3x →			
	Serie 101.8			
	Total 412.3			

<p><b>Prov</b></p>	<table border="1" style="width:100%; border-collapse: collapse;"> <tr><td>1:</td><td>9.7</td><td>↓</td></tr> <tr><td>2:</td><td>10.5x</td><td>↖</td></tr> <tr><td>3:</td><td>10.5x</td><td>↙</td></tr> <tr><td>4:</td><td>9.4</td><td>↓</td></tr> <tr><td>5:</td><td>10.1</td><td>↓</td></tr> <tr><td>6:</td><td>10.0</td><td>↑</td></tr> <tr><td>7:</td><td>10.3x</td><td>↖</td></tr> <tr><td>8:</td><td>9.1</td><td>↖</td></tr> <tr><td>9:</td><td>10.2x</td><td>↖</td></tr> <tr><td>10:</td><td>9.6</td><td>↖</td></tr> <tr><td colspan="2"><b>Serie</b></td><td><b>99.4</b></td></tr> <tr><td colspan="2"><b>Total</b></td><td><b>0.0</b></td></tr> </table>	1:	9.7	↓	2:	10.5x	↖	3:	10.5x	↙	4:	9.4	↓	5:	10.1	↓	6:	10.0	↑	7:	10.3x	↖	8:	9.1	↖	9:	10.2x	↖	10:	9.6	↖	<b>Serie</b>		<b>99.4</b>	<b>Total</b>		<b>0.0</b>	<p><b>Prov</b></p> <table border="1" style="width:100%; border-collapse: collapse;"> <tr><td>11:</td><td>10.3x</td><td>↗</td></tr> <tr><td>12:</td><td>10.0</td><td>↙</td></tr> <tr><td>13:</td><td>10.4x</td><td>↗</td></tr> <tr><td colspan="2"><b>Serie</b></td><td><b>30.7</b></td></tr> <tr><td colspan="2"><b>Total</b></td><td><b>0.0</b></td></tr> </table>	11:	10.3x	↗	12:	10.0	↙	13:	10.4x	↗	<b>Serie</b>		<b>30.7</b>	<b>Total</b>		<b>0.0</b>																					
1:	9.7	↓																																																																								
2:	10.5x	↖																																																																								
3:	10.5x	↙																																																																								
4:	9.4	↓																																																																								
5:	10.1	↓																																																																								
6:	10.0	↑																																																																								
7:	10.3x	↖																																																																								
8:	9.1	↖																																																																								
9:	10.2x	↖																																																																								
10:	9.6	↖																																																																								
<b>Serie</b>		<b>99.4</b>																																																																								
<b>Total</b>		<b>0.0</b>																																																																								
11:	10.3x	↗																																																																								
12:	10.0	↙																																																																								
13:	10.4x	↗																																																																								
<b>Serie</b>		<b>30.7</b>																																																																								
<b>Total</b>		<b>0.0</b>																																																																								
<p><b>40 Skott</b></p>	<table border="1" style="width:100%; border-collapse: collapse;"> <tr><td>1:</td><td>10.3x</td><td>↖</td></tr> <tr><td>2:</td><td>9.0</td><td>↑</td></tr> <tr><td>3:</td><td>10.4x</td><td>↗</td></tr> <tr><td>4:</td><td>10.3x</td><td>↗</td></tr> <tr><td>5:</td><td>9.6</td><td>↗</td></tr> <tr><td>6:</td><td>9.4</td><td>→</td></tr> <tr><td>7:</td><td>10.6x</td><td>→</td></tr> <tr><td>8:</td><td>10.8x</td><td>→</td></tr> <tr><td>9:</td><td>10.1</td><td>↗</td></tr> <tr><td>10:</td><td>10.5x</td><td>→</td></tr> <tr><td colspan="2"><b>Serie</b></td><td><b>101.0</b></td></tr> <tr><td colspan="2"><b>Total</b></td><td><b>101.0</b></td></tr> </table>	1:	10.3x	↖	2:	9.0	↑	3:	10.4x	↗	4:	10.3x	↗	5:	9.6	↗	6:	9.4	→	7:	10.6x	→	8:	10.8x	→	9:	10.1	↗	10:	10.5x	→	<b>Serie</b>		<b>101.0</b>	<b>Total</b>		<b>101.0</b>	<p><b>40 Skott</b></p> <table border="1" style="width:100%; border-collapse: collapse;"> <tr><td>11:</td><td>10.1</td><td>↖</td></tr> <tr><td>12:</td><td>10.8x</td><td>↖</td></tr> <tr><td>13:</td><td>10.1</td><td>↖</td></tr> <tr><td>14:</td><td>10.0</td><td>↓</td></tr> <tr><td>15:</td><td>10.0</td><td>↓</td></tr> <tr><td>16:</td><td>9.9</td><td>↙</td></tr> <tr><td>17:</td><td>10.4x</td><td>↙</td></tr> <tr><td>18:</td><td>9.6</td><td>↖</td></tr> <tr><td>19:</td><td>9.8</td><td>↖</td></tr> <tr><td>20:</td><td>10.4x</td><td>↗</td></tr> <tr><td colspan="2"><b>Serie</b></td><td><b>101.1</b></td></tr> <tr><td colspan="2"><b>Total</b></td><td><b>202.1</b></td></tr> </table>	11:	10.1	↖	12:	10.8x	↖	13:	10.1	↖	14:	10.0	↓	15:	10.0	↓	16:	9.9	↙	17:	10.4x	↙	18:	9.6	↖	19:	9.8	↖	20:	10.4x	↗	<b>Serie</b>		<b>101.1</b>	<b>Total</b>		<b>202.1</b>
1:	10.3x	↖																																																																								
2:	9.0	↑																																																																								
3:	10.4x	↗																																																																								
4:	10.3x	↗																																																																								
5:	9.6	↗																																																																								
6:	9.4	→																																																																								
7:	10.6x	→																																																																								
8:	10.8x	→																																																																								
9:	10.1	↗																																																																								
10:	10.5x	→																																																																								
<b>Serie</b>		<b>101.0</b>																																																																								
<b>Total</b>		<b>101.0</b>																																																																								
11:	10.1	↖																																																																								
12:	10.8x	↖																																																																								
13:	10.1	↖																																																																								
14:	10.0	↓																																																																								
15:	10.0	↓																																																																								
16:	9.9	↙																																																																								
17:	10.4x	↙																																																																								
18:	9.6	↖																																																																								
19:	9.8	↖																																																																								
20:	10.4x	↗																																																																								
<b>Serie</b>		<b>101.1</b>																																																																								
<b>Total</b>		<b>202.1</b>																																																																								
<p><b>40 Skott</b></p>	<table border="1" style="width:100%; border-collapse: collapse;"> <tr><td>21:</td><td>9.9</td><td>→</td></tr> <tr><td>22:</td><td>10.3x</td><td>↙</td></tr> <tr><td>23:</td><td>10.6x</td><td>→</td></tr> <tr><td>24:</td><td>10.3x</td><td>↙</td></tr> <tr><td>25:</td><td>10.8x</td><td>↖</td></tr> <tr><td>26:</td><td>10.0</td><td>↓</td></tr> <tr><td>27:</td><td>10.7x</td><td>↖</td></tr> <tr><td>28:</td><td>10.8x</td><td>↖</td></tr> <tr><td>29:</td><td>10.3x</td><td>↖</td></tr> <tr><td>30:</td><td>10.2x</td><td>↑</td></tr> <tr><td colspan="2"><b>Serie</b></td><td><b>103.9</b></td></tr> <tr><td colspan="2"><b>Total</b></td><td><b>306.0</b></td></tr> </table>	21:	9.9	→	22:	10.3x	↙	23:	10.6x	→	24:	10.3x	↙	25:	10.8x	↖	26:	10.0	↓	27:	10.7x	↖	28:	10.8x	↖	29:	10.3x	↖	30:	10.2x	↑	<b>Serie</b>		<b>103.9</b>	<b>Total</b>		<b>306.0</b>	<p><b>40 Skott</b></p> <table border="1" style="width:100%; border-collapse: collapse;"> <tr><td>31:</td><td>10.5x</td><td>↖</td></tr> <tr><td>32:</td><td>10.4x</td><td>↖</td></tr> <tr><td>33:</td><td>10.2x</td><td>↙</td></tr> <tr><td>34:</td><td>9.3</td><td>↖</td></tr> <tr><td>35:</td><td>10.4x</td><td>↙</td></tr> <tr><td>36:</td><td>10.5x</td><td>↑</td></tr> <tr><td>37:</td><td>9.2</td><td>↖</td></tr> <tr><td>38:</td><td>10.5x</td><td>↑</td></tr> <tr><td>39:</td><td>9.5</td><td>↗</td></tr> <tr><td>40:</td><td>9.9</td><td>↑</td></tr> <tr><td colspan="2"><b>Serie</b></td><td><b>100.4</b></td></tr> <tr><td colspan="2"><b>Total</b></td><td><b>406.4</b></td></tr> </table>	31:	10.5x	↖	32:	10.4x	↖	33:	10.2x	↙	34:	9.3	↖	35:	10.4x	↙	36:	10.5x	↑	37:	9.2	↖	38:	10.5x	↑	39:	9.5	↗	40:	9.9	↑	<b>Serie</b>		<b>100.4</b>	<b>Total</b>		<b>406.4</b>
21:	9.9	→																																																																								
22:	10.3x	↙																																																																								
23:	10.6x	→																																																																								
24:	10.3x	↙																																																																								
25:	10.8x	↖																																																																								
26:	10.0	↓																																																																								
27:	10.7x	↖																																																																								
28:	10.8x	↖																																																																								
29:	10.3x	↖																																																																								
30:	10.2x	↑																																																																								
<b>Serie</b>		<b>103.9</b>																																																																								
<b>Total</b>		<b>306.0</b>																																																																								
31:	10.5x	↖																																																																								
32:	10.4x	↖																																																																								
33:	10.2x	↙																																																																								
34:	9.3	↖																																																																								
35:	10.4x	↙																																																																								
36:	10.5x	↑																																																																								
37:	9.2	↖																																																																								
38:	10.5x	↑																																																																								
39:	9.5	↗																																																																								
40:	9.9	↑																																																																								
<b>Serie</b>		<b>100.4</b>																																																																								
<b>Total</b>		<b>406.4</b>																																																																								
<p><b>40 Skott</b></p>	<table border="1" style="width:100%; border-collapse: collapse;"> <tr><td>41:</td><td>10.5x</td><td>↖</td></tr> <tr><td>42:</td><td>10.3x</td><td>↑</td></tr> <tr><td>43:</td><td>10.1</td><td>↓</td></tr> <tr><td>44:</td><td>9.3</td><td>↓</td></tr> <tr><td>45:</td><td>10.0</td><td>→</td></tr> <tr><td>46:</td><td>10.0</td><td>↓</td></tr> <tr><td>47:</td><td>10.2x</td><td>↖</td></tr> <tr><td>48:</td><td>9.9</td><td>↖</td></tr> <tr><td>49:</td><td>10.2x</td><td>↙</td></tr> <tr><td>50:</td><td>9.9</td><td>↓</td></tr> <tr><td colspan="2"><b>Serie</b></td><td><b>100.4</b></td></tr> <tr><td colspan="2"><b>Total</b></td><td><b>506.8</b></td></tr> </table>	41:	10.5x	↖	42:	10.3x	↑	43:	10.1	↓	44:	9.3	↓	45:	10.0	→	46:	10.0	↓	47:	10.2x	↖	48:	9.9	↖	49:	10.2x	↙	50:	9.9	↓	<b>Serie</b>		<b>100.4</b>	<b>Total</b>		<b>506.8</b>	<p><b>40 Skott</b></p> <table border="1" style="width:100%; border-collapse: collapse;"> <tr><td>51:</td><td>10.8x</td><td>→</td></tr> <tr><td>52:</td><td>10.6x</td><td>↖</td></tr> <tr><td>53:</td><td>10.4x</td><td>↖</td></tr> <tr><td>54:</td><td>9.6</td><td>↗</td></tr> <tr><td>55:</td><td>10.4x</td><td>↙</td></tr> <tr><td>56:</td><td>9.5</td><td>↖</td></tr> <tr><td>57:</td><td>9.7</td><td>↑</td></tr> <tr><td>58:</td><td>10.2x</td><td>→</td></tr> <tr><td>59:</td><td>10.2x</td><td>↑</td></tr> <tr><td>60:</td><td>10.8x</td><td>↖</td></tr> <tr><td colspan="2"><b>Serie</b></td><td><b>102.2</b></td></tr> <tr><td colspan="2"><b>Total</b></td><td><b>609.0</b></td></tr> </table>	51:	10.8x	→	52:	10.6x	↖	53:	10.4x	↖	54:	9.6	↗	55:	10.4x	↙	56:	9.5	↖	57:	9.7	↑	58:	10.2x	→	59:	10.2x	↑	60:	10.8x	↖	<b>Serie</b>		<b>102.2</b>	<b>Total</b>		<b>609.0</b>
41:	10.5x	↖																																																																								
42:	10.3x	↑																																																																								
43:	10.1	↓																																																																								
44:	9.3	↓																																																																								
45:	10.0	→																																																																								
46:	10.0	↓																																																																								
47:	10.2x	↖																																																																								
48:	9.9	↖																																																																								
49:	10.2x	↙																																																																								
50:	9.9	↓																																																																								
<b>Serie</b>		<b>100.4</b>																																																																								
<b>Total</b>		<b>506.8</b>																																																																								
51:	10.8x	→																																																																								
52:	10.6x	↖																																																																								
53:	10.4x	↖																																																																								
54:	9.6	↗																																																																								
55:	10.4x	↙																																																																								
56:	9.5	↖																																																																								
57:	9.7	↑																																																																								
58:	10.2x	→																																																																								
59:	10.2x	↑																																																																								
60:	10.8x	↖																																																																								
<b>Serie</b>		<b>102.2</b>																																																																								
<b>Total</b>		<b>609.0</b>																																																																								

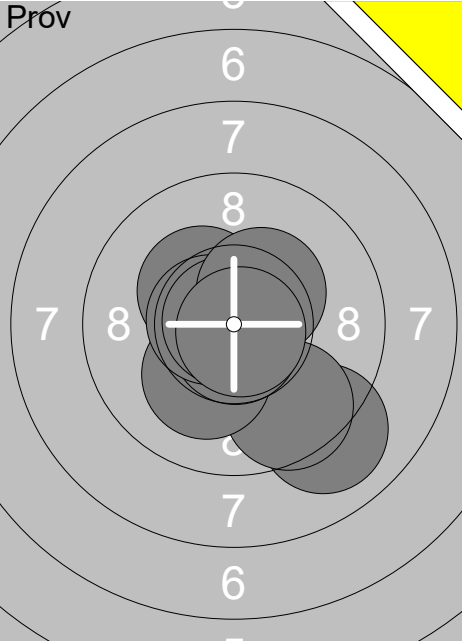
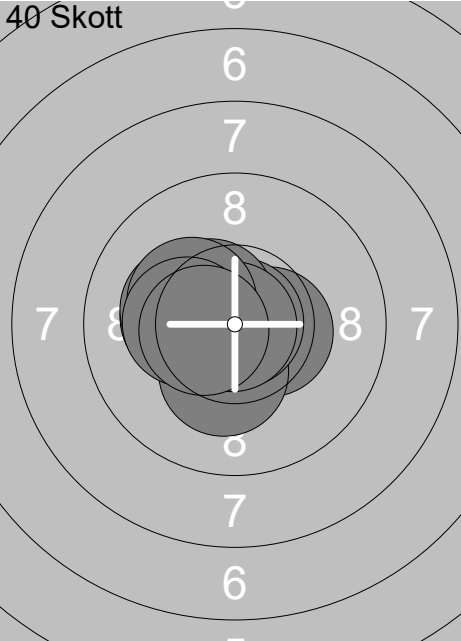
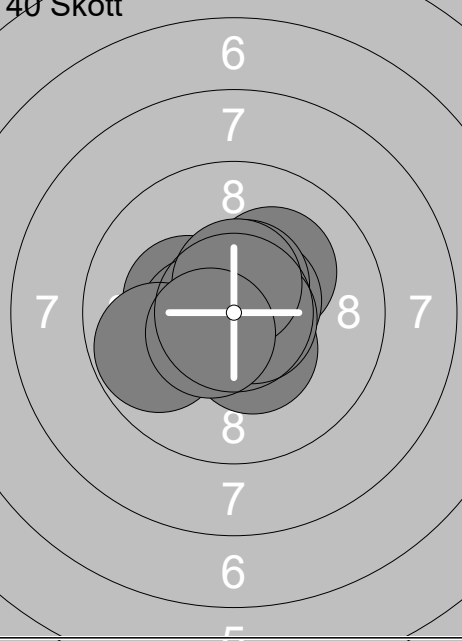
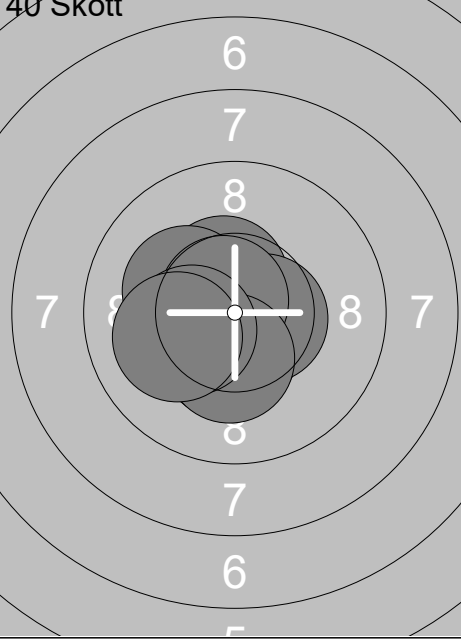
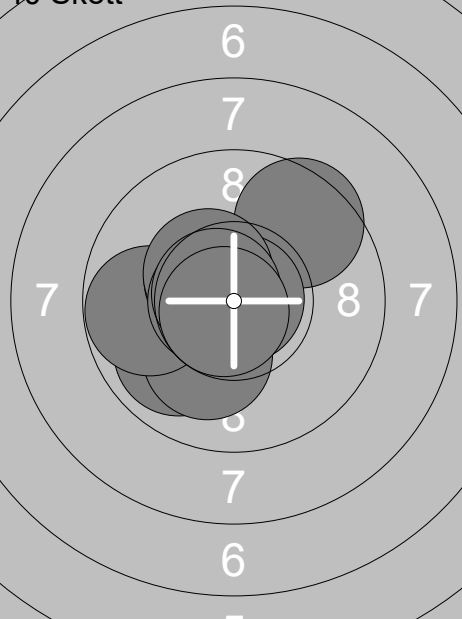
Skjutlag <b>2</b>	Tavla <b>36</b>	<b>Edwin Strömberg</b>	
Ramselefors	Vännäs	13	Vb
13.01.2018	Skyttiadens distriktsfinal 2018	Ramselefors SKF	
<b>Prov</b> 	1: 9.0 ↘ 2: 9.6 ↘ 3: 10.2x ↘ 4: 10.3x ↗ 5: 10.7x ↘ 6: 10.6x ← 7: 10.8x ← 8: 10.4x ↗ 9: 10.8x ↘ Serie 92.4 Total 0.0	<b>40 Skott</b> 	1: 10.3x ← 2: 10.2x ← 3: 10.5x → 4: 10.3x ↘ 5: 10.9x → 6: 10.5x ↗ 7: 10.9x ← 8: 10.3x ← 9: 10.3x ← 10: 10.5x ← Serie 104.7 Total 104.7
<b>40 Skott</b> 	11: 10.3x ← 12: 10.2x ↗ 13: 10.6x → 14: 10.5x ↗ 15: 10.5x ← 16: 10.4x ↘ 17: 10.7x → 18: 9.8 ← 19: 10.5x ↗ 20: 10.5x ↘ Serie 104.0 Total 208.7	<b>40 Skott</b> 	21: 10.5x ↘ 22: 10.5x ↗ 23: 10.9x ↘ 24: 10.4x ↘ 25: 10.2x ← 26: 10.5x → 27: 10.7x ↗ 28: 10.3x ↘ 29: 10.3x ← 30: 10.1 ← Serie 104.4 Total 313.1
<b>40 Skott</b> 	31: 9.9 ↙ 32: 10.1 ↘ 33: 9.5 ↗ 34: 9.8 ← 35: 10.5x ↗ 36: 10.9x → 37: 10.4x ↗ 38: 10.7x ← 39: 10.7x ← 40: 10.7x ↘ Serie 103.2 Total 416.3		

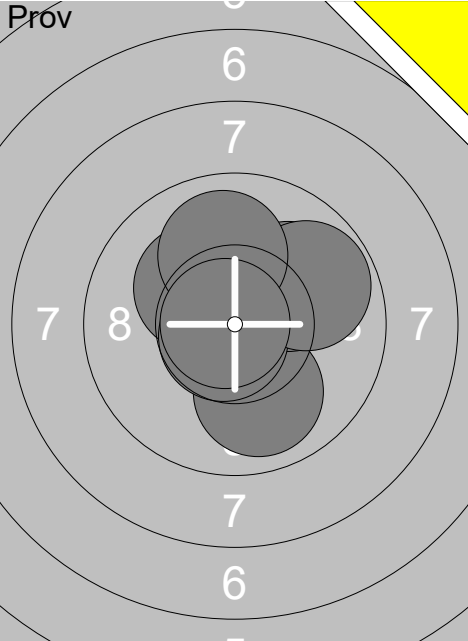
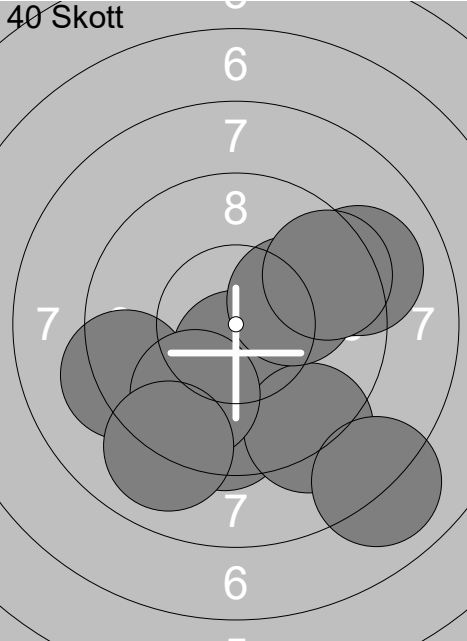
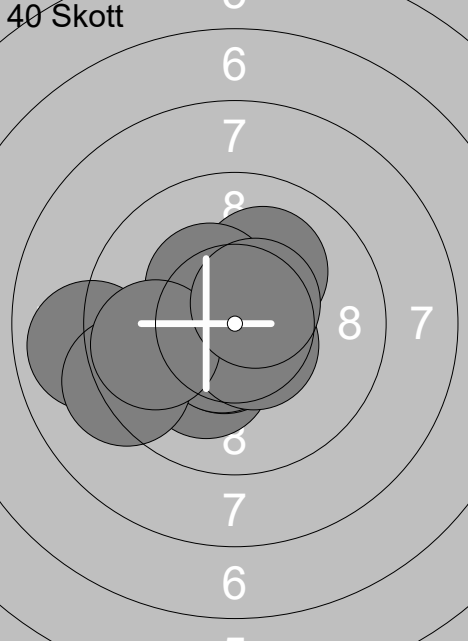
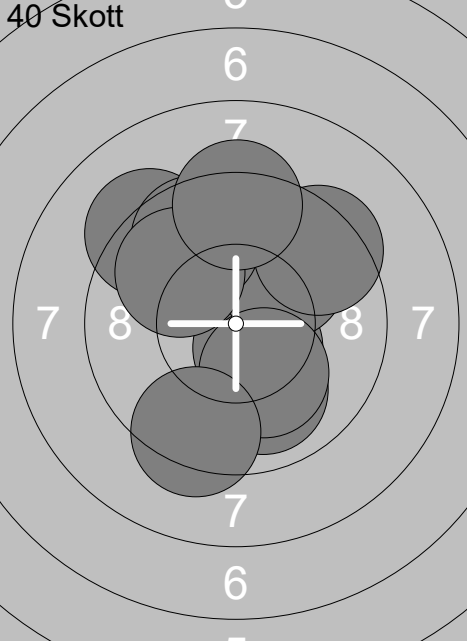
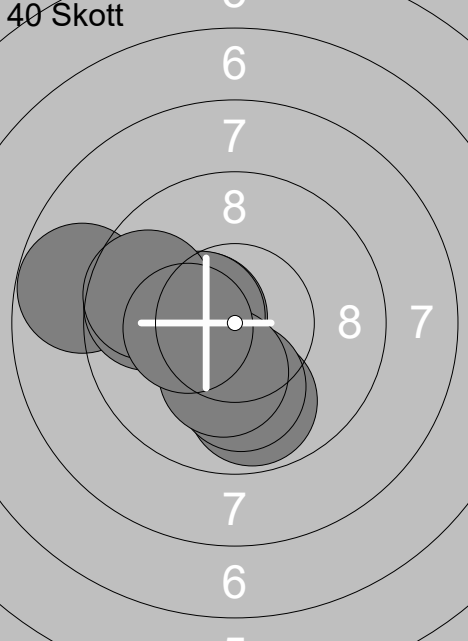
Skjuttlag	Tavla	Sture Lönnefjord		Funk	Vb
2	38	Ramselefors	Ramselefors		
13.01.2018		Skyttiadens distriktsfinal 2018	Ramselefors SKF		
Prov		1: 10.2x ↖ 2: 10.0 ↓ 3: 10.0 ↗ 4: 10.7x ↙ 5: 9.8 ↗ 6: 10.0 ↑ 7: 10.8x ←	40 Skott	1: 9.5 ↓ 2: 10.5x ↓ 3: 9.3 ← 4: 9.2 ↘ 5: 9.1 ↗ 6: 9.8 ↓ 7: 10.1 ↗ 8: 9.0 ↓ 9: 9.5 ↗ 10: 8.0 ↘	
		Serie 71.5 Total 0.0		Serie 94.0 Total 94.0	
40 Skott		11: 10.1 ↓ 12: 10.1 ↗ 13: 10.6x ↓ 14: 10.6x ↓ 15: 8.9 ← 16: 9.2 ← 17: 10.6x ↘ 18: 10.3x ↖ 19: 9.8 ← 20: 10.5x ↗	40 Skott	21: 10.5x ↘ 22: 10.0 ↓ 23: 10.0 ↗ 24: 10.2x ↘ 25: 9.4 ↗ 26: 9.2 ↖ 27: 9.4 ↓ 28: 9.7 ↑ 29: 9.9 ↖ 30: 9.3 ↑	
		Serie 100.7 Total 194.7		Serie 97.6 Total 292.3	
40 Skott		31: 9.8 ↓ 32: 10.1 ↓ 33: 10.3x ← 34: 10.5x ← 35: 8.8 ← 36: 10.5x ← 37: 9.7 ← 38: 10.3x ↓ 39: 9.7 ← 40: 10.3x ←			
		Serie 100.0 Total 392.3			

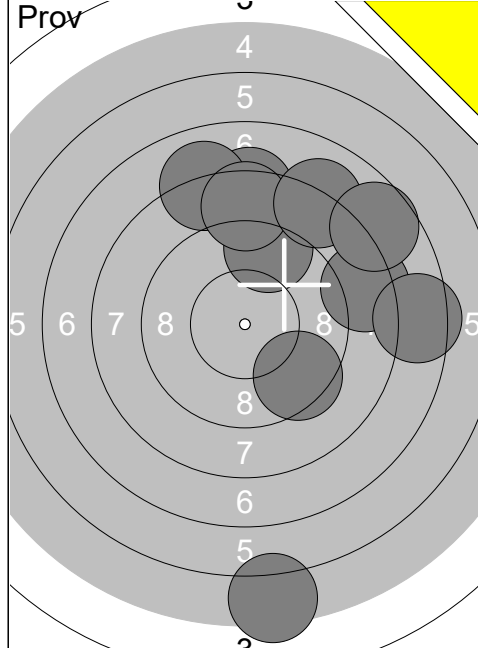

1:	8.4	→
2:	9.3	↑
3:	8.3	↑
4:	8.0	↑
5:	7.5	→
6:	8.6	↑
7:	5.4	↓
8:	8.1	↗
9:	9.5	↘
10:	7.7	↗
<b>Serie</b>	<b>80.8</b>	
<b>Total</b>	<b>0.0</b>	

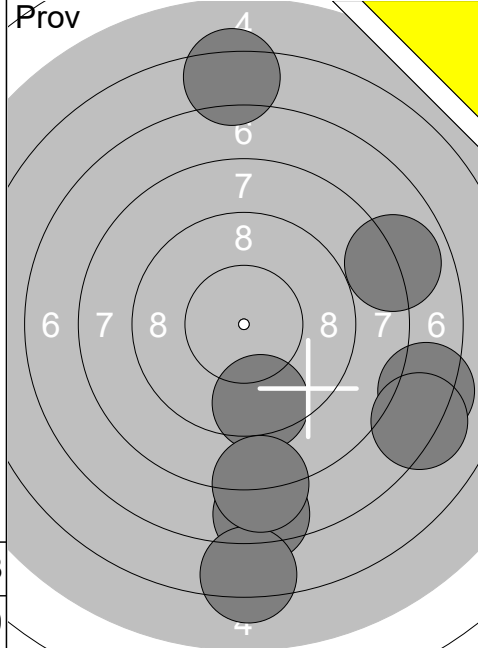

11:	6.3	↑
12:	7.4	↓
13:	7.3	→
14:	6.3	↓
15:	7.9	↗
16:	9.4	↓
17:	7.9	↓
18:	7.2	↘
<b>Serie</b>	<b>59.7</b>	
<b>Total</b>	<b>0.0</b>	

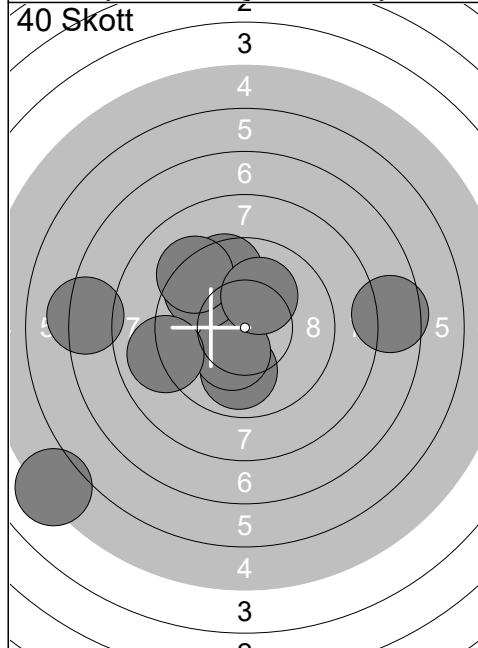

1:	7.6	→
2:	9.6	↑
3:	9.9	↓
4:	10.3x	↓
5:	9.7	↖
6:	5.2	↙
7:	9.3	↗
8:	10.1	↑
9:	7.2	←
10:	9.0	←
<b>Serie</b>	<b>87.9</b>	
<b>Total</b>	<b>87.9</b>	

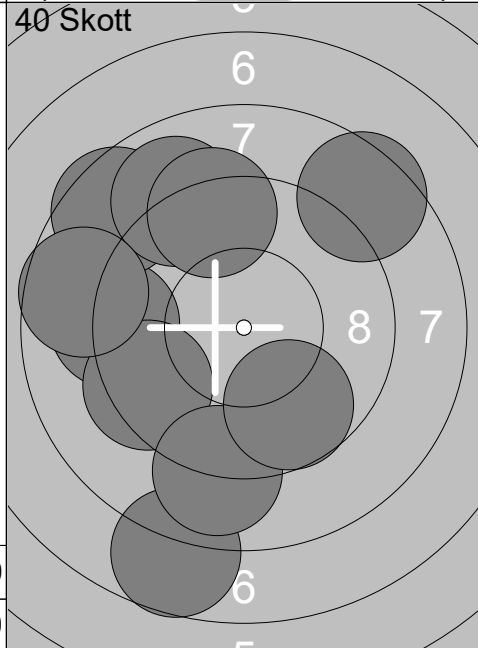

11:	9.2	←
12:	9.4	↙
13:	8.6	↖
14:	9.0	↗
15:	7.7	↓
16:	8.7	←
17:	9.3	↑
18:	8.5	↗
19:	8.9	↓
20:	9.7	↘
<b>Serie</b>	<b>89.0</b>	
<b>Total</b>	<b>176.9</b>	

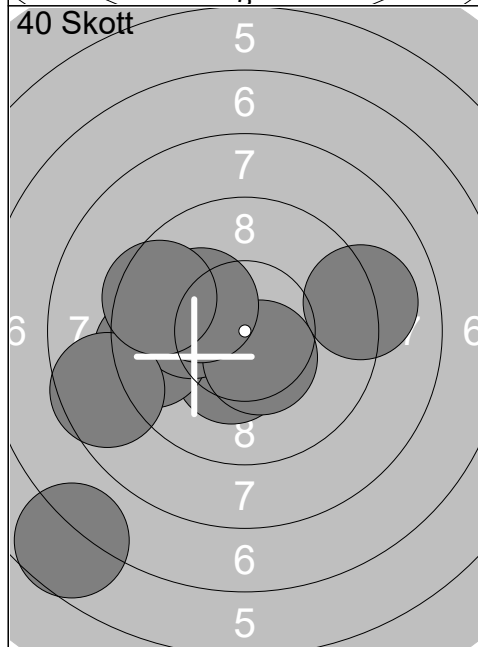

21:	9.6	←
22:	10.3x	↓
23:	9.5	←
24:	10.1	←
25:	9.1	→
26:	10.5x	↓
27:	10.2x	↖
28:	6.7	↓
29:	8.6	←
30:	9.5	←
<b>Serie</b>	<b>94.1</b>	
<b>Total</b>	<b>271.0</b>	

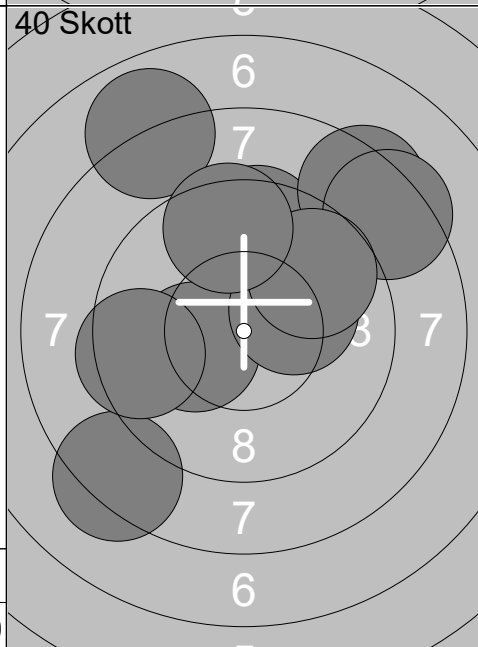

31:	10.2x	↙
32:	9.5	↑
33:	8.3	↙
34:	8.4	↗
35:	9.5	←
36:	8.4	↗
37:	10.2x	→
38:	9.7	↗
39:	7.9	↑
40:	9.5	↑
<b>Serie</b>	<b>91.6</b>	
<b>Total</b>	<b>362.6</b>	