

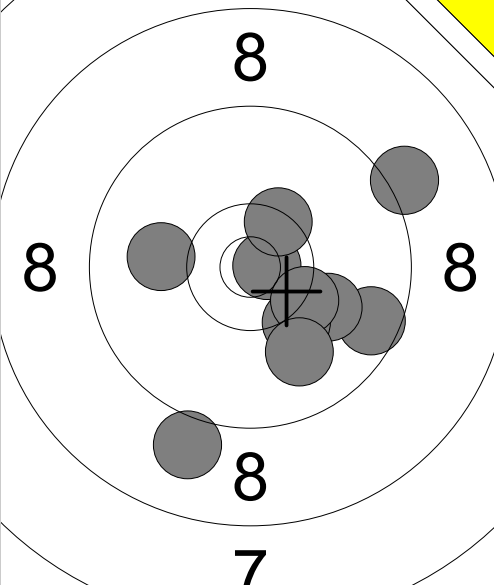

<p>Prov</p> 	<p>1: 9.6 →                  2: 9.0 ↓                  3: 10.8x →                  4: 10.1 →                  5: 9.1 ↗                  6: 10.4x ↗                  7: 10.2 ↓                  8: 10.3x ↓                  9: 10.0 ←                  10: 9.9 ↓</p>	<p>Prov</p> 
	11: 10.2 ← 12: 10.4x ←	
Serie 96		Serie 20
Total 192		Total 192

<p>1. Serie 10 Skott</p> 	<p>1: 8.9 ←                  2: 9.9 ←                  3: 9.5 ↗                  4: 8.9 ↗                  5: 10.2 ↓</p>	<p>1. Serie 10 Skott</p> 
		6: 9.6 ↓ 7: 9.8 ↓ 8: 9.4 → 9: 9.8 ← 10: 9.4 ←
Serie 44		Serie 45
Total 236		Total 281

<p>2. Serie 1 Skott</p> 	<p>1: 10.1 ↖                  2: 10.5x ↓                  3: 10.4x ←                  4: 9.8 ↖                  5: 10.1 ↖</p>	
Serie 49		
Total 330		

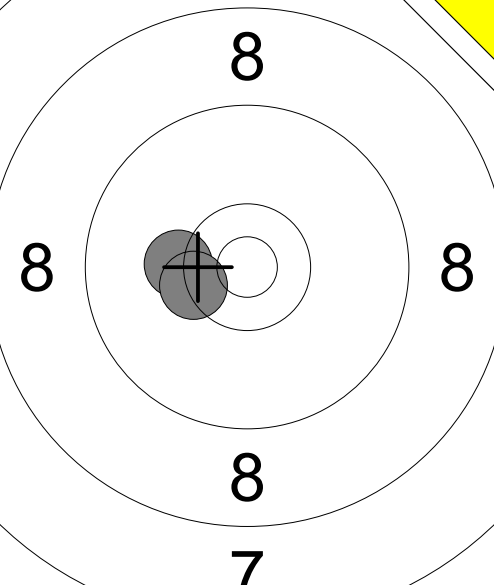
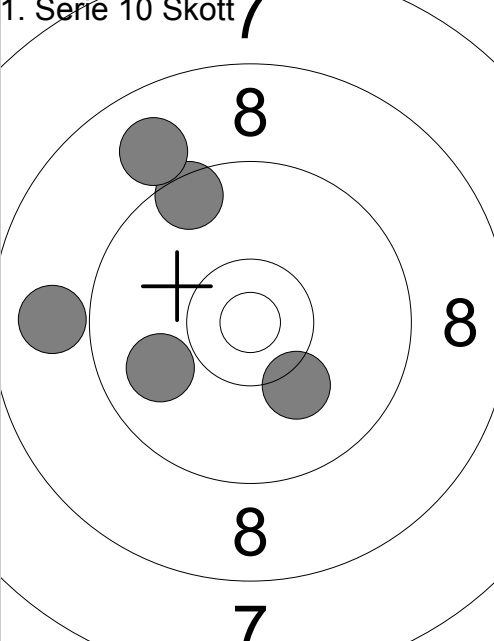
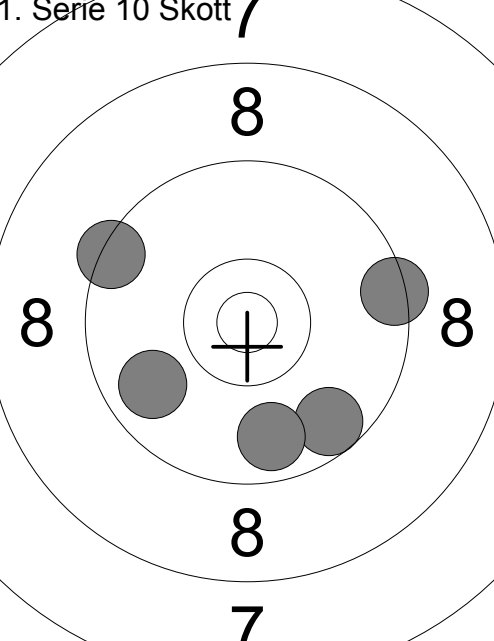
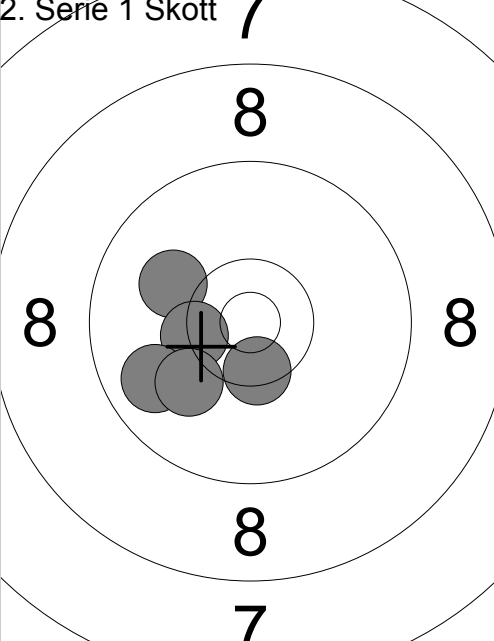
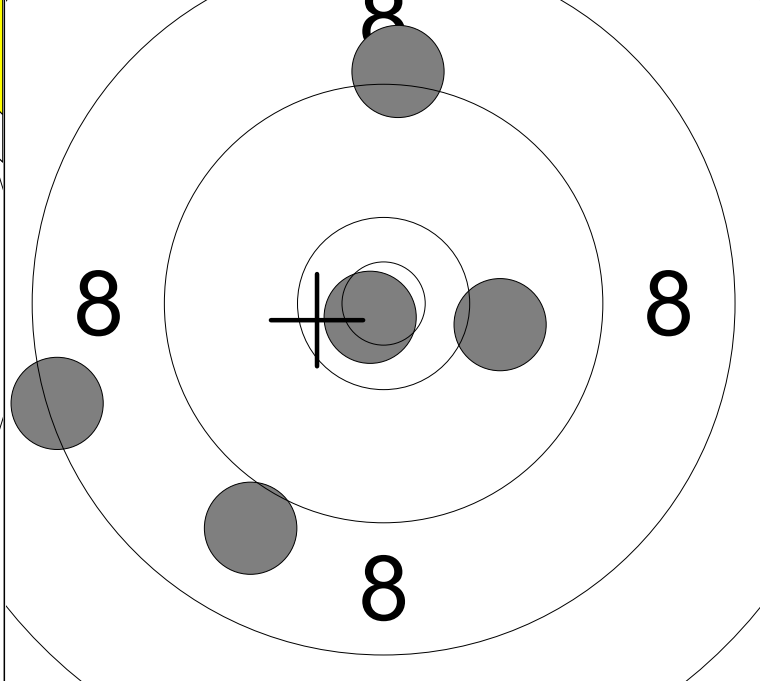
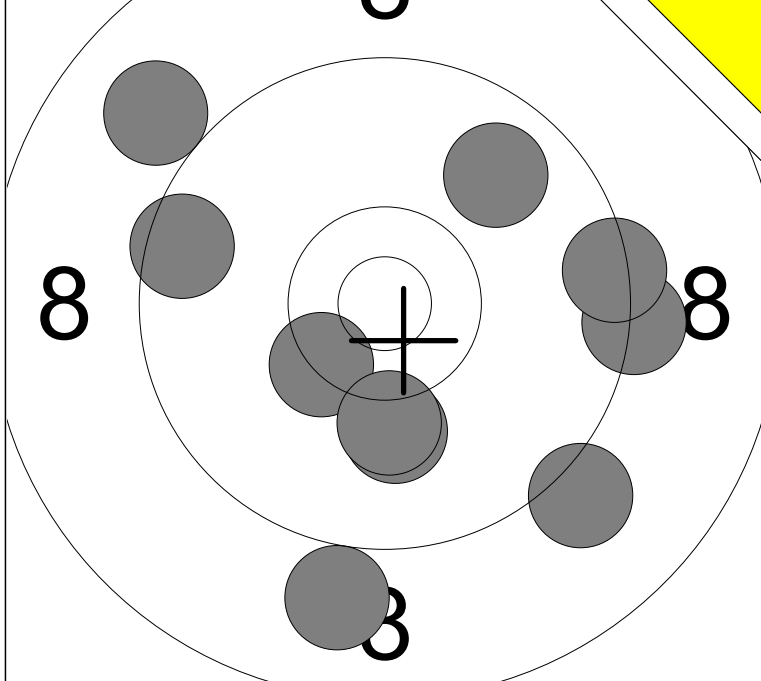

1: 9.8 ↗	6: 9.3 →	Serie 93
2: 9.5 ←	7: 9.4 →	
3: 10.4x ↙	8: 9.0 ↓	Total 190
4: 9.0 ↗	9: 10.1 ↓	
5: 9.1 ↘	10: 10.2 ↓	

1: 9.0 ↓	Serie 46
2: 10.8x ↙	
3: 8.4 ←	Total 236
4: 9.2 ↑	
5: 10.1 →	

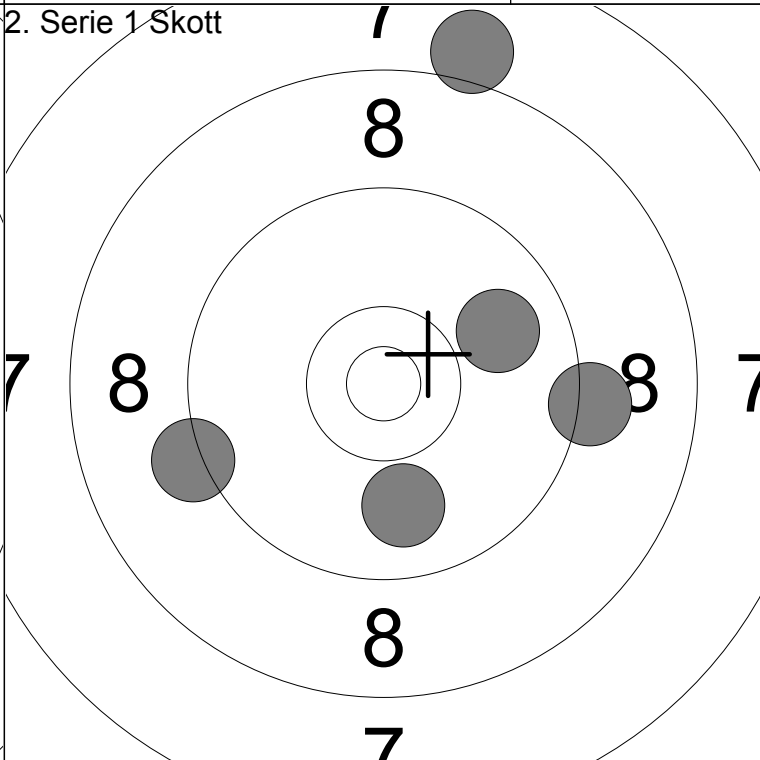
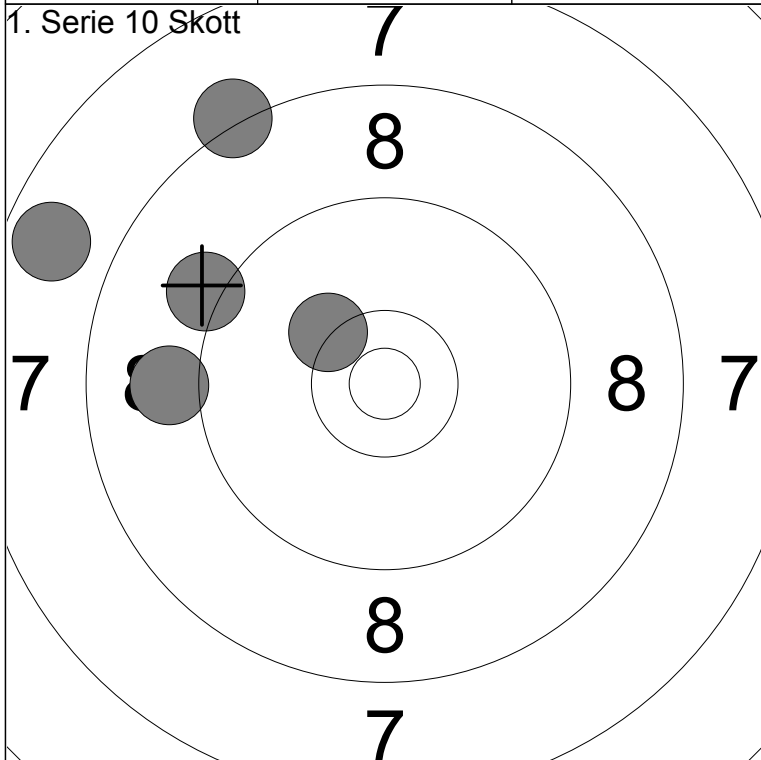

6: 9.0 ←	Serie 43
7: 9.2 ↗	
8: 8.2 ↗	Total 279
9: 10.3 ↗	
10: 7.7 ←	

1: 8.1 ↑	Serie 44
2: 9.9 ↓	
3: 9.9 →	Total 323
4: 9.2 ←	
5: 9.2 →	

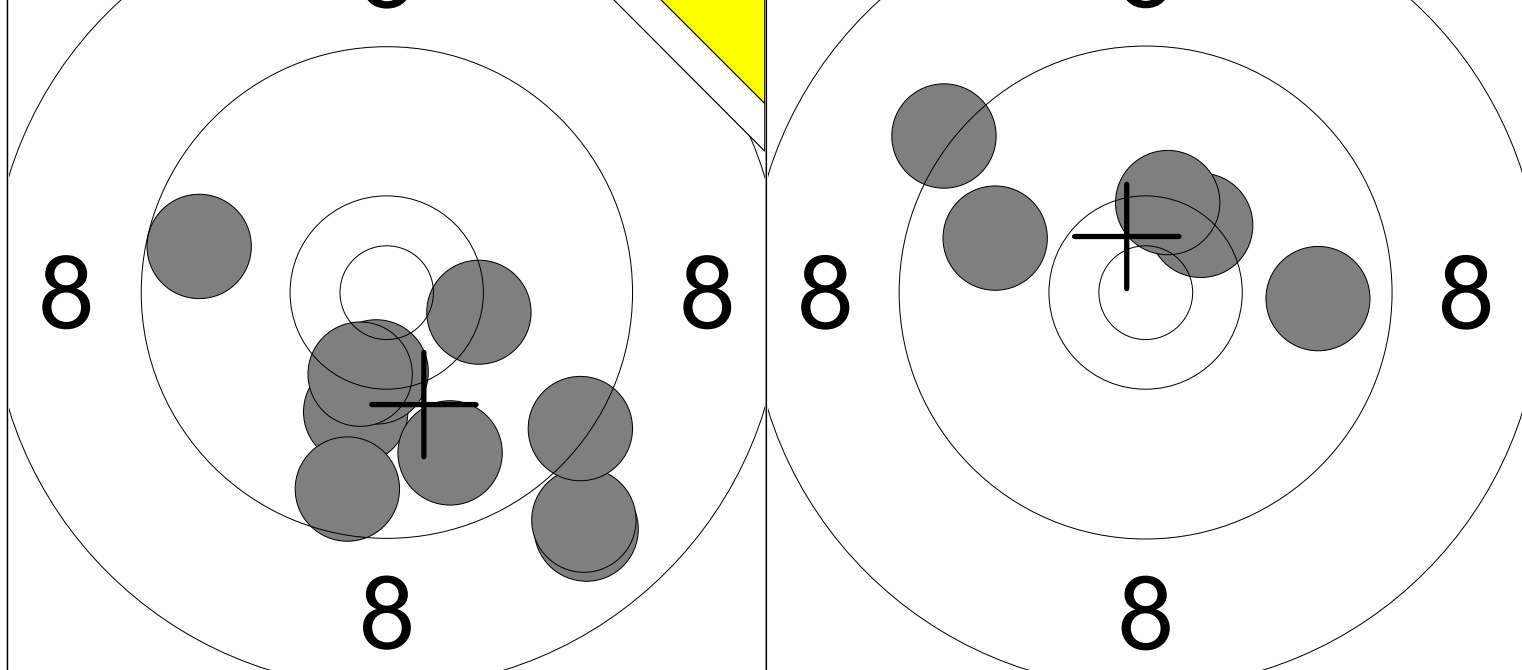

1: 8.9 ↘	6: 10.4x ↓		1: 9.9 ↖		
2: 10.1 ↓	7: 10.4x ↓	Serie 92	2: 9.8 →	Serie 47	
3: 10.3x →	8: 9.8 ↓		3: 9.2 ↗		
4: 8.9 ↓	9: 9.6 ↓	Total 173	4: 10.4x ↗	Total 220	
5: 9.4 ↓	10: 9.7 ←		5: 10.3x ↗		

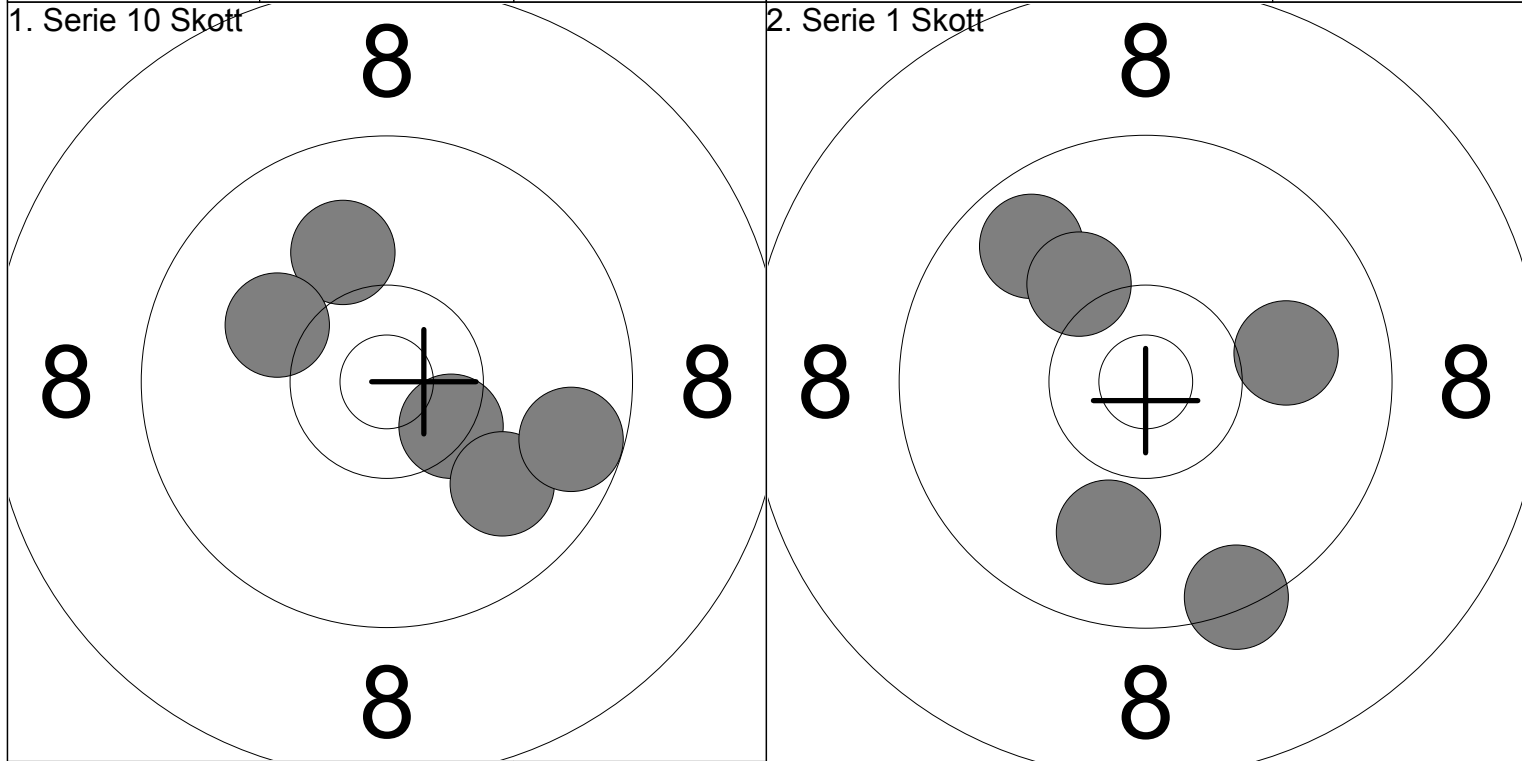

6: 10.4x ↓		1: 9.4 ↓			
7: 9.9 ↓	Serie 48	2: 9.8 ↗	Serie 47		
8: 9.7 ↓		3: 9.9 ↓			
9: 10.0 ↗	Total 268	4: 10.0 →	Total 315		
10: 10.1 ↗		5: 10.2 ↗			

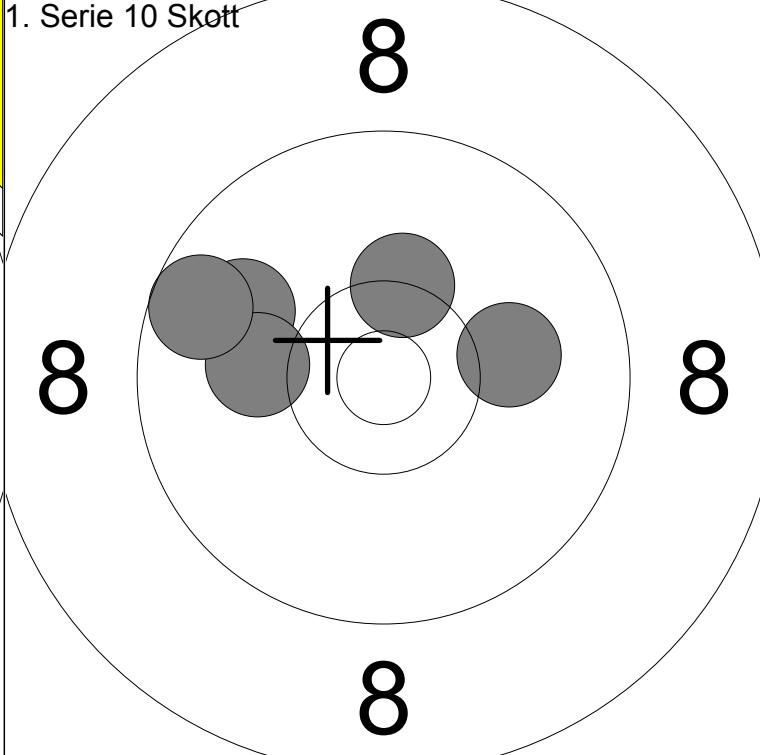
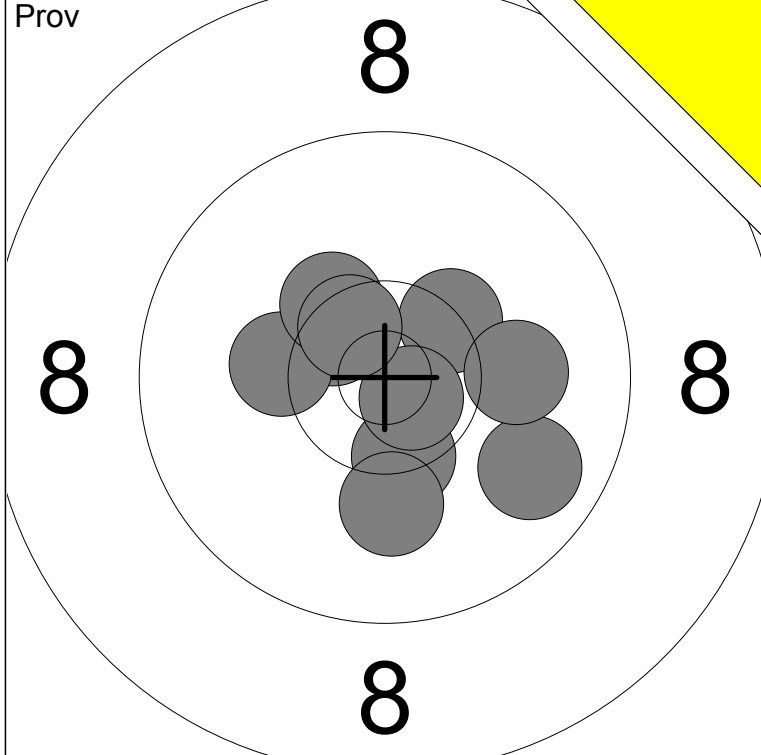

1: 10.4x ↓	6: 9.8 ↘	Serie	99
2: 10.5x ↗	7: 10.2 ←		
3: 10.4x ↗	8: 10.3x ↗	Total	196
4: 10.7x ↘	9: 10.1 →		
5: 10.1 ↓	10: 10.5x ↗		

1: 9.9 ↖	Serie	48
2: 10.1 ←		
3: 10.3x ↑	Total	244
4: 9.6 ↖		
5: 10.1 →		

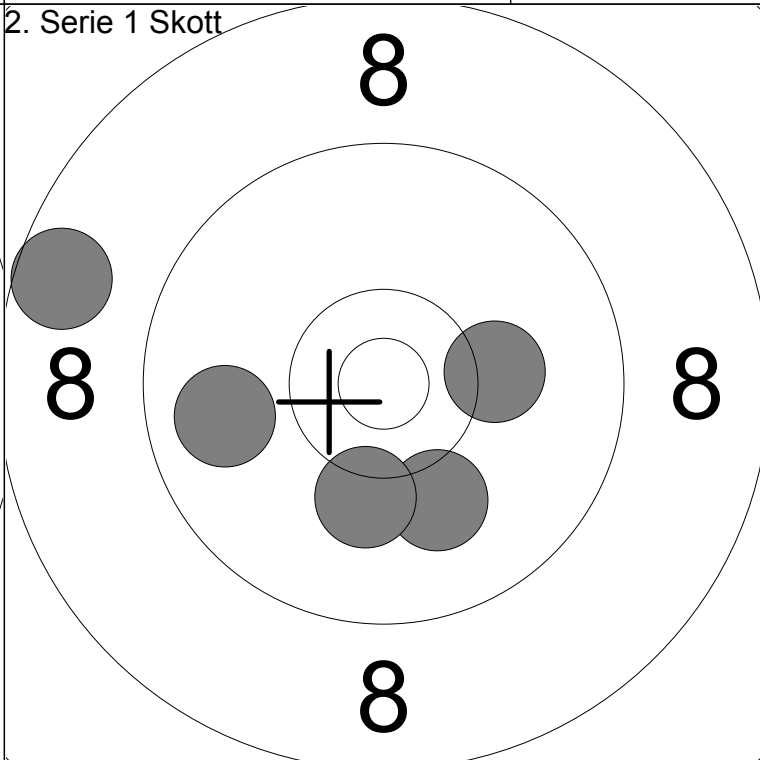
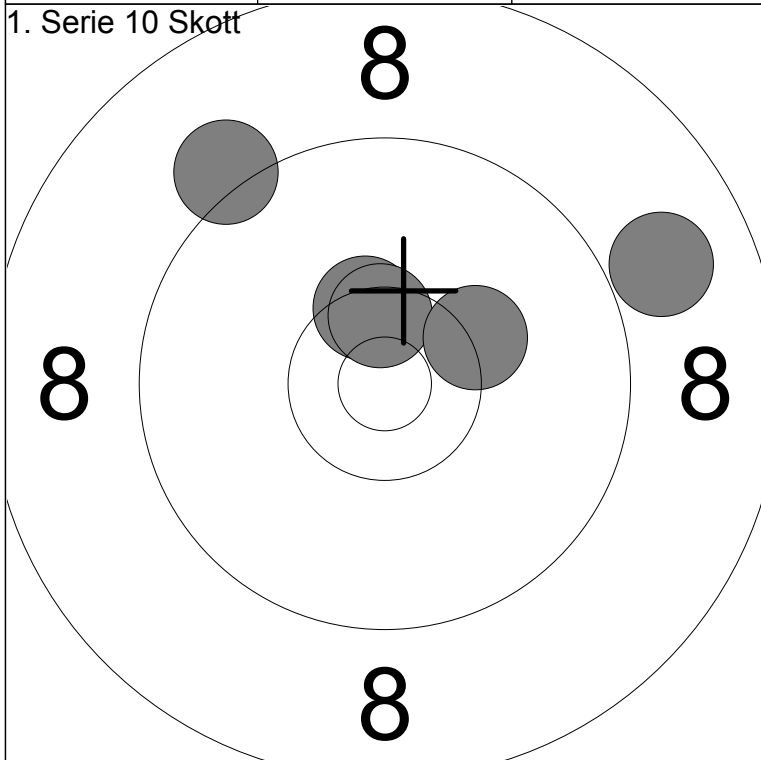

6: 10.4x ↑	Serie	47
7: 10.5x ↑		
8: 9.2 ↗	Total	291
9: 10.3 ↗		
10: 8.9 →		

1: 9.8 ←	Serie	47
2: 8.6 ←		
3: 10.1 ↓	Total	338
4: 10.2 ↓		
5: 10.2 →		

Prov 	1: 8.6 → 2: 10.5x → 3: 9.7 ↑ 4: 8.7 ↓ 5: 9.2 ↓ 6: 10.1 ↑ 7: 9.8 → 8: 9.7 ↑ 9: 9.8 ↑	1. Serie 10 Skott 7 	1: 10.5x ↘ 2: 9.3 ← 3: 10.0 ↑ 4: 10.5x ↖ 5: 9.7 ↑
Serie 81		Serie 48	
Total 190		Total 238	

1. Serie 10 Skott 7 	6: 10.1 ↓ 7: 10.1 ↗ 8: 9.7 ↖ 9: 9.8 ↙ 10: 10.5x →	2. Serie 1 Skott 7 	1: 9.8 ↗ 2: 9.6 ↙ 3: 10.7x ↗ 4: 9.7 → 5: 9.1 ↙
Serie 48		Serie 46	
Total 286		Total 332	

1 Skott Extra 7 	1: 9.6 ←		
Serie 9			
Total 332			

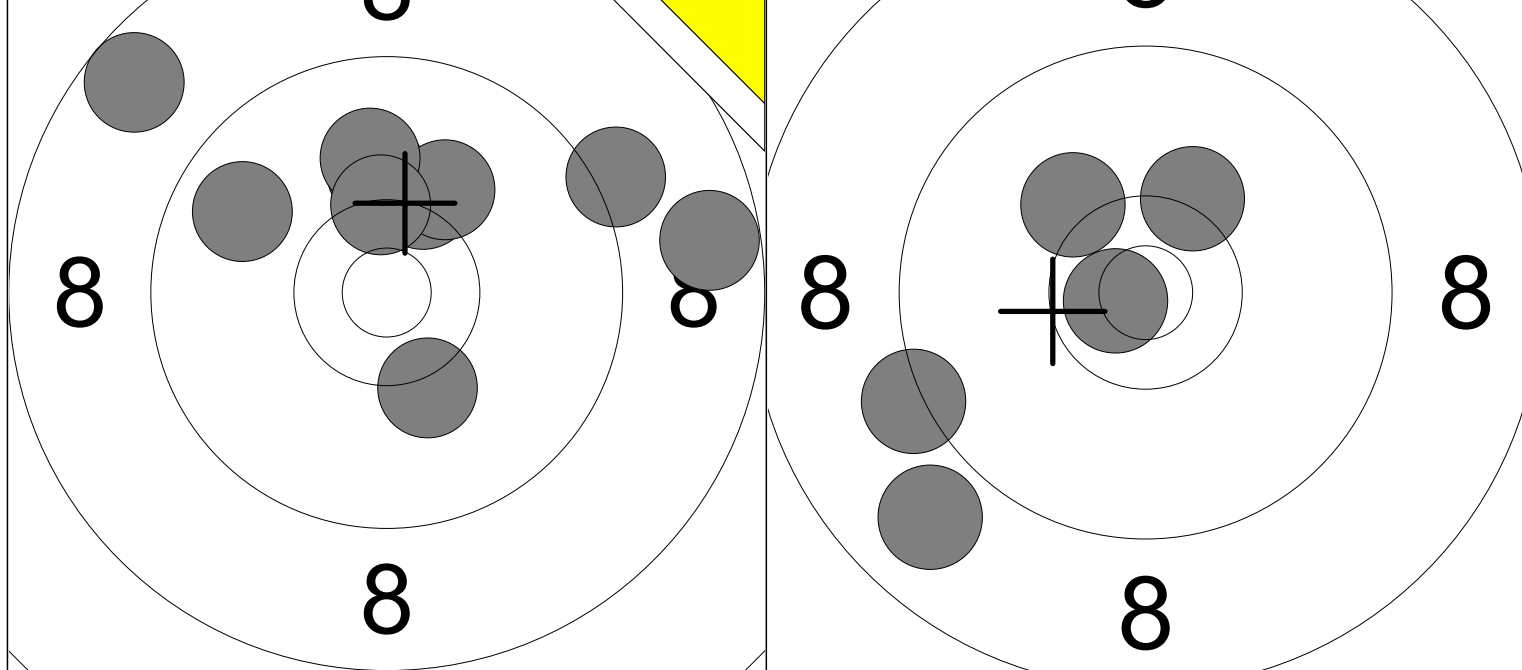

1: 8.7 →	6: 10.1 ↗			1: 9.2 ↙			
2: 9.2 ↗	7: 10.0 ↑	Serie	94	2: 8.9 ↙	Serie	47	Total
3: 10.1 ↑	8: 9.8 ↖			3: 10.7x ↖			
4: 10.3 ↗	9: 10.3x ↑	Total	190	4: 10.2 ↗	Total	237	
5: 10.2 ↓	10: 8.6 ↖			5: 10.2 ↗			

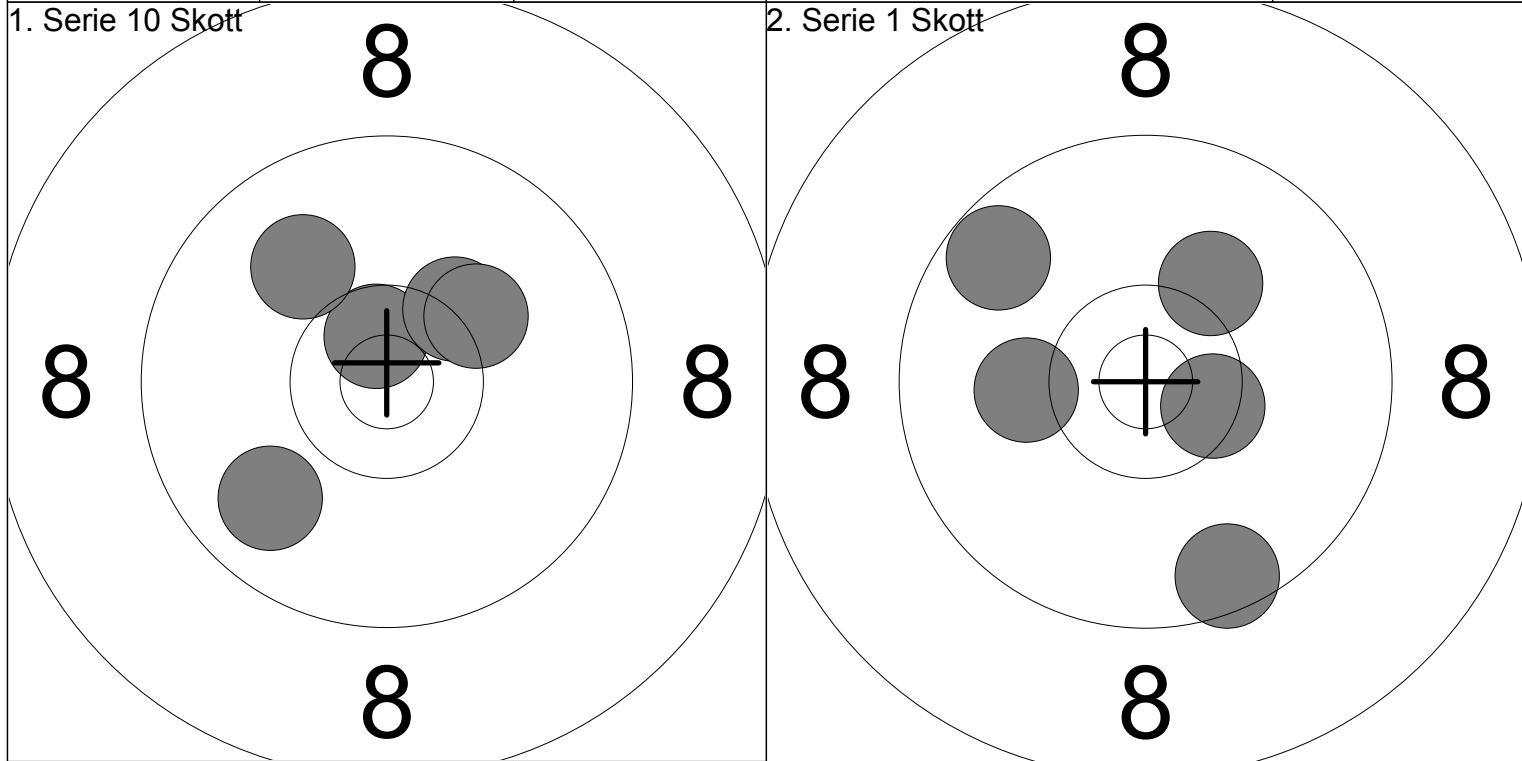

6: 9.8 ↙				1: 10.1 ←			
7: 10.6x ↑		Serie	49	2: 9.7 ↗	Serie	48	Total
8: 10.3 ↗				3: 10.2 ↗			
9: 10.2 ↗		Total	286	4: 10.5x ↘	Total	334	
10: 10.0 ↖				5: 9.5 ↓			

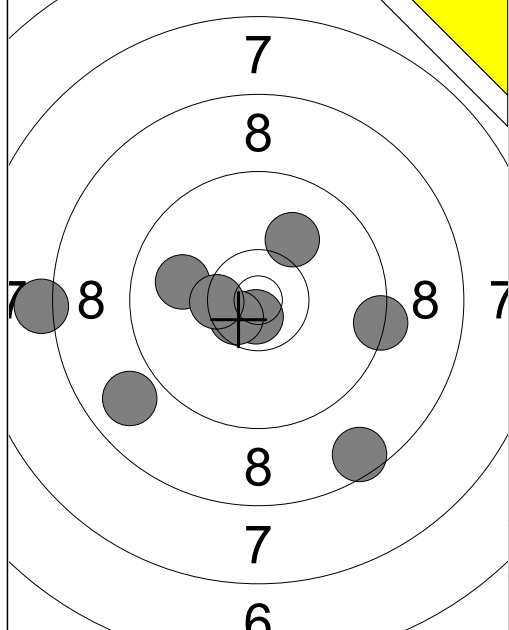

1:	8.6	↘
2:	9.3	→
3:	10.1	↗
4:	10.7x	↘
5:	10.6x	↙
6:	10.0	←
7:	8.2	←
8:	10.4x	←
9:	8.9	↙
Serie		83
Total		189

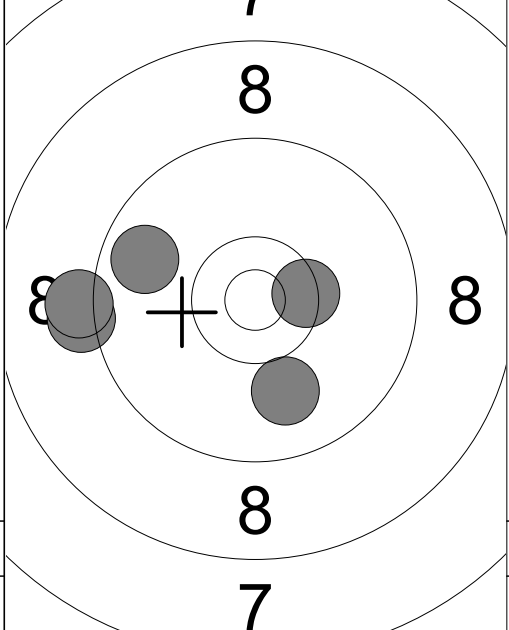

1:	9.7	←
2:	9.2	←
3:	9.2	←
4:	10.0	↘
5:	10.4x	→
Serie		47
Total		236

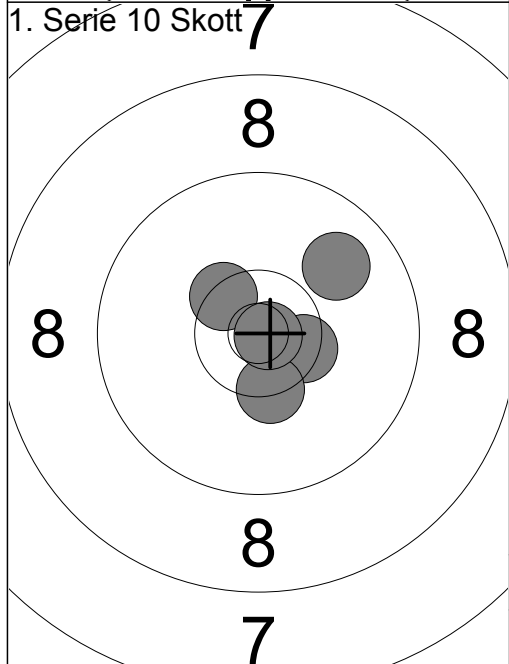

6:	9.9	↗
7:	10.5x	→
8:	10.4x	↖
9:	10.4x	↘
10:	10.8x	→
Serie		49
Total		285

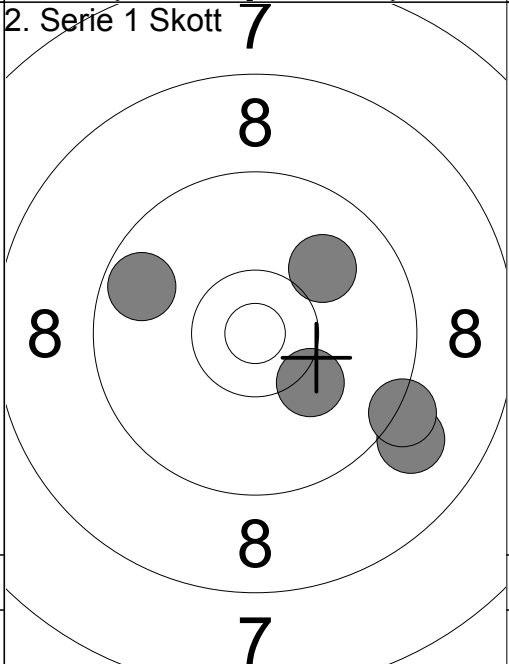

1:	10.0	↗
2:	9.7	←
3:	10.2	↘
4:	9.0	↘
5:	9.2	↘
Serie		47
Total		332

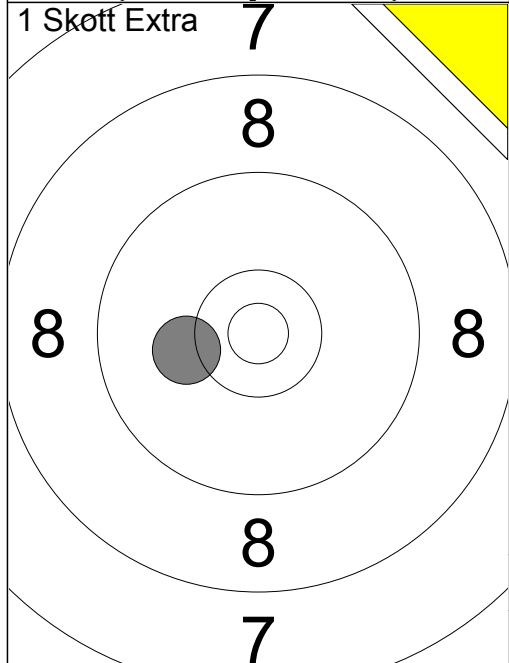

1:	10.2	←
Serie		10
Total		332



	<p>1: 8.6 ↓ 2: 9.6 ↓ 3: 9.3 ↓ 4: 8.8 ↓ 5: 9.6 ↑ 6: 9.7 ↓ 7: 10.7x ↙ 8: 9.8 ↑ 9: 10.5x ↗ 10: 9.1 ↖</p> <p>Serie 90 Total 182</p>	<p>Prov</p> <p>11: 9.6 ↑ 12: 9.8 ↖ 13: 9.0 ↖ 14: 10.4x ↑</p> <p>Serie 37 Total 182</p>
--	---	--

<p>1. Serie 10 Skott</p>	<p>1: 9.9 ↑ 2: 8.5 ↖ 3: 8.2 ↙ 4: 8.2 ↑ 5: 8.9 ↓</p> <p>Serie 41 Total 223</p>	<p>1. Serie 10 Skott</p> <p>6: 9.9 ↑ 7: 8.5 ↖ 8: 9.0 ↗ 9: 10.3x ↙ 10: 9.3 ↑</p> <p>Serie 45 Total 268</p>
--------------------------	---	---

<p>2. Serie 1 Skott</p>	<p>1: 9.1 ↗ 2: 8.8 ↑ 3: 9.5 ↗ 4: 9.5 ↘ 5: 7.9 ↑</p> <p>Serie 42 Total 310</p>	
-------------------------	---	--

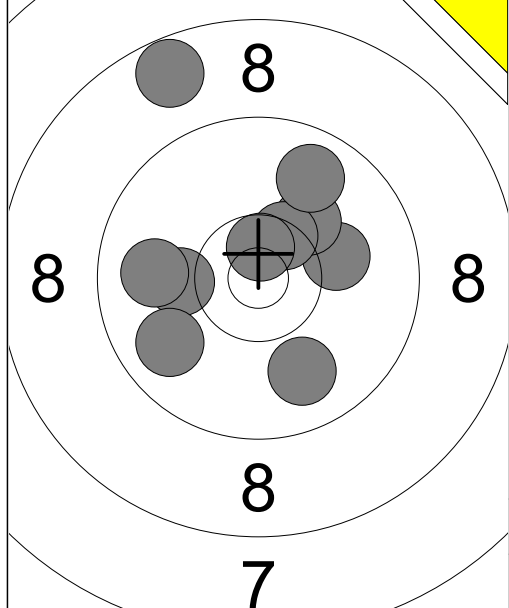

1:	8.7	↖
2:	10.1	→
3:	10.2	↗
4:	10.2	←
5:	9.8	↙
6:	9.9	←
7:	10.4x	↗
8:	10.6x	↑
9:	9.8	↗
10:	9.9	↘
Serie		94
Total		188

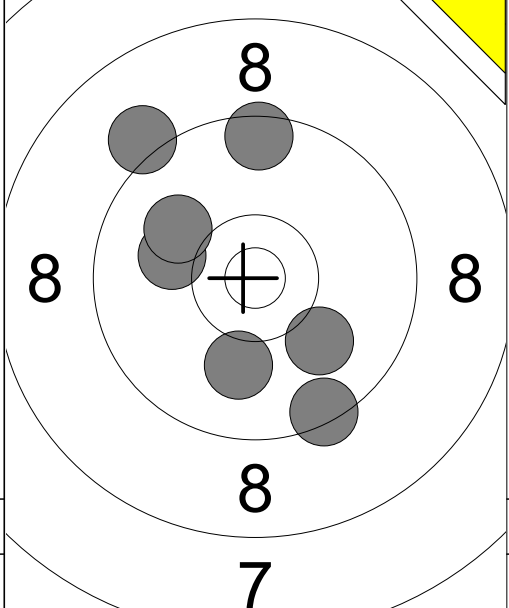

11:	9.1	↗
12:	10.1	←
13:	10.0	↖
14:	9.4	↘
15:	9.5	↑
16:	10.0	↘
17:	10.0	↘
Serie		67
Total		188

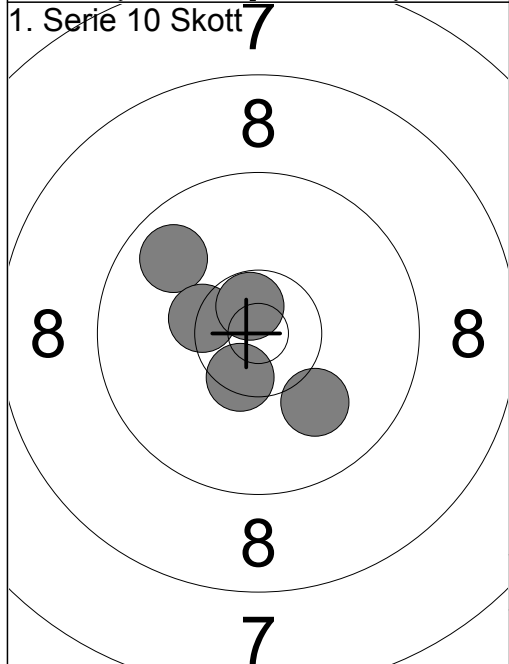

1:	10.0	↘
2:	9.8	↗
3:	10.4x	↖
4:	10.5x	↘
5:	10.7x	↗
Serie		49
Total		237

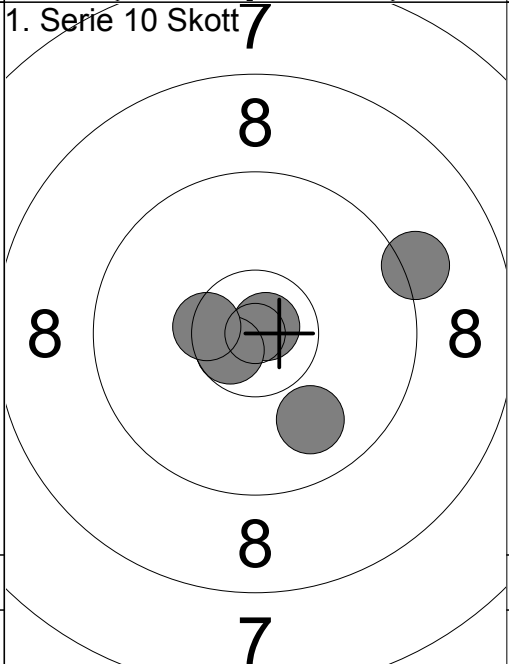

6:	9.9	↘
7:	10.8x	↗
8:	10.6x	↙
9:	10.5x	↖
10:	9.2	→
Serie		48
Total		285

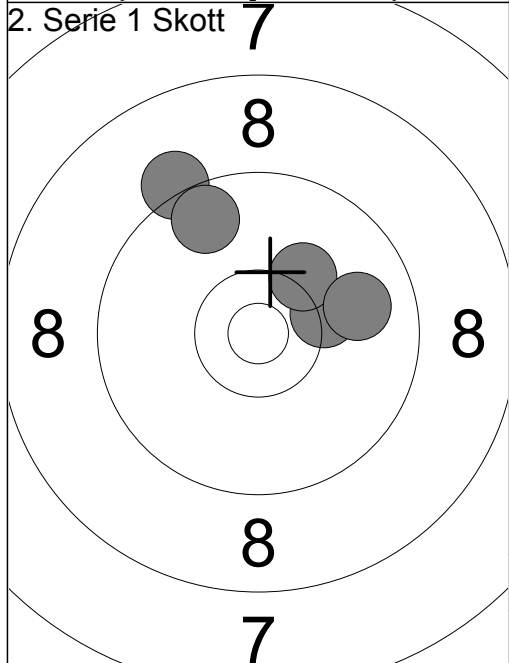

1:	9.2	↖
2:	10.3	→
3:	9.7	↖
4:	10.2	↗
5:	9.9	→
Serie		47
Total		332

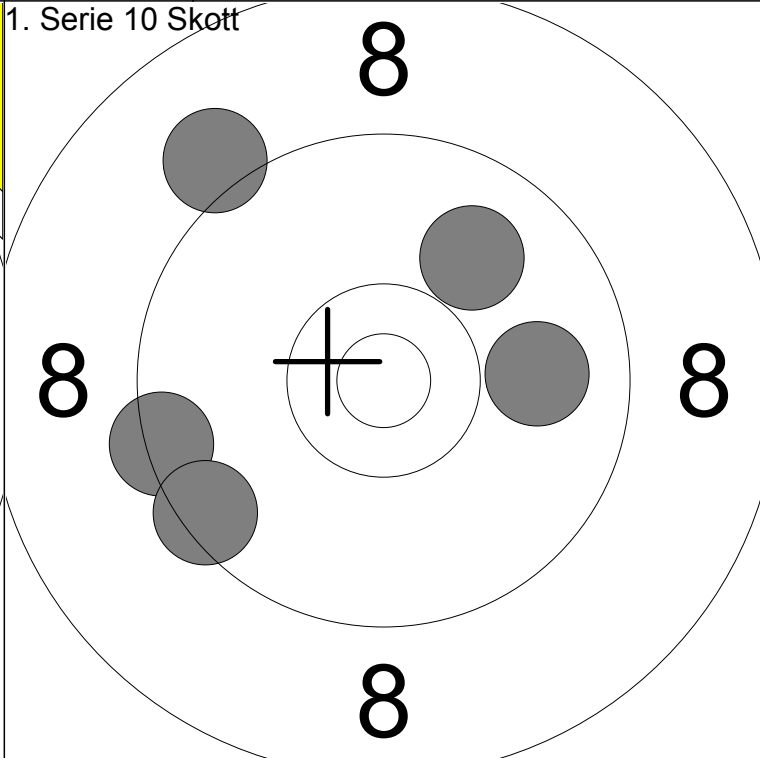
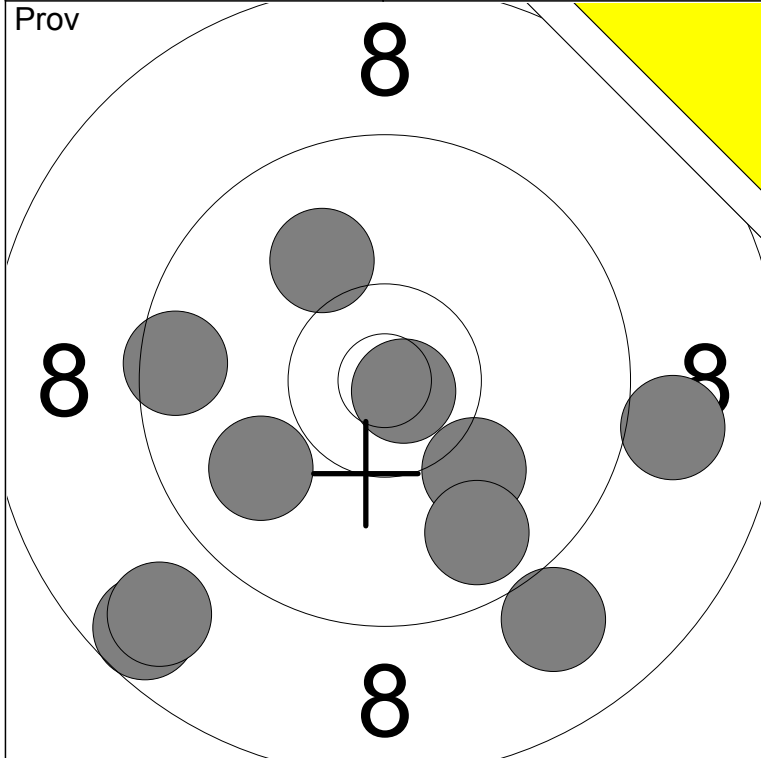

1: 9.9 ↙	6: 9.8 ↘	Serie	91
2: 10.1 ↘	7: 9.0 ↘		
3: 9.5 ←	8: 9.0 →	Total	184
4: 10.0 ↗	9: 8.8 ↘		
5: 8.6 ↙	10: 10.8x ↘		

1: 9.9 →	Serie	45
2: 9.4 ←		
3: 9.1 ↗	Total	229
4: 9.9 ↗		
5: 9.5 ↙		

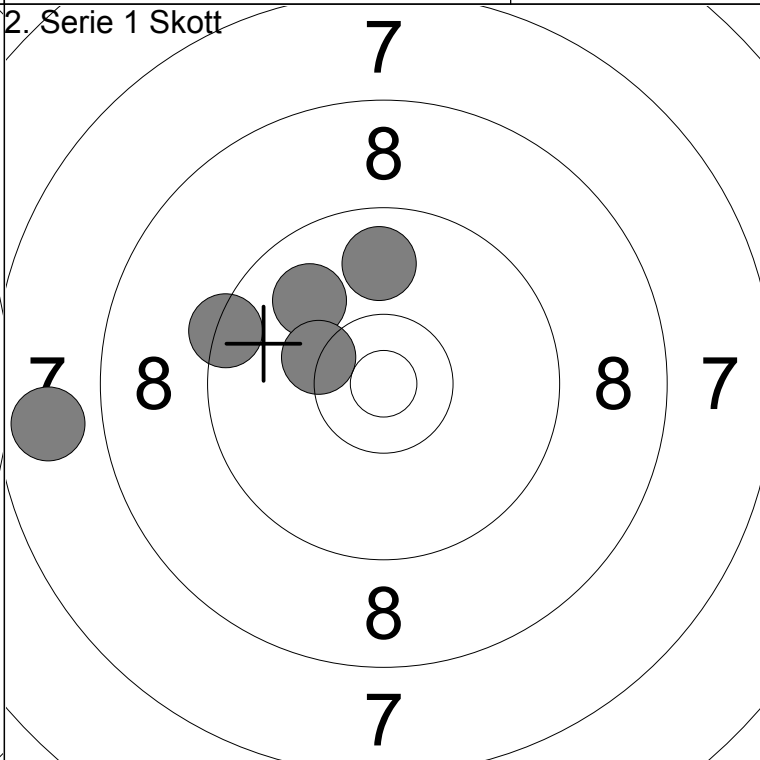
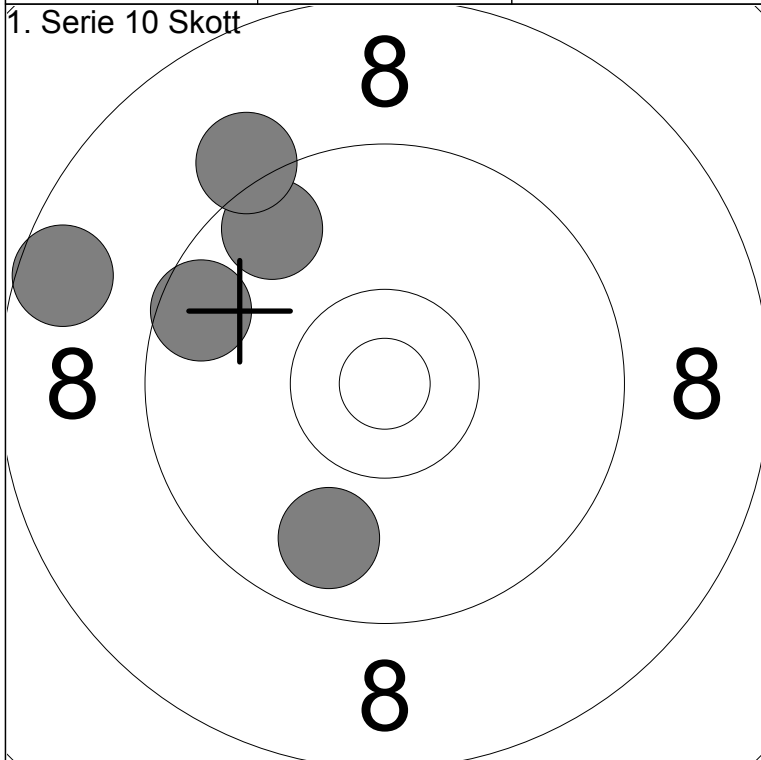

6: 9.8 ↙	Serie	44
7: 9.6 ↗		
8: 8.6 ↗	Total	273
9: 9.6 ↗		
10: 9.2 ↗		

1: 9.9 ↗	Serie	44
2: 9.8 ↗		
3: 7.8 ←	Total	317
4: 10.3x ↗		
5: 9.4 ←		

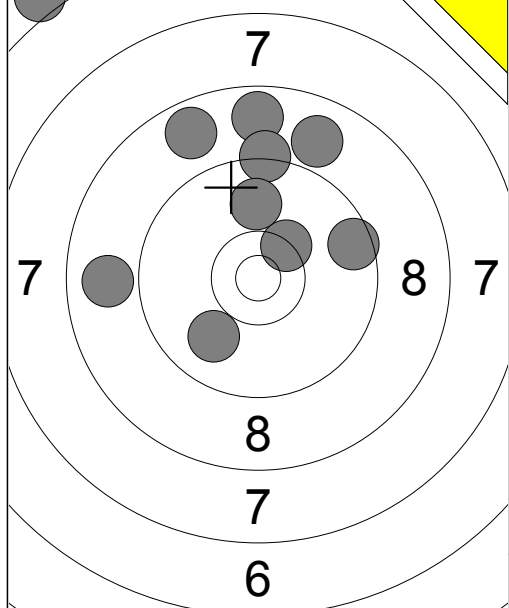

1:	8.7	↑
2:	9.6	→
3:	10.4x	↗
4:	9.3	↑
5:	6.0	↖
6:	9.9	↙
7:	8.7	↖
8:	8.9	↗
9:	9.9	↑
10:	8.9	←
Serie		84
Total		177

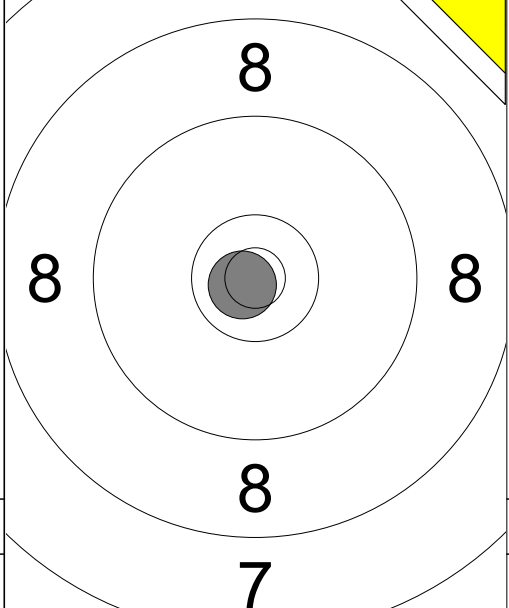

11:	10.8x	↙
Serie		10
Total		177

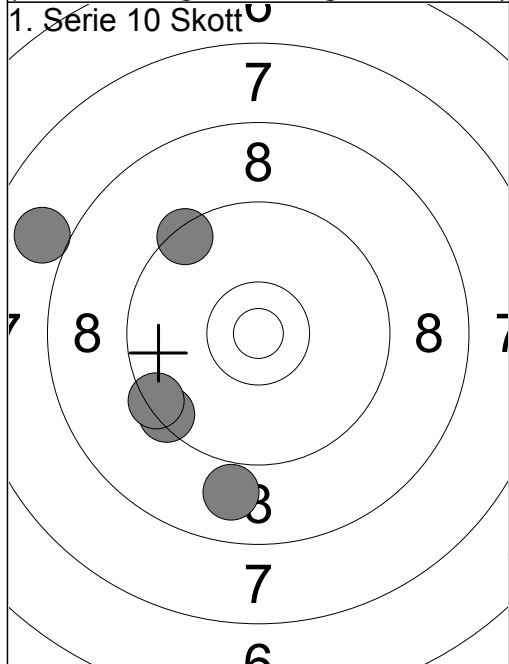

1:	8.9	↓
2:	8.0	↖
3:	9.4	↙
4:	9.4	↙
5:	9.4	↗
Serie		43
Total		220

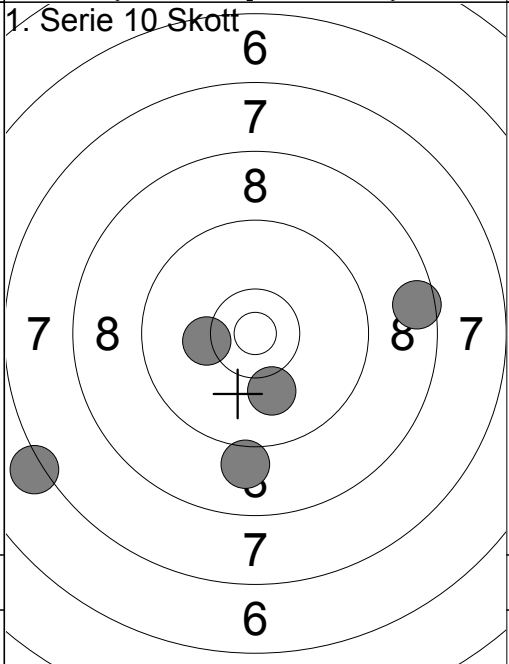

6:	9.0	↓
7:	7.2	↙
8:	10.2	←
9:	10.1	↓
10:	8.6	→
Serie		44
Total		264

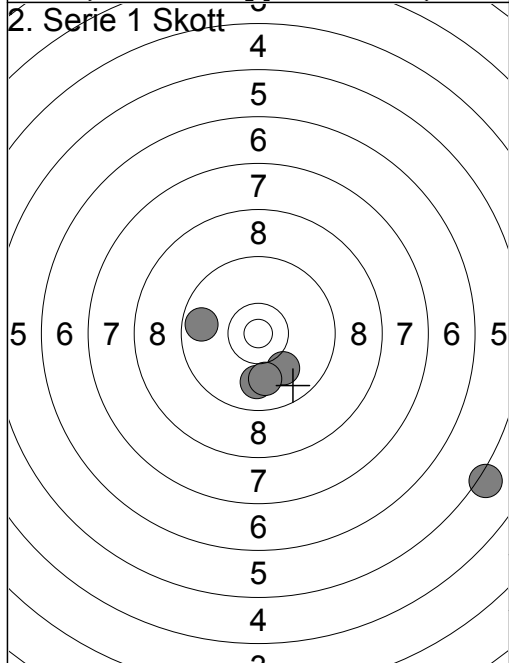

1:	9.7	←
2:	9.9	↓
3:	10.0	↘
4:	10.0	↓
5:	5.1	↘
Serie		43
Total		307

Ramselefors	Ramselefors	Ung-L	Vb
02.09.2017	Höstträffen 2017	Ramselefors SKF	

Prov 	1: 8.6 ↑ 2: 8.7 ↙ 3: 8.7 ↗ 4: 9.9 ↑ 5: 8.9 ↑ 6: 10.7x ↖ 7: 9.1 ↗ 8: 10.1 ← 9: 10.3x ↖ 10: 9.9 ↑ <hr/> Serie 89 Total 187	Prov 	11: 9.5 ↑ 12: 9.7 ↙ 13: 10.3 ← 14: 9.9 ↑ <hr/> Serie 37 Total 187
1. Serie 10 Skott 	1: 8.3 ↖ 2: 9.0 ↙ 3: 8.5 ↙ 4: 9.7 ↖ 5: 10.6x ↖ <hr/> Serie 44 Total 231	1. Serie 10 Skott 	6: 9.7 ← 7: 9.9 ↓ 8: 10.7x ↑ 9: 9.5 ← 10: 10.5x ↘ <hr/> Serie 47 Total 278
2. Serie 1 Skott 	1: 9.1 ↑ 2: 10.2 ← 3: 8.4 ↖ 4: 9.6 ↖ 5: 10.6x ↓ <hr/> Serie 46 Total 324	1 Skott Extra 	1: 9.8 ↗ <hr/> Serie 9 Total 324

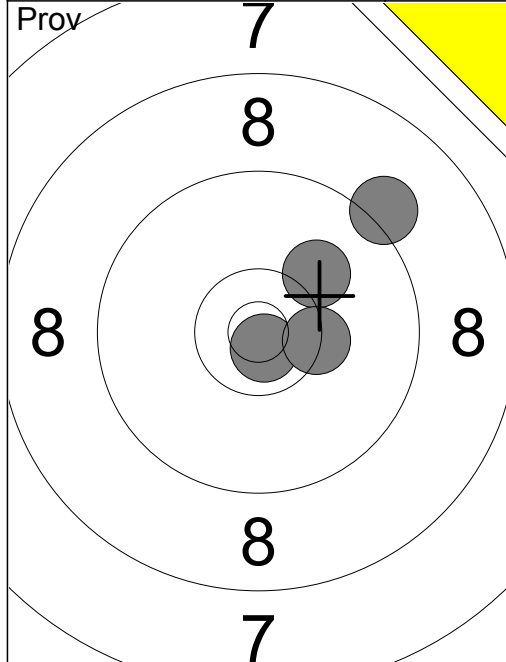

1: 9.2 ↗
2: 10.8x ↓
3: 10.1 ↗
4: 10.3x →
Serie 39
Total 182

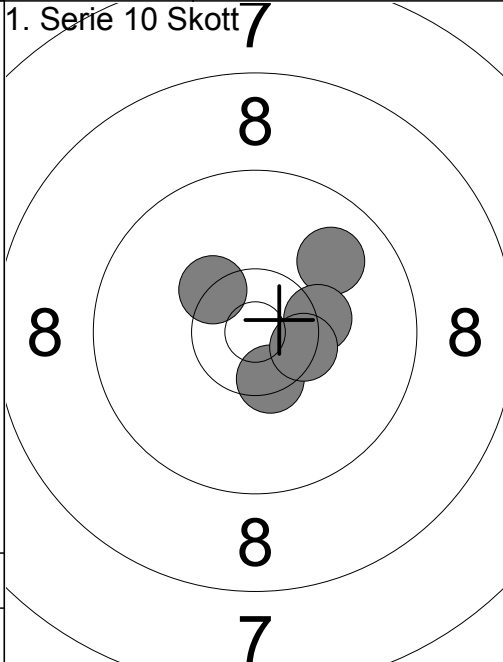

1: 9.9 ↗
2: 10.4x ↓
3: 10.3x ↖
4: 10.3x →
5: 10.4x →
Serie 49
Total 231

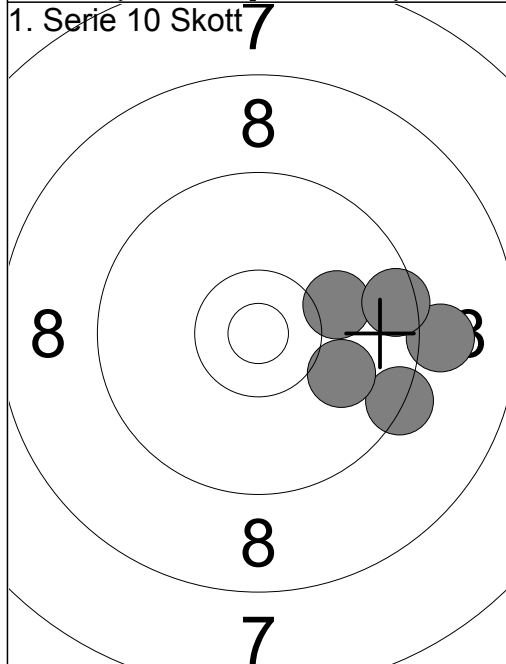

6: 9.3 →
7: 10.1 →
8: 9.1 →
9: 10.0 →
10: 9.5 →
Serie 47
Total 278

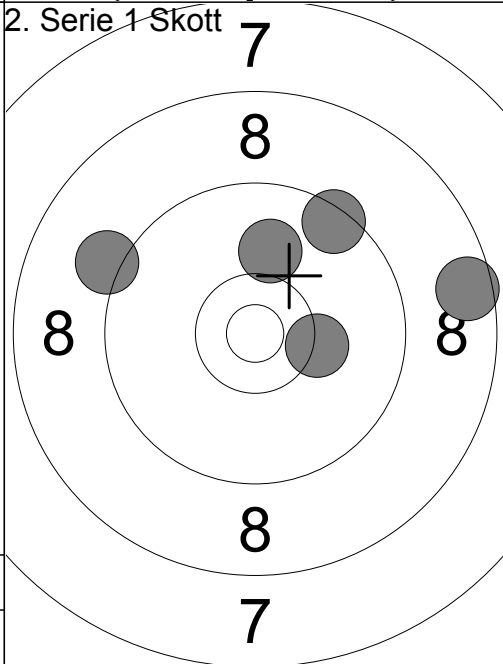

1: 9.1 ↖
2: 10.3 →
3: 9.4 ↗
4: 10.0 ↑
5: 8.6 →
Serie 46
Total 324

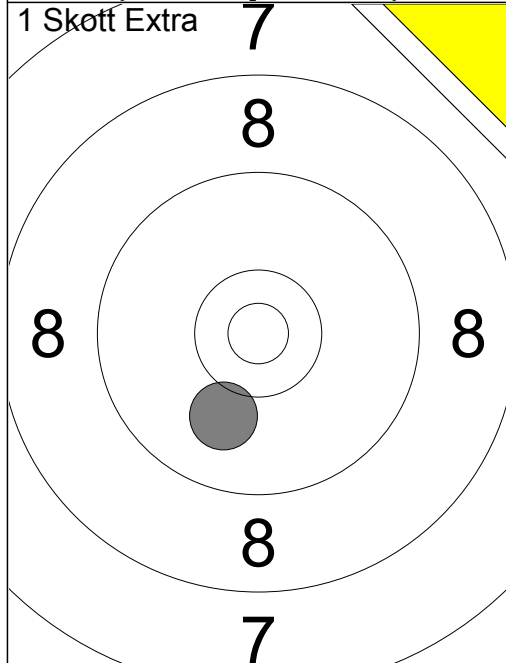

1: 10.0 ↓
Serie 10
Total 324

Prov 	1: 9.0 ← 2: 9.4 → 3: 10.4x ↑ 4: 7.7 → 5: 9.4 → 6: 8.3 ↖ 7: 8.6 ↖ 8: 10.5x ← 9: 9.3 ↗ 10: 9.5 ↗ Serie 88 Total 186	Prov 	11: 10.0 ↖ 12: 9.1 ← 13: 10.0 ↗ 14: 9.0 ↖ 15: 9.4 ↗ 16: 9.6 ↑ 17: 8.9 ↑ 18: 8.3 ↑ 19: 7.5 ↖ 20: 9.0 ↑ Serie 88 Total 186
----------	--	----------	---

1. Serie 10 Skott 	1: 8.9 ↑ 2: 7.7 ↑ 3: 9.7 ↑ 4: 8.4 ↖ 5: 8.3 ↑ Serie 40 Total 226	1. Serie 10 Skott 4 	6: 8.9 ↗ 7: 8.0 ↗ 8: 8.5 ↗ 9: 3.7 ↗ 10: 8.7 ↑ Serie 35 Total 261
-----------------------	---	-------------------------	--

2. Serie 1 Skott 	1: 0.0 2: 0.0 3: 0.0 4: 0.0 5: 0.0 Serie 0 Total 261		
----------------------	--	--	--

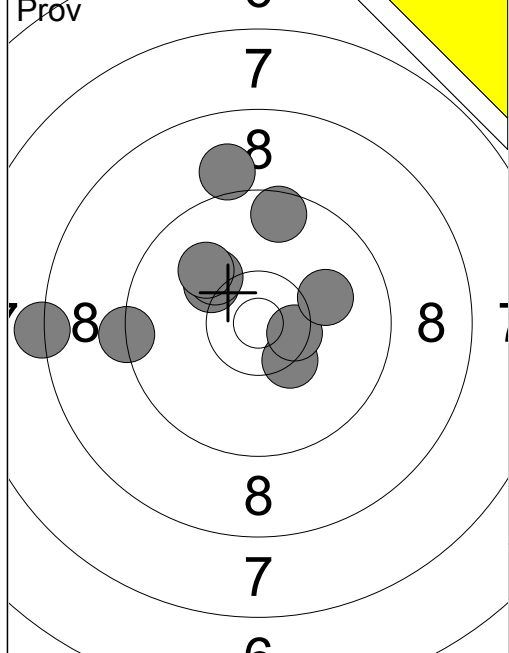

1:	8.3	←
2:	10.3x	↘
3:	10.5x	→
4:	10.2	↗
5:	10.1	→
6:	10.2	↗
7:	9.6	↑
8:	9.3	←
9:	9.0	↑
10:	10.0	↖
Serie		95
Total		178

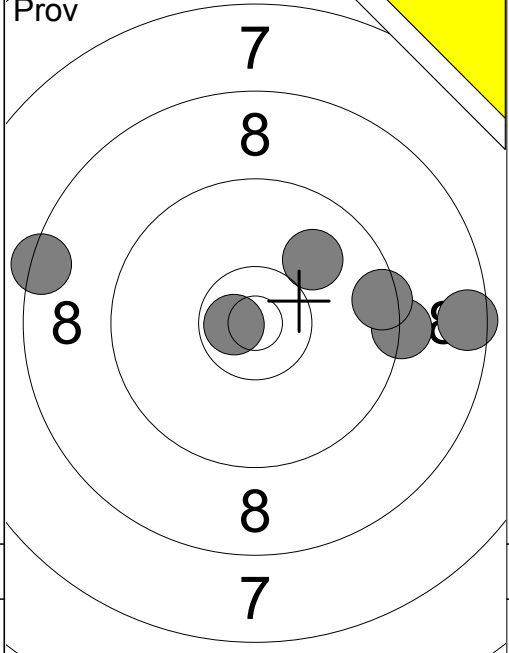

11:	8.5	→
12:	10.0	↗
13:	10.7x	←
14:	9.3	→
15:	9.5	→
16:	8.4	←
Serie		54
Total		178

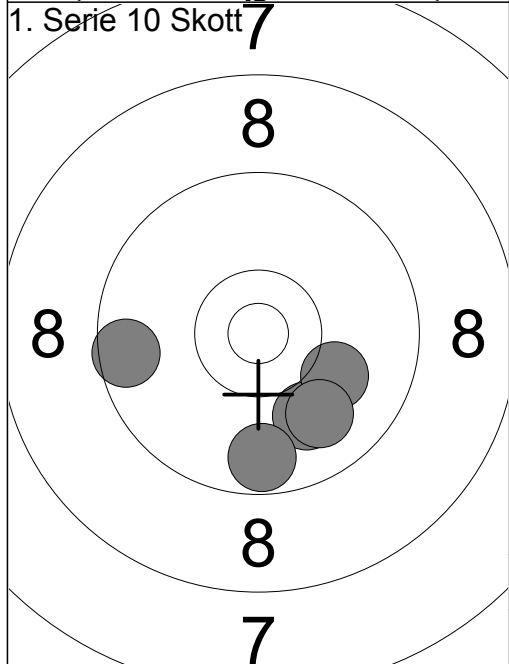

1:	10.0	↘
2:	10.1	→
3:	9.6	←
4:	9.7	↓
5:	9.9	↘
Serie		47
Total		225

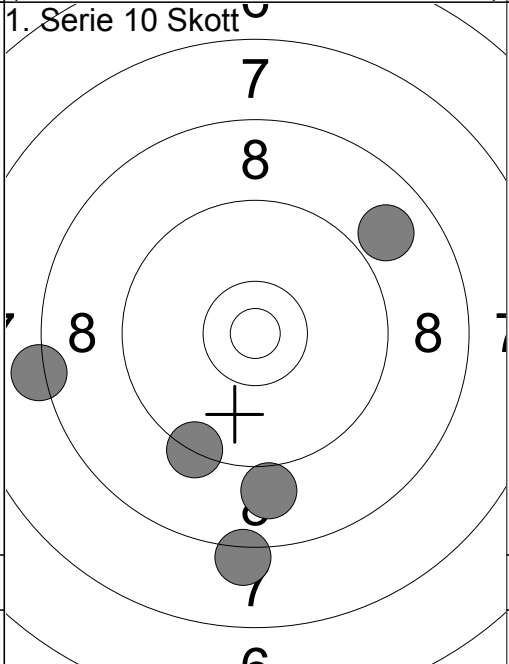

6:	9.3	↘
7:	8.2	↓
8:	9.0	↓
9:	8.2	←
10:	8.9	↗
Serie		42
Total		267

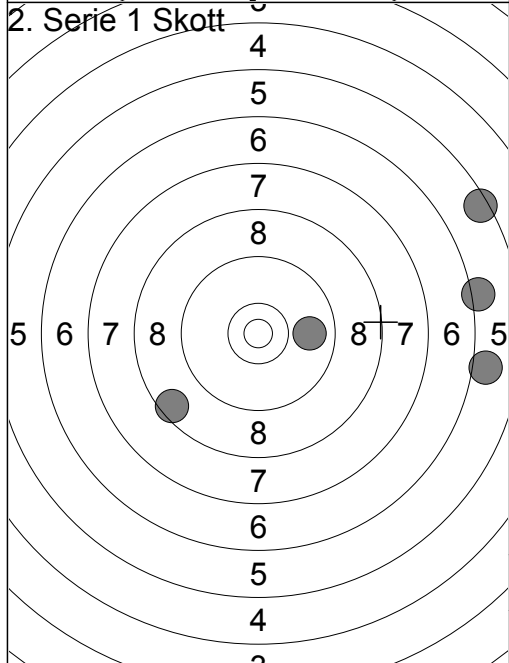

1:	9.8	→
2:	6.2	→
3:	5.5	↗
4:	6.0	→
5:	8.5	↘
Serie		34
Total		301



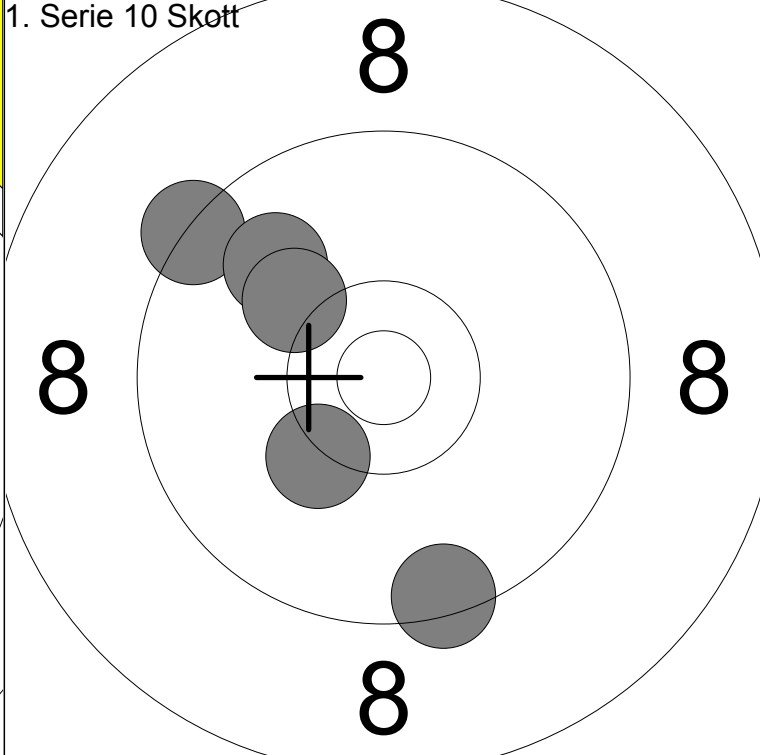
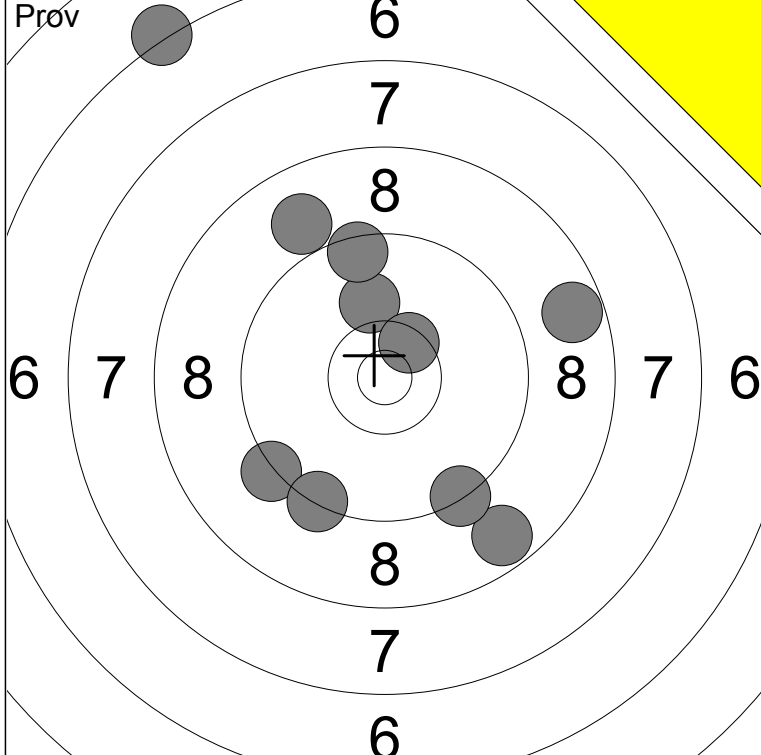

1: 6.2 ↗	6: 9.3 ↘	Serie	86
2: 8.7 ↘	7: 9.5 ↑		
3: 9.3 ↘	8: 8.7 →	Total	173
4: 9.3 ↙	9: 10.5x ↗		
5: 10.1 ↑	10: 8.9 ↖		

1: 10.3 ↘	Serie	47
2: 9.3 ↗		
3: 9.4 ↘	Total	220
4: 9.9 ↗		
5: 10.2 ↗		

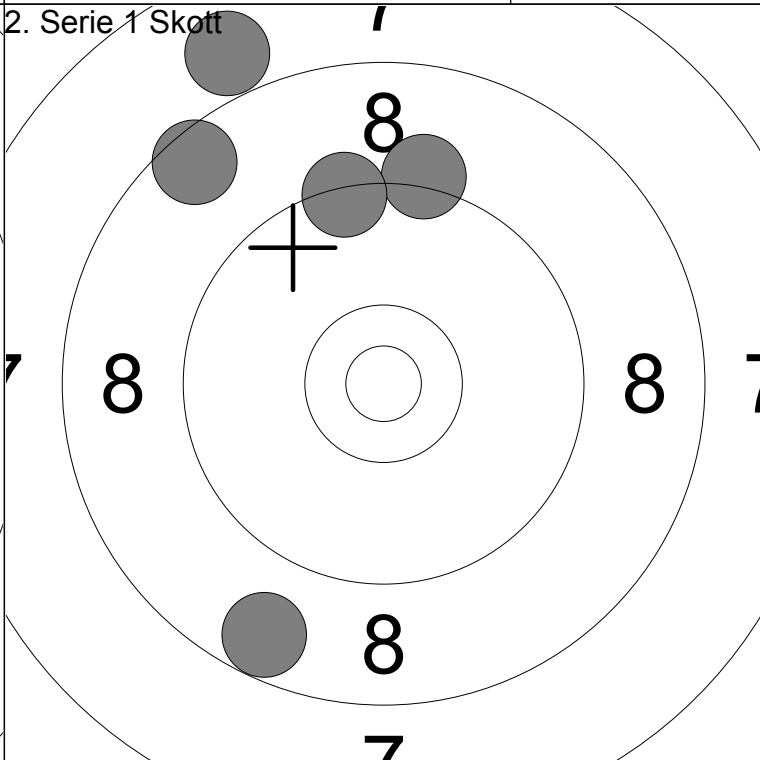
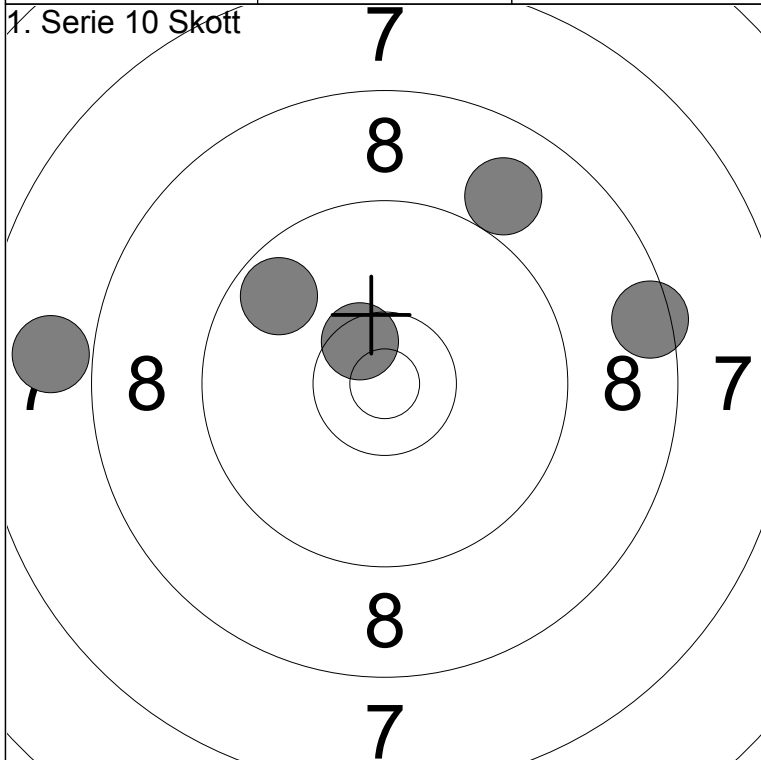

6: 8.9 ↗	Serie	42
7: 8.5 →		
8: 7.9 ←	Total	262
9: 9.7 ↗		
10: 10.5x ↗		

1: 9.2 ↑	Serie	41
2: 9.4 ↑		
3: 8.5 ↗	Total	303
4: 8.7 ↘		
5: 7.9 ↗		

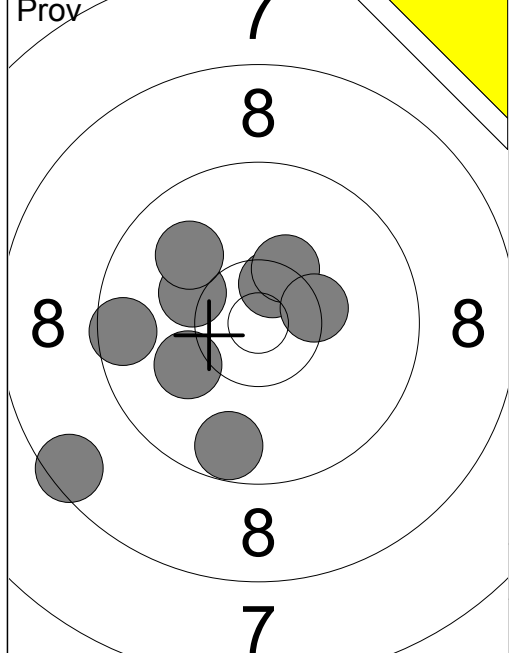

- 1: 10.5x ↗
- 2: 10.3x ↗
- 3: 10.4x →
- 4: 9.6 ←
- 5: 8.5 ↙
- 6: 9.7 ↓
- 7: 10.1 ↙
- 8: 10.2 ↙
- 9: 10.0 ↙

Serie 86  
Total 186

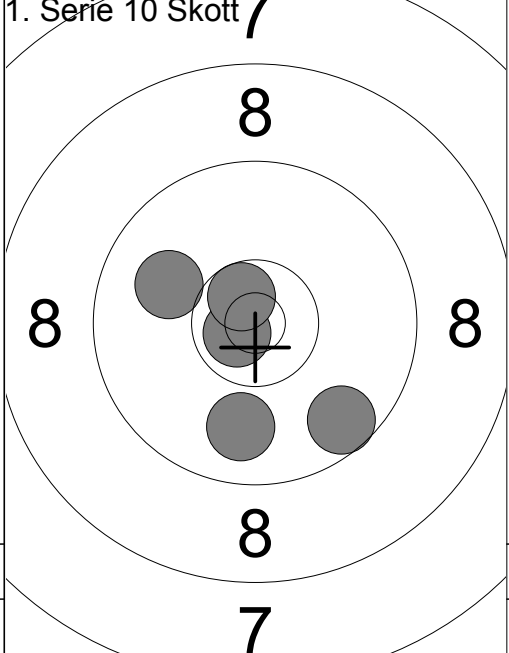

- 1: 9.6 ↓
- 2: 10.7x ↙
- 3: 10.0 ↙
- 4: 10.6x ↗
- 5: 9.9 ↓

Serie 48  
Total 234

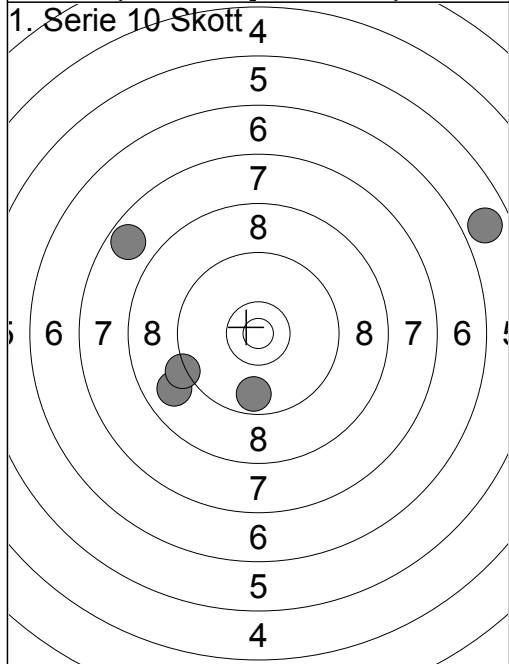

- 6: 7.7 ↙
- 7: 5.8 →
- 8: 8.9 ↙
- 9: 9.2 ↙
- 10: 9.7 ↓

Serie 38  
Total 272

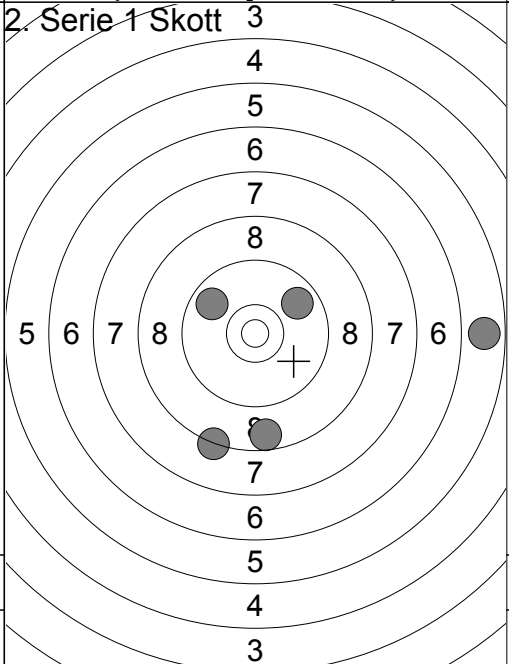

- 1: 8.7 ↓
- 2: 9.8 ↗
- 3: 5.8 →
- 4: 9.8 ↙
- 5: 8.3 ↓

Serie 39  
Total 311

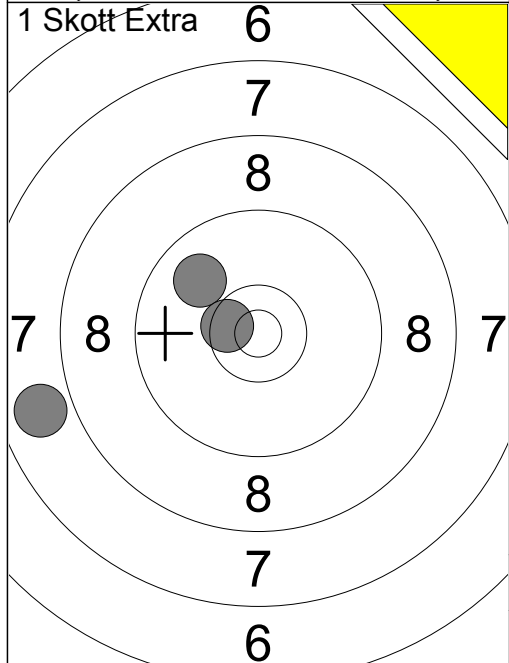

- 1: 9.9 ↙
- 2: 7.9 ←
- 3: 10.5x ↙

Serie 26  
Total 311

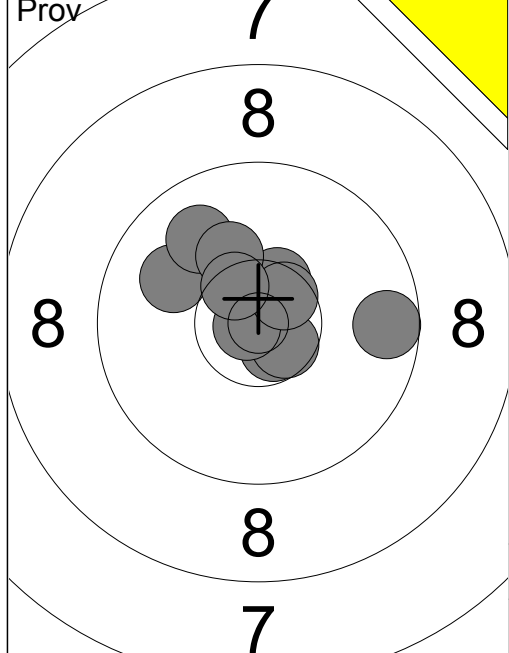

- 1: 10.7x ↘
- 2: 10.6x ↘
- 3: 9.6 →
- 4: 10.0 ↙
- 5: 10.5x ↗
- 6: 10.8x ↙
- 7: 9.9 ↗
- 8: 10.6x ↗
- 9: 10.2 ↗
- 10: 10.5x ↗

Serie 98  
Total 180

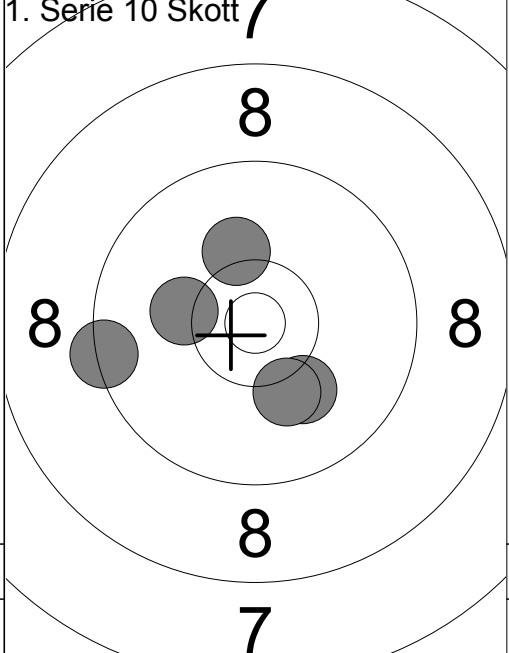

- 1: 9.4 ↙
- 2: 10.1 ↘
- 3: 10.2 ↗
- 4: 10.2 ↙
- 5: 10.2 ↘

Serie 49  
Total 229

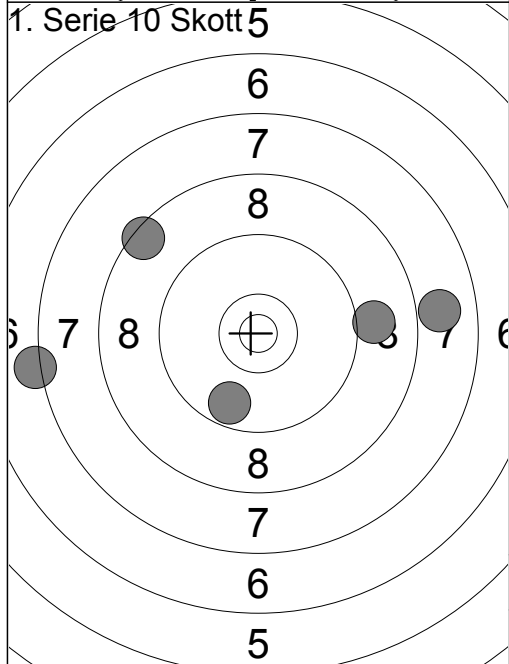

- 6: 9.0 →
- 7: 9.7 ↘
- 8: 7.9 →
- 9: 8.5 ↗
- 10: 7.2 ↙

Serie 40  
Total 269

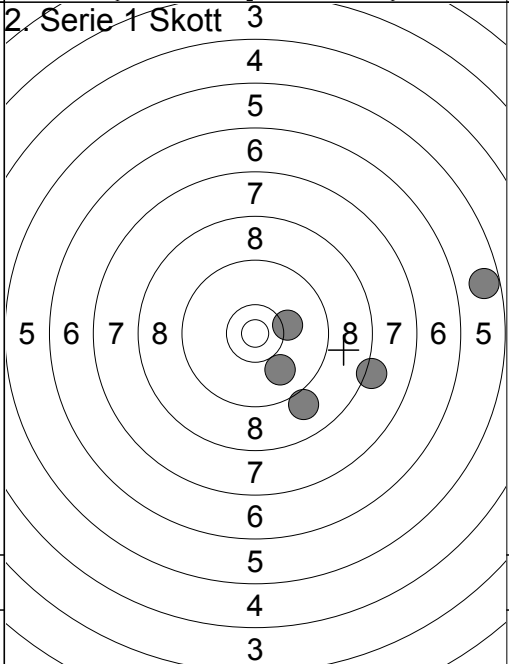

- 1: 10.2 →
- 2: 10.0 ↘
- 3: 9.0 ↘
- 4: 5.7 →
- 5: 8.2 →

Serie 42  
Total 311

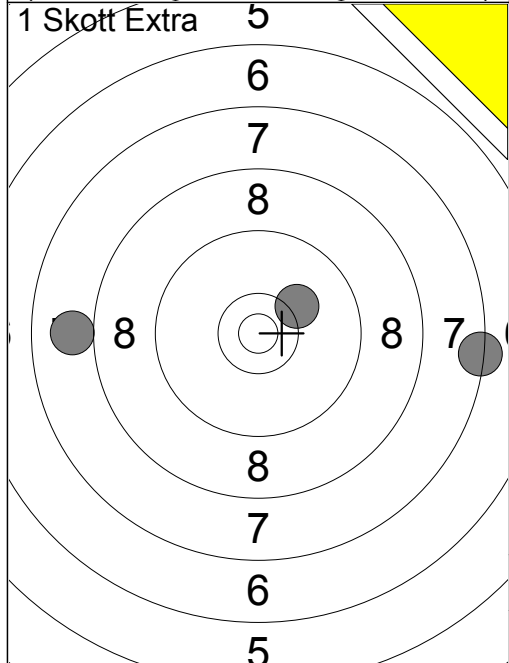

- 1: 7.4 →
- 2: 10.2 ↗
- 3: 8.0 ↙

Serie 25  
Total 311

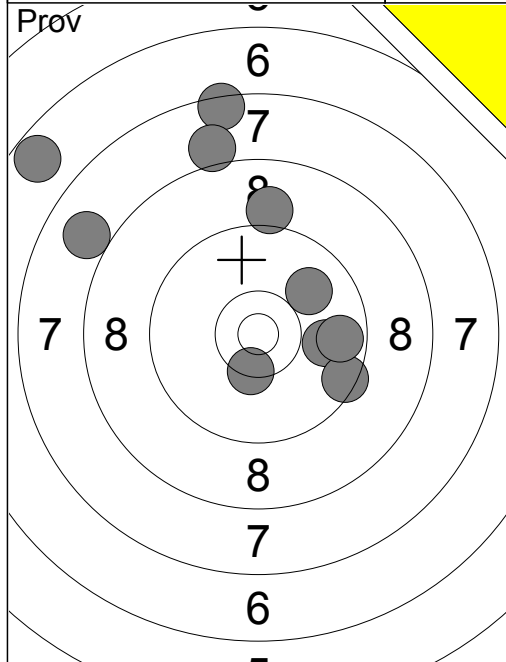

1:	7.5	↑
2:	9.1	↑
3:	9.9	↗
4:	9.9	→
5:	8.0	↑
6:	7.9	↖
7:	6.7	↖
8:	10.4x	↓
9:	9.5	→
10:	9.7	→
Serie		83
Total		168

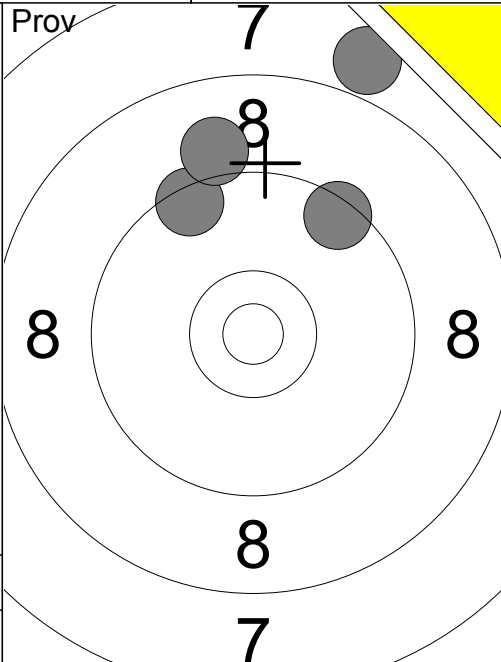

11:	7.9	↑
12:	9.5	↗
13:	9.4	↖
14:	9.0	↑
Serie		34
Total		168

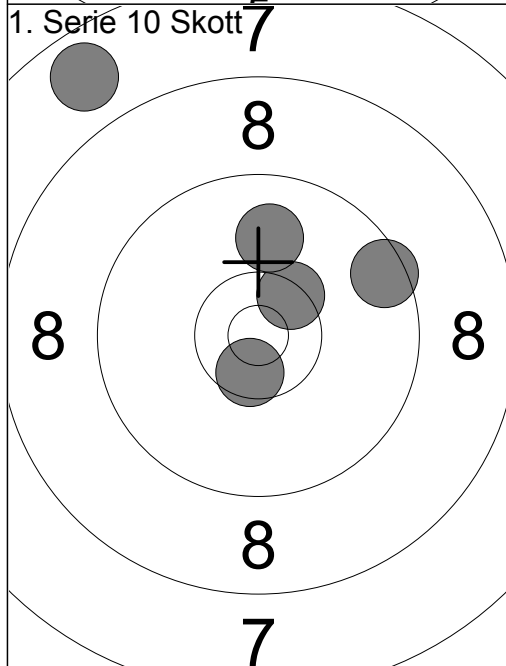

1:	10.4x	↗
2:	10.6x	↓
3:	7.8	↖
4:	9.5	↗
5:	9.9	↑
Serie		45
Total		213

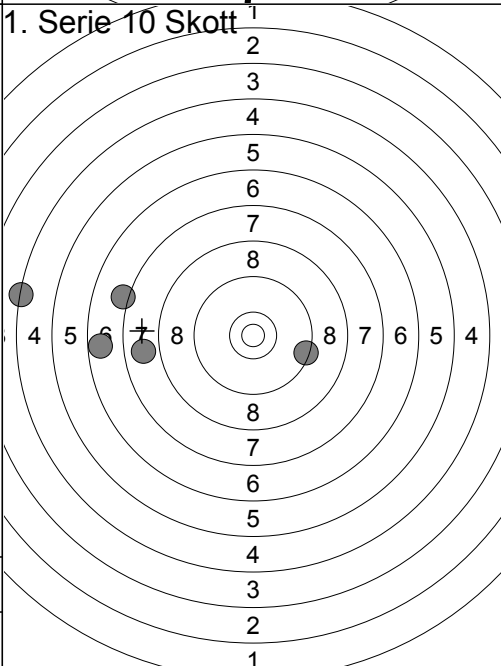

6:	4.3	↖
7:	6.6	↖
8:	7.8	↖
9:	9.4	→
10:	7.1	↖
Serie		33
Total		246

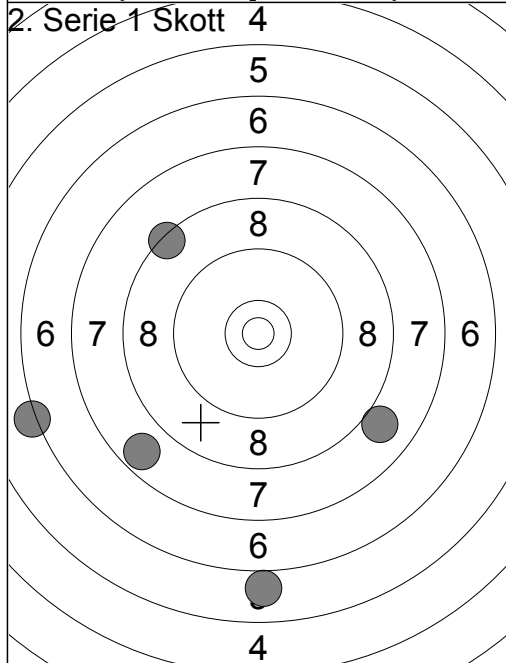

1:	8.0	→
2:	7.7	↖
3:	8.4	↖
4:	6.0	↓
5:	6.2	↖
Serie		35
Total		281

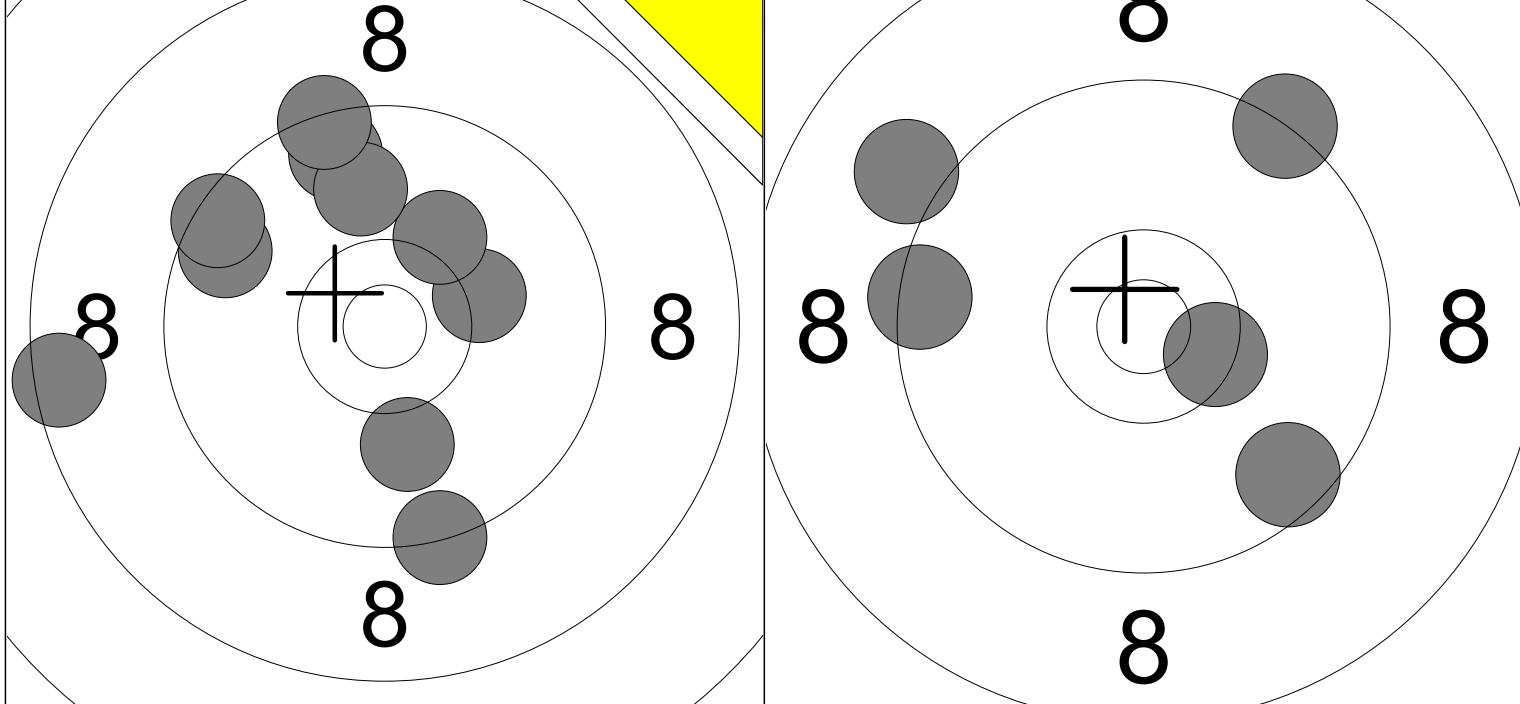

1: 9.3 ↓	6: 9.6 ↑	Serie	92	1: 9.6 ↓	Serie	46
2: 10.1 ↓	7: 9.9 ↑			2: 9.4 ←		
3: 10.2 →	8: 9.5 ↖	Total	165	3: 9.3 ↗	Total	211
4: 10.2 ↗	9: 9.4 ↑			4: 9.1 ↗		
5: 9.6 ↖	10: 8.5 ←			5: 10.4x ↘		

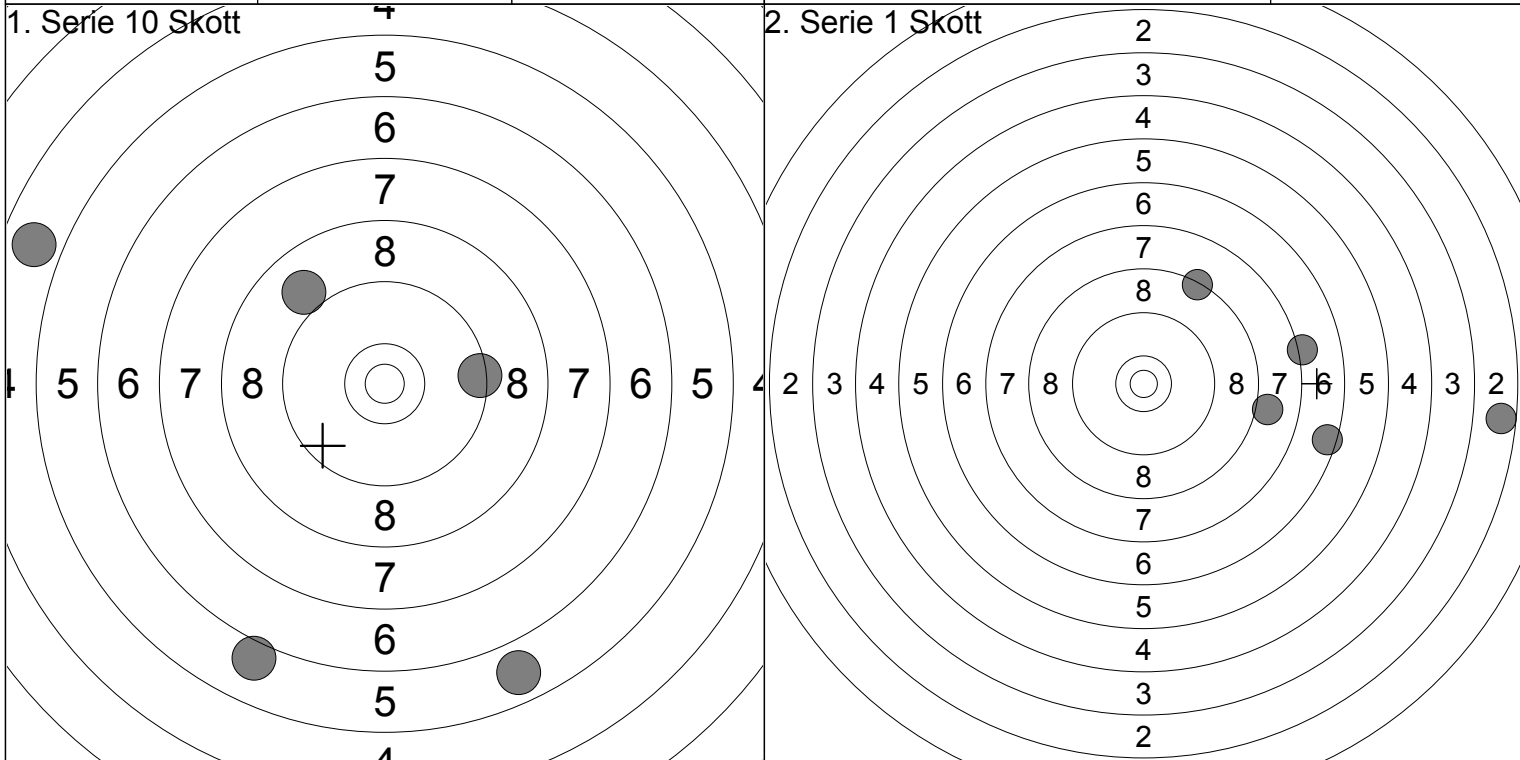

6: 4.8 ↖	Serie	33	1: 2.6 →	Serie	31
7: 9.4 →			2: 7.2 →		
8: 9.0 ↗	Total	244	3: 6.5 →	Total	275
9: 5.8 ↓			4: 8.0 →		
10: 6.0 ↓			5: 8.4 ↗		

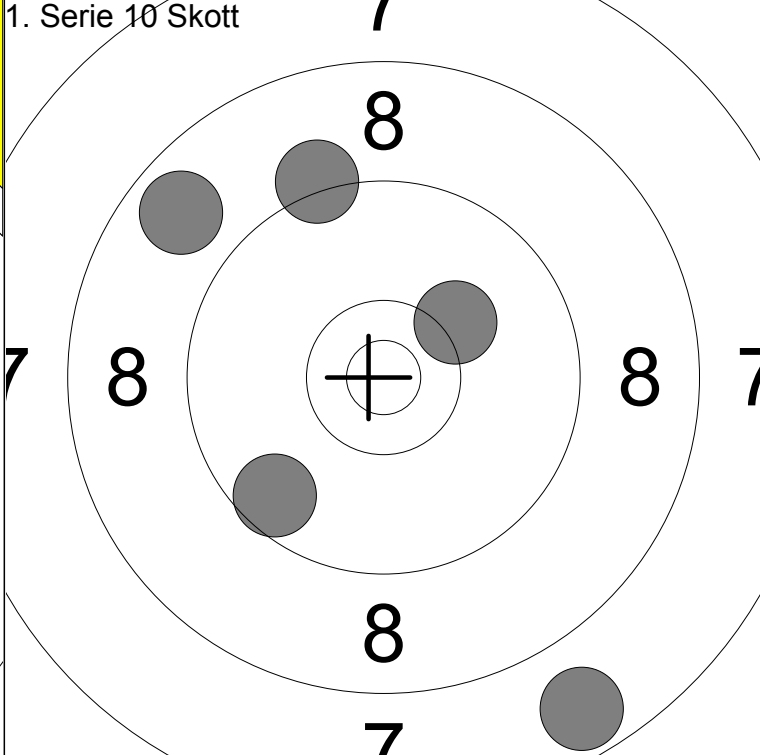
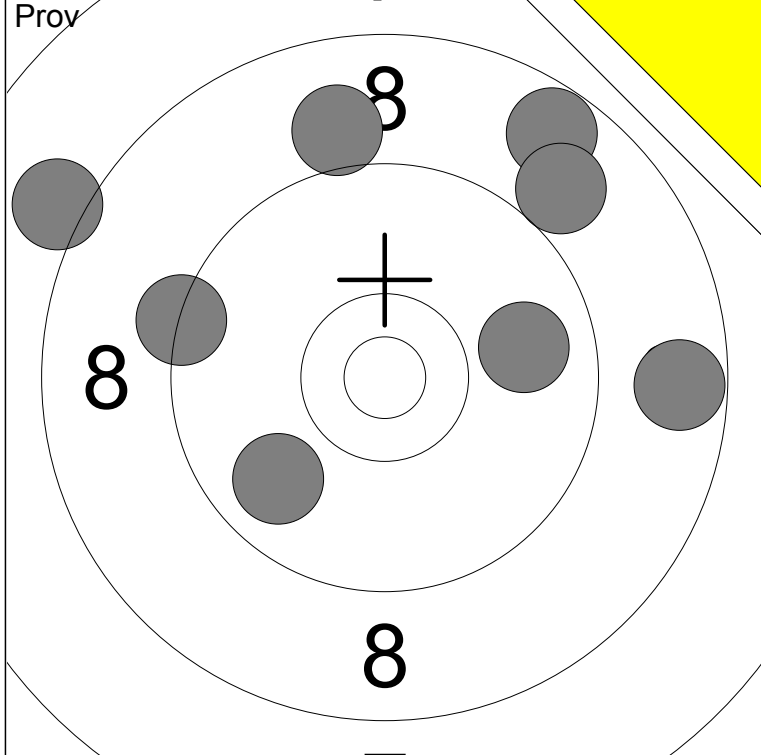

1: 8.7 ↗	6: 8.1 ↖	Serie	69
2: 8.7 →	7: 9.0 ↑		
3: 9.9 →	8: 9.8 ↘	Total	159
4: 9.0 ↗			
5: 9.3 ←			

1: 7.7 ↓	Serie	43
2: 9.6 ↘		
3: 10.2 ↗	Total	202
4: 9.2 ↑		
5: 8.8 ↖		

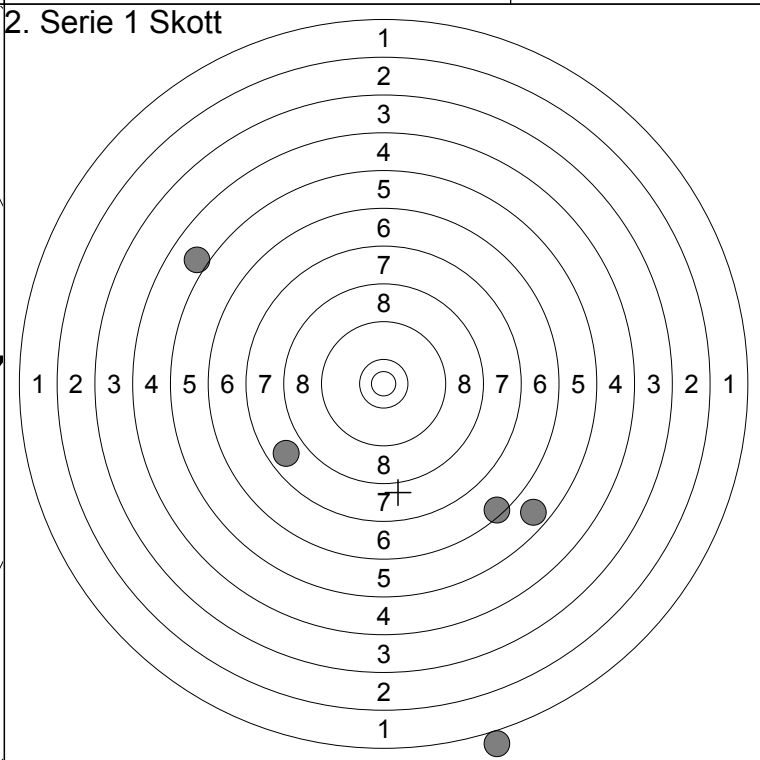
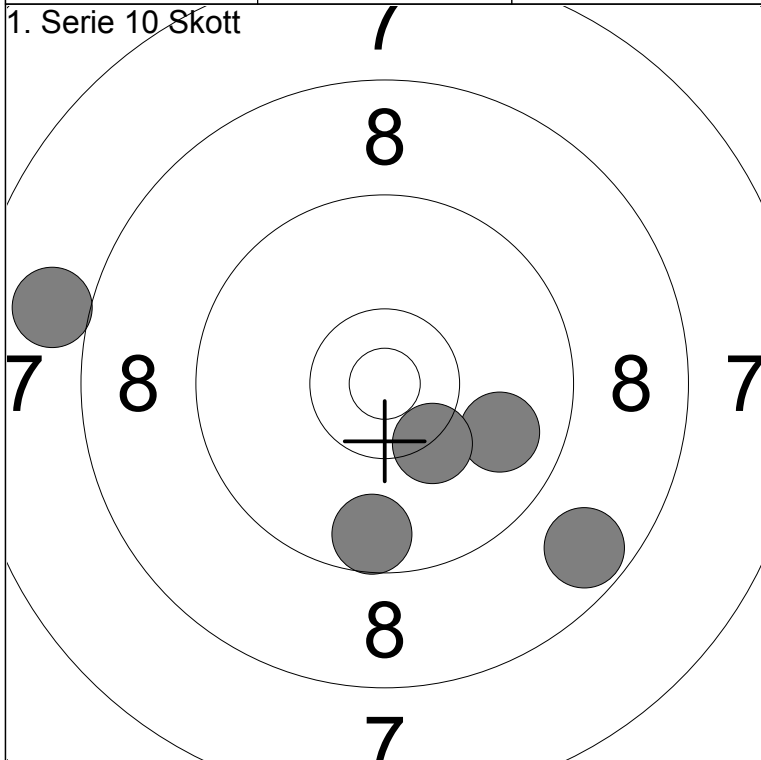

6: 9.9 ↘	Serie	44
7: 8.7 ↘		
8: 9.6 ↓	Total	246
9: 8.0 ↑		
10: 10.3 ↓		

1: 5.0 ↗	Serie	24
2: 5.7 ↘		
3: 6.5 ↘	Total	270
4: 1.0 ↓		
5: 7.8 ↘		

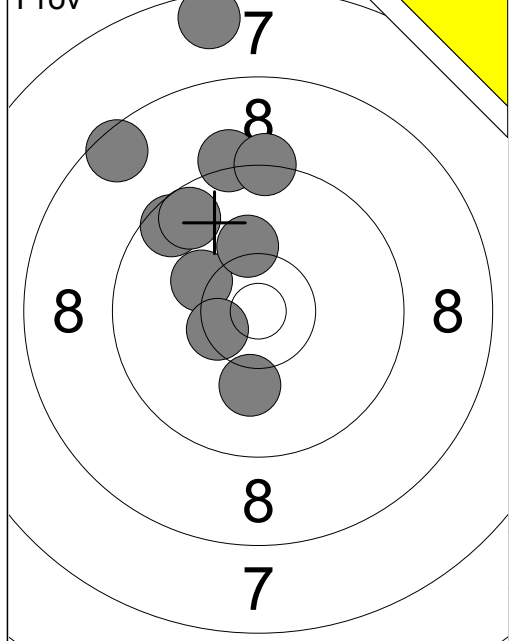

1:	9.6	↗
2:	9.6	↗
3:	7.6	↑
4:	9.2	↑
5:	9.3	↑
6:	8.5	↖
7:	10.2	↖
8:	10.4x	↖
9:	10.2	↑
10:	10.1	↓
Serie		91
Total		184

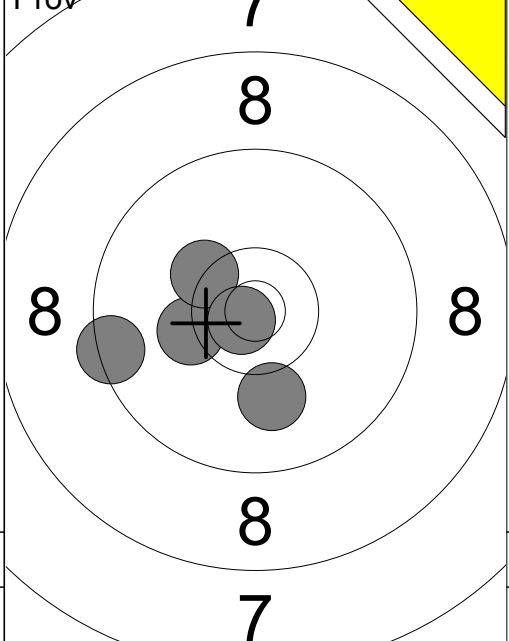

11:	10.3	←
12:	10.3x	↖
13:	10.1	↓
14:	10.8x	↖
15:	9.4	←
Serie		49
Total		184

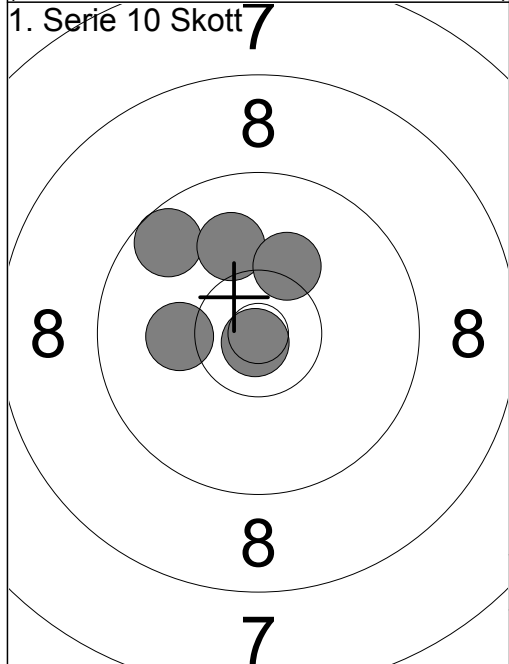

1:	9.6	↖
2:	10.9x	↓
3:	10.1	←
4:	10.0	↑
5:	10.2	↗
Serie		49
Total		233

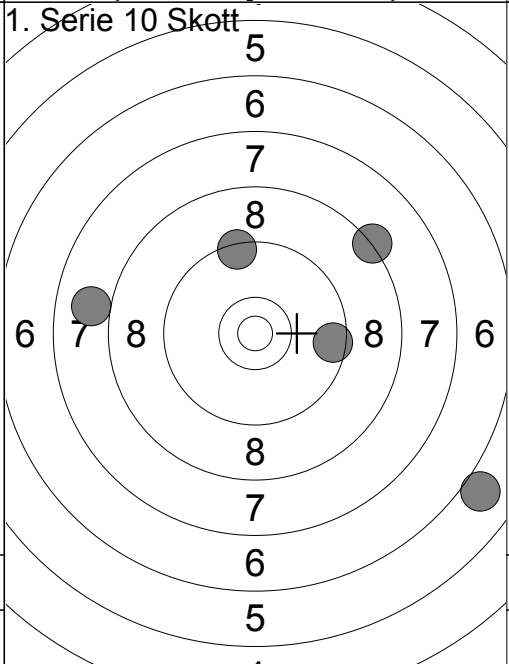

6:	6.0	↘
7:	7.9	←
8:	9.4	↑
9:	8.3	↗
10:	9.5	→
Serie		39
Total		272

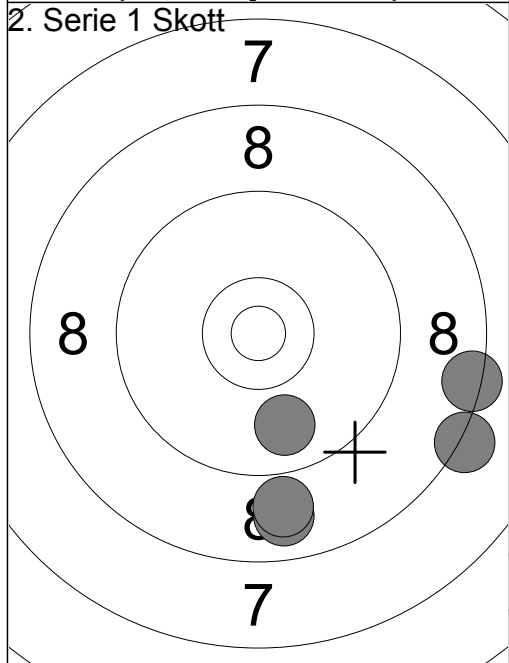

1:	8.2	→
2:	8.8	↓
3:	9.8	↓
4:	8.9	↓
5:	8.4	→
Serie		41
Total		313