

1:	10.3	↗
3:	8.6	↗
4:	9.2	↗
5:	8.4	↘
6:	8.6	↗
7:	9.6	↗
8:	9.1	↗
9:	9.0	↖
10:	7.7	↘
Serie		77
Total		0

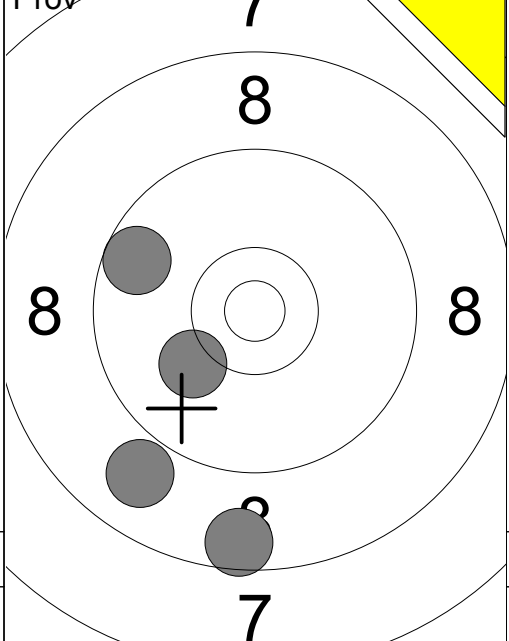

11:	10.1	↘
12:	9.6	↖
13:	8.9	↘
14:	8.6	↘
Serie		35
Total		0

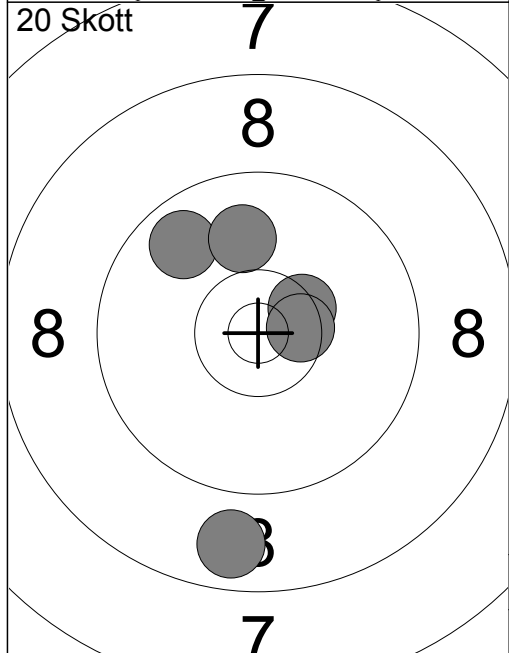

1:	8.8	↘
2:	10.4x	↗
3:	9.8	↖
4:	10.0	↗
5:	10.5x	↗
Serie		47
Total		47

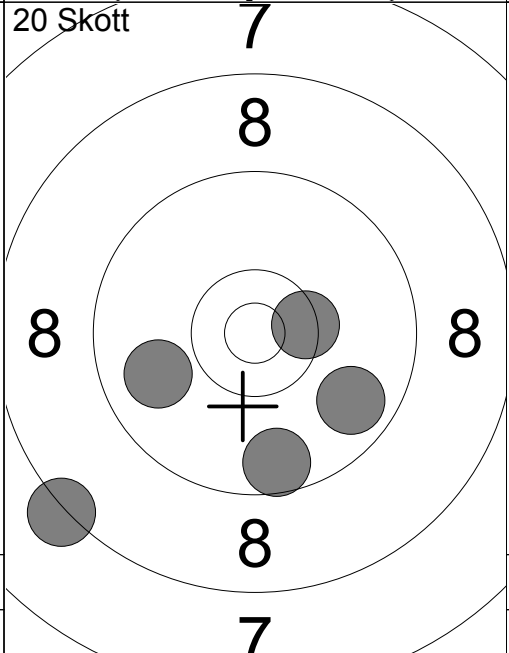

6:	10.4x	↗
7:	8.3	↘
8:	9.9	↖
9:	9.6	↘
10:	9.7	↘
Serie		45
Total		92

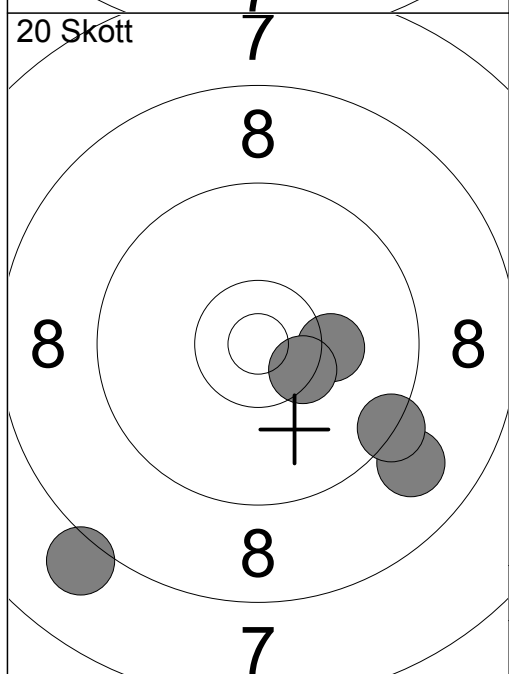

11:	10.2	↗
12:	9.0	↘
13:	10.4x	↗
14:	8.1	↘
15:	9.3	↘
Serie		46
Total		138

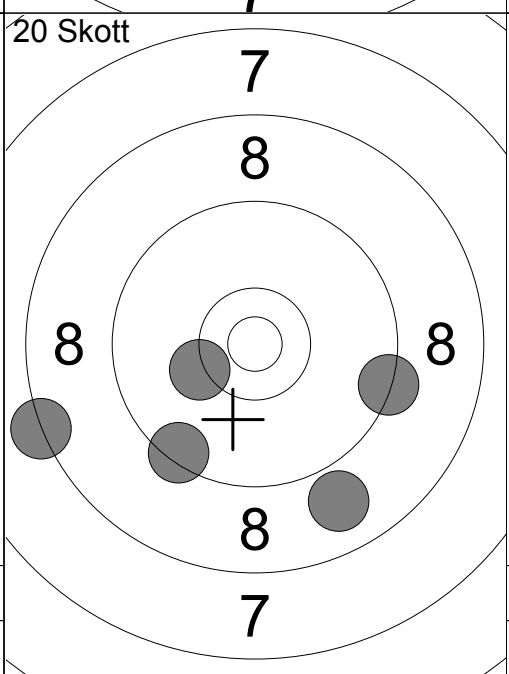

16:	8.9	↘
17:	10.2	↖
18:	9.4	↘
19:	9.3	↗
20:	8.3	↖
Serie		44
Total		182

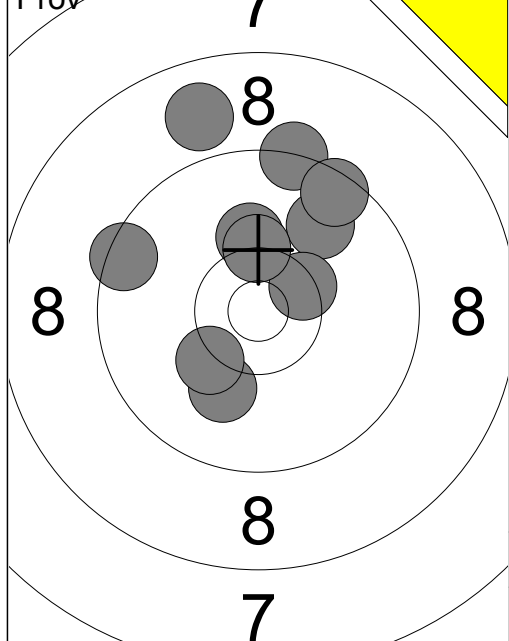

1:	9.9	↗
2:	10.1	↘
3:	9.3	↗
4:	9.5	↖
5:	8.9	↗
6:	10.2	↗
7:	10.4x	↗
8:	9.5	↗
9:	10.2	↘
10:	10.3x	↗
Serie		94
Total		0

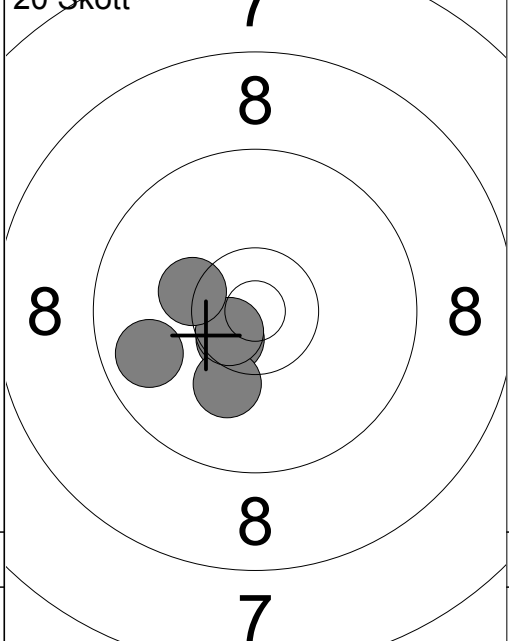

1:	10.6x	↘
2:	10.2	↘
3:	10.6x	↘
4:	10.3	↖
5:	9.8	↖
Serie		49
Total		49

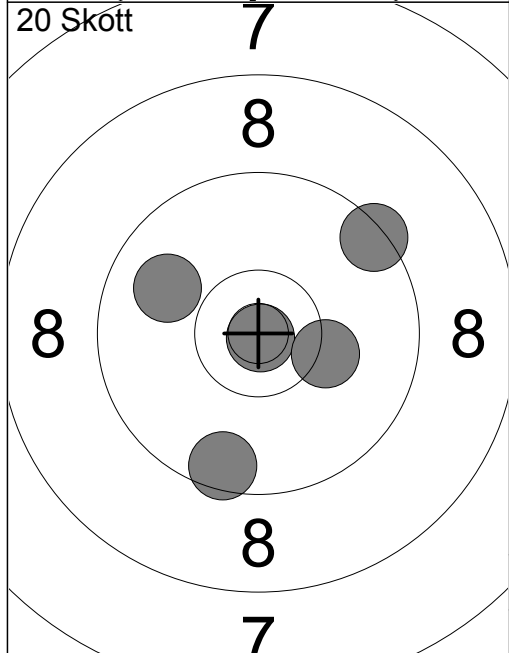

6:	9.5	↘
7:	10.9x	↘
8:	9.9	↖
9:	10.2	→
10:	9.4	↗
Serie		47
Total		96

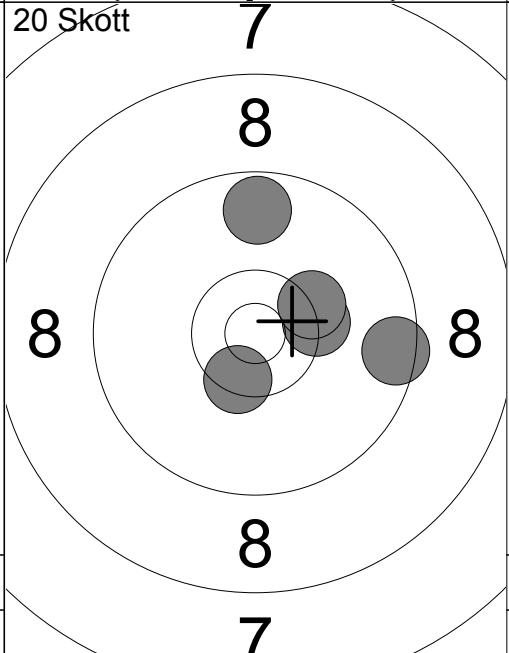

11:	10.4x	↘
12:	10.3x	→
13:	9.7	↗
14:	10.3x	↗
15:	9.5	→
Serie		48
Total		144

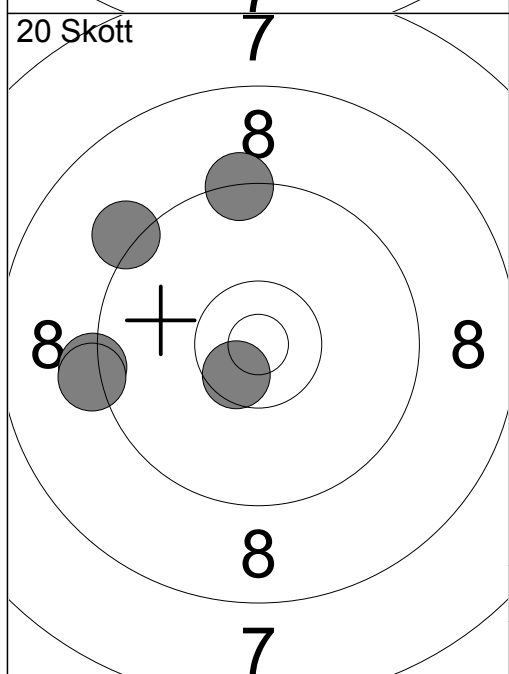

16:	9.2	↖
17:	9.3	↗
18:	9.2	↖
19:	9.2	↖
20:	10.6x	↘
Serie		46
Total		190

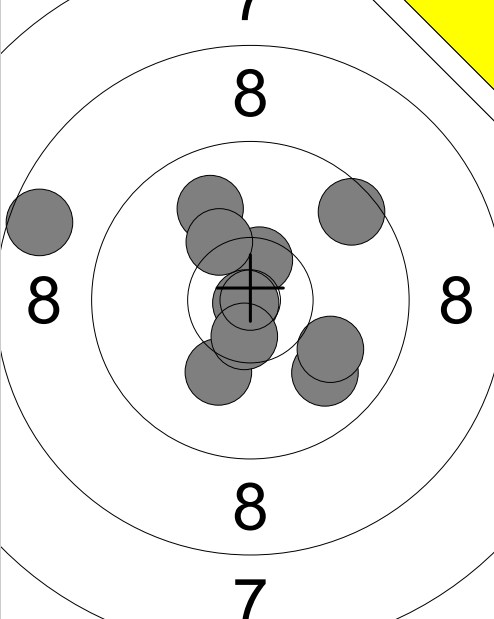
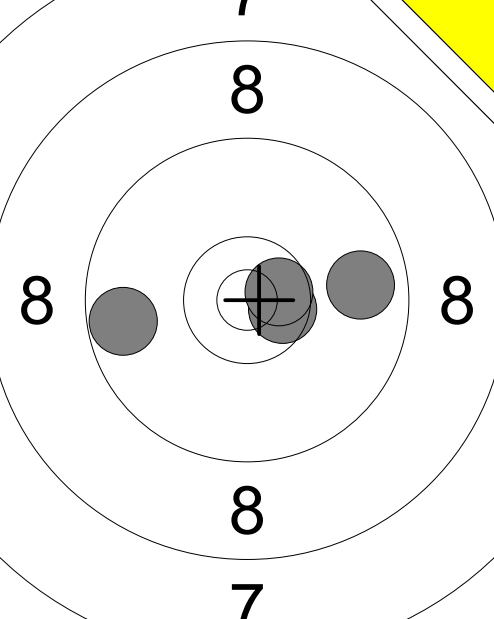
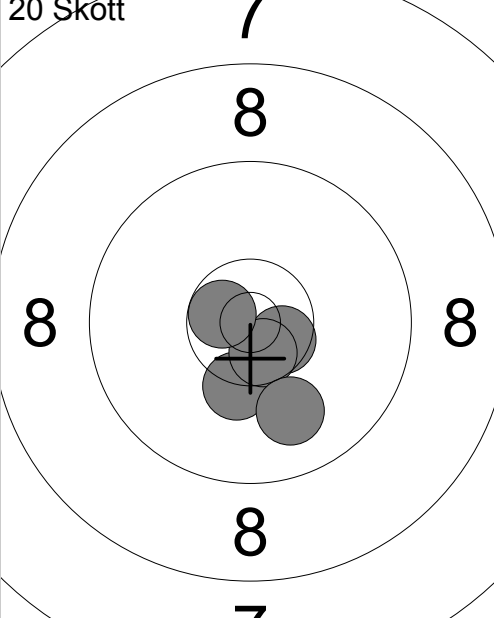
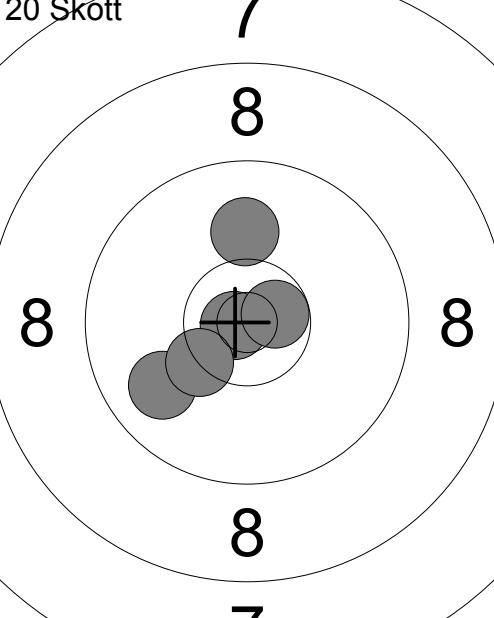
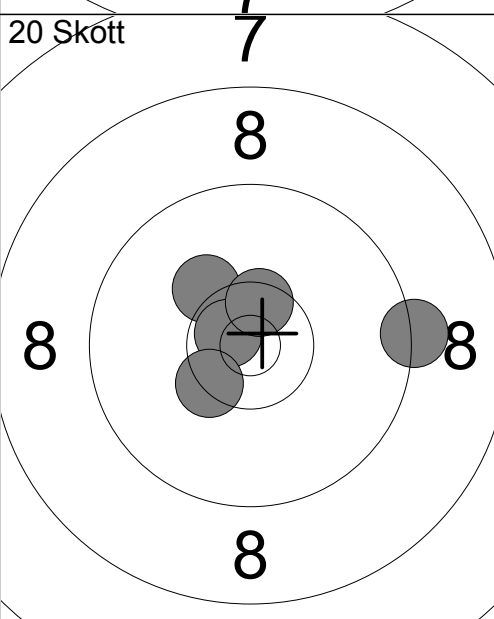
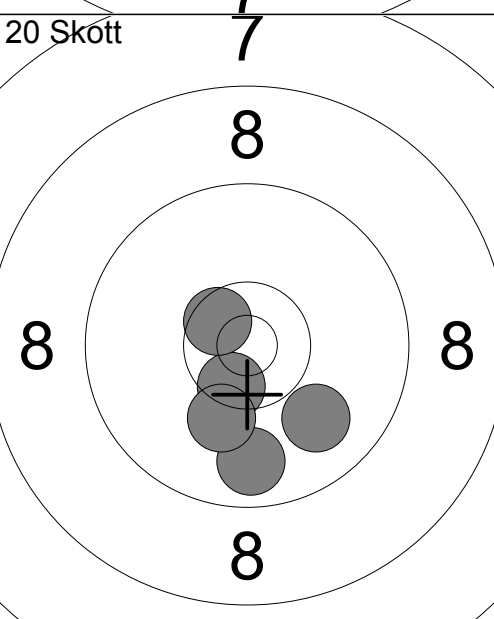
Prov 	1: 10.1 ↓ 2: 9.9 ↓ 3: 10.5x ↑ 4: 10.0 ↓ 5: 8.6 ← 6: 9.9 ↑ 7: 10.9x ↙ 8: 10.6x ↓ 9: 9.5 ↗ 10: 10.3 ↑ Serie 95 Total 0	Prov 	11: 9.7 ← 12: 10.6x → 13: 9.8 → 14: 10.6x → Serie 38 Total 0
20 Skott 	1: 10.3x ↓ 2: 10.6x → 3: 10.6x ↓ 4: 10.0 ↓ 5: 10.6x ← Serie 50 Total 50	20 Skott 	6: 10.8x ← 7: 9.9 ↙ 8: 10.3x ↙ 9: 10.0 ↑ 10: 10.7x → Serie 49 Total 99
20 Skott 	11: 10.2 ↑ 12: 10.7x ↙ 13: 9.3 → 14: 10.5x ↑ 15: 10.4x ↙ Serie 49 Total 148	20 Skott 	16: 9.9 ↓ 17: 10.5x ↓ 18: 9.8 ↓ 19: 10.2 ↓ 20: 10.6x ↙ Serie 48 Total 196

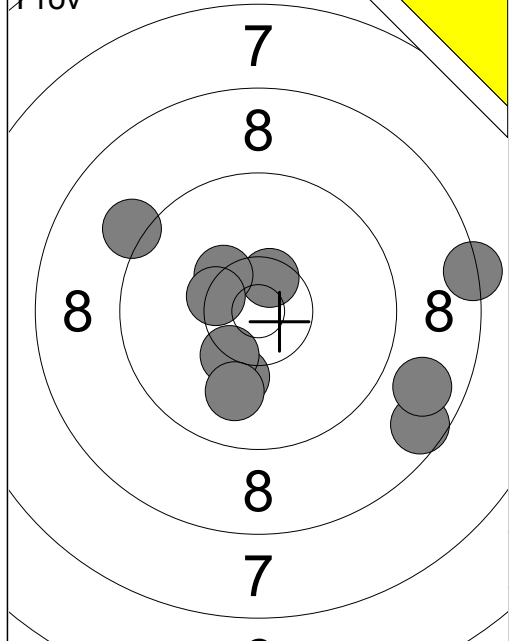

1:	8.6	↘
2:	8.8	↘
3:	8.3	→
4:	9.2	↖
5:	10.5x	↑
6:	10.4x	↖
7:	10.4x	↖
8:	10.1	↓
9:	10.3x	↘
10:	10.0	↓
Serie		93
Total		0

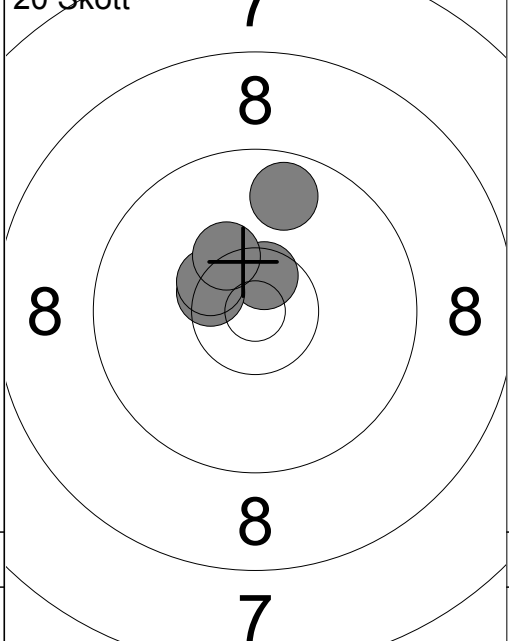

1:	10.6x	↑
2:	10.5x	↖
3:	10.4x	↖
4:	10.3x	↖
5:	9.7	↑
Serie		49
Total		49

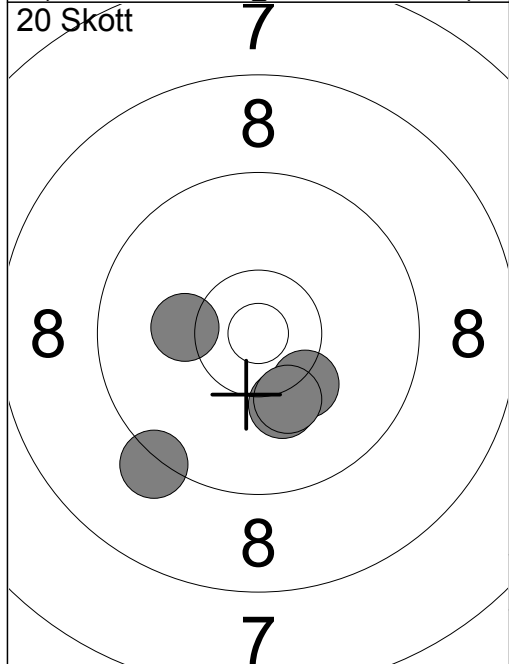

6:	9.2	↘
7:	10.2	↓
8:	10.2	←
9:	10.2	↘
10:	10.2	↘
Serie		49
Total		98

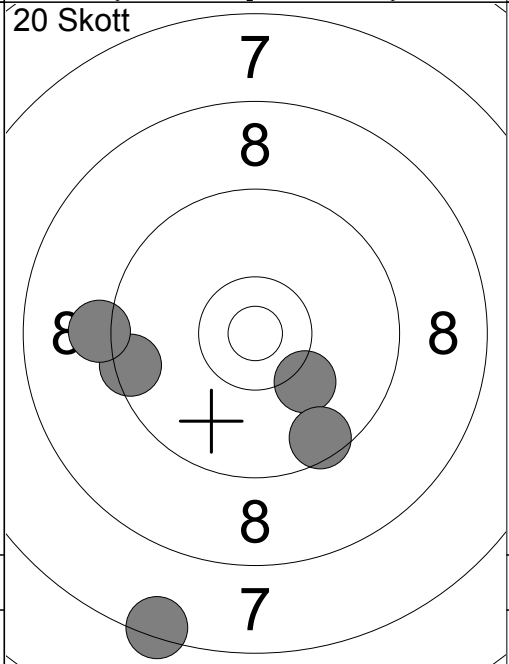

11:	10.2	↘
12:	7.4	↓
13:	9.5	←
14:	9.2	←
15:	9.5	↘
Serie		44
Total		142

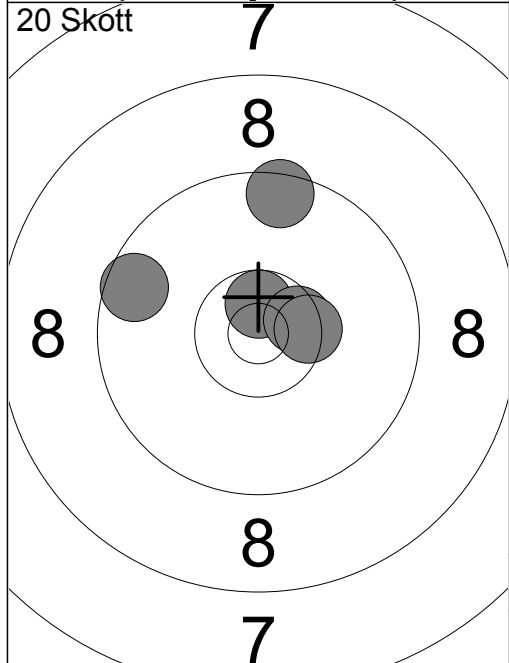

16:	9.6	←
17:	10.7x	↑
18:	10.5x	→
19:	10.4x	→
20:	9.5	↑
Serie		48
Total		190

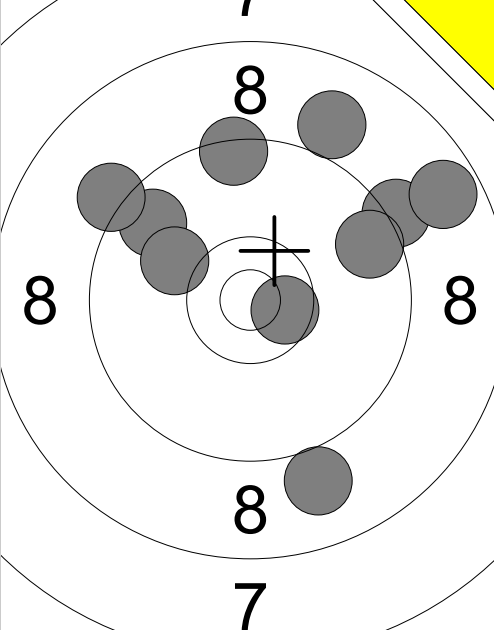
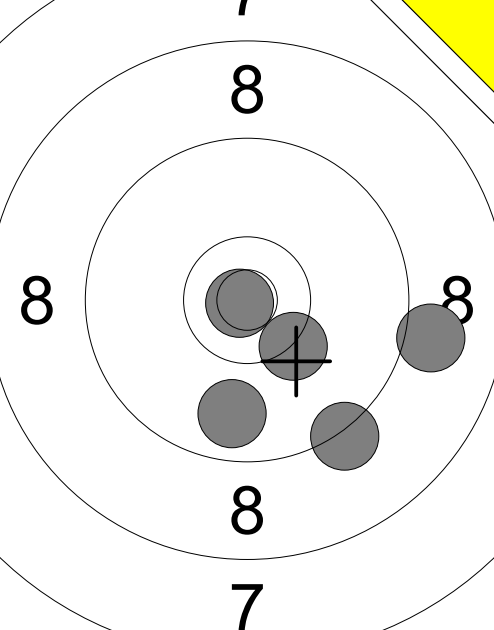
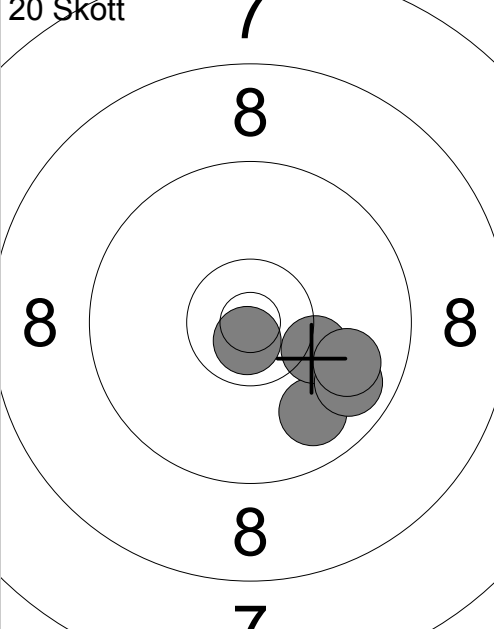
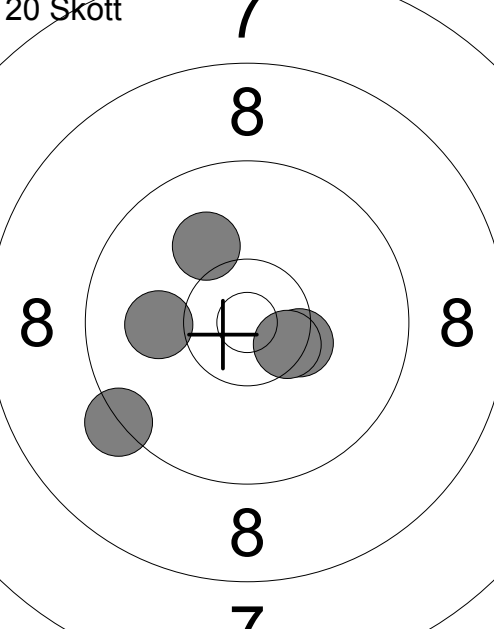
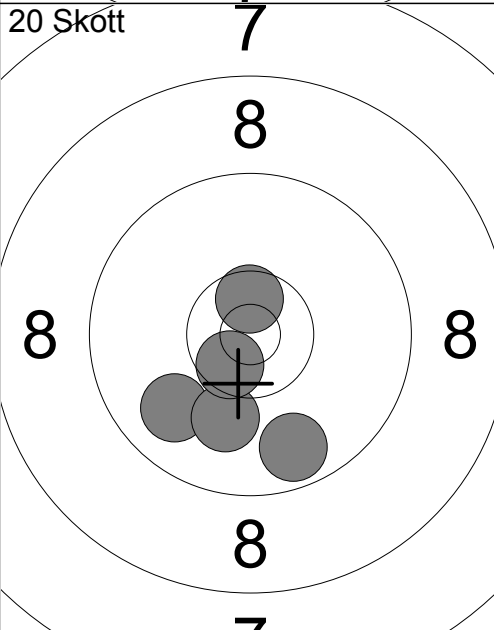
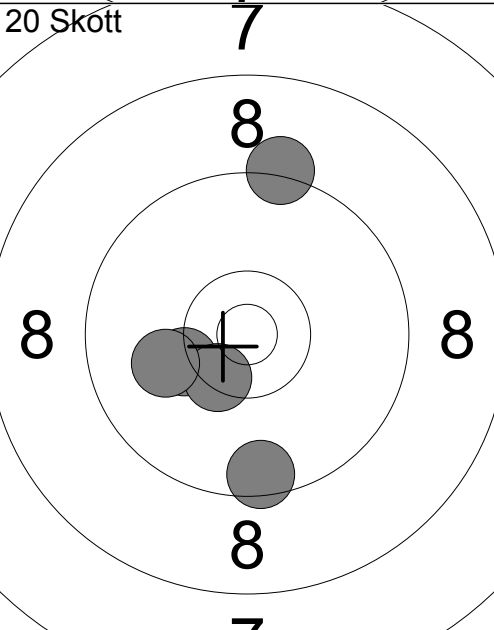
Prov 	1: 9.7 ↗ 2: 9.2 ↗ 3: 9.0 ↗ 4: 10.6x → 5: 9.2 ↗ 6: 8.7 ↗ 7: 10.1 ↖ 8: 9.6 → 9: 9.4 ↑ 10: 9.0 ↓ <hr/> Serie 91 Total 0	Prov 	11: 9.0 → 12: 10.9x ↙ 13: 10.3 ↘ 14: 9.8 ↓ 15: 9.2 ↓ <hr/> Serie 47 Total 0
20 Skott 	1: 9.8 ↓ 2: 10.2 → 3: 9.8 ↓ 4: 9.9 → 5: 10.8x ↓ <hr/> Serie 47 Total 47	20 Skott 	6: 9.3 ↙ 7: 10.4x → 8: 10.5x → 9: 10.0 ← 10: 10.1 ↗ <hr/> Serie 49 Total 96
20 Skott 	11: 9.9 ↙ 12: 10.6x ↑ 13: 10.1 ↓ 14: 10.6x ↙ 15: 9.7 ↓ <hr/> Serie 48 Total 144	20 Skott 	16: 10.3 ↙ 17: 9.5 ↓ 18: 10.4x ↙ 19: 10.1 ← 20: 9.2 ↑ <hr/> Serie 48 Total 192

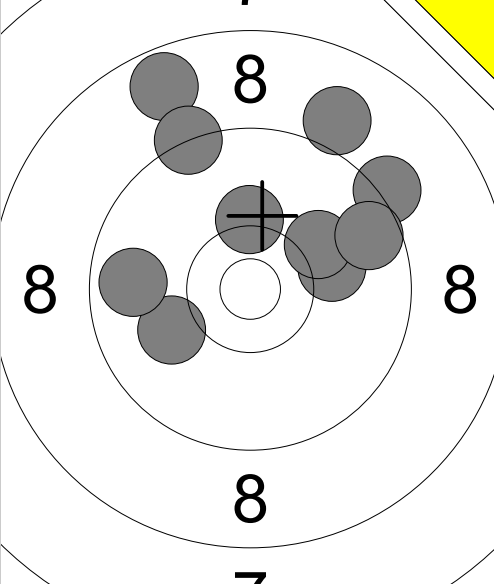
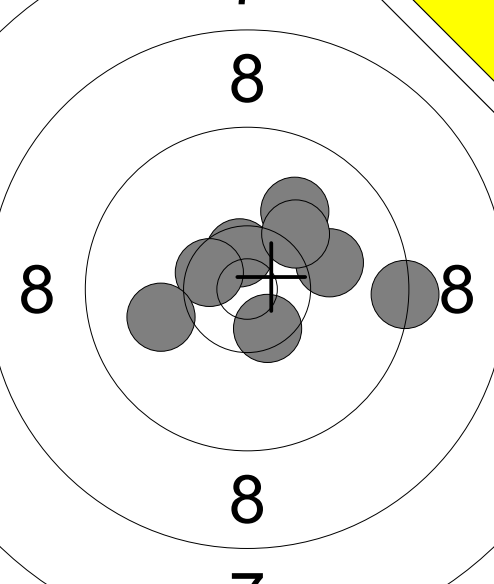
Prov 	1: 10.0 ← 2: 9.2 ↗ 3: 9.0 ↗ 4: 10.2 ↑ 5: 10.1 → 6: 10.1 ↗ 7: 8.7 ↑ 8: 9.3 ↑ 9: 9.6 → 10: 9.8 ← Serie 93 Total 0	Prov 	11: 10.0 ↗ 12: 10.6x ↑ 13: 10.1 → 14: 10.5x ↓ 15: 10.5x ↖ 16: 10.2 ↗ 17: 10.0 ← 18: 9.3 → Serie 79 Total 0
--	--	--	---

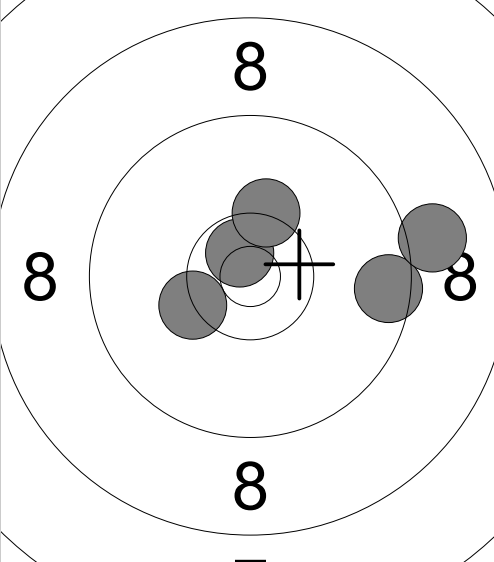
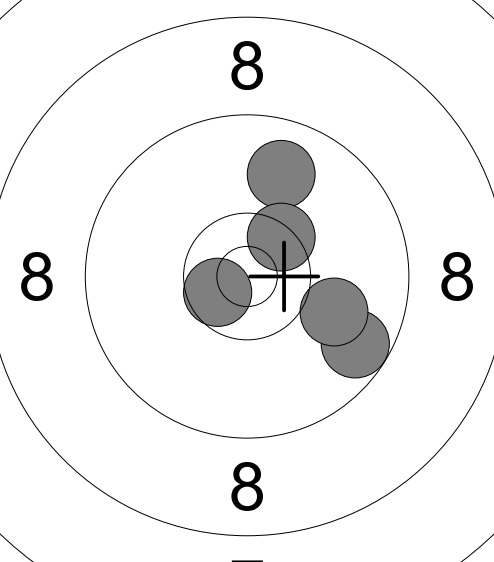
20 Skott 	1: 9.5 → 2: 10.3x ↖ 3: 10.7x ↗ 4: 10.3 ↑ 5: 9.0 → Serie 48 Total 48	20 Skott 	6: 9.8 ↑ 7: 10.6x ↖ 8: 10.4x ↗ 9: 9.6 ↘ 10: 10.0 → Serie 48 Total 96
---	---	---	--

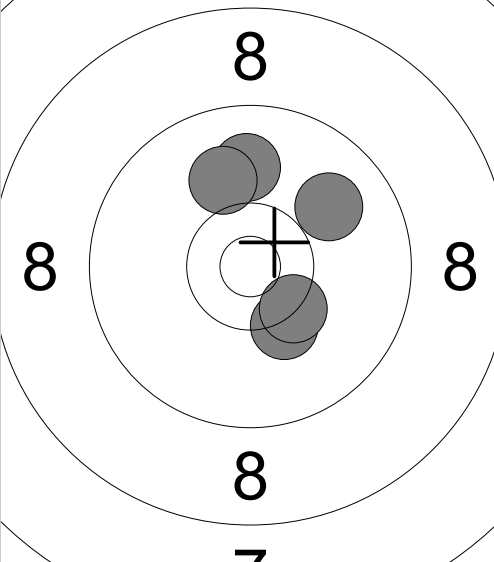
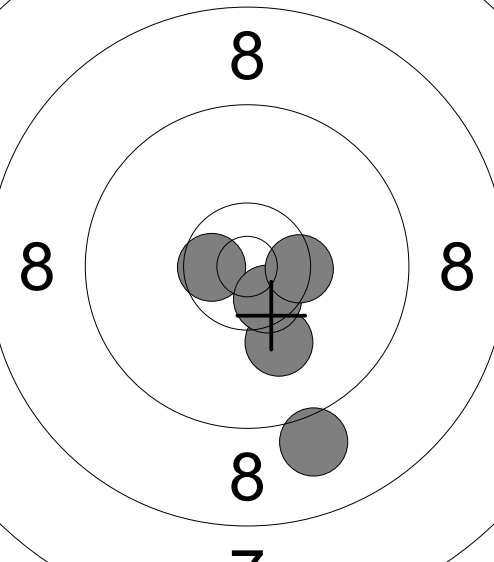
20 Skott 	11: 9.9 ↑ 12: 10.0 ↑ 13: 10.3 ↓ 14: 9.9 ↗ 15: 10.3x ↘ Serie 48 Total 144	20 Skott 	16: 9.0 ↓ 17: 10.6x ↖ 18: 10.1 ↓ 19: 10.6x ↓ 20: 10.4x → Serie 49 Total 193
--	--	--	---

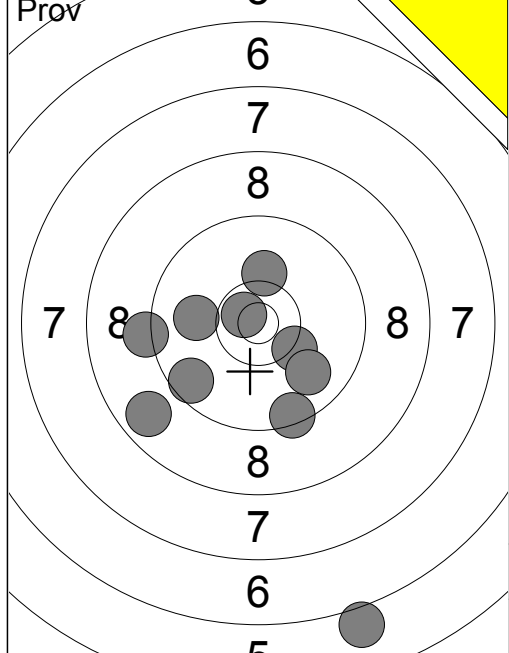

1:	10.3	↘
2:	10.7x	↖
3:	9.4	↘
4:	9.6	↙
5:	8.8	↙
6:	10.2	↑
7:	10.0	←
8:	6.0	↘
9:	9.9	↘
10:	9.2	←
Serie		90
Total		0

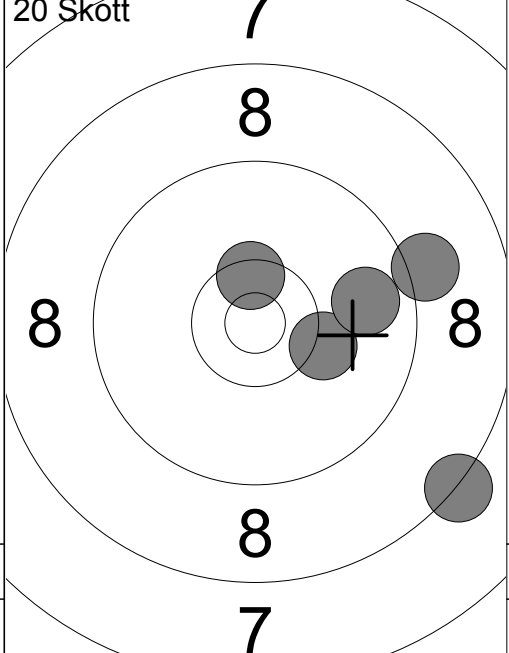

1:	8.3	↘
2:	10.5x	↑
3:	9.1	→
4:	10.2	→
5:	9.8	→
Serie		46
Total		46

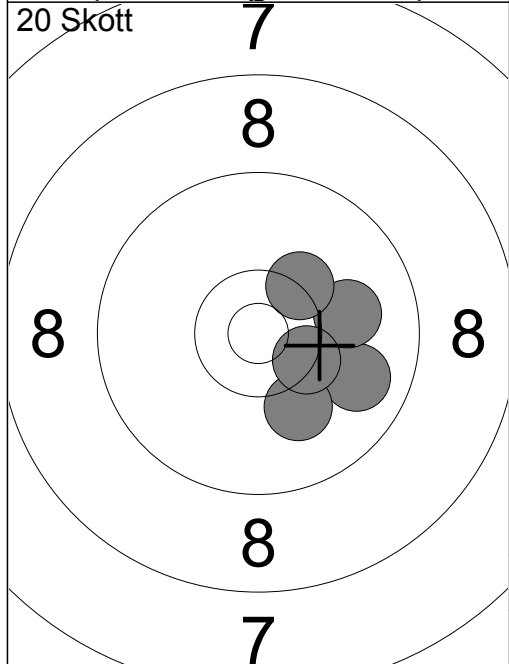

6:	9.8	→
7:	10.1	↘
8:	10.0	→
9:	10.4x	→
10:	10.3x	↗
Serie		49
Total		95

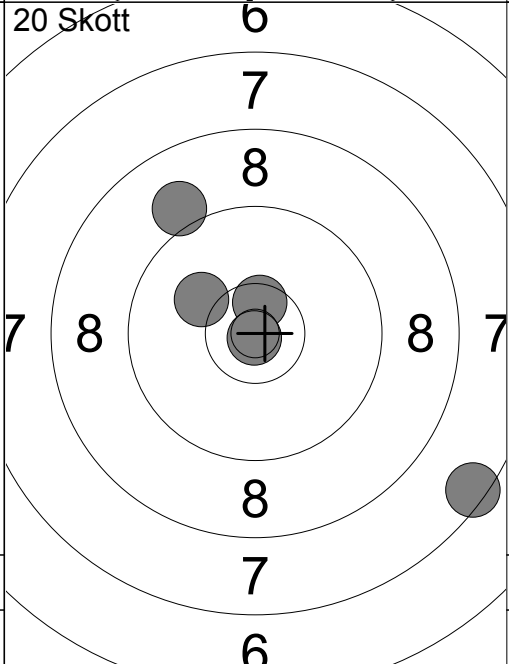

11:	10.5x	↑
12:	10.9x	↘
13:	9.1	↗
14:	7.5	↘
15:	10.1	↗
Serie		46
Total		141

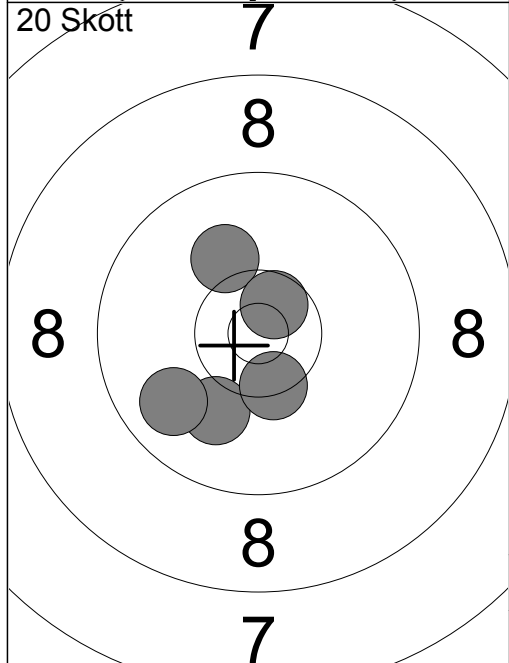

16:	10.0	↘
17:	10.4x	↘
18:	9.8	↙
19:	10.1	↗
20:	10.6x	↗
Serie		49
Total		190

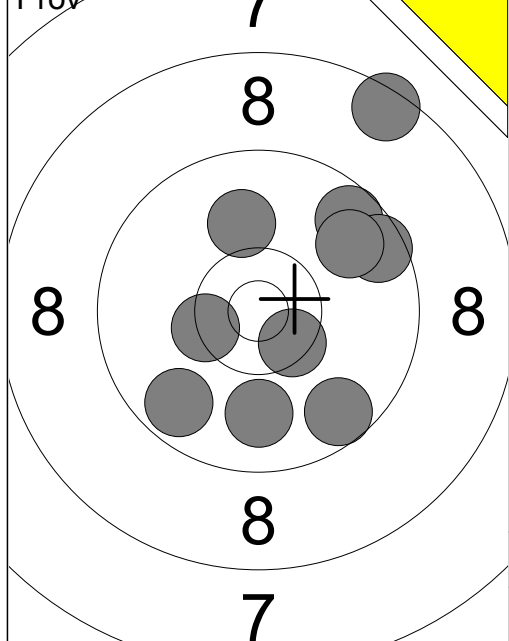

1:	8.5	↗
2:	9.6	↗
3:	9.6	→
4:	9.8	↗
5:	10.0	↑
6:	9.6	↘
7:	9.9	↓
8:	9.7	↙
9:	10.4x	←
10:	10.5x	↘
Serie		92
Total		0

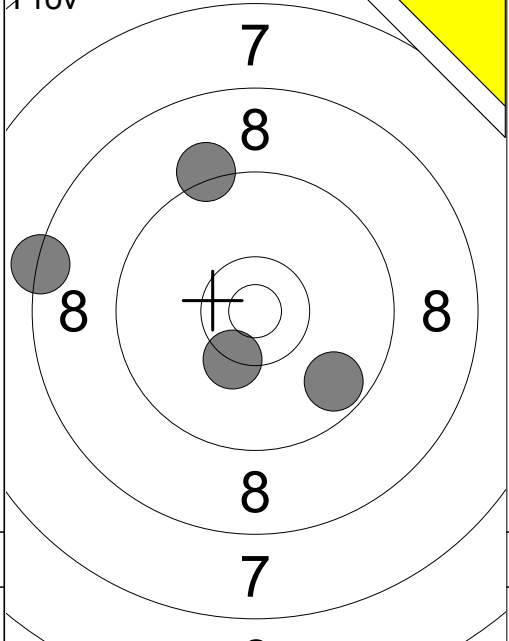

11:	9.2	↑
12:	9.7	↘
13:	10.3x	↘
14:	8.3	←
Serie		36
Total		0

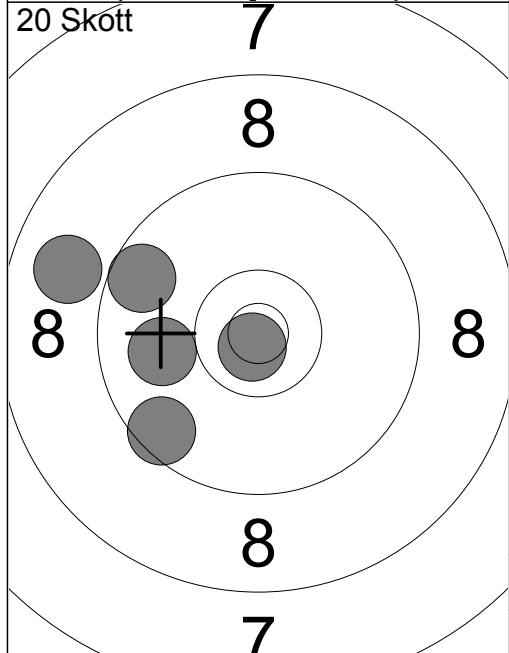

1:	9.9	←
2:	8.9	←
3:	9.6	←
4:	9.5	↘
5:	10.8x	↘
Serie		45
Total		45

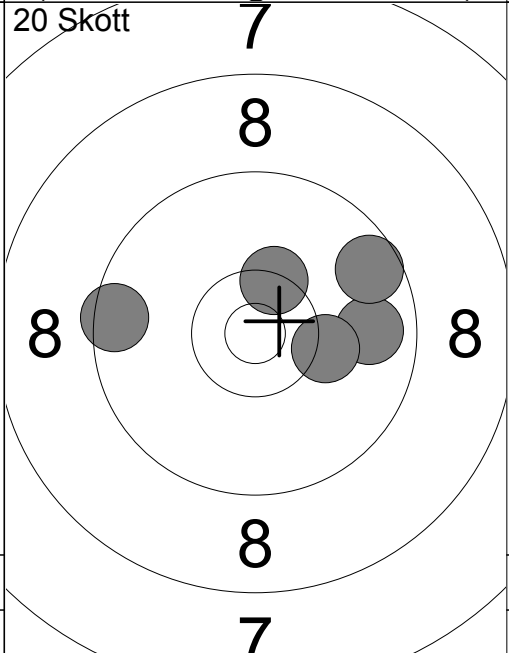

6:	9.8	→
7:	9.5	←
8:	10.4x	↑
9:	10.2	→
10:	9.6	↗
Serie		47
Total		92

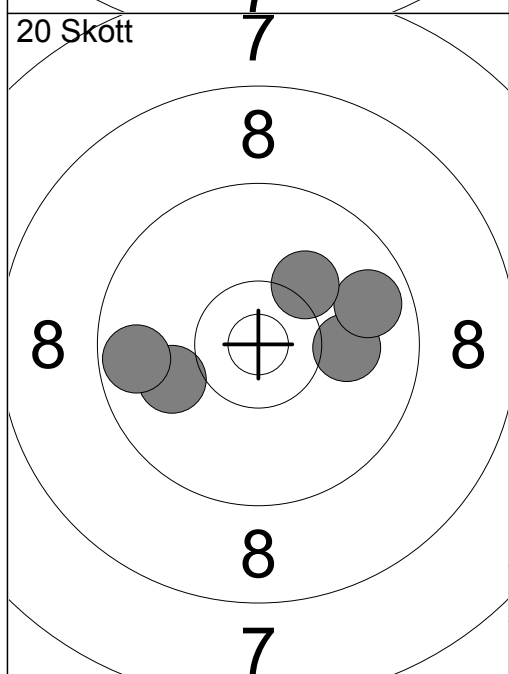

11:	10.0	→
12:	9.8	→
13:	10.0	←
14:	10.2	↗
15:	9.7	←
Serie		48
Total		140

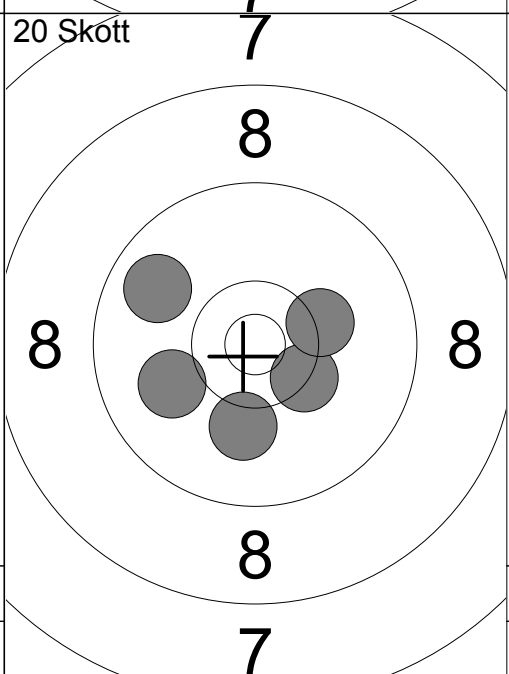

16:	10.3x	↘
17:	9.8	↖
18:	10.1	↓
19:	10.2	→
20:	10.0	←
Serie		49
Total		189

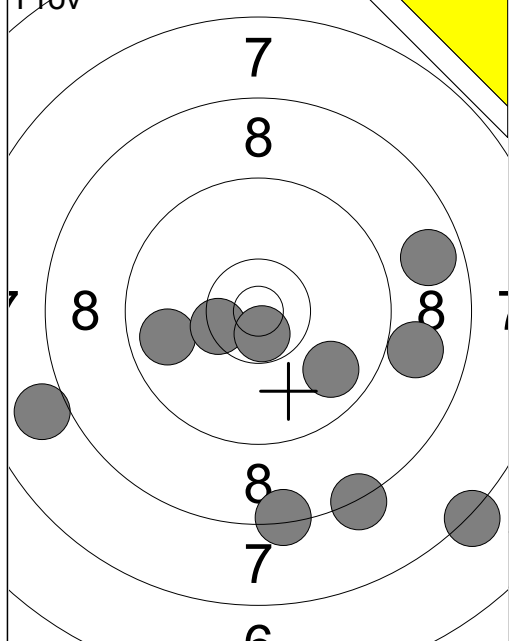

1:	9.8	↘
2:	7.2	↘
3:	8.3	↘
4:	8.7	→
5:	8.9	→
6:	9.8	←
7:	10.4x	←
8:	8.0	←
9:	8.4	↓
10:	10.7x	↓
Serie		85
Total		0

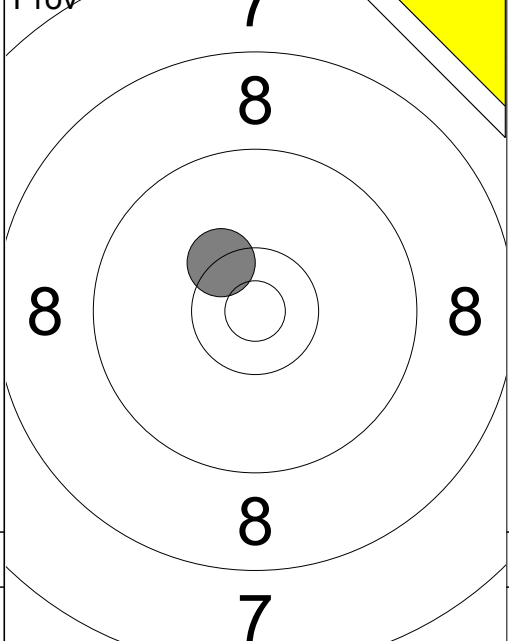

11:	10.3x	↖
Serie		10
Total		0

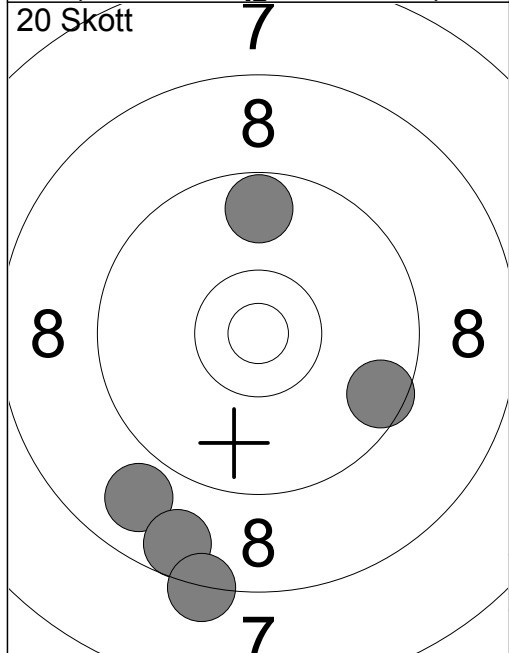

1:	8.9	↘
2:	9.7	↑
3:	8.6	↘
4:	8.3	↘
5:	9.6	→
Serie		42
Total		42

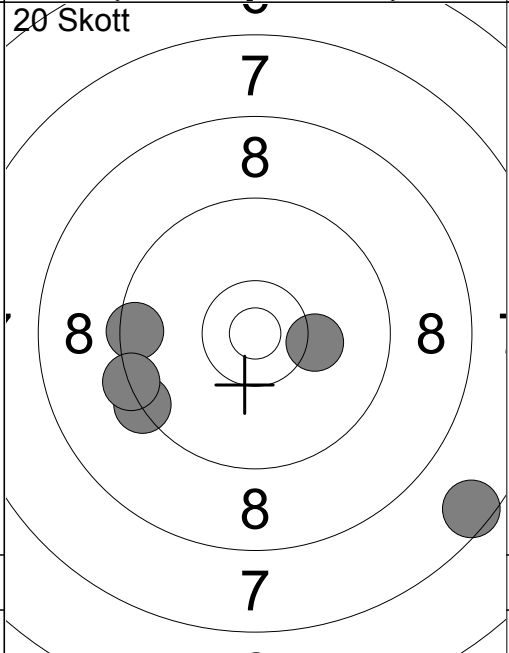

6:	10.2	→
7:	7.5	↘
8:	9.5	←
9:	9.3	←
10:	9.3	←
Serie		44
Total		86

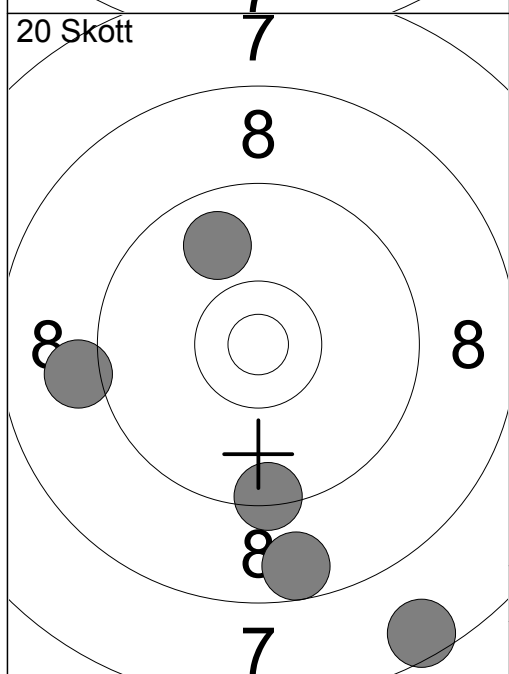

11:	9.4	↓
12:	8.6	↘
13:	9.9	↗
14:	7.6	↘
15:	9.1	←
Serie		42
Total		128

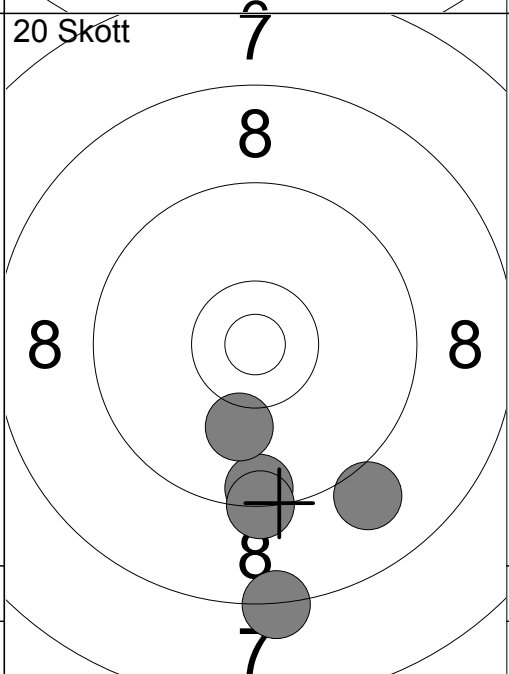

16:	9.0	↘
17:	8.3	↓
18:	9.5	↓
19:	10.1	↓
20:	9.3	↓
Serie		45
Total		173

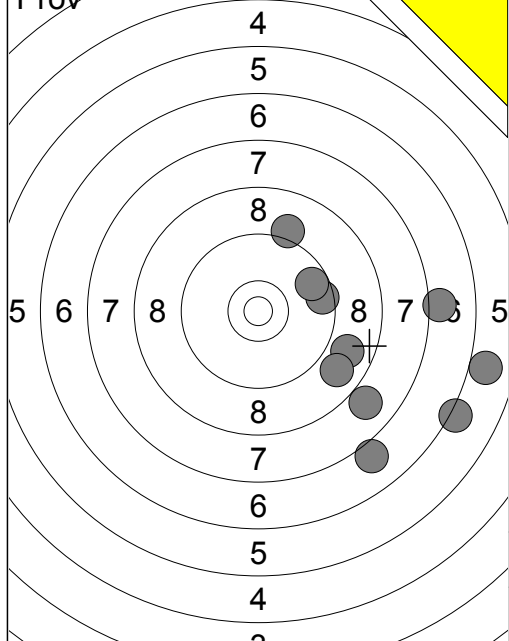

1:	9.1	↗
2:	8.9	→
3:	6.2	→
4:	7.0	↘
5:	8.8	↘
6:	7.1	→
7:	7.9	↘
8:	5.9	→
9:	9.5	→
10:	9.7	↗
Serie		75
Total		0

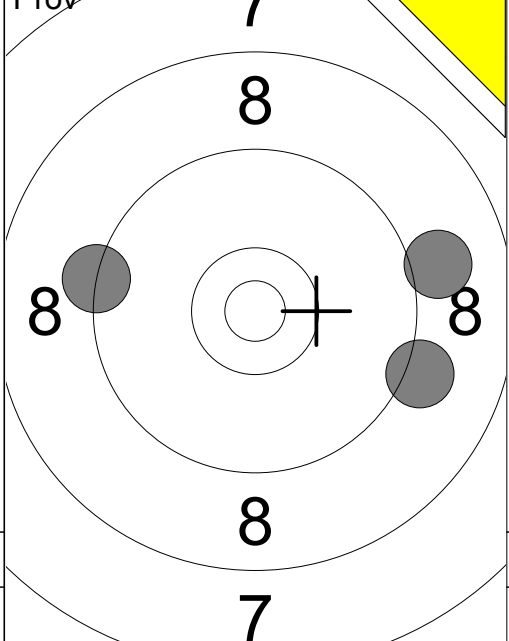

11:	9.0	→
12:	9.1	→
13:	9.3	←
Serie		27
Total		0

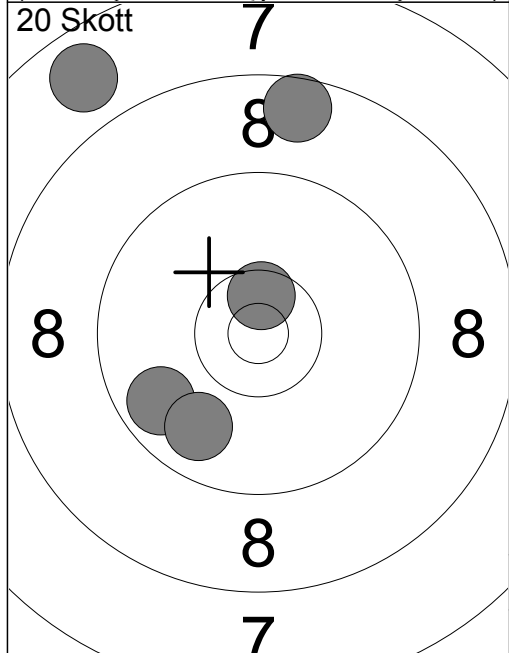

1:	7.8	↖
2:	10.6x	↗
3:	9.7	↖
4:	9.8	↖
5:	8.6	↗
Serie		43
Total		43

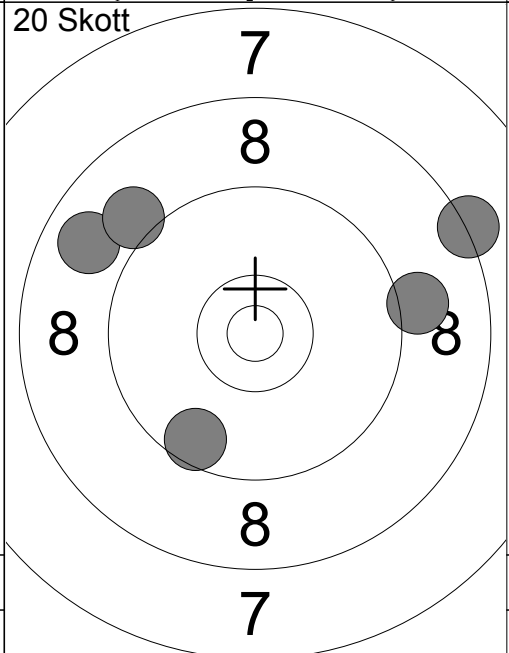

6:	9.6	↘
7:	8.8	↖
8:	8.3	↗
9:	9.1	↖
10:	9.1	→
Serie		43
Total		86

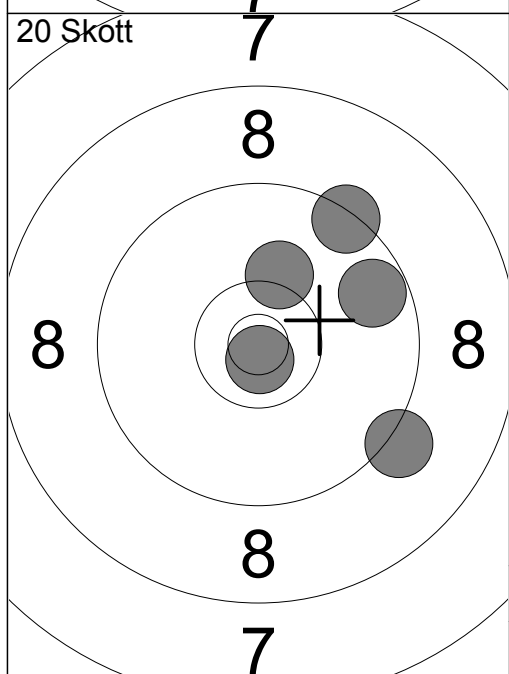

11:	9.7	→
12:	9.4	↗
13:	10.8x	↘
14:	9.2	→
15:	10.2	↗
Serie		47
Total		133

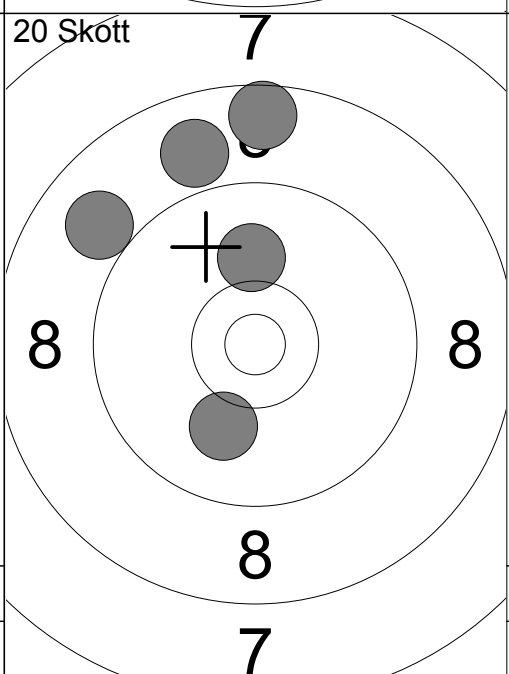

16:	8.6	↗
17:	8.9	↖
18:	10.1	↘
19:	8.9	↗
20:	10.1	↗
Serie		44
Total		177

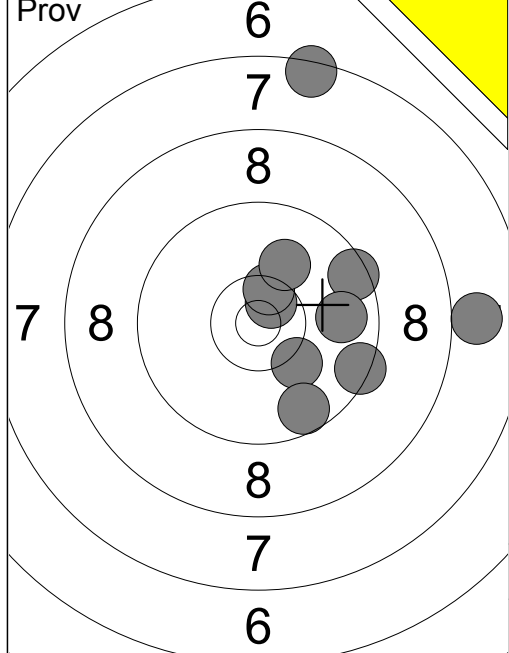

- 1: 7.4 ↑
- 2: 10.6x ↗
- 3: 9.4 →
- 4: 8.0 →
- 5: 9.5 →
- 6: 10.5x ↗
- 7: 9.8 →
- 8: 10.2 ↘
- 9: 9.6 ↘
- 10: 10.1 ↗

Serie 91
Total 0

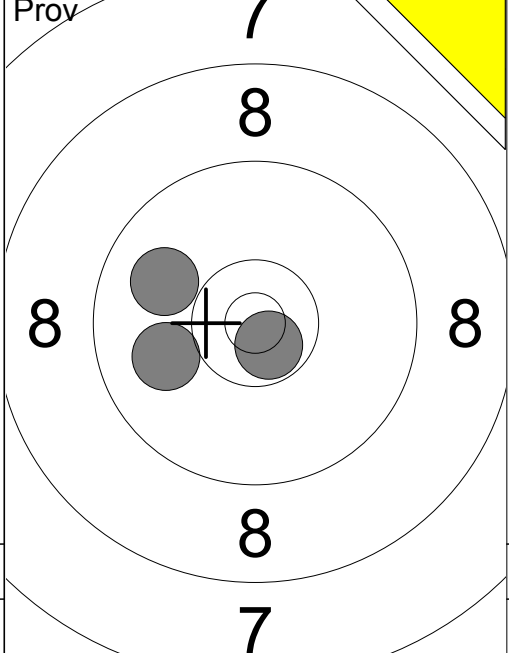

- 11: 10.0 ←
- 12: 9.9 ←
- 13: 10.7x ↘

Serie 29
Total 0

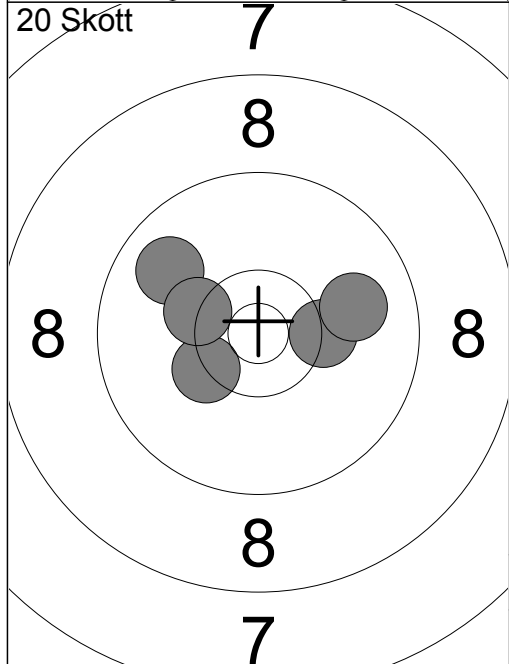

- 1: 10.3 →
- 2: 9.9 →
- 3: 10.3x ↙
- 4: 9.8 ←
- 5: 10.3x ↙

Serie 48
Total 48

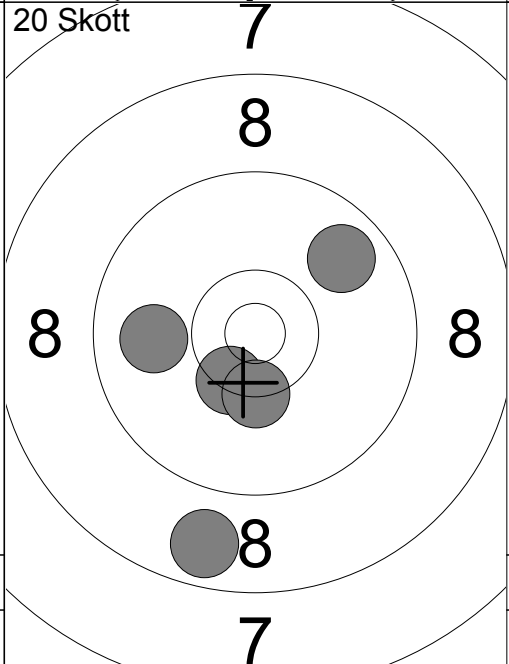

- 6: 9.8 ↗
- 7: 9.9 ←
- 8: 10.4x ↘
- 9: 10.3x ↘
- 10: 8.7 ↘

Serie 46
Total 94

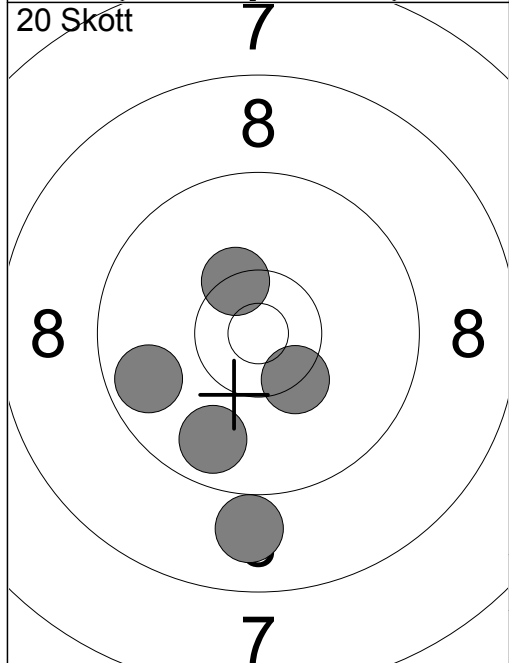

- 11: 8.9 ↘
- 12: 10.3x ↘
- 13: 9.8 ↘
- 14: 10.4x ↗
- 15: 9.7 ←

Serie 46
Total 140

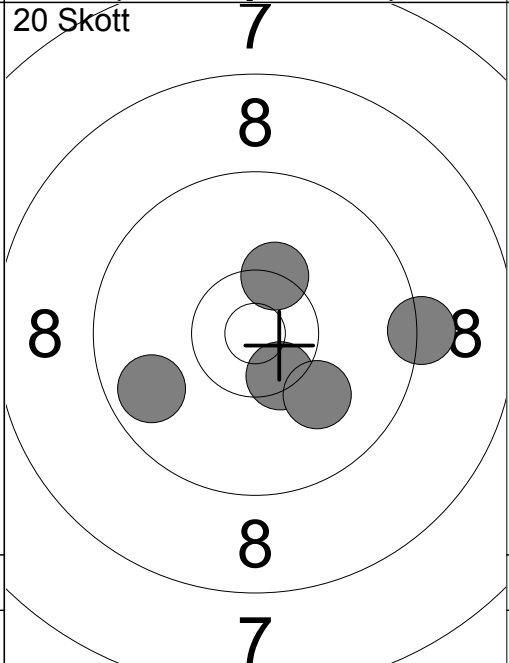

- 16: 9.7 ←
- 17: 10.4x ↘
- 18: 10.1 ↘
- 19: 9.2 →
- 20: 10.3x ↗

Serie 48
Total 188

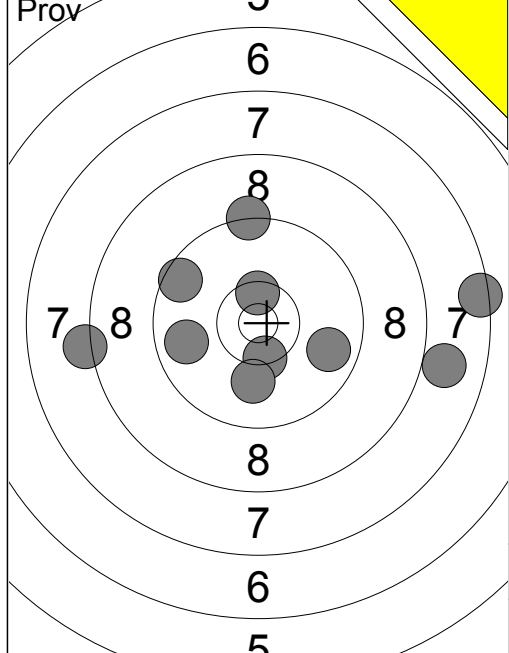

1:	8.2	←
2:	10.4x	↓
3:	7.4	→
4:	9.3	↑
5:	8.0	→
6:	10.5x	↑
7:	9.8	→
8:	10.0	↓
9:	9.8	←
10:	9.6	↖
Serie		89
Total		0

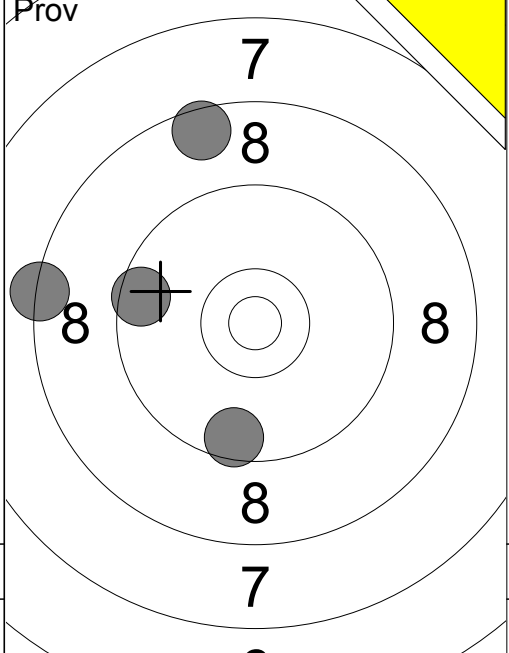

11:	8.3	←
12:	8.6	↑
13:	9.6	↓
14:	9.6	←
Serie		34
Total		0

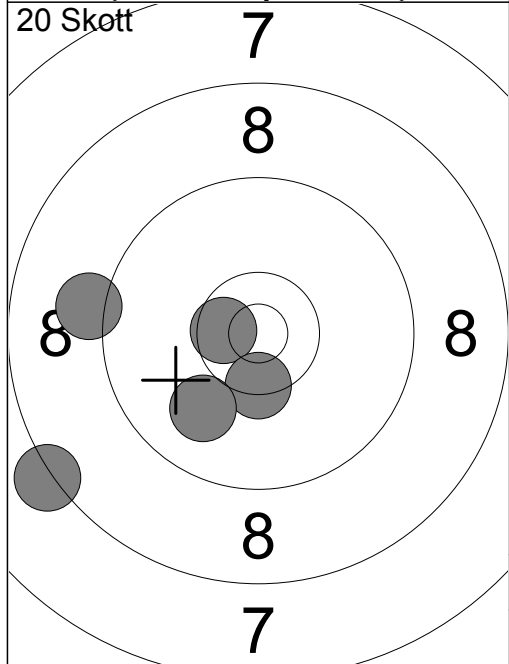

1:	10.6x	←
2:	10.4x	↓
3:	9.1	←
4:	10.0	↙
5:	8.2	↙
Serie		47
Total		47

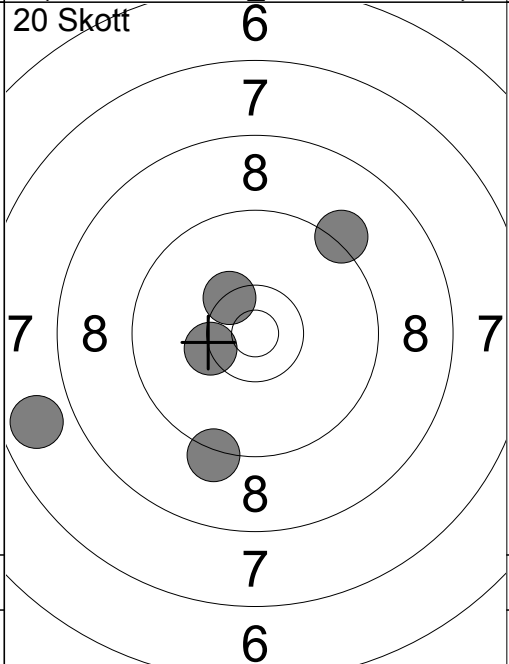

6:	9.2	↓
7:	7.8	←
8:	9.2	↗
9:	10.3x	←
10:	10.4x	↖
Serie		45
Total		92

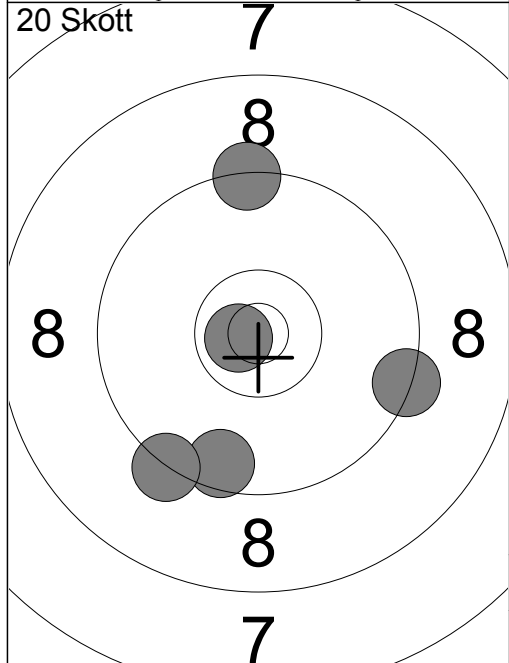

11:	9.6	↓
12:	9.3	↙
13:	9.3	↑
14:	10.7x	←
15:	9.4	→
Serie		46
Total		138

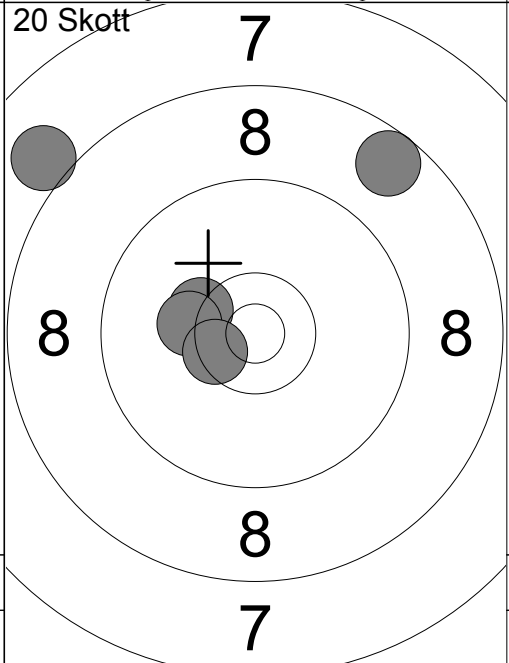

16:	8.0	↖
17:	10.3x	←
18:	10.2	←
19:	10.5x	←
20:	8.6	↗
Serie		46
Total		184

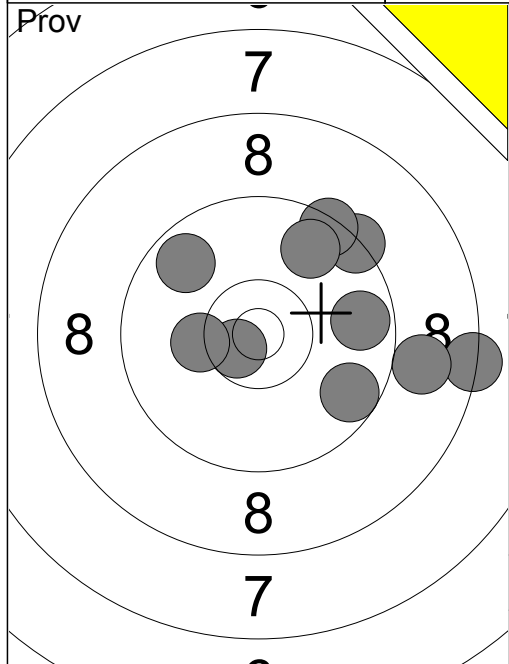

1:	9.4	↗
2:	8.3	→
3:	9.4	↗
4:	9.7	→
5:	9.7	↗
6:	9.0	→
7:	10.6x	↙
8:	10.2	←
9:	9.7	↘
10:	9.8	↗
Serie		91
Total		0

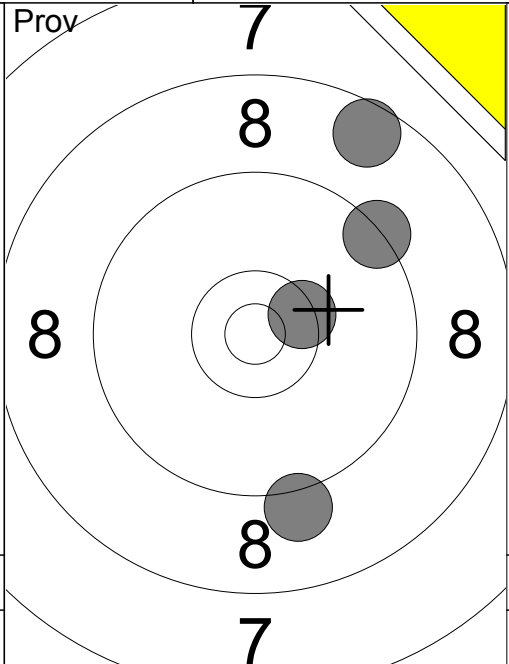

11:	8.6	↗
12:	10.4x	→
13:	9.3	↗
14:	9.1	↘
Serie		36
Total		0

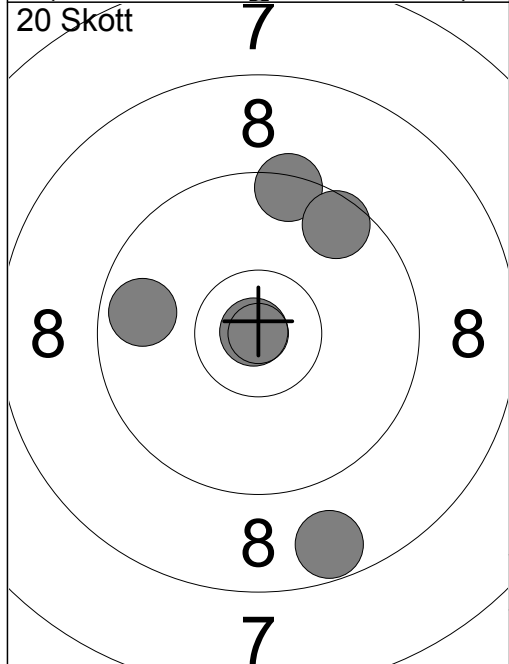

1:	9.7	←
2:	9.4	↗
3:	10.9x	↙
4:	9.6	↗
5:	8.7	↘
Serie		45
Total		45

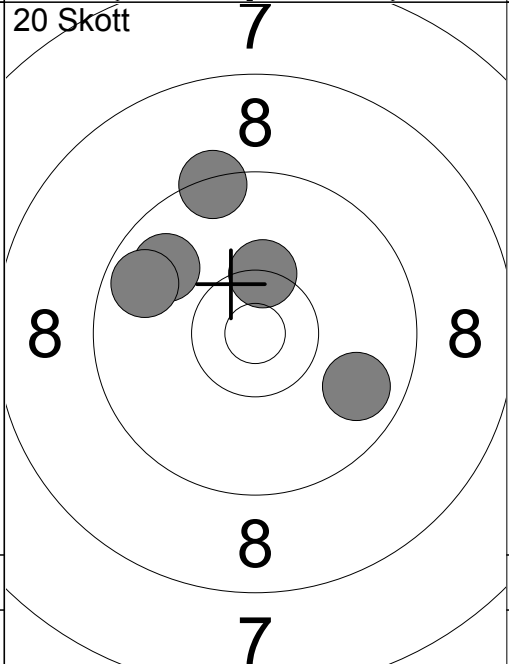

6:	9.4	↗
7:	9.8	↙
8:	10.3x	↗
9:	9.7	↙
10:	9.8	↘
Serie		46
Total		91

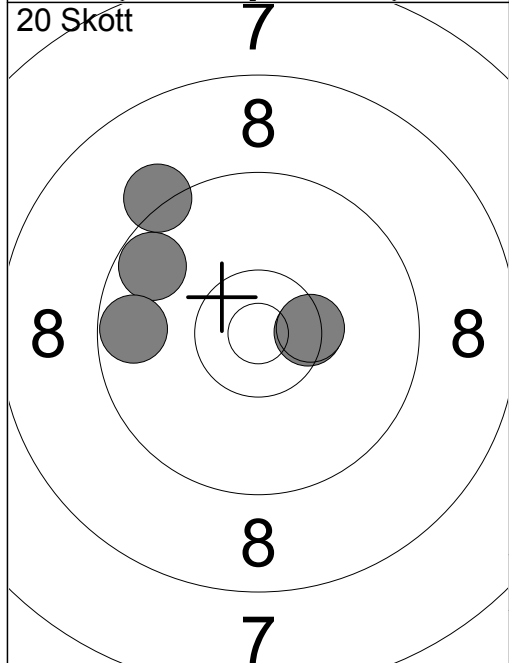

11:	10.4x	→
12:	10.4x	→
13:	9.7	↙
14:	9.2	↗
15:	9.7	←
Serie		47
Total		138

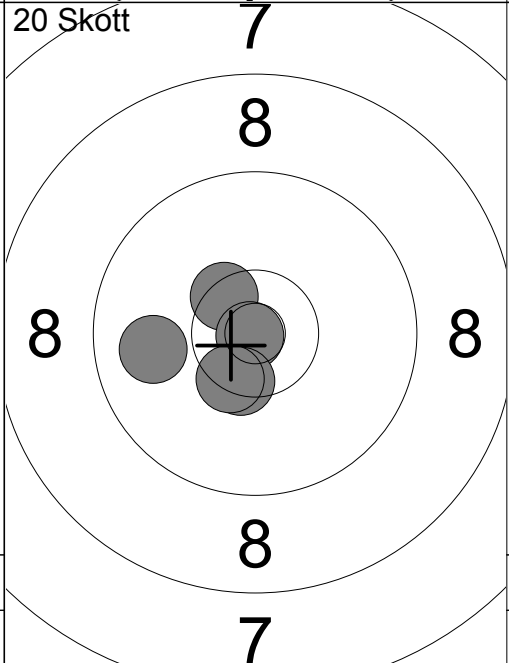

16:	10.5x	↖
17:	10.9x	↙
18:	10.4x	↘
19:	10.4x	↙
20:	9.9	←
Serie		49
Total		187

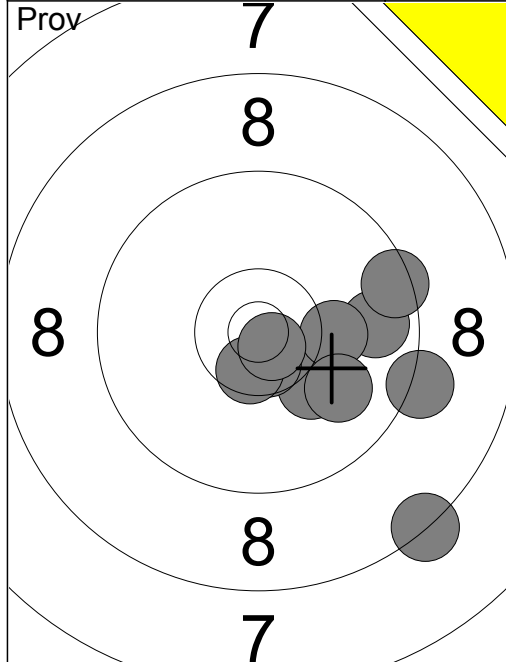

1:	10.2	↘
2:	10.6x	↘
3:	9.7	→
4:	9.2	→
5:	9.5	→
6:	10.2	→
7:	10.6x	↘
8:	8.3	↘
9:	9.9	↘
10:	10.7x	↘

Serie	94
Total	0

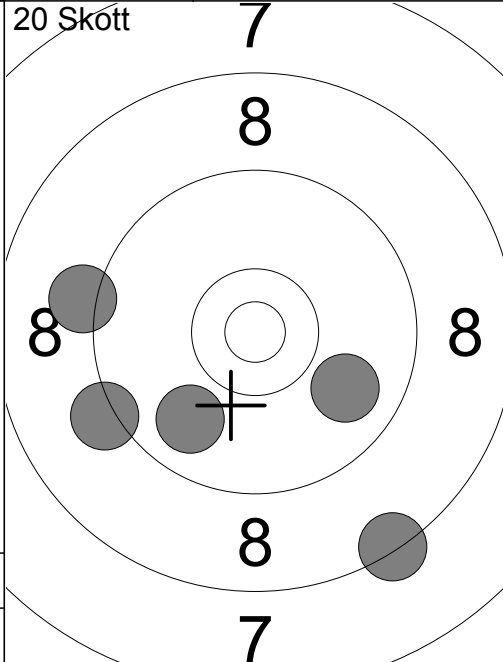

1:	9.8	↘
2:	9.2	←
3:	9.2	↙
4:	9.9	↘
5:	8.3	↘

Serie	44
Total	44

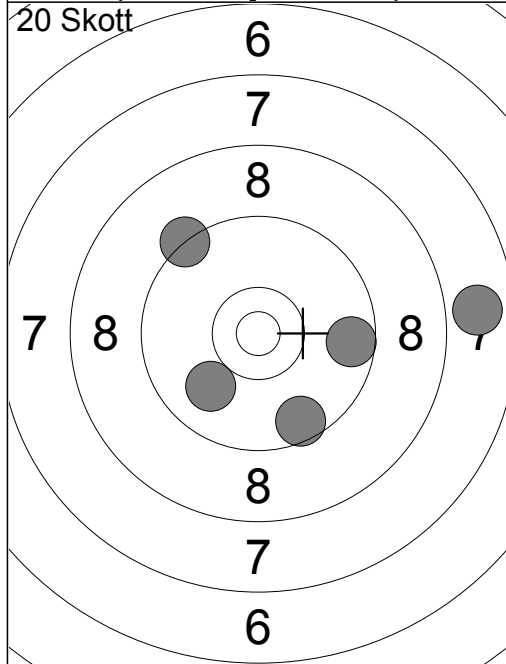

6:	7.8	→
7:	9.9	↙
8:	9.6	↘
9:	9.3	↗
10:	9.6	→

Serie	43
Total	87

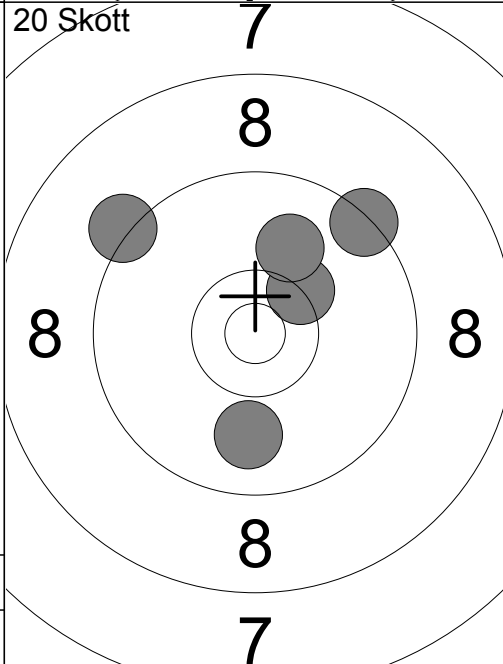

11:	10.3x	↗
12:	9.4	↗
13:	9.2	↖
14:	9.9	↘
15:	10.0	↗

Serie	47
Total	134

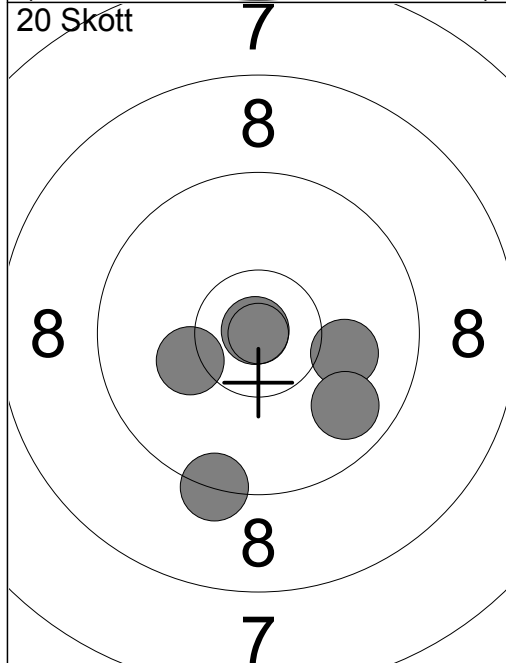

16:	10.0	→
17:	10.2	←
18:	9.8	↘
19:	10.9x	↗
20:	9.3	↘

Serie	48
Total	182

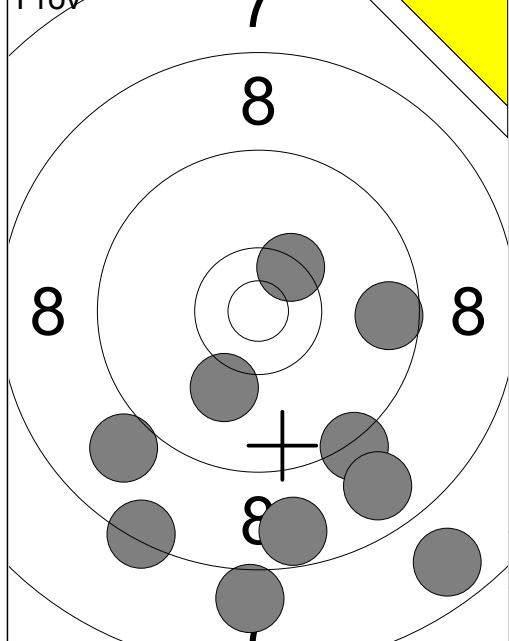

1:	10.1	↘
2:	8.0	↓
3:	8.4	↘
4:	9.2	↘
5:	7.7	↘
6:	9.6	→
7:	8.7	↘
8:	9.0	↙
9:	8.8	↘
10:	10.4x	↗
Serie		86
Total		0

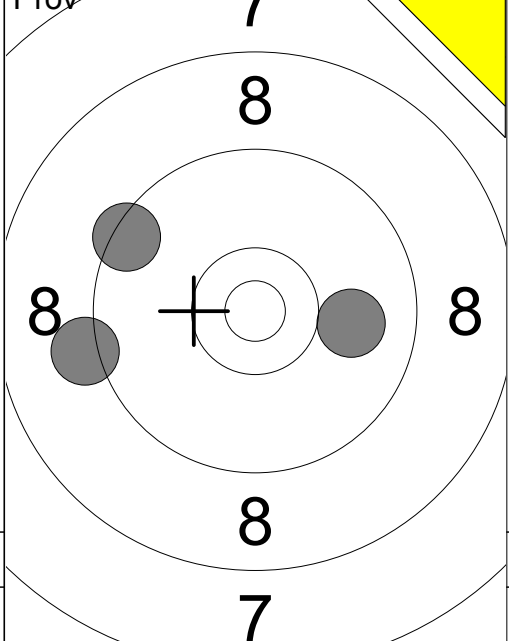

11:	9.2	↙
12:	9.4	↖
13:	10.0	→
Serie		28
Total		0

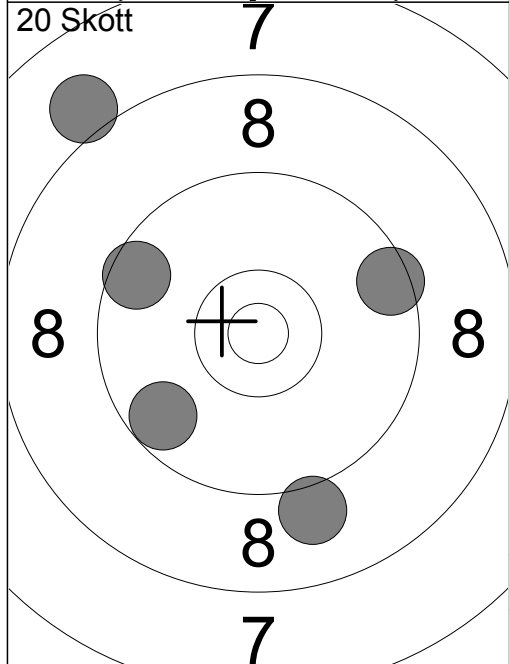

1:	9.6	↖
2:	9.5	→
3:	8.0	↗
4:	9.1	↓
5:	9.7	↙
Serie		44
Total		44

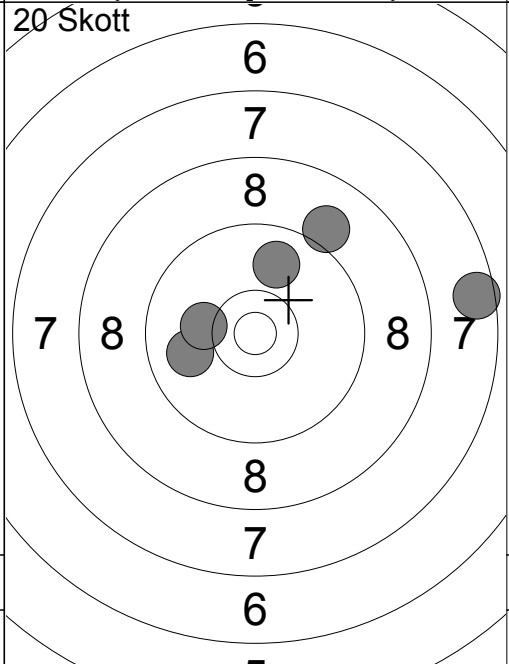

6:	9.1	↗
7:	9.9	↑
8:	7.6	→
9:	9.9	↙
10:	10.2	↙
Serie		44
Total		88

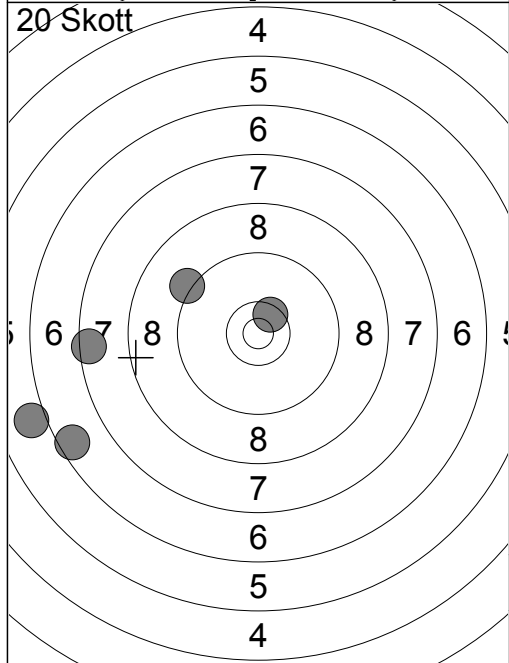

11:	6.6	↙
12:	7.5	↙
13:	9.2	↖
14:	6.0	↙
15:	10.5x	↗
Serie		38
Total		126

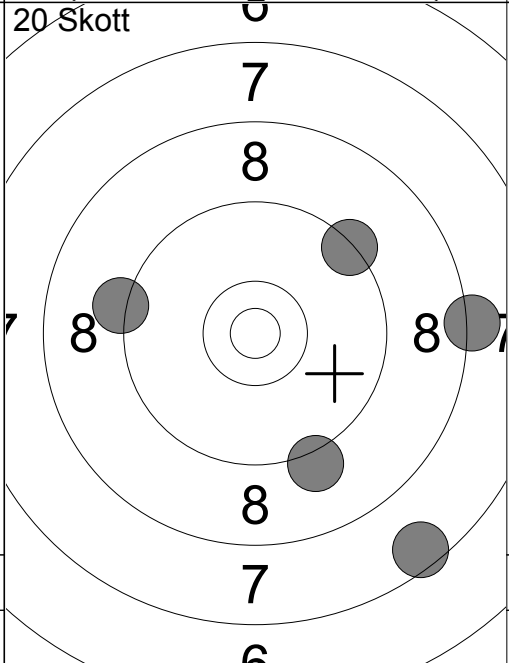

16:	9.3	↗
17:	7.5	↘
18:	8.2	→
19:	9.2	↘
20:	9.2	↙
Serie		42
Total		168

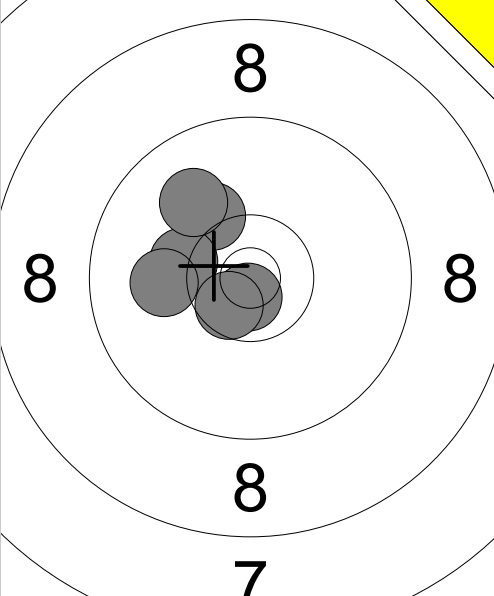
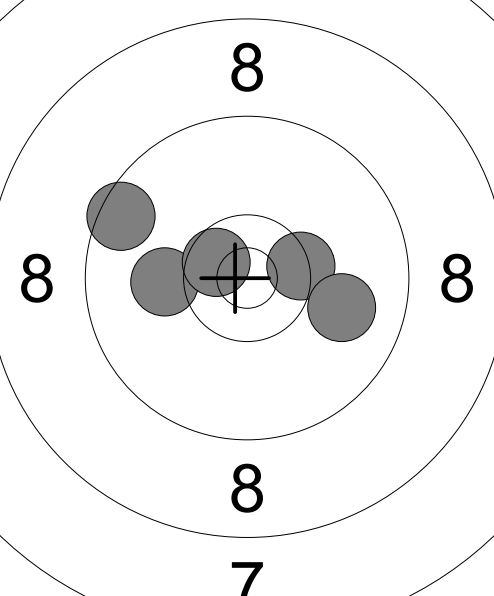
Prov	7	20 Skott	7
	1: 10.8x ↓ 2: 10.2 ↗ 3: 10.3 ← 4: 10.0 ↗ 5: 10.1 ← 6: 10.6x ↓		1: 10.1 ← 2: 10.6x ↖ 3: 9.5 ↖ 4: 10.4x → 5: 9.9 →
	Serie 60		Serie 48
	Total 0		Total 48

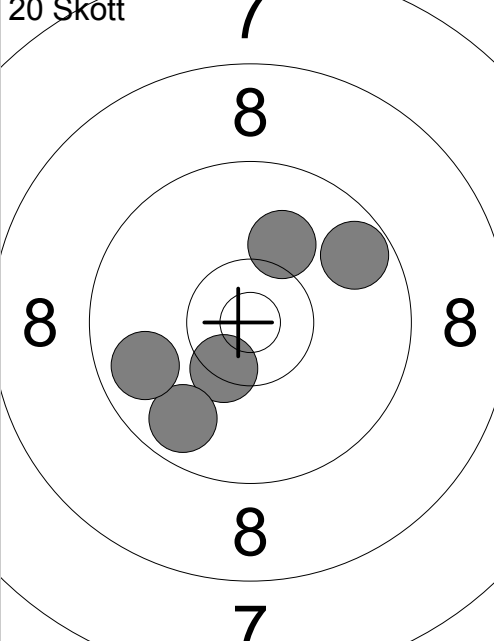
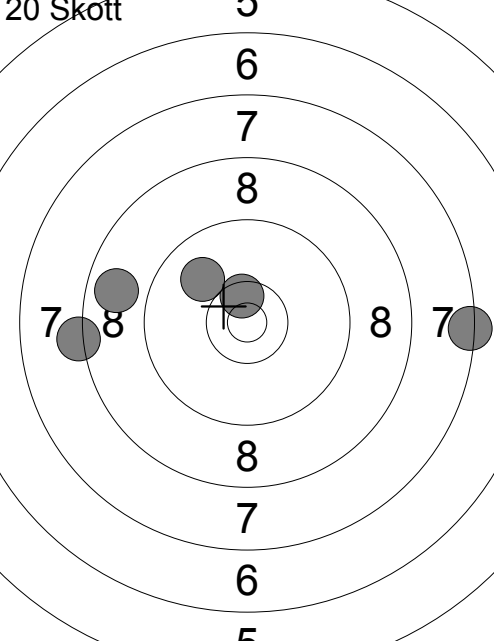
20 Skott	7	20 Skott	5
	6: 10.1 ↑ 7: 9.7 ↗ 8: 10.4x ↓ 9: 9.8 ↓ 10: 9.8 ←		11: 8.2 ← 12: 10.5x ↑ 13: 7.4 → 14: 8.8 ← 15: 10.0 ↗
	Serie 47		Serie 43
	Total 95		Total 138

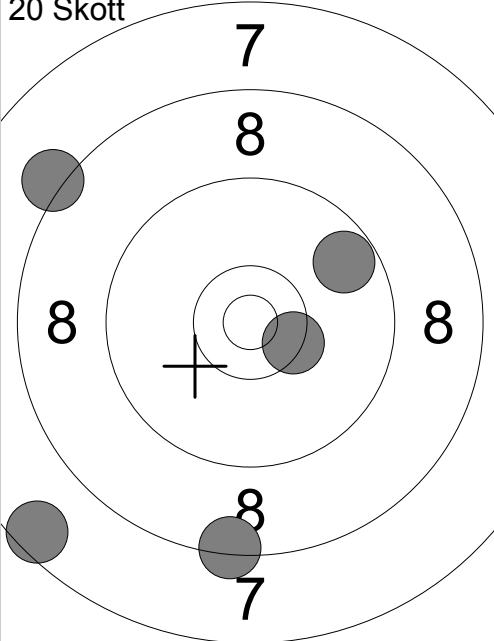
20 Skott	7		
	16: 8.4 ↓ 17: 9.7 ↗ 18: 8.2 ↖ 19: 10.4x → 20: 7.5 ↓		
	Serie 42		
	Total 180		

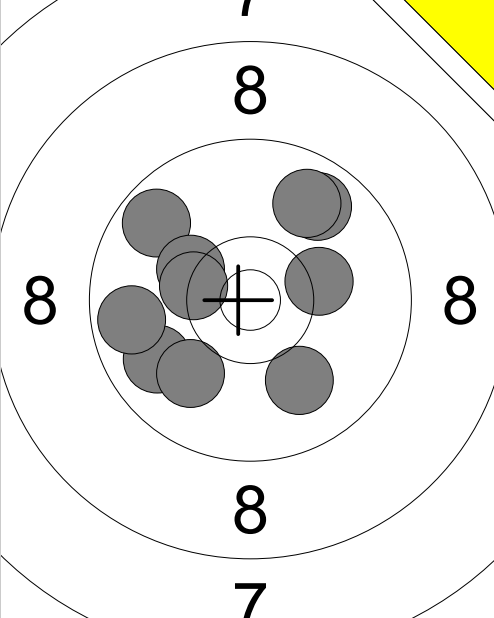
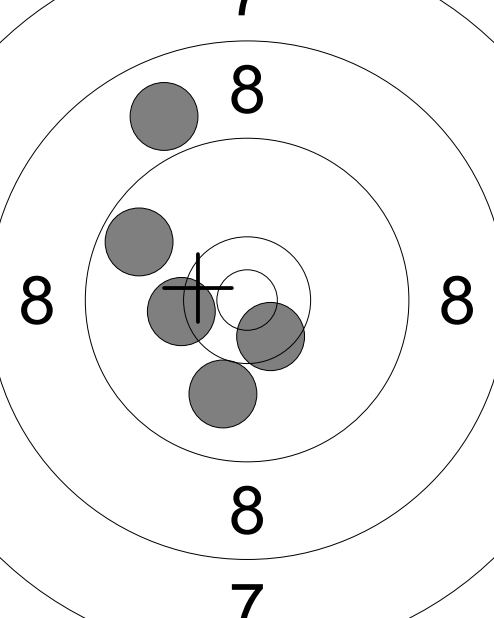
Prov 	1: 10.0 ↓ 2: 9.8 ← 3: 9.8 ↗ 4: 10.2 → 5: 9.7 ← 6: 9.7 ↖ 7: 10.0 ↓ 8: 10.3 ↖ 9: 9.8 ↗ 10: 10.3x ←	20 Skött 	1: 9.7 ↖ 2: 10.3 ← 3: 10.0 ↓ 4: 8.9 ↗ 5: 10.5x ↓
Serie	95	Serie	47
Total	0	Total	47

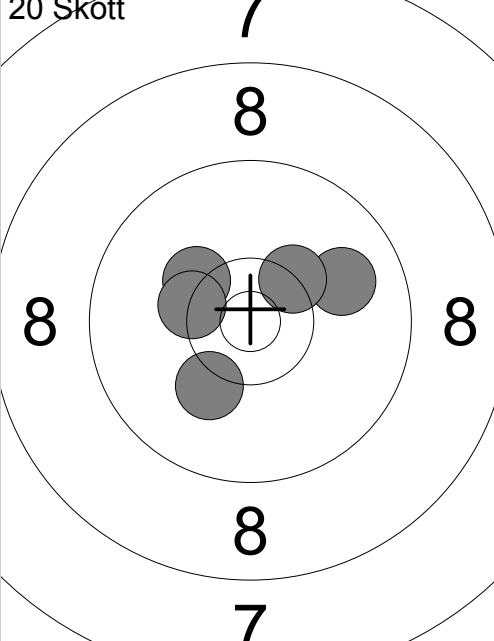
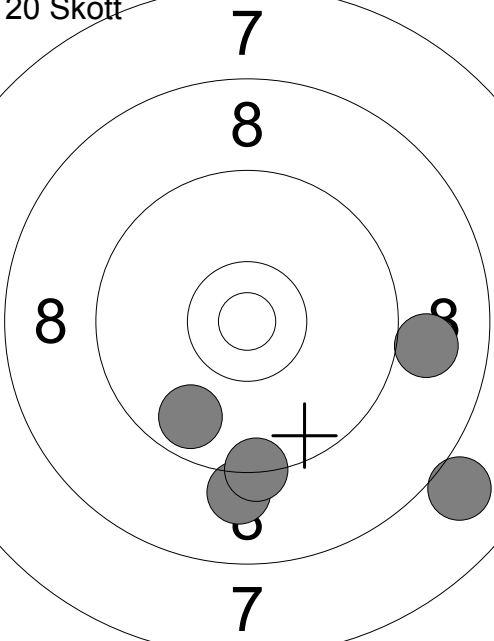
20 Skött 	6: 10.3 ↖ 7: 10.3x ← 8: 9.9 → 9: 10.3x ↗ 10: 10.2 ↓	20 Skött 	11: 9.7 ↓ 12: 9.0 → 13: 8.0 ↘ 14: 9.1 ↓ 15: 9.3 ↓
Serie	49	Serie	44
Total	96	Total	140

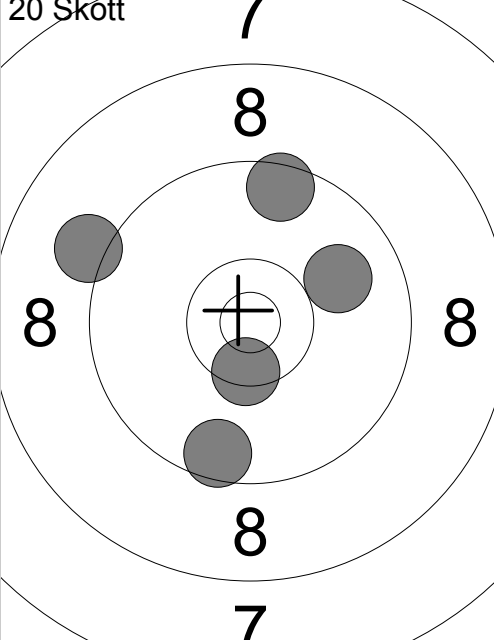
20 Skött 	16: 9.5 ↑ 17: 10.4x ↓ 18: 9.1 ↖ 19: 9.6 ↓ 20: 9.9 →		
Serie	46		
Total	186		

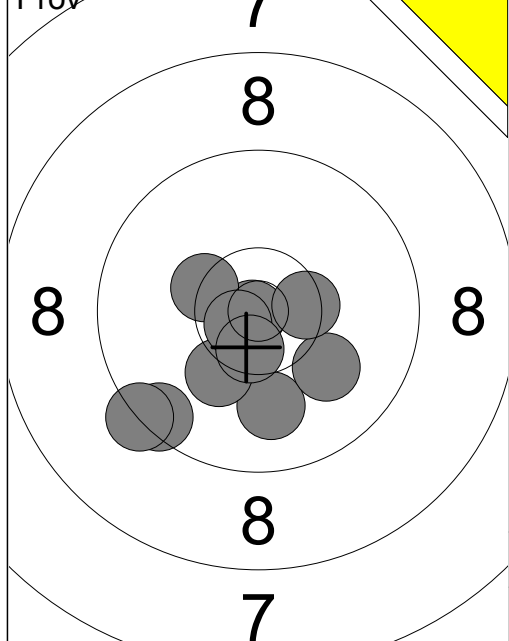

1:	10.0	↓
2:	10.9x	↙
3:	10.4x	↙
4:	10.2	↓
5:	10.1	↓
6:	10.7x	↙
7:	10.6x	↓
8:	9.5	↙
9:	9.3	↙
10:	10.5x	→
Serie		98
Total		0

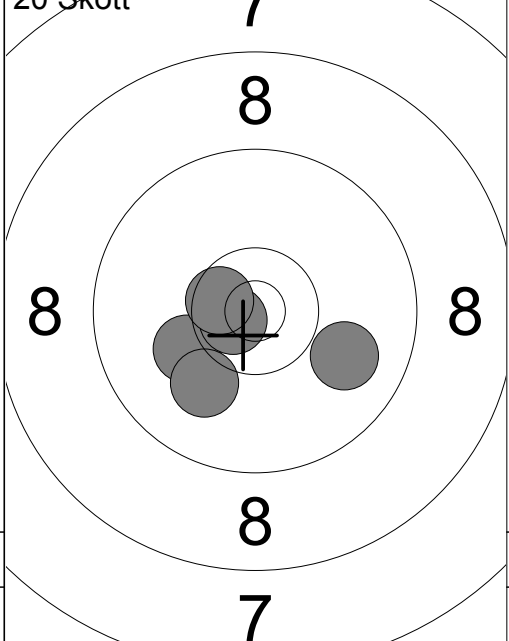

1:	9.9	↘
2:	10.2	↙
3:	10.1	↙
4:	10.7x	↙
5:	10.6x	↙
Serie		49
Total		49

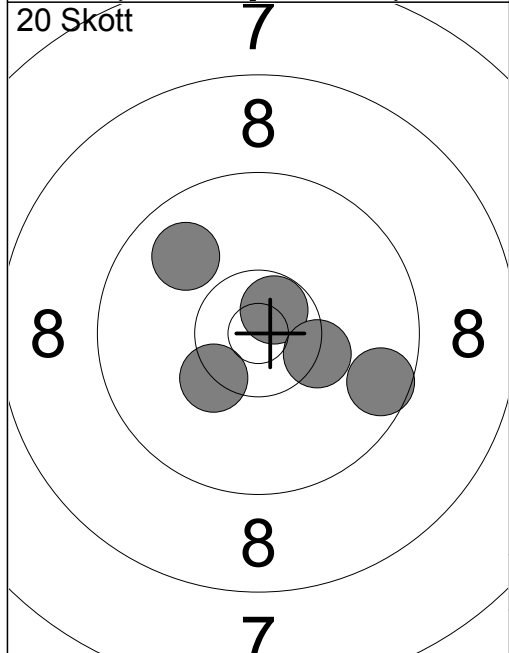

6:	10.7x	↗
7:	10.3x	↙
8:	9.9	↗
9:	10.3x	→
10:	9.6	→
Serie		48
Total		97

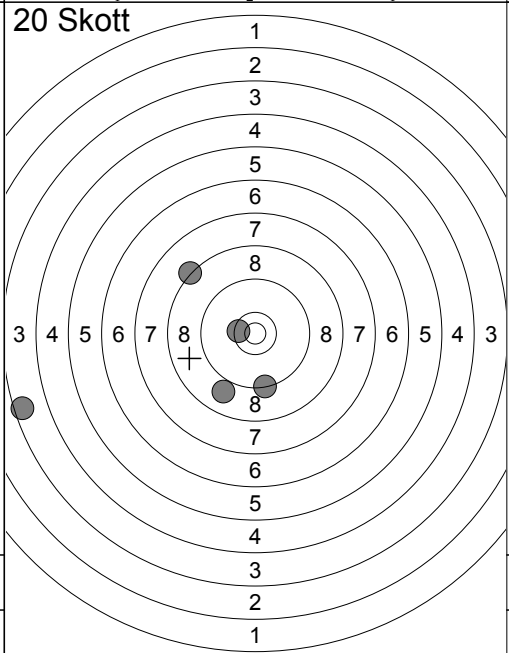

11:	3.5	↙
12:	9.3	↓
13:	10.4x	↙
14:	8.9	↙
15:	8.3	↗
Serie		38
Total		135

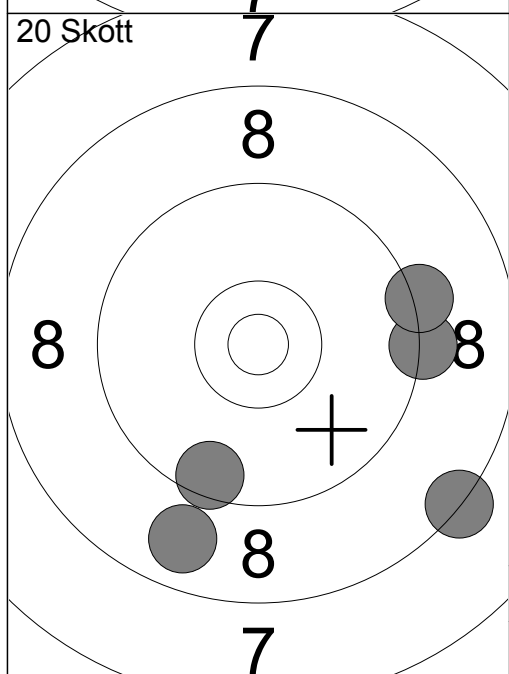

16:	8.8	↓
17:	9.3	→
18:	8.3	↘
19:	9.5	↓
20:	9.2	→
Serie		43
Total		178

Ramselefors	Ramselefors	Jun-S	Vb
02.09.2017	Höstträffen 2017	Ramselefors SKF	

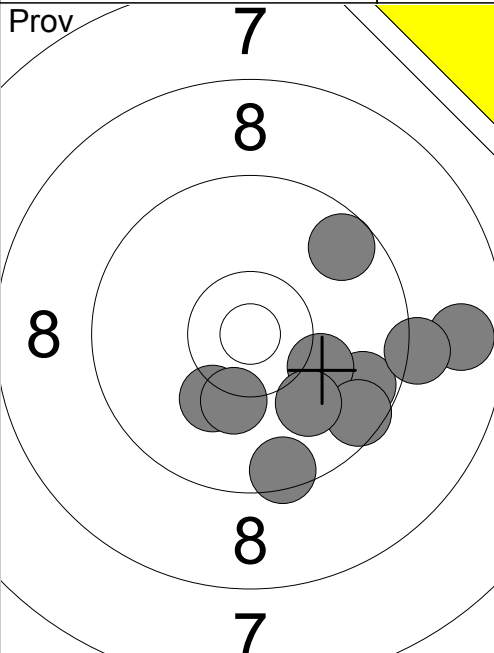
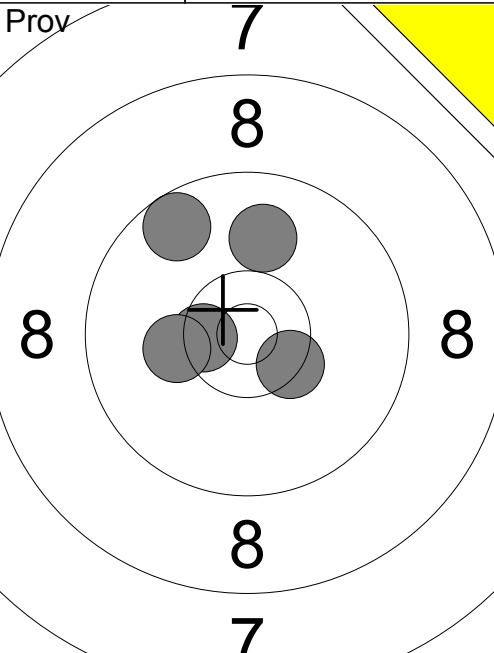
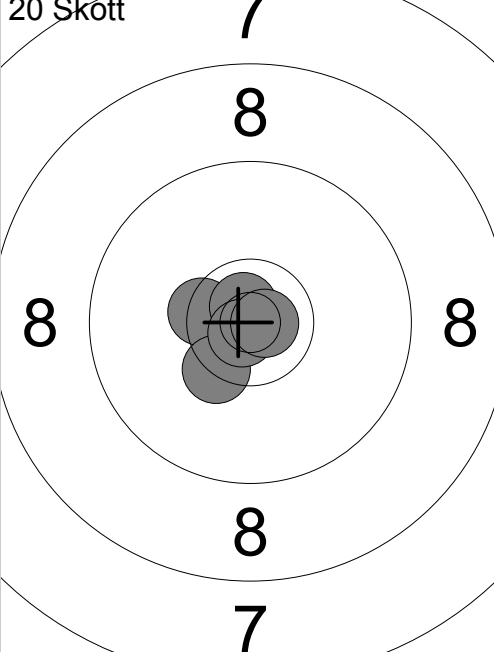
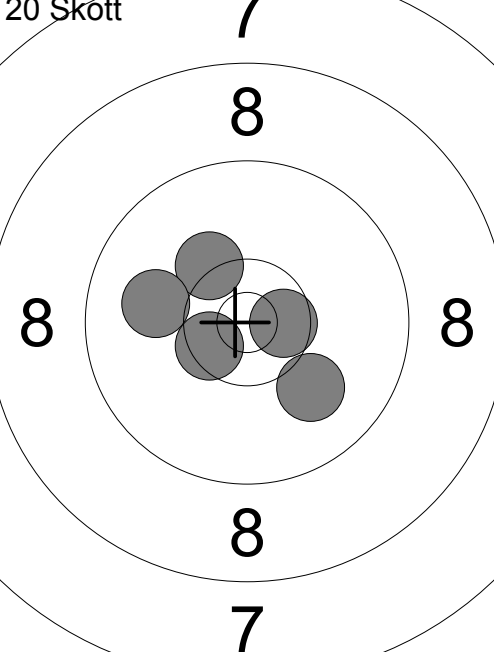
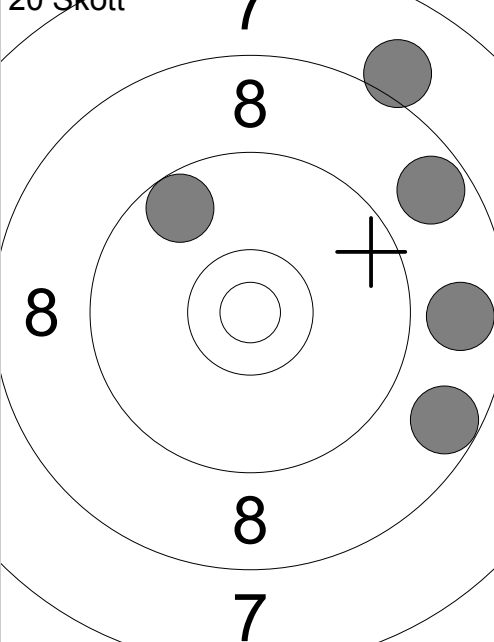
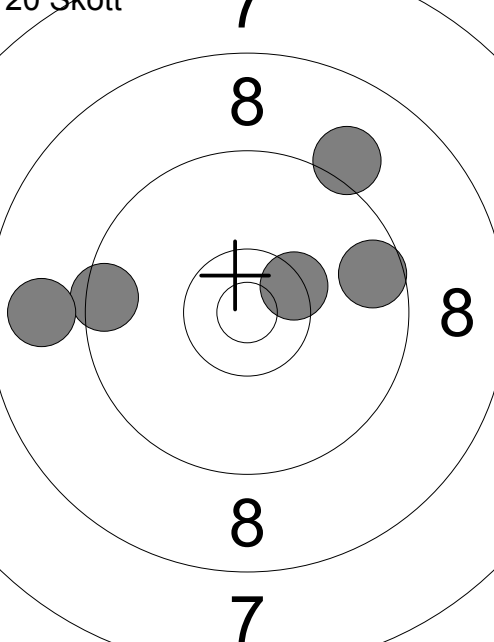
Prov 	1: 9.5 ↓ 2: 8.8 → 3: 9.7 → 4: 9.6 ↗ 5: 9.2 → 6: 10.1 → 7: 9.6 ↓ 8: 10.2 ↓ 9: 10.0 ↓ 10: 10.2 ↓ Serie 93 Total 0	Prov 	11: 10.4x ↘ 12: 9.6 ↗ 13: 10.5x ← 14: 10.0 ↑ 15: 10.2 ← Serie 49 Total 0
20 Skott 	1: 10.4x ← 2: 10.4x ↓ 3: 10.8x ↗ 4: 10.8x ↓ 5: 10.8x → Serie 50 Total 50	20 Skott 	6: 10.6x → 7: 10.3 ↗ 8: 10.0 ↓ 9: 10.0 ← 10: 10.5x ↘ Serie 50 Total 100
20 Skott 	11: 8.1 ↗ 12: 8.7 → 13: 8.8 → 14: 8.7 ↗ 15: 9.7 ↗ Serie 41 Total 141	20 Skott 	16: 9.5 ← 17: 8.8 ← 18: 9.6 → 19: 10.4x ↗ 20: 9.1 ↗ Serie 45 Total 186

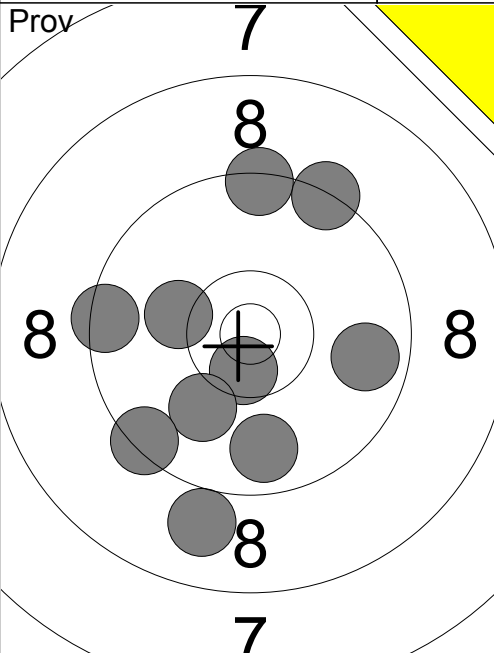
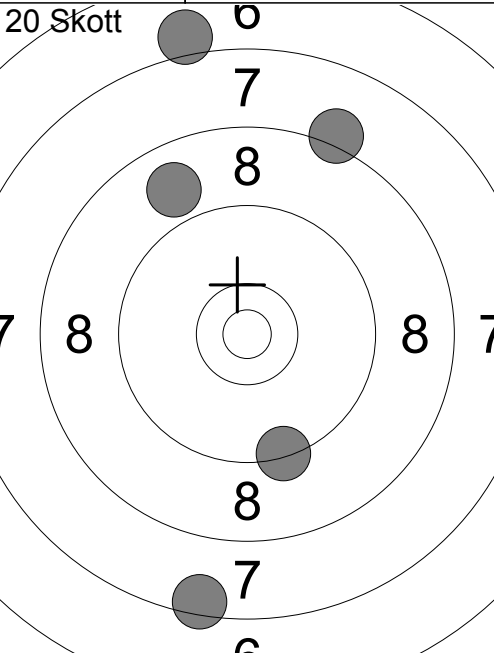
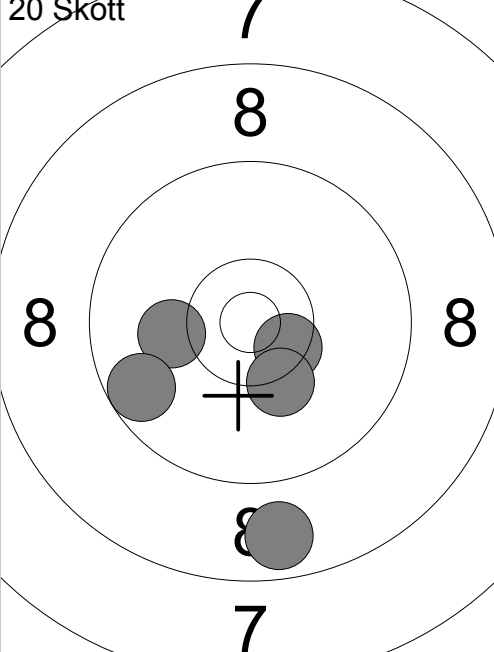
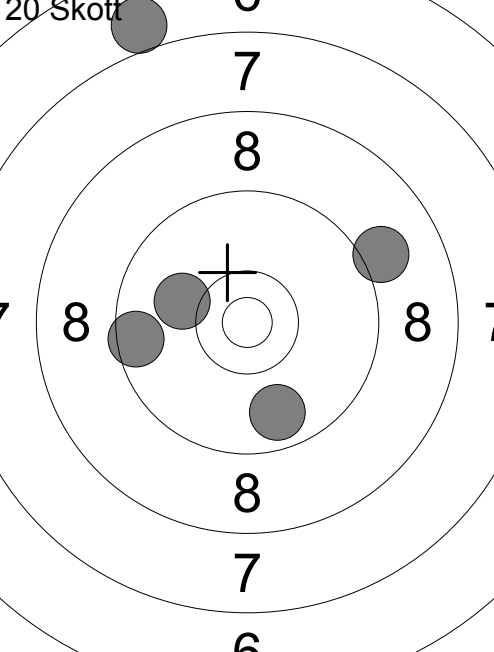
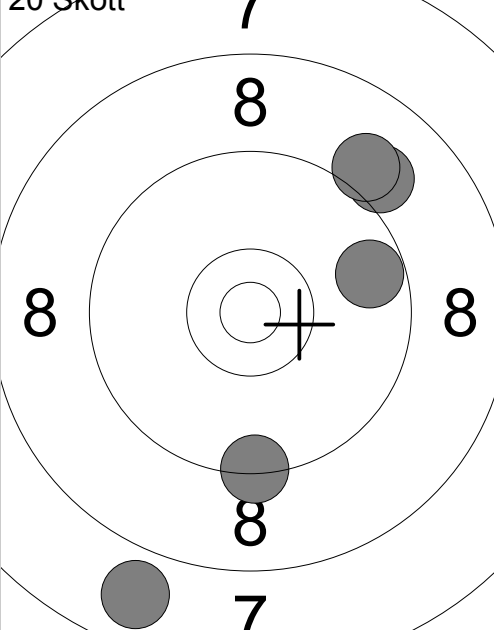
Ramselefors	Ramselefors	Jun-S	Nb
02.09.2017	Höstträffen 2017	Ramselefors SKF	
Prov 	1: 9.4 ↑ 2: 10.6x ↓ 3: 10.1 ↙ 4: 9.3 ↗ 5: 10.2 ← 6: 9.8 → 7: 9.4 ↙ 8: 9.8 ↓ 9: 9.0 ↓ 10: 9.5 ← Serie 93 Total 0	20 Skott 	1: 7.1 ↑ 2: 8.2 ↗ 3: 8.9 ↗ 4: 7.5 ↓ 5: 9.4 ↓ Serie 39 Total 39
20 Skott 	6: 10.5x → 7: 10.3 ↓ 8: 8.7 ↓ 9: 10.1 ← 10: 9.7 ↙ Serie 47 Total 86	20 Skott 	11: 7.0 ↑ 12: 10.1 ← 13: 9.5 ← 14: 9.1 → 15: 9.8 ↓ Serie 44 Total 130
20 Skott 	16: 7.8 ↓ 17: 9.7 → 18: 9.0 ↗ 19: 9.3 ↓ 20: 9.0 ↗ Serie 43 Total 173		

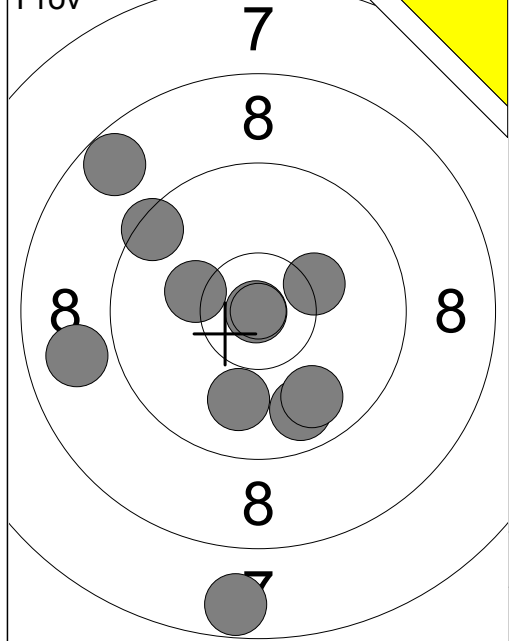

1:	9.9	↓
2:	8.7	↗
3:	10.9x	↙
4:	8.9	↙
5:	9.8	↓
6:	10.2	↙
7:	9.5	↗
8:	7.7	↓
9:	9.8	↓
10:	10.3	↗
Serie		89
Total		0

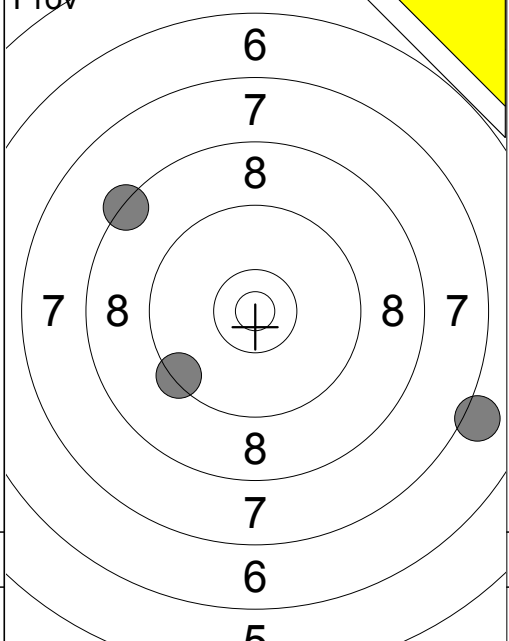

11:	8.4	↗
12:	7.1	↘
13:	9.4	↙
Serie		24
Total		0

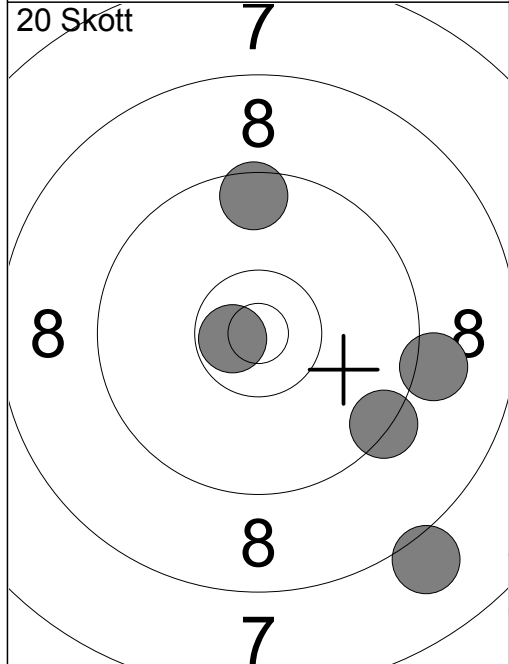

1:	9.4	↘
2:	10.7x	↙
3:	8.1	↓
4:	9.5	↑
5:	9.1	↗
Serie		45
Total		45

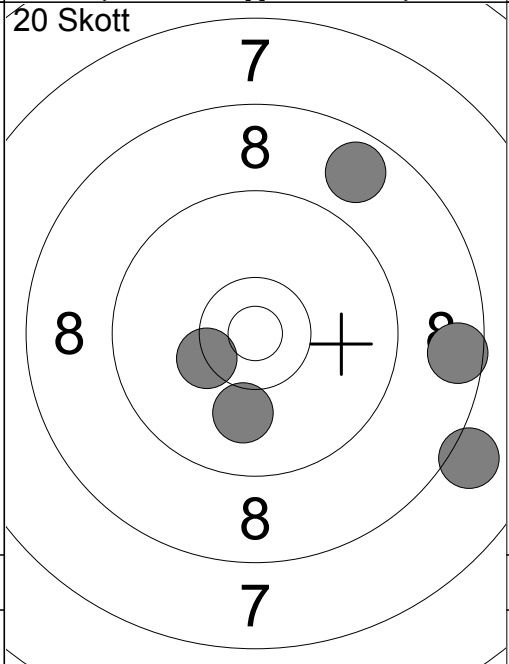

6:	10.3x	↙
7:	8.1	↘
8:	8.6	→
9:	8.8	↗
10:	10.0	↓
Serie		44
Total		89

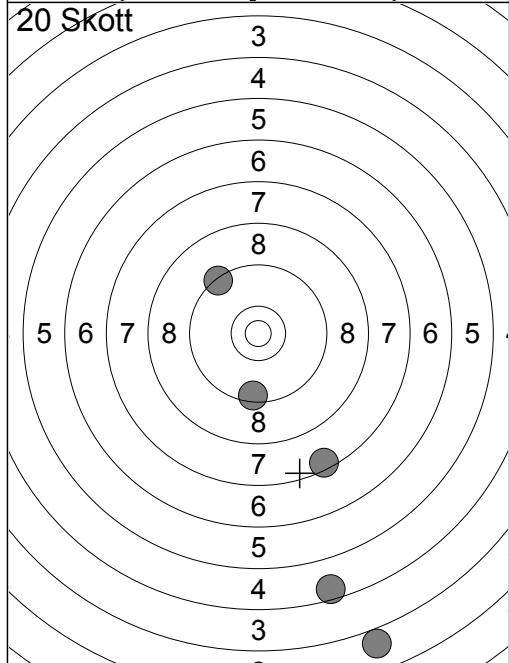

11:	4.6	↓
12:	9.4	↗
13:	9.5	↓
14:	7.5	↓
15:	3.0	↓
Serie		32
Total		121

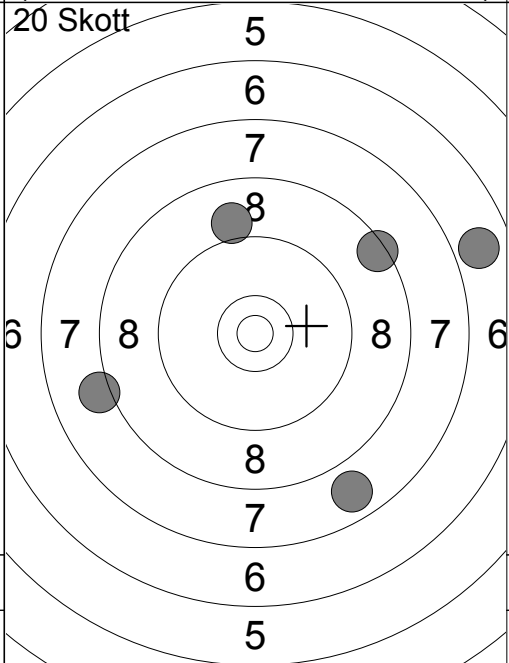

16:	7.8	↓
17:	8.1	↙
18:	8.4	↗
19:	6.9	↗
20:	9.0	↑
Serie		38
Total		159

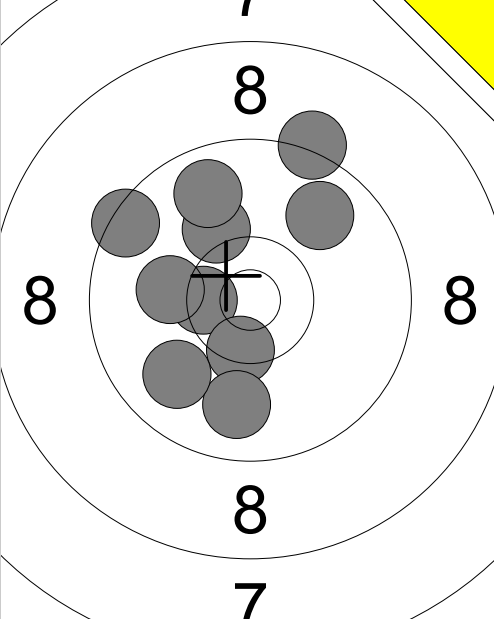
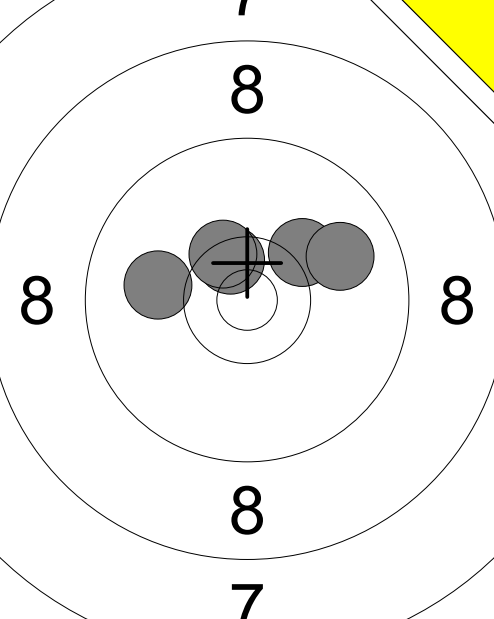
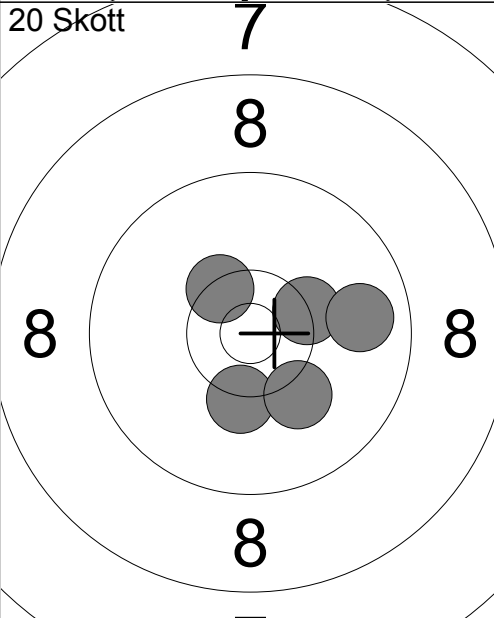
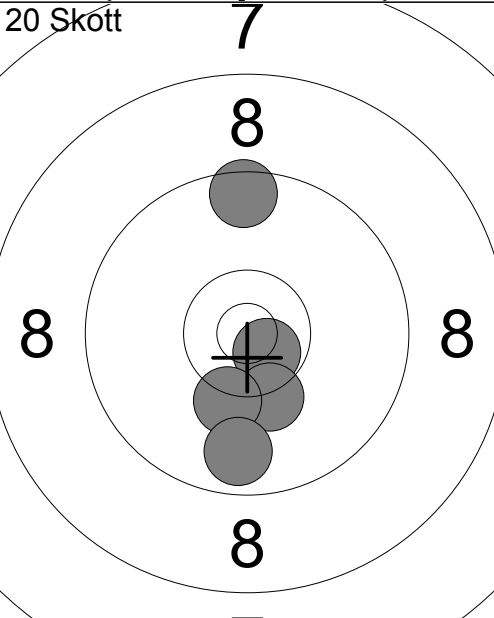
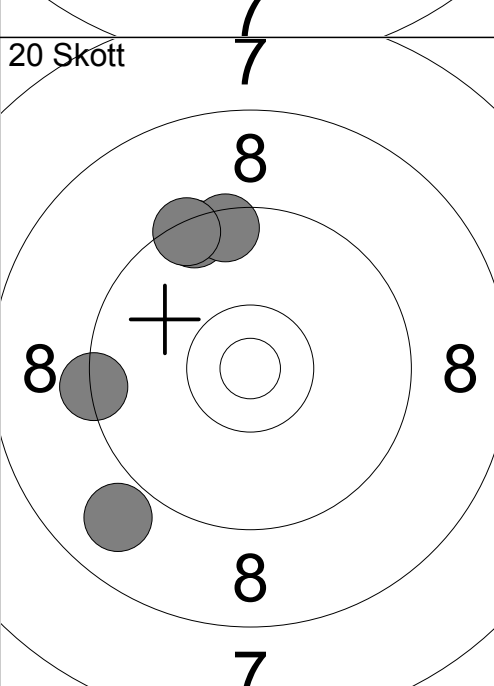
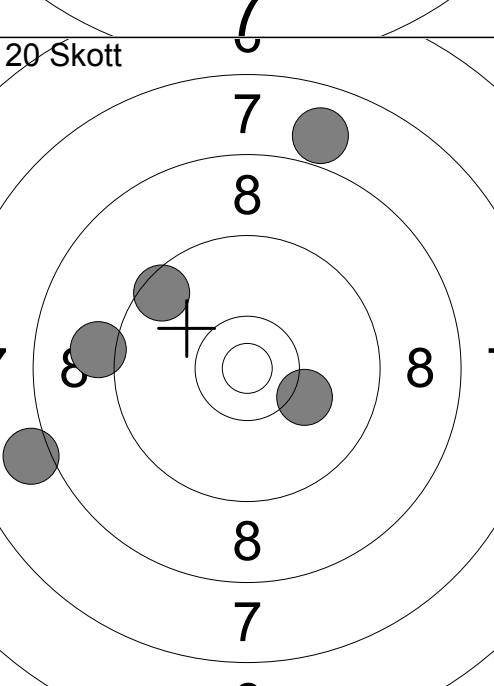
Prov 	1: 9.2 ↗ 2: 9.8 ↗ 3: 10.1 ↗ 4: 9.5 ↖ 5: 10.5x ← 6: 10.4x ↓ 7: 9.9 ↓ 8: 9.9 ↙ 9: 10.1 ← 10: 9.8 ↗ Serie 94 Total 0	Prov 	11: 10.2 ↗ 12: 9.9 ↗ 13: 10.5x ↗ 14: 10.4x ↖ 15: 10.0 ← Serie 49 Total 0
20 Skött 	1: 10.4x ↖ 2: 10.3 ↓ 3: 10.3x → 4: 10.2 ↘ 5: 9.8 → Serie 49 Total 49	20 Skött 	6: 10.7x ↘ 7: 10.3 ↓ 8: 10.2 ↓ 9: 9.7 ↓ 10: 9.5 ↑ Serie 48 Total 97
20 Skött 	11: 9.3 ← 12: 8.9 ↙ 13: 9.5 ↗ 14: 9.5 ↗ 15: 9.4 ↗ Serie 44 Total 141	20 Skött 	16: 7.9 ↗ 17: 9.5 ↖ 18: 8.1 ← 19: 10.2 ↘ 20: 9.1 ← Serie 43 Total 184

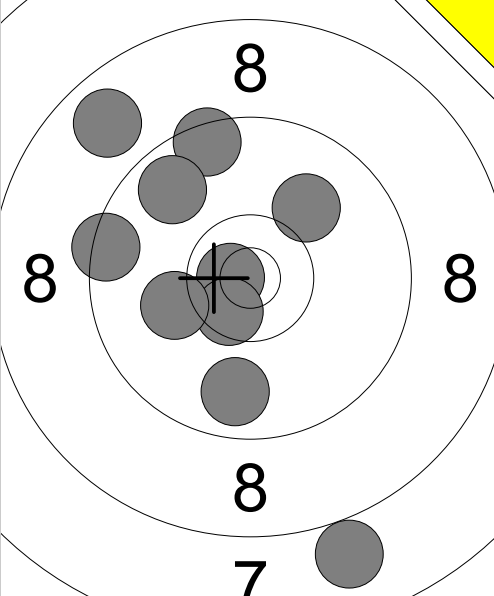
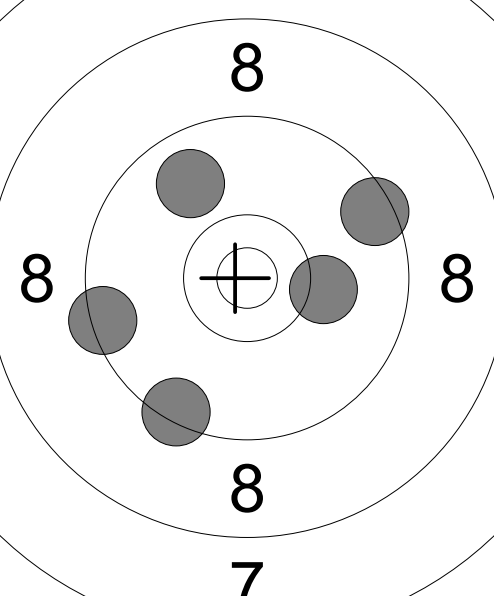
<p>Prov</p>  <p style="text-align: center;">7 8 8 8 7</p>	<p>1: 7.9 ↓</p> <p>2: 10.0 ↗</p> <p>3: 8.8 ↖</p> <p>4: 10.8x ←</p> <p>5: 9.5 ↑</p> <p>6: 9.7 ↗</p> <p>7: 9.8 ↓</p> <p>8: 9.4 ←</p> <p>9: 10.5x ↓</p> <p>10: 10.1 ←</p> <p>Serie 91</p> <p>Total 0</p>	<p>20 Skott</p>  <p style="text-align: center;">7 8 8 8 7</p> <p>1: 9.8 ↖</p> <p>2: 10.2 →</p> <p>3: 9.5 ↗</p> <p>4: 9.4 ←</p> <p>5: 9.4 ↓</p> <p>Serie 46</p> <p>Total 46</p>
---	---	--

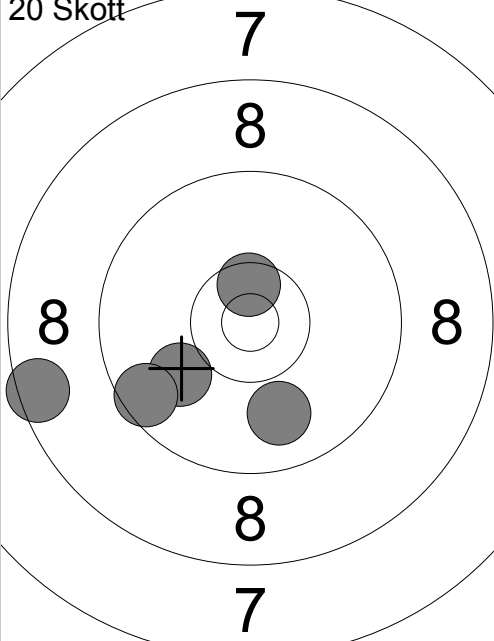
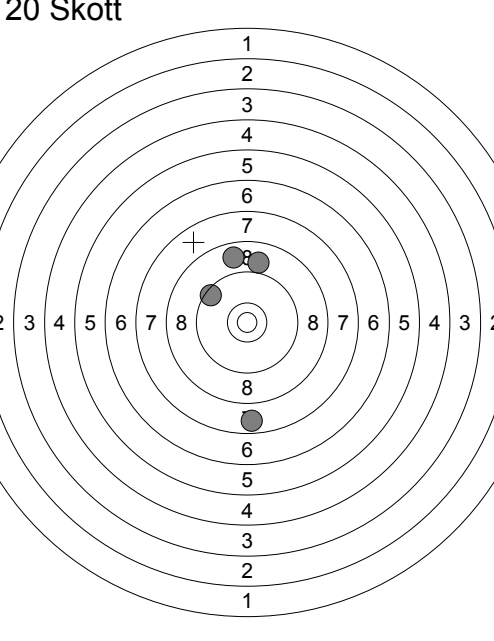
<p>20 Skott</p>  <p style="text-align: center;">7 8 8 8 7</p> <p>6: 10.5x ↑</p> <p>7: 10.0 ↖</p> <p>8: 8.5 ←</p> <p>9: 9.9 ↓</p> <p>10: 9.6 ↖</p> <p>Serie 46</p> <p>Total 92</p>	<p>20 Skott</p>  <p style="text-align: center;">1 2 3 4 5 6 7 8 8 7 6 5 4 3 2 1</p> <p>11: 9.5 ↖</p> <p>12: 0.0 ↖</p> <p>13: 7.7 ↓</p> <p>14: 8.8 ↑</p> <p>15: 9.0 ↑</p> <p>Serie 33</p> <p>Total 125</p>
--	--

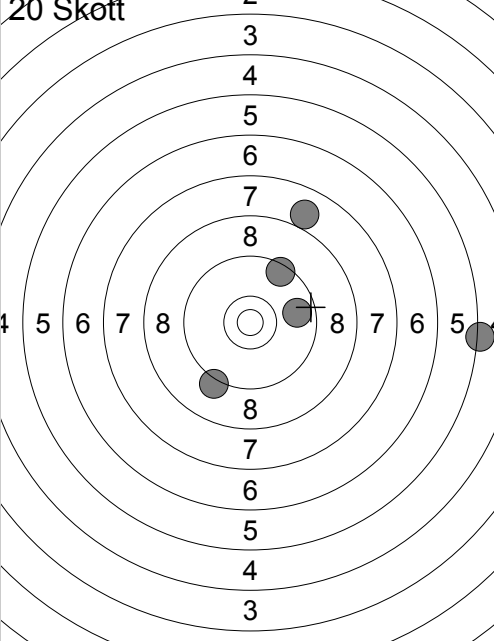
<p>20 Skott</p>  <p style="text-align: center;">2 3 4 5 6 7 8 8 7 6 5 4 3 2</p> <p>16: 5.2 →</p> <p>17: 9.5 ↗</p> <p>18: 8.0 ↗</p> <p>19: 9.2 ↓</p> <p>20: 9.8 →</p> <p>Serie 40</p> <p>Total 165</p>		
---	--	--