

Skjutlag 4	Tavla 3	Linus Eriksson	
Vindeln	Delsbo-Bjuråker		Gä
18.03.2017	SM & JSM Luftgevär 2017	Ramselefors SKF	
Pröv 	1: 10.1 → 2: 10.0 ↓ 3: 9.8 ↓ 4: 10.2x ↓ 5: 9.8 → 6: 8.7 ← 7: 10.1 → 8: 9.4 ← 9: 10.6x ↑ 10: 10.4x ↓ Serie 99.1 Total 0.0	Pröv 	11: 9.6 ↗ 12: 10.1 ← 13: 9.8 ← 14: 9.1 → 15: 6.5 ↖ 16: 9.7 ← 17: 10.5x ↓ 18: 10.7x ↗ 19: 10.8x ↗ 20: 10.4x ↑ Serie 97.2 Total 0.0
Pröv 	21: 9.7 → 22: 9.9 ← 23: 9.5 ← 24: 10.4x → 25: 10.7x ↑ 26: 9.8 → 27: 8.0 ↗ 28: 10.1 ↓ Serie 78.1 Total 0.0	60 Skott 	1: 8.9 ← 2: 9.7 → 3: 10.7x ↓ 4: 10.1 ↓ 5: 10.1 → 6: 10.6x ↑ 7: 9.7 ↑ 8: 10.9x → 9: 10.0 → 10: 9.9 ↖ Serie 100.6 Total 100.6
60 Skott 	11: 10.1 → 12: 9.2 ← 13: 9.5 ↑ 14: 10.2x ← 15: 9.8 → 16: 9.4 ↗ 17: 10.5x ← 18: 10.1 ↖ 19: 8.4 ↗ 20: 9.1 → Serie 96.3 Total 196.9	60 Skott 	21: 10.7x ↗ 22: 10.4x ↑ 23: 10.4x ↓ 24: 9.8 → 25: 9.1 ↖ 26: 9.2 ↑ 27: 9.6 → 28: 10.1 ↖ 29: 9.9 ↑ 30: 9.7 ← Serie 98.9 Total 295.8
60 Skott 	31: 9.4 ↘ 32: 9.2 → 33: 10.4x ↑ 34: 9.9 → 35: 10.1 ↗ 36: 9.8 ↖ 37: 10.7x ↓ 38: 10.4x ↑ 39: 10.5x ↑ 40: 10.6x ← Serie 101.0 Total 396.8	60 Skott 	41: 9.1 ↑ 42: 10.3x ↗ 43: 9.9 ← 44: 10.1 ↑ 45: 9.9 ↑ 46: 9.6 ↗ 47: 9.8 ↑ 48: 9.6 ← 49: 9.6 ↓ 50: 9.8 ↓ Serie 97.7 Total 494.5
60 Skott 	51: 10.2x → 52: 10.2x ↘ 53: 10.0 → 54: 10.2x ↗ 55: 10.5x ↓ 56: 10.0 → 57: 9.5 ← 58: 10.1 → 59: 8.6 → 60: 9.4 ← Serie 98.7 Total 593.2		

Skjuttag	Tavla	Hugo Nyberg	
4	4		
Vindeln	Drängsmark		Vb
18.03.2017	SM & JSM Luftgevär 2017	Ramselefors SKF	
Prov 	1: 9.8 ← 2: 9.6 ↑ 3: 9.5 ↗ 4: 10.2x ↑ 5: 8.9 ↑ 6: 9.1 ↖ 7: 9.6 ↑ 8: 8.9 ← 9: 10.1 ← 10: 9.7 ↗ Serie 95.4 Total 0.0	Prov 	11: 8.8 ↖ 12: 8.2 ↙ 13: 9.0 ↗ 14: 10.4x ↑ 15: 10.4x ↗ 16: 8.7 → 17: 8.9 ← Serie 64.4 Total 0.0
60 Skott 	1: 9.1 ↓ 2: 8.8 ← 3: 10.1 ↖ 4: 9.5 ↙ 5: 9.7 → 6: 9.5 ↗ 7: 9.9 ↗ 8: 10.4x ↑ 9: 10.0 → 10: 10.2x ↙ Serie 97.2 Total 97.2	60 Skott 	11: 9.3 ↗ 12: 8.8 ↗ 13: 10.6x ↙ 14: 10.3x → 15: 10.5x ↙ 16: 9.3 ← 17: 10.0 → 18: 8.7 ← 19: 9.0 ↙ 20: 9.7 ↙ Serie 96.2 Total 193.4
60 Skott 	21: 9.9 → 22: 9.2 → 23: 8.1 ↙ 24: 9.7 ← 25: 7.1 ← 26: 9.3 ↙ 27: 10.1 ↙ 28: 9.7 ↗ 29: 10.7x → 30: 10.2x ↑ Serie 94.0 Total 287.4	60 Skott 	31: 8.8 ← 32: 9.5 ↓ 33: 8.8 ↓ 34: 9.7 ↙ 35: 9.3 ← 36: 10.0 ↗ 37: 10.6x → 38: 8.9 ← 39: 9.7 ↗ 40: 9.3 ↖ Serie 94.6 Total 382.0
60 Skott 	41: 9.7 ← 42: 10.0 ↗ 43: 9.9 → 44: 9.7 ↑ 45: 10.0 → 46: 10.2x ↑ 47: 10.2x ↗ 48: 10.1 ← 49: 10.1 ↙ 50: 10.4x ↙ Serie 100.3 Total 482.3	60 Skott 	51: 8.3 ↙ 52: 10.1 ↙ 53: 9.1 → 54: 10.1 ↑ 55: 9.8 ↙ 56: 9.2 ↙ 57: 9.0 ↙ 58: 8.7 ← 59: 9.7 ↙ 60: 9.5 → Serie 93.5 Total 575.8

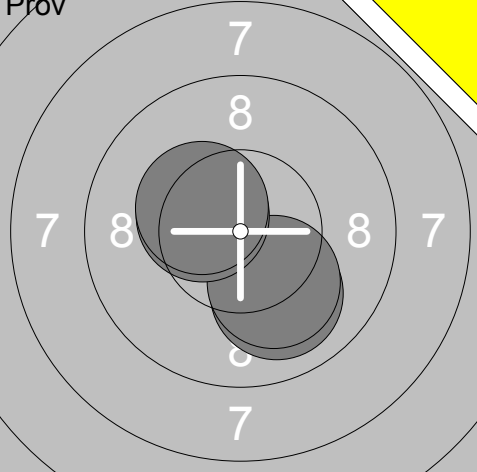
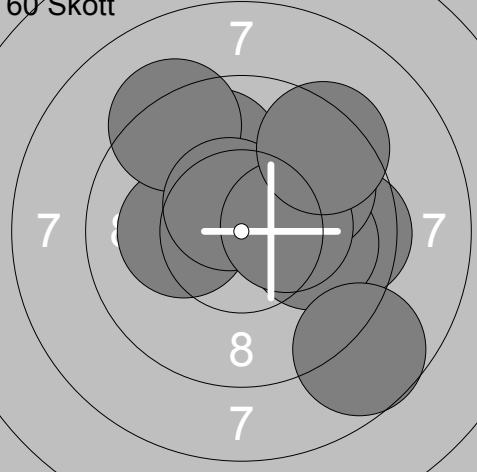
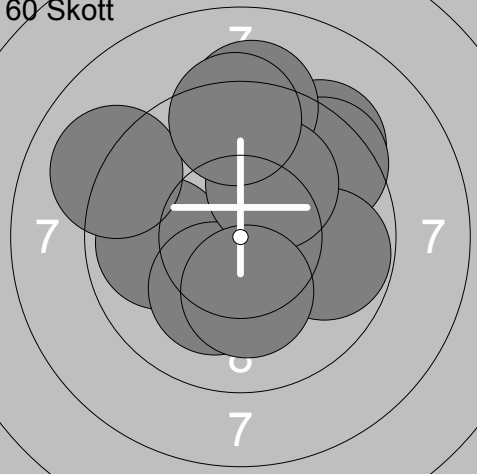
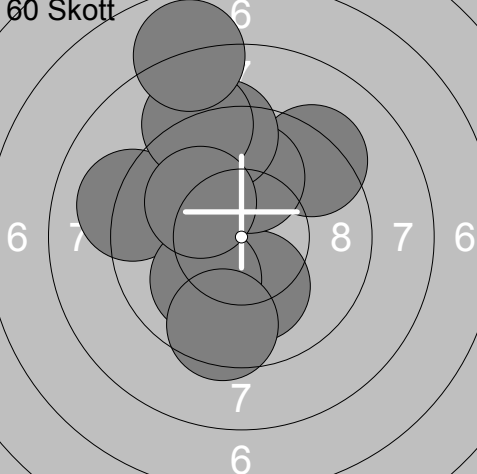
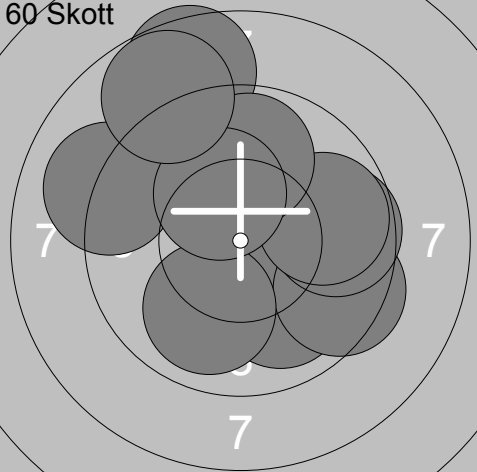
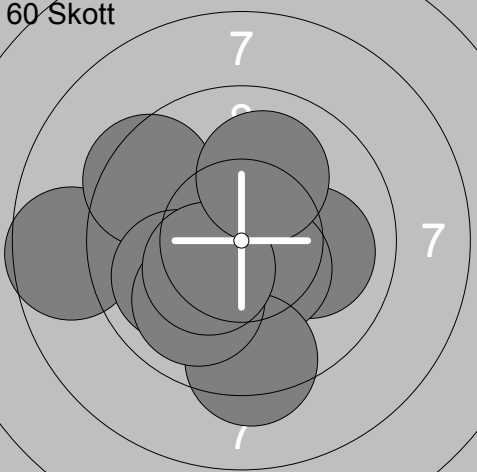
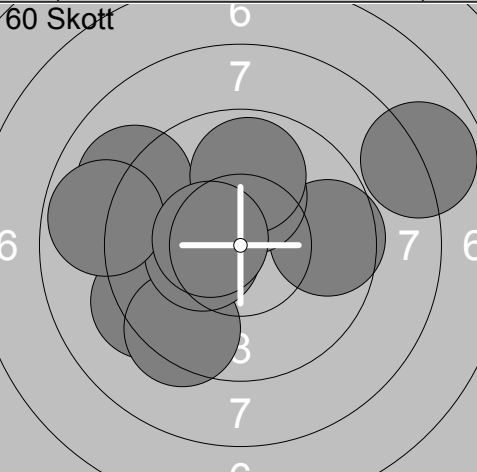

Skjutlag	Tavla	Klas Jonsson	
4	5		
Vindeln	Aspås		Jä
18.03.2017	SM & JSM Luftgevär 2017	Ramselefors SKF	
Pröv 	1: 9.6 ↙ 2: 10.3x ↓ 3: 9.6 ↗ 4: 8.9 → 5: 9.5 ↖ 6: 8.5 ← 7: 8.9 ↖ 8: 10.7x ↗ 9: 10.4x ↑ 10: 7.0 ↘	Pröv 	11: 10.2x ↑ 12: 9.5 ← 13: 8.6 ↑ 14: 10.7x ↓ 15: 10.1 ↗ 16: 8.2 ↗ 17: 10.6x ← 18: 10.5x ↓
	Serie 93.4		Serie 78.4
	Total 0.0		Total 0.0
60 Skott 	1: 10.7x ↓ 2: 10.4x ↗ 3: 10.4x ↗ 4: 10.1 ↓ 5: 8.9 → 6: 7.3 ↖ 7: 10.4x → 8: 8.9 ← 9: 9.8 ↓ 10: 9.7 ↖	60 Skott 	11: 9.6 ↖ 12: 8.4 ↗ 13: 9.6 ↑ 14: 10.6x ↓ 15: 9.7 ↓ 16: 10.5x ← 17: 9.2 ↓ 18: 9.1 ← 19: 9.9 ← 20: 10.7x ↘
	Serie 96.6		Serie 97.3
	Total 96.6		Total 193.9
60 Skott 	21: 8.6 → 22: 10.3x ↗ 23: 9.3 ↘ 24: 10.7x → 25: 10.5x → 26: 8.6 ↘ 27: 9.8 ↘ 28: 10.1 ↗ 29: 9.6 ↓ 30: 9.2 ↗	60 Skott 	31: 9.4 ← 32: 9.7 ← 33: 9.7 → 34: 8.5 → 35: 10.2x → 36: 9.0 → 37: 10.7x ← 38: 10.4x → 39: 10.9x ↓ 40: 9.8 →
	Serie 96.7		Serie 98.3
	Total 290.6		Total 388.9
60 Skott 	41: 10.3x → 42: 10.2x ↗ 43: 10.3x ↗ 44: 9.3 ↗ 45: 9.8 → 46: 10.9x ↗ 47: 10.3x → 48: 10.1 ↓ 49: 9.7 ← 50: 9.2 ↑	60 Skott 	51: 9.9 ↘ 52: 10.3x ← 53: 9.6 ↑ 54: 10.5x ← 55: 8.9 → 56: 10.4x ↓ 57: 10.1 ↓ 58: 10.2x ↑ 59: 10.3x ← 60: 10.2x ↓
	Serie 100.1		Serie 100.4
	Total 489.0		Total 589.4

<p>Pröv</p>	<p>1: 9.5 ↘ 2: 10.3x ↑ 3: 10.3x ← 4: 10.0 ← 5: 10.2x → 6: 10.2x ↘ 7: 10.4x ↑ 8: 9.6 ↘ 9: 10.5x ↘ 10: 9.2 →</p> <p>Serie 100.2 Total 0.0</p>	<p>Pröv</p>	<p>11: 10.2x ↘ 12: 10.2x ↑</p> <p>Serie 20.4 Total 0.0</p>
<p>60 Skott</p>	<p>1: 9.7 ↖ 2: 8.9 ↑ 3: 10.4x ↑ 4: 9.0 ↑ 5: 10.2x → 6: 8.8 ↑ 7: 9.2 → 8: 10.3x ↘ 9: 10.5x ← 10: 9.4 →</p> <p>Serie 96.4 Total 96.4</p>	<p>60 Skott</p>	<p>11: 10.1 ↑ 12: 9.5 ↘ 13: 10.1 ↘ 14: 10.5x ← 15: 10.3x → 16: 10.8x ↓ 17: 10.5x ↑ 18: 10.1 ↓ 19: 10.4x ↘ 20: 10.1 ↓</p> <p>Serie 102.4 Total 198.8</p>
<p>60 Skott</p>	<p>21: 9.3 ← 22: 10.7x ↘ 23: 10.9x → 24: 10.7x ↘ 25: 10.6x ↘ 26: 9.8 ↘ 27: 9.5 → 28: 10.0 → 29: 10.7x ↘ 30: 10.4x ↑</p> <p>Serie 102.6 Total 301.4</p>	<p>60 Skott</p>	<p>31: 10.1 ↘ 32: 10.0 ↓ 33: 10.1 → 34: 9.6 ↘ 35: 9.7 ↖ 36: 10.0 ↘ 37: 9.8 ↖ 38: 9.3 ↖ 39: 10.4x ← 40: 10.1 ↖</p> <p>Serie 99.1 Total 400.5</p>
<p>60 Skott</p>	<p>41: 9.9 ↘ 42: 10.0 ↘ 43: 9.9 ↘ 44: 10.6x ↘ 45: 10.8x → 46: 8.7 ← 47: 9.6 ↘ 48: 10.5x ↘ 49: 10.6x ↑ 50: 9.9 ↗</p> <p>Serie 100.5 Total 501.0</p>	<p>60 Skott</p>	<p>51: 10.1 ← 52: 9.9 ↑ 53: 9.9 ↘ 54: 10.4x ↘ 55: 10.5x ↑ 56: 9.1 ← 57: 10.5x ← 58: 10.1 → 59: 10.5x → 60: 10.6x ↓</p> <p>Serie 101.6 Total 602.6</p>

<p>Pröv</p>  <p style="text-align: center;">7 8 7 8 8 7 8 7</p>	<p>1: 10.0 ↘ 2: 10.1 ↘ 3: 10.4x ↗ 4: 10.3x ↗</p> <p>Serie 40.8 Total 0.0</p>	<p>60 Skott</p>  <p style="text-align: center;">7 8 7</p> <p>1: 9.9 ↗ 2: 10.2x ← 3: 9.3 ↗ 4: 9.5 → 5: 10.0 → 6: 8.7 ↘ 7: 9.9 ↗ 8: 10.5x ↗ 9: 10.3x → 10: 9.4 ↗</p> <p>Serie 97.7 Total 97.7</p>
<p>60 Skott</p>  <p style="text-align: center;">7 7</p>	<p>11: 9.3 ↗ 12: 9.9 ← 13: 9.5 ↗ 14: 9.2 ↗ 15: 9.1 ↗ 16: 9.8 → 17: 10.2x ↘ 18: 10.1 ↗ 19: 10.2x ↘ 20: 9.4 ↗</p> <p>Serie 96.7 Total 194.4</p>	<p>60 Skott</p>  <p style="text-align: center;">6 7 8 7 6</p> <p>21: 9.3 ↗ 22: 9.1 ← 23: 10.1 ↘ 24: 10.1 ↘ 25: 10.0 ↗ 26: 9.3 ↗ 27: 9.0 ↗ 28: 7.9 ↗ 29: 9.5 ↘ 30: 10.1 ↗</p> <p>Serie 94.4 Total 288.8</p>
<p>60 Skott</p>  <p style="text-align: center;">7 7</p>	<p>31: 9.0 ← 32: 10.0 ↘ 33: 9.5 ↘ 34: 10.0 ↘ 35: 8.6 ↗ 36: 9.7 → 37: 9.8 → 38: 9.9 ↗ 39: 10.3x ↗ 40: 8.8 ↗</p> <p>Serie 95.6 Total 384.4</p>	<p>60 Skott</p>  <p style="text-align: center;">7 7</p> <p>41: 8.6 ← 42: 10.7x ← 43: 9.5 ↗ 44: 10.0 ← 45: 10.0 → 46: 10.5x ↘ 47: 9.3 ↘ 48: 10.0 ↘ 49: 10.4x ← 50: 10.0 ↗</p> <p>Serie 99.0 Total 483.4</p>
<p>60 Skott</p>  <p style="text-align: center;">6 7 6</p>	<p>51: 7.9 → 52: 9.3 ← 53: 9.6 → 54: 9.1 ↗ 55: 9.4 ↘ 56: 10.4x ← 57: 8.8 ← 58: 10.2x ↗ 59: 9.9 ↗ 60: 10.5x ←</p> <p>Serie 95.1 Total 578.5</p>	

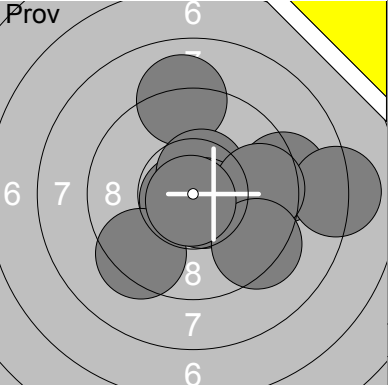
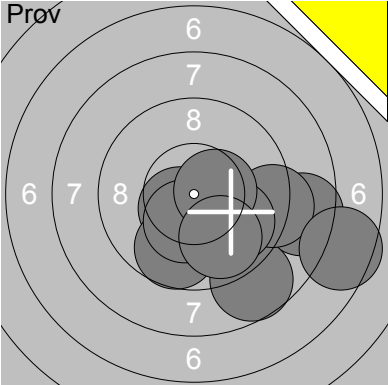
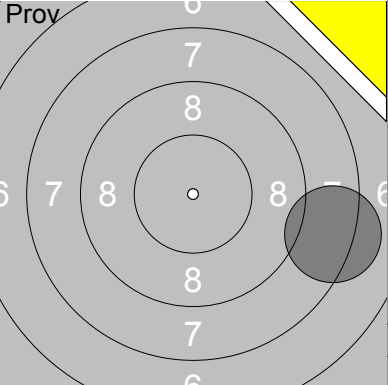
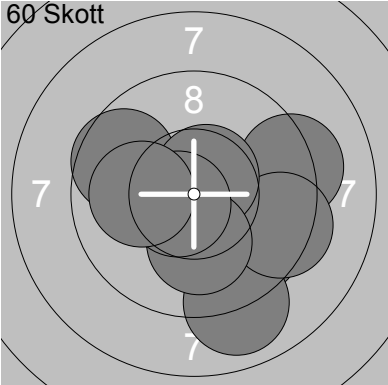
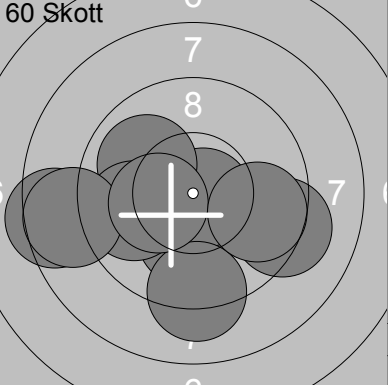
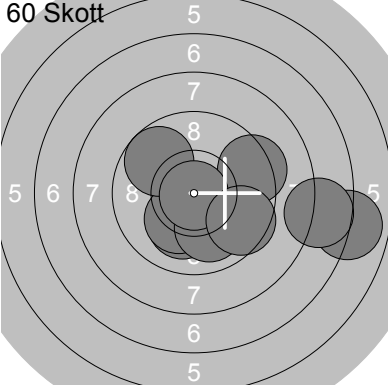
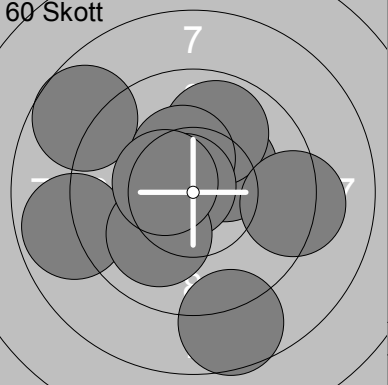
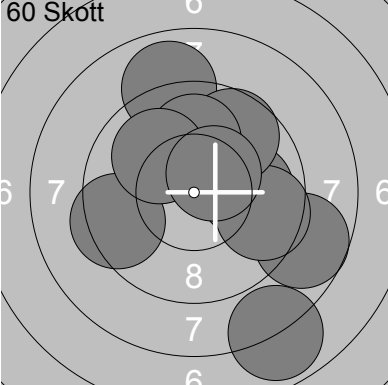
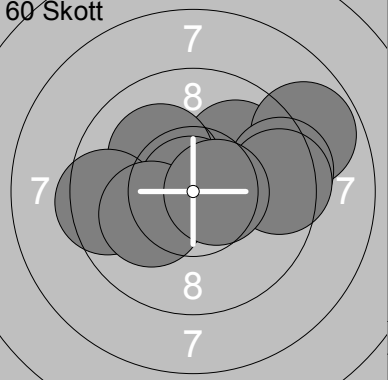
Skjutlag	Tavla	Axel Djupenström	
4	9		
Vindeln	Gefle Frivilliga Skarp		Gä
18.03.2017	SM & JSM Luftgevär 2017	Ramselefors SKF	
Prov 	1: 8.7 ↘ 2: 9.8 ↙ 3: 8.5 ↘ 4: 9.8 ↘ 5: 9.7 ↘ 6: 10.0 ↘ 7: 10.2x ↘ 8: 9.1 ↘ 9: 10.2x ↘ 10: 9.4 ↗	Prov 	11: 10.2x ↖ 12: 10.6x ↗ 13: 8.8 ↑ 14: 10.1 → 15: 9.6 →
	Serie 95.4		Serie 49.3
	Total 0.0		Total 0.0
60 Skott 	1: 9.6 ↑ 2: 10.1 ↗ 3: 9.3 ↑ 4: 9.6 ↗ 5: 8.9 ↗ 6: 10.4x ↗ 7: 10.7x ↘ 8: 9.9 → 9: 10.3x ↗ 10: 9.7 ↓	60 Skott 	11: 9.5 ↑ 12: 10.2x ← 13: 10.2x → 14: 9.1 ← 15: 10.3x ↘ 16: 10.3x ↘ 17: 9.2 ↘ 18: 9.3 ↘ 19: 9.5 ↘ 20: 10.4x →
	Serie 98.5		Serie 98.0
	Total 98.5		Total 196.5
60 Skott 	21: 10.5x ↘ 22: 10.3x ← 23: 9.5 ↑ 24: 9.6 → 25: 9.8 ↗ 26: 9.3 ← 27: 9.6 ↗ 28: 10.3x ↘ 29: 9.2 ↗ 30: 10.0 ←	60 Skott 	31: 9.2 ← 32: 10.8x ↗ 33: 10.1 ← 34: 10.7x ↗ 35: 10.5x ↘ 36: 9.7 ↗ 37: 9.1 ↗ 38: 10.6x ↑ 39: 10.2x ← 40: 8.7 ↖
	Serie 98.1		Serie 99.6
	Total 294.6		Total 394.2
60 Skott 	41: 10.7x ↘ 42: 10.6x ↘ 43: 9.9 ↗ 44: 9.5 ← 45: 10.4x ↘ 46: 9.4 ↗ 47: 10.6x ↘ 48: 8.6 ← 49: 9.4 ↑ 50: 9.4 ←	60 Skott 	51: 10.4x → 52: 10.3x ↘ 53: 10.1 ↗ 54: 10.0 ↗ 55: 10.2x ↗ 56: 8.9 ↑ 57: 9.5 ← 58: 10.5x ← 59: 9.8 ← 60: 8.7 ↑
	Serie 98.5		Serie 98.4
	Total 492.7		Total 591.1

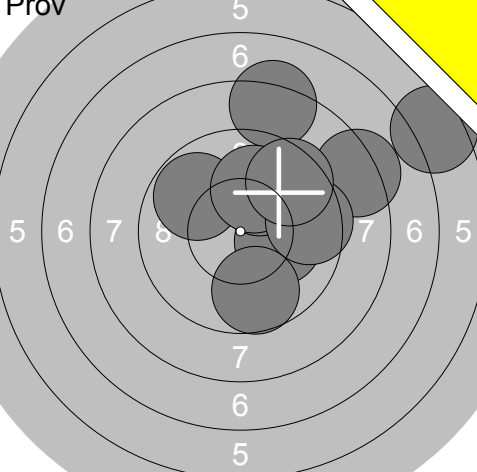
Skjuttlag 4	Tavla 10	Wilhelm Wallin	
Vindeln	Forsa		Gä
18.03.2017	SM & JSM Luftgevär 2017	Ramselefors SKF	
	1: 10.8x ↙ 2: 9.1 ↑ 3: 9.4 ↘ 4: 9.1 → 5: 8.1 → 6: 10.5x ↑ 7: 10.7x ↘ 8: 9.6 → 9: 9.3 ↘ 10: 10.8x ↓ Serie 97.4 Total 0.0		11: 8.5 → 12: 8.7 ↓ 13: 10.5x ↘ 14: 9.2 → 15: 9.7 ↓ 16: 7.5 → 17: 10.3x ↓ 18: 9.9 ↘ 19: 10.5x → 20: 9.9 ↓ Serie 94.7 Total 0.0
	21: 8.2 → Serie 8.2 Total 0.0		1: 9.7 ↘ 2: 9.6 ↗ 3: 9.2 → 4: 10.6x ↘ 5: 9.0 ↓ 6: 9.4 → 7: 10.6x ↗ 8: 10.1 ↓ 9: 10.6x ↙ 10: 10.1 ← Serie 98.9 Total 98.9
	11: 10.2x ↓ 12: 10.8x → 13: 9.2 → 14: 10.0 ↗ 15: 9.8 ← 16: 8.4 ← 17: 9.2 ↓ 18: 8.7 ← 19: 10.3x ← 20: 9.7 → Serie 96.3 Total 195.2		21: 9.3 → 22: 10.1 ↓ 23: 10.2x ↘ 24: 9.7 ↗ 25: 6.9 → 26: 10.0 ↓ 27: 0.0 28: 7.7 → 29: 10.9x ↓ 30: 9.6 ↘ Serie 84.4 Total 279.6
	31: 10.3x ↗ 32: 8.7 ↗ 33: 9.9 ↑ 34: 10.3x ↑ 35: 10.8x ↗ 36: 8.9 ← 37: 8.7 ↘ 38: 10.0 ↓ 39: 9.2 → 40: 10.4x ← Serie 97.2 Total 376.8		41: 7.9 ↓ 42: 8.7 ↘ 43: 10.0 → 44: 9.4 ← 45: 8.9 ↑ 46: 9.6 → 47: 9.7 ↗ 48: 10.0 ↑ 49: 10.0 ↗ 50: 10.4x ↗ Serie 94.6 Total 471.4
	51: 10.0 ↗ 52: 10.4x ↗ 53: 10.1 ↗ 54: 8.8 → 55: 9.4 → 56: 10.9x ↗ 57: 9.5 → 58: 9.5 ← 59: 10.2x ↙ 60: 10.6x → Serie 99.4 Total 570.8		

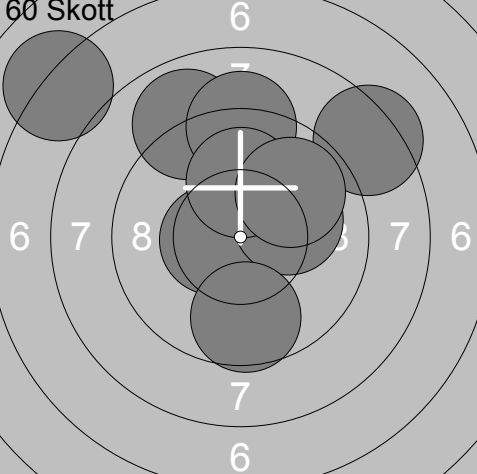
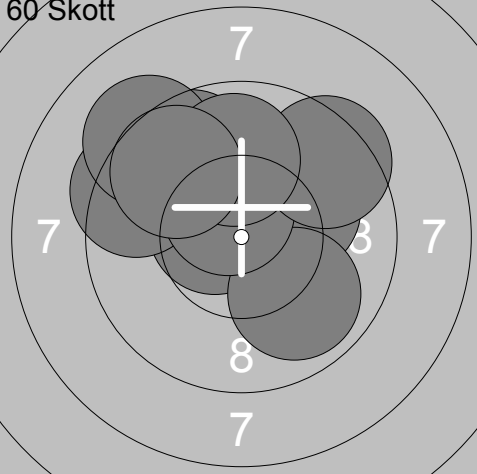
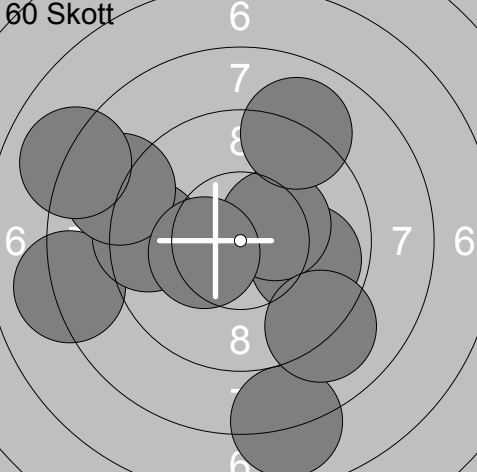
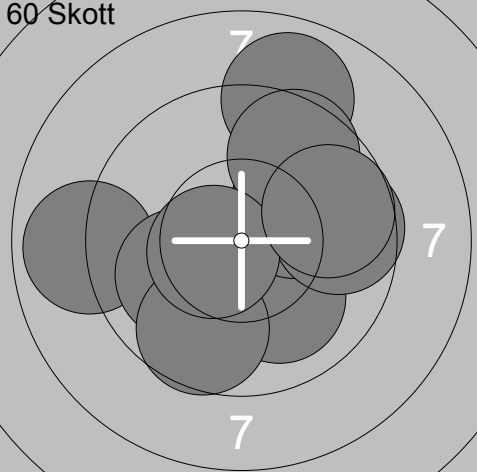
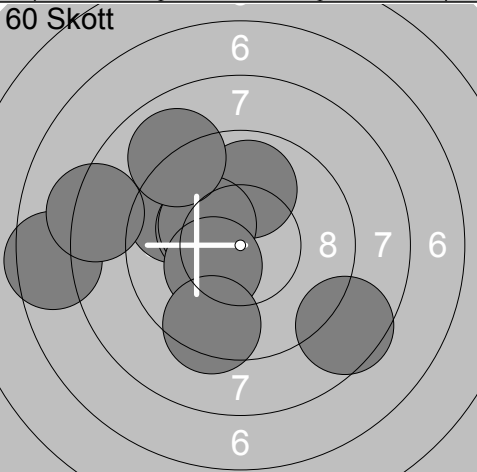
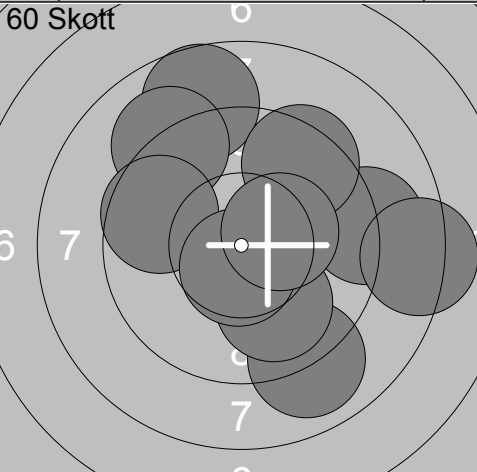
Prov 	<table border="1" style="width:100%; border-collapse: collapse;"> <tr><td>1:</td><td>10.1</td><td>→</td></tr> <tr><td>2:</td><td>10.0</td><td>↑</td></tr> <tr><td>3:</td><td>9.8</td><td>↖</td></tr> <tr><td>4:</td><td>8.3</td><td>→</td></tr> <tr><td>5:</td><td>6.4</td><td>→</td></tr> <tr><td>6:</td><td>8.2</td><td>↑</td></tr> <tr><td>7:</td><td>10.0</td><td>↑</td></tr> <tr><td>8:</td><td>9.5</td><td>→</td></tr> <tr><td>9:</td><td>9.5</td><td>↗</td></tr> <tr><td>10:</td><td>9.7</td><td>↓</td></tr> <tr><td colspan="2">Serie</td><td>91.5</td></tr> <tr><td colspan="2">Total</td><td>0.0</td></tr> </table>	1:	10.1	→	2:	10.0	↑	3:	9.8	↖	4:	8.3	→	5:	6.4	→	6:	8.2	↑	7:	10.0	↑	8:	9.5	→	9:	9.5	↗	10:	9.7	↓	Serie		91.5	Total		0.0	Prov  <table border="1" style="width:100%; border-collapse: collapse;"> <tr><td>11:</td><td>8.0</td><td>↑</td></tr> <tr><td>12:</td><td>10.8x</td><td>→</td></tr> <tr><td>13:</td><td>10.3x</td><td>↑</td></tr> <tr><td colspan="2">Serie</td><td>29.1</td></tr> <tr><td colspan="2">Total</td><td>0.0</td></tr> </table>	11:	8.0	↑	12:	10.8x	→	13:	10.3x	↑	Serie		29.1	Total		0.0																					
1:	10.1	→																																																																								
2:	10.0	↑																																																																								
3:	9.8	↖																																																																								
4:	8.3	→																																																																								
5:	6.4	→																																																																								
6:	8.2	↑																																																																								
7:	10.0	↑																																																																								
8:	9.5	→																																																																								
9:	9.5	↗																																																																								
10:	9.7	↓																																																																								
Serie		91.5																																																																								
Total		0.0																																																																								
11:	8.0	↑																																																																								
12:	10.8x	→																																																																								
13:	10.3x	↑																																																																								
Serie		29.1																																																																								
Total		0.0																																																																								
60 Skott 	<table border="1" style="width:100%; border-collapse: collapse;"> <tr><td>1:</td><td>10.9x</td><td>←</td></tr> <tr><td>2:</td><td>8.9</td><td>↑</td></tr> <tr><td>3:</td><td>7.1</td><td>↖</td></tr> <tr><td>4:</td><td>10.5x</td><td>←</td></tr> <tr><td>5:</td><td>9.1</td><td>↑</td></tr> <tr><td>6:</td><td>10.1</td><td>→</td></tr> <tr><td>7:</td><td>10.1</td><td>↑</td></tr> <tr><td>8:</td><td>8.3</td><td>↗</td></tr> <tr><td>9:</td><td>9.9</td><td>↗</td></tr> <tr><td>10:</td><td>9.6</td><td>↓</td></tr> <tr><td colspan="2">Serie</td><td>94.5</td></tr> <tr><td colspan="2">Total</td><td>94.5</td></tr> </table>	1:	10.9x	←	2:	8.9	↑	3:	7.1	↖	4:	10.5x	←	5:	9.1	↑	6:	10.1	→	7:	10.1	↑	8:	8.3	↗	9:	9.9	↗	10:	9.6	↓	Serie		94.5	Total		94.5	60 Skott  <table border="1" style="width:100%; border-collapse: collapse;"> <tr><td>11:</td><td>10.1</td><td>↗</td></tr> <tr><td>12:</td><td>10.6x</td><td>↖</td></tr> <tr><td>13:</td><td>9.4</td><td>↖</td></tr> <tr><td>14:</td><td>9.9</td><td>↓</td></tr> <tr><td>15:</td><td>10.5x</td><td>↑</td></tr> <tr><td>16:</td><td>9.7</td><td>↑</td></tr> <tr><td>17:</td><td>9.4</td><td>↗</td></tr> <tr><td>18:</td><td>9.2</td><td>↗</td></tr> <tr><td>19:</td><td>9.9</td><td>↑</td></tr> <tr><td>20:</td><td>9.7</td><td>↗</td></tr> <tr><td colspan="2">Serie</td><td>98.4</td></tr> <tr><td colspan="2">Total</td><td>192.9</td></tr> </table>	11:	10.1	↗	12:	10.6x	↖	13:	9.4	↖	14:	9.9	↓	15:	10.5x	↑	16:	9.7	↑	17:	9.4	↗	18:	9.2	↗	19:	9.9	↑	20:	9.7	↗	Serie		98.4	Total		192.9
1:	10.9x	←																																																																								
2:	8.9	↑																																																																								
3:	7.1	↖																																																																								
4:	10.5x	←																																																																								
5:	9.1	↑																																																																								
6:	10.1	→																																																																								
7:	10.1	↑																																																																								
8:	8.3	↗																																																																								
9:	9.9	↗																																																																								
10:	9.6	↓																																																																								
Serie		94.5																																																																								
Total		94.5																																																																								
11:	10.1	↗																																																																								
12:	10.6x	↖																																																																								
13:	9.4	↖																																																																								
14:	9.9	↓																																																																								
15:	10.5x	↑																																																																								
16:	9.7	↑																																																																								
17:	9.4	↗																																																																								
18:	9.2	↗																																																																								
19:	9.9	↑																																																																								
20:	9.7	↗																																																																								
Serie		98.4																																																																								
Total		192.9																																																																								
60 Skott 	<table border="1" style="width:100%; border-collapse: collapse;"> <tr><td>21:</td><td>9.9</td><td>→</td></tr> <tr><td>22:</td><td>8.1</td><td>←</td></tr> <tr><td>23:</td><td>9.5</td><td>←</td></tr> <tr><td>24:</td><td>10.3x</td><td>→</td></tr> <tr><td>25:</td><td>8.8</td><td>↖</td></tr> <tr><td>26:</td><td>9.0</td><td>↑</td></tr> <tr><td>27:</td><td>10.3x</td><td>←</td></tr> <tr><td>28:</td><td>8.0</td><td>↓</td></tr> <tr><td>29:</td><td>8.0</td><td>↑</td></tr> <tr><td>30:</td><td>9.1</td><td>↓</td></tr> <tr><td colspan="2">Serie</td><td>91.0</td></tr> <tr><td colspan="2">Total</td><td>283.9</td></tr> </table>	21:	9.9	→	22:	8.1	←	23:	9.5	←	24:	10.3x	→	25:	8.8	↖	26:	9.0	↑	27:	10.3x	←	28:	8.0	↓	29:	8.0	↑	30:	9.1	↓	Serie		91.0	Total		283.9	60 Skott  <table border="1" style="width:100%; border-collapse: collapse;"> <tr><td>31:</td><td>10.0</td><td>↓</td></tr> <tr><td>32:</td><td>8.9</td><td>←</td></tr> <tr><td>33:</td><td>10.0</td><td>↖</td></tr> <tr><td>34:</td><td>10.1</td><td>→</td></tr> <tr><td>35:</td><td>8.9</td><td>↑</td></tr> <tr><td>36:</td><td>9.7</td><td>↓</td></tr> <tr><td>37:</td><td>9.6</td><td>↑</td></tr> <tr><td>38:</td><td>9.6</td><td>→</td></tr> <tr><td>39:</td><td>10.5x</td><td>↖</td></tr> <tr><td>40:</td><td>9.7</td><td>→</td></tr> <tr><td colspan="2">Serie</td><td>97.0</td></tr> <tr><td colspan="2">Total</td><td>380.9</td></tr> </table>	31:	10.0	↓	32:	8.9	←	33:	10.0	↖	34:	10.1	→	35:	8.9	↑	36:	9.7	↓	37:	9.6	↑	38:	9.6	→	39:	10.5x	↖	40:	9.7	→	Serie		97.0	Total		380.9
21:	9.9	→																																																																								
22:	8.1	←																																																																								
23:	9.5	←																																																																								
24:	10.3x	→																																																																								
25:	8.8	↖																																																																								
26:	9.0	↑																																																																								
27:	10.3x	←																																																																								
28:	8.0	↓																																																																								
29:	8.0	↑																																																																								
30:	9.1	↓																																																																								
Serie		91.0																																																																								
Total		283.9																																																																								
31:	10.0	↓																																																																								
32:	8.9	←																																																																								
33:	10.0	↖																																																																								
34:	10.1	→																																																																								
35:	8.9	↑																																																																								
36:	9.7	↓																																																																								
37:	9.6	↑																																																																								
38:	9.6	→																																																																								
39:	10.5x	↖																																																																								
40:	9.7	→																																																																								
Serie		97.0																																																																								
Total		380.9																																																																								
60 Skott 	<table border="1" style="width:100%; border-collapse: collapse;"> <tr><td>41:</td><td>9.6</td><td>↖</td></tr> <tr><td>42:</td><td>10.2x</td><td>↖</td></tr> <tr><td>43:</td><td>9.9</td><td>↑</td></tr> <tr><td>44:</td><td>7.5</td><td>←</td></tr> <tr><td>45:</td><td>10.2x</td><td>↖</td></tr> <tr><td>46:</td><td>8.2</td><td>↖</td></tr> <tr><td>47:</td><td>10.3x</td><td>↖</td></tr> <tr><td>48:</td><td>9.0</td><td>↗</td></tr> <tr><td>49:</td><td>8.6</td><td>↓</td></tr> <tr><td>50:</td><td>9.4</td><td>↓</td></tr> <tr><td colspan="2">Serie</td><td>92.9</td></tr> <tr><td colspan="2">Total</td><td>473.8</td></tr> </table>	41:	9.6	↖	42:	10.2x	↖	43:	9.9	↑	44:	7.5	←	45:	10.2x	↖	46:	8.2	↖	47:	10.3x	↖	48:	9.0	↗	49:	8.6	↓	50:	9.4	↓	Serie		92.9	Total		473.8	60 Skott  <table border="1" style="width:100%; border-collapse: collapse;"> <tr><td>51:</td><td>8.7</td><td>↑</td></tr> <tr><td>52:</td><td>9.0</td><td>↓</td></tr> <tr><td>53:</td><td>9.1</td><td>↗</td></tr> <tr><td>54:</td><td>9.6</td><td>↖</td></tr> <tr><td>55:</td><td>9.0</td><td>→</td></tr> <tr><td>56:</td><td>10.0</td><td>↓</td></tr> <tr><td>57:</td><td>10.6x</td><td>↓</td></tr> <tr><td>58:</td><td>8.2</td><td>→</td></tr> <tr><td>59:</td><td>9.4</td><td>↗</td></tr> <tr><td>60:</td><td>10.3x</td><td>→</td></tr> <tr><td colspan="2">Serie</td><td>93.9</td></tr> <tr><td colspan="2">Total</td><td>567.7</td></tr> </table>	51:	8.7	↑	52:	9.0	↓	53:	9.1	↗	54:	9.6	↖	55:	9.0	→	56:	10.0	↓	57:	10.6x	↓	58:	8.2	→	59:	9.4	↗	60:	10.3x	→	Serie		93.9	Total		567.7
41:	9.6	↖																																																																								
42:	10.2x	↖																																																																								
43:	9.9	↑																																																																								
44:	7.5	←																																																																								
45:	10.2x	↖																																																																								
46:	8.2	↖																																																																								
47:	10.3x	↖																																																																								
48:	9.0	↗																																																																								
49:	8.6	↓																																																																								
50:	9.4	↓																																																																								
Serie		92.9																																																																								
Total		473.8																																																																								
51:	8.7	↑																																																																								
52:	9.0	↓																																																																								
53:	9.1	↗																																																																								
54:	9.6	↖																																																																								
55:	9.0	→																																																																								
56:	10.0	↓																																																																								
57:	10.6x	↓																																																																								
58:	8.2	→																																																																								
59:	9.4	↗																																																																								
60:	10.3x	→																																																																								
Serie		93.9																																																																								
Total		567.7																																																																								

Skjuttag	Tavla	Jonas Olofsson			
4	13				Jä
Vindeln	Aspås				
18.03.2017	SM & JSM Luftgevär 2017	Ramselefors SKF			
Pröv 	1: 9.2 ↗	Pröv 	11: 10.6x ↗		
	2: 10.1 →		12: 9.0 ↗		
	3: 9.4 ↑		13: 10.6x ←		
	4: 8.7 ↗		14: 8.5 ↗		
	5: 10.3x ↗		15: 8.7 ↗		
	6: 9.5 ↗				
	7: 8.8 ↗				
	8: 10.4x ←				
	9: 9.8 →				
	10: 8.4 ↗				
	Serie 94.6		Serie 47.4		
	Total 0.0		Total 0.0		
60 Skott 	1: 9.4 ↗	60 Skott 	11: 10.1 ←		
	2: 9.4 ←		12: 9.4 ↗		
	3: 10.5x ↘		13: 10.0 ↗		
	4: 8.7 ←		14: 8.6 ←		
	5: 9.1 ←		15: 10.7x ↗		
	6: 10.5x →		16: 10.5x ↗		
	7: 9.4 ←		17: 9.4 ↘		
	8: 9.1 ←		18: 9.5 →		
	9: 10.5x ↑		19: 10.1 →		
	10: 9.4 →		20: 9.2 ↘		
	Serie 96.0		Serie 97.5		
	Total 96.0		Total 193.5		
60 Skott 	21: 8.5 ←	60 Skott 	31: 8.3 ←		
	22: 9.8 ←		32: 10.9x ↘		
	23: 10.2x ↗		33: 10.3x ↗		
	24: 10.8x ↗		34: 8.5 →		
	25: 10.2x ↑		35: 9.7 ↗		
	26: 9.3 →		36: 9.8 →		
	27: 10.4x ←		37: 10.0 ↗		
	28: 9.4 →		38: 9.6 ←		
	29: 10.2x ↗		39: 9.8 ↗		
	30: 10.4x ←		40: 8.6 ↗		
	Serie 99.2		Serie 95.5		
	Total 292.7		Total 388.2		
60 Skott 	41: 10.0 ←	60 Skott 	51: 9.5 ←		
	42: 10.4x ↘		52: 10.0 ↗		
	43: 9.8 ←		53: 9.4 ↗		
	44: 10.9x ↘		54: 9.3 ↗		
	45: 9.8 ↘		55: 9.0 ↗		
	46: 9.0 ↑		56: 10.2x ↘		
	47: 8.9 ↗		57: 9.2 ←		
	48: 9.7 ↘		58: 10.1 →		
	49: 10.1 ←		59: 10.5x →		
	50: 9.5 ←		60: 9.3 →		
	Serie 98.1		Serie 96.5		
	Total 486.3		Total 582.8		

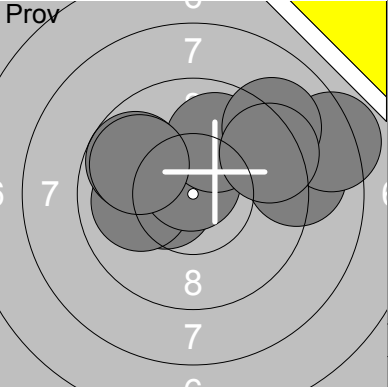
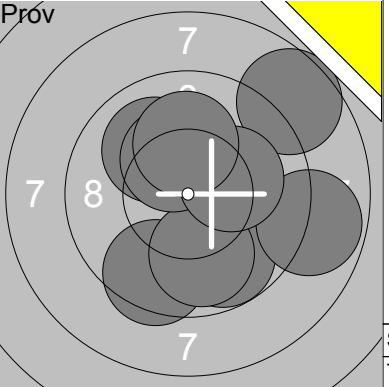
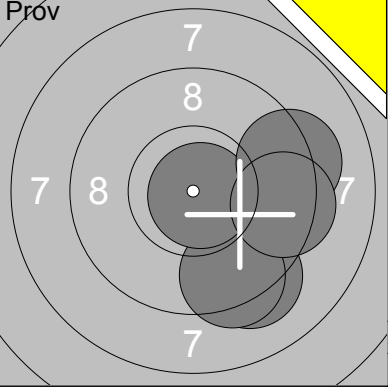
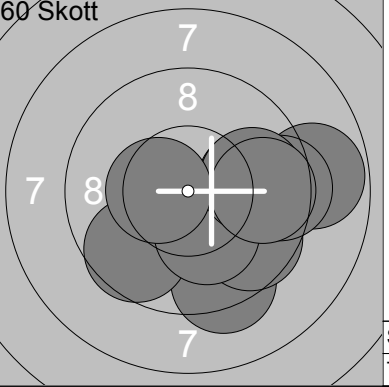
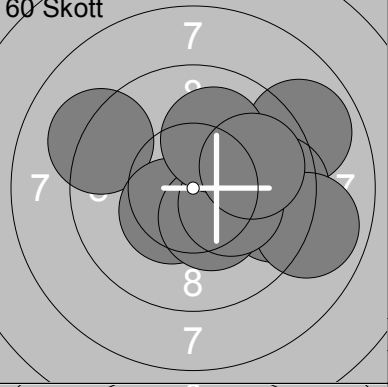
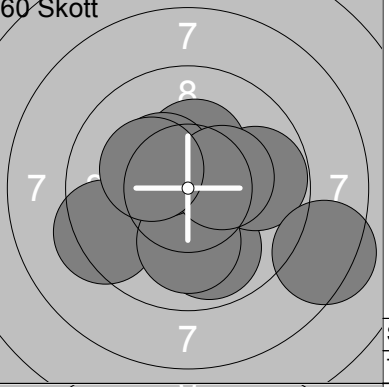
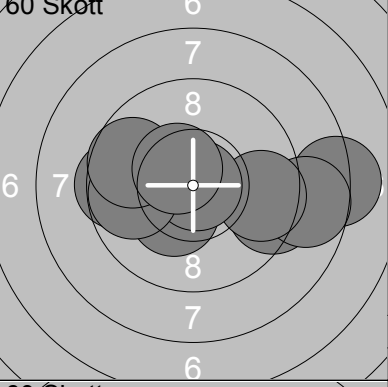
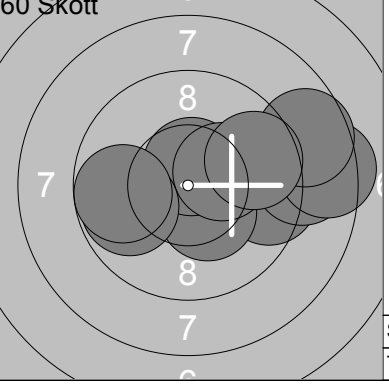
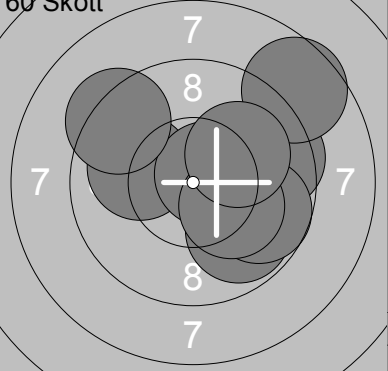
Skjutlag	Tavla	Vincent Stridsson	
4	14		
Vindeln	Gällivare		No
18.03.2017	SM & JSM Luftgevär 2017	Ramselefors SKF	
	1: 10.4x ←		11: 10.0 ↖
	2: 10.0 ←		12: 8.6 ↗
	3: 9.0 →		13: 10.2x →
	4: 8.3 →		14: 9.8 ↓
	5: 10.7x ↑		15: 9.5 ↓
	6: 9.9 ↑		16: 9.9 ↓
	7: 9.1 ↗		17: 10.3x ↑
	8: 9.7 ↖		18: 8.8 →
	9: 9.8 ↖		19: 10.2x →
	10: 9.4 →		20: 10.1 ↑
	Serie 96.3		Serie 97.4
	Total 0.0		Total 0.0
	21: 9.2 ↓		1: 9.3 ↓
	22: 9.4 ↓		2: 9.9 →
	23: 10.8x ↓		3: 9.6 ↓
	24: 9.2 →		4: 8.8 →
	25: 9.4 →		5: 9.6 ↓
	Serie 48.0		Serie 96.7
	Total 0.0		Total 96.7
	11: 8.9 →		21: 9.9 ↓
	12: 9.2 ←		22: 9.3 ←
	13: 9.5 →		23: 9.8 →
	14: 10.4x ↙		24: 10.6x →
	15: 10.4x ↓		25: 10.3x ↑
	16: 9.5 →		26: 8.4 →
	17: 8.9 →		27: 10.0 ↓
	18: 10.3x →		28: 10.4x ↗
	19: 10.1 ↑		29: 10.3x →
	20: 9.9 →		30: 10.3x ↖
	Serie 97.1		Serie 99.3
	Total 193.8		Total 293.1
	31: 9.3 →		41: 9.5 →
	32: 10.3x ↓		42: 8.9 →
	33: 8.1 →		43: 8.4 →
	34: 9.5 ←		44: 10.3x ↓
	35: 8.7 →		45: 10.6x ↑
	36: 9.6 →		46: 8.6 →
	37: 10.9x →		47: 10.3x →
	38: 9.8 ←		48: 9.7 →
	39: 9.7 ←		49: 9.8 ←
	40: 10.5x ↗		50: 9.7 ←
	Serie 96.4		Serie 95.8
	Total 389.5		Total 485.3
	51: 10.2x →		
	52: 9.5 →		
	53: 10.0 ←		
	54: 10.7x →		
	55: 9.8 ↓		
	56: 9.7 →		
	57: 8.6 ↗		
	58: 10.2x ↓		
	59: 9.3 ↗		
	60: 10.1 →		
	Serie 98.1		
	Total 583.4		

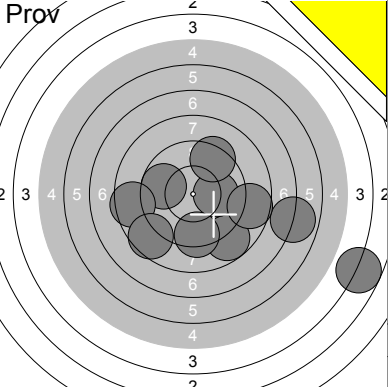
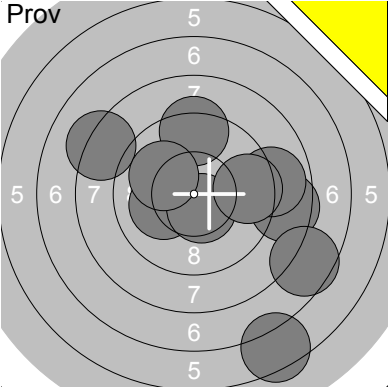
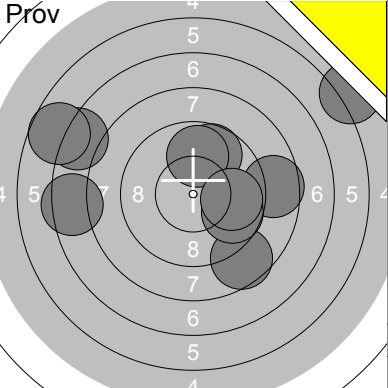
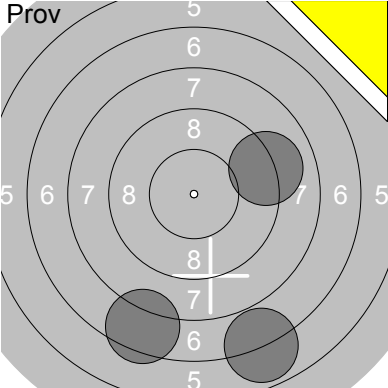
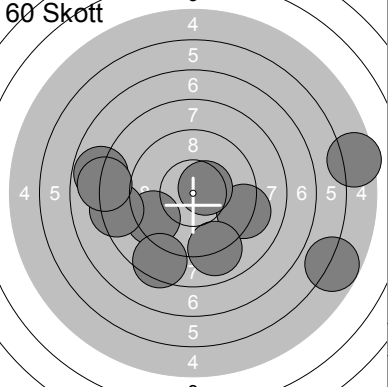
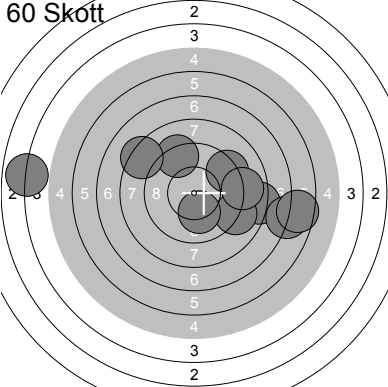
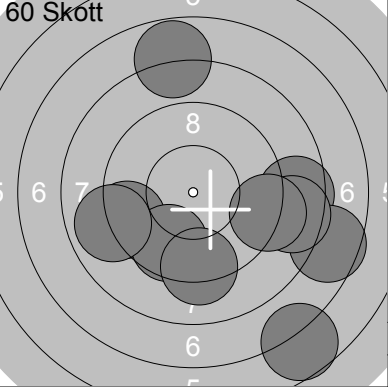
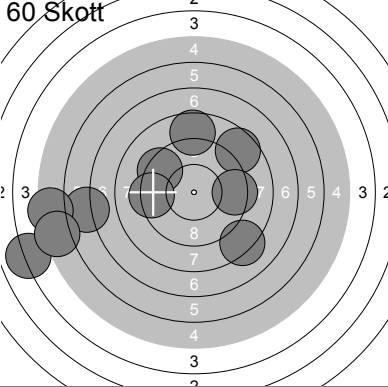
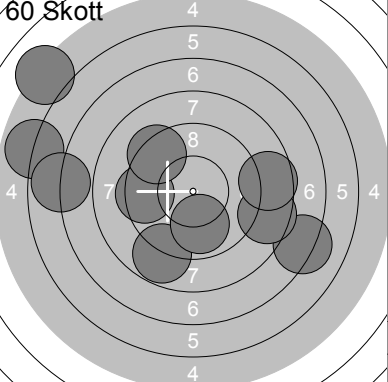
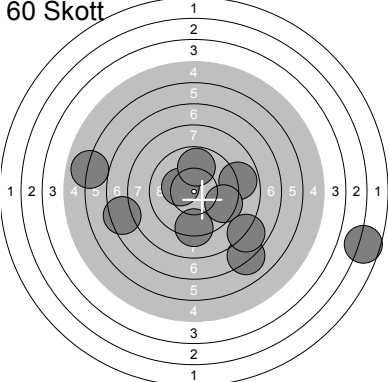
Skjutlag	Tavla	William Wallin		
4	15			
Vindeln	Aspås		Jä	
18.03.2017	SM & JSM Luftgevär 2017	Ramselefors SKF		
Prov		1: 6.9 → 2: 8.8 ↓ 3: 9.3 ↓ 4: 9.8 ← 5: 8.5 ← 6: 8.6 ↓ 7: 3.7 ↓ 8: 10.1 → 9: 9.4 ↑ 10: 8.7 → Serie 83.8 Total 0.0		11: 10.1 ← 12: 8.6 → 13: 6.4 ↓ 14: 10.5x ↓ 15: 8.9 → 16: 9.5 → 17: 8.2 ↖ 18: 9.3 ↑ 19: 10.0 ↖ 20: 7.6 ↓ Serie 89.1 Total 0.0
Prov		21: 7.4 ← 22: 7.2 ↖ 23: 9.7 ↑ 24: 9.8 ↑ 25: 5.5 → 26: 8.6 ↓ 27: 8.6 → 28: 9.7 ↓ 29: 9.8 → 30: 6.7 ↖ Serie 83.0 Total 0.0		31: 9.1 → 32: 7.5 ↓ 33: 6.9 ↓ Serie 23.5 Total 0.0
60 Skott		1: 9.2 → 2: 5.5 → 3: 9.4 ← 4: 8.4 ← 5: 9.0 ↓ 6: 7.8 ← 7: 5.8 ↓ 8: 8.0 ← 9: 8.5 ↓ 10: 10.5x → Serie 82.1 Total 82.1		11: 8.2 → 12: 9.0 → 13: 6.9 → 14: 9.3 ↗ 15: 9.2 ↗ 16: 8.9 → 17: 8.3 ↗ 18: 10.1 ↓ 19: 3.9 ← 20: 6.5 → Serie 80.3 Total 162.4
60 Skott		21: 9.3 ← 22: 9.6 ↓ 23: 8.9 ← 24: 7.8 ↑ 25: 8.5 → 26: 6.7 ↓ 27: 7.6 ↓ 28: 8.6 → 29: 9.2 ↓ 30: 9.1 → Serie 85.3 Total 247.7		31: 8.6 ↗ 32: 4.0 ← 33: 9.4 ↖ 34: 6.7 ← 35: 9.3 ← 36: 9.4 → 37: 5.3 ← 38: 5.4 ← 39: 8.2 ↓ 40: 8.6 ↑ Serie 74.9 Total 322.6
60 Skott		41: 8.8 ↓ 42: 7.2 → 43: 5.9 ← 44: 5.1 ↖ 45: 9.9 ↓ 46: 8.6 → 47: 9.4 ← 48: 9.4 ↗ 49: 8.6 → 50: 6.8 ← Serie 79.7 Total 402.3		51: 8.8 → 52: 10.3x ← 53: 9.5 → 54: 9.3 ↓ 55: 6.0 ← 56: 9.8 ↑ 57: 2.7 → 58: 7.1 ↓ 59: 7.4 ← 60: 7.8 ↓ Serie 78.7 Total 481.0

<p>Prov</p>	<p>1: 10.1 ↗ 2: 9.6 ← 3: 10.6 ✕ 4: 10.1 → 5: 9.1 ↓ 6: 9.2 ← 7: 9.7 ↘ 8: 10.0 ↓ 9: 9.8 ↘ 10: 9.0 ↓</p> <p>Serie 97.2 Total 0.0</p>	<p>Prov</p>	<p>11: 9.9 → 12: 9.7 ↗ 13: 10.6 ✕ 14: 9.9 ←</p> <p>Serie 40.1 Total 0.0</p>
<p>40 Skott</p>	<p>1: 8.9 ↙ 2: 10.7 ✕ 3: 9.9 ↗ 4: 10.9 ✕ 5: 9.8 ↑ 6: 9.9 ↓ 7: 10.6 ✕ 8: 10.2 ✕ 9: 10.1 ↗ 10: 10.2 ✕</p> <p>Serie 101.2 Total 101.2</p>	<p>40 Skott</p>	<p>11: 8.8 ↗ 12: 8.9 ← 13: 10.6 ✕ 14: 9.6 ↗ 15: 10.2 ✕ 16: 9.5 ← 17: 10.3 ✕ 18: 10.4 ✕ 19: 9.9 ↙ 20: 10.4 ✕</p> <p>Serie 98.6 Total 199.8</p>
<p>40 Skott</p>	<p>21: 9.9 ↙ 22: 10.4 ✕ 23: 10.3 ✕ 24: 10.4 ✕ 25: 10.3 ✕ 26: 10.5 ✕ 27: 9.9 ↗ 28: 10.7 ✕ 29: 10.9 ✕ 30: 10.2 ✕</p> <p>Serie 103.5 Total 303.3</p>	<p>40 Skott</p>	<p>31: 10.6 ✕ 32: 10.8 ✕ 33: 10.1 → 34: 9.7 ← 35: 10.2 ✕ 36: 9.6 ↙ 37: 9.8 ← 38: 10.4 ✕ 39: 10.3 ✕ 40: 9.9 →</p> <p>Serie 101.4 Total 404.7</p>

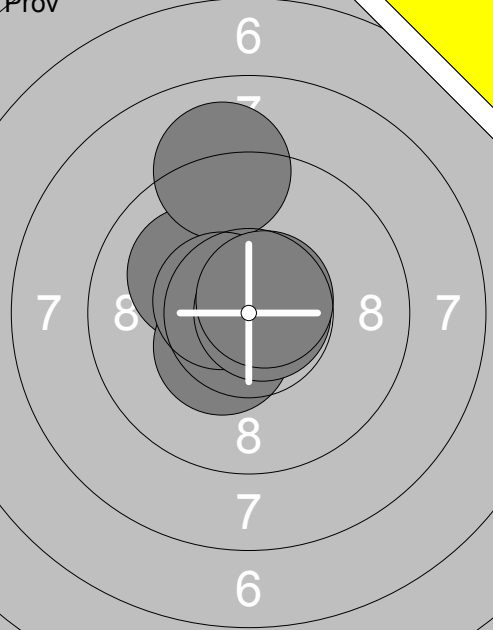
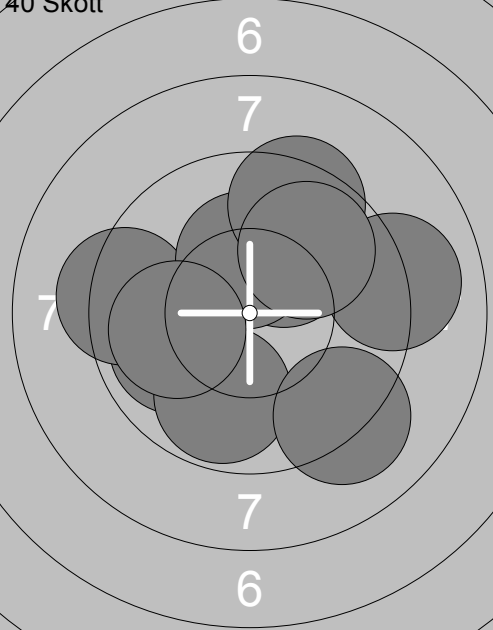
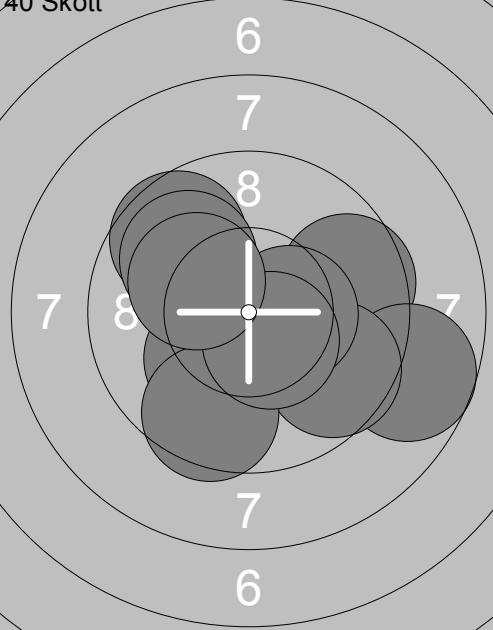
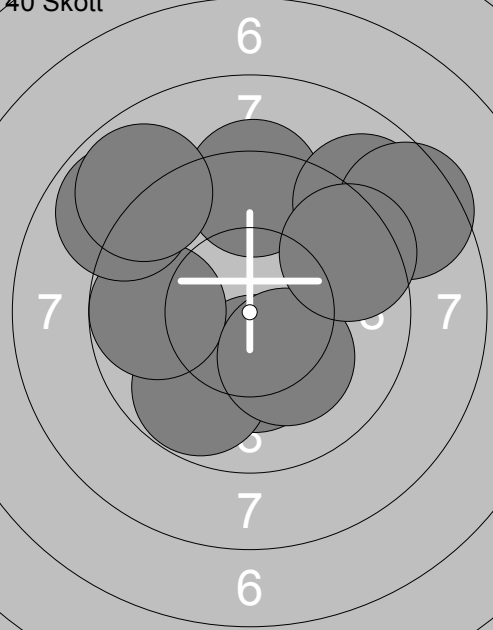
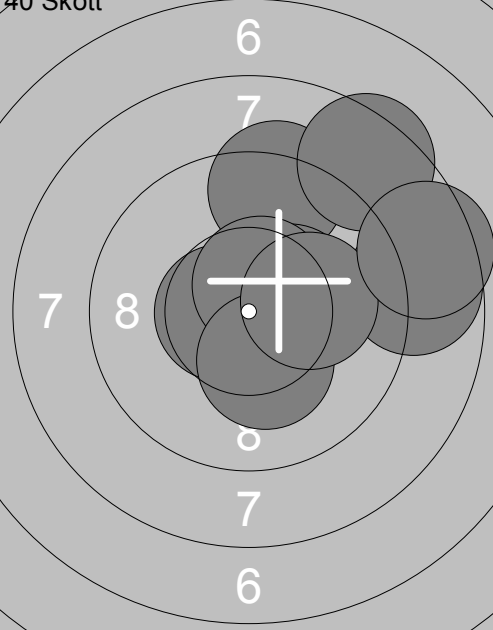
<p>Pröv</p>  <p style="text-align: center;">6 7 8 8 8 8 7 6</p>	<p>1: 10.1 ↖ 2: 9.1 ↑ 3: 10.4x ↘ 4: 10.6x ↖ 5: 10.8x → 6: 10.7x ↗</p> <p>Serie 61.7 Total 0.0</p>	<p>40 Skott</p>  <p style="text-align: center;">6 7 7 7 6</p> <p>1: 9.9 ← 2: 9.3 ← 3: 10.1 ↗ 4: 10.3x↑ 5: 9.0 → 6: 9.8 ↓ 7: 10.0 ← 8: 9.1 ↘ 9: 9.4 ↗ 10: 9.8 ↗</p> <p>Serie 96.7 Total 96.7</p>
<p>40 Skott</p>  <p style="text-align: center;">6 7 8 7 6</p>	<p>11: 9.6 → 12: 8.7 → 13: 9.6 ↘ 14: 9.6 ↖ 15: 10.4x→ 16: 10.2x↘ 17: 9.5 ↓ 18: 9.9 ↖ 19: 10.5x↘ 20: 10.2x↖</p> <p>Serie 98.2 Total 194.9</p>	<p>40 Skott</p>  <p style="text-align: center;">6 7 7 7 6</p> <p>21: 10.3x↓ 22: 9.8 ↓ 23: 9.3 ↑ 24: 9.7 ← 25: 8.9 ↗ 26: 8.9 ↖ 27: 10.2x↘ 28: 8.9 ↖ 29: 8.5 ↗ 30: 9.4 ↗</p> <p>Serie 93.9 Total 288.8</p>
<p>40 Skott</p>  <p style="text-align: center;">6 7 8 6 7 6</p>	<p>31: 10.7x→ 32: 9.3 ↑ 33: 8.8 → 34: 10.6x← 35: 8.5 ↗ 36: 10.4x→ 37: 10.6x↗ 38: 10.3x↓ 39: 10.1 → 40: 8.5 →</p> <p>Serie 97.8 Total 386.6</p>	

<p>Prov</p> <p style="text-align: center;">6 7 8 7 6</p> <p style="text-align: center;">Serie 103.3</p>	<p>1: 10.7x↓ 2: 9.9 → 3: 10.6x↖ 4: 9.7 → 5: 10.8x↓ 6: 10.2x↖ 7: 10.4x↓ 8: 10.2x↗ 9: 10.0← 10: 10.8x↖</p> <p style="text-align: center;">Serie 103.3</p> <p style="text-align: center;">Total 0.0</p>	<p>Prov</p> <p style="text-align: center;">6 7 8 7 6</p> <p style="text-align: center;">Serie 80.9</p>	<p>11: 10.6x↓ 12: 10.6x↓ 13: 9.6 → 14: 10.3x↖ 15: 10.7x↖ 16: 10.2x↗ 17: 9.4 ↓ 18: 9.5 ↓</p> <p style="text-align: center;">Serie 80.9</p> <p style="text-align: center;">Total 0.0</p>
<p>40 Skott</p> <p style="text-align: center;">6 7 8 7 6</p> <p style="text-align: center;">Serie 102.0</p>	<p>1: 10.3x↗ 2: 10.7x↖ 3: 9.6 ↓ 4: 10.0 ↗ 5: 9.7 ↓ 6: 10.4x↖ 7: 10.4x↗ 8: 10.1↖ 9: 10.5x↗ 10: 10.3x↓</p> <p style="text-align: center;">Serie 102.0</p> <p style="text-align: center;">Total 102.0</p>	<p>40 Skott</p> <p style="text-align: center;">6 7 8 7 6</p> <p style="text-align: center;">Serie 99.9</p>	<p>11: 10.2x↖ 12: 9.7 ↓ 13: 10.8x↗ 14: 9.5 → 15: 10.7x↖ 16: 10.1↗ 17: 9.9 → 18: 10.0↗ 19: 10.0 ↓ 20: 9.0 →</p> <p style="text-align: center;">Serie 99.9</p> <p style="text-align: center;">Total 201.9</p>
<p>40 Skott</p> <p style="text-align: center;">6 7 8 7 6</p> <p style="text-align: center;">Serie 99.7</p>	<p>21: 10.2x↓ 22: 10.2x↓ 23: 10.0↖ 24: 9.3 ↗ 25: 10.6x↗ 26: 10.1 ↓ 27: 10.0← 28: 9.3 ↗ 29: 10.2x↖ 30: 9.8 →</p> <p style="text-align: center;">Serie 99.7</p> <p style="text-align: center;">Total 301.6</p>	<p>40 Skott</p> <p style="text-align: center;">6 7 8 7 6</p> <p style="text-align: center;">Serie 100.9</p>	<p>31: 10.3x↖ 32: 9.7 ↖ 33: 10.0↗ 34: 9.8 ↗ 35: 10.2x↓ 36: 9.4↖ 37: 10.0← 38: 10.6x↖ 39: 10.7x↖ 40: 10.2x↓</p> <p style="text-align: center;">Serie 100.9</p> <p style="text-align: center;">Total 402.5</p>

<p>Prov</p>	<p>Prov</p> <p>1: 9.6 ↗ 2: 10.3x↖ 3: 9.2 → 4: 9.9 ← 5: 10.4x↗ 6: 9.4 → 7: 10.5x↘ 8: 9.7 ↑ 9: 10.5x↖ 10: 9.8 ↓</p> <p>Serie 99.3 Total 0.0</p>	<p>Prov</p> <p>11: 9.9 ← 12: 8.7 → 13: 10.7x↑ 14: 10.1 ↓ 15: 9.8 ↓</p> <p>Serie 49.2 Total 0.0</p>
<p>40 Skott</p>	<p>1: 10.1 ↗ 2: 9.7 ↑ 3: 9.5 ↖ 4: 9.9 → 5: 10.8x↗ 6: 10.7x↘ 7: 9.7 ↓ 8: 10.3x→ 9: 9.9 ← 10: 9.3 ↘</p> <p>Serie 99.9 Total 99.9</p>	<p>40 Skott</p> <p>11: 10.1 ↓ 12: 9.4 ← 13: 9.4 ← 14: 9.0 → 15: 10.3x↘ 16: 9.4 ↓ 17: 10.6x↗ 18: 9.7 ↖ 19: 10.1 ↘ 20: 10.0 ↘</p> <p>Serie 98.0 Total 197.9</p>
<p>40 Skott</p>	<p>21: 9.0 ↓ 22: 10.2x↑ 23: 10.0 ↘ 24: 9.3 → 25: 10.1 ↗ 26: 8.8 ↗ 27: 10.5x↗ 28: 9.0 ↘ 29: 10.4x↖ 30: 10.6x↘</p> <p>Serie 97.9 Total 295.8</p>	<p>40 Skott</p> <p>31: 8.6 ← 32: 10.1 ↓ 33: 9.3 ← 34: 10.3x↗ 35: 10.5x↖ 36: 9.8 → 37: 10.2x↓ 38: 10.4x↖ 39: 9.3 ← 40: 9.7 ↓</p> <p>Serie 98.2 Total 394.0</p>

<p>Prov</p>	<p>1: 10.1 ←</p> <p>2: 8.9 →</p> <p>3: 9.4 ←</p> <p>4: 9.1 ←</p> <p>5: 10.5x ↘</p> <p>6: 10.7x ↘</p> <p>7: 9.7 ↓</p> <p>8: 9.6 ←</p> <p>9: 9.7 ↓</p> <p>10: 10.0 ↗</p>	<p>Prov</p>	<p>11: 10.8x ↘</p> <p>12: 9.9 →</p> <p>13: 9.3 ↗</p> <p>14: 10.5x ↗</p> <p>15: 9.8 ↖</p> <p>16: 8.7 ↘</p> <p>17: 9.3 ↓</p> <p>18: 9.5 ↘</p>
Serie 97.7		Serie 77.8	
Total 0.0		Total 0.0	

<p>40 Skott</p>	<p>1: 10.1 ↘</p> <p>2: 9.6 ↘</p> <p>3: 9.5 →</p> <p>4: 10.0 ←</p> <p>5: 9.4 ←</p> <p>6: 9.8 ↘</p> <p>7: 10.8x ↘</p> <p>8: 9.1 →</p> <p>9: 10.3x ↘</p> <p>10: 10.2x ↗</p>	<p>40 Skott</p>	<p>11: 9.9 ↓</p> <p>12: 10.2x ↘</p> <p>13: 8.1 →</p> <p>14: 9.2 ↓</p> <p>15: 10.7x ↘</p> <p>16: 10.2x ↘</p> <p>17: 10.3x ↘</p> <p>18: 10.3x ↗</p> <p>19: 10.0 ↓</p> <p>20: 10.5x ↘</p>
Serie 98.8		Serie 99.4	
Total 98.8		Total 198.2	

<p>40 Skott</p>	<p>21: 9.8 ←</p> <p>22: 10.4x ↘</p> <p>23: 9.6 →</p> <p>24: 8.7 ←</p> <p>25: 10.7x ↘</p> <p>26: 9.6 ←</p> <p>27: 9.2 ↘</p> <p>28: 9.3 ↓</p> <p>29: 10.1 ↘</p> <p>30: 9.1 →</p>	<p>40 Skott</p>	<p>31: 9.0 ↘</p> <p>32: 10.0 ↘</p> <p>33: 10.0 ↘</p> <p>34: 9.8 →</p> <p>35: 10.7x ↗</p> <p>36: 9.5 →</p> <p>37: 10.0 →</p> <p>38: 10.2x ↘</p> <p>39: 10.0 ↗</p> <p>40: 9.0 →</p>
Serie 96.5		Serie 98.2	
Total 294.7		Total 392.9	

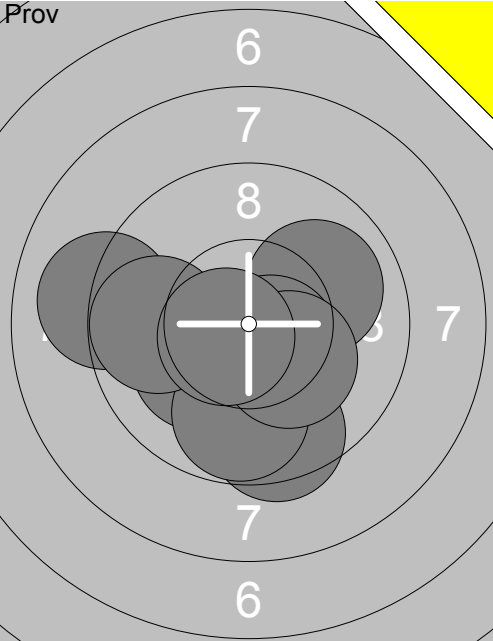
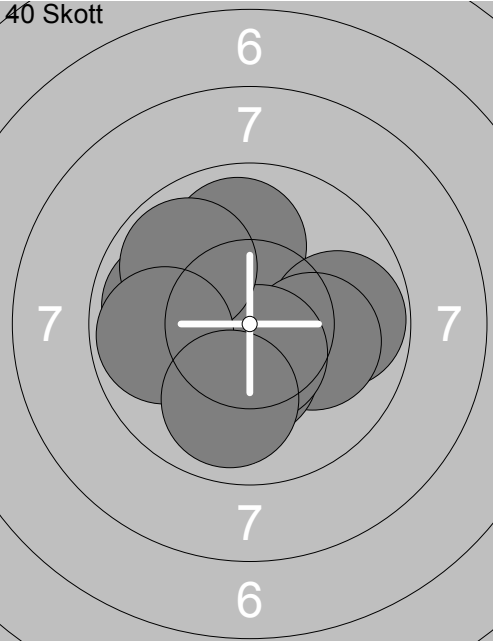
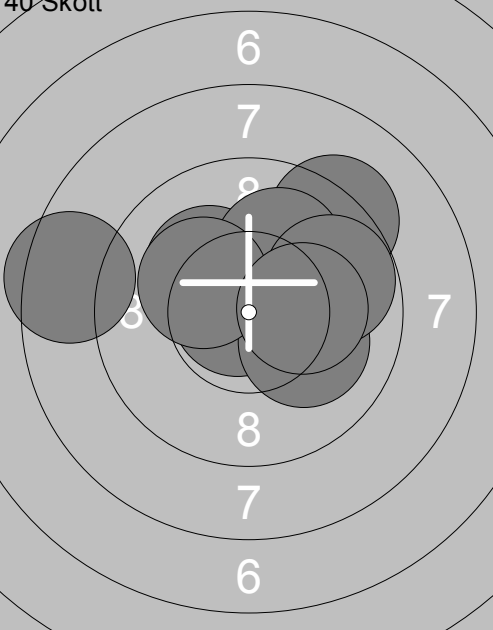
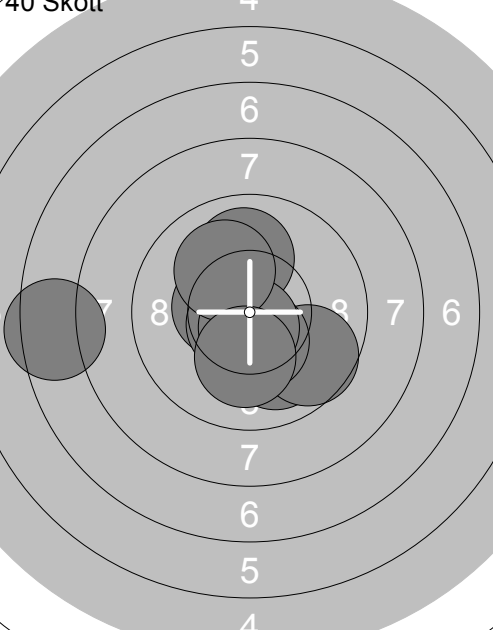
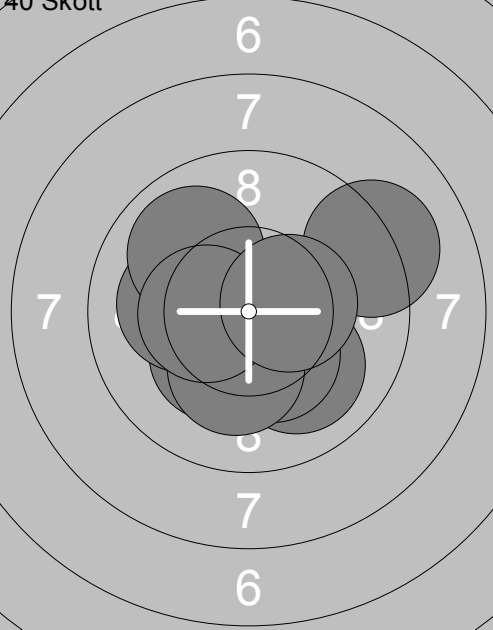
Skjutlag	Tavla	Lina Lindström	
4	26		
Vindeln	Gefle Frivilliga Skarp		Gä
18.03.2017	SM & JSM Luftgevär 2017	Ramselefors SKF	
Prov 	1: 10.0 ↗ 2: 9.5 ↓ 3: 9.1 ← 4: 10.6x↘ 5: 10.1 ↙ 6: 9.8 ↓ 7: 9.8 ← 8: 10.2x↘ 9: 10.6x↙	40 Skott 	1: 9.9 ← 2: 10.4x↖ 3: 9.9 ↑ 4: 9.8 → 5: 10.1 → 6: 10.3x↓ 7: 10.5x↓ 8: 9.9 ↖ 9: 9.8 ← 10: 9.9 ↓
	Serie 89.7		Serie 100.5
	Total 0.0		Total 100.5
40 Skott 	11: 10.2x↖ 12: 10.0 ↗ 13: 10.8x← 14: 10.1 → 15: 9.3 ↗ 16: 10.0 ↗ 17: 10.2x↖ 18: 8.5 ← 19: 9.8 → 20: 10.2x→	40 Skott 	21: 10.5x↖ 22: 10.0 ↑ 23: 10.0 ↓ 24: 9.7 → 25: 10.6x↙ 26: 10.4x↓ 27: 10.7x↓ 28: 10.1 ↖ 29: 7.5 ← 30: 10.2x↓
	Serie 99.1		Serie 99.7
	Total 199.6		Total 299.3
40 Skott 	31: 10.0 ↓ 32: 10.3x↓ 33: 10.3x↙ 34: 10.6x↙ 35: 10.2x↓ 36: 10.1 ← 37: 9.2 ↗ 38: 9.9 ↖ 39: 10.4x← 40: 10.4x→		
	Serie 101.4		
	Total 400.7		

<p>Prov</p>	<p>1: 9.8 ↖ 2: 10.6x➤ 3: 9.9 ↗ 4: 9.7 ↖ 5: 9.3 ← 6: 9.7 ↗ 7: 9.3 ↖ 8: 10.5x↘ 9: 9.9 ↓ 10: 9.9 ↖</p> <p>Serie 98.6 Total 0.0</p>	<p>Prov</p>	<p>11: 10.4x↖ 12: 10.4x↘</p> <p>Serie 20.8 Total 0.0</p>
<p>40 Skott</p>	<p>1: 10.5x↖ 2: 9.3 ↓ 3: 9.8 ↗ 4: 9.8 ↖ 5: 10.2x↖ 6: 10.3x➤ 7: 10.0 ➤ 8: 9.0 ➤ 9: 10.6x↖ 10: 9.9 ↗</p> <p>Serie 99.4 Total 99.4</p>	<p>40 Skott</p>	<p>11: 10.7x↖ 12: 10.1 ➤ 13: 9.5 ➤ 14: 8.9 ↖ 15: 8.4 ↘ 16: 10.1 ↗ 17: 10.6x↖ 18: 9.5 ↘ 19: 9.4 ↗ 20: 8.4 ➤</p> <p>Serie 95.6 Total 195.0</p>
<p>40 Skott</p>	<p>21: 9.4 ↖ 22: 9.2 ↓ 23: 9.5 ↓ 24: 9.6 ↗ 25: 8.8 ↖ 26: 8.9 ↗ 27: 10.1 ↘ 28: 9.4 ↗ 29: 10.1 ↗ 30: 9.8 ↗</p> <p>Serie 94.8 Total 289.8</p>	<p>40 Skott</p>	<p>31: 9.4 ➤ 32: 9.4 ↗ 33: 8.9 ➤ 34: 9.7 ↗ 35: 9.1 ↖ 36: 9.7 ↘ 37: 10.3x➤ 38: 9.4 ↖ 39: 10.3x↗ 40: 10.2x➤</p> <p>Serie 96.4 Total 386.2</p>

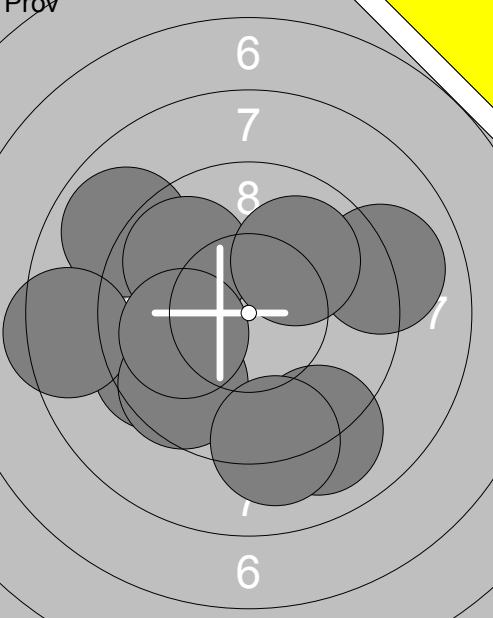
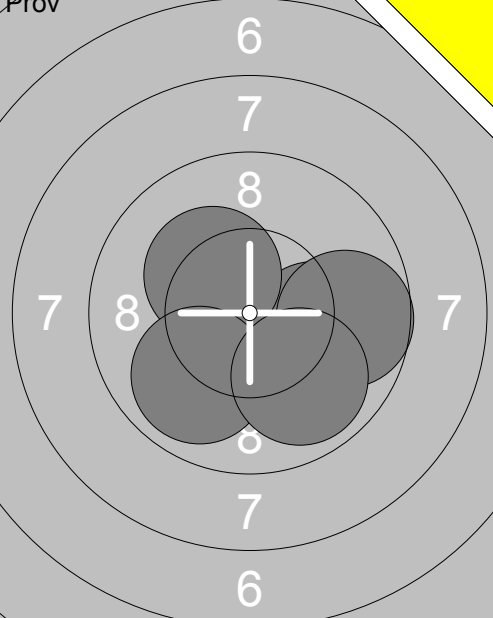
Prov 	1: 9.1 ↘ 2: 9.0 → 3: 8.9 ↖ 4: 9.5 ↙ 5: 9.8 ↖ 6: 8.4 ← 7: 9.6 ↘ 8: 10.0 ↗ 9: 10.0 ← 10: 9.1 ↘ Serie 93.4 Total 0.0	Prov 	11: 10.1 → 12: 10.3x ↖ 13: 9.9 ↘ 14: 9.7 → 15: 9.9 ↘ Serie 49.9 Total 0.0
--	--	--	---

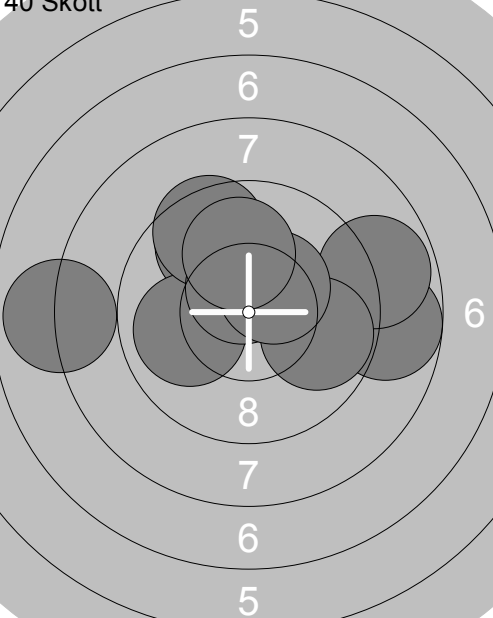
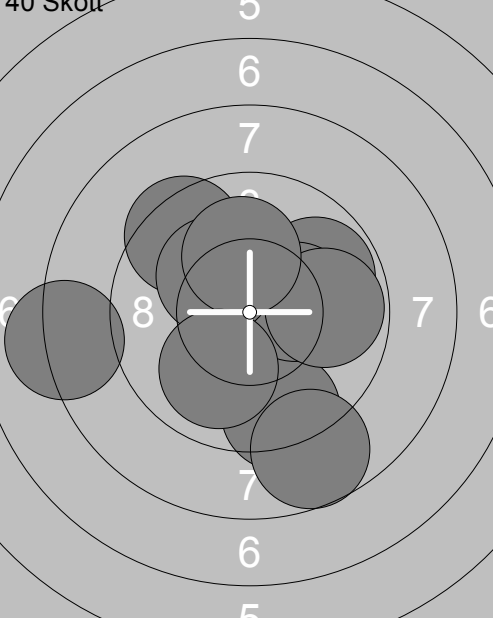
40 Skott 	1: 9.7 ↖ 2: 10.0 ← 3: 9.5 ↗ 4: 8.8 → 5: 10.5x ↗ 6: 7.9 ← 7: 8.8 → 8: 9.8 → 9: 10.4x ↗ 10: 10.0 ↑ Serie 95.4 Total 95.4	40 Skott 	11: 9.4 ↘ 12: 8.7 ↘ 13: 9.8 ↗ 14: 10.3x → 15: 8.1 ← 16: 9.4 ↖ 17: 9.8 → 18: 10.2x ↖ 19: 10.1 ↑ 20: 10.0 ↘ Serie 95.8 Total 191.2
---	---	---	---

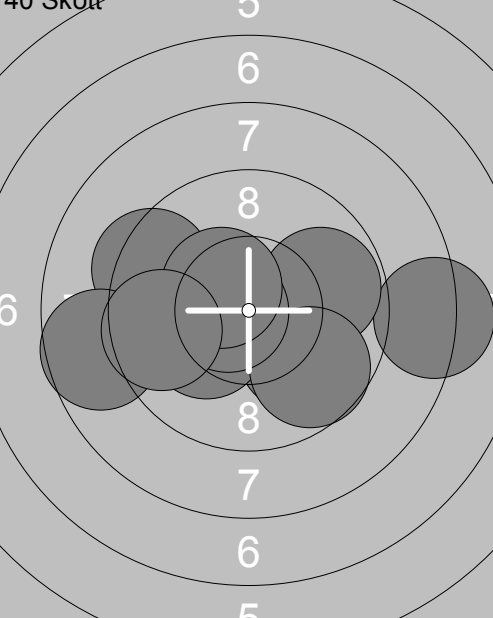
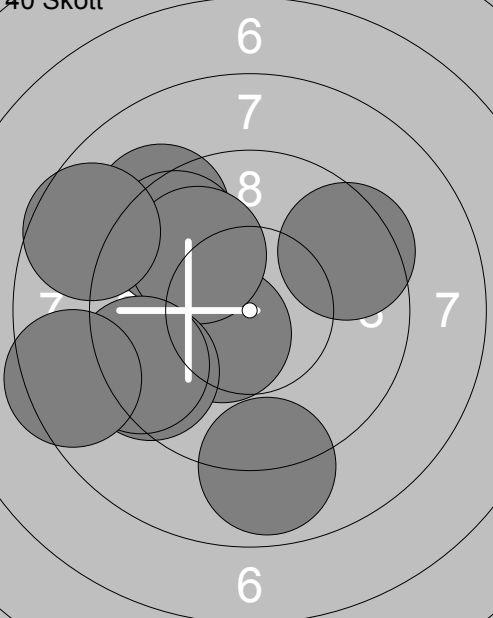
40 Skott 	21: 10.0 ↘ 22: 8.2 → 23: 10.2x ↖ 24: 9.8 → 25: 9.7 ↘ 26: 9.4 ← 27: 10.6x ← 28: 8.7 ← 29: 10.4x ↖ 30: 9.6 ← Serie 96.6 Total 287.8	40 Skott 	31: 10.5x ↖ 32: 9.2 ↖ 33: 9.6 ↖ 34: 10.0 ↖ 35: 9.4 ← 36: 9.4 ← 37: 8.6 ← 38: 9.5 ↗ 39: 8.9 ↘ 40: 8.5 ← Serie 93.6 Total 381.4
--	--	--	--

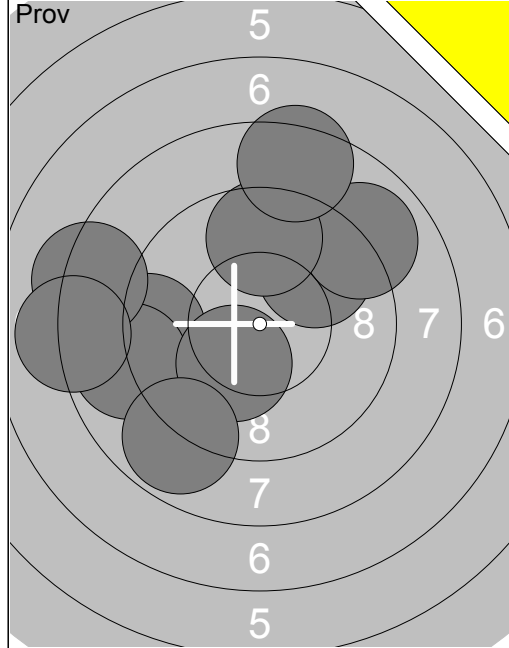

1:	9.2	←
2:	9.8	↗
3:	8.9	←
4:	10.2	↘
5:	8.2	←
6:	8.1	←
7:	8.9	↗
8:	9.6	↑
9:	8.8	↘
10:	8.4	↑
Serie	90.1	
Total	0.0	

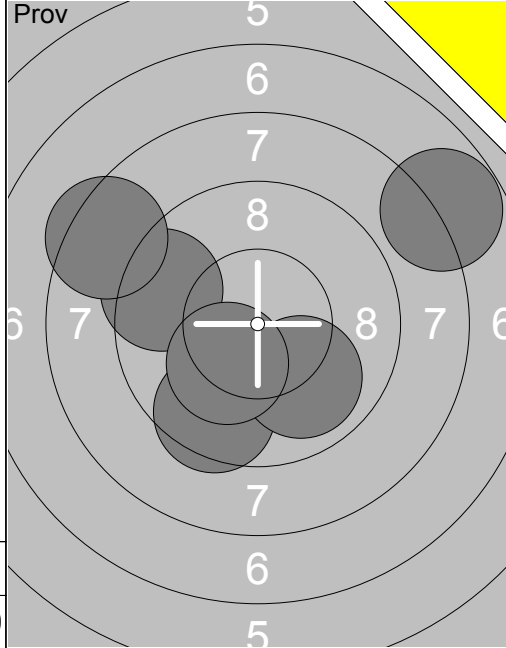

11:	7.8	↗
12:	9.5	↘
13:	10.0	↘
14:	9.5	←
15:	8.4	↖
16:	10.2	↘
Serie	55.4	
Total	0.0	

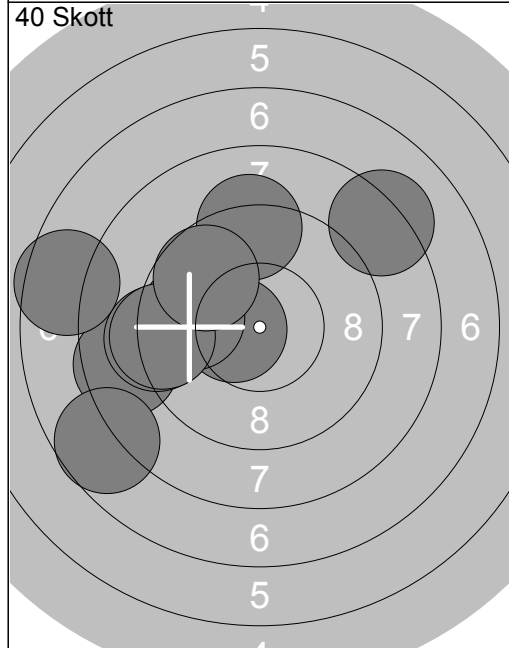

1:	9.2	↑
2:	10.5	↘
3:	8.6	←
4:	9.2	←
5:	7.6	←
6:	9.8	←
7:	7.7	↘
8:	9.3	←
9:	8.2	↗
10:	9.7	↖
Serie	89.8	
Total	89.8	

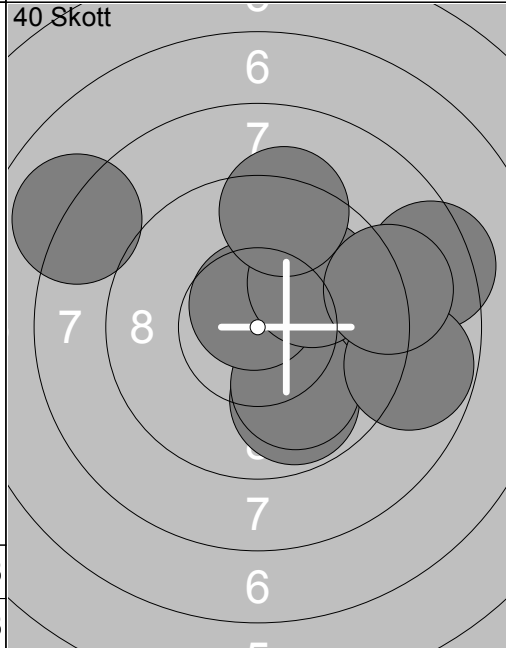

11:	10.0	→
12:	8.4	→
13:	8.0	↖
14:	9.8	↘
15:	10.0	↘
16:	8.8	→
17:	10.6	↗
18:	10.0	↗
19:	9.1	→
20:	9.3	↑
Serie	94.0	
Total	183.8	

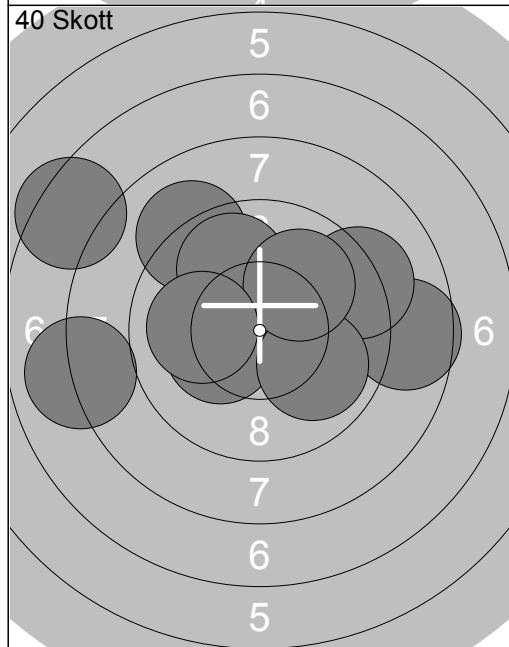

21:	9.1	↖
22:	8.6	→
23:	10.3	↘
24:	9.2	↗
25:	7.4	↖
26:	9.9	↑
27:	9.9	↘
28:	10.0	↗
29:	8.0	←
30:	10.0	←
Serie	92.4	
Total	276.2	

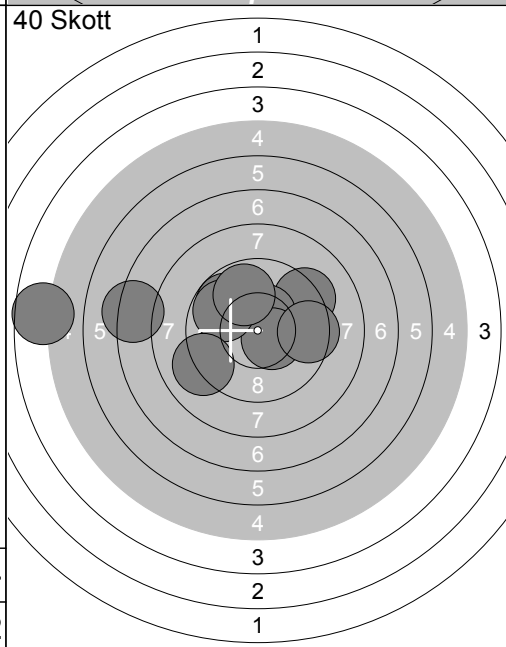

31:	4.7	←
32:	7.3	←
33:	9.3	↗
34:	9.8	↖
35:	10.4	↗
36:	10.5	↘
37:	9.5	→
38:	9.8	↖
39:	9.1	↖
40:	9.8	↑
Serie	90.2	
Total	366.4	

Skjutlag	Tavla	Elsa Krigsman	
4	31		
Vindeln	Gällivare	No	
18.03.2017	SM & JSM Luftgevär 2017	Ramselefors SKF	
	1: 9.7 ← 2: 9.1 ↓ 3: 9.8 ↙ 4: 10.7x↘ 5: 10.1 ↑ 6: 9.5 ↓ 7: 9.7 ← 8: 9.6 → 9: 10.6x↓ 10: 8.9 → Serie 97.7 Total 0.0		11: 10.0 ↓ 12: 9.9 ↓ 13: 8.9 ↙ Serie 28.8 Total 0.0
	1: 9.7 ↓ 2: 9.9 ↑ 3: 9.0 ↑ 4: 9.6 → 5: 10.9x↘ 6: 7.4 ← 7: 8.8 ← 8: 9.9 ↗ 9: 9.8 ↗ 10: 9.6 ← Serie 94.6 Total 94.6		11: 9.3 ↑ 12: 10.0 ↙ 13: 8.7 → 14: 9.9 → 15: 10.6x↑ 16: 9.0 ← 17: 9.3 ↑ 18: 9.2 → 19: 10.0 → 20: 10.3x↗ Serie 96.3 Total 190.9
	21: 10.2x⇒ 22: 10.8x← 23: 9.7 ↑ 24: 7.7 ↑ 25: 8.2 ↙ 26: 9.4 → 27: 9.3 ↓ 28: 9.1 ↗ 29: 10.6x↘ 30: 10.0 ↓ Serie 95.0 Total 285.9		31: 10.7x⇒ 32: 9.8 → 33: 9.0 ← 34: 10.0 ↙ 35: 9.2 ↓ 36: 9.0 ↓ 37: 7.9 ↓ 38: 9.6 ↘ 39: 10.6x↓ 40: 9.6 ⇒ Serie 95.4 Total 381.3

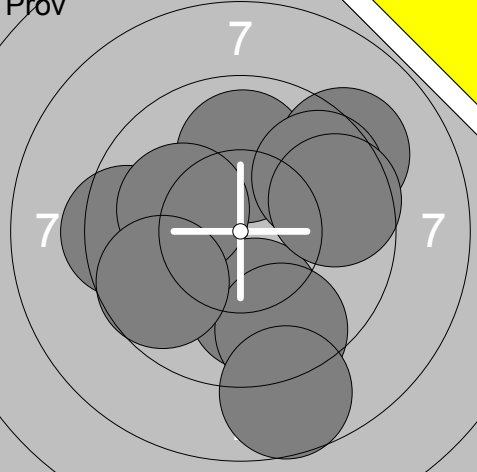
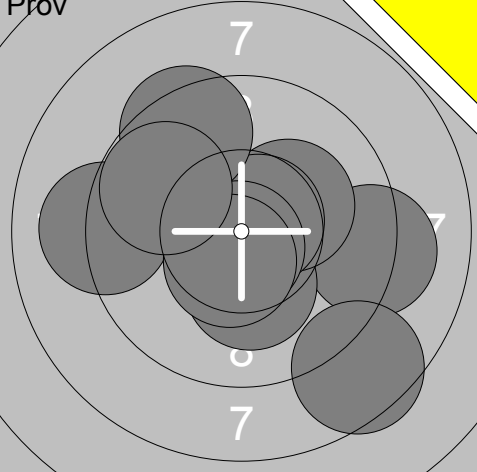
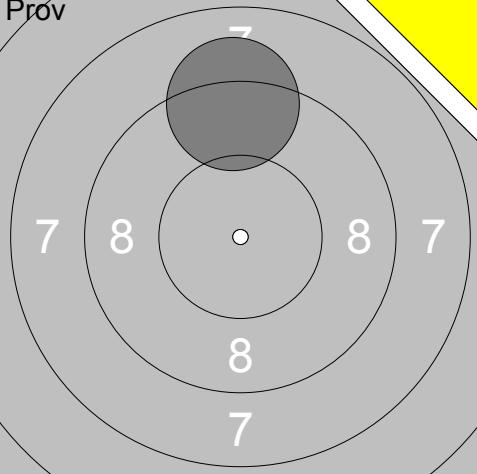
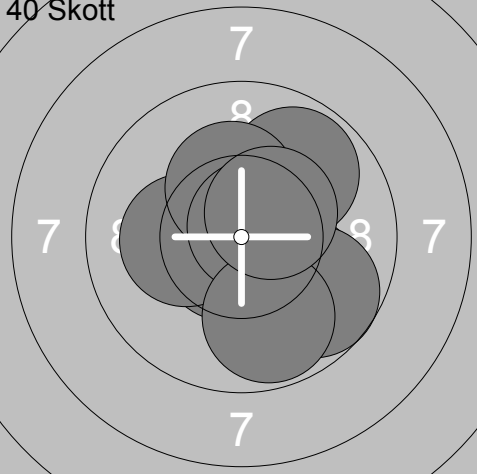
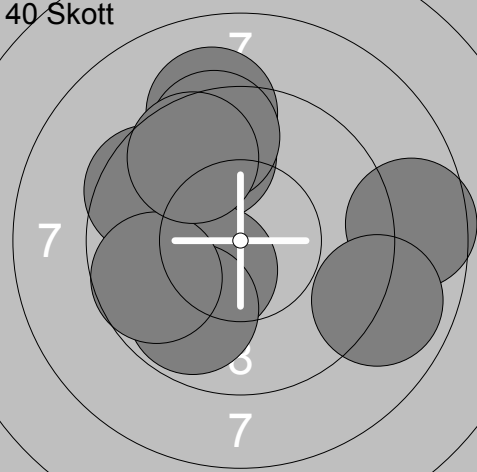
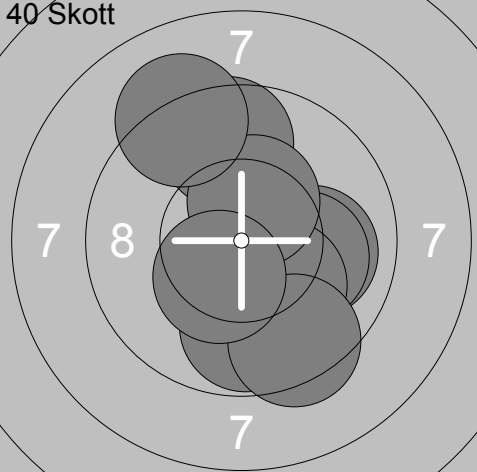
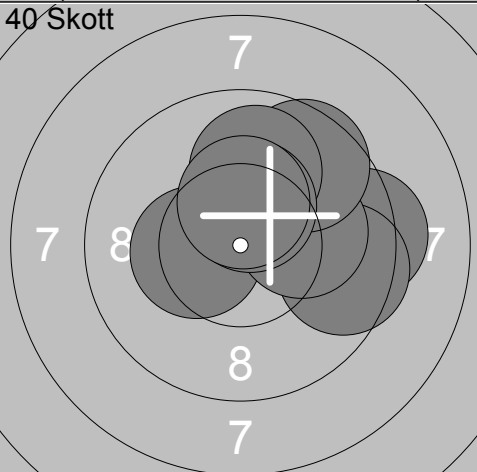
Pröv 	1: 9.9 ↑ 2: 9.4 ← 3: 9.2 ↗ 4: 9.7 ↗ 5: 9.9 ↓ 6: 9.6 → 7: 10.1 ← 8: 9.5 ↓ 9: 9.7 ← 10: 8.7 ↓ <hr/> Serie 95.7 Total 0.0	Pröv 	11: 9.2 → 12: 8.5 ↓ 13: 10.2x ↓ 14: 9.1 ← 15: 10.2x ↗ 16: 10.7x ↗ 17: 10.7x ↓ 18: 10.5x ↓ 19: 9.4 ↗ 20: 9.8 ↖ <hr/> Serie 98.3 Total 0.0
Pröv 	21: 9.2 ↑ <hr/> Serie 9.2 Total 0.0	40 Skott 	1: 10.0 ↓ 2: 9.8 ↗ 3: 10.7x ↓ 4: 10.6x ↓ 5: 10.2x ← 6: 10.3x ↑ 7: 9.7 ↓ 8: 10.7x ↗ 9: 9.8 ↓ 10: 10.4x ↗ <hr/> Serie 102.2 Total 102.2
40 Skott 	11: 9.5 ↖ 12: 9.7 ↗ 13: 9.2 ↑ 14: 10.4x ↓ 15: 9.8 ↓ 16: 9.5 ↑ 17: 9.7 ← 18: 8.6 → 19: 8.9 ↗ 20: 9.6 ↗ <hr/> Serie 94.9 Total 197.1	40 Skott 	21: 10.6x ↓ 22: 10.0 → 23: 9.6 ↑ 24: 10.1 → 25: 9.8 ↓ 26: 10.1 ↓ 27: 10.4x ↑ 28: 9.4 ↓ 29: 10.4x ↓ 30: 9.1 ↗ <hr/> Serie 99.5 Total 296.6
40 Skott 	31: 9.3 → 32: 9.5 → 33: 10.5x ↑ 34: 10.1 ↗ 35: 10.3x ← 36: 10.1 → 37: 9.6 ↗ 38: 9.9 ↑ 39: 10.4x ↑ 40: 10.4x ↑ <hr/> Serie 100.1 Total 396.7		

Prov 	Prov 	
1: 9.6 ↘ 2: 8.7 ↘ 3: 10.5x ↘ 4: 9.2 ↘ 5: 10.9x ↘ 6: 9.8 → 7: 9.9 ← 8: 9.5 ← 9: 10.0 → 10: 9.8 ↘ Serie 97.9 Total 0.0	11: 10.6x ↘ 12: 10.2x ↘ 13: 10.0 ↓ 14: 9.9 ↗ 15: 10.4x ↘ Serie 51.1 Total 0.0	

40 Skott 	40 Skott 	
1: 10.0 → 2: 9.9 ↗ 3: 9.8 → 4: 10.2x ↘ 5: 10.0 ↓ 6: 10.3x ↗ 7: 10.2x ↗ 8: 8.6 → 9: 10.4x ↗ 10: 10.1 ← Serie 99.5 Total 99.5	11: 9.9 ↓ 12: 10.1 ↖ 13: 10.0 ↖ 14: 9.7 → 15: 9.3 → 16: 9.9 ↓ 17: 10.3x ↗ 18: 10.1 → 19: 10.5x ↗ 20: 9.6 ↗ Serie 99.4 Total 198.9	

40 Skott 	40 Skott 	
21: 10.5x ↘ 22: 10.2x ↘ 23: 10.2x ↘ 24: 10.4x → 25: 8.8 ↖ 26: 9.6 ← 27: 9.8 ← 28: 10.2x ↘ 29: 9.0 ← 30: 9.3 ↘ Serie 98.0 Total 296.9	31: 10.6x ↘ 32: 10.2x ↘ 33: 10.3x ↘ 34: 9.9 → 35: 9.1 ↗ 36: 9.6 ↖ 37: 8.9 ← 38: 10.4x ↘ 39: 9.3 ↓ 40: 10.5x ↘ Serie 98.8 Total 395.7	

Prov 	1: 8.9 ↘ 2: 8.9 ↖ 3: 9.5 ↗ 4: 7.9 → 5: 9.5 ↑ 6: 8.1 ↘ 7: 8.8 → 8: 10.9x→ 9: 10.2x↗ 10: 10.2x↗ Serie 92.9 Total 0.0	Prov 	11: 9.4 ↘ 12: 10.1← 13: 10.5x↗ 14: 10.2x↖ Serie 40.2 Total 0.0
----------	---	----------	---

40 Skott 	1: 9.3 → 2: 9.7 → 3: 9.1 → 4: 10.7x→ 5: 9.1 → 6: 9.1 ← 7: 10.3x↓ 8: 9.3 → 9: 9.0 ← 10: 7.2 ← Serie 92.8 Total 92.8	40 Skott 	11: 8.1 → 12: 10.1↖ 13: 9.5 → 14: 7.5 ↗ 15: 10.6x↖ 16: 7.7 ↓ 17: 10.4x→ 18: 9.8 → 19: 7.8 ↗ 20: 9.6 → Serie 91.1 Total 183.9
--------------	---	--------------	---

40 Skott 	21: 9.7 ↖ 22: 9.9 ↑ 23: 10.0→ 24: 9.1 ↘ 25: 10.0 ↓ 26: 10.7x↗ 27: 9.4 → 28: 10.5x↓ 29: 9.7 ↖ 30: 10.1→ Serie 99.1 Total 283.0	40 Skott 	31: 9.3 ↖ 32: 8.5 ↘ 33: 10.0→ 34: 8.8 ↖ 35: 9.5 ↗ 36: 10.8x↖ 37: 9.5 ← 38: 10.6x↖ 39: 8.9 → 40: 10.4x→ Serie 96.3 Total 379.3
--------------	--	--------------	--

	1: 9.4 ↑ 2: 9.6 → 3: 9.5 ↓ 4: 10.5x↑ 5: 9.6 → 6: 9.7 ↑ 7: 9.5 → 8: 9.9 → 9: 9.4 ↗ 10: 10.2x↓		11: 7.1 → 12: 9.6 ↗ 13: 8.7 ↖ 14: 10.0 ↖ 15: 7.5 ← 16: 7.9 → 17: 9.4 → 18: 10.0 ↓
	Serie 97.3 Total 0.0		Serie 70.2 Total 0.0

	1: 9.9 ← 2: 9.6 ← 3: 8.8 → 4: 8.5 → 5: 10.4x↓ 6: 10.4x↑ 7: 10.0 → 8: 10.3x↓ 9: 10.6x→ 10: 9.8 ↑		11: 9.4 ↗ 12: 9.7 → 13: 9.2 ↑ 14: 9.8 ↗ 15: 9.2 ↗ 16: 9.5 ↗ 17: 9.2 ↑ 18: 9.3 ↑ 19: 9.8 ↑ 20: 8.8 →
	Serie 98.3 Total 98.3		Serie 93.9 Total 192.2

	21: 10.5x↑ 22: 10.5x→ 23: 10.2x↓ 24: 8.1 → 25: 9.6 ↖ 26: 8.5 → 27: 10.3x→ 28: 10.0 ↗ 29: 10.3x→ 30: 8.9 ↗		31: 10.6x↓ 32: 10.2x↗ 33: 8.8 → 34: 10.7x↓ 35: 9.5 ↑ 36: 8.7 → 37: 9.7 ↑ 38: 8.6 ← 39: 9.3 → 40: 9.8 →
	Serie 96.9 Total 289.1		Serie 95.9 Total 385.0

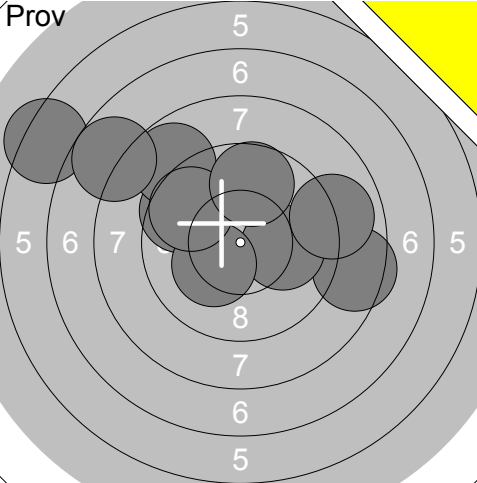
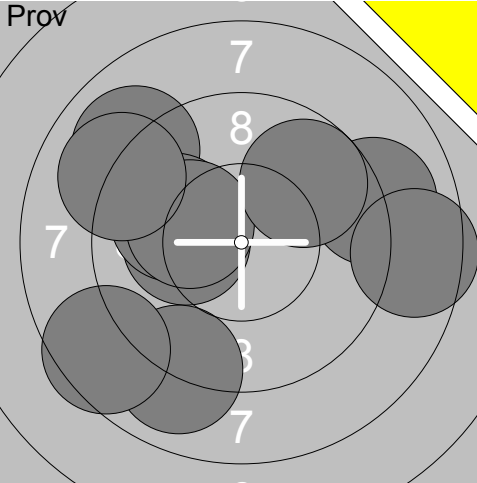
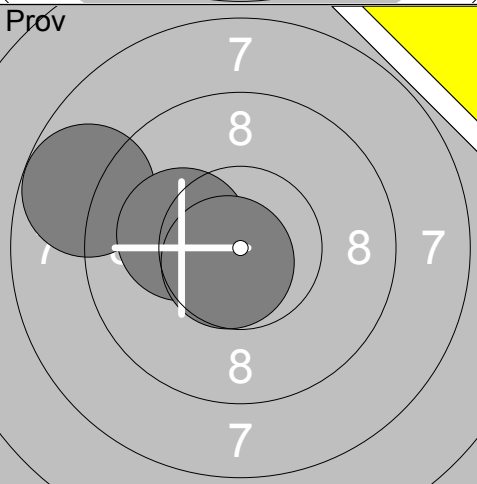
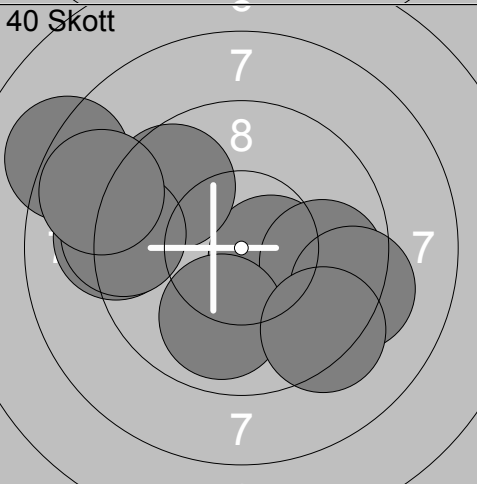
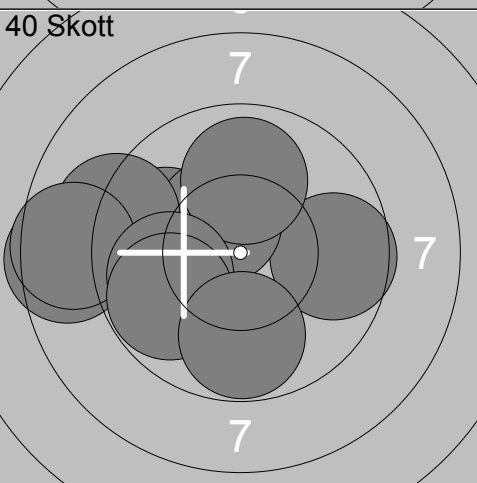
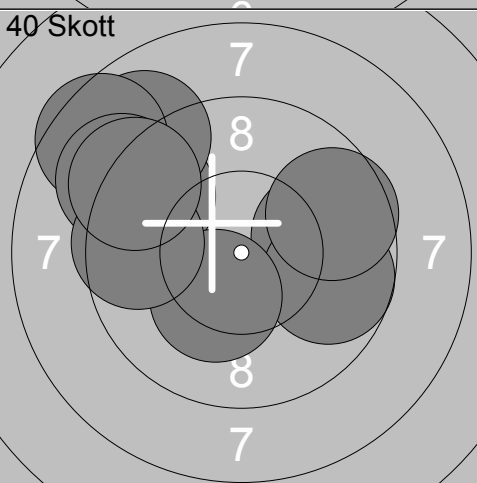
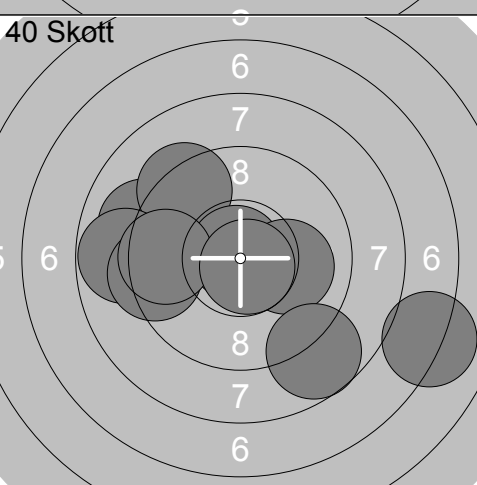
Skjutlag	Tavla	Alwa Wiklund	
4	36		
Vindeln	Aspås		Jä
18.03.2017	SM & JSM Luftgevär 2017	Ramselefors SKF	
Prov		1: 8.5 → 2: 10.0 → 3: 9.5 ↗ 4: 10.2x ↙ 5: 6.3 ↗ 6: 8.8 ↗ 7: 8.9 → 8: 9.7 ↗ 9: 9.7 ↑ 10: 7.7 ↗ Serie 89.3 Total 0.0	Prov  11: 9.0 → 12: 10.2x ← 13: 9.0 ↗ 14: 9.9 ↗ 15: 9.0 ↓ 16: 10.2x ↗ 17: 9.8 ↗ 18: 9.0 ↗ 19: 8.5 → 20: 8.5 ↙ Serie 93.1 Total 0.0
Prov		21: 8.8 ← 22: 10.2x ← 23: 10.7x ↙ Serie 29.7 Total 0.0	40 Skott  1: 10.5x → 2: 9.2 ← 3: 9.6 ↗ 4: 8.2 ↗ 5: 9.8 → 6: 9.3 ← 7: 9.9 ↓ 8: 8.8 ↗ 9: 9.3 → 10: 9.3 ↓ Serie 93.9 Total 93.9
40 Skott		11: 9.9 ← 12: 9.6 → 13: 10.4x ↗ 14: 9.1 ← 15: 9.9 ↑ 16: 8.5 ← 17: 8.6 ← 18: 9.9 ← 19: 9.8 ↙ 20: 9.8 ↓ Serie 95.5 Total 189.4	40 Skott  21: 9.5 ↗ 22: 8.9 ↗ 23: 9.9 → 24: 8.5 ↗ 25: 9.7 → 26: 9.1 ↗ 27: 10.3x ↓ 28: 9.5 ← 29: 9.6 → 30: 9.2 ↗ Serie 94.2 Total 283.6
40 Skott		31: 9.1 ← 32: 9.3 ↗ 33: 10.8x ↗ 34: 8.8 ← 35: 10.1 → 36: 7.1 ↓ 37: 9.3 ← 38: 8.7 ↓ 39: 9.5 ← 40: 10.8x ↓ Serie 93.5 Total 377.1	

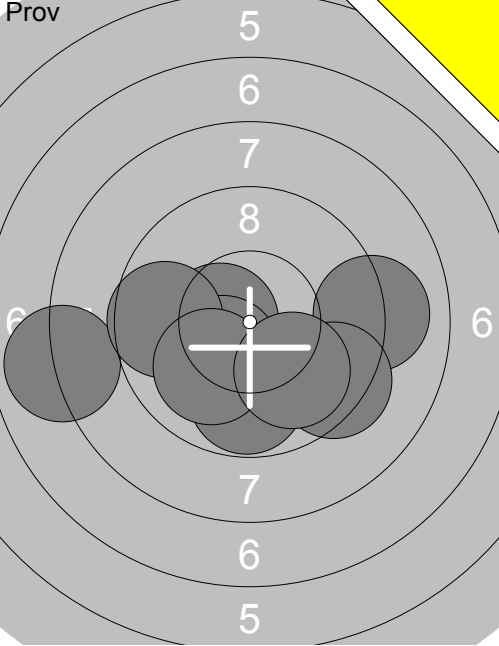
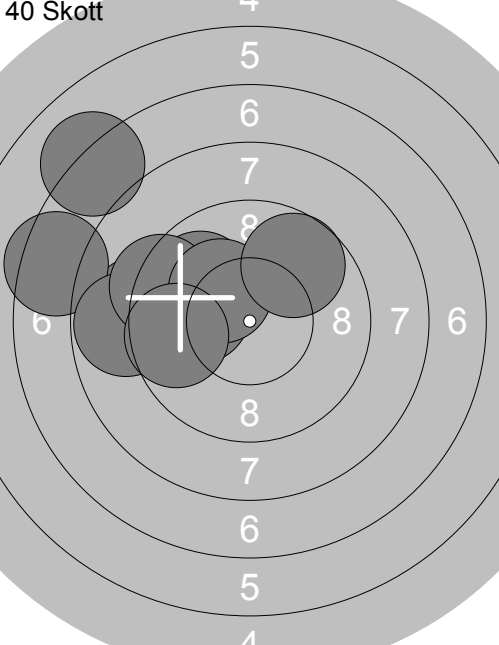
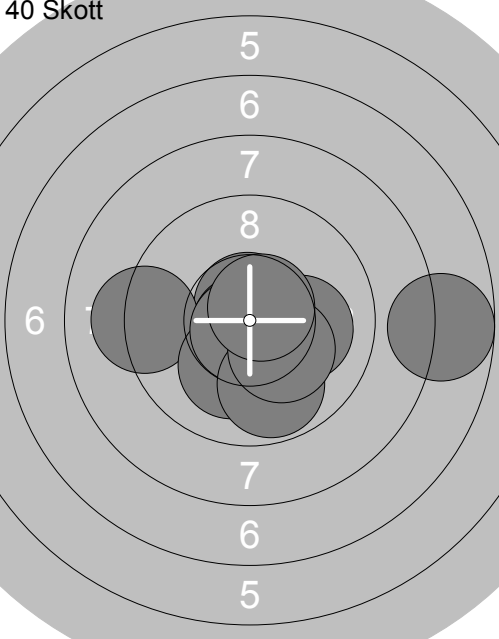
Skjutlag	Tavla	Emma Eriksson	
4	37		
Vindeln	Ramselefors		Vb
18.03.2017	SM & JSM Luftgevär 2017	Ramselefors SKF	
Prov		1: 9.1 → 2: 10.2x↖ 3: 10.5x↖ 4: 10.3x↖ 5: 8.0 ← 6: 9.6 ← 7: 9.8 ↓ 8: 10.0 ↘ 9: 9.4 ↘ 10: 10.0 ↘ Serie 96.9 Total 0.0	11: 9.7 ← 12: 10.1 ↓ 13: 9.3 ↖ 14: 10.5x↖ 15: 8.7 ← 16: 9.3 ↖ 17: 10.6x↗ 18: 10.2x↖ 19: 8.3 ← Serie 86.7 Total 0.0
40 Skott		1: 9.0 ← 2: 9.9 ↖ 3: 10.1← 4: 7.5 ← 5: 8.8 ← 6: 7.1 ↖ 7: 9.3 ↖ 8: 10.2x↖ 9: 9.7 ← 10: 9.7 ↗ Serie 91.3 Total 91.3	11: 9.6 ↑ 12: 9.5 ⇒ 13: 10.3x↖ 14: 10.1← 15: 10.4x⇒ 16: 10.0← 17: 10.2x↗ 18: 8.7 → 19: 10.5x↓ 20: 7.3 ⇒ Serie 96.6 Total 187.9
40 Skott		21: 10.7x↗ 22: 10.8x↖ 23: 7.7 → 24: 9.2 ← 25: 10.1⇒ 26: 10.1↓ 27: 10.8x↖ 28: 9.8 ↓ 29: 10.2x↖ 30: 10.7x↗ Serie 100.1 Total 288.0	31: 8.9 → 32: 9.7 ↖ 33: 10.1 ↗ 34: 9.0 ← 35: 10.6x↗ 36: 10.4x↖ 37: 10.1↓ 38: 10.2x⇒ 39: 10.1↓ 40: 10.7x↖ Serie 99.8 Total 387.8

	1: 8.6 ↓		11: 10.3x➤
	2: 10.0 ↓		12: 8.7 ➤
	3: 10.4x↗		13: 10.2x↘
	4: 9.6 ↓		14: 9.4 ↓
	5: 10.1 ↙		15: 10.2x↘
	6: 8.5 ➔		16: 10.3x↘
	7: 9.9 ➤		17: 9.6 ↙
	8: 10.6x↖		18: 10.6x➤
	9: 9.5 ←		
	10: 10.4x↓		
Serie	97.6	Serie	79.3
Total	0.0	Total	0.0

	1: 10.5x➤		11: 10.2x↘
	2: 9.6 ↓		12: 9.9 ↑
	3: 9.6 ➤		13: 9.6 ➤
	4: 10.9x↑		14: 10.4x↑
	5: 9.9 ↑		15: 9.8 ↗
	6: 10.4x↘		16: 9.1 ←
	7: 9.8 ↗		17: 10.4x↘
	8: 9.6 ←		18: 10.5x↘
	9: 10.6x↖		19: 9.7 ↓
	10: 10.4x↓		20: 10.2x↓
Serie	101.3	Serie	99.8
Total	101.3	Total	201.1

	21: 9.0 ↙		31: 9.5 ↑
	22: 10.4x↘		32: 9.4 ↖
	23: 10.5x↘		33: 10.1 ↖
	24: 9.4 ←		34: 10.4x↘
	25: 9.9 ←		35: 10.3x↘
	26: 9.9 ↓		36: 10.9x↑
	27: 9.8 ↓		37: 9.8 ➤
	28: 10.7x➤		38: 10.8x↘
	29: 9.6 ↓		39: 10.6x↘
	30: 10.7x↓		40: 10.0 ←
Serie	99.9	Serie	101.8
Total	301.0	Total	402.8

<p>Prov</p>	<p>1: 10.2x↘ 2: 9.6 ↑ 3: 10.7x➤ 4: 10.1 ↘ 5: 10.3x↘ 6: 10.5x↘ 7: 10.3x↘ 8: 9.7 ← 9: 9.9 ↗ 10: 9.0 ←</p> <p>Serie 100.3 Total 0.0</p>	<p>Prov</p>	<p>11: 10.1 ↖ 12: 10.5x↘ 13: 10.1 ← 14: 10.7x➤</p> <p>Serie 41.4 Total 0.0</p>
<p>40 Skott</p>	<p>1: 9.8 ↑ 2: 8.9 ↙ 3: 10.0 ↑ 4: 9.8 ↘ 5: 10.4x↘ 6: 10.7x↗ 7: 10.4x↘ 8: 10.6x↘ 9: 9.7 ← 10: 10.7x↘</p> <p>Serie 101.0 Total 101.0</p>	<p>40 Skott</p>	<p>11: 10.0 ↘ 12: 10.4x↘ 13: 10.3x↘ 14: 9.9 ↘ 15: 10.4x↘ 16: 10.2x↗ 17: 10.6x↘ 18: 9.6 ↑ 19: 9.7 ← 20: 10.3x↘</p> <p>Serie 101.4 Total 202.4</p>
<p>40 Skott</p>	<p>21: 9.9 ↑ 22: 9.0 ➤ 23: 10.7x➤ 24: 10.1 ↘ 25: 10.4x↘ 26: 10.7x↘ 27: 9.9 ← 28: 9.8 ➡ 29: 10.5x↗ 30: 10.3x↗</p> <p>Serie 101.3 Total 303.7</p>	<p>40 Skott</p>	<p>31: 9.6 ↖ 32: 10.5x↘ 33: 10.1 ↘ 34: 9.8 ↘ 35: 10.3x↗ 36: 10.4x↘ 37: 10.5x➤ 38: 10.8x↗ 39: 10.0 ↘ 40: 9.4 ↙</p> <p>Serie 101.4 Total 405.1</p>

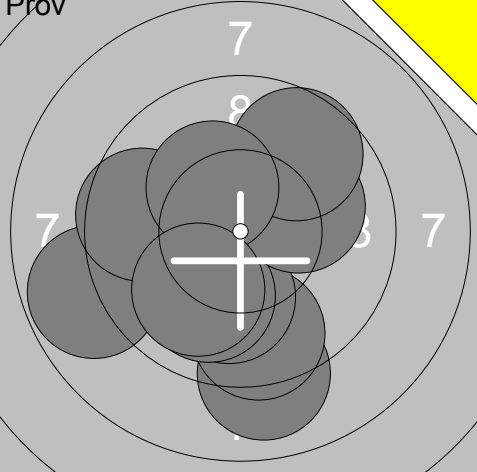
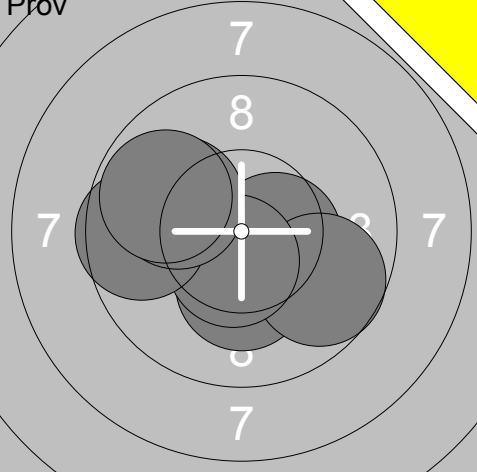
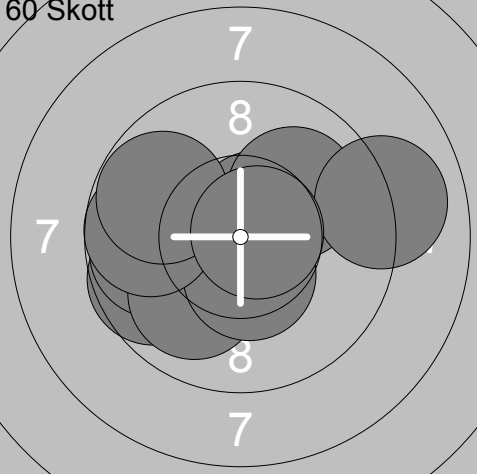
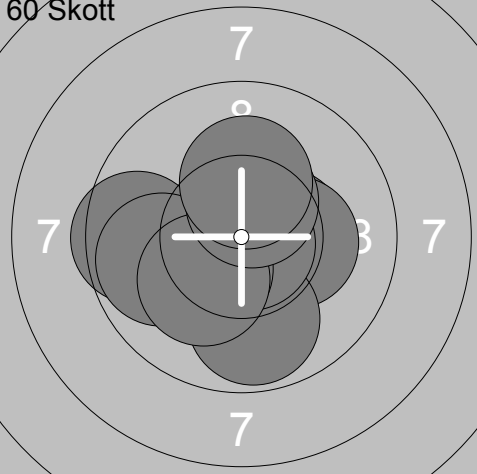
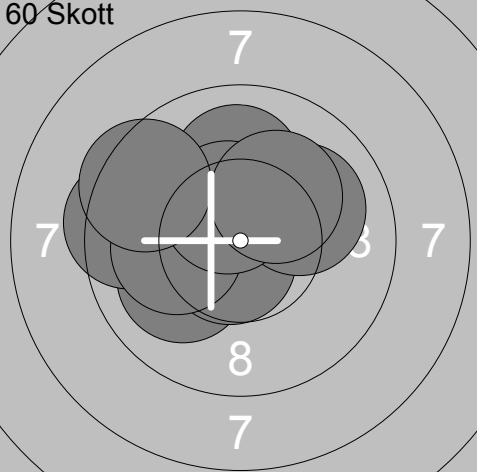
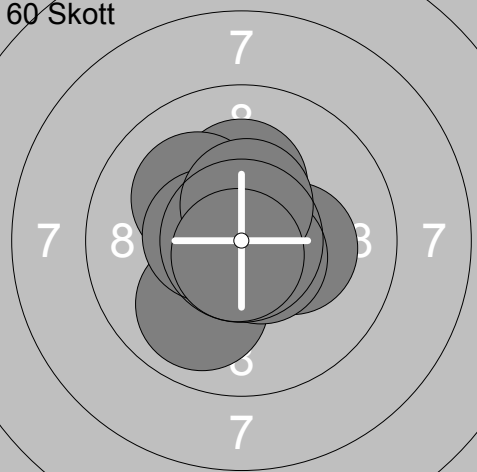
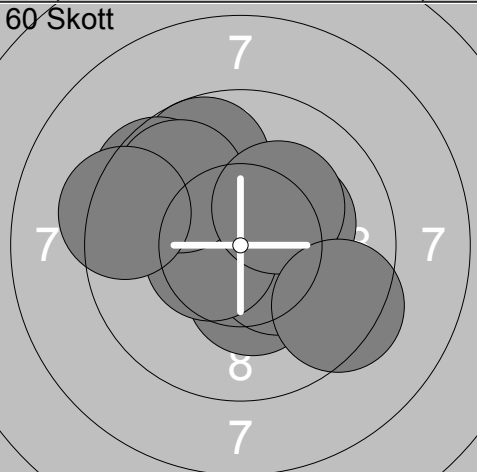
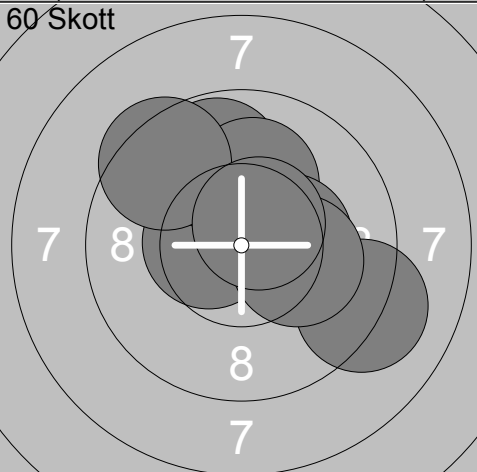
<p>Pröv</p> 	<table style="width:100%; border-collapse: collapse;"> <tr><td>1:</td><td>9.0</td><td>↘</td></tr> <tr><td>2:</td><td>9.6</td><td>↘</td></tr> <tr><td>3:</td><td>10.0</td><td>↘</td></tr> <tr><td>4:</td><td>10.0</td><td>↘</td></tr> <tr><td>5:</td><td>10.1</td><td>→</td></tr> <tr><td>6:</td><td>8.8</td><td>←</td></tr> <tr><td>7:</td><td>9.7</td><td>↗</td></tr> <tr><td>8:</td><td>9.6</td><td>←</td></tr> <tr><td>9:</td><td>10.2x</td><td>↗</td></tr> <tr><td>10:</td><td>10.0</td><td>↘</td></tr> <tr><td colspan="2">Serie</td><td>97.0</td></tr> <tr><td colspan="2">Total</td><td>0.0</td></tr> </table>	1:	9.0	↘	2:	9.6	↘	3:	10.0	↘	4:	10.0	↘	5:	10.1	→	6:	8.8	←	7:	9.7	↗	8:	9.6	←	9:	10.2x	↗	10:	10.0	↘	Serie		97.0	Total		0.0	<p>Pröv</p>  <table style="width:100%; border-collapse: collapse;"> <tr><td>11:</td><td>10.5x</td><td>→</td></tr> <tr><td>12:</td><td>10.2x</td><td>↘</td></tr> <tr><td>13:</td><td>9.7</td><td>↘</td></tr> <tr><td>14:</td><td>10.5x</td><td>↘</td></tr> <tr><td>15:</td><td>9.6</td><td>←</td></tr> <tr><td>16:</td><td>10.0</td><td>↖</td></tr> <tr><td>17:</td><td>9.8</td><td>↖</td></tr> <tr><td colspan="2">Serie</td><td>70.3</td></tr> <tr><td colspan="2">Total</td><td>0.0</td></tr> </table>	11:	10.5x	→	12:	10.2x	↘	13:	9.7	↘	14:	10.5x	↘	15:	9.6	←	16:	10.0	↖	17:	9.8	↖	Serie		70.3	Total		0.0									
1:	9.0	↘																																																																								
2:	9.6	↘																																																																								
3:	10.0	↘																																																																								
4:	10.0	↘																																																																								
5:	10.1	→																																																																								
6:	8.8	←																																																																								
7:	9.7	↗																																																																								
8:	9.6	←																																																																								
9:	10.2x	↗																																																																								
10:	10.0	↘																																																																								
Serie		97.0																																																																								
Total		0.0																																																																								
11:	10.5x	→																																																																								
12:	10.2x	↘																																																																								
13:	9.7	↘																																																																								
14:	10.5x	↘																																																																								
15:	9.6	←																																																																								
16:	10.0	↖																																																																								
17:	9.8	↖																																																																								
Serie		70.3																																																																								
Total		0.0																																																																								
<p>60 Skott</p> 	<table style="width:100%; border-collapse: collapse;"> <tr><td>1:</td><td>9.6</td><td>←</td></tr> <tr><td>2:</td><td>9.8</td><td>←</td></tr> <tr><td>3:</td><td>10.0</td><td>↘</td></tr> <tr><td>4:</td><td>10.6x</td><td>↗</td></tr> <tr><td>5:</td><td>10.0</td><td>↗</td></tr> <tr><td>6:</td><td>10.4x</td><td>↘</td></tr> <tr><td>7:</td><td>9.7</td><td>←</td></tr> <tr><td>8:</td><td>9.8</td><td>↗</td></tr> <tr><td>9:</td><td>9.0</td><td>→</td></tr> <tr><td>10:</td><td>10.7x</td><td>→</td></tr> <tr><td colspan="2">Serie</td><td>99.6</td></tr> <tr><td colspan="2">Total</td><td>99.6</td></tr> </table>	1:	9.6	←	2:	9.8	←	3:	10.0	↘	4:	10.6x	↗	5:	10.0	↗	6:	10.4x	↘	7:	9.7	←	8:	9.8	↗	9:	9.0	→	10:	10.7x	→	Serie		99.6	Total		99.6	<p>60 Skott</p>  <table style="width:100%; border-collapse: collapse;"> <tr><td>11:</td><td>10.4x</td><td>→</td></tr> <tr><td>12:</td><td>10.3x</td><td>→</td></tr> <tr><td>13:</td><td>9.8</td><td>↘</td></tr> <tr><td>14:</td><td>10.8x</td><td>↘</td></tr> <tr><td>15:</td><td>10.3x</td><td>↘</td></tr> <tr><td>16:</td><td>9.5</td><td>←</td></tr> <tr><td>17:</td><td>9.8</td><td>←</td></tr> <tr><td>18:</td><td>10.2x</td><td>↘</td></tr> <tr><td>19:</td><td>10.5x</td><td>↗</td></tr> <tr><td>20:</td><td>10.2x</td><td>↗</td></tr> <tr><td colspan="2">Serie</td><td>101.8</td></tr> <tr><td colspan="2">Total</td><td>201.4</td></tr> </table>	11:	10.4x	→	12:	10.3x	→	13:	9.8	↘	14:	10.8x	↘	15:	10.3x	↘	16:	9.5	←	17:	9.8	←	18:	10.2x	↘	19:	10.5x	↗	20:	10.2x	↗	Serie		101.8	Total		201.4
1:	9.6	←																																																																								
2:	9.8	←																																																																								
3:	10.0	↘																																																																								
4:	10.6x	↗																																																																								
5:	10.0	↗																																																																								
6:	10.4x	↘																																																																								
7:	9.7	←																																																																								
8:	9.8	↗																																																																								
9:	9.0	→																																																																								
10:	10.7x	→																																																																								
Serie		99.6																																																																								
Total		99.6																																																																								
11:	10.4x	→																																																																								
12:	10.3x	→																																																																								
13:	9.8	↘																																																																								
14:	10.8x	↘																																																																								
15:	10.3x	↘																																																																								
16:	9.5	←																																																																								
17:	9.8	←																																																																								
18:	10.2x	↘																																																																								
19:	10.5x	↗																																																																								
20:	10.2x	↗																																																																								
Serie		101.8																																																																								
Total		201.4																																																																								
<p>60 Skott</p> 	<table style="width:100%; border-collapse: collapse;"> <tr><td>21:</td><td>10.0</td><td>←</td></tr> <tr><td>22:</td><td>9.4</td><td>←</td></tr> <tr><td>23:</td><td>10.2x</td><td>↖</td></tr> <tr><td>24:</td><td>10.7x</td><td>↘</td></tr> <tr><td>25:</td><td>10.0</td><td>↗</td></tr> <tr><td>26:</td><td>10.1</td><td>←</td></tr> <tr><td>27:</td><td>10.0</td><td>↗</td></tr> <tr><td>28:</td><td>10.5x</td><td>↗</td></tr> <tr><td>29:</td><td>10.2x</td><td>↗</td></tr> <tr><td>30:</td><td>9.5</td><td>↖</td></tr> <tr><td colspan="2">Serie</td><td>100.6</td></tr> <tr><td colspan="2">Total</td><td>302.0</td></tr> </table>	21:	10.0	←	22:	9.4	←	23:	10.2x	↖	24:	10.7x	↘	25:	10.0	↗	26:	10.1	←	27:	10.0	↗	28:	10.5x	↗	29:	10.2x	↗	30:	9.5	↖	Serie		100.6	Total		302.0	<p>60 Skott</p>  <table style="width:100%; border-collapse: collapse;"> <tr><td>31:</td><td>9.9</td><td>↘</td></tr> <tr><td>32:</td><td>10.4x</td><td>↗</td></tr> <tr><td>33:</td><td>10.2x</td><td>↗</td></tr> <tr><td>34:</td><td>10.7x</td><td>→</td></tr> <tr><td>35:</td><td>10.3x</td><td>→</td></tr> <tr><td>36:</td><td>10.6x</td><td>↘</td></tr> <tr><td>37:</td><td>10.1</td><td>↗</td></tr> <tr><td>38:</td><td>10.5x</td><td>←</td></tr> <tr><td>39:</td><td>10.5x</td><td>↗</td></tr> <tr><td>40:</td><td>10.8x</td><td>↘</td></tr> <tr><td colspan="2">Serie</td><td>104.0</td></tr> <tr><td colspan="2">Total</td><td>406.0</td></tr> </table>	31:	9.9	↘	32:	10.4x	↗	33:	10.2x	↗	34:	10.7x	→	35:	10.3x	→	36:	10.6x	↘	37:	10.1	↗	38:	10.5x	←	39:	10.5x	↗	40:	10.8x	↘	Serie		104.0	Total		406.0
21:	10.0	←																																																																								
22:	9.4	←																																																																								
23:	10.2x	↖																																																																								
24:	10.7x	↘																																																																								
25:	10.0	↗																																																																								
26:	10.1	←																																																																								
27:	10.0	↗																																																																								
28:	10.5x	↗																																																																								
29:	10.2x	↗																																																																								
30:	9.5	↖																																																																								
Serie		100.6																																																																								
Total		302.0																																																																								
31:	9.9	↘																																																																								
32:	10.4x	↗																																																																								
33:	10.2x	↗																																																																								
34:	10.7x	→																																																																								
35:	10.3x	→																																																																								
36:	10.6x	↘																																																																								
37:	10.1	↗																																																																								
38:	10.5x	←																																																																								
39:	10.5x	↗																																																																								
40:	10.8x	↘																																																																								
Serie		104.0																																																																								
Total		406.0																																																																								
<p>60 Skott</p> 	<table style="width:100%; border-collapse: collapse;"> <tr><td>41:</td><td>9.8</td><td>↗</td></tr> <tr><td>42:</td><td>10.2x</td><td>→</td></tr> <tr><td>43:</td><td>9.6</td><td>↗</td></tr> <tr><td>44:</td><td>10.3x</td><td>↘</td></tr> <tr><td>45:</td><td>10.3x</td><td>↘</td></tr> <tr><td>46:</td><td>10.5x</td><td>←</td></tr> <tr><td>47:</td><td>9.8</td><td>↗</td></tr> <tr><td>48:</td><td>10.2x</td><td>↗</td></tr> <tr><td>49:</td><td>9.3</td><td>←</td></tr> <tr><td>50:</td><td>9.4</td><td>↘</td></tr> <tr><td colspan="2">Serie</td><td>99.4</td></tr> <tr><td colspan="2">Total</td><td>505.4</td></tr> </table>	41:	9.8	↗	42:	10.2x	→	43:	9.6	↗	44:	10.3x	↘	45:	10.3x	↘	46:	10.5x	←	47:	9.8	↗	48:	10.2x	↗	49:	9.3	←	50:	9.4	↘	Serie		99.4	Total		505.4	<p>60 Skott</p>  <table style="width:100%; border-collapse: collapse;"> <tr><td>51:</td><td>10.7x</td><td>↗</td></tr> <tr><td>52:</td><td>10.1</td><td>↗</td></tr> <tr><td>53:</td><td>10.5x</td><td>←</td></tr> <tr><td>54:</td><td>9.8</td><td>↗</td></tr> <tr><td>55:</td><td>9.1</td><td>→</td></tr> <tr><td>56:</td><td>10.1</td><td>↗</td></tr> <tr><td>57:</td><td>10.3x</td><td>→</td></tr> <tr><td>58:</td><td>10.2x</td><td>→</td></tr> <tr><td>59:</td><td>9.4</td><td>↖</td></tr> <tr><td>60:</td><td>10.6x</td><td>↗</td></tr> <tr><td colspan="2">Serie</td><td>100.8</td></tr> <tr><td colspan="2">Total</td><td>606.2</td></tr> </table>	51:	10.7x	↗	52:	10.1	↗	53:	10.5x	←	54:	9.8	↗	55:	9.1	→	56:	10.1	↗	57:	10.3x	→	58:	10.2x	→	59:	9.4	↖	60:	10.6x	↗	Serie		100.8	Total		606.2
41:	9.8	↗																																																																								
42:	10.2x	→																																																																								
43:	9.6	↗																																																																								
44:	10.3x	↘																																																																								
45:	10.3x	↘																																																																								
46:	10.5x	←																																																																								
47:	9.8	↗																																																																								
48:	10.2x	↗																																																																								
49:	9.3	←																																																																								
50:	9.4	↘																																																																								
Serie		99.4																																																																								
Total		505.4																																																																								
51:	10.7x	↗																																																																								
52:	10.1	↗																																																																								
53:	10.5x	←																																																																								
54:	9.8	↗																																																																								
55:	9.1	→																																																																								
56:	10.1	↗																																																																								
57:	10.3x	→																																																																								
58:	10.2x	→																																																																								
59:	9.4	↖																																																																								
60:	10.6x	↗																																																																								
Serie		100.8																																																																								
Total		606.2																																																																								

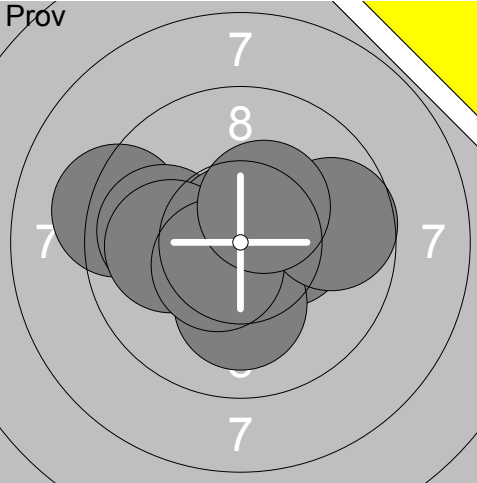
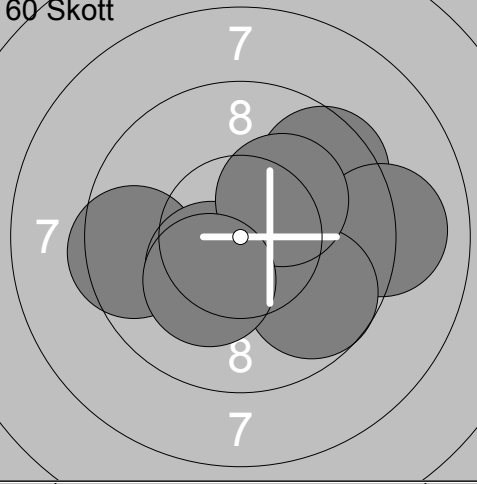
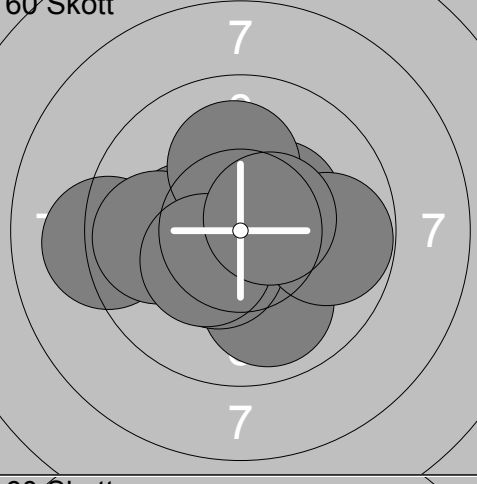
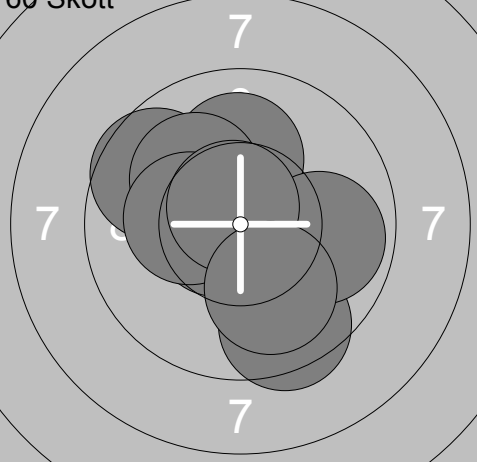
Skjutlag	Tavla	Tom Axelsson			
5	6			Vindeln	Ös
18.03.2017		SM & JSM Luftgevär 2017		Ramselefors SKF	
Prov		1: 9.2 ← 2: 10.5x → 3: 9.9 ← 4: 10.4x → 5: 10.8x ↗ 6: 10.1 ↓ 7: 10.0 ← 8: 10.5x ↙ 9: 9.7 → 10: 10.4x ↗	Prov	11: 10.4x ↙ 12: 10.1 ↗ 13: 9.9 ↙ 14: 8.3 → 15: 10.4x ↙	
		Serie 101.5		Serie 49.1	
		Total 0.0		Total 0.0	
60 Skott		1: 9.5 ← 2: 9.7 → 3: 10.5x ↙ 4: 10.5x → 5: 9.5 ↗ 6: 10.4x ↙ 7: 9.0 → 8: 9.7 ↙ 9: 10.2x ↗ 10: 10.2x ↙	60 Skott	11: 9.9 → 12: 9.5 ↙ 13: 10.5x ↙ 14: 10.3x ↗ 15: 10.6x ↗ 16: 10.1 → 17: 9.7 ↗ 18: 9.9 ↙ 19: 9.8 ↗ 20: 10.5x ↗	
		Serie 99.2		Serie 100.8	
		Total 99.2		Total 200.0	
60 Skott		21: 9.9 ↙ 22: 10.3x ← 23: 9.2 ← 24: 9.8 ← 25: 10.4x ↙ 26: 10.4x ↗ 27: 10.1 ↑ 28: 10.3x ↙ 29: 9.8 → 30: 10.5x ↗	60 Skott	31: 10.3x ↗ 32: 9.8 ← 33: 10.3x ↙ 34: 9.7 → 35: 10.0 ↙ 36: 10.7x ↙ 37: 10.5x ↗ 38: 10.5x ↙ 39: 10.3x ↗ 40: 10.0 →	
		Serie 100.7		Serie 102.1	
		Total 300.7		Total 402.8	
60 Skott		41: 9.6 ↗ 42: 10.3x ↗ 43: 10.6x ← 44: 10.1 ↑ 45: 10.1 ↗ 46: 10.3x ← 47: 9.5 ↙ 48: 9.9 → 49: 10.7x ↗ 50: 10.0 ↙	60 Skott	51: 10.1 ↙ 52: 10.1 → 53: 9.9 ↙ 54: 9.9 ↗ 55: 9.8 ↗ 56: 9.5 → 57: 10.1 → 58: 10.2x ↙ 59: 10.0 ↗ 60: 9.9 →	
		Serie 101.1		Serie 99.5	
		Total 503.9		Total 603.4	

Skjuttag	Tavla	Einar Nilsson	
5	7		
Vindeln	Björksta		Vm
18.03.2017	SM & JSM Luftgevär 2017	Ramselefors SKF	
Pröv		1: 10.5x → 2: 9.2 ← 3: 10.4x ↑ 4: 9.2 ↗ 5: 10.3x → 6: 9.4 ← 7: 9.4 ↓ 8: 10.1 ← 9: 10.5x → 10: 9.7 ↓	Pröv
		Serie 98.7 Total 0.0	11: 10.2x → 12: 9.9 → 13: 9.7 ← 14: 10.4x ↙ 15: 10.6x ↓ 16: 10.6x ↓ 17: 9.5 ← 18: 10.4x ↗ 19: 9.3 ← 20: 8.7 →
			Serie 99.3 Total 0.0
Pröv		21: 10.9x ← 22: 10.1 ↓	60 Skott
		Serie 21.0 Total 0.0	
			Serie 100.0 Total 100.0
60 Skott		11: 10.1 → 12: 10.4x → 13: 10.4x → 14: 10.8x → 15: 9.7 ↓ 16: 9.8 ← 17: 9.8 ↓ 18: 10.0 ↓ 19: 10.7x ↗ 20: 9.6 ↓	60 Skott
		Serie 101.3 Total 201.3	
			Serie 98.9 Total 300.2
60 Skott		31: 10.3x ↓ 32: 10.1 ← 33: 8.3 ← 34: 10.2x ← 35: 10.5x ↗ 36: 10.7x ↓ 37: 9.7 ↗ 38: 9.7 ↗ 39: 10.3x ↑ 40: 9.6 ↓	60 Skott
		Serie 99.4 Total 399.6	
			Serie 100.8 Total 500.4
60 Skott		51: 10.1 ↑ 52: 10.4x → 53: 8.8 ↗ 54: 9.1 ← 55: 10.6x ↗ 56: 9.9 ← 57: 9.9 ↓ 58: 9.3 ← 59: 10.4x ↓ 60: 10.6x ↗	
		Serie 99.1 Total 599.5	

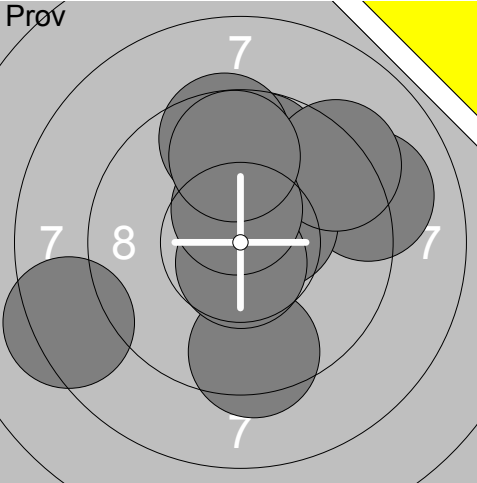
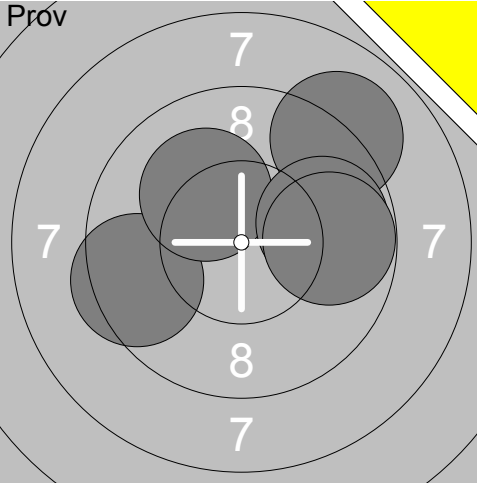
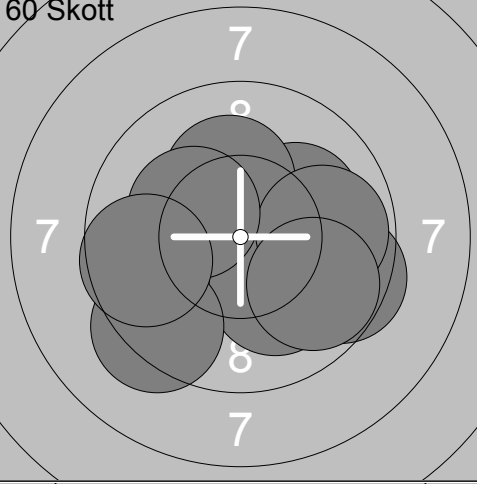
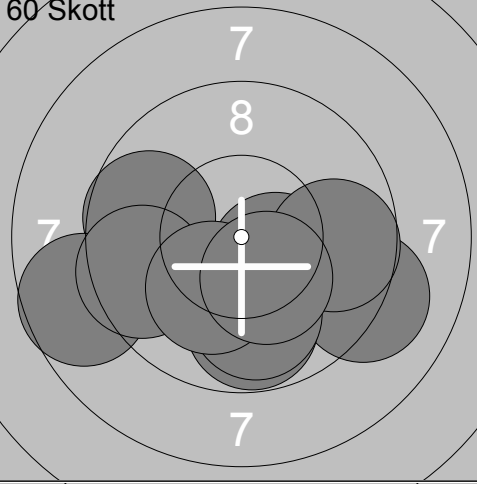
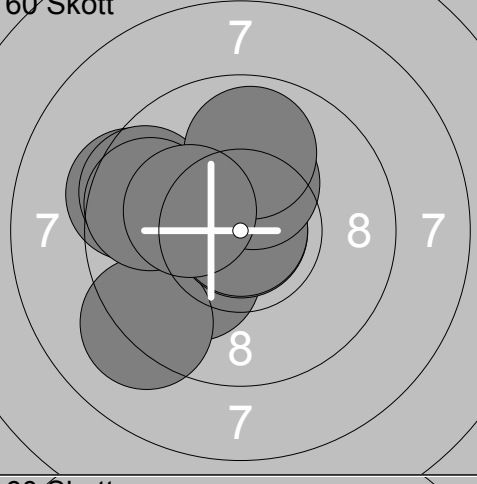
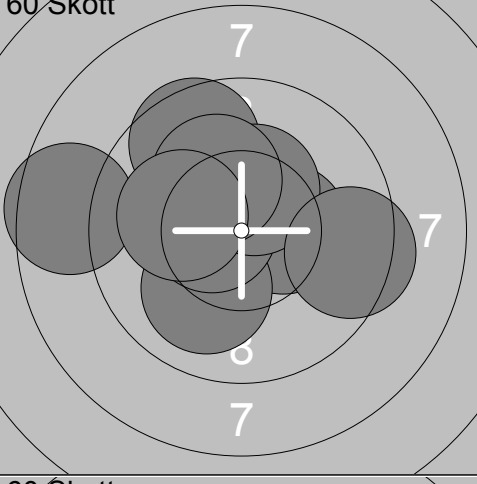
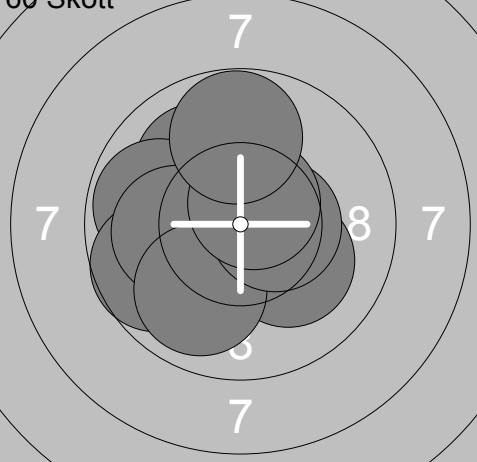
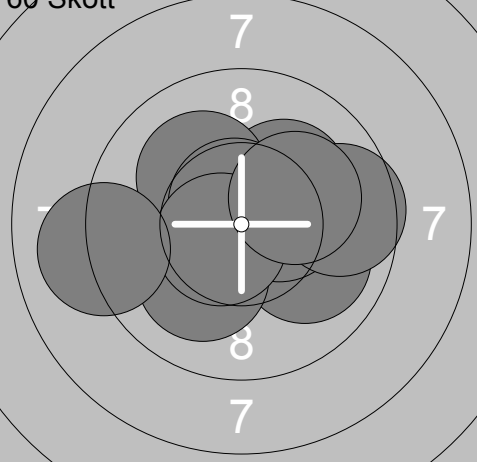

<p>Pröv</p>	<table border="1" style="width:100%; border-collapse: collapse;"> <tr><td>1:</td><td>8.9</td><td>↘</td></tr> <tr><td>2:</td><td>9.4</td><td>↘</td></tr> <tr><td>3:</td><td>10.2x</td><td>↘</td></tr> <tr><td>4:</td><td>10.1</td><td>↗</td></tr> <tr><td>5:</td><td>10.0</td><td>→</td></tr> <tr><td>6:</td><td>10.3x</td><td>→</td></tr> <tr><td>7:</td><td>10.1</td><td>↖</td></tr> <tr><td>8:</td><td>10.3x</td><td>↗</td></tr> <tr><td>9:</td><td>8.4</td><td>↗</td></tr> <tr><td>10:</td><td>8.5</td><td>↘</td></tr> <tr><td colspan="2">Serie</td><td style="text-align: right;">96.2</td></tr> <tr><td colspan="2">Total</td><td style="text-align: right;">0.0</td></tr> </table>	1:	8.9	↘	2:	9.4	↘	3:	10.2x	↘	4:	10.1	↗	5:	10.0	→	6:	10.3x	→	7:	10.1	↖	8:	10.3x	↗	9:	8.4	↗	10:	8.5	↘	Serie		96.2	Total		0.0	<p>Pröv</p>	<table border="1" style="width:100%; border-collapse: collapse;"> <tr><td>11:</td><td>10.0</td><td>↘</td></tr> <tr><td>12:</td><td>9.2</td><td>→</td></tr> <tr><td>13:</td><td>9.7</td><td>↘</td></tr> <tr><td>14:</td><td>10.3x</td><td>↗</td></tr> <tr><td colspan="2">Serie</td><td style="text-align: right;">39.2</td></tr> <tr><td colspan="2">Total</td><td style="text-align: right;">0.0</td></tr> </table>	11:	10.0	↘	12:	9.2	→	13:	9.7	↘	14:	10.3x	↗	Serie		39.2	Total		0.0																		
1:	8.9	↘																																																																									
2:	9.4	↘																																																																									
3:	10.2x	↘																																																																									
4:	10.1	↗																																																																									
5:	10.0	→																																																																									
6:	10.3x	→																																																																									
7:	10.1	↖																																																																									
8:	10.3x	↗																																																																									
9:	8.4	↗																																																																									
10:	8.5	↘																																																																									
Serie		96.2																																																																									
Total		0.0																																																																									
11:	10.0	↘																																																																									
12:	9.2	→																																																																									
13:	9.7	↘																																																																									
14:	10.3x	↗																																																																									
Serie		39.2																																																																									
Total		0.0																																																																									
<p>60 Skott</p>	<table border="1" style="width:100%; border-collapse: collapse;"> <tr><td>1:</td><td>10.0</td><td>↘</td></tr> <tr><td>2:</td><td>9.6</td><td>↗</td></tr> <tr><td>3:</td><td>9.1</td><td>↗</td></tr> <tr><td>4:</td><td>8.4</td><td>↗</td></tr> <tr><td>5:</td><td>9.4</td><td>↗</td></tr> <tr><td>6:</td><td>10.2x</td><td>↘</td></tr> <tr><td>7:</td><td>10.1</td><td>↗</td></tr> <tr><td>8:</td><td>8.4</td><td>↘</td></tr> <tr><td>9:</td><td>10.8x</td><td>→</td></tr> <tr><td>10:</td><td>8.8</td><td>↘</td></tr> <tr><td colspan="2">Serie</td><td style="text-align: right;">94.8</td></tr> <tr><td colspan="2">Total</td><td style="text-align: right;">94.8</td></tr> </table>	1:	10.0	↘	2:	9.6	↗	3:	9.1	↗	4:	8.4	↗	5:	9.4	↗	6:	10.2x	↘	7:	10.1	↗	8:	8.4	↘	9:	10.8x	→	10:	8.8	↘	Serie		94.8	Total		94.8	<p>60 Skott</p>	<table border="1" style="width:100%; border-collapse: collapse;"> <tr><td>11:</td><td>10.0</td><td>↖</td></tr> <tr><td>12:</td><td>10.1</td><td>↗</td></tr> <tr><td>13:</td><td>8.1</td><td>↗</td></tr> <tr><td>14:</td><td>10.5x</td><td>→</td></tr> <tr><td>15:</td><td>9.3</td><td>→</td></tr> <tr><td>16:</td><td>9.0</td><td>↑</td></tr> <tr><td>17:</td><td>10.5x</td><td>↗</td></tr> <tr><td>18:</td><td>9.2</td><td>↖</td></tr> <tr><td>19:</td><td>9.6</td><td>↑</td></tr> <tr><td>20:</td><td>9.8</td><td>↗</td></tr> <tr><td colspan="2">Serie</td><td style="text-align: right;">96.1</td></tr> <tr><td colspan="2">Total</td><td style="text-align: right;">190.9</td></tr> </table>	11:	10.0	↖	12:	10.1	↗	13:	8.1	↗	14:	10.5x	→	15:	9.3	→	16:	9.0	↑	17:	10.5x	↗	18:	9.2	↖	19:	9.6	↑	20:	9.8	↗	Serie		96.1	Total		190.9
1:	10.0	↘																																																																									
2:	9.6	↗																																																																									
3:	9.1	↗																																																																									
4:	8.4	↗																																																																									
5:	9.4	↗																																																																									
6:	10.2x	↘																																																																									
7:	10.1	↗																																																																									
8:	8.4	↘																																																																									
9:	10.8x	→																																																																									
10:	8.8	↘																																																																									
Serie		94.8																																																																									
Total		94.8																																																																									
11:	10.0	↖																																																																									
12:	10.1	↗																																																																									
13:	8.1	↗																																																																									
14:	10.5x	→																																																																									
15:	9.3	→																																																																									
16:	9.0	↑																																																																									
17:	10.5x	↗																																																																									
18:	9.2	↖																																																																									
19:	9.6	↑																																																																									
20:	9.8	↗																																																																									
Serie		96.1																																																																									
Total		190.9																																																																									
<p>60 Skott</p>	<table border="1" style="width:100%; border-collapse: collapse;"> <tr><td>21:</td><td>9.2</td><td>↖</td></tr> <tr><td>22:</td><td>9.2</td><td>↑</td></tr> <tr><td>23:</td><td>10.0</td><td>↗</td></tr> <tr><td>24:</td><td>9.8</td><td>↘</td></tr> <tr><td>25:</td><td>9.0</td><td>↗</td></tr> <tr><td>26:</td><td>9.8</td><td>↖</td></tr> <tr><td>27:</td><td>10.0</td><td>→</td></tr> <tr><td>28:</td><td>9.2</td><td>↘</td></tr> <tr><td>29:</td><td>10.3x</td><td>↗</td></tr> <tr><td>30:</td><td>10.3x</td><td>↖</td></tr> <tr><td colspan="2">Serie</td><td style="text-align: right;">96.8</td></tr> <tr><td colspan="2">Total</td><td style="text-align: right;">287.7</td></tr> </table>	21:	9.2	↖	22:	9.2	↑	23:	10.0	↗	24:	9.8	↘	25:	9.0	↗	26:	9.8	↖	27:	10.0	→	28:	9.2	↘	29:	10.3x	↗	30:	10.3x	↖	Serie		96.8	Total		287.7	<p>60 Skott</p>	<table border="1" style="width:100%; border-collapse: collapse;"> <tr><td>31:</td><td>9.3</td><td>↘</td></tr> <tr><td>32:</td><td>10.5x</td><td>↖</td></tr> <tr><td>33:</td><td>9.7</td><td>↘</td></tr> <tr><td>34:</td><td>8.9</td><td>↘</td></tr> <tr><td>35:</td><td>10.8x</td><td>↖</td></tr> <tr><td>36:</td><td>10.5x</td><td>↘</td></tr> <tr><td>37:</td><td>9.5</td><td>↗</td></tr> <tr><td>38:</td><td>10.2x</td><td>→</td></tr> <tr><td>39:</td><td>10.0</td><td>↘</td></tr> <tr><td>40:</td><td>9.6</td><td>↘</td></tr> <tr><td colspan="2">Serie</td><td style="text-align: right;">99.0</td></tr> <tr><td colspan="2">Total</td><td style="text-align: right;">386.7</td></tr> </table>	31:	9.3	↘	32:	10.5x	↖	33:	9.7	↘	34:	8.9	↘	35:	10.8x	↖	36:	10.5x	↘	37:	9.5	↗	38:	10.2x	→	39:	10.0	↘	40:	9.6	↘	Serie		99.0	Total		386.7
21:	9.2	↖																																																																									
22:	9.2	↑																																																																									
23:	10.0	↗																																																																									
24:	9.8	↘																																																																									
25:	9.0	↗																																																																									
26:	9.8	↖																																																																									
27:	10.0	→																																																																									
28:	9.2	↘																																																																									
29:	10.3x	↗																																																																									
30:	10.3x	↖																																																																									
Serie		96.8																																																																									
Total		287.7																																																																									
31:	9.3	↘																																																																									
32:	10.5x	↖																																																																									
33:	9.7	↘																																																																									
34:	8.9	↘																																																																									
35:	10.8x	↖																																																																									
36:	10.5x	↘																																																																									
37:	9.5	↗																																																																									
38:	10.2x	→																																																																									
39:	10.0	↘																																																																									
40:	9.6	↘																																																																									
Serie		99.0																																																																									
Total		386.7																																																																									
<p>60 Skott</p>	<table border="1" style="width:100%; border-collapse: collapse;"> <tr><td>41:</td><td>10.7x</td><td>↘</td></tr> <tr><td>42:</td><td>10.2x</td><td>↘</td></tr> <tr><td>43:</td><td>9.9</td><td>↖</td></tr> <tr><td>44:</td><td>9.5</td><td>↘</td></tr> <tr><td>45:</td><td>9.0</td><td>↖</td></tr> <tr><td>46:</td><td>10.1</td><td>→</td></tr> <tr><td>47:</td><td>9.4</td><td>↘</td></tr> <tr><td>48:</td><td>9.3</td><td>→</td></tr> <tr><td>49:</td><td>10.2x</td><td>↖</td></tr> <tr><td>50:</td><td>9.9</td><td>↘</td></tr> <tr><td colspan="2">Serie</td><td style="text-align: right;">98.2</td></tr> <tr><td colspan="2">Total</td><td style="text-align: right;">484.9</td></tr> </table>	41:	10.7x	↘	42:	10.2x	↘	43:	9.9	↖	44:	9.5	↘	45:	9.0	↖	46:	10.1	→	47:	9.4	↘	48:	9.3	→	49:	10.2x	↖	50:	9.9	↘	Serie		98.2	Total		484.9	<p>60 Skott</p>	<table border="1" style="width:100%; border-collapse: collapse;"> <tr><td>51:</td><td>8.9</td><td>↖</td></tr> <tr><td>52:</td><td>9.3</td><td>↘</td></tr> <tr><td>53:</td><td>10.6x</td><td>↘</td></tr> <tr><td>54:</td><td>7.8</td><td>↘</td></tr> <tr><td>55:</td><td>10.1</td><td>↖</td></tr> <tr><td>56:</td><td>9.6</td><td>↘</td></tr> <tr><td>57:</td><td>10.6x</td><td>↗</td></tr> <tr><td>58:</td><td>9.8</td><td>↗</td></tr> <tr><td>59:</td><td>10.3x</td><td>↗</td></tr> <tr><td>60:</td><td>9.9</td><td>↘</td></tr> <tr><td colspan="2">Serie</td><td style="text-align: right;">96.9</td></tr> <tr><td colspan="2">Total</td><td style="text-align: right;">581.8</td></tr> </table>	51:	8.9	↖	52:	9.3	↘	53:	10.6x	↘	54:	7.8	↘	55:	10.1	↖	56:	9.6	↘	57:	10.6x	↗	58:	9.8	↗	59:	10.3x	↗	60:	9.9	↘	Serie		96.9	Total		581.8
41:	10.7x	↘																																																																									
42:	10.2x	↘																																																																									
43:	9.9	↖																																																																									
44:	9.5	↘																																																																									
45:	9.0	↖																																																																									
46:	10.1	→																																																																									
47:	9.4	↘																																																																									
48:	9.3	→																																																																									
49:	10.2x	↖																																																																									
50:	9.9	↘																																																																									
Serie		98.2																																																																									
Total		484.9																																																																									
51:	8.9	↖																																																																									
52:	9.3	↘																																																																									
53:	10.6x	↘																																																																									
54:	7.8	↘																																																																									
55:	10.1	↖																																																																									
56:	9.6	↘																																																																									
57:	10.6x	↗																																																																									
58:	9.8	↗																																																																									
59:	10.3x	↗																																																																									
60:	9.9	↘																																																																									
Serie		96.9																																																																									
Total		581.8																																																																									

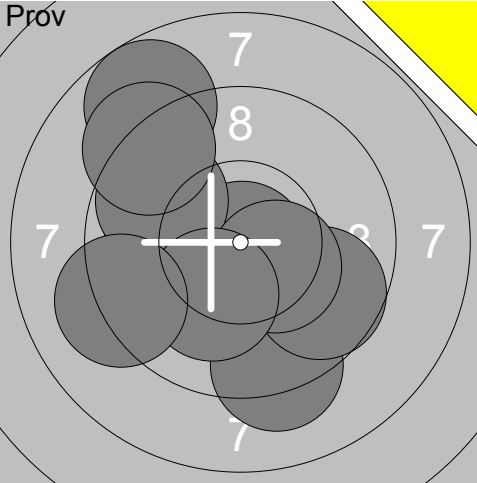
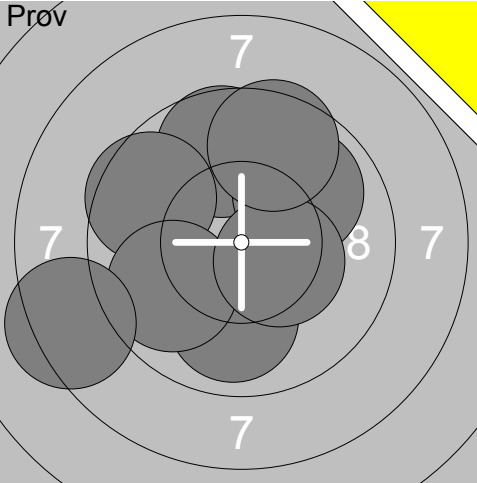
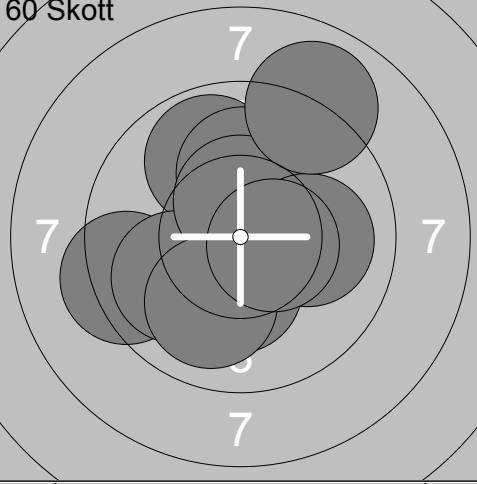
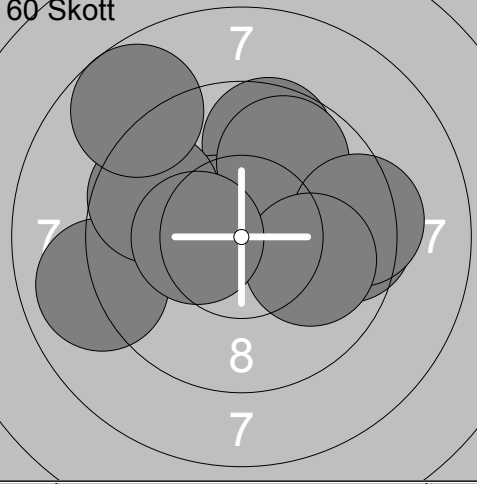
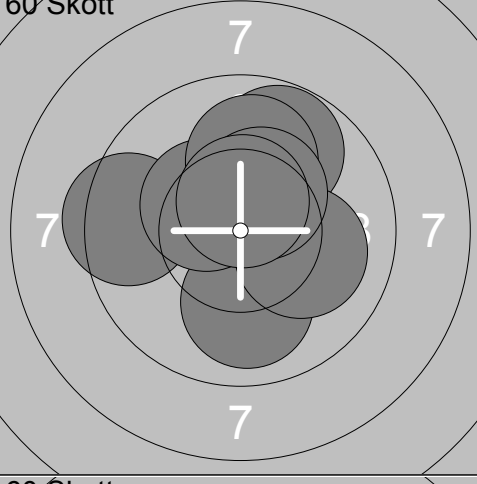
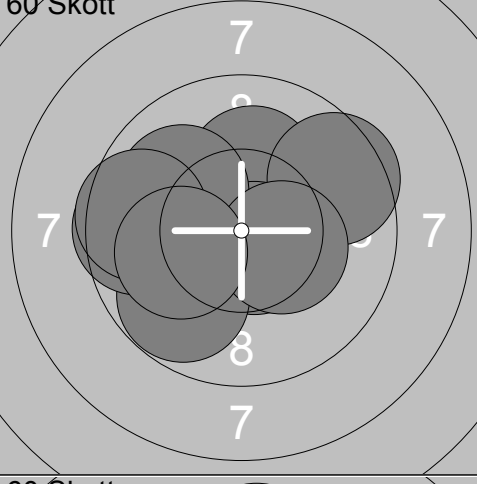
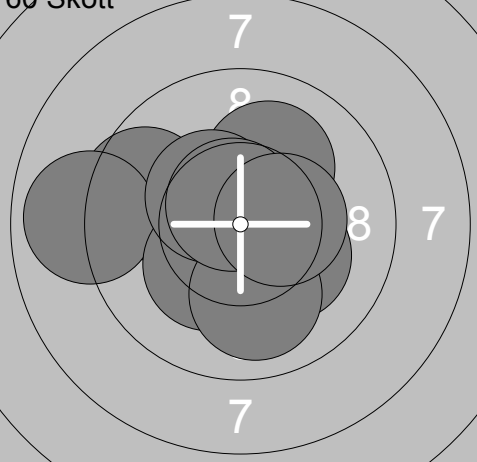
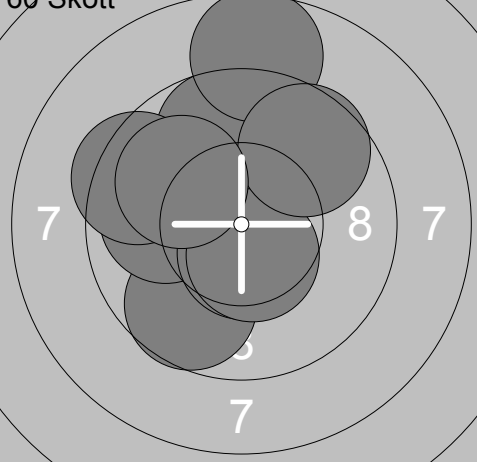
Skjutlag	Tavla	Mattias Jonsson	
5	9		
Vindeln	Forsa		Gä
18.03.2017	SM & JSM Luftgevär 2017	Ramselefors SKF	
Pröv		1: 9.4 ↓ 2: 9.1 → 3: 10.4x → 4: 10.7x ↓ 5: 8.3 ← 6: 9.8 ↑ 7: 9.5 ↑ 8: 9.3 ↗ 9: 10.5x ↑ 10: 9.8 ↑ Serie 96.8 Total 0.0	Pröv  11: 9.0 ↗ 12: 9.4 ← 13: 10.1 ↗ 14: 9.8 → 15: 9.8 → Serie 48.1 Total 0.0
60 Skott		1: 10.4x ↓ 2: 9.5 → 3: 10.1 → 4: 10.2x ↑ 5: 10.1 ↓ 6: 9.8 → 7: 9.3 ↓ 8: 10.2x ↗ 9: 9.8 ↓ 10: 9.6 ← Serie 99.0 Total 99.0	60 Skott  11: 10.4x ↘ 12: 9.1 → 13: 9.7 ← 14: 9.8 ↓ 15: 8.7 ← 16: 9.9 ↓ 17: 9.5 ← 18: 10.2x ↓ 19: 9.7 → 20: 10.3x ↓ Serie 97.3 Total 196.3
60 Skott		21: 10.1 ← 22: 9.4 ← 23: 9.2 ← 24: 10.9x ↓ 25: 10.9x ↗ 26: 9.6 ← 27: 9.7 ← 28: 10.3x ↑ 29: 9.9 ↑ 30: 10.2x ← Serie 100.2 Total 296.5	60 Skott  31: 10.4x → 32: 10.0 ↓ 33: 10.2x ↗ 34: 8.6 ← 35: 10.5x ← 36: 9.6 ↗ 37: 10.4x ↑ 38: 10.2x ↗ 39: 10.1 ← 40: 9.4 → Serie 99.4 Total 395.9
60 Skott		41: 10.0 ↗ 42: 9.8 ← 43: 10.6x → 44: 9.7 ← 45: 10.1 ← 46: 10.1 ↓ 47: 9.9 ↓ 48: 10.5x → 49: 10.6x ↗ 50: 9.8 ↑ Serie 101.1 Total 497.0	60 Skott  51: 10.0 → 52: 10.4x → 53: 10.1 ↓ 54: 10.2x ↗ 55: 10.1 ↗ 56: 9.6 → 57: 10.7x ↗ 58: 10.6x ← 59: 9.1 ← 60: 10.1 ↗ Serie 100.9 Total 597.9

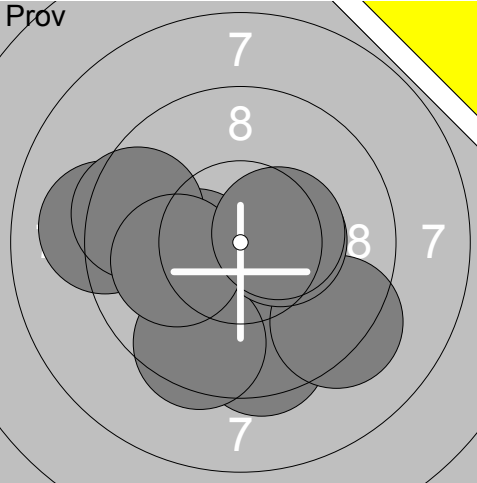
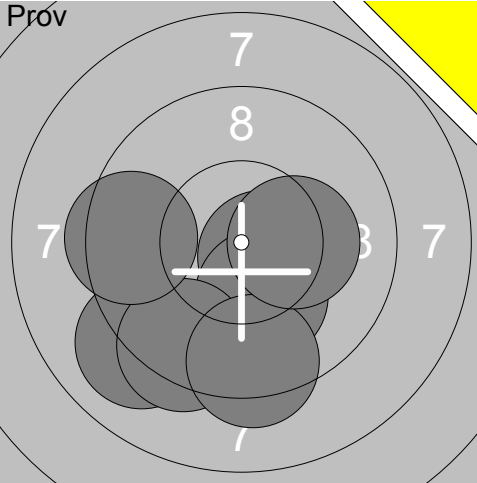
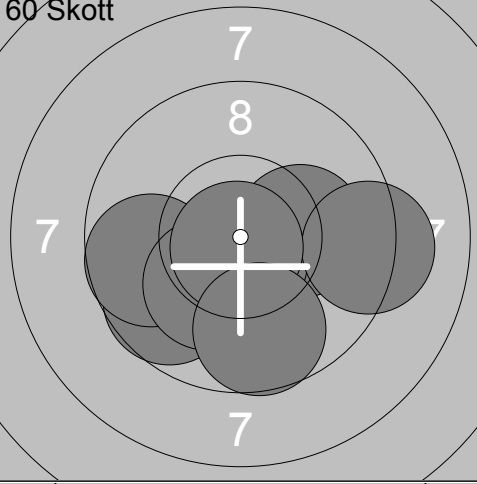
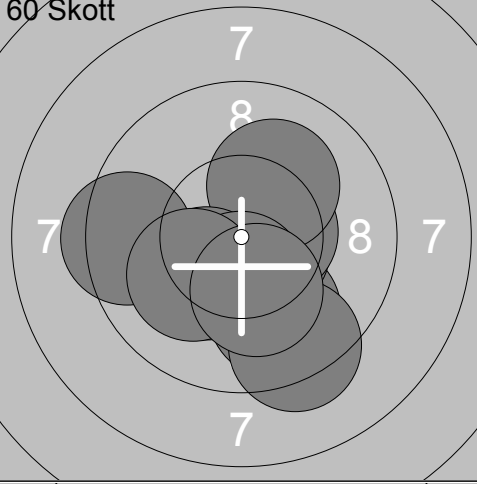
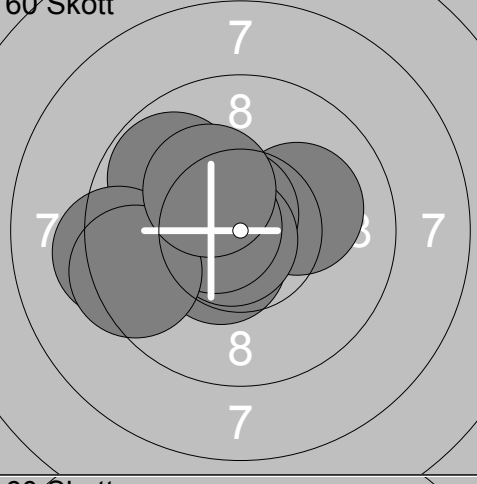
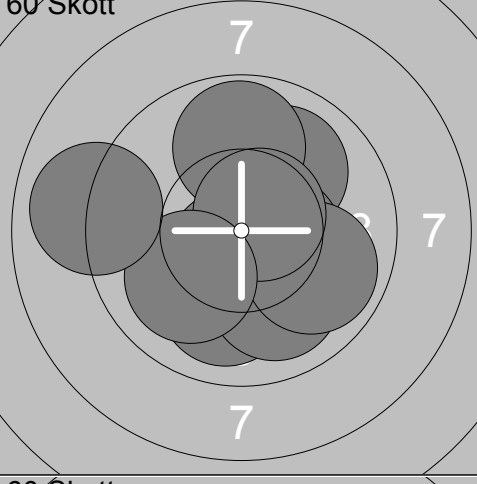
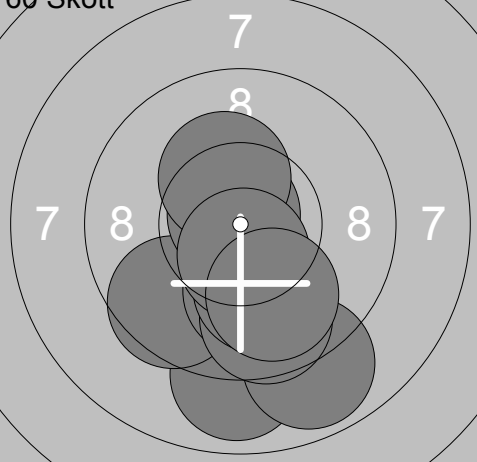
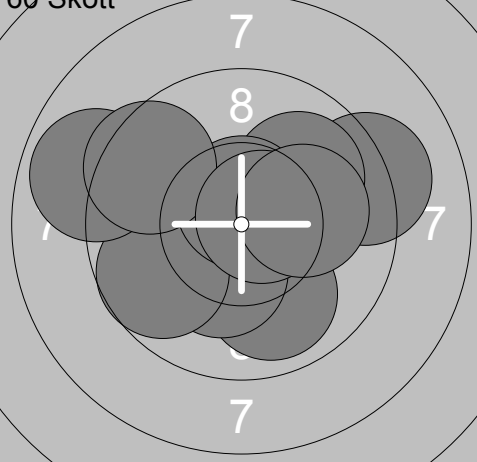
Skjutlag	Tavla	Andreas Nagysson	
5	10		
Vindeln	Christianstad		Sk
18.03.2017	SM & JSM Luftgevär 2017	Ramselefors SKF	
Pröv		1: 10.0 ← 2: 10.9x ↓ 3: 9.8 ↑ 4: 8.7 ↗ 5: 9.2 ↗ 6: 9.2 ↓ 7: 9.7 ↓ 8: 10.4x ↓ 9: 10.1 ↓ 10: 9.2 ↙ Serie 97.2 Total 0.0	Pröv  11: 9.9 ↓ 12: 9.7 ↑ 13: 9.9 ↗ 14: 9.6 ↖ 15: 9.8 ↖ 16: 10.4x → 17: 9.6 ↑ 18: 8.4 ↖ Serie 77.3 Total 0.0
60 Skott		1: 9.3 ← 2: 10.3x ↓ 3: 9.9 ↑ 4: 9.9 ↖ 5: 10.1 ↑ 6: 10.5x ↑ 7: 10.0 → 8: 9.0 ↗ 9: 10.0 ↓ 10: 10.5x → Serie 99.5 Total 99.5	60 Skott  11: 9.6 ↑ 12: 10.5x ↖ 13: 9.0 ↖ 14: 9.5 → 15: 9.7 ↖ 16: 8.7 ↗ 17: 9.8 ↗ 18: 9.4 → 19: 10.0 → 20: 10.4x ← Serie 96.6 Total 196.1
60 Skott		21: 10.0 ↓ 22: 10.3x ↑ 23: 9.4 ← 24: 9.8 ↑ 25: 10.4x ↖ 26: 10.3x ↑ 27: 10.0 ↑ 28: 10.1 → 29: 10.4x ↗ 30: 10.6x ↑ Serie 101.3 Total 297.4	60 Skott  31: 10.2x ↖ 32: 10.2x ↑ 33: 10.7x ↓ 34: 9.5 ↗ 35: 10.0 ↖ 36: 9.8 ↖ 37: 9.6 ← 38: 10.4x → 39: 9.6 ← 40: 10.1 ↖ Serie 100.1 Total 397.5
60 Skott		41: 10.5x ↓ 42: 9.6 ↖ 43: 10.2x ↖ 44: 8.9 ← 45: 10.3x ↖ 46: 10.1 ↗ 47: 10.4x ↗ 48: 10.0 ↓ 49: 10.7x ↗ 50: 10.4x → Serie 101.1 Total 498.6	60 Skott  51: 10.2x ← 52: 9.7 ↓ 53: 9.9 ← 54: 10.6x ↓ 55: 9.7 ↑ 56: 10.5x ↓ 57: 8.7 ↑ 58: 9.4 ↖ 59: 9.6 ↗ 60: 10.0 ↖ Serie 98.3 Total 596.9

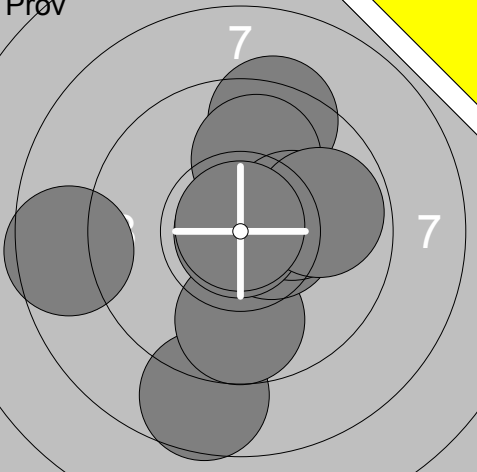
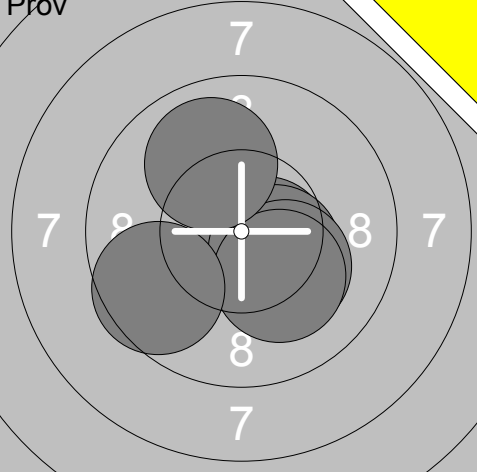
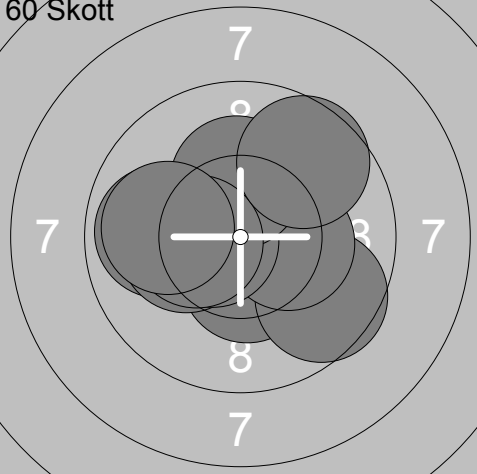
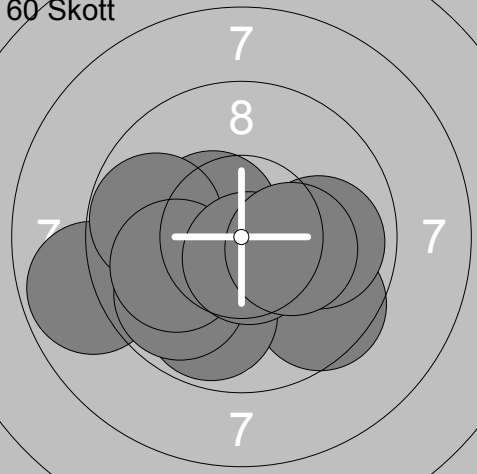
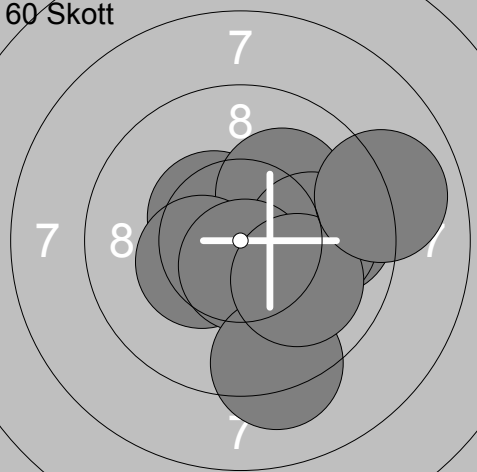
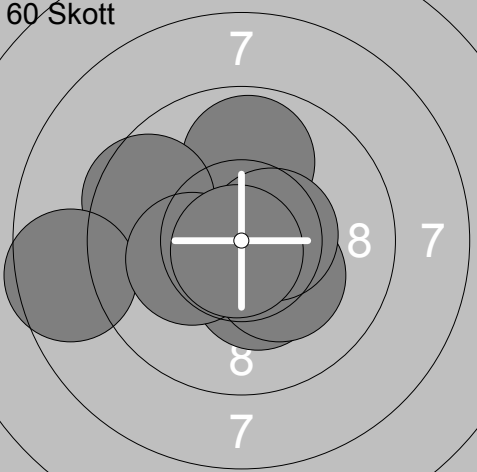
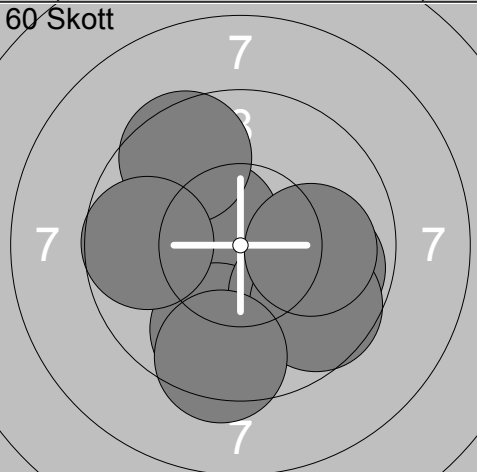
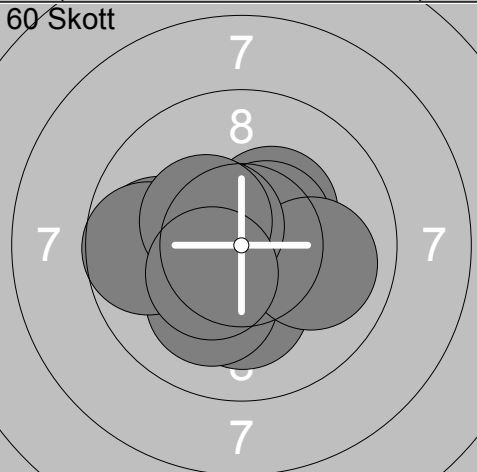
Skjutlag	Tavla	Alexander Pösl Hyvärinen	
5	11		
Vindeln	Fagersta		Vm
18.03.2017	SM & JSM Luftgevär 2017	Ramselefors SKF	
Pröv 	1: 10.0 ↘	Pröv 	11: 9.0 ↘
	2: 10.3x ←		12: 10.6x ↘
	3: 9.1 ←		13: 10.2x ↓
	4: 9.5 ↓		14: 9.4 ↓
	5: 9.3 ↓		15: 9.3 ↓
	6: 9.5 ↓		16: 9.5 ←
	7: 10.4x →		17: 10.2x →
	8: 9.5 ←		
	9: 10.1 ←		
	10: 10.4x →		
	Serie 98.1		Serie 68.2
	Total 0.0		Total 0.0
60 Skott 	1: 10.2x ↘	60 Skott 	11: 9.8 ↓
	2: 10.1 →		12: 10.6x ↘
	3: 10.3x ↓		13: 10.5x →
	4: 9.7 ↘		14: 10.1 ↗
	5: 10.6x ↓		15: 9.4 ←
	6: 9.7 ←		16: 10.3x ↘
	7: 9.2 →		17: 10.4x ↓
	8: 10.2x ↘		18: 9.3 ↓
	9: 10.8x ↓		19: 10.1 ↘
	10: 9.7 ↓		20: 10.2x ↓
	Serie 100.5		Serie 100.7
	Total 100.5		Total 201.2
60 Skott 	21: 10.5x ↘	60 Skott 	31: 10.0 ↓
	22: 10.1 →		32: 10.0 ↗
	23: 10.7x ↗		33: 9.8 ↑
	24: 10.8x ↘		34: 10.6x ↓
	25: 10.0 ↗		35: 10.5x →
	26: 10.6x ←		36: 10.0 ↓
	27: 9.8 ↗		37: 9.9 ↘
	28: 9.3 ←		38: 10.6x ↗
	29: 9.4 ←		39: 10.0 ↘
	30: 10.3x ↗		40: 9.0 ←
	Serie 101.5		Serie 100.4
	Total 302.7		Total 403.1
60 Skott 	41: 8.9 ↓	60 Skott 	51: 9.9 ↓
	42: 9.6 ↘		52: 10.3x ↓
	43: 8.9 ↓		53: 9.7 ←
	44: 10.8x ↗		54: 9.2 →
	45: 10.0 ↓		55: 10.0 ↗
	46: 9.7 ↘		56: 10.7x ↑
	47: 10.3x ↗		57: 8.9 ←
	48: 10.1 ↓		58: 9.5 ↘
	49: 10.5x ↓		59: 10.7x →
	50: 9.9 ↓		60: 10.1 →
	Serie 98.7		Serie 99.0
	Total 501.8		Total 600.8

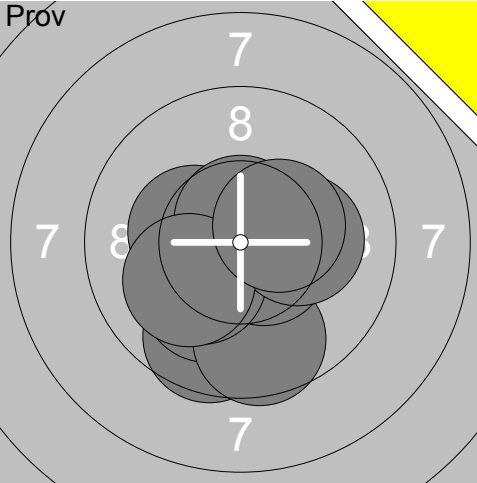
Pröv 	1: 8.6 ↓ 2: 9.7 ↓ 3: 8.6 ← 4: 10.5x → 5: 9.4 ↑ 6: 9.9 ↑ 7: 10.2x → 8: 10.9x ↙ 9: 9.8 → 10: 10.9x ↑ <hr/> Serie 98.5 Total 0.0	Pröv 	11: 10.6x → 12: 10.4x ↘ 13: 10.2x ↘ 14: 10.2x ↘ 15: 9.6 ↙ 16: 10.0 ↑ <hr/> Serie 61.0 Total 0.0
60 Skott 	1: 10.4x ↓ 2: 9.6 ↘ 3: 9.9 ← 4: 10.3x → 5: 10.2x ← 6: 10.6x ← 7: 10.2x ↑ 8: 10.4x ← 9: 9.6 ↗ 10: 10.0 ← <hr/> Serie 101.2 Total 101.2	60 Skott 	11: 8.8 ← 12: 10.5x ↗ 13: 9.8 ← 14: 9.6 ↘ 15: 9.8 ↓ 16: 9.9 → 17: 9.8 ↙ 18: 10.0 ← 19: 10.6x ↘ 20: 10.3x → <hr/> Serie 99.1 Total 200.3
60 Skott 	21: 9.8 → 22: 10.5x ↗ 23: 10.0 → 24: 10.1 ↗ 25: 10.0 → 26: 10.4x ← 27: 10.6x ↘ 28: 9.2 ↓ 29: 10.0 ↘ 30: 9.0 → <hr/> Serie 99.6 Total 299.9	60 Skott 	31: 10.7x ↙ 32: 9.9 ↑ 33: 10.3x ↘ 34: 10.5x ↘ 35: 10.2x ↘ 36: 9.6 ↗ 37: 8.6 ← 38: 10.5x → 39: 10.2x ← 40: 10.8x ↘ <hr/> Serie 101.3 Total 401.2
60 Skott 	41: 10.3x ↘ 42: 10.5x ↗ 43: 9.8 ↙ 44: 9.5 ↗ 45: 9.8 → 46: 10.0 ↘ 47: 9.7 ↘ 48: 9.7 ← 49: 10.0 → 50: 9.4 ↓ <hr/> Serie 98.7 Total 499.9	60 Skott 	51: 10.2x ↓ 52: 10.1 ↓ 53: 10.3x ↗ 54: 9.8 ← 55: 10.5x ↗ 56: 10.0 → 57: 9.7 ← 58: 10.5x ↗ 59: 10.4x ↗ 60: 10.4x ↙ <hr/> Serie 101.9 Total 601.8

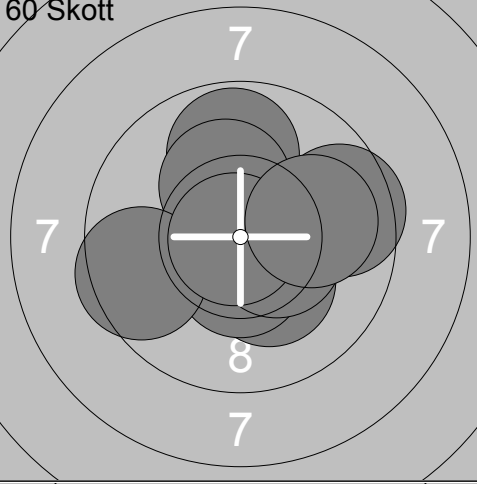
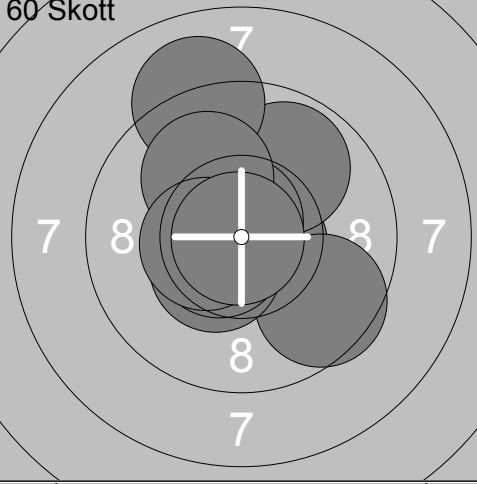
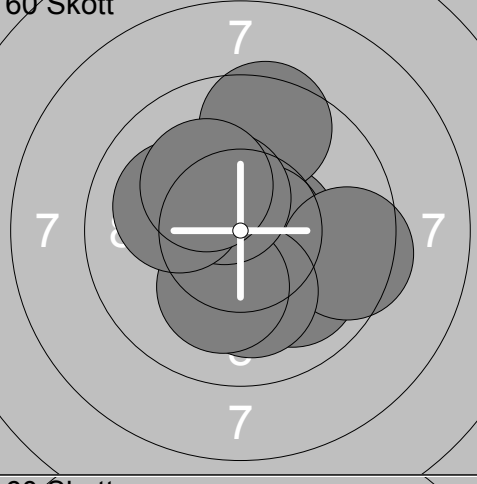
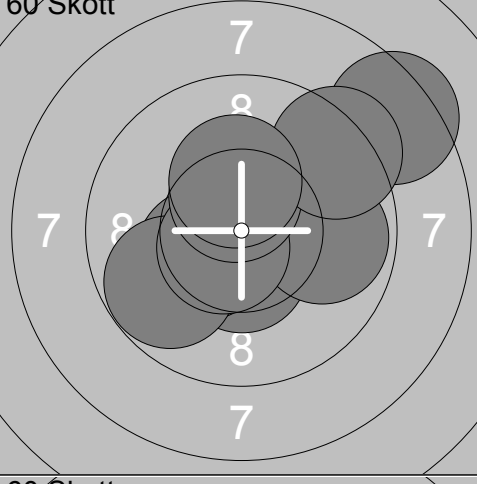
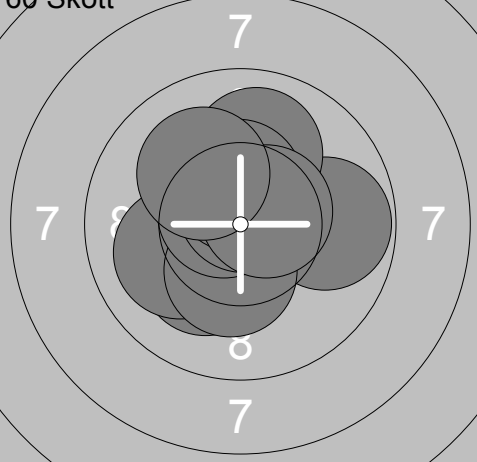
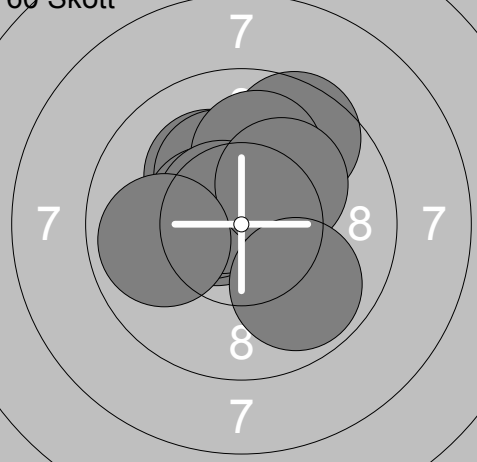
Skjutlag	Tavla	Felix Gäfvert			
5	13				Vm
Vindeln	Fagersta				
18.03.2017	SM & JSM Luftgevär 2017	Ramselefors SKF			
Pröv 	1: 9.6 ↓	Pröv 	11: 10.7x ↗		
	2: 10.1 ↓		12: 10.1 ↗		
	3: 9.6 ↓		13: 10.3x ↗		
	4: 10.6x ↘		14: 10.5x ↖		
	5: 10.2x ↘				
	6: 10.3x ↖				
	7: 10.7x ↑				
	8: 10.2x →				
	9: 10.1 ↖				
	10: 10.4x ↗				
	Serie 101.8		Serie 41.6		
	Total 0.0		Total 0.0		
60 Skott 	1: 9.8 ↑	60 Skott 	11: 10.7x →		
	2: 10.3x ↘		12: 9.9 ↗		
	3: 10.7x ↓		13: 9.6 ↘		
	4: 10.5x ↓		14: 10.4x ↖		
	5: 10.2x ↑		15: 9.1 ↗		
	6: 9.5 ↖		16: 10.6x ↖		
	7: 9.6 →		17: 10.7x ↗		
	8: 10.4x →		18: 10.0 ↗		
	9: 10.9x ↖		19: 10.5x ↖		
	10: 10.0 →		20: 10.9x ↖		
	Serie 101.9		Serie 102.4		
	Total 101.9		Total 204.3		
60 Skott 	21: 10.5x →	60 Skott 	31: 10.5x ↓		
	22: 10.0 ↘		32: 10.3x ↗		
	23: 9.5 ↑		33: 9.9 →		
	24: 10.7x →		34: 10.3x ↖		
	25: 9.5 →		35: 9.8 ↖		
	26: 10.1 ↓		36: 10.6x ↖		
	27: 10.2x ↘		37: 10.5x ↑		
	28: 10.5x ↗		38: 8.4 ↗		
	29: 10.1 ↖		39: 9.3 ↗		
	30: 10.2x ↗		40: 10.3x ↑		
	Serie 101.3		Serie 99.9		
	Total 305.6		Total 405.5		
60 Skott 	41: 9.8 →	60 Skott 	51: 10.6x ↖		
	42: 10.2x ↘		52: 10.2x ↗		
	43: 10.1 ↖		53: 9.6 ↗		
	44: 10.3x ↓		54: 10.2x ↗		
	45: 10.7x ↗		55: 10.0 ↑		
	46: 10.7x ↑		56: 10.5x ↖		
	47: 10.0 ↑		57: 10.6x ↗		
	48: 10.4x ↑		58: 10.2x ↗		
	49: 10.6x →		59: 9.9 ↘		
	50: 10.1 ↖		60: 9.9 ↖		
	Serie 102.9		Serie 101.7		
	Total 508.4		Total 610.1		

Skjutlag	Tavla	Martin Kronberg	
5	14		
Vindeln	Filipstad		Vä
18.03.2017	SM & JSM Luftgevär 2017	Ramselefors SKF	
Prov 	1: 8.2 ↘ 2: 9.7 → 3: 10.2x ↗ 4: 9.5 → 5: 10.0 → 6: 10.3x ↙ 7: 10.8x ↙ 8: 8.4 ↘ 9: 9.5 ↙ 10: 10.0 → Serie 96.6 Total 0.0	Prov 	11: 9.7 ↙ 12: 9.9 → 13: 9.3 → 14: 9.3 → 15: 9.7 ↙ 16: 10.1 ↗ 17: 10.6x ↙ Serie 68.6 Total 0.0
60 Skott 	1: 10.7x ↗ 2: 10.4x ↘ 3: 10.1 ↘ 4: 10.8x ↙ 5: 9.9 ↘ 6: 10.6x ↗ 7: 9.7 ↗ 8: 10.1 ↘ 9: 9.9 ↗ 10: 9.8 ↗ Serie 102.0 Total 102.0	60 Skott 	11: 9.9 ← 12: 10.0 ↓ 13: 10.4x ← 14: 10.4x ← 15: 10.3x ← 16: 10.7x → 17: 10.5x ↗ 18: 10.2x ↘ 19: 9.9 ↗ 20: 9.6 ↗ Serie 101.9 Total 203.9
60 Skott 	21: 9.8 → 22: 10.6x ↗ 23: 10.5x ↘ 24: 10.1 ↗ 25: 9.8 ↗ 26: 9.8 ↗ 27: 9.6 ← 28: 10.3x ← 29: 10.3x → 30: 9.9 ↑ Serie 100.7 Total 304.6	60 Skott 	31: 10.3x ↘ 32: 10.8x ← 33: 10.0 ↘ 34: 10.6x → 35: 10.5x ↗ 36: 10.2x ↗ 37: 10.6x ↗ 38: 10.1 ↘ 39: 10.3x ↗ 40: 9.7 ↗ Serie 103.1 Total 407.7
60 Skott 	41: 9.0 ↙ 42: 10.6x ↗ 43: 10.0 ↗ 44: 9.9 ← 45: 10.4x ↑ 46: 10.5x ↗ 47: 10.5x ← 48: 9.9 → 49: 10.1 ← 50: 10.8x ↑ Serie 101.7 Total 509.4	60 Skott 	51: 10.3x ↑ 52: 9.9 → 53: 10.6x ↗ 54: 10.2x ↓ 55: 10.0 ↙ 56: 10.9x ← 57: 10.1 ↑ 58: 10.1 ↗ 59: 10.2x ↓ 60: 9.7 ↗ Serie 102.0 Total 611.4

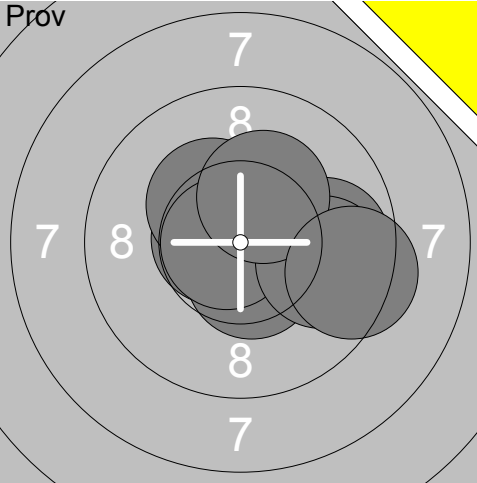
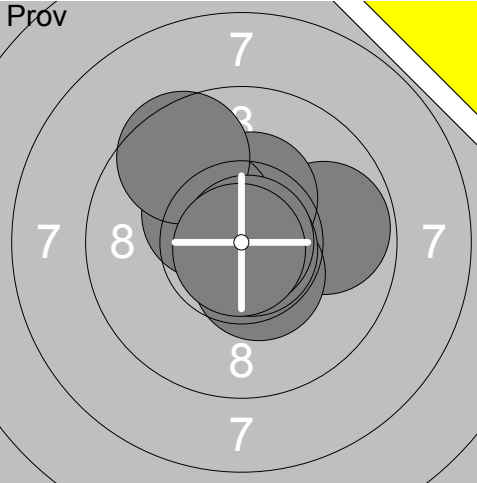
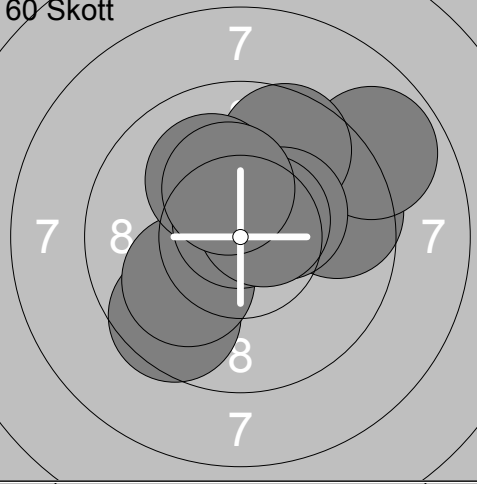
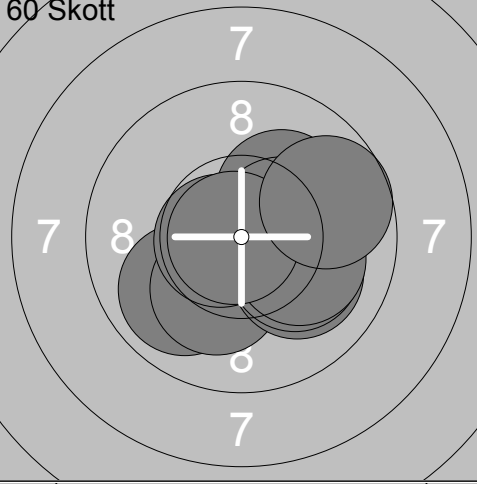
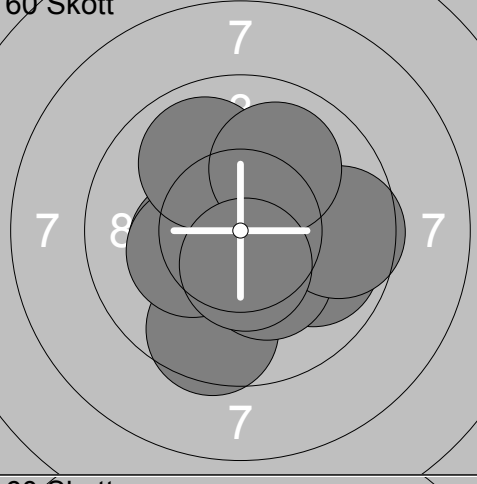
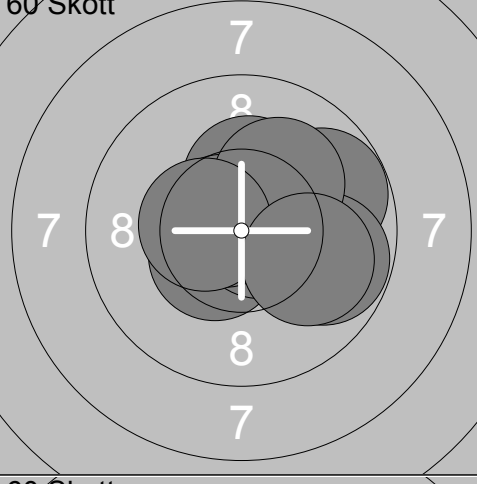
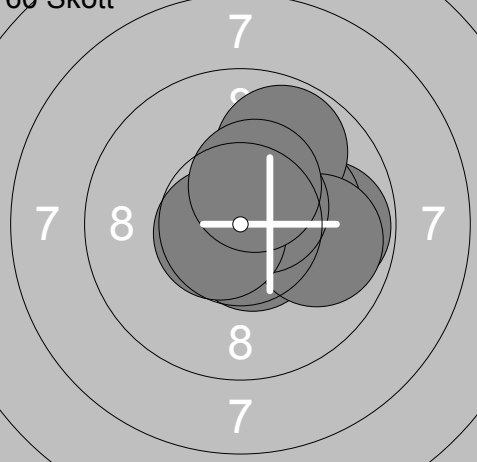
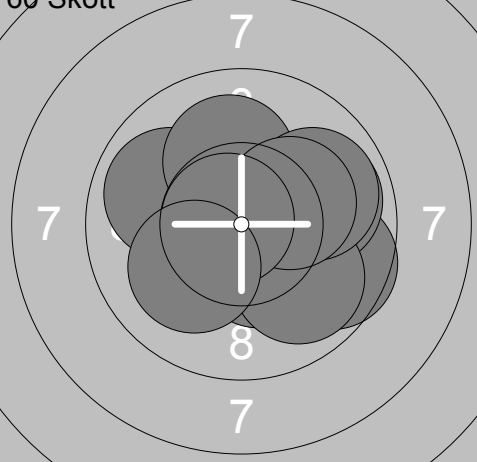

Skjutlag	Tavla	Oskar Jansson	
5	15		
Vindeln	Eskilstuna		Sö
18.03.2017	SM & JSM Luftgevär 2017	Ramselefors SKF	
Prov 	1: 8.6 ↙ 2: 8.8 ← 3: 8.9 ↙ 4: 9.4 ← 5: 8.3 ↘ 6: 8.8 → 7: 9.7 ← 8: 8.3 ← 9: 10.5x ↗ 10: 10.2x ↑	Prov 	11: 8.8 ← 12: 8.7 ↗ 13: 9.9 ↘ 14: 10.1 → 15: 9.2 → 16: 9.9 ↗ 17: 9.1 ↘ 18: 10.4x ←
	Serie 91.5		Serie 76.1
	Total 0.0		Total 0.0
60 Skott 	1: 8.4 ↑ 2: 10.7x ↘ 3: 9.3 ↘ 4: 10.0 ↗ 5: 8.3 ← 6: 10.7x ↘ 7: 9.8 ↗ 8: 10.2x ↘ 9: 10.5x ↘ 10: 9.7 ←	60 Skott 	11: 8.8 ↑ 12: 10.5x ↗ 13: 9.5 ↑ 14: 9.8 ↑ 15: 9.4 → 16: 10.1 ↘ 17: 10.4x ↑ 18: 9.4 → 19: 10.0 ↖ 20: 9.4 →
	Serie 97.6		Serie 97.3
	Total 97.6		Total 194.9
60 Skott 	21: 9.4 ↑ 22: 10.1 ← 23: 10.5x → 24: 7.6 ↖ 25: 10.2x ↘ 26: 9.5 ← 27: 9.1 ↗ 28: 8.5 ↘ 29: 10.6x ↗ 30: 8.4 ←	60 Skott 	31: 9.3 → 32: 9.5 ↖ 33: 10.8x ↗ 34: 10.4x ↗ 35: 9.2 ↗ 36: 10.5x ↘ 37: 10.3x ↑ 38: 8.6 ↗ 39: 9.8 ← 40: 9.9 ↘
	Serie 93.9		Serie 98.3
	Total 288.8		Total 387.1
60 Skott 	41: 8.0 ← 42: 9.1 ← 43: 9.3 ↘ 44: 9.3 ← 45: 10.9x ↗ 46: 9.6 ↘ 47: 8.8 ↗ 48: 9.3 ↗ 49: 9.7 ↗ 50: 10.4x ↗	60 Skott 	51: 9.3 ↘ 52: 9.6 ← 53: 10.2x ↘ 54: 9.4 ↖ 55: 10.4x ↑ 56: 9.0 ↑ 57: 9.9 ↑ 58: 10.5x → 59: 10.1 → 60: 10.1 ↗
	Serie 94.4		Serie 98.5
	Total 481.5		Total 580.0

Skjutlag	Tavla	Albin Johansson	
5	16		
Vindeln	Lekvattnet-Torsby		Vä
18.03.2017	SM & JSM Luftgevär 2017	Ramselefors SKF	
Pröv		1: 9.9 → 2: 10.3x ↓ 3: 10.2x → 4: 9.9 ↓ 5: 10.1 ↓ 6: 10.1 ↓ 7: 9.9 → 8: 10.3x ↑ 9: 9.7 ↓ 10: 9.6 ↗	Pröv
		Serie 100.0	
		Total 0.0	
			11: 10.8x ↖ 12: 9.9 → 13: 10.6x ↑ 14: 10.2x ↓ 15: 10.1 ↑ 16: 9.3 ↑ 17: 10.4x ↑ 18: 9.9 → 19: 10.8x ↓ 20: 10.5x →
			Serie 102.5
			Total 0.0
Pröv		21: 10.3x ↓	60 Skott
		Serie 10.3	
		Total 0.0	
			1: 10.1 ↗ 2: 9.6 ↑ 3: 10.8x ↗ 4: 10.6x ↖ 5: 9.7 ↑ 6: 10.7x ↑ 7: 9.6 ↑ 8: 10.3x ↗ 9: 10.2x ↑ 10: 10.0 →
			Serie 101.6
			Total 101.6
60 Skott		11: 10.3x ↓ 12: 10.4x ↖ 13: 9.7 ↓ 14: 10.2x ↑ 15: 9.7 ↖ 16: 10.7x ↑ 17: 10.3x ↑ 18: 10.8x ↗ 19: 9.3 → 20: 10.4x ↖	60 Skott
		Serie 101.8	
		Total 203.4	
			21: 10.1 ↗ 22: 10.1 ↑ 23: 10.3x ↓ 24: 10.4x → 25: 10.2x → 26: 10.4x ↗ 27: 10.1 ↑ 28: 10.4x ↖ 29: 10.2x ↓ 30: 10.5x →
			Serie 102.7
			Total 306.1
60 Skott		31: 10.4x ↘ 32: 10.3x ↖ 33: 9.4 ↖ 34: 9.8 ↖ 35: 10.4x → 36: 10.1 ↗ 37: 10.3x ↗ 38: 9.5 ↖ 39: 9.1 ↖ 40: 10.4x ↖	60 Skott
		Serie 99.7	
		Total 405.8	
			41: 10.5x ↖ 42: 10.0 ↖ 43: 10.4x → 44: 10.3x ↖ 45: 10.1 ↖ 46: 10.6x ↗ 47: 10.6x ↖ 48: 10.1 ↗ 49: 10.6x ↖ 50: 10.3x ↑
			Serie 103.5
			Total 509.3
60 Skott		51: 9.9 ↑ 52: 9.7 ↗ 53: 10.7x ↑ 54: 10.5x ↓ 55: 9.5 ↗ 56: 9.4 → 57: 10.5x ↗ 58: 10.0 ↖ 59: 10.9x ↑ 60: 10.5x ↓	
		Serie 101.6	
		Total 610.9	

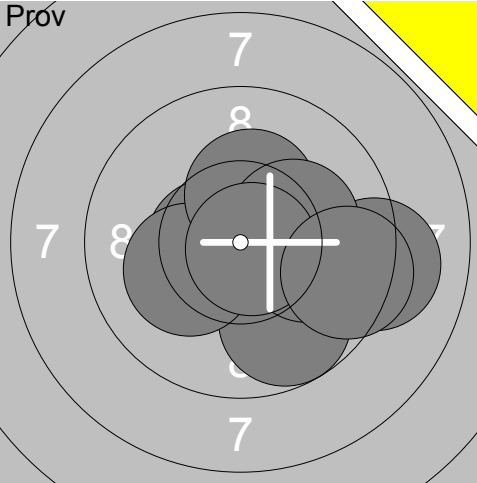
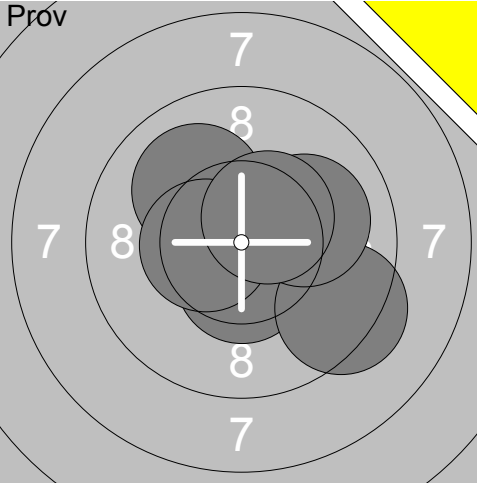
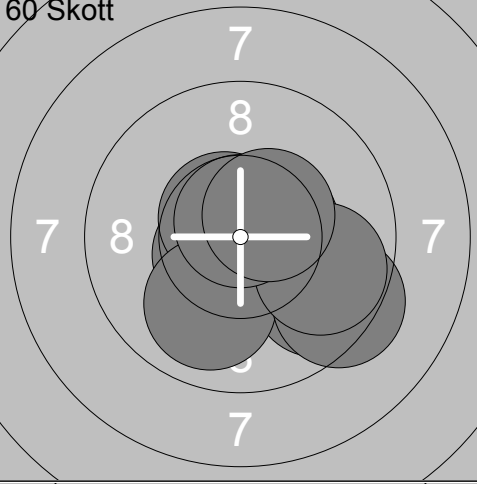
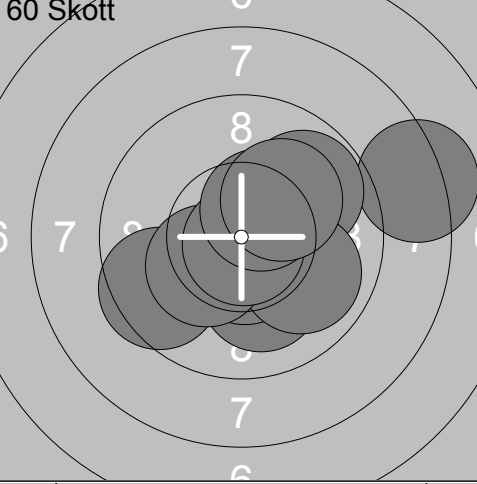
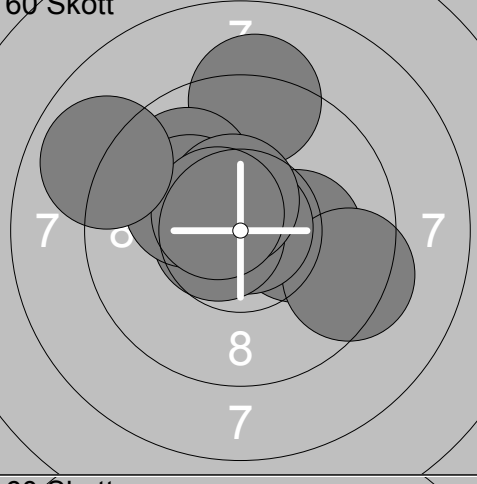
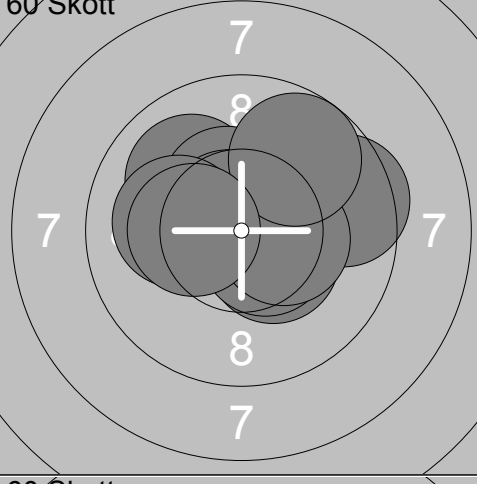
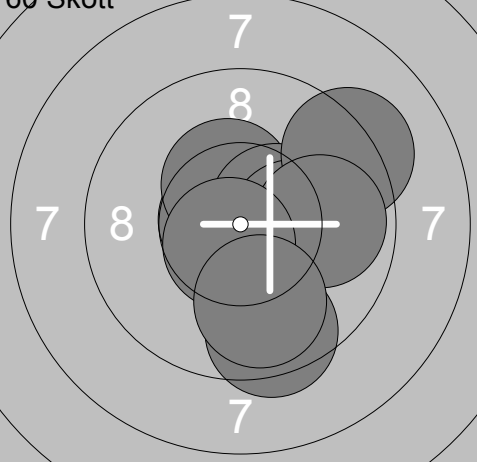
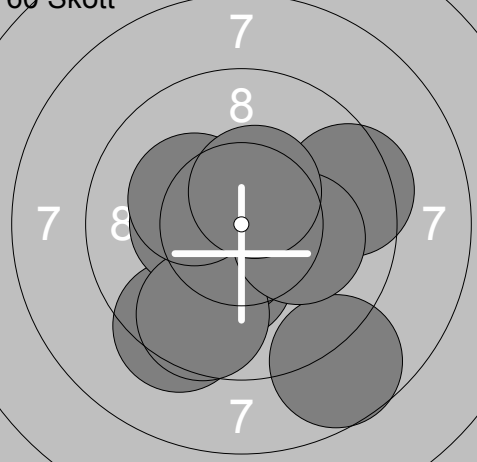
Skjutlag	Tavla	Saul Johansson	
5	17		
Vindeln	Ramselefors		Vb
18.03.2017	SM & JSM Luftgevär 2017	Ramselefors SKF	
Pröv 	1: 10.6x ← 2: 10.9x ↗ 3: 10.3x ↗ 4: 10.5x ↘ 5: 10.8x ← 6: 9.8 → 8: 9.8 → 9: 10.3x ↗ 10: 9.4 → Serie 92.4 Total 0.0	Pröv 	11: 9.8 → 12: 10.5x ↘ 13: 10.3x ↗ 14: 10.4x ↗ 15: 10.8x ↘ 16: 9.6 ↗ 17: 10.9x → 18: 10.8x ↘ Serie 83.1 Total 0.0
60 Skott 	1: 9.6 → 2: 8.8 ↗ 3: 9.6 ↗ 4: 9.6 ↘ 5: 10.0 ↘ 6: 10.3x → 7: 10.1 ↗ 8: 10.7x ↗ 9: 10.6x → 10: 10.3x ↗ Serie 99.6 Total 99.6	60 Skott 	11: 9.9 ↘ 12: 10.2x ↘ 13: 10.2x ↗ 14: 10.1 ↘ 15: 10.1 → 16: 10.4x → 17: 10.1 → 18: 10.7x ← 19: 10.8x ← 20: 9.7 → Serie 102.2 Total 201.8
60 Skott 	21: 10.3x ← 22: 9.6 ↘ 23: 10.4x → 24: 9.9 → 25: 10.3x ← 26: 9.9 ↗ 27: 10.3x ↘ 28: 9.6 → 29: 10.0 ↗ 30: 10.5x ↘ Serie 100.8 Total 302.6	60 Skott 	31: 10.5x ↘ 32: 9.8 → 33: 10.5x → 34: 9.8 → 35: 10.7x → 36: 10.3x ↗ 37: 10.7x ↗ 38: 10.1 ↗ 39: 10.5x ← 40: 10.0 → Serie 102.9 Total 405.5
60 Skott 	41: 9.8 → 42: 10.2x → 43: 10.4x → 44: 10.4x ↗ 45: 9.8 ↗ 46: 10.6x ↘ 47: 9.9 → 48: 10.6x ↗ 49: 10.6x ← 50: 10.4x ↗ Serie 102.7 Total 508.2	60 Skott 	51: 9.6 → 52: 10.4x ↘ 53: 9.9 → 54: 9.9 ↗ 55: 9.9 ↘ 56: 10.1 ↗ 57: 9.9 → 58: 10.2x → 59: 10.8x ← 60: 10.1 ↘ Serie 100.8 Total 609.0

Skjutlag	Tavla	Emanuel Söderlund	
5	18		
Vindeln	Kristinehamn		Vä
18.03.2017	SM & JSM Luftgevär 2017	Ramselefors SKF	
Pröv 	1: 9.7 ↘ 2: 10.8x → 3: 10.6x ← 4: 10.2x ↙ 5: 10.3x ↑ 6: 9.1 → 7: 10.0 → 8: 10.2x → 9: 10.8x ↘ 10: 9.5 ↘ Serie 101.2 Total 0.0	Pröv 	11: 10.0 ↗ 12: 10.5x ↓ 13: 9.3 ↘ 14: 10.5x ← 15: 10.1 → 16: 10.5x ↗ Serie 60.9 Total 0.0
60 Skott 	1: 10.5x → 2: 10.3x ↘ 3: 9.7 ↘ 4: 10.6x ↙ 5: 10.6x ↗ 6: 10.0 ↙ 7: 9.4 ↘ 8: 9.8 → 9: 10.7x ↑ 10: 10.5x ↗ Serie 102.1 Total 102.1	60 Skott 	11: 9.5 ← 12: 10.1 ↓ 13: 8.2 → 14: 9.8 ↗ 15: 10.6x ↓ 16: 9.9 ↘ 17: 10.3x ↙ 18: 10.8x ↓ 19: 10.5x ↗ 20: 10.1 ↗ Serie 99.8 Total 201.9
60 Skott 	21: 9.2 ↑ 22: 10.2x → 23: 9.4 ↘ 24: 10.9x ↗ 25: 10.6x ← 26: 9.9 ↗ 27: 10.2x ↗ 28: 10.5x ↗ 29: 10.6x ↗ 30: 8.9 ↗ Serie 100.4 Total 302.3	60 Skott 	31: 10.0 ↗ 32: 10.4x ↗ 33: 9.5 → 34: 10.7x ↗ 35: 10.1 ← 36: 10.4x ↓ 37: 10.5x ↓ 38: 10.4x → 39: 9.8 ↗ 40: 10.3x ← Serie 102.1 Total 404.4
60 Skott 	41: 10.7x ↙ 42: 10.7x ↘ 43: 10.4x ↗ 44: 10.4x → 45: 10.2x → 46: 9.2 ↗ 47: 9.5 ↓ 48: 9.9 → 49: 10.6x ↘ 50: 9.9 ↓ Serie 101.5 Total 505.9	60 Skott 	51: 10.2x ↓ 52: 9.4 ↓ 53: 10.6x ↓ 54: 9.4 → 55: 10.3x ← 56: 9.6 ↓ 57: 10.2x ↗ 58: 8.7 ↓ 59: 10.2x → 60: 10.5x ↗ Serie 99.1 Total 605.0

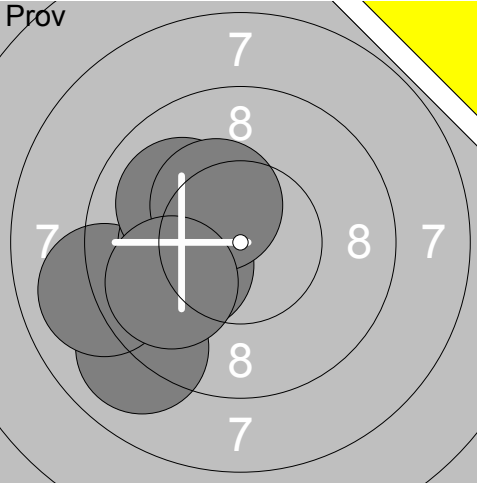
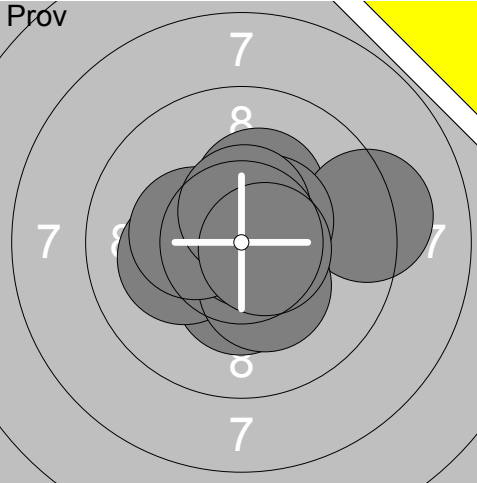
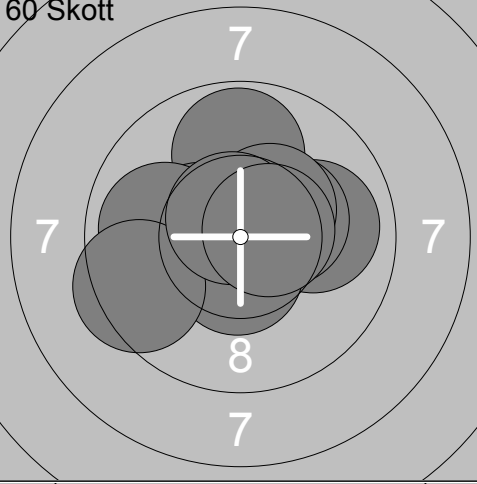
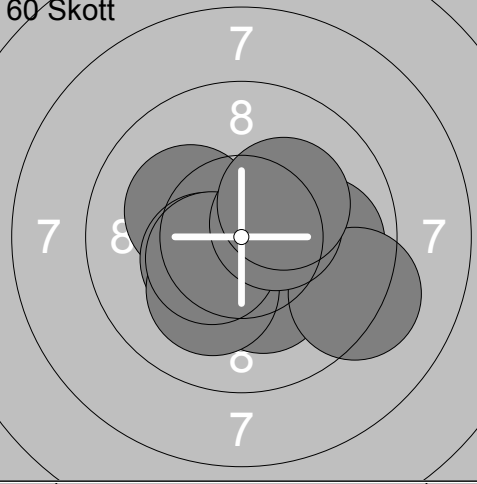
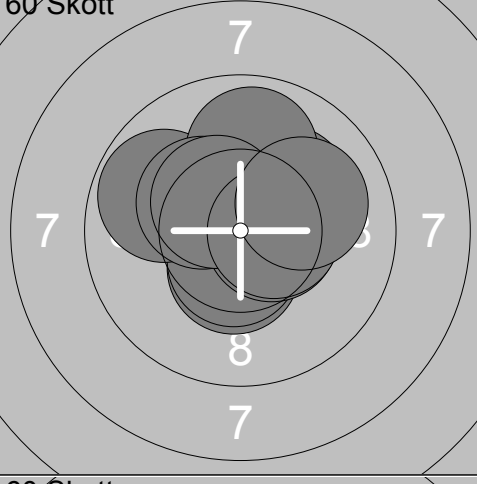
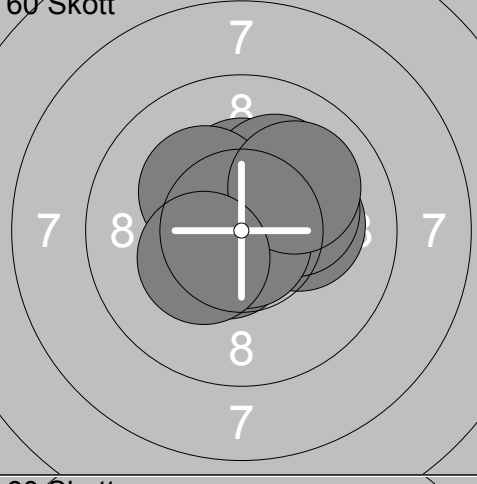
Skjuttag 5	Tavla 19	Daniel Wallberg				
Vindeln		Ramselefors		Vb		
18.03.2017		SM & JSM Luftgevär 2017		Ramselefors SKF		
Pröv		1: 10.2x ← 2: 9.8 ↓ 3: 10.4x ← 4: 10.3x ↓ 5: 10.9x ← 6: 10.4x ↓ 7: 9.5 ↙ 8: 10.4x ↓ 9: 9.8 → 10: 9.9 ↖	Pröv	11: 9.7 ↑ 12: 10.5x ↑ 13: 10.8x ↓ 14: 10.5x ↓ 15: 10.7x ↓ 16: 9.6 → 17: 10.6x ← 18: 10.7x ← 19: 10.0 ← 20: 10.3x ↖	Serie 101.6 Total 0.0	Serie 103.4 Total 0.0
Pröv		21: 10.6x ↗ 22: 10.3x ↘	60 Skott	1: 10.3x ↙ 2: 9.9 ↘ 3: 10.4x ↑ 4: 10.1 → 5: 10.1 ↑ 6: 10.5x → 7: 9.5 ← 8: 10.0 ↗ 9: 10.9x ↖ 10: 9.4 ←	Serie 20.9 Total 0.0	Serie 101.1 Total 101.1
60 Skott		11: 10.6x ↖ 12: 10.9x ↑ 13: 10.5x ← 14: 10.2x → 15: 10.1 ↙ 16: 10.4x ↓ 17: 9.6 ← 18: 10.2x ← 19: 9.6 ↖ 20: 10.1 ↖	60 Skott	21: 10.4x ↑ 22: 9.9 ← 23: 10.0 ↖ 24: 9.7 → 25: 9.9 ← 26: 10.3x ↙ 27: 10.1 ↑ 28: 10.1 ↑ 29: 10.0 ← 30: 10.6x ↗	Serie 102.2 Total 203.3	Serie 101.0 Total 304.3
60 Skott		31: 10.6x ↑ 32: 10.7x ↓ 33: 10.6x ↓ 34: 10.5x ↓ 35: 10.5x ↑ 36: 10.5x → 37: 10.3x → 38: 10.8x ↓ 39: 10.3x ↗ 40: 10.6x →	60 Skott	41: 10.5x ↑ 42: 10.5x ↙ 43: 10.5x ↖ 44: 10.4x ← 45: 9.9 → 46: 10.4x ↑ 47: 10.2x → 48: 10.3x ↗ 49: 10.5x ↗ 50: 10.1 →	Serie 105.4 Total 409.7	Serie 103.3 Total 513.0
60 Skott		51: 10.3x ↖ 52: 10.3x ↑ 53: 10.5x ← 54: 10.0 → 55: 10.6x ↓ 56: 10.2x ↓ 57: 10.7x ← 58: 10.8x ↓ 59: 10.5x ↓ 60: 10.5x →			Serie 104.4 Total 617.4	

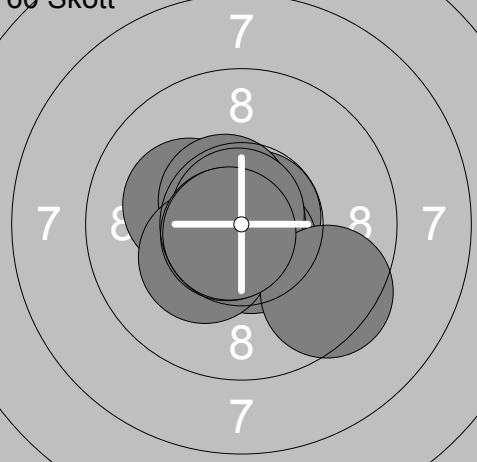
Skjutlag	Tavla	Anders Henricsson				St	
5	20						
Vindeln	Tyresö			Ramselefors SKF			
18.03.2017	SM & JSM Luftgevär 2017						
Pröv		1: 9.8	←	Pröv		11: 10.3x	↓
		2: 9.0	↙			12: 10.1	←
		3: 9.0	←			13: 10.3x	↗
		4: 10.2x	←			14: 9.2	→
		5: 10.2x	↗			15: 10.5x	↗
		6: 10.2x	←			16: 10.3x	↓
		7: 10.0	↗			17: 10.8x	→
		8: 10.3x	↗			18: 10.3x	←
		9: 10.3x	↗			19: 10.5x	↑
		10: 9.9	↙			20: 10.6x	→
		Serie	88.6			Serie	102.9
		Total	0.0			Total	0.0
60 Skott		1: 9.8	↑	60 Skott		11: 10.2x	↖
		2: 10.4x	↖			12: 9.9	→
		3: 10.0	→			13: 10.4x	↘
		4: 9.9	←			14: 10.4x	↖
		5: 10.3x	→			15: 10.2x	↘
		6: 10.4x	↗			16: 9.2	↘
		7: 10.5x	↓			17: 10.1	↘
		8: 9.4	←			18: 10.5x	↖
		9: 10.7x	↗			19: 10.5x	→
		10: 10.6x	→			20: 10.2x	↗
		Serie	102.0			Serie	101.6
		Total	102.0			Total	203.6
60 Skott		21: 10.4x	↓	60 Skott		31: 10.2x	→
		22: 10.5x	↓			32: 10.2x	→
		23: 9.8	↖			33: 10.7x	←
		24: 10.2x	↗			34: 10.6x	↘
		25: 9.9	↑			35: 10.3x	↑
		26: 10.5x	→			36: 10.1	↗
		27: 10.3x	↗			37: 10.8x	↓
		28: 10.4x	↗			38: 10.2x	↖
		29: 10.5x	→			39: 10.0	↗
		30: 10.0	↗			40: 10.3x	↖
		Serie	102.5			Serie	103.4
		Total	306.1			Total	409.5
60 Skott		41: 10.1	←	60 Skott		51: 10.8x	↗
		42: 10.2x	↘			52: 10.2x	↖
		43: 10.5x	↗			53: 10.6x	↗
		44: 10.6x	↑			54: 10.6x	↘
		45: 10.6x	↗			55: 10.9x	←
		46: 10.4x	↗			56: 10.3x	↖
		47: 10.2x	→			57: 10.8x	↗
		48: 10.3x	↓			58: 10.7x	↖
		49: 10.7x	←			59: 9.5	↘
		50: 10.6x	→			60: 10.7x	↖
		Serie	104.2			Serie	105.1
		Total	513.7			Total	618.8

Pröv 	1: 10.6x ↗ 2: 9.7 ↘ 3: 10.7x ↓ 4: 10.6x ← 5: 10.6x ↗ 6: 10.4x ↓ 7: 10.3x ↑ 8: 10.0 → 9: 10.5x ↑ 10: 9.6 ↘ Serie 103.0 Total 0.0	Pröv 	11: 10.6x ↗ 12: 10.3x ↘ Serie 20.9 Total 0.0
60 Skott 	1: 10.8x ← 2: 9.8 → 3: 10.5x ↘ 4: 10.0 ↓ 5: 10.0 ↓ 6: 10.5x ↗ 7: 10.0 ↑ 8: 10.5x ↓ 9: 10.2x ↓ 10: 10.4x ← Serie 102.7 Total 102.7	60 Skott 	11: 10.3x ↘ 12: 10.6x ↘ 13: 10.5x ← 14: 10.2x ↑ 15: 10.4x ↘ 16: 10.3x ↓ 17: 10.5x ↖ 18: 10.2x ↗ 19: 10.5x ↖ 20: 10.8x → Serie 104.3 Total 207.0
60 Skott 	21: 10.8x → 22: 10.4x ↘ 23: 10.0 ← 24: 10.2x ← 25: 10.8x ← 26: 10.8x ↓ 27: 9.7 ↑ 28: 9.7 ↗ 29: 10.3x ← 30: 9.4 ↗ Serie 102.1 Total 309.1	60 Skott 	31: 10.9x ↗ 32: 10.3x ↘ 33: 10.4x ↘ 34: 10.6x ↓ 35: 9.1 ← 36: 10.4x ↑ 37: 9.7 ↑ 38: 10.5x ↗ 39: 10.1 ← 40: 10.3x ↗ Serie 102.3 Total 411.4
60 Skott 	41: 10.4x ↑ 42: 10.4x ↗ 43: 9.8 ← 44: 10.1 ↖ 45: 10.1 ↖ 46: 10.6x ← 47: 10.7x ← 48: 10.5x → 49: 10.0 ↑ 50: 10.4x → Serie 103.0 Total 514.4	60 Skott 	51: 10.2x ↖ 52: 10.6x ↘ 53: 10.2x ↑ 54: 10.8x ↗ 55: 9.9 ↖ 56: 10.4x ↗ 57: 10.6x ← 58: 10.5x ↖ 59: 10.0 ↑ 60: 10.2x ↑ Serie 103.4 Total 617.8

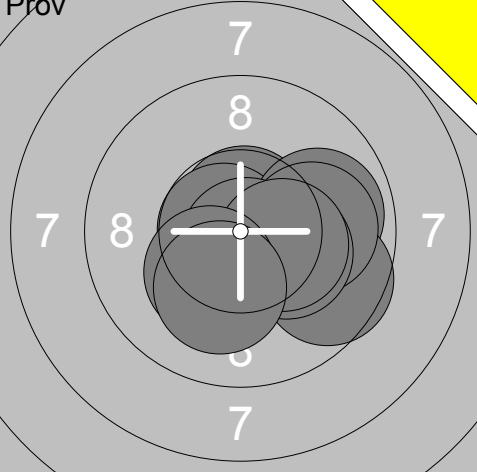
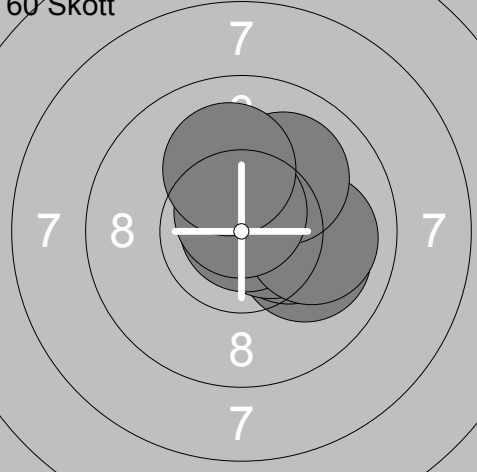
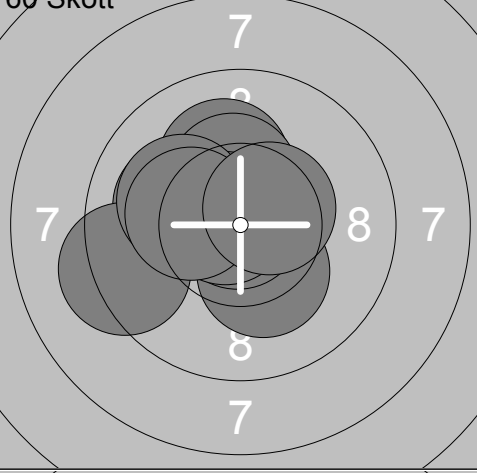
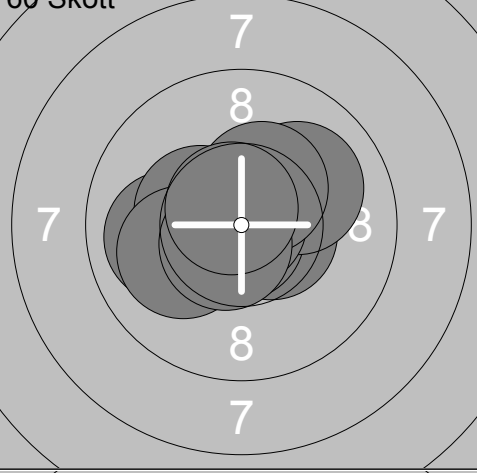
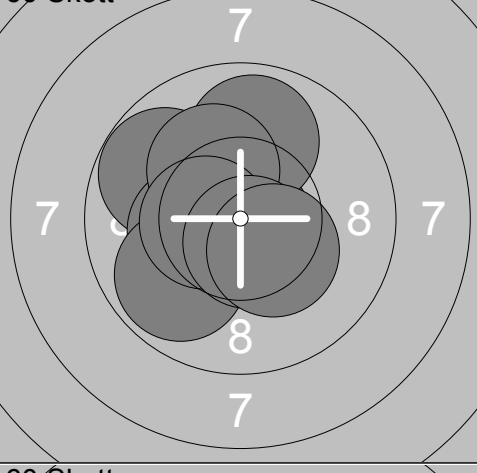
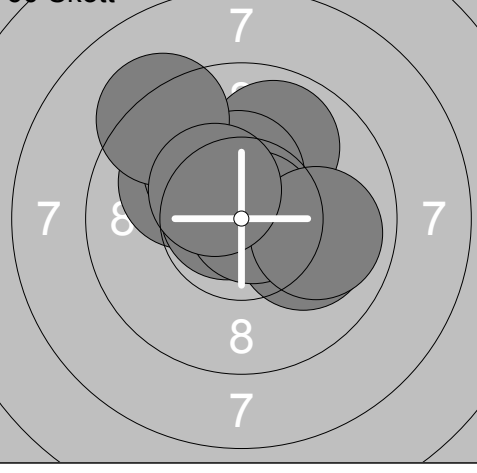
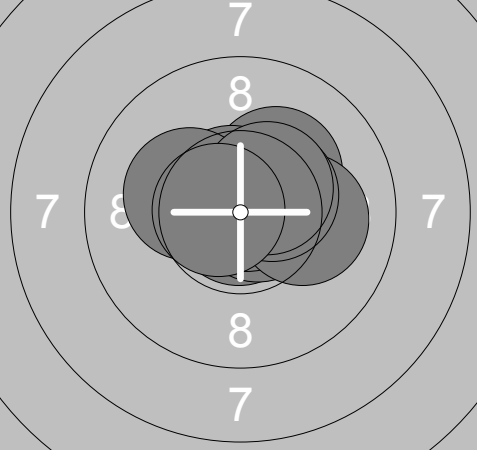
<p>Pröv</p> 	<p>1: 10.7x ↑</p> <p>2: 10.7x ←</p> <p>3: 9.9 →</p> <p>4: 9.6 ↘</p> <p>5: 10.0 →</p> <p>6: 10.8x ↘</p> <p>7: 10.3x ↘</p> <p>8: 10.4x →</p> <p>9: 10.3x ↙</p> <p>10: 10.1 ↓</p> <hr/> <p>Serie 102.8</p> <p>Total 0.0</p>	<p>60 Skott</p> 	<p>1: 10.0 →</p> <p>2: 10.3x →</p> <p>3: 10.6x →</p> <p>4: 10.2x ↑</p> <p>5: 10.7x ↑</p> <p>6: 10.9x ↗</p> <p>7: 10.0 →</p> <p>8: 10.0 ↗</p> <p>9: 10.7x ↑</p> <p>10: 10.1 ↑</p> <hr/> <p>Serie 103.5</p> <p>Total 103.5</p>
<p>60 Skott</p> 	<p>11: 10.1 ↑</p> <p>12: 10.3x ↘</p> <p>13: 10.1 ←</p> <p>14: 9.3 ←</p> <p>15: 10.9x ↗</p> <p>16: 10.3x ↑</p> <p>17: 10.7x ↗</p> <p>18: 10.1 ↗</p> <p>19: 10.3x ←</p> <p>20: 10.5x ↗</p> <hr/> <p>Serie 102.6</p> <p>Total 206.1</p>	<p>60 Skott</p> 	<p>21: 10.0 ←</p> <p>22: 10.5x →</p> <p>23: 10.8x ↘</p> <p>24: 10.4x ←</p> <p>25: 10.0 ↗</p> <p>26: 10.9x ↑</p> <p>27: 10.1 ←</p> <p>28: 10.4x ↗</p> <p>29: 10.6x ↙</p> <p>30: 10.7x ↗</p> <hr/> <p>Serie 104.4</p> <p>Total 310.5</p>
<p>60 Skott</p> 	<p>31: 9.8 ↗</p> <p>32: 10.9x ↘</p> <p>33: 10.3x ←</p> <p>34: 10.6x ↙</p> <p>35: 9.8 ↙</p> <p>36: 9.9 ↑</p> <p>37: 10.2x ↗</p> <p>38: 10.5x ←</p> <p>39: 10.6x ↘</p> <p>40: 10.3x ↘</p> <hr/> <p>Serie 102.9</p> <p>Total 413.4</p>	<p>60 Skott</p> 	<p>41: 10.0 →</p> <p>42: 10.0 ↗</p> <p>43: 10.1 ↗</p> <p>44: 9.9 ↑</p> <p>45: 10.7x ←</p> <p>46: 10.4x ↑</p> <p>47: 9.2 ↗</p> <p>48: 10.8x →</p> <p>49: 9.9 →</p> <p>50: 10.4x ↗</p> <hr/> <p>Serie 101.4</p> <p>Total 514.8</p>
<p>60 Skott</p> 	<p>51: 10.9x ↘</p> <p>52: 10.7x →</p> <p>53: 10.2x ↗</p> <p>54: 10.6x ↗</p> <p>55: 10.8x ↗</p> <p>56: 10.1 →</p> <p>57: 10.5x ↗</p> <p>58: 10.2x ←</p> <p>59: 10.5x ↗</p> <p>60: 10.6x ←</p> <hr/> <p>Serie 105.1</p> <p>Total 619.9</p>		

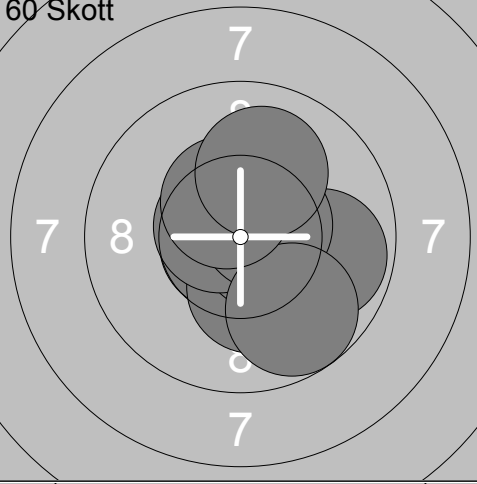
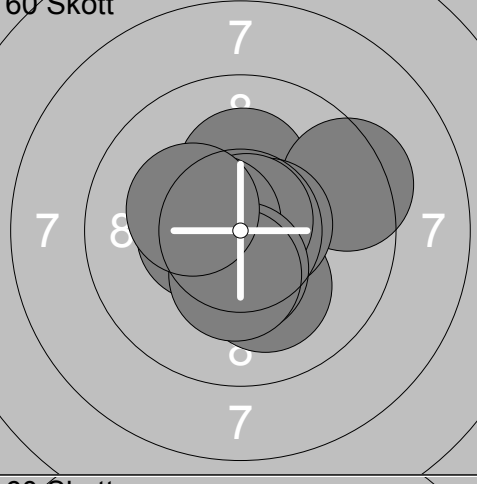
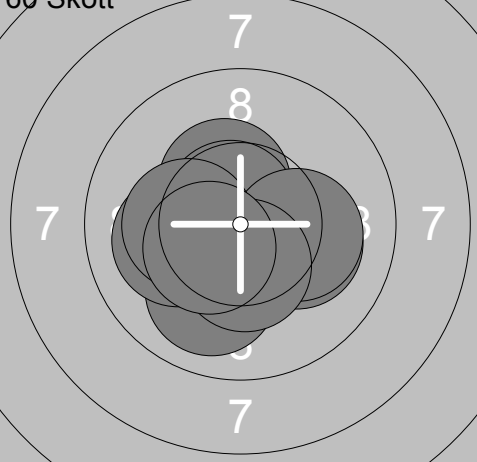
Skjutlag	Tavla	Karl Olsson	
Vindeln	Eskilstuna		Sö
18.03.2017	SM & JSM Luftgevär 2017	Ramselefors SKF	
Pröv		1: 9.3 ↘ 2: 8.6 ↘ 3: 10.7x ↘ 4: 10.0 → 5: 9.6 → 6: 10.6x → 7: 9.9 ↘ 8: 10.5x → 9: 10.8x ↘ 10: 9.9 ↘	11: 10.4x ← 12: 10.6x ↘ 13: 10.2x → 14: 10.3x ↘ 15: 10.8x ↘ 16: 10.5x ↑
	Serie 99.9	Serie 62.8	
	Total 0.0	Total 0.0	
60 Skott		1: 10.7x ← 2: 10.1 ↘ 3: 10.3x ↘ 4: 10.6x ↘ 5: 9.8 → 6: 10.6x ↗ 7: 10.6x → 8: 9.8 ↘ 9: 10.4x ↗ 10: 10.0 ↑	11: 9.4 ↗ 12: 10.3x ↗ 13: 10.3x ↘ 14: 10.3x ← 15: 10.1 → 16: 10.6x ↗ 17: 10.5x ↘ 18: 10.3x ↘ 19: 10.1 ↘ 20: 10.0 ↘
	Serie 102.9	Serie 101.9	
	Total 102.9	Total 204.8	
60 Skott		21: 10.2x ↑ 22: 9.4 → 23: 10.1 ↘ 24: 10.6x → 25: 10.4x ← 26: 10.8x ↗ 27: 10.6x ↗ 28: 10.4x ↘ 29: 10.4x ↘ 30: 10.2x ↗	31: 10.5x ↑ 32: 10.0 → 33: 10.6x → 34: 9.7 ↘ 35: 10.4x → 36: 10.3x ↗ 37: 9.9 ↑ 38: 10.7x ↗ 39: 10.5x ↘ 40: 10.8x ↑
	Serie 103.1	Serie 103.4	
	Total 307.9	Total 411.3	
60 Skott		41: 10.2x → 42: 10.4x ↗ 43: 10.7x ↗ 44: 10.2x → 45: 10.3x ← 46: 10.0 ↘ 47: 10.1 ← 48: 10.2x ← 49: 10.4x ↘ 50: 10.4x ↘	51: 10.6x ↗ 52: 10.5x ↘ 53: 10.6x ↗ 54: 10.7x ↘ 55: 10.4x ↑ 56: 10.1 ↑ 57: 10.4x → 58: 10.6x → 59: 10.1 ← 60: 10.3x ←
	Serie 102.9	Serie 104.3	
	Total 514.2	Total 618.5	

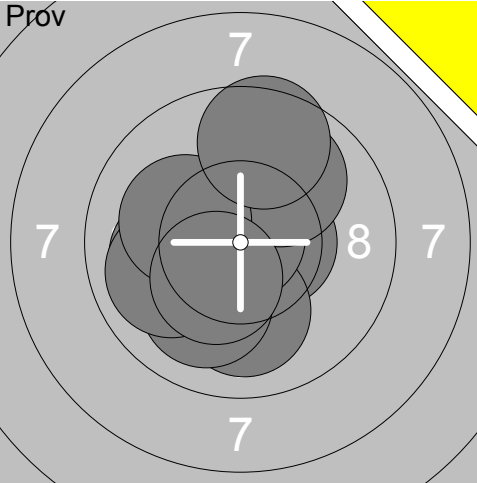
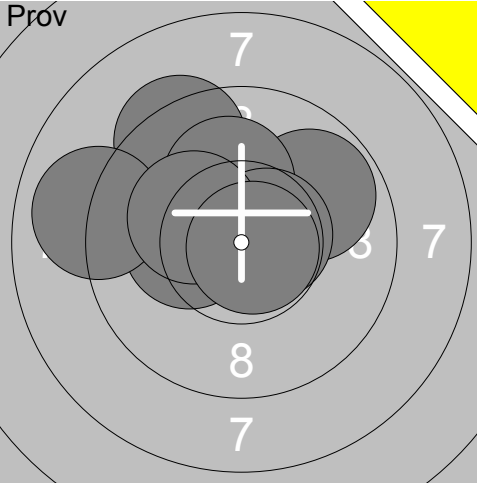
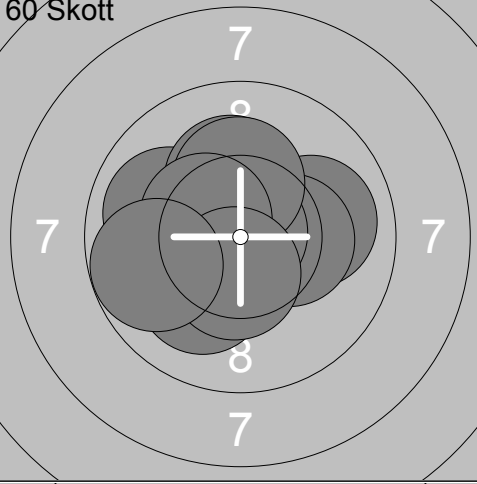
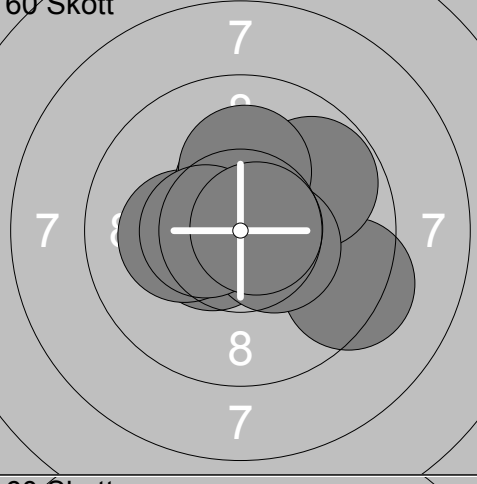
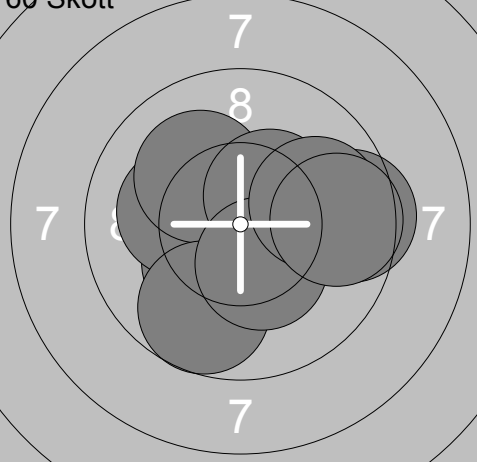
Skjutlag	Tavla	Joar Karlsson	
5	24		
Vindeln	Söderala		Gä
18.03.2017	SM & JSM Luftgevär 2017	Ramselefors SKF	
Pröv		1: 10.5x → 2: 10.0 ↓ 3: 10.1 ← 4: 10.0 ↓ 5: 9.9 ← 6: 10.9x ↑ 7: 10.0 ↗ 8: 10.2x ← 9: 9.6 ↑ 10: 10.4x ↓	Pröv  11: 9.4 ↖ 12: 10.6x ↗ 13: 10.3x ← 14: 9.8 ↗ 15: 10.1 ↑ 16: 9.0 ← 17: 10.6x → 18: 10.2x ← 19: 10.8x →
	Serie 101.6	Serie 90.8	
	Total 0.0	Total 0.0	
60 Skott		1: 10.0 → 2: 9.9 ← 3: 10.2x ↑ 4: 10.3x → 5: 10.9x ↑ 6: 10.2x ↑ 7: 10.1 ↓ 8: 10.4x ↗ 9: 10.5x ↓ 10: 9.8 ←	11: 10.2x → 12: 10.2x ← 13: 10.2x ↗ 14: 10.3x ↓ 15: 8.9 ← 16: 10.8x ↗ 17: 10.2x ← 18: 10.7x → 19: 8.8 → 20: 9.5 ↖
	Serie 102.3	Serie 99.8	
	Total 102.3	Total 202.1	
60 Skott		21: 10.5x ← 22: 10.2x ← 23: 10.2x ↗ 24: 10.4x ↑ 25: 9.3 → 26: 9.8 ↗ 27: 10.2x ↑ 28: 10.4x → 29: 10.5x ← 30: 10.7x →	31: 10.2x ↓ 32: 10.6x ↓ 33: 10.4x ← 34: 10.4x ↓ 35: 10.7x ← 36: 9.4 ↗ 37: 10.3x ← 38: 10.0 ← 39: 9.9 ↑ 40: 9.8 ↖
	Serie 102.2	Serie 101.7	
	Total 304.3	Total 406.0	
60 Skott		41: 9.5 → 42: 10.3x ↓ 43: 10.3x → 44: 10.2x ← 45: 10.1 ↗ 46: 9.7 ↓ 47: 10.4x ↗ 48: 10.3x ↓ 49: 9.9 → 50: 9.7 →	51: 10.3x ↓ 52: 10.2x → 53: 10.5x → 54: 10.9x ↑ 55: 10.5x ← 56: 9.8 ↗ 57: 10.4x ↓ 58: 9.9 ↑ 59: 10.3x ↗ 60: 10.0 ↓
	Serie 100.4	Serie 102.8	
	Total 506.4	Total 609.2	

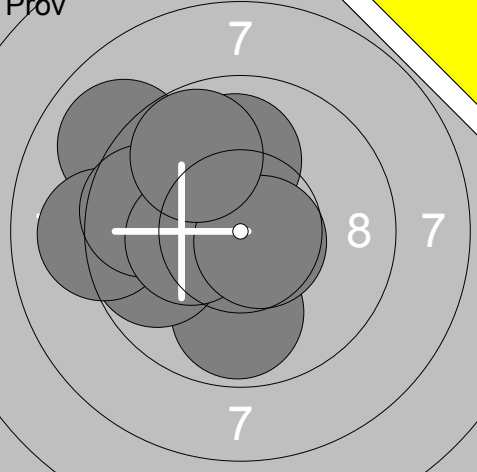
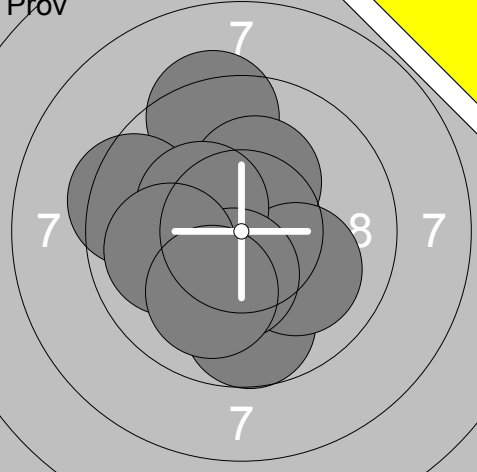
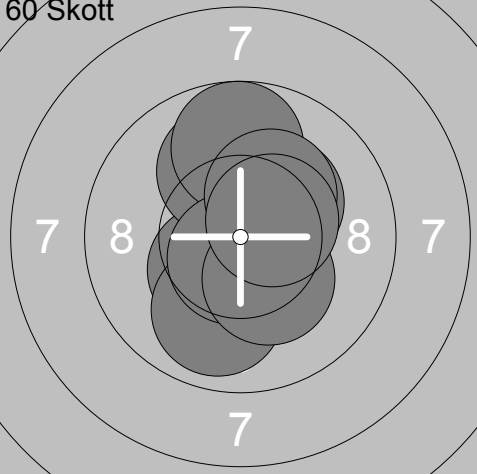
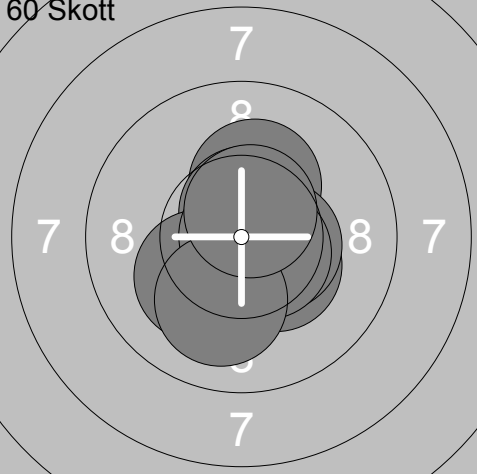
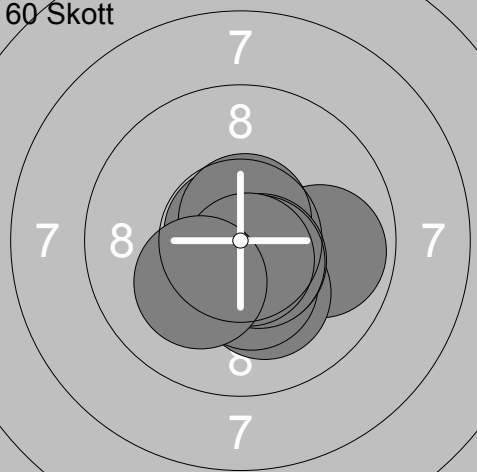
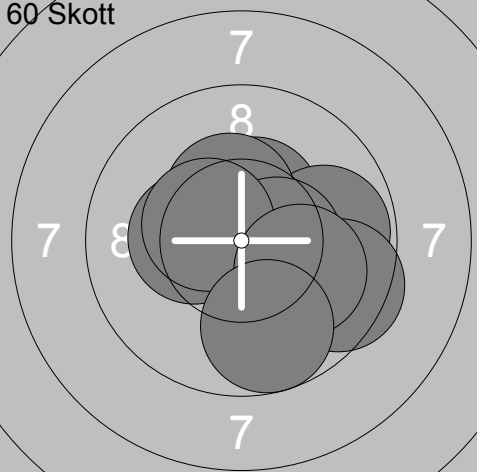
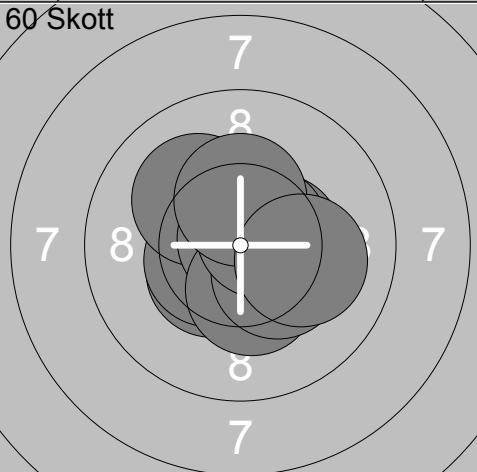
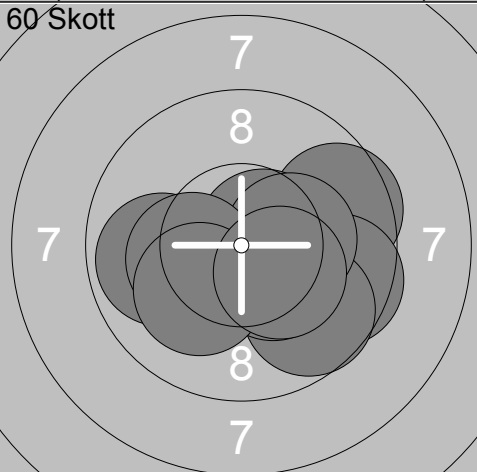

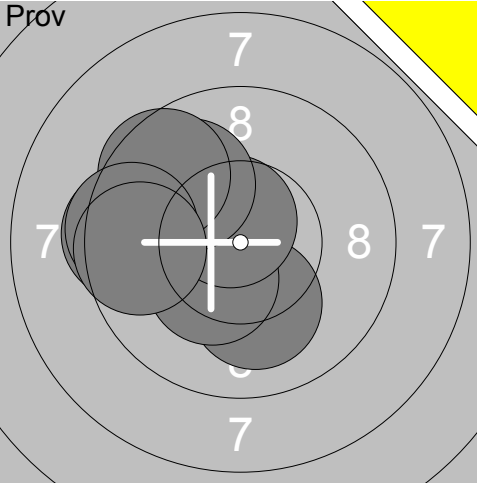
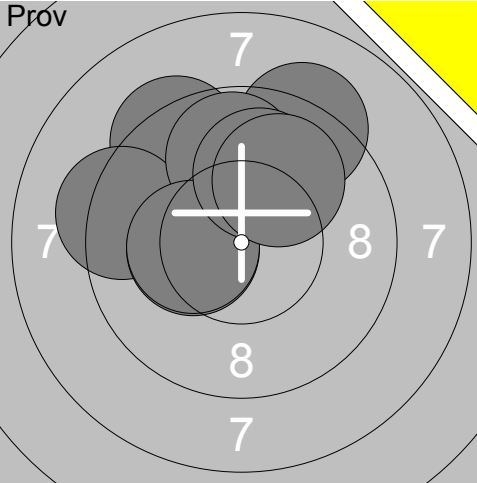
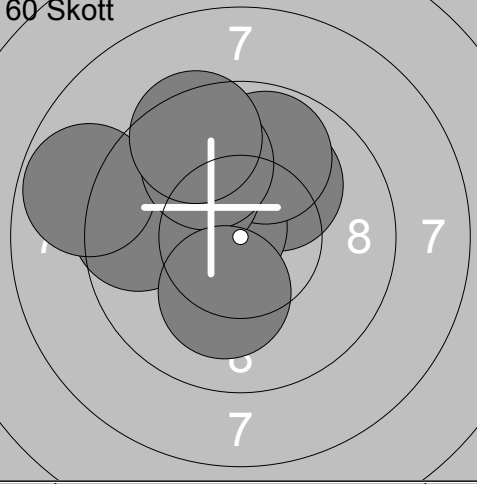
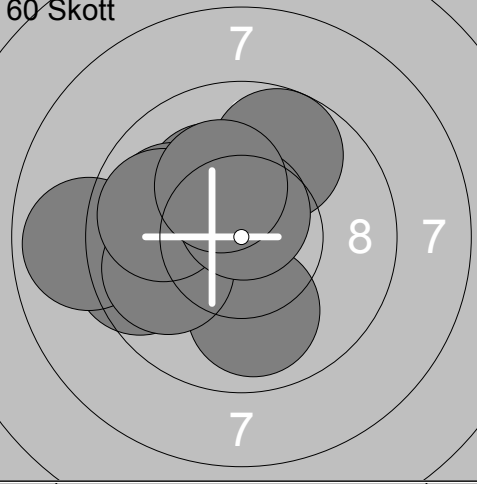
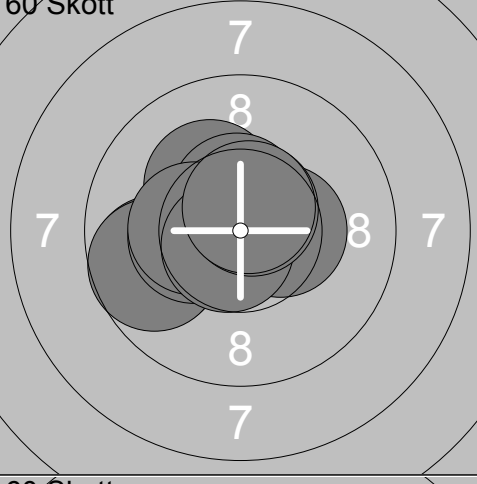
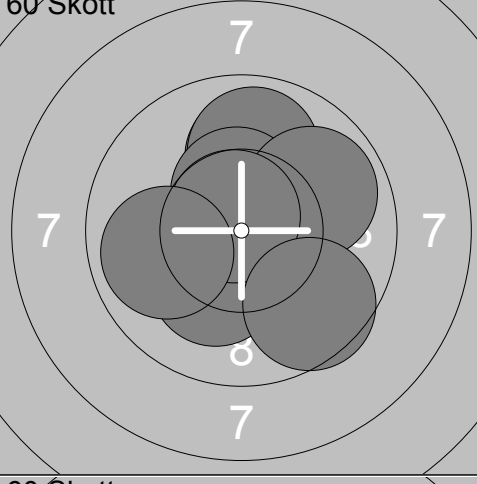
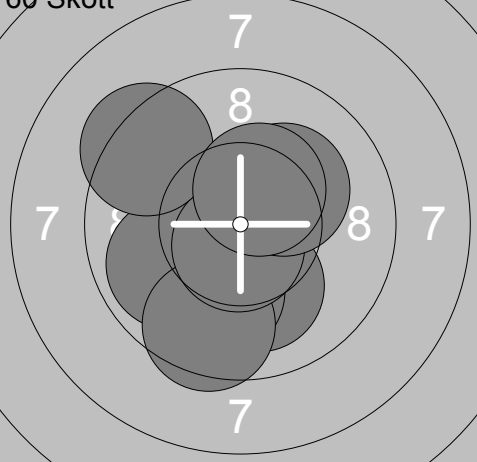
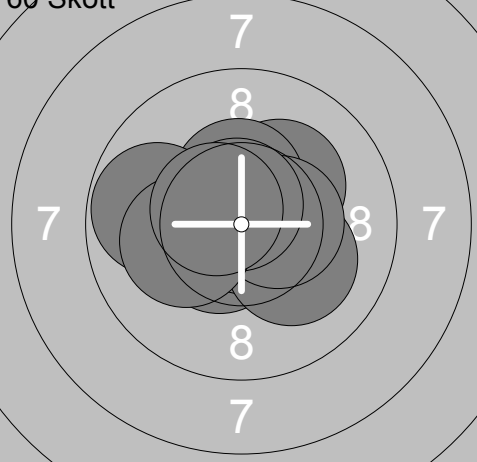
<p>Pröv</p> 	<p>1: 9.4 ↗ 2: 9.0 ↗ 3: 9.9 ↓ 4: 9.8 ← 5: 9.1 ← 6: 10.0 ↑ 7: 9.6 ← 8: 10.3x ← 9: 10.6x → 10: 9.8 ↗</p> <p>Serie 97.5 Total 0.0</p>	<p>Pröv</p> 	<p>11: 10.2x ↓ 12: 9.4 ↗ 13: 10.3x ↗ 14: 9.7 ↓ 15: 9.4 ← 16: 10.1 ↓ 17: 10.3x ↗ 18: 10.4x ↓ 19: 10.0 ← 20: 10.0 ↓</p> <p>Serie 99.8 Total 0.0</p>
<p>60 Skott</p> 	<p>1: 10.4x ↓ 2: 9.9 ↓ 3: 10.7x ↓ 4: 10.0 ↑ 5: 9.7 ↑ 6: 10.3x ↗ 7: 10.7x ↓ 8: 10.3x ↓ 9: 10.3x ↗ 10: 10.5x ↗</p> <p>Serie 102.8 Total 102.8</p>	<p>60 Skott</p> 	<p>11: 10.2x ↑ 12: 10.6x ↑ 13: 10.7x → 14: 10.4x ↓ 15: 10.2x ↙ 16: 10.9x → 17: 10.5x → 18: 10.6x → 19: 10.1 ↓ 20: 10.6x ↗</p> <p>Serie 104.8 Total 207.6</p>
<p>60 Skott</p> 	<p>21: 10.4x ↓ 22: 9.9 → 23: 10.2x ↓ 24: 10.3x ↓ 25: 10.8x ↗ 26: 10.7x ↗ 27: 10.6x ↓ 28: 10.6x ↓ 29: 10.7x ↓ 30: 10.2x ↙</p> <p>Serie 104.4 Total 312.0</p>	<p>60 Skott</p> 	<p>31: 10.9x ← 32: 10.4x ↗ 33: 9.8 → 34: 10.3x ← 35: 10.4x ↗ 36: 9.5 → 37: 10.5x → 38: 10.4x ↗ 39: 10.1 → 40: 9.7 ↓</p> <p>Serie 102.0 Total 414.0</p>
<p>60 Skott</p> 	<p>41: 10.4x ↙ 42: 10.5x ↙ 43: 10.5x → 44: 10.1 ↗ 45: 10.9x ↗ 46: 10.3x ↓ 47: 10.3x ↓ 48: 10.6x ↗ 49: 10.3x ↑ 50: 10.1 →</p> <p>Serie 104.0 Total 518.0</p>	<p>60 Skott</p> 	<p>51: 9.6 → 52: 9.6 → 53: 9.7 ↓ 54: 10.4x ↓ 55: 10.6x → 56: 9.9 ← 57: 10.3x → 58: 10.3x ← 59: 10.1 ↙ 60: 10.3x ↓</p> <p>Serie 100.8 Total 618.8</p>

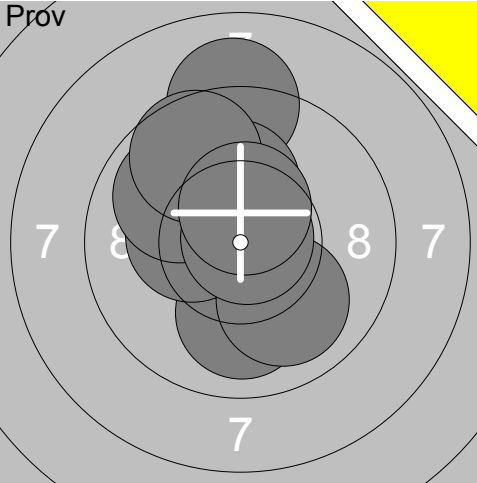
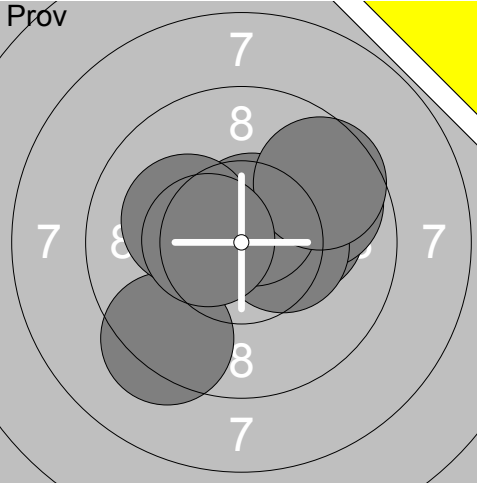
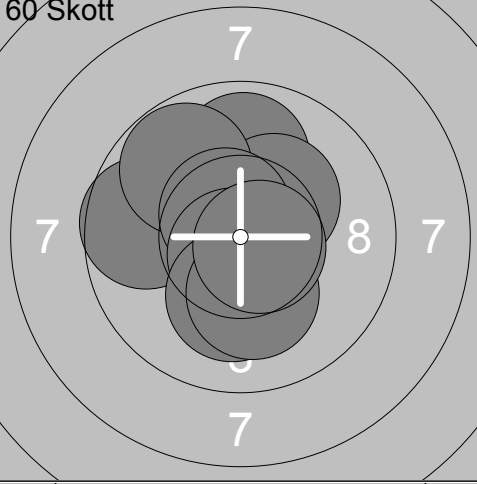
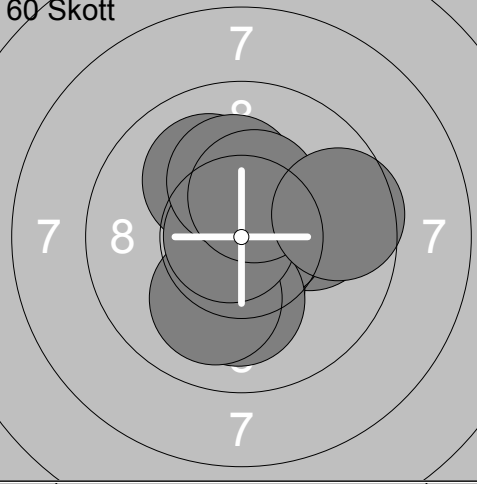
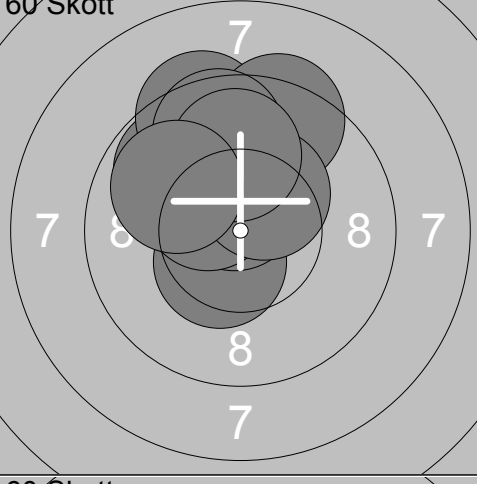
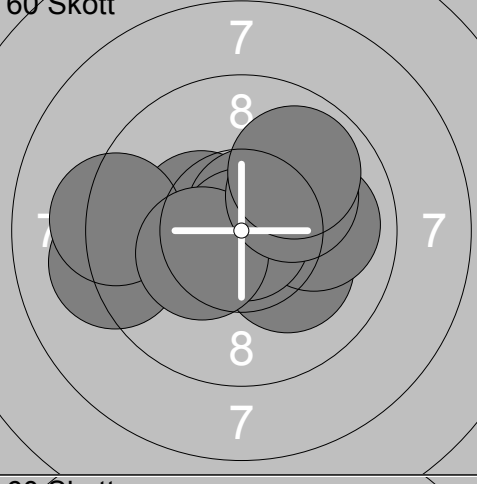
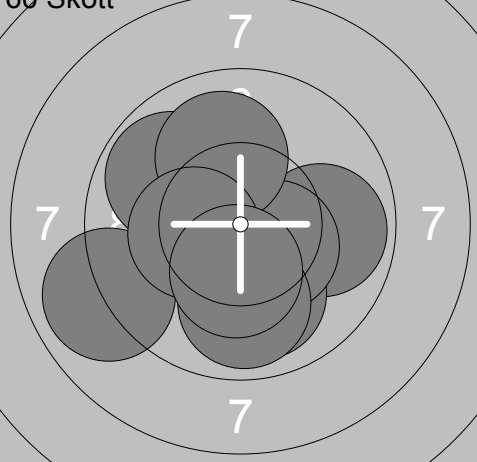
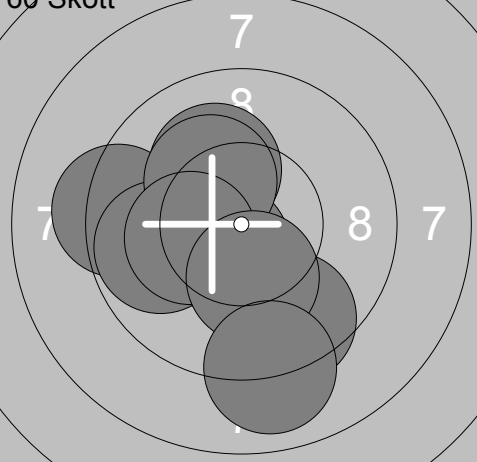
Skjutlag	Tavla	William Grydén	
5	26		
Vindeln	Vaksala		Up
18.03.2017	SM & JSM Luftgevär 2017	Ramselefors SKF	
Pröv		1: 10.1 ← 2: 10.3x ← 3: 10.1 ↓ 4: 10.3x ↓ 5: 10.6x ↗ 6: 9.9 ↗ 7: 9.4 ← 8: 9.6 ↗ 9: 9.5 ← 10: 9.6 ← Serie 99.4 Total 0.0	Pröv  11: 10.2x ← 12: 9.3 ↗ 13: 9.3 ← 14: 10.3x ← 15: 9.2 ↗ 16: 9.8 ↗ 17: 10.3x ← 18: 10.0 ↗ 19: 10.0 ↗ Serie 88.4 Total 0.0
60 Skott		1: 10.1 ↗ 2: 10.7x ↗ 3: 10.1 ↗ 4: 9.8 ↗ 5: 10.0 ↗ 6: 9.6 ← 7: 8.8 ← 8: 9.9 ↗ 9: 10.2x ↓ 10: 9.5 ↗ Serie 98.7 Total 98.7	60 Skott  11: 9.5 ← 12: 9.9 ↓ 13: 8.9 ← 14: 9.7 ↗ 15: 10.2x ↗ 16: 10.0 ← 17: 9.9 ← 18: 9.9 ← 19: 10.6x ↑ 20: 10.2x ↗ Serie 98.8 Total 197.5
60 Skott		21: 10.2x ↗ 22: 10.5x ↑ 23: 9.8 ← 24: 10.4x → 25: 9.7 ← 26: 10.3x ← 27: 10.3x ← 28: 10.7x ↓ 29: 10.6x ↗ 30: 10.6x ↗ Serie 103.1 Total 300.6	60 Skott  31: 10.0 ↑ 32: 10.7x ↓ 33: 9.9 ↑ 34: 10.5x ↑ 35: 10.7x ↘ 36: 9.9 ↗ 37: 10.2x ↓ 38: 10.7x ↗ 39: 9.9 ← 40: 9.6 ↘ Serie 102.1 Total 402.7
60 Skott		41: 10.4x ← 42: 10.7x ← 43: 10.1 ↓ 44: 10.0 ↓ 45: 9.9 ← 46: 9.5 ↓ 47: 10.7x ↓ 48: 10.2x ↗ 49: 9.3 ↗ 50: 10.4x ↗ Serie 101.2 Total 503.9	60 Skott  51: 10.2x ↗ 52: 10.5x ↓ 53: 10.9x ↘ 54: 10.1 ↘ 55: 10.4x ↑ 56: 9.8 ← 57: 10.5x → 58: 10.7x ↗ 59: 10.2x ← 60: 10.6x ↗ Serie 103.9 Total 607.8

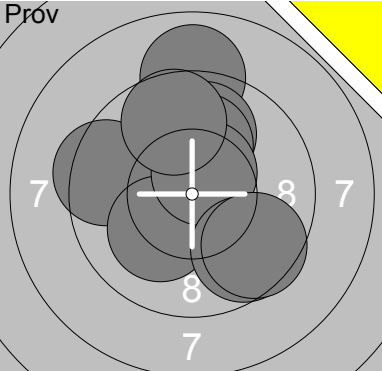
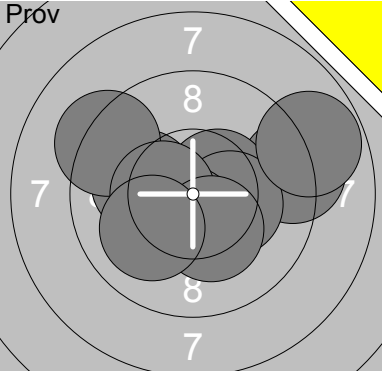
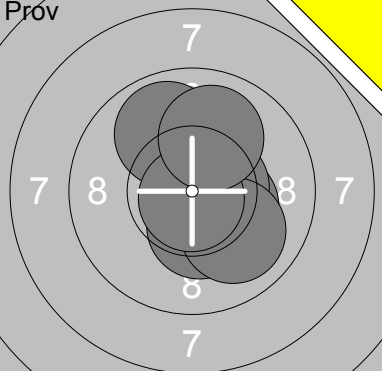
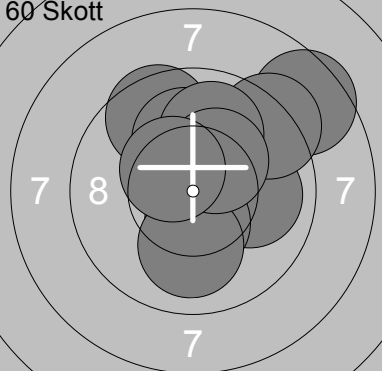
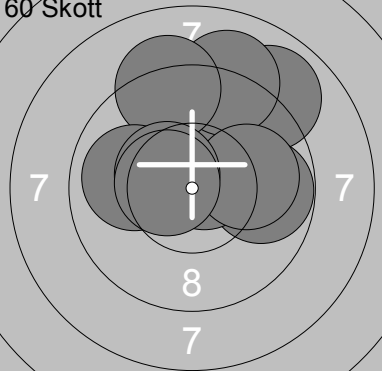
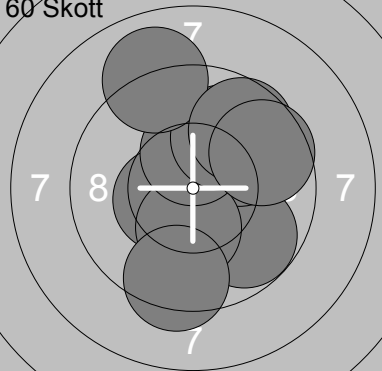
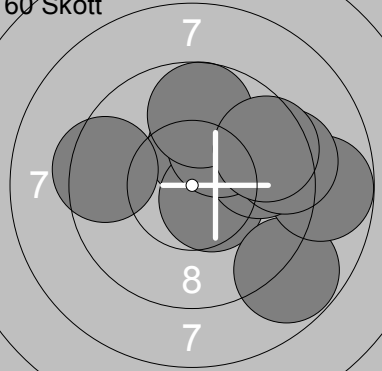
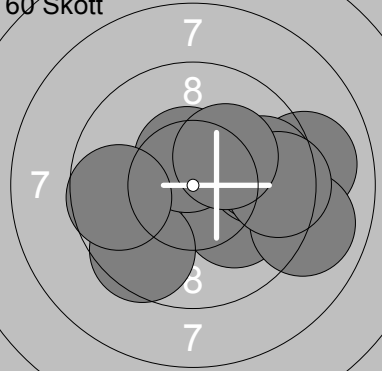
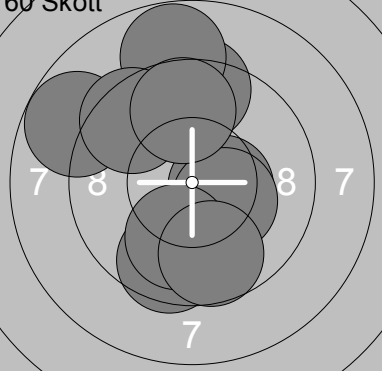
Skjutlag	Tavla	Tomas Hed	
5	27		
Vindeln	Forsa		Gä
18.03.2017	SM & JSM Luftgevär 2017	Ramselefors SKF	
Pröv 	1: 9.8 ↗	Pröv 	11: 10.2x →
	2: 10.0 ↓		12: 10.1 ↗
	3: 10.3x ←		13: 9.8 →
	4: 9.1 ↑		14: 10.4x →
	5: 10.2x ↑		15: 10.6x ↑
	6: 9.9 ↗		16: 9.3 ↓
	7: 10.0 ↓		17: 10.2x ↖
	8: 10.8x ↗		18: 9.6 ↗
	9: 9.6 ↑		19: 10.5x ←
	10: 10.5x ↑		
	Serie 100.2		Serie 90.7
	Total 0.0		Total 0.0
60 Skott 	1: 10.5x ↓	60 Skott 	11: 10.0 →
	2: 9.9 ↑		12: 10.2x ↓
	3: 9.7 ←		13: 10.1 ↗
	4: 10.3x ↗		14: 10.7x →
	5: 9.8 ↗		15: 10.1 ↓
	6: 10.6x ↗		16: 10.1 ↓
	7: 10.7x ↓		17: 10.8x ←
	8: 10.2x ↓		18: 10.2x ↑
	9: 10.2x ↓		19: 10.4x ↑
	10: 10.7x ↘		20: 9.6 →
	Serie 102.6		Serie 102.2
	Total 102.6		Total 204.8
60 Skott 	21: 9.8 ↗	60 Skott 	31: 10.4x ↖
	22: 10.4x ↓		32: 9.2 ←
	23: 9.3 ↗		33: 10.2x ↘
	24: 9.4 ↗		34: 9.3 ←
	25: 10.6x ↑		35: 10.7x ↗
	26: 9.6 ↑		36: 10.0 →
	27: 10.4x ↗		37: 10.9x ↓
	28: 10.4x ↗		38: 10.3x ↖
	29: 9.9 ↑		39: 10.1 ↗
	30: 9.9 ↗		40: 9.9 ↗
	Serie 99.7		Serie 101.0
	Total 304.5		Total 405.5
60 Skott 	41: 8.9 ←	60 Skott 	51: 10.1 ←
	42: 9.9 →		52: 9.5 ↓
	43: 10.0 ↓		53: 10.6x ↓
	44: 10.4x ↓		54: 9.3 ←
	45: 9.8 ↗		55: 9.8 ←
	46: 10.4x ↘		56: 10.1 ↗
	47: 9.9 ↓		57: 10.2x ↗
	48: 10.0 ↑		58: 10.2x ←
	49: 10.3x ←		59: 10.2x ↓
	50: 10.3x ↓		60: 9.0 ↓
	Serie 99.9		Serie 99.0
	Total 505.4		Total 604.4

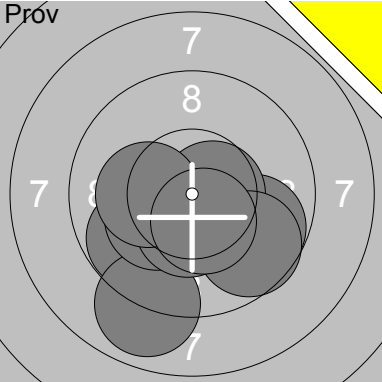
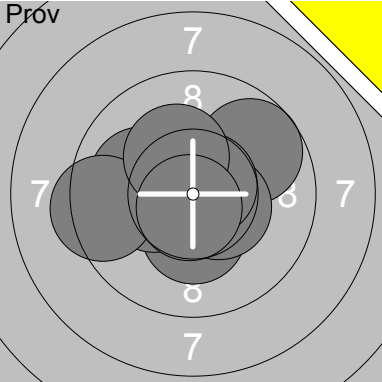
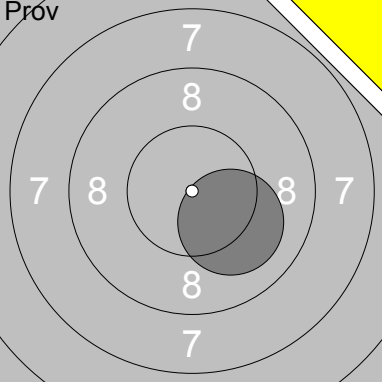
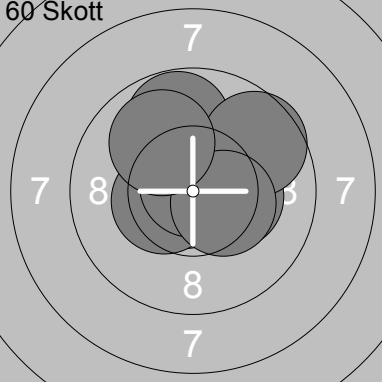
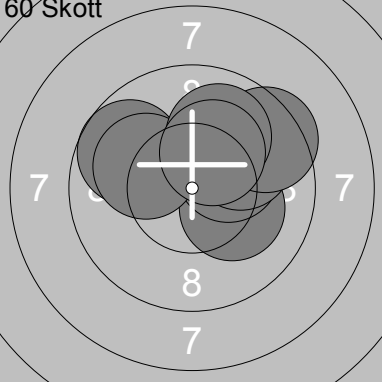
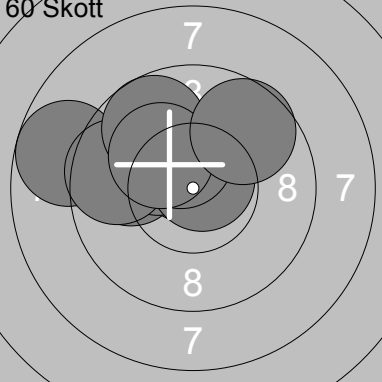
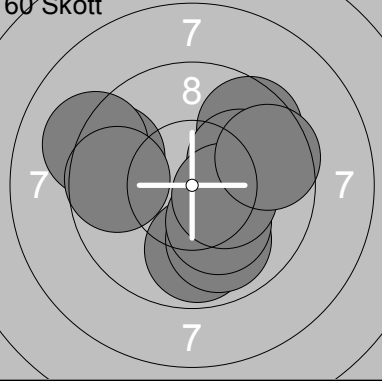
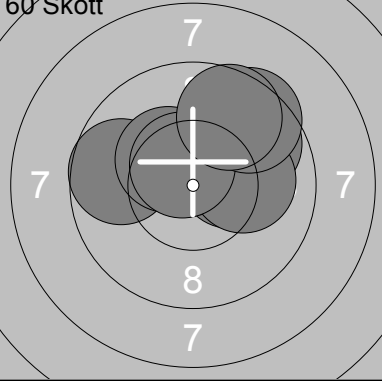
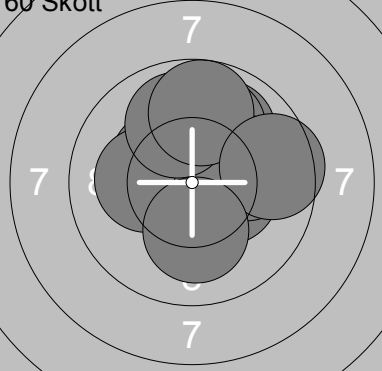
Skjuttag	Tavla	Åke Stener			
5	28				Jä
Vindeln	Aspås				
18.03.2017	SM & JSM Luftgevär 2017		Ramselefors SKF		
Pröv		1: 9.0 ↑ 2: 10.4x ↖ 3: 9.9 ↑ 4: 9.4 ↖ 5: 10.2x ↙ 6: 10.1 ↑ 7: 10.5x ↗ 8: 9.7 ↘ 9: 9.6 ↘ 10: 9.7 ↑	Pröv		11: 9.2 → 12: 10.5x ↗ 13: 10.3x → 14: 8.8 → 15: 10.1 ↖ 16: 10.5x ↓ 17: 9.3 ↖ 18: 10.4x ← 19: 10.3x ↓ 20: 10.0 ↙
		Serie 98.5		Serie 99.4	
		Total 0.0		Total 0.0	
Pröv		21: 9.9 ↑ 22: 10.3x → 23: 10.3x ↓ 24: 10.5x → 25: 10.0 ↘ 26: 10.8x ↓ 27: 10.0 ↑	60 Skott		1: 8.5 ↗ 2: 10.0 → 3: 9.6 ↗ 4: 10.1 ↑ 5: 9.2 ↗ 6: 10.4x ↓ 7: 10.0 ↓ 8: 9.9 ↑ 9: 10.3x ↗ 10: 10.4x ↖
		Serie 71.8		Serie 98.4	
		Total 0.0		Total 98.4	
60 Skott		11: 8.9 ↗ 12: 9.8 → 13: 10.4x ↖ 14: 10.7x ↗ 15: 9.1 ↑ 16: 10.0 → 17: 9.2 ↑ 18: 10.0 ← 19: 10.5x ↖ 20: 10.5x ←	60 Skott		21: 9.8 ↘ 22: 10.4x ← 23: 10.0 ↗ 24: 10.3x ↓ 25: 10.3x ↑ 26: 9.4 ↓ 27: 9.9 ↗ 28: 9.0 ↖ 29: 9.7 ↗ 30: 9.6 →
		Serie 99.1		Serie 98.4	
		Total 197.5		Total 295.9	
60 Skott		31: 10.3x ↑ 32: 10.5x ↘ 33: 8.8 ↘ 34: 8.8 → 35: 9.5 ↖ 36: 9.8 → 37: 10.1 ↗ 38: 9.7 ↑ 39: 9.3 → 40: 9.5 →	60 Skott		41: 10.1 ↘ 42: 9.0 → 43: 9.6 ↙ 44: 9.8 → 45: 10.5x ↑ 46: 9.0 → 47: 9.7 → 48: 9.5 → 49: 9.7 ← 50: 10.2x ↗
		Serie 96.3		Serie 97.1	
		Total 392.2		Total 489.3	
60 Skott		51: 10.5x → 52: 9.4 ↑ 53: 9.6 ↓ 54: 10.3x ↘ 55: 8.8 ↑ 56: 8.8 ↖ 57: 10.0 ↓ 58: 9.5 ↗ 59: 9.7 ↑ 60: 9.7 ↓			
		Serie 96.3			
		Total 585.6			

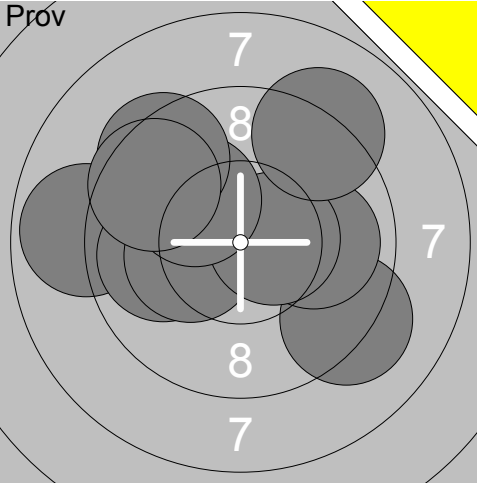
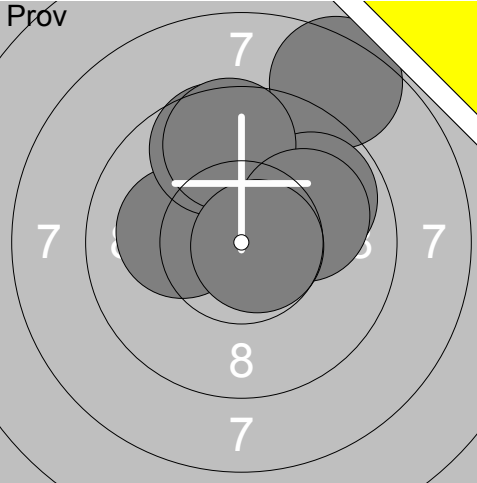
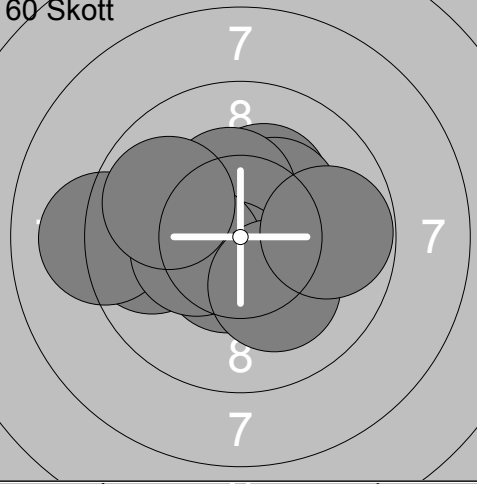
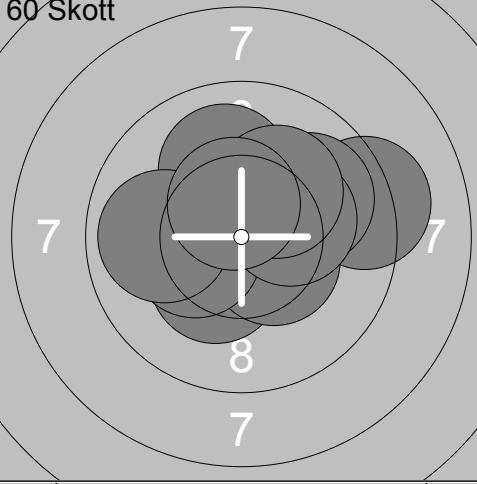
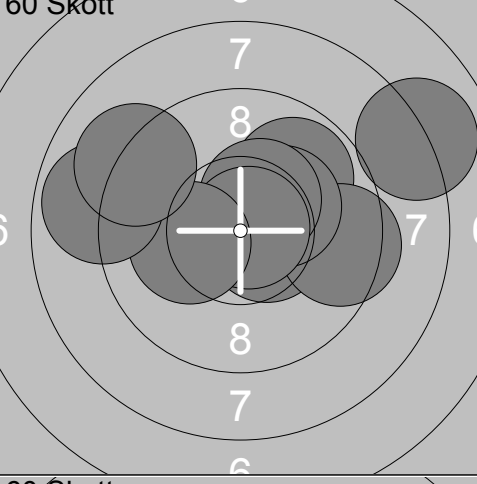
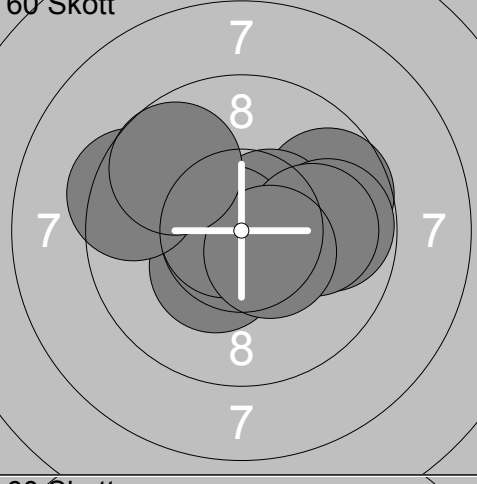
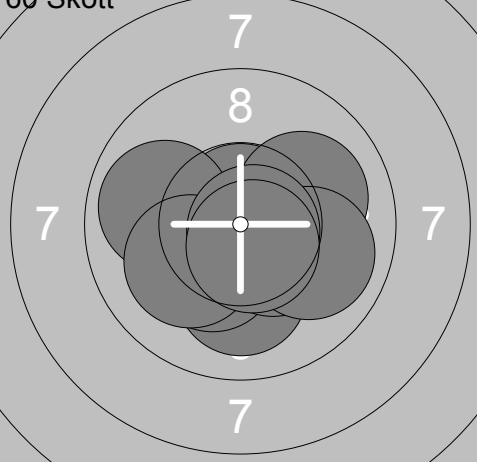
Skjutlag	Tavla	Mikael Lundell																																																																									
5	29																																																																										
Vindeln	Vaksala		Up																																																																								
18.03.2017	SM & JSM Luftgevär 2017	Ramselefors SKF																																																																									
Pröv	 <table border="1"> <tr><td>1:</td><td>9.8</td><td>↙</td></tr> <tr><td>2:</td><td>8.9</td><td>↓</td></tr> <tr><td>3:</td><td>10.2x</td><td>↙</td></tr> <tr><td>4:</td><td>9.8</td><td>↘</td></tr> <tr><td>6:</td><td>10.6x</td><td>→</td></tr> <tr><td>7:</td><td>9.7</td><td>↘</td></tr> <tr><td>8:</td><td>10.4x</td><td>↓</td></tr> <tr><td>9:</td><td>10.2x</td><td>←</td></tr> <tr><td>10:</td><td>10.5x</td><td>↓</td></tr> <tr><td>Serie</td><td>90.1</td><td></td></tr> <tr><td>Total</td><td>0.0</td><td></td></tr> </table>	1:	9.8	↙	2:	8.9	↓	3:	10.2x	↙	4:	9.8	↘	6:	10.6x	→	7:	9.7	↘	8:	10.4x	↓	9:	10.2x	←	10:	10.5x	↓	Serie	90.1		Total	0.0		Pröv	 <table border="1"> <tr><td>11:</td><td>10.4x</td><td>↙</td></tr> <tr><td>12:</td><td>9.7</td><td>↗</td></tr> <tr><td>13:</td><td>10.3x</td><td>↓</td></tr> <tr><td>14:</td><td>10.3x</td><td>←</td></tr> <tr><td>15:</td><td>10.1</td><td>↙</td></tr> <tr><td>16:</td><td>10.5x</td><td>→</td></tr> <tr><td>17:</td><td>9.4</td><td>←</td></tr> <tr><td>18:</td><td>10.7x</td><td>↗</td></tr> <tr><td>19:</td><td>10.3x</td><td>↖</td></tr> <tr><td>20:</td><td>10.7x</td><td>↓</td></tr> <tr><td>Serie</td><td>102.4</td><td></td></tr> <tr><td>Total</td><td>0.0</td><td></td></tr> </table>	11:	10.4x	↙	12:	9.7	↗	13:	10.3x	↓	14:	10.3x	←	15:	10.1	↙	16:	10.5x	→	17:	9.4	←	18:	10.7x	↗	19:	10.3x	↖	20:	10.7x	↓	Serie	102.4		Total	0.0				
1:	9.8	↙																																																																									
2:	8.9	↓																																																																									
3:	10.2x	↙																																																																									
4:	9.8	↘																																																																									
6:	10.6x	→																																																																									
7:	9.7	↘																																																																									
8:	10.4x	↓																																																																									
9:	10.2x	←																																																																									
10:	10.5x	↓																																																																									
Serie	90.1																																																																										
Total	0.0																																																																										
11:	10.4x	↙																																																																									
12:	9.7	↗																																																																									
13:	10.3x	↓																																																																									
14:	10.3x	←																																																																									
15:	10.1	↙																																																																									
16:	10.5x	→																																																																									
17:	9.4	←																																																																									
18:	10.7x	↗																																																																									
19:	10.3x	↖																																																																									
20:	10.7x	↓																																																																									
Serie	102.4																																																																										
Total	0.0																																																																										
Pröv	 <table border="1"> <tr><td>21:</td><td>10.1</td><td>↘</td></tr> <tr><td>Serie</td><td>10.1</td><td></td></tr> <tr><td>Total</td><td>0.0</td><td></td></tr> </table>	21:	10.1	↘	Serie	10.1		Total	0.0		60 Skott	 <table border="1"> <tr><td>1:</td><td>10.8x</td><td>↙</td></tr> <tr><td>2:</td><td>10.7x</td><td>↗</td></tr> <tr><td>3:</td><td>10.4x</td><td>←</td></tr> <tr><td>4:</td><td>10.5x</td><td>↑</td></tr> <tr><td>5:</td><td>10.3x</td><td>→</td></tr> <tr><td>6:</td><td>10.8x</td><td>↑</td></tr> <tr><td>7:</td><td>9.8</td><td>↑</td></tr> <tr><td>8:</td><td>9.6</td><td>↗</td></tr> <tr><td>9:</td><td>10.4x</td><td>→</td></tr> <tr><td>10:</td><td>10.0</td><td>↖</td></tr> <tr><td>Serie</td><td>103.3</td><td></td></tr> <tr><td>Total</td><td>103.3</td><td></td></tr> </table>	1:	10.8x	↙	2:	10.7x	↗	3:	10.4x	←	4:	10.5x	↑	5:	10.3x	→	6:	10.8x	↑	7:	9.8	↑	8:	9.6	↗	9:	10.4x	→	10:	10.0	↖	Serie	103.3		Total	103.3																												
21:	10.1	↘																																																																									
Serie	10.1																																																																										
Total	0.0																																																																										
1:	10.8x	↙																																																																									
2:	10.7x	↗																																																																									
3:	10.4x	←																																																																									
4:	10.5x	↑																																																																									
5:	10.3x	→																																																																									
6:	10.8x	↑																																																																									
7:	9.8	↑																																																																									
8:	9.6	↗																																																																									
9:	10.4x	→																																																																									
10:	10.0	↖																																																																									
Serie	103.3																																																																										
Total	103.3																																																																										
60 Skott	 <table border="1"> <tr><td>11:</td><td>10.4x</td><td>↗</td></tr> <tr><td>12:</td><td>9.7</td><td>↙</td></tr> <tr><td>13:</td><td>10.2x</td><td>↘</td></tr> <tr><td>14:</td><td>10.3x</td><td>↗</td></tr> <tr><td>15:</td><td>10.0</td><td>↗</td></tr> <tr><td>16:</td><td>10.0</td><td>↗</td></tr> <tr><td>17:</td><td>10.1</td><td>↙</td></tr> <tr><td>18:</td><td>9.5</td><td>↗</td></tr> <tr><td>19:</td><td>10.0</td><td>↗</td></tr> <tr><td>20:</td><td>10.3x</td><td>↗</td></tr> <tr><td>Serie</td><td>100.5</td><td></td></tr> <tr><td>Total</td><td>203.8</td><td></td></tr> </table>	11:	10.4x	↗	12:	9.7	↙	13:	10.2x	↘	14:	10.3x	↗	15:	10.0	↗	16:	10.0	↗	17:	10.1	↙	18:	9.5	↗	19:	10.0	↗	20:	10.3x	↗	Serie	100.5		Total	203.8		60 Skott	 <table border="1"> <tr><td>21:</td><td>9.9</td><td>↙</td></tr> <tr><td>22:</td><td>8.7</td><td>↙</td></tr> <tr><td>23:</td><td>10.6x</td><td>↑</td></tr> <tr><td>24:</td><td>10.2x</td><td>↙</td></tr> <tr><td>25:</td><td>9.6</td><td>↙</td></tr> <tr><td>26:</td><td>10.7x</td><td>↗</td></tr> <tr><td>27:</td><td>10.4x</td><td>↖</td></tr> <tr><td>28:</td><td>9.7</td><td>↖</td></tr> <tr><td>29:</td><td>10.2x</td><td>↖</td></tr> <tr><td>30:</td><td>9.7</td><td>↗</td></tr> <tr><td>Serie</td><td>99.7</td><td></td></tr> <tr><td>Total</td><td>303.5</td><td></td></tr> </table>	21:	9.9	↙	22:	8.7	↙	23:	10.6x	↑	24:	10.2x	↙	25:	9.6	↙	26:	10.7x	↗	27:	10.4x	↖	28:	9.7	↖	29:	10.2x	↖	30:	9.7	↗	Serie	99.7		Total	303.5	
11:	10.4x	↗																																																																									
12:	9.7	↙																																																																									
13:	10.2x	↘																																																																									
14:	10.3x	↗																																																																									
15:	10.0	↗																																																																									
16:	10.0	↗																																																																									
17:	10.1	↙																																																																									
18:	9.5	↗																																																																									
19:	10.0	↗																																																																									
20:	10.3x	↗																																																																									
Serie	100.5																																																																										
Total	203.8																																																																										
21:	9.9	↙																																																																									
22:	8.7	↙																																																																									
23:	10.6x	↑																																																																									
24:	10.2x	↙																																																																									
25:	9.6	↙																																																																									
26:	10.7x	↗																																																																									
27:	10.4x	↖																																																																									
28:	9.7	↖																																																																									
29:	10.2x	↖																																																																									
30:	9.7	↗																																																																									
Serie	99.7																																																																										
Total	303.5																																																																										
60 Skott	 <table border="1"> <tr><td>31:</td><td>9.5</td><td>↙</td></tr> <tr><td>32:</td><td>9.9</td><td>↓</td></tr> <tr><td>33:</td><td>9.9</td><td>↓</td></tr> <tr><td>34:</td><td>9.6</td><td>↗</td></tr> <tr><td>35:</td><td>10.1</td><td>↗</td></tr> <tr><td>36:</td><td>10.2x</td><td>↓</td></tr> <tr><td>37:</td><td>10.4x</td><td>→</td></tr> <tr><td>38:</td><td>9.6</td><td>→</td></tr> <tr><td>39:</td><td>9.2</td><td>↙</td></tr> <tr><td>40:</td><td>9.7</td><td>←</td></tr> <tr><td>Serie</td><td>98.1</td><td></td></tr> <tr><td>Total</td><td>401.6</td><td></td></tr> </table>	31:	9.5	↙	32:	9.9	↓	33:	9.9	↓	34:	9.6	↗	35:	10.1	↗	36:	10.2x	↓	37:	10.4x	→	38:	9.6	→	39:	9.2	↙	40:	9.7	←	Serie	98.1		Total	401.6		60 Skott	 <table border="1"> <tr><td>41:</td><td>9.7</td><td>↙</td></tr> <tr><td>42:</td><td>10.3x</td><td>→</td></tr> <tr><td>43:</td><td>10.3x</td><td>↖</td></tr> <tr><td>44:</td><td>9.8</td><td>↗</td></tr> <tr><td>45:</td><td>10.5x</td><td>↑</td></tr> <tr><td>46:</td><td>10.1</td><td>↗</td></tr> <tr><td>47:</td><td>10.1</td><td>→</td></tr> <tr><td>48:</td><td>10.6x</td><td>↖</td></tr> <tr><td>49:</td><td>9.5</td><td>↗</td></tr> <tr><td>50:</td><td>9.6</td><td>↗</td></tr> <tr><td>Serie</td><td>100.5</td><td></td></tr> <tr><td>Total</td><td>502.1</td><td></td></tr> </table>	41:	9.7	↙	42:	10.3x	→	43:	10.3x	↖	44:	9.8	↗	45:	10.5x	↑	46:	10.1	↗	47:	10.1	→	48:	10.6x	↖	49:	9.5	↗	50:	9.6	↗	Serie	100.5		Total	502.1	
31:	9.5	↙																																																																									
32:	9.9	↓																																																																									
33:	9.9	↓																																																																									
34:	9.6	↗																																																																									
35:	10.1	↗																																																																									
36:	10.2x	↓																																																																									
37:	10.4x	→																																																																									
38:	9.6	→																																																																									
39:	9.2	↙																																																																									
40:	9.7	←																																																																									
Serie	98.1																																																																										
Total	401.6																																																																										
41:	9.7	↙																																																																									
42:	10.3x	→																																																																									
43:	10.3x	↖																																																																									
44:	9.8	↗																																																																									
45:	10.5x	↑																																																																									
46:	10.1	↗																																																																									
47:	10.1	→																																																																									
48:	10.6x	↖																																																																									
49:	9.5	↗																																																																									
50:	9.6	↗																																																																									
Serie	100.5																																																																										
Total	502.1																																																																										
60 Skott	 <table border="1"> <tr><td>51:</td><td>10.3x</td><td>↖</td></tr> <tr><td>52:</td><td>10.2x</td><td>←</td></tr> <tr><td>53:</td><td>9.9</td><td>↗</td></tr> <tr><td>54:</td><td>10.0</td><td>↗</td></tr> <tr><td>55:</td><td>10.3x</td><td>→</td></tr> <tr><td>56:</td><td>10.0</td><td>→</td></tr> <tr><td>57:</td><td>9.9</td><td>↑</td></tr> <tr><td>58:</td><td>9.8</td><td>↑</td></tr> <tr><td>59:</td><td>9.6</td><td>→</td></tr> <tr><td>60:</td><td>10.1</td><td>↓</td></tr> <tr><td>Serie</td><td>100.1</td><td></td></tr> <tr><td>Total</td><td>602.2</td><td></td></tr> </table>	51:	10.3x	↖	52:	10.2x	←	53:	9.9	↗	54:	10.0	↗	55:	10.3x	→	56:	10.0	→	57:	9.9	↑	58:	9.8	↑	59:	9.6	→	60:	10.1	↓	Serie	100.1		Total	602.2																																							
51:	10.3x	↖																																																																									
52:	10.2x	←																																																																									
53:	9.9	↗																																																																									
54:	10.0	↗																																																																									
55:	10.3x	→																																																																									
56:	10.0	→																																																																									
57:	9.9	↑																																																																									
58:	9.8	↑																																																																									
59:	9.6	→																																																																									
60:	10.1	↓																																																																									
Serie	100.1																																																																										
Total	602.2																																																																										

Skjutlag	Tavla	Kristoffer Eriksson	
5	30		
Vindeln	Åker-Länna		Sö
18.03.2017	SM & JSM Luftgevär 2017	Ramselefors SKF	
Pröv		1: 9.2 ↘ 2: 10.0 → 3: 8.9 ← 4: 9.9 ← 5: 10.3x ← 6: 10.5x → 7: 10.1 ↗ 8: 9.4 ↗ 9: 9.2 ↗ 10: 9.6 ↗	Pröv  11: 8.5 ↗ 12: 10.1 ← 13: 9.6 ↗ 14: 9.8 ↗ 15: 9.6 ↗ 16: 10.0 → 17: 10.7x →
	Serie 97.1	Serie 68.3	
	Total 0.0	Total 0.0	
60 Skott		1: 9.7 ← 2: 10.2x ↗ 3: 10.3x ↗ 4: 10.3x ↗ 5: 10.5x ↘ 6: 9.1 ← 7: 10.3x ← 8: 10.2x ↘ 9: 9.8 → 10: 9.9 ↗	60 Skott  11: 10.3x ↘ 12: 9.2 → 13: 10.4x ↘ 14: 10.0 ↗ 15: 10.3x ← 16: 9.9 ↗ 17: 9.9 ← 18: 10.2x → 19: 10.2x ↗ 20: 10.5x ↗
	Serie 100.3	Serie 100.9	
	Total 100.3	Total 201.2	
60 Skott		21: 9.9 ↗ 22: 10.5x → 23: 9.5 → 24: 10.3x ↗ 25: 10.4x ↗ 26: 10.8x ↗ 27: 10.2x ← 28: 8.9 ← 29: 8.0 → 30: 9.1 ↗	60 Skott  31: 9.7 → 32: 10.5x → 33: 10.7x ↘ 34: 9.8 → 35: 10.4x ↘ 36: 10.7x ← 37: 10.0 → 38: 10.5x ↘ 39: 9.4 ← 40: 9.7 ↗
	Serie 97.6	Serie 101.4	
	Total 298.8	Total 400.2	
60 Skott		41: 10.8x ↗ 42: 10.1 ↘ 43: 10.3x ↘ 44: 9.9 ← 45: 10.1 ← 46: 10.4x ↘ 47: 10.0 → 48: 10.0 → 49: 10.8x → 50: 10.6x ↘	60 Skott  51: 10.2x ← 52: 10.7x ↗ 53: 10.3x ← 54: 10.7x ↘ 55: 10.2x ↘ 56: 10.6x → 57: 10.6x ↗ 58: 10.9x → 59: 10.4x ↗ 60: 10.6x ↘
	Serie 103.0	Serie 105.2	
	Total 503.2	Total 608.4	

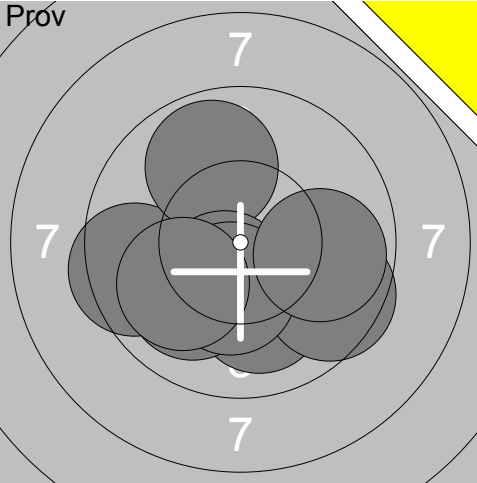
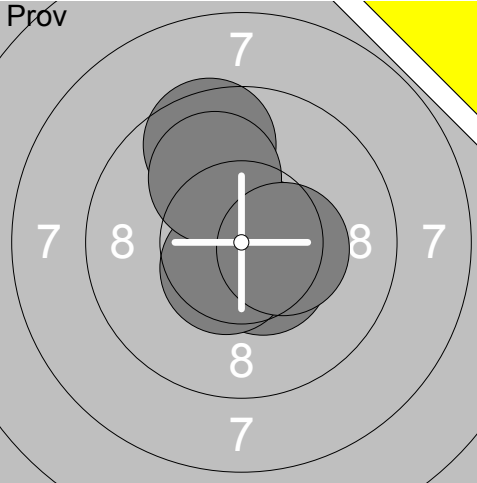
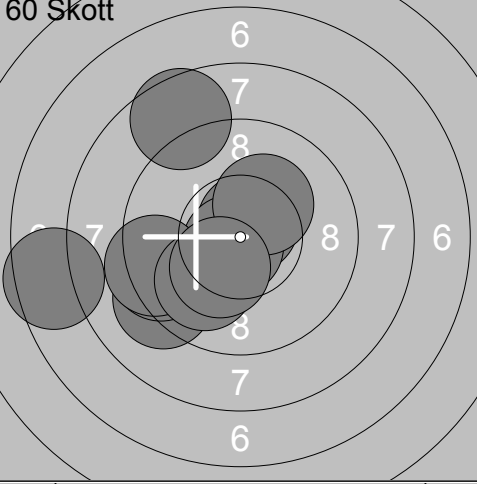
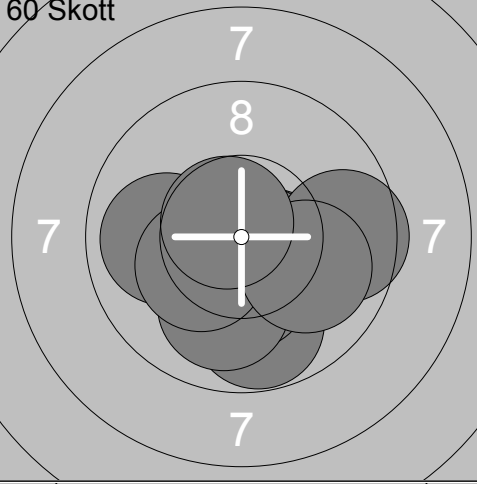
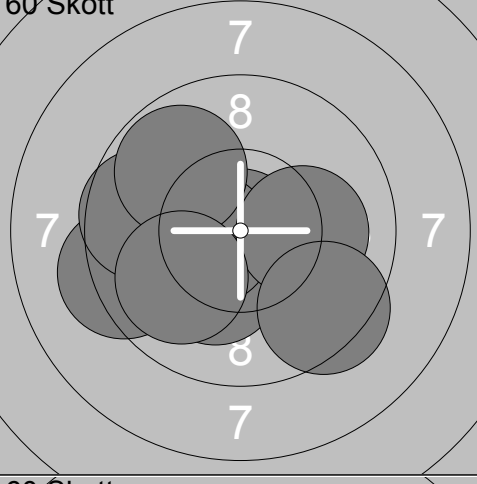
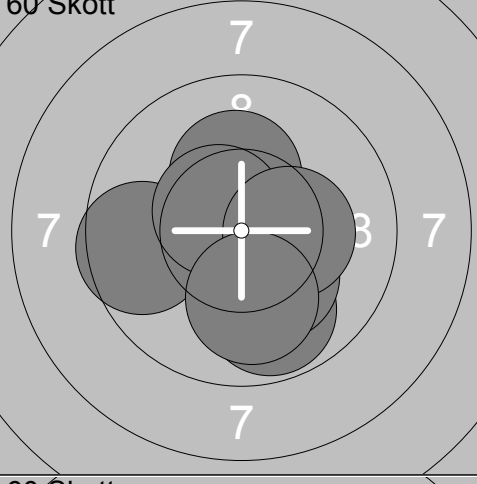
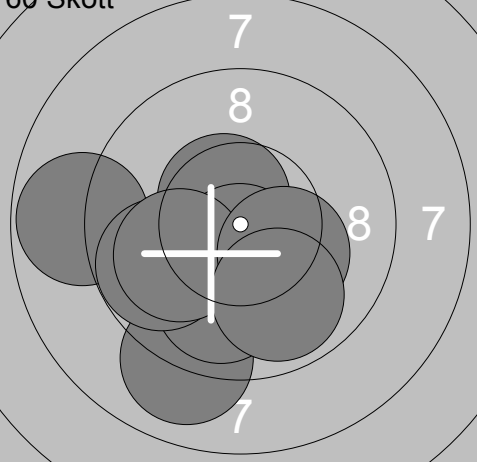
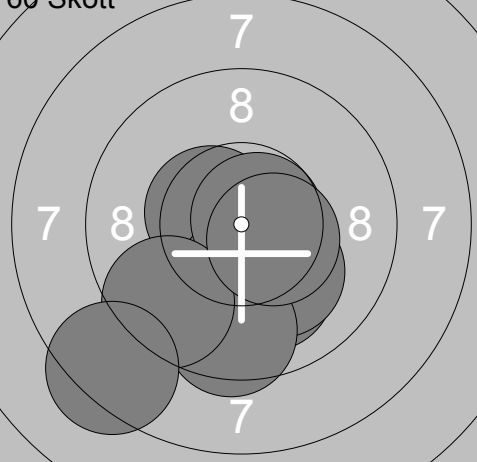
Skjuttag	Tavla	Rune Andersson	
5	31		
Vindeln	Gunnebo		Sm
18.03.2017	SM & JSM Luftgevär 2017	Ramselefors SKF	
Pröv		1: 9.5 ← 2: 9.9 ↗ 3: 10.0 ↓ 4: 10.1 ↓ 5: 10.0 ↓ 6: 9.6 ↘ 7: 10.4x ↓ 8: 10.3x ↓ 9: 9.9 → 10: 10.0 ↙ Serie 99.7 Total 0.0	Pröv  11: 10.6x → 12: 9.6 ↗ 13: 10.5x ↓ 14: 10.5x ↓ 15: 10.0 ↗ 16: 10.4x → Serie 61.6 Total 0.0
60 Skott		1: 9.2 ↙ 2: 7.5 ← 3: 10.7x ↗ 4: 10.7x ↓ 5: 8.6 ↗ 6: 10.2x ↗ 7: 9.4 ← 8: 9.3 ← 9: 10.0 ↓ 10: 10.3x ↓ Serie 95.9 Total 95.9	60 Skott  11: 9.9 ← 12: 10.5x ↘ 13: 10.6x ↘ 14: 9.8 ↓ 15: 10.3x ↓ 16: 10.0 ↓ 17: 10.3x ↙ 18: 9.6 → 19: 10.0 → 20: 10.7x ↗ Serie 101.7 Total 197.6
60 Skott		21: 10.5x ← 22: 9.3 ← 23: 9.6 ← 24: 10.9x ↓ 25: 10.2x ↓ 26: 10.5x ← 27: 9.8 ↗ 28: 10.1 → 29: 9.4 ↓ 30: 9.9 ↙ Serie 100.2 Total 297.8	60 Skott  31: 10.6x ← 32: 10.8x ← 33: 9.8 ↓ 34: 10.5x ↓ 35: 10.2x ↓ 36: 10.2x ↗ 37: 9.6 ← 38: 10.6x ↗ 39: 10.3x → 40: 10.0 ↓ Serie 102.6 Total 400.4
60 Skott		41: 10.1 ↙ 42: 9.0 ↓ 43: 8.8 ← 44: 10.6x ↗ 45: 10.6x ↓ 46: 9.9 ↓ 47: 9.8 ← 48: 10.0 ← 49: 10.3x ↘ 50: 9.9 ↓ Serie 99.0 Total 499.4	60 Skott  51: 10.8x ↙ 52: 10.1 ↓ 53: 10.5x ↗ 54: 10.2x ↓ 55: 10.1 ↓ 56: 9.5 ↓ 57: 10.7x → 58: 9.5 ↙ 59: 8.3 ↙ 60: 10.5x ↘ Serie 100.2 Total 599.6

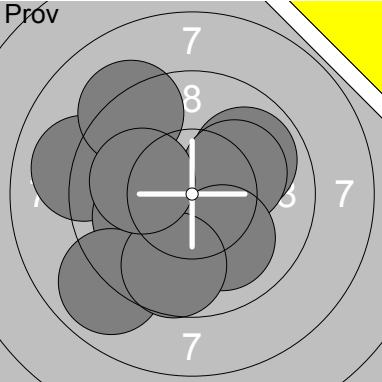
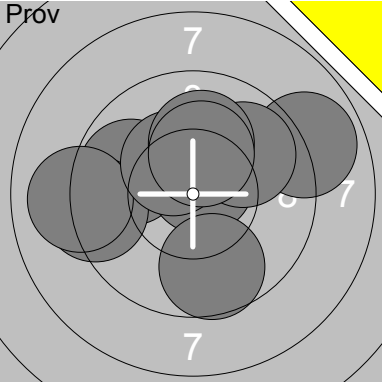
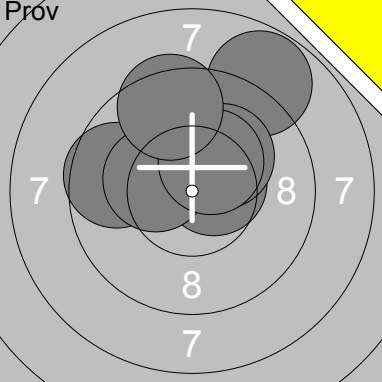
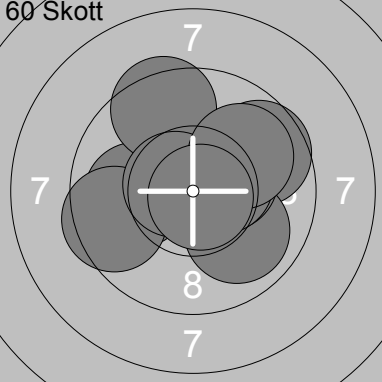
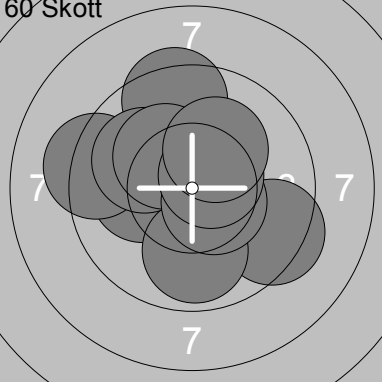
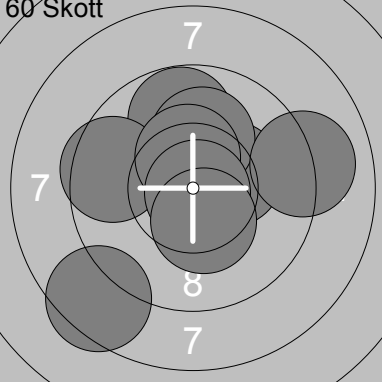
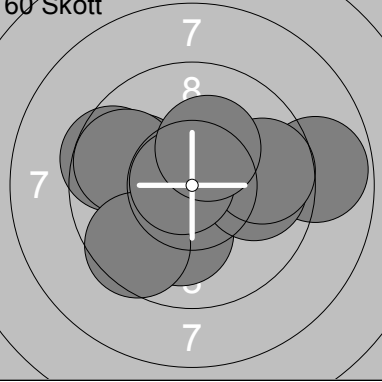
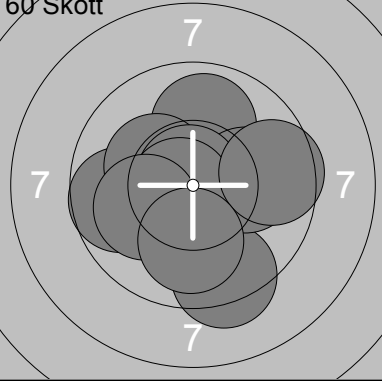
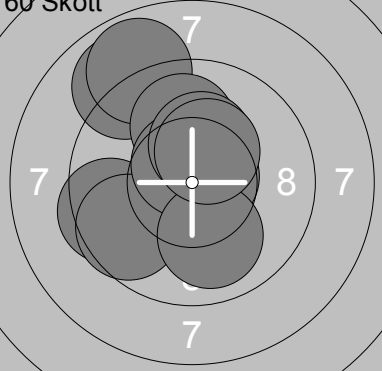
Skjutlag	Tavla	Albin Alexandersson			
5	33				
Vindeln	Gullabo		Sm		
18.03.2017	SM & JSM Luftgevär 2017	Ramselefors SKF			
Pröv		1: 10.4x ↘ 2: 9.9 → 3: 9.1 ← 4: 10.1 → 5: 10.1 ← 6: 8.9 ↙ 7: 10.0 ↘ 8: 9.7 ↓ 9: 9.2 ↗ 10: 10.1 ← Serie 97.5 Total 0.0	Pröv		11: 9.8 ← 12: 9.3 ← 13: 10.7x ↗ 14: 9.7 ↓ 15: 8.9 → 16: 9.9 ↗ 17: 9.0 ← 18: 10.3x ↗ 19: 10.1 ↑ 20: 10.3x ↑ Serie 98.0 Total 0.0
Pröv		21: 10.6x → 22: 8.8 ↗ 23: 9.6 ← 24: 10.3x ← 25: 10.2x ↗ 26: 10.4x ↗ 27: 9.5 ↑ Serie 69.4 Total 0.0	60 Skott		1: 9.7 → 2: 10.0 ↘ 3: 10.4x → 4: 10.0 ← 5: 9.5 ↑ 6: 9.5 ← 7: 10.5x → 8: 10.6x ← 9: 9.9 ↗ 10: 10.8x ↘ Serie 100.9 Total 100.9
60 Skott		11: 10.1 ← 12: 9.3 ← 13: 9.4 ↘ 14: 9.9 ↓ 15: 9.4 ↑ 16: 10.0 ← 17: 10.3x ↗ 18: 10.5x ↘ 19: 10.6x ↗ 20: 10.2x ↗ Serie 99.7 Total 200.6	60 Skott		21: 9.8 ↑ 22: 8.5 ↘ 23: 10.6x ↘ 24: 10.3x → 25: 10.1 ↑ 26: 9.5 ← 27: 9.0 → 28: 10.4x ↑ 29: 10.8x ↘ 30: 10.4x ↘ Serie 99.4 Total 300.0
60 Skott		31: 8.8 → 32: 10.0 ← 33: 9.5 ← 34: 10.1 ↓ 35: 9.8 ← 36: 9.6 ↙ 37: 9.9 → 38: 9.7 → 39: 10.8x ← 40: 10.3x ↑ Serie 98.5 Total 398.5	60 Skott		41: 9.9 ↑ 42: 9.3 ↓ 43: 9.7 ← 44: 10.1 → 45: 10.3x ↖ 46: 10.8x ↗ 47: 10.7x ← 48: 9.6 → 49: 10.1 ← 50: 10.0 ↓ Serie 100.5 Total 499.0
60 Skott		51: 9.0 ↗ 52: 8.9 ↗ 53: 10.7x → 54: 9.5 ← 55: 10.0 ↑ 56: 9.6 ← 57: 10.6x ↗ 58: 10.3x ↑ 59: 10.0 ↓ 60: 10.4x ↗ Serie 99.0 Total 598.0			

Skjutlag	Tavla	Axel Ström	
5	34		
Vindeln	Björksta		Vm
18.03.2017	SM & JSM Luftgevär 2017	Ramselefors SKF	
Prov 	1: 9.5 → 2: 10.1 ← 3: 8.1 → 4: 9.8 → 5: 10.1 → 6: 9.5 ↗ 7: 8.9 ↑ 8: 10.7x ← 9: 9.6 ↗ 10: 10.2x ↗	Prov 	11: 9.2 ← 12: 9.6 ↗ 13: 8.6 ↘ 14: 8.6 ↗
	Serie 96.5		Serie 36.0
	Total 0.0		Total 0.0
60 Skott 	1: 10.0 ← 2: 10.2x ↘ 3: 8.3 → 4: 10.0 ↗ 5: 8.9 → 6: 9.1 → 7: 10.6x → 8: 9.9 ↑ 9: 10.3x ↗ 10: 10.5x ↑	60 Skott 	11: 10.3x ↘ 12: 10.3x ↘ 13: 8.7 ← 14: 10.6x ← 15: 10.0 → 16: 9.9 ↗ 17: 10.4x ↑ 18: 10.5x ↘ 19: 9.8 ← 20: 10.7x ↘
	Serie 97.8		Serie 101.2
	Total 97.8		Total 199.0
60 Skott 	21: 10.1 → 22: 10.1 ↑ 23: 10.0 ↗ 24: 8.6 ← 25: 10.0 ← 26: 10.2x ↓ 27: 10.5x ↗ 28: 9.4 ↘ 29: 10.4x ↘ 30: 9.9 →	60 Skott 	31: 9.5 ← 32: 9.6 ← 33: 10.1 ↘ 34: 9.6 ↗ 35: 10.2x ↑ 36: 9.8 ↓ 37: 10.2x ↘ 38: 10.2x ← 39: 8.1 → 40: 10.2x ↘
	Serie 99.2		Serie 97.5
	Total 298.2		Total 395.7
60 Skott 	41: 9.7 → 42: 9.8 → 43: 10.2x ↘ 44: 10.0 ↘ 45: 10.5x ↘ 46: 10.2x ↘ 47: 9.9 ← 48: 10.4x ↘ 49: 10.6x ← 50: 8.8 ↘	60 Skott 	51: 9.5 ↘ 52: 10.2x ← 53: 9.6 ↘ 54: 9.7 ↘ 55: 10.1 ← 56: 10.0 ↓ 57: 7.7 → 58: 9.6 ↓ 59: 9.5 ↘ 60: 10.1 ↗
	Serie 100.1		Serie 96.0
	Total 495.8		Total 591.8

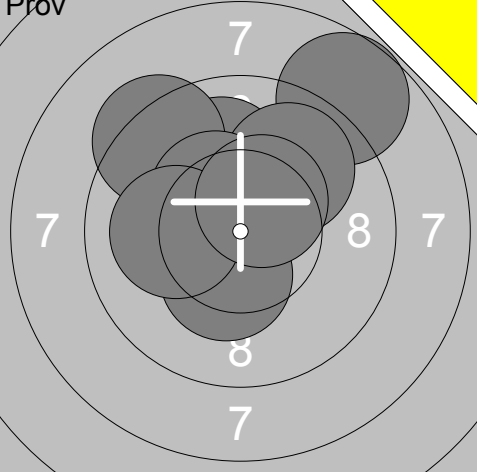
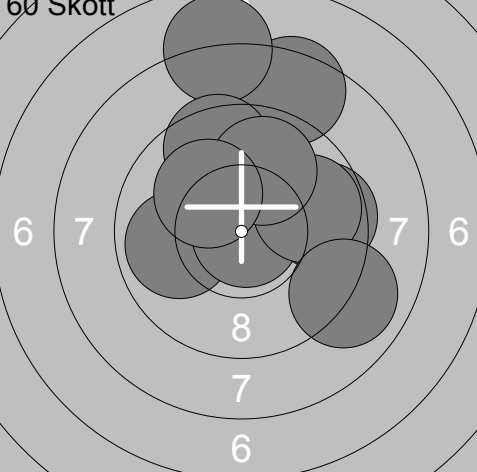
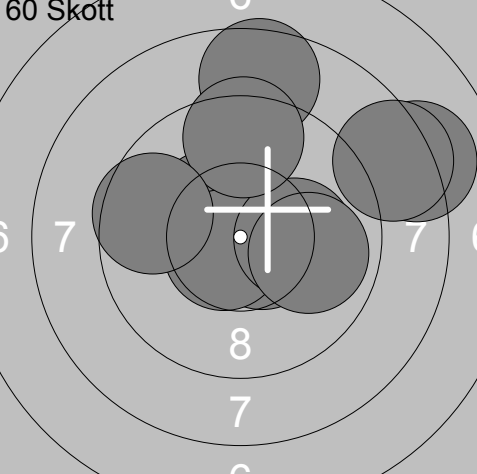
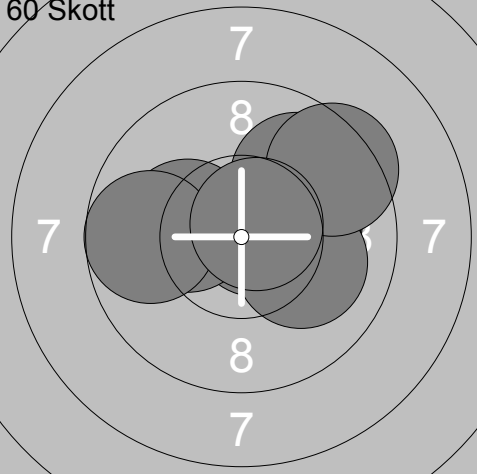
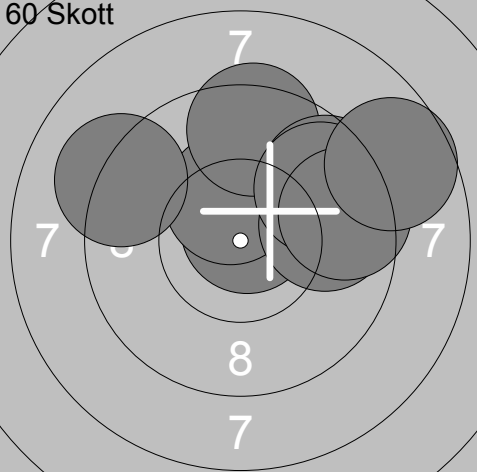
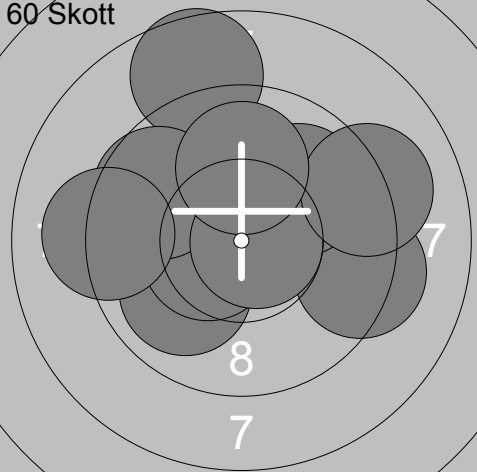
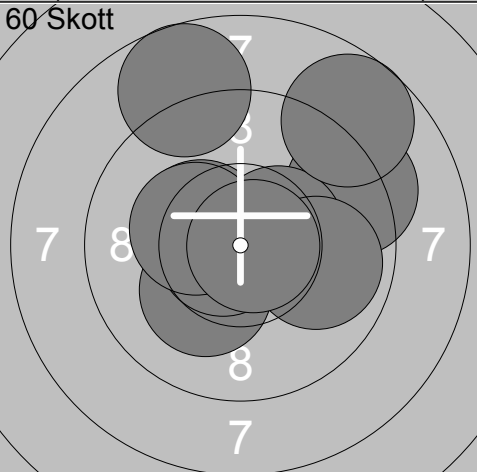
Pröv 	1: 8.7 ↗ 2: 10.0 ↑ 3: 9.3 ↗ 4: 9.9 ↗ 5: 10.4x ↗ 6: 10.3x ↓ 7: 10.1 ← 8: 10.5x ↗ <hr/> Serie 79.2 Total 0.0	60 Skott 	1: 8.5 ↗ 2: 7.9 ↑ 3: 9.9 ← 4: 9.5 ↑ 5: 10.9x → 6: 9.6 → 7: 9.8 → 8: 9.9 ↑ 9: 9.0 → 10: 10.1 ↖ <hr/> Serie 95.1 Total 95.1
60 Skott 	11: 10.4x ↖ 12: 8.6 ↑ 13: 10.6x → 14: 8.1 → 15: 10.6x ← 16: 8.4 → 17: 10.2x → 18: 9.5 ↑ 19: 9.9 → 20: 9.6 ← <hr/> Serie 95.9 Total 191.0	60 Skott 	21: 10.3x → 22: 10.2x → 23: 9.9 ↗ 24: 10.2x → 25: 10.7x → 26: 10.2x ← 27: 9.7 ← 28: 10.1 → 29: 9.4 ↗ 30: 10.7x ↗ <hr/> Serie 101.4 Total 292.4
60 Skott 	31: 9.8 → 32: 10.7x ↑ 33: 10.4x ↑ 34: 9.8 → 35: 9.4 ↑ 36: 9.6 ↗ 37: 9.7 ↗ 38: 9.5 → 39: 9.1 ↖ 40: 8.7 → <hr/> Serie 96.7 Total 389.1	60 Skott 	41: 8.6 ↑ 42: 10.0 ↖ 43: 9.3 → 44: 10.5x ← 45: 9.9 ↗ 46: 9.7 ↖ 47: 10.7x → 48: 9.1 → 49: 10.0 ↑ 50: 9.1 ← <hr/> Serie 96.9 Total 486.0
60 Skott 	51: 10.2x ↖ 52: 9.3 → 53: 10.7x ← 54: 10.4x ↖ 55: 10.4x → 56: 10.3x ↖ 57: 8.7 ↗ 58: 8.7 ↑ 59: 9.9 → 60: 10.8x → <hr/> Serie 99.4 Total 585.4		

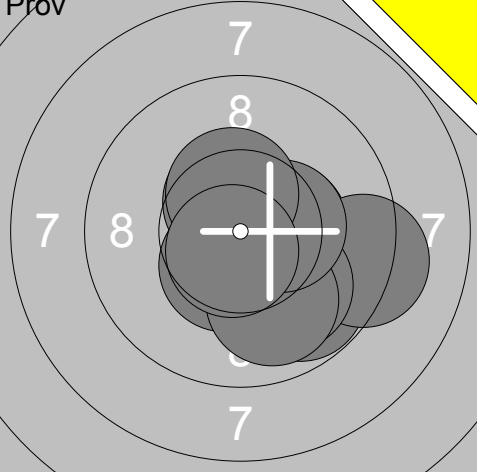
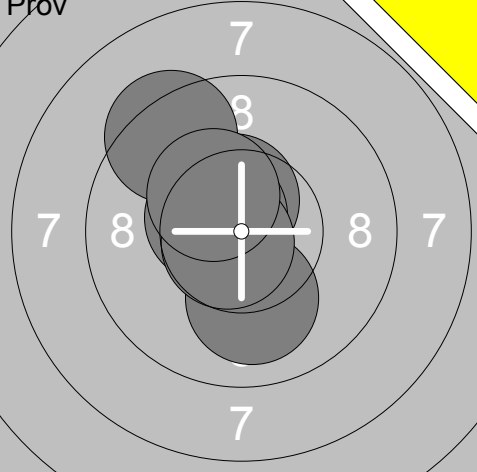
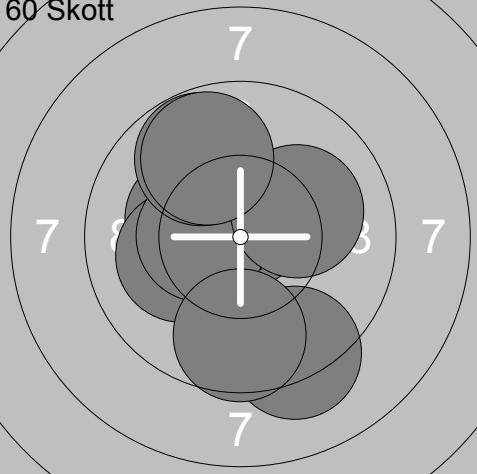
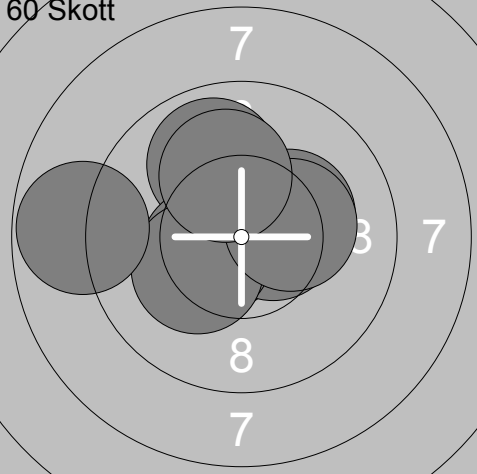
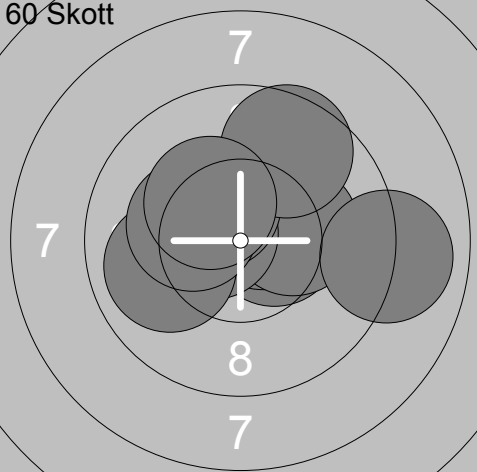
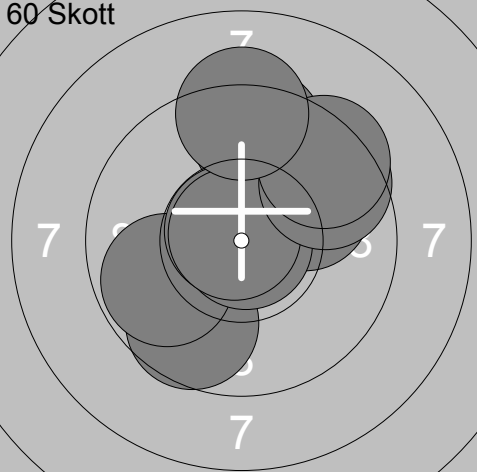
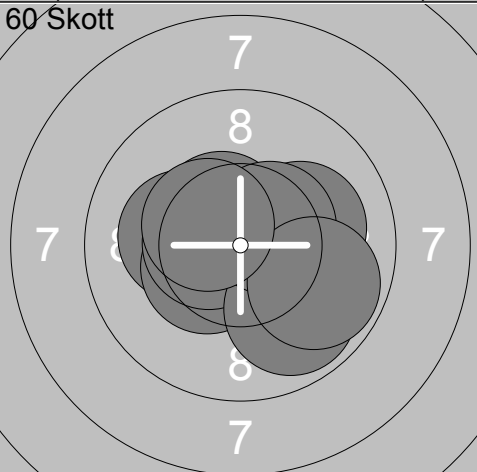
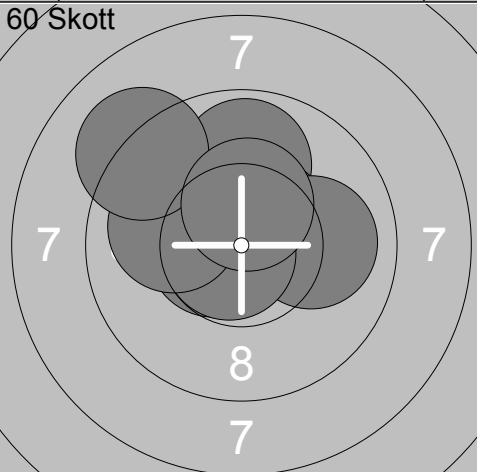
Pröv 	1: 10.5x ↘ 2: 10.4x → 3: 9.8 ↘ 4: 9.2 → 5: 10.5x ↗ 6: 10.0 ↘ 7: 9.9 ↘ 8: 10.4x → 9: 10.4x ↗ 10: 10.7x ↘ <hr/> Serie 101.8 Total 0.0	Pröv 	11: 10.5x ↗ 12: 10.6x ↖ 13: 10.0 ↘ 14: 9.4 ↗ 15: 10.5x ↖ 16: 10.7x ↙ 17: 10.3x ↗ <hr/> Serie 72.0 Total 0.0
60 Skott 	1: 10.2x ↖ 2: 10.1 ↖ 3: 10.8x ↗ 4: 10.5x ↗ 5: 10.4x ↖ 6: 9.2 ↘ 7: 10.1 → 8: 9.6 ↘ 9: 9.8 ↗ 10: 9.8 ↗ <hr/> Serie 100.5 Total 100.5	60 Skott 	11: 10.6x ↖ 12: 9.9 ↗ 13: 10.5x → 14: 10.2x → 15: 10.6x ↗ 16: 10.4x ↖ 17: 10.2x ↖ 18: 10.3x → 19: 10.1 ↗ 20: 8.8 ↖ <hr/> Serie 101.6 Total 202.1
60 Skott 	21: 10.5x → 22: 10.6x ↗ 23: 10.2x → 24: 10.5x ↖ 25: 10.3x ↗ 26: 9.6 ↗ 27: 9.9 ↖ 28: 10.3x ↖ 29: 9.0 → 30: 10.3x ↗ <hr/> Serie 101.2 Total 303.3	60 Skott 	31: 9.5 ↗ 32: 9.7 ↘ 33: 9.8 ↖ 34: 10.8x ↖ 35: 10.0 ↗ 36: 10.9x → 37: 10.8x ↖ 38: 9.6 ↗ 39: 9.4 ↗ 40: 9.2 ↗ <hr/> Serie 99.7 Total 403.0
60 Skott 	41: 10.5x ↗ 42: 10.2x ↖ 43: 10.8x ↖ 44: 10.4x ↖ 45: 10.5x ↖ 46: 10.1 → 47: 9.9 ↘ 48: 10.5x ↗ 49: 9.8 ↘ 50: 10.4x ↗ <hr/> Serie 103.1 Total 506.1	60 Skott 	51: 10.7x ↖ 52: 9.9 ↗ 53: 10.5x ↗ 54: 10.0 → 55: 10.6x ↖ 56: 10.4x ↖ 57: 10.8x ↖ 58: 10.0 ↖ 59: 9.1 ↗ 60: 10.4x ↗ <hr/> Serie 102.4 Total 608.5

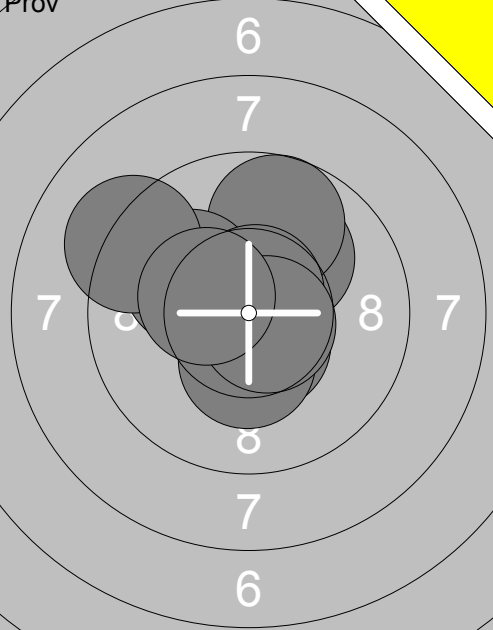
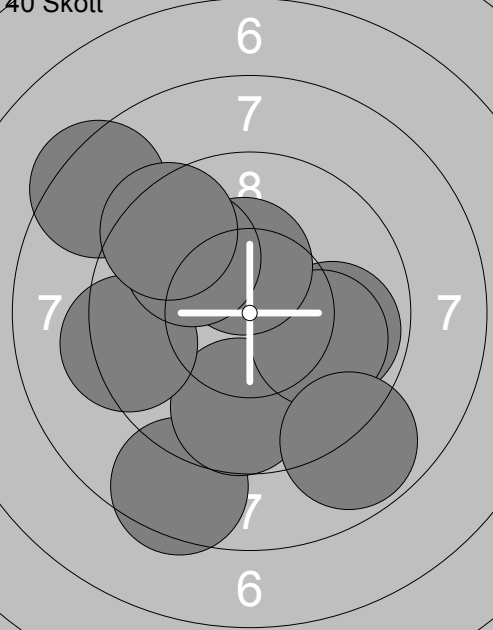
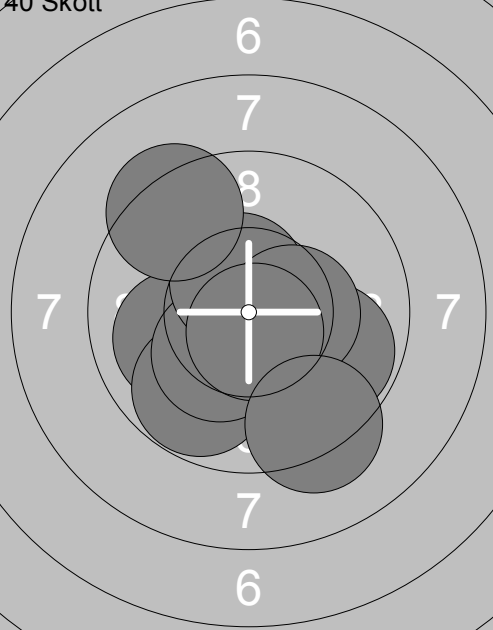
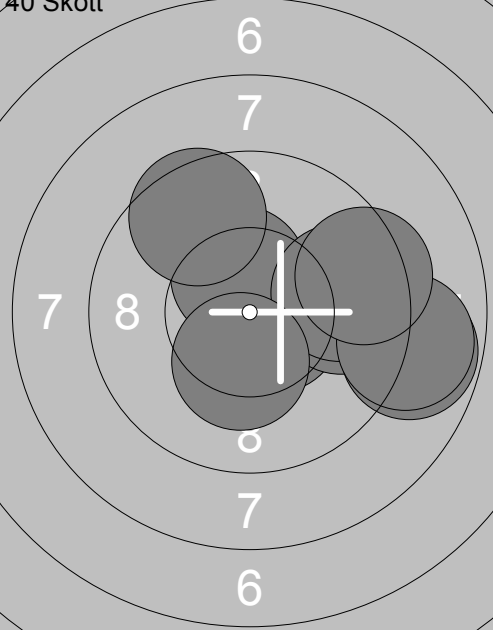
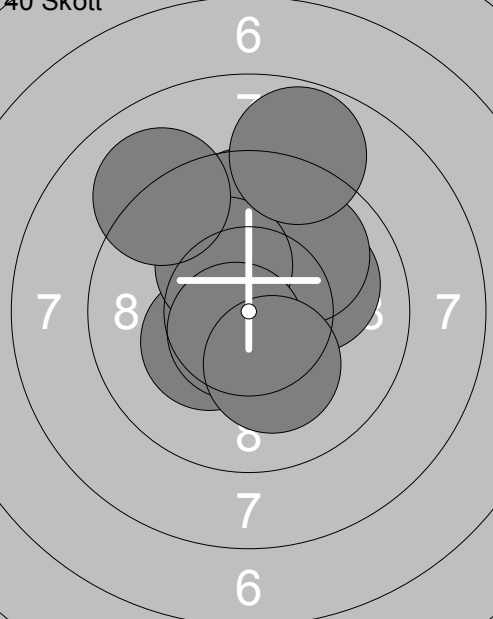
<p>Prov</p> 	<p>40 Skott</p> 	<p>1: 10.1 ↗ 2: 9.7 ↑ 3: 10.1 ↖ 4: 10.7x↗ 5: 10.5x↘ 6: 9.2 ↖ 7: 10.3x↘ 8: 10.7x↘ 9: 10.4x↖</p> <p>1: 9.9 → 2: 8.5 ↓ 3: 9.7 ↓ 4: 9.3 ← 5: 10.0 → 6: 10.3x↗ 7: 9.9 ↗ 8: 8.4 ↗ 9: 9.4 ↗ 10: 8.8 ↓</p>
Serie 91.7	Serie 94.2	
Total 0.0	Total 94.2	
<p>40 Skott</p> 	<p>40 Skott</p> 	<p>11: 10.0 ← 12: 9.8 ↓ 13: 10.6x→ 14: 10.3x↘ 15: 9.8 → 16: 10.5x↗ 17: 10.4x→ 18: 10.7x↘ 19: 9.3 ↓ 20: 9.3 ↖</p> <p>21: 10.7x↘ 22: 10.6x↘ 23: 9.8 → 24: 10.4x↗ 25: 8.8 → 26: 9.8 → 27: 10.3x↘ 28: 8.9 → 29: 9.5 ↗ 30: 9.4 →</p>
Serie 100.7	Serie 98.2	
Total 194.9	Total 293.1	
<p>40 Skott</p> 	<p>31: 10.7x↘ 32: 10.1 → 33: 10.3x↘ 34: 9.7 ↑ 35: 9.9 ↗ 36: 10.3x↖ 37: 10.6x↘ 38: 10.2x↘ 39: 9.1 ↖ 40: 8.8 ↑</p>	
Serie 99.7		
Total 392.8		

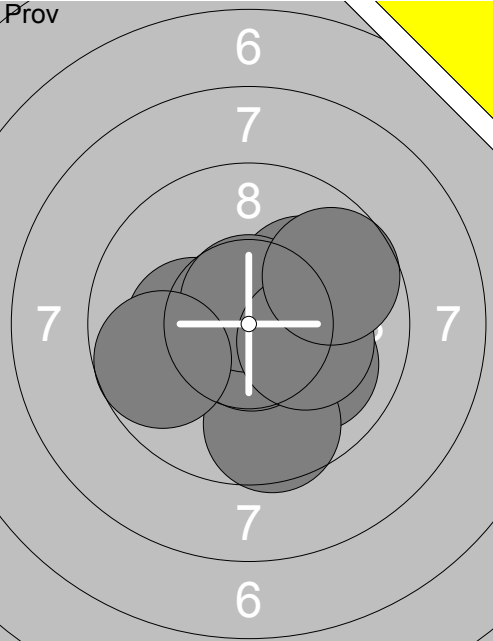
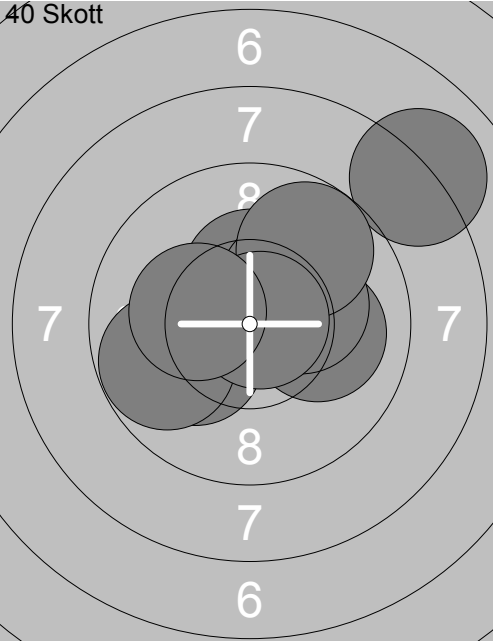
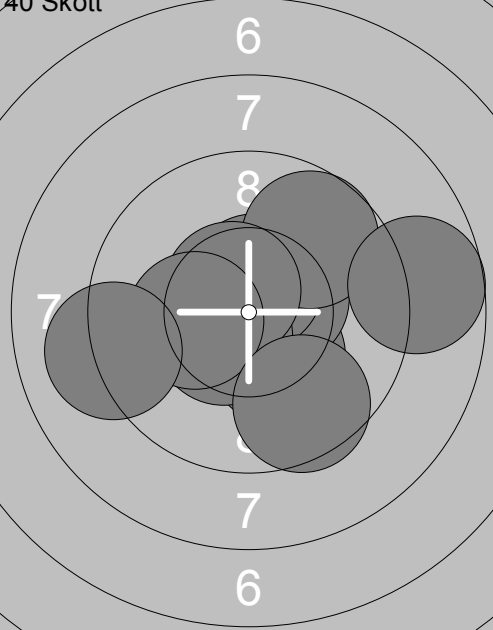
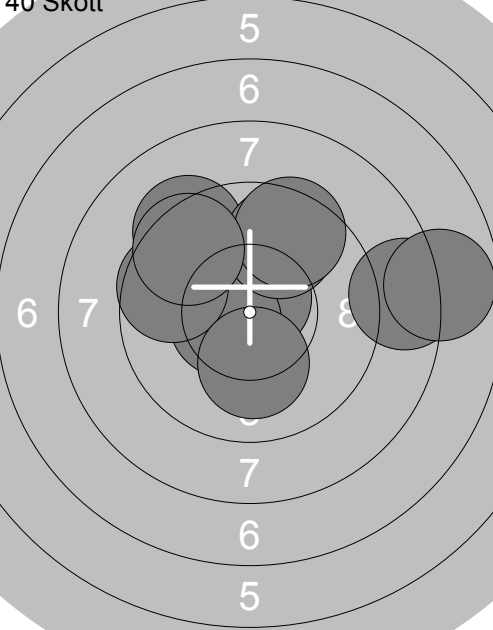
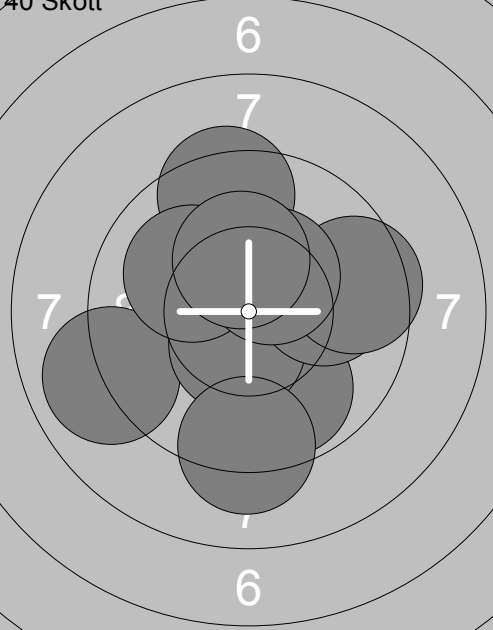
Skjuttag	Tavla	Nina Englund	
6	5		
Vindeln	Gefle Frivilliga Skarp		Gä
18.03.2017	SM & JSM Luftgevär 2017	Ramselefors SKF	
Prov 	1: 10.0 ↘ 2: 10.4x ↗ 3: 10.2x ← 4: 9.6 ↓ 5: 10.1 ↗ 6: 10.7x ↓ 7: 10.7x ↑ 8: 10.2x → 9: 9.7 ↗ 10: 9.7 ← Serie 101.3 Total 0.0	40 Skott 	1: 10.1 → 2: 10.3x ↑ 3: 10.1 ↙ 4: 9.8 ← 5: 10.2x ↗ 6: 8.0 ↗ 7: 10.2x ↗ 8: 9.8 ↗ 9: 10.8x ↗ 10: 10.2x ← Serie 99.5 Total 99.5
40 Skott 	11: 10.3x ↓ 12: 10.5x ↗ 13: 10.6x ↑ 14: 10.5x ↙ 15: 9.7 ↗ 16: 10.6x ↘ 17: 10.2x ← 18: 9.1 ← 19: 8.7 → 20: 9.6 ↓ Serie 99.8 Total 199.3	40 Skott 	21: 10.7x ↑ 22: 9.3 ↖ 23: 10.5x ← 24: 9.6 ← 25: 8.4 → 26: 9.7 ↑ 27: 7.8 → 28: 10.1 ↓ 29: 9.5 ↑ 30: 9.5 ↖ Serie 95.1 Total 294.4
40 Skott 	31: 9.9 ↓ 32: 9.4 ↑ 33: 9.0 ← 34: 10.5x ↓ 35: 10.1 ↙ 36: 10.0 → 37: 9.5 → 38: 10.4x ↗ 39: 9.2 ↓ 40: 10.3x ↑ Serie 98.3 Total 392.7		

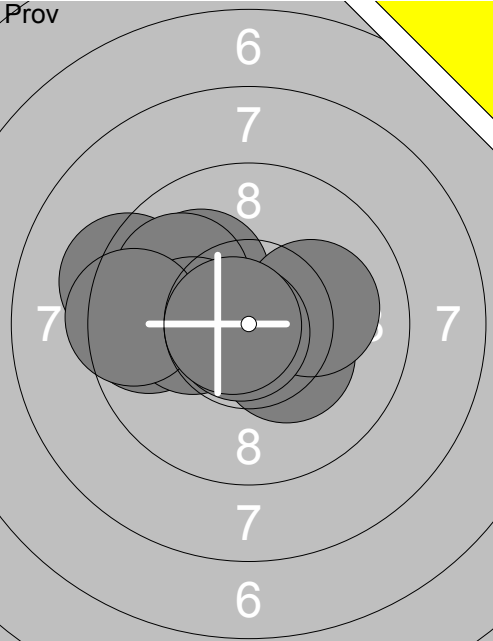
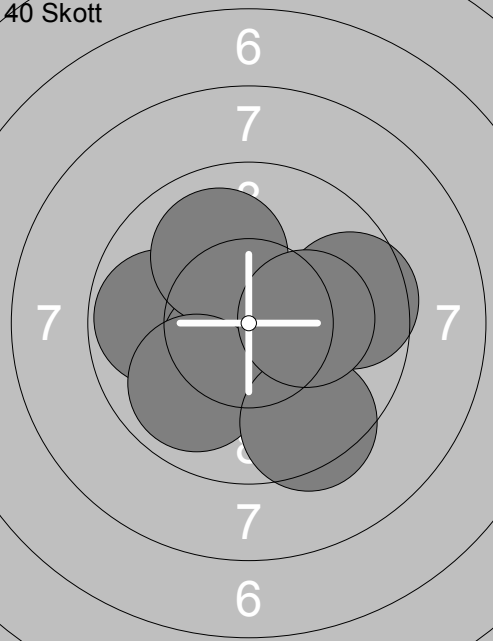
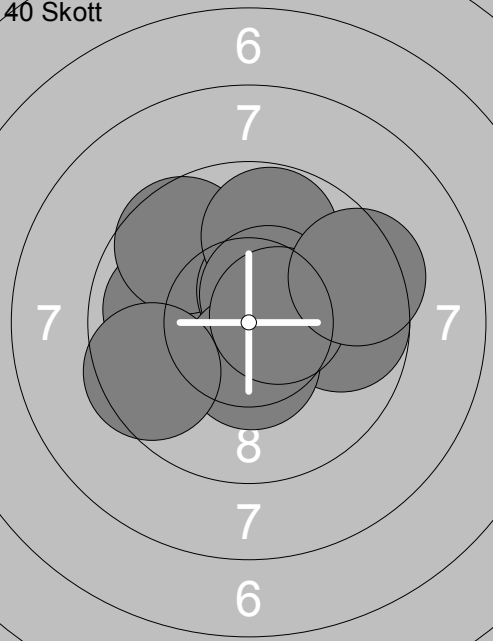
Skjuttag	Tavla	Isabella Erkki		Vg
6	6			
Vindeln	Axvall			
18.03.2017	SM & JSM Luftgevär 2017	Ramselefors SKF		
Prov		1: 10.3x ↘ 2: 9.3 ← 3: 10.1 ↖ 4: 9.7 ← 5: 10.1 → 6: 9.9 ↖ 7: 10.2x ← 8: 9.4 ← 9: 10.8x ↘ 10: 10.7x ←	11: 10.2x ↘ 12: 9.5 ← 13: 9.1 →	
		Serie 100.5	Serie 28.8	
		Total 0.0	Total 0.0	
40 Skott		1: 10.2x ← 2: 9.8 ← 3: 10.7x ↘ 4: 10.5x ↘ 5: 10.5x ↘ 6: 10.0 ↖ 7: 9.6 → 8: 9.9 ↘ 9: 9.4 ↘ 10: 10.2x →	11: 10.6x ↘ 12: 10.4x ↖ 13: 10.3x → 14: 10.9x → 15: 10.7x → 16: 10.3x ↘ 17: 10.0 ↗ 18: 10.0 ↘ 19: 9.2 ← 20: 10.1 ↘	
		Serie 100.8	Serie 102.5	
		Total 100.8	Total 203.3	
40 Skott		21: 9.9 ← 22: 9.6 ↖ 23: 10.5x ↗ 24: 9.7 → 25: 9.8 ↗ 26: 10.5x ↗ 27: 10.4x ↘ 28: 10.6x → 29: 9.4 → 30: 9.5 ←	31: 8.8 ← 32: 10.5x ↘ 33: 10.5x → 34: 10.7x ↘ 35: 10.2x ← 36: 10.6x ↘ 37: 9.6 ↖ 38: 9.9 ↗ 39: 10.8x ↘ 40: 9.8 ↖	
		Serie 99.9	Serie 101.4	
		Total 303.2	Total 404.6	

Skjutlag	Tavla	Moa Lindmark	
6	7		
Vindeln	By		Da
18.03.2017	SM & JSM Luftgevär 2017	Ramselefors SKF	
Prov 	1: 9.7 ↓ 2: 9.9 ↘ 3: 10.0 ↓ 4: 10.8x↗ 5: 10.3x↘ 6: 10.2x↓ 7: 10.1 ← 8: 9.6 ↖ 9: 10.1 ↖ 10: 9.8 → Serie 100.5 Total 0.0	Prov 	11: 9.8 ← 12: 10.1 ↘ 13: 10.0 ← Serie 29.9 Total 0.0
40 Skott 	1: 10.3x↗ 2: 9.8 → 3: 10.0 ← 4: 10.7x↗ 5: 10.6x↘ 6: 10.1 ← 7: 10.4x↘ 8: 9.1 ← 9: 10.2x↓ 10: 10.3x↘ Serie 101.5 Total 101.5	40 Skott 	11: 9.9 → 12: 9.5 → 13: 9.5 ← 14: 10.8x↓ 15: 10.4x↗ 16: 10.0 ↑ 17: 10.5x↘ 18: 10.0 ↑ 19: 9.9 ↖ 20: 9.7 ↘ Serie 100.2 Total 201.7
40 Skott 	21: 10.3x↓ 22: 9.9 ↗ 23: 9.5 ← 24: 10.5x→ 25: 10.1 ← 26: 10.3x↗ 27: 10.4x↘ 28: 10.3x→ 29: 10.0 ← 30: 10.2x↘ Serie 101.5 Total 303.2	40 Skott 	31: 9.4 ↓ 32: 10.4x↗ 33: 9.7 ← 34: 10.1 ← 35: 10.5x↘ 36: 10.3x↓ 37: 9.5 ↖ 38: 9.9 ↖ 39: 10.0 ↗ 40: 10.3x↘ Serie 100.1 Total 403.3

Skjuttag	Tavla	Moa Andersson	
6	8		
Vindeln	Eskilstuna		Sö
18.03.2017	SM & JSM Luftgevär 2017	Ramselefors SKF	
Prov 	1: 10.2x 2: 10.8x 3: 10.1 4: 9.3 5: 10.3x 6: 10.2x 7: 9.0 8: 10.8x 9: 10.4x 10: 10.4x Serie 101.5 Total 0.0	Prov 	11: 10.0 12: 10.4x 13: 10.7x Serie 31.1 Total 0.0
40 Skott 	1: 9.9 2: 9.7 3: 10.2x 4: 9.4 5: 9.7 6: 10.6x 7: 9.8 8: 10.4x 9: 9.8 10: 10.5x Serie 100.0 Total 100.0	40 Skott 	11: 9.8 12: 10.5x 13: 10.3x 14: 10.1 15: 9.8 16: 10.5x 17: 9.5 18: 10.6x 19: 10.0 20: 10.1 Serie 101.2 Total 201.2
40 Skott 	21: 10.3x 22: 10.5x 23: 9.7 24: 10.6x 25: 9.5 26: 10.3x 27: 10.0 28: 9.8 29: 10.4x 30: 10.6x Serie 101.7 Total 302.9	40 Skott 	31: 9.8 32: 10.0 33: 9.2 34: 9.8 35: 10.5x 36: 10.3x 37: 10.3x 38: 10.4x 39: 10.1 40: 9.3 Serie 99.7 Total 402.6

<p>Prov</p>	<p>Prov</p>	<p>11: 10.2x↓</p> <p>12: 10.9x↑</p> <p>13: 9.8 ↓</p>
<p>Serie 101.2</p> <p>Total 0.0</p>	<p>Serie 30.9</p> <p>Total 0.0</p>	
<p>40 Skott</p>	<p>40 Skott</p>	<p>11: 10.5x➤</p> <p>12: 9.0 ➔</p> <p>13: 10.3x➤</p> <p>14: 10.7x↑</p> <p>15: 9.3 ↗</p> <p>16: 10.8x↑</p> <p>17: 10.3x↗</p> <p>18: 10.3x↘</p> <p>19: 9.9 ↙</p> <p>20: 9.6 ↓</p>
<p>Serie 100.9</p> <p>Total 100.9</p>	<p>Serie 100.7</p> <p>Total 201.6</p>	
<p>40 Skott</p>	<p>40 Skott</p>	<p>31: 10.6x↘</p> <p>32: 10.5x➤</p> <p>33: 9.9 ↗</p> <p>34: 10.5x↓</p> <p>35: 9.8 ➔</p> <p>36: 10.7x↔</p> <p>37: 9.2 ➔</p> <p>38: 10.3x↓</p> <p>39: 9.4 ➔</p> <p>40: 10.6x↔</p>
<p>Serie 101.1</p> <p>Total 302.7</p>	<p>Serie 101.5</p> <p>Total 404.2</p>	

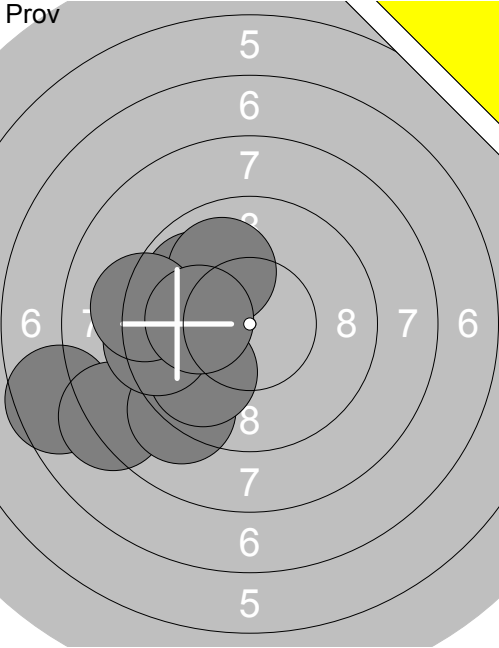
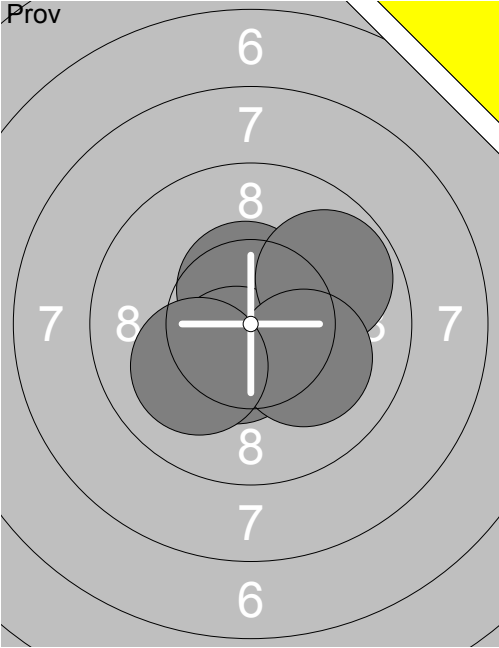
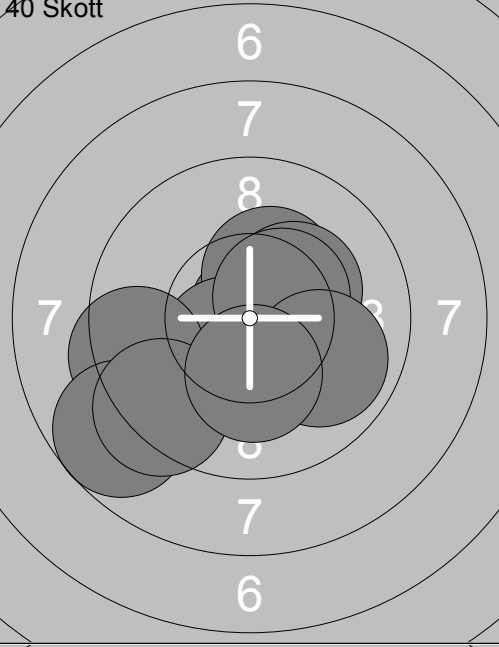
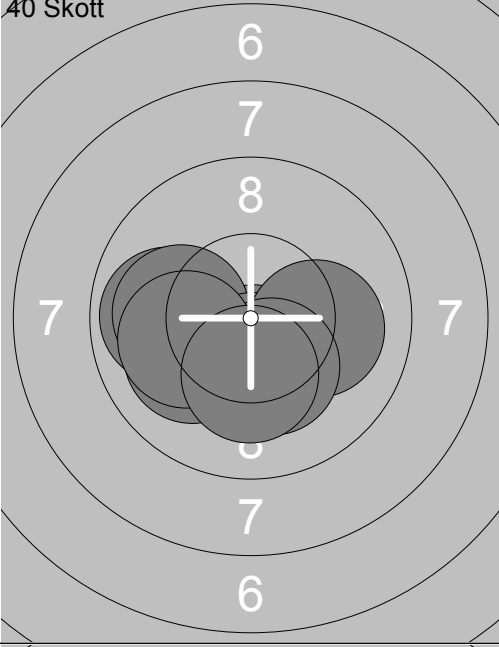
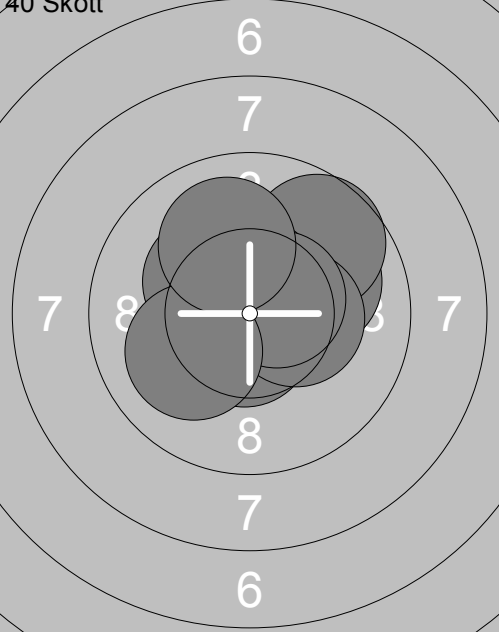
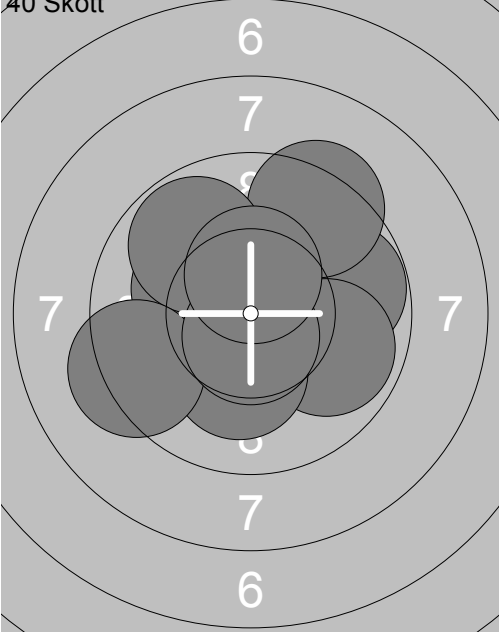
Skjuttag	Tavla	Johanna Carlsson	
6	10		
Vindeln	Gullabo		Sm
18.03.2017	SM & JSM Luftgevär 2017	Ramselefors SKF	
Prov		Prov	
	1: 7.6 ←		11: 10.5x↑
	2: 8.2 ↙		12: 10.5x↓
	3: 9.2 ↘		13: 9.8 ↗
	4: 9.9 ↖		14: 10.1 ↘
	5: 10.0←		15: 10.1↙
	6: 9.8 ↘		
	7: 9.4 ←		
	8: 10.0 ↗		
	9: 9.2 ←		
	10: 10.1←		
	Serie 93.4		Serie 51.0
	Total 0.0		Total 0.0
40 Skott		40 Skott	
	1: 10.8x↗		11: 10.1←
	2: 10.3x↑		12: 9.9 ←
	3: 10.5x↓		13: 10.1↙
	4: 10.3x↗		14: 10.5x↓
	5: 9.4 ←		15: 10.0←
	6: 10.4x↗		16: 10.4x↓
	7: 8.7 ↘		17: 10.1→
	8: 9.9 ↘		18: 10.3x↓
	9: 9.3 ↘		19: 10.1←
	10: 10.2x↓		20: 10.2x↓
	Serie 99.8		Serie 101.7
	Total 99.8		Total 201.5
40 Skott		40 Skott	
	21: 10.6x↓		31: 10.2x↖
	22: 10.0 ↗		32: 10.7x↖
	23: 9.7 ↗		33: 9.8 →
	24: 10.2x↑		34: 9.3 ↗
	25: 10.6x↑		35: 9.9 ↘
	26: 10.3x→		36: 9.8 ↖
	27: 10.3x↖		37: 10.2x↓
	28: 10.5x↗		38: 9.3 ←
	29: 10.1↙		39: 10.7x↓
	30: 10.0 ↗		40: 10.4x↑
	Serie 102.3		Serie 100.3
	Total 303.8		Total 404.1

Skjuttag	Tavla	Hanna Lundin	
6	11		
Vindeln	Umeå		Vb
18.03.2017	SM & JSM Luftgevär 2017	Ramselefors SKF	
	1: 9.5 ↑ 2: 8.2 ↑ 3: 9.6 ↑ 4: 9.3 → 5: 10.3x↑ 6: 9.7 ↑ 7: 10.8x↘ 8: 10.4x→ 9: 8.8 → 10: 9.3 ↑ Serie 95.9 Total 0.0		11: 9.5 ↗ 12: 8.8 ← 13: 8.8 ↖ 14: 9.1 ← 15: 10.2x↑ 16: 10.5x→ 17: 9.9 → Serie 66.8 Total 0.0
	1: 10.3x↘ 2: 10.6x→ 3: 10.3x↗ 4: 10.4x↘ 5: 10.4x→ 6: 10.5x↘ 7: 10.0 → 8: 9.7 ↘ 9: 10.1 ↑ 10: 10.0 ↘ Serie 102.3 Total 102.3		11: 9.6 ↑ 12: 8.2 ← 13: 10.8x→ 14: 9.7 ↗ 15: 10.4x↑ 16: 10.5x↘ 17: 9.3 ← 18: 9.5 ↖ 19: 9.7 ↗ 20: 10.2x↘ Serie 97.9 Total 200.2
	21: 10.1 ↘ 22: 10.5x↗ 23: 10.5x↘ 24: 9.8 ← 25: 10.5x↑ 26: 10.5x↘ 27: 10.3x→ 28: 9.8 ← 29: 9.9 ← 30: 10.2x→ Serie 102.1 Total 302.3		31: 10.4x↘ 32: 10.1 → 33: 10.6x↘ 34: 9.5 ← 35: 9.9 ↑ 36: 10.2x↘ 37: 9.7 ↗ 38: 10.7x↘ 39: 10.1 ↗ 40: 10.1 ← Serie 101.3 Total 403.6

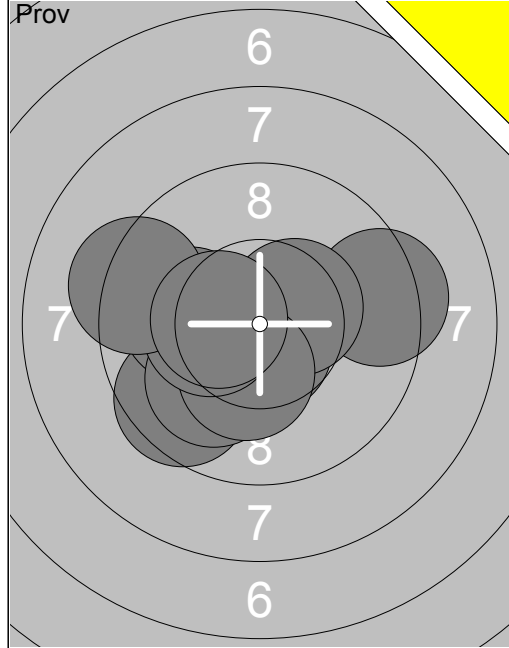

1:	9.6 ↙
2:	10.0 ←
3:	10.7x ↓
4:	10.0 ↙
5:	9.3 →
6:	10.4x ↗
7:	10.3x ↓
8:	10.3x ←
9:	9.3 ←
10:	10.4x ←
Serie	100.3
Total	0.0

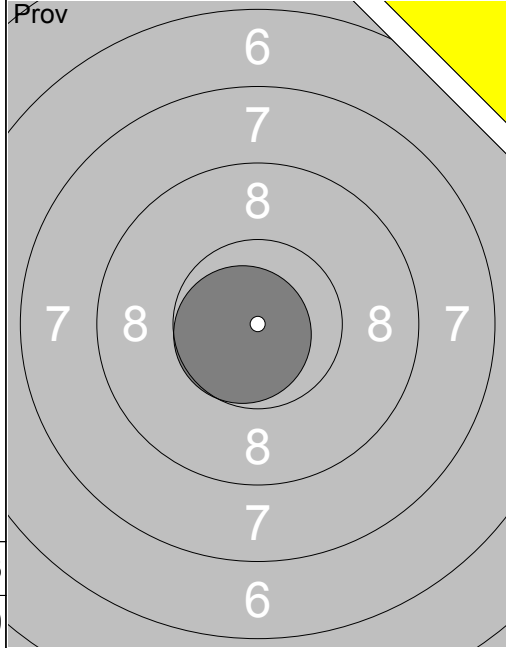

11:	10.7x ↙
Serie	10.7
Total	0.0

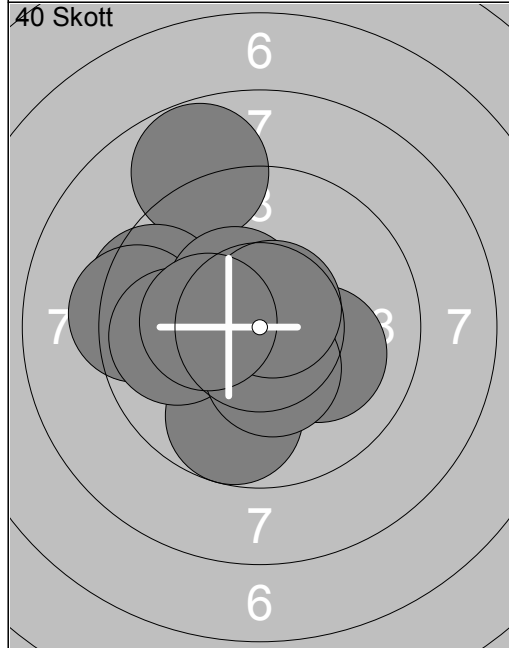

1:	8.8 ↗
2:	9.5 ←
3:	9.3 ←
4:	10.4x ↘
5:	9.7 ↓
6:	10.1 →
7:	9.9 ←
8:	10.4x ↓
9:	10.7x ↗
10:	10.3x ←
Serie	99.1
Total	99.1

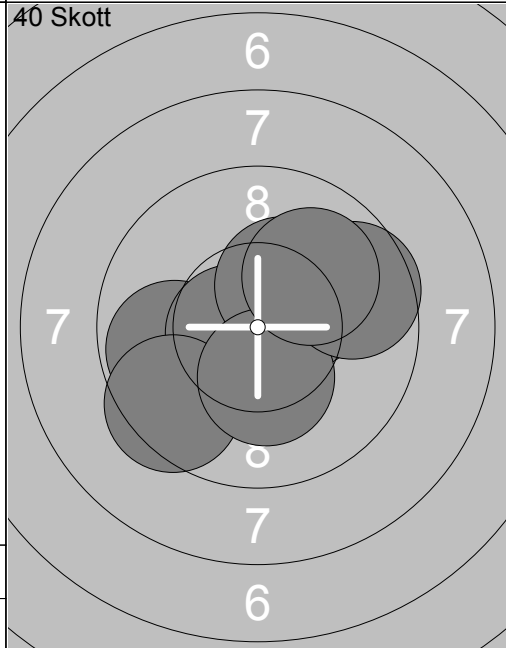

11:	10.4x ↓
12:	9.8 ←
13:	10.3x ↗
14:	10.6x ↓
15:	10.6x ←
16:	9.5 ↙
17:	10.3x ↗
18:	10.3x ↓
19:	9.6 →
20:	10.0 ↗
Serie	101.4
Total	200.5

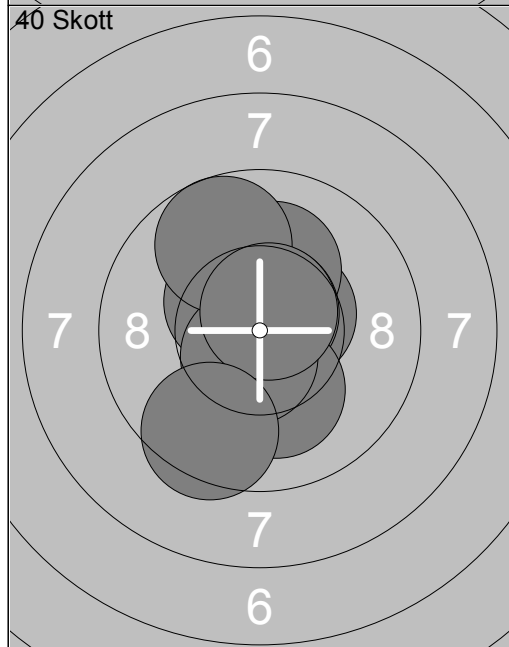

21:	10.7x ↓
22:	10.5x ↗
23:	10.1 ↗
24:	10.7x ↗
25:	10.4x ↘
26:	10.2x ↓
27:	10.6x ↓
28:	9.7 ↗
29:	10.7x ↗
30:	9.5 ↓
Serie	103.1
Total	303.6

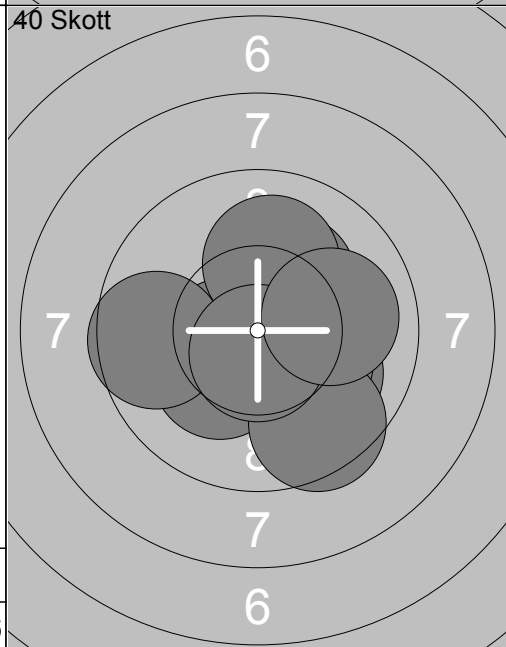

31:	10.0 ↘
32:	10.5x ←
33:	10.2x ↗
34:	10.1 ↗
35:	10.2x ↘
36:	10.2x ↘
37:	9.6 ←
38:	9.5 ↓
39:	10.7x ↓
40:	10.0 →
Serie	101.0
Total	404.6

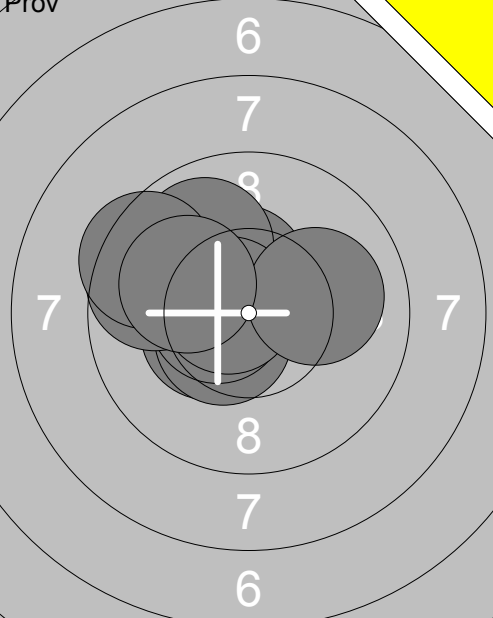
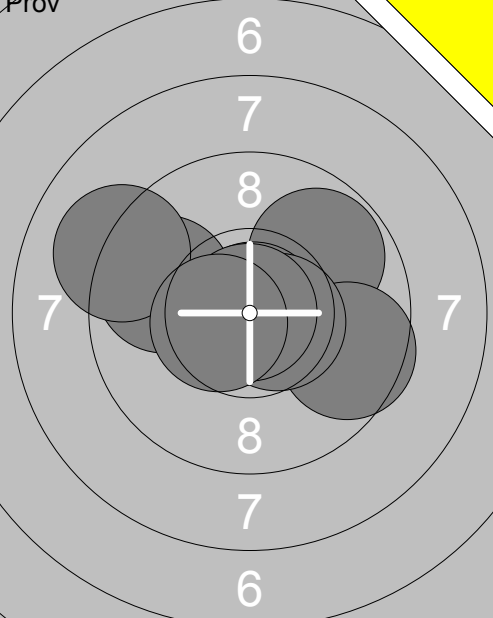
Prov 	1: 10.4x ↗ 2: 10.4x ↘ 3: 10.5x ↘ 4: 10.5x ↘ 5: 9.7 ← 6: 9.9 ↗ 7: 10.7x ↘ 8: 10.1 → 9: 9.5 ← 10: 10.1 ← Serie 101.8 Total 0.0	Prov 	11: 9.8 ↗ 12: 10.8x ↘ 13: 9.8 ← 14: 9.6 → 15: 9.1 ← 16: 10.9x ↗ 17: 10.6x → 18: 10.9x ↘ 19: 10.5x ↘ Serie 92.0 Total 0.0
--	---	--	--

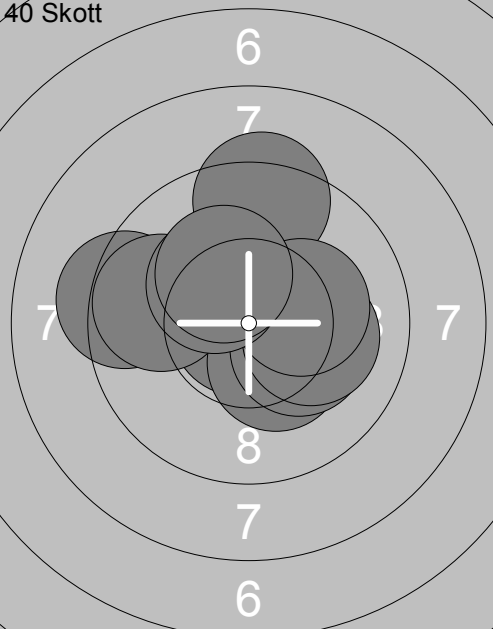
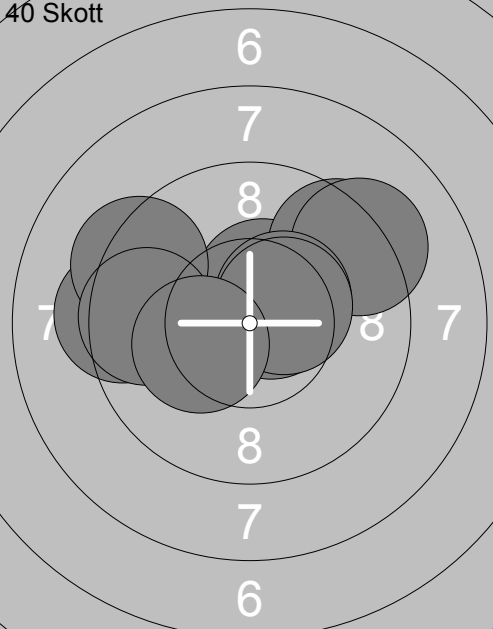
40 Skott 	1: 10.8x ↘ 2: 10.3x ↘ 3: 9.3 ← 4: 9.3 ↑ 5: 10.2x → 6: 10.1 → 7: 10.2x → 8: 9.8 ← 9: 10.3x ↘ 10: 10.2x ↗ Serie 100.5 Total 100.5	40 Skott 	11: 10.6x ↗ 12: 10.5x ↗ 13: 9.5 ↗ 14: 9.3 ← 15: 9.2 ↗ 16: 10.4x ↗ 17: 9.3 ← 18: 10.5x ↗ 19: 9.6 ← 20: 10.3x ↘ Serie 99.2 Total 199.7
---	--	---	---

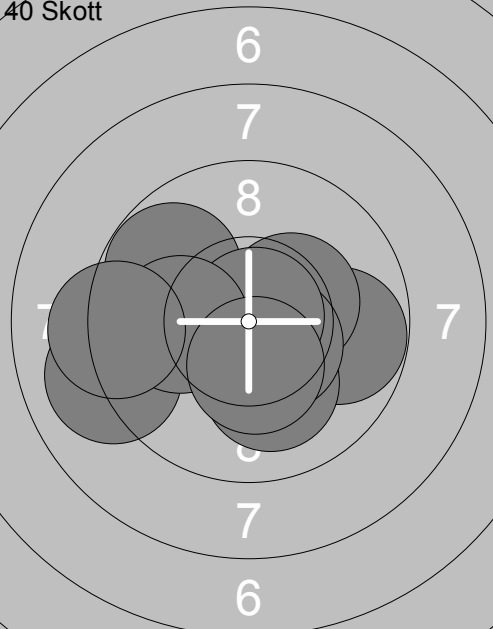
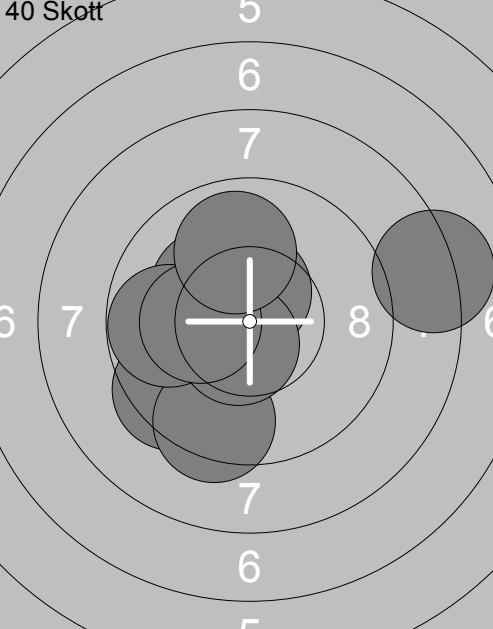
40 Skott 	21: 9.1 ← 22: 9.8 → 23: 9.8 ← 24: 10.3x → 25: 10.1 ↓ 26: 10.5x ↘ 27: 10.8x ↗ 28: 10.1 ← 29: 10.4x ↓ 30: 9.2 ← Serie 100.1 Total 299.8	40 Skott 	31: 9.4 ↘ 32: 8.2 → 33: 10.2x ↘ 34: 10.5x ↑ 35: 9.4 ↓ 36: 9.8 ← 37: 10.5x ↘ 38: 10.6x ↘ 39: 10.2x ← 40: 9.9 ↑ Serie 98.7 Total 398.5
--	--	--	---

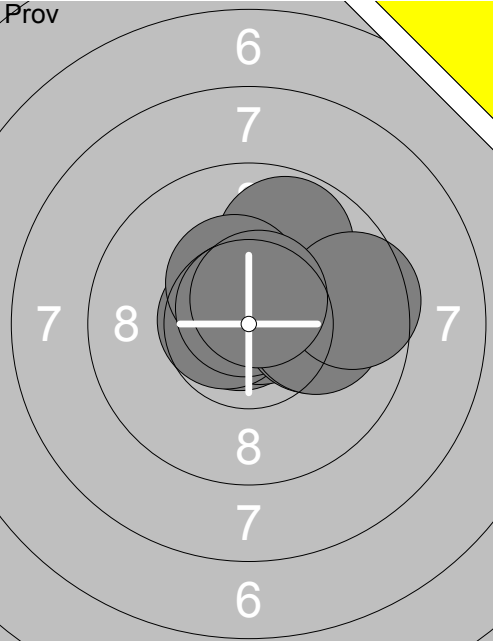
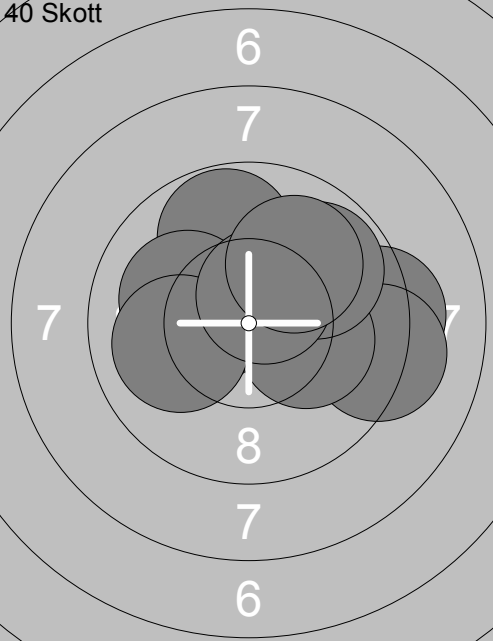
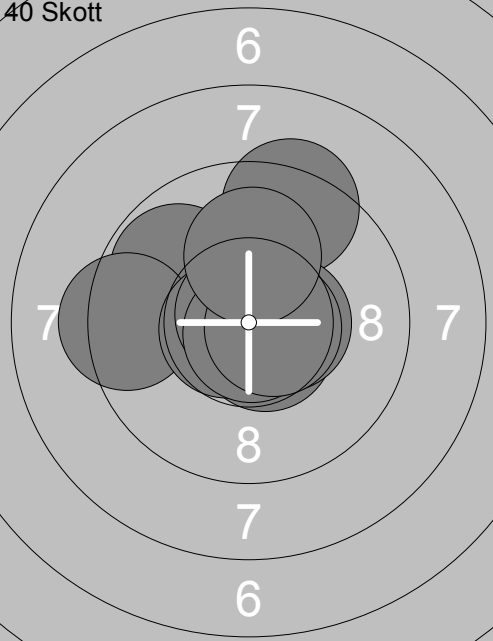
Skjutlag	Tavla	Emelie Hallén	
6	14		
Vindeln	Trosa-Hölebo		Sö
18.03.2017	SM & JSM Luftgevär 2017	Ramselefors SKF	
Prov		1: 10.8x↘ 2: 9.8 ↗ 3: 10.8x↗ 4: 10.7x↘ 5: 10.4x↗ 6: 10.7x↗ 7: 10.1→ 8: 10.1→ 9: 9.6 → 10: 10.6x↗ Serie 103.6 Total 0.0	11: 10.3x↗ 12: 10.5x↗ 13: 10.4x↘ Serie 31.2 Total 0.0
40 Skott		1: 10.4x↘ 2: 9.3 → 3: 9.2 → 4: 9.8 ↗ 5: 10.1↖ 6: 10.2x→ 7: 9.8 ↗ 8: 10.0↖ 9: 10.5x↗ 10: 10.0 ↗ Serie 99.3 Total 99.3	11: 9.7 ↖ 12: 10.5x↗ 13: 10.1 ↗ 14: 10.1↖ 15: 10.7x↘ 16: 10.0 ↗ 17: 10.9x↗ 18: 10.7x↘ 19: 10.0↖ 20: 10.4x→ Serie 103.1 Total 202.4
40 Skott		21: 9.4 ↗ 22: 10.6x↘ 23: 10.5x→ 24: 9.8 ↖ 25: 9.4 ← 26: 10.7x↘ 27: 10.8x↗ 28: 10.8x↘ 29: 10.6x→ 30: 10.1 ↗ Serie 102.7 Total 305.1	31: 10.1↖ 32: 10.4x→ 33: 10.8x↘ 34: 10.6x↘ 35: 10.3x↘ 36: 10.1 ↗ 37: 10.4x↘ 38: 10.2x↘ 39: 10.6x↗ 40: 10.1↖ Serie 103.6 Total 408.7

	<p>1: 10.4x ↘ 2: 10.1 ↘ 3: 10.1 ↗ 4: 9.8 ↘ 5: 8.9 ↘ 6: 9.6 ↑ 7: 10.2x → 8: 10.3x ↑ 9: 10.5x ↑ 10: 9.8 ↑</p> <p>Serie 99.7 Total 0.0</p>		<p>11: 9.9 ↖ 12: 10.4x ↗ 13: 9.8 ← 14: 10.6x → 15: 9.9 ↘</p> <p>Serie 50.6 Total 0.0</p>
--	---	--	---

	<p>1: 10.0 → 2: 10.0 ↖ 3: 10.5x ↑ 4: 10.1 → 5: 10.7x ↘ 6: 10.3x → 7: 10.0 ↖ 8: 10.6x ↖ 9: 9.9 → 10: 9.8 →</p> <p>Serie 101.9 Total 101.9</p>		<p>11: 10.5x ↖ 12: 10.1 → 13: 10.6x → 14: 9.9 ↑ 15: 10.6x ↖ 16: 10.5x ↖ 17: 9.6 ↑ 18: 9.7 ↖ 19: 10.2x ↘ 20: 10.2x ↘</p> <p>Serie 101.9 Total 203.8</p>
--	--	--	--

	<p>21: 10.5x ↘ 22: 10.2x ↘ 23: 9.7 ↗ 24: 10.5x ↑ 25: 9.9 ↗ 26: 10.4x ↖ 27: 9.8 ↖ 28: 9.9 ← 29: 10.0 ↘ 30: 9.7 ↘</p> <p>Serie 100.6 Total 304.4</p>		<p>31: 9.3 ↘ 32: 10.2x → 33: 10.4x → 34: 9.8 ↘ 35: 10.1 ↘ 36: 10.3x ↖ 37: 10.3x → 38: 10.8x ↖ 39: 10.1 ↖ 40: 10.0 ↖</p> <p>Serie 101.3 Total 405.7</p>
--	--	--	--

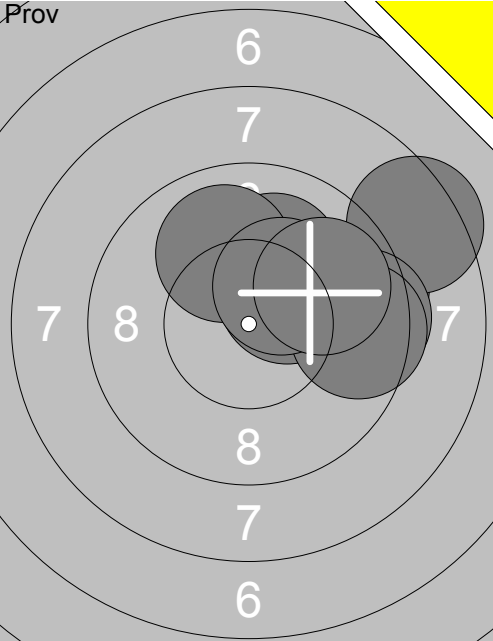
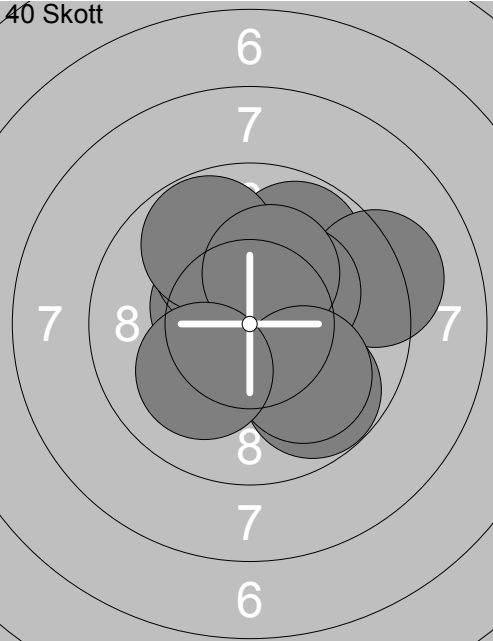
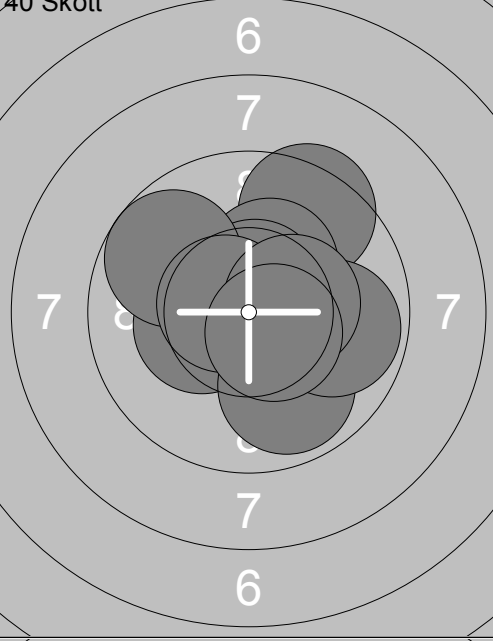
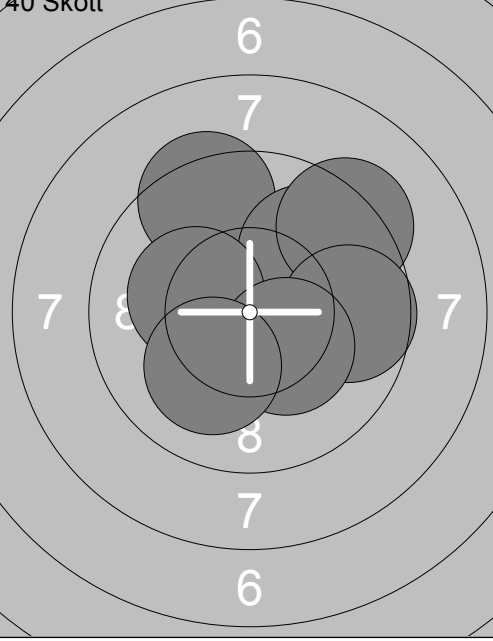
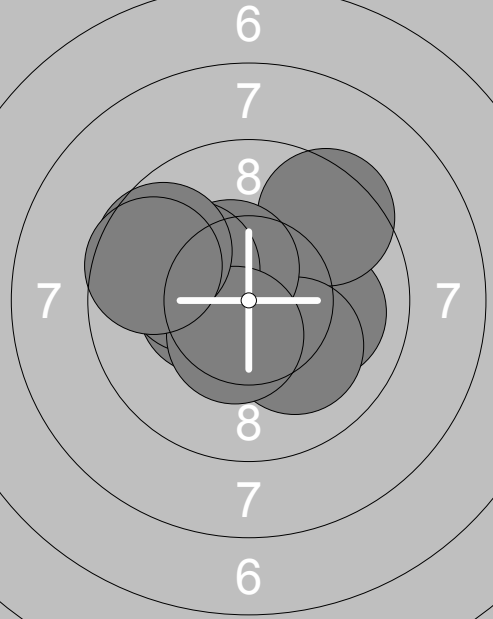
Skjutlag	Tavla	Emelie Cekal	
6	16		
Vindeln	Avesta		Da
18.03.2017	SM & JSM Luftgevär 2017	Ramselefors SKF	
Prov 	1: 9.4 → 2: 8.4 ↗ 3: 10.1 ↗ 4: 9.5 → 5: 10.0 ↗ 6: 10.3x ↗ 7: 9.5 → 8: 10.3x ↗ 9: 9.9 ↗	40 Skott 	1: 9.8 ↘ 2: 9.8 ↗ 3: 9.2 → 4: 10.3x ↗ 5: 10.5x ↗ 6: 10.1 ↗ 7: 9.8 ↗ 8: 10.2x ↗ 9: 10.0 ↘ 10: 10.1 ↘
	Serie 87.4		Serie 99.8
	Total 0.0		Total 99.8
40 Skott 	11: 9.4 ↗ 12: 10.3x ↗ 13: 9.9 ↘ 14: 10.3x ↗ 15: 10.6x ↗ 16: 9.8 → 17: 9.7 ↗ 18: 10.6x ↗ 19: 10.4x → 20: 10.5x ↘	40 Skott 	21: 10.1 → 22: 10.6x ↗ 23: 10.7x ↗ 24: 9.4 ↗ 25: 9.9 ↗ 26: 10.2x ↗ 27: 9.3 ↗ 28: 9.7 → 29: 10.3x ↘ 30: 10.1 ↘
	Serie 101.5		Serie 100.3
	Total 201.3		Total 301.6
40 Skott 	31: 10.0 → 32: 10.4x ↗ 33: 9.5 ↗ 34: 10.2x ↗ 35: 10.1 ↘ 36: 10.5x ↗ 37: 10.1 ↗ 38: 10.5x ↘ 39: 9.7 ↗ 40: 9.6 ↗		
	Serie 100.6		
	Total 402.2		

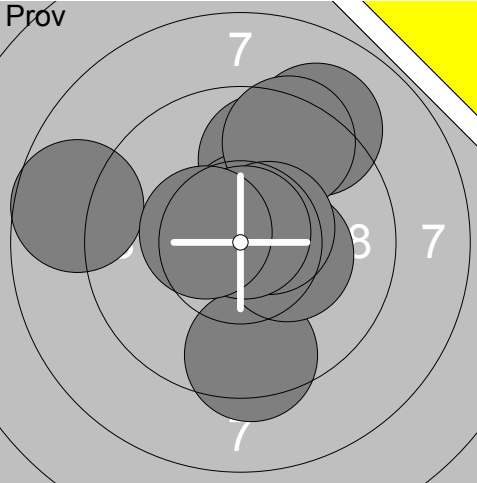
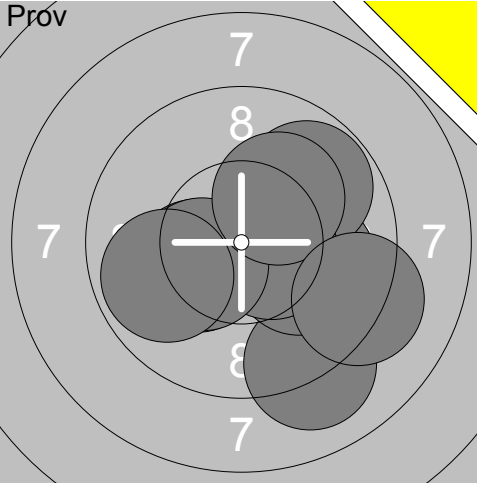
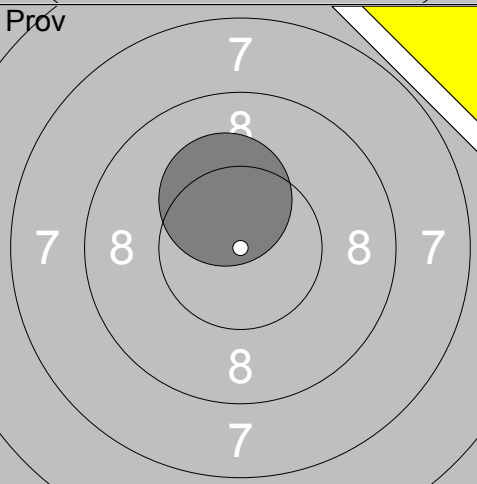
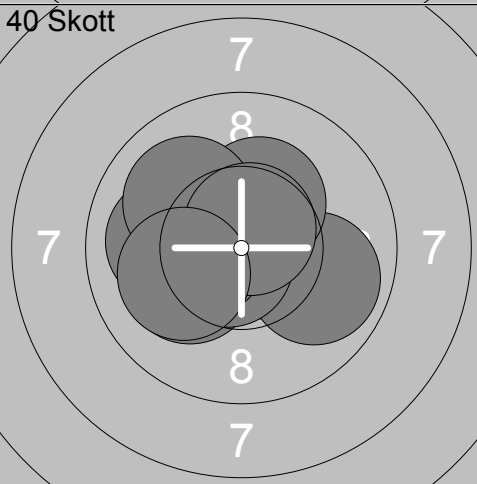
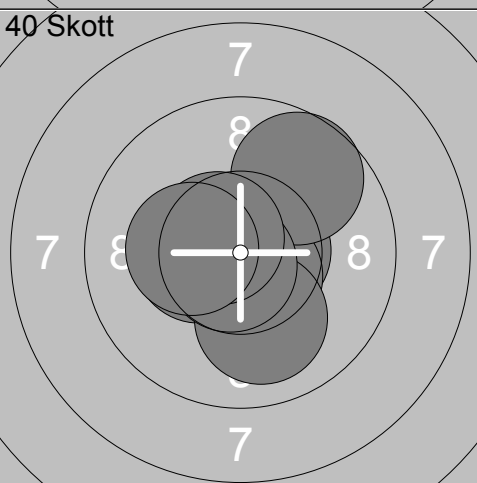
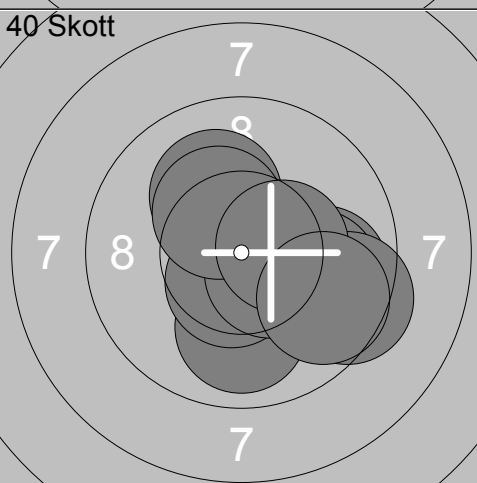
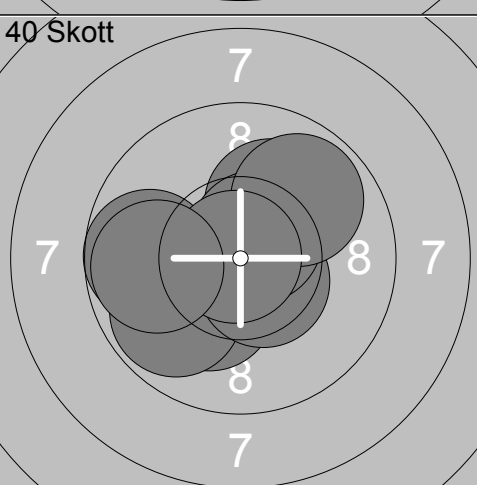
Skjutlag	Tavla	Hilde Karlsson			
6	17				Vb
Vindeln	Ramselefors				
18.03.2017	SM & JSM Luftgevär 2017		Ramselefors SKF		
Prov		1: 9.1 ↗ 2: 9.8 ↑ 3: 10.6x ↑ 4: 9.5 ↑ 5: 9.4 ↓ 6: 10.3x → 7: 10.5x → 8: 8.7 ← 9: 10.8x ↑ 10: 10.5x ←	Prov		11: 10.0 → 12: 10.3x ← 13: 9.1 ↓ 14: 10.1 → 15: 9.8 ↗ 16: 10.5x → 17: 10.3x ← 18: 10.2x ↗ 19: 9.9 ← 20: 9.2 ↘
		Serie 99.2		Serie 99.4	
		Total 0.0		Total 0.0	
Prov		21: 10.3x ↑	40 Skott		1: 10.7x → 2: 10.1 ← 3: 9.9 → 4: 10.7x ← 5: 10.3x ↑ 6: 10.0 ← 7: 10.4x ← 8: 10.0 ↗ 9: 10.7x ↑ 10: 10.1 ←
		Serie 10.3		Serie 102.9	
		Total 0.0		Total 102.9	
40 Skott		11: 10.6x → 12: 10.8x ← 13: 10.9x ↓ 14: 10.4x ← 15: 10.6x ↓ 16: 10.0 ↓ 17: 9.7 ↗ 18: 10.7x ↓ 19: 10.6x ↗ 20: 10.3x ←	40 Skott		21: 9.8 → 22: 10.1 ↗ 23: 10.0 ↓ 24: 10.5x ↓ 25: 9.9 → 26: 10.5x ↓ 27: 9.4 → 28: 10.3x ↗ 29: 10.4x → 30: 9.7 ↘
		Serie 104.6		Serie 100.6	
		Total 207.5		Total 308.1	
40 Skott		31: 10.2x ↓ 32: 10.7x → 33: 9.8 ← 34: 10.1 ↗ 35: 10.5x ↓ 36: 10.6x ↗ 37: 9.8 ↗ 38: 9.7 ← 39: 10.9x ← 40: 9.8 ←			
		Serie 102.1			
		Total 410.2			

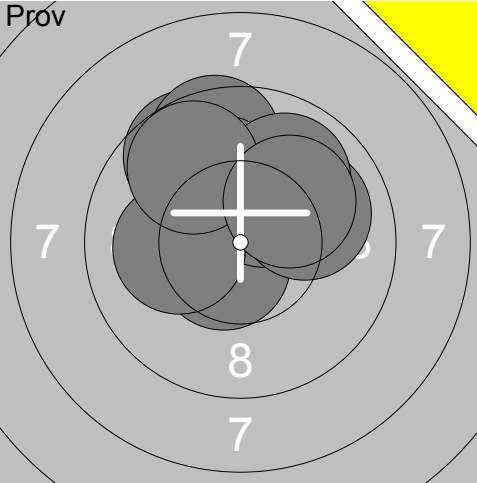
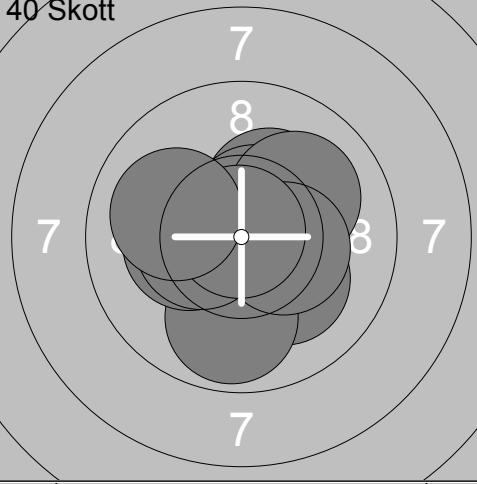
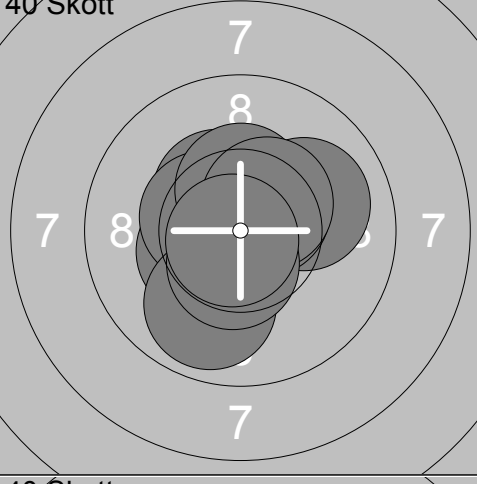
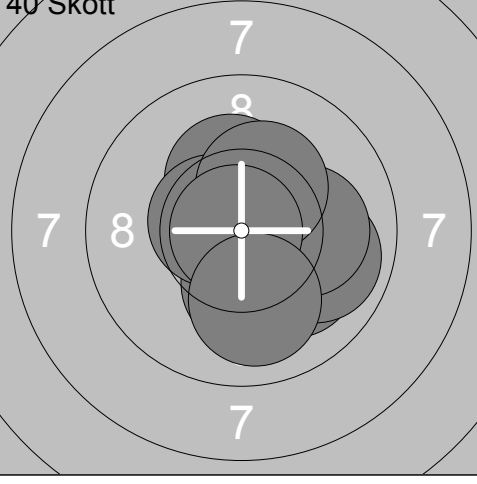
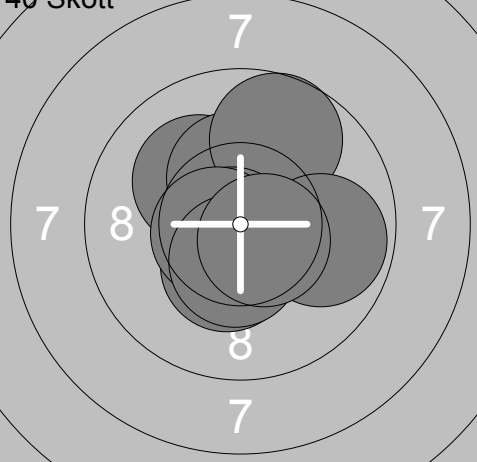
Skjutlag	Tavla	Johanna Andersson		Vg
6	18	Dalstorp		
18.03.2017	SM & JSM Luftgevär 2017	Ramselefors SKF		
Pröv 	1: 9.6 ↗ 2: 9.5 ↑ 3: 10.6x ↓ 4: 10.1 ↑ 5: 10.3x ↗ 6: 10.1 ← 7: 10.0 → 8: 9.9 ↗ 9: 9.8 ↗ 10: 10.1 ↗ Serie 100.0 Total 0.0	Pröv 	11: 10.1 ↗ 12: 10.2x → 13: 9.5 → 14: 10.6x ↓ 15: 10.7x ← 16: 9.9 ↗ 17: 9.5 ↓ 18: 10.2x ← 19: 10.5x → 20: 10.2x ↑ Serie 101.4 Total 0.0	
Pröv 	21: 10.4x ↗ 22: 9.9 ↑ Serie 20.3 Total 0.0	40 Skott 	1: 10.1 ↘ 2: 10.3x ↗ 3: 9.9 ↓ 4: 10.6x ↗ 5: 10.1 ↗ 6: 10.4x → 7: 10.2x ← 8: 10.4x ← 9: 10.9x ↗ 10: 10.0 ← Serie 102.9 Total 102.9	
40 Skott 	11: 10.4x ← 12: 10.0 → 13: 10.4x ↗ 14: 10.4x ← 15: 10.5x ↗ 16: 10.4x ↑ 17: 10.4x ↗ 18: 9.9 ↓ 19: 10.5x ↓ 20: 10.8x ↓ Serie 103.7 Total 206.6	40 Skott 	21: 10.2x ↓ 22: 10.9x ← 23: 10.1 ↘ 24: 9.9 → 25: 10.3x ↗ 26: 10.1 → 27: 10.6x ← 28: 10.3x ↗ 29: 10.9x ← 30: 10.0 ↓ Serie 103.3 Total 309.9	
40 Skott 	31: 10.7x ↘ 32: 10.1 ↗ 33: 10.3x ↗ 34: 9.7 ↗ 35: 10.8x ↓ 36: 9.8 → 37: 10.4x ↓ 38: 10.6x ← 39: 10.5x ↓ 40: 10.6x ↘ Serie 103.5 Total 413.4			

	1: 9.5 ←		11: 10.4x ↗
	2: 10.3x ↘		12: 10.1 ↑
	3: 9.4 ←		13: 10.5x ↗
	4: 10.0 ←		14: 10.7x ↘
	5: 10.3x →		15: 9.3 ↓
	6: 10.8x ↗		16: 10.3x ↘
	7: 10.4x ↘		17: 9.9 →
	8: 10.2x ↘		18: 9.9 →
	9: 9.4 →		
	10: 9.7 →		
Serie 100.0		Serie 81.1	
Total 0.0		Total 0.0	

	1: 9.1 ↓		11: 10.0 ←
	2: 10.6x ↘		12: 9.9 ↖
	3: 10.0 ↓		13: 10.2x ↘
	4: 10.3x ↘		14: 10.2x ↘
	5: 9.9 →		15: 10.1 ↓
	6: 10.6x ←		16: 10.2x ↘
	7: 9.7 ↘		17: 10.6x ↗
	8: 10.3x ↗		18: 10.6x ↘
	9: 10.4x ↗		19: 10.0 ↓
	10: 10.3x ↘		20: 10.5x →
Serie 101.2		Serie 102.3	
Total 101.2		Total 203.5	

	21: 10.3x ↗		31: 10.7x ↘
	22: 10.4x ↘		32: 10.5x ↗
	23: 10.8x ↘		33: 9.5 ↓
	24: 10.6x →		34: 10.1 ↓
	25: 10.1 ↓		35: 10.5x ↘
	26: 10.7x →		36: 9.7 →
	27: 9.9 ↓		37: 9.9 ↓
	28: 9.7 ←		38: 10.2x ↘
	29: 10.4x →		39: 10.2x →
	30: 10.3x ↗		40: 10.2x ↘
Serie 103.2		Serie 101.5	
Total 306.7		Total 408.2	

Skjuttag	Tavla	Anna Mårtensson	
6	20		
Vindeln	Kyrkås		Jä
18.03.2017	SM & JSM Luftgevär 2017	Ramselefors SKF	
Prov		1: 10.1 ← 2: 10.7x ↘ 3: 10.5x ↓ 4: 10.1 ↖ 5: 10.8x ↓ 6: 10.6x ↗ 7: 10.7x → 8: 10.0 → 9: 10.1 ↖ 10: 10.2x ↙	11: 10.0 ↖ 12: 10.7x ↗ 13: 10.0 → 14: 10.2x ↘ 15: 9.7 →
	Serie 103.8	Serie 50.6	
	Total 0.0	Total 0.0	
40 Skott		1: 10.0 ← 2: 10.8x ↘ 3: 10.7x ↘ 4: 10.9x → 5: 10.1 → 6: 10.7x ↗ 7: 10.1 ← 8: 9.7 ↓ 9: 9.9 ↖ 10: 10.3x →	11: 10.7x ↓ 12: 9.9 ← 13: 10.0 ↘ 14: 10.8x → 15: 10.1 ↖ 16: 10.5x ↗ 17: 10.7x ↓ 18: 10.7x ↓ 19: 10.3x ↘ 20: 10.5x ↓
	Serie 103.2	Serie 104.2	
	Total 103.2	Total 207.4	
40 Skott		21: 10.3x ↘ 22: 10.5x ↓ 23: 10.7x ↘ 24: 10.6x ← 25: 10.4x ↗ 26: 10.2x → 27: 10.0 ↓ 28: 10.7x ↗ 29: 10.2x ↘ 30: 10.5x ↘	31: 10.4x ↘ 32: 10.2x ↘ 33: 10.0 → 34: 10.2x ↗ 35: 10.7x ↘ 36: 10.4x → 37: 10.2x ↗ 38: 10.1 ↓ 39: 9.6 ↑ 40: 9.9 ↓
	Serie 104.1	Serie 101.7	
	Total 311.5	Total 413.2	

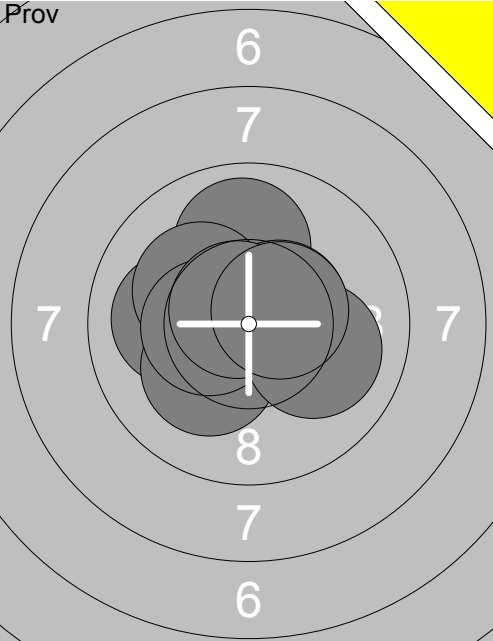
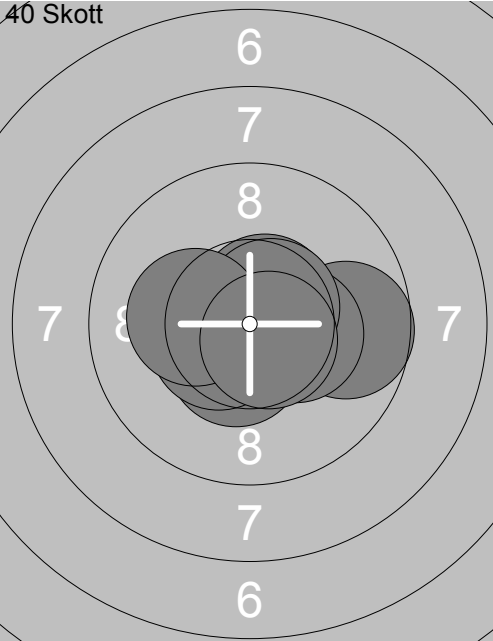
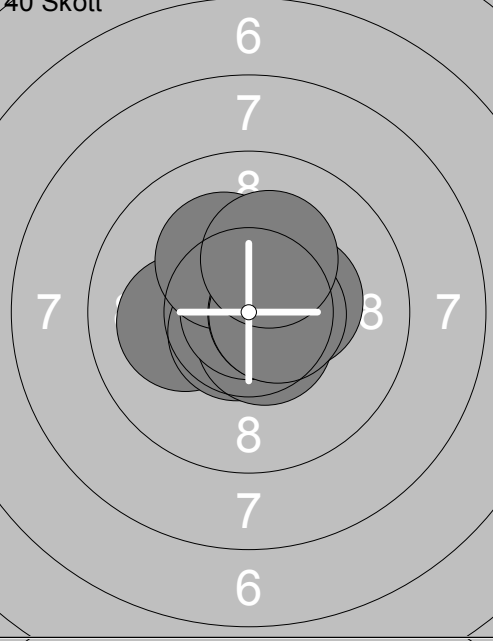
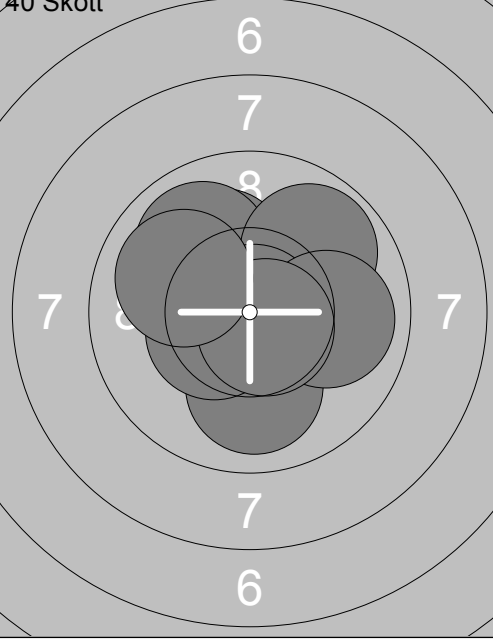
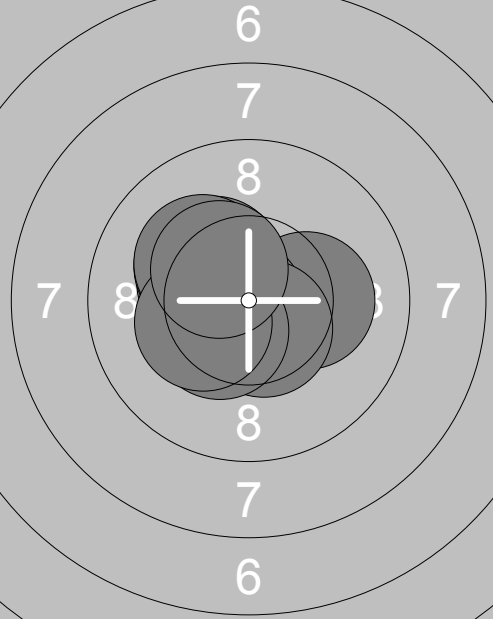
Skjutlag	Tavla	Michaela Arvidsson	
6	21		
Vindeln	Eskilstuna		Sö
18.03.2017	SM & JSM Luftgevär 2017	Ramselefors SKF	
Prov 	1: 9.9 ↑ 2: 10.5x↗ 3: 10.1← 4: 10.2x↘ 5: 10.2x↘ 6: 10.4x↘ 7: 10.7x↘ 8: 10.0⇒ 9: 10.5x↗	40 Skott 	1: 9.7 → 2: 10.6x↗ 3: 10.8x⇒ 4: 10.5x↘ 5: 10.5x↘ 6: 10.3x⇒ 7: 10.6x↗ 8: 10.5x↘ 9: 10.2x↘ 10: 10.6x↘
	Serie 92.5		Serie 104.3
	Total 0.0		Total 104.3
40 Skott 	11: 10.6x↘ 12: 10.1← 13: 10.7x↘ 14: 10.3x⇒ 15: 10.6x↘ 16: 10.9x↑ 17: 10.2x↗ 18: 10.6x⇒ 19: 10.6x⇒ 20: 10.2x↗	40 Skott 	21: 10.1 ↖ 22: 10.8x↘ 23: 10.0 ↓ 24: 9.9 ↖ 25: 9.9 ↗ 26: 10.9x⇒ 27: 9.9 → 28: 10.4x↘ 29: 10.7x↘ 30: 10.0 ↖
	Serie 104.8		Serie 102.6
	Total 209.1		Total 311.7
40 Skott 	31: 10.2x⇒ 32: 10.8x↘ 33: 10.3x↘ 34: 10.5x↘ 35: 10.3x↘ 36: 10.2x↘ 37: 10.2x↘ 38: 10.4x↘ 39: 10.3x↘ 40: 10.4x↘		
	Serie 103.6		
	Total 415.3		

<p>Prov</p>	<table border="1" style="width:100%; border-collapse: collapse;"> <tr><td>1:</td><td>9.8</td><td>↘</td></tr> <tr><td>2:</td><td>10.1</td><td>↑</td></tr> <tr><td>3:</td><td>10.5x</td><td>↘</td></tr> <tr><td>4:</td><td>10.2x</td><td>↗</td></tr> <tr><td>5:</td><td>10.0</td><td>↙</td></tr> <tr><td>6:</td><td>10.1</td><td>←</td></tr> <tr><td>7:</td><td>10.0</td><td>↗</td></tr> <tr><td>8:</td><td>10.2x</td><td>↑</td></tr> <tr><td>9:</td><td>10.5x</td><td>←</td></tr> <tr><td>10:</td><td>10.6x</td><td>↘</td></tr> <tr><td colspan="2">Serie</td><td>102.0</td></tr> <tr><td colspan="2">Total</td><td>0.0</td></tr> </table>	1:	9.8	↘	2:	10.1	↑	3:	10.5x	↘	4:	10.2x	↗	5:	10.0	↙	6:	10.1	←	7:	10.0	↗	8:	10.2x	↑	9:	10.5x	←	10:	10.6x	↘	Serie		102.0	Total		0.0	<p>Prov</p>	<table border="1" style="width:100%; border-collapse: collapse;"> <tr><td>11:</td><td>10.1</td><td>→</td></tr> <tr><td>12:</td><td>9.0</td><td>→</td></tr> <tr><td>13:</td><td>10.1</td><td>↗</td></tr> <tr><td>14:</td><td>10.6x</td><td>↑</td></tr> <tr><td>15:</td><td>10.5x</td><td>→</td></tr> <tr><td>16:</td><td>10.0</td><td>↘</td></tr> <tr><td>17:</td><td>10.5x</td><td>↘</td></tr> <tr><td>18:</td><td>9.9</td><td>→</td></tr> <tr><td>19:</td><td>10.4x</td><td>←</td></tr> <tr><td>20:</td><td>10.1</td><td>→</td></tr> <tr><td colspan="2">Serie</td><td>101.2</td></tr> <tr><td colspan="2">Total</td><td>0.0</td></tr> </table>	11:	10.1	→	12:	9.0	→	13:	10.1	↗	14:	10.6x	↑	15:	10.5x	→	16:	10.0	↘	17:	10.5x	↘	18:	9.9	→	19:	10.4x	←	20:	10.1	→	Serie		101.2	Total		0.0
1:	9.8	↘																																																																									
2:	10.1	↑																																																																									
3:	10.5x	↘																																																																									
4:	10.2x	↗																																																																									
5:	10.0	↙																																																																									
6:	10.1	←																																																																									
7:	10.0	↗																																																																									
8:	10.2x	↑																																																																									
9:	10.5x	←																																																																									
10:	10.6x	↘																																																																									
Serie		102.0																																																																									
Total		0.0																																																																									
11:	10.1	→																																																																									
12:	9.0	→																																																																									
13:	10.1	↗																																																																									
14:	10.6x	↑																																																																									
15:	10.5x	→																																																																									
16:	10.0	↘																																																																									
17:	10.5x	↘																																																																									
18:	9.9	→																																																																									
19:	10.4x	←																																																																									
20:	10.1	→																																																																									
Serie		101.2																																																																									
Total		0.0																																																																									
<p>Prov</p>	<table border="1" style="width:100%; border-collapse: collapse;"> <tr><td>21:</td><td>9.0</td><td>↙</td></tr> <tr><td>22:</td><td>10.1</td><td>↑</td></tr> <tr><td>23:</td><td>10.4x</td><td>↗</td></tr> <tr><td colspan="2">Serie</td><td>29.5</td></tr> <tr><td colspan="2">Total</td><td>0.0</td></tr> </table>	21:	9.0	↙	22:	10.1	↑	23:	10.4x	↗	Serie		29.5	Total		0.0	<p>40 Skott</p>	<table border="1" style="width:100%; border-collapse: collapse;"> <tr><td>1:</td><td>10.1</td><td>←</td></tr> <tr><td>2:</td><td>10.2x</td><td>↙</td></tr> <tr><td>3:</td><td>10.2x</td><td>↓</td></tr> <tr><td>4:</td><td>10.1</td><td>↙</td></tr> <tr><td>5:</td><td>10.8x</td><td>↓</td></tr> <tr><td>6:</td><td>10.7x</td><td>↓</td></tr> <tr><td>7:</td><td>9.8</td><td>↙</td></tr> <tr><td>8:</td><td>10.7x</td><td>←</td></tr> <tr><td>9:</td><td>10.5x</td><td>→</td></tr> <tr><td>10:</td><td>10.8x</td><td>↑</td></tr> <tr><td colspan="2">Serie</td><td>103.9</td></tr> <tr><td colspan="2">Total</td><td>103.9</td></tr> </table>	1:	10.1	←	2:	10.2x	↙	3:	10.2x	↓	4:	10.1	↙	5:	10.8x	↓	6:	10.7x	↓	7:	9.8	↙	8:	10.7x	←	9:	10.5x	→	10:	10.8x	↑	Serie		103.9	Total		103.9																					
21:	9.0	↙																																																																									
22:	10.1	↑																																																																									
23:	10.4x	↗																																																																									
Serie		29.5																																																																									
Total		0.0																																																																									
1:	10.1	←																																																																									
2:	10.2x	↙																																																																									
3:	10.2x	↓																																																																									
4:	10.1	↙																																																																									
5:	10.8x	↓																																																																									
6:	10.7x	↓																																																																									
7:	9.8	↙																																																																									
8:	10.7x	←																																																																									
9:	10.5x	→																																																																									
10:	10.8x	↑																																																																									
Serie		103.9																																																																									
Total		103.9																																																																									
<p>40 Skott</p>	<table border="1" style="width:100%; border-collapse: collapse;"> <tr><td>11:</td><td>10.0</td><td>←</td></tr> <tr><td>12:</td><td>10.2x</td><td>←</td></tr> <tr><td>13:</td><td>10.0</td><td>↑</td></tr> <tr><td>14:</td><td>10.5x</td><td>←</td></tr> <tr><td>15:</td><td>10.3x</td><td>↑</td></tr> <tr><td>16:</td><td>10.3x</td><td>↑</td></tr> <tr><td>17:</td><td>10.4x</td><td>↑</td></tr> <tr><td>18:</td><td>10.7x</td><td>↑</td></tr> <tr><td>19:</td><td>10.4x</td><td>→</td></tr> <tr><td>20:</td><td>10.7x</td><td>↖</td></tr> <tr><td colspan="2">Serie</td><td>103.5</td></tr> <tr><td colspan="2">Total</td><td>207.4</td></tr> </table>	11:	10.0	←	12:	10.2x	←	13:	10.0	↑	14:	10.5x	←	15:	10.3x	↑	16:	10.3x	↑	17:	10.4x	↑	18:	10.7x	↑	19:	10.4x	→	20:	10.7x	↖	Serie		103.5	Total		207.4	<p>40 Skott</p>	<table border="1" style="width:100%; border-collapse: collapse;"> <tr><td>21:</td><td>9.9</td><td>↖</td></tr> <tr><td>22:</td><td>9.4</td><td>→</td></tr> <tr><td>23:</td><td>9.7</td><td>↘</td></tr> <tr><td>24:</td><td>9.8</td><td>→</td></tr> <tr><td>25:</td><td>10.5x</td><td>↗</td></tr> <tr><td>26:</td><td>10.4x</td><td>←</td></tr> <tr><td>27:</td><td>10.0</td><td>↙</td></tr> <tr><td>28:</td><td>9.8</td><td>←</td></tr> <tr><td>29:</td><td>10.3x</td><td>↓</td></tr> <tr><td>30:</td><td>10.0</td><td>→</td></tr> <tr><td colspan="2">Serie</td><td>99.8</td></tr> <tr><td colspan="2">Total</td><td>307.2</td></tr> </table>	21:	9.9	↖	22:	9.4	→	23:	9.7	↘	24:	9.8	→	25:	10.5x	↗	26:	10.4x	←	27:	10.0	↙	28:	9.8	←	29:	10.3x	↓	30:	10.0	→	Serie		99.8	Total		307.2
11:	10.0	←																																																																									
12:	10.2x	←																																																																									
13:	10.0	↑																																																																									
14:	10.5x	←																																																																									
15:	10.3x	↑																																																																									
16:	10.3x	↑																																																																									
17:	10.4x	↑																																																																									
18:	10.7x	↑																																																																									
19:	10.4x	→																																																																									
20:	10.7x	↖																																																																									
Serie		103.5																																																																									
Total		207.4																																																																									
21:	9.9	↖																																																																									
22:	9.4	→																																																																									
23:	9.7	↘																																																																									
24:	9.8	→																																																																									
25:	10.5x	↗																																																																									
26:	10.4x	←																																																																									
27:	10.0	↙																																																																									
28:	9.8	←																																																																									
29:	10.3x	↓																																																																									
30:	10.0	→																																																																									
Serie		99.8																																																																									
Total		307.2																																																																									
<p>40 Skott</p>	<table border="1" style="width:100%; border-collapse: collapse;"> <tr><td>31:</td><td>9.9</td><td>→</td></tr> <tr><td>32:</td><td>10.4x</td><td>→</td></tr> <tr><td>33:</td><td>10.5x</td><td>↖</td></tr> <tr><td>34:</td><td>10.4x</td><td>↗</td></tr> <tr><td>35:</td><td>10.3x</td><td>↗</td></tr> <tr><td>36:</td><td>9.7</td><td>↘</td></tr> <tr><td>37:</td><td>9.9</td><td>↙</td></tr> <tr><td>38:</td><td>10.1</td><td>←</td></tr> <tr><td>39:</td><td>10.5x</td><td>↗</td></tr> <tr><td>40:</td><td>10.4x</td><td>←</td></tr> <tr><td colspan="2">Serie</td><td>102.1</td></tr> <tr><td colspan="2">Total</td><td>409.3</td></tr> </table>	31:	9.9	→	32:	10.4x	→	33:	10.5x	↖	34:	10.4x	↗	35:	10.3x	↗	36:	9.7	↘	37:	9.9	↙	38:	10.1	←	39:	10.5x	↗	40:	10.4x	←	Serie		102.1	Total		409.3																																						
31:	9.9	→																																																																									
32:	10.4x	→																																																																									
33:	10.5x	↖																																																																									
34:	10.4x	↗																																																																									
35:	10.3x	↗																																																																									
36:	9.7	↘																																																																									
37:	9.9	↙																																																																									
38:	10.1	←																																																																									
39:	10.5x	↗																																																																									
40:	10.4x	←																																																																									
Serie		102.1																																																																									
Total		409.3																																																																									

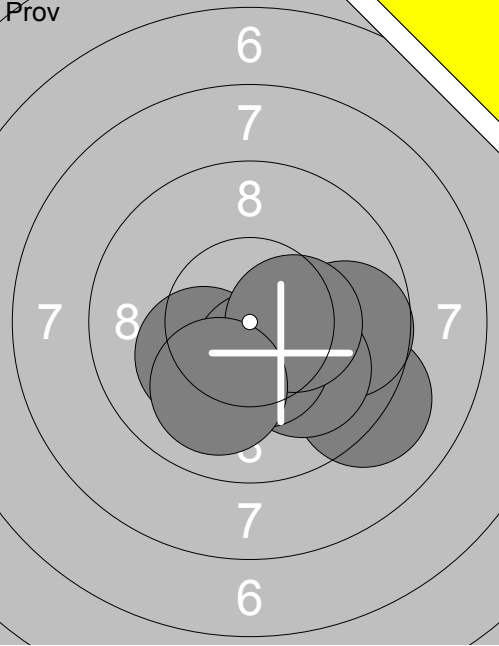
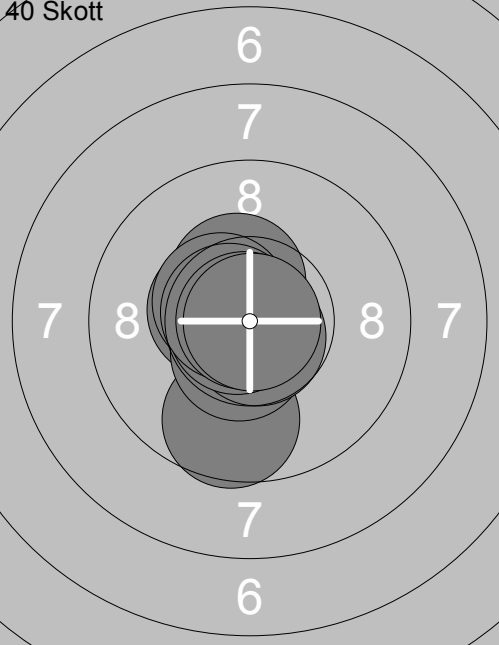
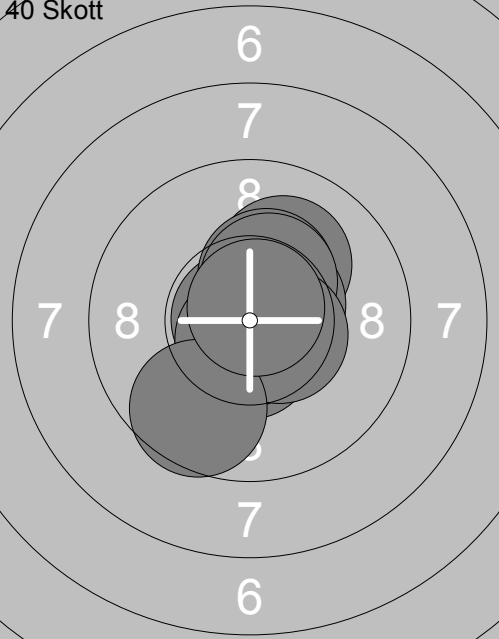
Skjuttag	Tavla	Emilia Bédoire	
6	23		
Vindeln	Filipstad		Vä
18.03.2017	SM & JSM Luftgevär 2017	Ramselefors SKF	
Prov		1: 10.0 ↘ 2: 10.5x↓ 3: 9.2 ↘ 4: 9.7 → 5: 10.4x↓ 6: 10.0 ↘ 7: 10.2x↘ 8: 10.4x↓ 9: 10.4x→ 10: 10.0 ↓ Serie 100.8 Total 0.0	11: 10.4x→ 12: 10.8x↘ 13: 9.2 → Serie 30.4 Total 0.0
40 Skott		1: 10.4x↗ 2: 10.5x↘ 3: 10.5x↘ 4: 9.6 ↓ 5: 10.5x↓ 6: 10.7x↓ 7: 10.8x↘ 8: 10.7x↘ 9: 10.9x↘ 10: 10.9x→ Serie 105.5 Total 105.5	11: 10.9x↘ 12: 10.2x↗ 13: 10.7x↓ 14: 10.4x↘ 15: 10.2x↘ 16: 10.8x↗ 17: 10.2x↗ 18: 9.7 → 19: 10.2x↗ 20: 10.3x↗ Serie 103.6 Total 209.1
40 Skott		21: 10.8x↘ 22: 10.1 ↗ 23: 10.6x↓ 24: 10.4x↗ 25: 10.5x↗ 26: 10.7x↓ 27: 10.4x↗ 28: 10.5x↘ 29: 9.6 ↓ 30: 10.8x↗ Serie 104.4 Total 313.5	31: 10.7x↗ 32: 9.7 → 33: 9.6 ↓ 34: 9.9 ↓ 35: 10.3x↓ 36: 10.8x↗ 37: 9.9 ↓ 38: 10.5x↘ 39: 10.2x↗ 40: 10.2x↘ Serie 101.8 Total 415.3

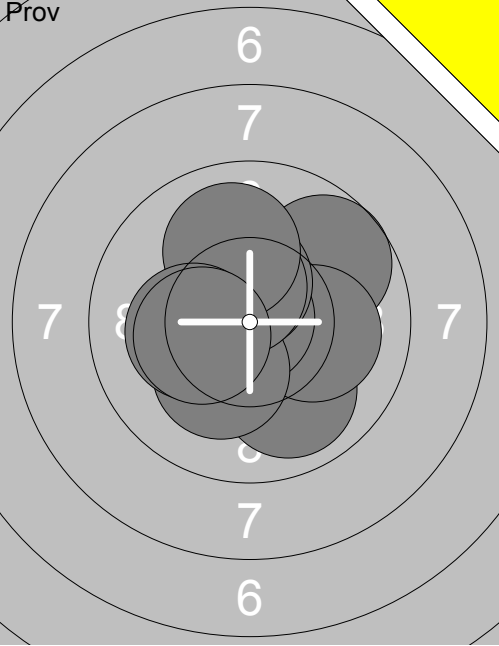
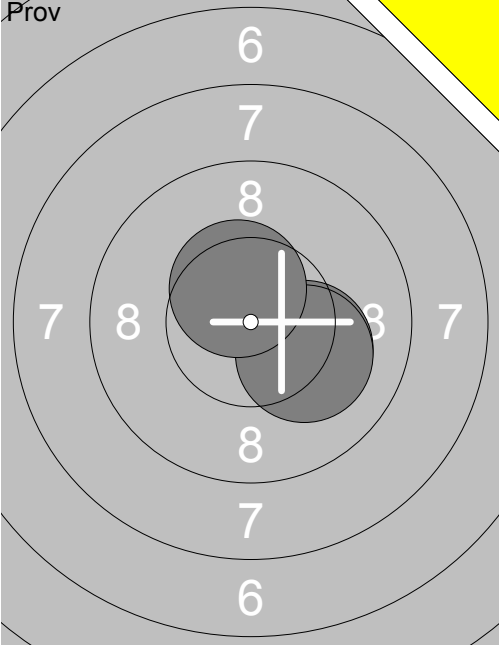
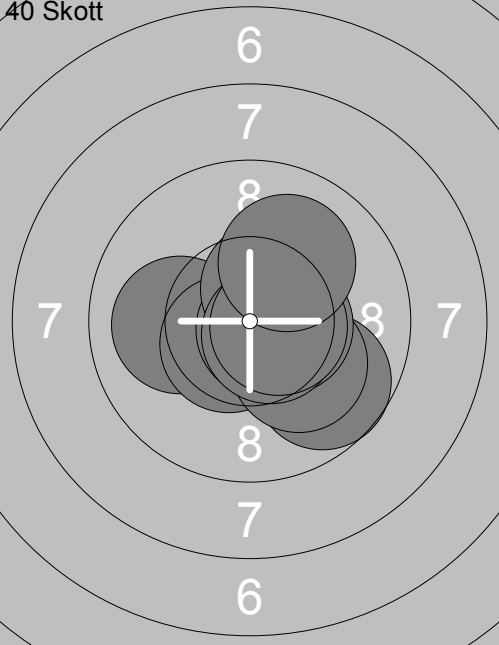
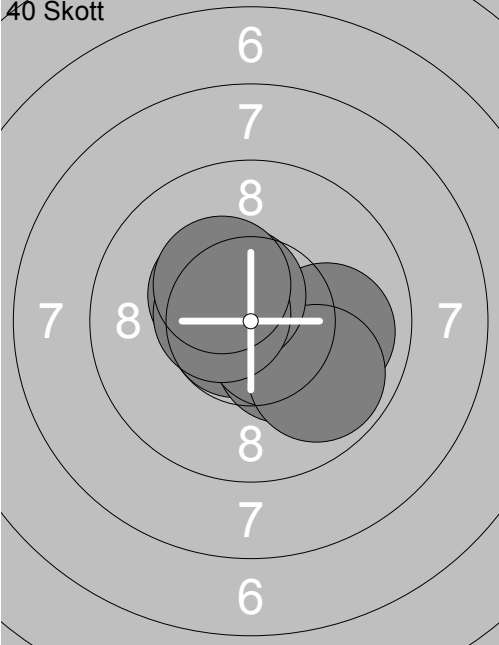
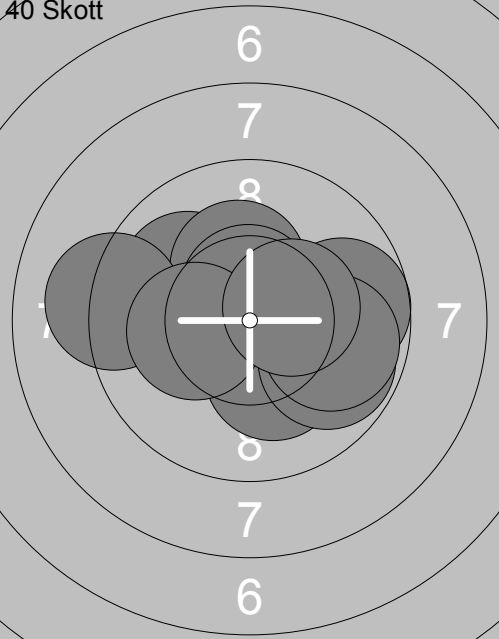
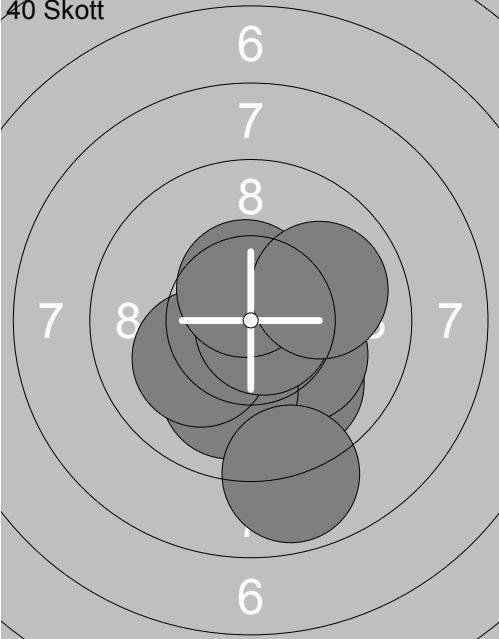
Skjuttag	Tavla	Malin Stafås	
6	24		
Vindeln	Skoga-Ekshärad		Vä
18.03.2017	SM & JSM Luftgevär 2017	Ramselefors SKF	
	1: 9.7 ↗ 2: 9.9 ↓ 3: 10.1 → 4: 10.9 ↗ 5: 10.2 ↘ 6: 10.4 ↗ 7: 10.5 ↗ 8: 10.0 ↑ 9: 10.2 ↘ 10: 10.3 ↘ Serie 102.2 Total 0.0		11: 10.2 ↘ 12: 10.1 ↘ 13: 10.5 ↗ Serie 30.8 Total 0.0
	1: 10.0 ← 2: 10.5 ↘ 3: 9.7 ↓ 4: 10.1 ↓ 5: 10.7 ↘ 6: 10.5 ↗ 7: 10.5x → 8: 10.6x ↘ 9: 10.6x → 10: 10.0 ↗ Serie 103.2 Total 103.2		11: 10.7 ↘ 12: 10.4 ↘ 13: 10.8x → 14: 10.3x ↘ 15: 10.6x ↘ 16: 10.0 → 17: 9.9 ↓ 18: 10.6x ↗ 19: 10.6x ↘ 20: 10.3x ↗ Serie 104.2 Total 207.4
	21: 10.0 ↖ 22: 10.2x ↘ 23: 10.3x ↗ 24: 9.7 → 25: 9.2 ← 26: 9.8 → 27: 10.6x ↗ 28: 10.2x ↘ 29: 9.9 → 30: 10.4x → Serie 100.3 Total 307.7		31: 9.9 ↓ 32: 10.7x → 33: 10.2x ↘ 34: 10.0 ↓ 35: 10.8x ↘ 36: 10.1 ↖ 37: 8.9 ↓ 38: 10.8x ↘ 39: 10.5x ↗ 40: 10.0 → Serie 101.9 Total 409.6

<p>Prov</p>	<p>1: 10.5x ↘ 2: 10.5x ↓ 3: 10.5x → 4: 10.0 ↓ 5: 10.8x ↑ 6: 10.3x → 7: 9.5 ↘ 8: 10.2x → 9: 10.3x → 10: 9.2 →</p> <p>Serie 101.8 Total 0.0</p>	<p>Prov</p>	<p>11: 10.0 → 12: 10.1 ↑ 13: 10.5x ↘ 14: 10.5x ↘ 15: 10.6x ↘</p> <p>Serie 51.7 Total 0.0</p>
<p>40 Skott</p>	<p>1: 9.6 ↑ 2: 10.6x ↘ 3: 10.2x ↘ 4: 10.0 ↘ 5: 10.5x ↓ 6: 10.8x ↓ 7: 10.7x → 8: 9.9 ↓ 9: 10.1 → 10: 10.0 ↘</p> <p>Serie 102.4 Total 102.4</p>	<p>40 Skott</p>	<p>11: 10.2x ↓ 12: 10.6x ↘ 13: 10.6x ↘ 14: 10.5x ↘ 15: 10.2x ↗ 16: 10.4x ↘ 17: 10.5x ↘ 18: 9.7 ← 19: 10.4x ↘ 20: 10.4x ↘</p> <p>Serie 103.5 Total 205.9</p>
<p>40 Skott</p>	<p>21: 10.6x ↘ 22: 10.6x ↘ 23: 10.2x ↘ 24: 9.7 ← 25: 10.2x → 26: 10.3x ↘ 27: 10.5x ↑ 28: 9.8 ↗ 29: 10.3x ↑ 30: 9.6 ←</p> <p>Serie 101.8 Total 307.7</p>	<p>40 Skott</p>	<p>31: 9.5 → 32: 10.1 → 33: 10.5x ↘ 34: 10.4x ↘ 35: 10.4x ↓ 36: 10.1 ↗ 37: 10.9x ↓ 38: 10.2x ↗ 39: 10.6x ↘ 40: 10.4x ↘</p> <p>Serie 103.1 Total 410.8</p>

<p>Pröv</p>	<p>1: 9.8 ↙ 2: 10.4x ↗ 3: 9.5 ↗ 4: 10.3x → 5: 10.1 ← 6: 10.7x ↗ 7: 10.1 ↗ 8: 10.0 ← 9: 10.8x ↓ 10: 9.4 ←</p> <p>Serie 101.1 Total 0.0</p>	<p>Pröv</p>	<p>11: 10.4x ← 12: 10.6x → 13: 10.2x ↗ 14: 10.0 ← 15: 10.4x ↙ 16: 10.2x ↗ 17: 10.0 ← 18: 10.4x ↗ 19: 10.4x ↗ 20: 10.4x ↙</p> <p>Serie 103.0 Total 0.0</p>
<p>Pröv</p>	<p>21: 10.6x ↙ 22: 10.4x ↗ 23: 10.0 ↓</p> <p>Serie 31.0 Total 0.0</p>	<p>40 Skott</p>	<p>1: 10.5x ↗ 2: 10.6x → 3: 10.0 → 4: 10.0 → 5: 10.5x ↘ 6: 9.4 ↙ 7: 9.9 ← 8: 10.1 ← 9: 9.5 ← 10: 10.6x ↗</p> <p>Serie 101.1 Total 101.1</p>
<p>40 Skott</p>	<p>11: 10.4x ↗ 12: 10.7x ↗ 13: 10.5x ↘ 14: 10.7x → 15: 10.5x ↘ 16: 10.1 ↘ 17: 10.1 ← 18: 10.2x ↘ 19: 10.6x ↓ 20: 10.2x ←</p> <p>Serie 104.0 Total 205.1</p>	<p>40 Skott</p>	<p>21: 9.9 ← 22: 9.8 ← 23: 9.9 ↗ 24: 10.4x ↘ 25: 10.4x ← 26: 10.5x → 27: 9.9 ↘ 28: 9.7 ↗ 29: 10.2x ↗ 30: 10.4x ←</p> <p>Serie 101.1 Total 306.2</p>
<p>40 Skott</p>	<p>31: 10.7x → 32: 10.6x ↗ 33: 10.1 ↘ 34: 10.1 ↗ 35: 10.6x → 36: 9.3 ← 37: 10.3x ← 38: 9.7 ↗ 39: 10.4x ↘ 40: 10.8x ←</p> <p>Serie 102.6 Total 408.8</p>		

<p>Prov</p>	<p>1: 10.3x↓ 2: 10.6x↑ 3: 9.7 ↑ 4: 10.4↖ 5: 10.2x↖ 6: 10.0 ↖ 7: 9.4 ← 8: 10.1 ↗ 9: 10.2x↗ 10: 10.3x➤</p> <p>Serie 101.2 Total 0.0</p>	<p>Prov</p>	<p>11: 10.5x↓ 12: 10.0 ➤ 13: 9.7 ↙ 14: 10.2x↖</p> <p>Serie 40.4 Total 0.0</p>
<p>40 Skott</p>	<p>1: 10.5x↑ 2: 10.5x↓ 3: 10.6x↑ 4: 10.6x↘ 5: 10.2x↖ 6: 10.5x➤ 7: 10.1 ↓ 8: 9.9 ↘ 9: 10.8x➤ 10: 10.0➔</p> <p>Serie 103.7 Total 103.7</p>	<p>40 Skott</p>	<p>11: 10.3x↖ 12: 10.7x↓ 13: 10.6x↓ 14: 9.8 ↑ 15: 10.6x➤ 16: 10.5x↖ 17: 9.6 ↙ 18: 10.7x↗ 19: 9.5 ↑ 20: 9.9 ↑</p> <p>Serie 102.2 Total 205.9</p>
<p>40 Skott</p>	<p>21: 9.9 ↑ 22: 9.1 ↑ 23: 9.6 ↑ 24: 10.8x↘ 25: 10.5x↗ 26: 10.3x↓ 27: 10.3x↓ 28: 9.3 ↗ 29: 10.1 ↘ 30: 10.0↙</p> <p>Serie 99.9 Total 305.8</p>	<p>40 Skott</p>	<p>31: 9.0 ➤ 32: 10.5x↗ 33: 10.3x➤ 34: 10.0↖ 35: 10.1 ↖ 36: 10.5x↖ 37: 9.9 ↑ 38: 10.1 ↓ 39: 10.8x➤ 40: 10.0 ↑</p> <p>Serie 101.2 Total 407.0</p>

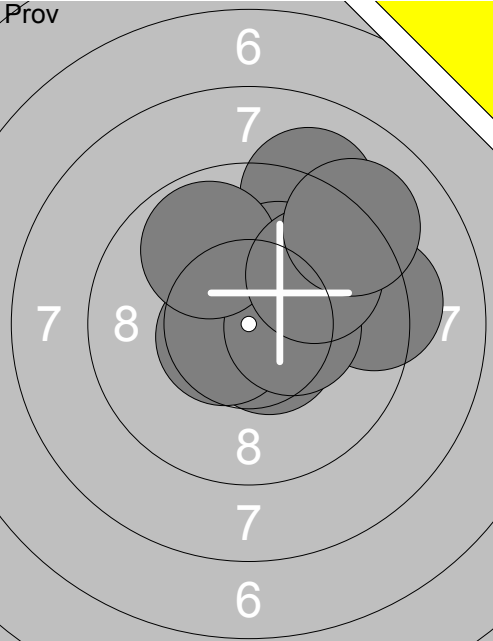
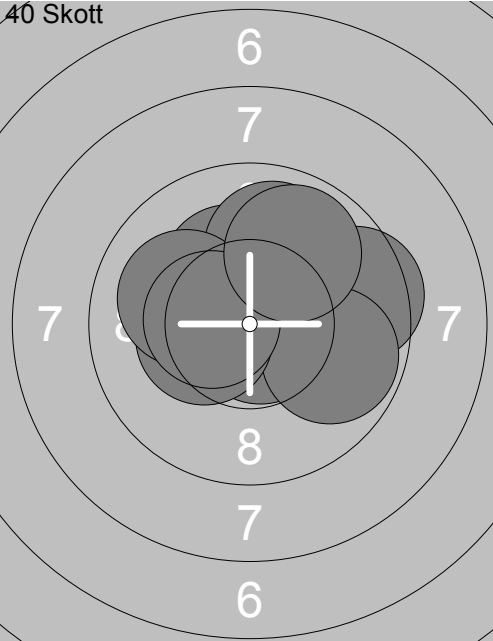
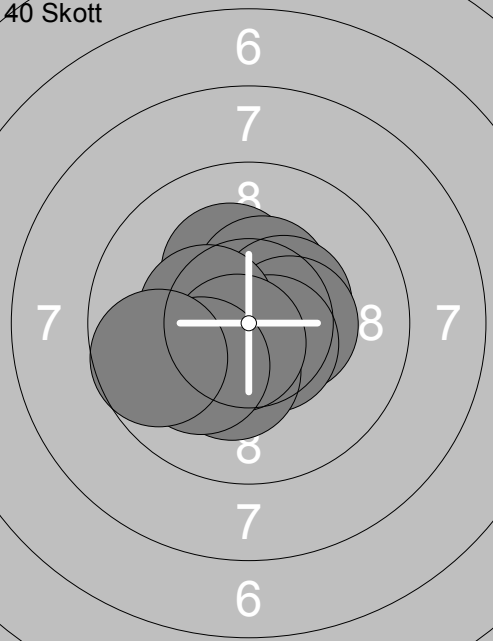
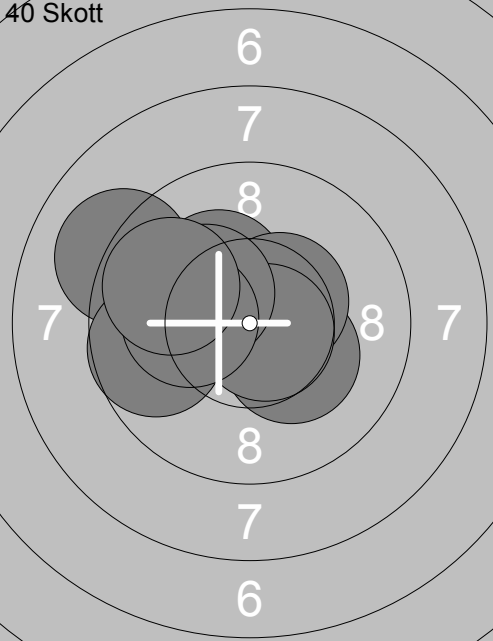
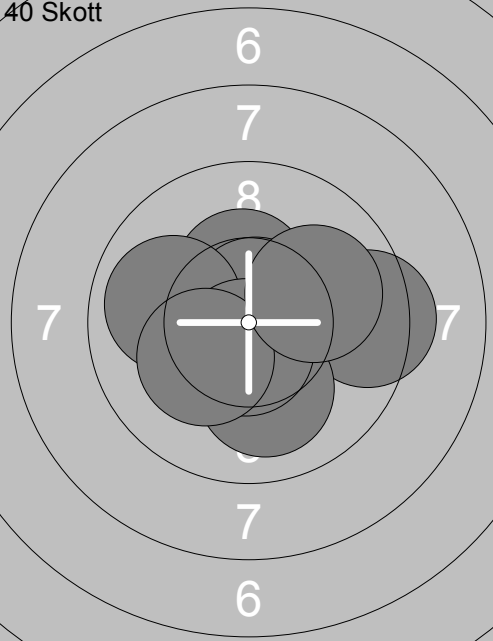
Skjutlag 6	Tavla 28	Hanna Karlsson	
Vindeln	Ramselefors		Vb
18.03.2017	SM & JSM Luftgevär 2017	Ramselefors SKF	
	1: 9.1 ↗ 2: 10.6x↘ 3: 9.9 ↗ 4: 10.2x↗ 5: 9.3 → 6: 10.6x↖ 7: 10.4x→ 8: 9.9 ↖ 9: 9.9 ↗ 10: 9.1 ↗ Serie 99.0 Total 0.0		1: 10.5x→ 2: 9.5 → 3: 10.2x↖ 4: 10.7x↘ 5: 9.8 → 6: 10.3x↖ 7: 9.9 ↗ 8: 10.1↖ 9: 10.4x↖ 10: 9.9 ↗ Serie 101.3 Total 101.3
	11: 10.2x↖ 12: 10.4x↗ 13: 10.4x↗ 14: 10.4x→ 15: 10.6x↘ 16: 10.3x↘ 17: 10.4x↖ 18: 10.7x↘ 19: 10.1↘ 20: 9.7 ← Serie 103.2 Total 204.5		21: 10.2x↖ 22: 10.7x↗ 23: 10.3x↘ 24: 9.1 ↖ 25: 10.5x↗ 26: 10.7x↘ 27: 10.3x↖ 28: 9.7 ← 29: 10.2x↖ 30: 9.8 ↖ Serie 101.5 Total 306.0
	31: 10.4x↗ 32: 10.6x↘ 33: 10.5x↘ 34: 9.4 → 35: 10.7x↗ 36: 9.9 ← 37: 10.1 ↘ 38: 10.6x↘ 39: 10.2x↖ 40: 10.0 → Serie 102.4 Total 408.4		

<p>Prov</p>	<p>1: 9.9 ↖ 2: 10.1 ↑ 3: 9.3 → 4: 10.3x➤ 5: 10.7x↙ 6: 9.4 → 7: 10.7x➤ 8: 8.7 ← 9: 9.9 ↖ 10: 9.7 ↘</p> <p>Serie 98.7 Total 0.0</p>	<p>Prov</p>	<p>11: 10.3x↘ 12: 10.0 ↓</p> <p>Serie 20.3 Total 0.0</p>
-------------	--	-------------	---

<p>40 Skott</p>	<p>1: 10.4x↘ 2: 10.4x➤ 3: 9.9 → 4: 9.8 ← 5: 9.7 → 6: 10.1↙ 7: 10.8x↗ 8: 9.4 → 9: 10.2x↙ 10: 9.5 ←</p> <p>Serie 100.2 Total 100.2</p>	<p>40 Skott</p>	<p>11: 10.2x↙ 12: 9.3 ↘ 13: 10.1↙ 14: 10.0↙ 15: 10.5x↙ 16: 10.1→ 17: 10.3x↙ 18: 10.0→ 19: 10.0→ 20: 10.5x↗</p> <p>Serie 101.0 Total 201.2</p>
-----------------	---	-----------------	--

<p>40 Skott</p>	<p>21: 9.5 ↙ 22: 10.3x↘ 23: 10.0↙ 24: 10.1 ↓ 25: 9.1 ← 26: 9.8 ↙ 27: 10.6x↗ 28: 10.4x↗ 29: 10.4x➤ 30: 9.7 ←</p> <p>Serie 99.9 Total 301.1</p>	<p>40 Skott</p>	<p>31: 10.6x↙ 32: 10.5x➤ 33: 10.6x↘ 34: 10.0↙ 35: 9.8 ↙ 36: 10.4x↗ 37: 9.3 ↗ 38: 10.4x↙ 39: 10.9x↗ 40: 10.6x↙</p> <p>Serie 103.1 Total 404.2</p>
-----------------	--	-----------------	---

Skjuttag	Tavla	Sara Svensson	
6	30		
Vindeln	Delsbo-Bjuråker		Gä
18.03.2017	SM & JSM Luftgevär 2017	Ramselefors SKF	
Prov		Prov	
	1: 8.8 → 2: 10.4x↓ 3: 9.7 ↖ 4: 10.0 ↗ 5: 10.1 → 6: 10.7x↘ 7: 9.1 → 8: 9.9 ↖ 9: 10.6x↓ 10: 9.5 →		11: 10.1 → 12: 10.4x↖ 13: 10.3x↗
	Serie 98.8		Serie 30.8
	Total 0.0		Total 0.0
40 Skott		40 Skott	
	1: 10.7x↘ 2: 10.0 → 3: 10.2x↖ 4: 10.6x↖ 5: 10.4x↗ 6: 10.3x↗ 7: 10.1 ↖ 8: 10.5x↖ 9: 10.7x↖ 10: 10.4x→		11: 10.5x↖ 12: 9.6 ↖ 13: 8.7 ↖ 14: 10.4x↗ 15: 10.3x↖ 16: 10.3x↖ 17: 10.3x↘ 18: 10.0 ↖ 19: 10.4x↓ 20: 10.2x↖
	Serie 103.9		Serie 100.7
	Total 103.9		Total 204.6
40 Skott		40 Skott	
	21: 9.7 ↖ 22: 10.2x↖ 23: 10.1 ↓ 24: 10.2x→ 25: 10.3x↓ 26: 10.2x↓ 27: 10.8x↖ 28: 10.0 ↓ 29: 10.9x↖ 30: 10.9x→		31: 10.6x↖ 32: 10.4x→ 33: 10.6x→ 34: 9.9 ↓ 35: 10.0 ↓ 36: 10.1 ↓ 37: 9.7 ↖ 38: 9.8 ↖ 39: 9.9 ↖ 40: 9.7 ↖
	Serie 103.3		Serie 100.7
	Total 307.9		Total 408.6

<p>Prov</p> <p style="text-align: center;">6 7 7 7 8 7 6</p>	<p>1: 9.3 ↗ 2: 10.3x↘ 3: 10.7x↘ 4: 9.6 → 5: 10.9x→ 6: 10.1← 7: 10.6x→ 8: 9.7 ← 9: 10.0 ↑ 10: 10.7x↘</p> <p>Serie 101.9 Total 0.0</p>	<p>Prov</p> <p style="text-align: center;">6 7 8 7 6</p>	<p>11: 10.1 → 12: 10.2x↗ 13: 10.0 ↖ 14: 9.9 ↘ 15: 10.2x↗</p> <p>Serie 50.4 Total 0.0</p>
<p>40 Skott</p> <p style="text-align: center;">6 7 7 7 6</p>	<p>1: 9.6 → 2: 9.8 ↘ 3: 10.1← 4: 9.7 ↗ 5: 9.9 ← 6: 9.6 → 7: 9.2 → 8: 9.5 ← 9: 10.2x↗ 10: 10.2x↘</p> <p>Serie 97.8 Total 97.8</p>	<p>40 Skott</p> <p style="text-align: center;">6 7 8 7 6</p>	<p>11: 9.4 ↗ 12: 10.2x→ 13: 9.9 ↗ 14: 10.4x↘ 15: 10.6x↘ 16: 10.5x↘ 17: 10.4x↖ 18: 10.8x↖ 19: 9.8 → 20: 10.0 ↗</p> <p>Serie 102.0 Total 199.8</p>
<p>40 Skott</p> <p style="text-align: center;">6 7 8 7 6</p>	<p>21: 10.7x→ 22: 9.8 → 23: 9.9 ↓ 24: 10.6x↘ 25: 10.0 ↗ 26: 10.6x↗ 27: 9.9 ↖ 28: 10.4x↗ 29: 10.7x→ 30: 10.5x↖</p> <p>Serie 103.1 Total 302.9</p>	<p>40 Skott</p> <p style="text-align: center;">6 7 8 7 6</p>	<p>31: 9.8 ↓ 32: 10.7x↘ 33: 9.5 ← 34: 9.7 ↓ 35: 10.3x↖ 36: 10.2x↘ 37: 10.2x↘ 38: 10.0 ↖ 39: 10.3x↗ 40: 9.5 ↘</p> <p>Serie 100.2 Total 403.1</p>

	<p>1: 10.1 ↘</p> <p>2: 10.0 ↗</p> <p>3: 9.8 ↗</p> <p>4: 10.8 ↘</p> <p>5: 9.9 ↗</p> <p>6: 9.2 ↗</p> <p>7: 10.2x ↗</p> <p>8: 10.0 ↘</p> <p>9: 10.3x ↗</p> <p>10: 10.2x ↘</p> <p>Serie 100.5</p> <p>Total 0.0</p>		<p>11: 10.3x ↗</p> <p>12: 10.4x →</p> <p>13: 8.8 ↗</p> <p>14: 9.8 ↗</p> <p>15: 10.1 ↗</p> <p>16: 10.7x ↗</p> <p>17: 9.7 ↘</p> <p>18: 9.9 ↗</p> <p>Serie 79.7</p> <p>Total 0.0</p>
--	--	--	---

	<p>1: 9.7 ↗</p> <p>2: 10.0 ↘</p> <p>3: 9.3 →</p> <p>4: 10.8x ↗</p> <p>5: 9.9 ↗</p> <p>6: 9.9 ↘</p> <p>7: 9.9 ↖</p> <p>8: 10.1 →</p> <p>9: 10.3x ↗</p> <p>10: 10.2x ↗</p> <p>Serie 100.1</p> <p>Total 100.1</p>		<p>11: 10.2x ↘</p> <p>12: 9.9 ↘</p> <p>13: 9.6 ↖</p> <p>14: 10.9x ↘</p> <p>15: 10.5x ↘</p> <p>16: 10.5x ↘</p> <p>17: 10.6x ↗</p> <p>18: 9.7 ←</p> <p>19: 10.5x ↘</p> <p>20: 9.9 ↗</p> <p>Serie 102.3</p> <p>Total 202.4</p>
--	--	--	---

	<p>21: 10.1 ↖</p> <p>22: 10.2x ↘</p> <p>23: 10.0 →</p> <p>24: 10.2x ↘</p> <p>25: 9.5 ←</p> <p>26: 10.4x ↘</p> <p>27: 9.2 ←</p> <p>28: 10.4x ↗</p> <p>29: 9.4 ←</p> <p>30: 10.3x ↗</p> <p>Serie 99.7</p> <p>Total 302.1</p>		<p>31: 10.5x ↘</p> <p>32: 8.8 ↓</p> <p>33: 10.4x ↘</p> <p>34: 10.0 ↗</p> <p>35: 10.0 ←</p> <p>36: 10.5x →</p> <p>37: 8.2 ↘</p> <p>38: 9.5 ←</p> <p>39: 10.0 ↘</p> <p>40: 9.5 ↘</p> <p>Serie 97.4</p> <p>Total 399.5</p>
--	--	--	---

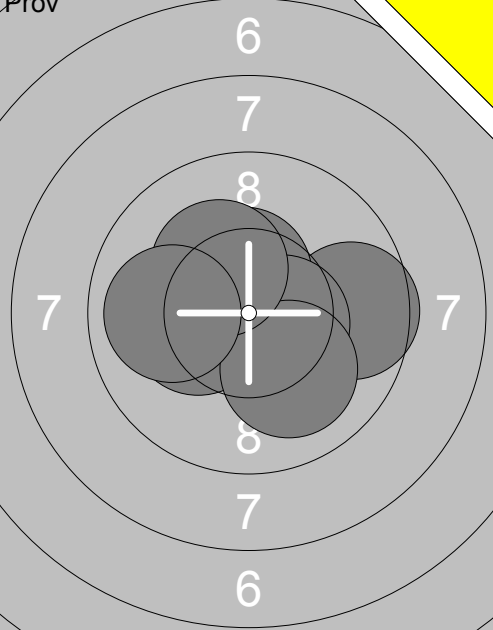
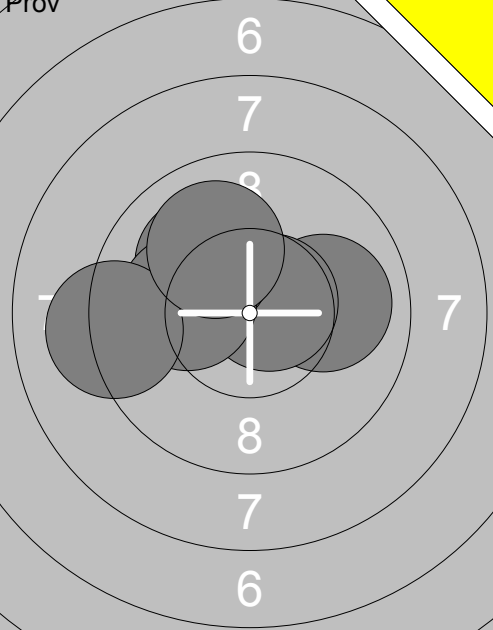
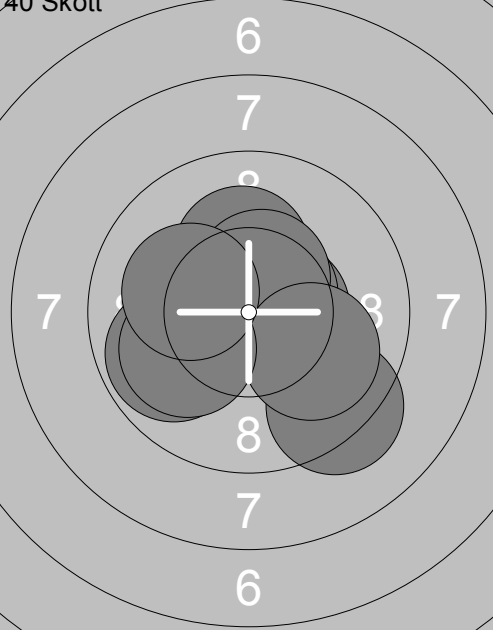
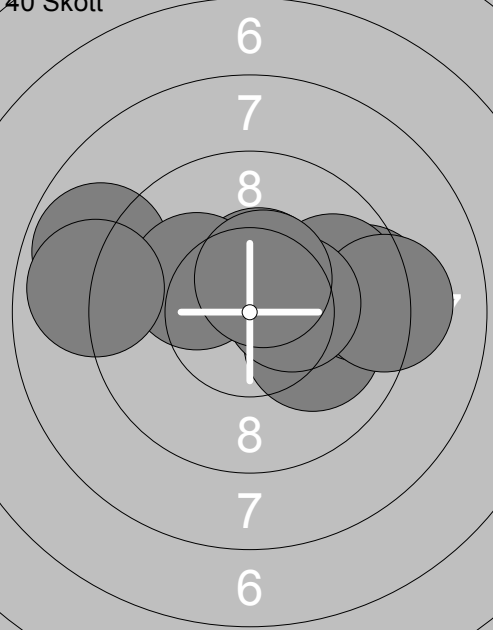
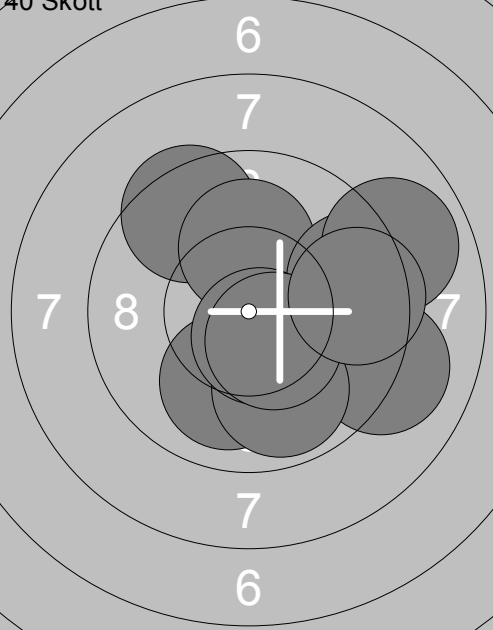
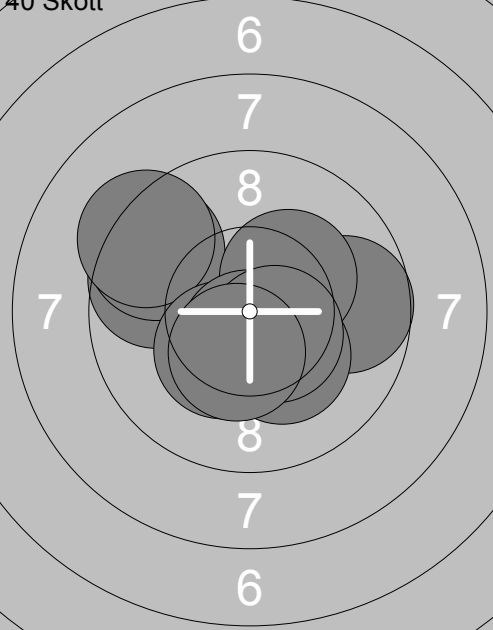
<p>Prov</p> 	<p>1: 10.5x↘ 2: 10.3x↘ 3: 9.6 → 4: 10.3x↙ 5: 10.6x↘ 6: 10.5x↗ 7: 10.5x→ 8: 10.0 ↓ 9: 10.3x↘ 10: 9.9 ←</p> <p>Serie 102.5 Total 0.0</p>	<p>Prov</p> 	<p>11: 10.0 → 12: 10.7x↗ 13: 10.1 ↖ 14: 10.1 ← 15: 9.2 ← 16: 10.0 ↖</p> <p>Serie 60.1 Total 0.0</p>
<p>40 Skott</p> 	<p>1: 10.5x→ 2: 10.2x↗ 3: 9.8 ← 4: 10.6x↗ 5: 10.6x↗ 6: 9.3 ↓ 7: 10.5x↗ 8: 10.0 ↓ 9: 10.0 ← 10: 10.1 ←</p> <p>Serie 101.6 Total 101.6</p>	<p>40 Skott</p> 	<p>11: 10.5x↗ 12: 8.9 ← 13: 10.1 ↖ 14: 10.0 → 15: 9.5 → 16: 9.8 → 17: 9.2 → 18: 10.4x→ 19: 8.9 ← 20: 10.5x↗</p> <p>Serie 97.8 Total 199.4</p>
<p>40 Skott</p> 	<p>21: 9.5 ↖ 22: 10.1 ↑ 23: 10.0 ↓ 24: 9.5 → 25: 9.1 → 26: 9.9 ↓ 27: 10.6x↓ 28: 8.9 → 29: 10.4x↓ 30: 9.5 →</p> <p>Serie 97.5 Total 296.9</p>	<p>40 Skott</p> 	<p>31: 9.7 ← 32: 9.5 ↖ 33: 9.7 → 34: 10.3x↗ 35: 9.3 ↖ 36: 10.2x↓ 37: 10.3x↙ 38: 10.6x↓ 39: 10.5x↘ 40: 10.4x↓</p> <p>Serie 100.5 Total 397.4</p>

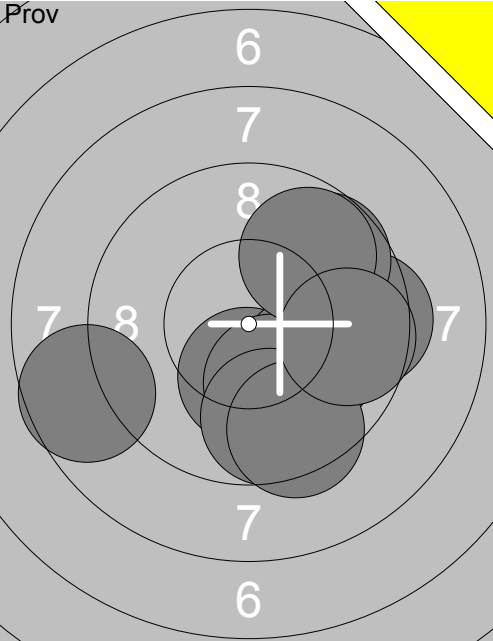
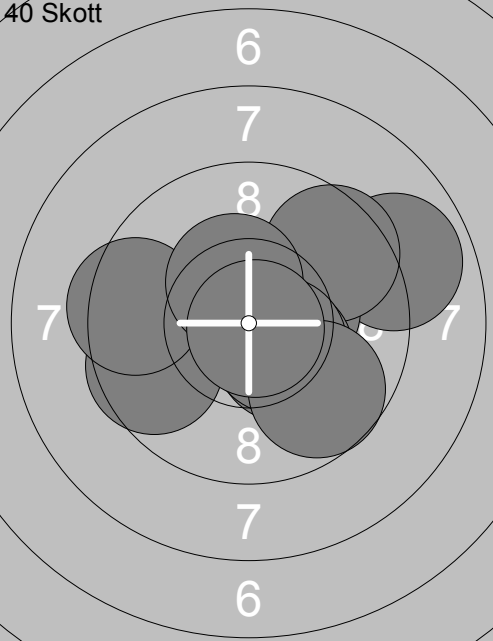
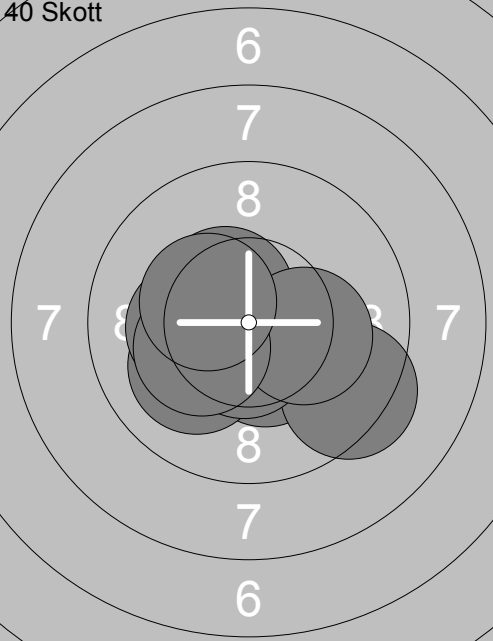
Skjuttag	Tavla	Mathilda Hjelm	
6	34		
Vindeln	Gullabo		Sm
18.03.2017	SM & JSM Luftgevär 2017	Ramselefors SKF	
Prov		1: 10.3x↓ 2: 9.4 → 3: 10.0 ↘ 4: 10.1 ↓ 5: 9.7 ↗ 6: 9.8 ↗ 7: 9.7 ↓ 8: 9.4 ↓ 9: 8.7 ← 10: 9.7 →	11: 9.7 ↓ 12: 10.1 ↓ 13: 9.5 ↗
		Serie 96.8	Serie 29.3
		Total 0.0	Total 0.0
40 Skott		1: 9.6 ← 2: 9.5 ← 3: 8.9 → 4: 10.4x→ 5: 9.5 ↗ 6: 10.4x↗ 7: 10.3x↘ 8: 10.5x↘ 9: 9.7 ↓ 10: 10.8x↘	11: 9.8 → 12: 10.1 ↗ 13: 9.2 → 14: 10.0 ↓ 15: 9.1 → 16: 10.1→ 17: 8.6 ← 18: 10.2x↘ 19: 9.8 → 20: 9.8 ↓
		Serie 99.6	Serie 96.7
		Total 99.6	Total 196.3
40 Skott		21: 10.4x↓ 22: 10.4x← 23: 10.1 ↓ 24: 9.4 ↘ 25: 10.5x↘ 26: 10.6x↓ 27: 10.2x← 28: 10.2x→ 29: 10.3x← 30: 10.4x←	31: 10.2x↘ 32: 10.4x↗ 33: 10.4x↗ 34: 10.4x↘ 35: 10.1→ 36: 9.9 ↓ 37: 10.0← 38: 10.2x↗ 39: 9.4 ← 40: 10.4x←
		Serie 102.5	Serie 101.4
		Total 298.8	Total 400.2

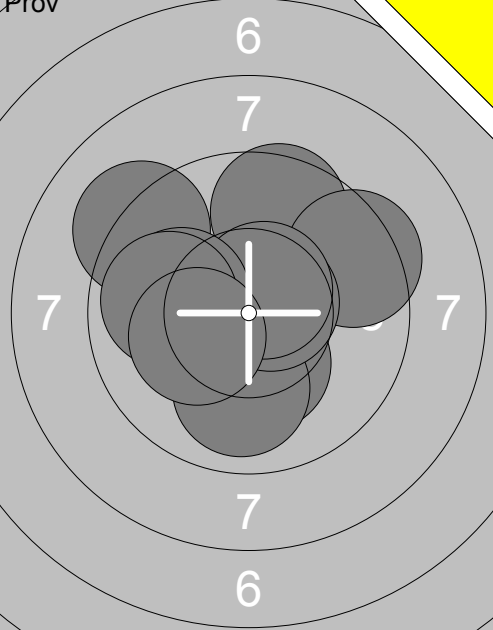
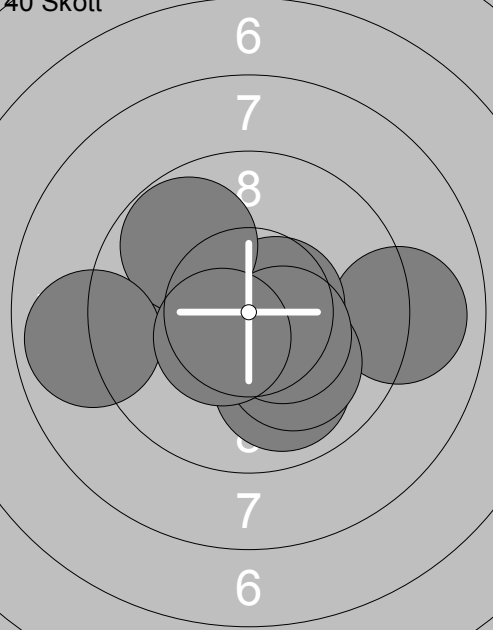
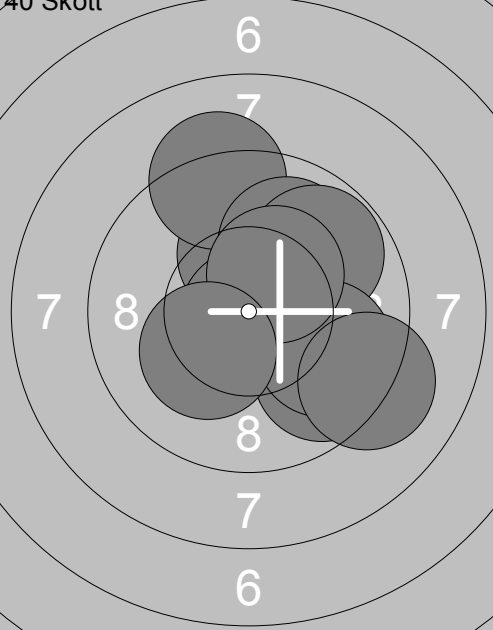
Pröv	Pröv	
	1: 10.3x↓ 2: 10.0 ↓ 3: 9.6 ↑ 4: 9.4 ↗ 5: 10.6x↗ 6: 9.2 ↖ 7: 10.6x↗ 8: 10.0← 9: 9.9 ← 10: 10.2x↖	11: 10.5x↖ 12: 10.2x↓ 13: 8.5 ← 14: 10.6x↖ 15: 9.6 ↘ 16: 10.2x↓ 17: 9.1 →
Serie 99.8	Serie 68.7	
Total 0.0	Total 0.0	
40 Skott 	1: 9.0 → 2: 9.9 ↓ 3: 10.1 ↓ 4: 10.2x↖ 5: 10.5x↖ 6: 10.6x↗ 7: 10.4x↘ 8: 9.8 ↖ 9: 8.9 ← 10: 10.5x↖	11: 9.7 ↖ 12: 10.0← 13: 9.1 → 14: 8.4 ← 15: 10.6x↖ 16: 9.9 ↓ 17: 10.5x↖ 18: 10.7x↖ 19: 9.4 → 20: 10.4x↓
Serie 99.9	Serie 98.7	
Total 99.9	Total 198.6	
40 Skott 	21: 10.2x↑ 22: 9.2 ↑ 23: 10.0 ↗ 24: 9.8 ↗ 25: 9.7 ↘ 26: 10.9x↓ 27: 9.9 ↘ 28: 10.4x↗ 29: 9.2 ↘ 30: 10.2x↖	31: 10.1 ↑ 32: 9.7 ↘ 33: 10.5x↑ 34: 9.4 → 35: 9.8 → 36: 10.4x↑ 37: 10.8x↗ 38: 10.2x↑ 39: 9.4 → 40: 10.1 ↓
Serie 99.5	Serie 100.4	
Total 298.1	Total 398.5	

Skjuttag	Tavla	Mikaela Alexandersson	
6	36		
Vindeln	Gullabo		Sm
18.03.2017	SM & JSM Luftgevär 2017	Ramselefors SKF	
Prov		1: 10.6x ↗ 2: 9.8 ↖ 3: 10.4x ↗ 4: 9.2 ↖ 5: 9.8 ← 6: 9.7 ↗ 7: 9.9 ↖ 8: 9.9 → 9: 9.9 ↗ 10: 9.3 →	11: 9.4 ↗ 12: 9.5 ↖ 13: 10.5x ↘ 14: 10.5x ↘ 15: 9.6 ↘ 16: 10.0 ← 17: 10.3x ↗
	Serie 98.5	Serie 69.8	
	Total 0.0	Total 0.0	
40 Skott		1: 10.3x → 2: 9.7 ↗ 3: 10.5x ← 4: 9.7 ↖ 5: 9.4 ↘ 6: 10.7x → 7: 10.0 ↖ 8: 10.1 ↘ 9: 10.5x ↗ 10: 9.9 ←	11: 10.3x → 12: 10.8x ← 13: 9.6 ↘ 14: 9.5 ↘ 15: 9.9 ↗ 16: 10.8x ↗ 17: 10.5x → 18: 10.7x ↘ 19: 10.8x ↗ 20: 10.6x ↘
	Serie 100.8	Serie 103.5	
	Total 100.8	Total 204.3	
40 Skott		21: 9.4 ↖ 22: 9.9 ↘ 23: 10.4x ↘ 24: 9.3 ↖ 25: 10.9x ← 26: 10.3x ↘ 27: 10.5x ↘ 28: 10.3x ← 29: 10.1 ← 30: 9.4 ↗	31: 10.0 ↖ 32: 10.6x ↗ 33: 10.3x ↗ 34: 10.6x ↘ 35: 9.4 → 36: 9.9 ↑ 37: 10.0 ↖ 38: 10.1 ← 39: 10.0 ↘ 40: 9.8 →
	Serie 100.5	Serie 100.7	
	Total 304.8	Total 405.5	

Skjutlag	Tavla	Elin Persson	
6	37		
Vindeln	Aspö		BI
18.03.2017	SM & JSM Luftgevär 2017	Ramselefors SKF	
Prov 	1: 9.0 ← 2: 9.6 ↓ 3: 9.8 ↖ 4: 10.6x→ 5: 9.4 ↓ 6: 10.3x↘ 7: 10.2x↗ 8: 10.0 → 9: 9.7 ↓ 10: 10.3x↘ Serie 98.9 Total 0.0	Prov 	11: 9.2 ↓ 12: 10.6x↗ 13: 10.2x↘ Serie 30.0 Total 0.0
40 Skott 	1: 9.6 ↘ 2: 10.5x↖ 3: 10.2x↘ 4: 10.1 ↓ 5: 10.3x↘ 6: 9.9 → 7: 10.5x↘ 8: 10.4x↓ 9: 9.0 ↗ 10: 10.3x→ Serie 100.8 Total 100.8	40 Skott 	11: 10.0 ↓ 12: 9.3 → 13: 10.1 ↓ 14: 10.0 ↑ 15: 9.5 ↗ 16: 10.1 ↑ 17: 10.5x↗ 18: 10.4x↘ 19: 10.5x↖ 20: 10.9x↗ Serie 101.3 Total 202.1
40 Skott 	21: 9.0 → 22: 8.2 ← 23: 9.9 ↓ 24: 10.1 ↓ 25: 10.5x↗ 26: 8.8 → 27: 9.4 ↓ 28: 9.6 → 29: 9.7 ↓ 30: 10.2x↖ Serie 95.4 Total 297.5	40 Skott 	31: 10.7x↘ 32: 10.4x↖ 33: 9.0 → 34: 9.9 ← 35: 10.2x↖ 36: 8.9 ↓ 37: 9.9 → 38: 8.2 ↓ 39: 10.7x↘ 40: 10.1 ↓ Serie 98.0 Total 395.5