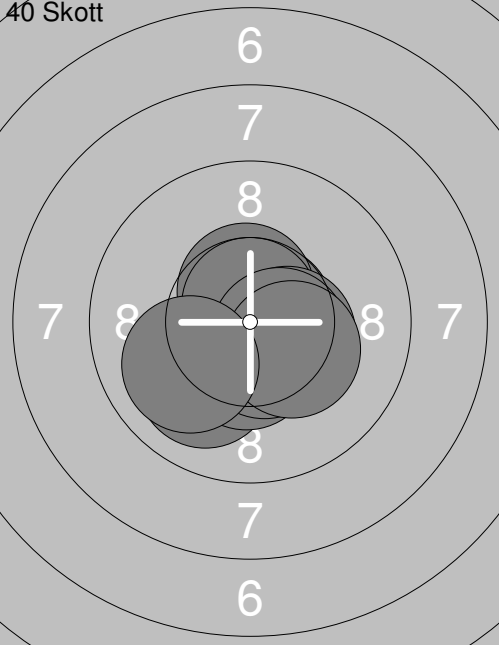
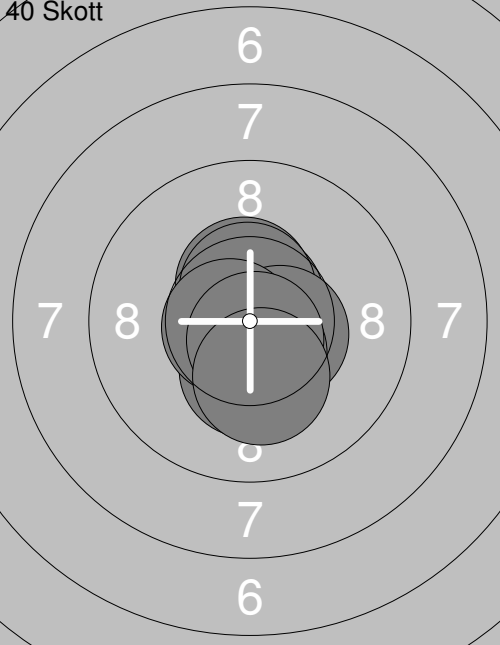
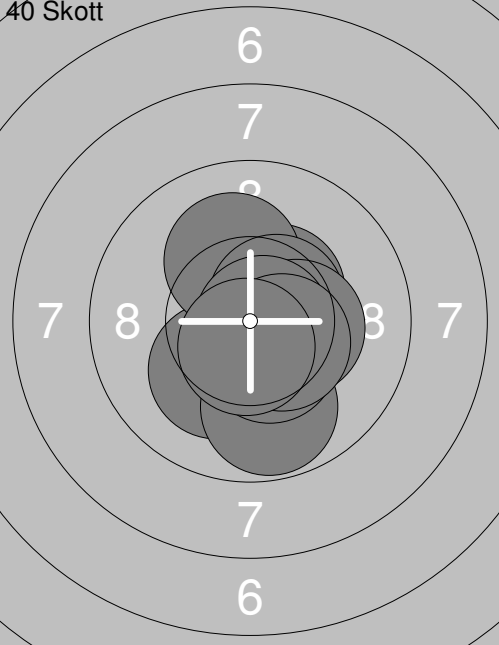
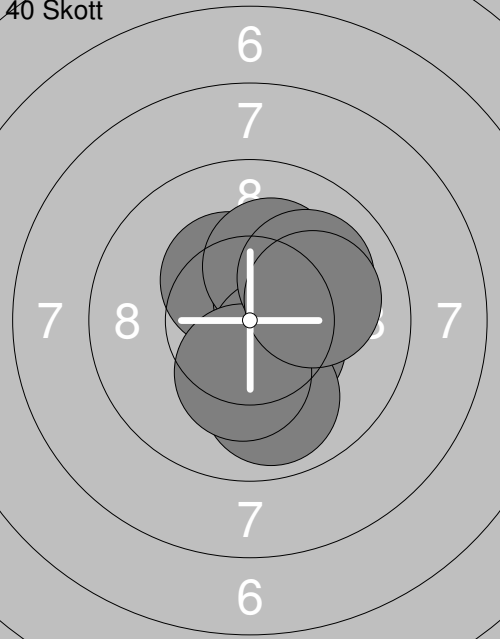
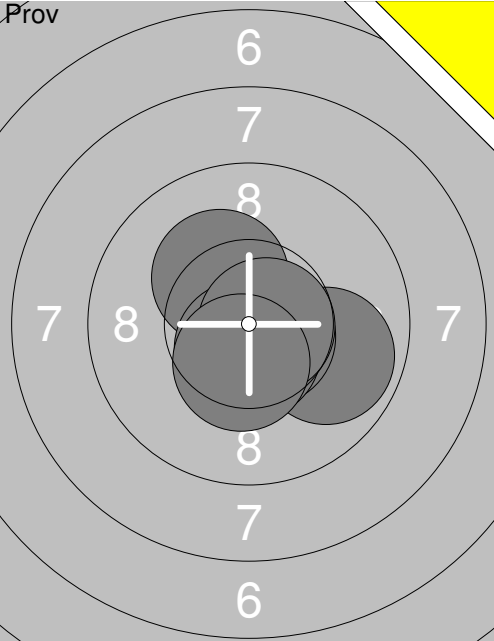
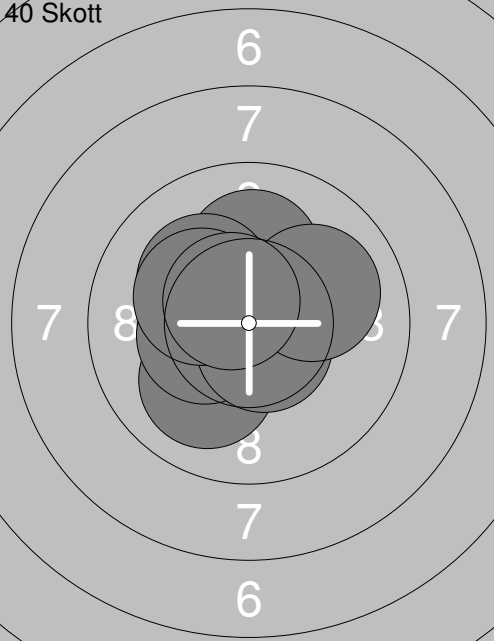
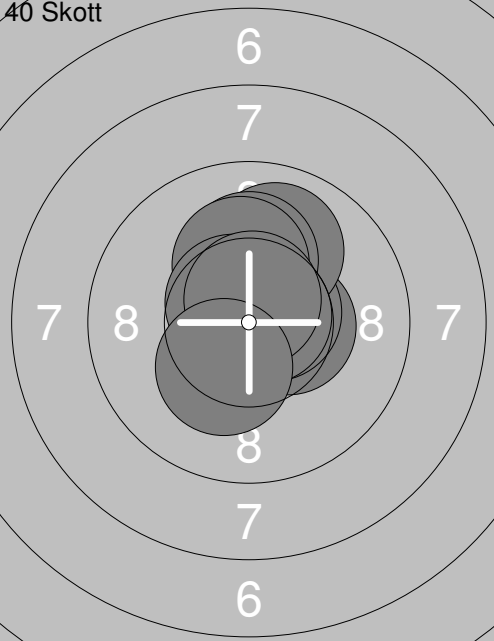
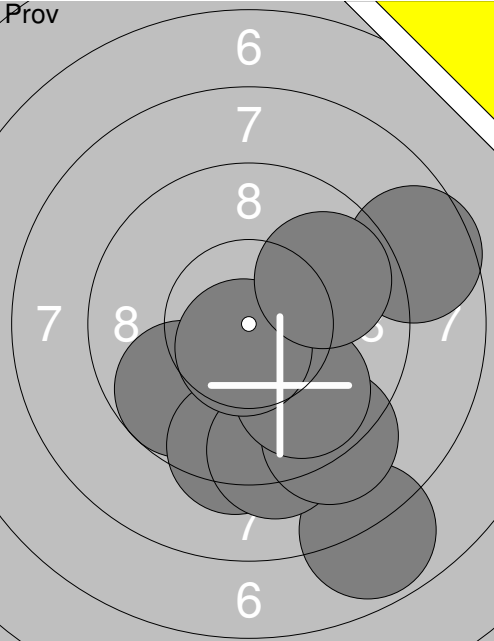
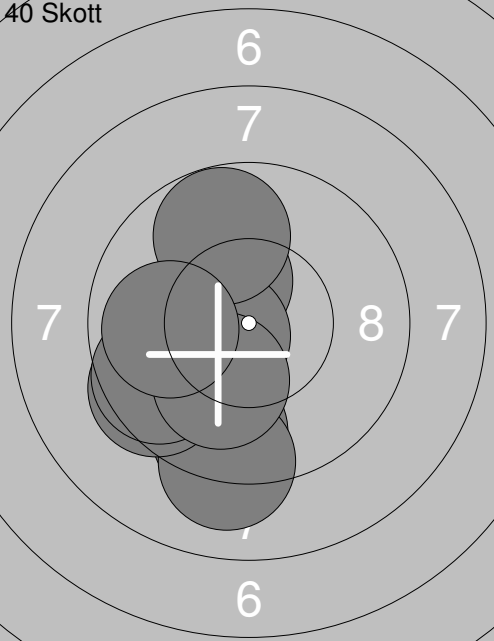
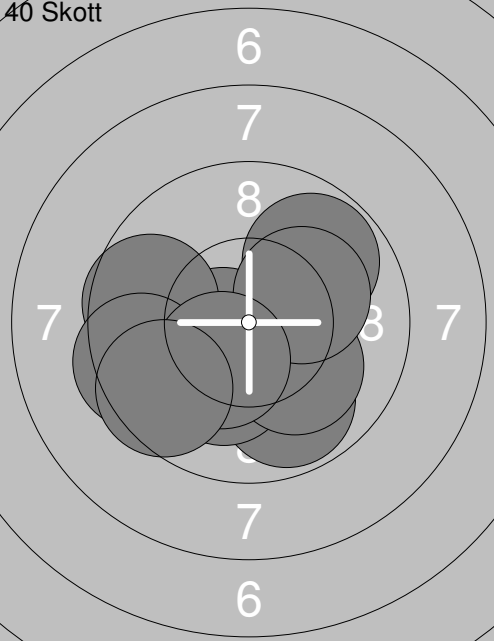

Skjuttag	Tavla	Wilma Roos	
S		Hammerdal Skf	
04.02.2017	Skyttiaden Regionfinal	Umeå skytteallians	
Prov		11: 10.1 ↖	
	1: 8.5 ↘ 2: 9.8 ↘ 3: 10.8 ↗ 4: 10.4 ↖ 5: 9.7 → 6: 10.8 ↖ 7: 10.1 ↘ 8: 10.6 ↖ 9: 10.7 ↗ 10: 10.7 ↗		
	Serie 91.4		Serie 10.1
	Total 0.0		Total 0.0
40 Skott		11: 10.2 ↖	
	1: 10.2 ↖ 2: 9.6 ↖ 3: 10.3 ↖ 4: 9.7 ↘ 5: 10.5x → 6: 10.2x ↗ 7: 10.2x ↖ 8: 10.7x ↖ 9: 10.5x ↘ 10: 10.5x ↖		11: 10.2x ↖ 12: 9.9 ↘ 13: 10.8x ↗ 14: 10.1 ↖ 15: 9.8 ← 16: 9.8 ↖ 17: 10.8x ↖ 18: 10.5x ↖ 19: 10.8x → 20: 10.4x ↗
	Serie 102.4		Serie 103.1
	Total 102.4		Total 205.5
40 Skott		21: 10.3x ↖	
	21: 10.3x ↖ 22: 10.3x ↗ 23: 9.9 ↘ 24: 10.5x ↗ 25: 10.3x ↘ 26: 9.4 ↘ 27: 9.8 ↖ 28: 10.6x ↖ 29: 9.3 ↑ 30: 9.9 ↘		31: 10.0 ↑ 32: 9.1 ↘ 33: 9.7 ↘ 34: 10.1 ↖ 35: 10.4x ↘ 36: 10.3x ↗ 37: 10.0 ↑ 38: 10.7x ↖ 39: 10.6x ↗ 40: 10.3x ↘
	Serie 100.3		Serie 101.2
	Total 305.8		Total 407.0

Skjutlag	Tavla	Petter Asplund	
1	2		
S	I19 Uskf		
04.02.2017	Skyttiaden Regionfinal	Umeå skytteallians	
Prov		1: 10.7x➤ 2: 10.6x↙ 3: 10.4x➤ 4: 10.6x➤ 5: 10.3x↓ 6: 10.7x↙ 7: 10.1↑ 8: 10.2x↑ 9: 10.6x↙ 10: 10.8x➤ Serie 105.0 Total 0.0	40 Skott  1: 10.0↙ 2: 10.4x↓ 3: 10.7x↗ 4: 10.5x↓ 5: 10.5x↑ 6: 10.7x↑ 7: 10.4x➤ 8: 10.5x➤ 9: 10.3x➤ 10: 10.0↙ Serie 104.0 Total 104.0
40 Skott		11: 10.7x↑ 12: 10.3x↓ 13: 10.5x↑ 14: 10.6x↑ 15: 10.5x↓ 16: 10.5x➤ 17: 10.5x↓ 18: 10.7x↙ 19: 10.7x↓ 20: 10.2x↓ Serie 105.2 Total 209.2	40 Skott  21: 10.2x↙ 22: 9.8↓ 23: 10.4x↓ 24: 10.4x↗ 25: 10.1↑ 26: 10.5x↗ 27: 10.3x➤ 28: 10.8x➤ 29: 10.5x➤ 30: 10.6x↓ Serie 103.6 Total 312.8
40 Skott		31: 10.6x↑ 32: 10.4x↗ 33: 10.4x↙ 34: 10.4x↗ 35: 10.2x↑ 36: 10.5x➤ 37: 9.9↓ 38: 10.3x↓ 39: 10.0↗ 40: 10.1➤ Serie 102.8 Total 415.6	

Skjutlag	Tavla	Joel Bergqvist	
S		Umeå Skf	
04.02.2017		Skyttiaden Regionfinal	Umeå skytteallians
Prov		40 Skott	40 Skott
		1: 9.9 ➤ 2: 10.7x↘ 3: 10.6x↓ 4: 10.2x↖ 5: 10.6x↓ 6: 10.7x➤ 7: 10.4x↓	1: 10.2x↑ 2: 10.3x➤ 3: 10.6x↖ 4: 10.9x↓ 5: 10.0 ↑ 6: 9.9 ↗ 7: 10.4x↓ 8: 10.4x↘ 9: 10.4x↑ 10: 10.5x↘
		Serie 73.1 Total 0.0	Serie 103.6 Total 103.6
40 Skott		40 Skott	40 Skott
		11: 10.0 ↙ 12: 10.4x↘ 13: 10.2x↑ 14: 10.8x↖ 15: 10.1 ↑ 16: 10.6x↓ 17: 10.2x↖ 18: 10.3x↘ 19: 10.0 ➤ 20: 10.6x↖	21: 10.7x↖ 22: 10.2x↑ 23: 10.7x↖ 24: 10.5x↘ 25: 10.6x➤ 26: 10.3x↑ 27: 10.2x↘ 28: 10.8x↘ 29: 10.7x↑ 30: 10.8x↖
		Serie 103.2 Total 206.8	Serie 105.5 Total 312.3
40 Skott		40 Skott	
		31: 10.4x➤ 32: 10.6x➤ 33: 10.0 ↑ 34: 10.1 ↑ 35: 10.2x↑ 36: 10.8x↑ 37: 10.6x↖ 38: 10.7x➤ 39: 10.7x↑ 40: 10.3x↓	
		Serie 104.4 Total 416.7	

Skjutlag	Tavla	Jenna Nyman	
S		Kubikborg Uskf	
04.02.2017	Skyttiaden Regionfinal	Umeå skytteallians	
Prov		1: 7.8 ↘ 2: 9.5 ↓ 3: 9.7 ↙ 4: 9.4 ↓ 5: 9.3 ↓ 6: 9.1 ↘ 7: 9.8 ↘ 8: 10.6x↓ 9: 8.6 → 10: 9.8 → Serie 93.6 Total 0.0	11: 9.2 → 12: 10.8x→ 13: 10.6x↗ 14: 10.2x↘ 15: 10.6x↘ Serie 51.4 Total 0.0
40 Skott		1: 10.3x↘ 2: 9.5 ↓ 3: 10.3x↘ 4: 9.1 ↓ 5: 9.5 ↙ 6: 10.6x↘ 7: 9.8 ↑ 8: 9.6 ↙ 9: 10.1 ↓ 10: 9.9 ← Serie 98.7 Total 98.7	11: 8.9 ← 12: 10.6x↘ 13: 10.0 ↙ 14: 9.9 ← 15: 9.6 ↑ 16: 9.0 ↑ 17: 9.3 ↑ 18: 7.9 ↗ 19: 8.7 ← 20: 9.6 ← Serie 93.5 Total 192.2
40 Skott		21: 9.8 ↘ 22: 10.6x↘ 23: 10.2x↘ 24: 9.6 ← 25: 9.8 ↗ 26: 10.1 ↘ 27: 9.5 ← 28: 10.2x→ 29: 10.3x↘ 30: 9.5 ↙ Serie 99.6 Total 291.8	31: 10.4x↘ 32: 9.4 ↓ 33: 10.3x↗ 34: 9.3 ↓ 35: 10.2x↙ 36: 9.8 ↘ 37: 8.6 ↙ 38: 9.3 ↓ 39: 10.6x↗ 40: 8.9 ↑ Serie 96.8 Total 388.6

<p>Prov</p>	<p>1: 9.6 ↘ 2: 9.0 ↓ 3: 10.0 ↘ 4: 10.6x↘ 5: 10.0 ↓ 6: 9.8 ↓ 7: 9.3 ← 8: 9.3 ↙ 9: 9.8 ↘ 10: 10.6x↗</p> <p>Serie 98.0 Total 0.0</p>	<p>Prov</p>	<p>11: 10.2x↘ 12: 10.2x↘ 13: 10.3x↘ 14: 10.5x↘ 15: 10.1 ← 16: 10.7x↘ 17: 10.8x↗ 18: 10.5x↘</p> <p>Serie 83.3 Total 0.0</p>
<p>40 Skott</p>	<p>1: 9.9 ← 2: 10.2x↘ 3: 10.5x↗ 4: 10.7x↗ 5: 9.6 ↗ 6: 10.4x↘ 7: 10.5x↘ 8: 10.8x↗ 9: 10.7x↗ 10: 10.7x↘</p> <p>Serie 104.0 Total 104.0</p>	<p>40 Skott</p>	<p>11: 10.7x↘ 12: 10.6x↗ 13: 10.1 ↗ 14: 10.7x↘ 15: 10.6x↘ 16: 10.9x↗ 17: 9.6 ← 18: 9.9 ↗ 19: 10.5x↘ 20: 10.8x↘</p> <p>Serie 104.4 Total 208.4</p>
<p>40 Skott</p>	<p>21: 10.0 ↗ 22: 10.3x↗ 23: 10.9x↘ 24: 10.2x↘ 25: 10.4x↗ 26: 10.3x↘ 27: 10.6x↗ 28: 10.0 ↗ 29: 10.0 ↓ 30: 10.6x↘</p> <p>Serie 103.3 Total 311.7</p>	<p>40 Skott</p>	<p>31: 10.3x↘ 32: 10.8x↘ 33: 10.7x↗ 34: 9.9 ↗ 35: 10.6x↘ 36: 10.5x↘ 37: 10.7x↘ 38: 10.0 ↓ 39: 10.0 ↓ 40: 10.4x↘</p> <p>Serie 103.9 Total 415.6</p>

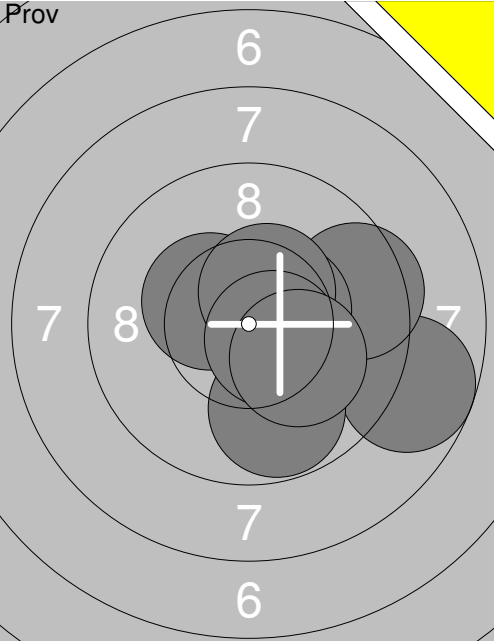
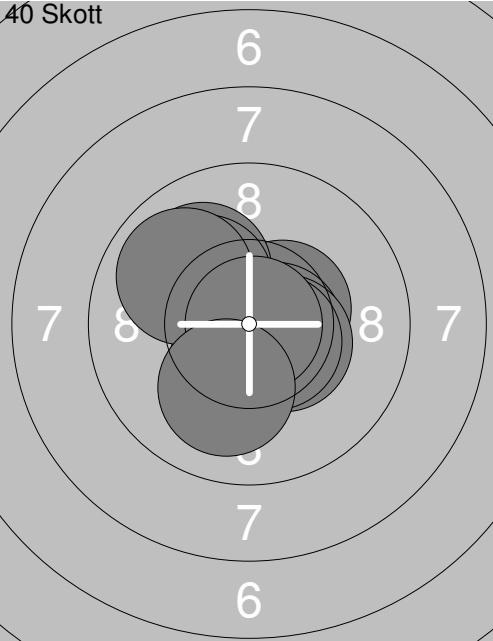
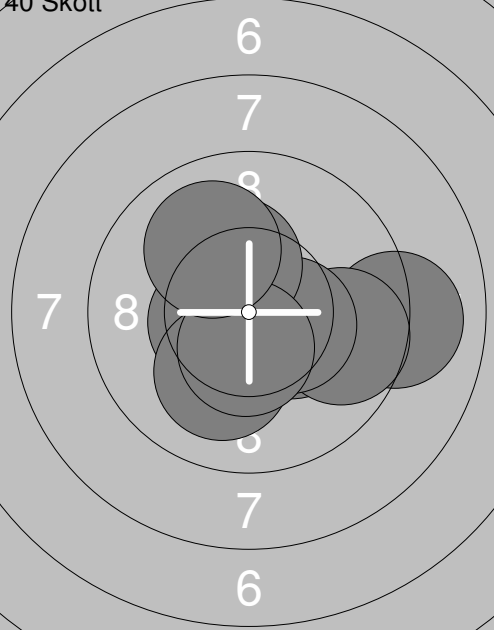
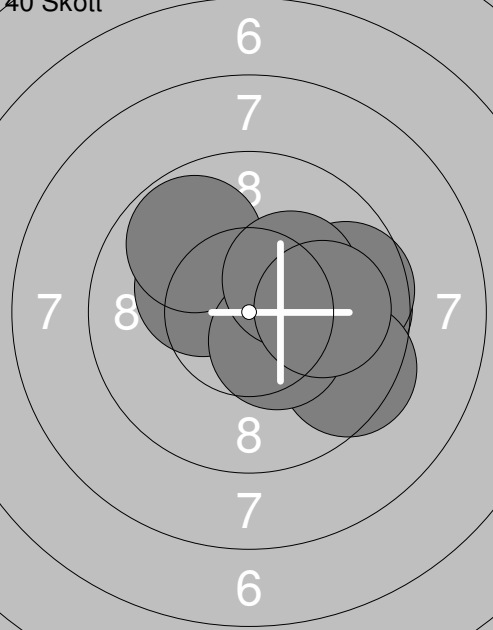
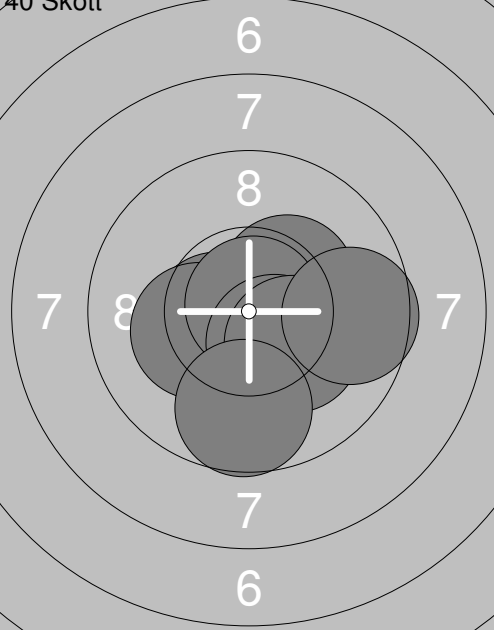
Skjutlag <b>1</b>	Tavla <b>6</b>	<b>Einar Kurkkio</b>	
S		Gällivare Skf	
04.02.2017		Skyttiaden Regionfinal	Umeå skytteallians
Prov		1: 8.8 → 2: 9.8 ↓ 3: 9.5 → 4: 10.4↔ 5: 10.5x→ 6: 10.5x↗ 7: 10.6x↘ 8: 10.2x↘ Serie 80.3 Total 0.0	40 Skott  1: 10.5x↗ 2: 10.6x↘ 3: 10.0 ↖ 4: 10.4x↘ 5: 10.2x↔ 6: 10.4x↓ 7: 9.9 ↖ 8: 10.6x↘ 9: 10.9x→ 10: 10.1 ↓ Serie 103.6 Total 103.6
40 Skott		11: 10.4x↘ 12: 9.0 → 13: 10.5x↔ 14: 10.7x↘ 15: 9.7 → 16: 10.4x↘ 17: 10.1 ↓ 18: 10.3x↗ 19: 10.5x↓ 20: 10.0 ↖ Serie 101.6 Total 205.2	40 Skott  21: 9.7 → 22: 10.0 → 23: 10.3x↔ 24: 9.8 ↖ 25: 9.7 → 26: 9.5 ↓ 27: 10.2x→ 28: 10.4x↘ 29: 10.3x↗ 30: 10.0 → Serie 99.9 Total 305.1
40 Skott		31: 10.3x↗ 32: 10.5x↓ 33: 10.5x↔ 34: 10.7x↘ 35: 10.3x↔ 36: 10.8x↗ 37: 10.4x↘ 38: 10.2x↘ 39: 9.6 → 40: 9.7 ↓ Serie 103.0 Total 408.1	

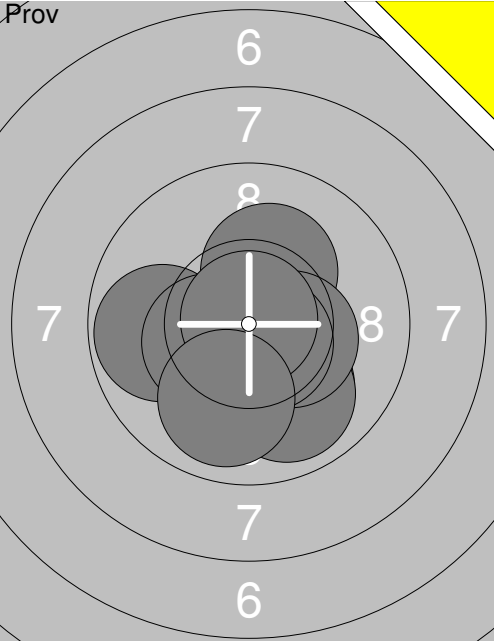
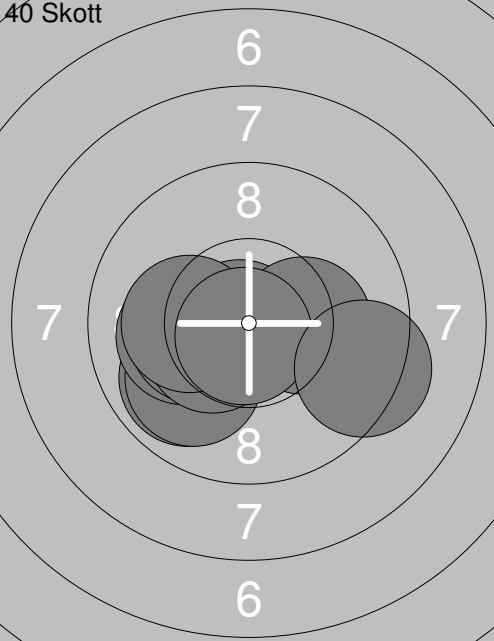
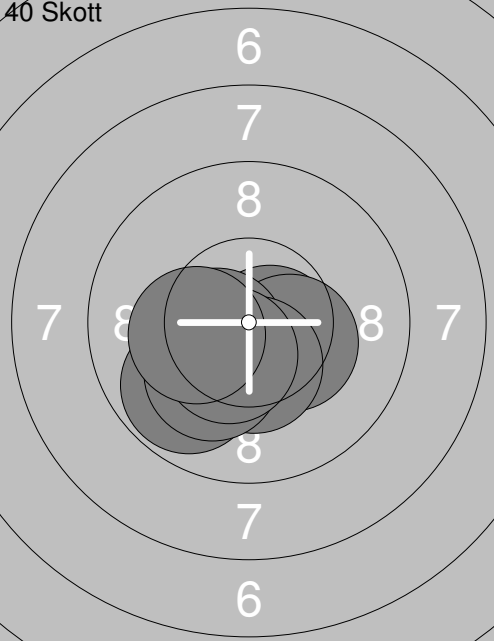
Skjutlag	Tavla	Edvin Strömberg	
S	Vännäs Skf		
04.02.2017	Skyttiaden Regionfinal	Umeå skytteallians	
Prov		1: 10.4x↘ 2: 10.0 ↓ 3: 9.9 ↓ 4: 10.2x↗ 5: 10.4x→ 6: 10.6x↘ 7: 9.8 ← 8: 10.4x↖ 9: 10.9x↗ 10: 9.9 ↓ Serie 102.5 Total 0.0	11: 10.9x↘ 12: 10.6x↘ 13: 10.5x→ 14: 10.2x↖ 15: 10.3x↗ 16: 10.0 → 17: 10.5x↘ 18: 10.5x↖ 19: 10.2x↖ 20: 10.3x↓ 21: 10.6x→ 22: 10.4x→ 23: 10.4x→ 24: 10.2x↗ 25: 10.5x↘ 26: 9.7 ← 27: 10.2x↗ 28: 10.7x↘ 29: 10.4x↓ 30: 10.7x↘ Serie 103.8 Total 412.1
40 Skott		1: 9.9 ↖ 2: 9.9 ↖ 3: 10.8x↖ 4: 10.1← 5: 10.3x↖ 6: 10.2x→ 7: 10.4x↖ 8: 10.2x↖ 9: 10.8x↓ 10: 9.3 → Serie 101.9 Total 101.9	11: 10.9x↘ 12: 10.6x↘ 13: 10.5x→ 14: 10.2x↖ 15: 10.3x↗ 16: 10.0 → 17: 10.5x↘ 18: 10.5x↖ 19: 10.2x↖ 20: 10.3x↓ 21: 10.6x→ 22: 10.4x→ 23: 10.4x→ 24: 10.2x↗ 25: 10.5x↘ 26: 9.7 ← 27: 10.2x↗ 28: 10.7x↘ 29: 10.4x↓ 30: 10.7x↘ Serie 103.8 Total 412.1
40 Skott		21: 10.5x↘ 22: 10.5x↘ 23: 10.6x↘ 24: 10.4x↘ 25: 9.8 ↖ 26: 10.5x↖ 27: 10.4x↓ 28: 10.1 ↖ 29: 10.5x↓ 30: 10.2x↖ Serie 103.5 Total 308.3	31: 10.6x→ 32: 10.4x→ 33: 10.4x→ 34: 10.2x↗ 35: 10.5x↘ 36: 9.7 ← 37: 10.2x↗ 38: 10.7x↘ 39: 10.4x↓ 40: 10.7x↘ Serie 103.8 Total 412.1



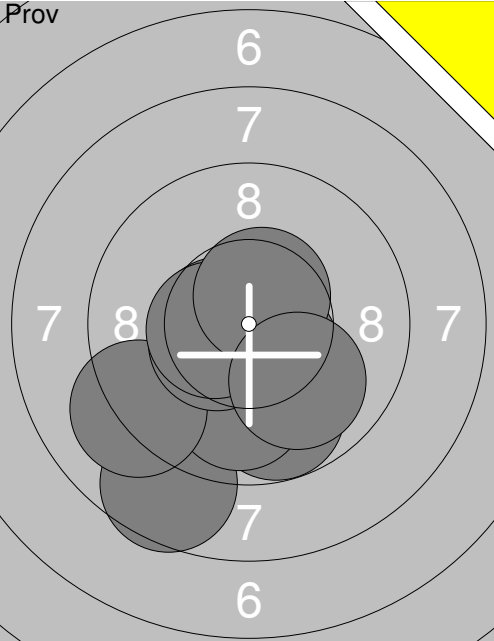
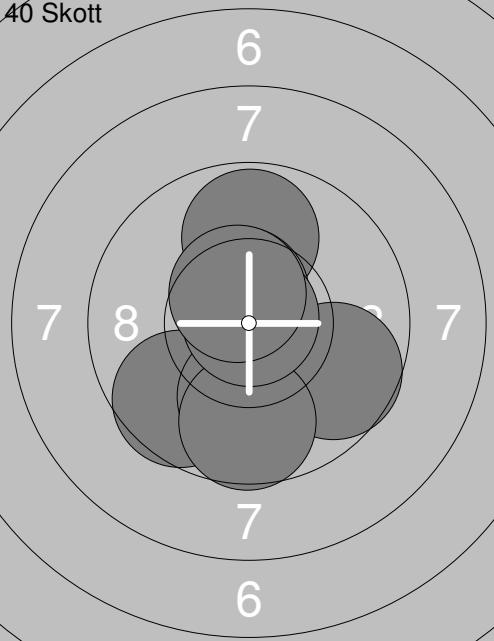
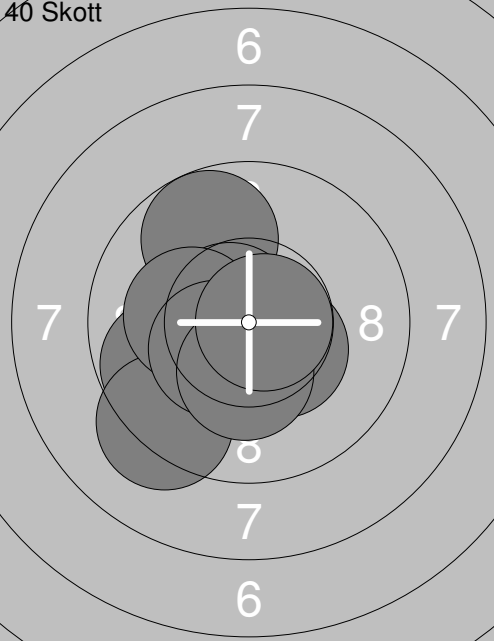

<p>Prov</p>	<p>1: 7.6 ↖                  2: 9.4 ↑                  3: 8.6 ↗                  4: 10.1 ↖                  5: 10.3x ↘                  6: 10.2x ↗                  7: 9.7 ↑                  8: 10.4x ↗                  9: 10.6x ↘                  10: 9.8 ➡</p> <p>Serie 96.7                  Total 0.0</p>	<p>Prov</p>	<p>11: 10.1 ➡                  12: 10.3x ↗                  13: 10.9x ↘</p> <p>Serie 31.3                  Total 0.0</p>
<p>40 Skott</p>	<p>1: 10.9x ↗                  2: 10.3x ↘                  3: 10.3x ↘                  4: 10.5x ➡                  5: 10.2x ➡                  6: 10.2x ↗                  7: 9.7 ➡                  8: 10.9x ↘                  9: 10.6x ↘                  10: 9.9 ➡</p> <p>Serie 103.5                  Total 103.5</p>	<p>40 Skott</p>	<p>11: 10.5x ➡                  12: 10.4x ↗                  13: 9.9 ➡                  14: 10.5x ↘                  15: 10.5x ↗                  16: 10.1 ↑                  17: 10.2x ↘                  18: 9.8 ➡                  19: 10.0 ↗                  20: 10.4x ➡</p> <p>Serie 102.3                  Total 205.8</p>
<p>40 Skott</p>	<p>21: 9.8 ➡                  22: 10.6x ↗                  23: 10.4x ➡                  24: 10.3x ↘                  25: 10.6x ↘                  26: 10.5x ➡                  27: 10.5x ↗                  28: 10.2x ↘                  29: 10.4x ↗                  30: 9.9 ➡</p> <p>Serie 103.2                  Total 309.0</p>	<p>40 Skott</p>	<p>31: 10.4x ↗                  32: 10.3x ➡                  33: 9.8 ↘                  34: 10.6x ↘                  35: 10.0 ↘                  36: 8.5 ↘                  37: 9.0 ➡                  38: 9.8 ↘                  39: 10.0 ↑                  40: 10.2x ➡</p> <p>Serie 98.6                  Total 407.6</p>

Skjutlag	Tavla	Nadja Kurkkio	
S		Gällivare Skf	
04.02.2017		Skyttiaden Regionfinal	Umeå skytteallians
Prov		1: 10.5x↘ 2: 8.6 ↙ 3: 9.7 ↙ 4: 9.9 ↙ 5: 9.1 ↙ 6: 10.6x↔ 7: 10.5x↔ 8: 10.5x↔ 9: 10.6x↗ 10: 10.0 ↘ Serie 100.0 Total 0.0	11: 10.4x↘ 12: 10.0 ↙ 13: 10.1 ↘ 14: 10.6x↘ Serie 41.1 Total 0.0
40 Skott		1: 10.2x↘ 2: 9.6 ↙ 3: 10.0 ↙ 4: 10.2x↘ 5: 9.8 ↗ 6: 9.7 ↘ 7: 10.6x↗ 8: 9.7 ↙ 9: 10.9x↗ 10: 10.5x↗ Serie 101.2 Total 101.2	11: 10.0 ↙ 12: 10.5x↗ 13: 10.1 ↗ 14: 10.1 ↘ 15: 10.1 ↗ 16: 10.4x↘ 17: 8.8 ↗ 18: 9.3 ↙ 19: 9.8 ↙ 20: 10.7x↘ Serie 99.8 Total 201.0
40 Skott		21: 9.7 ↗ 22: 9.8 ↙ 23: 10.7x↔ 24: 10.5x↘ 25: 10.4x↘ 26: 9.3 ↙ 27: 10.2x↔ 28: 10.4x↘ 29: 10.3x↘ 30: 10.7x↗ Serie 102.0 Total 303.0	31: 10.1 ↙ 32: 9.8 ↙ 33: 10.3x↔ 34: 10.9x↗ 35: 10.3x↘ 36: 10.3x↔ 37: 9.9 ↙ 38: 9.3 ↙ 39: 10.5x↔ 40: 10.7x↘ Serie 102.1 Total 405.1

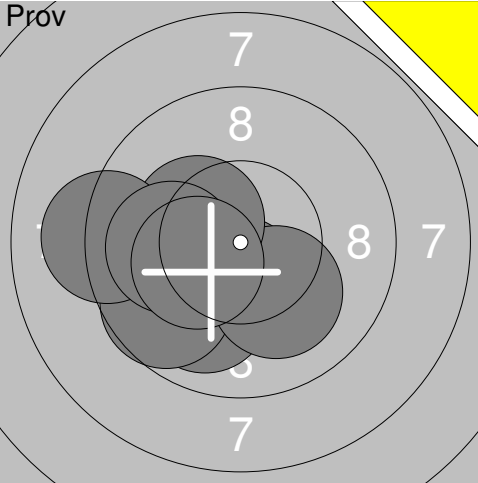
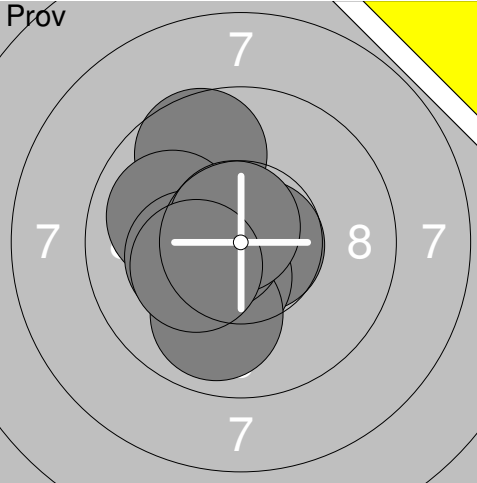
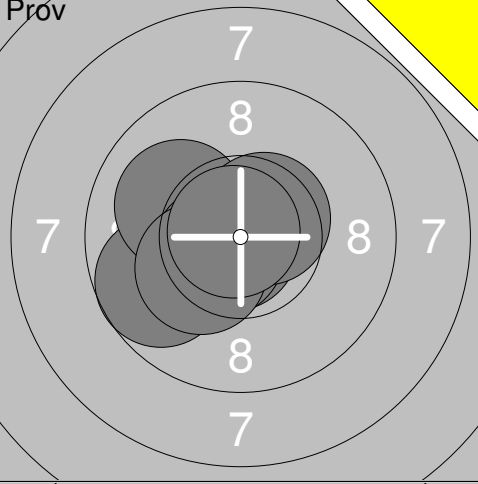
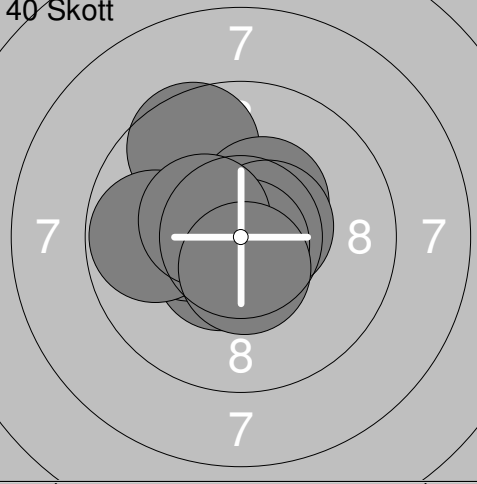
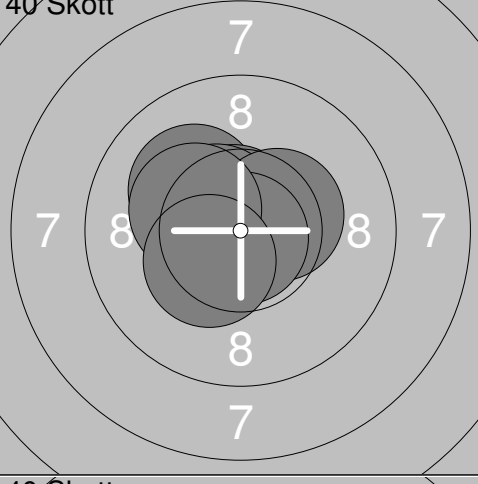
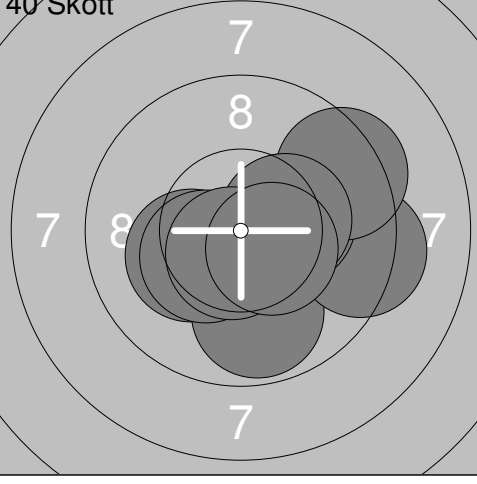
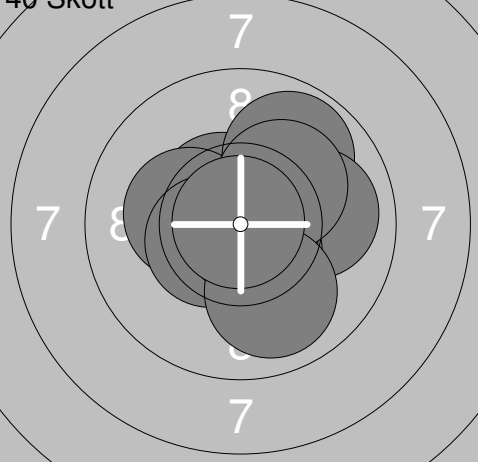
Skjutlag <b>1</b>	Tavla <b>11</b>	<b>Agnes Ebbhagen</b>			
S		Ramselefors Skf			
04.02.2017		Skyttiaden Regionfinal		Umeå skytteallians	
Prov		1: 9.8 ↙ 2: 10.4x ↓ 3: 10.0 ↙ 4: 10.0 ↙ 5: 9.7 ↙ 6: 10.1 ↘ 7: 10.3x ↗ 8: 9.2 ← 9: 10.0 ← 10: 10.3x ↙	Prov		11: 10.7x → 12: 10.7x ← 13: 10.4x ↓ 14: 9.9 ↓ 15: 9.7 ↗ 16: 10.0 ↗ 17: 10.6x ← 18: 10.2x ← 19: 10.7x ↗ 20: 10.3x ↙
		Serie 99.8		Serie 103.2	
		Total 0.0		Total 0.0	
Prov		21: 9.7 ← 22: 10.0 ↗ 23: 10.8x ↙ 24: 10.6x ↙ 25: 10.5x ↗ 26: 10.3x ↙ 27: 10.8x ↗	40 Skott		1: 9.6 ↗ 2: 10.6x ← 3: 10.5x ↙ 4: 10.4x ↗ 5: 10.6x → 6: 10.3x ← 7: 10.8x ↓ 8: 9.8 ← 9: 10.4x ↗ 10: 10.5x ↓
		Serie 72.7		Serie 103.5	
		Total 0.0		Total 103.5	
40 Skott		11: 10.1 ↗ 12: 10.6x ← 13: 10.7x → 14: 10.7x ↗ 15: 10.8x ↗ 16: 10.5x ↗ 17: 10.4x → 18: 10.8x ↓ 19: 10.3x ↗ 20: 10.4x ↙	40 Skott		21: 10.2x ↙ 22: 10.6x ↘ 23: 9.8 ↓ 24: 9.3 → 25: 10.4x ↙ 26: 10.3x → 27: 9.4 → 28: 10.3x → 29: 10.6x ↓ 30: 10.5x ↘
		Serie 105.3		Serie 101.4	
		Total 208.8		Total 310.2	
40 Skott		31: 10.5x ↗ 32: 9.8 ↗ 33: 10.3x ← 34: 10.0 → 35: 10.5x ↓ 36: 10.5x ↙ 37: 10.8x ↘ 38: 10.2x ↗ 39: 10.0 ↓ 40: 10.9x ↗			
		Serie 103.5			
		Total 413.7			

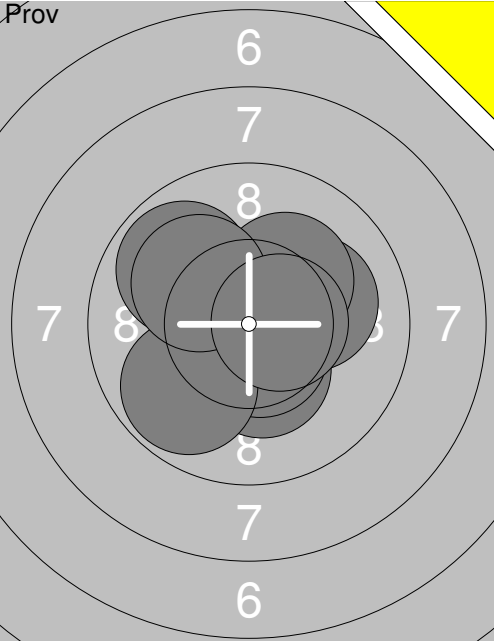
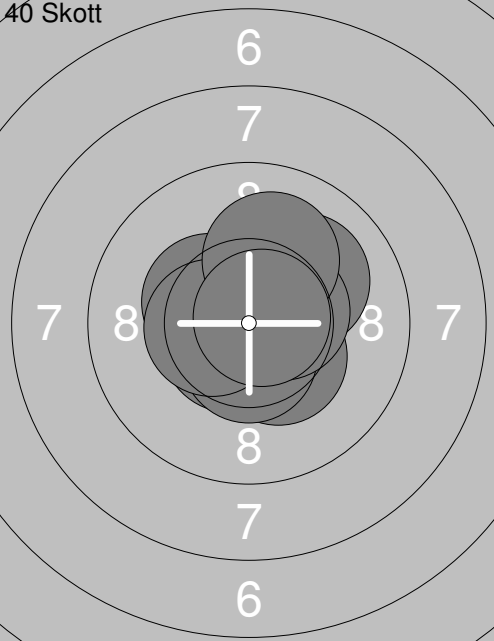
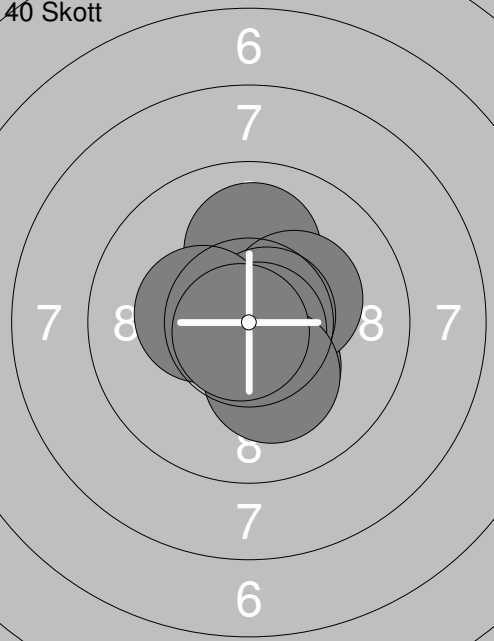
Skjuttag	Tavla	Chris Johansson	
S		Hammerdal Skf	
04.02.2017		Skyttiaden Regionfinal	Umeå skytteallians
Prov		1: 10.8x↗ 2: 10.1 → 3: 10.2x↗ 4: 9.9 ↖ 5: 10.3x↓ 6: 10.6x↘ 7: 10.6x↓ 8: 9.8 ↙ 9: 10.1 ↖ 10: 10.5x>	11: 10.6x↗ 12: 10.7x→ 13: 10.6x↓ 14: 10.2x↘ 15: 10.5x↓ 16: 10.4x↗ 17: 10.4x↘ 18: 10.2x↖ 19: 10.1 ↑ 20: 10.7x↓
		Serie 102.9	Serie 104.4
		Total 0.0	Total 0.0
40 Skott		1: 10.8x↘ 2: 10.4x↘ 3: 10.6x↘ 4: 10.5x↓ 5: 10.4x↖ 6: 10.5x↖ 7: 10.1 ↗ 8: 10.5x> 9: 10.1 ↑ 10: 10.8x>	11: 9.8 ↑ 12: 9.9 ↗ 13: 10.3x> 14: 10.9x↘ 15: 10.4x↘ 16: 10.6x↑ 17: 10.4x↘ 18: 10.8x↘ 19: 10.8x↘ 20: 10.3x↓
		Serie 104.7	Serie 104.2
		Total 104.7	Total 208.9
40 Skott		21: 10.3x↓ 22: 10.0 ↑ 23: 10.8x↓ 24: 10.3x> 25: 10.8x↘ 26: 10.7x> 27: 10.8x↘ 28: 10.3x↖ 29: 10.2x↓ 30: 10.8x↘	31: 10.7x> 32: 10.4x↓ 33: 10.8x> 34: 10.5x> 35: 10.3x↑ 36: 10.5x↓ 37: 10.7x↓ 38: 10.6x↖ 39: 10.6x> 40: 10.2x↖
		Serie 105.0	Serie 105.3
		Total 313.9	Total 419.2

	<p>1: 9.6 ↓</p> <p>2: 10.3x →</p> <p>3: 9.9 →</p> <p>4: 9.5 →</p> <p>5: 9.9 ←</p> <p>6: 10.2x ↗</p> <p>7: 10.3x ↓</p> <p>8: 10.6x ↘</p> <p>9: 9.6 ↓</p> <p>10: 10.2x →</p>		<p>11: 10.3x ↘</p> <p>12: 10.8x ↘</p> <p>13: 10.1 ↗</p>
Serie 100.1	Serie 31.2	Serie 31.2	Serie 31.2
Total 0.0	Total 0.0	Total 0.0	Total 0.0

	<p>1: 9.2 ↗</p> <p>2: 10.6x ↓</p> <p>3: 8.5 ↖</p> <p>4: 8.8 ↖</p> <p>5: 10.4x ↗</p> <p>6: 10.2x ↓</p> <p>7: 8.6 ↖</p> <p>8: 10.3x ↘</p> <p>9: 9.6 ←</p> <p>10: 9.7 ↓</p>		<p>11: 9.3 ←</p> <p>12: 9.9 ←</p> <p>13: 9.9 ↖</p> <p>14: 9.3 ↗</p> <p>15: 9.4 ←</p> <p>16: 10.8x ↖</p> <p>17: 9.9 ←</p> <p>18: 9.7 ↗</p> <p>19: 8.1 ←</p> <p>20: 9.5 ←</p>
Serie 95.9	Serie 95.8	Serie 95.8	Serie 95.8
Total 95.9	Total 191.7	Total 191.7	Total 191.7

	<p>21: 10.3x ↘</p> <p>22: 10.6x ↗</p> <p>23: 6.9 →</p> <p>24: 9.2 ↓</p> <p>25: 9.6 ↓</p> <p>26: 9.8 ←</p> <p>27: 10.2x ↘</p> <p>28: 9.8 ↓</p> <p>29: 10.6x ↘</p> <p>30: 10.8x ↘</p>		<p>31: 9.9 ↗</p> <p>32: 10.1 →</p> <p>33: 10.6x ↓</p> <p>34: 8.5 ↗</p> <p>35: 9.6 →</p> <p>36: 9.4 ↘</p> <p>37: 10.4x ↗</p> <p>38: 9.5 ←</p> <p>39: 9.4 ↗</p> <p>40: 9.7 ←</p>
Serie 97.8	Serie 97.1	Serie 97.1	Serie 97.1
Total 289.5	Total 386.6	Total 386.6	Total 386.6

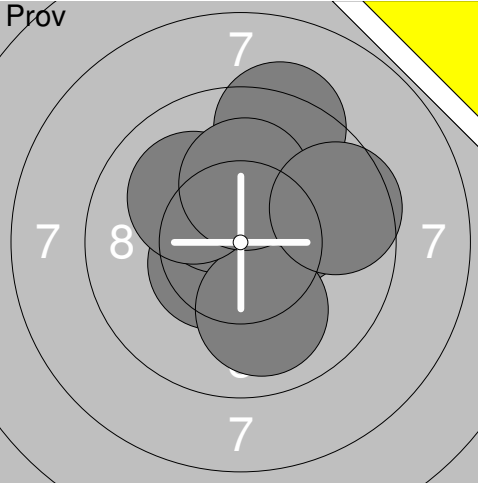
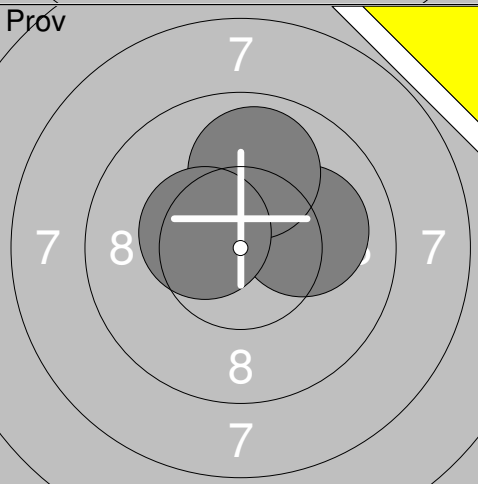
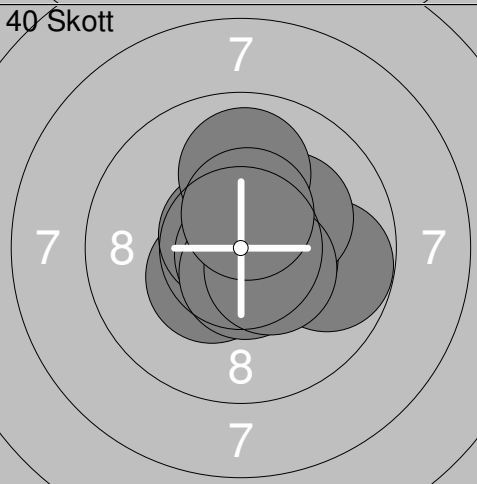
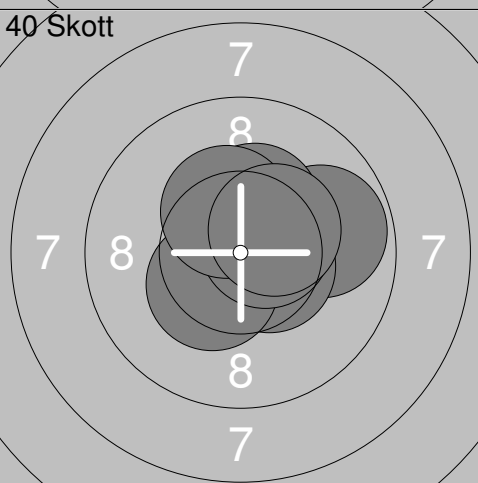
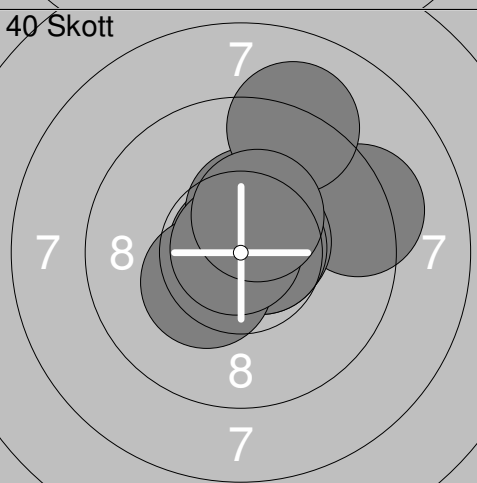
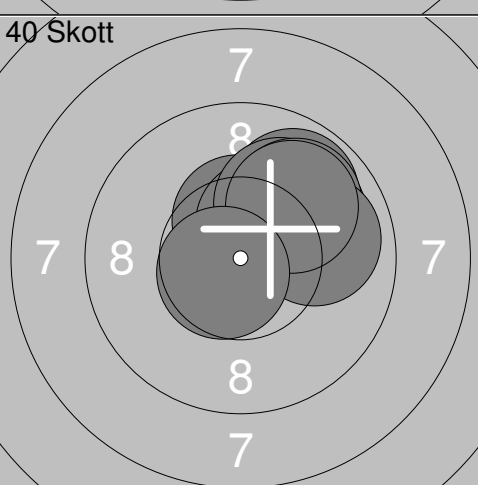

Skjutlag	Tavla	Erika Georgsson		
1	14			
S	Bjurholm-Balsjö Skf			
04.02.2017	Skyttiaden Regionfinal	Umeå skytteallians		
Prov		1: 9.3 ↗ 2: 10.6x ↗ 3: 10.3x → 4: 10.8x ← 5: 10.5x ↙ 6: 10.4x ↗ 7: 10.0 ↓ 8: 10.1 ↗ 9: 10.2x ↑ 10: 9.6 →	11: 9.9 → 12: 10.1 → 13: 10.6x ↗ 14: 10.5x ← 15: 10.1 ↑ 16: 10.7x ↗ 17: 9.7 → 18: 9.8 ↗ 19: 10.0 → 20: 10.5x ↘	
	Serie	101.8	Serie	101.9
	Total	0.0	Total	0.0
Prov		21: 10.1 → 22: 9.9 ↑ 23: 10.4x ←	40 Skott	 1: 9.8 → 2: 10.4x ↙ 3: 10.5x → 4: 10.2x → 5: 10.7x ↗ 6: 10.9x ↓ 7: 10.6x ↓ 8: 10.0 ↑ 9: 10.5x ↘ 10: 10.5x ↑
	Serie	30.4	Serie	104.1
	Total	0.0	Total	104.1
40 Skott		11: 10.8x ↘ 12: 10.4x ↗ 13: 10.6x → 14: 9.8 → 15: 10.5x ↘ 16: 10.3x ↑ 17: 10.4x ↙ 18: 10.6x → 19: 10.4x ↑ 20: 10.4x →	40 Skott	 21: 10.7x → 22: 9.3 → 23: 10.8x ↗ 24: 10.6x → 25: 10.7x → 26: 10.3x ↙ 27: 10.4x ↑ 28: 10.9x ↗ 29: 9.1 ↑ 30: 10.4x ↗
	Serie	104.2	Serie	103.2
	Total	208.3	Total	311.5
40 Skott		31: 10.4x ↑ 32: 9.8 ↗ 33: 10.4x ↗ 34: 10.0 → 35: 10.0 ↗ 36: 10.1 → 37: 9.9 ↗ 38: 9.9 → 39: 10.0 ↗ 40: 10.6x ↙		
	Serie	101.1		
	Total	412.6		

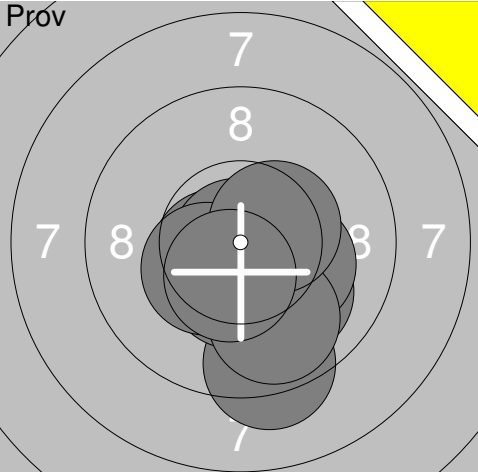
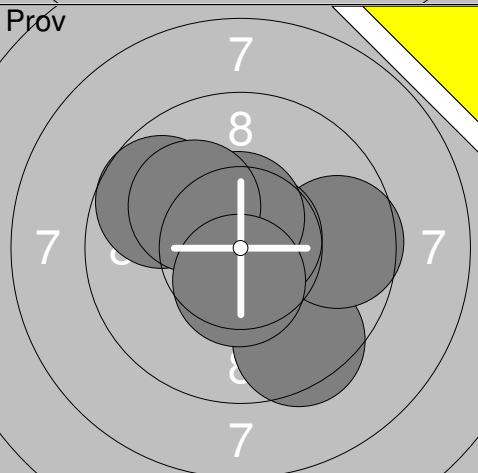
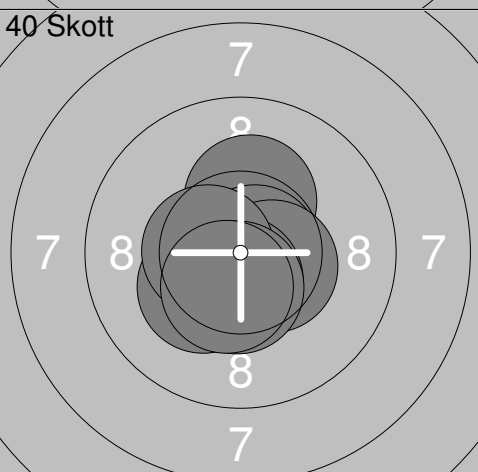
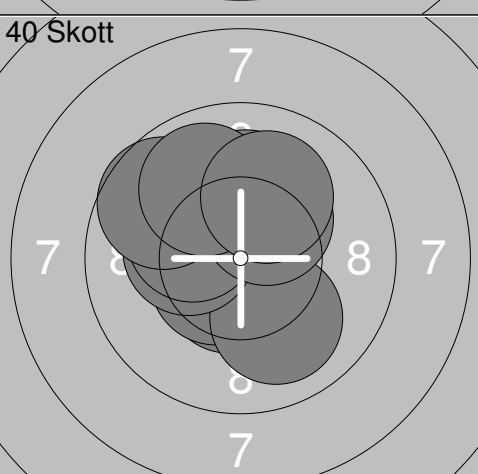
Skjuttag	Tavla	Anders Eliasson	
S	15	Aspås Uskf	
04.02.2017	Skyttiaden Regionfinal	Umeå skytteallians	
Pröv		1: 10.7x → 2: 10.5x ↓ 3: 9.7 ↑ 4: 9.0 ← 5: 10.3x ← 6: 9.5 ↖ 7: 10.5x ↗ 8: 9.0 ↑ 9: 9.8 → 10: 10.2x ↓ Serie 99.2 Total 0.0	Pröv  11: 9.9 ↖ 12: 9.9 ↑ 13: 9.5 ↑ 14: 10.5x ↓ 15: 10.2x ↑ 16: 10.0 ↗ 17: 10.3x ↗ 18: 10.7x ↑ 19: 9.6 ↖ 20: 10.9x ↗ Serie 101.5 Total 0.0
Pröv		21: 8.0 ↗ 22: 10.8x ↗ 23: 9.7 ↗ 24: 10.1 ← 25: 10.4x ↓ 26: 10.7x ← 27: 10.0 ← 28: 9.5 ↖ 29: 10.4x ↗ 30: 10.5x ↑ Serie 100.1 Total 0.0	Pröv  31: 9.7 ↖ 32: 10.2x ↗ 33: 10.1 ↗ 34: 9.9 ↑ 35: 9.9 ↘ 36: 9.5 ↗ 37: 10.8x ← 38: 10.0 ↗ 39: 10.2x ← 40: 9.5 ↓ Serie 99.8 Total 0.0
Pröv		41: 9.8 ↗ 42: 10.4x ↖ 43: 9.7 → 44: 10.1 ↗ 45: 9.7 ↑ 46: 9.7 ↑ 47: 9.8 ↗ 48: 9.8 ↑ 49: 10.2x → 50: 10.1 ↗ Serie 99.3 Total 0.0	Pröv  51: 10.1 → 52: 10.2x ↗ 53: 10.1 → 54: 10.1 ↑ 55: 10.0 → 56: 10.5x ↗ Serie 61.0 Total 0.0
40 Skott		1: 10.4x → 2: 10.2x ↗ 3: 9.9 → 4: 10.1 ↓ 5: 10.4x ↓ 6: 10.8x ↓ 7: 10.4x ↗ 8: 10.2x ↓ 9: 10.0 ↓ 10: 10.0 → Serie 102.4 Total 102.4	40 Skott  11: 10.6x ↑ 12: 10.5x ← 13: 10.4x ↖ 14: 10.1 ↘ 15: 10.3x ← 16: 10.6x ↗ 17: 8.5 ↗ 18: 10.1 ← 19: 10.4x ↖ 20: 10.2x ↖ Serie 101.7 Total 204.1
40 Skott		21: 10.1 ↗ 22: 10.3x ↓ 23: 10.3x ↓ 24: 10.3x ↓ 25: 10.6x ← 26: 10.6x ↓ 27: 10.4x → 28: 10.1 ↓ 29: 9.8 → 30: 10.8x → Serie 103.3 Total 307.4	40 Skott  31: 9.2 ↖ 32: 10.8x ↖ 33: 10.7x ↓ 34: 10.4x ↓ 35: 10.3x ← 36: 10.1 ↖ 37: 10.5x ↗ 38: 10.7x → 39: 10.4x ↓ 40: 10.5x ↖ Serie 103.6 Total 411.0

Skjutlag <b>1</b>	Tavla <b>16</b>	<b>Ebba Lundstedt</b>	
S		Ramselefors Skf	
04.02.2017		Skyttiaden Regionfinal	Umeå skytteallians
Prov		1: 10.0 ↘ 2: 10.6x ↙ 3: 9.3 ↘ 4: 10.9x ↙ 5: 10.4x ↘ 6: 10.2x → 7: 10.4x ↙ 8: 9.8 ↘ 9: 10.4x → 10: 10.5x ↘	11: 9.9 ↘ 12: 10.5x ← 13: 10.6x ↘ 14: 10.3x ← 15: 10.5x ↘ 16: 10.5x ↑ 17: 10.4x ← 18: 10.8x ↑ 19: 10.4x ← 20: 10.1 ↘
		Serie 102.5	Serie 104.0
		Total 0.0	Total 0.0
Prov		21: 9.5 ↘ 22: 9.6 → 23: 10.7x → 24: 10.5x ↑ 25: 9.7 ↗ 26: 10.1 ↗ 27: 10.5x ↘	40 Skott
		Serie 70.6	Serie 102.4
		Total 0.0	Total 102.4
40 Skott		11: 10.8x ← 12: 10.8x ↗ 13: 10.2x ↑ 14: 10.8x → 15: 10.5x → 16: 10.3x ↙ 17: 10.6x ↘ 18: 10.5x ← 19: 10.5x ↘ 20: 10.5x ↘	40 Skott
		Serie 105.5	Serie 101.9
		Total 207.9	Total 309.8
40 Skott		31: 10.5x ↘ 32: 10.5x ↙ 33: 10.0 ↘ 34: 10.2x ← 35: 10.1 ↑ 36: 10.2x ↗ 37: 10.3x ↗ 38: 9.7 ↗ 39: 9.9 ↗ 40: 10.0 ↗	
		Serie 101.4	
		Total 411.2	

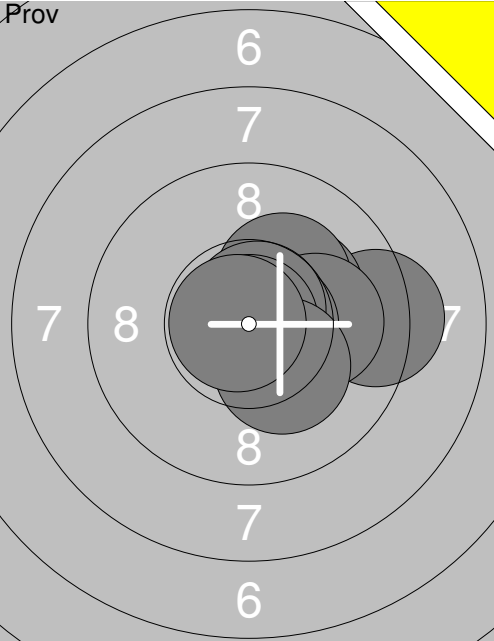
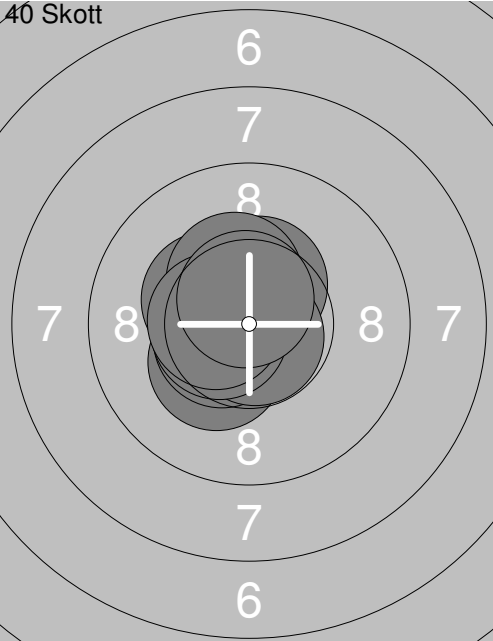
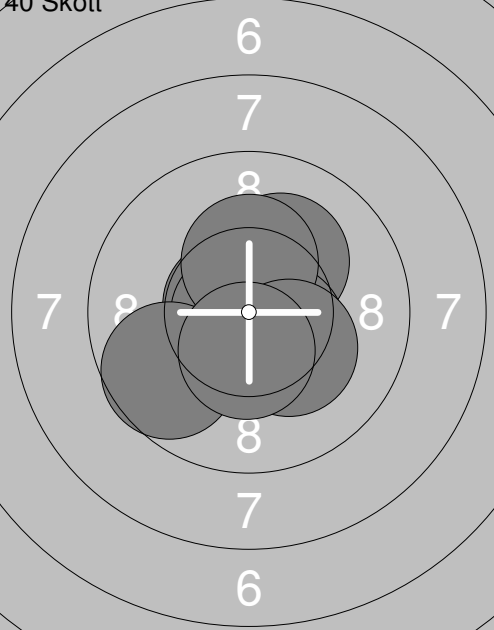
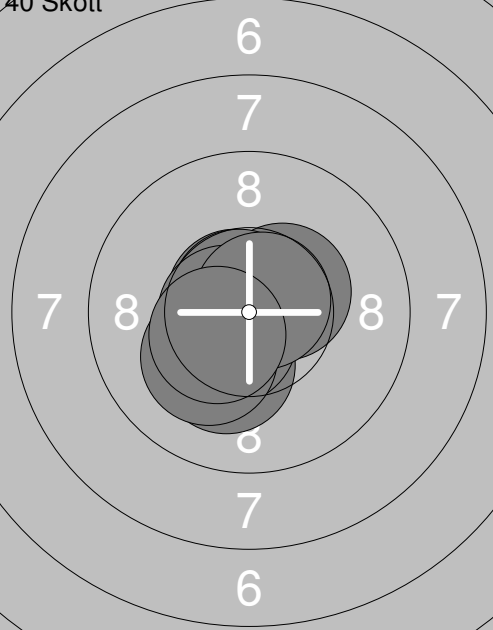
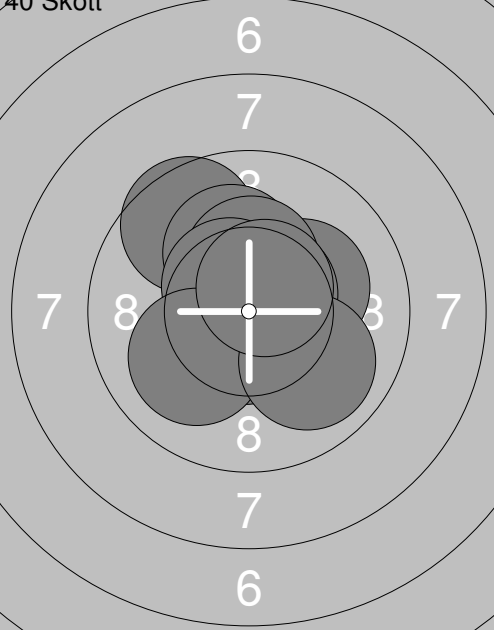

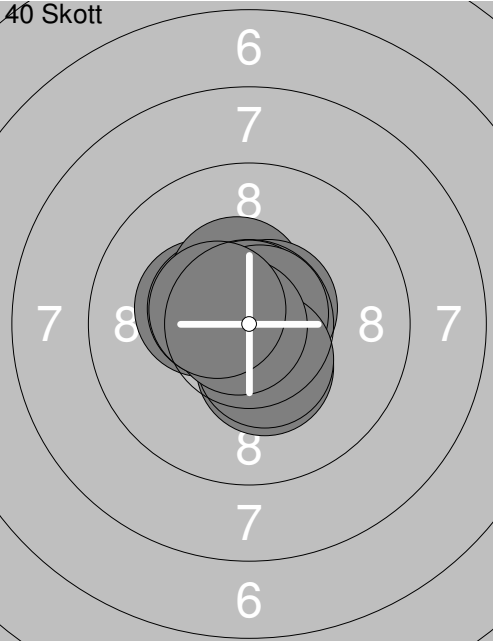
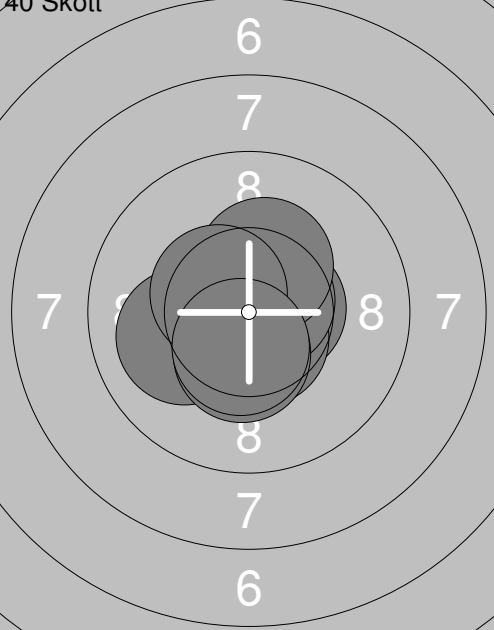
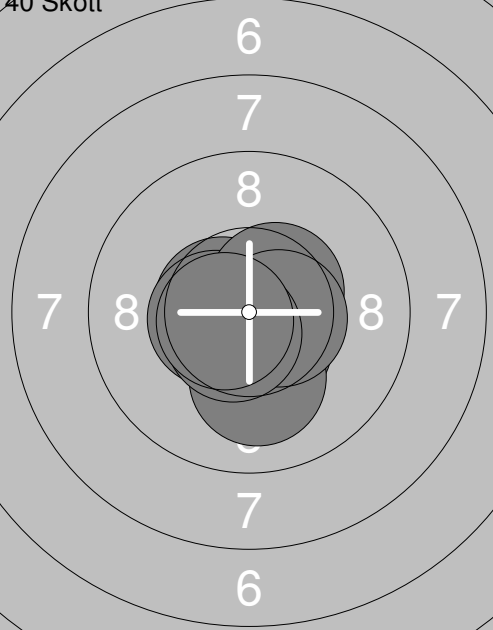
Skjutlag <b>1</b>	Tavla <b>18</b>	<b>Alva Persson</b>	
S		Kyrkås Skf	
04.02.2017		Skyttiaden Regionfinal	Umeå skytteallians
	1: 9.3 → 2: 10.2x↗ 3: 10.2x↗ 4: 10.1 → 5: 10.7x→ 6: 10.7x↗ 7: 10.9x↗ 8: 10.3x↘ 9: 10.8x←		1: 10.3x↘ 2: 10.7x← 3: 10.4x↖ 4: 10.4x↗ 5: 10.5x↘ 6: 10.4x↗ 7: 10.8x↘ 8: 10.6x↖ 9: 10.5x← 10: 10.6x↗
	Serie 93.2		Serie 105.2
	Total 0.0		Total 105.2
	11: 10.8x↗ 12: 10.9x↗ 13: 10.2x↗ 14: 10.7x↖ 15: 10.8x← 16: 10.5x↘ 17: 10.3x↗ 18: 10.3x↘ 19: 9.7 ↙ 20: 10.4x↘		21: 10.4x↗ 22: 10.7x↖ 23: 10.2x↘ 24: 10.7x↖ 25: 10.4x↘ 26: 10.5x↘ 27: 10.7x← 28: 10.7x↗ 29: 10.2x↘ 30: 10.4x↘
	Serie 104.6		Serie 104.9
	Total 209.8		Total 314.7
	31: 9.6 ↖ 32: 10.2x↗ 33: 10.6x↗ 34: 10.2x↗ 35: 10.3x↗ 36: 10.6x↘ 37: 10.5x↖ 38: 10.1 ↙ 39: 9.9 ↘ 40: 10.6x↗		
	Serie 102.6		
	Total 417.3		

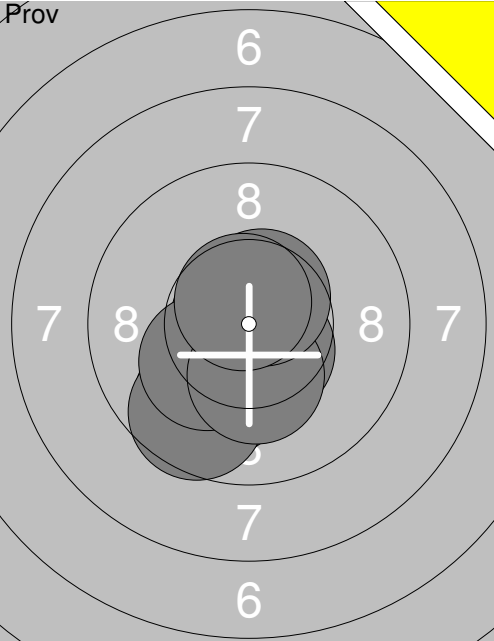
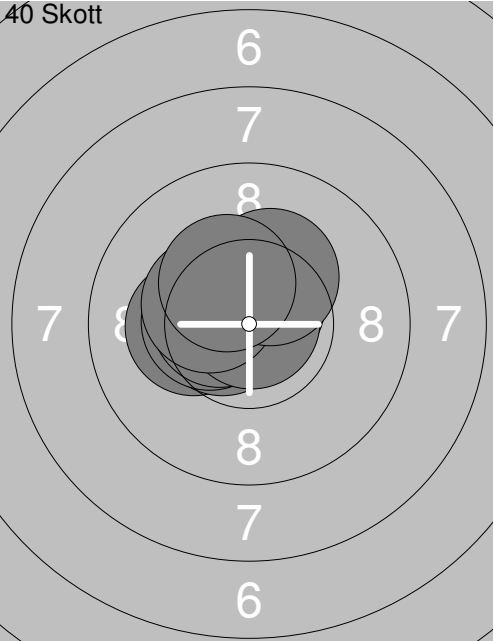
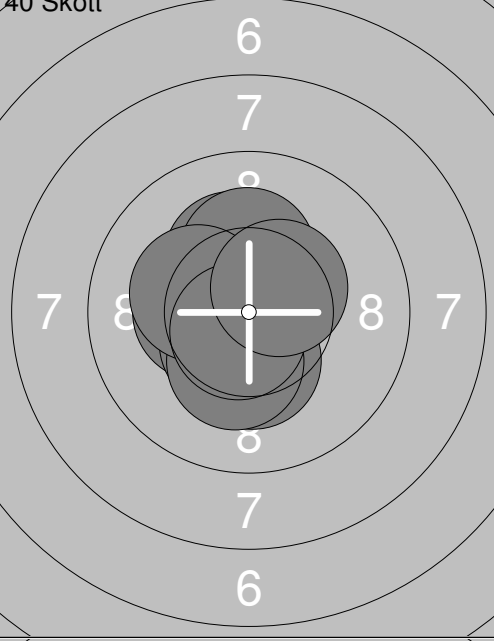
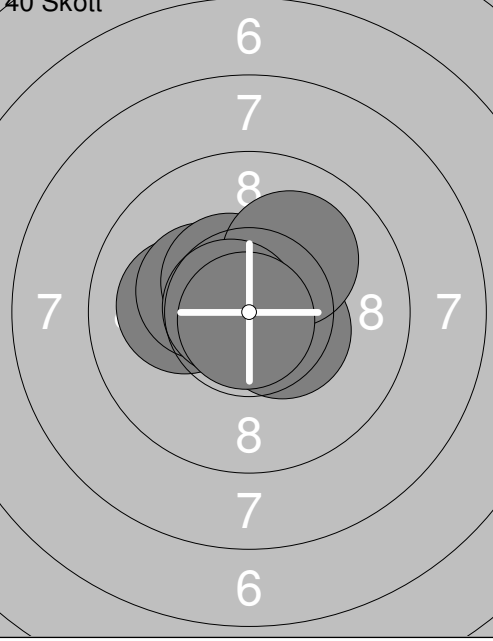
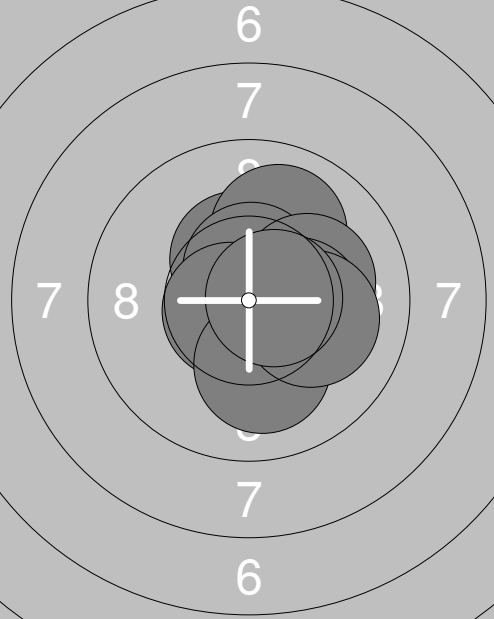

Skjutlag <b>1</b>	Tavla <b>19</b>	<b>Martin Blombäck</b>	
S		Piteå Skf	
04.02.2017		Skyttiaden Regionfinal	Umeå skytteallians
Prov		1: 10.7x➤ 2: 10.5x↗	40 Skott 
		Serie 21.2 Total 0.0	1: 10.3x↖ 2: 10.5x↖ 3: 10.4x↗ 4: 10.4x↘ 5: 10.6x↗ 6: 10.7x↗ 7: 10.8x↗ 8: 10.4x↘ 9: 10.8x↖ 10: 10.5x↖ Serie 105.4 Total 105.4
40 Skott		11: 10.1x↖ 12: 10.7x↗ 13: 10.7x↘ 14: 10.6x➤ 15: 10.6x↘ 16: 10.7x↗ 17: 10.3x↗ 18: 10.4x↘ 19: 10.5x↖ 20: 10.5x↘ Serie 105.1 Total 210.5	40 Skott 
			21: 10.6x↖ 22: 10.5x↖ 23: 10.6x↘ 24: 10.5x↘ 25: 10.7x↘ 26: 10.1x↓ 27: 10.5x↗ 28: 10.6x➤ 29: 10.6x↘ 30: 10.6x↖ Serie 105.3 Total 315.8
40 Skott		31: 10.2x↘ 32: 10.4x➤ 33: 10.5x➤ 34: 10.5x↘ 35: 10.6x➤ 36: 10.3x➤ 37: 10.7x➤ 38: 10.6x↗ 39: 10.9x➤ 40: 10.8x➤ Serie 105.5 Total 421.3	

Skjutlag	Tavla	Hanna Augustsson	
S	Vännäs Skf		
04.02.2017	Skyttiaden Regionfinal	Umeå skytteallians	
Prov		Prov	
	1: 10.6x↓ 2: 10.5x↘ 3: 10.9x↗ 4: 10.2x↓ 5: 10.7x↑ 6: 10.4x↓ 7: 10.5x↑ 8: 10.4x↖ 10: 10.5x↗		11: 10.3x↓ 12: 10.8x↘ 13: 10.4x↓ 14: 10.4x↗ 15: 10.3x↓ 16: 10.3x↓ 17: 10.5x↗
	Serie 94.7 Total 0.0		Serie 73.0 Total 0.0
40 Skott		40 Skott	
	1: 10.1↖ 2: 10.5x↗ 3: 10.0↓ 4: 10.7x↗ 5: 10.6x↑ 6: 10.4x↘ 7: 10.3x↓ 8: 10.7x↘ 9: 10.7x↘ 10: 10.4x↖		11: 10.6x↘ 12: 10.4x↘ 13: 10.8x↓ 14: 10.5x↗ 15: 10.8x↑ 16: 10.8x↘ 17: 10.4x↘ 18: 10.7x↗ 19: 10.1↗ 20: 10.3x↘
	Serie 104.4 Total 104.4		Serie 105.4 Total 209.8
40 Skott		40 Skott	
	21: 10.6x↘ 22: 10.6x↘ 23: 10.4x↗ 24: 10.4x↗ 25: 10.8x↑ 26: 10.7x↗ 27: 10.5x↓ 28: 10.4x↑ 29: 10.8x↑ 30: 10.5x↘		31: 10.3x↓ 32: 10.8x↖ 33: 10.1→ 34: 10.1↖ 35: 10.4x↑ 36: 10.5x↘ 37: 10.6x↗ 38: 10.4x↗ 39: 10.0↖ 40: 10.3x↗
	Serie 105.7 Total 315.5		Serie 103.5 Total 419.0

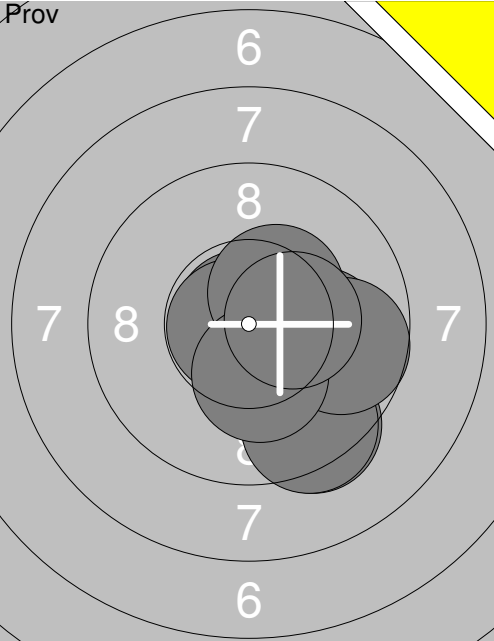
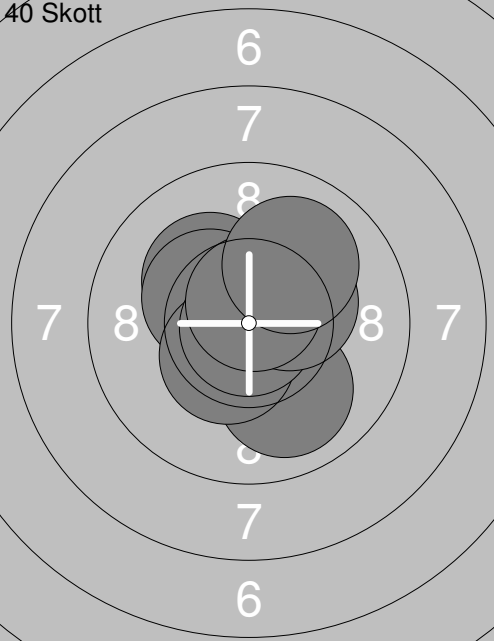
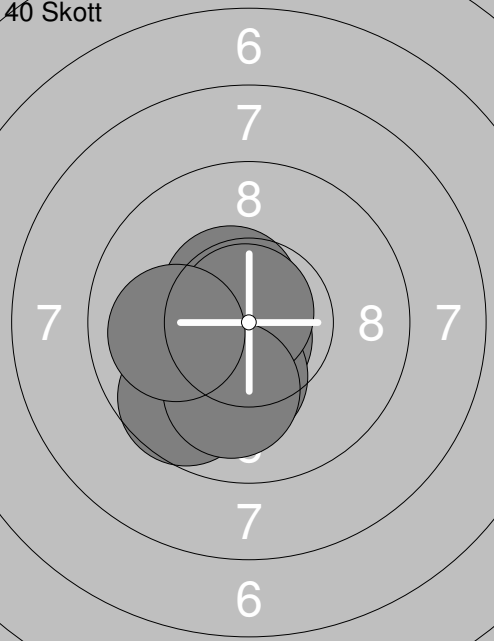
Skjutlag <b>1</b>	Tavla <b>21</b>	<b>Isabella Hahlin</b>	
S		Sundsvalls Skf	
04.02.2017		Skyttiaden Regionfinal	Umeå skytteallians
Prov		1: 9.8 ↘ 2: 10.8 ✕ 3: 10.5 ✕ 4: 10.0 ↘ 5: 10.2 ✕ 6: 9.6 ↘ 7: 10.2 ✕ 8: 10.3 ✕ 9: 10.6 ✕ 10: 10.7 ✕ Serie 102.7 Total 0.0	40 Skott  1: 10.2 ✕ 2: 10.7 ✕ 3: 10.6 ✕ 4: 10.7 ✕ 5: 10.4 ✕ 6: 10.6 ✕ 7: 10.9 ✕ 8: 10.4 ✕ 9: 10.3 ✕ 10: 10.3 ✕ Serie 105.1 Total 105.1
40 Skott		11: 10.3 ✕ 12: 10.3 ✕ 13: 10.2 ✕ 14: 10.7 ✕ 15: 10.5 ✕ 16: 10.3 ✕ 17: 10.2 ✕ 18: 10.2 ✕ 19: 10.7 ✕ 20: 10.4 ✕ Serie 103.8 Total 208.9	40 Skott  21: 10.6 ✕ 22: 10.5 ✕ 23: 10.1 ✕ 24: 10.8 ✕ 25: 10.5 ✕ 26: 10.3 ✕ 27: 10.5 ✕ 28: 10.1 ✕ 29: 10.7 ✕ 30: 10.8 ✕ Serie 104.9 Total 313.8
40 Skott		31: 10.7 ✕ 32: 10.4 ✕ 33: 10.0 ↗ 34: 10.6 ✕ 35: 10.2 ✕ 36: 10.7 ✕ 37: 10.1 ↘ 38: 10.3 ✕ 39: 10.1 → 40: 10.6 ✕ Serie 103.7 Total 417.5	

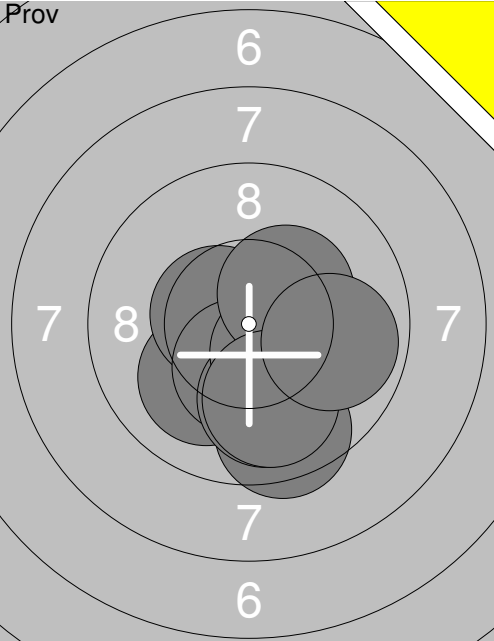
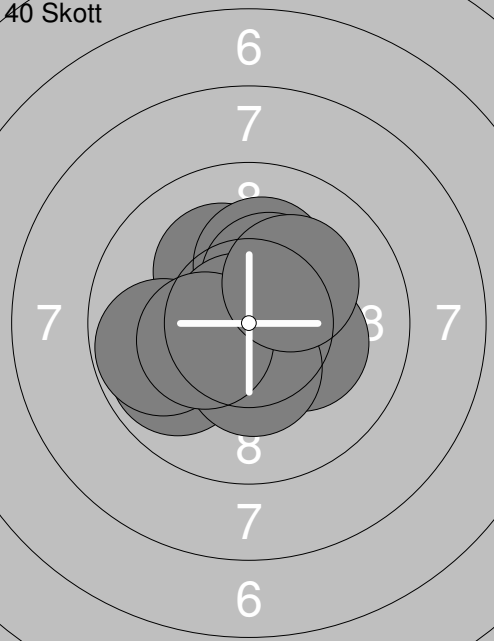
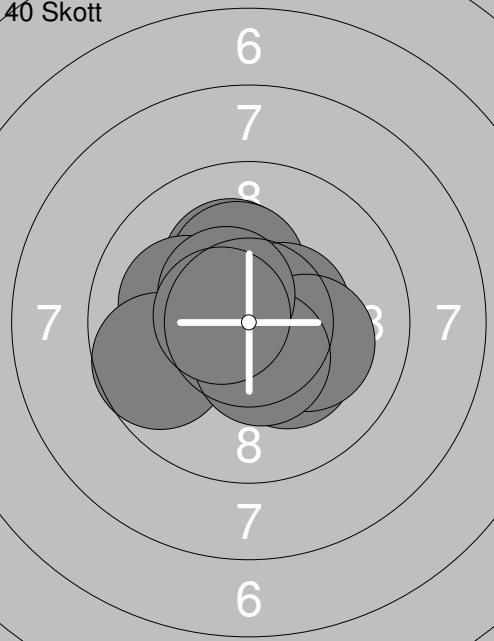

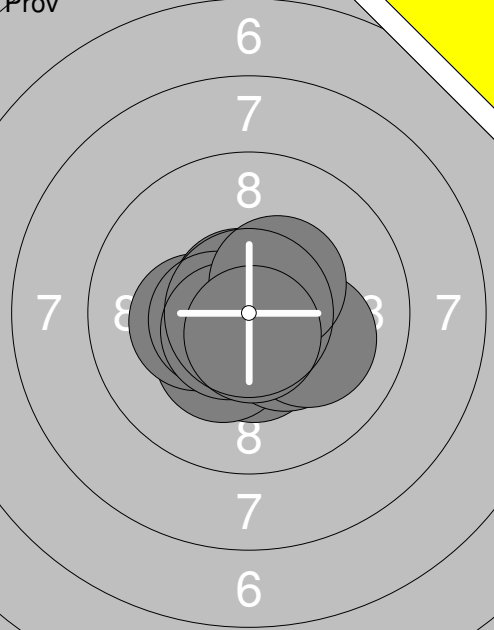
Skjutlag	Tavla	Mattis Hemå	
1	22		
S	Fältjägarna Skf		
04.02.2017	Skyttiaden Regionfinal	Umeå skytteallians	
Prov		1: 10.8x↘ 2: 10.0→ 3: 10.8x← 4: 10.4x↗ 5: 9.4 ↓ 6: 10.2x→ 7: 9.4 ↓ 8: 9.7 → 9: 10.3x↓ 10: 10.4x→ Serie 101.4 Total 0.0	11: 10.2x↓ 12: 10.6x→ 13: 10.8x↓ Serie 31.6 Total 0.0
40 Skott		1: 10.7x↓ 2: 10.9x← 3: 10.2x↘ 4: 10.0 ↓ 5: 10.3x↘ 6: 10.4x↓ 7: 10.9x↓ 8: 10.3x→ 9: 10.7x↗ 10: 10.0 ↗ Serie 104.4 Total 104.4	11: 9.6 ↗ 12: 9.7 ↗ 13: 10.6x↘ 14: 10.4x→ 15: 10.5x↘ 16: 10.6x↘ 17: 10.1 ↓ 18: 10.4x↓ 19: 9.9 ↓ 20: 10.0 ↘ Serie 101.8 Total 206.2
40 Skott		21: 10.7x↘ 22: 10.7x↓ 23: 10.2x↓ 24: 10.5x↘ 25: 10.1 ↓ 26: 10.3x← 27: 9.7 ↓ 28: 10.8x↗ 29: 10.0 ↓ 30: 10.0← Serie 103.0 Total 309.2	31: 10.0 ↙ 32: 10.6x→ 33: 9.6 ↓ 34: 10.4x↘ 35: 10.0 ↗ 36: 10.3x↗ 37: 10.6x↗ 38: 10.0 ↑ 39: 10.1 ↑ 40: 10.3x↘ Serie 101.9 Total 411.1

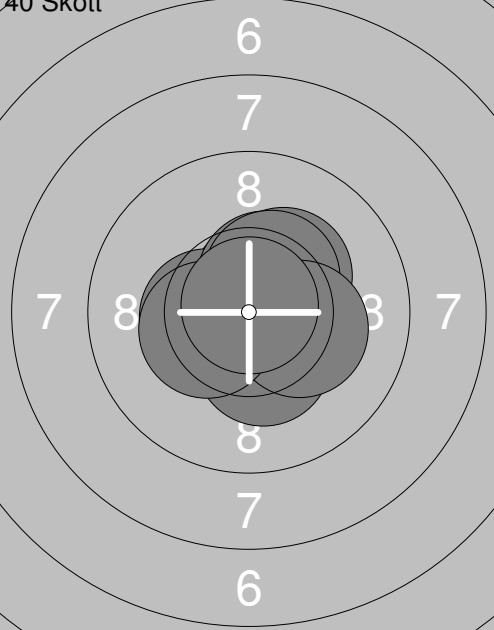
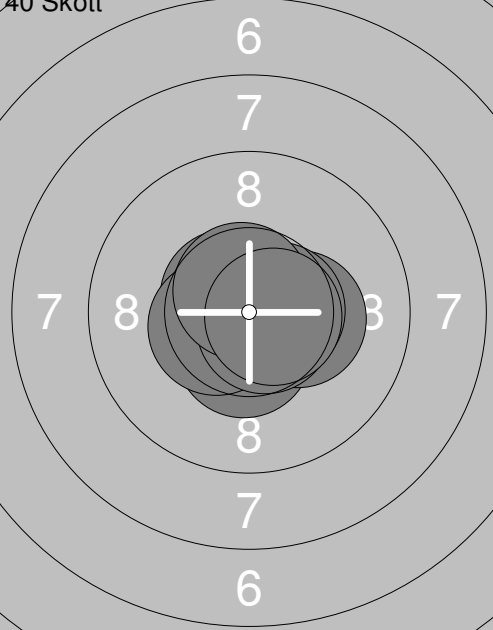
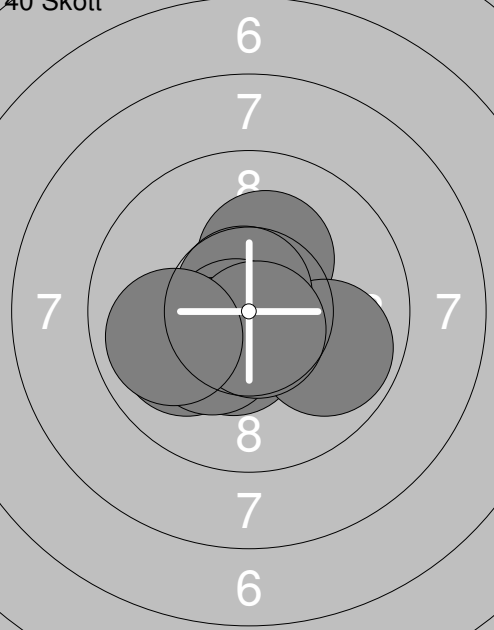
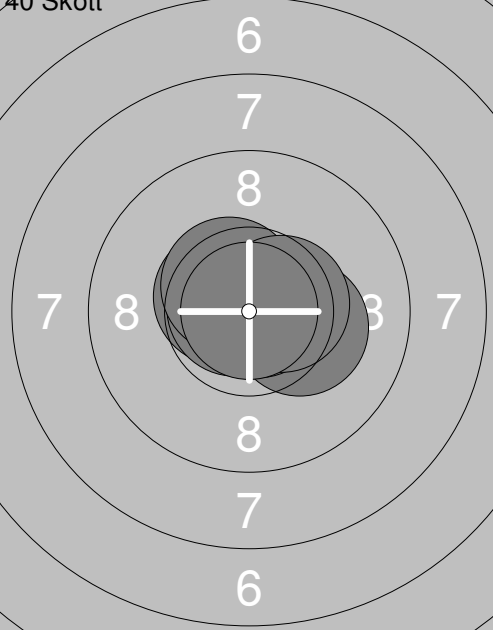
Skjutlag	Tavla	Axel Vikström	
1	23		
S	I19 Uskf		
04.02.2017	Skyttiaden Regionfinal	Umeå skytteallians	
Prov		1: 10.1 ↘ 2: 10.9x ↘ 3: 10.5x ↘ 4: 9.5 ↓ 5: 10.4x ↓ 6: 10.0 ↓ 7: 10.4x ↘ 8: 10.3x ↗ 9: 9.9 ↓ 10: 9.9 →	11: 9.8 → 12: 10.7x ↘ 13: 10.2x ↘ 14: 10.0 ↓ 15: 9.9 ↓
		Serie 101.9	Serie 50.6
		Total 0.0	Total 0.0
40 Skott		1: 10.2x ↗ 2: 10.2x ↗ 3: 10.2x ↘ 4: 10.3x ↗ 5: 10.8x ↘ 6: 9.9 ↙ 7: 10.4x ↓ 8: 9.8 ← 9: 10.3x ↘ 10: 10.2x ↗	11: 10.6x ↗ 12: 10.4x ↘ 13: 10.7x ↘ 14: 10.5x ↗ 15: 9.1 ↖ 16: 10.4x ↗ 17: 10.1 ↖ 18: 10.8x ↗ 19: 10.4x ↗ 20: 10.7x ↘
		Serie 102.3	Serie 103.7
		Total 102.3	Total 206.0
40 Skott		21: 10.2x ↗ 22: 10.3x ↗ 23: 10.1 ↙ 24: 10.3x ↘ 25: 10.5x ↗ 26: 9.7 ↙ 27: 10.2x ↘ 28: 10.5x ↓ 29: 10.5x ↗ 30: 10.6x ↘	31: 10.5x ↗ 32: 9.4 → 33: 10.3x ↗ 34: 10.6x ↓ 35: 10.4x ↗ 36: 10.4x ↘ 37: 10.4x ↓ 38: 10.2x ↗ 39: 10.2x ↗ 40: 10.0 ↑
		Serie 102.9	Serie 102.4
		Total 308.9	Total 411.3

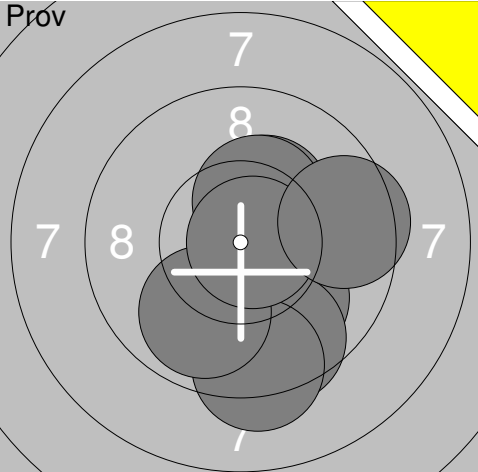
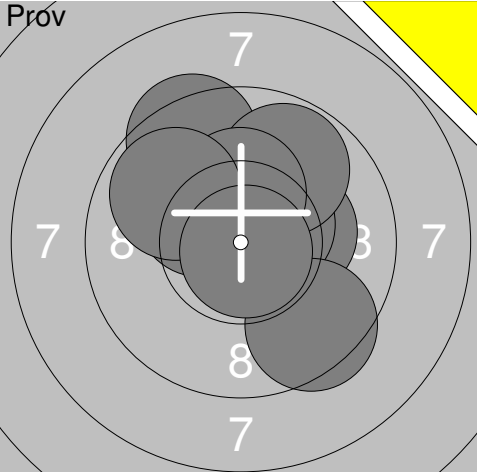
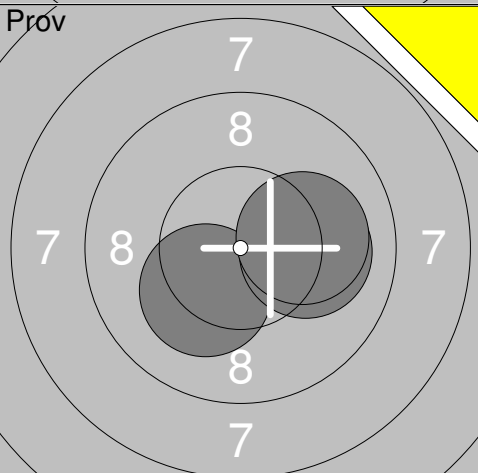
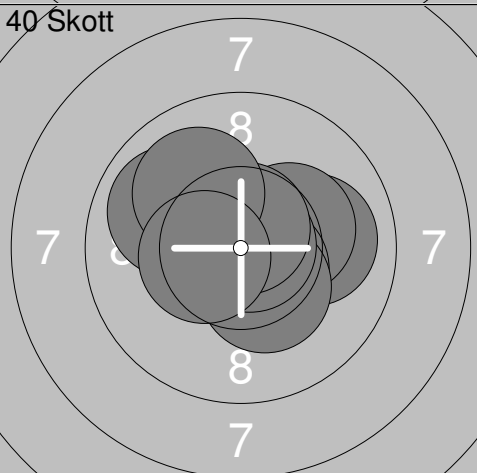
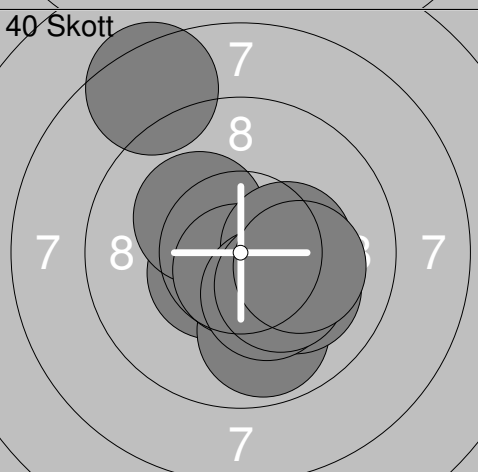
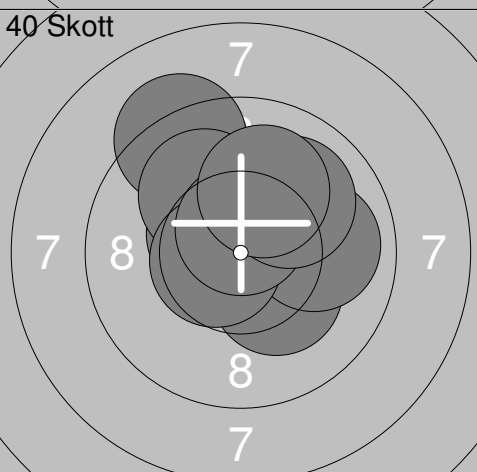
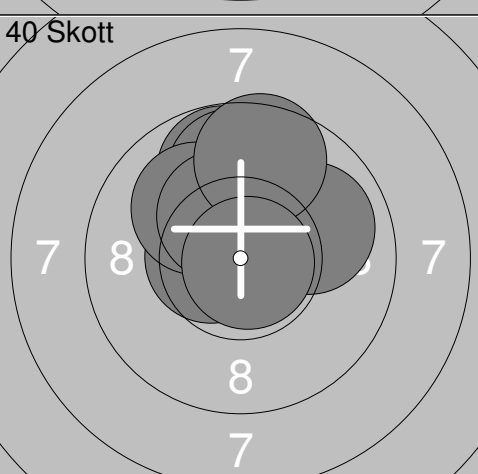
<p>Prov</p>  <p style="text-align: center;">6 7 8 7 8 7 6</p>	<p>1: 10.4x↓ 2: 10.3x↓ 3: 10.3x↔ 4: 10.7x↗ 5: 10.5x↔ 6: 10.6x↘ 7: 10.3x↘ 8: 10.1x→ 9: 10.4x↗ 10: 10.7x↓</p> <p>Serie 104.3 Total 0.0</p>	<p>Prov</p>  <p style="text-align: center;">6 7 8 8 7 6</p>	<p>11: 10.5x↗ 12: 10.5x↗ 13: 10.6x↓ 14: 10.7x↗ 15: 10.8x↔</p> <p>Serie 53.1 Total 0.0</p>
<p>40 Skott</p>  <p style="text-align: center;">6 7 8 7 8 7 6</p>	<p>1: 10.6x↗ 2: 10.3x↗ 3: 10.9x↔ 4: 10.4x↔ 5: 10.5x↗ 6: 10.3x↓ 7: 10.4x↗ 8: 10.3x→ 9: 10.4x↔ 10: 10.9x↗</p> <p>Serie 105.0 Total 105.0</p>	<p>40 Skott</p>  <p style="text-align: center;">6 7 8 8 7 6</p>	<p>11: 10.7x↔ 12: 10.5x↓ 13: 10.3x→ 14: 10.6x↔ 15: 10.6x→ 16: 10.7x↔ 17: 10.5x↔ 18: 10.7x↓ 19: 10.7x↗ 20: 10.6x→</p> <p>Serie 105.9 Total 210.9</p>
<p>40 Skott</p>  <p style="text-align: center;">6 7 8 7 8 7 6</p>	<p>21: 10.4x↘ 22: 10.2x↗ 23: 10.0x↙ 24: 10.4x↓ 25: 9.9x→ 26: 10.7x↗ 27: 10.7x↓ 28: 10.3x↘ 29: 10.7x↓ 30: 9.9x↙</p> <p>Serie 103.2 Total 314.1</p>	<p>40 Skott</p>  <p style="text-align: center;">6 7 8 8 7 6</p>	<p>31: 10.9x↗ 32: 10.8x→ 33: 10.3x→ 34: 10.8x→ 35: 10.5x↔ 36: 10.8x↔ 37: 10.8x↗ 38: 10.5x↘ 39: 10.5x→ 40: 10.9x↗</p> <p>Serie 106.8 Total 420.9</p>

Skjutlag <b>1</b>	Tavla <b>25</b>	<b>Rebecka Bäckman</b>	
S		Gideå Skf	
04.02.2017		Skyttiaden Regionfinal	Umeå skytteallians
Prov		1: 9.5 ↓ 2: 10.0 ↓ 3: 10.1 ↓ 4: 9.6 ↓ 5: 9.3 ↓ 6: 9.9 ↓ 7: 10.3x ↗ 8: 10.4x ↗ 9: 10.8x → 10: 9.5 → Serie 99.4 Total 0.0	Prov  11: 10.3x ↖ 12: 10.0 ↗ 13: 10.3x → 14: 10.5x ↗ 15: 9.5 ↓ 16: 9.4 ↗ 17: 9.8 ↗ 18: 10.3x ↑ 19: 9.9 ↗ 20: 10.8x ↓ Serie 100.8 Total 0.0
Prov		21: 10.2x ↓ 22: 10.1 → 23: 10.1 → Serie 30.4 Total 0.0	40 Skott  1: 9.9 ↖ 2: 10.0 → 3: 10.2x → 4: 10.7x ↗ 5: 10.5x ↓ 6: 10.3x ↓ 7: 10.8x → 8: 10.7x ↑ 9: 10.0 ↗ 10: 10.4x ← Serie 103.5 Total 103.5
40 Skott		11: 10.5x ↖ 12: 10.2x ↗ 13: 9.9 ↓ 14: 8.4 ↗ 15: 10.7x ↓ 16: 10.3x → 17: 10.1 ↓ 18: 10.3x ↓ 19: 10.3x ↓ 20: 10.1 → Serie 100.8 Total 204.3	40 Skott  21: 10.5x ↖ 22: 9.2 ↗ 23: 10.3x ↑ 24: 10.3x ↓ 25: 10.0 → 26: 10.0 ↗ 27: 10.6x ← 28: 10.6x ↑ 29: 10.0 ↗ 30: 10.1 ↗ Serie 101.6 Total 305.9
40 Skott		31: 9.8 ↑ 32: 10.5x ← 33: 9.8 ↑ 34: 10.1 ↗ 35: 10.3x ↗ 36: 9.9 ↑ 37: 9.9 → 38: 10.3x ↗ 39: 9.6 ↑ 40: 10.8x ↘ Serie 101.0 Total 406.9	

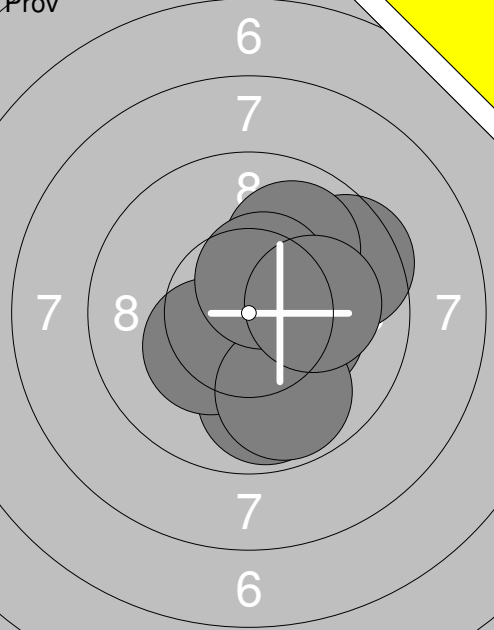

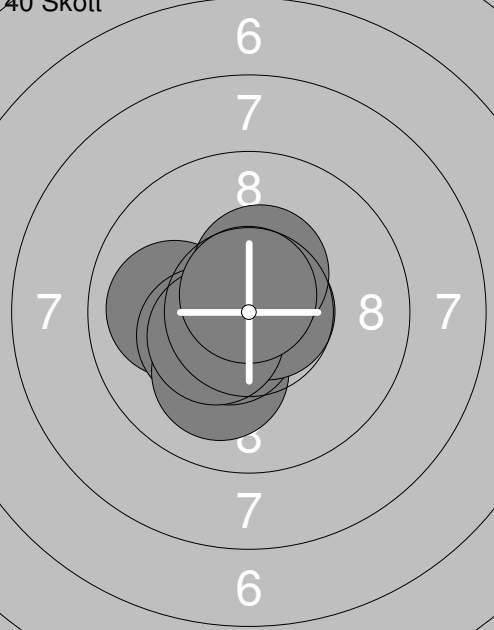
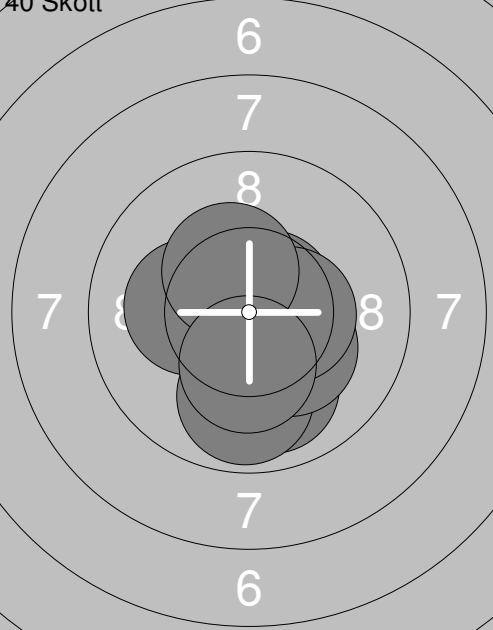
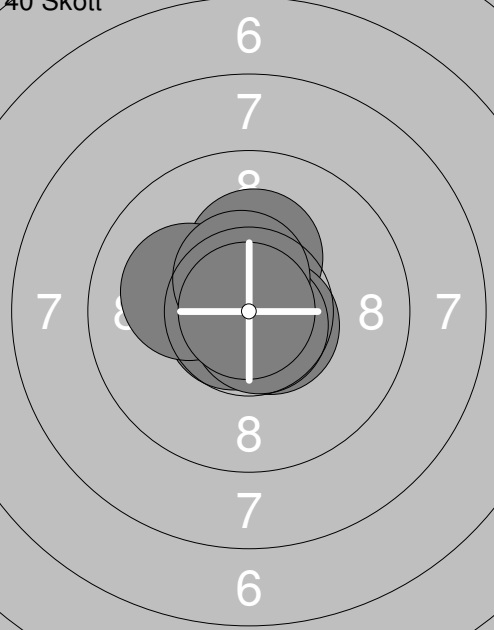
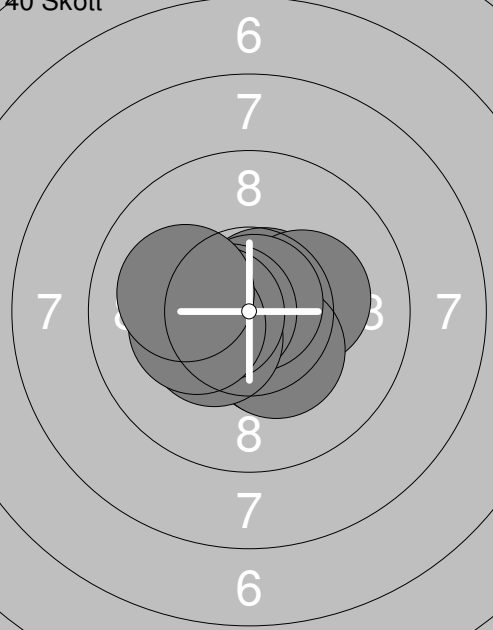
<p>Prov</p> 	<p>1: 10.3x➤</p> <p>2: 9.5 ➤</p> <p>3: 9.8 ↓</p> <p>5: 10.0 ↗</p> <p>6: 10.5x↘</p> <p>7: 10.3x↙</p> <p>8: 9.8 ↓</p> <p>9: 10.5x↗</p> <p>10: 10.1➔</p>	<p>Prov</p> 	<p>11: 10.3x↗</p> <p>12: 10.6x➤</p> <p>13: 10.5x↙</p> <p>14: 10.7x↙</p> <p>15: 10.6x↘</p> <p>16: 10.4x↙</p>
Serie 90.8		Serie 63.1	
Total 0.0		Total 0.0	
<p>40 Skott</p> 	<p>1: 10.8x↙</p> <p>2: 10.3x↙</p> <p>3: 10.0↔</p> <p>4: 10.3x↙</p> <p>5: 10.1 ↓</p> <p>6: 10.5x↙</p> <p>7: 10.7x➤</p> <p>8: 10.4x↗</p> <p>9: 10.4x↙</p> <p>10: 10.7x↗</p>	<p>40 Skott</p> 	<p>11: 10.8x↙</p> <p>12: 10.2x↘</p> <p>13: 10.0 ↓</p> <p>14: 9.9 ↓</p> <p>15: 10.7x↗</p> <p>16: 10.3x↘</p> <p>17: 10.2x↔</p> <p>18: 10.4x➤</p> <p>19: 10.4x↙</p> <p>20: 10.3x↘</p>
Serie 104.2		Serie 103.2	
Total 104.2		Total 207.4	
<p>40 Skott</p> 	<p>21: 10.7x↘</p> <p>22: 10.2x↗</p> <p>23: 10.8x↙</p> <p>24: 10.7x↙</p> <p>25: 10.9x↘</p> <p>26: 10.6x↘</p> <p>27: 10.1↔</p> <p>28: 10.7x↘</p> <p>29: 10.5x↗</p> <p>30: 10.9x↔</p>	<p>40 Skott</p> 	<p>31: 10.7x↗</p> <p>32: 10.4x↘</p> <p>33: 10.2x➤</p> <p>34: 10.3x↘</p> <p>35: 10.8x↗</p> <p>36: 10.7x↔</p> <p>37: 10.4x↙</p> <p>38: 10.5x↔</p> <p>39: 10.2x↔</p> <p>40: 10.1↔</p>
Serie 106.1		Serie 104.3	
Total 313.5		Total 417.8	

<p>Prov</p>	<p>1: 10.7x ↗                  2: 10.3x ↘                  3: 10.4x ↘                  4: 10.1 ↗                  5: 10.7x ↗                  6: 9.8 ↗                  7: 10.2x ↗                  8: 10.8x ↘                  9: 9.8 →                  10: 10.3x ↘</p> <p>Serie 103.1 Total 0.0</p>	<p>Prov</p>	<p>12: 10.4x ↗                  13: 10.1 ←                  14: 10.5x ↘</p> <p>Serie 31.0 Total 0.0</p>
<p>40 Skott</p>	<p>1: 10.5x ↘                  2: 10.3x ↘                  3: 10.6x →                  4: 10.6x ↘                  5: 10.0 ↘                  6: 10.3x ↘                  7: 10.3x ↘                  8: 10.4x ↘                  9: 10.4x ↘                  10: 10.1 ←</p> <p>Serie 103.5 Total 103.5</p>	<p>40 Skott</p>	<p>11: 10.4x ↘                  12: 10.1 ↘                  13: 10.3x ←                  14: 10.2x ←                  15: 10.9x →                  16: 10.9x →                  17: 10.3x ←                  18: 9.4 →                  19: 10.3x ←                  20: 10.5x ↗</p> <p>Serie 103.3 Total 206.8</p>
<p>40 Skott</p>	<p>21: 9.8 ↘                  22: 10.1 ↘                  23: 10.8x ↘                  24: 10.7x ↘                  25: 10.8x →                  26: 10.7x ↘                  27: 9.1 ←                  28: 10.7x ↘                  29: 10.5x →                  30: 10.4x →</p> <p>Serie 103.6 Total 310.4</p>	<p>40 Skott</p>	<p>31: 10.6x ↘                  32: 10.6x ↘                  33: 10.6x ↘                  34: 10.6x ↘                  35: 10.3x →                  36: 10.0 ↗                  37: 10.7x ↗                  38: 10.6x ↗                  39: 10.7x ↘                  40: 10.3x →</p> <p>Serie 105.0 Total 415.4</p>

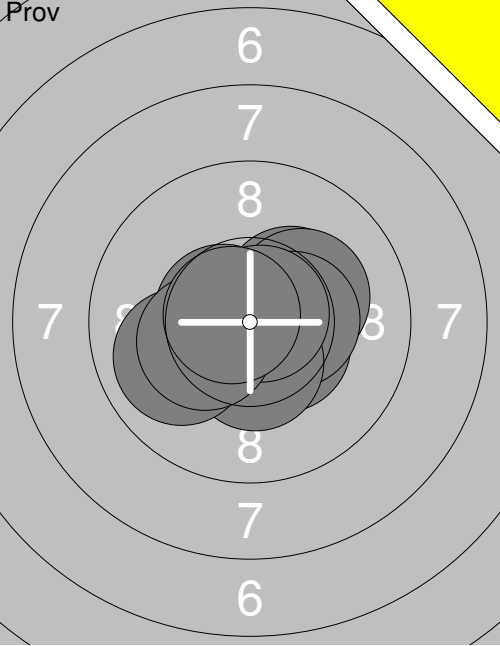
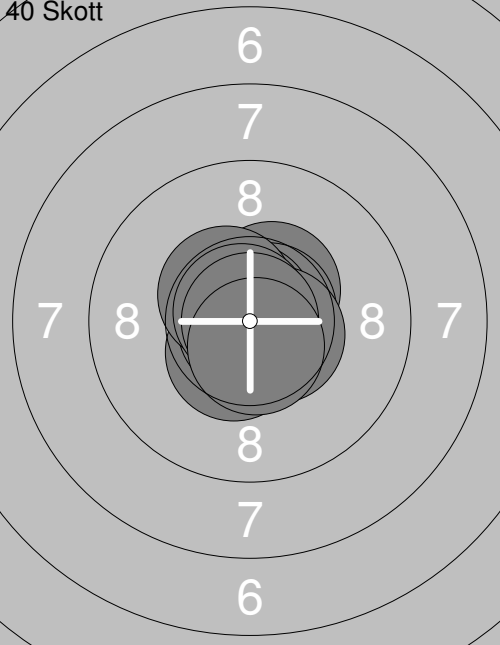
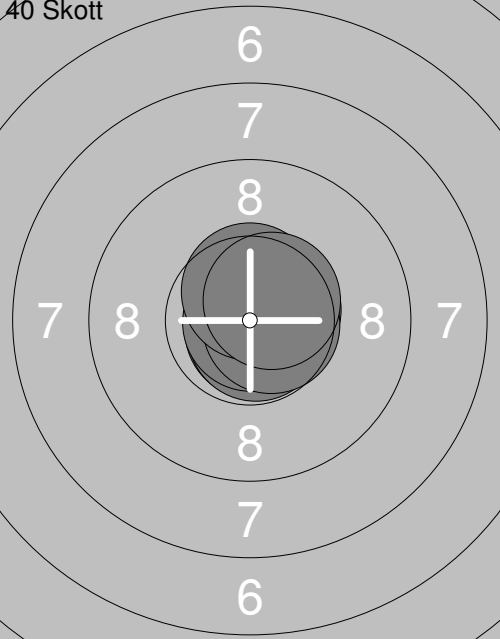
Skjutlag	Tavla	Erika Augustsson	
S	Vännäs Skf		
04.02.2017	Skyttiaden Regionfinal	Umeå skytteallians	
Prov		1: 10.3x↗ 2: 10.2x↗ 3: 10.4x↘ 4: 10.4x➤ 5: 10.4x↓ 6: 9.9 ↙ 7: 10.8x↗ 8: 10.6x↘ 9: 10.3x↘ 10: 10.7x↘ Serie 104.0 Total 0.0	11: 10.4x↓ 12: 10.6x↓ Serie 21.0 Total 0.0
40 Skott		1: 10.5x↗ 2: 10.7x↗ 3: 10.8x↘ 4: 10.5x↓ 5: 10.9x↓ 6: 10.6x➤ 7: 10.5x↘ 8: 10.8x↘ 9: 10.9x↘ 10: 10.6x↓ Serie 106.8 Total 106.8	11: 10.5x➤ 12: 10.5x↘ 13: 10.2x↗ 14: 10.6x↓ 15: 10.9x↘ 16: 10.8x↘ 17: 10.7x➤ 18: 10.4x↗ 19: 10.6x↘ 20: 10.6x↓ Serie 105.8 Total 212.6
40 Skott		21: 10.8x➤ 22: 10.8x↓ 23: 10.9x➤ 24: 10.6x↗ 25: 10.8x↓ 26: 10.7x↗ 27: 10.9x↓ 28: 10.7x➤ 29: 10.6x↗ 30: 10.6x↗ Serie 107.4 Total 320.0	31: 10.7x↓ 32: 10.5x↘ 33: 10.6x↓ 34: 10.7x➤ 35: 10.7x↓ 36: 10.2x↗ 37: 10.7x↗ 38: 10.7x↘ 39: 10.8x↓ 40: 10.4x↗ Serie 106.0 Total 426.0

<p>Prov</p>	<p>1: 10.1 →</p> <p>2: 10.6x ↗</p> <p>3: 10.1 ↑</p> <p>4: 10.0 ↑</p> <p>5: 10.0 ↖</p> <p>6: 10.3x ↗</p> <p>7: 10.1 ↙</p> <p>8: 10.5x ↗</p> <p>9: 10.7x ↗</p> <p>10: 9.8 ←</p> <p>Serie 102.2</p> <p>Total 0.0</p>	<p>Prov</p>	<p>11: 9.9 ↖</p> <p>12: 10.6x ↗</p> <p>13: 9.7 →</p> <p>14: 10.8x ↙</p> <p>15: 10.8x ↘</p> <p>Serie 51.8</p> <p>Total 0.0</p>
<p>40 Skott</p>	<p>1: 10.1 ←</p> <p>2: 10.6x ↙</p> <p>3: 9.9 ↓</p> <p>4: 10.2x ↙</p> <p>5: 10.2x →</p> <p>6: 10.0 ↘</p> <p>7: 10.2x ↘</p> <p>8: 9.7 ↑</p> <p>9: 10.1 ↗</p> <p>10: 9.8 ↑</p> <p>Serie 100.8</p> <p>Total 100.8</p>	<p>40 Skott</p>	<p>11: 9.7 ↑</p> <p>12: 10.1 ↖</p> <p>13: 10.4x ↘</p> <p>14: 10.2x →</p> <p>15: 10.6x ↗</p> <p>16: 10.6x ↙</p> <p>17: 10.4x ↘</p> <p>18: 10.2x ↗</p> <p>19: 10.7x ↘</p> <p>20: 10.2x ↘</p> <p>Serie 103.1</p> <p>Total 203.9</p>
<p>40 Skott</p>	<p>21: 10.2x ↘</p> <p>22: 10.5x ↘</p> <p>23: 10.3x ↗</p> <p>24: 10.7x →</p> <p>25: 10.8x ↘</p> <p>26: 10.2x ↗</p> <p>27: 10.8x →</p> <p>28: 10.5x ↙</p> <p>29: 10.7x ↗</p> <p>30: 10.2x ↘</p> <p>Serie 104.9</p> <p>Total 308.8</p>	<p>40 Skott</p>	<p>31: 10.7x ↙</p> <p>32: 10.4x →</p> <p>33: 10.3x ↗</p> <p>34: 10.4x ↘</p> <p>35: 10.9x ↗</p> <p>36: 10.8x →</p> <p>37: 10.0 →</p> <p>38: 10.1 ↗</p> <p>39: 9.9 ↘</p> <p>40: 10.1 ↗</p> <p>Serie 103.6</p> <p>Total 412.4</p>

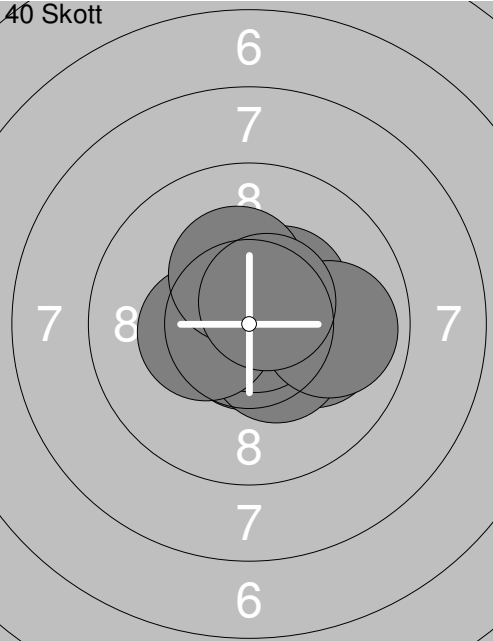
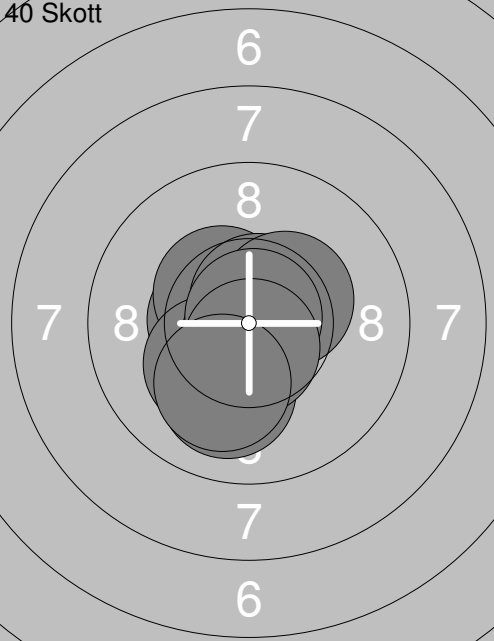
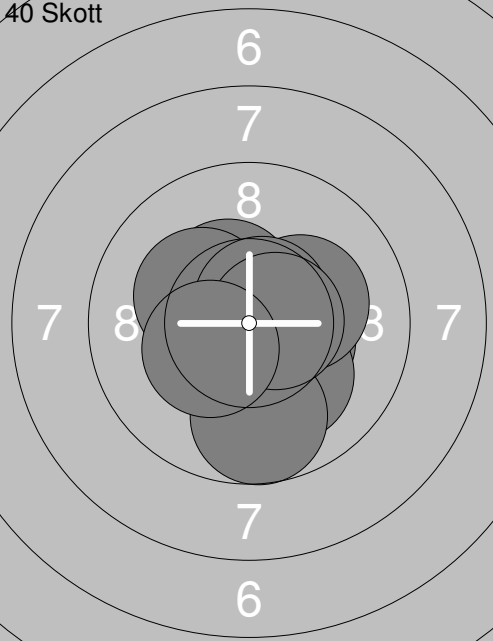
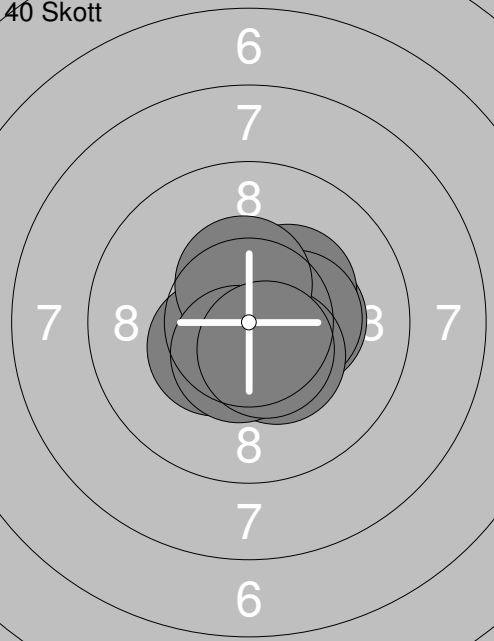
Skjutlag <b>1</b>	Tavla <b>30</b>	<b>Anton Landin</b>	
S		Fältjägarna Skf	
04.02.2017		Skyttiaden Regionfinal	Umeå skytteallians
Prov		1: 10.3x↗ 2: 10.2x↘ 3: 10.6x↗ 4: 10.2x↘ 5: 10.8x↗ 6: 10.5x↘ 7: 10.3x➤ 8: 10.5x↖ 9: 10.6x↘ 10: 10.5x↘ Serie 104.5 Total 0.0	40 Skott  1: 10.4x➤ 2: 10.1➤ 3: 10.7x↘ 4: 10.4x↘ 5: 10.9x➤ 6: 10.4x↗ 7: 10.4x↖ 8: 10.3x↗ 9: 9.9➡ 10: 10.6x↗ Serie 104.1 Total 104.1
40 Skott		11: 10.5x↖ 12: 10.4x↗ 13: 10.6x↗ 14: 10.4x↗ 15: 10.2x↘ 16: 10.7x↘ 17: 10.9x↗ 18: 10.0↘ 19: 10.6x↘ 20: 10.1↘ Serie 104.4 Total 208.5	40 Skott  21: 10.4x↗ 22: 10.4x➤ 23: 10.5x↘ 24: 10.1↘ 25: 10.2x➤ 26: 10.2x↖ 27: 10.7x↗ 28: 9.7↘ 29: 10.6x➤ 30: 10.3x↘ Serie 103.1 Total 311.6
40 Skott		31: 10.5x↗ 32: 10.8x↗ 33: 10.3x➤ 34: 10.4x↘ 35: 10.3x↗ 36: 10.4x➤ 37: 10.4x↘ 38: 10.4x↗ 39: 10.5x↘ 40: 10.5x↘ Serie 104.5 Total 416.1	

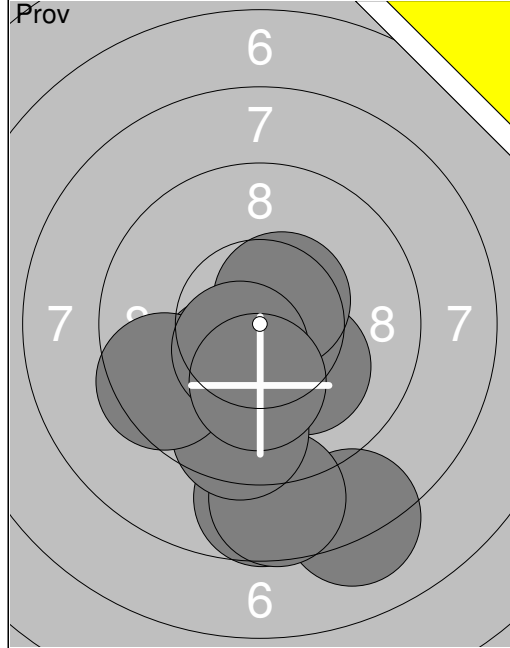

1:	8.2	↓
2:	8.7	↓
3:	8.7	↓
4:	10.2	x↓
5:	9.5	↓
6:	10.3	x↓
7:	9.5	↙
8:	10.5	x↗
9:	10.5	x↓
10:	10.2	x↓
Serie		96.3
Total		0.0

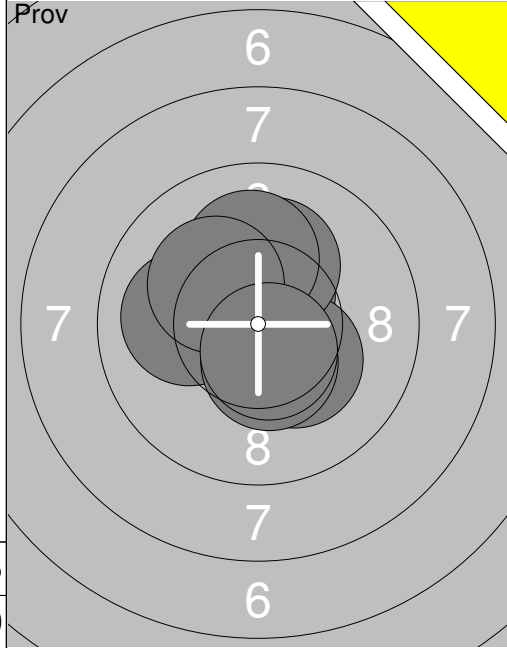

11:	10.1	←
12:	10.6	x↗
13:	10.3	x↘
14:	10.4	x↓
15:	10.2	x↗
16:	10.1	↑
17:	10.2	x↘
18:	10.6	x↓
Serie		82.5
Total		0.0

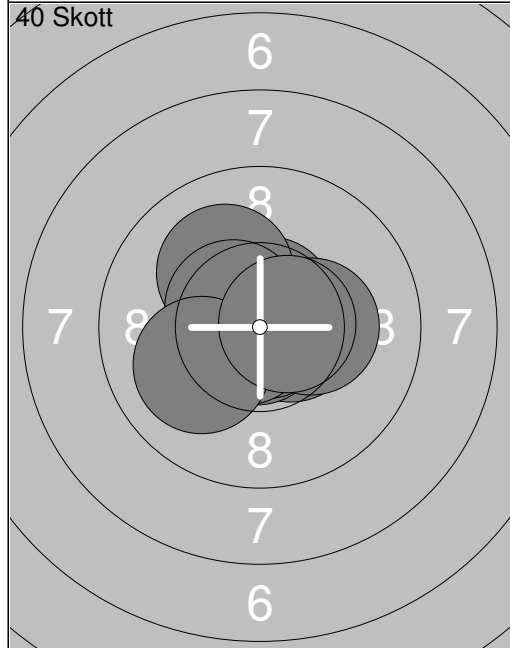

1:	10.5	x>
2:	10.8	x↓
3:	10.6	x↗
4:	10.3	x>
5:	10.9	x>
6:	10.1	↖
7:	10.7	x↘
8:	10.5	x↘
9:	10.0	↙
10:	10.6	x>
Serie		105.0
Total		105.0

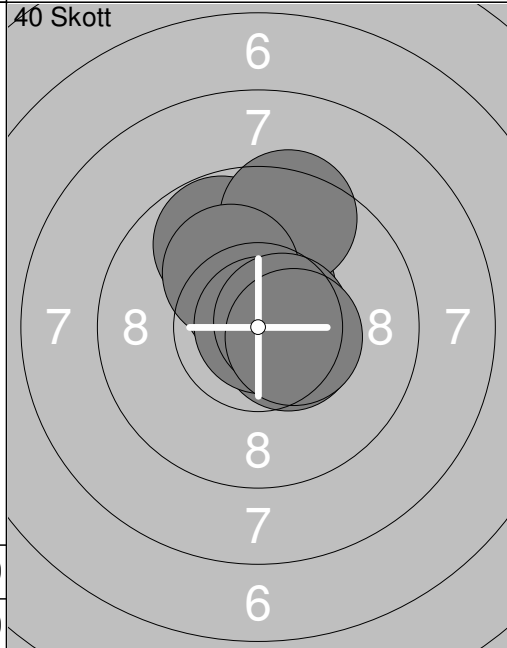

11:	9.8	↖
12:	10.5	x↗
13:	10.6	x>
14:	10.5	x↗
15:	10.5	x>
16:	9.5	↑
17:	10.2	x↖
18:	10.9	x↗
19:	10.6	x>
20:	10.5	x>
Serie		103.6
Total		208.6

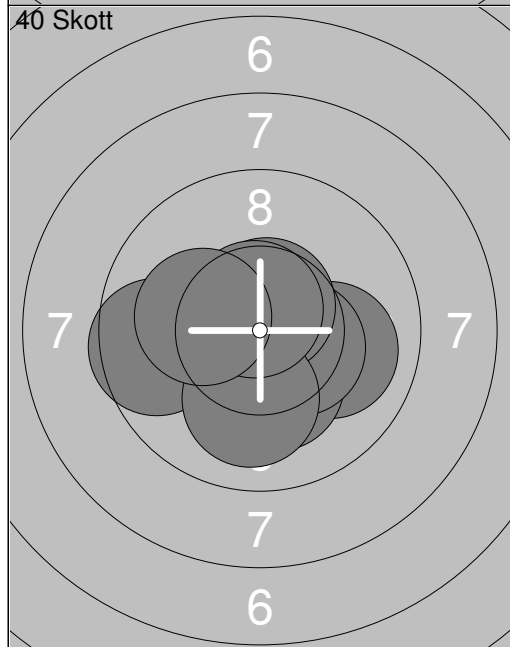

21:	10.0	→
22:	10.8	x↓
23:	10.0	←
24:	9.6	←
25:	10.2	x↓
26:	10.4	x>
27:	10.6	x↗
28:	10.1	↓
29:	10.7	x↗
30:	10.2	x↘
Serie		102.6
Total		311.2

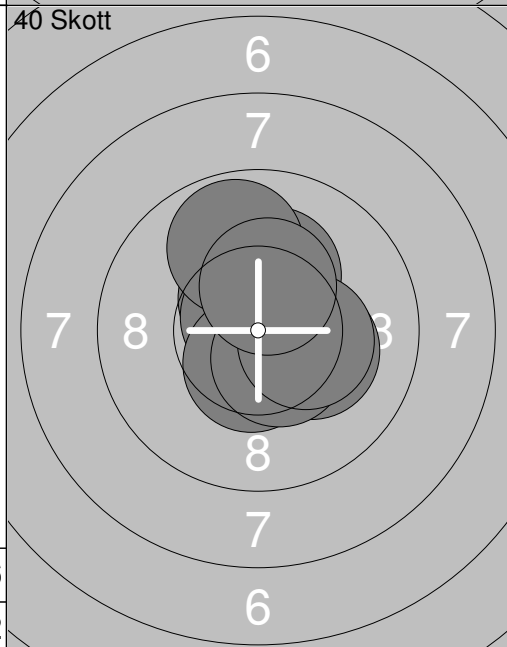

31:	10.5	x↗
32:	10.2	x>
33:	10.5	x↗
34:	10.2	x↗
35:	10.7	x↘
36:	10.5	x↓
37:	10.5	x↘
38:	9.8	↑
39:	10.3	x>
40:	10.4	x↗
Serie		103.6
Total		414.8

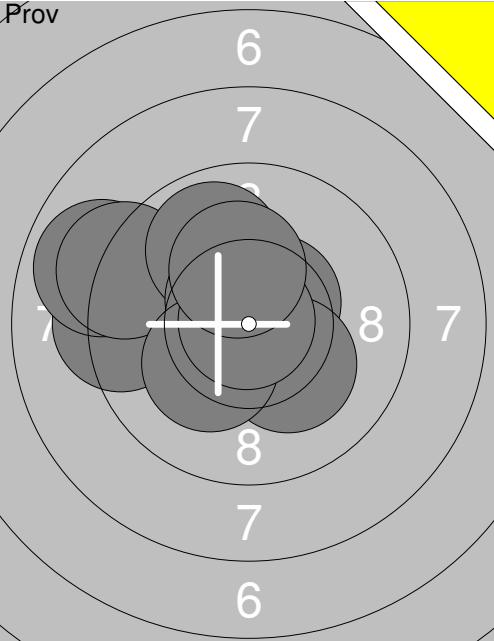
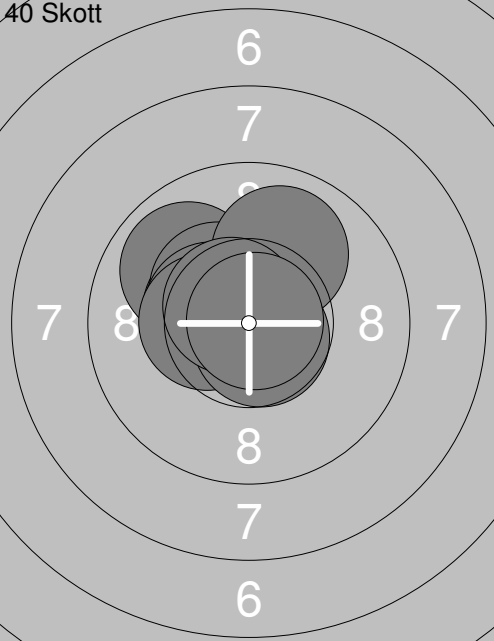
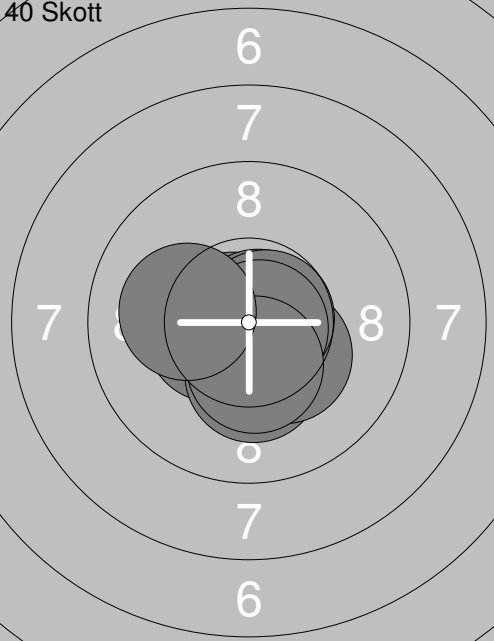
Skjutlag	Tavla	Cassandra Sjödin	
1	33		
S	Hammerdal Skf		
04.02.2017	Skyttiaden Regionfinal	Umeå skytteallians	
Prov		1: 9.3 ← 2: 8.9 ← 3: 9.2 ← 4: 9.9 ↑ 5: 10.6x↘ 6: 10.5x↗ 7: 10.2x↘ 8: 10.2x↘ 9: 10.9x↘ 10: 10.2x↑ Serie 99.9 Total 0.0	11: 10.2x↑ 12: 10.7x↘ Serie 20.9 Total 0.0
40 Skott		1: 9.9 ↖ 2: 10.4x↘ 3: 10.4x↘ 4: 10.8x↗ 5: 10.4x↘ 6: 10.0 ↑ 7: 10.4x↖ 8: 10.7x↘ 9: 10.6x↘ 10: 10.9x↗ Serie 104.5 Total 104.5	11: 10.0 → 12: 10.7x↗ 13: 10.1 ↑ 14: 10.8x↖ 15: 10.4x↑ 16: 10.2x↗ 17: 10.7x↘ 18: 10.8x↘ 19: 10.3x→ 20: 10.8x↑ Serie 104.8 Total 209.3
40 Skott		21: 10.5x↖ 22: 10.7x↖ 23: 10.9x↗ 24: 10.3x↓ 25: 10.3x↘ 26: 10.8x↗ 27: 10.7x→ 28: 10.8x↘ 29: 10.4x↓ 30: 10.1 ← Serie 105.5 Total 314.8	31: 10.2x↓ 32: 10.4x↓ 33: 10.7x↘ 34: 10.8x↗ 35: 10.7x↓ 36: 10.9x↖ 37: 10.5x↘ 38: 10.5x↖ 39: 10.8x↖ 40: 10.4x↑ Serie 105.9 Total 420.7

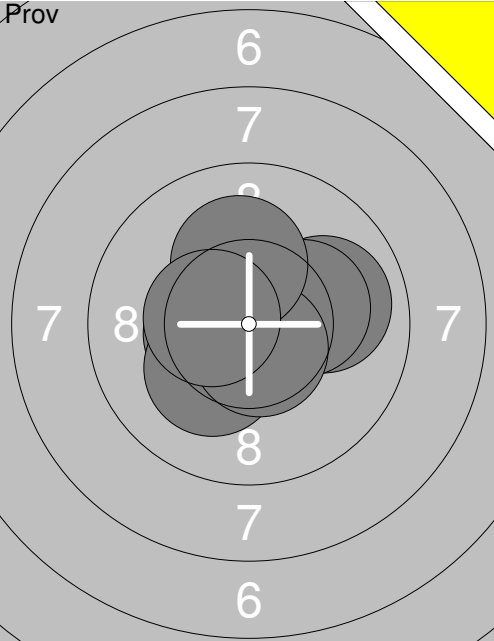
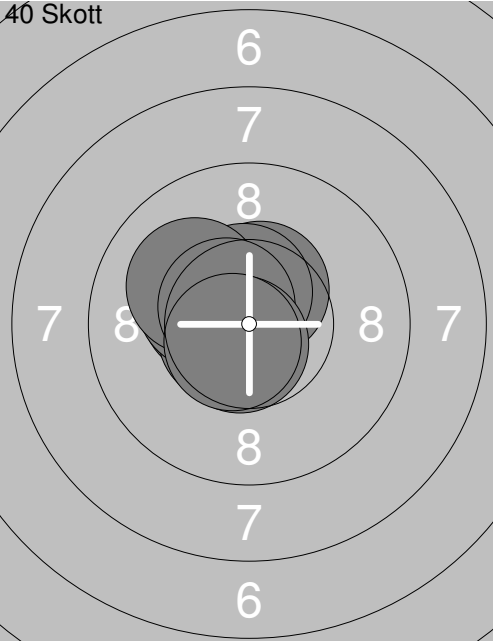
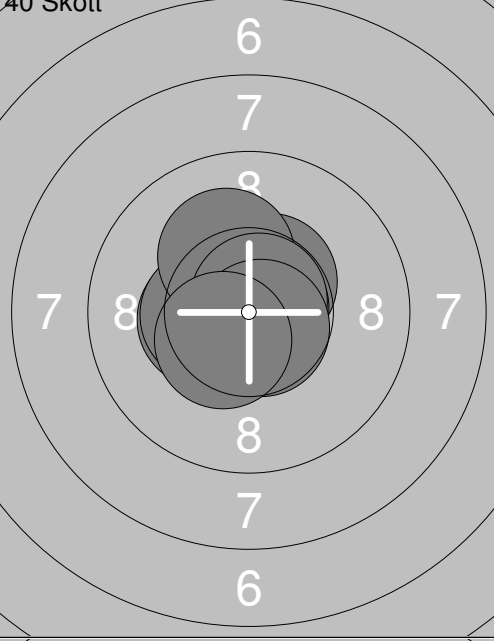
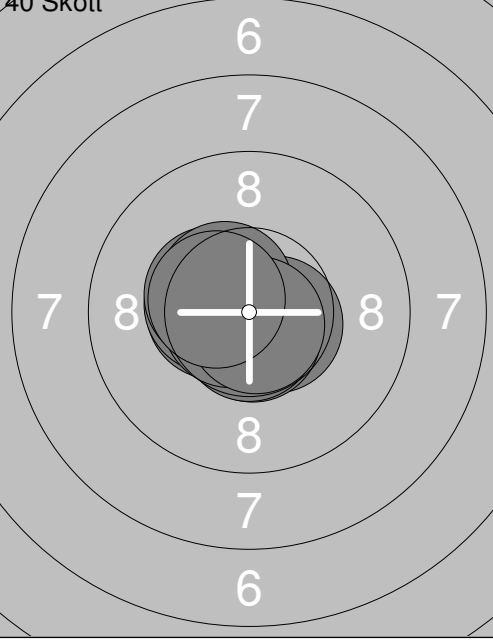
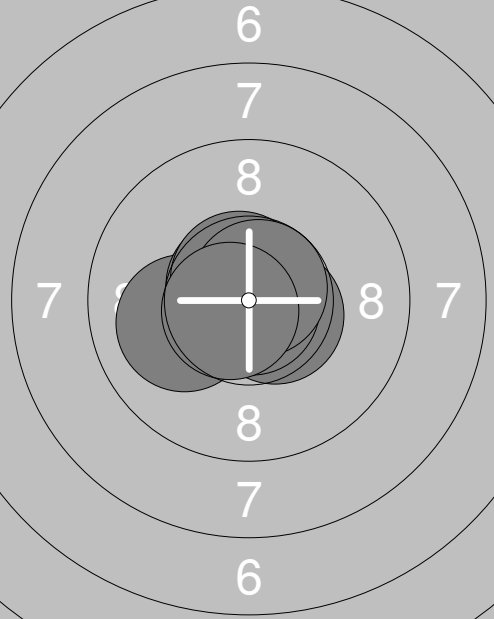
Skjutlag <b>1</b>	Tavla <b>34</b>	<b>Anna Grönlund</b>	
S		Piteå Skf	
04.02.2017		Skyttiaden Regionfinal	Umeå skytteallians
Prov 	1: 10.0 → 2: 10.2x → 3: 10.6x ← 4: 10.5x ← 5: 10.4x ↘ 6: 10.6x ↘ 7: 10.2x ↘ 8: 10.6x ↘ 9: 10.2x ↑ 10: 10.5x ← Serie 103.8 Total 0.0	40 Skott 	1: 10.4x ← 2: 10.8x ↘ 3: 10.5x ↗ 4: 10.6x ← 5: 10.5x ↗ 6: 10.3x ← 7: 10.1 ← 8: 10.6x ← 9: 10.7x ↘ 10: 10.6x ↘ Serie 105.1 Total 105.1
40 Skott 	11: 10.7x ← 12: 10.4x ← 13: 10.8x ↘ 14: 10.4x ← 15: 10.5x ↗ 16: 10.8x → 17: 10.2x ↗ 18: 10.8x ↗ 19: 10.7x ↘ 20: 10.5x ↘ Serie 105.8 Total 210.9	40 Skott 	21: 10.5x ← 22: 10.6x ↘ 23: 10.7x ↘ 24: 10.7x ↘ 25: 10.5x ← 26: 10.4x ← 27: 10.7x ← 28: 10.5x ← 29: 10.8x ↘ 30: 10.5x ← Serie 105.9 Total 316.8
40 Skott 	31: 10.6x ← 32: 10.7x ← 33: 10.1 ← 34: 10.7x ↘ 35: 10.8x ↗ 36: 10.7x ↘ 37: 10.6x ↘ 38: 10.9x ↘ 39: 10.8x ↗ 40: 10.7x ← Serie 106.6 Total 423.4		

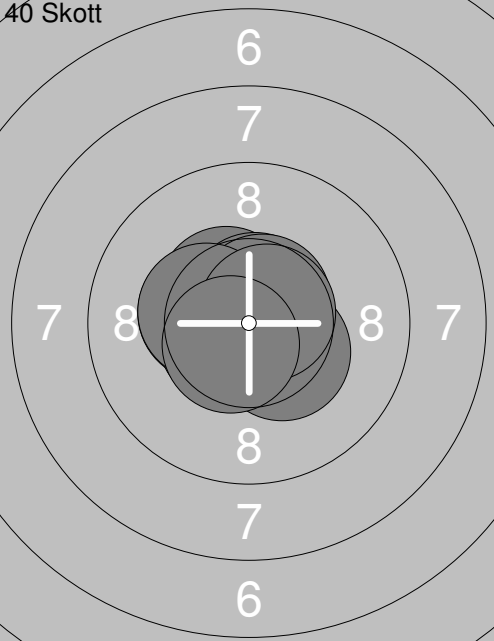
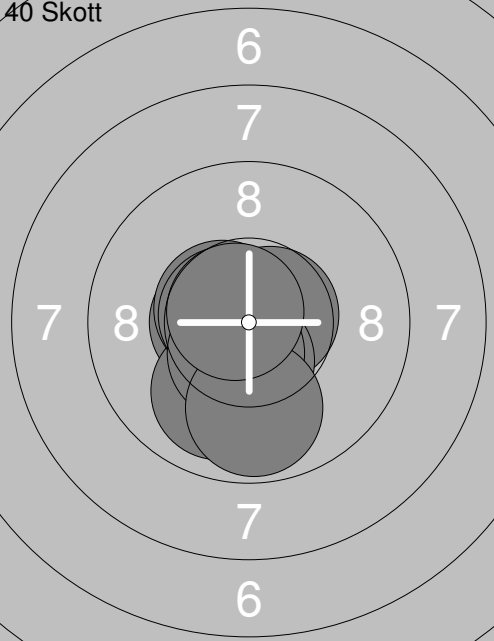

Skjutlag	Tavla	Fluk Jonsson	
S		Ramselefors Skf	
04.02.2017		Skyttiaden Regionfinal	Umeå skytteallians
Prov		1: 10.5x↓ 2: 10.2x↓ 3: 9.9 ↓ 4: 10.5x↓ 5: 10.8x↓ 6: 10.8x↗ 7: 10.8x↖ 8: 10.6x↗ 9: 10.8x→ 10: 10.4x↖ Serie 105.3 Total 0.0	11: 10.4x↖ 12: 10.3x↖ 13: 10.5x↖ Serie 31.2 Total 0.0
40 Skott		1: 10.9x↖ 2: 10.4x↖ 3: 10.5x↖ 4: 10.4x↖ 5: 10.7x↗ 6: 10.6x↖ 7: 10.6x↗ 8: 10.4x↖ 9: 10.7x↗ 10: 10.6x↖ Serie 105.8 Total 105.8	11: 10.7x↗ 12: 10.6x↖ 13: 10.7x↖ 14: 10.5x↖ 15: 10.2x↖ 16: 10.6x↖ 17: 10.8x↗ 18: 10.8x↗ 19: 10.1 ↖ 20: 10.7x↖ Serie 105.7 Total 211.5
40 Skott		21: 10.7x↓ 22: 10.5x↖ 23: 10.0 ↓ 24: 10.6x↖ 25: 10.6x↖ 26: 10.7x↗ 27: 10.4x↓ 28: 10.5x↓ 29: 9.8 ↓ 30: 10.7x↖ Serie 104.5 Total 316.0	31: 10.0 ↓ 32: 10.5x↖ 33: 10.1 ↖ 34: 10.3x↖ 35: 10.6x↖ 36: 10.5x↖ 37: 10.5x↖ 38: 10.3x↖ 39: 10.4x↓ 40: 10.5x↗ Serie 103.7 Total 419.7

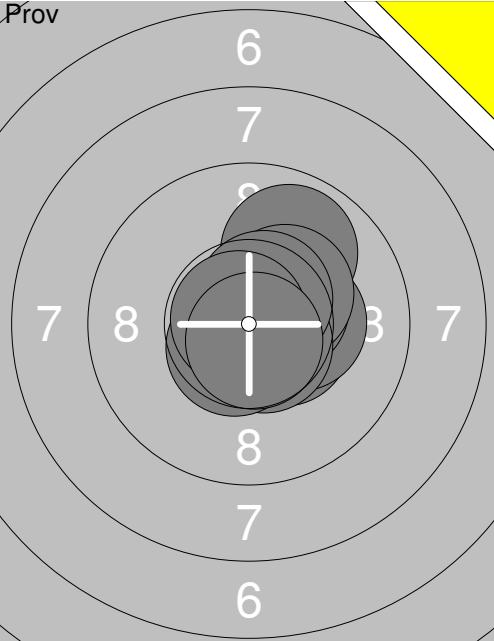
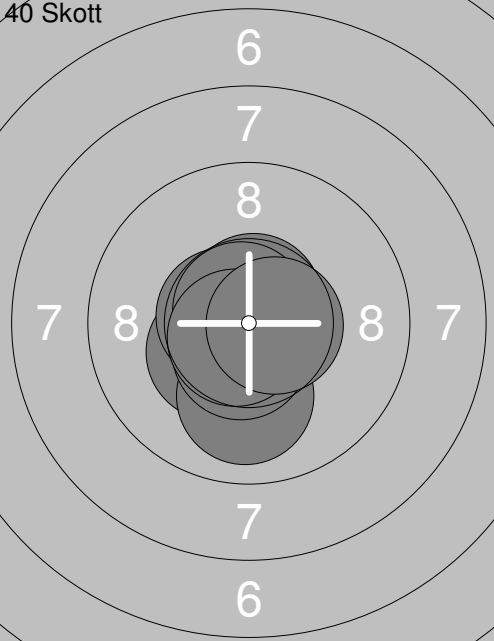
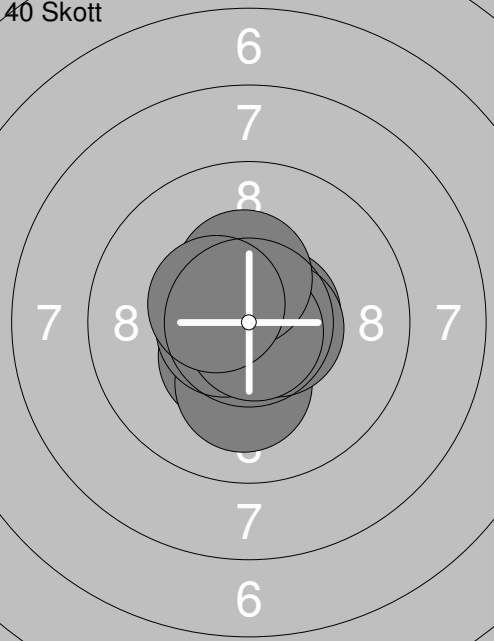
Skjutlag	Tavla	Petter Hemå	
1	37		
S	Fältjägarna Skf		
04.02.2017	Skyttiaden Regionfinal	Umeå skytteallians	
Prov		1: 10.5x➤ 2: 9.9 ↗ 3: 10.3x➤ 4: 10.5x➤ 5: 10.3x➤ 6: 10.6x↘ 7: 10.6x↘ 8: 10.6x↗ 9: 10.8x↘ 10: 10.7x↘ Serie 104.8 Total 0.0	11: 10.7x↗ Serie 10.7 Total 0.0
40 Skott		1: 10.8x↘ 2: 10.7x↗ 3: 10.4x↘ 4: 10.0 ↓ 5: 10.6x↘ 6: 10.9x➤ 7: 10.6x↘ 8: 10.8x↗ 9: 10.7x↘ 10: 10.6x➤ Serie 106.1 Total 106.1	11: 10.6x↘ 12: 10.5x↘ 13: 10.8x↘ 14: 10.9x↘ 15: 10.6x↗ 16: 10.2x➤ 17: 10.4x➤ 18: 10.8x➤ 19: 10.6x➤ 20: 10.2x↘ Serie 105.6 Total 211.7
40 Skott		21: 10.4x↘ 22: 10.6x➤ 23: 10.8x↘ 24: 10.1 ↓ 25: 10.6x↗ 26: 10.6x↘ 27: 10.6x➤ 28: 10.8x↘ 29: 10.4x↗ 30: 10.5x↘ Serie 105.4 Total 317.1	31: 10.6x➤ 32: 10.8x➤ 33: 10.9x↘ 34: 10.7x➤ 35: 10.6x↗ 36: 10.7x↗ 37: 9.7 ↗ 38: 10.5x↗ 39: 10.3x➤ 40: 10.5x↘ Serie 105.3 Total 422.4

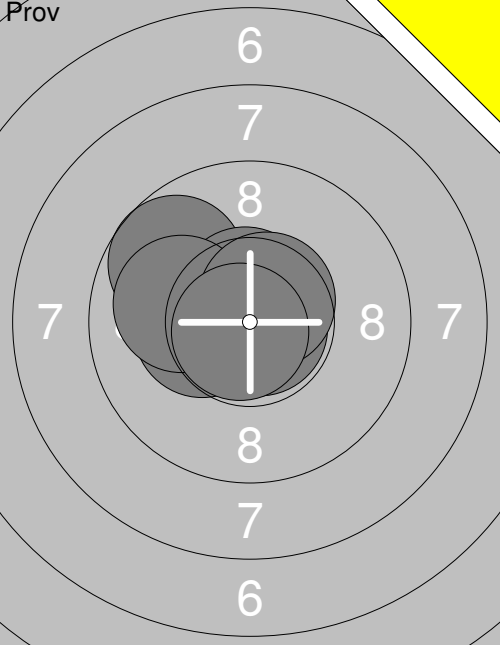
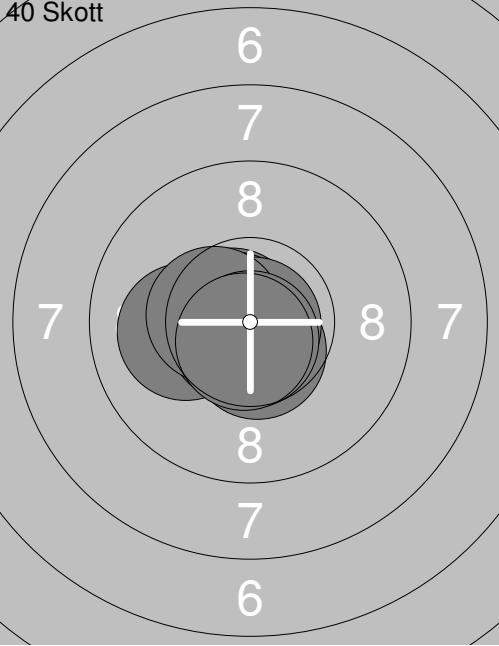
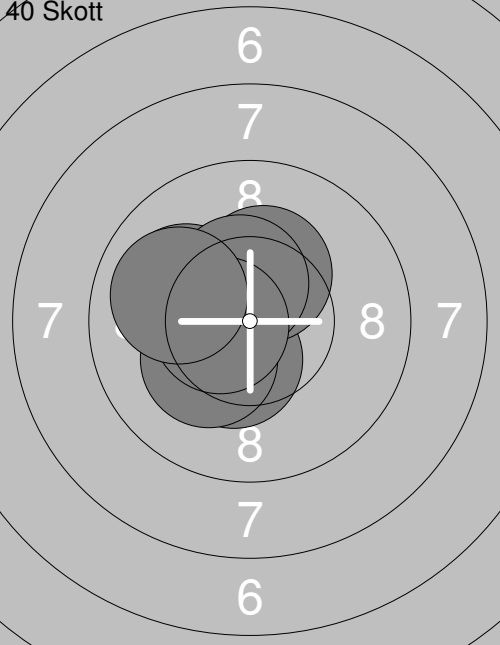
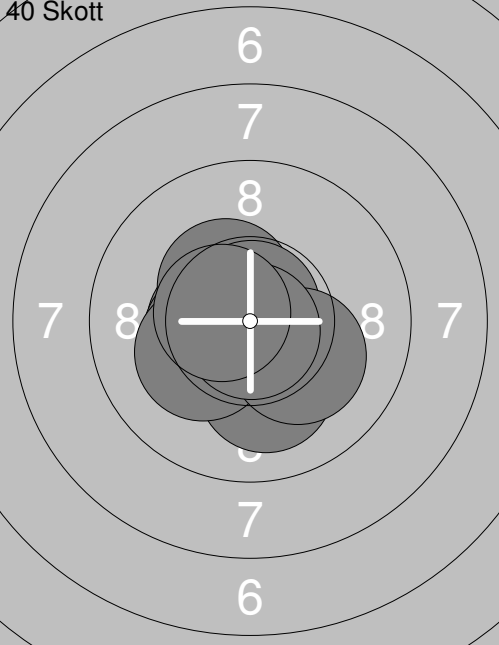
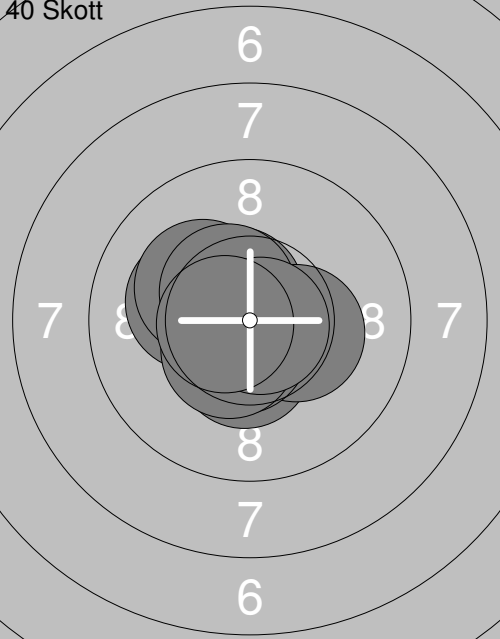
Skjutlag <b>1</b>	Tavla <b>38</b>	<b>Sofi Jonsson</b>	
S		Ramselefors Skf	
04.02.2017		Skyttiaden Regionfinal	Umeå skytteallians
Prov		1: 10.5↘ 2: 10.2↗ 3: 10.8↘ 4: 9.7 ↗ 5: 10.3↗ 6: 10.8↘ 7: 10.6↗ 8: 10.0← 9: 10.6↗ 10: 10.8↘ Serie 104.3 Total 0.0	40 Skott  1: 10.1← 2: 10.7↗ 3: 10.9↘ 4: 10.6↘ 5: 10.7↗ 6: 10.7↘ 7: 10.9↘ 8: 10.5↗ 9: 10.7↘ 10: 10.7↘ Serie 106.5 Total 106.5
40 Skott		11: 10.6↘ 12: 10.6↗ 13: 10.5↘ 14: 10.4↘ 15: 10.3↗ 16: 10.0← 17: 10.2↘ 18: 10.4↗ 19: 10.6↗ 20: 10.0← Serie 103.6 Total 210.1	40 Skott  21: 10.5↗ 22: 10.4↘ 23: 10.6↗ 24: 10.1 ↓ 25: 10.4↗ 26: 10.8↗ 27: 10.2↘ 28: 10.2↘ 29: 10.8↘ 30: 10.6↗ Serie 104.6 Total 314.7
40 Skott		31: 10.2↗ 32: 10.6↘ 33: 10.4↘ 34: 10.3↗ 35: 10.2↗ 36: 10.6↘ 37: 10.5↘ 38: 10.5↘ 39: 10.8↘ 40: 10.6↗ Serie 104.7 Total 419.4	

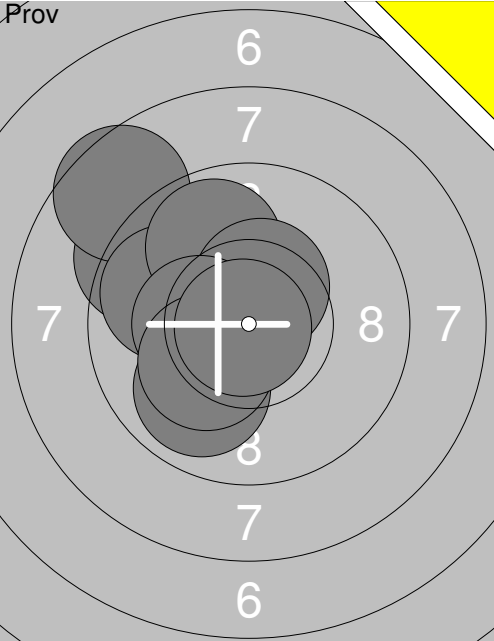
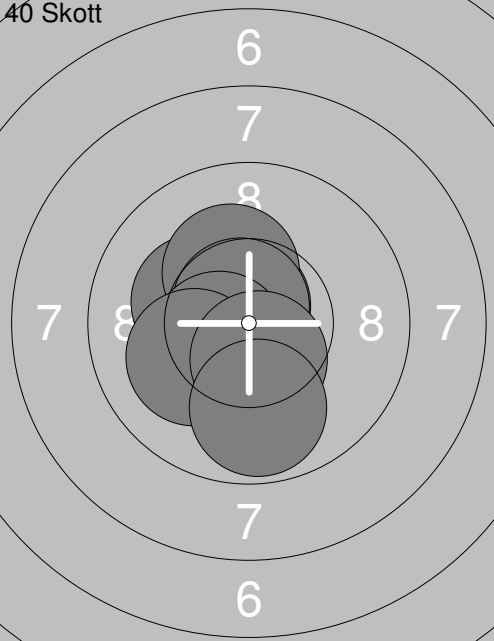
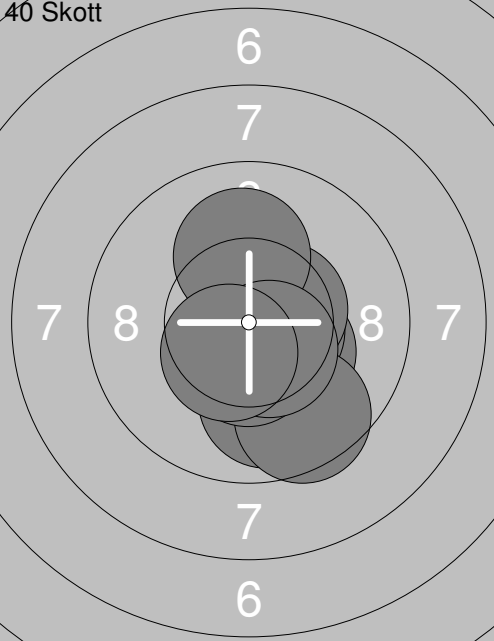
Skjutlag <b>1</b>	Tavla <b>40</b>	<b>Emma Eriksson</b>	
S		Ramselefors Skf	
04.02.2017		Skyttiaden Regionfinal	Umeå skytteallians
Prov		1: 9.3 ↖ 2: 8.6 ↖ 3: 9.8 ↖ 4: 9.9 ↗ 5: 9.9 ↘ 6: 10.4x↗ 7: 10.3x← 8: 10.2x↘ 10: 10.9x↘ Serie 89.3 Total 0.0	Prov
			11: 10.7x➤
			Serie 10.7
			Total 0.0
40 Skott		1: 10.4x↘ 2: 10.3x↘ 3: 10.7x↗ 4: 10.3x↘ 5: 10.3x↗ 6: 10.7x↗ 7: 10.5x↘ 8: 10.1↙ 9: 10.5x↓ 10: 9.8 ↓ Serie 103.6 Total 103.6	40 Skott
			11: 10.7x↘
			12: 9.5 ↘
			13: 10.8x↘
			14: 10.5x↘
			15: 10.1 ↗
			16: 10.6x↘
			17: 10.2x➤
			18: 10.3x↓
			19: 10.1 ↓
			20: 9.9 ↑
			Serie 102.7
			Total 206.3
40 Skott		21: 10.8x↓ 22: 10.3x↘ 23: 10.6x➤ 24: 9.9 ↓ 25: 10.5x➤ 26: 9.6 ↓ 27: 10.5x↓ 28: 10.1 ↑ 29: 10.5x↘ 30: 10.5x↘ Serie 103.3 Total 309.6	40 Skott
			31: 10.8x↓
			32: 10.1 ↗
			33: 10.7x↗
			34: 10.4x➤
			35: 10.1 ➔
			36: 10.6x↘
			37: 10.2x↗
			38: 8.9 ➤
			39: 10.1 ➔
			40: 9.7 ➔
			Serie 101.6
			Total 411.2

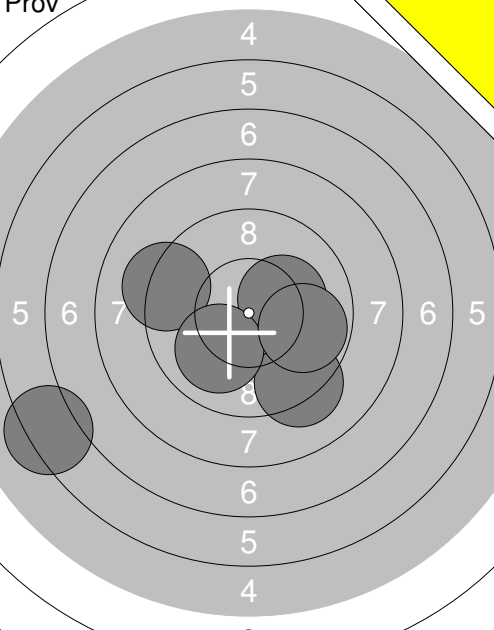
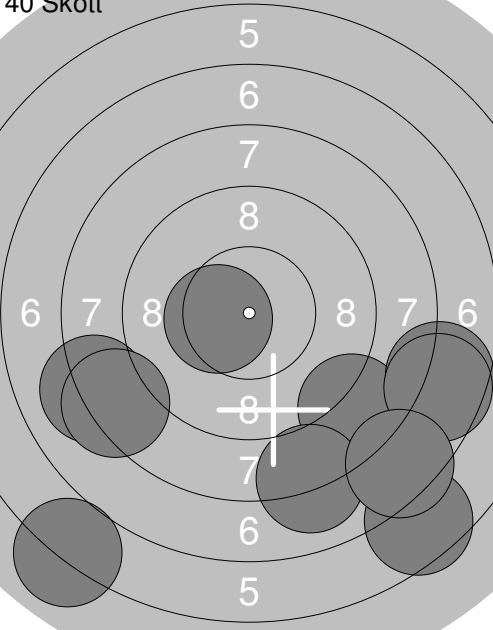
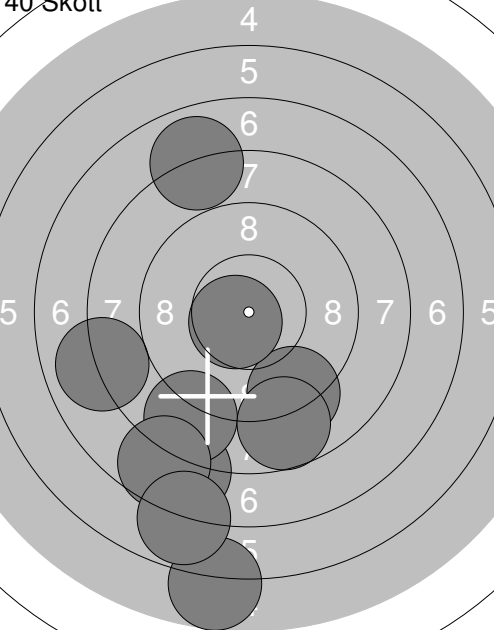
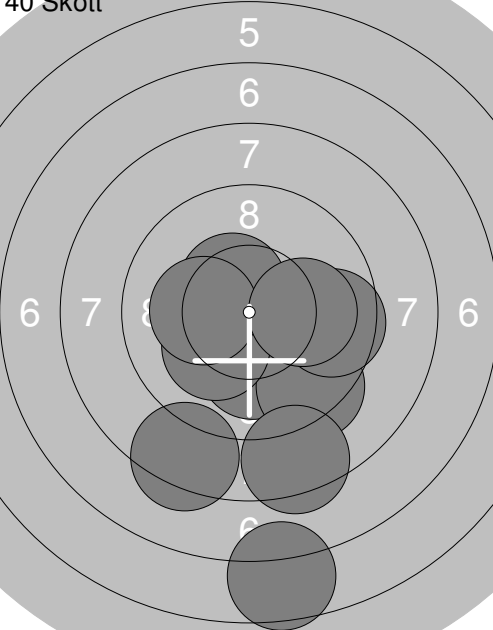
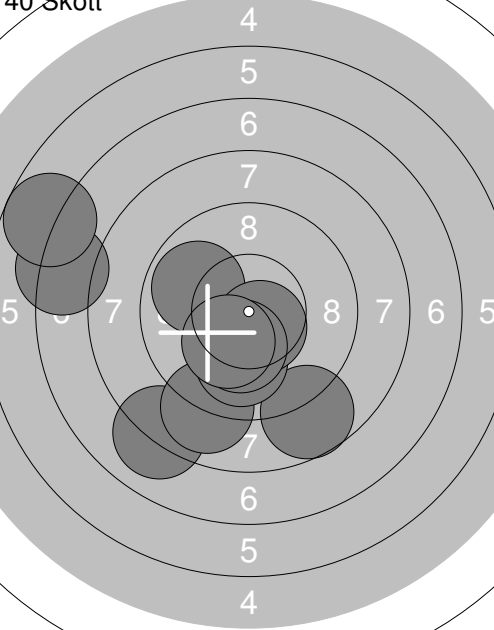
Skjutlag <b>2</b>	Tavla <b>2</b>	<b>Elin Elnrud</b>	
S		Fältjägarna Skf	
04.02.2017		Skyttiaden Regionfinal	Umeå skytteallians
Prov		1: 10.2x ↗ 2: 9.2 ↘ 3: 9.2 ↖ 4: 10.0 ↘ 5: 6.3 ↖ 6: 9.8 →	40 Skott  1: 8.6 ↘ 2: 10.4x ↖ 3: 7.6 → 4: 6.5 ↘ 5: 8.1 ↖ 6: 7.6 → 7: 8.3 ↖ 8: 8.0 ↘ 9: 7.4 ↘ 10: 6.0 ↘
		Serie 54.7	Serie 78.5
		Total 0.0	Total 78.5
40 Skott		11: 5.7 ↘ 12: 7.7 ↘ 13: 9.2 ↘ 14: 8.0 ↖ 15: 8.6 ↘ 16: 10.6x ↖ 17: 7.9 ↗ 18: 8.7 ↘ 19: 7.6 ↘ 20: 6.8 ↘	40 Skott  21: 10.1 ↘ 22: 6.6 ↘ 23: 9.4 ↘ 24: 8.4 ↘ 25: 9.6 → 26: 10.5x ↖ 27: 10.2x ↖ 28: 8.3 ↘ 29: 10.2x ↖ 30: 10.1 →
		Serie 80.8	Serie 93.4
		Total 159.3	Total 252.7
40 Skott		31: 7.3 ↖ 32: 8.1 ↘ 33: 8.7 ↘ 34: 9.0 ↘ 35: 10.0 ↘ 36: 6.7 ↖ 37: 9.9 ↖ 38: 10.6x ↖ 39: 10.3x ↘ 40: 10.2x ↘	
		Serie 90.8	
		Total 343.5	

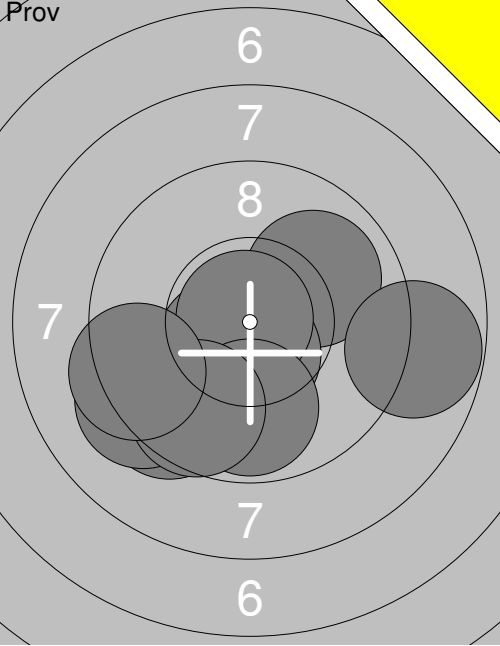
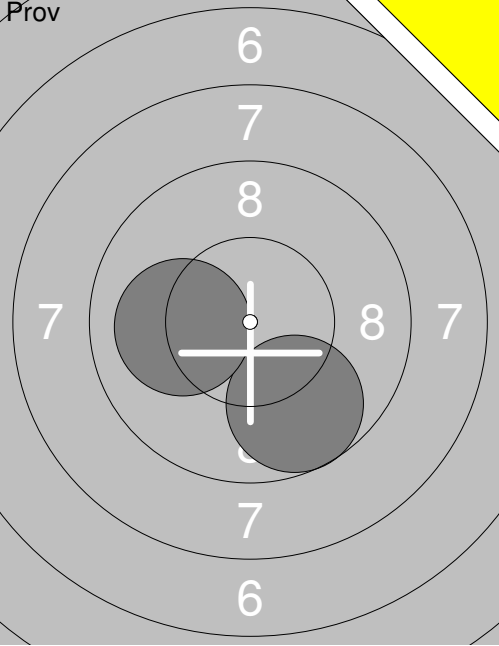
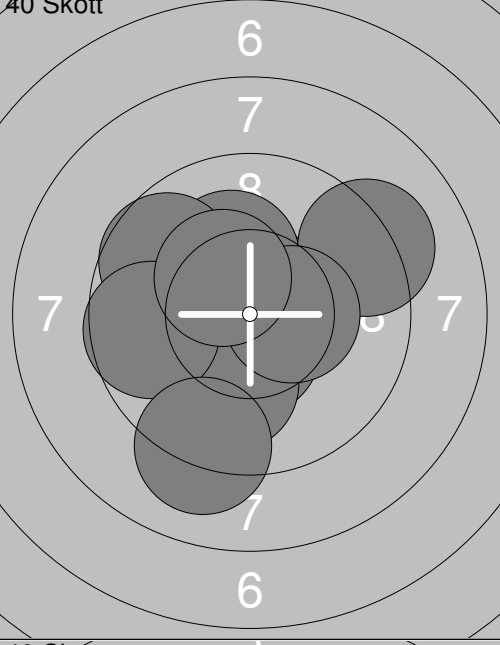
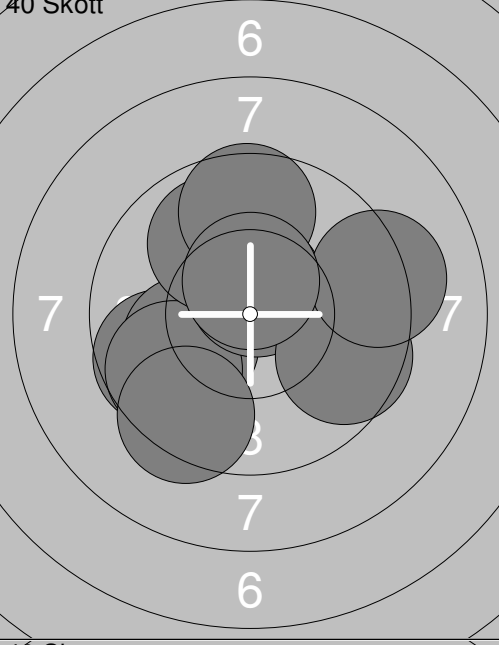
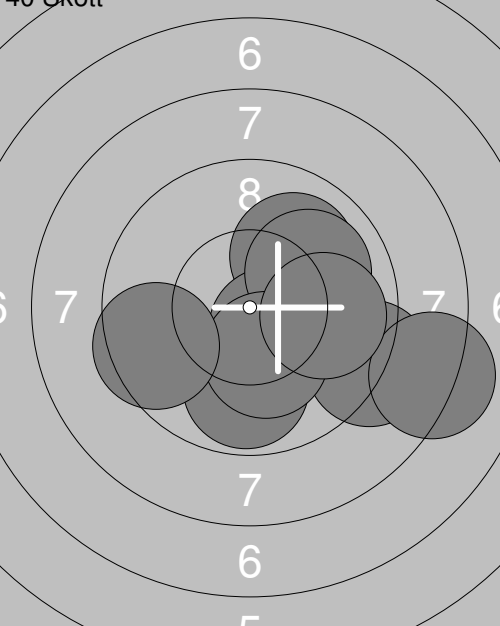
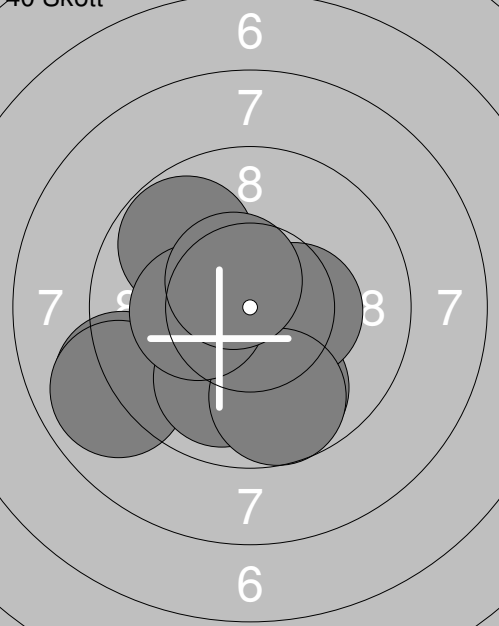
Skjuttag	Tavla	Helena Dreyer	
2	3		
S	Umeå Skf		
04.02.2017	Skyttiaden Regionfinal	Umeå skytteallians	
Prov		Prov	
	1: 10.5x↘ 2: 10.0↗ 3: 10.5x↓ 4: 9.4↙ 5: 10.9x↘ 6: 9.8↓ 7: 8.8→ 8: 9.2↙ 9: 9.6↙ 10: 9.3↙		11: 9.7↘ 12: 10.1↙
	Serie 98.0		Serie 19.8
	Total 0.0		Total 0.0
40 Skott		40 Skott	
	1: 10.5x↑ 2: 10.5x↓ 3: 10.2x↑ 4: 9.7↖ 5: 10.0↓ 6: 9.6↖ 7: 9.1↓ 8: 9.2↗ 9: 10.4x→ 10: 10.4x↘		11: 9.7↖ 12: 10.1↖ 13: 9.7↖ 14: 10.6x↑ 15: 9.9↗ 16: 9.4↓ 17: 9.6↑ 18: 9.6→ 19: 9.2→ 20: 10.5x↑
	Serie 99.6		Serie 98.3
	Total 99.6		Total 197.9
40 Skott		40 Skott	
	21: 9.1→ 22: 10.3x↘ 23: 10.0↗ 24: 8.2→ 25: 10.5x↘ 26: 9.8↓ 27: 10.0↗ 28: 10.2x↓ 29: 9.9→ 30: 9.5↖		31: 9.0↖ 32: 10.1↓ 33: 8.9↖ 34: 10.0↓ 35: 9.8↓ 36: 9.8↖ 37: 10.4x→ 38: 9.7↓ 39: 10.3x↖ 40: 10.5x↘
	Serie 97.5		Serie 98.5
	Total 295.4		Total 393.9

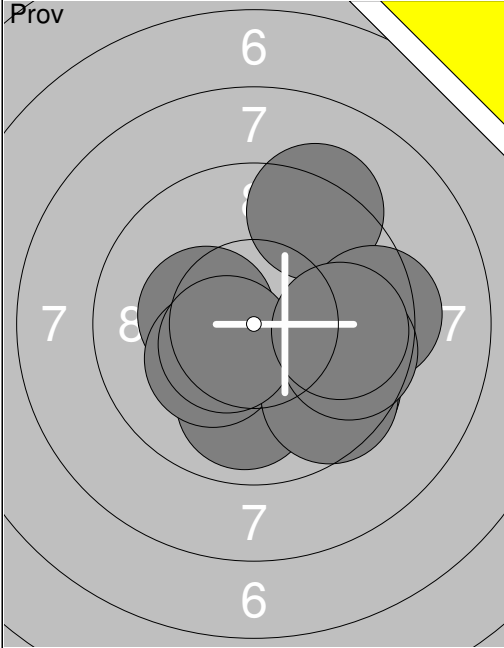
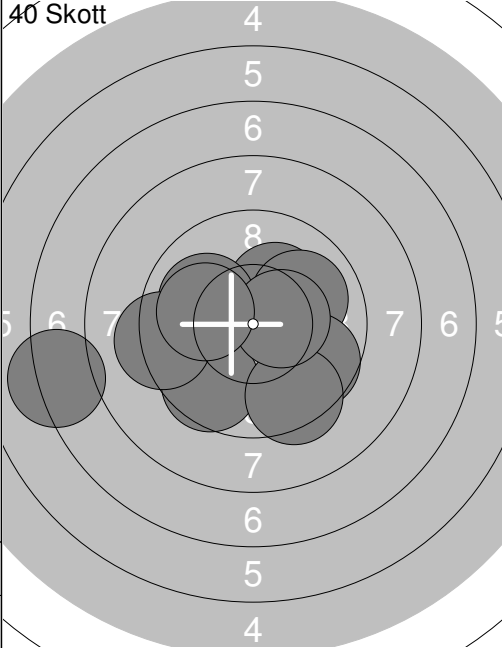
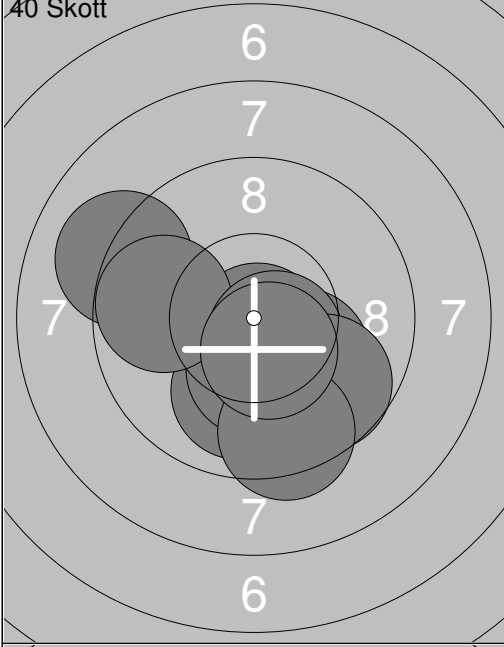
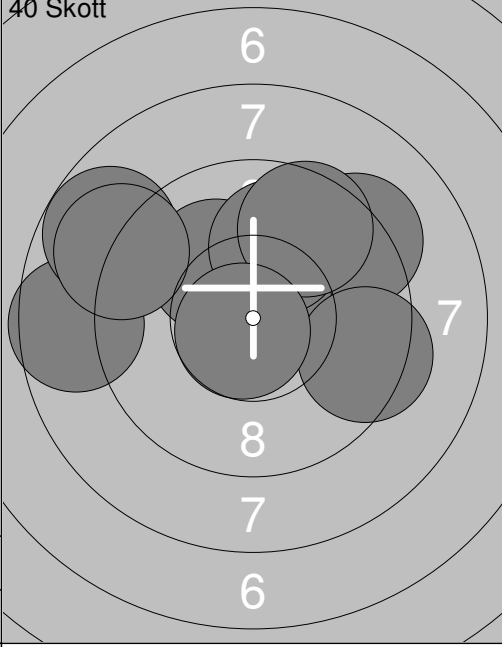
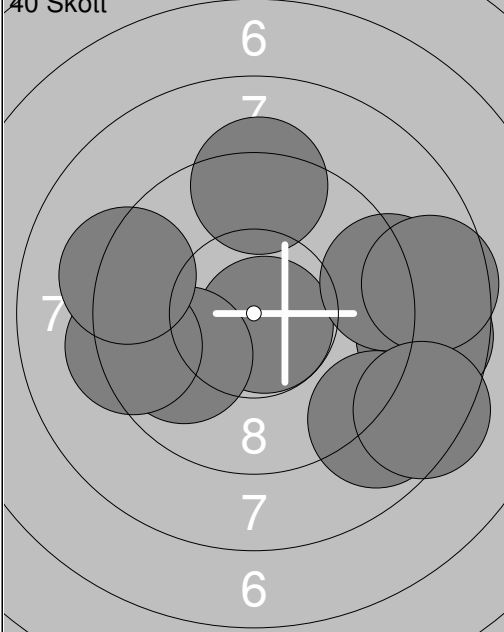
Skjutlag	Tavla	Vincent Stridsson	
S		Gällivare Skf	
04.02.2017		Skyttiaden Regionfinal	Umeå skytteallians
Prov		1: 10.3x ↗ 2: 9.9 ↓ 3: 9.3 ↗ 4: 10.2x ↗ 5: 9.4 → 6: 9.6 ↘ 7: 9.6 ↘ 8: 9.7 → 9: 10.5x ↗ 10: 9.8 → Serie 98.3 Total 0.0	40 Skott  1: 7.2 ← 2: 10.2x ↗ 3: 10.0 ↗ 4: 10.0 ← 5: 9.6 ↘ 6: 9.7 ↘ 7: 9.3 ← 8: 9.4 ↘ 9: 10.4x → 10: 10.1 ← Serie 95.9 Total 95.9
40 Skott		11: 10.0 ↓ 12: 9.1 ← 13: 10.8x ↓ 14: 10.3x ↓ 15: 10.2x ↘ 16: 9.8 ← 17: 10.6x ↘ 18: 9.7 ↘ 19: 9.4 ↓ 20: 10.5x ↓ Serie 100.4 Total 196.3	40 Skott  21: 9.3 ↗ 22: 8.6 ← 23: 8.8 ← 24: 10.7x ↗ 25: 10.1 ↖ 26: 10.0 ↗ 27: 9.6 ↗ 28: 9.4 → 29: 9.0 ← 30: 10.7x ↗ Serie 96.2 Total 292.5
40 Skott		31: 9.3 ↑ 32: 10.7x ↘ 33: 8.7 → 34: 9.1 → 35: 9.9 ← 36: 8.8 ↘ 37: 8.6 → 38: 8.4 ↘ 39: 9.3 ← 40: 9.2 ← Serie 92.0 Total 384.5	

Prov 	1: 10.3x ↗ 2: 8.8 ↗ 3: 10.6x ↗ 4: 9.6 ↑ 5: 9.8 ← 6: 9.5 → 7: 10.4x ↗ 8: 9.8 ← 9: 10.4x ↘ 10: 9.7 ↓	Prov 	11: 10.1 →
Serie	98.9	Serie	10.1
Total	0.0	Total	0.0

40 Skott 	1: 9.3 ↙ 2: 10.0 ↓ 3: 10.1 ↓ 4: 9.9 ↙ 5: 9.1 ↑ 6: 10.5x ↓ 7: 10.0 → 8: 8.9 ↗ 9: 9.8 ↙ 10: 10.4x ↗	40 Skott 	11: 10.3x ↓ 12: 9.7 ↘ 13: 9.8 ↗ 14: 9.2 ← 15: 10.1 ↗ 16: 10.5x ↗ 17: 9.3 ↙ 18: 9.4 ↗ 19: 8.4 → 20: 8.9 →
Serie	98.0	Serie	95.6
Total	98.0	Total	193.6

40 Skott 	21: 9.1 ↙ 22: 9.6 ↗ 23: 10.3x ↗ 24: 10.1 ↓ 25: 10.6x ↗ 26: 10.0 ↓ 27: 10.2x ↗ 28: 9.3 → 29: 9.2 ↑ 30: 10.4x ↙	40 Skott 	31: 10.3x ↗ 32: 10.6x ↗ 33: 10.7x ↘ 34: 10.5x ↘ 35: 10.3x ↗ 36: 10.4x ↙ 37: 9.2 ↑ 38: 10.7x ↘ 39: 10.2x ↙ 40: 9.7 ↙
Serie	98.8	Serie	102.6
Total	292.4	Total	395.0

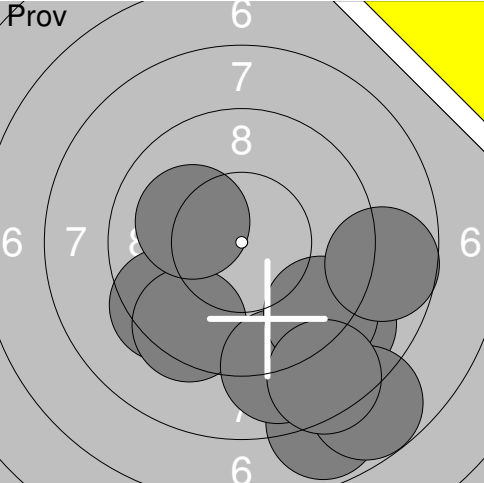
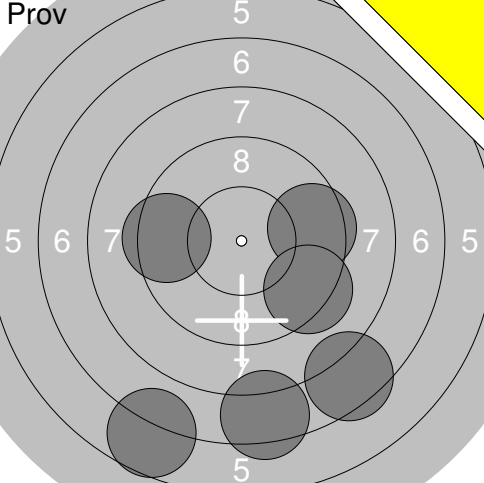
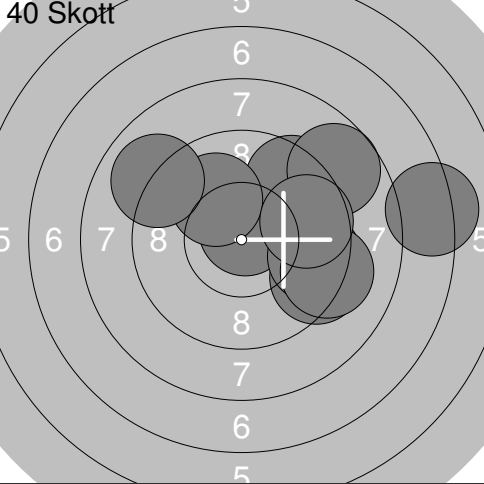
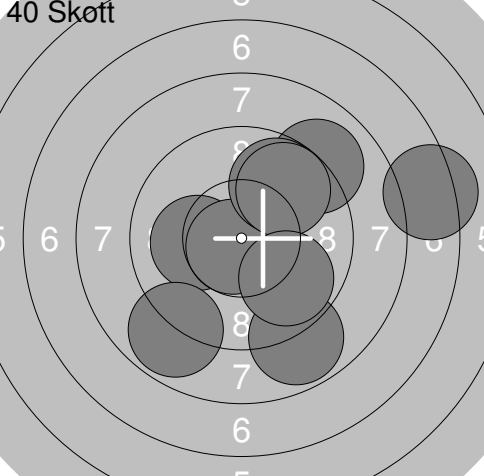

Skjutlag	Tavla	Elinore Selin	
S	6	Aspås USkf	
04.02.2017	Skyttiaden Regionfinal	Umeå skytteallians	
Prov		1: 9.0 ↘ 2: 7.8 ↘ 3: 9.4 ↘ 4: 9.4 ↘ 5: 8.9 ↘ 6: 9.3 ↘ 7: 10.1 ↗ 8: 7.8 ↘ 9: 8.7 → 10: 8.5 ↘ Serie 88.9 Total 0.0	11: 9.4 ↘ 12: 5.0 ↘ 13: 8.5 ↘ 14: 9.0 ↘ 15: 8.5 ↘ 16: 7.2 ↘ 17: 8.7 ↘ 18: 9.6 ↘ 19: 10.0 ↘ 20: 7.9 ↘ Serie 83.8 Total 0.0
Prov		21: 7.5 ↘ 22: 7.4 ↘ 23: 6.7 ↘ 24: 9.4 ← 25: 9.5 → 26: 9.3 ↘ Serie 49.8 Total 0.0	40 Skott
40 Skott		11: 10.7x ↗ 12: 9.5 ↗ 13: 8.7 ↗ 14: 9.3 ↘ 15: 9.5 ↘ 16: 10.0 ↗ 17: 7.2 → 18: 9.2 ↘ 19: 9.0 ↗ 20: 9.7 → Serie 92.8 Total 184.9	1: 10.9x ↑ 2: 8.4 ↘ 3: 10.4x → 4: 9.6 ↘ 5: 9.0 → 6: 8.9 ← 7: 8.1 ← 8: 7.8 ↘ 9: 10.2x ↘ 10: 8.8 ← Serie 92.1 Total 92.1
40 Skott		31: 7.3 → 32: 10.1 ← 33: 10.7x ↘ 34: 9.0 ↗ 35: 8.8 ↘ 36: 9.8 ↗ 37: 9.8 ↗ 38: 8.8 ↘ 39: 9.8 ↗ 40: 9.8 ↘ Serie 93.9 Total 371.1	21: 8.9 → 22: 9.1 ↘ 23: 10.1 → 24: 8.5 → 25: 10.1 ↑ 26: 8.9 ↑ 27: 9.9 ↗ 28: 8.6 ↗ 29: 8.2 ↗ 30: 10.0 ↗ Serie 92.3 Total 277.2

<p>Prov</p>	<p>40 Skott</p>	
1: 6.9 ↑ 2: 9.9 ⇒ 3: 9.2 → 4: 9.2 ↗ 5: 10.4x↔ 6: 9.2 ↗ 7: 10.3x↑ 8: 9.7 ↙ 9: 10.6x⇒ 10: 10.2x↑ Serie 95.6 Total 0.0	1: 9.6 ↗ 2: 10.0 ↗ 3: 9.2 ← 4: 9.2 ↑ 5: 10.4x⇒ 6: 10.5x↓ 7: 10.2x↔ 8: 10.8x↑ 9: 10.0 ↓ 10: 9.6 ← Serie 99.5 Total 99.5	

<p>40 Skott</p>	<p>40 Skott</p>	
11: 7.8 ⇒ 12: 9.4 ← 13: 9.9 ← 14: 10.3x⇒ 15: 10.5x↗ 16: 8.3 ↑ 17: 10.4x↔ 18: 8.6 ↓ 19: 10.2x↓ 20: 10.2x↔ Serie 95.6 Total 195.1	21: 9.7 ↘ 22: 10.0 ↑ 23: 10.6x↔ 24: 10.1 ↙ 25: 9.4 ← 26: 10.0↔ 27: 9.2 ↗ 28: 9.8 → 29: 10.0 ↘ 30: 10.1 ↙ Serie 98.9 Total 294.0	

<p>40 Skott</p>		
31: 9.6 ↙ 32: 9.9 ↘ 33: 10.1 ↙ 34: 10.1↔ 35: 10.1 ↗ 36: 9.6 ↓ 37: 10.1→ 38: 9.3 ↙ 39: 9.6 ⇒ 40: 10.1 ↗ Serie 98.5 Total 392.5		

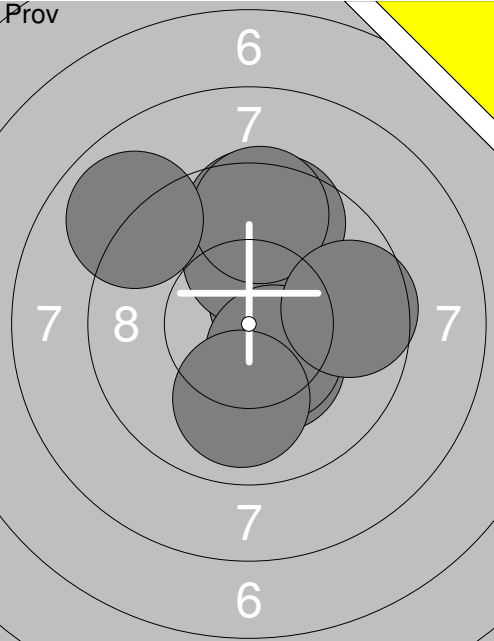
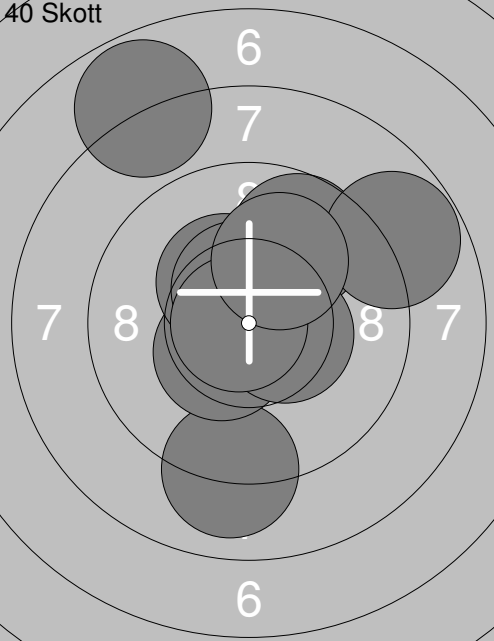
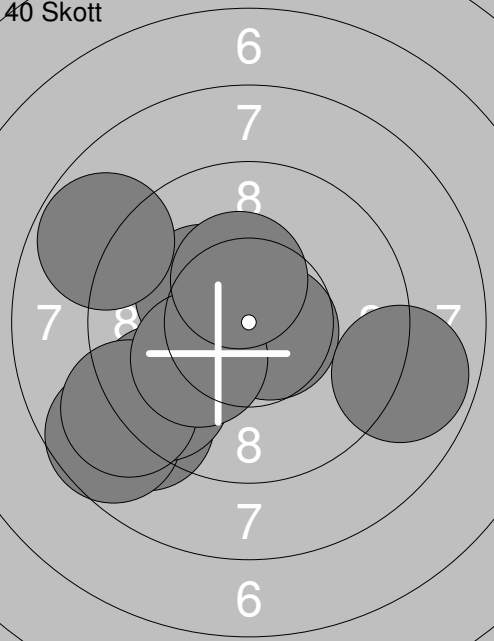
Skjuttlag	Tavla	Emilia Nordin	
S	8	Umeå Skf	
04.02.2017	Skyttiaden Regionfinal	Umeå skytteallians	
Prov		1: 9.6 ↑ 2: 10.3x↘ 3: 10.5x↗ 4: 9.6 ↑ 5: 10.1 ↑ 6: 9.5 ↑ 7: 10.4x↘ 8: 8.9 ↖ 9: 9.6 → 10: 10.0 ↓ Serie 98.5 Total 0.0	11: 9.5 ↘ 12: 9.6 ↓ 13: 10.3x↖ 14: 9.3 → 15: 9.1 ← 16: 10.0 ↖ Serie 57.8 Total 0.0
40 Skott		1: 9.0 ↓ 2: 10.4x↘ 3: 9.7 ↗ 4: 8.8 ↗ 5: 10.3x↖ 6: 7.8 ↖ 7: 10.5x↗ 8: 10.5x↗ 9: 10.8x← 10: 10.0 ↗ Serie 97.8 Total 97.8	11: 9.9 ↗ 12: 8.3 ↖ 13: 10.6x↖ 14: 9.6 ↖ 15: 8.7 ↘ 16: 9.3 ↗ 17: 8.9 ↑ 18: 9.9 ↘ 19: 10.0 ↘ 20: 9.7 ↓ Serie 94.9 Total 192.7
40 Skott		21: 10.2x↖ 22: 9.1 ↘ 23: 8.7 ↘ 24: 9.5 ↘ 25: 9.0 ↘ 26: 8.8 ↖ 27: 10.7x↗ 28: 10.1 ↘ 29: 10.4x↗ 30: 8.9 → Serie 95.4 Total 288.1	31: 10.1← 32: 10.2x↖ 33: 10.1↗ 34: 8.2 ↘ 35: 10.2x↗ 36: 8.7 ↘ 37: 10.4x↗ 38: 8.9 ↘ 39: 8.9 ↘ 40: 9.3 ↗ Serie 95.0 Total 383.1

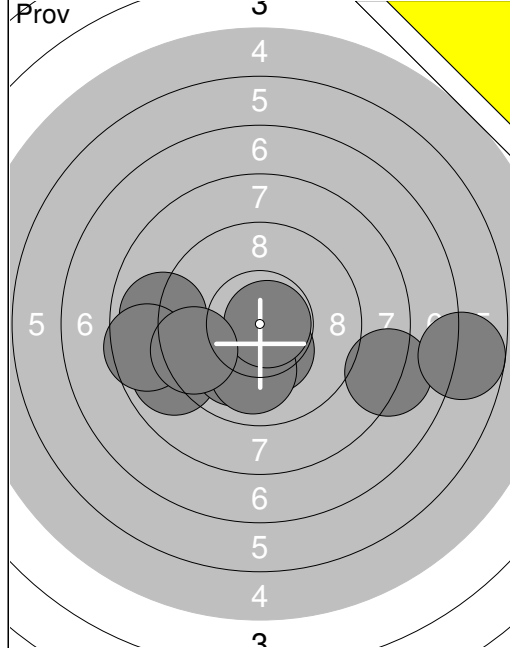

1:	8.9	↙
2:	8.9	←
3:	10.0	↘
4:	10.4x	↘
5:	8.1	→
6:	10.0	↘
7:	10.8x	→
8:	8.6	←
9:	9.5	←
10:	6.7	→
Serie	91.9	
Total	0.0	

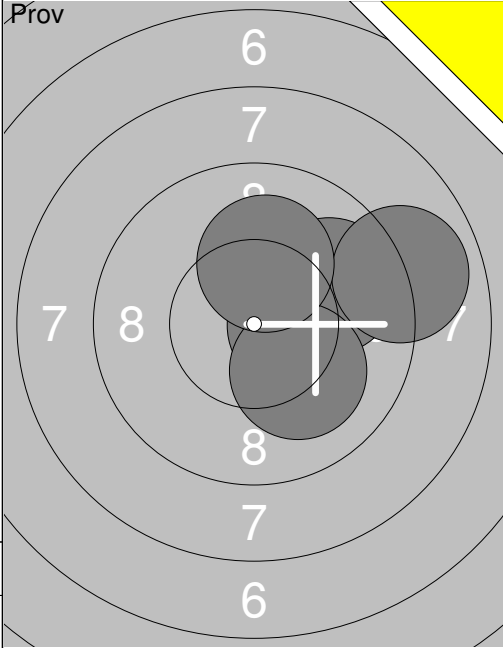

11:	10.4x	→
12:	9.9	↗
13:	10.1	↘
14:	8.9	↗
15:	10.1	↑
Serie	49.4	
Total	0.0	

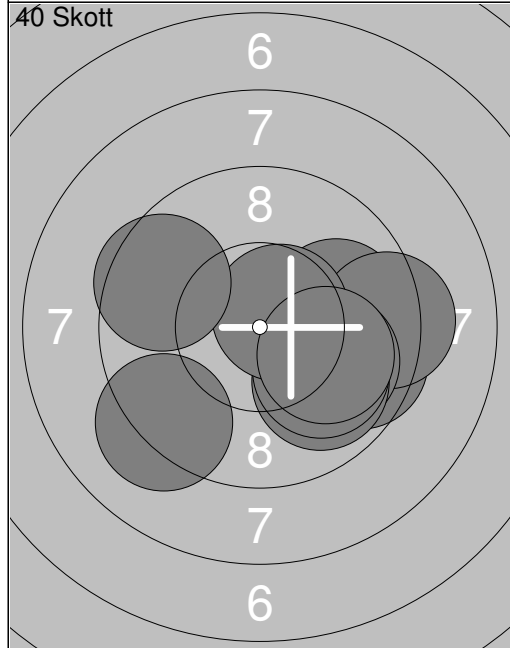

1:	9.6	→
2:	9.2	↙
3:	9.9	→
4:	9.3	→
5:	9.9	→
6:	9.9	↘
7:	10.0	↘
8:	10.6x	↗
9:	10.0	→
10:	9.5	↙
Serie	97.9	
Total	97.9	

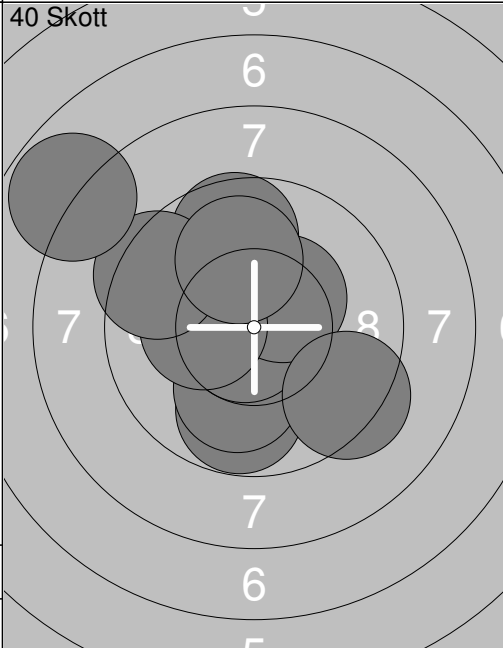

11:	9.8	↘
12:	10.1	↘
13:	9.6	↑
14:	10.7x	↘
15:	10.4x	↗
16:	10.2x	←
17:	9.4	↙
18:	7.8	↙
19:	9.3	↘
20:	10.0	↑
Serie	97.3	
Total	195.2	

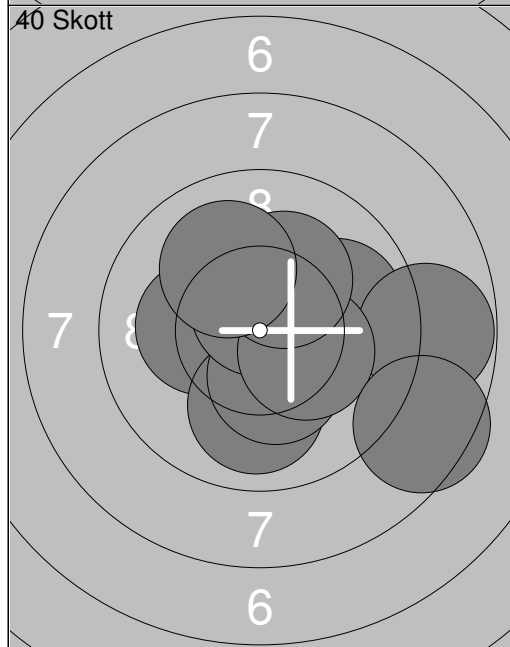

21:	10.2x	←
22:	10.0	↘
23:	10.3x	↘
24:	9.9	→
25:	8.8	→
26:	10.6x	↑
27:	10.3x	→
28:	10.2x	↑
29:	8.5	↘
30:	10.1	↖
Serie	98.9	
Total	294.1	

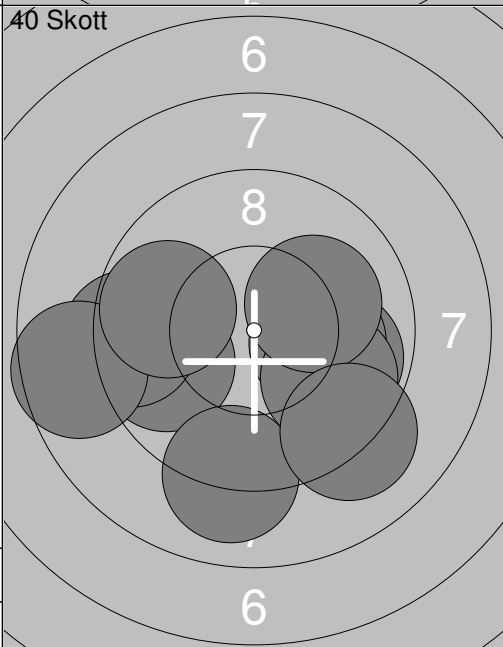

31:	9.8	→
32:	10.1	→
33:	9.7	←
34:	9.3	←
35:	9.8	↘
36:	10.1	↗
37:	8.6	←
38:	9.8	←
39:	9.1	↘
40:	9.1	↘
Serie	95.4	
Total	389.5	

Prov 	40 Skott 1: 8.9 ← 2: 8.7 ↗ 3: 9.4 ↗ 4: 7.5 → 5: 9.2 ↗ 6: 9.4 ↓ 7: 9.6 → 8: 9.1 ↓ 9: 8.9 ↗ 10: 10.3x↘ Serie 91.0 Total 0.0	40 Skott  1: 9.9 ← 2: 10.6x↘ 3: 9.4 ↘ 4: 10.6x↘ 5: 10.2x↘ 6: 9.9 → 7: 9.0 ↘ 8: 10.0 ↓ 9: 10.4x↗ 10: 9.6 ↓ Serie 99.6 Total 99.6
------------------------------------------------------------------------------------------	---------------------------------------------------------------------------------------------------------------------------------------------------------------	-------------------------------------------------------------------------------------------------------------------------------------------------------------------------------------------------------------------------------------------------------

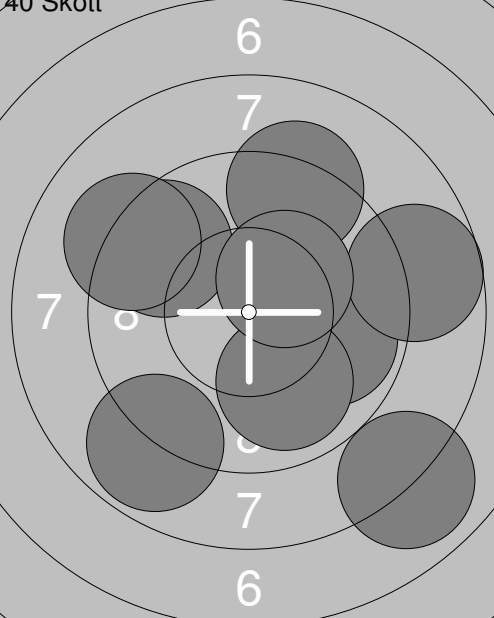
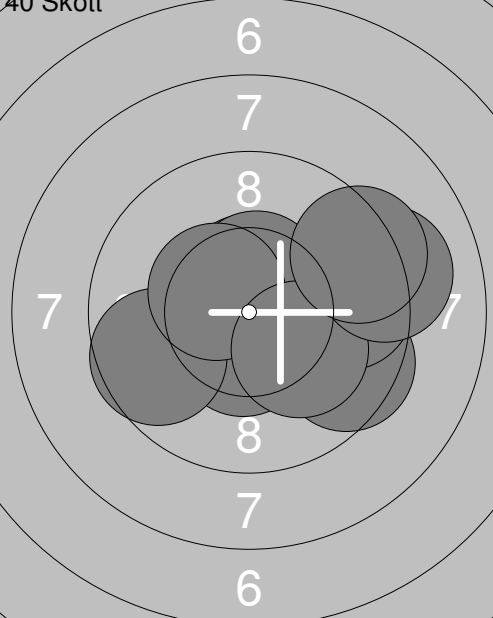
40 Skott 	40 Skott 11: 8.9 ↓ 12: 9.6 ↖ 13: 10.2x→ 14: 9.9 → 15: 9.3 ↗ 16: 8.7 → 17: 9.2 ↖ 18: 9.9 ↓ 19: 7.9 ↓ 20: 10.3x↗ Serie 93.9 Total 193.5	40 Skott  21: 10.5x↓ 22: 9.5 → 23: 10.6x↑ 24: 9.7 → 25: 10.5x↑ 26: 9.6 ← 27: 10.4x↘ 28: 10.1 ↘ 29: 9.1 → 30: 9.3 ↗ Serie 99.3 Total 292.8
-----------------------------------------------------------------------------------------------	---------------------------------------------------------------------------------------------------------------------------------------------------------------------------	------------------------------------------------------------------------------------------------------------------------------------------------------------------------------------------------------------------------------------------------------------------

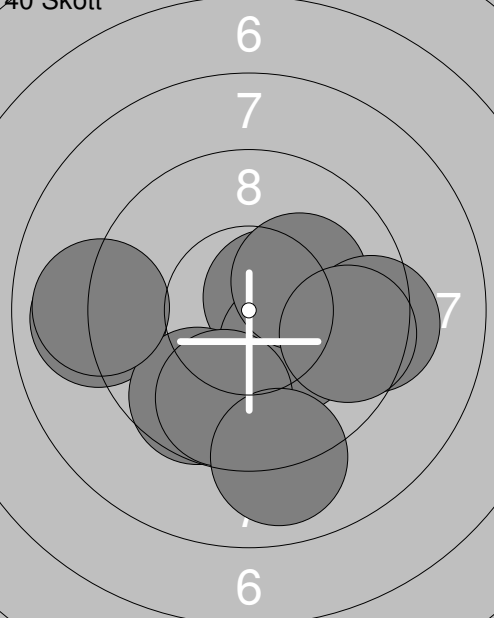
40 Skott 	31: 9.0 ← 32: 10.6x↗ 33: 9.7 ↓ 34: 10.3x↘ 35: 9.8 ↓ 36: 9.0 ← 37: 10.2x↗ 38: 9.3 → 39: 9.6 → 40: 9.0 ↓ Serie 96.5 Total 389.3	
------------------------------------------------------------------------------------------------	----------------------------------------------------------------------------------------------------------------------------------------------------------------	--

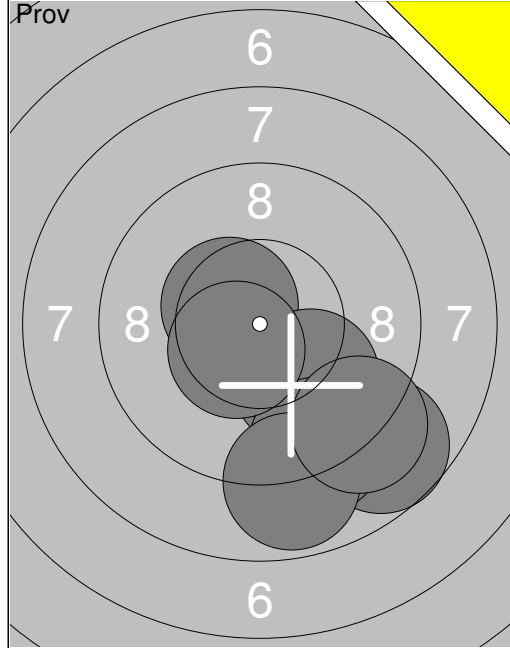

1:	8.7	↘
2:	10.0	↘
3:	10.5	x↘
4:	9.4	↘
5:	10.0	↘
6:	9.2	↘
7:	10.5	x↘
8:	8.9	↘
9:	9.1	↘
Serie	86.3	
Total	0.0	

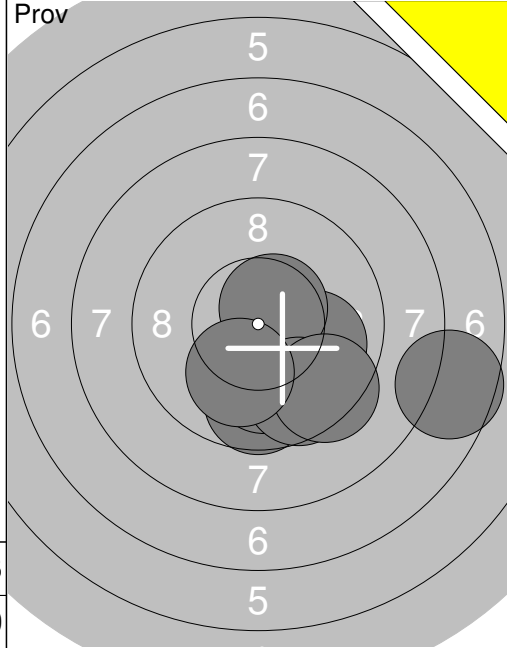

11:	7.6	→
12:	9.7	↓
13:	10.0	↓
14:	10.0	→
15:	10.6	x↗
16:	9.6	↘
17:	9.4	↘
18:	10.1	↓
Serie	77.0	
Total	0.0	

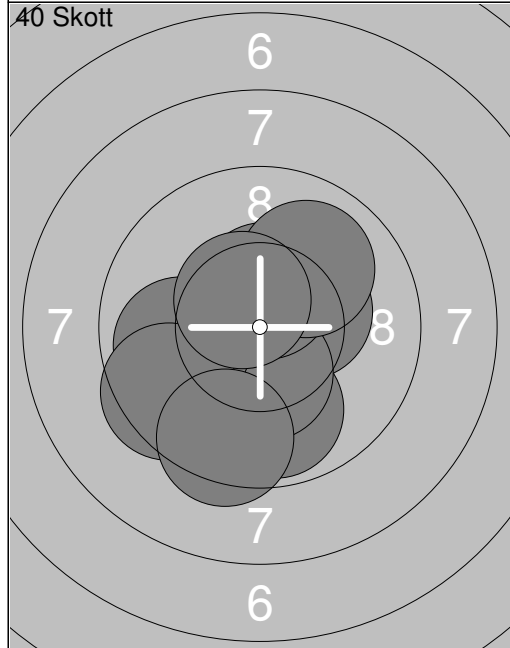

1:	9.9	↓
2:	10.3	x↗
3:	10.7	x↘
4:	10.4	x↓
5:	9.9	←
6:	9.5	↙
7:	10.5	x↗
8:	10.0	↗
9:	10.5	x↘
10:	9.4	↓
Serie	101.1	
Total	101.1	

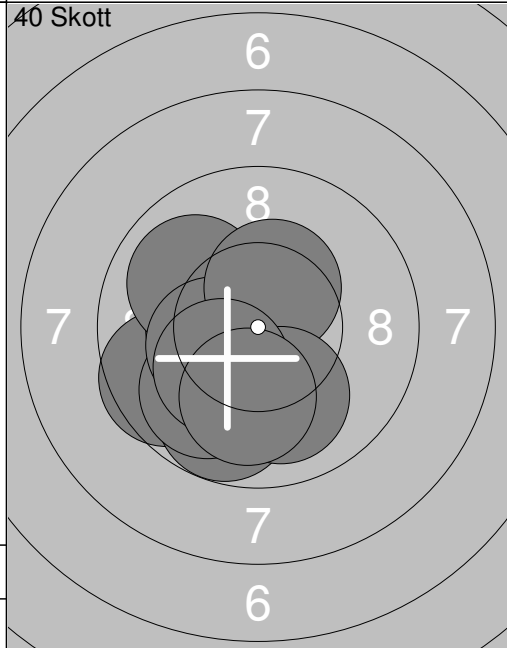

11:	9.6	↙
12:	9.8	↓
13:	10.4	x←
14:	10.0	↖
15:	9.9	↘
16:	10.3	x←
17:	10.4	x↗
18:	10.0	↓
19:	10.2	x↘
20:	10.0	↓
Serie	100.6	
Total	201.7	

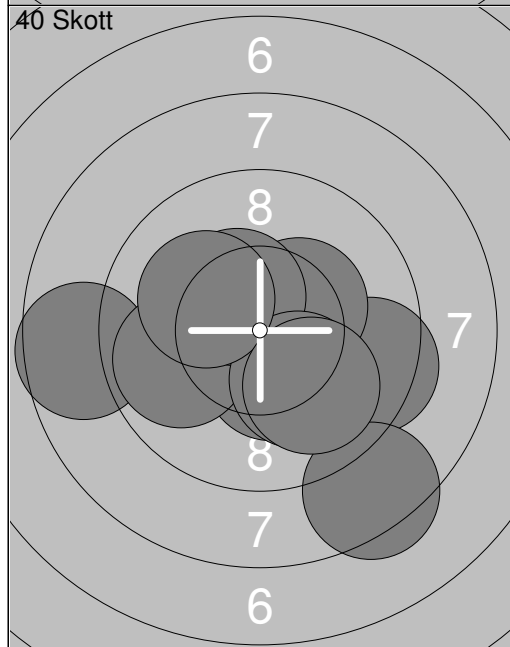

21:	9.4	→
22:	10.3	x↗
23:	8.6	←
24:	10.4	x↓
25:	9.9	←
26:	10.4	x↗
27:	8.4	↘
28:	10.1	↘
29:	10.1	↖
30:	10.0	↓
Serie	97.6	
Total	299.3	

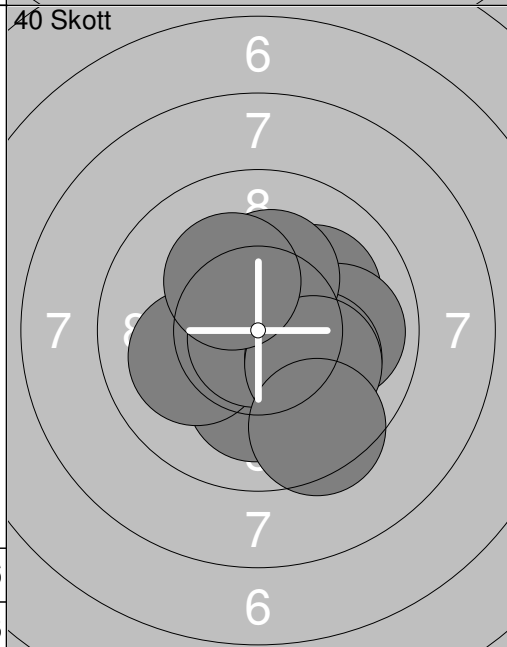

31:	10.1	↗
32:	9.9	→
33:	10.1	↓
34:	10.1	↙
35:	10.8	x↓
36:	10.1	→
37:	10.2	x↗
38:	10.1	→
39:	9.5	↘
40:	10.2	x↘
Serie	101.1	
Total	400.4	

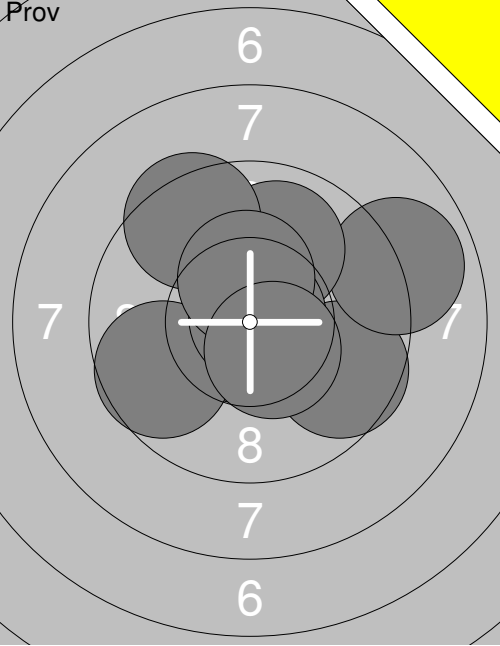
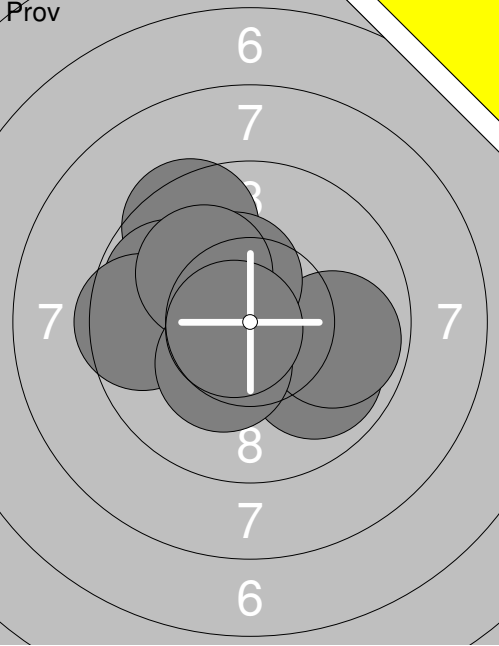
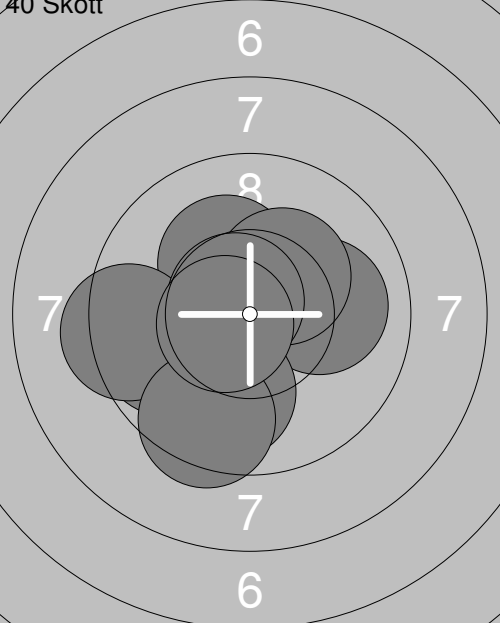
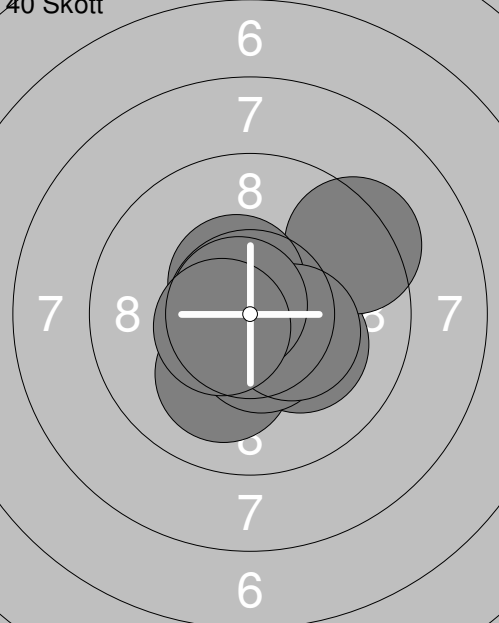
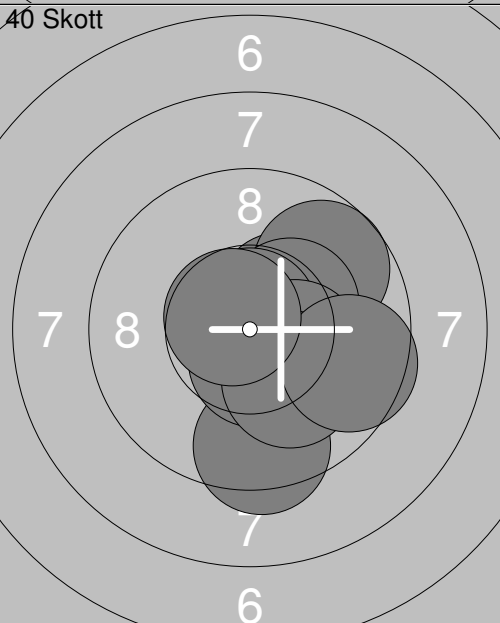
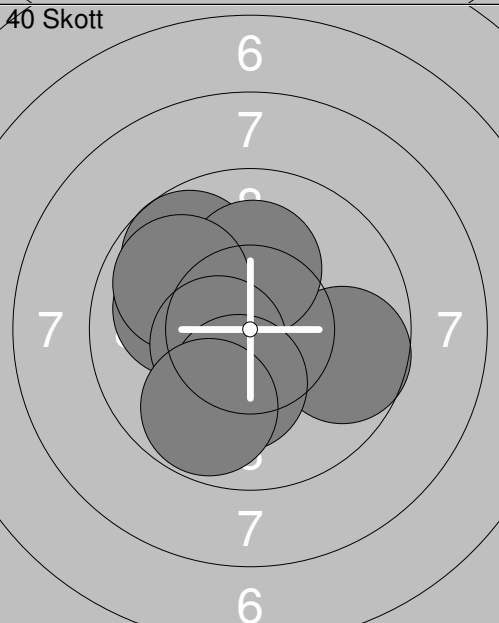
Skjutlag	Tavla	Hanna Lundin	
S	Umeå Skf		
04.02.2017	Skyttiaden Regionfinal	Umeå skytteallians	
Prov		Prov	
	1: 9.6 ↘ 2: 8.9 ↗ 3: 10.8x↘ 4: 9.7 ↙ 5: 9.9 ↗ 6: 9.4 ↖ 8: 10.8x↗ 9: 10.4x↗ 10: 10.5x↘		11: 9.9 ↘ 12: 9.5 ↖ 13: 9.8 ↙ 14: 9.9 → 15: 10.4x↗ 16: 9.6 ← 17: 10.1 ↖ 18: 10.3x↘ 19: 10.7x↘
Serie 90.0	Total 0.0	Serie 90.2	Total 0.0
40 Skott		40 Skott	
	1: 10.0 → 2: 10.6x↔ 3: 10.2x↖ 4: 9.9 ↓ 5: 9.8 ↙ 6: 10.3x↗ 7: 9.4 ← 8: 10.7x↖ 9: 9.5 ↓ 10: 10.6x↔		11: 10.3x↘ 12: 10.2x↘ 13: 9.3 ↗ 14: 10.8x↖ 15: 10.5x↖ 16: 10.1 ↓ 17: 10.5x↘ 18: 10.4x↘ 19: 10.8x↖ 20: 10.5x↖
Serie 101.0	Total 101.0	Serie 103.4	Total 204.4
40 Skott		40 Skott	
	21: 9.4 ↓ 22: 10.4x↗ 23: 9.7 ↗ 24: 10.3x↗ 25: 10.8x↗ 26: 10.6x↘ 27: 10.3x↘ 28: 10.1 ↓ 29: 9.6 → 30: 10.7x↖		31: 9.9 ↖ 32: 10.0 ↙ 33: 9.7 → 34: 9.7 ↖ 35: 10.2x↖ 36: 10.2x↗ 37: 9.9 ↖ 38: 10.5x↖ 39: 10.2x↘ 40: 9.8 ↓
Serie 101.9	Total 306.3	Serie 100.1	Total 406.4

<p>Prov</p>	<p>Prov</p>	
1: 7.8 ← 2: 9.2 ↖ 3: 8.0 ↖ 4: 9.6 ↗ 5: 9.2 ↑ 6: 9.4 ↗ 7: 9.5 ↘ 8: 9.5 ↑ 9: 10.2x↗ 10: 10.2x↘	11: 9.9 ↘ 12: 9.7 ↗ 13: 9.7 ↓ 14: 10.5x→ 15: 10.0→	
Serie 92.6 Total 0.0	Serie 49.8 Total 0.0	

<p>40 Skott</p>	<p>40 Skott</p>	
1: 9.6 ← 2: 10.3x→ 3: 10.5x↗ 4: 10.4x← 5: 8.7 ↓ 6: 10.0→ 7: 9.5 ← 8: 10.2x↘ 9: 10.4x→ 10: 10.4x↘	11: 10.6x→ 12: 10.0 ↓ 13: 10.2x→ 14: 9.7 ↗ 15: 10.0 ↓ 16: 10.5x↑ 17: 10.4x↘ 18: 10.2x→ 19: 10.6x↑ 20: 9.2 ↓	
Serie 100.0 Total 100.0	Serie 101.4 Total 201.4	

<p>40 Skott</p>	<p>40 Skott</p>	
21: 10.5x↘ 22: 10.1 ← 23: 10.4x↘ 24: 9.9 ↓ 25: 9.9 ↖ 26: 10.7x↘ 27: 10.1 ↓ 28: 9.9 ↗ 29: 10.8x↘ 30: 9.9 ←	31: 10.9x↖ 32: 10.5x↘ 33: 10.6x↖ 34: 10.0← 35: 9.9 ↓ 36: 9.1 ← 37: 9.5 ↖ 38: 10.5x↑ 39: 10.5x→ 40: 10.3x↖	
Serie 102.2 Total 303.6	Serie 101.8 Total 405.4	



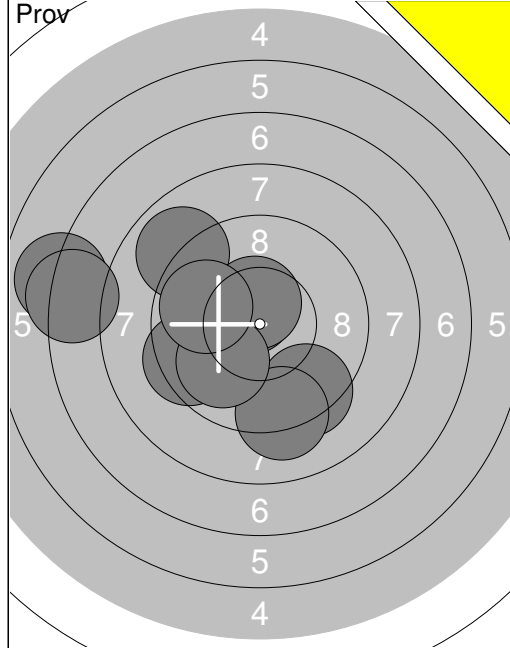

1:	8.9 ↖
2:	7.0 ←
3:	7.3 ←
4:	10.6x↗
5:	9.4 ↓
6:	9.2 ↓
7:	9.4 ←
8:	10.5x↗
9:	9.9 ↓
10:	9.9 ←
<b>Serie</b>	<b>92.1</b>
<b>Total</b>	<b>0.0</b>

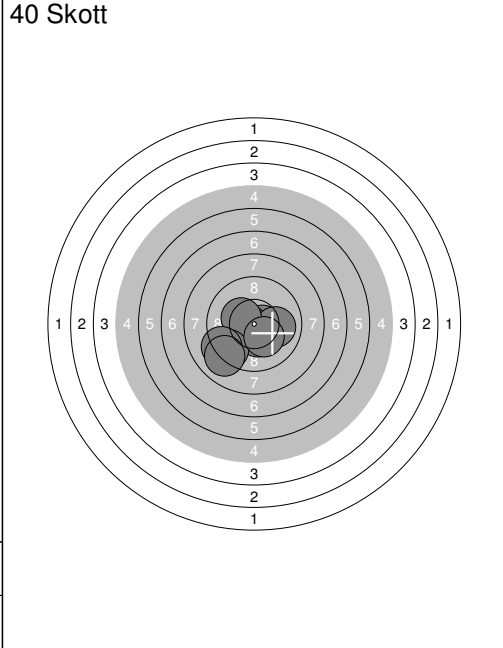

1:	10.6x➤
2:	10.7x↙
3:	10.0 ➡
4:	10.4x↘
5:	10.3x↘
6:	9.3 ↙
7:	0.0 ➡
8:	9.2 ↙
9:	10.3x↘
10:	9.0 ↙
<b>Serie</b>	<b>89.8</b>
<b>Total</b>	<b>89.8</b>

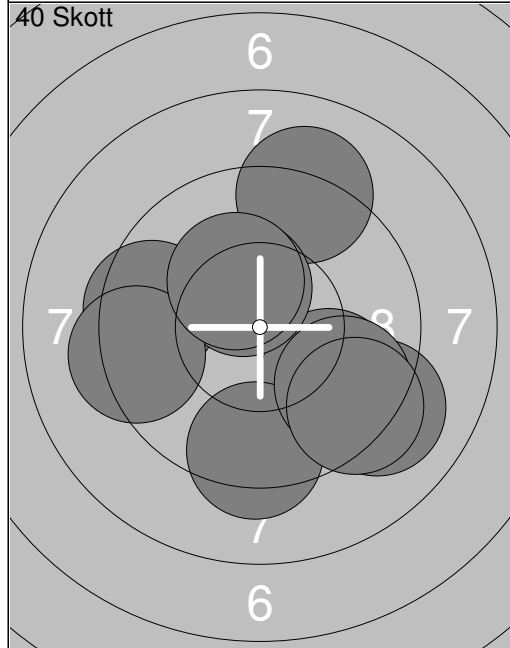

11:	9.1 ➤
12:	9.1 ↗
13:	9.5 ←
14:	9.8 ➤
15:	9.3 ↓
16:	9.6 ➤
17:	9.3 ➤
18:	10.4x↗
19:	9.3 ←
20:	10.3x↗
<b>Serie</b>	<b>95.7</b>
<b>Total</b>	<b>185.5</b>

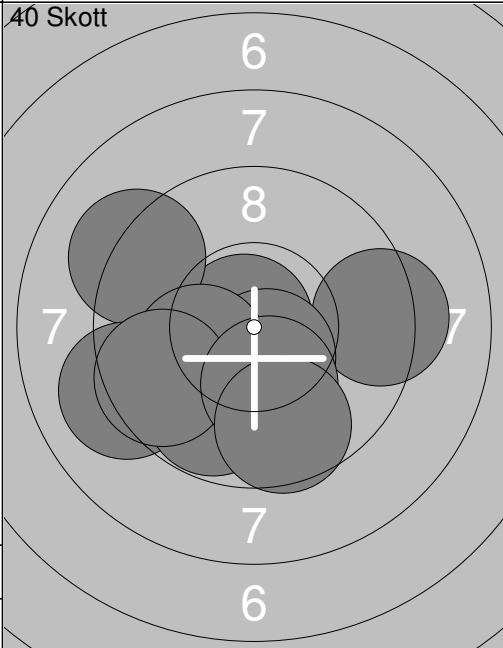

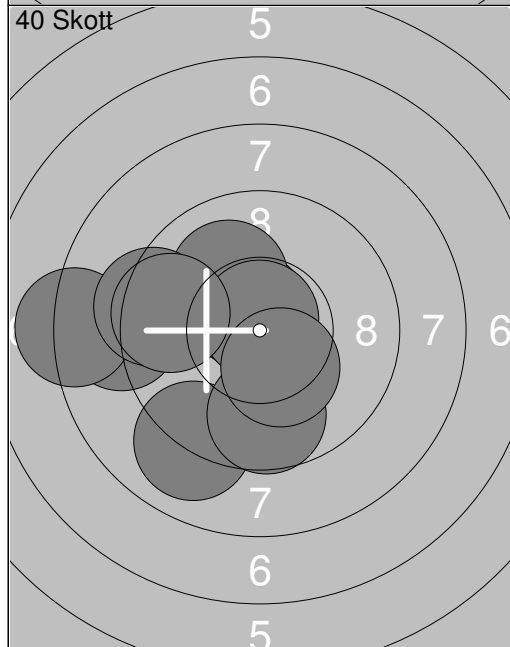

21:	10.8x↘
22:	9.3 ➡
23:	9.2 ↖
24:	9.1 ↖
25:	9.8 ↓
26:	10.5x↘
27:	10.2x↖
28:	9.6 ↖
29:	10.2x↘
30:	9.6 ↓
<b>Serie</b>	<b>98.3</b>
<b>Total</b>	<b>283.8</b>

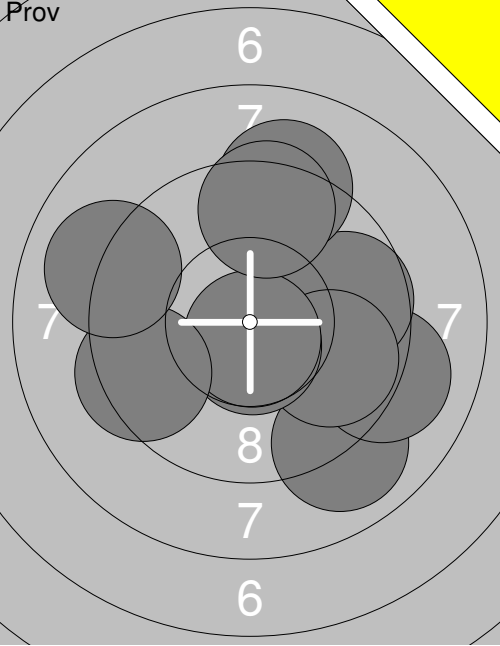
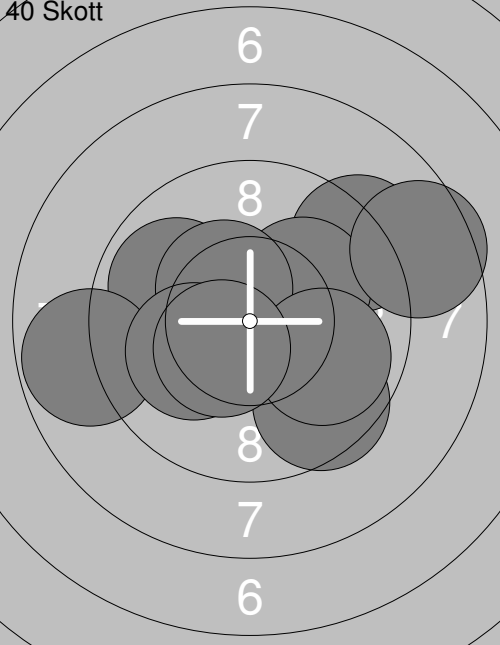
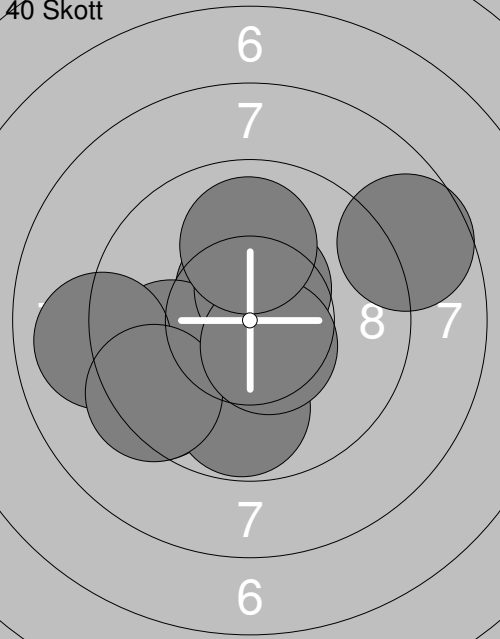

31:	10.6x↗
32:	9.0 ↓
33:	10.1 ↖
34:	8.9 ←
35:	8.2 ←
36:	10.8x↗
37:	9.7 ↓
38:	9.3 ←
39:	10.3x↘
40:	9.6 ←
<b>Serie</b>	<b>96.5</b>
<b>Total</b>	<b>380.3</b>

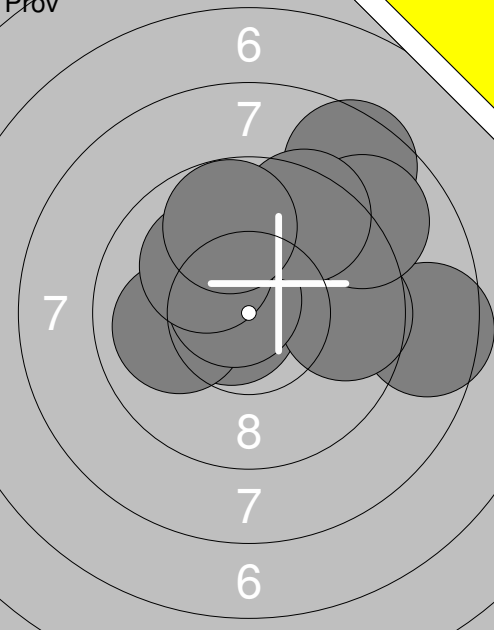
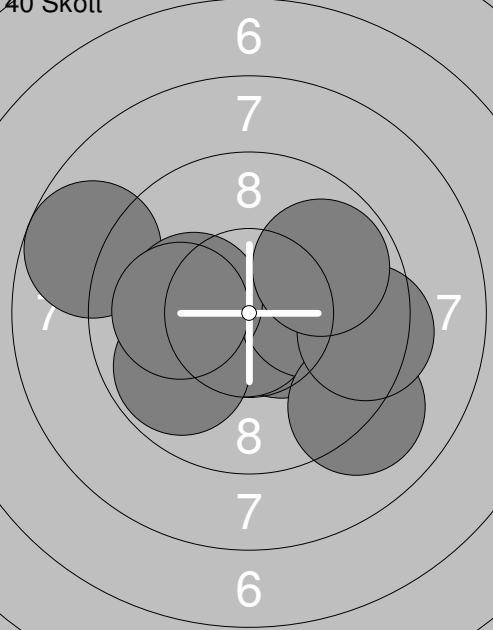
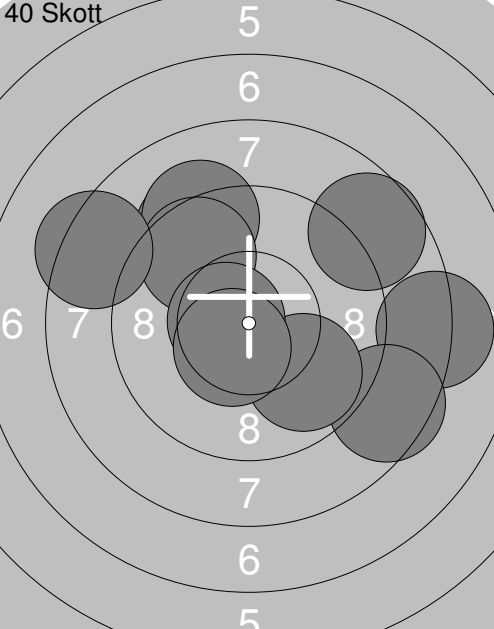
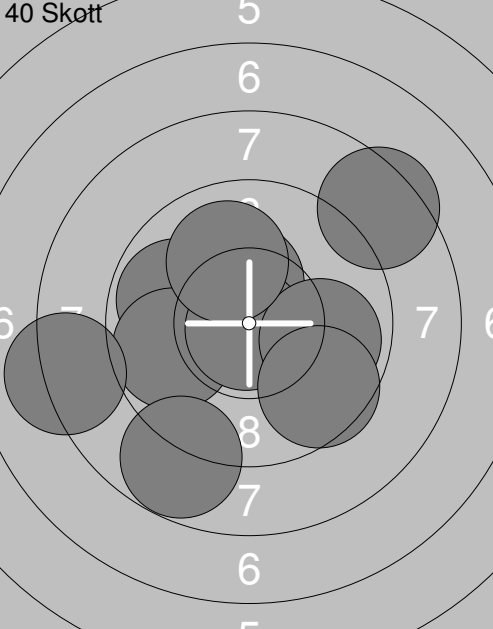
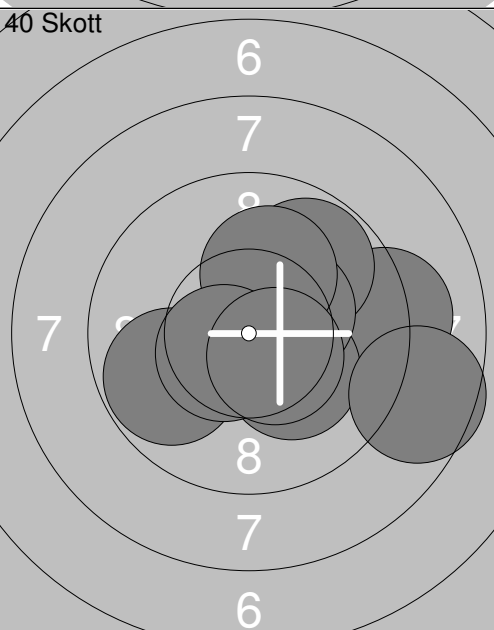
Skjutlag	Tavla	Miranda Karlsson	
S		Gällivare Skf	
04.02.2017	Skyttiaden Regionfinal	Umeå skytteallians	
Prov		1: 9.0 ↘ 2: 9.1 ➡ 3: 9.7 ➡ 4: 9.8 ➡ 5: 10.6x↓ 6: 10.7x↓ 7: 9.1 ↑ 8: 9.5 ↑ 9: 9.4 ↙ 10: 9.0 ↙	11: 10.5x↓ 12: 10.4x↗ 13: 9.1 ↑
		Serie 95.9	Serie 30.0
		Total 0.0	Total 0.0
40 Skott		1: 9.2 ↗ 2: 9.9 ↙ 3: 10.1 ↗ 4: 9.5 ↓ 5: 8.8 ↙ 6: 10.4x↘ 7: 9.9 ➡ 8: 10.1↙ 9: 10.4x↘ 10: 8.6 ➡	11: 7.2 ➡ 12: 10.0 ↑ 13: 9.9 ↙ 14: 10.4x➡ 15: 10.4x➡ 16: 9.3 ↗ 17: 9.9 ↑ 18: 10.4x↙ 19: 10.4x↗ 20: 10.5x↘
		Serie 96.9	Serie 98.4
		Total 96.9	Total 195.3
40 Skott		21: 10.6x↗ 22: 9.4 ↙ 23: 9.8 ↓ 24: 9.9 ↙ 25: 10.5x↗ 26: 9.0 ↙ 27: 9.4 ↙ 28: 10.5x↓ 29: 10.0 ↑ 30: 8.7 ➡	31: 10.4x↘ 32: 9.7 ↑ 33: 8.3 ↗ 34: 8.8 ↙ 35: 10.4x↘ 36: 10.4x↗ 37: 10.4x↗ 38: 9.8 ↗ 39: 9.5 ↗ 40: 10.5x↓
		Serie 97.8	Serie 98.2
		Total 293.1	Total 391.3

Pröv 	40 Skott 	1: 10.7x↗ 2: 10.0← 3: 8.6 ↗ 4: 8.5 → 5: 9.6 → 6: 10.7x↗ 7: 9.0 ↗ 8: 9.5 ↗ 9: 10.1↖ 10: 9.8 ↑ <hr/> Serie 96.5 Total 0.0	1: 10.5x↘ 2: 10.8x↓ 3: 8.7 ← 4: 10.1→ 5: 10.2x↗ 6: 9.8 ↖ 7: 9.1 ↘ 8: 9.4 → 9: 10.1← 10: 9.8 ↗ <hr/> Serie 98.5 Total 98.5
40 Skott 	40 Skott 	11: 9.3 ↖ 12: 8.1 → 13: 9.2 ↗ 14: 9.7 ↗ 15: 8.7 ↗ 16: 8.5 ↘ 17: 8.3 ← 18: 9.8 ↘ 19: 10.6x← 20: 10.5x↘ <hr/> Serie 92.7 Total 191.2	21: 9.8 ← 22: 10.4x↑ 23: 9.8 ← 24: 8.2 ← 25: 10.9x↘ 26: 9.9 → 27: 10.0 ↑ 28: 9.6 ↘ 29: 8.8 ↘ 30: 8.4 ↗ <hr/> Serie 95.8 Total 287.0
40 Skott 	40 Skott 	31: 9.2 → 32: 10.2x↘ 33: 10.8x↓ 34: 9.8 ← 35: 9.8 ↗ 36: 8.6 → 37: 10.4x↗ 38: 10.1 ↑ 39: 10.5x↗ 40: 10.5x↘ <hr/> Serie 99.9 Total 386.9	

 <p>Prov</p>	<p>1: 8.3 ↗                  2: 9.7 ↙                  3: 8.3 ➡                  4: 8.5 ←                  5: 9.4 ↙                  6: 9.4 ↙                  7: 9.1 ➡                  8: 7.6 ↑                  9: 9.9 ←                  10: 8.2 ↘</p> <p>Serie 88.4 Total 0.0</p>	 <p>Prov</p>	<p>11: 9.0 ↗                  12: 7.9 ↘                  13: 9.5 ↗                  14: 7.7 ←                  15: 8.1 ←</p> <p>Serie 42.2 Total 0.0</p>
----------------------------------------------------------------------------------------------	--------------------------------------------------------------------------------------------------------------------------------------------------------------------------------------------------------------------------------------------------------------------------------------------------------------------------------	------------------------------------------------------------------------------------------------	------------------------------------------------------------------------------------------------------------------------------------------------------------------------------

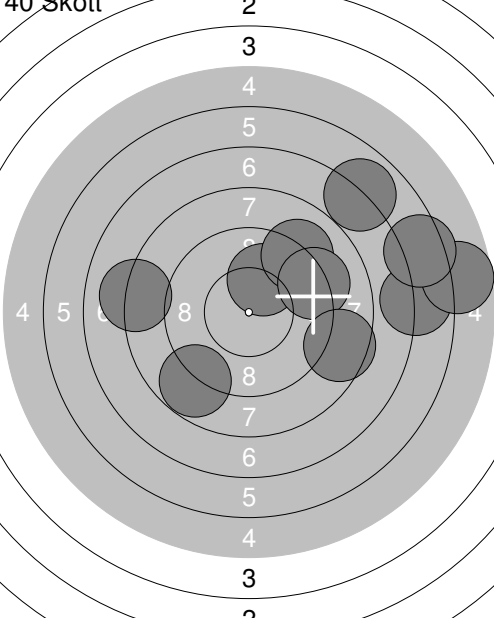
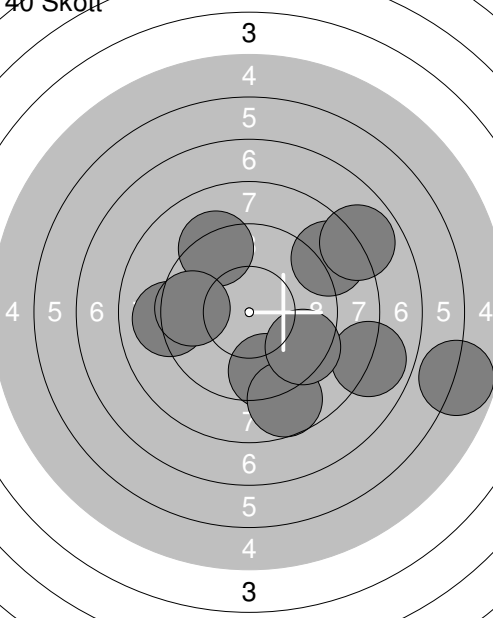
 <p>40 Skott</p>	<p>1: 6.8 ➡                  2: 5.7 ➡                  3: 10.1 ↗                  4: 9.1 ↗                  5: 9.2 ➡                  6: 6.4 ➡                  7: 8.5 ➡                  8: 8.8 ↘                  9: 6.9 ↗                  10: 8.1 ←</p> <p>Serie 79.6 Total 79.6</p>	 <p>40 Skott</p>	<p>11: 7.9 ➡                  12: 9.1 ←                  13: 9.3 ↗                  14: 9.5 ↘                  15: 8.7 ↘                  16: 5.8 ➡                  17: 9.6 ←                  18: 8.7 ↗                  19: 7.9 ↗                  20: 9.4 ↘</p> <p>Serie 85.9 Total 165.5</p>
---------------------------------------------------------------------------------------------------	----------------------------------------------------------------------------------------------------------------------------------------------------------------------------------------------------------------------------------------------------------------------------------------------------------------------------------	-----------------------------------------------------------------------------------------------------	-------------------------------------------------------------------------------------------------------------------------------------------------------------------------------------------------------------------------------------------------------------------------------------------------------------------------------------------

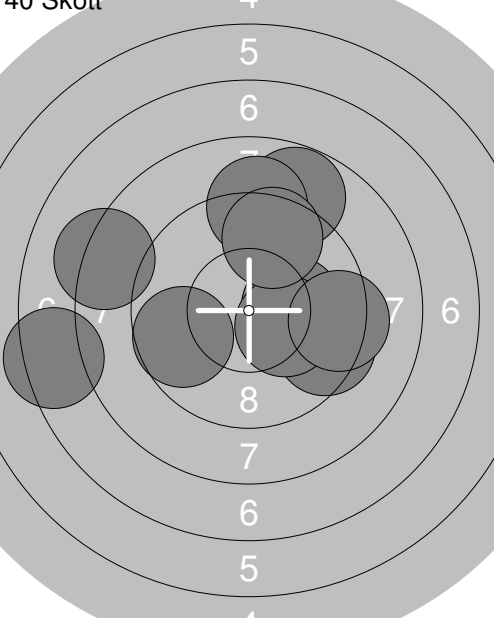
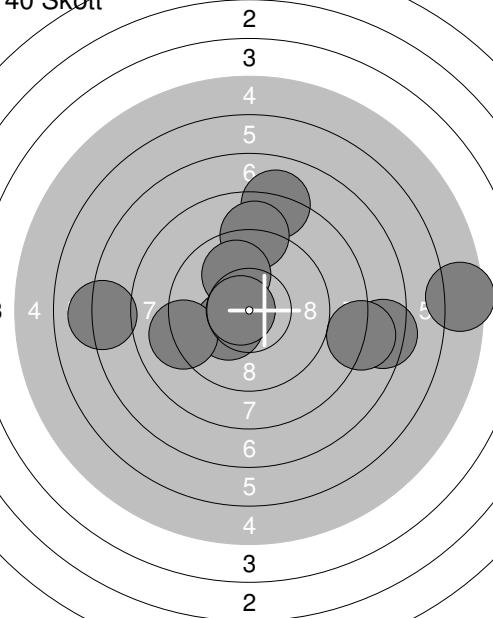
 <p>40 Skott</p>	<p>21: 10.2x➡                  22: 9.5 ➡                  23: 10.2x➡                  24: 7.4 ←                  25: 9.7 ←                  26: 8.8 ↗                  27: 9.1 ↗                  28: 8.2 ←                  29: 9.3 ➡                  30: 9.6 ↗</p> <p>Serie 92.0 Total 257.5</p>	 <p>40 Skott</p>	<p>31: 8.1 ↗                  32: 5.4 ➡                  33: 7.4 ➡                  34: 7.1 ←                  35: 10.3x↙                  36: 8.0 ➡                  37: 9.0 ↗                  38: 10.0 ↗                  39: 9.1 ←                  40: 10.7x↙</p> <p>Serie 85.1 Total 342.6</p>
----------------------------------------------------------------------------------------------------	---------------------------------------------------------------------------------------------------------------------------------------------------------------------------------------------------------------------------------------------------------------------------------------------------------------------------------------------	------------------------------------------------------------------------------------------------------	----------------------------------------------------------------------------------------------------------------------------------------------------------------------------------------------------------------------------------------------------------------------------------------------------------------------------------------------

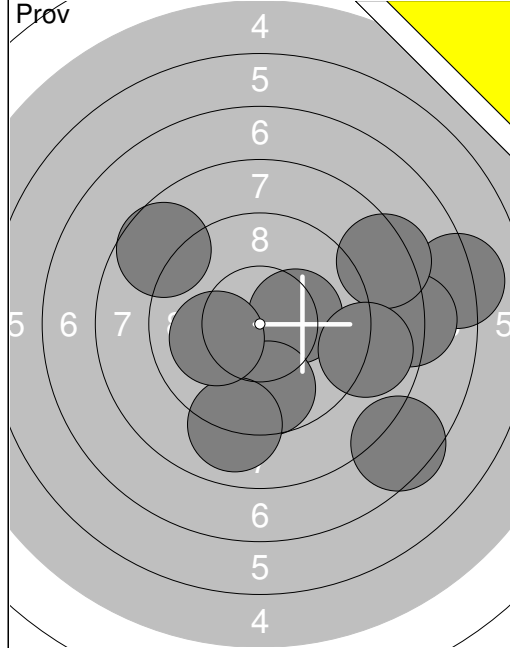

1:	10.3x	→
2:	7.5	↘
3:	7.1	→
4:	9.7	↓
5:	8.1	→
6:	9.0	↓
7:	8.3	↗
8:	8.7	↖
9:	10.1	←
10:	8.9	→
Serie	87.7	
Total	0.0	

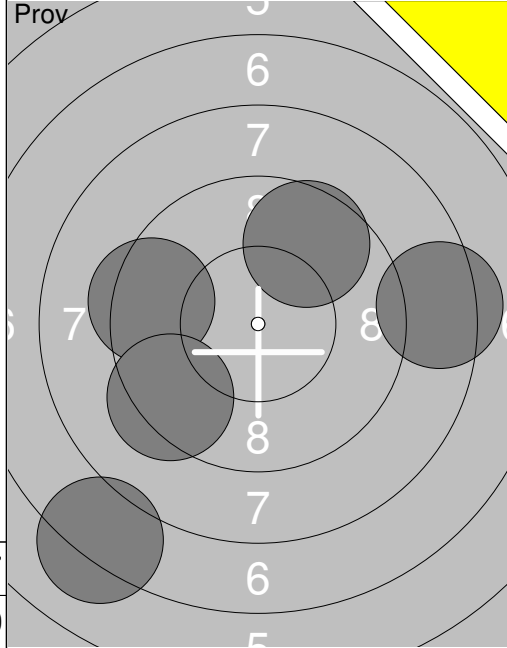

11:	8.4	→
12:	9.4	←
13:	7.2	↘
14:	9.3	↙
15:	9.6	↗
Serie	43.9	
Total	0.0	

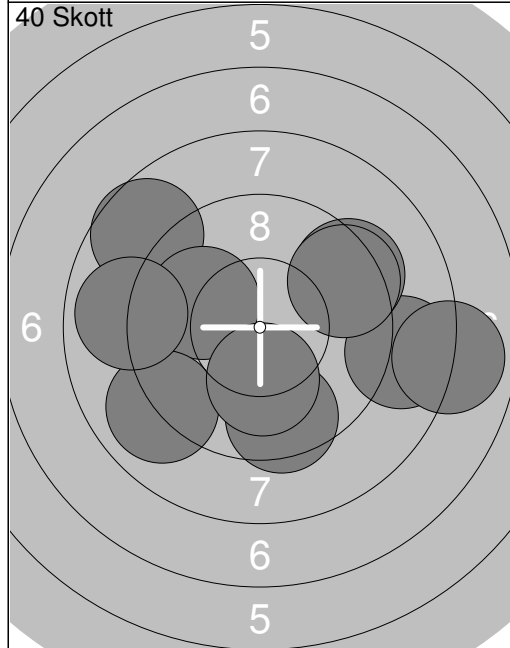

1:	8.7	→
2:	8.7	↖
3:	10.0	←
4:	7.9	→
5:	9.0	↙
6:	9.3	↗
7:	9.4	↗
8:	9.5	↓
9:	8.9	←
10:	10.1	↓
Serie	91.5	
Total	91.5	

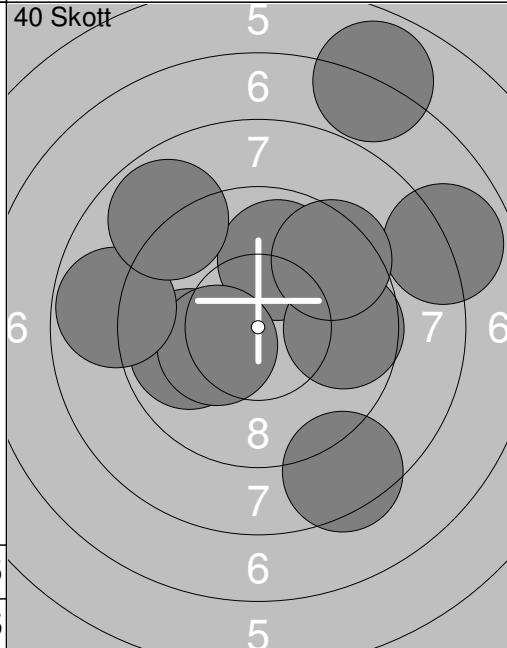

11:	7.9	↗
12:	9.9	↗
13:	8.4	↘
14:	9.9	←
15:	6.9	↗
16:	9.7	→
17:	10.3x	←
18:	9.5	↗
19:	8.8	←
20:	8.9	↖
Serie	90.2	
Total	181.7	

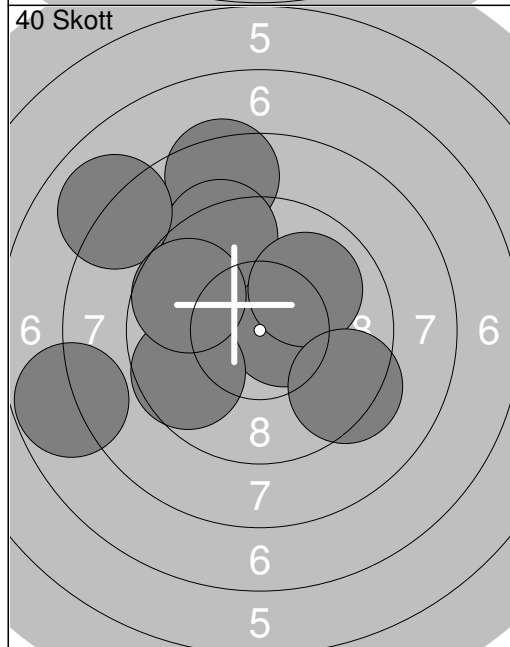

21:	10.6x	↘
22:	8.4	↗
23:	9.4	↗
24:	7.8	←
25:	10.6x	→
26:	9.6	←
27:	8.0	↖
28:	10.0	↗
29:	9.7	↖
30:	9.3	↘
Serie	93.4	
Total	275.1	

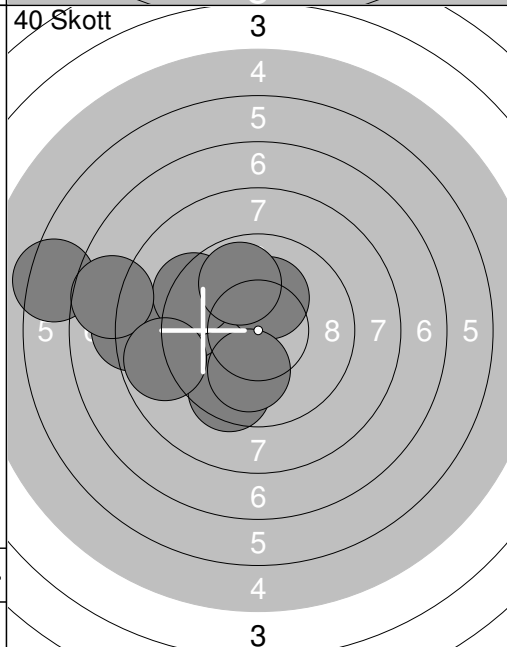

31:	9.9	←
32:	8.2	←
33:	10.2x	↗
34:	6.4	←
35:	9.4	↖
36:	7.7	←
37:	9.9	↗
38:	9.5	↘
39:	8.8	←
40:	10.1	↓
Serie	90.1	
Total	365.2	

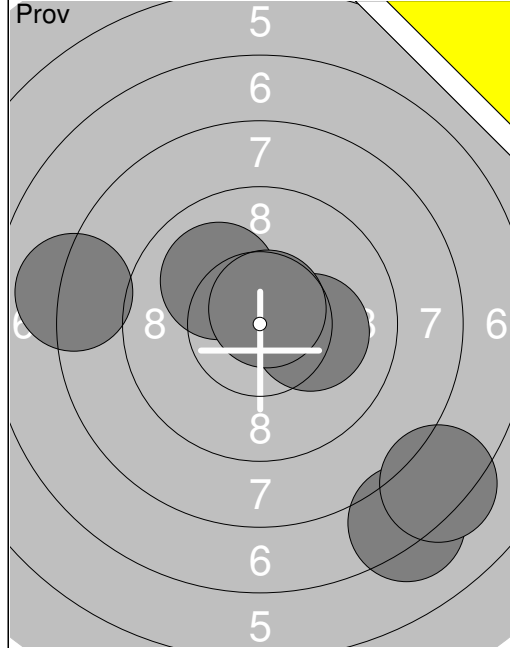

1:	7.2	↘
2:	7.3	↘
3:	10.2x	→
4:	10.0	↖
5:	8.1	←
6:	10.7x	↗
<b>Serie</b>		<b>53.5</b>
<b>Total</b>		<b>0.0</b>

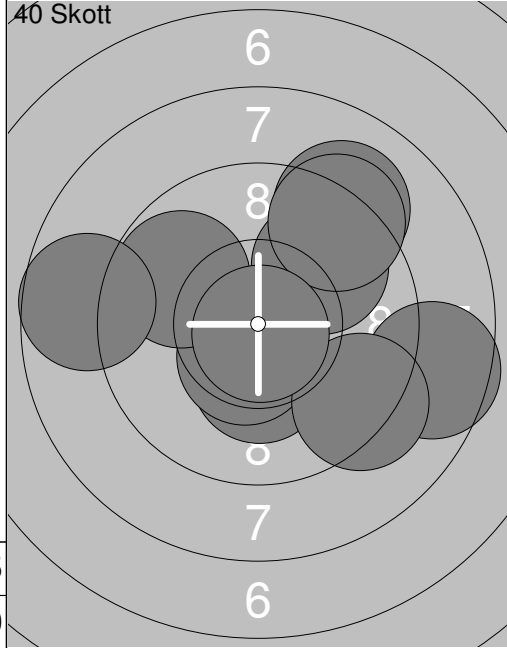

1:	10.3x	↘
2:	9.1	↗
3:	8.6	→
4:	9.8	↗
5:	10.5x	↘
6:	9.3	↗
7:	9.8	↖
8:	9.3	↘
9:	10.8x	↘
10:	8.7	←
<b>Serie</b>		<b>96.2</b>
<b>Total</b>		<b>96.2</b>

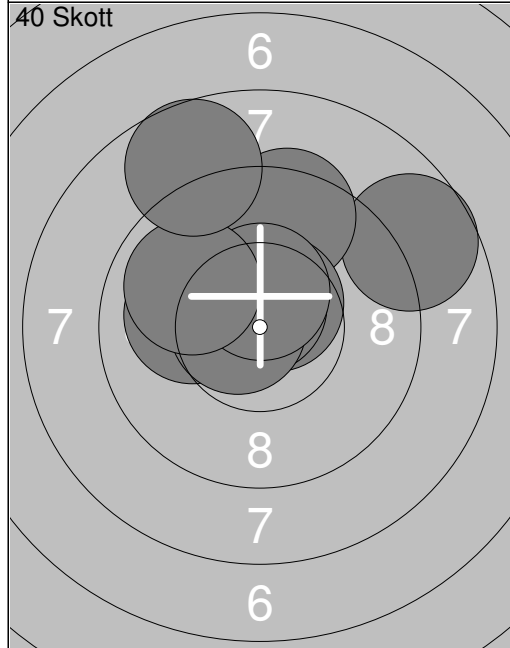

11:	10.1	←
12:	8.7	↗
13:	10.6x	↗
14:	9.5	↗
15:	10.6x	↗
16:	10.7x	↗
17:	10.7	↖
18:	10.5x	↗
19:	9.9	↖
20:	8.7	↗
<b>Serie</b>		<b>100.0</b>
<b>Total</b>		<b>196.2</b>

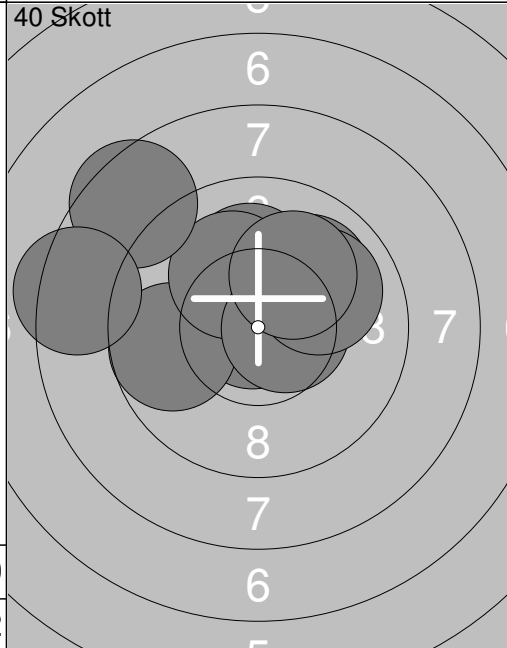

21:	10.9	↖
22:	9.7	←
23:	10.1	↗
24:	10.1	↖
25:	10.6x	→
26:	10.0	↗
27:	10.0	↗
28:	10.1	↗
29:	8.5	↖
30:	8.4	←
<b>Serie</b>		<b>98.4</b>
<b>Total</b>		<b>294.6</b>

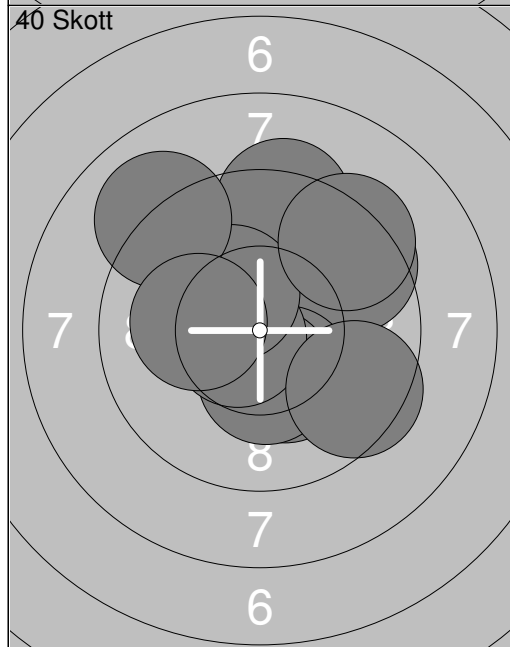

31:	9.5	↗
32:	10.3x	↘
33:	10.3x	↘
34:	10.6x	↖
35:	9.5	↘
36:	9.3	↗
37:	10.3x	↖
38:	9.0	↖
39:	9.3	↗
40:	10.1	←
<b>Serie</b>		<b>98.2</b>
<b>Total</b>		<b>392.8</b>

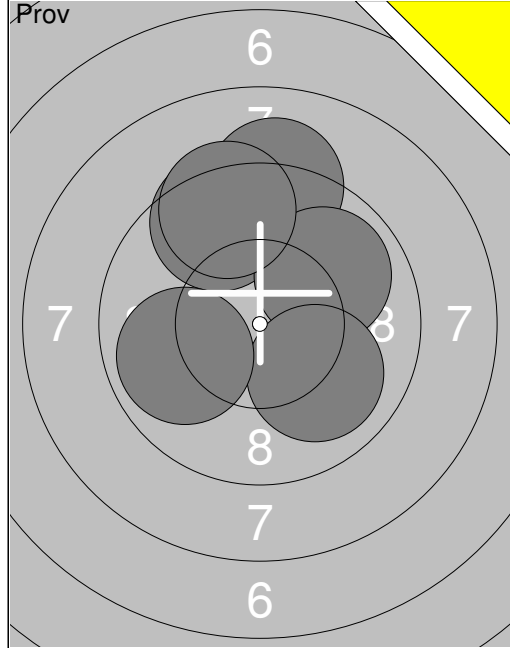

1:	9.5	↗
2:	9.1	↑
3:	9.9	↗
4:	10.0	↘
5:	9.9	←
6:	9.4	↑
<b>Serie</b>		<b>57.8</b>
<b>Total</b>		<b>0.0</b>

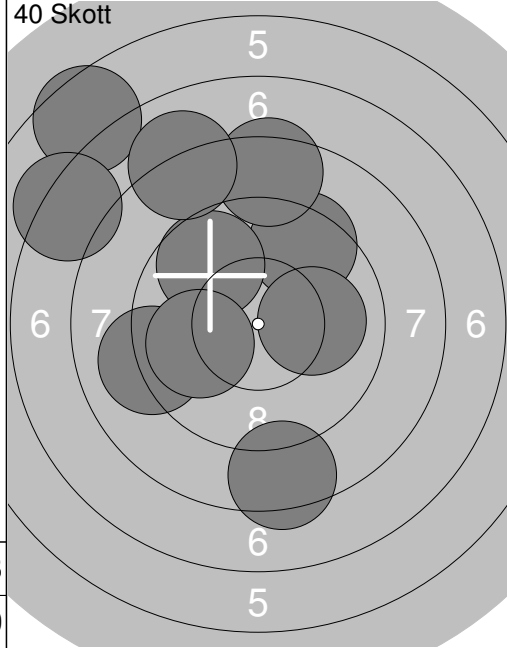

1:	9.5	↗
2:	8.4	↓
3:	8.4	↑
4:	9.1	←
5:	6.6	↖
6:	7.3	↖
7:	9.7	↗
8:	8.0	↑
9:	9.9	←
10:	10.1	→
<b>Serie</b>		<b>87.0</b>
<b>Total</b>		<b>87.0</b>

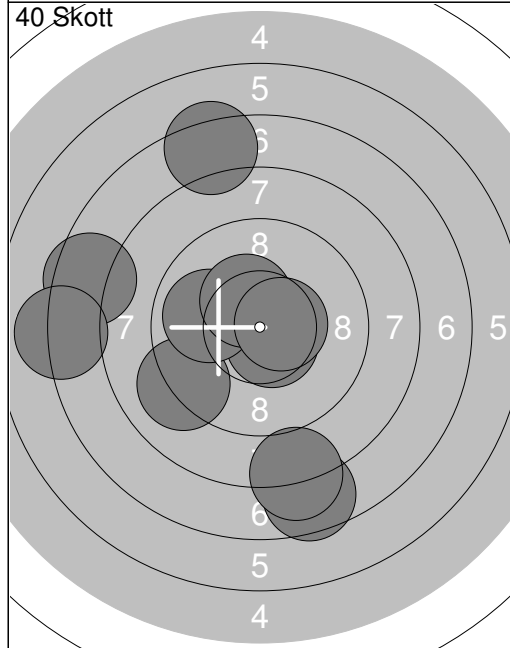

11:	7.5	←
12:	7.6	↓
13:	9.1	↖
14:	10.6	↘
15:	7.4	↑
16:	9.9	←
17:	10.4	↗
18:	8.0	↓
19:	7.1	←
20:	10.5	→
<b>Serie</b>		<b>88.1</b>
<b>Total</b>		<b>175.1</b>

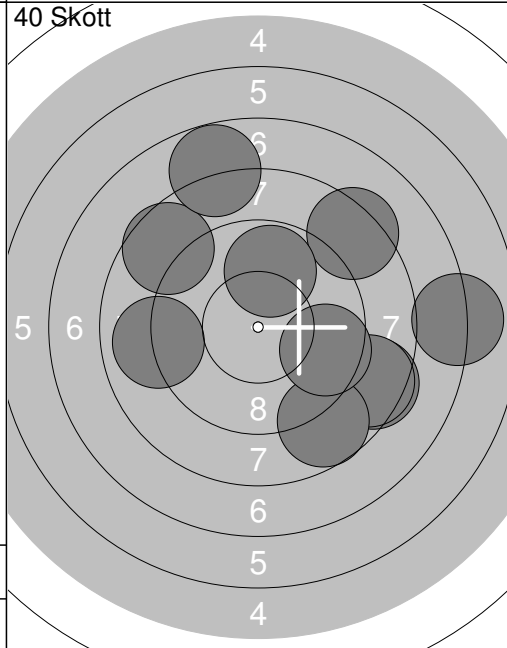

21:	8.4	↘
22:	8.5	↘
23:	9.0	←
24:	7.0	→
25:	8.6	↖
26:	8.7	↓
27:	8.3	↗
28:	7.8	↑
29:	9.6	↘
30:	9.8	↑
<b>Serie</b>		<b>85.7</b>
<b>Total</b>		<b>260.8</b>

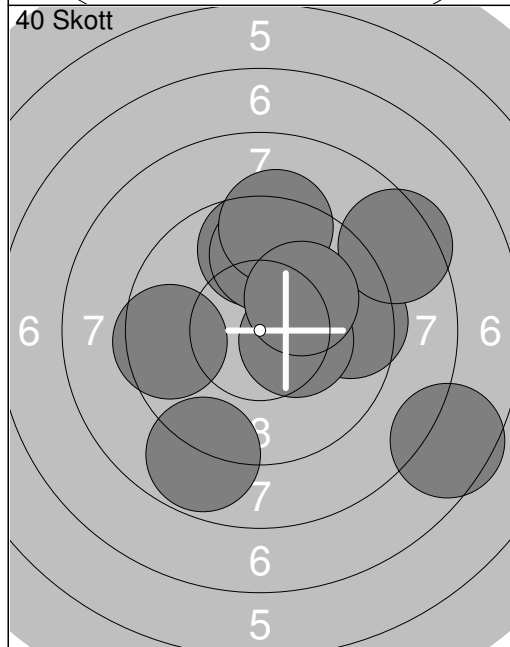

31:	9.7	↑
32:	7.5	↘
33:	8.8	↓
34:	9.5	→
35:	9.5	←
36:	9.8	↑
37:	10.4	→
38:	9.3	↑
39:	8.5	↗
40:	10.1	↗
<b>Serie</b>		<b>93.1</b>
<b>Total</b>		<b>353.9</b>

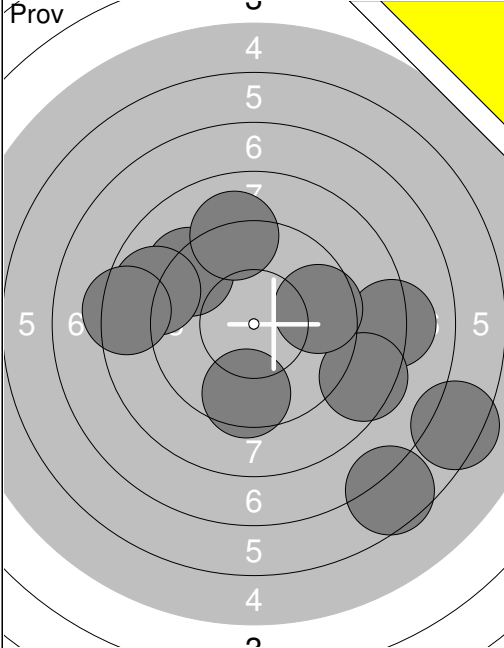
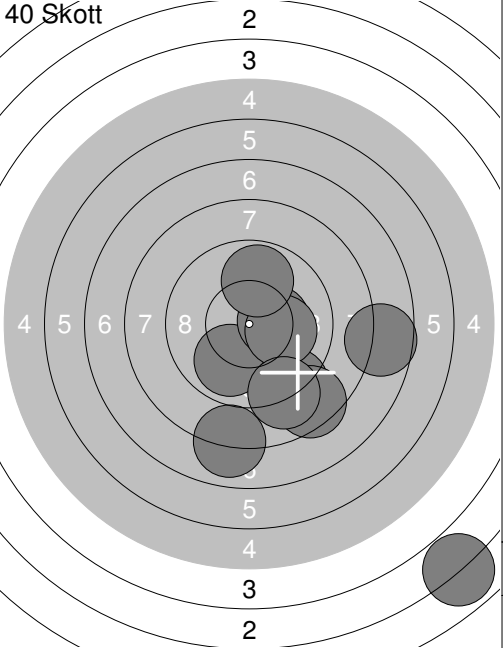
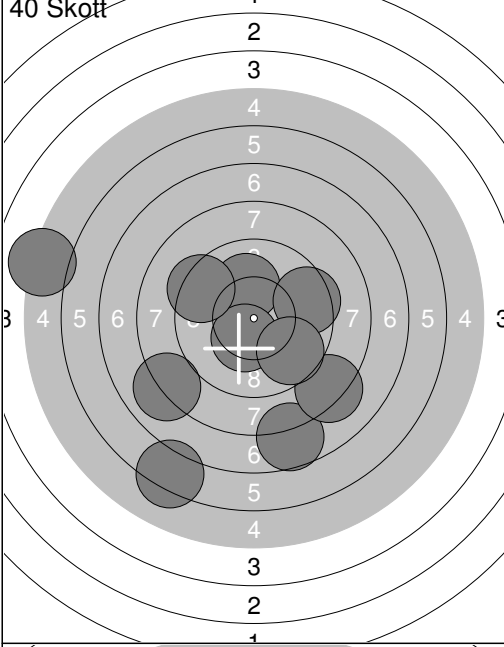
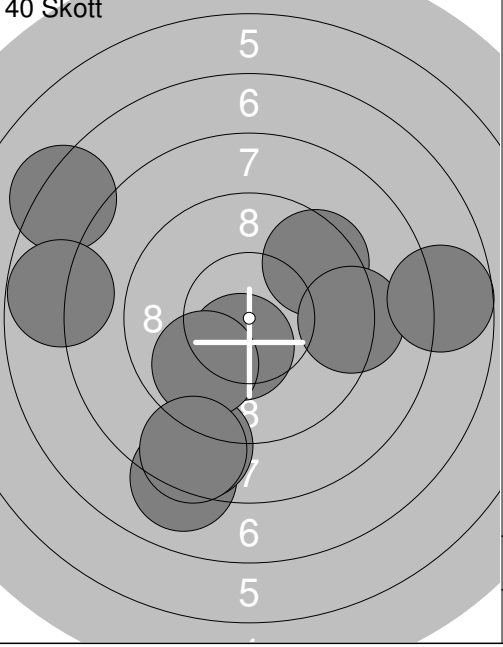
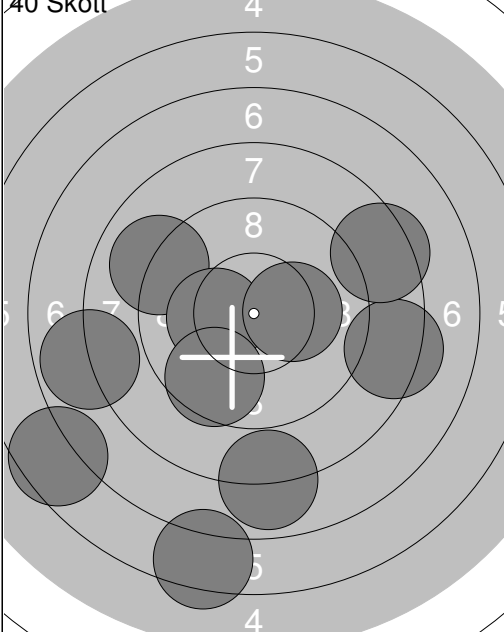
Skjutlag	Tavla	Petter Hemå	
<b>2</b>	<b>22</b>		
S	Fältjägarna Skf		
04.02.2017	Skyttiaden Regionfinal	Umeå skytteallians	
Prov			
	1: 8.2 →		1: 9.9 ↘
	2: 9.3 ↖		2: 10.3x→
	3: 9.1 ↑		3: 7.6 →
	4: 8.9 ↖		4: 9.1 ↘
	5: 6.6 ↘		5: 8.5 ↘
	6: 8.5 →		6: 8.0 ↓
	7: 9.5 ↓		7: 10.1 →
	8: 6.4 ↘		8: 2.9 ↘
	9: 8.4 ←		9: 9.9 ↑
	10: 9.6 →		10: 9.0 ↘
	Serie 84.5		Serie 85.3
	Total 0.0		Total 85.3
	11: 7.7 ↓		21: 8.1 ↓
	12: 10.1 ↑		22: 9.5 ↗
	13: 8.2 ↘		23: 10.5x↓
	14: 6.3 ↓		24: 8.7 ↓
	15: 5.2 ←		25: 9.9 ↘
	16: 10.4x↓		26: 8.6 ↓
	17: 9.5 →		27: 9.2 →
	18: 9.4 ↖		28: 7.2 ↖
	19: 8.0 ↘		29: 7.7 →
	20: 9.6 ↘		30: 7.8 ←
	Serie 84.4		Serie 87.2
	Total 169.7		Total 256.9
	31: 8.3 →		
	32: 9.0 ↖		
	33: 6.6 ↖		
	34: 7.9 ↓		
	35: 7.9 ←		
	36: 10.3x←		
	37: 6.4 ↓		
	38: 10.3x→		
	39: 8.4 ↗		
	40: 9.6 ↘		
	Serie 84.7		
	Total 341.6		



	<p>1: 8.4 ←</p> <p>2: 9.9 →</p> <p>3: 8.7 ←</p> <p>4: 8.3 ←</p> <p>5: 8.7 ↑</p> <p>6: 9.2 ←</p> <p>7: 8.9 →</p> <p>8: 9.7 ↓</p> <p>9: 10.3x ↘</p> <p>10: 6.7 →</p>		<p>11: 9.8 ↑</p> <p>12: 9.7 ←</p> <p>13: 10.0 ↗</p> <p>14: 9.3 ↗</p> <p>15: 10.5x ↗</p> <p>16: 10.2x ↖</p>
Serie 88.8		Serie 59.5	
Total 0.0		Total 0.0	

	<p>1: 8.9 ↖</p> <p>2: 9.2 ↗</p> <p>3: 10.0 ↗</p> <p>4: 9.6 ↖</p> <p>5: 9.0 ↑</p> <p>6: 9.6 →</p> <p>7: 9.4 →</p> <p>8: 8.0 →</p> <p>9: 8.4 ↓</p> <p>10: 9.3 ←</p>		<p>11: 10.7x ↖</p> <p>12: 8.2 ↑</p> <p>13: 9.0 →</p> <p>14: 9.2 ↑</p> <p>15: 9.2 ↑</p> <p>16: 7.5 ↗</p> <p>17: 9.3 →</p> <p>18: 8.8 ←</p> <p>19: 7.8 →</p> <p>20: 10.5x ↗</p>
Serie 91.4		Serie 90.2	
Total 91.4		Total 181.6	

	<p>21: 10.0 ↘</p> <p>22: 9.4 ↗</p> <p>23: 9.7 ↖</p> <p>24: 10.7x ↖</p> <p>25: 10.1 ←</p> <p>26: 8.4 ←</p> <p>27: 10.1 →</p> <p>28: 9.7 ↑</p> <p>29: 9.4 ←</p> <p>30: 9.6 ↓</p>		<p>31: 9.8 ↓</p> <p>32: 10.4x ↖</p> <p>33: 9.7 ↓</p> <p>34: 10.4x ↗</p> <p>35: 10.6x ↘</p> <p>36: 9.1 ←</p> <p>37: 10.5x ↗</p> <p>38: 9.5 →</p> <p>39: 7.5 ↘</p> <p>40: 10.1 →</p>
Serie 97.1		Serie 97.6	
Total 278.7		Total 376.3	

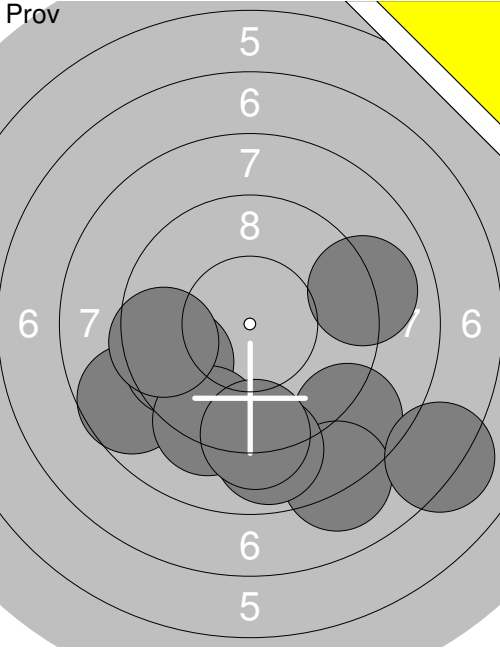
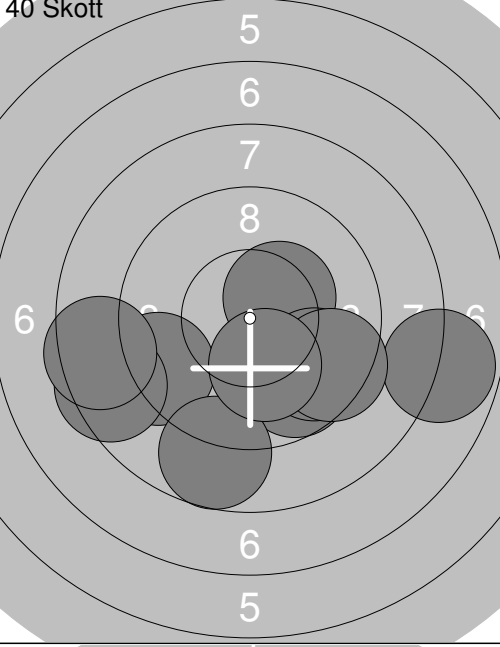
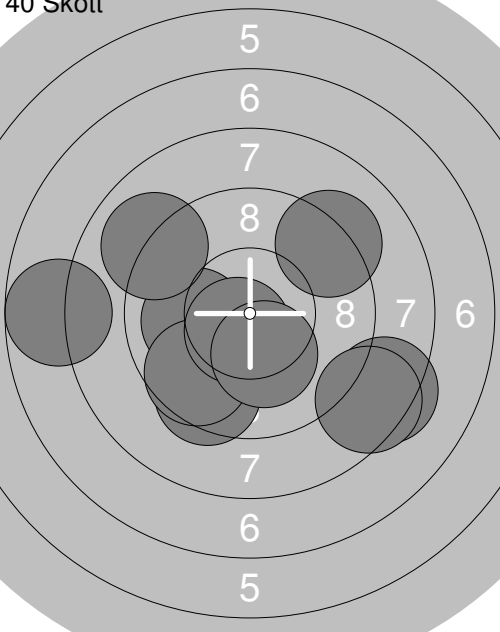
Skjutlag	Tavla	Sofi Jonsson	
S		Ramselefors Skf	
04.02.2017	Skyttiaden Regionfinal	Umeå skytteallians	
Prov		1: 8.7 ↙ 2: 9.6 ↙ 3: 8.7 ↘ 4: 9.2 ↓ 5: 8.1 ↓ 6: 7.2 ↘ 7: 9.0 → 8: 9.5 ← 9: 8.9 ↓ 10: 9.2 ↓ Serie 88.1 Total 0.0	11: 10.3x↓ 12: 7.9 ↘ 13: 10.6x↓ 14: 8.2 ↓ 15: 7.5 ↘ Serie 44.5 Total 0.0
40 Skott		1: 7.8 → 2: 9.7 ↓ 3: 9.3 ↙ 4: 10.4x↗ 5: 9.7 ↘ 6: 8.5 ← 7: 8.7 ↓ 8: 8.5 ← 9: 9.5 ↘ 10: 10.2x↓ Serie 92.3 Total 92.3	11: 10.3x→ 12: 10.3x↙ 13: 9.2 → 14: 9.4 ↓ 15: 9.8 → 16: 6.4 → 17: 9.8 ← 18: 8.9 ↘ 19: 8.5 ↖ 20: 10.1 → Serie 92.7 Total 185.0
40 Skott		21: 9.2 ↗ 22: 10.0← 23: 8.4 ↘ 24: 9.5 ↓ 25: 8.5 ↘ 26: 9.6 ↙ 27: 9.0 ↖ 28: 10.6x↓ 29: 7.7 ← 30: 10.2x↓ Serie 92.7 Total 277.7	31: 9.2 ← 32: 8.4 → 33: 8.4 ↘ 34: 10.9x↓ 35: 9.5 ↙ 36: 9.0 ↓ 37: 8.9 ↙ 38: 10.4x↙ 39: 9.2 → 40: 10.0 ↓ Serie 93.9 Total 371.6

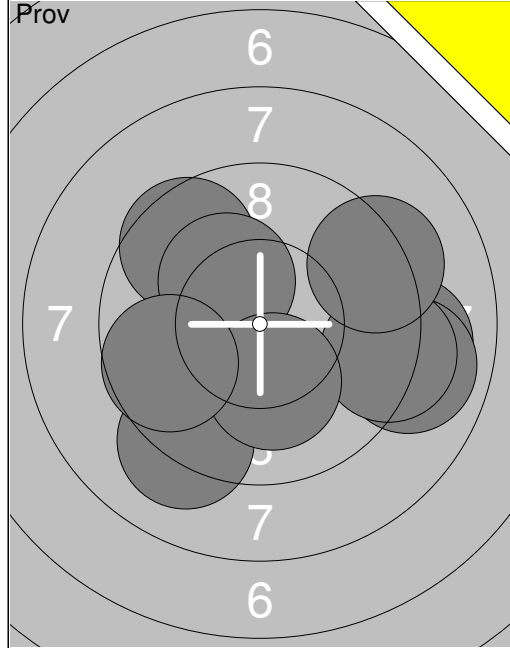

1:	9.1	→
2:	8.9	→
3:	10.3	↘
4:	9.6	↖
5:	9.2	↙
6:	9.2	→
7:	9.3	↗
8:	10.2	↘
9:	10.2	↙
10:	9.7	←
Serie		95.7
Total		0.0

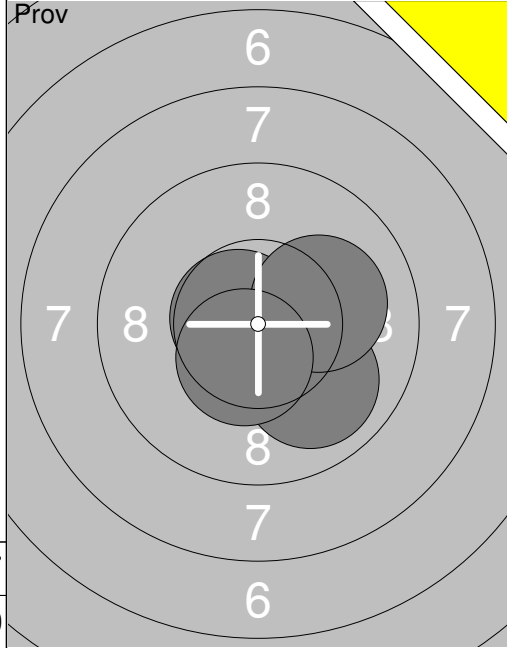

11:	10.7	↘
12:	9.9	↙
13:	10.1	→
14:	10.5	↙
Serie		41.2
Total		0.0

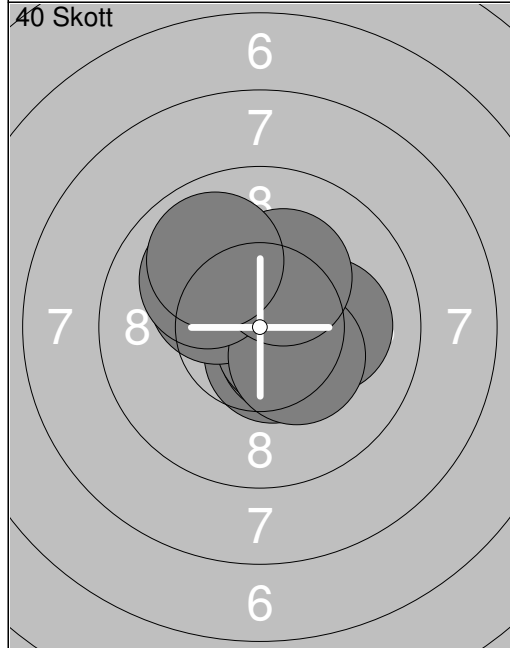

1:	10.1	→
2:	10.6	↙
3:	10.5	↘
4:	10.6	↗
5:	10.6	↘
6:	10.3	↘
7:	10.3	↘
8:	10.0	↖
9:	10.2	↗
10:	9.9	↖
Serie		103.1
Total		103.1

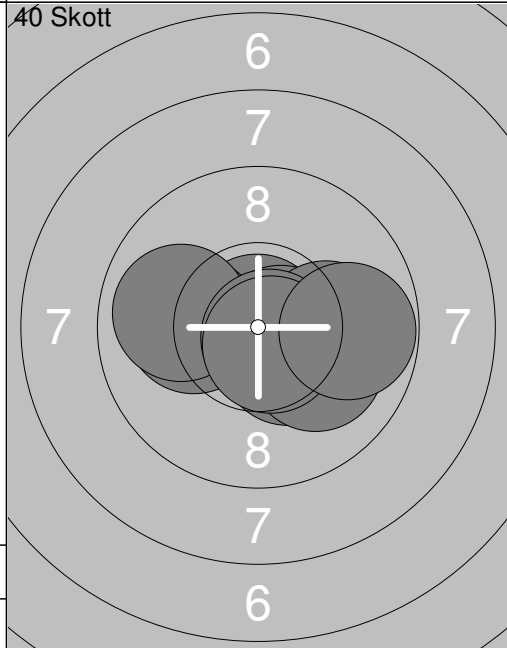

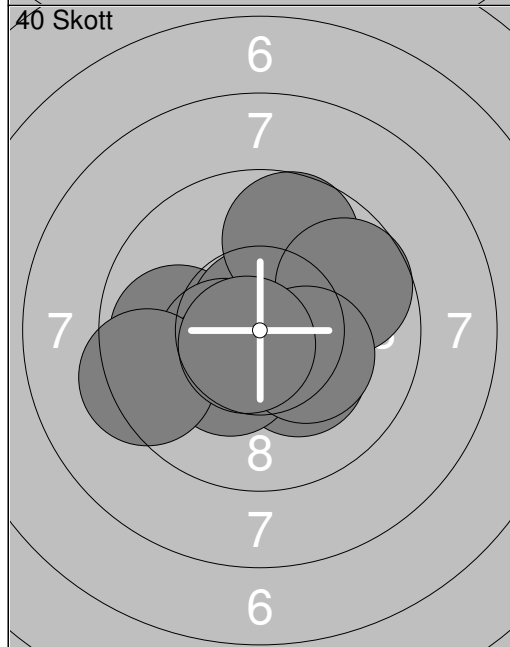

11:	10.9	↗
12:	10.1	←
13:	10.6	↘
14:	10.4	↘
15:	10.1	→
16:	10.1	↙
17:	9.9	←
18:	10.7	↘
19:	10.7	↙
20:	9.8	→
Serie		103.3
Total		206.4

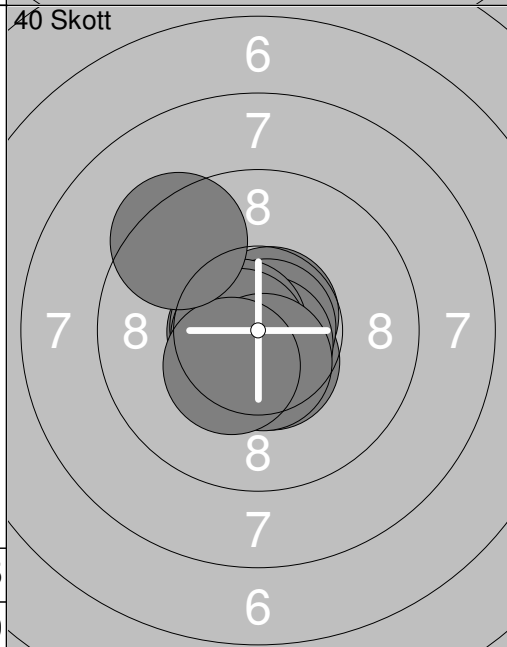

21:	9.9	←
22:	10.3	↘
23:	10.8	↗
24:	9.7	↗
25:	10.4	↘
26:	10.3	↘
27:	9.7	↗
28:	10.3	↘
29:	9.4	←
30:	10.7	↘
Serie		101.5
Total		307.9

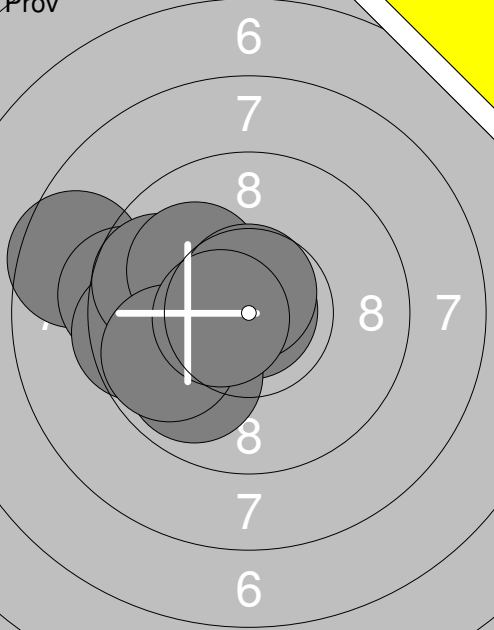

31:	10.7	↗
32:	10.5	↙
33:	10.7	↘
34:	10.8	↗
35:	10.8	↘
36:	10.7	↘
37:	10.7	↘
38:	10.5	↙
39:	10.4	↘
40:	9.4	↖
Serie		105.2
Total		413.1

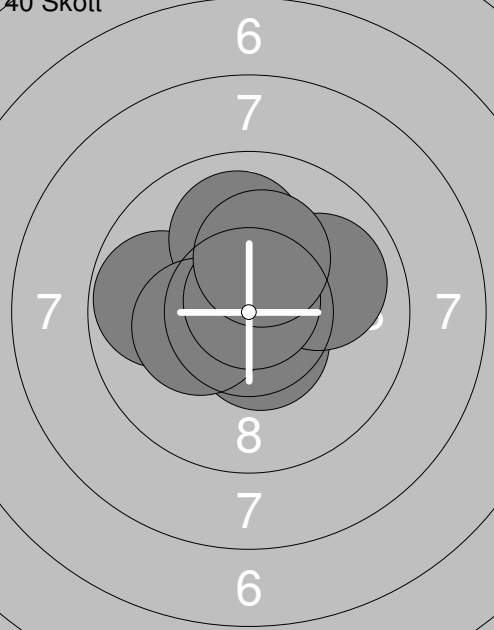
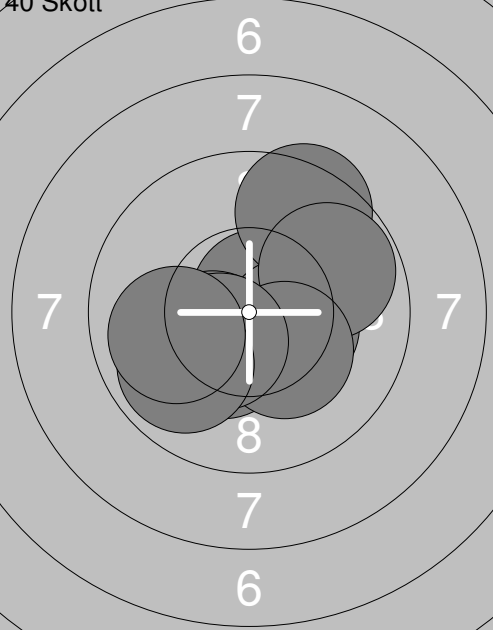
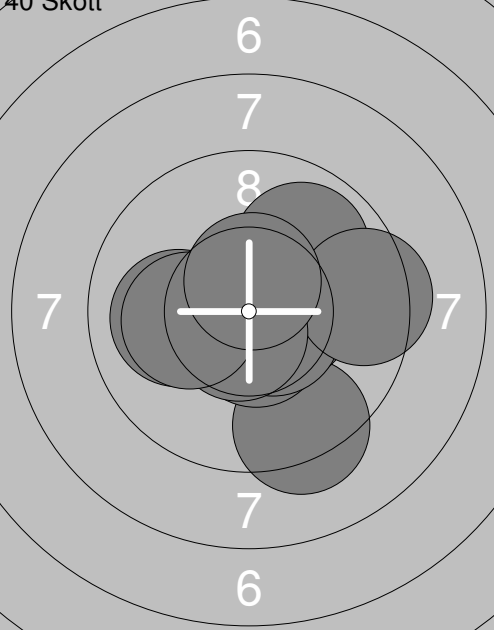
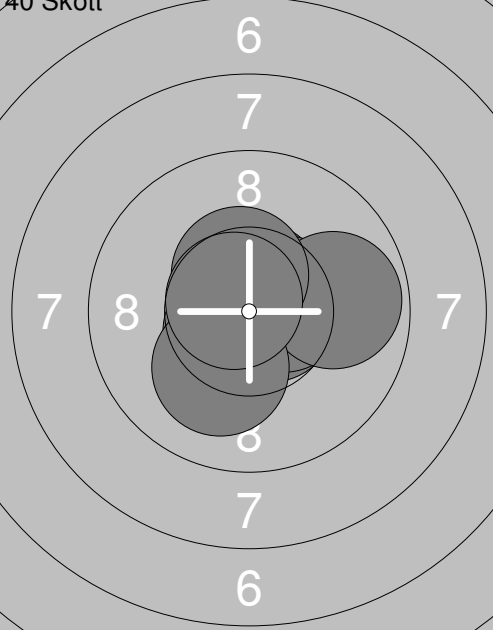
<p>Prov</p> 	<p>1: 8.6 ←</p> <p>2: 10.9x↑</p> <p>3: 9.9 ↙</p> <p>4: 9.3 ←</p> <p>5: 9.5 ←</p> <p>6: 9.7 ←</p> <p>7: 10.1 ↖</p> <p>8: 9.8 ←</p> <p>9: 10.7x↑</p> <p>10: 10.6x←</p> <p>Serie 99.1</p> <p>Total 0.0</p>	<p>Prov</p> 	<p>11: 9.9 →</p> <p>12: 10.8x↓</p> <p>13: 10.6x↓</p> <p>Serie 31.3</p> <p>Total 0.0</p>
<p>40 Skott</p> 	<p>1: 10.4x↗</p> <p>2: 10.6x↑</p> <p>3: 9.8 ←</p> <p>4: 10.0 ↑</p> <p>5: 10.5x↓</p> <p>6: 10.5x↑</p> <p>7: 10.3x←</p> <p>8: 10.0 →</p> <p>9: 10.8x↑</p> <p>10: 10.2x↑</p> <p>Serie 103.1</p> <p>Total 103.1</p>	<p>40 Skott</p> 	<p>11: 10.4x↓</p> <p>12: 10.7x↑</p> <p>13: 10.4x→</p> <p>14: 9.5 ↗</p> <p>15: 9.8 →</p> <p>16: 10.4x←</p> <p>17: 10.3x↓</p> <p>18: 10.4x↓</p> <p>19: 9.9 ↙</p> <p>20: 10.0←</p> <p>Serie 101.8</p> <p>Total 204.9</p>
<p>40 Skott</p> 	<p>21: 9.3 ↘</p> <p>22: 10.5x→</p> <p>23: 10.6x↓</p> <p>24: 9.9 ↗</p> <p>25: 10.0←</p> <p>26: 10.6x→</p> <p>27: 9.4 →</p> <p>28: 10.6x↓</p> <p>29: 10.2x←</p> <p>30: 10.6x↑</p> <p>Serie 101.7</p> <p>Total 306.6</p>	<p>40 Skott</p> 	<p>31: 10.7x↑</p> <p>32: 10.9x↓</p> <p>33: 10.6x↓</p> <p>34: 10.7x→</p> <p>35: 10.5x→</p> <p>36: 10.6x↑</p> <p>37: 9.8 →</p> <p>38: 10.5x↑</p> <p>39: 10.1 ↘</p> <p>40: 10.7x←</p> <p>Serie 105.1</p> <p>Total 411.7</p>

Skjutlag	Tavla	Klas Jonsson	
2	28		
S	Aspås USkf		
04.02.2017	Skyttiaden Regionfinal	Umeå skytteallians	
Pröv		1: 9.9 ↓ 2: 9.3 → 4: 10.7x ↗ 6: 10.1 ↓ 7: 10.5x ↗ 8: 9.7 → 9: 9.3 ↗ 10: 10.3x ↗	Pröv
	11: 9.7 → 12: 10.4x ↗ 13: 8.6 ↑ 14: 10.0 ↗ 15: 9.4 → 16: 10.1 ↓ 17: 10.1 ↗ 18: 9.5 ↓ 19: 10.0 ↓ 20: 10.2x →	Serie 79.8	Serie 98.0
	Total 0.0	Total 0.0	Total 0.0
Pröv		21: 10.8x ↑ 22: 10.4x ↓	40 Skott
	Serie 21.2	Serie 96.8	
	Total 0.0	Total 96.8	
40 Skott		11: 10.4x ↓ 12: 10.0 → 13: 10.2x ↗ 14: 10.5x ↑ 15: 8.8 ↑ 16: 10.0 ↗ 17: 8.9 → 18: 10.3x ↗ 19: 10.8x ↗ 20: 10.5x ↑	40 Skott
	Serie 100.4	Serie 94.9	
	Total 197.2	Total 292.1	
40 Skott		31: 10.0 → 32: 10.6x → 33: 9.8 ↗ 34: 10.1 ↗ 35: 10.3x ↑ 36: 8.2 ↗ 37: 9.3 ↗ 38: 7.4 → 39: 9.9 ↑ 40: 10.3x ↓	
	Serie 95.9		
	Total 388.0		

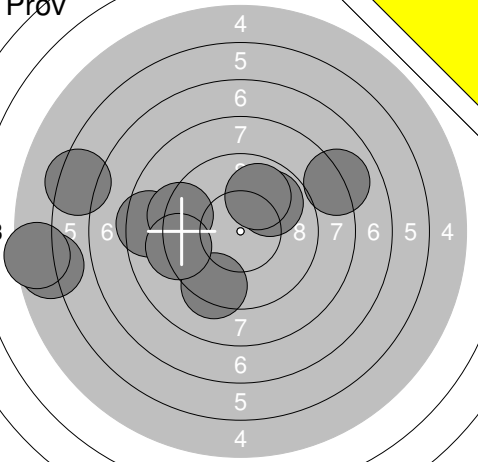
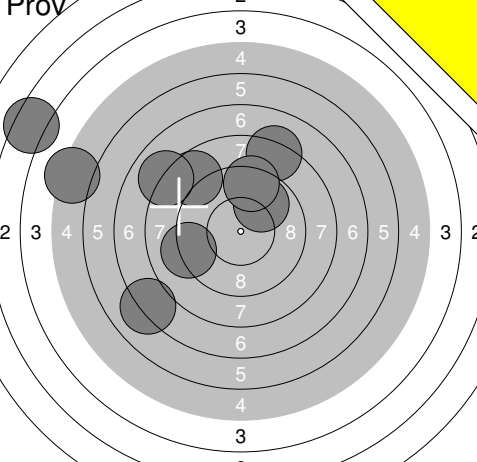
<b>Prov</b> 	<table border="1" style="width:100%; border-collapse: collapse;"> <tr><td>1:</td><td>8.0</td><td>↗</td></tr> <tr><td>2:</td><td>6.4</td><td>↖</td></tr> <tr><td>3:</td><td>5.7</td><td>↖</td></tr> <tr><td>4:</td><td>9.3</td><td>↘</td></tr> <tr><td>5:</td><td>9.9</td><td>↗</td></tr> <tr><td>6:</td><td>5.4</td><td>↖</td></tr> <tr><td>7:</td><td>9.9</td><td>↗</td></tr> <tr><td>8:</td><td>8.5</td><td>↖</td></tr> <tr><td>9:</td><td>9.3</td><td>↖</td></tr> <tr><td>10:</td><td>9.2</td><td>↖</td></tr> <tr><td colspan="2"><b>Serie</b></td><td><b>81.6</b></td></tr> <tr><td colspan="2"><b>Total</b></td><td><b>0.0</b></td></tr> </table>	1:	8.0	↗	2:	6.4	↖	3:	5.7	↖	4:	9.3	↘	5:	9.9	↗	6:	5.4	↖	7:	9.9	↗	8:	8.5	↖	9:	9.3	↖	10:	9.2	↖	<b>Serie</b>		<b>81.6</b>	<b>Total</b>		<b>0.0</b>	<b>Prov</b> 	<table border="1" style="width:100%; border-collapse: collapse;"> <tr><td>11:</td><td>9.9</td><td>↗</td></tr> <tr><td>12:</td><td>9.2</td><td>↖</td></tr> <tr><td>13:</td><td>8.7</td><td>↗</td></tr> <tr><td>14:</td><td>8.2</td><td>↗</td></tr> <tr><td>15:</td><td>3.4</td><td>↖</td></tr> <tr><td>16:</td><td>7.1</td><td>↖</td></tr> <tr><td>17:</td><td>8.0</td><td>↗</td></tr> <tr><td>18:</td><td>5.2</td><td>↖</td></tr> <tr><td>20:</td><td>9.4</td><td>↗</td></tr> <tr><td colspan="2"><b>Serie</b></td><td><b>69.1</b></td></tr> <tr><td colspan="2"><b>Total</b></td><td><b>0.0</b></td></tr> </table>	11:	9.9	↗	12:	9.2	↖	13:	8.7	↗	14:	8.2	↗	15:	3.4	↖	16:	7.1	↖	17:	8.0	↗	18:	5.2	↖	20:	9.4	↗	<b>Serie</b>		<b>69.1</b>	<b>Total</b>		<b>0.0</b>
1:	8.0	↗																																																																						
2:	6.4	↖																																																																						
3:	5.7	↖																																																																						
4:	9.3	↘																																																																						
5:	9.9	↗																																																																						
6:	5.4	↖																																																																						
7:	9.9	↗																																																																						
8:	8.5	↖																																																																						
9:	9.3	↖																																																																						
10:	9.2	↖																																																																						
<b>Serie</b>		<b>81.6</b>																																																																						
<b>Total</b>		<b>0.0</b>																																																																						
11:	9.9	↗																																																																						
12:	9.2	↖																																																																						
13:	8.7	↗																																																																						
14:	8.2	↗																																																																						
15:	3.4	↖																																																																						
16:	7.1	↖																																																																						
17:	8.0	↗																																																																						
18:	5.2	↖																																																																						
20:	9.4	↗																																																																						
<b>Serie</b>		<b>69.1</b>																																																																						
<b>Total</b>		<b>0.0</b>																																																																						

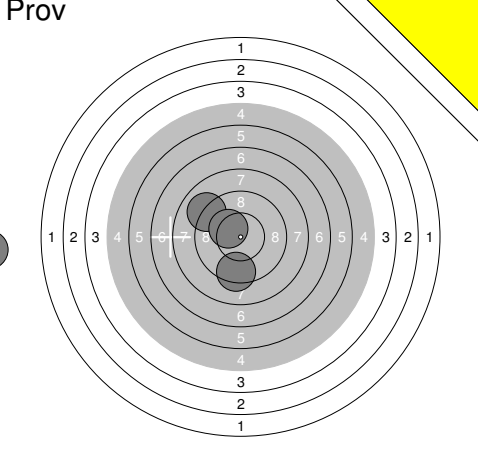
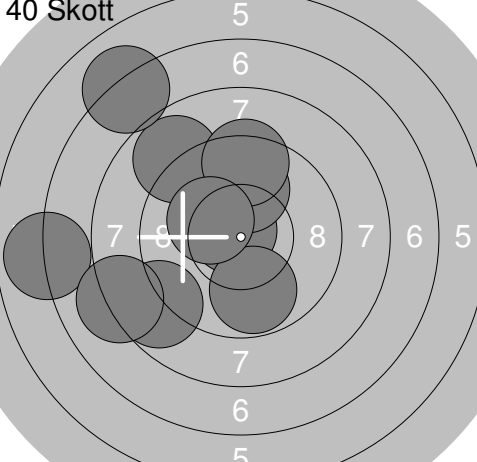
<b>Prov</b> 	<table border="1" style="width:100%; border-collapse: collapse;"> <tr><td>21:</td><td>0.0</td><td>↖</td></tr> <tr><td>22:</td><td>9.0</td><td>↗</td></tr> <tr><td>23:</td><td>9.3</td><td>↘</td></tr> <tr><td>24:</td><td>10.3x</td><td>↗</td></tr> <tr><td colspan="2"><b>Serie</b></td><td><b>28.6</b></td></tr> <tr><td colspan="2"><b>Total</b></td><td><b>0.0</b></td></tr> </table>	21:	0.0	↖	22:	9.0	↗	23:	9.3	↘	24:	10.3x	↗	<b>Serie</b>		<b>28.6</b>	<b>Total</b>		<b>0.0</b>	<b>40 Skott</b> 	<table border="1" style="width:100%; border-collapse: collapse;"> <tr><td>1:</td><td>8.9</td><td>↗</td></tr> <tr><td>2:</td><td>6.9</td><td>↖</td></tr> <tr><td>3:</td><td>7.1</td><td>↗</td></tr> <tr><td>4:</td><td>10.7x</td><td>↗</td></tr> <tr><td>5:</td><td>8.8</td><td>↖</td></tr> <tr><td>6:</td><td>10.0</td><td>↗</td></tr> <tr><td>7:</td><td>9.4</td><td>↗</td></tr> <tr><td>8:</td><td>9.8</td><td>↘</td></tr> <tr><td>9:</td><td>8.1</td><td>↖</td></tr> <tr><td>10:</td><td>10.2x</td><td>↖</td></tr> <tr><td colspan="2"><b>Serie</b></td><td><b>89.9</b></td></tr> <tr><td colspan="2"><b>Total</b></td><td><b>89.9</b></td></tr> </table>	1:	8.9	↗	2:	6.9	↖	3:	7.1	↗	4:	10.7x	↗	5:	8.8	↖	6:	10.0	↗	7:	9.4	↗	8:	9.8	↘	9:	8.1	↖	10:	10.2x	↖	<b>Serie</b>		<b>89.9</b>	<b>Total</b>		<b>89.9</b>
21:	0.0	↖																																																							
22:	9.0	↗																																																							
23:	9.3	↘																																																							
24:	10.3x	↗																																																							
<b>Serie</b>		<b>28.6</b>																																																							
<b>Total</b>		<b>0.0</b>																																																							
1:	8.9	↗																																																							
2:	6.9	↖																																																							
3:	7.1	↗																																																							
4:	10.7x	↗																																																							
5:	8.8	↖																																																							
6:	10.0	↗																																																							
7:	9.4	↗																																																							
8:	9.8	↘																																																							
9:	8.1	↖																																																							
10:	10.2x	↖																																																							
<b>Serie</b>		<b>89.9</b>																																																							
<b>Total</b>		<b>89.9</b>																																																							

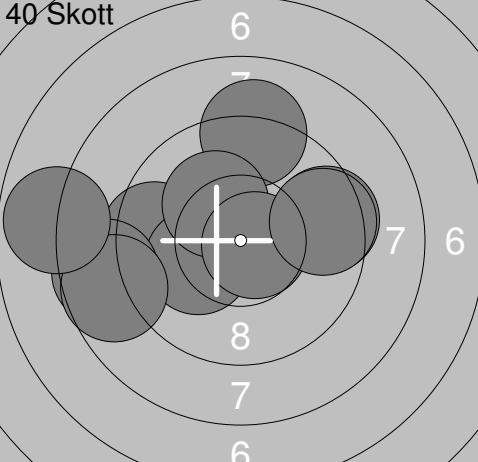
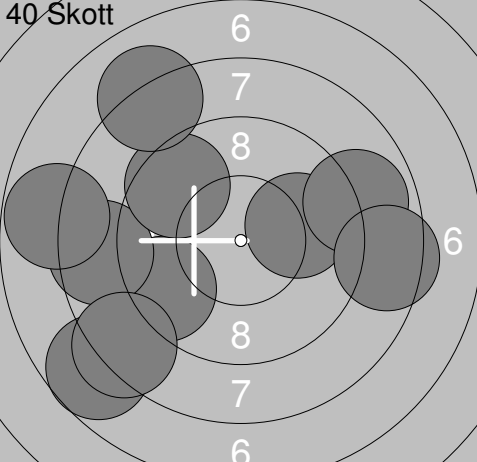
<b>40 Skott</b> 	<table border="1" style="width:100%; border-collapse: collapse;"> <tr><td>11:</td><td>9.1</td><td>↗</td></tr> <tr><td>12:</td><td>9.5</td><td>↖</td></tr> <tr><td>13:</td><td>10.2x</td><td>↖</td></tr> <tr><td>14:</td><td>8.6</td><td>↖</td></tr> <tr><td>15:</td><td>8.7</td><td>↖</td></tr> <tr><td>16:</td><td>7.9</td><td>↖</td></tr> <tr><td>17:</td><td>10.2x</td><td>↗</td></tr> <tr><td>18:</td><td>10.7x</td><td>→</td></tr> <tr><td>19:</td><td>9.5</td><td>→</td></tr> <tr><td>20:</td><td>9.5</td><td>→</td></tr> <tr><td colspan="2"><b>Serie</b></td><td><b>93.9</b></td></tr> <tr><td colspan="2"><b>Total</b></td><td><b>183.8</b></td></tr> </table>	11:	9.1	↗	12:	9.5	↖	13:	10.2x	↖	14:	8.6	↖	15:	8.7	↖	16:	7.9	↖	17:	10.2x	↗	18:	10.7x	→	19:	9.5	→	20:	9.5	→	<b>Serie</b>		<b>93.9</b>	<b>Total</b>		<b>183.8</b>	<b>40 Skott</b> 	<table border="1" style="width:100%; border-collapse: collapse;"> <tr><td>21:</td><td>9.4</td><td>↖</td></tr> <tr><td>22:</td><td>7.7</td><td>↖</td></tr> <tr><td>23:</td><td>8.6</td><td>↖</td></tr> <tr><td>24:</td><td>10.0</td><td>→</td></tr> <tr><td>25:</td><td>9.5</td><td>↗</td></tr> <tr><td>26:</td><td>8.9</td><td>→</td></tr> <tr><td>27:</td><td>8.5</td><td>→</td></tr> <tr><td>28:</td><td>7.8</td><td>↖</td></tr> <tr><td>29:</td><td>8.3</td><td>↖</td></tr> <tr><td>30:</td><td>8.1</td><td>↗</td></tr> <tr><td colspan="2"><b>Serie</b></td><td><b>86.8</b></td></tr> <tr><td colspan="2"><b>Total</b></td><td><b>270.6</b></td></tr> </table>	21:	9.4	↖	22:	7.7	↖	23:	8.6	↖	24:	10.0	→	25:	9.5	↗	26:	8.9	→	27:	8.5	→	28:	7.8	↖	29:	8.3	↖	30:	8.1	↗	<b>Serie</b>		<b>86.8</b>	<b>Total</b>		<b>270.6</b>
11:	9.1	↗																																																																									
12:	9.5	↖																																																																									
13:	10.2x	↖																																																																									
14:	8.6	↖																																																																									
15:	8.7	↖																																																																									
16:	7.9	↖																																																																									
17:	10.2x	↗																																																																									
18:	10.7x	→																																																																									
19:	9.5	→																																																																									
20:	9.5	→																																																																									
<b>Serie</b>		<b>93.9</b>																																																																									
<b>Total</b>		<b>183.8</b>																																																																									
21:	9.4	↖																																																																									
22:	7.7	↖																																																																									
23:	8.6	↖																																																																									
24:	10.0	→																																																																									
25:	9.5	↗																																																																									
26:	8.9	→																																																																									
27:	8.5	→																																																																									
28:	7.8	↖																																																																									
29:	8.3	↖																																																																									
30:	8.1	↗																																																																									
<b>Serie</b>		<b>86.8</b>																																																																									
<b>Total</b>		<b>270.6</b>																																																																									

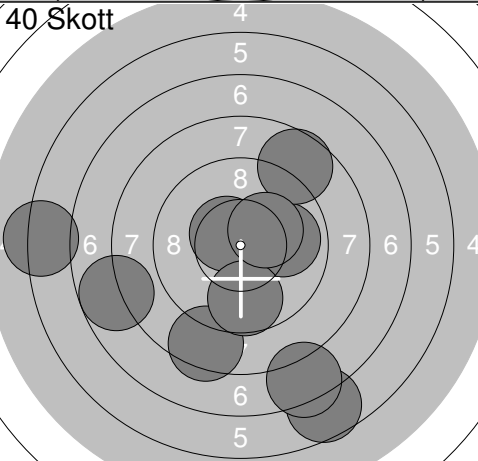
<b>40 Skott</b> 	<table border="1" style="width:100%; border-collapse: collapse;"> <tr><td>31:</td><td>7.8</td><td>↖</td></tr> <tr><td>32:</td><td>10.5x</td><td>↗</td></tr> <tr><td>33:</td><td>6.6</td><td>↘</td></tr> <tr><td>34:</td><td>8.4</td><td>↘</td></tr> <tr><td>35:</td><td>7.4</td><td>↘</td></tr> <tr><td>36:</td><td>9.9</td><td>→</td></tr> <tr><td>37:</td><td>8.7</td><td>↗</td></tr> <tr><td>38:</td><td>6.2</td><td>↖</td></tr> <tr><td>39:</td><td>9.7</td><td>↘</td></tr> <tr><td>40:</td><td>10.3x</td><td>↗</td></tr> <tr><td colspan="2"><b>Serie</b></td><td><b>85.5</b></td></tr> <tr><td colspan="2"><b>Total</b></td><td><b>356.1</b></td></tr> </table>	31:	7.8	↖	32:	10.5x	↗	33:	6.6	↘	34:	8.4	↘	35:	7.4	↘	36:	9.9	→	37:	8.7	↗	38:	6.2	↖	39:	9.7	↘	40:	10.3x	↗	<b>Serie</b>		<b>85.5</b>	<b>Total</b>		<b>356.1</b>		
31:	7.8	↖																																					
32:	10.5x	↗																																					
33:	6.6	↘																																					
34:	8.4	↘																																					
35:	7.4	↘																																					
36:	9.9	→																																					
37:	8.7	↗																																					
38:	6.2	↖																																					
39:	9.7	↘																																					
40:	10.3x	↗																																					
<b>Serie</b>		<b>85.5</b>																																					
<b>Total</b>		<b>356.1</b>																																					

<p>Prøv</p>	<p>1: 9.8 ←</p> <p>2: 9.4 ↓</p> <p>3: 10.0 ↙</p> <p>4: 9.8 ↗</p> <p>5: 9.5 →</p> <p>6: 10.4x↓</p> <p>7: 9.2 →</p> <p>8: 9.9 ↓</p> <p>9: 9.3 ←</p> <p>10: 8.3 ←</p>	<p>Prøv</p>	<p>11: 9.9 ←</p> <p>12: 10.7x←</p> <p>13: 9.1 →</p> <p>14: 9.9 →</p> <p>15: 10.5x→</p>
Serie 95.6	Serie 50.1	Serie 50.1	Serie 50.1
Total 0.0	Total 0.0	Total 0.0	Total 0.0

<p>40 Skott</p>	<p>1: 10.5x↓</p> <p>2: 10.0 ↓</p> <p>3: 9.8 →</p> <p>4: 10.3x↓</p> <p>5: 9.9 →</p> <p>6: 9.9 ←</p> <p>7: 9.2 ↗</p> <p>8: 10.2x↓</p> <p>9: 9.8 ←</p> <p>10: 10.9x→</p>	<p>40 Skott</p>	<p>11: 10.4x→</p> <p>12: 10.2x↙</p> <p>13: 9.6 ↓</p> <p>14: 10.2x↘</p> <p>15: 10.1←</p> <p>16: 9.5 ←</p> <p>17: 10.2x↙</p> <p>18: 10.6x↗</p> <p>19: 10.2x↓</p> <p>20: 9.6 ←</p>
Serie 100.5	Serie 100.6	Serie 100.6	Serie 100.6
Total 100.5	Total 201.1	Total 201.1	Total 201.1

<p>40 Skott</p>	<p>21: 10.6x↗</p> <p>22: 10.1 ↙</p> <p>23: 9.9 ←</p> <p>24: 10.3x←</p> <p>25: 10.4x↙</p> <p>26: 9.7 ↗</p> <p>27: 8.6 →</p> <p>28: 10.7x←</p> <p>29: 10.0 ↗</p> <p>30: 10.5x↑</p>	<p>40 Skott</p>	<p>31: 10.3x↗</p> <p>32: 10.0 ↑</p> <p>33: 9.9 →</p> <p>34: 9.2 ↗</p> <p>35: 9.7 ↗</p> <p>36: 10.1←</p> <p>37: 10.0 ↗</p> <p>38: 10.5x↓</p> <p>39: 9.9 ←</p> <p>40: 10.3x↓</p>
Serie 100.8	Serie 99.9	Serie 99.9	Serie 99.9
Total 301.9	Total 401.8	Total 401.8	Total 401.8

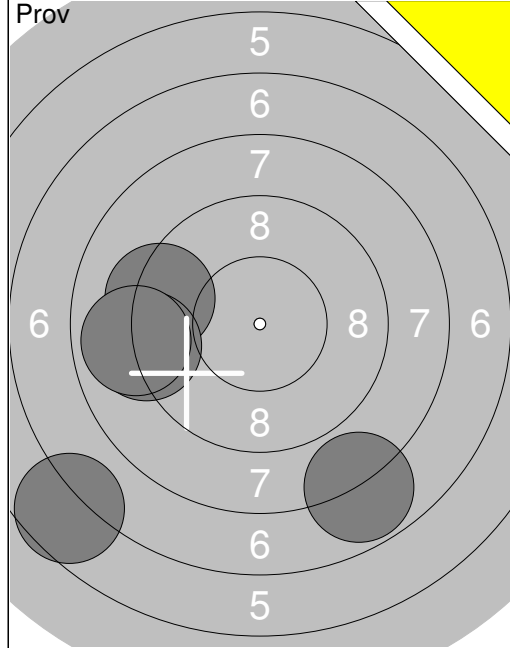

1:	6.6	↙
2:	9.3	←
3:	7.8	↘
4:	9.1	←
5:	8.9	←
<b>Serie</b>	<b>41.7</b>	
<b>Total</b>	<b>0.0</b>	

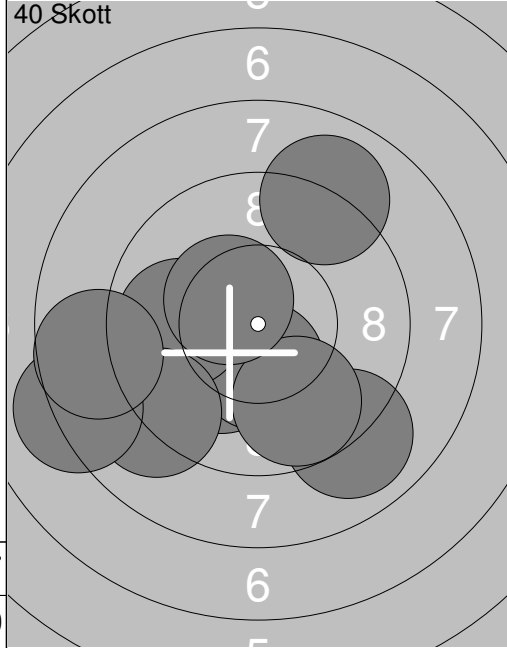

1:	10.2	↘
2:	10.4	↘
3:	9.0	↘
4:	9.9	←
5:	9.1	↙
6:	9.8	↘
7:	8.2	←
8:	10.4	↘
9:	9.0	↗
10:	8.7	←
<b>Serie</b>	<b>94.7</b>	
<b>Total</b>	<b>94.7</b>	

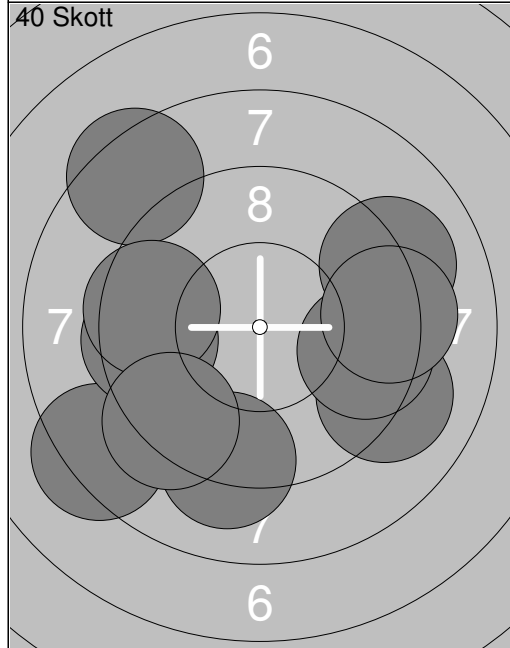

11:	8.3	↙
12:	9.5	←
13:	8.4	↗
14:	9.1	↘
15:	9.5	←
16:	9.1	↗
17:	9.2	↘
18:	9.5	→
19:	9.3	↙
20:	9.3	→
<b>Serie</b>	<b>91.2</b>	
<b>Total</b>	<b>185.9</b>	

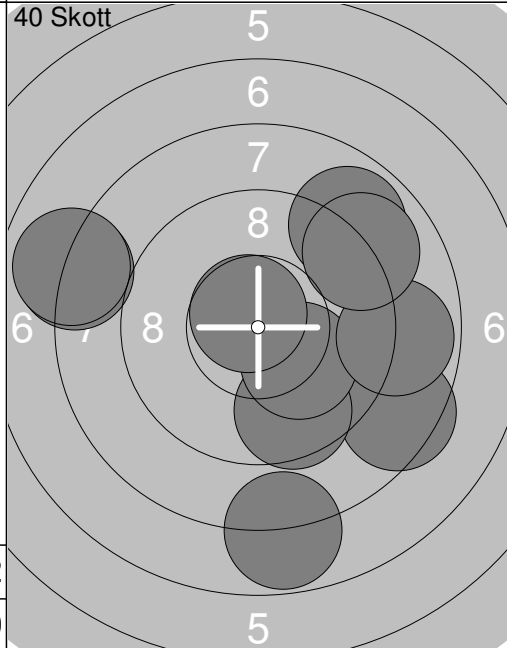

21:	8.0	←
22:	7.8	↘
23:	8.5	↘
24:	9.6	↘
25:	8.9	↗
26:	10.1	↘
27:	8.9	→
28:	10.7	↘
29:	8.0	←
30:	9.0	↗
<b>Serie</b>	<b>89.5</b>	
<b>Total</b>	<b>275.4</b>	

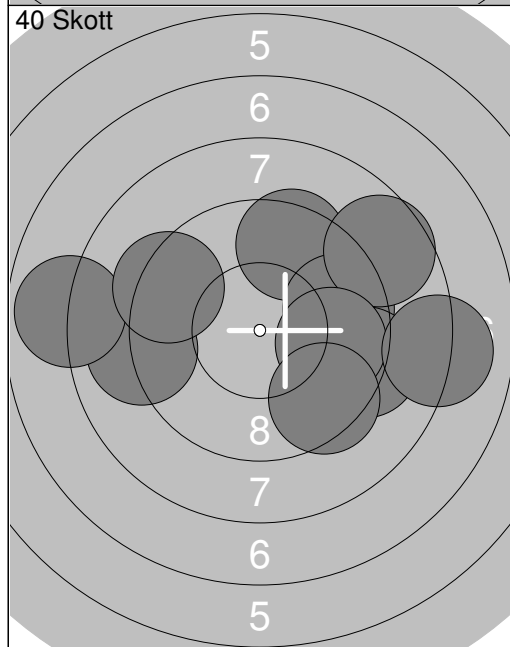

31:	9.5	↗
32:	9.0	←
33:	9.6	→
34:	8.6	↗
35:	7.9	←
36:	9.2	→
37:	9.3	←
38:	9.8	→
39:	9.4	↘
40:	8.1	→
<b>Serie</b>	<b>90.4</b>	
<b>Total</b>	<b>365.8</b>	

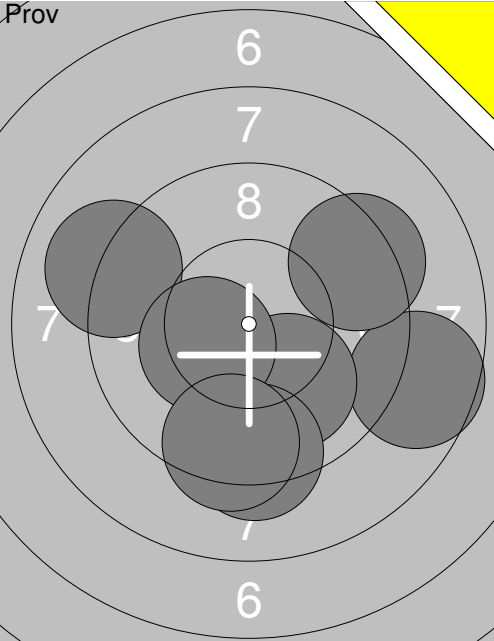
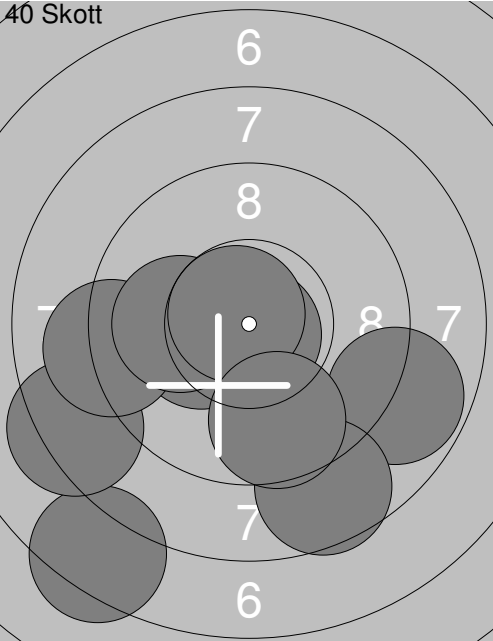
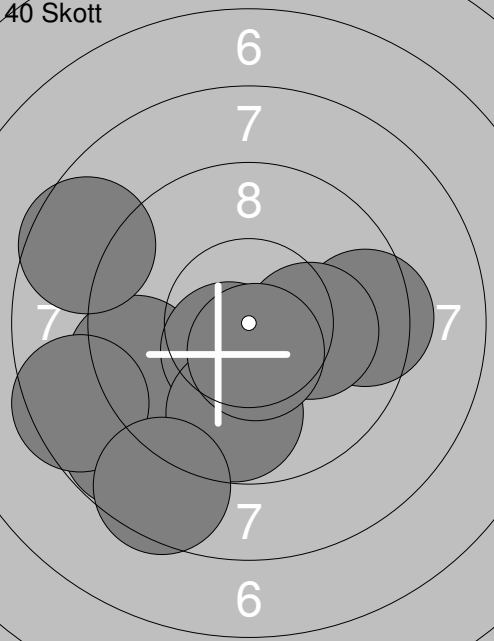
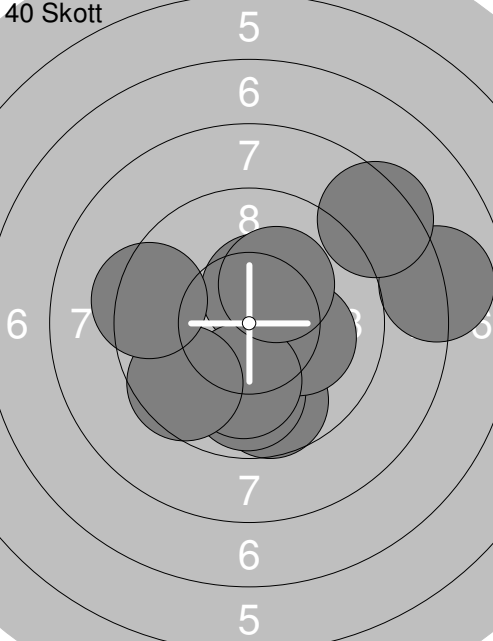
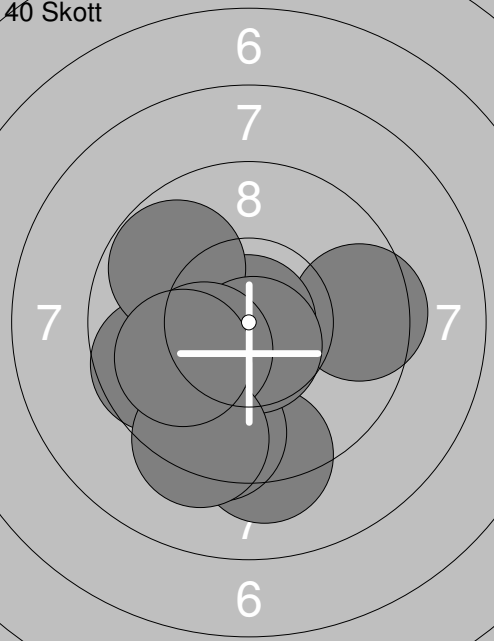

Skjutlag <b>2</b>	Tavla <b>36</b>	<b>Emma Andersson</b>		
S		Kubikborg Uskf		
04.02.2017		Skyttiaden Regionfinal	Umeå skytteallians	
Prov		1: 8.7 → 2: 10.0 ↓ 3: 10.0 ↓ 4: 9.0 ← 5: 10.3x 6: 9.3 ↗ 7: 9.3 ↓ 8: 9.4 ↓	40 Skott 	1: 8.8 → 2: 10.8x↓ 3: 7.4 ↓ 4: 8.3 ← 5: 10.3x 6: 9.1 ← 7: 10.1← 8: 10.7x 9: 8.6 ↓ 10: 9.7 ↓
		Serie 76.0		Serie 93.8
		Total 0.0		Total 93.8
40 Skott		11: 8.8 ← 12: 9.4 ← 13: 10.5x 14: 8.5 ← 15: 9.8 ↓ 16: 9.4 → 17: 10.2x→ 18: 8.6 ← 19: 8.5 ↓ 20: 10.6x↓	40 Skott 	21: 10.4x↗ 22: 9.7 ↓ 23: 9.9 ↓ 24: 10.2x→ 25: 8.0 → 26: 10.1 ↓ 27: 8.4 ↗ 28: 9.6 ← 29: 10.2x↗ 30: 9.4 ←
		Serie 94.3		Serie 95.9
		Total 188.1		Total 284.0
40 Skott		31: 9.7 ← 32: 9.5 → 33: 9.2 ↓ 34: 10.9x 35: 9.5 ↓ 36: 9.8 ↖ 37: 10.6x↓ 38: 10.3x 39: 9.3 ↓ 40: 10.0↖		
		Serie 98.8		
		Total 382.8		

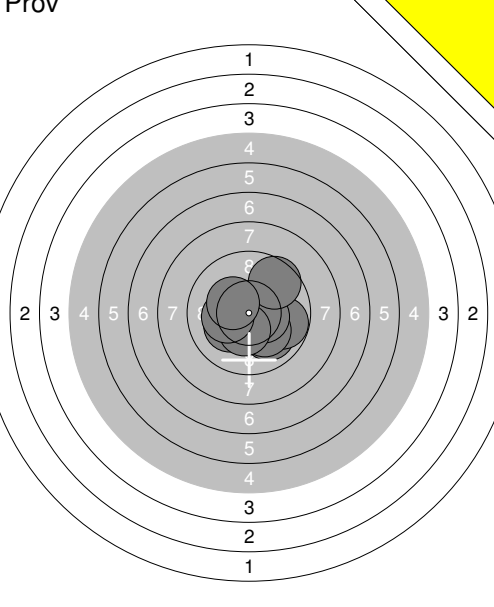
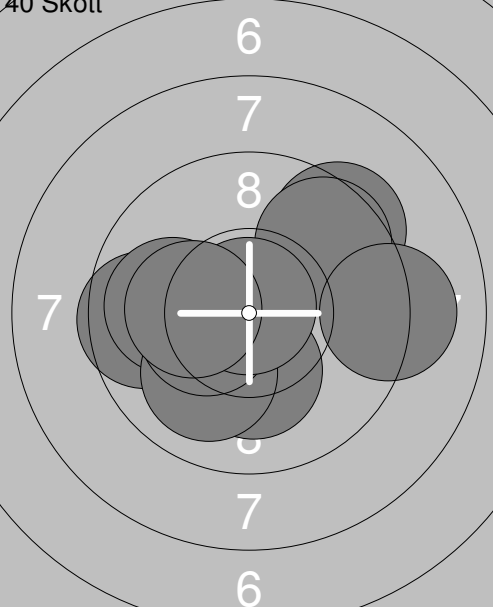
<p>Prov</p> 	<p>1: 10.0 ↘</p> <p>2: 0.0 ↓</p> <p>3: 9.8 ➔</p> <p>4: 10.2x ↙</p> <p>5: 10.1 ↘</p> <p>6: 10.4x ➔</p> <p>7: 9.6 ↗</p> <p>8: 10.4x ↘</p> <p>9: 10.2x ↙</p> <p>10: 10.3x ↙</p>	<p>40 Skott</p> 	<p>1: 9.6 ←</p> <p>2: 10.0 ←</p> <p>3: 9.4 ↗</p> <p>4: 9.6 ↗</p> <p>5: 9.1 →</p> <p>6: 10.2x ↘</p> <p>7: 10.0 ↘</p> <p>8: 10.4x ↙</p> <p>9: 10.9x ↗</p> <p>10: 10.2x ↙</p>
	Serie 91.0		Serie 99.4
	Total 0.0		Total 99.4

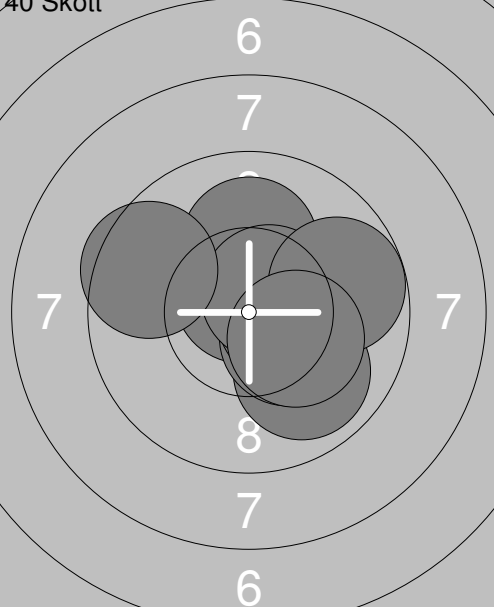
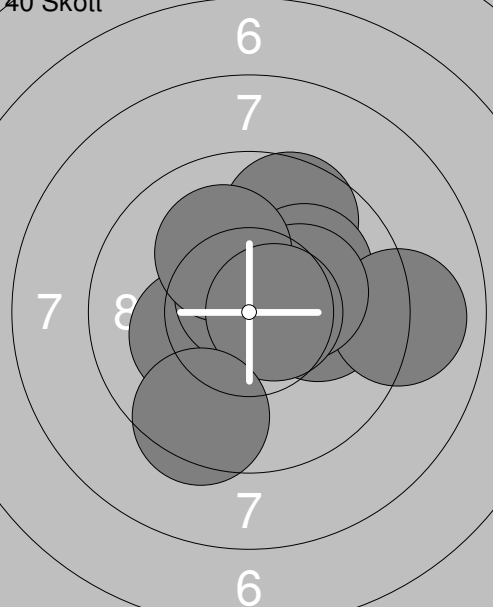
<p>40 Skott</p> 	<p>11: 10.7x ↗</p> <p>12: 9.9 ↘</p> <p>13: 10.3x ↘</p> <p>14: 10.5x ➔</p> <p>15: 10.5x ➔</p> <p>16: 10.1 ↑</p> <p>17: 10.6x ↗</p> <p>18: 9.8 ➔</p> <p>19: 10.2x ↘</p> <p>20: 9.5 ←</p>	<p>40 Skott</p> 	<p>21: 10.1 →</p> <p>22: 10.2x ↙</p> <p>23: 9.6 ↗</p> <p>24: 10.7x ↗</p> <p>25: 10.1 ↗</p> <p>26: 9.0 →</p> <p>27: 10.2x ➔</p> <p>28: 10.1 ↖</p> <p>29: 10.6x ➔</p> <p>30: 9.5 ↘</p>
	Serie 102.1		Serie 100.1
	Total 201.5		Total 301.6

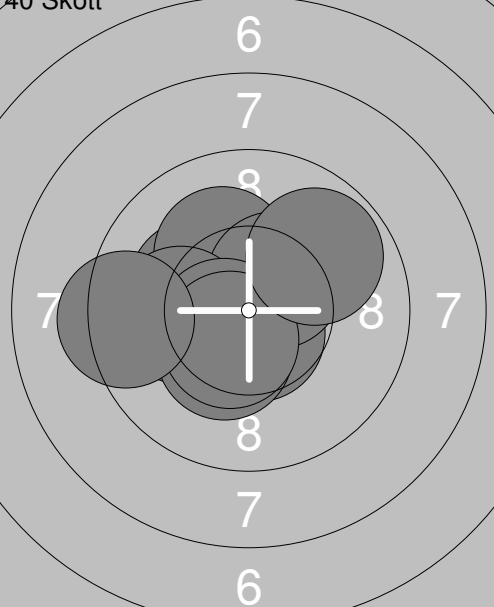
<p>40 Skott</p> 	<p>31: 10.2x ↙</p> <p>32: 10.6x ↘</p> <p>33: 10.2x ↗</p> <p>34: 10.4x ↗</p> <p>35: 10.1 ←</p> <p>36: 10.3x ↘</p> <p>37: 10.6x ↙</p> <p>38: 10.5x ↘</p> <p>39: 9.3 ←</p> <p>40: 9.8 ↗</p>		
	Serie 102.0		
	Total 403.6		